

# POPULAR SCIENCE

MONTHLY

MECHANICS - AUTOS - HOMEBUILDING



Courteous Cops Cut Crashes  
PAGE 62

25¢

July



*Build Your Own  
Diving Lung*

PAGE 160

How to Outwit Poison Ivy

PAGE 116

Copyrighted material



# SCIENCE NOW PROVES YOU CAN



**Extra Pep, Speed, Get-Away & Pick-Up  
YOURS with ANY car!**

## **YOU CAN CUT YOUR COSTS—GET ADDED POWER USING METHODS REVEALED BY SCIENTIFIC SPECIALISTS**

You probably read about the recent contest in Illinois—run by one of the world's leading gasoline companies—to discover how many miles could possibly be squeezed out of a single gallon of gas. The winning car came through with 168 miles! This mark was verified by experts in charge of the scientific experiment at Wood River, where the contest was held.

The amazing results were obtained with a standard gasoline, standard stock cars and approved scientific methods. **YOU** can now reap the benefits of this fantastic experiment and discover **HOW TO USE** all the eye-opening secrets uncovered at Wood River! You will find all these advanced methods in the amazing new volume, "**HIGHER SPEED AND EXTRA POWER**"—the *newest* auto manual now available in America!

This remarkable book gives you down-to-earth facts on how to get 30, 40 or *even* 50 miles on a single gallon of gas. It shows you exactly how to get extra car power . . . how to add up to 30 miles per hour to your top speed . . . how to zoom ahead from 0 to 60 miles in 12 seconds flat!

It gives you the very latest inside "dope"—scientific information gathered from automotive engineers, armed forces technicians and industrial experts! You get money-saving, power-building **METHODS** developed by Indianapolis Speedway champions and contestants in the Sun Valley Economy Run (recently described in *TIME* magazine)!



### **EASY PICTURES SHOW YOU HOW**

"Higher Speed and Extra Power" makes it extremely easy for you to carry out these labor-saving, cost-cutting ideas. It is chock full of splendid pictures and easy-to-understand drawings—no windy jargon, no complex diagrams or technical blueprints. A child will find it as easy to follow as a first grade reader . . . women can use it with the same simplicity they find in an ordinary cookbook recipe. Down-to-earth directions and clear pictures show you hundreds of ways to get more speed, extra power, greater economy with only a screwdriver. You don't need to be a mechanic **AND** you avoid the expensive headaches of "sucker" repairs! You learn how to turn a junkyard jalopy into a streamlined eye-filler . . . how to save up to \$500 a year in car costs . . . how to increase the re-sale value of your car, no matter how old the model.

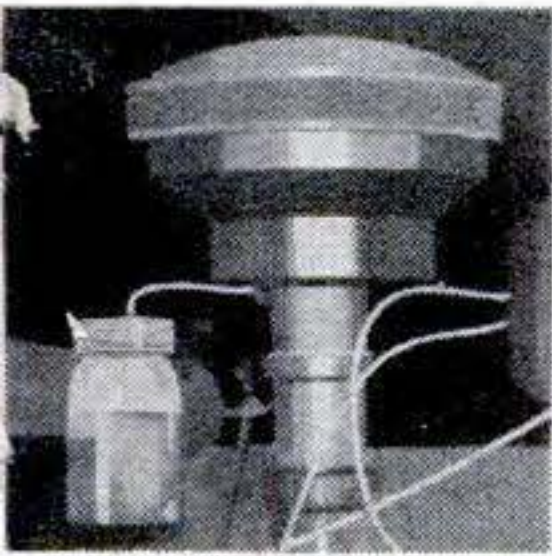
### **100's OF VALUABLE MONEY SAVING SECRETS!**

You get hundreds of tips, ideas, methods, tricks, suggestions and **FACTS** in this amazing new book! Here is some of the **DO-IT-YOURSELF** information given you: 20 ways to save gas and oil; extra power methods for summer driving; mixing air and fuel, water and gas; better pick-up on hills; rainy weather remedies; 10,000 extra tire miles; "soup-up" tricks; hot rod techniques; simple ways to remove body dents; speed tuning; repair short-cuts; supercharging systems; ventilation and air-cooling secrets.



# GET 35-50 MILES A GALLON

## Inside Information from Auto Engineers Reveals Amazing Power, Economy Secrets!

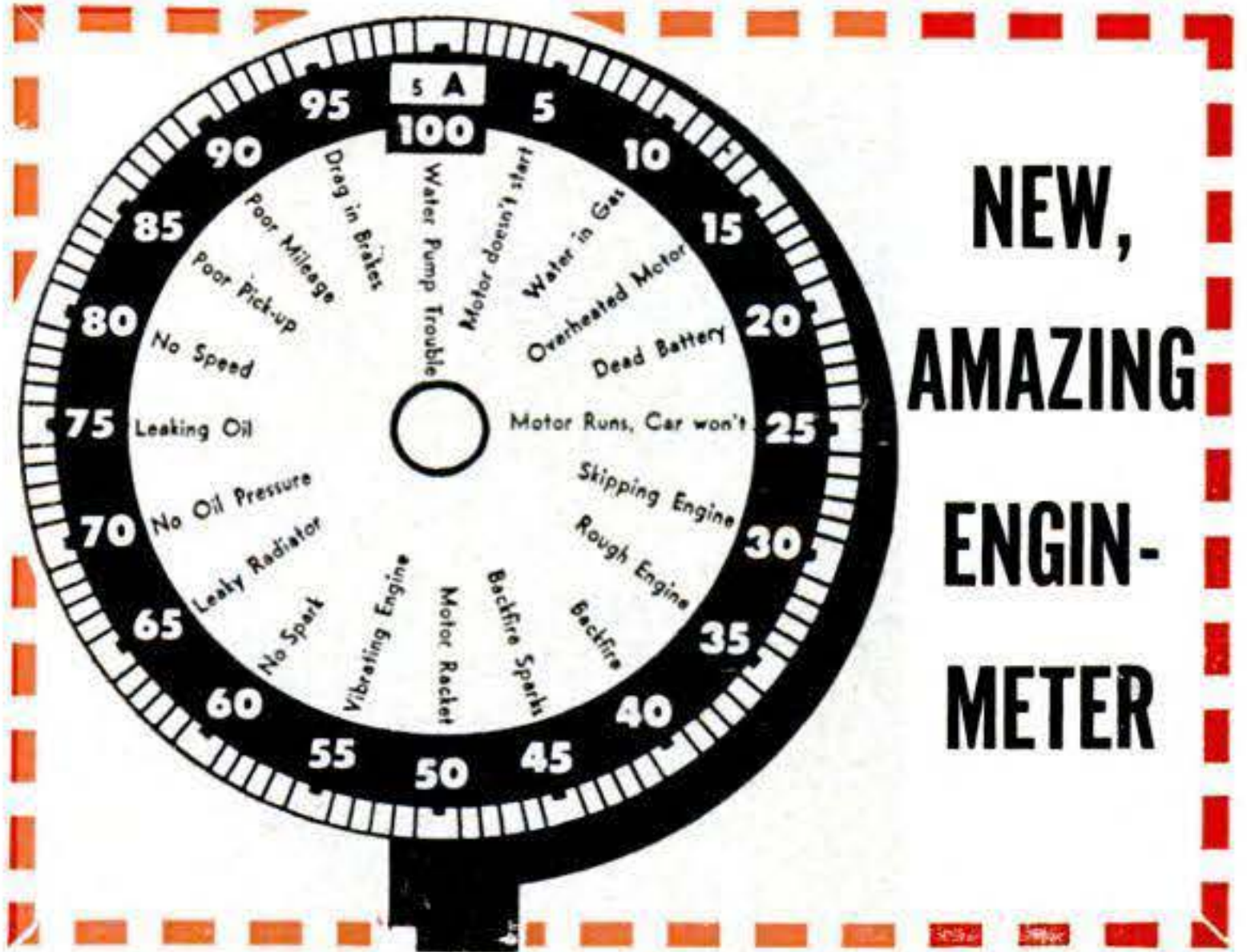


U. S. Government Scientist Says  
**"MIX WATER SAVE GAS"**

Here's just ONE of the hundreds of marvelous secrets that you'll find in "Higher Speed and Extra Power"—a renowned scientist of the U.S. Government is responsible for this clever money-saver: all you need is a discarded mason jar and a 10-cent piece of hose. You install it in seconds! With it you have a completely modern Moisture Injector. It acts in much the same way that rainy weather affects your engine—it causes fuel to burn slower. It lengthens the power stroke, reduces ping and saves you a lot of money! Full details of this cost-cutting device are found on pages 29 and 30 of "Higher Speed and Extra Power". You'll be pleased as Punch with the terrific new power you get with this modern water injector!

# FREE

OF EXTRA COST



NEW,  
 AMAZING  
 ENGIN-  
 METER

4 Pocket Manuals Rushed to You  
**FREE!**

OF EXTRA COST

With your copy of "Higher Speed and Extra Power" you get a FREE Engin-Meter PLUS an added bonus of 4 pocket manuals. They are all YOURS TO KEEP—even if you return the large authoritative volume for a refund. Here are the 4 handy manuals:

1. "SAVE ON ACCESSORIES"—Helps you save on tires, radios, batteries, gadgets and appliances through a co-op buying plan.
2. "33 WAYS TO INCREASE TRADE-IN VALUE"—Gives the used-car dealers' methods for fixing your car value. Shows you how to make your car more valuable to them.
3. "TROUBLE SHOOTER"—Lists 100's of motor troubles—saves on repair bills—worth plenty to you in emergencies.
4. "ECONOMY DRIVING"—Gives you brand names, hints and "inside dope" you don't get elsewhere! Gives you the latest low-down on economy techniques and methods.



THE BRAND-NEW attractive ENGIN-METER is yours absolutely FREE—it is a trouble-shooter and cost-cutter all in one! Use it on your dash or steering wheel. All you do is glance at it occasionally. It helps you find the cause of motor trouble immediately! An easy Alphabet Indicator refers you to the complete answer in "Higher Speed and Extra Power". Result: you save on gas, oil, batteries, "sucker" repairs and adjustments. You get this amazing Engin-Meter FREE with the book—PLUS the 4 pocket auto manuals described in full at left. The Engin-Meter and the 4 manuals are yours to KEEP forever—even if you return the book!

Then clip and mail the coupon TODAY!

**RUSH THE COUPON TODAY!**  
**READ IT AT OUR RISK!**

SEND NO MONEY!

This spectacular book—NEWEST ON THE MARKET—is yours to read for 7 days without any obligation! You send no money. You pay ONLY 1.98 plus a few pennies postage when it is delivered. Read it through—from cover to cover. Just ONE of the hundreds of ideas in it may save you a large sum of money immediately. If, within 7 days, you don't get RESULTS—just send it back and we refund your money. We KNOW the value of this amazing volume—that's why we offer you this unprecedented no-risk guarantee! AND—even if you return it, you may keep the FREE Engin-Meter and 4 handy pocket auto manuals! Act NOW! Our supply is limited. Drop the coupon in the mail TODAY!

**SPEEDWAY BOOKS**

127 West 33rd St. • Dept. 7-G-999 • New York 1, N.Y.

**SEND NO MONEY—Try without obligation!**

**SPEEDWAY BOOKS, Dept. 7-G-999**

**127 West 33rd Street, New York 1, N.Y.**

Please rush me my copy of the sensational "Higher Speed and Extra Power." I will pay 1.98 plus a few pennies postage on arrival. ALSO, send FREE the following: "Save On Accessories," "33 Ways To Increase Trade-in Value," "Trouble Shooter" and "Economy Driving" PLUS the money-saving Engin-Meter. All 5 of the latter are mine to keep even if I return the large volume within 7 days.

NAME.....

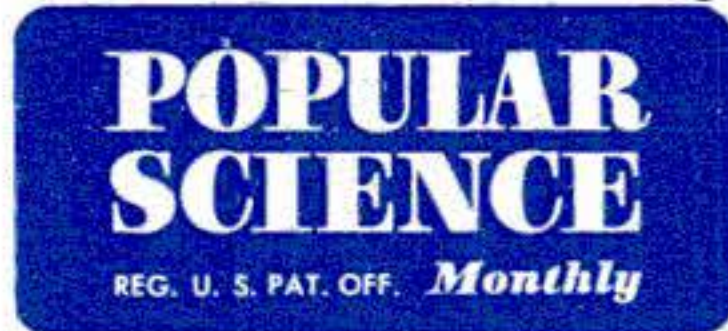
ADDRESS.....

CITY.....STATE.....

SAVE MONEY! Send a \$2 check, money order or cash with this coupon and we will pay the full postage and include a motorist's compass at NO EXTRA COST! Same MONEY-BACK GUARANTEE!

JULY 1953 |





VOLTA TORREY, EDITOR • Howard Allaway, MANAGING EDITOR  
Howard C. Jensen, ART EDITOR • Frank Rowsome Jr., ASSISTANT MANAGING EDITOR

SENIOR EDITORS: Harry Walton (Mechanics & Handicraft), Hartley E. Howe (Features), Martin Mann (Copy).

ART: Harry Samuels (Director), Herbert Anthony, Rolf O. Erikson, Eric Karminski Jr., Richard Meyer, Frances Cooper Daniels.

ASSOCIATE EDITORS: Alden P. Armagnac, Thomas Berger, Henry B. Comstock, Devon Francis, Sheldon M. Gallagher, Kendall W. Goodwyn, Herbert O. Johansen, Herbert R. Pfister, Denis Sneigr, Robert P. Stevenson, Ruth Westphal.

PHOTOGRAPHY: W. W. Morris (Director), Hubert Luckett, Orlando Guerra.

EDITORIAL ASSISTANTS: Harriet Trowbridge, Susan Dennen, Carol Ennis, Teresa Robbins, Georgette Sparks, Katharine W. Townsend, Jeanne Van Houten.

MIDWESTERN EDITOR: Wesley S. Griswold (Chicago) • WESTERN EDITOR: Andrew R. Boone (Los Angeles)

JULY, 1953

# Don't Lose This Issue!

It is the first of the 163rd volume of POPULAR SCIENCE MONTHLY. Indexes to the Mechanics and Homebuilding pages of the two previous volumes (12 issues) start on page 187. They are worth saving.

Want to finish something built of plywood? Under *Plywood, Painting or Home Maintenance* you'll find *Nine Fancy Finishes Transform Plywood* (April, p. 212). Or do you want to know what gas mileage your car gives? Under *Automobiles* you'll find an article on measuring it—and just in case it's low, there's another on boosting it.

Buying a portable saw? Then you will want to re-read two articles listed in the Index under *Saws and Sawing*: how to use portable saws (Nov., p. 226) and how to make jigs that let them do more (Dec. p. 214).

They Trap Counterfeiters Everywhere.....	49
How to Train a Seal.....	56
Courteous Cops Cut Crashes.....	62
Doctor Tackles "The Unclimbable Peak"....	70
Wilbur Shaw Reports on the "Studillac".....	76
He Builds America's Finest Wagons.....	84
Man-Made Meteors to Spy on Space.....	93
Building the Fastest Outboards.....	100
Death Rays That Only Tickle Your Spine....	109
How to Outwit Poison Ivy.....	116
Play Planks Build Junior Town.....	129
Installing a Rebuilt Engine.....	140
Gus Calls a Close One.....	146
These Sawhorses Do Anything.....	152
Extra Jobs for Your Portable Sander.....	156
How to Make and Use a Diving Lung.....	160
Shoot the Works in Color.....	178
Painting Pointers .....	180

HARRY WALTON

(More features and departments are listed on page 4.)

Godfrey Hammond, PUBLISHER • Stephen P. Glennon, ADVERTISING DIRECTOR

ADVERTISING OFFICES: NEW YORK—353 Fourth Ave.; CHICAGO—360 North Michigan Ave.; DETROIT—820 Book Bldg.; SAN FRANCISCO—681 Market St.; CLEVELAND—328 Citizens Bldg.; LOS ANGELES—2550 Beverly Blvd.  
EDITORIAL OFFICES: 353 Fourth Avenue, New York 10, N. Y.

Published monthly at 353 Fourth Avenue, New York 10, N. Y., by Popular Science Publishing Co., Inc., Godfrey Hammond, President and Treasurer; R. C. Wilson, Stephen P. Glennon, Vice-Presidents; F. W. Briggs, Secretary. Entered as second-class matter Dec. 28, 1918, re-entered as second-class matter July 26, 1948, at the Post Office in New York, N. Y., under the act of March 3, 1879; additional entry as second-class matter at Dayton, Ohio. Entered as second-class matter at the Post Office Department, Canada. Printed in U.S.A. Copyright, 1953, by Popular Science Publishing Co., Inc. All rights reserved in the United States, Great Britain, and in all countries participating in the International Copyright Convention and Pan-American Copyright Convention. Yearly subscriptions to United States, its possessions and Canada, \$3.00 (2 years, \$5.50; 3 years \$7.50); foreign countries \$1 per year extra. Four weeks' notice is needed to change a subscriber's address. Please give both old and new addresses, including postal zone numbers.





**for any engine!**

# Perfect Circle

## 2 in 1 chrome piston ring set

The standard of comparison



**Perfect Circle's 2-in-1 Chrome** piston ring set is the truly modern piston ring equipment that seals compression, controls oil for over twice as long as ordinary rings, with no tedious break-in period. And only 2-in-1 furnishes an alternate Hi-Pressure spring with each oil ring to assure positive oil control even in badly worn cylinders.

**When you install Perfect Circle's 2-in-1 Chrome Set** in your car, you'll understand why it has established a new standard of piston ring performance! Perfect Circle Corporation, Hagerstown, Indiana; The Perfect Circle Co., Ltd., Toronto, Ontario.



# NEWS from SCIENCE

## ABOUT YOUR HAIR

### Laboratory discovery outdates messy hair oils!



"V-7," completely new greaseless grooming agent, now in Vitalis Hair Tonic. It's *not* an animal, vegetable or mineral oil!

### Hair stays neat all day

No gummy film, no oily or matted-down look with new Vitalis!



HAVE HANDSOMER HAIR!

### Kills dandruff germs, too!



New Vitalis kills on contact germs many doctors associate with infectious dandruff. Feels "tingling good" on scalp!

NEW FINER  
**VITALIS**<sup>®</sup>  
HAIR TONIC

WITH **V-7**

Product of Bristol-Myers

### News and Pictures

\$4,000,000 Cafeteria Feeds Ore Ships....	60
New Mill Rolls Out Uranium.....	74
Barge Turns Into Dock.....	83
What's Passing You Now?.....	90
Once Upon a Time.....	98
Science Fashion Show.....	105
How a Speedometer Works.....	106
Gadget-Hung Car Wins Distance Race..	113
Plane Engine Weds Turbine and Diesel..	114
Golf Gadgets.....	121
I Ain't Got No Body.....	122
What's Your Funniest Model T Story?....	126

### Mechanics and Homebuilding

Wordless Workshop.....	138
Products for Your Car.....	145
Racked Cans Keep Workbench Neat.....	151
Second Switch Safeguards Water Pump..	159
This Rig Shoots Pictures Under Water....	166
What You Can Do with a Snorkel.....	168
Well Cover and Pump Dress Up Garden..	170
Aircraft Generator Is Portable Welder....	182
Know Your Nails.....	190

### Departments

Letters .....	6
New Ideas from the Inventors.....	81
I'd Like to See Them Make.....	92
P.S. Last Minute News and Notes.....	128
New for the Handy Man.....	136
Hints from the Model Garage.....	149
Keeping the Home Shipshape.....	172
New Tools.....	174
New Shop Ideas.....	184

### NEXT MONTH . . . How Are Your Garage Doors?



A smoothly balanced overhead garage door has a lot in its favor: it glides up out of the way, won't thrash around in the wind, doesn't wedge on snow or ice, and doesn't snag unwary fenders. Next month PSM will tell you how you can fit these doors to your garage at surprisingly little cost, using ingenious new hardware.





# Picture yourself going places

You've done it often. Call it day-dreaming if you like, but you've seen yourself in a bigger job — giving orders and making decisions — driving off in a smart new car — buying your family a fine home.

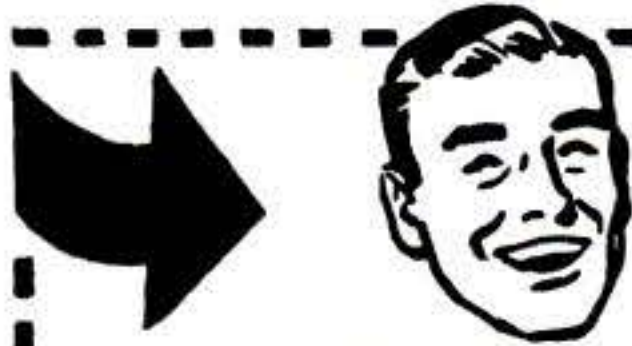
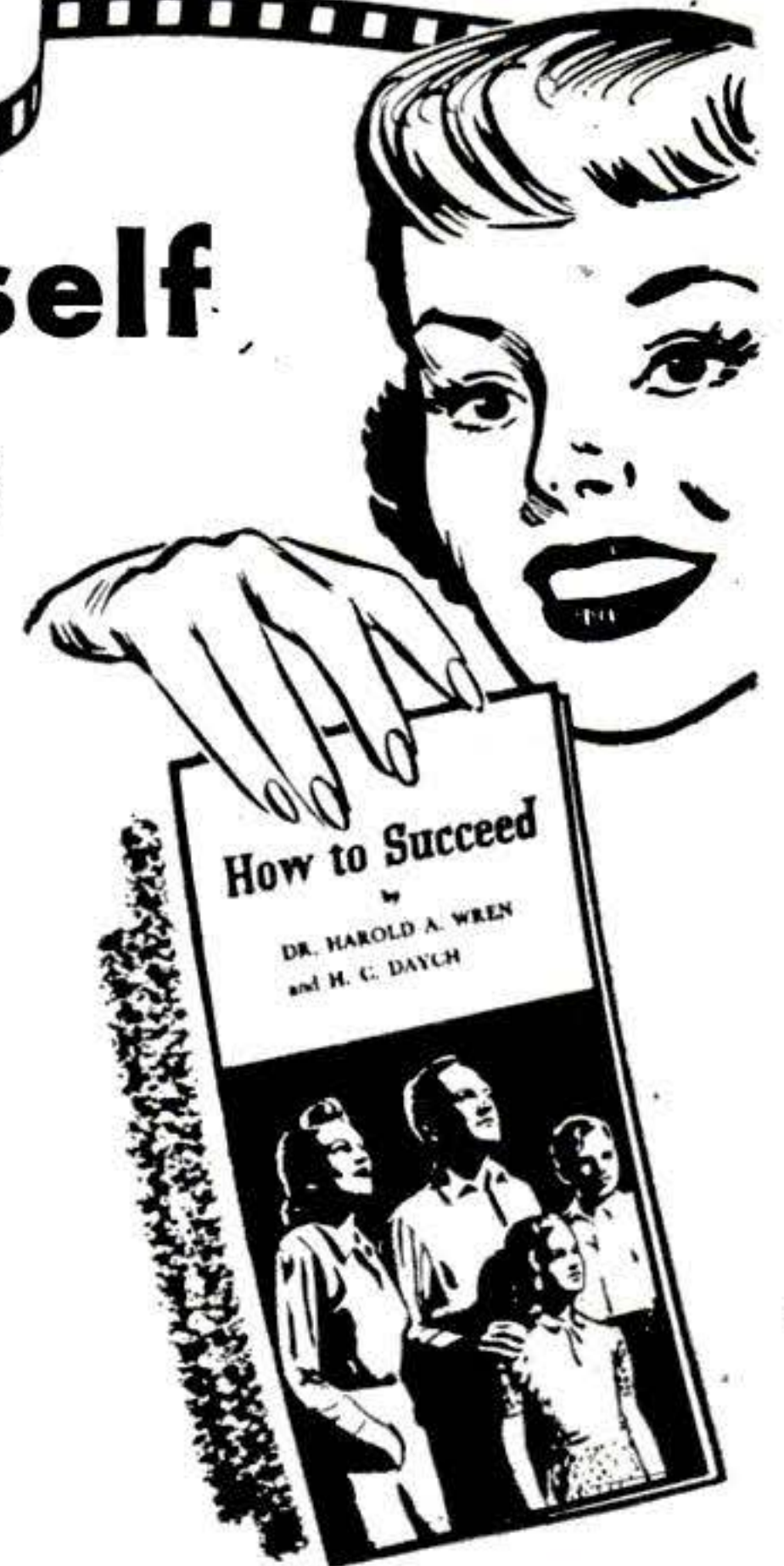
There's nothing wrong with dreams. But how about making them come true? *You can do it*, if you're willing to try!

Look around you. The men who are going places are the *trained* men. They've learned

special skills that bring them better jobs and higher pay. It's the men *without* training whose dreams never come true.

What are you going to do about it? Just wait and wish? If you really *want to succeed*, you can get the training you need by studying at home in your spare time. International Correspondence Schools offer you a course in just about any field you choose, giving you the practical plus the bedrock facts and theory. No skimming or skimping! And you'll be earning while you learn. Students report better jobs and more pay within a few months.

Look over the list of subjects in the coupon below. Pick out the one that interests you most — the one that holds the greatest future for you. Then mark the coupon, and mail it today. *Find out* what I. C. S. can do for you. It costs only a stamp or postcard, but it's the first step if you want to go places!



## SMARTEST THING HE EVER DID

"I noticed that the trained men held the better jobs. That's when I decided to take an I. C. S. course. Enrolling with I. C. S. was one of the smartest things I ever did. The position as Plant Engineer I hold today is largely due to the 'know-how' derived from my I. C. S. texts. I. C. S. can help any man who will study."

L. P. S., Elkhart, Ind.

## FREE BOOK

"How to Succeed." 36 pages packed with worthwhile success tips. Step-by-step plan of action. Pocket size edition. Absolutely free. Send coupon below.

# INTERNATIONAL CORRESPONDENCE SCHOOLS



BOX 7654-N, SCRANTON 9, PENNA.

Without cost or obligation, send me "HOW to SUCCEED" and the booklet about the course BEFORE which I have marked X:

- |  |   |  |   |   |
|--|---|--|---|---|
| <p><b>ART</b></p> <ul style="list-style-type: none"> <li><input type="checkbox"/> Commercial Art</li> <li><input type="checkbox"/> Magazine and Book Illustrating</li> <li><input type="checkbox"/> Cartooning</li> <li><input type="checkbox"/> Show Card and Sign Lettering</li> <li><input type="checkbox"/> Fashion Illustrating</li> </ul> <p><b>AUTOMOTIVE</b></p> <ul style="list-style-type: none"> <li><input type="checkbox"/> Automobile, Mechanic</li> <li><input type="checkbox"/> Auto-Elec. Technician</li> <li><input type="checkbox"/> Auto Body Rebuilding and Refinishing</li> <li><input type="checkbox"/> Diesel—Gas Engines</li> </ul> <p><b>AVIATION</b></p> <ul style="list-style-type: none"> <li><input type="checkbox"/> Aeronautical Engineering Jr.</li> <li><input type="checkbox"/> Aircraft Engine Mechanic</li> <li><input type="checkbox"/> Airplane Drafting</li> </ul> <p><b>BUILDING</b></p> <ul style="list-style-type: none"> <li><input type="checkbox"/> Architecture</li> <li><input type="checkbox"/> Arch. Drafting</li> <li><input type="checkbox"/> Building Contractor</li> <li><input type="checkbox"/> Estimating</li> <li><input type="checkbox"/> Carpenter and Mill Work</li> <li><input type="checkbox"/> Carpenter Foreman</li> <li><input type="checkbox"/> Reading Blueprints</li> <li><input type="checkbox"/> House Planning</li> <li><input type="checkbox"/> Plumbing</li> </ul> | <ul style="list-style-type: none"> <li><input type="checkbox"/> Heating</li> <li><input type="checkbox"/> Steam Fitting</li> <li><input type="checkbox"/> Air Conditioning</li> <li><input type="checkbox"/> Electrician</li> </ul> <p><b>BUSINESS</b></p> <ul style="list-style-type: none"> <li><input type="checkbox"/> Business Administration</li> <li><input type="checkbox"/> Certified Public Accountant</li> <li><input type="checkbox"/> Accounting</li> <li><input type="checkbox"/> Bookkeeping</li> <li><input type="checkbox"/> Stenography and Typing</li> <li><input type="checkbox"/> Secretarial</li> <li><input type="checkbox"/> Federal Tax</li> <li><input type="checkbox"/> Business Correspondence</li> <li><input type="checkbox"/> Personnel and Labor Relations</li> <li><input type="checkbox"/> Advertising</li> <li><input type="checkbox"/> Retail Business Management</li> <li><input type="checkbox"/> Managing Small Business</li> <li><input type="checkbox"/> Sales Management</li> <li><input type="checkbox"/> Salesmanship</li> <li><input type="checkbox"/> Traffic Management</li> </ul> <p><b>CHEMISTRY</b></p> <ul style="list-style-type: none"> <li><input type="checkbox"/> Chemical Engineering</li> <li><input type="checkbox"/> Chemistry</li> <li><input type="checkbox"/> Analytical Chemistry</li> <li><input type="checkbox"/> Petroleum—Nat'l Gas</li> <li><input type="checkbox"/> Pulp and Paper Making</li> <li><input type="checkbox"/> Plastics</li> </ul> | <p><b>CIVIL, STRUCTURAL ENGINEERING</b></p> <ul style="list-style-type: none"> <li><input type="checkbox"/> Civil Engineering</li> <li><input type="checkbox"/> Structural Engineering</li> <li><input type="checkbox"/> Surveying and Mapping</li> <li><input type="checkbox"/> Structural Drafting</li> <li><input type="checkbox"/> Highway Engineering</li> <li><input type="checkbox"/> Reading Blueprints</li> <li><input type="checkbox"/> Concrete Construction</li> <li><input type="checkbox"/> Sanitary Engineering</li> </ul> <p><b>DRAFTING</b></p> <ul style="list-style-type: none"> <li><input type="checkbox"/> Aircraft Drafting</li> <li><input type="checkbox"/> Architectural Drafting</li> <li><input type="checkbox"/> Electrical Drafting</li> <li><input type="checkbox"/> Mechanical Drafting</li> <li><input type="checkbox"/> Structural Drafting</li> <li><input type="checkbox"/> Sheet Metal Drafting</li> <li><input type="checkbox"/> Mine Surveying and Drafting</li> </ul> <p><b>ELECTRICAL</b></p> <ul style="list-style-type: none"> <li><input type="checkbox"/> Electrical Engineering</li> <li><input type="checkbox"/> Electrician</li> <li><input type="checkbox"/> Electrical Maintenance</li> <li><input type="checkbox"/> Electrical Drafting</li> <li><input type="checkbox"/> Electric Power and Light</li> <li><input type="checkbox"/> Lineman</li> </ul> <p><b>HIGH SCHOOL</b></p> <ul style="list-style-type: none"> <li><input type="checkbox"/> High School Subjects</li> </ul> | <ul style="list-style-type: none"> <li><input type="checkbox"/> College Preparatory</li> <li><input type="checkbox"/> Mathematics</li> <li><input type="checkbox"/> Commercial</li> <li><input type="checkbox"/> Good English</li> </ul> <p><b>MECHANICAL AND SHOP</b></p> <ul style="list-style-type: none"> <li><input type="checkbox"/> Mechanical Engineering</li> <li><input type="checkbox"/> Industrial Engineering</li> <li><input type="checkbox"/> Industrial Supervision</li> <li><input type="checkbox"/> Foremanship</li> <li><input type="checkbox"/> Mechanical Drafting</li> <li><input type="checkbox"/> Machine Design-Drafting</li> <li><input type="checkbox"/> Machine Shop Practice</li> <li><input type="checkbox"/> Tool Design</li> <li><input type="checkbox"/> Industrial Instrumentation</li> <li><input type="checkbox"/> Machine Shop Inspection</li> <li><input type="checkbox"/> Reading Blueprints</li> <li><input type="checkbox"/> Toolmaking</li> <li><input type="checkbox"/> Gas—Electric Welding</li> <li><input type="checkbox"/> Heat Treatment—Metallurgy</li> <li><input type="checkbox"/> Sheet Metal Work</li> <li><input type="checkbox"/> Sheet Metal Pattern Drafting</li> <li><input type="checkbox"/> Refrigeration</li> </ul> <p><b>POWER</b></p> <ul style="list-style-type: none"> <li><input type="checkbox"/> Combustion Engineering</li> <li><input type="checkbox"/> Diesel—Electric</li> <li><input type="checkbox"/> Electric Light and Power</li> </ul> | <ul style="list-style-type: none"> <li><input type="checkbox"/> Stationary Steam Engineering</li> <li><input type="checkbox"/> Stationary Fireman</li> </ul> <p><b>RADIO, TELEVISION, COMMUNICATIONS</b></p> <ul style="list-style-type: none"> <li><input type="checkbox"/> General Radio</li> <li><input type="checkbox"/> Radio Operation</li> <li><input type="checkbox"/> Radio Servicing—FM</li> <li><input type="checkbox"/> Television</li> <li><input type="checkbox"/> Electronics</li> <li><input type="checkbox"/> Telephone Work</li> </ul> <p><b>RAILROAD</b></p> <ul style="list-style-type: none"> <li><input type="checkbox"/> Locomotive Engineer</li> <li><input type="checkbox"/> Diesel Locomotive</li> <li><input type="checkbox"/> Air Brakes</li> <li><input type="checkbox"/> Car Inspector</li> <li><input type="checkbox"/> Railroad Administration</li> </ul> <p><b>TEXTILE</b></p> <ul style="list-style-type: none"> <li><input type="checkbox"/> Textile Engineering</li> <li><input type="checkbox"/> Cotton Manufacture</li> <li><input type="checkbox"/> Rayon Manufacture</li> <li><input type="checkbox"/> Woolen Manufacture</li> <li><input type="checkbox"/> Loom Fixing</li> <li><input type="checkbox"/> Finishing and Dyeing</li> <li><input type="checkbox"/> Textile Designing</li> </ul> |
|--|---|--|---|---|

**YEAR OF THE SIX MILLIONTH STUDENT**

Name \_\_\_\_\_ Age \_\_\_\_\_ Home Address \_\_\_\_\_  
 City \_\_\_\_\_ Zone \_\_\_\_\_ State \_\_\_\_\_ Working Hours \_\_\_\_\_ A.M. to \_\_\_\_\_ P.M.  
 Occupation \_\_\_\_\_

Special tuition rates to members of the U. S. Armed Forces. Canadian residents send coupon to International Correspondence Schools Canadian, Ltd., Montreal, Canada.



**PERMATEX  
FORM-A-GASKET®**  
"Seals Cylinder Head  
Gaskets...so it will  
seal about everything"



**Manufacturers and  
mechanics every-  
where use—  
FORM-A-GASKET**

A foreman of a big engine rebuilding shop says, "We coat both sides of all cylinder head gaskets with Form-A-Gasket and brush it into the stud and cap screw threads. It is a positive seal without cementing."

Keep Form-A-Gasket handy in your workshop as an all-purpose gasket and pipe fitting compound.



**3 TYPES** for your  
convenience

No. 1 sets quickly, dries hard. No. 2 sets slowly, is non-hardening. Aviation No. 3 is a brushable liquid that sets to a paste. All three make leakproof, pressure-tight seals in threaded, hose and flange connections.

**PERMATEX COMPANY, INC.**  
Brooklyn 35, New York

# Letters



## Safety Award for 1952

Congratulations!

It is a real pleasure for me to inform you that your organization has been voted the National Safety Council's Public Interest Award for 1952.

We here at the Council have been aware of all you have been doing for safety, and we are delighted that the judges agreed.

I am sure you feel, as we do, that there is another, less tangible result of your safety efforts—the knowledge that you have helped prevent many accidents.

Many thanks for your splendid support.

NED H. DEARBORN, President  
National Safety Council, Chicago.

*This is the second consecutive year that POPULAR SCIENCE MONTHLY has received the National Safety Council's Public Interest Award.*

## Modern Sales Pitch

For 20 years I had more than 75 stereoscopes in stock and no demand for them. Noting the recent interest in third-dimen-



sional movies, I put a sign in my store window reading "3-Dimension Viewers with Pictures, \$2.00." Within a month I had sold them all.

JOSEPH PUSATERI, Brooklyn, N. Y.

## Rolls vs. Chrysler

Your Wilbur Shaw asks: "Where except in the Rolls-Royce can you find a car that will go 90,000 to 100,000 miles before re-





How these 18 Experts can help you

# Get into a High Pay ACCOUNTING CAREER

LaSalle's famous staff of Accounting authorities are helping thousands prepare for fast promotions and bigger pay. They can do the same for you!

If your heart is set on a larger income and all that it means . . . better home—fine car—larger bank account—more of the good things of life. . . .

If that's your ambition and you are really serious about it, then you owe it to yourself to get the REAL FACTS about Accountancy, and the many good-pay opportunities that can be YOURS through LaSalle's famous Problem Method plan.

It matters not whether you've had a single day of experience in this field—or whether you have already started but want to climb higher. LaSalle's expert training is designed to take you *from where you are . . . to where you want to be . . .* in higher positions and a lifetime career of security and good income.

## WHY YOU CAN'T FAIL TO GAIN

You see on this page a panel of experts who know Accounting from A to Z . . . all the way from simple bookkeeping, on up through advanced accounting, cost accounting, auditing, income tax, and coaching for the C.P.A. degree. These are only part of LaSalle's instruction staff. But what is most important to you . . .

... THESE C. P. A. EXPERTS KNOW HOW TO IMPART THEIR KNOWLEDGE TO OTHERS... HOW TO HELP YOU PREPARE QUICKLY YET THOROUGHLY FOR SUCCESS IN THIS VERY LUCRATIVE FIELD

The proof? What stronger proof could there be than



more than 3,500 Certified Public Accountants (approximately 10% of the U.S. total) who have trained with LaSalle? Or the hundreds of thousands of men and women whom LaSalle has helped qualify rapidly for more money, a brighter future, in a high-pay-lifetime career? These thousands came to us with different backgrounds of experience and varying degrees of ambition. Many have reported raises and promotions after only a few weeks of training. Thousands of them have written to say they are now earning 50% more—even *double* their former incomes—often in less than a year. These letters are published in book form for your inspection. They were written by real people, with real income, problems and ambitions—people who might be your next-door neighbor.

Yes, if you are really sincere in wanting to better your position—start your income climbing—enjoy a lifetime career of high standing and high reward—this friendly staff of experts can help you.

## SEND FOR FREE SAMPLE LESSON... ALSO BIG 48-PAGE BOOK OF LATEST INFORMATION ABOUT CAREER OPPORTUNITIES

You don't have to wonder what LaSalle's Accountancy plan is like. You will be sent a free sample lesson, which does not obligate you in any way. Study it—keep it—see for yourself how simple, clear, and easy it is to master. This is an actual lesson right out of the regular training—to show you exactly how LaSalle's Problem Method has trained more than 1,275,000 men and women from all walks of life.

Also . . . the 48-page book, "Accountancy, the Profession That Pays," gives all the latest facts about the new and growing opportunities in five different fields of profitable employment.

This can be an important day in your life. A coupon like the one below has started hundreds of thousands of men and women toward a bigger job, a larger income. It can do the same for you.

Mail the Coupon Today!

FREE 48-PAGE CATALOG

## LA SALLE EXTENSION UNIVERSITY

A Correspondence Institution

417 S. Dearborn St., Dept. 783-H, Chicago 5, Ill.

Send free Sample Lesson in Accounting—also, 48-page free book, "Accountancy, the Profession That Pays" . . . all without cost or obligation.

Name.....Age.....

Address.....

City & Zone.....State.....

FREE SAMPLE LESSON





# Quietest Tread on Earth Outgrips, Outwears them all!

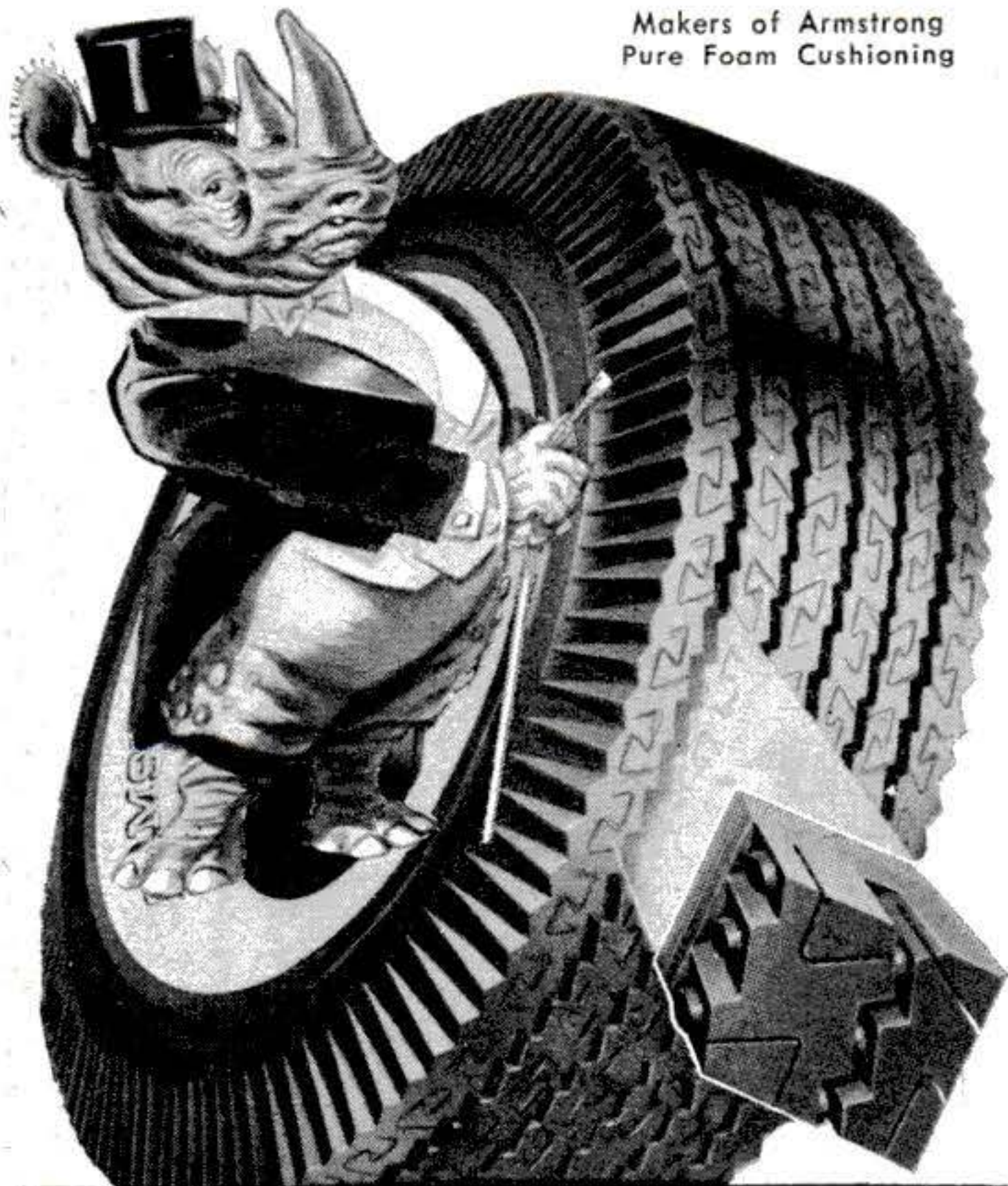


● **FOUR EXCLUSIVES** give safety, silence, comfort found in no other tire. (1) **Interlocking Safety Tread** for greater "hold" in all directions. (2) **Silent Traction Design** cancels out hum. (3) **Intra-Tread Bumpers** hold tread ribs apart, muffle squeal. (4) **Uni-Cushion Contour**—more rubber on road for smoother riding, longer wear.

## UNCONDITIONALLY GUARANTEED 3 YEARS!

Unserviceable tire will be replaced by comparable new tire with full credit for the period of guarantee not realized.

Makers of Armstrong  
Pure Foam Cushioning



**FREE!** Armstrong's handy 88-page Road Atlas-Radio Guide! Send 10¢ to cover postage. Dept. P-2, Armstrong Rubber Company, West Haven 16, Conn.

quiring a piston-ring job and 150,000 miles before a cylinder rebore?"

I am the satisfied owner of a 1946 Chrysler sedan that has gone over 183,000 miles without rings, valve grind, or having the head off the motor.

I'm a minister and travel in evangelistic campaigns—over 42,000 miles last year. I get from 18 to 20 miles per gallon if I don't drive over 50 m.p.h.

My Chrysler didn't cost me any \$10,000 either.

REV. WM. R. HANNAN, Springfield, O.

## Airboat for Borneo

Your article on airboats [May, p. 168] interested me very much because I've had such a boat in mind for about four years. I do missionary work in Eastern Borneo. In



our section there are no roads or trails so I always travel by river. During the past 13 years I guess I've broken a thousand shear pins, figuratively speaking, because of shallow channels and rapids. I'm home on furlough now, but expect to return this summer. An airboat looks like just what I need.

F. R. WHETZEL, Portland, Ore.

## Autos Run Mostly on Air

Can you tell me how many cubic inches of vaporized fuel mixture you get from one gallon of gas, when it is combined with the necessary amount of air?

S/SGT. C. A. RAMIREZ  
APO 74, San Francisco.

*For the best explosive mixture, about 1,000 gallons of air are required for each gallon of gasoline that the automobile engine uses. The gallon equals 231 cubic inches. It can be said then that one gallon of gasoline is converted into 231,000 cubic inches of explosive mixture when it is atomized.*

## Add Howling Buildings

I noticed that a reader who built a cabin in the woods was disappointed that the wind didn't howl around it to his satisfac-



## YOU PRACTICE COMMUNICATIONS with Kits I Send You

### Build This Transmitter

As part of my Communications Course I send you parts to build the low power Broadcasting Transmitter shown at the right. Use it to get practical experience putting a station "on the air," perform procedures required of Broadcast Station operators. You build many other pieces of equipment with kits I send. I train you for your FCC Commercial Operator's License.



You Get Valuable, Practical Experience Using My Kits. All Equipment Yours to Keep.



J. E. Smith has trained more men for Radio-TV than any other man.

## YOU PRACTICE SERVICING with Kits I Send You

### Build This Tester

You build this Multitester from parts I send, use it to earn extra money in your spare time fixing neighbors' Radios. I also send you speaker, tubes, chassis, transformer, loop antenna, everything you need to build a modern Radio and other equipment. You get practical experience working with circuits common to both Radio and Television. All equipment is yours to keep. See and read about it in my FREE 64-page book. Just cut out and mail coupon below!



# I Will Train You at Home to be a RADIO-TELEVISION Technician

## TELEVISION

### Today's Good Job Maker



TV now reaches from coast-to-coast. Over 15 million TV sets are now in use; 108 TV stations are operating and 1800 new TV stations have been authorized. This means more jobs, good pay jobs with bright futures. Now is the time to get ready for success in TV. Find out what Radio-Television offers you. Mail coupon now for my 2 Books FREE!

## America's Fast Growing Industry Offers You Good Pay, Success

Do you want a good pay job, a bright future, security? Then get into the fast growing RADIO-TELEVISION industry. Hundreds I've trained are successful RADIO-TELEVISION TECHNICIANS. Most had no previous experience, many no more than grammar school education. Keep your job while training at home. Learn RADIO-TELEVISION principles from easy-to-understand lessons. Get practical experience on actual equipment you build with parts I send you.

### Make Extra Money in Spare Time While Training

The day you enroll I start sending you SPECIAL BOOKLETS that show you how to service neighbors' Radios in spare time while training. Use MULTITESTER you build to help service sets, get practical experience working on circuits common to both Radio and Television. Find out how you can realize your ambition to be successful in the prosperous RADIO-TELEVISION industry. Even without Television, the industry is bigger than ever before. 105 million home and auto Radios, over 2900 Radio Stations, expanding Aviation and Police Radio. Micro-Wave Relay, FM and Television are making opportunities for Servicing and Communications Technicians.

### Mail Coupon — Find Out What Radio-TV Offers You

Send for my FREE DOUBLE OFFER. Cut out and mail coupon below. Send in envelope or paste on postal. You will get actual Servicing Lesson to prove it's practical to learn at home. You'll also receive my 64-page Book, "How to Be a Success in Radio-Television." Read what my graduates are doing, earning, see photos of equipment you practice with at home. J. E. Smith, President, Dept. 3GB National Radio Institute, Washington 9, D. C.

## Good for Both - FREE

MR. J. E. SMITH, President, Dept. 3GB  
National Radio Institute, Washington 9, D. C.  
Mail me Sample Lesson and 64-page Book,  
FREE. (No salesmen will call. Please  
write plainly.)

Name ..... Age .....  
Address .....  
City ..... Zone ..... State .....

**VETS** write in date of discharge .....



## I TRAINED THESE MEN



**Has Growing Business**  
"I am becoming an expert Teletician as well as Radiotrician. Without your practical course I feel this would have been impossible. My business continues to grow."  
—Philip G. Brogan, Louisville, Ky.

### Good Job with Station



"I am Broadcast Engineer at WLPM. Another technician and I have opened a Radio-TV service shop in our spare time. Big TV sales here. As a result we have more work than we can handle."  
—J. H. Bangle, Jr., Suffolk, Va.

### Praises NRI as Best Course



"I was a high school student when I enrolled. My friends began to bring their Radios to me. I realized a profit of \$300 by the time I completed the course."  
—John Hopper, Nitro, West Va.

## NRI Training Leads to Good Jobs Like These



Broadcasting: Chief Technician, Chief Operator, Power Monitor, Recording Operator, Remote Control Operator, Servicing: Home and Auto Radios, P.A. Systems, Television Receivers, Electronic Controls, FM Radios. In Radio Plants: Design Assistant, Transmitter Design Technician, Tester, Serviceman, Service Manager. Ship and Harbor Radio: Chief Operator, Assistant Operator, Radiotelephone Operator. Government Radio: Operator in Army, Navy, Marine Corps, Coast Guard; Forestry Service Dispatcher, Airways Radio Operator. Aviation Radio: Transmitter Technician, Receiver Technician, Airport Transmitter Operator. Television: Pick-up Operator, Voice Transmitter Operator, Television Technician, Remote Control Operator, Service and Maintenance Technician.



## Tested Way to Better Pay

AVAILABLE to all qualified **VETERANS** UNDER G.I. BILLS





**shake it on  
every morning  
then...**



**every step  
of the day**

# QUINSANA FIGHTS ATHLETES FOOT INFECTION

QUINSANA works full-time—and fast! 9 out of 10 report amazing results.

91% of foot specialists interviewed used it on their patients. For burning, itching feet—cracking, peeling skin... get QUINSANA quick!

**Soothes, cools  
tired feet!**



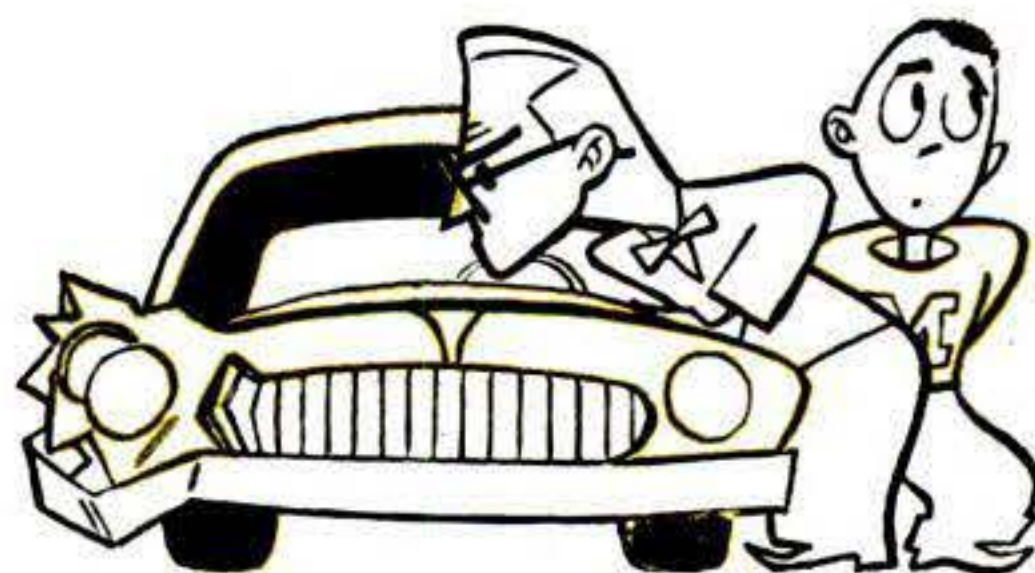
tion [Dec. '52, p. 8]. I would like to know how to stop one.

Two years ago, I built a small shop in my back yard. I spend many hours there, making gadgets and reading PSM. There's only one disturbing factor—winter or summer the slightest breeze makes a howl like a thousand yowling coyotes. I would like to trade that reader an A-1 cabin howl, complete with yowls and groans, for a formula for stopping same.

T. J. MITCHELL, Fort Worth, Tex.

## Who Has Most Accidents

In your May issue you state that, "High-school kids have more smashups than any other age group." You also say that the accident toll in the teen-age group is "the



highest by far in any age group." I believe that a look at the record will show that the age group which has "by far" the most accidents—more than half of all accidents—is the 25-44 age group.

CHARLES DAY, Groton, Mass.

*We should have said accident rate. In 1951, the latest year for which a breakdown of accidents by age groups is available, drivers 20 years old and younger were involved in 12 percent of all the automobile accidents. Drivers 25 to 44 years old were involved in 52 percent of the accidents.*

*But the teen-agers constituted only seven percent of the U. S. population; the older group, 35 percent. For their numbers, the 25-44 group had a better record by eight percent.*

## Let's Time It Right

In your article on automobile timing lights [March, p. 193], you advise the reader to accelerate the engine and watch the timing mark after the timing has been set. You then point out that the timing mark "should move forward (in the direction of rotation) to indicate that the automatic spark-advance mechanism is functioning."

If the engine fires on TDC while idling,



**Train QUICK  
in Big Coyne  
Shops**

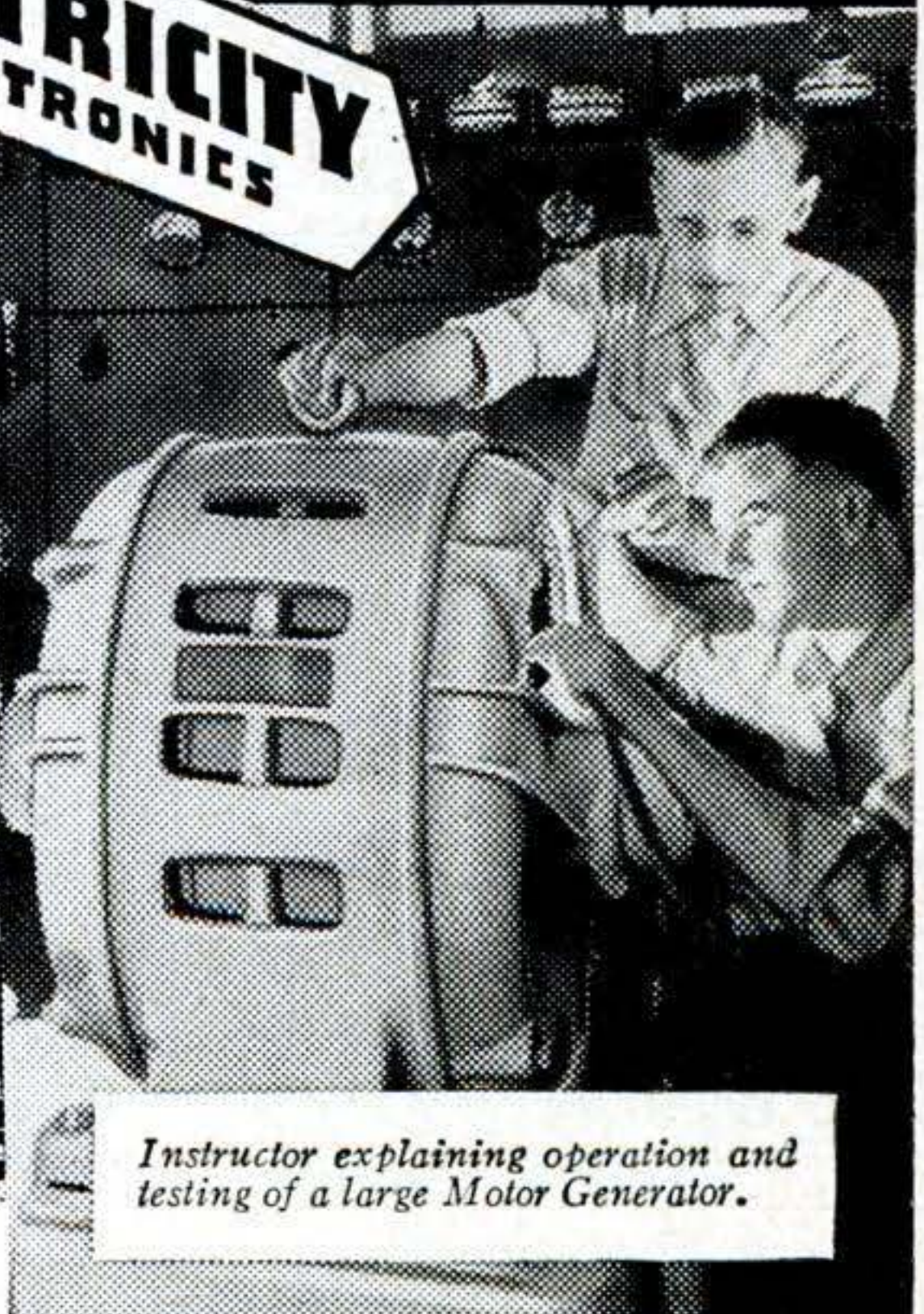
# GREAT OPPORTUNITY FIELDS!



*Instructor helping students check the wiring and trace the circuits of television receivers.*



*This big fire-proof building is occupied entirely by Coyne.*



*Instructor explaining operation and testing of a large Motor Generator.*

## TRAINED YOUNG AND OLDER MEN— URGENTLY NEEDED IN VITAL FIELDS!

ELECTRICITY—RADIO—TELEVISION—ELECTRONICS—VITAL in defense program. Trained men whether 16 or up to 50 needed. **TRAIN QUICKLY** for better rating if drafted—Vital job in industry if not.

## TELEVISION-RADIO      ELECTRICITY

Here at COYNE you're retrained for Television, Testing, Trouble-Shooting on Radio, Public Address, F. M. Sound Units, etc. Many Coyne trained men in good jobs or own well paying Television-Radio businesses of their own.

Big future in Power Plant Work, Motors, Industrial Electronics, Armature Winding, Home and Factory Wiring, Appliances, Refrigeration, Maintenance, Illumination, etc. Lifetime job service to Coyne graduates.

## WE TRAIN YOU IN CHICAGO

Our famous Practical-Technical method gives you practical experience on a massive outlay of equipment. Actual shop work plus necessary technical training. You are trained right here in the great Coyne shops. Send for **BIG FREE BOOK**.

**APPROVED  
FOR  
VETERANS**

### START NOW—PAY LATER

Enroll now, pay most of tuition after graduation. Special plan for men of draft age. We'll help you get part-time work, if you need it to help pay living costs while at Coyne.

B. W. COOKE, President

**COYNE** SCHOOL

A TECHNICAL TRADE INSTITUTE  
CHARTERED NOT FOR PROFIT  
Established 1899  
500 S. Paulina Dept. B3-73H  
Chicago 12, Illinois

ELECTRICITY ★ TELEVISION ★ RADIO ★ REFRIGERATION ★ ELECTRONICS

## LARGEST, OLDEST, BEST EQUIPPED SCHOOL OF ITS KIND IN THE U.S.

### Mail Coupon for Big FREE Book!



Whether you prefer Television-Radio or Electricity, train on actual equipment at Coyne. We will send you a Big, fully Illustrated Book. Indicate below which course interests you most. No salesman will call. Mail coupon TODAY.

B. W. Cooke, President  
COYNE SCHOOL, 500 S. Paulina St.  
Dept. B3-73H, Chicago 12, Ill.

Send me your Big Free book. I am interested in field checked below. This does not obligate me.

TELEVISION-RADIO       ELECTRICITY

NAME.....

ADDRESS.....

CITY.....STATE.....



# How **HATLESS MEN** keep hair neat all day long!



● **New-formula grooming aid gives hair naturally-neater look without gooey grease or cream!**

● **Removes flaky dandruff . . . makes scalp feel better, more refreshed!**

Whether you go hatless or not, keep hair neatly groomed *all day* the way so many outdoor men do—with Fitch Ideal!

See the neatest trick of all—as Ideal's secret grooming agent . . . *not* a grease, oil nor cream . . . makes thin hair look thicker—thick hair *stay slicker!*

Ideal *also* relieves dry, itchy scalp—*also* removes loose dandruff—*while* it works its grooming miracles!

Feel its new tonic action. Feel your scalp tingle with invigorating freshness! Note—there's *no* lingering, tell-tale odor!

Start tomorrow. Just seconds—massaging hair and scalp with a dash of new Fitch Ideal—will pay off *all day!* You can count on Fitch Ideal for that smart, *naturally-neater* look of the man who's going places! At all drug counters—also ask Barbers for professional applications.

Get new

**FITCH** *Ideal* **HAIR TONIC**

then the automatic advance should advance the timing as we accelerate. This would make our timing light flash before TDC and the timing mark would not have reached the pointer. Therefore the timing mark would move against rotation. Right?

EDWIN A. MARSHALL, Natrona Heights, Pa.

*Right!*

## **Self-Announcing Records**

The suggestion that phonograph records be made with a brief announcement at the beginning telling what you are about to hear [March, p. 131] is at least 50 years old. Between 1903 and 1906 all records had this feature.

ALBERT H. MACMULLAN, Tampa, Fla.

*Around 1900 Victor had it on popular-artist recordings, Columbia on operatic recordings.*

## **Overhead Cams**

In your article "All About 18 Little Cars" [April, p. 118] you say that the Singer has an overhead cam and that no car in mass production on this side of the Atlantic has one. That's where you're wrong—Crosley manufactures a four-cylinder overhead-cam engine.

ARTHUR F. KOLBERG JR., Baroda, Mich.

*You were as right as rain up to the time last year when manufacture of the Crosley was discontinued.*

## **In Defense of Small Ships**

A caption in your article "Battling 'Boxer' Flings 1-2 Punch off Korea" [March, p. 126] says that the helicopter has replaced the destroyer as plane guard. I don't agree. Even though the helicopter is in use as a plane guard, destroyers still perform the same task as before.

Let's put it this way: If the large ships didn't have small ships in their company, where would they be? You guessed it—down under with Davy Jones.

R. C. ZASKODA, QMSN, USS WILTSIE  
FPO San Francisco.

## **Ice Makes Medicine Easy to Take**

You won't taste medicine if you swallow it after holding a piece of ice on the tip of your tongue. The ice will temporarily anesthetize your taste buds so that you can't detect any flavor.



# How long since your last raise?



Sure, you've had a "cost of living increase." But what about the *big* pay boost?—the kind the boss asks you not to talk about and the kind that starts you thinking about a new car, a better home, luxuries for your family!

If you've had one of these in the past six months, stop reading right here. If not, it's time to start doing something about it.

**Look around you. The men who are advancing are the trained men. They've learned special skills that bring them higher pay. It's the men without training who get what's left.**

What are you going to do about it? Just wait and hope for the jackpot to pay off? If you really want the *big money*, you can start by getting the necessary training at home in your spare time.



## Why Home Study?

When you learn the I. C. S. way, your time is your own. Arrange your schedule to suit yourself. No tiresome traveling to and from school. No classes missed because of other engagements. Home study through I. C. S. has proved out for millions of ambitious men and women. You, too, can use it to get ahead!

International Correspondence Schools offer you a course in 391 success-proved subjects. You get the practical plus the bedrock facts and theory. You earn while you learn. Students often report their first *big* pay increases right after enrolling.

**Read carefully the list of subjects in the coupon below.** Pick out the field of study that interests you most—the one with the greatest future for you. Then mark and mail the coupon and *find out* what I. C. S. can do for you. All it costs is a stamp or a postcard. Why not do it right away—it may be the most important step you've ever taken!

## wide choice of courses

I. C. S. offers a total of 391 different courses — 391 roads to advancement. Among them is the one you want. You'll find the lessons modern, simple, easy to understand. Each one you study takes you farther along the road to knowledge and success.

## machine operator to shop foreman

"When I enrolled for my I. C. S. course in Carpentry and Millwork, I was a machine operator. Today, eleven months later, I am a shop foreman. As a consequence my salary has been increased 73.3%."

# INTERNATIONAL CORRESPONDENCE SCHOOLS



BOX 7655-N, SCRANTON 9, PENNA.

Without cost or obligation, send me "HOW to SUCCEED" and the booklet about the course BEFORE which I have marked X:

- |  |   |  |   |   |
|--|---|--|---|---|
| <p><b>ART</b></p> <ul style="list-style-type: none"> <li><input type="checkbox"/> Commercial Art</li> <li><input type="checkbox"/> Magazine and Book Illustrating</li> <li><input type="checkbox"/> Cartooning</li> <li><input type="checkbox"/> Show Card and Sign Lettering</li> <li><input type="checkbox"/> Fashion Illustrating</li> </ul> <p><b>AUTOMOTIVE</b></p> <ul style="list-style-type: none"> <li><input type="checkbox"/> Automobile, Mechanic</li> <li><input type="checkbox"/> Auto-Elec. Technician</li> <li><input type="checkbox"/> Auto Body Rebuilding and Refinishing</li> <li><input type="checkbox"/> Diesel—Gas Engines</li> </ul> <p><b>AVIATION</b></p> <ul style="list-style-type: none"> <li><input type="checkbox"/> Aeronautical Engineering Jr.</li> <li><input type="checkbox"/> Aircraft Engine Mechanic</li> <li><input type="checkbox"/> Airplane Drafting</li> </ul> <p><b>BUILDING</b></p> <ul style="list-style-type: none"> <li><input type="checkbox"/> Architecture</li> <li><input type="checkbox"/> Arch. Drafting</li> <li><input type="checkbox"/> Building Contractor</li> <li><input type="checkbox"/> Estimating</li> <li><input type="checkbox"/> Carpenter and Mill Work</li> <li><input type="checkbox"/> Carpenter Foreman</li> <li><input type="checkbox"/> Reading Blueprints</li> <li><input type="checkbox"/> House Planning</li> <li><input type="checkbox"/> Plumbing</li> </ul> | <ul style="list-style-type: none"> <li><input type="checkbox"/> Heating</li> <li><input type="checkbox"/> Steam Fitting</li> <li><input type="checkbox"/> Air Conditioning</li> <li><input type="checkbox"/> Electrician</li> </ul> <p><b>BUSINESS</b></p> <ul style="list-style-type: none"> <li><input type="checkbox"/> Business Administration</li> <li><input type="checkbox"/> Certified Public Accountant</li> <li><input type="checkbox"/> Accounting</li> <li><input type="checkbox"/> Bookkeeping</li> <li><input type="checkbox"/> Stenography and Typing</li> <li><input type="checkbox"/> Secretarial</li> <li><input type="checkbox"/> Federal Tax</li> <li><input type="checkbox"/> Business Correspondence</li> <li><input type="checkbox"/> Personnel and Labor Relations</li> <li><input type="checkbox"/> Advertising</li> <li><input type="checkbox"/> Retail Business Management</li> <li><input type="checkbox"/> Managing Small Business</li> <li><input type="checkbox"/> Sales Management</li> <li><input type="checkbox"/> Salesmanship</li> <li><input type="checkbox"/> Traffic Management</li> </ul> <p><b>CHEMISTRY</b></p> <ul style="list-style-type: none"> <li><input type="checkbox"/> Chemical Engineering</li> <li><input type="checkbox"/> Chemistry</li> <li><input type="checkbox"/> Analytical Chemistry</li> <li><input type="checkbox"/> Petroleum—Nat'l Gas</li> <li><input type="checkbox"/> Pulp and Paper Making</li> <li><input type="checkbox"/> Plastics</li> </ul> | <p><b>CIVIL, STRUCTURAL ENGINEERING</b></p> <ul style="list-style-type: none"> <li><input type="checkbox"/> Civil Engineering</li> <li><input type="checkbox"/> Structural Engineering</li> <li><input type="checkbox"/> Surveying and Mapping</li> <li><input type="checkbox"/> Structural Drafting</li> <li><input type="checkbox"/> Highway Engineering</li> <li><input type="checkbox"/> Reading Blueprints</li> <li><input type="checkbox"/> Concrete Construction</li> <li><input type="checkbox"/> Sanitary Engineering</li> </ul> <p><b>DRAFTING</b></p> <ul style="list-style-type: none"> <li><input type="checkbox"/> Aircraft Drafting</li> <li><input type="checkbox"/> Architectural Drafting</li> <li><input type="checkbox"/> Electrical Drafting</li> <li><input type="checkbox"/> Mechanical Drafting</li> <li><input type="checkbox"/> Structural Drafting</li> <li><input type="checkbox"/> Sheet Metal Drafting</li> <li><input type="checkbox"/> Mine Surveying and Drafting</li> </ul> <p><b>ELECTRICAL</b></p> <ul style="list-style-type: none"> <li><input type="checkbox"/> Electrical Engineering</li> <li><input type="checkbox"/> Electrician</li> <li><input type="checkbox"/> Electrical Maintenance</li> <li><input type="checkbox"/> Electrical Drafting</li> <li><input type="checkbox"/> Electric Power and Light</li> <li><input type="checkbox"/> Lineman</li> </ul> <p><b>HIGH SCHOOL</b></p> <ul style="list-style-type: none"> <li><input type="checkbox"/> High School Subjects</li> </ul> | <ul style="list-style-type: none"> <li><input type="checkbox"/> College Preparatory</li> <li><input type="checkbox"/> Mathematics</li> <li><input type="checkbox"/> Commercial</li> <li><input type="checkbox"/> Good English</li> </ul> <p><b>MECHANICAL AND SHOP</b></p> <ul style="list-style-type: none"> <li><input type="checkbox"/> Mechanical Engineering</li> <li><input type="checkbox"/> Industrial Engineering</li> <li><input type="checkbox"/> Industrial Supervision</li> <li><input type="checkbox"/> Foremanship</li> <li><input type="checkbox"/> Mechanical Drafting</li> <li><input type="checkbox"/> Machine Design-Drafting</li> <li><input type="checkbox"/> Machine Shop Practice</li> <li><input type="checkbox"/> Tool Design</li> <li><input type="checkbox"/> Industrial Instrumentation</li> <li><input type="checkbox"/> Machine Shop Inspection</li> <li><input type="checkbox"/> Reading Blueprints</li> <li><input type="checkbox"/> Toolmaking</li> <li><input type="checkbox"/> Gas—Electric Welding</li> <li><input type="checkbox"/> Heat Treatment—Metallurgy</li> <li><input type="checkbox"/> Sheet Metal Work</li> <li><input type="checkbox"/> Sheet Metal Pattern Drafting</li> <li><input type="checkbox"/> Refrigeration</li> </ul> <p><b>POWER</b></p> <ul style="list-style-type: none"> <li><input type="checkbox"/> Combustion Engineering</li> <li><input type="checkbox"/> Diesel—Electric</li> <li><input type="checkbox"/> Electric Light and Power</li> </ul> | <ul style="list-style-type: none"> <li><input type="checkbox"/> Stationary Steam Engineering</li> <li><input type="checkbox"/> Stationary Fireman</li> </ul> <p><b>RADIO, TELEVISION, COMMUNICATIONS</b></p> <ul style="list-style-type: none"> <li><input type="checkbox"/> General Radio</li> <li><input type="checkbox"/> Radio Operation</li> <li><input type="checkbox"/> Radio Servicing—FM</li> <li><input type="checkbox"/> Television</li> <li><input type="checkbox"/> Electronics</li> <li><input type="checkbox"/> Telephone Work</li> </ul> <p><b>RAILROAD</b></p> <ul style="list-style-type: none"> <li><input type="checkbox"/> Locomotive Engineer</li> <li><input type="checkbox"/> Diesel Locomotive</li> <li><input type="checkbox"/> Air Brakes</li> <li><input type="checkbox"/> Car Inspector</li> <li><input type="checkbox"/> Railroad Administration</li> </ul> <p><b>TEXTILE</b></p> <ul style="list-style-type: none"> <li><input type="checkbox"/> Textile Engineering</li> <li><input type="checkbox"/> Cotton Manufacture</li> <li><input type="checkbox"/> Rayon Manufacture</li> <li><input type="checkbox"/> Woolen Manufacture</li> <li><input type="checkbox"/> Loom Fixing</li> <li><input type="checkbox"/> Finishing and Dyeing</li> <li><input type="checkbox"/> Textile Designing</li> </ul> |
|--|---|--|---|---|

**YEAR OF THE SIX MILLIONTH STUDENT**

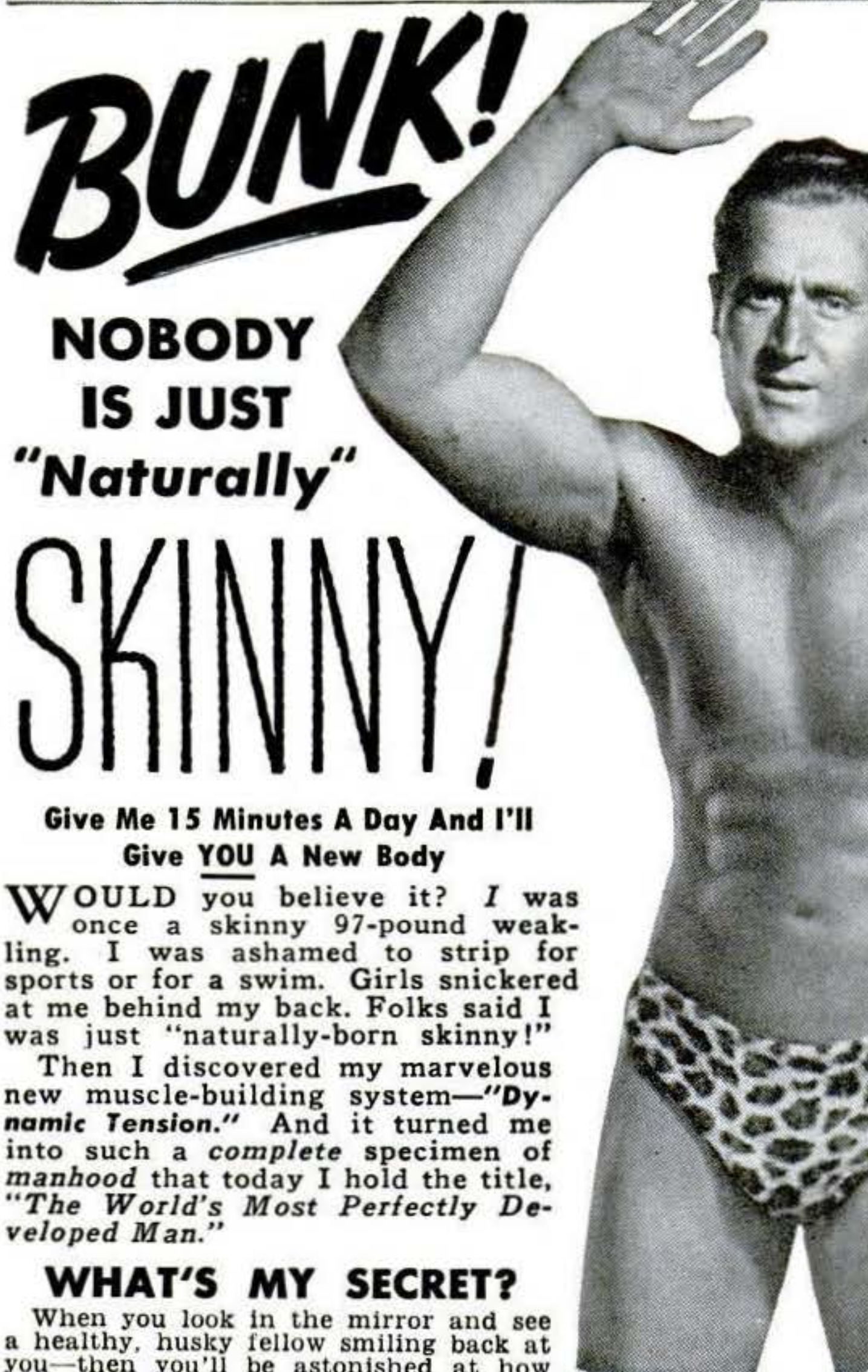
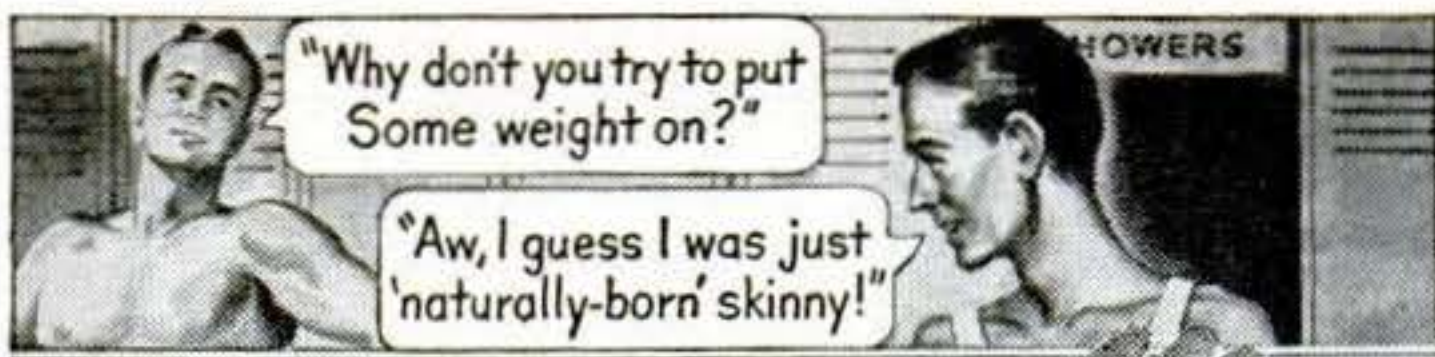
Name \_\_\_\_\_ Age \_\_\_\_\_ Home Address \_\_\_\_\_

City \_\_\_\_\_ Zone \_\_\_\_\_ State \_\_\_\_\_ Working Hours \_\_\_\_\_ A.M. to \_\_\_\_\_ P.M.

Occupation \_\_\_\_\_

Special tuition rates to members of the U. S. Armed Forces. Canadian residents send coupon to International Correspondence Schools Canadian, Ltd., Montreal, Canada.





**BUNK!**  
**NOBODY IS JUST "Naturally" SKINNY!**

Give Me 15 Minutes A Day And I'll Give YOU A New Body

WOULD you believe it? I was once a skinny 97-pound weakling. I was ashamed to strip for sports or for a swim. Girls snickered at me behind my back. Folks said I was just "naturally-born skinny!" Then I discovered my marvelous new muscle-building system—"Dynamic Tension." And it turned me into such a complete specimen of manhood that today I hold the title, "The World's Most Perfectly Developed Man."

**WHAT'S MY SECRET?**

When you look in the mirror and see a healthy, husky fellow smiling back at you—then you'll be astonished at how fast "Dynamic Tension" gets results! And you'll be using the method which many great athletes use for keeping in condition—prize fighters, wrestlers, baseball and football players, etc.

"Dynamic Tension" is the easy, natural method that you can practice in the privacy of your own room—just 15 minutes each day—while your scrawny chest and shoulder muscles begin to swell . . . those spindly arms and legs bulge . . . and your whole body starts to feel full of zip, self-confidence, new energy!

**FREE My 32-Page Illustrated Book is Yours —Not for \$1.00 or 10c—But FREE**

Send NOW for my famous book, "Everlasting Health and Strength." 32 pages, packed from cover to cover with actual photographs, valuable advice, answers to many vital questions. Page by page it shows what I can do for YOU. This book is a real prize for any fellow who wants a better build. Yet I'll send you a copy absolutely FREE. Just glancing through it may mean the turning point in your whole life! Rush the coupon to me personally: **CHARLES ATLAS, Dept. 17, 115 East 23rd St., New York 10, N. Y.**



*Charles Atlas*  
 Awarded the title of "The World's Most Perfectly Developed Man."

**CHARLES ATLAS, Dept. 17, 115 East 23rd St., New York 10, N. Y.**  
 Send me—absolutely FREE—a copy of your famous book, "Everlasting Health and Strength"—32 pages, crammed with actual photographs, answers to vital health questions, and valuable advice to every man who wants a better build. I understand this book is mine to keep, and sending for it does not obligate me in any way.

Name.....Age.....  
 (Please print or write plainly)

Address.....

City.....State.....

**114 Different STAMPS—25¢**

**Includes Most Famous Stamp Ever Issued: SPAIN GOYA NUDE**

You get a big—valuable—imported collection of 114 all-different stamps from all over the world—including:

- ALBANIA—Churchill-Roosevelt Liberation
- UNITED NATIONS—Very First Stamp Issued
- ALLIED MILITARY GOV'T—Set of 3
- GREAT BRITAIN—War Propaganda Set of 4

STALIN DEATH STAMP—plus hundreds of other fascinating stamps and sets. Have days of fun sorting through this giant collection—and fill your album at the amazing bargain rate of 5 stamps for only 1¢! Regular \$2.50 value—yet yours for 25¢ to introduce our Bargain Approvals. Money back if not delighted. **FREE**—"Midget Encyclopedia of Stamps"—plus Stamp Dictionary—plus Stamp Identifier!

**SEND 25¢ TODAY ASK FOR LOT EH-11**  
**ZENITH CO., 81 Willoughby St., Brooklyn 1, N. Y.**

**LEARN TO MOUNT BIRDS**

**ANIMALS, FISH, PETS**

Be a Taxidermist. Save your hunting TROPHIES. Have a fine home-museum. Hunters, save and MOUNT your beautiful DUCKS, QUAIL, DEER, TAN skins, FURS. Great Fun. Spare-time PROFITS.

**FREE BOOK** Tells ALL about it. 100 fine wild-game pictures, 48 pages. SEND TODAY, don't delay. Get this WONDERFUL FREE BOOK, MEN AND BOYS. Learn Taxidermy. Double your hunting pleasure. Rush letter or POSTAL today. STATE YOUR AGE.

**N. W. SCHOOL OF TAXIDERMISTRY, Dept. 2607 Omaha, Neb.**

**Learn TELEVISION RADIO—ELECTRONICS**

Prepare in spare hours for good pay in Television, Radio and Electronics. Train at home with Frank L. Sprayberry, America's outstanding Radio instructor. Big Kits of equipment furnished. Build testers, sets, etc. VETERANS: Approved for Training under GI Bill. Rush name and address for details and 2 BIG RADIO BOOKS—ALL FREE! No salesman will call. Write today!

**Sprayberry Academy of Radio, Dept. 55-Y 111 N. Canal Chicago 6, Illinois**

**'How to Make Money with Simple Cartoons'**

A book everyone who likes to draw should have. It is free; no obligation. Simply address

**FREE BOOK**

**CARTOONISTS' EXCHANGE**  
 Dept. 197D Pleasant Hill, Ohio

**MAKE \$5 PER HOUR WITHOUT A PRINTING PRESS**

**PRINTING** **FREE** complete "BIG MONEY" Plan and SAMPLE!

**REVOLUTIONARY NEW SCREEN METHOD**

PRINT colorful signs, posters, banners, fabrics, wall paper, show cards—ANYTHING! Print on any surface. NO printing press or special equipment is needed with this amazing "approved" new printing secret. 300% profit on nearly every job. Easy to learn —NO EXPERIENCE or art ability necessary. Exceptional opportunity. Complete illustrated detailed plan and colorful sample FREE—Write:

**SCREEN-PRINT COMPANY, Dept. 17 1010 So. Los Angeles St., Los Angeles 15, Calif.**

**EARN AT HOME SPARE or FULL Time**





# INVENTORS

Learn how to protect your invention. The U. S. Patent Laws provide that any new and useful art, machine, article of manufacture, or composition of matter, or any new and useful improvement thereof, may be patented if the act of invention is involved. Therefore, every inventor with a valuable invention should take advantage of the Patent Laws and proceed for patent protection in order to safeguard his rights.

A patent gives the inventor the exclusive right to prevent others from making, using, or selling the invention claimed in the patent for a period of seventeen years.

The Patent Laws were enacted for the benefit of the inventor to give him protection for the features of his invention which are patentable. These features must be properly and concisely set forth and claimed in a formal application for patent, in order to comply with the requirements of the Patent Laws. For that reason, unless the inventor is familiar with patent matters, he should engage a competent registered patent attorney or agent to represent him. We are registered to practice before the U. S. Patent Office and are prepared to serve you in the handling of your patent matters.

A specially prepared booklet entitled "Patent Guide for the Inventor", containing detailed information with respect to patent protection and procedure, together with a "Record of Invention" form will be promptly forwarded to you without obligation upon request.

**CLARENCE A. O'BRIEN & HARVEY JACOBSON**

*Registered Patent Attorneys*

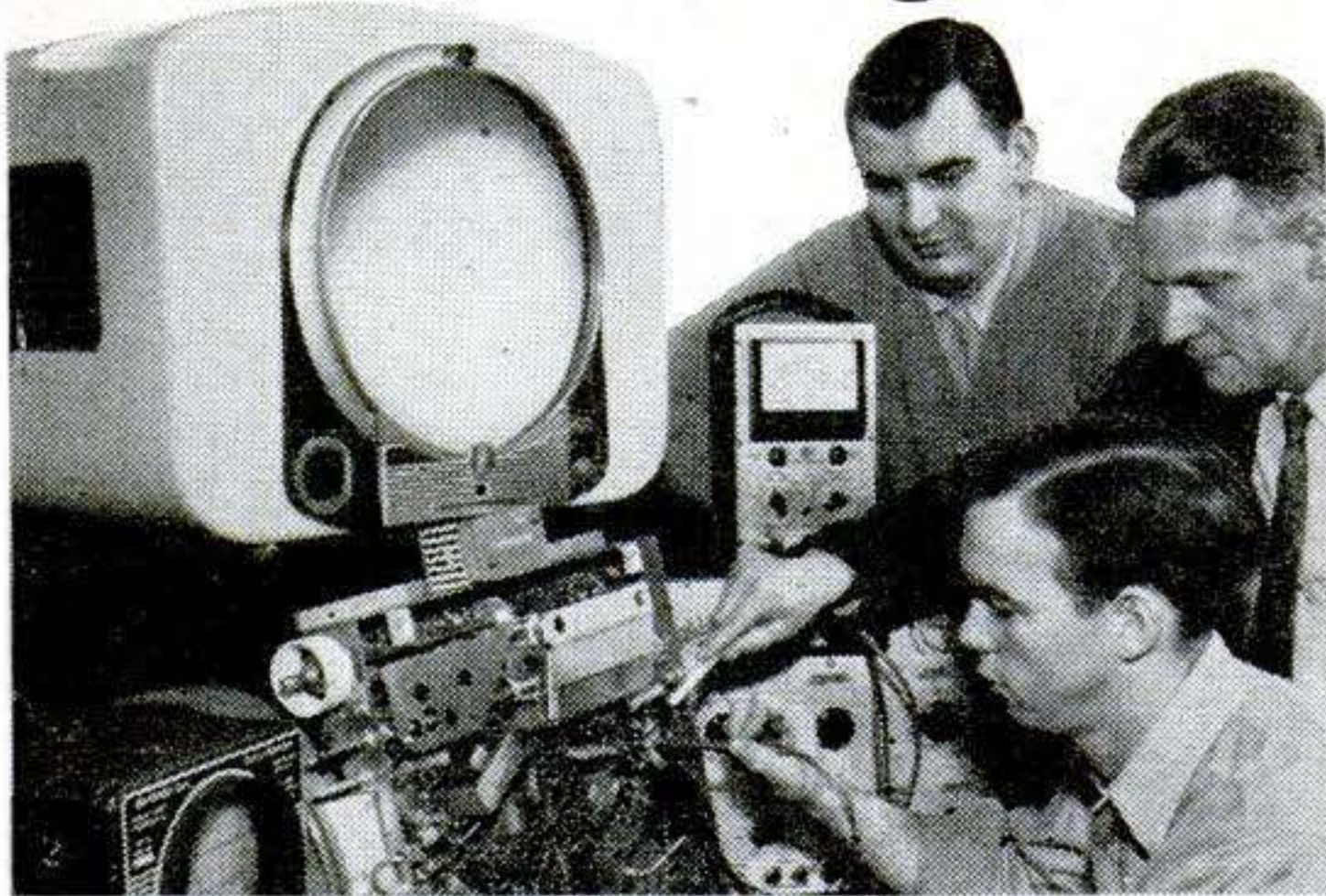
32 - G DISTRICT NATIONAL BUILDING

WASHINGTON 5, D. C.

JULY 1953 15



# BECOME AN Electrical Engineer



- Major in Electronics or Power
- Earn B. S. Degree in 36 months

Over 50% of the nation's industrial leaders began their careers with engineering training. Today, the demand for young, trained Electrical Engineers and Technicians is constantly expanding. Eight separate programs give you a wide range of career opportunities.

## Plan Your Career From these Courses in Electrical Technology

### ENGINEERING COURSES

Electrical Engineering — Bachelor of Science Degree  
Save a valuable year through optional year 'round study.  
Electronics major .....36 months  
Power major .....36 months

### TECHNICIAN COURSES

Electro Technician .....12 months  
Electronics Technician .....12 months  
Radio Technician .....12 months  
Radio and Television Technician .....18 months

### SERVICE COURSES

Electrical Service ..... 6 months  
Radio and Television Service .....12 months

Terms open September,  
January, April, July

Approved for veterans.  
Prior Military, Practical  
or Academic training  
evaluated for advanced  
credit. Faculty of special-  
ists. 50,000 former  
students. Annual enroll-  
ment from 48 states and  
23 overseas countries.  
50th year. Non-profit.

**MECHANICAL TECHNOLOGY  
COURSES** — Also available,  
Service Technician courses 6  
to 18 months — Heating,  
Refrigeration, Welding, Air  
Conditioning and Mechanical  
— Mechanical Engineering  
with a major in Design, Met-  
al Fabrication or Plant Engi-  
neering.

Also, general 3-month pre-  
paratory course.

Send handy coupon for  
complete information.



## MILWAUKEE SCHOOL OF ENGINEERING

MILWAUKEE SCHOOL OF ENGINEERING  
Dept. PS-753, 1025 N. Milwaukee  
Milwaukee 1, Wisconsin

Send free pictorial "Your Career Booklet"

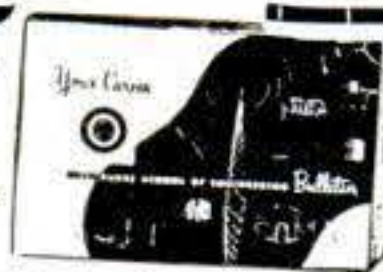
I am interested in .....  
name of course

Name .....Age .....

Address .....

City .....Zone .....State .....

If veteran, indicate date of discharge .....



## OIL FROM THE PUBLIC LANDS

Get the amazing story of how U. S. citizens  
can file for oil rights on public land in the  
West. Profits made as high as \$250,000 for  
\$250; \$11,000 monthly for \$200. We select  
lands in possible oil areas, show you how  
to file. Send for free booklet.

### CALIFORNIA LEASE CO.

7075-PS Hollywood Blvd., Los Angeles 28, Calif.

## EYE GLASSES by MAIL As low as \$1<sup>95</sup>

WRITE for FREE  
CATALOG with 14  
LENS SAMPLE CARD

Thousands of  
Customers  
Est. 1939



QUALITY READING-MAGNIFYING OR  
BIFOCAL GLASSES FOR FAR AND NEAR

**ADVANCE SPECTACLE COMPANY, Inc.**  
537 S. Dearborn St., Dept. SP7 Chicago 5, Illinois



## EARN BIG MONEY BE YOUR OWN BOSS • GET A BETTER JOB

### IN CUSTOM FURNITURE UPHOLSTERY

#### You Can Earn While You Learn

AT HOME you "Learn-by-Doing" with easy Up-  
holstery Trades School Course. Pay for training with  
spare time earnings, while learning.

You learn custom furniture upholstery; furniture fin-  
ishing and repairs, plus 5 big extras; window cornice,  
drapery, slipcover, cushion making and car upholstery.



Course includes FREE OF EXTRA  
COST 4 big outfits of ALL tools,  
frames, materials and fabrics to  
make 3 beautiful pieces of upholstered furniture and  
slip covers—yours to keep or sell.

FREE Illustrated book "A New Way to a Success-  
ful Career" tells about this billion dollar field. Read  
success stories of UTS graduates! Mail coupon today.

Paul de  
Vita, for-  
mer Auto  
Mechanic,  
says: "Dou-  
bled my  
income—  
Thanks to  
UTS Train-  
ing."

SEND  
FOR  
BIG  
FREE  
BOOK

UPHOLSTERY TRADES SCHOOL  
Dept. BL-1607, 721 Broadway, New York 3, N.Y.  
Send me FREE book on Home Study Course

Name.....

Address.....

City.....Zone.....State.....



# INVENTORS

If you believe that you have an invention, you should find out how to protect it. The first step is to have a search made of the prior pertinent U. S. patents. If a report on this search indicates that the invention appears patentable you can apply for a patent, and the specifications and claims should be prepared.

The firm of McMorrow, Berman & Davidson, with offices in Washington, D. C., is qualified to take the necessary steps for you. We can make a preliminary search on your invention, advise you whether we think it can be patented, and prepare your application for

patent.

Unless you are fully familiar with the U. S. Patent Laws, we recommend that you engage the services of a Registered Patent Attorney to protect your interests. The patent laws are *your* laws. A patent gives you the right to prevent others from making, using or selling the invention claimed in your patent for a period of 17 years.

Use these patent laws for your protection. Investigate whether your invention can be patented. If you have what you believe to be an invention, we suggest that you have this firm make a search for you.

*Send for a copy of our Patent Booklet entitled "How To Protect Your Invention," containing information about patent protection and patent procedure. Along with this we will also send you an "Invention Record" form, for your use in writing down and sketching details of your invention. We will mail them promptly. No obligation. They are yours for the asking.*

## McMORROW, BERMAN & DAVIDSON

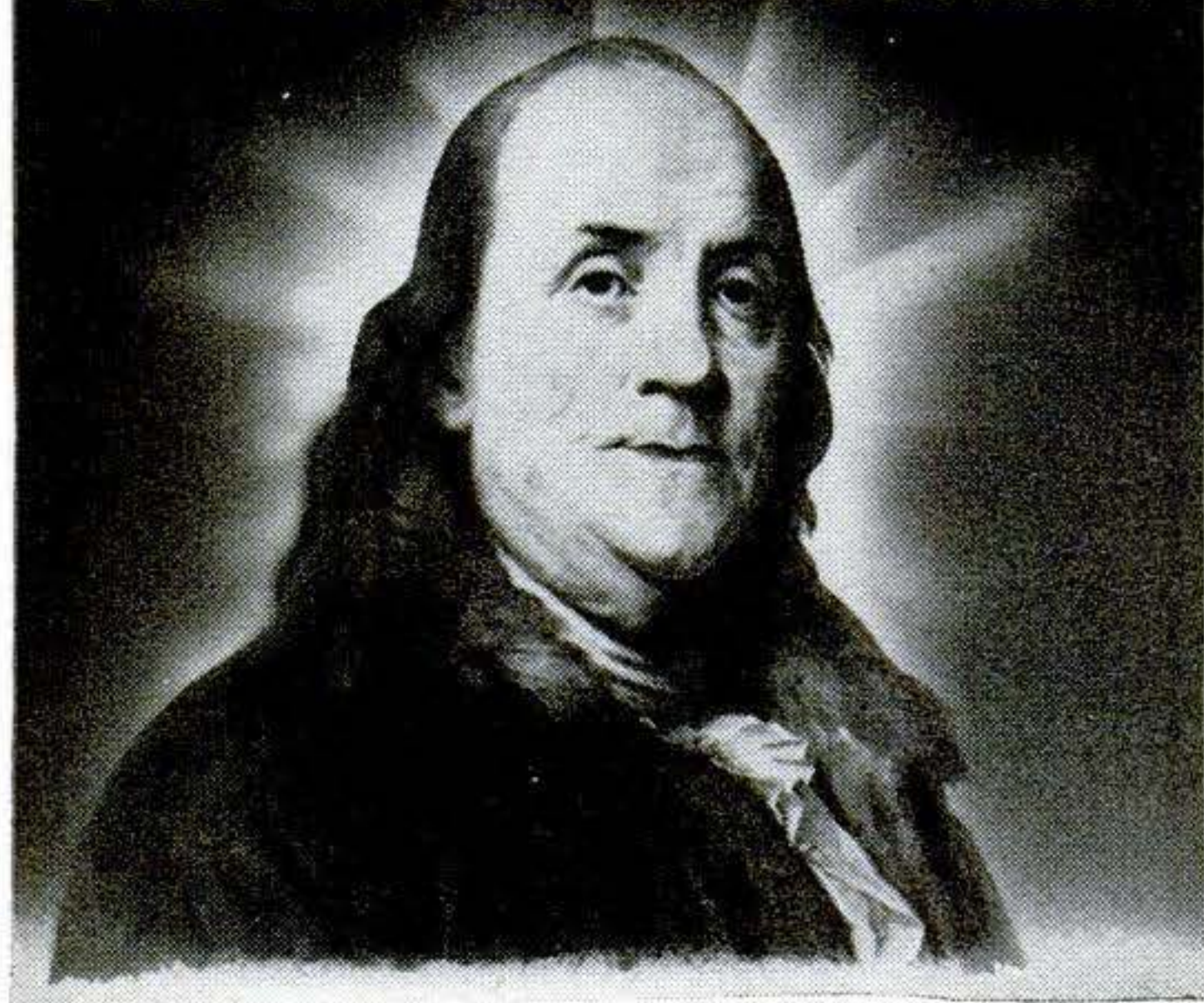
*Registered Patent Attorneys*

**PATENTS • COPYRIGHTS • PATENTS**

142 - M VICTOR BUILDING, WASHINGTON 1, D. C.



# WHAT SECRET POWER DID THIS MAN POSSESS?

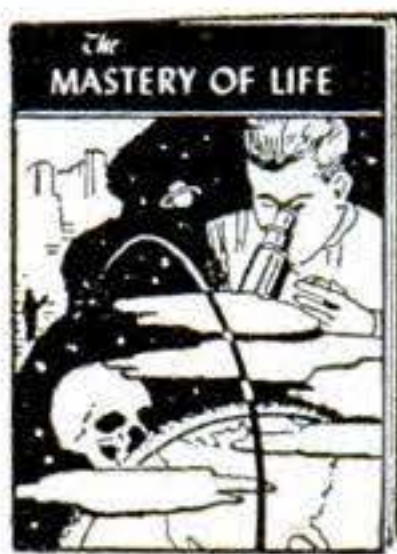


**BENJAMIN FRANKLIN**  
(A Rosicrucian)

**WHY** was this man great? How does anyone—man or woman—achieve greatness? Is it not by mastery of the powers within ourselves? Know the mysterious world within you! At-tune yourself to the wisdom of the ages! Grasp the inner power of your mind! Learn the secrets of a full and peaceful life!

Benjamin Franklin—like many other learned and great men and women—was a Rosicrucian. The Rosicrucians (NOT a religious organization) first came to America in 1694. Today, headquarters of the Rosicrucians send over seven million pieces of mail annually to all parts of the world. Write for YOUR FREE COPY of "The Mastery of Life"—TODAY. No obligation. No salesmen. A non-profit organization. Address: Scribe V.V.J.

**THIS BOOK FREE!**



## The ROSICRUCIANS

SAN JOSE • (AMORC) • CALIFORNIA

—SEND THIS COUPON—

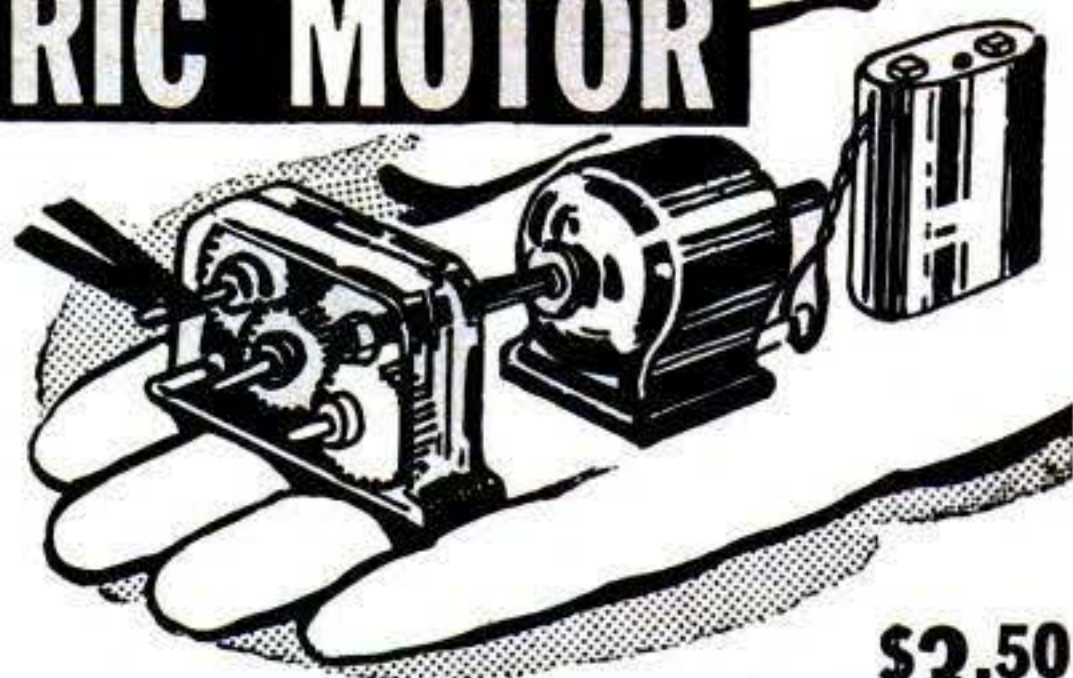
Scribe V.V.J.  
The ROSICRUCIANS (AMORC)  
San Jose, California  
Please send me the free book, *The Mastery of Life*, which explains how I may learn to use my faculties and powers of mind.

Name \_\_\_\_\_  
Address \_\_\_\_\_  
City \_\_\_\_\_

## Powerful Midget "DYNA-MITE" ELECTRIC MOTOR

WATCH IT WORK WONDERS!

**GEAR BOX**  
Forward  
Reverse  
**REMOTE CONTROL**  
**POWER PLANT**



**\$3.50**

ALL 3 UNITS COMPLETE **3ppd.**

The most powerful midget motor ever built! Will drive your model trains, boats, planes, cars and construction sets with high speed . . . real power. Measures only 1"x1"x1 1/4", but turns up to 6800 r.p.m. . . . top speed for any midget motor! REMOTE CONTROL—reverses quickly with the new Power Plant holding two standard flashlight batteries. REDUCTION GEARS reduce speed as low as 50 r.p.m. Works perfect with gears, belt drive, or direct drive. Endless hours of fun . . . educational, too! Non-shock, safe! ORDER TODAY! This terrific midget motor, gear box, and remote control battery power plant is yours complete for only \$3.50 (add 25c if batteries are desired). Send check or money order and save on postage.

**ELECTRO-KRAFT CO.**

Dept. B-10, Box 237 Old Chelsea Station, New York 11, N. Y.

**BOOST YOUR EARNING POWER WITH**

# DIESEL

**Train Now For This Big Pay Trade!**

Are you mechanically inclined? Then you'll like DIESEL! You'll like working on these modern engines . . . pulling down the big pay of DIESEL-TRAINED men. Train at home for Diesel opportunities with simple, practical UEI Training. Learn DIESEL engine operation, fuel systems, repairs, maintenance PLUS Scientific Motor Tune-up. Course includes shop training in our big, well-equipped shops, working on Diesel engines. Write now for FREE booklet!

**UTILITIES ENGINEERING INSTITUTE (Founded 1927)**  
2521 Sheffield Avenue, Dept. DM-23, Chicago 14, Illinois



## "Advanced Techniques of Hypnosis"

A new authentic photo-illustrated hypnotism book written by a practicing professional hypnotist. You are given the latest as well as original methods for inducing deep hypnosis and self-hypnosis. Detailed information about: Waking Hypnosis, Self-hypnosis, Instantaneous Hypnosis, Stage Hypnosis, Hypno-therapy, Mass-Hypnosis. Truly a remarkable book.

Free catalog of new hypnotism books sent on request.  
Send for the enlightening book "Advanced Techniques of Hypnosis" → \$1  
78 RPM Phonograph Record Inducing Self-Hypnosis & Group Hypnotism → \$5

Another excellent illustrated book, "Hypnotism Revealed" \$1  
Thought of using sleep for learning, self-development? Send for new intriguing book, "Mental Power Through Sleep Suggestion." → \$1

MELVIN POWERS, Master Hypnotist, 1324 Wilshire, Dept. 103, Hollywood 17, Calif.

**GO PLACES**   
**LEARN ANOTHER LANGUAGE EASILY - QUICKLY**  
by **LINGUAPHONE** **IN 20 MINUTES A DAY**

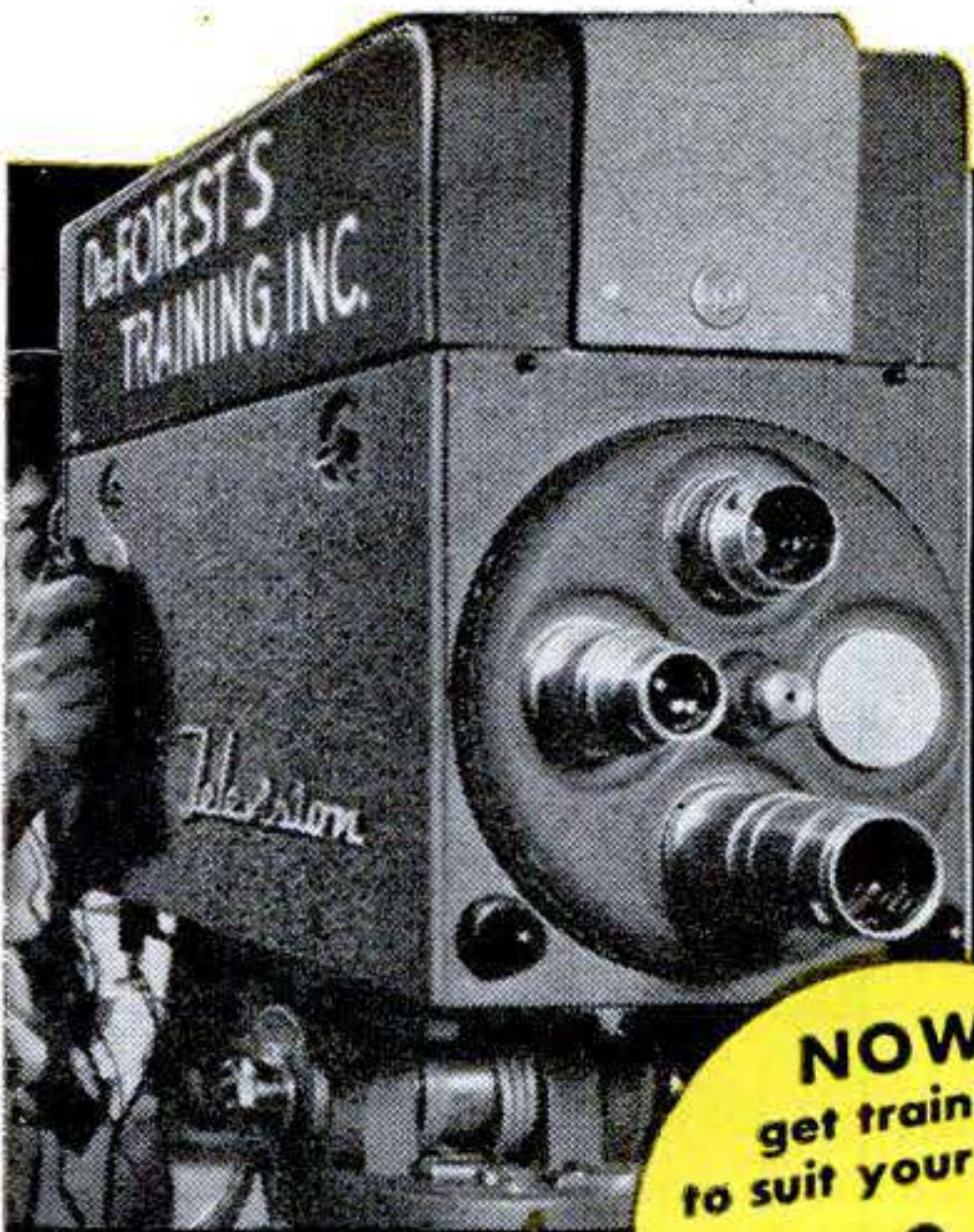
World's-Standard CONVERSATIONAL METHOD

**FRENCH SPANISH GERMAN RUSSIAN JAPANESE NORWEGIAN**  
—any of 29 Languages  
Are interesting job, travel, cultural opportunities passing you by because you speak only one tongue? Learn another language AT HOME the same natural, easy way you learned English long before you went to school. YOU LISTEN—you hear native men and women speak—you understand—YOU SPEAK. World-wide educational, business endorsement; over a million home-study students of all ages. FREE BOOK, "Passport to a New World of Opportunity," gives fascinating facts. WRITE TODAY!

LINGUAPHONE INSTITUTE, 147-07 Mezz., Rockefeller Plaza, N. Y. 20, N. Y.  
Send me your FREE book. I want to learn . . . language.  
Name . . . . .  
Address . . . . .  
City, Zone & State . . . . .



**NOW...from D.T.I.'s MILLION DOLLAR TRAINING CENTER**



**Learn to master**

# TELEVISION

**RADIO - ELECTRONICS**

**by getting EVERYTHING YOU NEED!**

**NOW—  
get training  
to suit your NEEDS**

**TAKE YOUR  
CHOICE**

America's amazing multi-billion dollar Television field now offers you a chance of a lifetime to get started toward a grand job or your own business. With TV station limit now raised from over 100 to 2053, Television is headed for almost every community. Mail coupon today. See how you may prepare to cash in on the coming TV BOOM.

**Get ALL of your training  
AT HOME!...including setting  
up your own HOME LABORATORY**

**Come to  
D.T.I.'s  
great CHICAGO  
LABORATORIES  
...one of the Nation's FINEST!**

Now, in the heart of the nation's TV Center, you can get all of your preparation in D.T.I.'s big, modern, wonderfully equipped training laboratories. Loads of commercial equipment and ample, well qualified instructors help you get a thorough, practical preparation in the SHORTEST POSSIBLE TIME. Part time student Employment assistance can help you pay your way while in training.

### EMPLOYMENT SERVICE

As soon as you complete either the Chicago Laboratory or Home Training, you'll find D.T.I.'s grand Employment Service ready to help you start earning real money. Get full facts. Mail coupon today.

**MILITARY SERVICE:** If subject to military service, the training information we have for you should prove very helpful. Mail coupon today.

**89 WAYS  
TO  
EARN  
MONEY  
IN TELEVISION  
RADIO ELECTRONICS**

**ACT NOW! MAIL COUPON TODAY  
Get this publication FREE!**

**DeFOREST'S TRAINING INC. Dept. PS-7-J  
2533 N. ASHLAND AVE., CHICAGO 14, ILL.**

I would like your Opportunity News Bulletin showing "89 Ways to Earn Money In Television-Radio-Electronics"; also, complete facts about the training opportunity made possible by your organization.

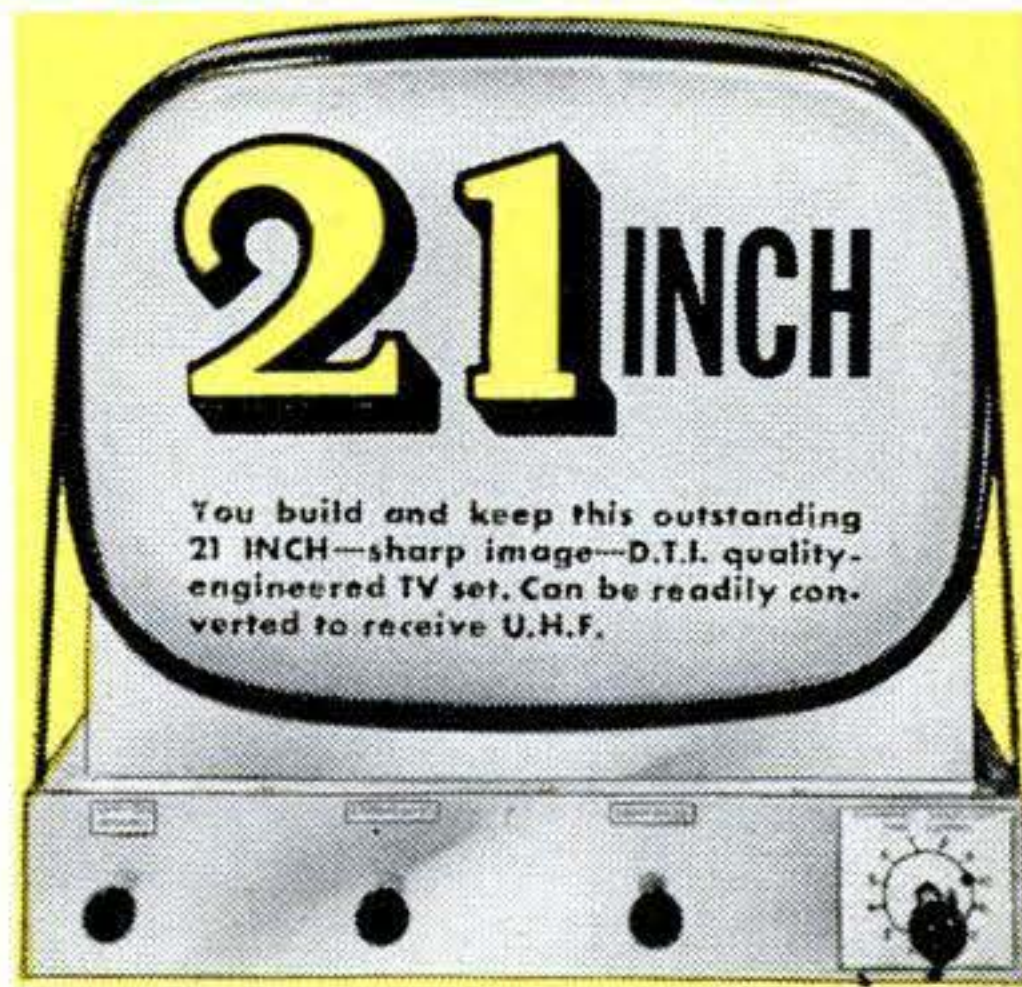
Name \_\_\_\_\_ Age \_\_\_\_\_  
Address \_\_\_\_\_ Apt. \_\_\_\_\_  
City \_\_\_\_\_ Zone \_\_\_\_\_ State \_\_\_\_\_



**ABOVE:** You build and keep this big 5 INCH commercial-type oscilloscope — one of the most useful test units used in TV today.



See how you may now get one of today's most complete, effective combinations of major home training aids—including (1) well illustrated lessons, (2) the wonderful aid of HOME TRAINING MOVIES and (3) 21 big shipments of electronic parts for setting up your own HOME LABORATORY. You work over 400 construction and test procedures to get the practical experience you need. This includes building and keeping a 5 INCH "SCOPE", jewel bearing MULTI-METER and a big 21 INCH TV SET. (D.T.I. offers another home training in Television-Radio-Electronics, but without the TV set.) Mail coupon today for exciting facts.



**Use 16 mm. MOVIES** Only D.T.I. provides you with the loan of visual training movies at home to help you master important basic points faster . . . easier . . . better!

**"ONE OF AMERICA'S FOREMOST  
TELEVISION TRAINING CENTERS"  
— Established 1931 —**

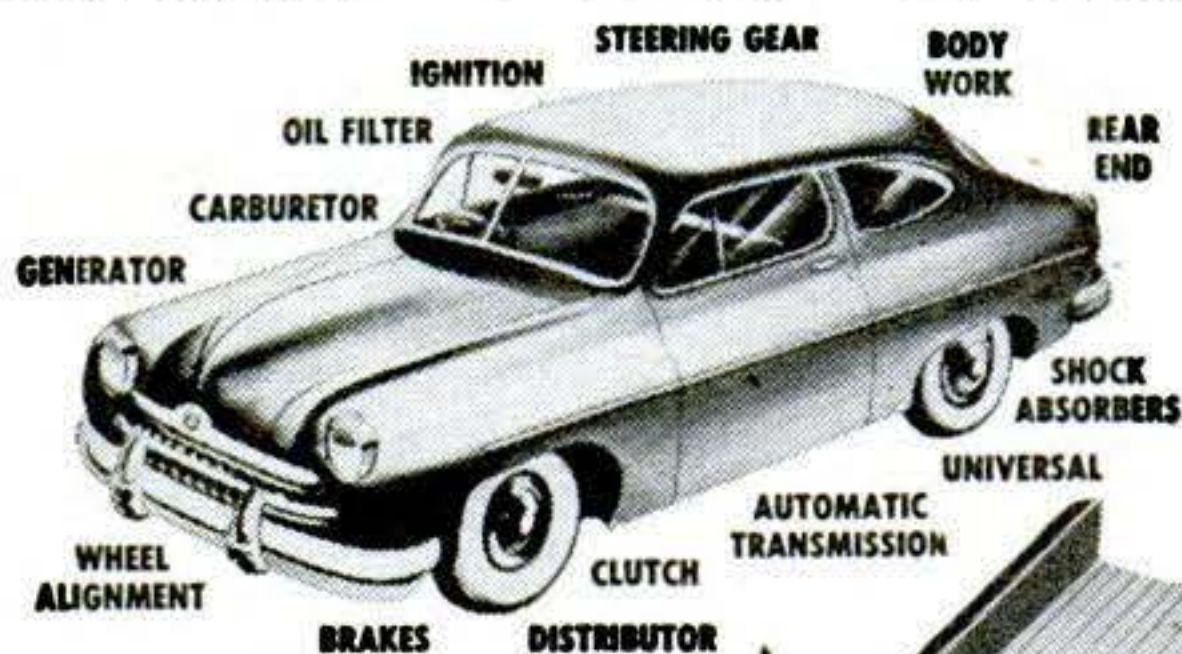


**DeFOREST'S TRAINING, INC.**  
AFFILIATED WITH  
**DeVRY Technical INSTITUTE**  
CHICAGO 14, ILLINOIS



# HOW TO FIX ANY PART OF ANY CAR

**QUICKLY--EASILY--RIGHT!**



**FREE 7-DAY TRIAL**

Whether you're a beginner or an expert mechanic — now you can "breeze through" any "fix-it" job from simple carburetor adjustment to complete overhaul. Just look up job in index of MOTOR'S Brand-New 1953 Auto Repair Manual. Follow simple step-by-step directions, clear pictures. Presto—the job is done!

No guesswork! MOTOR'S MANUAL takes you from "scratch" — shows WHERE to start, WHAT tools to use Covers EVERY job on EVERY car built from 1935 thru 1953!

**Everything You Need to Know "Boiled Down" from 189 Official Shop Manuals**

NEW, REVISED, ENLARGED, 1953 Edition contains the "meat" from over 189 OFFICIAL shop manuals — simplified for YOU. 37,000 essential repair specifications on 907 car models. Over 850 big pages. More than 2500 "this-is-how" pictures. 227,000 service and repair facts. Leads beginners every step of the way. Time-saving factory repair procedures for experts. Instructions and pictures so clear you CAN'T go wrong. Used by U. S. Army and Navy.

**Try Book FREE 7 Days**

SEND NO MONEY! Pay postman nothing. Make Manual show you what it's got. Unless you agree this is the greatest time and work saver you've ever seen—return book in 7 days and pay nothing. Mail coupon today to: MOTOR — Book Dept., Desk 27, 250 W. 55th St., New York 19, N. Y.

**MOTOR'S AUTO REPAIR MANUAL**

**Covers 907 Models All These Makes**

- |           |            |
|-----------|------------|
| Buick     | La Salle   |
| Cadillac  | Lincoln    |
| Chevrolet | Mercury    |
| Chrysler  | Nash       |
| Crosley   | Nash       |
| De Soto   | Rambler    |
| Dodge     | Oldsmobile |
| Ford      | Packard    |
| Frazer    | Plymouth   |
| Henry J   | Pontiac    |
| Hudson    | Studebaker |
| Kaiser    | Terraplane |
| Lafayette | Willys     |

**Same FREE Offer On MOTOR'S Truck and Tractor Manual**

Covers EVERY job on EVERY popular make gasoline truck, tractor made from 1936 thru 1952. FREE 7-Day Trial. Check proper box in coupon.



**MAIL COUPON NOW FOR 7-DAY FREE TRIAL**

**MOTOR BOOK DEPT.**  
**Desk 27, 250 W. 55th St., New York 19, N. Y.**  
 Rush to me at once (check box opposite book you want):

**MOTOR'S New AUTO REPAIR MANUAL.** If O.K., I will remit \$1 in 7 days, \$2 monthly for 2 months and a final payment of 95c (plus 35c delivery charges) one month after that. Otherwise I will return the book postpaid in 7 days. (Foreign price, remit \$8 cash with order.)

**MOTOR'S New TRUCK & TRACTOR REPAIR MANUAL.** If O.K., I will remit \$2 in 7 days, and \$2 monthly for 3 months, plus 35c delivery charges with final payment. Otherwise I will return book postpaid in 7 days. (Foreign price, remit \$10 cash with order.)

Print Name..... Age.....

Address .....

City..... State.....

Check box and save 35c delivery charge by enclosing WITH coupon entire payment of \$5.95 for Auto Repair Manual (or \$8 for Truck & Tractor Repair Manual.) Same return-refund privilege.



**ITALIAN ACCORDIONS AT LOWEST WHOLESALE PRICES**

**5-DAY FREE TRIAL**

**"PAY AS YOU PLAY"**  
 Small Down Payment  
 As Little As  
**\$10** per month

**DIRECT from Importer to You!**

SATISFACTION GUARANTEED, or your money back! NOW you can save up to 50% by direct purchase from America's leading distributor of famous genuine ITALIAN ACCORDIONS.

Send for FREE Illustrated Catalog!

**ACCORDION MANUFACTURERS & WHOLESALE OUTLET**  
 2003 West Chicago Ave. Dept. P-73, Chicago 22, Ill.

**ELECTRIC APPLIANCE REPAIRMEN**

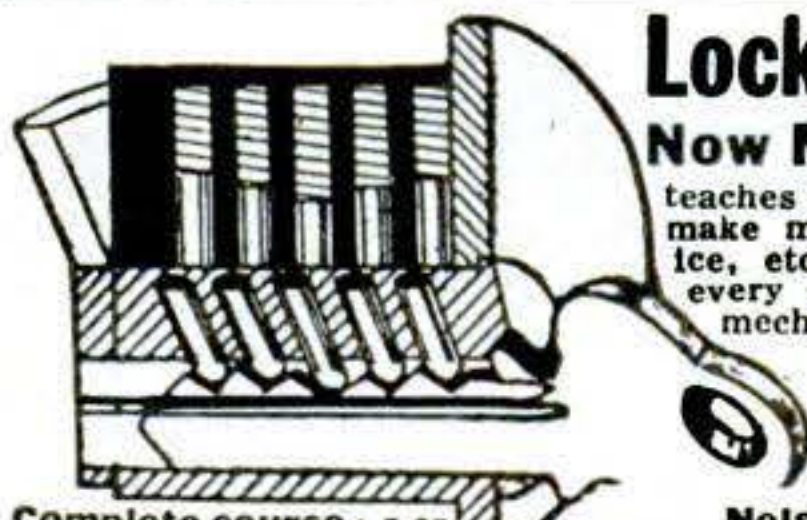


Find all the sources of supply for parts on all ELECTRIC APPLIANCES... Washing Machines, Vacuum Cleaners, Ranges, Sewing Machines, Small Appliances, etc.

**The Only Publication Especially for the Appliance Repairman**

SEND ONLY 20¢ IN STAMPS OR COINS FOR SAMPLE COPY

**ELECTRIC APPLIANCE SERVICE NEWS**  
 Dept. S-50 176 W. Adams St., Chicago 3, Ill.



**Locksmithing AND KEY MAKING**

**Now Made Easy!** Practical up-to-date course teaches you how to pick locks, de-code, make master keys, repair, install, service, etc. New self-instruction lesson for every handyman, homeowner, carpenter, mechanic, service station operator, fix-it shop, hardware dealer, gunsmith. 53 easy illustrated lessons. Full price only \$4.95, postpaid; or C.O.D. plus postage. Satisfaction or refund guaranteed.

**Nelson-Hall Co., Dept. GX-1**  
 210 S. Clinton St., Chicago 6, Ill.

**TASOPE PHOTO-ENGRAVING PLANTS**



Establish your own profitable PHOTO-ENGRAVING business. Make cuts for newspapers, printers, and advertisers. Make etched name plates, plaques etc. Instructions furnished, no experience necessary. Sold direct from factory since 1931. First five hundred cuts sold locally or by mail will pay for plant and pay you well for your time. Write for FREE catalog.

**TASOPE DEPT. PS-7, AURORA, MO.**



**WALK ON AIR**—For quick relief from calluses, blisters, spur or bruised heels, general foot fatigue, place Albin Air Cush'n Innersoles in your shoes. Air moves thru small channel, gently massaging feet. Odorless, non-absorbent, almost weightless. Order by men's or women's shoe size. \$2.95 a pair. No COD's, please. Money back if not delighted. Albin of California, Room 107, 1401-99 W. 8th St., Los Angeles 17, Calif.



# START YOUR FUTURE TODAY!

Get the facts on NATIONAL SCHOOLS' famous Shop-Method Home Training!



## RADIO-TELEVISION & ELECTRONICS

A BRIGHT FUTURE awaits you in booming Radio-TV industry. More than 100 million radio sets, 20 million TV sets, now in use! Backed by National Schools' famous Shop-Method Training from America's Radio-TV Capital you can command good wages in the opportunity-career of your choice — engineer, service-repair, inspector, designer — in radar, electronics — or your own profitable business! Make that bright future come true... start now!

**WE GIVE YOU COMPLETE PARTS, INCLUDING HIGH-MU TUBES!**

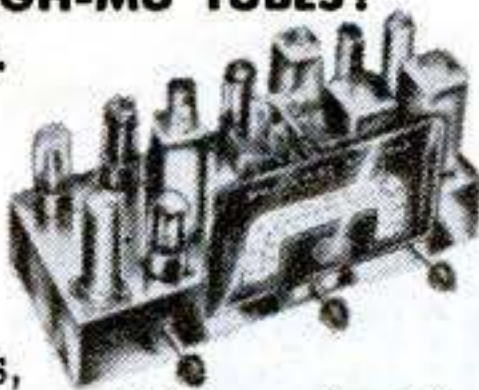
Yours to keep.

You learn by doing, actually build

generators, R-F oscillators, and this big Super-Het receiver!

**WE GIVE YOU THIS STANDARD PROFESSIONAL MULTITESTER!**

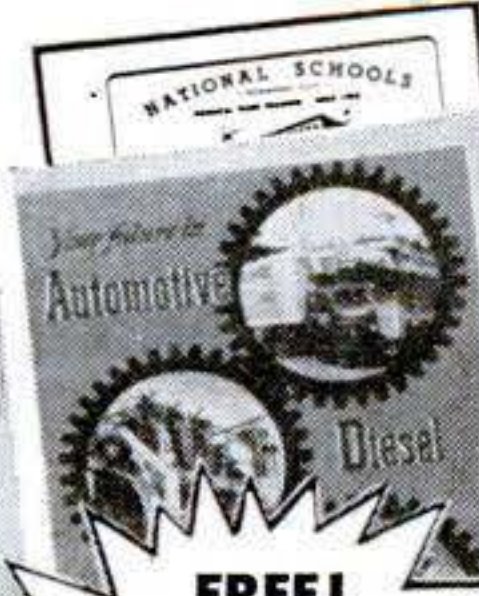
Locates trouble, adjusts delicate circuits—a valuable profit-earner



for you when you become a qualified Radio-TV technician!



**FREE! RADIO-TV BOOK & LESSON!**



**FREE! AUTO-DIESEL BOOK & LESSON!**

LEARN HOW YOU TOO CAN EARN TOP MONEY IN THESE BOOMING INDUSTRIES!



LET NATIONAL SCHOOLS of Los Angeles, California, a Resident Technical Trade School for nearly half a century, train you at home for a high-paying future in these big-future industries.

### Earn While You Learn!

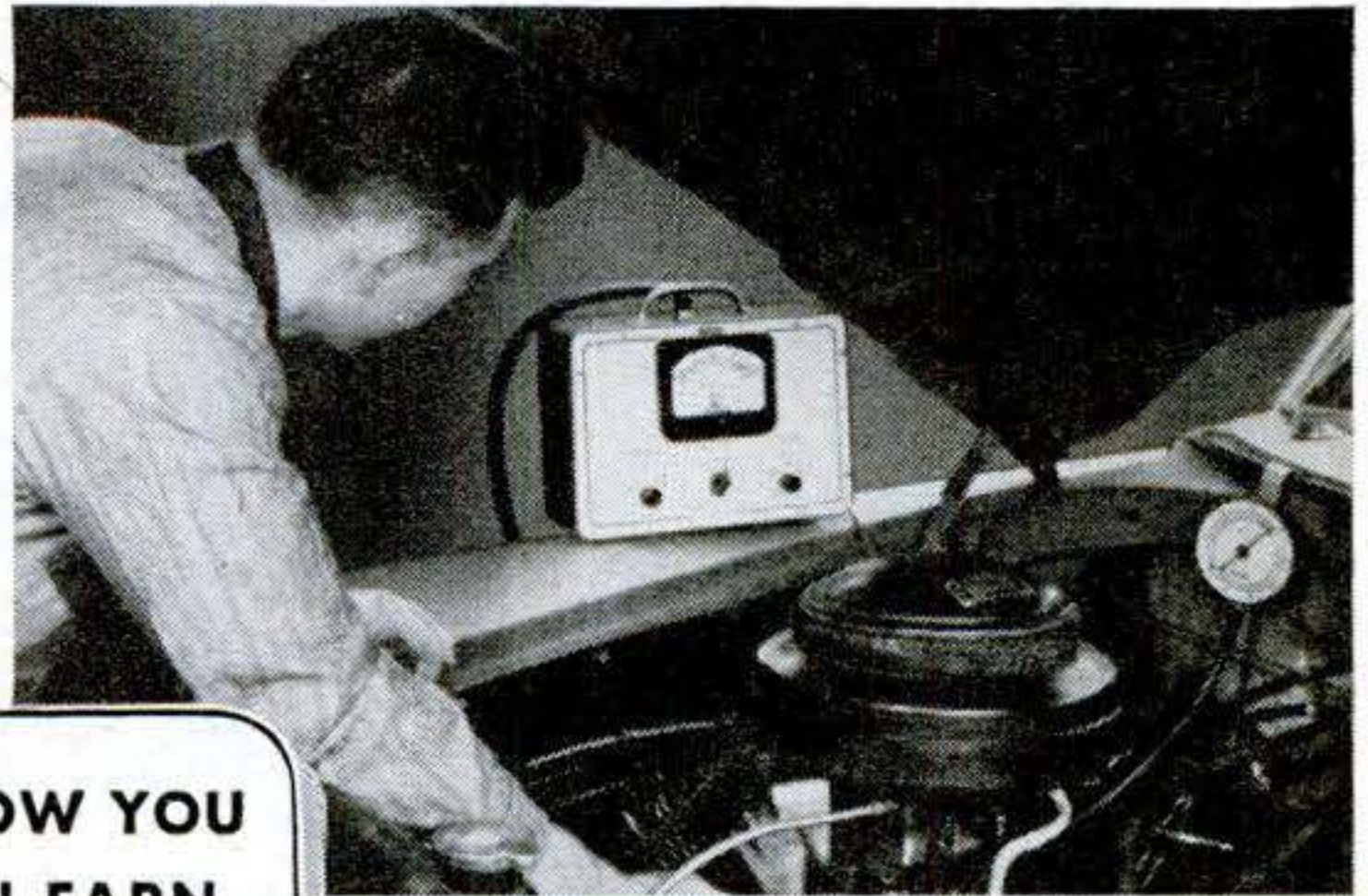
Make extra money repairing friends' and neighbors' cars, trucks, radios, TV sets, appliances. Every step fully explained and illustrated in National Schools' famous "Shop-Tested" lessons. Latest equipment and techniques covered. You master all phases—start part-time earnings after a few weeks!

**YOU RECEIVE FRIENDLY GUIDANCE**, both as a student and graduate. Our special Welfare Department is always at your service, to help you with technical and personal problems. You receive full benefit of our wide industry contacts and experience.

**DRAFT AGE?** National Schools training helps you get the service branch, and higher pay grade you want.



**APPROVED FOR G. I. TRAINING**



## AUTOMOTIVE-DIESEL & ALLIED MECHANICS

EXPANDING AUTO-DIESEL INDUSTRY needs more and more trained men! 55 million vehicles now operating, 6 million more this year—plus 150,000 new Diesel units! Garages, car dealers, transit lines, defense plants, manufacturers, are desperate for

the kind of *trained specialists* produced by National Schools' "Shop-Method Home Training." Start *now* on the road to lifetime security. Mail the coupon today!

**WE GIVE YOU THE TOOLS OF YOUR TRADE!** This fully-equipped, all-metal Tool Kit is yours to keep. We

also give you a complete set of precision

drawing

instruments, and Slide Rule. These professional tools help you learn, then *earn!*



## NATIONAL SCHOOLS

Technical Trade Training Since 1905

LOS ANGELES 37, CALIFORNIA

In Canada: 193 East Hastings Street  
Vancouver 4, B. C.

Both Home Study and Resident Courses Offered

**MAIL COUPON NOW START YOUR HIGH-PAYING FUTURE TODAY!**

### MAIL TODAY—YOU'RE "ON YOUR WAY"!

National Schools, Dept. C-73  
4000 South Figueroa Street  
Los Angeles 37, California

Mail in envelope or paste on postal card

Rush me Free Book and Free Sample Lesson checked below. I understand there is no obligation, and no salesman will call.

- My Future In Radio-Television & Electronics  
 My Future In Automotive-Diesel & Allied Mechanics

NAME \_\_\_\_\_ AGE \_\_\_\_\_

ADDRESS \_\_\_\_\_

CITY \_\_\_\_\_ ZONE \_\_\_\_\_ STATE \_\_\_\_\_

- Check here if released from service less than 4 years ago.  
 Check here if interested in Resident Training at Los Angeles.



# I GAINED 60 LBS.

of SHAPELY MIGHTY MUSCLES

"Hey YOU SKINNY You look like SOMETHING THE CAT DRAGGED IN!"

the boys yelled as I dragged myself into the gym, says

CLEVELAND BEFORE 90 lb. Skeleton

Jowett Pupil, Gleason R. Cleveland. Then I gained 70 lbs. and made the football team.

GLEASON CLEVELAND AFTER JOWETT TRAINING 160 lbs. of Muscle

I was a 125 lb. Skinny Weakling I added 7 IN. to my CHEST 3 1/2 IN. to each ARM and to the rest of my body in proportion as YOU can. Yours

John Sill UTAH

Mail the "ALL-FREE" coupon get this "AMAZING SECRETS" Photo Book while you can.

**FREE**



This BOOK will also show You HOW YOU CAN WIN \$100.00 and A BIG 15" tall SILVER TROPHY (Your Name On It) as I have just done. You'll LOOK, FEEL, ACT like A Real HE-MAN! Win Women and Men Friends. Win in Sports! Win Promotion, Praise, Popularity.

Let's go, young fellow, Now YOU give me 10 PLEASANT MINUTES A DAY IN YOUR HOME LIKE SLIM JOHN SILL DID and I'll give YOU a New HE-MAN BODY as I gave MANY Thousands like You

NO! I don't care how skinny or flabby you are. I'll make you OVER by the SAME method I turned myself from a wreck to the strongest of the strong. Why can't I do for you what I did for MANY THOUSANDS of skinny fellows like You?

Develop YOUR 520 MUSCLES. Gain Pounds, INCHES!

YES! You'll see INCHES of MIGHTY MUSCLE added to your ARMS and CHEST. Your BACK and SHOULDERS broadened. From head to heels, you'll gain SIZE, POWER, SPEED. You'll be A WINNER in EVERYTHING you tackle.



Before \$1 price goes back YOUR LAST CHANCE TO GET ALL 5 FREE!

PICTURE PACKED COURSES MILLIONS HAVE BEEN SOLD FOR \$1 AND MORE Just send me a dime for postage and handling

GEORGE F. JOWETT "Champion of Champions" 4 times Winner Perfect Man Contest



**LAST CHANCE - ALL FREE COUPON!**

1. Photo Book of STRONG MEN
2. MUSCLE METER
3. FIVE COURSES

Dept. PS-37

Tell Me How To WIN \$100, etc.

"Jowett Courses greatest in World for Building All-Around HE-MEN" - R. F. Kelley Physical Director

JOWETT INSTITUTE OF PHYSICAL TRAINING 220 FIFTH AVENUE, NEW YORK 1, N. Y.

Dear George: Please mail to me FREE Jowett's Photo Book of Strong Men and a Muscle Meter, plus all 5 HE-MAN Building Courses: 1. How to Build a Mighty Chest. 2. How to Build a Mighty Arm. 3. How to Build a Mighty Grip. 4. How to Build a Mighty Back. 5. How to Build Mighty Legs—Now all in One Volume "How to become a Mighty HE-MAN." ENCLOSED FIND 10c FOR POSTAGE AND HANDLING (no C.O.D.'s).

NAME.....AGE.....

ADDRESS.....

CITY.....ZONE.....STATE.....

## HOW TO WORK WITH PLASTICS ...AND WHERE TO BUY THEM



Over 100 pages packed with practical plastics facts—materials—equipment—supplies. Includes actual samples, manual with charts, definitions, properties of plastics and the latest information on this amazing new field. Plus, the most complete catalog of all types of plastics materials and supplies ever offered. A must for everyone interested in plastics—hobbyists—industry—modelers—schools—home decorators, etc. How to cast, laminate and fabricate all plastics for both fun and profit. Money-back Guarantee if returned within 7 days.

**\$1** Postpaid

FRY PLASTICS CO.

Dept. S-7 7826 S. Vermont Ave., Los Angeles 44, Calif.

## AVIATION

Pays You More With a Schooling at PARKS

### NOW! A&E MECHANIC LICENSE COURSE

45-week course, all phases aircraft & engines. Start Sept. 7, 1953.

**FLIGHT COURSES**—Private, Commercial, Instrument, Instructor, Multi-Engine.

**DEGREE COURSES**—B.S. degree in 3 yrs. from Saint Louis University—Aero. Engineering, Maint. Engineering, Aero. Administration.

All Parks Schooling Approved for G.I. Training. Write Today.

## PARKS COLLEGE

DEPT. S East St. Louis, Ill.

## A "GOOD HAND" HELPS YOU SUCCEED! LEARN TO WRITE WELL

Your Name beautifully written, plus special pen-point for shaded writing. Only 10¢

Handwriting quickly improves with our easy-to-understand picture lessons! Put your spare time to good use; send today for  FREE BOOKLET, "How to Become a Good Penman," or check volumes wanted below at \$1 each:  Business Writing  Artistic Writing  Card Writing  Bird & Design Flourishing  Engrossing Alphabets. COMPLETE SET \$4.50. Ask for price list of penman's supplies.

OUR 53rd YEAR

TAMBLYN SCHOOL of PENMANSHIP S. A. Ziller, Pres. 438 Ridge Bldg., Kansas City, Mo., USA

## MEN WANTED Job Offers Coming in Faster than they can be filled

Men who are ambitious and mechanically inclined can get into these key professions; **TOOL ENGINEER, TOOL & DIE DESIGNER, DRAFTSMAN, TOOL MAKER, MASTER MACHINIST.** No previous experience necessary. You may enroll in our short term courses or study progressively for a degree of Bachelor of Tool Engineering. Write for free Bulletin on  HOME STUDY or  RESIDENT training Veterans get free copy on "Facts on Veteran Education."

**ALLIED SCHOOL OF MECHANICAL TRADES** 1138 S. Michigan Ave., Dept. PS-7 Chicago, Ill.



Start as high as \$3,795.00 a year!

**U.S. GOVERNMENT JOBS**



Veterans Get Preference

FRANKLIN INSTITUTE, Dept. A-80 Rochester 4, N. Y. (Not Govt. Controlled)

Men—Women Prepare NOW for next examinations.

Experience Often not needed.

Mail Coupon today sure.

Sirs: Rush to me without charge (1) 32-page book with list of U. S. Government jobs, (2) Tell me immediately how to qualify for one of these jobs.

Name.....

Street.....

Address.....Age...

COUPON



# MEN-WOMEN! GROW HOME-BLOOMING ORCHIDS

Louis  
and  
Gladys  
Schirmer



**IN YOUR  
LIVING ROOM!**

**HUGE DEMAND COAST TO  
COAST—HELP US FILL IT!  
Make Up to \$10 an Hour**

**SUCCESSFUL  
HOME-GROWER SAYS:**  
"We'll Show You  
How We Raised  
Orchid Plants Worth A  
Fortune—Starting At  
Home in Spare Time"  
Yes! We'll show you in  
complete detail just  
how we started raising  
Orchids at home in spare  
time—soon had so much  
business we retired from  
other work. We now have  
orchid plants worth a  
fortune and will reveal  
all our secrets and  
explain to you in detail exactly  
how we achieved this wonderful  
success. We offer our personal  
help and advice so you may do  
the same. *The Schirmers*

**← YEAR 'ROUND**

**← No Equipment Needed**

**← Any Climate - Maine to California**

**Fabulous Profits—SPARE OR FULL TIME—LOADS OF FUN FOR THE FAMILY**  
Big profit—little effort. No age limit—many of our home-growers are 60 and 70 years old—some older. The whole family can join in—even the children. Grow all commercial varieties—also **RARE ORCHIDS**. Yellow Orchids, Green Whites, Pinks, Browns—every Rainbow color. Many start as a hobby—make money almost without trying.

**HOME-BLOOMING ORCHIDS BRING UP TO \$25 a Flower—\$1000 a Plant**  
Orchids bring high prices everywhere. Corsages up to \$25 and more. Bridal bouquets up to \$250. Also big, ready and waiting market for Orchid plants at \$25, \$50 and up to \$100 and more. **LEARN HOW ORCHID PLANTS MULTIPLY**—How a single plant may become hundreds—each as valuable as the first. (This is the "MAGIC-KEY" to big Orchid profits.)

**SUCCESS IN ORCHIDS FROM ANY LOCATION**  
No matter where you live—in a small town or big city—in a village or on a farm—you can go after big Orchid profits. The Schirmers show you how profitable orders come from Individuals, Flower Shops, Hotels, Clubs etc., Orchids are the most popular year 'round Gift of all—Millions sold by Mail-Order. The Schirmers show you How. Complete instructions give you all of their Mail-Order secrets.

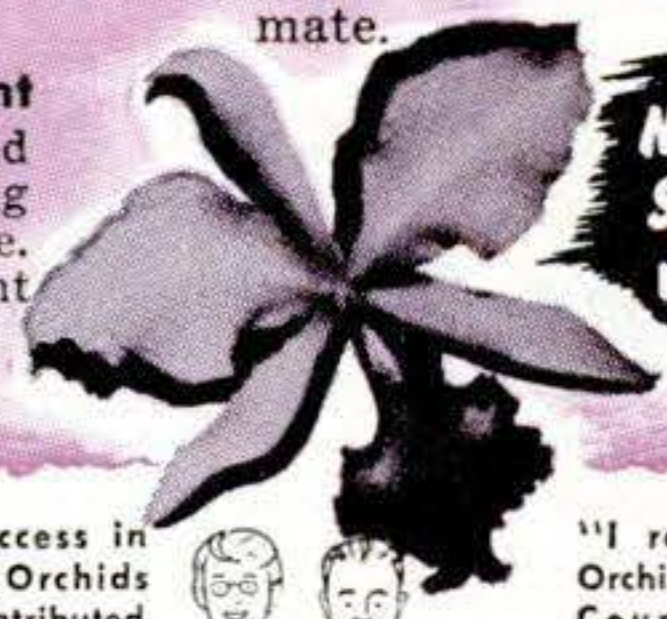
*Complete Instructions  
and Blooming-Size Orchid Plants*  
**Sent for You TO EXAMINE at Home WITHOUT RISK**

Complete instruction—secrets of the experts—in simple language, jam-packed with "show-how" drawings and gorgeous full-color pictures of Orchids. Also Certified healthy, living Orchid Plants—Cattleya, Cymbidium, & Epidendrum—from the Schirmer's own Orchid Gardens. Everything you need to start is yours to examine at home, without risk. **FREE**, full details. Learn how you and your family may follow in the Schirmer's footsteps to gain independence and financial security with Orchids. Send no money. Just mail coupon. Air Mail is quicker.

**TROPICAL FLOWERLAND DEPT. 2K**

4622 Wilshire Blvd.,  
Los Angeles 5, Calif.

**YES!** Fill your home with gorgeous blooming Tropical **ORCHIDS**—lovely big Lavender Cattleyas like you see in every Flower Shop. Sensational Cymbidiums which have produced nearly 1000 Orchids on a single plant. Cypripediums, Oncidium, Laelias, Epidendrums and hundreds of others, many grow without soil—take food from the air. Now all yours to grow at home in any climate.



**NO DELAYS  
Start Making Money Right Now  
with Amazing Quick Profit Plan**

Tropical Flowerland offers you a complete and easy way to start yourself in the Orchid business immediately. With our help, and our entire organization behind you, you actually have an opportunity to make up to \$10 an hour, \$100 or more a week—right from the very first day you receive our "Quick-Profit" Home Plan. No obligation. Examine everything at home before deciding.

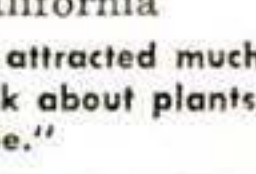
**These and Many More Home Orchid Growers Learned From the Schirmer Family**

"Our success in growing Orchids can be contributed entirely to the instructions we have received from you both." G. B.—California

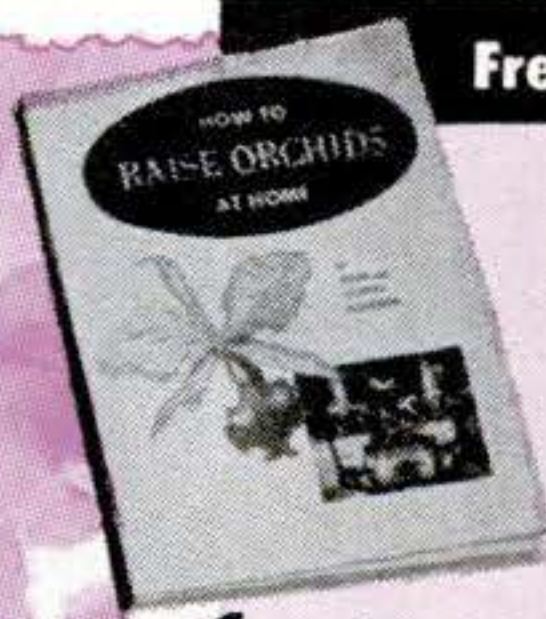


"I received my Orchid Plants and Course several days ago and have 2 beautiful flowers in full bloom." L. S.—Utah

"My Orchids have attracted much attention. People I never heard of call to ask about plants, and it has turned out to be profitable for me."



J. E.—Kansas



**Free! Airmail Coupon Now—Send No Money!**

**TROPICAL FLOWERLAND, Dept. 2K  
4622 Wilshire Blvd., Los Angeles 5, Calif.**

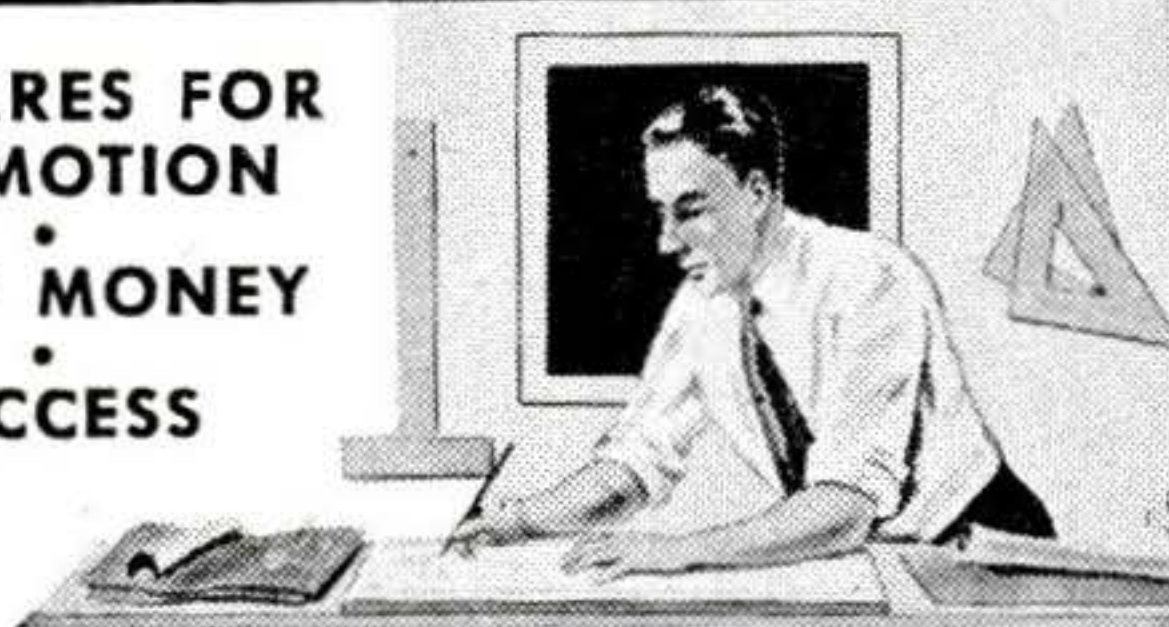
Rush me complete **FREE PLAN** for raising Home-Blooming Orchid Plants, also your "Quick-Profit" Home Business Plan. I understand the instructions and Business Plan will include **LIVE Blooming-size Orchid Plants**, including a mature Cattleya plant producing the big lavender Cattleya Orchids which are carried in every flower shop. This request does not obligate me in any way.

Name \_\_\_\_\_  
Address \_\_\_\_\_  
City \_\_\_\_\_ Zone \_\_\_\_\_ State \_\_\_\_\_



# C. T. C. TRAINING IN DRAFTING

PREPARES FOR  
PROMOTION  
MORE MONEY  
SUCCESS



"Here I am at work making good money as a draftsman. I'm glad I sent the coupon to Chicago Tech for that Free Trial Lesson and found out how easy it is to learn Drafting in spare time at home. Today, I feel secure in my job. What's more, I feel I'm slated for promotion and more pay."

**LEARN IN SPARE TIME—AT HOME!**

(or at the College in Chicago)

A few hours of pleasant home study every week—that's all. All the tools you need; drawing outfit included. This tested method—developed over 48 years of C.T.C. progress—prepares men quickly for good positions in industry.



**FREE INFORMATION — SEND COUPON**

To prove to you how easy it is to learn Drafting at home by the Chicago Tech method, we will send you this FREE TRIAL LESSON. No charge for this lesson, now or later. Fill out and mail coupon, or send post card today.

## CHICAGO TECHNICAL COLLEGE

H-221 Tech Bldg., 2000 So. Michigan Ave.,  
Chicago 16, Illinois

Mail me FREE Lesson with information about big opportunities in DRAFTING.

Name.....Age.....

Address.....

City.....Zone.....State.....

# Inventors

The following are the usual preliminary steps to take toward patent protection.

Make a disclosure of your invention; sign, date and have this document witnessed by two or more people who understand your invention; authorize your registered patent attorney or agent to conduct a preliminary search among previously granted U. S. patents for similar types of invention; secure a report on the probable patentability of your invention and a recommendation of the further course to take.

We shall be glad to send you without obligation our instructive booklet, "Patent Protection for Inventors" and our "Evidence of Invention" disclosure form.

**VICTOR J. EVANS & Co.** *Merlin M. Evans*  
REGISTERED PATENT ATTORNEY  
840-H MERLIN BUILDING, WASHINGTON 6, D. C.

# IMPORT PAYS BIG!



"We operate a profitable World Trade Business from our home ...Thanks to MELLINGER." Mr. and Mrs. Beke, N.Y.

WORLD TRADE BOOM OFFERS BIG-MONEY OPPORTUNITIES FOR MEN AND WOMEN TO BUY — SELL, WORLD WIDE, WITHOUT CAPITAL, or previous experience. Import at low foreign prices for local buyers at high U.S. prices. Operate Export-Import, mail-order business from home, spare or full time, no matter where you live. Also, for your own use, save on clothes, tools, watches, cameras, etc. Established World Trader shows you how. World travel opportunities. **START NOW**—training includes many exciting imports from 'round the world—also business contacts in 42 countries. Write **NOW**, for **FREE** details. **MELLINGER CO.**, Suite 247, 1717 Westwood Blvd., Los Angeles 24, Calif.

# INVENTORS

I shall be pleased to furnish you, upon request, with information relative to patent procedure—without any obligation on your part.

**PATRICK D. BEAVERS**

*Registered Patent Attorney*

937 Columbian Building, Washington 1, D. C.

# INVENTORS

Send for  
**PATENT INFORMATION**

Book and

**INVENTOR'S RECORD**

without obligation

**GUSTAVE MILLER**

73PS Warner Building  
Washington 4, D. C.

**REGISTERED PATENT  
ATTORNEY**

**PATENT ATTORNEY & ADVISOR**  
U. S. NAVY DEPT. 1930-1947

**ASSOCIATE EXAMINER**  
U. S. PAT. OFF. 1922-1929

**PATENT LAWYER**

# PATENTS

## C. A. SNOW & CO.

REGISTERED PATENT ATTORNEYS

WRITE FOR INFORMATION TO

426 SNOW BUILDING, WASHINGTON 1, D. C.

# INVENTORS

Whether an invention is patentable can be substantially determined by a search of the U. S. Patent records. Without obligation, write for information explaining the steps you should take to secure a patent.

**JOHN N. RANDOLPH**

*Registered Patent Attorney*

205 Columbian Building Washington 1, D. C.

# INVENTORS

IF YOU WISH TO PROTECT YOUR INVENTION, You should take steps to protect it by a U. S. Patent. Write me for "INVENTION RECORD" FORM

**CARL MILLER**  
REGISTERED PATENT ATTORNEY

WOOLWORTH BLDG., 35th FLOOR, 73C  
NEW YORK CITY



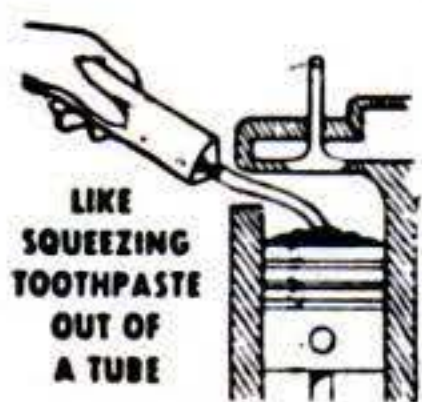
# CAR BURNING OIL?

## Engineer's Discovery Stops it Quick

### Without A Cent For Mechanical Repairs!

If your car is using too much oil—if it is sluggish, hard to start, slow on pickup, lacks pep and power—you are paying good money for oil that's burning up in your engine instead of providing lubrication. Why? Because your engine is leaking. Friction has worn a gap between pistons and cylinder wall. Oil is pumping up into the combustion chamber, fouling your motor with carbon. Gas is exploding down through this gap, going to waste.

#### SAVE \$50 TO \$150 REPAIR BILL



Before you spend \$50.00 to \$150.00 for an engine overhaul, read how you can fix that leaky engine yourself, in just a few minutes, without buying a single new part, without even taking your engine down. It's almost as easy as squeezing toothpaste or shaving cream out of a tube, thanks to the discovery of a new miracle substance called Power Seal. This revolutionary, new compound combines

the lubricating qualities of Moly, the "greasy" wonder metal, with the leak-sealing properties of Vermiculite, the mineral product whose particles *expand* under heat. (Up to 30 times original size.)

Just squeeze Power-Seal out of the tube into your motor's cylinders through the spark plug openings. It will spread over pistons, piston rings and cylinder walls as your engine runs and it will PLATE every surface with a smooth, shiny, metallic film *that won't come off!* No amount of pressure can scrape it off. No amount of heat can break it down. It fills the cracks, scratches and scorings caused by engine wear. It closes the gap between worn piston rings and cylinders with an automatic self-expanding seal that stops oil pumping, stops gas blow-by and restores compression. No more piston slapping; no more engine knocks. You get more power, speed, mileage.

This genuine plating is self-lubricating too for Moly, the greasy metal lubricant, reduces friction as nothing else can! It is the only lubricant indestructible enough to be used in U. S. atomic energy plants and jet engines. It never drains down, never leaves your engine dry. Even after your car has been standing for weeks, even in coldest weather, you can start it in a flash, because the lubrication is in the metal itself. That's why you'll need amazingly little oil; you'll get hundreds, even thousands of more miles per quart.

#### TRY IT FREE!

You don't risk a penny. Prove to yourself that Power-Seal will make your car run like new. Put it in your engine on 30 days' Free Trial. If you are not getting better performance out of your car than you thought possible—if you have not stopped oil burning and have not increased gas mileage—return the empty tube and get your money back in full. Power-Seal is absolutely harmless; it cannot hurt the finest car in any way. It can only preserve and protect your motor.

**RUDSON AUTOMOTIVE INDUSTRIES**  
Dept. 182, 24 East 67th Street  
New York 21, N. Y.



#### POWER SEAL MAKES WORN OUT TAXI ENGINE RUN LIKE NEW

Here are the Test Engineer's notarized figures showing the sensational increase in compression obtained in a 1950 De Soto taxi that had run for 93,086 miles. Just one POWER SEAL injection increased pep and power, reduced gas consumption, cut oil burning nearly 50%.

	Cyl. 1	Cyl. 2	Cyl. 3	Cyl. 4	Cyl. 5	Cyl. 6
BEFORE	90 lbs.	90 lbs.	105 lbs.	90 lbs.	80 lbs.	100 lbs.
AFTER	115 lbs.	115 lbs.	117 lbs.	115 lbs.	115 lbs.	115 lbs.

#### BEST INVESTMENT WE EVER MADE, SAYS DRIVER-OWNER

"We simply inserted the POWER SEAL per instructions and made no other repairs or adjustments. Compression readings were taken before and after and showed a big improvement in both cars. As a result the engine gained a lot more pick-up and power which was especially noticeable on hills. What impressed us most was the sharp reduction in oil consumption. In one cab, we've actually been saving a quart a day and figure we have saved \$11.20 on oil alone since the POWER SEAL was applied a month ago. In the other cab, oil consumption was cut practically in half. We have also been getting better gas mileage. All in all, POWER SEAL turned out to be just about the best investment we ever made. It paid for itself in two weeks and has been saving money for us ever since, to say nothing of postponing the cost of major overhauls that would have run into real money." *Town Taxi, Douglaston, N. Y.*

#### SEND NO MONEY!

Simply send the coupon and your Power-Seal injection will be sent to you at once C.O.D. plus postage and handling charges. Or, to save the postage and handling charges, simply enclose full payment with the coupon. For 6-cylinder cars order the Regular Size, only \$4.95. For 8-cylinder cars order the Jumbo Size, \$7.95. Power-Seal is now available only by mail from us. Send the coupon at once.

**RUDSON AUTOMOTIVE INDUSTRIES, Dept. 182**  
24 East 67th St., New York 21, N. Y.

Please send me ..... tubes of the amazing new POWER SEAL.  
 Regular Size, for 6-cyl. cars, \$4.95     Jumbo Size, for 8-cyl. cars, \$7.95  
 On arrival, I will pay the postman the price indicated above plus postage and delivery charges. I must see an immediate improvement in the pep and power of my car, less oil consumption, greater gas mileage, reduced engine noise, easier starting, faster pickup, within 30 days, or you will refund my full purchase price.

Name .....

Address .....

City ..... Zone ..... State .....

Save More! Send cash, check, or money order with coupon and we pay all postage charges. Same money-back guarantee.



# PREPARE FOR BETTER JOB, BIGGER PAY IN SPARE TIME AT HOME

Today, choose the job you want—and prepare for it in time you might otherwise waste. Or if you are already in the work you like best, start training now for quicker promotion and increased pay. During more than 50 years AMERICAN SCHOOL has helped ambitious people to reach higher goals. Check subject that interests you and mail coupon for full information.

AMERICAN SCHOOL, Dept. GB46, Drexel at 58th, Chicago 37, Ill.

Without obligation, please send FREE and postpaid, full particulars about the subject checked below.

- |  |   |   |
|--|---|---|
| <input type="checkbox"/> Accounting              | <input type="checkbox"/> Drafting—Building Trades | <input type="checkbox"/> Plastics Engineering |
| <input type="checkbox"/> Air Conditioning        | <input type="checkbox"/> Drafting—Machine Trades  | <input type="checkbox"/> Plumbing—Practical   |
| <input type="checkbox"/> Architecture & Building | <input type="checkbox"/> Electrical Engineering   | <input type="checkbox"/> Private Secretary    |
| <input type="checkbox"/> Automotive Technician   | <input type="checkbox"/> Electricity—Practical    | <input type="checkbox"/> Refrigeration        |
| <input type="checkbox"/> Better Foremanship      | <input type="checkbox"/> Electronics—Industrial   | <input type="checkbox"/> Retail Merchandising |
| <input type="checkbox"/> Bookkeeping             | <input type="checkbox"/> High School Courses      | <input type="checkbox"/> Salesmanship—Outside |
| <input type="checkbox"/> Business Management     | <input type="checkbox"/> Machine Shop Operations  | <input type="checkbox"/> Sheet Metal Work     |
| <input type="checkbox"/> Contracting             | <input type="checkbox"/> Mathematics & Slide Rule | <input type="checkbox"/> Tool Making          |
| <input type="checkbox"/> Diesel Technician       | <input type="checkbox"/> Mechanical Engineering   |   |

NAME..... OCCUPATION.....  
HOME ADDRESS..... AGE.....  
CITY..... STATE.....

MAIL COUPON NOW 

## \$1,000<sup>00</sup> Worth of Furniture for Cost of Materials Alone!

Make over \$1,000 worth of furniture for indoors and out with help of amazing new book "WISE HOME FURNITURE BUILDER." Over 500 pictures, plans, and step-by-step instructions. No special tools or experience needed. Save \$10.00 to \$200.00 on Tool Cabinets, Workbench, Portable Tool Box, Tennis Table, Built-In Wardrobe Closet, Storage Chest, Barbecue Pit, Garden Furniture and much more! 256 big double-column pages. Thousands paid \$2.95 and \$3.95. Now we SLASH price to only \$1.95. Mail card for week's FREE-Trial today. Write Dept. 807A Wm. H. Wise & Co., Inc., 50 W. 47th St., N. Y. 36, N. Y.

## ENGINEERING DEGREE IN 27 MONTHS

### Big Demand for Graduates

AERONAUTICAL, CHEMICAL, CIVIL, ELECTRICAL, MECHANICAL and RADIO ENGINEERING (inc. TV and Electronics).

Hundreds of young men are earning B.S. ENGINEERING DEGREES annually in this recognized institution—year around operation. New terms start quarterly. Many students earn a major part of their college expenses in this large industrial center.

Low tuition. Competent instruction. Thorough, intense, practical program. Modern, well-equipped laboratories including new physics laboratory and modern wind tunnel. Individualized instruction emphasized.

Gov't approved for G.I.'s. Engineering preparatory courses. Students from 48 states and 21 foreign countries. Enter September, December, March, June. Send coupon for free catalog and full information. Enroll now.

SEND COUPON TODAY

## INDIANA TECHNICAL COLLEGE

673 E. Washington Boulevard  
Fort Wayne 2, Indiana

Please send me free information on B. S. Engineering degree in 27 months as checked.

- Aeronautical,  Chemical,  Civil,  
 Electrical,  Mechanical,  Radio-Television.

Name.....

Address.....



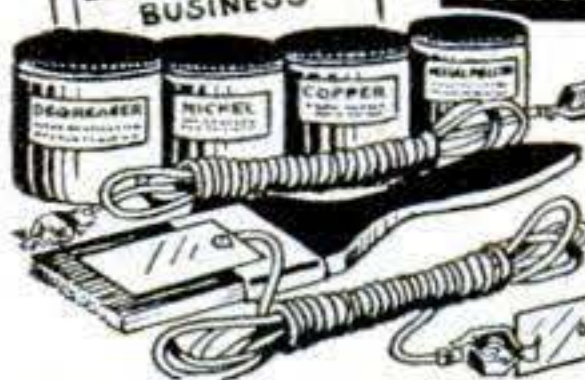
# AQUA-LUNGS FROGMEN SUITS SPEAR GUNS

**SELF-CONTAINED DIVING**—A comprehensive diving digest reviewing various types of equipment and a thorough study of underwater pressure and its effects. Includes a decompression table showing how much time can be safely spent at various depths. Send now 60c in coin to receive this 95c booklet.  
**DIVING GEAR**—A 16 page beautifully illustrated catalogue showing the latest available foreign and domestic diving equipment: frogman suits, masks, spear guns, snorkle tubes, swim fins and "Aqua-Lungs." Send only 15c in coin.  
**SEND FOR THESE VALUABLE BOOKLETS TODAY**  
U. S. DIVERS CO. 1045 Broxton Ave., W. Los Angeles 24, Cal.

NO TANKS USED  
NEW SIMPLIFIED METHOD

## ELECTROPLATE

ANY OBJECT IN HOME, SHOP, GARAGE OR START  
YOUR OWN WELL PAYING ELECTROPLATING BUSINESS.



**SUCCESS IN THE  
ELECTROPLATING  
BUSINESS**

NOW, using NEW plating kit, it's easy to electroplate any object. Complete kit and instructions on plating metal and non-metal objects, with nickel, copper, chrome, gold, etc., plus full data on obtaining all the business you desire and make **BIG MONEY** full or spare time. **ONLY \$5.95**  
**SEND NO MONEY**—everything sent COD plus postage—OR send \$5.95 now and receive it postpaid. Money back in 7 days if not satisfied.

TOOLS,  
SILVER WARE,  
HOUSEHOLD  
ARTICLES,  
JEWELRY,  
BABY SHOES,  
AUTO PARTS  
& 1001  
ARTICLES

M. Z. NATIONAL SALES CO., 113-B West 42 St., N. Y. 36, N. Y.

## CASTING SECRETS REVEALED!



Now you can learn how to make big money by casting thousands of perfect plaques, book ends, figurines, etc., with X.L. rubber molds. **NO EXPERIENCE, VERY LITTLE CAPITAL NEEDED.** X.L. Rubber, Pts. \$2.50; Qts. \$4.00 (postage extra). Models and enough rubber for three molds, \$1.50 prepaid. Send 25c (refunded with order) for informative catalog (40 pages) describing this wonderful, exciting Profit-making business.

**HUGE PROFITS!  
MORE MONEY!**

PLASTIC ARTS STUDIO 3403 S. MADISON, DEPT. 3  
MUNCIE, INDIANA



## How to Make Money in PHOTOGRAPHY

If you are OVER 17—good pay, fascinating work await you in photography! Start making money quickly in sparetime—step into your own studio or exciting job. LEARN-BY-DOING method trains you at home! Write TODAY for FREE catalog. Also Resident Training. 43rd Year! GI Approved.

NEW YORK INSTITUTE OF PHOTOGRAPHY  
Dept. 5, 10 W. 33 St., New York 1, N. Y.



## LEARN MEAT CUTTING



Train quickly in 8 short weeks at Toledo for a bright future with security in the vital meat business. Big pay, full-time jobs—HAVE A PROFITABLE MARKET OF YOUR OWN! Pay after graduation. Diploma given. Job help. Thousands of successful graduates. Our 28th year! Send NOW for FREE catalog. No obligation. G. I. Approved. NATIONAL SCHOOL OF MEAT CUTTING, Dept. 51-T, Toledo 4, Ohio

## NEW FALSE PLATE

FROM YOUR OLD ONE IN 18 HOURS

AS LOW AS \$14<sup>95</sup>



Send us your old broken, cracked or loose plates and we'll transform them into new lightweight wonder plastic plates. NO IMPRESSIONS needed with our revolutionary method. We use your own old plates. We remake them completely in only 18 hours. Missing teeth carefully matched and replaced. We GUARANTEE TO SATISFY YOU OR REFUND YOUR MONEY.

SEND NO MONEY—Send us your name today and we'll RUSH COMPLETE DETAILS. Begin to enjoy life right now. Clip this Ad; save it and send for free facts.

CHICAGO DENTAL PLATE LABORATORY • Dept. PS-7  
30 N. Dearborn St. • Suite 807 • Chicago 2, Ill.



# NORMAN ROCKWELL says: "WE'RE LOOKING FOR PEOPLE WHO LIKE TO DRAW!"



Norman Rockwell,  
noted cover artist,  
faculty member of the  
Famous Artists Course

## America's 12 Most Famous Artists Test Your Talent

This test for men and women shows your sense of design, composition, form, observation, imagination, originality and picture sense. Yours if you act today!

## If you have talent, you can be trained for success and security... Find out with our FREE ART TALENT TEST

Never before has there been such a demand for artists to fill high-paid jobs. That's why America's 12 Most Famous Artists make you this special offer: Even though thousands paid \$1.00 to take our revealing 8-page Talent Test, it's yours FREE if you

act at once. This is your once-in-a-lifetime chance to find out if you have real, hidden talent—without charge or obligation of any kind. Quantity of tests is limited. You must mail coupon NOW!

*Norman Rockwell*

### THIS COUPON ENTITLES YOU TO FREE TEST!

## FAMOUS ARTISTS COURSE

Studio 11-G3, Westport, Connecticut

Send me with no obligation the Famous Artists Talent Test

Mr. \_\_\_\_\_  
Mrs. \_\_\_\_\_ Age \_\_\_\_\_  
Miss \_\_\_\_\_ (please print)  
Address \_\_\_\_\_  
City, Zone, State \_\_\_\_\_

Norman Rockwell  
Jon Whitcomb  
Stevan Dohanos  
Harold Von Schmidt  
Peter Helck  
Fred Ludekens  
Al Parker  
Ben Stahl  
Robert Fawcett  
Austin Briggs  
Dong Kingman  
Albert Dorne



## I TRAIN YOU AT HOME FOR A BETTER PAY JOB

# IN TELEVISION



L. C. Lane, B.S., M.A.  
President, RTTA &  
Pierce Schools

TV Receiver takes  
up to 21-inch  
picture tube

Veterans—Civilians!

Many New TV Stations to be Built Soon in Every State Earn While You Learn. My modern training prepares you *at home* in your spare time... often within months. You learn the practical easy way by using actual parts and equipment. Many of my students make \$25.00 a week repairing Radio-TV sets in their spare time *while learning*... start their own profitable service business.

### GET MORE! LEARN MORE! EARN MORE!

- 1. MORE EQUIPMENT!** You build and keep this BIG SCREEN TV RECEIVER, plus Super-Het Radio Receiver, RF Signal Generator, Combination Voltmeter-Ammeter-Ohmmeter, C-W Telephone Receiver, AC-DC Power Supply. Complete with all tubes, including big TV picture tube.
- 2. NEW YORK ROUND TRIP!** Only RTTA gives you a ROUND TRIP TO NEW YORK CITY at NO EXTRA COST! Yes, from anywhere in the continental U.S. or Canada, I'll pay your way to New York and return after you finish your complete Radio-TV course. Get 2 FREE weeks, 50 hours of advanced study at our affiliated PIERCE SCHOOL of Radio.
- 3. FCC LICENSE COACHING COURSE!** Prepares you at home for better pay jobs that require an FCC License. Given to all my students at NO EXTRA COST after TV Theory and Practice.
- 4. ADVANCED FM-TV TRAINING!** For men with previous Armed Forces or civilian radio experience. Advanced Course comes complete with kits, including BIG SCREEN TV RECEIVER and FREE FCC License Coaching Course.

## VETERANS!

MY SCHOOLS FULLY APPROVED TO TRAIN VETERANS UNDER NEW G.I. BILL! If discharged after June 27, 1950—CHECK COUPON BELOW! Also approved for RESIDENT TRAINING in New York City... qualifies you for full subsistence allowance up to \$160 per month.

### NO SALESMAN WILL CALL!

Mr. Leonard C. Lane, President  
RADIO-TELEVISION TRAINING ASSOCIATION  
1629 Broadway, New York 19 Dept. P-7

Dear Mr. Lane: Mail me your New Free Book & Sample Lesson. Show me how I can make Big Money in Television. I understand I am under no obligation (PLEASE PRINT PLAINLY)

Name \_\_\_\_\_ Age \_\_\_\_\_

Address \_\_\_\_\_

City \_\_\_\_\_ Zone \_\_\_\_\_ State \_\_\_\_\_

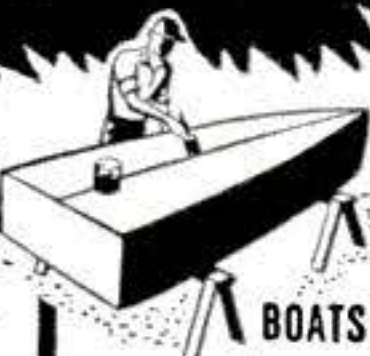
CHECK HERE IF:  VETERAN  NON-VETERAN

MAIL COUPON  
TODAY for FREE  
Illustrated Book and  
Sample Lesson

**RADIO-TELEVISION TRAINING ASSOCIATION**  
1629 Broadway, Radio City Station, New York City 19, N. Y.  
LICENSED BY THE STATE OF NEW YORK



# The WONDERS of LIQUID PLASTICS



## MANUFACTURE WITHOUT TOOLS OR MACHINERY!

We believe this is one of the most astonishing and important offers ever made to ambitious people everywhere... because we **TEACH YOU** and actually show you how to make the most remarkable, the most unusual line of beautiful and useful things of **ENDLESS VARIETY** with enormous possibilities for **PROFIT and PLEASURE!**

### NO SPECIAL ABILITY REQUIRED!

No previous experience or special ability is required! **NO TOOLS OR MACHINERY** are required... *the entire process is about as easy as pouring water out of a glass!* The **WONDERS OF LIQUID PLASTICS** make all this possible!

### UNLIMITED POSSIBILITIES!

Work with **LIQUID IVORY, LIQUID GLASS, LIQUID MARBLE, LIQUID EBONY, LIQUID PORCELAIN, LIQUID WOOD, LIQUID GEMSTONE** and many other **LIQUID PLASTICS** and in a matter of minutes turn them into an endless and valuable procession of beautiful imbedded jewelry, novelties, ornamentals, statues, book-ends, lamps, pensets, lighters, ashtrays, keychains, figurines, curios, souvenirs, art and gift products, fishing lures, **BOATS, GADGETS** galore, exquisite **GEMS!** Make gears, tools, dies, forms, handles, dials, knobs, **MACHINE PARTS**, models of inventions, pistol grips... the list is endless! The only **LIMITATION** is your **IMAGINATION!**

### WE SUPPLY EVERYTHING

We supply everything, the materials, the ideas, and the free instructions! If you have the need or the desire to make any of the products mentioned above (and countless others), as well as your own pet gadget or invention, then take advantage of our remarkable materials, our unusual process and this great offer today! The possibilities for pleasure and profit are practically unlimited!

### VALUABLE BOOK GIVEN!

Just send 25c and we will send you our book, **HOW TO MANUFACTURE WITHOUT TOOLS OR MACHINERY**. We will also send you our big 64 page catalog describing all the materials mentioned above. Do it today... we want you to share in these wonderful opportunities as soon as possible!

**PLASTICAST CO., (Dept. A)**  
P.O. Box 6737 (Write to P.O. Box 987  
Chicago 80, Ill. either address) Palo Alto, Calif.



GEARS



FISHING LURES



PEN SETS



HANDLES KNIVES DIALS



STATUES FIGURINES



JEWELRY GEMS



NOVELTIES GADGETS

# SENSATIONAL OPTICAL BARGAINS



**A BRAND NEW IDEA! COMBINATION 50X MICROSCOPE AND 10X TELESCOPE.** Amazingly practical and useful. Carry it right in your pocket—has convenient holding clip. The 50 power microscope is easily focused by tilting slightly. Achromatic objective lens. Used for any close-up examination or inspection. Just remove metal cap and draw out sliding tube for focusing telescope. An imported instrument at a bargain price. Chrome and black finish. Length closed 5"—dia. 1 1/16".

Stock No. 30,059-N.....\$4.50 Postpaid.

**SIMPLE LENS KITS**—Include plainly written, illustrated booklet showing how you can build lots of optical items. Use these lenses in photography and for dozens of other uses in experimental optics, building **TELESCOPES**, low power **Microscopes**, etc.  
Stock #2-N—10 lenses.....\$ 1.00 postpaid  
Stock #5-N—45 lenses.....5.00 postpaid  
Stock #10-N—80 lenses.....10.00 postpaid

Order By Stock No. We have Literally Millions of War Surplus Lenses and Prisms for Sale at Bargain Prices. Also numerous Types of Instruments including low price, imported microscopes. Write for **FREE CATALOG-N**.  
Send check or M.O.

**EDMUND SCIENTIFIC CORP., Barrington, N. J.**

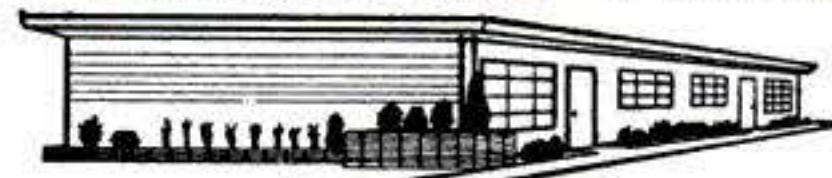
## BREED RARE TROPICAL FISH FOR PROFIT!... AT HOME!



HELP US FILL HUGE DEMAND... Wonderful \$\$\$\$ Opportunity. No experience. No expensive equipment needed. **SOME SELL FOR \$75 PAIR AND MORE!** Fascinating! Beautiful! Entertaining! We supply everything. Make Big Money spare-time at home.

**FREE!** HOME-BUSINESS PLAN, Illustrated Folder, all DETAILS Write: **TROPICAL FISH BREEDERS OF AMERICA** Dept. C-7 Los Angeles 15, California  
Give your age and, IF **HOBBYIST** list your equipment if any.

## INCOME UNITS ARE YOUR CHANCE FOR FINANCIAL INDEPENDENCE



• COMPLETE PLANS FOR LOW COST MODERN UNITS YOU CAN BUILD YOURSELF IN YOUR SPARE TIME

**750<sup>00</sup>** PER BASIC UNIT BUILDS SINGLE, DUPLEX, OR TRIPLEX PLANS, ELEVATIONS, ETC. Postpaid **\$1<sup>00</sup>**  
**ROY F. WILICK, 5026 ESCALON AVE., LOS ANGELES, 43**

**FREE SAMPLE LESSON**

## WATCHMAKING

**CHICAGO SCHOOL OF WATCHMAKING**  
2330 Milwaukee, Dept. 473, Chicago 47, Illinois

Show me without obligation how I can learn watch repairing at home. Rush free sample.

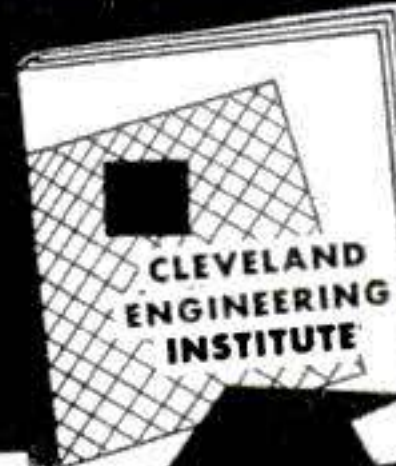
Name.....  
Address.....  
City.....Zone.....State.....

## FREE—Amazing Book on RHEUMATISM, ARTHRITIS

If you suffer the aches, pains and discomforts of Rheumatism, as manifested in **ARTHRITIS, NEURITIS, SCIATICA** or **LUMBAGO**, send today for the **FREE Book**. It reveals important facts about why drugs and medicine give only temporary relief without removing causes. Explains fully a proven, specialized system of treatment that may save you years of distress. No obligation. Write for this **FREE Book** today!

**BALL CLINIC, Dept. 36, Excelsior Springs, Mo.**

# LEARN DRAFTING TODAY'S IMPORTANT JOB



### It's Easy—At Home In Your Spare Time

There is a growing, desperate need for draftsmen—the key men in all industry. CEI can quickly give **YOU** the necessary technical skill. Bigger income, jobs, and opportunities are yours with a CEI diploma. Thousands have succeeded. So can you! CEI guarantees to train you until you qualify. Write today!



You Get This Professional Set of Instruments at no Extra Cost

Cleveland Engineering Institute  
Extension Division P57C  
6300 Euclid Avenue,  
Cleveland 3, Ohio

( ) Aeronautical ( ) Mechanical

NAME.....

ADDRESS.....

CITY.....STATE.....

No Obligation—No Salesmen

get **FREE** success book

**MECHANICAL**



**AERONAUTICAL**



**CLEVELAND ENGINEERING INSTITUTE**



Special Offer to Readers of  
Examine  
**FREE!**

**POPULAR SCIENCE**

... the first book ever written especially for the  
salesman who wants to be in business for himself!

# HOW TO BECOME A SUCCESSFUL MANUFACTURER'S REPRESENTATIVE



**N**OW... for the salesman who wants to start and operate a business of his own in the lucrative sales agency field... here's the first book ever devoted exclusively to showing ambitious salesmen how they can earn \$10,000, \$15,000, \$25,000, or more a year through representative selling.

It shows you how you can start your own business right now... **with no other investment but your own sales experience!** It shows you, right down to the minutest detail, everything you need to know to make a success out of being a manufacturers' representative.

For example, you'll find such necessary and valuable data as:

- How to set up the physical structure of your business.
- 10 Agencies that will help you get started.
- How to get non-competitive lines with profit potential.
- 7 ways to uncover manufacturers who need representation.
- Expert tips on eliminating costly mistakes at the outset.
- 9 things to look for before accepting an account.
- 3 types of contracts that protect you and your clients.
- Advantages and disadvantages of various lines.
- How to build loyal customer following for volume sales.
- How to set up territories that give more "sales mileage."

### Just Look at the Scores of Money-Making Ideas You Get

- 4 quick ways to get yourself known in the field.
- 14 "bargaining position" tips that win more accounts.
- Fool-proof ways to test marketable lines.
- How to give all your principals ample representation.
- How to switch a buyer's interest from line to line.
- 4 sure-fire compensation plans.
- Tested ways to establish compensation plans.
- 11 elements of a protective contract.
- How to eliminate excessive distribution costs.
- How to step up sales volume without expanding.
- How to use direct-mail advertising to build your business.
- 15 sales techniques slanted toward the manufacturers' representative
- The 20 best areas for representative selling.

If you want to start in business, this book can be your "right arm," help you take advantage of every profit opportunity that arises, show you what dangers and pitfalls to avoid.

### 10-DAY FREE TRIAL!

See for yourself how the step-by-step guidance of this new book can open up for you a whole new future... help you make more money in selling than you ever dreamed possible! Send the coupon at right TODAY for a FREE-Examination copy of HOW TO BE A SUCCESSFUL MANUFACTURERS' REPRESENTATIVE.

### MAIL COUPON TODAY

PRENTICE-HALL, INC., Dept. M-PS-753  
70 Fifth Avenue, New York 11, N. Y.

Please send me a FREE EXAMINATION copy of "How to Become a Successful Manufacturers' Representative." Within 10 days I will either send you \$4.95 plus postage, or return the book and owe nothing.

Name.....  
Address.....  
City.....Zone.....State.....

## "YOU ARE UNDER ARREST!"



### Help Bring Crooks to Justice Through Scientific CRIME DETECTION!

We have taught thousands this exciting, profitable, pleasant profession. Let us teach you in your own home. Learn Finger Printing, Firearms Identification, Police Photography, Secret Service Methods thoroughly, quickly, at small cost. Over 800 of all American Bureaus of Identification employ I.A.S. students or graduates. We can prepare you for this fascinating work during spare time. Write today, stating age, for "Blue Book of Crime."

INSTITUTE OF APPLIED SCIENCE, 1920 Sunnyside Ave., Dept. 136-B, Chicago 40, Ill.  
(A correspondence school since 1916)

## MASTER MIND!



### Learn Short-Cut Mathematics

Juggle figures, do baffling number tricks. Make people gasp at your marvelous lightning-quick mind. Multiply 4 figures by 4 figures without using old-fashioned multiplication! Big cloth-bound volume: fully illustrated course for self-instruction.

### Sharpen up Your Brain Power

Includes worked-out problems, answers, etc. Sensational bargain, only \$2.95, postpaid or COD plus postage. Satisfaction guaranteed or refund. Order this amazing "Short-Cut Mathematics" today!

NELSON-HALL CO., 210 S. Clinton St.  
Dept. 4GX-1 Chicago 6, Ill.

\$2.95  
Complete

## Beautiful Gifts From Abroad Direct By Mail Only \$2 ea.

From Denmark, Holland, Spain, India, Italy, France - wherever our treasure hunters find a rare and exquisite bargain-come fabulous gifts for our club members. American dollars obtain tremendous values abroad, gifts worth \$3 to \$5 for only \$2 each. Mailed direct to your home from overseas, duty free, and postage paid. Every package contains the fascinating story of the origin and significance of the article you receive. And an EXTRA GIFT FROM ABROAD awaits you if you join now! Send at once for FREE illustrated brochure, or enclose \$6.00 for 3 months' trial membership, \$11 for 6 mos., or \$20 for 12 mos. Satisfaction guaranteed!



### AROUND-THE-WORLD SHOPPERS CLUB

Dept. 808, 24 Treat Place, Newark 2, N. J.

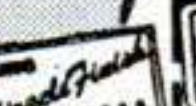
## GET FASCINATING NEW FREE PROFIT PLAN



AUTO DASHBOARD  
PHONOGRAPH TURNTABLES  
SHOES  
AUTOTRUNK INTERIORS



RADIOS  
TOYS  
LAMPS  
JEWELRY BOXES



COVERS ANY SURFACE

MR. NELS IRWIN  
SEND NO MONEY. I WANT YOU TO EXAMINE EVERYTHING WITHOUT RISKING A CENT.

### BIG DEMAND FOR NEW MIRACLE FINISH.

We show you every step. Filing huge year-round demand... easy to understand instructions tell you how. Earn up to \$5 an hour spare-full time. A few cents' worth of materials-brings you dollars!

### GRASP THIS OPPORTUNITY TODAY.

It's too good to miss... Fill out coupon, mail today. Get FREE sample, FREE plan, big IDEA booklet. No salesman will call! Do it NOW... be first in your community to cash in on this huge new market!

COAST INDUSTRIES Dept. 17, 1004 S. Los Angeles Street Los Angeles 15, California.

Tired of monotonous, low-pay jobs - of working for the other fellow? Tap rich profits in huge NEW field. Have your own lifetime business - earn REAL money -

say goodbye forever to time clocks bosses! Become part of tremendous expanding industry - yet work right at home!

### LEARN IN A FEW DAYS THROUGH PROVED, TESTED METHODS

to start earning more money with this amazing MIRACLE finish-gives a velvety, luxurious surface to radios, lamps, toys, signs, store displays,

figurines, auto dashboards-hundreds of items. FREE PROFIT PLAN offers everything you need to start at once. Fill out coupon, mail today.

PROFIT  
UP TO  
\$500  
PER HOUR

### INVESTIGATE TODAY!

USE COUPON FOR FREE SAMPLE

FLOK KRAFT  
COAST INDUSTRIES Dept. 17  
1004 S. Los Angeles St., Los Angeles 15, Calif.  
Gentlemen: Please rush me all details FREE

NAME.....  
STREET.....  
CITY.....STATE.....



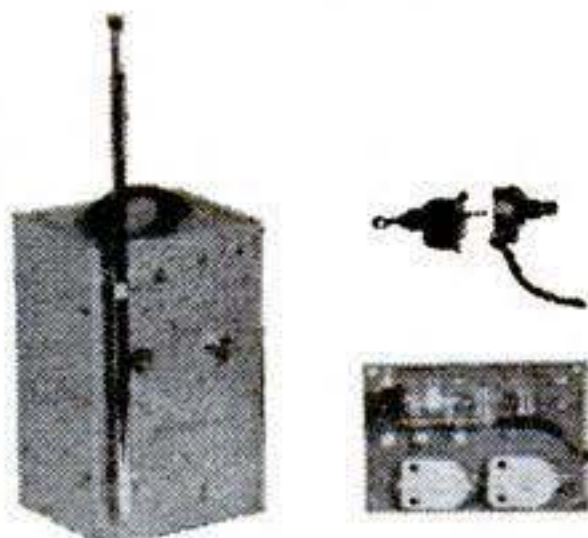
**BIG VALUES**  
from **ALLIED'S**  
**TV-RADIO CATALOG**  
& **SUPPLEMENT**

**FREE!** SEND FOR BOTH!



**KNIGHT PORTABLE RADIO KIT**  
Build this powerful 3-way super-het portable for AC, DC or battery operation. Tunes 535-1650 kc broadcast band; has built-in antenna, PM speaker, handsome carrying case. Easy to assemble from illustrated manual. High-quality kit includes all parts, tubes and case (less batteries). Shpg. wt., 6 lbs.  
83-730. Only.....\$18.75  
Battery Kit.....\$ 3.64

**PHILMORE RADIO CONTROL KIT**  
Build your own remote-control transmitter and receiver! Operates model airplanes, boats, autos, etc. Crystal-controlled transmitter for 27.255 mc. (requires easily obtained FCC operating permit). High-gain receiver. Easy to build. Complete with all parts, antenna, crystal and cabinet; less batteries.  
83-034. Only.....\$41.47  
Complete Set of Batteries....\$ 7.15



**BARGAIN TV BOOSTER**  
Precision designed printed-circuit TV booster—at less than half original price. Gives uniform gain on all 12 VHF TV channels. Easy to tune—improves reception. For 110-120 v., 60 cy. AC. 4 lbs.  
97-233. While they last, only.....\$9.95

**WELLER SOLDERING GUNS**  
Squeeze the trigger—you solder in 5 seconds! Latest heavy-duty instant-heat gun; with 2 spotlights that light up working area. Air-cooled transformer. 3½ lbs.  
46-642. 250 watts, single-heat, only. \$ 9.75  
46-641. 200-275 w., dual-heat, only. \$11.71



**MICRO-VOX WIRELESS MICROPHONE**  
Mike with built-in midget radio transmitter plays magically (without wires) through any radio within 50 feet. Easy to use for home entertainment or as small P.A. system. Provides endless amusement. Complete with built-in batteries and instructions. 3 lbs.  
99-485. Only.....\$6.50

**ALLIED RADIO**

**FREE Catalogs**

ALLIED RADIO CORP., Dept. 7-G-3  
833 W. Jackson Blvd., Chicago 7, Ill.

- Send FREE Catalog and Supplement
- Enter order for \_\_\_\_\_ \$ \_\_\_\_\_ enclosed.

Name \_\_\_\_\_

Address \_\_\_\_\_

City \_\_\_\_\_ Zone \_\_\_\_\_ State \_\_\_\_\_

**SUCCESS • BIG PAY**  
*in Aviation*  
**MASTER A & E MECHANICS**  
*urgently needed*

Maximum training in minimum time! Thorough, practical instruction backed by more than 25 years of aviation technical experience. Training authorized under G.I. Bill.

Write today!  
Illustrated Catalog  
Registrar, Dept. 91,  
Miami 30, Florida



**TRAIN IN MIAMI -- AIR CAPITAL OF THE WORLD**

**MONEY for MEN ALL FREE**  
DATA

THE PLASTEX Industry needs manufacturers on small scale and for big production of Lamp and Clock Stands, Art Goods and Novelties in Plastex and Marble imitation. Experience unnecessary. ½c material makes regular 10c store sellers. Rubber moulds furnished for speed production. Small investment brings good returns. We are now placing big chain store orders with manufacturers. Ambitious men have chance for real prosperity. Our Free booklet will interest and benefit you.  
PLASTEX INDUSTRIES, Dept. 2, 3400 Third Ave., New York 56, N. Y.

**HYPNOTISM**

Learn to apply this tremendous POWER. Develop will-power, self-confidence, self-control. ANYONE can master this exciting profitable profession in short time by training at home, with **GUARANTEED RESULTS. DON'T DELAY . . .** Write to America's oldest Hypnotic school for free information now—today!

**INSTITUTE OF APPLIED HYPNOLOGY**  
Dept. 27, 120 Central Park So., N. Y. 19, N. Y.

**LEARN LOCKSMITHING**

Learn Locksmithing and Keymaking from Experts in Your Spare Time at Home!  
Age or physical handicap no disadvantage. Year-round, steady income in this permanent, respected field. Full or part time. Practical, illustrated lessons show you how to make money even while learning! All materials and special tools supplied. Send for **FREE BOOKLET**.  
**LOCKSMITHING INSTITUTE, Dept. PS43**  
15 Park Ave. Rutherford, N. J.  
Lic. by State of N. J. V.A. Approved

**HE-MAN VOICE!**

**STRENGTHEN** your voice this tested scientific way. Yes—you may now be able to improve the POWER of your speaking and singing voice . . . in the privacy of your own room! Self-training lessons, mostly silent. No music required.

**FREE BOOK** Write TODAY for Eugene Feuchtinger's great booklet "How to Develop a Successful Voice." It's absolutely FREE! You must state your age. Booklet mailed postpaid in plain wrapper. No salesman will call. Send your name and age **RIGHT NOW!** Perfect Voice Institute, 210 S. Clinton St., Studio GX-1, Chicago 6, Ill.



**SEE HOW EASY IT IS Step by Step!**

**TEST YOUR TALENT: EARN WHILE LEARNING**  
Write for test—and booklet "Art for Pleasure and Profit." Both free. Test your ability to learn commercial art, or "Art as a Hobby" . . . at home. Send postcard stating name, age, address.

**WASHINGTON SCHOOL OF ART**  
Studio 137 K Washington 5, D. C.

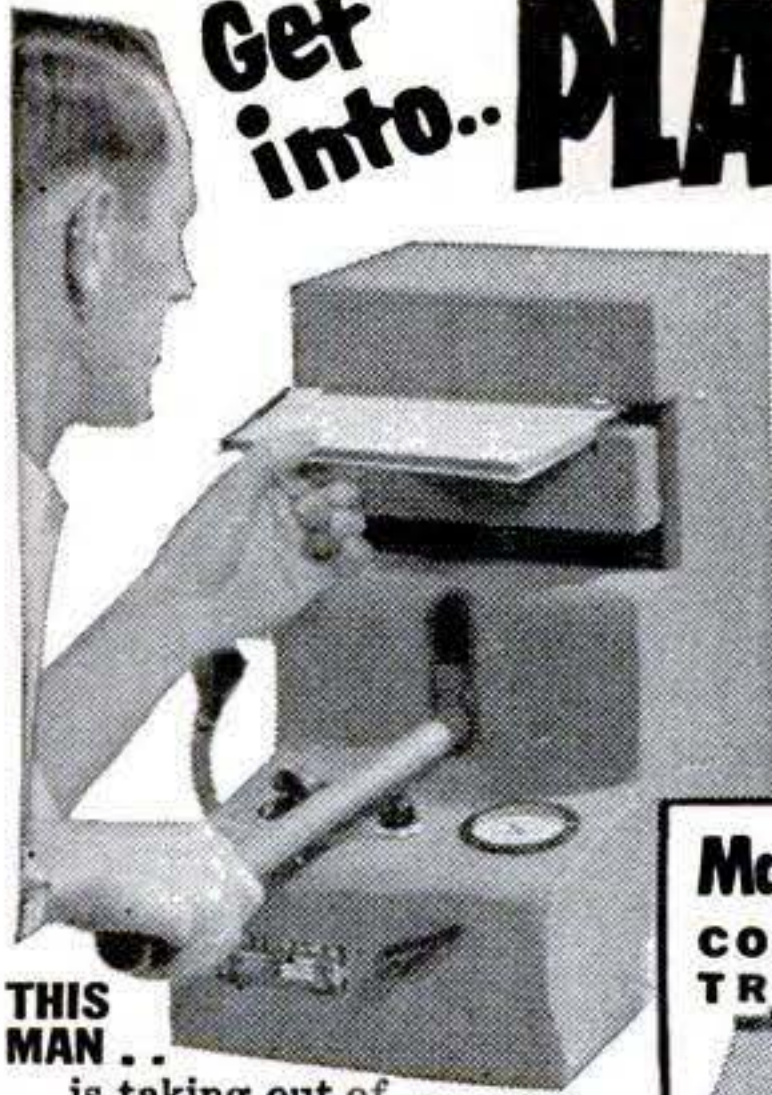
**ART**



Get info.

# PLASTIC LAMINATING AT HOME!

Make \$20 to \$30 a Day by..  
**MAGIC MAIL PLAN!**

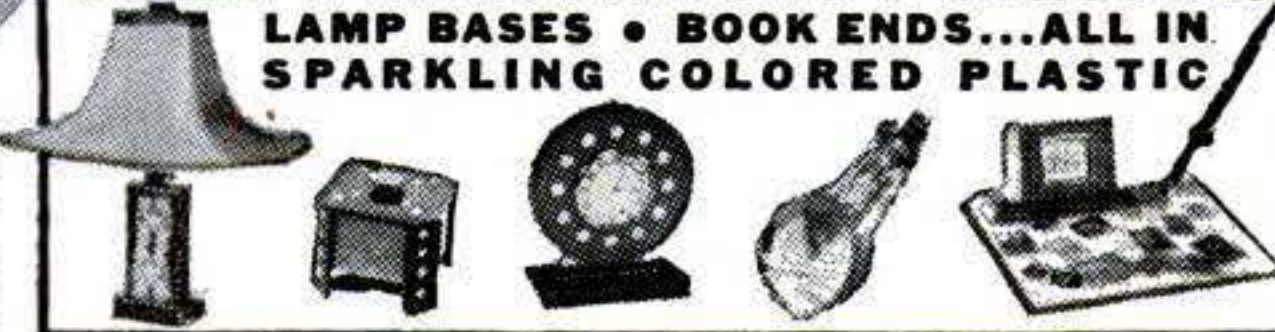


Get **ORDERS** and **CASH** from your mailman—do work in **SPARE TIME** at home—or expand into **FULL TIME** business. Send coupon for Free facts about the newest and most fascinating of all home operated businesses. For the first time a simplified machine brings the fabulous profits of **Plastic Sealing** and **Plastic Laminating** within the reach of the small operator. Anyone can learn to operate the machine with a few minutes practice—then with our **Magic Mail Plan** can get mail orders pouring in daily with cash in every envelope. **No canvassing—no selling.** We even

supply the circulars you mail to bring back cash and orders. Don't waste a minute. Rush your name. We'll send you **FREE** and postpaid, pictures, prices, details, and all the facts you need to start. Mail coupon or send name on postcard. No charge. Warner Electric Co., 1512 Jarvis Av., Dept. L-97, Chicago 26, Illinois

**THIS MAN**... is taking out of the machine a Plastic Sealing Job—ordered by mail—only 11c in material cost brings back \$2.58 in cash by mail. Capacity of machine: **\$25.00 profit per hour of operation.**

**Make Thousands of Beautiful Art Creations**  
COSTUME JEWELRY • CIGARETTE BOXES  
TRAYS • CANDLESTICKS • COASTERS  
LAMP BASES • BOOK ENDS...ALL IN  
SPARKLING COLORED PLASTIC



**WARNER ELECTRIC CO., 1512 Jarvis Av. Dept. L-97, Chicago 26, Ill.**

At no cost to me, please rush complete details postage prepaid. I am under no obligation.

Name \_\_\_\_\_  
Address \_\_\_\_\_  
City \_\_\_\_\_ Zone \_\_\_\_\_ State \_\_\_\_\_

## Wake Up To More Comfort

Without Nagging Backache

Nagging backache, loss of pep and energy, headaches and dizziness may be due to slowdown of kidney function. Doctors say good kidney function is very important to good health. When some everyday condition, such as stress and strain, causes this important function to slow down, many folks suffer nagging backache—feel miserable. Minor bladder irritations due to cold or wrong diet may cause getting up nights or frequent passages.

Don't neglect your kidneys if these conditions bother you. Try Doan's Pills—a mild diuretic. Used successfully by millions for over 50 years. It's amazing how many times Doan's give happy relief from these discomforts—help the 15 miles of kidney tubes and filters flush out waste. Get Doan's Pills today!

## Start Your OWN ELECTRICAL APPLIANCE REPAIR BUSINESS

Repair electrical appliances of friends and neighbors. Service electrical equipment in factories, stores, etc. Work full or part time! New Shop Method home-training system. Rush name today for **FREE BOOK** and special form for getting Electronic Kit. Valuable Heating Element Kits. Advisory Service and Illustrated Instructions on new easy-payment plan. Pay later from **EARNINGS WHILE LEARNING.** Rush name today.

**CHRISTY TRADES SCHOOL**

4432 N. Kedzie, Dept. D-2901, Chicago 25



**Wheels  
Wheels**



**Wheels  
Wheels**

- 7" Disc Wheel 3/4" Tire 3/8" sleeve..... 45c ea.
  - 8" Disc Wheel 1 1/8" Tire 1/2" sleeve..... 70c ea.
  - 7" Disc Wheel 1" Tire 1/2" ball bearing..... 80c ea.
  - 8" Disc Wheel 1 1/8" Tire 1/2" ball bearing..... \$1.00 ea.
  - 6" Disc Wheel 1.50 semi-pneum. Tire 1/2" B.B..... \$1.35 ea.
  - 8" Disc Wheel 2" semi-pneum. T. 1/2" B.B..... \$1.50 ea.
  - 10" Disc Wheel 1.75 semi-pneum. T. 1/2" B.B..... \$1.50 ea.
  - 10" Disc Wheel 2.75 semi-pneum. Tire 5/8" B.B..... \$3.50 ea.
  - 12" Disc Wheel 1.75 semi-pneum. T. 1/2" B.B..... \$1.85 ea.
- Above wheel prices includes hub cap. Plus Postage. C.O.D.'s accepted.  
AXLES—Sizes 5/16 in., 3/8 in., 1/2 in.—Cut to size—End holes drilled.

**UNITED WHEEL STAMPING CO.**

12131 S. PEORIA STREET PS-7 CHICAGO 43, ILLINOIS

**STUDY AT HOME LAW FREE BOOK!**

**Prepare for the Bar!**

Write today for a copy of our **FREE** book, "The Law-Trained Man," which gives the bar rules in your state and tells how ambitious men and women since 1890 have been preparing at home in spare time for the practice of law by studying the famous Blackstone bar-training course. All needed instruction material is furnished including big 16-volume law library. Law diploma awarded. Moderate tuition; easy monthly terms. Write for **FREE** book today!

**BLACKSTONE SCHOOL OF LAW**  
225 N. Michigan Ave., Dept. 120-B, Chicago 1, Illinois



**YOU CAN BE THE MAN WHO KNOWS...**

## "Test-Don't Guess"\* MODERN Automotive DIAGNOSIS TECHNIQUE



Experienced or not—you can learn the modern scientific **SUN** Diagnosis Method of testing and servicing today's cars... IN **JUST 12 WEEKS.** In this fast growing field, **trained men** are in demand **right now** by leading service organizations in every part of the country. This means **MORE MONEY** for you, a secure future—and your choice of location when you graduate. **SUN**, the world's largest manufacturer of scientific automotive test equipment, offers you the opportunity now to join their 12 week course. You **train** in Detroit—the Motor City—where you study the latest

automotive developments. You **learn** basic operating principles by working on all types of the **latest engines**, transmissions, rear axles, etc. You **use** every type of scientific test instrument designed to observe performance and pin-point trouble. **INVESTIGATE TODAY!** This is a completely equipped resident school where trained instructors focus your attention on scientific testing—the **only way** to avoid guesswork in servicing cars. Recommended by leading motor manufacturers and approved for GIs. **THINK CAREFULLY**... this may be your opportunity!

\*Copyright Sun Electric Corp.

**Sun Electric Corporation, Dept PS-3**  
6323 Avondale Ave., Chicago 31, Illinois  
Please send free details on MODERN AUTOMOTIVE SERVICE course.

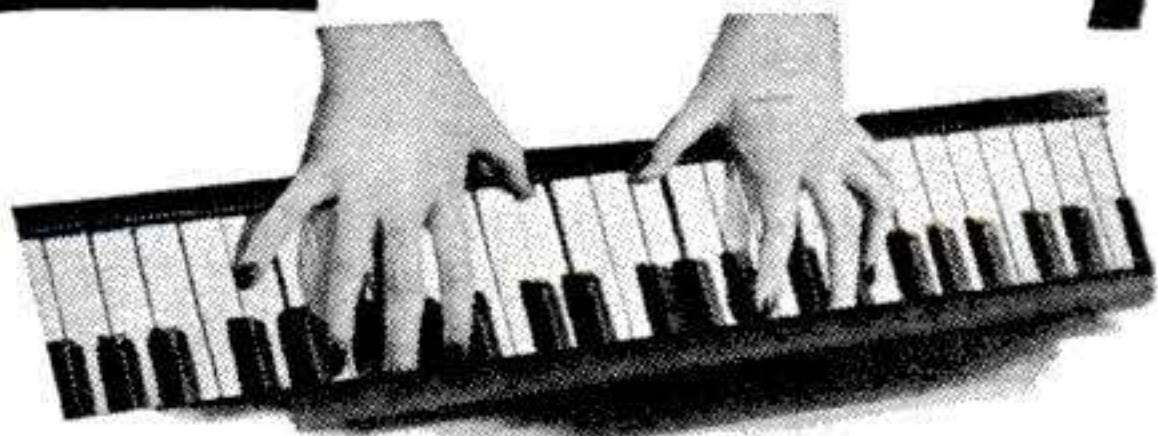
NAME \_\_\_\_\_  
ADDRESS \_\_\_\_\_  
CITY \_\_\_\_\_ ZONE \_\_\_\_\_ STATE \_\_\_\_\_

Classes scheduled in...  
Detroit Technical Training Center

**SEND FOR FREE BROCHURE... ALL DETAILS... NO OBLIGATION**



# You Can Play



... even if you don't know a single note of music now!

IMAGINE! Even if you never dreamed you could play . . . you can soon surprise your friends with your musical ability. No special talent or previous training needed. Spend just a few minutes a day—and only a few cents per lesson. Teach yourself to play piano, guitar, accordion, whatever instrument you choose. Make amazingly rapid progress because you start right out playing real pieces by note. No boring exercises to do. Over 900,000 people have chosen this easy home study method.

## FREE BOOK and FREE LESSON-SAMPLE

See actual proof that YOU can play. Mail coupon for FREE BOOK and Lesson-Sample to: U. S. SCHOOL OF MUSIC, Studio C157, Port Washington, N. Y. (55th SUCCESSFUL YEAR)



U. S. SCHOOL OF MUSIC  
Studio C157, Port Washington, N. Y.

Please send me Free Book and Free Lesson-Sample.

I'm interested in playing (name instrument).....  
 I do  I do NOT—have instrument now.

Name.....  
(please print)

Address.....



## OWN a Business

If employed, start part time. Alert dealers can gross \$5 hourly profit on own service plus \$3 on EACH serviceman. Clean, revive, mothproof rugs & upholstery on location. No shop needed. Services nationally advertised. Repeat customers. Easy to learn. Quickly established. Easy terms. Send today for FREE booklet. No obligation.

Duraclean Co., 3-187 Duraclean Bldg., Deerfield, Ill

# UNLIMITED OPPORTUNITIES IN ENGINEERING DEGREE IN 27 MONTHS

Study Engineering in this world-famed school. Established 1884. Demand for our graduates exceeds supply. Approved for Korean Vets. Bachelor of Science Degree in Mechanical, Civil, Electrical, Chemical, Aeronautical, Radio (Television) Engineering; Business Administration and Accounting. Also—36 weeks certificate courses in Surveying and Drafting. Personalized Instruction. Accelerated courses. Non-essentials eliminated. For ambitious, earnest students. Earn your degree in the shortest possible time. Preparatory courses. Placement service. Extensive Campus. Well equipped, new and modernized buildings; up-to-date labs. Low cost. New terms start quarterly. Enter June, September, January, March.

Mail Coupon Today

## TRI-STATE COLLEGE

573 College Avenue, Angola, Indiana

Please send me free catalog and special information. I am particularly interested in courses as checked:

- Mechanical  Civil  Electrical  Chemical  Aeronautical  
 Radio (Television)  Business Administration  Accounting  
 Short Diploma Courses

Name.....

Address.....

## ELECTRIC DRILL ADAPTER

Convert Your 1/4" Drill Instantly to

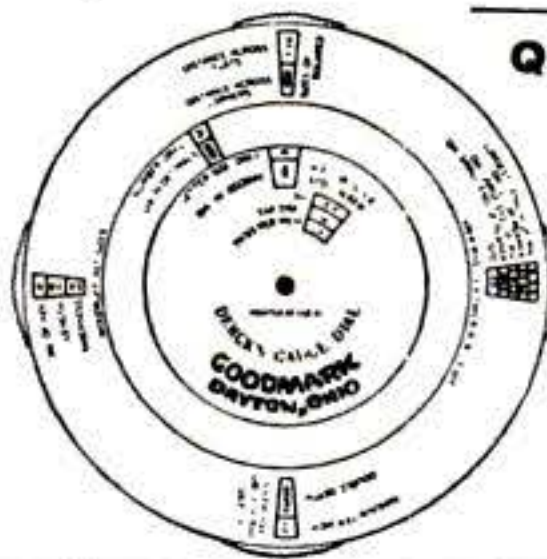
1/2" ELECT. DRILL CAPACITY

For hand or elect. drill. flexible shaft, etc. or shop and home

Quickly Makes 2 Drills in 1



2 95 POST PAID



Quick answers to 1000 questions!

## DERCK'S GAUGE DIAL

For Machinists, Designers, Toolmakers, Pattern Men, Foremen, etc.

Thirteen complete, up-to-date tables give you quick, accurate reckoning without data books. Immediate answers to many problems at the flick of a finger! AMAZINGLY SIMPLE TO USE...WORTH TEN TIMES THE PRICE.

\$1.00

We pay the postage . . . Send for Free Catalog.

21 E. 2nd St., Dept. A37  
DAYTON 1, OHIO

GOODMARK inc.

## NOW LEARN TV-RADIO Servicing AT HOME!

EARN WHILE YOU LEARN! No previous training needed. New, simplified lessons with complete parts kits. Build your own TV set! One of the largest schools of its kind! Approved for Korean vets. Also Residential Course (day & eve. classes). Send for FREE sample lessons and full details on a profitable, thrilling career. Write today to Dept. A7.

## CRESCENT SCHOOL

500 PACIFIC ST.

BROOKLYN 17, N. Y.

# REAL ESTATE BE A BROKER

PAYS BIG! SEND FOR FREE, BIG, ILLUSTRATED CATALOG NOW! Graduates report making substantial incomes. Start and run your own business quickly. Men, women of all ages learn easily. Course covers Sales, Property Management, Appraising, Loans, Mortgages, and related subjects. STUDY AT HOME or in classrooms in leading cities. Diploma awarded. Write TODAY for free book! No obligation.



WEAVER SCHOOL OF REAL ESTATE (Est. 1936)  
Suite 300 Law Bldg. Dept. PS Kansas City, Mo.

# BE A MENTAL WIZARD

## AMAZE—MYSTIFY FRIENDS

You get prestige, Popularity, become the life of the party! Real MONEY possibilities. Your friends will gasp at the uncanny way YOU know their intimate thoughts, just through handwriting.

FREE BOOK AND LESSON!

Gorgeous picture-book tells what others have done. Get it FREE. No obligation. Merely write, giving age, to:

IGAS, Inc., Dept. E, Wilhoit Bldg., Springfield 4, Missouri.



## LEARN MODERN WATCH AND CLOCK REPAIRING

Complete Course—Only \$5.95

At home, spare time. Good field now . . . security and contentment in future. Start part-time business and EARN while you learn. Horology is precision instrument work...a great and growing field, sensational opportunities. Easy self-instruction course. Full price, only \$5.95. SEND NO MONEY. Just pay postman, plus C.O.D. postage. Or send \$5.95 with order, we'll ship postpaid. Satisfaction guaranteed or refund. NELSON-HALL CO., 210 S. Clinton St., Dept. 3GX-1, Chicago 6, Ill.

## Worry of

# FALSE TEETH

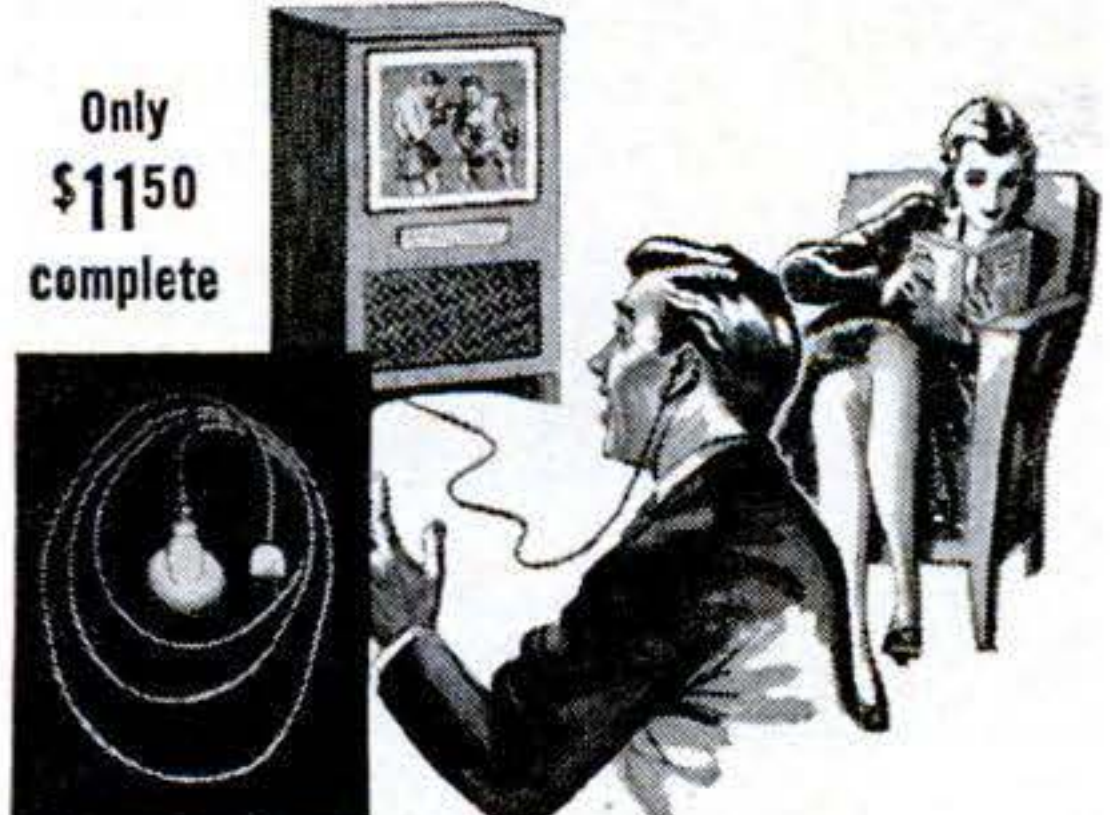
Slipping or Irritating?

Don't be embarrassed by loose false teeth slipping, dropping or wobbling when you eat, talk or laugh. Just sprinkle a little FASTEETH on your plates. This pleasant powder gives a remarkable sense of added comfort and security by holding plates more firmly. No gummy, gooey, pasty taste or feeling. It's alkaline (non-acid). Get FASTEETH at any drug store.



# NOW! Control Your Television Sound!

# Hear It or Not-as you wish



Only  
**\$11.50**  
complete

## EVEN IN THE SAME ROOM

Yes, even in the same room, one or more persons can now listen perfectly to television programs while others in the room read, play cards, talk, study or even sleep . . . and do not hear a sound. A single turn of a dial and everyone can hear the program if they wish.

Now the youngsters can enjoy their loud, thrilling programs, Father can watch and listen to sport programs while Mother talks, reads or works in peace and quiet—even in the same room. Television reception greatly improved but now controlled.

Kentrol is a small, compact unit for only **\$11.50 COMPLETE**. Easily attached to any set in 3 minutes. No wires to cut, no splicing. No tools needed. Anyone can do it. Full directions with every unit. Improves your television reception amazingly.

### INVENTED BY TELEVISION ENGINEER

Kentrol is the invention of a nationally known television engineer, who for 25 years was a top production man for one of America's very largest radio manufacturers. Patents are pending. It is the only accessory of its kind on the market.

**MAIL THIS ORDER  
COUPON TODAY**

## KENTROL

**CORPORATION**  
10 E. Coulter Street  
Philadelphia 44, Pa.

*Try Kentrol in your own home, on your own set. If not completely delighted, return it in 10 days for your money back.*

**KENTROL CORP., Philadelphia 44, Pa.**

*(Check in square below the way you want to buy)*

- Please send me one Kentrol complete at \$11.50. Enclosed is my remittance for full amount to save postage and C.O.D. charge.
- Enclosed find \$1, and I will pay the balance of \$10.50, plus postage and C.O.D., to postman on delivery.

Name.....

Address.....

City.....Zone.....State.....

## PAY YOUR GROCERY BILL

**EARN \$50.00 A WEEK**  
LAUNDERING VENETIAN BLINDS

Fascinating new business with thousands of customers. No experience needed—no age limit. Start at home—basement, garage, utility room. Small investment brings 90% profit on every job. Others earning \$50 a week working 5 hours! Full time pays over \$500 a month. **FREE!** Learn all about this new, patented, portable machine. Get facts, figures, prices, profits—names of successful men in your state. Act now—be the first in your area—no obligation. No salesman will call. **SEND NAME AT ONCE!**

Out of Spare-Time Earnings



**VENETIAN BLIND LAUNDRY EQUIPMENT CO., INC.**  
442 NORTH SENECA, DEPT. 12-K • WICHITA 12, KANSAS

## High School at Home

**Many Finish in 2 Years**

No classes. No time wasted going to and from school. Progress as fast as your time and abilities permit. Standard H. S. texts supplied. Thousands enroll each year in this 55-year-old school. Send for **FREE** descriptive booklet.

**AMERICAN SCHOOL, Dept. HB46**  
Drexel at 58th St., Chicago 37, Ill.

Without obligation, please send **FREE** descriptive booklet.

Name.....

Address.....

**EARN BIG MONEY!**

## GROW "LIVING" MIDGET TREES!

**AT HOME — SPARE TIME — NO EXPERIENCE NEEDED!**

It's new! Amazing! At last, the secret of growing miniature (MING) trees can be yours. **FULL GROWN**, dwarf trees—only a few inches high. Beautiful miniature fir, orange, oak, Chinese elm, peach, pine, cypress—any kind! All **BLOOM** and even **BEAR FRUIT**. All perfect healthy specimens—but miniature in size! Make costly home decorations and expensive centerpieces. (**SOLD FOR OVER \$1,500 EACH.**) Big demand. Costs only pennies—takes only minutes per week. **IT'S EASY! Fun!** A new fascinating hobby—a new fabulous \$\$\$\$ business. Send for free secret plan details and real seed.

**HELP US FILL HUGE DEMAND**

These trees are being demanded by **STORES · CLUBS · HOTELS**  
**FLORISTS**  
**HOUSEWIVES · INTERIOR DECORATORS**  
**COLLECTORS**  
**HOBBYISTS—**  
Big Money Opportunity for you.



**MAIL TODAY FOR FREE  
SEED AND PLAN!**

**NATIONAL NURSERY GARDENS, Dept. N7**  
8463 South Van Ness, Inglewood 4, California  
Rush me **FREE PLAN** and **SEED** IMMEDIATELY!

Name.....

Address.....Zone.....

City.....State.....



# DYNA-MITE POCKET RADIO

**POWERFUL! PERSONAL! PORTABLE!**

- Palm Size REAL RADIO (not a toy) covers 550 to 1600 KC
- Selective 250 Mile Daytime reception. 1000 mile reception at night
- All parts fit within case
- Tiny Acorn tube outperforms sub-miniature types or transistors
- Loud Clear Tone
- Hearing Aid Battery powered. Long Life
- Ideal for Schools
- Picture diagram with instructions for radio beginners



A POWERFUL VACUUM TUBE MINIATURE KIT designed for your personal enjoyment. Take it on camping trips, to your office or to bed, use it without disturbing others. ALL PARTS FULLY GUARANTEED. Hearing aid batteries INCLUDING EXTRA "A" BATTERY supplied at \$1.50 per set. ALNICO MAGNET POWERED 1500 ohm EARPHONE only \$1.45 when purchased with kit. C.O.D. ORDERS ACCEPTABLE WITH \$1.00 deposit within U. S. and possessions.

**\$5.95**  
Postpaid

**PRECISION ELECTRONICS, Dept. 3**  
PLACERVILLE, CALIF.

MAKE EXTRA MONEY

## PLASTICS

LEARN AT HOME

LEARN HOW TO MAKE fast-selling PLASTIC NOVELTIES FURNITURE JEWELRY

There are RICH OPPORTUNITIES for MEN and WOMEN with "know-how" in Plastics. Interstate's new Plastics course tells and shows how to make hundreds of fast selling items out of Plastics. Gives complete training in fabrication, casting, lamination, molding, internal carving, etc., in simple, easy, step-by-step language and pictures. Plastics and Fabricating Kits for 23 valuable Plastic items come with training at no extra cost. START A PLASTICS BUSINESS OF YOUR OWN. No other industry holds such promise for the future. You can make big money manufacturing novelties, toys, signs, etc., in your own home in spare or full time. Don't wait! Learn NOW how Interstate's Plastics Training qualifies you for success in the Plastics field.

SIGNS TOYS LAMPS

WRITE TODAY!

PLASTICS AND SUPPLIES FURNISHED FOR 23 VALUABLE PROJECTS

**INTERSTATE TRAINING SERVICE**

Dept. C2G

Portland 13, Oregon

## GET INTO TELEVISION

**BIG JOBS AT TOP PAY**

Earn to \$125 as a TV service man! Over 20,000 jobs waiting now—100,000 by 1955! C.T.I. trains you at home. You build (and keep) a 17-in. receiver. Parts sent. Free job placement. Write for valuable booklet

**COMMERCIAL TRADES INSTITUTE, Dept. T1-7**  
1400 Greenleaf Avenue • Chicago 26, Illinois

## SHORTHAND

**IN 6 WEEKS**

**LOW COST AT HOME**

Write 120 words per minute. Age no obstacle.

Famous Speedwriting Shorthand. No symbols, no machines; uses ABC's. Easiest to learn and use. Fast preparation for a better position. Nationally used in leading offices and Civil Service; also by executives, students, etc. 120 words per minute. 50% FASTER than Civil Service requirements. Over 150,000 taught by mail. The very low cost will surprise you. Also typing. 30th Year. Schools in over 360 cities in U. S., Canada, Cuba and Hawaii.

WRITE FOR FREE BOOKLET TO:

**Speedwriting**

Dept. 2607-3, 55 W. 42 St., N. Y. 36

Stamp Collectors!

## CORONATION of ELIZABETH II

GENUINE OFFICIAL 1st DAY COVER



plus 300 DIFFERENT STAMPS. ALL for ONLY **25c**

An historic treasure that you will cherish as one of the choice rare items in your collection. The exciting new **QUEEN ELIZABETH STAMP** on a regal artistically designed envelope, that becomes even **MORE VALUABLE** because it is **CANCELLED & MAILED DIRECT FROM THE CORONATION DAY CEREMONIES AT WESTMINSTER.** This historic show-piece **PLUS a WORLD-WIDE COLLECTION of 300 ALL DIFFERENT, UNUSUAL STAMPS,** specifically chosen because of their desirability and valued for at least \$2.50

**ARE ALL YOURS** at the fantastic price of only 25c as an introduction to our **BARGAIN APPROVALS.**

**FREE;** if you act **AT ONCE!** A **GIANT 40 PAGE STAMP DICTIONARY & GUIDE.**  
**STAMPEX CO., 116-EP NASSAU ST., NEW YORK 38, N.Y.**



## ILLUSTRATED COMIC BOOKLETS

**THE KIND MEN LIKE!**  
**THE GIRLS LIKE IT TOO!!**  
(VEST POCKET SIZE)

They are loaded with rare cartoons. Full of Fun and Humor. **20 DIFFERENT** booklets sent for \$1 in plain wrapper. No C.O.D.

BULCO, Dep. 627,

P.O. Box 89-K, Bklyn. 29, N.Y.

## Secrets of VENTRILOQUISM Now Revealed!



Easy to learn in 60 to 90 days with our Home Study Course. **RESULTS GUARANTEED.** Make Money! Be Popular! Have Fun! Big Opportunity! Radio, Television, Stage Appearances! For Free Information regarding price and terms, **WRITE.** You must state your age. Dummy Catalog 25c. **FRED MAHER SCHOOL OF VENTRILOQUISM**  
Box 36, Studio 7 Kensington Station  
Detroit 24, Michigan

## STUDY TO BE A DOCTOR of Psychology or Metaphysics

Obtain a Ps.D., Ms.D., or Ph.D. Be a Teacher, Lecturer or Accredited Practitioner. Teach others how to achieve Health, Happiness and Contentment. Chartered by State. Write for **FREE** book telling how.

**THE NEOTARIAN FELLOWSHIP**

Desk 5, Pickwick Building

Kansas City 6, Missouri

**MEN PAST 40**

Men afflicted with Bladder Trouble, Getting Up Nights, Pains in Back, Hips, Legs, Nervousness, Dizziness, Physical Inability and General Impotency send for our amazing **FREE BOOK** that

tells how you may correct these conditions and have new health and Zest in Life. Write today. No Obligation.  
Excelsior Institute, Dept. B-5, Excelsior Springs, Mo.



## Party Records FOR ADULTS ONLY

**THEY'RE SENSATIONAL!** Brand new series of exclusive phonograph records. Spicy songs that will make your party a howling success. Songs and music in a style you will like. Complete set of **SIX DIFFERENT** songs on good quality 10-inch 78 R.P.M. records, sent prepaid for \$4.95 in sealed package. No C.O.D.'s.

**NATIONAL, Dept. 478,**  
TOLEDO 9, OHIO

BOX 5—STA. E



Classified Ads only 80c per word per insertion, payable in advance. Minimum ad 10 words. To be included in September issue, copy should be in our office by July 24. No cancellations accepted after July 15.

# CLASSIFIED OPPORTUNITIES

POPULAR SCIENCE MONTHLY - 351 FOURTH AVE. - NEW YORK CITY 10

## 1 AUTOMOBILES & MIDGET CARS

HI-Mileage-Speed equipment from the world's largest supplier. Dual manifolds, finned heads, electric doors, lowering sets, chrome panels, thousands of items for all cars. 1953 catalog 25c (illustrated literature free). Wholesale to garages. Newhouse Automotive Industries, Los Angeles 22.

"The Truth About American Cars" a sensational new automotive book by A. J. White, director of MVR! Tells about actual reports of accidents, behind-the-scene thrills during tests, the brake of the future... 73 sections in all! Order today... only \$1 ppd. Motor Vehicle Research, Dept. PS7, South Lee, N. H.

AUTOMOBILE Literature, old, new and foreign; glossy photos; dealer books; repair manuals; free motor magazines. Contact auto nuts everywhere. Write today; get on free mailing list. Auto Maniacs, Inc., Stockbridge, Michigan.

MAKE your own sports car body. Polyester-Fiberglas. Instructions. New catalog—10c. Airmailed—25c. Gem-O'-Lite, Box 6865C, North Hollywood, California.

CROSLY members from Coast to Coast. Parts, speed equipment, tires re-capped, big discount. Crosley service manuals, Club bulletins, windshield decal, identification card, etc. Write: Crosley Car Owner's Club, Charlotte, N. C.

FREE life Membership Great, National Gane Economy Club in exchange for giving Life Memberships "On Approval" to four friends. After receiving yours. Send only Name-Address. Membership sent you immediately with Free "Gas" Coupons. Gane Economy Club, San Gabriel 2, Calif.

FENDER ding tool for amitures \$5.00. Plans to make tool \$1.00. K&K Sales, Box 369, Comstock Park, Michigan.

SPORTS car bodies, boats. Build your own with sensational fiberglas-plastic. Complete instructions 25c refundable. Plastic Parts, 1157-C South Kingshighway, St. Louis 10, Missouri.

## 2 AUTO SUPPLIES & EQUIPMENT

NEW and used guaranteed parts for civilian and Army cars and trucks. Largest stock in America. Mail orders. Pioneer Auto & Truck Parts Company, 788 W. 13th Avenue, Denver, Colorado.

BRUSH Plating Outfits connect to a battery. No tanks or shop required. Free particulars. Gunmetal Co., Ave. K, Decatur, Illinois.

"BUY Speed equipment without money." No selling. Information free. Newhouse Industries, Los Angeles 22.

1953 EDITION. It's New! It's Different! Get world's largest Auto Accessory & Parts Catalog and save money. 132 pages. Over 50,000 items, including Hollywood Accessories Hi-Speed Equipment, Rebuilt Engines, all parts and accessories for all cars and trucks. We have that Hard-To-Get part! Jam packed with bargains. Completely illustrated. Send 25c (refundable). J. C. Whitney, 1919-KB Archer, Chicago 16.

SAVE—California Custom Accessories headquarters. Buy direct from original designers. Electric push button door-trunk conversions, Bull Noses, Custom Grilles, Speed-Dress-Up Equipment, 40 page catalog, hundreds of photos. Send 25c to Eastern Auto, 3319B South Grand, Los Angeles 7, Calif.

KAR-Kool Makes summer driving enjoyable. Easily constructed unit fits under hood, blows ice-conditioned air into car. Make your own for less than \$10.00. Complete plans, \$1.00. Box 1234, Fort Smith, Arkansas.

GM71 Discarded injector parts wanted. Hogen, 7120 Carnegie, Cleveland, Ohio.

"SAVE 50%"—Speed Equipment, Hollywood Mufflers, Dual Manifolds, Racing Cams, Heads, Customizing Accessories! Giant 1953-4 Catalog—25c (Literature Free). Almquist Engineering, Milford 7Z, Penna.

COMPRESSION gauges—surplus stock of famous Gale Hall professional models, brand new, original cartons. Reduced for quick sale from \$10.75 to \$2.98 plus 40c postage. Order now! New England Surplus Sales, Dept. PS-7, 67 High St., Newburyport, Mass.

STOP Ping! Add Power! Or Your Money Back! New Ping-Out Compensating Control Valve fits on vacuum line, permits spark advance. Easy to install. Send \$2.95 to P-B Products, Dept. 7-B, 7958 Beverly Blvd., Los Angeles 48, Calif.

MAKE \$12.00 each sale selling new invention—saves gas, oil, filters cooling system. Cleans carbon and gives more power. Free information. Jos. Dunnigan, 401 S. Central Ave., Baltimore 2, Md.

LACHAPPELLE'S Treatment. (Patented.) For a better motor for \$3.00. Write. Ferns Products, 8120-D Walnut Dr., Los Angeles 1, Calif., for free information.

ELECTROPLATE autoparts, novelties, mirrors. Easy, inexpensive home processes. Free booklet. Tyco Metals, Box 13231-FC, Houston 19, Texas.

BEAT Gas Tax legally with Tur-B-Lizer, users report saves up to 6 miles per gallon. Send \$3.00. 6-cylinder model, \$4.50. 8-cylinder. Money-back guarantee. Universal Co., 621 East State, Milwaukee.

VISOR Clip. Patented device. Fits visor. Holds maps, papers, pencil, etc. Delightful convenience. Only 40c. R.E.K. Mfg., 8530 Woodward, Detroit 2, Michigan.

NEW Vacuum-operated oil changer can save you up to \$1.25 per oil change on your car, truck, tractor or boat. Clean. Fast. Only \$6.95 postpaid. Illustrated particulars on request. Bender Company, 7964-F South Chicago Avenue, Chicago 17, Illinois.

CHEVROLET Owners: Stop tappet noise with Key Tappet Silencers. Quality product. Easy to install. Complete set \$5.95. Kaye Products, P.O. Box 1423C, Milwaukee, Wisconsin.

PERFORMANCE calculator—improved airline navigator type. Compute behind the wheel. Dial any ratio, percentage, multiplication or division—gas mileage, average speed, time-distance problems. \$1 postpaid with instructions. Cal-Q-Lator, 59 Kohanza Rd., Danbury, Conn.

HI-COMPRESSION Heads \$15.95 Up. Write Auto Parts Service, West Salem 3, Ohio.

"WATER Injection", Free descriptive illustrated information. Neher Industries, LaVerne 6, California.

CAR burning oil? Losing compression? Try Clifford's Compression Seal. \$2 Postpaid. Clifford's, 1329 Seventh, Aurora, Ill.

LUBRICATE with molyplate. Free details. Write Molyplate, Box 303, Palo Alto, California.

## 3 AUTO TRAILERS

BUILD your own trailer! Plans for all kinds. Illustrated catalog 10c. Jim Dandy, 125-S, Wausau, Wisconsin.

TRAILERCOACH blueprints. All kinds. Slip-on coach for pickups. Combination boat, utility, sleeper trailer. Illustrated catalog 10c. Comstock Trailers, 585-S, Parsons, Kansas.

## 4 MOTORCYCLES, BICYCLES AND SUPPLIES

REBUILT Gasoline Engines, \$17.00 to \$37.00. Cauffiel Motor Industries, Temperance, Michigan.

RECONDITIONED motorcycles and motors. Chromium accessories. Complete stock Indian parts. Expert rebuilding. Fast service. Indian Motorcycle Sales, Kansas City 27, Mo.

WHIZZER \$20; Servicycle (good tires) \$20; Motorbike conversion kit \$25; Cushman motorscooter \$25; Harley twin \$25. Rush 25c (35c first class mail) for catalog #955 listing many other amazing bargains in motors, midget cars, motorscooters, motorbikes, construction plans. Associated, Box 1764-CS, Toledo, Ohio.

NSU Motorcycles, Motorbikes, 1953 NSU-Lambretta Motorscooters. Seven models (100cc-500cc). Fast parts service. Ask for folder. Some Dealerships open. Butler & Smith Trading Corp., 117 West 63rd St., Dept. S, New York City.

INDIAN Scout motorcycle \$50; Whizzer motorbike \$25; 1952 Allstate Motorscooter \$75; Midget car kit with engine \$80. Engines \$3.50 up; (Mailorder only). Send 25c for catalogue Number 54, just out listing the above and hundreds of other bargains in new and used midget cars, motorscooters, homebuilders parts, plans, etc. (35c by First Class Mail). Midget Motors Directory, Athens, Ohio.

"BUZZZZ"—The Motorcycle Magazine. Lots pictures. Worldwide Coverage. \$2.00 Year. Sample 20c. 5424-B Sawyer, Chicago 25.

WHIZZERS \$20; Midget Car \$15; Motorscooter belt drive \$6; 3-wheel scooter car \$39.50. Send 25c (35c first class mail) for catalog #24 jammed with sensational bargains in wheels, motors, motorscooters, midget cars, motorbikes, construction plans, etc. Gail, 538 Erie, Toledo, Ohio.

## 5 AVIATION

PROPELLERS, plans, for snow sleighs, airboats. Literature. Gano Propeller, Box 3284B, Ft. Worth, Texas.

AMERICAN Triplane plans \$10. Lillian Holden, Box 1614, Ft. Worth, Texas.

WORLD Record Breaking Shoot-Up Glider with Silk Parachute \$1.00. Bill Cotter, Washington 18, D. C.

PROPELLERS, Plans, Supplies, for snow sleighs, air boats. Immediate delivery. Catalog 25c. Banks-Maxwell, Box 3301G, Ft. Worth, Texas.

## 6 BATTERIES, GENERATORS, ETC.

EDISON Nickel odorless storage batteries. 12 to 600 ampere hour. Any voltage. Long guarantee. Literature, Hawley Smith Co., Croton Falls 2, New York.

## 7 ELECTRICAL SUPPLIES & EQUIPMENT

LAMPS—25c brings bargain parts catalog containing instructions for electrifying oil lamps, vases, etc. Gyro Lamps, 5402B Clark, Chicago 40.

LAMP Supplies—Wholesale—any amounts. Prompt shipment on all parts for repairing and building lamps. Illustrated catalog 15c. Brown Specialties Co., No. 501—Wellston Sta., St. Louis 12, Mo.

MAKE your own Electric Fuse Plugs. Model \$1.00. W. Stonebraker, 6006 Harney, St. Louis 20, Missouri.

DELAYED action (50 seconds) switch. Sample, \$2. Belco, Tucson 5, Arizona.

## 8 WELDING, SOLDERING

"BUILD-Ur-Own" a.c. welder and a.c. power plant with a good used engine and low cost Hobart generator. Welds anywhere and supplies 5KW stand-by power for any emergency. Write Hobartweld, Box P-733, Troy, Ohio.



ACETYLENE Welding Outfits new \$49.00; used \$29.00; Arcwelders \$49.50; Eagle Welding, Dept. 42, 5085 Broadway, Chicago 40, Ill.

A.C. Welders. 4 Sizes, Lowest Prices. Free Literature. Holgerson's Serv., Canton, Kan.

## 9 MACHINERY, TOOL SUPPLIES, ETC.

MOTOR driven rotary Hone sharpens all Keen Edge tools. A must for all shops. Immediate delivery. Moore Industries, Fredonia, Pennsylvania.

GOOD machines for your shop. 20"x8' lathe \$380.00. 14"x6' lathe \$280.00. Lodge Shipley Q.C. 16"x12' lathe, Drive-All, motor, chuck \$1200.00. Fellows #6 gear maker, motorized \$700.00. Horizontal boring mill \$450.00. 24" drill \$320.00. 18" shaper \$520.00. Brainard Universal #13 milling machine \$450.00. Hand miller \$240.00. Pitchburg planer 20"x4' \$700.00. Money back if you are not satisfied. Conversion Parts Co., 277 Adams St., Boston 22, Massachusetts.

SMALL sizes short lengths Type 18-8 Stainless Steel (non-magnetic) suitable for home work shop use. Send \$1.35 for 2 lb. assortment postpaid in U.S.A. 5 lb. assortment \$3.00. Johnston Sales, Box 1174, Erie, Pa.

TOOLCHESTS \$50—complete list free. Foster's, 244 W. 106th, New York 25.

SELF-Oiler for electric motors 3 for \$1.00. United States Petroleum Co., Dept. M, Clifton, N. J.

## 10 ENGINES, MOTORS, ETC.

WINDING Data, listing 225 motors, single and three phase, \$1.00. Motor Data, Box 7631, Kansas City 3, Mo.

ALTERNATING Current Generators 750 Watt \$38.50, 5000 \$185. Motors 1/2 horse \$15, 3/4 \$22, 1 \$35. Butler, 1885 Milwaukee, Chicago 47.

REBUILT Gasoline Engines, \$17.00 to \$37.00. Cauffiel Motor Industries, Temperance, Michigan.

## 11 BOATS, OUTBOARD MOTORS

BUILD marine engines with Federal Conversion Kits. Federal Marine Motors, 9011 Cottage Grove Ave., Chicago 19, Ill.

FULL size, cut to shape boat patterns, blueprints, 7 1/2-38 feet. Illustrated "Build a Boat" catalog 25c (coin). "How to Build Boats" book \$1.00. Polywog houseboat Plans \$10.00. Cleveland Boat Blueprint Co., Dept. A-77, Cleveland 4, Ohio.

NEW, used rebuilt marine motors. Marine conversions, fittings. Free Catalog. Stokes Marine Supply, Dept. 23, Coldwater, Mich.

OUTBOARD Motor Parts—New—Used for all makes. Send stamp for price quotation, listing parts needed. Outboard Motor Marv, Inc., 229D State Street, Boston, Massachusetts.

NOW Faster Than Ever! Champion Boats—the choice of champions now available to you! Easy-to-read plans; easy-to-assemble kits; or easy-to-afford custom built speed boats. (18 models, outboard and inboard). Send 25c today for multi-colored, illustrated catalogue. Champion Boats, 1524 W. 15th St., Long Beach, Calif. Dept. 23-G.

COMPLETE 12' boat kit only \$59.00 semi-vee car-top, wooden parts accurately cut, assembled frames, brass screws. Write for literature. Penney Woodcraft Industries, Defiance, Ohio. Dept. C9.

MARINE conversions for Ford and Jeep engines. Catalog 10c. Lehman Manufacturing Co., 972A Broad St., Newark 2, N.J.

PERMANENT boat coating. Polyester-Fiberglas. New catalog tells you how—how much. 10c. Airmailed—25c. Gem-O-Lite, Box 6865B, North Hollywood, California.

PERMANENT Boat Protection—Use Castoglas (Liquid Plastic and Glass Cloth). Apply it like paint to new or old boats. Forms plastic skin. Lighter than aluminum, tougher than steel. Once on, stays. Makes boats stronger, permanently leak-proof, rot-proof, mildew-proof, weather-proof. Won't rust, corrode, crack. Unaffected by gasoline, oil, alcohol, salt water, hot sun. Also used for sealing leaks, patching, caulking. Free Folder, Marine Division, Dept. MH-102, Castolite, Woodstock, Ill.

CURE that leaking boat with Fiberglas—plastic covering. Ends caulking and painting. Nationally approved process. Complete instructions. New low prices. Industrial Plastics, 3807 Harrison, Oakland 11, California.

OUTBOARD. Cruiser, Sailboat Kits; compare values! Marine Supplies, reasonable. Boatbuilders Marine, 55-P Sorrento, Allston, Mass.

BOAT Owners—See "New . . . oil changer" ad under Auto Supplies.—Bender.

## 12 BODY-BUILDING COURSES, JIU JITSU & ATHLETIC EQUIPMENT

"POLICE Jiu Jitsu," "Scientific Boxing." Both courses \$1 postpaid. Books, 3100 Ocean Parkway, Brooklyn 35.

HANDBALANCING self-taught. Write today. Power, 923-a W. Vine, Kalamazoo, Michigan.

BARBELLS, Gymnasium Equip. Southern Barbell Co., 1510 E. Cary, Richmond, Va.

FIFTY proven exercises—60c. A. Gordon, 210 Cheney Lane, St. Louis 19, Mo.

BARBELLS, Dumbbells, Exercise equipment. Courses. Free booklet. Good Barbell Co. Reading, Penna.

## 14 FIELD GLASSES, TELESCOPES

WAR Surplus Bargains. Binoculars, Telescopes, Sextants. Millions of Lenses, Prisms, Reticles, Eyepieces, Objectives, etc. Mail 10c for Big "Catalog CN." Send \$1.00 for Stock CN-10-piece Lens Kit and Big Instruction Booklet. Edmund Scientific Corp., Barrington, New Jersey.

GIANT telescopes and telescope makers kits. Perfect merchandise. Save 50% or more. Riverhead Telescope Co., Calverton, New York.

AMAZING prices, binoculars, telescopes, microscopes. Free trial. Folder, "Binocular Selecting" optical catalog free. Prentiss Importers, Mercury Bldg., West Los Angeles 25, California.

GIANT astronomical telescope complete with 6 foot tripod. 45X, 75X, 100X eyepieces. Sun projector lens. Full power, clear vision guaranteed. \$15.00. Suffolk Science Service, Riverhead 4, New York.

FREE Catalogue! Thousand war surplus optical bargains. Lenses, Prisms, Telescopes, Binoculars, etc. Send \$1.00 for 10 Lens Hobbyist Set and Project booklet. G. Jaegers, 691 West Merrick Road, Lynbrook, New York.

SAVE Money—Get interesting facts! Free 52 page three color catalog. 80 different models. United Binoculars, 9043 S. Western, A-7616, Chicago 20.

REFLECTOR telescope kits—Precision eyepieces, Mirror cells, Diagonal holders, Tubing, other optical bargains. Free illustrated bulletins. Esco Products, 1426 Willow Ave. Hoboken, New Jersey.

TELESCOPE complete Lens set kit 250 power consists of 80 inch focal length ground and polished objective lens, eyepiece lenses for 50-100-150-200-250 power, and all necessary fittings. Easy to make from simple step by step instructions. Conquer space, explore the universe. Planets, Moon, new Stars. Only \$3.49 postpaid. Money back guarantee. Busse Sales, Hartford, Conn. Dept. BS-2

GIANT telescope easily made. Deluxe 100 power kit and instructions \$2.00. Perfect lenses. All mounted. Carl Jamer, Manorville, New York.

SAVE! Save! New Binoculars! Free Catalog. Free Book, "How To Select Binoculars." Write Today! Bushnell's, 43-P67 Green, Pasadena 1, Calif.

REFLECTING Telescopes, completely assembled. 60X, \$29.75. Guaranteed Observatory clearness. Free information, Skyscope, 475 Fifth Avenue, New York 17.

TELESCOPES and telescope makers kits. Don't buy until you have our free catalog and instruction booklet. Perfect merchandise. Terrific Savings, Suffolk Science, Riverhead 4, New York.

ASTRONOMICAL Telescopes, Bardou, Unitron, Sans-Streiffe; Microscopes, Binoculars. Rasmussen-Reece, Amsterdam, New York.

BINOCULARS. Lowest prices. 8x30. \$32.00 guaranteed. Telescopes, microscopes. Free catalog: All sizes, Joe's Binocular Sales, 4827 Second Blvd., Detroit 1, Mich.

## 15 SPORTING GOODS, GUNS, FISHING TACKLE, ARCHERY, TRAPPING

120 PROFUSELY illustrated pages, antique pistols, swords, daggers, armor, etc. 50c. Robert Abels, PS860 Lexington Ave., New York 21.

MINK Raising information free. Complete. Lake Superior Mink Farm, Superior E E5, Wisconsin.

FISHERMEN—make your own sinkers with our molds. Free illustrated booklet. Reading Instrument Co., Box 78, Reading, Penna.

DON'T Hurry!!—Fish wait for you—with Surebite Live Grubs. Everytime—200 postpaid \$1.00—Keeps Weeks—SureBite Live Bait, Torrance (9), Calif.—Dealers Inquire.

5,000 BARGAINS, firearms, binoculars, war relics, catalog 50c. Smith Museum, Runnemedede, N. J.

JAP rifles altering American shells \$6.00, catalog 5c. TP Shop, West Branch 10, Michigan.

SEND 10c for lists either shotguns, rifles, handguns, ammunition or send 25c for all lists. Frayseth's, Willmar, Minn.

MOLDS for Fisherman's Sinkers, Jigs, Squids, Casting and Spinning Lures. Sweet's Molds, Tonawanda 3, New York.

LEARN Gunsmithing! Information, interesting Gun, Gunsmith's Catalog, 25c. Gunsmith, 4233 N. Harlem, Chicago.

PRECISION Casting-Trolling reel, thumb brake, drag adjustment, 5" spool holds 500 feet of line. Self oiling stainless steel shaft, \$3.95. Kel-Don, Dept. C, 1507 North 38th Street, Seattle 3, Washington.

OVER 500 guns, modern, obsolete. List 10c coin. Ed Howe, 26 Main, Coopers Mills, Maine.

IMPORTED knives. Write for illustrated literature. J. D. Clinton, Mt. Clemens 3, Michigan.

FISHERMEN. Our Formula Guarantees Anytime, Finest Worms, Quick, Easy—25c coin. 19409 Cherokee Avenue, Cleveland, Ohio.

## 16 CAMPING EQUIPMENT & TENTS

TENTS, camping equipment. 100 page free catalogue. Mor-San Sales, 10-21G 50th Avenue, Long Island City 1, N. Y.

## 17 DOGS, BIRDS, HAMSTERS, RABBITS & PETS

MAKE Big Money! Raise Chinchilla Rabbits. Cash Markets Supplied. Write Today! Rockhill Ranch, Sellersville 16, Pa.

YOUNG Parrots—make fine talkers. Herb Miller, 1911-N, Lubbock, Texas.

SALE—Tame Red Striped Squirrels. Dewey H. Balch, Castleton, Vermont.

GUINEA Pigs. Highly profitable. Booklet free. Taylors, B426B, Hapeville, Georgia.

RAISE Fishworms—Highly profitable! Illustrated booklet explains raising, feeding, marketing, shipping. 25c. Ozark Worm Farm-V, Willow Springs, Missouri.

"RAISING Chinchillas For Profit," 141 page book. Authentic. Illustrated, \$3.50. Ellsworth, Box 6PS, San Mateo, Calif.

HAMSTERS for pets or profit. Free Literature. Murray's, Box 513, Ottumwa, Iowa.

## 19 FARMS, OTHER REAL ESTATE

FARM-Ranch Opportunities. Favorable conditions, Washington, Minnesota, Montana, Idaho, Oregon, North Dakota. Literature, farm descriptions. Specify which state. J. W. Haw, 120 Northern Pacific R., St. Paul 1, Minn.

CALIFORNIA Ranch Lands. 50c to \$5 acre minimum bid. Farm-ranch-hunt-fish-retire. 10c brings illustrated land catalog, outline maps. Tax Land Sales, Box 2350BX, Hollywood 28, Calif.

STROUT Farm Catalog Free! Farms, Homes, Businesses, etc. Over 3200 Large gains described, 31 States. World's Largest, 53 years service. Strout Realty, 255-ZB 4th Ave., New York 10, N. Y.

FREE List Farms, Auto Courts, Homes, Missouri Ozarks. Johnson Realty-PS, Marshfield, Missouri.



**MAKE Money in Houston!** World famous "Land of the Big Rich"—Greatest fortune-making Center on earth. Houston is the largest Metropolis in entire South and fastest growing City. Profit from this tremendous money-making growth—buy big, desirable Tracts here now for \$345—payable \$15 monthly. Free Booklet. Nathan Wood, Box 413, Houston, Texas.

## 21 POULTRY & SUPPLIES

**RAISE** pheasants on \$100 week plan. Little capital and space can make you independent. Free details. Great Central System, Columbus 6, Kansas.

## 22 PROFITABLE OCCUPATIONS

"**HOW to Make Money With Home Workshop**" describes amazing methods used by hundreds of successful craftsmen. Tells what to make. How to sell workshop output spare time. Write at once for details. Craftsman, 115B7 Worth St., NYC.

**DETECTIVES Earn Big Money.** Excellent opportunity. Detective Particulars free. Write. Wagoner, P-125 W. 86th. N.Y. 24.

**\$10,800 PROFITS!** Your own mailorder Business! No Capital Risk! "Success Plan" (worth \$2) Free! Write today! Treasury, 709 Webster Avenue, New Rochelle P-13, New York.

**\$5000 FROM** half acre growing Ginseng, crop bought. Particulars 10c. Associated Growers, Sperling, Manitoba.

**WANT A Diesel Job?** New Opportunities to increase income. Higher Pay. More Money. We can help you Qualify. Tools. Shop method home training. Write today! Diesel, Tractor, Heavy Equipment Division, Interstate Training Service, Dept. B2-G, Portland 13, Oregon.

**ADDRESS** and mail postcards. Make over \$50 week. Send \$1 for instructions. Lundo, Watertown, Mass.

"**AUCTIONEER'S Pitch!**" Complete Proven Format! Cash in!! Rush \$10.00. "Mart", Box 575-A, Hollywood 28, Calif.

**MAILING Post Cards** Offering Fast-Selling Merchandise is profitable! Everything furnished! Work at home. Clara's Mail Service, Dorsey, Illinois.

**WELDING Pays \$\$\$.** Learn easily at best equipped school in country. Non-profit School with low cost training. G.I. approved. Write Hobart Trade School, Box P-732, Troy, Ohio.

**FREE Details!** \$900 monthly possible. Raise and sell Chinchillas part time. Guaranteed market provided. Colonel Richardson, Dept. 673, 65 Lucille, Manchester, N. H.

**FREE Booklet** reveals amazing secrets behind 301 new profitable enterprises! Many mailorder! Includes confidential instructions for starting wholesale buying service. Deumant Business Surveys, 85-S Deumant, Kenmore 23, N. Y.

**BUY Wholesale** thousands nationally advertised products at big discount. Free "Wholesale Plan." American Buyers, 628-T Linden, Buffalo, New York.

**DESIGN House\$!** Easy. Write. Wat Engineering, Box 207, Berea, 1, Ohio.

**GROW Mushrooms.** Cellar, shed, and outdoors. Spare, full time, year round. We pay \$3.50 Lb. We paid Babbitt \$4,165 in few weeks. Free Book. Washington Mushroom Ind., Dept. 101, 2954 Admiral Way, Seattle, Wash.

**DID you ever try fly-tying?** Make your own fishing lures. Sell them too! Beginner's kit is only \$5.00. Many other kits and fly-tying tools. Send 10c for catalog. D. H. Thompson, 335 Walnut Avenue, Elgin, Illinois.

**MUSHROOMS** grown boxes barrels. Manureless process 50c. Spawn \$1.00. Gordens, 553 William, Winnipeg, Manitoba.

**SAIL Ho!** Merchant Marine employment opportunities, complete information, \$1.98. Satisfaction guaranteed. Seaways, Box 1231P, Baltimore 3, Maryland.

**SPECTACLES.** Wholesale. Exciting details free. Reedeey, 112 Adams, Hoboken 6, New Jersey.

**\$40.00 WEEKLY.** Make growing mushrooms. Dominion Patent 331,583. Free spawn with Order. North American, 169Y Yonge, Toronto, Canada.

**FREE Book "505 Odd, Successful Businesses."** Work home! Expect "Odd"! Pacific—37C. Oceanside, Calif.

**LEARN** mailorder; operate home business. Write René Girard, Coventry, R. I.

## 23 BOOKS & MAGAZINES

**SPARETIME Profits** Taking Subscriptions. All Magazines. Wholesale Catalog Free. Cassell Agency, Westfield 1, N. J.

**BIG Catalogue;** 1500 bargains, send 10c. Books, 3100 Ocean Parkway, Brooklyn 35.

**GOOD Used Books,** 50c—\$1.00. Postal brings lists. Editions, Dept. PS, Hempstead, New York.

**BOOKHUNTERS!** All Subjects. Send Wants! Jaher Book Service, 620-K East 178 Street, New York 57.

**NATIONAL Geographic Magazines** 1888-1952. Any Issue. Periodical Service, Box 465-PS, Wilmington, Delaware.

**ATHEIST books.** Catalogue free. Truth Seeker Co., 38 Park Row, New York 8.

**BOOKHUNTERS!** Scarce, unusual, miscellaneous books supplied. Atlantic Book Service, 2 Lawrence, Charlestown 29, Mass.

**KING James Bibles** \$1.00 up. Fabrikoid Zipper \$1.60. Leather with Concordance \$4.25. Postage 25c per order. Foreign Editions available. Maison de Nivla, Box 23, Albany 1, N. Y.

"**MENTAL Action Miracles.**" Many uses. Easily learned, \$1.00. Guaranteed. Scientific Information Service, 2259 Houghton Ave., New York 72, N. Y.

**SENSATIONAL Book Bargains!** Free Catalogue! Write: Old Prof's Book Shop, Pontiac 15, Michigan.

**BOOKS** any subject supplied. Henderson, 243 Munn Avenue, Irvington, N. J.

## 24 HYPNOTISM

"**25 LESSONS** in Hypnotism." "84 Card Tricks." both courses \$1 postpaid. Books, 3100 Ocean Parkway, Brooklyn 35.

"**HYPNOTIZE the First Day**" instantaneous hypnotic sleep, or your money back. \$2.00. Lewis, 4009 Lake Park, Chicago 15.

**FREE Illustrated Hypnotism.** Selfhypnosis Catalogue. Write: Hypnotist, 1324 Wilshire, Hollywood 17P, California.

**MECHANICAL Hypnotist,** new invention causes hypnotic trance. Instructions, secrets included. \$2.00. Click, G.P.O. Box 1312, New York 1.

**AMAZING record!** Hypnotizes; transfers control to you. Instructions, \$2.95 ppd. Information free. Hypno Records, Dept. P, Box 405, Hermosa Beach, Calif.

**JOIN National Guild Hypnotists.** Details. Hypnodiscs, etc. 10c. Guild, 48B Harlem, Dorchester 21, Massachusetts.

"**SELF-Hypnosis Feats**", "25 Hypnotism Lessons". Catalogue. 25c. Lloyd Collins, Appalachia, Virginia.

## 24A GAMES & ENTERTAINMENT

**ANCIENT Orientals** had a system of adding and subtracting that has stood without change for 3600 years. Now you can learn this system. For full instructions, send \$1.00 to "Wisdom," 6024 Loveland, Bell, Calif.

**CERAMIC Chessmen,** \$12.50 per set. Hairston, P. O. Box 78507, Los Angeles 16.

**AMAZING Flying Saucer Toy!** Fun for all. Throws 6" disc up to 500 feet. \$1.00 prepaid. Anderson, 586 Jerome, Astoria, Oregon.

## 25 MAGIC TRICKS, PUZZLES, ETC.

**MAGICIANS.** Gamblers books, supplies exposed. Catalog 10c. Book, Box 671, St. Louis 1, Mo.

**500 TRICKS.** Douglas famous 120-page Catalog, only 10c. Fastest service to magicians for 30 years. Send 10c today. Douglas Magicland, Dept. 2, Dallas, Texas.

**VENTRILOQUISM** Amateur and professional. Write to Smith, 801 Bigelow, Peoria 5, Ill.

**MYSTERY Statue** comes to life under water. Causes laff riot in bars, parties. Ideal gag-gift. Special Introductory Offer \$1 postpaid. No COD's. Teedee Enterprises, 5864-P Hollywood Blvd., Hollywood 28, California.

**VENTRILOQUIAL Dummies—low price**—any type—custom-made. Send 25c for pictures and information. C. R. Gough, 218 N. Jefferson, Hartford City, Ind.

**JOKER'S Novelties.** Send 10c for new list and free Joke item. Garden City Fun Shop, 654 Franklin Ave., Garden City, N. Y.

**MAGIC—Parlor Stage.** Joker's Supplies. Lower Prices. Giant Catalog 25c. (Refunded). Top Hat Magic, Evanston 22, Illinois.

**90 PAGE Novelty-Magic catalog** with exciting trick. 25c. Allen, Dept. PST, Clinton, Missouri.

**FREE trick and large illustrated catalog**—35c. Lerro's Magic, 8111 Fifth Avenue, Brooklyn 9, N. Y.

**2500 TRICK Catalogue** (512-pages), pocket, parlor, stage. World's Finest Magic. Catalogue \$2.00 (dollar trick included free). Kanter's, S-1311 Walnut, Philadelphia 7.

**GUARANTEED magic Tricks!** Catalog free. Newton Magic Company, Bonham 8, Texas.

**AMAZING pocket trick** 25c (coin). Bork, 1356 Sycamore, Buffalo 11, New York.

## 26 COIN COLLECTING

**WANTED—1894-S Dime Pay \$500.00.** Certain 1913 nickel \$1,000.00. 1901-S quarter \$20.00 to \$150.00. Wanted Half Dollars 1892-S, 1892-O, 1893-S, 1896-S, 1897-S. Certain Lincoln cents \$20.00. Silver dollars 1893-S, 1895-P, 1903-O \$5.00 to \$50.00. Wanted—certain dates will pay following prices—Half Cents \$100.00. Large Cents \$50.00. Small Cents \$150.00. 2c pieces \$35.00. 3c pieces \$45.00. Half Dimes \$500.00. Buffalo nickels \$6.00. Old dimes \$300.00. Old quarters \$250.00. Old Half Dollars \$1,500.00. Hundreds of others. Know their true value. Large illustrated complete guarantee buying catalogue 25c. 6 for \$1.00. Money refundable. Worthy-coin Corporation, Leaders of Numismatic Quotations (D-434), Boston 8, Mass.

**GET Profit and Pleasure** in collecting old coins. Send 10c for 56-page illustrated coin catalog. You'll be delighted with it. Send for it now. B Max Mehl, 374 Mehl Building, Fort Worth, Texas. Largest rare coin establishment in U. S. Established 53 years.

**FREE!** Foreign coin, banknote and Coin Collectors' Illustrated Catalog to approval service applicants. Send 3c postage. Tatham Coin Co., Springfield-50, Mass.

**OLD Money Wanted.** Will pay Fifty Dollars for nickel of 1913 with Liberty Head (not Buffalo). We pay cash premiums for all rare coins. Send 4c for Large Coin Folder. May mean much profit to you. Numismatic Co., Dept. 30, Fort Worth, Tex.

**SET** nine Japanese invasion notes for U. S. \$2.00. Illustrated coin catalogue 25c. Shultz, Salt Lake 10, Utah.

**WORLD'S** greatest monthly magazine for coin collector's and wooden nickel 10c. Lawrence Brothers, Anamosa, Iowa.

## 28 STAMP COLLECTING

**AMAZING Offer!** 200 United States stamps—including commemoratives, airmails, high denominations to \$5.00—Only 10c to Approval Applicants!! Illustrated Bargain Lists free. Mystic Stamp Co., Dept. 55, Camden, New York.

**FREE—Complete set of Famous Americans.** Flags, Parks and Presidentials to approval buyers. Send 3c for 15 of the above stamps plus full particulars. Triboro Stamp Company, 145 Nassau Street, Dept. 207, New York 28, N. Y.

**POLAR Bear Triangle;** Giant George Washington, Six Colored Ecuador, Arctic Triangle, first American commemorative, Corsica, Devils Island, others. Everything free with approvals. Capital Stamps, Little Rock 10, Ark.

**VALUABLE Airmail book** plus gorgeous world-wide airmail collection 10c. Includes \$10,000 stamp. Zeppelin, scarce triangle, many others with beautifully illustrated book, only 10c with choice approvals and bargain lists. Jamestown Stamp Co., Jamestown 707 New York.

**GREAT Free Offer—Weird mosquito stamp,** thrilling bicycle race, gorgeous orchid, colorful native drummer, gigantic diamond airmail, stamp albums, all to our approval buyers. Bell Stamp Service, Dept. W-4, Bell, California.



200 DIFFERENT, including Roosevelt triangle. 5c to approval applicants. S. Avon Stamp Co., Springfield, Mass.

FLAG Stamp—Free with hygrade U. S. approvals. Wenigman's, 1933 Patterson, Chicago 13.

327 DIFFERENT Stamps 25c! Including Early Canada, Newfoundland, British Colonies, Vatican, Red Russia, Hitler Heads, Indian States, Animals, Airmails, French Colonies, rarities, unusuals. Every stamp different. Rare bargain only 25c with our Bargain Approvals. Money back guarantee. Niagara Stamp Co., Niagara-on-the-Lake 62, Canada.

FREE! Powerful Magnifying Glass for 5c Post. Bargain lists and approvals. Jamestown Stamp Co., Dept. 202, Jamestown, New York.

300 STAMPS For Only 10c! This mammoth value includes Airmails, Pictorials; stamps from strange countries cataloguing up to 25c each!! Also approvals. Mystic Stamp Company, Camden 55, New York.

65 ALL Different U.S. Stamps includes 19 Century, Commemoratives, Airmails and \$5.00 Stamp Only 10c. Approvals. Willett Co., Box 511M, Port Chester, N.Y.

NUDES Set; Colorful approvals—10c! Atlas. 2830-P Eisenhower, Racine, Wisc.

FREE Stamp Collection:—100 different stamps from Europe, Africa, Asia, Scandinavia, Balkans, etc., 3c to approval applicants. Tatham Stamp Co., Springfield 50, Massachusetts.

MINT King George Coronations from 5 different British Colonies only 10c with approvals. Walter Welles, Box 1246-V, Church St. Station, New York 8.

"WOW! 203 All Different Germany 15c" Zeppelins, Semi-Postals, Airmails, High Values. Big bargain lists and approvals included. Jamestown Stamp, Jamestown 509, N. Y.

PAY Less—Get More—Packets by country or subject—Mammoth list free—introductory special 100 different Air Mails regularly 1.10—only 40c. Econopackets, Box 168, Riverside 22, Calif.

100 DIFFERENT Beautiful Pictorials 50c. Scott, 2653 Midwood, Toledo 6, Ohio.

125 DIFFERENT U.S.—\$1.00, Approvals. Utechts, 1143A North Keeler, Chicago 51.

FREE Stamp Zoo! Rhinoceros, Snake, Giant, Pygmy, Emu, Kangaroos, Koala-bear, Kookaburra and other wild animals. Free with exciting approvals. Niagara Stamp Co., Niagara-On-the-Lake 52, Can.

50 DIFFERENT worldwide absolutely free, just to introduce our incomparable approvals. Kent Stamp Company, GPO Box 87-zm, Brooklyn, New York.

SAVE unnecessary wear on your album pages, save time, but most of all, save money and buy from our quality approvals. Everything mounted and marked with Scott's catalog number and prices, but at a big discount. First try will satisfy. Rose-land Stamp Co., Dept. 9-A, Spring Lake, Michigan.

FINE Approvals. Fast, personal service. What countries do you prefer? I'll send their stamps. Milton Skinner, 438 Locust, Long Beach 12, California.

GIGANTIC Collection Free—Includes Triangles—Early United States—Animals—Commemoratives—British Colonies—High Value Pictorials, etc. Complete Collection plus Big Illustrated Magazine all free. Send 5c for postage. Gray Stamp Company, Dept. PR, Toronto, Canada.

APPROVALS U.S. & Foreign, O.K. Stamp Co., Box 326, Marshfield, Wisc.

222 ALL different 10c to approval applicants. Jayne, Gravesend Sta. Brooklyn 23, New York.

FREE. Scott's International Album, other premiums. Details with approvals. Raymax, 35-X Maiden Lane, New York City.

OPPORTUNITY! Gorgeous lot with Triangles, Giants, Midgets, Flags, Airmails and Railroad Stamps. Also, Guiana, Brunei, Mongolia, Sarawak, Etc. Everything only 10c to approval applicants. Evden, Valley Stream 15, New York.

1/2-1-2c APPROVALS. Bargains Galore! Cole, 43G Rine-w-lt, Buffalo 21, N. Y.

500 MIXED U.S. airs, coils, etc. 20c. Sibley, Mendon, Mass.

FREE Bahawalpur Jubilee set to approval applicants. Lighthouse, Box 1516, Colorado Springs, Colorado.

GERMANY, Austria, France—beautiful mint approvals for International Part II and Master Global Albums. Henry Faville, Box 2005, Madison 5, Wisconsin.

ARABS riding camels, bicolored beauties with approvals 10c. Hart, Box 204, Racine, Wisconsin.

1000 DIFFERENT British colonies \$7.00, 300 different \$1.50 For advanced collectors Free illustrated mailsales catalogue. Imre Rozsa, 69-46 136th Street, Flushing 67, New York.

INDONESIA—10 mint bicolored dazzling pictorials—just 5c to introduce our famous approvals. Viking, 130-PP Clinton St., Brooklyn, New York.

UNITED States—40 different 10c; 40 different Commemoratives 25c. No approvals. Seidenberg, Appleton 944, Wisconsin.

100 DIFFERENT 10c. 1000-\$1.00, 5000 Mounted \$12.50. Ransom, 1333 Pontiac, Ann Arbor, Michigan.

TRIANGLES, Airmails, Bicolors, USA stamp centenary, Columbus, Trieste, Garibaldi, fortresses, large historical pictorials, 3c to Approval Buyers. Fortune Stamp Company, PSM3, Washington 10, D. C.

FREE topicals! Tropicals! Generous pictorial assortment 10c. Bristol Stamps, Collinsville, Conn.

OLD scarce U. S. seconds on approval. Slightly defective, bargain prices. Hearnfeld, Clintonhill Station, Newark 8, N. J.

SENSATIONAL Guaranteed Bargains! 1,000 Different, colorful attractive mounted stamps, 1 & 2c each. Rushed immediately. Niagara Stamps Niagara-on-the-Lake 72, Canada.

FREE Sample—Interesting, informative. Illustrated! National Stamp News, Anderson, South Carolina.

FREE, Valuable mystery gift. Approvals. Raymax, 37-X Maiden Lane, New York City.

GIGANTIC surprise packet, containing hundreds, catalog to 40c each, only 10c—bargainful approvals—Dresel, P.O.B. 270-R, New York 25, N. Y.

SAVAGES—African "Beauties"—"Queer Countries"—Free with approvals! Saxon, Vista, California.

UNITED States—58 different including 8 airmails, 15 commemoratives, 10c. Approvals. Sunsets, Box 47, South Gate, Calif.

1/3-1-2c-APPROVALS in books. Povilauskas, 212 East 3 Street, New York 9, N. Y.

PACKETS world different 2,000-\$3.00, 3,000-\$6.00, 5,000-\$15.00, 10,000-\$47.00, 20,000-\$200.00 P.O. money orders please. Smoky Mountain, Box 2011P, Natural Bridge Station, St. Louis 15, Mo.

PENNY Approvals by country. M. H. Hoerning, 102, Farmington, Ark.

FREE Mint Set Manchukuo, Approvals. Eagleco, 6004 Columbia, Philadelphia 31, Pa.

100 DIFFERENT Spain 25c. Penny approvals included. Reed, Box 980, Chicago 90, Illinois.

UNITED States approvals. Select copies used, mint. Kingsbury, So. Woodbury 3, Vt.

APPROVALS 1/2c up from 33,000 collection. Chur, Box 245, Buffalo 12, New York.

TRUMAN, Hitlers, latest Hungary—San Marino Triangles, others; Free to "Approval Buyers". William Deems, Ravenswood, West Virginia.

IS Your Hobby Too Expensive? Are high prices keeping your collection on the shelf? Try our 1c and 2c foreign approvals in books of 1,000 or U.S. at bargain prices. Clark Stamp Co., Dept. U5, Muskegon Heights, Michigan.

ROOSEVELT Triangle, 25 others, 3c with approvals. Simmons, Friendship, Me.

UNBEATABLE! Nauru, Brunei, Cayman, Nyasaland, Liberia, Sarawak, Borneo, over 100 different. Everything 10c with approvals. Albert Ftacek, Route 1-PS, Ottawa, Ill.

ARMENIA, Hongkong, Siam, Ukrania, Mongolia, Free with Approvals. Choice Stampco, Box 2126, Miami 40, Florida.

SENSATIONAL U.S. Confederate States catalogue free. Stone, 45-S Bromfield, Boston 8, Mass.

FREE, 250 stamp hinges and 20 different Canada with approvals. Jaydee, 218 West Dickinson, Grand Rapids 7, Michigan.

MAGNIFICENT! Nineteenth Century U. S. Plus Civil and Spanish War Revenues, 20 Different 10c To Approval Applicants. AAA Stamp Company, Arcade Building, St. Louis 1, Missouri.

SWEDEN 15-25c, 35-50c, all different. Bengt Liljestrand, 339 E. Main Street, Rockaway, New Jersey.

FREE! Unique illustrated bargain catalog listing hundreds mixtures, packets, accessories. Rare buys galore! Towerco, 1714 South Ashland, Chicago 8.

STAMPS of Tibet & Nepal set of 5 denominations each country postmarked \$2.00. Nirvana, P.O. Rhenock, Sikkim, India.

1000 COLORFUL worldwide off paper \$1.00. 500 Chinese pictorials \$1.00. Grab-bags 25c. Midwestern, 4628 Hollywood Ave., Milwaukee 11, Wisconsin.

"MONACO Nudes" (5), 10c with approvals. Royal Stamp Company, Tamaqua 2, Penna.

## 29 ANTIQUES, RELICS & INDIAN GOODS

ANTIQUE, Firearms, pistols, percussion, flintlock, list 25c coin. Westbrook, 738 Royal Street, New Orleans 16, Louisiana.

6 ANCIENT Indian Arrowheads \$2.00. Grooved Tomahawk \$3.00. List free. Lear's, Glenwood, Arkansas.

## 30 MINERALS & PRECIOUS STONES

GEMS, minerals, free information on cutting, collecting, enjoying. Send postal. Gembooks, Palmdale 4, California.

"GENUINE" red Arizona Rubies (Garnets). Send quarter for packet. Bitner's, Box 1025C, Scottsdale, Arizona.

GEMSTONES, Mineral specimens, Every variety. Lowest prices. Postcard brings free booklet. Plummer's, 4720 Point Loma Ave., San Diego 7, Calif.

GEMS, Precious and semi-precious, genuine, from world-wide sources. Deal Direct, no overhead, save money. Catalog 10c. Hill Co, 5450-K Portland Rd., Salem, Ore.

THEY lived 60,000,000 years ago. Cretaceous fossils (Exogyra arietina) 2 for 25c, 10 for \$1.00. Hawkins, Route 4, Georgetown, Texas.

## 31 HOBBIES, COLLECTIONS

INVENTING can be an interesting and profitable hobby. Write for complete particulars. Institute of American Inventors, Dept. 30-E, 631-E St., N. W., Washington 6, D. C.

50 DIFFERENT army embroidered patches \$1. Other bargains. Insignia Mart, 703B Broadway, N. Y. C. 3.

WANTED—Cigarette, tobacco cards. Write Charles Bray, East Bangor, Penna.

EXCITING Hobby; collect Authentic Military Patches, Insignias, Campaign Ribbons, Navy Rates, etc. 57 assorted \$1.00. Free gift. Pritt, Dept. S-7, 12 West 27th, N. Y. C.

LEATHERCRAFT is fun especially now. Make your own leather belts, billfolds, purses, hats, dresses, blouses from durable low-priced leathers. Supplement your seasonal wardrobe with leather articles. Free Catalog. Tandy Leather, Box 397-D, Tulsa, Oklahoma.

NAZI, Soviet, Campaign ribbons, big packet. Lists \$1.00. Medcrafts, 1923 34th St. SW, Calgary 3, Canada.

UNUSED matchbook covers—100 different \$1.00—36 page Catalog 25c—Charles Edelman, 1311P East 84, Cleveland 3, O.

## 32 PHOTO FINISHING, PHOTOCOPIES, ETC.

TWO Prints each good negative, 8-exp. 35c; 12-exp. 50c; 16-exp. 65c; Reprints 4c. Mayfair Photo Service, Box 617-A, Toledo, Ohio.



**WE Will Copy Your Favorite Picture.** Send picture—receive new negative, plus 8x10 studio print, by insured mail—only \$2.25. New Photo Studios, Box 381, Smyrna, Delaware.

35 MM—36 Exp. Develop & Jumbo Print each \$1! Guaranteed Quality—Free Mailer. Flash Photo, Box 36P, Parkville Sta., Brooklyn 4, N. Y.

7-HOUR Service, custom quality at no extra cost. 8-exposure roll 25c; reprints 3c. The Photo Nook, Box 2134, Billings, Montana.

**YOUR** eight exposure roll developed with three prints each good negative 50c. Two each 40c, one each 30c. Reprints 3c. Postage appreciated. Billfold size prints from print or negative. 20 for \$1.00. L. A. Eastman Studio, Bode, Iowa.

**ENLARGEMENTS!** Eight 5x7's or five 8x10's. \$1.00. Wilart Enlargers, Box 967, Little Rock, Arkansas.

**ROLL** developed and 4x6 or 3 1/4x4 1/2 oversize glossy velox prints 8 exposure 40c. 12 exposure 60c, 16 exposure 80c. Hagner Photo Service, 1318 West Columbia Avenue, Philadelphia 22, Pa.

**"BILLFOLD Photos"** 20 for \$1.00. Ideal for application or student exchange. Send any size photo or negative with money. Photo-Print, Box 906, Enid, Okla.

**SENSATIONALLY New**—16 oversize contact prints or 8 plastic bound superpak album jumbo prints with your first roll 25c. Album Studios, Weatherford, Okla.

**JUMBO** prints, 8 exposure roll 40c, 12—55c, glossy reprints 5c. Special custom double weight dull jumbos 8c. Western Photo, Dept. PS73, Box 298, San Francisco 1, Calif.

**TOP Quality Fast Service.** 8 Exposure Roll Jumbo Finish Super Pak Album Only 35c—16 contacts 40c. Free Mailers, Complete Photo Finishing Service. Satisfaction Guaranteed. Grand Fotos, GPO Box 1410, New York 1, New York.

### 33 MOTION PICTURES, SLIDES SOUND EQUIPMENT

**GUARANTEED** Fresh 8mm roll, magazine; 16 mm roll, magazine movie film. Color, b&w. Free catalog. Eso-S, 47th Holly, Kansas City 2, Missouri.

**MOVIE** Camera Film: 8 mm roll \$1.50, 16mm 100' \$3.00. Free processing. Better Films, 742 New Lots, Brooklyn, N. Y.

8-16MM. Silent-sound films. Complete rental library. All latest subjects. Free catalogue. (sample film 10c). Garden Film, 317 West 50th, New York 19.

**FREE** Giant catalog of 8mm & 16mm films for home movie enthusiasts. Films for every occasion. Lee Stann, Dept. PS7, 11 Willard Ave., Mt. Vernon, New York.

**WILD** Life Films. Exciting, dramatic action in the natural habitat of animals of forest and plain. 8mm or 16mm in beautiful color or B & W. Also 2"x2" color slides. Write for free illust. literature. Wild Life Films, 5151BG Strohm Avenue, No. Hollywood, Calif.

**TAPE** Recorders, Tapes, Accessories. Unusual Values. Dressner, 624 East 20th Street, New York City 9.

5,000 **NEW-Used** 8-16mm. Silent-Sound Films. International, 2120 Strauss, Brooklyn 12, New York.

**RENT** 16MM sound films 50c reel. Large selection; free catalog U. C. Film Service, 128 Chestnut St., Roselle Park, N. J.

**EXCHANGE** 16mm. sound films, also for sale. Bedner, 5300 So. Talman, Chicago.

**EARN** up to \$15.00 daily with your movie projector! Metcalf, 10806 Glenroy, Chicago.

### 34 CAMERAS, PHOTO SUPPLIES

**BASS** Says: Trading cameras a national habit since 1910. Write to Bass the old "Horse Trader." A postcard will do. Simply say: "Bass, I have and I want . . . How much will you allow me?" Satisfaction guaranteed. Bass Camera Company, Dept. AG, 179 W. Madison St., Chicago 2.

**EARN** Money Selling Cameras. Send for Free Dealers Bulletin. University Camera Exchange, 11-D Waverly Place, New York 3, N. Y.

**GE PR-1** memory meters, \$23.97. . . Weston Master II's \$19.98. Factory Boxed Originals. Free Catalog. Dealer's Mart, Dept. S6, 11 Willard Ave., Mt. Vernon, N. Y.

**BUY** wholesale nationally advertised cameras, photo supplies, thousands other products at big discount. Free "Wholesale Plan." American Buyers', 629-TT Linden, Buffalo 16, N. Y.

**NEW**—Argus C-4 W/Case \$79.95, Kodak Signet \$67.50, Argus C-3 Telephoto \$44.95. Other terrific savings. Free catalog, Camera Shoppe, Box 601-S, Mount Vernon, N. Y.

**SEND** \$1.00 for mammoth 275-page illustrated catalog. Dollar refunded with first order. Bloom's Photo Supply, 1657-PS Main, Springfield, Mass.

**"ARUBA 35"** camera! Bargain \$6.00. (Details 5c stamp.) Tsuboi, Kamakura 27, Japan.

### 35 MUSIC, INSTRUMENTS & SONG WRITERS

**WANTED!** Poems for musical settings. Write Songwriters' Service, Clifton, N. J.

**POEMS** Wanted to be set to music. Free examination. Send poems. McNeil, Master of Music, 510-PS, S. Alexandria, Los Angeles, California.

**POEMS** Wanted for musical setting. Send poems for free examination. Five Star Music Masters, 646 Beacon Bldg., Boston, Mass.

**POEMS** Wanted for musical setting. Send poems. Free examination. Crown Music Co., 1472 Broadway, New York City 36.

**SONGPOEMS** Wanted. Mail to: Tin Pan Alley, Inc., 1650 Broadway, New York 19, N. Y.

**SONGWRITERS!** Protect your poems and songs! Don't mail anywhere! Write for safe procedure! Song Service, 333 W. 56th, Dept. P.S., New York 19, N. Y.

**SONGWRITERS!** Send poems, songs. Music Service, 243 West 72nd St., PS, New York 23.

**FREE** record—your words with my tune. Free information. Johnny Mack, Dep't. "K", 1094 West 39 Street, Los Angeles 37.

**POEMS** Wanted for musical setting. Send poem for immediate consideration and Free Rhyming Dictionary. Richard Brothers, 46 Woods Building, Chicago 1.

**POPULAR** Songs. How to write and sell them. Write for free booklet Successful Songwriting. Gateway Songs, Box 2470, Hollywood 28, California.

1953 **ACCORDIONS** — Wholesale. Free catalog. American Accordion Center, 5329 Belmont, Chicago.

**ELECTRIC** Guitars, accordions, amplifiers. Wholesale. Free catalog. Carvin, Baldwin Park, Calif.

### 36 RADIO, TELEVISION, SUPPLIES & EQUIPMENT

**MAKE** simple, tubeless, batteryless, distance-getting crystal radios. Crystal and illustrated instructions 25c postpaid. Allen, 427-S, Clinton, Mo.

**ELECTRONIC** Ear—\$1.00. Obeys spoken commands. Turns lights, radios, etc. on or off. Not a toy. Plans—Mail \$1.00 to Dept. S-1, National Industries, Inc., 951 No. LaCienega, Los Angeles, California.

**AMAZING** newly developed, permanently fixed crystal detector with warranty guarantee and complete plans for building crystal radios only \$1.00 postpaid. Allen, 427-PS10, Clinton, Missouri.

**FREE** Radio Tester, Tools, Soldering Iron. Build and keep 15 guaranteed high quality Radios and Test Equipment—only \$19.95 complete. No experience required. Money-back guarantee. Order direct or send for descriptive literature. Free—valuable Radio and TV Repair Guide on request. Progressive Electronics, 497 Union Ave., Dept. PS-7, Brooklyn 11, N. Y.

**CRYSTAL** Operates Loudspeaker. Illustrated Instructions, 25c. Hulet, R4, Lakewood, New Jersey.

**TELEVISION** tubes at lowest prices ever 50c each 6AQ5, 5U4G, 6AL5, 6AU6, 6BA6, 6V6GT, 68c each 6AB4, 6SL7GT, 6SN7GT, 12AU7, 98c 6BG6G. Free price list. Crown Television, Box 194, Hicksville, N. Y.

**LIMITED** Quantity surplus double headphones. High quality. Slightly used. \$7.95 Value. Special now \$2.95 postpaid. Guaranteed. Allen, Dept. PSH, Clinton, Mo.

**EXPERIMENTER'S** plans, diagrams, booklets. All kinds. Free catalog. Dittofax, 5208-B Onacrest, Los Angeles 43.

15 **TESTED** One-tube circuits 25c including "Radiobuilder." Catalog. Laboratories, 1131-T Valota, Redwood City, Calif.

**"CRYSTAL** Radio Booster." Plans and crystal, 25c. Neher, 4308 Iroquois, Long Beach 8, California.

**BUILDER'S** "Construction Plans". Free List. Alena, Box 24, Astoria 6, New York.

**T.V.** Blower. Attaches easily to back cover of set. Lengthens life of parts. Order Now \$7.95 postpaid. TV Aids, Box 8061, Long Beach, California.

**MAKE** Louder crystal radio. Plans, mounted crystal, catwhisker, 25c. Complete kit \$1.00. Mallory, Box 1031-S, Tacoma, Wash.

**NEW!** Simplest capacity relay yet! Uses one tube, no idling power. Ideal for burglar alarms, window displays. Complete schematic, illustrated instructions, \$1.00 postpaid. Not mimeographed sheets. Technix Laboratories, 568RF Riley, Buffalo 8, New York.

**MAKE** Money repairing radios televisions, experience unnecessary. Course, parts, tools \$20.00. Literature free. Stego-tronics, Colchester, Connecticut.

### 37 BUSINESS OPPORTUNITIES

**EXTRA** Money—No Selling—operate vendors. Amazing profits, details Free. Silver King, Suite 221, 622 Diversey, Chicago 14.

**GOOD** Paying Business Silvering mirrors, plating autoparts, reflectors, bicycles, bathroom fixtures, etc., by late methods. No tanks or shop required, outfit furnished. Free Booklet. Gunmetal Co., Ave. E, Decatur, Illinois.

**OPERATE** profitable mail order business. Write Walter Service, 4159-B East 112th, Cleveland 5, Ohio.

**MAKE** money addressing envelopes. Our instructions reveal how. Glen Glenway, 5713 Euclid, Cleveland 3, Ohio.

**IMPORT-Export!** Opportunity, profitable, world-wide, mail-order business from home, without capital; or travel abroad. Established World Trader ships instructions for no-risk examination. Experience unnecessary. Free details. Melinger 17, Los Angeles 24.

**NEWEST** Spare. Full-Time Business. \$5 to \$10 hour possible. Paint with Suede—the finish with touch And eye-appeal. Beautify auto dashboards, signs, radios, toys, figurines, lamps—100, 1 others. Complete. Step-By-Step Instructions sent for no-risk examination. Free details. Coast, 1004-HC, So. Los Angeles St., Los Angeles 15.

\$25 **WEEKLY** Working two hours daily. No canvassing. No manufacturing. Lycke, Box 2471-B, Cleveland 12, Ohio.

**BOOKKEEPERS**, increase earnings operating seasonal bookkeeping service. C.P.A. system. Kern, 4942-B Vineland, North Hollywood, Calif.

**MAKE** Money At Home as renewal headquarters for all magazines. Liberal commissions. No experience—no capital needed. Supplies furnished. Write for Free Catalog. McGregor Magazine Agency, Dept. 510B, Mount Morris, Illinois.

**START** Venetian Blind Laundry. Profitable lifetime business. New Machine. Free Booklet. F.D. Co., 442 N. Seneca, Wichita 12, Kansas.

**ENVELOPES** addressed accurately, reasonably. Fast Service. We have capable addressers in your city. Glenway System, 5713-X Euclid, Cleveland 3, Ohio.

**VENDING** Machines—No selling. Operate a route of coin machines and earn amazing profits. 32-page Catalog Free! Parkway Machine Corporation, Dept. 73, 715 Ensor St., Baltimore 2, Maryland.

**MAKE** Money spare or full time, casting Metal Toys and Novelties. Big wholesale and chain store demand for Autos, Soldiers, Ashtrays, Banks, etc. keeps manufacturers busy. Production moulds furnished for up to 100 and more castings per hour. No experience or special place necessary. Write for information and illustrations of patterns needed. Metal Cast Products Co., Dept. E, 1696 Boston Road, New York 60, N. Y.

137 **PLANS** for starting home business. Details: Elite Co., 220-A Grand St., N. Y. 13.



**TROPICAL Fish supplies.** Save! Representative your area will supply. Nmoae, Box 4635, Los Angeles 24, California.

**RECAST** old batteries into new. Latest achievements. Battery Laboratories, Minneapolis.

**LIVING** miniature ("Ming") trees only 10 to 20 inches tall. Grow at Home. Big Profits! Spare time opportunity. Fascinating! Amazing! Write or Free Seed and Plan. National Nursery, Dept. CC, Inglewood 4, California.

**BREED** Rare Tropical Fish at home. Earn Big Money! Learn Secrets! Help fill huge demand. Amazing Opportunity! Free Plan. Tropicals, 1008-G Los Angeles St., Los Angeles 15.

**ADDRESS** and mail postcards. Make over \$50 week. Send \$1 for instructions. Lundo, Watertown, Mass.

**"MAKE Products"**—sell Mailorder—Formula Catalogue Free—"Imisco," 6347 Parnell PS-7, Chicago 21, Illinois.

**ADVERTISING** book matches—Cash in on big demand—sell Union Label matches. Cuts for all businesses and political parties—Free powerhouse selling kit—low prices—protection guaranteed on repeat orders—Cash commissions. Superior Match Co., Dept. PX-753, 7530 Greenwood, Chicago.

**LEARN** metalizing baby shoes, gifts, etc. Bronze, gold, silver, Folio Free, Kik-tavi, 7217-PS South Broadway, Los Angeles 3.

**TYPISTS** and long-hand addressers needed by national mail order concern. Work evenings at home. International Enterprises, Stillwater 25, Minnesota.

**PEARL** Finishing. New amazing home, full-time business. Free success plan. Pearlco, Box 73136, Los Angeles 3.

**"MAKE Perfume"** Catalogue Free—"International," 6347 Parnell-PS-7, Chicago 21, Illinois.

**LEARN** Sewing Machine Repair, electrify, rent, trade, sell. Make up to \$150 week spare time setup. Motor kits, zigzag machines, etc. wholesale. Free Particulars. Taylor Service, Hamilton PS-7, Ohio.

**FIX** typewriters. Free booklet describes our modern, inexpensive home-study course. Factory methods taught. Write Typewriter, Building 4, Tarentum, Penna.

**NATURAL** Molding Rubber. Free Sample. Supplies—Flock—Tinsel. W. Wooley, 115 Donald, Peoria, Illinois.

**MAIL** Order Business using profitable Free Advertising Method reaching 66½ million. Revealing information free. H. G. Seidel, 7070 Hollywood Blvd., Hollywood 28, California.

**AMAZING!** Two business fields growing tremendously. Startling Success Plan. Free! Trends-A37, Box 5564, Crosstown Station, Memphis, Tennessee.

**BRONZED** Baby Shoe Metallizing equipment. New and used. Big selection of metal and onyx mountings. Free catalogue. Hollywood Bronze Supply, Dept. PA, 1624 E. First Street, Los Angeles 33, Calif.

**HOW** to Raise the Money You Need. Free Details. Enterprise Bureau, Syracuse 2-S, New York.

**PROFITABLE** mail order business information free. Buckner, Box 175, Mount Pleasant, Texas.

**ELECTROPLATE** for big profits with famous Easyplater Process. \$3.50 buys complete outfit Box 293-4, Red Lion, Pa.

**MAKE \$6.73** Every Time You sell one—and they're amazingly easy to sell! We have new Adding Machines in original factory cartons you can sell for only \$14.95 and you make 45%. They're executive model portables, precision built with automatic clearance, direct subtraction, fully guaranteed. Send for life size color photo with full details. Write today to Lightning Adding Machine Co., Inc., Dept. PS-15, 1260 West Second Street, L. A. 26, California.

**"MONEY** Bulletin" magazine shows how to make money in home mail business. Sample 10c. Costar, G.P.O. Box 972, New York 1.

**START** A Buying Service, buy wholesale thousands nationally advertised products. Make big profits selling at sizeable discounts. Postcard brings details. American Buyers, 627-T Linden, Buffalo, N. Y.

**HOW** and where to obtain Capital? Free details. Star Service, Wapakoneta, Ohio.

**THRILLING** Profitable Home Business. Make fast-seller chenille monkey trees, dolls, flowers. Terrific holiday demand. Information free. Velva, Bohemia 17, N. Y.

**FREE** Booklet reveals amazing secrets behind 301 new profitable enterprises! Many mailorder! Includes confidential instructions for starting wholesale buying service. Deumant Business Surveys, 79-S Deumant, Kenmore 23, N. Y.

**WANTED!** Home Producers! By Manufacturers in our Clearing House Service. Become a sub-contractor, casting plastic products for these companies. Thousands of easy-to-make items required for consumer and industrial use. Cash in at home, without previous experience. Write Plastic Service Associates, Dept. PS2, East Boston 28, Mass.

**TO \$35.00** Weekly. Spare Time. Home Operated Mailorder Business. Successful "Beginner's" Plan. Everything supplied. Lynn, 10420-C National, Los Angeles 34, Cal.

**SELL** books by mail! Wholesale catalog. 25c. Monarch, Auburn, New York.

**MAKE** Tough, Durable plastic—1c lb. Makes attractive floors, walls, built-ins, roof. Build good home \$150.00 room. Bays Laboratory, Oklahoma City 9.

**WE** Love our mailman—He leaves over \$1000 monthly in our rural mailbox. My college professor husband drafted a scientific plan for a home mail-order business. It pays. We bought a Texas ranch, live as we always wanted to. Now we sell the "Ranch Mail Order Method". Write: Eveningshade Ranch, Helotes 3, Texas.

**RAISE** Earthworms: Easy, Profitable. Free Literature. Earthworm Gardens, Dept. D, 224 W. Valley, El Monte, Calif.

**MONEY** in new greaseless doughnuts. Start in kitchen. No smoke. Sell stores. Free recipes. S. Ray Co., 3605 South 15 Ave., Minneapolis 7, Minn.

**ARE** You Tired Working For Someone Else? Be your own boss in good paying mail order business. Complete success details send \$1.00. Kayel Sales, Box 1388, Milwaukee 1, Wisconsin.

**LIQUID** Rubber, make flexible molds. Free Sample. Chaney, 1130 E. 16th St., Jacksonville 6, Fla.

**EARN** \$15,000-\$30,000 annually. Franchise protected. Guaranteed minimum \$12,500 or money back. Live at home. No merchandise to buy. Self-employed. One of most exclusive and noncompetitive businesses in United States and Canada. Send 50c for explanatory book. Money refunded when book returned. Harrell & Company, Box A-2, Louisville, Illinois.

**MAKE** Perfumes At Home. Write. "Carey Laboratories," 1914 Chouteau PS-7, St. Louis 3, Missouri.

**SPECIALIZED** Magazines help You to greater success. Latest copies of business, trade, professional, educational, sport, hobby, baking, chemistry, dairying, electrical, food, garden, horticulture, insurance, juvenile, lumber, medical, novelties, optical, pets, real estate, selling, travel and others covering All interests. List Free. Commercial Engraving Publishing Company, 34S North Ritter, Indianapolis 19, Indiana.

**OPERATE** "Escalator" Mailorder system, selling our products or any products. Fastest, most revolutionary mailorder system known. Write: Selbyco, Decatur 170, Ill.

**NEW** Exceptionally profitable plans, ideas for home operated mail business. Rush name, Miller, 1772-R Carlyon Road, East Cleveland 12, Ohio.

**POPCORN** and Potato Chip equipment. Long Eakins Company, 5363 High, Springfield 99, Ohio.

**YOUR** Own business. No investment required. No selling. No Mfg. Make big money. Particulars \$1. Effanee, Box 145, La Grange, Illinois.

**BUY** Wholesale. Make, save money. Sensational details. Younge's, Kent, Ohio.

**50 PLANS** for home mail business. Proven money-makers. Personal Help assures success. Verdo, Box 37B, Huntsville, Mo.

**PROFIT!** Without Investment! Through our Watch-Clock-Jewelry Repair Service. Inquire. Modern Technical Supply, 55-PS West 42nd Street, New York 36.

**\$50.00** AN hour. Unusual, spare time home business. Johnson, 351-D, Ithaca, New York.

**MAKE** flexible molds! Cast plaques, bookends, figurines! Free sample! H. Tooker, 630-A Chestnut, Hamilton, Ohio.

**MAKE** Rubber Stamps, repair dolls, learn invisible reweaving. Molding Latex. New Low Prices. Catalogue of "40 Ideas," Universal, Box 1076-B, Peoria, Illinois.

**\$15.00** THOUSAND, highest prices addressing envelopes at home—longhand, typewriter. Almon Torrey, Rowley, Mass.

**START** your own profitable home mail-order business! We supply everything! Write today! Studio Products, Box 564-"D," Glendale 5, California.

**HOME** business. Processed flowers live years. \$2.00. Literature free. J. Huntington, Box 838, Honolulu, Hawaii.

**PROFITABLE** Home business, electroplating novelties, giftwares, autoparts, mirrors. Easy inexpensive home processes. Free booklet, Tyco Metals, Box 13231-CM, Houston 19, Texas.

**\$250** WEEK reported! Free book "505 Odd, Successful Businesses." Work home! Expect something Odd! Pacific-36C, Oceanside, California.

**SELL** fine household products during spare time. Big profits. Free samples. Beautiful bonus gifts. Jova Company, Edwardsville, Illinois.

**MAKE** Money mailing cards; circulars. Pleasant; Profitable. Paton, Box 55-A, New York 23, N. Y.

**\$200** WEEK Possible! Sensational new hand cleaner. Manufacture, distribute. Easy. Free plan! Keenelo, 2445-D Larimer, Denver 2, Colorado.

**SELL** Religious Items By Mail—Millions of prospects. Big Profits. Everything Furnished. Literature Free. Kelley, Box 1315B, San Francisco, California.

**NEWSPAPERS.** Turn them into cash. Eighteen methods. Instructions 50c. Charles Company, 12-EBA, Norwood, Ohio.

**"INCOME"** from local information. No Selling. Write Neherco, LaVerne 6, Calif.

**BUY** it wholesale. Manufacturers. Distributors. Over 850,000 items. Literature free. Olsen, 1231-B East Third St., Duluth 5, Minnesota.

**COLORGLAZED** Concrete pottery made without molds. Patented method. Cemetery products, novelties, tiles. Basement leak-sealing. Money-making projects. Booklet, details free. Men only. National Potteries, Grand Rapids, "Minnesota."

**START** Your Own thrilling mail-order business, on small capital; brand new plan. Write Paragon, Box PS-2194, Houston 1, Texas.

**FREE** Vending Machines; if used to sell our profitable nuts. Continental, Box 1361-B, Milwaukee 1, Wisconsin.

**PRINT** Without A Printing Press. Big Money! See page 14.

**START** Exciting New Mail Order Business! No inventory or advertising. Constant reorders, \$5. Manuscript free with instructions! Adelbert Torrey, Rowley, Mass.

**\$46** FROM Square Foot Plywood; Jigsaw necessary. Write: Woodart, Bridgewater, Mass.

**EARN** Extra Money weekly mailing circulars for advertisers. Complete instructions—25c. Siwaslian, 4317-B Gleane Street, Elmhurst 73, New York.

**EARN** Money With Typewriter—Sewing Machine! Details Free. Edwards, 3915-PS, 12th, Des Moines 13, Iowa.

**EARN \$2.00** Hour! I do—making Sandals. Youngs, 1308-PS South First, Arcadia, California.

**EXCITING** Liquid Marble information. Free Catalog. Write: Bing Products, PS-753, Watertown 72, Mass.

**"EVERYBODY** Likes Candy." Learn to make professionally. (Our 43rd year.) Ragsdale Candies, East Orange, N. J.

**START** home jewelry making business. No equipment. All supplies wholesale. Terrific profits. Eberts, Box B183, E. Orange, New Jersey.

**SUCCESS?** Profits? "Mail Order Enterprises" for aspiring inventors, writers, everyone. Literature Free. Jones Agency, 405 W. Fulton, Grand Rapids, Michigan.

## 38 MONEYMAKING OPPORTUNITIES

**NOTARY** Public commands more money. Be One. Stationers, Helotes, Texas.



**DETECTIVES Earn Big Money.** Experience unnecessary. Detective Particulars free. Wagoner, P-125 West 86th, N. Y. 24.

**\$10,800 PROFITS!** Your own Mailorder Business! No Capital Risk! "Success Plan" (worth \$2) Free! Write today! Treasury, 709 Webster Ave., New Rochelle PS-13, N. Y.

**SELL Titania gems;** \$9.75 carat wholesale. More brilliant than Diamonds. Free catalogue. Diamonite, 1404-S Mitchell, Oakland 1, Calif.

**SPARETIME Profits Taking Subscriptions.** All Magazines. Wholesale Catalog Free. Cassell Agency, Westfield 1, N. J.

**SIDELINE Salesmen—Auctioneers—Agents—Free wholesale list—watches \$3.88.** Jewelry sets \$4.20, also name brands jewelry, merchandise, everything guaranteed. Casey Hofeller Corp., Dept. 90, 618 Jackson, Chicago 6.

**START your own business on shoe-string,** and earn a substantial income by mail, in your spare time at home. Full details free. Standout Products, 141-B North La Brea, Los Angeles 36, Calif.

**FREE Samples Personalized Post Cards.** Earn money at home details. Vibra-Whirl, 6006 Floyd, Houston 7, Texas.

**START A Buying Service,** buy wholesale thousands nationally advertised products. Make big profits selling at sizeable discounts. Postcard brings details. American Buyers, 630-T Linden, Buffalo, N. Y.

**FREE Booklet reveals amazing secrets** behind 301 new profitable enterprises! Many mailorder! Includes confidential instructions for starting wholesale buying service. Deumant Business Surveys, 83-S Deumant, Kenmore 23, N. Y.

**EARN Money Evenings,** copying and duplicating comic cartoons for advertisers. Adservice, Argyle 2, Wisconsin.

**WE Pay Cash For Bostops, Labels, Wrappers, Coupons, etc!!** Particulars free. Bostops, PS-983-E Main, Columbus 5, O.

**"FLOATING Henryburger" Systems** Franchise. Rare Opportunity. Small Investment. Box 936PS, Wichita, Kansas.

**FREE! Your own mailorder business!** Everything furnished! No investment! Terrific profits! Write today. California Vitamins, 2908PS Beverly Boulevard, Los Angeles 57, California.

**AMERICA'S largest selling mail order plan,** 25c complete. Satisfaction guaranteed. David S. Lee, Box 142, Hampton, Va.

**CEYLON Gems,** so lovely, everyone buys. Begin \$12 collection airmailed. John Rajapakse, Negombo, Ceylon.

**\$300 WEEK possible.** Complete plans 50c. Norval Roland, Langhorne, R.D.#4, Pa.

**WIN contest money.** General Contest Bulletin gives hundreds of tips. Lists current contests and rules. Sample 25c. General Contests, 1609-A East 5th, Duluth, Minnesota.

**FREE Book "505 Odd Successful Businesses,"** Work Home! Expect something Odd! Pacific-35C, Oceanside, Calif.

**HIGHLY Profitable Home Work—Doing Addressing, Mailing,** Darnell, Box 586, Jackson, Tenn.

**MANUFACTURE Rhinestone and Pearl Jewelry at home.** Latest creations, tremendous profits, no skill needed. Postcard brings illustrated catalog of settings, stones, etc. A. V. Cutt Co., Inc., 210-H Fifth Ave., New York 10, New York.

**WANTED: Typewriter owners.** Make handsome profits. Write today. Groves Company, 682 Hastings 3, Nebraska.

**WEEKLY extra income mailing circulars** for advertisers. Complete instructions 25c. Enterprise, 21-B Sanford, Boston 26, Mass.

**\$35 WEEKLY addressing envelopes.** Instructions \$1, refundable. Adservice, Spring Valley 36, New York.

**MAKE to \$4.50 hour doing common pen lettering.** National Artists, 801½-C North Marsalis, Dallas 3, Texas.

**DO you want money, a home, your own business?** Information free. L. Minkoff, Box 52, Flushing, New York.

**FOR Pleasure Or Profit.** Complete business plan and instruction book: perma-nize, ceramize, porcelainize, metalize baby shoes, cloth, keepsake items. No equipment, firing, or baking. Send 25c to Jay Sales, 192 North Clark, Chicago, Ill.

**\$\$\$ IN Personalized Baby Record Books.** Sell By Mail Use Same Literature We Do. No-Co-Ro, Oakland 6-P, Calif.

**WE Pay Cash Commissions! Moneymaking Homework!** Hirsch, 1301B Hoe, New York City 59.

**YOUR ideas are worth big money.** Experienced consultants will develop and sell your ideas. Patent protection. Get quick professional results. Send for free information. Scientific Enterprises, Box 2100C, Cleveland 8, Ohio.

**SAVE money—Make money,** with the Wholesaler Plan. Write McCairns, Box 432, Detroit 31, Michigan.

**START profitable home operated mail-order business.** We fill orders, no stock to carry. Complete details, \$1.00. Vali's, Box 1042, Muncie 10, Indiana.

**SELL printing by mail!** We fill orders. Free plans, samples. Sutton Printing, Box 853-N, Waycross, Georgia.

**VISIT junkyards.** Pick up items and resell instantly to me for 200% profit. Send \$1.00 for plan. Refundable first deal. Willson, 1425 Roscoe, Chicago 13, Illinois.

**STOP Money Worries.** Sell Merchandise by Mail. Own profitable business. Use our stock. Write, Specialty Products, Box 166-PS2, Mt. Holly Springs, Pa.

### 39 FORMULAS, PLANS, ETC.

**FORMULAS—All kinds.** Latest products. Literature free. Kemico, Park Ridge 15, Ill.

**FREE Formula Catalog.** Anything analyzed \$35.00. Western Chemical, Salem, Ore.

**ANY Formula \$3.00.** Chemical Instruction Sheet—catalog 10c. J. Belfort, 216 W. Jackson Chicago 6.

**LATEST and best in modern manufacturing formulas since 1897.** Literature free! Lescomb Miller, Chemist, Tampa, Fla.

### 40 PLASTICS

**PLASTIC Sheets, Rods, Tubes; etc.** Free List. Plastic Supply Co., 2901 N. Grand Blvd., St. Louis 7, Mo.

**LUCITE, Plexiglas.** Any size sheets masked Square foot (12 x 12) cost 1/16" \$1.20; 1/8" \$1.40; 3/16" \$1.75; 1/4" \$2.08. Include 10% postage. Almac Plastics, 600 Broadway, N. Y. C.

**PLASTICS home-craft course for Men and Women.** Tells and shows how to make hundreds of fast selling plastics products. All plastics and materials for 23 projects included in course. No special tools needed. Course pays for itself. Write for Free booklet. Interstate Training Service, Dept. D2-G, Portland 13, Oregon.

**PLASTIC—Fiberglass materials in any quantity** for boat coatings or auto bodies. Van Horn Plastics, 1905 Ingersoll, Des Moines, Iowa.

**PLASTICS—Lucite, Plexiglas, Acetate, Vinylite, Polyester-Fiberglass.** Low, low prices. Value-packed, bargain-filled catalog—10c. Airmailed—25c. Gem-O-Lite, Box 6855P, North Hollywood, California.

**LAMINATED Plastics,** special parts, projects, dull jigs etc; Free Estimate. Harry Smith Specialties, Box 9378, Akron, Ohio.

**PLASTICS—Cements—Dyes—Findings—Carvings.** Wholesale prices, 64 page catalog free. "Trace & Carve" pattern book for carving and coloring fish, birds, animals, only 35c. Taylor & Art, Inc., 1710 East 12th St., Oakland 6, California.

**NEW liquid casting plastic.** Clear, colors. Embed flowers, insects, coins. Saw, drill, carve. Send 25c for Castolite Creations Manual and proved Success Plan showing how to make money at home. Castolite, Dept. H-102, Woodstock, Ill.

### 41 CHEMICALS & APPARATUS

**NEW Idea Chemical and Apparatus Outfits for Home Experimenting** Photo-Scales, Microscopes, Chemicals, Biological and Laboratory Supplies in Small Quantities. Catalog 25c. Established 1931. John H. Winn, 124-B West 23rd Street, New York, N. Y.

**SPECTROSCOPE for quick chemical analysis** \$3.00. Book 200 electric stunts \$1.00. Cutting Sons, Los Altos, Calif.

**CHEMICALS and apparatus for industrial, analytical, and private laboratories.** Catalog 25c. Dept. M-26, Biological Supply Co., 1176 Mt. Hope Ave., Rochester 20, N. Y.

**ILLUSTRATED Catalog: Chemistry, mineralogy, biology.** 10c. Tracey Laboratories, Evanston, Illinois.

**AMAZING New Book of Science Experiments.** Formulas and catalogue of Laboratory Supplies. Only 25c. National Scientific Co., Dept. 15, 2204 W. North Ave., Chicago 47, Illinois.

### 42 HELP WANTED

**FOREIGN & Latin American Employment 1953 "Foreign Service Directory"** gives Up-To-Minute Facts on Military & Civilian Construction, Government Jobs, Major Oil Listings, Aviation, Transportation, Steamship Lines, Mining, Importers, Exporters. How-When-Where to apply, application forms. Hot List Firms Hiring. \$1.00 postpaid. Global Reports, Box 883-S, Hollywood 28, Calif.

**ALASKA!! Last American Frontier.** \$1.00 brings 1953 Business Directory & Government Map, Military & Civilian Construction; Homestead & Highway facts; Mining, Aviation, Fur Farming, Grazing, Timber, Travel directions. List of firms hiring. How to apply. Alaska Opportunist, Box 92-S, Hollywood 28, Calif.

**ADDRESS and mail postcards.** Make over \$50 week. Send \$1 for instructions. Lundo, Watertown, Mass.

**\$1,000,000 FOREIGN & Domestic Construction Projects published Monthly,** gives Contractor & Locale, How-When-Where to apply with application form. \$1.00 postpaid. Global Reports, Box 883-PX, Hollywood 28, Calif.

**REVEALED At Last! Valuable plans** Guaranteed to get desirable, worthwhile jobs. \$1.00. Employcraft, 37 Crittenden Street, NE, Washington 11, D.C.

**UNIVERSAL Construction News!** New monthly publication describes big U.S. and overseas construction projects, firms seeking applications, etc. \$1 per copy. Universal, UPS-2, Box 30, Billings, Montana.

**NEW York job opportunities are plentiful.** Complete classified ads for \$1.00. Dept. J, Box 113, Upper Montclair, N. J.

**FOREIGN—Employment Construction Work.** If interested in foreign projects with high pay, write Foreign Service Bureau, Dept. PS, Metuchen, New Jersey.

**WORLDWIDE Employment Opportunities \$1.** for current report. Big pay positions. Construction, aviation, shipping, petroleum, mining, importers, exporters, manufacturing, Mechanics, operators, professional. Dominion Service, 915 No. Wayne #301, Arlington 1, Virginia.

**CALIFORNIA—Men needed now.** Unlimited openings. Jobs for everyone. Skilled—unskilled. Highest wages. Send \$1.00; California Job Opportunities, Box 870-J, Los Angeles 53, California.

**\$1300.00 MONTHLY For Truck Drivers,** \$1400.00 monthly for carpenters, electricians, plumbers and mechanics. \$1200.00 for clerks and laborers, over \$2000.00 for superintendents. Limited hiring now being done. Full information and complete foreign listings \$1.00. \$1,200,000,000 state-side project, over 15,000 will be hired. Complete information, opportunities, living conditions, etc., and domestic listing, \$1.00. Specify listing. Dept. 4-G, Opportunities Unlimited, 1110 Commerce Bldg., St. Paul, Minn.

**BOOMING South America!** Industrial expansion has opened construction job opportunities for trades and professional men. Folio lists firms with contracts, firms seeking applications, etc. Just \$1. Jobservice, PS-2, Box 30, Billings, Mont.

**EXCITING New York—Work, live, play!** (Biggest employment listings, best room advice, souvenir knife.) (\$1.00) Carlson's, 2523W Aqueduct, New York 68, N. Y.

### 42A EMPLOYMENT SERVICES

**OVERSEAS Jobs.** Big pay, transportation expenses. Clerical, professional, mechanical workers. Most all trades. Latest listings airline, construction, manufacturing, oil, steamship companies, government agencies, many other opportunities. Up to date information on securing employment, contracts, income tax, applications forms. \$1.00. Overseas Jobs, Box 335-B11, Baton Rouge, La.

**CONSTRUCTION Job List.** Published Monthly. \$1.00 Dempster's Construction Scout News, Dept. 268-NM, Bridgeport, Ill.



**FOREIGN Jobs.** Contracts underway and soon starting in Africa, South America, Canada, England, Europe, South Pacific, Middle East, Mexico and Alaska. Send \$1.00 for foreign job news, information, application forms, etc. DCS Foreign Job News, Dept. 268-NN, Bridgeport, Ill.

#### 43 AGENTS WANTED

**NEW Bathroom Deodorizer.** Hangs on wall. Banishes odors bathroom, kitchen. Lightning seller. Samples sent on trial. Kristee 122, Akron, Ohio.

**NEW Jobs open in selling!** Send name, address for five free issues of Opportunity Magazine's money-making guide, listing hundreds of companies who'll pay you well, full or part-time. No experience needed. Opportunity 28 E. Jackson, Dept. 18, Chicago 4, Illinois.

**BE A Money Maker . . .** Use your home as magazine headquarters. Liberal commissions. No experience—No capital needed. Everything furnished. Write for Free Catalog. McGregor Magazine Agency, Dept. 510A, Mount Morris, Illinois.

**AGENTS—300% profit** selling genuine gold window letters; stores and offices. Free samples. Metallic Sign Letter Co., 431-E North Clark, Chicago

**WHERE To Buy 800,000 articles** direct from manufacturers at wholesale prices. Send name, address for free outline. Glass Publishing Company, Ellwood City 8, Pa.

**ABSOLUTELY Free—Sales Kit.** Yours for the asking. Send postcard today requesting kit showing new line, belt buckles with your name or personal initials, cap badges, choice 3000 different emblems. Write Hook-Fast, Box 1425PS, Providence, R. I.

**ADDRESS and mail postcards.** Make over \$50 week. Send \$1 for instructions. Lundo, Watertown, Mass.

**GOLD, Silver lacquered letters.** Windows, doors, trucks, Standard sizes. Penny and up. Big profits. Samples, Atlas-E, 544 West 79th, Chicago 20.

**ANYONE Can Sell Hoover DuPont Nylon Uniforms** for beauty shops, waitresses, doctors, nurses, others. In white and colors. Exclusive styles. Top quality. Low priced. Exceptional income. Real future. Equipment free. Write fully. Hoover, Dept. P-101, New York 11, New York.

**SALESMEN—make up to \$50 in a day** selling brand new item going to every type of food and beverage store, factories, laboratories, hospitals, etc. Samples furnished. Utility Durawear, 53 West Jackson Blvd., Dept. PS-7, Chicago 4, Illinois.

**AT Last! Something New and Sensational** in Christmas Cards. Make Extra Money Fast! Show Satins, Velours, Metallics. Gets Easy Orders. Pays up to 100% Cash Profit. 30 Free Samples. With Name 50 for \$1.50. Big Line. Amazing new Glo-In-The-Dark Ornaments. Personalized Matches. Stationery. Several \$1.00 Boxes on Approval. Puro Greetings, 2801 Locust, Dept. 341-J, St. Louis, Mo.

**MONEY For Xmas.** Make at least \$50 showing beautiful Elmira Christmas and All-Occasion Greeting Card Assortments—Name Imprinted Christmas Cards. Stationery, Napkins, Book Matches, Playing Cards—Gift Wraps, Books, Games, Household, Hostess Items. All unbeatable values. Make money while you make friends. No Experience Necessary—No Risk—Send No Money. Free Samples. Catalog. Bonus Plan. Display Assortments on Approval. Write Today! Elmira Greeting Card Co., Dept. C-176, Elmira, N. Y.

**RUN a Spare-Time Greeting Card and Gift Shop** at home. Show friends samples of our new 1953 Christmas and All-Occasion Greeting Cards. Take their orders and earn up to 100% profit. No experience necessary. Costs nothing to try. Write today for samples on approval. Regal Greetings, Dept. 28, Ferndale, Michigan.

**START Your Own Business on credit.** Your own boss 1658 of our Dealers sold \$5,000 to \$27,500 in 1952. We supply stocks, equipment on credit. 200 home necessities. Sales experience unnecessary. Pleasant, profitable business backed by world-wide industry. Write Rawleighs, Dept. G-U-PSC, Freeport, Ill.

**MAKE Money Introducing World's cutest children's dresses.** Big selection adorable styles. Low prices. Complete display free. Rush name. Harford, Dept. K-1341, Cincinnati 25, Ohio.

**DROP everything! Sensational earnings** now to Christmas with fastest-selling, popular-priced personal Christmas Cards, name-imprinted. Also album of deluxe designs. Box assortments, too. Send name for samples. Wallace Brown, 225 Fifth Ave., Dept. E-4, New York 10, N. Y.

**AGENTS—Salesmen:** Sell beautiful hand colored plastic enlargements and sensational new personalized photo compacts, rings, bracelets, lockets, etc. Experience unnecessary. 40% advance commissions. We deliver, collect. Wonderful sideline—better full time. Free sample outfit. Novel Portrait Co., 3343 North Ave., Chicago, Ill.

**\$1 STARTS you in business.** Sell ties. Send \$1 for 2 sample ties, special doz. price \$5.75 plus selling plan, wholesale order blanks. Radio City Neckwear, P. O. Box 25-P1, Sta. A, Flushing 58, N. Y.

**116 DIFFERENT Ways To Make Extra Money!** Sell Christmas. All Occasion greeting cards. Big profits. New bonus reward. Experience unnecessary. Write for Feature samples on approval, free samples Imprinted Christmas Cards, exclusive Stationery, free color illustrated Catalog. Selling Guide, New England Art Publishers, North Abington 733-D, Mass.

**ATTENTION Former Seabees.** Here's job where your experience with heavy equipment qualifies you for big earnings. For further information write J. C. McCarroll, 211 E. Bruce Ave., Dayton, Ohio.

**BUY Wholesale thousands nationally** advertised products at big discount. Free "Wholesale Plan." American Buyers, 629-T Linden, Buffalo, New York

**HOME Agents.** Power Lawn Mowers. "Red Hot" Special. Rotacut-PS, Excelsior Springs, Missouri.

**IS \$210 a week worth a postcard to you?** Then rush card with name and address for special Free Trial Plan that sells amazing new Automatic Refrigerator Defroster "like hot cakes!" Write to Mr. Lewis, D-Frost-O-Matic Corp., Dept. D-103, 173 W. Madison, Chicago 2, Ill.

**NAMEPLATES, Desk Signs, Free Samples** for Homes, Offices, Whitney's, West Springfield, Mass.

**SELL books—plans by mail.** Huge profits. Wholesale catalog—10c. Mann, 17 William, Hillsdale, New Jersey.

**1953—WHOLESALE Dealer Kit** on appliances, typewriters, recorders, cameras, giftware, lighting fixtures Free. Write Arrow Distributing, 154J, Nassau St., NYC.

**CALIFORNIA sweet smelling beads,** sensational sellers. Particulars free. Mission, 2328P West Pico, Los Angeles 6, Calif.

**MAKE money selling ties.** Buy direct from manufacturer. Write to Philip's Neckwear, 20 West 22nd, Dept. 148, New York.

**COULD you sell nylon stockings at 49c.** That's all they cost if they run or snag within guarantee period! Also men's and children's socks. Lingerie. Earn to \$3 an hour spare time writing orders. We deliver and collect. Advance cash plus huge 40% cash bonus. Armstrong earned \$202 in 9 days. Watkins sent 92 orders one day. Opportunity become manager appointing others. Rush postcard for free samples and money-making outfits. Kendex, Babylon 24, New York.

**SELL Big Money-Maker to Men and Women.** Easy handwork makes fast-selling useful articles. Sample free. Sunmade Company, Brockton 64, Mass.

**MEXICAN Feather Pictures.** Terrific Profits. Adelphi, Box 57-G, Bellerose 26, New York.

**SENSATIONAL money-maker!** New portable dishwashing machine sets on drainboard—washes, dries all dishes for average family in minutes—automatically! Ends dishwashing drudgery! Under \$100.00—big profit. Easy payment plan. Write Bessen, Dept. 102, 22 W. Division, Chicago 10, Ill.

**BALL Pens \$10.00 Gross.** D.E. S.E. Blades \$4.20 M. Assorted Prints Plastic Aprons \$1.40 dozen up. Lutzker, 871SP East 170th, New York 59.

**FREE book "505 Odd, Successful Businesses."** Work Home! Expect something Odd! Pacific-38C, Oceanside, Calif.

**MAKE Extra Money.** Sell front door name plates to friends, neighbors. Retail \$1.98—you make \$1.00! Free selling kit. Modern Engraving Co., P.O. Box 194, Boston 14, Mass.

**JUST Out! New Thrilling Sensation** in Christmas Cards. Make Big Money! Show Lustre Foils, Satins, Brilliants. Amazing Values bring Easy Orders! Magic Glo-In-The-Dark Ornaments. Personalized Stationery, Matches, 30 Free Samples. With Name 50 for \$1.50. Several \$1.00 Boxes on Approval. Joy Greeting, 507 N. Cardinal, Dept. 61-K, St. Louis, Mo.

**AGENTS.** Good profits. Low priced ball point pens. Short line of fast sellers. Samples on approval. Free list. Crescent Sales, 150-C Broadway, New York City.

**MEXICAN Feather Pictures.** Sell on sight; 200% profit! Free details. Sample 20c stamps. (No Coins). Sylvias, Apartado 9036, Mexico City.

**SELL New Waterproofing** for damp basements or concrete foundations—direct or through stores. \$1.25 package does 100 square feet two coats. Aquadry, 5511 North Ave., Chicago 39.

**\$1.00 PROFIT selling \$2.95 photo enlargement offer** Allen Studio, Riegler Bldg., Little Rock, Arkansas.

**QUALITY Ties—Your profit, 140%.** Catalog free. Loren Specialties, 4351-B Flournoy, Chicago 24, Illinois.

**SALESMEN! No Calls—Sales made by mail.** Get in the Big Time quick! Write: Maxson, 117 Leesburg Pike, Falls Church 14, Virginia.

**SEND 25c for Wholesale Novelty Catalogue.** Magic, Box 2929, Odessa, Texas.

**MAN earn \$500 monthly.** National company. Exclusive territory. Full or part time. Prospects everywhere. Big profit. Unusual automatic fire extinguisher. Write Superior Products, Inc., Dept. 143, 3410 Main, Kansas City, Missouri.

**SHINE Shoes Without "Polish".** New invention. Lightning seller. Shoes gleam like mirror. Samples sent on trial. Kristee 121, Akron, Ohio.

#### 44 HIGH-GRADE SALESMEN

**ADVERTISING book matches—Cash** in on big demand—sell Union label matches. Cuts for all businesses and political parties—Free powerhouse selling kit—low prices—protection guaranteed on repeat orders—Cash commissions. Superior Match Co., Dept. P-753, 7530 Greenwood, Chicago.

**NEW "Tas" Expense Account Report and Income Tax Deduction Record,** sells on sight. Companies, Stores, Individuals. 100% profit, automobile owner's necessity. 30 second demonstration, write for details. Dept. PS-102, Box 9013, Houston 11, Texas.

**AD Matches! Sell Amazing Designs—** 20, 30, 40 and 240-light book matches. Biggest spot cash commissions; every business a prospect. Low prices for high quality. Repeats. Start without experience; men, women; full, part time. Buy Nothing! Sales kit furnished. Match Corp., Dept. PS-43, Chicago 32, Illinois.

#### 45 EDUCATIONAL & INSTRUCTION

**HIGH School Diploma at home.** Certified teachers. All materials furnished. Southern States Academy, Box 144, Station E, Atlanta, Georgia.

**USED Correspondence Courses** and Books sold and rented. Money back guarantee. Catalog free. (Courses Bought.) Lee Mountain, Pisgah, Alabama.

**HIGH School—No Classes.** Study at home. Spare time. Diploma awarded. Write for Free catalog. HBA-26, Wayne School, 2527 N. Sheffield, Chicago 14, Ill.

**BOOKKEEPERS! Increase your earnings!** Operate your own simplified "Dollar-A-Week" Bookkeeping and Tax Service. Full or spare time. Details Free. No obligation. Ellis, Box 203-G, Cedar Grove, North Carolina

**BE a Real Estate Broker.** Study at home or in classroom in leading cities. Write for Free Book today. Weaver School of Real Estate, 301 Law Bldg., Kansas City, Mo.

**FOR an extremely profitable lifetime business,** operate a Collection Agency. Quickly learned. Write Cole Associates, Syracuse 2, New York.



**WANT A Diesel Job?** New Opportunities to increase income. Higher Pay. More Money. We can help you Qualify. Tools. Shop method home training. Write today! Diesel, Tractor, Heavy Equipment Division, Interstate Training Service, Dept. B2-G, Portland 13, Oregon.

**PIANO Tuning Pays.** Learn this profitable profession at home. Our Tonometer and mechanical aids make learning easy. No knowledge music necessary. Diploma granted. Largest and oldest school—55th year. G. I. Approved. Write for booklet. Niles Bryant School, 77 Bryant Bldg., Washington 16, D. C.

**COMPLETE Your High School at home** in spare time with 55-year-old school. Texts furnished. No classes. Diplomas. Information booklet free. American School, Dept. XB46, Drexel at 58th, Chicago 37, Ill.

**WELDING training pays at Hobart Welding School.** Box P-731, Troy, Ohio. VA Contract. Best equipment. Catalog Free.

**BECOME a Doctor of Psychology or Metaphysics.** Learn secret of contentment, happiness. Win degree of PsD, or MsD. Solve mental worries. Free book. College of Universal Truth, 5038-K Broadway, Chicago.

**MEDICAL Laboratory Technicians** in great demand. We train you in your own home. Catalogue free. Imperial Technical Institute, Box 973-B, Austin, Texas.

**MINISTER'S—laymen's religious courses.** Free Bulletin! Midwestern Schools, 517 Merchants Bank Building, Indianapolis, Ind.

**FORMER Anatomy Teacher** will share fascinating hobby. Make frogs, goldfish, chameleons, etc., completely transparent. Study skeleton, heart, etc., in your finished specimens. Send \$1.00 for colored photo transparent specimen like you can make. Send \$5.00 for complete chemical kit including three preserved specimens. Detailed instructions free with either order. No expensive equipment needed. Shipped postpaid. No C.O.D.'s please. Liaison Corp., Box 509, Peabody, Mass.

**OWN A Collection Agency.** Big Money! Free booklet. Franklin Credit, Roanoke 7, Virginia.

**"HOW To Break And Train Horses"**—A book every farmer and horseman should have. It is free; no obligation. Simply address Beery School of Horsemanship, Dept. 587, Pleasant Hill, Ohio.

**PLAY Piano By Ear—Write Mackey,** Box 411, Hudson, New York.

**FREE home study course** in basic economics, offered as a public service. Recommended by many leaders. Send postcard for complete information. Henry George School, Dept. P, 50 E. 69th Street, New York 21, New York.

**INCREDIBLE! Become Mental Superman Overnight!** Free Booklet! Bijou, Box 1727-V7, Hollywood 28, California.

**BARTENDING and management.** American Bartending School, P-334 S. Wabash, Chicago, Illinois.

**WORK For U.S. Gov't! Men-Women.** Start high as \$316.00 month. 35,000 jobs open. Experience often unnecessary. Qualify Now! Get Free 32-page book showing jobs, salaries, requirements, sample tests. Write today: Franklin Institute, Dept. B-22, Rochester, New York.

**DIESEL Home Study Close-Out.** 23 lessons \$9.80. Established 20 years. Author Died. Western Pennsylvania Institute, 807 Ridge, Pittsburgh, Penna.

**STRUCTURAL Drafting and Design.** Home study. Complete drawing outfit furnished. Summer rate \$69.00. Free information. Roth Technical Institute, Dept. S7, Box 2283, Youngstown, Ohio.

#### 46 CONTESTS

**TIE-Breaker picture puzzles exposed.** \$5.00 Wenograd, Box 1495, Phila. 5, Pa.

**\$300,000—CONTESTS.** Puzzle-tiebreaker help. Write. John Green, 210 Fifth Ave., New York 10.

#### 47 DETECTIVES

**DETECTIVE Training.** Phillips Secret Service System, 1917-C North Kenneth, Chicago 39, Ill.

**DETECTIVES—Work home—Travel.** Experience unnecessary. Detective Particulars free. Write. Wagoner, P-125 West 86th, New York 24.

#### 48 LANGUAGE OUTFITS

**LISTEN And Learn a language by Linguaphone.** At home, in leisure time, quickly, easily master French, Spanish, German, Russian, Japanese—29 languages by Linguaphone World's Standard Conversational Method. You listen-you hear men and women speak-you understand-you speak. Save time, work, money. Gain job, school, travel, cultural opportunities. Write for Free book. Linguaphone Institute, 5407 Mezz., Rock. Plaza, New York 20, N. Y.

#### 50 BUSINESS SERVICE, INFORMATION, NAME LISTS

**WOMEN Mail Buyers List.** \$5.00 thousand. Lakeland Sales, Butler, New Jersey.

**MAILING Lists.** All kinds 1000 \$5.00. Dixie Service, King, North Carolina.

**LIST 200 New Parents \$1.00.** Boyd G. Plymire, Route 20, Vance Station Road, Washington, Pennsylvania.

**MAILING Lists; Many classifications.** Literature free. R. J. Dunlap, Box 1046, Colorado Springs, Colorado.

**RADIO advertising, commission basis.** Free details. Broadcast Service, 1412 Great Northern Building, Chicago 4, Illinois.

#### 51 SPECIAL SERVICES

**LETTERS reairmailed Mexico Postmark** 50c. Luna, Apartado 21159, Mexico City.

#### 52 AUTHORS SERVICE

**NO Luck finding a book publisher!** Write for Free Booklet PS. Vantage Press, 120 West 31st, New York.

**BEGINNING Writers: Get \$1 to \$20 checks daily** writing simple children's stories, articles, poetry in your sparetime. Experience unnecessary. Our instructions reveal how. Details Free. W. Herman, 7016 Euclid, Cleveland 3, Ohio.

#### 54 CARTOONING, SIGN PAINTING, CHALK TALKS

**DRAW Pretty Girls! Details free.** Cartoon Club, 1506 Goodlett, San Bernardino, Calif.

**LEARN Sign Painting at Home.** Test Lesson Free. Ben Kerns, Box 812-PS, Greenville, South Carolina.

**CARTOONISTS: Amateur, Professional.** Prepare for Animation with Max Fleischer's plan. Write Vera Coleman, 60 East 42nd Street, New York, N. Y.

**CHALK Talks.** Laugh Producing Program, \$1.00. Illustrated Catalog 10c. Cartoonist Balda, Oshkosh, Wisconsin.

#### 55 TYPEWRITERS & OFFICE MACHINES

**TYPEWRITERS \$20.00.** Duplicators, adders \$12.95; Meier's, 118 Spruce, Wichita 7, Kansas.

**ROYAL Quiet Deluxe Portable typewriters.** New, \$76.83. Free Catalog, 1001 bargains, Dealers Mart, Dept. S6A, 11 Willard Ave., Mt. Vernon, N. Y.

**TYPEWRITERS.** Printing Devices. Office Machines, supplies, appliances. Dixie Graph, King, North Carolina.

**OFFICE supplies & equipment,** typewriters, adding machines, new & used, low prices. Atlas Supply Co., 313 Adams St., Fairmont, West Virginia.

#### 57 PRINTING, MULTIGRAPHING, ETC.

**QUALITY letterheads, envelopes.** Low rates—free samples. Whicro Printing Co., 1251 Ormewood Avenue, Atlanta, Georgia.

**100 8½x11 LETTERHEADS, 100 6¾ Envelopes,** \$2.00, 250 each, \$3.75, 500 Business cards \$1.95, 1,000, \$2.50. Postpaid. Allen, Dept. PSP, Clinton, Missouri.

**2 COLOR 8½x11 letterheads, 500—\$3.50.** Samples. D'Yarmett Service, Newark, O.

**DISTINCTIVE Printing.** Free samples, prices. McDonald, 545 North Oakland, Pasadena 4, California.

**500 Gummed ½ x 2½" Labels,** printed three lines. 50c. Extra lines 15c. Hunziker, Box 725—XF, Minneapolis 1, Minnesota.

**LETTERHEADS, envelopes, circulars, booklets.** Quality workmanship. Pricelist free. Lonelm Printers, Paulding, Ohio.

**PRINTING that pleases.** Send copy for estimate. Samples, prices. Mercury Press, Box 69P, Marengo, Iowa.

#### 58 PRINTING OUTFITS, SUPPLIES

**DO your own printing.** Save money. Simple rules. We supply everything. Print for others; good profit. Raised printing like engraving, too. Have home shop. Details free. Kelsey Presses, V-8, Meriden, Conn.

**MAKE your own, self-molding, rubber printing cuts.** Plexirubber, Argyle 2, Wisc.

**PRINTING Presses, Type Supplies.** Lists 3c. Turnbaugh Service, Loysville, Penna.

**PRESSES, Supplies, Paper catalog 10c.** Custom, Box 211-S, Springfield, Missouri.

#### 59 PATENT ATTORNEYS

**C. A. Snow & Co.—S-427, Snow Building,** Washington 1, D. C. Registered Patent Attorneys. Write for information.

**INVENTORS: Without obligation,** write for information explaining the steps you should take to secure a Patent. John N. Randolph, Registered Patent Attorney, 207 Columbian Bldg., Washington 1, D. C.

**INVENTORS.** For "Invention Record" form, contact Carl Miller, Registered Patent Attorney, Woolworth Building, N. Y.

**INVENTORS! For "Copyright, Design and Patent Guide"** contact Patent Attorney Metzler, 11 West 42nd, New York 18.

**INVENTORS—Send today for booklet "Patent Protection for Inventors"** giving detailed patent information and preliminary steps to take toward patent protection, also "Evidence of Invention" form. Victor J. Evans & Co., 841-H Meriin Building, Washington 6, D. C.

**INVENTORS: Learn how to protect your invention.** Special booklet "Patent Guide for the Inventor" containing detailed information concerning patent protection and procedure together with "Record of Invention" form will be promptly forwarded to you upon request—without obligation. We are registered to practice before the U.S. Patent Office and prepared to serve you in the handling of your patent matters. Clarence A. O'Brien & Harvey Jacobson, Registered Patent Attorneys, 32B-G District National Building, Washington, D. C.

**"INVENTOR'S Guide" free.** Frank B. Ledermann, Registered Patent Attorney, 154 Nassau Street, New York.

**INVENTORS—If you believe you have an invention,** we can make a preliminary search on your invention and advise you whether we think it can be patented. Send for copy of our Patent Booklet "How to Protect Your Invention" and "Invention Record" form. No obligation. Mc-Morrow, Berman & Davidson, Registered Patent Attorneys, 143-G Victor Building, Washington 1, D. C.

**PATENTS—Irving L. McCathran,** 316 McLachlen Bldg., Washington 1, D. C. Registered Patent Attorney.

**INVENTORS: When you are satisfied that you have invented something of value write me, without obligation,** for information as to what steps you should take to secure a Patent. Write Patrick D. Beavers, Registered Patent Atty., 938 Columbian Bldg., Washington 1, D. C.

#### 60 FOR INVENTORS

**INVENTORS, if you have an invention for sale, patented or unpatented,** write Institute of American Inventors, Dept. 30A, 631-E St., N.W., Washington 6, D. C.

**INVENTORS: Without obligation,** write for information explaining the steps you should take to secure a Patent on your invention. John N. Randolph, Registered Patent Attorney, 206 Columbian Bldg., Washington 1, D. C.

**INVENTORS.** For "Invention Record" form, contact Carl Miller, Registered Patent Attorney, Woolworth Building, N. Y.

**INVENTIONS Promoted.** Patented or Unpatented. Established 1911. Write Adam Fisher Company, 183 Enright, St. Louis, Mo.

**CASH For your ideas.** 280 Manufacturers need inventions, patented or unpatented. List free. Invention Bureau, 208-S Clinton, Oak Park, Illinois.

**INVENTORS! For "Copyright, Design and Patent Guide"** contact Mr. Metzler, 11 West 42nd, New York 18.



**INVENTORS**—Send for free patent information book and inventor's record. Registered Patent Attorney, Associate Examiner, Patent Office 1922-1929; Patent Attorney & Advisor, Navy Department 1930-1947. Gustave Miller, 73PSI Warner Building, Washington 4, D. C.

**INVENTORS:** Learn how to protect your invention. Special booklet "Patent Guide for the Inventor" containing detailed information concerning patent protection and procedure together with "Record of Invention" form will be promptly forwarded to you upon request—without obligation. We are registered to practice before the U.S. Patent Office and prepared to serve you in the handling of your patent matters. Clarence A. O'Brien & Harvey Jacobson, Registered Patent Attorneys, 32A-G District National Building, Washington, D. C.

**INVENTORS**—If you consider your invention to be something of importance, take steps to protect it with a United States Patent which gives you the right to exclude others from making, using and selling your invention as claimed. "Patent Protection for Inventors" outlines steps to take to secure patent protection. Mailed promptly without obligation. Victor J. Evans & Co., Merlin M. Evans, Registered Patent Attorney, 842-H Merlin Building, Washington 6, D. C.

**INVENTORS**—If you believe you have an invention, we can make a preliminary search on your invention and advise you whether we think it can be patented. Send for copy of our Patent Booklet "How to Protect Your Invention" and "Invention Record" form. No obligation. Mc-Morrow, Berman & Davidson, Registered Patent Attorneys, 143-F Victor Building, Washington 1, D. C.

**PATENT Searches.** \$5.00 including Patent copies. Reliable, accurate reports. Free protection forms. 48 hour service. Patent Service Institute, 945-B Pennsylvania Avenue, Washington 4, D. C.

**OBTAIN patents yourself.** Eliminate attorneys fees. Information \$2.00. Satisfaction or money refunded. D. Davidson, 5645 11th Ave. N.E., Seattle 5, Washington.

**SEARCHES**—Put your patent searches in the hands of a Registered Patent Attorney or Agent as he qualifies to give a worthwhile patentability report. Record of invention form upon request and information on patent protection. Patrick D. Beavers, Registered Patent Attorney, 939 Columbian Bldg., Washington 1, D. C.

**INVENTORS:** For a free Record of Invention form, with full information on how to obtain a patent, call any Western Union office in the United States (by number), ask for Operator 25, then mention our name: Patent Engineering Service of Washington, D. C. She will take your name and address and send your request to us at no cost to you. Try this amazing way to get started on your patent idea today. Western Union Operator 25 service is available in continental United States only. Residents of Canada or other countries should address: Patent Engineering Service, 711 14th Street, N.W., Washington 5, D. C.

**PATENT Searches \$5.00.** 48-hour service. Patent Applications prepared, and inventions marketed. Record of Invention forms free. Write Miss Ann Hastings, P.O. Box 176, Washington 4, D. C.

**INVENTORS**—Now available—Detailed booklet telling how to prepare, protect and sell inventions. One Dollar. O. W. Wood, 90 Church Street, Liberty Corner, N. J.

**7,000-WORD "Story of a Patent"** itemizes inventor's expenditures, describes successful procedures. Chart compares your probable patent cost. \$1.00. Excerpts free. Gamecraft, Red Lion, Pennsylvania.

#### 61 INVENTIONS WANTED

**INVENTIONS promoted.** Patented or Unpatented. Established 1911. Write Adam Fisher Company, 183 Enright, St. Louis, Mo.

**INVENTORS:** Hundreds of manufacturers have requested our assistance in locating marketable new products. Complete information, free. Institute of American Inventors, Dept. 30C, 631—E Street, N.W., Washington 4, D. C.

**MARKETING Aid**—Nation Wide. Patented, patent pending. Booklet free. Market Contacts, 719-B2, Magnolia, Tupelo, Mississippi.

**INVENTIONS wanted.** Patented; unpatented. Tremendous Manufacturers lists. Global Marketing Service, 1404 Mitchell, Oakland 1, Calif.

**INVENTIONS Wanted.** Patented or Patent Pending. 21 years experience Promoting Inventions. National Service Bureau, 3122 Meramec, St. Louis 18, Mo.

**ATTENTION:** Inventors of Electronic, Electrical, Audio, Automobile Products—Will buy or pay royalties on any manufacturable ideas if inventions are possible money makers. We manufacture. Please write c/o Mr. Dave Harris, Cleveland Electronics, Inc., 6611 Euclid Avenue, Cleveland 3, Ohio. Advise arrangement for discussion.

**CASH buyers for ideas and inventions.** Write National Inventors Institute, 4097 East 131st St., Cleveland 5, Ohio.

**INVENTIONS Wanted.** Patented, Pending only. Inventors Patent Exchange, Hartford 1, Conn.

**INVENTIONS Wanted.** Patented, unpatented. Send for free form "R". Gilbert Adamec, Patent Broker, 55 West 42 St., N. Y.

#### 63 MANUFACTURING

**MANUFACTURING.** Model Making. Metal stampings. Tools. Dies. Plastic molding. Small or large quantities. Estimates cheerfully furnished. Correspondence invited. Allen, Dept. PSM, Clinton, Mo.

#### 64 MODELS, MODEL SUPPLIES

**SHIP and Yacht model fittings;** blueprints. Send 25c for illustrated catalog No. 28—Listing hundreds of items. A. J. Fisher, 1002-2 Etowah, Royal Oak, Mich.

**MINIATURE surreys, stagecoaches, horses, buckboards.** Free folder. Tontz, Elsinore 10, Calif.

**MINIATURE furniture kits.** Solid cherry. Easily assembled. Large selection. Cat. 20c. Culver Miniatures 194 61st, Niagara Falls, New York, Dept. E.

**SHIP Models Ltd.** Kits, fittings, Plans. Custom Work. 1953 catalog 25c. Box 751, Brookline 47, Mass.

**STEAM engines, boilers, castings.** Catalog 25c. Anton Bohaboy, 2297 Price, Rahway, N. J.

#### 65 HOME CRAFTSMAN

**16 NEW lawn chairs, 22 picnic tables, benches, trellises, etc.** All 38 plans with necessary full size patterns. \$1.00. Mastercraft 73S, 7041 Olcott, Chicago 31, Ill.

**LEATHER, tools, lacing, supplies.** Free Catalog. National Handicraft, 199 William St., New York 7.

**"PRACTICAL Painting, Wood Finishing"** shows how to get professional results. Furniture finishing, workshop projects, home decorating. Complete Modern brush and spray methods. Tricks you've never seen. Write Home Craftsman, 115-F Worth St., N. Y. 13.

**BIG money assembling driftwood lamps.** S. Patchett, 2187—N.W. 24 Court, Miami, Florida.

**"TOPS" in everything for Leathercraft.** Lowest prices. Genuine "Craftool" stamps. Catalog 10c. Crown Leather Company, 22 Spruce Street, New York 38.

**PLASTICS home-craft course for Men and Women.** Tells and shows how to make hundreds of fast selling plastics products. All plastics and materials for 23 projects included in course. No special tools needed. Course pays for itself. Write for Free booklet. Interstate Training Service, Dept. D2-G, Portland 13, Oregon.

**89 FULL size Jig Saw patterns of beautiful shelves, ornaments, toys, novelties plus "How, Where to Sell."** Only \$1.00. Mastercraft 74S, 7041 Olcott, Chicago 31, Ill.

**LEATHERCRAFT.** Metal Tooling, Textile Painting, Beadcraft, Shellcraft, Many other crafts. Send for Free, big illustrated catalog today! Kit Kraft, Hollywood 46, Calif.

**LEATHERCRAFT.** Everything needed by beginners, advanced hobbyists and professional leatherworkers. Largest stock of supplies in U. S. Moderate-priced tooling leathers top-quality calfskins, tools, supplies, kits. Send 10c for Big Catalog. J. C. Larson Co., 820 S. Tripp, Dept. 3254, Chicago 24, Illinois.

**BUY wholesale nationally advertised power, hand tools, thousands other products at big discounts.** Free "Wholesale Plan" American Buyers, 628-TT Linden, Buffalo 16, New York.

**LEATHERCRAFT**—Complete supplies, leather kits, tools. Lowest prices. Quantity discounts. Free 64-page catalog includes instruction. Tandy Leather Company, Box 791-WE, Fort Worth, Texas.

**MAGNETS Permanent Alnico.** Never loses magnetism. Many uses. 12 for \$1.00. Pritt Co., Dept. MS-7, 12 West 27th, New York City.

**LEATHERCRAFT.** New Stylecraft folder Free. New Kits illustrated. Filigree Belts, Billfolds, Purses, etc. Send 25c new catalog. Refunded first order. Apache Leather Co., 2804 East Washington St., Phoenix, Arizona.

**MAKE your own leather articles for seasonal use.** Your leather belts, billfolds, purses, made at home brings pleasure to all members of the family. Free Catalog. Tandy Leather, Box 397-D, Tulsa, Okla.

**MODERN, easy made Planters, Shelves, Cabinets, Toys, Novelties, Quality plans.** \$1.00. We market finished work. Nu-Craft, 2044A South St., Long Beach, Calif.

**90 ALL new full size lawn ornament and novelty patterns, up to 20" high.** Only \$1.00. Mastercraft, 72S, 7041 Olcott, Chicago 31, Illinois.

**KNOCKDOWN Cedar Chest, Lumber and Veneers.** Free Price List. Giles Co., Brownsboro, Alabama.

**LAMP size cypress knee \$1.00.** Cy Products, Dept. 5, Lafayette, La.

**KNOCKDOWN cedar chest and lumber free price list.** Bedford Lumber Company, Shelbyville, Tennessee.

**SIGN Brackets—Ornamental Steel.** Four for \$5. (Postpaid U.S.A.) 28" Length. Holes Drilled, Immediate Delivery. Satisfaction Guaranteed. (C.O.D.'s plus postage.) Croom, 867W 42nd, Norfolk 8, Va.

**LEATHERCRAFT Tools.** Leather Embossing Plates, Craft Accessories, Dies, Catalogue 10c. Louis Jones Engineering Company, 1613 Main, Fort Worth, Texas.

**SQUAREKNOTTERS:** Make belts, handbags, lanyards, dog leashes, etc. Special offer! Beginner's book, catalog and quality cord samples 15c. P. C. Herwig Co., Dept. P41, 121 Sands St., Brooklyn 1, New York.

#### 66 BUILD IT YOURSELF

**BUILD Crystal Radios.** Sensational Melomite Crystal and detector with instructions and plans—50c postpaid. Satisfaction guaranteed. Allen, 427-PS5, Clinton, Missouri.

**BUILD Your Own "Tractor".** Free information. Eltraco D-5, Camptonville, Calif.

**GRANDFATHER Clock shoptested plans dollar.** Thousands built. Kuempel Clocks, Minneapolis 16.

**AIR Conditioner, save \$300.00!** Build your own from junked refrigerator. Send 50c for instruction booklet. John Schmidt, 4809 N. Seeley Ave., Chicago 25, Illinois.

**BUILD Your Own Venetian Blind Washer.** Send 25c for details. Write Venetian, 723 Hickman, Vincennes, Indiana.

**ORNAMENTAL iron porch railings.** Build your own. Complete plans \$1.00. Befro, Box 45, Fond du Lac, Wisconsin.

**SAVE money sharpen your own reel type lawn mower easily without special tools, illustrated instructions \$1.00.** Steves, 212½ West 7th, Topeka, Kansas.

#### 67 OLD GOLD, JEWELRY, WATCHES, ETC.

**HIGHEST Cash Paid For Old, Broken Jewelry, Gold Teeth, Watches, Silverware, Diamonds, Spectacles, Platinum.** Free information. Satisfaction Guaranteed. Rose Smelting Company, 29-Y East Madison, Chicago.

**ENAMEL-Art**—New way of making costume jewelry. Simply assemble and brush on sparkling colors. Sample set, Pin and Earrings—\$1.98. Catalog—25c. Barry's, 160 Ardsley Court, Newark, N. J.

**RHINESTONES, jewelry settings, cameos, sequins, beads.** Send 10c for Illustrated Catalog. J & M Novelties, Dept. CH-4, Griffith, Indiana.



JEWELRY making. Send 20c for illustrated catalog. Milady-Fair Co., G.P.O. 1328, New York City 1.

#### 68 TOBACCO & PIPES

SET of 3 imported briar pipes \$12.98. Smoking satisfaction guaranteed or your money back. Val-Do Products, Box 44, Vanderveer Station, Brooklyn 10, N. Y.

HAND Made Cigars. Write for price list. Ideal Cigar, 1903 Nebraska, Tampa, Florida.

#### 69 FOR THE HOME

"SAFETY-Set" Burglar Proofs All wooden windows. Tests 90,000 P.S.I. Sold nationally since 1948. No losses! Guaranteed, 50c per window; 6 locks \$2.50 ppd. Count All windows, buy in sets of 6, save money! Send payment to "Safety-Set", Box 19125, Los Angeles 43, Calif.

CESSPOOLS, septic tanks, outdoor toilets cleaned, deodorized. No pumping, digging or moving necessary. Inexpensive. Details, Chemical Cesspool Cleaning Co., Boston 34, Mass.

FOAM Rubber Furniture Cushions—Factory Seconds—50% discount. Prices Free. Perma-Foam, 140-A Main Street, East Orange, New Jersey.

#### 71 FOR SALE MISCELLANEOUS

FREE catalog on government surplus bargains from country's largest surplus organization specializing in outdoor, sporting goods, clothing, camping equipment, Tents, rubber boats, tarpaulins, swim fins, hundreds of other items. Rockaway Sales Co., Box PS, Route 46, Rockaway, New Jersey.

AQUARIUM heaters, submergible, all wattages \$1.25. Reine, Casilla Correo 1343, Montevideo, Uruguay.

THERMOSTAT Sets \$12.50 including gas valve, transformer, installation manual, (reg. \$35.00). Free Catalog. Arrow Heating, 633 North Myers Street, Burbank, California.

10 POUNDS Stainless Steel Sheets assorted sizes only \$7.50 Prepaid. Send M.O. L. J. Michles Co., Box 111, Fremont, Ohio.

PEN Set. Mechanical pencil, Fountain pen, Ball pen Metal Caps and clips 50c. William Anderson, Box 855, Mountain Home 3, Tenn.

SAVE! New merchandise. Anything! Send card, lowest price, any item, Dickman's, Box 301, Margaretville, New York.

REFLECTORIZED House Numbers for your lawn, visible Day & Night. Durable all Aluminum. Up to four numbers each side. \$1.50 Postpaid. Lite-Up Signs, Inc., P.O. Box 5146, Gulfport, Fla.

#### 72 WANTED MISCELLANEOUS

SCRAP Mercury (Quicksilver) containers supplied. Tantalum—Bismuth—Tungsten. Metallurgical Products Co.—Established 1909, 35th & Moore Streets, Philadelphia 45, Pa.

#### 75 TATTOOING SUPPLIES

TATTOOING Course and Supply Brochures, 25c. Zeiss School, 728 Lesley, Rockford, Illinois.

#### 76 DRAWING, SUPPLIES & EQUIPMENT

DRAFTING and artists' materials catalog—thousands of items—25c (deductible first \$2 order). Gordon's, 219 Madison, Chicago.

DRAFTSMEN, Engineers, Students, Famous high quality Swedish ruling pen, only \$2 cash or cheque. Airmailed, from Angström, Grevgatan 57, Stockholm, Sweden.

DISPENSAPOINT—New development. Improved draftsman's pencil pointer \$1.00. Illustrated information. Reed Co., 3601 Fourth, Boulder 1, Colorado.

ATTENTION: Draftsmen, Engineers, Students—Limited openings for agents. Take orders in spare time on drafting supplies. Attractive commissions. Alvin Company, Windsor, Conn.

SPECIAL desk set offer. Simulated genuine onyx, 4x6 base. Metal parts 22K gold plated. Fully guaranteed pen. Gift boxed. Only \$1.98. Order now. Jimmy Linton, Box 30-A, Russellville, Arkansas.

#### 77 TREASURE FINDERS

TREASURE Hunters! New 11-pound featherweight Model 101 locator for gold, silver and minerals. Money-back guarantee best available. Also Geiger Counters for uranium prospectors. Complete information free. The Goldak Company, 1540 W. Glenoaks Blvd., Glendale 1, Calif.

SELECTIVE metal and mineral detector. Revolutionary design. Distinguishes metals from black magnetic sands. Readily detects metals under salt water. Also Geiger Counters. Free literature. Gardiner Electronics Company, 2018 N. Dayton, Phoenix, Arizona.

GOLD, Silver, Metal Detectors, Geiger Counters for Uranium, Mineralights, Sensational new fully guaranteed models. None Finer, Information Free. Detectron Co., 5420 Vineland Ave., North Hollywood, California.

TREASURE—M-Scope Geiger Counters—Mineral Locators. Why buy something inferior when you can buy the best at a lower price? Backed by years of experience. Fully guaranteed by factory. Detects minerals, metals, gold, silver, coins. Payment plan available. Proven superior performance. Free 16 page illustrated booklet. Fisher Research Lab., Inc., Palo Alto, Calif.

LOCATE Hidden Treasure and metal with the Model 100 detector. Weighs 5 pounds, detects .04 square inches of metal, distinguishes minerals from metals. Available factory assembled (\$69.99) and in kit form (\$34.99). Kit includes clearly illustrated construction procedure, tubes, batteries, headphones, transformer, electronic components, drilled chassis—nothing more to buy. Unconditionally guaranteed—order today! Remit 25% with C.O.D. orders. Dept. G, Electronic Applications, P.O. Box 4975, Washington 8, D.C. Literature on request.

SEEK Gold, Uranium, Treasure! Latest super-sensitive detectors. Circulars free. Glen Scientific, Box 151-D, Glen Ellyn, Ill.

#### 78 WATCH REPAIRING

WATCHMAKERS'—Jewelers' complete informative catalogue 20c. Bengal Company, Culver City, California.

CLEANINGS \$2.50 Guaranteed. Wholesale Repair List, Simon, Huron St., Lake Ronkonkoma, New York.

WATCHMAKERS' Journal contains helpful hints on watch repairing. \$1.00 year. Sample copy 20c. Dean Co., Box 3218, Daytona Beach, Fla.

10 HIGH-grade Swiss Ladies' and Gents' Wristwatches needing minor repairs. \$18.00. Write for prices. B. Lowe, Holland Bldg., St. Louis 1, Mo.

#### 79 MISCELLANEOUS

ADDRESS and mail postcards. Make over \$50 week Send \$1 for instructions. Lundo, Watertown, Mass.

GIANT Mails Crammed Money Making Opportunities, Surprises, Samples, Catalogs, 3 Mo. 25c. Miller, 24 Whitwell Place, Brooklyn 15, New York.

SAVE 20% on gifts. Giant new catalog Free. Sanford Sales Co., PS-7, 170 Broadway, New York 38, N. Y.

BE the first in your town to open and close, lock and unlock, your garage door from fifty feet or more by radio control, either from button in car or house. Install yourself with a few simple tools on most overhead doors. Now, buy direct from world's largest manufacturer of the popular V-type friction drive operators, only \$189.50 F.O.B. Write for complete information. The Door Masters, Inc., 1655 Euclid Street, Santa Monica, California.

PANNING Gold lesson—Catalogue Beginners supplies, Mining Books, Maps, "Where To Go" Free. Old Prospector, Box 792D2, Lodi, Calif.

BIG interesting mails three months 25c. year \$1.00 Harvey Teeple, Decatur, Ind.

SAVE 20%-95% on Name Brand Products. Details Free. Sickbert Enterprises, Box 297, Sedgwick, Kansas.

RECEIVE Magazines, samples, catalogues. Mails from everywhere. Offers, hundreds. Get listed 25c. Rorick, Box 86-M, Cincinnati 26, Ohio.

BUY vitamins direct. Amazing savings. Catalog free. Matoska, White Bear Lake, Minn.

40 ACRE government oil leases—\$100. You do no drilling, pay no taxes. You may realize profit on your lease without ever leaving home. Free literature mailed on request. Write American Oil Scouts, Dept. P, 7321 Beverly Blvd., Los Angeles 36, Calif.

#### 80 PERSONAL

DETECTIVES Opportunities. Detective particulars free. Write, Wagoner, P-125 West 86th, New York 24.

"HOW Can I Find Out?" You Can! Information confidentially developed. Any matter, person, problem, World-wide. Officially licensed. Established 1922. William Herman, 170 Broadway, New York.

4 TAHITI Postcards, Retailed free. \$1.00. Ives Jarsaillon, Poste Restante, Papeete, Tahiti.

DENVER Remail—25c each letter. From the Snowcapped Rockies, Box 6544, Denver 16, Colorado.

LOS Angeles Postmark letters retailed. Fool Friends, 25c. Private receiving-Forwarding address available. Box 1-3592, Los Angeles 25, California.

HAVE God's Peace. Write Allman, 90 Coral St., Paterson 2, N. J.

HAVE Letter Postmark from the Big State Texas 25c Confidential. Gables Remail Service, 1184 College, Beaumont, Tex.

"X-RAY Mind". Dangerous power over others. Inquire, Send 6c. Krishnar Institute, 1912 Lincoln-Park-West, 217-SZ, Chicago 14.

LETTERS Air Mailed from Australia. \$1.00. Tipping, Box 107, Newtown, N.S.W., Australia.

BIBLE reveals Time Of End. Free. Write: Harvest, Jefferson City, Missouri.

HAND Guide. Corrects your Penmanship in 10 hours. Write, Perfect Penmanship, Box 665-35P, St. Louis, Missouri.

LETTERS retailed from Sweden \$1. P.O.B. 10010, Stockholm 10, Sweden.

LETTERS retailed promptly 25c. L. Venice, 930 E. Taylor St., Phoenix, Ariz.

LETTERS retailed 25c. Replies Forwarded. Private Address Available Hollywood, Los Angeles. Scenic postcards. Lenza, 3122-B Arizona, Santa Monica 2, Calif.

INCREDIBLE! Become Mental Superman Overnight! Free Booklet! Bijou, Box 1727-V7, Hollywood 28, California.

"INTERESTING Mails"—25c keeps your mail box full three months. Bentz, Desk-I/46, Chatawa, Mississippi.

LETTERS retailed 25c. Private receiving-forwarding address available scenic postcards. Michael, 1347 North Bronson, Hollywood 28, California.

WRITE Best Sellers. (Quick riches!) Experience unnecessary. Inquire, Send 5c. Olympic Pub. Co., 1912 Lincoln-Park-West, 191-7A, Chicago 14.

HOLLYWOOD Postmark, letters retailed 25c. Box 9391, Los Angeles 5, Calif.

REMAIL letters, Air \$1, Sea 4 for \$1, beautiful view cards, 4 for \$1, retailed free. Laurent, 45 Rue Cambronne, Dept. 3, Paris, France.

CO-ORDIPATHIC. — Normalizing Concept; Taught by Mail. Diploma awarded. Prof. Caldwell, Box 4132, Phoenix, Ariz.

HYPERTELL pocket pulsimeter, high blood-pressure alarm. Extremely fascinating, life and money saving, for self and others. \$3.00 post paid—free folder available. Hypertell, Box 336, Coulee Dam, Washington.

MEXICAN Law, General Practice Attorney, 1203 Arizona Street, El Paso, Texas.

LOVELAND postmark retails from Sweetheart Town 25c. Luke Montore, Box 176, Loveland, Colorado.

LETTERS Retailed 25c. Beautiful Beach Resort Area. John Butler, 902 Lusk St. (Riverside Park), Norfolk 6, Virginia.

IF you are nervous, write The Herbmater, Forestville 8, Virginia.

LETTERS reairmailed from Havana \$1.00. Jos' Rabade, Apartado 3404, Havana, Cuba.

LETTERS retailed San Francisco Postmark 25c. Private receiving-forwarding address available. Shanks, Box 3110-G, San Francisco 19, California.





Stamp pictures African giraffe.

Zebra—Another animal of this exotic country.

Stamp pictures unusual sailboat.

Stamp shows native huts.

Handsome triangle stamp pictures huge snake.

Stamp shows great stone Fortress.

# Yours ALMOST AS A *Gift!*

Only 25¢ for this fascinating set of **MOZAMBIQUE COMPANY PRIZED STAMPS**

Yours *practically as a gift*—this fascinating set of stamps from Mozambique Company, in Africa. **ALL DIFFERENT!** Colorful, attractive stamps, picturing animals, fortresses, native huts and other phases of life in this far-off Portuguese colony. *Only one set to a customer.*

If you act at once, you will receive—**FREE**—84 Coats-of-Arms from all over the world, in gorgeous **FULL COLOR**. A strikingly handsome collection. They can be pasted up in a stamp album, used for decorating personal objects, etc.

## Free!

**IF YOU ACT PROMPTLY!**

**84 Coats-of-Arms of the World All in Dazzling FULL COLOR!**



Strikingly handsome collection of Coats-of-Arms from all over the world! (Only a few are shown here, greatly reduced in size.) In **GORGEOUS FULL COLOR!** **FREE**—while supply lasts!

### MAIL COUPON AT ONCE

Mail coupon now, and we will also send **FREE** helpful information on how to collect stamps, how to trade stamps, etc., plus other interesting offers for your inspection. But this offer may have to be withdrawn at any time. Rush coupon **TODAY** to **Littleton Stamp Co., Dept. 7-PS, Littleton, N. H.**

**LITTLETON STAMP CO.**  
Dept. 7-PS, Littleton, N. H.

I enclose 25c. Please send set of colorful Mozambique Company Stamps—all different. Also send **FREE**—while supply lasts—the 84 Coats-of-Arms from all over the world, **PLUS FREE** information on how to collect stamps, trade them, recognize rare stamps, etc.

NAME.....  
ADDRESS.....  
CITY.....STATE.....

**NEW**

1 for \$1.00    6 for \$5.50  
4 for \$3.75    8 for \$7.00  
12 for \$10.00

Prices Post Paid

## Lobstix

Patent No. 2,807,988

**LOBSTER FORK**

INDISPENSIBLE FOR  
— BARBEQUES — PICNICS —  
BUFFET SUPPERS — BEACH PARTIES  
— COOK-OUTS AND — CAMPING.

A VERSATILE, ALL-PURPOSE FORK  
DESIGNED PRIMARILY FOR USE WITH  
"LOBSTER" — CRAWFISH — SHRIMP —  
CRABS — OYSTERS — CLAMS —  
PICKLED PRODUCTS — OLIVES.

Send check or money order.  
Sorry — No C. O. D.

Dealer inquiries invited.

DESIGN TESTED  
DURABLE "TENITE" MOLDED  
PLASTIC • STAINLESS STEEL TINES.  
LIGHT WEIGHT AND BALANCE  
FOR HANDLING EASE • LUSTROUS  
COLOR AND BEAUTY  
FOR YOUR TABLE.

MAIL ORDER TO  
**S & W Manufacturing Company**  
BOX 184    WOBURN    MASSACHUSETTS

★ *Unusual & Unique items!*  
**for MEN**

★ Send only 25¢ for  
Sample, Lists, and Catalogue.

**HOLLYWOOD SALES CO.** Dept. 3.  
3414 W. Magnolia Blvd., Burbank, Calif.

**JITTERBUG • CATCHES MORE FISH**

Noisy surface bait. World's best hooker — day or night. Gurgling, paddling action of the double-lobed lip makes fish strike hard. 5/8 oz. or 3/8 oz. or 1/4 oz. spinning size \$1.25. Musky size \$2.00.

**FRED ARBOGAST & Co., Inc., 2347 W. North St., Akron 3, Ohio**

**FREE** WRITE TODAY FOR YOUR BIG FREE ARBOGAST COLOR CATALOG — FULL OF PICTURES OF CATCHES

**\$5,000 To \$10,000 YEARLY**  
**Raising CHINCHILLAS!**

**YOU RAISE THEM — WE BUY THEM!**

Send no money — write **TODAY** for free booklet... real success stories of folks everywhere who make fabulous profits raising these valuable animals.

**NATIONAL CHINCHILLAS**  
1020 N. RICHMAN • FULLERTON, 18 CALIF.

# COLOR PRINTS

From Your Transparencies

Electronically controlled for superb results. Rapid service and satisfaction guaranteed.

Prints from any size transparency

4 x 5	5 x 7	8 x 10
<b>50¢</b>	<b>\$1</b>	<b>\$2</b>

PROCESSING: ANSCO & EKTACHROME  
24 hours — Roll Film 120-620, 35 mm,  
20 ex mtd. . . . Only \$1.00 roll

**25c**  
2 1/4 x 3 1/4

Min. order \$1.  
No C.O.D.'s

**COLORFAX LABORATORIES** DEPT. S-73, BOX 3521  
Georgetown Sta., Wash. 7, D.C.



# SIBCO Insect Killer Vaporizer

That's Thermostatically Controlled

# KILL INSECTS

**AUTOMATICALLY  
—QUICKLY  
—SILENTLY!**

Kill Flies, Mosquitoes, Palmetto Bugs, Ants, Beetles, Gnats, Flying Moths and hundreds of other destructive and disease bearing insects DEAD "in their tracks."

The wonderfully new SIBCO VAPORIZER protects your establishment from these pests "at all times." People can now come and go in your premises without being annoyed by these dreadful insects—you won't see another insect any more within the confines of your place, once the SIBCO VAPORIZER gets started. This revolutionary electric insect killer (with Kiltex tablets) does all the work for you SAFELY, INVISIBLY, ECONOMICALLY, INCONSPICUOUSLY. Just plug in the cord—"presto" the SIBCO VAPORIZER goes to work quietly giving off the vapors which destroy insect pests. Imagine a butcher shop free of flies or a grocery store that can have food about without worrying about these insects being attracted.

**NOISELESS • STAINLESS • ODORLESS**

Throw out that old fashioned fly paper, spray gun, fly swatter, insecticide bomb, etc. Sit back—relax—let the SIBCO VAPORIZER kill automatically those insects that enter your quarters. You can't afford to be without this continuous protection.

SIBCO VAPORIZER plugs into any 110 volt AC or DC outlet, on just 10 watts of current. Completely effective up to 15,000 cubic feet. Requires no attention . . .

**THOROUGHLY TESTED**

A prominent Testing Laboratory found after extensive tests that after 7 minutes, 80 to 90% of the insects in a room where the SIBCO VAPORIZER was performing, were dead. After 9 minutes, 100% were dead. Amazing . . . yet it's been proven true.

Recommended for business establishments, farms and wherever the nuisance and menace of flies, bugs, insects exist: Barns, Hotels, Commercial Kitchens, Kennels, Motels, Poultry Houses, Printing Plants, Textiles Manufacturers, Theatres, Restaurants, Supermarkets, Bakeries, Groceries, Butcher Shops, Warehouses, etc.

Watch LEKTRO-KIL go to work right in your own home, killing insects "like greased lightning." Don't suffer the annoyance of Flies, Ants, Gnats, Mosquitoes, Silverfish, etc., any longer. Use LEKTRO-KIL in your Living Room, Bedroom, Dining Room, Bath Rooms, Kitchen, Basement, Porch, Attic, Garage, etc. Take LEKTRO-KIL with you on vacation. It's ideal for Cabins, Bungalows, Country Homes, Cabanas or wherever you may spend this summer.

**CONTINUOUS PROTECTION THROUGHOUT YOUR HOUSE**

Protect your children at play or sleep. Keep those pesty divebombing Mosquitoes away from your child at all times. Enjoy restful sleep. LEKTRO-KIL assures you of healthful comfort.



**NOW ONLY \$4.98 COMPLETE**

**One Treatment Keeps Your Living Quarters Free from Insects for Over 336 Hours**

Just plug in LEKTRO-KIL in the electric socket, fill with the enclosed KILTIX. That's all you do. No more Flies buzzing. No more Mosquitoes stinging. Completely harmless. Made especially for home use. Only \$4.98 complete with 3 months supply of KILTIX for 1000 cubic feet. Completely guaranteed for 90 days or your money refunded.

## H. SEARS INDUSTRIES

Dept. V-147 799 Broadway, New York 3, N. Y.

**FREE TO MEN**

Reprint of 6-page illustrated article from *Vue* magazine entitled

**"HOW TO GROW HAIR IN 20 MINUTES"**

The subject of this amazing article is Miss Patricia Stenz who, for nearly 20 years, has been promoting the growth of hair so successfully that she now operates 3 jam-packed clinics in Los Angeles, and has a mail order clientele throughout the U.S. and many foreign countries.

Miss Stenz does not claim to grow hair in 20 minutes. The story, titled by *Vue* Magazine editors, deals with her demonstration — made many times, for many people—that even entirely "bald" heads often have considerable live hair, completely grown over by membranous tissues, which ordinary scalp treatments do not penetrate. Microphotographs in the *Vue* article show that when this tissue is penetrated by a 20-minute Stenz treatment, hair may appear dramatically over a considerable portion of the formerly bare scalp.

Other publications, too, have carried feature articles on the Stenz Hair Clinics — *Time* Magazine, *New Liberty*, *Everybody's Digest*, and newspapers coast to coast. Famous motion picture stars, including Dick Powell and James Stewart, are among those who enthusiastically credit her with saving their hair

**FREE DETAILS and No-Risk Trial Offer**

Miss Stenz will be glad to send you a reprint of the article from *Vue* Magazine—also a detailed explanation of her whole startling theory regarding the cause and relief of baldness, and a history-making offer to let you TRY HER HOME TREATMENT WITHOUT RISKING A CENT! Write for full information today, without obligation.

**FREE! Send NO MONEY**

**PATRICIA STENZ Hair and Scalp Clinic, Dept. 67**  
1493 North Vine Street, Hollywood 28, Calif

**IN ALL STAGES OF BALDNESS**

**MONEY BACK GUARANTEE**

**H. SEARS INDUSTRIES**  
799 Broadway, Dept. V-147, New York 3, N. Y.

Please send me the

SIBCO VAPORIZER at \$6.98 and supply of Kiltex

LEKTRO-KIL Home User at \$4.98 and supply of KILTIX

I enclose payment now. Send postage prepaid

Send C.O.D. I will pay postman. (Plus postage and handling)

Name..... Address.....

City..... State.....

Check here for refills:

1 Month Supply 50c  1 Season Supply 98c

Dealer Inquiries are Invited



**Be a FROGMAN**

**JOIN! JOIN!**

Join the new NATIONAL FROGMAN CLUB today! Send \$1.00 with your name and address to the club headquarters. Here is what you will get:

1. FREE COUPONS totalling \$1.00 in value which can be used toward the purchase of official Frogman equipment, redeemable in your local sporting goods store or department.
2. A miniature rubber replica of a pair of FROG FEET water flippers for your key chain, lapel or windshield.
3. Attractive membership card certifying you are a FROGMAN.
4. A FROGMAN decal.
5. A booklet on "How to Swim Underwater" and "The Supreme Sport of Spearfishing."
6. Complete catalog of FROGMAN equipment.
7. Periodic newspapers for a year of club news, pictures and articles about FROGMAN activities, equipment and instruction.

Send your \$1.00 TODAY!

**NATIONAL FROGMAN CLUB**

Dept. PS7  
1428 S. Maple Avenue  
Los Angeles 15, California

Gentlemen: Attached is \$1.00 in cash, check or money order. Enroll me in the NATIONAL FROGMAN CLUB for one year, and send me the above items.

Name.....  
Address.....  
City..... State.....



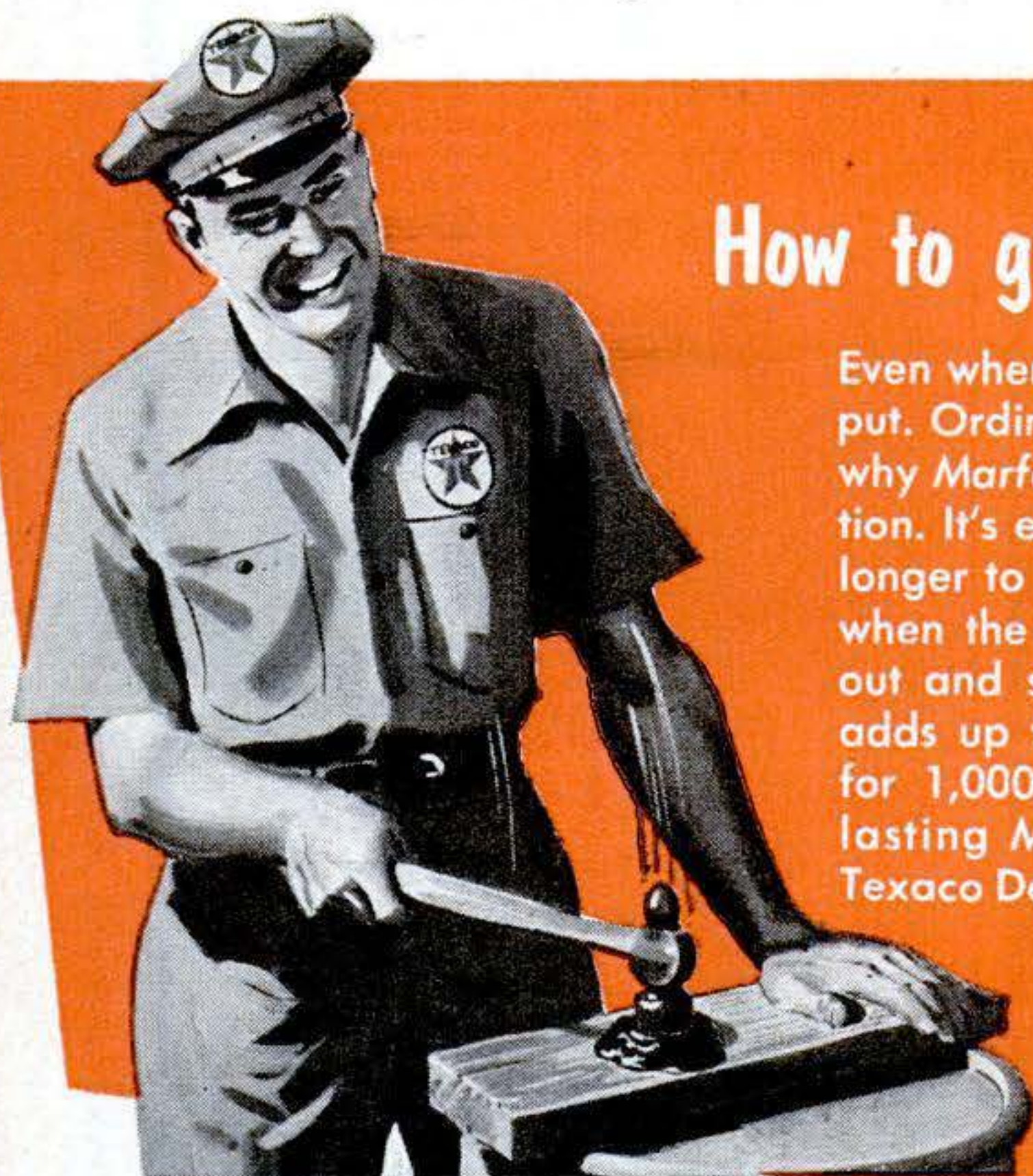


# Texaco Tips

on car care

## How oil filter inspections save you money

If your car's oil filter is clogged, it can't filter out dirt and other abrasives that occur in normal engine operation. And that can mean trouble and expense for you! To keep your oil filter functioning properly, see your Texaco Dealer for an oil filter check-up. He will inspect it — and replace it, or the filter cartridge if necessary. This assures a constant flow of cleaner oil to your engine's moving parts. Care like this can help you enjoy more miles of trouble-free motoring.



## How to get that "cushiony" ride

Even when *Marfak* is hit with a hammer, it stays put. Ordinary grease would splatter. This shows why *Marfak* gives your car better chassis protection. It's extra tough and stretchy . . . clings far longer to points of friction and wear. And even when the going gets rough, *Marfak* resists jar-out and squeeze-out — wash-out, too. All this adds up to smooth, cushiony riding for you — for 1,000 miles or more! Drive in for longer lasting *Marfak* lubrication today. See your Texaco Dealer, the best friend your car ever had.

THAT "CUSHIONY" FEELING LASTS LONGER WITH



# THE TEXAS COMPANY

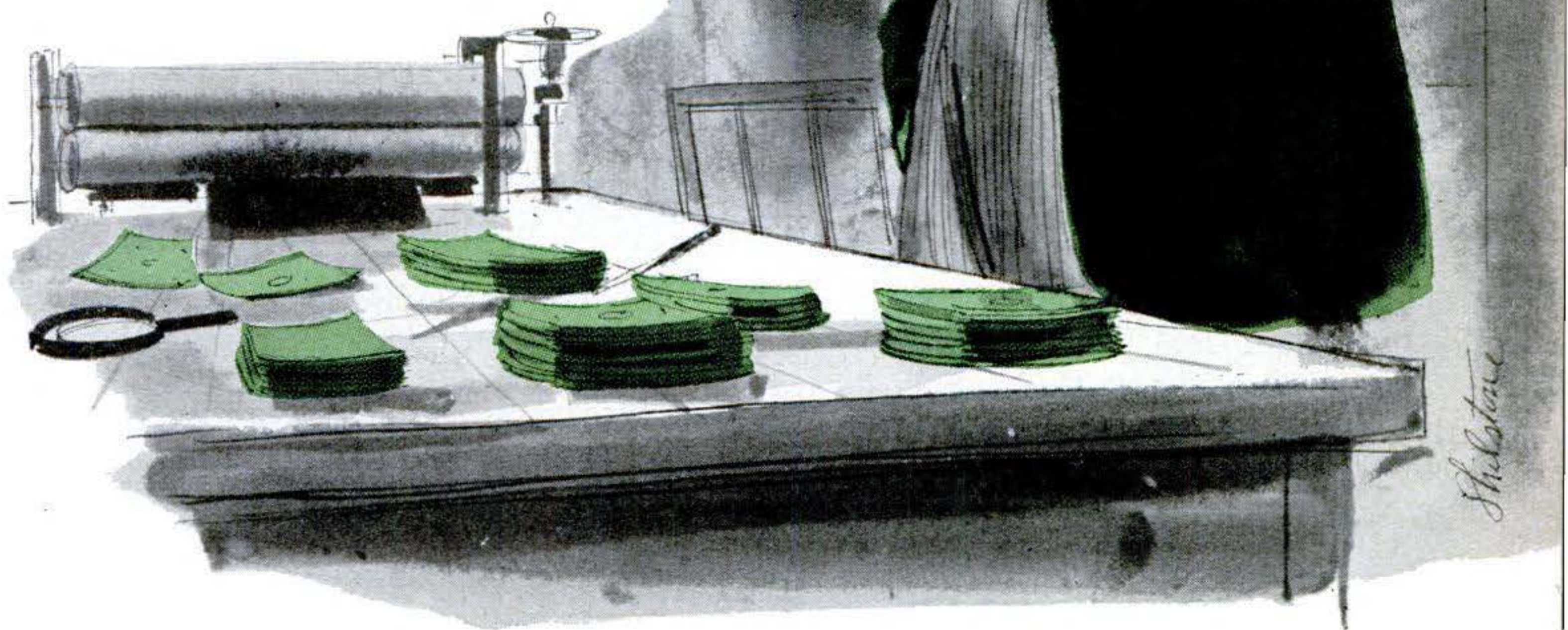
TEXACO DEALERS IN ALL 48 STATES

Texaco Products are also distributed in Canada and in Latin America



# They Trap Counterfeiters Everywhere

*When a counterfeiter is arrested by Interpol member, he is turned over for trial to the country with the strongest case against him.*



*International cops now cover a 48-nation beat  
in their fight against the phony-money racket.*

**By Phil Gustafson**

**A** NEW and deadly weapon for use against civilian populations emerged late in World War II. Like the Germans' V-2 rocket, it came too late to be decisive, but in another war things might be different. It might even be turned against us as a tactic in the cold war.

That weapon is counterfeit money. The Nazis boldly recruited professional bogus-money artists, and in the Sachsenhausen concentration camp near Berlin set up the biggest counterfeiting plant the world has ever known.

Hitler planned to shower England with fake notes, parachuted from planes, but the Luftwaffe lost control of the air



over the British Isles before the stunt could be pulled. The Nazis did circulate so many false bills through neutral embassies and commercial channels that the Bank of England finally was forced to withdraw all pound notes of three denominations and issue others in their stead.

Total-war strategists picture what might happen if great quantities of bogus money were dropped by parachutes in a town. They visualize workers scurrying along the streets, furtively picking up bills. Workers reporting in sick and rushing off to the stores. All the stores swamped with bad money and forced to close their doors. "Infected" towns isolated by the High Command to keep the bad money in. All forms of travel forbidden. Buying and selling halted.

When bankers and government officials think about such things now, they feel a lot happier because they know that a world-wide network of anti-counterfeiting sleuths is operating around the clock in a little-publicized but highly effective organization called Interpol.

Interpol is the everyday name for the International Criminal Police Commission which links national police organizations of 48 nations—the Sûreté Nationale, Scotland Yard, Rome's Questura, our own Treasury Department, police headquarters of Athens, Istanbul, Sydney, Johannesburg, Rangoon—each with its own specialists who devote full time to bringing international counterfeiters to grief.

The fight against counterfeiting is so universal that Interpol even gets co-operation from bankers behind the Iron Curtain.

It used to be possible to pull a big coup in bad money and light out for some far corner of the world like the South Sea Islands—there to languish among the dancing girls without fear of detection. That's the way it *was*.

But, brother, don't try it today. By radio, teletype, telephone or airmail, information on your departure will go out to 48 nations. No matter where you get off the boat, chances are you'll be shadowed when you move away from the dock.

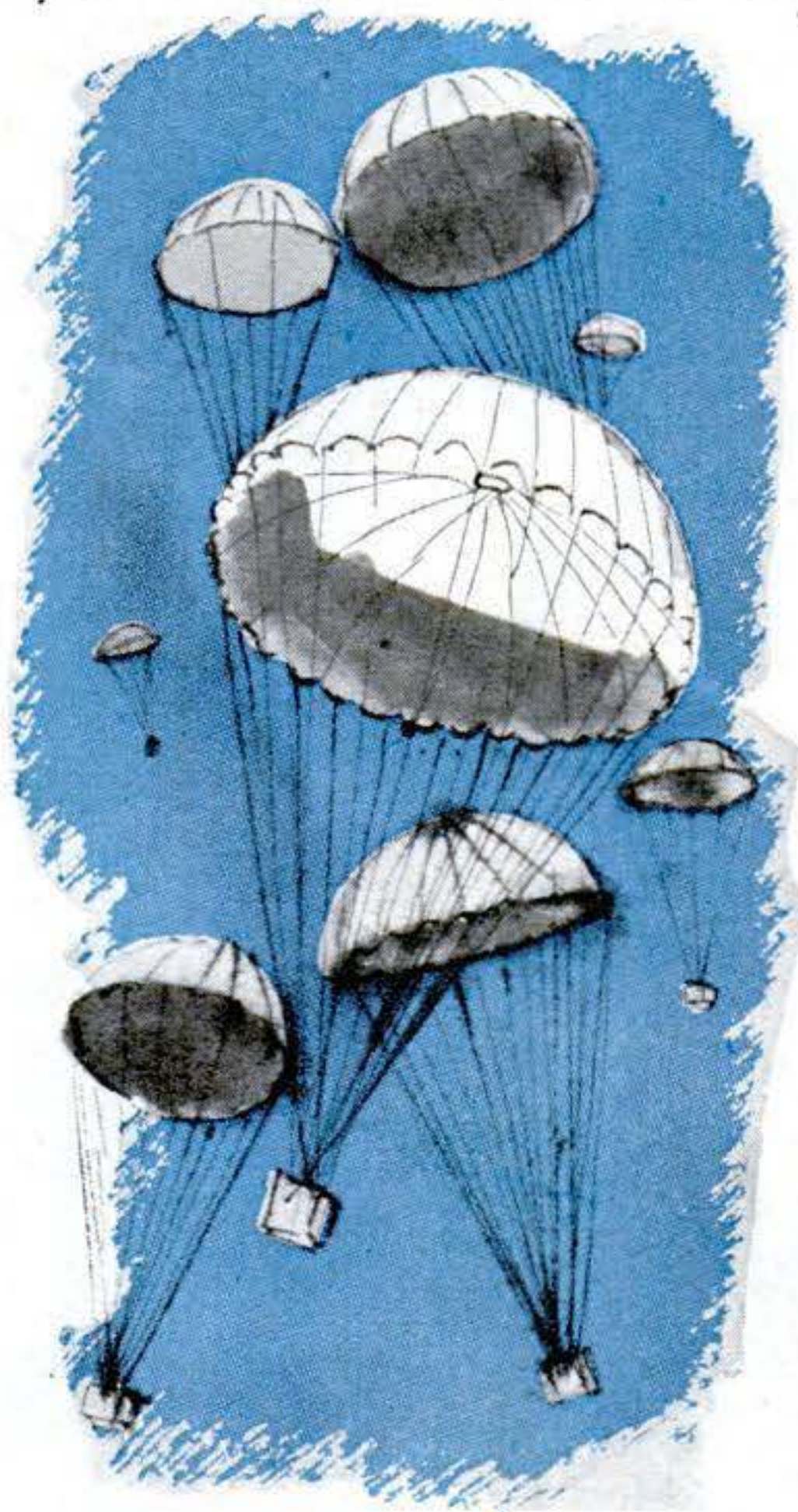
Headquarters of this anti-counterfeiting net is in the long, low Ministry of the Interior Building in Paris. Here, in Interpol's International Bureau, the world war against bogus money is carried on by a special counterfeiting section of some 15 persons, mostly trained police specialists.

And here I ran across the most interesting set of files I've ever barked my shins on. The most fascinating of all is a section

which houses a record of every kind of bogus money in the world—escudos from Portugal, cruzeiros from Brazil, pesos from Mexico, rials from Iran, dinars from Iraq, rupees from Pakistan—some 800 specimens in all. In the dollar file alone are 335 different types of phony bills.

#### *Phony-Bill Photos Go Around World*

Whenever a new type of bogus money is turned in by one of the member countries, the International Bureau gets up a printed folder with photos, descriptions and classifications of the money and a detailed account of the case. These folders are fired out by the fastest means to national police offices and banks around the world. All these



*Hitler planned to shower England with fake notes, parachuted from planes, but the Nazis lost control of the air.*



# The Case of the Bogus-Buck Passer

*These scenes from a new documentary movie, made by the U. S. Mutual Security Agency in Paris, show how Interpol directs the police of three nations in tracking down a counterfeiting ring.*



**1 EXACTING CUSTOMER** exchanges U. S. dollars for an expensive bracelet in a smart Amsterdam jewelry shop. Store owner is pleased—until his bank finds bills are bogus.



**2 AMSTERDAM POLICE** scan bill for peculiarities in design and printing, compare it with replicas in Interpol book listing all known types of phony money.



**3 ROGUES' GALLERY PHOTOS** are shown jeweler, who recognizes suspect. Police then notify Paris headquarters of Interpol, which sends file on man to 48 member countries.



**4 FAST-MOVING** counterfeiter's next stop is Ankara, Turkey. Here he again succeeds in passing bad money for costly jewelry. Proprietor of store calls mobile police.



**5 CULPRIT**, a slippery customer, hurries to airport after making purchase and boards Paris-bound plane. Ankara police meanwhile have identified him from Interpol file.

**To see how counterfeiters were trapped, please turn page.** JULY 1953 51





**6** **TURKISH COPS** arrive at airport just as plane takes off. Counterfeiter has escaped again. But Paris police are alerted to pick him up on arrival.



**7** **PARIS POLICE** shadow suspect instead, hoping he will lead them to head of ring. They see him get money from an accomplice. When men leave cafe, both are followed.



**8** **SECOND MAN** is trailed to door of print shop, where he stops and looks around anxiously. Police have picked up first counterfeiter just as he was boarding train.



**9** **THE TRAIL** may be false, but detectives take no chances. When suspect enters shop, they signal reinforcements who have been standing by, and close in on press.

**10** **DETECTIVES BREAK THROUGH** false wall at rear of shop and capture chief forger.

Arrests of remaining accomplices complete smashup of another international ring.





folders, bound together in a hard cover, make a book as big as Webster's International Dictionary.

Its opposite number is a similar book listing, describing and illustrating every type of good money in use today.

Fourteen file drawers are crammed with up-to-date records of every known counterfeiting case in all of the 48 member countries as far back as 1926. Each folder contains the record, specialty and characteristics of each of the individuals involved, plus his photo and fingerprints if available. On international gangs, there are charts that diagram the movements of money between the members.

#### **Countries Get Data on Culprit**

When the national police of any member of Interpol arrest a man on charges of counterfeiting, the essential information is sent out to the other 47 countries by teletype, followed by a printed circular containing photos, fingerprints and all available details. This vast circulation often results in returns showing that the suspect is wanted in several countries; and in this event he is turned over for trial to the country with the strongest case against him.

The scope of Interpol's tireless operations is well illustrated by the record on Ben Graumann, a 60-year-old Pole who has a record of a dozen convictions in six countries over a period of 20 years. Among other things, he has been an international trafficker in false money under six different names, on dozens of different false passports.

Graumann's latest brush with the law occurred after the West German police discovered a printing plant turning out bogus \$10 scrip bills in a refugee camp. After circulating his record, Interpol found that there was a better case against Graumann in Paris, where he was charged with committing a jewel holdup two years before while traveling with a false Spanish passport under the name of Fernando Ordas. The German

case against Graumann was shelved while a French court put him out of circulation for some time on the jewel-theft conviction.

Counterfeiters, traveling by air, are the fastest-moving criminals in the world. In one recent case, Interpol reached halfway around the world for one pair. The case came into the International Bureau when Secret Service in Washington asked member countries to watch out for two men who had been using counterfeit dollars to buy moving picture equipment. A month later, they were in custody. One of the pair, Percy Lean, convicted thirteen times for assault, rape, gambling and fraud, had strong cases against him in such widely separated points as England and South Africa. His partner, Raymond Bassett, was handed back to authorities in Australia who put him away for stealing automobiles.

In France alone, police ran down 10 counterfeit printing offices in a year. Cases have decreased 40 percent since 1948 but the specialists of the Bureau still handle an average of 500 cases a year.

One of Interpol's most interesting characters is Sale Somodoff, born in 1895 in Poland and rated as the best designer

**[Continued on page 216]**

**By radio, teletype or telephone, information on the culprit's departure will go out to 48 nations. No matter where he gets off plane or boat, the law will be waiting for him.**







### Radiator Keeps Food Hot

LIKE the warming oven of an old-fashioned coal stove, this cupboard built into a radiator will heat rolls, keep food warm between servings or hold over dinner for a late-comer. An Italian invention, the dual-purpose radiator is in use in the homes and restaurants of Florence.



### Convertible Window Zips Out

ZIP—and the plastic rear window of this convertible is out. Zip it back into place and a pair of rubber lips fold over the metal teeth of the fastener to seal out air and moisture. A wartime development of B. F. Goodrich, the self-sealing zipper is now in use on the Mercury and the Lincoln.



### You Can Ride This Table Saw to Work

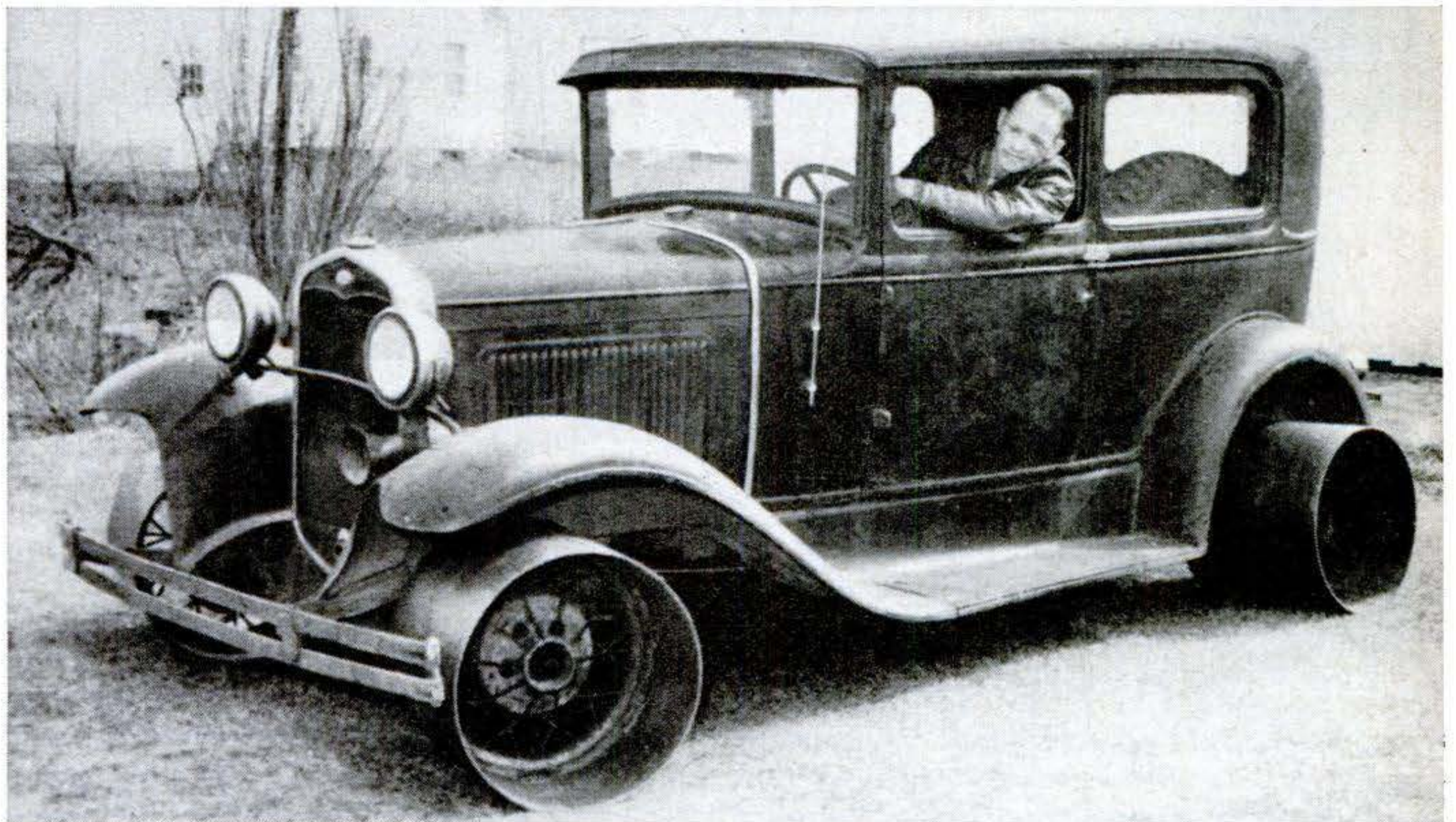
HAVING carried the carpenter and his table saw to the job, the baby tractor at left now powers the whirling blade. The same two-cycle, 1½-hp. gasoline engine does both jobs. Latest brain child of Stanley Hiller, Jr., boy wonder of the helicopter industry, the little riding tractor can also haul mowers, a spreader, a cart, a roller or a sweeper. A double-pulley arrangement provides two speeds forward. Low, with a 40-1 reduction, gives two m.p.h.; high, four m.p.h. The 127-lb. tractor is said to be able to carry a 250-lb. man up a 26 percent grade while hauling a 360-lb. roller. Besides a clutch, there are ratchet clutches in each of the rear wheels, so that the inside wheel can be disconnected from the drive for a sharp turn.





### Undercover War—on Termites

THEY'RE not gift-wrapping that house above, they're getting ready to fumigate it. A penetrating gas fed from a cylinder through tubing under the plastic tarpaulin (right) diffuses into every cranny of the house to exterminate wood-happy termites. The system, pioneered by the Neil A. Maclean Co., Los Angeles, is in use in subtropical California, Florida and Hawaii.



### Gardener Rigs Up Car to Iron Out Lawn Problems

W. J. LESTER, a gardener of Rockford, Ill., got tired of pushing a heavy roller over expansive lawns so he adapted his car

to do it for him. He rolls to the job on conventional wheels, then jacks up the car and replaces the tires with four rollers.



# How to Train a Seal

*Trial and error are the steps on which he climbs from savage pup to star performer.*

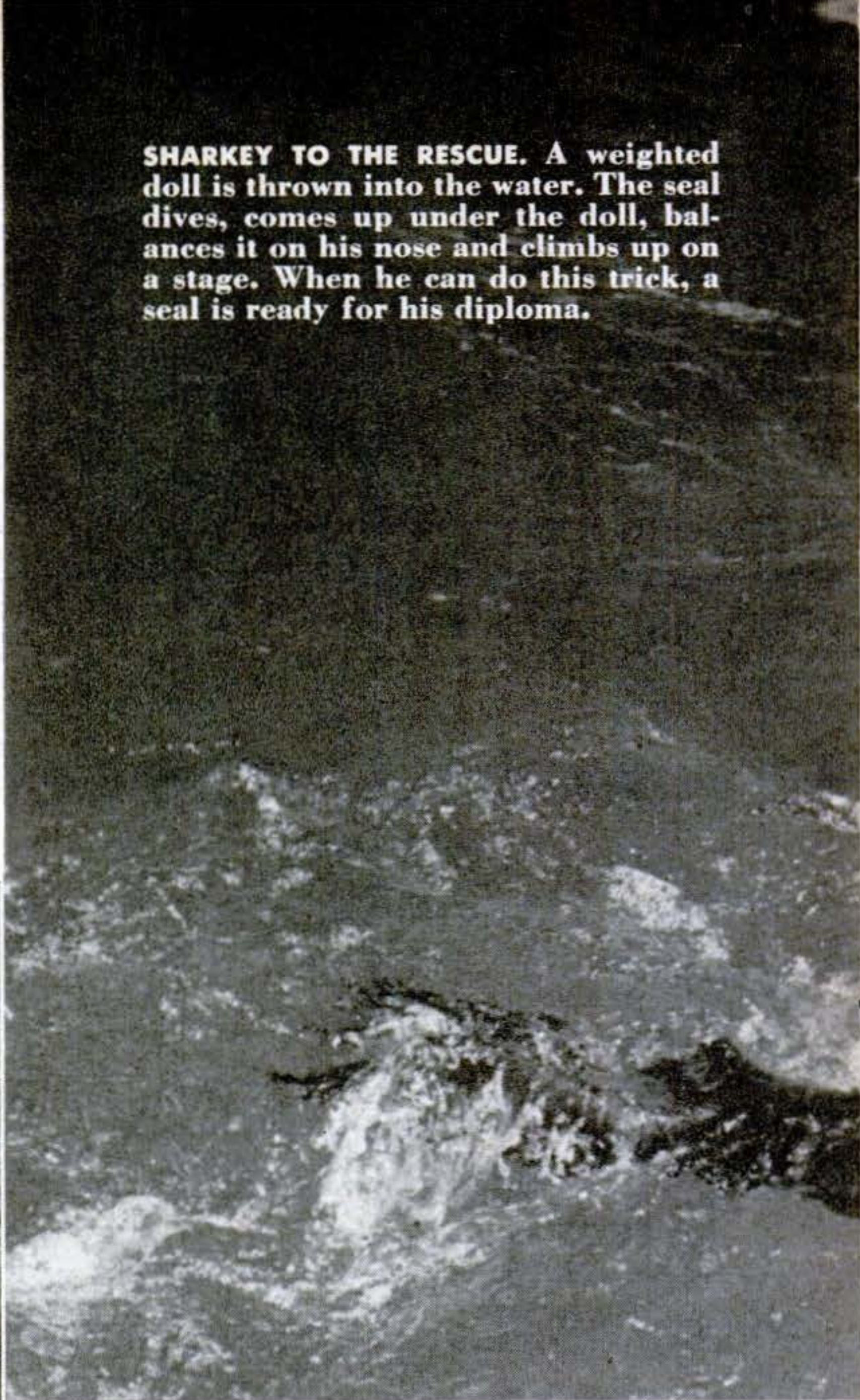


**A**DS, cartoons and hundreds of magazine and newspaper stories about trained seals have implanted the impression that a seal's chief mission in life is to balance a ball on its nose. Nothing could be farther from the truth. A seal is a marvelously intelligent animal. He can be taught to do almost anything within his physical limitations.

Trained seals aren't really seals at all. They're California sea lions. True seals haven't got what it takes to make top billing in show business. Their necks are too short; they are stubby and awkward. Sea lions, on the other hand, have long flexible necks, are graceful, beautiful animals. And they are always called seals in the entertainment world.

The career of trained seals starts early in life. They are netted when from one to four years old. Like humans they have to be taught. The first lesson comes from mother,

**SHARKEY TO THE RESCUE.** A weighted doll is thrown into the water. The seal dives, comes up under the doll, balances it on his nose and climbs up on a stage. When he can do this trick, a seal is ready for his diploma.



who teaches them to swim. When first captured they are confused. Everything is unfamiliar. They become frightened. Afraid of a man, they will run away from him or attack him.


The first job of a trainer with a new seal is to condition him to his surroundings. He must learn to look to his trainer for food and security. Once a seal has learned to trust his trainer, he becomes anxious to please. The extent of his training is limited by one big factor—the man's ability to make the seal understand just what he is supposed to do.

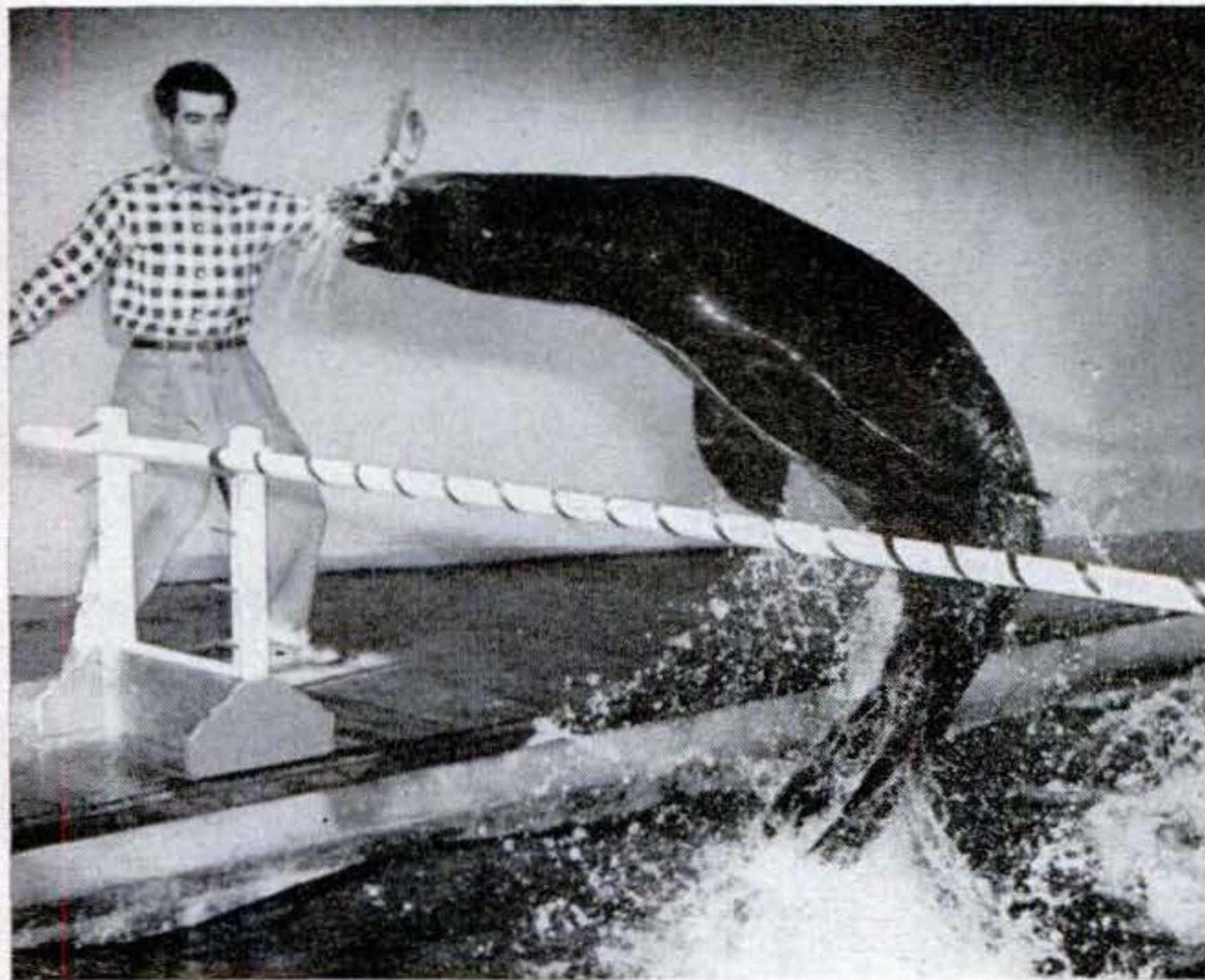
To show how a seal is trained, PSM photographer Bill Morris used a 16-year-old veteran, Sharkey, as a model. He knows all the tricks, hundreds of them. His home is Seal College, Kingston, N. Y., where he exercises every day in a 15- by 30-foot pool—that is, when he is not on the road, a star of stage, screen, radio and television.





**TRICK BELOW IS KINDERGARTEN STUFF.** At first the pole is held slightly under water so the seal can swim over it. It is raised gradually until he has to hurdle the pole.

**A SEAL MUST BE TAUGHT** to eat dead fish, which he doesn't recognize as food as he is used to the live, swimming kind. Dangling a fish on a string soon changes his eating habits. 







**IN EARLY STAGES** of training, a seal is unfriendly, may attack savagely. During this familiarization period the trainer protects himself by wearing steel and leather pants.

**"GIVE US A KISS,"** says trainer William Roe. At this stage the iron pants can be eliminated. Confidence and understanding between animal and trainer have been established.



**BALANCING A BALL** on his nose doesn't come easily for even the smartest seal. First he is taught to nuzzle it. Constant praise and rewards of fish put over balancing idea.

**A TRIUMPH IN SEAL TRAINING.** Sharkey balances tempting fish on nose and waits until he gets signal that he may toss it into the air and eat it. Seals are always hungry.

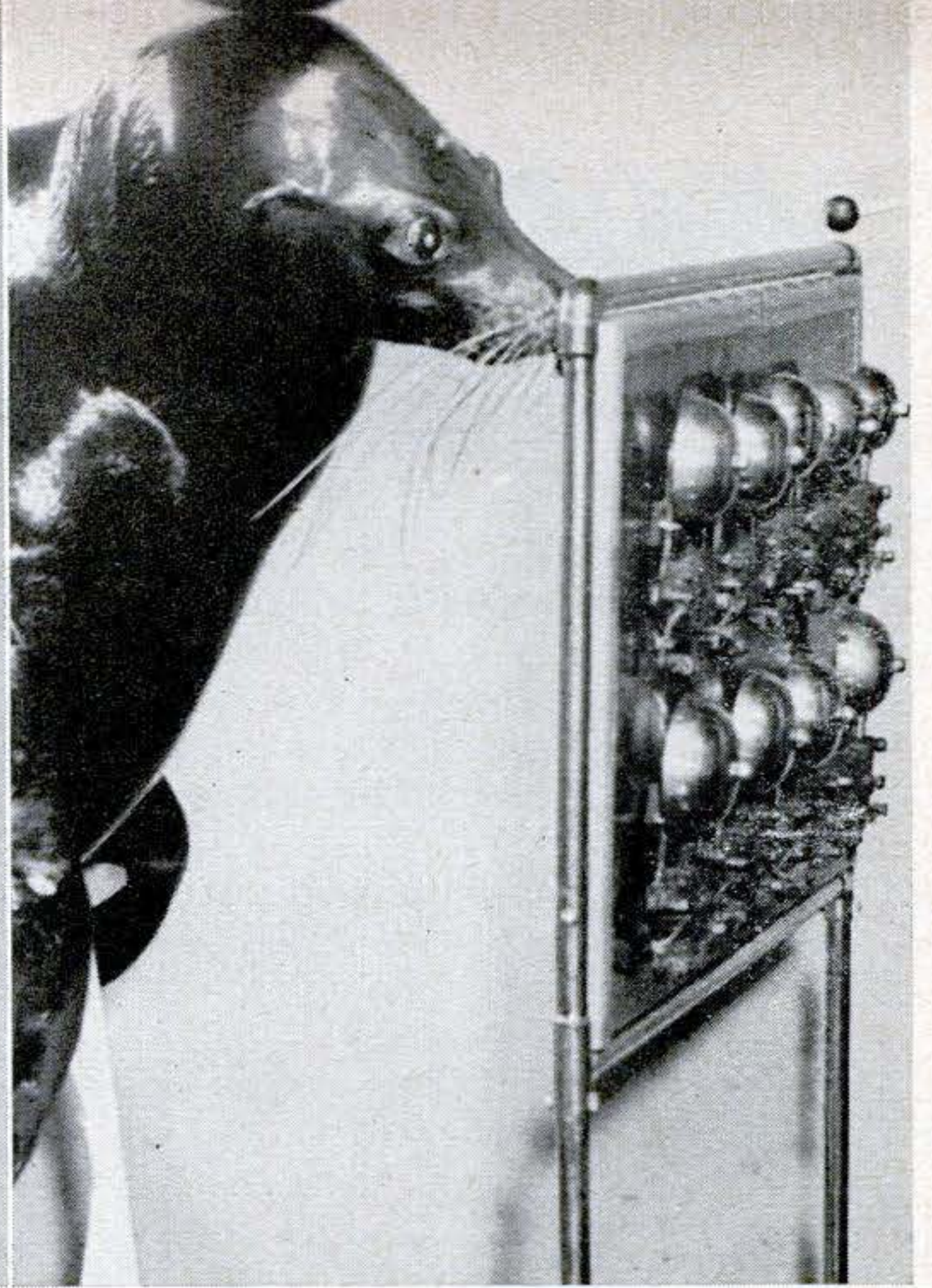






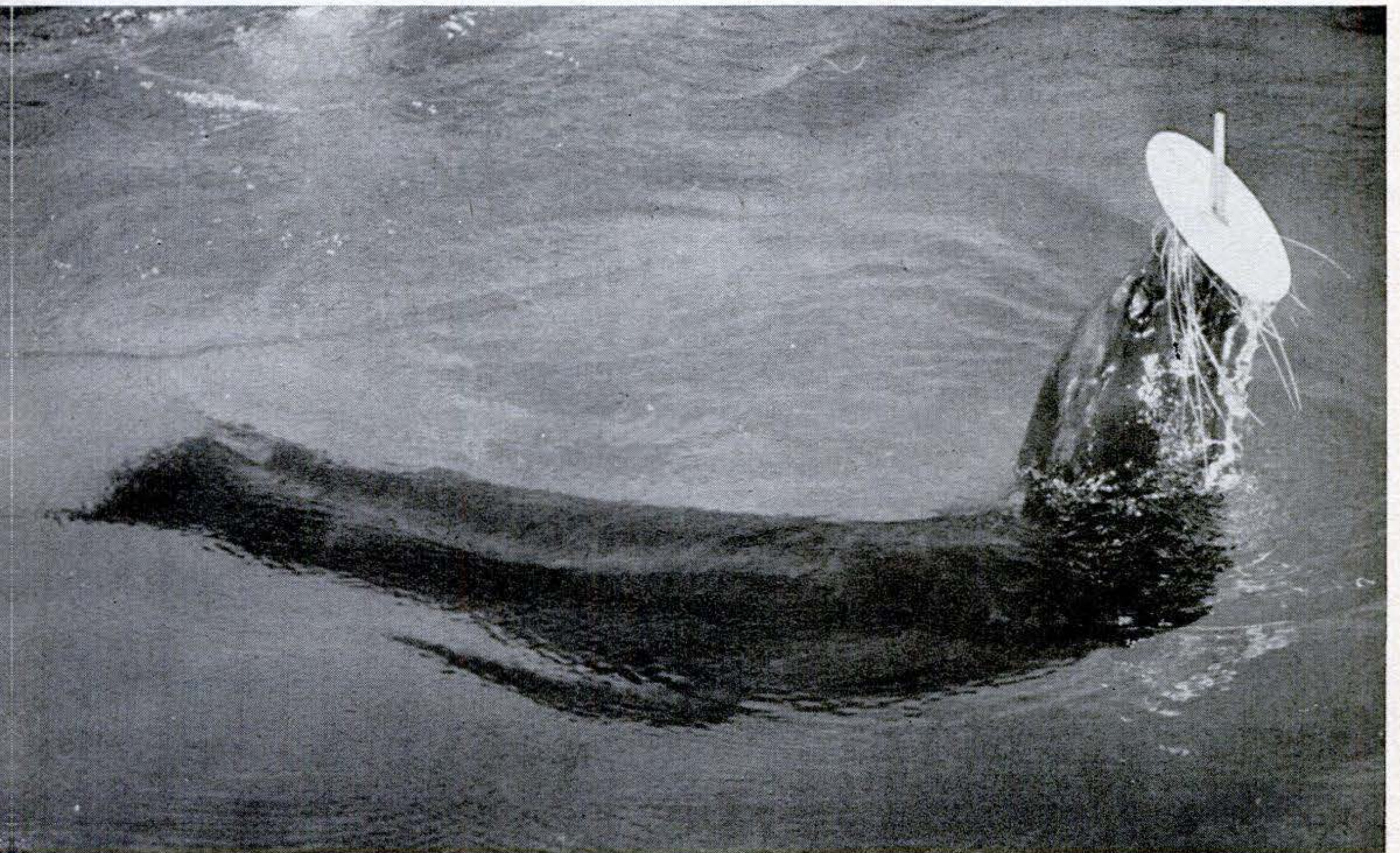
**MOUNTING A PEDESTAL** while balancing an object is the next step. Pedestal is a trained-seal act tradition. It elevates him and gives the audience a better view of the show.

**A TOUGH ONE**, even for a seasoned seal performer. For this act, the seal is fitted with a leather mouthpiece to which is attached a short protruding steel prong. The trainer



**RINGING BELLS** to play a tune is part of advanced course. Trainer teaches trick by using baton to indicate the sequence in which the seal should nose the bell buttons.

throws a wooden disk, with a one-inch hole in the center, into the water. The animal must dive and come up under the disk so that the prong enters the tiny hole. **END**





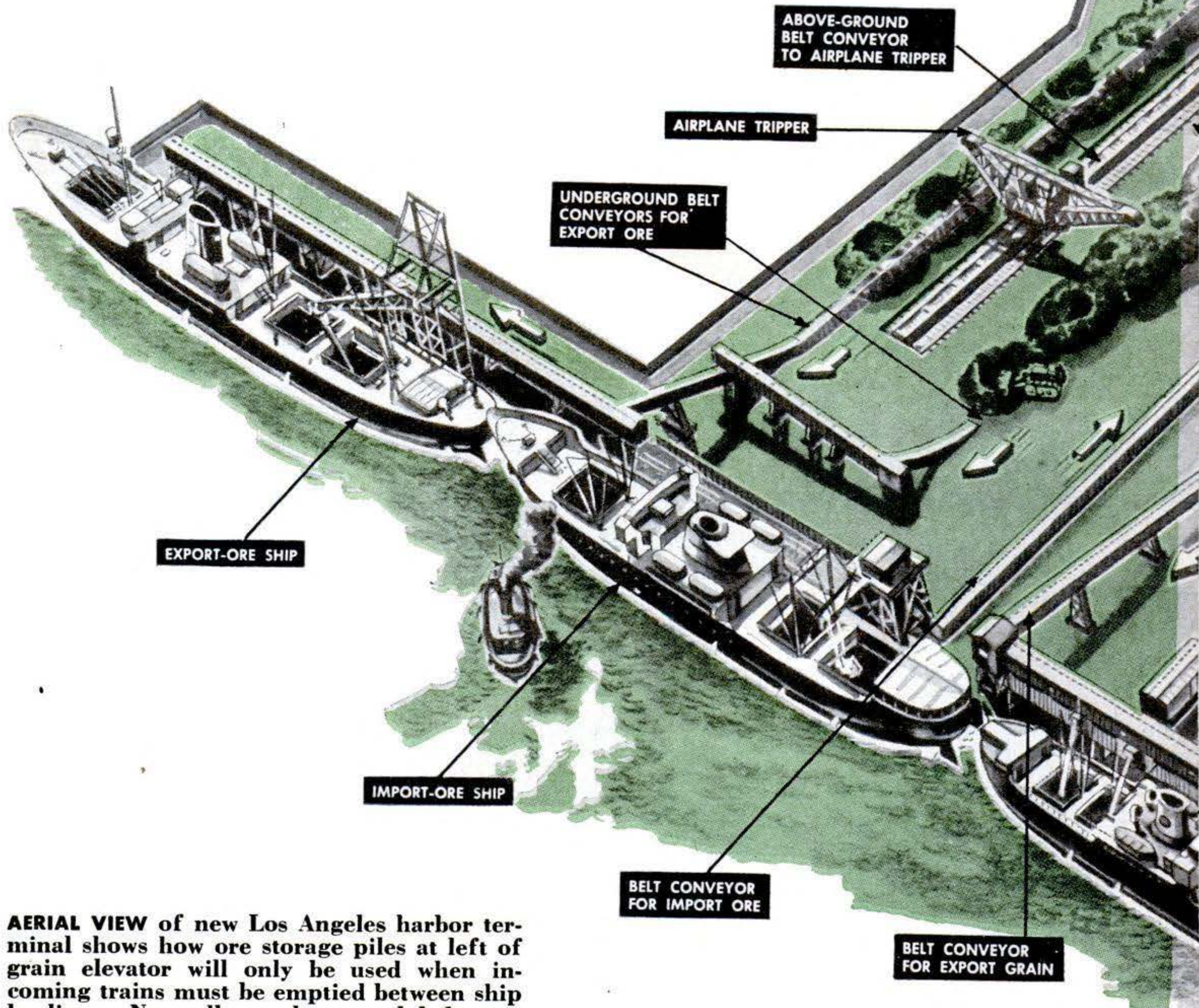
# \$4,000,000 'Cafeteria' to Serve 3 Ships Daily

**A** CAFETERIA-STYLE marine-rail terminal that will dish out helpings of grain and ore at the rate of 2,600 tons an hour soon will be catering to the greedy appetites of grain and ore ships and railroad cars entering the heart of the Los Angeles harbor district.

Speedy conveyor belts are the key to the operation. Running smoothly through

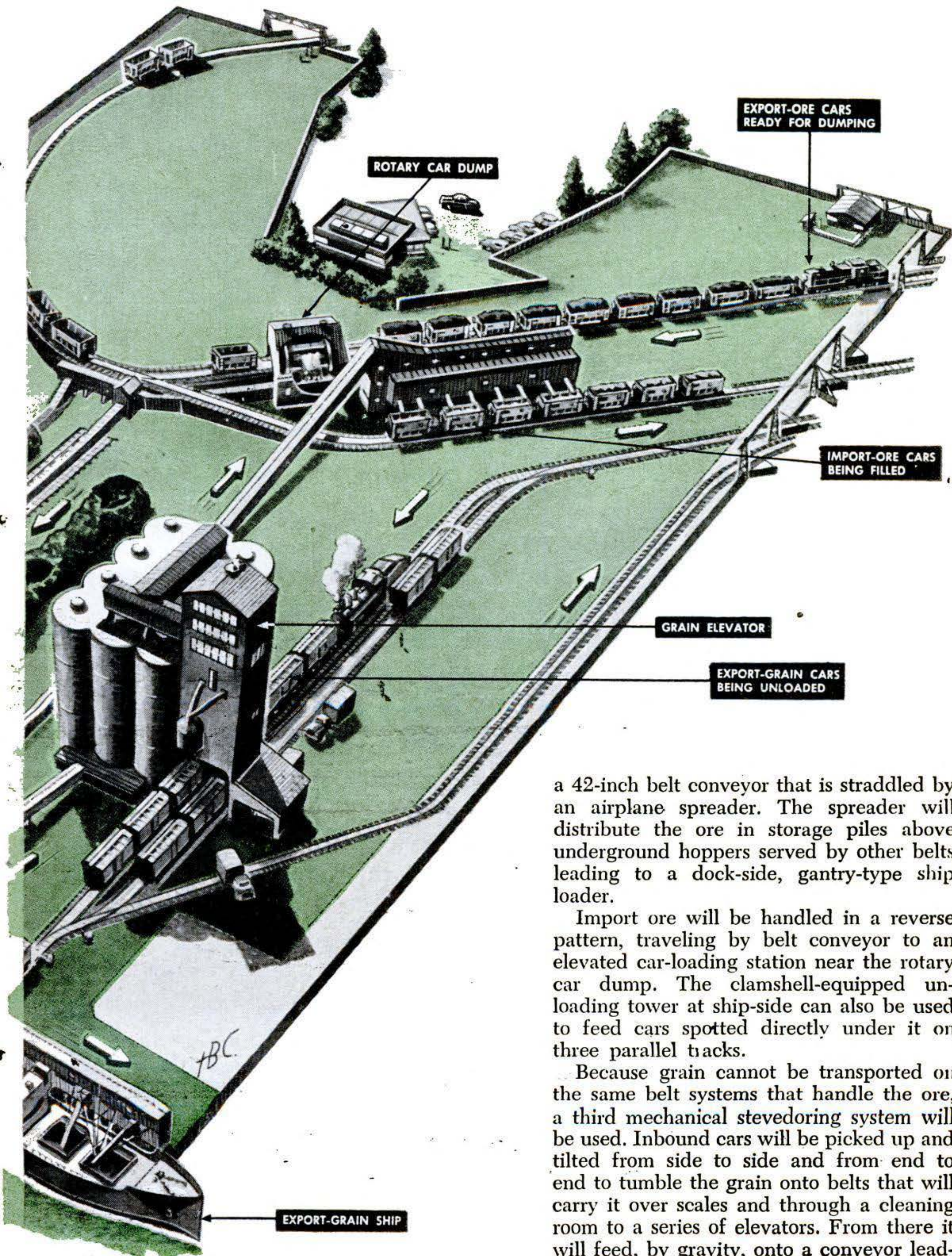
weatherproof housings above and below ground, they will carry the bulk shipments dumped onto them at 15 points in the 28-acre yard and discharge them at 13 others to keep 800 cars and three 10,000-ton freighters moving in and out of the terminal each day.

Cars carrying export ore will be picked up bodily and their contents rolled onto



**AERIAL VIEW** of new Los Angeles harbor terminal shows how ore storage piles at left of grain elevator will only be used when incoming trains must be emptied between ship loadings. Normally, underground belt conveyor at left of airplane spreader forms direct route from car dumper to ship. Bulk Unloaders, Inc., will operate the yard.





a 42-inch belt conveyor that is straddled by an airplane spreader. The spreader will distribute the ore in storage piles above underground hoppers served by other belts leading to a dock-side, gantry-type ship loader.

Import ore will be handled in a reverse pattern, traveling by belt conveyor to an elevated car-loading station near the rotary car dump. The clamshell-equipped unloading tower at ship-side can also be used to feed cars spotted directly under it on three parallel tracks.

Because grain cannot be transported on the same belt systems that handle the ore, a third mechanical stevedoring system will be used. Inbound cars will be picked up and tilted from side to side and from end to end to tumble the grain onto belts that will carry it over scales and through a cleaning room to a series of elevators. From there it will feed, by gravity, onto a conveyor leading to ship-loading chutes.





*New Jersey Turnpike's crack safety patrol serves as a model for other superhighways.*



EVERY morning at eight, rain or shine, a dozen men climb into a dozen cars and begin driving along the 118-mile New Jersey Turnpike—the East's newest superhighway. By four each afternoon, each

man has clocked about 200 miles, seen to the safety of some 20,000 drivers.

These 12 men make up one of the three 'round-the-clock' patrols of New Jersey State Police that are helping to make the mile-a-minute Turnpike the best-patrolled and safest high-speed road in the country. They are a part of a

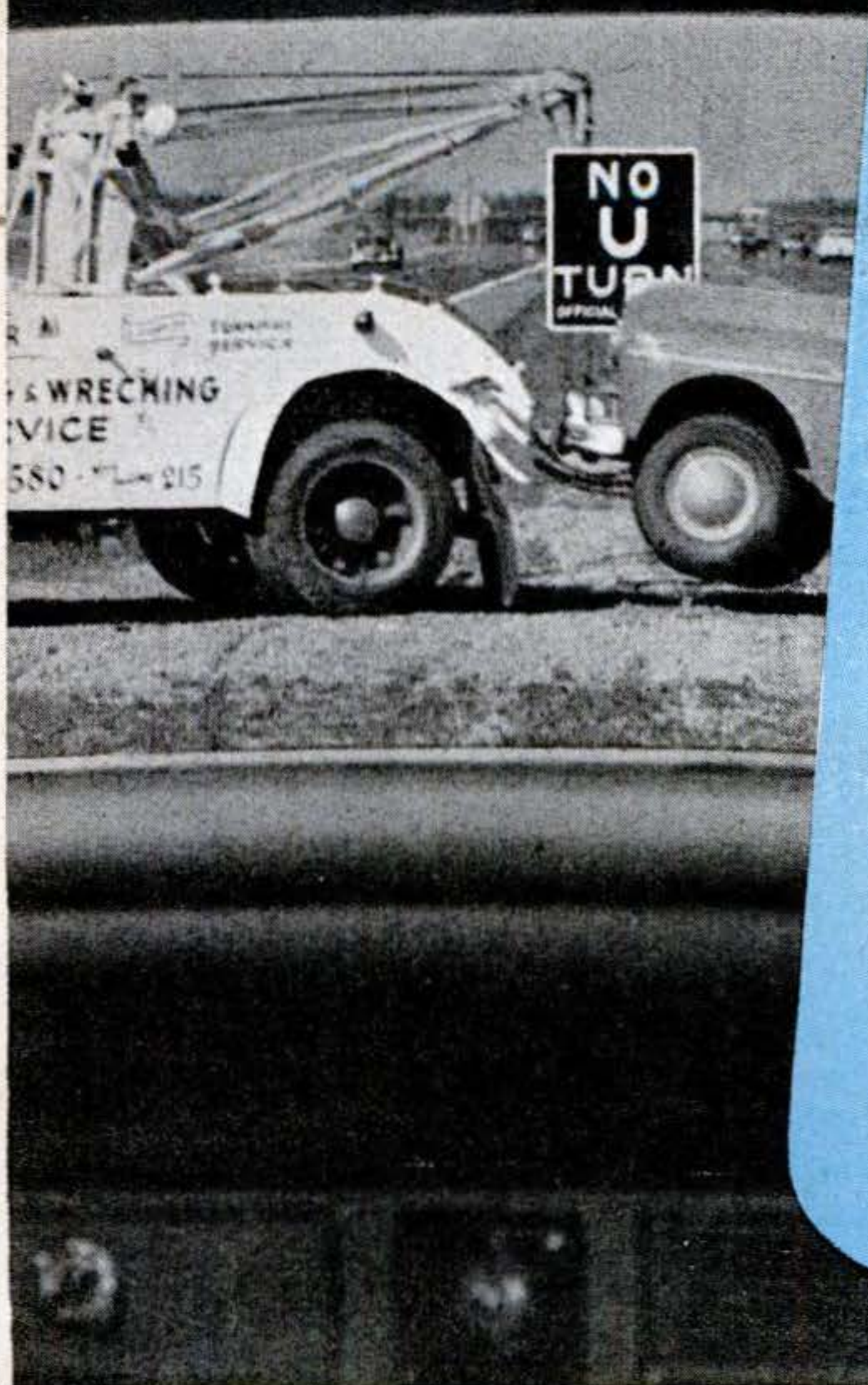
crack 65-man detachment of troopers who blend courtesy with strict law enforcement to cut down accidents and speed motorists on their way.

Their courtesy is paying off in safety.

During the Turnpike's first year of operation, 1952, deaths caused by accidents occurred at the rate of 6.1 for every 100 million miles traveled—compared with a rate of 7.7 for all the national highways and a rate of 7.3 for the older Pennsylvania Turnpike.

This year, if the record of the early months is maintained, fatalities on the Turnpike will be cut down to around four for every 100 million miles traveled, perhaps even lower. That would be an all-time safety record for a heavily traveled road.





# Courteous Cops Cut Crashes

By George H. Waltz Jr.

Every Turnpike trooper is a graduate of the New Jersey State Police Academy in West Trenton, N. J. There he learned motor mechanics, first aid, traffic control and accident investigation. To enter the Academy he had to be between the ages of 22 and 35, a high-school graduate, weigh at least 150 pounds but no more than 225, top 5 ft. 8 in., and be physically perfect.

### *Troopers Can Handle Anything*

This training, plus required years of experience patrolling other Jersey highways before being assigned to the Turnpike, fit a Turnpike trooper to handle just about any kind of an emergency, from delivering a baby to coping with a gun-toting hoodlum.

And on the Turnpike he is likely to be called on to do both. Last year the troopers, besides aiding motorists and passing out traffic tickets, made 295 arrests for criminal violations ranging

from armed robbery to the illegal possession and transportation of narcotics.

The fast, radio-equipped cars the troopers drive have been selected after long tests on the road. Besides a fleet of 23 blue-and-white police cars—Fords fitted with Mercury engines, dual exhausts, souped-up rear ends and heavy-duty cooling systems—there are 10 sleek, unmarked black Chrysler sedans. These black Chryslers, capable of 120 m.p.h., look just like other cars except for their drivers' light-blue uniforms.

Backing up the troopers and their patrol cars are three portable radar timers that can be set up at any point along the road for instantaneously clocking cars and alerting patrol cars. There is also an integrated three-way radio hookup that allows the cruising troopers to talk with each other as well as with the dispatchers at headquarters.

Recently, I spent the better part of a week riding with the troopers in their



patrol cars and talking with them around headquarters, learning firsthand just how superhighway accidents are born and how they can be avoided.

As each trooper starts out on his Monday patrol he knows that by week's end he and his patrolmates will have felt obliged to hand out at least 300 tickets for speeding and foolhardy driving. He also knows that he will be called on to help out with about 700 assists to motorists stalled by empty gas tanks, blowouts, broken fan belts and motor failures.

#### *Breakdown of Summonses*

During a recent week, the batch of summonses broke down like this: 240 for speeding (210 for speeds between 60 and 70, and 30 for speeds above 70), 17 for failing to drive on the right, 21 for unregistered cars and unlicensed drivers, two for impeding traffic, 10 for careless and reckless driving, and a dozen or so for miscellaneous violations.

The 700 weekly assists to motorists

included aid to 150 who had run out of gas (even though gas stations are located every 20 or 30 miles), 220 who needed to be towed because their cars had broken down, 170 who had flat tires and 20 whose fan belts had parted under the strains of high-speed driving.

This weekly total, say the troopers, pinpoints two major causes of accidents on superhighways: (1) the cocksureness of the driver who thinks he can handle his car as well at 60 or more as he can at 35 or 40; and (2) the poor mechanical condition of many cars.

To the trooper, giving a ticket is mainly a means to an end. It gives him a chance to establish in one more driver's mind, through his pocketbook, the fact that speed laws are made for safety—his safety. It is also an opportunity to give one more driver a friendly lecture on safe driving.

The value of safety education and preventive policing was dramatically demonstrated shortly after the Turnpike

Flat tires account for about 170 of the assists that troopers give motorists every week.





was opened to traffic. Records soon showed that Friday was the worst accident day, with a large percentage of the accidents involving servicemen on weekend passes heading north from Army camps. Pushing for time, many a driver fell asleep and plowed his car and his mates into fatal trouble.

Immediately, the Turnpike Authority, with the help of the Armed Services, started a safety-education campaign. Safe-driving posters were displayed at the camps, safe-driving reminders were handed out with all weekend passes and every car driven by a serviceman was flagged down by a trooper as it entered the Turnpike and its occupants given a 60-second briefing on safe driving. The program is still in effect and accidents involving servicemen have all but disappeared from the weekly statistics.

Up until now, no one has come up with any set of sure-fire rules for safe superhighway driving. Too many factors other than speed are involved. Speed

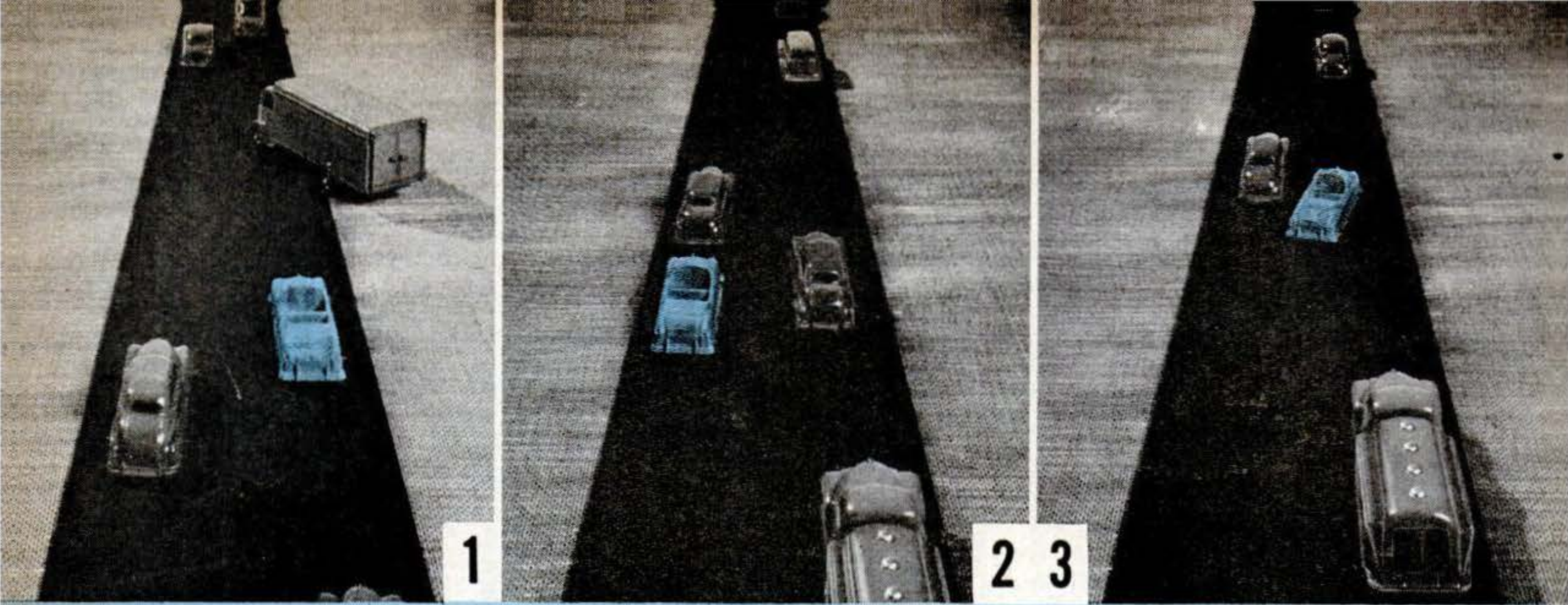


**700 ASSISTS A WEEK** are given to motorists by the Turnpike troopers. Among other things, they help some 220 motorists stranded by breakdowns by radioing for tow trucks.

**Special dry-powder extinguishers** carried in the patrol cars douse gasoline fires quickly.

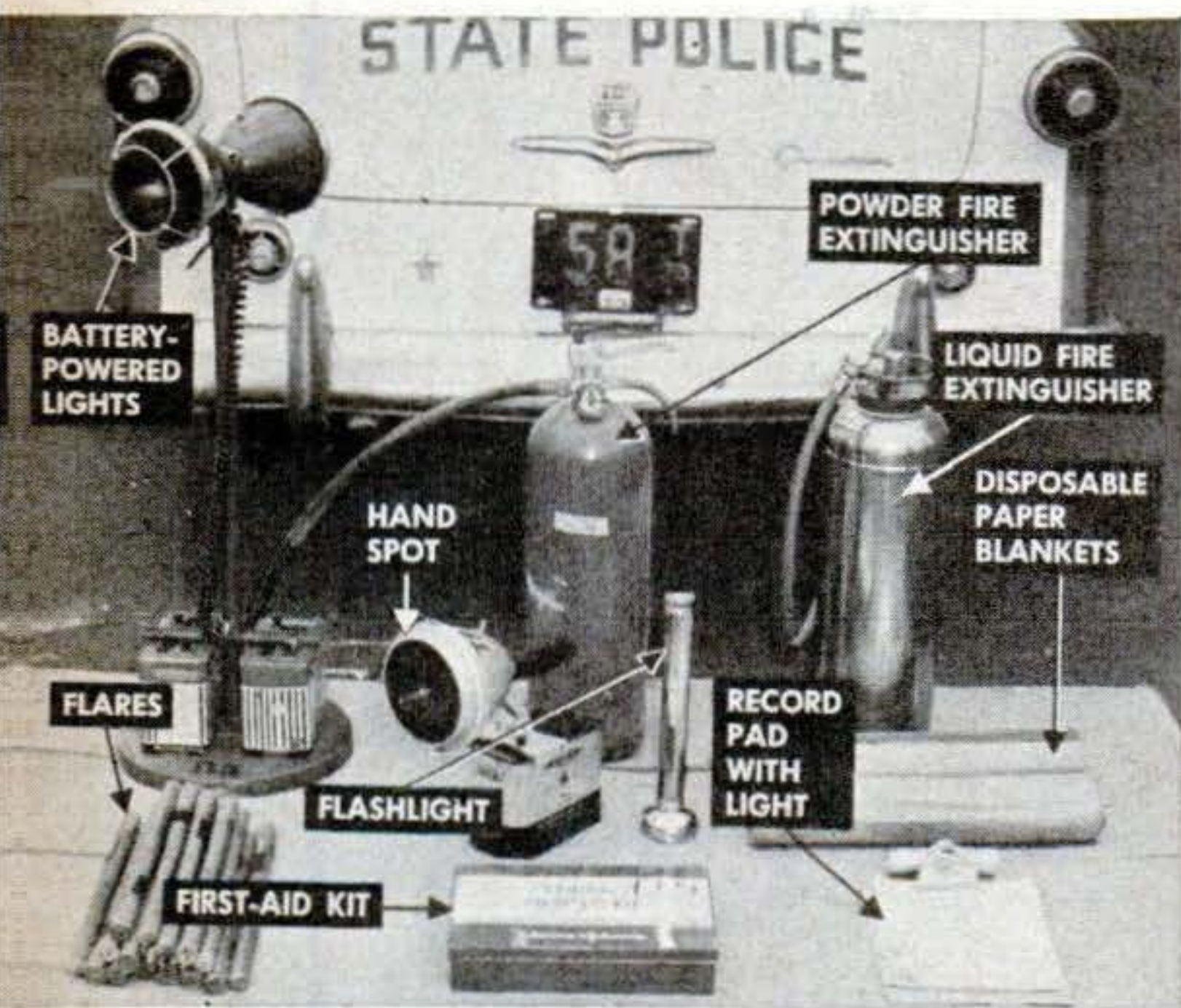






## What Is the Convertible Doing Wrong?

**Next to excessive speed, these are the six most common causes of superhighway accidents.**



**PATROL EQUIPMENT** carried in trooper's car includes two kinds of fire extinguishers—a liquid type for fighting truck-tire fires and a powder type for gasoline fires.

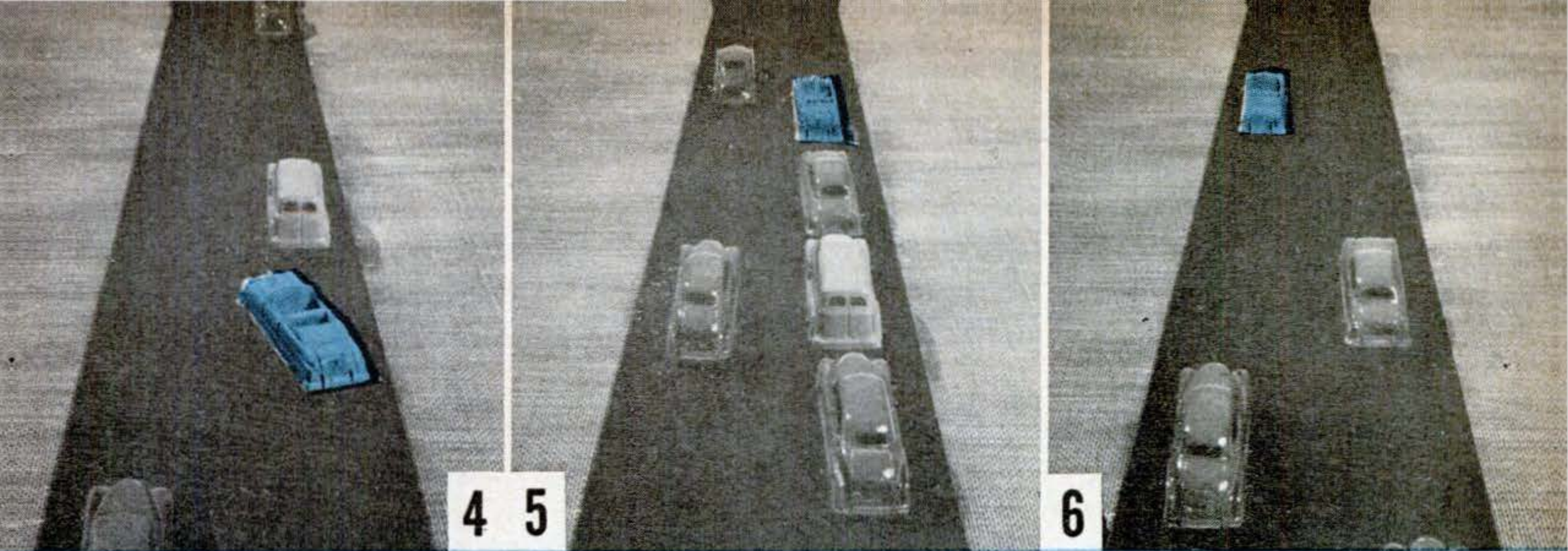
alone doesn't cause most accidents, it just makes them worse. However, the facts learned by the New Jersey Turnpike's troopers do form a pattern for safe driving that can be applied to any high-speed, nonstop road:

- Stay under the posted speed limit—the road was designed originally for that top speed. In bad weather, cut that top speed at least in half. In any case, never drive at any speed that tenses you. Don't exceed your personal speed limit.
- On the other hand, don't drive too slowly. Slowpokes cause accidents, too. If you're uncomfortable at the slowest pace of traffic, don't drive on superhighways. Use the parallel roads.
- Don't hang onto the tail of the fellow in front of you. Never have less than a yard of road between your car and the

Ten unmarked Chryslers and 23 blue-and-white police cars are used by the Turnpike patrol.







1. Failing to slow down for slower-moving trucks or trucks pulling back onto the highway. 2. "Bumper riding." Riding too close to the car ahead. Leave one yard for every mile of speed. 3. Passing a car on the right. 4. Not allowing enough time or space when

passing another car. Turning out too late or cutting back into right lane too soon. 5. Going too slow for normal superhighway traffic and holding up cars behind. 6. Deliberately staying in the left or passing lane after passing a car.

one ahead for every mile of speed. (At 60 m.p.h. that's 60 yards or 180 feet.) You'll need that much space to stop or change course in case he does.

- Give yourself plenty of time and space when passing a car or a truck, particularly a truck. Comparative speeds are difficult to judge when you are traveling fast. On the New Jersey Turnpike in 1952, 36 percent of all fatal accidents were caused by rear-end collisions.
- Keep right, except when passing.
- If you get drowsy, don't pull off on the shoulder of the road for a snooze. Park completely off the highway or, better still, drive to the next service and restaurant area. Park there and sleep.
- Don't take car on a superhighway un-

less it is in top mechanical condition.

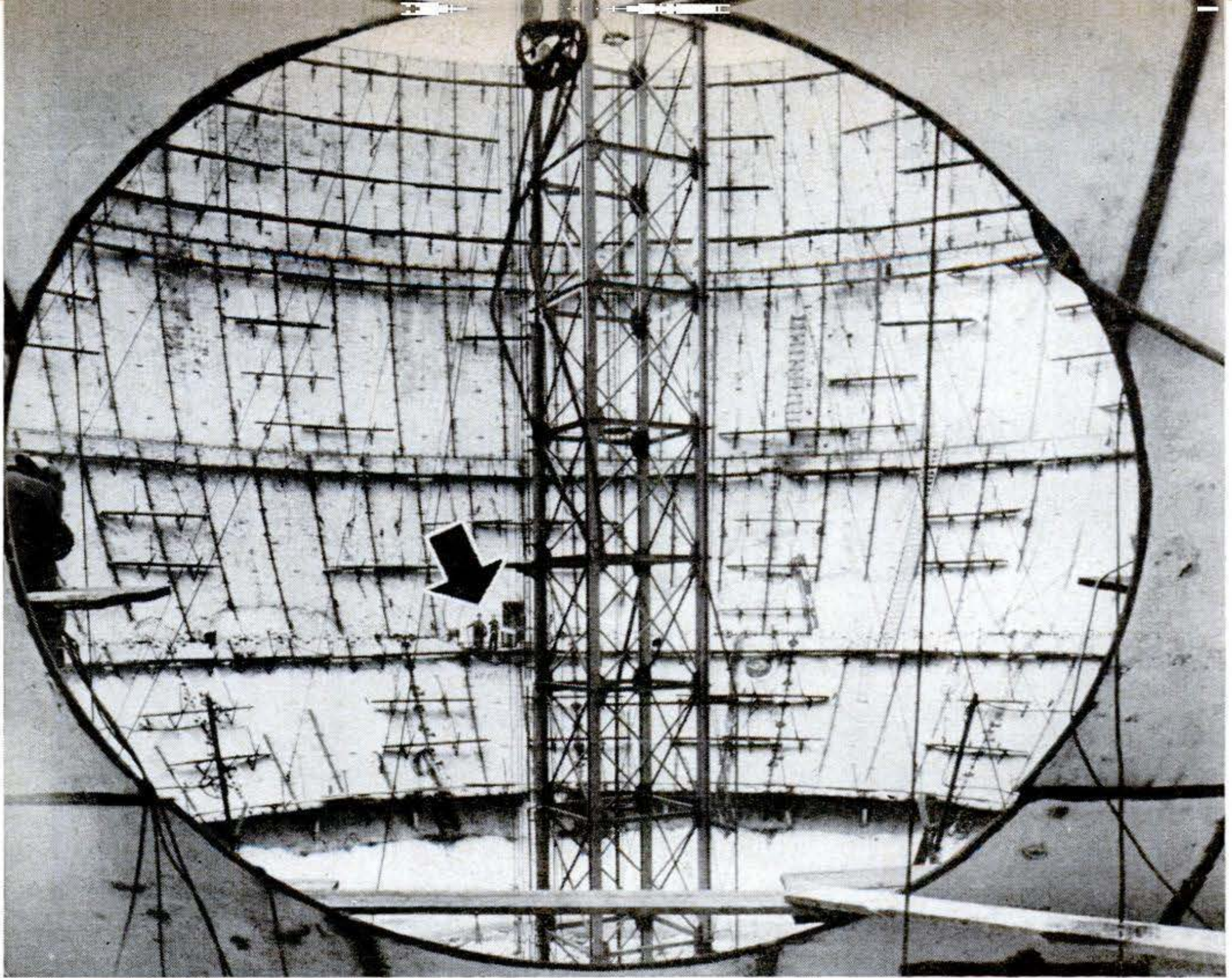
- Add a red flare or heavy-duty lamp to your tool kit for use as a danger signal if your car breaks down at night and you can't get it completely off the highway.
- If you are off on a vacation tour, don't plaster your windshield and windows with stickers. It's much more important to be able to see where you're going and stay alive than to brag about where you've been.
- Finally, when you drive on a superhighway, make it your full-time job. Remember, when it comes to safe driving, car manufacturers haven't yet devised mechanical substitutes for your eyes on the road, your mind on your driving and both hands on the wheel. END

**TROOPERS MIX COURTESY** with law enforcement when ticketing speeders. They try to impress driver with idea that speed laws are made for his and other drivers' safety.

**OUT-OF-STATE SPEEDER** may park car at an interchange while trooper takes him to court to pay fine and returns him to car. Home-state speeder gets ticket returnable in five days.







## Looking into Huge Globe to Hold Sub's Atomic Power Plant

THROUGH an entrance-lock opening, the camera peers into a half-completed, 225-foot-diameter steel sphere that will enclose a submarine's atomic power plant being developed by General Electric at Schenectady,

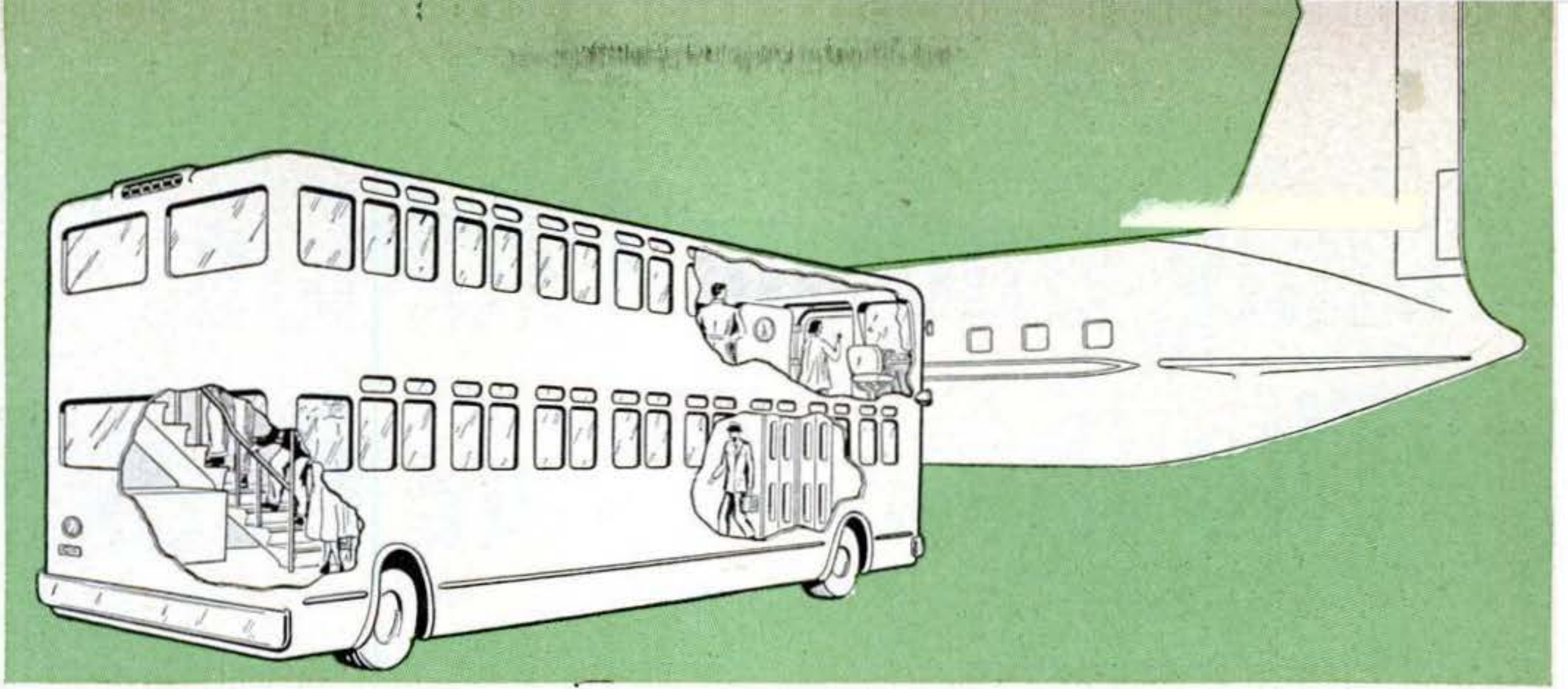
N. Y. At far side, men (arrow) in similar opening show comparative size. The airtight globe would safeguard the countryside against escape of a radioactive cloud from a "runaway" reactor, if safety controls failed.



## Liquid Fuel Runs Atomic Pile

LARGEST liquid-fuel atomic pile to date, the AEC's experimental "homogeneous reactor" at Oak Ridge, Tenn., has just had its first public showing. At left, operators man its controls as they did when they recently harnessed it to generate 150 kilowatts of electric power. Instead of fuel rods of uranium metal, it uses uranium salt dissolved in water, simplifying fuel replenishment and by-product recovery. Experts call it a pilot-size version of a promising type for future large-scale atomic power.





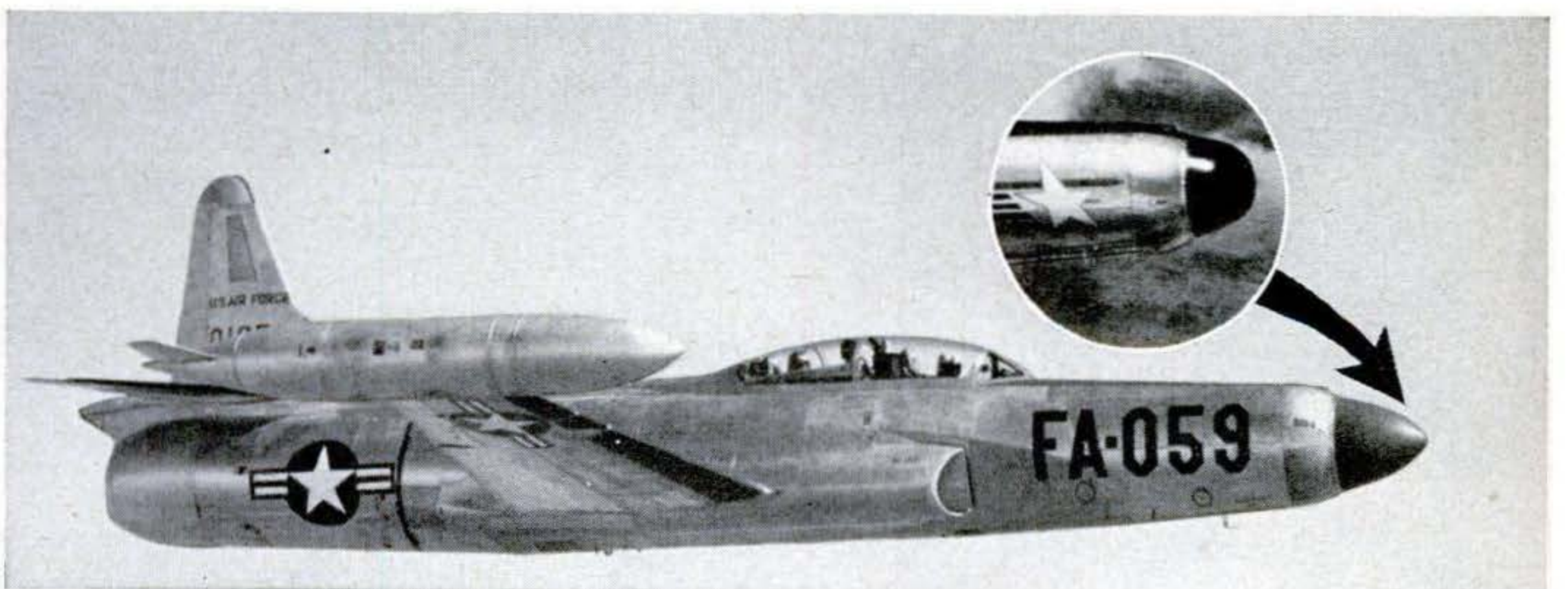
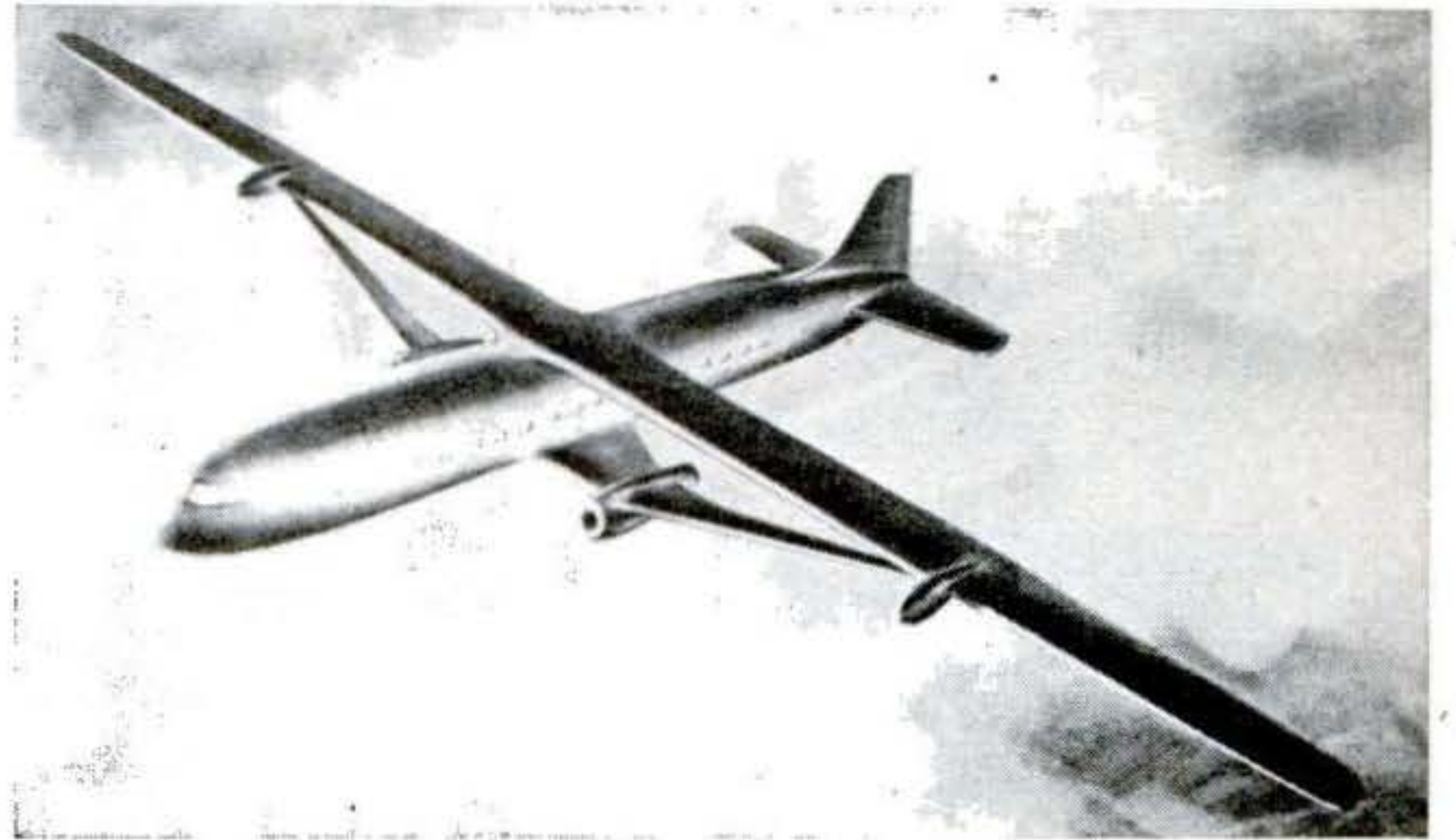
### Airport Bus Would Haul Passengers Right to Plane

AS AIRPORTS spread over more acres to accommodate larger planes carrying more passengers, and jet transports edge closer looking for elbow room, engineers are busy anticipating traffic snafus. E. W. Fuller of American Airlines has come up with one

answer—a mobile gatehouse. The double-decker bus would eliminate the building of costly concrete aprons and loading fingers, and would allow planes to take on or disembark passengers as far as a mile and a half away from the embarkation terminal.

### New Wing to Lift More

MAURICE HUREL, French designer, believed that a narrow, knifelike wing with a wide span would lift heavier loads than a conventional wing. After building two such propellered planes for the French Government, he now has designed a similar turbojet job (right). It will carry 80 passengers and have a cruising speed of 452 m.p.h., Hurel estimates.



### Jet-Powered Starfire Now Gets There Faster by a Nose

THE F-94C Starfire (above) has undergone a little plastic surgery to reshape its nose. The change-over from the bulb-like plastic radome shown in the inset to the

streamlined, pointed ellipse resulted in a five-mile-an-hour increase in speed. Key units of the Lockheed plane's electronic gear are carried in the radome.



# Young Doctor Tackles "The Unclimbable Peak"

**New Englander leads team of Americans against perils of second-highest mountain.**

**By Gardner Soule**

.....  
*"Something hidden. Go and find it. Go and look behind the Ranges—  
 Something lost behind the Ranges.  
 Lost and waiting for you. Go!"*  
 RUDYARD KIPLING, "The Explorer."  
 .....

**S**EVEN Americans and one Englishman have gone behind Kipling's ranges to try something that's rarer than

trying to climb Mount Everest. They're attempting to scale Godwin Austen, or K-2, the world's second-highest mountain after Everest alone—and second to none in frightfulness.

One detail that makes K-2 appalling is the final climb to the summit: up the sheer sides of a 12,000-foot-high pyramid of rock so rotten it often falls away from under you.

The eight men met in May and laid their plans. In June they would march to K-2. They would have July to try for the summit. They would return home in August.

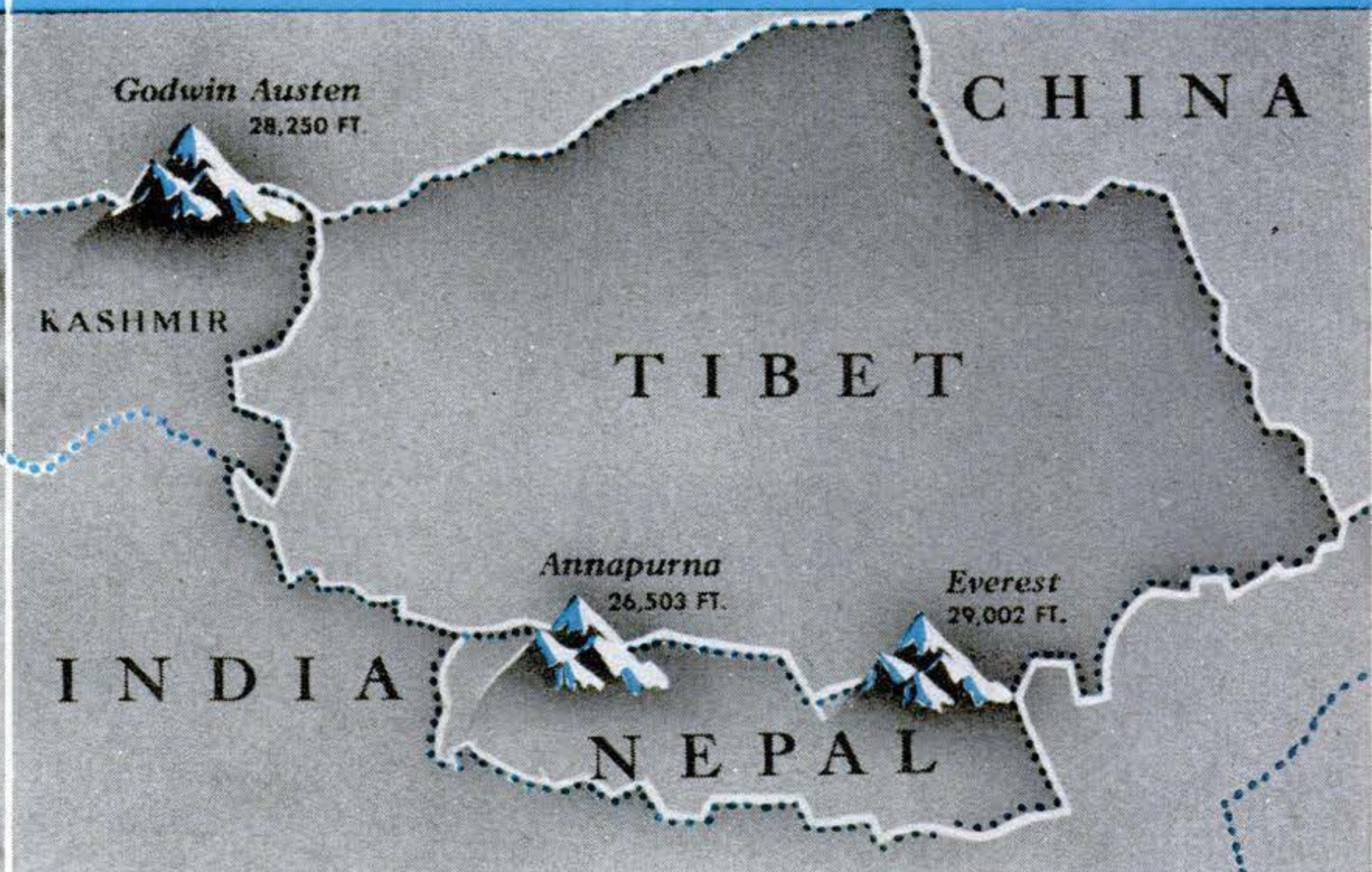
For years, mountaineers called K-2

## The Man



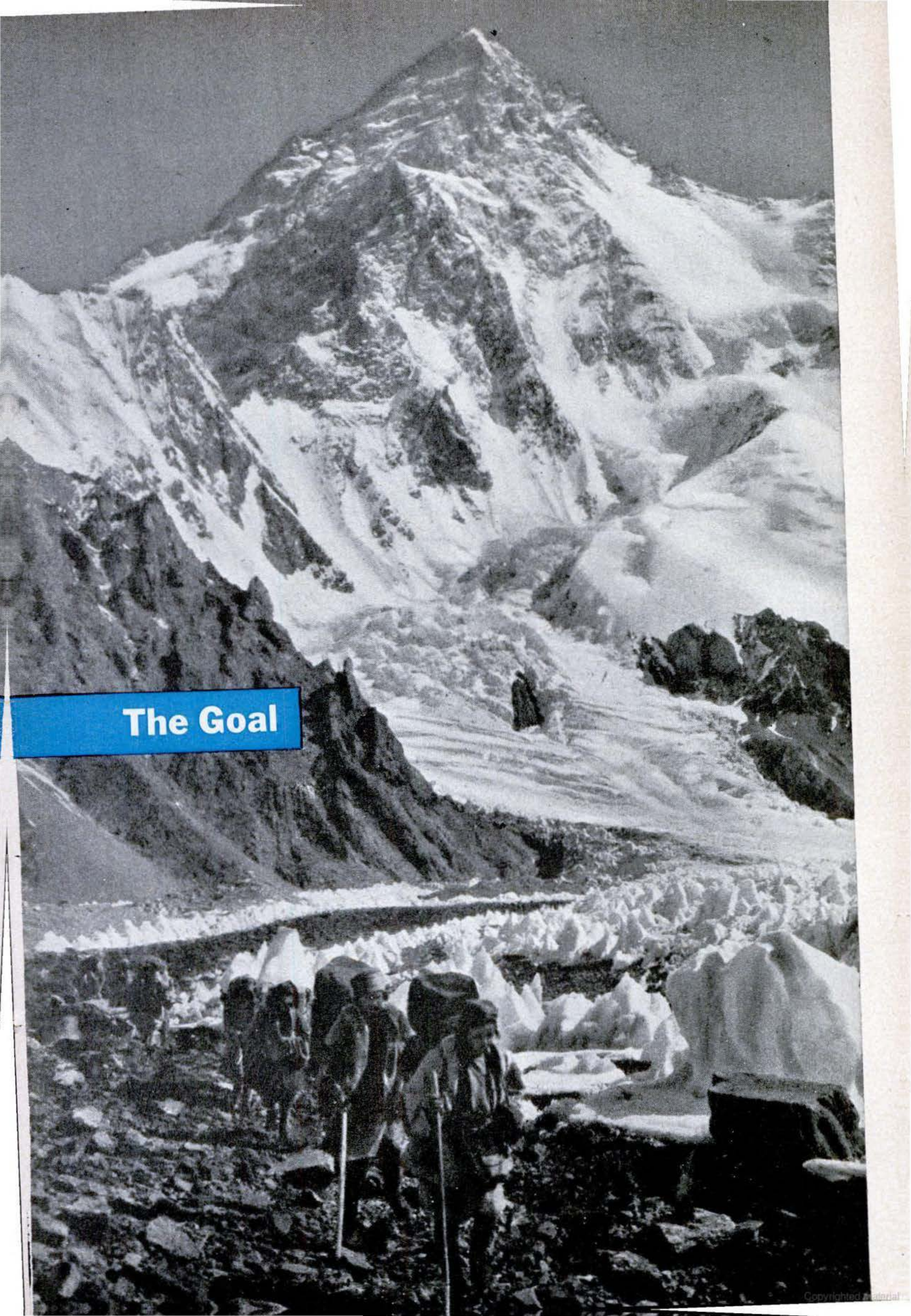
**DR. CHARLES HOUSTON, 39,** is America's No. 1 Himalayan climber. Picture shows him on only U.S. expedition to Mt. Everest area. Map and photo at far right show his current goal,

## The Place



also called K-2, 1,000 miles northwest of Everest and nearby Annapurna, loftiest peak scaled in past years. K-2 is located in a wilderness so remote that few have seen it.

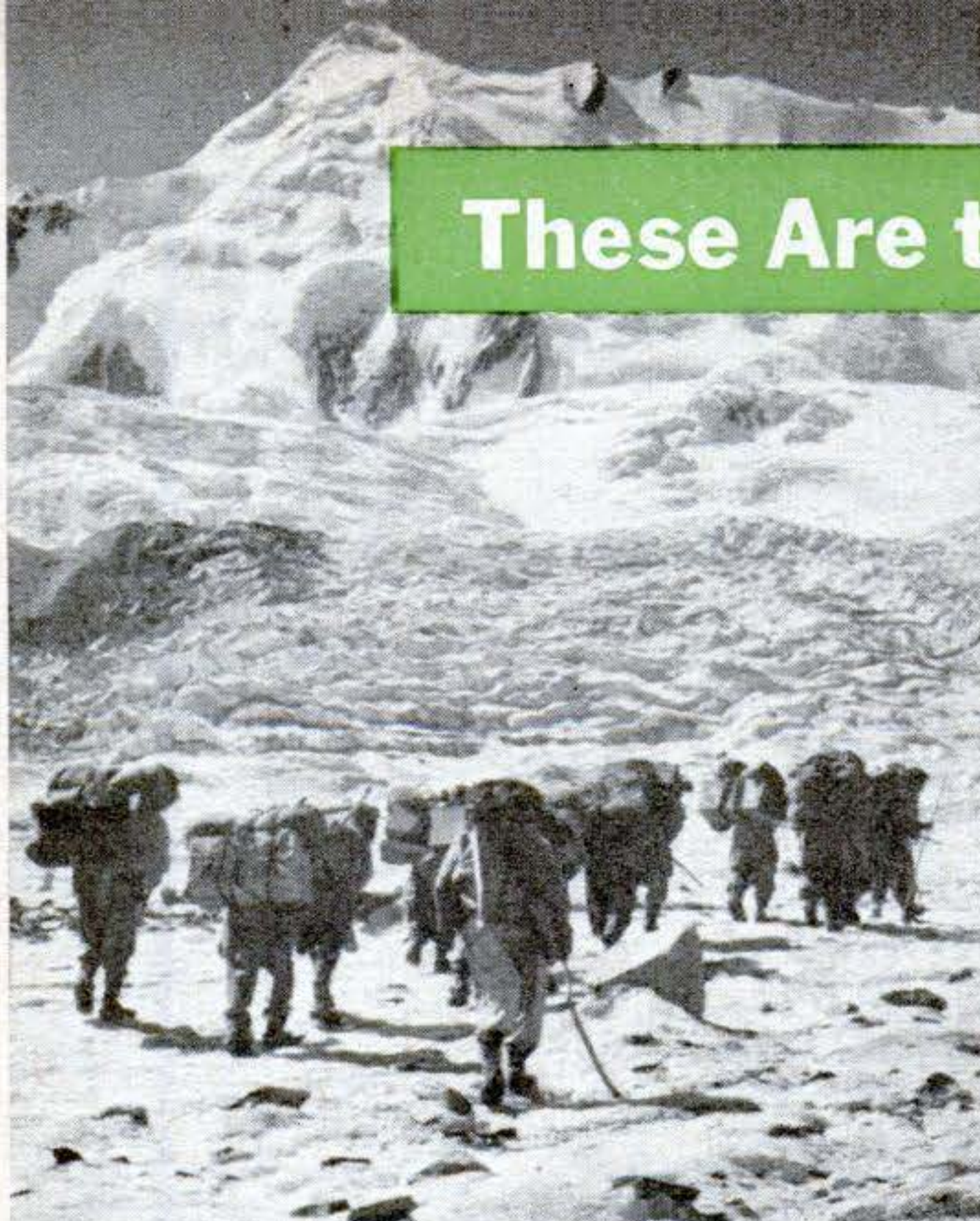




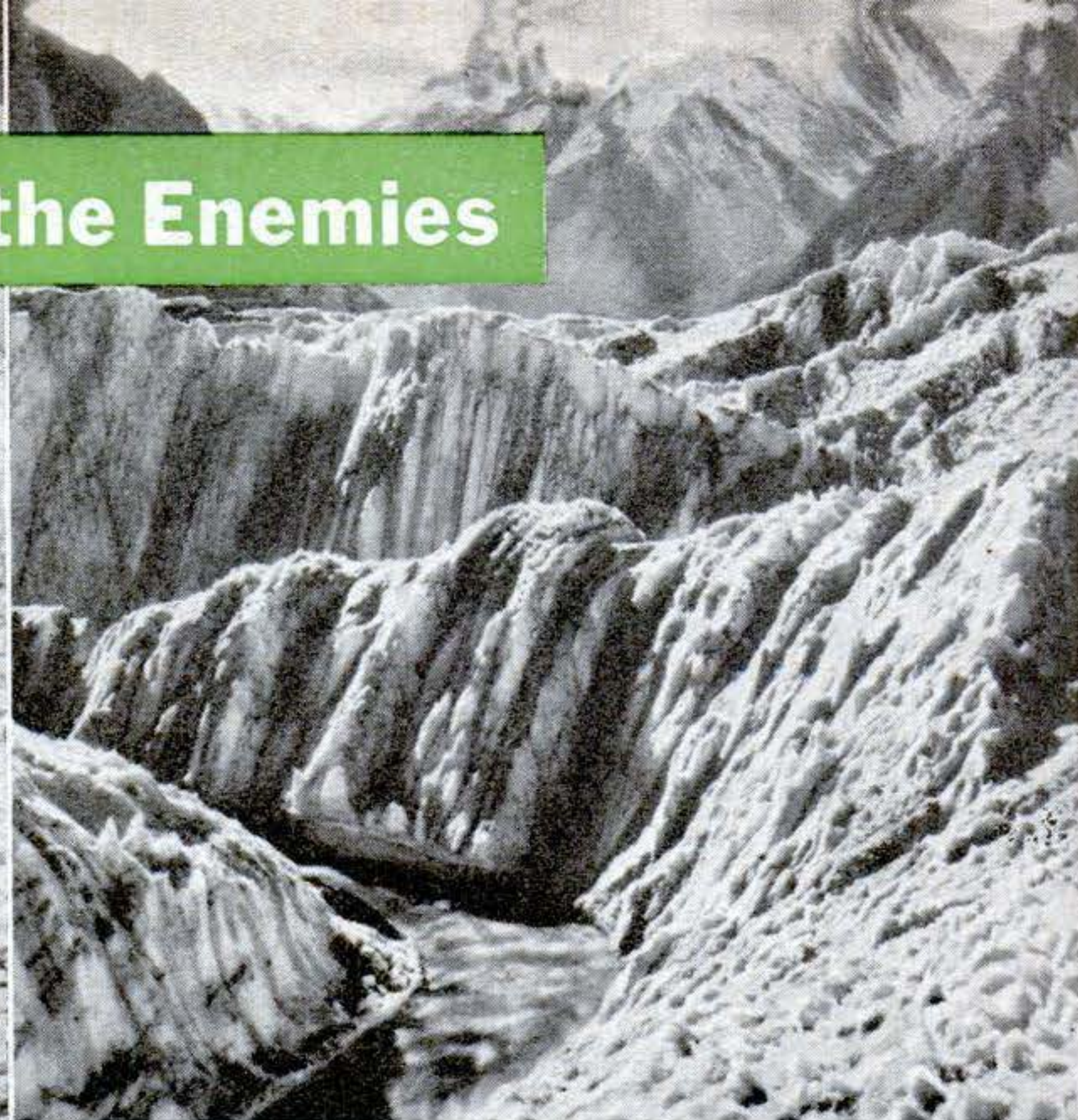
**The Goal**



## These Are the Enemies



**THE ROUTE IN:** K-2 is twice as far from civilization as Everest. Everything must be carried on men's backs over 175 miles of rough ground, rock, ice. Speed: nine miles a day.



**MOUNTAIN TORRENTS:** Water from snow fields pitches downward in July between walls of rotting ice. Roaring rivers must be crossed by rafts, rope bridges or breeches buoy.

**CRUMBLING ROCK:** The pyramid that caps K-2 has sides of black rock so rotten that it splin-

ters under a climber's boot and comes off in tufts as he tries to grab a handhold.







**THE GLACIERS:** They are the largest on earth, outside the poles. Their gullies "looked insignificant," said report of Houston's first K-2 trip—"although we did not find them so."



**FEW CAMPSITES:** Level spots are scarce on K-2. Most campsites must be hacked out of hard snow, ice, rock. This one is 4,000 feet above glaciers. Higher camps are even smaller.

"unclimbable." Then in 1938 a third-year U. S. medical student named Charles Houston almost got to the top. Charles Houston, now 39 and a small-town (Exeter, N. H.) doctor, is the leader of this year's expedition.

Also along is Robert Bates of Exeter, the only other veteran of the 1938 trip to K-2, and Arthur Gilkey, the Columbia University glacier expert. The Englishman is H. R. A. Streather of Warminster. The others are among the best U. S. mountain climbers, with long experience in the Alps, Rockies, Alaska and elsewhere: George R. Bell of Los Alamos, N. M.; Robert W. Craig and Dee Moleenaar of Colorado Springs, Colo.; and Peter Schoening of Seattle, Wash.

#### ***K-2 Wasn't Found Until 1861***

"Something hidden," Kipling wrote. "Something lost."

K-2 is so lost that, despite its towering height, it wasn't even discovered until 1861. What hides K-2 and its neighbors is a vast icy wilderness crossed and re-crossed by dozens of mountain ranges.

There is no food for man or beast along the trail. All food and equipment

must be carried on men's backs, step after weary step, over pathless ground.

"*Behind the Ranges*," wrote Kipling, pointing the way.

Over the ranges, through the cold wilderness, the U. S. party headed for a knot-point of Asia: a spot in northernmost Pakistan near the boundaries of five other nations (China, Russia, India, Tibet, Afghanistan), which makes a good jumping-off place for the assault on the Karakoram Mountains. The Karakorams, home of K (for Karakoram)-2, extend across the Indian state of Kashmir, and are a higher range—so far as average mountain height is concerned—than even the nearby Himalayas (which contain Everest).

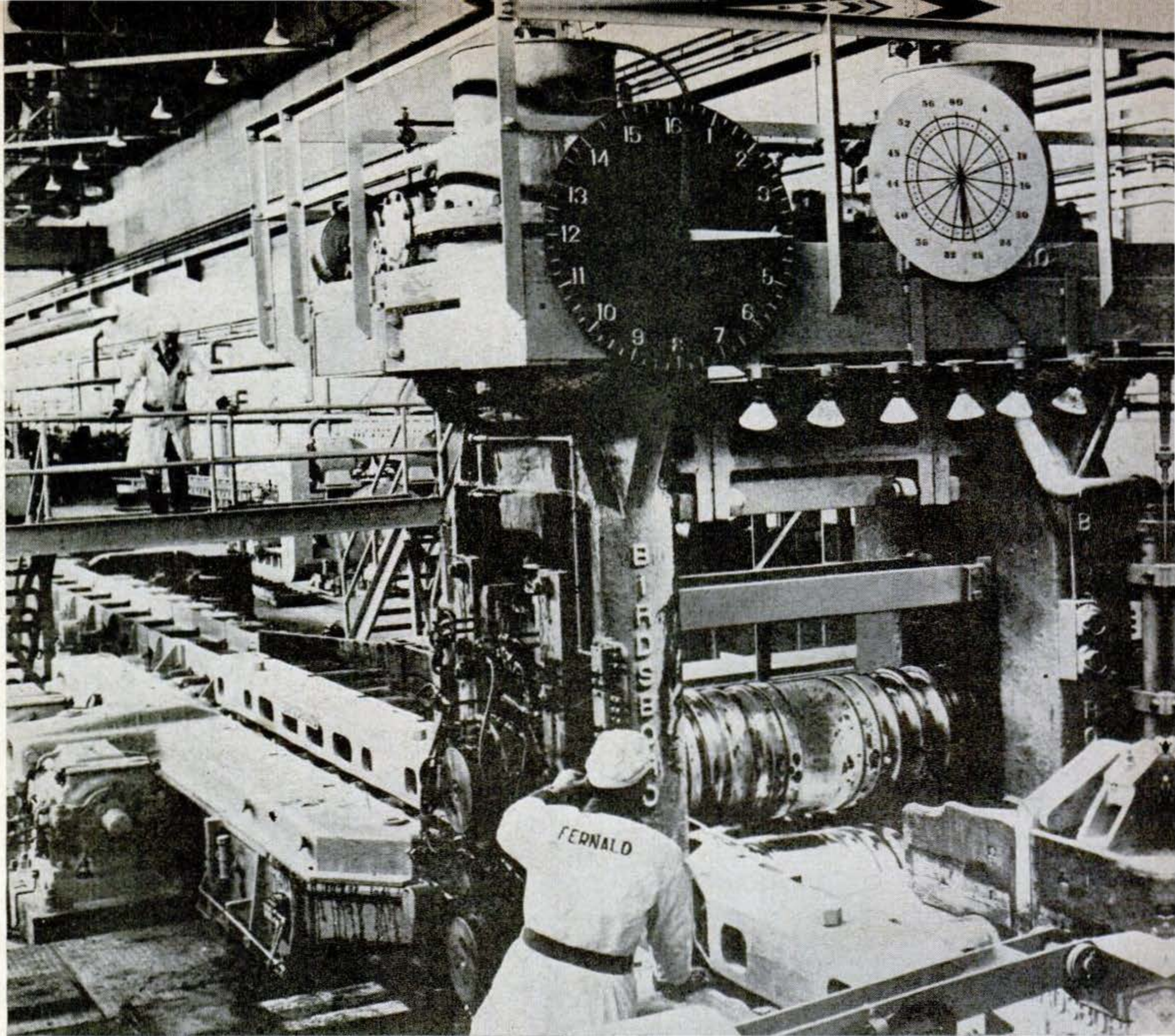
K-2, at 28,250 feet high, only 750-odd feet lower than Everest, rises right out of this astounding group of super-eminent peaks: the tallest mountain of the tallest range on earth.

"Go!" commanded Kipling.

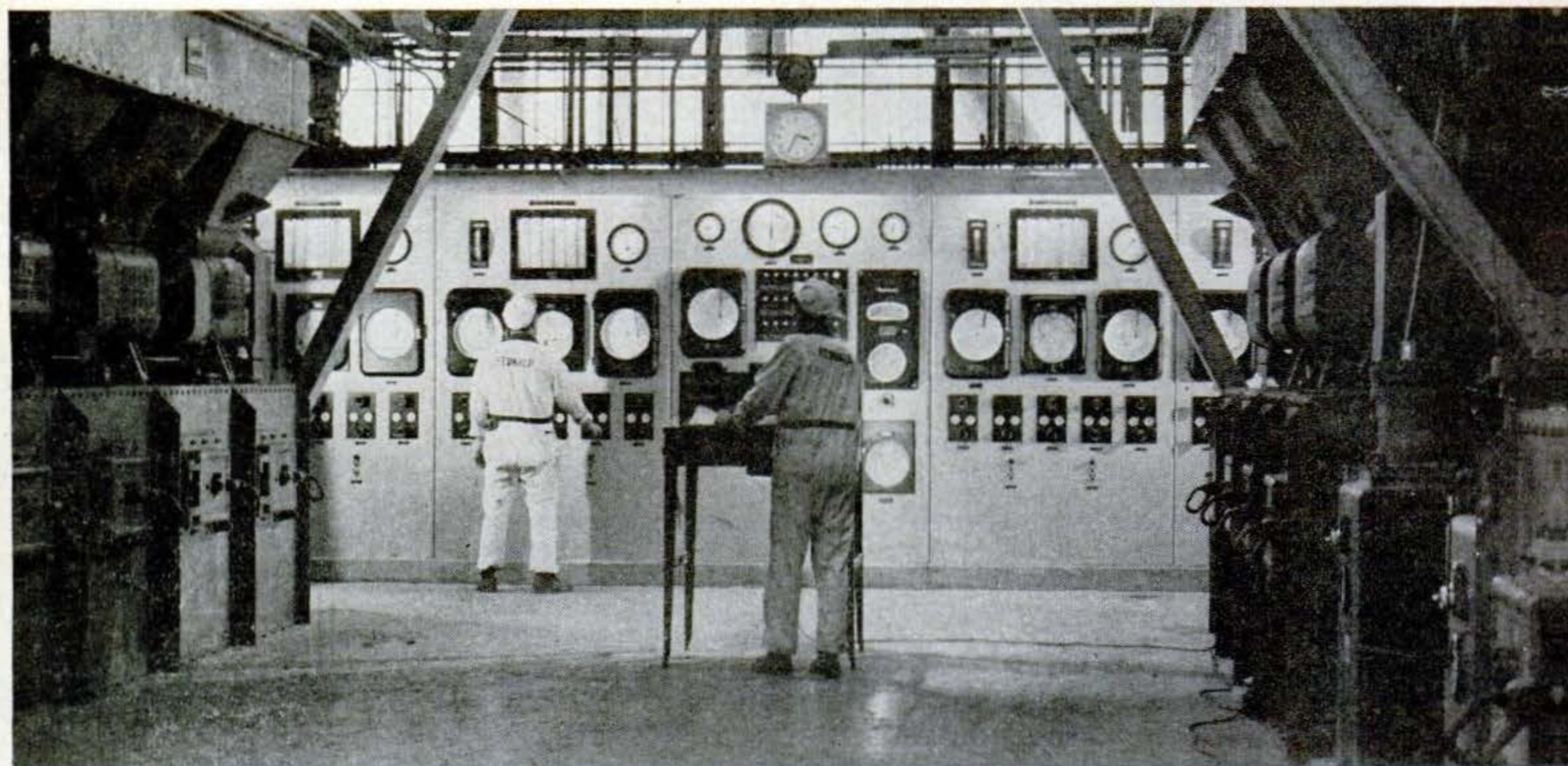
When a mountaineer finds a route he can climb, he says it will "go," and he says he can "go." As the Americans this month try to go up K-2, they will face

**[Continued on page 206]**



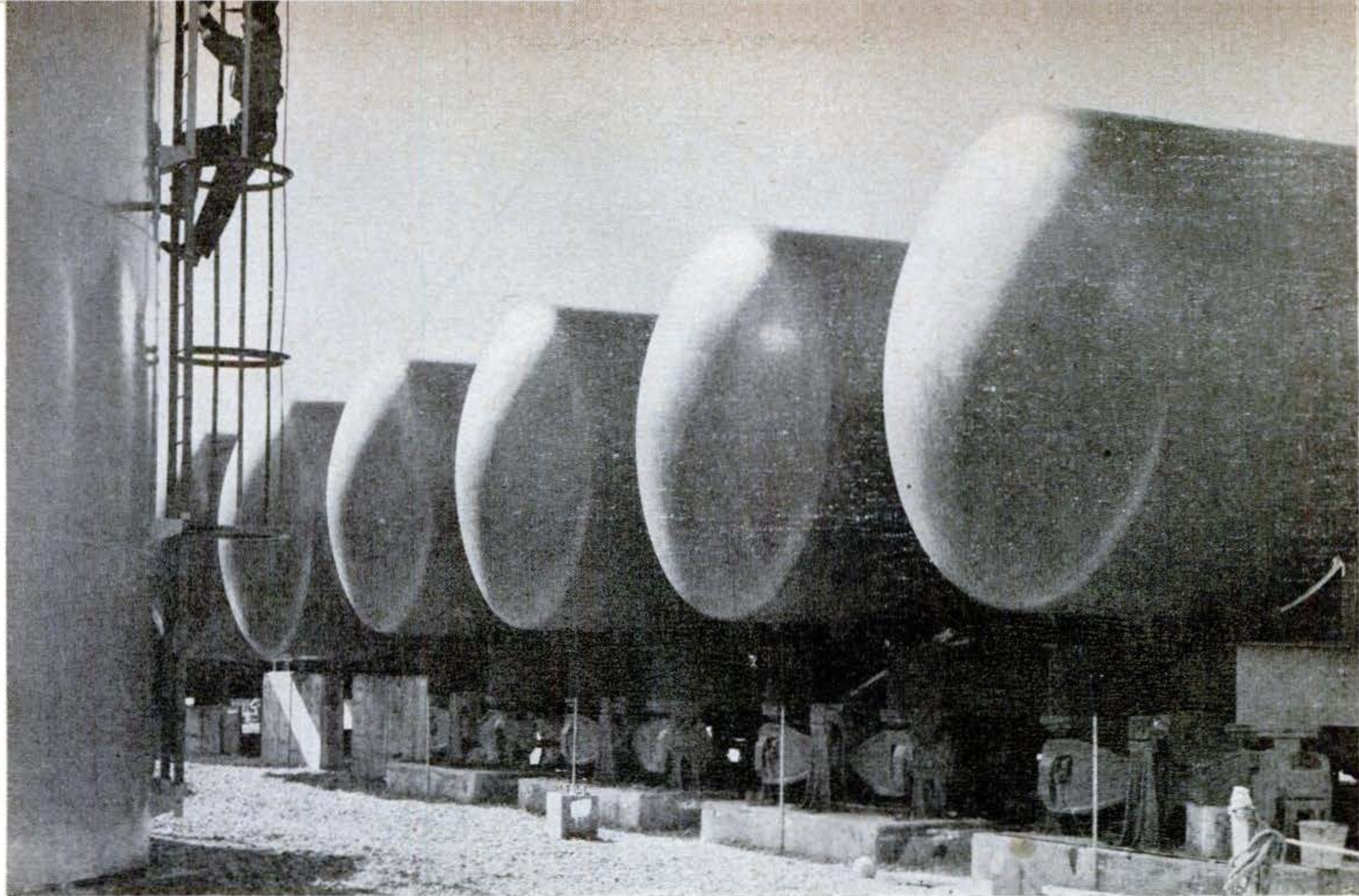


Rolling mill, already operating, turns uranium ingots into bars for making fuel "slugs."



Operators at one of mill's control panels will keep tabs on boilers and processing equipment.





Huge tanks hold chemicals to treat ores, and solutions of the uranium compounds obtained.

## New Mill Rolls Out Uranium

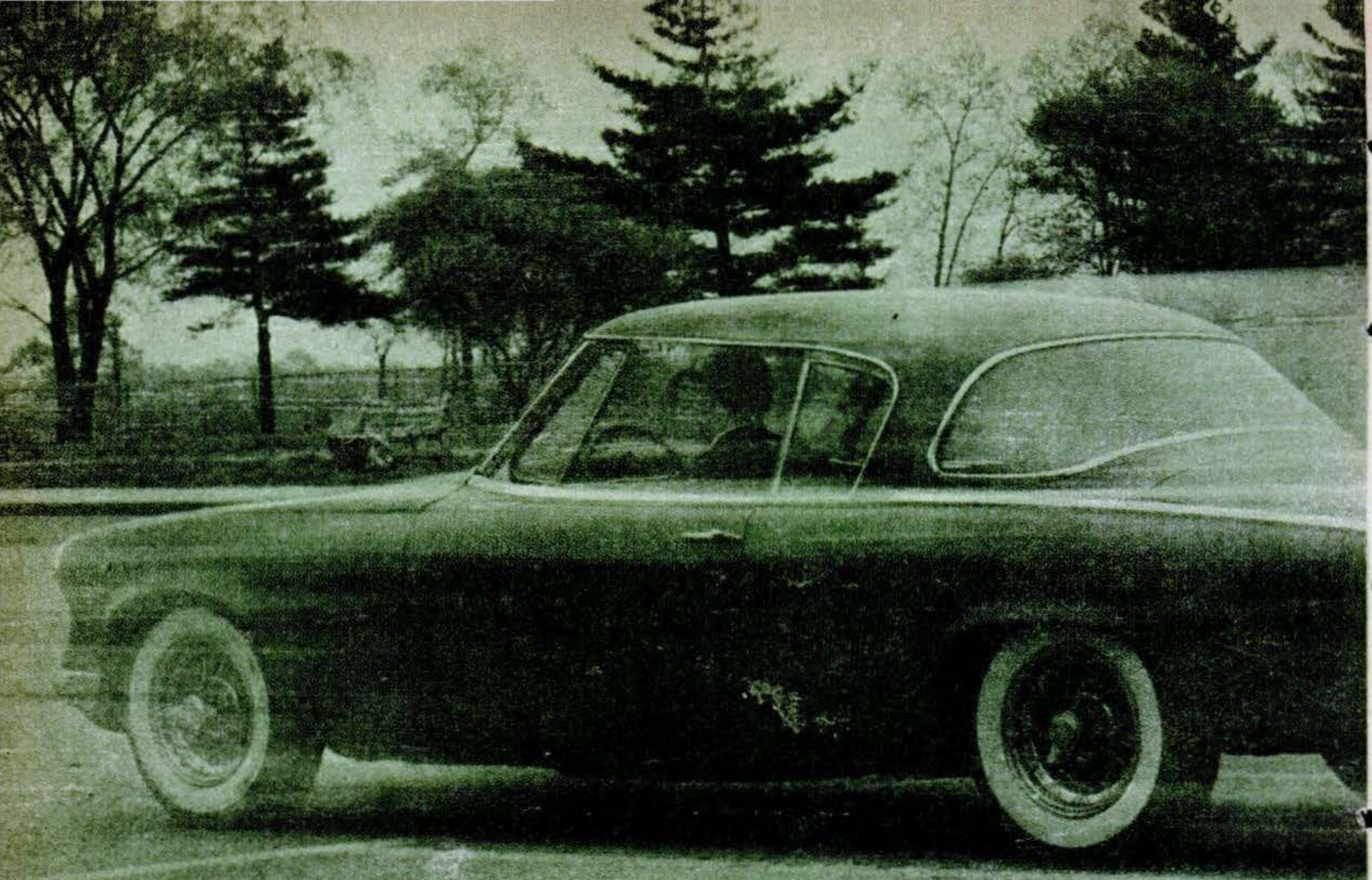
**O**RE from uranium mines will enter a \$78,000,000 mill, nearing completion for the Atomic Energy Commission at Fernald, Ohio—and out will come uranium metal, highly purified and rolled into bars and “slugs.” The product will serve as fuel for great atomic piles like those of Savannah River, near Augusta, Ga., and Hanford, Wash.—and, also, as the material from which fissionable U-235, suitable for “fast-reactor” fuel or for A-bombs, will be extracted in gaseous-diffusion separation plants at Oak Ridge, Tenn., and Paducah, Ky.

Official name of the Fernald mill is the Feed Materials Production Center, FMPC for short. It combines the functions of a smelter and a metal-shaping plant, using equipment that includes “a precision mill especially for rolling ingots into bars in production quantities.” Intermediate products of its operations will be “orange oxide” and “green salt,” the oxide and fluoride compounds of uranium from which the metal itself is finally won.



“SLUGS” OF URANIUM from mill, in aluminum cans, will fuel atomic piles as above.





REPORT FROM THE



DRIVER'S SEAT ...

Studillac, packing 210 hp., cuts around Cadillac to demonstrate pickup.

# Studebaker with

*Bill Frick's newest hybrid looks as innocent as a kitten—but has the getaway of a scalded wildcat.*

**By Wilbur Shaw**

**B**ILL FRICK is a guy with a head of hair that won't stay combed and a knack for building cars—from stock parts—that go 125 miles an hour.

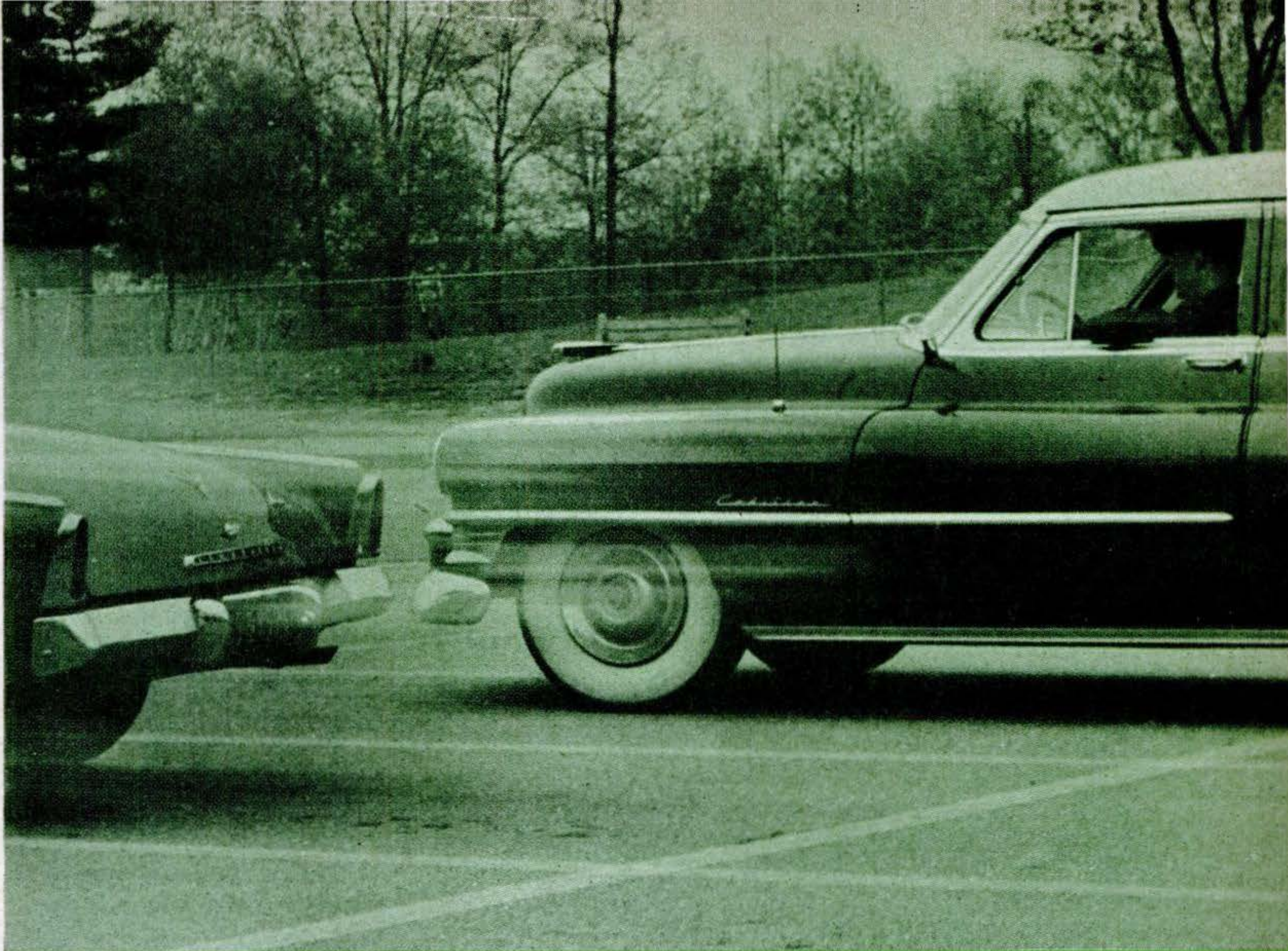
Frick is the father of the Studillac, newest of America's hybrid cars.

Frick's Studillacs look like Studebakers and behave like scalded wildcats. Under their sleek skins are Cadillac en-

gines, Chevrolet rear-engine supports, Lincoln drive shafts, Mercury rear axles and brakes.

The first of these hybrids that came off Frick's "production line" was driven at a top of 125 miles per hour. He thinks that a carefully tuned one ought to reach 130. It would do even better if the engine could be wound up beyond 4,500 r.p.m. But around that speed the hydraulic valve lifters begin to "float."





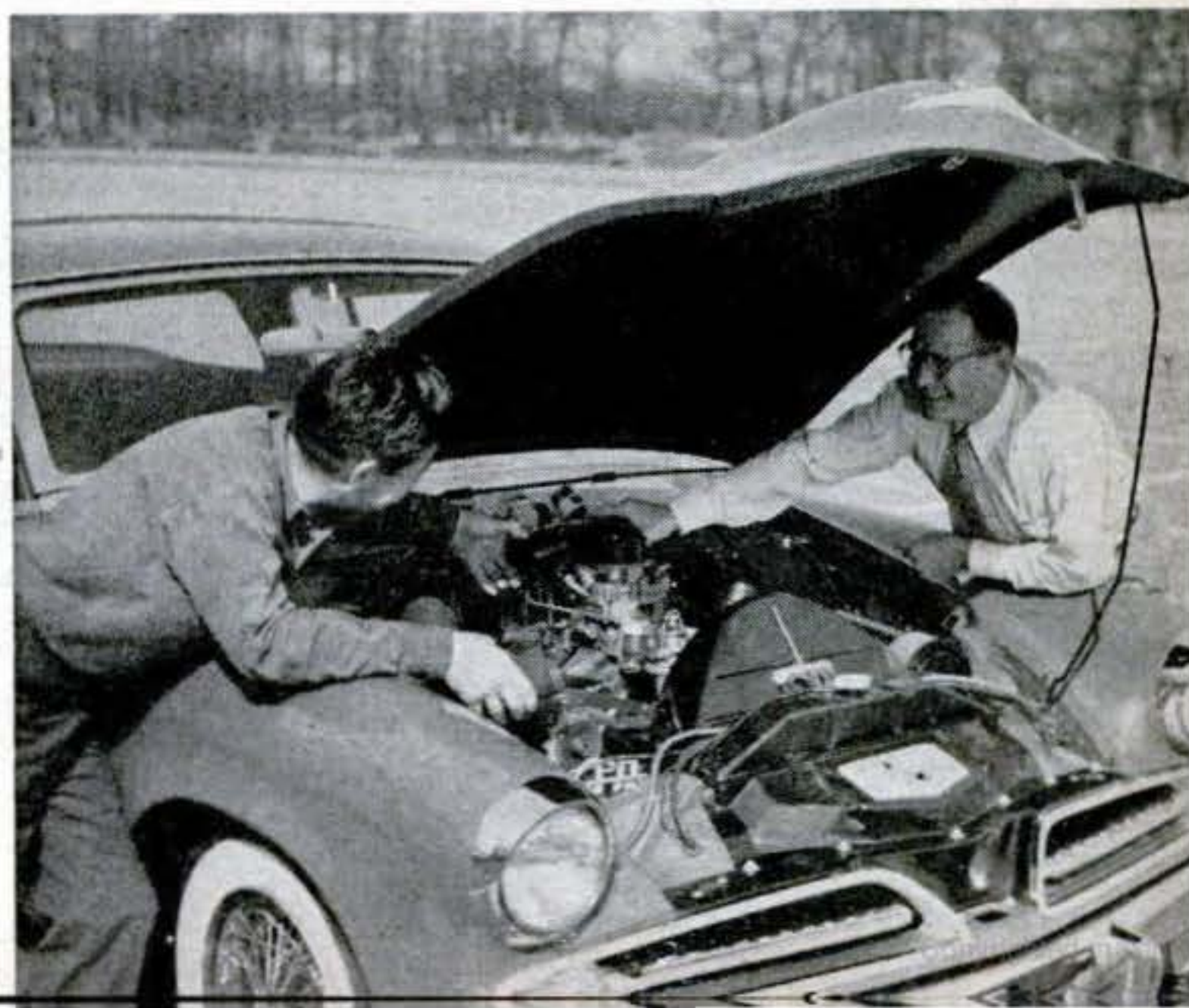
It will reach 80 m.p.h. from zero in 13½ seconds. Only twin exhausts show it's a hot rod.

# a Cadillac Engine

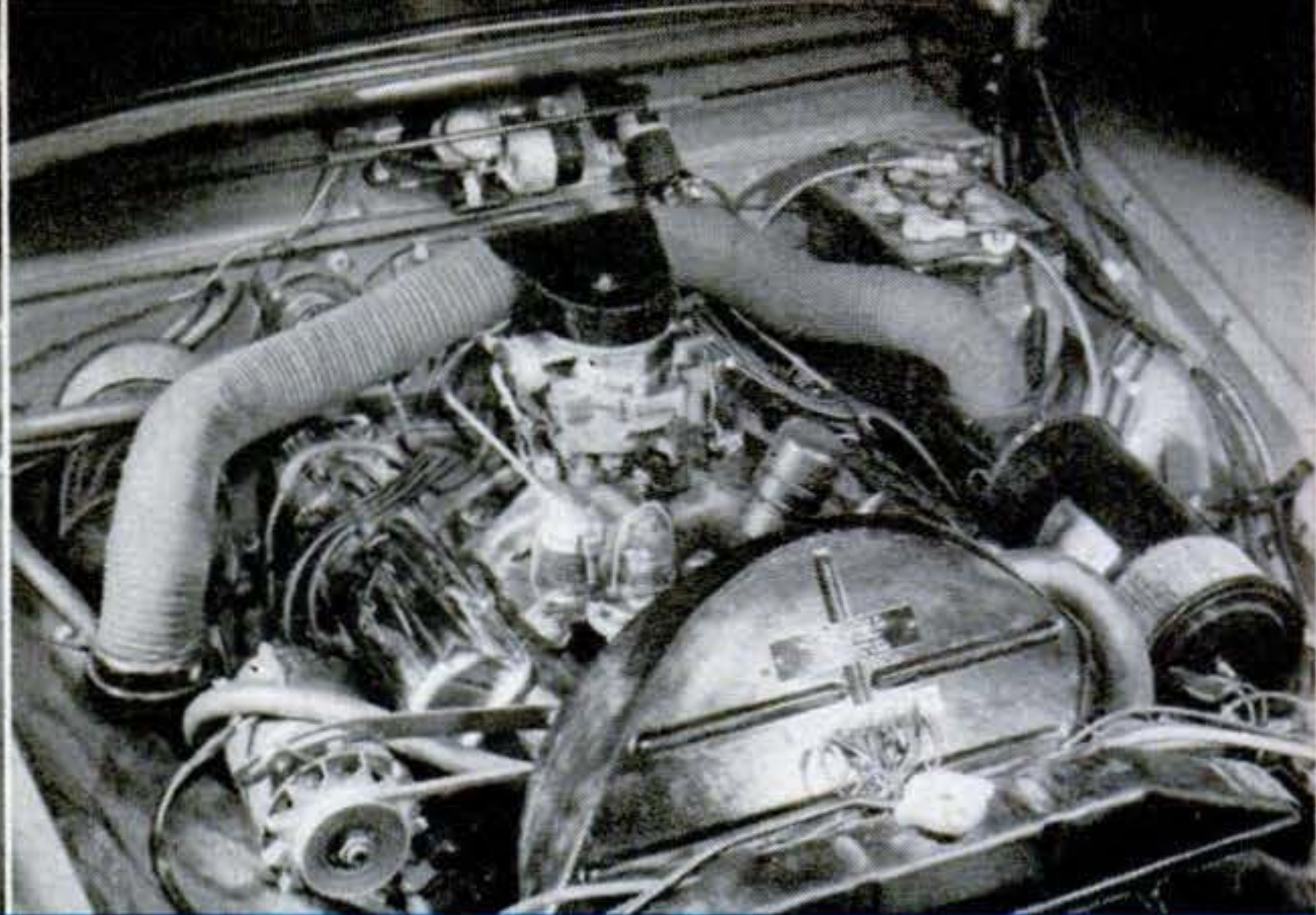
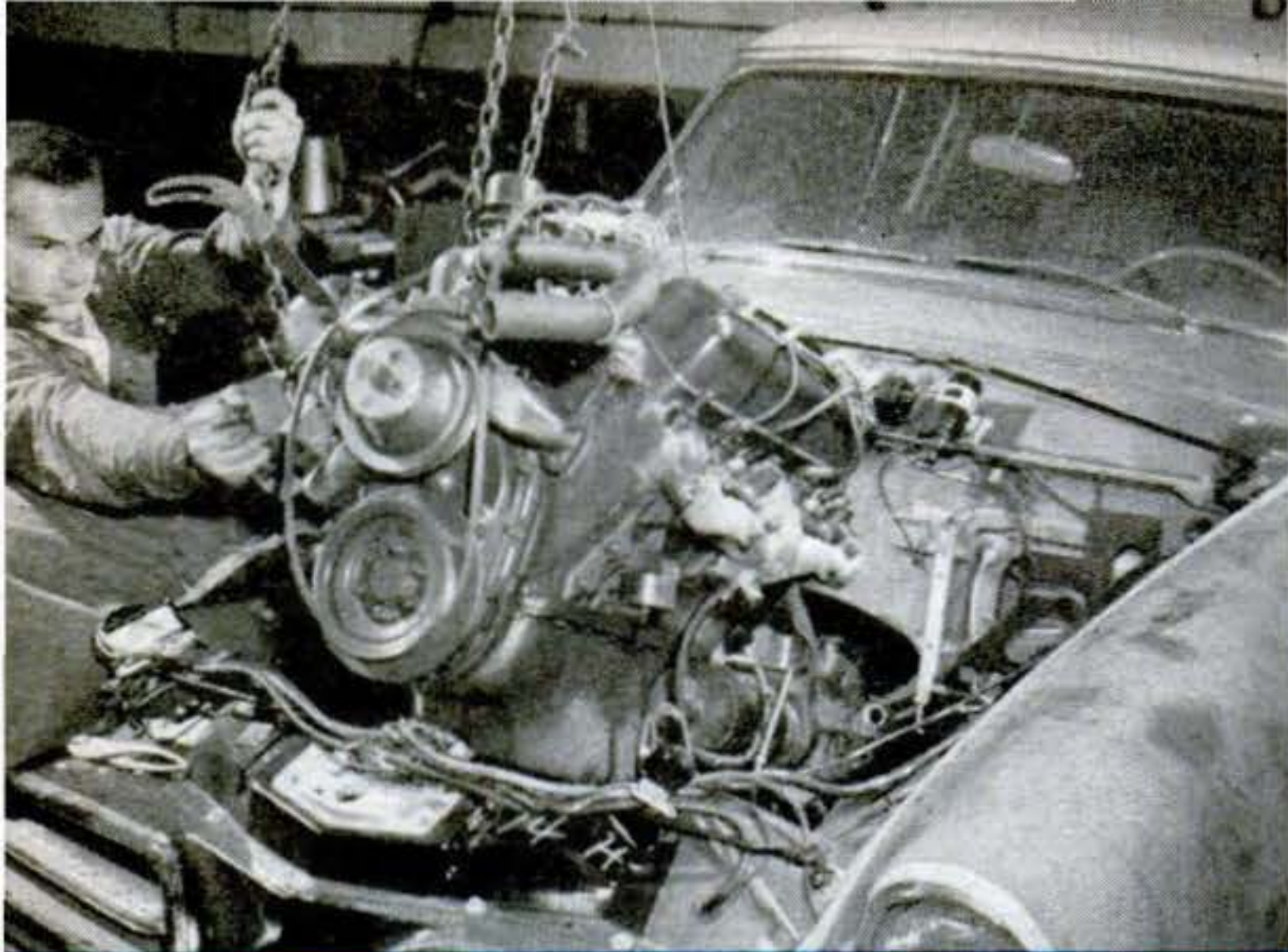
Frick was the first of a handful of men in this country who custom-build these hot numbers from standard automobile parts—instead of hopping-up cars by means of multiple carburetors, jumping camshafts and other applications of the hypodermic needle. He pioneered the Fordillac—a Ford with a Cadillac engine—and still builds them on special order.

The hypodermic car suffers from a permanent state of nerves. Frick's cars, by contrast, perform as beautifully at low speeds as at high. They look no different from other cars. Any woman with

**FRICK** is telling me he prefers the Cadillac to the Chrysler or Lincoln engine for Studebaker because of size. It measures only 33" by 33" by 26" without the bell housing.







**TO MAKE** a Studillac, you first pull out the Commander engine (left). From there on: install 1949 Cadillac front-engine supports (they're lower) and a 1948 Chevrolet rear-engine support; substitute a '49 Lincoln

drive shaft, a Mercury rear end and brakes; build up a second exhaust system; make an adapter for two air cleaners; change control quadrant and accelerator linkages; and install the Caddy engine (right), with 90 more hp.

a sensitive accelerator toe can drive one to the grocery store.

Frick is a sort of Luther Burbank of mechanics.

I met him the other day when I drove out to Rockville Centre, Long Island, to take a turn at the wheel of a Studillac. It had that spanking-new European-style Studebaker body and a 1953 Cadillac engine of 210 horsepower.

The merest tap of the accelerator made the car quiver. When it took off at hard throttle, you were plastered against the back of your seat.

"If you want to have some fun," remarked Frick, "take a look at the faces of the Cadillac drivers as you go by them."

**WE PHOTOGRAPHED** the new drive shaft and twin mufflers with the Studillac up on a hoist.

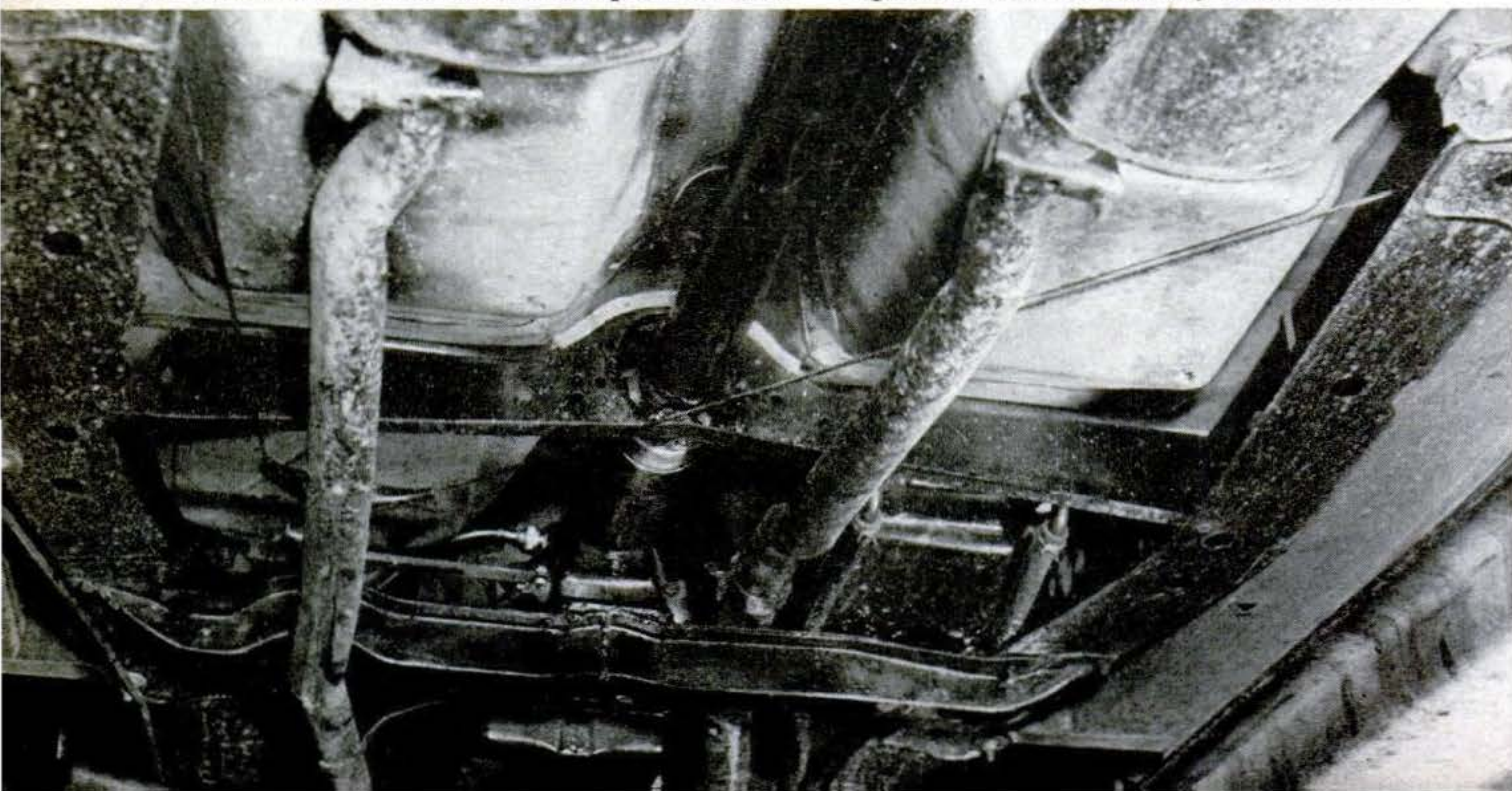
Their astonishment was excusable. In the heavy Cadillac sedan each horsepower in this engine toted almost 21 pounds of car. As a conventional Commander before conversion, the Studebaker V-8 carried 27 pounds per horsepower. In the Studillac the engine's load was only a little more than 16 pounds.

#### *He Trims the Fat Off a Car*

"What we do," explained Frick as the car touched 80 before I realized that the thing sizzled even at part throttle, "is simply cut the fat off a car. Put a big engine in a little car, and you've got performance."

He had *that*, all right. I couldn't say

The Commander's 3.54:1 rear axle has been replaced with a Mercury 3.31:1 axle.







**TEMPLATES**, like this one for an exhaust-pipe bracket, help Frick speed up conversion. The Caddy engine fits snugly. The crankshaft pulley misses the center steering-gear pivot by  $\frac{1}{4}$ ". Steering column must be moved  $\frac{3}{8}$ ".

much for the braking, though. That much acceleration, that speed, called for faster stopping. Frick agreed.

"Imagine!" he said. "Nine-inch drums on this job. I'm going to give it 11-inch Mercury brakes and later put Cadillac brakes on the front. Caddy drums have the same circumference as the Mercury's but they're a half-inch wider."

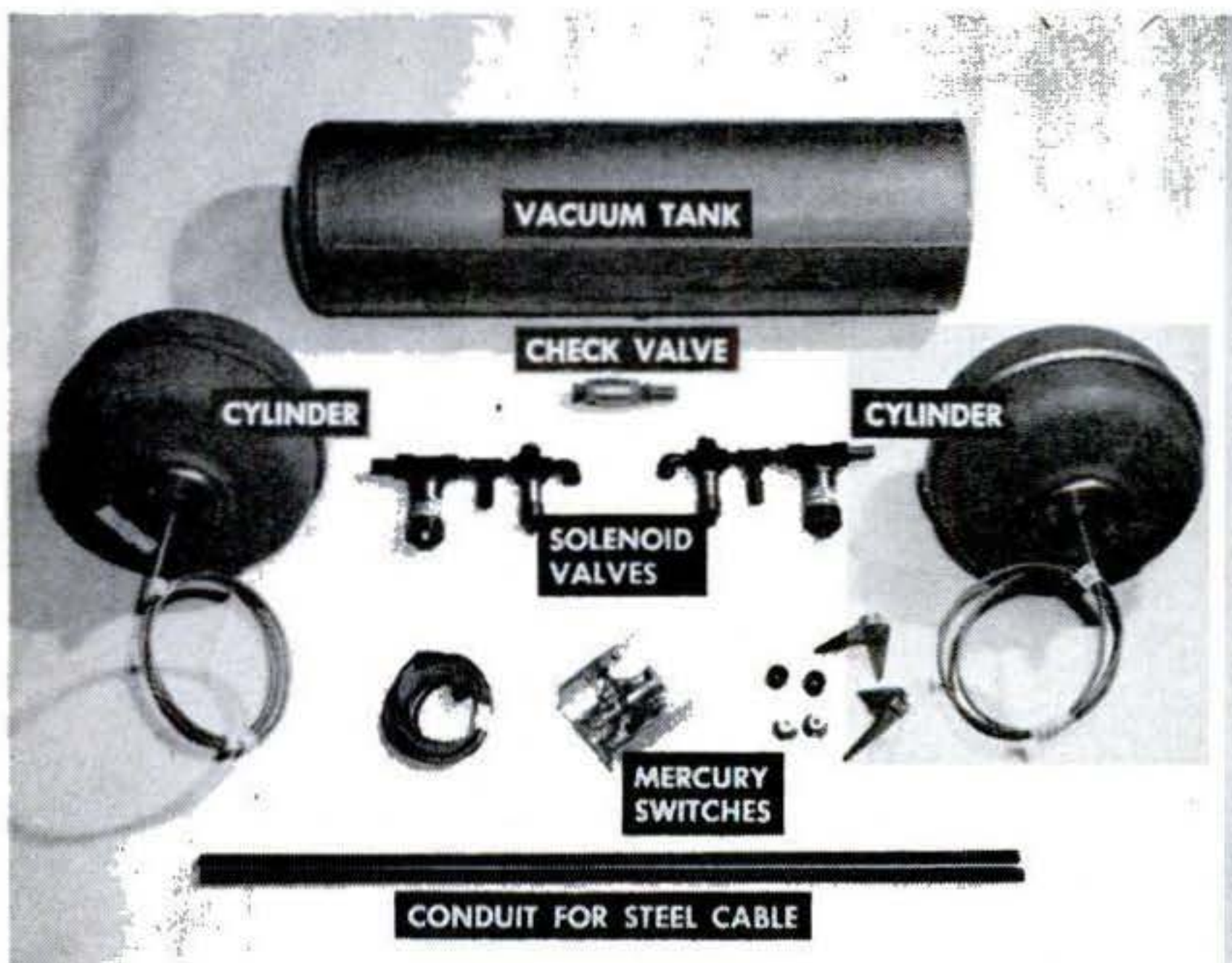
The Studillac had another basic fault. With the spectacular acceleration, I found that the steering ratio was too slow for really safe driving.



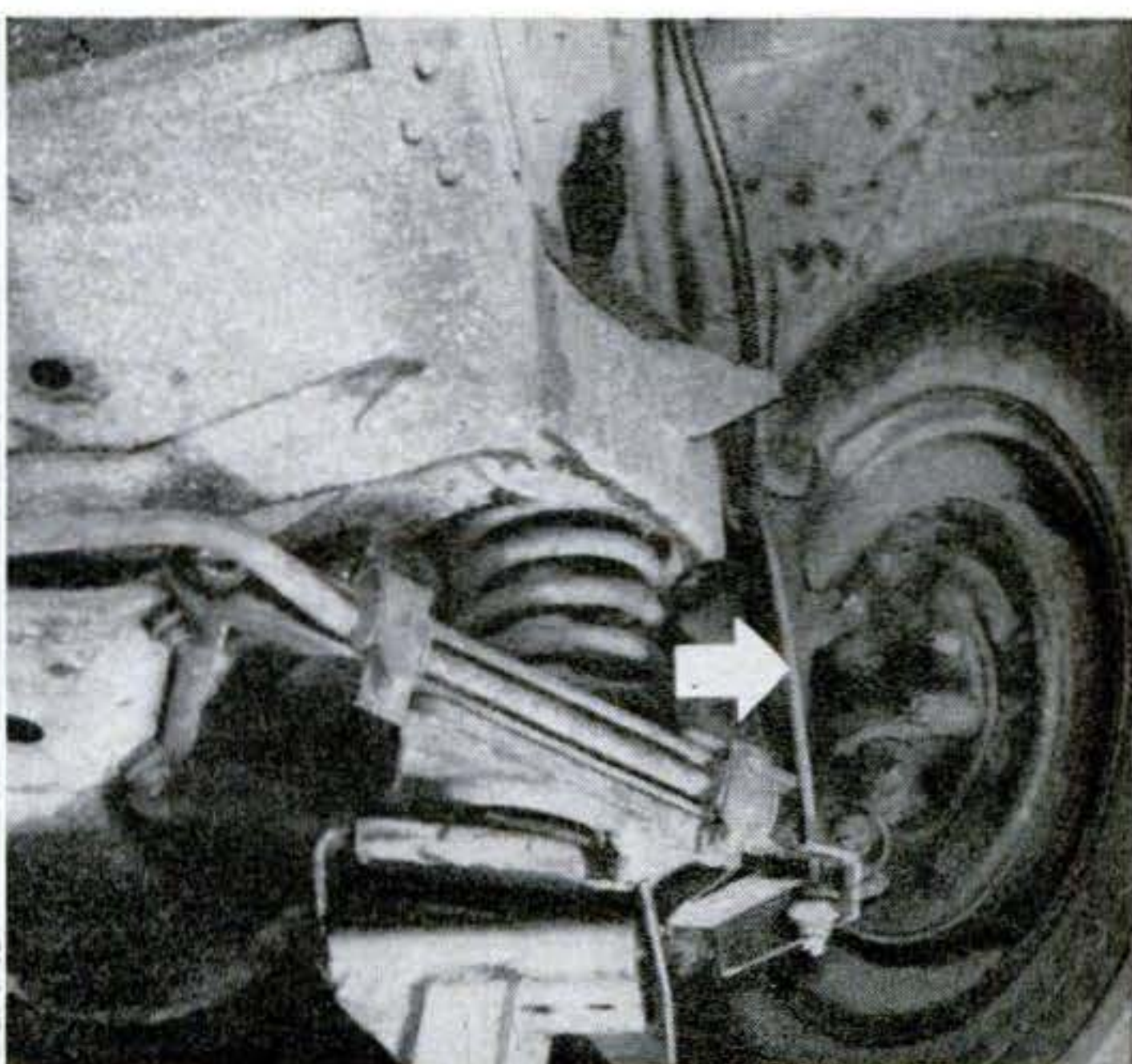
**THIS WILL** give you an idea of what Frick means about more braking area. At the top are the new shoes, at the lower left the old drum and (right) the new drum. Eventually Studillacs will have Caddy front brakes.

Frick makes these cars on order. If you come to him with nothing (except money), the cost of a '53 Commander fitted with a new '53 Caddy engine comes to around \$4,500 or \$5,000—more if you want the works. But if you drive in your own '53 Studie, and don't want fancy extras like wire wheels, Frick charges \$1,700 for the engine and conversion.

He buys the engines directly from the factory. They are strictly stock. His first conversion took him 140 man-hours of



**FOR \$250 EXTRA**, Frick will install this Curve Master to keep your Studillac from heeling on a hard turn. It works by pulling down the front spring that would otherwise hike up—left side on a left turn, right on a right.



Manifold vacuum, valved to the proper cylinder by a mercury switch tripped by centrifugal force, does the job. Cables (arrow) are linked to piston in vacuum cylinder mounted above. Result: almost no lean on a curve.



work. He expects to have Studillacs rolling out of his place in 40 man-hours soon.

Some of the modifications I assumed he would make he doesn't make at all. The Caddy engine puts 100 more pounds of weight on the front wheels but it doesn't stiffen up the steering. He doesn't beef up the springs. The Studebaker radiator cools the engine all right except if it idles for prolonged periods. He uses the standard Caddy engine accessories—generator, fuel pump, starter and so on—but substitutes a twin Studebaker air cleaner so the engine will fit under that low hood. (It clears by a quarter of an inch.)

#### *Disposes of Engines Easily*

Frick has no trouble disposing of the Commander V-8 engines he acquires in the process of his conversions. He either sells them outright or installs them in other cars he has for sale. He is looking forward to getting some Siata chassis from Italy that are specifically designed to take the Commander engine.

Business must be good. He had orders enough last spring to keep him busy into

midsummer—turning out a car each week—and they were still rolling in.

The Bill Fricks of the motor world are a breed unto themselves. They were born with mitts that fit wrenches. They were weaned on gasoline. To them, cars are pulsing, living things. They wince when they see a motorist abuse an engine. To them, remembering what will fit what is as natural as breathing.

Frick completely ignored the problem of a drive shaft for the Studillac till the conversion was almost complete. Then he crawled under the car with a steel tape. He came out looking thoughtful.

"Send me," he told a Lincoln dealer on the telephone, "a drive shaft for a 1949 Lincoln Cosmopolitan with Hydra-Matic." It fitted.

Yet Frick can't remember his home telephone number. Every time he calls there he has to look it up.

Frick is 36. He began hanging around a garage near his home when he was 14. To keep from getting shooed out, he ran errands for the mechanics. At 15 he was a Saturday apprentice. From then on, his

*[Continued on page 210]*



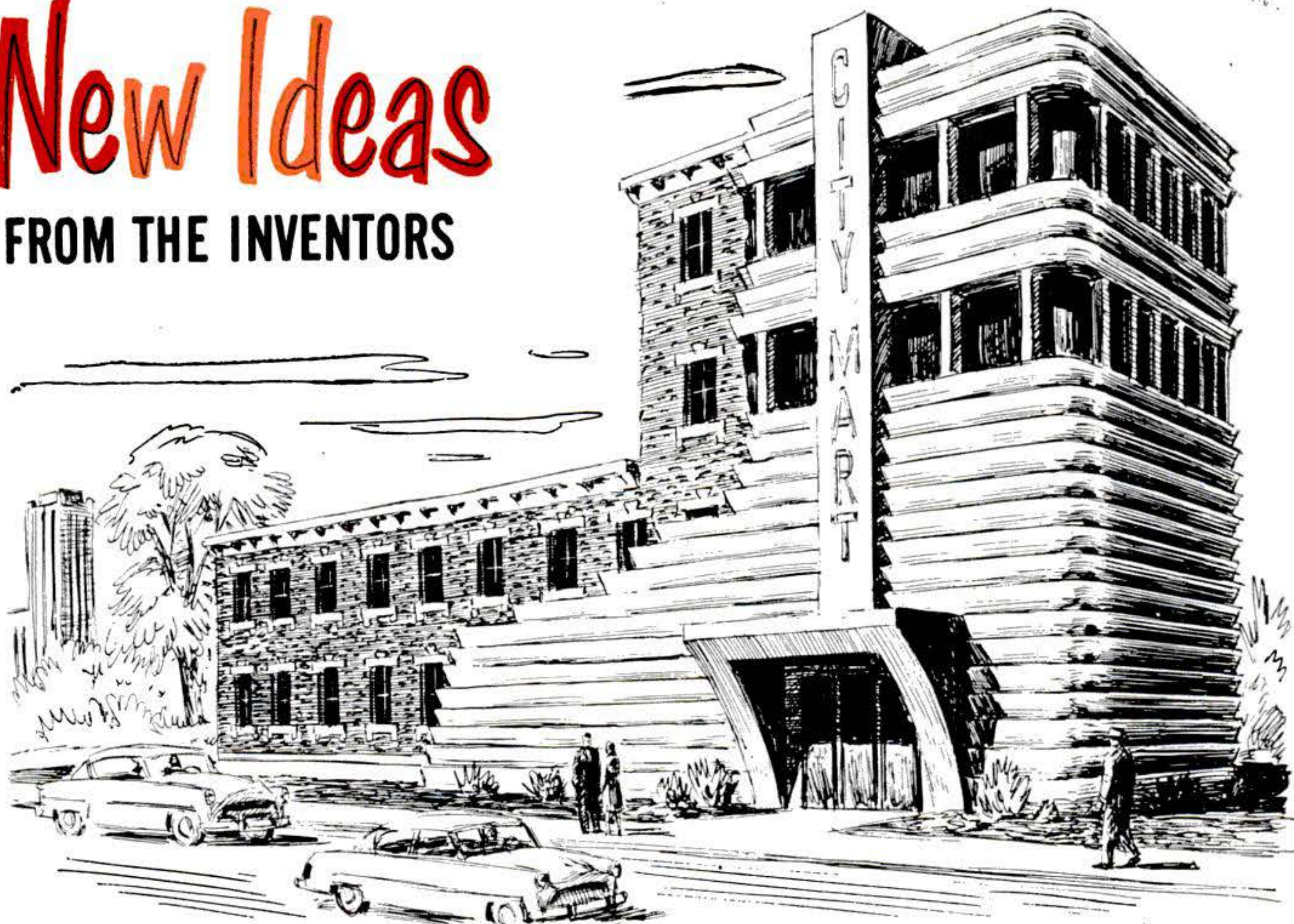
**CONCRETE FIXTURE** helps in welding up the new tailpipe, assures the bends will be just

right. Finished Studillac weighs 3,425 pounds, only 150 more than Studebaker.



# New Ideas

## FROM THE INVENTORS



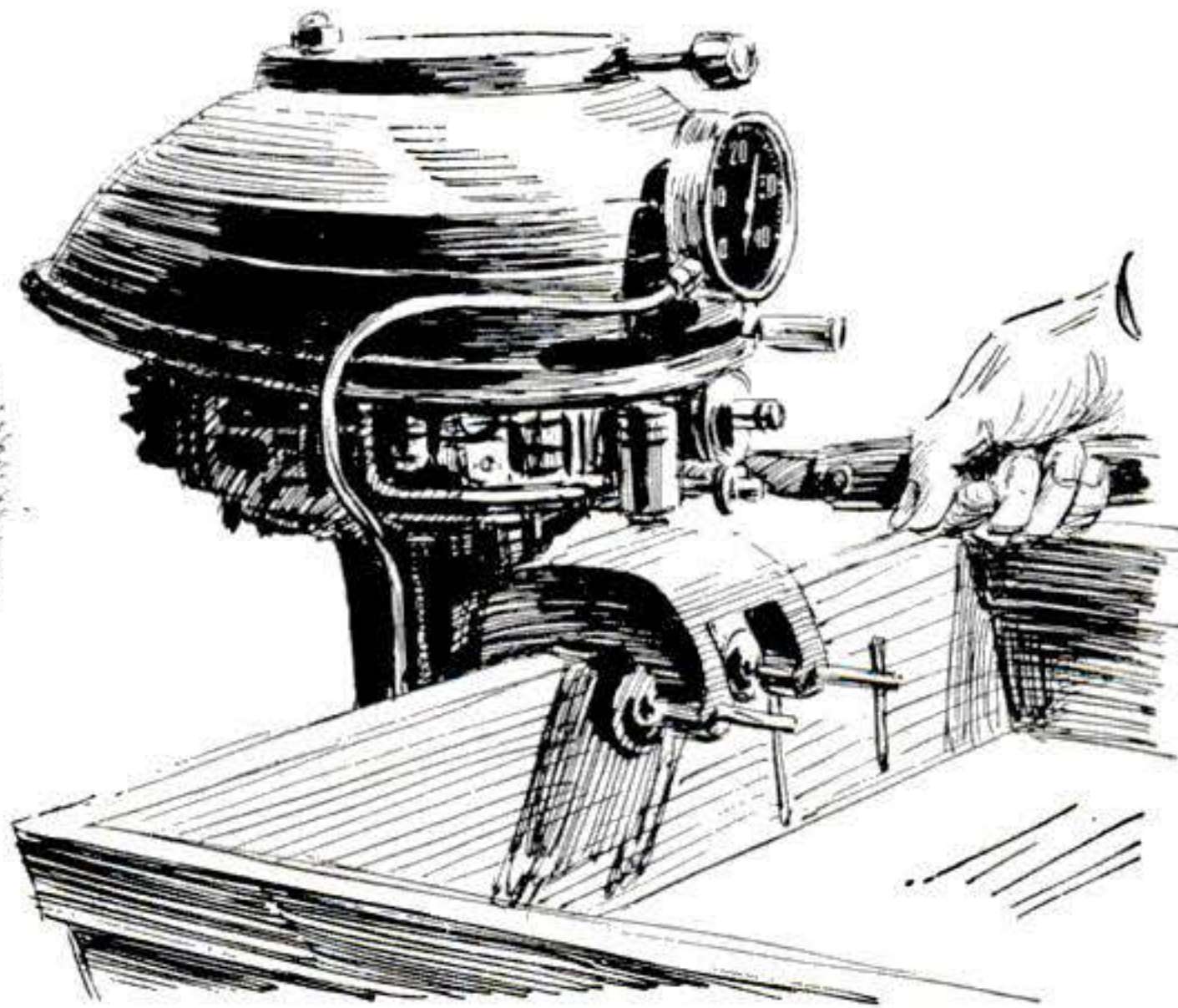
### 1 False Front to Modernize Building.

Putting a new face on an old building—or on a group of dissimilar buildings in a block—would be simple, quick and inexpensive if done this way. Metal arms bolted

to the front of the structure would support a façade of horizontal strips arranged in a modern architectural style. Standing off from the building the angled strips would admit light and air to hidden windows.



**2 Bike Light to Signal Turns.** Directional signals and running lights in the handle bars of a bicycle would make night riding easier for a cyclist and for any motorist behind him. The lights of course would face to the rear. An assembly comprising the lights, a thumb switch, battery carrier and hand grip would slip into handle bar.



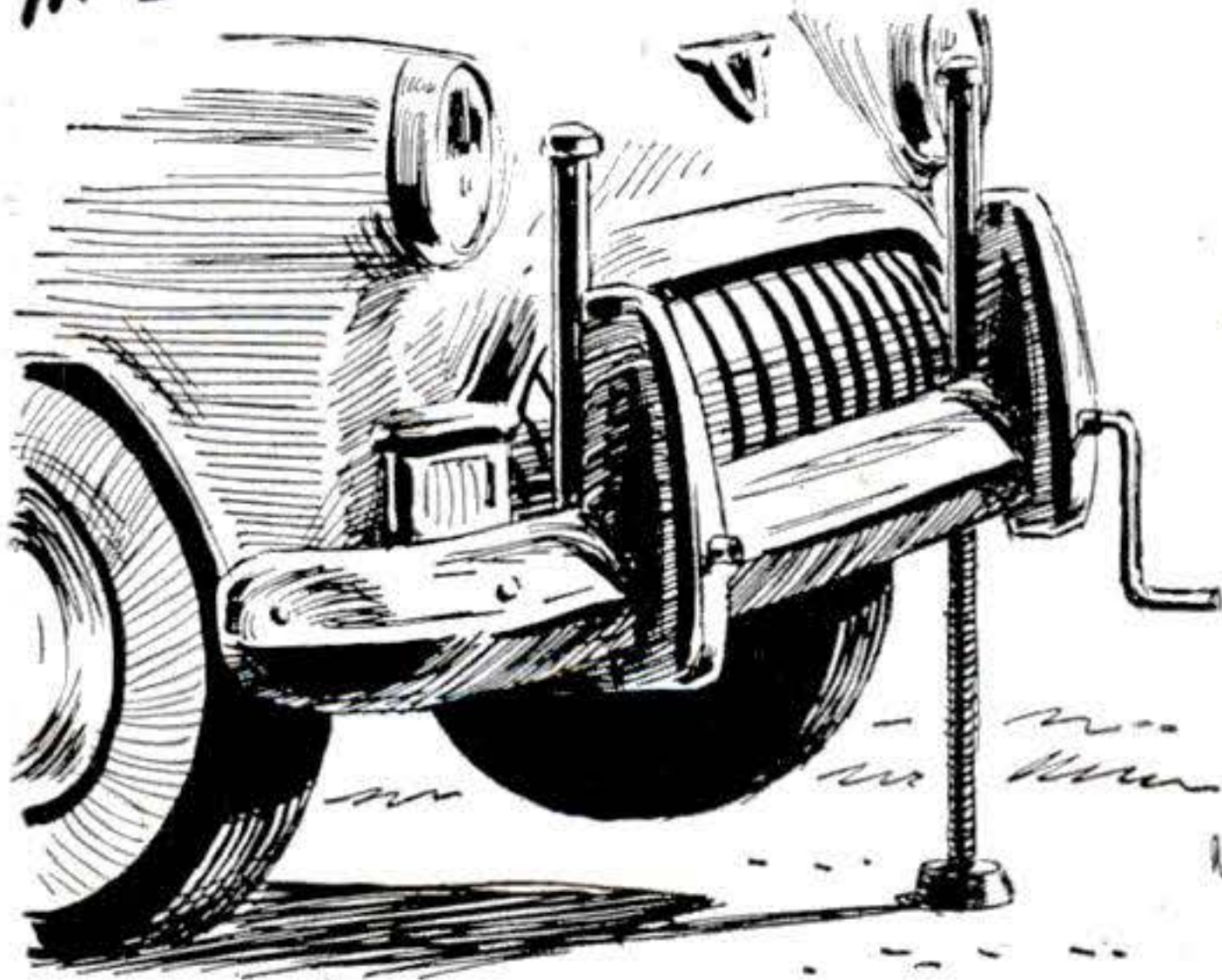
**3 Gauge to Clock Outboard Speed.** Water pressure would work the needle on this outboard-motor speedometer. The intake tube would open in the direction of the boat's motion. It would be separated from the propeller so the prop's turbulence would not affect the amount of water being piped up to the pressure-sensitive gauge.

*Please turn the page for more new ideas.*

JULY 1953 81



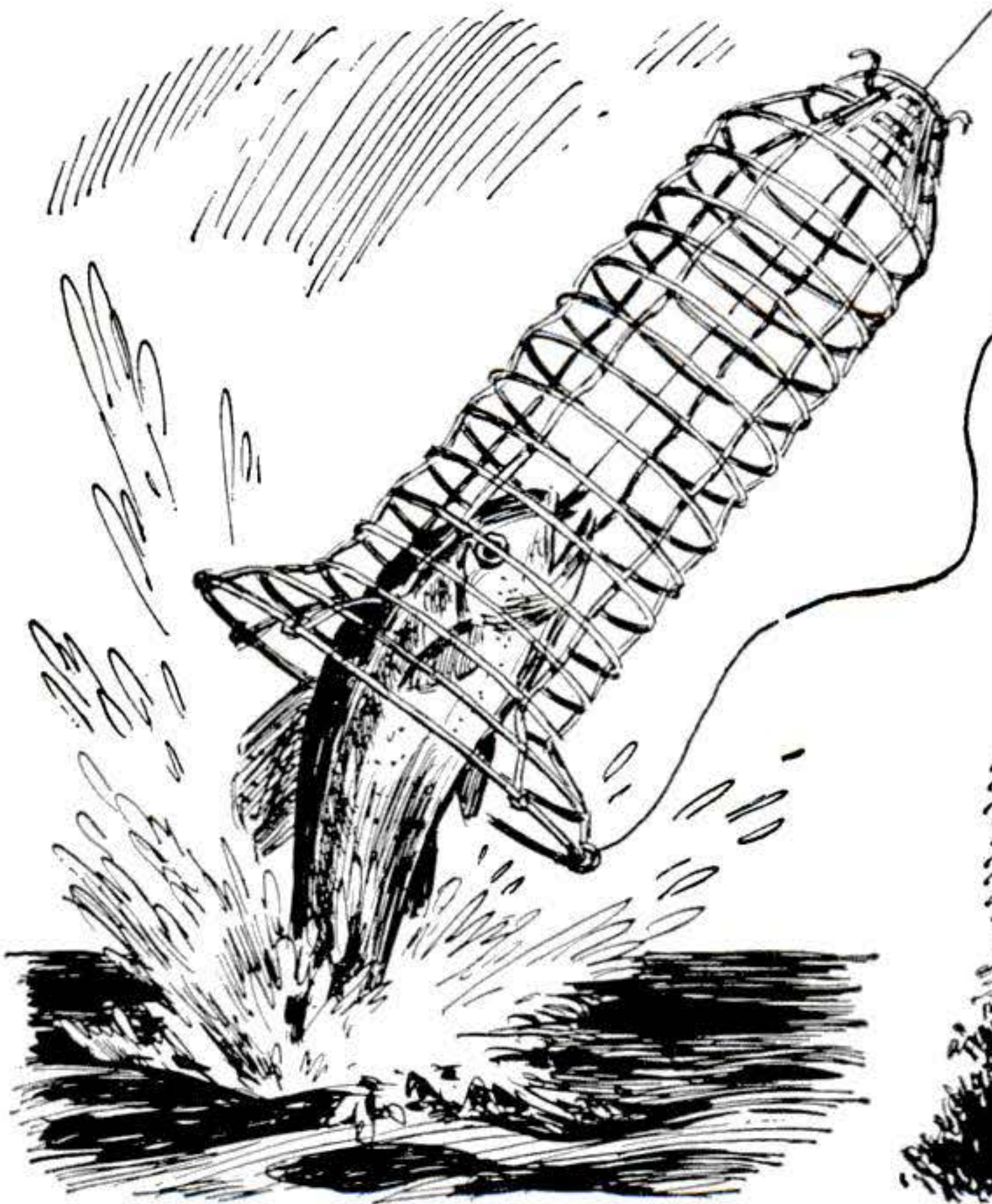
## ***MORE*** New Ideas from the Inventors



**4 Bumper Guard to Double as Jack.** The hollow casing of this combination bumper guard and jack would contain a jackscrew mechanism. Jackshaft and crank handle would be carried separately, could be inserted any time the car needed a lift.



**5 Electric Tool to Pluck Weeds.** This lightweight garden accessory is intended to be hand-carried. The user would simply place the head over a weed patch. Rotating toothed disks, driven by a high-speed electric motor, would do the rest.



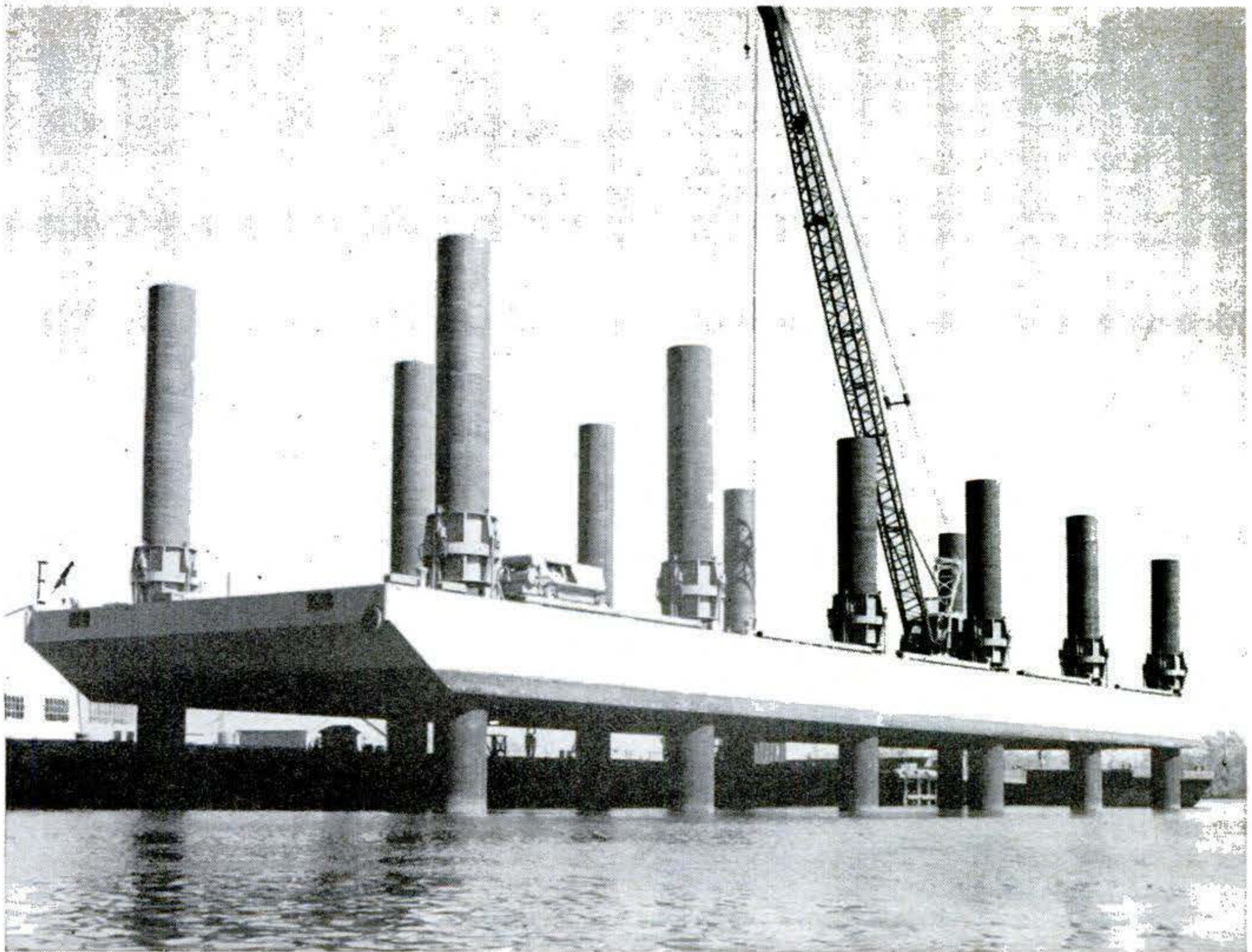
**6 Net to Cage Hooked Fish.** The big ones wouldn't often get away if you had a net like this on your line. Fixed around the line, the cagelike net would be released by a tug on the hook. It would slide over the fish, make it easy for you to land him.



**7 Golf Club to Have Two Heads.** This one club, says its inventor, could take the place of a matched set. The balanced shaft would have the same "feel" from either end. The head not in use would be turned inward, out of the way.

*Patents on these inventions have been granted to: 1. R. W. Wood, Swarthmore, Pa.; 2. H. C. Schadel Jr., Corona, N. Y.; 3. E. C. Kiekhaefer, Cedarburg, Wis.; 4. F. Brown, Tampa, Fla.; 5. W. C. Hands Jr., Rutherford, N. J.; 6. O. C. Richardson, Detroit; 7. H. H. Murphy, Walpole, Mass.*



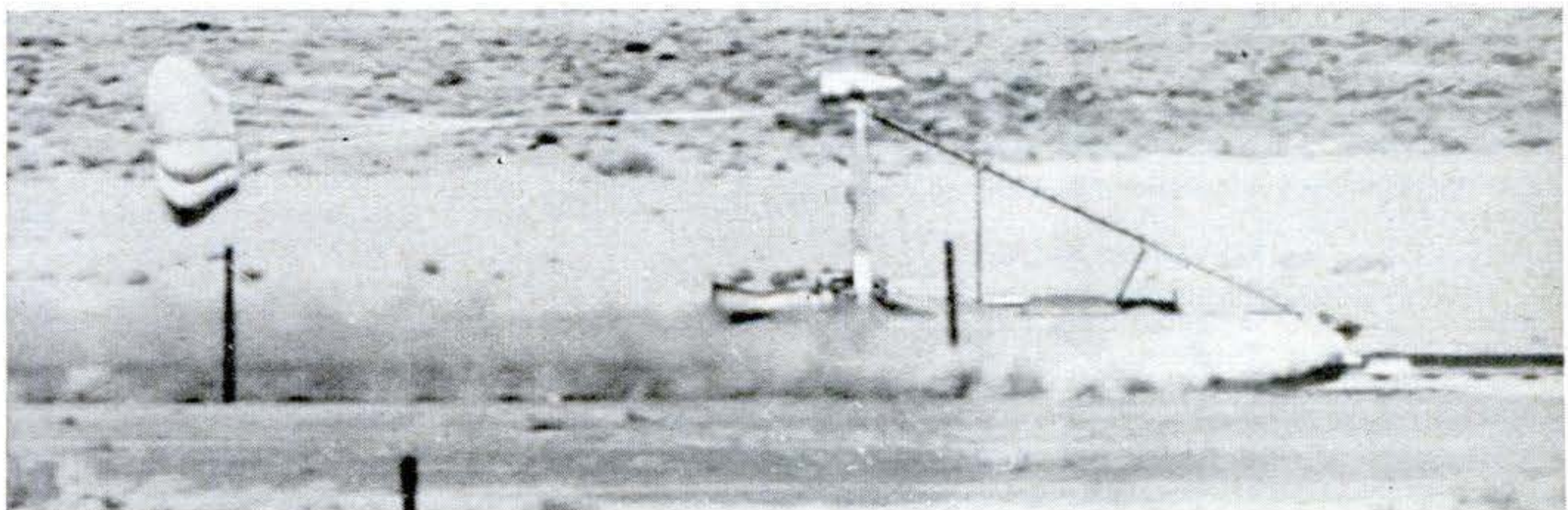


## Barge Turns Into Dock, Shinnies Up Tubes to Pier Height

THIS dock hauls itself up to pier height the way a boy shinnies up a tree. Air jacks climb the big caisson stilts, taking the hull up with them. The steel stilts—six feet across, 100 or more feet long—are set in position after the dock is floated to its site. They are dropped through wells and jacks

set around the tops of the wells, and pile-driven through the sand bed to solid footing. Then the jacks go into action.

The dock was designed by Consolidated Western Steel for military use, offshore drilling and commercial operations. Some of the first barges are serving in Greenland.



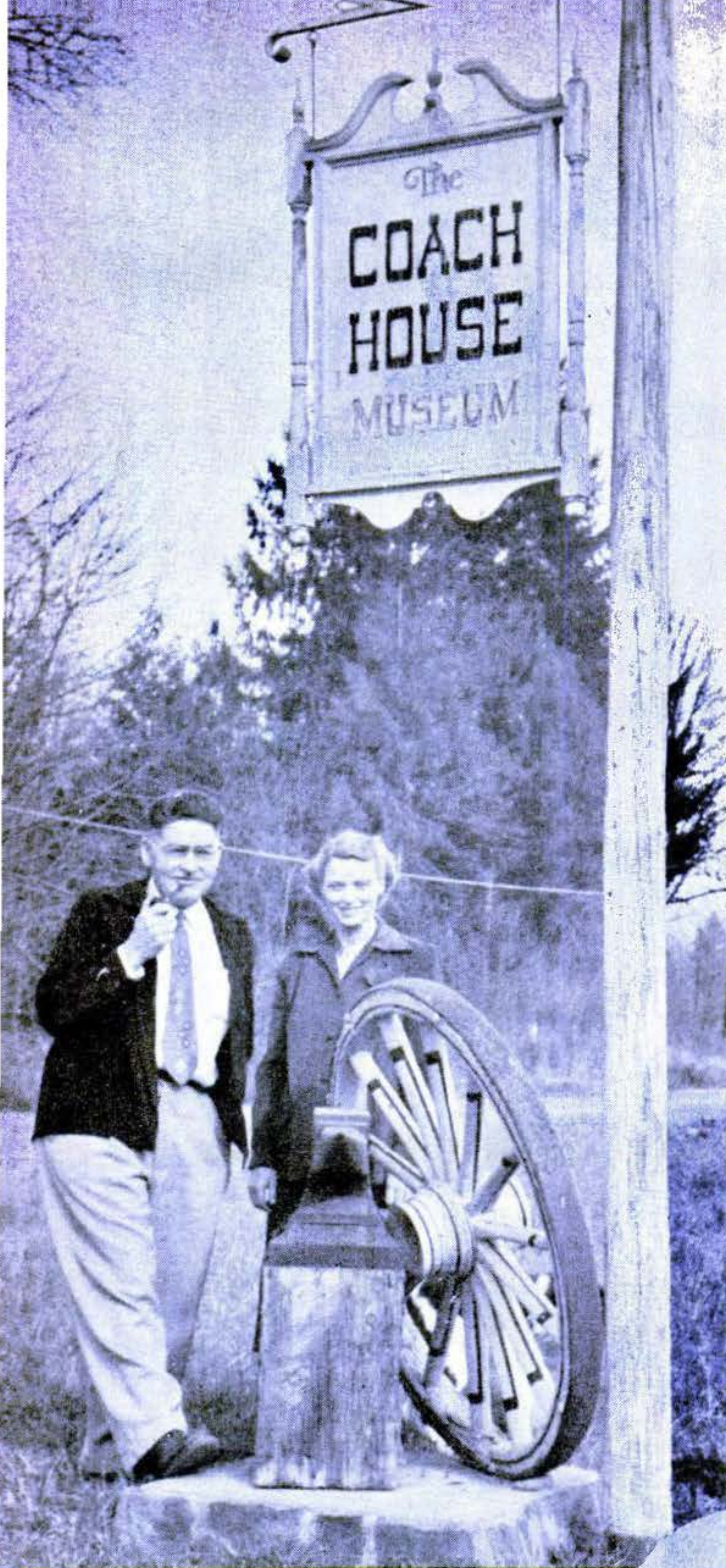
## World's Fastest "Railroad" Hits 1,500 M.P.H. to Test Chutes

THAT'S a rocket-powered sled above, zipping along steel rails at 1,500 miles an hour to test chutes and other equipment for jet planes. It hits this peak speed in  $4\frac{1}{2}$  seconds, but in that time it travels 5,500 feet. About

\$100 worth of alcohol-oxygen fuel is used for each 10,000-foot run. A scoop dips into a trough of water between the rails to bring the sled to a stop in about 300 feet. The Cook Research Laboratories created it.



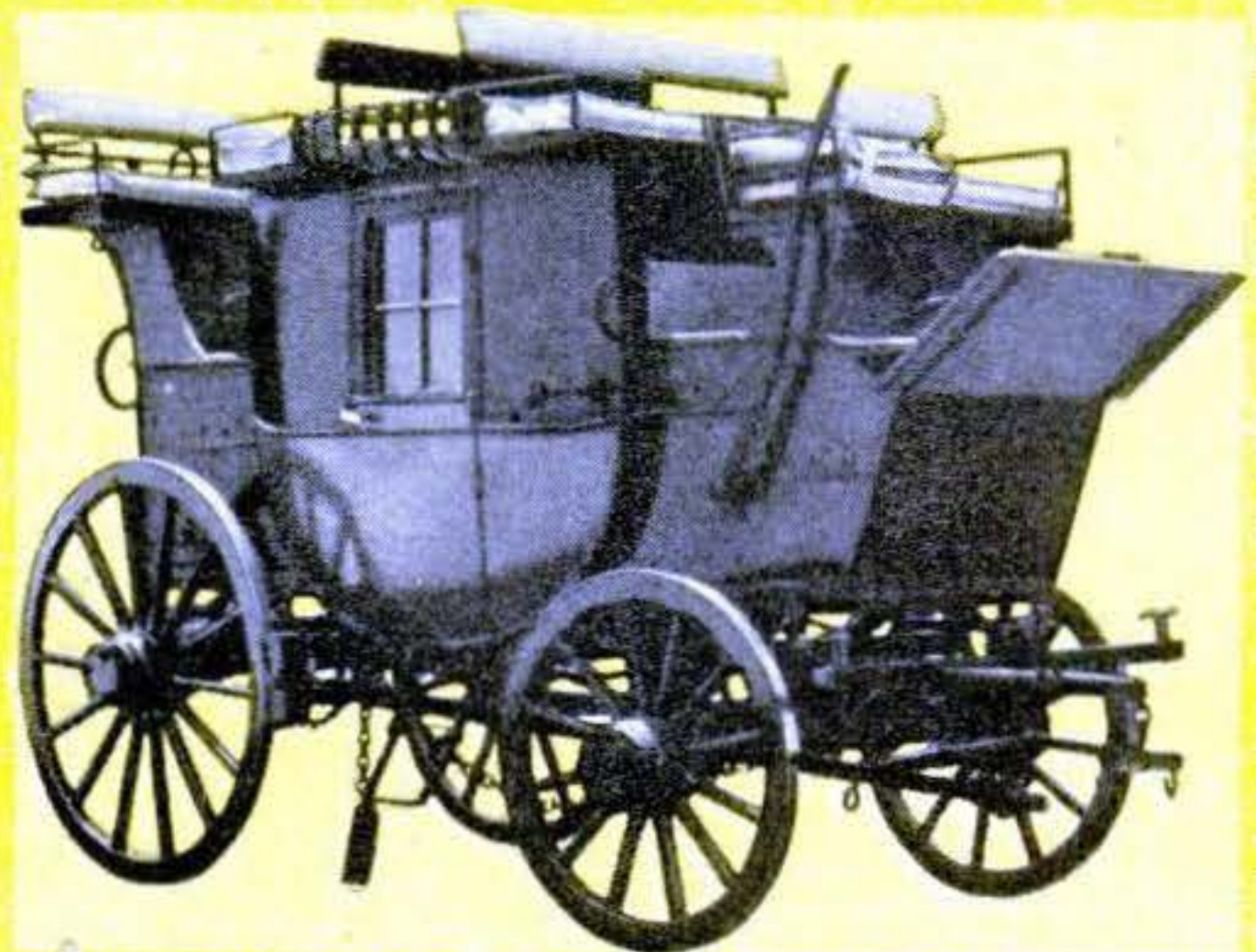
# He Builds



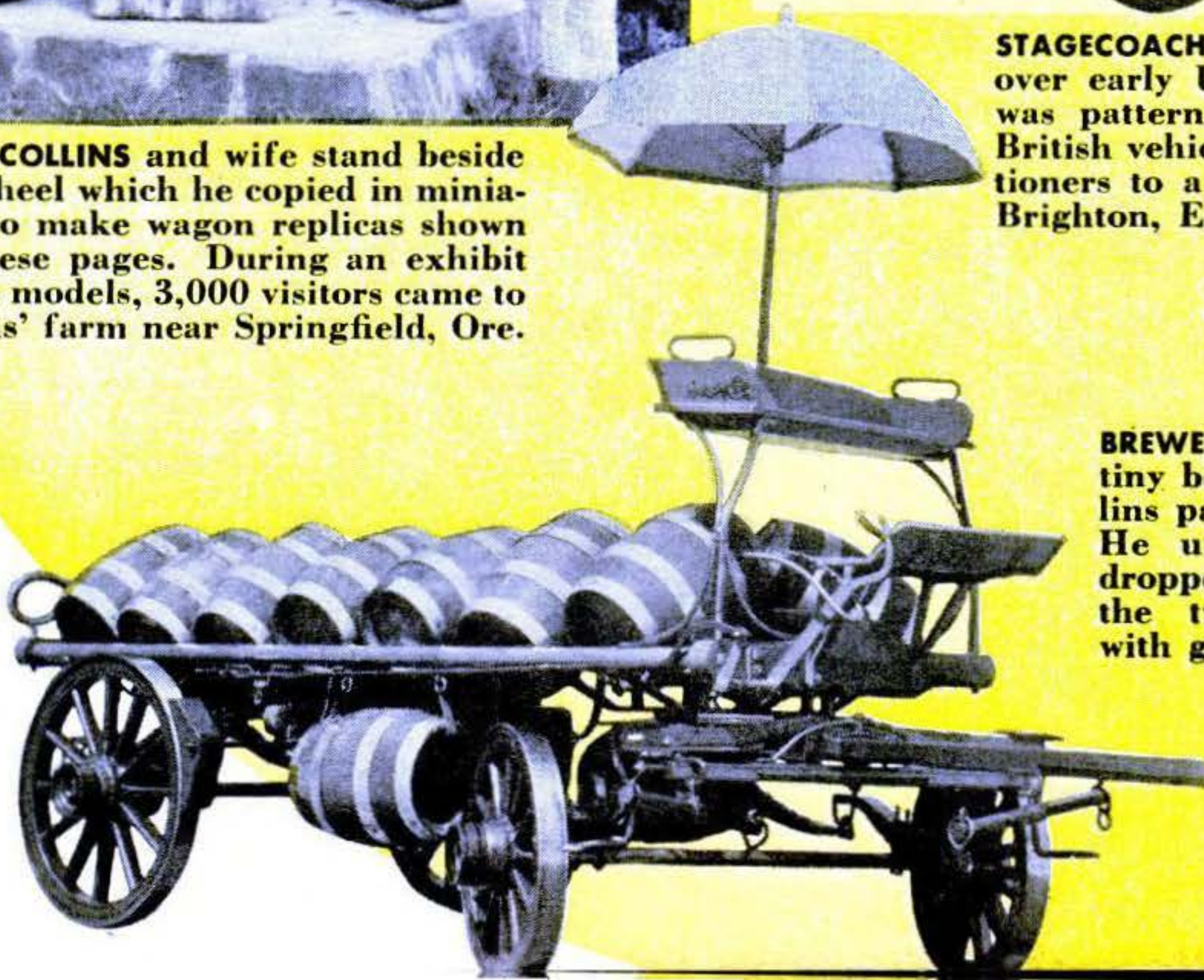
**IVAN COLLINS** and wife stand beside old wheel which he copied in miniature to make wagon replicas shown on these pages. During an exhibit of his models, 3,000 visitors came to Collins' farm near Springfield, Ore.



**LOGGING WAGON** like this model carried timber out of the thick forests of the Pacific Northwest in frontier days. Oak pegs were pounded into the wheels for strength.



**STAGECOACH** above rumbled over early U.S. highways. It was patterned after a heavy British vehicle that took vacationers to a seaside resort in Brighton, England.



**BREWERY WAGON** has 16 tiny beer kegs that Collins painstakingly built. He used a medicine dropper to fill each of the two-ounce barrels with genuine brew.



# America's Finest Wagons

*Prairie schooner, brewery wagon, or surrey with the fringe on top—each little replica takes 600 hours' work.*

**By Richard L. Neuberger**

SOME folks thrill to the sight of a diesel-electric locomotive, giving its all to hoist tonnage over a mountain. Others get misty-eyed when they glimpse an ocean liner standing majestically out to sea. Then there is that numerous breed which looks upon a gleaming convertible as one of earth's grandest spectacles.

But a bushy-haired, 47-year-old mechanical designer named Ivan Linus Collins feels his pulse slipping into high gear whenever he stumbles upon an ancient, dilapidated wagon.

The older and crustier the wagon, the more do Collins' well-thatched temples throb with excitement. In his back pocket he invariably carries a carpenter's folding rule, to be used in measuring from tonneau to tongue any animal-

**The Conestoga wagon, rugged grandsire of all American wagons, was built as early as 1725.**







**U.S. presidents saw the canyons and geysers of Yellowstone National Park from this coach.**

drawn contraption which looms into view.

Collins, who lives along the foaming reaches of the trout-filled McKenzie River near Springfield, Ore., is a man with a single burning purpose. That purpose is to create authentic models of the vast assortment of vehicles which moved Americans and their belongings during

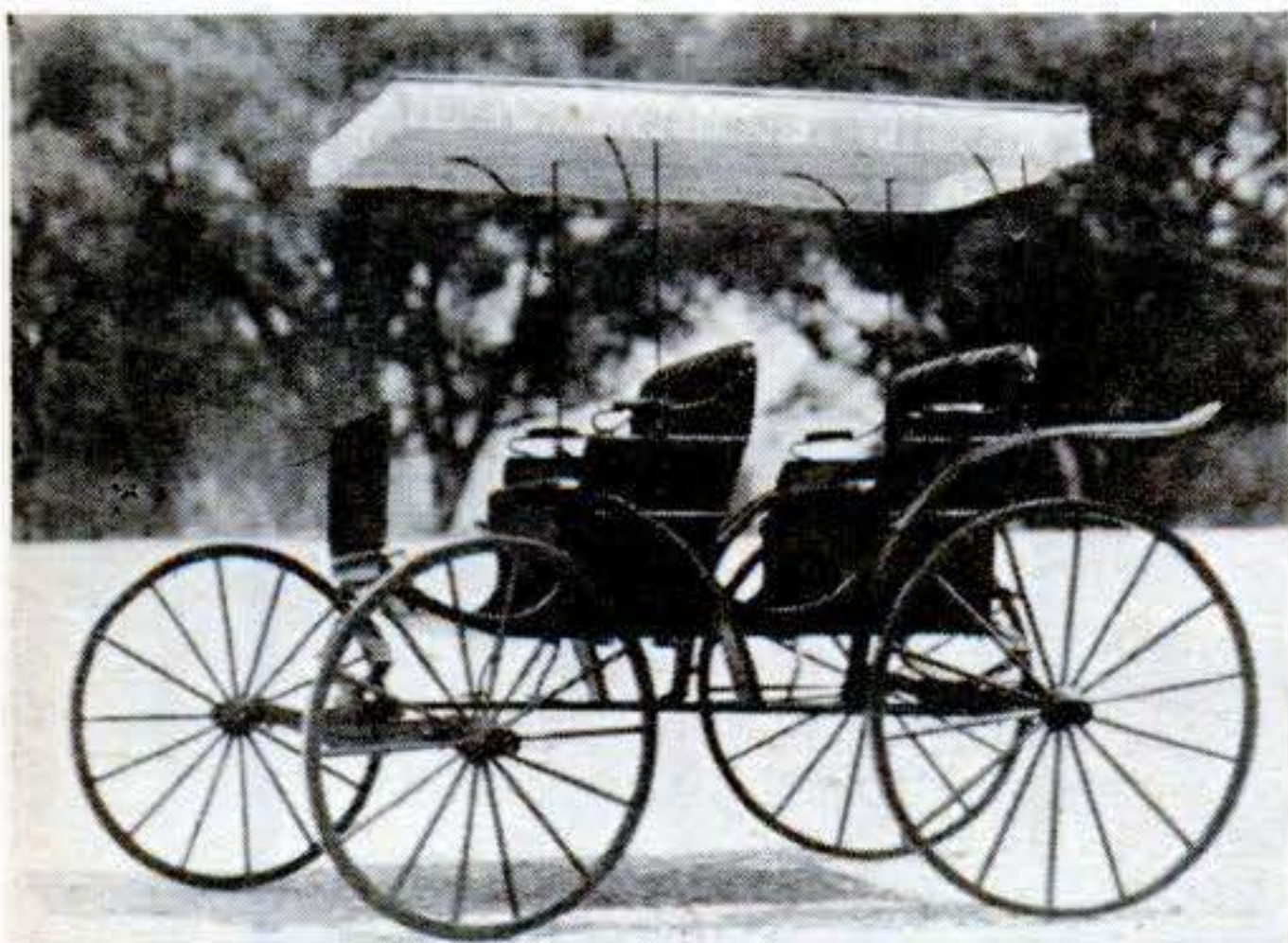
the long years that preceded full development of rail and motor-car transportation on this continent.

It often takes Collins a week to inch across a rural county. This is because he pokes around behind barns and crumbling livery stables in quest of drays and carriages which were left stranded when horses gave way to horsepower.

***Only Builder of Wagon Replicas in U.S.***

"Thousands of people are making miniatures of old trains, pioneer airplanes and the first steamboats and river packets," explains Collins. "The automobile manufacturers are immortalizing their own early products. But I believe I'm just about the only person in the United States who is trying to preserve exact and accurate copies of wagons."

During the past 18 years Collins has built precise replicas of 46 different horse-drawn vehicles which once were fairly commonplace. His ultimate goal is at least 100. Lest this seem a modest



**SURREY WITH THE FRINGE ON TOP** was a light, fast vehicle for driving the family around. Canopy protected the occupants of the carriage from hot summer sun.





Oxen or mules furnished "horsepower" for pulling a freight wagon over Western plains.

ambition, it should be noted that a minimum of 600 hours of painstaking effort must be spent on each of Collins' models. For example, nine separate coats of paint are par for the course when he is giving a wagon its gleaming finish.

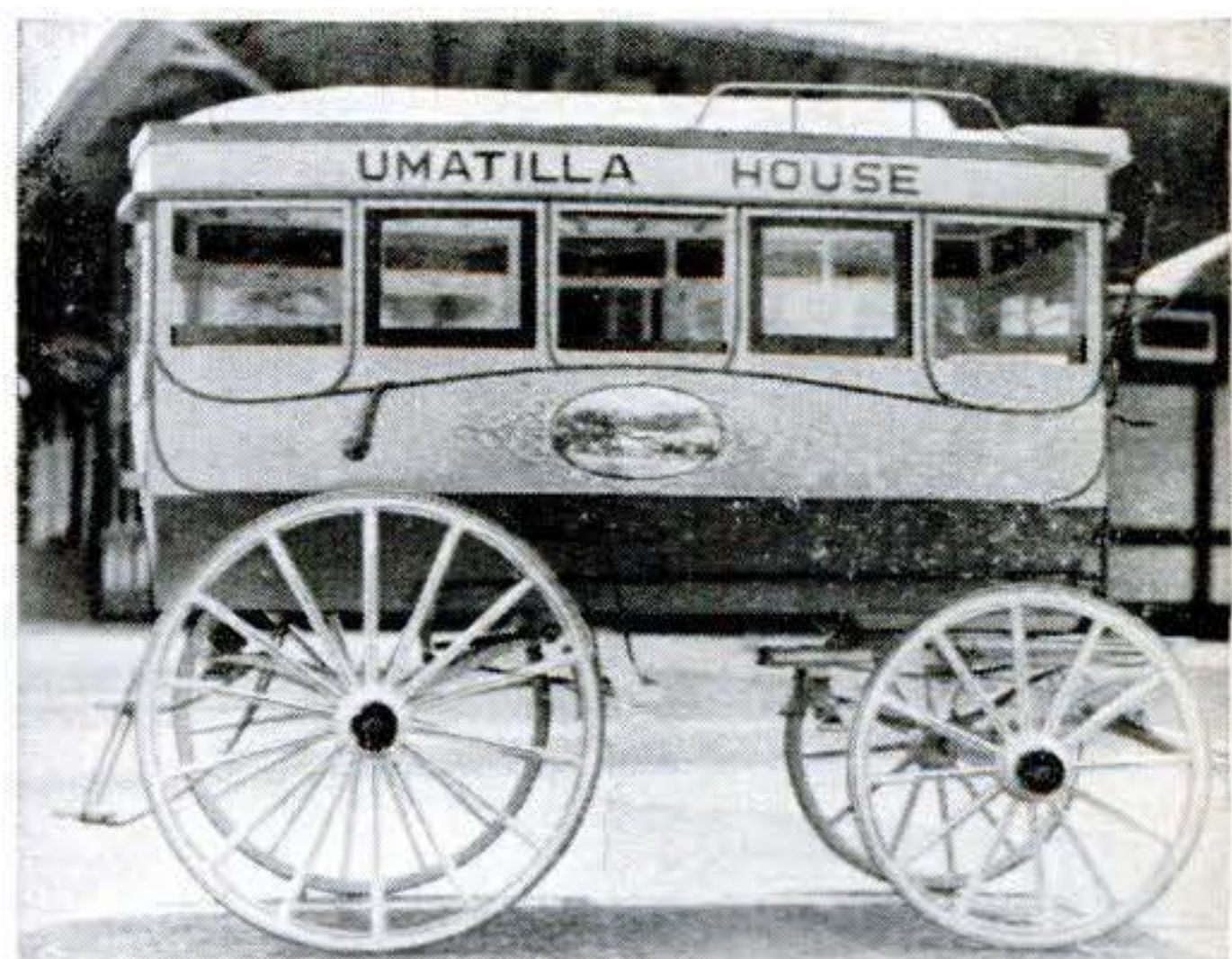
Collins abandoned his job as a model-builder at Lockheed Aircraft in California and returned to his native state five years ago, just so he could spend more time on his wagons. He now designs mechanical equipment for the University of Oregon, but the five o'clock whistle merely starts him on an eight-hour swing shift in his compact wheelwright's shop at home.

The models emerging from this shop are one-eighth the size of the original wagons from which they have been copied. Every separate item is built to scale, even lanterns and springs and buggy whips. In over-all bulk, a miniature van built by Collins matches the general proportions of a portable radio set.

Furthermore, everything works—the

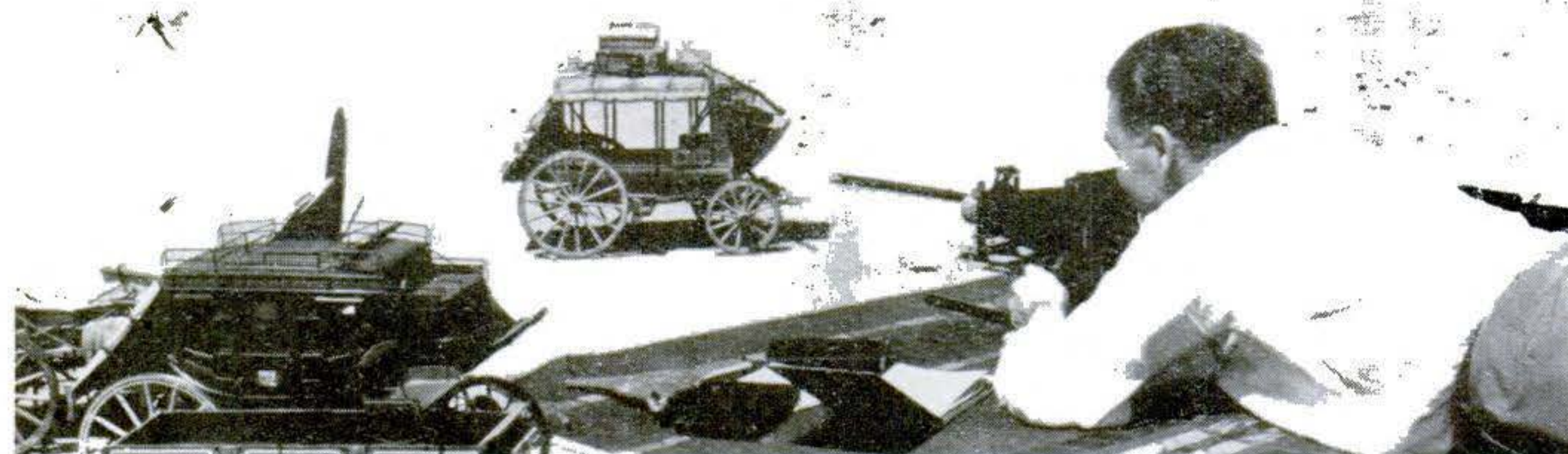
springs bounce, doors open and shut, tops fold back smoothly, blankets the size of a dollar bill fold neatly into cutter seats, the fringe of the surrey flutters if a bystander breathes upon it.

Collins is a hairsplitter for accuracy. In the strongbox of his stagecoach, he insisted on depositing genuine gold dust, flushed laboriously from an Oregon



THIS HOTEL OMNIBUS picked up passengers from frontier trains. Collins painted postage-stamp-size oil paintings on the inside of this coach model.





**TO PHOTOGRAPH** the model above, Collins places it 75 feet from a woods background,

then shoots it from a distance of three feet. He uses a 59-year-old camera.

creek bed near Springfield. Into the upholstery of the carriages, he and his blonde wife Laura wove identically as many threads per square inch as were used in the real vehicles. For the fire engine Laura knotted a rope life net, smaller than their two-year-old daughter's handkerchief, but of just the right mesh.

One of Collins' favorite miniatures is a replica of the oblong, top-heavy wagon which generated gas for the first daredevil observation balloons, during the Civil War. His foot-long model actually will produce hydrogen gas. All he has to do is add hydrochloric acid to the iron filings and water in the tanks of the little vehicle.

Collins has taught himself to become an expert draftsman, metal worker, blacksmith, wheelwright, wood carver, upholsterer and leather tooler. He thought this comprised the works—until he found the Umatilla House omnibus behind a commercial garage along the upper Columbia River. Then he had to be a landscape painter.

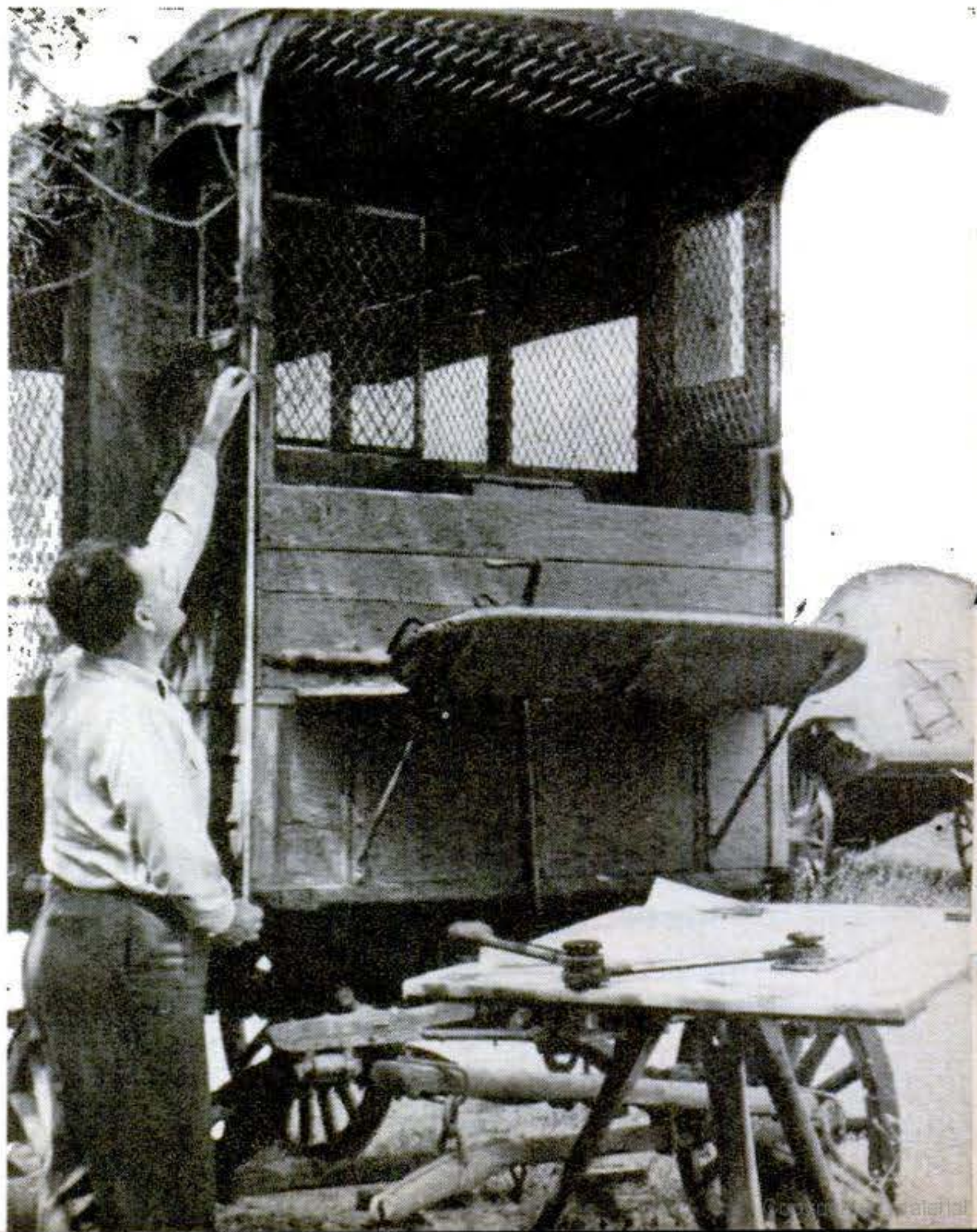
#### *Old Carriage Reflects Past Glory*

The first Union Pacific trains on the twisting Oregon short line were met by a gaudy, high-wheeled carriage, which took weary travelers to the Umatilla House, where there were chicken din-

ners, champagne suppers and elegant ladies. When Collins discovered the crumbling omnibus, the glory was departed. The mud of generations clung to it like frosting to a cake. But he still could tell that inside the dashing vehicle, over the windows, there had been different Pacific Northwest scenes in oils.

Collins' passion for detail forced him

**COLLINS MEASURES** an original wagon below, then makes plans with drawing instruments.





to paint a panel of tiny landscapes of Mount Hood, the Columbia Gorge and other natural wonders.

Yet he waves aside airily any tendency to marvel at his persistence. "I've got to be exact," says Collins, with the zeal of a man with a mission. "Other model-makers act as a check on each other because they're working in the same general categories of transportation. But, so far as I know, I have no competitors."

This spring the Stanford University Press, which usually features the works of erudite scientists and scholars, published a book of photographs of Collins' wagons. The title is "Horse Power Days."

Taking pictures of the models is an art in itself. Collins places the wagon from three to five feet away from the camera lens. At least 75 feet behind the vehicle hovers an appropriate background—Oregon trees for a logging wagon, Idaho desert for a stagecoach, bridge piers for an Army munitions van, a railroad station for an express wagon, a park plaza for a stately victoria.

The wagon is in sharp focus, the back-

ground is blurred. Yet the tiny vehicle, a foot in length, seems perfectly matched with the distant firs, 175 feet high. A miniature dray and a huge warehouse synchronize harmoniously.

After experimenting with many cameras, Collins finally settled on a Bausch & Lomb Ray No. 7 which his uncle had purchased in Seattle in 1894. Its ancient lens can be stopped to a pin-hole outlet. It was what Collins sought to capture the detail of his miniatures.

"Besides," he confesses, "it made me feel in keeping with the whole project to be able to photograph models of old vehicles with an old camera. I guess I just didn't want anything streamlined about this undertaking—not even the camera!"

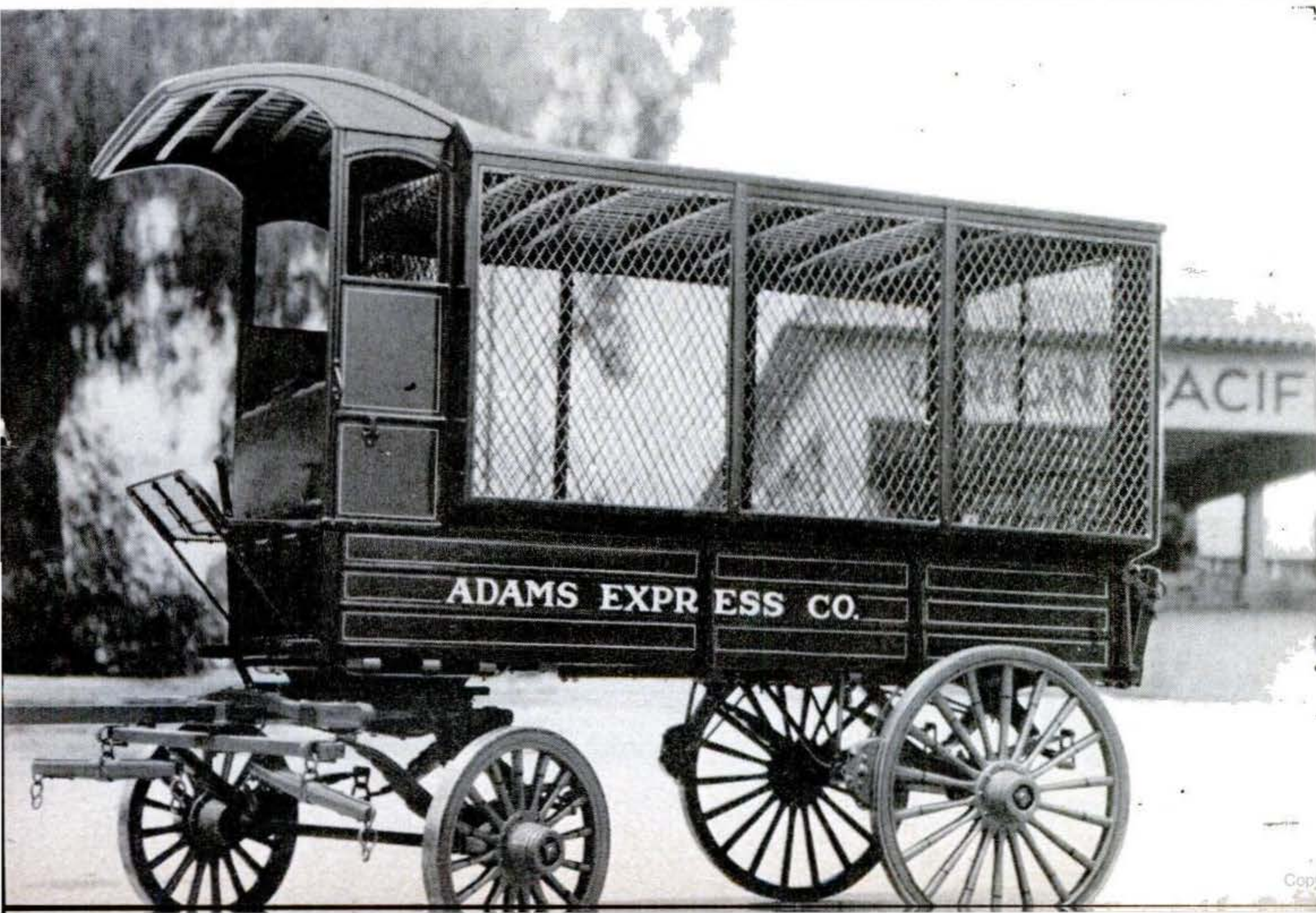
#### *Doctor Suggested Model Building*

Collins was in bed with an ulcer in 1935 when the doctor counseled some form of handicraft as a means of relieving nervous tension. The physician himself suggested a prairie-schooner kit for Collins to assemble.

[\[Continued on page 198\]](#)

**EXPRESS-WAGON** photo shows how skillfully Collins uses real-life background in photo-

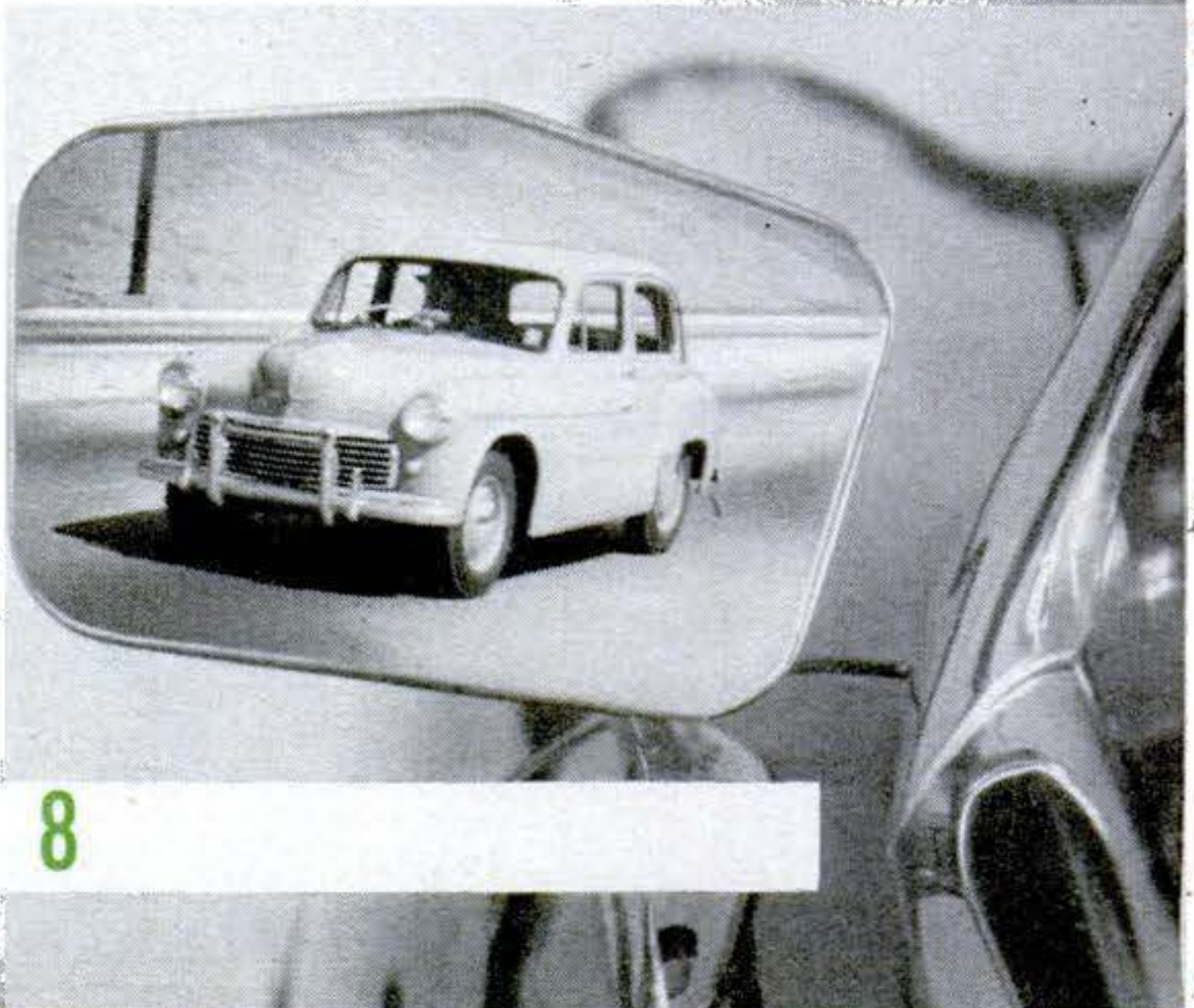
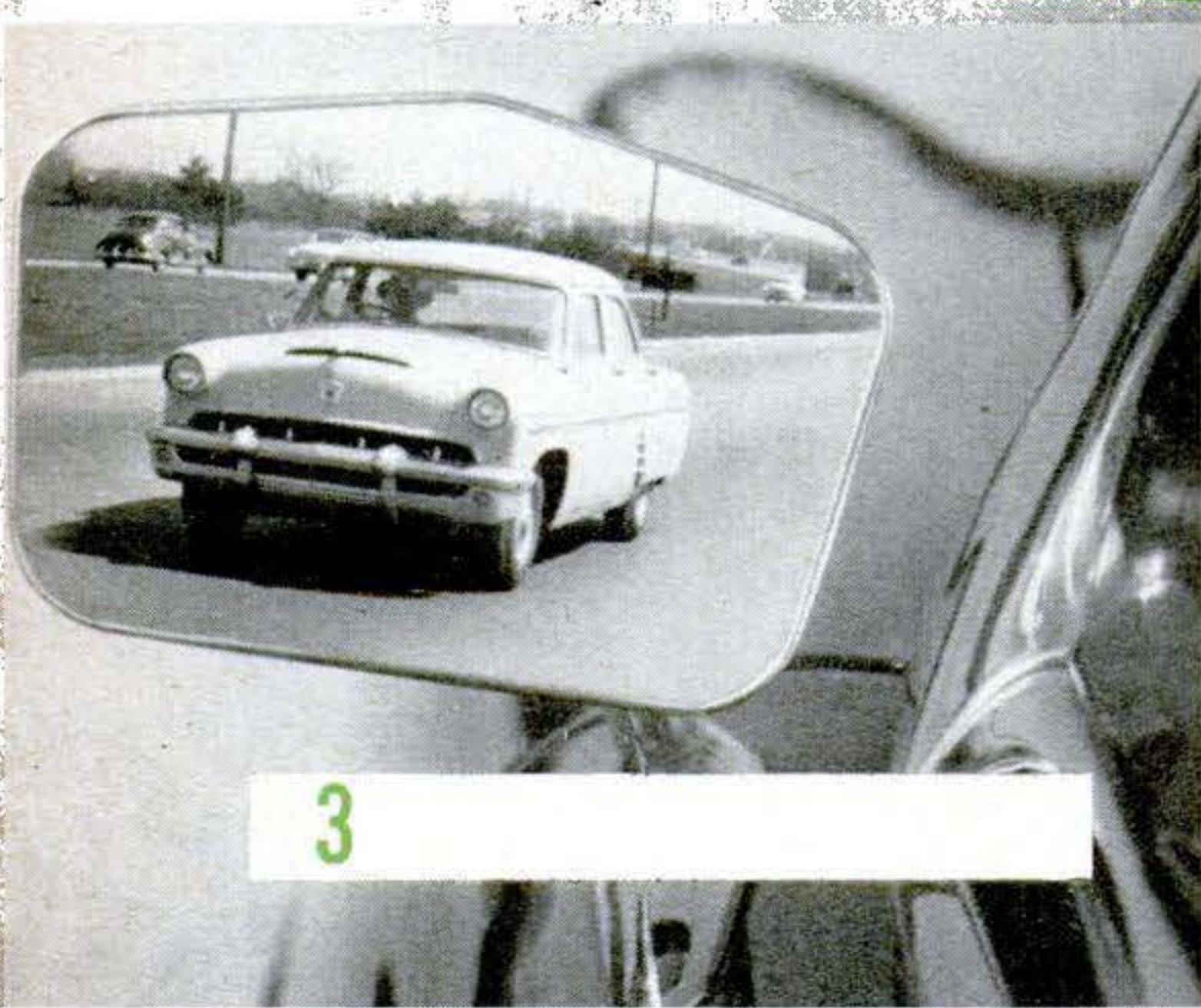
graphing his miniatures. An actual Union Pacific Railroad station is behind the model.





# What's Passing You Now?

You're pretty good at identifying the cars you meet on the highway. But it's a little harder to tick off the ones that you glimpse only in your rear-view mirror as they creep up from behind to pass. See how many of these cars, old and new, you can recognize that way in the pictures on these pages. Then check with the answers printed upside down at the bottom.



7. De Soto; 8. Hillman Minx; 9. Cadillac; 10. Oldsmobile.





1



2



5



6



9



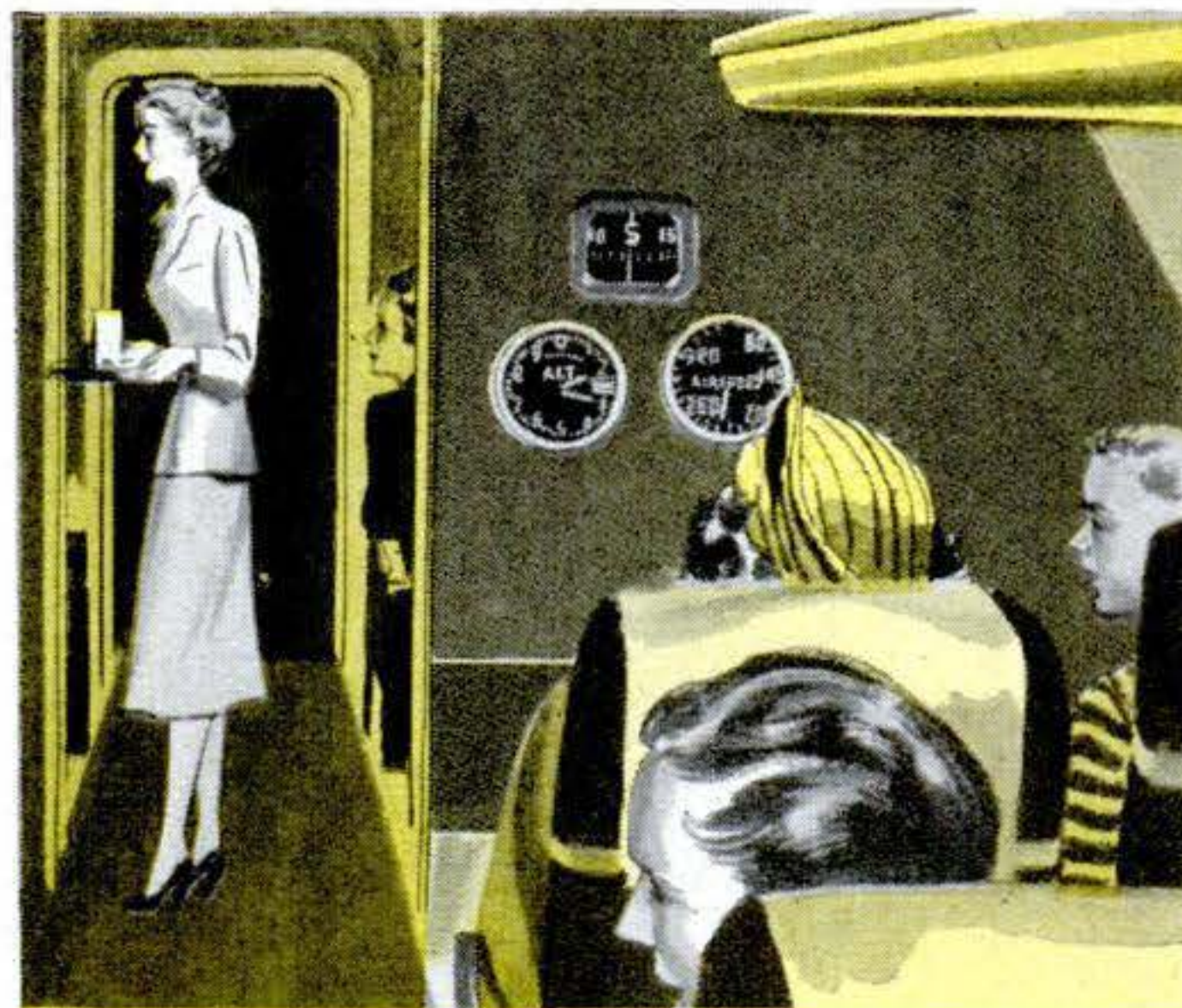
10

Answers: 1. Lincoln; 2. Hudson; 3. Mercury; 4. Henry; 5. Nash Rambler; 6. Packard;

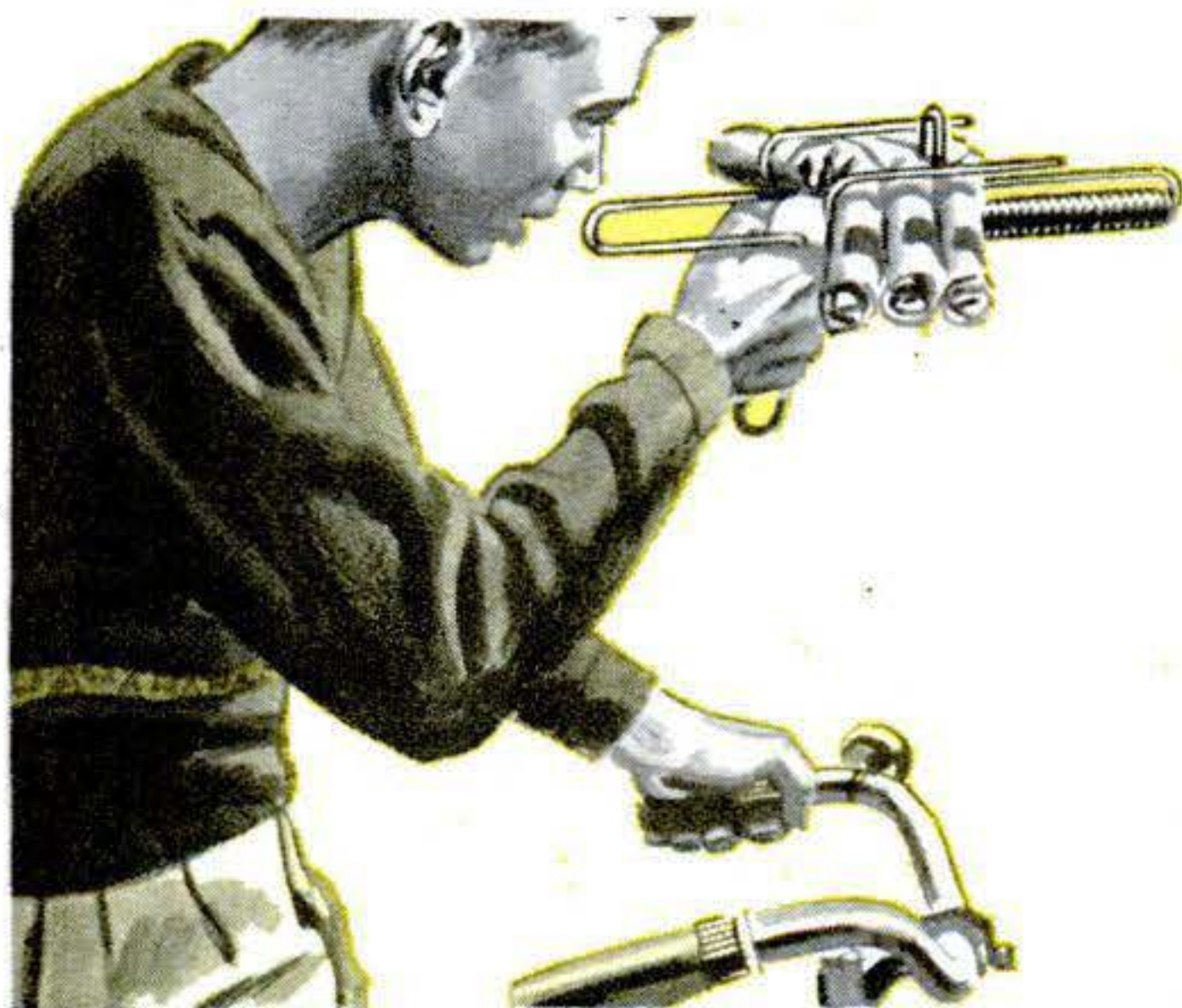


I'd Like  
to see them  
make...

Everyone has his own pet idea of some gadget he would like to see in general use. What is YOURS? Popular Science Monthly will pay \$5.00 for each one published. Use government postcards only. Contributions cannot be acknowledged or returned.



**INSTRUMENT DIALS** in airliner cabins, so that passengers could tell the speed, altitude and direction they were flying.—*Samuel Harris, Huntington, N.Y.*



**A REPEATING SPRING GUN** for shooting newspapers up front walks. It would save lots of steps for newsboys with long routes.—*Wm. Campbell, Bakersfield, Calif.*



**FAUCETS WITH WASHER SIZE** stamped on the exterior so you wouldn't have to turn off the water to check diameter before buying a replacement.—*C. B. Bailey, Puyallup, Wash.*



**SPRAY-ON RUBBERS** of liquid plastic that would dry to a hard, waterproof film but could be peeled off the leather when the streets dried.—*R. E. West, Lyndhurst, N.J.*



**A LOW-WATT HEADLAMP** wired across the fuse terminal of a car. It would give some light if a fuse blew during a night drive.—*S. Ramya, Panadure, Ceylon.*



# Man-Made Meteors to Spy on Space



*Radiomen have already put nature's shooting stars to use—and now scientists plan to pelt the skies with some of their own.*

Set off in air, shaped charge gives artificial meteor shower at White Sands Proving Ground.

**By Edward Hutchings Jr.  
and Olin J. Eggen**

**D**ESPITE the promise of spaceships and guided missiles, the first man-made thing to sail out into interplanetary space will probably be a meteor.

Long before the first passenger-carrying rocket ship takes off, artificial meteors may go out as scouts. To overcome the earth's gravitational pull and escape into outer space, you must attain a speed of almost seven miles a second. The fastest rocket tested to date has gone about

1½ miles a second. But man-made meteors already have reached speeds close to seven miles a second.

By firing these artificial meteors from high-flying rockets or balloons, it should be possible to project them into satellite orbits of the earth, so that they would circle the globe, as the moon does—or send them out into interplanetary space, never to return.

Like the genuine article, an artificial meteor is basically very simple. One of the easiest ways to produce one is to fire a chunk of metal from a shaped explosive



charge. This gives almost incredible speed. Friction with the air makes them incandescent, like real meteors.

Meteors are the only tangible substances that reach the earth now from outer space; more than a billion of them enter the earth's atmosphere every day. They travel at an average speed of about 30 miles a second. That's faster than any of the present-day classifications of missile speeds, like supersonic or hypersonic; so scientists have invented a new classification to describe it—ultra-flight.

When they plunge into the earth's atmosphere, these fast-flying chunks of stone or metal encounter air resistance for the first time, and trails of hot gas form in their wakes. This incandescent gas—and not the meteor itself—is what we see as a shooting star or a fireball. (A fireball, as one astronomer defines it, is nothing more than a meteor bright enough to cause people to report it.)

#### **5,000 Hit Earth Yearly**

Usually meteors appear at a height of about 60 miles and burn out by the time they are down to 40 miles. Occasionally, a fireball will plunge to less than 10 miles above earth and then explode with a rumble heard 200 miles away.

Most meteors are no bigger than a grain of sand. Every year, though, there are about 5,000 meteors large enough to pass through the atmosphere without burning completely. After they fall to the ground we give them a new name—meteorites. About five tons of meteorites—and dust from burned-out meteors—fall to the ground every day.

Fortunately, not many are as big as one that landed in Russia 45 years ago.

Illevitch Ilyinsky, stationmaster at the city of Tansk, on the Trans-Siberian Railroad, was waiting for freight train No. 92 to come in from Tomsk. It was a bright June morning and Illevitch noted that it was just seven o'clock as the train appeared around the bend. Suddenly the air was split with a tremendous roar. The ground shook violently. The engine was thrown from the rails and Illevitch was knocked off his feet.



**BRIGHT TRAIL OF METEOR** was caught while photographing an extragalactic nebula with aid




**RADIO ECHOES** from 70-mile-high meteors are studied with camera and oscillograph by Drs. O. G. Villard Jr., and Allen M. Peterson in Stanford's Radio Propagation Laboratory.

Five hundred miles to the north, at the hamlet of Kovinsk, a herd of more than a thousand reindeer was burned to death by the heat of a tremendous explosion. Thousands of acres of virgin forest were blown down by the concussion, and the earth tremors were recorded as far away as London.

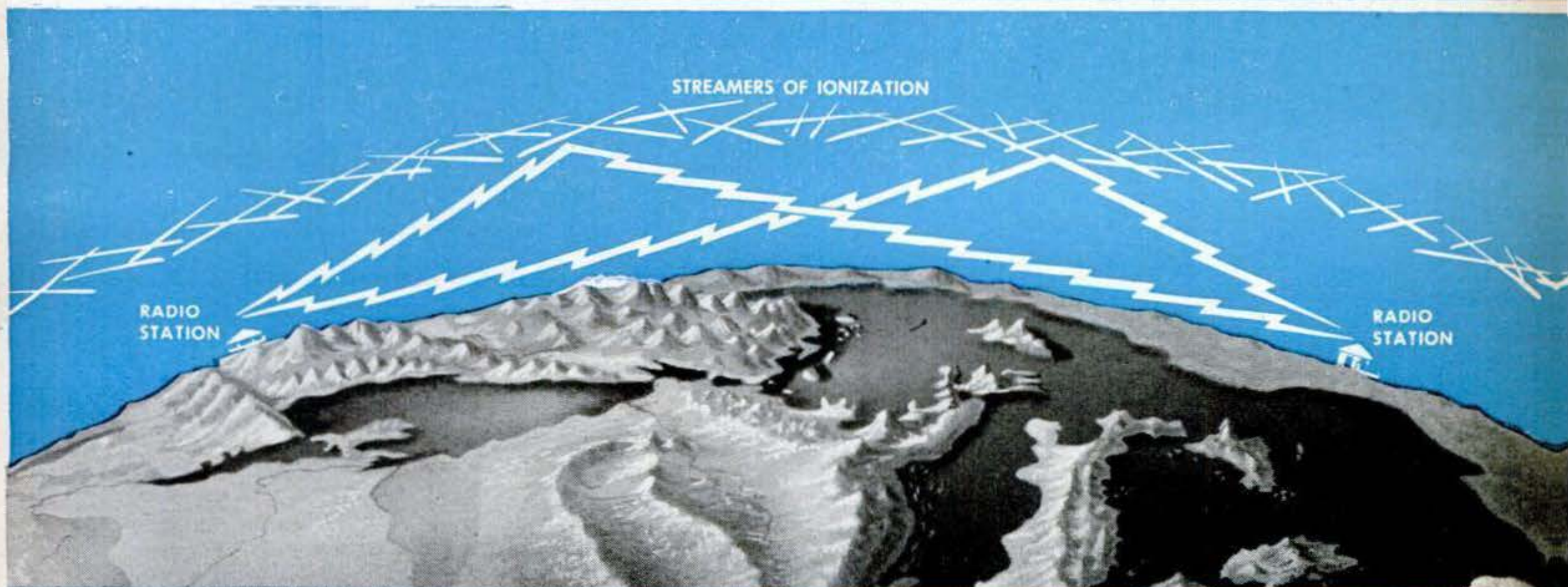
This was in 1908, not 1953, and the cause of the destruction was more powerful than five Nagasaki-type atomic bombs. This was a heavenly bomb—a meteor composed of 5,000 tons of solid iron. If it had struck just four hours and 47 minutes later, the earth would have turned enough to have brought the city of Leningrad into position, and the force of the impact would have completely wiped out the city.





of a great astronomical telescope. When a meteor enters the earth's atmosphere, it

makes both a streak of light and a trail of ionized particles producing radio echoes.



**PUTTING METEORS TO USE**, radio amateurs now bounce signals off their trails. This maintains communication between stations 700 to 1,000 miles apart whenever conventional

path, by reflection of radio waves from ionosphere, goes dead. There are enough meteors, and trails last long enough, for continuous transmission of code messages.

This Siberian meteorite left nearly 100 holes spread over several miles of land. At rare intervals, the earth encounters a meteor of sufficient size to blast a hole in the ground such as the great crater at Canyon Diablo, in Arizona. This 4,000-foot-wide hole was probably formed about 50,000 years ago when a 1,000-ton ball of fire plowed into the Arizona countryside, scattering its fragments over many acres.

There are about a dozen other large meteor craters scattered over the world. The largest may well be the two-mile-wide Chubb Crater in northwest Quebec, discovered in 1951. In Australia there is a group of 13 craters, from 30 feet to 275 feet in diameter. The meteorite that was responsible for them obviously fell a long

time ago; trees over 500 years old are growing in the craters today.

Most meteor research to date has been done with telescopes and cameras—like the meteor traps set up by the Harvard Observatory in 1936. Two wide-angle cameras, 25 miles apart, kept watch on a section of the sky. Each photographed every meteor that flashed through the area. By comparing its position on the plates from the two cameras, it was possible to determine its height. By equipping one camera with a rotating shutter, so that meteor trails were recorded as broken lines, it was possible to determine a meteor's speed as well as its path. The cameras caught few meteors though—maybe a dozen a year.

Today, a powerful and efficient new



tool has taken over this job—the Super-Schmidt Meteor Camera. A 5,000-pound camera, specially designed for photographing meteors, it covers 1/10 of the visible sky at a time and traps 40 times as many meteors as the old cameras did.

Radar also is being used to track meteors today, giving a sizable boost to meteor research. Radar makes it possible to study daytime meteor showers for the first time. It distinguishes single meteors from groups; it discovers particles too small to be caught by cameras; and it works in all kinds of weather.

#### *Ionized Trails Echo Radar Beams*

This research is adding to our understanding of the upper atmosphere, too. When a meteor enters the atmosphere, it leaves a trail of electrons behind it as well as a streak of glowing gas. Radar echoes from these ionized trails are giving us information about such things as wind motions in the atmosphere, and facts about the ionosphere—the region from 40 to 60 miles above the earth which reflects short-wave radio waves back to us.

Radio hams are even putting the meteor trails to practical use. When transmission by other paths fails, communication can be maintained by bouncing signals off the trails of meteors. This has been demonstrated in nighttime experi-

ments by two amateur radio operators of Stanford, Calif., Drs. Oswald G. Villard Jr., and Allen M. Peterson. Enough meteors bombard the earth, they report, to crisscross the upper atmosphere constantly with a reflecting fabric of ionized trails, from which signals of favorable wave length echo back to earth and afford uninterrupted contact between stations several hundred miles apart. For an 800-mile distance, a relatively low frequency of 14 megacycles was found best.

But meteor research is still comparatively slow and difficult. Scientists still lack a good deal of fundamental data on meteors and they still need a lot more physical observations. This is where artificial meteors come in. True meteors come at random and they're hard to catch. By shooting off man-made meteors we can make visual and photographic observations at will.

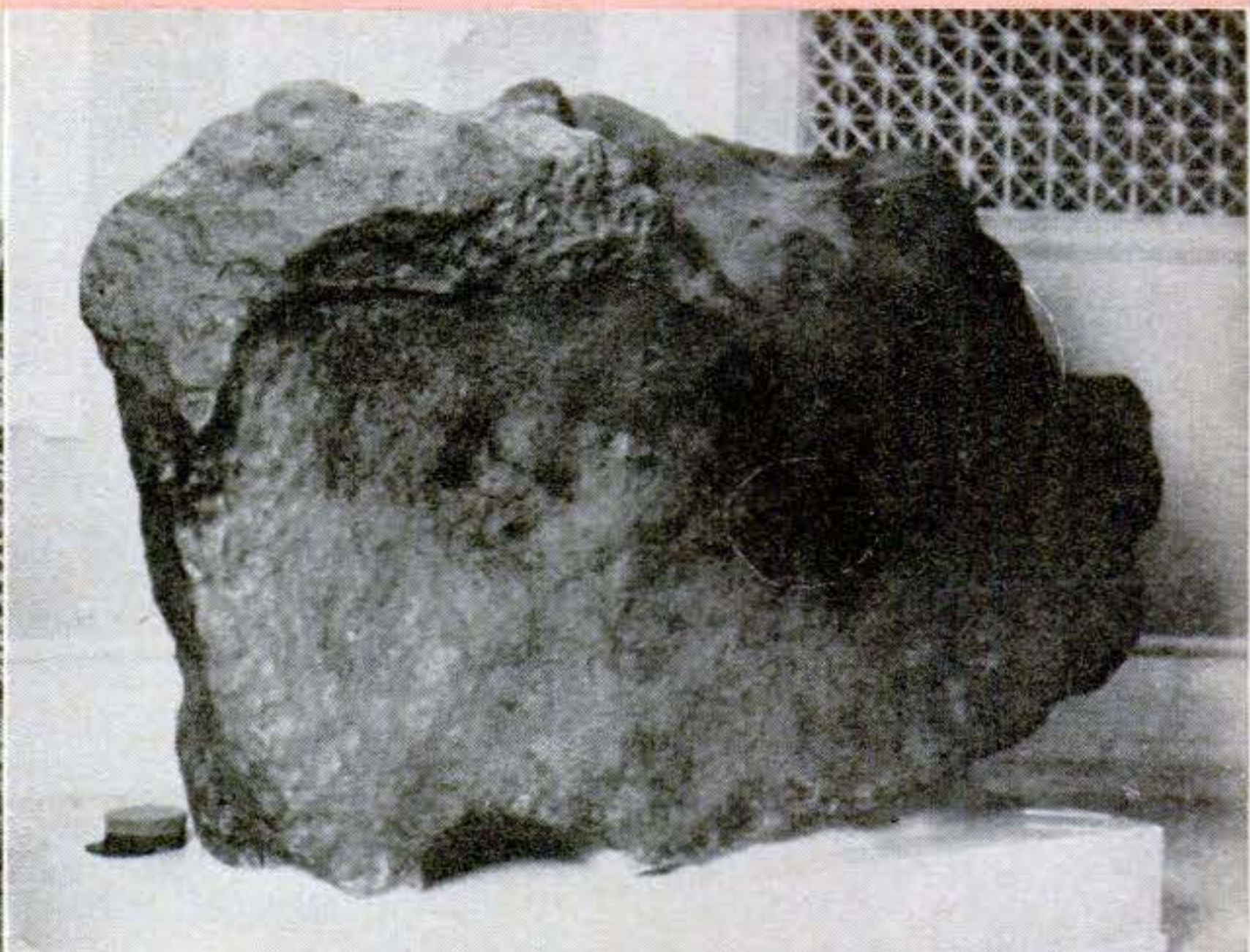
The artificial meteor project is being most actively pursued today by Dr. Fritz Zwicky, professor of astrophysics at the California Institute of Technology, and chief research consultant for the Aerojet Engineering Corporation of Azusa, Calif.

In ground experiments, most artificial meteors burn up because of air friction by the time they have traveled about 100 yards. With increasing height and decreasing air density, the tracks of arti-

**FOREST IN SIBERIA** was leveled by blast, not of an atomic bomb, but of a gigantic meteorite that fell nearby in 1908. This photo shows scene as it looked 20 years later.



**BIGGEST METEORITE** in captivity is this 36½-ton specimen brought from Greenland by Admiral Peary. Only larger one known, of 60 tons, lies where it fell in South-West Africa.





ficial meteors become longer. Since Zwicky's experiments have already produced particles with speeds of almost seven miles a second near the ground, at altitudes of 20 miles or more the velocities of these particles should surpass the speed necessary to escape from the earth's gravitational pull.

#### *Tries to Fire Meteors from Rocket*

The only attempt so far to launch artificial meteors from great heights took place on Dec. 17, 1946. With the cooperation of Army Ordnance, Dr. Zwicky mounted six shaped charges in the nose of a V-2 rocket on the White Sands Proving Ground at Las Cruces, N. M. This was the first night firing of a V-2, and it was scheduled primarily to observe the six showers of artificial meteors to be ejected from the rocket—two at a time and in opposite directions.

The time schedule was carefully worked out. Seventy seconds after the rocket left the ground, at a probable height of 140,000 feet, two showers of meteors were to be ejected. Ten seconds later, when the rocket had reached a height of about 180,000 feet, two more showers were to shoot out. At 90 seconds and 220,000 feet, there was to be a final flare of meteors.

*[Continued on page 240]*

**HUGE CRATER** in Arizona, nearly a mile across, marks spot where it is believed one of history's greatest meteorites hit. Many tons of meteoric iron have been found nearby.



**MOON'S CRATERS** may be result of meteorite bombardment. Recent studies favor this over rival hypothesis that craters were of volcanic origin.



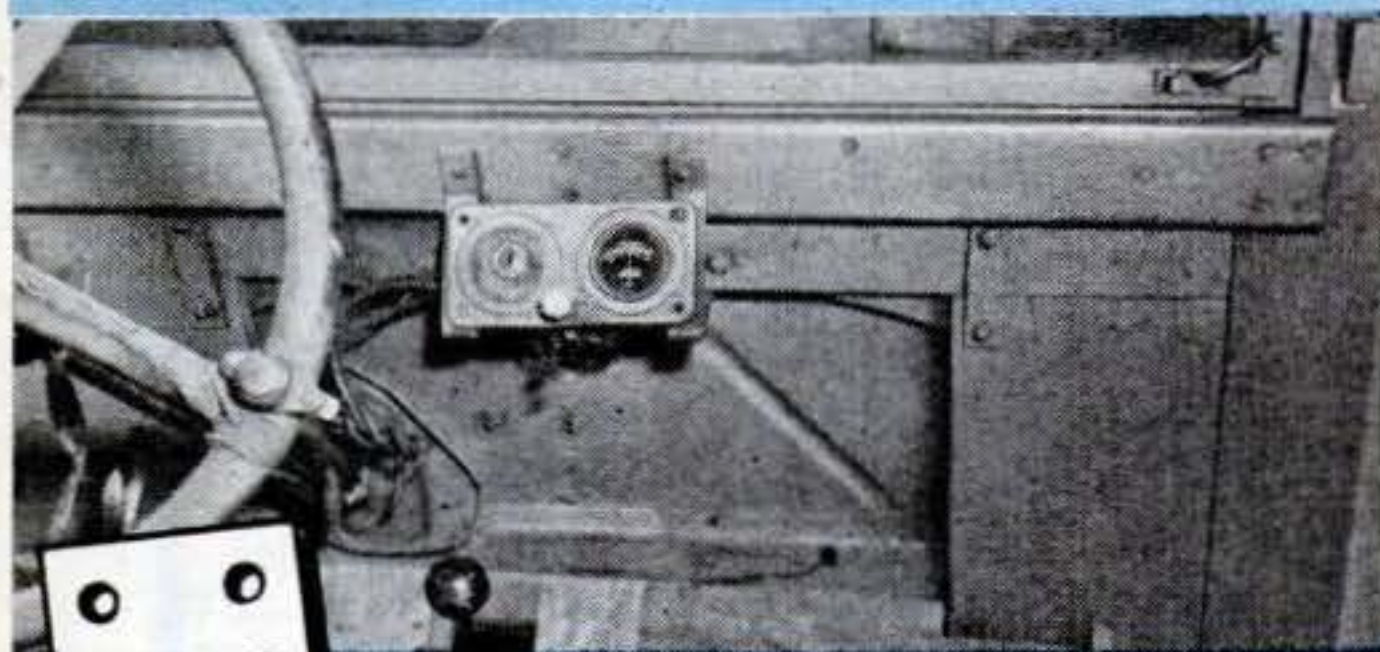
# Once Upon a Time...

... a motorist had nothing to worry about but driving. Now the galaxy of dials, gauges, levers and buttons he faces would dazzle an airliner pilot. The evolution of dashboard complexity is traced here in photos reprinted from *Alumination*, a Kaiser Aluminum distributors' magazine.



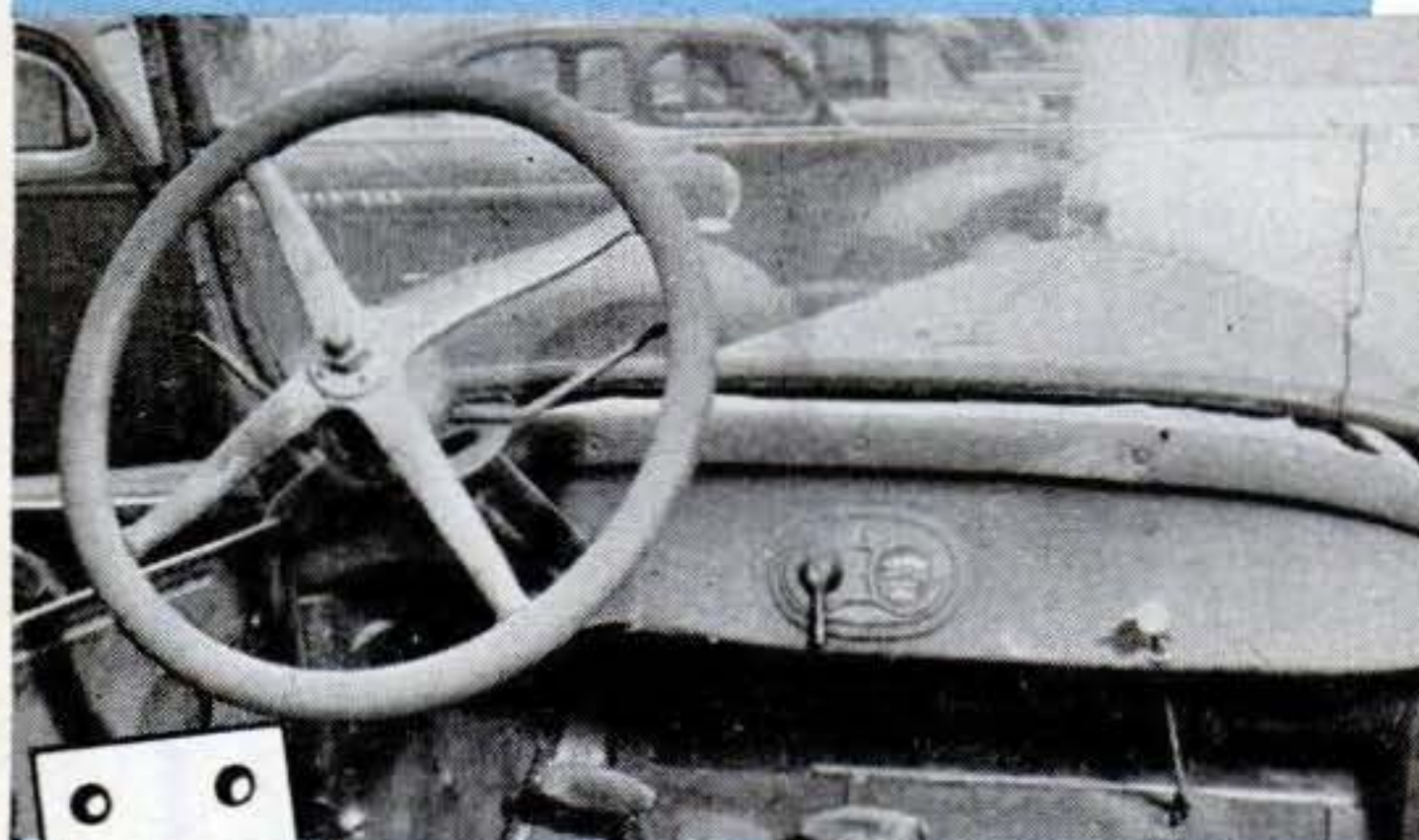
1906

**HOW SIMPLE** can you get? It's either on or it's off.



1923

**HOW'S A MAN** going to keep track of all these gadgets?



1927

**NOW WE GOT** a choke. But nothing to tell you how fast you're going.



1934

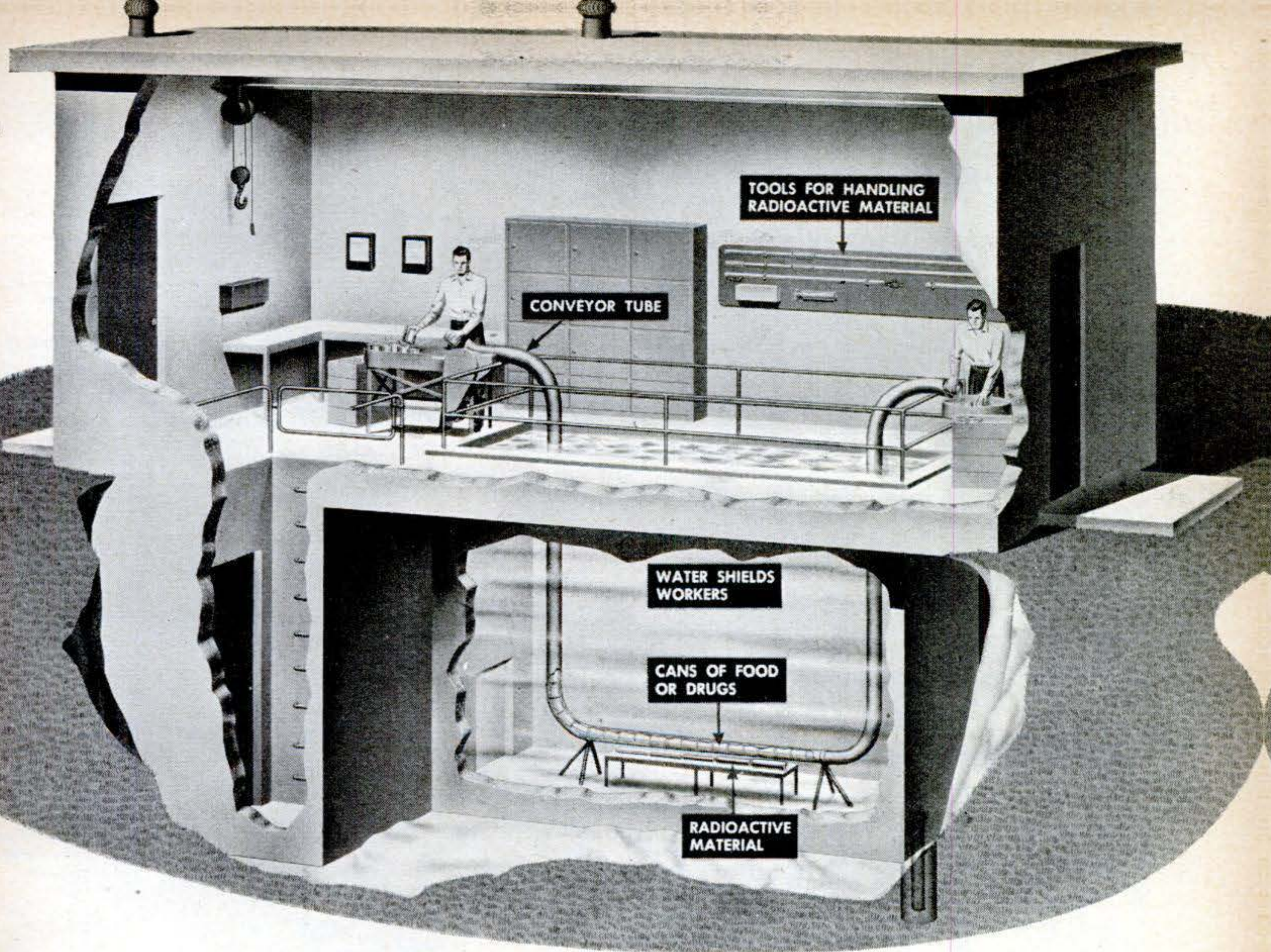
**AT LAST** the little woman's got a place to lose her sunglasses.



## Neck Stretcher Eases Backache

THE Air Force officer above is about to be strung up—for his health! A therapy that looks as if it might result in a pain in the neck, it's supposed to remove one. Traction eases neck- and backaches by relieving pressure. The patient puts his head in the noose daily for a 30-second treatment at Offutt AFB hospital in Nebraska.

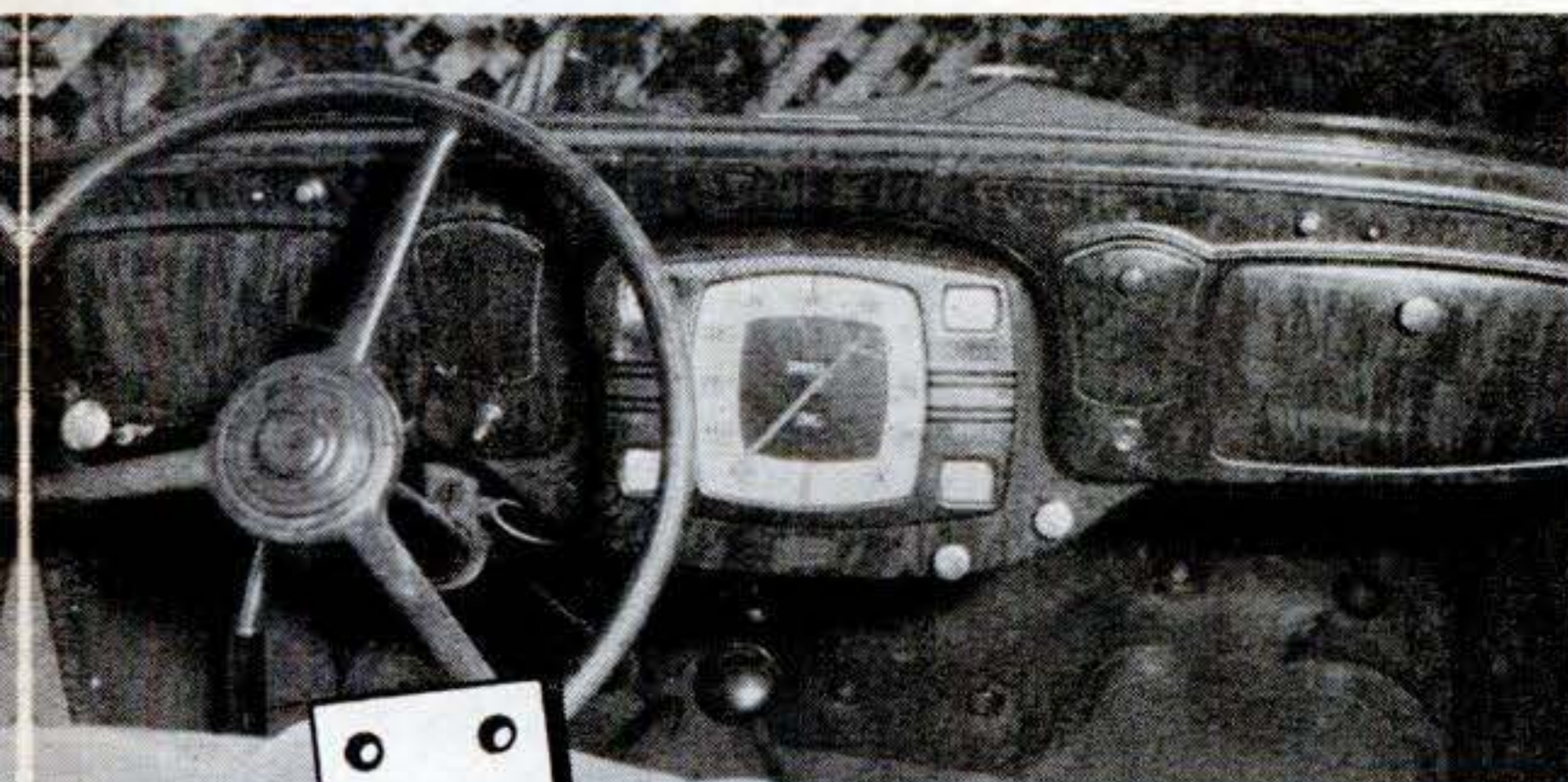




### Atomic Canning Preserves Food Without Heat, Protects Taste

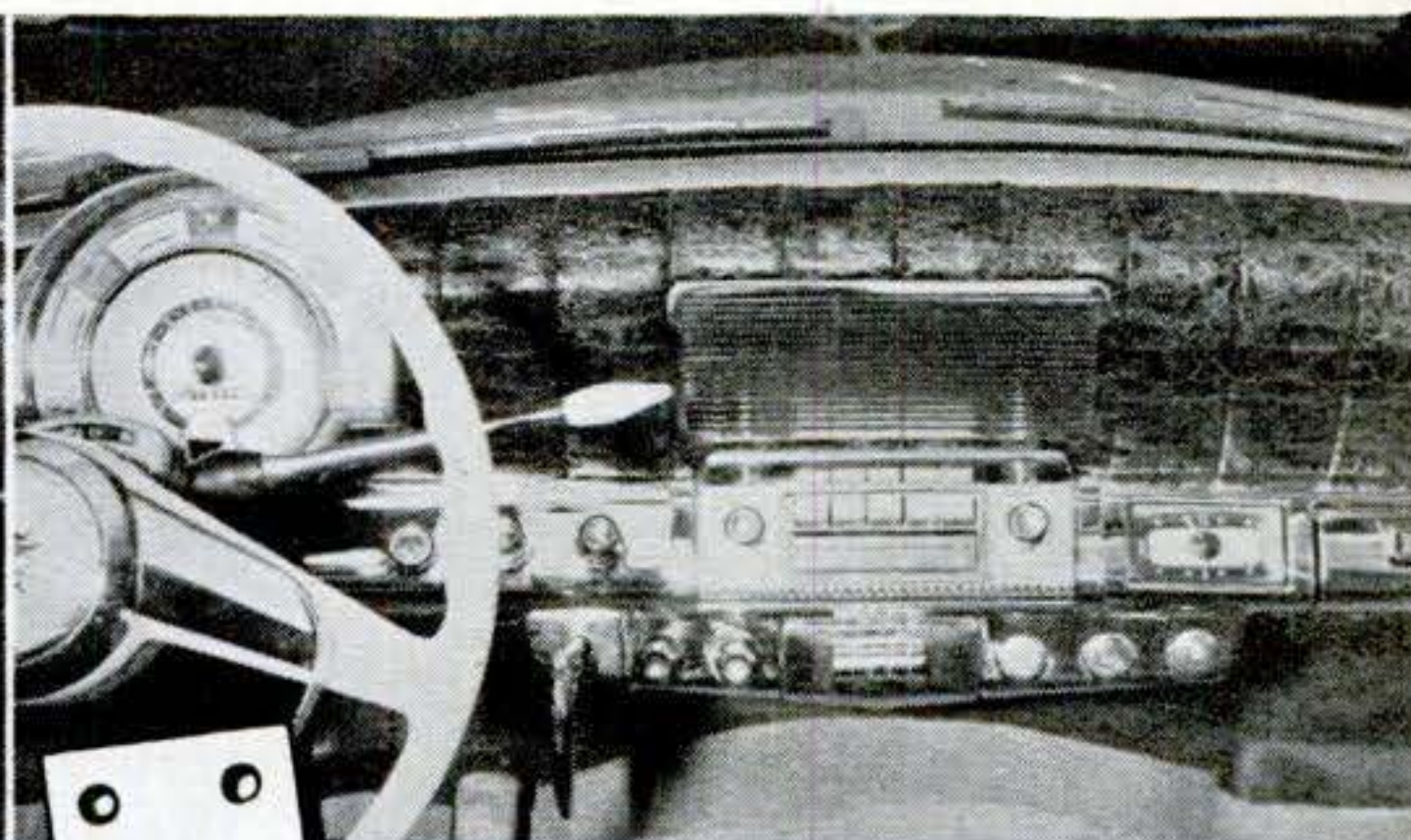
ATOMIC rays are now being used to preserve food. Since no heat is used, as in ordinary canning, the irradiated food keeps its fresh flavor. The process works on drugs, meats and vegetables—uncooked hamburger, which usually spoils in a few days under ordinary refrigeration, has been kept palatable for two months.

Several atomic canneries, all experimental, are already in operation. One at Stanford Research Institute, Calif. (above) sends vials of penicillin through a U-shaped tube in a pool containing radioactive cobalt. At MIT, scientists working with the Navy use the electron beam from a Van de Graaff atom smasher to treat meats and vegetables.



1936

AND A RADIO—flanked by dummy panels for, maybe, radar and TV.



1953

PILOT TO COPILOT: When does a man find time to steer?

page 126 for details on how to win a Model T Ford.

JULY 1953 99





In first water trials, Boat No. 6 lives up to wind-tunnel promise.

# He Builds the Fastest Outboards



*From garage to rowboats to racers—that's the story of Pop Willis, who has lost count of the records his sleek craft have broken.*


**By Fred Pass**

WHEN a hundred or more curved slabs of mahogany go skimming across Lake Dallas, Tex., at the National Outboard Association's championship races next September, the chances are better than eight out of 10 that a boat

built by S. C. "Pop" Willis will lead the pack.

So well have his speedlined racers performed at past meets that Pop Willis has lost count of the national and international trophies they have won. But he does know that more than 80 percent of the boats which race in the favorite





**POP WILLIS** works on a Comet. What the buyer gets is a hull 13 feet long, 51 inches wide, and weighing 200 pounds. It is constructed of Philippine mahogany and airplane spruce. Pop boasts that each piece of mahogany is free of blemishes. His Dallas, Tex., boat works turn out some 200 of these popular Class C race-winning boats a year.

C Class (boats powered by motors of 20 to 30 cubic-inch displacement) are made in his shop in Dallas.

Each year the Willis Boat Works turns out at least 200 Class C racing boats that go to all parts of the country and sell for \$400. Never one to open the throttle on a racing outboard himself,

Pop has gained immense pleasure, a measure of renown and fair profit by outwitting wind and water resistance.

Pop used to own a filling station and garage in Dallas. But because he loves the graceful lines of boats and gets a kick out of being around the vibrant, energetic fraternity of men who race



them, a hobby became his business.

It started during the depression days of the early 1930s. Pop had learned how to build fishing boats when a boy on the Cumberland River in Tennessee. With business slack, he cleared away a corner of his garage and built a boat with the intention of going fishing at a nearby lake. He got the boat to the lake, but before he could wet a hook, a man offered him \$90 for the boat. He sold it.

Pop made more boats for friends, and because they were good boats, orders stacked up. Boatbuilding grew to more than a sideline. He moved to larger quarters and gave equal space to the garage and the boat works.

### *Develops Interest in Racing*

One afternoon he was at work on a boat when a man came into the shop and said he owned a racing boat that needed repairs. Pop explained that he knew nothing about racing boats, but he would take a look. He must have done a good job, for other racing enthusiasts brought their boats to him when repairs were needed.

From this new work, his interest in racing developed. He would go and watch a race any Sunday there was one within driving distance of Dallas. He picked up some new ideas about boats and talked them over with a Sunday racing enthusiast named Jack Barbee. Barbee, whose main job was selling harvester machinery, was interested. The two men started working on a boat that would incorporate Pop's suggestions.

He and Barbee put in months of labor before the boat was finished. Then they

**A SPRAY** of Texas lake water and a competitor are left behind as a Comet easily takes

took it to Dallas' White Rock Lake for testing. Barbee opened the throttle and the boat went crazy. It was all Barbee could do to keep it upright.

This boat was a failure, but Pop and Barbee thought they knew what corrections were needed. They built another. And another.

Five boats and three years later, they took stock of their experimental racers. Each boat, they agreed, had performed better than the one before it. But they were losing too much time on turns. They had to cut down wind resistance.

Then Pop had the idea that put him in the trophy-winning department. At Dallas' Love Field the Air Force was operating a wind tunnel. Pop and Barbee carted Boat No. 5 to the airfield and talked the officer in charge of the wind tunnel into giving the boat a test. The wind was turned on and the boat went into wild spins. The officer told Pop how to reshape the boat. Take three inches off the prow, taper her more here and there . . .

### *Flies Boat in Wind Tunnel*

Boat No. 6 was built according to the recommendations of the wind-tunnel officer. Then Pop took the boat to the airfield. The craft was suspended, across the transom, on a horizontal steel rod that could ride up and down on ball-bearing tracks on either side of the tunnel. On went the air, and the boat climbed gracefully off the floor and remained suspended in the wind, perfectly balanced in the stream of air.

From the tunnel the boat was taken to White Rock Lake. The boat rode the ripples in a straight, smooth line. Bar-

the lead in an outboard race. Winning races has become a habit with Willis boats.





bee got set to give the boat its big test. He put it in a turn. The little craft slid smoothly around and quickly was off again on the straightaway.

A few days later, a Texas boat club held a race at Inks Lake, near Austin in Central Texas. In that race, Barbee clocked a new unofficial world's record.

That race put Pop in the speedboat business. He named his boat the Comet, and the name stands today as a shining emblem of speed on water.

#### *First Big Win Was in '47*

A Comet won its first official national record in 1947. In fact, Wally Harper of Detroit, Mich., won three trophies in a Comet, and enough points to claim the NOA's title of Mr. Outboard of 1947.

The following year Pop was working in his shop when a telegram came from Lake Alfred, Fla. The message read: "Frank Stanford, Lake Alfred, Fla., won C Racing Runabout in Willis Comet, setting new world record 53.223 miles per hour. Herman second, Henry third."

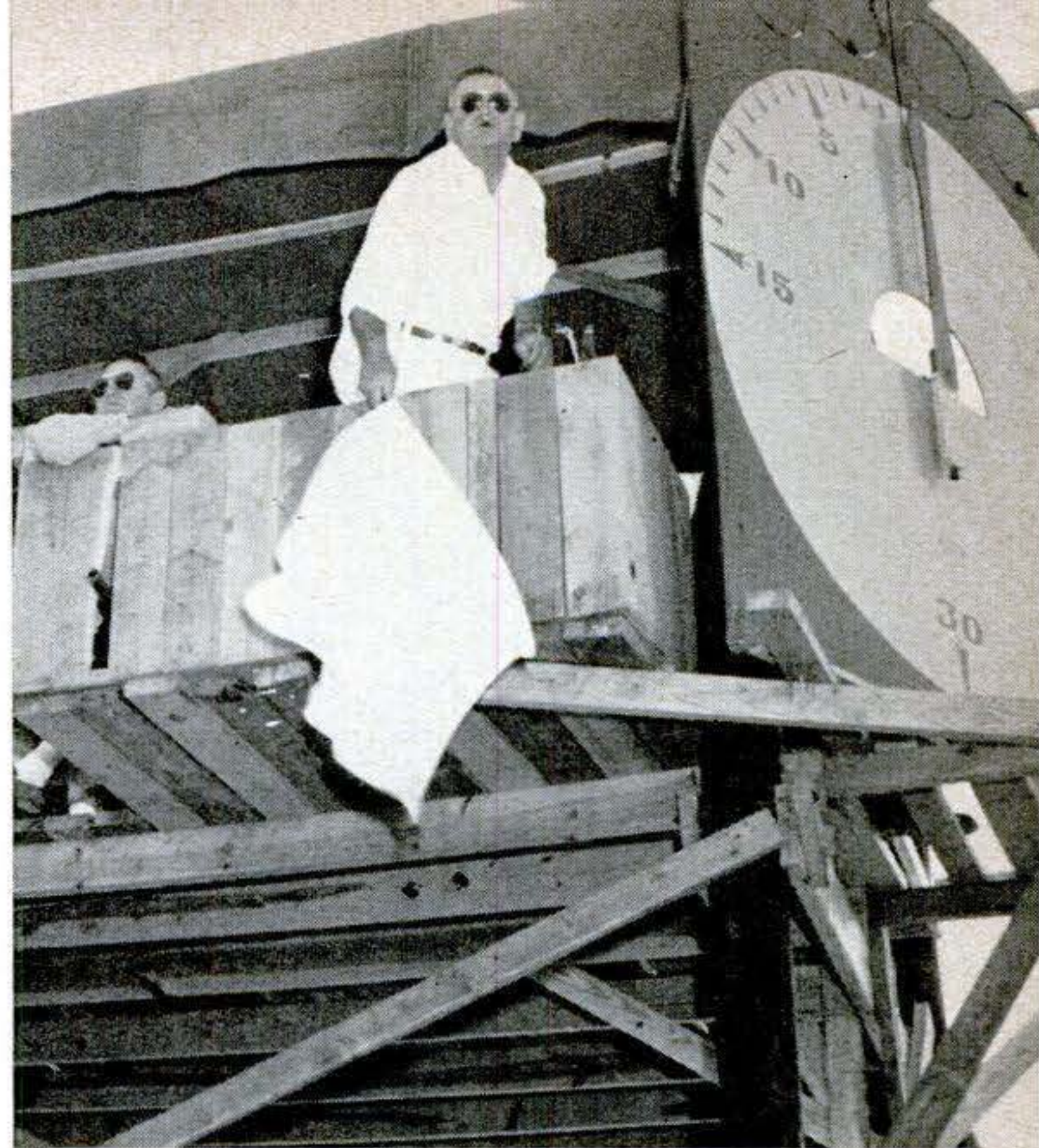
The other men mentioned were Herman Mayhew of Dallas and Henry Taubert of San Antonio. They also were Pop's customers.

Since then, Pop has sold the garage equipment and turned all the space over to boatmaking. Popularity of his boats was demonstrated at the 1950 championship races at Salina, Tenn. Nineteen boats had lined up for the Class C Runabout finals when a friend asked Pop for whom was he rooting.

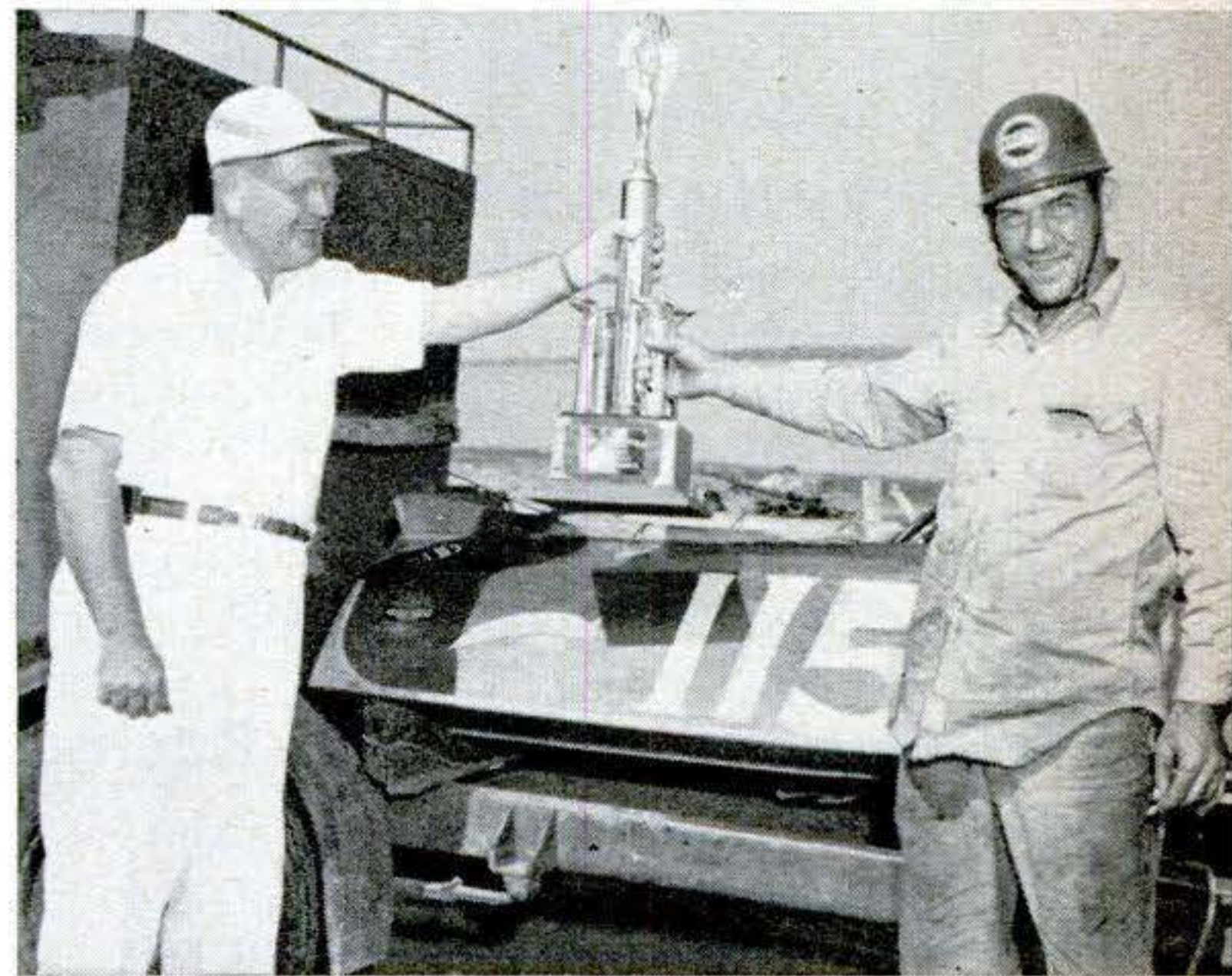
"Well," drawled Pop, "all I can say right now is—'Come on, boats!'"

Because every boat in the race was a Willis Comet. END

**TAKING THE LEAD** in a turn, a Comet justifies Pop Willis' unorthodox use of a wind tunnel

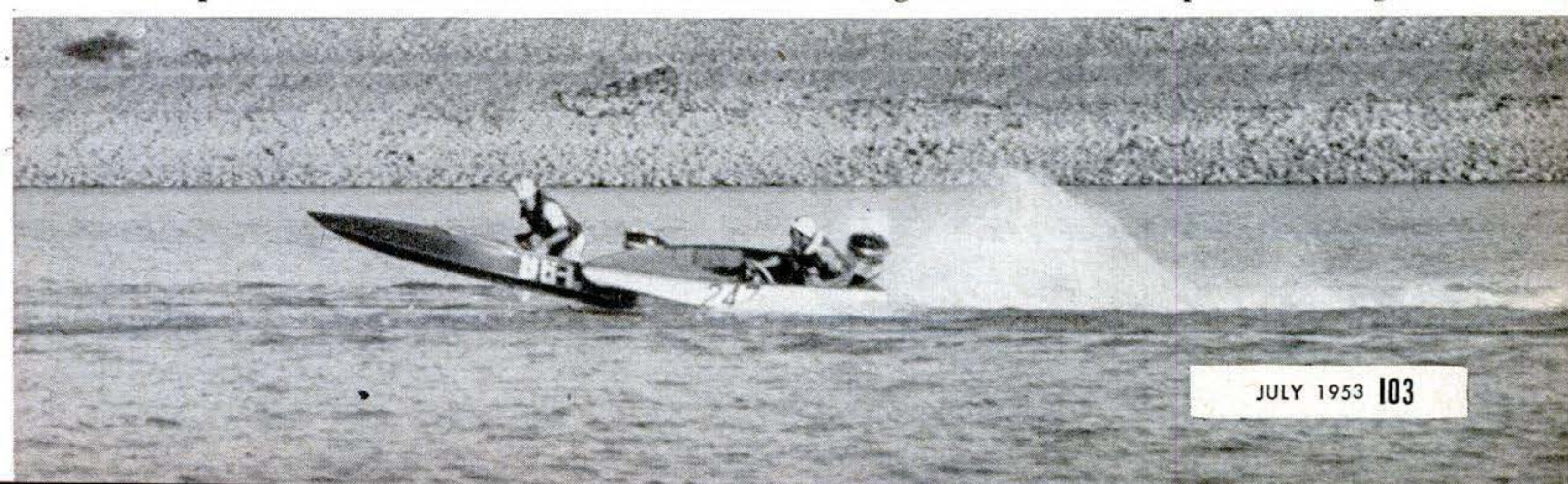


**"COME ON, BOATS!"** yells Pop Willis as he starts a race. Since most of the craft in the race are probably his, he can't play favorites by rooting for any one of the entries.



**SMILING WINNER** of a National Outboard Association's championship race accepts his trophy from Pop Willis. The winning boat? A Comet, naturally, shown on trailer.

to iron out kinks that made early models navigate turns with the speed of a barge.







### He Packs His Own Power

OTHER gadgeteers have used propellers to power their bikes, but Josef Redenboeck of Munich went them one better—he put the engine and prop on a pack he straps to his back. He dreamed up the rig when he grew tired of pumping over German hills to get to ski runs (note skis hung on bike).



### They Got in by the Front Door

THE whole front of this Italian two-seater swings open and the steering column angles forward to let the riders in and out easily. The engine—in the rear, naturally—produces  $9\frac{1}{2}$  horsepower and is claimed to deliver 120 miles to a gallon of gasoline. Top speed of the Iso is 55 miles an hour.

### Messerschmitt's Back in Business — with Scooters

WILLY MESSERSCHMITT made a name for himself during World War II as designer of some of the Luftwaffe's hottest warplanes. His postwar product is about as peaceable as you can get—motor scooters like the two below, displayed at a show in Frankfurt.

The motorized ricksha at left below is powered by a one-cylinder, two-stroke engine. It is said to give 60 miles to a gallon. The cabin scooter (right) has a plastic-bubble top that flops down over the passengers. They sell for about \$500 each.





## Science Fashion Show



### Physicist Dresses for Dinner

DR. WILLIAM SHOCKLEY wore this headset radio at an American Physical Society banquet to amuse fellow scientists with a mind-reading act. Seated on stage, he unerringly identified objects handed to his wife as she moved among the guests. She carried a hidden, pocket-sized radio transmitter that relayed her whispered answers. Tiny Bell Lab transistors made the sets possible.



### Tank Cleaner Dons Weird Garb

IT MAY not be glamorous, but it's safe. This costume is worn by GIs who climb inside and clean the wing tanks of Air Force Globemaster transports. The suit protects against strong cleaning solvents and a hose supplies oxygen for breathing.

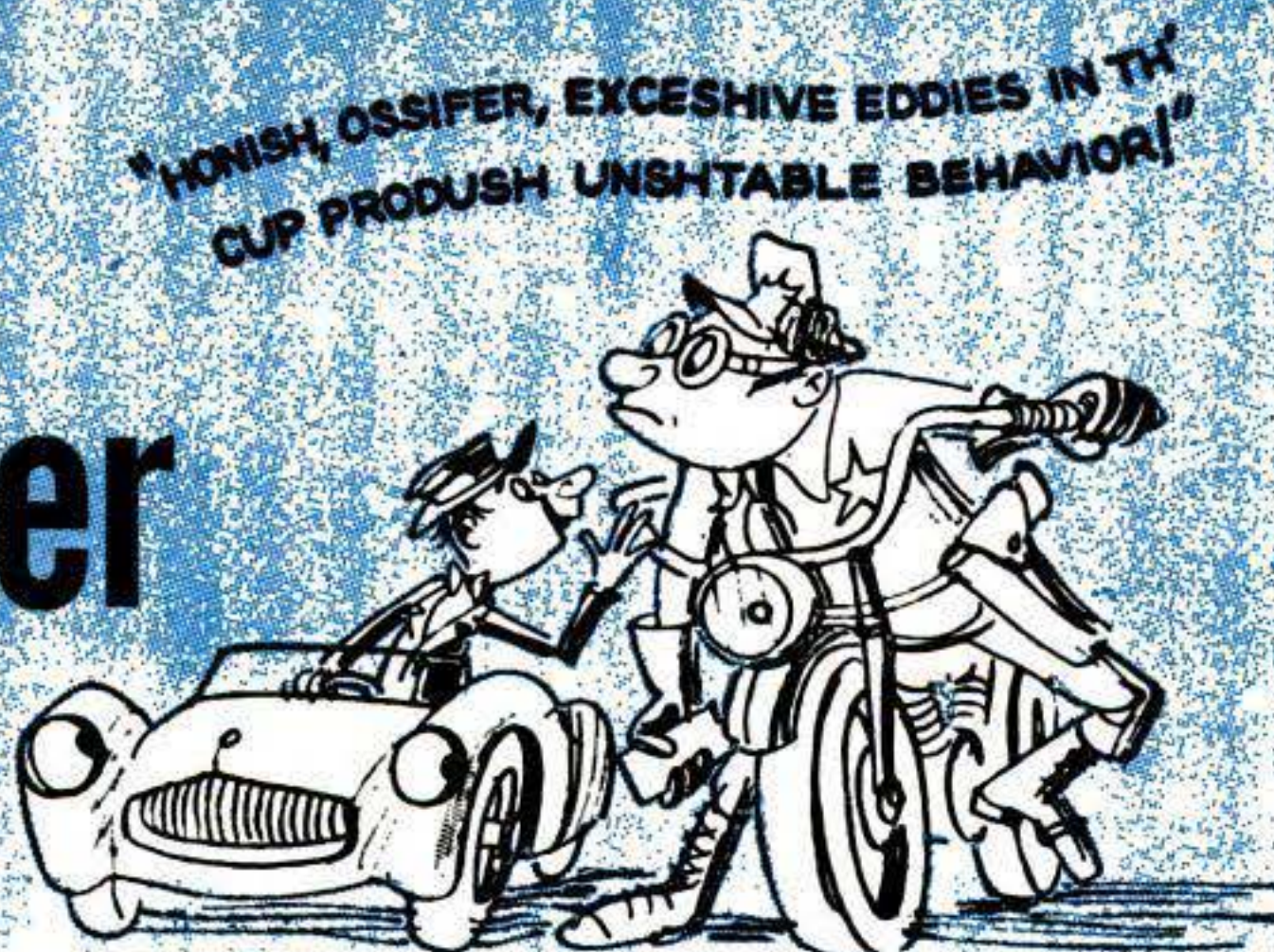
### All Wrapped Up in Their Work

WEARING heat-resistant coats, foundrymen look like actors in a movie fantasy. They are casting a six-ton aluminum-bronze part for a hydroelectric-plant turbine. The inferno-like scene was photographed at Ampco Metal, Inc., Milwaukee.





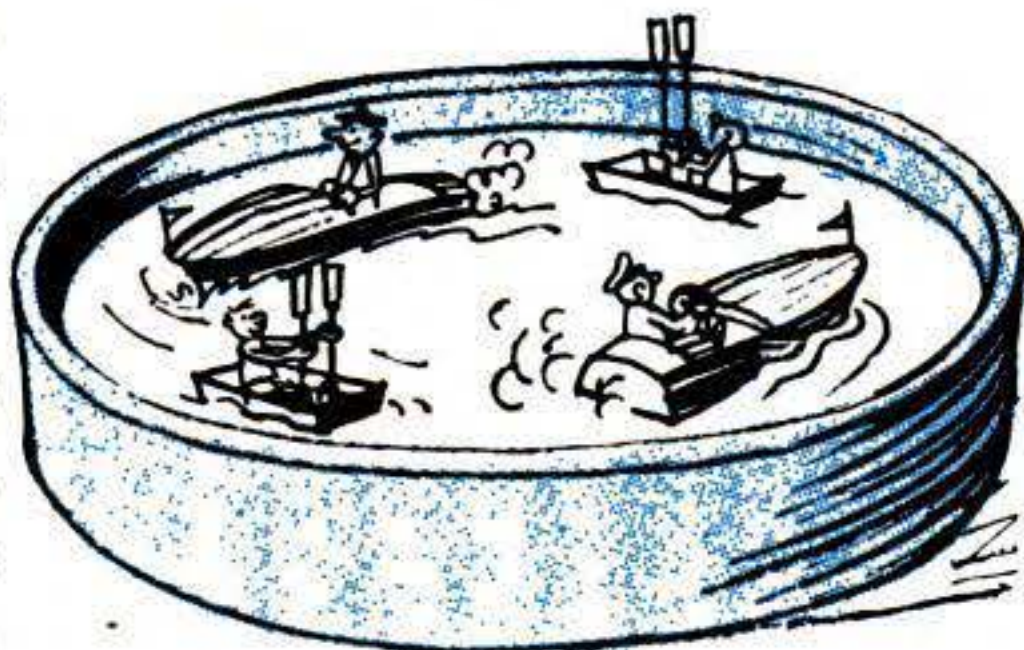
# How a Speedometer Works



**Precision-built but rugged, it uses a whirling magnetic field to swing the pointer across the dial.**

**D**ON'T try to tell a traffic cop that your speedometer is slipping. But it's a fact. The trim case of the most-read gauge on the dashboard houses one of the weakest, and at the same time most useful, "fluid" couplings ever devised.

To get a rough idea of how it works, picture a couple of tiny motorboats whirling in tight circles in a shallow tub. Between these motorboats and the walls of the tub are two lazy little men

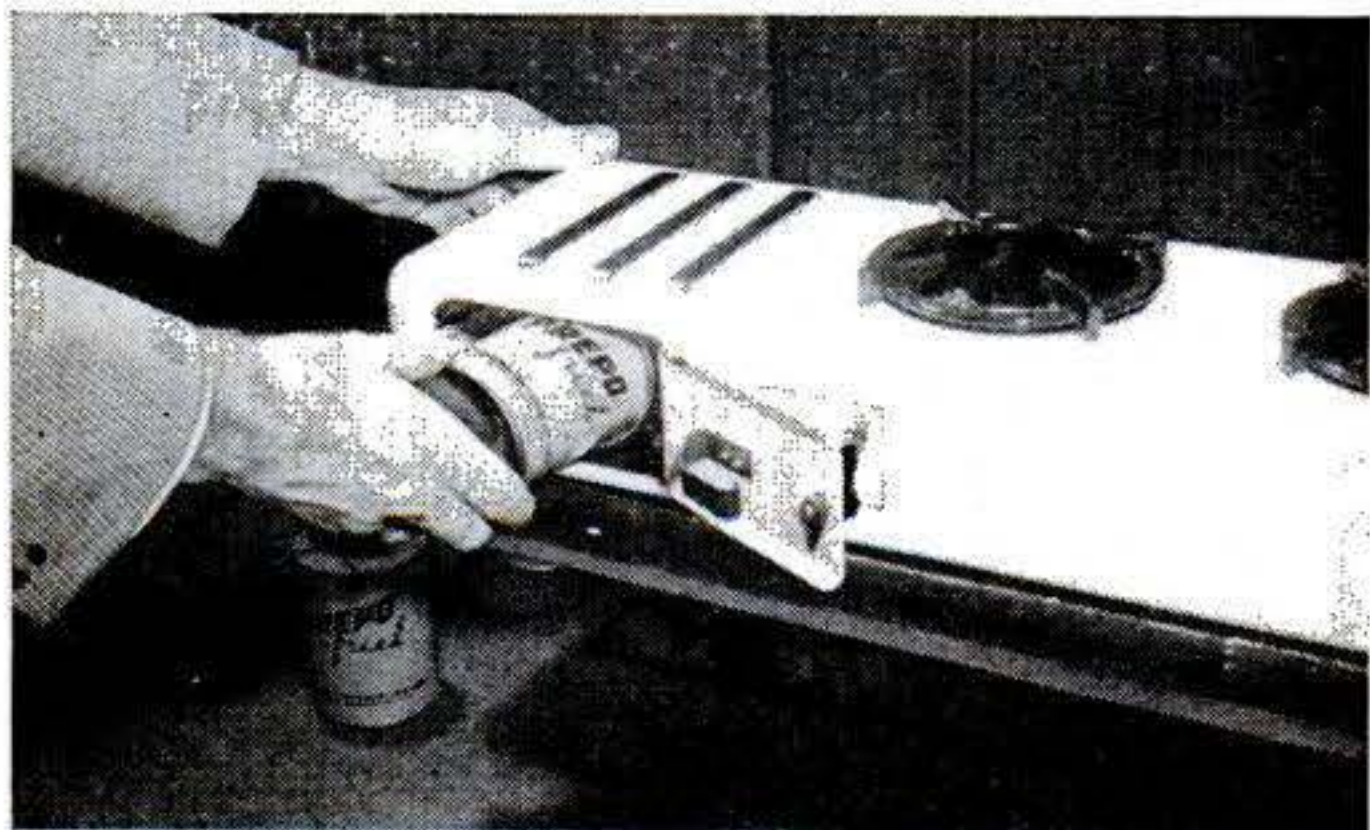


in rowboats. They have found that they can ship their oars and let the current set up by the motorboats draw them along. Naturally the rowboats won't move at anything like the speed of the motorboats. But their rate of travel will be proportional—if the motorboats go faster, so will the rowboats.

In the speedometer we also have a tub. It is made of iron and called a field cup. At its center is a bearing,

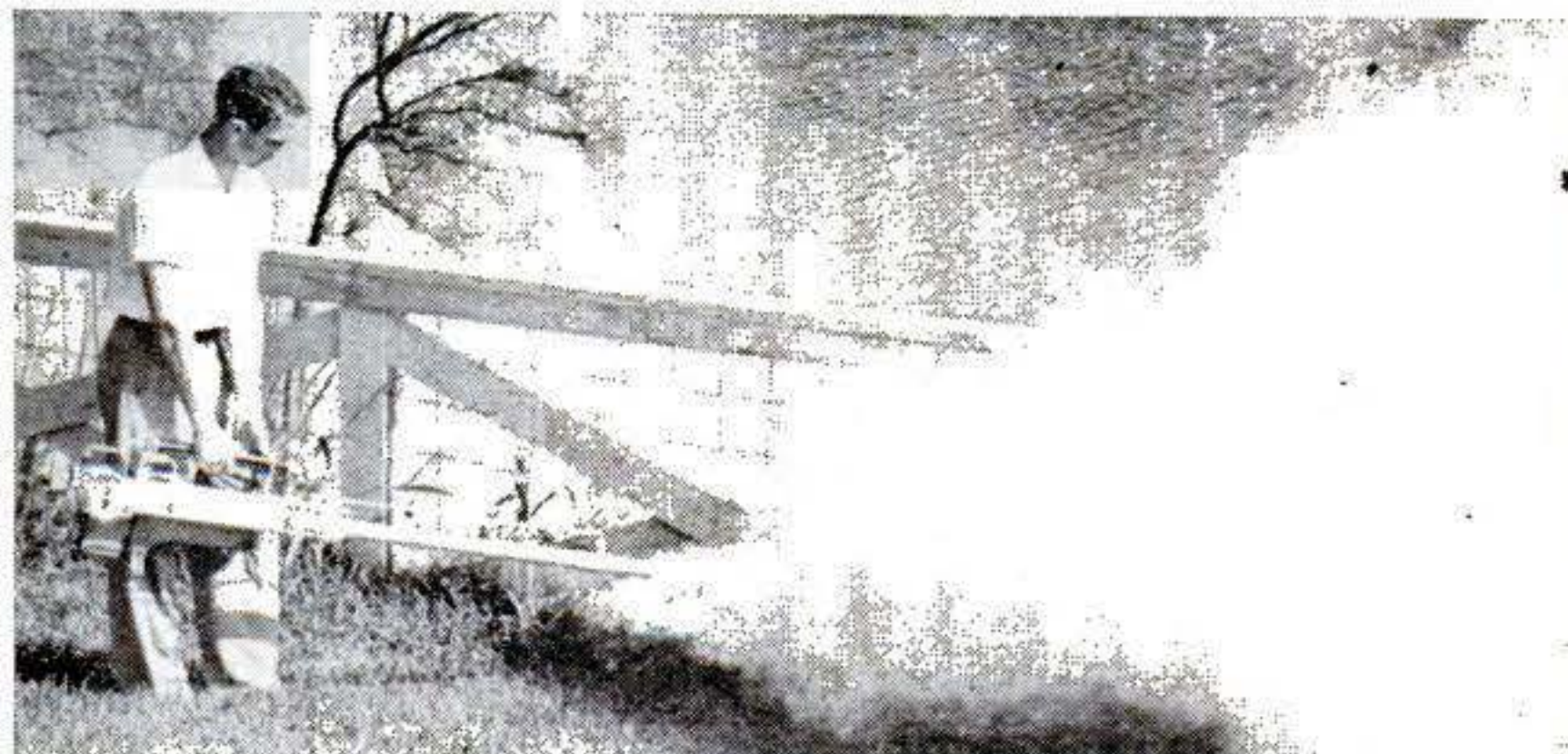
## Canned Gas Fuels Stove

THIS portable two-burner, porcelain-enameled stove will cook outdoors or take over in the kitchen when you're short on burners or suffering a power failure. It burns liquefied-gas fuel from cans that look like bug bombs. Prepo Corp., Skokie, Ill., makes it.

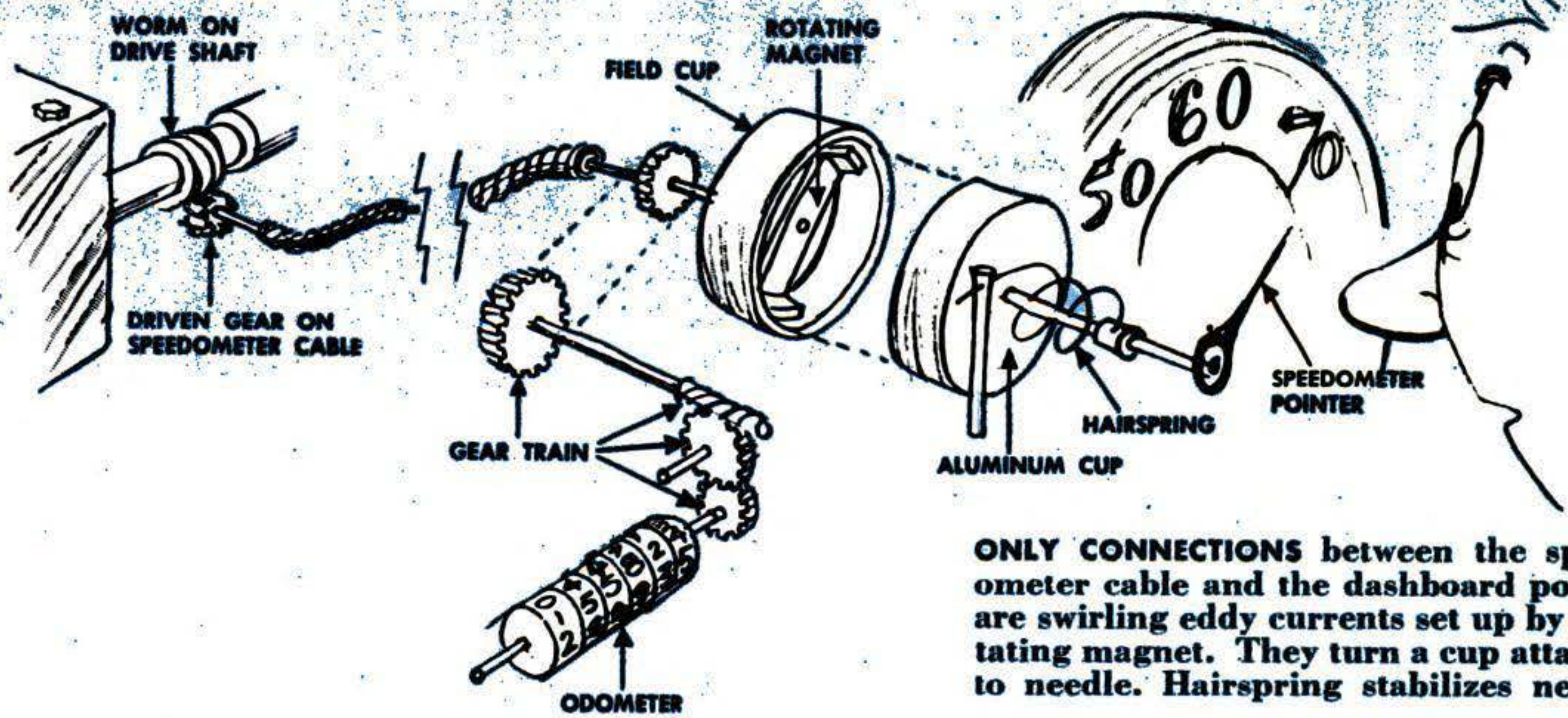


## Sprayer Works Like Buzz Bomb

THE pulse-jet engine that flew V-1 buzz bombs in World War II now has a more peaceful use—powering a new spray gun. Its exhaust vaporizes insecticide into a dense bug-killing fog. Made in Germany, Swing-fog is sold here by Devenco, Inc., NYC.







**ONLY CONNECTIONS** between the speedometer cable and the dashboard pointer are swirling eddy currents set up by a rotating magnet. They turn a cup attached to needle. Hairspring stabilizes needle.

with a short shaft passing through it. Attached to the end of the shaft inside the cup is a permanent bar magnet. The other end of the shaft is coupled to the speedometer cable. When your car gets under way the magnet becomes a whirling paddle. Its ends set up a swirling magnetic field in the cup.

The pointer is mounted on a shaft attached to a second cup, made of aluminum. It fits loosely inside the field cup, within the rotating magnetic field set up by the bar magnet. This moving field generates minute electric currents—called eddy currents—in the aluminum. Each eddy current produces

a tiny magnetic field of its own. These temporary local fields interact with the spinning magnet, turning the aluminum cup much as the rowboats are moved by the motorboats.

Unlike the rowboats, however, the driven cup must not be allowed to travel in circles. That's where the slippage comes in. To stabilize the pointer, speedometer manufacturers place a fine hairspring on the shaft behind it. As carefully adjusted as the hairspring in your watch, it holds the needle right on the nose in the lower speed range, but lifts it a couple of miles above true readings when your bus gets up to 50.

## Ribbon Chute Cools the Heels of a Hot Fighter Plane

RIBBON chutes, already used for braking the big fellows, are now doing a job for interceptors, too. With a drag chute, the F-94C Starfire below can come in to land rolling faster than 200 miles an hour and coast to a stop in half the usual distance.

Lockheed engineers say the chute doubles the life of brakes and tires.

Important for forward-area operations, the 65-pound assembly can be repacked in five minutes and installed in the plane ready for flight in another 90 seconds.







### Scooter Unfolds from a Box the Size of a Suitcase

STOWED in the package at left above is a complete motor scooter weighing about 84 pounds. The detachable front wheel and handle bars tuck away underneath the seat

to form a box 21 inches long, 10 inches wide and 15 inches high. When set up for the road, as at right, the French Valmobile can make 43 miles an hour.



### Fabric Dresses Up Refrigerator

EVERY time the kitchen is redecorated, the face of this all-porcelain refrigerator can be changed, too. Molding and trim lift off the door so that it can be covered with fabric to match curtains or walls. It's an International Harvester refrigerator.

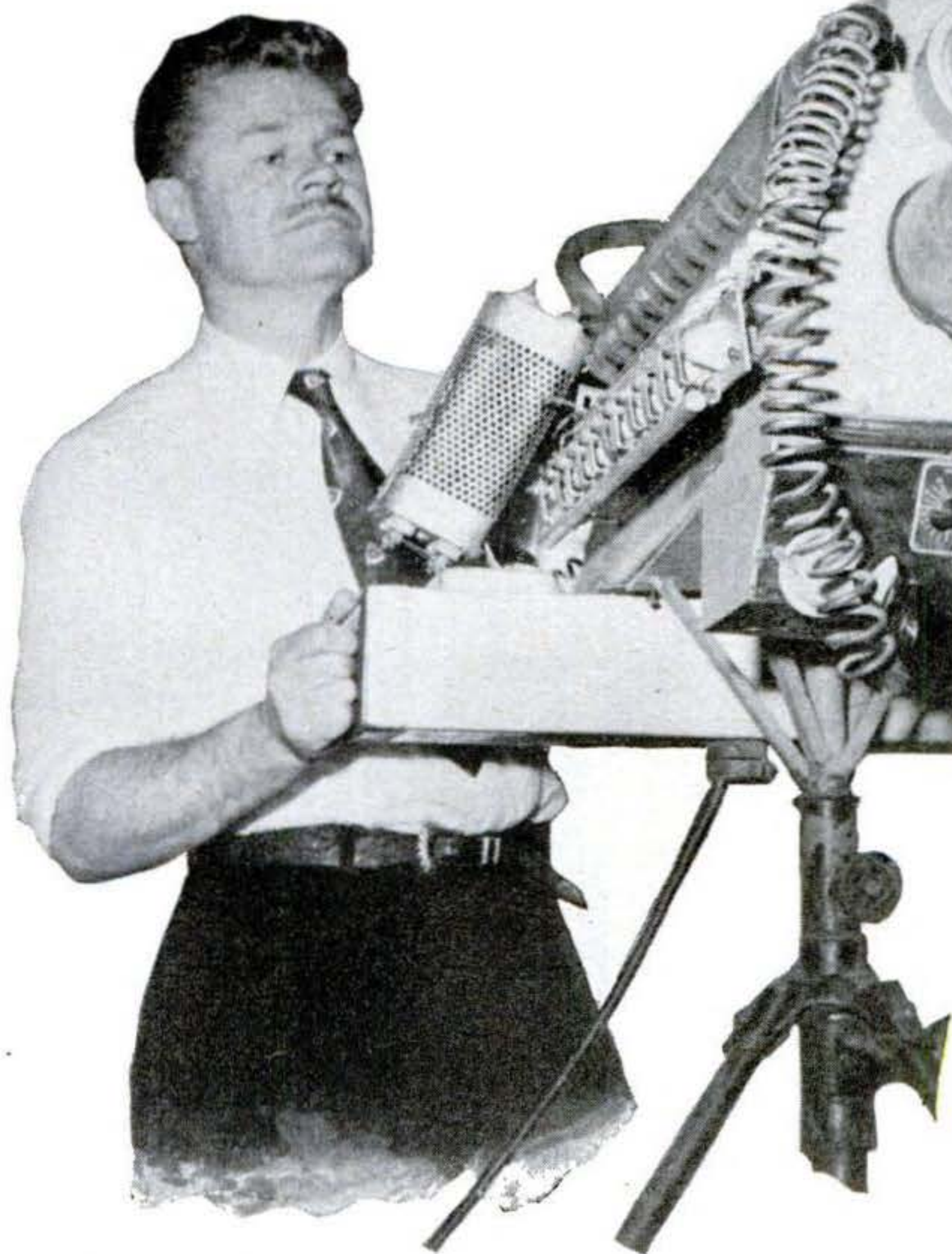


### Safe Deposit for Hot Isotopes

HERE'S how they store "hot" isotopes at the new Argonne Cancer Research Hospital in Chicago. Sealed in lead containers two feet high, the radioisotopes are dropped into steel tubes embedded in a concrete vault extending eight feet below the basement.



**THERMIC DISINTEGRATOR**, complete to flickering neon coils, was built by Dallons on two days' notice. Movie audiences are critical, and last year's death-ray machines are as obsolete as slingshots and crossbows.



*Oscar Dallons' pseudo-science gizmos make him Hollywood's top inventor of fantastic props.*

# His Death Rays Only Tickle Your Spine

**B**Y TURNING a scientifically trained imagination, part time, to thinking up startling gadgets for science-fiction movies, Oscar Dallons has become Hollywood's No. 1 designer of "effect machines." It's a dull week when he doesn't turn out at least one thermic disintegrator, quadro-oscillator or degravitizer.

Dallons would like people to think of him as a painstaking scientist who makes medical apparatus for hospitals and doctors' offices—which he also does. But at heart he's a gadgeteer.

The 49-year-old physicist gets a big bang out of his neon-lighted potboilers, and frankly admits that he tosses a good



part of his technical knowledge out of the window whenever a studio asks him to go space-happy.

"Gizmo-minded movie audiences don't care what's back of an instrument panel," he says. "All they want is something that looks convincing, with plenty of action and sound."

Dallons dishes out the special effects at a breath-taking pace. Literally, as well as figuratively, for glass-blowing is a basic part of his art. With brothers Paul and Franz supplying the lung power, coiled tubes, globes, viewing screens and parabolic cones sprout like mushrooms, overnight, in Dallons' laboratory. They are the real eye catchers—gimmicks which produce distorted images, flicker with eerie light, and provide the transparent arteries for vegetable-dyed liquids charged with air bubbles.

Smoke comes next as a pseudo-science thriller-diller. The A-bomb has little to do with it. A well-timed puff of nebulous vapor is the oldest trick in the witch doctor's medicine bag, and Dallons has been using it effectively for 20 years.

#### *Space Helmets Lose Antennas*

"But it's a fact," he admits, "that my super-cosmic machines quickly grow stale. Take as simple a thing as an interplanetary helmet. A few years back it had to be equipped with towering antennas. Today, the youngest space cadet knows that it's no trick to contact Jupiter with a mind monitor no larger than a transistor."

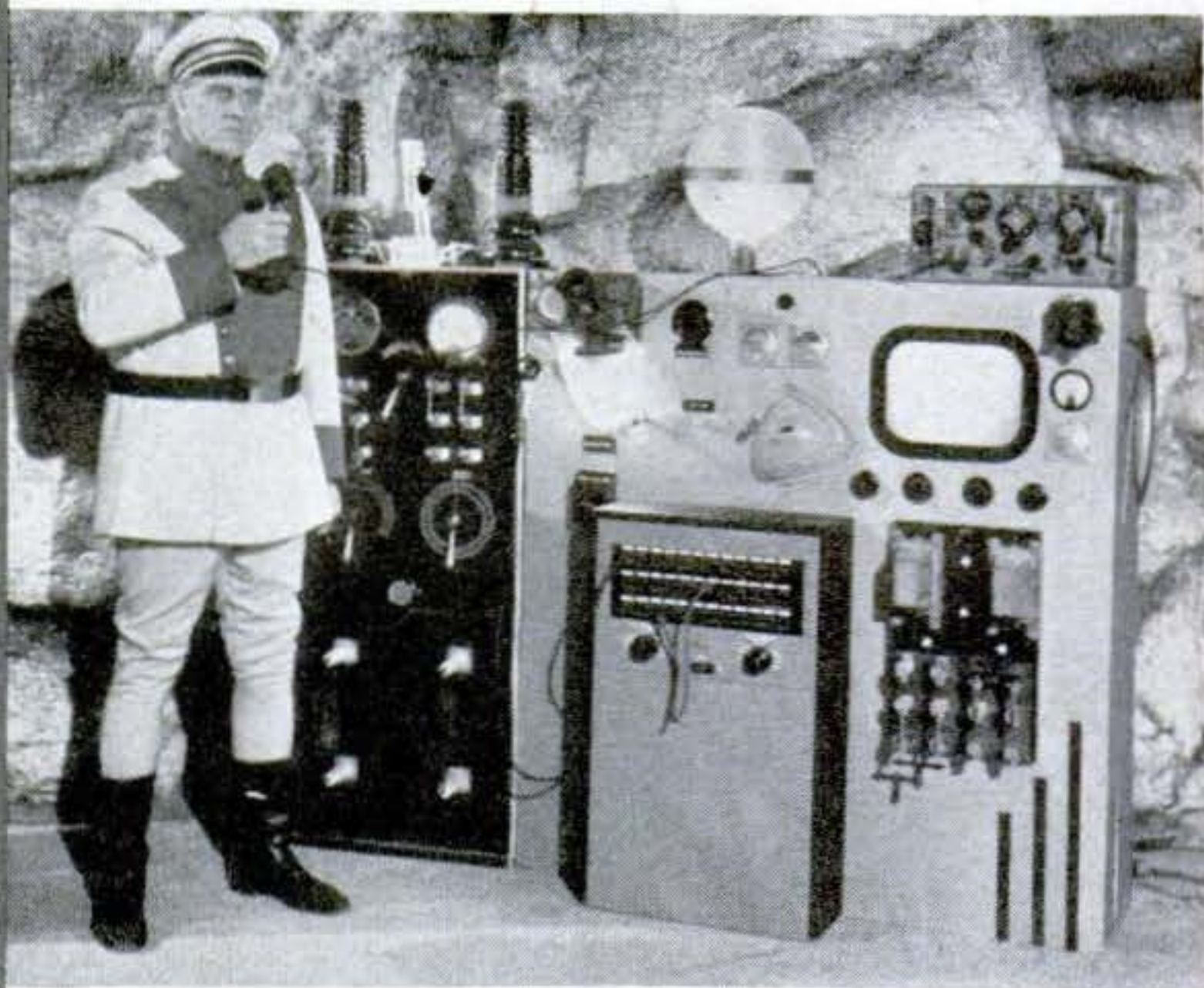
That's why Dallons carts truckloads of obsolete equipment to the dumps each year. About the only permanent props are the generators, transmitters and transformers which furnish basic power for ever more efficient hypnotic-ray cabinets, telopticons, sonic vibrators, prysmic catapults, and you-name-its.

When directors meet Dallons on the street and ask, "What are you building now?" he answers them with a question of his own.

"What do you want? I'll have it for you by tomorrow morning."—*Andrew R. Boone.*



**DEATH-RAY MACHINE** spumes fire and smoke in a Columbia Pictures thriller. "White-hot" gun barrel is internally lighted cylinder of frosted glass.

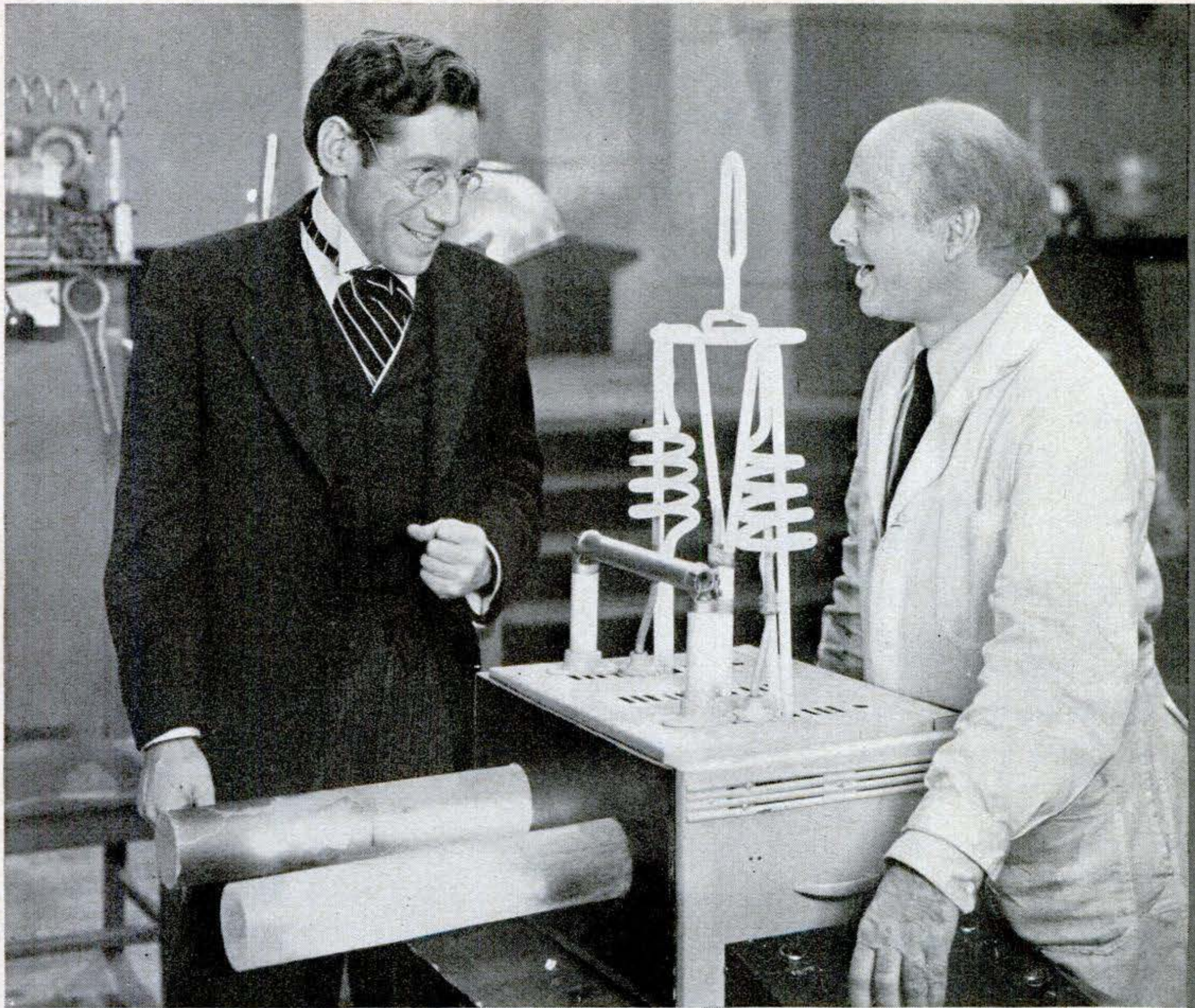


**INTERPLANETARY SWITCHBOARD** combines all the tricks in Dallons' trade. Globes glow and relays chatter as image appears on scanning screen.

**ELECTRONIC HYPNOTIZER**, which puts subjects in superhuman work-producing trance, makes use of dramatic lighting behind observation window.





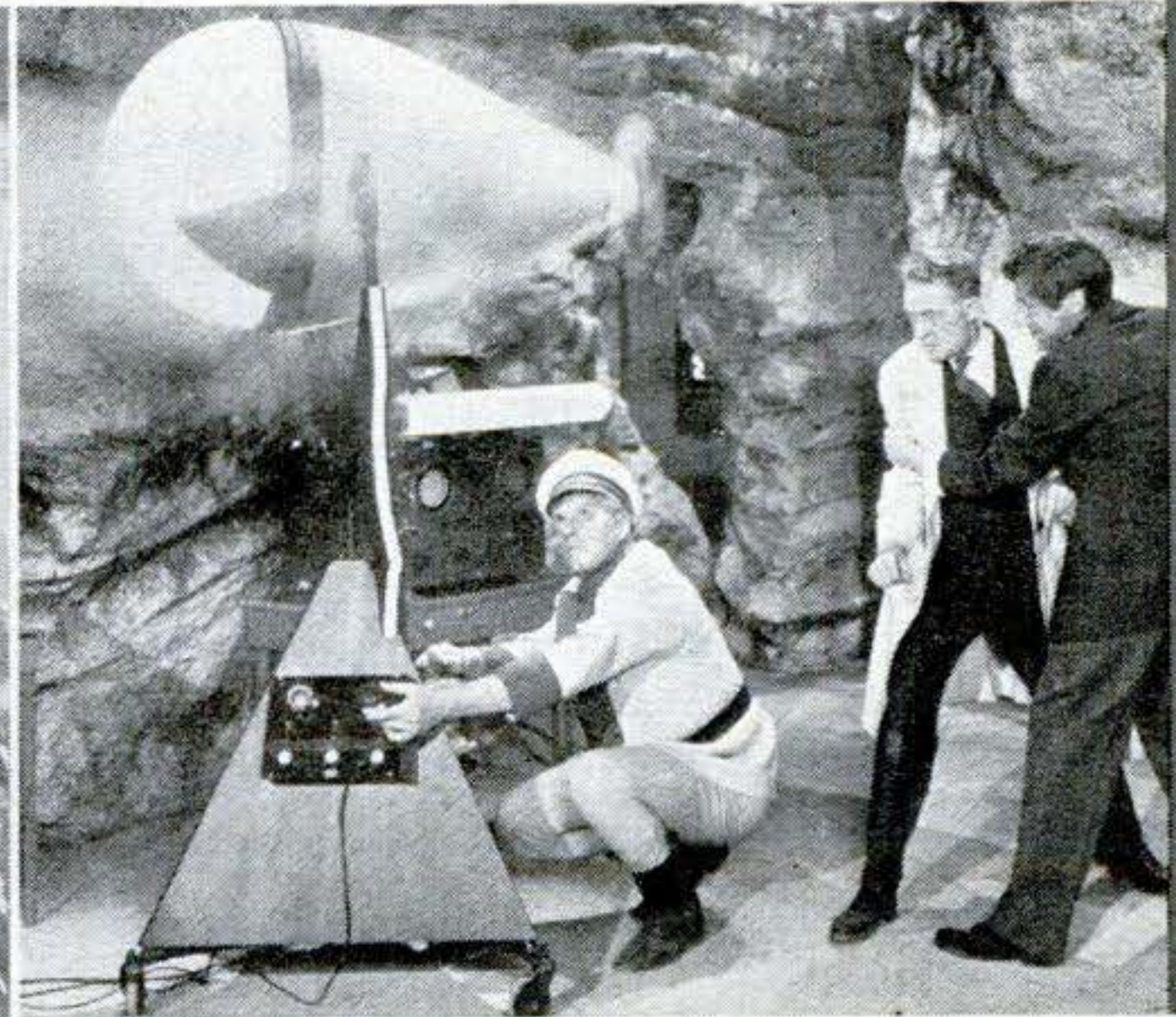
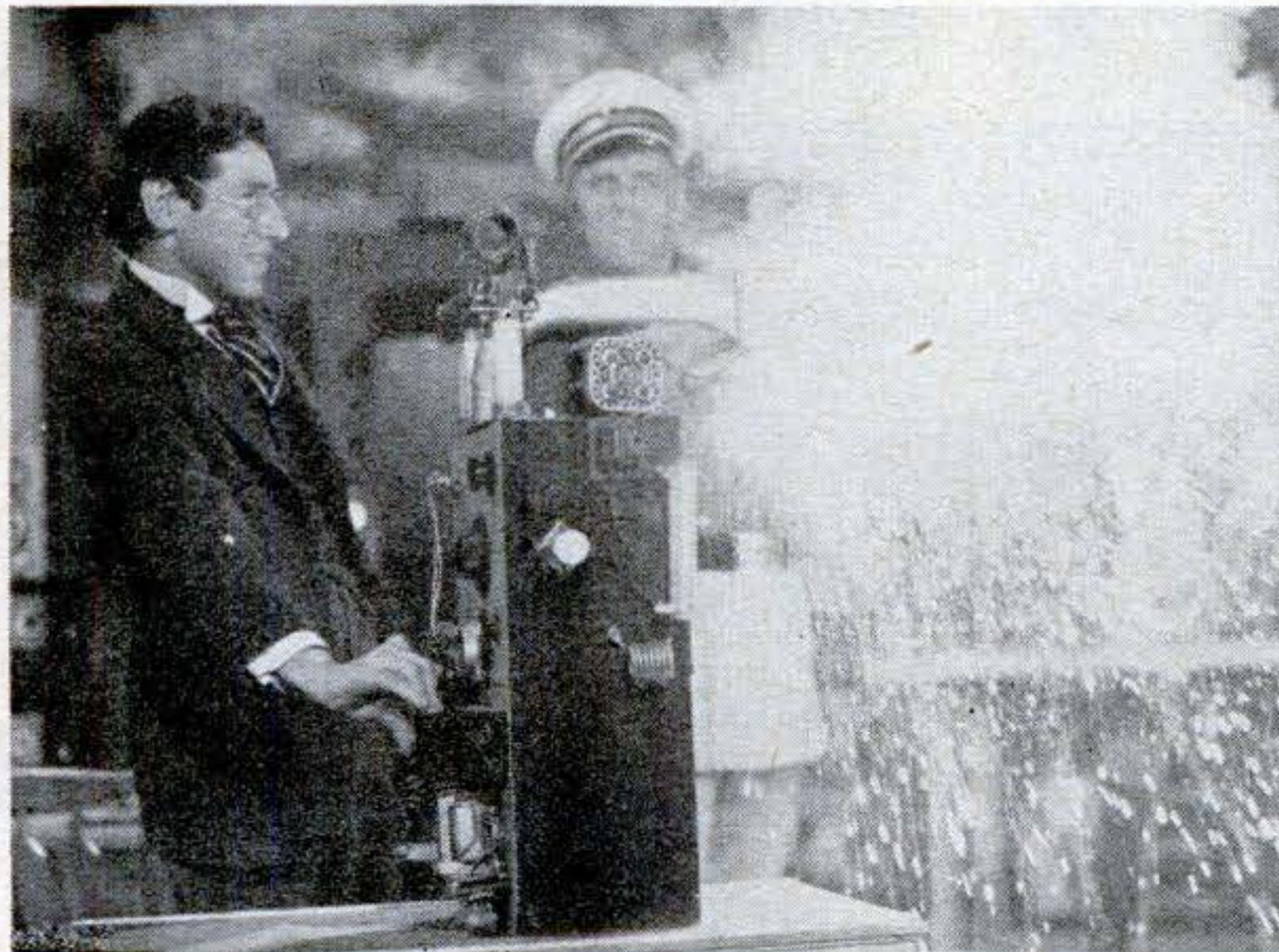


**COSMIC VAPORIZER** was tube-bending job for Dallons' glass-blowing brothers, Paul and Franz. Apart from its ion circulators, this gadget called for a resistor, trans-

former case and heavy-duty insulators—all stock items in Dallons' huge war-surplus collection. Snapping switches and power-hum heighten realistic effect.

**HIGH-VOLTAGE DECIMATOR** throws flash powder—not juice—from horn-shaped firing ports. Pilot light accents buzz of synchronized audio signal.

**GYRO DEATH RAY** has warhead made of a B-29 landing light. Propeller at rear throws darts of light reflected from cathode tube attached to rotor mast.







### Curbside Mike Takes Orders

CAR-HOPS at a drive-in restaurant in Willowick, Ohio, make only one round trip to serve a customer. The motorist calls in his order over an intercom fixed to the curbside standard shown above.

### Clock-Radio Made Portable

THIS portable radio has a spring-wound clock to turn it off and on or to chime an alarm. A power-saver switch saves the set's batteries when high volume isn't needed. It's the Skymaster, made by Crosley.



### Truck Bumper Shields Shop

TEN feet off the ground may seem like an odd place to find an automobile bumper (above), but it's there to do the same job it does on a car. It protects the shop overhang from damage by high trucks passing down the narrow English village street.

### It's Always Raining on This Cadillac

CAR testers don't wait for bad weather to find out how a windshield wiper will act in a downpour or a drizzle. They make it rain. At the GM Proving Ground (right) a trailer hauls drums of water and a pump to supply spray pipes at the front of this Cadillac that keep the car's windshield wet.



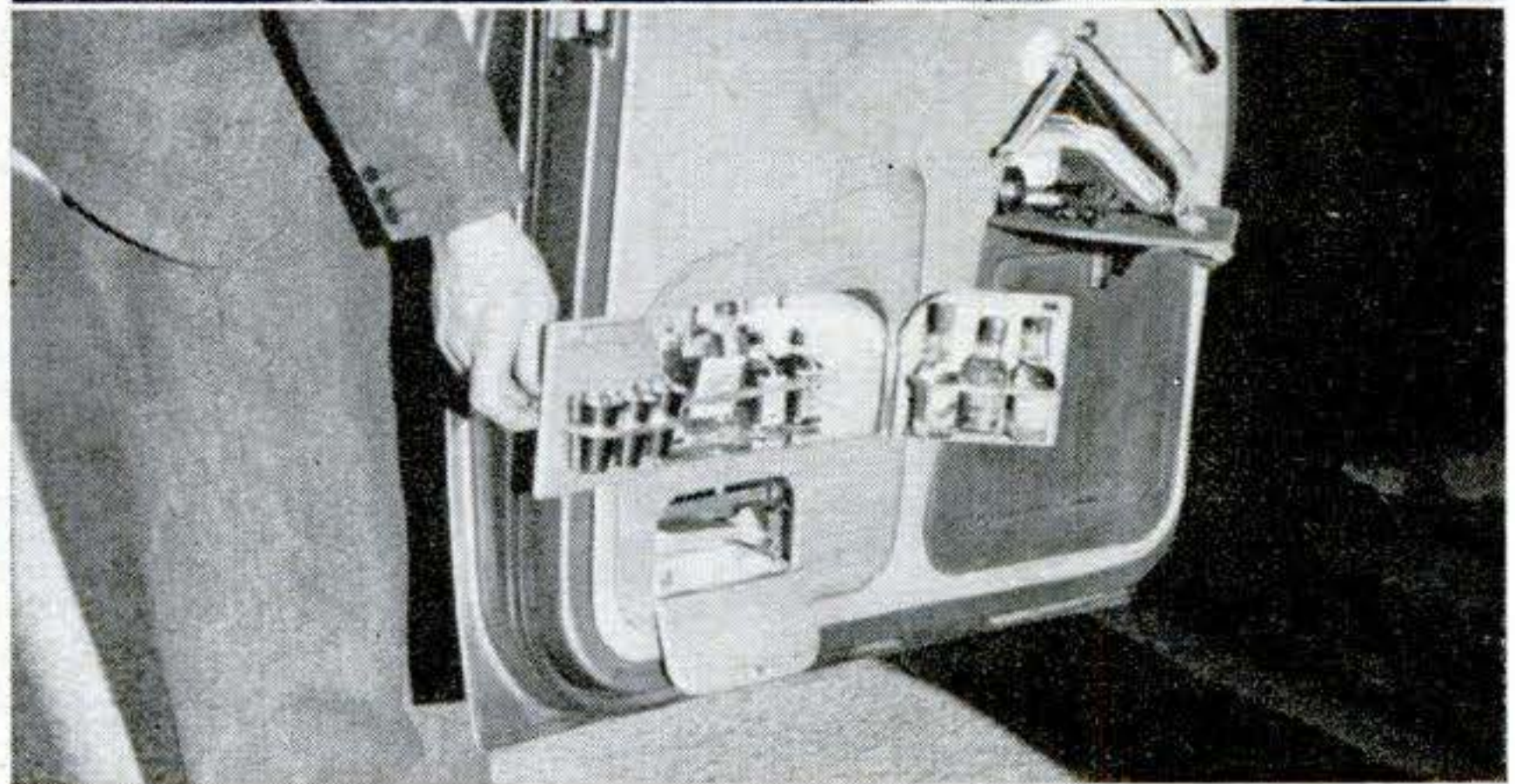




### Gadget-Hung Car Wins Distance Race

THIS Hillman Minx, five-time winner of the annual Monte Carlo Rally, was lavishly rigged up to give M. B. Anderson solid comfort on the 1,000-mile drive. A washbasin with running water is set in one door, a first-aid kit and a bar in the other (photos at right).

Fresh water, pumped from a tank under the floor, is heated by circulation through a copper coil around the exhaust pipe. A second sink, and an oven heated by the engine's hot-water system, is in front of the co-driver. A tape recording describing the route eliminated the chore of map reading.



### They Say Now.....

*"As the scientist continues to bring forth new knowledge, the engineer will continue to use it to open new doors."*—EVERETT S. LEE, EDITOR, GENERAL ELECTRIC REVIEW.

*"Most of the achievements we have were beaten out of stubborn resistance . . . in a deliberate manner*

*toward a deliberate goal."*—MAURICE NELLES, RESEARCH DIRECTOR, BORG-WARNER CORP.

*"You'll never hear an airline pilot say that he's under the weather. That's where he wants to be. Everyone else wants to get up in the world, but his problem is how to get down."*—CAPT. HIRAM W. SHERIDAN, AMERICAN AIRLINES.





### Refrigerator Goes Places

THE Wonderbar not only brings refrigeration out of the kitchen, but a new tricycle, tubular-steel cart enables it to be wheeled from room to room and onto a terrace. Main unit is Servel's refrigerette.



### Flak Didn't Faze This Prop

HERE is evidence that the propeller is still doing a job in this jet age. Even with an 18-inch bite in it from enemy fire in Korea, the prop brought its Navy AD fighter-bomber back to a repair base.

---

## Newest Airplane Engine Weds Turbine and Diesel

HIGH-SPEED jet airliners will no doubt capture the luxury air-travel business of tomorrow, but some British designers believe there will be a place for a slow but really low-fare and cheap-freight transport. Its power plant would be a new combination diesel-turbine engine driving a propeller. By slow, they mean a 350-mile-an-hour cruising speed.

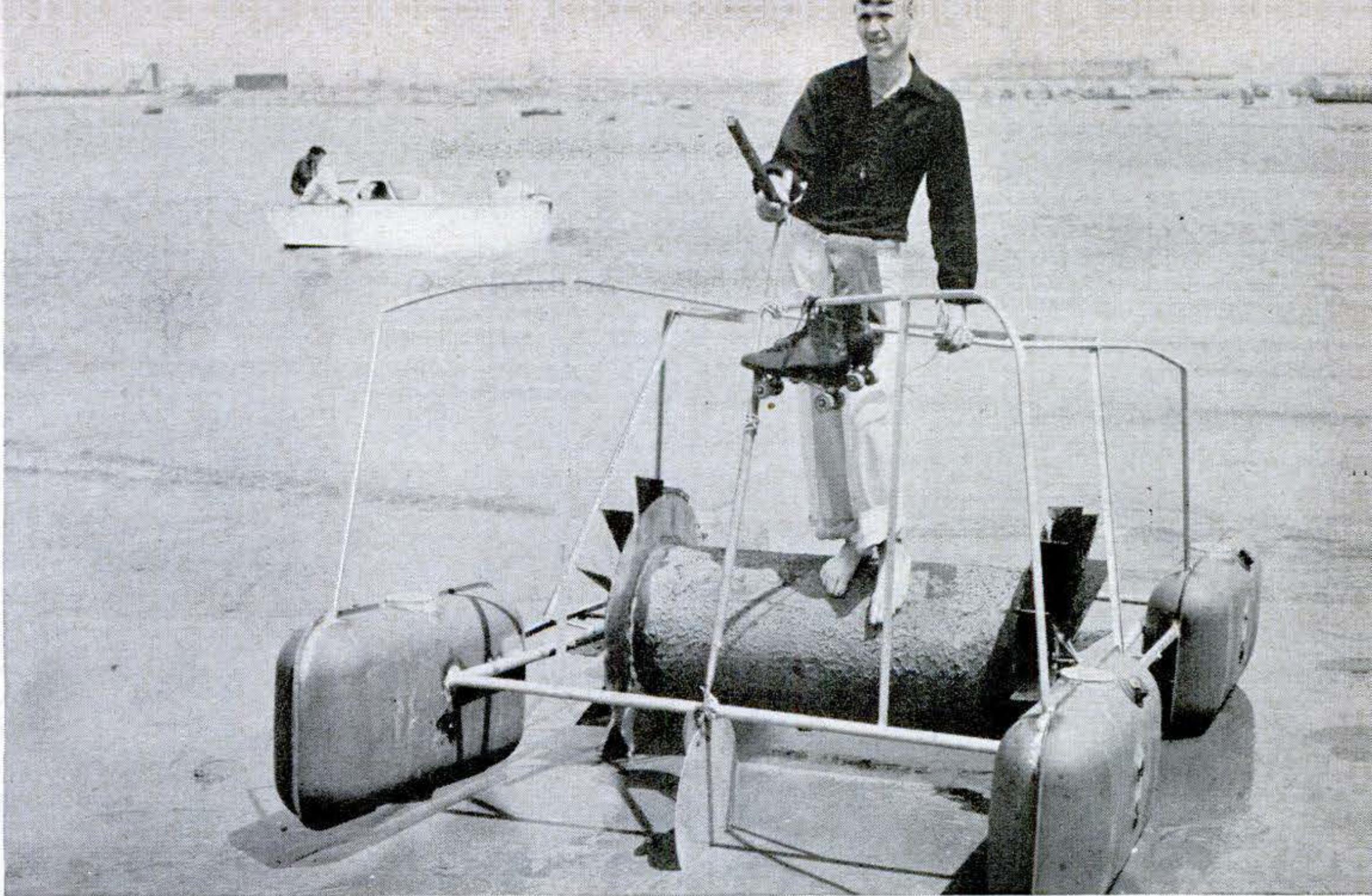
This Nomad power plant (opposite page) is basically a simple diesel engine, with 12 cylinders horizontally opposed. But unlike other diesels, it is two-stroke, without either poppet or sleeve valves. In the past, the two-stroke has not been used for compression ignition because of the difficulty of getting a sufficiently high compression ratio.

The Nomad meets this difficulty by super-

charging, using an axial-flow compressor of the jet-engine type. The compressor is mounted below the diesel unit, and is driven by a gas turbine mounted at the rear. The turbine is fed by exhaust gases from the diesel cylinders. It, in turn, drives the compressor through a straight shaft connection. There is power to spare from the turbine, however, and this is added to the crankshaft by a gear train located at the rear of the diesel unit.

Engineers of the Napier Co., who designed the engine, point out that although the Nomad is heavier than a pure turboprop, this disadvantage is more than counterbalanced by a very low fuel consumption. It can operate on diesel fuel, kerosene or low-quality gasoline.

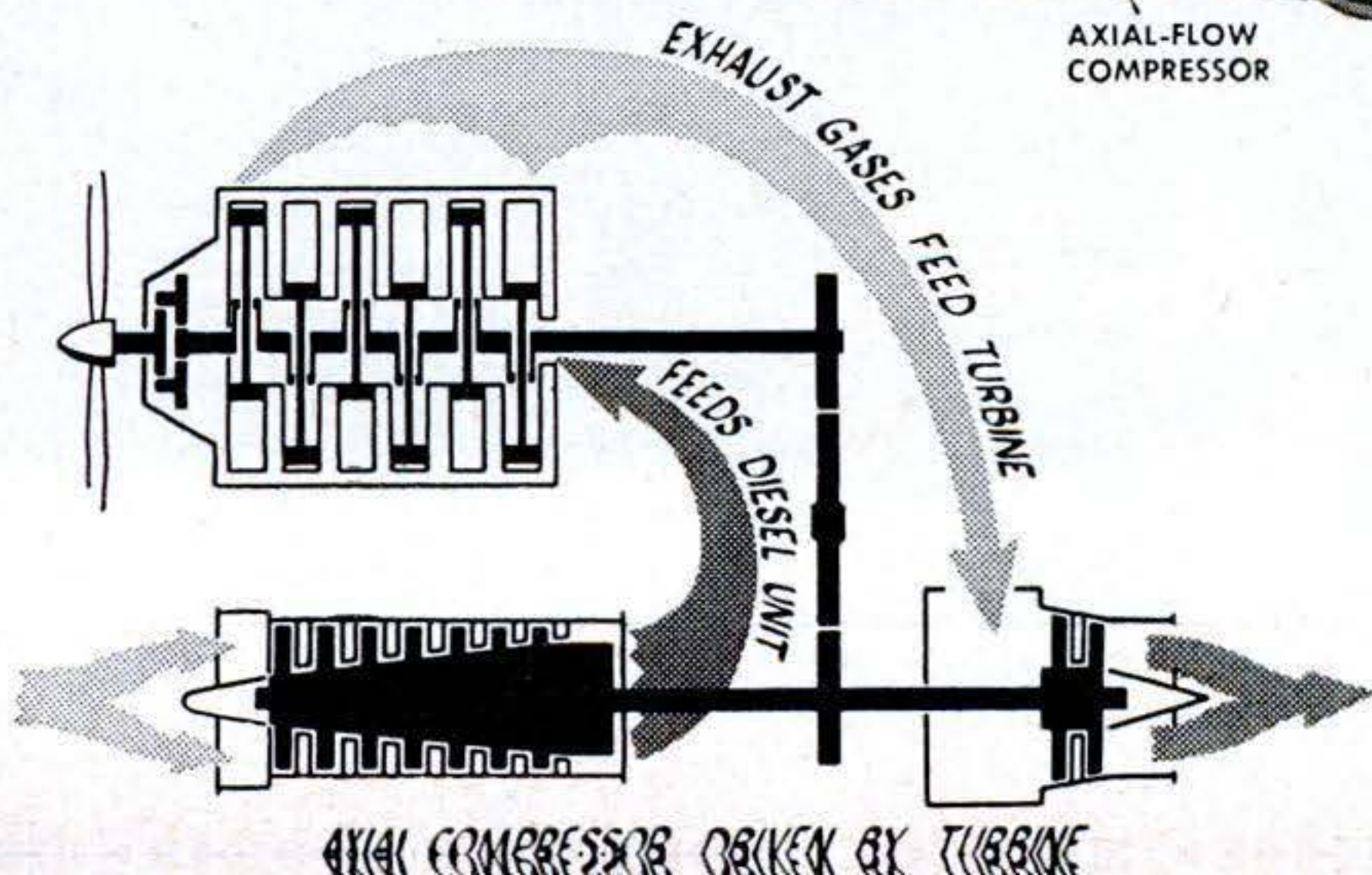
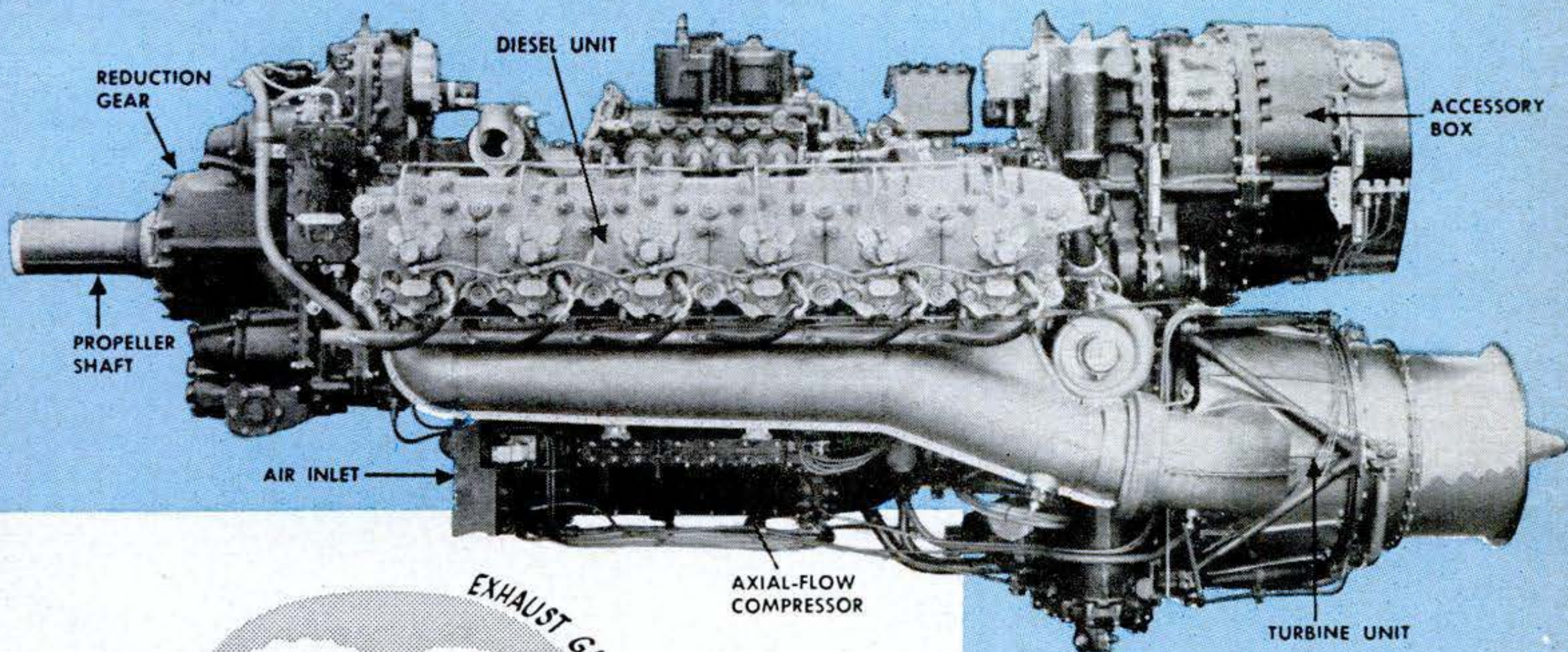




### When Roller Skates Fail, Mr. Smith Walks on Water

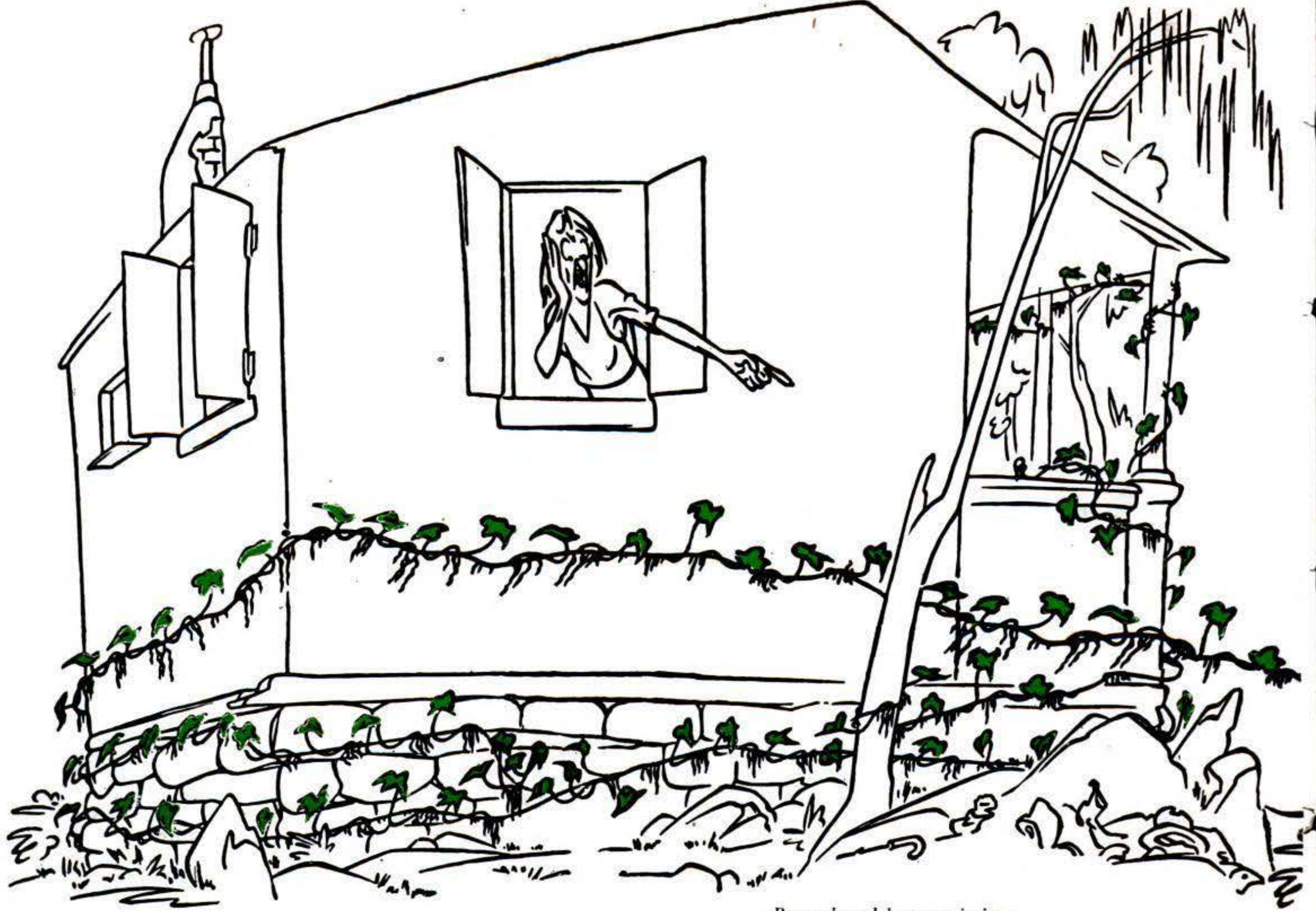
THE aqua-skater invented by Charles F. Smith of Los Angeles consists of a revolving barrel in the center of an aluminum-tube framework. It is supported in the water by four surplus airplane gasoline tanks. The

idea was to spin the barrel while wearing roller skates. When that didn't work on the rubber-coated cylinder, Smith hung his skates on a crossbar and did the barrel-spinning with his bare feet.



**DIESEL-PLUS-TURBINE** engine is shown in photo above. Drawing at left illustrates how this new British Napier Nomad airplane power plant operates to give maximum fuel economy.





Reproduced by permission.  
Copyright 1939. The New Yorker Magazine, Inc.

“Watch out, Fred! Here it comes again!”

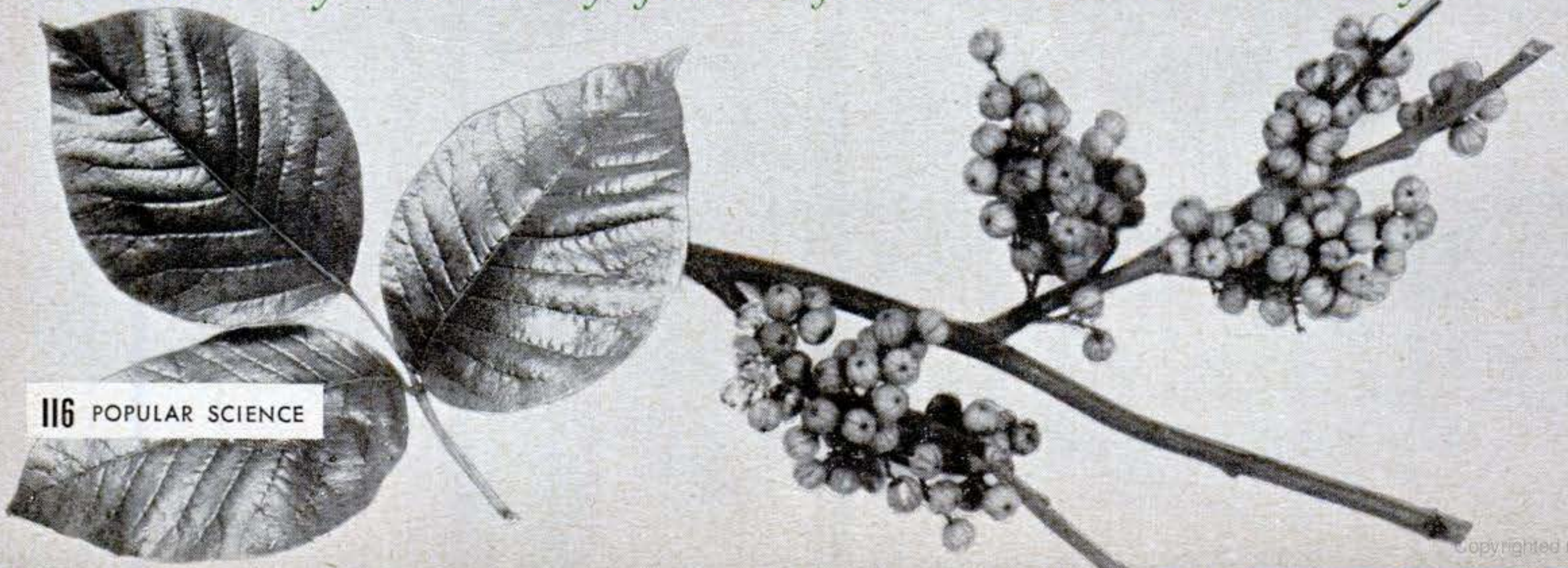
A GOLFER got poison ivy recently because he drove his ball into the rough. The ball crushed leaves of the ivy, picked up the sap, then bounced back onto the fairway. The golfer touched the sap on the ball and it gave him the rash. He never saw the plant that poisoned him.

To catch poison ivy, you don't have to touch, or even see, the plant itself. You have to contact the sap.

Why does the sap, or oil, poison you? That's the \$64 question. The man who could answer it in July, when ivy is full of early-summer oil, could make a lot more than \$64, particularly if his answer resulted in an immunizer.

No man can—yet. But at Columbia University, in New York City, Professor of Chemistry Charles R. Dawson has gotten closer to the answer than anyone before him. One of these Julys he may

*Poison ivy has many forms, from berries to a variety*





# Here's the Know-How You Need to

**... And now's a good time to root out this unwelcome visitor before it settles down in your yard as a year-round resident.**



have it. If so, there may be a pill that will prevent your catching poison ivy.

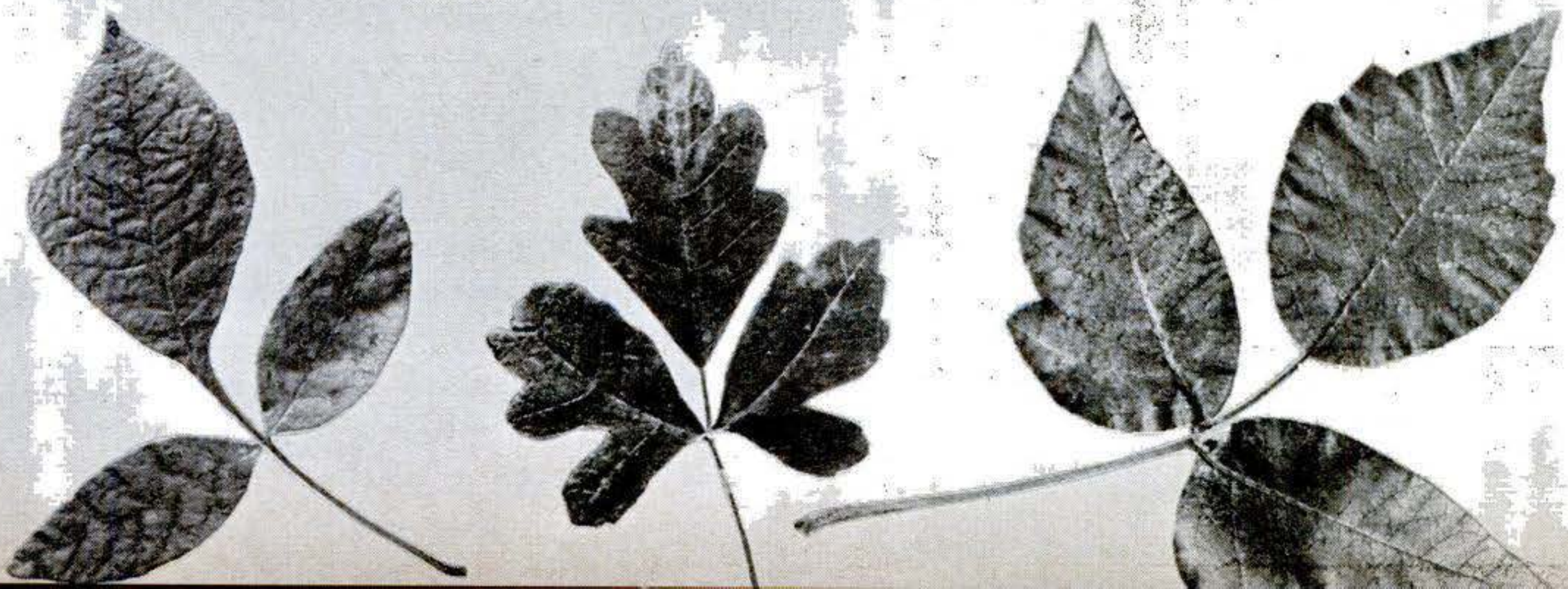
Professor Dawson has become the first scientist to break down the poison-ivy oil so that he knows its four distinct parts: one solid, three liquids. Now he's trying to find out exactly what each of the four parts does, that is, which poisons you.

For 50 years scientists have argued over what it is in the sap that poisons

people. Professor Dawson, like some other leading chemists today and like many modern skin specialists, thinks that perhaps this confusion has come about because poison ivy works on you with more than one part of the sap, and that you need two exposures to break out with the rash.

His assertion is that one, or more, of the four parts of the oil acts on you as a sensitizer. At your first contact, this pre-

*of three-leaved plants, but none is friendly to humans.*





*Do This*



# 10 Ways You Can Fight Poison Ivy

*Don't Do This*



*Photos taken with the assistance of  
The New York Botanical Garden.*



**WEAR OLD CLOTHES** and leather gloves when you start out to fight ivy. And, to be on the safe side, burn clothing later.



**SPRAY IVY** with any one of 15 killing sprays recommended by the U. S. Dept. of Agriculture. Respray plants also.



**DON'T TOUCH** ivy with bare hands. If you touch it accidentally, scrub immediately with strong laundry soap.



**DON'T BURN** uprooted plants. Poisonous sap is carried on smoke particles and can be as dangerous as live plants.

prepares you to be poisoned later. Then, at a later exposure, one or more of the parts gives you the rash. The exposures can be 96 hours to one year apart.

This idea of two exposures shows, for example, why a person can think he is immune while he actually is not. He may have had one exposure and need only another one to break out.

Here are some reported cases of ivy poisoning. The two-exposure theory means that all these people had been exposed to the sap somewhere before a second contact caught them:

- A child broke out with ivy poisoning from hand-me-down clothes sent him by a cousin 500 miles away. The cousin had worn the clothes as he romped in an ivy patch. The sap, a thick, brownish-yellow liquid, retains its power to poison a year or longer after leaving the plant, even when it's turned black and hard.

- Families have caught ivy poisoning simply by petting their dogs. The pets had rambled through the ivy, and carried the oil on their hair. Most animals do not break out with the rash.

- Persons have got ivy poisoning by driving in their cars into the country, brushing ivy with a door handle, and touching oil on the handle when opening or closing the door later.

### *Sap on Wheel Stays Poisonous*

This car-door business can cause you the dickens of a time if, after getting sap on your hand, you spread it over the steering wheel. If you have had a sensitizing exposure, you can break out all over again every time you pick up new oil from the steering wheel.

With poison ivy so pesky, a pill to immunize you would be a blessing indeed. That's why Dr. Dawson and a group of





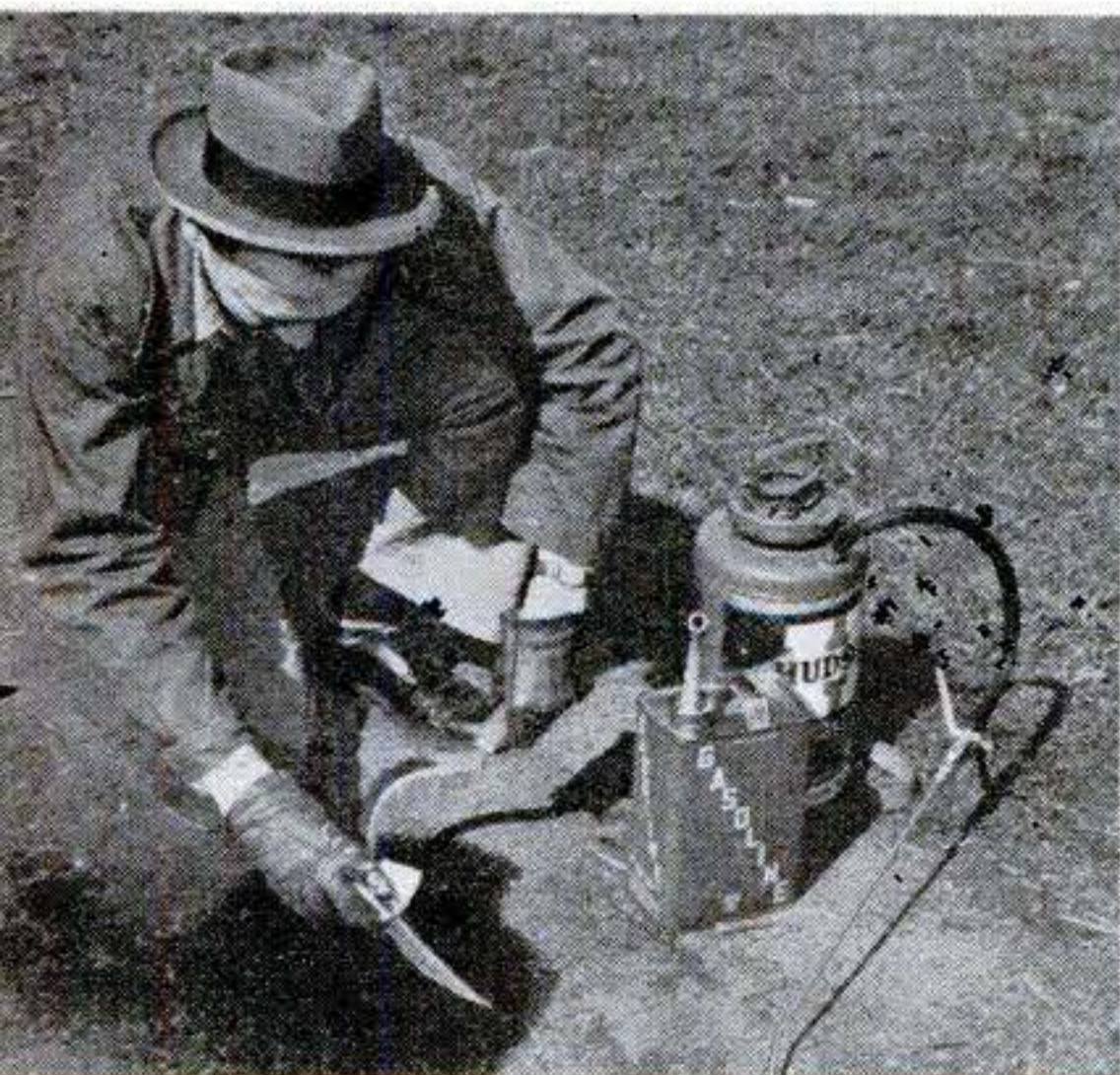
**CUT SHOOTS** with sickle if roots are intertwined with harmless, ornamental plants. Don't touch blade until it's cleaned.



**PULL UP IVY** when ground is soft and destroy it with a chemical spray. When ground is hard, break off shoots.



**SEAR PLANTS** with blowtorch, passing flame over until leaves blacken, wilt. Several searings are needed to kill roots.



**DON'T RE-USE** tools before cleaning them with gasoline. Scour sickle blade and sprayer parts that touched ivy.



**DON'T TAKE** chances with unknown three-leaved plants resembling poison ivy. "Leaves three, let it be," is good rule.



**DON'T EAT** ivy to get immunity. It won't work, despite old wives' tales. And ivy can be irritating internally.

graduate chemistry students at Columbia are working furiously.

That—and the fact that poison ivy is spreading. Already it exists in every state, Canada and Mexico. But, unlike most wild plants, poison ivy does not die or do poorly when human beings move into its area. In fact, it does better than ever around people—in towns, camps, new home developments.

It is found along paths or roads. It runs across your lawn, hiding in the grass, or along your hedge. It can mingle with ornamental shrubbery. It can climb your lamppost, rock wall, tree, or even the outside wall of your home. Many a homeowner has prized his new ivy—till unfortunate results (redness, blisters, itching, burning) showed up on hands, face, or other skin areas. Yet, if the homeowner discovers the vine and cuts it back, it can change itself into a

shrub up to 30 inches high and live without vining at all.

It lives many years, yet it takes only two months for a seedling to get so well dug in that one mowing won't kill it. It can even play possum. A plant can appear lifeless for months, then revive.

If there is no pill, you ask, what to do about it? The answer is to eradicate it where you can, to recognize it always, and to keep away from it.

At the University of California College of Agriculture, Researchers Oliver A. Leonard and Lem Osborn have just announced a new eradicator. They report that a mixture of 2, 4-D and 2, 4, 5-T will control poison oak, and will kill it permanently if treatments are continued over two years.

Poison oak is either the same thing as, or the first cousin of, poison ivy. Botanists have not classified the plants defi-



nately. Poison ivy and oak operate on you exactly the same way—by their sap—and the results are the same to you. In this case, if you don't know what hit you, it doesn't matter. The rash and other symptoms are the same.

Spring and early summer are the best times to apply 2, 4-D and 2, 4, 5-T, Leonard and Osborn reported, with re-treatment later in the season necessary—and a new treatment about June 1 the following year for permanent killing.

The Department of Agriculture Farmers' Bulletin 1972 lists earlier eradicators. You can get the Bulletin from the Superintendent of Documents, Washington 25, D.C. (10 cents, no stamps.)

Chemicals are the best eradicators. The most successful ones kill all leaves and 90 percent of roots in one treatment, they are easy to use, and with a long nozzle on a sprayer you need not get close to the ivy.

Ammonium sulfamate is best of all, says Bulletin 1972. This is not harmful to soil, not dangerous under ordinary conditions, will not burn, but will corrode spray equipment. It should be dissolved in water 12 ounces to one gallon for enough solution to kill 98 percent of ivy growing fairly densely in one square rod—272 square feet. To get all the ivy, use this chemical first about June 1; repeat August 1; repeat June 1 next year. Wash sprayer with a solution of lime or soda immediately after use. A week or so will elapse before leaves die.

#### *Spray Is Good for Weed Crop*

The second most effective chemical is 2, 4-D. Follow directions on can; one gallon is enough for one square rod of dense ivy, or two to four square rods of scattered ivy. The third is ammonium thiocyanate, preferably as white crys-

tals: one to one-and-one-half pounds in a gallon of water for one square rod. This harms skin and leather, says the Bulletin, and in time corrodes metal. What's more, because it is rich in nitrogen it causes a crop of weeds a month or two after treatment.

Borax—the only chemical not used as a spray—is listed as fourth best. You scatter borax on the soil 10 to 15 pounds per square rod, and it kills poison ivy over a period of eight weeks. It's easy to handle, nonpoisonous, won't burn, is easy to obtain and not expensive.

Whether you use one of these or any of 11 other chemicals on Bulletin 1972's list, you will probably need several treatments to get rid of all your poison ivy.

Sprays kill many plants besides ivy. Therefore, they can't be used where the ivy appears among valuable plants.

Cut ivy shoots, says Bulletin 1972, only when the first leaf on each stem is full-size. It will take four or more mowings to effect a kill.

Another way to eradicate is to sear the ivy with a hand blowtorch. This means to pass the flame over the plants long enough to wilt the leaves. Three or four searings usually kill roots. Another way still is to spray with fuel oil or crankcase drainings. Like other sprays, oil kills or harms valuable plants as well as poison ivy. Unlike other sprays, oil can harm the thick bark of a tree.

If you think you have been exposed (as when pulling up ivy), run—do not walk—to a shower, wash twice with copious suds from a strong alkaline laundry soap, and rinse, rinse, rinse to try to get the sap off. If you do get rid of it, you'll not break out.

If, despite everything, someone in

[Continued on page 214]



**IVY ON TREES** is decorative, but it's same old poison.





# Golf Gadgets

## Puts Swing in the Groove

THE lightweight training aid at left will teach a duffer to drive as clean and straight as experts do, the maker says. Linked by a chain to a loop on a curved guide, an arm band reminds him by gentle pressure whenever he deviates from approved form. He's ready to graduate from using the device, called the Swingroov, when his "muscle memory" has made a good swing instinctive.

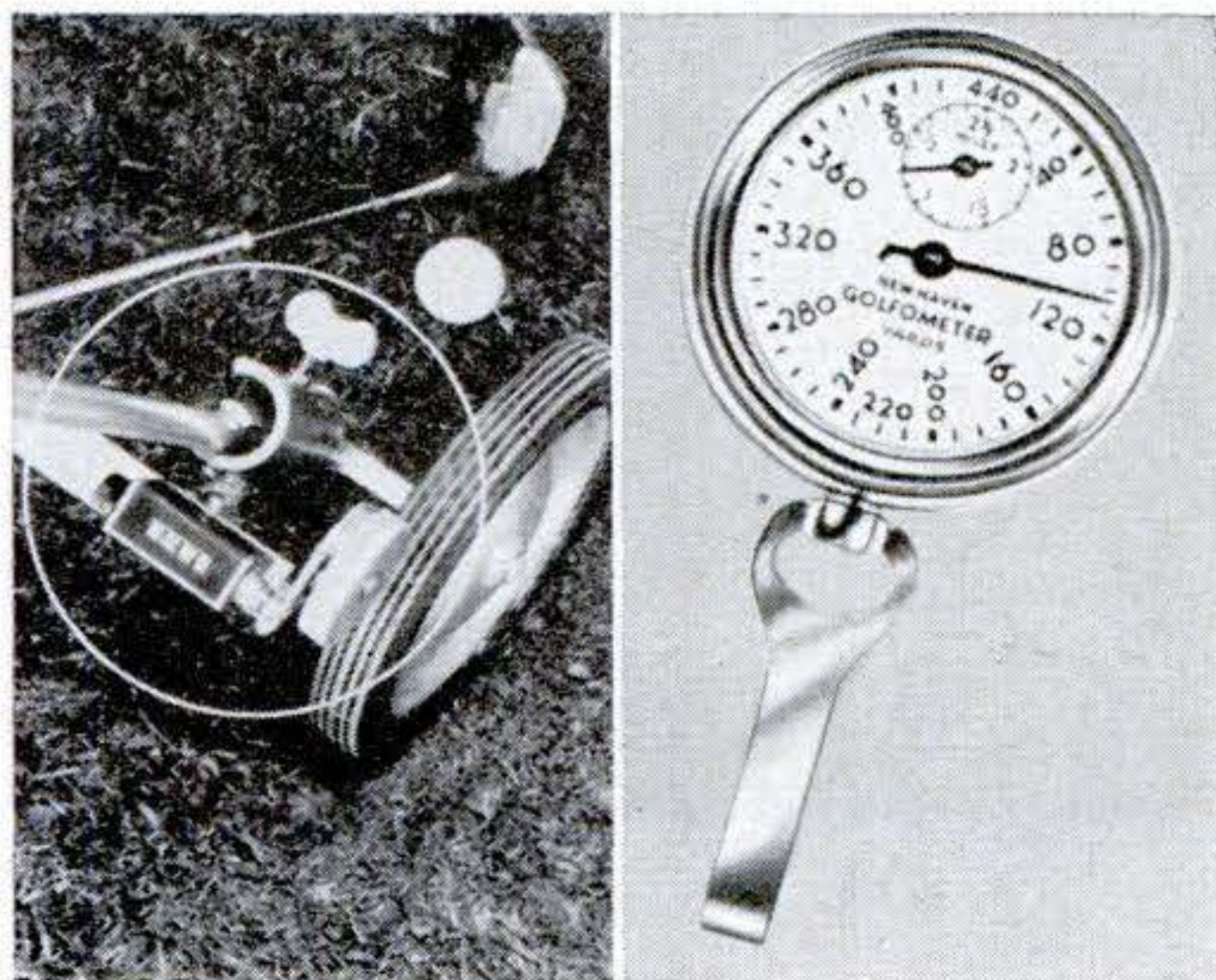
## Tee Stands on Three Legs

TRIPOD-SHAPED, the tee at right holds a ball steady, and needn't be pushed into sunbaked, frozen or muddy ground. The ball rests in a hollow at its top; height is adjustable by bending the legs. Bright colors make the plastic Pee Gee Tees hard to lose.



## New Devices Measure Yardage

How long was my drive? How far to the green? Two new aids answer questions like these. Attached to a caddy cart, the Yard-o-Meter (left below) registers yardage as a wheel rolls over the ground. The Golfometer (right below) clips on your belt and works like a pedometer, telling on a dial how many yards you have walked.

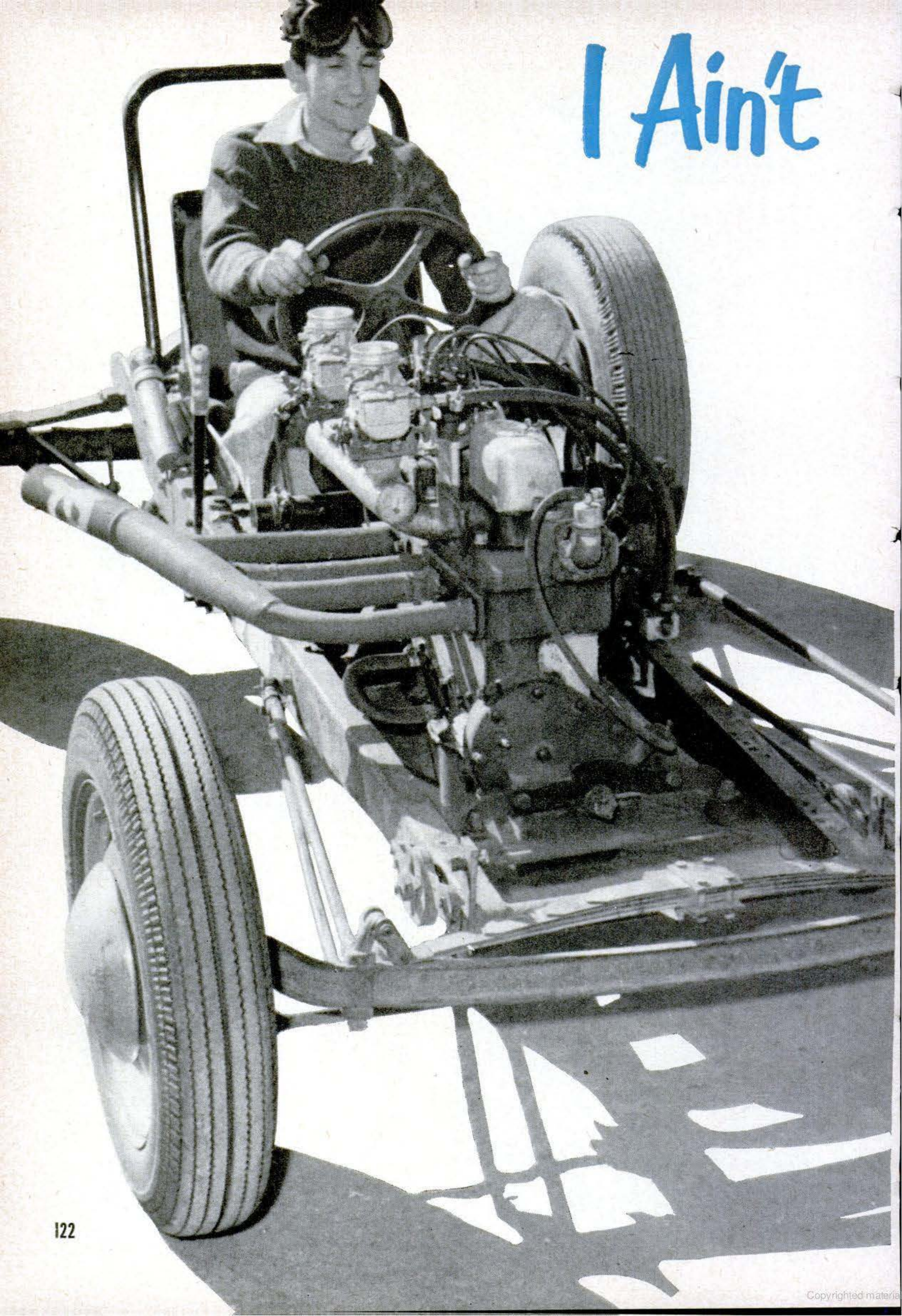


## Clubs Carried Without Bag

NO NEED for a caddy or golf bag either, if up to eight clubs are enough, and you use this four-ounce Go-Lite carrier to tote them. Raising a bar frees them instantly for use. A pouch holds balls and tees.



I Ain't





# Got No Body

By Andrew R. Boone

**Meet the railster: a screaming, nitro-burning skeleton on wheels that can leap from zero to 128 m.p.h. in a quarter of a mile.**

**J**AKE SMITH jams his right foot all the way in it. The wide rear tires take a quick bite and his mount leaps from the chute. He watches his tach closely. At 5,600 the singing Merc engine sounds all undone. Jake hits the clutch and shift lever, jamming into high. Thirteen seconds and a quarter of a mile later, he is hitting 128 miles an hour.

That's the railster, the newest darling of the super hot-rodders. A railster is a screaming skeleton on wheels, a hot rod

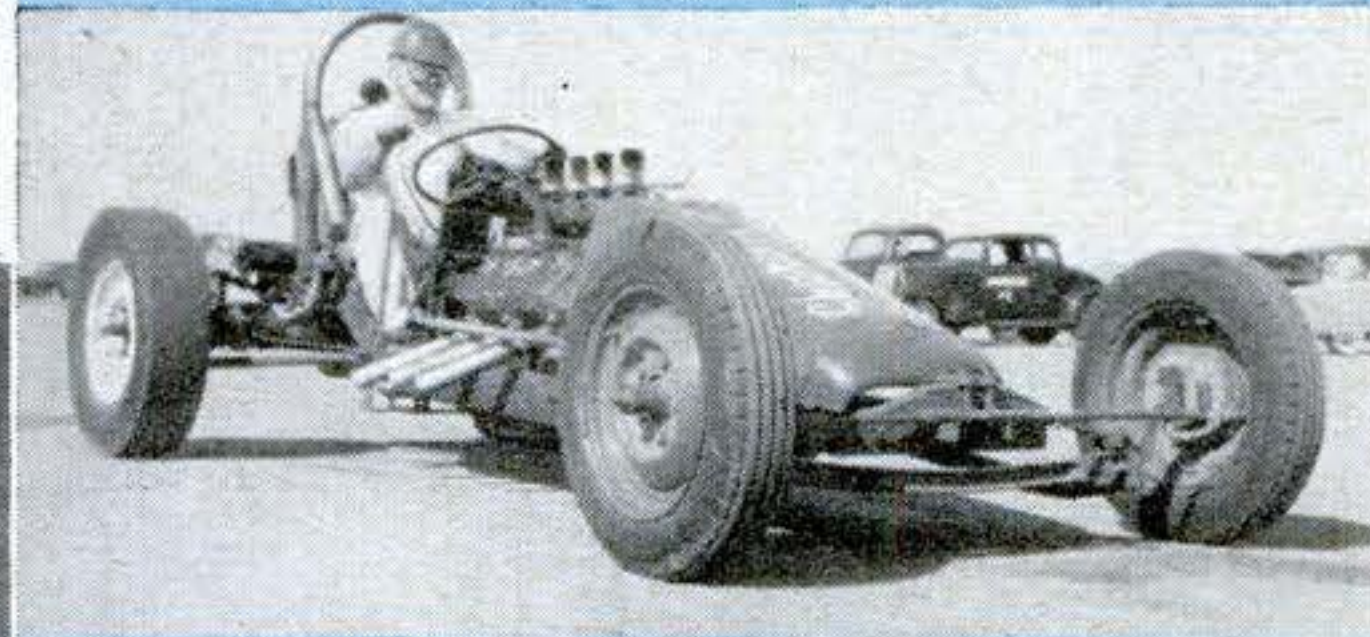
that has been starved to less than half its weight. Essentially, it's an engine mounted on rails cut down from an old car or especially built up from tough chrome moly.

Jake and his fellow rail jockeys are out for one thing—maximum pickup. Take a look at Joaquin Arnett's record-smashing "Bean Bandit."

The Bandit's 1,325 pounds pack a 275-cubic-inch Merc with 3 5/16-inch bore and four-inch stroke. The ported and relieved block uses 1 5/8-inch intake and stock exhaust valves. The front-end assembly came from a '37 Ford, while a

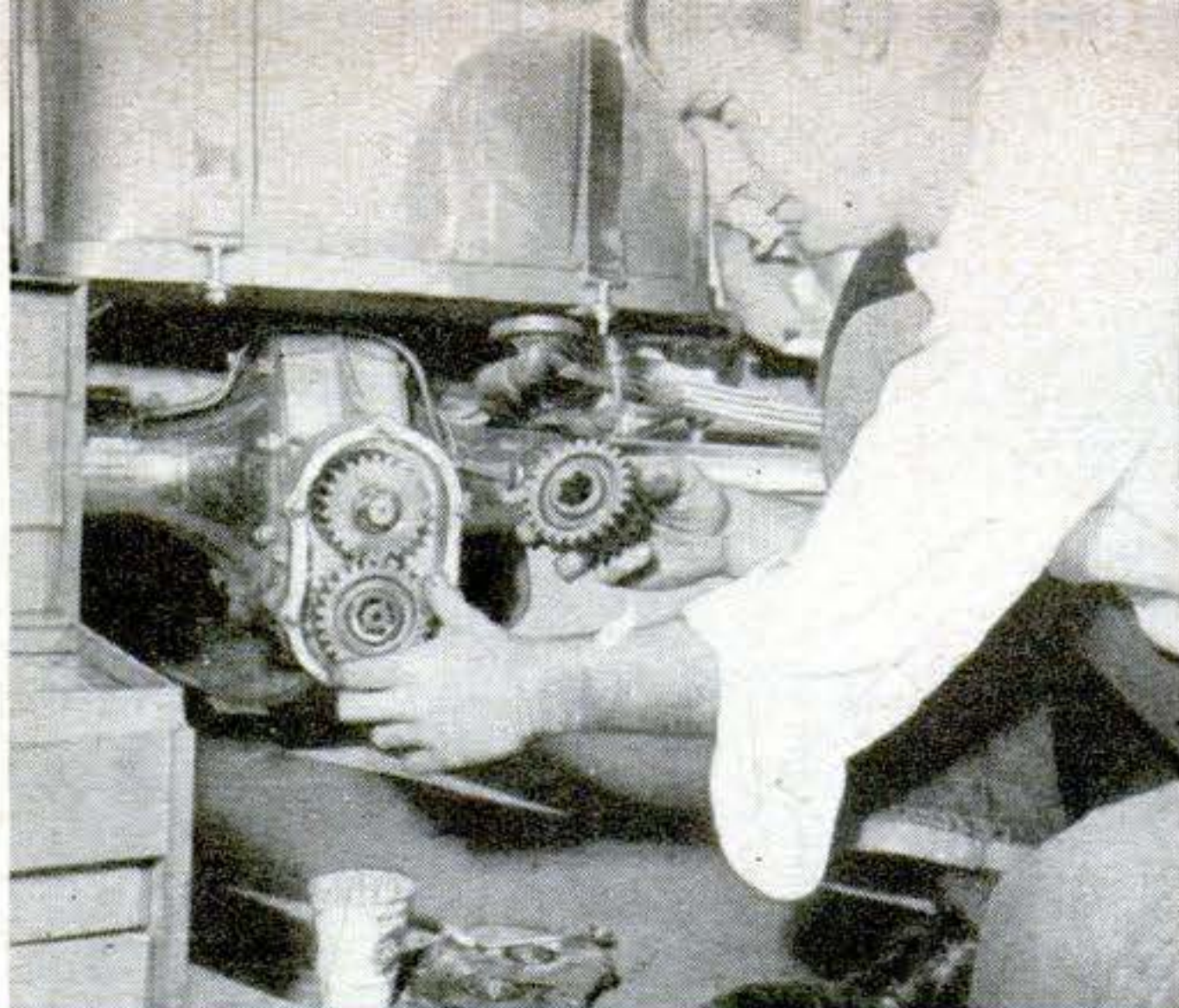


**MODIFIED RAILSTER** run by Bob Gorman has Austin body and G-string hood for safety if 1,565-lb. car capsizes or engine blows up. Car has hit 121 m.p.h.

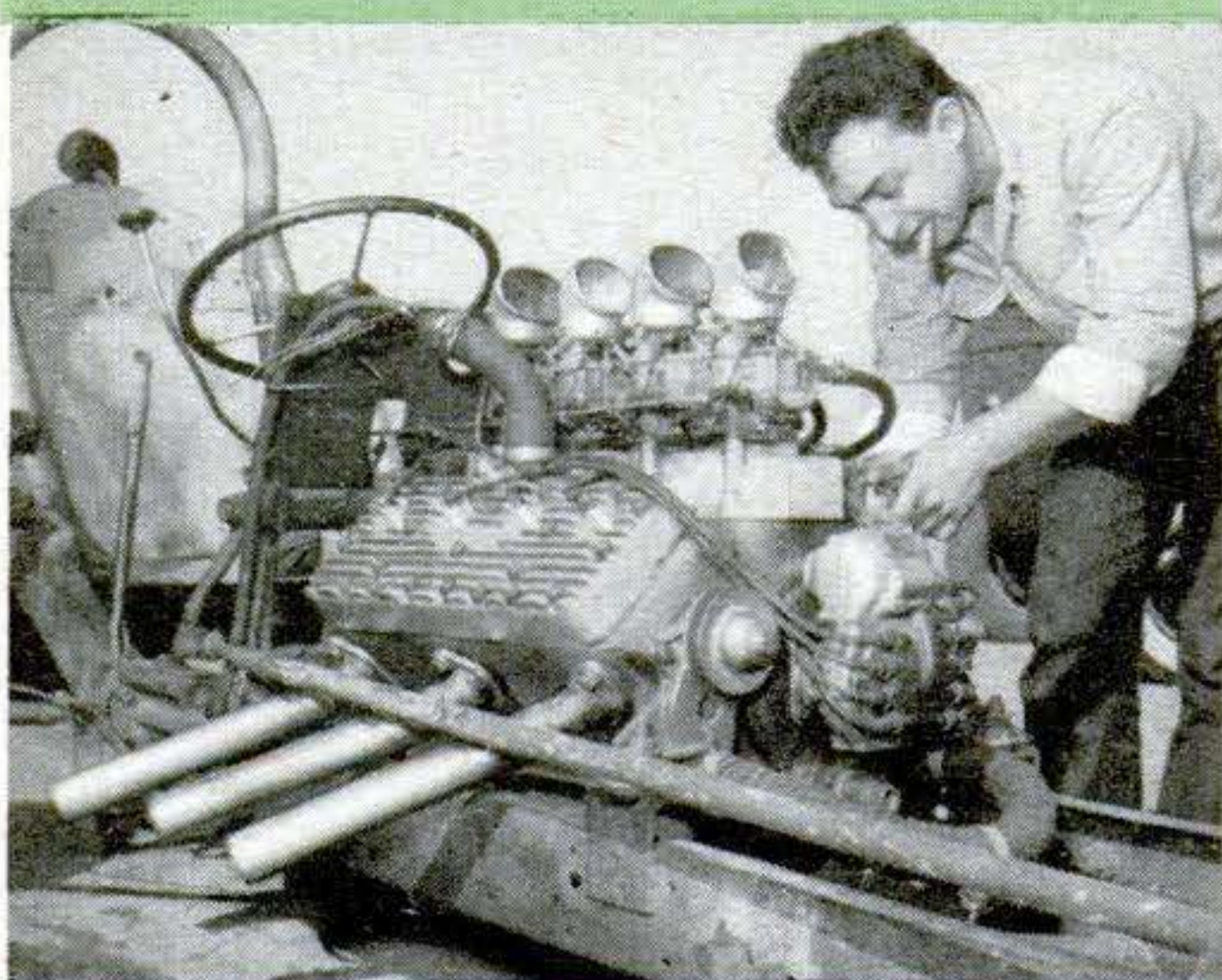


**HOOD** on this railster aids streamlining, cuts cooling. Car has '29 Chevy rails, narrowed four inches in the front and 12 in the rear.





**GEARS** are swapped into quick-change rear end by driver Art Chrisman. Five sets of gears give him plenty of combinations. Car has made 138 m.p.h.



**MECHANICS** work feverishly between dashes. Carburetor jets, spark plugs, fuel mix are changed often. Plugs may burn in single run.



**FOUR GALLONS** of water are poured into tubes connecting two sides of engine block. Radiators are not used. Some engines slant toward rear for traction.

Ford rear end encloses a locked differential and 3.78 gears. A '41 Ford front-stabilizer bar replaces the rear cross spring, giving torsion-bar suspension. Speed to date: 135 miles per hour.

The railster's fuel is nitromethane and alky. Standard mixture: nitro and alky 50-50. A 10-minute warm-up, quarter-mile dash, and return to the pits takes nearly a gallon. Cost: \$2.00.

Pounding one of these babies down the straightaway is both an art and a science.

"From the time the flag drops," explains Art Chrisman, whose slick red beauty has been winning drags regularly, "you're on the verge of no traction. I've seen rear ends leap six inches at the take-off. That's why we move the engine back to get at least half the weight on the rear. You install wide asphalt slicks in the rear for maximum traction—standard tires capped with a flat strip.

"The flag drops. You hit the throttle and drop the clutch off to get going fast. We use only two gears—second and high. An event can be won or lost in the split second of shifting. I ease off on the throttle only briefly, because I've got to keep the r.p.m. high. Unless traction breaks we go all the way at full throttle."

#### *A Handful of Fans Start Fad*

The rail craze started with a handful of riders trying for more speed by eliminating bodies, including hoods. As weight went down, pickup and speed went up. But one boy lost his life when his car sideswiped another, and the drag operators, such as the Pomona Choppers (PSM, Sept. '52, p. 142), took a closer look. Drivers, they knew, must be protected in case a hose blows off or an engine fire starts. Now Pomona has ruled that each dragster must have some type of body, fire wall, hood, floor boards or belly pan, safety belt and crash helmet.

A fellow may lay out \$1,000 and put in 1,000 hours reworking a junker into a railster. If he's good, he may be tops now and then. What is his reward? Perhaps a \$50 bond, more likely an engraved cup. Nothing more except personal satisfaction—and the hope of hitting 150. **END**

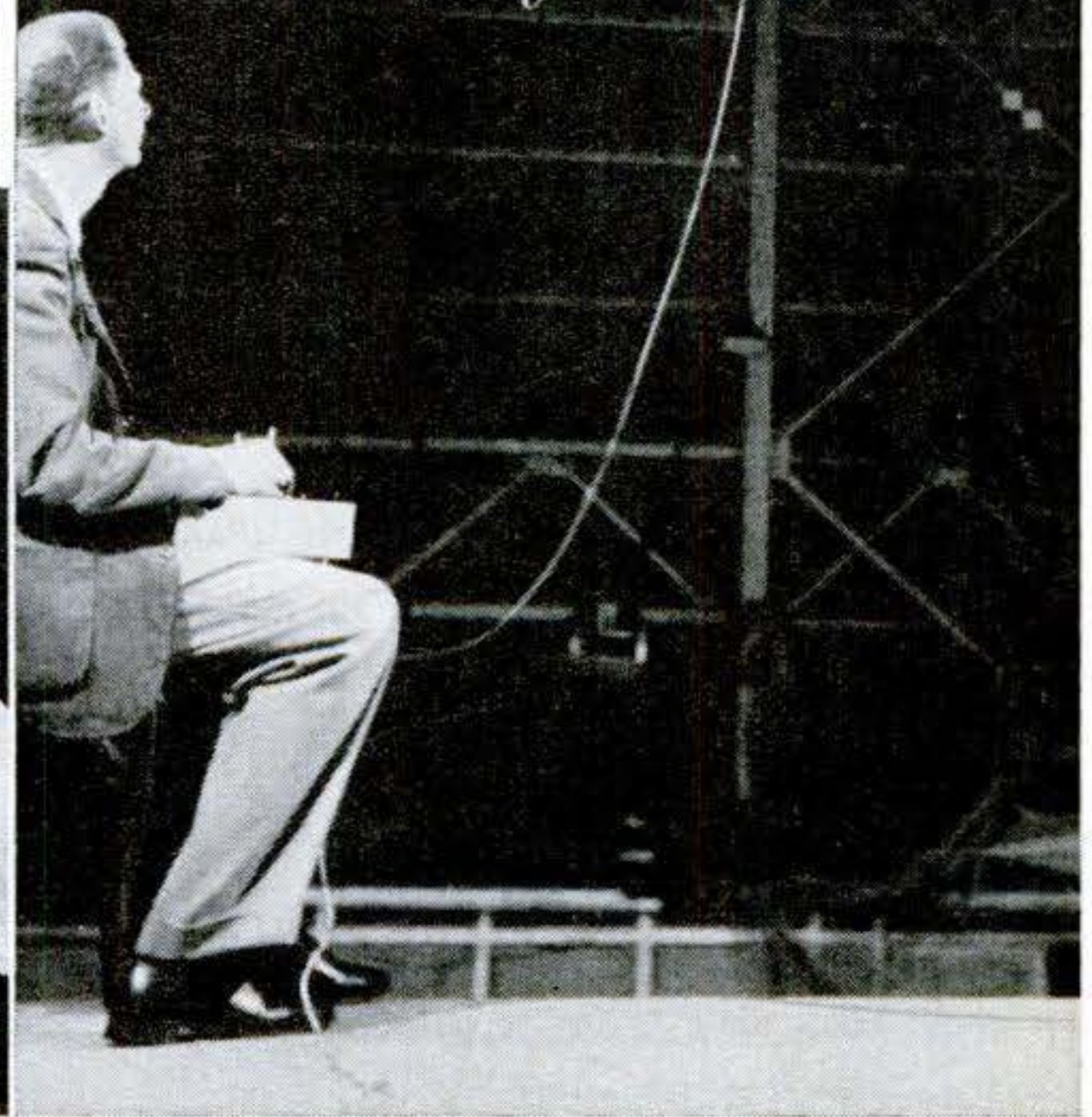
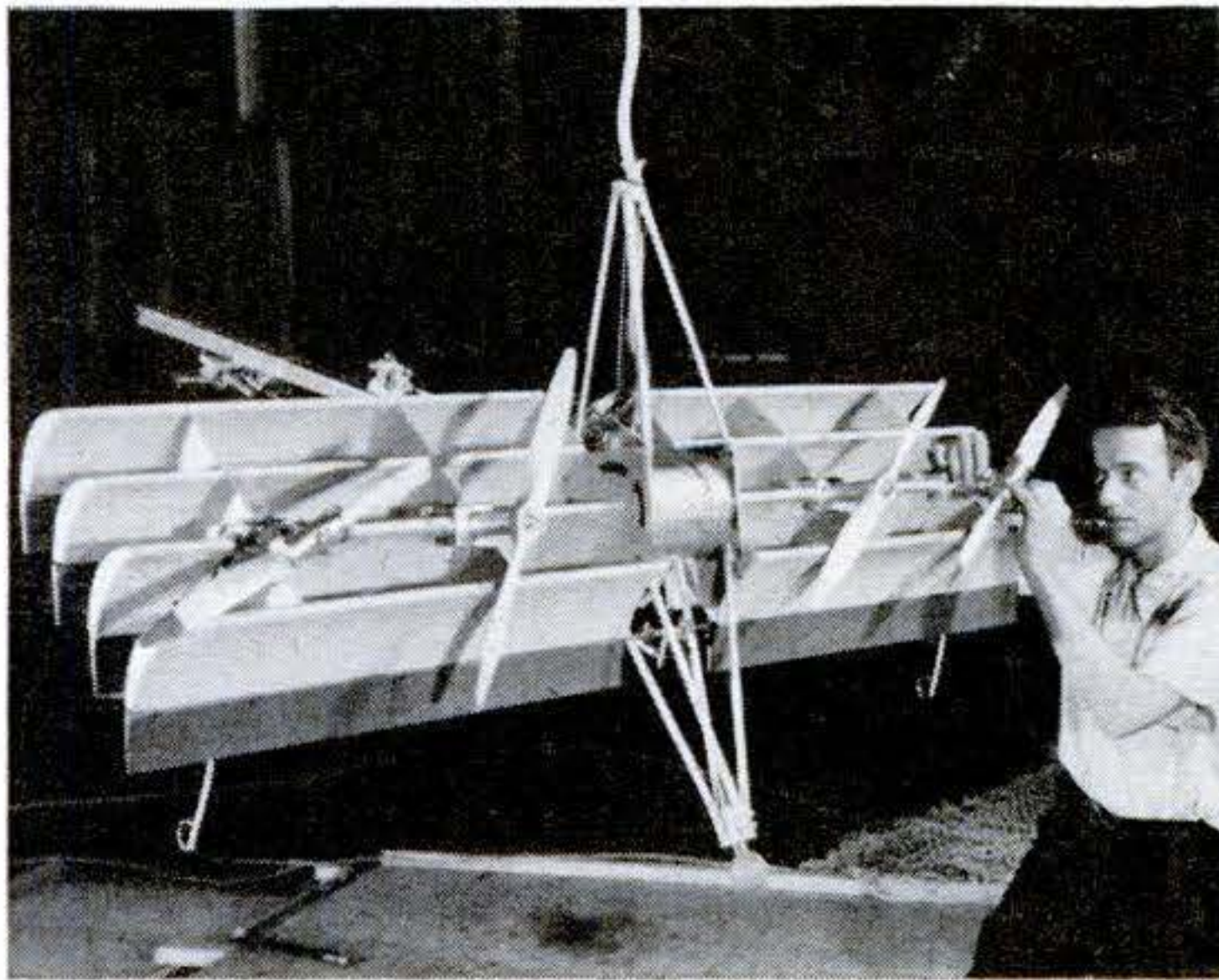


## Slat Plane Goes Straight Up

HIGH-SPEED airliners of the future may have "Venetian-blind" wings that will enable them to take off straight up and to hover in flight like this model being "flown" in a National Advisory Committee for Aeronautics laboratory at Langley, Va.

How it works is shown in photo below. The propellers remain in fixed position at all times. For vertical take-off and for hovering in mid-air, the variable slats are curved downward, thus forcing the powerful slipstream downward instead of rearward.

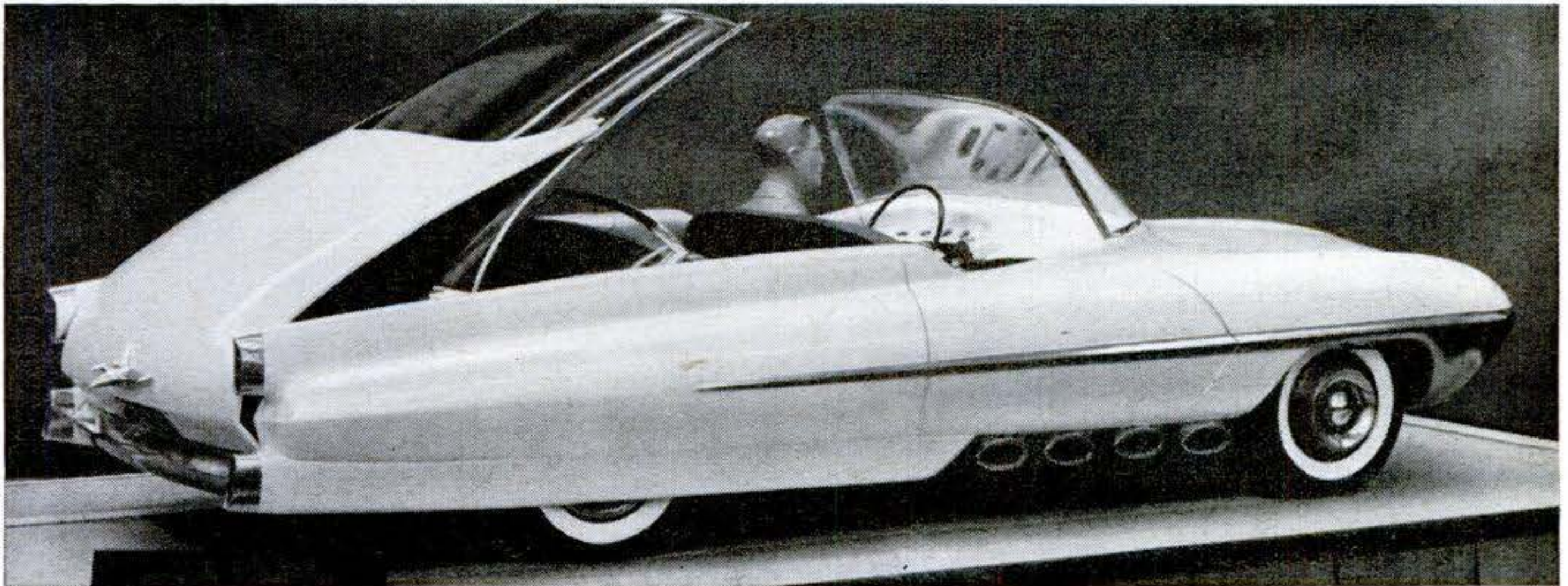
For forward flight in an actual plane of this type, the pilot would slowly close the slats to form a solid wing, directing the slipstream rearward. Jet or turboprop engines with very high power for their weight would be needed, says NACA.



## This Hardtop Convertible Really Converts

ADD dream cars: Ford's new Syrtis, shown in a model below. The Roof-O-Matic top is its main innovation. Press a button and the top lowers into a level position beneath the

rear-deck lid. The rear window can be swung overhead and against the back of the front seat as a windshield. It is still in the development stage.





# What's Your Funniest



Maybe it's funny enough to win you this Model T:

These men will decide whose story is best:



**Bennett Cerf** is known for his best-selling collections of humorous stories, among them *Try and Stop Me*, *Anything for a Laugh* and *Shake Well Before Using*. He is president of two publishing firms, Modern Library, Inc., and Random House, both of which he founded.



**Wilbur Shaw** knows a good car when he sees one, a good story when he hears one. Now president of the Indianapolis Motor Speedway Corp., he won the big Memorial Day race there in 1937, 1939 and 1940. For the past three years, his Reports from the Driver's Seat have helped keep POPULAR SCIENCE popular.



**A. K. Mills**, director of the Ford Museum and Greenfield Village, was once a newspaper reporter. He went to Europe in 1928 to make preparations for Amelia Earhart's Atlantic flight. In 1949 he joined the Ford Motor Co., after stints with *Time*, *Life*, and service in the Air Force.



**Frederick Lewis Allen** is editor of *Harper's Magazine* and author of a series of books. In *Only Yesterday*, an informal history of the 1920s, he observed that the "high, hideous, but efficient Model T" was the most common car of that period. Other books include *The Big Change*, and *Since Yesterday*.



**Henry E. Edmunds** heads the Ford Motor Co. Archives. He has the job of collecting and indexing the records and papers of Henry Ford and the Ford Motor Co., as well as outside material relating to both. He previously served as archivist of the War Production Board and the International Monetary Fund.

WHEN talk turns to Model Ts, everyone who ever owned or drove one tries to get in the act. They all want to tell a story.

Now you can make your Model T story pay off. We will give the Model T you see on these pages to the person who sends in the best story about:

*"My funniest experience with a Model T."*

The Model T we're giving away is the 1925 runabout we restored and told about in a series of articles in February, March and April. The car is now in top condition. Nothing extra to buy or do. Just hop in and drive it—if you still remember how.

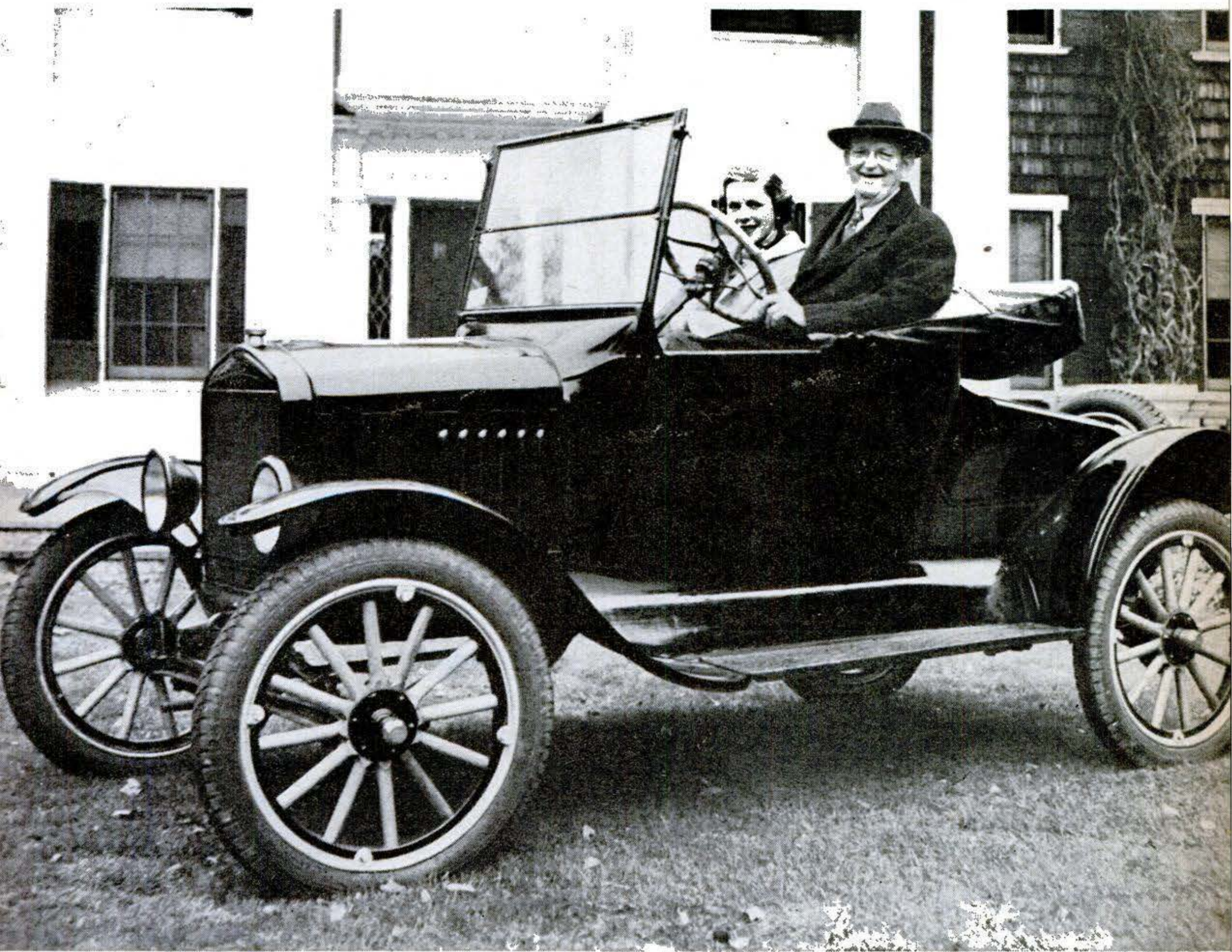
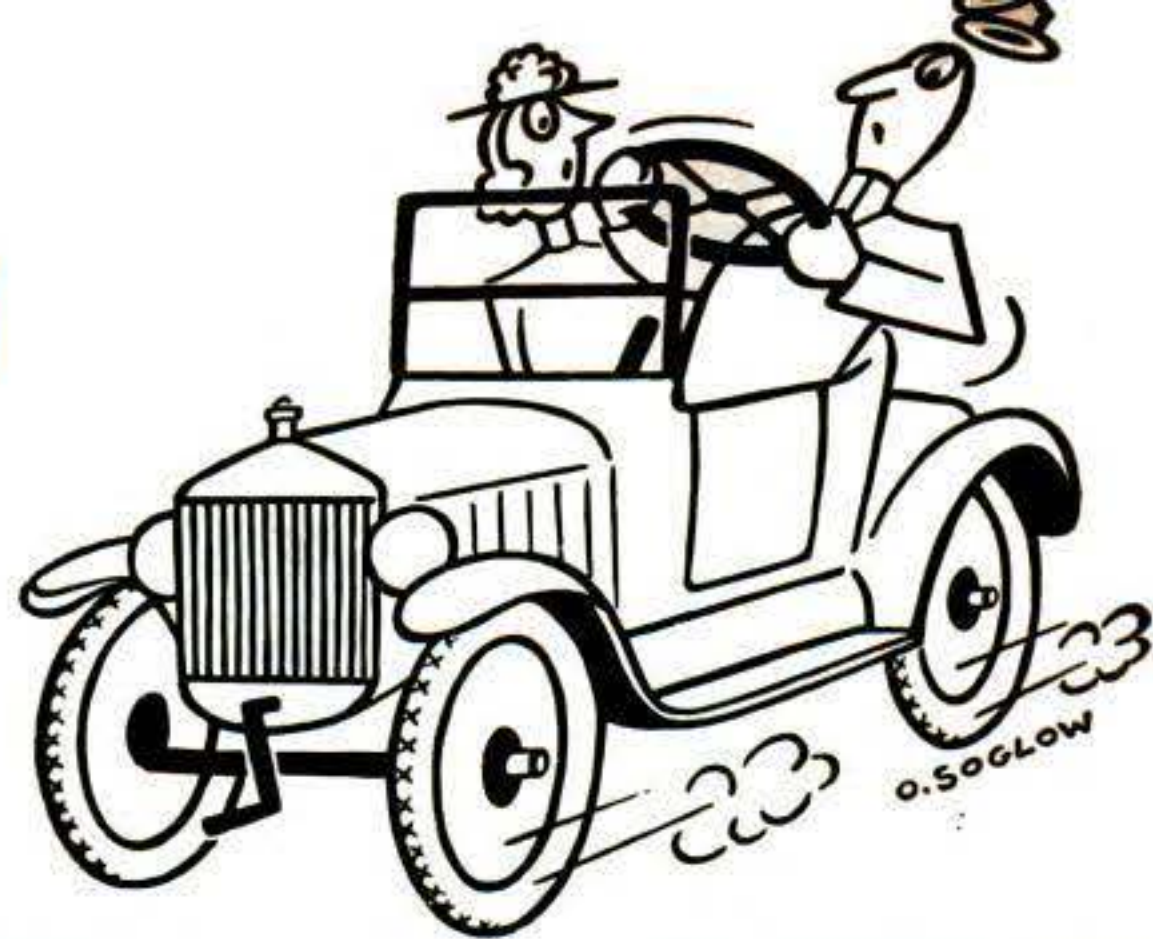
The Ford Motor Company, which is celebrating its 50th anniversary this year, will deliver the runabout anywhere in the United States. The Ford dealer in the winner's home town will present the car.

Besides giving away our Model T, we will pay 10 bucks for every anecdote published in POPULAR SCIENCE MONTHLY. The person who sends the best story will receive the runabout and 10 bucks.





# Model T Story?



## All You Need to Do:

*Write your story—preferably on a typewriter—on one side of a single sheet of paper. Write your name and complete address on the same sheet.*

*Better keep a copy of your story; we expect to receive too many to acknowledge or return the ones we do not pick for publication. Send your story—by August 1—to*

**Model T Editor, POPULAR SCIENCE MONTHLY,  
313 FIFTH AVENUE, NEW YORK 10, N.Y.**





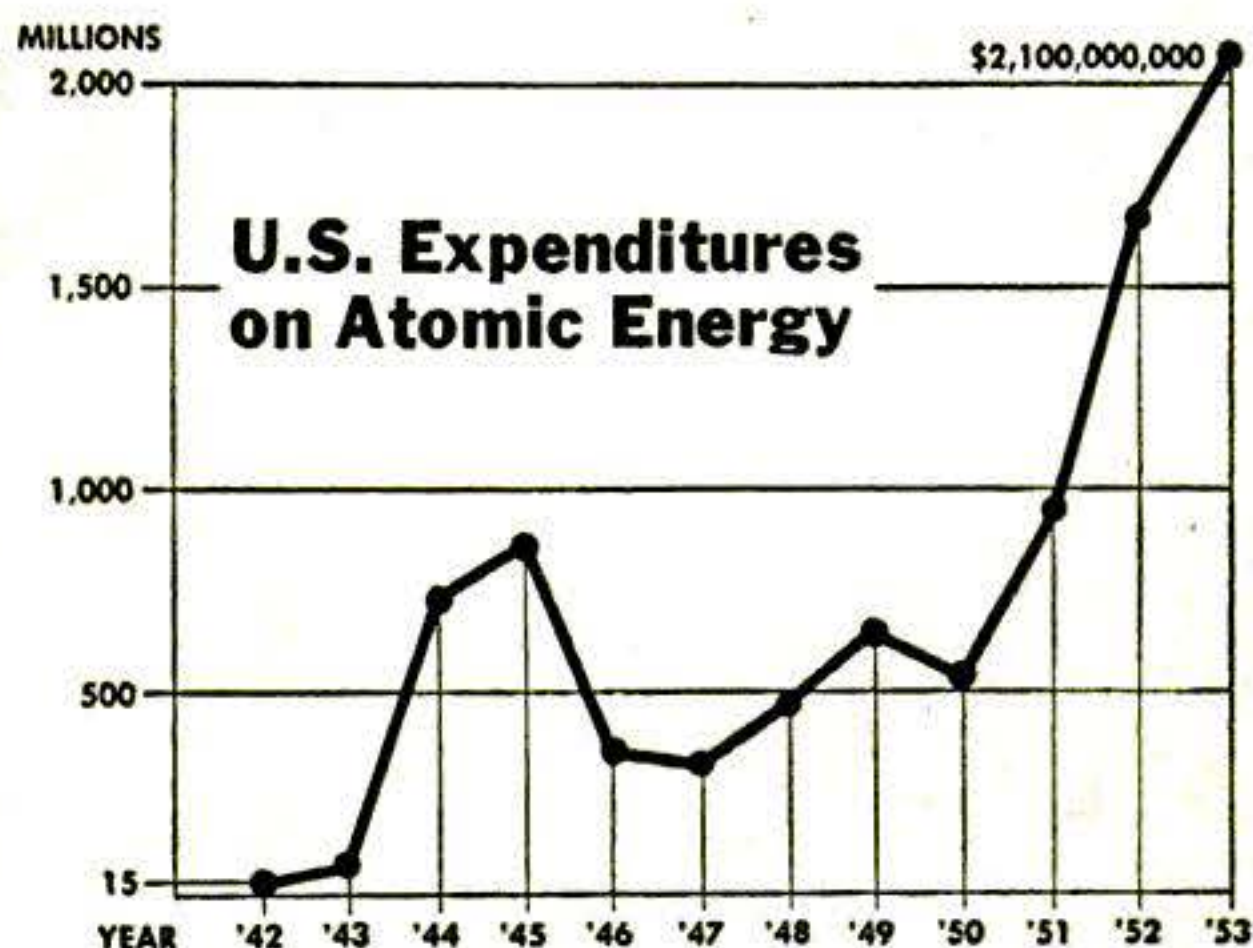
# P.S.

## Last minute news & notes...

SAFER SWIMMING POOLS are promised by a new method of chlorination that uses 10 to 20 times the normal amount of chlorine. This does not cause eye irritation if the water is made alkaline, reports Eric W. Mood, Yale public-health expert.

A NEW GASOLINE ADDITIVE is reported to give 15 percent more power, extra mileage and increased spark-plug life. Called TCP (for tricresyl phosphate), it's said to keep plugs free of metallic deposits that upset engine performance. Gasoline containing it will be sold by Shell stations for half a cent a gallon over the present price of premium fuel . . . Heat pumps to cool cars in summer, warm them in winter are predicted by Auto-Lite's engineering chief . . . It's the de luxe model that American motorists want, conclude Pontiac executives--customers order 15 expensive cars for every "standard" one.

THE LEANING TOWER OF PISA, now 14 feet out of plumb, can be straightened, suggests Charles B. Spencer, foundation engineer who worked on the White House rebuilding job. Just drill holes to loosen the soil on the high side and let the tower settle back. Otherwise, he warns, it won't last another century.



A MACHINE THAT HAS BABIES has been developed--in mathematics only, not in reality--by Dr. Claude E. Shannon, the Bell Labs' mechanical-brain expert who built the electronic mouse (PSM, Mar. '52, p. 99). He describes it as a "somewhat sinister" computer that would collect parts like its own, then assemble the parts into a duplicate of itself . . . 3-D movies may help some people see better, reports R. A. Sherman of the Bausch & Lomb Optical Co. He says that watching stereo films can help the eyes overcome some coordination defects.

A MAJOR VICTORY OVER TUBERCULOSIS--deaths were halved in the past 12 years--has been reported by the United Nations World Health Organization. Principal cause, says WHO, was not wonder drugs but better public-health measures and improved living conditions . . . If a surgeon forgets a sponge inside his patient, he can find out easily now--a new surgical sponge made by Parke, Davis contains barium sulfate so that it will show up in X rays.

AN ANTI-A-BOMB PILL may come from experiments on mice at Argonne National Laboratory. The animals were protected against killing doses of X rays by cysteine. There's a catch--the cysteine would have to be taken shortly before exposure to the deadly rays.

THE CONQUEST of Mount Everest by a New Zealand beekeeper, Edmond Hillary, and the famous Sherpa guide, Tensing Norkay, on May 29, has shifted the spotlight to K-2, monarch of the Karakoram, as the world's highest unclimbed mountain (p. 70). It took 30 years of trying and 11 expeditions to scale Everest. K-2 has turned back three.

CANNED SODA POP is being introduced in New York this summer . . . A pen that "burps" is said to hold 40 percent more ink. The Eversharp Ventura is designed to force out air that ordinarily prevents complete filling . . . Frozen bread, recently introduced, will taste better, stay fresh for months according to Arnold Bakers.

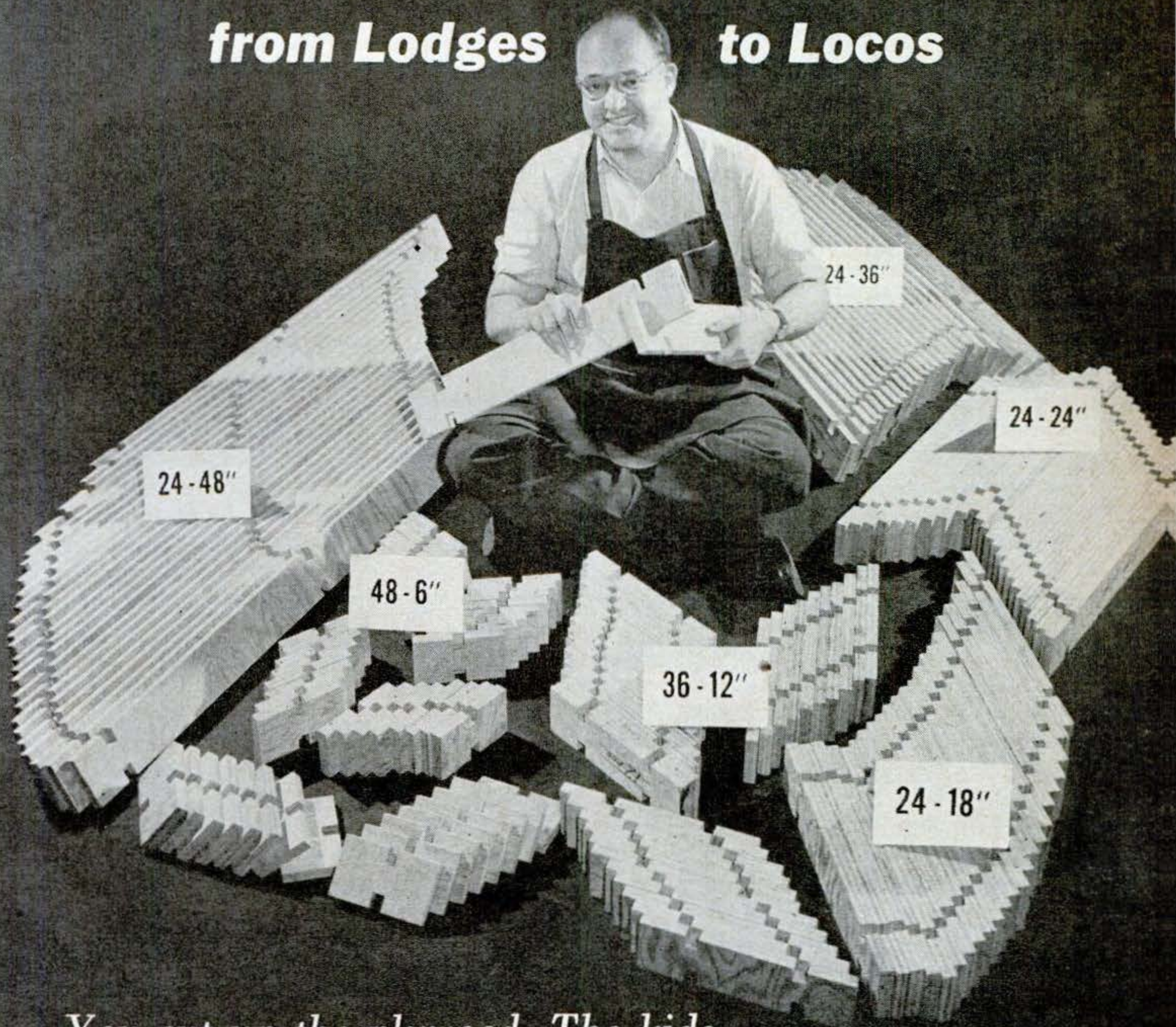
*The Editors*



**Easy to Make**

# Play Planks Build Everything

**from Lodges to Locos**



*You cut up the plywood. The kids put it back together—into sturdy playhouses.*

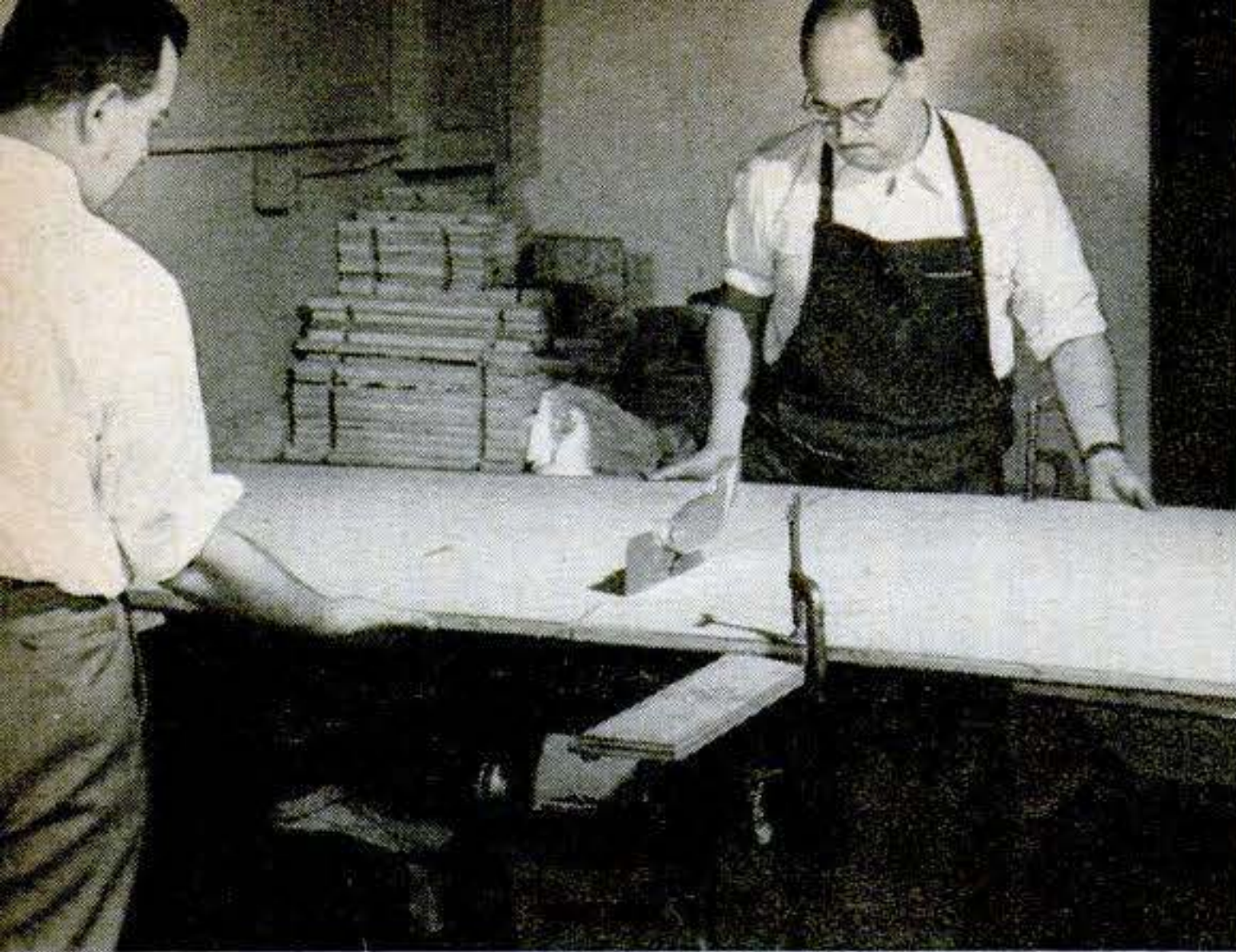
**By Hartley E. Howe**

**S**TACKED around the cheerful gent in the picture above are a bandit shack, a doghouse, a pioneer fort, Blackbeard's brig and a spaceship. Also a medieval castle, Gus Wilson's Model Garage, a schoolhouse,

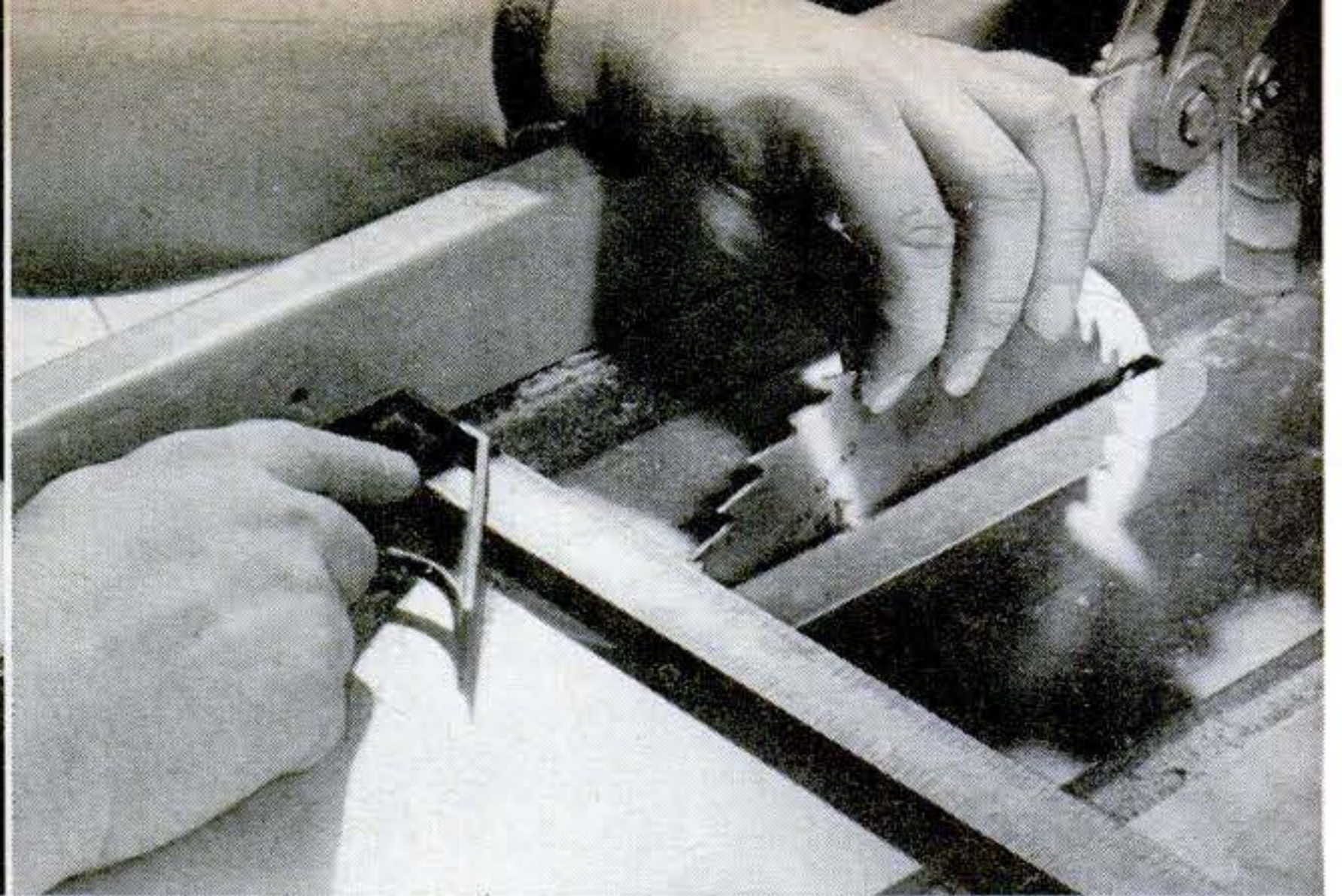
a general store, and Casey Jones' locomotive.

Not all at the same time, to be sure. But in rapid succession, as any small boy can quickly show you. For those neat piles of lumber are a construction set—Play Planks—but a set that is as different from the ordinary building toy as an MG is from a pedal car. And you make





**1 CUTTING 4'-by-8' PLYWOOD SHEET** in half for easier handling is first step. Board clamped under sheet rides along edge of saw table, helps hold sheet in line. Friend to pull it through is handy. Keep splitter lined up with blade or it will push you off line.



**2 RIPPING PLANKS** comes next. Set fence 4" from center of saw-blade edge so kerf is divided equally between each two pieces as they are cut. Measure from both ends of saw slot to make sure fence and blade are parallel. Beware fence slip as you tighten clamp.

it yourself with a table saw and a little sweat.

- It makes things big enough for kids to get into and climb on and squirm through.
- It goes together easily for little kids.
- While it isn't cheap—even when you build it yourself—any father will appreciate a toy that isn't going to be discarded when the gang decides to stop being cowboys and become space cadets or grease monkeys.
- For the beginner with power tools it's an ideal starting project. You'll learn three basic ways of using a table saw—ripping, crosscutting and dado work. And despite the mistakes and clumsy workmanship that go with a first project, the set is so designed that you're almost certain to turn out a plaything that will give the kids a lot of fun.

Play Planks are the brainchild of a Tacoma, Wash., kindergarten teacher, who designed them so that the notches fit together like a log cabin. You can buy a readymade set from a West Coast firm for about \$100. But thanks to the Douglas Fir Plywood Association, which has made the plans available, and Monsanto Chemical Corp., which is helping to distribute them, you can build it yourself for about half that amount.

**Materials.** The basic set shown in picture can be made from three and a half 4'-by-8' sheets of plywood. This cuts into:

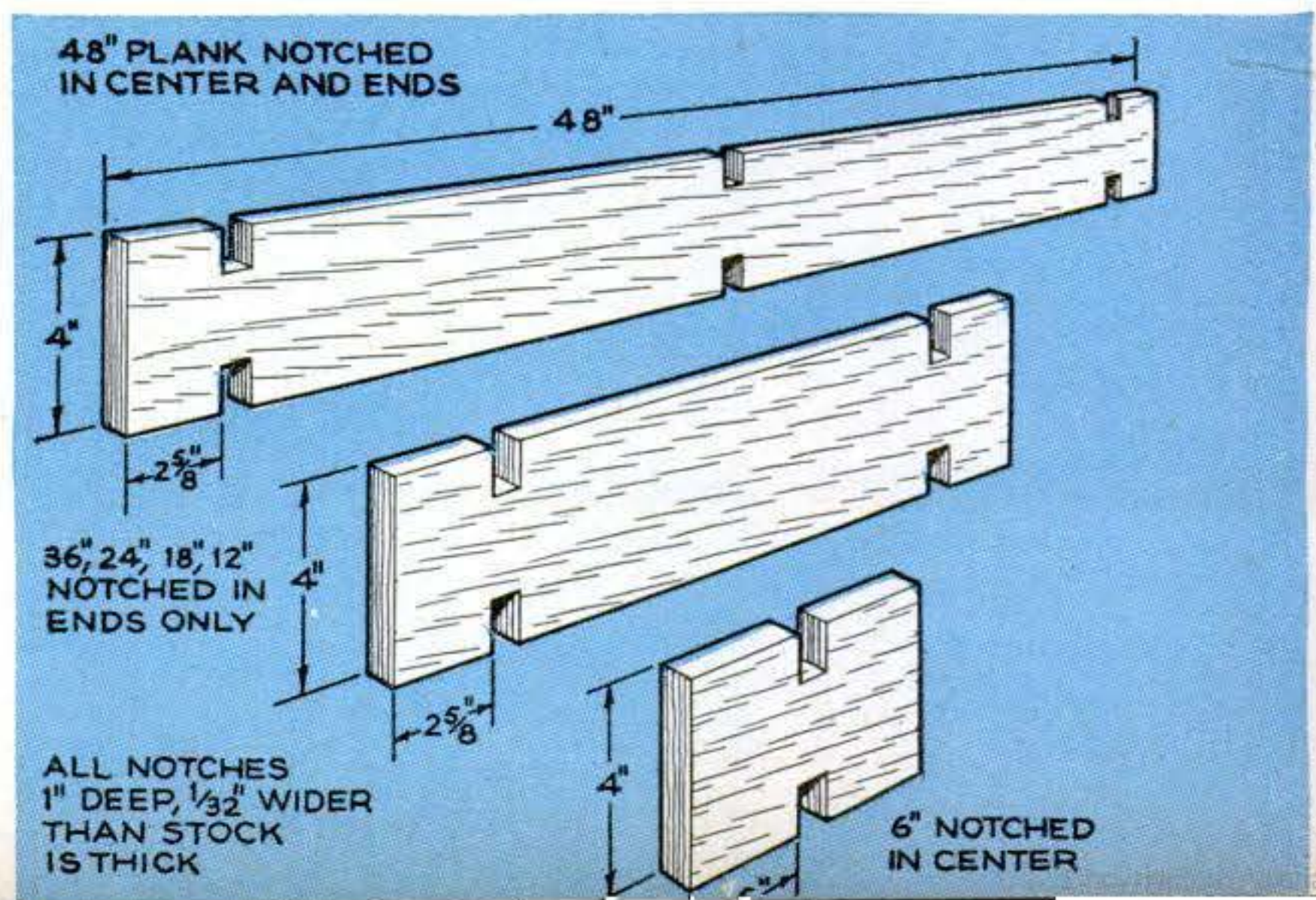
- Four dozen planks 6" long,
- Three dozen planks 12" long,
- Two dozen planks 18" long,
- Two dozen planks 24" long,
- Two dozen planks 36" long,
- Two dozen planks 48" long.

Don't worry if your lumberyard will sell you only full sheets. Your kids can always use extra planks. But don't make them up until you see what sizes are needed.

For sets that are to receive heavy use by fairly large kids,  $\frac{3}{4}$ " sheets are recommended. For smaller kids, or light use,  $\frac{5}{8}$ " or even  $\frac{1}{2}$ " sheets will do. Each time you go down a size you save about three cents a square foot. In any case, good-on-one-side stock works fine. And if the set is to be used outdoors, you want to get exterior-grade plywood. The wood for the planks shown in the pictures— $\frac{3}{4}$ ", good-on-one-side, exterior-grade fir plywood—cost about \$50 in the vicinity of New York City.

The planks can be used for the roofs as well as the walls of structures. But you can make the set go a lot further if you cut up some roof panels. These can be softboard for indoor use; tempered hardboard for outdoors. Two 4'-long panels about 17" wide, and two about 29" wide are all you need. These will fit respectively on roof supports made of 2' and 3' planks.

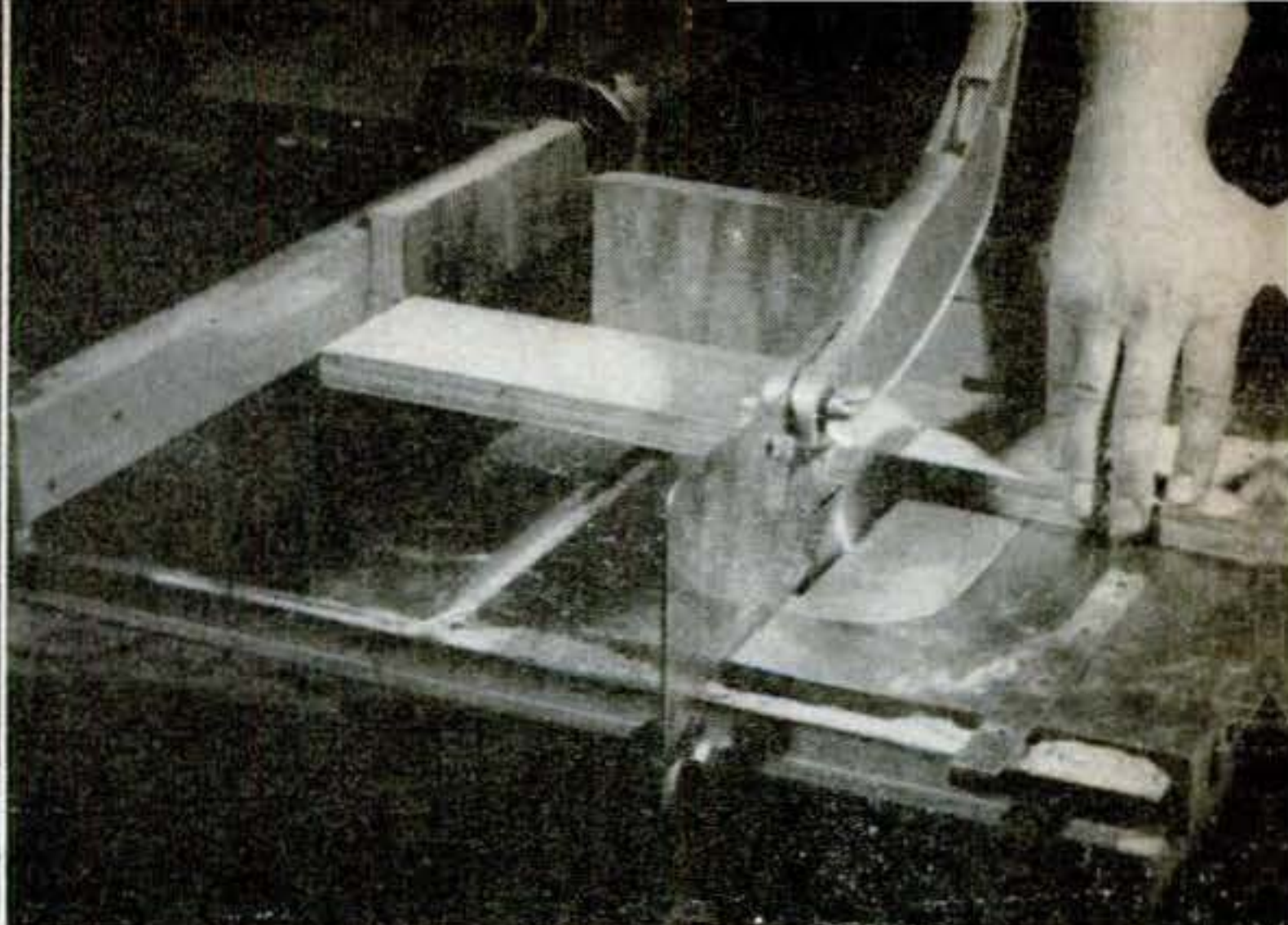
**Ripping the planks.** If possible, get







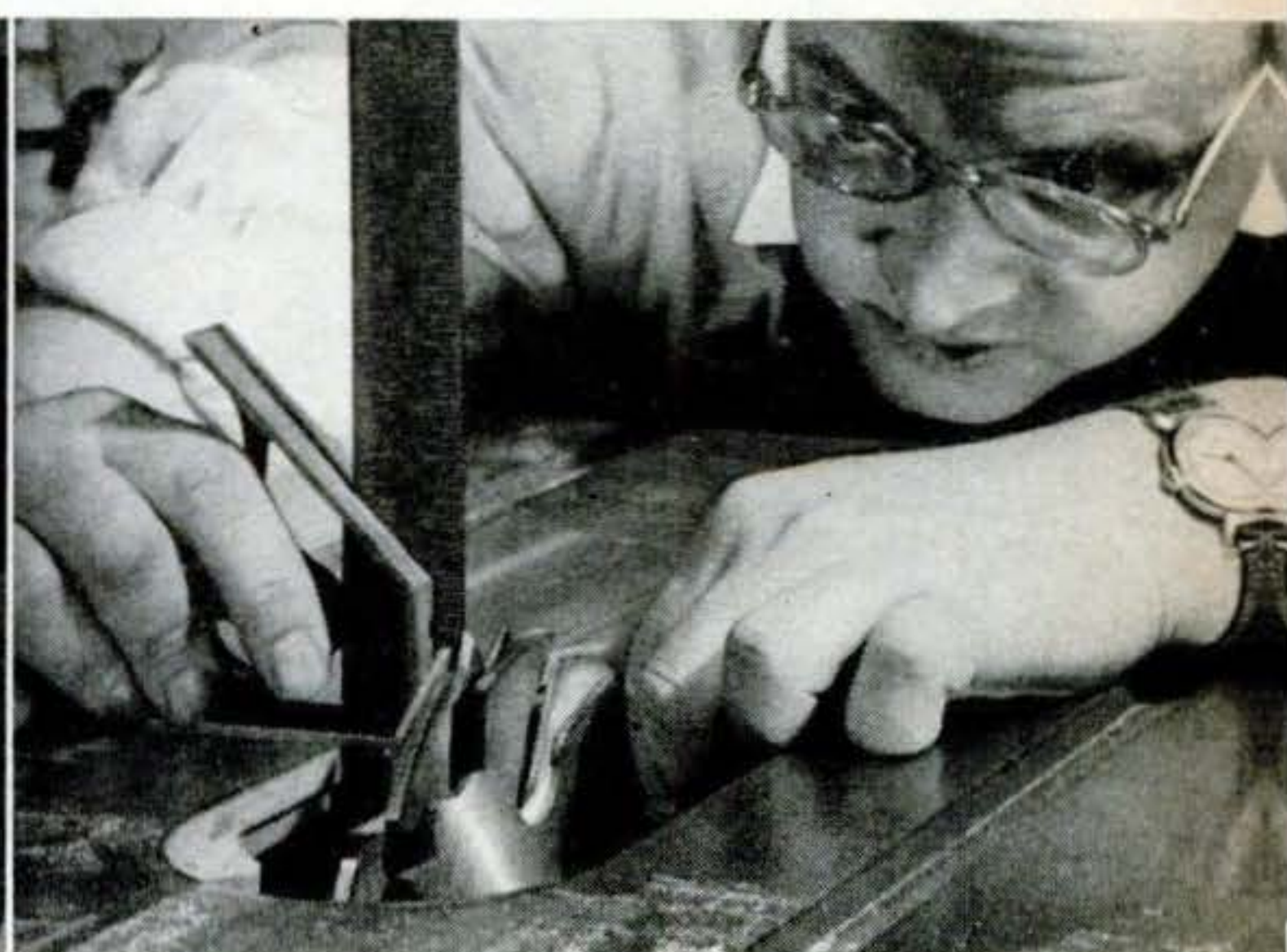
**3** PUSHING THE SHEET through to rip the planks requires extra care, especially for first few cuts while sheet is still awkward size. Push it against the fence. Watch where sheet meets the fence, not the blade. The sheet may pull away from the fence.



**4** CUTTING PLANKS TO LENGTH comes next. Note block clamped to fence so plank end slides along it until just before reaching saw. This leaves space between blade and fence so cutoff piece doesn't jam. Push through with plank held against miter gauge.



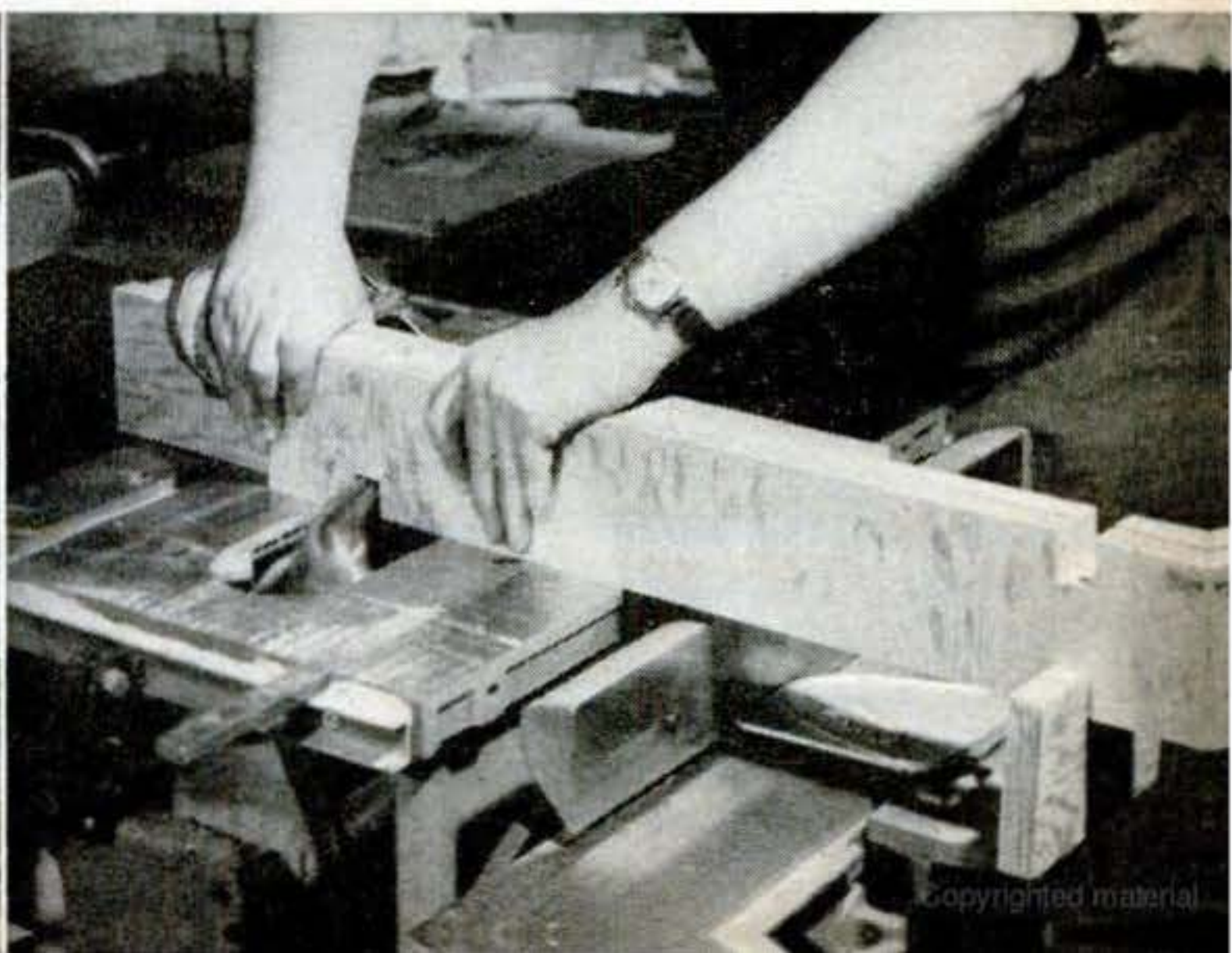
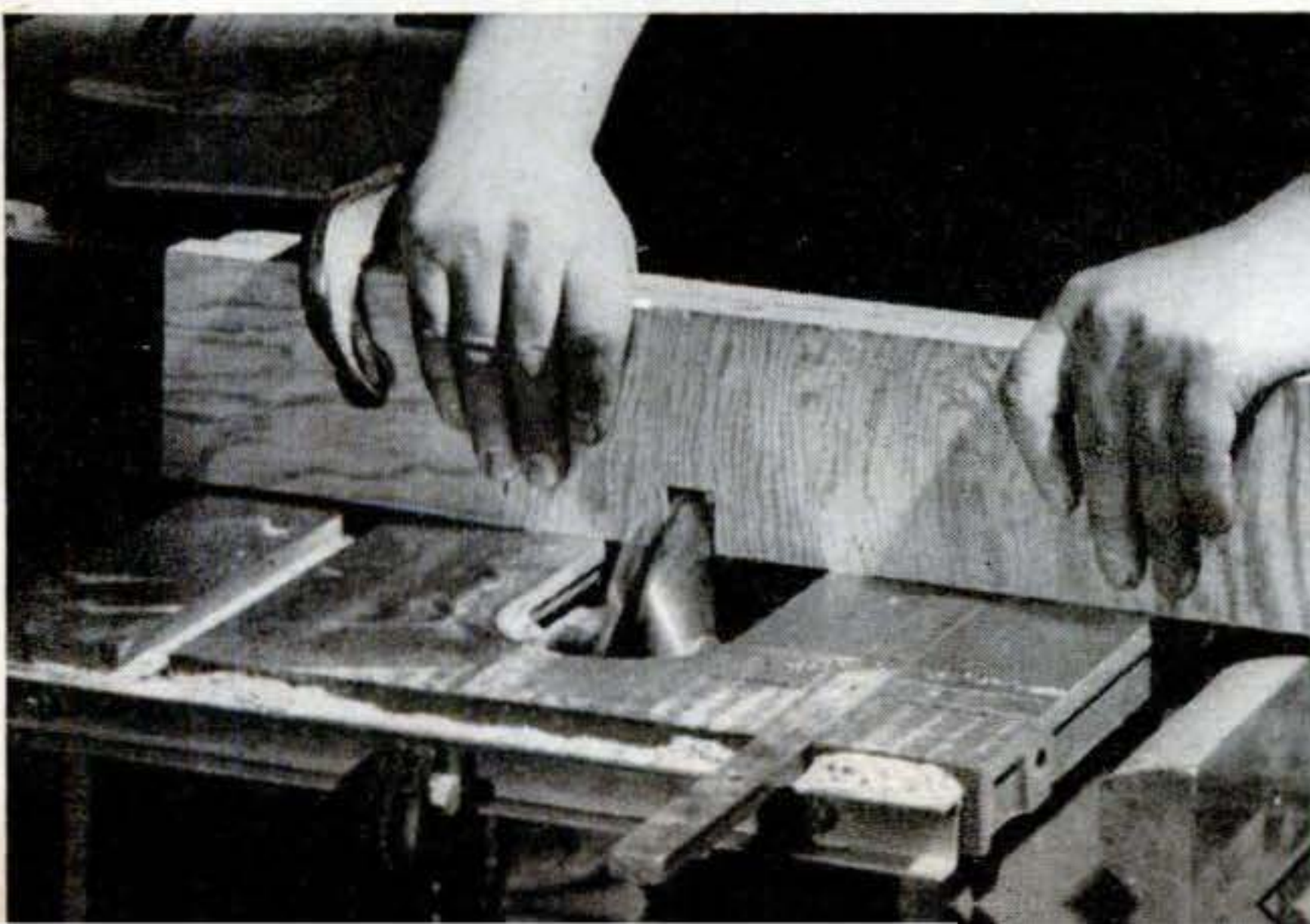
**5** DADO HEAD FOR CUTTING NOTCHES must be slightly wider than planks are thick. Pieces of paper between the cutters will permit you to make fine adjustments of width. No matter how accurately you think you measure, make a trial notch on scrap before starting.



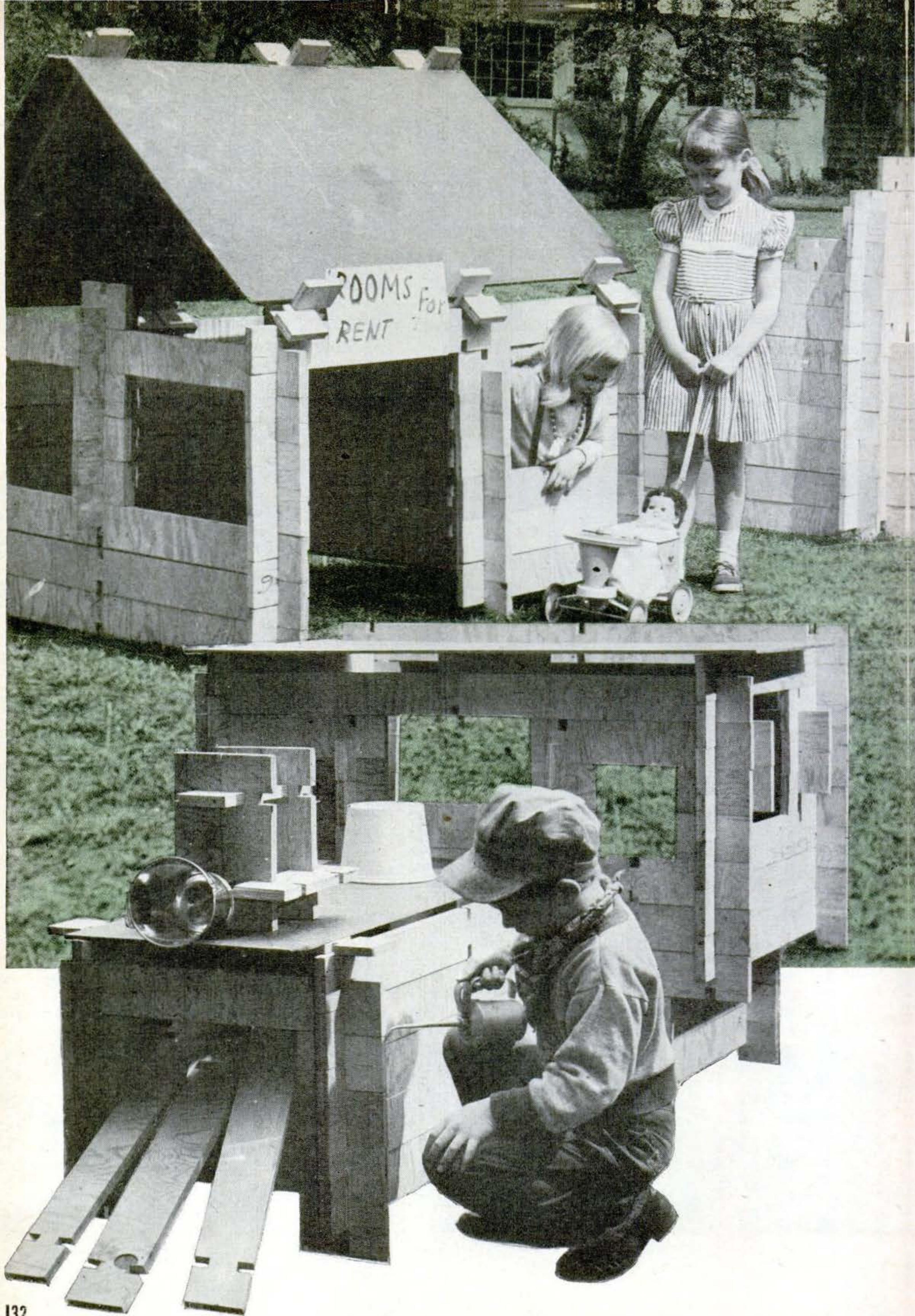
**6** HEIGHT OF DADO HEAD above table should be exactly the depth of the desired notch - 1". Make sure you measure directly above the saw spindle, where the blade tips are highest. And remember to lock the height adjustment in place so it doesn't shift.

**7** IN CUTTING NOTCHES, clamp a block against wood extension of miter gauge at the exact distance from cut that you want the notch to be from plank end. Then hold planks snug against block and you can be sure that distances from notch to end will be uniform.

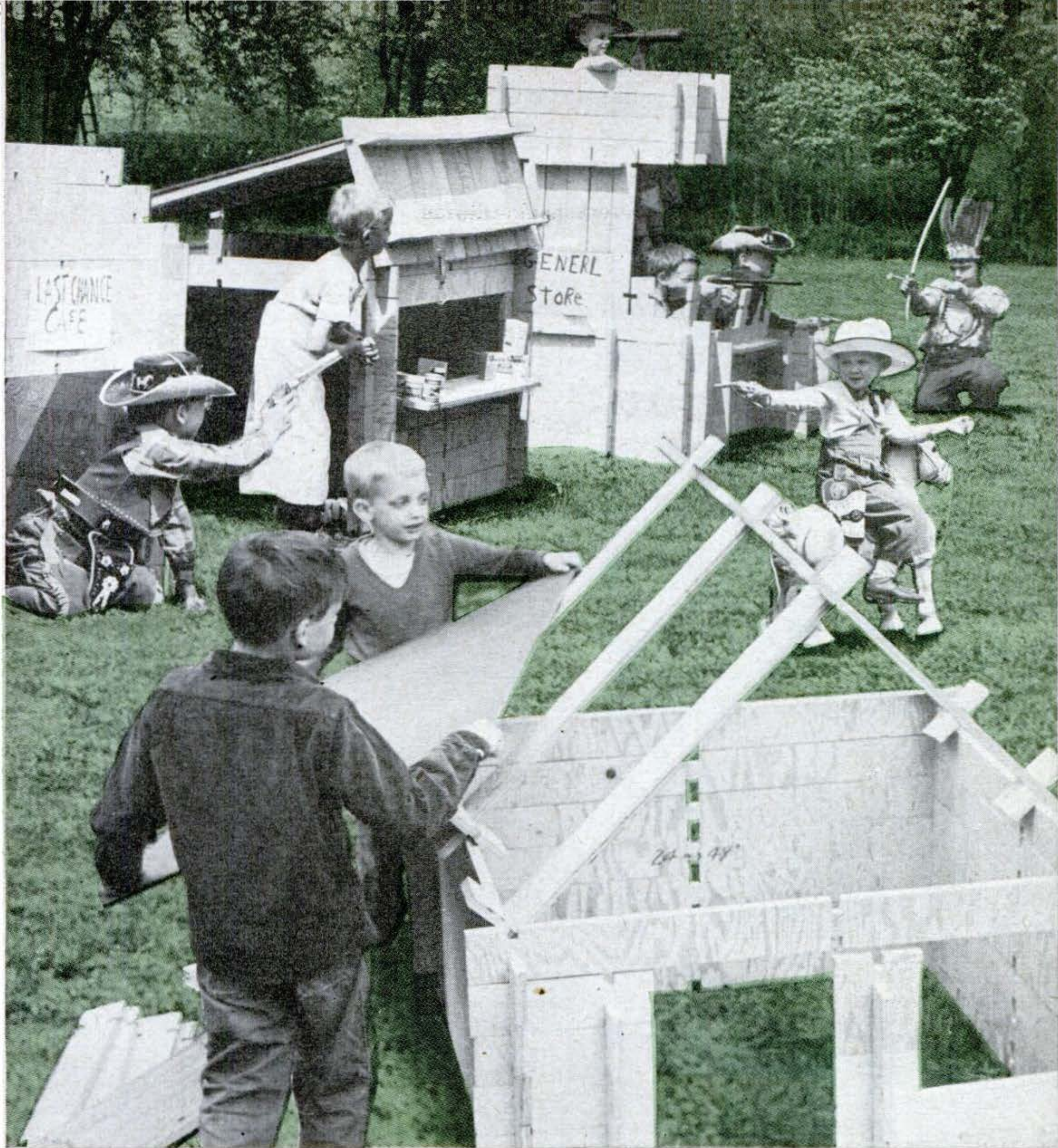
**8** IF PLANKS VARY IN LENGTH, jig must be used to keep distance between notches uniform in each set. Cut notches in one end of all pieces. Then when you notch other ends, line up each plank with master plank by piece of scrap through first notches.











the lumberyard to cut each 4'-by-8' sheet in half for you. If they don't provide this service, you'll have to do it yourself—and a  $\frac{3}{4}$ " sheet this size is heavy enough so you'll be glad to have help.

An alternate method is to rip the planks out of the full 8' length of the sheets. This requires only half as many rips, but makes you handle the awkward full-length sheets repeatedly.

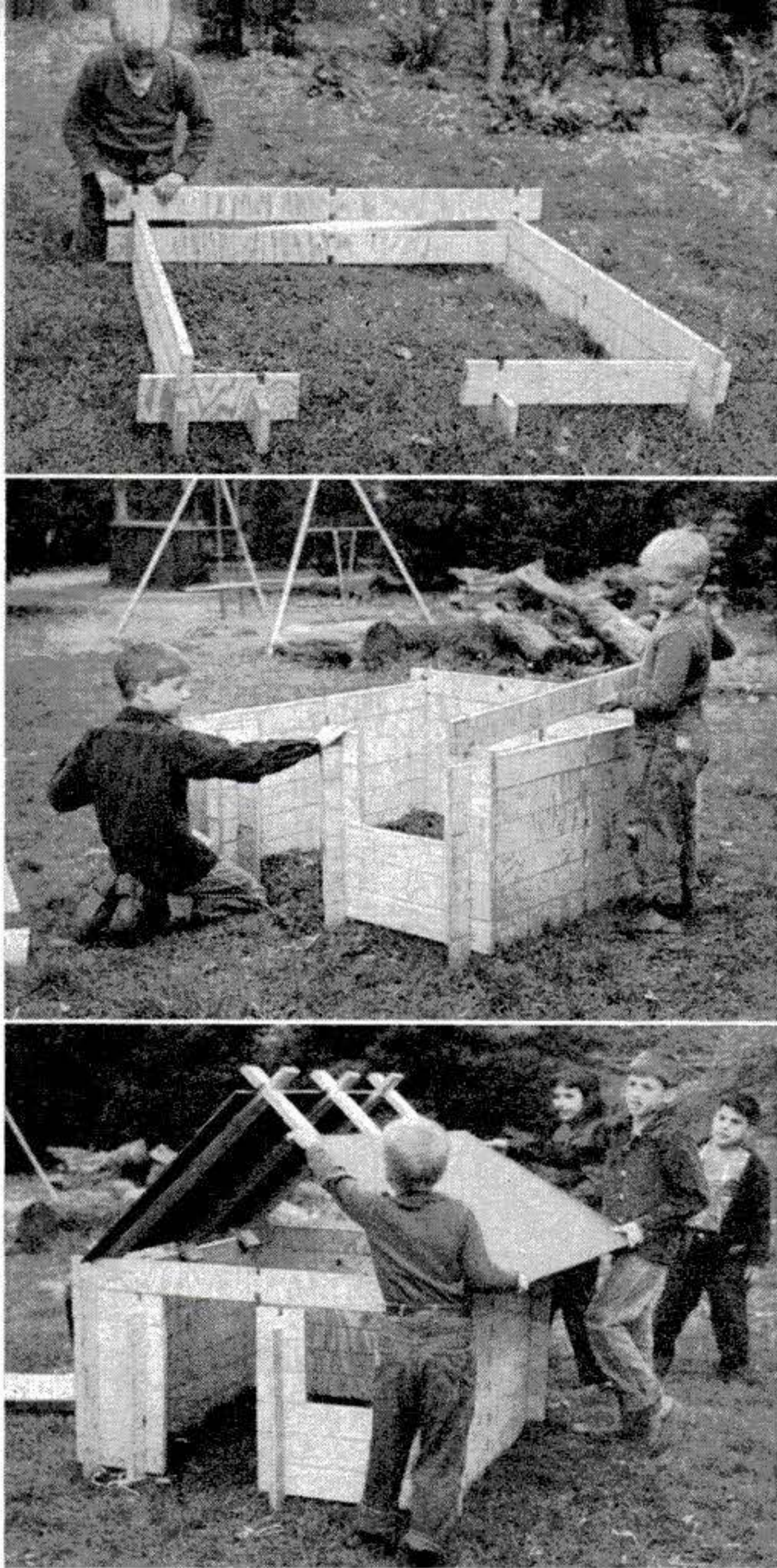
With the sheets halved to 4' by 4' you can probably rip the planks by yourself. Make the cuts across the original 4' width of the sheet. Then if you wavered a little

in cutting the sheet in half it won't result in planks of varying lengths.

If you're a beginner, you'll find it harder than it looks to turn out an even plank. If the irregularity is too great, you can set the saw fence for the width of the narrowest plank and push the others through again to make them match. But don't worry too much if your planks vary slightly in width. It won't affect their fitting together.

**Cutting the lengths.** You'll find it easier to end up with the right number of planks if you go about it methodically. You start with 84 planks 4' long. Put aside





**PLAYHOUSE** goes up quickly—and teaches kids to cooperate. Note how 6" pieces are used around doors and windows. Rafters for roof pieces have 6" pieces notched across lower ends so they can rest on upper edge of wall.

two dozen that will stay that length. Set your saw fence at 2' and cut 54 two-footers. Put aside 24 of these. Set your fence at 12" and cut a foot off two dozen 4' pieces. This will give you your 36" planks and part of your 1' set at the same time. Cut six two-footers in half to make the other dozen one-footers needed.

Now set the fence at 6" for the final cut. Running two dozen two-footers through will give you your 18" planks and half your 6" ones. For the rest of the 6" planks you can cut up three more four-footers. You'll have six extra 4' lengths left at the end.

**Notching.** All pieces have notches one inch deep, cut  $2\frac{3}{8}$ " from each end. In addition, the 4' planks have notches midway between the ends. The notches should be

slightly wider than the thickness of the plywood you're using. But remember that it's a lot easier to make the notches bigger later for easier fitting, than smaller if they're too loose. Sets for small children should fit fairly loosely so they can put them together easily. Those for bigger kids can be made tighter to provide greater rigidity.

The one critical dimension in the whole set is the distance between the notches. If this varies even a little from plank to plank the pieces won't fit together. If your planks of each size are all exactly the same length, making the notches the same distance in from each end will work fine. But if your planks vary slightly in over-all length, use the jig shown in the accompanying pictures to keep the notch distance uniform.

Clamping a bundle of planks together will let you notch a lot at the same time—but you may find that any timesaving is eaten up by clamping and unclamping. Whichever way you do it, you'll want a wooden extension on your miter-gauge head to help hold the planks in place. This also keeps the back edges of the notch from splintering as the dado head bites through. Be sure the notch in the backing is no higher than the notch you're going to make.

**Finishing.** You'll want to sand the planks to remove rough edges. Edge holes, left by knots in the core layers of plywood, should be plugged with composition wood so water doesn't gather in them. It's also a good idea to varnish or paint the planks for long life outdoors, but you'll have to sand the notches wider first or they'll jam. Incidentally, wax in the notches will help fitting.

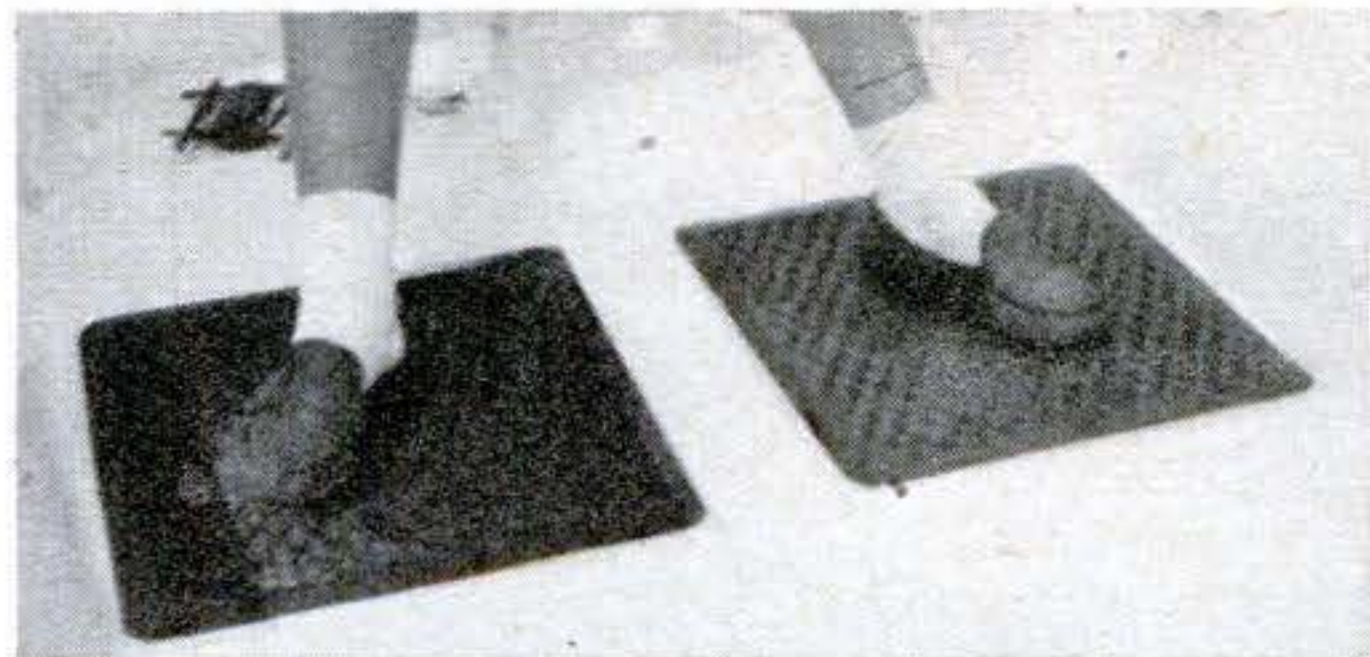
Once the kids have succeeded in getting the pieces away from you, they'll turn out some astonishing structures. But of course father has to help out with a little creative imagination. Personally, I'm proudest of the little combination of a frontier blockhouse and Italian villa I ran up the other weekend. But if I can only keep the kids from sneaking away the planks I'm sure that next Saturday I can do even better. Just let me show you. You see you take four four-footers like this, and . . .

Look out, it's catching. And after all why should the kids have all the fun—especially when they're not really old enough to appreciate it?

END

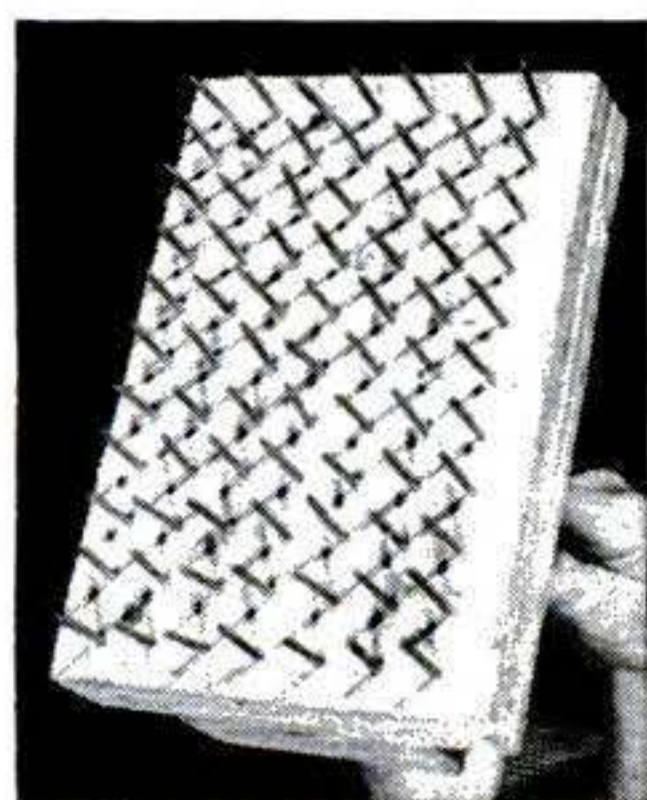


## Car Mats Make Boat Pads



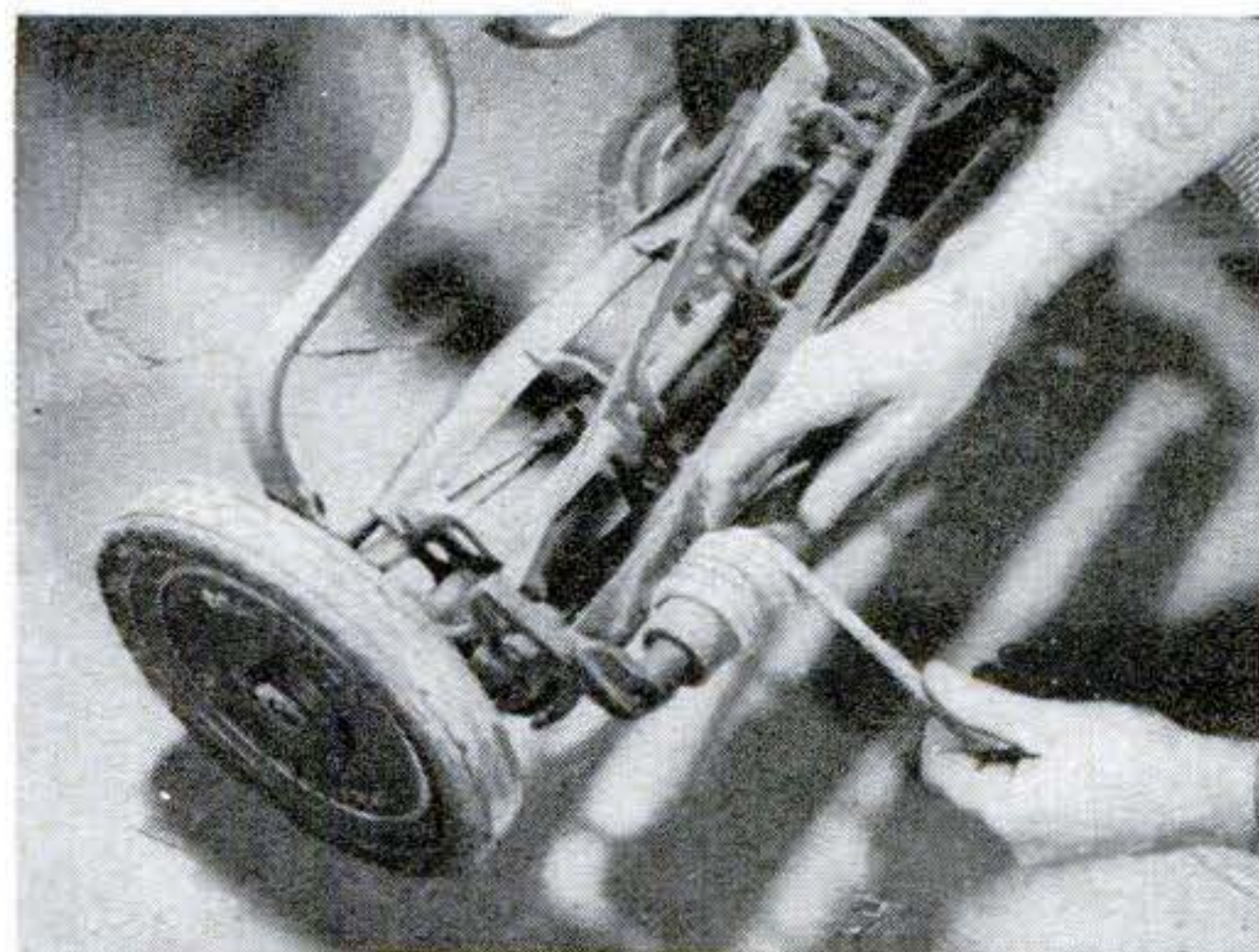
Two inexpensive rubber car mats on the floor of your rowboat will protect the paint and provide a nonslip surface for your feet while rowing. Rubber cement on each corner of the mats will keep them in place.—*R. M. Woodbury, Natick, Mass.*

## Lawn Aerator Sets Grass Seed



A LAWN aerator, quickly made by driving nails through a board, will help set newly sown grass seed and keep it from blowing or washing away. The seed is spread evenly and the ground tamped with the aerator. A light sprinkling then washes the seed into the hundreds of tiny holes where it is safe from birds, wind and rain.

## Rope Helps Cut Grass High

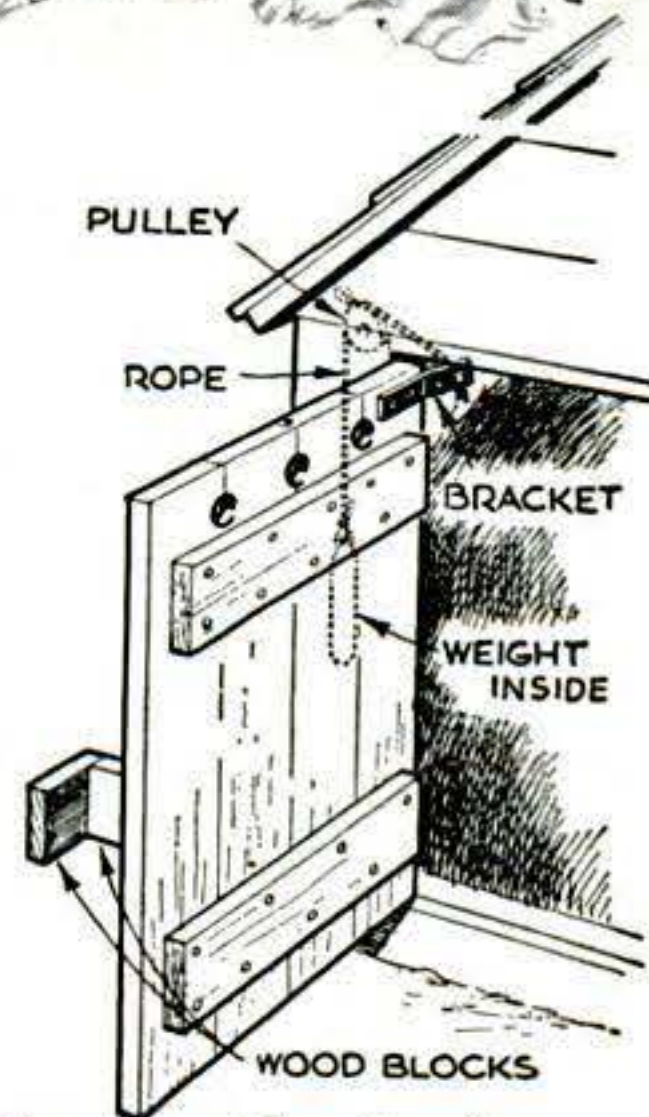


A LENGTH of clothesline wrapped around the roller of your lawn mower will enlarge its diameter, permitting you to cut the grass extra high during the hot midsummer months. This will keep the roots shaded so that the sun can't burn out the lawn. Wire staples, driven into the roller at intervals, will hold the clothesline in place.—*Floyd McGuckin, Ridgewood, N. J.*

## Dog Opens Door Himself



OUR cocker spaniel just nudges the door of his house with his nose when he wants to get out of the rain—two wood blocks mounted at right angles make it easy for him. On the inside edge of the door I fastened a flattened angle bracket. A length of rope is attached to the bracket, then passed over a pulley inside the house. I weighted the free end of the rope to make the door swing easily on its hinges.—*John J. Rea, Urbana, Ill.*



## Initials Identify Beach Toys



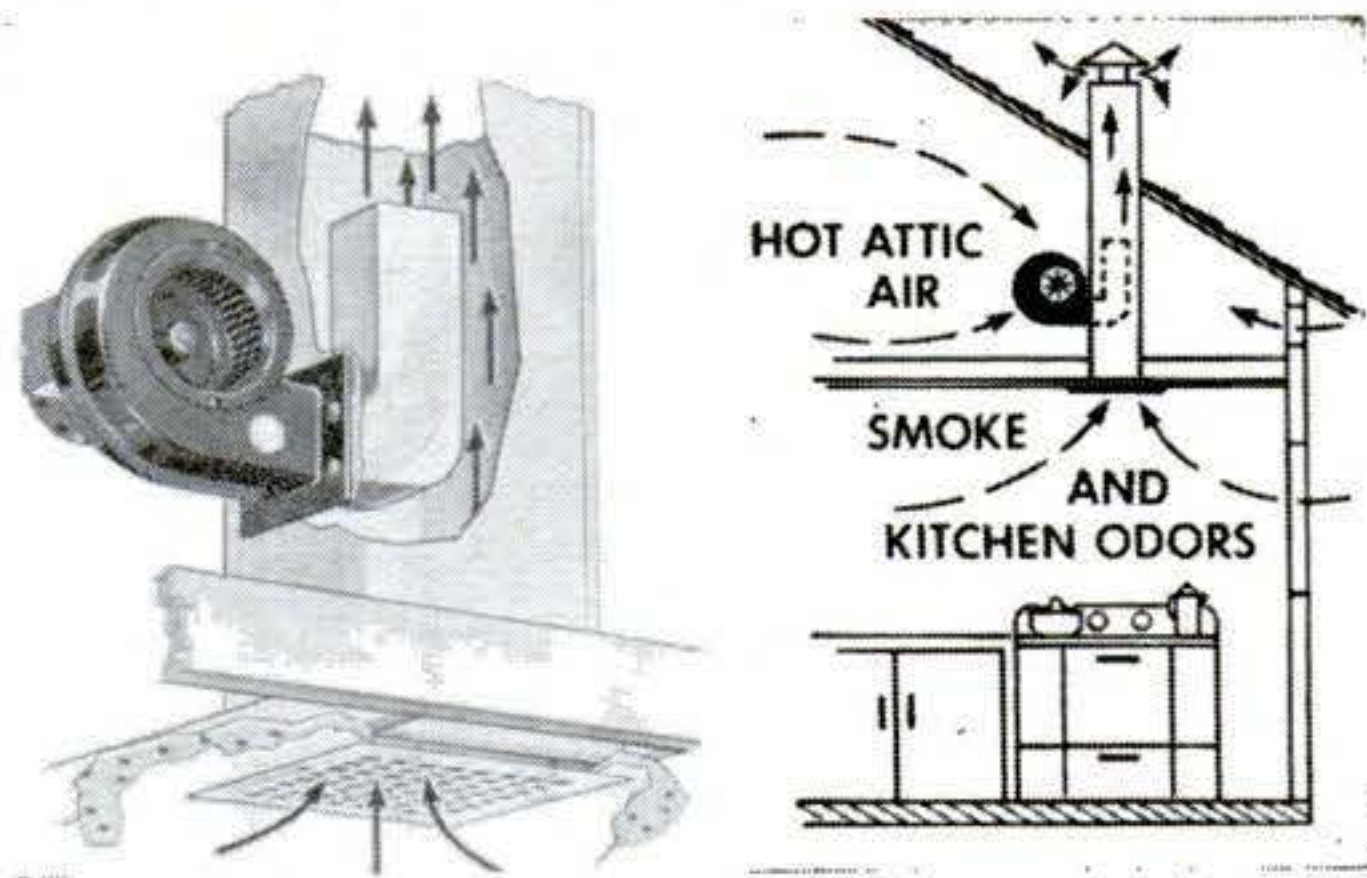
TEARS and tempers will be saved at the beach if you identify the children's water toys so that there can't be any argument over what belongs to whom. It is easy to do with a patching kit. Just cut initials out of a patch and cement them to the toy.—*Will Thomas, Buffalo.*



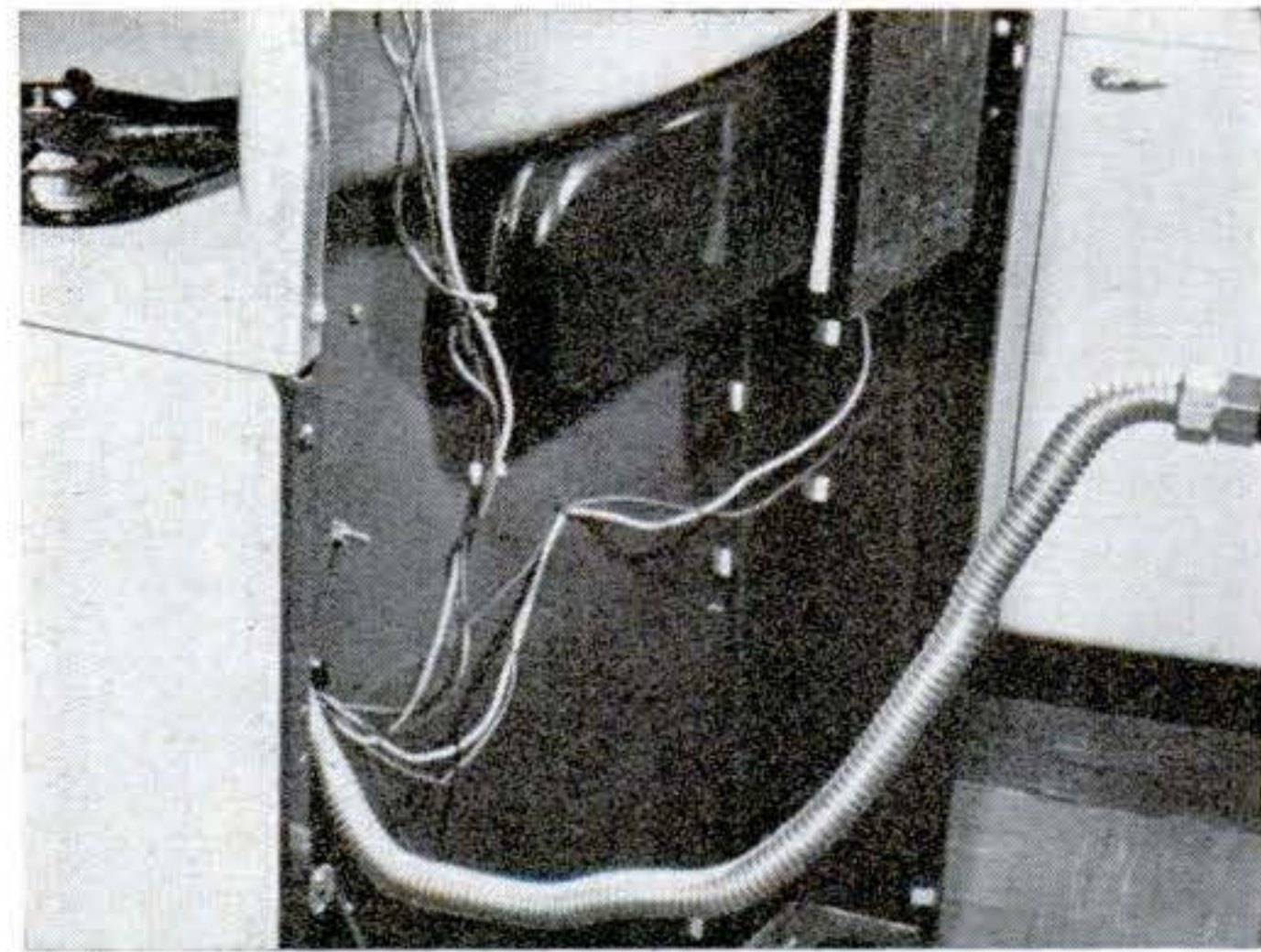
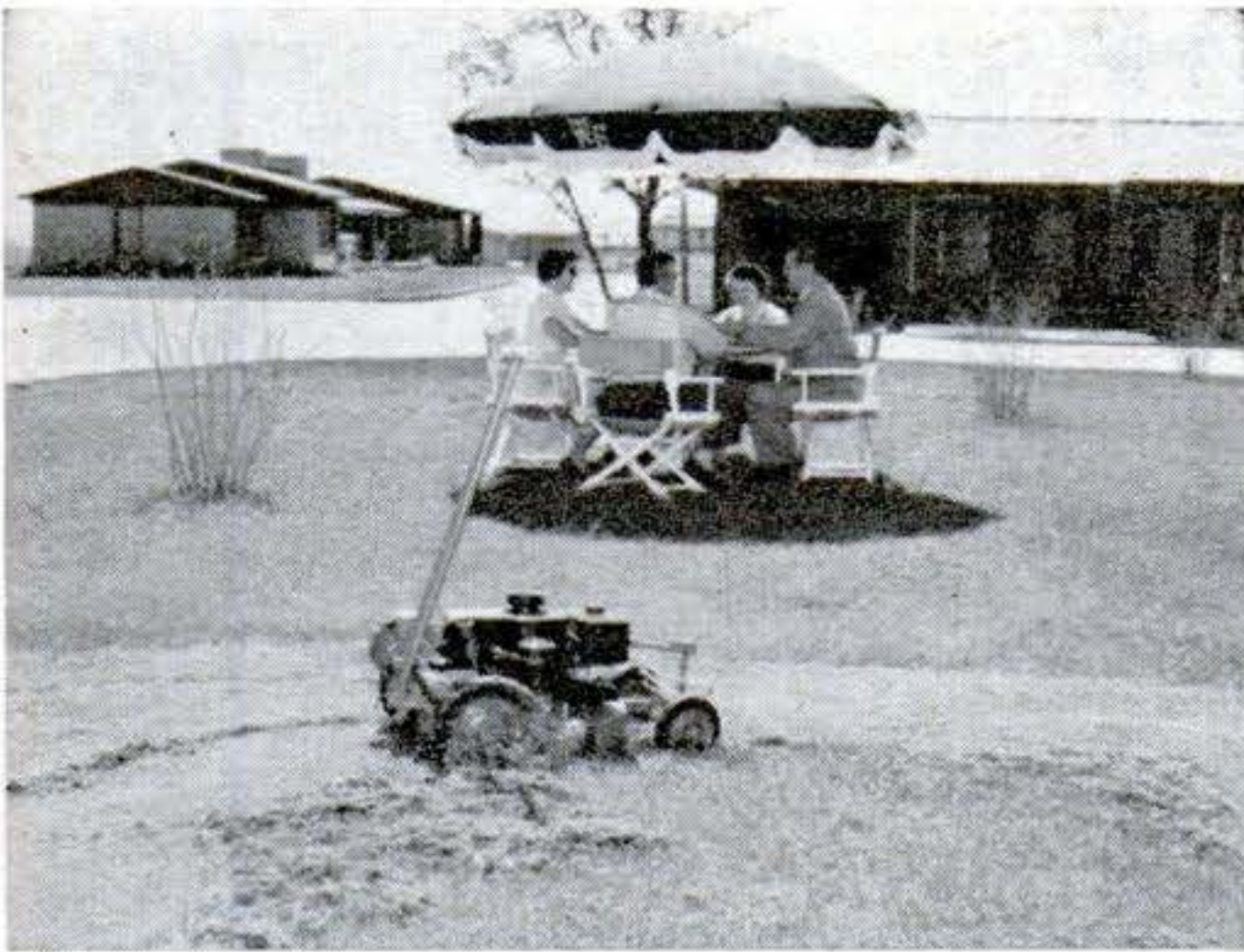


# New for the Handy Man

**1. Fancy Fans Cool House.** The chimney above blows air instead of smoke. Housing an exhaust fan, it draws hot air from the center of an attic instead of one end, providing more even cooling of the entire house. It's also said to permit a small ceiling louver in each room instead of one big central opening that's harder to frame. The housing fits between standard-spaced rafters (right above), can be cut to any roof pitch and has built-in drains. Louvers open when the fan is on and close when it's off, making a watertight seal. The fan at right exhausts hot attic air and kitchen odors at the same time. Installed in any new or existing ventilating duct that's 6" or larger, it pulls attic



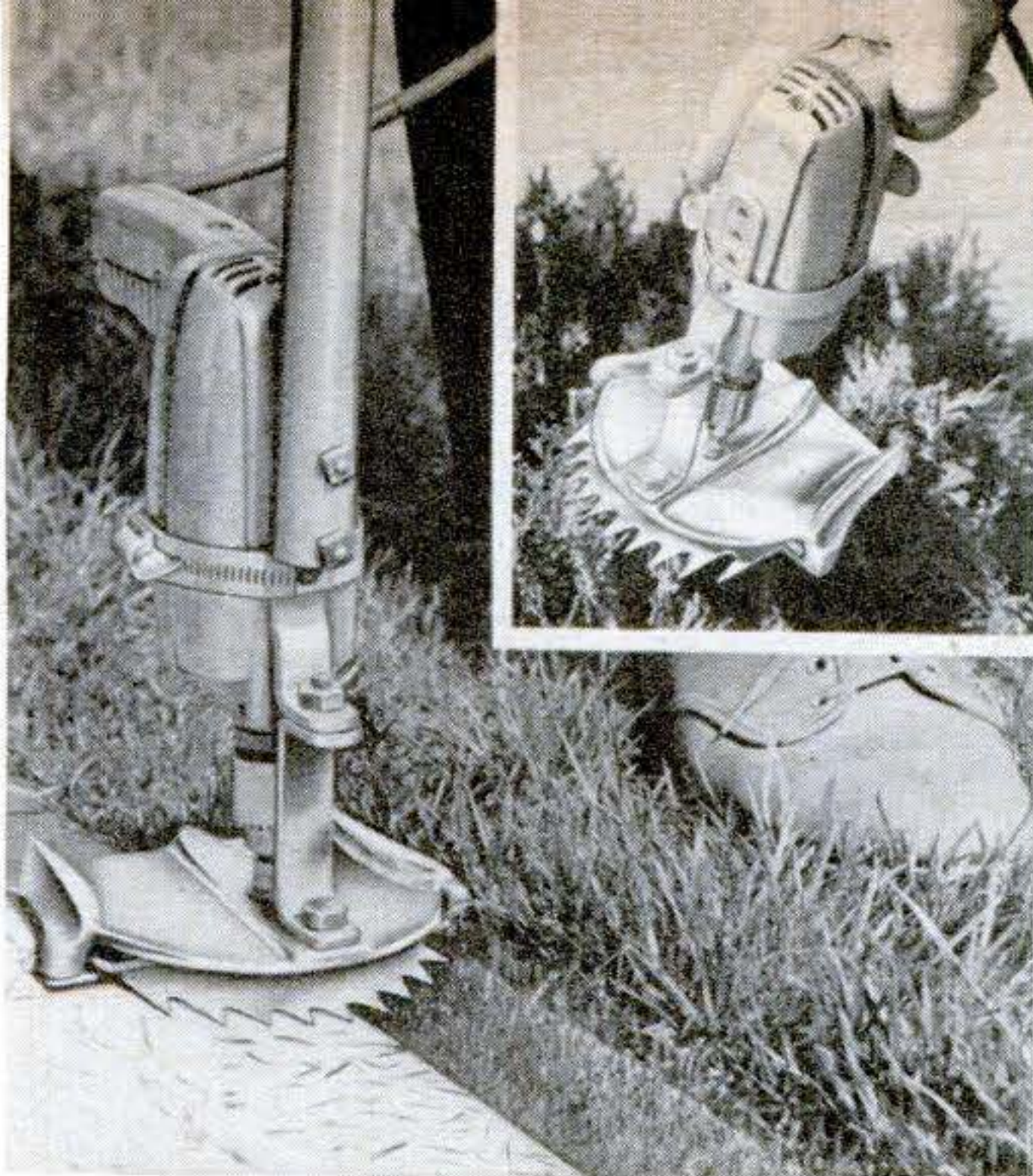
air in through the blower and creates an updraft that draws out cooking smoke from below. The fan can move 2,000 cubic feet per minute.



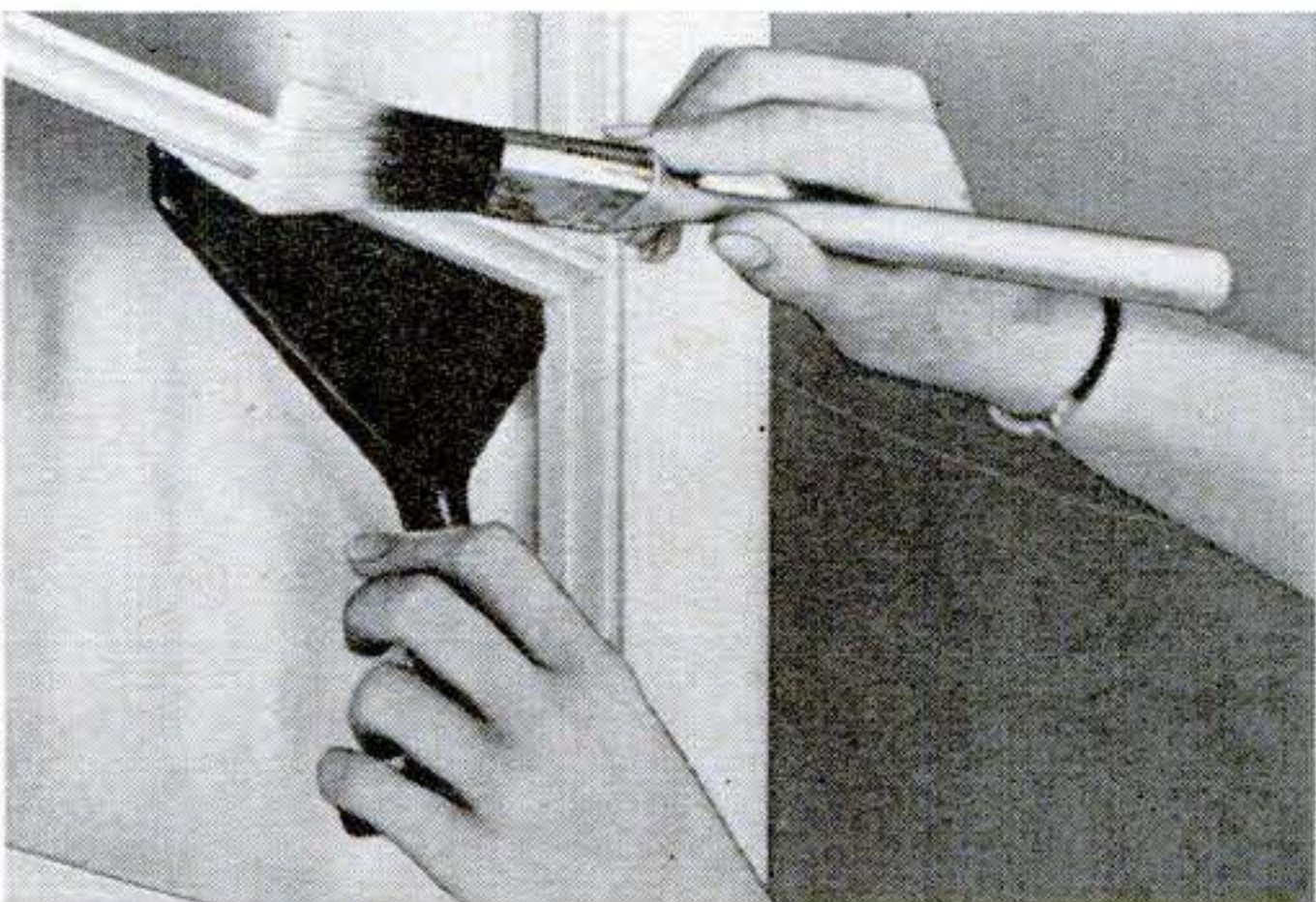
**2. Robot Mower Follows Grass.** Just start this mower around your lawn and you can concentrate on the card game. The mower will continue on by itself, following the uncut grass with a feeler bar on the front. Cuttings are thrown to one side so they are recut into a fine mulch that need not be raked. When all the grass is cut, you'll have to put down your cards long enough to turn the gasoline-powered mower off.

**3. Flexible Pipe Connects Range.** This flexible brass hose lets you move a range out from the wall for easy cleaning behind it without disconnecting the gas line. It moves several feet in any direction without danger of kinks or leaks, also making it possible to rearrange kitchen appliances without altering the plumbing. The hose has threaded ends so that it can be attached to standard pipe connections with a wrench.

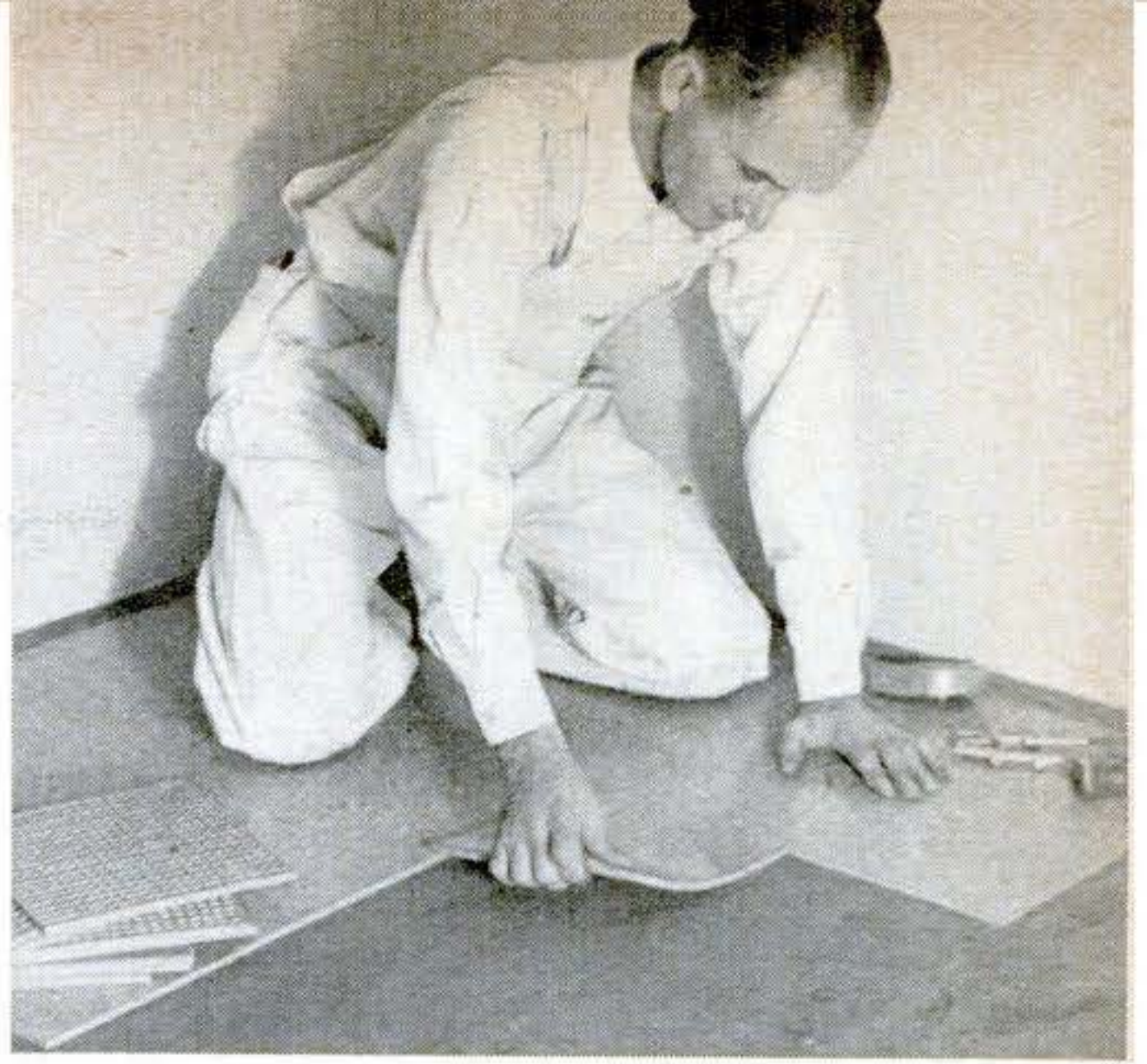




**4. Lawn Edger Fits Drill.** Any  $\frac{1}{4}$ " electric drill will power this grass-trimming attachment. The rotary blade is chucked in the drill and the cutter's frame clamped to the drill housing with a metal strap. The drill can be held in the hand for trimming hedges and bushes (inset) or a handle attached for use as a lawn edger. A toothed guard picks up grass ends so they can be easily cut and also prevents the blade from being damaged by stones.



**6. Paint Guide Can't Smear.** You can slide this painting guide right along a window sash without wiping it clean after each stroke. Tiny pads under the plastic blade raise it slightly, preventing adhesion that often draws paint under the edge and onto the glass. The blade also has a slight curve in it that flattens out when pressed against the sash, then snaps back when the blade is released, making a quick, clean break that keeps paint from smearing.



**5. Floor Tile Needs No Cement.** You can put these plastic tiles right down over a wood or concrete floor without adhesive or other fastening. Waffle-like pockets in the underside create suction that helps hold the tiles down and provide air spaces for added insulation. The tiles are also kept firmly in place by a slight wedging action between walls. Twice as thick as ordinary tiles, they are said to be 10 times as resilient. They come in 16 colors.

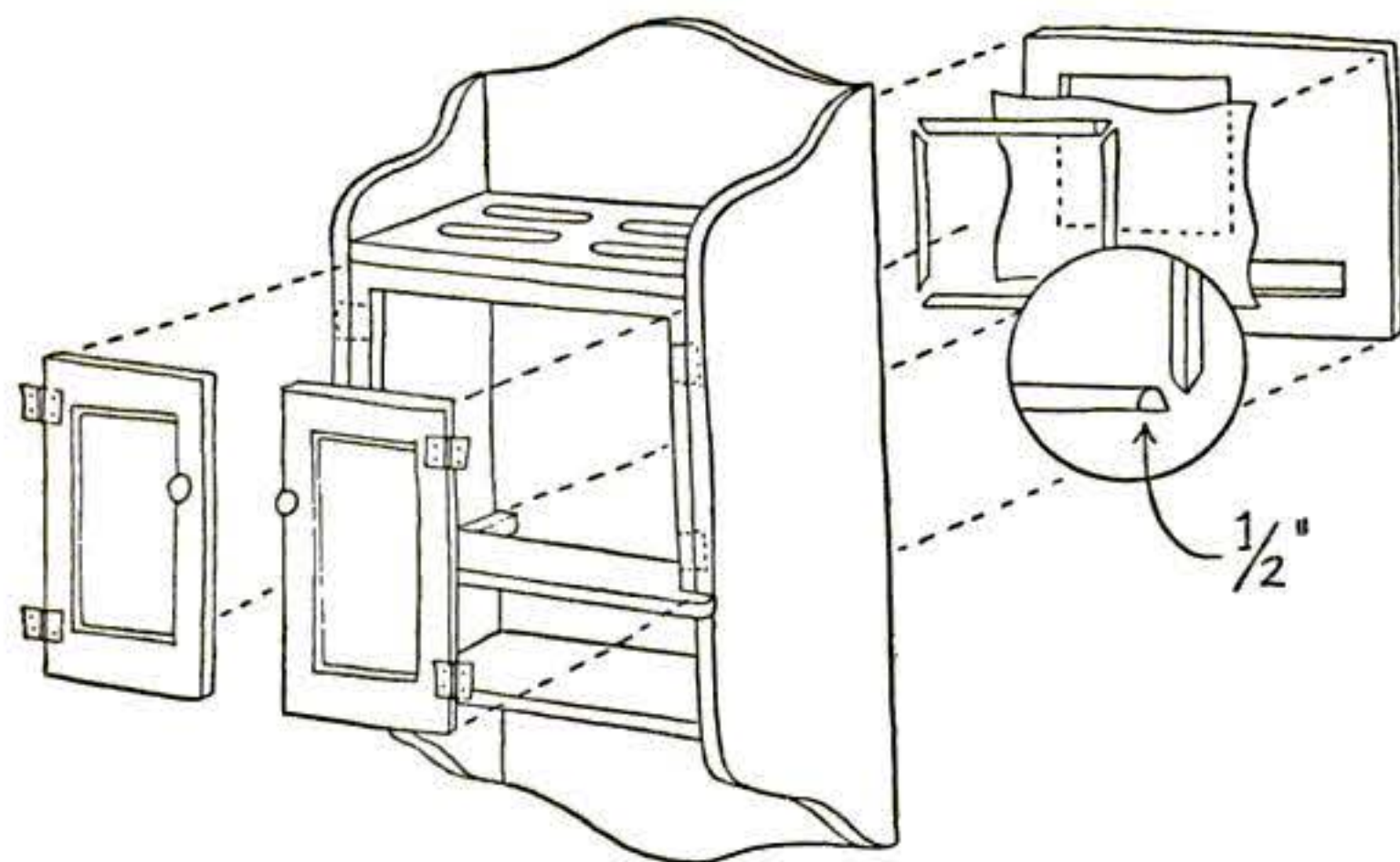
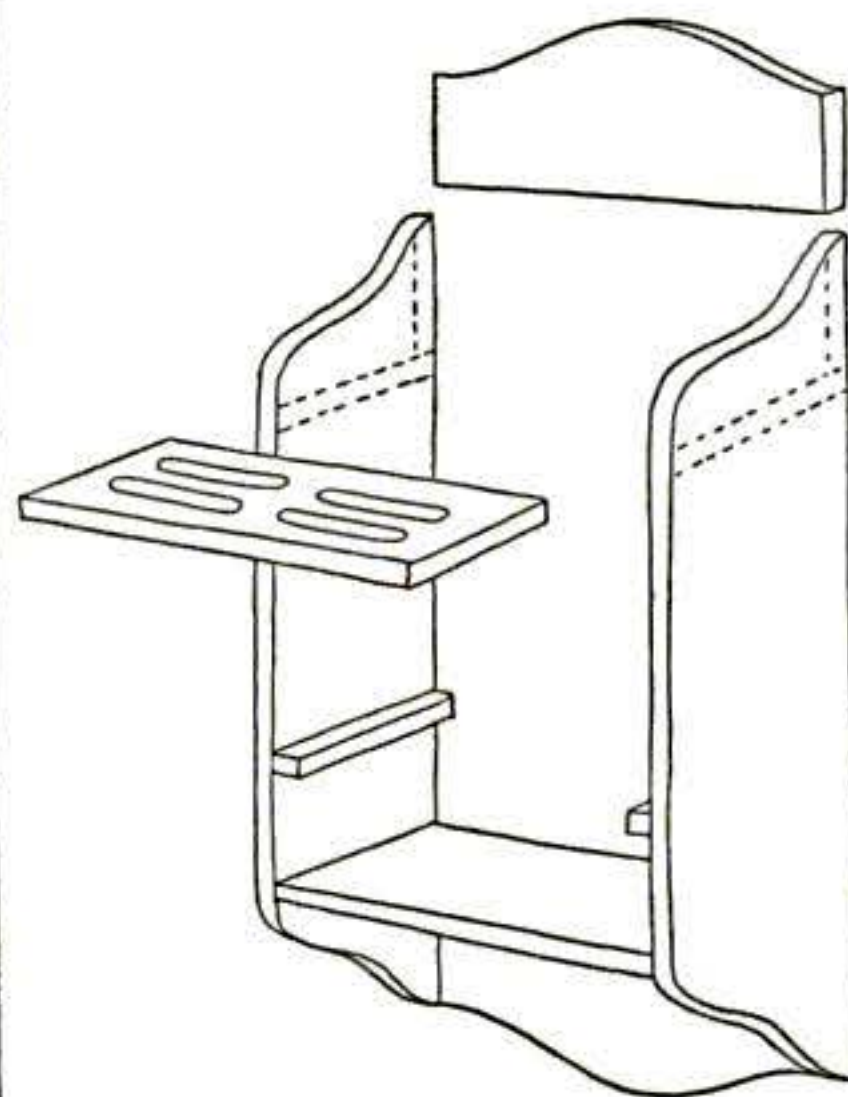
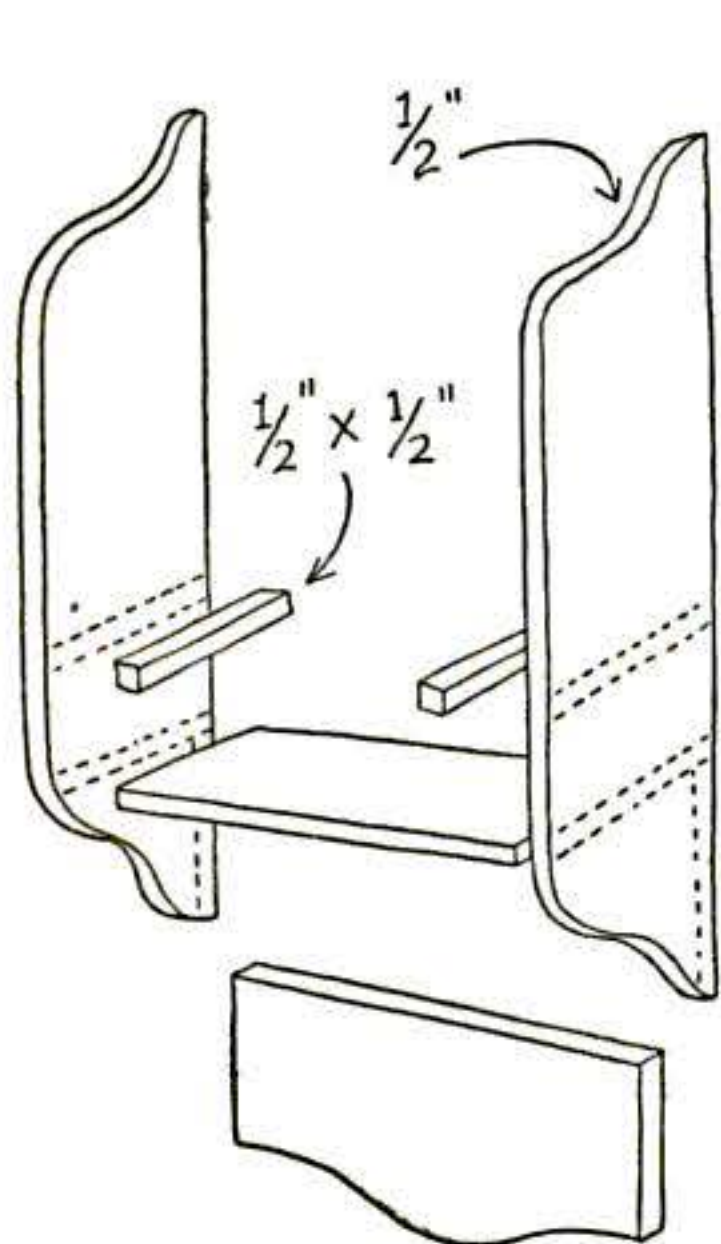


**7. Pavement Comes in a Bag.** You just empty out a bag of this ready-mixed asphalt, rake it out, roll it and you have a finished pavement in a few minutes. It requires no heating or mixing and can be laid directly on the ground for walks, terraces and tennis courts or over a gravel bed for driveways. The mixture comes in two grades, coarse and fine, and can also be used to patch or resurface old paving. Each 100-lb. bag covers eight square feet 1" thick.

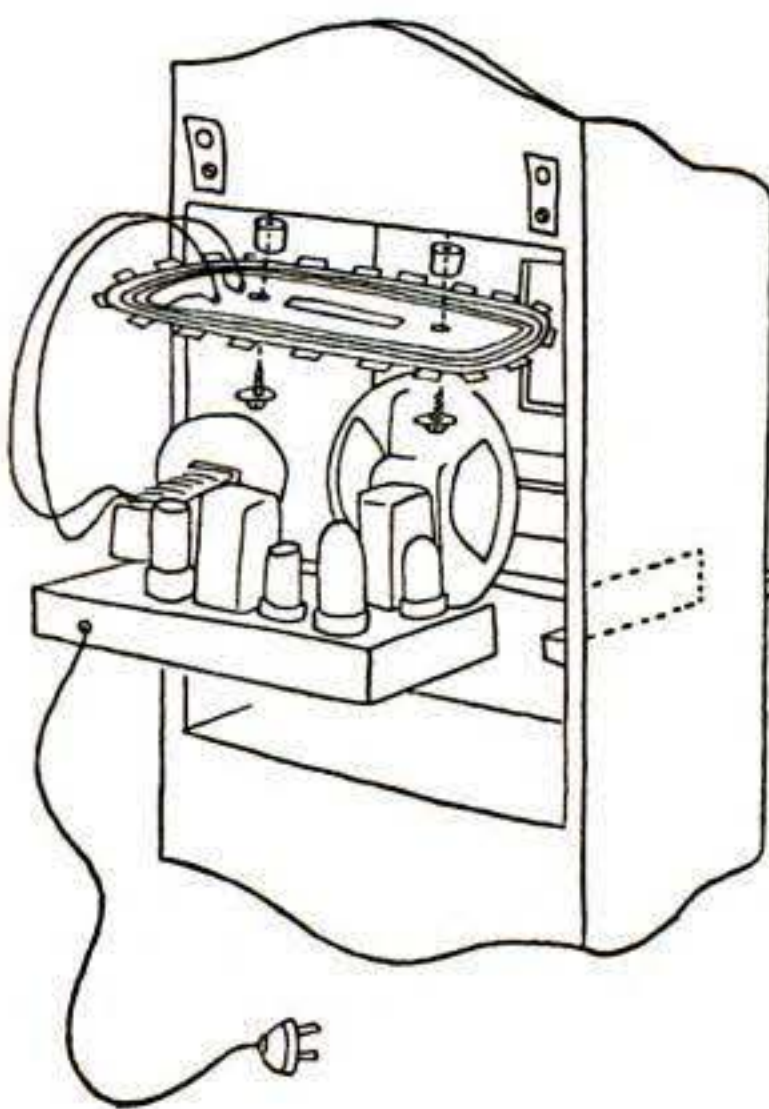
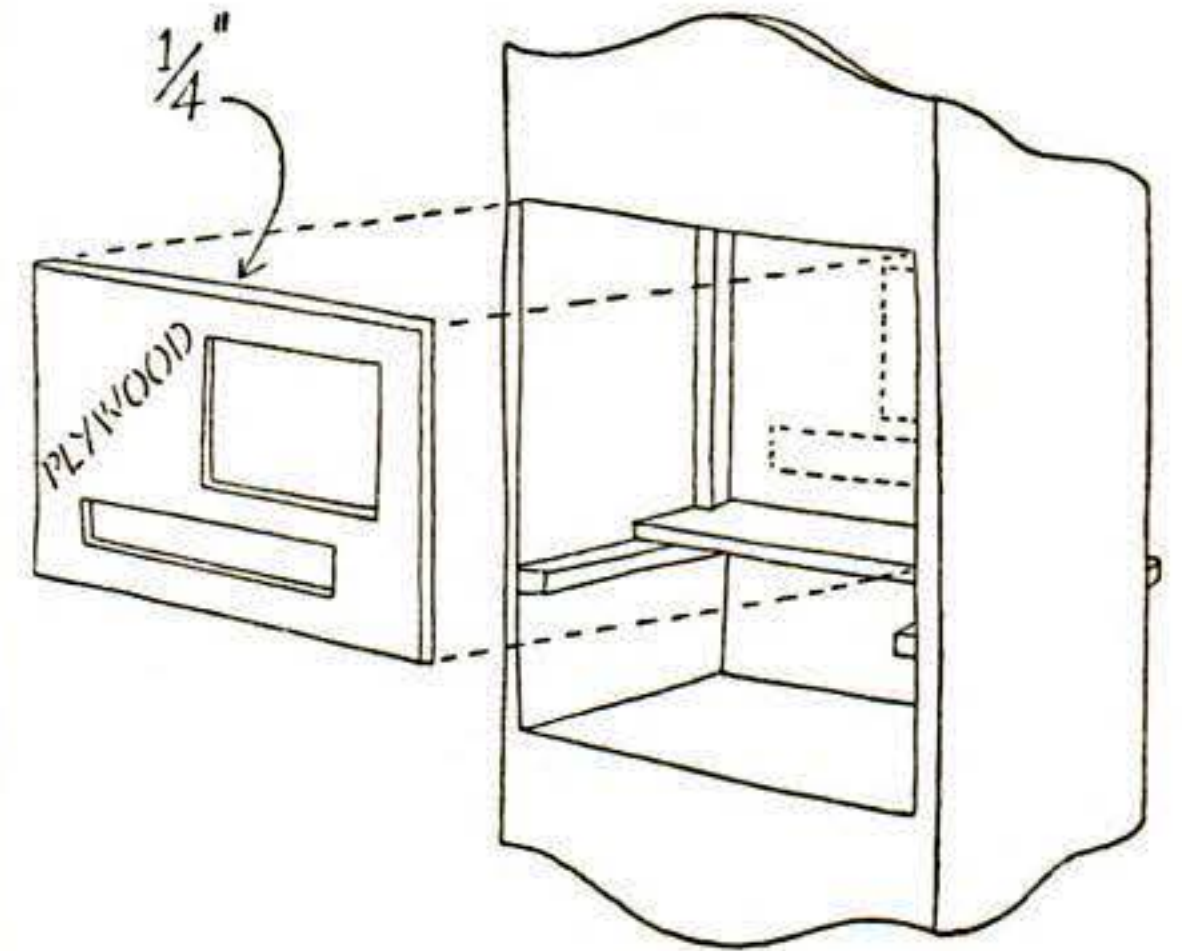
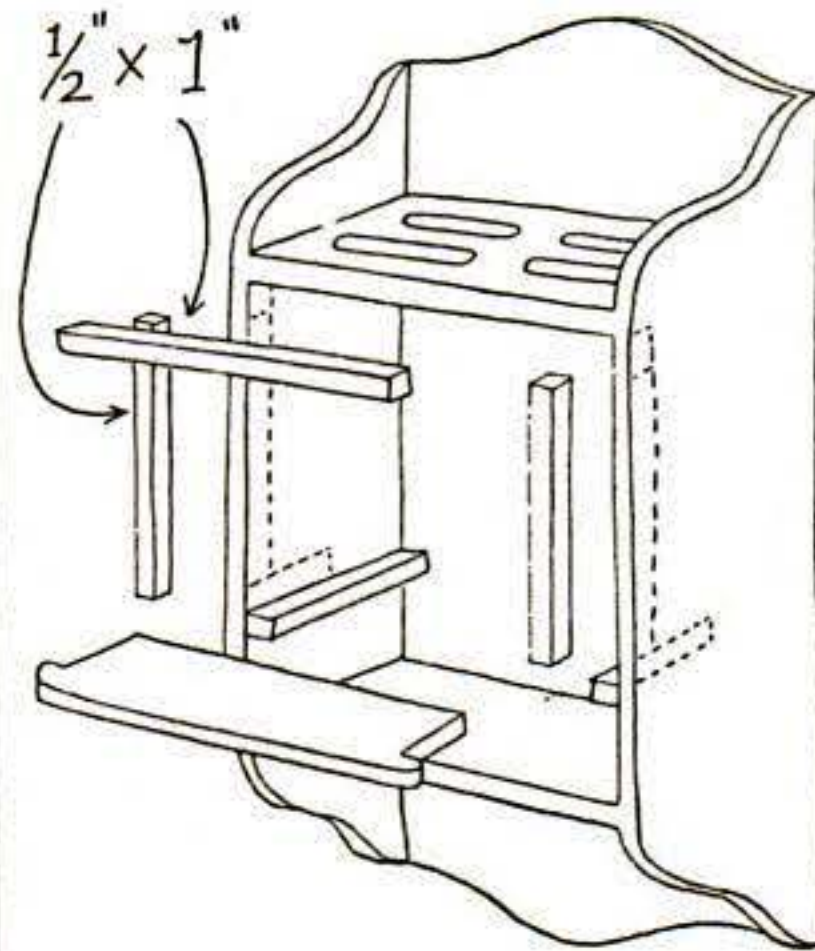
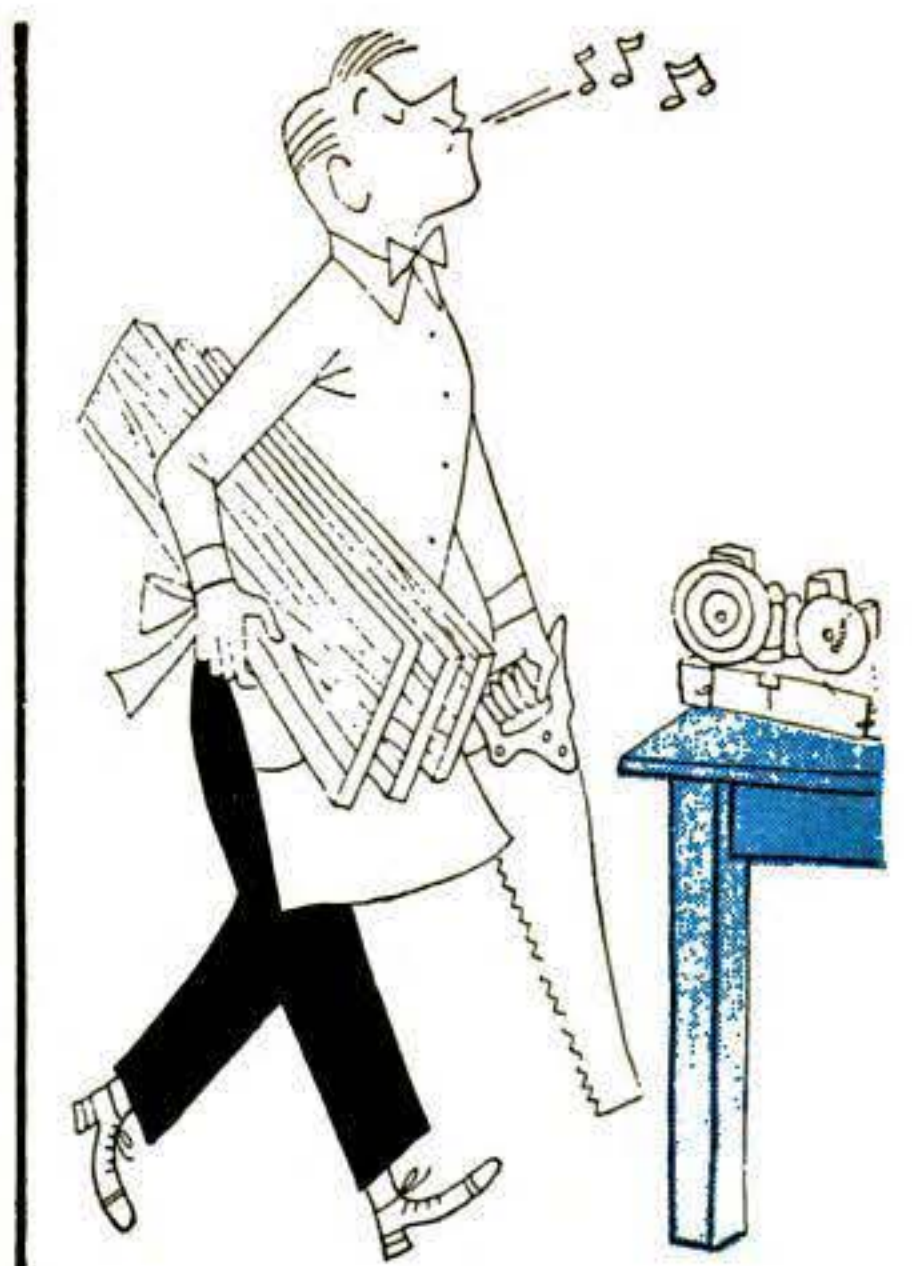
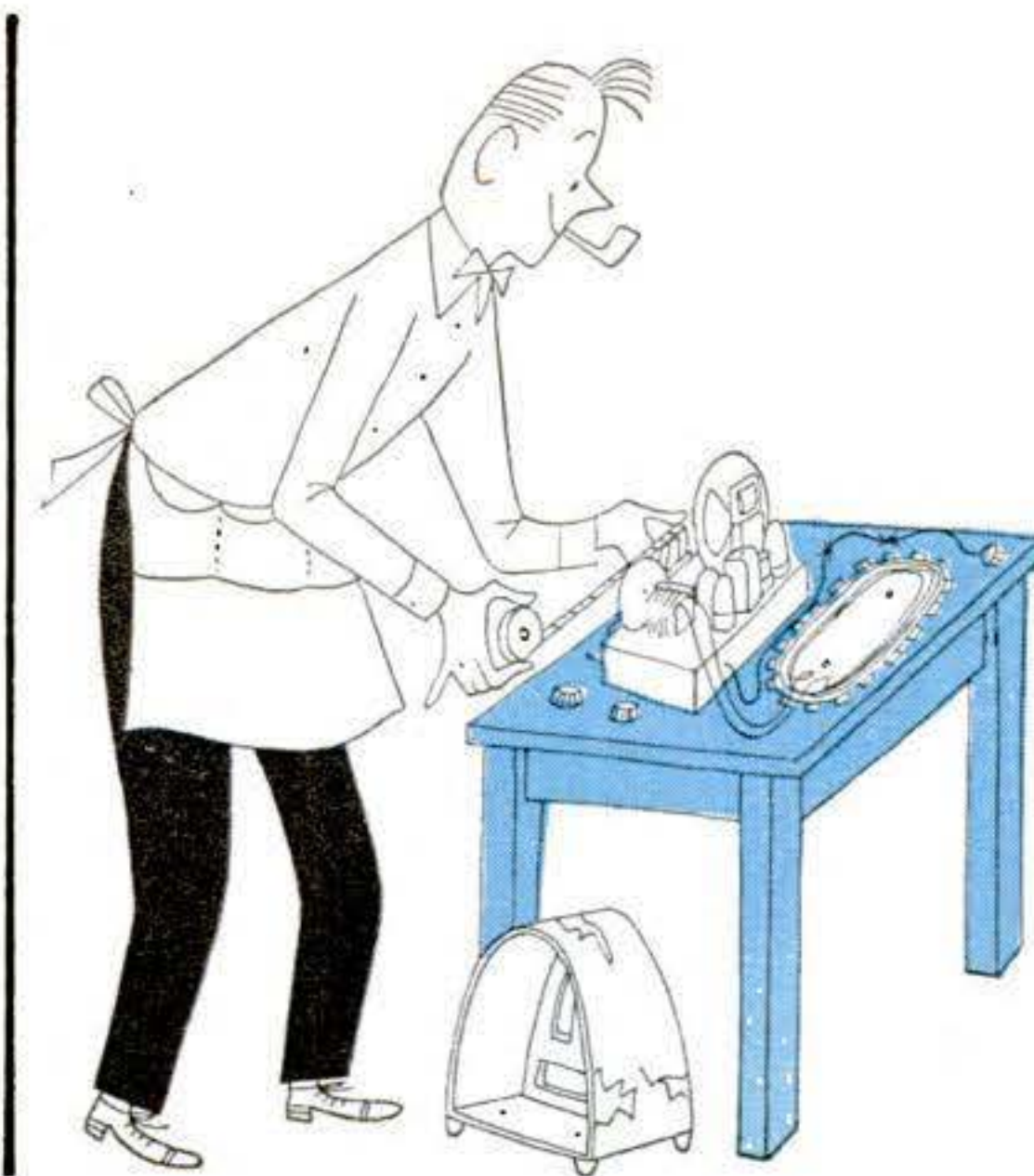
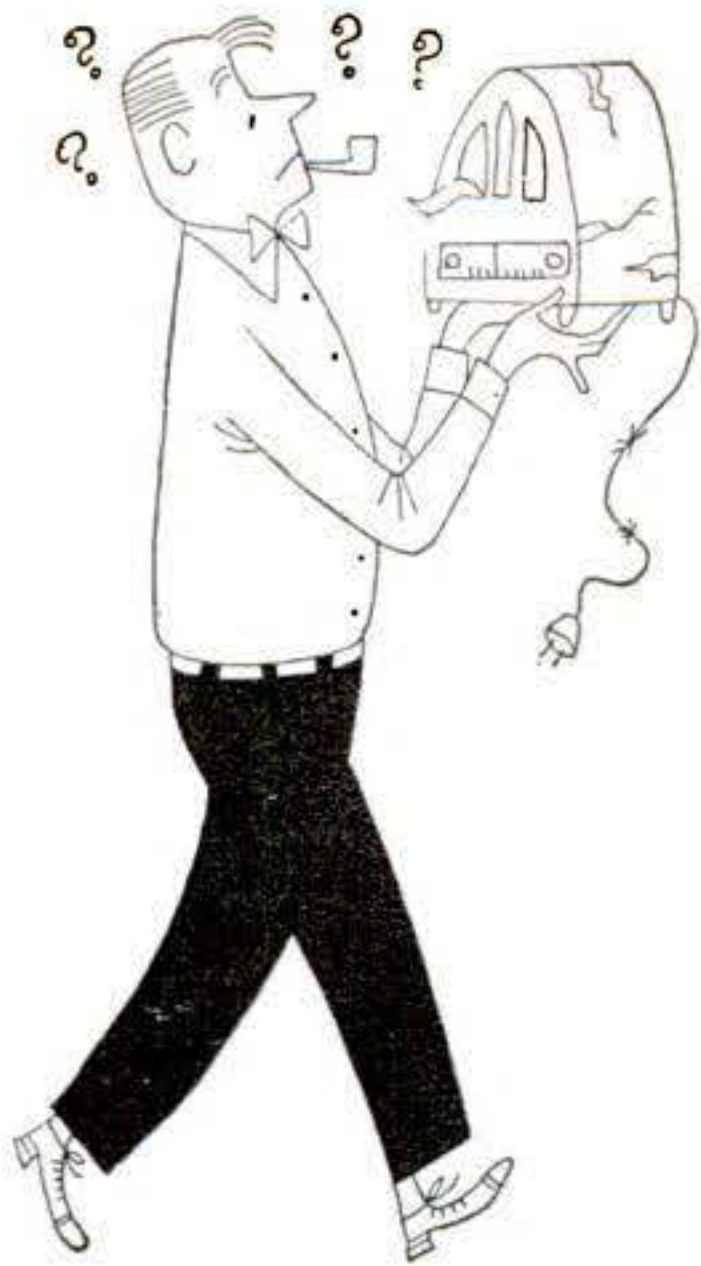
Further information on these products can be obtained from: 1. Loren Cook Co., 664 Front St., Berea, Ohio (chimney fan); Selectric Products Co., 2803 Los Flores Blvd., Lynwood, Calif. (attic-kitchen fan); 2. Fairbanks, Morse & Co., Fairbanks-Morse Bldg., Chicago 5; 3. Techniflex Corp., Port Jervis, N.Y.; 4. Bertram Engineering and Supply Co., 3125 Harrison, Kansas City, Mo.; 5. Robbins Floor Products, Inc., Tusculumbia, Ala.; 6. Thoss Mfg. Co., 206 W. Third St., North Manchester, Ind.; 7. Package Pavement Co., Carmel, N.Y.



# Wordless Workshop





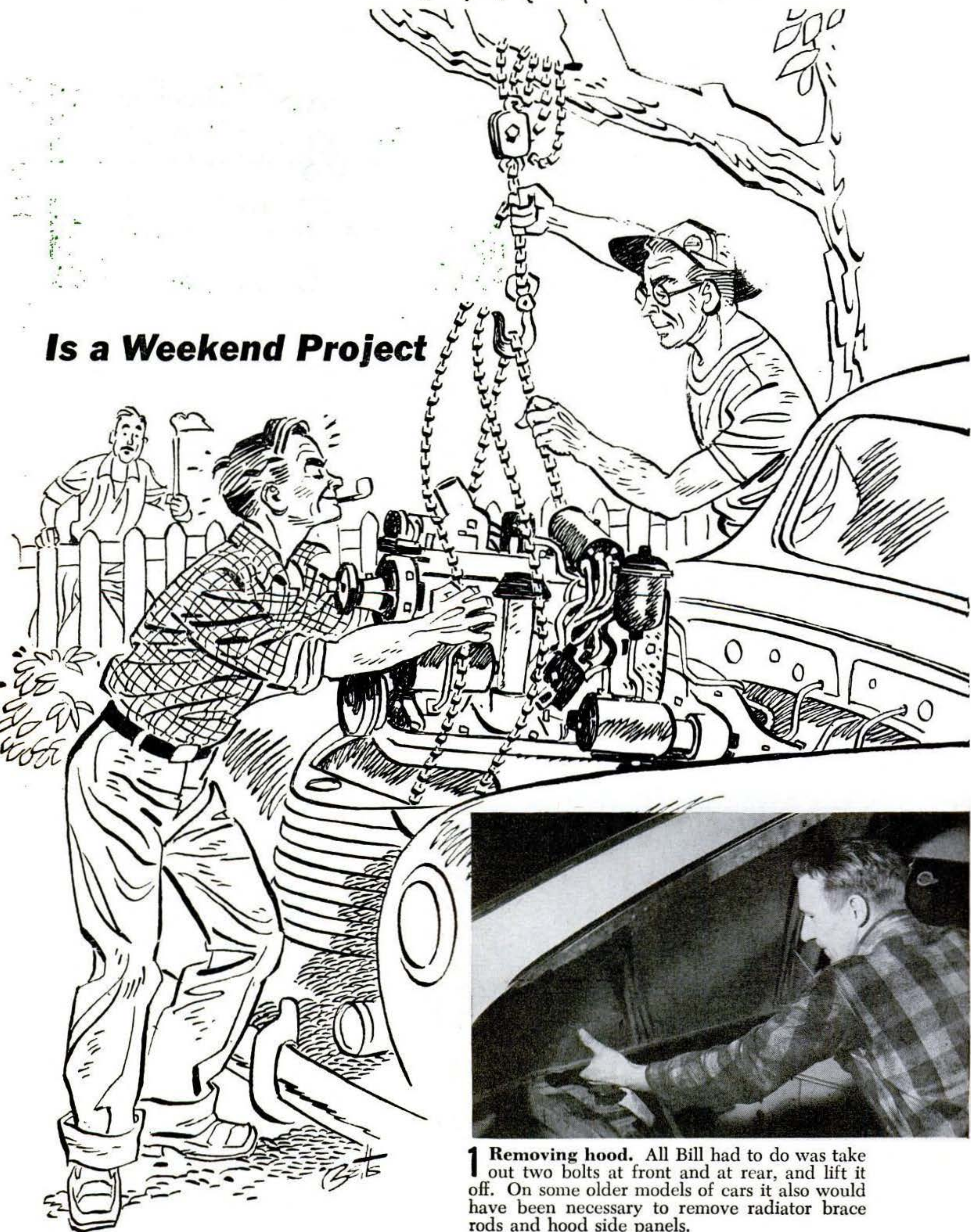


See PSM next month for another Wordless Workshop.



There's more to it than push-pull, click-click, but these

## Is a Weekend Project



**1 Removing hood.** All Bill had to do was take out two bolts at front and at rear, and lift it off. On some older models of cars it also would have been necessary to remove radiator brace rods and hood side panels.



*two amateur mechanics did the whole job in 24 man-hours.*

## **By Wesley S. Griswold**

**W**HEN an engine starts to grow old and tired, a lot of car owners nowadays order a rebuilt engine. Some of them install the engines themselves. It's not as easy as painting screens; on the other hand, it doesn't require a trained mechanic's know-how.

Take the example of William Ahlstrom of Dalton, Ill., the proud and careful owner of a 1947 Dodge sedan. A few weeks ago, when Bill's original engine had begun to show its age—57,492 miles—he ordered a rebuilt engine from Sears, Roebuck, which happens to sell more of them than any other company in the U.S.

### *Neighbor Helps*

The crated engine arrived on a Friday. By Sunday evening, after a total of 12 hours' work during the weekend, Bill and his helpful next-door neighbor, young Bernard Corbin, had the rebuilt engine in place and running, and the old engine bolted into the return crate to ship to Sears, Roebuck for \$23 credit.

They were no better mechanics than the average, though both had fooled around with cars ever since they had first owned one.

But they did have three special advantages: a two-car garage to work in, a small hydraulic jack and a professional-size

hoist, borrowed from a friend with a small trucking business.

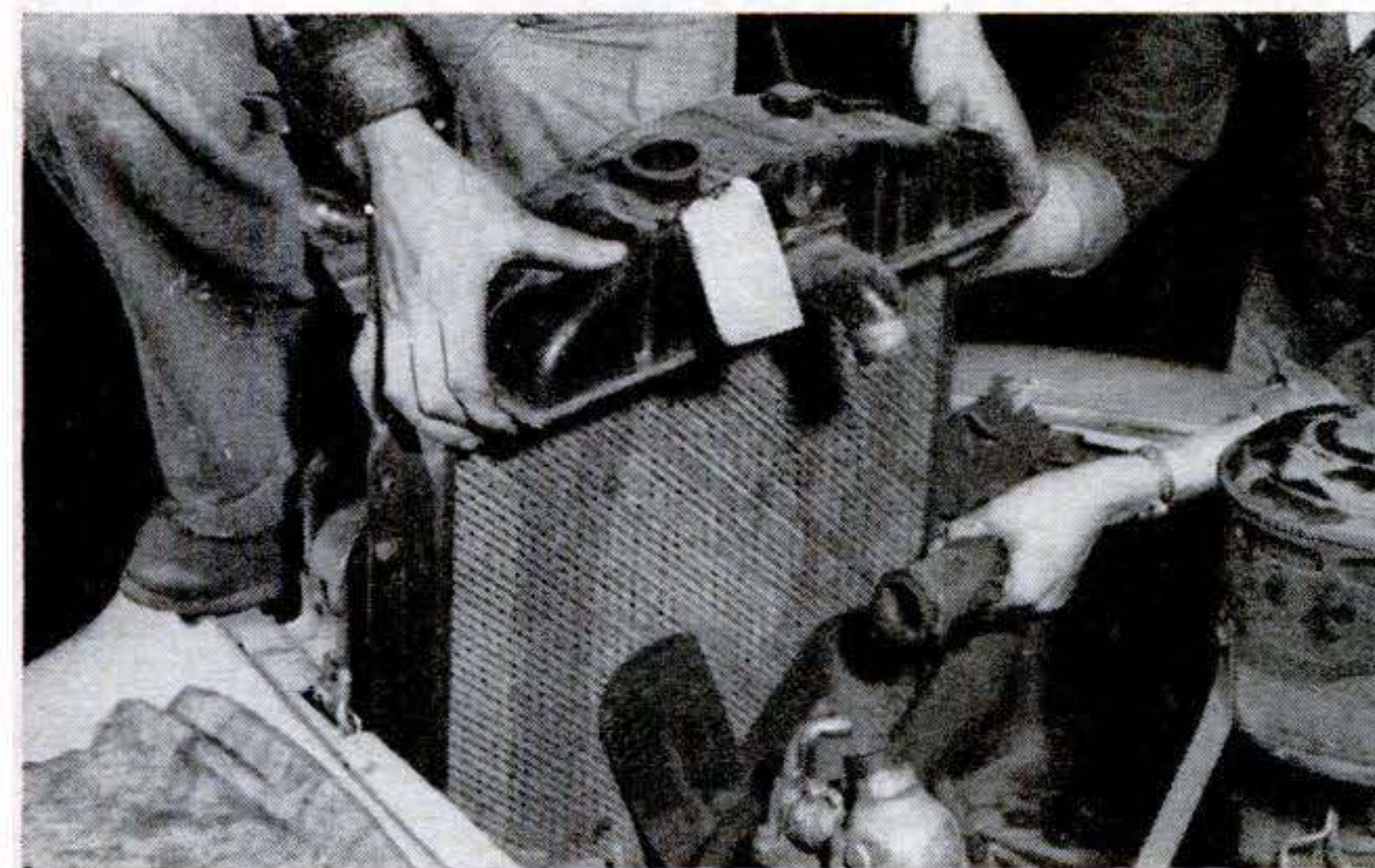
If you plan to install a rebuilt engine in your own car, you could get along all right with these three substitutes: a back yard, blocks in place of a jack and a heavy rope sling suspended from a sturdy tree limb. (Be sure it's sturdy; this Dodge engine weighed 430 lb., and a Ford V-8 tips the beam at about 455 lb.)

### *Tools Were Simple*

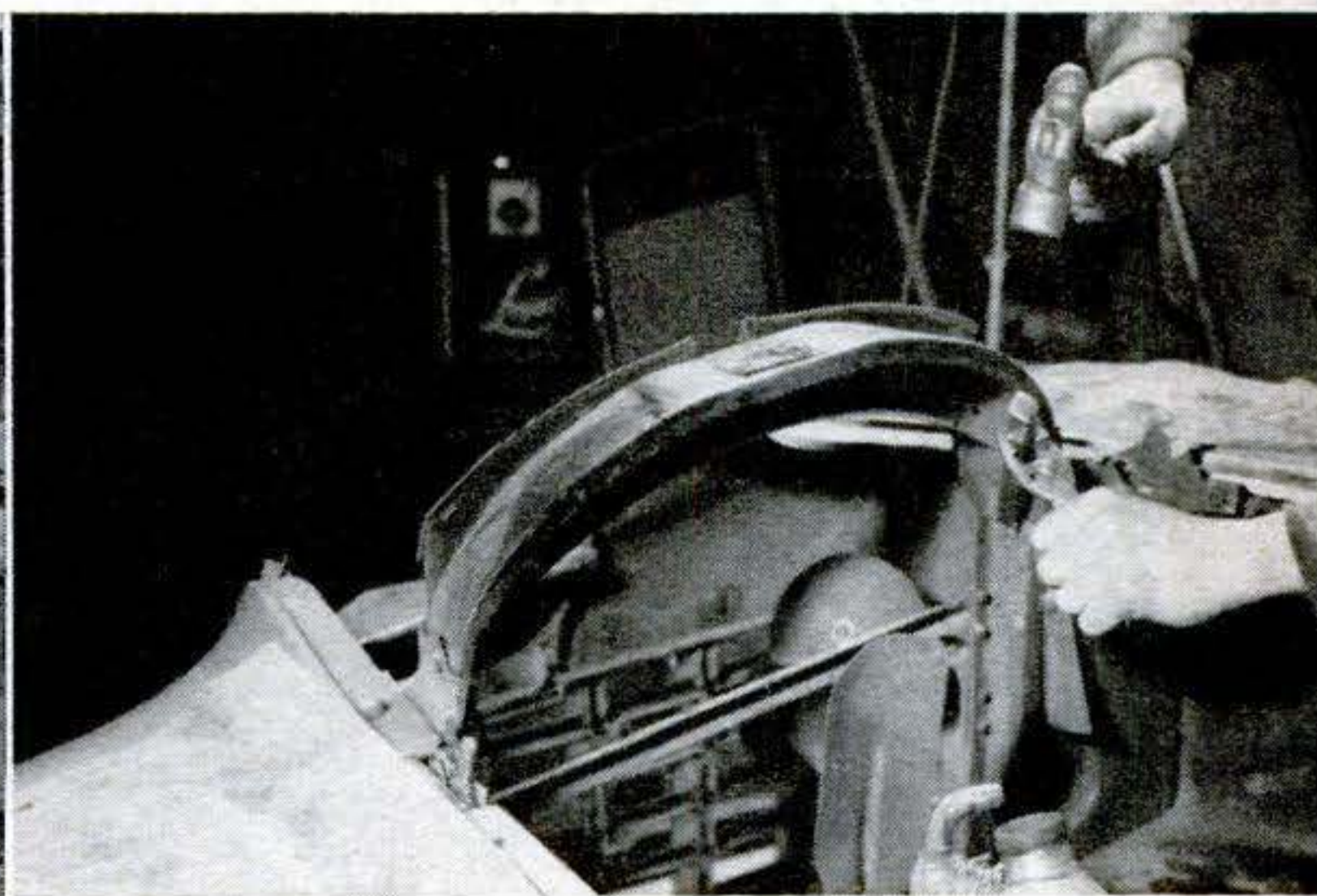
Bill and Bernie used the following tools: a  $\frac{3}{8}$ " ratchet wrench with a 6" extension,  $\frac{9}{16}$ " and  $\frac{7}{8}$ " wrenches with open and box ends,  $\frac{3}{8}$ ",  $\frac{7}{16}$ " and  $\frac{1}{2}$ " open-end wrenches, side cutters, long-nose pliers, chisel, hammer, screwdrivers and a big crescent wrench.

If Bill had been changing engines in a Ford or Chevy, he'd probably have left the transmission in place. This would make the job of shoehorning it out and in somewhat easier, though it would have left him with the fussy task of sliding the splined shaft into place on reassembly. If he hadn't been able to borrow the tracked hoist, he'd probably have used the classic shade-tree ritual: pull the engine up, roll the car away, let the engine down, switch blocks, and do it again.

Bill let us bring along a photographer and follow the job, step by step, as he did it. The pictures show how he and Bernie went about it.



**2 Lifting out radiator.** Bill and Bernie first drained it, then disconnected top and bottom hoses and took out six bolts, three to a side. On older models it would have been advisable to remove bumper, grille and fenders also.



**3 Knocking out radiator fender.** Bill chiseled off the six rivets that held it. (Small bolts will hold it in later.) Now there was plenty of room in which to lift the engine forward, even with the transmission attached.

***Please turn the page for more engine photos.***

JULY 1953 **141**

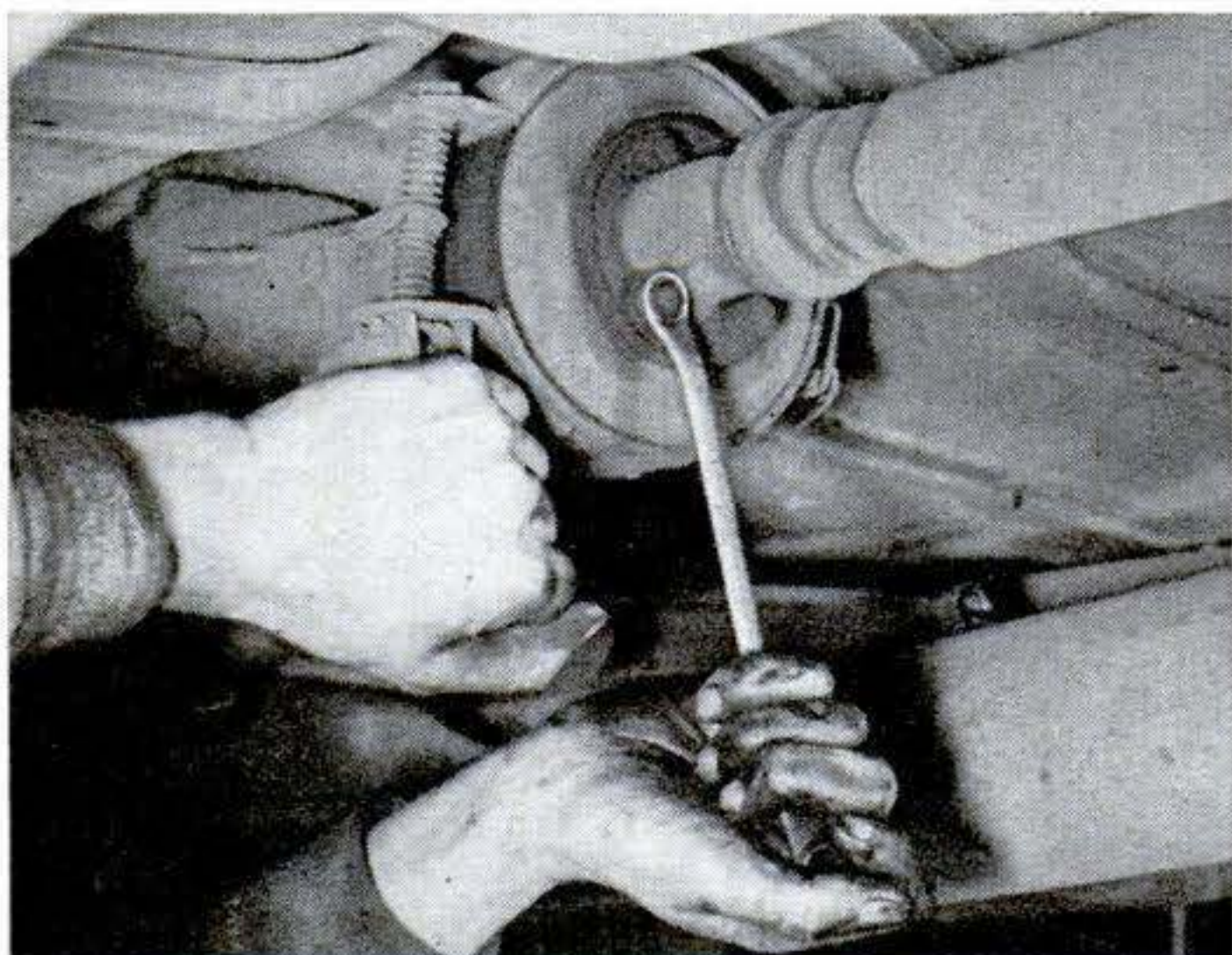




**4 Removing engine-mount bolts.** The ratchet wrench and extension came in handy here. Next Bill took off the fan. Bernie meanwhile was disconnecting gas and oil lines, heat indicator, air filter and accelerator linkage. But most engine accessories were left on for the moment.



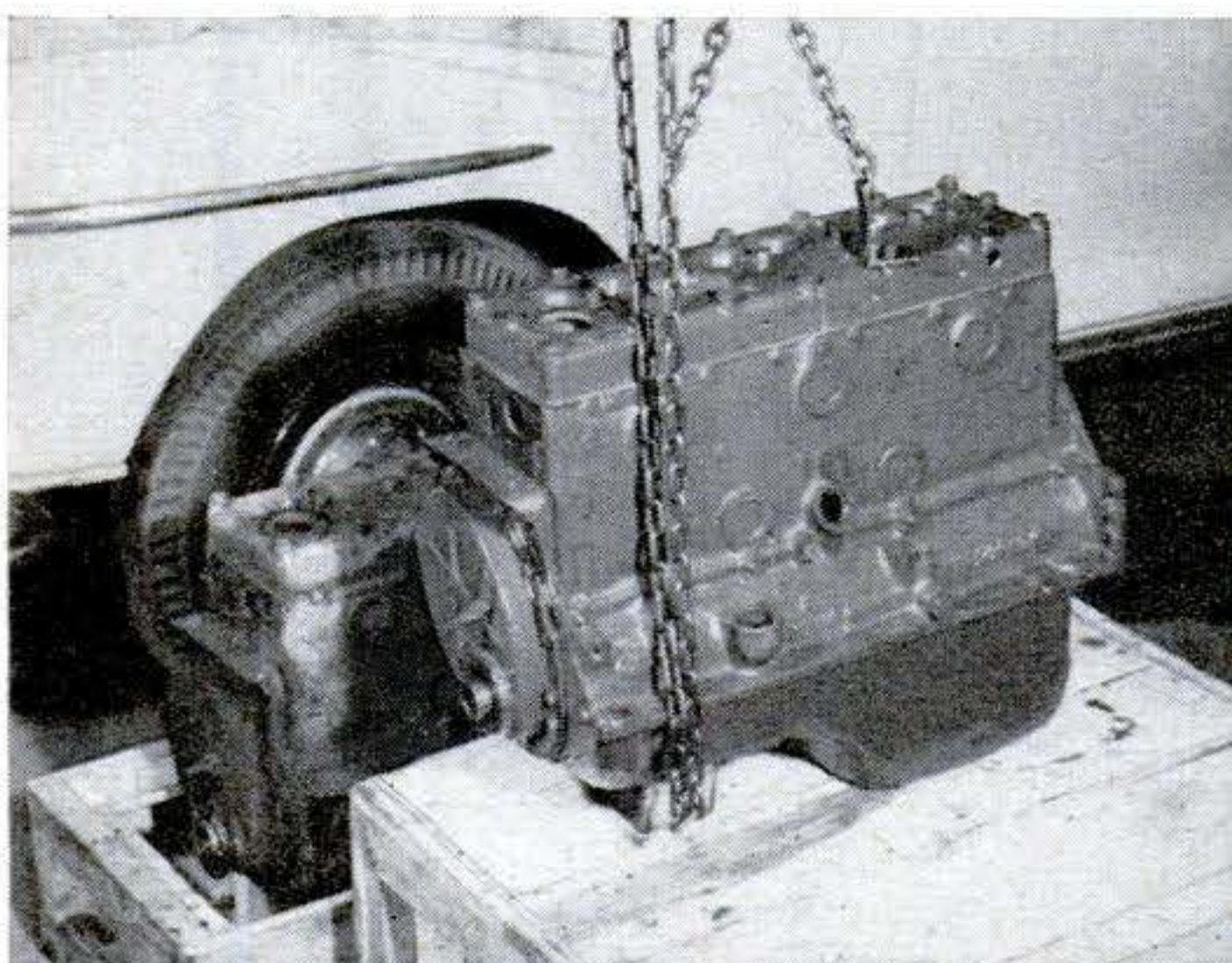
**5 Removing vibration damper.** This meant taking out six bolts with ratchet wrench, removing fan belt and pulley. Meanwhile Bernie was disconnecting starter, coil and generator wires and battery ground cable, also removing bolts connecting exhaust to manifold.



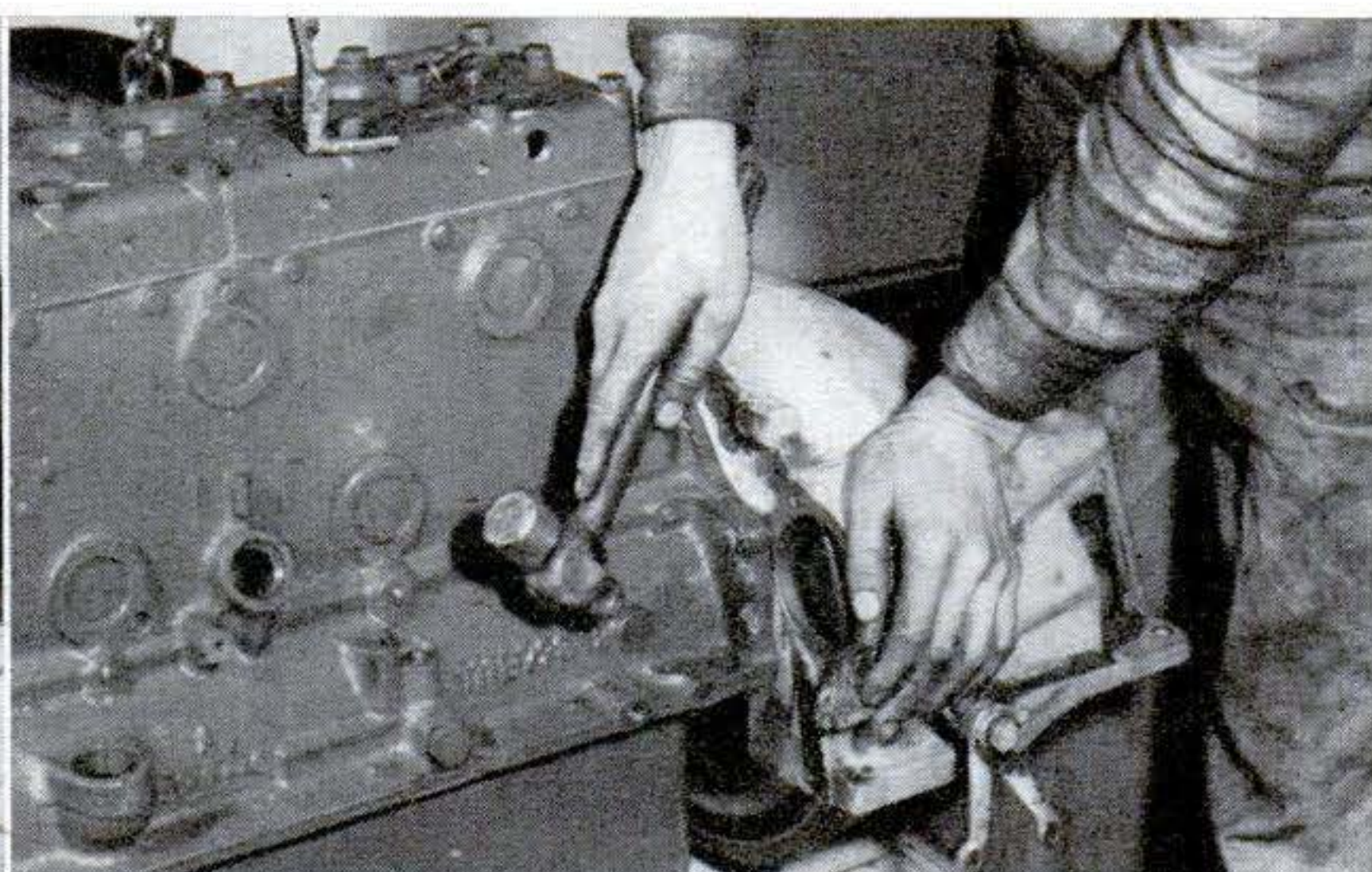
**6 Disconnecting drive shaft** from transmission. While Bill was under the car, he also disconnected emergency-brake cable, shift and clutch linkage and speedometer cable. One safe way to get working clearance is to run front wheels up on planks laid flat.



**7 Sling is bolted** to the head, using the third pair of bolts from the front. With front of engine thus supported, Bill removed rear mount bolts and used a hydraulic jack to take up weight of bell housing. Engine and transmission could now be slid forward and lifted.



**9 Engines are transposed,** the old one resting in the crate, the rebuilt one on top. Sling position was changed to balance block without transmission. A rebuilt engine, experts say, may even be better than a new one, because it is seasoned, has no expansion in it.



**10 First step of reassembly** was sliding the fluid-drive unit onto eight supporting bolts at the rear of the block. Here Bill is driving dowel pin from block into bell housing. Bernie removed protective grease from all bolt holes and surfaces that were to mate with accessories.



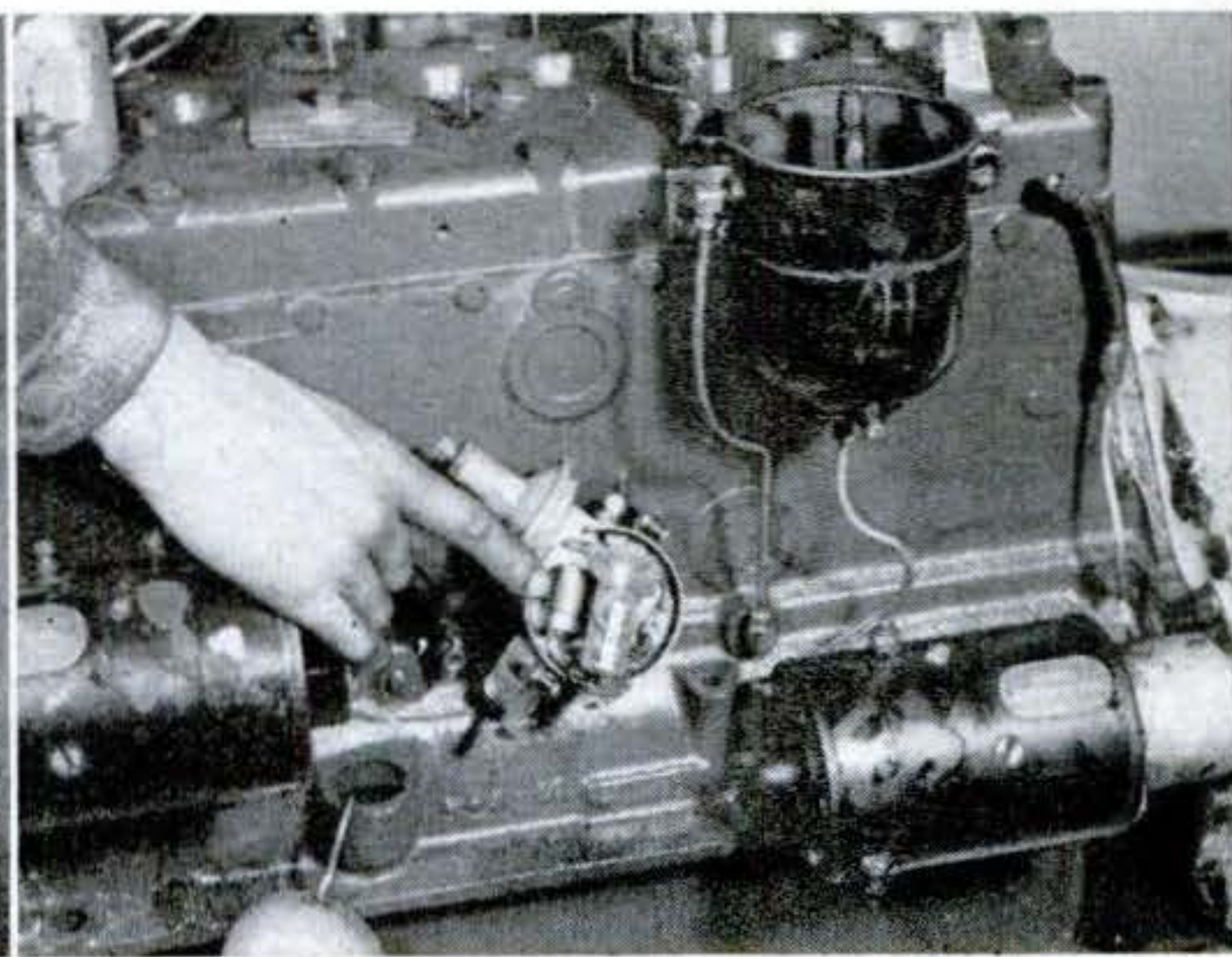


**8** Ready for dismantling, the old engine rests on the crate containing the rebuilt one. The men then completely stripped it. They scraped dirt and grease off the engine accessories with a putty knife and then washed the parts clean with solvent, which was not allowed to get in-

side starter, generator, distributor, or fluid-drive unit. The big thing, as always in taking anything apart, was to remember what was what and where it went. Bill and Bernie made an effort to keep bolts grouped together with their parts.



**11** Adding the transmission, its splined shaft being inserted into the clutch assembly and fluid-drive unit before its housing was bolted to the bell housing. Six bolts do the job. A fussier man might have cleaned off the transmission before putting it back on.

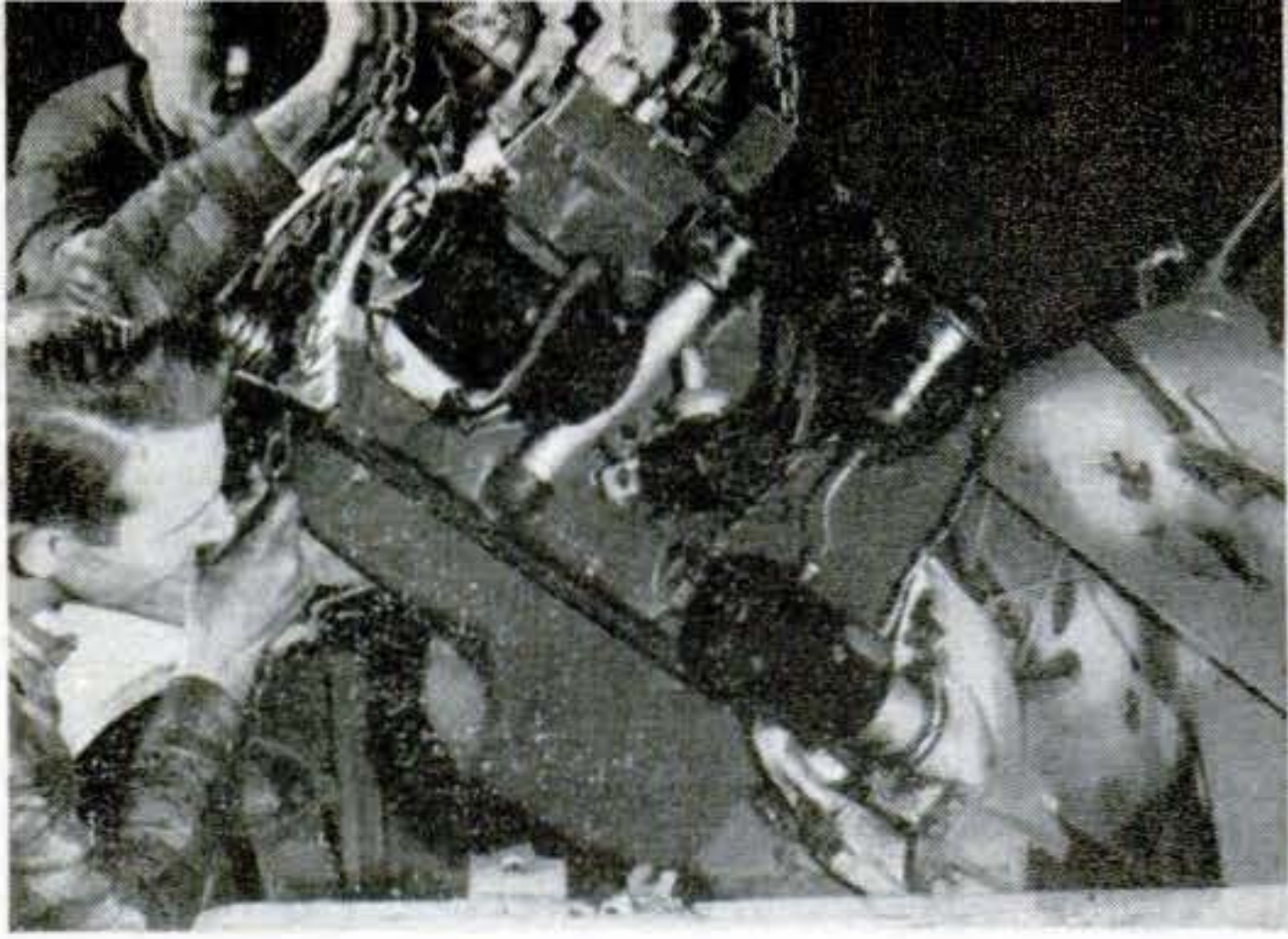


**12** For correct timing, Bernie held thumb on No. 1 spark-plug hole while Bill cranked engine until Bernie felt compression and saw that timing pointer was lined up. Then Bill inserted distributor with rotor in position to fire on No. 1.

*Please turn the page for more engine photos.*

JULY 1953 143

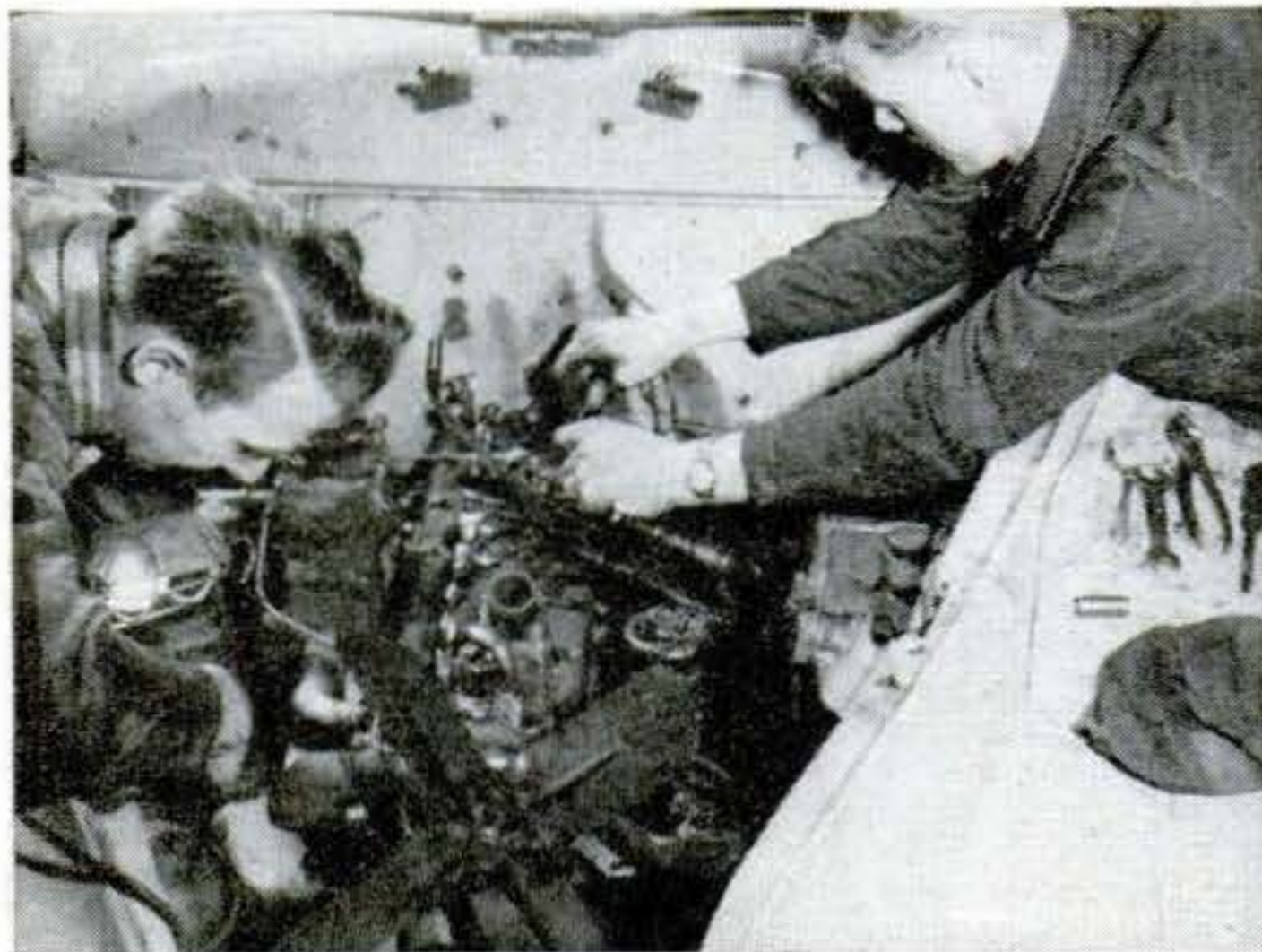




**13** Easing the rebuilt engine in, after attaching most of the cleaned original outside parts. Sling is now back in its original position, so that the transmission will tip downward and rest on the hydraulic jack. Bill and Bernie put in new clutch throw-out bearing, spark plugs and oil-filter cartridge, and used a tune-up kit to rejuvenate the old distributor.



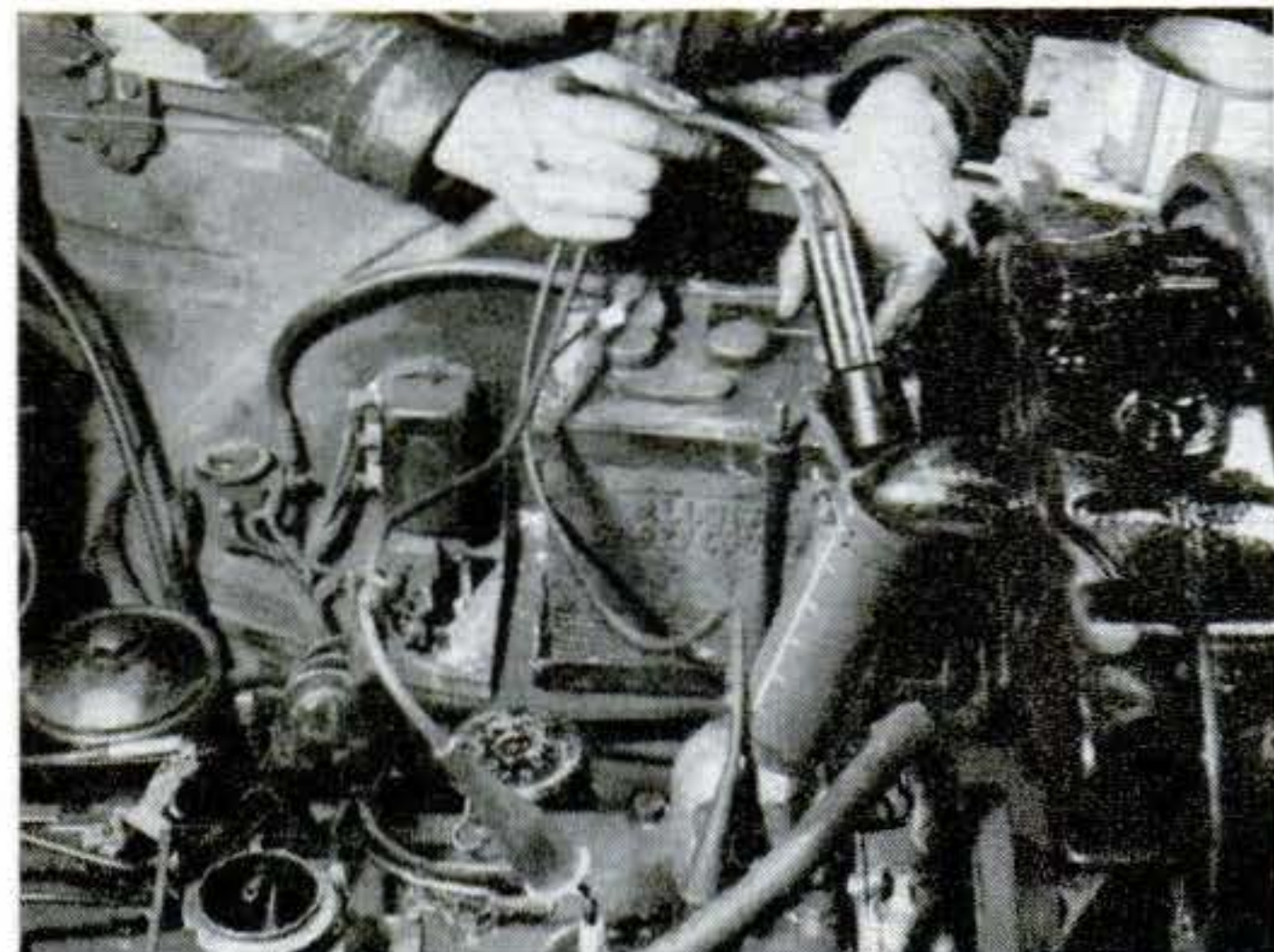
**14** With the help of a pry bar, Bill eases the rebuilt engine onto its mounts. The chain still holds most of the weight. Bernie was under the car by the hydraulic jack, making sure the bell housing didn't push the rubber mountings off the frame's front cross member. With a little horsing, the engine lined up dead true on its mounts.



**15** On the home stretch, Bill hooks up the flexible gas line to the fuel pump, which had had to be replaced. He had also installed new gaskets. Bernie is busy with the accelerator linkage. The washed-out air cleaner and new radiator hoses are all that have to be put on.



**16** Thoroughly cleaned and spruced up, the radiator is slid back into place. Bill had sprayed the tank with a thin, quick-drying varnish on Saturday afternoon. Small bolts with lock washers under the nuts replaced the rivets cut from radiator fender.



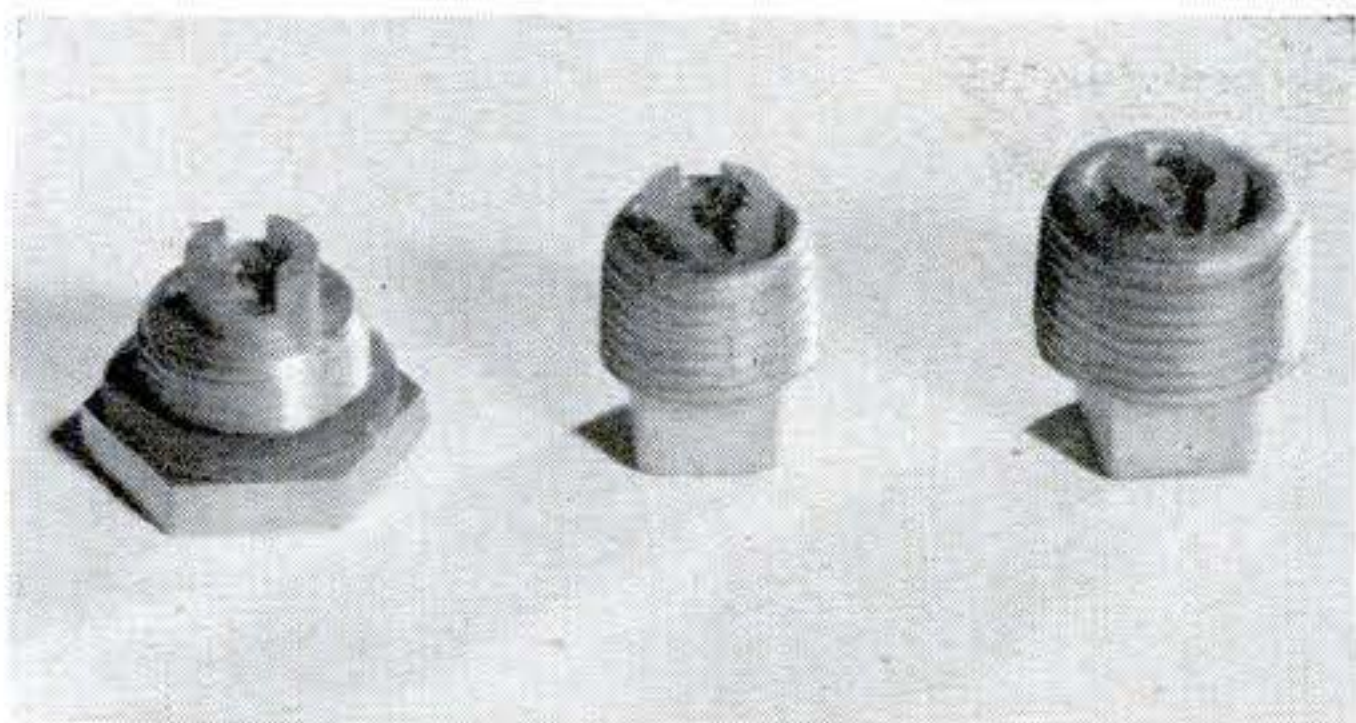
**17** Checking the timing with a neon timing light. The crankcase was now full of clean oil and the radiator filled. The timing needed only slight adjustment. When the engine was warmed to 160°, Bill checked all the head bolts again for tightness.



**18** The road check was okay, and Bill waves a happy goodbye to the kibitzers who had watched him and Bernie switch engines on the '47 Dodge. Bill has to remember that he must drive the rebuilt engine as carefully for the first 1,000 miles of use as the engine of a new car.



# Products for Your Car



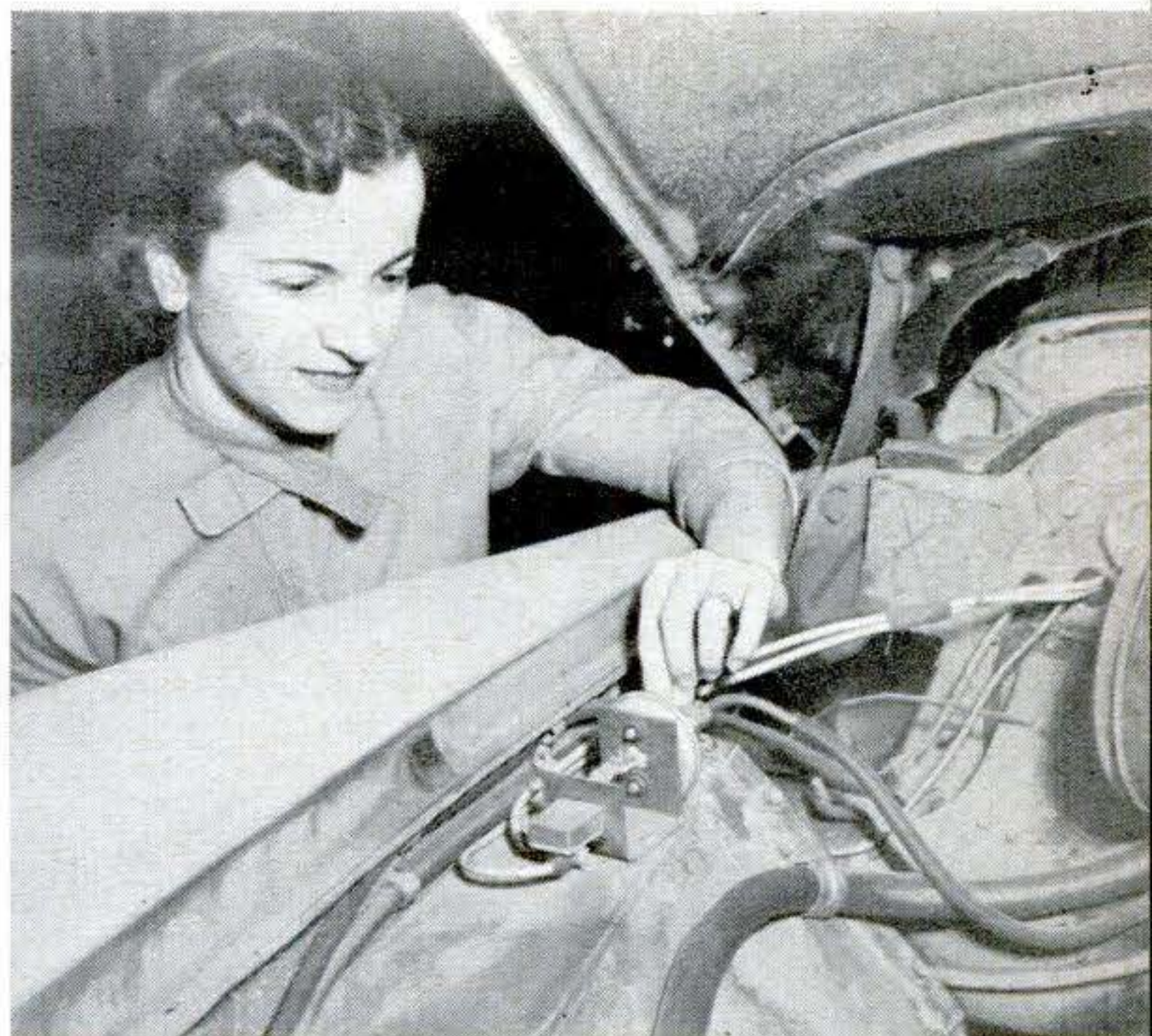
## Magnetic Plugs Clean Oil

MAGNETIC plugs are now available for full protection of your car's lubrication. Here is a typical set—for the crankcase, transmission and rear axle. Each plug has an Alnico magnet to attract iron particles from the oil or lubricant stream. The plugs cost about \$2 a set. *Magnetic Drain Plug Co., Wellington, Ohio.*



## Safety Belt Secures Door

THIS safety belt is designed to keep car doors closed in case of an accident and prevent occupants from being thrown out. One end of the belt is attached to the door, the other to the floor. When doors are kept closed, a car body also retains maximum structural strength, affording greater protection to the occupants. *Karbelt Mfg. Co., Mason, Mich.*



## Vacuum Turns Off the Lights

IF YOU tend to forget to turn off your parking lamps after using them in a fog or early morning light, this vacuum switch will protect your battery from being run down while you are at work.

Hooked up to the vacuum line and the parking-light circuit, the unit will automatically cut off the lamps from 30 seconds to two minutes after the ignition is turned off. Engine vacuum automatically restores the circuit when the engine is started again. *Cogg Manufacturers, Inc., 16 W. 4th St., Tulsa, Okla.*

## Bug Juice Sold in Bag

HERE is a liquid that was developed especially to help automatic windshield washers clear away the insects that often splatter the glass during summer driving. A transparent plastic envelope contains two ounces of it, enough to treat a washer jar of water. You snip off one corner of the envelope and pour the fluid into the jar. The product also serves as an antifreeze to keep the washer fluid from freezing on the windshield. *Vizo Sales Co., 1937 Book Tower, Detroit 26.*







# GUS CALLS

*With two strikes against him  
before he starts, Gus goes to bat  
for three old codgers in a wheezy sedan.* **BY MARTIN BUNN**

GUS WILSON'S rugged features lit up with a broad grin as he spotted the three old codgers pushing the battered sedan down the street toward his garage. Pete Blinstock was shoving on the rear, while Tom Hanratty bent a shoulder to a flapping fender. Ezra Hendricks, his gray beard thrust out belligerently, was at the wheel.

Stan Hicks, Gus's helper, ran out from the grease rack to give the three farmers a hand. Hendricks spun the wheel and the sedan rolled into the Model Garage.

"You boys out for a little exercise?" Gus asked, innocently.

"Exercise!" Ezra Hendricks' beard fairly bristled with indignation as he popped out of the car. "Pete and Tom, here, have been accusing me of busting up my own car. The old fools."

Pete Blinstock was puffing as he came around the car.

"Everybody knows," he wheezed, "that our team is going to beat the pants off Stanfield Corners today. Ezra insisted on taking us to the game in his car. Then he pulled something loose so we wouldn't get there."

## *The Old Car Gave Out*

"We couldn't coax another pop out of her," put in Tom Hanratty, tugging his watch from his pocket. "Hendricks tramps on the starter until the battery's dead, and here we are. If we miss that game—Gus, you've got to fix this thing up!"

Gus wiped the grin from his face as the seriousness of the situation dawned on him. This might be just another Saturday to some folks. But it was "the" day to these old codgers. The local Little League baseball team was about to play Stanfield Corners for the county championship. On the Stan-

field nine was Ezra's grandson, Frank. Stacked against him were Sammy Blinstock and Clyde Hanratty—grandsons of Pete and Tom. The three proud old rooters were

*Stan Hicks ran out to give the three old farmers a hand, and the battered sedan rolled into the Model Garage.*





# A CLOSE ONE

taking the game as a personal matter, and they had very little time to make it to Stanfield, 40 miles away.

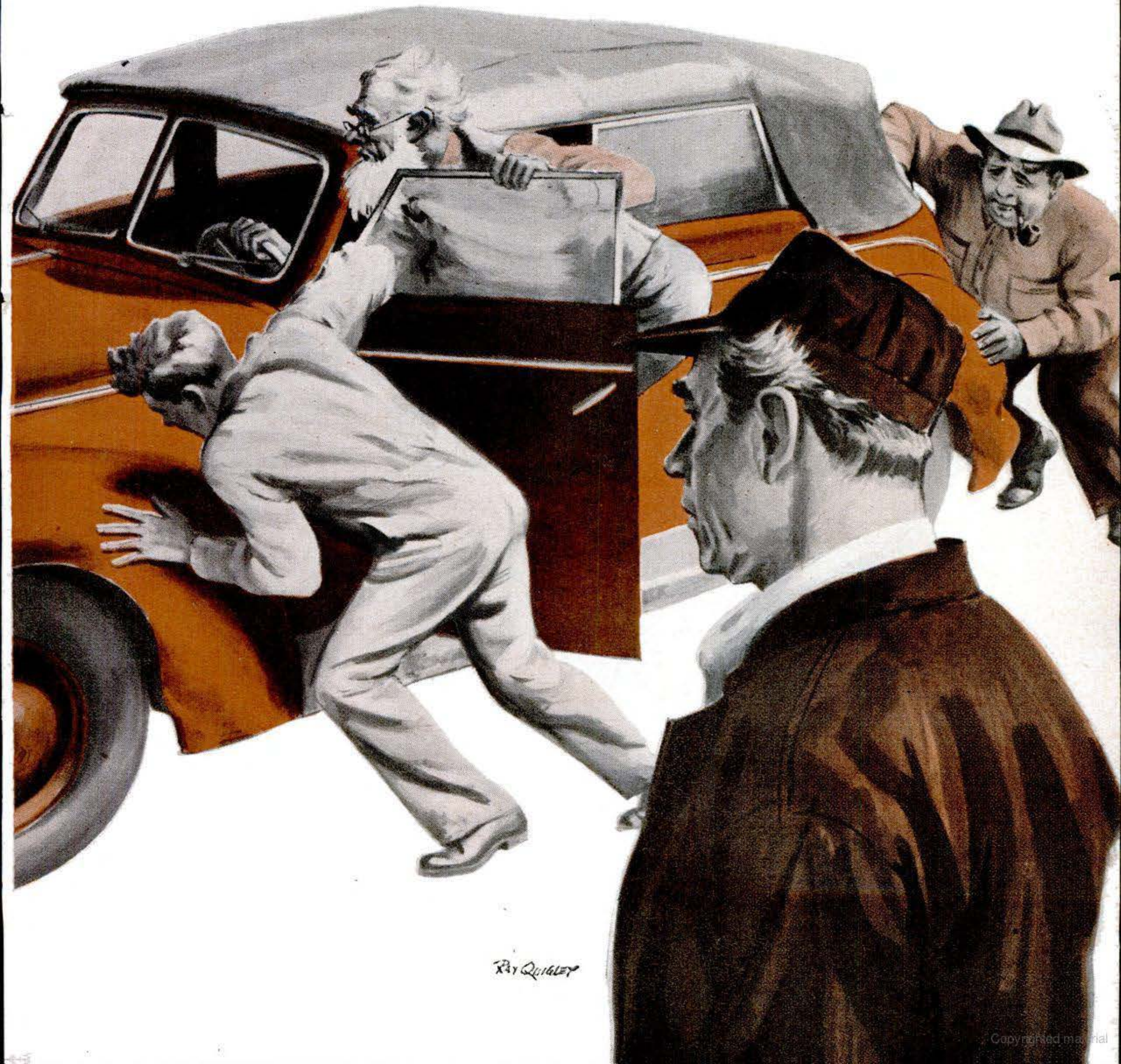
Gus glanced at the clock and made a rapid calculation. He knew this old car like the palm of his hand, and the trouble shouldn't be hard to find. Yet a feeling of apprehension ran up his spine. Baffling situations had a way of cropping up at times like this.

"Slap in a rental battery, Stan," he told

his helper, "while I start checking the ignition."

Gus moved fast. He removed the distributor cap, put the car in gear, and rocked the points up on one cam of the distributor rotor shaft, to open them wide.

The points were slightly pitted. He smoothed them with a point file, and checked the gap with a gauge. A little off. He loosened the lock screw on the movable point, wiggled the eccentric screw back and



RAY QUIGLEY



forth until he had the right gap, and tightened the lock screw again. As he stepped back to see how Stan was getting on with the battery change, he collided with the three anxious grandfathers.

"Find it, Gus?" Hendricks asked hopefully.

"Of course he didn't!" Hanratty snorted. Gus Wilson's eyes twinkled.

"Give me room, boys," he chuckled. "Is the battery in, Stan?"

"All bucked up, Gus."

"Turn on the ignition switch."

Gus rocked the points back off the rotor cam, jerked the high-tension wire from the center of the distributor cap, and held it a quarter-inch from the engine block, snapping the points with his thumb. Spark flame arced across the quarter-inch gap. Gus frowned. The blue color of the flame, its husky width, and the audible snap it made, told him that coil and condenser were right. This wasn't ignition trouble, unless it was a matter of timing.

"How'd she act when she quit?" he asked. "Did she backfire?"

"No," grunted Hanratty. "She just sort of wilted and died."

"She'd perk up a mite," Hendricks added, "when I pulled out the choke."

"That," declared Blinstock, "was before she conked out for good at the edge of town."

Gus stroked his chin for a moment. "Step on it, Stan," he told his helper.

While Stan ground the starter on a motor that was as dead as last Sunday's pancakes, Gus loosened the clamp on the air filter and lifted it off. Taking a squirt can of gasoline from the bench, he shot a thin stream of gas down the carburetor throat. Instantly the motor sprang to life. It died as Gus put the can back on the bench.

"Gas trouble," Gus breathed.

The gauge showed full. The trouble must be in the fuel pump. Gus disconnected the

copper tubing from the pump outlet to the carburetor, removed the two cap screws that held the pump to the side of the engine block, and pulled the pump clear. This exposed the pump arm that worked on the eccentric on the camshaft, yet left the pump attached to the gas line from the tank. When he pumped the arm back and forth by hand, a stream of gas shot forcibly from the pump outlet.

Gus grunted, and twisted the pump around so he could see the bottom of the pump arm. In the past he'd been fooled by pumps that threw gas when worked by hand, yet failed to do so when attached to the engine, because arm wear had shortened the stroke. The pump arm showed no wear. It didn't add up. No gas to the engine. Yet the fuel line was clear, and the pump arm was working perfectly.

"Maybe," Blinstock said, "we ought to hustle out and hire a car to take us on to Stanfield."

"That," declared Hanratty, "is what we should have done in the first place."

"We've still got an hour," Hendricks said weakly.

"An hour for 40 miles!" exploded Blinstock. "Why you old faker, you know your

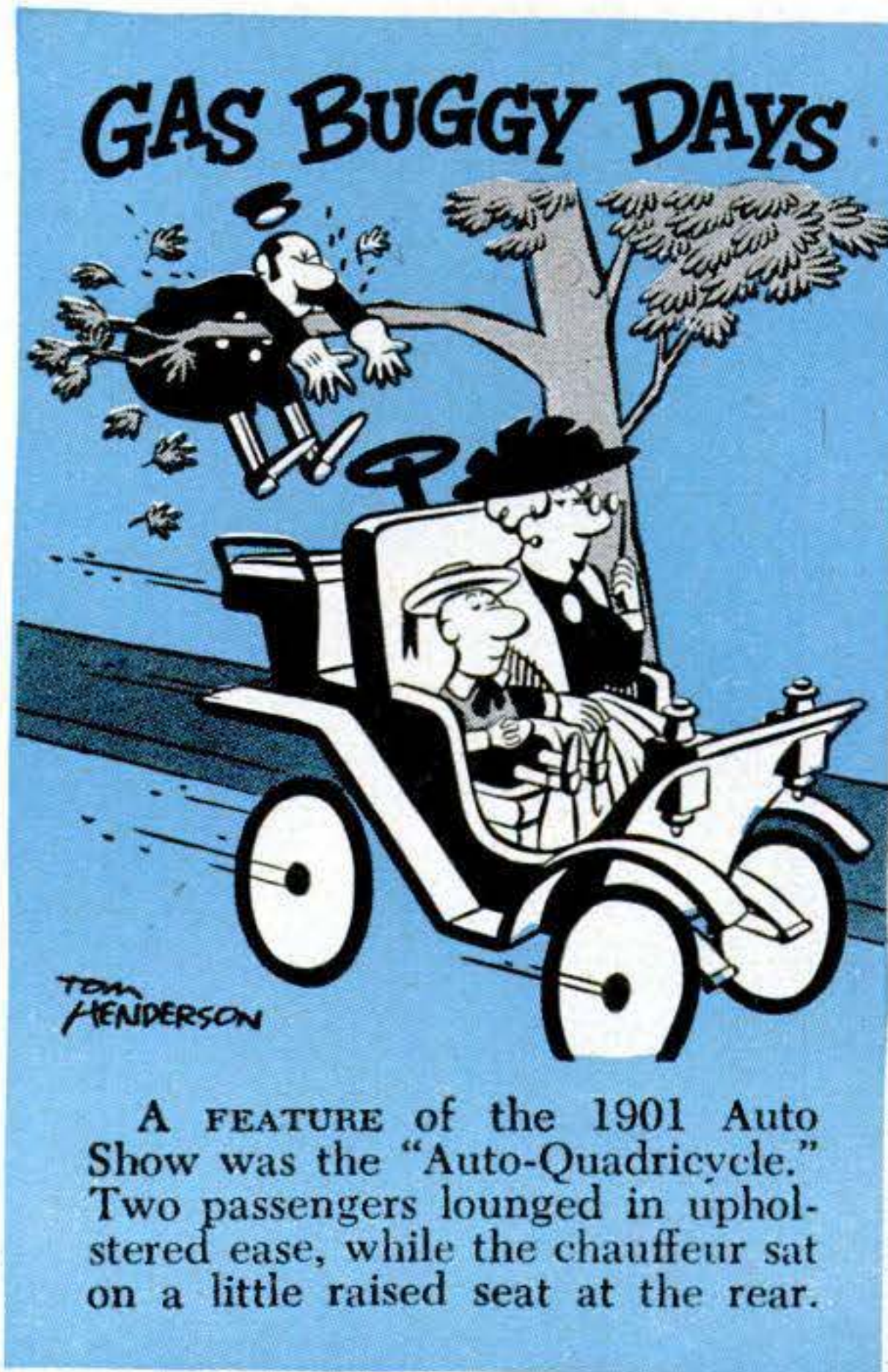
car won't do 40 miles an hour."

Hendricks flushed.

"Now look here, Hanratty," he sputtered. "My car'll do 60, once she sets her mind to it."

Gus kept his head discreetly under the hood. It wouldn't look well for the Model Garage if the three old fellows had to hire a car to take them to the game. But this thing was getting bad. No water showed in the sediment bowl of the gas pump. He checked the screen at the gasoline inlet of the carburetor. Gas line clear, screens clean, pump in good working order. Yet no gas was reaching the carburetor.

Gus's mind went back over each check

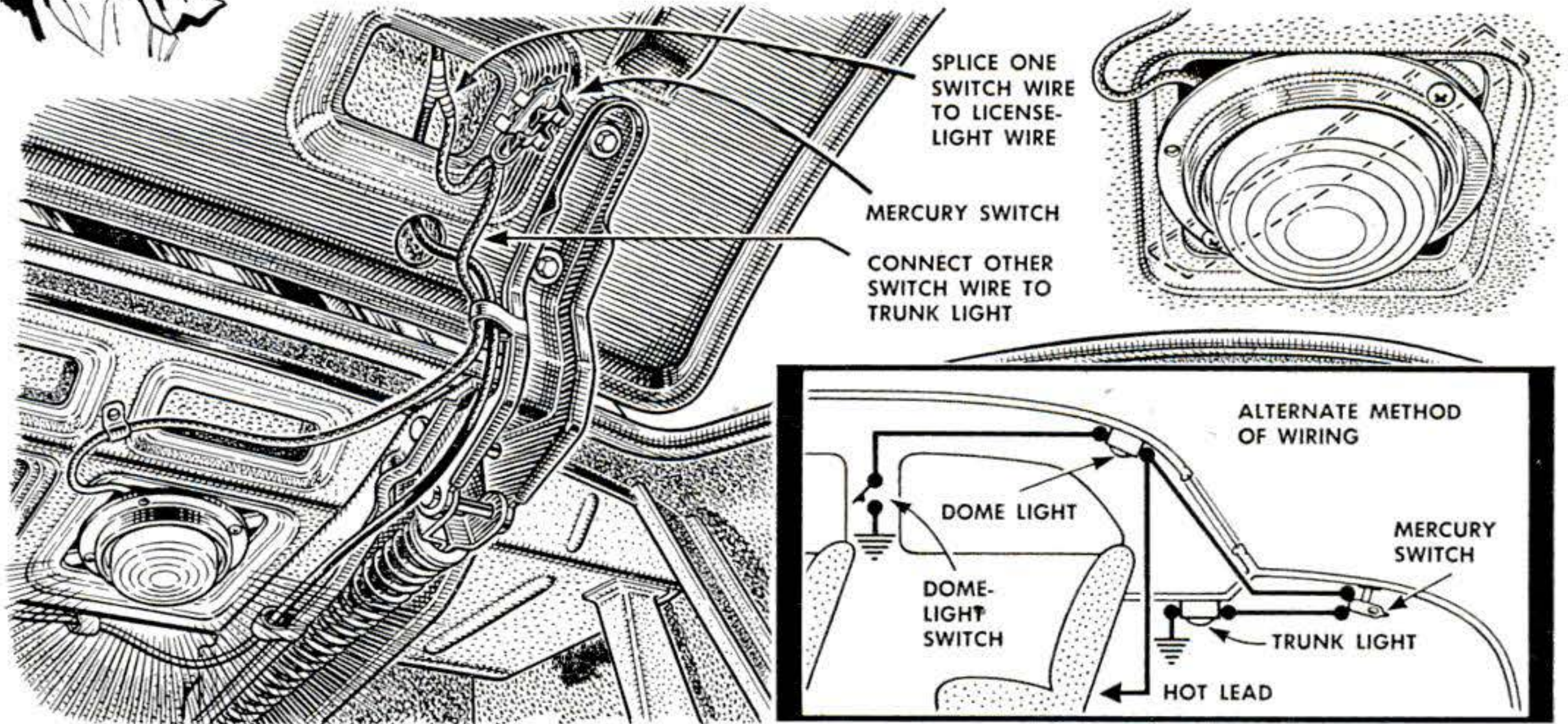


[Continued on page 240]



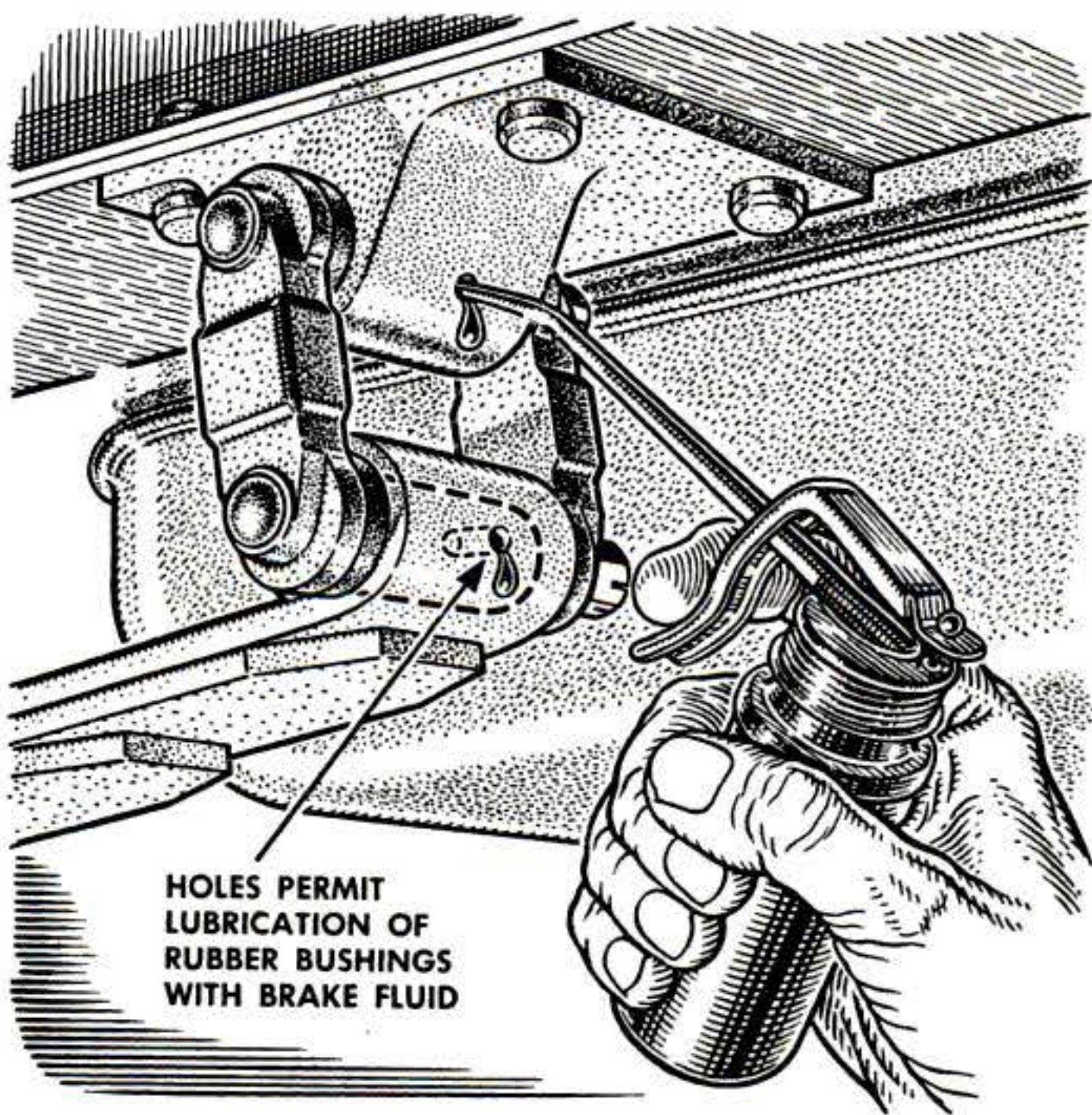
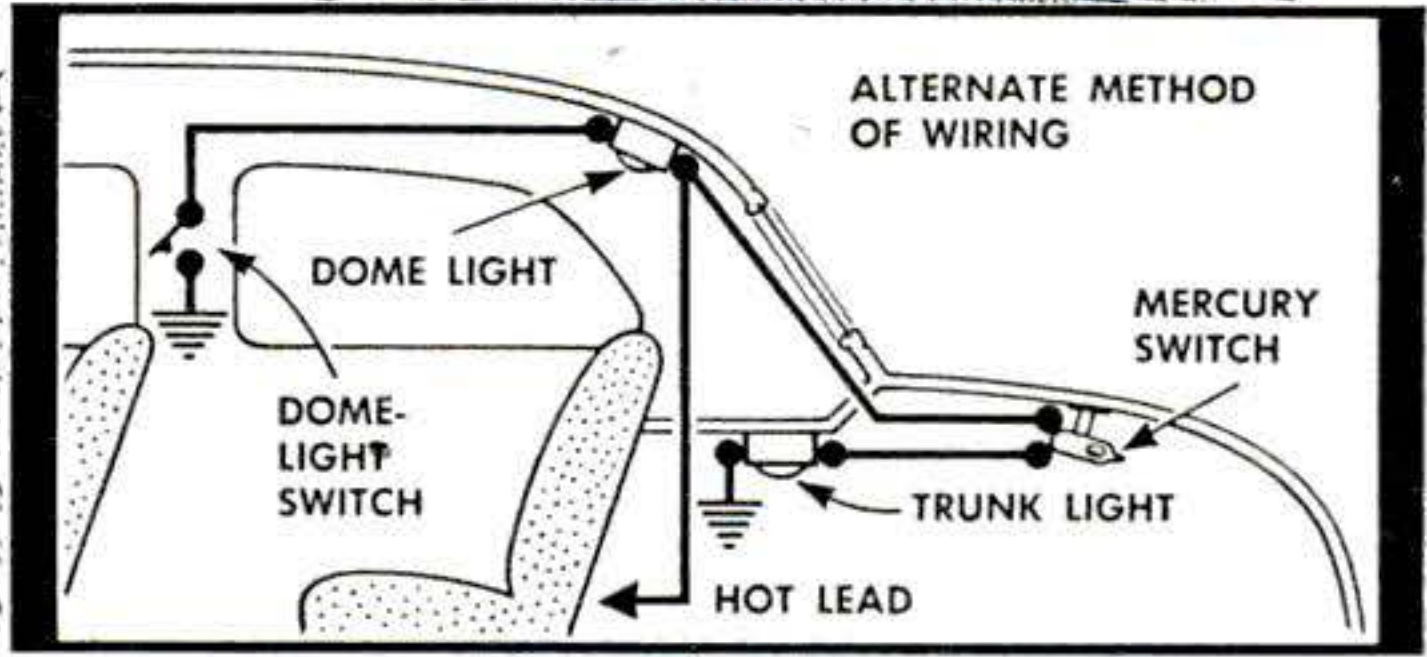


# Hints FROM THE MODEL GARAGE

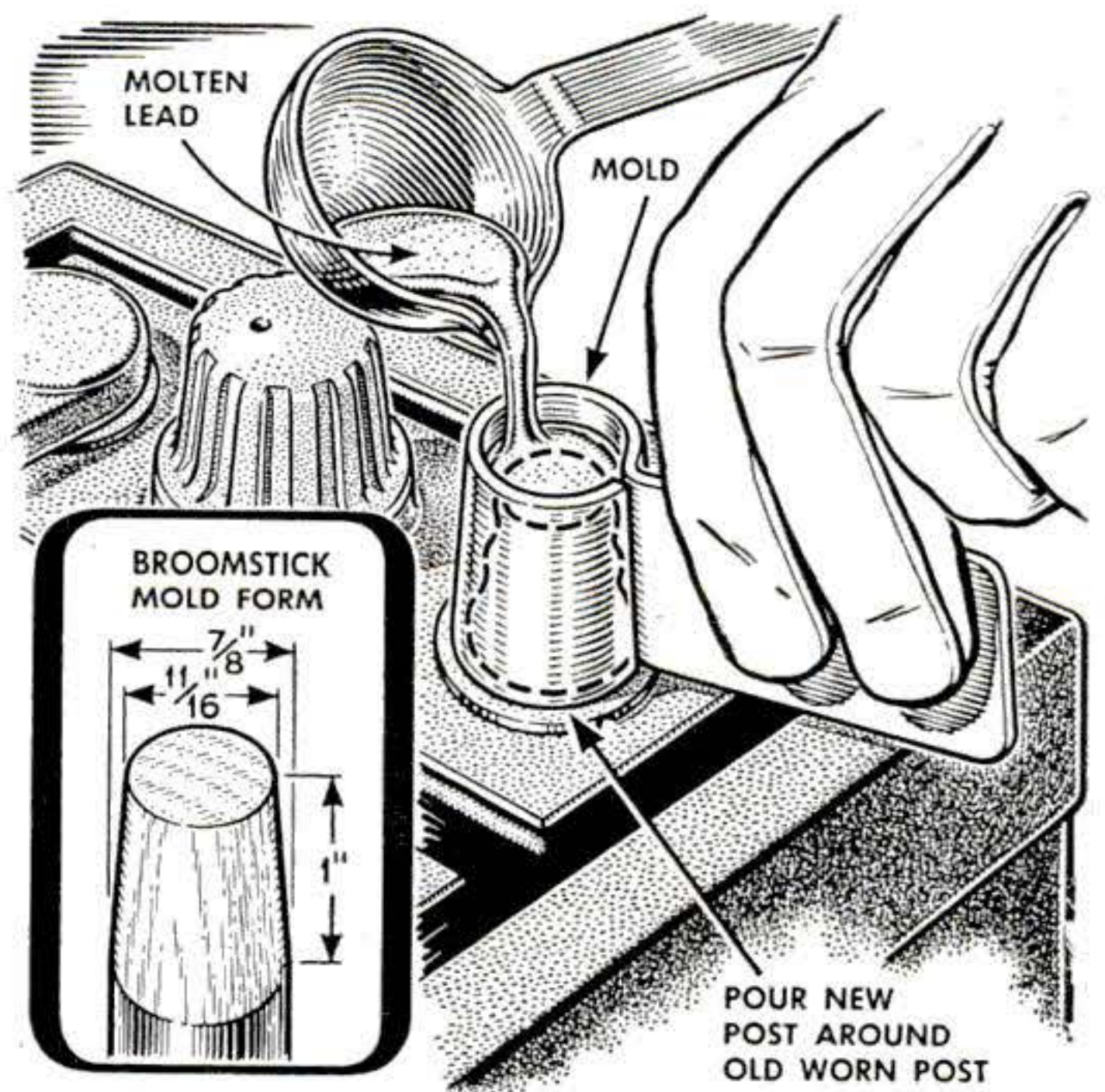


**A lamp that lights** automatically when you lift the trunk lid can be installed with parts that cost around a dollar. A mercury switch will take care of turning the light on and off. A flush-mounted clearance lamp with a clear lens is a good choice for the light. It usually can be set into a recess in the lid or body bracing by placing a metal

strip back of the opening and running sheet-metal screws through the holes in the flange. The strip or lamp must contact bare metal for a good circuit. If it is connected to the license-light wire, the lamp will come on only when the car lights are on. In the alternate method, the lamp will operate independently.



**A persistent squeak** in a rubber-bushed spring shackle usually can be eliminated by drilling a hole into the bushing and forcing in brake fluid with a pump oiler.

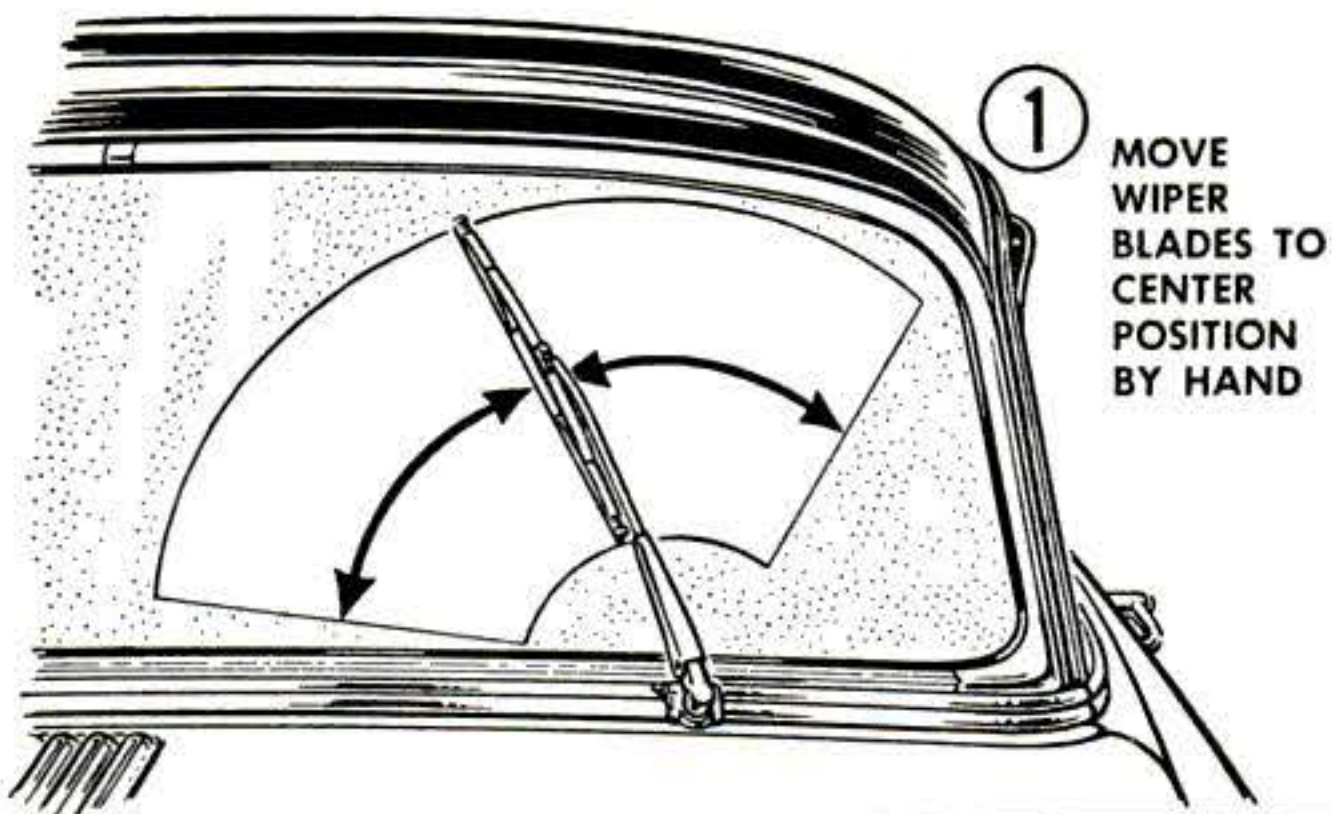


**If a battery post** is so worn the cable won't hold, cast a new post around the old one. Make a form by shaping aluminum around a broom handle tapered as shown.

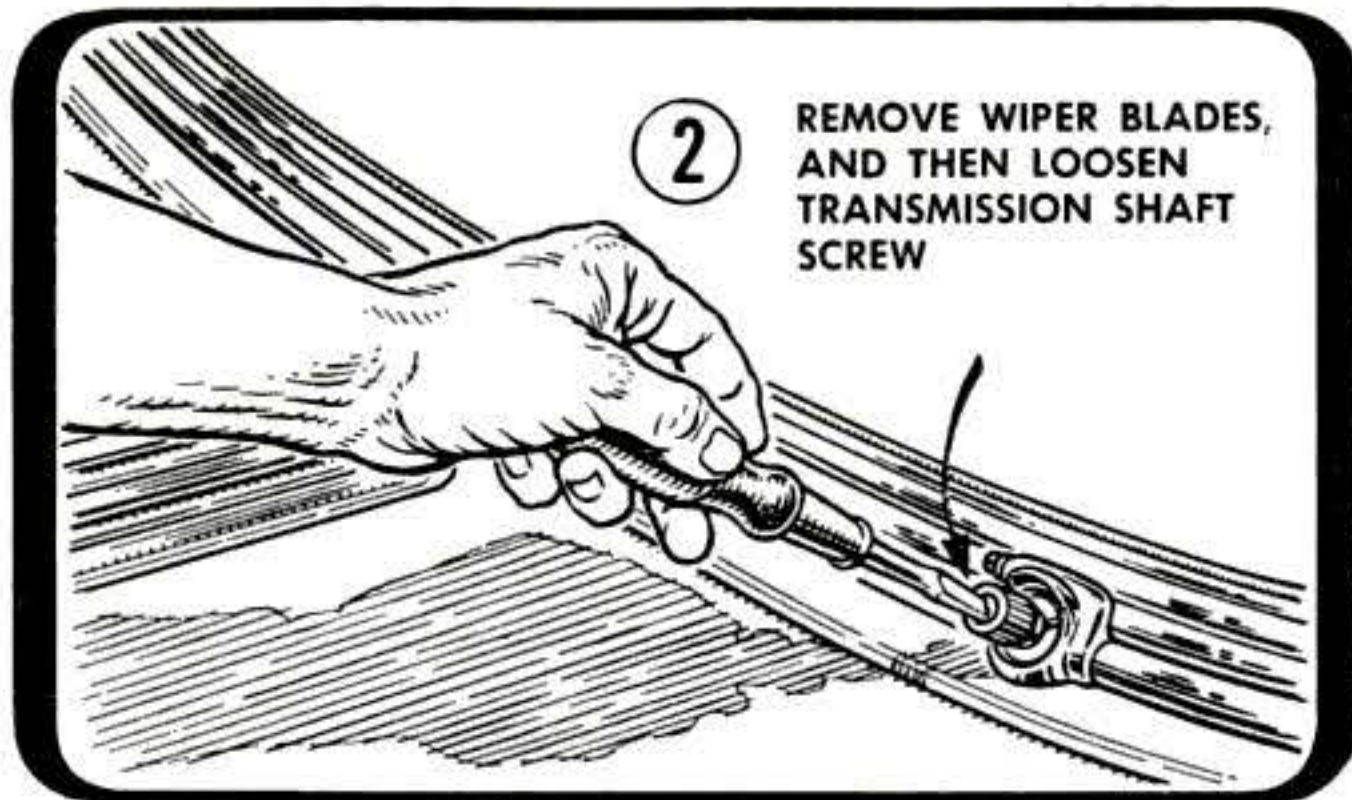
**Please turn the page for more auto hints.**



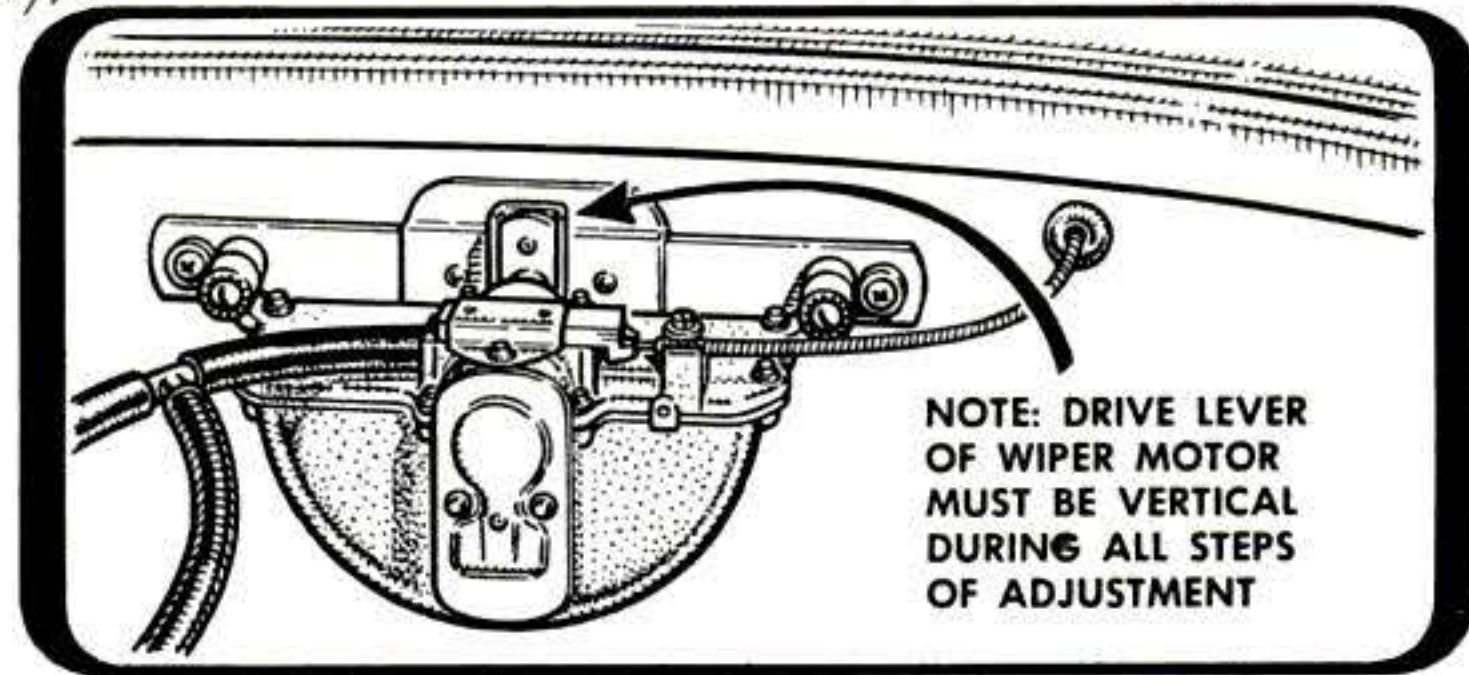
**MORE Hints from the Model Garage**



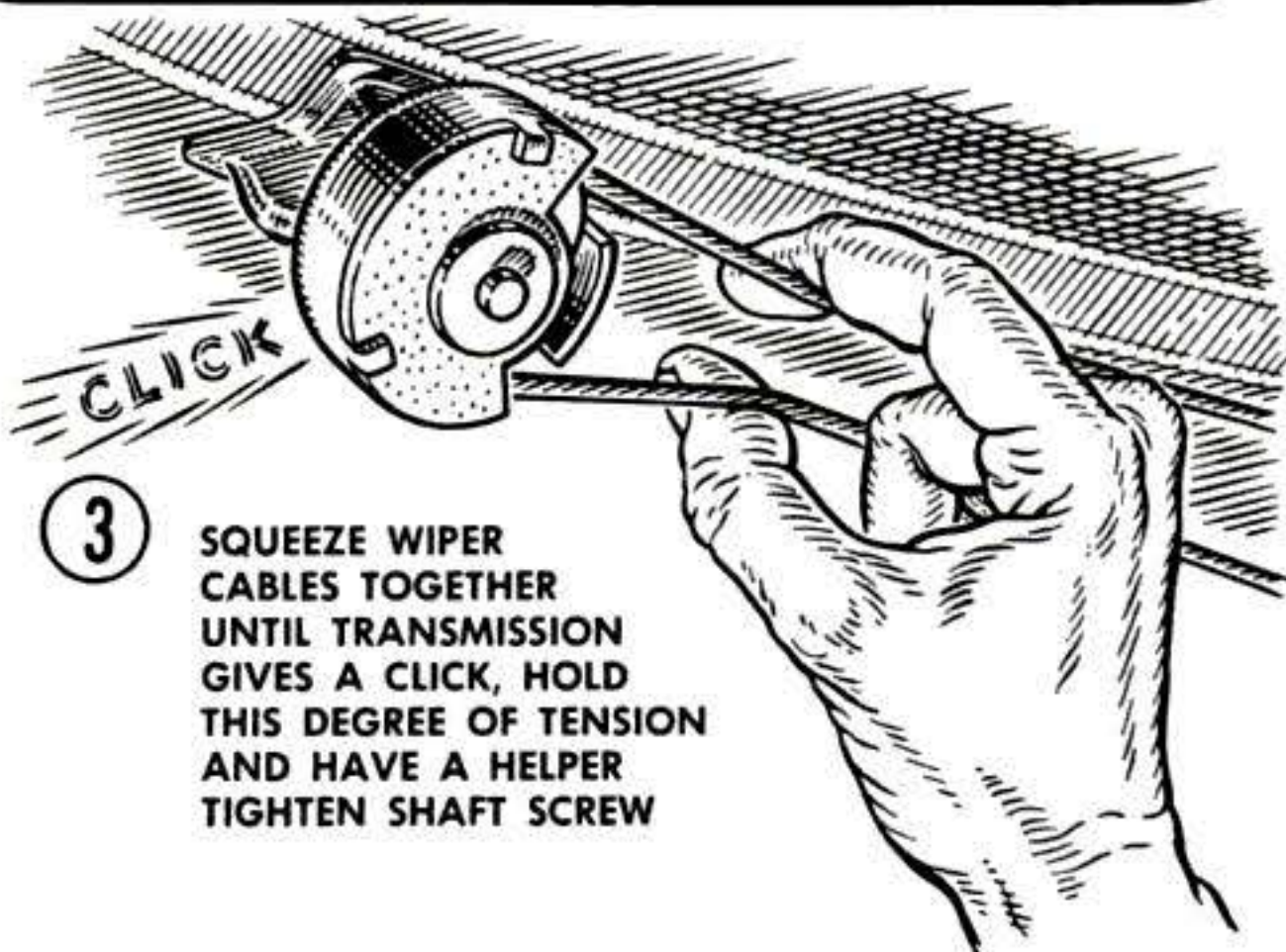
1 MOVE WIPER BLADES TO CENTER POSITION BY HAND



2 REMOVE WIPER BLADES, AND THEN LOOSEN TRANSMISSION SHAFT SCREW



NOTE: DRIVE LEVER OF WIPER MOTOR MUST BE VERTICAL DURING ALL STEPS OF ADJUSTMENT

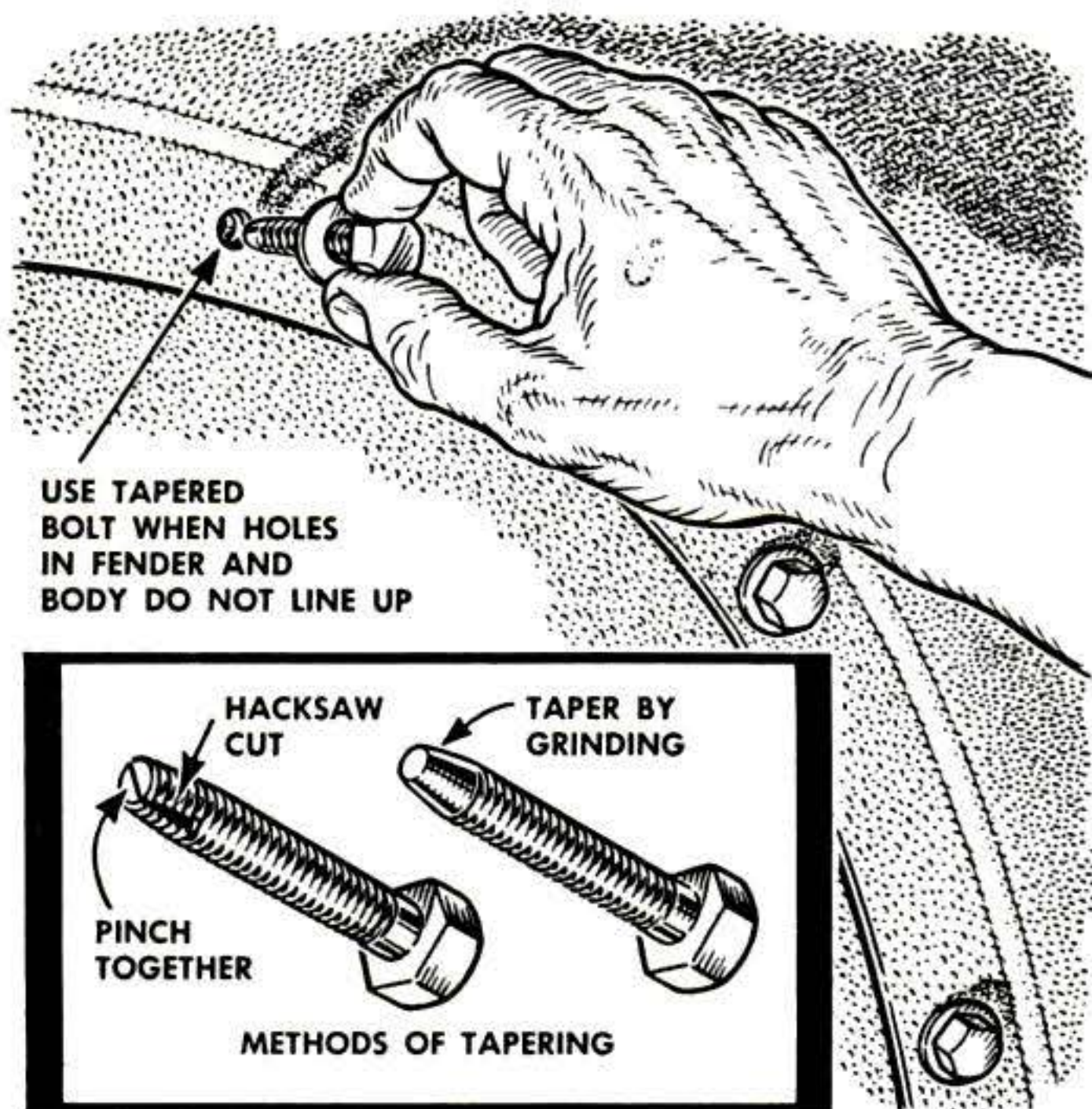


3 SQUEEZE WIPER CABLES TOGETHER UNTIL TRANSMISSION GIVES A CLICK, HOLD THIS DEGREE OF TENSION AND HAVE A HELPER TIGHTEN SHAFT SCREW

**Sluggish wipers** can often be traced to cable drives that are too tight. The remedy is to slack off the cables a trifle.

Center the wiper arms by hand (upper left), bringing drive lever to vertical position (lower left above). Remove wiper arms

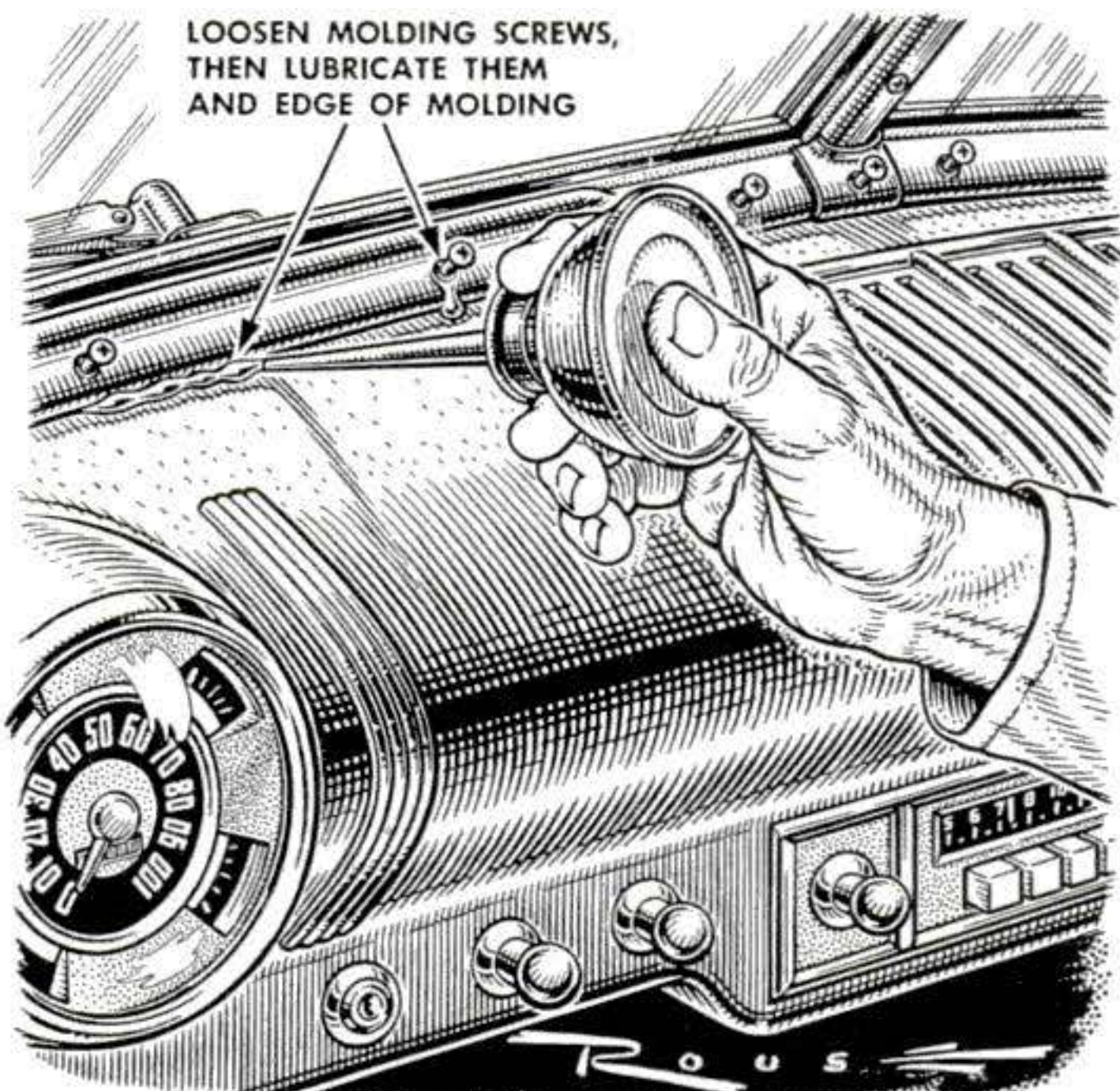
and loosen screw at end of wiper shaft about  $\frac{1}{4}$  turn (upper right). Pinch the cables together (lower right above) until you hear the serrations in the wiper drive slip one notch. Tighten the shaft screw and repeat this operation on the opposite shaft.



USE TAPERED BOLT WHEN HOLES IN FENDER AND BODY DO NOT LINE UP

HACKSAW CUT TAPER BY GRINDING  
PINCH TOGETHER  
METHODS OF TAPERING

**If one or more of the fender holes** do not line up with those in the body when a fender is being installed, taper the ends of the bolts by one of the methods shown. When the bolt is pulled tight, the taper will force the holes into matching position.

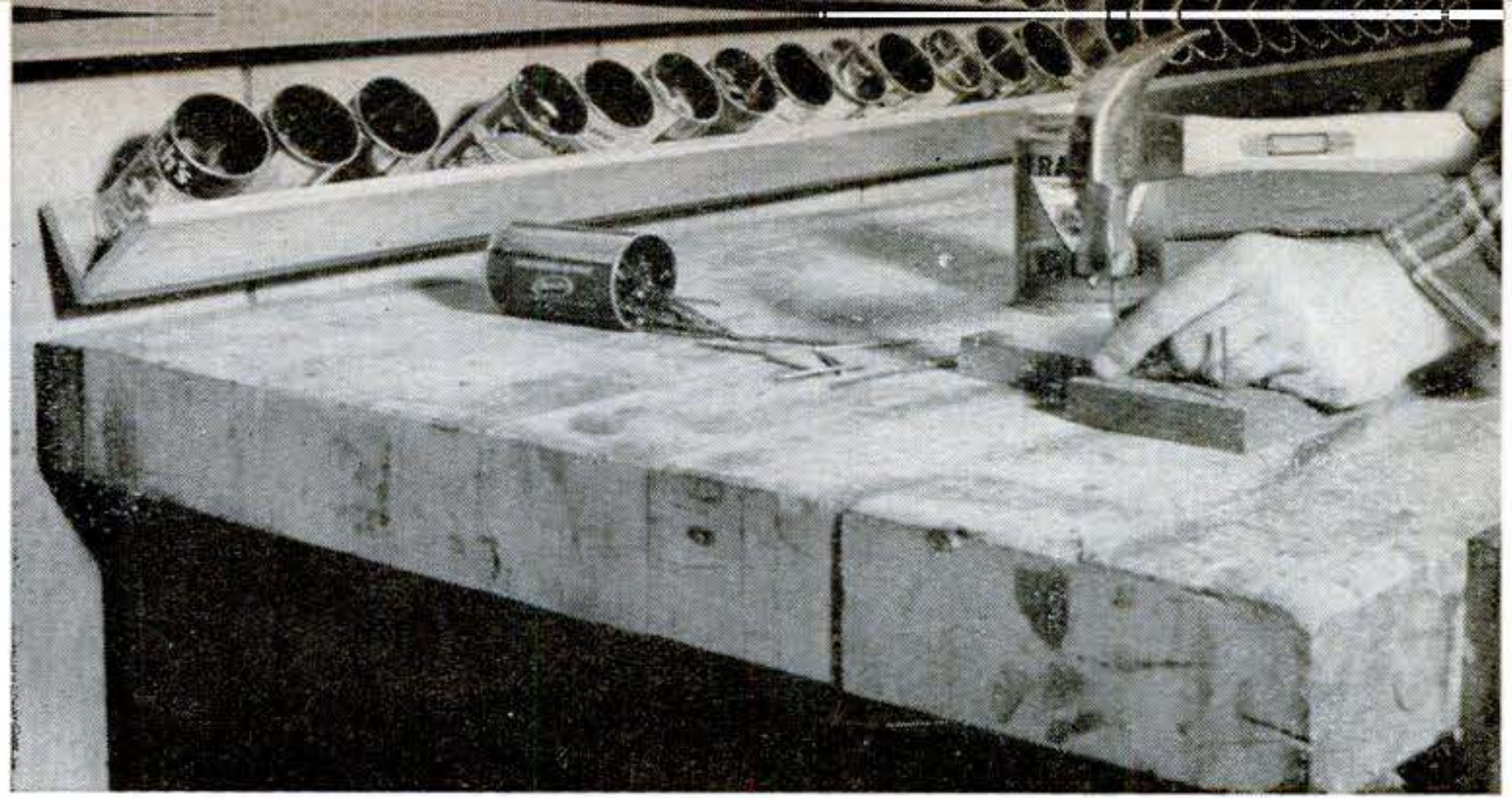


LOOSEN MOLDING SCREWS, THEN LUBRICATE THEM AND EDGE OF MOLDING

**An annoying squeak** often develops in the molding that fits between the instrument panel and windshield. You usually can get rid of it by loosening the screws and squirting penetrating oil containing graphite on the screws and under the molding.



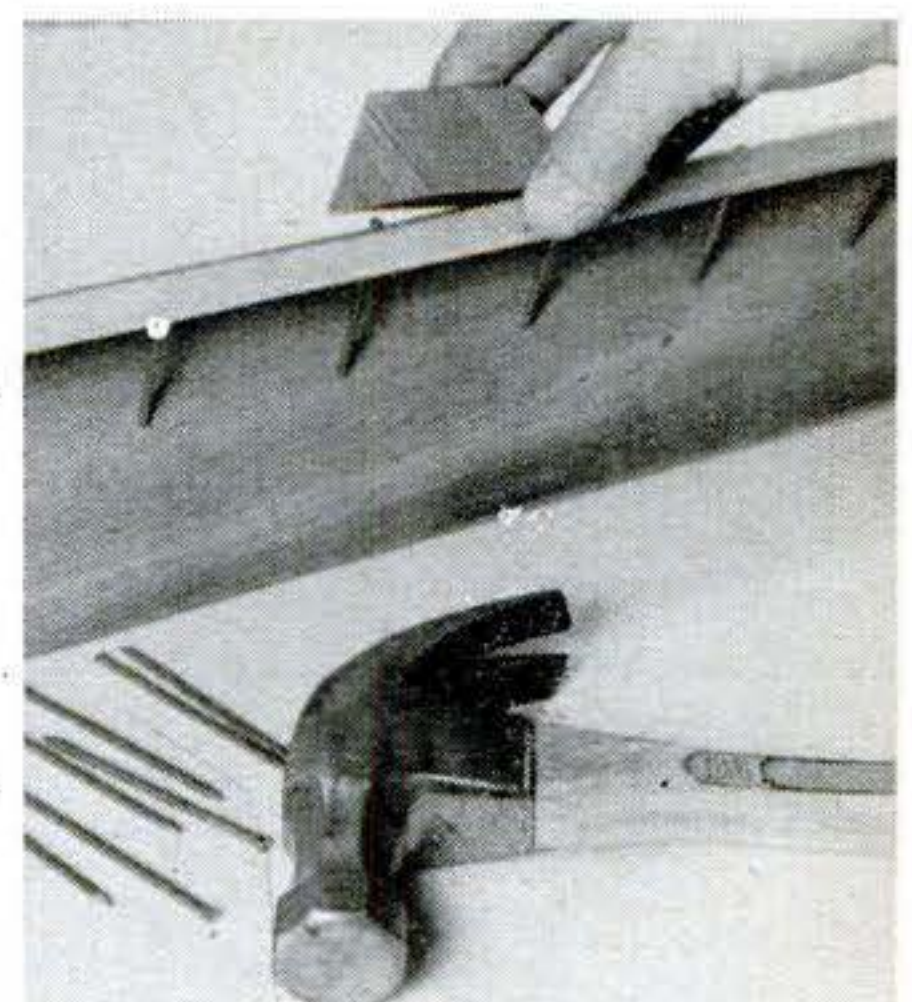
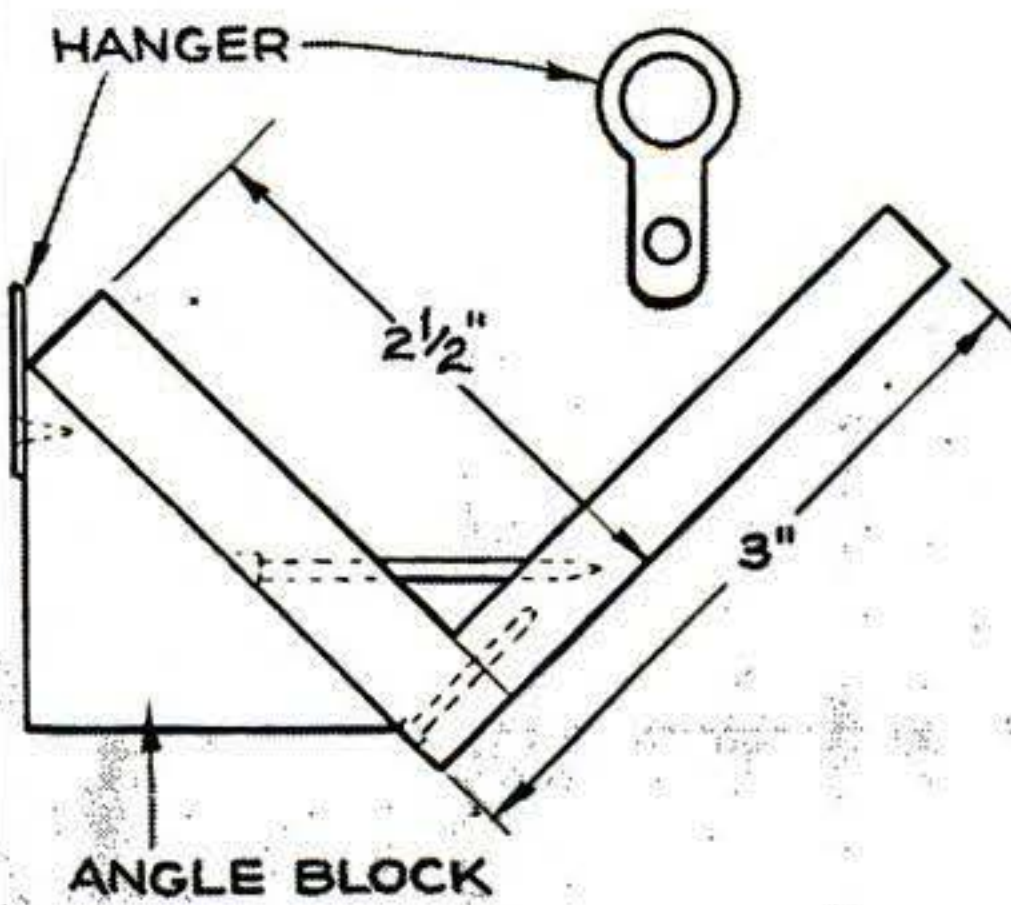
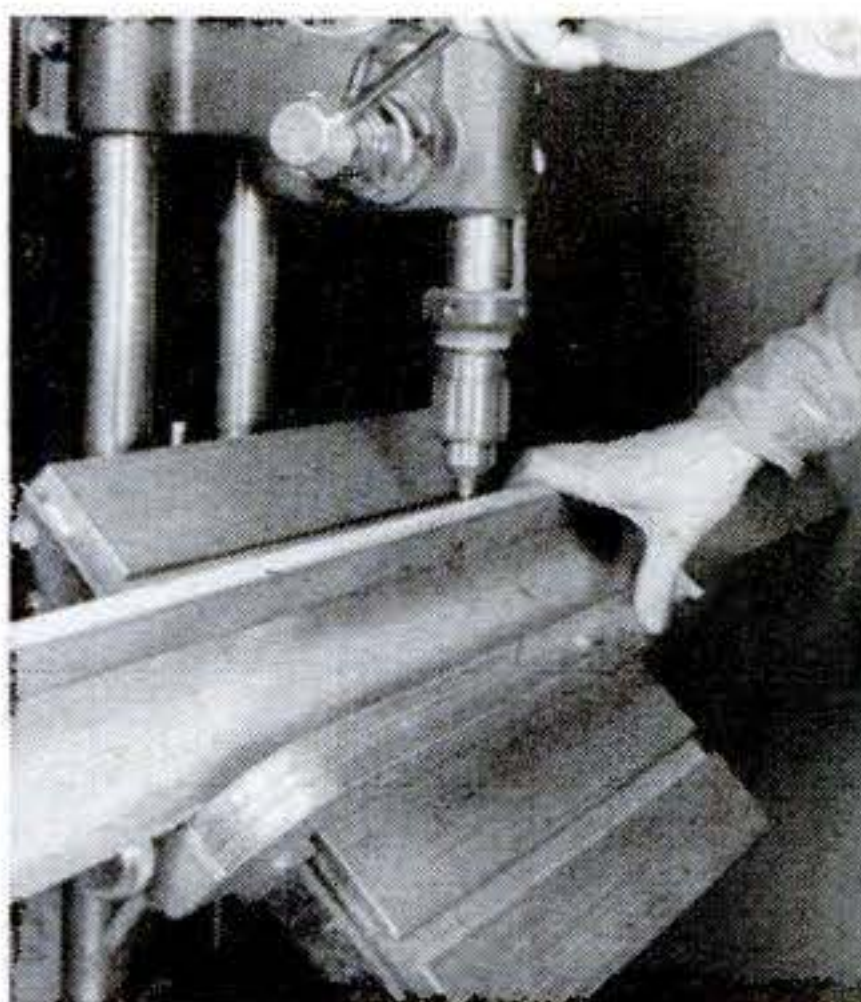
Keep things sorted and save pick-out time with a can rack like this. Dividers keep each can in its place and prevent tipping when neighboring ones are out. The contents of each may be identified with lettering on the edge of the rack facing the user.



## Racked Juice Cans Help Keep Your Workbench Neat

OUR shop is less cluttered and the workbench easier to keep clean since we put empty juice cans to work. The long rack above holds more than two dozen of them, at an angle that makes it easy to see what's in them—nails, screws, hooks, fasteners, washers or what have you.

Frozen orange, grape, lemon and other juices all come in cans this size, so it is easy to collect as many as you need. If you prefer a vertical arrangement, short rack sections can be mounted one above the other in tiers, perhaps between two studs.—*Darrell Huff, Sonoma, Calif.*



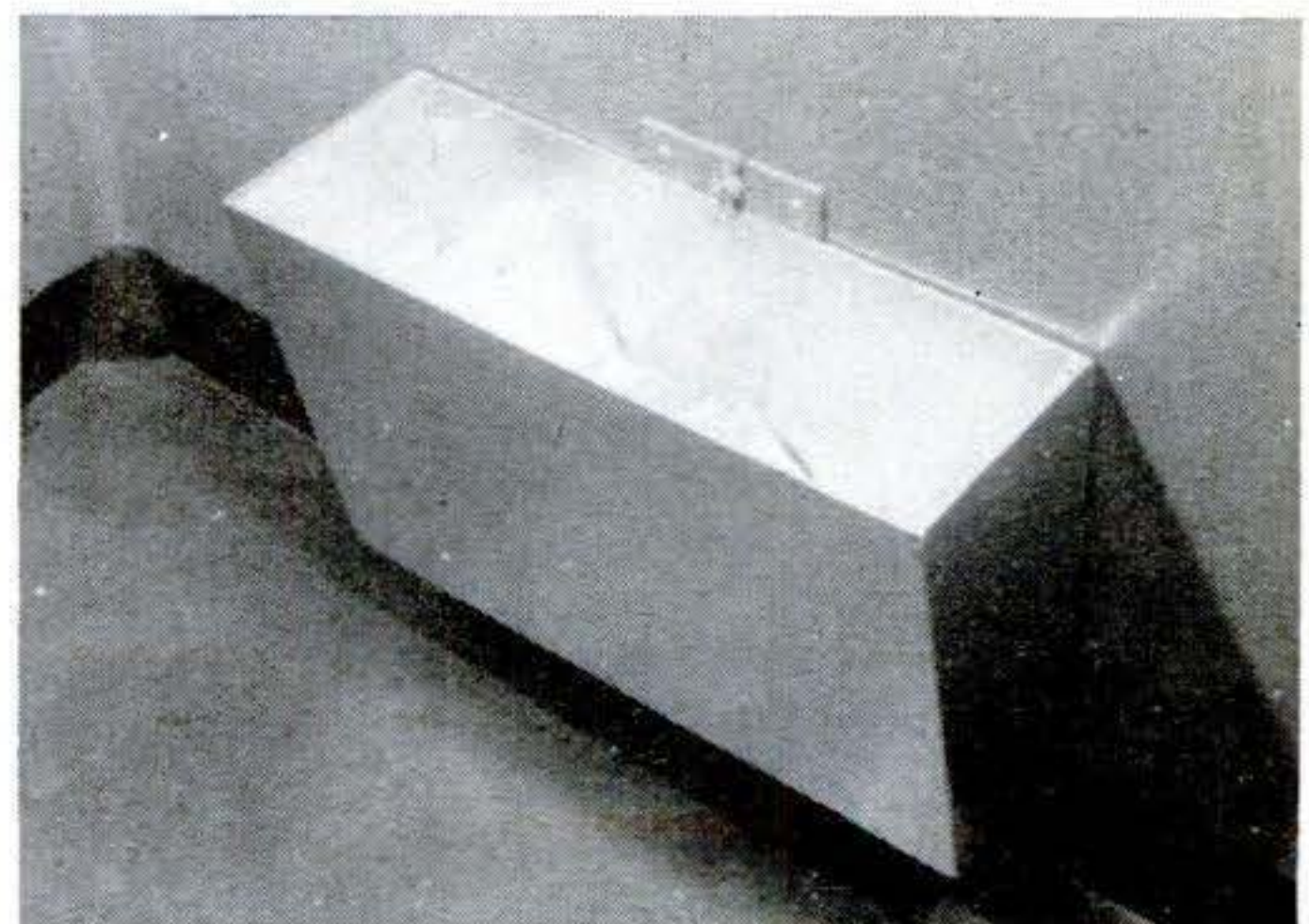
Two strips of  $\frac{1}{2}$ " lumber  $2\frac{1}{2}$ " and 3" wide are nailed together as in the drawing above. Finishing nails are driven through the  $2\frac{1}{2}$ " strip at intervals of  $2\frac{1}{4}$ " as dividers. Predrilling nail holes at  $45^\circ$  as above makes this easier. Angle

blocks about  $2\frac{1}{2}$ " on the long face, which can be cut from a scrap of two-by-four, are nailed to the back strip along its top edge as at right above. Small shelf hangers screwed to these make it easy to hang rack on a wall.

## Wall Wastebasket Makes Your Workshop Easy to Sweep

THE ordinary shop wastebasket has to be lifted when you sweep, and shows a knack for getting underfoot just when you're juggling a four-by-eight plywood panel.

This one, fastened 4" above the floor, on a wall, is never in the way and need not be moved except for emptying. It was made by nailing a front and back of thin composition board to a bottom and ends cut from heavier wood. The back extends a bit past the bottom to fit into a grooved cleat fastened to the wall. A turn button engages the top.—*Will Thomas, Buffalo, N.Y.*





# These Sawhorses

## Do More Than You Think

By Edwin M. Love

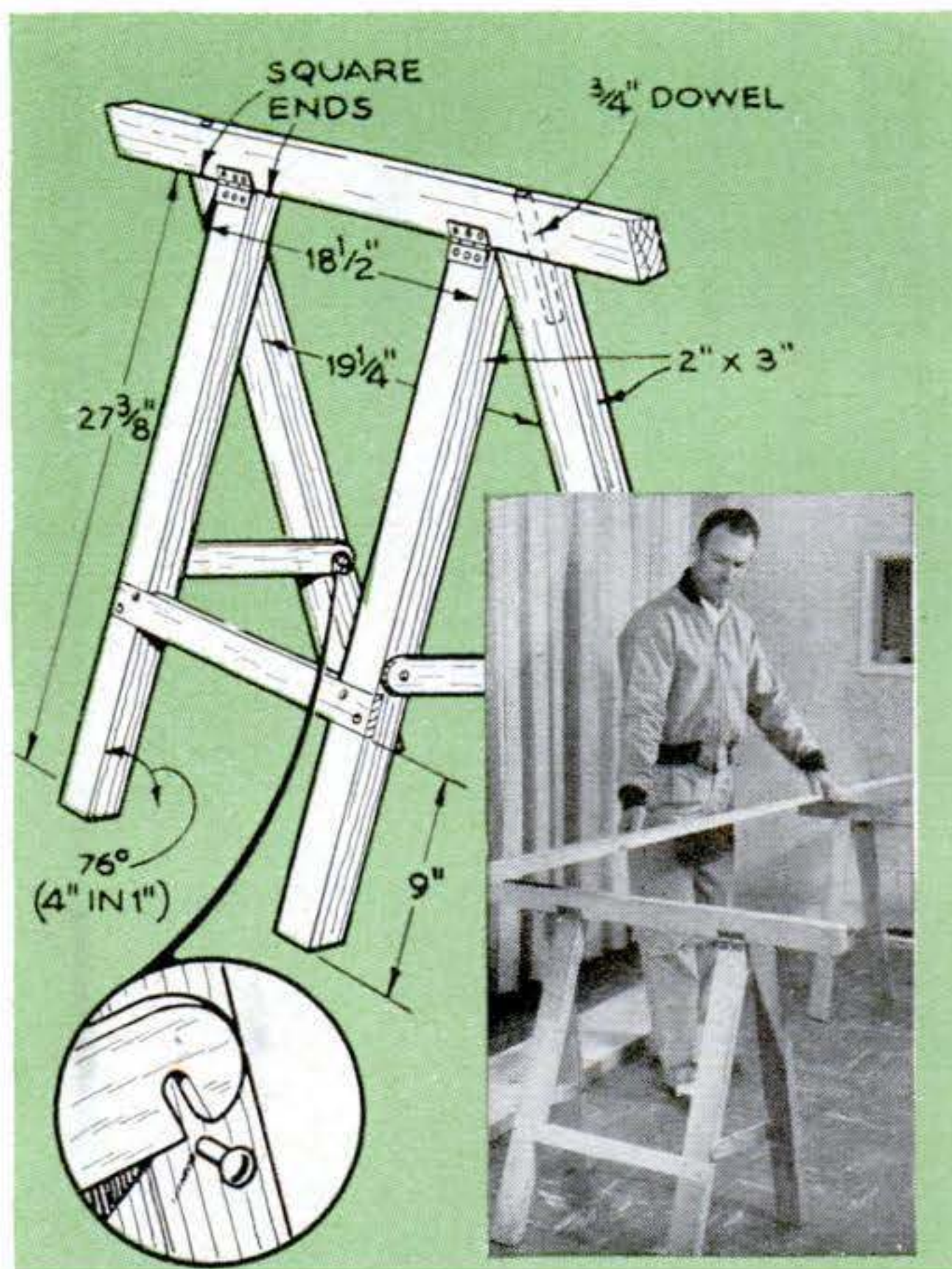
**No oat burners, these ponies will earn their keep in scores of jobs around the home, shop and garage. They're fun to build, too.**

**Y**OU can make sawhorses become the real work horses around your home and shop. Besides holding wood for sawing, modern horses do everything from supporting scaffolds to propping up your car. Some tote their own tool racks and special jigs for holding work more easily. Others fold up like a card table for easy storing in a small

**You can build either of these horses in an hour or two**



**Simple but strong**, these horses are held together by a single carriage bolt through each pair of legs. The upper ends of the legs are tapered to give the outward splay and are attached with thick casein glue before the bolts are tightened. The cross braces are  $\frac{1}{2}$ " aluminum tubing flattened at the ends, drilled, and screwed to the legs.



**Collapsible horses** fold flat for easy storage, make good supports for picnic tables, table-tennis tops and other structures that must be put up and taken down often. One pair of legs is permanently attached to crossbeam with dowels and glue, while other pair is hinged for folding. Spreader strips pivot on screws in hinged legs, hook over screws on fixed legs.



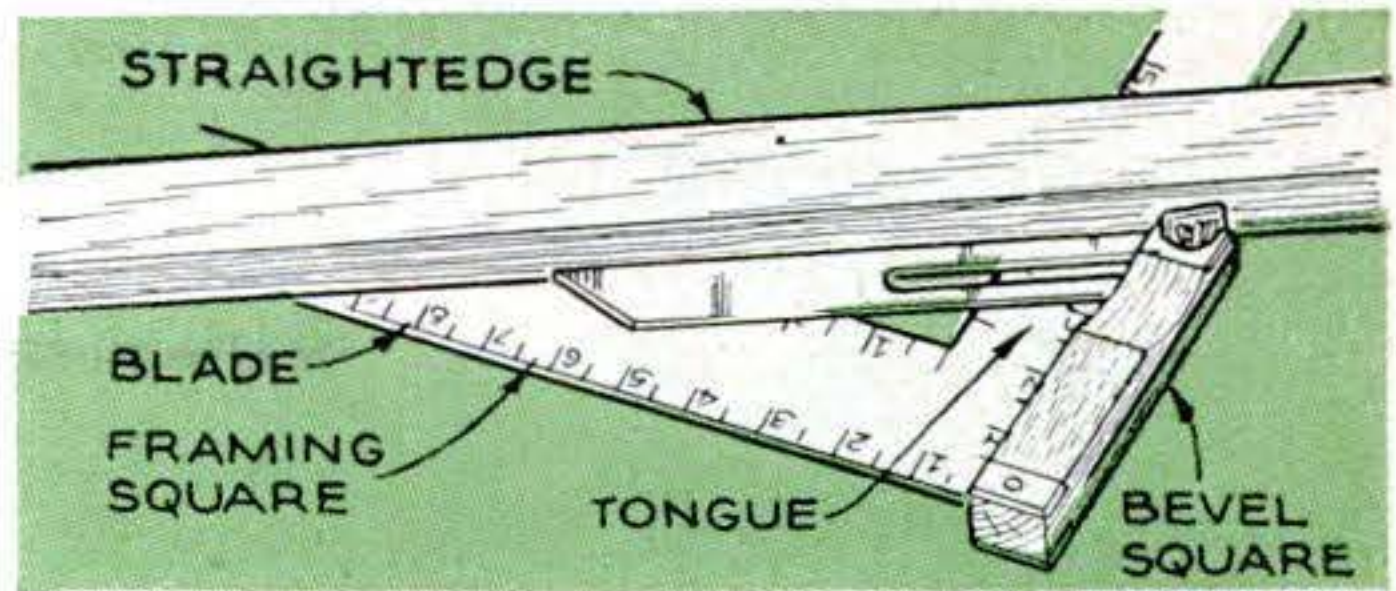
space or carrying in the trunk of your car.

**Brackets speed building.** Metal brackets, fitting stock lumber sizes, make horses that you can put together in a couple of minutes, then take apart when they're not in use. One set of brackets and some legs of different lengths will build you a picnic table or a hoisting rig as fast as you can change the legs.

**Little things make a horse good.** When nailing, stagger the nails to distribute the wedging action and reduce splitting. Screws in place of nails will add years of life, as will the use of glue. Chamfering the edges will keep splinters out of you and save wear on the horse. A finish coat of shellac or varnish keeps out moisture and lessens checking.

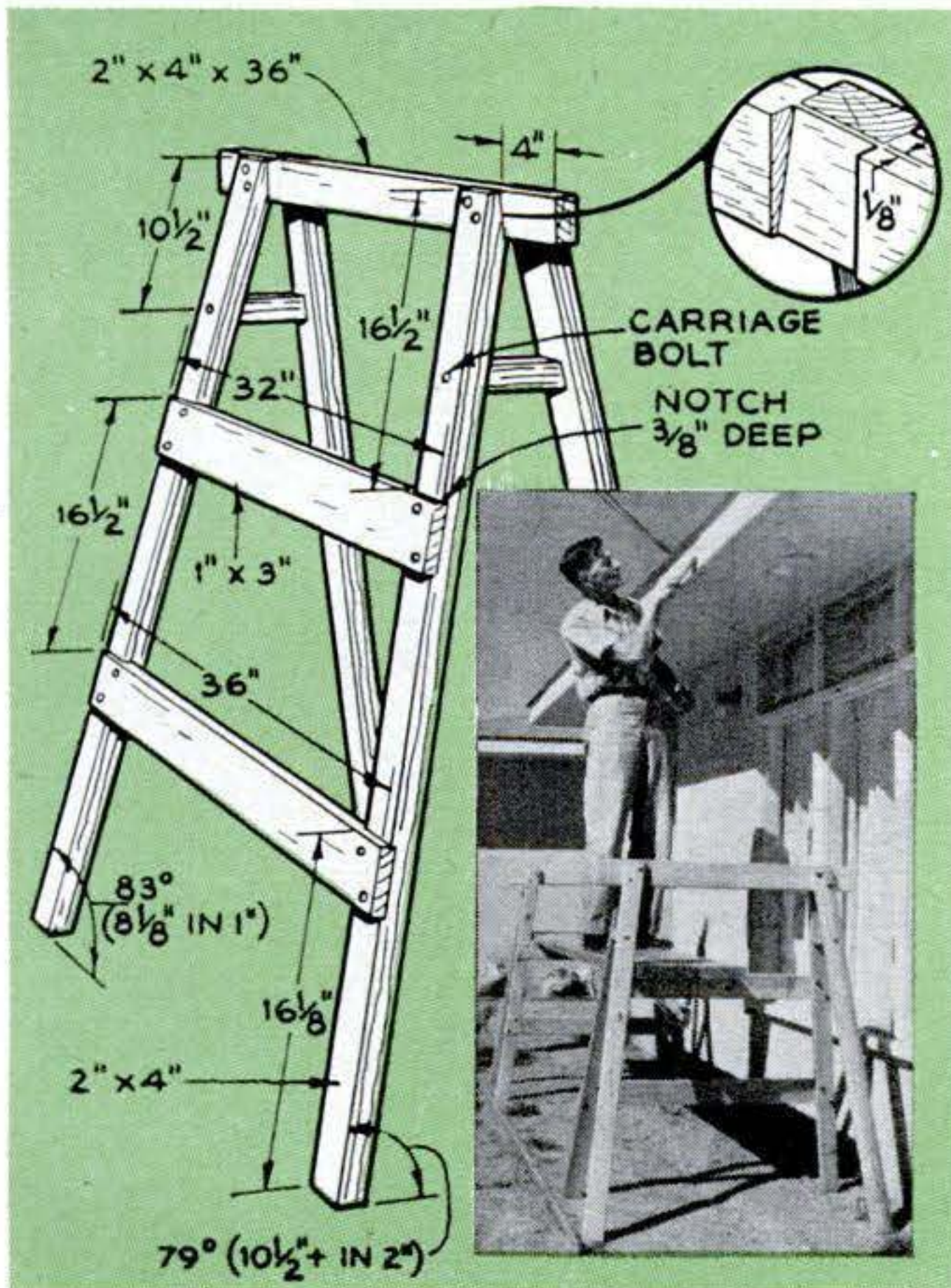
Shown here are basic horses for all purposes. From them you can build up a stable of your own that will take care of nearly any job you have to do.

### How to measure leg angles

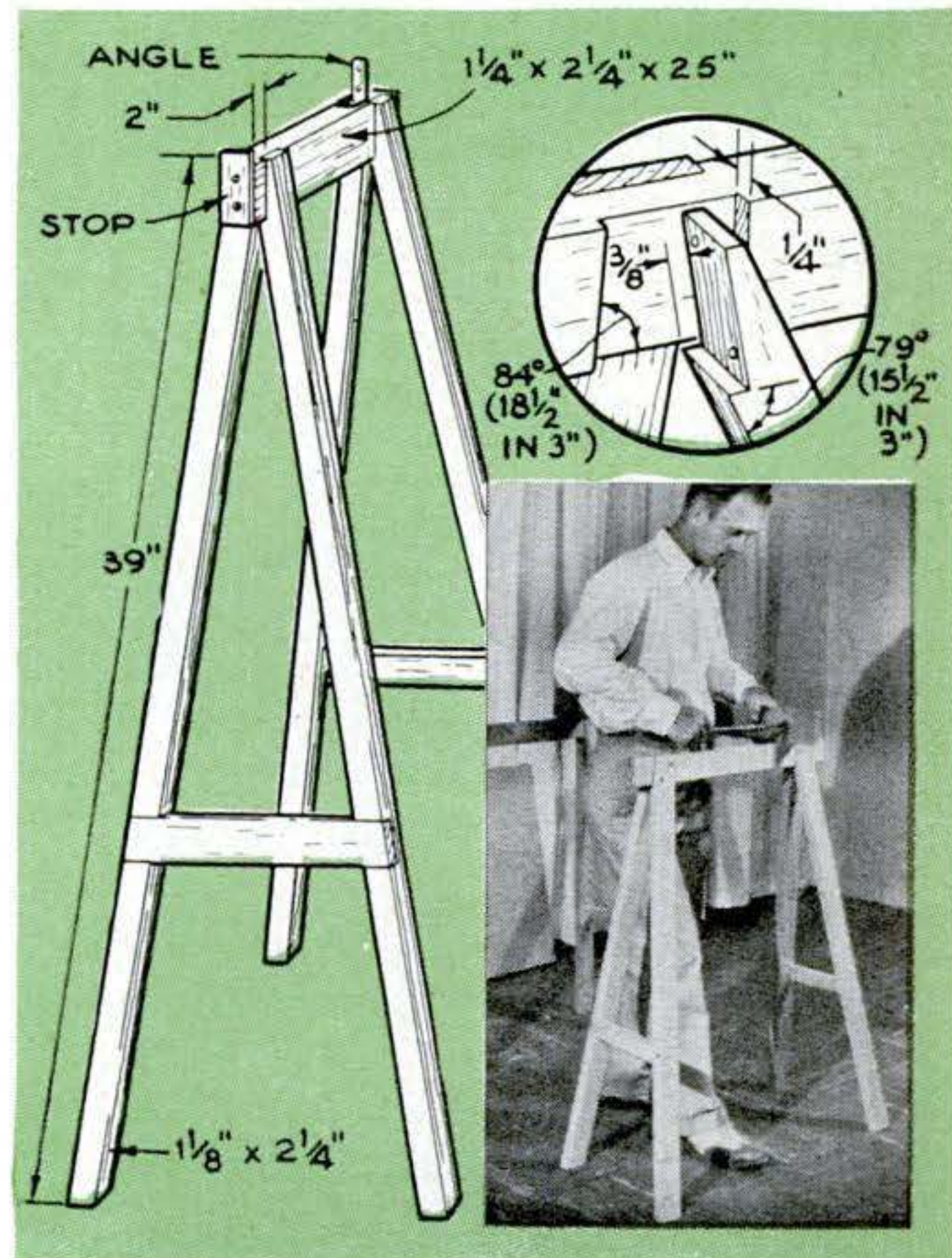


Accurate angles for cutting legs of sawhorses can be measured with a framing square, straightedge and bevel square, as shown above. Lay the straightedge across the framing square, intersecting the larger number on the blade and the smaller one on the tongue. An angle designated as 15" in 5 3/4", for instance, means 15" on the blade and 5 3/4" on the tongue. This produces an angle of 69°. Once the angle is set, the handle of the bevel square is placed against the tongue and the adjustable blade tightened against the straightedge. The bevel square can then be used to transfer the angle to the wood before making the cut. A 45° angle can be made by intersecting any two identical numbers on the blade and tongue, such as 8" and 8", 6" and 6" and so on. Other angles are given on the drawings.

### Long-legged models hold scaffolds and tables



**Scaffold horses** hold planks at any one of three levels for easy reaching of high places either outdoors or in. By making legs longer or adding extensions, horses could be safely made several feet higher. For maximum strength, top beams and crosspieces should be notched into legs as shown. Spreader blocks that hold legs apart are grooved to slip over the carriage bolts.

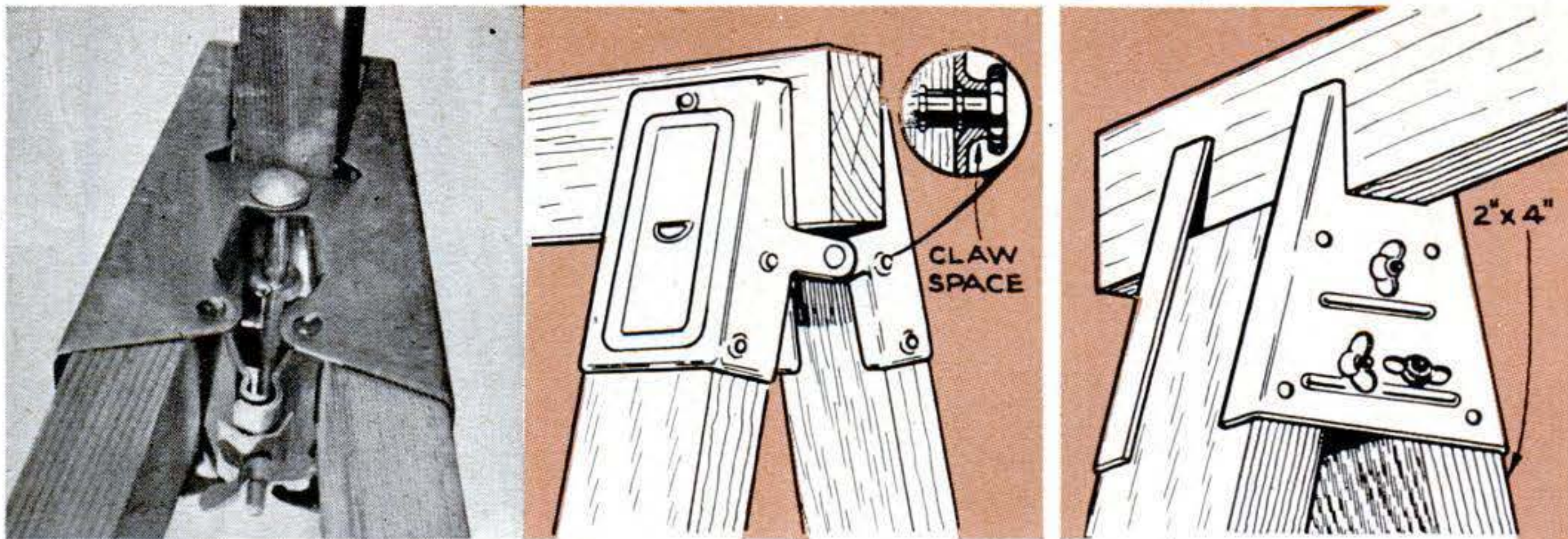


**Drafting table** is easily made from a pair of these extra-tall horses. Crossbeam, fastened to horses with metal angles, supports back edge of drawing board and gives it proper tilt. Front edge of board rests against wood stops that keep it from slipping off. Without tilting bar, horses make ideal supports for wall-paper-pasting table or elevated work table.

Please turn the page for more sawhorses.

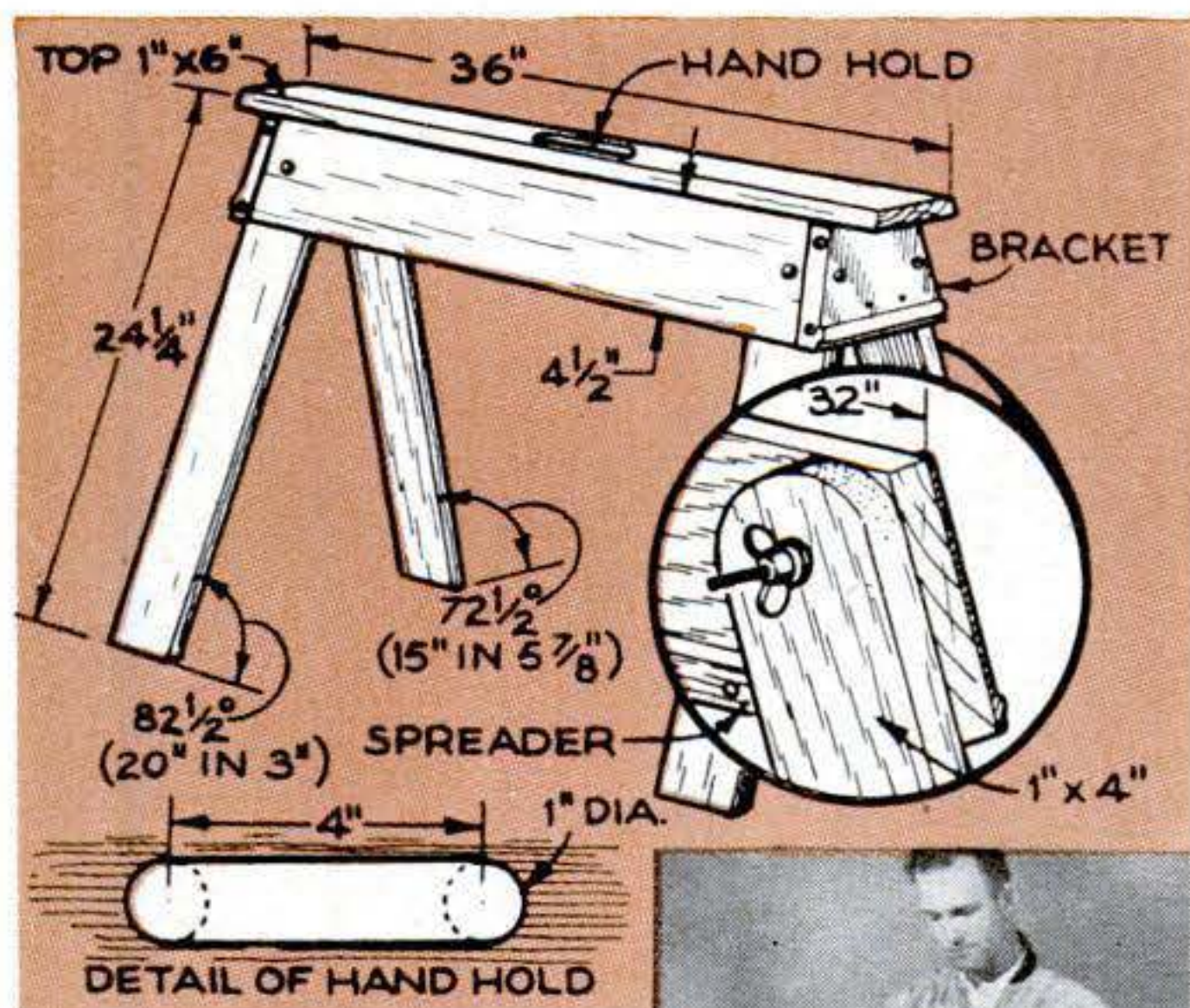


## Horses built with metal brackets go together quickly



**Self-gripping bracket**, made by Dalton, holds two-by-four legs securely to crossbeam by single wing nut (left above). As nut is tightened, bracket spreads, locking in legs and forcing metal teeth into wood beam for a tight grip. Quick-assembly Dalton bracket (center) is nailed

to legs and crossbeam, but has flanged holes that hold nailheads extended for easy removal with hammer claw. Heavy-duty Larson bracket (right) has solid sides for rigid bracing, is clamped to legs by three bolts and can also be nailed for extra strength.

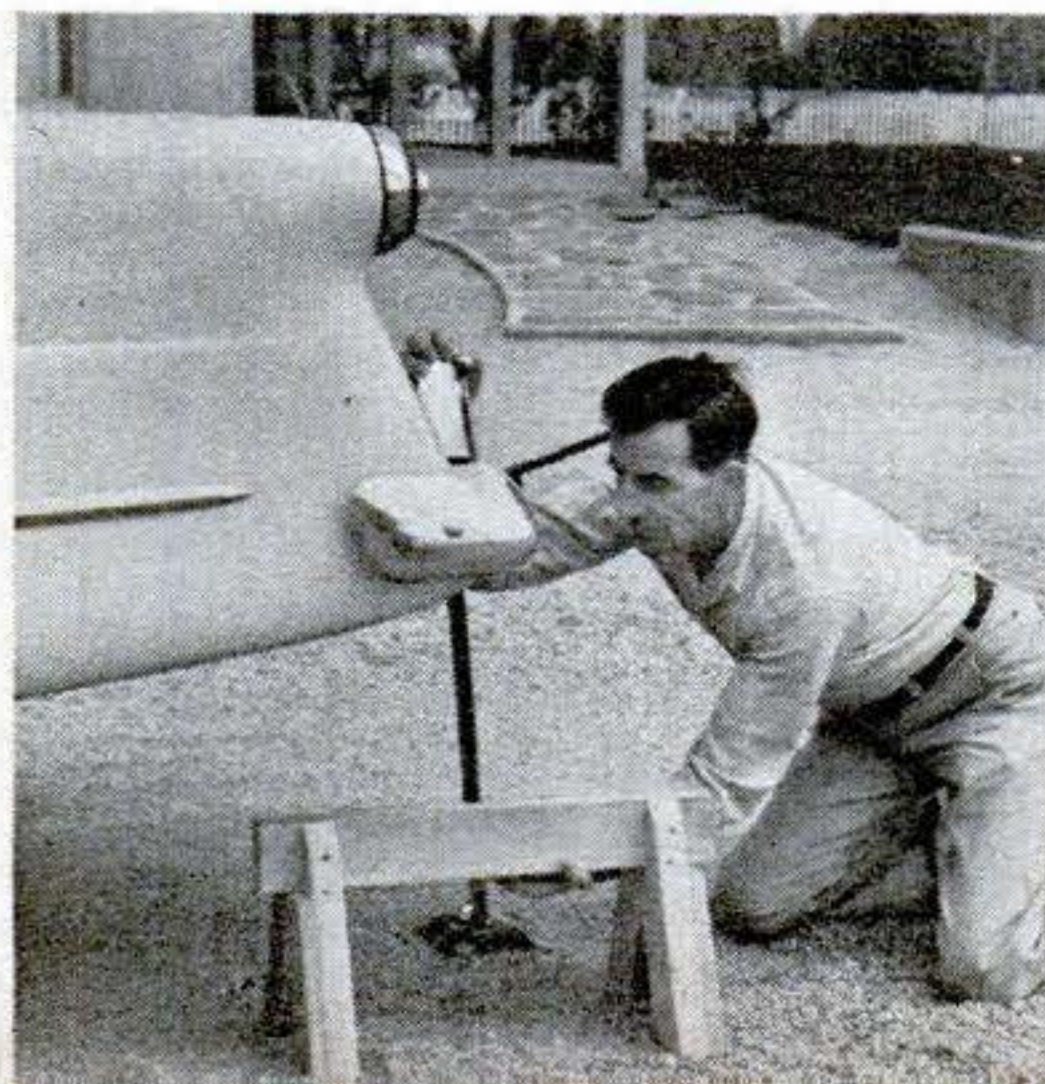


**Folding horse** has legs that swing up into side rails for easy storage. Rails are held together by metal Larson brackets screwed on at ends, and each leg pivots on a single 3" carriage bolt. Spreader strips, screwed on inside of rails, lock legs against end plates when nuts are tightened.



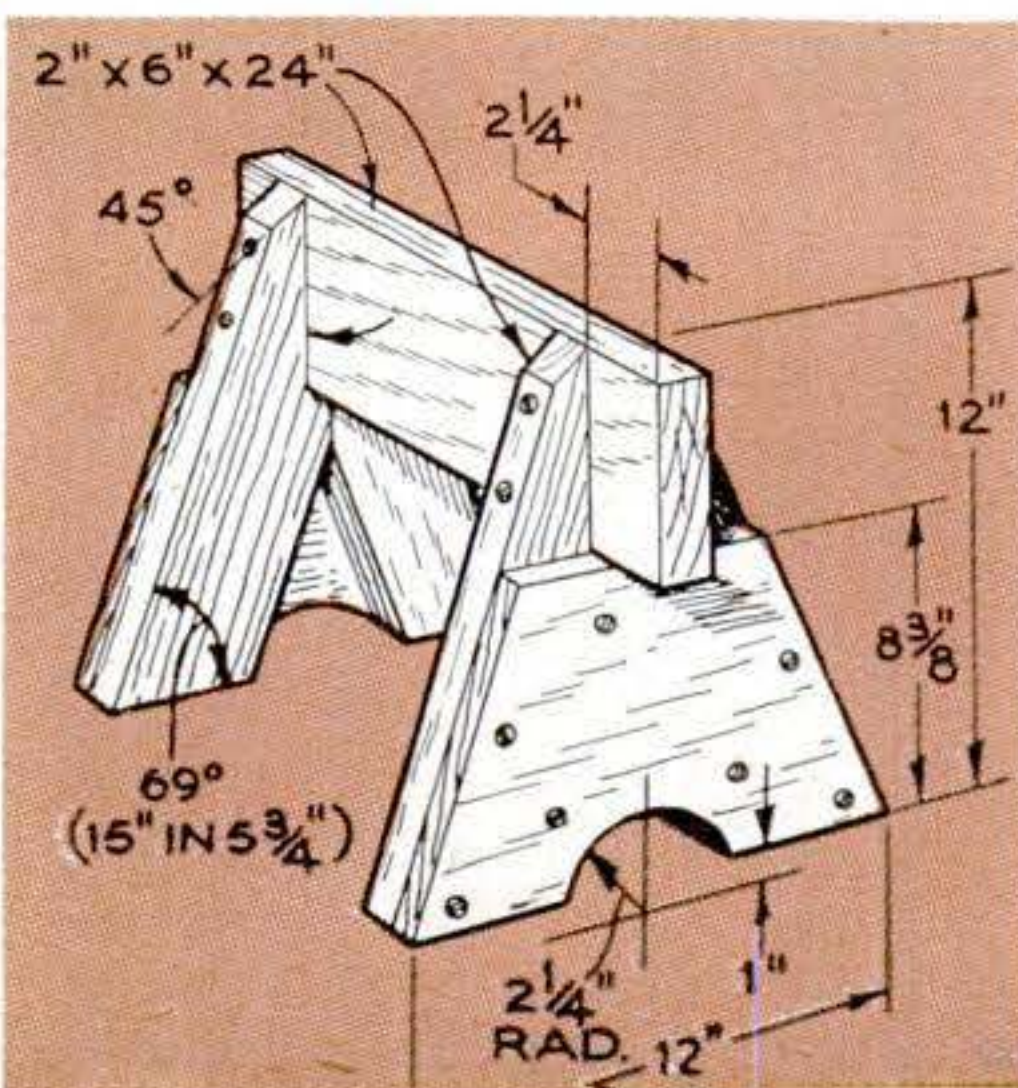
**Hoisting rig** is simply an overgrown sawhorse made with conventional metal brackets and extra-long legs. Temporary braces are nailed to legs to avoid spreading, while planks wedged against each end prevent sway.

## Husky, short-legged ones shoulder heavy jobs easily



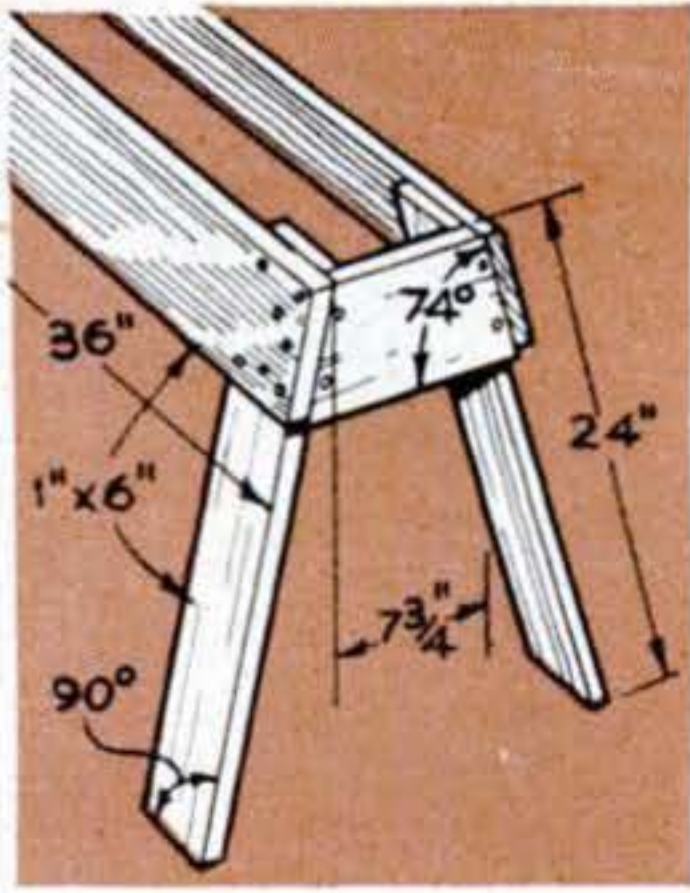
**Midget horse**, designed by F. Shelford of Los Angeles, makes a safe, solid support for holding up a car while you're working under it or switching tires around. Wide, 1"-thick side braces make sure that legs can't spread apart.

154 POPULAR SCIENCE

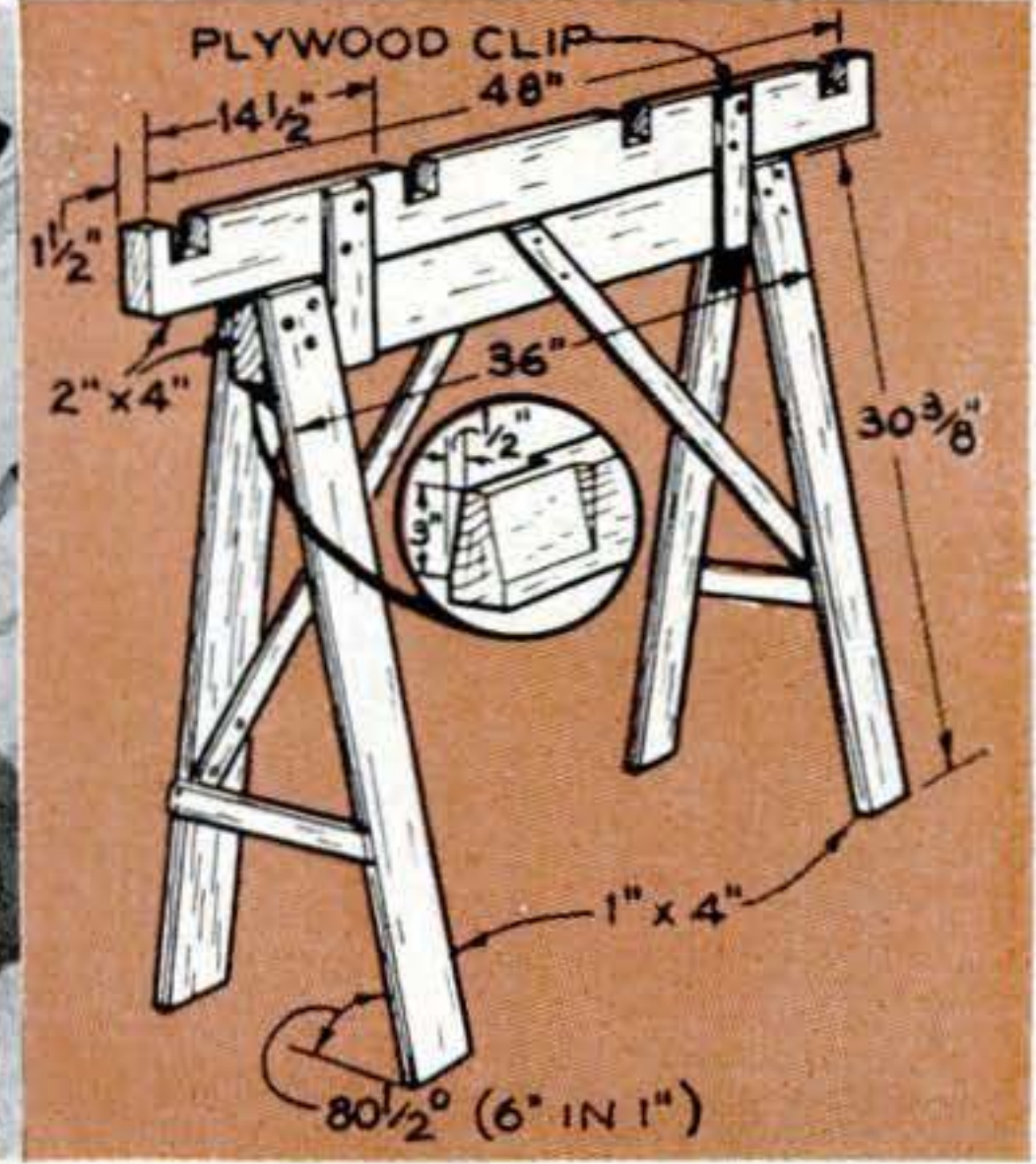
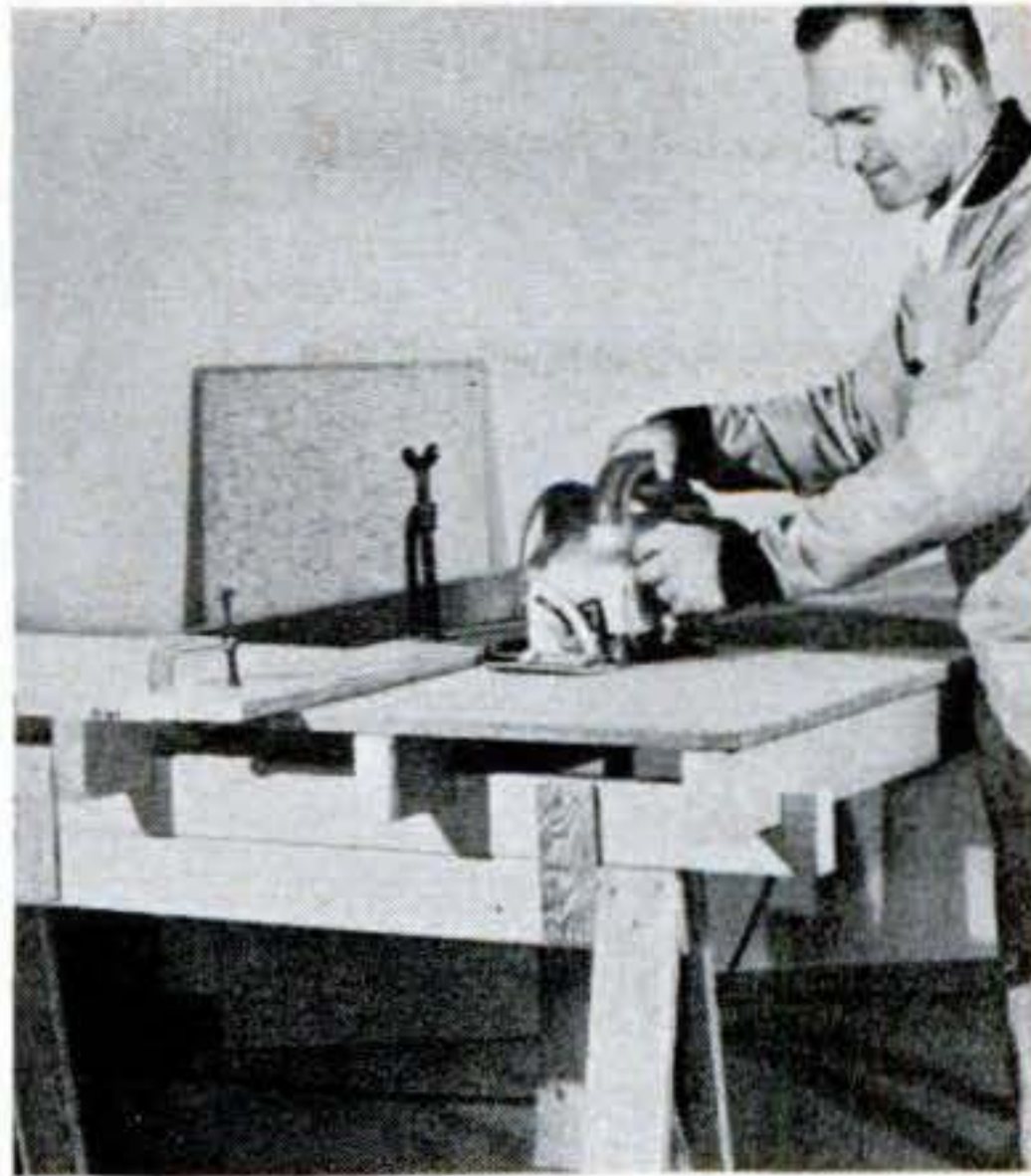




## Horses you can saw through make big cutting easier

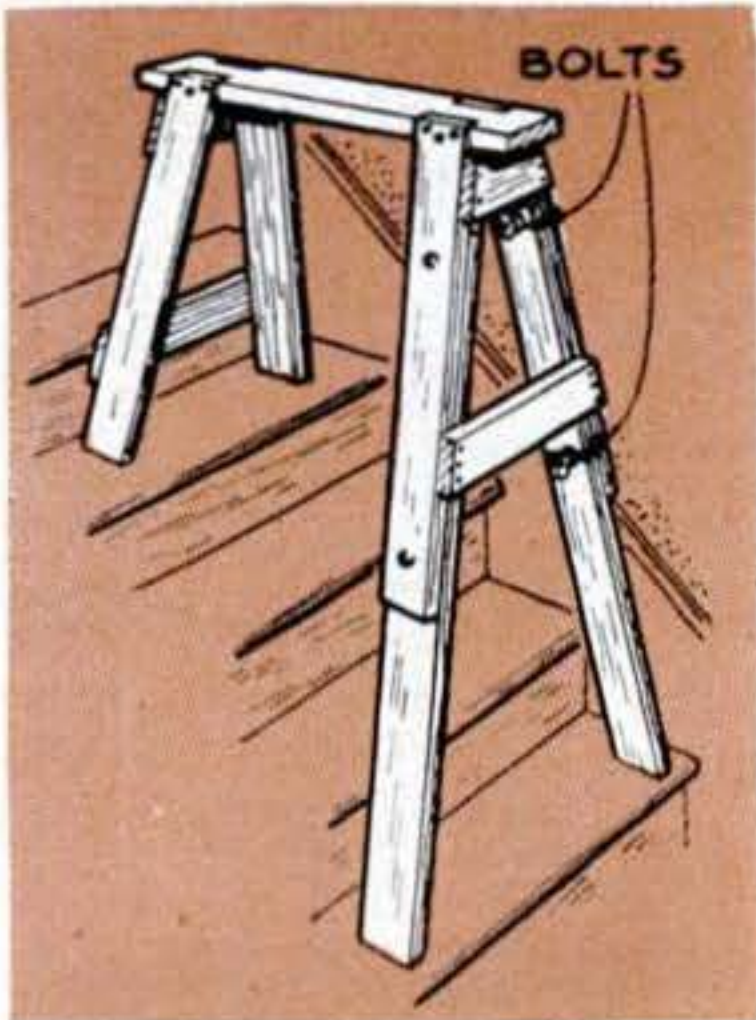


**Hollow horse** lets you saw, drill or drive nails down between side rails, giving solid support at both sides of work and lessening chance of cutting into the beam or legs. Horse was designed by Charles Kimball of Los Angeles.

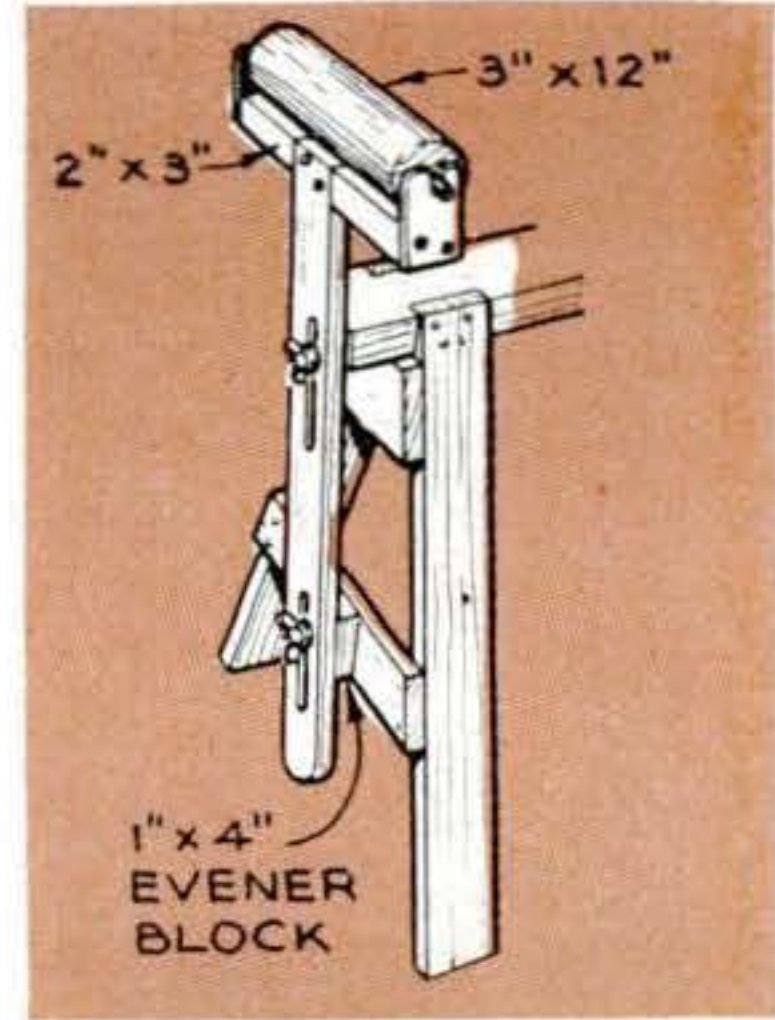


**Table horse**, designed by W. G. Waggoner of Sacramento, Calif., makes it easy to saw large sheets of plywood without calling the Marines to help you hold them. Two ordinary horses are joined with four two-by-four bars 8' long, forming a 4'-by-8' trestle. Ends of bars fit in notched beams attached to horses. For lengthwise cuts, clamp guide fence to panel and saw between bars. For cutting across a panel, lay down cross strips to raise blade so it will clear bars.

## These accessories get more work out of any horse

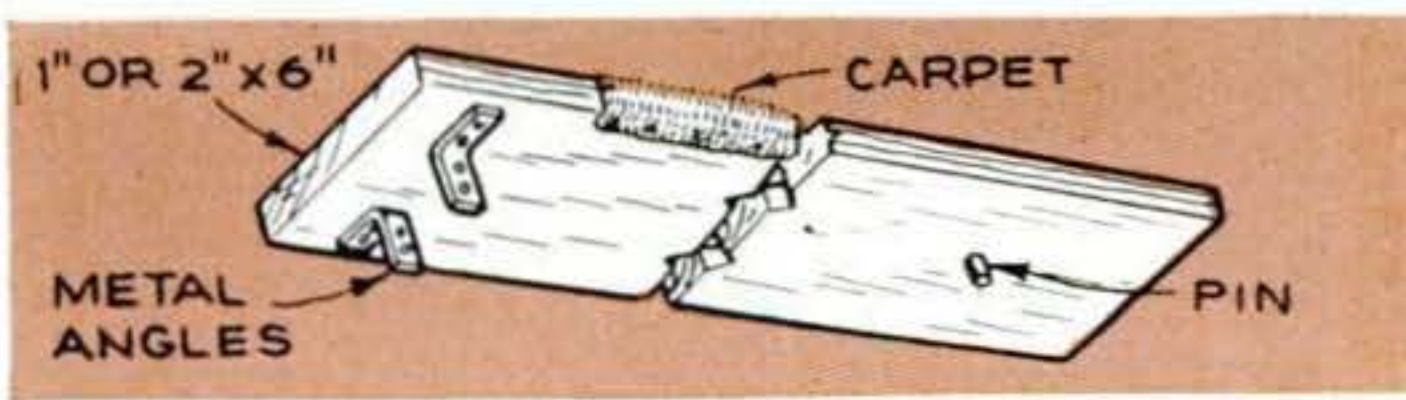


**Extension legs** adapt a horse for working on stairs, sloping ground or other uneven surfaces. To make length adjustable, you can add series of bolt holes 1" or 2" apart, but avoid a slot-type, sliding arrangement that might let go with you on it. For extensions longer than 2', nail on extra cross braces at bottom to keep legs from spreading.

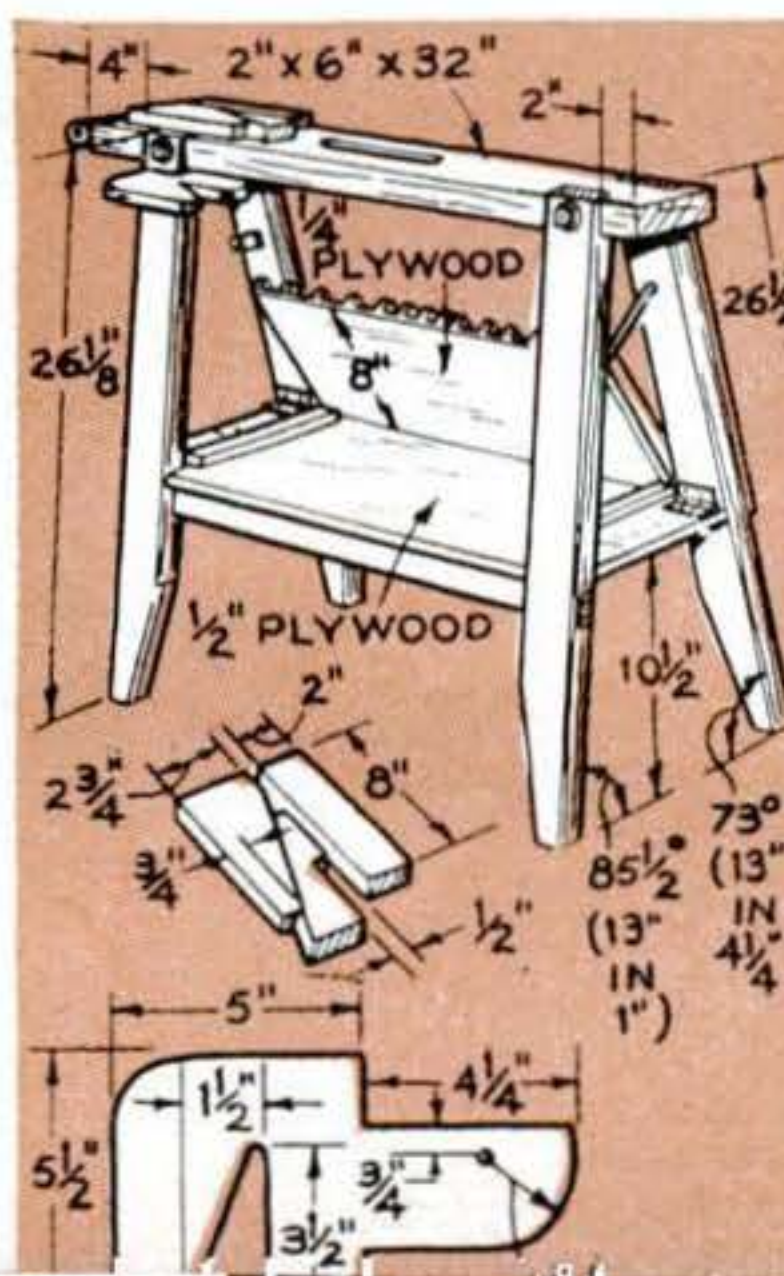


**Ripping roller**, mounted on the end of a horse and adjusted to the height of your saw table, gives you a third hand for holding long boards while you run them through a saw. Slots in support permit it to be raised and lowered quickly.

**Padded rail**, slipped over regular crossbeam, keeps scratches off finely finished pieces. Wrap old carpet around board and tack edges underneath. Metal angles hold rail on beams set on edge. For beams turned flat, use several dowel pins.



**Tools are at your fingertips** when kept in a folding rack like this one under the sawhorse. Rack is hinged to back edge of shelf, and shelf, in turn, is hinged to legs so both fold up flat against hard-board back when leg bolts are loosened. Front edge of shelf rests on stretcher notched into legs, and rack is held at angle by short chain. Wedge-type stop mounted on top of beam holds small work for planing or jointing; pivoted side stop swings out from under beam to take doors and larger pieces. End of cross-beam is rubber-padded so horse can be braced against wall without marring wall.





# Extra Jobs for Your Portable Sander

**A sander is a nice investment—make it pay off by handling jobs other than just plain sanding.**

A CRAFTSMAN I know uses his oscillating sander after he has finished one of those long, hard days in his workshop. He takes off the sandpaper (and his shoes) and lets the machine massage his tired feet.

Portable sanders can do lots of jobs the maker may never have thought of—from sharpening pencils to frosting glass. Here are a few ideas to keep your sander buzzing around your workshop instead of resting idly on a shelf.—*Walter E. Burton, Akron, Ohio.*



**ETCHING GROUND GLASS** for camera. Strip of sheet metal is agitated by sander over glass covered with oil-moistened valve-grinding compound or abrasive grit.



**TO REMOVE RUST**, apply satin finish to lacquered surfaces or smooth shellac between coats, drive steel-wool with coarse sandpaper.



**CIRCULAR KNIFE** is quickly given new edge by holding it against sheet of metal-cutting abrasive mounted on sander shoe. Knife rotates as it is sharpened.



**AX EDGE** is restored with disk sander. Coarse abrasive disk is used to remove nicks, fine disk to produce sharp edge, extra fine disk to brighten ax head.



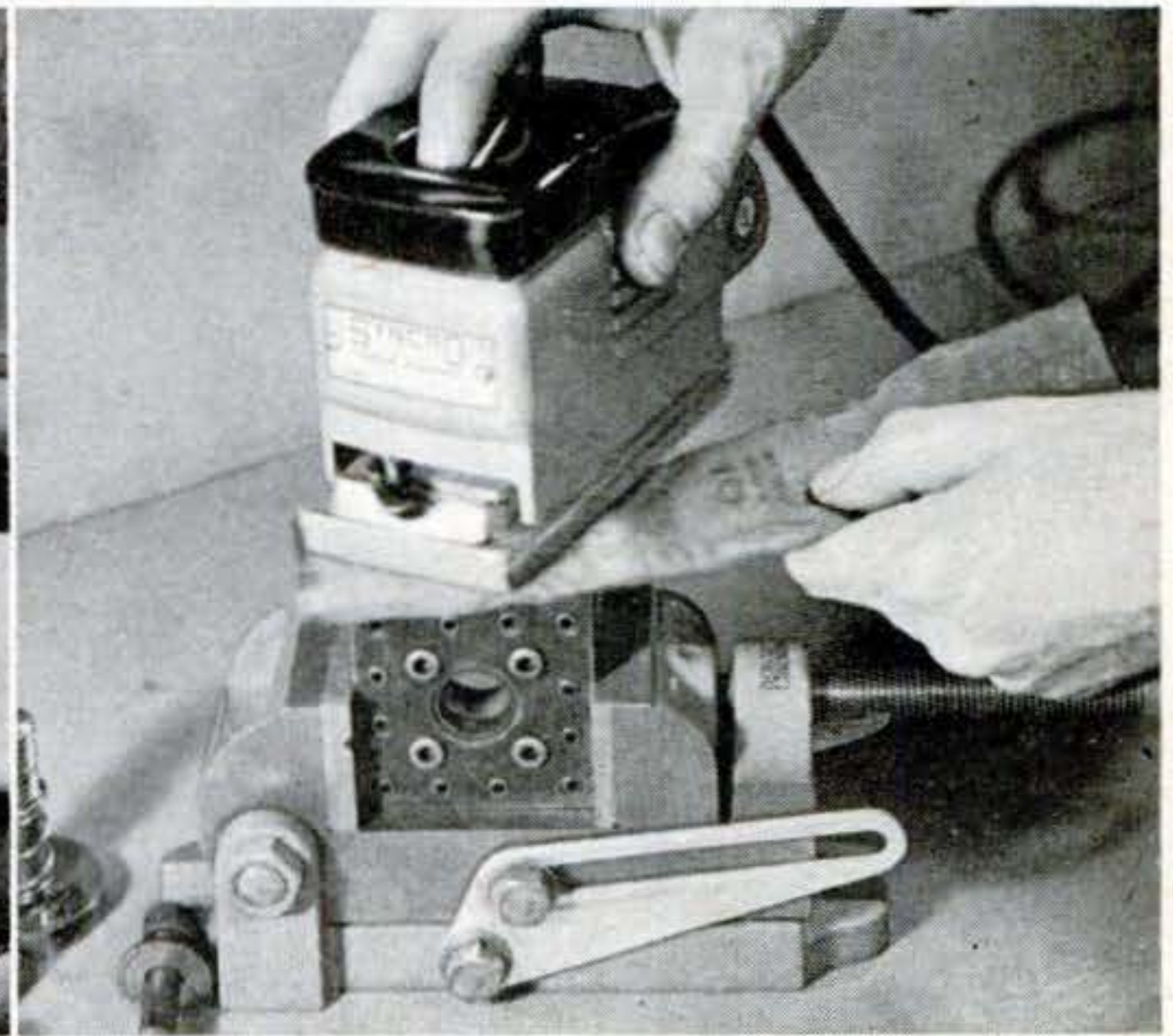


**DECORATIVE DESIGNS** or monograms can be etched in metal, plastic or glass by cutting stencil from masking tape (left), applying valve-grinding compound mixed with light

oil (center) and agitating strip of sheet metal over cutaway portion (right). Design will be ground in before protective tape wears away. After job, wash work with soap and water.



**FLANNEL PAD** used with mild rubbing compound quickly imparts luster to surfaces that would require lengthy hand polishing.



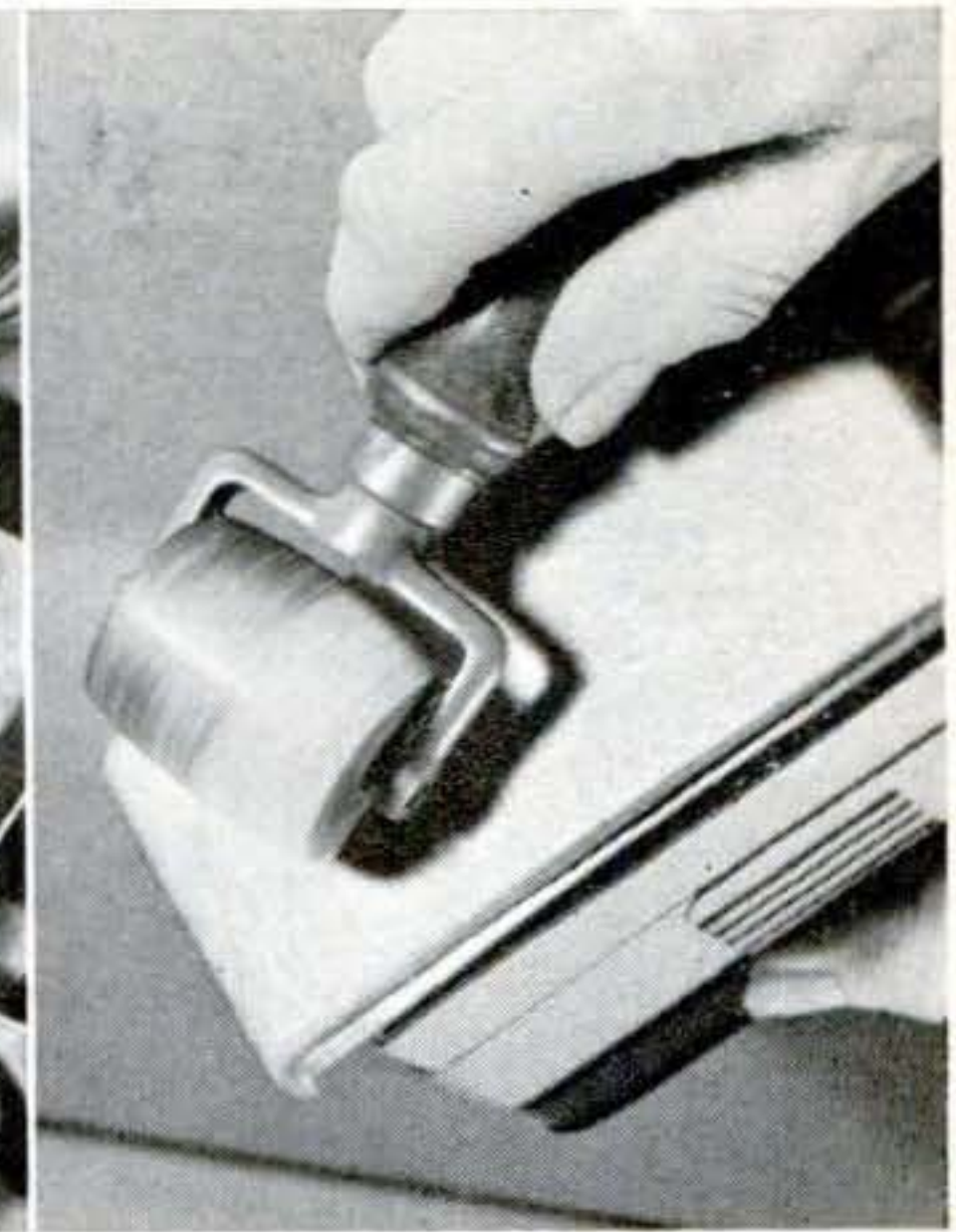
**MACHINE PARTS** are brightened in a jiffy by agitating a loose strip of fine abrasive cloth with the sandpaper-covered sander shoe.



**HELD UPSIDE DOWN**, sander presents a working surface for small freehand jobs. Here turnings are deburred.



**PENCIL SHARPENER.** Pencils are brought to a needle point in seconds. Pointed tools are likewise renewed.



**PAPERHANGER'S ROLLER,** roughened by use, is smoothed and crowned by holding it on platen.



## Telephone Can Help Your Radio



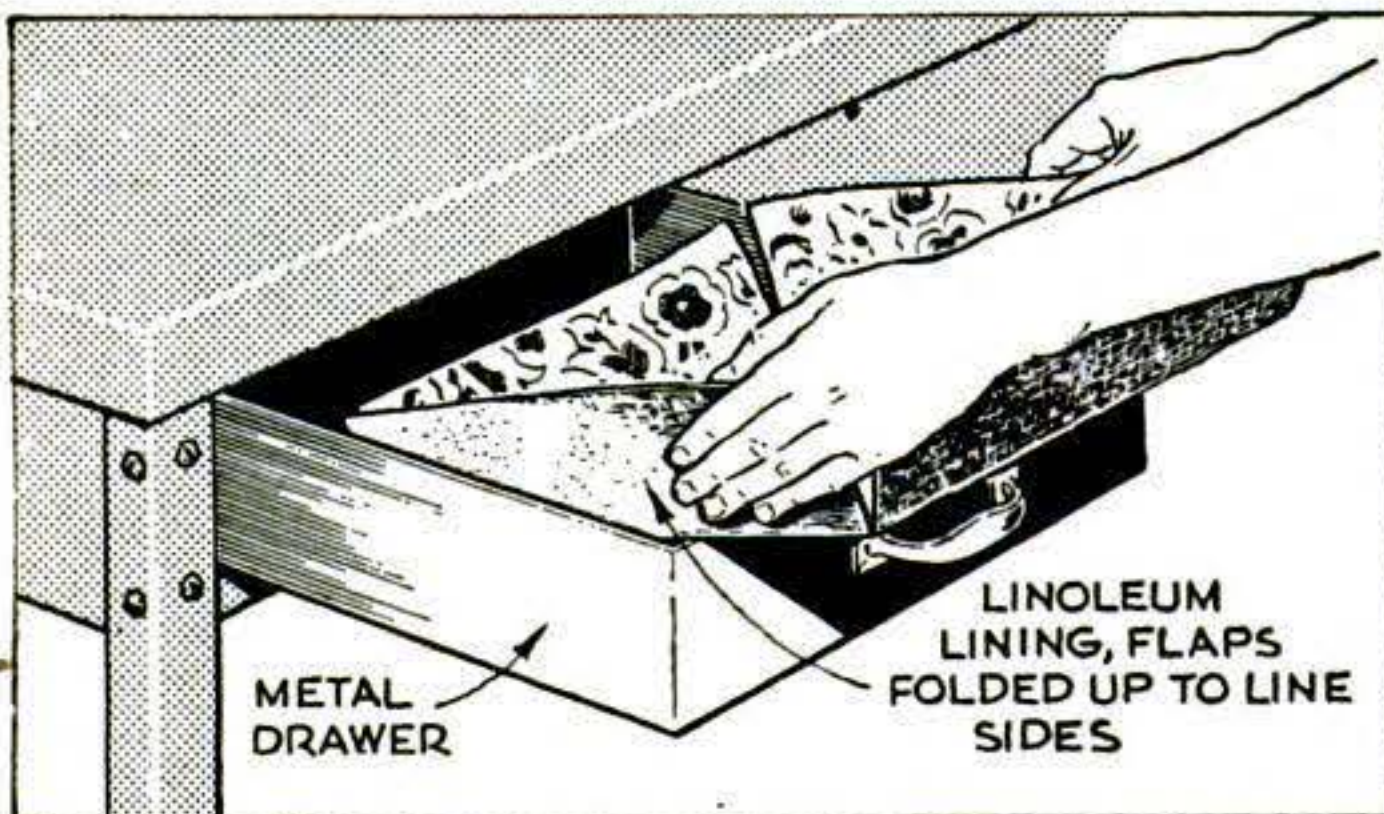
IF YOU live in the country and your radio won't quite pull in that favorite station, try this. Connect a wire from the antenna terminal on your radio to a pie tin or any metal disk about 6" in diameter. Set your telephone on the pan, and you'll be surprised at the difference.

## Rivets Lessen Heel Wear



METAL heel protectors can be quickly made from ordinary  $\frac{1}{4}$ " split copper rivets. Hammer them into the heel-nailing holes, and the nailheads will force the split sides apart to lock the rivets in.

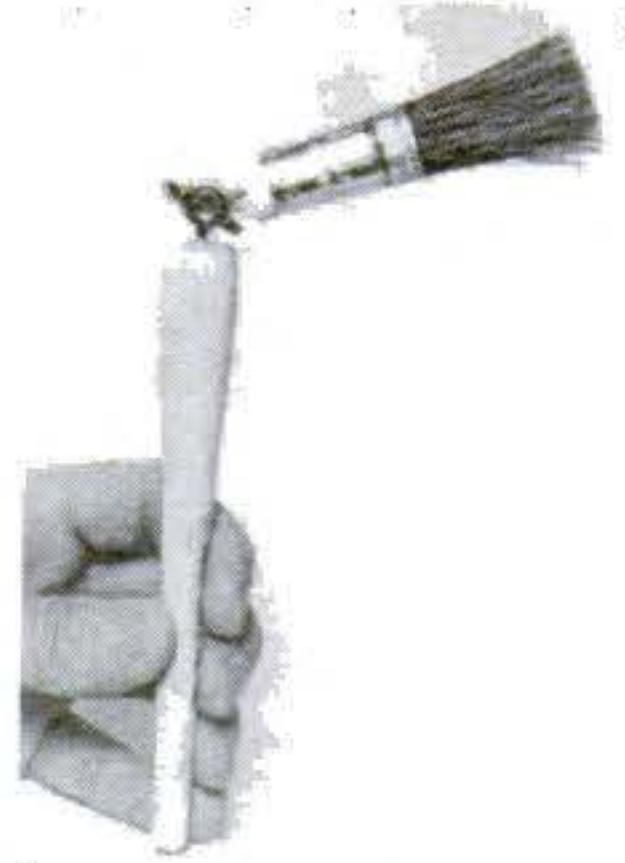
## Drawer Lining Saves Tools



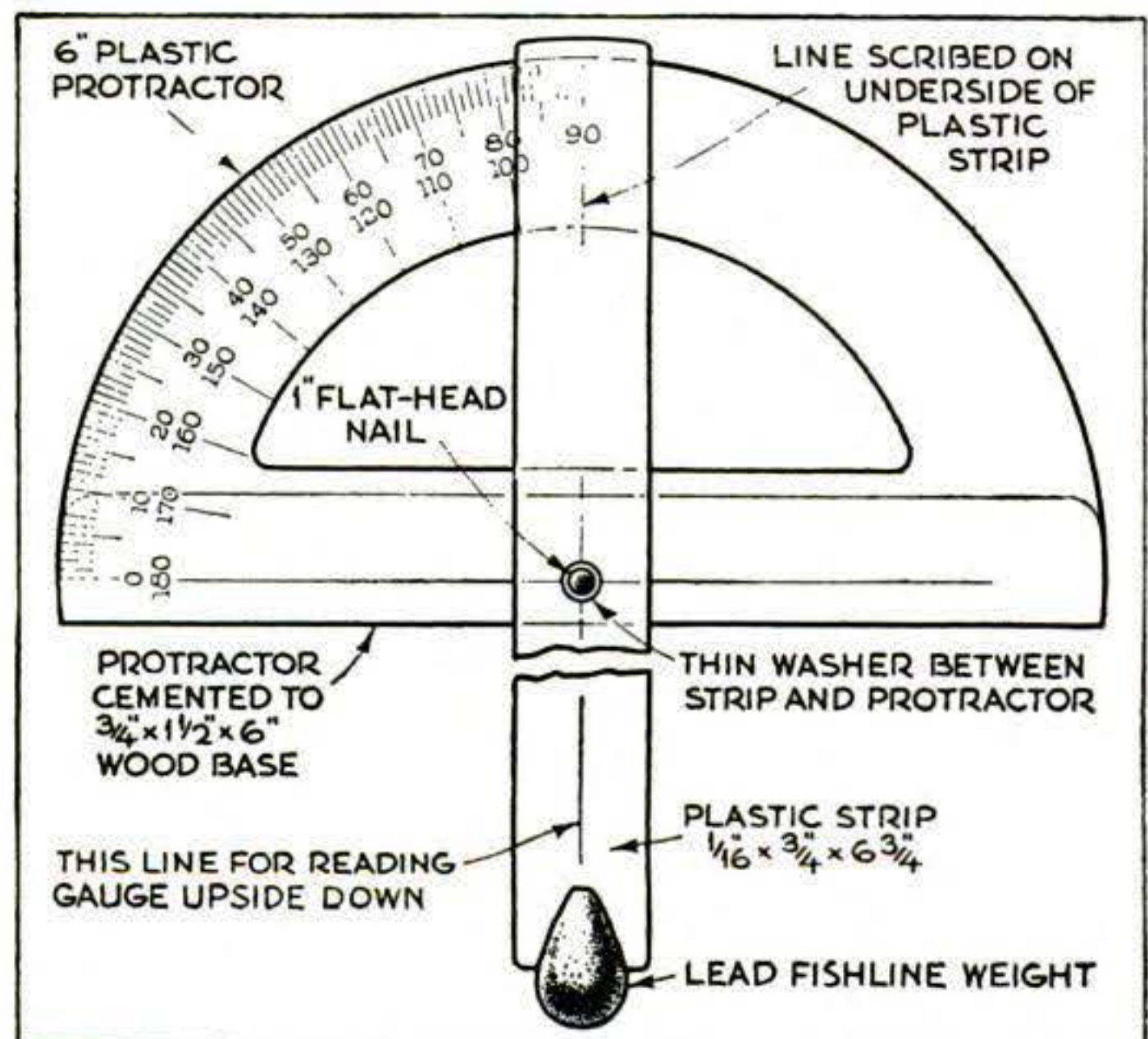
A LINOLEUM lining for your tool-storage drawers will protect cutting edges and surfaces of tools. Deep drawers or drawers holding chisels should be lined on the sides as well by folding up flaps.—*Hugh Lineback, Stillwater, Okla.*

## This Paintbrush Turns Corners

FOR getting into tight spots, a tilt-handle paintbrush can be made by sawing apart an ordinary brush and twisting screw eyes into the cut ends. A machine screw and wing nut join the screw eyes and tighten the brush handle at any angle.



## Angle Gauge from Protractor

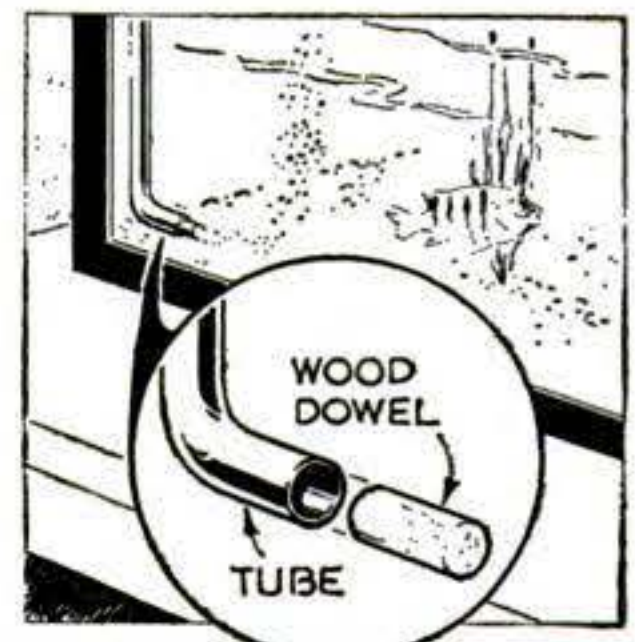


THE correct angle on roof rafters can be indicated by a free-swinging arm mounted on a plastic protractor.

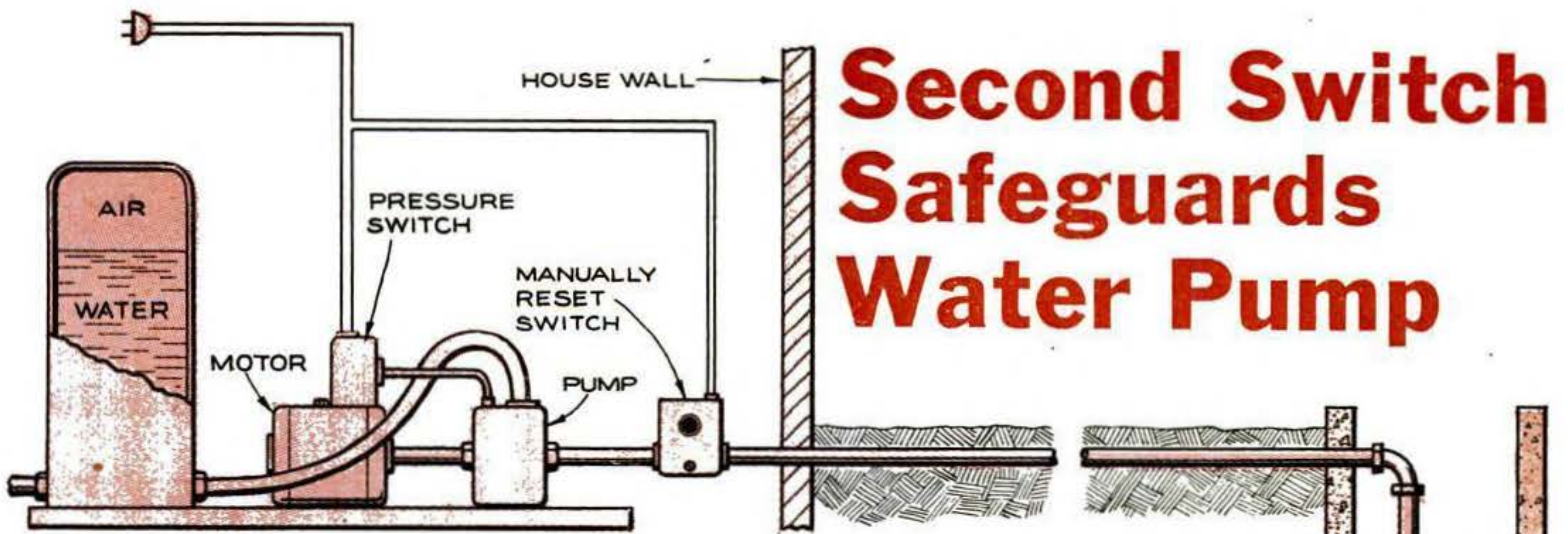
The straight edge of the protractor is reinforced with a strip of wood, and the wire-nail pivot pin is driven into it. A fish-line sinker, slotted and cemented to the end of the clear-plastic pendulum, holds the pendulum plumb regardless of the angle of the protractor. Angle readings are shown by a line scribed on the center of the pendulum.—*A. Trauffer, Council Bluffs, Iowa.*

## Dowel Aerates Fish Tank

A WOOD dowel inserted in the tube of an aquarium aeration pump is a good way to get the tiny bubbles of air necessary for efficient oxygenation of the water. Any fairly hard-grained wood will do. Only a little pressure is needed to force the air through the pores of the wood.





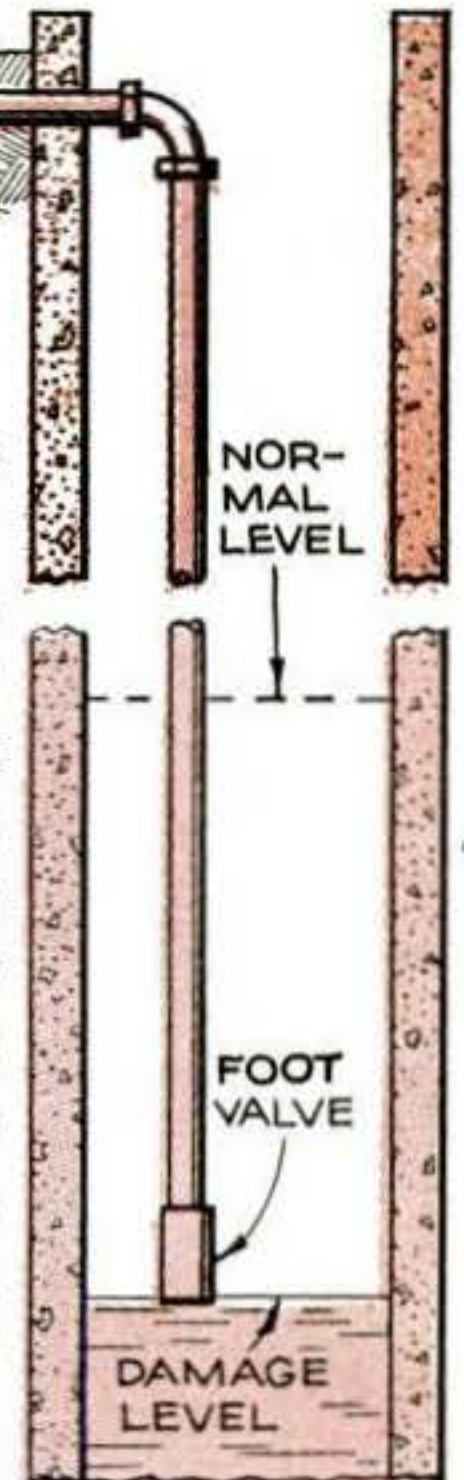


**Mounted in suction line, it can be set to overrule the main switch.**

**I**F AN automatic pump provides your water supply, installing an extra pressure switch now may forestall an expensive repair bill if your well should go dry during a period of drought. Without it, the pump would run continuously if the water level dropped below the intake pipe and the priming water were lost. Unless you were present to shut off the pump, it wouldn't take long to burn up the shaft seal that normally is water-lubricated and -cooled. A faucet left running also might eventually

drain the well and lead to the same damage.

A manually reset pressure switch in the suction line ahead of the pump should provide protection against such failure. The pressure switch normally used to start the pump is generally set to kick on the motor when tank pressure drops below 20 lb. Adjust the new reset switch to open the circuit if the pressure drops below approximately 18 lb. This will prevent loss of the prime.—Andrew Pfeiffer, Old Lyme, Conn.

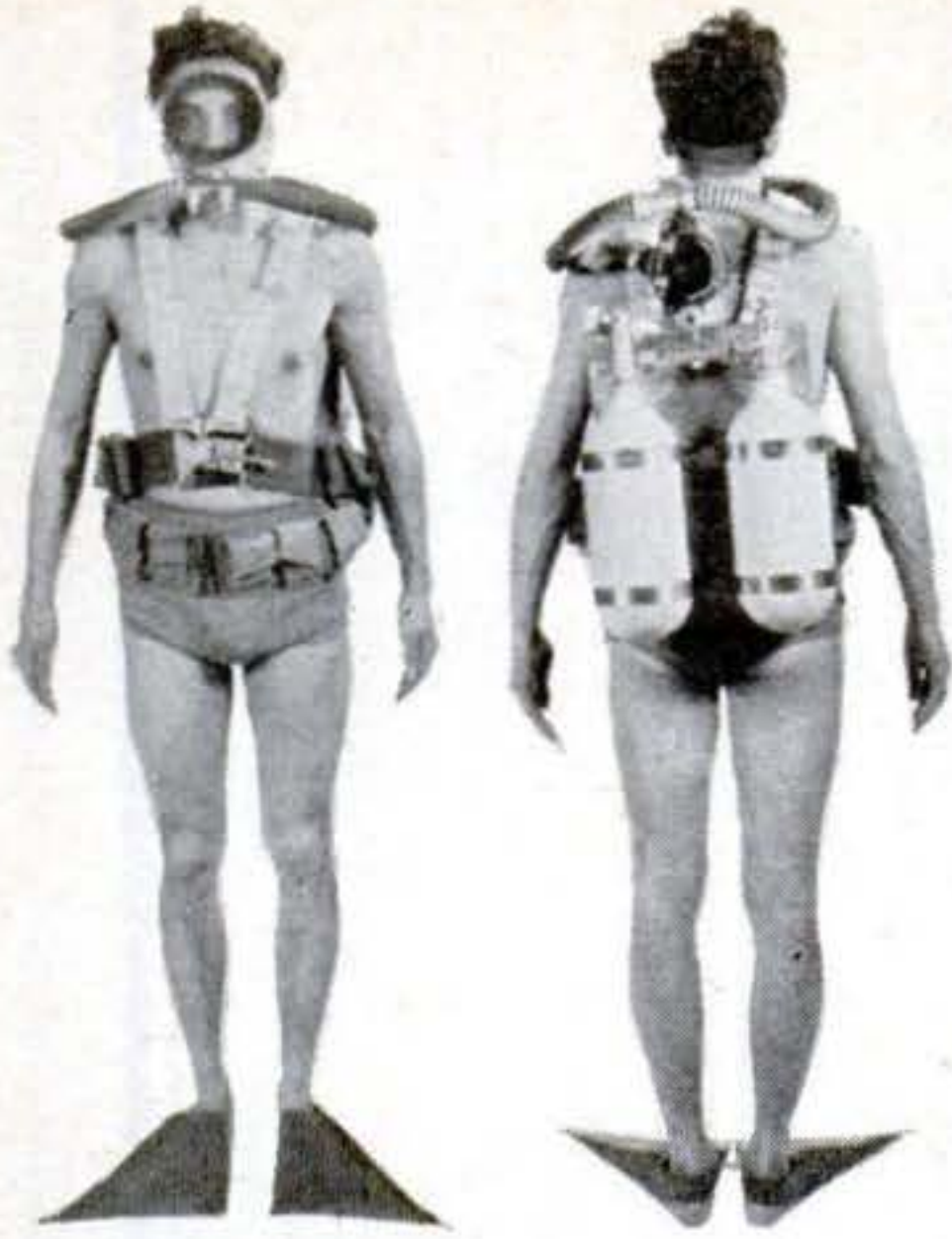


**Watch Out... in JULY** for poisons. More people die from poisons in July than in any other month. Most victims are children under four, but this month many adults will die, principally from overdoses of sleeping pills.

**O**NLY one-third as many people die of poisons today as was the case 40 years ago. Since then, most people have learned (1) to see that all drugs and medicines are properly labeled; (2) to put tiny bells around bottle necks or pins in the corks of bottles holding poison, as warnings; (3) never to take medicine in the dark; (4) to store drugs, weed killers, insecticides and mole killers out of children's reach. If, despite all precautions, someone swallows poison, induce vomiting by lots of warm salt water, and call the doctor immediately.

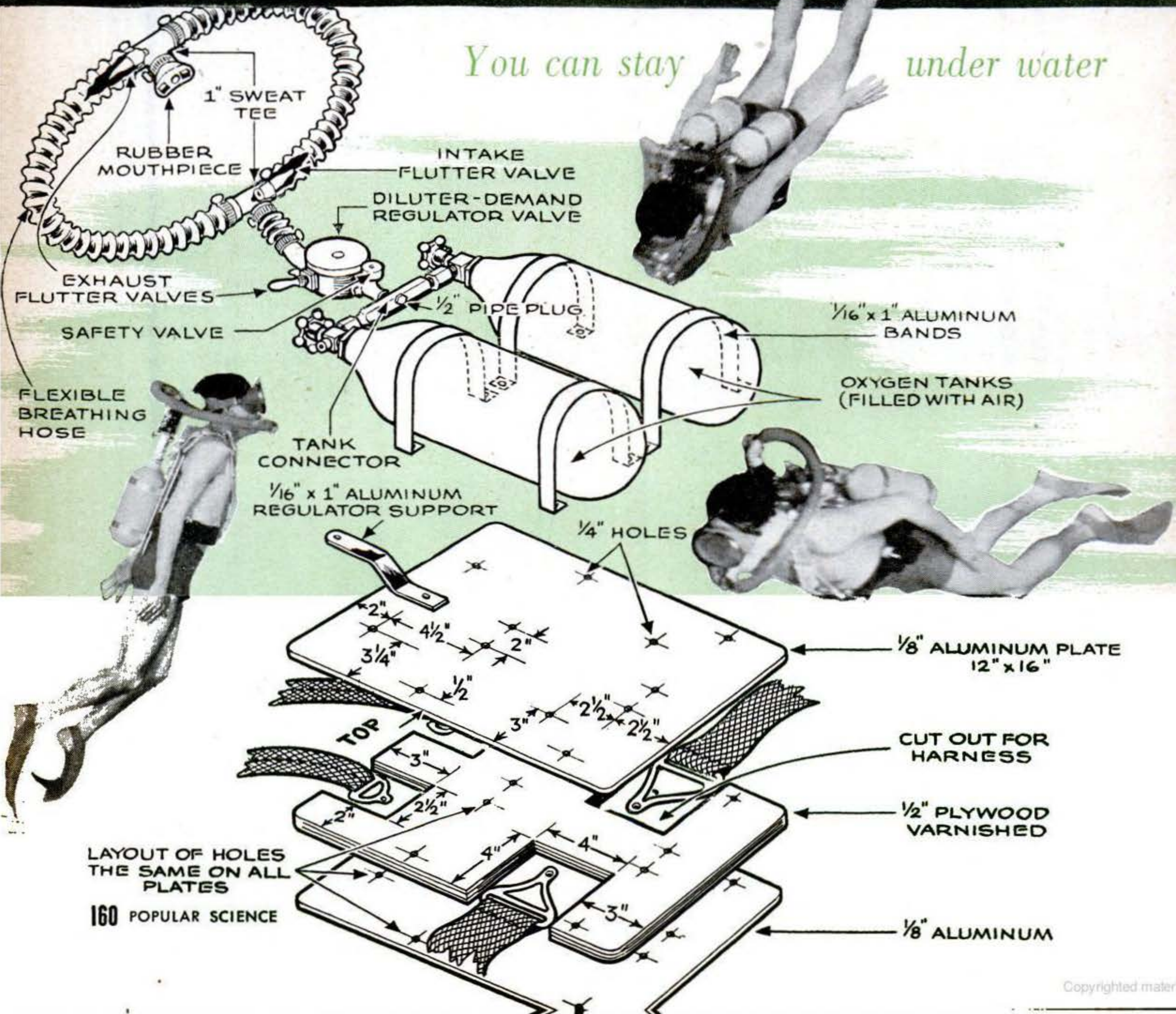


# How to Build



**COMPLETE OUTFIT** costs about \$40, not including face mask and swim fins—less if you shop shrewdly or use only one large tank. Weight belt is surplus cartridge belt; pockets contain lead.

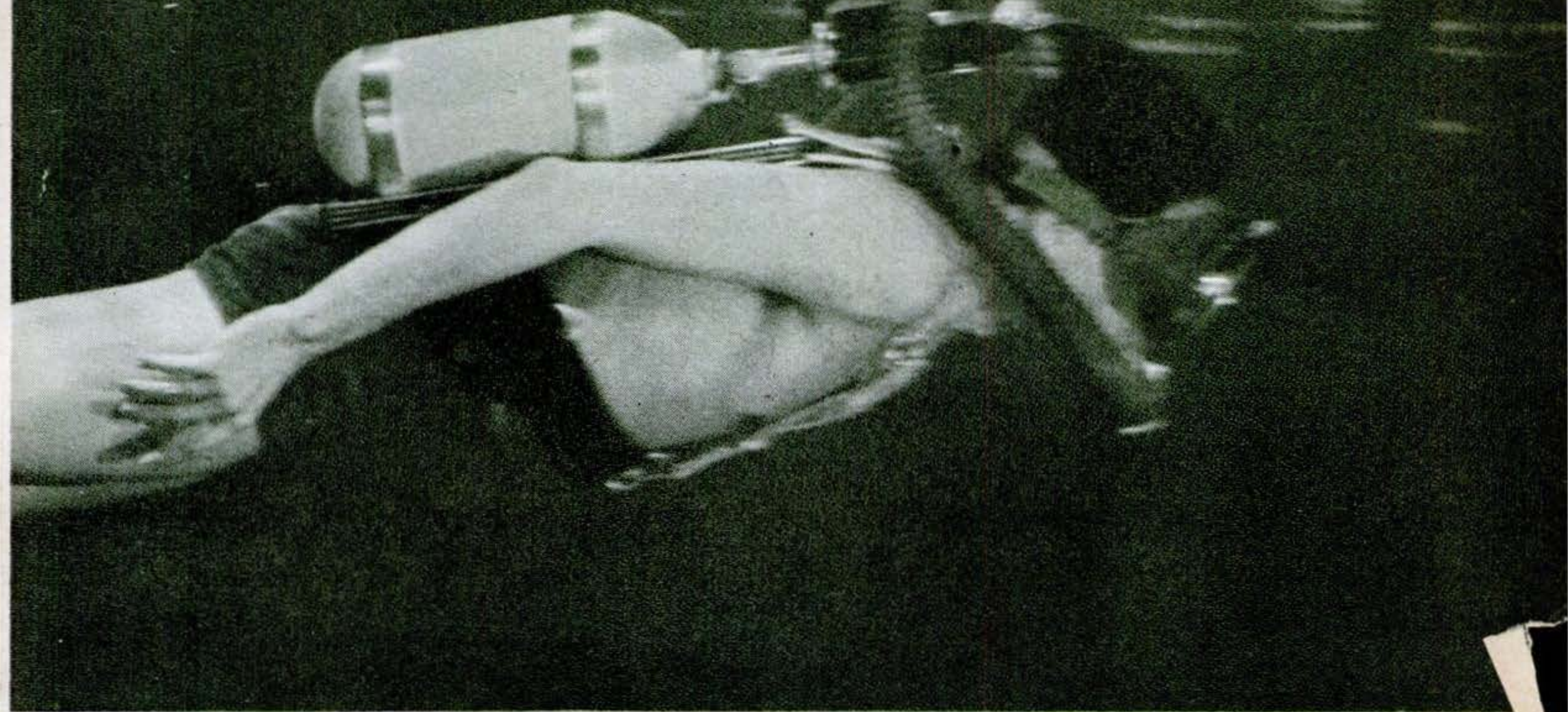
*You can stay under water*



LAYOUT OF HOLES THE SAME ON ALL PLATES



# and Use a Diving Lung



*nearly an hour with your air supply strapped to your back.*

**By Herb Pfister**

**FUN**  
**UNDERWATER**

**F**OR a brand-new sensation, a feeling of really being out of this world, try the latest thing in water sport—a self-contained diving outfit.

You can make your lung pay for itself, too. One outboard motor salvaged from the mud, or one boat propeller replaced without pulling the boat up on shore, will net you the price of the parts.

Once you become accustomed to breathing air gradually instead of gulping it freely as you do on the surface, you'll swim leisurely and safely below 25 or 30 feet of water. And you can stay down for nearly an hour if you like.

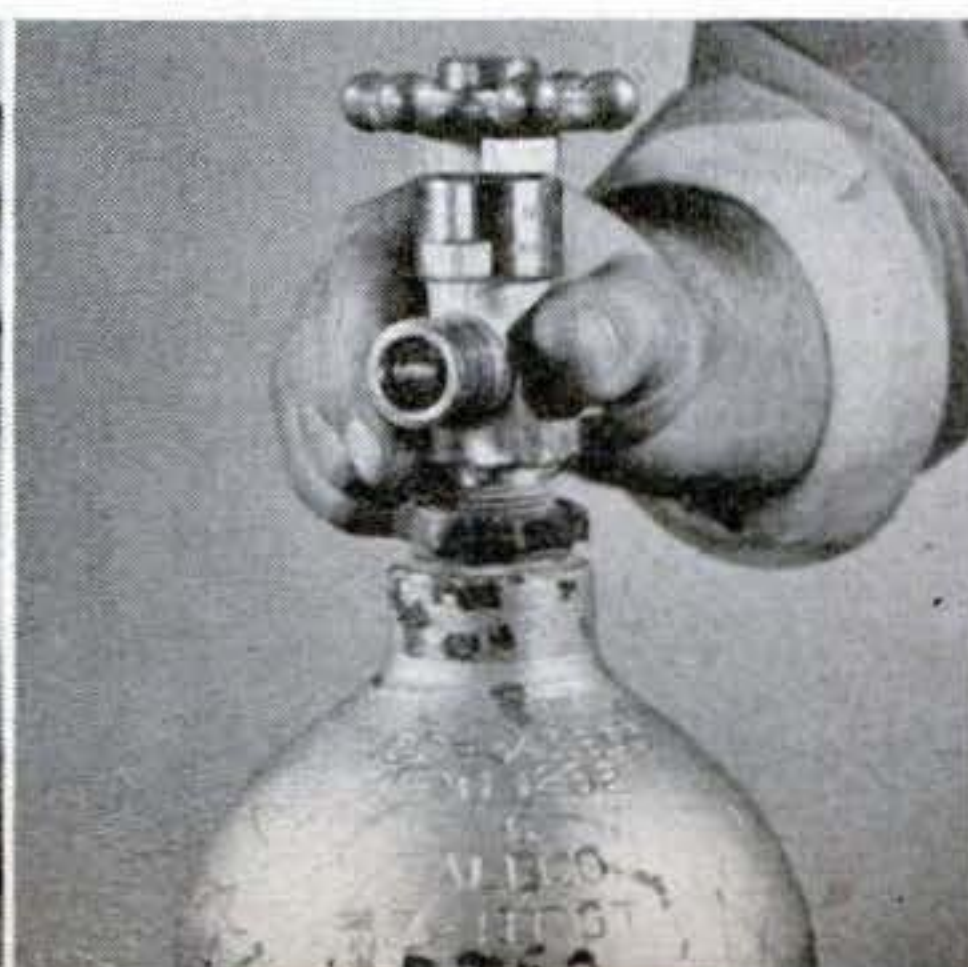
The experience of hunting and exploring under water is yours for the price of a pair of surplus oxygen tanks, an oxygen demand valve and some fittings. After you've rounded up the parts, you can build your diving lung in two or three evenings' time with ordinary hand tools.

**1** New valves were fitted to this pair of surplus CO<sub>2</sub> tanks. They came with valveless trigger head, held in hand. Tanks were first flushed clean with hot water to remove all trace of CO<sub>2</sub>.

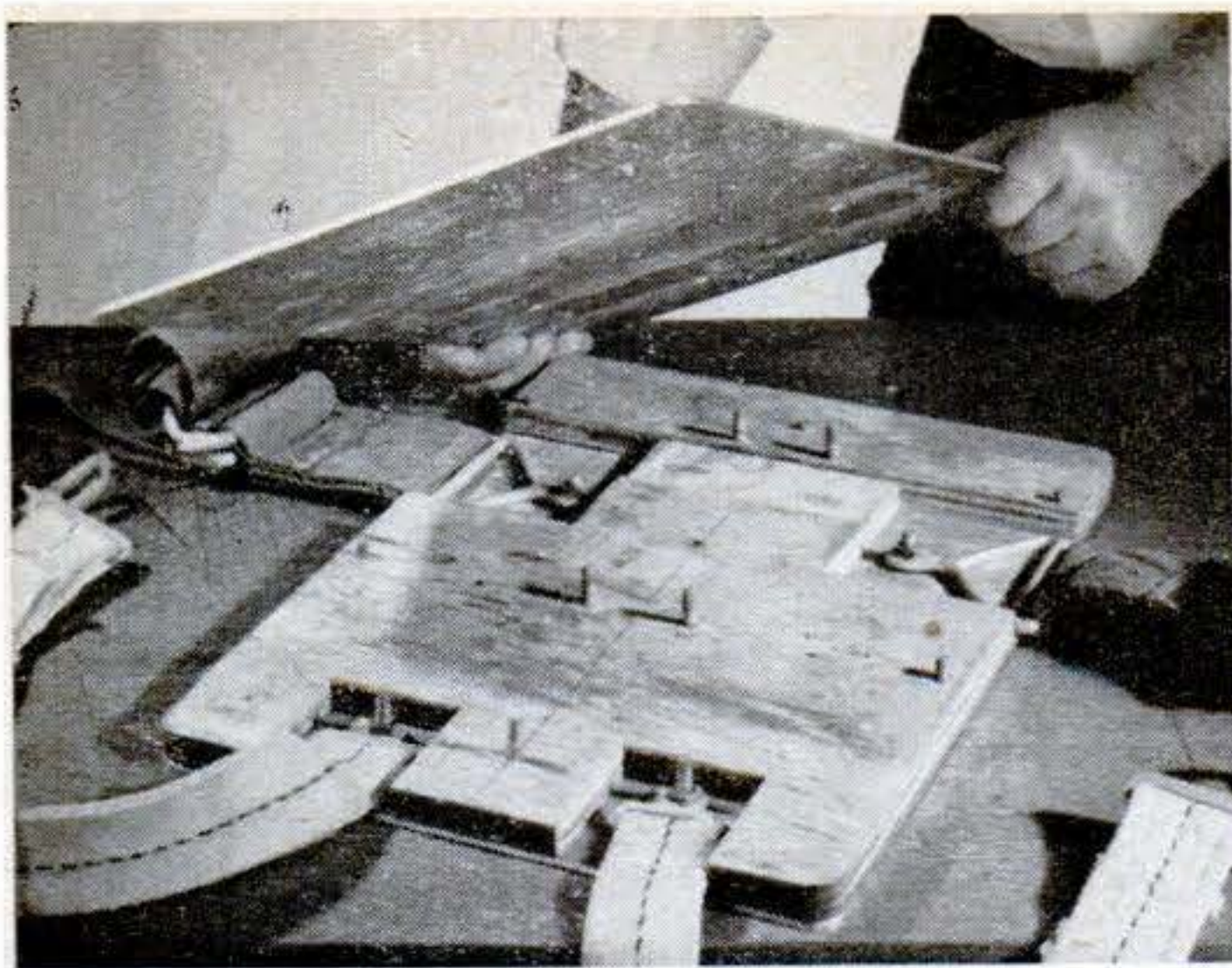
**2** Specifications are stamped on all high-pressure tanks. Top line gives service pressure (1,800 p.s.i.). Other markings show test dates. Fresh markings show date of latest test, March, 1953.

**3** High-pressure connector, obtainable in surplus stores or from oxygen-therapy-equipment dealers, joins tanks. It should space tanks one or two inches apart.

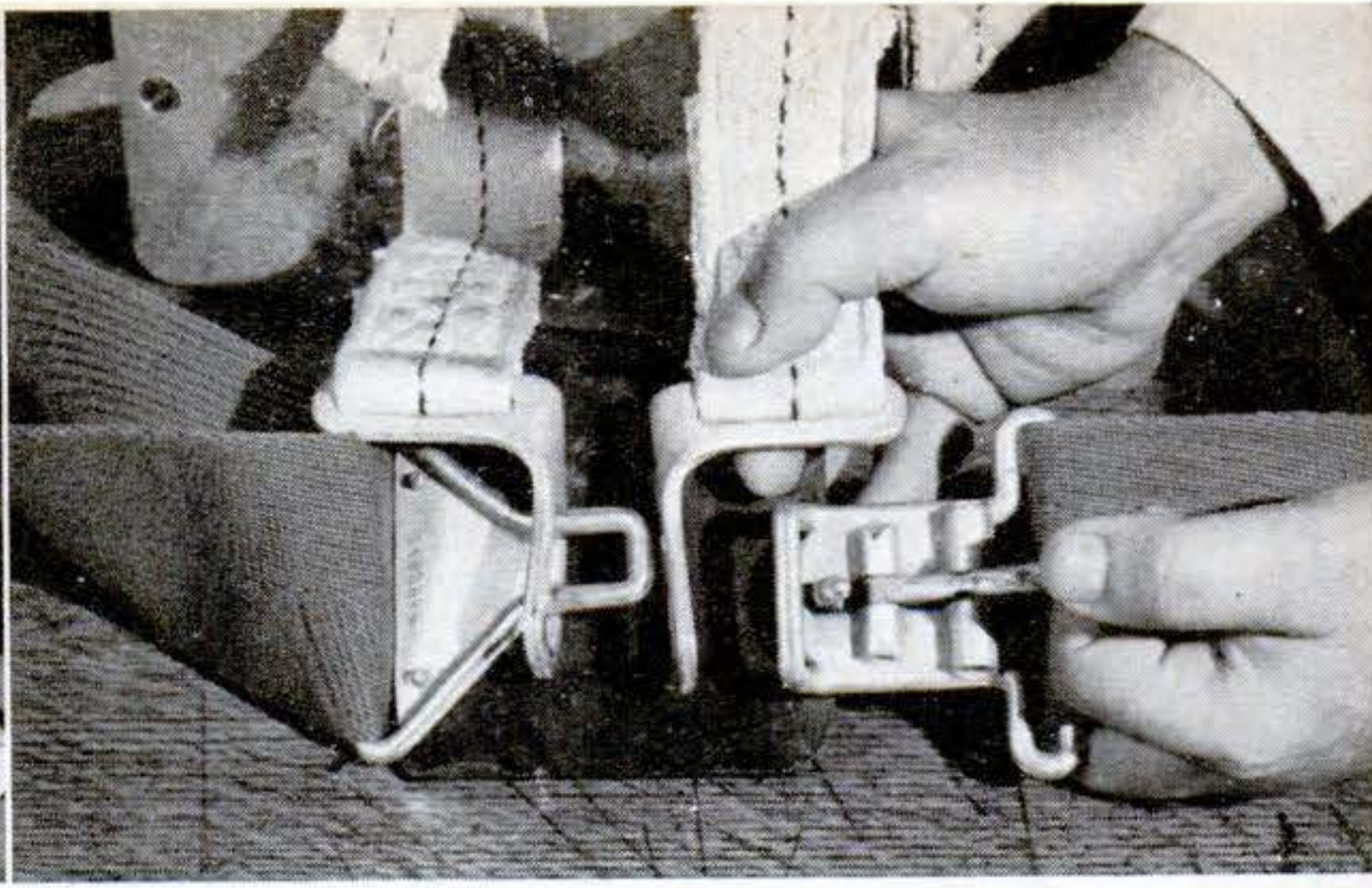
*(Continued on next page.)*







**4** Supporting plate is  $\frac{1}{2}$ " plywood sandwiched between two sheets of  $\frac{1}{8}$ " aluminum. Plywood is cut out to receive harness ends.



**5** Harness is quick-release type, No. AN-1201-1. When lever is pulled, all buckle parts separate instantly and harness slips off.



**8** Demand valve. No. AN-6004-1 Diluter-Demand Regulator is type best suited for underwater use, as it has built-in pressure regulator.



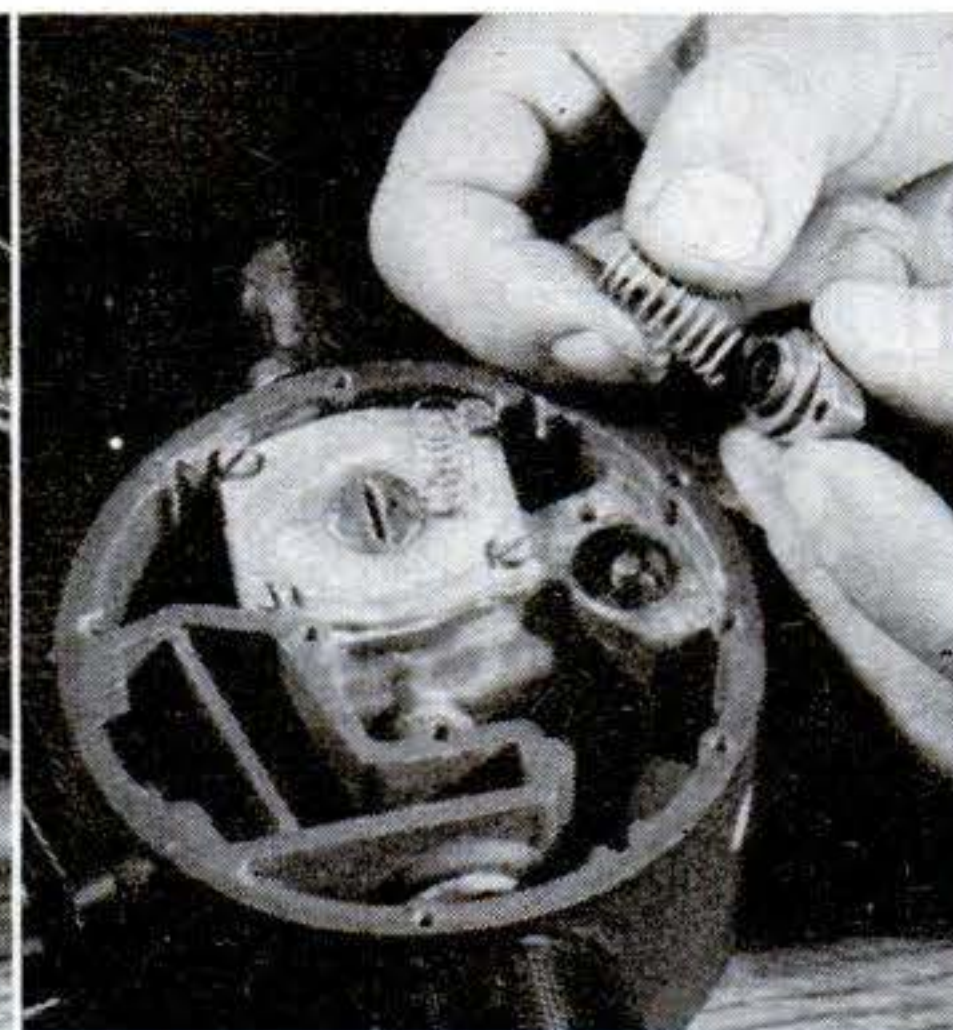
**9** Do not use. Oxygen regulator type A-13 is also a demand valve, but it is made for low pressure and is not suitable for diving.



**10** Converting demand regulator. First step is removal of diluter knob and clapper valve located beneath it. Save O ring for later use.



**14** Plug small opening at side of regulator with  $\frac{1}{8}$ " pipe plug. Use Permatex No. 1 on all threaded connections and plugs.

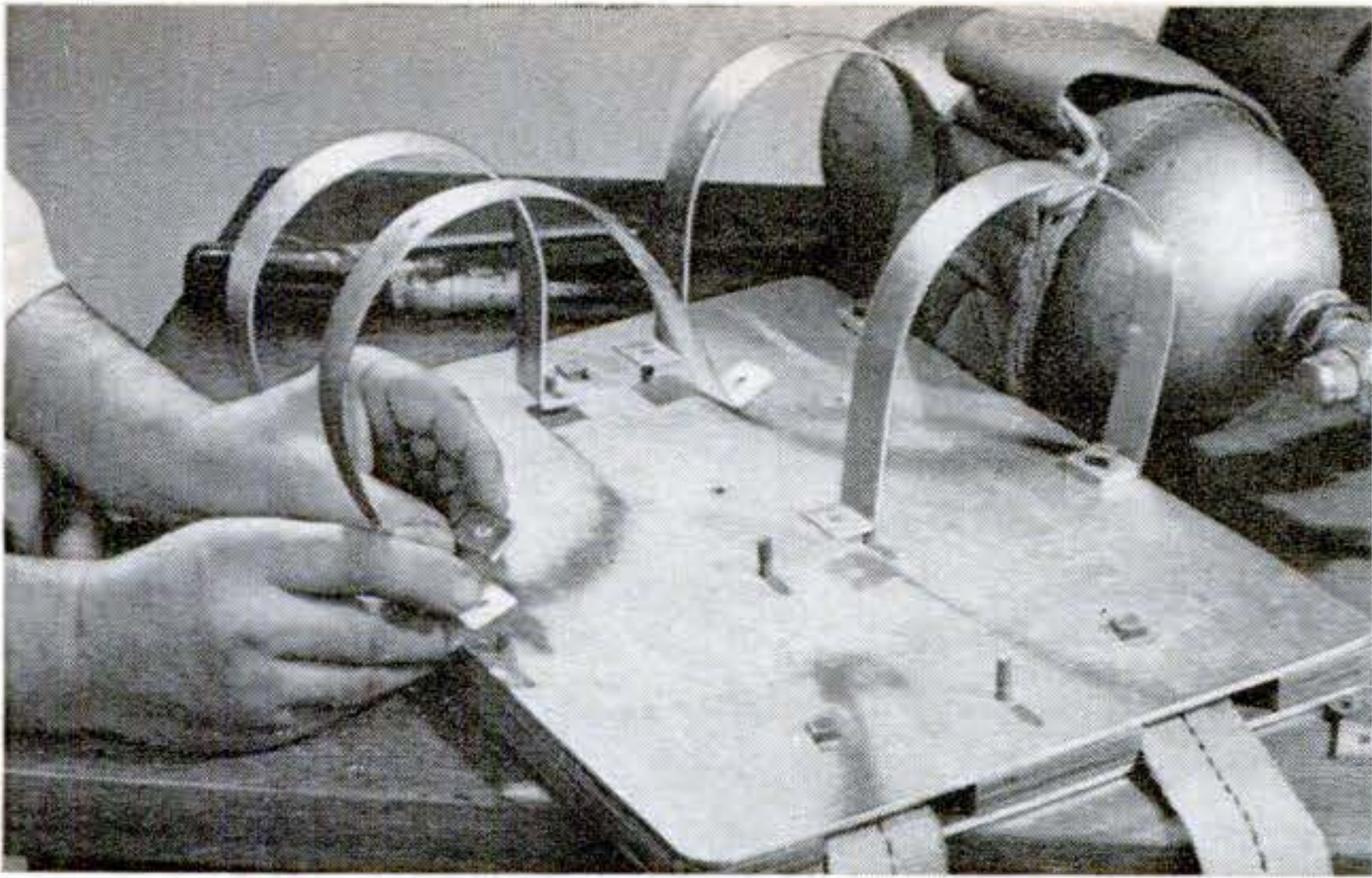


**15** Replace spring of diaphragm lever with one of same length and diameter, but heavier, to add snap to diaphragm return action.

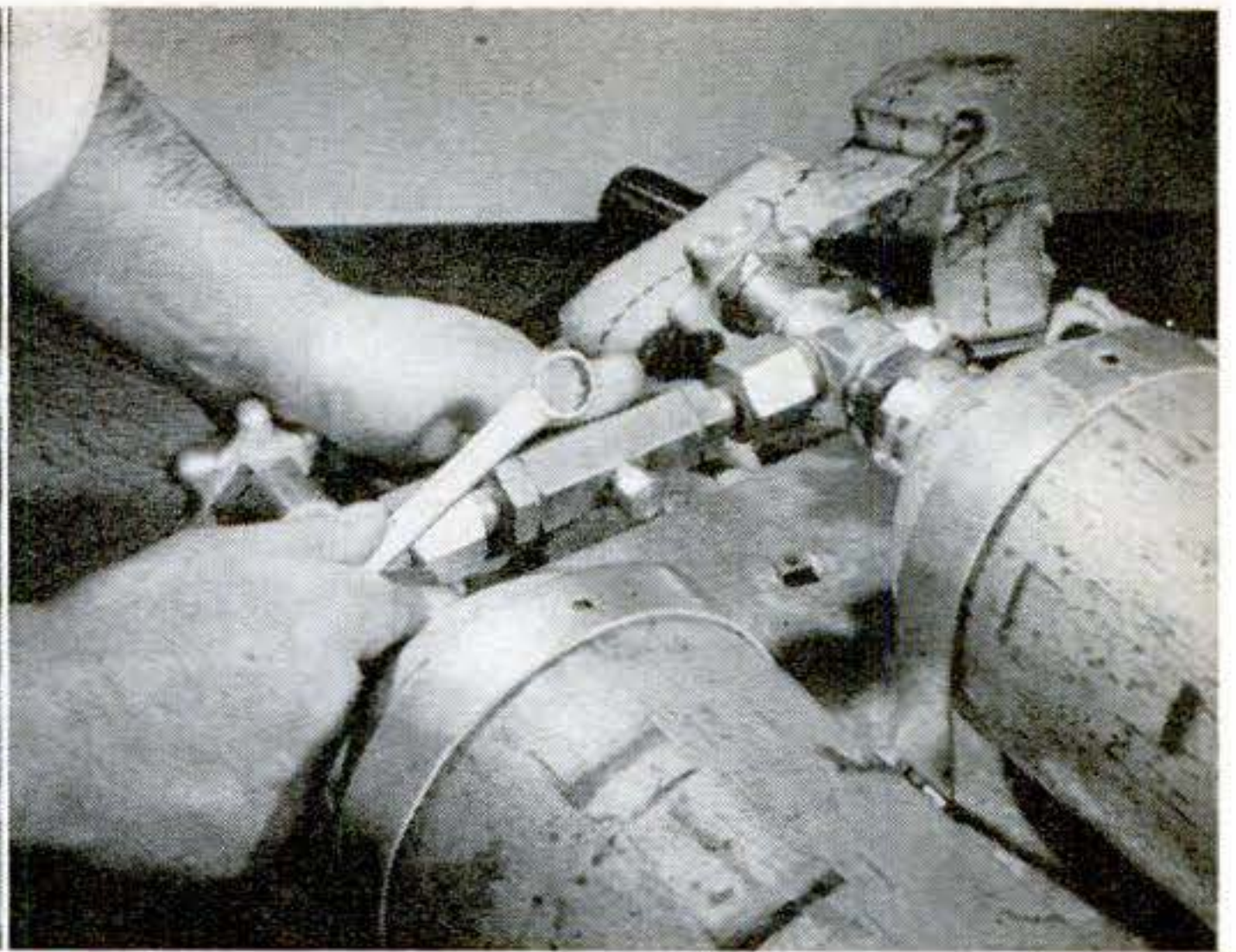


**16** Back off screw on pressure regulator to cut air flow. Adjust this screw after underwater trials if you get insufficient or excess air.

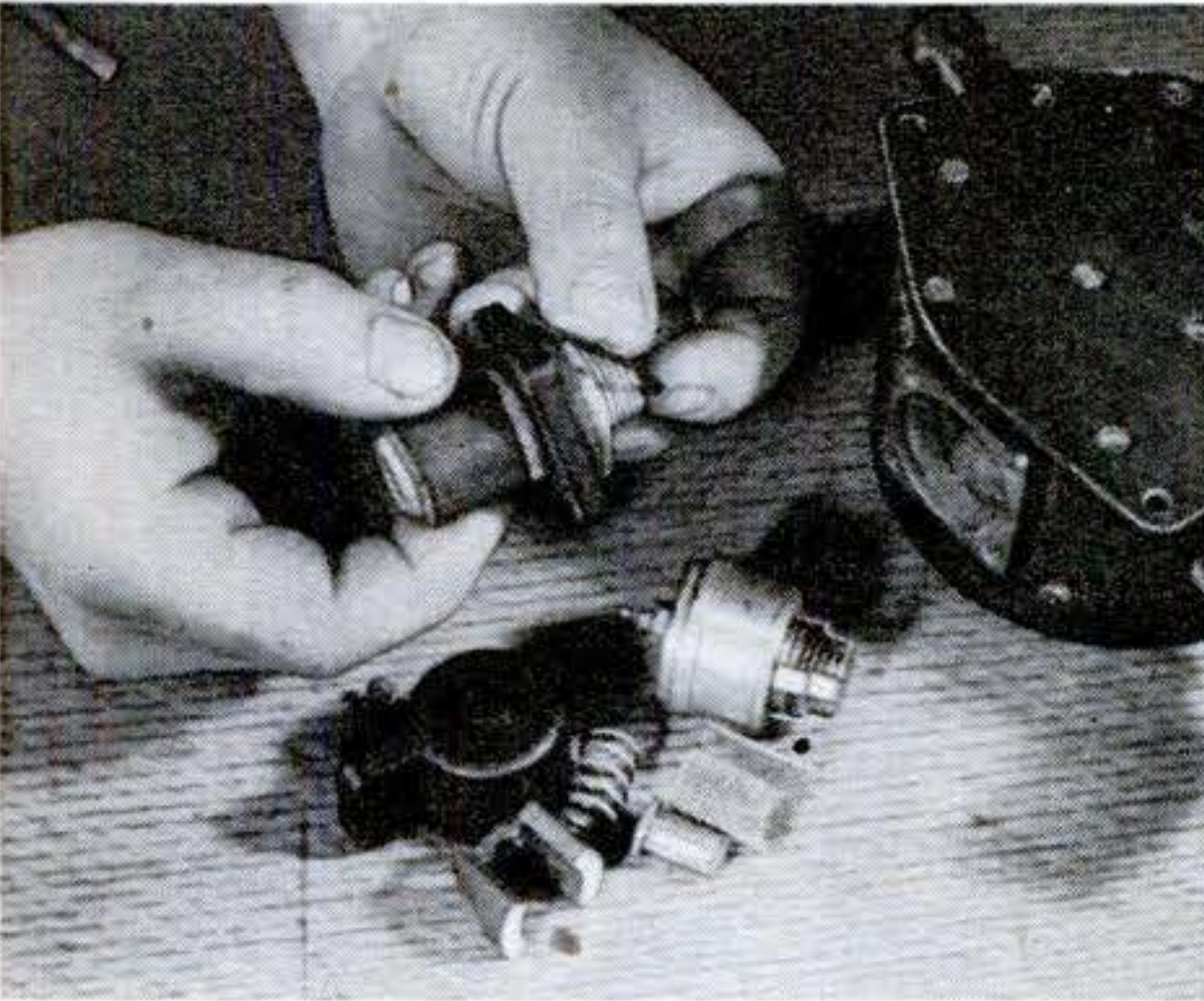




**6** Aluminum straps, 1" wide, hold tanks in place on supporting plate. Length of tank connector determines spacing of straps.



**7** Brass pipe plug closes lower opening in connector. This plug can be removed and gauge substituted to check tank pressure.



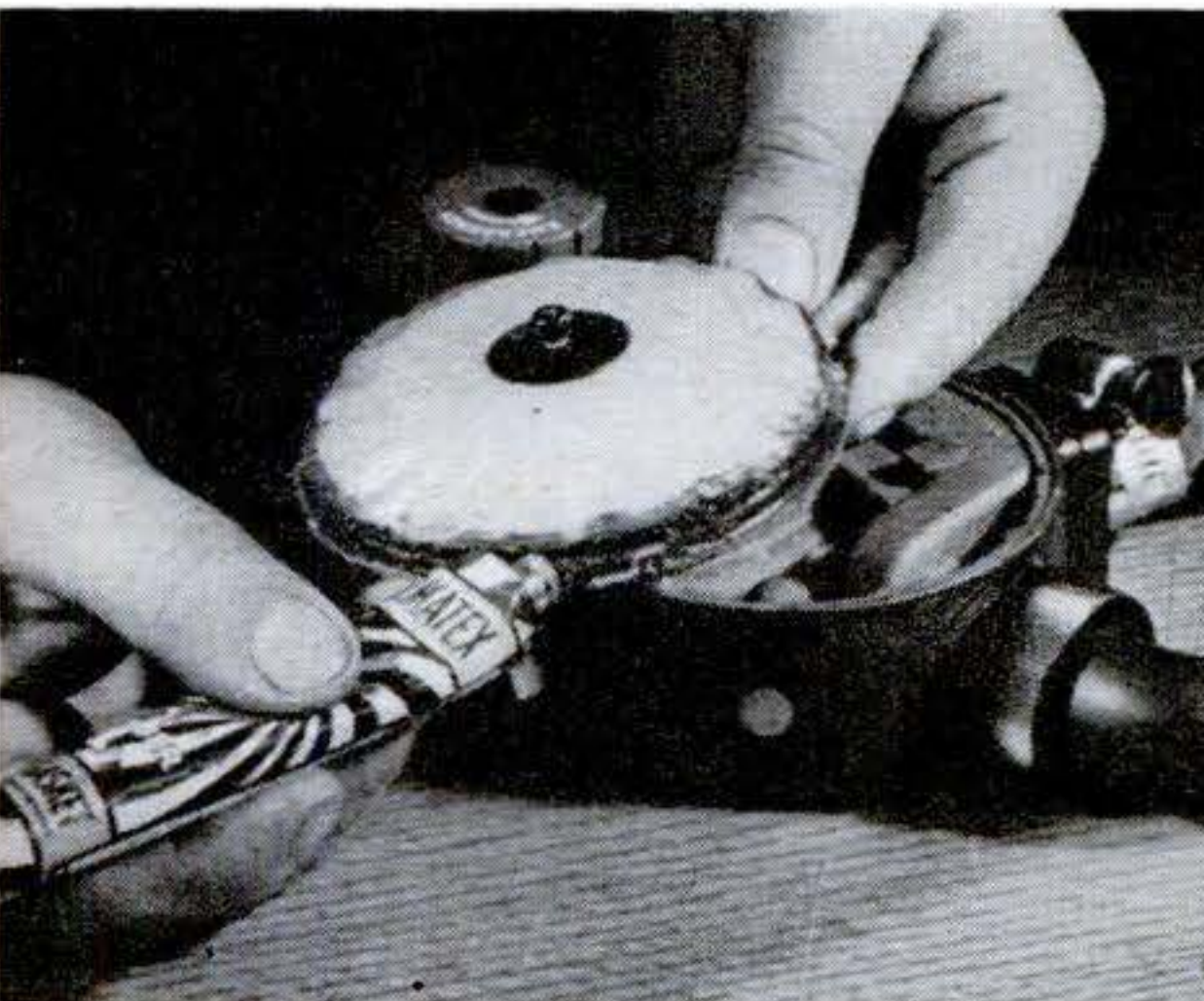
**11** Install auto-heater-hose fitting after cutting off diluter-knob pivot with hack-saw. Use O ring to seal flange.



**12** Screw flange back in original position and force short length of auto-heater hose over heater fitting. Grease all screws.



**13** Slip flutter valve over heater fitting and clamp with screw-type hose clamp. Rubber noisemaker can be used as flutter valve.



**17** Seal edge of diaphragm with Permagasket to keep water out of regulator. Apply several built-up layers rather than one thick one.



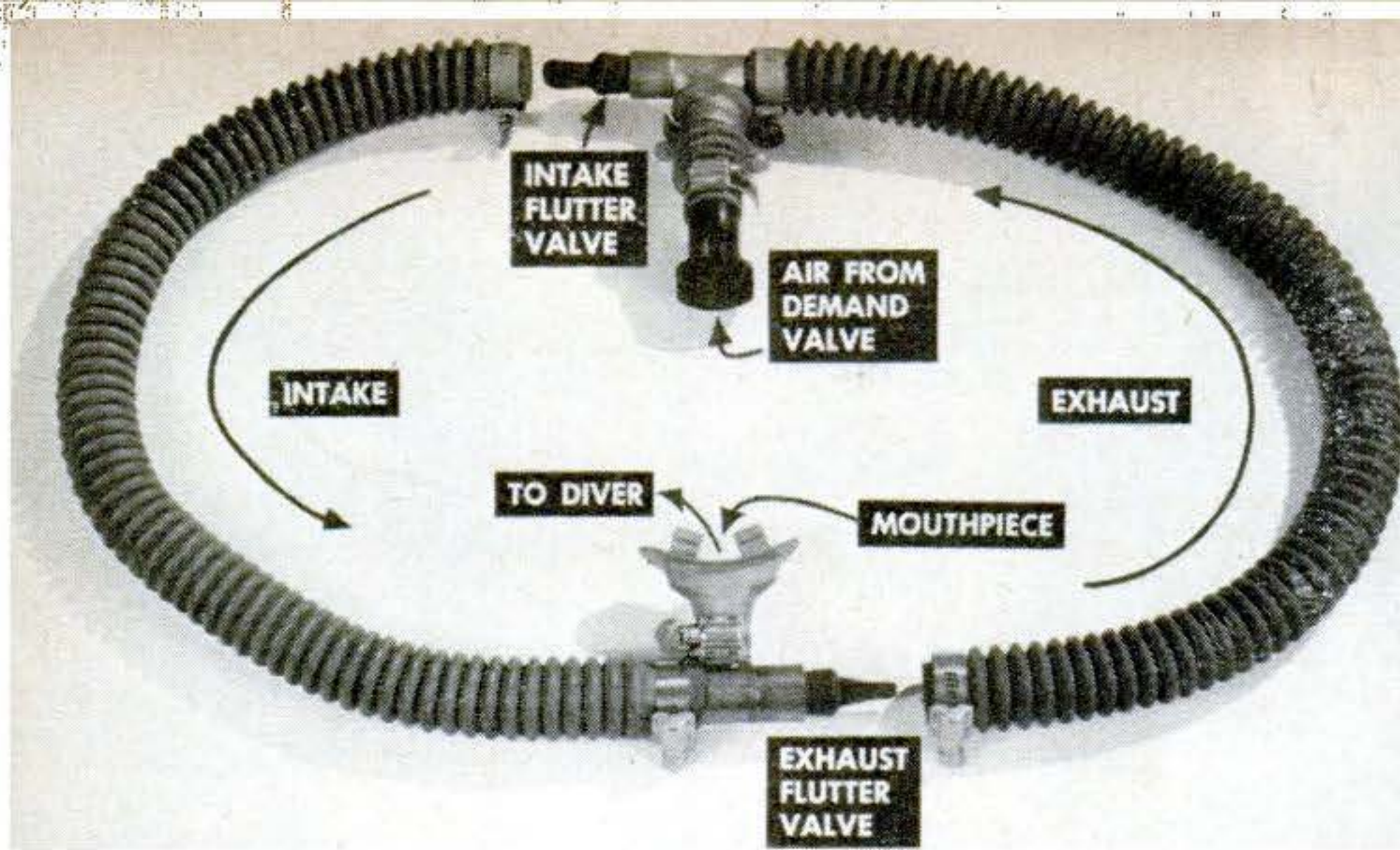
**18** Waterproof diaphragm with several coats of rubber cement. Dust final coat with talcum to prevent it from sticking to cover.



**19** Mount regulator on tank connector and brace it with aluminum strip. Use 1/8" pipe nipple to join regulator to connector.

**Please turn the page for more diving-lung photos.**



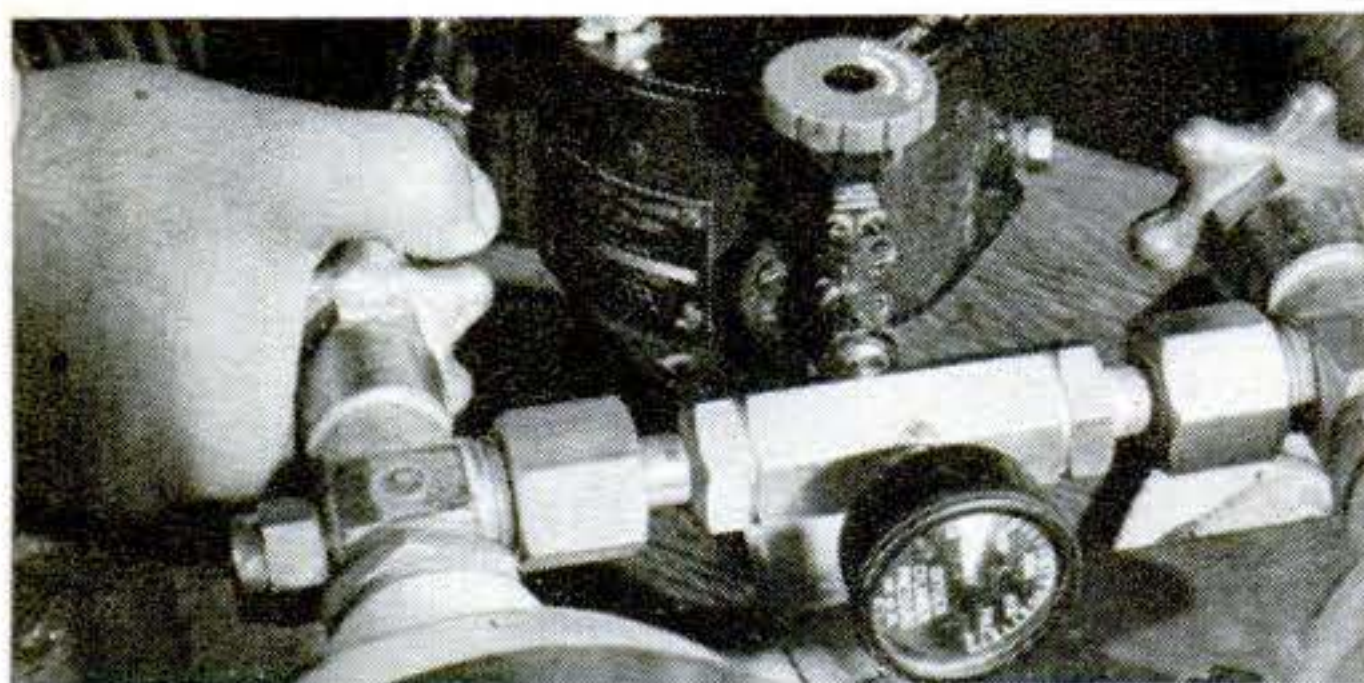


**20** Breathing hose is valved with two rubber noisemakers to control flow of air. Arrows show path of pure air (intake) and exhaled air (exhaust). Mouthpiece is type used on snorkel tubes. It can be bought separately at sporting-goods or department stores.

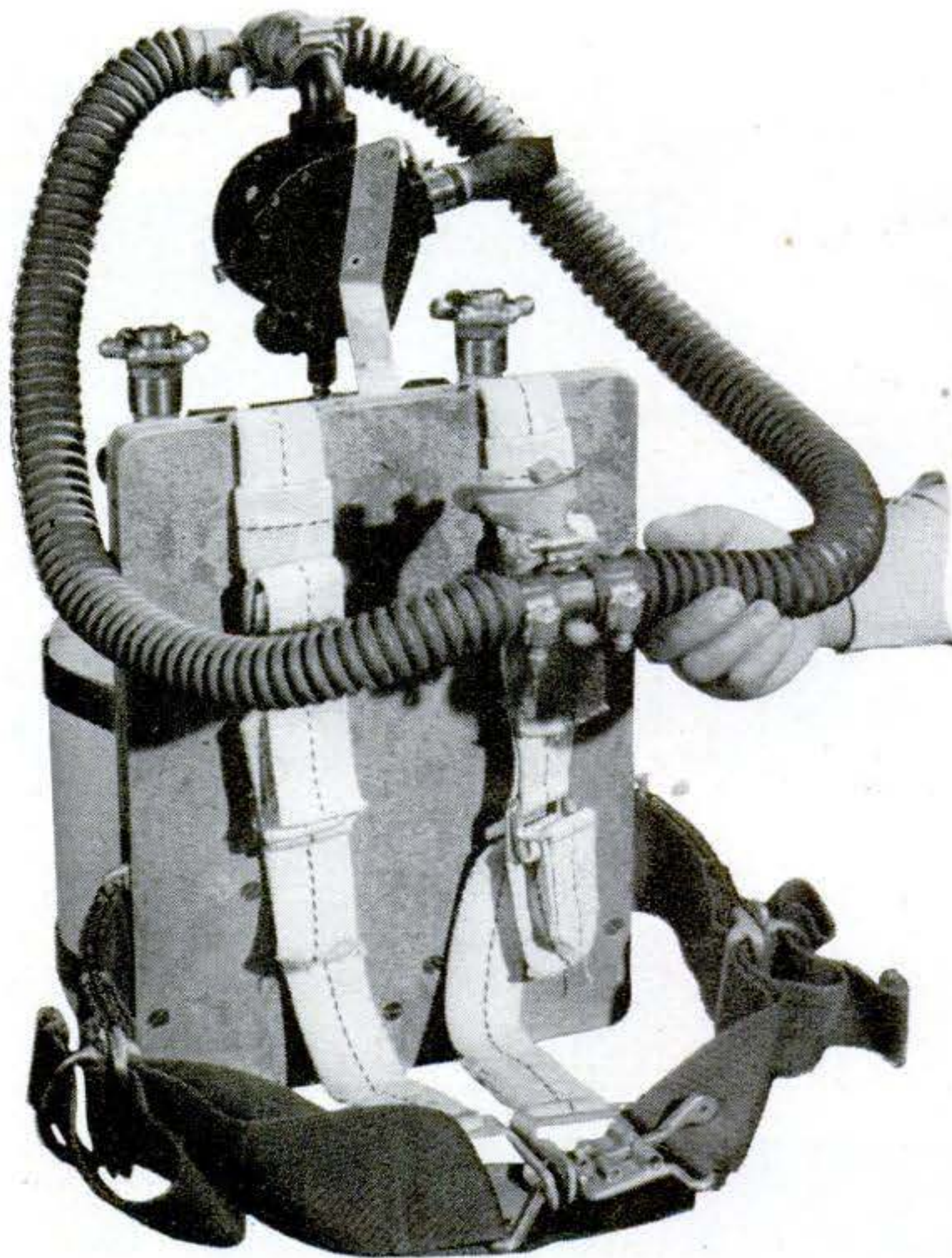
**21** Ready to go. Hose is positioned so that it falls naturally into mouth area.



**22** Flutter valve consists of rubber noisemaker forced over a wooden thread spool. Half of spool is wrapped with tape and driven into tee. Rubber is cut short to reduce noise.



**23** Pressure gauge tells tank pressure before and after each dive; remove it when diving. Emergency valve provides constant air flow if diaphragm sticks or fails to function.



## Tips on Air and Tanks

**Filling tanks.** Only purified compressed air should be used in the diving lung. You can have your tanks filled at fire-fighting equipment dealers: they stock air for firemen's rescue equipment. Your local oxygen-therapy-equipment dealer may have compressed air, or he may get you a large tank from which you can draw several charges (left). For this you'll need a filling attachment that consists of a short length of high-pressure tubing fitted with a compression fitting at each end to match the valves. Renting one large tank probably will save you money in the long run.

Transferring the air should be a gradual process, both to keep the lung tanks from get-





# How to Use Your Diving Lung

**U**SING a diving lung is as safe as crossing a street. However, you wouldn't send a child across a street without telling him to cross with the traffic light and to watch out for the cars. *You*, for the first time, are about to cross into a new medium—deep water. Knowing how to act and what to expect will make your trip safe.

▶ Take several deep breaths before diving. They'll clear your lungs and get you a little ahead on your oxygen needs.

▶ Dive with someone, or have someone on the surface ready to give aid if needed.

▶ Take a light rope along on your first few dives. Tied to the boat or pier, it will be a comforting contact with your own world.

▶ Stay by the rope until you get your weight belt adjusted. If you take too many weights down with you, you'll have to throw off the belt to get back up.

▶ Establish a rhythm of breathing and maintain it. If the rhythm is upset you may take water in your mask or mouthpiece.

▶ Swallow any water that enters your mouth. It's easier than trying to blow it out.

▶ Blow through your nose to get rid of water that enters your mask. The water will leave with the air around the edges of the mask.

▶ Swim quietly and without undue exertion. This will conserve air and let you breathe normally. Use fins for easy swimming.



▶ Take your air gradually rather than trying to fill your lungs all at once. You'll find that a long slow breath will bring in all you need; a quick sharp breath may panic you as the air will not seem to come through fast enough. If you get too little or too much air, readjust valve shown in photo 16.

▶ Important. Never hold your breath while coming up. Air taken into your lungs at the bottom will expand as you rise, forcing your lungs out and possibly injuring them.

▶ Dive without ear plugs. They trap air inside your ears which reacts to pressure changes to create discomfort. Water pressure can also force plugs deep into your ears.

▶ You'll feel the pressure of the water on your head and ears as you go down. Pause a moment, press your mask tightly against your face and blow through your nose to relieve the pressure. After a few dives, you'll become accustomed to the pressure around you.

▶ Swim to the surface immediately when you feel your breathing growing difficult. When tank pressure drops to about 300 p.s.i. it becomes slightly more difficult to pull it from the tanks, but easy breathing will get you topside. Beginning with a full charge, the two tanks shown give a useful diving time of about 40-45 minutes.

▶ Limit your dives to a maximum of 30 feet. If for any reason you must release the outfit, you'll have to swim to the surface; and more than 30 feet is a long way up.

ting hot and to avoid pressure surge. It's a good idea, too, after filling the tanks, to cover the demand valve with a blanket before opening the tank valves to let 1,800 p.s.i. into it for the first time. The demand valve specified is designed for high pressure, but they've been tossed around in the surplus stores for several years so the precaution is a good one.

**Buying tanks.** Most surplus oxygen or CO<sub>2</sub> tanks are suitable for diving-lung use. The following tips will help you to get your money's worth:

● Look for dents or deep scratches; no reliable fire-fighting equipment station will charge a damaged tank.

● Look for the last test date stamped on the tank. The Interstate Commerce Commission

requires that high-pressure tanks be tested hydrostatically every five years. You'll very likely have trouble getting outdated tanks filled.

● Avoid the so-called shatterproof tanks that are bound with brass wire. The wire must be removed when the tanks are tested.

● Look for tanks that are equipped with valves. Some CO<sub>2</sub> tanks are automatically operated and have no valves. This means additional expense for you.

● Be sure your tanks—especially CO<sub>2</sub> tanks—are empty before you take them apart for washing out the inside. If you should puncture the seal on the valveless type, you'll have a very active unguided missile on your hands. Best bet if you're doubtful, or if the tanks feel heavy, is to let a pro unload them.

END





# This Rig Shoots Pictures Underwater

By Harry Walton

*Want a seagoing camera? Put yours in a watertight box.*

## FUN UNDERWATER

FOR real thrills, take your camera under the waves. In clear, sunlit water you can stop the lunge of a spear fisherman, catch the upturn at the end of a dive, or freeze an underwater swimmer even with a modest f/6.3 lens. Such marine photos can make this summer's vacation one you'll never forget.

All you need to shoot a few feet under is a watertight box and a rubber glove. The glove, fitted in one side of the box, enables you to snap, wind the film, and even change lens and shutter settings.

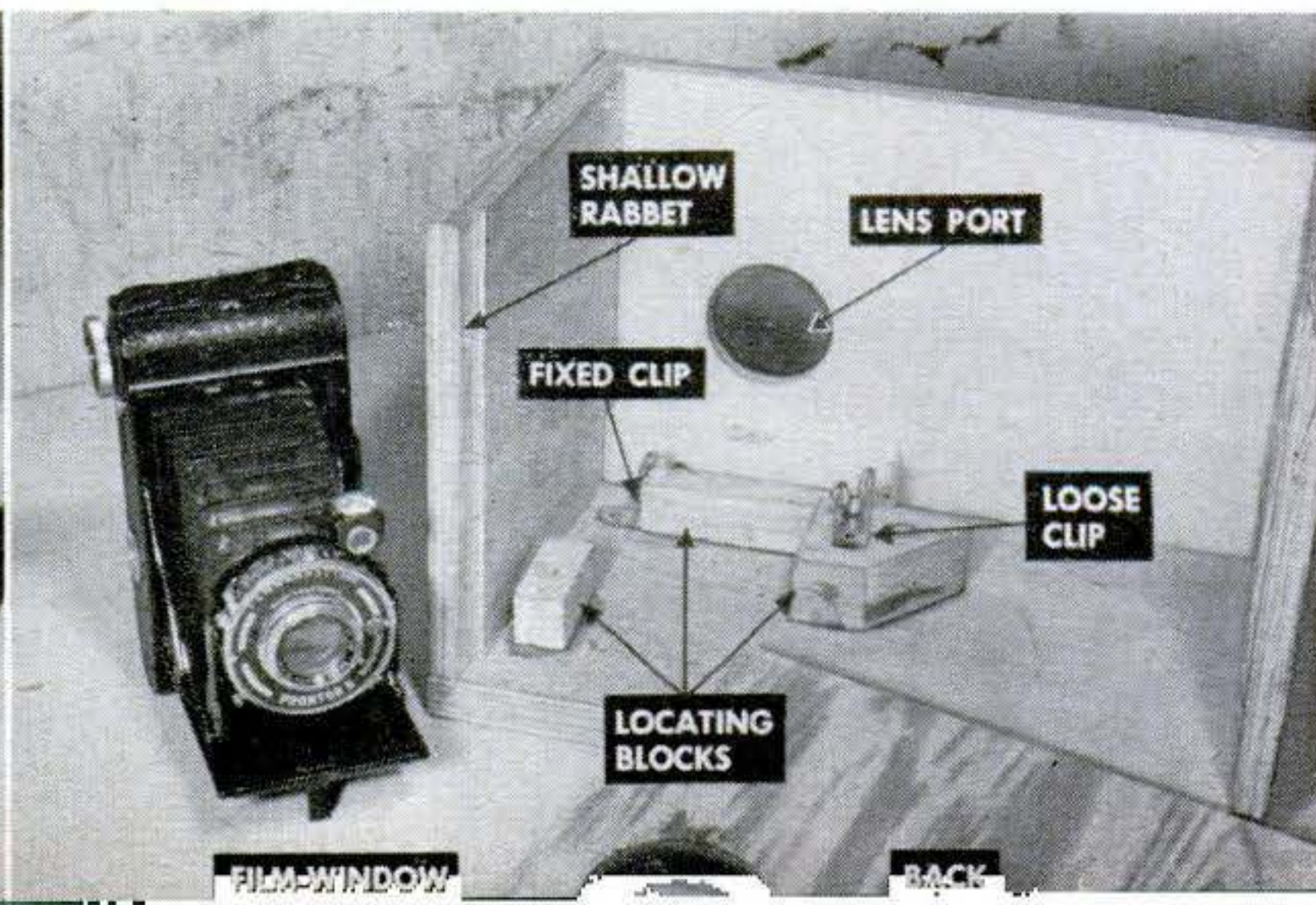
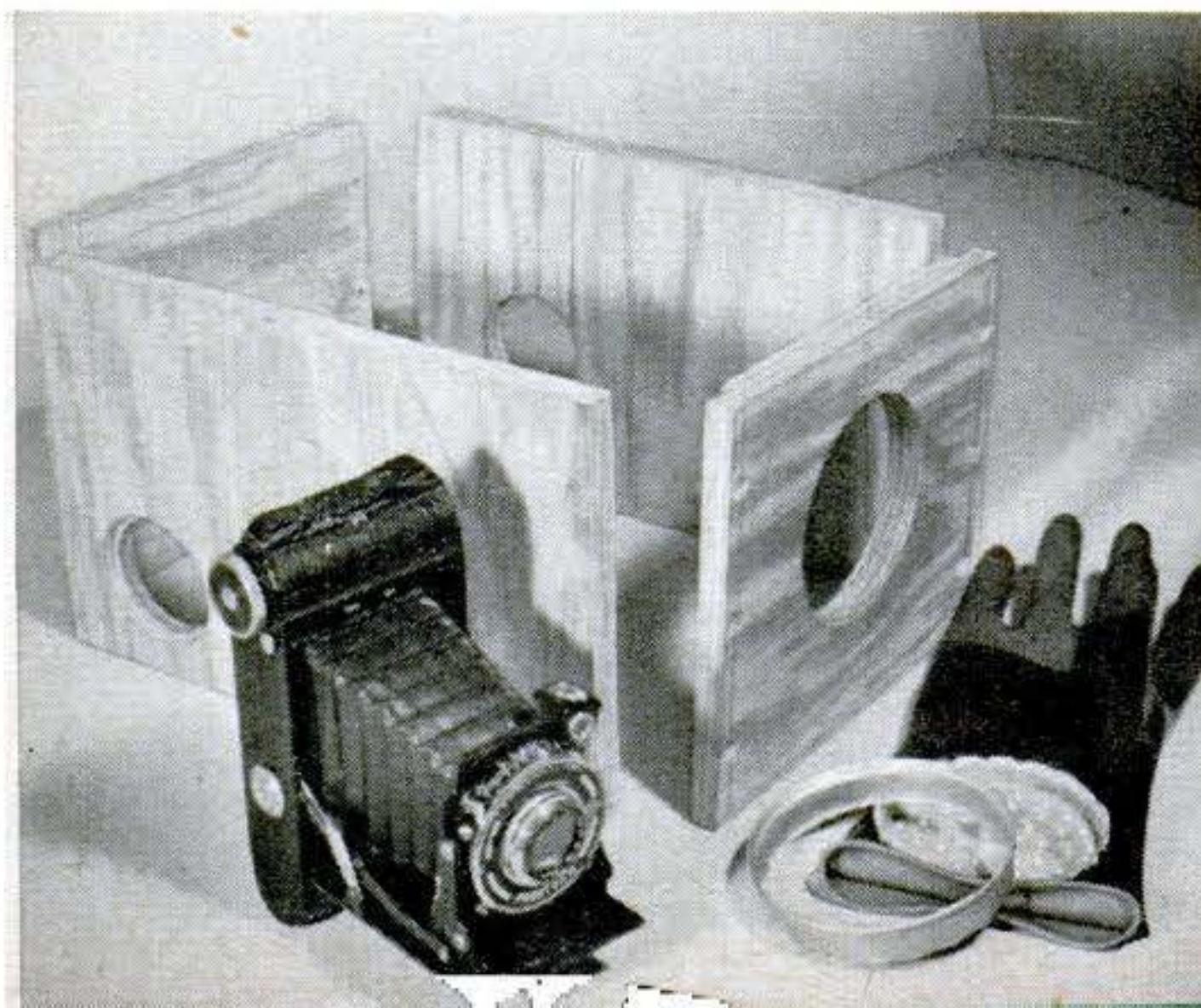
**RUBBER GLOVE** must be of top quality, while flexible enough to let fingers feel camera controls. Flanged ring that fits snugly into the glove clamps it in. Ring shown was cut from an old percolator filter. Corner joints require marine glue and 1¼" wood screws.

You can't go deep, for water pressure builds up with every inch, soon ballooning the glove until it is too stiff to work. But you can have a lot of fun with it, and if later you want to try going deeper, you can pressurize the box.

**The camera.** One using roll film is the most convenient. The winding knob and shutter release should be on the same side. If both are on top, try to mount the camera sideways to bring both within easy reach of the glove. Or, a cable release may move the shutter release to the right.

Flash would be handy, and a socket and reflector mounted outside the box will make

**WATERTIGHT BOX** has rabbeted endpieces into which front and back fit. Top and bottom overlap these. Blocks glued to bottom position the camera accurately behind lens port. Left side of bedplate hooks under fixed clip; other side is clamped down by wing nut.





it easier to change bulbs than a camera-attached rig. The bulbs will fire in water, although extra voltage may be necessary to compensate for electrical leakage. You can get the necessary wallop from an inexpensive capacitor outfit.

**Building the box.** The inside depth and height of the box need be little more than the corresponding dimensions of your camera, but to its width must be added space for your gloved hand. You can determine this from a trial setup. With the camera held as it will be in the box, and your gloved fingers on the controls, measure from the camera to the glove cuff.

Either marine or exterior-type plywood,  $\frac{3}{4}$ " thick, should be used for the box. Cut the parts to size, but before assembling any, make the holes for ports and the glove mounting. Unless your camera has a winding stop, you'll need a port for the film window as well as one for the lens.

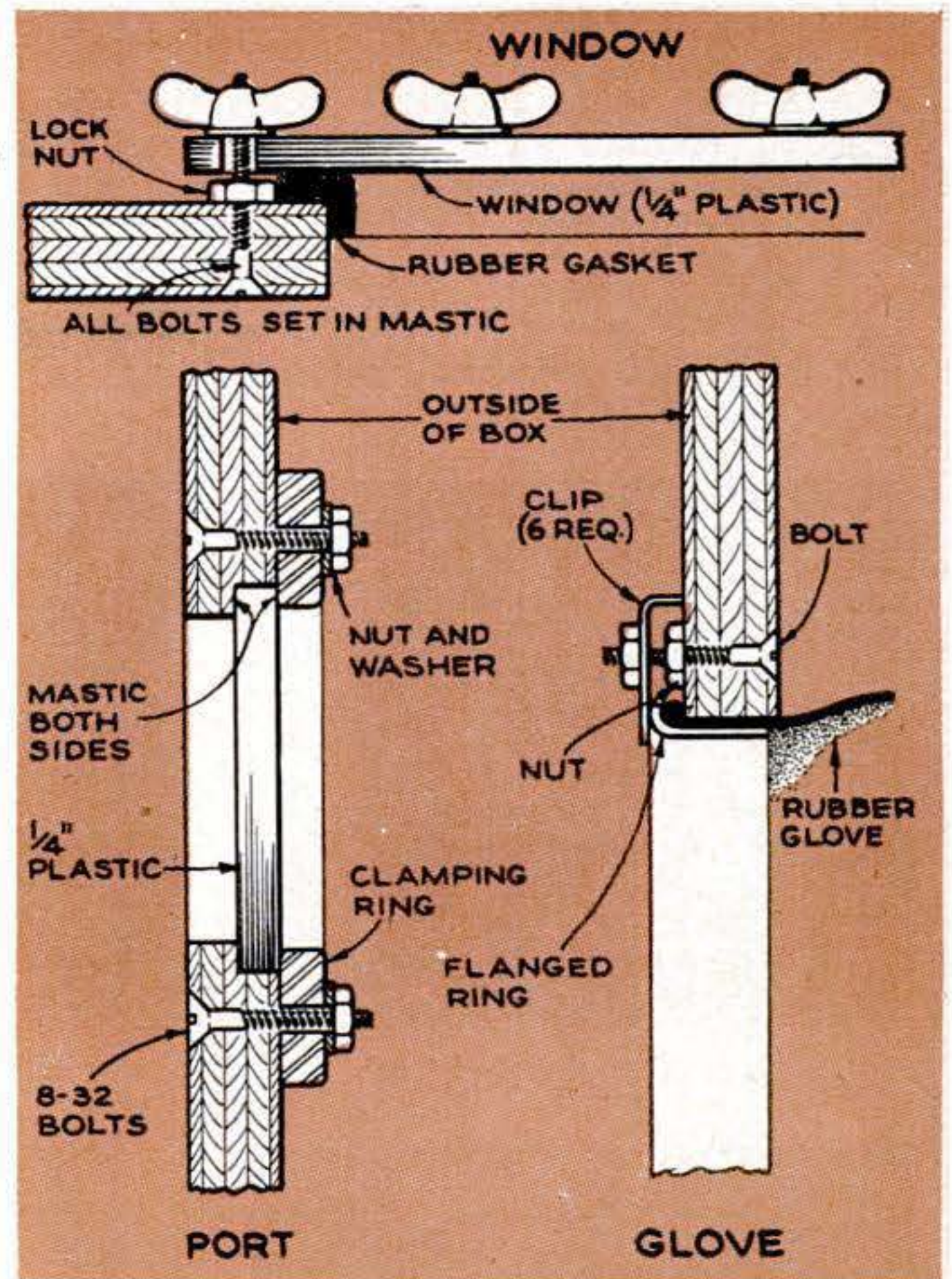
Form steps or rabbets in the port openings by boring with a circle cutter or expansive bit to half depth from the outside face, then resetting the bit  $\frac{1}{4}$ " smaller for boring the final half. Splintering is reduced if you break through from the other face. Make the ports big enough to let light onto the film window, and to avoid masking any part of the lens—2" at least.

Drill and countersink holes in the ends, the top and the bottom for  $1\frac{1}{4}$ " brass wood screws to secure all the box joints. Then assemble front, ends and bottom temporarily with a few screws, leaving the back off.

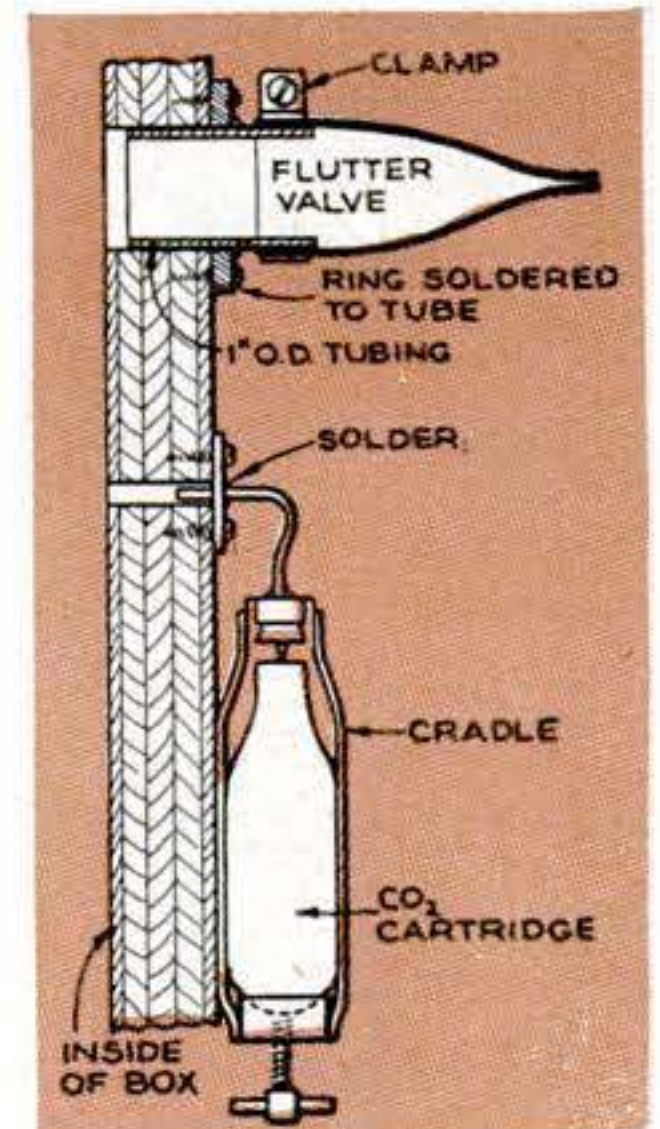
**Mounting the camera.** You will have to devise some means of holding your camera in the required position, leaving it removable through the top opening. Wood

[Continued on page 186]

**BOX IS BUOYANT** and unmanageable below surface unless heavily ballasted. Lead sheets (available from plumbing supply dealers) are punched to fit bolts in bottom. Box should be weighted until it just floats awash; this one required over 15 lb. of sheet lead.

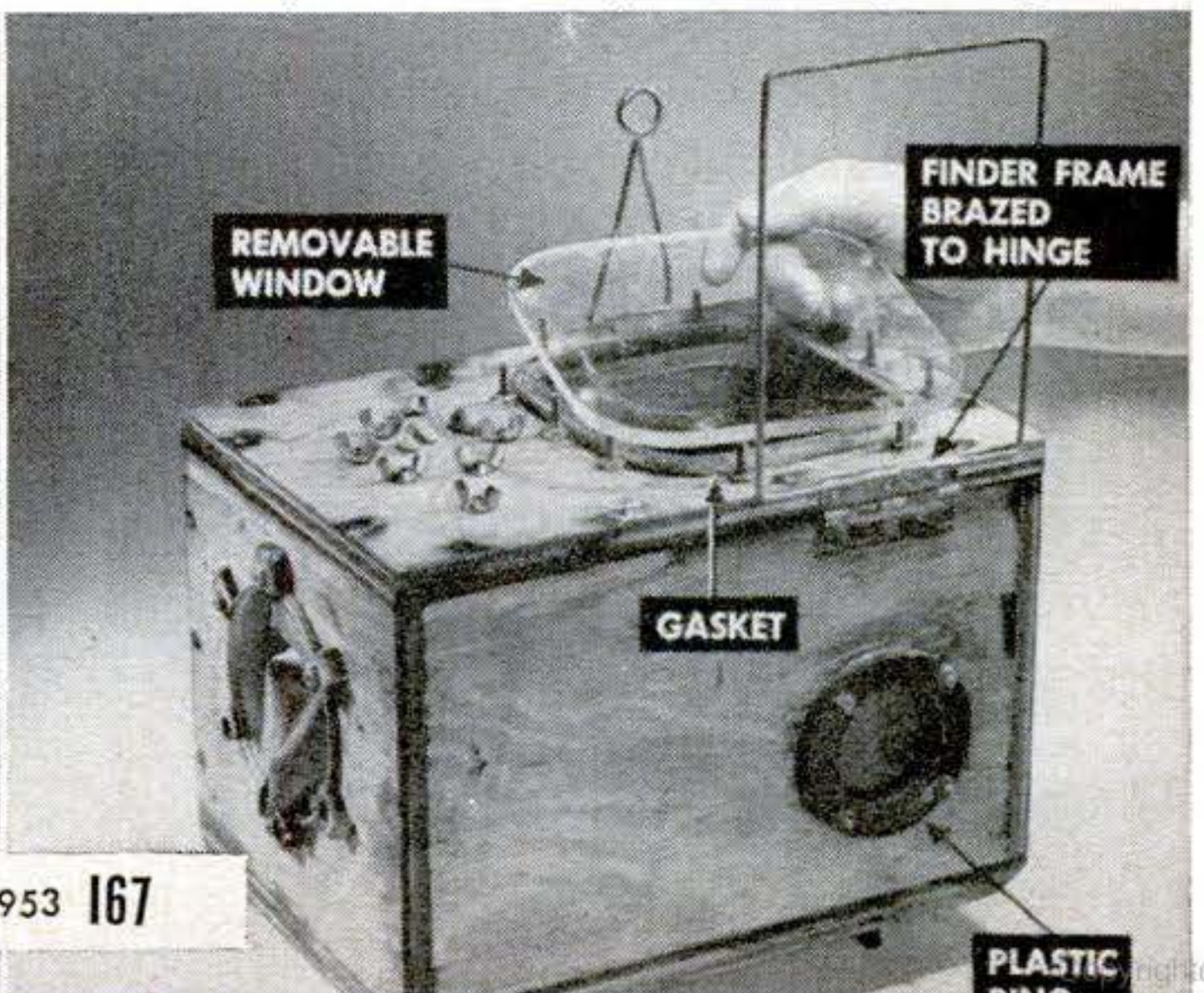
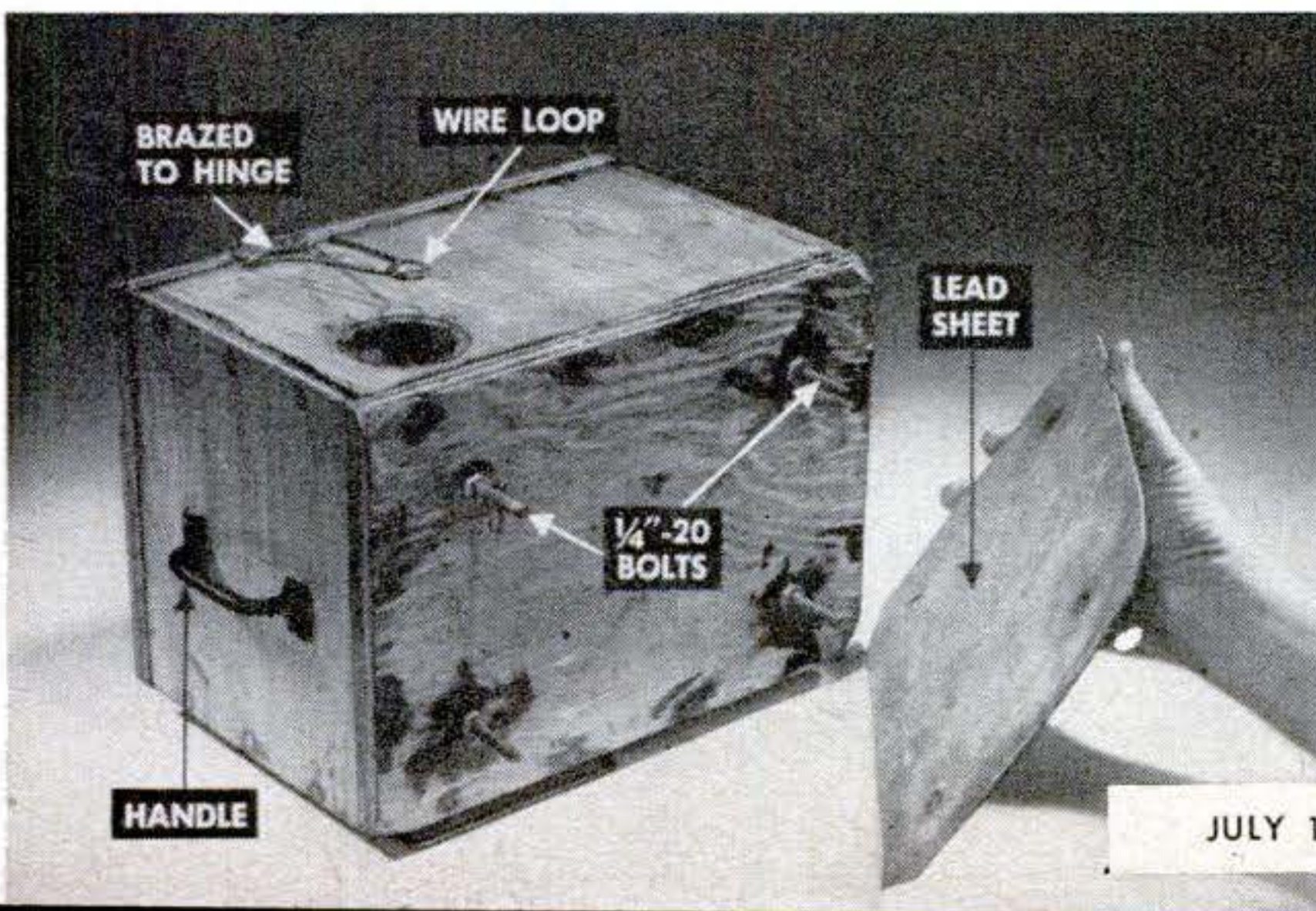


**JIGSAWED RING** over lens port will protect plastic surface from scratches. Bolts holding glove clips and window are secured by lock nuts tightened directly against box.



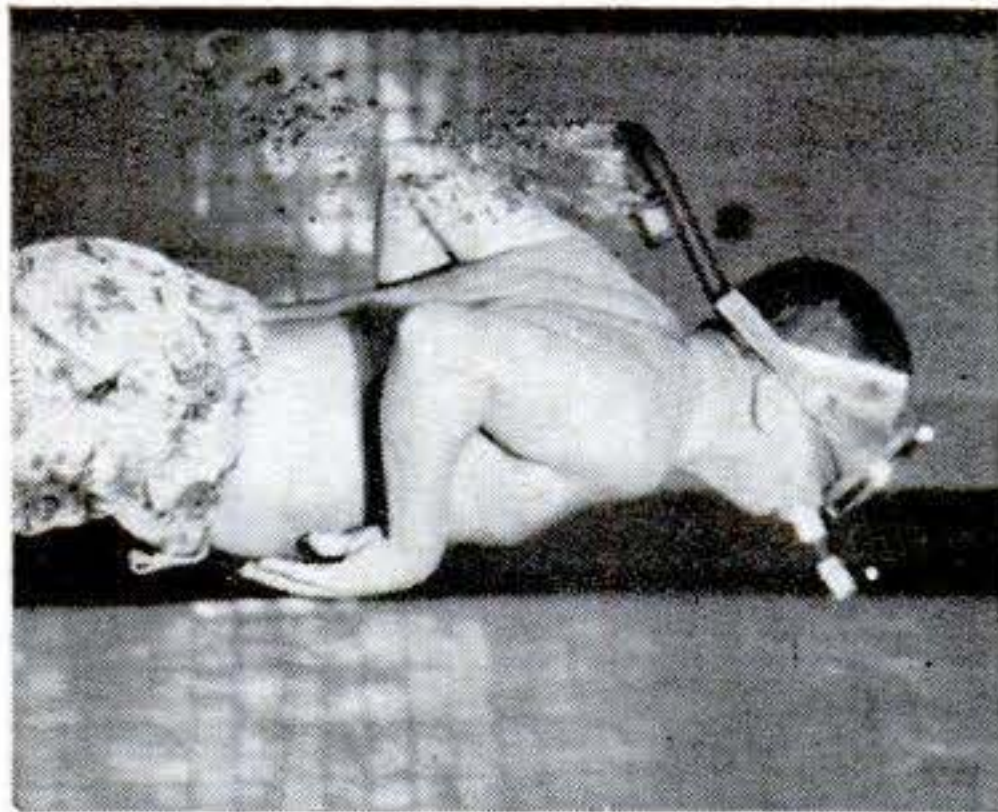
**PRESSURIZING** enables box to be taken deeper. Carbon dioxide cartridge (right) or midget oxygen tank (air-filled) will supply pressure. Don't omit flutter valve.

**SIX CLIPS** pinch head of glove cuff between flanged ring and box. Rear peep sight and finder frame are bent from brazing rod and silver-soldered to brass hinges. Camera is inserted through plastic window (in hand), which slips over bolts, is held by wing nuts.

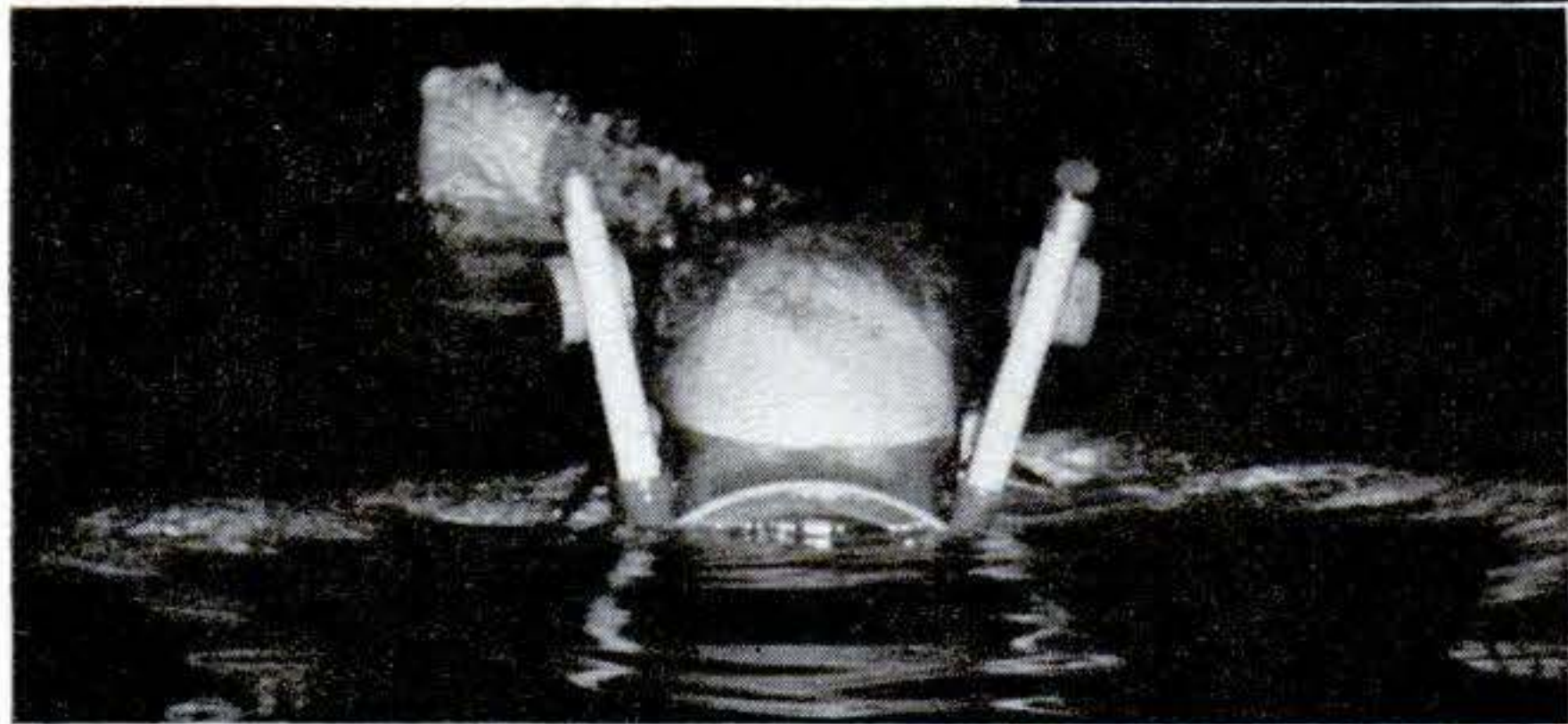




# What You Can Do with a Snorkel



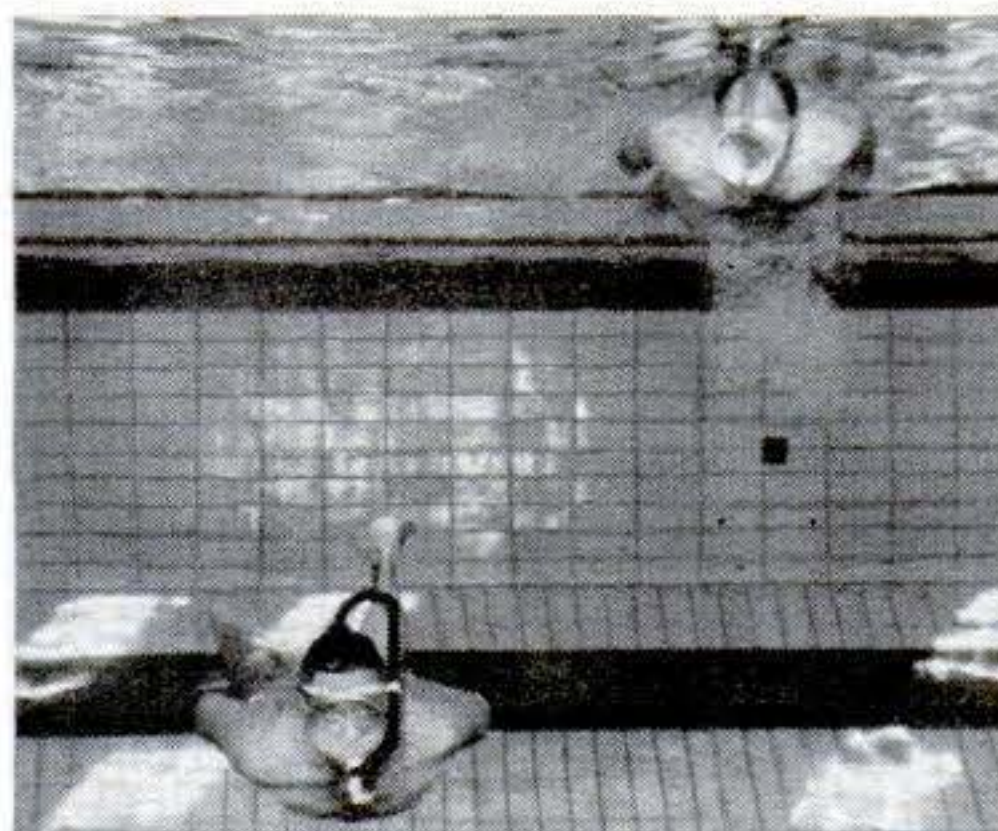
Ball valve keeps out water.



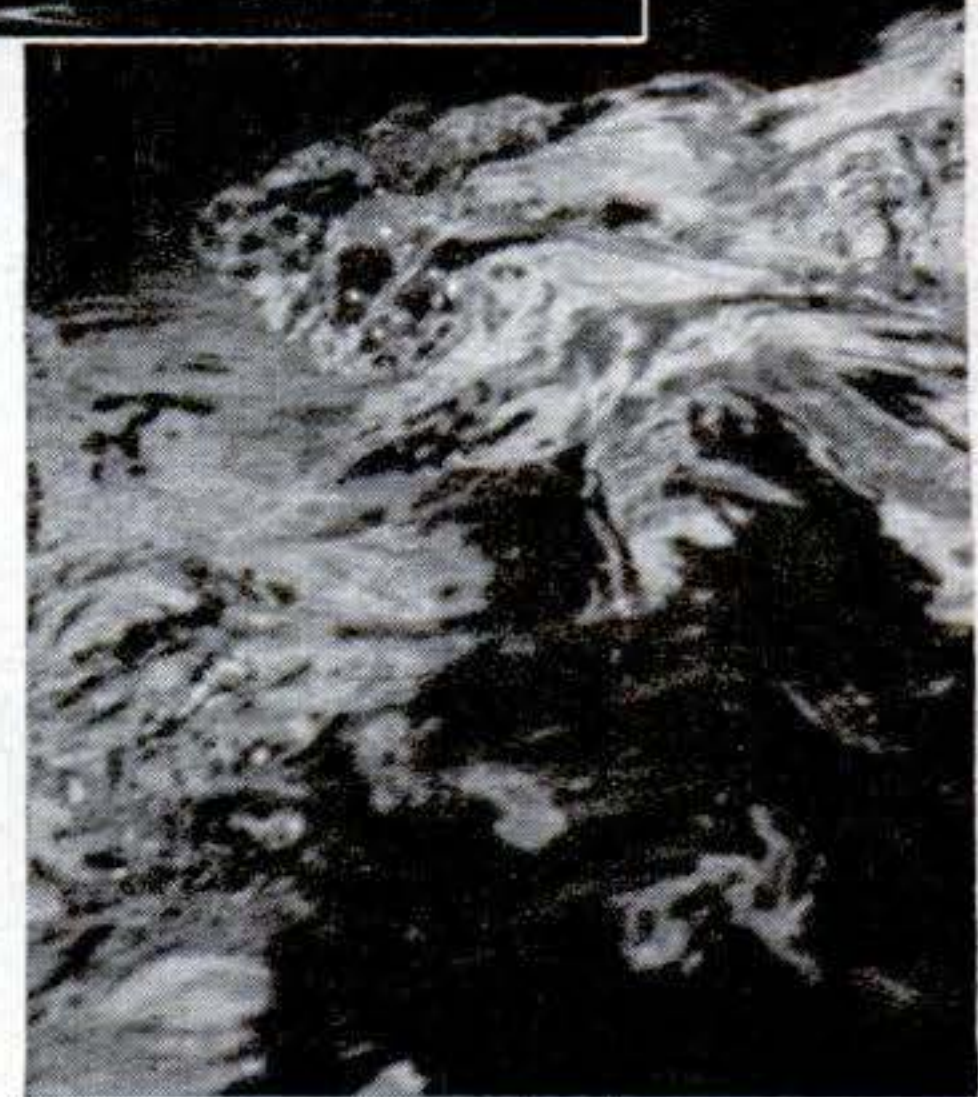
Floats close tubes under water.



Surface cruising is easy.



Surface dives are simple.



*A breathing tube will let you swim or float effortlessly.*

## FUN UNDERWATER

FINDING a dollar bill on the bottom of the Atlantic was as big a surprise as if I'd seen Wilbur Shaw pacing a tricycle race. It was in a tangle of seaweed 10 feet down in the clear water off Key West, Florida. I was snorkeling along, surface-diving occasionally to pick up a shell, when I saw it.

**Why.** Even when you don't find sunken treasure, snorkeling is a lot of fun. More of these gadgets than ever are being used this summer. The purpose is *not* to make a submarine out of you, churning along with all but the tube tip submerged. Instead, the idea is to let you breathe normally while swimming or floating face down.

**How.** Most snorkels have a 180° curve

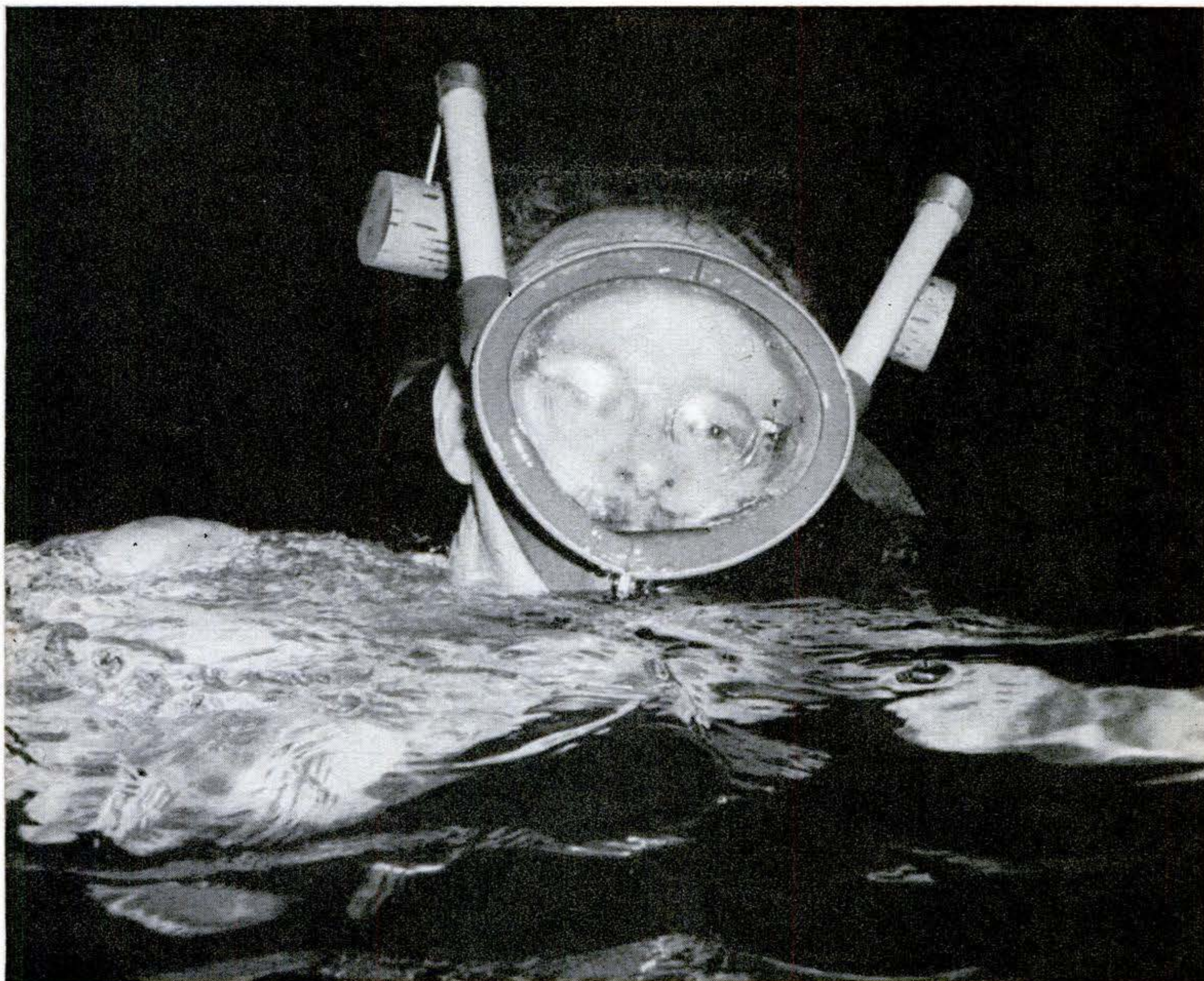
at the mouthpiece end. Some of them also have a 180° curve at the above-water end. These usually have a ball valve at the upper end to keep out water. The snorkels without a ball valve can be cleared of water by blowing into the mouthpiece.

For most fun, you should wear a face mask and swim fins. The mask protects your nose and greatly improves your underwater vision. Fins on your feet take practically all effort out of swimming.

**Green world.** You'll see a brand-new world under water and you'll be surprised how closely you can approach fish. Some of them will almost let you touch them.

I followed a fat, striped little fish for 10 minutes one afternoon. He swam slowly about three feet down. Occasionally he would half turn, look at me and then swim



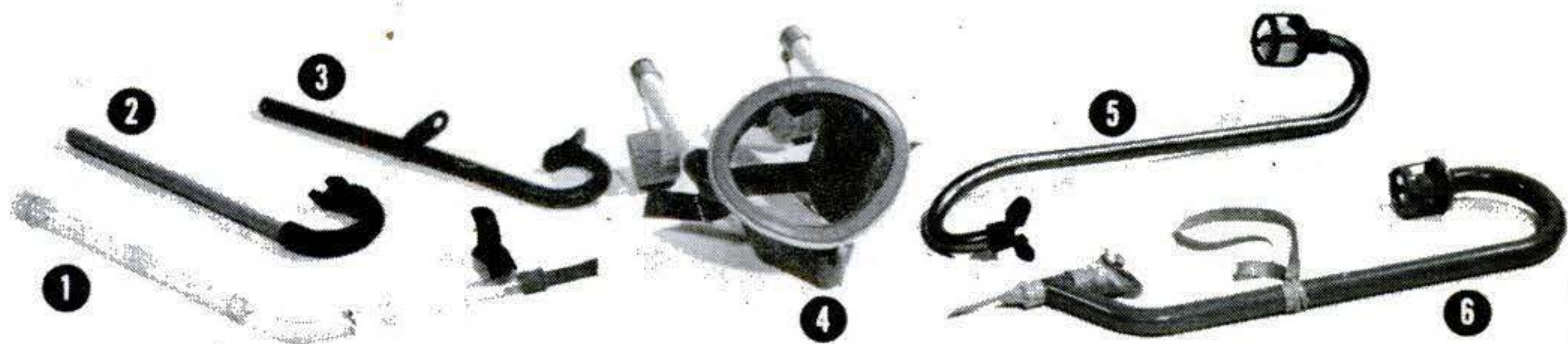


• **Combination mask-snorkel (above) has two breathing tubes, covers eyes, nose and mouth.**

on. Finally, he became bored with the routine or thought of something better to do. He quickened his pace and lost me in a minute. If following fish isn't your dish, you might want to try spear fishing (PSM, Feb. '52, p. 148).

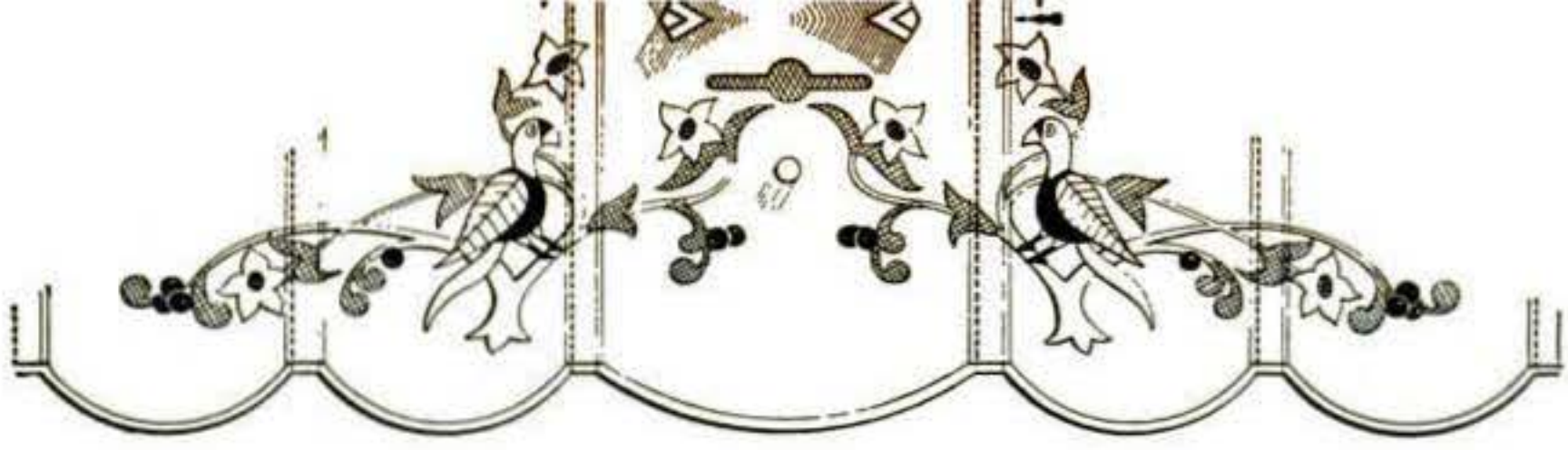
Should you be tempted to curve yourself a snorkel of plastic tubing, don't make it

too long. You can't draw air very far below the surface—your lungs would have a tough job expanding against water pressure. Don't exceed 12 or 13 vertical inches from inlet to mouthpiece. Whatever you use your snorkel for, you'll find your pleasure in swimming greatly increased. You might also find a dollar bill.—*Denis Sneigr*.



*Snorkels are sold by many department and sporting-goods stores. Those above were obtained from: 1. Abercrombie & Fitch, NYC; 2. and 4. Aqua-Gun Co., 1121 N. Broadway, Yonkers 3, N.Y.; 3. Bel-Aqua Water Sports Co., 3720 W. 54th St., Los Angeles 43; 5. U.S. Divers Co., 1045 Broxton Ave., W. Los Angeles 24; 6. Bloomingdale Bros., NYC. Prices range from \$2 to \$12.*

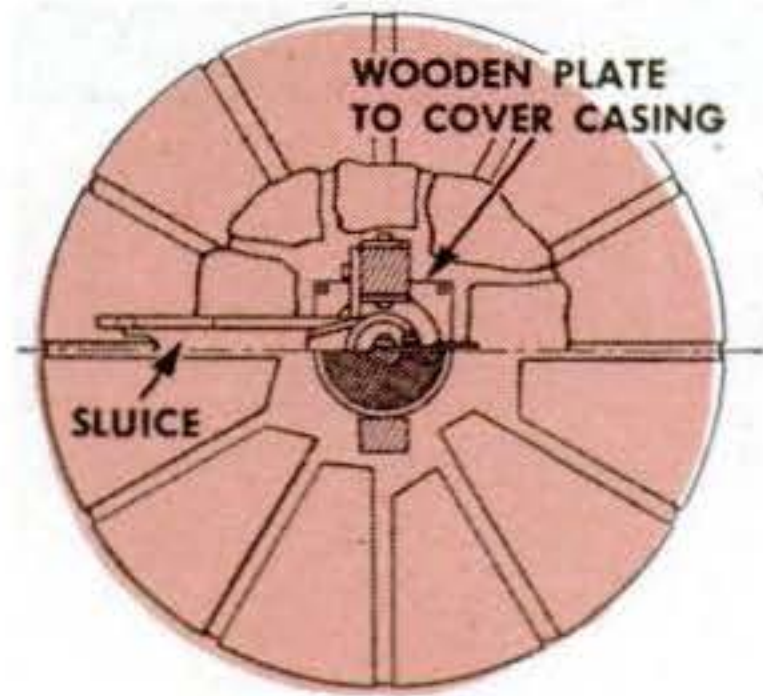
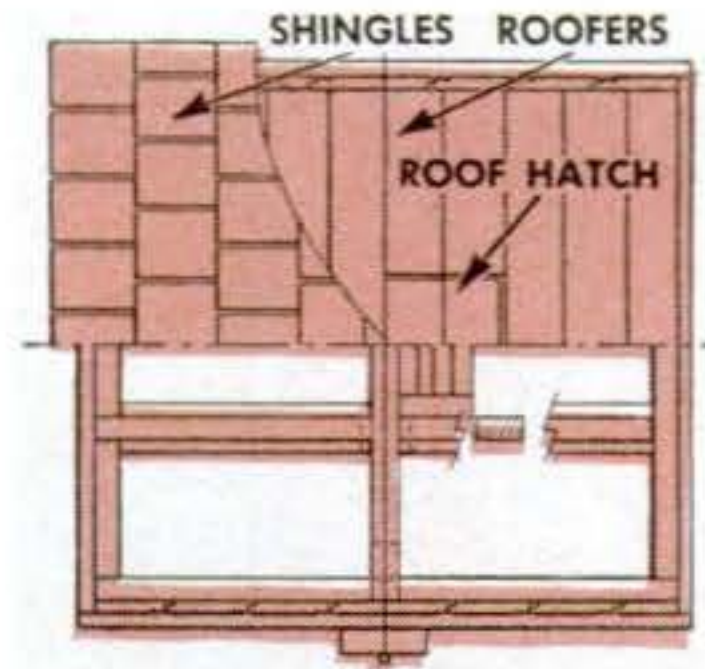




# Well Cover and Pump Dress Up Garden



**SLUICE**, above, carries water beyond stonework and holds bucket bail. Two Pennsylvania-Dutch goldfinches add a colorful note to the roof ends. Wren house is small box hinged behind them.



## Inner-Tube Valve Makes Sander

A SANDPAPER disk cemented to the bottom of a rubber inner-tube valve is a handy accessory for your electric drill or flexible-shaft outfit.

Insert the metal tip in the chuck for sanding inside curves and irregular surfaces. Keep several valves on hand with different grades of sandpaper mounted on them for coarse and fine sanding.—*Norman Hume, San José, Costa Rica.*

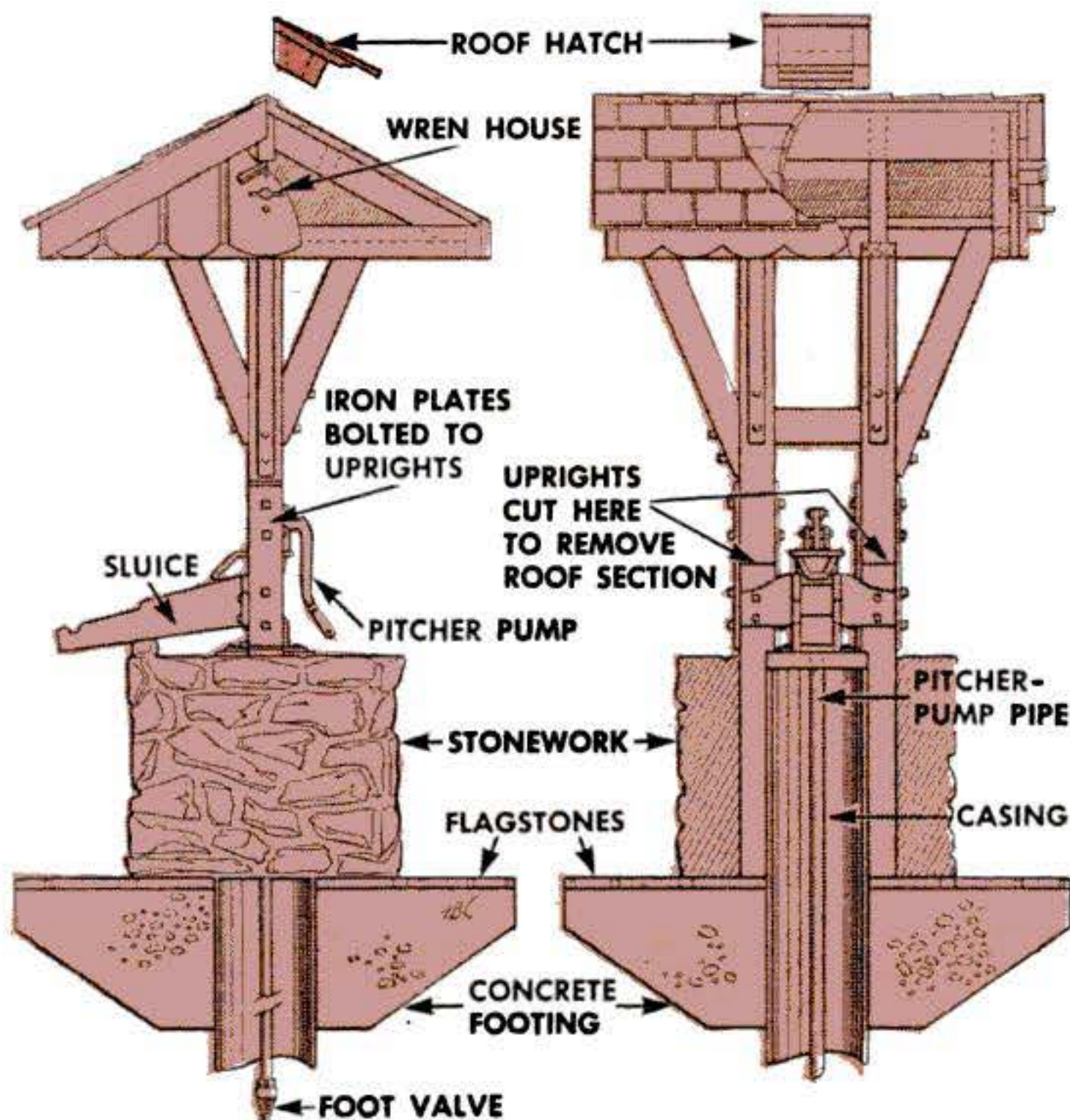


## Cool, cool water from a well-house pitcher pump beats the best outpourings of a chromium-plated tap.

WE NEVER miss the water when the power lines go down because we've set a hand pump over our drilled-well casing. What's more, the old strong-arm model has been prettied up with a well house that adds a decorative note to the garden.

The design and construction of such a well house is not difficult. But for performance and maintenance there are a few points worth remembering. A simple hand pump can lift water just so far (about 21', according to the experts). The normal water level in a well casing is usually higher than that, but it's best to check, because if the distance from the water to the pump is greater, you'll need a high-lift hand pump.

This does not mean that the drop line



from the pump cannot be longer than 21'. It should be, to insure a cold, clean supply of water, free from surface flotsam. A filter isn't necessary, but a foot valve is a good investment. Without it, the pump will have to be primed each time it is used.

Because I knew in advance that I wanted a well house, I had the drillers burn off the top of the well casing 2' above the surface of the ground. That gave me a water- and dirt-tight form around which to build a stone base.

To get at the line to the deep-well pump in my home, I made the top of the well house removable by sawing completely through the two upright members which support the roof section. I waited until these four-by-fours were solidly embedded in the stone-and-cement work, and the whole roof applied, before making the cuts. That insured alignment of the post sections and, because I cut them one at a time and spliced the joints with strap-iron plates and  $\frac{3}{8}$ " bolts as I went along, there was no need to lower the roof section to the ground, or to prop it in place during the operation. A small hatch in the roof lets me lift the pitcher-pump pipe without removing the bolts and angling the top section to one side.

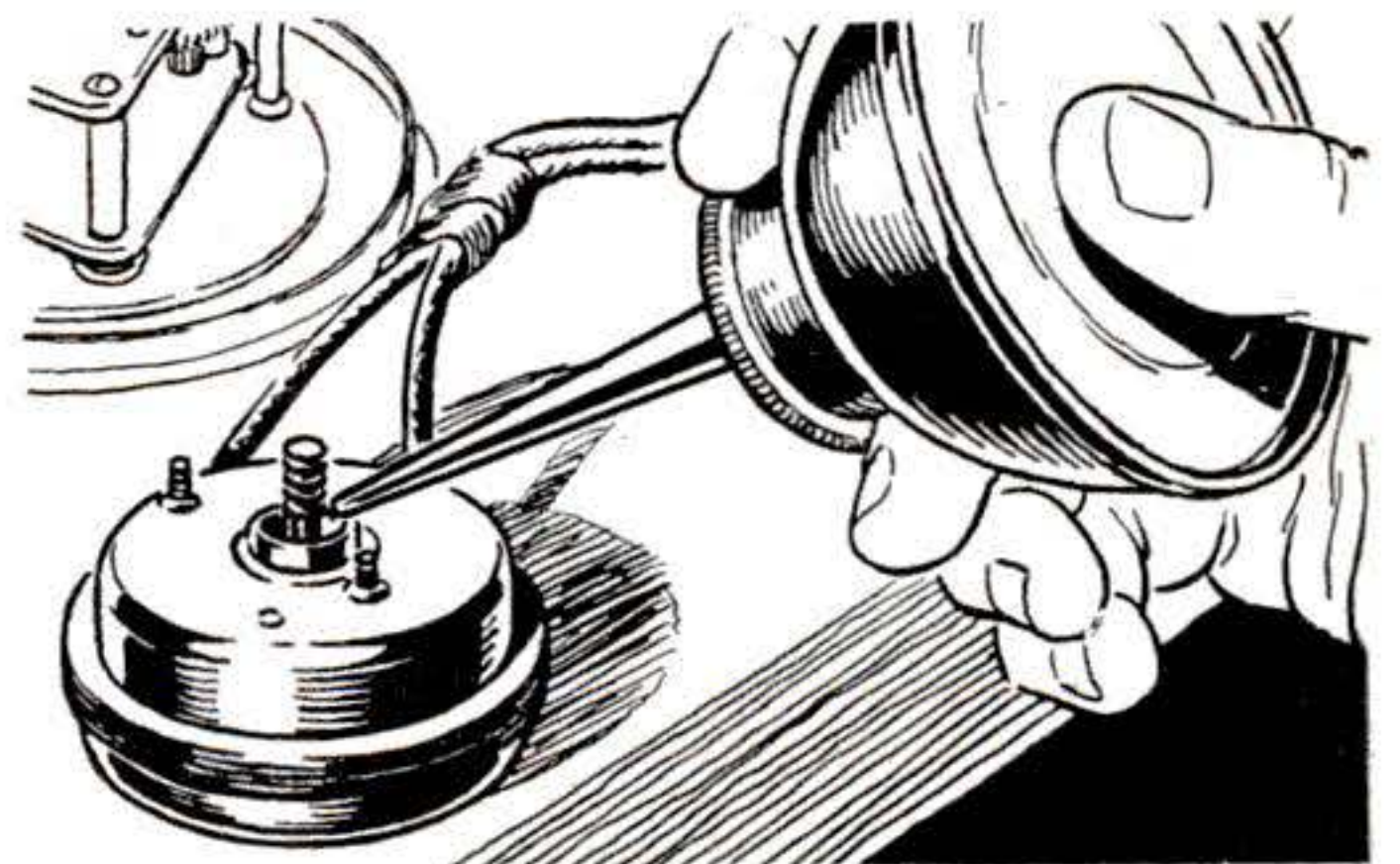
Our pitcher pump provided poor clearance for a bucket. So I anchored a high-walled sluce to a crossbar below the spout. Extending beyond the stone base, it has two notched extensions that hold the bucket bail.

The birdhouse opening (with a cross slot to make nest-building easy) was cut directly through the facing of the well-house gable. Behind it I put a hinged box, which can be swung open for winter house cleaning.—

*Henry B. Comstock.*

### Oiling Sealed Clock Motors

SEALED electric-clock motors that have become noisy can often be oiled and silenced this way. Remove the gear-train unit, warm it slightly, and then place a few drops of high-grade light oil in the cup around the gear shaft. Then place the unit in the refrigerator for a few minutes. The contraction of the warmed air inside the gear-train unit draws the oil in during cooling.—*C. L. Bossmeyer, Rockford, Ill.*



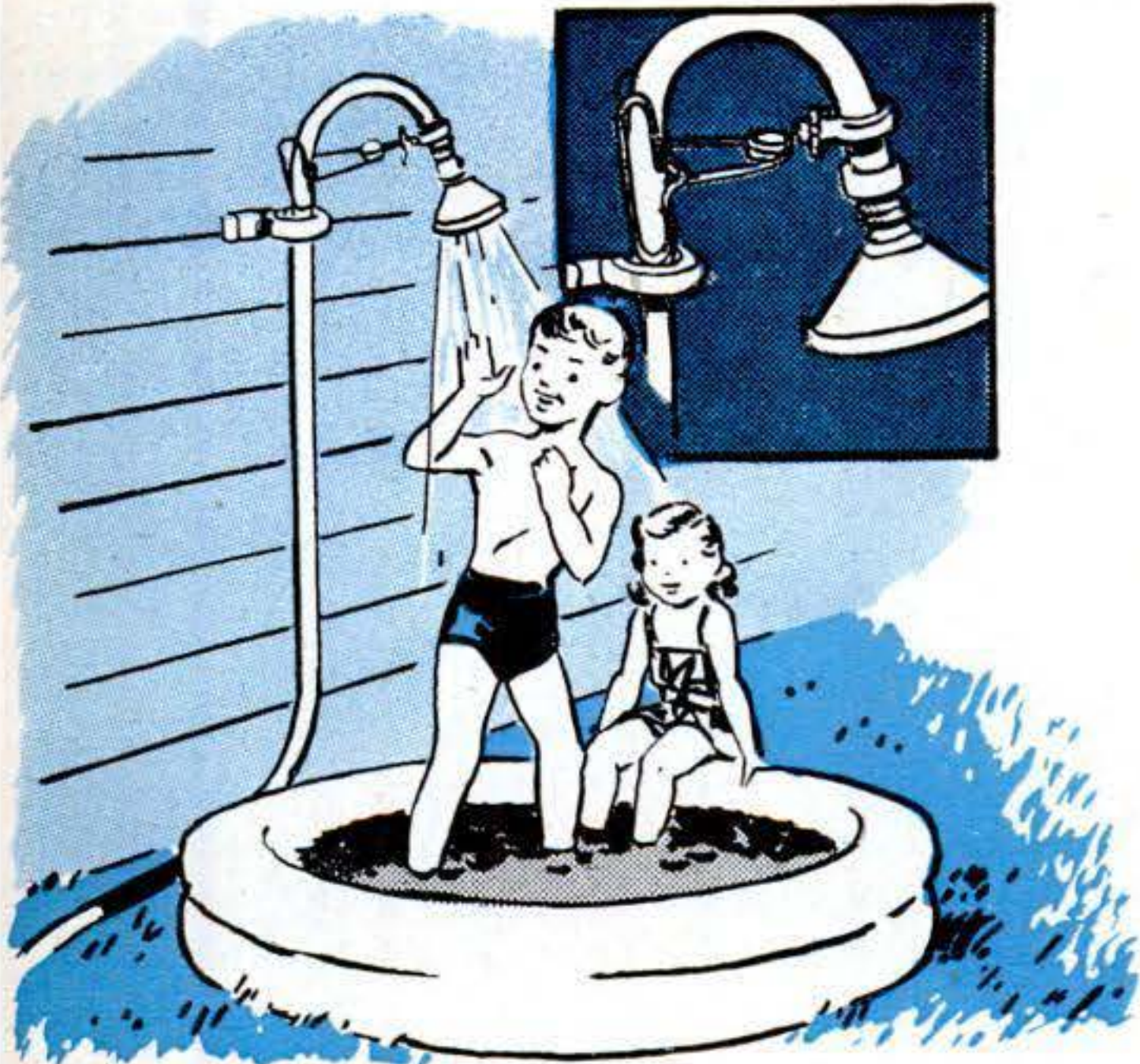
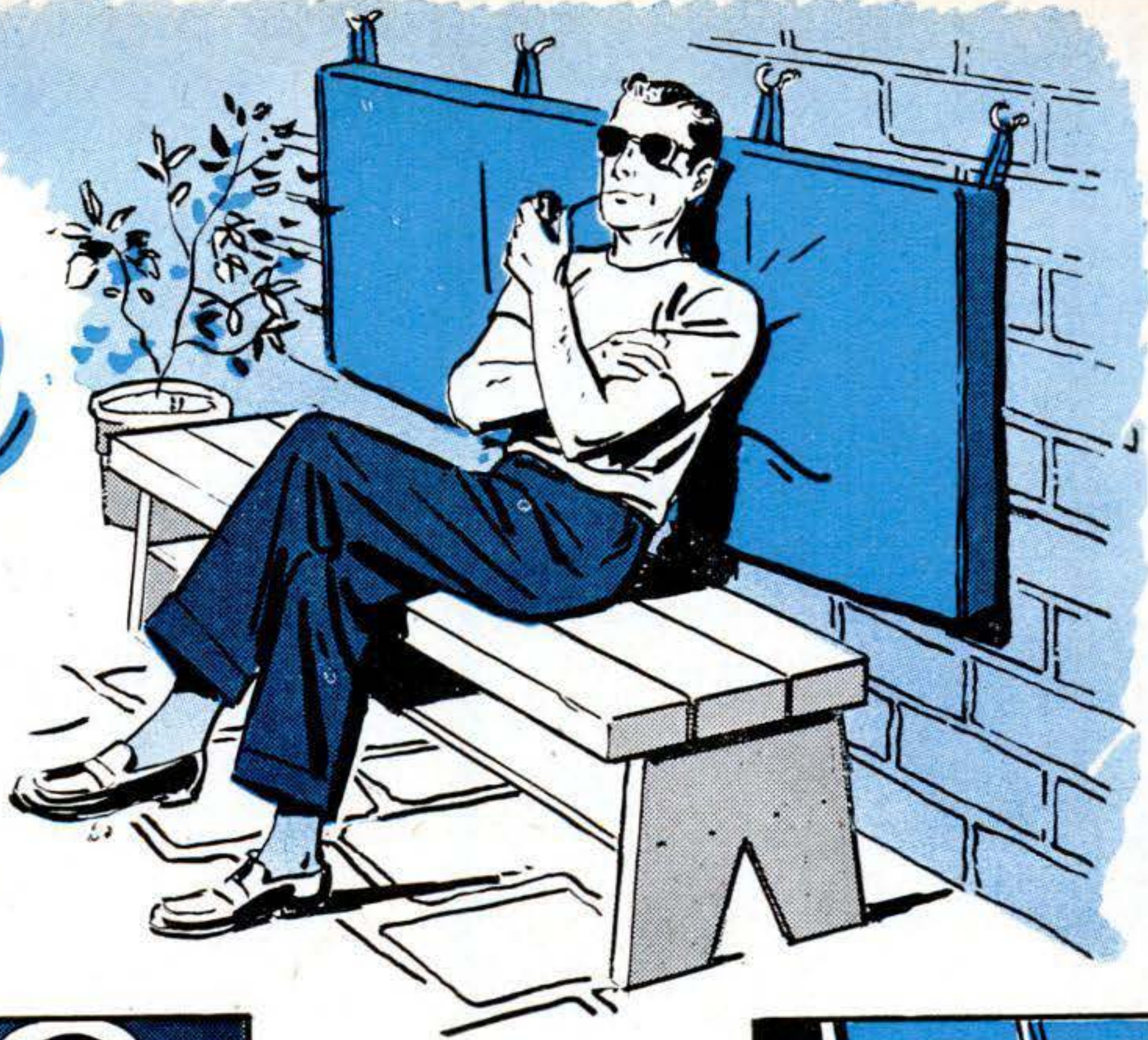


## KEEPING THE

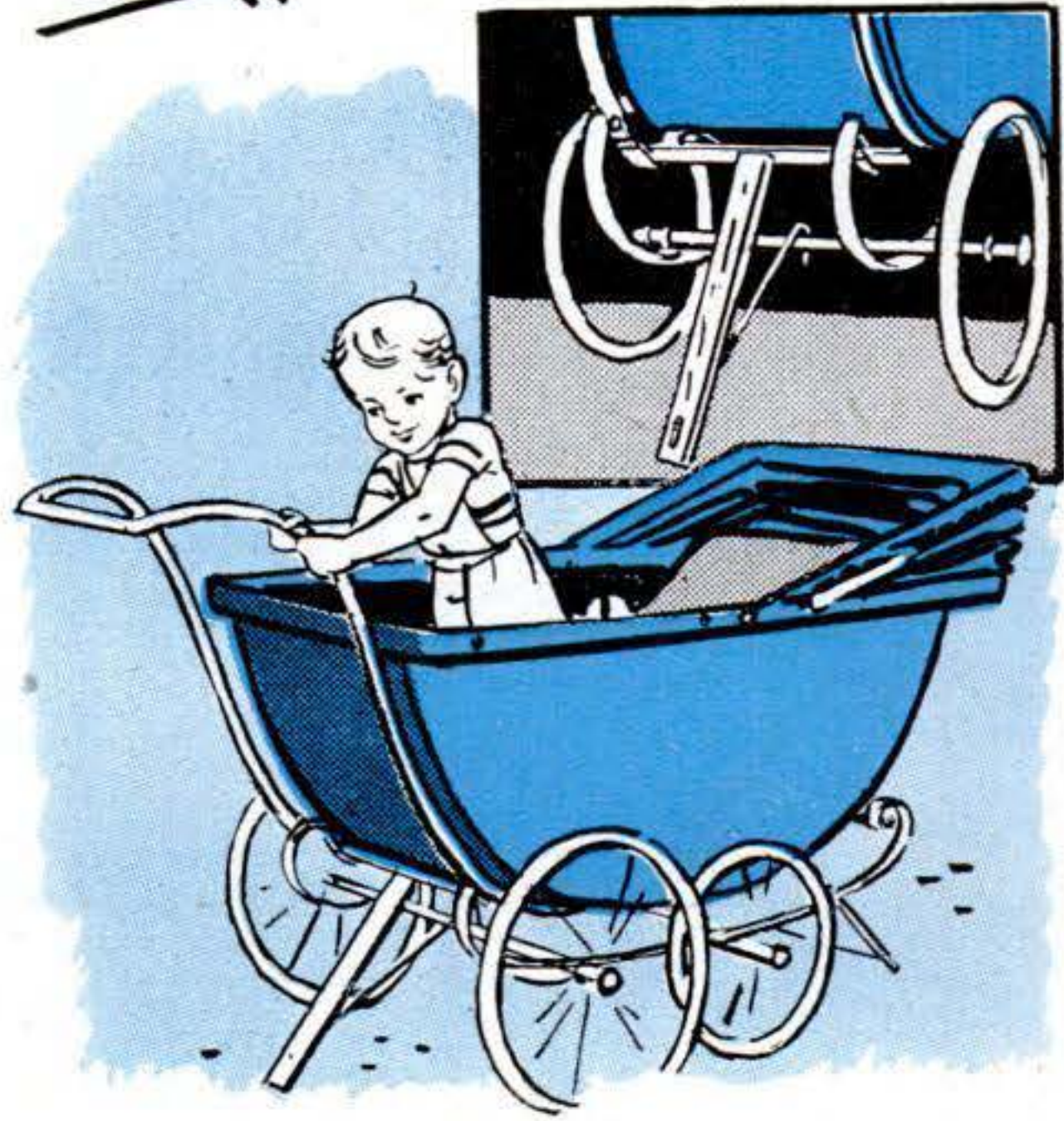
# Home

## SHIPSHAPE

**Bench warmers** can relax in comfort on patio or porch if the bench is backed up against a wall and a foam-rubber cushion or a quilted pad is hung above it.



**A backyard shower** like this goes up or comes down easily. Crooked in a photo-lamp clamp, the hose is gripped by a spring-type screen-door latch screwed to the house. With a little forcing, a rubber-necked faucet spray head will fit the hose nozzle.

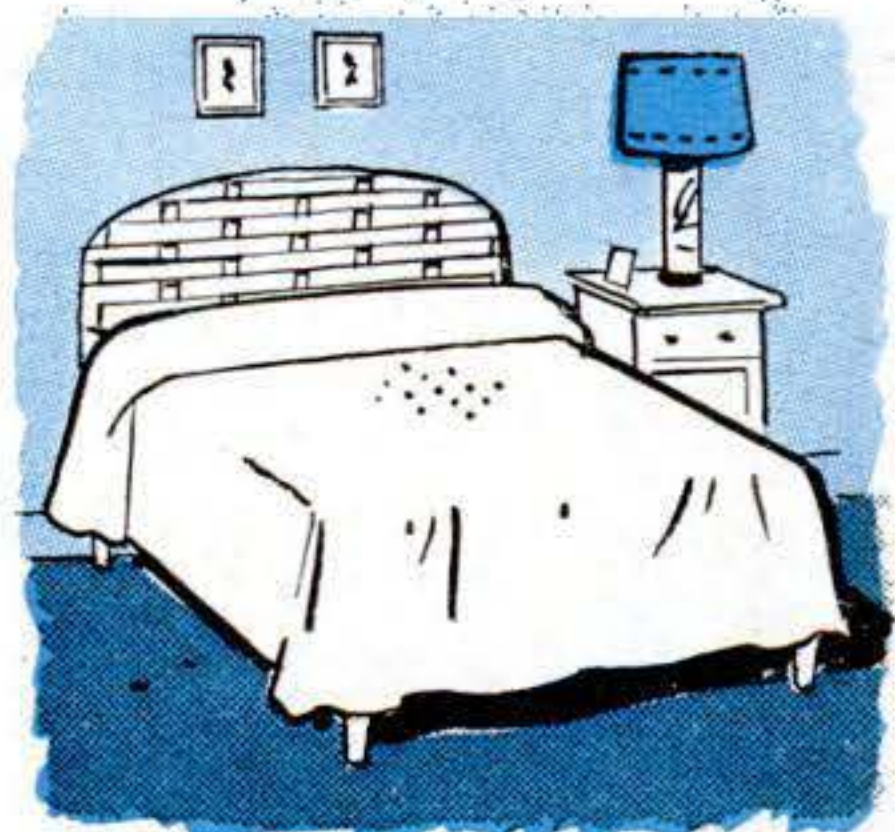


**Baby won't tip out** if T-shaped legs with tapered arms are set in the straps that support the carriage. Each leg is a bit longer than strap height from ground. Wire hooks keep them from slipping.

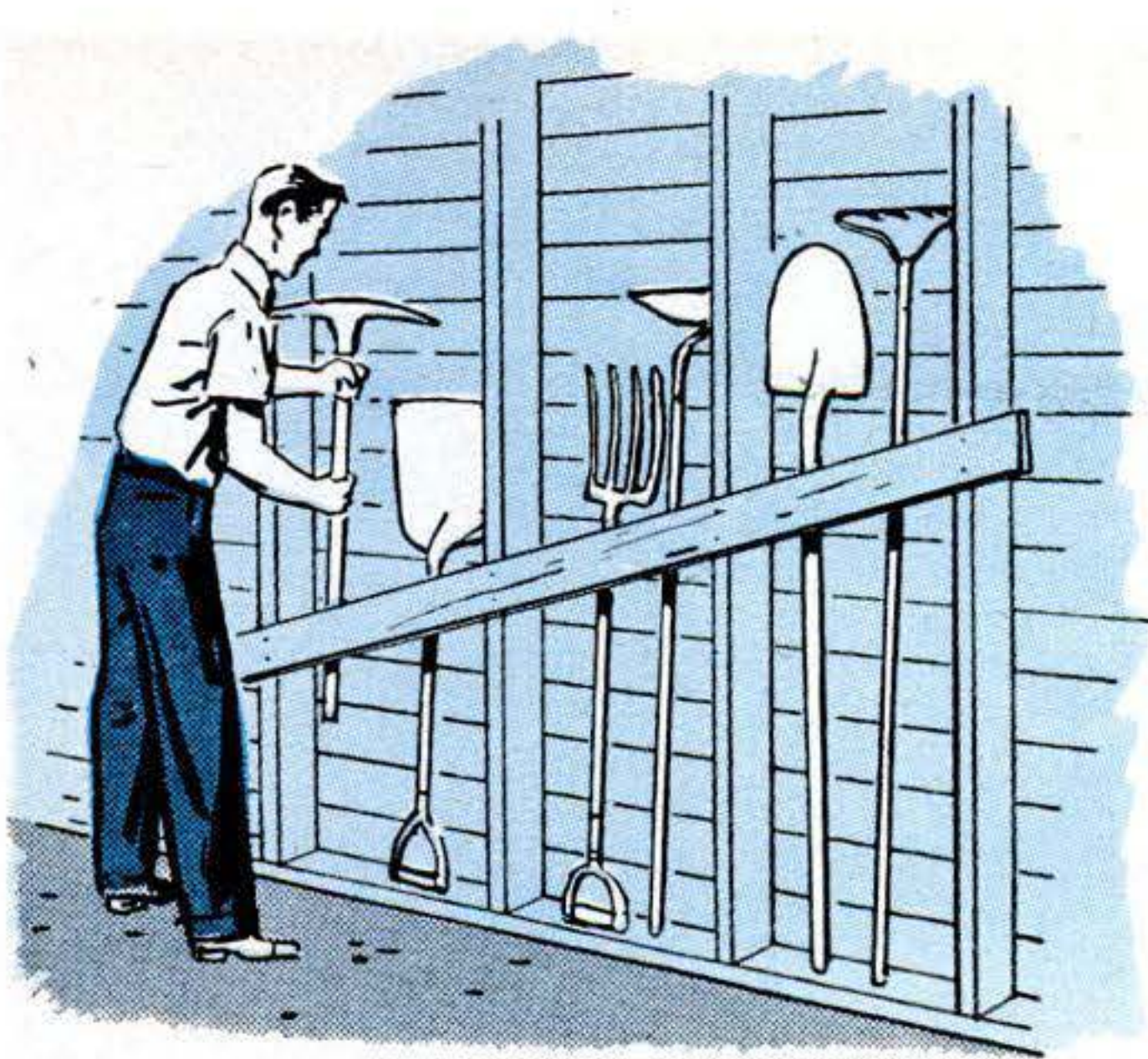


**Need extra ice?** You can freeze cylinders in plastic bottles. Cut the bottles in two to remove the ice intact. Coffee, tea or fruit juices can be frozen handily this way, too.

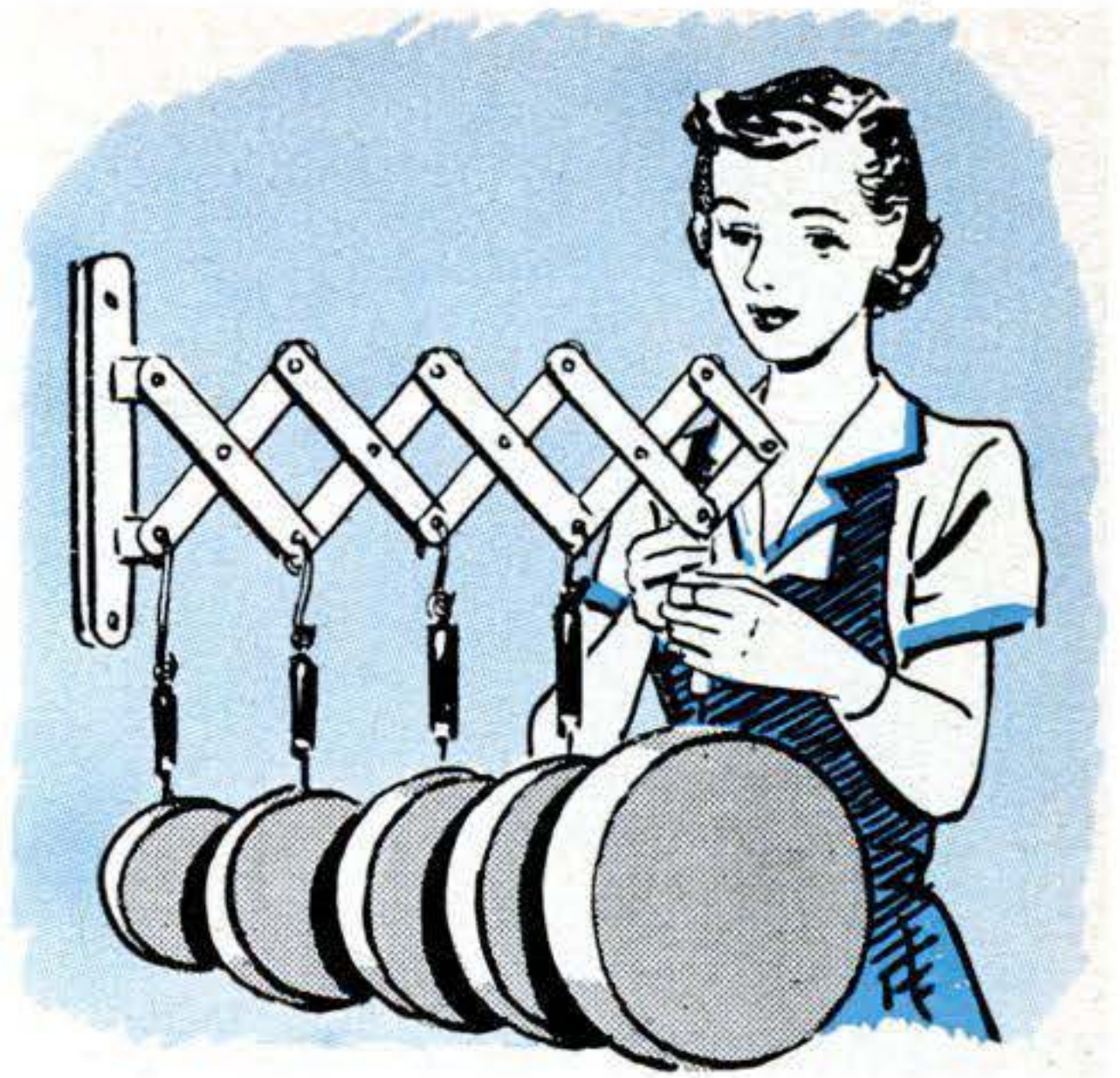
**Modernize that bed** with wood slats or metal tubes by painting it, then interweaving with matching or contrasting plastic webbing. Discard the headboard if it is too high.





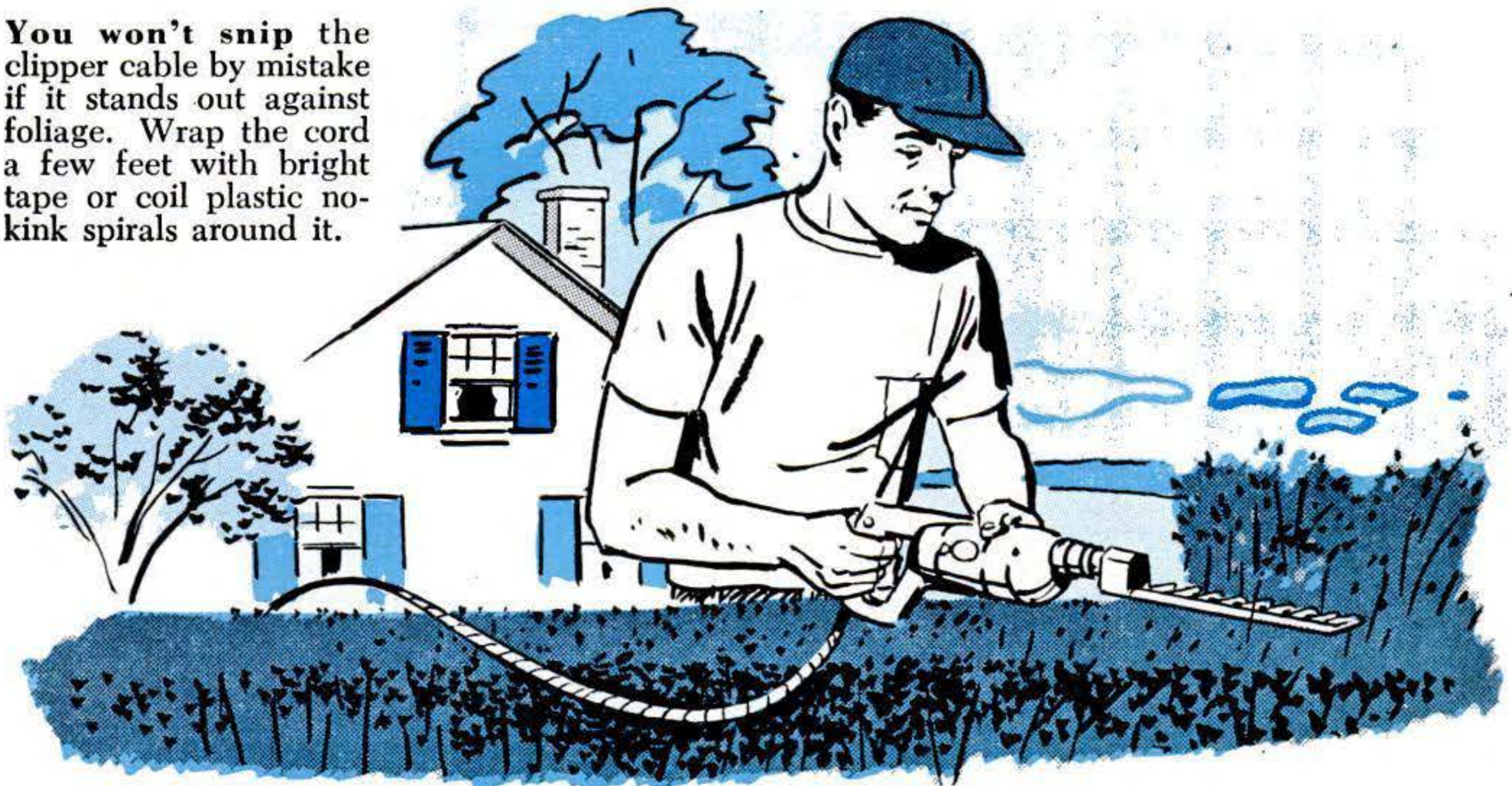


An easy way to keep garden tools racked in order is to nail a board at an angle across four or more studs in your garage.

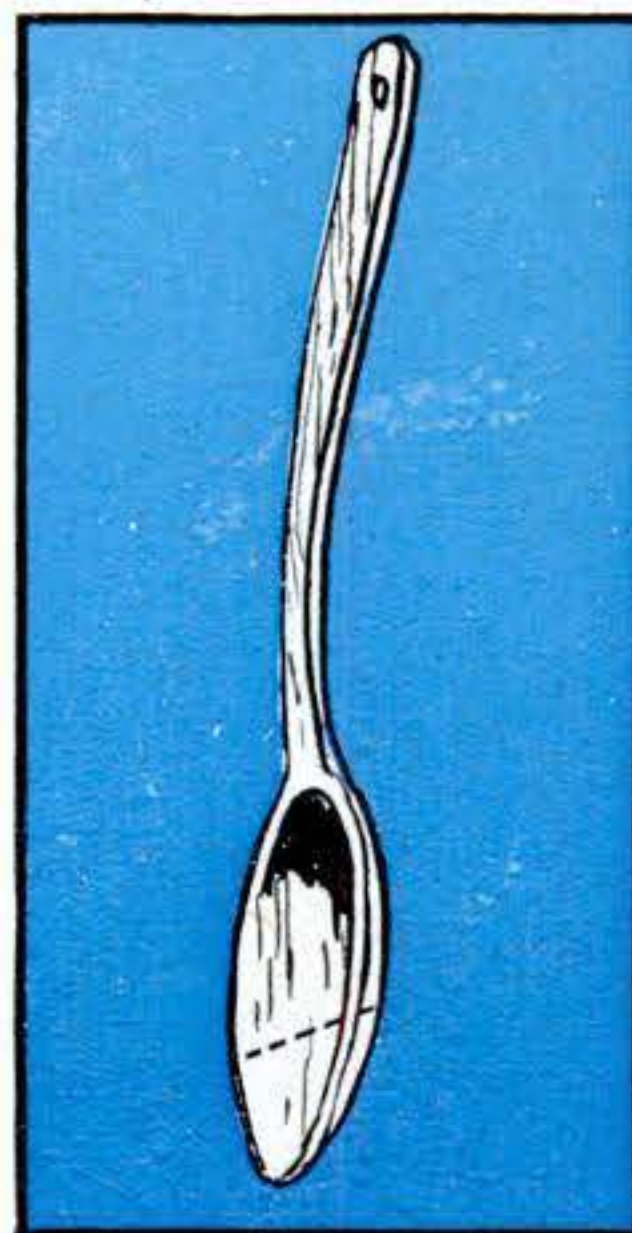


Cooking pots nest against the wall and take up less room in a tiny camp kitchen if hung on the extension arm of an old shaving mirror.

You won't snip the clipper cable by mistake if it stands out against foliage. Wrap the cord a few feet with bright tape or coil plastic no-kink spirals around it.

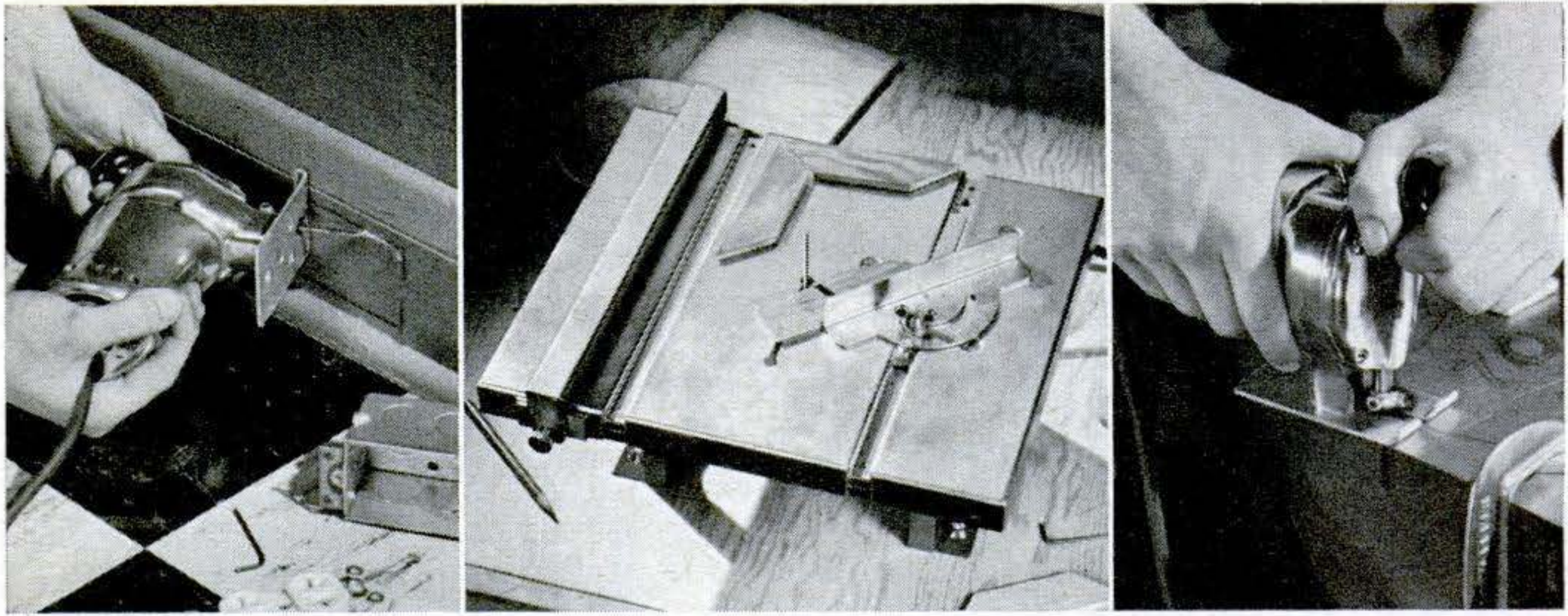


Keep some old socks stowed away in each suitcase and when you pack for a trip, they'll be right at hand to slip over the shoes you pack, keeping them from dirtying your clothes.



Fit it to the pot and a stirring spoon will really scrape bottom to prevent sticking of jams and jellies. Saw diagonally across the bowl of a wooden spoon and sand smooth.





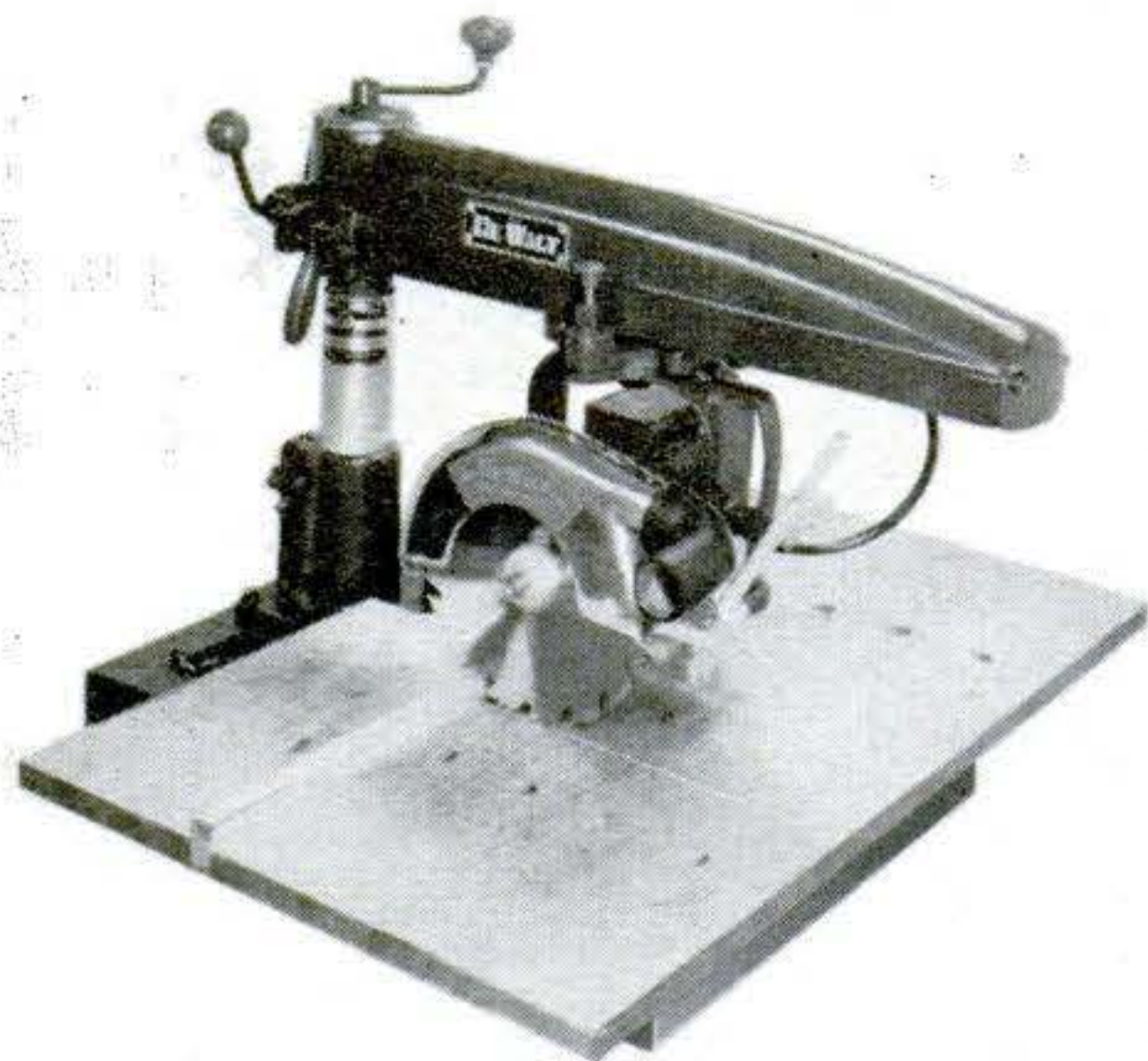
## **New Tools**

**1 Portable Jigsaw Cuts Anything.** This electric hand jigsaw will cut wood, metal, rubber, leather, plastic, composition board and other materials simply by inserting one of five different blades. As a keyhole saw, it will make internal cuts in wood without

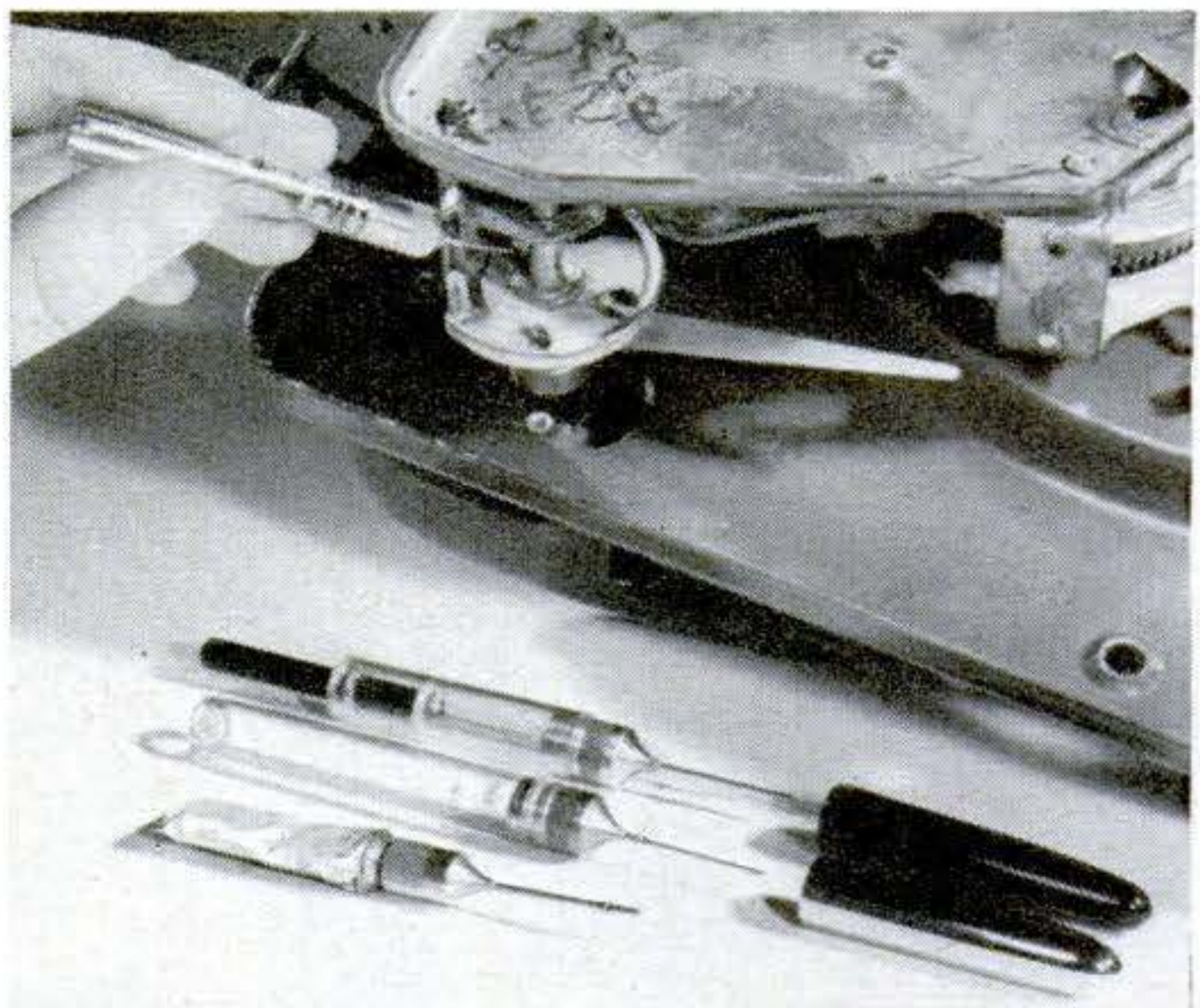
a starting hole (left above). Clamped under an accessory table (center), it becomes a stationary saw for accurate cuts with guide fence and miter gauge, or can be used free-hand to do many bandsaw jobs. Attachments are available for cutting circles and box joints. The saw also slices through metal easily (right above). It weighs 3 lb., runs on AC or DC and will cut to a depth of 1½" in softwood and 1" in hardwood.



**2 Drill Attachment Drives Screws.** Any ¼" electric drill will drive screws with this speed reducer. By varying hand pressure on the revolving drum, speed of the screwdriver bit can be regulated from zero to the full speed of the drill. A special connector permits it to take various screw- and nut-driving accessories.

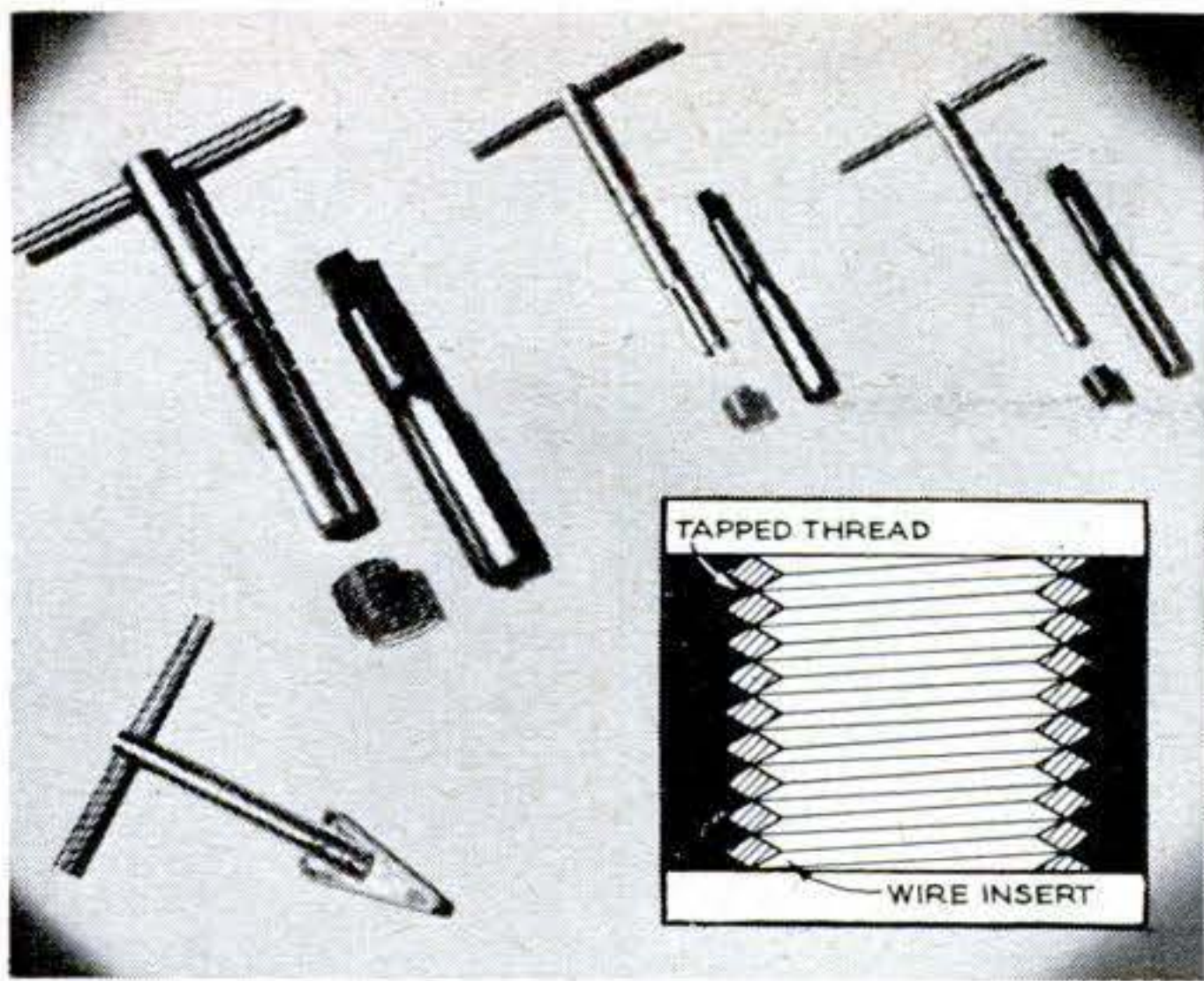


**3 Radial Arm Has Longer Reach.** You can cut to the middle of a 4'-wide panel with this new radial-arm saw. Designed especially for homeowners working with large sheets of plywood and other materials, it has an arm 3" longer than previous models and a table 4" wider and 3" deeper. Controls are also redesigned for easier handling.



**4 Tiny Oilers Reach Tight Spots.** Small, hard-to-get-at places can be lubricated easily with this kit of four tiny oilers. It has two fine-needle, squeeze-type dispensers for light oils, a plunger type with a larger needle for heavier oils and greases, and a screw-on needle that fits the threaded nipples on small tubes of grease and glue.





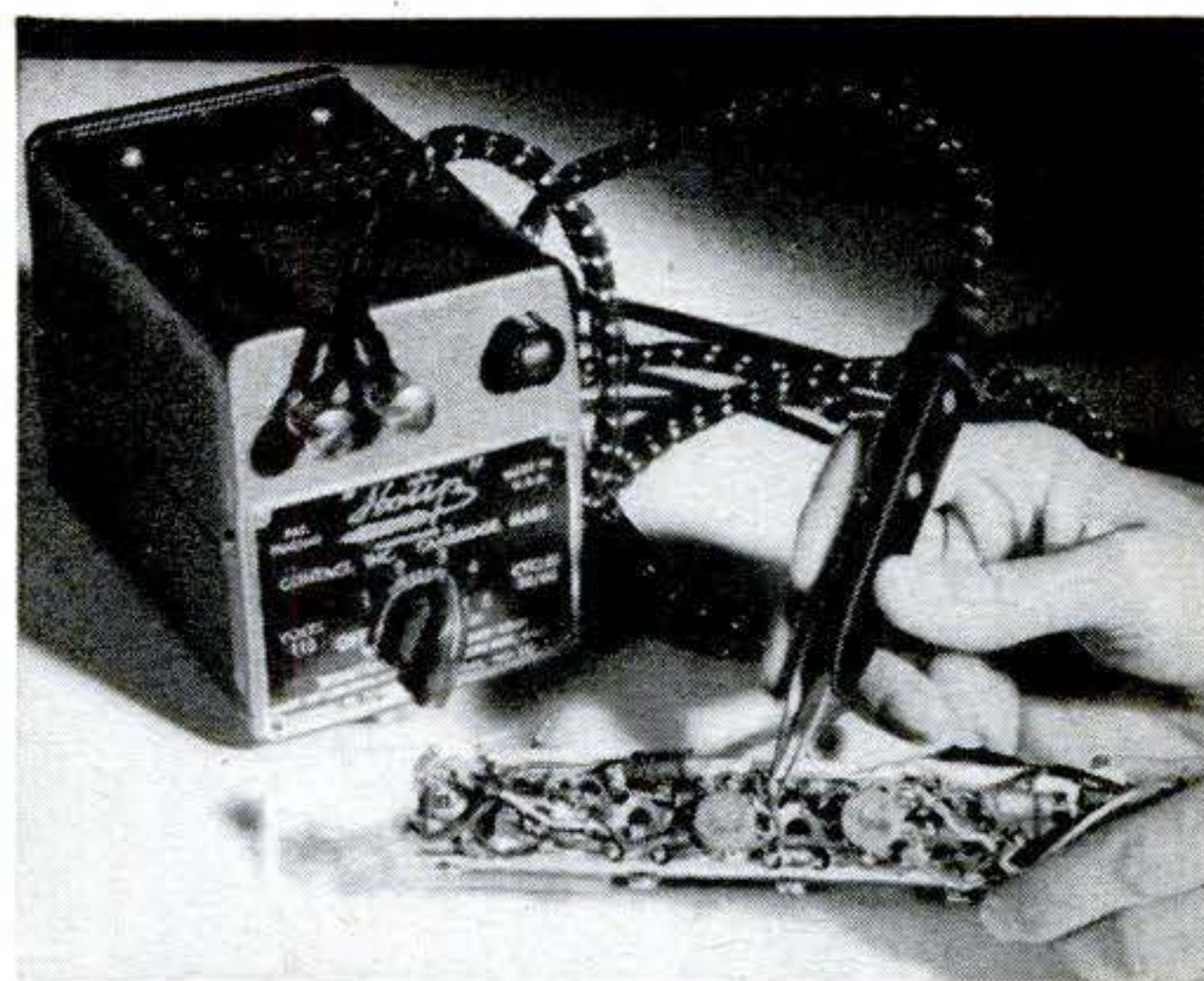
**5 Kit Restores Threads.** Worn or damaged threads in metal, wood or plastic can be restored with this rethreading kit. Old threads are first tapped out to a slightly larger diameter but at the same pitch. Then a spring-like wire insert, with a diamond-shaped cross section (inset), is screwed into the new threads, bringing them back to the original diameter. The kit includes three taps, three sizes of inserts, a tool for winding in the inserts and an extracting tool. Other sizes of inserts are available.



**7 Envelopes Protect Tools.** Tools stored in these envelopes never rust, even in damp cellars. No oil or grease is used. The envelopes have a chemical coating that vaporizes, depositing a protective film on all parts of the tool.

They come in several sizes and shapes, including special sleeves for saws, guns and fishing rods.

**8 Pouch Keeps Chuck Key Handy.** This leather pouch will hold either a pinion key or a hex key taped to the cord of an electric drill. The pinion key is slipped through a hole and the sides snapped around it. A second hole takes a hex key.

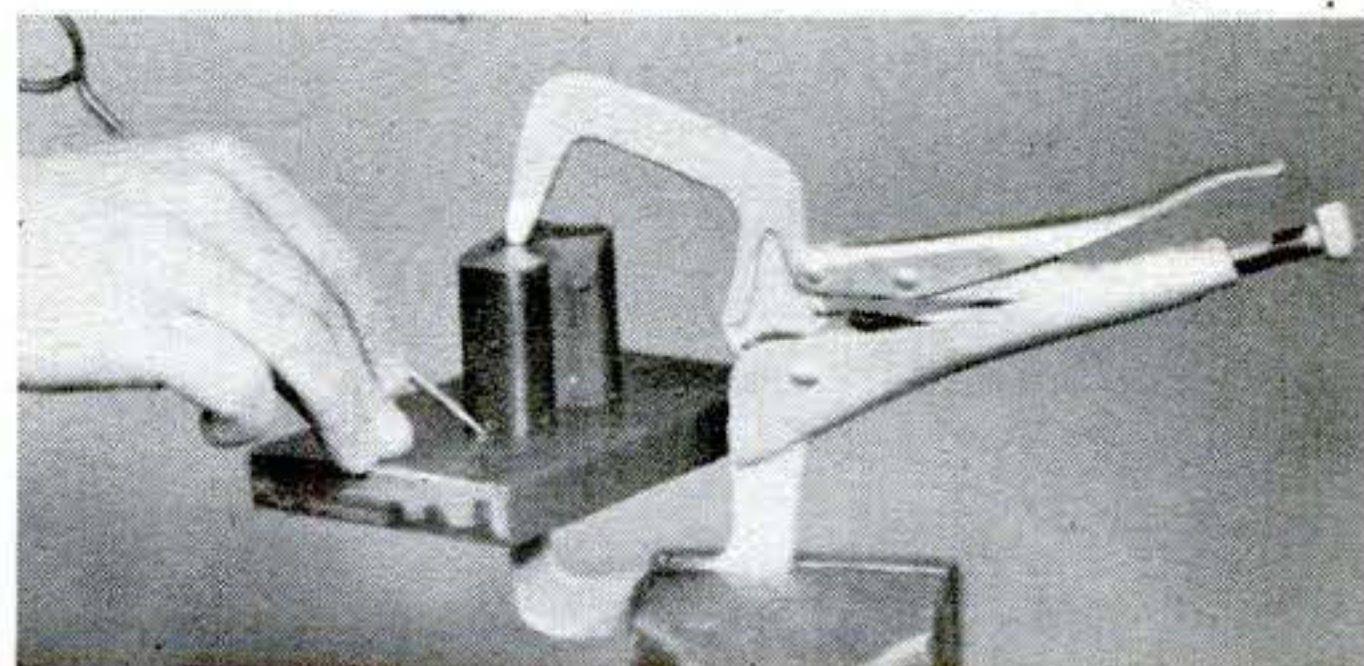


**6 Tweezers Solder Small Parts.** You can grip tiny parts and solder them at the same time with the tweezer tips on this resistance soldering unit. Heat is generated only when the tips are squeezed together, saving current and eliminating the danger of fire and burns. A foot switch leaves hands free and permits parts to be accurately positioned before current is applied.

**9 Emery Cloth Won't Clog.** The



open mesh in this woven emery cloth permits metal particles to pass right on through and out the other side instead of piling up and clogging the abrasive surface. The cloth comes in six grit sizes from 280 to 600 and will soon be available in coarser grits and in belts, rolls and disks.



**10 Hand Lever Locks C Clamp.** You can tighten or release this lever-action C clamp with one hand, leaving the other hand free to position the work. The jaws are first set to the proper opening by the screw in the handle, then the lever is pressed down to lock the jaws closed.

Further information on these products can be obtained from: 1. Black & Decker Mfg. Co., Towson 4, Md.; 2. Drilo Corp., 201 E. Carson St., Pittsburgh; 3. De Walt Inc., Lancaster, Pa.; 4. Baker Enterprises, P.O. Box 457, Canfield, Ohio; 5. Heli-Coil Corp., Danbury, Conn.; 6. Contact, Inc., 238 Main St., Cambridge 42, Mass.; 7. V-Lopes, Westport, Conn.; 8. Par-Kee, P.O. Box 5211, Corpus Christi, Tex.; 9. Bay State Abrasive Products Co., Westboro, Mass.; 10. Petersen Mfg. Co., DeWitt, Nebr.

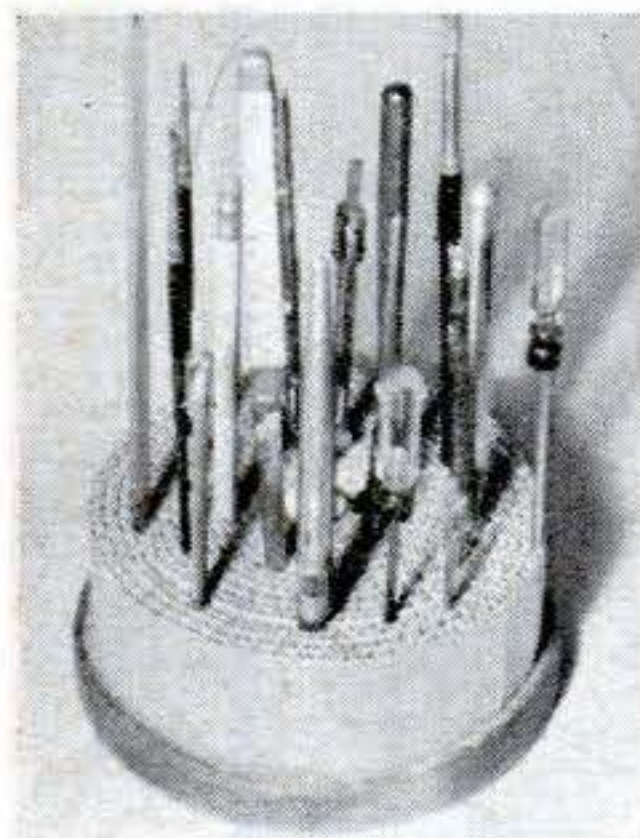


## Old Slats Form New Chair Seat



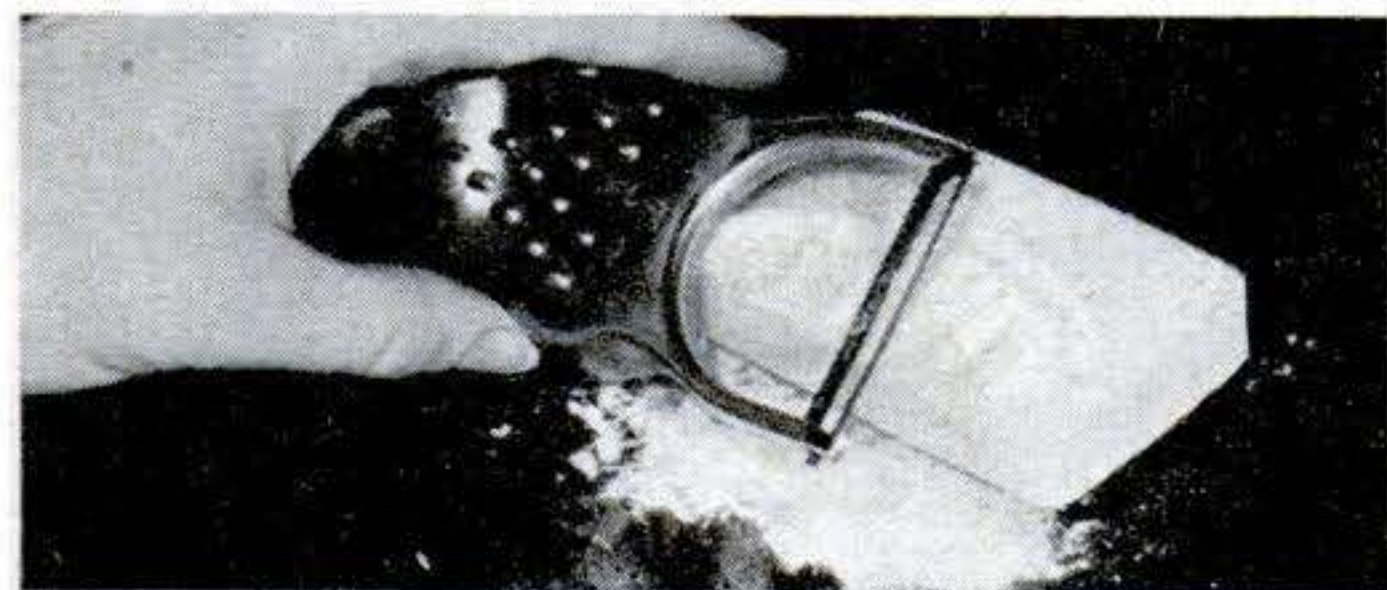
ONE of the best materials I know of for neat and sturdy seats for outdoor furniture are Venetian-blind slats—the metal kind. They can be cut to size with tin snips and holed with a hammer and nail. Round any sharp corners with a file, interlace them and brad them to the seat frame.—*Joseph Gould, Trenton, N.J.*

## Cardboard Holds Small Tools



A COILED-UP strip of corrugated cardboard makes a safe and convenient holder for small sharp-pointed tools like knives, scribers, files and screwdrivers. Glue the coil together and fasten it to a wood base for firmness.

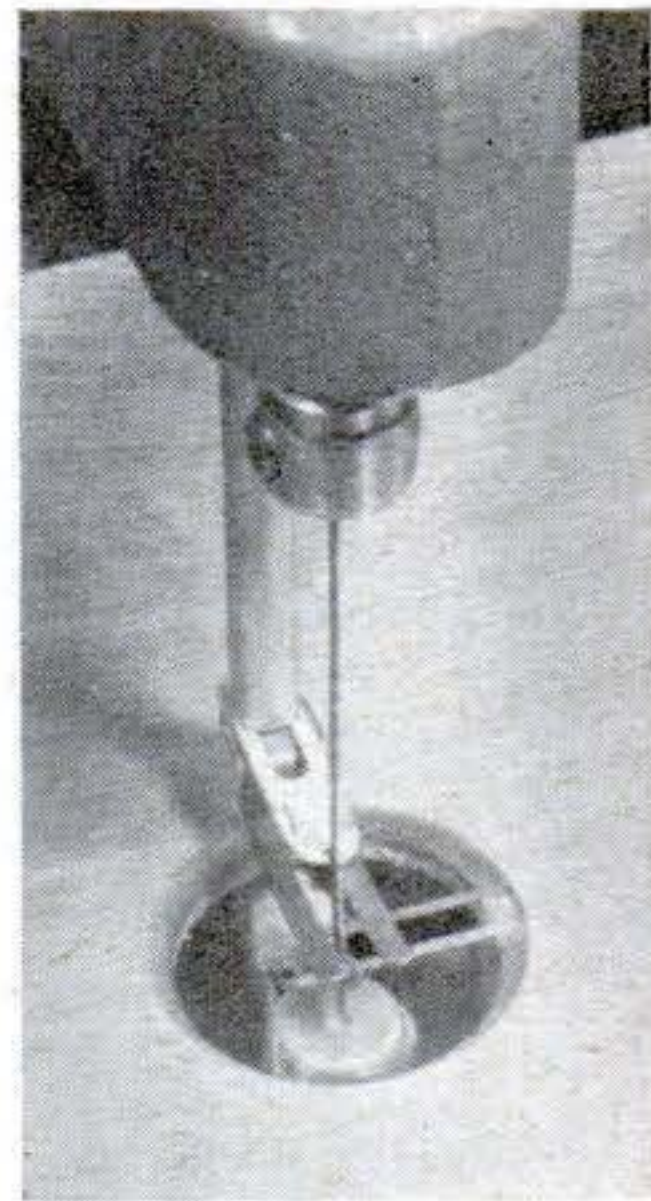
## Soap Powder Scraped from Bar



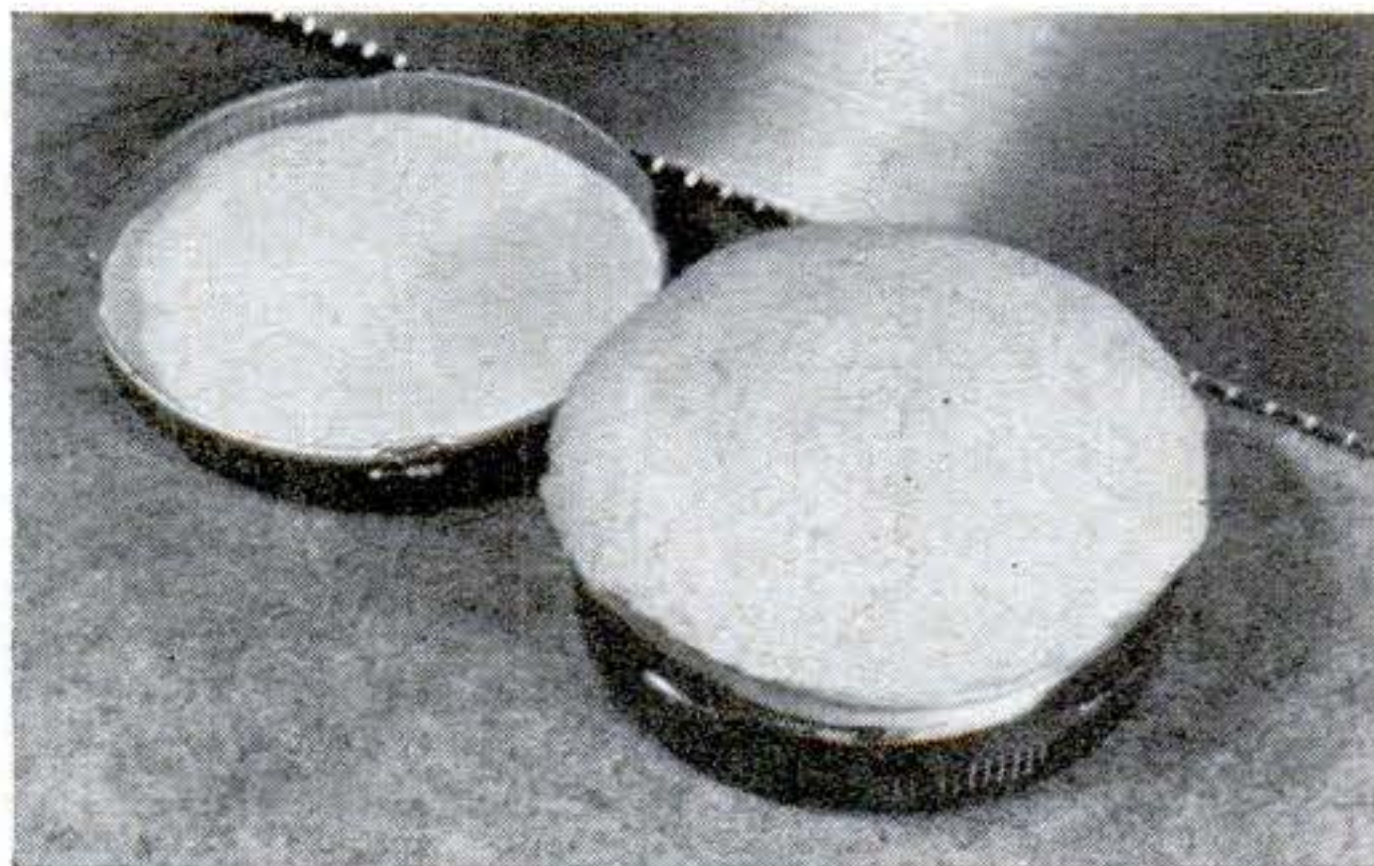
SOAP powder for hair washing or one more load in the washing machine can be made by scraping a bar of soap with a vegetable scraper. Scraping a dry bar will give you powder while a wet bar turns out flakes.—*John J. Rea, Urbana, Ill.*

## Plastic Insert for Jigsaw

A CLEAR-PLASTIC insert plate cut to fit the jigsaw-table opening will speed blade changing. The plastic permits a clear view of the lower chuck and blade guide, making it unnecessary to remove the plate to change blades. The plastic should be of the same thickness as the metal insert plate. Scratches caused by work can be buffed.



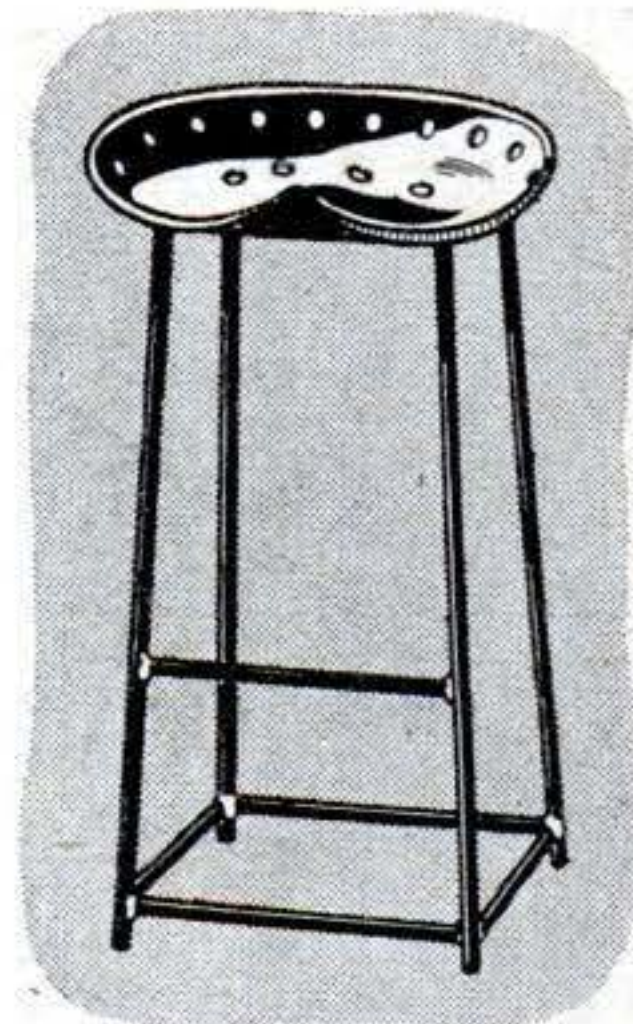
## Saw Oiler Is Leakproof



AN EMPTY shoe-polish can and a cellulose sponge cut to fit in it will help keep your saw clean and free from rust. The sponge is pressed into the shallow can, and when oil is added, it swells to hold itself in. At the end of the day, it's easy to remove the cover and wipe the saw with the oil-soaked sponge.—*Will Thomas, Buffalo.*

## Stool from Tractor Seat

THE discarded seat from an old tractor or other farm implement and some pieces of metal scrap can be made into a comfortable stool for shop or outdoor use. Weld four  $\frac{1}{2}$ " metal rods together for the frame and attach crosspieces between the legs. To protect floors, weld small metal disks to the legs and slip on rubber feet.—*J. R. Johnston, Dallas.*





"This tool kit  
is my bread and butter.  
I never forget to lock it!"



"Every mechanic who invests in good tools feels the same way. The right kind of tools help put more dough in your pay envelope.

Take my advice and stick with Bonney—the *best* wrenches at standard tool prices.

If you're short of cash once in a while—then take a look at BON-E-CON\* tools. Like *all* Bonney tools, they're real knuckle-savers. And they carry the regular Bonney guarantee."



\* The new Bonney  
economy line

Remember. Your local Bonney Jobber, as well as Bonney, stands behind the tools you buy. He has Bonney tools priced to fit your needs as well as your pocketbook.





Fiery beauty salutes a nation's birthday. Photo was taken on daylight Ektachrome at f/3.5.

Blue fire illuminates this marine fantasy.

Three exposures made this (see next page).





# Shoot the Works in Color

*The breath-taking glory of July Fourth fireworks is yours for keeps when you catch it on color film.*

**By Jack Wilson**

**N**OTHING is more beautiful—or briefer—than the burst and flare of a fireworks display. You've probably often wished it would last longer. With color film, you can capture the glory of such lights lastingly, and your projected pictures will draw "Ah's" and "Oh's" from any audience.

Shooting fireworks is fascinating because it takes a quick eye, a fast shutter finger and a dash of luck. You won't know how good you are until the film comes back—but maybe you're wonderful!

To make up for the uncertainty, such shots require no special equipment. You can even get extra mileage from film by making multiple exposures, which better your chances of getting something really exciting on every roll.

A camera with an f/4.5 or faster lens will make good color exposures at the long range from which you usually see fireworks. If you can shoot closer, even a slower lens may give good results, especially if the display is brilliant and the air clear.

**Camera must have support.** The one must is a solid camera support—a tripod, fence, auto fender or wall. With indoor or daylight color film in the camera, open the diaphragm to f/3.5 or as far as possible and set the shutter on bulb. Attach a cable release if you have one.

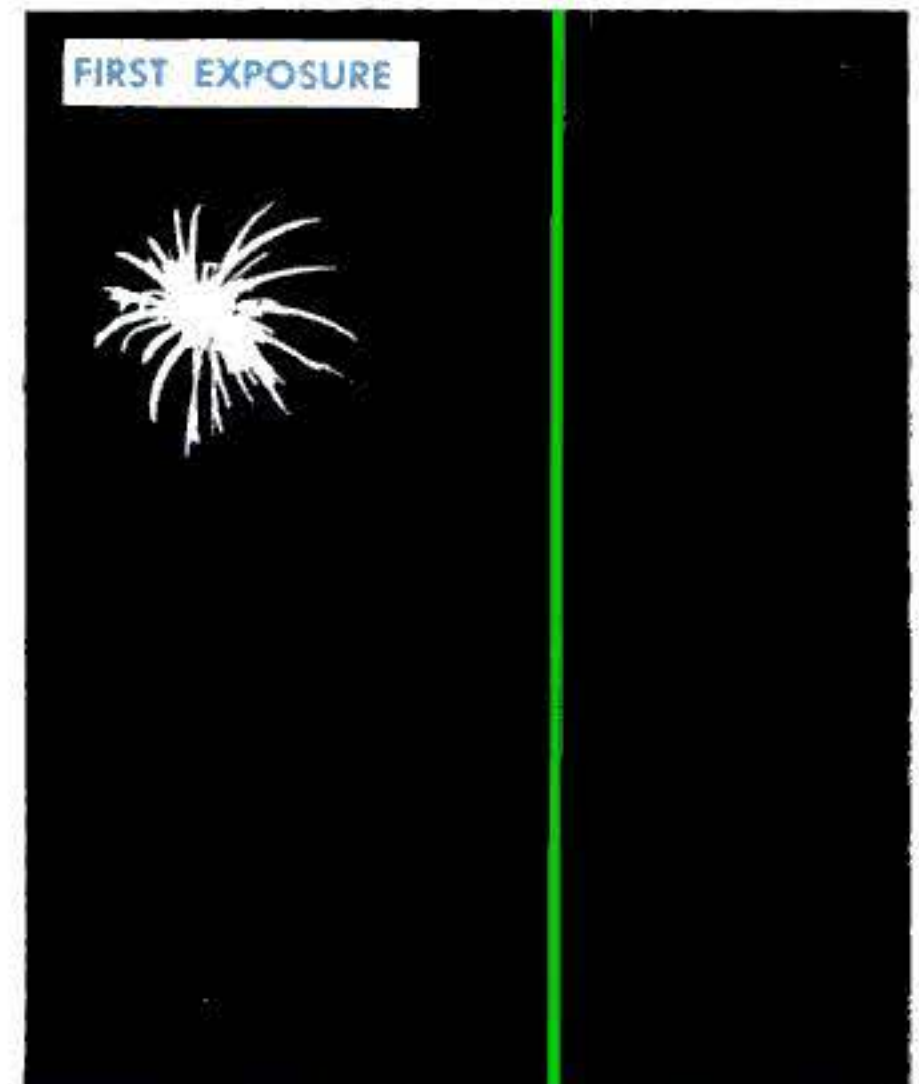
Using the first warm-up burst as a target, aim the camera into the sky where the display will occur. With your eye glued to the finder, watch for the firework's ascending trail and open the shutter. When the shower has reached its climax, close it. Do not advance the film. A single burst probably won't fill your finder or make much of a picture.

Remembering where the first burst appeared in the finder, shift the camera slightly so that the next one will appear elsewhere. Judgment, luck and deft control will all have a hand in the result. A pan-and-tilt tripod top will be a help.

**If the bursts are well spaced** in the finder, you may get three to five on one frame of film. More may overlap and detract from the effect, so advance the film for your next try. In shooting, remember that the human retina sees a split second after the display has vanished. Film doesn't, so open your shutter early rather than late.

Try to shoot where electric signs and auto headlights will not shine into the camera. If moving lights occasionally flash across, shield the lens until they pass.

END







**Remove knobs or handles and other hardware.** You'll find it easier to brush paint smoothly on drawer fronts and cabinet doors. Attach knobs to cardboard as shown above and paint them with a small brush.



**Keep bugs out of wet paint** applied outdoors by adding insect repellent to each batch that you mix.

**Save painting time** by using the widest brush you can for each job. A 4" brush is the most popular width for large, flat surfaces. Use a trim or sash brush, available in 1" to 3" widths, for woodwork, paneling and trim. For narrow table legs and chair rungs, use the narrowest sash brush. A sash brush may be flat or oval.

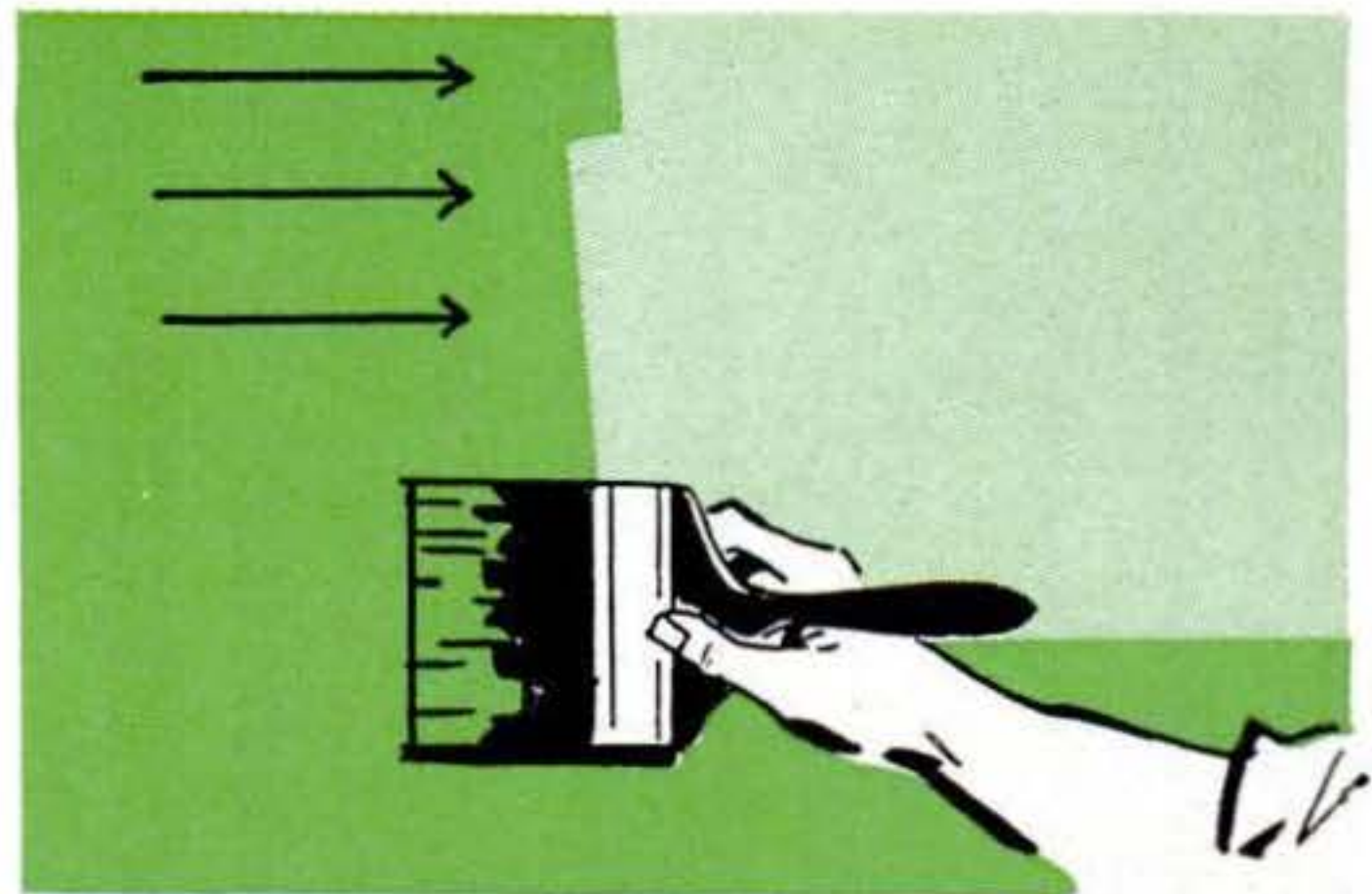
# PAINTING

*Copy the dodges used by master painters*



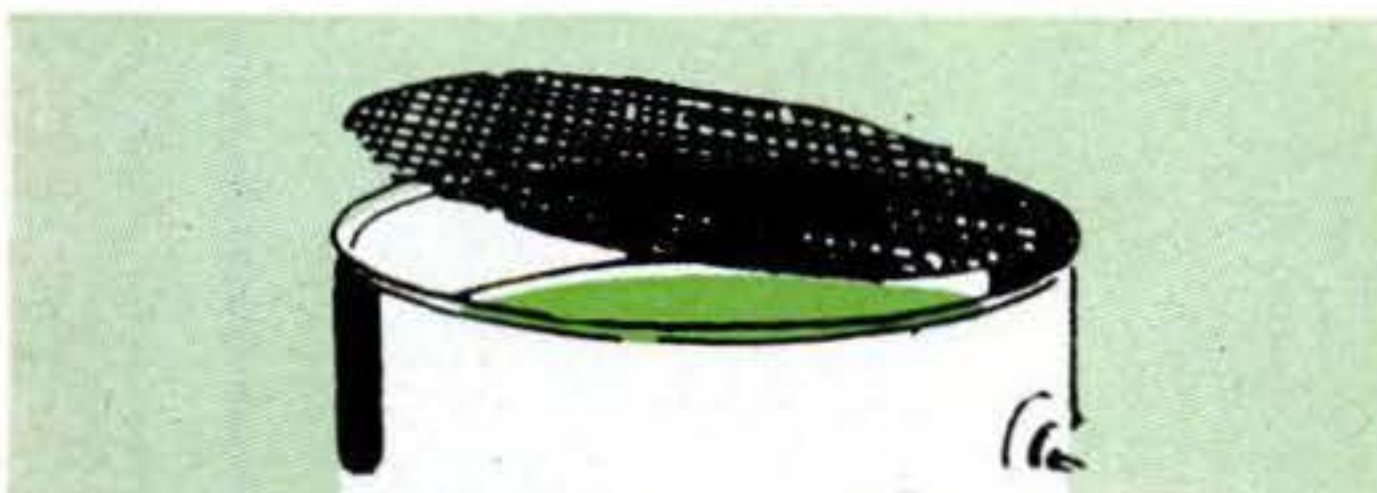
**Avoid a ring of paint** where you put down can by keeping a paper plate under it. Daub a little paint on the bottom of can, press the plate against it and the plate will stick.

**Unpainted furniture** should first be sealed by brushing a very thin wash coat of shellac on the raw wood. When dry, smooth lightly with sandpaper. Apply undercoat, brush out thoroughly, let dry at **least 24 hours** and sand again. Apply finish coat with smooth, light brush strokes, using just the tip of the bristles.



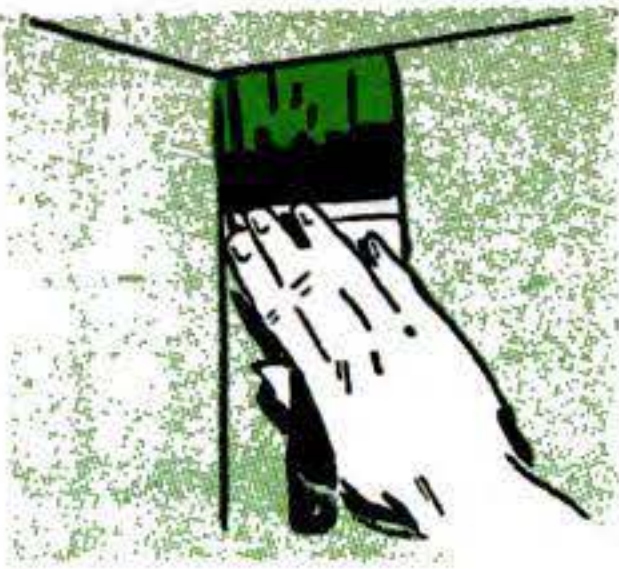
**Blend each stroke** toward the wet paint area, not away from it, to avoid ridges and lap marks.

**Keep bristles pointed downward**, or at least tilted at an angle below the horizontal, while you work. Tilt a brush upward only for ceiling work. Pointing the bristles down helps keep paint from running into the heel. If the paint hardens in the heel it will swell the ferrule and perhaps ruin the brush. For the same reason, dip a brush no more than halfway into paint each time you charge it.



**Fit a disk of window screening** inside can after mixing paint well. As the screen sinks, it will carry lumpy paint particles to bottom.

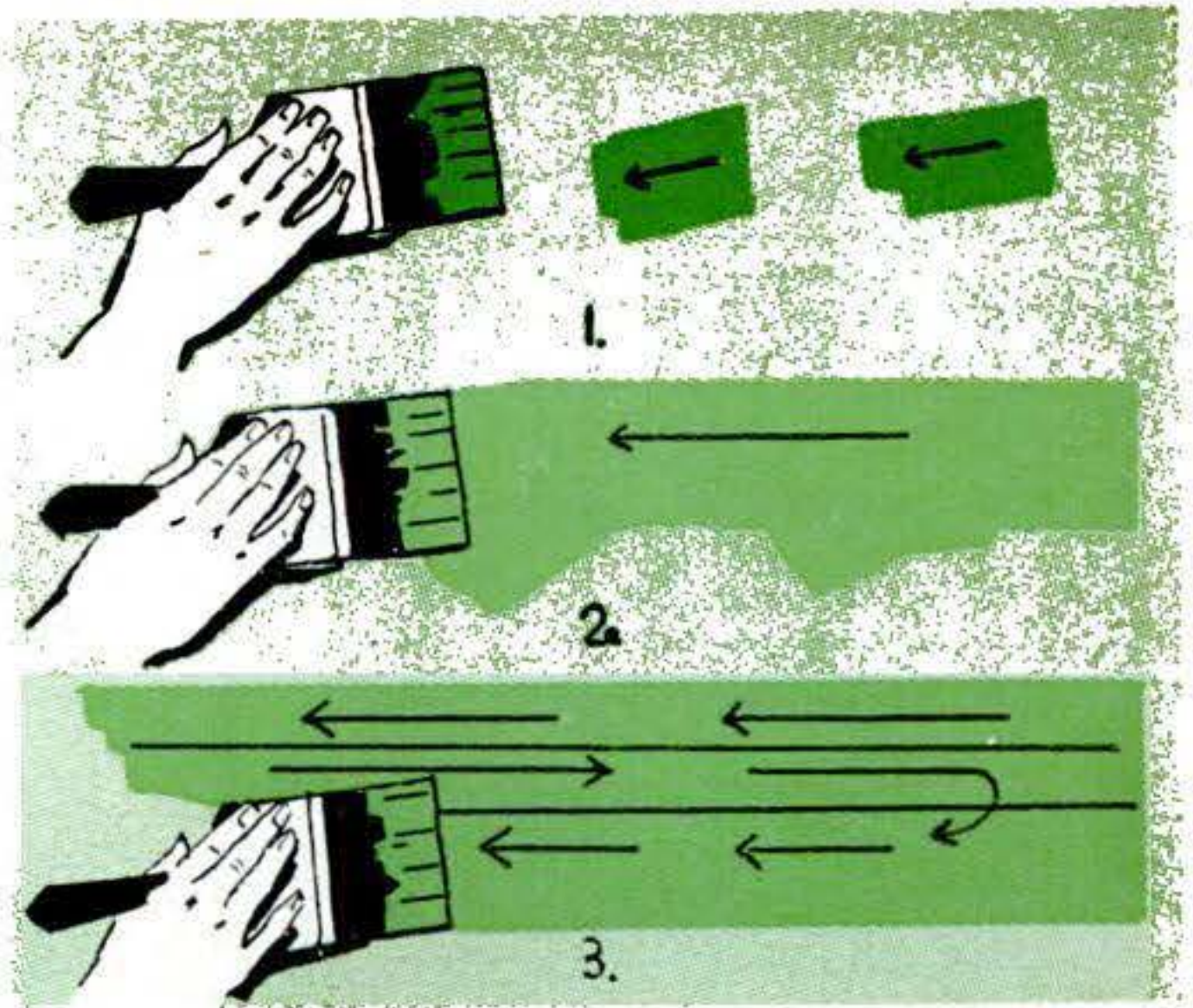
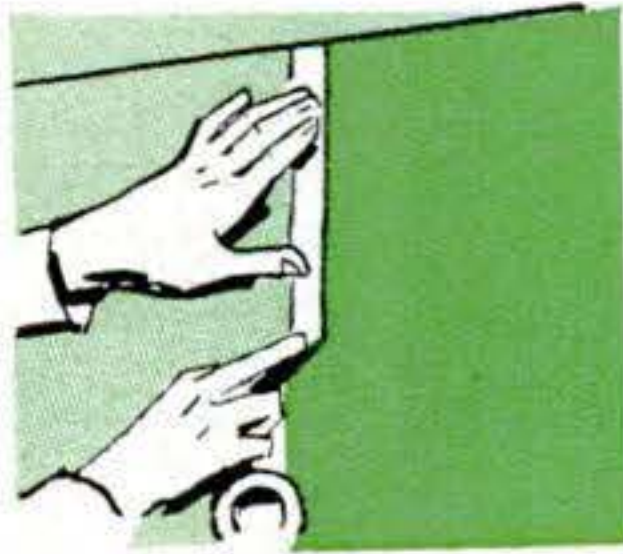




Angle your brush into corners; never paint with its sides. Angling in protects the bristles and gives you a smoother, more even finish.

You can lengthen the life of a fine, pure-bristle brush by using it only to apply finish coats. Keep brushes with synthetic or mixed bristles handy for priming and for use on rough surfaces that wear down bristles fast.

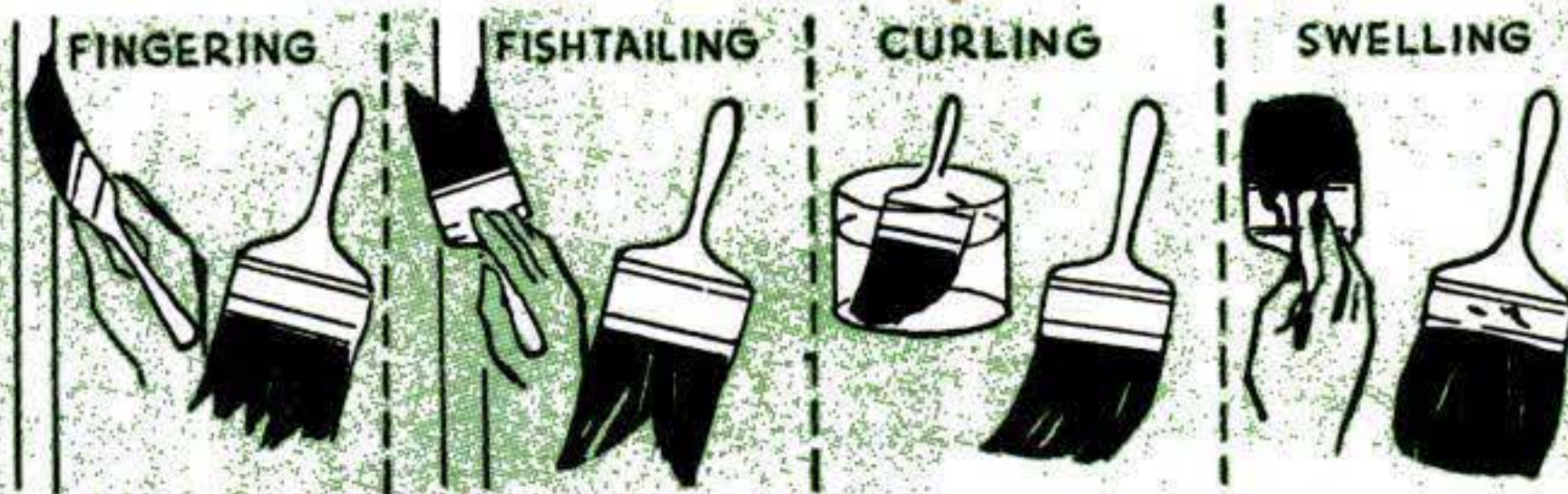
Use masking tape where two shades are to meet. Paint on one color, let it dry, apply tape at the dividing line and then brush on the second color. The result will be a neater job and you'll save time.



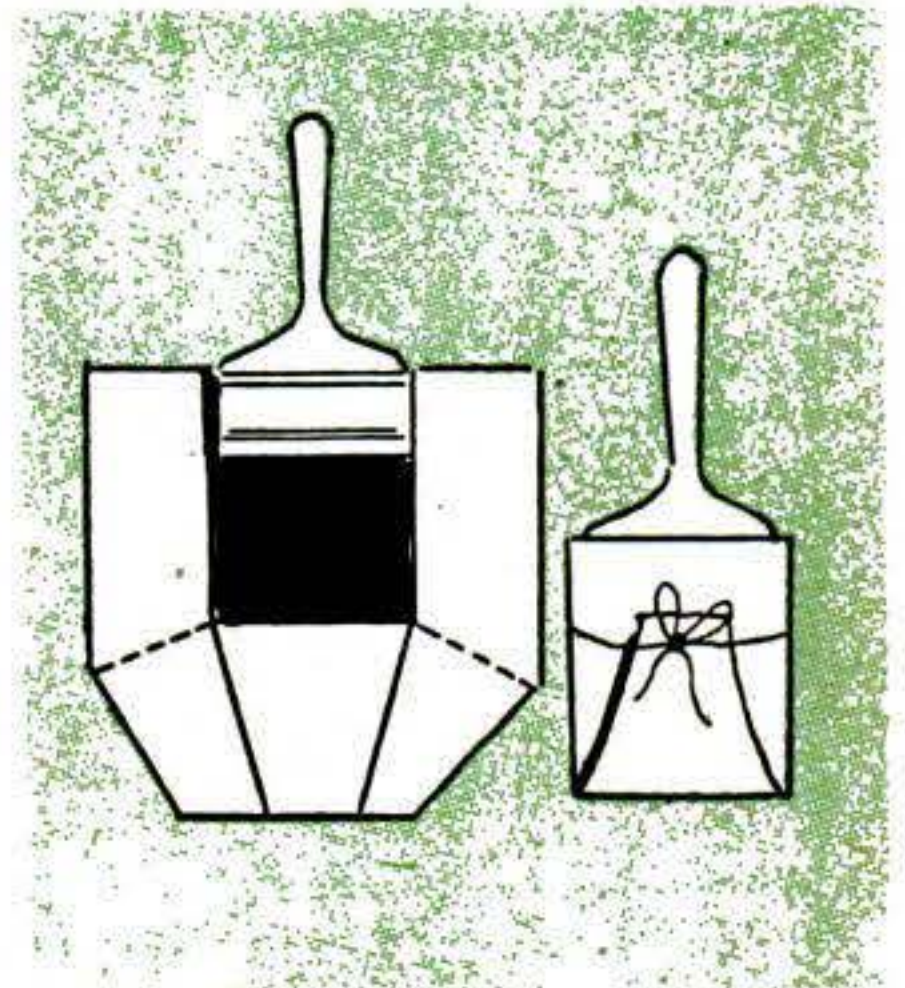
In painting exterior surfaces, you can get a smoother and more uniform job by daubing paint on in spots (1) before stroking. Then use long, leveling brush strokes (2) to spread the paint smoothly. Finish the brush stroke (3) in a zigzag path and you'll have a good-looking job.

# POINTERS

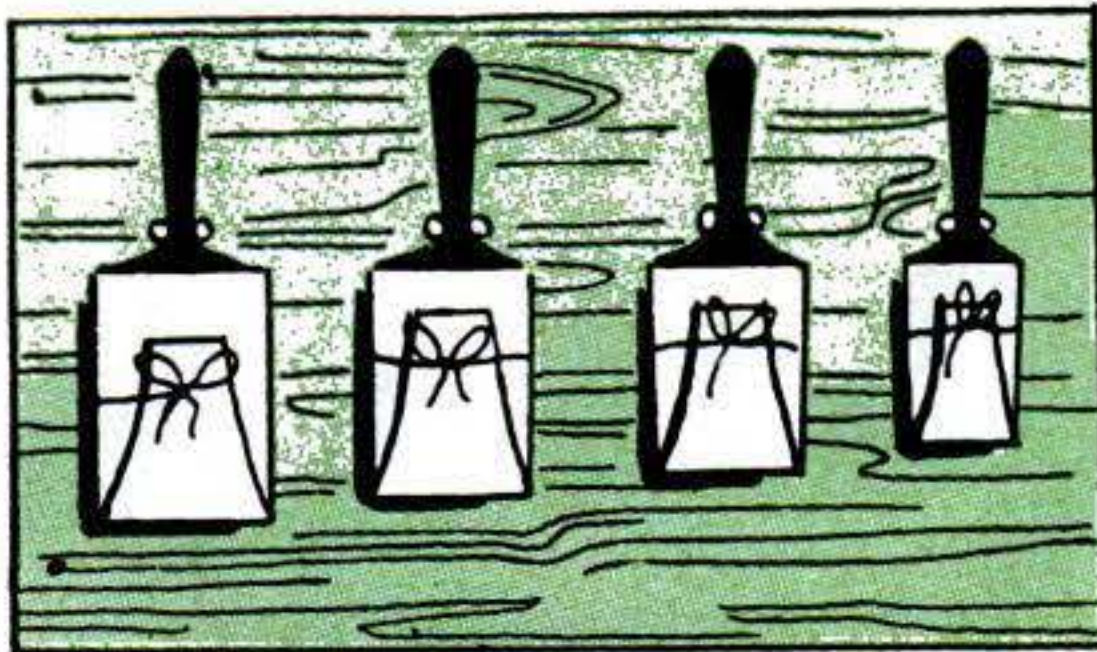
to get best results with the least effort.



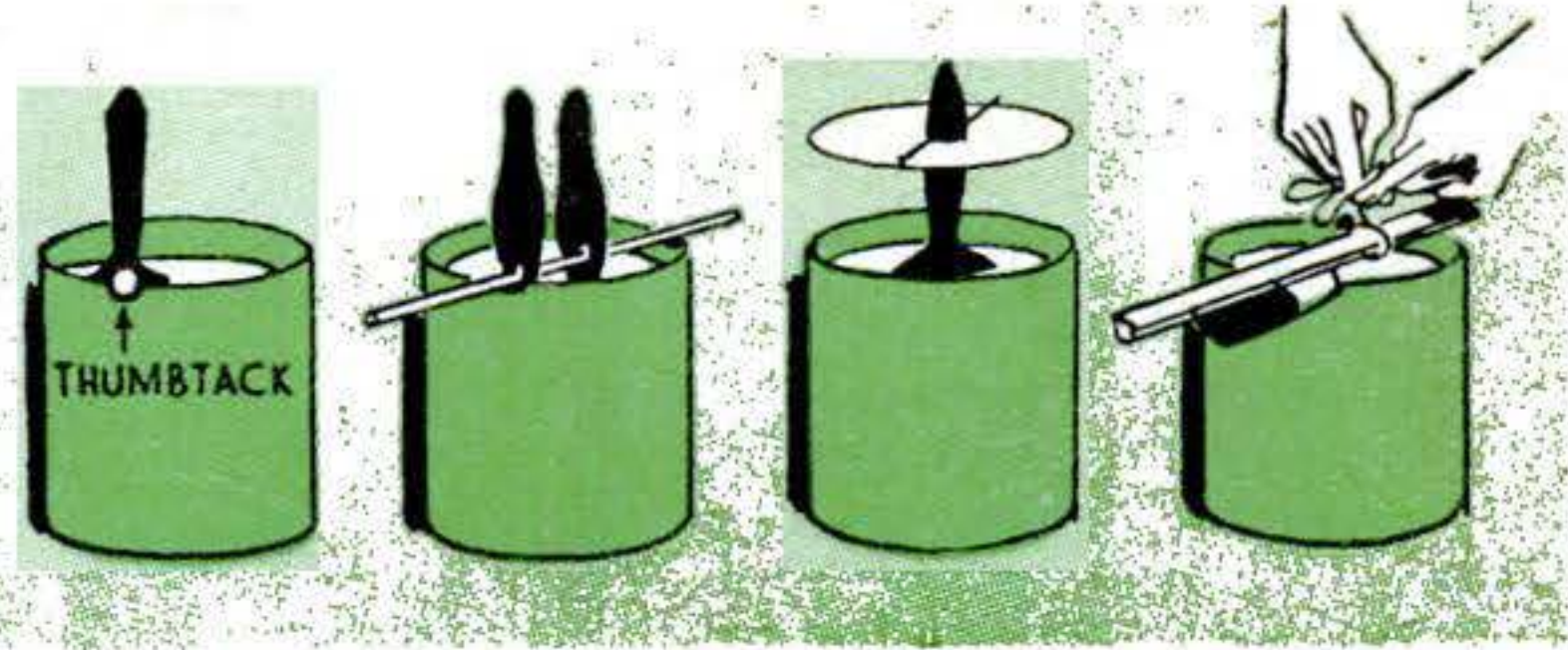
These paintbrush defects all result from misuse of the brush. Painting with side of brush is a major cause of "fingering." If you use a wide brush to paint pipes and similar surfaces it will take a fishtail shape. Swelling may occur if you dip the brush too deeply. If paint hardens in the heel, it will swell the ferrule. Avoid curling by hanging the brush up.



Wrap brush for storage, using heavy paper, oilcloth or aluminum foil. Be sure that the bristles lie straight and that end of brush is not compressed by the wrapping. Suspend the brush with the bristles down. If it's a fine-quality brush used in oil paints, saturate the brush with linseed oil before wrapping it.

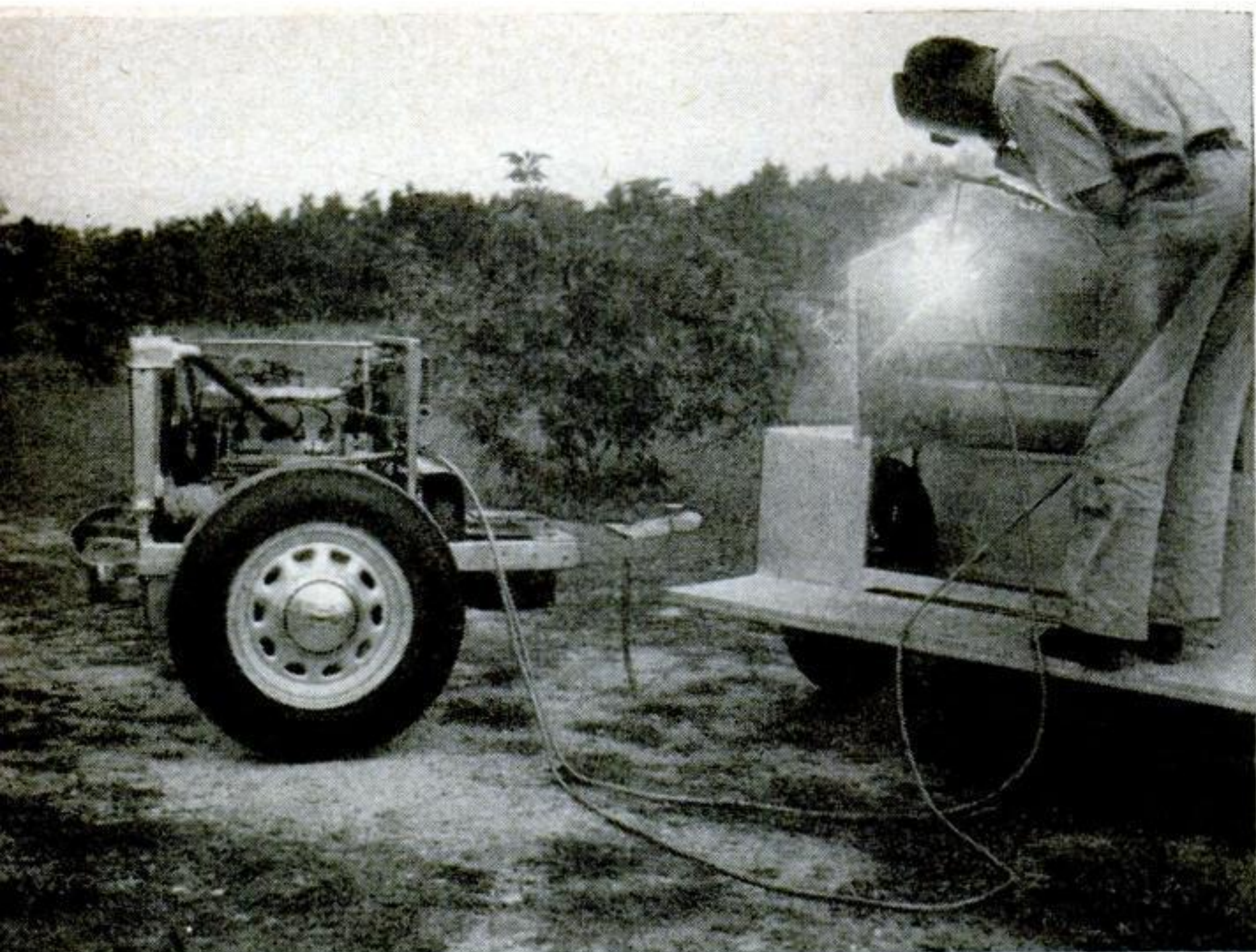


Brush storage rack can be made by driving short nails part way into  $\frac{3}{4}$ " plywood so brushes can rest on handles. Mount board on door or shop wall. Wrap brushes before storage.



Store brushes in solvent overnight, suspending them in the container by one of methods illustrated here. In method at far right, the handle is tied to thin stick extending beyond bristles. Brush can then stand upright without resting on bristles.





**Match one of these hot little OHV engines with a war-surplus generator —you'll get a welder with juice to spare.**

**ON-THE-SPOT** welding is routine for this powerful little rig. The generator supplies enough juice to weld with  $\frac{3}{8}$ " rod. It will also operate a few 6-volt or a string of 32-volt bulbs for lighting.

## Aircraft Generator + Crosley Engine

**P**ACKING a 300-amp. punch, this midget welding generator does man-sized jobs. With it I can make repairs right in the field or on the road. Being small, it can be dragged to places where a car couldn't go.

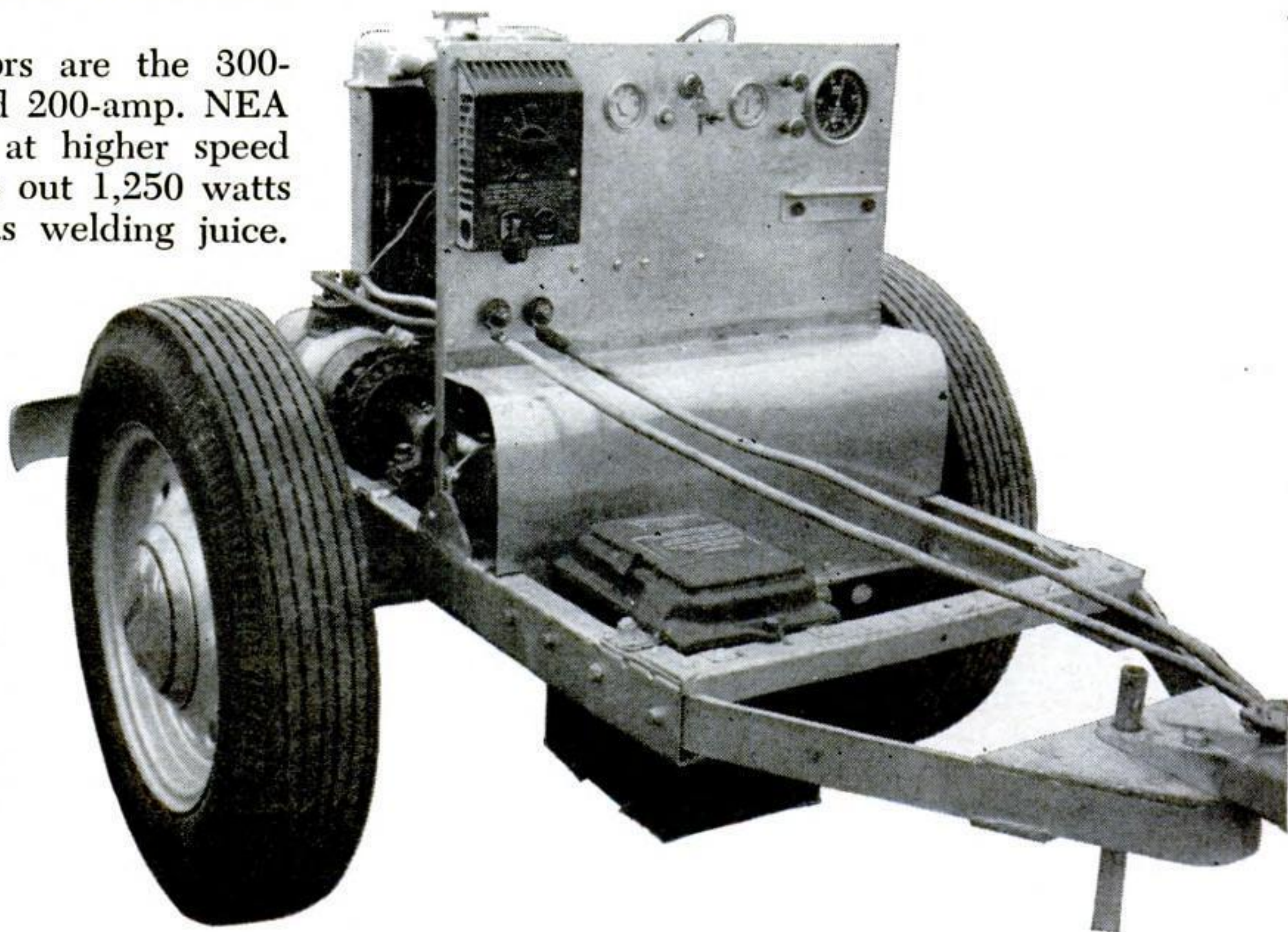
To build one like it, make the war-surplus dealers and auto-wrecking yards your hunting grounds. The generator I finally picked is an R1 Westinghouse aircraft unit rated at 28.5 volts, 300 amp. and fitted with high-altitude brushes. These reduce commutator arcing under heavy loads.

Other suitable generators are the 300-amp. R2, 200-amp. P1 and 200-amp. NEA 5. The latter must run at higher speed (5,000 r.p.m.) but it puts out 1,250 watts of 115-volt AC as well as welding juice.

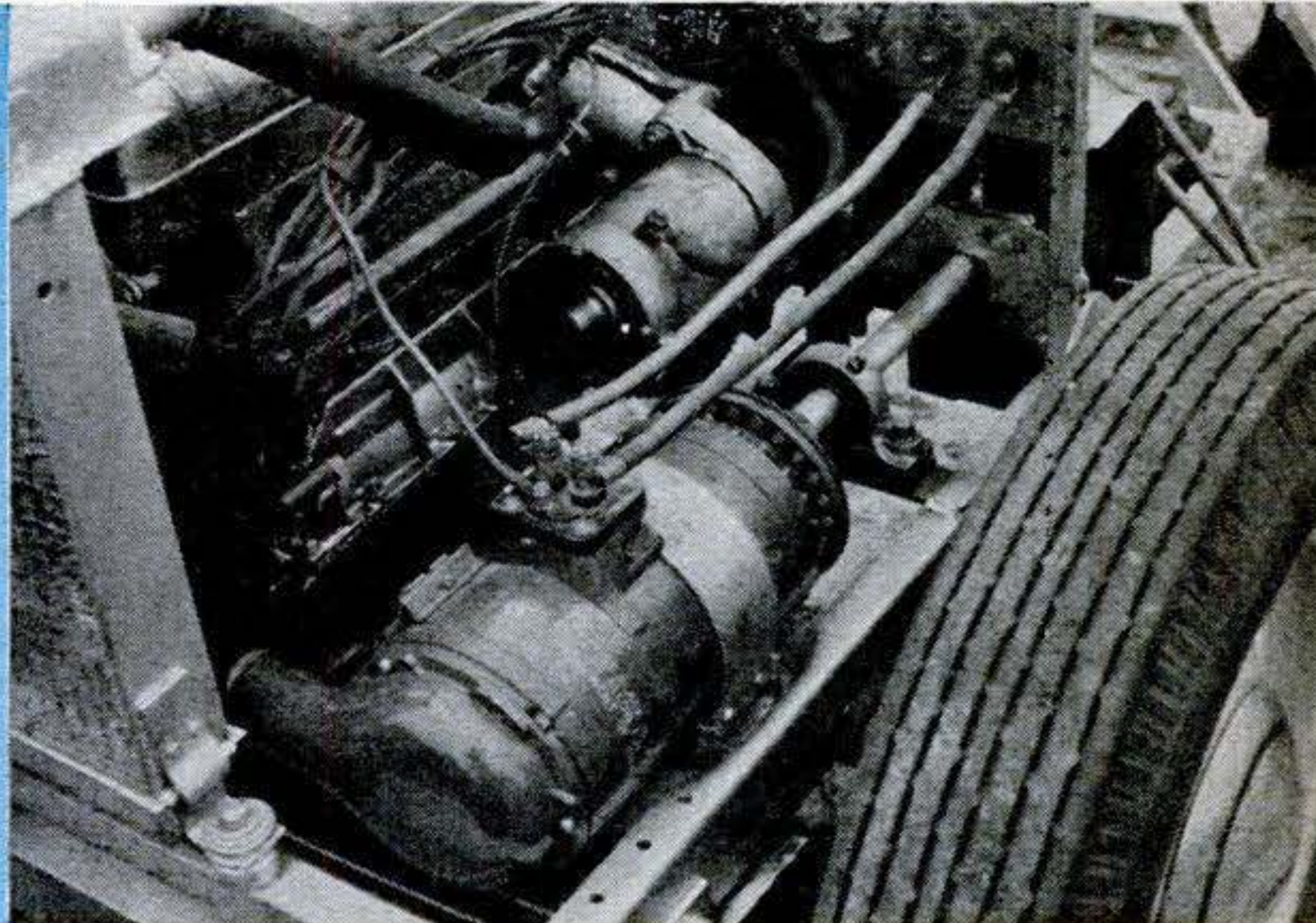
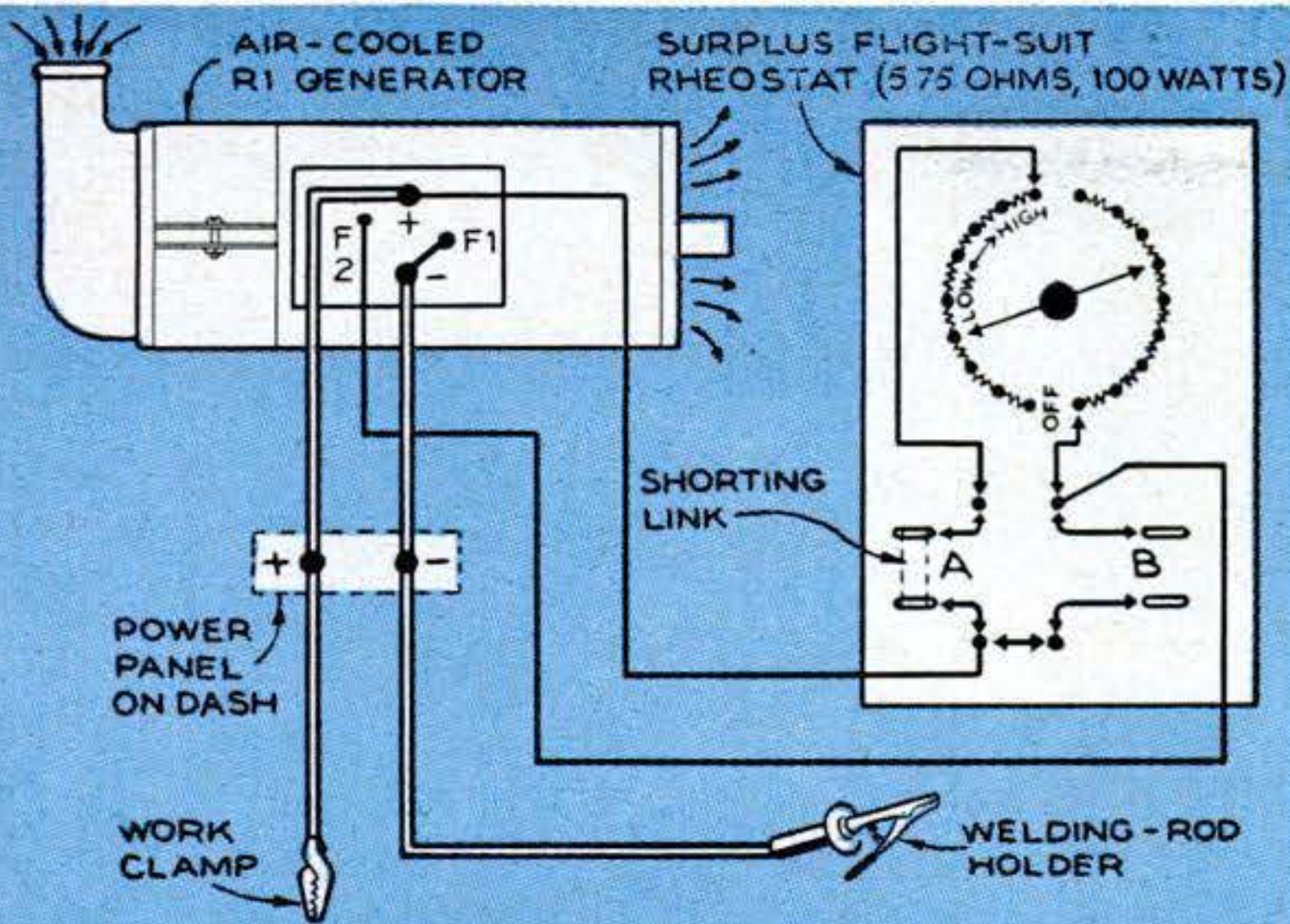
**COMPACT AND ROADWORTHY**, the trailer can be rolled about and hitched up by one man. Car battery mounted in the frame supplies starting and ignition juice for the Crosley engine. Surplus tachometer (upper right of dash) gives r.p.m. and engine hours. Hole was drilled at rear end of engine camshaft, a drive pin inserted, and a tachometer-cable connecting flange mounted on the valve cover.

My rig is powered by a Crosley brazed-block auto engine. However, any 10- to 12-hp. job capable of maintaining 2,000 to 2,500 r.p.m., such as an Austin, would serve.

After removing everything back of the flywheel, I shouldered down a 1"-diameter stub shaft to fit the pilot hole in the crankshaft and welded a driving plate on it for bolting to the flywheel. The shaft runs through a self-aligning ball bearing on one







**HEAVY CABLES** run from output posts atop generator to the welding terminals. Field terminal F1 is grounded to negative post; F2 gets current from positive post through the

field-control rheostat. For light welding, a 4- or 5-ohm auxiliary resistance is plugged into A in place of the shorting link. Four 6-volt, 32-cp. bulbs can be lit from socket B.

## = 300-Amp. Portable Welder

frame member and has a two-groove belt sheave keyed on its end.

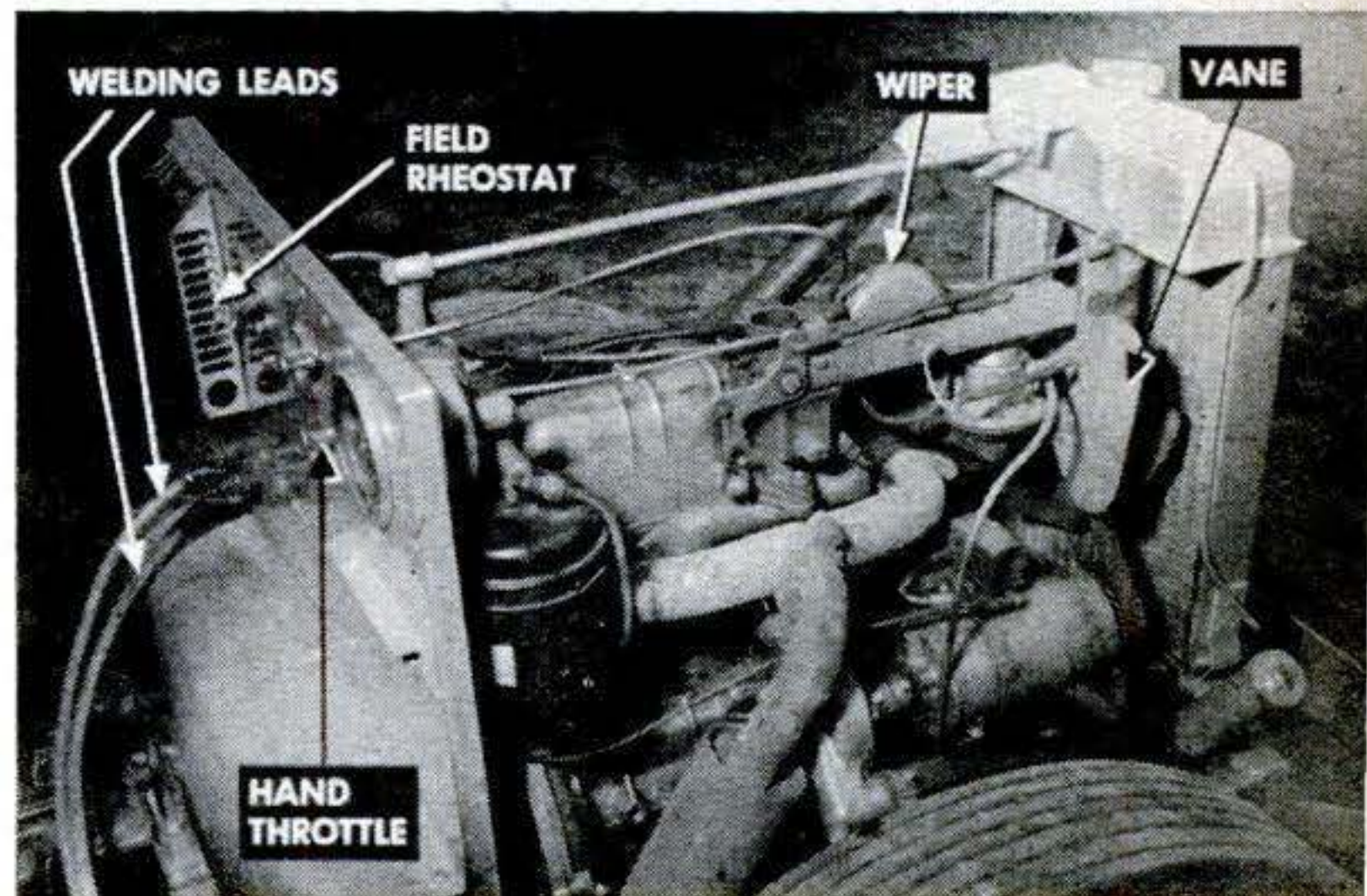
Two similar bearings support the generator-shaft extension. The drive is by twin  $\frac{3}{8}$ " B-type industrial V belts running on two-groove sheaves. These are sized to give a speed reduction of .8 to 1.

A surplus rheostat made for electrically heated flying suits controls the field current, regulating generator output. This unit has two plug-in sockets, one of which must be shorted to complete the circuit.

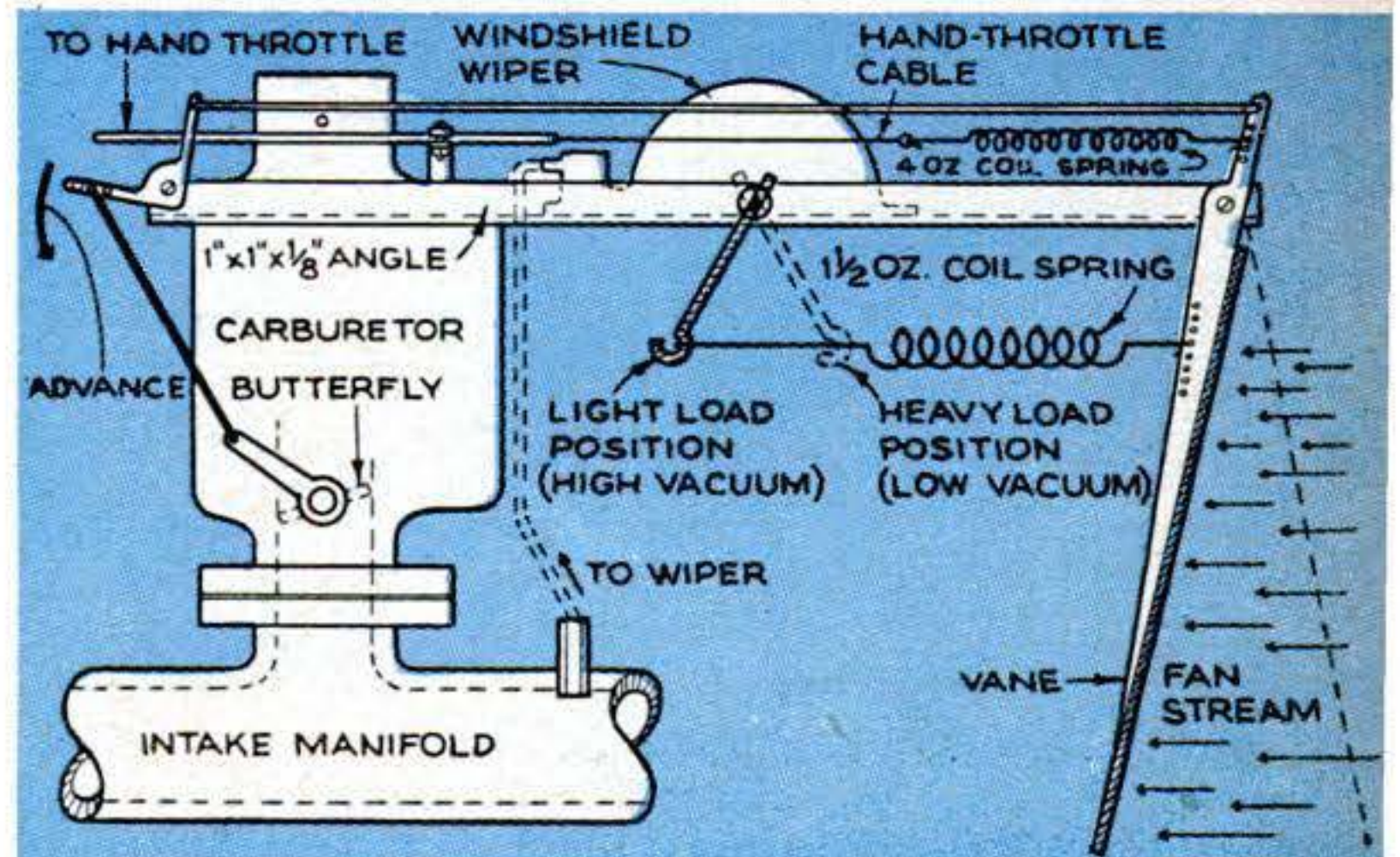
The homemade governor shown gives quick response to varying loads. Pulling out the hand throttle applies spring tension against the vane, holding it against the fan stream and opening the butterfly. Fan action tends to close the throttle.

On light load, the vane is helped by engine vacuum working on one side of an old windshield wiper. Under full or sudden increase of load, vacuum drops and the vane spring immediately opens the throttle farther, until vacuum builds up again to balance the vane at the new load setting.

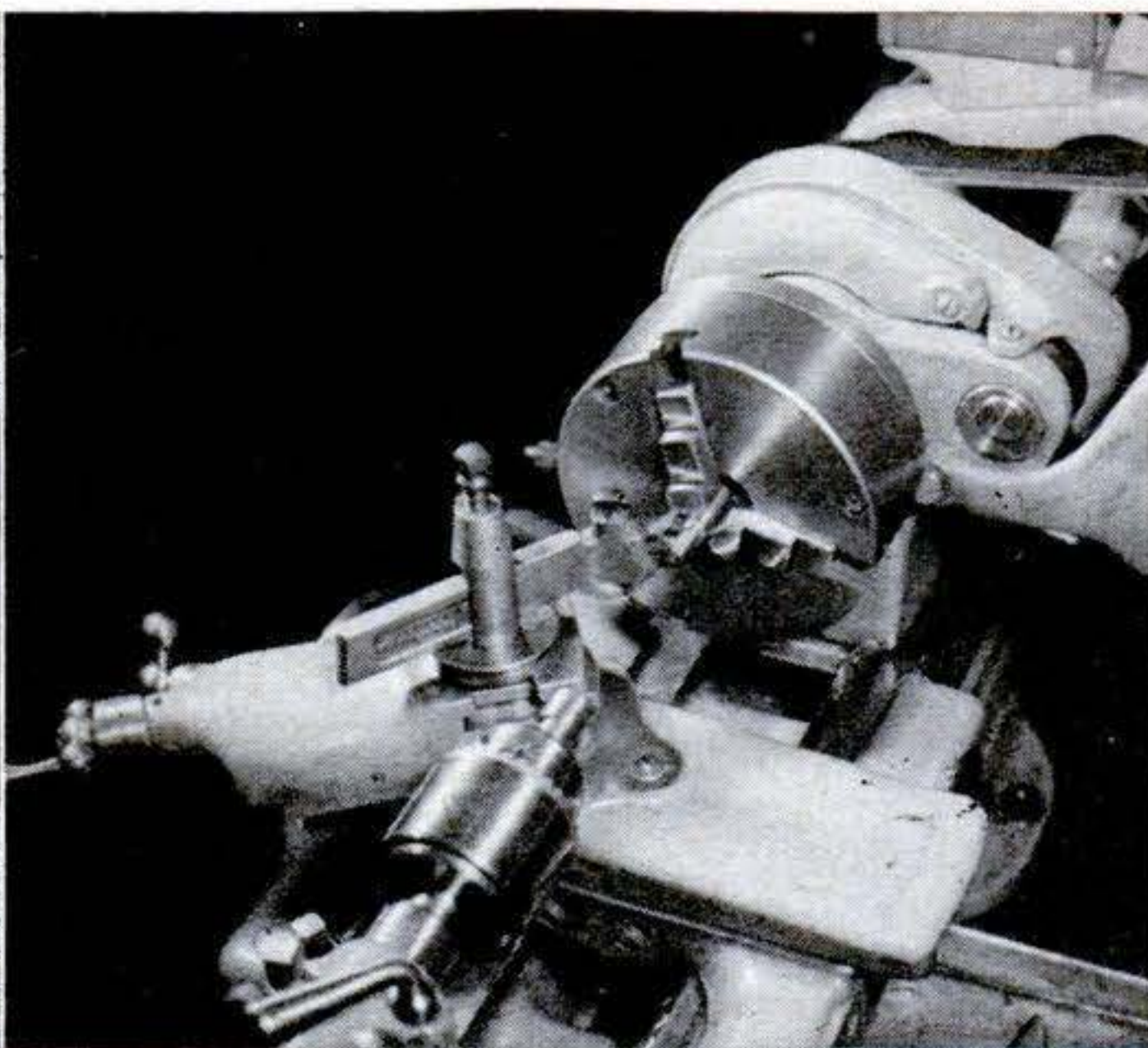
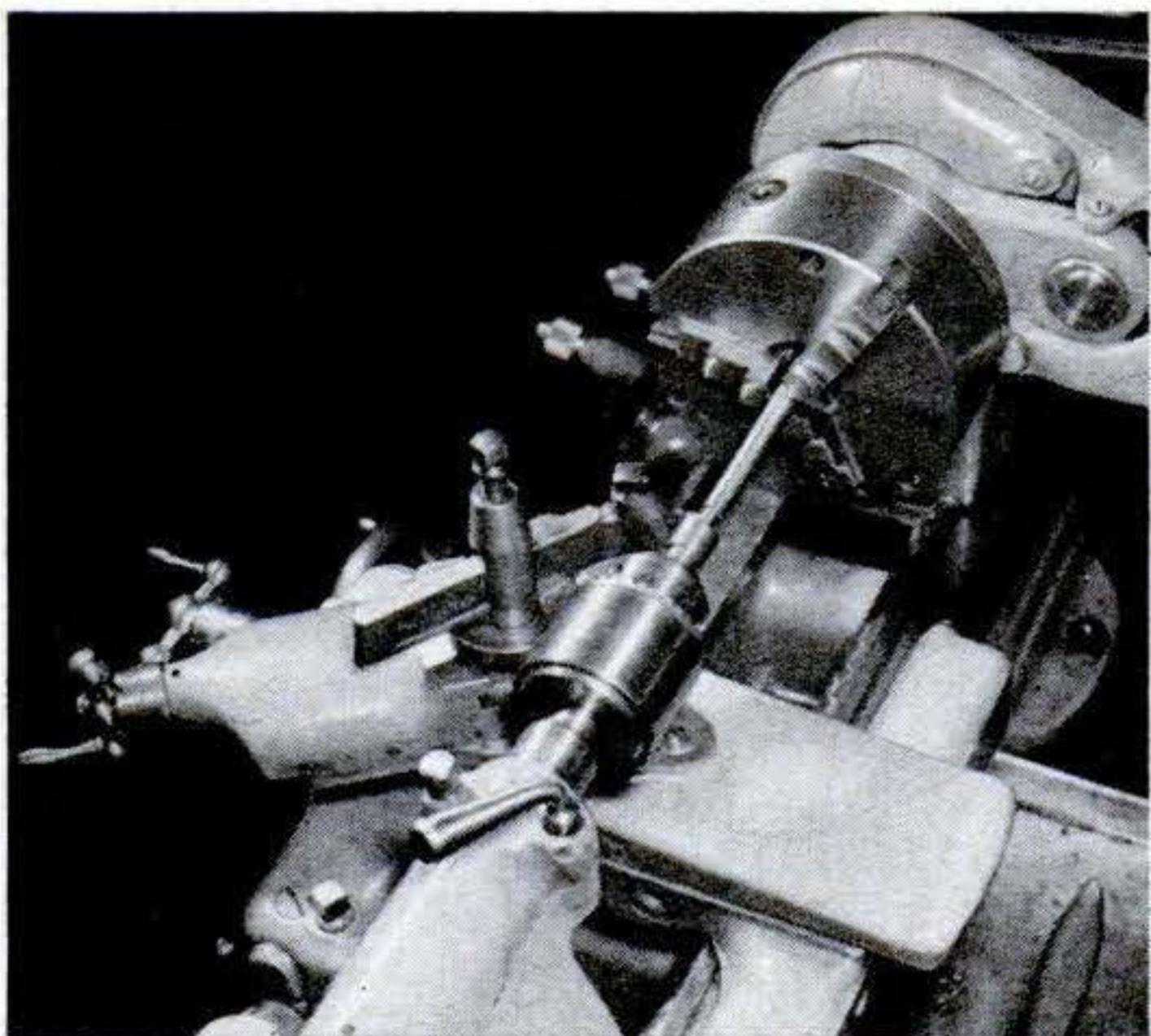
Parts of a light auto chassis were welded to make the trailer frame. It was fitted with a Plymouth rear axle that had been cut apart and rewelded into a smaller unit. A sleeve between the two wheel axles aligns them while leaving them free to turn independently on curves.—Harold George Schneider, Homestead, Fla.



**HOMEMADE GOVERNOR** controls engine under varying arc load. Throttling action of vane behind fan is balanced against manifold vacuum by a salvaged windshield wiper. Wiper valve is shut so that vacuum pulls one way.





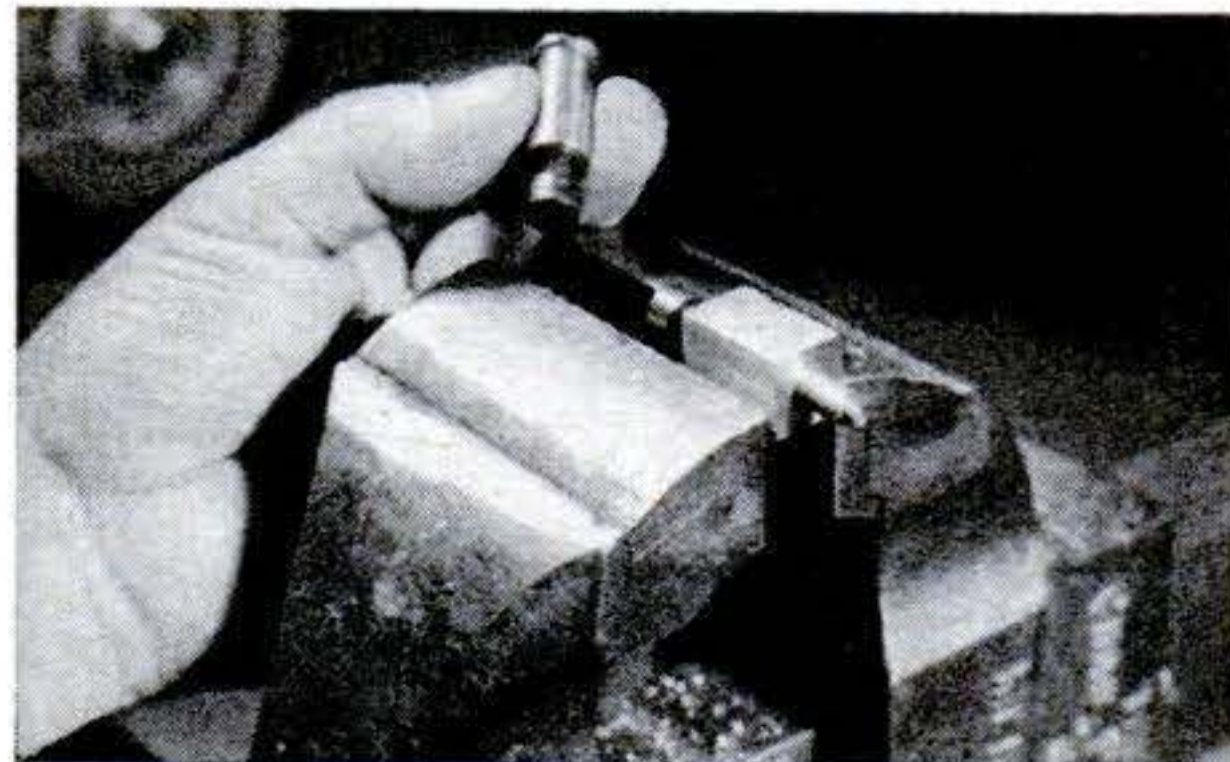


## NEW Shop Ideas

**Follower Rest Fits Tailstock.** Here is one way to support a slender rod while it is being turned. A bushing drilled to receive the finished diameter of the work is held in the tailstock chuck. The end of the rod is first turned to the finished diameter (left above). Then a cut to the desired length is made, and the tailstock bushing is slid up over the end of the rod. A rough cut is made to bring the rod near the finished diameter and the final cut is taken while advancing the tailstock spindle to keep the bushing close to the cutter bit (right above). Slender turnings several inches long can be made in this way.—*Joseph Tracy, NYC.*

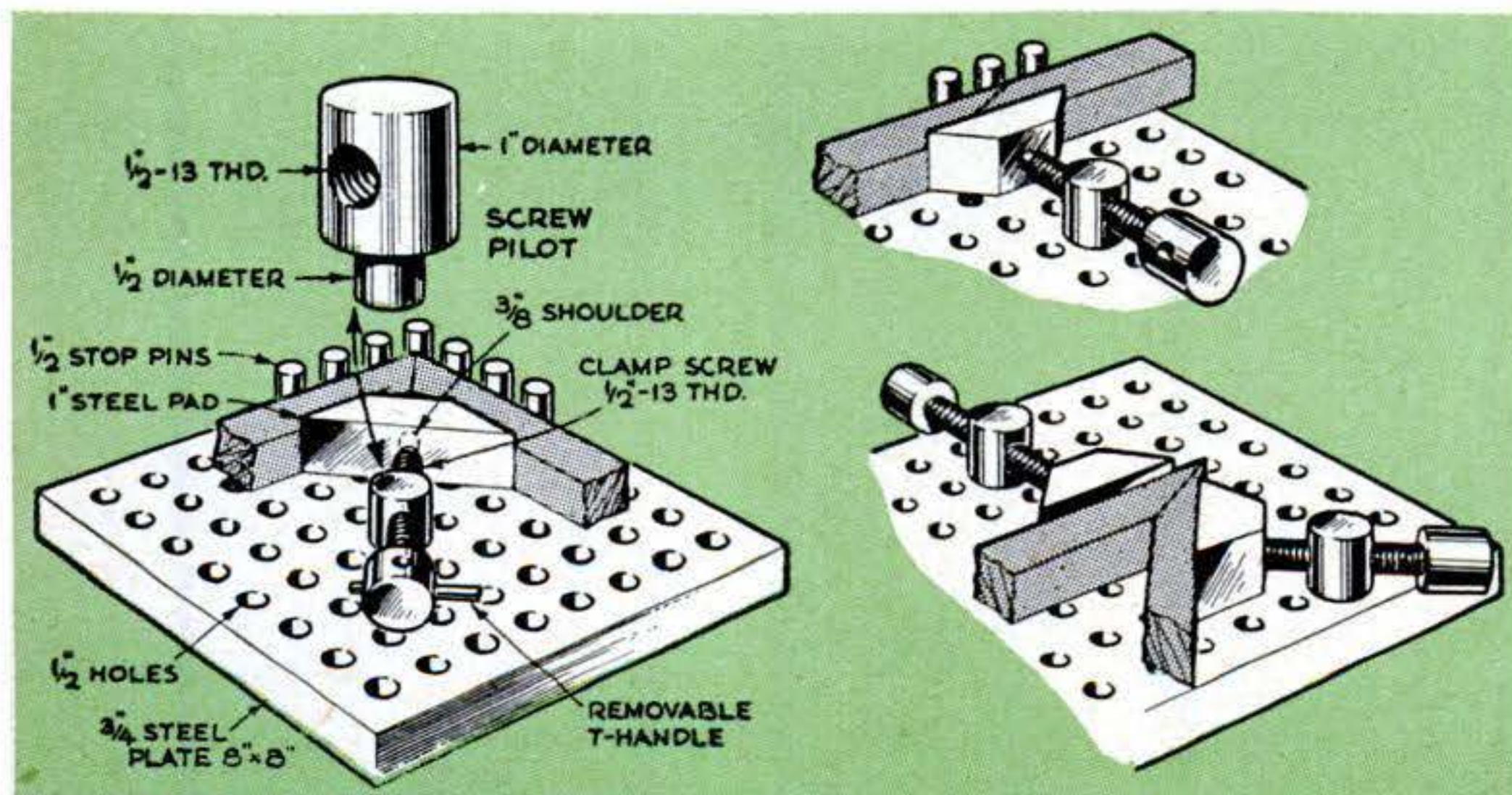
**Holder Grips Threaded Work.** When working on threaded rod or machining the heads of screws, it is difficult to clamp or chuck them without marring the threads. The two holders shown will grip such work safely.

The one held in the hand is for use in the lathe, while the other one is for use in the vise. The work is threaded part way into the tapped hole and locked by tightening the setscrew against it. Loosening the setscrew frees the work.



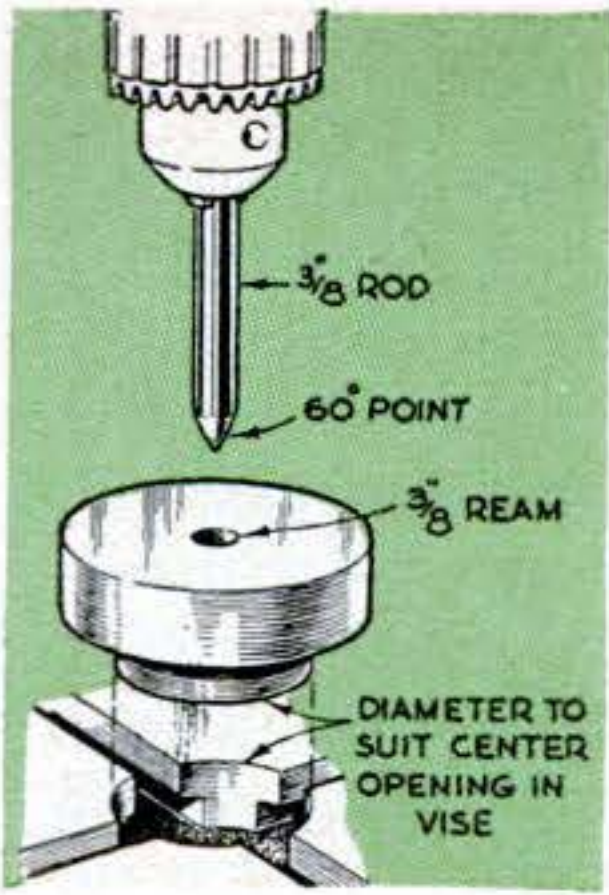
**Clamping Fixture Adjusts.** You can set up work in a jiffy for welding or brazing with this useful clamping fixture.

The  $\frac{1}{2}$ " stop pins and clamp-screw pilots can be placed anywhere on the plate to hold work together at any angle.



The clamp screws shown (left) were turned from  $\frac{3}{4}$ " rod and drilled for  $\frac{1}{4}$ " drill-rod T-handles. Long  $\frac{1}{2}$ " bolts with the threads cut all the way up to their heads can be used to simplify the construction. They can be tightened with a wrench, eliminating the T-handle.—*Charles Willey, Penacook, N. H.*

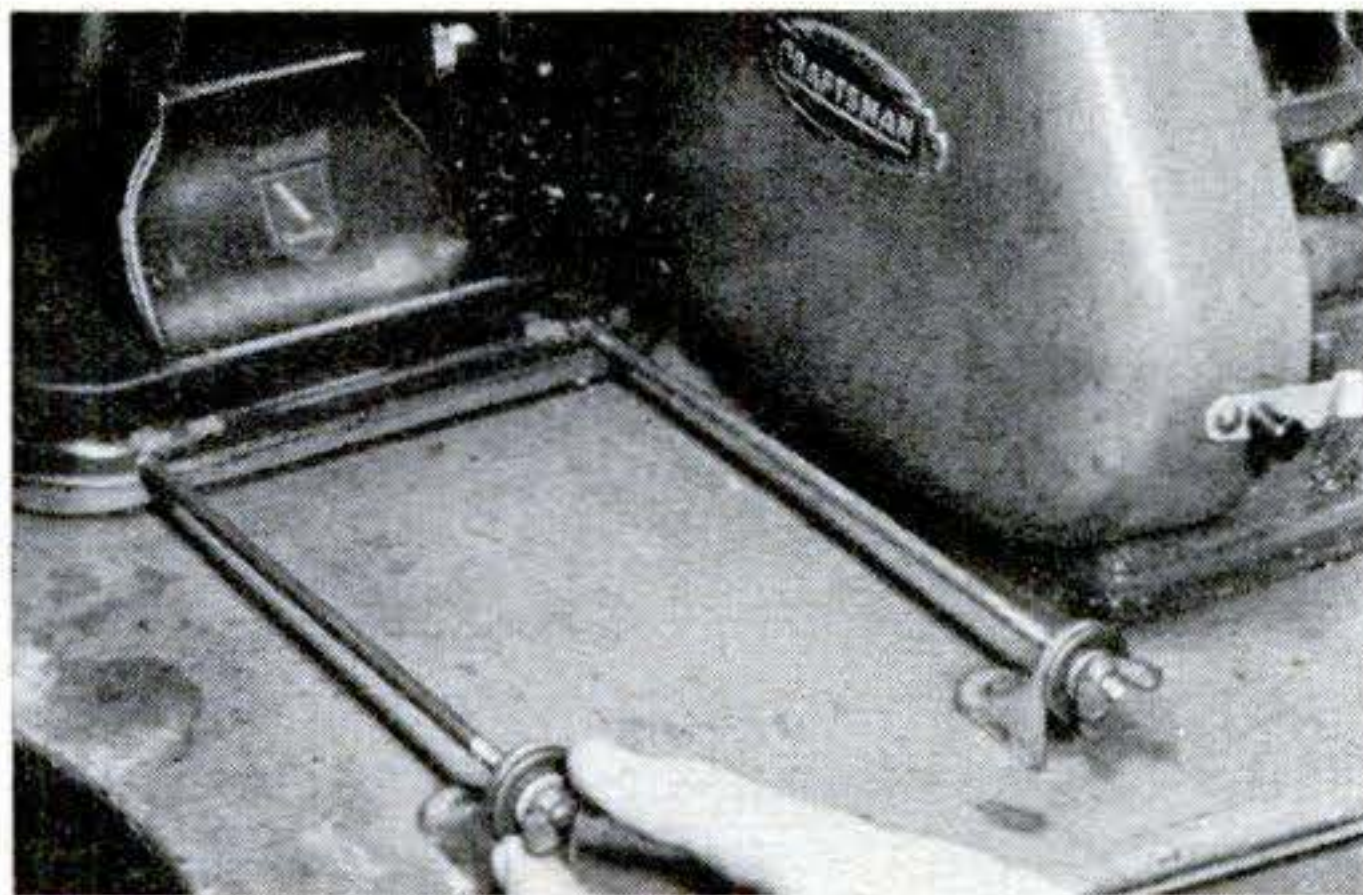
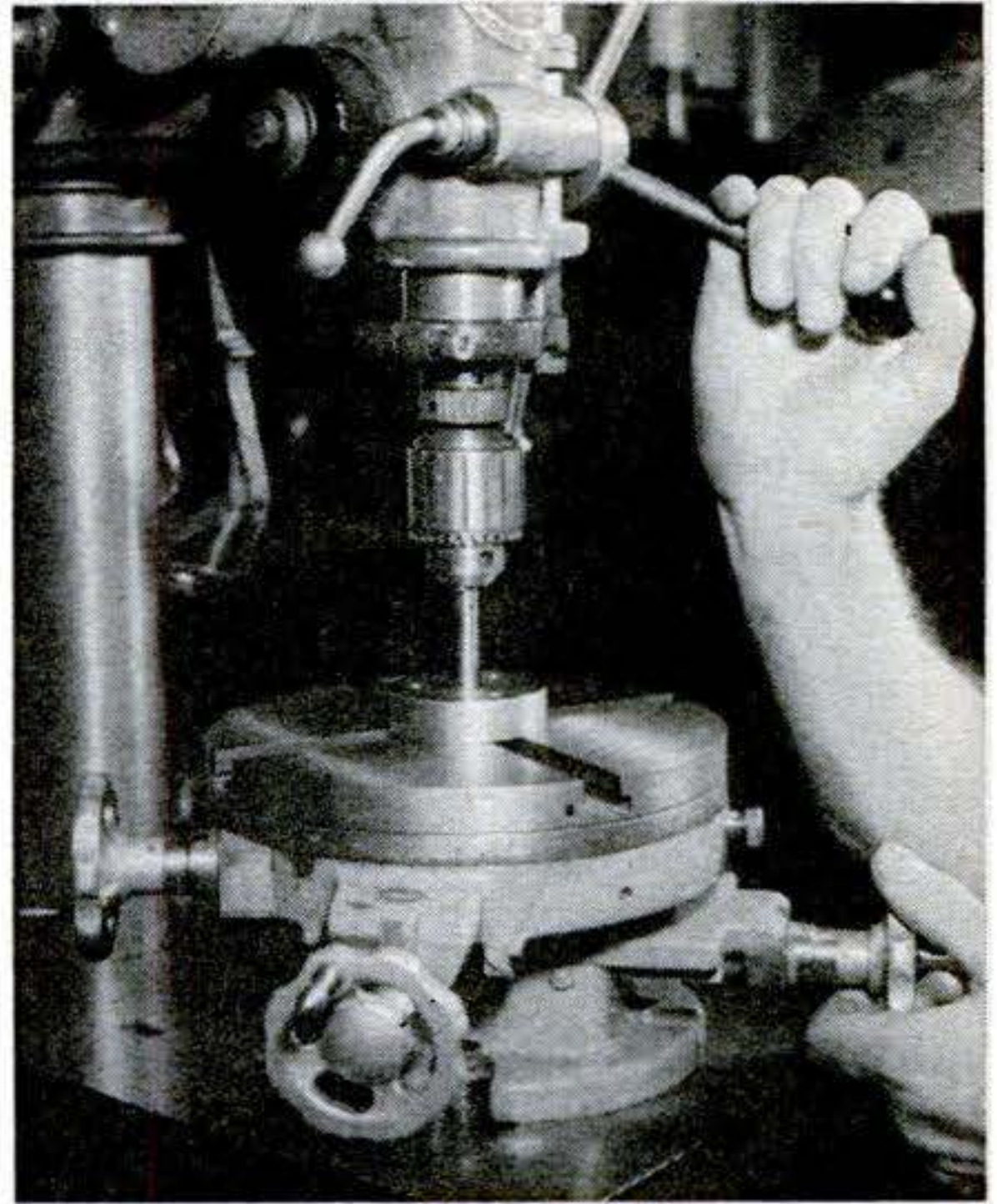




**Bushing Centers Rotary Vise.** Locating the axis of a rotary vise in line with the drill-press spindle can be a ticklish job. This setup makes it quick and easy.

Turn a flanged bushing to fit snugly in the center opening of the vise table and drill a  $\frac{3}{8}$ " hole through its center. Bolt the vise to the table with the bushing in place and ad-

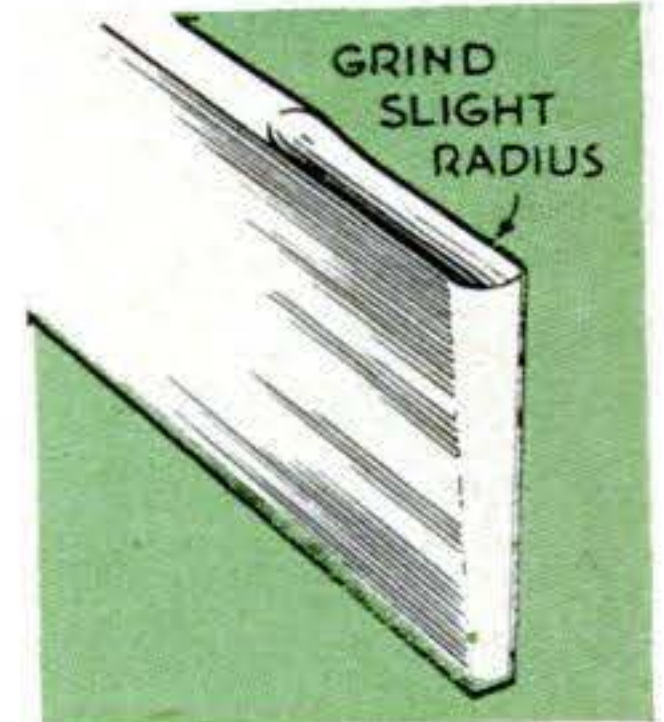
just the cross-feeds until the  $\frac{3}{8}$ " rod enters the hole. This centers the axis of the table, and work to be clamped to it is centered under the point of the rod. Adjusting the cross-feed will then set the work at any radius from the center for circular or in-line drilling.—*W. W. Lacey, Springfield, Gardens, N. Y.*



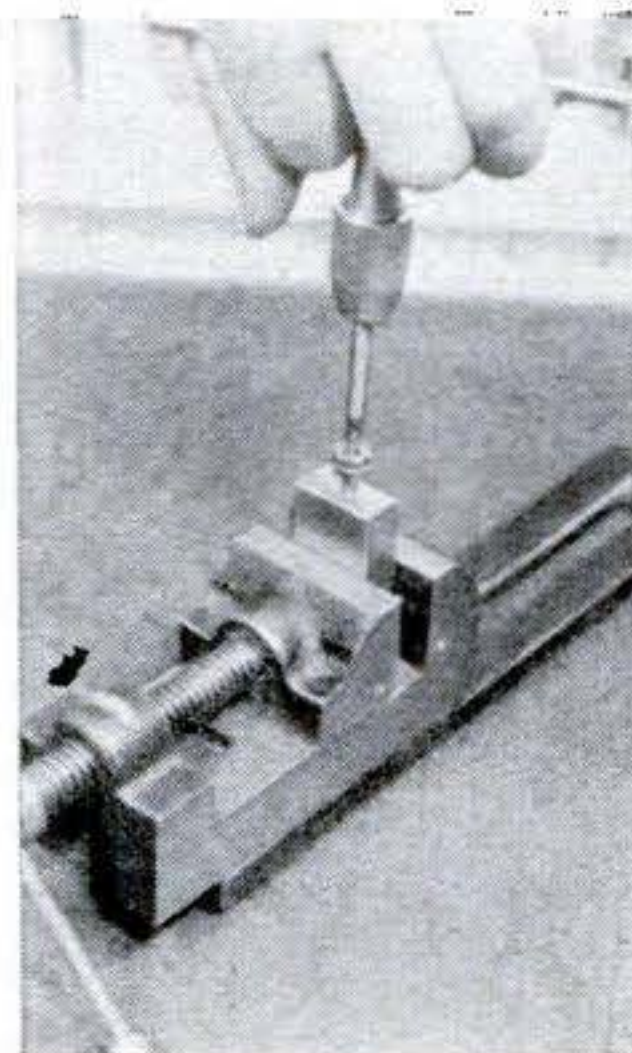
**Threaded Rods Adjust Belt Tension.**

You can use one motor for several bench-mounted power tools by attaching a pair of long threaded rods to its base as shown. The rods are set to the proper length by wing nuts that bear against a pair of cabinet-maker's corner brackets mounted beside the machine. Removing the wing nuts will permit you to slide the rods out of the brackets and transfer the motor to another tool.

**Improving Cutoff Tool.** A slight radius ground along the top edge of the cutoff tool will help reduce chatter and improve the finish of the cut.

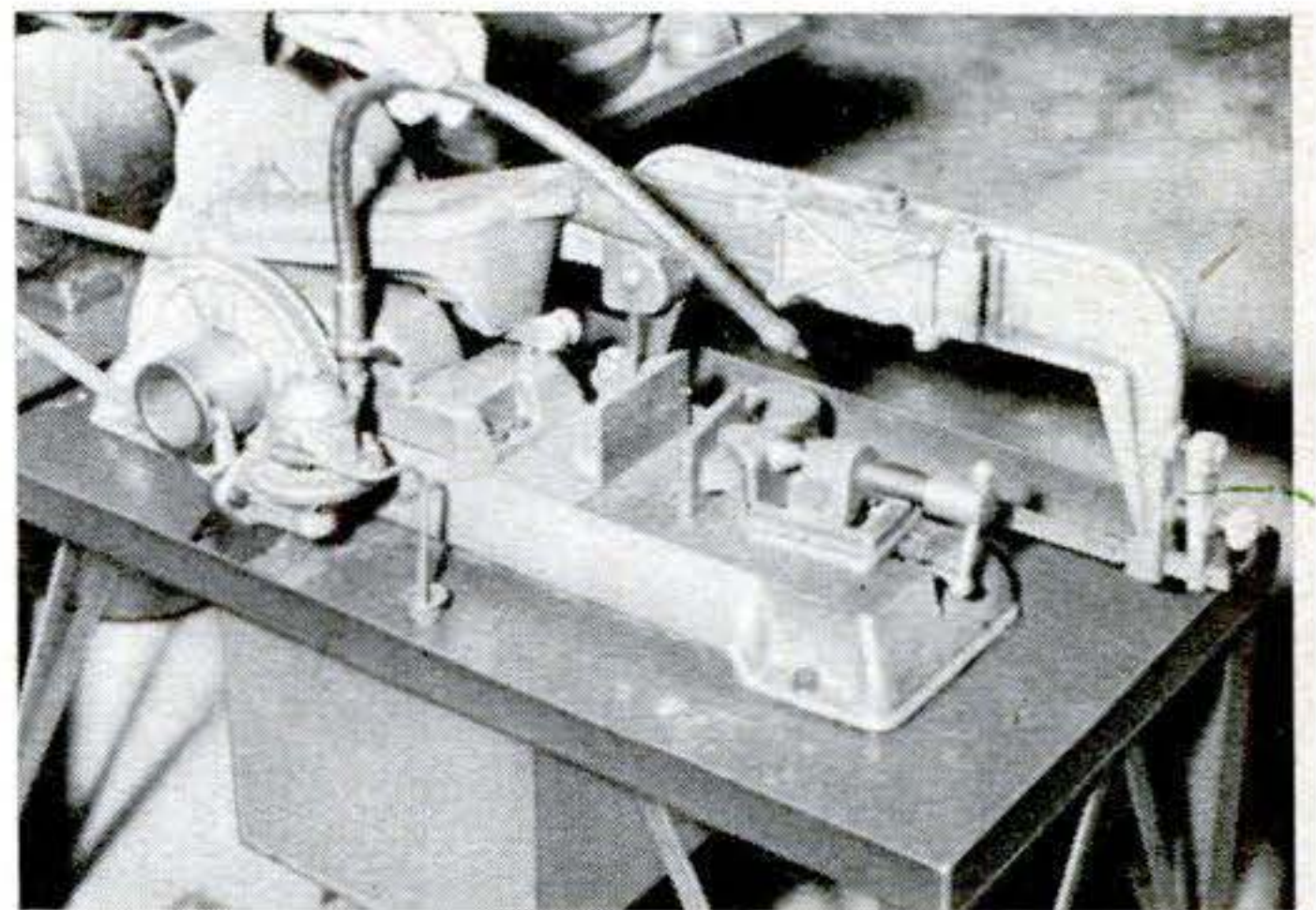


The radius breaks up the chip and makes easier cutting than the flat edge presented by the ordinary cutoff tool ground in the conventional manner.—*Hugh A. Wells, Winston-Salem, N. C.*



**Nuts Limit Tapping Depth.**

When tapping blind holes, lock two nuts against each other on the tap as shown to stop the tapping operation at the desired depth. A tap that bottoms in the work is often extremely difficult to remove and it is frequently broken.—*Will Thomas, Buffalo, N. Y.*



**Auto Fuel Pump Feeds Coolant.** A controlled flow of coolant or cutting oil can be maintained over work being machined by means of an auto fuel pump. An eccentric mounted on the V-belt pulley strokes the pump arm. Oil is drawn from a reservoir under the bench and directed to the work through a flexible hose. The amount of flow is controlled by a valve mounted on the discharge side of the pump.



## **This Rig Shoots Pictures Underwater**

[Continued from page 167]

blocks, angle brackets, clips and wing nuts may all be useful. Use brass hardware.

**Fitting the ports.** Sheet Plexiglas or Lucite  $\frac{1}{4}$ " thick is recommended. It is shatterproof, and both easier to cut and more transparent than glass. Jigsaw the ports to an easy push fit in their rabbets. Before inserting them, smear rubber cement, latex putty, or similar mastic liberally into the seat. Bed the plastic on this and apply more around the outside edges.

**The finder.** Since the one in the camera cannot be used, a frame finder is mounted on the case. Remove the camera back, tape some tracing paper in the film plane, and mount the camera in the box. Attach the box top temporarily.

Make and mount a rear peep sight first. It may be a wire loop as in the photos, or a  $\frac{1}{2}$ " hole in one leaf of a strap hinge. While wearing your face mask, sight through it at a scene 15' away. Adjust a pair of cardboard "L's" held above the front of the box until you see in the rectangle they frame what is visible on the tissue-paper. A flashlight moved within the viewed area will give you a bright spot to see.

Bend a frame of  $\frac{1}{8}$ " brass wire (brazing rod) to the shape determined by the cardboard pieces. Mount this where you held the cardboard. It can be hinged or made to slide in brass clips if you prefer.

**Fitting the glove.** An ordinary dish-washing glove or similar cheap type will soon rupture, leaving you with a wet camera. Heavy-duty electrician's gloves are too thick to leave you any sense of touch. Buy a high-grade pair just thin enough to let your fingers know what they are doing.

You will also need a flanged ring to pinch the glove bead against the side of the box and keep it tight against the edge of the mounting hole. The one shown was cut from an old aluminum percolator disk. Cut the hole in the side of the box to be a close push fit for the ring with the glove slipped over it. Smear mastic generously inside before inserting the glove.

Clamp the ring down with six homemade clips held with nuts. Before inserting the bolts for these, smear mastic liberally in the holes. Lock the bolts with extra nuts.

**Removable window.** Cut out the top opening big enough to put your camera through and cement a soft rubber gasket all around it. Cut the  $\frac{1}{4}$ " plastic window about

$\frac{3}{4}$ " larger all around. Drill the bolt holes in it and use it as a jig to locate those in the box top. Put mastic in the holes, insert bolts, and draw hex nuts up on them tightly after using a little more mastic around the bolt shanks. Enlarge the holes in the window slightly to make it an easy fit over the bolts.

**Assembly.** Bolt a husky drawer handle outside the box for your left hand and a second one inside where your gloved hand can seize it. Run the bolts right through the walls, for the box will be heavy when ballasted. Also insert four  $\frac{1}{4}$ "-20 brass bolts through the bottom to hold the sheet-lead ballast. Drill all bolt holes a close fit and push mastic into them.

If everything checks, you are ready to take the box apart and reassemble it with phenolic-resin glue in all joints. Apply three coats of enamel or varnish inside and out, and you're ready for a water test.

With the window snugged down evenly, weight the empty box down in a tub and cover it with water. Bubbles will pinpoint any air leaks, which may come from joints or from edge-grain pores in the plywood. A little mastic should seal them readily.

**Get set for pictures.** Having fastened the loaded camera inside the box, pull the glove inside out before bolting down the window. This traps extra air that helps counteract water pressure.

If the box has been well ballasted with lead on the bottom, it should prove easy to handle in the water. Shoot only in clear water—even flash won't penetrate murk.

**Pressurizing the rig.** As shown, the outfit kept a camera bone-dry in shallow water. If you want to shoot in deep water, water pressure must be balanced by pumping air or carbon dioxide into the box. You can't do this before taking the rig under water, as the glove would pop out. It can be done by mounting a small CO<sub>2</sub> cylinder—the kind used to charge soda water—outside in the bracket furnished with CO<sub>2</sub> model-airplane engines. By turning a screw on this, pressure can be released a little at a time.

With pressure inside, all ports must be held by a clamping ring, and a safety valve is a must. This can be the single flutter type used on some snorkel outfits. As the camera is taken deeper, water pressure will swell the glove, tipping you off to let more gas in. Excess pressure will bubble out. END



# Mechanics and Homebuilding

# INDEX

Items in heavy type are page or more in length

## A

Air-cleaner cover, removing.....Sept. 184  
 Air-hose hanger from wheel.....Nov. 197  
**Airplane, toy, flying.....Dec. 200**  
 Altimeter used as barometer Aug. 175  
**Antenna, TV, improving.....Oct. 188**  
**Appliance plugs, choosing.....Jul. 184**  
**Arc welding, how to do.....Sept. 202**  
**Attic ladder, how to rig.....Sept. 188**

## AUTOMOBILES

Bed in station wagon.....Aug. 167  
 Car has extra generator.....Dec. 179  
**Car with bed, food storage..Oct. 195**  
**Chrysler super hot rod.....Jul. 140**  
**Driveway, how to make....Aug. 172**  
**Gas mileage, how to measure.....Sept. 172**  
**Gas saving, tips on.....Sept. 175**  
**Hints from Model Garage**  
 Jul. 151, Aug. 165, Sept. 183,  
 Oct. 199, Nov. 197, Dec. 183  
**Hot-rod dictionary.....Dec. 185**  
**Trailer from old car.....Jul. 145**  
 Two accelerators on car.....Dec. 179  
**Winter driving tips.....Oct. 203,**  
**Dec. 178**  
**Would your car pass inspection?**  
 Aug. 151

## ACCESSORIES

Antenna, draining water from..Oct. 200  
 Coat hangers.....Aug. 165  
**Continental spare tire.....Oct. 190**  
 Horn-wire breaks, bypassing..Aug. 166  
 Horn wiring, repairing.....Oct. 200  
 Rear-view mirror, sealing.....Sept. 183  
**Tachometer, how to build..Dec. 174**  
 Ventilating car.....Sept. 183

## BODY CARE

Door-lock knob, replacing.....Jul. 151  
 Fenders, strengthening.....Aug. 166  
 Grease fittings with caps.....Nov. 197  
 Headlight bulb, installing.....Aug. 166  
 Open grille, how to make.....Nov. 192  
 Patching hole in body.....Aug. 165  
 Rust spots, touching up.....Oct. 199  
 Upholstery, renewing.....Oct. 272  
 Waxing car.....Dec. 183  
 Windshields, care of.....Dec. 183

## ENGINE CARE

Air-cleaner cover, removing.....Sept. 184  
 Batteries, care of.....Dec. 184  
**Battery, meter for.....Oct. 192**  
 Battery charger, connecting.....Nov. 198  
 Battery tests.....Oct. 194  
 Coolant, how to drain.....Oct. 199  
 Cylinder-head gasket.....Oct. 200  
 Cylinder-head lifters, making..Aug. 166  
 Cylinder, reboring.....Jul. 151  
 Dipstick cleaner.....Aug. 165  
 Hot sparks.....Nov. 198

Muffler clamp, removing.....Nov. 197  
 Oil consumption.....Oct. 200  
 Radiator, cooling.....Aug. 167  
 Rocker arm, setting.....Aug. 165  
 Scraping carbon from engine..Sept. 184  
 Spark-plug leaks, locating.....Nov. 198  
**Spark plugs can tell story..Aug. 156**  
 Tailpipe, installing.....Jul. 152

## WHEELS AND TIRES

Air-hose hanger from wheel.....Nov. 197  
 Balancing weights, painting....Nov. 197  
 Bearings, protecting.....Jul. 196  
 Chains, care of.....Dec. 184  
 Chains, container for.....Oct. 199  
**Chains, how to attach.....Oct. 204**  
 Front end, cleaning.....Dec. 183  
**Front end, how to install..Nov. 188**  
 Hub-cap removing tool.....Jul. 152  
 Tire, changing.....Jul. 152  
 Tire-gauge mount.....Jul. 151  
**Tires, how to read.....Sept. 176**  
**Which blowouts are worse?**  
 Aug. 159  
 White sidewalls, treating.....Nov. 198  
**Winter tires.....Oct. 201**  
 Wrench for adjusting brakes..Sept. 184

## B

Baby play pen, improving.....Dec. 197  
 Balancing weights, painting....Nov. 197  
 Bandsaw clearance guide.....Jul. 183  
 Barn stalls, lock for.....Jul. 179  
**Barometer from altimeter....Aug. 175**  
 Barometer readings chart.....Aug. 175  
**Basement, excavating.....Aug. 205**  
**Basement, how to improve..Oct. 206**  
**Basement, remodeling.....Nov. 218**  
 Basement posts, greasing.....Oct. 226  
**Bathroom cabinets, making..Sept. 185**  
 Batteries, care of.....Dec. 184  
**Battery, meter for.....Oct. 192**  
 Battery charger, connecting.....Nov. 198  
 Battery tests.....Oct. 194  
**Beads, glass, glazing with...Dec. 212**  
 Bearings, wheel, protecting.....Jul. 196  
**Bed-chest, how to build.....Nov. 186**  
 Bed lamp, making.....Dec. 196  
 Bike basket, mailbox from.....Aug. 182  
 Bike hub caps, making.....Jul. 179  
 Bird feeders, making.....Dec. 196

## BOATS AND BOATING

Beach dolly.....Jul. 176  
 Boat-carrier cups, storing.....Jul. 176  
 Boat table.....Jul. 177  
 Buoy reflectors.....Jul. 176  
 Knife under boat seat.....Aug. 181  
 Outboard-motor lock.....Jul. 178  
 Outboard arm, removing.....Jul. 177  
 Outrigger oars, making.....Jul. 178  
 Rowlock safety pins.....Jul. 177  
 Skylight for cabin.....Jul. 177  
 Storing boat.....Jul. 177  
**Twin-motored outboards....Jul. 174**

Bolt serves as file.....Oct. 226  
 Book trough, table, making.....Oct. 219  
 Boots, rack for.....Nov. 184  
**Boxes, mailing, how to make..Dec. 194**  
 Bracket for house numbers.....Nov. 204  
 Brakes, wrench for adjusting...Sept. 184  
**Brush, how to burn.....Nov. 206**  
 Brush, wire, sharpening.....Sept. 205  
 Bulletin board, making.....Dec. 190

## C

Cake box.....Nov. 216  
 Calking gun, positioning.....Oct. 183  
 Canvas on cot, replacing.....Jul. 179  
**Car, state inspection of.....Aug. 151**  
**Cardboard toy racer,**  
**how to make.....Dec. 198**  
 Chamois skins, making.....Oct. 219  
 Charcoal grill, case for.....Jul. 157  
**Christmas decorations.....Dec. 163**  
 Christmas tree, care for.....Dec. 194  
**Chrysler super hot rod.....Jul. 140**  
 Clamp, four-fingered.....Dec. 206  
 Clamp from window stop.....Jul. 155  
 Clock face, making.....Dec. 191  
 Clock-plant holder.....Oct. 184  
 Clothes hamper, building.....Aug. 182  
 Clothes rack, making.....Nov. 217  
 Coat hangers for car.....Aug. 165  
 Coffee pot as paint can.....Jul. 160  
 Coffee stand, how to make.....Dec. 190  
 Coffee table, making.....Oct. 184  
 Coffee table from door.....Nov. 204  
 Collets, slotting.....Nov. 235  
 Conestoga wagon, toy.....Jul. 196  
**Continental spare tire.....Oct. 190**  
 Cookbook rack.....Nov. 216  
 Coolant, how to drain.....Oct. 199  
 Corner plate makes hangers.....Aug. 181  
 Cot, replacing canvas on.....Jul. 179

## CRAFTSMEN IN UNIFORM

Baby jeep.....Jul. 139  
 Battery elevator.....Jul. 139  
 Bus into auto-home.....Oct. 216  
**Contest winner.....Nov. 183**  
 Crossbow.....Jul. 138  
 Customized scooter.....Sept. 199  
 Fly-power motor.....Aug. 202  
 Hamper hides in table.....Aug. 202  
 Inboard runabout.....Oct. 217  
 Living-room photo lab.....Oct. 217  
 Midget steam engine.....Oct. 217  
 Model Chris-Craft.....Sept. 198  
 Model coach.....Aug. 203  
 Model crane.....Sept. 198  
 Model crane.....Oct. 217  
 Model DC-3.....Aug. 202  
 Model medieval siege gun.....Sept. 199  
 Motorcycle radio.....Jul. 138  
 Pictures in leather.....Oct. 216  
 Plane turret into power saw....Oct. 216  
 Power ski-sled.....Sept. 199  
 Rebuilt plane.....Aug. 203  
 Reflecting telescope.....Sept. 198  
 Rowboat.....Aug. 203  
 Tiny turbojet engine.....Jul. 138  
 Two-faced cabinet.....Aug. 203  
 Woodcuts from carved blocks..Aug. 202

## CRAFTWORK

Bracket for house numbers.....Nov. 204  
 Clock-plant holder.....Oct. 184  
**Decoys, carving.....Aug. 184**  
**Glazing with glass beads..Dec. 212**  
 Crib-leg pads.....Sept. 201  
 Cupboard for soap.....Jul. 179  
 Curtain hanger, making.....Dec. 230  
 Cylinder, reboring.....Jul. 151  
 Cylinder-head gasket.....Oct. 200  
 Cylinder-head lifters, making...Aug. 166

## D

**Decoys, carving.....Aug. 184**  
 Depth gauge from clip.....Sept. 192  
 Diameter gauge, how to make...Dec. 207  
 Die-stock extension.....Sept. 209  
 Dipstick cleaner.....Aug. 165  
 Dish shelves, making.....Oct. 185  
 Doilies as stencils.....Oct. 219  
 Drawer pulls.....Jul. 161



## DRILLS AND DRILLING

- Centerdrill extension.....Jul. 181
- Drill, regrinding for plastic.....Aug. 197
- Drill case.....Dec. 196
- Drill-press oil feed.....Oct. 240
- Drill-press punch.....Aug. 198
- Drill-press speed changer.....Jul. 180
- Drilling casehardened steel.....Sept. 209
- Four-fingered clamp.....Dec. 206
- Taper-shank drills.....Aug. 199
- Tubing, how to drill.....Nov. 184
- Driveway, how to make.....Aug. 172**
- Dynaflows for home machines**  
Sept. 219

## E

- Electric cords, protecting.....Jul. 212
- Electric meter, box for.....Oct. 226
- End table, how to make.....Nov. 205
- Engine, four-cylinder,**  
**built by craftsman.....Nov. 225**
- Exhaust fan, installing.....Aug. 186**

## EXPERIMENTS

- How to see flying saucers.....Sept. 167**
- Stereo fools your eyes.....Dec. 220**

## F

- Fence-picket guard.....Aug. 204
- Fenders, strengthening.....Aug. 166
- File from bolt.....Oct. 226
- Files, cleaning.....Oct. 241
- Fire safety hints.....Oct. 182**
- Fireproofing Christmas tree.....Dec. 194
- Fisherman's rack, making.....Oct. 219
- Flashlights, how to repair.....Dec. 226**
- Flexible shaft, base for.....Sept. 210
- Flowerpot brackets.....Jul. 156
- Flying saucers, how to see.....Sept. 167**
- Foil foils stuck tops.....Dec. 198
- Fail-lined paint tin.....Sept. 201
- Fowl, how to clean.....Nov. 216
- Front end, auto, cleaning.....Dec. 183
- Front end, auto, how to**  
**install.....Nov. 188**
- Furnace, extra pipe on.....Nov. 203
- Furnace, gas, starting.....Dec. 192

## FURNITURE

- Bathroom cabinets, how to**  
**make.....Sept. 185**
- Bed-chest.....Nov. 186**
- Coffee table, making.....Oct. 184
- Coffee table from door.....Nov. 204
- Dish shelves.....Oct. 185
- End table.....Nov. 205
- Magazine rack.....Dec. 191
- Modern furniture, how to**  
**build.....Nov. 177**
- Plastic liquid finish.....Aug. 194**
- Table book trough.....Oct. 219
- Fuse, hot water, how to**  
**change.....Dec. 192**

## G

- Gangplank for swimming pool.....Aug. 204
- Garage, rear-view mirror for.....Aug. 204
- Garage-door lining.....Sept. 184

## GARDENS AND GARDENING

- Brush, how to burn.....Nov. 206**
- Flowerpot brackets.....Jul. 156
- Garden basket.....Jul. 161
- Hose, old, ways to use.....Aug. 196**
- Hose guard.....Aug. 183
- Kneeling pads.....Jul. 160
- Lawn sweeper, how to**  
**make.....Sept. 193**
- Gas furnace, starting.....Dec. 192
- Gas mileage, how to**  
**measure.....Sept. 172**
- Gas saving, tips on.....Sept. 175**
- Gear, toy motor as.....Jul. 196
- Glass, cutting.....Nov. 184
- Glass edges, protecting.....Jul. 224
- Glassware, rack for.....Sept. 201
- Glazing with glass beads.....Dec. 212**
- Glider, model, launching.....Oct. 183
- Globe of world, stand for.....Sept. 197
- Grille, auto, how to make.....Nov. 192

## GUS

- gets the pitch.....Oct. 196**
- goes fishing.....Jul. 148**
- pulls a trick play.....Sept. 181**
- rescues ten little angels.....Dec. 180**
- stops the music.....Nov. 194**
- trails a hot cargo.....Aug. 162**

## H

- Hammer pulls flush nails.....Aug. 197
- Hammock-stand protectors.....Aug. 183
- Headlight bulb, installing.....Aug. 166
- Hints from Model Garage.....Jul. 151,**  
**Aug. 165, Sept. 183, Oct. 199,**  
**Nov. 197, Dec. 183**
- Hitch, jack support for.....Oct. 189
- Hobbyhorse, motorized.....Dec. 223**
- Hole in car body, patching.....Aug. 165

## HOME MAINTENANCE

- Appliance plugs, choosing.....Jul. 184**
- Attic ladder, how to rig.....Sept. 188**
- Basement, excavating.....Aug. 205**
- Basement, how to improve.....Oct. 206**
- Basement, remodeling.....Nov. 218**
- Basement posts, how to grease.....Oct. 226
- Basketball wastebasket.....Dec. 190
- Bathroom cabinets, how to**  
**make.....Sept. 185**
- Bulletin board, making.....Dec. 190
- Bumper on laundry tub.....Sept. 201
- Cake box.....Nov. 216
- Chamois skins, making.....Oct. 219
- Charcoal grill, case for.....Jul. 157
- Christmas decorations.....Dec. 163**
- Christmas tree, care for.....Dec. 194
- Clothes hamper, building.....Aug. 182
- Clothes rack, making.....Nov. 217
- Cookbook rack, placing.....Nov. 216
- Corner plate makes hangers.....Aug. 181
- Crib-leg pads.....Sept. 201
- Curtain, hanging.....Dec. 230
- Dish shelves, making.....Oct. 185
- Drawer pulls.....Jul. 161
- Driveway, how to make.....Aug. 172**
- Electric meter, box for.....Oct. 226
- Electric mixer, operating.....Oct. 181
- Exhaust fan, installing.....Aug. 186**
- Fence-picket guard.....Aug. 204
- Fowl, how to clean.....Nov. 216
- Furnace, extra pipe on.....Nov. 203
- Furnace, gas, starting.....Dec. 192
- Fuse, hot-water, changing.....Dec. 192**
- Grease guard for stove.....Jul. 160
- Hammock-stand protectors.....Aug. 183
- Home Handyman's Calendar**  
**Jul. 155, Aug. 185, Sept. 197,**  
**Oct. 211, Nov. 233, Dec. 227**
- House numbers.....Jul. 160
- House numbers, bracket for.....Nov. 204
- Iron-cord bracket.....Sept. 210
- Jar tops, loosening.....Sept. 200
- Ladder shelf, securing.....Sept. 192
- Lamp for bed.....Dec. 196
- Laundry tub from old washer.....Oct. 218
- Mailbox from bike basket.....Aug. 182
- Mail rack, how to make.....Nov. 205
- Mirror, small, mounting.....Nov. 184
- Mirror frame, making.....Nov. 217
- Mirrors, cleaning.....Oct. 218
- Mixing-bowl scraper.....Jul. 161
- Numbers from license plates.....Dec. 195
- Nuts, how to crack.....Nov. 216
- Oil-burner switch guard.....Dec. 196
- Pantry shelf, rolling.....Nov. 217
- Paperhanger's table, making.....Nov. 216
- Plumbing, draining.....Oct. 215
- Plumbing, how to prevent**  
**freeze-ups.....Oct. 212**
- Porch converted to room.....Sept. 224**
- Porch roofing, plastic, ap-**  
**plying.....Jul. 131**
- Rack for boots.....Nov. 184
- Rack for glassware.....Sept. 201
- Salt-shaker tops, protecting.....Jul. 160
- Sandwiches, packing.....Jul. 161
- Shingling old roof.....Sept. 220**
- Soap cupboard.....Jul. 179
- Soap dish.....Aug. 182
- Stains, removing.....Aug. 182
- Storage rack for lumber.....Sept. 201
- Table leaves, storing.....Jul. 161
- Toaster knobs, replacing.....Oct. 218
- Toenailing wood.....Sept. 200

- Tool tray.....Sept. 200
- Towel holder.....Aug. 182
- Vacuum-cleaner clip guard.....Aug. 183
- Venetian-blind cord, improving  
Oct. 219
- Wall, how to tile.....Nov. 199**
- Wallpaper, blueprints as.....Sept. 200
- Wallpaper, removing.....Oct. 218
- Weatherstripping, how to apply**  
**Oct. 230**

## Window louvers, how to make

- Jul. 158
- Window shade, how to make.....Nov. 207
- Yard, how to pave.....Sept. 163**
- Zipper tabs, improving.....Nov. 217
- Horn-wire breaks, bypassing.....Aug. 166
- Horn wiring, repairing.....Oct. 200
- Hose, old, ways to use.....Aug. 196**
- Hose guard.....Aug. 183
- House numbers.....Jul. 160
- House numbers, bracket for.....Nov. 204
- Hot-rod dictionary.....Dec. 185**
- Hot-water fuse, changing.....Dec. 192**
- Hub-cap removing tool.....Jul. 152

## J, K

- Jar tops, loosening.....Sept. 200
- Jig, rotary.....Nov. 206
- Jig cuts tenons.....Jul. 182**
- Jointer, pusher for.....Jul. 156
- Jointer support.....Dec. 230
- Karsh photographs celebrities**  
**Oct. 220**
- Keeping the Home Shipshape**  
**Jul. 160, Aug. 182, Sept. 200,**  
**Oct. 218, Nov. 216, Dec. 196**
- Keys, separating.....Dec. 230
- Kite launches model glider.....Oct. 183
- Kneeling pads.....Jul. 160

## L

- Ladder for attic, how to rig.....Sept. 188**
- Ladder shelf, securing.....Sept. 192
- Lamp, modern, making.....Nov. 202
- Lamp for bed.....Dec. 196

## LATHE

- Chuck-key holder.....Aug. 199
- Drill mounted on tailstock.....Dec. 206
- Idler belt.....Sept. 209
- Indexing by level.....Sept. 208
- Lathe dog, shield for.....Aug. 198
- Lube system.....Oct. 241
- Oil feed.....Oct. 240
- Template jig.....Nov. 185
- Laundry tub, bumper for.....Sept. 201
- Laundry tub, making.....Oct. 218
- Lawn sweeper, how to make**  
**Sept. 193**
- Lazy susan, making.....Dec. 191
- Level adapted to pitch.....Oct. 226
- License plates, numbers from.....Dec. 195
- Lock for barn stalls.....Jul. 179
- Louvers, window, making.....Jul. 158**
- Lumber, storage racks for.....Sept. 201

## M

- Magazine rack.....Dec. 191
- Mail rack, how to make.....Nov. 205
- Mailbox from bike basket.....Aug. 182
- Mailing, packaging for.....Dec. 196
- Mailing boxes, how to make.....Dec. 194**
- Mastic spreader improved.....Aug. 197
- Memo holders, making.....Oct. 186**
- Meter, electric, box for.....Oct. 226
- Micrometer device.....Oct. 240
- Micrometer measures slots.....Nov. 235
- Milling vise, T wrench for.....Aug. 198
- Mirror, small, mounting.....Nov. 184
- Mirror frame, making.....Nov. 217
- Mirrors, cleaning.....Oct. 218
- Mixer, electric, operating.....Oct. 181
- Mixing-bowl scraper.....Jul. 161
- Model-Garage Hints.....Jul. 151,**  
**Aug. 165, Sept. 183, Oct. 199,**  
**Nov. 197, Dec. 183**

## MODEL MAKING

- Fuel tanks for tiny engines.....Aug. 150
- Model glider, launching.....Oct. 183
- Model-railroad hints.....Nov. 236,**  
**Dec. 204**



Pin vise.....Jul. 180  
Modern furniture, making.....Nov. 177  
Muffler clamp, removing.....Nov. 197

## N, O

Nails, bent, removing.....Aug. 209  
Nails, pulling.....Aug. 197  
Natural finishes, applying.....Aug. 145  
New Jersey inspects car.....Aug. 152  
New Shop Ideas.....Jul. 180,  
Aug. 198, Sept. 208, Oct. 240,  
Nov. 234, Dec. 206  
Noah's Ark animals.....Dec. 189  
Numbers from license plates.....Dec. 195  
Nuts, how to crack.....Nov. 216  
Nuts, knurled, pliers for.....Oct. 241  
Oars, outrigger, making.....Jul. 178  
Oil burner, portable.....Nov. 203  
Oil-burner switch guard.....Dec. 196  
Outboard-motor arm, removing.....Jul. 177  
Outboard-motor lock.....Jul. 178  
Outboards, twin-motored.....Jul. 174

## P

### PAINT AND PAINTING

Brush, drill dries.....Jul. 196  
Brush, extension for.....Oct. 211  
Coffee pot as paint can.....Jul. 160  
Drying rack.....Dec. 197  
Foil foils stuck tops.....Dec. 198  
Foil-lined paint tin.....Sept. 201  
Natural finishes, applying.....Aug. 145  
Natural finishes chart.....Aug. 149  
Paint remover, using.....Nov. 217  
Paraffin guards paint.....Aug. 183  
Plastic liquid finish.....Aug. 194  
Pouring paint.....Dec. 197  
Stencils from doilies.....Oct. 219  
Twin cans clean brushes.....Aug. 208  
Pantry shelf, rolling.....Nov. 217  
Paper cups, shop uses for.....Oct. 229  
Paperhanger's table, making.....Nov. 216  
Paraffin guards paint.....Aug. 183

### PHOTOGRAPHY

Better pictures.....Nov. 212  
Device for close-ups.....Aug. 192  
Don't shoot with sun behind you  
Aug. 190  
Flashbulb duds, avoiding.....Aug. 230  
How Karsh pictures celebrities  
Oct. 220  
Kitchen darkroom.....Jul. 162  
Light, how to bounce.....Nov. 208  
Photo masks, drawing.....Jul. 158  
Photo on key ring.....Dec. 189  
Photographing the World Series  
Sept. 211  
Plastic ground glass.....Jul. 224  
Rack for small tools.....Jul. 159  
Stereo fools your eyes.....Dec. 220  
Stereo photography.....Dec. 218  
Pin vise.....Jul. 180  
Plane irons, sharpening.....Dec. 199  
Plastic, regrinding drill for.....Aug. 197  
Plastic film, uses for.....Aug. 189  
Plastic liquid finish.....Aug. 194  
Plastic porch roofing.....Jul. 131  
Plastic table topping.....Nov. 223  
Plastic tool guards, making.....Nov. 230  
Plated parts, rustproofing.....Nov. 185  
Play pen, baby, improving.....Dec. 197  
Pliers for knurled nuts.....Oct. 241  
Plugs, appliance, choosing.....Jul. 184  
Plumbing, draining.....Oct. 215  
Plumbing freeze-ups, preventing  
Oct. 212  
Porch converted to room.....Sept. 224  
Protractor, making.....Aug. 209  
Pump, water, portable.....Aug. 200  
Punch, bend-proofing.....Sept. 209  
Punching bag, quieting.....Jul. 224  
Radiator, cooling.....Aug. 167  
Radio, 7-ounce, making.....Sept. 215  
Radio, transistor, how to build  
Oct. 237  
Radio emergency crystal.....Dec. 222  
Rear-view mirror, sealing.....Sept. 183  
Rear-view mirror for garage.....Aug. 204  
Reduction gear for toy motor.....Jul. 196

## R

Ribbon, tying.....Dec. 197  
Ripping bar, improved.....Dec. 230  
Rocker-arm clearances, setting.....Aug. 165  
Roof, shingling.....Sept. 220  
Roofing, plastic, applying.....Jul. 131  
Rowlock safety pins.....Jul. 177  
Rust spots on car, treating.....Oct. 199  
Rustproofing plated parts.....Nov. 185

## S

Salt-shaker tops, protecting.....Jul. 160  
Sander, pusher for.....Jul. 156  
Sander, vacuum-cleaner attachment for  
Sept. 208  
Sander belts, rack for.....Jul. 154  
Sandwiches, packing.....Jul. 161  
Saucers, flying, how to see Sept. 167

### SAWS AND SAWING

Bandsaw clearance guide.....Jul. 183  
Homemade jig cuts tenons.....Jul. 182  
Jigs, how to make.....Dec. 214  
Portable saws, how to use  
Nov. 226  
Radial guide, making.....Dec. 216  
Saws, slotting, arbor for.....Oct. 241  
Table for saw, building.....Dec. 216  
Screw blanks, turning.....Jul. 181  
Screw-tractor sizes.....Dec. 210  
Screws, broken, removing.....Dec. 208  
Scriber, how to make.....Oct. 241  
Scriber for cardboard.....Oct. 189  
Scriber made from pen.....Aug. 199  
Shaper-jig, improving.....Aug. 174  
Sheet metal, scoring.....Nov. 233  
Shingling roof.....Sept. 220  
Skylight for boat cabin.....Jul. 177  
Slots, measuring.....Nov. 235  
Small parts, boxes for.....Sept. 210  
Small-parts tumbling barrel.....Aug. 199  
Soap cupboard.....Jul. 179  
Soap dish.....Aug. 182  
Soldered joints, cleaning.....Nov. 185  
Soldering, aid to.....Sept. 192  
Spare-tire carrier, making.....Oct. 190  
Spark-plug leaks, locating.....Nov. 198  
Spark plugs tell story.....Aug. 156  
Spring steel, punching.....Dec. 207  
Stains, removing.....Aug. 182  
Stamp moistener.....Dec. 197  
Stand for power tools.....Nov. 235  
Steel, casehardened, drilling.....Sept. 209  
Stencils from doilies.....Oct. 219  
Stereo fools your eyes.....Dec. 220  
Stereo photography.....Dec. 218  
Stove, grease guard for.....Jul. 160  
Suction cup, uses for.....Oct. 211  
Swimming-pool gangplank.....Aug. 204  
Swing rope, reinforcing.....Aug. 204

## T

Table book trough.....Oct. 219  
Table leaves, storing.....Jul. 161  
Tachometer as counter.....Oct. 226  
Tachometer for car, building  
Dec. 174  
Tailpipe, installing.....Jul. 152  
Taps and dies, sorting.....Nov. 234

### TELEVISION

Antenna, improving.....Oct. 188  
Five ways to house set.....Oct. 177  
Kansas fan gets coasts.....Jul. 171  
Picture, how to improve.....Nov. 180  
Speaker box improves sound  
Aug. 168  
Tenons, jig cuts.....Jul. 182  
Terrace wagon.....Jul. 153  
T-hinge holds drawer.....Aug. 181  
Tie rack, making.....Dec. 191  
Tiling wall.....Nov. 199  
Tin snip guard.....Jul. 156  
Tire blowouts, which are  
worse?.....Aug. 159  
Tire chains, care of.....Dec. 184  
Tire chains, container for.....Oct. 199  
Tire chains, how to attach.....Oct. 204  
Tire changing.....Jul. 152  
Tire-gauge mount.....Jul. 151  
Tires, how to read.....Sept. 176  
Tires, whitewall, treating.....Nov. 198  
Toaster knobs, replacing.....Oct. 218  
Toenailing wood.....Sept. 200

## TOOLS

Bolt or screw serves as file.....Oct. 226  
Collets, slotting.....Nov. 235  
Files, cleaning.....Oct. 241  
Hammer pulls flush nails.....Aug. 197  
Jointer, pusher for.....Jul. 156  
Jointer support.....Dec. 230  
Level adapted to pitch.....Oct. 226  
Milling vise, T wrench for.....Aug. 198  
Pin vise.....Jul. 180  
Plane irons, sharpening.....Dec. 199  
Plastic tool guards.....Nov. 230  
Pliers for knurled nuts.....Oct. 241  
Power tool from vacuum cleaner  
Aug. 176  
Power-tool stand.....Nov. 235  
Punch, bend-proofing.....Sept. 209  
Ripping bar improved.....Dec. 230  
Sander, pusher for.....Jul. 156  
Sander, vacuum-cleaner on.....Sept. 208  
Sander belts, rack for.....Jul. 154  
Scriber, how to make.....Oct. 241  
Shaper jig, improving.....Aug. 174  
Taps and dies, sorting.....Nov. 234  
Tin snip guard.....Jul. 156  
Tool rack on door.....Jul. 196  
Tool tray.....Sept. 200  
Tools from broken drills.....Dec. 207  
Vise, extra uses for.....Jul. 166  
Vise, pad for.....Oct. 189  
Vise light.....Dec. 207  
Vise lock, adjusting.....Jul. 181  
Wire sizes (for tools).....Nov. 229  
Towel holder.....Aug. 182  
Toy motor as gear.....Jul. 196

## TOYS

Airplane, how to make.....Nov. 213  
Cardboard racer.....Dec. 198  
Chest closes safely.....Oct. 211  
Conestoga wagon.....Jul. 196  
"Do-nothing" box.....Dec. 203  
Flying airplane.....Dec. 200  
Hobbyhorse, motorized.....Dec. 223  
Noah's Ark animals.....Dec. 189  
Tractor from GI gas can.....Dec. 222  
Tractor shield helps pick corn.....Sept. 192  
Trailer from old car.....Jul. 145  
Transistor radio, building.....Oct. 237  
Truck body, compartments for.....Dec. 184  
Tub, laundry, bumper for.....Sept. 201  
Tub, laundry, making.....Oct. 218  
Tubing, how to drill.....Nov. 184  
Tweezers improved.....Jul. 181

## U, V, W, Y, Z

Upholstery, car, renewing.....Oct. 272  
V blocks, extra uses for.....Nov. 234  
Vacuum cleaner, power tool from  
Aug. 176  
Vacuum-cleaner clip guard.....Aug. 183  
Vacuum cleaner on sander.....Sept. 208  
Venetian-blind cord, improving.....Oct. 219  
Ventilating car.....Sept. 183  
Vise, extra uses for.....Jul. 166  
Vise, pad for.....Oct. 189  
Vise light.....Dec. 207  
Vise lock, adjusting.....Jul. 181  
Wagon, toy Conestoga.....Jul. 196  
Wall, tiling.....Nov. 199  
Wallpaper, removing.....Oct. 218  
Wallpaper from blueprints.....Sept. 200  
Wastebasket, making.....Dec. 190  
Water pump, portable.....Aug. 200  
Waxing car.....Dec. 183  
Weatherstripping, applying.....Oct. 230  
Welding, arc, how to do.....Sept. 202  
Window louvers, making.....Jul. 158  
Window shade, how to make.....Nov. 207  
Windshields, care of.....Dec. 183

### WINTER SUGGESTIONS

Tire chains, care of.....Dec. 184  
Tire chains, container for.....Oct. 199  
Winter driving tips.....Oct. 203-205,  
Dec. 178  
Winter tires.....Oct. 201  
Wire brush, sharpening.....Sept. 209  
Wood-filler scraper.....Aug. 183  
World, globe of, stand for.....Sept. 197  
World Series, photographing the  
Sept. 211  
Yard, how to pave.....Sept. 163  
Zipper tabs, improving.....Nov. 217





**COMMON NAILS**

**FINISHING NAILS**

COMMON NAILS			
Size	Length	No. Gauge	Quantity Per Pound
2d	1"	15	850
3d	1 1/4"	14	545
4d	1 1/2"	12 1/2	295
5d	1 3/4"	12 1/2	250
6d	2"	11 1/2	170
7d	2 1/4"	11 1/2	150
8d	2 1/2"	10 1/4	100
9d	2 3/4"	10 1/4	85
10d	3"	9	65
12d	3 1/4"	9	60
16d	3 1/2"	8	45
20d	4"	6	30
30d	4 1/2"	5	20
40d	5"	4	16

**G**OT a box full of assorted nails? Wish you could tell one from the other? Just hold 'em up against these actual-size drawings to identify them in a jiffy. The charts at the bottom of the page tell all about nails, even to how many you get in a pound ("d" means penny size).

FINISHING NAILS			
Size	Length	No. Gauge	Quantity Per Pound
3d	1 1/4"	15 1/2	890
4d	1 1/2"	15	635
6d	2"	13	295
8d	2 1/2"	12 1/2	200
10d	3"	11 1/2	125



VOLUME 162 • NOS. 1 TO 6

JANUARY TO JUNE 1953

POPULAR SCIENCE MONTHLY

# Mechanics and Homebuilding INDEX

Items in heavy type are page or more in length

## A

**Air conditioner, plastic ducts extend.....May 191**  
Air-hose guard for garage.....Apr. 197  
**Air prop, hitch boat to.....May 168**  
Ammeter adapter checks loads.....May 226  
Angle iron, grinding.....Mar. 243

## AUTOMOBILES

Air-hose guard.....Apr. 197  
Bed, folding, in car.....May 177  
**Dynamometer tests cars.....Apr. 205**  
Garage, bumping board for.....Feb. 199  
Garage doorstop, making.....May 181  
**Hints from the Model Garage**  
**Jan. 197, Feb. 199, Mar. 199,**  
**Apr. 197, May 181, June 197**  
**How to photograph your car**  
**May 202**  
**Model T Ford, restoring.....Feb. 190;**  
**overhauling engine.....Mar. 201;**  
**restoring body.....Apr. 199**  
**Push-button seat.....May 183**  
Steering wheel, cut-down.....June 193  
Wiring, tracing short in.....June 198

## ACCESSORIES

Accelerator pedal, pad for.....Mar. 199  
Antenna, broken, repairing.....June 197  
Clip holds sunglasses.....June 198  
Dimmer switch, relocating.....Apr. 198  
Drilling holes in metal.....Mar. 200  
Floor lights.....Feb. 200  
Luggage shelf in trunk.....Mar. 200  
**Radio speaker, back-seat.....Apr. 193**  
Shades for car windows.....May 181  
Storage box under seat.....May 182  
Toolbox under hood.....May 184  
Trunk-lock cover, modifying.....Apr. 198  
Umbrella holder.....Apr. 197  
Windshield sponge.....Jan. 198

## BODY CARE

Convertible top tied down.....May 182  
Dent in roof, removing.....June 197  
Door hinges, oiling.....Feb. 200  
Gravel guards, making.....May 182  
License plate, reinforcing.....Feb. 199  
License plate, relocating.....Apr. 197  
Rain troughs, improving.....Jan. 197  
Seat-rattle, eliminating.....June 198  
Window-door, making.....June 193  
Windshield, sealing.....Mar. 199

## ENGINE CARE

Accelerator spring, replacing.....May 182  
Ball-check fittings, oiling.....Apr. 198  
**Compression gauge, using.....Feb. 201**  
Distributor cam, lubricating.....June 198  
Distributor cap, washing.....May 181  
Head gasket leakage, checking.....Jan. 198  
Hood, locking it open.....Mar. 200  
**Muffler, checking.....Jan. 193**  
Ring compressor from clamp.....June 193

Speedometer cable, oiling.....Jan. 198  
Tailpipe extension.....Mar. 199  
**Timing light, using.....Mar. 193**  
Timing marks on U.S. cars.....Mar. 194  
Tubing as cable housing.....Mar. 199  
Under-hood light.....Mar. 200  
**Valves, noisy, how to cure.....June 190**

## WHEELS AND TIRES

**Front end, aligning.....Jan. 186**  
Hub-cap clips, padding.....Feb. 199  
Inner tube, changing.....June 197  
Jack, storage for.....June 197  
**Models explain alignment.....Jan. 190**  
Pump, tire, improving.....Feb. 200  
Sand, carrying.....Jan. 198  
Shock absorber, removing.....Feb. 200  
Tire-pressure gauge holder.....May 181  
Winter tires, storing.....Apr. 198  
Wrapping on tires, removing.....Jan. 197

## B

Ball bearing smooths turned surfaces  
Feb. 228  
Bandsaw, tailstock supports.....May 212  
**Barbecue fireplace, making.....Apr. 226**  
Barbecue grills.....June 223  
Bearings, burnishing.....Jan. 231  
Bike, adapting girl's model for boy  
June 238

## Bike parts make boat trailer

**Apr. 233**  
**Birdhouses, how to build.....Mar. 238**  
Boards carried under car.....Feb. 235

## BOATS AND BOATING

**Air prop, hitch boat to.....May 168**  
Bike on floats.....June 223  
**Kit boats, all about.....Mar. 183**  
**Light boat trailer, making.....Apr. 233**  
**Moorings save your back.....June 212**  
Splash rails for outboard.....June 215  
**Steam-powered side-wheeler**  
**June 238**

**Bolts, projects with.....Mar. 214**  
Book ends, how to make.....Feb. 211  
Book rack, making.....Mar. 215  
Bookshelves, divider for.....June 181  
Bottles, sealing.....Mar. 187  
**Brace, sawed-off, making.....May 217**  
Brush broom paints fence.....Apr. 232  
Brush scours scaly paint.....May 199  
Bubble levels guide drills.....Apr. 239  
**Budget, touring on a.....May 173**  
Buffing data card.....Mar. 231  
**Buffing metalware.....Mar. 228**  
Burr-removing tool.....June 233  
Burrs, inside, removing.....Jan. 230  
Bushings, Woodruff keys drive.....June 233

## C

**Cabin for \$200, building.....Feb. 179**  
Cabinet dries clothes.....June 224  
**Camera, how to hold.....Apr. 223**

**Camera, hunting with.....June 182**  
Camp cook kit.....May 174  
Camp icebox, making.....May 175  
Camping in converted truck.....May 176  
Candle holder, making.....Mar. 215  
Candle makes bottle stopper.....May 199  
**Cans, five-gallon, uses for.....May 224**  
Cans, trash, repairing.....Mar. 223  
Capsules make tiny oil cans.....May 185  
**Car, how to photograph.....May 202**  
**Car seat, adjustable.....May 183**  
Card table makes bed desk.....Mar. 217  
Cement, bags of, stacking.....Apr. 211  
**Chain saw, how to use.....Mar. 224**  
Chain-saw safety rules.....Mar. 226  
Chalk, screen sharpens.....Feb. 241  
Chalk, strengthening.....Mar. 187  
Chest, miniature.....Jan. 223  
**Chest stores records.....Feb. 216**  
**Chopping-block cabinet.....Jan. 213**  
Chuck, safety key for.....Feb. 229  
Chuck key snaps back.....June 233  
**Cigarette lighter, electric.....May 205**  
Circuit loads, checking.....May 226  
Circular cuts with router jig.....Feb. 209  
**Circular-saw blades.....June 234**  
Circular-saw blades data card.....June 237  
**Clamps, types of.....Jan. 205**  
**Clay, modeling, using.....Apr. 191**  
Clay holds measuring wires.....June 233  
Clip board, making.....Feb. 213  
Clip holds scrap paper.....Feb. 240  
Clock key makes drawer pull.....June 217  
Closet, shallow, improved.....Mar. 268  
Closet rod for child.....Mar. 217  
Closet shelves, pull-out.....June 217  
Clothes hanger holds paint can.....May 212  
Clothesline, spring tightens.....Feb. 241  
Clothespins, holder for.....Feb. 212  
Coat hooks make tool holder.....June 224  
Coffee pot, campfire frame for.....May 177  
**Coffee table, lazy susan.....Mar. 209**  
**Compression gauge for auto.....Feb. 202**  
**Concrete mixer.....May 206**  
Connections, insulating.....May 212  
Cooking kit for camp.....May 174  
Cooking pots, cleaning.....June 216  
Copper tubing houses cables.....Mar. 199  
Cornice, angle brackets hold.....Mar. 223  
Crucible, lampblack-coating.....Feb. 233  
**Cruiser, model, from tin cans.....Mar. 218**

## D

Dolly, winch-equipped.....Mar. 268  
Draft deflectors, window.....Jan. 221  
Drapes, wooden, making.....June 216  
Drawing ink, jigsaw shakes.....May 216  
Duct elbows, separating.....Feb. 233

## DRILLS AND DRILLING

Bolt holds work in press.....Jan. 231  
Bubble levels guide drills.....Apr. 239  
Chuck key snaps back.....June 233  
Deburring tool.....June 233  
Drilling car metal.....Mar. 200  
Drill-rod scraps, uses for.....Mar. 243  
Feed handle improved.....Jan. 231  
Guide centers holes.....June 232  
Light warns of damage.....June 224  
Driveways, killing grass in.....Mar. 216  
**Dynamometer tests cars.....Apr. 205**

## E

**Electric cigarette lighter.....May 205**  
**Elevator mounts outdoor incline**  
**Apr. 240**  
**Engine, marine, model.....Jan. 214**

## EXPERIMENTS

**Handling the humidity.....June 220**  
**How twisters are born.....Apr. 184**  
**Why the days grow longer**  
**Mar. 212**  
**Your senses may tell fibs.....Feb. 220**  
Eye-dropper bulbs, uses for.....Mar. 268  
Eye droppers shoot glue.....May 216

## F

File handles from CO<sub>2</sub> bottles.....Apr. 232  
File handles from washers.....Feb. 229  
**File holds back copies of PSM**  
**June 226**



Filing saw teeth.....Apr. 232  
 Film drier, making.....June 224  
 Film hangers, rack for.....Mar. 241  
**Fire alarms, making.....Feb. 186**  
 Fireside set.....Jan. 223  
**Firewood holder, making.....Jan. 211**  
**Five-gallon cans, uses for.....May 224**  
 Flagpole pulley, threading.....June 205  
 Flashlight, explosion-proof.....May 185  
**Flight lessons with paper glider**  
 Feb. 214

Floor boards, filling gaps in.....Jan. 221  
 Flying saucer, homemade.....Apr. 217  
**Flying saucers, photographing**

Jan. 227  
 Foil cut outs, mounting.....Feb. 223  
 Foil decorates candles.....Apr. 181  
**Ford, T Model, restoring.....Feb. 190;**  
**overhauling engine.....Mar. 201;**  
**restoring body.....Apr. 199**  
**Freezer, home, tips on.....Feb. 185**  
 Freezer bag protects camera.....May 185  
 Freezer bags seal woolens.....May 198  
**Front end, aligning.....Jan. 186**  
 Fruit basket, making.....Mar. 215  
 Funnels from auto oil filter.....Jan. 197

#### FURNITURE

Cabinet hides trunk.....Mar. 192  
 Lazy susan coffee table.....Mar. 209  
 Snack table.....Feb. 211  
 Stacking makes new pieces.....Feb. 213  
 Stool, making.....Mar. 215

#### G

Garage, bumping board for.....Feb. 199  
 Garage doorstep, making.....May 181

#### GARDENS AND GARDENING

Cultivator measures distances.....Mar. 208  
 Garden furniture, making.....June 216  
 Garden-tool hangers.....Apr. 210  
 Kneeling pad-tool pouch.....May 198  
 Markers from ice-cream sticks.....Apr. 211  
 Plants, watering.....May 198  
 Seeds, old, testing.....Apr. 217  
 Tool handles, broken,  
 removing.....June 217  
 Weed cutter from hoe.....Apr. 232  
 Gasoline storage tank.....Jan. 210  
 Gauge glass, protecting.....Mar. 216  
 Glass-fiber swimming pool.....June 204  
**Glider, paper, tests flight.....Feb. 214**  
 Gloves, drying on car engine.....Feb. 199  
**Glues and gluing.....Jan. 199**  
 Gravel guards, car, making.....May 182  
 Grease gun, protecting.....Jan. 197  
 Grooves, measuring.....Jan. 230

#### GUS

—answers an ambulance  
 call.....Mar. 196  
 —finds a golden thread.....Apr. 194  
 —fixes their wagon.....Jan. 194  
 —meets a deadline.....Feb. 196  
 —puts the heat on an MG.....June 194  
 —takes a gamble.....May 178

#### H

Hair, how to cut.....May 196  
 Hamper for child's clothes.....Jan. 220  
 Hanger for fur pieces.....Apr. 211  
**Hardware, cleaning.....Apr. 209**  
**Heating, radiant, for**  
**bathroom.....Jan. 177**  
**Hints from the Model**  
 Garage.....Jan. 197,  
 Feb. 199, Mar. 199, Apr. 197,  
 May 181, June 197

#### HOME MAINTENANCE

Air conditioner, plastic ducts  
 extend.....May 191  
 Back-yard barbecue grills.....June 223  
**Barbecue fireplace,**  
**making.....Apr. 226**  
 Bathroom scales, testing.....May 198  
 Book rack, making.....Mar. 215  
 Cabinet dries clothes.....June 224  
 Candle holder, making.....Mar. 215  
 Candle makes bottle stopper.....May 199

Candles, decorating.....Apr. 181  
**Canvas sun roof shades**

terrace.....June 218  
**Chopping-block cabinet.....Jan. 213**  
 Closet, shallow, improved.....Mar. 268  
 Closet rod for child.....Mar. 217  
 Clothespins, holder for.....Feb. 212  
 Cooking pots, cleaning.....June 216  
 Cornice held by brackets.....Mar. 223  
 Doorknob for child.....May 198  
 Doors make convertible porch.....May 216  
 Dough, cookie, freezing.....Feb. 213  
 Draft deflectors, window.....Jan. 221  
 Drapes, wooden.....June 216  
 Drawer pulls, making.....June 217  
 Driveways, killing grass in.....Mar. 216  
**Fire alarms, making.....Feb. 186**  
 Fireside set.....Jan. 223  
**Firewood holder, making.....Jan. 211**  
 Floor boards, filling gaps in.....Jan. 221  
 Freezer bags seal woolens.....May 198  
**Freezer fails, what to do if Feb. 185**  
 Fruit basket, making.....Mar. 215  
 Gauge glass, protecting.....Mar. 216  
**Hair, how to cut.....May 196**  
 Hamper for child's clothes.....Jan. 220  
 Hanger for fur pieces.....Apr. 211  
**Hardware, cleaning.....Apr. 209**  
 Hot plate, making.....Mar. 214  
**Hut, all-purpose.....June 177**  
 Ironing board, portable.....Apr. 181

#### Keeping the Home

Shipshape.....Jan. 220, Feb. 212,  
 Mar. 216, Apr. 210, May 198,  
 June 216

Kitchen clip board.....Feb. 213  
 Knife, blunting.....Jan. 220  
 Laundry catcher, making.....Jan. 223  
**Lawn edger, motorized.....Apr. 231**  
 Magazine rack, making.....Mar. 214  
 Magazine rack on door.....Feb. 210  
**Metalware, buffing.....Mar. 228**  
**Mixer retracts into**  
**cabinet.....Jan. 212**  
 Mixer spatter shield.....Jan. 220  
 Night light, making.....Feb. 210  
**Oil burner, checking.....Jan. 182**  
 Oil on screen foils gnats.....May 199  
 Overshoes, storage box for.....Feb. 212  
 Paint around doorknob.....Feb. 213  
**Picnic equipment.....May 213**  
 Picture windows, protecting.....Apr. 210  
 Pictures, framing.....Jan. 221  
 Pillars, old, uses for.....Mar. 217  
**Plastic bottles, uses for.....June 225**  
**Plastic pipe, using.....June 208**  
**Plywood, finishing.....Apr. 212**  
**Plywood, paneling with.....Feb. 204**  
**Plywood tiles, using.....Jan. 236**  
 Pot holders, making.....June 216  
 Pull-out shelves, closet.....June 217  
**Radiant-heating bathroom Jan. 177**  
 Radiators, painting.....Mar. 216  
 Rubbers, rack for.....Apr. 210  
 Screen wire, trimming.....May 185  
**Screens, how to make.....Apr. 177**  
 Screens, painting.....Apr. 210  
 Shadow box, making.....Feb. 211  
 Shoelace, knotted, opening.....Apr. 210  
 Snack table, making.....Feb. 211  
 Spring cleanup, hint on.....Mar. 217  
**Spruce up your home.....Mar. 179**  
 Stack furniture for new pieces.....Feb. 213  
**Storage chest hides trunk Mar. 192**  
**Storage space,**  
**how to find.....May 186**  
 Storm windows, treating.....Mar. 217  
 Suspender clips hold mittens.....Feb. 212  
 Table, snack, folding.....Apr. 181  
 Tool pouch.....Feb. 213  
 Trash cans, repairing.....Mar. 223  
 Trellises, hanging.....Apr. 211  
 Trousers, hanger for.....May 199  
 Vacuum-cleaner hose rack.....Apr. 211  
 Valve-stem safety catch.....Mar. 207  
 Wall shelf, building.....Mar. 214  
 Waste cans.....Jan. 221  
**Waste space,**  
**making use of.....May 186**  
 Windowpane, repairing.....Feb. 212  
 Windows, jammed, freeing.....Mar. 182  
 Yard, drainage ditch for.....June 217  
 Hot plate, making.....Mar. 214  
**Humidity, how to handle.....June 220**  
**Hunting with a camera.....June 182**

Hurricane lamps.....Jan. 222  
**Hut, all-purpose, building.....June 177**

#### I, J, K

Icebox, portable, making.....May 175  
 Inclined dock meets river level.....Apr. 240  
 Inner tube, changing.....June 197  
 Insulation, glued, won't fray.....May 215  
 Insulation on wires, stripping.....Mar. 207  
 Ironing board, portable.....Apr. 181  
 Jack, auto, spring holds.....June 197  
 Jig turns inside radius.....Mar. 242

#### Keeping the Home

Shipshape.....Jan. 220, Feb. 212,  
 Mar. 216, Apr. 210, May 198,  
 June 216

Kerosene, lighter burns.....May 205  
 Key chain makes ruler.....Apr. 217  
**Kid's hair, how to cut.....May 196**  
**Kit boats, all about.....Mar. 183**  
 Kneeling pad-tool pouch.....May 198  
 Knife, blunting.....Jan. 220

#### L

Lamps, hurricane, making.....Jan. 222

#### LATHE

Boring-bit holder, small.....Apr. 238  
 Carriage stop, indicator.....Feb. 229  
 Deep bores, making.....Apr. 238  
 Foot-lever control.....May 223  
 Jig turns inside radius.....Mar. 242  
 Lathe cuts keyways.....Jan. 230  
 Mandrel set.....June 232  
**Overhead motor drives**  
**milling spindle.....Feb. 227**  
 Plastic reflects pattern image.....Feb. 223  
**Routing jig, making.....Feb. 230**  
 Spindle chuck holds mills.....May 223  
 Spindles, cleaning.....Mar. 242  
 Tailstock accessories.....Mar. 242  
 Tailstock stop.....Apr. 239  
 Tool holder, open-side.....Apr. 238  
 Tool rest for wood turning.....Feb. 228  
 Laundry catcher.....Jan. 223  
**Lawn edger, motorized.....Apr. 231**  
 Level adjusted to slope.....May 199  
 Light steers model boat.....Jan. 219  
 Luggage shelf in car trunk.....Mar. 200

#### M

Magazine rack, making.....Mar. 214  
 Magazine rack on door.....Feb. 210  
 Magnet holds removed tacks.....Mar. 207  
**Magnetos, all about.....June 228**  
 Magnetos data card.....June 231  
 Marking pen is shop aid.....Feb. 229  
**Metalware, buffing.....Mar. 228**  
**Mixer retracts into cabinet.....Jan. 212**  
 Mixer spatter shield.....Jan. 220  
**Model-Garage hints.....Jan. 197,**  
**Feb. 199, Mar. 199, Apr. 197,**  
**May 181, June 197**

#### MODEL MAKING

Generator.....Jan. 219  
**Marine engine.....Jan. 214**  
**Model-airplane engines,**  
**running.....Apr. 218**  
**Model planes, radio locator**  
**for.....Mar. 237**  
**Model railroaders,**  
**hints for.....Jan. 241**  
**Motor cruiser from tin**  
**cans.....Mar. 218**  
**Model T Ford, restoring.....Feb. 190;**  
**overhauling engine.....Mar. 201;**  
**restoring body.....Apr. 199**  
**Mooring your boat.....June 212**  
 Mower knives, outworn, uses for.....Mar. 208  
**Muffler, checking.....Jan. 186**

#### N, O

**New Shop Ideas.....Jan. 230, Feb. 228,**  
**Mar. 242, Apr. 238, May 222,**  
**June 232**  
 Newspaper baler.....Jan. 182  
 Night light, making.....Feb. 210  
 Nuts, tapping.....Jan. 231  
**Oil burner, checking.....Jan. 182**



Oil-can spout improved.....May 212  
 Oil cans from capsules.....May 185  
 Oil cup, spout opens.....May 212  
 Outboard, splash rails for.....June 215  
 Overshoes, storage box for.....Feb. 212

**P**

**PAINT AND PAINTING**

Brush, cleaning.....Feb. 212  
 Brush, trimming.....Jan. 183  
 Brush scours scaly paint.....May 199  
 Clip holds wiping paper.....Feb. 240  
 Clothes hanger holds can.....May 212  
**Hardware, cleaning.....Apr. 209**  
**Plywood, nine finishes for Apr. 212**  
**Pump spray, foot-powered Feb. 234**  
 Radiators, painting.....Mar. 216  
 Refrigerator unit sprays paint Apr. 242  
 Roller for trim.....Feb. 237  
**Rubber-base paint, using Apr. 234**  
 Screens, window, painting.....Apr. 210  
 Settle dust before job.....June 217  
 Varnish, old, scraping.....Feb. 237  
 Wallpaper, protecting.....Mar. 216  
 Wire fence, painting.....Apr. 232  
 Parts, small, rack for.....Mar. 187  
**Pet carrier, making.....Apr. 224**  
**Phonograph, record caddy holds June 180**

**PHOTOGRAPHY**

**Camera, how to hold.....Apr. 223**  
 Camera strap, replacing.....May 226  
 Developing tank.....Mar. 241  
 Developing tank, using.....Apr. 222  
 Equipment shelf.....Apr. 222  
 Film drier, making.....June 224  
 Film hangers, rack for.....Mar. 241  
 Fluorescent-lamp enlarger.....Apr. 222  
**Flying saucers, photographing.....Jan. 227**  
 Focusing hood.....Mar. 241  
 Freezer bag holds camera.....May 185  
**How not to take pictures.....Feb. 224**  
**How to photograph your car.....May 202**  
**Hunting with a camera.....June 182**  
 Print tongs, padded.....Mar. 241  
 Roller wipes away water.....Mar. 241  
**Picnic equipment, hints on.....May 213**  
 Picture frames, gluing.....June 180  
 Picture windows, protecting.....Apr. 210  
 Pictures, framing.....Jan. 221  
 Pipe, carrying under car.....Feb. 235  
**Pipe, plastic, using.....June 208**  
 Pipe cabinet.....Jan. 222  
 Pipe elbows, separating.....Feb. 233  
 Piston groove, measuring.....Jan. 230  
**Planes, hand, all about.....Apr. 188**  
 Plasterboard, patching.....May 212  
**Plastic bottles, uses for.....June 225**  
**Plastic ducts extend air conditioner.....May 191**  
**Plastic pipe, using.....June 208**  
**Plastic veneer, using.....Feb. 240**  
 Pliers, clamp locks.....May 223  
 Pliers from scissors.....Mar. 268  
 Plow improved.....May 216  
**Plywood, finishing.....Apr. 212**  
**Plywood, paneling with.....Feb. 204**  
 Plywood paneling, types of.....Feb. 208  
**Plywood tiles, using.....Jan. 236**  
**Pool for \$300.....May 161, June 200**  
 Porch, convertible, doors make.....May 216  
 Porch pillars, old, uses for.....Mar. 217  
 Post holes, digging.....Mar. 216  
**Power concrete mixer.....May 206**  
 Print tongs, photo, padding.....Mar. 241  
**PSM back copies, file for.....June 226**  
 PSM scooter, three versions of.....Feb. 226  
 Pump, tire, improving.....Feb. 200  
 Pump oiler, improving.....Apr. 198  
 Punch bound to compass.....Mar. 187  
 Punching-bag platform.....Jan. 221  
 Push stick for saw.....Mar. 268

**R**

**Rabbeting on circular saw.....Jan. 232**  
 Rack for parts, sliding.....May 212  
 Rack for parts, swinging.....Mar. 187  
**Radiant heating for bathroom.....Jan. 177**

Radiators, painting.....Mar. 216  
**Radio, back-seat speaker for.....Apr. 193**  
 Radio coil forms, plastic.....Jan. 210  
 Radio-desk set.....Jan. 219  
 Radio in flashlight case.....Jan. 219  
**Radio locator for lost model planes.....Mar. 237**  
**Record caddy holds phonograph.....June 180**  
**Recorder, tape, building.....May 232**  
 Recorder saves radio shows.....May 214  
 Ring compressor from clamp.....June 193  
 Router jig makes circular cuts.....Feb. 209  
**Routing jig for lathe.....Feb. 230**  
**Rubber bands, uses for.....Mar. 298**  
**Rubber-base paint, using.....Apr. 234**  
 Ruling special scales.....May 222

**S**

**SAWS AND SAWING**

Bandsaw, tailstock supports.....May 212  
**Chain saw, how to use.....Mar. 224**  
 Chain-saw safety rules.....Mar. 226  
**Circular-saw blades, choosing.....June 234**  
 Circular-saw blades data card June 237  
 Push stick, making.....Mar. 268  
**Rabbeting on circular saw Jan. 232**  
 Smoked teeth file faster.....Apr. 232  
 Scales, testing.....May 198  
 Scooter loaded with gadgets.....May 226  
 Screen, treating for gnats.....May 199  
 Screen helps patch plasterboard May 212  
 Screen door, child can open.....May 198  
 Screen wire, trimming.....May 185  
**Screens, how to build.....Apr. 177**  
 Screens, window, painting.....Apr. 210  
 Scribing, polish as layout fluid.....May 223  
 Sealer insulates connections.....May 212  
 Seesaw from scrap pipe.....June 215  
**Senses may tell you fibs.....Feb. 220**  
 Sewing machines, furniture from June 216  
 Shadow box, making.....Feb. 211  
 Shaper table, checking.....Jan. 230  
**Sharpening cutting tools.....May 218**  
 Sheet-metal braking machine.....Apr. 242  
 Shelf, wall, building.....Mar. 214  
 Ski, curving.....Jan. 224  
**Skis, water, how to make.....May 192**  
 Small parts, shelves for.....Mar. 243  
 Small-parts rack.....May 212  
 Small-tools rack.....Feb. 239  
 Snack table, folding.....Apr. 181  
 Snack table, making.....Feb. 211  
 Socket chucks nuts.....Jan. 231  
 Soldering heat, clamps absorb.....Apr. 217  
 Soldering-iron handle, cooling.....Jan. 224  
**Soldering know-how.....Jan. 240**  
 Spindle chuck holds mills.....May 223  
 Spindles, brush cleans.....Mar. 242  
 Stapler, refilling hint.....Apr. 181  
 Static charges, how to kill.....Feb. 214  
 Steam engine built from memory.....Feb. 226  
 Steam engine from PSM plans.....Feb. 226  
**Steamboat, homemade.....June 238**  
**Storage space, how to find.....May 186**  
 Storm windows, treating.....Mar. 217

**SUMMER SUGGESTIONS**

**Air conditioner, plastic ducts extend.....May 191**  
 Back-yard barbecue grills.....June 223  
**Garden furniture, making.....June 216**  
**Handling the humidity.....June 220**  
**Icebox, portable, making.....May 175**  
**Picnic equipment.....May 213**  
 Screen, treating for gnats.....May 199  
**Screens, how to make.....Apr. 177**  
 Skiing, water, tips on.....May 195  
**Skis, water, how to make.....May 192**  
**Spruce up your home.....Mar. 179**  
 Sunglasses, clip holds.....June 198  
**Sun roof shades terrace.....June 218**  
 Swimming pool, glass-fiber.....June 204  
**Swimming pool for \$300.....May 161, June 200**

**T**

Tacker is heavy-duty stapler.....Feb. 240  
 Tacks, pulling.....Mar. 207

Tape, four uses for.....Mar. 187  
 Tape dispenser, anchoring.....June 216  
**Tape recorder, portable.....Mar. 232**

**TELEVISION**

Antenna tuned by switch.....May 215  
 Bumper guards door of set.....June 205  
 Crank rotates antenna.....May 214  
 Guy-wire hum, ties stop.....May 214  
 Insulation, glued, won't fray.....May 215  
**Picture tube, how to wash Feb. 238**  
 Rod discharges condensers.....May 215  
 Service notes kept in set.....May 215  
 TV stool, making.....Mar. 215  
**TV tips.....May 214**  
 Window antenna, movable.....May 215  
 Television mast as flyrod case.....May 216  
**Terrace, sun roof shades.....June 218**  
 Thread diameters, measuring.....June 233  
 Threading flagpole pulley.....June 205  
**Timing light, what it can tell.....Mar. 193**  
 Timing marks on U. S. cars.....Mar. 194  
**Tire pump sprays paint.....Feb. 234**  
 Tires, winter, storing.....Apr. 198

**TOOLS**

**Brace, sawed-off.....May 217**  
 Broken handles, removing.....June 217  
**Cutting tools, sharpening.....May 218**  
 Inside burrs, removing.....Jan. 230  
**Planes, all about.....Apr. 188**  
 Rack for small tools.....Feb. 239  
 Ruling special scales.....May 222  
 Shaper table, how to check.....Jan. 230  
 Threads, brush cleans.....May 222  
 Tool holder from coat hooks.....June 224  
 Tool pouch.....Feb. 213  
 Tool rack.....Jan. 220  
 Tools from drill-rod scraps.....Mar. 243  
 Torch, tank, wood base for.....Feb. 237  
**Tornadoes, all about.....Apr. 184**  
**Touring on a budget.....May 173**

**TOYS**

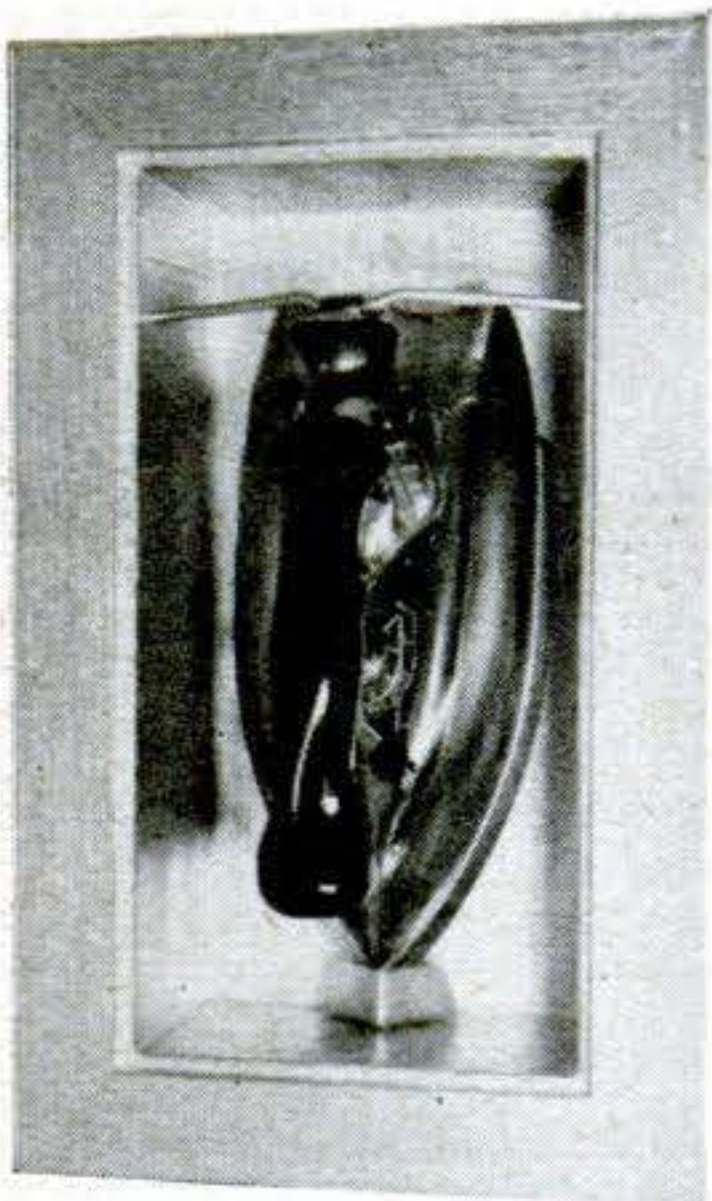
Gate-go-round.....May 185  
 Seesaws from scrap pipe.....June 215  
 Toy bin.....Jan. 220  
 Tractor exhaust piped away.....May 226  
**Treasure chest, making.....Feb. 216**  
 Trellises, hanging.....Apr. 211  
 Trunk hidden in cabinet.....Mar. 192  
 Tubing, expanding.....June 233  
 Tubing, holding in vise.....Jan. 231  
 Tubing, steel, V block from.....Feb. 228

**V, W, Y**

Vacuum-cleaner hose rack.....Apr. 211  
 Vacuum cleans varnish dust.....Feb. 237  
 Valve-stem safety catch.....Mar. 207  
**Valves, noisy, how to cure.....June 190**  
 V block from steel tubing.....Feb. 228  
**Veneer, plastic, using.....Feb. 240**  
 Vise, holding tubing in.....Jan. 231  
 Vise jaws for small work.....June 233  
 Walk, sloping, laying.....May 199  
 Wall, radiant-heated, drilling.....June 224  
 Washers make file handles.....Feb. 229  
 Waste cans.....Jan. 221  
**Waste space, making use of May 186**  
**Water skis, how to make.....May 192**  
 Water tricycle.....June 223  
 Well cover from wheel.....June 205  
**Wheel alignment, models explain.....Jan. 190**  
**Why the days grow longer.....Mar. 212**  
 Winch-equipped dolly.....Mar. 268  
 Window-door in car.....June 193  
**Window screens, how to build.....Apr. 177**  
 Window screens, painting.....Apr. 210  
 Windowpane, repairing.....Feb. 212  
 Windows, jammed, freeing.....Mar. 182  
 Windows, picture, protecting.....Apr. 210  
 Windshield sponge.....Jan. 198  
**Wire-brushing wood.....Mar. 206**  
 Wires, stripping insulation off Mar. 207  
**Wizard's boxes you can build.....Mar. 188**  
**Wood, wire-brushing.....Mar. 206**  
 Woodruff keys drive bushings.....June 233  
 Yard, drainage ditch for.....June 217

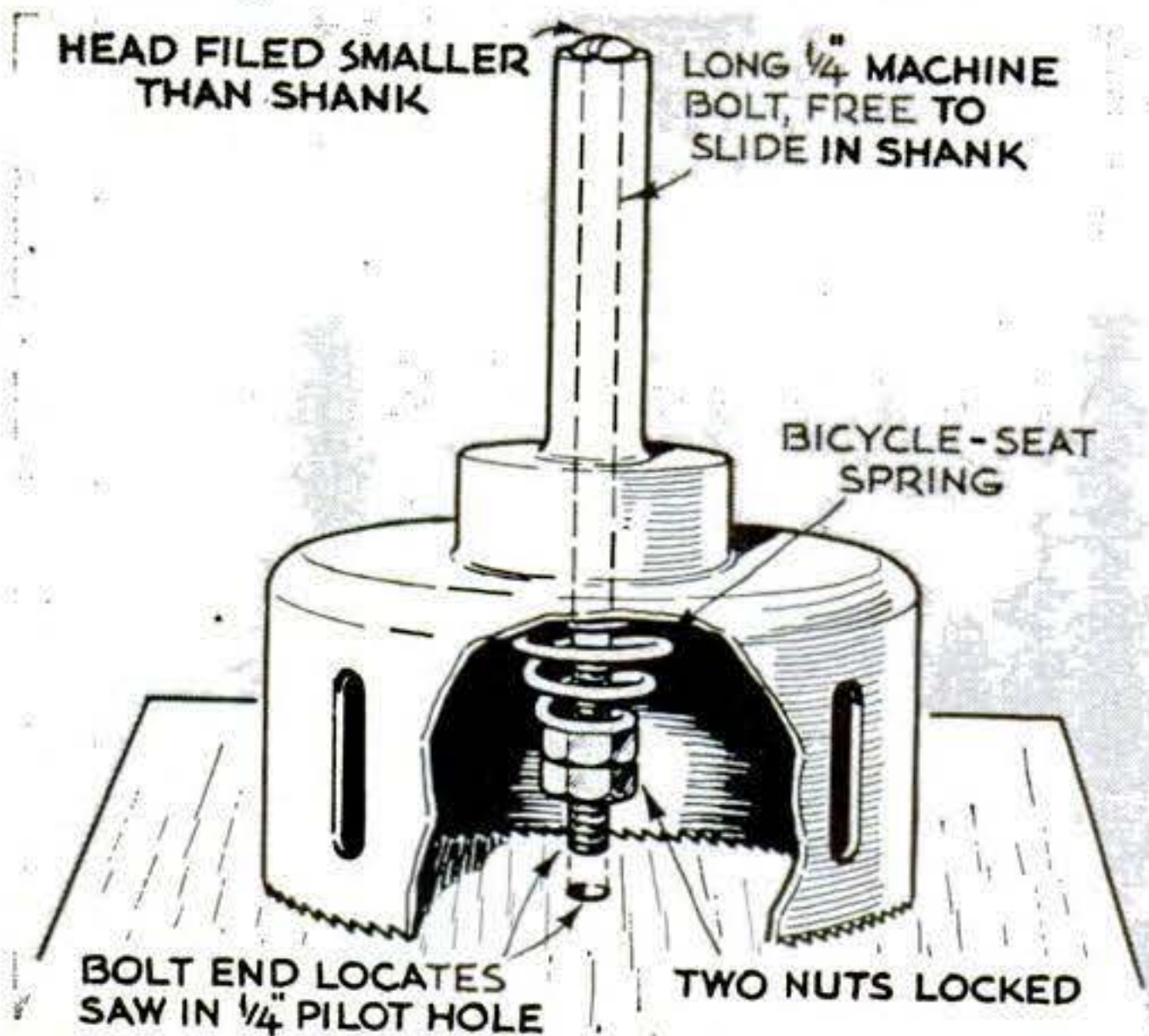


## Cooling Cabinet for Iron



TO PROVIDE a safe place for a hot iron to cool, I built a cabinet near the ironing board. The iron hangs from the rod and is steadied by the sheet-metal angle plate in the bottom of the cabinet. There is an inch of space between the iron and the metal-lined walls.—*Arne O. Salonen, Raymond, Wash.*

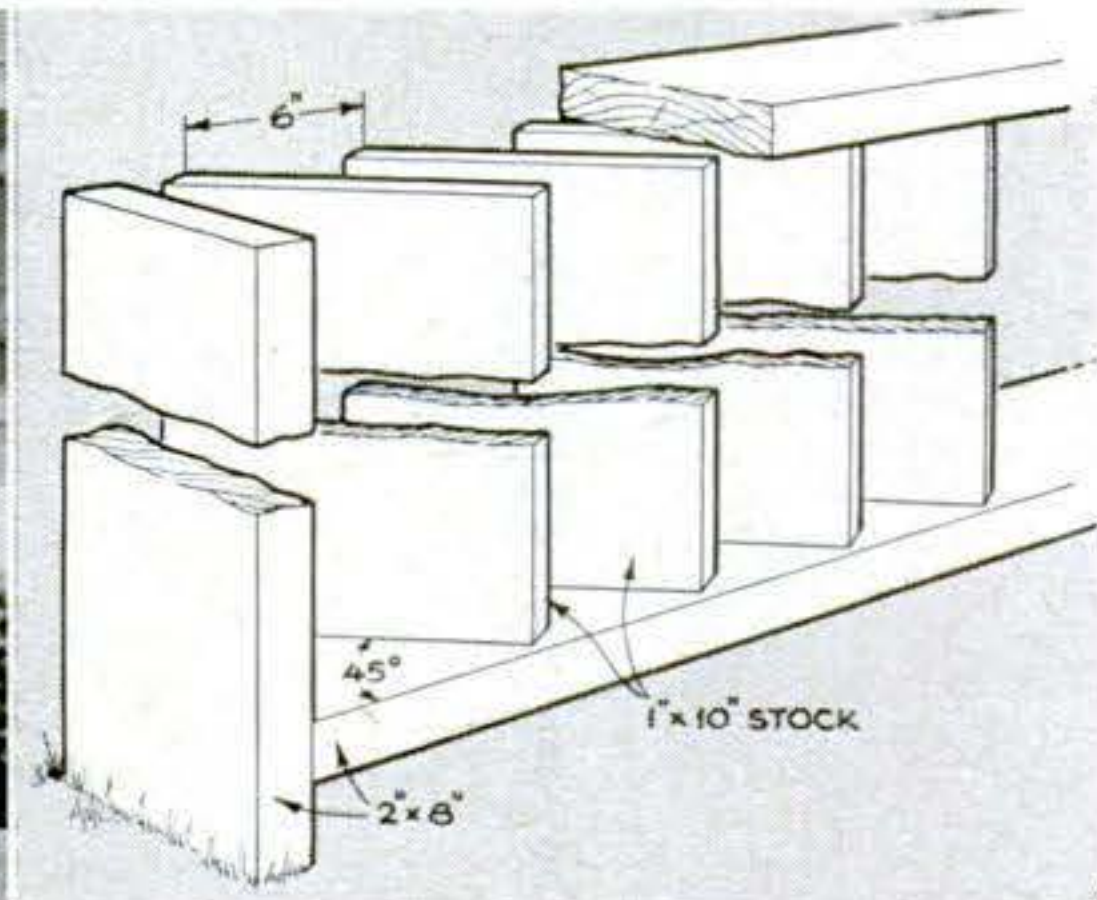
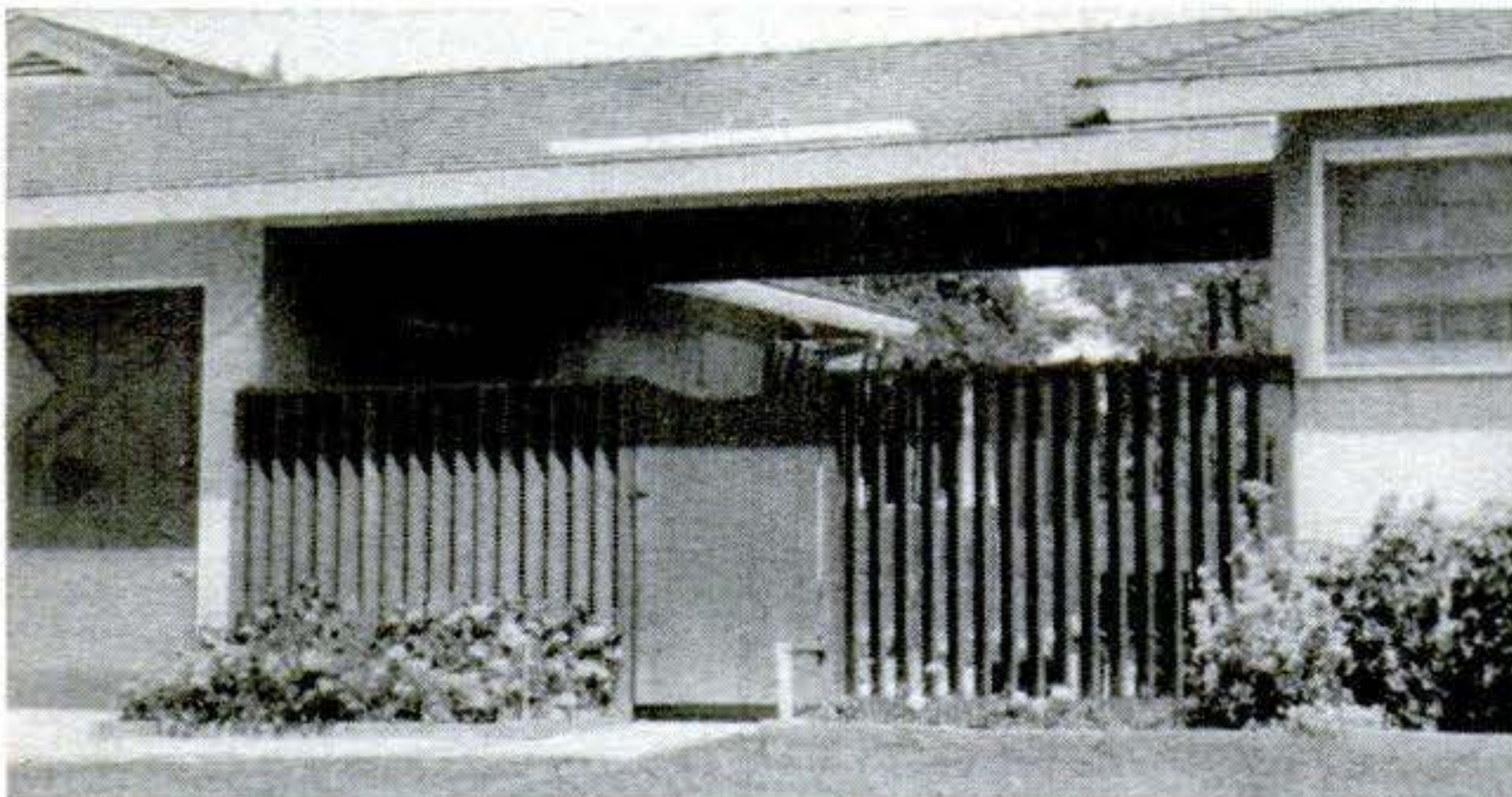
## Disk Ejector for Hole Saw



PRYING the scrap disks out of a hole saw is a bottleneck to any production effort. This spring ejector, mounted in place of the  $\frac{1}{4}$ " pilot drill, will push them out as fast as you can cut them.

The pilot drill is replaced by a long  $\frac{1}{4}$ " machine bolt. Two nuts locked together near the end of the bolt hold a bicycle-seat spring in place in the cutter. Pilot holes,  $\frac{1}{4}$ " in diameter, are drilled in the workpiece, and the end of the bolt is guided into them to locate the saw. As the saw cuts into the wood, the surface presses on the lower nut, forcing the bolt upward against the spring. The shank of the hole saw must not be inserted all the way into the drill chuck as space must be left for the bolt head to rise. When the hole is cut through and the saw is raised, pressure exerted by the spring ejects the disk.—*Ralph K. Golden, Elkhart, Ind.*

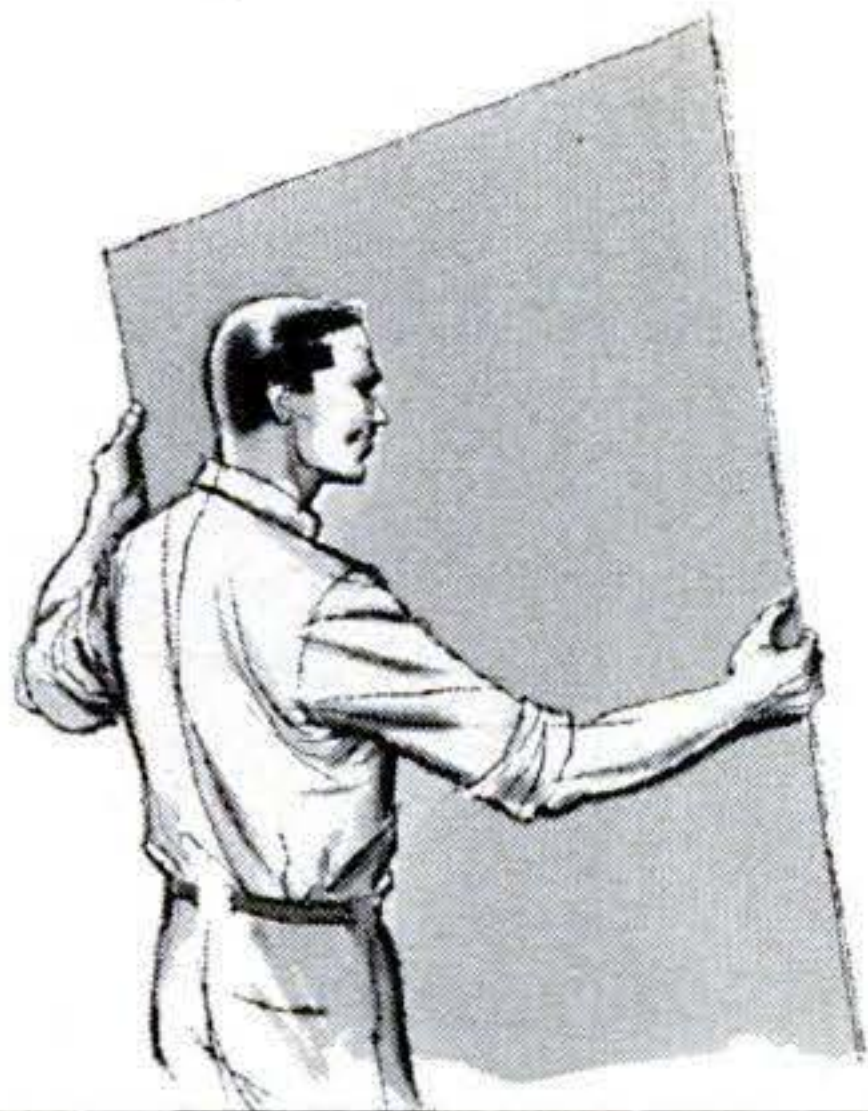
## Louvered Fence Affords Privacy But Lets in Breezes



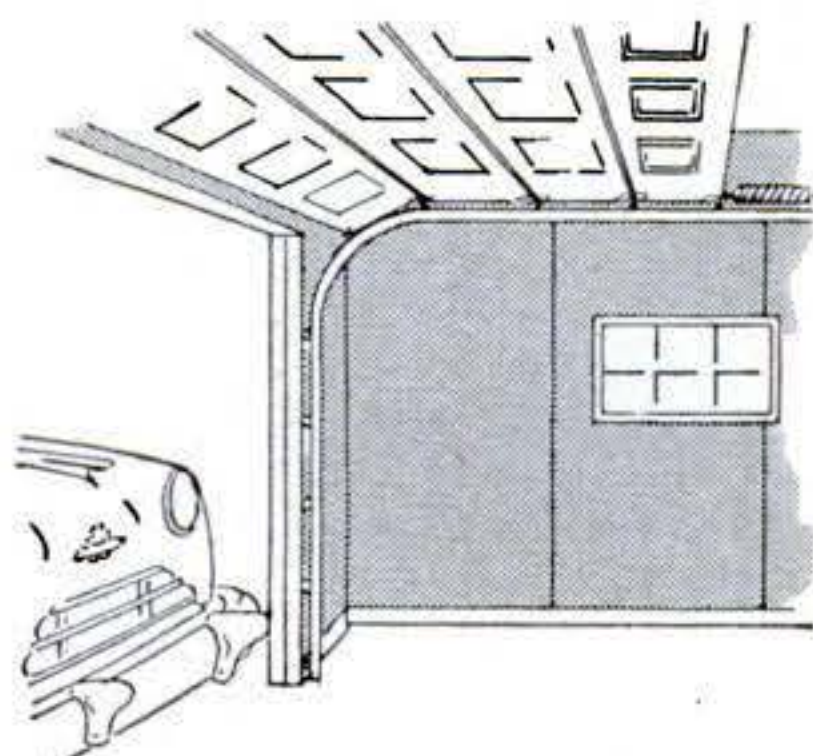
You can have privacy in your yard and still not stop cool breezes. A louvered fence is the answer. The louvers that take the place of pickets are set at  $45^\circ$  to the rails,

letting a passerby see in only at limited angles. Redwood was used for this fence but most anything available will do.—*Hi Sibley, Nuevo, Calif.*

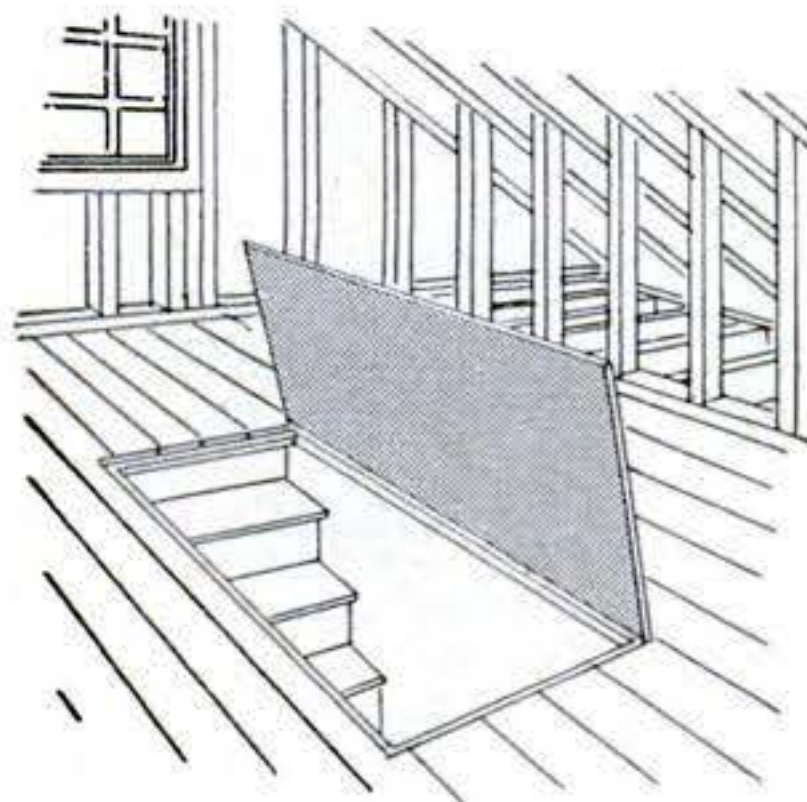




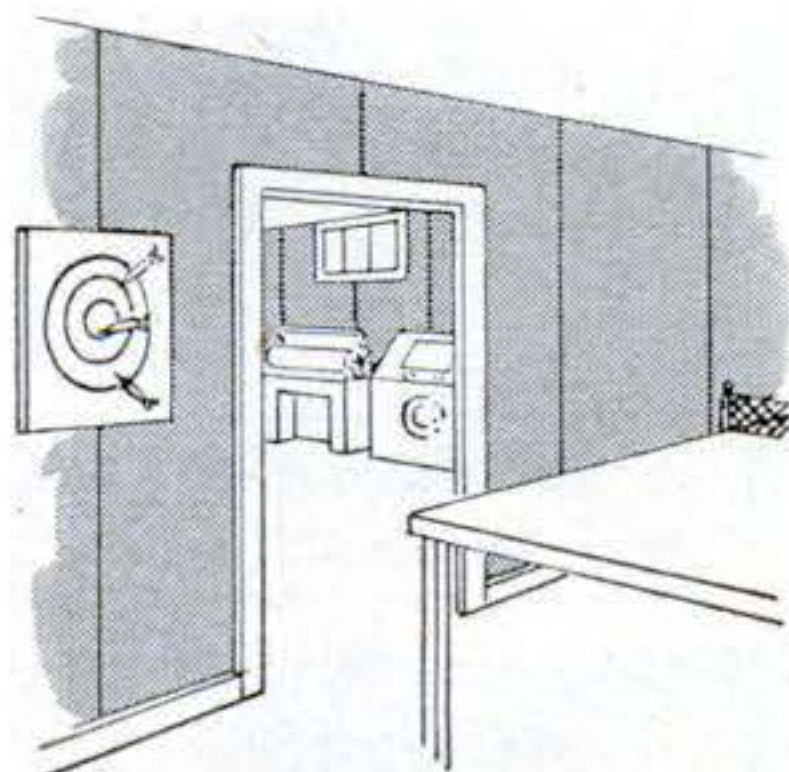
# Jobs you can do with Armstrong's TEMLOK BOARD



Finish garage interior



Insulate attic trap door



Build playroom walls

There are dozens of places in your home where you can use Armstrong's Temlok Insulation Board.

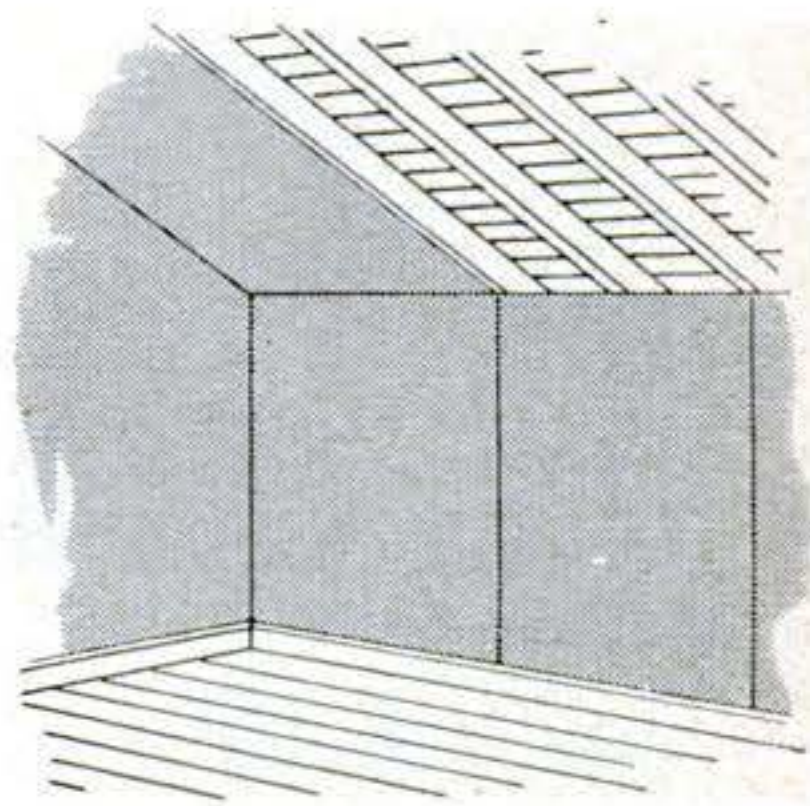
Temlok is the low-cost way to finish walls and ceilings of any extra rooms you may be adding in the attic or basement. It's useful, too, if you're converting an open porch to inside living space. If you're building a summer home and want to keep interior finishing costs down, Temlok Board is your answer.

Temlok is a pre-finished fiberboard material. It builds, decorates, and insulates in one operation. Temlok comes in 4' widths, and lengths up to 12'. Its big size speeds application, minimizes joints.

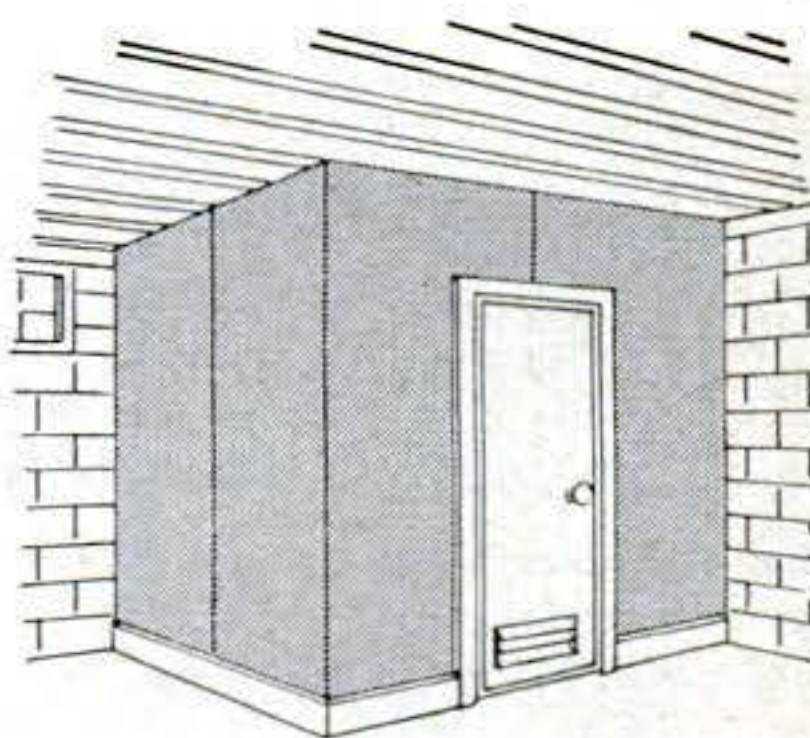
This material is available in two types. Temlok Insulation Board is 1/2" thick, with a two-coat, Light Ivory finish. Temlok Wallboard is lower in cost, comes 3/8" thick with a textured Ivory finish. Both are easy to work and handle.



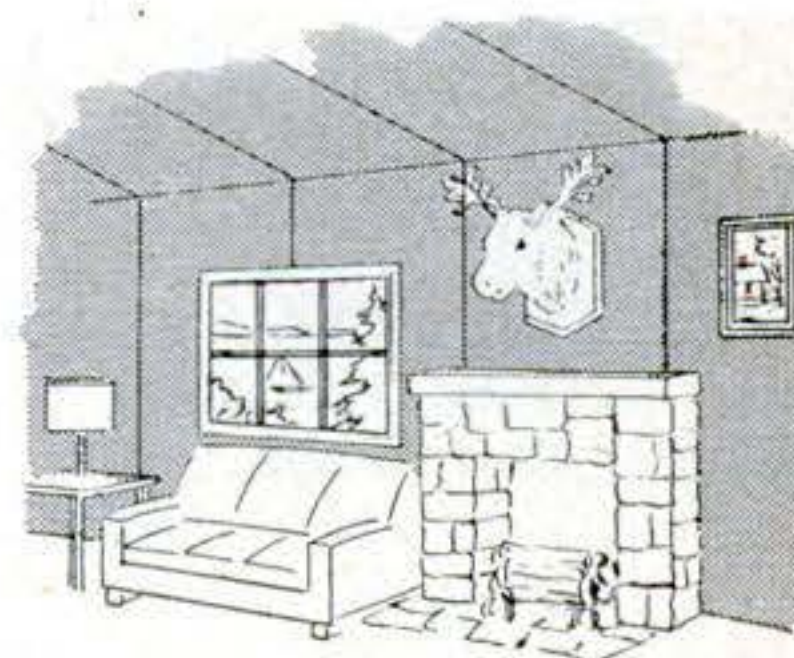
Send for this free booklet, "New Ways to Remodel Your Home." Write Armstrong Cork Company, 3507 Washington Avenue, Lancaster, Pa.



Finish attic walls



Build darkroom



Finish cabin interior

## ARMSTRONG'S BUILDING MATERIALS

Temlok® • M-67 Monowall® • Cushiontone® • Insulating Wool • Hardboards



# See how filters can improve your summer snapshots

Nothing could be simpler! Slip an inexpensive Kodak Wratten Filter over your camera lens for new realism and interest in your outdoor black-and-whites.

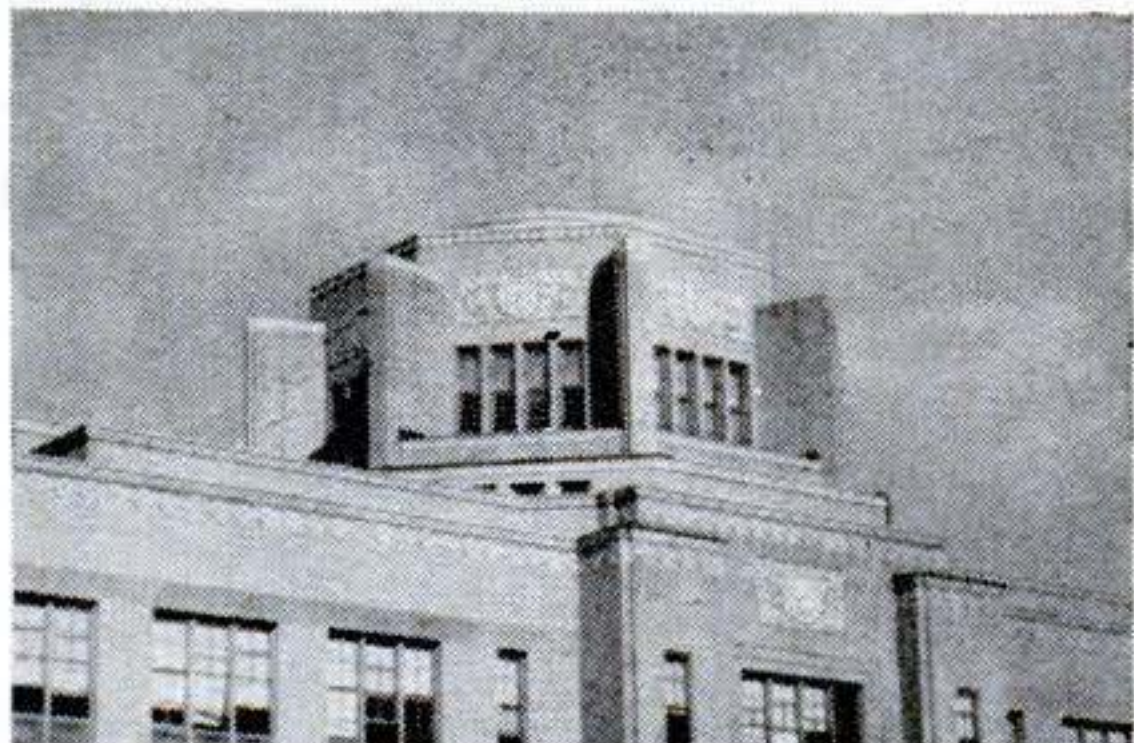
Preview your results in the filter ex-

amples shown below. Get ready now to take your best summer and vacation pictures. Have your Kodak dealer fit the right filters to your camera. Prices? Very reasonable, from \$1.75.

## Without filter



**Normal Photograph**—This snapshot has good composition but little else. The sky is especially flat.



**Normal Photograph**—Again this is a nice album snapshot—everything in order, but without real life.

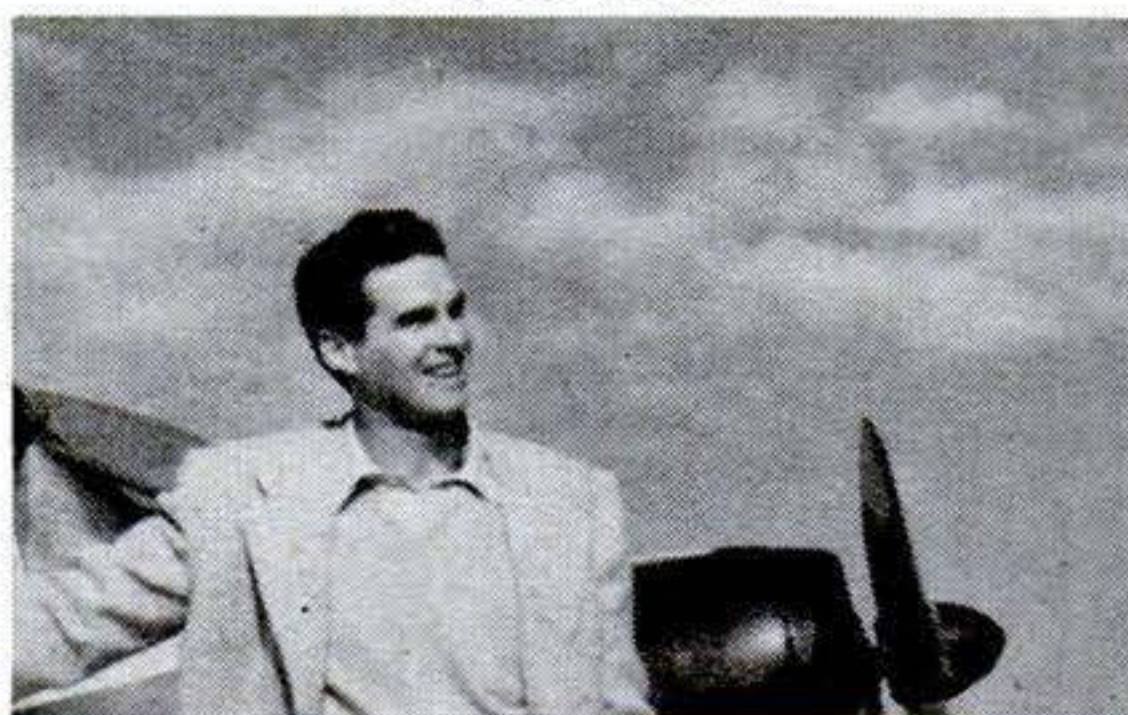


**Normal Photograph**—Here you need a green filter to emphasize foliage and clouds and improve skin tones.



**Normal Photograph**—A "bare" lens has missed the excitement of this potentially dramatic shot.

## With filter



**Taken with Yellow (K2) Filter**—Picture now has life, quality. Skies are darkened, clouds well defined.



**Taken with Yellow (G) Filter**—More powerful. Gives you even more sky emphasis, more drama.



**Taken with Green (XI) Filter**—See the difference? It's simple to do the same for your pan film snapshots.



**Taken with Red (A) Filter**—You get the ultimate in dramatic contrast, with pan and infrared films.

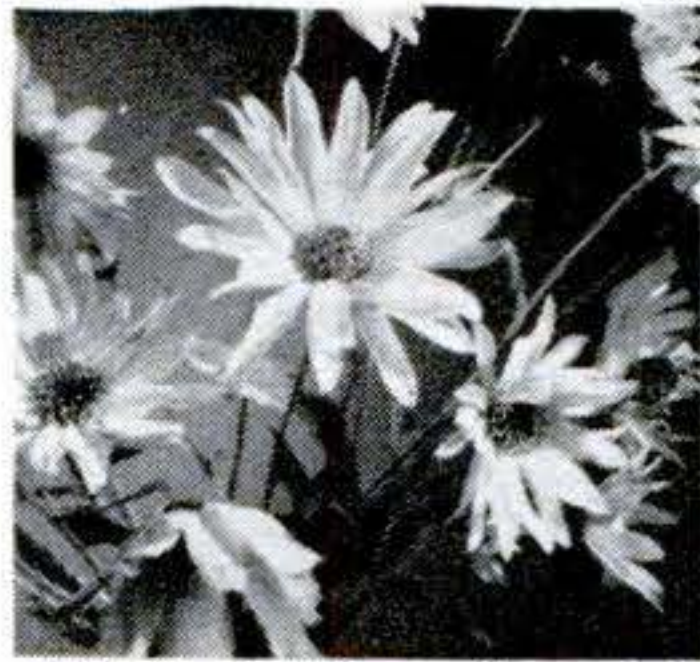




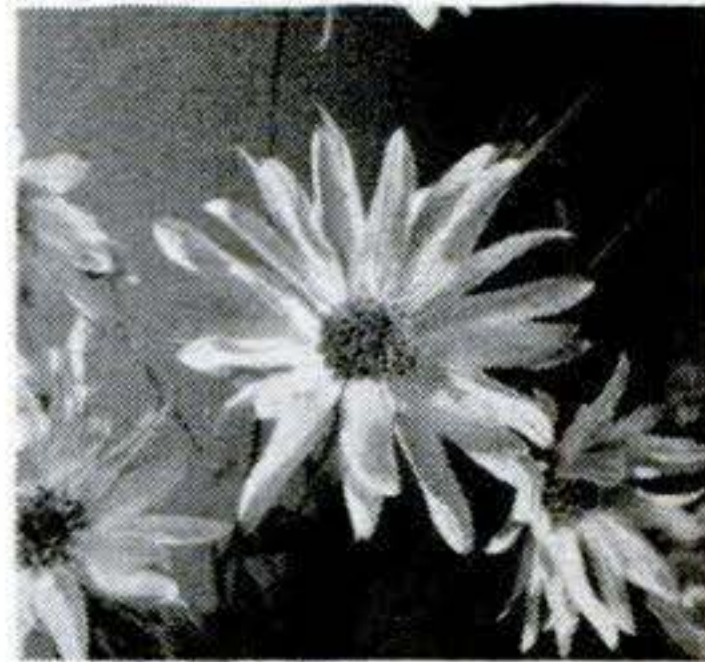
Normal Close-Up



With Kodak Portra Lens 1 +



With Kodak Portra Lens 2 +



With Kodak Portra Lens 3 +

**For extreme close-ups**—Kodak Portra Lenses 1 +, 2 +, and 3 + for both still and movie cameras. Place one in front of your camera lens to step up its power for short-range photography of people, nature studies, and table-top subjects.

Kodak Portra Lenses are graduated in power, as their numbers indicate. To secure even stronger effects, the lenses may be used in combination. The pictures above show how you can "move in" with a Kodak Portra Lens. From \$2.65.

## See the close-ups you can get with other inexpensive lens attachments

**Doubles the scope of your camera**—There's a Kodak Close-Up Attachment for most any Kodak or Brownie camera, or fixed-focus movie camera. It lets you shoot at closer than normal range. You get extra-big, sharp images of people, flowers, and small still-life objects. It's a simple, inexpensive way to enjoy a new experience in picture taking. All sizes \$1.63.



A Kodak Close-Up Attachment slips easily over most any camera lens, gives you pictures like one at right.

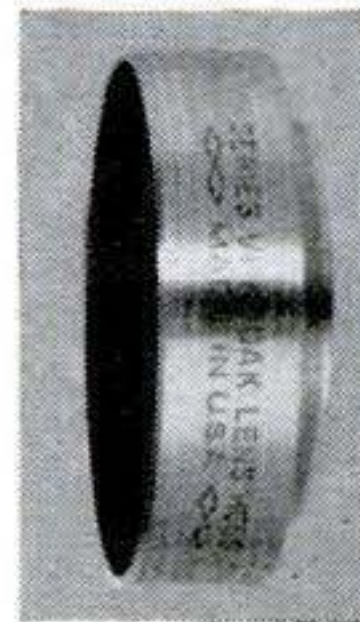
### Use Kodak Filters for color films too

**"Warm up" your color shots with a Kodak Skylight Filter**—With this filter you get warmer-tone color pictures of subjects photographed in open shade and on overcast days. Use it, too, to reduce the bluish cast that often appears in distant mountain and marine scenes. And when you have occasion to take pictures of sunlit snow scenes, you'll find the Skylight Filter highly valuable. Prices from \$1.75.

**Kodak Daylight Filter (No. 85)** for Kodak Type A color films adapts these films for daylight exposures, and permits use of the same exposure settings as with Daylight Type Kodak color films. From \$1.75.

**Kodak Light Balancing Filter 81C** adds warmth to flash pictures taken with Class M Flash lamps (such as No. 5) when using Kodachrome Film, Type A, and reduces the bluishness that sometimes appears. From \$1.75.

**Summertime is snapshot time.** Your Kodak dealer has anything and everything you'll need to make this summer's snapshots the kind you'll be proud to show. Always make him your headquarters for your photo needs.



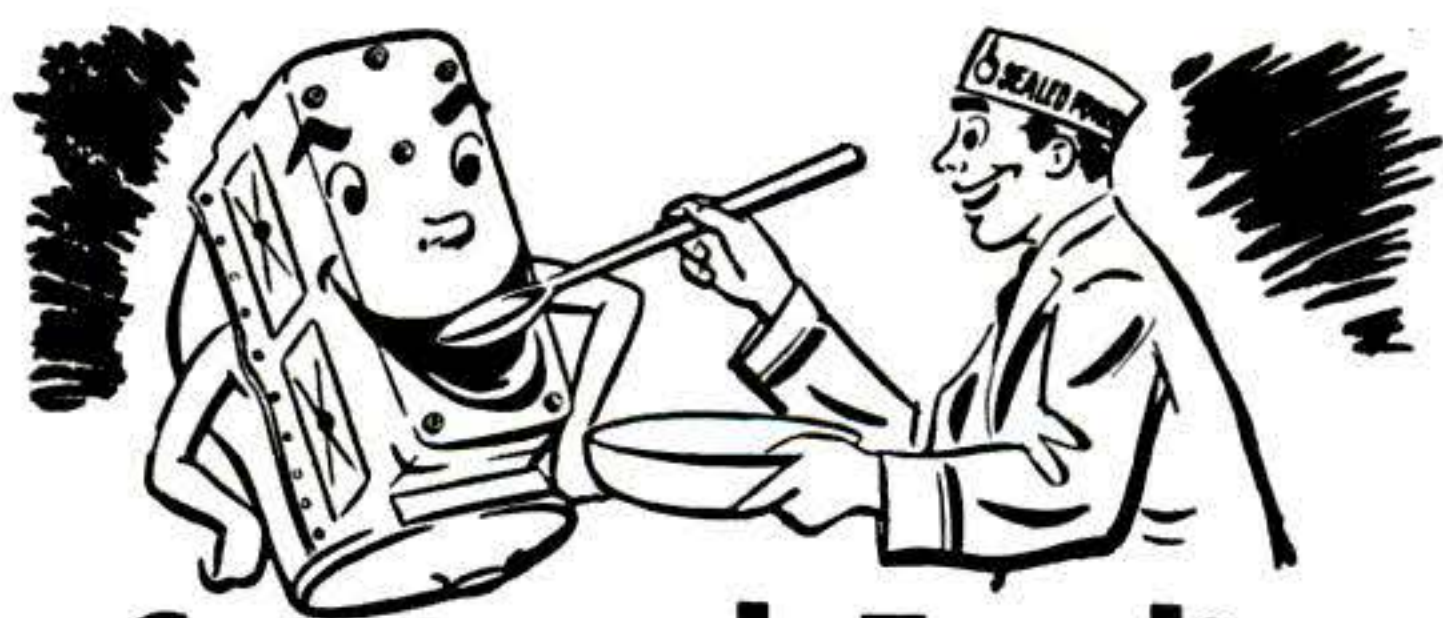
(left) **Handy shade for lens**—The Kodak Lens Hood is recommended when subjects are side-lighted or back-lighted. It tends to centralize the light and eliminate edge-flare in a picture. Can be fitted to most any camera. From \$1.75.

*Prices are subject to change without notice*

**Eastman Kodak Company, Rochester 4, N. Y.**

# Kodak



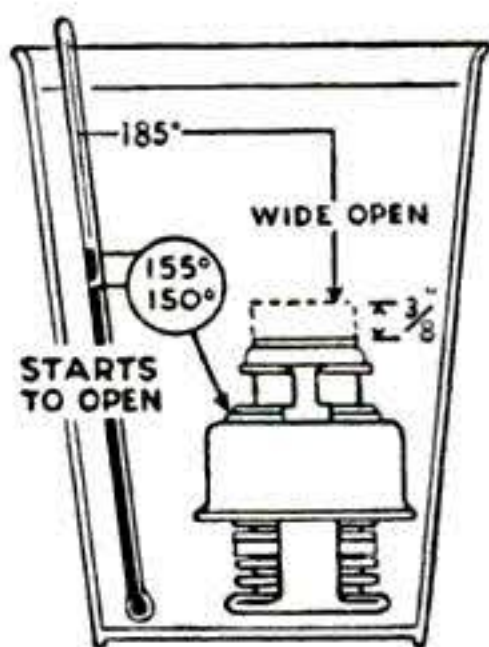


# Care and Feeding of Engines

BY S. P. CORP

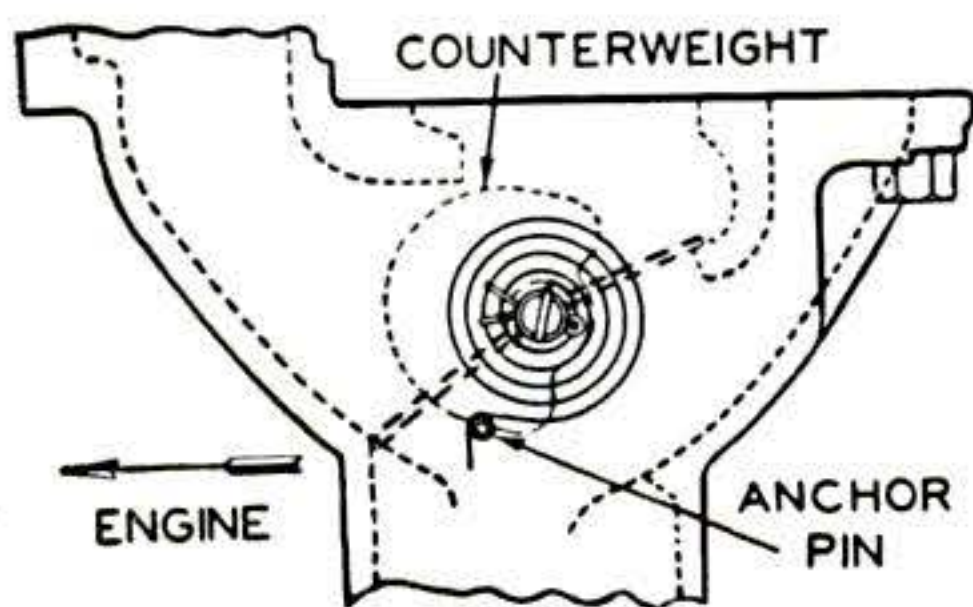
## ENGINES REQUIRE HEAT

If you still have a winter thermostat in your engine, perhaps it should be replaced with a summer thermostat. In hot weather your engine should operate at 160°, but winter thermostats don't start to open until they reach 180°. Suspend your thermostat in a pail of water and heat water gradually until thermostat starts to open. At this point thermometer should read 150° to 155°. Valve should be wide open (5/16 inch off seat) at 180°. Winter thermostats open wide at 200°. This is too hot for summer driving. If yours is not wide open at 180°, replace it for hot weather.



## MANIFOLD HEAT CONTROL VALVE

A spring thermostat in the exhaust manifold controls the valve that controls heat to the intake manifold. Check the operation by moving the counterweight



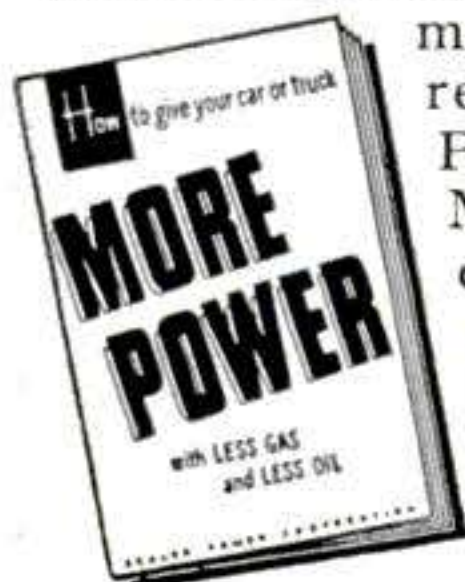
with your hand, or watching counterweight as engine is accelerated. If it remains closed, intake manifold will be overheated, reducing your speed, causing sluggish operation or erratic speeds with a steady throttle. To correct this, use penetrating oil around the shaft, then work shaft until free.

## WATER DISTRIBUTING TUBE

If your car is two years old and has a water distributing tube, remove water pump and inspect tube. If it is plugged or rusted away, overheating may be caused.

## FREE BOOKLET ON CAR CARE

"More Power, Less Gas, Less Oil," is an illustrated manual on care of your car—free on request. It tells all about Sealed Power KromeX Ring Sets and the MD-50 Steel Oil Ring, best for oil control even in badly tapered and out-of-round bores. It can save you a lot of money. Just address a postal card to Sealed Power Corp., Dept. H-7, Muskegon, Mich.



## He Builds America's Finest Wagons

[Continued from page 89]

But the finished result was sad to see. "I had been brought up on a wheat ranch in the wide-open spaces of Oregon," Collins recalls, "but I never had seen or heard of a covered wagon like the one which came from that kit. It was not even approximately accurate. All at once I realized what a gap this was in our knowledge of American transportation. There were fine models of trains and cars galore, yet none of wagons—and wagons had served our people for nearly 250 years before the first steam railroads."

## Catalogue Gives Real Low-Down

Collins at last found a hardware store which had a dog-eared catalogue of wagons in the basement. He got it for the asking and put together his first model from its specifications.

It was a ranch wagon. Collins' tools were a pocket knife, egg-beater drill, hacksaw, screwdriver and pair of pliers. The task challenged him, and the effort made him forget his anxieties.

A genuine covered wagon was Collins' next project. He had to get a prairie schooner out of his system, to erase the bad taste left over from that disappointing kit. This time Collins had a real-life model—a canvas-covered wagon near a Los Angeles movie set.

## Schooner Built with Precision

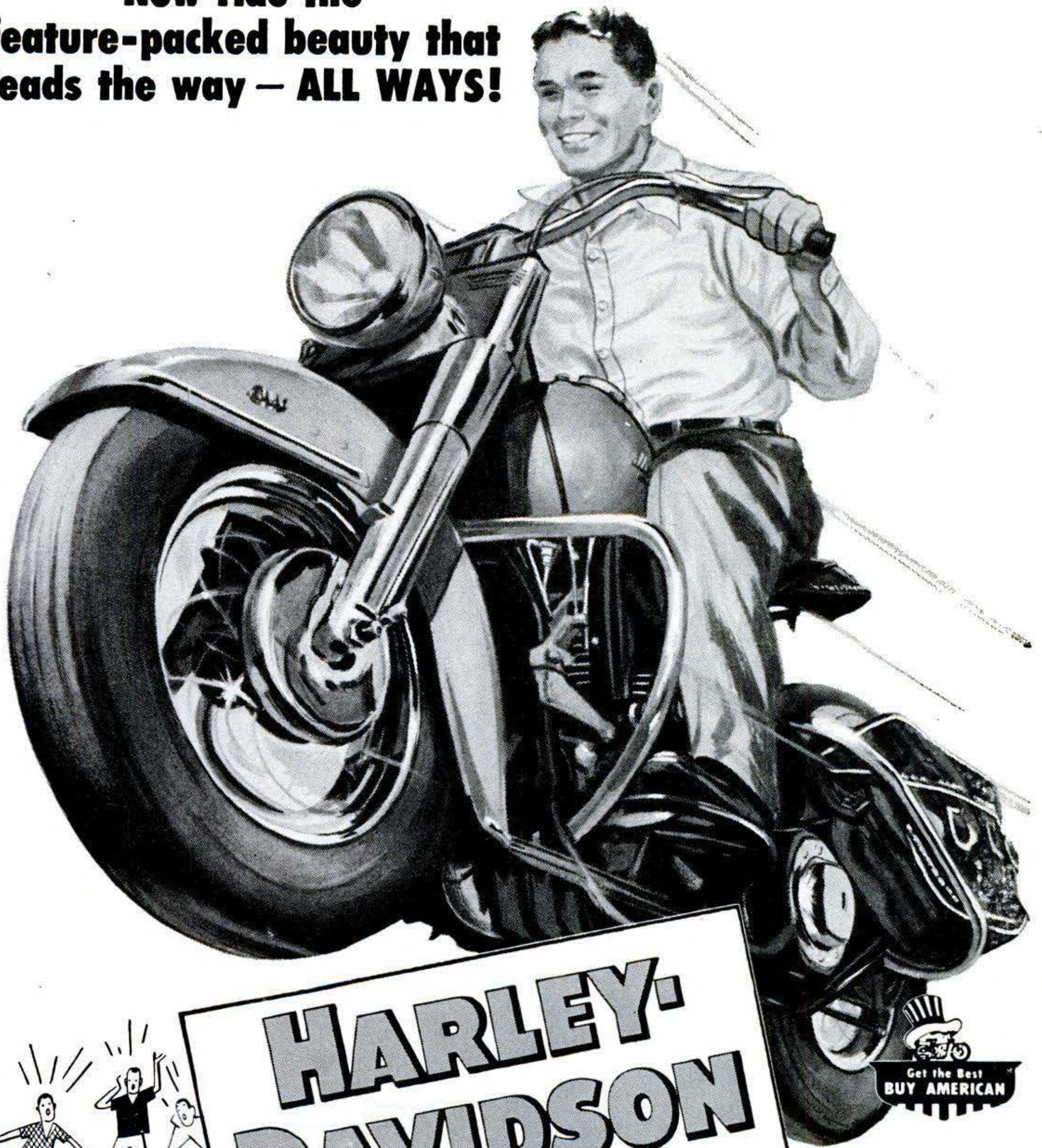
Collins' persistence for detail began with this wagon. It would be as accurate as the kit had been inaccurate. He read voluminously about horns and lanterns. All were built precisely to scale. The barrels contained water from the Snake River, which thousands of frontier families had forded at great peril.

Of course, the powder horns were full of actual gunpowder. Could Ivan Collins leave his imaginary pioneers to face Indian hostiles, with only perfumed talcum to pour into the pygmy muzzle-loaders on which their legendary lives depended?

[Continued on page 200]



**Now ride the  
feature-packed beauty that  
leads the way — ALL WAYS!**



# HARLEY- DAVIDSON

**HYDRA-GLIDE®**



**I**T'S a powerhouse on wheels . . . a beauty to look at, to handle, to own. It's built to rule the highways, with a 55 HP, 74 OHV engine . . . to take the byways in stride, with shock-absorbing action that smooths out the rough spots as no other motorcycle can. It's the Harley-Davidson Hydra-Glide, *the only*

*motorcycle in its class!* Go see this great performer at your dealer's today. Bring along a buddy. For literature and a copy of the ENTHUSIAST Magazine, filled with exciting action pictures and stories, send 10 cents to HARLEY-DAVIDSON MOTOR COMPANY, Department PS, Milwaukee 1, Wisconsin.



Saves hours polishing the car, waxing furniture, polishing floors.



Packs real power for tough disc sanding — removing paint, refinishing woodwork.

**Easy Does It**

with **Millers Falls remarkable No. 966**



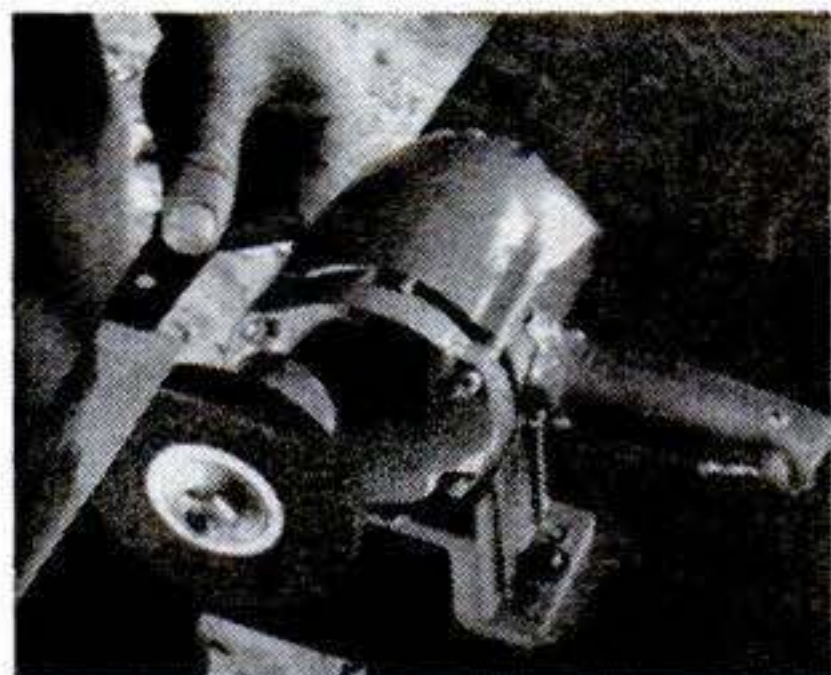
**\$37<sup>50</sup>**

complete with 6" rubber pad — 6" lamb's wool bonnet — and three 6" sanding discs.



Finishes flat surfaces to "piano" smoothness with No. 980 Orbital Attachment.

Grinds, buffs, wire brushes. A powerful bench unit in the No. 9668 Stand.



**AND THAT'S ONLY THE BEGINNING!** Millers Falls No. 966 Sander-Polisher also drills, mixes paints and does countless other jobs. It's rugged . . . powerful . . . the greatest time-saver a man can own.

WRITE FOR FREE FOLDER

**MILLERS FALLS COMPANY**

Greenfield, Mass.



*The Mark of Superiority*

## He Builds America's Finest Wagons

[Continued from page 198]

The model wagons were incredibly expensive for a working man to produce. Collins ran through his savings, buying materials. Journeys to far-off wagon Valhallas took all of his vacation time. He sought out former employees of the Brewster Company, which had occupied the Cadillac and Lincoln realm of an earlier day, when it manufactured pompous Victorias and ceremonial hearses.

### Sets Up a Wheelwright Shop

He fitted a tiny wheelwright's shop with a tire bender for shaping the steel rims and with a tenoning bench for mortising in the delicate spokes. Like a brawny village smithy, Collins heated the metal rims and then shrunk them on the wheels as the steel cooled.

Collins made only one minor concession to necessity. The wheels that carried early Americans over field and stream were fashioned of sturdy hardwood, principally oak and hickory and ash. But these solid fibers proved too coarse-grained for miniature work.

At length Collins surrendered and turned to mountain maple, which was softer and more pliable. Equally important, it was close-grained and comparatively easy to shape.

In tracking down details about the horse-pulled vehicles in America's past, the wagon-building project of Ivan L. Collins has had something of the element of the chase.

### London Cabby Helps Him

In California Collins heard about George Stone, a former London cabby who made his stake in retail business and then sent to Piccadilly Circus for his old hansom as a sentimental gesture. Collins latched onto Stone like a Canadian Mountie seizing his quarry.

The hansom cab in Collins' collection was constructed while using Stone's one-time perambulating place of employment as a model. It is the sole vehicle among the 46 which never was widely

[Continued on page 202]





# Kelvinator's "Dampness Doctor" MAKES DAMP BASEMENTS DRY AND HEALTHY!

• Does your basement serve as another "living" room—dry, pleasant, free from musty odors? Does your laundry dry quickly? You can have

a dry, comfortable basement, with a Kelvinator Air Drier. Just plug it in, and say goodbye to dripping pipes . . . rust . . . mold . . . mildew . . . warped woodwork! The Kelvinator Air Drier will take the excess moisture from the air—makes your basement a room you'll enjoy!



**Makes basements as dry as any other room in your home!**

*Mail Today*

No chemicals—no muss. Simply plug the Kelvinator Air Drier into any AC outlet, and your basement will soon be dry and comfortable. Removes up to 3 gallons of water every 24 hours. Smart styling for home, office or store—and costs just a few pennies to operate! See your Kelvinator dealer for a Free Demonstration, or mail coupon TODAY!

## **Kelvinator AIR DRIER** ELECTRIC DEHUMIDIFIER

**KELVINATOR AIR DRIERS**  
152 Lucas St., Columbus 8, Ohio

Send free literature on the Kelvinator Air Drier

NAME \_\_\_\_\_

ADDRESS \_\_\_\_\_

CITY \_\_\_\_\_ STATE \_\_\_\_\_

# How a New GRAPHIC Can Pay For Itself!

**Big Opportunities for Extra Money!**

Owning a Graphic marks you as a man who is out of the "snapshot class" . . . a man who knows the secrets of making great pictures. With it you can earn enough in your spare time to pay for the camera itself. In fact, a Graphic opens wide the door of opportunity in the profitable photography profession.

That's because it's a professional, precision camera built to take clear, sharp, professional quality pictures. No matter in what exciting branch of photography you're shooting—news, fashion, advertising, portrait, industrial—you'll find your Graphic gets the pictures that get the money.



**WEDDINGS**



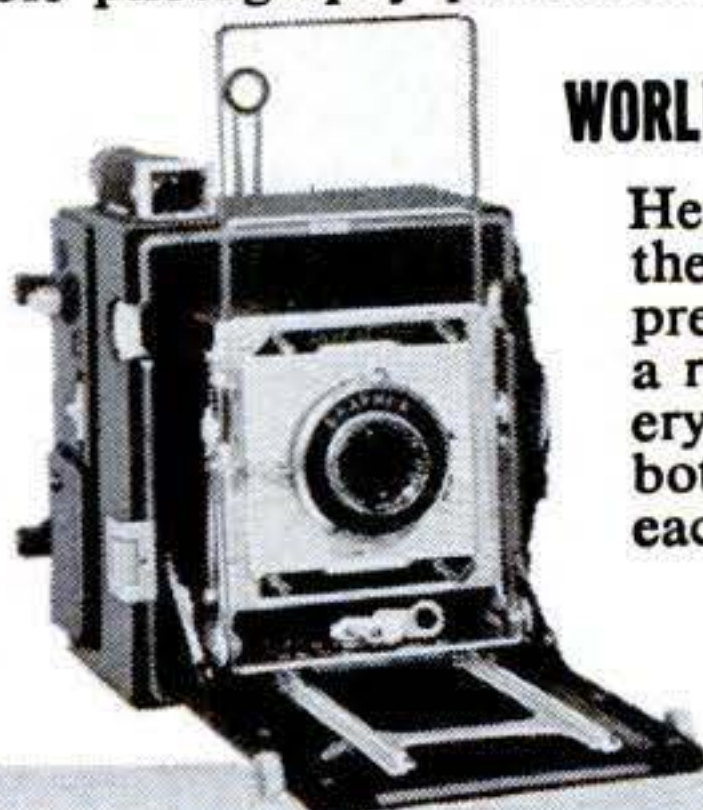
**PORTRAIT**

**NEWS**

## **WORLD'S FINEST PROFESSIONAL CAMERA!**

Here's the only camera that's passed the acid test of daily use by 95% of press photographers. It's the Graphic, a rugged dependable performer on everything from action to portraits. See both the Speed and Crown Graphics—each in three sizes—and the Century Graphic now only \$108 with color corrected f/4.5 lens.

*Prices subject to change*



**GRAFLEX®** *Prize-Winning Camera*

Graflex Inc., Dept. 23B  
Rochester 8, New York

Please send me the new FREE 48-page GRAFLEX booklet.

Name \_\_\_\_\_

Street \_\_\_\_\_

City \_\_\_\_\_

County or Zone \_\_\_\_\_ State \_\_\_\_\_



# If You Make Painting a Hobby-



You'll get a lot more real satisfaction and pride of ownership out of a home that is clean and neat and trim in a fresh coat of paint! Pays its own way by improving your property, too!

Because Archer Pol-mer-ik contains polymerized oil, it gives you a tougher, more durable paint film than ordinary linseed oil. When you reduce your paints with Pol-mer-ik, they brush easier, level better, and give you a smoother, dirt-resisting finish. Wonderful brush conditioner, too!

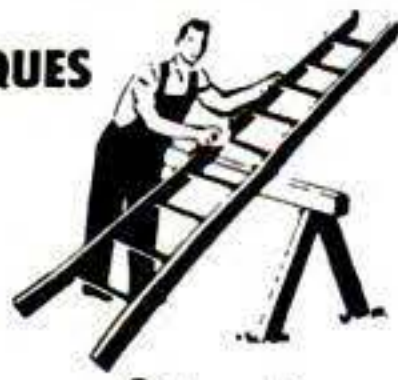
Handiest single product in your house or shop. Does the job of a dozen specialized products. A few of

## POL-MER-IK'S 101 HANDY USES:



REFINISHING ANTIQUES

PROTECTING LADDERS



SEALING SCREWS

PROTECTING GUN STOCKS



**ARCHER**  
*Pol-mer-ik*  
**LINSEED OIL**  
**PROTECTS MOST EVERYTHING**

## He Builds America's Finest Wagons

[Continued from page 200]

adapted in the United States. However, Collins justifies its inclusion by pointing out that many wagons for use in America were made by the firm of Laurie & Marnier, producer of the hansom.

Upon finding and measuring a vehicle which had seen better days, Collins would draft a detailed set of blueprints to guide him in building the miniature. Frequently he had to wash off straw, mud and clods of dried manure before he even could identify the wagon he was surveying. This deterioration of his models stoked Collins with extra zeal.

### Feared Originals Would Rot

"I knew," he remarks, "that if I didn't construct the miniatures pretty soon, it would be virtually impossible to do so. The originals would collapse into heaps of rotting lumber."

Of course, a few originals already were gone when Collins made up his mind that some craftsman had better devote his attention to wagons before it was too late. He created the hydrogen wagon for Union Army balloons from sketches in the National Museum in Washington, D. C.

With pardonable pride Collins observes, "Several Civil War historians told me that the balloon wagon was exactly like the descriptions contained in War Department journals."

### Models Are Heavily Insured

Ivan Collins values each of his wagons at approximately \$2,000. The collection is insured for \$100,000 and all records for attendance were broken when it went on display at the Los Angeles Museum recently. Ransom Mathews, the museum's director of mechanical arts, said of the miniature wagons: "They represent the finest craftsmanship I have seen, either here or in Europe."

Collins has been urged to publish blueprints, in order that other model-makers around the nation can vary their locomotives and motor cars with buckboards and Concord coaches. He is con-

[Continued on page 204]



# For The Smoothest, Most Perfect Finishes!

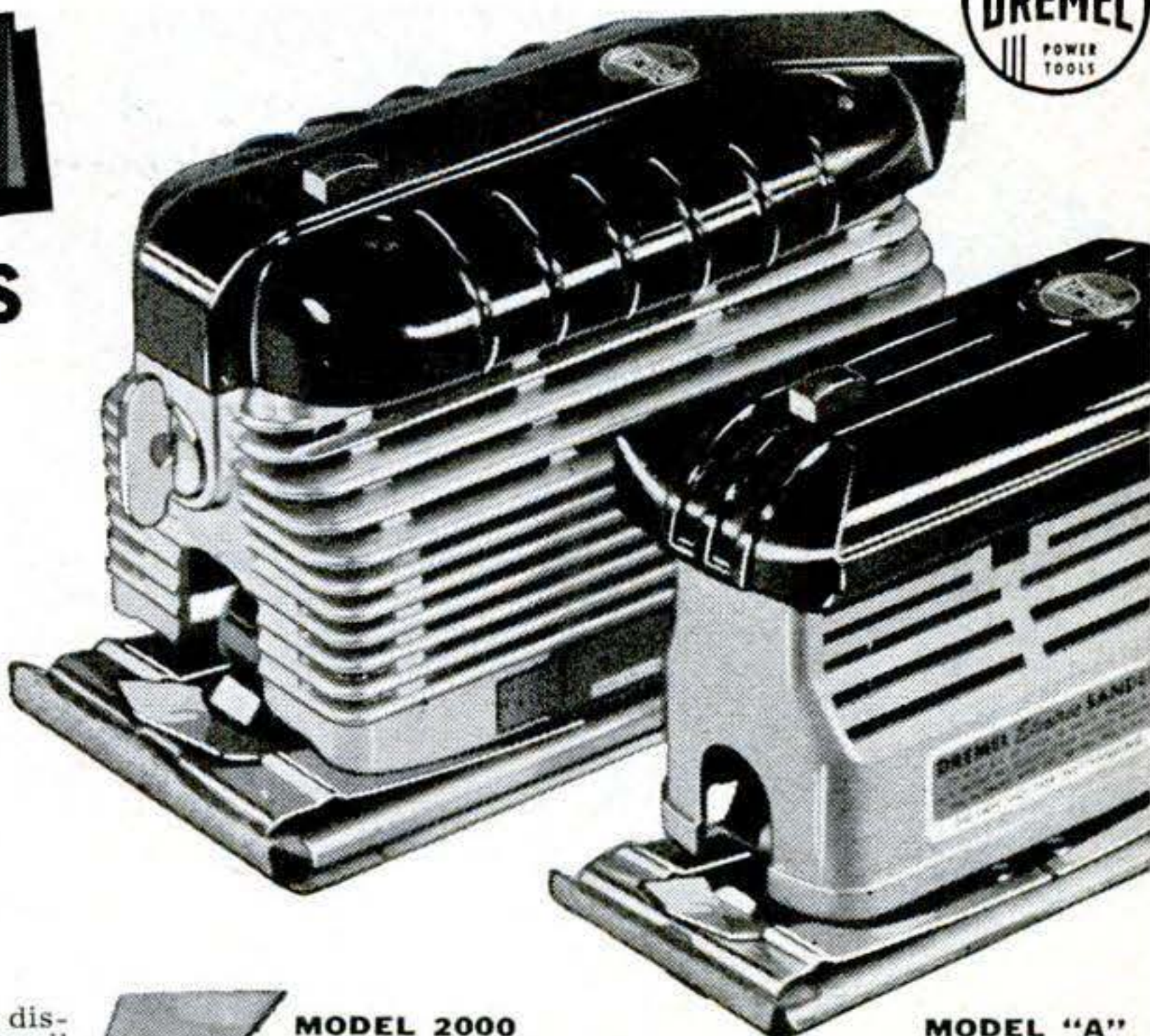
## DREMEL

# STRAIGHT-LINE ACTION

## SANDERS

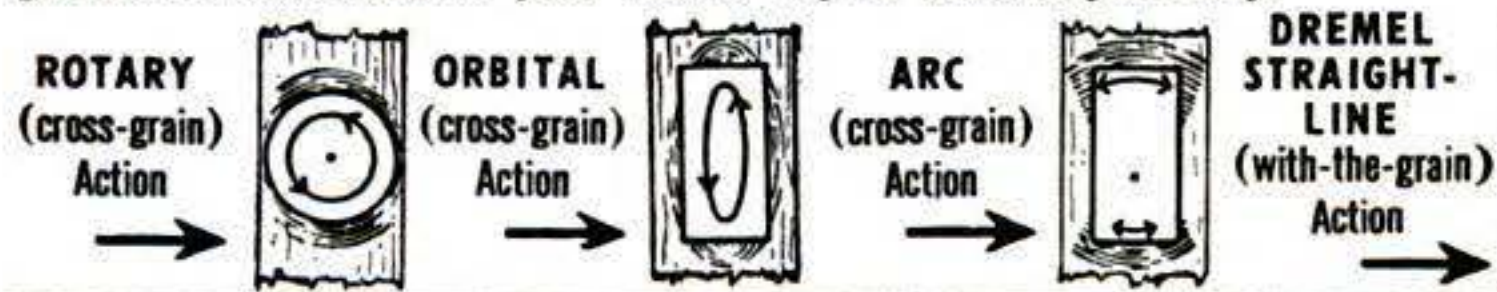


**Only DREMEL Offers All These Features:**  
**WORLD'S FINEST FINISHING SANDERS**—Patented Straight-Line Action sands with the grain of the wood—eliminates cross-grain scratches and orbital swirls.  
**MORE SANDING SURFACE PER DOLLAR** means more work done. Faster action (14,400 sanding strokes per min.); more than three times as fast as other type sanders!  
**POWERFUL**, high-speed, Lifetime reciprocating motor (110 V. 60 cycle A.C.)  
**EASY, ONE-HAND OPERATION** less tiring on vertical and overhead operations. Sands into corners—other tight places.  
**TROUBLE-FREE USE** assured. Only two moving parts; never needs oiling. No armatures, brushes, gears or bearings to wear out and replace.



**FREE SANDING GUIDE**  
 A handy, 16-page "How-to-do-it" booklet containing helpful hints on sanding and refinishing procedures packed FREE with each Dremel Sander. Extra copies, 25c.

**MAKE THIS COMPARISON TEST**  
 Sand a piece of wood by hand, using the four distinct sander motions shown below. Note how small scratches and swirl marks appear whenever the slightest cross-grain motion is used. Now compare these results with the beautiful, satin-smooth, absolutely scratch-free surface produced only by straight-line, with-the-grain sanding. You'll see why we guarantee professional-quality, scratch-free finishes. You'll be convinced that Dremel Straight-Line Action produces the results you want. Try it before you buy!



**MODEL 2000**  
 Heavy-duty model: 21 sq. in. (3 1/8" x 7") sanding base. Price includes sturdy steel storage case, 25 asst'd. abrasives, 1 polishing pad. **\$24.50**

**MODEL "A"**  
 Hobby and household model sander, polisher, massager (above, right); 12 sq. in. (2 3/8" x 5 3/8") sanding base. Price includes 6 abrasives; 1 polishing pad, 1 massage pad. **\$14.85**

**SEE YOUR LOCAL DEALER:** Dremel Tools are sold at better dealers everywhere. If your dealer can't supply, order direct on a five-day trial, money-back guarantee. Remit in full, and we will ship postpaid. Or, send only \$2.00 now, pay postman balance plus postage and C.O.D. fee.

**DREMEL MFG. CO., Dept. 123-G, Racine, Wis.**

**NEED a Padlock or Cabinet Lock?**

**Look for the Corbin Lockshop at your hardware store**

**NOW!** It's easy to find just the lock YOU need in the CORBIN Lockshop!  
**CORBIN PADLOCKS** are tops for security . . . tops for economy.  
**CORBIN CABINET LOCKS** are easy to install on desks, drawers, chests, wardrobes, gun cases, tool chests, etc. Keep your valuables secure . . . keep the kids away from guns, tools and dangerous medicines.  
 Look for the CORBIN LOCKSHOP or ask your dealer.

**CORBIN**  
**CORBIN CABINET LOCK DIVISION**  
 The American Hardware Corporation  
 New Britain, Connecticut

**New cleaner saves brushes and time**

NOW you can easily clean and recondition old hard brushes—or quickly clean brushes after using. You simply place the brush in can of Paint-Trap and work it back and forth on the "Stay Clean" Paint Trap. Emulsifying action washes away any paint, varnish or shellac. After each use, old paint settles in paint trap—liquid stays clean and can be used over and over. It's safe for all bristles—even synthetics!

**ORDER NOW**—if your paint or hardware dealer doesn't have this new brush cleaner yet, send \$1.19 (check or money order) for quart size complete with "Stay-Clean" Paint Trap. Money refunded if you're not completely satisfied.

**THE KLEAN-STRIP CO.**  
 2378 S. Lauderdale Memphis 6, Tenn.





Have more fun outdoors this summer! Enjoy picnic lunches, play cards, etc., on this sturdy table with smooth, durable Masonite Tempered Presdwood® on top and seats. And for sun-soaking, the roomy lawn chair is ideal.

These tough, grainless, all-wood hardboard panels take plenty of knockabout punishment. Weather extremes won't bother them. Never sliver, splinter, or crack. Won't snag clothing and they withstand rain and snow. Easy to cut and fit with ordinary hand tools.

Masonite Presdwood can do scores of jobs around the house, quickly and at low cost. Send for complete information and free home craft plans.

See your local building materials dealer for  
**MASONITE PRESWOOD PRODUCTS**

**A type and thickness for every job!**

- Standard Presdwood—1/8", 3/16", 1/4" and 5/16" thick.
- Tempered Presdwood—black or brown. 1/8", 3/16", 1/4" and 5/16" thick.
- Tempertile®—1/8"
- Duolux—both sides smooth! Tempered. 4 ft. and 5 ft. widths. 1/8", 3/16" and 1/4" thick.
- Leatherwood—1/8"
- Panelwood—3/16" and 1/4" thick.

**Better Hardboards for Better Home Projects**

**MASONITE® CORPORATION**

Dept. PS-7, Box 777, Chicago 90, Ill.

"Masonite" signifies that Masonite Corporation is the source of the product

Please send me free plans for:

- Picnic table and chairs
- Built-in linen closet

Name.....

Address.....

City.....Zone.....

County.....State.....

**He Builds America's Finest Wagons**

[Continued from page 202]

sidering such a venture, but first he wants to try his skill with the bygone vehicles of countries overseas—with the carriages that carried Napoleon and the battle chariots of Julius Caesar.

Collins has compiled a vast quantity of data about every one of his miniatures. This makes it difficult for him to decide which is his favorite. He pictures himself on the high, swaying driver's seat, reins in hand, whip at the ready. One moment he thinks he would like to be driving Teddy Roosevelt through Yellowstone Park and in the next minute he imagines himself wheeling a silver-fitted brougham down Fifth Avenue.

But, finally, Collins settles for the Conestoga wagon which first was built in the Conestoga Valley of Pennsylvania.

**Why He Likes Conestoga**

"It's the wagon that made history," explains Collins. "It was the grandfather of all American wagons, in fact of all American transportation on wheels. It brought the settlers beyond the Allegheny Mountains and across the Mississippi. Wouldn't it have been something to drive one of those great billowing wagons, back of fine horses, through a wilderness where white men never had been before?"

The blue eyes of the tall craftsman light up zealously as he concludes, "I want my miniature wagons to make many generations of Americans conscious of their past. I want the people of today to be proud of the men and women who rode in those wagons and built up our country."

END

**Inside Shot**

A HUNTER was showing off his collection of trophies to some friends and explaining how he had acquired them.

"See that elephant?" he asked. "I shot it in my pajamas."

"My goodness," murmured a surprised young lady, "how did it get in there?"—*The Columbian Crew.*





# Ford Track Tests save you money

here...



The quality of materials, the dimensions, the workmanship used in fan and generator belts bearing the Genuine Ford Parts label . . . all were track-tested by Ford engineers before these products were approved for manufacture and general distribution. Thus, you are assured that the belts you buy under this label have been designed to require less tension for efficient operation, to give full traction with pulley surfaces, to fit precisely, minimizing twist, distortion and vibration, to resist destructive oil and dirt. These superior advantages have been proved by actual tests.

and here...



Yes, here again, radiator hoses of varying materials were track-tested and minutely examined after miles and miles of operation. The hose selected to carry the Genuine Ford Parts label has a tough Neoprene lining that resists corrosive radiator solutions. This feature tends also to cut down chipping and sloughing off, common sources of radiator clogging and hose breakdown. Molded without seams and reinforced with knit rayon, Genuine Ford hoses have the "give" to withstand vibrations, shocks, extreme temperatures . . . and their resistance to rust, oil, grease and dirt means added life.

and everywhere

Like Ford belts and hoses, all Genuine Ford Parts are carefully checked and rechecked after punishing track tests. This is your assurance that they're made *right* to fit *right* for quick installation and long life . . . saving you money on both replacement *and* repair time.

### Insist on these savings

Available at all Ford Dealers and the selected independent garages where you see this sign.



**KEEP YOUR FORD ALL FORD**

JULY 1953 205



# NEW POLARIZED PLASTIC MAKES CAR WAX OBSOLETE



**KELVEX**

Kelvex, a hard, transparent plastic is now being used for the first time in car polish by a leading manufacturer. It is extremely resistant to the common car wash detergents used by most car washers.

Because Kelvex is entirely different from other polish bases, I.C.U. PLASTICOTE will work in sun or shade — it is not affected by heat and will not smear or streak. It cleans, polishes, and leaves a thin film of clear plastic which has a deep natural lustre that requires no buffing to get a brilliant shine — all in one quick easy operation.

NOW for the first time you can realize the pleasure of a lasting polish that comes **ALL IN ONE CAN — AT A REASONABLE PRICE** — and will do a car in less than an hour!

— AN EXCLUSIVE FORMULA —  
NO OTHER POLISH CONTAINS THE  
POLARIZED PLASTIC "KELVEX!"

Next time, save time, get I.C.U. PLASTICOTE in the red-and-white can at your service station or auto supply store. \$1.25 full 16 oz. — enough for three cars.

**SOLD IN SOME WESTERN STATES UNDER THE TRADE MARK OF I.C.U. AUTO POLISH.**



THE LIVINGSTON COMPANY — I.C.U. PRODUCTS  
151 Amity Road, New Haven 15, Conn.

PLEASE RUSH  PINTS I.C.U. PLASTICOTE POST-PAID AT \$1.25 PER PINT, I AM ENCLOSING \$.....

SEND ME FREE LITERATURE ON THE NEW I.C.U. PLASTICOTE. SATISFACTION GUARANTEED OR MONEY BACK.

NAME.....

ADDRESS.....

CITY.....ZONE.....STATE.....

Manufactured and distributed in Canada by Ewart-Harris Company, Verdun, P. Q.

## Doctor Tackles "Unclimbable Peak"

[Continued from page 73]

obstacles that caused Eric Shipton, today's great British Everester, to say that K-2 demands better mountaineering "than at present exists." Some of them are shown on pages 72 and 73 in photos by Dr. Houston; Mrs. Elizabeth S. Cowles, a member of his party on a previous expedition to Everest; and Georgia Engelhard of Monkmeyer photo agency.

### Avalanche Roars Down on Camp

Base camp would be pitched on a glacier. Over base camp would loom K-2 itself, that 12,000-foot-high, pyramid of rotten rock, a four-sided pyramid with sides sloping 55 to 90 degrees.

The rock was so bad in '38 that the weight of climbers upon it started an avalanche. "The rocks," said the men caught under them, "came bouncing into Camp III with terrifying accuracy . . . Escape to either side was impossible, and the route below, like a funnel, caught all the stone fire."

High on the mountain there may be unfamiliar voices. There have been on earlier trips. Voices the explorer can't identify. But the natives do. They say the voices are the Abominable Snowman (PSM, Dec. '52, p. 133).

### Human Flies Leap Gaps

There are wide gaps in the rock of the mountain—gaps you may have to leap and stick like a fly on a vertical wall opposite. The slopes get more hazardous as the peak is approached. Five hundred feet becomes the distance between camps—the longest distance a man can climb and come down in a day, before he collapses from fatigue.

There can be tragedy. In 1939, near the peak, an American, Dudley Francis Wolfe of Boston, and three Sherpa porters were lost. A three-day mountaintop blizzard blotted out their fate and blocked heroic rescue attempts.

" . . . And waiting for you," wrote Kipling.

Unclimbed K-2 has waited a long time

[Continued on page 208]





# ... REAL ROLLING ECONOMY

You can't beat a CON-SOL for economical rolling. Hundreds of owners of previous models — home owners, managers of parks, golf courses and tennis clubs — all like its low first cost, its even lower upkeep and the way it handles.

Even greater value is built into the 1953 model, which includes no less than 10 important new features — all designed to increase strength, prolong roller life, improve performance, and increase ease of handling.

Weight adjustable from 300-1200 lbs. to suit soil conditions. The heavier All-Purpose Model with sprinkler tank which drips water on the rollers to prevent sticking when used on asphalt — very popular with contractors in laying driveways and sidewalks — is adjustable to over 1400 lbs.

Write for literature, Dept. PS. 7

Prices start at \$350.



**CONSOLIDATED INDUSTRIES, INC.**  
West Cheshire, Conn., U. S. A.

## 22.5 POWER MICROSCOPE \$1.00 THAT'S ALL



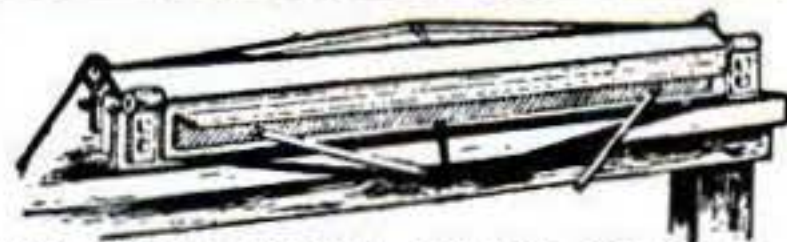
This instrument magnifies objects 20-30 times. See thousands of Nature's hidden secrets—study insects, foods, minerals, etc. Educational-Fascinating for youngsters 6-60. No end to its uses. Complete kit includes—sturdy base, tilting stand, adjustable reflector, powerful lens with focusing adjustment, glass slide and directions. Order several at this unbelievable low price of \$1.00 each (6 for \$5.00). Simply send \$1.00 check or money order for each. Sorry no COD's at this low price.

**IMPERIAL SALES CO.**

480 Lexington Ave., Dept. K-142, New York 17, N. Y.

## SHEET METAL BRAKES

Angles, flanges, Pittsburgh locks. 24 G. steel, heavier aluminum. Cam locking, mount on bench, truck or floor stand. Truss braced steel. Express collect. 30", 65 lbs. \$28.50. 36", 75 lbs. \$33.00. 48", 100 lbs. \$48.00. Portable stands, 32" hi, 30 lbs. \$7.00



**8 ft. BRAKE**, similar, 26 gauge steel, \$115.00  
**IRON BENDER** forms hooks, angles, eyelets, etc. Capacity 1/4x2", 5/16x1 1/2", 10 parts, all steel. Express Collect. \$9.50

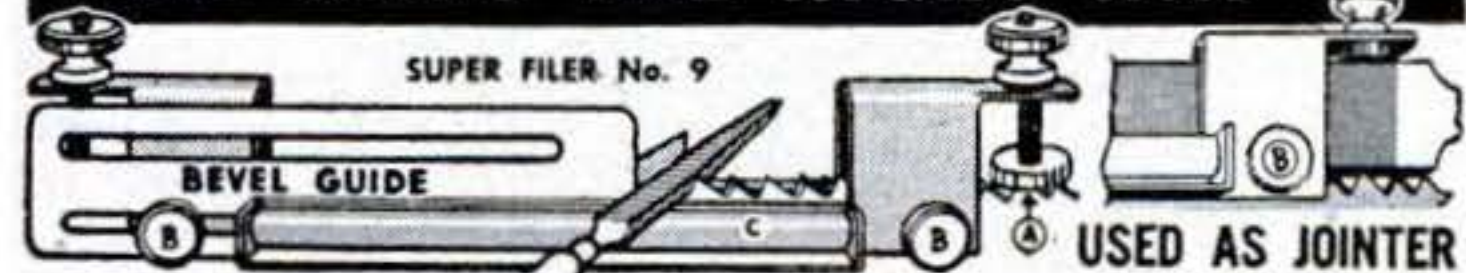


**30" CURVE FORMER**. Forms cylinders, ovals, round corners, etc. Capacity 20 gauge. Express Collect. \$9.50

(Immediate delivery. Order direct, cash or C.O.D., or send for folder.)

**VYKE BRAKE CO., S-3016 Leavenworth, Omaha 5, Nebr.**

## FILE SAWS THE RIGHT WAY



**SO EASY:** With this new filing jig and jointer anyone can now sharpen any handsaw like new! When file hits hardened steel rollers teeth are finished and EXACTLY SAME HEIGHT. All teeth cut and saw runs true and smooth. Jig and instructions \$2.95 postpaid. Free literature.

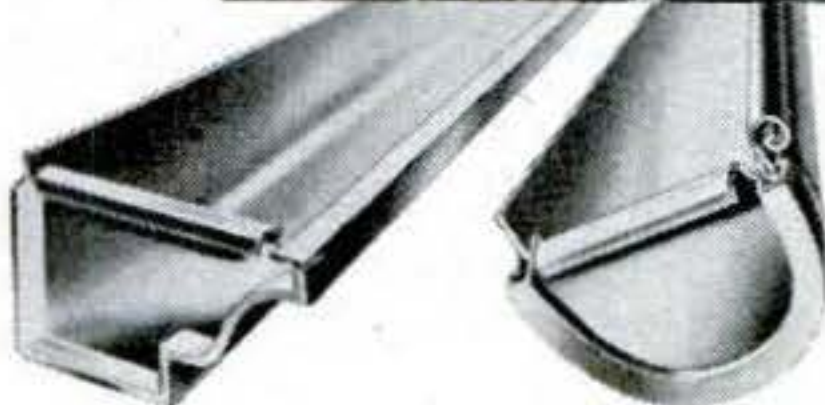
### SHARPEN YOUR CIRCULAR SAWS

The RIGHT WAY on your own saw table. Sharpens rip, cutoff, hollow ground and combination blades—8" to 10". Saws stay round with correct bevel. Precision made, easy to use. GUARANTEED. Only \$8.95. Includes \$3.00 Grinding wheel. "TRU-CIRCLE" saw set automatically sets teeth at 10° or more \$2.95.

**AT DEALERS OR POSTPAID**

**A. D. McBURNEY 317 E. 4th St., Los Angeles 13, Calif. Dept. S-31**

# REYNOLDS *Lifetime* ALUMINUM GUTTERS



Rustfree permanence at much lower cost than any other rust-proof material.

Amazing low cost for the most beautiful rustproof gutters—about \$60. should buy them for an average 6-room house! They go up like a charm—put 'em up yourself. They're lightweight—easy to carry. They won't rust—won't stain walls—never need paint. Non-toxic; won't affect the purity of collected water. No special skill needed to apply. All pieces assemble with slip joints. Half-round and Ogee styles—stippled or smooth finish—downspouts, fittings to match.

### Aluminum Sheet for Flashing,



Shielding, Shop Work. New all-purpose carton of ten 18" x 48" sheets, .019" thickness.

### Reynolds Aluminum Reflective Insulation



Like magic it reflects up to 95% of radiant heat. Aluminum foil bonded to kraft paper. Just tack or staple up. Rolls—250 sq. ft., 25", 33" and 36" wide.

See Your Building Supplies or Hardware Dealer

## REYNOLDS *Lifetime* ALUMINUM BUILDING PRODUCTS

### MAIL THIS COUPON NOW!

Reynolds Metals Company  
Building Products Division  
2032 So. Ninth St., Louisville 1, Ky.

Send full information about Gutters and Downspouts.  Details and FREE SAMPLES of Reflective Insulation;  Information on Nails;  Flashing.

Name \_\_\_\_\_

Address \_\_\_\_\_

City \_\_\_\_\_ State \_\_\_\_\_



Keep Filthy Flies Away from  
your Lawn, Garden, Patio —

Get —

# BIG STINKY

## Outdoor FLY TRAPS



Don't suffer inconvenience and discomfort with swarms of vicious flies around your yard this summer. Big Stinky lures, traps, and kills flies before they get to you — or into the house. The Control Fluid plus water on the starting bait attracts a few flies — which are digested to produce a scent which attracts gallons of filthy flies — and Big Stinky is regenerative—it feeds on flies to catch more flies.

Complete **BIG STINKY** with gal. jar — no parts to supply — and 8 oz. (season's supply) Control Fluid - - - - - \$4.95  
 Same with 1/2 gal. jar - - - - - \$4.49

**LITTLE STINKY**  
 — trap to fit standard jars. With 3 oz. of Control Powder, \$2.95

**WEE STINKY**  
 — economy-size trap to fit standard jars. With 1 1/2 oz. of Control Powder - - - \$1.69

**AT LEADING DEALERS EVERYWHERE**  
 mfd. by: **DIOPTRON CO., Milwaukee**

### Doctor Tackles "Unclimbable Peak"

[Continued from page 206]

between expeditions. There have been only four since 1861—against the dozen expeditions that have made Everest famous.

The first attempt on K-2, in 1901, was by an Englishman with Swiss and Austrian help. It was halted over two miles below the 5 1/2-mile-high summit. The second, in 1909, by the Italian Duke of Abruzzi, got only 470 feet higher. The Duke, one of the most respected mountaineers of all time, said of the chances of climbing K-2: "No hope."

#### Second Climb Hit 27,000 Feet

That stopped everyone for 29 years till 1938, when the American Alpine Club made its first attempt. Charles Houston and another American, Paul Petzoldt, that year surprised the mountaineering world by getting to 26,000 feet. This was about as high as France's Maurice Herzog was when he reached the top of Annapurna. But K-2's summit, though it was only two-fifths of a mile above the two men, remained unclimbed.

In 1939, the second American Alpine Club expedition, led by Fritz Wiessner, got past 27,000 feet, to a point only about a city block beneath the peak.

Until this month, no one has tried K-2 since.

Every man whose name is on the roll of the 1953 party—the American Alpine Club's Third Karakoram Expedition—hopes that the third time is the charm.

Until now, Americans have rarely attempted ascents in the Himalayas or the Karakorams. They have not often followed Kipling's instructions to "Go and look behind the ranges." But now they are. Their base camp is itself higher than the highest peak of the U. S. Rockies. END

#### Outdoor Life

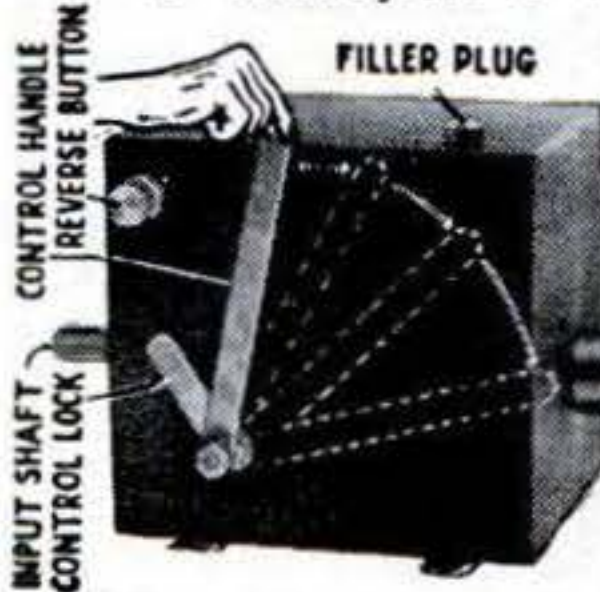
Fisherman: "Say, you've been standing there watching me fish for more than two hours. Why don't you try a bit of fishing yourself?"  
 Native: "Me? Heck, I ain't got the patience."  
 —L & N Magazine.



## HYDRAULIC SPEED REDUCER

WITH FINGERTIP CONTROL

USE FOR: ● Reamer Drives ● Midget Cars ● Feed Mills ● Canning Machines ● Conveyors ● Lathes ● Milling Machines ● Motor Boats ● Cream Separators ● Garden Tractors ● Pumps



Variable output speeds from 0 to input speed available by moving control handle. Locking handle maintains setting. Use input power of 1/4 to 1 1/2 H.P. This Westinghouse-Oil Gear Unit consists of a variable displacement hydraulic pump feeding a fixed displacement hydraulic motor. Adjustable relief valves set at factory for 100 inch pounds of torque may be reset up to 180 inch pounds. Independent reverse control allows full output power and speed selection in either direction of rotation. Shafts measure 5/8" diam., include keyway. Input rotation is counter-clockwise facing shaft. Recommended input speed not to exceed 750 R.P.M. Over-all dimensions, 7 1/2" x 7 1/2" x 11 1/2". Gov't acquisition cost \$428.00. Ship. wt. 31 lbs. Complete with 2 qts. of oil and full instructions. F.O.B. Chicago

**54.50**

**SHOP by MAIL**  
★ and **SAVE** ★  
at **GROBAN'S**

## D. C. ARC WELDER

NEW MODEL 353—  
DUAL RANGE

For Stationary or Portable Use  
HEAVY DUTY RANGE TO 250 AMPS.  
New 'Magic Terminal' for

Low Current 30 to 100 Amps. Ideal for ● FARM ● GARAGE ● FACTORY ● WORKSHOP



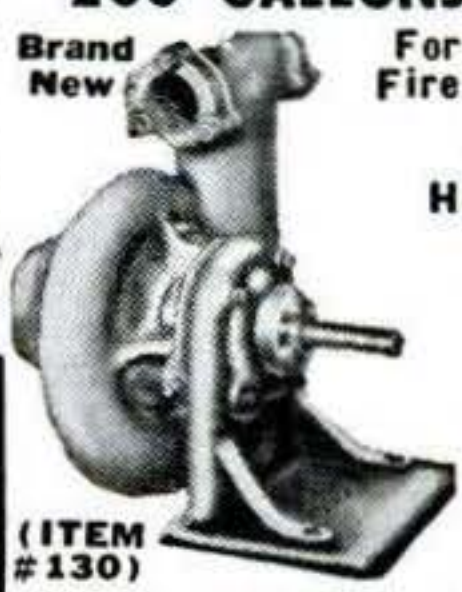
Welds Anything From Auto Fenders To Tractor Frames

● Dial Type Rheostat Control ● Use 1/16" to 1/4" Rod ● Generator-type Welder ● Reactor Coil for Smooth Even Arc ● Use 7 1/2 H.P. Electric Motor or 10 H.P. Gasoline Engine ● Run at 2500 R.P.M. ● Available with Either Flat Belt or Double V Pulley ● Complete Operating Instructions Shipping weight 107 lbs. \$350.00 Value. Item # 65. F.O.B. Chicago

**119.50**

## CENTRIFUGAL PUMP

General Motors — Allison  
200 GALLONS PER MINUTE



For Draining Basements Fire Fighting ● Irrigation Fuel Transfer Swimming Pools Home Water Systems Dewatering

Converted for high volume commercial, home, and industrial use. Standard 2 1/2" pipe thread inlet, twin 1 1/4" pipe thread outlets. Ball bearing supported 3/4" shaft. Easy priming. Rotation, counter-clockwise facing shaft. Gov't. acq. cost \$145.00.

(ITEM #130)

Complete with full instructions. Ship. wt. 35 lbs. F.O.B. Chicago **39.50**

### TYPICAL PERFORMANCE DATA

Suction Lift	Head Pressure	Gal. Per Min.	H.P.	R.P.M.
10'	75'	260	6.0	3500
10'	65'	200	5.2	3500
10'	80'	40	1.5	2500
10'	50'	140	5.0	3500
10'	30'	100	3.0	2500

## ELECTRIC GENERATOR SET MODEL 251

2500 watts, 115 volts, 60 cycles, single phase, A.C. electric generating plant, powered by dependable 6.5 H.P. Wisconsin engine—Two pole ball bearing belt driven high efficiency generator with heavy duty windings for high torque motor starting loads. Rated 3000 watts for intermittent service. Light weight portable rugged unit, easily transported to job site. Consumes 3 quarts of gas per hour at rated load. Dimensions: 24"x20"x24", ship. wt. 220 lbs. Complete with fused outlet box and voltmeter. F.O.B. CHICAGO



**329.00**

Item # 2510

## BRAND NEW MULTI PURPOSE HYDRAULIC PUMP OR MOTOR



Silent, High Efficiency, Helical Gear Type Ball Bearing, Hydraulic Pump or Motor. Rated 8 Gal. Per Min. At 1500 R.P.M. — Delivers — 1000 P.S.I. Using 6 H.P. — Reversible Rotation—3/4" Pipe Thread Inlet and Out-

let Ports—1/4" Drain Port—3/4" shaft with keyway and flat for either direct or pulley drive. Dimensions—5 3/8" high, 7 1/4" long, 5 1/8" wide. Shipping weight 18 lbs. F.O.B. Chicago

**45.50**

Item # 1036—Double acting hydraulic cylinder, 3" bore, 36" stroke, 1/2" pipe thread ports. 1 1/4" solid steel shaft. Overall length closed 49", clevis mounting at base and shaft. FEATURES ● Cup & Chevron Packing ● All Welded Construction ● Precision Ground and Honed Construction ● Will lift 7000 lbs. using 1000 P.S.I. line pressure. Weight (net) 57 1/2 lbs. F.O.B. Chicago

**50.00**

## HEAVY DUTY HYDRAULIC and AIR EQUIPMENT

Large supply of new labor-saving, economical hydraulic equipment in many types and sizes. Use these positive, highly efficient smooth pressure hydraulics on presses, arbors, lifts, loaders, power control, positioning, brakes, plastic dies, auto frame alignment, etc.

## EXTRA HEAVY DUTY DOUBLE ACTION Hydraulic Cylinder

Item # 224. 3 1/4" bore, 24" stroke, will lift 8250 lbs. with 1000 P.S.I. line pressure. 1/2" pipe thread ports—1 3/4" stress-proof ground, polished & plated—solid steel shaft. Overall length closed 36". 1/4" steel wall cylinder barrel clevis mounting at base and shaft. Features—Tie Rod construction. Honed barrel. Ship. wt. 50 lbs. F.O.B. Chicago **39.60**

Item # 150—Double acting hydraulic cylinder, 2 3/4" bore, 12" stroke. Use either foot or clevis mounting. Will lift 4400 lbs. using 1000 P.S.I. Overall length 19 1/2". Shipping weight 8 lbs. Post-paid..... **18.00**

### ALL ITEMS BRAND NEW—UNCONDITIONALLY GUARANTEED

Item # 126—Four-way, open center control valve with built in adjustable relief valve. Factory set at 1000 P.S.I., spring loaded neutral position, for use with one double acting cylinder. In neutral position cylinder is locked and pump unloaded. Fully balanced plunger type, smooth, positive, easy operation. Can be used as single unit or mounted in series of any combinations desired. Has 3/4" pipe thread inlet and outlet. 1/2" pipe thread cylinder ports. Newly manufactured to our specifications. Shipping weight 8 1/2 lbs. An outstanding buy! F.O.B. Chicago..... **21.50**



Item # 126

ITEM # 42—Double action hydraulic cylinder, 4" bore, 18" stroke. Rated lift capacity with 1000 P.S.I. line pressure is 12,500 lbs. Ship. wt. 30 lbs. F.O.B. Chicago. An Excellent Buy for... **32.50**

**GROBAN SUPPLY CO. DEPT. PS-7**  
1139 SO. WABASH AVE., CHICAGO 5, ILL.

FREE 1953 CATALOG 52 Pages, chock-full of unsurpassed war Surplus Equipment Bargains for farm, home, factory and workshop. Every item is unconditionally guaranteed. You save on everything! Write today.

## BUILD YOUR OWN POWER TOOLS—TILT/ARBOR SAW



TILT/ARBOR SAW BANDSAW BELT SANDER SAVE \$50. OR MORE

● 27 x 28 in. table stays level. Blade tilts full 45 degrees. ● 10 in. blade cuts 3 1/4 in. deep ● jackscrew depth adjustment. ● Floor model, 34 in. table height. ● New Departure ball bearing arbor, 3/4 in. precision shaft, ready to run, 5/8 in. bore blades. ● Quick positioning, self-aligning rip fence guide. ● Sturdy wood, steel and aluminum construction. ● No machining—build easily with hand tools only. ● Capacity and performance of floor saws selling for \$150.00 and up!

GIL-BILT Metal Parts Kit. includes Plans, ball-bearing arbor, cast aluminum miter gauge and bar, rip fence guide, machined lock knobs. Jackscrew mechanism with 4 1/2 in. handwheel, and all other metal parts (less blade)..... \$21.95 Same Kit with 10" combination blade..... 24.90 Same Kit with 8" combination blade..... 23.90 If not satisfied, return Kits in 10 days for refund of purchase price.

(Prices include postage up to 300 miles. Over 300 add 5%) GIL-BILT Step-by-Step pictorial plans (No blue-print reading required), full scale patterns—actual photographs for above 10" TILT/ARBOR SAW, 8" TILT/TABLE SAW, 12" BAND SAW, 18" BAND SAW, BELT SANDER. \$1.00 each postpaid anywhere in the world or WRITE FOR FREE descriptive catalog.

GILLIOM POWER TOOLS P. O. Box 1-VG, Lambert Field, St. Louis 21, Missouri

COMPLETE PLANS only \$1.00 EACH

## PAINT STRIPING TOOL

Works Like a Fountain Pen Stripes with PAINT instead of INK!

\$1.00

POST PAID



Tubular Glass Paint Fountain

A Visible Paint Supply

DEALERS Paint Striping Tool Packed in attractive Display Cartons of one dozen. Fast, profitable seller. Write for illustrated circular, discounts.

Thumb and Finger Rests. Easy to Guide Tool

Guide Keeps Lines Straight Knurled Wheel Distributes Paint

New Master Painters' STRIPING TOOL makes it easy to do expert striping on furniture, bikes, model planes, autos, signs, linoleum, toys, wall board, etc. Makes plain, painted walls look like tile. Paint straight lines, curved, circular or evenly spaced parallel lines the same way a professional painter does. Simply fill Tubular Glass Paint Fountain with any color paint & wheel tip feeds paint evenly. Tips interchangeable—jaws split apart for easy cleaning. Tool complete with tip for 1-16 in. stripe only \$1 postpaid. Other complete tools with 1-64, 1-32, 3-64, 5-64, 3-32, 1-8 in. tips, \$1.50 ea. Extra tips, 75c. Complete Kit with tool and 7 tips, \$5.00. Handiest tool in painter's kit. Get it now. C.O.D.'s postage collect.

WENDELL MFG. CO. 4234 N. Lincoln Avenue Dept. 27, Chicago 18, Illinois Paints Curved, Circular or Straight Lines



## Studebaker with a Cadillac Engine

[Continued from page 80]

hands were always greasy when he came to the supper table.

Even as a field representative for an aircraft company during World War II, Frick kept fiddling with cars. He made a handsome profit on one he reconditioned in his spare time in Australia. And to this day the U. S. Air Force doesn't know that it toted a Frick-reconditioned personal motorcycle from Sydney to New Guinea. Loath to leave a beautiful piece of machinery behind, Frick stenciled *Test Equipment* on the crate.

### Too Good at Racing

After the war he accumulated some money in midget and stock-car racing. But he ruined his own business. He won too often—41 out of 65 races. The promoters threw a fit when he showed up. He was spoiling the shows.

It took the other drivers a long time to catch on to what Frick was doing. Knowing that races were won and lost on the

turns, he found a way of keeping his speed up in negotiating them. He did it by crossing his suspension—by “loading” the right front and left rear wheels and nullifying a good deal of the tendency of the sprung weight to sway.

### Curve Master Does the Trick

He adapts the same idea to his Studilacs today with a patented refinement called Curve Master. It works like a dream. An expensive foreign sports car tried to follow Frick through a curve at 80 miles an hour the other day and had to burn rubber to stay on the road.

Frick started conversions some four years ago. Guys kept coming up to him in his racing days and demanding, “What'll you charge to put a hopped-up engine in my job?” Sensing a new field of profitable endeavor, he accommodated his clients. But they kept coming back with complaints that engines hop-

[Continued on page 212]



Get that successful look with  
America's largest selling Hair Tonic!

### CAN YOUR SCALP PASS THE FINGERNAIL TEST?

Don't give dandruff and dryness a chance to ruin the looks of your hair. Keep it neat and natural all day with Wildroot Cream-Oil. Made with the heart of Lanolin, so much like the natural oil of your skin! 29¢ 60¢ \$1





**PROVED** by Unbiased Road Tests

# CYLINDER WEAR CUT 49% with Miracle Power



You can't argue with *facts*. Wetmore Hodges & Associates, independent laboratory, road tested two engines—one with Miracle Power, one without.

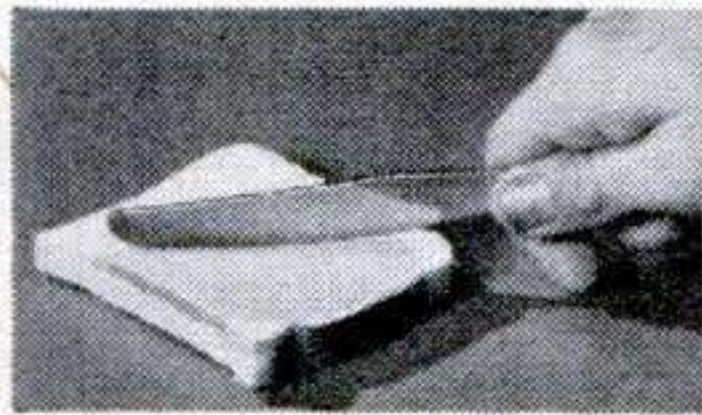
One of many benefits of Miracle Power proved by this test is its capacity to lubricate upper cylinders. Oil alone won't lubricate here because temperatures may reach up to 1400° and oil burns at 550°. But Miracle Power, a blend of petroleum

super lubricants including colloidal synthetic graphite in suspension, withstands far greater heat. That's why the Miracle Power test engine had only half as much bore wear as the engine without Miracle Power.

Other results: After 33,703 miles, the Miracle Power engine was using 33% less oil, had 13% more compression, 56% more plug life, 15% less ring wear.

Use Miracle Power in *your* gas and oil—accept no substitutes.

## Stops DRY STARTING Damage . . . Treats the Engine, Not the Oil!



**METAL ABSORBS MIRACLE POWER AS BREAD ABSORBS BUTTER**—Miracle Power fills microscopic valleys in metal with a breathlike graphoid film. This film holds oil preventing Dry Starting damage (metal to metal contact during the up to five minutes it takes to pump oil to vital parts after starting). It also lubricates when the oil film breaks or burns off.



**THE AP** *Miracle Power Division*  
**PARTS CORPORATION**  
815 AP Building • Toledo 1, Ohio  
*Manufacturers of:*  
MUFFLERS • PIPES • MIRACLE POWER • dgf 123

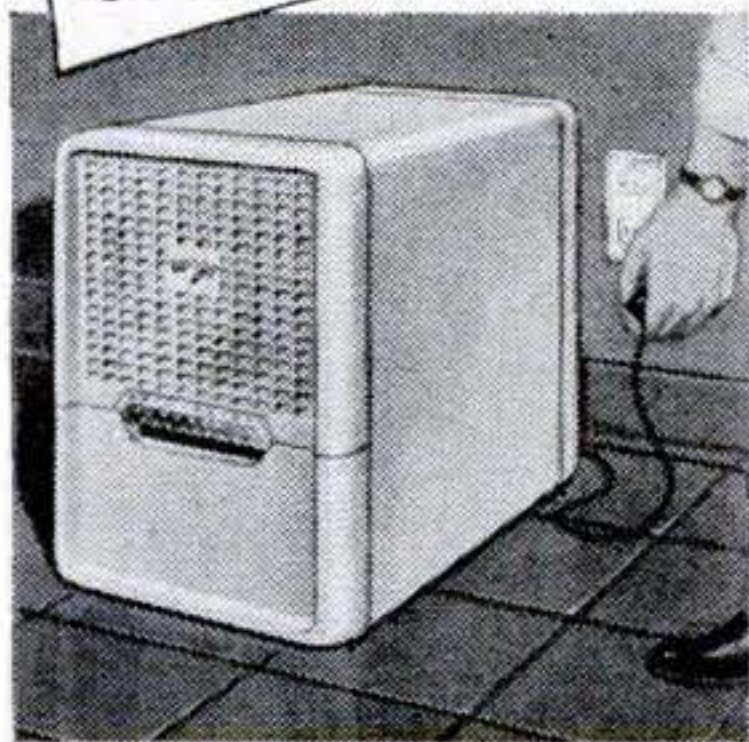
Lubricates *Right* . . . from the Start

Get Miracle Power (money back guarantee) at gas stations, garages and Ford, Kaiser-Frazer, Willys and other car dealers — 75c (\$1.00 in Canada)

© The AP Parts Corp., 1953

## DAMP BASEMENT?

Stop moisture damage



Plug in the amazing  
**FRIGIDAIRE**  
Electric  
Dehumidifier

Only 18¼" high —  
20½" long—11¾" wide

Plug this amazing device into any conven-

ient outlet, and presto — your moisture worries are over for good! Fan circulates moist air over refrigerated coil. Moisture is condensed and collected in container. May be connected to drain. Dry, filtered air flows into room. Positively controls moisture in any closed area up to 8,000 cu. ft.

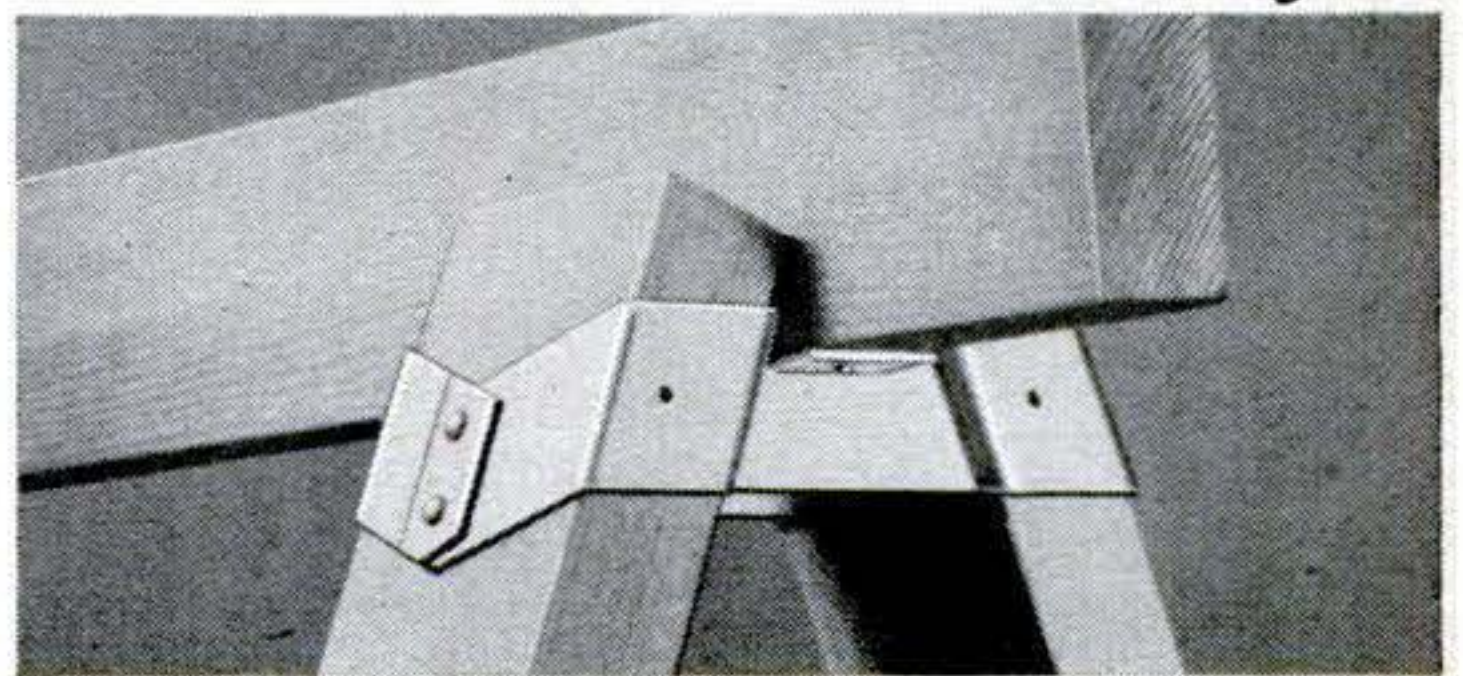
HOW DEHUMIDIFIER WORKS



**See your Frigidaire Dealer** for further details. Or write Frigidaire Division of General Motors, Dept. 2122, Dayton 1, O., for free descriptive folder. In Canada, Toronto 13, Ont.

Built and backed General Motors

## HOW TO... SET UP and KNOCK DOWN SAWHORSES FAST!



USE STRONG,  
PRECISION-  
ENGINEERED

**NU-WAY**  
SAWHORSE  
BRACKETS

**THOMAS PRODUCTS CO.**, 8490 Lyndon Ave., Detroit 21, Mich.

Set up or knock down sawhorses in jig time! Carry them in your car — or store them easily — the modern way . . . the NU-WAY!

SEE Your Hard-  
ware, Lumber or  
Paint dealer  
NOW!

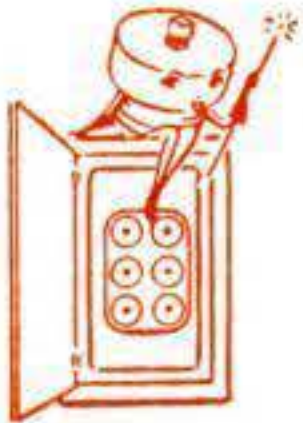
ONLY  
**\$1.50**  
Pair  
(\$1.60 West  
of Rockies)

JULY 1953 211



**Now!**  
**permanent circuit**  
**protection at a**  
**new low cost!**

## MINI-BREAKER<sup>®</sup>



**Fits like a fuse in any standard Edison base fuse socket! Safely interrupts dangerous overloads and short circuits!**

New safety, new convenience, new "push-button" protection against the danger of electrical fires! Yes, once you've installed amazing new MINI-BREAKERS, you can say "goodbye" forever to all the annoyance and expense of replacing expendable "one-shot" fuses. Because, whenever your circuits become dangerously overloaded . . . or when a "short" occurs for any reason . . . MINI-BREAKER trips instantly, breaking the circuit. Then, as soon as the circuit is safe again, all you have to do to restore electrical service is press the shock-proof reset button. Simple, practical, fool-proof! Inexpensive, too! Because you can install them yourself in a matter of seconds . . . just like an ordinary expendable fuse. No additional equipment to buy, no special wiring required!



The only device of its kind listed by Underwriter's Laboratories!

UNCONDITIONALLY GUARANTEED when installed on corresponding 15, 20, and 30 ampere A.C. circuits up to 125 volts maximum. **\$1.50**

SEE YOUR LOCAL DEALER or send for complete information today!

**MECHANICAL PRODUCTS, INC.**  
 1824 River Street • Jackson, Michigan

Please rush me full details on new MINI-BREAKER today!

NAME \_\_\_\_\_

ADDRESS \_\_\_\_\_

CITY \_\_\_\_\_ ZONE \_\_\_\_\_ STATE \_\_\_\_\_

### Studebaker with a Cadillac Engine

[Continued from page 210]

ped up for speed weren't good for anything else.

That's when Frick began making Fordillacs. He used Fords for low chassis and body weight and Cadillac engines because they fitted handily in the Ford chassis. At last he got performance. His cars could go from zero to 80 miles an hour in 15 seconds and top 115 miles an hour. When he switched from a 3.73:1 rear axle to a 3.31:1, he boosted the speed to 123.

#### Impatient to Try First Conversion

The Studillac idea was born months ago when Frick heard that Studebaker was going to adopt European styling. He sat down and began thinking. He thought about the Studebaker chassis and engine installation, and presently he decided maybe a Studillac could be built without too many changes. He could hardly wait to get his hands on a Studebaker for his first conversion.

There are a lot of tricks to Frick's trade, and he knows them all. He had to develop a lot of know-how on the Studillac as he went along. How do you modify a 1948 Chevrolet cross-member engine support to stiffen a 1953 Studebaker frame and support the rear of a 1953 Cadillac engine? Frick found out how.

He knows that eventually his competitors will learn to make Studillacs too. But competition doesn't bother him.

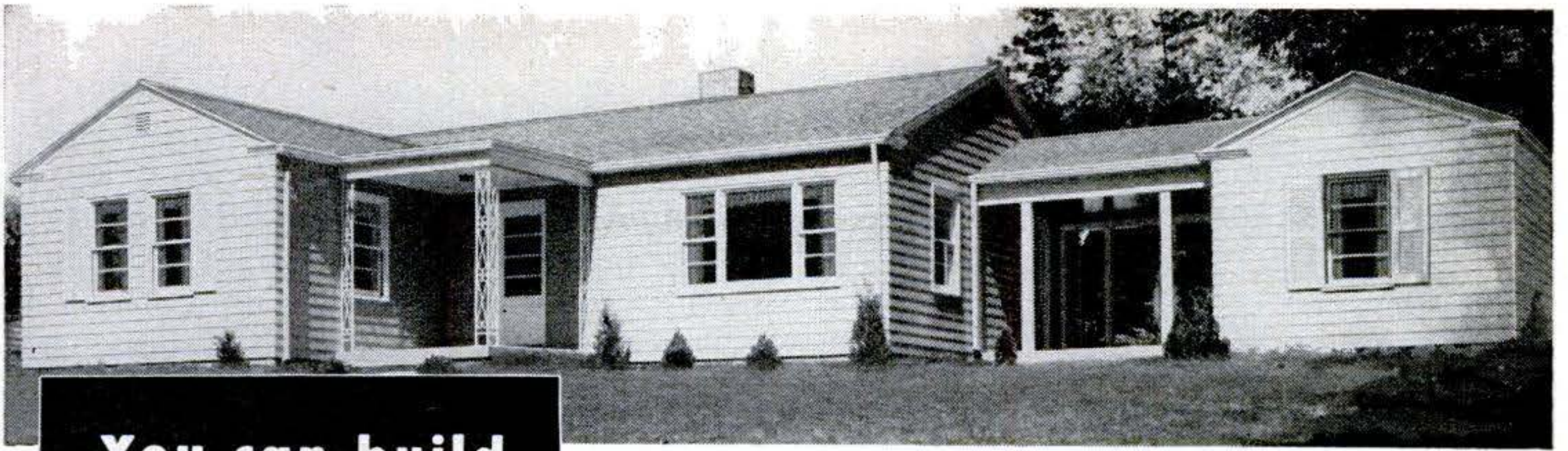
Nothing much of anything bothers Frick. "You know," he says, thinking and taking a final turn on a cylinder-head nut, "there aren't very many guys who can do what they like to do most, and make a living at it." **END**

#### Million-Dollar Look

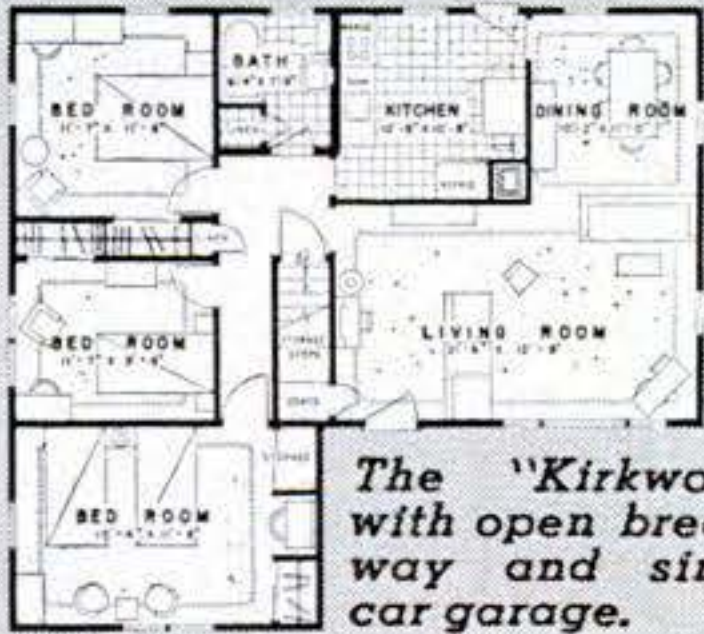
"Good heavens," said a guest at a party, "look at that long and lanky girl over there."

"Not so loud," whispered the host. "She used to be long and lanky, but she just inherited a million dollars. Now she's tall and stately."—*Dodge Job Rater.*





**You can build  
a PEASE Home  
yourself  
...and save!**



The "Kirkwood"  
with open breeze-  
way and single  
car garage.

*Save more than \$1000 . . . Save more than 60 days*

It's easy for you to build a spacious, distinctive, modern PEASE-FABRICATED HOME because we take care of the thousands of painstaking building details for you. As a result, your home can easily be put under roof and enclosed, safe from the weather, within a week. From then on you can finish it at your convenience.

Often, you can move into your PEASE-FABRICATED HOME more than two months ahead of the usual schedule. Best of all, you cut building costs more than \$1000. Engage a contractor and you still save money. Choose from 2, 3 and 4 bedroom homes offering many designs, variations, custom-built individuality and unsurpassed QUALITY. You'll be proud you built a PEASE!

*Write today for NEW Free CATALOG*

## PEASE-FABRICATED HOMES

TRADE MARK REG. U. S. PATENT OFFICE

PEASE WOODWORK COMPANY • Pease-Fabricated Homes Division  
919 Forest Avenue • Hamilton, Ohio

**The easy way to paint!**

*Speedy Sprayer*

**ONLY \$36<sup>50</sup>**  
Less motor

Favorite of home owners and craftsmen for 20 years! SPEEDY SPRAYER gives your work that professional paint finish everyone admires. Sprays paint, enamel, varnish, lacquer, etc. . . . 4 to 7 times faster than hand brushing! Lightweight, portable, uses any 1/4 H.P. motor. Improved diaphragm principle assures clean, oil-free air. You'll find dozens of time and money saving uses for SPEEDY SPRAYER, including spraying insecticides 2-4-D and DDT. Complete outfit, without motor, only \$36.50

At leading hardware, lumber, and auto supply dealers.  
**FREE**—write for handy booklet "How to Spray."

**W. R. BROWN CORPORATION**  
2637 N. Normandy Ave. • Chicago 39, Ill.

**NEW** *Atlas*  
**GRINDER-HONE**

**Slickest Tool You've Ever Seen!**

This unique new combination grinder and hone enables you to put a perfect edge on almost any tool or implement — from knives, scissors, hatchets, garden tools to plane blades, chisels, drills. Add a wire brush or buffing wheel and you're set to clean and polish a host of equipment.

The 6" grinding wheel turns 3000 RPM, the 5" oilstone hone (with 120 and 320 grits) turns 110 RPM. Tool is ruggedly built—grey-iron base, sealed-for-life ball bearings and Oilite bearings. Weighs 22 lbs. Operates from 1/4 to 1/3 HP, 1725 RPM motor. See your Atlas dealer, or write for literature. Price F.O.B. Kalamazoo \$31.50.

**ATLAS PRESS COMPANY**  
725 N. PITCHER ST. KALAMAZOO, MICHIGAN

*Atlas* **DEPENDABLE QUALITY TOOLS SINCE 1911**



# The Easy Way to do Expert Carpentry and Cabinet work . . .

Use a  
**Router**  
by

**Porter-Cable**  
*Quality Electric Tools*

● It takes modern, precision tools to do expert carpentry and cabinetwork quickly and easily . . . tools like Porter-Cable's Router, Plane and Shaper. With them, home craftsmen can get professional results on a list of operations that are difficult by hand, but simple and accurate by machine.

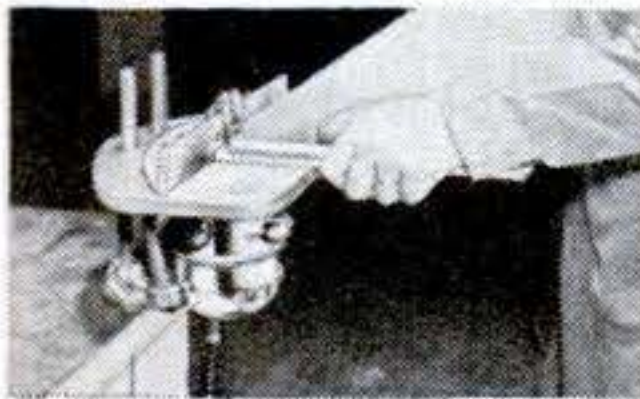
**ONE MOTOR** powers Router, Plane and Shaper — 115-volt, AC-DC, 20,000 RPM. Easily, quickly interchanged from tool to tool.



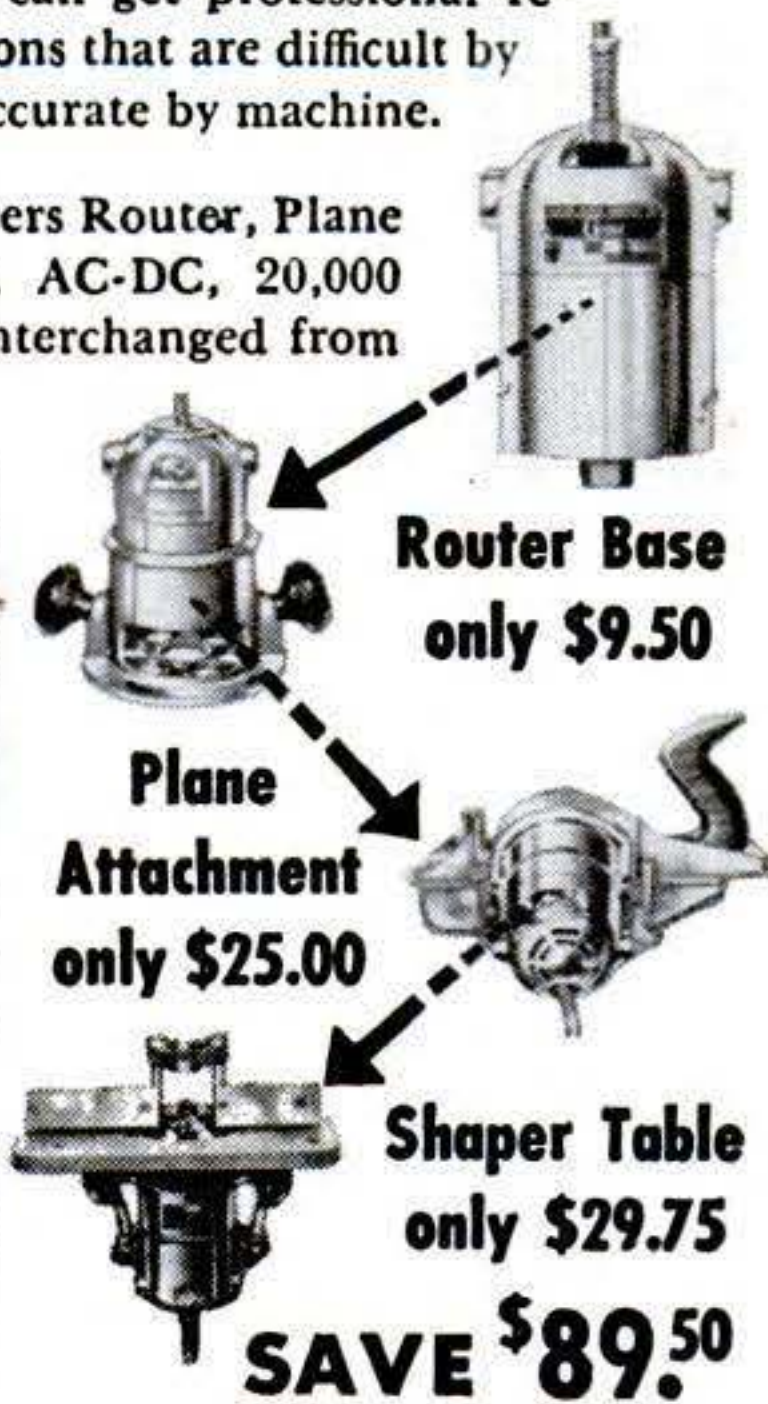
● Rout beaded edges, tongue, groove, rabbet, dovetail, carve on wood, plastic and composition.



● Plane dead-flat edges at accurately-set depths on bookcases, kitchen cabinets, pantry shelves, doors, etc.



● Shape furniture panels, toys, picture frames, valances, mouldings, etc., with hair-line accuracy.



If bought separately, each tool complete (motor with attachment) costs:

ROUTER . . . . .	\$49.50
PLANE . . . . .	65.00
SHAPER . . . . .	79.25
	<hr/>
	\$193.75

Using one interchangeable motor, the trio costs . . . . . 104.25

**YOU SAVE \$89.50**

Buy one complete tool now and add other attachments later, or buy all three now. Either way, you save!

PORTER-CABLE Machine Co.  
1467 N. Salina St., Syracuse 8, N. Y.  
(In Canada: Strongridge, Ltd., London, Ont.)

Send full information on the Porter-Cable Router, Plane and Shaper — also name of nearest dealer.

Name.....  
Address.....  
City..... County..... State.....

Manufacturers of SPEEDMATIC and GUILD Electric Tools

## How to Outwit Poison Ivy

[Continued from page 120]

your family gets a case, see your doctor. For one thing, he will be able to diagnose it. Many similar skin poisonings are due to other causes. For another thing, although he will have no specific cure (there is none), he can probably provide something to ease the pain, itching, and burning.

For yet another thing, self-treatment is risky and a doctor knows how to help nature cure you in about 12 days, maybe fewer. If new skin poisoning appears as time passes, either you are re-visiting a source of infection (an ivy patch, or your steering wheel, work clothes, shoes or garden tools to which sap is adhering), or the poisoning is not from poison ivy.

Ivy poisoning will not spread across your skin by itself, and will not expand because of your scratching. It will appear in new places of course if you spread the sap with your hands.

### You Can Get It by Parcel Post

Other people cannot catch poison ivy from your rash or blisters. But even though it is not contagious, poison ivy can sneak up on you not only via golf balls or across 500 miles via parcel post, but also from such things as ivy twigs clinging to fire logs, or from ivy roots among roots of other plants you're digging.

The sap sticks to almost anything—it is found in almost every part of the ivy: roots, leaves, twigs, stems, or unripe berries of the plant, maybe even in the wood itself.

But if you eradicate poison ivy in your neighborhood, recognize it elsewhere, and keep away from it, you will probably avoid breaking out with the rash altogether. If so, you will have sidestepped the greatest drawback to outdoor living in the U. S.—*Gardner Soule.*

### Hole in One

THE man who pokes fun at a woman trying to drive a car through a 12-foot garage door usually sobers up when he tries to thread a needle. —*Pure Oil News.*



# RED HOT NEWS for Fishermen!

KIEKHAEFER

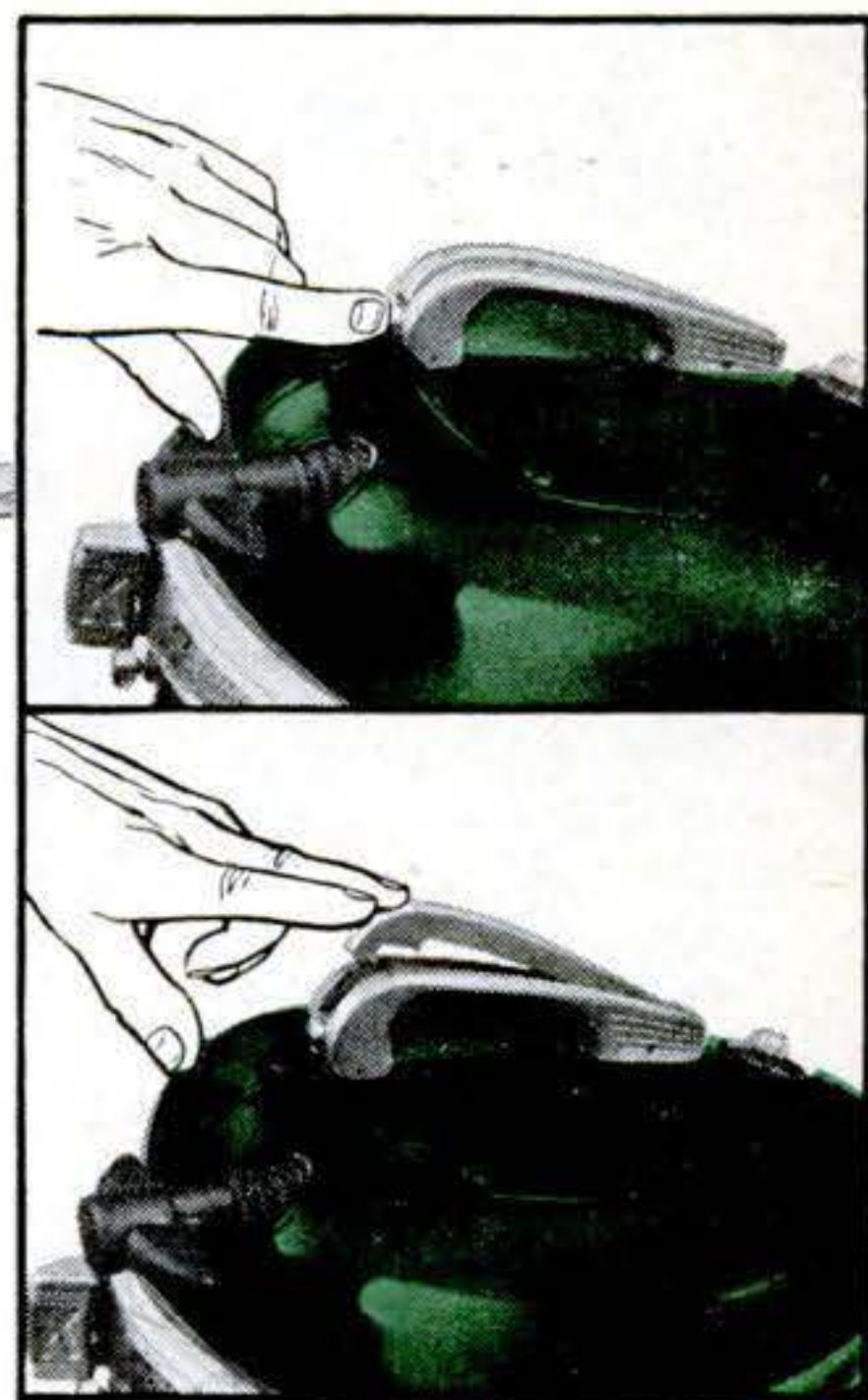
## MERCURY Mark 5 with

### Push-Button Neutral Clutch



#### The Only 5 H.P. Fishing Motor with All These Features:

- Push-Button Neutral Clutch
- 360 Degree Steering
- Dual-Purpose Drive — for truly weedless operation
- Multiple Disc Propeller Clutch — eliminates shear pin
- Superior Idling — for slower, smoother trolling
- Full Jeweled Power — ball and roller bearings throughout
- Variable Volume Rotex Water Pump — with low level water inlet
- Uni-Cast One-Piece Gear Housing — no gaskets to leak or soften
- Weight — Only 40 Pounds
- Performance — unmatched by any five!

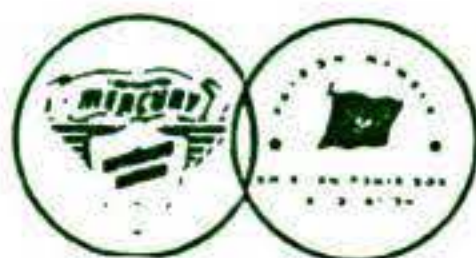


*The Simplest, Smoothest Neutral Clutch On Any Outboard — with FINGER-TOUCH ACTION!*

It's another great pace-setting Mercury development . . . the new Mark 5 with new Push-Button Neutral Clutch! Simplest, smoothest-working Neutral Clutch on any outboard—touch the button, and you're in neutral. Touch the handle lever—and away you go!

Kiekhaefer determination to make the best outboard today even better tomorrow . . . that's the tradition that makes Mercury a leader in the outboard field, makes Mercury America's most-wanted outboard!

See your dealer for a demonstration of the new Mark 5 with Push-Button Neutral Clutch. He's listed in the yellow pages of your phone book.



Write for FREE illustrated catalog! Kiekhaefer Corp., Fond du Lac, Wis.

Features of Mercury motors are protected by issued or pending patents.



# NEW P & C SNIPS

These versatile, all-purpose P&C Snips are at your tool dealer's in four types and 11 sizes. They are designed for smooth, speedy, accurate cutting with minimum effort and strain. Like all P&C quality tools, they're "the best money can buy". Fully guaranteed.

## Cut almost anything

sheet metal, screen, wire, ducts, straps, linoleum, carpeting, canvas, rubber, leather, plastics, fibreboard,

cardboard, and many more.

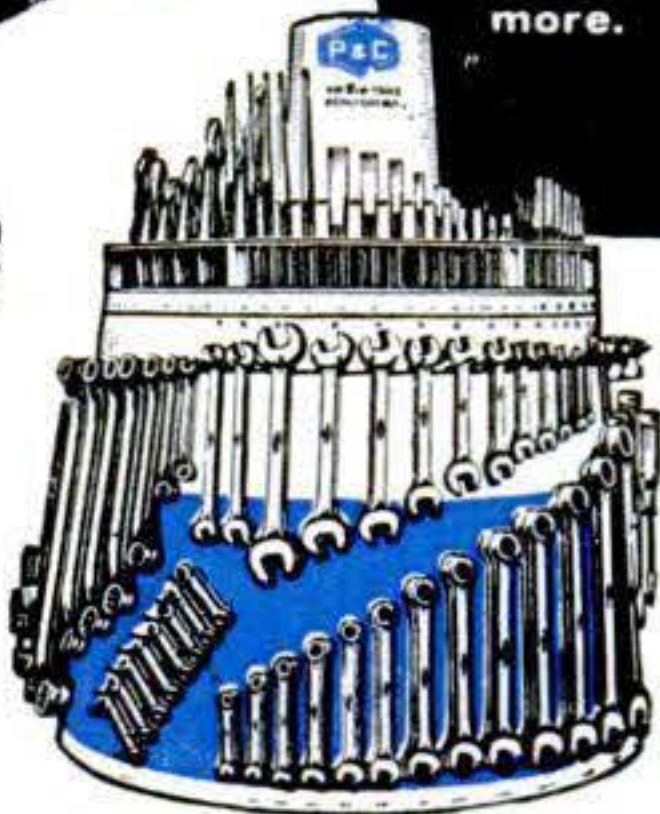


Buy P&C Tools from this handy display.

Send name, address, 10c for complete 48-page catalog. Complete information on 500 P&C Tools.

**P & C  
HAND-FORGED  
TOOL COMPANY**

Dept. F-753, Box 5926  
Portland 22, Oregon



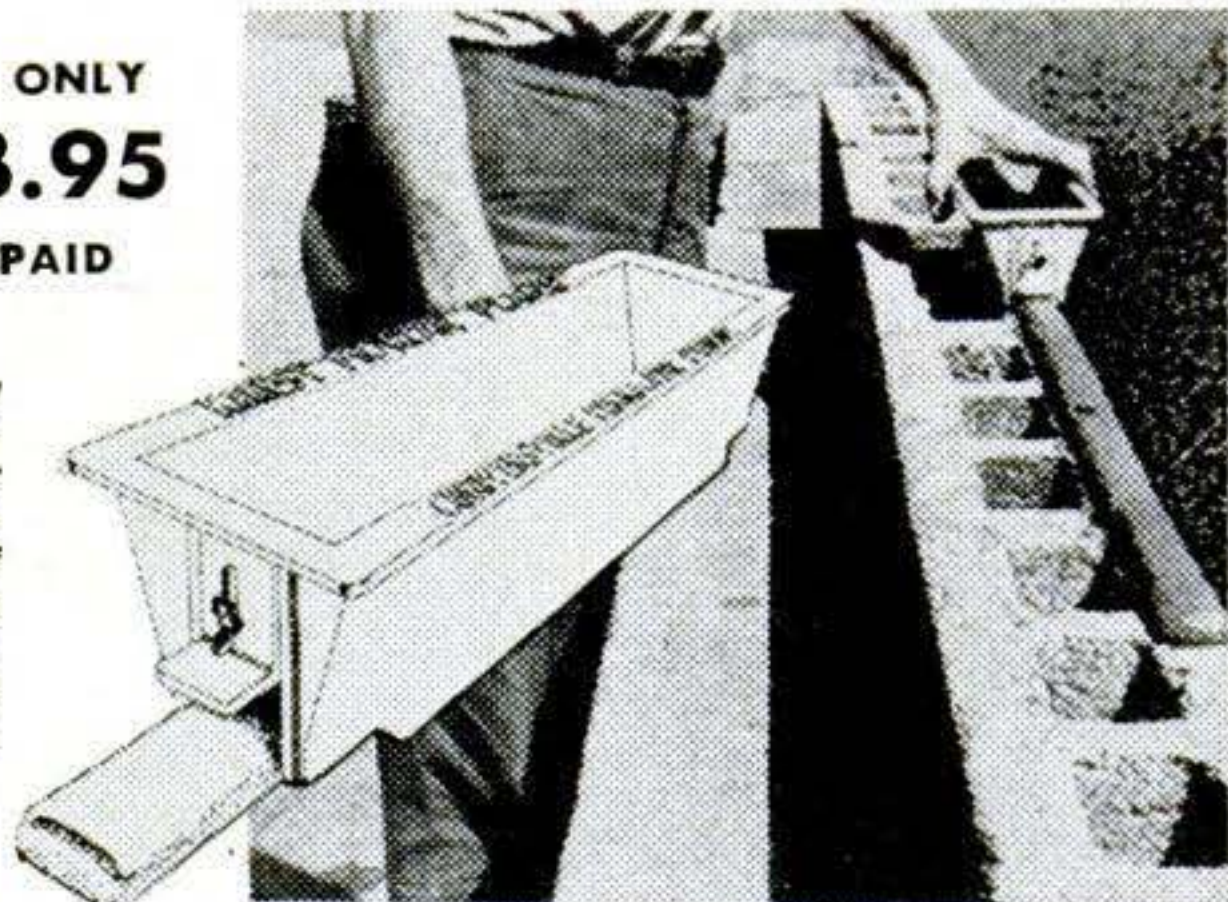
Building your own home? Garage? Tool house?  
Laying a new foundation or retaining wall?

DO IT EASIER, BETTER, CHEAPER  
& FASTER WITH THE AMAZING NEW

## KAKEST MORTAR PLANE

PRICE ONLY  
**\$13.95**  
POSTPAID

10-day guarantee. Your money refunded if you are not satisfied. Prompt delivery.



Even if you never laid cement or cinder blocks before you will be thrilled with the professional job you can do using this clever device. It is impossible to work as fast and neat with a trowel and mortar board. Why, in one day you will pay for the KAKEST MORTAR PLANE just by your savings of mortar and working time (to say nothing of the backaches and arm aches you will avoid!).

**EASY:** Even a child can use it. Weighs only 11½ lbs. Just set the end gates to the thickness you want, fill with mortar, "jiggle" the Mortar Plane as you slide it along the blocks on its own guides. The uniform ribbon of mortar gives complete levelness and requires less tamping.

**KAKEST CO., Curwensville, Penna.**

Gentlemen: Please send me Kakest Mortar Plane for laying concrete blocks. Enclosed check or money order for \$13.95.

Name.....  
Address.....

## They Trap Counterfeiters Everywhere

[Continued from page 53]

of counterfeit dollars in the world. Somodoff was the pupil of Ivan Massagoff, white-bearded former professor in the Beaux Arts Institute at Moscow, who has a long string of convictions in the bogus-money game himself. Somodoff ran up an illustrious record before the war but he has not been caught in any funny business since. However, Interpol keeps an eye on him—he's now in Uruguay—just in case.

### Time Ran Out on Nazis

Somodoff was the chief designer in Sachsenhausen concentration camp, where the Nazis had their bogus-money factory in World War II. There were many others with criminal records among the 140 men recruited by the Nazis from the concentration camp. In fact, it was only by turning to the "professionals" that Himmler was able to produce the perfect five-, 10- and 50-pound notes that he wanted. Earlier attempts, using German government engravers, had fizzled.

During 1944 and early 1945, these professional crews at Sachsenhausen, working two 12-hour shifts, produced between eight and nine million notes, worth an estimated half billion dollars. Of these, three million were so good that even the Bank of England didn't notice the difference. Then time ran out on the Nazis in the spring of 1945 and American troops closed in.

### 140 Counterfeiters Turned Loose

Himmler ordered the bogus money buried, burned or dumped in the river, and the greater share was thus disposed of. The frantic Nazis ordered 140 counterfeiters liquidated, but due to an error in the transmission of the orders they were all liberated instead, turning loose on the world the largest gang of trained counterfeiters ever assembled.

Somodoff had originally been brought in to design counterfeit dollars and he turned out an excellent product. A great

[Continued on page 218]



## Lt. Wt. Aluminum PIANO HINGE

Length 72 inches, thickness .040—width 1 1/4"—



Operating radius 275 degrees. Made of aluminum alloy, sold in 6 feet lengths only—\$1.15 per length...

## HEAVY DUTY STEEL PIANO HINGE

Length 56"—Thickness 3/32"—Width (open) 3-5/16"—Operating radius 330 degrees—Made of heavy duty steel—Drilled ready for use. Ideal for drop tables, heavy tool boxes, heavy doors, and many other uses where heavy hinges are required. Sold in 56" lengths only. Ship. Wt. 7 lbs. At a fraction of original cost \$1.45

## LIVE RUBBER SHOCK CORD



Made in accordance with rigid army specifications. Clean fresh stock, 1/4" contains approx. 40 strands of live rubber, 3/8" approx. 100 strands, 1/2" approx. 500 strands, etc. Sold in 25 ft. lengths or more. At about 20% of original cost. Excellent for marine and boat supplies, for trampolines, for tying down tarpaulins, etc.

DIA.	PRICE (per 25')	SHIP. WT.
1/4"	\$2.00	2 lbs.
3/8"	\$2.75	3 lbs.
1/2"	\$3.25	4 lbs.
5/8"	\$4.50	5 lbs.
3/4"	\$5.75	6 lbs.

Quantity price on application.

Prices F.O.B. Chicago. Include approx. postage on orders paid for in advance. C.O.D. orders enclose 25%, balance sent C.O.D.

**U. A. S. Corp.** Dept. PS-7 5637 W. 63rd Pl. Chicago, Ill.

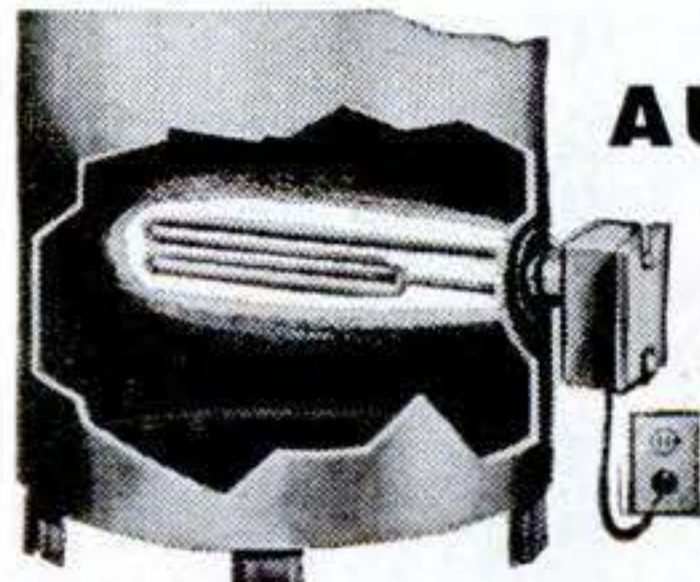
## New Low Cost Electric Water Heater Gives You

### HOT WATER AUTOMATICALLY

From Your Present Tank!

- No dirt, grime, soot, flame!
- SAFE! Every part UL approved!
- Install in 10 Minutes, or less!
- No new tanks or plumbing required.
- Works automatically—saves on fuel bills!

New, UL approved LECTROMATIC changes gas, coal or oil-burning water heater into modern ALL-ELECTRIC unit! Turns on automatically when needed, shuts off automatically when water is heated. To install, simply shut off water.



Complete—Ready to Plug In—Only \$19.95

Remove plug from water tank. Screw LECTROMATIC into opening (as shown), then PLUG IN any 110 volt AC outlet. Uses 1250 watts. Plenty of hot water all day long. Uses only 1/4-1/2c electricity per gal. of hot water. Temp. adjustable from 100 to 180 degrees. Save postage. Send check or money order for \$19.95 now. Money back in ten days if not delighted. Full one year guarantee! ORDER NOW!

COLLOID EQUIPMENT Co. Inc. Dept. PS-7, 50 Church Street NEW YORK 7, N. Y.

## NEW, IMPROVED CALCULATOR FOR WOODWORKERS only 25c

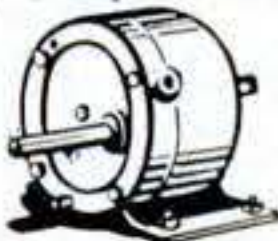
Instantly gives information on lumber, nails, concrete mixes, painting materials, etc. Convenient, simple to read. Just set dial for nail specifications, to convert linear to board feet, find bit sizes for screws, compare characteristics of woods. 6" diameter heavily varnished cardboard. Send 25c, no stamps, please to Greenlee Tool Co., 2127 Columbia Avenue, Rockford, Illinois.



## SAVE MIDDLEMAN'S PROFITS ... buy DIRECT from C&H

### HOT ROD SUPERCHARGER

Extra soup and go at a price you can't afford to miss! Mfr'd by Borg-Warner. Specifications: 7 1/2" deep, 7" high. Wgt. 17 lbs. Compact and sturdy, 4 base mounting holes, 3/4" outlet, 5/8" shaft with female Lovejoy coupling. Priced today at \$85. SPECIAL! NEW only \$31.00. Used \$18.95.



### 80-1 ratio Gear Reducer

Double reduction—reduces 1/6 to 1/2 HP electric motors 1750 rpm to 22 rpm. Reg. \$45. NOW \$26.

### RUBBER HOSE

Long wearing GOODRICH 2 ply 2" I.D. 25 ft. lengths worth \$25. Only \$4.95; 3 lengths for \$12.00.



### Sensational Winch Values!

Power and hand models for boats, trucks, farmers, loggers, contractors, etc. Prices start as low as \$16.95. Send for CATALOG.

Also parts, plans for dummy & incline elevators as described in April Pop. Science pp. 240-41. Send 25c for Build-It yourself diagram.

SEND TODAY FREE CATALOG

Hundreds of \$\$ saving buys. These are a few of the many items at sensationally low prices!

Pumps Tools Drop Cords Generators Compressors Saws Clutches Air Tanks

**C&H ELECTRIC MACHINE Co. Inc.**

438v W. Juneau Ave., Milwaukee 3, Wisconsin

# Hear What You're Missing

## Get a hallicrafters



Enjoy the thrills of short-wave at down to earth prices. Now, for no more than you'd expect to pay for an ordinary radio, you

hear regular broadcasts plus London, Paris, Moscow—ships at sea, aircraft and police calls—amateur broadcasts, emergency frequencies—and much more.

These are radios made by Hallicrafters, for years the leading manufacturer of precision communications equipment for the armed services, and for years the favorite of America's ham operators. Write for FREE information on the Hallicrafters line of outstanding receivers and transmitters.



HALLICRAFTERS MODEL S-53A—Only \$89.95

# hallicrafters

World's Leading Manufacturer of Precision Radio Communications Equipment for the Armed Forces

Hallicrafters, Dept. PS-73, 4401 W. Fifth Avenue Chicago 24, Illinois

Please send me complete information on Hallicrafters Short Wave.

Name.....

Address.....

City..... State.....



# AMAZING NEW VAPORIZER KILLS INSECTS

*Automatically protects  
family, food, guests from  
disease-bearing pests*

**SILENT! COLORLESS! STAINLESS!**



Here's the greatest boon in years to cleanliness, sanitation and more comfortable living. Now at last you can protect any room in your home from flies, mosquitos and other small flying insects.

Never before such wonderful freedom. And so easy to use. Simple as turning on a light bulb. Just place the Champ in any socket. Within seconds this miracle bulb starts to work, vaporizing a pellet about the size of an aspirin, that means sure death to small flying insects.

## CHAMP INSECT BULB

**298** complete with 6 weeks supply of pellets or \$3.98 with season's supply  
**MONEY BACK GUARANTEE** on sale at all dep't, drug, food, hardware stores or send \$2.98 (COD's accepted plus postage) to

**Insect Controls, Inc.**

20th & Market Sts., Dept. 28, Phila. 3, Pa.

## Expert help for WOODWORKERS

Develop skill with this complete how-to-do-it book on tools and woodworking by world's best known tool-maker. 182 pages, plenty of illustrations and diagrams. Get your copy today—only \$2.00 postpaid. STANLEY TOOLS, 473A Elm St., New Britain, Conn. In Canada: Stanley Tool Co. of Canada Ltd., 473A Stanley St., Roxton Pond, Quebec.



## New Gadget Dispenses "Instant" Shave Lather!

Now, science has declared "push-button" war on whiskers! Rich, creamy lather right out of a can . . . no brush, no greasy cream. Just push valve—out comes lather! It's the greatest shaving invention in 50 years. New AERO SHAVE contains 3 beard-softeners, wilts toughest whiskers in hard or soft water. And built-in Lano-Lotion soothes your skin. For slicker, quicker shaves, switch to the AERO SHAVE Lather Bomb. "Canned Lather"—ready to use! Only 59¢.



## They Trap Counterfeiters Everywhere

[Continued from page 216]

many of these were distributed before the jig was up and "Sachsenhausen dollars"—some 3,000 so far—are still popping up all over Europe. Of the 3,000,000 highest-quality pound notes, about 1,600,000 have been accounted for, according to Interpol records, while 1,400,000 have not.

Most of these may now have been destroyed, but Sachsenhausen pound notes are still turning up in one part of the world and another.

### Interpol Clams Up on Cold War

Interpol's anti-counterfeiting operatives continue to keep an eye on the remnants of this huge counterfeiting mob collected by the Nazis, not so much because they expect it ever to get together and start operating again but just because it's part of every day's work to keep counterfeiting from raising its ugly head anywhere in the world.

When you ask Interpol sleuths what part the organization would play in case some country started using counterfeiting as a weapon, in cold or hot war, they just smile and shake their heads. Interpol, you are reminded, is purely a police organization and does not enter into political activities of any kind.

But its officials will not deny that Interpol's experience and techniques provide a far more effective defense against international counterfeiting than we had when Hitler and Himmler almost pulled off their scheme only a little over eight years ago. **END**

### Sprint Training

A BIG-GAME hunter in Africa was on his way back to camp one night when a big lion came out of the jungle about 20 feet away. As the lion was about to spring, the hunter fired his last cartridge and missed. The lion sprang too far and landed 15 feet beyond the hunter, who then ran for camp and made it safely.

The next day the hunter went to the back of the camp to practice a little shooting at close range. He heard a strange noise in the brush and investigated. It was the lion—practicing short leaps.—*The Right Hand.*

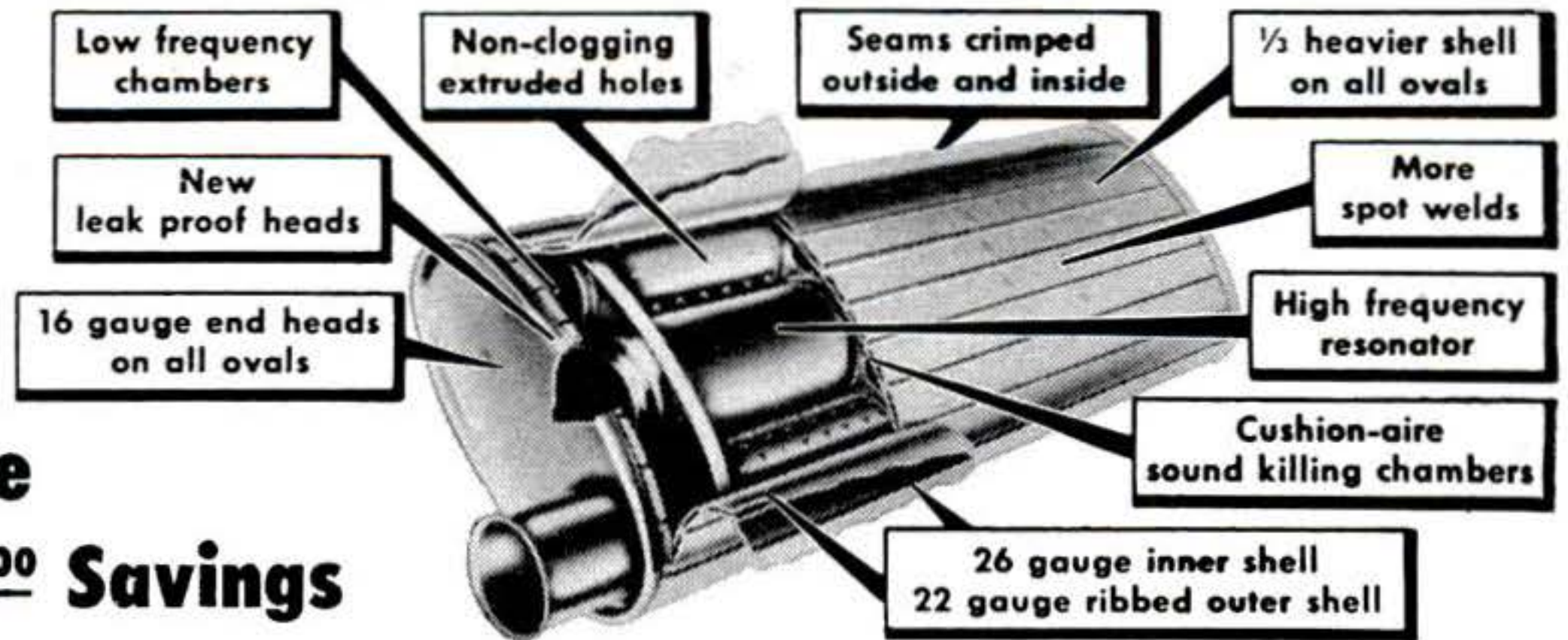


# All Mufflers are NOT Alike

## SILENTONE

gives  
you

- ★ Safety
- ★ Power
- ★ Long Life
- ★ Up to \$8<sup>00</sup> Savings



These features show why Silentones are the highest quality mufflers. They're made to car factory specifications or better • scientifically designed to lower back pressure which robs your engine of

power • made of heavy steel inside and out. Because Silentone Mufflers are sold only through leading automotive chain stores, you save as much as \$5.00—up to \$8.00 if you install it yourself.

## DYNATONE

### The Deep, Mellow Tone Muffler That's Engineered—Not Packed

Tuned for each make of car . . . costs less than "Hollywoods" • lower back pressure • more gas mileage • longer life. Ask about Dynatone duals for greater power and gas savings.

Write Dept. 8-G for name of your nearest Silentone dealer

# SILENTONE

SOLD ONLY BY AMERICA'S LEADING AUTOMOTIVE CHAIN STORES • TOLEDO 1, OHIO



**AMAZING, PERMANENT MAGNETS—WILL NOT WEAKEN! NON-ELECTRIC** retrieve guns, tackle, tools and other steel items from lake, river, plating tanks, drains or other hard-to-reach spots. Recover drills, taps, etc. from sweepings. Clear alley of harmful tacks, nails. Many other uses. Pays for itself quickly. **GUARANTEED.** Try any magnet one week. Money refunded if you are not well pleased.

No. S-725 (Weighs 54 oz.) Has pull of 225 lbs. on steel block \$15.00  
 No. S-675 (Weighs 49 oz.) Has pull of 175 lbs. on steel block \$10.50  
 No. S-650 (Weighs 41 oz.) Has pull of 150 lbs. on steel block \$ 8.50  
 No. S-500 (Weighs 15 oz.) Has pull of 50 lbs. on steel block \$ 4.00  
 No. S-30 Hobbyist assortment of six small magnets . . . . . \$ 1.50

Send Money Order or check. We pay postage. No C.O.D.'s.  
**MIAMI MAGNET COMPANY, 3240 N.W. 27th Ave., Miami 42, Fla.**

LOW OVERHEAD—LARGE VOLUME SALES & SMALL PROFITS  
 BRING YOU THESE "LOWEST PRICES"

WHAT GOOD IS A TIRE WITHOUT A TUBE?  
**TUBE GIVEN WITH EVERY TIRE AT NO EXTRA COST**

*Why Pay More!*

**SUMMER SPECIALS—AT LOW PRICES  
 SAVE TIME—SAVE MONEY—SEND THIS AD  
 GOOD USED TIRES—NOT RECAPS  
 19 YEARS AT THIS ADDRESS**

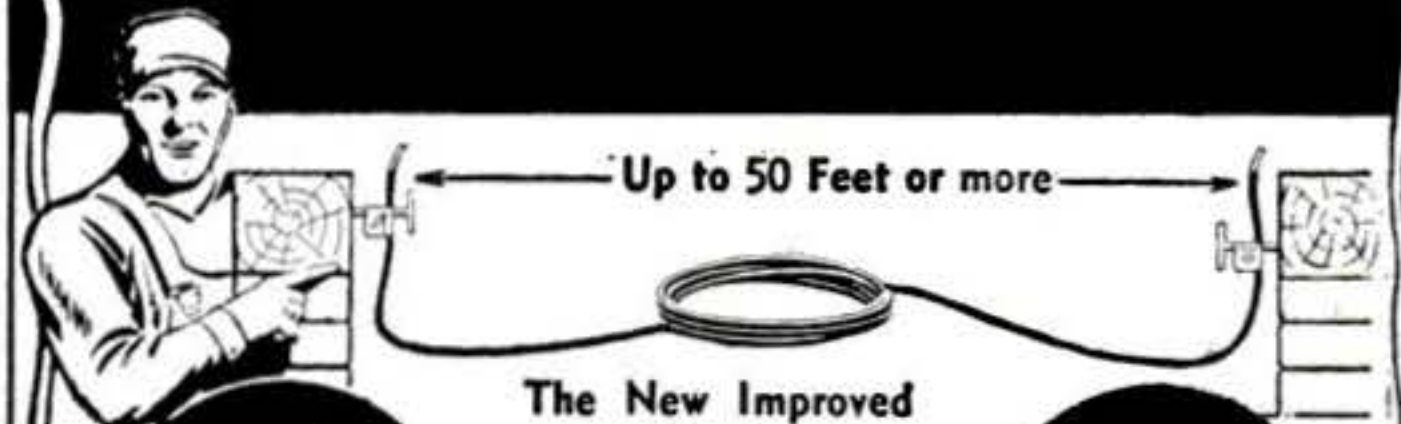
Be Wise—A TRIAL OF ONE TIRE WILL CONVINCE YOU.  
**EVERYBODY 10% off ON EVERY TIRE  
 MAY TAKE 20 MONTHS WRITTEN GUARANTEE**

600-16	\$4.10	820-15	\$5.35	600-20	\$7.10	32x6(8)	\$8.55
650-16	5.55	700-15	4.50	650-20	7.85	32x6(10)	9.85
700-16	5.00	670-15	4.45	700-20	8.45	900-20	13.15
650-15	4.35	710-15	4.65	750-20	8.55	1000-20	13.75
760-15	4.95	550-17	4.45	825-20	14.65	1100-20	13.85
<b>EXTRA SPECIAL 30 MONTH WRITTEN GUARANTEE</b>							
600-16	\$5.35	475-19	\$4.85	700-15(6)	\$8.95	00-20	\$11.00
600-16(6)	6.40	640-15	5.05	750-16(8)	10.75	750-20(10)	15.45
650-16	5.85	670-15	5.55	700-17	9.95	750-20(8)	15.05
650-16(6)	7.35	710-15	5.75	750-17	11.75	825-20	18.35
700-16	6.45	760-15	6.05	750-15	13.95	900-20	17.25
750-16	9.25	800-15	6.55	825-15	12.95	1000-20	17.75
525-18	5.00	820-15	6.65	600-20	8.75	1100-20	19.55
550-17	4.95	670-16	6.35	650-20	10.25	1000-22	19.45
650-15	5.35	760-16	7.15	32x6(8)	11.15	1100-22	20.45
700-15	5.45	700-16(6)	7.65	32x6(10)	11.75	1200-20	29.95
All White Walls \$1.50 Extra				Military treads 7.50-20 16.15			

Thousands of tires shipped all over U. S. A. All tires shipped F.O.B. Phila. Send Check or M.O. with this ad. Dept. 5.  
**STANDARD 834 N. Broad St., Philadelphia 30, Pa.**

# LEVELALL

FASTER THAN \$100 ENGINEER INSTRUMENTS



**Regular**  
 50 Feet  
**\$8.95**

The New Improved  
 Water Level  
 For Simplest  
 One Man Operation  
 Anything you need level  
 Levelall does it.  
 Dealer inquiries invited

**DeLuxe**  
 75 Feet  
**\$12.95**

A sturdy instrument that can be left on the job for any workman to use. Cannot be put out of adjustment and even with the most casual handling its principle is so simple anyone can level points quickly and accurately.

Complete with instructions, high quality vinyl polechloride tubing filled with Level-Flo Liquid, mounting brackets, and metal case.

For footings, forms, batter boards, sills, lintels, floors, ceilings, roads, driveways, lawns, piping, farm contouring and all general construction work normally needing an expensive instrument.

LEVELALL, 81M Webster St., Rockland, Mass.  
 Mail me . . . 75' DeLuxe Levelall @ \$12.95  
 Mail me . . . 50' Levelall Instruments @ \$ 8.95  
 you guarantee satisfaction or money back upon return of Levelall within ten days.

1 qt. extra Level-Flo Liquid shipped with Deluxe Model only.

Name \_\_\_\_\_  
 Address \_\_\_\_\_  
 City \_\_\_\_\_ Zone \_\_\_\_\_ State \_\_\_\_\_

Send C.O.D. I will pay postman full purchase price plus delivery charge on arrival.  
 Full purchase price is enclosed. Send postpaid. (Postage prepaid on orders in U.S.A. only). Prices higher in Canada. Order From:

Levelall Reg'd., 1072 St. Lawrence Blvd., Montreal, Que.



# MAN WANTED

IN EACH  
COMMUNITY

Become the "Seat  
Cover Man" in Your  
Locality with America's  
Greatest Line of  
Auto Seat Covers



COVERS FOR YOUR  
OWN CAR  
GIVEN AS  
BONUS!

AMAZING MONEY  
MAKING OPPOR-  
TUNITY WITHOUT  
INVESTMENT

Want extra money—plenty of it day after day? Then rush your name and address at once for Free Sample Outfit that will start you taking orders from car owners everywhere for Key expertly tailored Auto Seat Covers. EXCLUSIVE NEW PATTERNS to fit every make and model car. No one can compete with you, in wide choice, in quality—and in expert tailoring that makes covers fit like a pair of gloves—and when you quote prices that are only a

fraction of what the customer expects to pay, brother! You make money hand over fist writing up the fast orders! Line includes nationally advertised sensations like BLACK EBONY Saran, beautiful BAMBOO, brilliant FIESTA, colorful BULL FIGHTER PLAIDS, plus many other exclusive patterns to choose from, all at unbelievably low prices.

RUSH NAME FOR FREE OUTFIT

Give MAKE, YEAR and MODEL of YOUR CAR

No experience needed. Make all the extra money you need easily just by showing! Every car owner a "hot" prospect, YEAR AROUND STEADY PROFITS. No investment to make. Actual seat covers given to producers as a bonus for OWN USE! Write for Free Selling Kit valued at \$2.00 and actual samples TODAY!

KEY PRODUCTS CORP., Dept. 637, 800 N. Clark St., Chicago 10, Ill.

BENJAMIN SUPER CO<sub>2</sub> GAS PISTOL

MORE MODELS  
LOWER PRICES



SAFE • NON-TOXIC • HI-POWER  
ACCURATE • ECONOMICAL  
CONVENIENT • PRACTICAL

Easy to operate—Uses low cost Soda Cartridges. Cal. .22 or Cal. .177 Benjamin H-C Pellets & Darts or BB. Write Today for Illustrated Folder of All Models Benjamin Air Rifles and Benjamin Air Pistols. Benjamin Air Rifle Co., 852 Marion St., St. Louis 4, Mo., U.S.A.

\$13.50  
UP

## You Can Make DRAIN TILE

and Build a Profitable  
Community Enterprise

Farm drainage, home building, reclamation projects, highway construction. From these and other sources come the biggest demand for drain tile in history. More local plants are urgently needed.

Millions of dollars' worth of drain tile are used annually. Much of it, ordinarily, is shipped from far distant points. Local manufacturing is economical, logical, profitable. The Champion Drain Tile Machine makes manufacturing easy. Pares production costs. Requires no skilled labor. Makes all sizes from 3" to 12". Yet requires only a moderate investment.

Outstanding Manufacturing Opportunity

Champion-made cement tile are dense, strong, and truly round. No distortion, no shaling. Worth more than clay tile, but can be sold for less—and still leave a handsome profit margin.

Write for the DrainTile Book. Tells about cement tile as a local manufacturing enterprise. Tells about easy-payment terms. Write today.

Concrete Equipment Company  
521 Ottawa Ave., Holland, Michigan



E2

## POCKET-PAL PORTABLE

TINY PACKAGE OF ELECTRONIC MAGIC!

- ★ Fits in your shirt pocket
- ★ Only 2 inches wide, 5 inches tall
- ★ Covers the standard broadcast band
- ★ Plays as you walk along anywhere
- ★ Uses personal hearing-aid earphone
- ★ Unique built-in ferri-loop antenna
- ★ Powerful miniature low-drain tubes
- ★ Selective 25 mile daytime reception
- ★ 1,500 mile reception in night tests
- ★ New long-life mercuric "A" battery



POCKET-PAL is not a toy or gadget with dangling wires or silly clips to attach, but a REAL PORTABLE for indoor or outdoor use. This unique set features attractive metal case, variable condenser tuning, volume control with switch, fibre chassis with spring copper battery contacts and many expensive precision parts. Set can be assembled by anyone, using clear PICTURE PLANS, in an evening. Complete prefabricated kit, including all tubes, ONLY \$9.95 postpaid. Midget batteries \$1.75 per set. Use any earphone or hearing-aid unit furnished at wholesale cost. POCKET-PAL is GUARANTEED TO DELIGHT YOU or prompt refund. Order with confidence direct from WORLD'S LARGEST MANUFACTURER of prefabricated miniature radios.

\$9.95

ELECTRONIC MINIATURES, Beaverdam, Virginia

## BOAT KITS

Models from 39.25 complete

- Assemble your own boat
- No experience necessary
- Save 1/2 to 2/3 "factory built" prices
- Prices include freight and paint

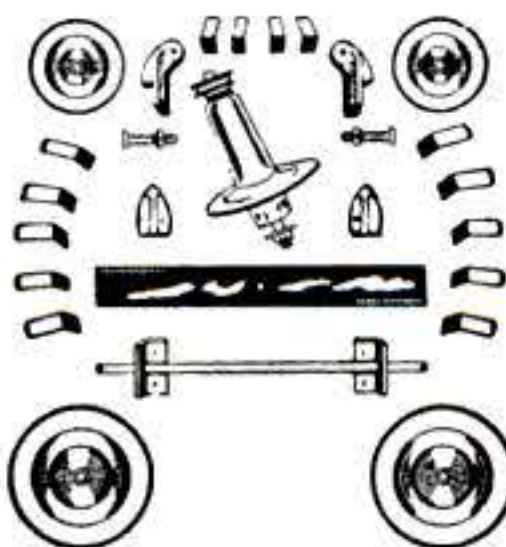
Free Catalog of all models



12 ft. model  
pictured

Marine hardware & complete accessories

LUGER Marine Division 3207 FREMONT AVE. SO. MINNEAPOLIS 8, MINN.



## POWER MOWERS AND KITS

Complete mower parts kit for either gasoline or electric power. Free plans and easy to follow instructions. Write today for descriptive folder, parts list and guarantee. Your name cast in metal platform of all "Custom" mowers no extra cost. Choice of 16", 18", 20" sizes, belt or direct drive. Many exclusive features. ALL AT LOW FACTORY PRICES

TEMCO MOWERS Springfield, Mo.

## COOK, HEAT without COAL

New cheap oil burner sets in fire-box of your furnace, heating or cooking stove. No more drudgery of coal and ashes. Sold on a 60-day MONEY-BACK GUARANTEE plus \$1.00 bonus offer. Send no money. Write for details today.

NORTHWEST MFG. CO. 20-J Main, Mitchell, S. Dak.

## DO MORE PLANING JOBS WITH LOW COST BELSAW



Exclusive MONEY-MAKING Features: • Full 12 1/4" x 6" capacity • Power feeds at 24' a minute • Provides for Grinding Knives in the Cutterhead • Attachments for Jointing, Rabbeting, Tongue, Groove, Matching. Convert low cost rough lumber into high priced cabinet finished stock... Easy to make flooring and popular patterns. Send today for free literature and prices.

Belsaw Machinery Co., 1023 Field Bldg., Kansas City II, Mo

## The QUICK-WAY to SHARPEN CIRCULAR SAWS



The complete sharpener, featured in FORTUNE and other leading magazines. Anyone can use... guarantees precise grinding and spacing of teeth. Operates on your own power table. Complete with patented Index Plate, facing block for jointing and \$3.00 grinding wheel—no extras needed. Sharpens circular saws up to 12" diameter. Saves time and money. Send check, cash or money order. We pay postage.

Model 6-12P  
\$16.50 Postpaid

QUICK-WAY Saw Company  
13 Riverside Corning, N.Y.



## BE A HIGH-PAID MAN IN YOUR COMMUNITY with this LONG NEEDED INVENTION

Earn up to \$10,000 or more per year! Nothing to invest! Be your own boss!

A worldwide product needed by every home, business and farm . . . priced to sell quickly at long profit! Automatic Red Comet goes into action as soon as fire starts . . . smother's fire without human aid. It's a sales natural.



### FREE SALES KIT

Demonstrator units, sales literature, etc., furnished you FREE. Handsome leather-type kit. Tried and proved, it will make you an independent businessman. ACT NOW! Someone in your community will be appointed soon. Write for details, today!

**RED COMET, INC.**

Dept. 376-F, R. C. Bldg., Littleton, Colo.



## AAF SURPLUS BARGAINS

**GENERATOR, AAF P-1, 24V, 200 amps, used, 60 lbs. . . . \$11.95**  
**GENERATOR, AAF L-3, 24V, 25 amps, excellent, 35 lbs. . . . \$9.95**  
**GENERATOR, AAF R-1, 24V, 300 amps, excellent, 60 lbs. . . . \$29.95**  
**MOTOR, electric, AC 115V, 60c, split phase, 1/2" shaft, 1/3 hp, 22 lbs. \$9.95**  
**REGULATOR, voltage, 24V, to 200 amps, carbon pile type. . . \$2.95**  
 (mounting base \$1.95)

**WINDSHIELD WIPER BLADES & frame, 48", use for cleaning windows, etc. . . . \$1.25\***

**MASK, oxygen . . . \$1.50\***  
**CLAMPS, hose, mixed. . . . 200 for \$5.00**  
**TELESCOPE, optical, 2 power 2x1" . . . \$1.00\***  
**PUMP, oil, AAF type, small. . . \$1.95, large. . . \$2.95**

All job except those so indicated (\*) which are postpaid. No parcel post over 20 lbs. Weights indicated are app. shipping weights.

**AERO PARTS SUPPLY, Dept. PS-Y, Municipal Airport, Houston 17, Texas**

## CARBURETOR TOO RICH MAKES MOTORIST TOO POOR



Car owners who are wasting money, getting poor gas mileage due to over-rich mixtures, will be pleased to learn how to save gasoline by **VACU-MATING OVER-RICH MIXTURES.** Vacu-Matic fits all cars, trucks and tractors. Automatic and operates on the supercharge principle. Easily installed in a few minutes.

**SALESMEN WANTED! Big Profits**

For FREE particulars, how you can install one on your own car for introducing, just send your name and address on a postcard to **VACU-MATIC, 7617-2021 W. State St., WAUWATOSA, WIS.**

## SHOPMASTER'S

NEWEST SENSATION

## COMBINATION POWER TOOL



It's a . . . Circle Saw, Drill Press, Sander, Router, Shaper, Lathe All in One

For Complete Information Write Dept. PS-7 1214 S. 3rd St., Minneapolis, Minn.

**SHOPMASTER, INC.**

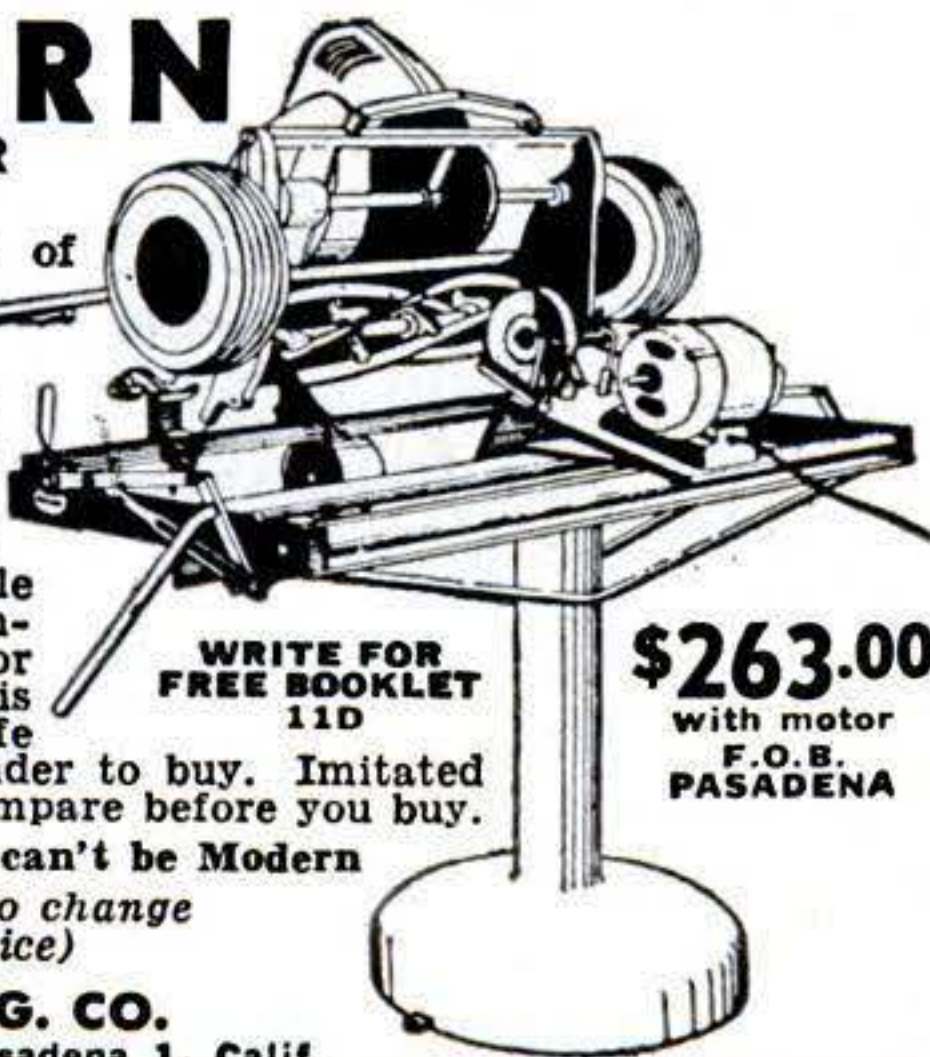
## MODERN LAWN MOWER SHARPENER

Service departments of leading Lawn Mower manufacturers use the Modern Lawn Mower Sharpener. One lever moves lawn mower into grinding position. Gasoline and oil remain in engine while sharpening, no dismantling of wheels, roller or handle. The Modern is a precision bed knife grinder—no extra grinder to buy. Imitated but never equaled—Compare before you buy.

If it isn't a Modern it can't be Modern (Prices subject to change without notice)

**MODERN MFG. CO.**

160 N. Fair Oaks - Pasadena 1, Calif.



WRITE FOR FREE BOOKLET 11D

**\$263.00** with motor F.O.B. PASADENA

## 10 POWER POCKET BINOCULAR



Etched into your United Binocular—Insist On It!

ACTUAL PHOTO

"TITAN MIDGET"! 3"x3 1/4"!

Weighs 6 1/2 oz.! Yet, a FULL 10 POWER with color corrected Achromatic lens. Interior surfaces of VITAL front and rear Achromatics are COATED to assure brighter, sharper, clearer images! Made by skilled optical craftsmen of precision, quality materials to rigid UNITED requirements. It explains why Price is LOW, Quality is HIGH. With genuine leather case, straps, \$24.95. OTHER POCKET MODELS. 6x Duo-Tone—\$17.95, 7x All Chrome—\$19.95.

## 16 x 50 — \$69.50 Weighs only 27 ounces!

The ultimate in high powered binoculars. Easy to hold—Easy to focus. 2" wide objective lens assures brighter, sharper, clearer images. Water-Dustproofed. Height only 7 inches.

6x30 15 oz. Economy . . . . \$34.50  
 7x35 5"x6 1/2" All purpose . . . 45.50  
 7x35 CENTER FOCUS . . . . 49.50  
 7x40 CENTER FOCUS . . . . 52.50  
 7x50 31 oz! Bargain! . . . . 36.00  
 7x50 CENTER FOCUS. SALE 39.50  
 8x30 18 oz! Favorite . . . . 39.50  
 8x40 More Power . . . . 54.50  
 8x40 CENTER FOCUS . . . . 59.50  
 10x30 Compact Power . . . . 45.00  
 10x50 CENTER FOCUS. 27 oz! 59.50  
 12x50 CENTER FOCUS. 27 oz! 67.50

**UNI-COATED\*** Interior sides of VITAL prisms and front and rear achromatics have been COATED with Magnesium Fluoride to assure brighter, sharper, clearer images. FROM 3 CONTINENTS come UNITED'S "Best-By-Test" binoculars. Made in Japan, unless stated otherwise, by skilled optical craftsmen of precision quality materials.



ALL Are Uni-Coated\*

## 8 x 30 GERMAN \$39.50 ONE OF WORLD'S LIGHTEST!



Prismatic "Whisper Weight" (11 oz!) binoculars from Germany, optical center of the world! 4"x5 1/4". Water-Dustproofed. Their performance will amaze you. Interior surfaces of VITAL front and rear Achromatics are COATED for that extra sharp, precise viewing. Quality, Economy priced. 7x35—Weighs 16 oz.—\$69.50. 20x56—Weighs 27 oz.—Size 9 1/2"x6 1/4"—\$99.50.

6 Telescopes in one. American Wollensak. Instant focusing at 15x, 20x, 30x, 40x, etc. Turn power tube to click—no guess work. Measures 9" closed, 27" extended. 18 oz. Rust proof chrome tubes. Objective 40 mm: All 12 optic surfaces COATED! See .22 bullet holes at 300 ft. Leather case included. Federal tax FREE.

## 15 Power to 40x \$33.50



## 7x35 WIDE ANGLE 525 FOOT FIELD

Angular Field 10° UNITED "Commander." See MORE, Pay LESS. Superbly made weighs only 26 ounces. 4 3/8"x7 5/8". UNI-COATED\*. Compare quality, compare performance, compare price . . . . . only \$79.50



**FREE**

40 page, 3 color fully illustrated Binocular Catalog. 75 different models from \$14.95 to \$270.00.

RUSH NAME

**DEALERS WANTED**

**30 DAY NO RISK TRIAL.** If not satisfied return for full refund. Cash orders postpaid. C.O.D.'s require \$2.00 deposit. Add Federal tax. Leather case, straps included with all binoculars.

**UNITED BINOCULAR CO.** United Bldg., 9043 S. Western Ave., Dept. ARF-8416, Chicago 20

DISPLAY SALES ROOMS OPEN 9:00-3:30 MON. thru FRI.

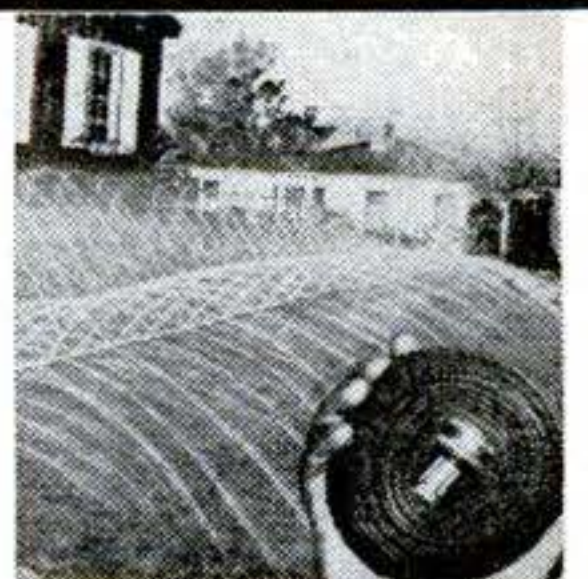
## NEW 2-WAY SPRINKLER

Sprays Area Up To 50 Feet All Around

Can Be Twisted, Wound Around Bushes and Flower Beds, Use As "Soaker"—Saves Water and Time. Durable, lightweight, made from flexible plastic. Will not rot or mildew, even if stored wet. Complete with brass connector.

20 ft. length. . . \$2.50  
 50 ft. length. . . \$4.75

**7-Day Free Trial**—Send payment now for sprinkler you want. We pay postage. C.O.D.'s also accepted (you pay postage). Money back within 7 days if not absolutely delighted. Order NOW!



- **SAVES WATER** Puts water where you want it when you want it.
- **SOAK OR SPRINKLE** A turn of the valve changes the sprinkler into a soaker.
- **EASILY STORED** So compact, it can be held in the palm of the hand.
- **FIVE-YEAR GUARANTEE** Will not rot or mildew—material and workmanship guaranteed.

**Homecrafts, 799 Broadway, Dept. SP14, New York 3, N. Y.**



SPORTSMEN • CAMPERS • BOATSMEN  
TOURISTS • PICKNICKERS • WORKERS

## COOK ANYWHERE—with Safety!

—with this world-famous portable safety stove, the OPTIMUS, imported from Sweden. Burns kerosene; no wick, no smell, no smoke; no sooty utensils to scour!



Clear, blue gas flame gives steady intense heat—instantly (boils water in 3½ minutes). One filling lasts hours—costs less than coal! Rugged construction, polished brass. Weighs only 2 lbs., 6 oz. 8" high. Dismounts to fit handy, square box.

**ONLY  
7.49**

**PREPAID**

An unbeatable value at only \$7.49 prepaid, direct to user. Don't wait to enjoy good, hot food wherever you are. Send \$7.49, ck. or M.O., for #45 Optimus Stove. Immediate shipment guaranteed. Address—

Dept. 3-P ROBERT E. MILLER & CO., Inc., 35 Pearl St., New York City 4



## EVER GLASTING

FIBERGLAS BOAT ARMOR

**FOR  
ALL  
BOATS**

New easy method designed for simple application. New laminator X-97 (pat. pend.) needs no experience. It's safe! Assures perfect job first time. X-97 is ready mixed! Requires no curing or sunlight. Can be used in normal temperatures. Has unlimited shelf life. Applied in morning, ready for use same day. X-97 available in colors, also clear, which can be painted. Apply glass cloth yourself! Make hulls watertight. Permanently stop leaks on decks, cabin roofs. Add structural strength, value, beauty. Keep new boats new longer, used boats in use longer. Save money on upkeep and repair bills.

### TRY IT! CONVINCE YOURSELF!

Send \$5 for complete repair kit (refundable on first order) or 10¢ for interesting illus booklet.

### DEALERS—INQUIRE NOW!

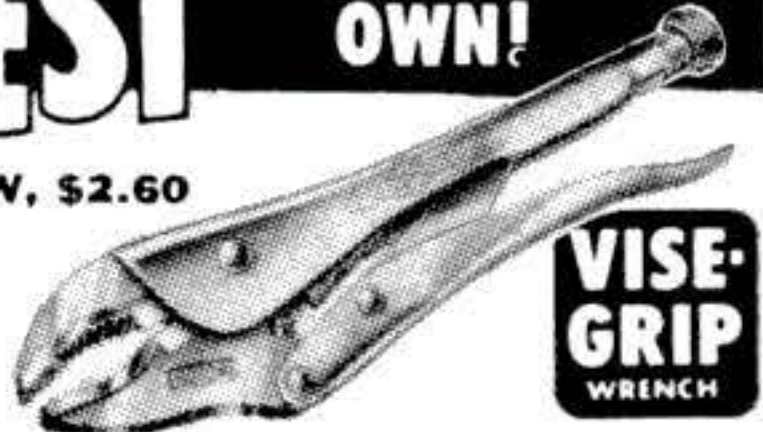
Excellent opportunity for established firms. Supply local demand. Be first in your town.

**EVER GLASTING** • DEVELOPED BY  
U-MAK-IT PRODUCTS  
725 WHITTIER ST., Bronx 59, New York City

## HANDIEST TOOL YOU CAN OWN!

No. 10-W, \$2.60

**Locks to Work  
with Ton-Grip!**



**WISE-GRIP  
WRENCH**

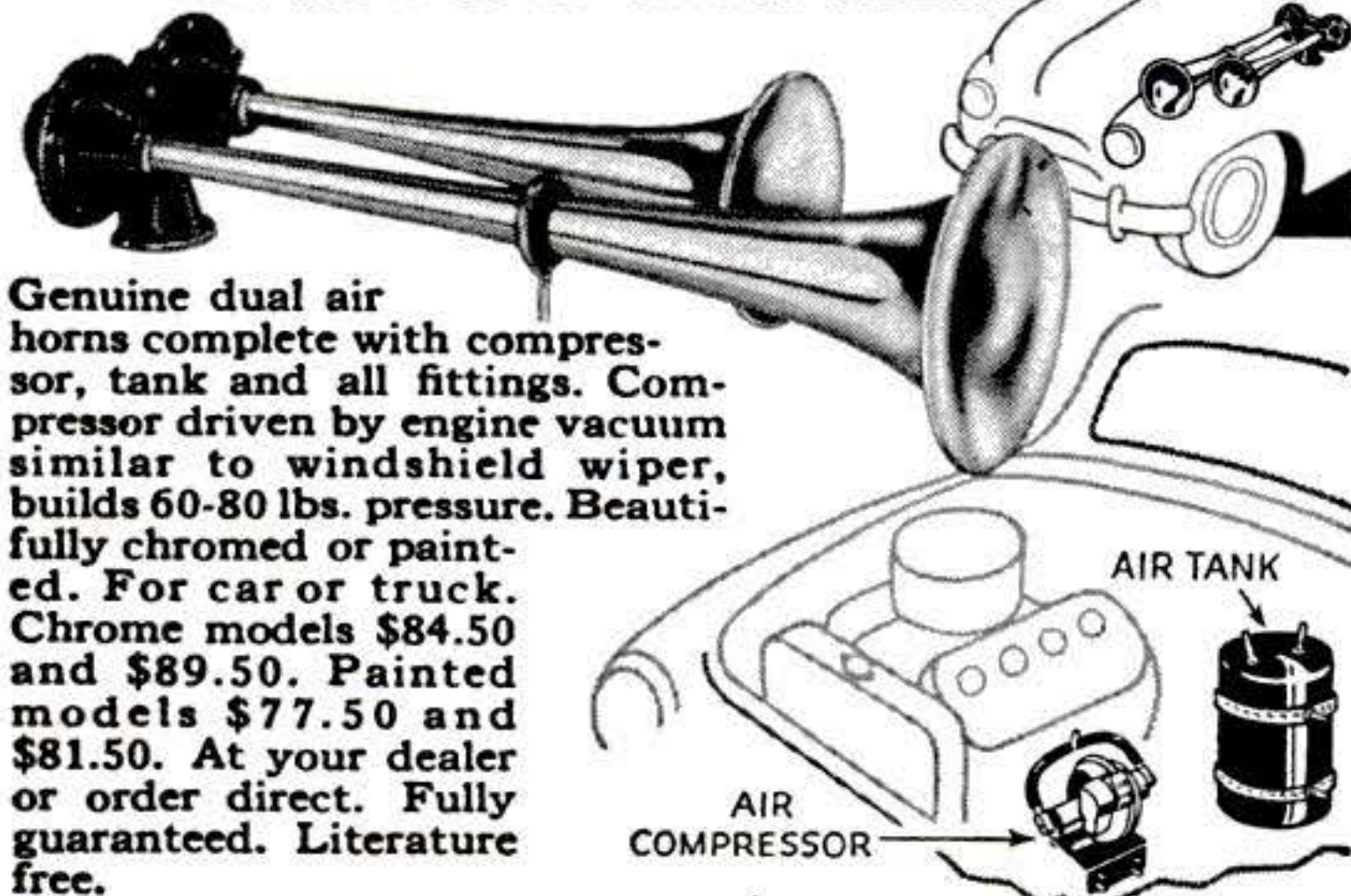
Does so MANY jobs EASIER! A squeeze of the hand locks jaws to work with Ton-Grip. Won't slip! Turns, twists, bends, pulls, cuts, ratchets. A whole tool kit in 1 trim tool! 7" and 10", only \$1.85 to \$2.60 at your dealer.

Made Only By PETERSEN MFG. CO., Dept. P-7, DeWitt, Nebraska

## HADLEY SUPER AIR HORNS

30 Times Louder—Easily Installed

on Fender or Under Hood



Genuine dual air horns complete with compressor, tank and all fittings. Compressor driven by engine vacuum similar to windshield wiper, builds 60-80 lbs. pressure. Beautifully chromed or painted. For car or truck. Chrome models \$84.50 and \$89.50. Painted models \$77.50 and \$81.50. At your dealer or order direct. Fully guaranteed. Literature free.

Hadley Mfg. Co.

2242 Smead, Toledo 6, Ohio

## Authenticast

SHIPS



DESTROYER ESCORT  
\$1.00

Perfectly scaled - Precision detailed miniature models that duplicate those used in U.S. military training. Full line of tanks, ships, planes of all nations.

SEND 35¢ TODAY!  
FOR COMPLETE CATALOGUE

COMET METAL PRODUCTS CO. INC. RICHMOND HILL 18, L.I., N.Y.

## SIGHT LEVELS INSTANTLY!

STRATEX SURVEYING  
Hand Level

\$10

IN U.S.A.



Positive slopes, elevations, drainage—farm, forest or construction. Built for life—simple to use—lets you plan, build, excavate with confidence; adjusts instantly from outside of instrument even in gusty weather! Put it to work now. It pays for itself on one job—fully guaranteed. \$2 cash, bal. C.O.D., or \$10 with order, we pay charges. Saddle leather case included. FREE price list.



STRATEX INSTRUMENT CO., INC.  
1861 D Hillhurst Ave., Los Angeles 27, Calif.



## SHOOT TELEVISION FILMS

FOR YOUR LOCAL TV STATION...make Extra Profits with the "Cine-Voice" Sound-On-Film 16mm Camera. \$695<sup>00</sup> Write for free information.

**BERNDT-BACH, Inc.**

7335 Beverly Blvd., Los Angeles 36, Calif.

SOUND-ON-FILM SINCE 1931



## New WHIRL-A-WAY JET-PROPELLED Car Washer

Waterpower makes this brush WHIRL, just like it makes dynamos go round! Thick, long bristles of finest horsehair whirl away dirt, dust, road haze; 4-ft. aluminum handle has built-in regulator and shut-off. Pays for itself over and over.

**\$4.95**

YOUNG PRODUCTS,

Dept. 1478, 2605 Elmhurst, Detroit 6, Mich.

## BUILD YOUR OWN

## POWER MOWER



Spindle & Blade

**With Parts We Furnish**  
Why break your back mowing field or lawn. Now anyone can save time, money and effort by building their own Power Mower. Build it to fit your needs, in a short time without special tools.

**PULLS  
ITSELF,  
STEERS  
ITSELF**

WRITE FOR FREE BUILDING INSTRUCTIONS—NO OBLIGATION!

T. & H. Mfg. Co., Dept. S-28, 811 E. 31 St., Kansas City, Mo.



**SEND FOR  
FREE  
CATALOG**



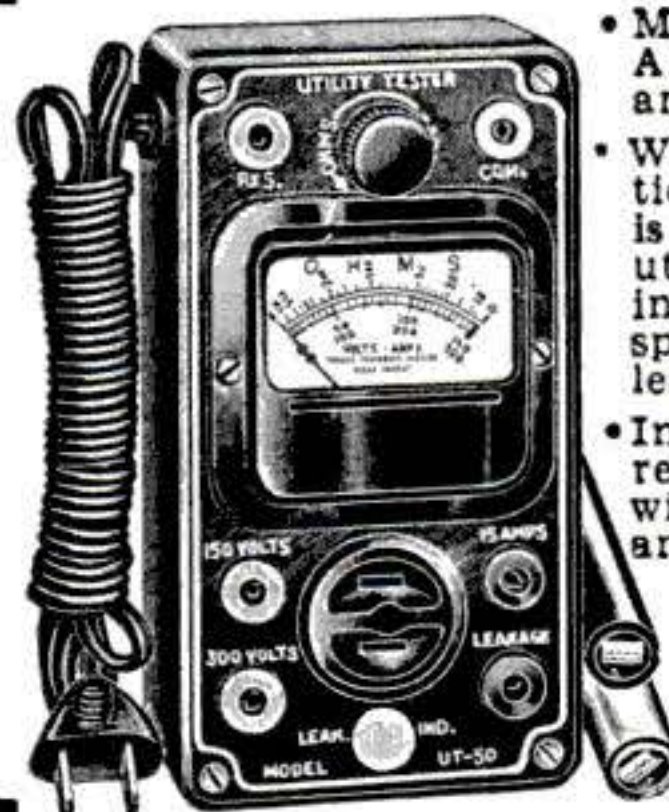
## Money-Making Tools!

It's easy to own the same "pay-off" tools used and endorsed by America's top-earning mechanics! You can start building your own kit with basic Snap-on sets—add others any time. Never sold in stores—direct to users only. Send today for free catalog!

Snap-on Tools Corporation  
8060-G 28th Ave., Kenosha, Wis.



## The NEW Model 50 UTILITY TESTER FOR REPAIRING ALL ELECTRICAL APPLIANCES-MOTORS an all-around electrical trouble shooter



- Measures A.C. and D.C. Voltages, A.C. and D.C. Current, Resistances, etc.
- Will measure the current consumption while the appliance under test is in operation. The appliance or utility may be plugged directly into the front panel receptacle. A special pair of insulated clip-end leads is included for motors, etc.
- Incorporates a sensitive direct-reading resistance range which will accurately measure all resistances commonly used in electrical appliances, motors, etc. This range will enable continuity checks and tests for shorts and opens.

Handsome round cornered molded bakelite case 3 1/8" x 5 7/8" x 2 1/4". Complete with all test leads and instructions.

- Will test thermostats, radio tube filaments, bulbs, fuses, fluorescents, condensers, switches, field coils, circuit breakers, lighting systems, etc.

**\$13.90**

**SHIPPED ON APPROVAL  
No Money With Order — No C.O.D.**

Try it for 10 days before you buy. If completely satisfied send \$3.90 and pay balance at rate of \$2.00 per month for 5 months — No Interest or Carrying Charges Added. If not completely satisfied, return to us, no explanation necessary.

**SUPERIOR ELECTRONIC CO., INC.**

Dept. D-66, 227 Fulton Street, New York 7, N. Y.

Please rush 1 Model 50. I agree to pay \$3.90 within 10 days after receipt and \$2.00 per month thereafter.

Name.....

Address.....

City..... Zone..... State.....

## WIN UP TO \$35,000!

### Famous Super Sniffer for URANIUM PROSPECTING

Compact 2 lb. Geiger counter. Uses only 2 flashlight batteries. Highly sensitive to both betas and gammas. Signals with flashing light and headphone clicks. Guaranteed, foolproof circuit. Complete with radium source, headphones, batteries, book, \$49.50 post paid. "Prospecting for Uranium." (no c.o.d.)



DEALERS INVITED

nuclear-chicago, 253 W. Erie St., Chicago 10

## MANUFACTURE BUILDING BLOCKS

Easy to start your own profitable business. General high speed, low cost Concrete Vibrator Block Machine produces 1000 blocks in 8-hour day. All sizes and shapes. Complete details FREE. Mail \$1 for wonderful book, "How to Build Your Own Concrete Block Home."

Only \$218  
Less Motor



**GENERAL ENGINES CO.**  
307 HUNTER ST., S-73 GLOUCESTER, N. J.



## INSURED TIRE SERVICE POPULAR BRANDS

**FREE** INSURANCE POLICY given with each used tire sold. We guarantee the amount of service you pay for.

Tube Given Free with Each Used Passenger Tire Upon Request

**SPECIAL!**  
Deduct 10% on orders for Two or More used tires

**YOU CAN'T LOSE!!**

Super Quality		Rugged Performance		15 Months Insured Service	
600x16	\$4.55	670x15	\$5.25	700x16	\$5.55
650x15	4.95	670x16	5.35	710x15	5.45
650x16	5.45	700x15	5.40	760x15	5.95
				550x17	4.75

Supreme Quality. Nothing Finer		30 Months Insured Service	
450x20	5.95	450x21	6.25
600x16	5.65	650x15	5.75
650x16	5.85	670x15	5.95
700x16	7.75	700x15	5.75
750x16	12.50	710x15	6.50
550x17	5.75	760x15	6.95
525x18	5.45	820x15	7.50
640x15	5.75	475x19	5.75
		700x15 (6)	10.45
		600x20	10.95
		650x20	11.75
		700x20	12.50
		32x6 (8)	11.95
		32x6 (10)	12.75
		750x20	14.50
		825x20	21.50
		750x16 (8)	15.95
		900x20	19.95
		1000x20	20.45
		1100x20	26.75
		1000x22	19.50
		1100x22	24.75
		1200x20	23.50
		1100x24	22.75

**MIDLAND  
TIRE SALES**

Speedy shipments on Mail Orders. F.O.B. Chicago. Insurance Policy sent with each order. Deduct 10% on orders for 2 or more used tires. Send CHECK or MONEY ORDER. No COD's.  
3701 S. Normal, Dept. 55-9, Chicago 9, Ill.

## PUMP WATER FAST!



**DRAIN WASH TUBS, CELLARS, CISTERNS  
IRRIGATE—FILL TANKS—DRAW WELL WATER**

Pumps 2800 GPH. 420 GPH at 75' High or 1600 GPH from 25' well. Sturdy, Rustproof Alloy Metal. Six Blade Impeller. Uses any 1/8 to 1/2 H P Motor Will not leak or clog. Fits any garden hose. Immediate Money Back Guarantee. Send Check, M.O., or C.O.D.

**895**  
IN U.S.

**MOORE MANUFACTURING CO.**  
SWEDESBORO 2 NEW JERSEY

## SEND \$1.00 DELTA'S SPECIAL SUMMER OFFER!

The DELTAGRAM for one year (6 issues) for only \$1.00, with choice of one FREE large scale project plan:

- |   |  |
|---|--|
| <input type="checkbox"/> Flower Box Designs | <input type="checkbox"/> Trellis Designs       |
| <input type="checkbox"/> Bird Feeder        | <input type="checkbox"/> 24-room Swallow House |
| <input type="checkbox"/> Book Trough        | <input type="checkbox"/> Reading Table         |

(Check first and second choice.)

DELTAGRAM is always full of shop-tested plans, ideas, money-saving tips. Send \$1.00 bill now: Delta Power Tool Div., Rockwell Mfg. Co., 504G N. Lexington Ave., Pittsburgh 8, Pa. Hurry! Special gift offer good only while limited supply of plans lasts.

Name.....

Address..... City.....





## REVERSIBLE AUTO SEAT COVERS

Made of FLEXTON plastic.  
Choice of: SNAKE-ZEBRA DESIGN  
or LEOPARD-COWHIDE DESIGN

Order from Mfr. and Save  
Colorful SNAKE AND ZEBRA DESIGN AND LEOPARD-COWHIDE DESIGN. Can Be Used On Either Side. Water And Stainproof. Tailored With Side Grip Panels For Tight Fit. Sewn With NYLON Thread For Long Wear. Simple To Install. Dress Up Your Car With A Set Of Either Of These Colorful Expensive Looking Covers!

**10 Day Money Back Guarantee**  
Choice Of SPLIT Or SOLID Front Seat Only \$2.98. Complete Set For Both Front & REAR ONLY \$5.00. When Ordering Specify Choice Of Design Wanted. Make of Car And Seat Style. Enclose Payment And Save Postage Or Sent C.O.D.

Each **\$2.98**  
Only

**MARDO SALES CORP., Dept. DS-120**  
480 Lexington Ave. New York 17, N. Y.

## PORTABLE GARAGE

**\$6.75** Plastic Vinyl  
USE IT ANYWHERE



- Folds compactly • Keeps rain, snow, dust, salt air, sun or sleet away • Protects your car's finish • Durably constructed of vinyl plastic • Springtite elasticized bottom, holds securely in all kinds of weather • Fits all makes • Direct from manufacturer • Enclose check or money order for **\$6.75**, or sent C.O.D. 10-Day Money Back Guarantee.

**MARDO SALES CORP.**

480 LEXINGTON AVE., Dept. G-118, NEW YORK 17, N. Y.

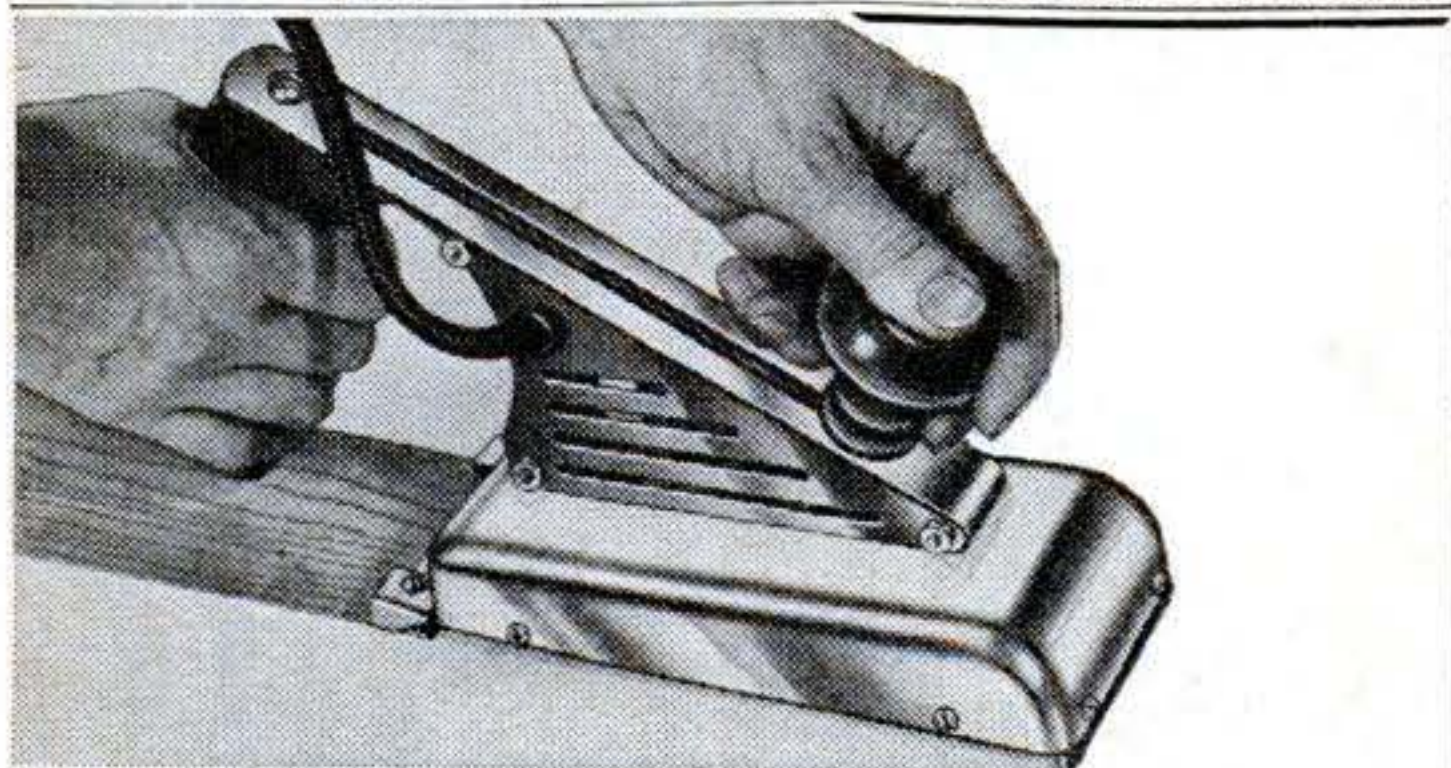
## NEW POWER FOR SLUGGISH AUTOS!



If your car wants to konk out on a hill . . . if it lacks power for emergencies or compression to pass on the highway . . . then you will want to try Fisher's Compression SEAL. Guaranteed to restore compression, reduce oil consumption and stop piston slap or your money back. Thousands of economy minded motorists who were faced with an expensive motor overhaul have been using it for years. Here's how it works—a small amount in each cylinder bore, expands up to 30 times, closing and sealing excessive clearance between the worn piston and cylinder bore . . . thus giving you 10,000 plus miles of "new" car economy. Takes only minutes to apply. Insured not to harm the finest engine.

Send cash, check or M.O. today. Only \$3.95 postpaid. Free literature. Dealers inquire!

**Car-Life Supply Co., Dept. PS-7** 4756 S. Central Ave., Los Angeles 11, Calif.



## PEEL PAINT ELECTRICALLY TO THE BARE WOOD GRAIN!

New, quality electric tool removes old layers of paint 3 1/2 sq. ft. per minute like slicing butter with a hot knife. Not a gadget but a working tool. Instantly softens paint electrically and peels it to the bare wood grain in one forward stroke. Eliminates scraping, cutting, burning, sanding and chemicals. Simply plug into any A.C. or D.C. outlet—allow to heat and remove paint to bare wood grain on interior or exterior surfaces—woodwork, floors, cupboards, doors, boats, etc. Complete with 8' U.L. approved heater cord. Absolute money back guarantee. Full price only \$9.95 postpaid. Send check, cash or money order to:

**SHEPHERD MACHINE & DIE CO.**

Dept. P.S. 15215 Chatfield Ave., Cleveland 11, Ohio

## HANDY FOR ALL METAL REPAIRS!

FREE Illustrated Booklet, "Soldering Simplified." Tells you how. Send postcard today.



**KESTER SOLDER COMPANY**  
4254 WRIGHTWOOD AVENUE  
CHICAGO 39, ILLINOIS

## SUPER DRILL GRINDER



Sharpen round shank drills from 3/32" to 1/2" in diameter, up to 6" long. Grinds old drills like new in 4 different point angles, using hand or power grinding wheels. Money-back guarantee, only **\$2.95**

At Dealers or Postpaid  
**A.D. McBURNEY** 317 E. 4th St., Dept. S-31  
Los Angeles 13, California

## BUILD YOUR OWN WINDOW or ATTIC FAN



IT'S EASY! SAVE UP TO 75%  
No Special tools or skill necessary  
Can be mounted in window or attic

Kits contain Fan spider, Masonite blades, Rubber-mounted bearings, Shaft, Pulleys, Belt, Bolts, and instructions. You furnish lumber and 1/4 HP motor. 24" Window Fan Kit (Cools office, apt., etc.), \$14.95 pp.

30" Size Parts Kit  
**\$15.95**  
P. P.

Cools average home

36" Attic Fan (Cools homes, churches, etc.), \$19.50 pp. Money back guarantee. Order today and keep cool this summer. Immediate shipment. Brochure free.

**FAN KIT CO., 154-E NO. BELVEDERE, MEMPHIS, TENNESSEE**

## SHIP MODEL KITS



Largest supply in New England. Fittings — Blueprints — Books. All prices. Write Dept. PS53. BIG ILLUSTRATED CATALOG ..... 25c

**JAMES BLISS & CO., INC.**

127 Years in Business 342 Atlantic Ave., Boston 10, Mass.



## CONTINENTAL Red Seal GAS ENGINE

NEW, in factory packed cartons.

Can be used for Lawn Mowers, Pumps, Compressors, Generators, and can be adapted for many other useful purposes.

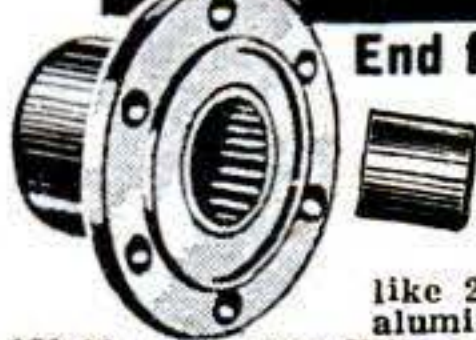
Model AC 6  
1 1/2 HP 3000 RPM  
Aircooled-4 cycle  
Single Cylinder  
Shipping Weight  
42 lbs.

Price **\$35.95**  
F.O.B. New York  
No C.O.D.

• COLUMBO TRADING CO., Inc., 383 Canal St., New York 13, N. Y. •

## WARN HUB CAPS MAKE

## 2 JEEPS OUT OF 1



End front wheel drag on all 4-wheel drive Willys and Dodge vehicles

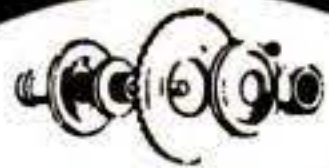
Save gas to 5 miles per gallon, reduce wear on front tires, axles; increase speed and power, stop front wheel shimmy—front wheels coast out of gear! 4-wheel drive handles, performs, climbs

like 2-wheel. Install or remove in 10 minutes. Polished aluminum, guaranteed. **STANDARD CAP** illustrated,

\$20.00 pair for Willys, \$23.00 pair for Dodge, prepaid U.S., Canada. **AUTOMATIC CAP** for Willys available, \$120.00 ppd. Permits use as 2- or 4-wheel drive automatically, all speeds. **LOCKING CAP** for Willys also available, \$65.00 ppd., which converts from 2- to 4-wheel drive or back with simple turn of lock. Fully guaranteed. See your Willys dealer or if no dealer near you order direct.

**WARN MFG. CO., Riverton Box 6064-B3, Seattle 88, Wash.**





**7 SLITTING SAWS WITH MANDREL . . . SET 34**

SET 7 different size high speed C4K slitting Saws, 6 pcs. 2 1/4" dia. x 1" arbor. Thickness from .040 to .071. Cuts wood, aluminum, brass, steel, etc. PLUS SPECIAL MANDREL which enables use of saws in 1/4" or 1/2" electric drill. \$25 value. PPD.

Only **\$4.95**

7 selected sharp H. S. Slitting Saw as above to use on your own mandrel or milling machine. New and used. PPD. Bargain at **\$4.95**

**BIG VALUES . . .**  
for the Little Guy—at the  
**SMALL MAN'S TOOL HOUSE!**

**HIGH SPEED WOODRUFF KEY SEAT CUTTER**

SET 5 different size cutters. Can be used as mounted milling cutter or circular saw. All with 3/8" and 1/2" shanks, widths up to 1/4", dia. up to 1". New and used. Ppd. Priced at only. . . . . **\$3.95**



**HIGH SPEED MORSE TAPER SHANK DRILLS**



SET 9 15 Different Size High Speed Morse Taper Shank Drills up to 9/16" with No. 1 and 2 tapers. New and used. \$50 value. Priced at only. . . . . **\$6.49**

SET 10 20 Different Size High Speed Morse Taper Shank Drills from 1/4" to 1". New and used. \$70 value. Priced at only. . . . . **\$12.95**

SET 15 10 Different Size High Speed Morse Taper Shank Drills from 1/2" to 1 1/4". New and used. \$50 value. Priced at only. . . . . **\$9.95**

**HIGH SPEED STRAIGHT SHANK CHUCKING REAMERS**



SET 16 20 Different Size High Speed Straight Shank 16 Chucking Reamers up to 1/2". New and used. Priced at only . . . . **\$7.95**

SET 18 15 Different Size High Speed Straight Shank 18 Chucking Reamers from 1/4" to 1". New and used. Priced at only **\$7.95**

**100 MOUNTED POINTS**

SET 21 1/8 and 3/32 shanks, assorted shapes and sizes. . . . . **\$8.98**



YOUR MONEY BACK if not satisfied. All mdse. mixture of new and reconditioned unless specified new. All orders (except those specified F.O.B. Detroit) shipped postpaid saving you up to 25% on total delivered cost.

Write for **FREE CATALOG**  
Dept. 103

**T & T TOOL CO.**

**7667 GRAND RIVER  
DETROIT 4, MICH.**

**WHEN IS WOOD GLUE REALLY WATERPROOF?**

ANSWER: when it meets Military Specifications for marine use.

Elmer's Waterproof Glue (formerly Cascophen) is the only cold-setting glue that passes these specs and comes in small packages!

Use it for permanent wood-to-wood bonds. Write for free folders. The Borden Co., Chemical Div., Dept. PS-73, 350 Madison Avenue, N. Y. 17, N. Y. B.3.10



IF IT'S *Borden's* IT'S GOT TO BE GOOD!

**CHAMPIONS**

**CHOICE of the EXPERTS**

for

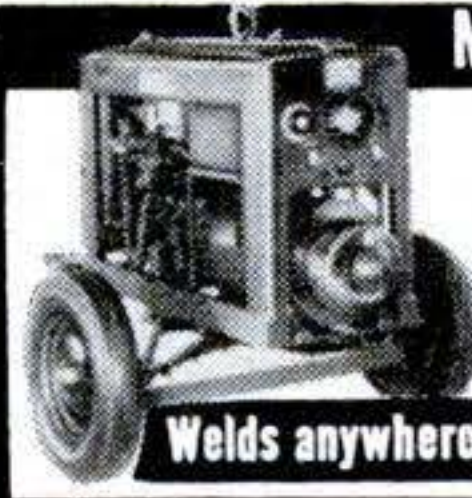
**Dependability, Performance and Long Life**

**INSIST ON CHAMPIONS FOR YOUR CAR!**



**CHAMPION SPARK PLUG COMPANY, TOLEDO 1, OHIO**

**Arc Welding pays big profits**  
when you're equipped with  
**HOBART WELDERS**



**Welds anywhere**

Mail this ad today with your name and address

If you want information on low cost, dependable welding that will bring you unusual profits, just check below and mail—no obligation. **Free!** Welder's Vest Pocket Guide

- Gas Drive (300 Amp.)
- Gas Drive (250 Amp.)
- Accessory Catalog
- Electric (300 Amp.)
- Electric (200 Amp.)
- Electrode Catalog

250 amp. road type welds anywhere. Lowest cost welder in its class. **HOBART BROS CO., BOX P-73, TROY, OHIO**

One of the world's largest builders of arc welders

**PILOT'S KNEE BOARD**

Strap this convenient aid to your leg, enjoy your flight with records at your finger tips. Weight only 9 oz. Designed by Aircraft Engineers. Proven by thousands of Fighter Pilots. Molded to fit the leg, quick release adjustable leg strap, equipped with 2 pencils, pencil sharpener, chart cards, and pilot's identification compartment. Write for quantity discounts.



**SEMCO RESEARCH INC.,**  
212 W. Florence Avenue,  
Inglewood 1, California

- 1. Knee Board **\$4.95**
  - 2. Nite-Lite (battery operated) **\$2.90**
  - 3. Bracket (your stopwatch) **\$2.90**
- Postage Paid if Paid in Advance. **Total \$10.75**  
**All Three \$9.90**



# Imagine! *Owning your Own* RANCH HOUSE, CABIN or HIDEAWAY

*by the Shore  
or in the  
Mountains*



**Only \$2.49**  
7 Days' FREE Trial!

**Amazing NEW Book Shows You How You Can Build Any of 27 Different Structures . . . for Mere Cost of Materials! 256 Pages, 207 Pictures, 23 Chapters!**

"How to Build Cabins and Ranch Houses" will slash the cost of your new home! This one great book shows how you can build it yourself at *lowest possible cost* from the foundation to the roof. And it's EASY! Just choose your favorite from the loads of illustrations (complete with floor plans) whether it be cabin, lake cottage, modern ranch house, or mountain retreat. With the aid of this brand-new, money-saving book, you'll complete your house in *record time!*

### SIMPLIFIED DETAILS

You don't need professional help when you start building your dream home. Here are simplified, detailed instructions on laying a foundation, building and caulking walls, constructing stairs, laying floor boards, estimating costs. Step-by-step plans on making windows, building fireplaces and chimneys, cutting doors, installing plumbing and lighting. You'll also find out how to beautify your cabin or ranch house, prevent wood decay, build rustic furniture, and speed up the building with many short cuts. Equip your house with all modern conveniences at a fraction of the usual cost!

### SEND NO MONEY NOW!

Detach and mail coupon below, then pay postman the low, *bargain* price of \$2.49, plus a few cents postage, when your book arrives. Examine this wonder-book with its 256 pages, 207 illustrations, and sturdy cloth binding for a *full week!* Then, if you don't agree that you'd pay twice as much ordinarily for such a big, jam-packed book, simply return it for refund with **NO OBLIGATION!** But, **HURRY**—get your copy while they last!

### MAIL ORDER FORM TODAY!

Popular Science Pub. Co., Dept. 753  
353 Fourth Avenue, N. Y. 10, N. Y.

Please send my trial copy of "How to Build Cabins and Ranch Houses" today. I'll pay postman \$2.49 (plus postage) on delivery. If not delighted, I may return book within 7 days for full refund.

Name .....

Address .....

City..... Zone..... State.....

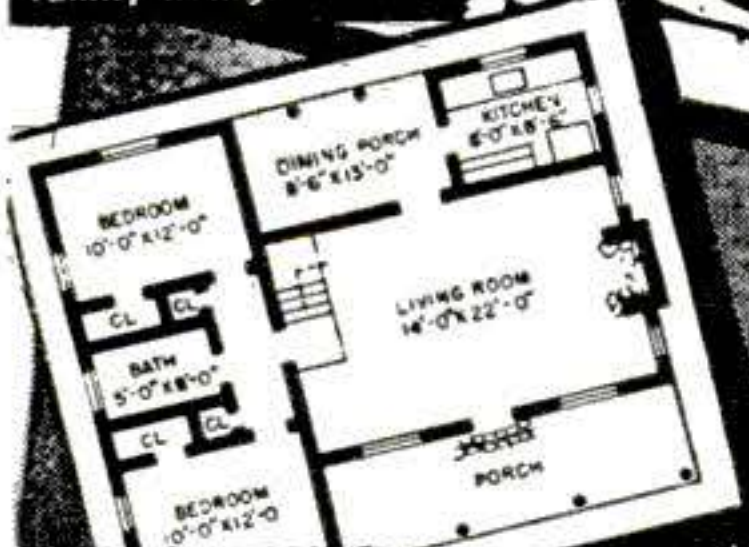
Check here if you remit now. We pay postage. Same refund guarantee.

### EXTRA!

Make *big* money by building for **PROFIT!** Valuable section shows you how to *build and sell* roadside stands, gas stations, colorful signboards and more! No complicated, expensive tools needed. This one section *alone* makes this the "Big Opportunity" book of your lifetime!



Sturdy snow-cabin perfect for one- and two-family living.



Only 1 of 19 fine floor plans!

You can build roomy wide-porch hideaway at saving of two-thirds or more!



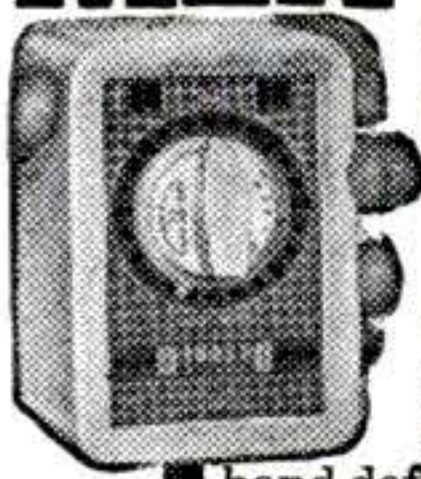
Simple cabin with kitchenette makes ideal summer home.



Complete plans for typical hunting-fishing lodge.



# MEN WANTED!



**Make \$15-\$20 in Few Hours Spare Time—up to \$210<sup>00</sup> a Week FULL TIME—with Amazing D-FROST-O-MATIC!**

Millions of housewives want this sensational new Automatic Refrigerator Defroster! No more messy hand defrosting! Just plug in D-FROST-O-MATIC and refrigerator is defrosted automatically every night! Sales easy, sure when you leave D-FROST-O-MATIC on FREE TRIAL—housewives won't let you take it out! Saves money, food, time, work! **Big profits for you**—up to \$210.00 a week full time—\$15 to \$20 in just a few spare hours! Start spare time and build big, prosperous business . . . quickly, easily!

**SELY of California** started in his spare time and now sells 1500 D-Frost-O-Matics a month!

**Rush Name Today for Profit Details and FREE TRIAL PLAN!**

More than 29,000,000 prospects waiting! Rush your name and address today. We'll airmail exciting facts, proof and sure-profit Free Trial plan. No obligation. Write today. **D-FROST-O-MATIC, Dept. D-14 173 W. Madison Street, Chicago 2, Ill.**

## Malayan THROWING DAGGER

**BALANCED TO STICK!**

**\$1.98** postpaid

The MALAYAN FIGHTING KNIFE is used for self-defense, killing game, target skill. Powerful, silent, accurate weapon. Splits 1" board at 30 ft.

EASY TO THROW!



Fun, Thrills, Excitement!

**MONEY BACK GUARANTEE**

Indoors—outdoors. Learn this Sport! Easy to throw accurately with our clear instructions. Beautiful, heavy-duty 10" knife. Tempered steel. Tough, rawhide-bound handle. Rare souvenir. If your sporting goods dealer can't supply you, send \$1.98

**WHOLESALE IMPORT CO. Dept. B, 604 Marengo, Alhambra, Calif.**

## DRAINS Cellars, Laundry Tubs; CIRCULATES Oil; IRRIGATES Gardens

Original "Type P" Pump has 2400 GPH capacity. 360 GPH 75' high, or 1500 GPH from 25' well. Use any 1/8 to 1/2 HP motor. DOES NOT CLOG. See Popular Science, August, Page 200. Only \$6.95 postpaid if cash with order. (West of Mississippi, add 50c.)

**MONEY BACK GUARANTEE!** Also Gear Pumps in all sizes.

**\$6.95**

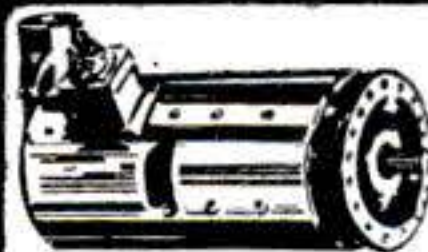
Motor coupling included.

**LABAWCO PUMPS, BELLE MEAD 3, N. J.**



now even better invest more in Defense Bonds

## WAR SURPLUS AND OTHER BARGAINS SAVE UP TO 90%



### D.C. GENERATORS

Finest aircraft quality. Heavy duty. Lifetime grease-sealed ball bearings. Ideal for truck & marine use, for welders, plating, D.C. appliances, lights, etc. Type P-1 Mfd. by Electric Auto-Lite. Rated 200 Amps., 28 Volts, 2500 RPM., can be "reved" up to 300 Amps. Shpg. Wt. 53 lbs. Approx. Govt. Cost \$350. NEW, now only \$21.50

**GE 300 Amp. Generator.** 24 to 32 volts. 2500 RPM. For building your own arc welder, lighting plant or mobile radio communication unit. Weight, 50 lbs. Approx. GOVT. COST \$450. Yours now for \$29.75.

**MAKE YOUR OWN ARC WELDER** Complete make-up package consisting of one New P1 Generator 200 Amps, one giant toggle switch, one voltage regulator and a wiring diagram chart showing conversion of Aircraft Generator to Arc Welder. Nothing else to buy. Special—WHILE THEY LAST—\$32.50

### Carbon Pile Generator

#### VOLTAGE REGULATOR



Like new. Adjustable from 24 to 32 volts. For use with 24 or 32 Volt D.C. Generators; also 200 AMP-300 AMP type generators to build your own light plant. Delco Remy. Weight 2 1/2 lbs. Approx. GOVT. COST \$50. From Airborne only \$5.50 ea.



### PUROLATOR OIL FILTERS

The perfect filter to keep motor oil or hyd. fluid clean at all times. Permanent type, No. G159J-32. Protect your pump, engine, midget racer or boat with this unit. To clean element, just turn handle. Inlet and outlet ports take pipe or straight threads up to 3/4" male pipe. Accommodates 16 GPM at 30 PSI. Mtg. brackets. Wt. 4 lbs. A \$15 value, NEW to you, with 2 FREE male reducer connectors for only \$3.85.

### MICROMETERS

Chrome plated, precision engineered, carefully tooled to give long life. All new 0-1" capacity—\$2.25 ea., 1-2" capacity—\$3.50.



Send 25¢ for big 1953 catalog. Bargains for everyone. Check, Money Order or Cash. 25% deposit on C.O.D. orders. Prices F.O.B. Culver City, Calif., Unless otherwise stated.

**AIRBORNE SALES CO. INC., Dept. PS753 8501 Stellar Dr., Culver City, Cal.**



## MAKE BIG MONEY!

Be a floor surfacing contractor and sand both new and old floors. Sanders are easy to operate and better still, you're your own boss. Write for latest "tell-all" booklet entitled "Opportunities In Floor Surfacing" enclosing 25 cents in coin or stamps to cover handling.

### AMERICAN

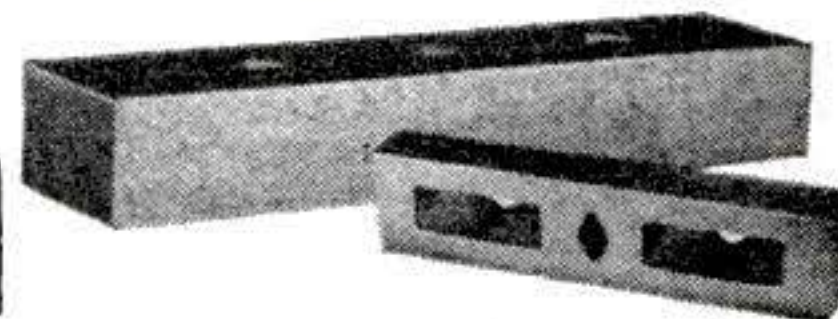
FLOOR SURFACING MACHINE CO. 532 So. St. Clair Street • Toledo 3, Ohio

# 473 MEN WANTED

## As Local Manufacturers of this New Masonry

CAVITEX is today's masonry—colorful, streamlined, scientific. Yet with price appeal to override competition. Size and proportion in direct line with modern architectural trends. Dimensions strictly according to modular standards. All the strength, safety and endurance of masonry at its peak point.

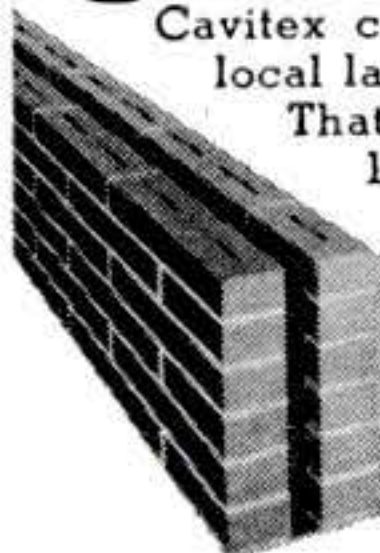
Outstanding Opportunities For Responsible Operators



Cavitex can be made locally—of local materials with local labor. Freight and distribution costs are saved.

That's why Cavitex can be sold so low, yet still allow 100% or more mark-up on material and labor.

We supply basic equipment on easy rental terms. Exclusive privileges in franchise-protected territories. Hundreds of territories open. Write or wire today for "Opportunity, Unlimited"—free. If requested, we will tentatively reserve territory desired.



**W. E. DUNN MFG. CO., 410 W. 24th St., Holland, Mich.**



**SAVE 75%  
ON**



**WORK CLOTHES!**

**SURPLUS STOCK FROM  
MIDWEST SUPPLY FIRM!**  
Terrific values you've got to see to believe!

**SHIRTS 79c**

Made to sell for 2.99! Now Only 4 for \$2.99

What a buy! 4 for the price of one! These shirts, though used, are washed, sterilized and ready for long, tough wear. In blue or tan. Send name, address, neck size.

**PANTS to match 99c**

Sold for 3.95 now only . . . . . 4 for \$3.75  
Unbelievable Bargains! Send waist measure and inside leg length.

**COVERALLS . . . wear 'em used and save plenty! Originally 5.95. Now only . . . \$1.95**  
3 for \$5.45  
Send chest measurement.

**SATISFACTION GUARANTEED!** Money back if you're not convinced these are bargains you can't beat! You can't lose so order TODAY for immediate delivery! Pay postman or send money with your order and save postage.

**GALCO SALES CO. Dept. 247**  
4064 East 71st Street • Cleveland 5, Ohio

**NEW, FAMOUS BRAND  
AIR  
COMPRESSOR**

Complete with deluxe Spray Gun, Tank, Hose and cushioned Baseboard mounting

**COMPARE WITH ANY \$60.00 UNIT! Guaranteed**

**SAVE OVER HALF!**

For professional paint spraying, tire inflating, insecticiding, and hundreds of other uses in Workshop, Farm, Garage, and Home! REAL BUY!

Nationally advertised! Revolutionary enclosed compressor with built-in carrying handle . . . COMPLETE WITH ALL ACCESSORIES. Can't be matched as an all-purpose economical outfit. Does hours of work in minutes. Produces factory-smooth finishes. Powerful oversize diaphragm when used with 1/4 HP motor drive develops up to 75 lb. pressure—2 cu. ft. oil-free air per minute. Compare price, SAVINGS, features . . . Syphon-feed Gun with one-piece aluminum cup thoroughly atomizes water and oil paints, calamine and insecticides . . . 10 ft. Air Hose to reach out-of-the-way places . . . Rubber cushioned Base prevents jarring and keeps Compressor stationary wherever used. Pre-lubricated OVERSIZE Ball Bearings. Order while supply lasts—for personal use and money-making opportunities. **SATISFACTION GUARANTEED 100% OR MONEY BACK!! WE PAY POSTAGE.**

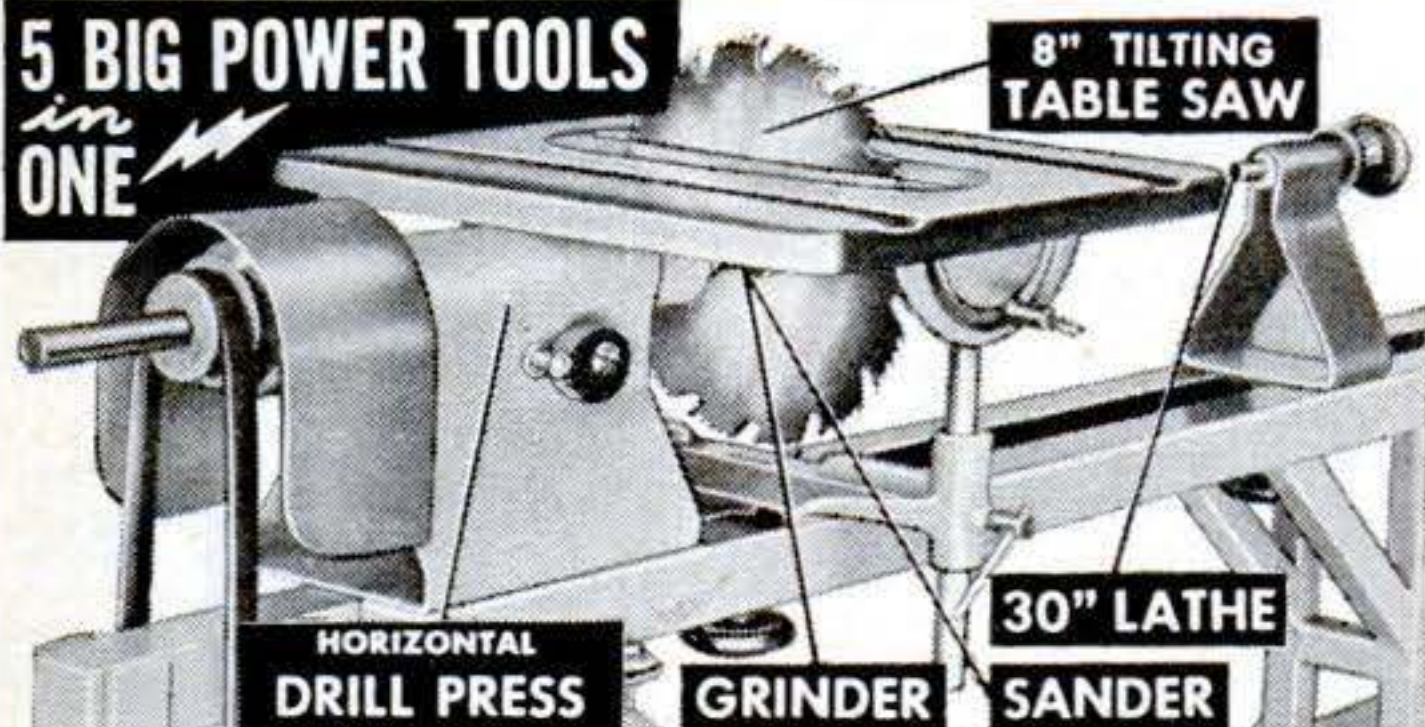
Send for FREE CATALOG

ROBERTS ELECTRIC CO., Dept. 75, 849 W. Grand, Chicago 22, Ill.



**\$19.75 PRE-PAID**

**5 BIG POWER TOOLS  
in ONE**

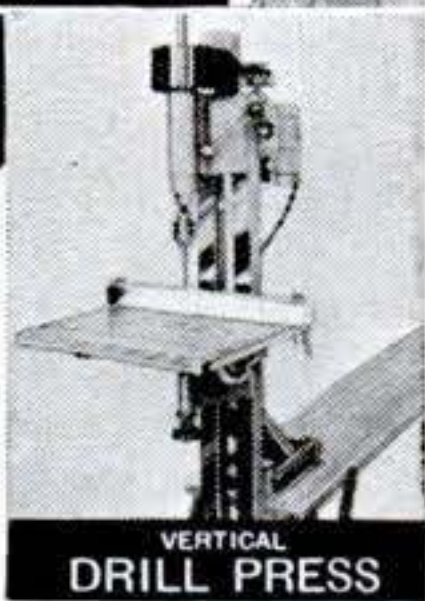


RETAIL PRICE \$125.00  
**FACTORY TO YOU \$79.95**

**SUPERSHOP** is a PRECISION-BUILT WORKSHOP. 100% ball bearing. All running parts precision ground. Big capacity. Extra rugged. Amazing value. Write for FREE catalog.

**BUY ON EASY PAYMENTS**

**POWER TOOLS, INC.** 249 YATES AVENUE, BELOIT, WISCONSIN



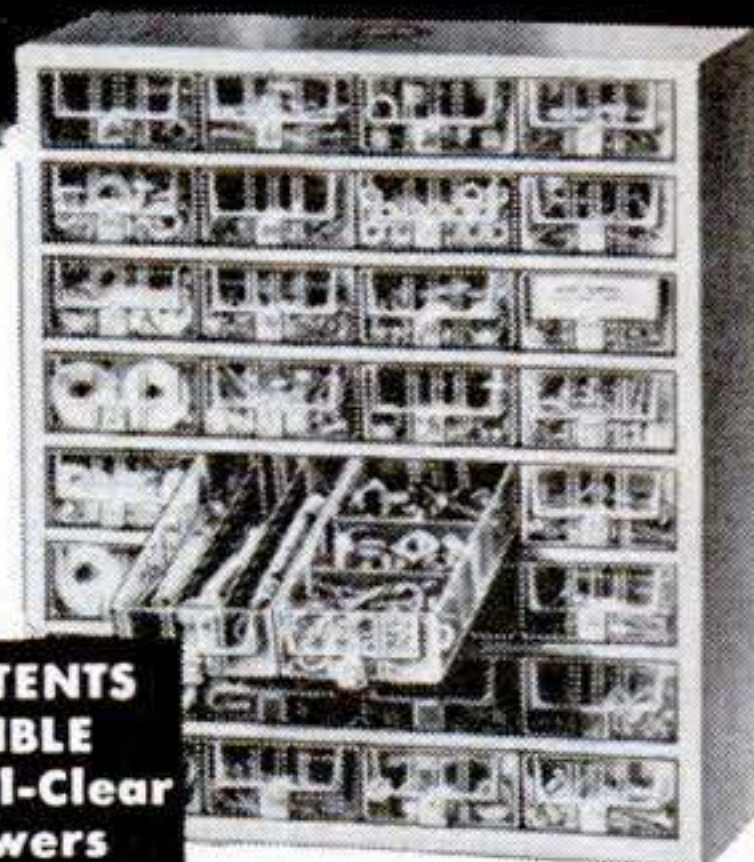
VERTICAL DRILL PRESS

**HANDIEST CABINET EVER MADE  
FOR STORING  
SMALL PARTS**

What a relief! No more frantic searching for misplaced items. No other cabinet has so many desirable features. Maximum strength, crystal-clear plastic drawers can't spill accidentally. Strong, all-steel welded cabinet with baked-on gray finish. 32 drawers subdivide into 96 compartments—lengthwise or crosswise. Drawers 5 7/8" long, 2 3/4" wide, 1 7/16" deep. Sent complete, postpaid. Money back if not satisfied within 10 days. Catalog FREE.

- J-32 32-drawers \$12.95
- J-64 64-drawers 24.95
- J-48 48-drawers 20.95
- J-24 24-drawers 10.95
- J-16 16-drawers 7.75

**CONTENTS  
VISIBLE  
Crystal-Clear  
Drawers**



MFD. BY AKRO-MILS, INC., 816 E. Market St., Akron 5, Ohio

32-drawer illustrated 15 1/4" high 12 1/2" wide 6" deep

**FLASHLIGHT BATTERY CHARGER**

**CUT FLASHLIGHT BATTERY COSTS 50% OR MORE**



MODEL F DEALERS WANTED

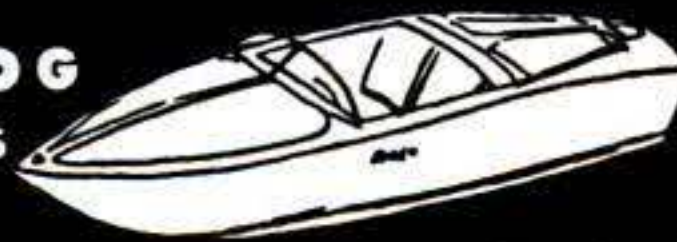
**Guaranteed To Improve Life of Batteries or your Money Back—Pays for itself in a short time.**

110 Volts A.C. or D.C.

**SHELBY INSTRUMENT COMPANY**  
1701 Magnolia Ave.  
Long Beach 13, Calif.

**MODEL F 995**  
Only Send cash with order. We pay postage.

**Bargains FREE CATALOG**  
WHOLESALE & SURPLUS  
MARINE EQUIPMENT



Boats, fittings, accessories, ready-to-paint hulls, misc. hardware, etc. All highest quality and at a fraction of their real value. WRITE TODAY FOR YOUR CATALOG

**CHOCK FULL OF SAVINGS. DIRECT BOAT SALES & SUPPLY**  
BOX 1263, DEPT. CT., EMORY UNIVERSITY, GA.

**BUILD YOUR OWN ARC-WELDER FROM AIRCRAFT GENERATOR**

**BUILD YOUR OWN**

**For Light or Heavy Work**

We show you how to build this NEW powerful welder without rewinding. Uses most any surplus aircraft generator. Produces 75-300 amps. Easy to build. Complete PLANS 35c. Send today & we'll include FREE our Big War Surplus and Electrical Catalog.

**LEJAY MFG. CO.,**  
1223 LeJay Bldg.,  
Minneapolis 8, Minn.



**FREE CRAFT CATALOG**



**120 PAGES . . .** Craft Supplies, Tools, Designs, Instruction Books from America's Largest, Most Complete Handcraft Stock.

Send for your free copy NOW!

**GRIFFIN CRAFT SUPPLIES**

5626-B Telegraph Ave. • Oakland 9, Calif.

When writing to Advertisers please mention Popular Science

CHOOSE FROM PROFESSIONAL QUALITY

**WESTCRAFT TOOLS**

AT WESTERN AUTO



**FREE CATALOG OF GOVERNMENT SURPLUS**

**100 MOUNTED STONES** only **8 98**  
P.P. & Hand. 50c  
—assorted shapes—3/32" to 1/4"  
Shanks—ALL NEW. A tremendous value



**HIGH SPEED WOODRUFF KEY SEAT CUTTER**  
6 Assorted Sizes. Shanks up to 1/2". Can also be used as mounted milling cutters or circular saws. Mixture of NEW AND USED priced at only **3.98** P.P. & Hand. 40c

Set of 4 High Speed **END MILLS** **1.98**  
The complete set Postpaid only  
SHANKS 1/8" to 1/4"—ALL NEW

**COASTAL ABRASIVE & TOOL CO.**  
An affiliate of DENTAL SPECIALTY & SALES CO.  
Dept. PS10, P.O. Box 692, Great Neck, N. Y.

**BUILD YOUR OWN FAN**

One-piece cast aluminum propellers for cooling and ventilating.

Size Inches	Polished 2 Blade	Polished 3 Blade	Unpolished 2 Blade	Unpolished 3 Blade	Bore Inches
15	\$3.00	\$4.00	\$2.50	\$3.00	1 1/2 x 3/4
18	3.75	5.00	3.00	4.00	1 5/8 x 3/4
20	4.00	5.50	3.25	4.50	1 7/8 x 3/4
24	4.50	6.50	4.00	5.50	1 3/4 x 3/4

Write for pamphlet on larger fan blades, wire guards, fan bases, shutters, pillow blocks, exhaust fan frames, etc. Dealers write for discount. Shipped prepaid if money accompanies order.

**KLOPPENBORG ALUMINUM FDY., Dept. PS-53, Davenport, Iowa**

**Build a power mower with the ALL STEEL Whirlmor cutting unit**

**\$15.50**  
No C.O.D.'s  
We have wheels

Send for Free Plans or order Direct-Add 50c for mailing.

- Double Shielded Ball Bearings
- 18" (or 20") Steel Blade—Easy to Remove
- Blade Height Easily Adjusted

*It's Guaranteed*

**GANADO MFG. CO.**  
Box 626 • Ganado, Texas

**Build your own JET ENGINE!**

Order these plans today

1. JET PROPELLED BICYCLE. Assemble your own. Photo and instructions \$1.00.
2. HOW TO MAKE EXPERIMENTAL JET ENGINES. Seven sheets drawings with information and instructions \$2.95.
3. BOTH OF ABOVE in one order \$3.75.

SEND NO MONEY. Order both at once \$3.75 C.O.D. in USA plus c.o.d. postage. Send check or Money Order and we pay postage. Get other information too. Rush Order.

**J. HOUSTON MAUPIN, Dept. 66, Tipp City, Ohio**

**OIL FACTS FREE BOOKLET**

**AUTO-TRUCK-TRACTOR OWNERS STOP CHANGING OIL!**

Impossible? Just send for free 32 page book, 'Oil Facts' and judge for yourself—you'll be amazed. Learn how air lines, bus lines, etc., save on oil!

**RECLAIMO, 5083 Elston Ave., Dept., P-7, Chicago, Ill.**  
Wm. Schwalze, U.S. Pats. 1757223, 1834654, 2068473

**SAVE \$65 ON THIS LUXURIOUS \$100 CONTOUR CHAIR**  
Genuine FOAM RUBBER

**\$34.95**

For Everything needed complete to **PUT IT TOGETHER IN ONE EVENING!**

Scientifically correct design for restful, healthful, relaxing. Adjusts for perfect sitting or reclining comfort. Proved beneficial to heart, nerves... most popular chair in every home. Firestone foam rubber and washable, pliable genuine Duran upholstery. Would cost \$100 or more in any store. Shipped all ready to put together in less than one evening, by anyone who can use a screwdriver.

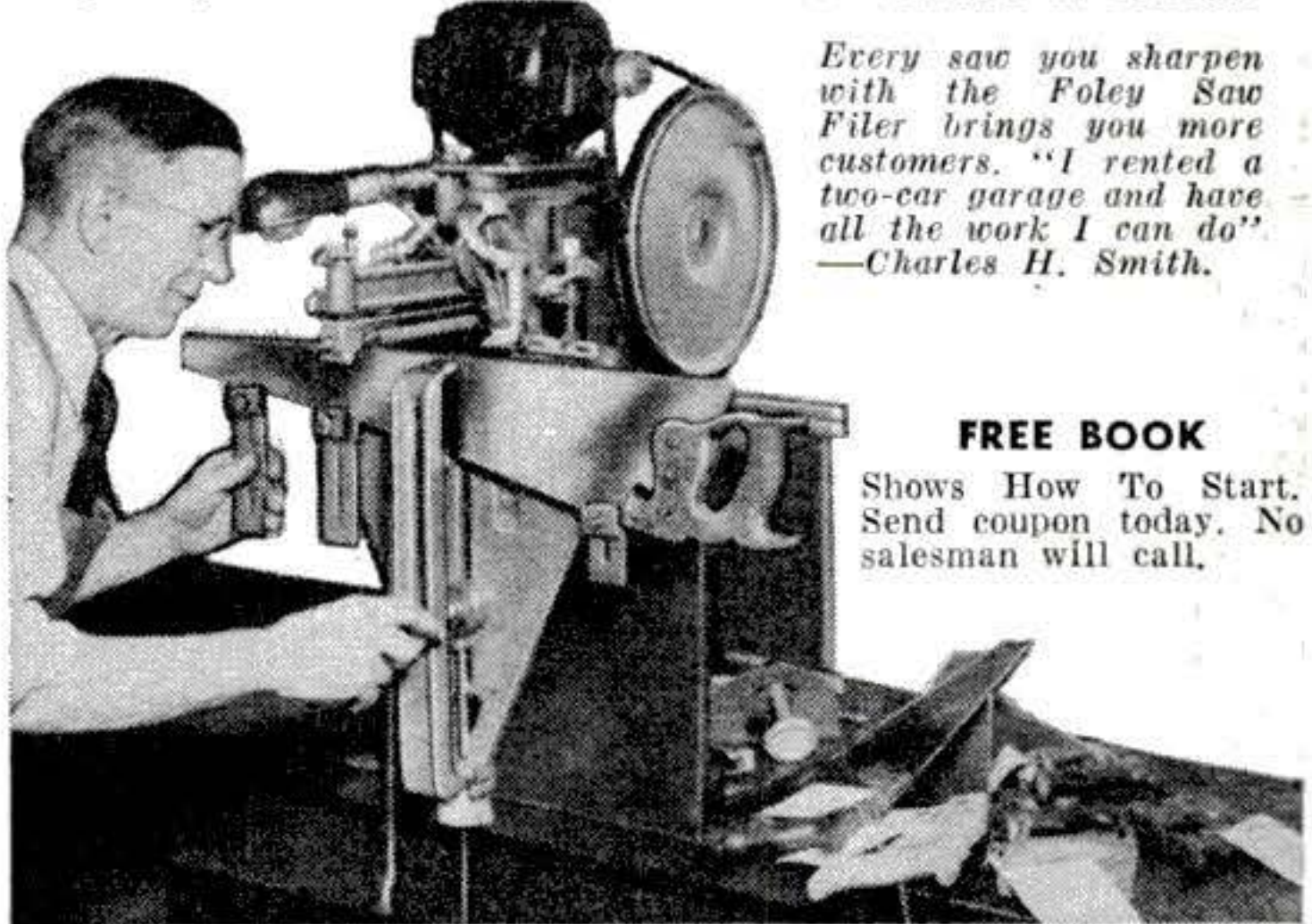
Make Money Selling and assembling contour chairs for friends

No cutting, no drilling, no skill needed. A woman can do it. Order now! Everything needed for only \$34.95, f.o.b. Balto. State color wanted: forest green, sapphire blue, lipstick red, walnut brown. Enclose \$5 deposit, pay balance on arrival. Money back guarantee. If not satisfied, return in 10 days.

**BESTECRAFT, Dept. 32, Mathieson Bldg., Baltimore 2, Md.**

**FREE PLAN**  
tells how to start your own business  
**FILING SAWS**

Here is a steady repeat CASH business you can start in your own basement or garage in your spare time. You can file hand, band and cross-cut circular saws on the Foley Saw Filer. No eye-strain—no experience needed. "The first saw I sharpened with my Foley Filer came out 100%"—writes Clarence E. Parsons.



Every saw you sharpen with the Foley Saw Filer brings you more customers. "I rented a two-car garage and have all the work I can do!"—Charles H. Smith.

**FREE BOOK**  
Shows How To Start. Send coupon today. No salesman will call.

**Send Coupon for Free Book**

**FOLEY MFG. CO., 719-3 Foley Bldg. Minneapolis 18, Minn.**  
Send me free book "Money Making Facts"

Name.....  
Address.....



**FREE! "HANDY TIPS FOR HANDY MEN"**

BOOK OF HINTS to make home repairs and hobby projects easier. 52 pages chock-full of information on sanding, polishing, sawing, filing, grinding and sharpening, and the care and use of hand and power tools! Write to: **THE BLACK & DECKER MFG. Co., Home Service Dept. H7S, Towson 4, Maryland.**

**now...make your own**

**"SCOTCHLITE BRAND" REFLECTING SIGNS**

You too can make your own reflecting signs and displays... with **SAFE-T-GLOW** products!

Ideal for Trucks, Service Shops, Motels, Restaurants, Farms, and similar uses. Now you can have the advantages of the new reflecting signs and displays—get sales results 24 hours a day—with the amazing new "Scotchlite Brand" Safe-T-Glow products.

**DIE CUT LETTERS—NUMERALS**  
Complete with full instructions and symbols to construct signs of professional quality. Specify red or silver.

2 inch	10c ea.
3 inch	20c ea.
4 inch	25c ea.
6 inch	50c ea.

Also in 1 inch wide strips—50c per ft.

Write for the complete line of **SAFE-T-GLOW** reflective materials and products.

**SAFE-T-GLOW PRODUCTS**  
Box 2467 Dept. PS6E Gary 5, Indiana



**DRILL SAW REAM CUT**

**INTERNATIONAL**

**HI-SPEED COPE SAW DRILL BIT**

**DRILL, SAW, REAM . . . metal, pipe, wood, plastic, Transite, etc. Use with any electric drill, slow drill press, lathe or milling machine. Drills own starting hole—upper part of bit is used to cut, saw or ream circles, ovals, squares or scrolls. Easy to operate. Ideal for carpenters, mechanics, electricians, plumbers, hobbyists, many others. Abrasive resistant, high speed steel. Flutes ground from solid. Will withstand severe continuous use without breaking. Resharp-ened at no charge. Takes place of up to \$50 in tools. 1/4" diameter, 2" cutting sections, total length 3 1/2". Available in three types—All Purpose, Wood, Heavy Metal. Specify type needed. Set of 3, \$11.50. Details on request. Shipped same day. Money-back guarantee. Dealer inquiries invited. ORDER NOW! SEND CASH, CHECK OR MONEY ORDER.**

Manufactured and distributed by  
**INTERNATIONAL TWIST DRILL CORP.**  
618 Wyandotte, Rm. 695, Kansas City 5, Mo.

**only \$3.95 POST PAID**

**MAKE YOUR OWN POWER LAWN MOWER \$13.95**

with this DRIVE CUTTER ASSEMBLY

Constructed for those who desire to build their own mower or to replace your old cutter assembly. Complete with 18" blade and double ball bearing drive . . . . .

Add 50c to cover handling & shipping. ANYWHERE IN USA  
Send check or M. O.

**ATLAS KEEN MOWER**  
229 S. W. BLVD. Dept. P.5.7 KANSAS CITY, MO

**SPECIAL OFFER—Only 10¢**

**50-Page "Tools and Rules" Book**

"The Tools and Rules for Precision Measuring" tells how to make accuracy a habit, shows the methods skilled mechanics use. 100 pictures plus reference tables. Send only one dime. Address Dept. PS.

**Only 10¢**

**THE L. S. STARRETT CO. • ATHOL, MASS., U. S. A.**

**Explore the MICRO-JUNGLE!**

Triple-turret microscopes as low as . . . . **\$9.95**

New Quadruple-turret models (as shown) **\$16.95**

All slide materials. Other optics from \$1. Send postcard. **FREE 44-PAGE CATALOG!**

World's greatest values in quality microscopes, telescopes, binoculars. All hobby and professional models.

**AKRON** 38 Akron Bldg., 4400 Sunset Blvd. Los Angeles 27, California

**U. S. GOV'T SURPLUS "BARGAIN BOOK"**

**SAVE ON WINTER NEEDS!**

It's loaded with bargains in genuine Gov't Surplus for farm-home-industry. Save up to 85% on clothing, hardware, sporting goods, etc. The "Book of the year". Send 10c for yours today.

**500 BARGAINS**  
• FARMS • SPORTS  
• HOME • SHOP

**MAIL TODAY Only 10¢**

**FISLER SALES CO.**  
1329 MAIN ST., DESK PS-7, KANSAS CITY, MO.

**MAKE BIG MONEY** SPARE OR FULL TIME

**Sharpening Lawn Mowers**

Mr. G. E. of Ark. writes, "I have had my Universal Grinder 2 mos. and made a net profit of \$227." Be your own boss in a business of your own in your garage or basement with the Universal Lawn Mower Grinder. No experience necessary. Send today for proven success plan FREE.

**ROGERS MFG. CO. Dept. P-73 LINDSEY, OHIO**

**Mustang** **LIGHTWEIGHT \$370.00**

(Fed. tax paid, at factory)

9.5 hp. 4-cycle. 3-speed. Foot-shift. Over 70 miles per gal. Over 60 m.p.h. Write for free circular.

**MUSTANG, Dept. PS**  
635 W. Colorado, Glendale 4, Calif.

**DAN LURIE** "America's Most Muscular Man" —on television's "Big Top."

**FAMOUS DAN LURIE BARBELLS**

with 4 courses—low factory prices

50 lb. set....\$ 8.48	150 lb. set....\$20.48
100 lb. set.... 13.98	200 lb. set.... 25.98

Order by Mail; 50% with order, bal. C.O.D. Extra wts. 13c per lb., F.O.B. plant

**DAN LURIE BARBELL CO.**  
1701-S7 Pitkin Ave., Dept. 370-G, Brooklyn, N. Y.

**TOOLS WHOLESALE**

**Start Your Own Business**  
Sell tools to your friends, neighbors, etc. in your spare time. **A MILLION DOLLAR INVENTORY AT YOUR FINGERTIPS**

Send \$1 for Dealer's Card and Wholesale Catalog.

**MAKE EXTRA MONEY!**

Stanley, Miller Falls, Plumb, Disston, Wiss. Skil and others at 30 to 50% off.

**SILVO HARDWARE CO., Dpt. S, 108 Market St., Phila. 6, Pa.**

**Complete PUMPING UNIT with MOTOR**

Ready For Use! **\$18.50** Pre-paid  
REGULARLY \$44.00

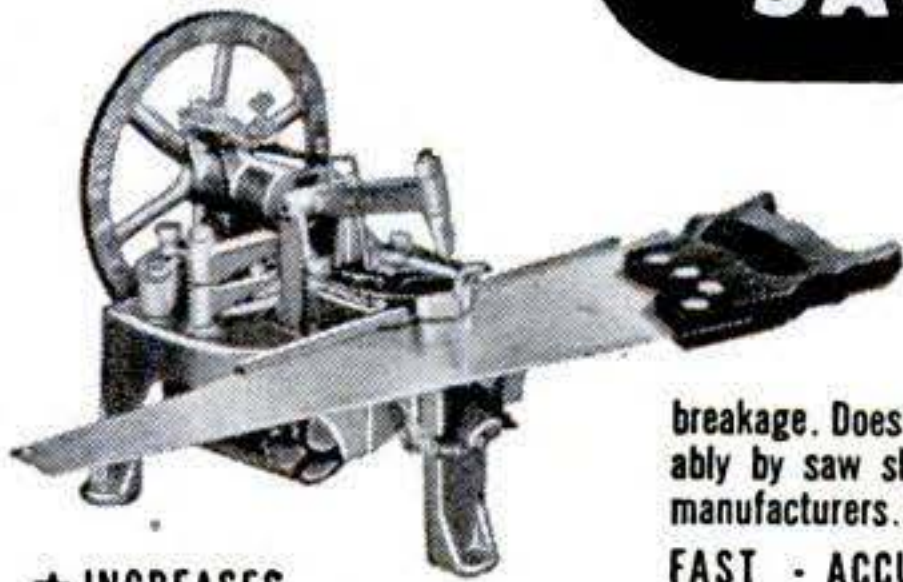
**Tremendous buy for farm, home, shop and garden. PUMPS UP TO 1,500 GALLONS PER HOUR!**

A powerful 1/4 HP motor, 110 volts, 60 cy., propels this whirlwind pump to do 1,001 suction and lifting jobs. Drains cellars, wash tubs—lifts waste water to overhead sewers, etc. up to 15 ft. high. Have running water system—lifts water from well to upper floors. Irrigates gardens. Waters livestock. Boat pumping. Circulates and transfers oil, liquids, etc. **NON-CLOGGING! NON-RUSTING!** Neoprene seal keeps pump from leaking. Attach any 3/4" garden hose. Anyone can operate it. A permanent investment of real value. **Satisfaction guaranteed 100% OR MONEY BACK.** Limited supply. Order NOW! WE PAY POSTAGE!!

**Send for FREE CATALOG**  
**ROBERTS ELECTRIC CO., Dept. 74, 849 W. Grand, Chicago 22, Ill.**



BeMaCo Dependable  
**AUTOMATIC  
SAW SET**



Sets 400 teeth per minute on hand or band saws 4 1/2 to 16 point. Hammer and anvil action sets teeth accurately and uniformly. . . No tooth breakage. Does a perfect job. Used profitably by saw shops everywhere and saw manufacturers. Every machine guaranteed!

★ INCREASES PROFITS

**BEAVER MFG. CO.**

Saw Machine Div. 5-5  
800 S. ISIS AVE. • INGLEWOOD, CALIF.



**ELECTRIC WELDER** AC or DC  
110 Volts

The "Little Marvel" all-metal welder. 5-year written guarantee. Welds 1/8" metal or money back. Repairs tanks, tools, fenders, machine parts etc. Complete with everything—rods, unit, eye shield, directions. \$6.45 plus 50c postage. Flame torch accessory for soldering, cutting, brazing \$3.95 complete with carbons, brass rods, flux. Sorry, no C.O.D. Buy direct and save.

**\$6.45** Complete

ESSAY MFG. CO., Dept. 47, Quincy 69, Mass.

**HOBBYISTS! SHOPMEN! Special** ONLY \$54.50

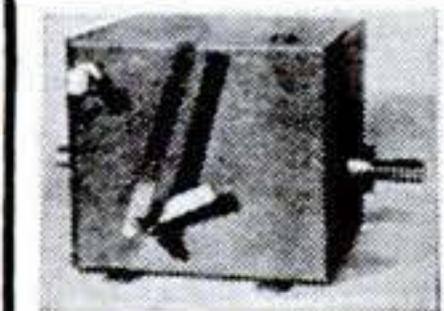
**PALMGREN "HOBB-E" Rotary, Index, Milling Table**

Ideal for Model Parts or Shop Work  
Mill-Grind-Drill-Index-Rout curved or straight-Rabbit and Mortise on drill press or lathe. 8" Table, 4" Cross Feed, 360° Rotation, Accurately Graduated. Bolts to table. Order NOW! SAVE \$100. Only \$54.50. Less Rotary Feed \$39.75. Write for "HOBB-E" Tool Circular. CHICAGO TOOL AND ENGINEERING CO. 8396 South Chicago Ave. Chicago 17, Ill.



**AMAZING NEW RADIO**  
POCKET SIZE  
NO TUBES, BATTERIES OR ELECTRIC "PLUG-INS" NEEDED. "TUNES IN" MOST LOCAL RADIO STATIONS with STATIC-FREE CLEAR TONE. Has new perma-crystal diode and TINY SELF-CONTAINED SPEAKER PHONE—A marvelous real tiny pocket size radio to take with you anywhere you go—FOR REAL FUN AND ENJOYMENT. GUARANTEED TO WORK and should last for years! SEND \$1.00 (cash, mo. ck) and pay postman \$3.99 C.O.D. postage or send \$4.99 for p.p. delivery. COMPLETE ready to play. By mail only from:  
**MIDWAY COMPANY**  
DEPT. PPS-7 KEARNEY, NEBRASKA

**VARIABLE SPEED HYDRAULIC POWER TRANSMISSION**



It has Infinite Speeds 0 to 550 Reverse Automatic Overload Protection: Adjustable Torque up to 180 inch pounds. 3/8" Input and Output Shafts. It will handle 1/4 to 1 1/2 H.P. Motor. Case measures 7 1/2" long 7" high 6 1/2" wide. VALUE OVER \$300. Shipping Wt. 25#. On C.O.D. Orders we require a 10% Deposit. **only \$54.50**  
Fob. Chicago

DIRZIUS MACHINE SHOP "P" 1423-25 So. 52nd Ave., Cicero 50, Ill.

**KING MIDGET AUTO**

Operate it for 75c per week. Amazing performance. Surprising comfort. All steel construction. Ready to run or assemble it yourself with our bolt together parts. Rider Agents wanted. Send 25c for detailed literature or \$1 (refunded first order) for actual assembly book and service manual filled with photos, drawings, specifications, etc.  
**MIDGET MOTORS MFG. CO., ATHENS, OHIO**

WORLD'S LOWEST PRICED  
2 PASSENGER AUTO



Save hundreds of Dollars with this  
**NEW ALL-METAL ELECTRIC  
SPRAY GUN—Pay Only \$1 a Week**  
**ENTIRE UNIT  
UL APPROVED!**



Hundreds of tough tasks are made easy with this NEW, All-Metal Spray Gun. The finished work cannot be told from high-costing professional jobs. Just press the trigger and you're doing the job evenly, cleanly and easily. No compressor needed. Use for spraying paints, including rubber-base paints—lacquers, enamels, varnishes, chemicals, oil, insecticides, deodorants, shellacs; for waxing, rust-proofing, waterproofing, etc. Built for heavy duty. AC current. Entire unit, every part, fully UL Approved, including 8-ft. S. J. Neoprene Cord & Plug Set. Given at no extra cost: 5 extra nozzle discs; 232 pg. "Home Fixit Guide".

25-Oz. Polished Aluminum Container All Metal—No Plastic or Glass Used! This New Model Available Only from Us \$1 down—\$1 weekly

**\$17.95**

No Carrying Charges Added

**MAIL 10-DAY FREE HOME-TRIAL COUPON**

**WALDORF SALES CO., Dept. AG-2507**  
363 Central Park Ave., Yonkers, N. Y.

- Send Spray Gun, include Free Book. I enclose \$1. Will pay postman \$16.95 plus postage. If not delighted can return Spray Gun within 10 days for purchase price refund.
- I enclose \$17.95, you pay postage. Same refund Guarantee.
- I enclose \$1 deposit. Will pay at rate of \$1 weekly after delivery (no interest or carrying charges added).
- Will pay wkly.  Will pay monthly.

Name.....  
Address.....  
City.....  
State.....  
APO, FPO, Canada & Foreign—No COD's

**MARVEL**  
*Mystery Oil*

- Frees Sticky Valves
- Stops Hydraulic Valve Clatter

Buy it at your favorite gas station

MONTH AFTER MONTH, YEAR AFTER YEAR, YOU SEE OUR AD. CHECK AND DOUBLECHECK BEFORE YOU BUY ANYWHERE!  
1 Are These Tires "Family-Safe"? Our Families Use Them.  
2 Are They Recaps, (Or "New Treads" Recaps)? Ours Are Not.  
3 Will I Get Goodyear & Other Famous Brands? From Us—Yes.  
4 Is The Guarantee "Unconditional"? See Our Fine Offers Below.  
5 Can Good Tires Be Bought Cheaper? It's Dangerous To Pay Less.  
6 Most Miles Per Dollar Make Our Tires Cost Less!

**GOOD YEAR Firestone**

GOODRICH, U.S., ARMSTRONG & OTHERS. BEST USED TIRES DOUBLE WARRANTY & FREE TIRE INSURANCE. YOU CAN'T LOSE.  
Our Policy is to select your tires so carefully, as if our very future depended on the service given by that particular tire.

**FREE TUBE WITH EVERY GOOD & FINEST GRADE TIRE** BE WISE—BE CONVINCED SAVE TIME, SAVE \$

GOOD SUPER GRADE, 20 MOS. GUARANTEE BOND.	
600-16 \$3.84	670-15 \$4.24
650-16 4.24	710-15 4.44
700-16 4.84	760-15 4.74
650-15 3.94	800-15 5.04
700-15 4.14	820-15 5.14
600-20 \$6.74	750-20 \$8.24
650-20 7.34	825-70 13.64
700-20 8.24	900-20 13.94
650-15 8.34	1000-20 13.34
700-15 9.64	1100-20 13.64

FINEST PREMIUM GRADE, 30 MOS. GOLDEN RULE GUAR. BOND	
THESE MADE THE BLATT NAME "WORLD FAMOUS"	
600-16 \$5.14	640-15 \$4.84
650-16 5.64	650-15 5.14
650-16(6) 6.64	670-15 5.04
700-16 6.34	710-15 5.54
700-16(6) 7.64	760-15 5.74
750-16 6.84	800-15 6.84
650-19 9.94	820-15 6.74
550-17 4.34	700-15 5.64
700-15(6) \$9.94	32x6(8) \$11.94
750-15 10.44	32x6(10) 13.24
750-16 9.34	825-20 17.84
700-18 15.84	900-20 17.04
600-20 8.54	1000-20 18.24
650-20 10.34	1100-20 18.24
700-20 10.44	1000-22 17.24
750-20 12.44	1100-22 17.24

YOU GET WHAT WE ADVERTISE	MILITARY MUD-GRIP TREAD	Rugged Guar. 32Mo
750-16Rg \$17.64	Std. Guar. 20Mos. \$11.44	750-20Rg \$16.04
	900-16Std \$11.94	900-16Rg. 15.94
	600-16Std 6.44	600-16Rg. 9.94

**BLATT** BLATT BLDG., GIRARD & LANCASTER AVES. DEPT. PS, PHILADELPHIA 31, PA.  
SEND CHECK OR MONEY ORDER & THIS AD.  
Thousands Of Shipments Rushed North, East, South, West, F.O.B. Phila.



**STOP FAUCET LEAKS**

**SNAP-in**

REPLACEMENT OR REFUND OF MONEY  
Guaranteed by Good Housekeeping  
IF NOT AS ADVERTISED THEREIN

two for 48¢

U.S. Pat. No. 2,443,012

Featured in **READER'S DIGEST**

## SNAP-in SWIVEL WASHERS & FAUCET SEATS

A lasting "do-it-yourself" repair—Ideal for hot or cold water faucets! Lasting—economical—easy to install. Lasts 10 to 20 times longer than ordinary bibb washers. Stainless steel and corrosion resistant metal parts—molded neoprene washer disc.

See your local hardware dealer

### SNAP PRODUCTS CORPORATION

3615 S. JASPER PLACE

CHICAGO 9, ILLINOIS.

BRAND NEW

**30 DAY FREE TRIAL**

**High Power BINOCULARS**

Finest Precision Optics  
Featherlight  
Money Back Guarantee  
Easy Pay Plan  
Leather Case Incl'd.

**Free! Catalog & Book**  
"How to Select Binoculars"  
Dealer Inquiries Invited

33 MODELS  
**\$14<sup>95</sup>** up

**BUSHNELL Binoculars**

Bushnell Bldg., Dept P67  
Pasadena 1, Calif.

**FREE!** New Johnson Sea-Horse Catalog. It describes, in detail, the four great Johnson outboard motors for 1953 — from 3 hp to 25 hp. A size for every outboard need — from canoe to cruiser. Write!

**JOHNSON MOTORS, 500 Pershing Rd., Waukegan, Ill.**

**BUILD YOUR OWN ARC WELDER OR LIGHT PLANT**

Save \$250 to \$500

**D-C GENERATOR**

**\$15.50** Instructions incl. for combination Welder & Light Plant. 200 Amps, 28 Volts, 2500 R.P.M. Wt. 50 lbs. No. 700.  
PRICE F.O.B. K. C., MO.

CONVERTS TO ARC WELDER 200-250 AMP. OR LIGHT PLANT CAP. LOAD 5000 WATTS

Stock No. 711 D. C. Generator R-1 Jack & Heintz, rated 300 Amp. 30 Volts. Gov't cost \$300.00. Instruction for converting to welder or light plant incl. . . . **\$25.50**

**CUNO OIL FILTER—BRAND NEW**  
Aircraft type. Filters oil without cartridge replacements. Just turn handle and cartridge is clean. Std. 3/8" inlet & outlet ports. . . . **\$4.95** post paid  
Instructions incl. . . .

Send check or M. Order. Prices f.o.b. KCMo Except when marked postpaid U.S.A.

**GENERAL SALVAGE CO., Dept. 173, 2922 E. 27 St., Kansas City, Mo.**

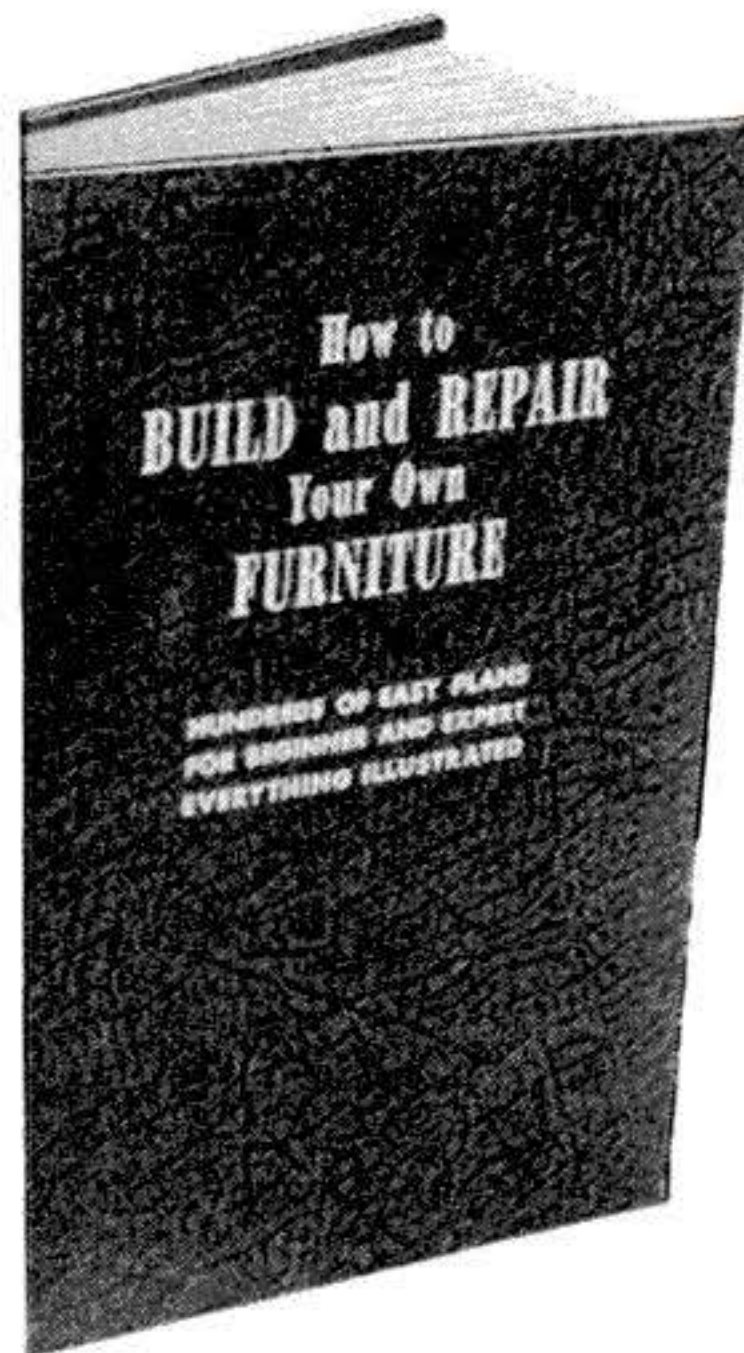
**BEAM ROTATOR MOTOR** New Applicable for 110V. A.C. or 24V. D.C. Powerful geared motor for TV aerials, Ham FM antennas etc. Approx. 9 R. P. M. free swing  
Instructions incl. Stock #AJ31  
\$35.00 value **\$7.50**

**VALUABLE GEARS BARGAIN SPEED REDUCER** 5-1 or 10-1 ratio 90 degree angle 1/2" splined shaft with 3 mounting holes rated 2 H.P. (add 50c postage)  
**\$5.95**

**RHEOSTAT #R-27** Brand New Heavy duty. dual unit, ideal for regulating voltage on electric welders. Instructions incl. A fabulous buy **\$6.95** post paid

# SAVE UP TO 74% ON FURNITURE...

Do Your Own



- ★ REPAIR
- ★ BUILDING
- ★ DECORATING
- ★ MODERNIZING
- ★ GLUING
- ★ REFINISHING
- ★ OVERHAULING
- ★ PAINTING
- ★ MAINTENANCE
- ★ REUPHOLSTERING

## SIMPLIFIED DETAILS IN NEW BOOK

With "How to Build and Repair Your Own Furniture", new 256-page "how-to" book, you'll be able to own that furniture you've always wanted—and make your present furniture look brand-new! Popular Science Editors have poured all their knowledge and skills of home furnishing into one great book written especially for men who want to furnish their homes handsomely—at little cost! Detailed, easy-to-follow photos and directions make it easy!

### BUILD FURNITURE FOR EVERY ROOM IN YOUR HOUSE!

You can make coffee tables, chairs, desks, lamps, book-cases, kitchen equipment, consoles, cabinets, children's furniture, plastic furniture, cabinets—for all types of decorating—period or modern! Most of the 163 simplified projects can be done with *simple tools* found in any home!

### SEND NO MONEY NOW!

Just mail coupon below with your name and address and pay postman the low, low price of \$2.49 (plus postage) on delivery. After 7 days free trial, if not satisfied, return book for money back. But hurry, supply is limited!

### MAIL FREE-TRIAL ORDER FORM TODAY!

**POPULAR SCIENCE PUBLISHING CO., Dept. 753, 353 Fourth Avenue, New York 10, N. Y.**

Please rush my copy of "How to Build and Repair Your Own Furniture" in edition checked below. When postman delivers my copy, I'll pay low price indicated, plus postage. If not completely satisfied, I may return book within 7 days for full refund.

- Regular Edition, bound in handsome Linen Finish Kivar, Only \$2.49
- Deluxe Edition, Stamped in Silver Color, bound in Red Duotone Kivar, Only \$2.99

NAME \_\_\_\_\_  
(Please print plainly)

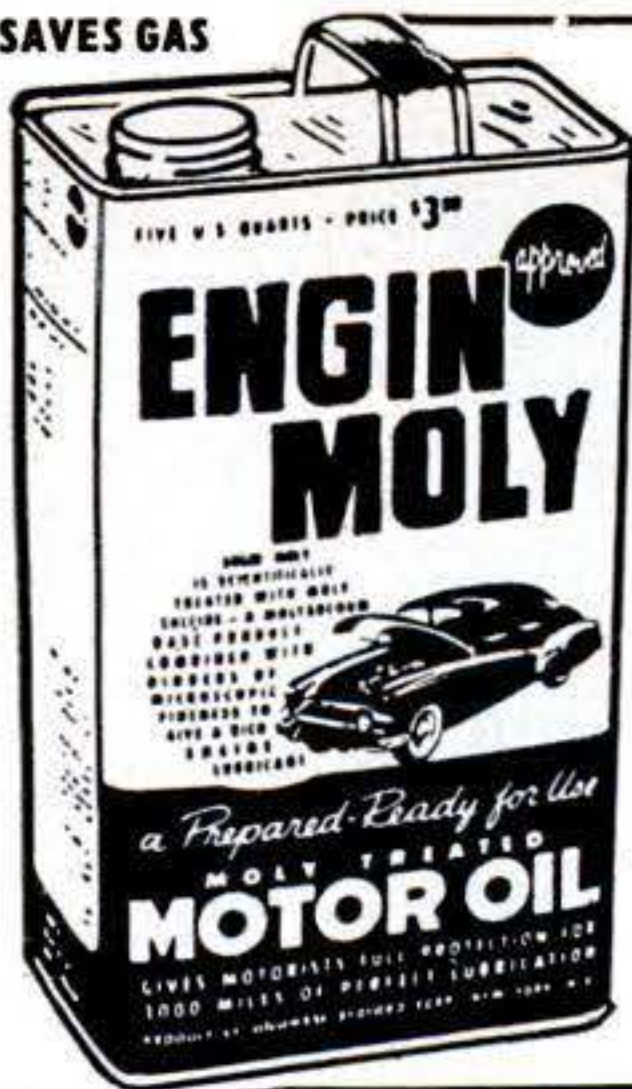
ADDRESS \_\_\_\_\_

CITY & ZONE \_\_\_\_\_ STATE \_\_\_\_\_

Check here if you remit now. We pay postage. Same return guarantee.



SAVES GAS



**NEW MIRACLE MOTOR OIL**  
*increases car engine life*

**ENGIN-MOLY**

Contains Full Treatment of Molybdenum (MoS<sub>2</sub>) that plates every friction surface of your car engine with millions of microscopic ball-bearings - Prevents Excessive Wear.

5 QT. CAN **\$1.98**  
Reg. \$3.00 Value

ENGIN-MOLY MOTOR OIL is a combination of highest quality premium oils plus MOLY (MoS<sub>2</sub>) - in complete suspension. A Perfect Lubricant for New or Old Cars. Sold with a Money Back Guarantee.

AVAILABLE AT YOUR LEADING AUTO SUPPLY STORE  
**COLUMBIA-BEDFORD CORP.**  
N. Y. 4, N. Y. EST. 1889

**PLYWOOD BOAT KITS**

(Freight Included) **\$97.00**



Build this 12-foot sport runabout from ready-cut parts. Kits include all hardware, etc., to complete the boat shown. Send for free folders of all models as low as \$32.00 freight included.

**TAFT MARINE WOODCRAFT**  
Dept. P, 636 39th Ave., N.E., Minneapolis 21, Minn.

**60 POWER TELESCOPE \$3.95**

VARIABLE EYEPIECE 20 x 40 x 60—BRASS BOUND

**NEW!** Three telescopes in one. 3 different magnifications. 20 power for ultra-bright images with 40 and 60 power for extra long range. Guaranteed to bring distant objects, people, sports events, ships, moon, stars, etc. Most powerful for anywhere near the money. 5 Sections. Closes to 1 ft. long. Contains 4 ground and polished lenses. Also used as a powerful compound microscope. Directions included. Mass production enables us to offer this instrument at amazing price of \$3.95. Nothing Else to Buy. We pay postage. Get yours now.



**CRITERION CO.**  
Dept. PSB-12 **331 Church St. Hartford 3, Conn.**

**AMAZING SAFE JIG SAW MOST POWERFUL OF ITS KIND**

CUTS 1" Soft WOOD, thin metal, plastic! Syncro "201" is very QUIET for apartment use, SAFE for kids, POWERFUL for Dad's use. Any length cuts. Stroke adjustable. Portable. COMPLETE with BUILT-IN Motor, \$24.95 at dealers or postpaid. Free Circular. SYNCRO Corporation, Dept. G-73, Oxford, Michigan.



**PARTS FOR MILITARY TRUCKS**

**and JEEPS** 4 & 6 WHEEL DRIVE. WRITE FOR PARTS CATALOG STATING MAKES.  
**JEEP TOPS and CURTAINS**  
All Brand New . . . Not Surplus  
Made of Heavy Canvas Duck . . . Waterproof  
MILITARY TYPE models, Top and Curtains, complete, less bows . . . **\$59.50**  
TOP and CURTAINS, HALF CAB . . . MODELS CJ2A and CJ3A, complete with hardware, less bows . . . **\$65.00**  
TOP and CURTAINS Complete, MODELS CJ2A and CJ3A, with hardware for entire Jeep, less bows . . . **\$88.80**

When ordering please state exact model. All prices FOB K. C., 25% dep. on CODs.  
**UNITED AUTO PARTS CO. INC**  
1901 TROOST • GR. 1800 • KANSAS CITY, MO.

**Last Week I Made \$259.92**



**RAY BARTA**

with Science's New Midget Miracle, **PRESTO** Fire Extinguisher

So reports RAY BARTA of Wisconsin. Many others "cleaning up"—so can YOU!



Science's New Midget Miracle "PRESTO"

**A**MAZING new kind of fire extinguisher. Tiny "Presto" (about size of a flashlight!) does job of bulky extinguishers that cost 4 times as much, are 8 times as heavy. Ends fires fast as 2 seconds. Fits in palm of hand. Never corrodes. **Guaranteed for 20 years!** Sells for only \$3.98!

Show it to civil defense workers, owners of homes, cars, boats, farms, etc., and to stores for re-sale—make good income. H. J. Kerr reports \$20 a day. C. Kama, \$1,000 a month. Write for FREE Sales Kit. No obligation. **MERLITE INDUSTRIES, Inc.**, Dept. 117, 201 East 16th St., New York 3, N. Y. **IN CANADA: Mopa Co., Ltd.**, 371 Dowd St., Montreal 1, P.Q. (If you want a regular Presto to use as a demonstrator, send \$2.50. Money back if you wish.)

Send for this **Giant Automotive Catalog**



& Save to 50% on All Parts & Accessories  
**1953 EDITION JUST OUT!**

World's largest Auto Accessory & Parts Catalog. Over 50,000 items:—Hollywood Accessories. Hi-Speed Equipment. Rebuilt Engines. Everything for all cars & trucks. We have that Hard-To-Get part. Jam packed with bargains. Completely illustrated. (134 pages). Send 25c (Refundable).  
**J. C. WHITNEY & CO.**, 1917-TT Archer Ave., Chicago 16, Ill.

**New Remodeling "How-to-do-it" Booklet!**



Need help in finding hidden "extra" space in your home? Then you'll want this beautifully illustrated 4-color remodeling booklet showing how to remodel quickly and

at low cost with pre-decorated Nu-Wood\* interior finish. "Before and after" photographs make every step clear. Send 25 cents now for your copy!

**WOOD CONVERSION COMPANY**

Dept. 244-73 First National Bank Bldg.  
St. Paul 1, Minnesota

\*Reg. U. S. Pat. Off.



# LICK SUMMER DROUGHTS

... with a low cost CON-SOL well driller. Have all the wells you need ... where you want them ... even in your cellar ... shallow or deep. Easily moved, easy to set up and operate. Sturdy and reliable, it drills many feet of rock before its extra hard drill insert needs renewal.

Used by U. S. Depts. of Agriculture and Forestry, U. S. Navy and many professional well drillers. Fully guaranteed.

For 4" casings, price \$385 F.O.B. factory, includes drill, bailer and 100' cable. Additional cable, up to 300', 3/4 hp motor or 1 1/2 hp gasoline engine, available at extra cost.

HEAVY DUTY MODEL, for 6" casings, available at \$1295 F.O.B. factory, equipped with gasoline engine.



Write for literature to Dept. PS7.



**CONSOLIDATED INDUSTRIES**  
WEST CHESHIRE, CONNECTICUT, U. S. A.

## POWER MOWERS & KITS **FREE PLANS**



America's Finest Power Mowers completely assembled in 3 and 4 wheel models. Belt or direct drive, 18" and 20" sizes. Nationally known make engine. Latest improved features, sturdy construction and money back guarantee fully described in color folder. Write Today.

TRIANGLE MANUFACTURING CO., Box S-23, Fort Scott, Kansas

Build your own quality mower with our LOW COST KITS. Parts Engines. Free Plans guide you, 3 and 4 Wheel Kits, complete. Parts precision finished, ready to use. Write TODAY for Free Plans, Low Prices, Parts List and Guarantee.



## MOTORISTS—Had your Oil Filter checked recently?

If not, chances are it's choked up—can't keep up its engine-saving, money-saving work. Better put in a new Purolator Refill. (Costs as little as \$1.60.)

### PUROLATOR

World's Finest OIL FILTER



## GIGANTIC SURPLUS SALE!

**AIR COMPRESSOR UNITS**  
Build your own air unit. • DeLuxe Air Kit. Compressor, tank, valves, gauges, etc. \$45.49. • 1-cyl. compressor, \$20.50; motor pressure switch, \$4.95; Adj. pressure regulator, \$2.65. Pop off valve \$1.95. 160-lb. gauge, \$1.89.

**WATER PUMPS and SYSTEMS**  
Small pumps for every use. Free advice. • Centrifugals, 25 g.p.m. \$18.90. • Rotary bronze self-priming 6 g.p.m. \$14.75 • Hi-Pressure (400 lb.) for cattle, orchards, \$54.50. • SUPER CLOSEOUTS. • \$250 row-crop weed spray, \$129.50. • Chain Saws, low as \$219. • Power Plants 110-v., \$189. Bargains in hydraulics, tools, etc.

We pay transportation Write for sales catalog



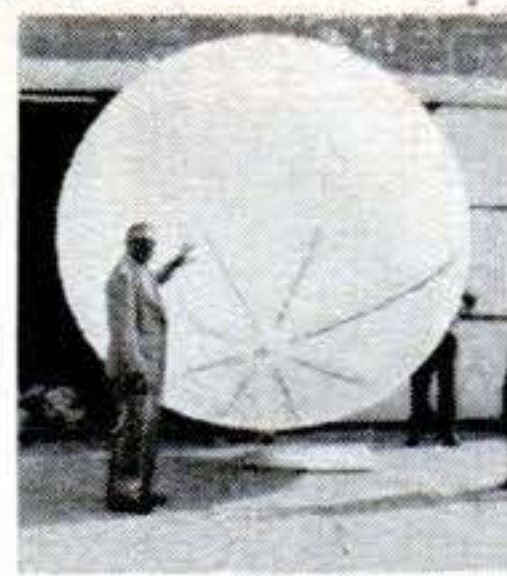
## BURDEN SALES COMPANY

829 "O" ST.

## SPECIAL For July



**AIR-SPRAY TANK**  
• War surplus buy! 10"x18" tank, complete with gauge, hose, chuck, spray nozzle. Use to fill tires, spray garden, lawn, etc. Fill with air at filling station. List \$29.50. SALE, \$14.95 2nd.



## GIANT BALLOONS

Weather, target balloons. For FUN or PROFIT. Great sport in the backyard; or for parties, picnics, dances, fairs. MONEY-MAKERS. Use these balloons to attract crowds to civic events, conventions, exhibitions, trade shows. TERRIFIC for high school and college PROMS. Special purchase makes these low prices possible.

3 ft. dia. 49c—6 ft. dia. 79c

13 ft. dia. \$1.59—20 ft. dia. \$1.95

All sizes are approx. inflated size.

Calif. residents please add sales tax on all items

**WAR ASSETS DIV. VOLUME SALES CO.**

Dept. S-7-53 3930 Sunset Blvd. Los Angeles 29, Calif.

## make your own Gems 29.50 F.O.B.

The Gem Maker comes complete with all necessary equipment, including a super-charged diamond blade for sawing, and all wheels for grinding, shaping and polishing; also complete instructions. The complete equipment as shown, less motor and belt, for only \$29.50, f.o.b. Burlington, Wisconsin. Write today for information and literature.

**B & I MANUFACTURING CO.**

Dept. S Burlington, Wis.



## BOYS BUILD YOUR OWN CRYSTAL RADIO

It's easy and lots of fun to build your own crystal radio set. You need no batteries or tubes when you use a "Melomite" Crystal and detector. Wonderful performance. "Melomite" crystal and detector with instructions and plans for building your own Crystal radio set—All for only 50c post-paid. Rush your order today, immediate delivery.

**ALVA ALLEN RADIO, Dept. PS-57, Clinton, Mo.**

## GOLD-SILVER-COINS

Easily located with new Lightweight M-Scope Detector. Superior performance, lowest price, monthly payment plan.

FREE LITERATURE

**FISHER RESEARCH LAB., INC.**

PALO ALTO

CALIF.



## ASSEMBLE YOUR OWN WATER SKIS AND SAVE \$20.

It takes only one hour to assemble this complete kit with laminated toes and heels, all-aluminum fasteners and adjustable foot grips. Full instructions with each kit. Only \$14.50 postpaid if accompanied by check or m.o. or C.O.D. plus postage.

**PAL PRODUCTS**

3005 Ave. N, Brooklyn 10, N.Y.

## Top Outdoor Book Again Available!

Famous Outdoor Life experts give you complete rod and gun information in newly-printed "Sportsman's Encyclopedia." Over 300 pages, 400 pictures, 900 thrilling subjects; fishing, hunting, dogs, camping, boating, equipment. Only \$2.98. Act now!

**POPULAR SCIENCE MONTHLY**

Dept. 753, 353-4th Ave. New York 10, N. Y.

## All-New Guide Cures Car Troubles!

"How to Take Care of Your Car," 256-page book by Popular Science experts shows you easy ways to beat high cost of car care. Over 750 pictures, instructions on making repairs at home, on road, save on gas, oil, more! Only \$2.49! Act NOW!

**POPULAR SCIENCE MONTHLY**

Dept. 753, 353-4th Ave. New York 10, N. Y.



**When you wash your  
CAR...wash the MOTOR!**



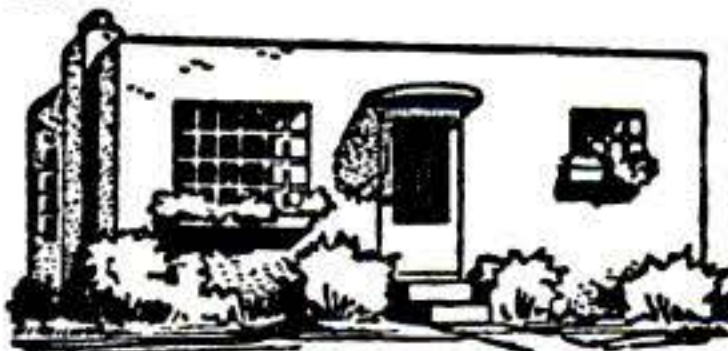
Just brush on KLANZ  
and hose off... your  
motor shines like new!

ASK YOUR DEALER FOR  
**KLANZ**  
motor cleanser

CONTINENTAL LABORATORIES INC. PORTLAND 13, OREGON

**\$750 BUILDS 4 ROOMS & BATH!**

**WHY PAY RENT?** For Seven Hundred Fifty Dollars and 30 days of your spare time, you can build yourself this Beautiful Home.



Living room, 11x15. Front bedroom 9x11. Back bedroom 10x12. Kitchen 9x11. Bath 5x8. Hall 3x4. Wind out steel easement windows. Concrete block, stuccoed. Step-by-step illustrated instructions, blueprint and material list. \$1.00 ppd. No C.O.D. Moneyback guarantee. Economy Home, Box 645, Dept. D, Columbus 16, Ohio

**NEWS**  
Only **TURTLE WAX**  
Auto Polish Gives Your Car  
a **HARD SHELL FINISH**

©PLASTONE CO., INC., CHICAGO 22, ILLINOIS

LEARN FASCINATING

## Leathercraft

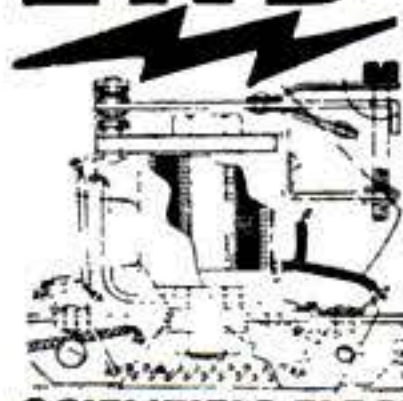


Make your own bags, belts, wallets, etc. Learn fascinating, profitable leathercraft in spare time. Send 25c for valuable Catalog, has over 200 photographs. (refunded first purchase).

**BURTONS LEATHERCRAFT**

Dept. PS-7 1727 Glendale Boulevard, Los Angeles 26, Calif.

## END BATTERY TROUBLE!!



WITH THE AMAZING NEW AND PROVEN  
**SELECT-A-CHARGE — WATTAGE REGULATOR**  
Revolutionary New Invention In Voltage Regulation  
**SENSATIONAL NEW DASHBOARD CHARGE-LEVEL CONTROL**

Greatest Feat In Auto-Electric Since The Self-Starter  
**UNCONDITIONALLY GUARANTEED — LUCRATIVE TERRITORIAL OPPORTUNITIES. CLEARLY ILLUSTRATED CATALOG ON THIS AMAZING DISCOVERY FREE — WRITE . . .**

**SCIENTIFIC ELECTRIC CO. • BOX 2162B CLEVELAND 8, O.**

NEVER ANOTHER WORRY  
OF DRIVING WRONG DIRECTIONS

● Get a world-famous **HULL AUTO COMPASS** Patented features assure years of accuracy, more positive adjustment against magnetic interference inside car. Simple clamp attaches to molding of one or two-piece windshield. Insist on Hull Quality! Write for local dealer's name, free literature.



More Huls in Use Than All  
Other Makes Combined

**HULL MFG. CO.**  
P. O. Box 246-E7, WARREN, OHIO

**Beaconlite** \$6.95  
illuminated  
**STREAMLINE** \$4.95  
non-illuminated

**NOW! SAW 2x4's  
IN ONE EASY CUT  
WITH NEW LARGER  
'ARCO-SAWS'**

AT  
BETTER  
HARDWARE  
STORES  
EVERY-  
WHERE

**ARCO  
SAW**

No. 455  
"ARCO-  
SAW"

For Depth & **\$12.50**  
Bevel Cuts.  
with ALL GAGES & 5"  
"ARCO SAFECUT" Blade.

No. 444 "ARCO-SAW"  
For Straight Cutting. Small-  
er model than above, cuts  
1-5/16". Same features, less  
Crosscut  
Blade **\$9.95**

**AMAZING NEW SAFE-  
CUT BLADE ALLOWS  
ANY 1/4" DRILL TO  
WHIZ THRU HEAVY  
LUMBER, WALLBOARD,  
PLYWOOD, etc.**

At last, here are the first—the only—gear driven saw attachments to whiz thru 2x4's in one cut! Imagine, now you can build anything from bookcases to a bungalow with these sensational new saws. A moderately priced drill will do the job because of new "ARCO SAFECUT" Blade.

**ONLY "ARCO" GIVES  
YOU THESE FEATURES:**  
5-inch Safecut Blade—

cuts faster—uses 30% less power,  
Graduated Depth & Bevel Gages for  
& Visual Guide, Sturdiest and Easily Adjusted Safety-  
Yoke keeps drill steady. Worm Drive Clamp releases drill  
in seconds. Precision Gear Box with Steel Gears.

**90-DAY FACTORY GUARANTEE.**

**REPLACEMENT BLADES: Specify 5" Safecut, \$1.75**  
or Combination, or Rip, or Crosscut Style. . . .

**UNCONDITIONAL 10-DAY MONEY-BACK GUARANTEE**

**DEALERS:** BUY THE BEST—see your hardware dealer now! Don't  
Write for nearest jobber accept inferior substitutes—if not available send us  
check or M.O. (Postpaid). C.O.D.'s—postage extra.

**ARROW METAL PRODUCTS CO.**

Dept. PS-7, 140 WEST BROADWAY, NEW YORK 13, N. Y.

**WELD**

**BRAZE**

**4WAY**

**SOLDER**

**CUT**

**ONLY  
\$14.75**  
f.o.b. factory



**WELDER**

Complete with  
Twin Carbon Arc  
Torch and ac-  
cessories . . . to  
handle all metal-  
craft work.

Acclaimed by thousands of Homeowners, Mechanics and Hobbyists as the welder of 1001 uses. Easily operated from properly wired 110 volt AC or DC line. The ideal gift with a life-long use. . . . Order today on 10 day money back guarantee.

**FOUR-WAY WELDER CO., Dept. F3-G'**  
2326 S. Michigan Ave. • Chicago 16, Ill.

**EXTERMINATE INSECTS THE  
New, PROFESSIONAL WAY.**



**STOP Disease-Breeding FLIES,  
MOSQUITOES and INSECTS  
All Season with One Application**

**of SMO-CLOUD**

**KILLS • FLIES • MOSQUITOES • ROACHES  
• WATERBUGS • SILVERFISH • WASPS • ANTS  
• And many other crawling and flying insects**

Exterminators all over the country use SMO-CLOUD—nothing like it! Use it yourself and SAVE! No work . . . no brushing . . . no spraying. **KILLS** insects and nests in one quick operation—and **LASTS ALL SEASON**. Flies are known to carry dysentery and typhoid . . . and suspected of transmitting dreaded polio virus. Banish this hazard. It's easy. Simply light contents of can and a fine vapor seeps into every crack and crevice. Insects disappear! Your money back if SMO-CLOUD fails. **ECONOMICAL! SAFE! 100% EFFECTIVE!** Order now for home, summer cottage and farm. **Guaranteed.**

**\$1.95**  
Post paid

**JAY SALES CO., Dept. PS-50, 192 N. Clark St., Chicago 1, Ill.**

JULY 1953 235



# NEW! THE "FLAT-JAK" STOWAWAY FILLER

Approved by Underwriters' Laboratories for outdoor use



**IDEAL FOR  
POWER LAWN MOWERS  
OUTBOARD MOTORS**

**SAFE**—Automatic shut-off valve in end of spout prevents spilling or splashing—eliminating fire hazard.

**EFFICIENT**—Gasoline flows by gravity through brass "swing-around" spout when crossbar of valve is pressed against tank opening.

#171¼—1¼ gal. cap. Retail price \$5.00 each

#172½—2½ gal. cap. Retail price \$6.00 each

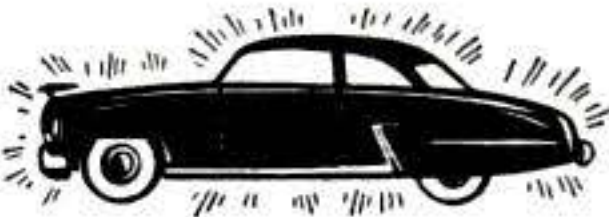
Buy one at your sportshop, marine or hardware dealer's.

**EAGLE MANUFACTURING CO.** WELLSBURG W. VIRGINIA

## AMAZING NEW DISCOVERY

# Washes Car So Clean Rain Can't Spot It!

One wipe with Magic Bubble Mitt removes toughest road film, grime without taking off wax! Secret is new cleaning agent (not a soap, not a powder) that leaves invisible protective coating that fills pores of finish so rain can't spot it. In fact, after washing your car this new way, rain actually washes your car next time free. Magic Bubble Mitt is genuine lamb's wool; can't scratch finish. Send only \$2 (we pay postage): try for 10 days—money back unless it does all we say! Mehren Industries 327 Mehren Bldg., Beverly Hills, Calif. FREE with your order: Auto Handbook with over 100 money-saving tips on car care and performance.



## .01" ACCURACY with MAGNA DADO!

Geared hub. Sets in 5 seconds with Allen wrench. Cuts any groove 5/32"-7/8" wide. 2" max. depth. 12-gauge tempered steel blade; 8" dia. Available at SHOPSMITH dealers. Fits most saws. \$12.95.

## WELLWORTH COMPRESSORS

2" x 1¾" up to 150 lbs. pressure 2.8 c.f.m. Operates with ¼ or ⅓ HP motor . . . \$20.50; with 12" x 24" tank and accessories as shown . . . \$38.25

Compressor 2½" x 2" motor required ½ HP 3.8 c.f.m. Price \$27.95. Price with tank and accessories \$45.70

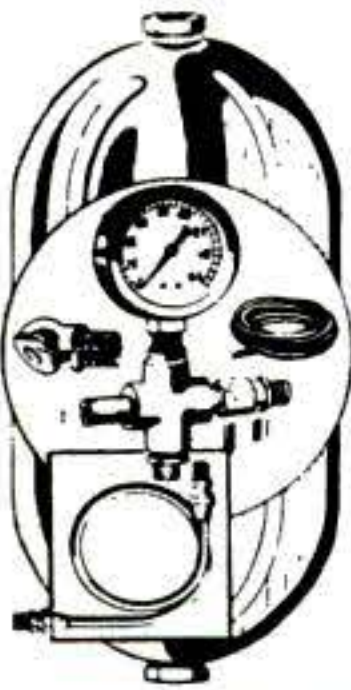
12" x 24" tank, 12 gal., air gauge and chuck, 20 ft. hose, pop-off valve, copper tubing with 4 brass flared fittings, 4 way cross, 3 nipples. Price \$17.75

Price of tank only . . . \$11.50

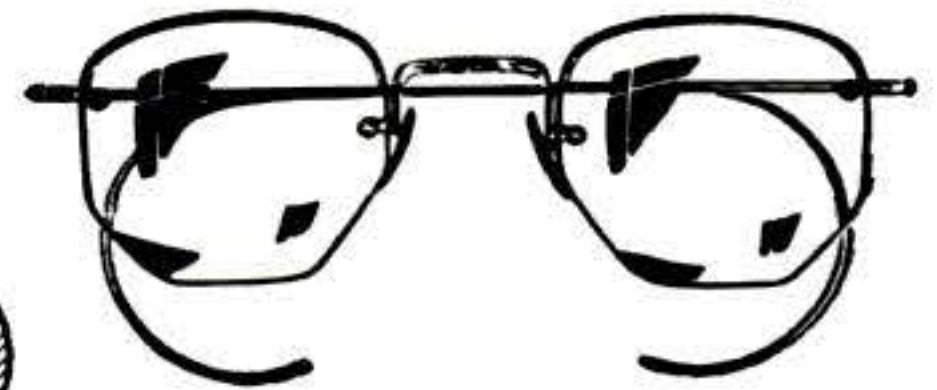
Prices F.O.B. Chicago. Money Back Guarantee. Send Check or Money Order Today. Prompt Shipment. Write for Free Catalog. Send 10c for Postage.

**WELLWORTH TRADING CO.**

1832 S. Wabash Avenue, Dept. B-753 Chicago 16, Illinois



## Sensational Device Tests Eyes



**SAVE up to \$15.00 on Glasses!** Big news to the millions of Spectacle Wearers and Prospects. Means Freedom from Outrageous Prices. Sold on Money-back Guarantee.

**MAKE BIG MONEY QUICK—FREE SAMPLE KIT!** Show it to friends and others. Let them use it Free and watch their amazement over this Self Testing system. Here is a great new opportunity in a tremendous new field of unlimited possibilities. Spare or full time. No experience needed. Write for Free sample kit.

**C. G. Optical Co., Dept. A-180, 20 E. Delaware Pl., Chicago 11, Ill**

## 2-BEDROOM HOME \$890

BUILD YOUR OWN

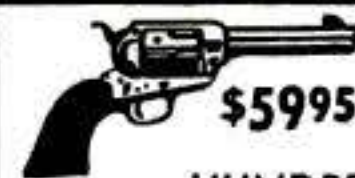


Living room 12x14. Master bedroom 10x12. Nursery-den 10x11. Kitchen 7x10. Bath 5x8. Concrete block built. Blue prints, material lists, exact instructions for 3 designs.

Complete \$1 ppd.

**SUNNY-CAL HOMES, Box 309-E7, Hollywood 28, Calif.**

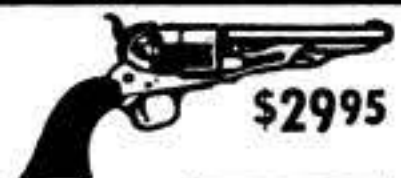
## ANTIQUE GUNS



\$5995



\$3000



\$2995

HUNDREDS OF BARGAINS!

**BIG ILLUSTRATED CATALOG**

**PIONEER GUN SHOP**

3029 W. BURBANK BLVD., BURBANK, CALIF.

SEND 50¢

## MAKE ANY SIZE FOLDAWAY TABLE, WORK BENCH ETC.

with **FOLDAWAY** TUBULAR STEEL **FOLDING LEGS**

COMPLETE 30" LEGS \$7.98 PLUS POSTAGE FOR 12# WEIGHT OR SHIPPED EXPRESS COLLECT ORDER TODAY!

SHIPPED COMPLETE, READY TO FASTEN TO YOUR TOP IN A MINUTE—FOLDS FLAT, EASY TO CARRY AND STORE—RUBBER TIPPED—MAKE A SMART PING PONG TABLE Satisfaction guaranteed.

THE DIAMOND MFG. CO. PS1 1100 ALTAMONT AVE. SCHENECTADY 7, N. Y.

## Catalog of 3000 Novelties 10c

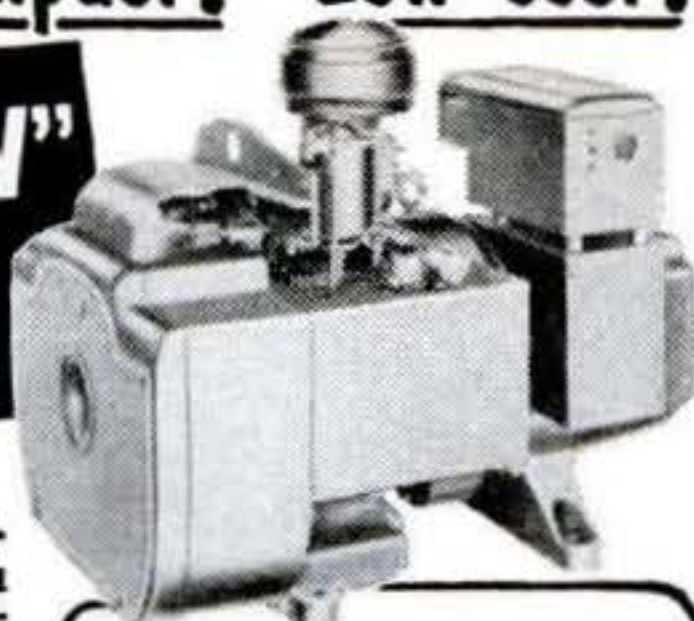
Send 10c for amazing catalog of novelties, live animals, scientific supplies, hobbies, funmakers, planes & boats, looms, magic tricks, joke articles, unusual seeds, gadget timesavers, cameras, optical goods, projectors, movies, lucky jewelry, religious novelties, disguises, musical instruments, stamps, coins, puzzles, fortune tellers, radios, auto & bike accessories, telescopes, magnifiers, compasses, banks, smokers' gadgets, artists' supplies, printing sets, engines, motors, shockers, knives, billfolds, fireworks, guns, rifles, sports, books, games, plants, etc. Send name, address & 10c to: **JOHNSON SMITH & CO., Dept. 658 Detroit 7, Michigan**





**High output! Compact! Low cost!**

**NEW ONAN "CW" ELECTRIC PLANTS**  
5,000 or 10,000 watts A.C.



YEARS AHEAD in design, performance, value! Give you regular 110-volt current for trailers, homes, farms, cabins, resorts. Air-cooled, heavy-duty engine. Costs less than any other complete electric plant.

- Quiet-running • Fits in small space • Vacuum air-cooled engine and generator • Lightweight • Completely equipped

WRITE FOR FOLDER.  
**D. W. ONAN & SONS INC.**  
6753 Univ. S.E. • Minneapolis 14, Minn.

**WHAM-O SPORTSMAN\***

**\$1.50 POSTPAID**

35-LB. PULL!

HITS LIKE A RIFLE—KILLS RABBITS, SQUIRRELS. Powerful, silent, accurate. For hunting, target, routing pests. Money back guarantee



**HUNTING SLINGSHOT**

Heavy duty 7" ash stock. 40 steel balls, extra rubber, target. \* Professional model of National Slingshot Assn. If your sporting goods dealer can't supply you, send \$1.50 to Wham-O Mfg. Co. Box 3B, South Pasadena, Calif.

**TREASURE -- \$10,000**

New locator detects metals, valuable minerals and buried treasure. Money-back guarantee of superiority.



Also geiger counters. Govt. reward of \$10,000 for uranium discovery. Write for FREE information.



**THE GOLDAK COMPANY**  
1544 W. GLENOAKS BLVD., GLENDALE 1, CALIF.

**6 GREAT SHAW DU-ALL**

Plow  
Plant  
Cultivate  
Mow  
Rake  
Cut  
Trees  
Saw Wood



Walking or Riding Tractors 1 1/2, 3, 5 H.P. walking models. 5, 8, 12 H.P. riding tractors. Get just the power you need in Shaw extra strength superior traction machines. All wanted tools, attachments. Dependable for nearly 50 years. See a Shaw dealer. Write for FREE literature, low prices—today.

**SHAW Mfg. Co.** 5707 Front St., Galesburg, Ks. 668-PS N. 4th St., Columbus, O.

**Get the FACTS!**



Write for complete information. Dept. 3107  
**SCHULT CORP., ELKHART, IND.**

**SCHULT TRAILERS**

**DIVING EQUIPMENT**

**Special AQUA LUNG**



Self-contained diving units now available for amateur use. Safest and easiest to use of any diving equipment. Standard "Frog-Man" equipment with armed forces. No hose or surface connection—dives to one hour. Several models: \$115.00 to \$160.00 complete. Also: DEEP-SEA DIVING RIGS (surplus) and all types shallow-water diving equipment . . . DESCO MASKS, Underwater Spears, variety of Sport Masks, flippers, etc., including French imports.

Write for Catalog—15c

**M & E MARINE SUPPLY CO., P.O. Box # 601-G, Camden 1, N. J.**

**JOIN THE FUN—SAVE 50%**

**PACKAGED BOAT KITS**



**EASY TO ASSEMBLE**

OUTBOARD CRUISERS from \$349.50

**SEND 25c FOR BIG 1953 CATALOG**

See our complete line before you Buy! World's most complete line of real Performance Boats: Dinghies, Skiffs, Pontoon Racers, Runabouts, Outboards, Cruisers. Exclusive features, mahogany parts plus brass screws. Also marine hardware, fittings, accessories and quality paints.

Catalog plus booklet "Boat Selection, Operation & Maintenance" \$1.00

SEND 35c for World's most complete Catalog of Full Racing and Speedboat Accessories, general boat hardware, fittings, paints, conversions and conv. kits. Also new "ARMOR-GLASS" covering material for boats. Catalog plus booklet "How to Paint, Outfit and Care For your Boat" send \$1.00

**BOAT PAINT, ACCESSORIES and FITTINGS**

**BOAT PLANS AND FULL-SIZE: PATTERNS**

Over 100 Modern plans and full size patterns. Racing classes, cruisers, inboards, outboards, sail boats. By famous designers. 6' to 30'. DESIGN CATALOG only 35¢. For Design Catalog plus boat building handbook send \$1.00.

CUSTOM-CRAFT (DEPT. B) BUFFALO 7, N. Y.

**FREE! SOUTH BEND CATALOGS**

- 9" to 16" SWING LATHES
- 14" DRILL PRESSES
- 7" BENCH SHAPER
- ATTACHMENTS

Write today—check catalog wanted

**SOUTH BEND LATHE WORKS**  
425 E. Madison St., South Bend 22, Ind.



**FULLY GUARANTEED TIRES COST LESS!**



Nationally famous FIRESTONE, GOODRICH, U.S. ROYAL, GOODYEAR, and other makes. Every tire selected and inspected for your safety.

**FREE TUBE WITH PASSENGER TIRE NEW TREAD TIRES GUAR. 24 MO. S (MUD & SNOW or WHITE WALL TIRES \$1 EXTRA)**

550x16	7.98	600x16(6)	9.98	650x20(8)	19.95	700x16(6)	14.48
550x17	7.98	650x15	9.98	640x15	8.98	710x15	10.48
600x15	7.98	650x16	10.48	670x15	9.98	760x15	11.48
600x16	7.98	650x16(6)	12.48	700x15	11.48	820x15	12.98

<b>AAA PREMIUM GRADE GUARANTEED 18 MONTHS</b>							
550x15	5.48	700x15	5.98	760x15	5.58	750x20(10)	14.98
600x16	5.28	700x16	6.78	550x17	5.48	825x20	18.68
600x16(6)	6.58	700x16(6)	7.98	600x20	9.78	900x20	18.98
640x15	5.68	750x16(6)	8.98	650x20	10.88	1000x20	19.98
650x16	5.78	800x15	6.88	700x20	12.88	1000x22	21.98
650x16(6)	6.98	820x15	7.48	32x6(8)	10.48	100x20	20.98
650x15	5.98	710x15	6.09	32x6(10)	12.48	1100x22	21.98
670x16	6.18	550x18	5.98	750x20(8)	12.98	1100x24	23.98

<b>GOOD TIRES GUARANTEED 12 MONTHS</b>							
600x16	4.14	700x16	5.14	32x6(8)	8.84	825x20	14.24
650x16	4.54	670x15	4.74	32x6(10)	10.84	900x20	13.34
650x15	4.34	650x20	7.84	750x20(8)	8.54	1000x20	14.14
700x15	4.64	700x20(8)	8.94	750x20(10)	9.94	1100x20	16.14

<b>MILITARY SPECIAL</b>			
<b>AA Guaranteed 12 Months—</b>			
900x16	10.69	900x20	19.98
750x20	10.98	1100x20	21.98
<b>AAA GUARANTEED 18 MONTHS</b>			
900x16	14.98	750x20	16.48

<b>New Tread Guar. 24 Mos.</b>	
600x16	8.98
600x16 (6)	9.98
700x15 (6)	15.95
750x20 (8)	24.98

Largest stock of used tires in the East. Thousands of satisfied customers. Write for Free Catalogue. MONEY ORDER OR CHECK WITH ORDER. NO C.O.D.'s

**PYRAMID TIRE CO.**  
1333-35 North 5th St. Dept. S., Phila. 22, Pa.



## Calling all Car Bugs! By POPULAR DEMAND

We are repeating this record-breaking offer for a limited time only. Not one, not TWO, but **THREE** famous booklets jam-packed with interesting, fascinating information for every car enthusiast. **HOW TO GET 150 MILES PER GAL.**—Factual reports revealing for the first time mileage secrets of the nation's leading economy experts. **HI-PERFORMANCE EQUIPMENT** a complete directory of Speed, Power, Custom & Economy products including specifications & prices for all makes & models. **ECONOMY IN DRIVING** tells how to double the life of brakes, tires, and battery. How to get superior performance and save \$\$\$\$\$\$ on your motor budget no matter what make or model you drive. All three exciting booklets for only 50c (regular value \$2.00). Send cash or stamps today to  
**Newhouse Automotive Industries, 5805 E. Beverly Blvd.**  
Dept. 45, Los Angeles 22, California



**BOOST YOUR INCOME WITH THE**

## IDEAL LAWNMOWER SHARPENER

You can earn extra cash with the Model 300 Ideal Lawnmower Sharpener. Used and recommended by leading manufacturers and service shops, the Ideal has everything you need, nothing else to buy. Grinds reel and bed knife, also recconditions. Get started now in this highly profitable business. Write for catalog today.

**The FATE-ROOT-HEATH Co**  
Dept. PS-7 Plymouth, Ohio

## Save Time!!! Save Money!!! SEND FOR THIS BIG, NEW Woodworkers Catalog No. 19

**ONLY 15c** New low prices...great selection of fine domestic and imported woods...bargains in hard to get supplies--144 pages of items and ideas for woodworkers. Quick delivery on mahogany, walnut, maple, cherry, poplar, oak, red cedar, and others properly seasoned, kiln dried. Send 15c for your copy--TODAY.

**RAFTSMAN WOOD SERVICE CO.**  
2729 S. MARY STREET • CHICAGO 8, ILLINOIS

## AMERICA'S BIGGEST FAN VALUE!!

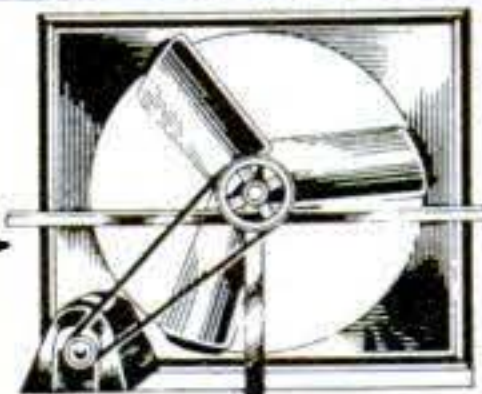
### WESTAIR 24" BELT DRIVE

Precision built belt drive Fan—for Homes, Stores, Factories, Barns, etc. Fan frame Dia. 29"x34", welded steel Blade Dia. 24", R.P.M. 550, CFM 5400. Completely Assembled.

Reconditioned 1/4 GE Mtr. \$8.95  
New Delco Motor \$15.95  
Aluminum Side Wall Shutter \$12.95  
Aluminum Counterbalanced Ceiling Shutter \$18.95

### Attic FAN

**\$39<sup>95</sup>**  
Less Mtr.



**5 YEAR GUARANTEE**

Kitchen Ventilators, Exhaust Fans, Attic Fans, Blowers, Heat Boosters, Desk Fans, Window Fans, Blades, Guards, Shutters, Motors, etc.



**EDWARDS BROS.**  
Estab. 21 yrs.

## WESTAIR FAN & BLOWER CO.

5650 Grand River, Dept. M Detroit 8, Mich.



Who me?

Yes, YOU can

## FIX TV AND RADIO TROUBLES YOURSELF

**Build Your Own Sets At Big Savings!**

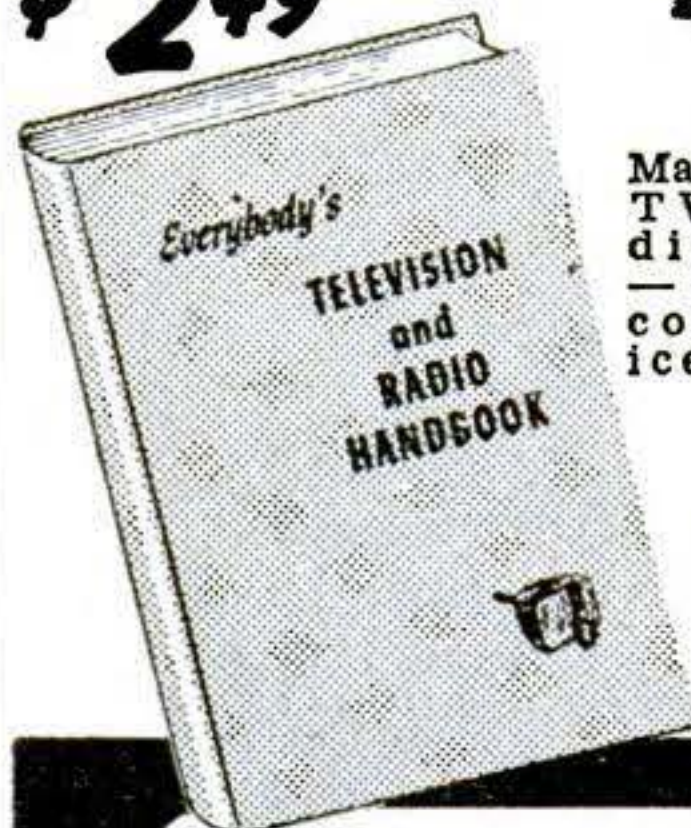
Yes, if you can turn a screwdriver, you can stop paying those \$5—\$10—\$15 repair bills!

You can fix up your present set so that it works better than ever, or construct — at a mere fraction of the store price — that powerful, good-looking TV set, radio, 3-speed phonograph, or beautiful console combination you've always wanted!

For the first time, it's all made so downright easy and enjoyable, that even if you've never seen the inside of a TV set or radio before, you'll soon be making expert repairs and improvements of professional quality.

Here is **EVERYTHING** you need—a Radio Builder's Guide, Television Repair Manual, a Radio Trouble-shooting Bible, and a TV and Radio Shopper's Guide — all packed into one **BIG, HELPFUL VOLUME**. All this is yours for less than 1/2 the cost of a single service call! Convince yourself with generous 10 day **FREE Trial!**

**\$ 2.49**



Make your own TV and Radio repairs — eliminate costly service charges!

### Simple Directions Show You How

To build many AC-DC shortwave radios, 3-speed phonographs, portables.

Convert your old TV set to modern Giant Screen

Build clever midget radios

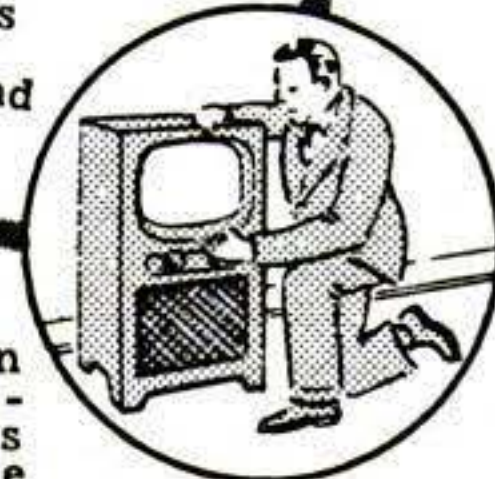
Construct television wave traps

Build television color converter

Double any radio's usefulness with inexpensive extension speakers

Rig up amazing electronic household servants

Do scores of other exciting TV and radio projects simply by following easy "show-me-how" "show-direc-tions and hundreds of diagrams and photos!



**256 Pages!**

**711 Illustrations!**

Popular Science Publishing Co. Dept. P.S.-753  
353 Fourth Avenue, New York 10, N. Y.

Please rush me **FREE Trial** copy of **EVERYBODY'S TELEVISION AND RADIO HANDBOOK**. When it arrives I'll deposit only \$2.49 plus postage with postman, as payment in full. Unless completely delighted, I may return book after 10 days **FREE Trial**, and get my money back.

NAME .....

ADDRESS .....

CITY ..... STATE .....

Check here if you remit now. We'll pay postage. Same guarantee.



**100-200-300 POWER 'HYPOWER' MICROSCOPE**



**NEW**  
A VALUE UNSURPASSED ANYWHERE! Triple objective revolving lenses allow selection of 100, 200 or 300 power magnification. Has built-in micro adjustment. Adjustable sub-stage mirror. Body is made to incline through 90°. Complete in dovetailed hardwood case. Ideal for student, lab, study of insects, etc.

**SPECIAL 9.95**

**SAVE UP TO 85% ON PALLEY SURPLUS FROGMAN SUIT**

Like those used by U.S. Navy. Made of pure Gum Rubber and designed to keep the diver warm and dry but still allow complete maneuverability. Has built-in exhaust valve to relieve trapped air and avoid buoyancy. Easy to put on and take off by the extra large back entry chute. Has short arms & legs. For use in water above 55° F. . . . . **34.95**



**NAVY PHONE SET**



Used by the NAVY for Flight Deck and Gun Control. An ideal emergency communication system because each set is "sound" powered - no other power supply needed. Perfect for office-to-shop, house-to-garage or barn or any point-to-point within the radius of 1/2 mile. Each set includes two phones on chest-plates, two headsets, button switches and approximately 35 feet of wire. A Tremendous Buy **9.95 SET**

One Phone and Headset . . . **5.95**

**2-WAY PHONES**

Install this set of desk phones for perfect two-way communication from any two points up to 100 feet apart. This handsome set is finished in blue, baked enamel. Has two phones, wire and simple hook-up instructions. Operates on ordinary flashlight batteries. Here is an ideal set for use room-to-room, house-to-garage or barn, darkroom-to-outside, office-to-office or shop, etc. A Time & Step saver. **7.50**



**FAMOUS PALLEY MIXES**



A WAR SURPLUS MIX! Has four hand tools plus an Army Scoop for Fireplace or Barbecue. The tools alone are worth far more than our price but we throw in the Scoop FREE! Tools include a Hammer-Punch, Chisel-Hammer, Stake Driver and a 17" Stanley Screwdriver. All have crucible cast-steel heads and hardwood handles. For home, farm, ranch, machine shop, garage, etc. All for ONLY . . . . . **2.89**

**AERO SEAL HOSE CLAMP MIX**

Another Palley Bargain Mix. 24 assorted hose clamps of various sizes & types. Ideal for use on autos, trucks, tractors, boats, planes, pumps, etc. All are finest, aircraft quality. Be Prepared. **2.25**

**FILE MIX** - Contains 10 assorted Files - 4 inch to 12 inch. This includes Vixens, Half Rounds, Mills, Bastards, etc. In seconds and used but good condition. One Vixen file alone is worth our price for the entire mix. . . . **99¢**

**GADGET MIX** - Another SURPLUS BARGAIN! This amazing mix includes a 'TREASURE' of small parts such as; Cogs, Worm Gears, Wheel Bearings, Rivets, Spacers, Bolts, Screws, Springs and Clamps. 5 pounds for ONLY **1.19**

**BRITISH ARMY PACK RACK**

The famous Everest Pack Carrier. Has an all steel frame with a canvas covered, fold-up bottom pack shelf. All straps are genuine leather. Designed so there is a minimum of rubbing and weight is evenly distributed. Strap across lower section acts to absorb shock and sway. Folds flat when not in use. Weight only 3-1/2 pounds. **6.95**



**230 PAGE CATALOG**

1000's of ITEMS! Fully ILLUSTRATED! For the MECHANIC, SPORTSMAN, HOBBYIST, HOME OWNER, etc.

War Surplus - Factory Closeouts and General Merchandise Values! Save on Hardware, Hand and Power Tools, Gadgets, Sports Equipment, Hydraulics etc. SEND 25¢ for HANDLING & MAILING.

**SELF CONTAINED NEW DIVING UNIT**



Designed to allow swimmer or diver to stay under water up to 1 hour at depths up to 300 ft. No hoses or compressors needed. Automatic regulator releases air as depth requires for breathing. Has automatic 5 minute warning before air is exhausted. ALL NEW! Used for 6 years without casualties. . . . . **160.00**

**'ARBALATE' SPEAR GUN**

Most efficient underwater gun made! Powerful, accurate, silent. Uses "crossbow" principle. Rubber powered. Has safety catch & will float after spear is released. Can be reloaded under water. Normal range is 14 feet. . . . . **24.95**

**SNORKLE BREATHING TUBES** - Plastic with rubber mouthpiece. Allows breathing with face under water. **1.95**

**CURVED TYPE** - Has automatic seal when immersed. **2.95**

**SWIM GOGGLES**  
Finest imported, live rubber goggles. 100% water tight. Has adjustable, elastic headband. "Seals" on Frogman suit. ONLY **3.25**

**SWIM FINS**  
Made of top quality rubber with pebble tread bottoms. Reinforced, adjustable heel strap. Vented for air & drainage. Ideal for diving & swimming. Available in men's, women's and childrens sizes. . . . . **5.95**

**DIVING MASK**  
A fine quality mask. Ideal for shallow water skin diving or swimming. Soft gum rubber with sturdy glass lens and adjustable head band. Lightweight & water-tight. Comes in 3 sizes. **JR. 2.59 MISS 2.69 MR 3.95**  
4 1/2" 5" 5 1/2"



We carry a complete line of Swimming, Diving and Fishing equipment. Write us your requirements.

**RADIO BARGAINS**

Popular Telephone Type. Highly sensitive. Has excellent, clear tone. Was the Signal Corps favorite. An ideal instrument for the Radio "Ham" and the professional recording studio, for broadcasting, home recording, public address systems, etc. Unit comes complete with cord & plug. **3.29**

**USAF THROAT MICROPHONE**

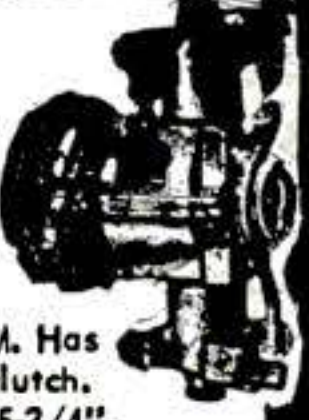
Genuine USAF type T-30-0. Gives clear, distinct voice reproduction for aircraft or the amateur broadcaster. Set consists of two microphones, mounted on rubber neckpiece which is fastened to elastic neck band. Operates between 100 and 300 ohms. . . . . **1.39**

**USAF HAND MICROPHONE**

Highly sensitive. Has thumb control switch on handle. Ideal for recording, public address systems, etc. Comes with 2 ft. rubber cord & plug. **5.95**

**WESTINGHOUSE COMPRESSOR**

A 2 cylinder, piston type Air Compressor. Ideal for spraying, inflating, air tools. Used in garages, shops, laboratories - on trucks, tractors, jeeps, etc. Will run off fan belt or power take-off. Operates on 1/2 HP. Gas or Electric motor. Runs in either direction. Delivers approx. 3.27 CFM at 600 RPM or 6.54 CFM at 1200 RPM. Has 2" bore, 1-1/2" stroke. Automatic clutch. Size: Width 9", height 11-7/8", depth 5-3/4". Approx. weight 23 lbs. We have motors, tanks and fittings to adapt this unit. **23.95**



Order From This Ad. Pay by M.O. or check. P.O.'s. acctpd. from D&B firms. 1/2 deposit with C.O.D.'s. All Prices FOB Los Angeles.

**PALLEY SUPPLY CO.** 2263 EAST VERNON AVENUE DEPT. PS-7 LOS ANGELES 58, CALIF.

**Rosco® SCREW DRIVERS**

**"45" HOLSTER SET**

Tool Steel Blades. MAGNETIZED TO PICK UP & HOLD SCREWS! Approved Shockproof Handles.

SIX precision-made screw drivers sized for most every purpose in a handy holster that can be worn on belt or hung over work-bench!

**ROSENBERG BROS & CO.**

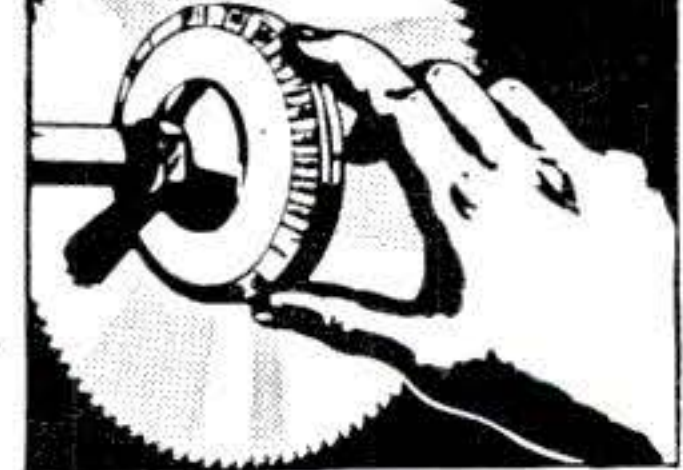
94 Landing Avenue Smithtown, L. I., N. Y.

There's a ROSCO Screw Driver Sold Every 7 Seconds!



If your dealer can't supply you - order direct sending his name and \$2.50 in check or money order.

**NOW - 40 different CUTS with AMAZING, NEW**



**Warren**

**DADO SAWING WASHERS On Your Saw Blade**

Just dial widths to cut parallel grooves perfectly smooth. No warp, vibration

or trick screws. Strengthens blade, perfect balance. GUARANTEED! At your dealer's or order direct. Give arbor size - 1/2", 5/8", 3/4", 1".

Send for free booklet  
**WARREN WASHERS COMPANY**  
Dept. 47, Box 98, North End Station, Detroit, Mich.

**ONLY \$4.95 PER SET**



## Man-Made Meteors to Spy on Space

[Continued from page 97]

Observers were set up around the rocket firing field and stationed in observatories in neighboring states to photograph the trails of the artificial meteors with a series of telescopes.

But the experiment didn't pay off. At the crucial moment the firing mechanism for the meteors failed.

Neither the necessary funds nor the firing facilities have been available for further high-altitude experiments with artificial meteors. Meanwhile Dr. Zwicky is experimenting with various charges to find the most suitable size and shape, and various inserts—both solid and liquid—to find the most efficient. If he can get the money, charges will be released at ever-increasing altitudes—from planes, anti-aircraft shells, high-altitude balloons and rockets.

### Could Explore Moon's Surface

In time, Dr. Zwicky believes, we will not only produce artificial meteors which act as satellite missiles or pioneer in interplanetary flight; we may well be using them to bombard the moon. By observing the flash made by a meteor on impact, and by analyzing the flash spectroscopically, the moon's surface can be explored for its chemical constituents.

"In trying to find a master key to space travel," as Dr. Zwicky puts it, "we must first throw a little something into the skies, then a little more, then a shipload of instruments and finally ourselves."

Today we know only that beyond our reach there is an enormous physics laboratory where great experiments are constantly in progress. We've got to find out a lot more about what goes on there before we ever put space travel on a commutation schedule. **END**

---

### Off Key

Soprano: "Your accompaniment certainly doesn't suit my voice."

Pianist: "Madam, I've tried all the white keys and all the black keys, but you sing in the cracks."—*The Wyatt Way*.

## Gus Calls a Close One

[Continued from page 148]

he'd made on the gas line. Had there been something queer in the feel of that pump when he had held it in his hands, or was he just imagining it? Tantalized by the thought, he disconnected the fabric-covered synthetic-rubber hose that connected the pump to the gas-tank line. The five-inch length of hose hanging limply to the pump outlet had a spongy feel.

Gus glanced at the clock, then at the waiting, expectant faces about him. He took a roll of friction tape from his pocket, wound several turns firmly about the full length of the hose, and replaced the pump.

"Try her now, Stan," he said.

Stan stepped on the starter, and pumped the gas. Suddenly the motor came to life.

### Gus Gets Them Started

"Hop in and get out of here, you old coots," Gus grinned. "But be sure to stop in on your way back, for a permanent repair. I've only fixed you up temporarily."

"What the heck was wrong?" Stan Hicks inquired as the car roared away.

"That flexible connecting hose. It looked all right, but it wasn't. The synthetic lining was so weak that the pump action flattened it. Just like when a kid sucks too hard on a wet soda straw—no liquid gets through. The tape will stiffen it for a while."

"But," protested Stan, "that couldn't be. You got gas through that hose by working the pump by hand."

"Sure I did," Gus agreed, as he moved into the office and snapped on the radio. "That's what had me fooled. But when I was holding the pump I had the hose stretched tight, not in its accustomed bend. So the suction of the pump didn't flatten it."

Gus twisted the dial and the roar of the crowd in the Stanfield stadium filled the office. "I can just see Ezra now," he chuckled, "with his foot down to the floor boards and Tom and Pete razzing him from the rear seat. To hear those fellows yammer you'd never guess they were friends. Wonder who'll be razzing who, tonight." **END**

*Next month: Gus gives Cupid a hand.*

---

### Times Change

IN THE good old days people turned over in their graves. Now they turn over in their cars first.—*Processing Equipment News*.



**PORTABLE LIGHT PLANTS**

**350 Watt Plant (Item 273)** 115 v. DC. 1 1/2 hp. Briggs Engine. Perfect for lights, radios and small power tools, etc. Wt. 65 lb. Factory price. **\$99.75**

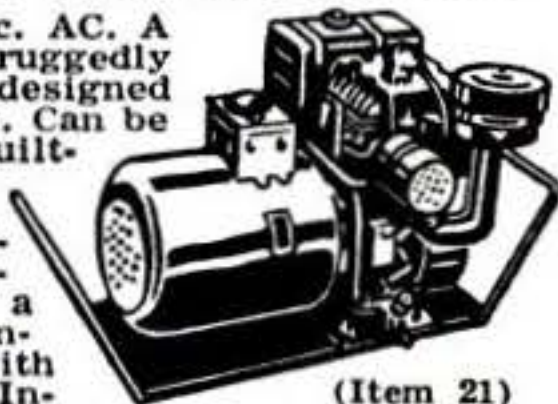


**PUSH BUTTON START**  
AC Plant 500-700 Watts—115 v.-60 cye. Powered by a rugged 2 hp. easy-starting Briggs gas engine. No wiring necessary; just plug in and operate. Plenty of current for any oil burner, freezer, brooder, emergency lights, etc. which require up to 700 w. Ideal for Civil Defense, Fire Depts., trailers and camps. Complete with Voltmeter and built-in winding to charge 6 v. auto batteries. Item 24. Wt. 85 lbs. Be prepared if war or storms knock out power lines. Reg. \$275.00 value. **\$143.50**

**700-800 Watt Plant (Item 44)** same as above but larger engine. **\$169.95**  
**1000-1200 Watt Plant (Item 45)** same as Item 24 but with larger generator and engine. **\$199.50**  
**1500-1700 Watt Plant (Item 20)**—Similar to Item 24, but has three times more capacity. Wt. 173 lb. Factory price **\$279.50**

**MASTER-LITE 2500 Watt PLANT**

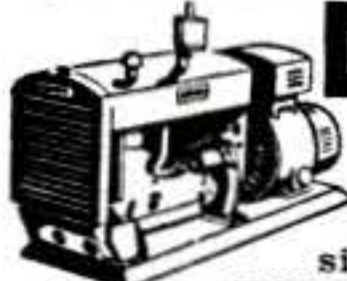
110/120 v. 60 cye. AC. A powerful plant, ruggedly constructed and yet designed for easy portability. Can be started by rope or built-in 12 v. electric push button starter. Built-in winding to charge battery. Powered by a big 5.10 Briggs engine, complete with all accessories. Includes control box, voltmeter and handy plug-in power receptacle. Ideal for permanent or stand-by service. Wt. 225 lb. Regular price \$645.00. Factory price. **\$329.50**



**GIANT 2000-2500 Watt Plant—110/120 v. AC, belt driven** so that engine may easily be utilized for other purposes. Powered by a rope start, 6 HP engine. Wt. 230 lb. Regular list price \$585.00. **\$299.50**  
Factory price (Item 31) **\$169.50**  
**Generator only and control box (Item 31a)** **\$169.50**  
**3000-3500 Watt Plant (Item 198)** 110-220 v. 60 cye. AC. Belt driven with Wis. engine. Push button start. Wt. 370 lb. Heavy duty **\$399.50**  
Generator only for belt drive. Wt. 115 lb. (Item 198a) **\$239.50**  
**3000-3500 Watt Plant (Item 23)** 115 v. 60 cye. AC. Push Button Start. Direct Drive. Wt. 270 lb. Factory Price **\$379.50**

**HI-LINE 6000 WATT PLANT**

(Item 162) Push Button Start, 115-230 v. 60 cye AC. A brute of a power plant with a rugged 13 hp. Wisconsin engine. Plenty of electricity for ranges, water heaters, freezers, pumps, machinery, etc. Affords both 110 and 220 volts. Ideal where heavy current is needed. Wt. 590 lbs. Easily worth \$995.00. With self starter. **\$645.00**  
Factory Spec. **\$585.00**  
Same plant but with Crank Start. (Item 166) **\$585.00**  
Generator and control box only, belt driven. Use your own engine or tractor. Wt. 240 lbs. (Item 163) Factory price **\$345.00**  
We make fully automatic controls to operate any of above light plants. Write for details.

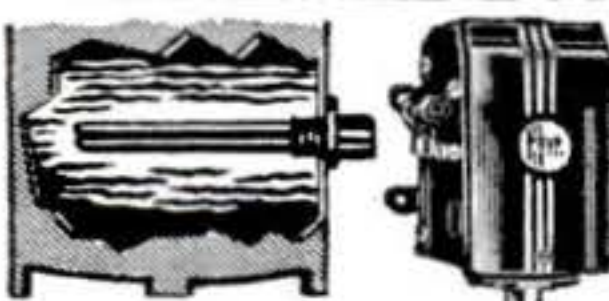


**DIESEL LIGHT PLANT**

(Item 1660) Diesel Master—11-12 kw. 115/230 v. AC single or 3 phase. 1800 rpm. direct connected. Designed and engineered for permanent power installations. Assures efficient, dependable, low cost operation where heavy current is important. Wt. 1350 lb. Reg. list \$3650.00. **\$1895.00**  
Factory price

**10-11 kw. GAS DRIVEN PLANT.** 115-230 v. 60 cye. AC, powered by 4 cylinder Wisconsin air cooled engine. Belt driven. With self-starter. Constructed similarly to Item 162 but much larger. (Item 217) Wt. 900 **\$1245.00**  
lb. Factory price. We make all sizes up to 25,000 Watts—Write.

**ELECTRIC WATER HEATER**



(Item 76) Modern electric hot water heater. Uses any tank with threaded openings 1" or 1 1/4". Works just like heater costing \$100. or more. Goes on and off automatically to heat water to desired temperature—using electricity only when needed. Takes only 1/4 to 1/2 cent of electricity per gallon of steaming hot water. Heater element and thermostat, wt. 8 lb. Regularly **\$14.95**  
Heater only for manual temperature control. Wt. 3 lb. **\$7.95**

**BUY DIRECT FROM FACTORY**

**MASTER GARDENER SELF-PROPELLED**

It's a plow It's a rotary tiller  
It's a power sickle It's a bulldozer  
It's a cultivator It's a snow-blower

Where else can you get a power tool that does so many jobs? Works for you year 'round. Does terrific job of cutting grass or weeds. Or prepares mellowed, deep seed beds without labor. Built-in power take-off to drive pumps, saw, generators, etc. Safety clutch—can't burn out. More versatile and efficient than tractors costing twice as much. Converts in minutes to Tiller, Power Sickle, etc. Basic self-propelled 2 hp. tractor. Briggs or Clinton famous engine. **\$119.50**

Tractor shown with 20" Rotary Mower Attachment (Item 206)

Rotary Lawn Mower **\$42.50**  
Sickle Bar Mower **\$42.50**  
Lawn Mower Hitch **\$4.50**  
Furrowing Tool **\$8.75** Rotary Tiller **\$42.50**  
Cultivator **\$8.75** Disc Harrow **\$15.75**  
Snow Blow **\$39.50** Plow **\$8.75**  
Freight prepaid to most areas. Easy payment plan available.

**Sensational Fishing Kit SPECIAL**



106 pc. **\$29.95**

**"BIG STRIKE" FISHING SET**

You'll enjoy every minute of every fishing trip with this sensational Master fishing equipment offer. This complete high grade set includes a famous 5' Deluxe glass rod with polished aluminum pistol grip handle shaped to fit the hand. Handle and rod eyes automatically align by keyed ferrule. Precision reel is equipped with silent gears, quadruple multiplying, level wind and adjustable click. Heavy duty tackle box has cantilever tray, baked enamel finish and plenty of room for all the plugs, spoons, spinners, nylon lines, hooks, sinkers, floats, scaler, rod bag, etc. included in this giant set. 106 pieces in all—far too many to illustrate. Complete with 36 page guide on "How to Land the Big Ones." Easily worth \$75.00. Truly the BUY of the Month at **\$29.95**. (Item 175). **SPECIAL—106 pc. Special Deluxe set** similar to the one above but with Aristocrat anti-backlash reel and tip-proof, two tray tackle box. (Item 176) Factory price **\$32.50**

**MASTER AIR COMPRESSOR**

(Item 209) High pressure type for large volume of air for heavy duty service. For paint spraying, truck and auto tires, greasing and the hundreds of other jobs done by compressed air. Piston type. 2" bore compressor with built-in air filter. Master built with high-strength alloys and precision bearings. Stainless steel tank, 12"x24", 2100 cu. in. cap. Safe up to 500 lb. Equipped with automatic switch that starts and stops motor to maintain desired pressure (up to 150 lb.) and check valve, safety valve, gauge, shut-off valve, 20 ft. air hose and tire chuck. Beautifully balanced on ball bearing wheels and rubber tires. Low factory prices. With 1/2 hp., 110 v. A.C. motor. (Reg. \$175.00) **\$98.50**  
(Item 209) **\$98.50**  
With 1/2 hp. motor. Reg. **\$119.50**  
**\$119.50** (Item 209A) **\$109.50**  
With 2 hp. Briggs Gas Engine. **\$109.50**  
Reg. \$199.50 (Item 209B)



**MASTER SHOP COMPRESSOR**

Big and rugged. This stationary compressor provides 8 c.f.m. — plenty of air for industrial uses, powered by heavy duty repulsion induction 3/4 HP, 115/230 v. motor. Factory type twin cylinder compressor designed for continuous operation. Mounted on heavy 20 gal. steel tank. Complete with unloader type automatic switch, pressure relief valve, check valve, gauge, shut-off valve, and 20 ft. heavy duty air hose. (Item 209h) **\$189.50**  
Regular retail \$319.50. Factory price **\$189.50**  
Write for prices of compressors only. A complete line of spray guns and air tanks available.



**EXTENSION CORD**

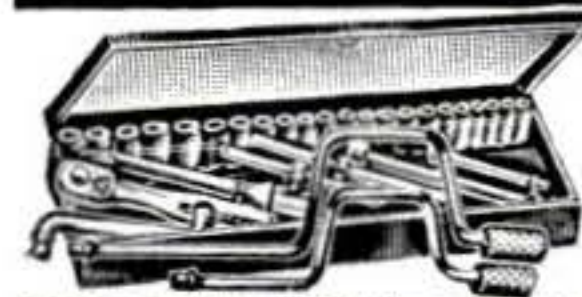


Heavy duty, made of Buna insulated #14, 2 conductor stranded wire encased in a treated braid jacket moderately flexible and ideal where frequent coiling is not required. Resists oil, grease or water. Use indoors or out. Complete with heavy rubber plug and outlet. (Item 16) **\$1.99**  
40 ft. 2 1/2 lbs. **\$4.95**  
Combination 2-40 ft. and 1-20 ft. (total 100 ft.) **\$4.95**  
100 ft. length (1 piece) **\$4.85**

**NEOPRENE EXTENSION CORD**

#16, 2 conductor stranded wire, extremely flexible, ideal for hedge trimmers, lawn mowers, power tools, etc. Tough and rugged, withstands any abuse. Complete with rubber plug and outlet. 40 ft. (Item 16a) wt. 2 1/2 lbs. Regularly **\$4.95**. **SPECIAL** **\$2.49**  
100 foot length (1 piece) **\$5.85**  
Wire only. No fittings **\$5.00**  
**NEOPRENE CABLE #14-2 (Item 185)** Heavy duty, very flexible. 20 year quality. Wt. 9 lbs. 100 ft. **\$8.95**  
A terrific buy at only **\$8.95**  
**NO. 12-2 POWER CABLE.** Very flexible rubber covered, special outside shield for grounding power tools, etc. 50 ft. (Item 199) wt. 8 lbs. **\$6.96**. 100 ft. (Item 200) **\$12.95**

**32 Pc. SOCKET SET**



32-pc. Socket Set (Item 59) Highest quality guar. non-breakable sockets made by Husky. Beautiful, matched chrome alloy, absolutely the best. Complete range of 21 sockets from 1/4" thru 7/16" in 1/4" drive and 7/16" thru 1-1/16" in 1/2" drive; 2 extensions, reversible 1/2" ratchet, adaptor bit, slide head, all angle coupling, 2 end wrenches, 1/2" speeder handle and sturdy metal tool box. For prof. mechanics who want the best. **\$16.95**  
Wt. 14 lb. Reg. \$49.50 (Item 59)

**44 Pc. SOCKET SET**

Consists of above described set, but includes a big doghouse tool box with ample room for other tools plus a 5 pc. hi-chrome alloy combination wrench set and a 7 pc. offset wrench set. Easily worth \$49.50 **\$19.95**  
(Item 59b)

**52 Pc. SOCKET SET**

(Item 205) Contains a complete set of sockets in 1/2" drive, 3/8" drive and 1/4" drive, plus all necessary extensions, handles, speeders, reversible ratchets, etc.; all uncond. guaranteed against breakage. Beautiful matched chromed thin wall alloy sockets in a sturdy handsome steel tool box. Wt. 17 lbs. List Price \$62.90. **Factory Special \$26.95**

**NEW MOTOR BIKE**



Our Commando Motor Bike is trouble-free—carries amazing 5 yr. guarantee. Goes up to 150 miles per gal. on all roads. Speed to 40 mph. No oil or gas fumes. Easy automatic pedal or pull starting. Has new principle of automatic transmission. No belts or chains—power transmitted directly to rear wheel. Accelerates quickly. Complete motor and kit ready to attach to your bike in one hour. Get FREE folder. **Factory Price \$125.00**  
Complete motor and Chassis **\$199.50**

**VENTILATING FAN**

(Item 10) Mount in wall or ceiling to ventilate any area. Over range, removes kitchen smoke and odors. Easily installed in furnace pipes. Forces even heat to all rooms. Powerful continuous duty motor, 110-120 v. AC. Quiet, super efficient fan moves huge volume of air (400 to 600 C.F.M.) 8" Fan, wt. 5 lbs., **\$6.85**; 9" Fan, wt. 6 lbs., **\$7.85**; 10" Fan, wt. 7 lbs., **\$8.85**; 12" Fan, wt. 8 lbs., **\$9.85**. **HEAVY DUTY FAN.** Semi-enclosed motor, suitable for spray booths, restaurant exhausts, poultry houses, etc. 10" Fan, wt. 8 lbs. (Item 10E) **\$11.95**  
12" Fan, wt. 10 lbs. (Item 10D) **\$12.95**



**HEAVY DUTY D-C ARC WELDER**

Use as portable or shop welder. Up to 300 amps. Senior model. Made for years of trouble-free, continuous service. Will handle light or heavy jobs. Easily welds up to 3/4" plate using 1/4" rods. Built-in air cooling system. Arc is easy to strike and hold, because of specially designed arc stabilizer. Hi-lo switch and dial control gives wide range of welding heats. Run welder at 2600 rpm. with tractor, jeep or 15 hp. gas engine, or 7 hp. elec. motor. Complete with instructions, guar. and double V belt or flat pulley. You can pay more, but you can't buy a better welder. Wt. 110 lbs. \$400 value at **\$99.75**  
**DUAL CONTROL MODEL** same as above but with built-in dual rheostat for low heat **\$119.50**  
**WELDING KIT.** Two 10 ft. leads, welding helmet, electrode holder, ground clamp. Sold only with welder at **\$10.50**  
Write for prices on A.C. Arc Welders



Send check or M.O. Prices f.o.b. Factory. 10 day Money back guarantee. Send 10c for BIG Catalog. **MASTER MECHANIC MFG. CO., DEPT. 67C Burlington, Wis.**



# WHAT Every AUTO MECHANIC Wants to Know

A motor vehicle is a machine of many parts, each part designed and constructed for its own special function. All good mechanics, like good doctors, should know the working theory and operation of each part and understand what causes trouble and how to remedy it.

## LET AUDELS AUTO GUIDE SOLVE YOUR PROBLEMS

Every auto mechanic, helper, serviceman and operator can use a copy of AUDELS AUTOMOBILE GUIDE. The information it gives saves time, money and worry. Highly indorsed by all users. It presents the whole subject of auto mechanics from A to Z in plain language and simple terms.

This Big Practical Book gives full information with working diagrams covering the principles, construction, ignition, service and repair of modern cars, trucks and buses.

A complete Guide of 1800 pages, with over 1500 illustrations showing inside views of the working parts, with instructions for service jobs. Diesel engines, Fluid and Hydra-matic drives fully explained.

## IT PAYS TO KNOW HOW TO

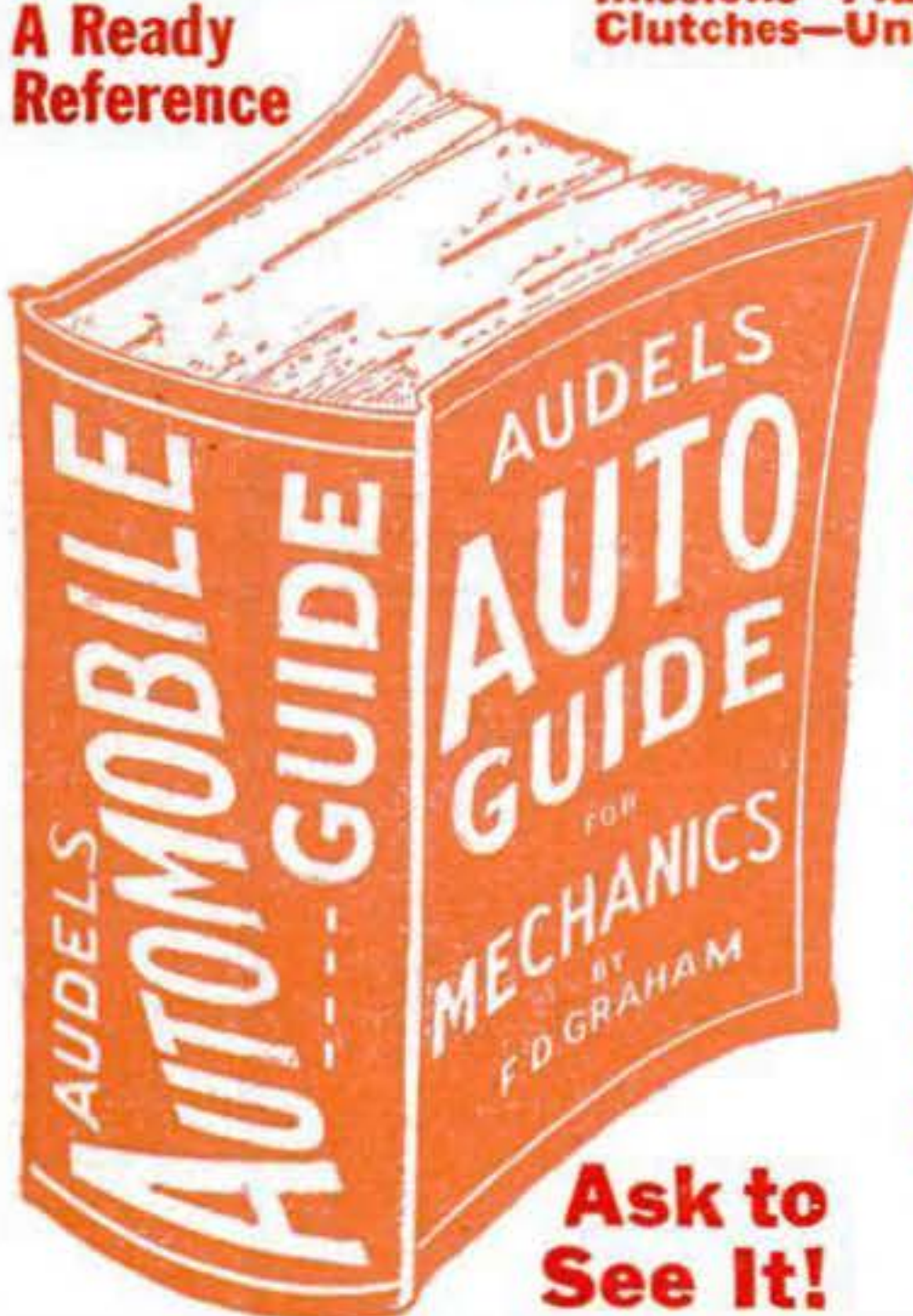
How to fit pistons—How to locate engine knocks—How to fit connecting rod bearings—How to service main bearings—How to recondition valves—How to time valves—How to adjust fan belts—How to adjust carburetors & chokes—How to rebuild a clutch—How to service automatic transmissions—How to service brakes—How to adjust steering gear—How to cope with ignition troubles—How to service distributors—How to time ignition—How to "tune up" an engine.

## INFORMATION IN A HANDY FORM

**73 INTERESTING CHAPTERS**—Read this partial list of subjects on which practical information is fully given for quick reference under the headings as shown below. Ready Reference Index.

**All Parts of an Automobile—Automotive Physics—The Gas Engine—Gas Engine Principles—Multi-Cylinder Engines—Horse Power—Automobile Engines—Stationary Parts—Moving Parts—Pistons—Piston Rings—Connecting Rods—Crank Shafts—Valves—Valve Gear—Cams and Cam Action—Valve Timing—Cooling Systems—Fuel Feed Systems—Dual Fuel Feed—Mixture—Carburetors—Carburetor Service—Automatic Choke—Super-Chargers—Transmissions—Special Transmissions—Fluid and Hydra-matic Drives—Clutches—Universals and Propeller Shafts**

**A Ready Reference**



**Ask to See It!**

**—The Differential—Rear Axles—Rear and Front Suspension—Running Gear—Brakes—Wheel Alignment—Knee Action—Steering Gear—Tires—Lubricants and Lubrication—Automotive Electricity—Ignition Systems—Magneto Ignition—Spark Plugs—Ignition Coils—Distributors—Automatic Spark Control—Ignition Timing—Generators—Starters—Generator and Starter Testing—Lighting Systems—Storage Batteries—Charging and Testing—Diesel Engines and Trouble Shooting.**

**7 DAYS' FREE TRIAL TO GET THIS ASSISTANCE FOR YOURSELF SIMPLY FILL IN AND MAIL COUPON TODAY.**

**\$4 COMPLETE PAY \$1 A ONLY 1 MO.**



## O. K. SAY READERS.....

"Well Worth the Price" "SAVED ME \$50"  
 "Most Useful and Complete"  
 "It has my Highest Recommendation"  
 "The Best Money can Buy"  
 "Easy for the Mechanic to Understand"

## Sent on 7 Days Approval

Step up your own skill with the facts and figures of your trade. Audels Mechanics Guides contain Practical Inside Trade Information in a handy form. Fully illustrated and Easy to Understand. Highly Endorsed. Check the book you want for **7 DAYS FREE EXAMINATION.** Send No Money. Nothing to pay postman.

## CUT HERE MAIL ORDER

**AUDEL, Publishers, 49 W. 23 St., NEW YORK 10, N. Y.**

Please send me postpaid for FREE EXAMINATION books marked (X) below. If I decide to keep them I agree to mail \$1 in 7 Days on each book or set ordered and further mail \$1 monthly on each book or set until I have paid price, otherwise I will return them.

- TRUCK & TRACTOR GUIDE, 1299 Pages . . . \$ 4
- AUTOMOBILE MECHANICS GUIDE, 1800 Pages . . . 4
- DIESEL ENGINE MANUAL, 575 Pages . . . . . 2
- MACHINISTS HANDY BOOK, 1650 Pages . . . . . 4
- WELDERS GUIDE, 400 Pages . . . . . 1
- BLUE PRINT READING, 416 Pages . . . . . 2
- MATHEMATICS & CALCULATIONS, 700 Pages. . . . . 2
- SHEET METAL PATTERN LAYOUTS, 1100 Pages . . . . . 4
- SHEET METAL WORKERS HANDY BOOK, 388 Pgs. . . . . 1
- MECHANICAL DRAWING GUIDE, 160 Pages . . . . . 1
- MECHANICAL DRAWING & DESIGN, 480 Pages . . . . . 2
- AIRCRAFT WORKER, 240 Pages . . . . . 1
- TELEVISION SERVICE MANUAL, 384 Pages. . . . . 2
- RADIOMANS GUIDE, 914 Pages . . . . . 4
- ELECTRONIC DEVICES, 216 Pages . . . . . 2
- ELECTRIC MOTOR GUIDE, 1000 Pages . . . . . 4
- ELECTRIC WIRING DIAGRAMS, 272 Pages . . . . . 1
- ELECTRICIANS EXAMINATIONS, 250 Pages. . . . . 1
- ELECTRIC POWER CALCULATIONS, 425 Pages. . . . . 2
- HANDY BOOK OF ELECTRICITY, 1440 Pages. . . . . 4
- ELECTRIC DICTIONARY, 9000 Terms . . . . . 2
- ELECTRIC LIBRARY, 7000 Pages (12 Book Set) 18
- MARINE ENGINEERS HANDY BOOK, 1258 Pgs. . . . . 4
- SHIPFITTERS HANDY BOOK, 250 Pages . . . . . 1
- REFRIGERATION & Air Conditioning, 1280 Pgs. . . . . 4
- MILLWRIGHTS & MECHANICS GUIDE, 1200 Pgs. . . . . 4
- POWER PLANT ENGINEERS GUIDE, 1500 Pages . . . . . 4
- ENGINEERS & FIREMANS EXAMS, 525 Pages . . . . . 1
- PUMPS, Hydraulics & Air Compressors, 1658 Pgs. . . . . 4
- ENGINEERS LIBRARY (3 Book Set) . . . . . 9
- MECHANICAL DICTIONARY, 950 Pages . . . . . 4
- GARDENERS & GROWERS GUIDES (4 Book Set) 6
- CARPENTERS & BUILDERS GUIDES (4 Book Set) 6
- PLUMBERS & Steamfitters Guides (4 Book Set) 6
- MASONS AND BUILDERS GUIDES (4 Book Set) 6
- PAINTERS & DECORATORS MANUAL, 450 Pgs. . . . . 2
- HOUSE HEATING GUIDE, 1000 Pages . . . . . 4
- OIL BURNER GUIDE, 384 Pages . . . . . 1

Name \_\_\_\_\_

Address \_\_\_\_\_

Occupation \_\_\_\_\_

Employed by \_\_\_\_\_

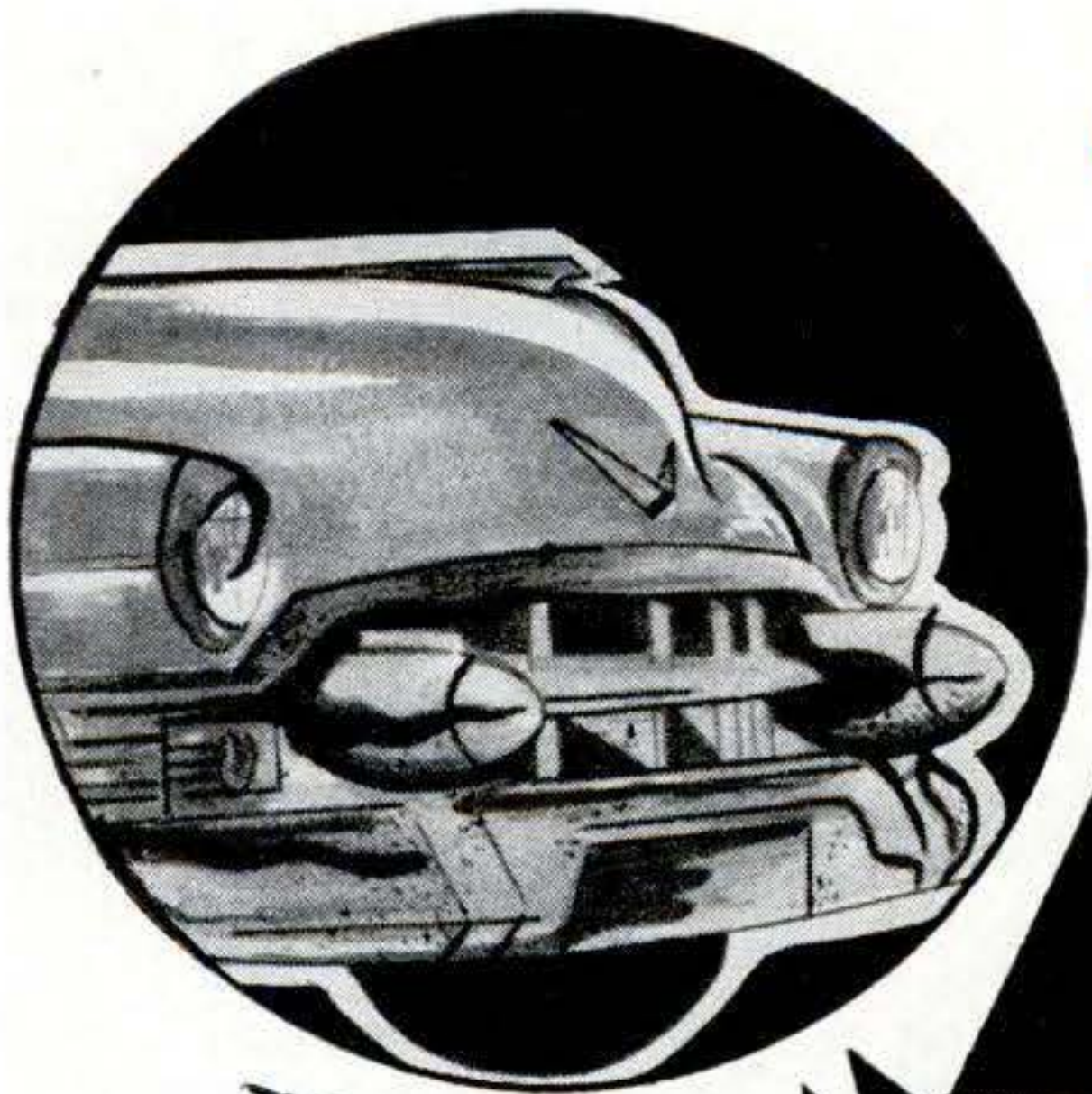
57

**AUDEL, Publishers, 49 W. 23 St., New York 10, N. Y.**



# This New, Guaranteed **CHROME RESTORER** **REALLY WORKS!**

◀ **CHANGE THIS INTO—**  
**THIS**



**WIPE OFF**  
**RUST**  
**QUICK!**  
**EASY!**



**Pits,  
corrosion  
vanish before  
your eyes!**

**Chrome stays rust-free all season!**

Bring back that Sunny Smile of gleaming bumpers, headlights and other chrome trim on your car—in just minutes! Then relax and enjoy the summer, driving a car you can be proud of! This is yours with new, amazing **PRO-KROME**—the 5 in 1 **CHROME RESTORER**. Truly a marvel! It removes the ugly spots, corrosion, road film and rust—quickly, easily, without back-breaking toil. Your chrome takes on a new, brilliant appearance. What's more, it prevents the destructive erosion of rain, fog, salt air from eating away the naked metal until it is beyond repair.

## **ONE APPLICATION PROTECTS WHOLE SEASON!**

**PRO-KROME** contains **BU-LAN-PLATE\***, a tough, protective ingredient developed by American industrial chemists. One application a season gives you amazing protection against rust and erosion of sun, salt air, rain, snow, humidity, etc! **SO QUICK AND EASY!** Just a swish or two with the Rust Removing liquid and the rust is off—no matter how deeply pitted, how badly scarred. Another swish with the Chrome **RESTORER** and presto! The magic is complete! The bright chrome appearance is restored in all its new car beauty.

### **100% Guarantee! Satisfaction or Your \$2 Back!**

Try the **PRO-KROME KIT**—entirely at our risk! Take 5 days if you wish! You must be delighted. You must agree it's the best you've ever tried. It must restore your chrome appearance to look **LIKE NEW**. Otherwise return the **EMPTY** bottles and get your \$2 back. No questions asked—**YOUR WORD** is good enough for us! Send 2.00 for prompt prepaid delivery. (C.O.D.'s sent plus post). Get your **PRO-KROME KIT** at once!

**Moto-Matic Company**

**129 West 33rd St. Dept. 7-G-33 New York 1, N. Y.**

\*BU-LAN-PLATE is a Trade Mark

**C O M P L E T E \$ 2**  
**5 - I N - 1 K I T !**

**Nothing else to buy!**

You receive: 1 Bottle Rust Remover, 1 Remover Pad, 1 Tube Protector, 2 Special chemically treated cloths. Enough for 16 applications or 2 years! All this yours on **5 DAY HOME TRIAL**. Your money back unless thrilled!

## **RUSH NOW FOR HOME TRIAL!**

**MOTO-MATIC COMPANY, DEPT. 7-G-33**

**129 West 33rd Street, New York 1, N. Y.**

**RUSH.....5-IN-1 PRO-KROME KITS at \$2.**

If I am not delighted in every way with the results; if one application does not restore my chrome to look like new, you will refund purchase price at once—no questions asked.

- Remittance enclosed. Send prepaid.  
 Send COD plus postage.

Name.....

Address.....

Town.....State.....



# The **NEW** way to enjoy **SPORTS** **Movies, Plays, Nature,** **Television!**

## **NOW!**

**GET CLOSE-UP  
 VIEWS ALL DAY  
 WITHOUT  
 FATIGUE!**



**Save \$8.00  
 NOW!  
 \$1.98  
 F.T.L.**

**IMPORTED FROM  
 GERMANY**

Here for the first time—Germany's famous **SPEKTOSCOPIES**—a revolutionary concept in binoculars. Wear them like ordinary eye glasses—hour after hour—without fatigue. Feather weight—only 1 oz. You'll hardly **FEEL** them! Yet here is a new, truly powerful optical design that gives you greater range than many expensive opera or field glasses and a far greater field of view than some selling for many times more! Has **INDIVIDUAL** eye focusing for clear, sharp viewing, whether you're looking at a play in the first row or a seashore scene miles away! **SPEKTOSCOPIES** are ideal for indoors, outdoors or distant scenes or close-by viewing. Special low price —1.98 a saving of \$8.00 or more!

**TRY AT OUR RISK—NO OBLIGATION!**

Enjoy at our risk for 5 days. You must be delighted! Otherwise your 1.98 will be refunded with no questions asked! Limited supply forces us to place a limit of 2 per customer. Send check or m.o. for prompt, free delivery. COD's sent plus COD Fees. Use convenient coupon below!

**International Binocular Co. Dept. 7-G-90  
 53 to 59 East 25th St., New York 10, N. Y.**

**FAVORABLE EXCHANGE RATE  
 MAKES THIS VALUE POSSIBLE!**

This is the first time that this type of optical instrument has ever sold for less than \$10.00. The favorable rate of exchange and Germany's need for dollars makes it possible. We have been chosen as the exclusive distributor for **SPEKTOSCOPIES** to the American public. Get yours now at our low, low introductory price of 1.98 tax & post paid!

**5 DAY FREE TRIAL!**

International Binocular Co.  
 53 to 59 East 25th St., Dept. 7-G-90  
 New York 10, N. Y.  
 RUSH.....**SPEKTOSCOPIES** at 1.98 each (LIMIT—2)  
 on 5 day home trial. You are to refund my 1.98 if I am not  
 fully delighted.

Payment enclosed. Send post free.  Send COD plus post.

Name \_\_\_\_\_

Address \_\_\_\_\_

Town \_\_\_\_\_ State \_\_\_\_\_