

POPULAR SCIENCE

MONTHLY

MECHANICS - AUTOS - HOMEBUILDING SM★

35¢ May



Free College for Ship's Officers

PAGE 142

**New Navy Planes
Leap Straight Up**

— PAGE 113



New Sports Cars PAGE 98



Outdoor Lighting PAGE 224



Crank-Up Trailer PAGE 100



Tractor Testers PAGE 152

GENUINE

ANTI-MAGNETIC WATCHES

NEW! DIFFERENT! PRECISION-BUILT!

SMART '54 STYLES FOR MEN AND WOMEN!

Natural GOLD Color!

NON-TARNISH

Direct-from-Importer to You!

YOUR CHOICE!
Any Model

7⁹⁸
TAX PAID
VALUES TO 19.95



EACH ONE BACKED BY THORESEN'S FAMOUS GUARANTEE!

We challenge you to pay less for these wonderful timepieces—even if you go to Switzerland itself to buy them! Every one of these smart, distinctive 1954 watches was made in Switzerland—the country where watch-making has become an art AND science! The thin modern cases are in the rich color of Natural Gold. (NOT cheap gold plating!) The Natural Gold Color is **GUARANTEED NEVER TO TARNISH!** Beautiful Pastel Color dials and deluxe suede or metal bands add charm and distinction. The illustrations can only **SUGGEST** the good looks & superb styling of these magnificent watches... when you wear one, your friends will rave about your new and "expensive-looking" eye filler! That's why we can be so confident when we say:

TAKE YOUR PICK . . . TRY AT OUR RISK!
When you first see one of these superb timepieces . . . when you check its **ACCURACY** with radio time signals . . . when you proudly wear one of these stunning models, you'll agree **IT'S THE BARGAIN OF A LIFETIME!** If not . . . simply return it and back comes your money **PROMPTLY**—no questions asked! But you'll be proud to keep and cherish yours—when you observe its rugged, quality construction . . . its **JEWELLED** movement . . . its thin streamlined appearance . . . its **DURAMATIC** mainspring! Rush the **FREE TRIAL COUPON** today! These are brand new model watches and only a few hundred have been imported—so be **SURE!** Send **TODAY!** Buy direct from the importer and you save **UP TO \$11.97 ON EACH WATCH!** **DON'T DELAY!** Use coupon on opposite page!

- (A) **THE SCARSDALE**
Gleaming Natural Gold and Nubian color men's watch with latest style white-stitched Black Suede band. Jeweled, Anti-magnetic. Sweep second hand. One of smartest looking watches available anywhere!
- (B) **THE RUMSON**
Superb Natural Gold color men's watch with matching Metal-Flex expansion band. Jeweled, Anti-magnetic. Vermillion-tipped Sweep second hand. Styled in very latest design! Ideal dress AND sports watch!
- (C) **THE SURREY**
Ultra-modern men's watch in Natural Gold color—with popular new Black Suede band. Sparkling Ebony color numerals on case rim. Jeweled, Anti-magnetic. Sweep second hand. A triumph of watchmaking!
- (D) **THE NORFOLK**
Handsome Natural Gold color men's watch—with matching Metal-Flex expansion band. Jeweled, Anti-magnetic. Different looking. Natural Gold color hands, numerals. Very latest streamlined styling!

- (E) **THE BIRTHMONTH**
In Natural Gold color, this ladies' Birthmonth watch has luminous hands, numerals, Sweep second hand. Jeweled, Anti-magnetic. Band of 2 Simulated Birthstones & 48 Rhinestones. (Give birthmonth with order.)
- (F) **THE ARDMORE**
Glamorous Natural Gold color ladies' watch with genuine black leather band. Natural Gold color hands, numerals & Sweep second hand. Jeweled, Anti-magnetic. A truly modernistic, superbly designed watch!
- (G) **THE BRIARCLIFF**
Petite, pert & plenty pretty! Natural Gold color ladies' watch—lovely contrasting Ebony color face, Gold color hands, numerals. Black Suede band. Sweep hand. Jeweled, Anti-magnetic. Expensive looking!
- (H) **THE NASSAU**
An ideal watch for the active woman! Natural Gold color with genuine leather strap. Luminous hands, numerals. Sweep second hand. Jeweled, Anti-magnetic. Rugged & durable, yet completely feminine looking!



ORDER NOW! USE COUPON ON OPPOSITE PAGE!

AMAZING BARGAINS!

Direct - from - Importer - to - You!

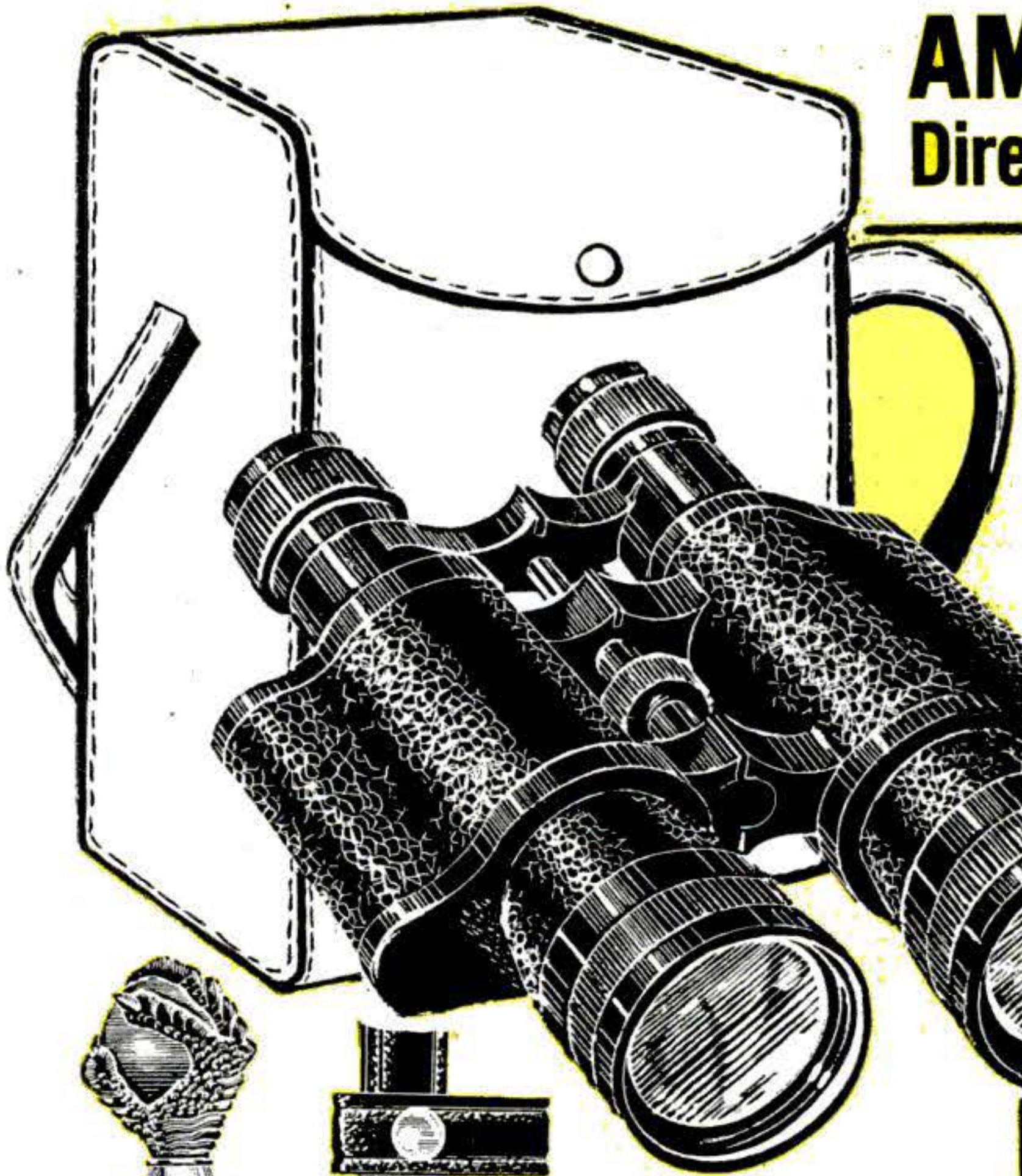

GERMAN POWERHOUSE BINOCULARS

9 X AREA MAGNIFICATION!

20 Mile Range!—Save \$7.00!

4.98
WITH CASE

A lifetime bargain for **POPULAR SCIENCE** readers! . . . **THORESEN** - - world's greatest importer of German binoculars - - now brings you the renowned **POWERHOUSE** Binoculars at an unbelievably low price! Actually give **9 X AREA MAGNIFICATION!** Latest streamlined design, as illustrated in greatly reduced size. A **HINGE** model - - you can adjust to the **EXACT** space between your eyes. Aluminum Center-post focusing gives you clear, sharp viewing - - **SEE UP TO 20 MILES AWAY!** Sturdy but lightweight (9½ oz.) A real triumph of the German optical industry!

PRECISION GROUND LENSES

The **POWERHOUSE LENSES** are the crowning feature of this great binocular - - each and every lens is ground & polished to a high tolerance, then carefully checked for accuracy! **NOT** moulded plastic type stamped out by the million! You get **CRYSTAL-CLEAR** viewing! No excessive distortion or "ghosts" found in cheap glasses. Were you to spend \$25, we wouldn't give you better lenses! Send coupon **TODAY** and get your **POWERHOUSE** Binoculars at this low introductory price of **4.98** tax paid, including handsome case. Sorry, but limited import supply forces us to restrict orders to **ONE** binocular per reader.

No. 6....**POWERHOUSE** Binoculars & Case.....4.98 tax paid

Enjoy **BASEBALL**, Racing, Movies, TV, Nature, Plays the **SPEKTOSCOPES** Way!



NOW!
1.98
FTI

GET CLOSE-UP VIEWS ALL DAY WITHOUT FATIGUE!

SAVE \$8.00

IMPORTED FROM
"GERMANY"

Western Germany's famed binocular-spectacles are worn just like ordinary eyeglasses - - they give **MAGNIFIED VIEWING** - - hour after hour - - without fatigue! Greater range than many expensive opera & field glasses and far greater field of view than some selling for many times more! **INDIVIDUAL** eye focusing - - clear, sharp viewing whether at a ball game, a movie or sitting beside your TV set! Sparkling **Ebony** design - - weigh only 1 oz! Germany's need for dollars makes the special low price possible . . . **1.98** tax & postpaid, a saving of \$8.00 or more. Use handy coupon, order **TODAY!**
No. 90....**SPEKTOSCOPES**.....1.98 tax paid

Solingen Steel HUNTING KNIFE

3.95 INCLUDING LEATHER SCABBARD

The famed **BLACK FOREST HUNTING KNIFE** made in Solingen, Western Germany of superfine Nicht Rostend (non-rusting) steel is **NOW** available through **THORESEN'S!** Rugged beauty of this superb knife has already won recognition for design in industrial circles on the Continent - - and its utility and value as an aid in hunting & fishing has made it a prime favorite with sportsmen all over Europe. Blade is actually sharp enough to shave with; will stand up against most rugged treatment; genuine leather scabbard is metal-tipped. Length, 10 in. Tough, sturdy Solingen Steel assures you years of dependable service.

MAKE THIS TEST!

Place a thick metal disc or foreign coin on the ground. Plunge the point of the Black Forest knife downward. The knife will completely pierce the thick metal - - with **NO** damage to the blade! The sleek, graceful lines of this German import also provide an ideal rec room or den decoration; a dandy gift for men! Send coupon **NOW** with 3.95 for knife & scabbard, tax & postpaid.

No. 80 Black Forest Knife & Scabbard.....3.95 tax paid

SAVE MONEY WITH THIS COUPON!

THORESEN'S, Dept. 7-E
352 Fourth Ave., New York 10, N. Y.
RUSH the items checked on 5 Day Free Trial—Money Back Guarantee. () Payment enclosed. Send tax & postpaid. () Send C.O.D. plus postal charges.

WATCHES — 7.98 EACH

- A—Scarsdale B—Rumson C—Surrey
- D—Norfolk E—Birthmonth F—Ardmore
- G—Briarcliff H—Nassau
- No. 6 —Powerhouse Binoculars (4.98)
- No. 90—Spektoscopes (1.98)
- No. 80—Black Forest Knife (3.95)

NAME.....

ADDRESS.....

CITY.....ZONE.....STATE.....

CANADIANS: Save Tariff. Send orders direct to **THORESEN** Dept. 7-E, 45 St. James St. W, Montreal 1, P. Q.

Use this coupon to order any item on these 2 pages



May, 1954	Page
Historian Dives for Spanish Treasures.....	81
Our Boy Lives in a Tree.....	93
What Is a Sports Car?.....	98
Telescoping Trailer Cranks Up at Night.....	100
10,000-Ton Cracker for Invisible Nuts.....	102
Wilbur Shaw Drives "Europe's Model A".....	108
New U. S. Planes Leap Straight Up.....	113
More New Planes Are Coming.....	116
An Ape Uses Our Household Tools.....	121
They're Searching for Smogproof Crops....	126
European Racing Invades America.....	128
Will All Cars Be "Box" Cars?.....	133
Taming America's Wildest River.....	137
Free College for Ship's Officers.....	142
They Torture Tractors for the World.....	152
Gus Clears a Traffic Jam.....	158
The Other Fellow's Shop.....	161

MORE FUN FOR YOUR MONEY

10 Pages of Tips on Traveling by Car

How to See More Per Day.....	166
How to Cook by the Road.....	168
How to Build a Folding Bedroom.....	169
How to Make Travel Accessories.....	172
How to Escape Car Troubles.....	174
New Yard and Garden Tools.....	176
Making Wood Last Longer.....	180
Now You Can Have Power Brakes.....	189
Fire-Net Lawn Lounge Turns with Sun.....	198
How to Build a Portable Garden.....	201
Boat Shelter Has One-Man Hoist.....	204
The Saw That Does 'Most Everything.....	208
Television As You Like It.....	216
How to Install Outdoor Lights.....	224

(More features and departments are listed on page 4)

Editor

VOLTA TORREY

Managing Editor

HOWARD ALLAWAY

Art Editor

HOWARD C. JENSEN

Associate Editors

Alden P. Armagnac, Devon Francis, Sheldon M. Gallager, Wesley S. Griswold, Hartley E. Howe, Herbert O. Johansen, Martin Mann, Herbert R. Pfister, Ruth Westphal.

Art

Harry Samuels (Director), Herbert Anthony, Henry B. Comstock, Mary E. Dee, Eric A. Karminski Jr., Leland H. Sweet.

Copy

Kendall W. Goodwyn (Director), Carol Ennis, Everett H. Ortner, Georgette Sparks.

Photography

W. W. Morris (Director), Hubert Lockett, Orlando Guerra.

Assistant Managing Editors

Frank Rowsome Jr.
Robert P. Stevenson

Mechanics and Handicraft

Harry Walton

Midwestern Editor

Kenneth Wylie (Chicago)

Western Editor

Andrew R. Boone (Los Angeles)

Editorial Assistants

Harriet Trowbridge, Stanley Beitler, Louise Levis, Trudie Ray, Teresa Robbins, Rose Weil.

Publisher

GODFREY HAMMOND

Advertising Director

STEPHEN P. GLENNON

Circulation Director

EUGENE WATSON

ADVERTISING OFFICES: NEW YORK—353 Fourth Ave.; CHICAGO—360 North Michigan Ave.; DETROIT—820 Book Bldg.; SAN FRANCISCO—681 Market St.; CLEVELAND—328 Citizens Bldg.; LOS ANGELES—1127 Wilshire Blvd.

EDITORIAL OFFICES: 353 Fourth Avenue, New York 10, N. Y.

Published monthly at 353 Fourth Avenue, New York 10, N. Y., by Popular Science Publishing Co., Inc., Godfrey Hammond, President and Treasurer; R. C. Wilson, Stephen P. Glennon, Vice-Presidents; F. W. Briggs, Secretary. Entered as second-class matter Dec. 28, 1918, re-entered as second-class matter July 26, 1948, at the Post Office in New York, N. Y., under the act of March 3, 1879; additional entry as second-class matter at Dayton, Ohio. Entered as second-class matter at the Post Office Department, Canada. Printed in U.S.A. Copyright, 1954, by Popular Science Publishing Co., Inc. All rights reserved in the United States, Great Britain, and in all the countries participating in the International Copyright Convention and Pan-American Copyright Convention. Yearly subscriptions to United States, its possessions and Canada, \$3.00 (2 years, \$5.50; 3 years, \$7.50); foreign countries \$1 per year extra. Four weeks' notice is needed to change a subscriber's address. Please give both old and new addresses, including postal zone numbers.

Which is hotter?

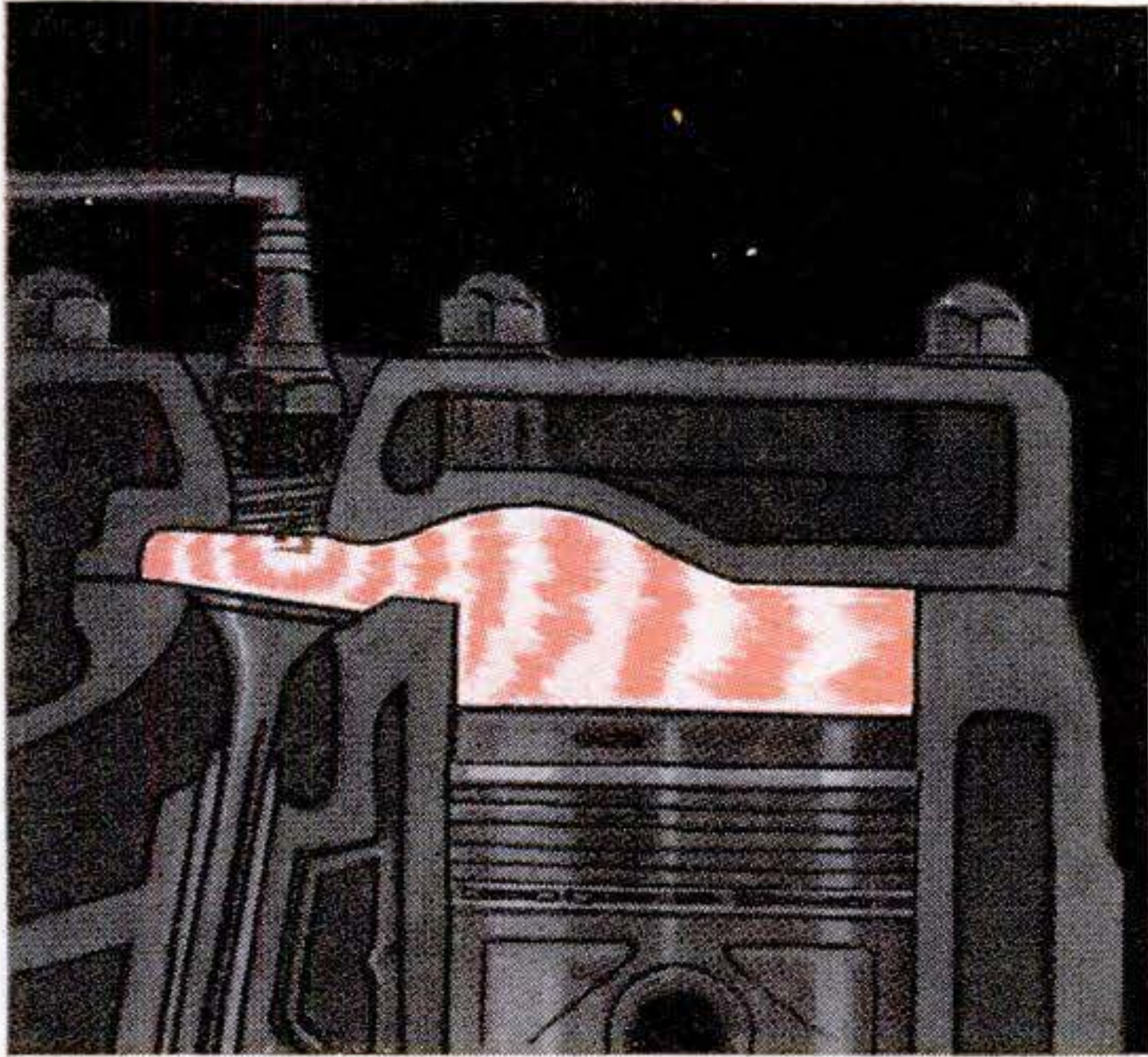

Inside an engine?



Inside molten lava?

Answer: When combustion occurs, the temperatures within the cylinders of an automobile engine frequently go as high as 4800° F. . . . *more than three times as hot as flowing volcanic lava!*

The advantages of chrome plated top piston rings in this area of intense heat, highest pressure and poorest lubrication have been recognized by automotive manufacturers everywhere . . . *and 34 out of 36 engine manufacturers installing chrome rings use Perfect Circles!*

For replacement, Perfect Circle 2-in-1 Chrome Sets offer solid chrome plating on BOTH top and bottom rings . . . for thousands and thousands of extra miles of sustained power and oil economy. Perfect Circle Corporation, Hagerstown, Indiana; The Perfect Circle Co., Ltd., Toronto.

Perfect Circle

2-in-1 Chrome Piston Rings

The Standard of Comparison

Solid chrome plating on top and bottom rings gives wear protection throughout entire area of ring travel. Rings are lapped-in at factory, eliminating tedious break-in.



Your engine's life depends on a film of oil
8 times thinner than a measuring tape!

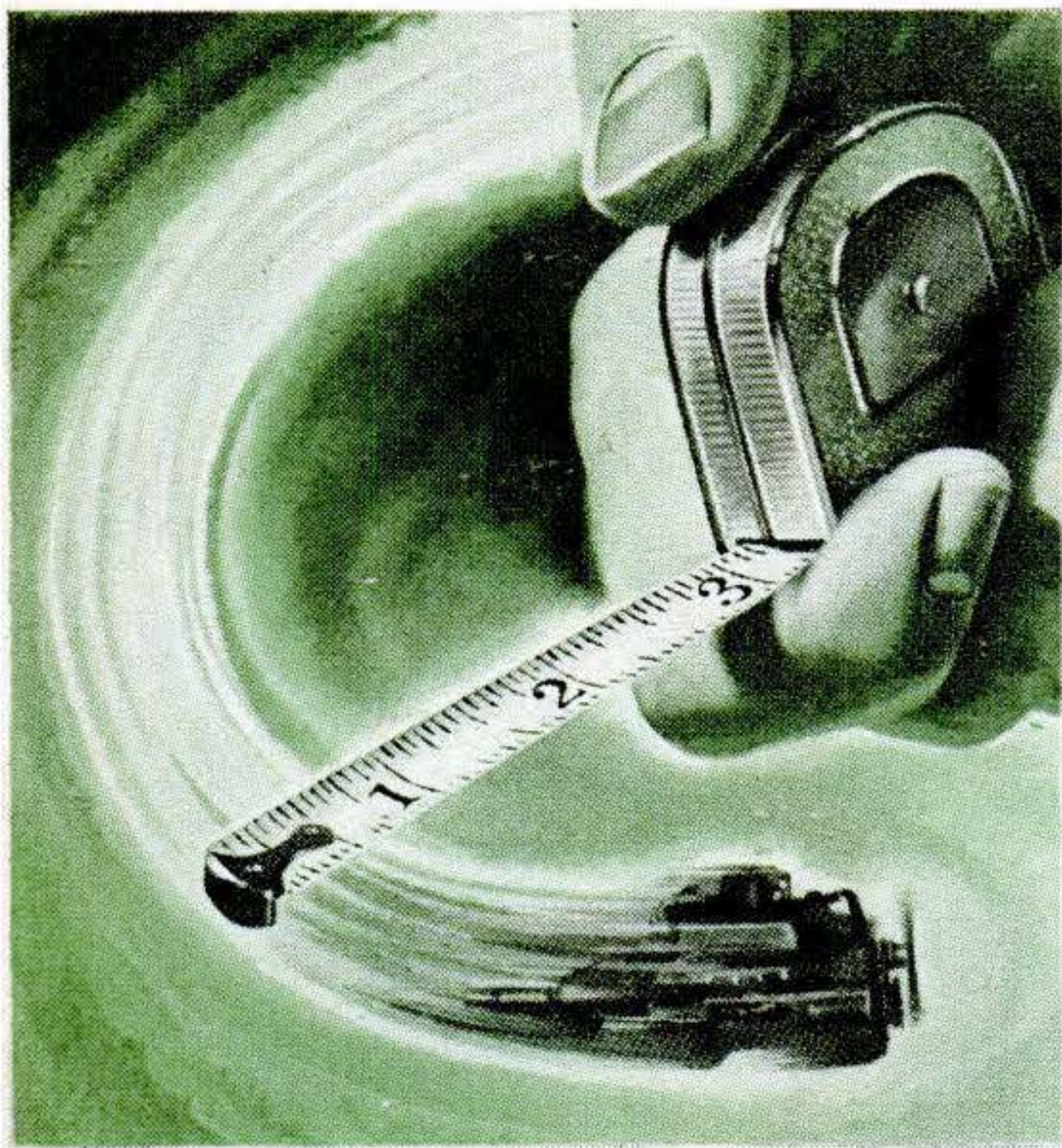

It's in the film-thin clearances between high-speed parts
—where an oil must be tough, enduring, free-flowing!

For the oil film that lasts longest, use high-quality Quaker State

IT'S A SUPER FILM! And only Quaker State Motor Oil gives the long-lasting lubrication—and extra oil mileage assured by this finest of oil films. Rich, pure, stable, it guards your engine from wear, damage from rust, and acid corrosion. Quaker State is refined from 100% Pure Pennsylvania Grade Crude Oil, and is the result of 50 years of continuous improvement. It is designed to meet the demands of today's high compression engines. There is no finer!

Quaker State Motor Oil is made to suit the requirements of all makes of cars and for every type of service. Ask your dealer.

ASK FOR...



QUAKER STATE OIL REFINING CORPORATION, OIL CITY, PA.
Member Pennsylvania Grade Crude Oil Association

News and Pictures

Power-Steering Unit in Steering Column..	89
New British Sub Uses Peroxide Fuel.....	101
Aluminum Tent Seats 12,000.....	112
Bank with Glass Walls.....	136
Jet-Fighter Pilot Flies Lying Down.....	156

Mechanics and Homebuilding

Screen-Door Tips.....	193
Lazy Susan Made from Scrap.....	197
New for Your Car.....	207
Outdoor Lamps in Williamsburg Mode..	231

Departments

Letters	12
Last-Minute News and Notes.....	76
I'd Like to See Them Make.....	147
New Ideas from the Inventors.....	149
New for the Handy Man.....	185
Wordless Workshop	186
One-Evening Shop Projects.....	194
Keeping the Home Shipshape.....	213
New Tools	215
Craftsmen at Work.....	236
New Shop Ideas.....	240
Hints from the Model Garage.....	246
How Much Did You Learn?.....	294

Senator Covers the Northwest



IF EVER a writer has staked out a literary claim, Richard L. Neuberger has done so. It is the Northwest, both American and Canadian, and hardly any other writer disputes his right to it. He has steadily and rewardingly mined its lode of story material since he

was 16. He has long been a valued contributor to POPULAR SCIENCE MONTHLY and to at least a dozen other national magazines, including the *Saturday Evening Post* and *Harper's*. In addition, he is *The New York Times'* Northwest correspondent.

Neuberger, a tall, big-framed, friendly man of 41, was born and bred in Oregon and for some time has been a state senator. His wife is a state representative. This year Dick Neuberger is running for the U.S. Senate. His article on page 137, "Taming America's Wildest River," deals with one of his favorite subjects.

For real job security...

FILL THE GAPS IN YOUR

TRAINING

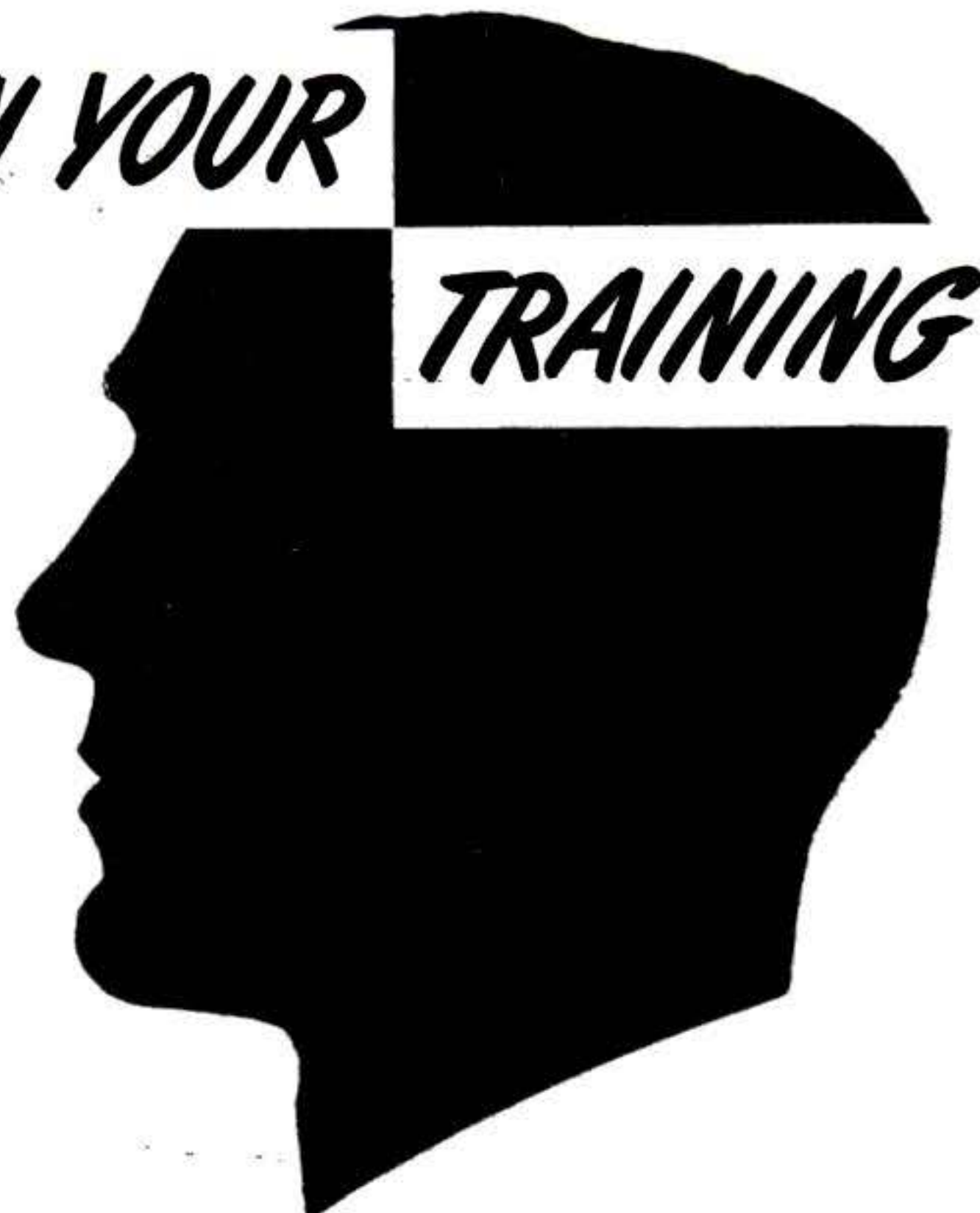

THE pressure is mounting. Competition for jobs is growing fast. Business and industry are tightening up. Every man or woman holding a good job is now, in effect, "on probation."

Are there "weak spots" in your training? Now's the time to get after them! Six months from now may be too late.

How can you fill the gaps — quickly? International Correspondence Schools can help you! There's no faster, surer way to get exactly the training you need!

You have 277 famous, spare-time I. C. S. Courses to choose from: trade, industrial engineering, office, executive, high school. Or you can arrange for "refresher" courses, advanced training or special instruction combining two or more specific business or technical subjects.

I. C. S. has the most complete line-up of job-related instruction you can find anywhere. Courses are tailored to fit your needs. This means you waste no time on subjects you can't use. You lose no time traveling back and forth to classes. You set your own schedule—no interference with business or social activities.

Find out for yourself how quickly, how thoroughly I. C. S. can fill the gaps in your training! No obligation. Just mark and mail the coupon!

2 FREE BOOKS

32-page, pocket-size gold mine of facts, "How to Succeed," plus catalog outlining opportunities in field that interests you!

For Real Job Security — Get I. C. S. Training!

I. C. S., Scranton 9, Penna.

INTERNATIONAL CORRESPONDENCE SCHOOLS



BOX 7678-N, SCRANTON 9, PENNA.

(Partial list of 277 courses)

Without cost or obligation, send me "HOW to SUCCEED" and the opportunity booklet about the field BEFORE which I have marked X:

- | | | | | |
|---|--|---|--|---|
| <p>ARCHITECTURE and BUILDING CONSTRUCTION</p> <ul style="list-style-type: none"> <input type="checkbox"/> Air Conditioning—Refrig. <input type="checkbox"/> Architecture <input type="checkbox"/> Building Contractor <input type="checkbox"/> Building Maintenance <input type="checkbox"/> Carpenter and Mill Work <input type="checkbox"/> Estimating <input type="checkbox"/> Heating <input type="checkbox"/> Painting Contractor <input type="checkbox"/> Plumbing <input type="checkbox"/> Reading Arch. Blueprints <input type="checkbox"/> Steamfitting <p>ART</p> <ul style="list-style-type: none"> <input type="checkbox"/> Cartooning <input type="checkbox"/> Commercial Art <input type="checkbox"/> Fashion Illustrating <input type="checkbox"/> Magazine Illustrating <input type="checkbox"/> Show Card and Sign Lettering <input type="checkbox"/> Sketching and Painting <p>AUTOMOTIVE</p> <ul style="list-style-type: none"> <input type="checkbox"/> Auto Body Rebuilding <input type="checkbox"/> Auto Elec. Technician <input type="checkbox"/> Auto-Engine Tune Up <input type="checkbox"/> Automobile Mechanic | <p>AVIATION</p> <ul style="list-style-type: none"> <input type="checkbox"/> Aeronautical Engineering Jr. <input type="checkbox"/> Aircraft & Engine Mechanic <p>BUSINESS</p> <ul style="list-style-type: none"> <input type="checkbox"/> Advertising <input type="checkbox"/> Bookkeeping and Accounting <input type="checkbox"/> Business Administration <input type="checkbox"/> Business Correspondence <input type="checkbox"/> Certified Public Accounting <input type="checkbox"/> Creative Salesmanship <input type="checkbox"/> Federal Tax <input type="checkbox"/> Letter-writing Improvement <input type="checkbox"/> Managing Small Business <input type="checkbox"/> Office Management <input type="checkbox"/> Retail Business Management <input type="checkbox"/> Sales Management <input type="checkbox"/> Stenographic-Secretarial <input type="checkbox"/> Traffic Management <p>CHEMISTRY</p> <ul style="list-style-type: none"> <input type="checkbox"/> Analytical Chemistry <input type="checkbox"/> Chemical Engineering <input type="checkbox"/> Chem. Lab. Technician <input type="checkbox"/> General Chemistry <input type="checkbox"/> Natural Gas Prod. & Trans. <input type="checkbox"/> Petroleum Engineering <input type="checkbox"/> Plastics <input type="checkbox"/> Pulp and Paper Making | <p>CIVIL, STRUCTURAL ENGINEERING</p> <ul style="list-style-type: none"> <input type="checkbox"/> Civil Engineering <input type="checkbox"/> Construction Engineering <input type="checkbox"/> Highway Engineering <input type="checkbox"/> Reading Struct. Blueprints <input type="checkbox"/> Sanitary Engineering <input type="checkbox"/> Structural Engineering <input type="checkbox"/> Surveying and Mapping <p>DRAFTING</p> <ul style="list-style-type: none"> <input type="checkbox"/> Aircraft Drafting <input type="checkbox"/> Architectural Drafting <input type="checkbox"/> Electrical Drafting <input type="checkbox"/> Mechanical Drafting <input type="checkbox"/> Mine Surveying and Mapping <input type="checkbox"/> Ship Drafting <input type="checkbox"/> Structural Drafting <p>ELECTRICAL</p> <ul style="list-style-type: none"> <input type="checkbox"/> Electrical Engineering <input type="checkbox"/> Electrical Maintenance <input type="checkbox"/> Electrician <input type="checkbox"/> Contracting <input type="checkbox"/> Lineman <p>HIGH SCHOOL</p> <ul style="list-style-type: none"> <input type="checkbox"/> Commercial <input type="checkbox"/> Good English <input type="checkbox"/> High School Subjects <input type="checkbox"/> Mathematics | <p>LEADERSHIP</p> <ul style="list-style-type: none"> <input type="checkbox"/> Foremanship <input type="checkbox"/> Industrial Supervision <input type="checkbox"/> Leadership and Organization <input type="checkbox"/> Personnel-Labor Relations <p>MECHANICAL AND SHOP</p> <ul style="list-style-type: none"> <input type="checkbox"/> Gas—Electric Welding <input type="checkbox"/> Heat Treatment <input type="checkbox"/> Metallurgy <input type="checkbox"/> Industrial Engineering <input type="checkbox"/> Industrial Instrumentation <input type="checkbox"/> Industrial Supervision <input type="checkbox"/> Machine Design—Drafting <input type="checkbox"/> Machine Shop Inspection <input type="checkbox"/> Machine Shop Practice <input type="checkbox"/> Mechanical Engineering <input type="checkbox"/> Quality Control <input type="checkbox"/> Reading Shop Blueprints <input type="checkbox"/> Refrigeration <input type="checkbox"/> Sheet Metal Worker <input type="checkbox"/> Tool Design <input type="checkbox"/> Toolmaking <p>RADIO, TELEVISION</p> <ul style="list-style-type: none"> <input type="checkbox"/> Electronics <input type="checkbox"/> Practical Radio—TV Eng'ng <input type="checkbox"/> Radio and TV Servicing <input type="checkbox"/> Radio Operating <input type="checkbox"/> Television—Technician | <p>RAILROAD</p> <ul style="list-style-type: none"> <input type="checkbox"/> Air Brakes <input type="checkbox"/> Car Inspector <input type="checkbox"/> Diesel Locomotive <input type="checkbox"/> Locomotive Engineer <input type="checkbox"/> Section Foreman <p>STEAM AND DIESEL POWER</p> <ul style="list-style-type: none"> <input type="checkbox"/> Combustion Engineering <input type="checkbox"/> Diesel—Elec. <input type="checkbox"/> Diesel Eng's <input type="checkbox"/> Electric Light and Power <input type="checkbox"/> Stationary Fireman <input type="checkbox"/> Stationary Steam Engineering <p>TEXTILE</p> <ul style="list-style-type: none"> <input type="checkbox"/> Carding and Spinning <input type="checkbox"/> Cotton, Rayon, Woolen Mfg. <input type="checkbox"/> Finishing and Dyeing <input type="checkbox"/> Loom Fixing <input type="checkbox"/> Textile Designing <input type="checkbox"/> Textile Eng'ng <input type="checkbox"/> Throwing <input type="checkbox"/> Warping and Weaving <p>MISCELLANEOUS</p> <ul style="list-style-type: none"> <input type="checkbox"/> Domestic Refrigeration <input type="checkbox"/> Marine Engineering <input type="checkbox"/> Ocean Navigation <input type="checkbox"/> Shipfitting <input type="checkbox"/> Short Story Writing <input type="checkbox"/> Telephony |
|---|--|---|--|---|

Name _____ Age _____ Home Address _____

City _____ Zone _____ State _____ Working Hours _____ A.M. to P.M. _____

Occupation _____

Canadian residents send coupon to International Correspondence Schools, Canadian, Ltd., Montreal, Canada. . . . Special tuition rates to members of the U. S. Armed Forces.



THAT'S YOU UP THERE

where
the living's good!

That's YOU, elevated to the world's best living by the proven brands of products that never let you down—and for a very down-to-earth reason: each manufacturer has to live up to the highest standard set by his competitors. His product *has* to be good to survive—it's as simple as that. So if he changes it at all, you can be sure he's aiming at something better.

That's why you can shop so confidently, so profitably, so easily, by buying products with responsible names. Living on top of the world?—you bet! But you're on ground as safe and sound as your own back yard.

*Easy to keep up on what's good:
just read the ads in this magazine.*

**BRAND NAMES
FOUNDATION**
INCORPORATED

A NON-PROFIT EDUCATIONAL FOUNDATION
37 WEST 57 STREET, NEW YORK 19, N. Y.

WANT CONFIDENCE? PATRONIZE THE DEALER
WHO PROVIDES YOUR FAVORITE BRANDS



I WILL TRAIN YOU AT HOME FOR GOOD PAY JOBS IN RADIO-TELEVISION

J. E. SMITH has trained more men for Radio-Television than any other man. OUR 40th YEAR.

America's Fast Growing Industry Offers You Good Pay—Bright Future—Security

I TRAINED THESE MEN

 "Started to repair sets six months after enrolling. Earned \$12 to \$15 a week in spare time."—Adam Kramlik, Jr., Sunneytown, Pennsylvania.

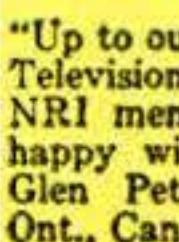
 "Up to our necks in Radio-Television work. Four other NRI men work here. Am happy with my work."—Glen Peterson, Bradford, Ont., Canada.

 "Am doing Radio and Television Servicing full time. Now have my own shop. I owe my success to N.R.I."—Curtis Stath, Ft. Madison, Iowa.

 "Am with WCOC. NRI course can't be beat. No trouble passing 1st class Radio-phone license exam."—Jesse W. Parker, Meridian, Mississippi.

 "By graduation, had paid for course, car, testing equipment. Can service toughest jobs."—E. J. Streitberger, New Boston, Ohio.

AVAILABLE TO **VETERANS** UNDER G. I. BILLS

Training plus opportunity is the PERFECT COMBINATION for job security, good pay, advancement. In good times, the trained man makes the BETTER PAY, GETS PROMOTED. When jobs are scarce, the trained man enjoys GREATER SECURITY. NRI training can help assure you more of the better things of life.

Start Soon to Make \$10, \$15 a Week Extra Fixing Sets

Keep your job while training. I start sending you special booklets the day you enroll, that show you how to fix sets. Multitester built with parts I send helps you make \$10, \$15 a week extra fixing sets while training. Many start their own Radio-Television business with spare time earnings.

My Training Is Up-To-Date

You benefit by my 40 years' experience training men at home. Well illustrated lessons give you basic principles you need. Skillfully developed kits of parts I send (see below) "bring to life" things you learn from lessons.

You Learn by Practicing with Parts I Send



Nothing takes the place of PRACTICAL EXPERIENCE. That's why NRI training is based on LEARNING BY DOING. You use parts I furnish to build many circuits common to Radio and Television. As part of my Communications Course, you build many circuits, including low power transmitter shown at left. You put it "on the air," perform procedures required of broadcast operators. With my Servicing Course you build modern Radio, etc.; use Multitester you build to make money fixing sets in spare time while training. You can stay at home, keep your job, learn Radio-TV in spare time at low cost. Mail coupon for book showing other equipment you build and keep.

The Tested Way To Better Pay!

2 FREE BOOKS SHOW HOW MAIL COUPON



Television Making Good Jobs, Prosperity—Even without Television, Radio is bigger than ever. 115 million home and auto Radios are big market for servicing. 3000 broadcasting stations use operators, technicians. Government, Aviation, Police, Ship, Micro-wave Relay, Two-way Radio Communications for buses, taxis, trucks, R. R. are growing fields. Television is moving ahead fast.

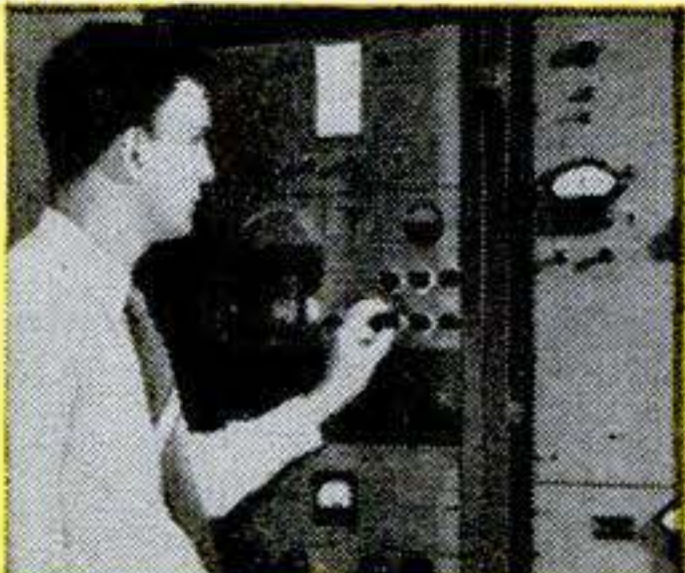

About 200 Television stations are now on the air. Hundreds of others being built. Good TV jobs opening up for Technicians, Operators, etc.



25 million homes now have Television sets. Thousands more are being sold every week. Get a job or have your own business selling, installing, servicing.

Radio-TV Needs Men of Action—Mail Coupon

Without obligating you in any way, I'll send an actual lesson to prove that my training is practical, thorough; 64-page book to show good job opportunities for you in Radio-TV. Terms for NRI training are as low as \$5 a month. Many graduates make more in two weeks than total cost of training. Mail coupon now. J. E. SMITH, President, National Radio Institute, Dept. 4EB, Washington 9, D. C. OUR 40TH YEAR.

Good for Both—FREE

MR. J. E. SMITH, President, Dept. 4EB, National Radio Institute, Washington 9, D. C. Mail me Sample Lesson and 64-page Book, FREE. (No salesman will call. Please write plainly.)

Name.....Age.....

Address.....

City.....Zone.....State.....

VETS write in date of discharge

The ABC's of SERVICING

How to Be a Success in RADIO-TELEVISION

REVOLUTIONARY NEW SELF-CONTAINED, COMPLETE SPRAY KIT MAKES PAINTING EASY!

Now Spray Anything In Minutes With Amazing New Super Jet!

**Nothing To Do But Pull The Trigger!
Astonishing New Principle Requires
No Air Compressor, No CO₂ Cartridges,
No Tank! Nothing Extra To Buy!**

Simply plug Super Jet into any 110 Volt A.C. electrical outlet and start spraying! The *patented* precision pumping mechanism allows you to spray from *open* or *closed* containers; spray paints, enamels, varnishes, shellacs, lacquers, water, oil, insecticides, fungicides, even water soluble fertilizers! And amazing Super Jet operates as well on a thimbleful or a barrelful of spraying liquid!

All metal Super Jet contains **NO BREAKABLE PLASTIC OR GLASS** parts! Lightweight and rugged, it sprays as well as professional equipment costing up to 3 times as much! Unlike cumbersome professional equipment or impractical toy-like spray guns, you can use Super Jet every time you have *anything* to paint or spray. It's so simple to use, so easy to clean. Super Jet pays for itself!

No Special Air Compressors or Extra Motors Needed!

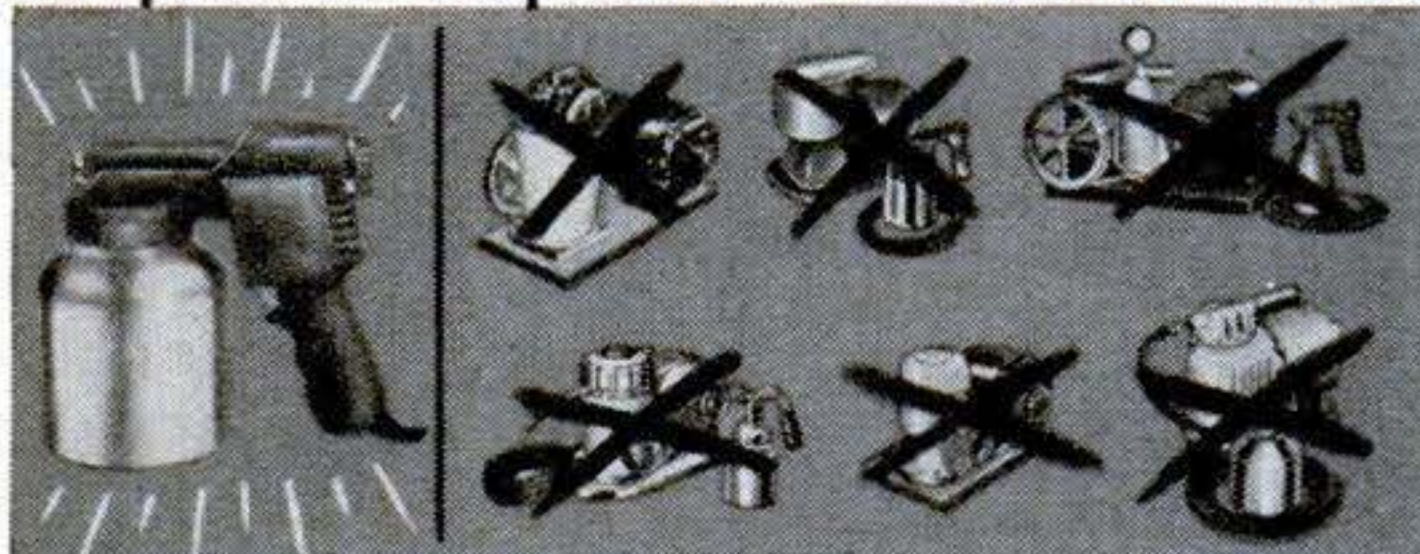

Laboratory Tests Prove SUPER JET Is Better!

Independent laboratory tests *plus* consumer testimonials show that *Super Jet* is the most versatile spray unit on the market! Super Jet is so rugged, so efficient and economical to use that Army, Navy and Air Corps used them. Thousands in use today in homes and industry. Simple to operate, non-clogging and easy to clean, amazing new Super Jet Spray Kit saves time, work, money!

3 DIFFERENT WAYS TO SPRAY WITH SUPER JET!

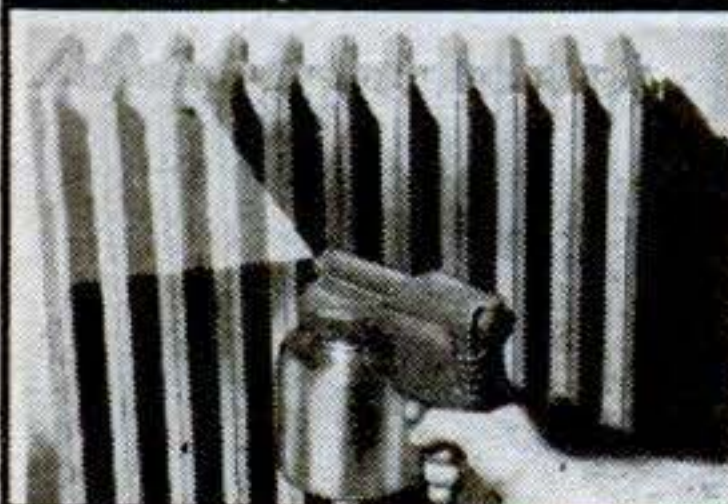

AVERAGE JOBS — Aluminum jar holds enough material for average paint jobs . . . chairs, tables, shelves, refrigerators, radiators, storm windows, screens, metal furniture, etc. Also perfect for spraying insecticides, liquid fertilizers, removing wall paper, lubricating tools and machinery, etc.



SMALL JOBS — Spray direct from container! Excellent for small spray jobs; painting garden tools, toys, metal grill work, flower pots, lamps, and hobby projects. Also permits spraying deodorizers or disinfectants right from bottle! This feature saves money too. Sprays last drop of paint or spray material!

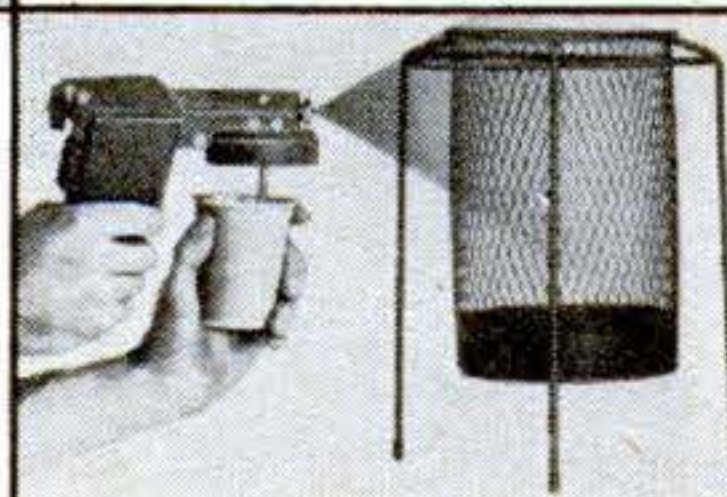

LARGE JOBS—Super Jet's revolutionary principle permits *continuous* spraying direct from large containers of spray material. Special "long-distance" tubing eliminates refilling. No expensive tanks or compressors to buy! Spray walls, floors, ceilings, gardens, lawns, etc.



**A COMPLETE SPRAY KIT!
Only \$29.95-\$1. a week!**

- NEW SUPER JET SPRAY GUN
 - POLISHED ALUMINUM JAR
 - AUTOMATIC PAINT STRAINER
 - 15 FT. DISTANCE TUBING
 - 23 FT. NEOPRENE CORD SET
 - SPARE PARTS
 - WALL CHART & INSTRUCTIONS
 - STEEL CARRYING CASE
- PLUS Your Name in 23 KARAT GOLD written on Super Jet Carrying Case



**FULLY GUARANTEED! 10 Day Free Trial
plus 90 Day Guarantee Against Mechanical Defects.**

POWER PRODUCTS, INC., 175 E. 87th St., N. Y. C.

AUTOMATIC FILTER!

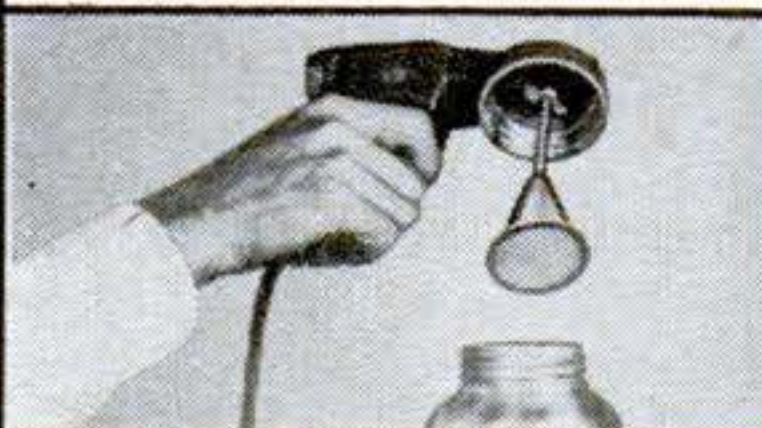

NO MORE STRAINING!—Super Jet comes equipped with an ingenious, fine screen, metal filter that *automatically strains* paint and spray materials. Dirt, pigments, lumps, paint skin, etc. are automatically filtered out and prevented from clogging the gun!

SELF-CLEANING!



NOTHING TO TAKE APART TO CLEAN!—Super Jet cleans itself. Simply spray solvent through the gun for 20 seconds and Super Jet is clean and ready for another job . . . for a different spray material . . . or for storage! No work! No time wasted!

FREE! Mail Coupon TODAY and get Free 5-piece pocket Screw Driver Set.

EXTRA BONUS! Send \$29.95 in full payment of your SUPER JET SPRAY KIT and receive as extra bonus tool kit pictured! Tempered steel 6 inch wrench, 7 inch pliers, screw driver blades and chuck, complete with carrying case. Not a toy!

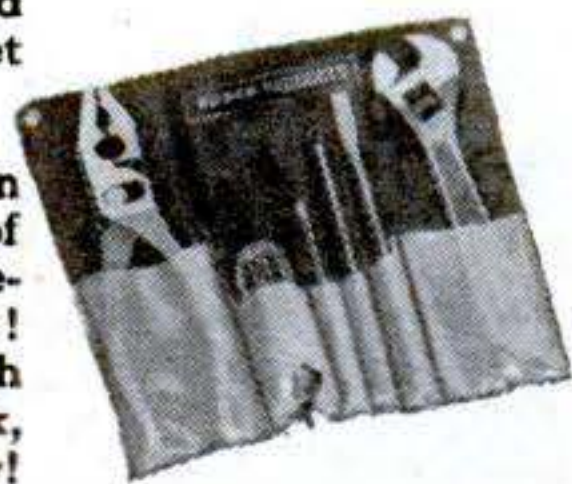

MAIL COUPON TODAY FOR 10 DAY FREE TRIAL

POWER PRODUCTS, INC.

Super Jet Division 5-D

175 E. 87 St., New York 28, N. Y.

Please send amazing new SUPER JET SPRAY KIT. I must be completely satisfied or I may return within 10 days for full refund. I am using payment plan checked below.

Enclosed is \$29.95 in FULL PAYMENT including postage. Be sure to send my FREE GIFT *plus* EXTRA BONUS for full payment.

OPEN CHARGE ACCOUNT. Enclosed is \$5.00. I will pay balance of \$24.95 plus postage at \$1.00 a week. Send FREE GIFT.

SEND C.O.D. Enclosed is \$5.00. I will pay postman \$24.95 plus postage and C.O.D. charges. Send FREE GIFT.

YOUR NAME will be written in 23 Karat Gold on your kit. Please Print Carefully.

NAME.....

ADDRESS.....

CITY.....ZONE.....STATE.....

CAR BURNING OIL?

Engineer's Discovery Stops it Quick

Without A Cent For Mechanical Repairs!

If your car is using too much oil—if it is sluggish, hard to start, slow on pickup, lacks pep and power—you are paying good money for oil that's burning up in your engine instead of providing lubrication. Why? Because your engine is leaking. Friction has worn a gap between pistons and cylinder wall. Oil is pumping up into the combustion chamber, fouling your motor with carbon. Gas is exploding down through this gap, going to waste.

SAVE \$50 TO \$150 REPAIR BILL

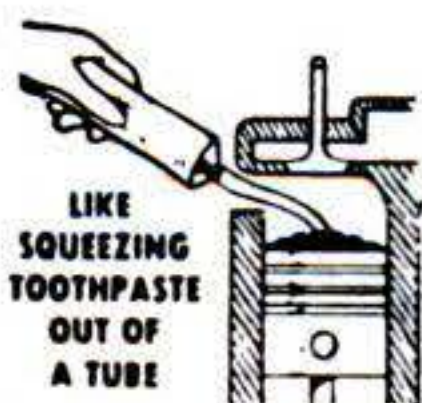

Before you spend \$50.00 to \$150.00 for an engine overhaul, read how you can fix that leaky engine yourself, in just a few minutes, without buying a single new part, without even taking your engine down. It's almost as easy as squeezing toothpaste or shaving cream out of a tube, thanks to the discovery of a new miracle substance called Power Seal. This revolutionary, new compound combines

the lubricating qualities of Moly, the "greasy" wonder metal, with the leak-sealing properties of Vermiculite, the mineral product whose particles expand under heat. (Up to 30 times original size.)

Just squeeze Power-Seal out of the tube into your motor's cylinders through the spark plug openings. It will spread over pistons, piston rings and cylinder walls as your engine runs and it will PLATE every surface with a smooth, shiny, metallic film that won't come off! No amount of pressure can scrape it off. No amount of heat can break it down. It fills the cracks, scratches and scorings caused by engine wear. It closes the gap between worn piston rings and cylinders with an automatic self-expanding seal that stops oil pumping, stops gas blow-by and restores compression. No more piston slapping; no more engine knocks. You get more power, speed, mileage.

This genuine plating is self-lubricating too for Moly, the greasy metal lubricant, reduces friction as nothing else can! It is the only lubricant indestructible enough to be used in U. S. atomic energy plants and jet engines. It never drains down, never leaves your engine dry. Even after your car has been standing for weeks, even in coldest weather, you can start it in a flash, because the lubrication is in the metal itself. That's why you'll need amazingly little oil; you'll get hundreds, even thousands of more miles per quart.

TRY IT FREE!

You don't risk a penny. Prove to yourself that Power-Seal will make your car run like new. Put it in your engine on 30 days' Free Trial. If you are not getting better performance out of your car than you thought possible—if you have not stopped oil burning and have not increased gas mileage—return the empty tube and get your money back in full. Power-Seal is absolutely harmless; it cannot hurt the finest car in any way. It can only preserve and protect your motor.

RUDSON AUTOMOTIVE INDUSTRIES
Dept. 235, 666 Fifth Avenue
New York 19, N. Y.

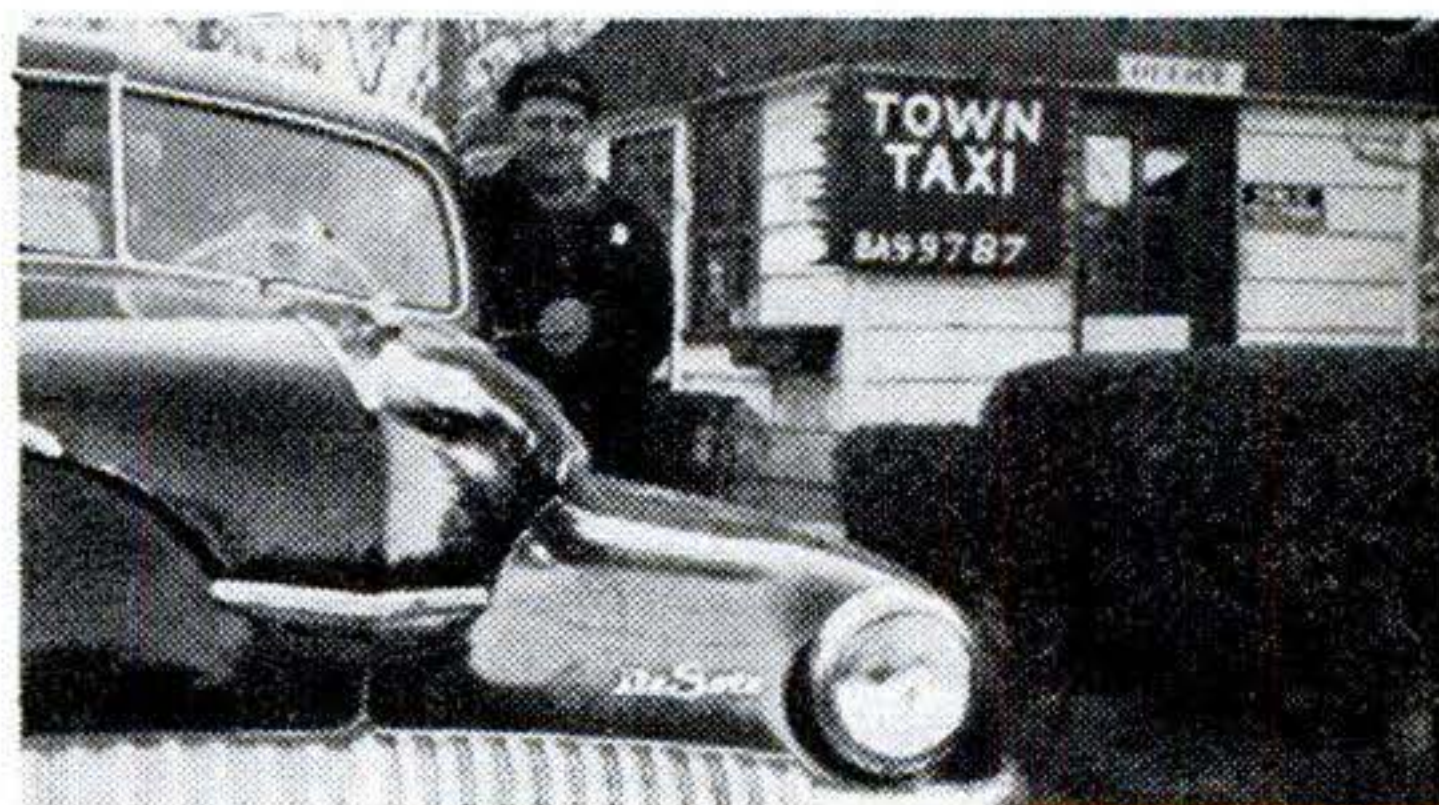

POWER SEAL MAKES WORN OUT TAXI ENGINE RUN LIKE NEW

Here are the Test Engineer's notarized figures showing the sensational increase in compression obtained in a 1950 De Soto taxi that had run for 93,086 miles. Just one POWER SEAL injection increased pep and power, reduced gas consumption, cut oil burning nearly 50%.

	Cyl. 1	Cyl. 2	Cyl. 3	Cyl. 4	Cyl. 5	Cyl. 6
BEFORE	90 lbs.	90 lbs.	105 lbs.	90 lbs.	80 lbs.	100 lbs.
AFTER	115 lbs.	115 lbs.	117 lbs.	115 lbs.	115 lbs.	115 lbs.

BEST INVESTMENT WE EVER MADE, SAYS DRIVER-OWNER

"We simply inserted the POWER SEAL per instructions and made no other repairs or adjustments. Compression readings were taken before and after and showed a big improvement in both cars. As a result the engine gained a lot more pick-up and power which was especially noticeable on hills. What impressed us most was the sharp reduction in oil consumption. In one cab, we've actually been saving a quart a day and figure we have saved \$11.20 on oil alone since the POWER SEAL was applied a month ago. In the other cab, oil consumption was cut practically in half. We have also been getting better gas mileage. All in all, POWER SEAL turned out to be just about the best investment we ever made. It paid for itself in two weeks and has been saving money for us ever since, to say nothing of postponing the cost of major overhauls that would have run into real money." *Town Taxi, Douglaston, N. Y.*

SEND NO MONEY!

Simply send the coupon and your Power-Seal injection will be sent to you at once C.O.D. plus postage and handling charges. Or, to save the postage and handling charges, simply enclose full payment with the coupon. For 6-cylinder cars order the Regular Size, only \$4.95. For 8-cylinder cars order the Jumbo Size, \$7.95. Power-Seal is now available only by mail from us. Send the coupon at once.

RUDSON AUTOMOTIVE INDUSTRIES, Dept. 235
666 Fifth Avenue, New York 19, N. Y.

Please send me tubes of the amazing new POWER SEAL.

Regular Size, for 6-cyl. cars, \$4.95 Jumbo Size, for 8-cyl. cars, \$7.95

On arrival, I will pay the postman the price indicated above plus postage and delivery charges. I must see an immediate improvement in the pep and power of my car, less oil consumption, greater gas mileage, reduced engine noise, easier starting, faster pickup, within 30 days, or you will refund my full purchase price.

Name

Address

City Zone State

Save More! Send cash, check, or money order with coupon and we pay all postage charges. Same money-back guarantee.

IN CANADA: 1184 CASTLEFIELD AVE., TORONTO 10, ONTARIO—ADD 55 CENTS



only **RALEIGH** has it!

3-SPEED and COASTER HUB

by **Sturmey-Archer**

Prices FOB Boston
Dynohub lighting additional

Ride the newest, most exciting Raleigh of them all—the beautiful Sports Light Coaster with the new Tri-Coaster Hub! The Sports Light Coaster, new bicycle with a safe, safe coaster brake and 3-speed gear! All this plus an emergency front hand brake.

See Raleigh and this AMAZING Tri-Coaster Hub!

The Sports Light Coaster \$69.75

And don't forget the handsome precision-built Sports Light Roadster, easy-to-handle Raleigh favorite at only \$63.75.

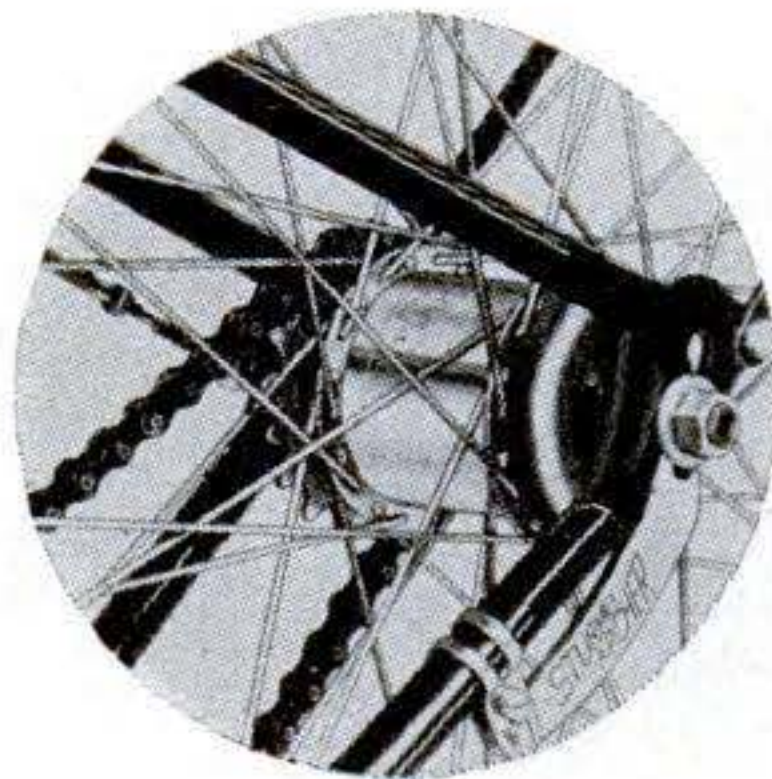

Write to

Raleigh Industries of America, Dept. P • 687 Boylston St. • Boston 16, Mass.

THE ONLY WOOD GLUE THAT'S WATERPROOF



For home craftsmen who want the best, a resorcin resin is the only cold-setting glue that meets U.S. government specifications for marine laminating. Defies cold or boiling water, mould, fungus, solvents, mild acids and alkalis, extreme heat or cold and continuous outdoor exposure. Use for boats, toys, outdoor furniture — wherever strongest possible waterproof bond is desired. Write for folder.



ELMER'S

©T.B.G. Resorcin Resin
WATERPROOF GLUE

THE BORDEN COMPANY, CHEMICAL DIVISION, DEPT. PS-54, 350 MADISON AVENUE, NEW YORK 17, N. Y.

10 POPULAR SCIENCE

U-MAK-IT BOAT KITS

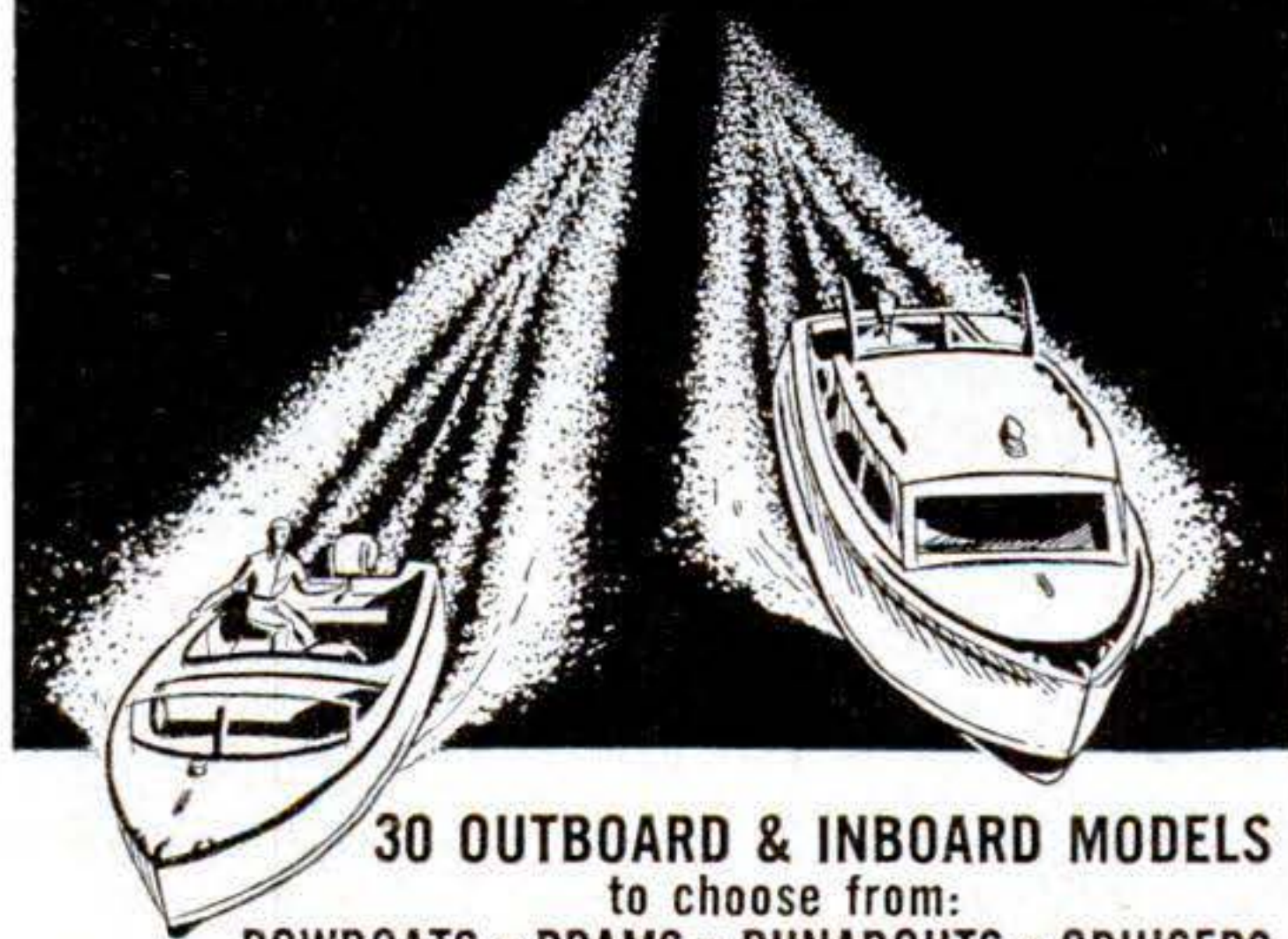

30 OUTBOARD & INBOARD MODELS
to choose from:

ROWBOATS • PRAMS • RUNABOUTS • CRUISERS

Now you can build your own boat with simple hand tools and no previous building experience. It's easy—you save half the cost. Each part of the famous U-Mak-It boat kit is precision machined—frames, stem, transom, keel, and planking, etc., are ready for assembly. Kits are complete in every detail. Only the finest materials are used. For high performance, safety and durability investigate U-Mak-It boat kits, today!

SEND FOR BIG ILLUS. CATALOG

Shows complete U-Mak-It line: construction details, incl. everything to build your own. Engines, conversions, hardware, paint and color chart.
SEND 35¢ COIN TODAY!

U-MAK-IT products

703 R-Whittier St. • Bronx 59, N.Y. City



whether you're building a house or a bike—
 planning a career or a fishing trip—
 or working on a house-gadget—

you'll SEE better

UNDERSTAND better

BUILD better

after reading....

THE PEEPHOLE OF THE PRESENT

by **SAMUEL ROTH**
 WITH INTRODUCTION BY
SIR ARTHUR EDDINGTON
 CAMBRIDGE UNIVERSITY



★ THE BIG NEWS FOR YOU

is that a new dimension is being brought into your life. An auxiliary pair of eyes function behind those you see with. You can now accomplish more with what you've got than you ever dreamed of.

It's as if you suddenly discovered that the figures in your bank account represent not dollars but millions of dollars.

It's a new *know-how* that applies to every department of your life. In his Introduction to *The Peep-Hole of the Present*, Sir Arthur Eddington (second only to Albert Einstein as interpreter of the new physics) calls it 100 years ahead of its time. How would you like to get that far ahead—in the ability to see, understand and build—*just for the price of a book?*

THE ASTONISHING PART is that *The Peep-Hole of the Present* is so simply written that anyone can read and understand it.

And there is drama in the book as well as simplicity of direction. You become a witness to a great revolution in ideas and techniques.

These are big promises. *But if you buy through the guaranteed coupon below, what chance do you take?*

DO YOU KNOW THAT

The earth is not one of those brass pin-points in the night-sky?

the law of gravity is not what you've been taught it is?

light has no velocity?

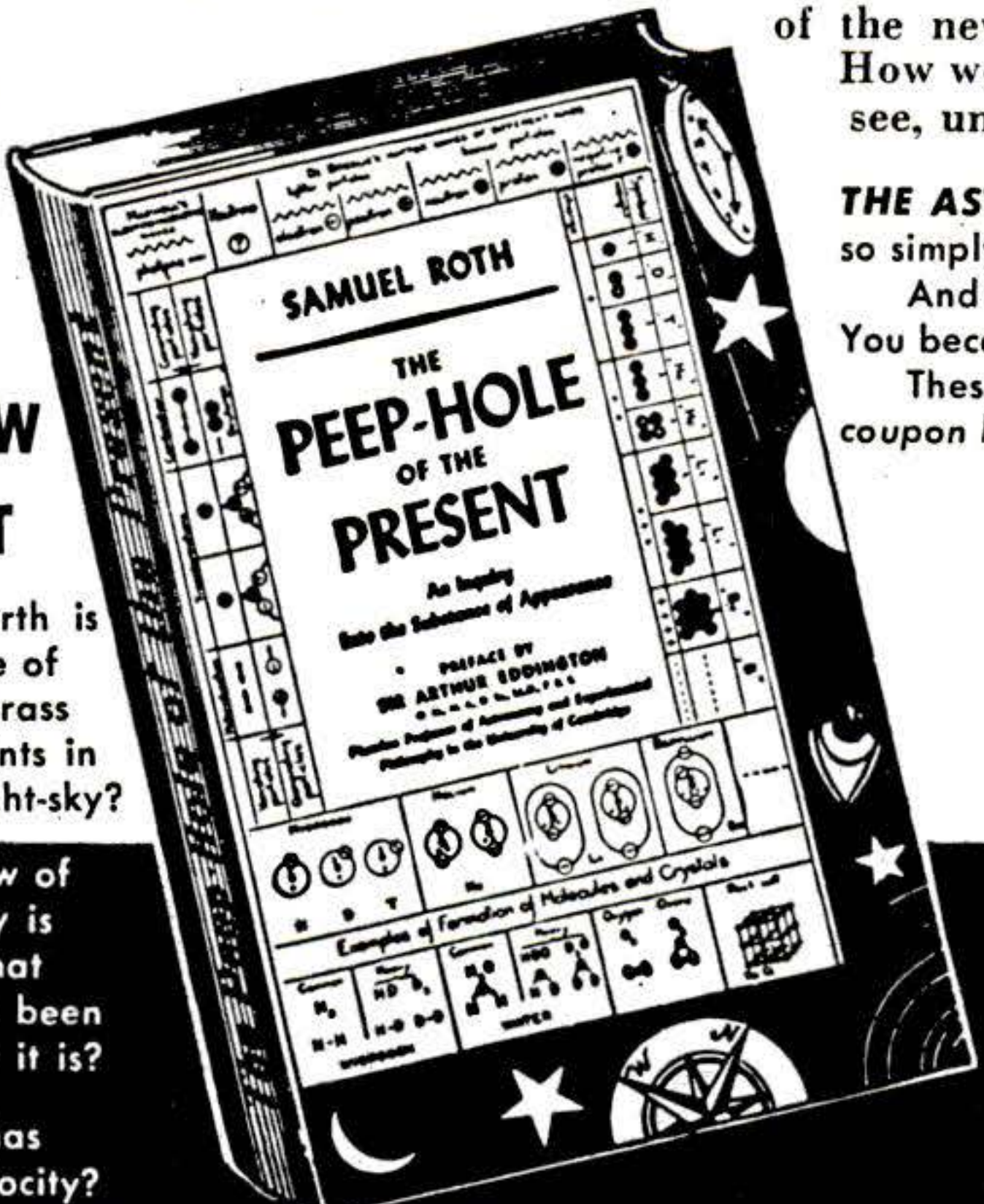

Special for the readers of this magazine

Originally \$5, Now Only **\$1.98**

BEACON BOOKS: 110 LAFAYETTE ST., N. Y. 13, N.Y. PS
 Gentlemen: I enclose \$1.98 for the new popular edition of *The Peep-Hole of the Present*. I may return it for full credit if it does not fulfill all my expectations.

NAME

ADDRESS

CITYZONE.....STATE.....

Send C.O.D.

STOP RUST

**FROM MOVING IN
WHEN ANTI-FREEZE
IS DRAINED OUT!**



**WITH
PERMATEX
WATER PUMP LUBRICANT
and RADIATOR ANTI-RUST**

All types of permanent Anti-Freeze contain a rust inhibitor. When you drain your anti-freeze for warm weather driving and refill with clear water . . . look out—that's when the rust moves in . . . Prevent this rust from forming . . . protect your engine and water pump . . . add a can of Permatex Water Pump Lubricant and Radiator Anti-Rust. It keeps water crystal clear and lubricates the pump . . . stops squeaks and squeals, prevents wear.

Send for free illustrated catalog

**LOOK FOR THE DISTINCTIVE
PERMATEX LABEL**

at your service station or garage.
It's been your guarantee of quality
for over 45 years.



OVER FIFTY CHEMICAL PRODUCTS FOR BETTER
AUTOMOTIVE MAINTENANCE

PERMATEX COMPANY, INC., Brooklyn 35, New York

Letters



Tracks Should Be Wider

I believe that Mr. Hastings, in your article "Catching the 8:05 Could Be a Thrill" [March, p. 120], has the right idea. However, railroad rolling stock will never attain really high speeds until the gauge of the track is widened to eight, 10 or 12 feet. The



wider gauge would also help to eliminate most of the sway which is so common in today's trains.

A. RAYMOND THOMAS, Wapato, Wash.

The Great Western Railway of England once had seven-foot-gauge tracks. It maintained consistently higher speeds and provided more comfortable rides than any standard-gauge railroad of the day. But nobody else would agree to switch to seven-foot gauge, so it had to be abandoned as impractical.

Too Fast for Long Island

I'm afraid I have to be somewhat more practical than ex-Senator Hastings has been in considering a "plan" for 150-mile-an-hour commuting on Long Island.

He hasn't bothered to explain how he could get those 150-mile-an-hour speeds, no matter what kinds of motors or cars he used, in the kind of commuter service required on Long Island, where stations average only a fraction over a mile apart. Two-G acceleration and deceleration certainly wouldn't make for comfortable travel.

Somewhere he has to compromise between speed and power. And if he has his

GOOD SALARY

FINE CAR

**To the man who wants to enjoy
an ACCOUNTANT'S CAREER**

A NICE HOME

BANK ACCOUNT

FREE SAMPLE LESSON

IF you're that man, here's something that will interest you.

Not a magic formula—not a get-rich-quick scheme—but something more substantial, more practical.

Of course, you need something more than just the desire to be an accountant. You've got to pay the price—be willing to study earnestly, thoroughly.

Still, wouldn't it be worth your while to sacrifice some of your leisure in favor of interesting home study—over a comparatively brief period? Always provided that the rewards were good—a salary of \$4,000 to \$10,000?

An accountant's duties are interesting, varied and of real worth to his employers. He has *standing!*

Do you feel that such things aren't for you? Well, don't be too sure. Very possibly they *can* be!

Why not, like so many before you, investigate LaSalle's modern Problem Method of training for an accountancy position?

Just suppose you were permitted to work in a large accounting house under the personal supervision of an expert accountant. Suppose, with his aid, you studied accounting principles and solved problems day by day—easy ones at first—then more difficult ones. If you could do this—and could turn to him for advice as the problems became complex—soon you'd master them all.

That's the training you follow in principle under the LaSalle Problem Method.

You cover accountancy from the basic Principles right up through Accountancy Systems and Income Tax Procedure. Then you add C. P. A. Training and prepare for the C. P. A. examinations.

As you go along, you absorb the principles of Auditing, Cost Accounting, Business Law, Statistical Control, Organization, Management and Finance.

Your progress is as speedy as you care to make it—depending on your own eagerness to learn and the time you spend in study.

Will recognition come? The only answer, as you know, is that success *does* come to the man who is really *trained*. It's possible your employers will notice your improvement in a very few weeks or months. Indeed, many LaSalle graduates have paid for their training—with increased earnings—before they have completed it! For accountants, who are trained in organization and management, are the executives of the future.

**Get Free Sample Lesson—Also
"Accountancy, The Profession That Pays"**

For your own good get all the facts. Write for Free Sample Lesson—also 48-page book "Accountancy, The Profession That Pays." They will prove that Accountancy offers brilliant futures to those who aren't afraid of serious home study, and will show the wide range of opportunities that exist today. No cost or obligation. If you want a position of higher income, greater prestige and professional standing... MAIL THE COUPON NOW!

**Over 4,000 Certified
Public Accountants among
LaSalle alumni**

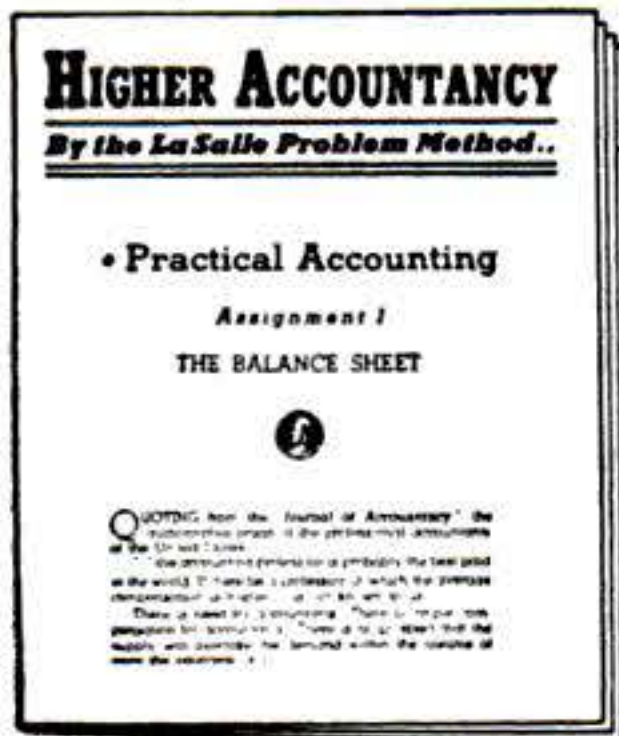

**LASALLE EXTENSION UNIVERSITY
A CORRESPONDENCE INSTITUTION**

417 S. Dearborn St. Dept. 583H Chicago 5, Ill.

I want to be an accountant. Send me without obligation, Free Sample Lesson—also "Accountancy, The Profession that Pays."

Name..... Age.....

Address.....

City, Zone & State.....

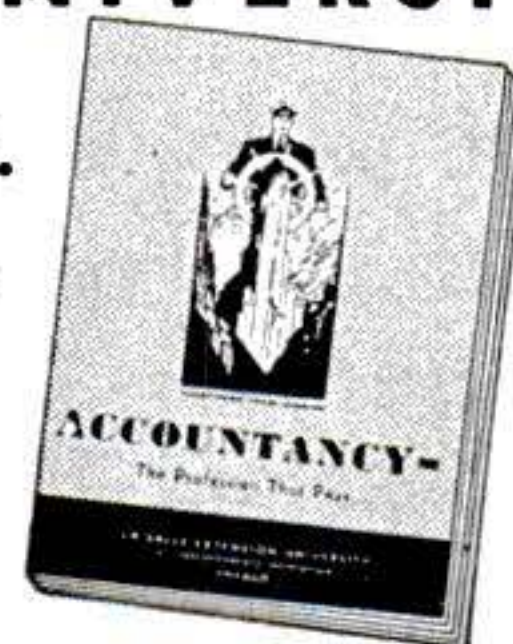

cars geared for 150-mile top speeds, he's not going to get more than 30 miles an hour between stations. If he wants the acceleration, his top speed is going to be just about where it is now—about 65 miles an hour.

Maybe Mr. Hastings has something in his prestressed concrete roadbed, but the French don't think so after experimenting with it. They've abandoned it for use as railroad ties, even with rubber inserts, because it broke up under the load of heavy traffic.

PAUL A. BLAUVELT, Jamaica, N.Y.

Watch Out for Bogs!

Three of us are contemplating a trip to South America in July, when we will be released from active duty. We'd like to

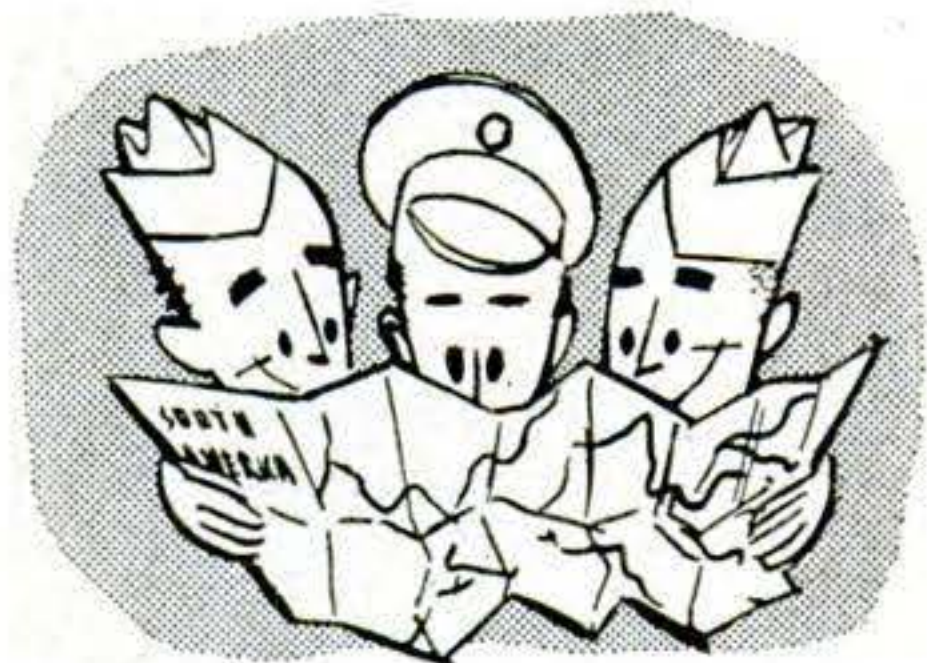

follow the route of the Pan-American Highway as much as possible.

We realize, of course, that this is no ordinary trip. We will need a car that will hold up under the severest of conditions. It is our hope that you can give us some helpful suggestions.

SGT. F. C. BOUDREAU, % PM, San Francisco

Perhaps you already know that eastern Panama is impassable for a car. You will have to get from that country to Colombia by sea. Also, the best vehicle for your proposed rugged journey is a Jeep with a four-wheel-drive transmission.

Silence Not Wholly Golden

Frank Fry had what sounded like a splendid idea when he suggested that automobile horns be fixed so that they couldn't blow except when cars' brakes were applied [Feb., p. 22]. This is one way of cutting the noise in a city. But I can think of a few people who wouldn't like the idea of putting on the brakes every time they wanted to signal another car that they were passing!

E. C. TUGGLE JR., Evergreen, Ala.

Could White Eagles Fly?

In a recent Letters column, you told a reader that Stutz and Duesenberg were



ONLY \$44
Approximate cost—1/4" knotty pine paneling for wall 8' x 12'

Bring your ideas to life with Weldwood paneling

Weldwood knotty pine paneling makes it easy to change an attic, basement or storage room into the cheerful work, play or guest room you see here. And see how little it actually costs!

But be sure it's Weldwood—the wide, smooth, easier to install panels which stand hard use, and have knots that are carefully selected and spaced. Finished job is better in every respect.

There's a host of other Weldwood hardwoods too—and Novoply, Weldtex and Surfwood. See them at your lumber dealer's or at any of the 72 United States Plywood or U. S.-Mengel Plywoods showrooms in principal cities, or mail coupon.

Novoply®—\$33 Surfwood®—\$26 Weldtex®—\$27

Weldwood® 
LIFETIME GUARANTEED INTERIOR PANELING

UNITED STATES PLYWOOD CORPORATION
World's Largest Plywood Organization
New York 36, N. Y.

United States Plywood Corporation
Box 61, New York 46, N. Y.

PS-5-54

- Please send free folder showing how to copy room above.
- Enclosed is 10¢ for full-color book "Beautiful Wood for Beautiful Homes."

NAME.....

ADDRESS.....

CITY.....STATE.....



INVENTORS

Learn how to protect your invention. The U. S. Patent Laws provide that any new and useful art, machine, article of manufacture, or composition of matter, or any new and useful improvement thereof, may be patented if the act of invention is involved. Therefore, every inventor with a valuable invention should take advantage of the Patent Laws and proceed for patent protection in order to safeguard his rights.

A patent gives the inventor the exclusive right to prevent others from making, using, or selling the invention claimed in the patent for a period of seventeen years.

The Patent Laws were enacted for the benefit of the inventor to give him protection for the features of his invention which are patentable. These features must be properly and concisely set forth and claimed in a formal application for patent, in order to comply with the requirements of the Patent Laws. For that reason, unless the inventor is familiar with patent matters, he should engage a competent registered patent attorney or agent to represent him. We are registered to practice before the U. S. Patent Office and are prepared to serve you in the handling of your patent matters.

A specially prepared booklet entitled "Patent Guide for the Inventor", containing detailed information with respect to patent protection and procedure, together with a "Record of Invention" form will be promptly forwarded to you without obligation upon request.

CLARENCE A. O'BRIEN & HARVEY JACOBSON

Registered Patent Attorneys

42 - E DISTRICT NATIONAL BUILDING
WASHINGTON 5, D. C.

DRAFTSMEN



**EARN
BIG MONEY!**

Want more money? Steady employment? Clean, interesting work? Look into Drafting. You'll quickly see why there's real opportunity, more money in this prosperous professional-type work. Want ads show trained draftsmen are in great demand. Find out how you can qualify in a few months for a good job in Drafting.

**LEARN IN SPARE TIME—AT HOME
(or at the College in Chicago)**

A few hours of pleasant home study every week—that's all. All the tools you need to train at home; valuable drawing outfit included. For 50 years this nationally famous school has prepared men quickly for good positions in industry.

FREE INFORMATION—SEND COUPON

Find out how C.T.C. practical training has boosted the pay for hundreds, what it can do for you. Learn what Chicago Tech graduates say about their work, earnings, success. Don't wait! Investigate now. Send for this **FREE TRIAL LESSON**. No charge for this lesson, now or later. Fill out and mail coupon or send post card today.



**CHICAGO
TECHNICAL COLLEGE**

**E-222 Tech Bldg., 2000 So. Michigan Ave.
Chicago 16, Illinois**

Mail me **FREE Lesson** with information about big opportunities in **DRAFTING**.

NAME..... AGE.....

ADDRESS.....

CITY..... ZONE..... STATE.....

probably the only 1928 stock cars that could go 100 miles an hour. I have another candidate. Along about that year, a car known as the Kissel White Eagle Speedster was guaranteed in current advertisements to do "an honest 100 miles per hour."

Maybe some other reader can tell us whether those White Eagles really flew or not.

JOHN T. ENGLISH, West Memphis, Ark.

Old Rule Gets New Look

In your February issue [p. 225], O. A. Nelson suggested a way to restore old steel



rules. It involved wire-brushing, sandpapering, and coating the rule with black lacquer, then sandpapering the lacquer off the smooth part.

In our sheet-metal shop, we have used an easier method for years. We coat the square or steel rule with aluminum paint and wipe it off at once. The figures really stand out.

Furthermore, this process does away with all that sanding, which soon dims the figures altogether.

LEE W. PANNEY, Ionia, Mich.

A Loyal and Loved Lizzie

I do not claim to have the oldest car in the U.S., but I would like to make the claim of having the most faithful car.

It is a 1924 Model T Ford. I have had it for 30 years, and in that time it has been in use almost every day, rain or shine, hot or cold. Since 1926, it has been kept out-of-doors day and night.

Can any **POPULAR SCIENCE MONTHLY** readers beat that record?

OLIVER H. HANSON, Oshkosh, Wis.

Can any?

You Call That a Motorcycle?

Your February issue had one article that I just can't take without comment. On page 116 you pictured what you carelessly called a motorcycle. [Ed. note: It was made from parts of two Harley-Davidsons, a John Deere

INVENTORS

If you believe that you have an invention, you should find out how to protect it. The first step is to have a search made of the prior pertinent U. S. patents. If a report on this search indicates that the invention appears patentable you can apply for a patent, and the specifications and claims should be prepared.

The firm of McMorrow, Berman & Davidson, with offices in Washington, D. C., is qualified to take the necessary steps for you. We can make a preliminary search on your invention, advise you whether we think it can be patented, and prepare your application for patent.

Unless you are fully familiar with the U. S. Patent Laws, we recommend that you engage the services of a Registered Patent Attorney to protect your interests. The patent laws are *your* laws. A patent gives you the right to prevent others from making, using or selling the invention claimed in your patent for a period of 17 years.

Use these patent laws for your protection. Investigate whether your invention can be patented. If you have what you believe to be an invention, we suggest that you have this firm make a search for you.

Send for a copy of our Patent Booklet entitled "How To Protect Your Invention," containing information about patent protection and patent procedure. Along with this we will also send you an "Invention Record" form, for your use in writing down and sketching details of your invention. We will mail them promptly. No obligation. They are yours for the asking.

McMORROW, BERMAN & DAVIDSON

Registered Patent Attorneys

PATENTS • COPYRIGHTS • PATENTS

1421 VICTOR BUILDING, WASHINGTON 1, D. C.

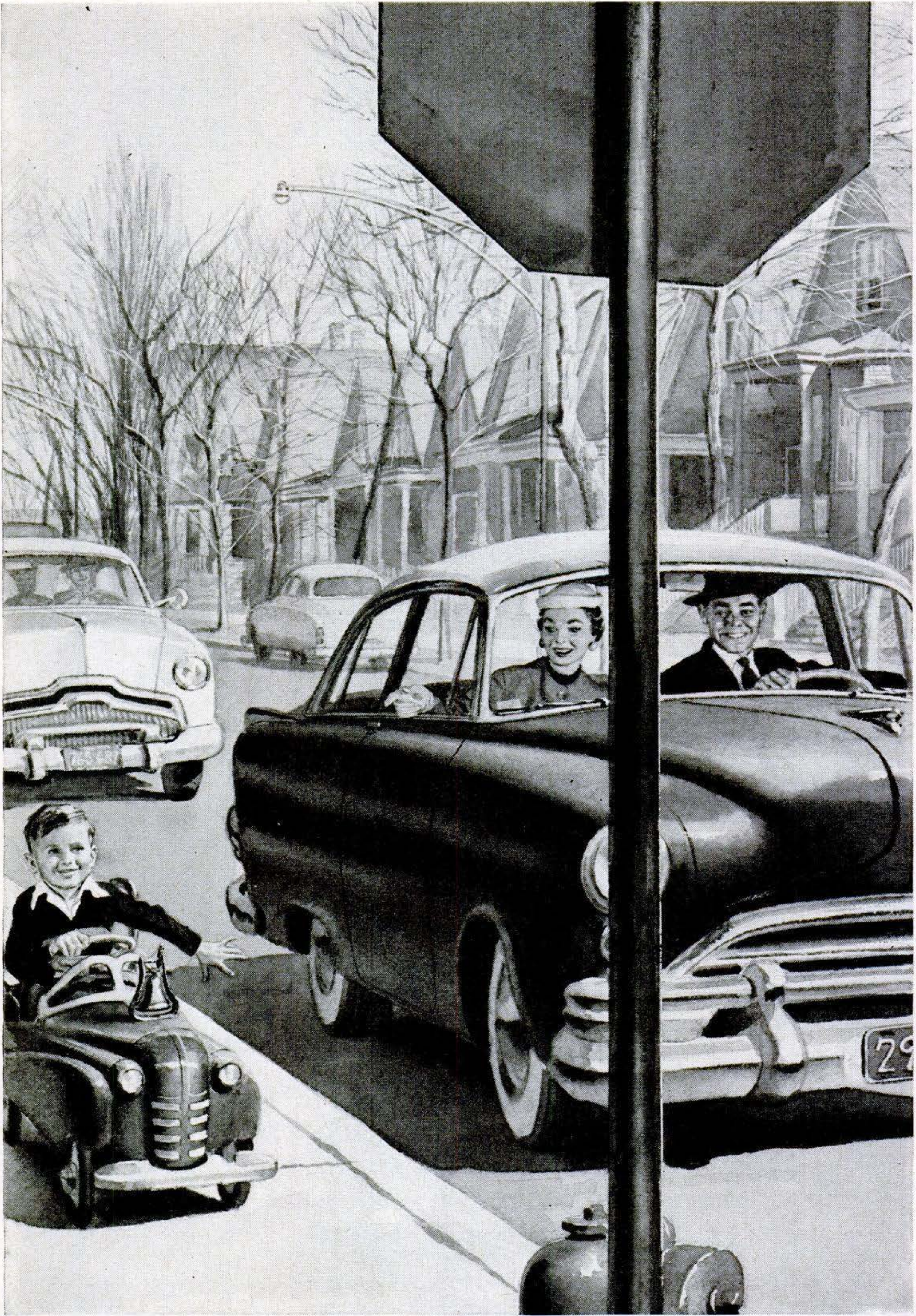

◀ Traffic laws say: "Full Stop at Stop Signs."

If you always stop, it can help you...

save up to 40% on your auto insurance!

Read why careful drivers get top-notch protection at rock-bottom rates with

STATE FARM MUTUAL

If you drive carefully, like the man in the picture (and his small friend on the sidewalk) . . . you're already well on your way toward reducing the cost of your auto insurance.

Now, all that's left to do is contact your State Farm agent. He will tell you how we seek to insure *careful drivers only* . . . how we save money on their accident-free driving . . . how we pass this saving back to our members in the form of *rock-bottom rates*.

If you qualify, he will quote you rates that are *as much as 40 percent lower* than the cost of equivalent protection from other good companies.

More than 3 million car owners (more by far than any other company insures) already save on our "careful driver" insurance. They buy it on a convenient semi-annual payment plan. If they *do* have an accident, they get prompt,

courteous "round the clock" service from State Farm's 7000 agents and 700 claim expeditors.

Want more information? Call the agent listed under "State Farm Insurance" in your classified directory, or write: State Farm Mutual, Dept. I-9, Bloomington, Illinois.

Can you qualify?

State Farm aims to insure careful drivers only.

Drivers who can be counted on to:

- Make full stop at stop signs
- Heed crossing signals
- Obey speed laws
- Be extra careful on slick pavements
- Keep car in good shape
- Avoid passing on hills or curves
- Avoid mixing alcohol and gasoline
- Yield pedestrians the right of way

STATE FARM MUTUAL

"the careful driver insurance company"



FREE TO MEMBERS!

Ask your agent for your new State Farm insignia (like above) in bright red headlight-reflecting Scotchlite. Display it proudly on left rear car bumper to identify yourself as "careful driver, soundly insured" . . . to provide emergency reflection when parked or if taillight fails.

State Farm Insurance is written only by the State Farm Mutual Automobile Insurance Co.

and its wholly owned affiliates:

State Farm Life Insurance Company
State Farm Fire and Casualty Company

Home office: Bloomington, Illinois. Field claim offices in 300 principal cities. 7,000 agents in 40 states, District of Columbia, and Canada

Hear "Jack Brickhouse Sports News" Saturdays and "Cecil Brown News Commentaries" Sundays over Mutual Stations.

Check local radio listings.

**"Cake"—not wood
mellows
your smoke**

**and the
exclusive
honey lining
cakes Yello-Bole
imported briar far faster
than any pipe at any price!**

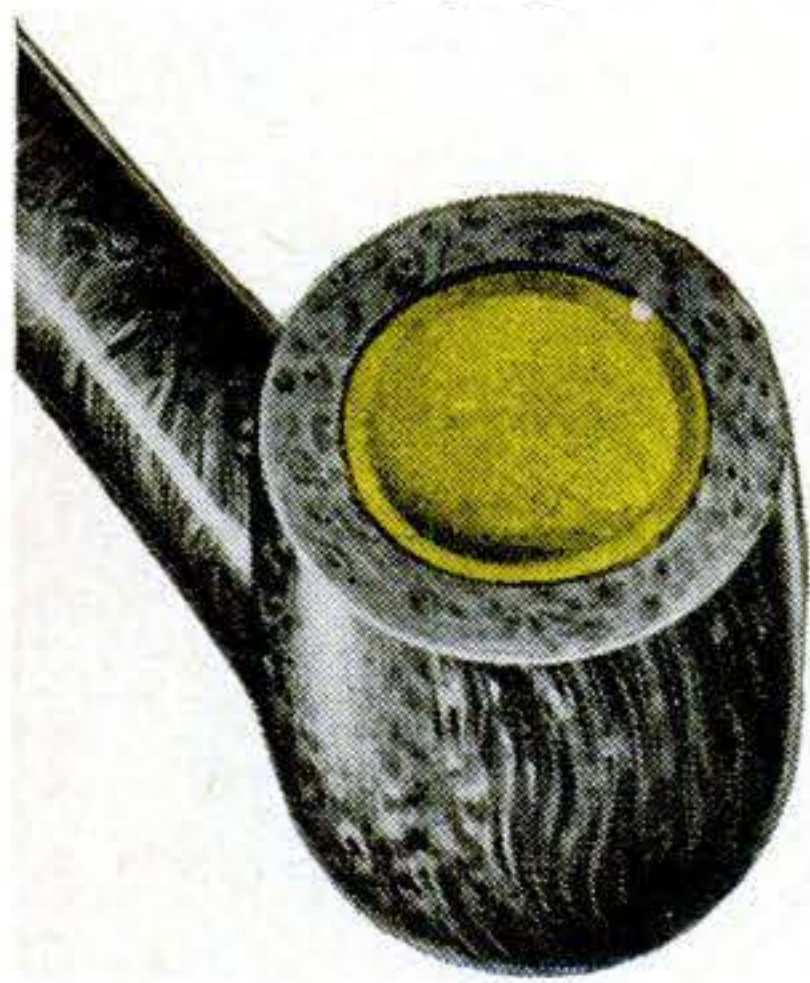

From the first puff, Yello-Bole's real honey builds up a healthy, protective cake. It mellows the smoke, absorbs tars and resins. The filter refines the rest. Yello-Bole smokes so clear, clean, cool and sweet you don't have to inhale to enjoy it. Treat yourself to a healthier-smoking, honey-lined Yello-Bole—in handsome new shapes and finishes!

PROOF?
Yello-Bole is the world's
largest selling pipe

YELLO-BOLE

**\$1.00
TO
\$2.50**



tractor and some beer cans.] I just won't accept this. You also said that the thing has two 80-cu.-in. engines and a top speed of 129.87 miles an hour.

Well, that displacement is just four times as much as my Triumph Thunderbird has. Yet motorcycles of the same type as mine, tuned and fitted with factory-made speed equipment, have hit 140 m.p.h. I consider this real efficiency and something to be proud of.

EDDIE YUNG JR., Columbia, Mo.

In Defense of Convertibles

I have a few words to say on the subject of the relative safety of convertibles, as opposed to other body types. Maybe these remarks will satisfy Mr. De Ware, who wrote to you on this matter in February [p. 16].

First, I have seen no convertibles that, under usual crash-accident conditions, evidenced serious structural failure below the deck line—that is, the body with the top and windshield removed. Any occupant securely braced below this line would have received, at the most, only minor injuries. Yet in similar accidents the roofs of many sedans are crushed down onto the seats, and structural failure in the main body has carried this crushing to a much lower point.

In a hurtling accident, passengers thrown against the roof of a standard sedan invariably suffer head injuries and concussions. In the convertible, the occupant tears



through the cloth top and is thrown clear. While injuries may be sustained in such an event, in general they are not caused by contact with parts of the car, and in any event the occupant is not crushed within a metal can.

Lastly, the metal-framed windows of the convertible tend to stand up better in an accident, even though fracturing may occur, than the unsupported glass areas of the standard sedan.

My personal conclusion is that the convertible is the *safest* body type.

FRANZ J. SCHNAUBELT, La Mesa, Calif.

How to **CRACK** the education barrier



Is there an "education barrier" between you and promotion? Are young college graduates being brought in to fill positions above you?

You can break down that barrier . . . gain real security, responsibility, prestige . . . *surprise fellow employees and win their respect.* You can match yourself against the smartest of the college boys and come out a WINNER. Here's how!

AN HOUR A DAY THE I. C. S. WAY!

If you can spare an hour a day, if you have the determination to make good, if you're willing to invest pennies now for dollars later on—then I. C. S. can help you. You can be a man or woman, young or old, skilled or unskilled. So long as you

can understand simple language and illustrated training manuals, you need have no doubts. The I. C. S. hour-a-day plan is SUCCESS-PROVED. You learn while you earn—anywhere, any time. And the cost?—*less than a quarter a day!*

Just pick the subject you want!

Only I. C. S. offers you such a wide range of subjects to choose from. Drafting. Engineering. Television. Aeronautics. Business. High School. 391 courses in all. *I. C. S. is the oldest, largest home-study school. It is also the best known in business and industry.*

Free catalog plus free book!

When you mail the coupon below, you get a complete catalog on the subject you check with information about employment opportunities, training requirements, etc. And you get "How to Succeed"—36 pages of valuable tips on winning recognition, pay raises, success. Both books rushed free if you mail the coupon TODAY!

For Real Job Security — Get I. C. S. Training!

I. C. S., Scranton 9, Penna.

INTERNATIONAL CORRESPONDENCE SCHOOLS



BOX 7679-N, SCRANTON 9, PENNA.

(Partial list of 277 courses)

Without cost or obligation, send me "HOW to SUCCEED" and the opportunity booklet about the field BEFORE which I have marked X:

- | | | | | |
|---|--|---|--|---|
| <p>ARCHITECTURE and BUILDING CONSTRUCTION</p> <ul style="list-style-type: none"> <input type="checkbox"/> Air Conditioning—Refrig. <input type="checkbox"/> Architecture <input type="checkbox"/> Building Contractor <input type="checkbox"/> Building Maintenance <input type="checkbox"/> Carpenter and Mill Work <input type="checkbox"/> Estimating <input type="checkbox"/> Heating <input type="checkbox"/> Painting Contractor <input type="checkbox"/> Plumbing <input type="checkbox"/> Reading Arch. Blueprints <input type="checkbox"/> Steamfitting <p>ART</p> <ul style="list-style-type: none"> <input type="checkbox"/> Cartooning <input type="checkbox"/> Commercial Art <input type="checkbox"/> Fashion Illustrating <input type="checkbox"/> Magazine Illustrating <input type="checkbox"/> Show Card and Sign Lettering <input type="checkbox"/> Sketching and Painting <p>AUTOMOTIVE</p> <ul style="list-style-type: none"> <input type="checkbox"/> Auto Body Rebuilding <input type="checkbox"/> Auto Elec. Technician <input type="checkbox"/> Auto-Engine Tune Up <input type="checkbox"/> Automobile Mechanic | <p>AVIATION</p> <ul style="list-style-type: none"> <input type="checkbox"/> Aeronautical Engineering Jr. <input type="checkbox"/> Aircraft & Engine Mechanic <p>BUSINESS</p> <ul style="list-style-type: none"> <input type="checkbox"/> Advertising <input type="checkbox"/> Bookkeeping and Accounting <input type="checkbox"/> Business Administration <input type="checkbox"/> Business Correspondence <input type="checkbox"/> Certified Public Accounting <input type="checkbox"/> Creative Salesmanship <input type="checkbox"/> Federal Tax <input type="checkbox"/> Letter-writing Improvement <input type="checkbox"/> Managing Small Business <input type="checkbox"/> Office Management <input type="checkbox"/> Retail Business Management <input type="checkbox"/> Sales Management <input type="checkbox"/> Stenographic-Secretarial <input type="checkbox"/> Traffic Management <p>CHEMISTRY</p> <ul style="list-style-type: none"> <input type="checkbox"/> Analytical Chemistry <input type="checkbox"/> Chemical Engineering <input type="checkbox"/> Chem. Lab. Technician <input type="checkbox"/> General Chemistry <input type="checkbox"/> Natural Gas Prod. & Trans. <input type="checkbox"/> Petroleum Engineering <input type="checkbox"/> Plastics <input type="checkbox"/> Pulp and Paper Making | <p>CIVIL, STRUCTURAL ENGINEERING</p> <ul style="list-style-type: none"> <input type="checkbox"/> Civil Engineering <input type="checkbox"/> Construction Engineering <input type="checkbox"/> Highway Engineering <input type="checkbox"/> Reading Struct. Blueprints <input type="checkbox"/> Sanitary Engineering <input type="checkbox"/> Structural Engineering <input type="checkbox"/> Surveying and Mapping <p>DRAFTING</p> <ul style="list-style-type: none"> <input type="checkbox"/> Aircraft Drafting <input type="checkbox"/> Architectural Drafting <input type="checkbox"/> Electrical Drafting <input type="checkbox"/> Mechanical Drafting <input type="checkbox"/> Mine Surveying and Mapping <input type="checkbox"/> Ship Drafting <input type="checkbox"/> Structural Drafting <p>ELECTRICAL</p> <ul style="list-style-type: none"> <input type="checkbox"/> Electrical Engineering <input type="checkbox"/> Electrical Maintenance <input type="checkbox"/> Electrician <input type="checkbox"/> Contracting <input type="checkbox"/> Lineman <p>HIGH SCHOOL</p> <ul style="list-style-type: none"> <input type="checkbox"/> Commercial <input type="checkbox"/> Good English <input type="checkbox"/> High School Subjects <input type="checkbox"/> Mathematics | <p>LEADERSHIP</p> <ul style="list-style-type: none"> <input type="checkbox"/> Foremanship <input type="checkbox"/> Industrial Supervision <input type="checkbox"/> Leadership and Organization <input type="checkbox"/> Personnel-Labor Relations <p>MECHANICAL AND SHOP</p> <ul style="list-style-type: none"> <input type="checkbox"/> Gas—Electric Welding <input type="checkbox"/> Heat Treatment <input type="checkbox"/> Metallurgy <input type="checkbox"/> Industrial Engineering <input type="checkbox"/> Industrial Instrumentation <input type="checkbox"/> Industrial Supervision <input type="checkbox"/> Machine Design-Drafting <input type="checkbox"/> Machine Shop Inspection <input type="checkbox"/> Machine Shop Practice <input type="checkbox"/> Mechanical Engineering <input type="checkbox"/> Quality Control <input type="checkbox"/> Reading Shop Blueprints <input type="checkbox"/> Refrigeration <input type="checkbox"/> Sheet Metal Worker <input type="checkbox"/> Tool Design <input type="checkbox"/> Toolmaking <p>RADIO, TELEVISION</p> <ul style="list-style-type: none"> <input type="checkbox"/> Electronics <input type="checkbox"/> Practical Radio—TV Eng'ng <input type="checkbox"/> Radio and TV Servicing <input type="checkbox"/> Radio Operating <input type="checkbox"/> Television—Technician | <p>RAILROAD</p> <ul style="list-style-type: none"> <input type="checkbox"/> Air Brakes <input type="checkbox"/> Car Inspector <input type="checkbox"/> Diesel Locomotive <input type="checkbox"/> Locomotive Engineer <input type="checkbox"/> Section Foreman <p>STEAM AND DIESEL POWER</p> <ul style="list-style-type: none"> <input type="checkbox"/> Combustion Engineering <input type="checkbox"/> Diesel—Elec. <input type="checkbox"/> Diesel Eng's <input type="checkbox"/> Electric Light and Power <input type="checkbox"/> Stationary Fireman <input type="checkbox"/> Stationary Steam Engineering <p>TEXTILE</p> <ul style="list-style-type: none"> <input type="checkbox"/> Carding and Spinning <input type="checkbox"/> Cotton, Rayon, Woolen Mfg. <input type="checkbox"/> Finishing and Dyeing <input type="checkbox"/> Loom Fixing <input type="checkbox"/> Textile Designing <input type="checkbox"/> Textile Eng'ng <input type="checkbox"/> Throwing <input type="checkbox"/> Warping and Weaving <p>MISCELLANEOUS</p> <ul style="list-style-type: none"> <input type="checkbox"/> Domestic Refrigeration <input type="checkbox"/> Marine Engineering <input type="checkbox"/> Ocean Navigation <input type="checkbox"/> Shipfitting <input type="checkbox"/> Short Story Writing <input type="checkbox"/> Telephony |
|---|--|---|--|---|

Name _____ Age _____ Home Address _____

City _____ Zone _____ State _____ Working Hours _____ A.M. to P.M. _____

Occupation _____

Canadian residents send coupon to International Correspondence Schools, Canadian, Ltd., Montreal, Canada. . . . Special tuition rates to members of the U. S. Armed Forces.

These great minds were Rosicrucians . . .



Francis Bacon Benjamin Franklin Isaac Newton

WHAT SECRET POWER DID THEY POSSESS?

Why were these men great?

How does anyone—man or woman—achieve greatness? Is it not by mastery of the powers within ourselves?

Know the mysterious world within you! At-tune yourself to the wisdom of the ages! Grasp the inner power of your mind! Learn the secrets of a full and peaceful life!

Benjamin Franklin, statesman and inventor . . . Isaac Newton, discoverer of the Law of Gravitation . . . Francis Bacon, philosopher and scientist . . . like many other learned and great men and women . . . were Rosicrucians. The Rosicrucians (NOT a religious organization) have been in existence for centuries. Today, headquarters of the Rosicrucians send over seven million pieces of mail annually to all parts of the world. Ad-dress: Scribe D.T.V.

THIS BOOK FREE



The ROSICRUCIANS

San Jose (AMORC) California, U.S.A.

SEND THIS COUPON

Scribe D.T.V.
 The ROSICRUCIANS
 (AMORC)
 San Jose, California, U.S.A.
 Please send me the free book, *The Mastery of Life*, which explains how I may learn to use my faculties and powers of mind.
 Name _____
 Address _____
 City _____
 State _____

this ONE GOVERNOR

fits ALL popular farm & industrial gasoline engines

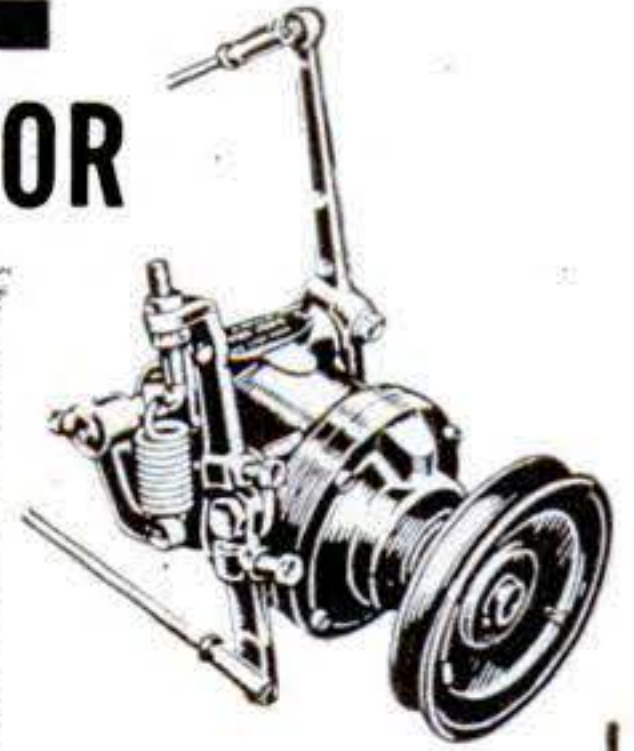

PIERCE LONG RANGE Universal Governor

● Instant variable speed selection and accurate engine control at any speed setting within 1200 to 2200 RPM. Higher and lower ranges obtainable by simple change of pulley. Also "constant speed" operation.

● Accurate, dependable speed control for engines operating corn shellers, drag lines, hoists, arc welders, trucks and tractors with power take-offs, etc.

Write for Complete Information.

DEALERSHIPS AVAILABLE

ONLY \$39.50

Pulley extra
 Send Check or Money Order.
 State Make, Model of engine.

"World's Most Experienced Governor Manufacturer"

THE PIERCE GOVERNOR CO., Inc.
 1654 Ohio Avenue, Box 1000
 Anderson, Indiana, U. S. A.



Bar Bells

BUY DIRECT FROM FACTORY
 Write for free booklet and price list

\$8.95 up

INDEPENDENT IRON WORKS
 2416 East 23rd Street, Dept. "C"
 Los Angeles 58, Calif.

FINE WORK CLOTHES AT LESS THAN

1/3 COST!

STERILIZED, CLEAN-AS-NEW

Surplus Stock. Terrific Values!



PANTS Worth \$3.95 new! You get 4 used pairs for less than the price of 1 new pair! Navy or green. Send waist and inside leg measurements.

99c
 4 for \$3.75

SHIRTS to Match. (Made to sell for \$2.99). 4 for the price of 1! Sturdy fabrics for long tough wear. Send neck size.

79c
 4 for \$2.99

COVERALLS. Made to sell for \$5.95. Yours for less than 1/3! Send chest measurement.

\$1.95
 3 for \$5.45

MONEY BACK GUARANTEE If you're not convinced these are terrific bargains, return 'em within 10 days for full refund. Order today. C.O.D., or send money and we'll pay postage.

TRU VALU SALES CO. Dept. PS-5 1294 E. 9th St. Cleveland 14, Ohio

**Train QUICK
in Big Coyne
Shops**

GREAT OPPORTUNITY FIELDS!

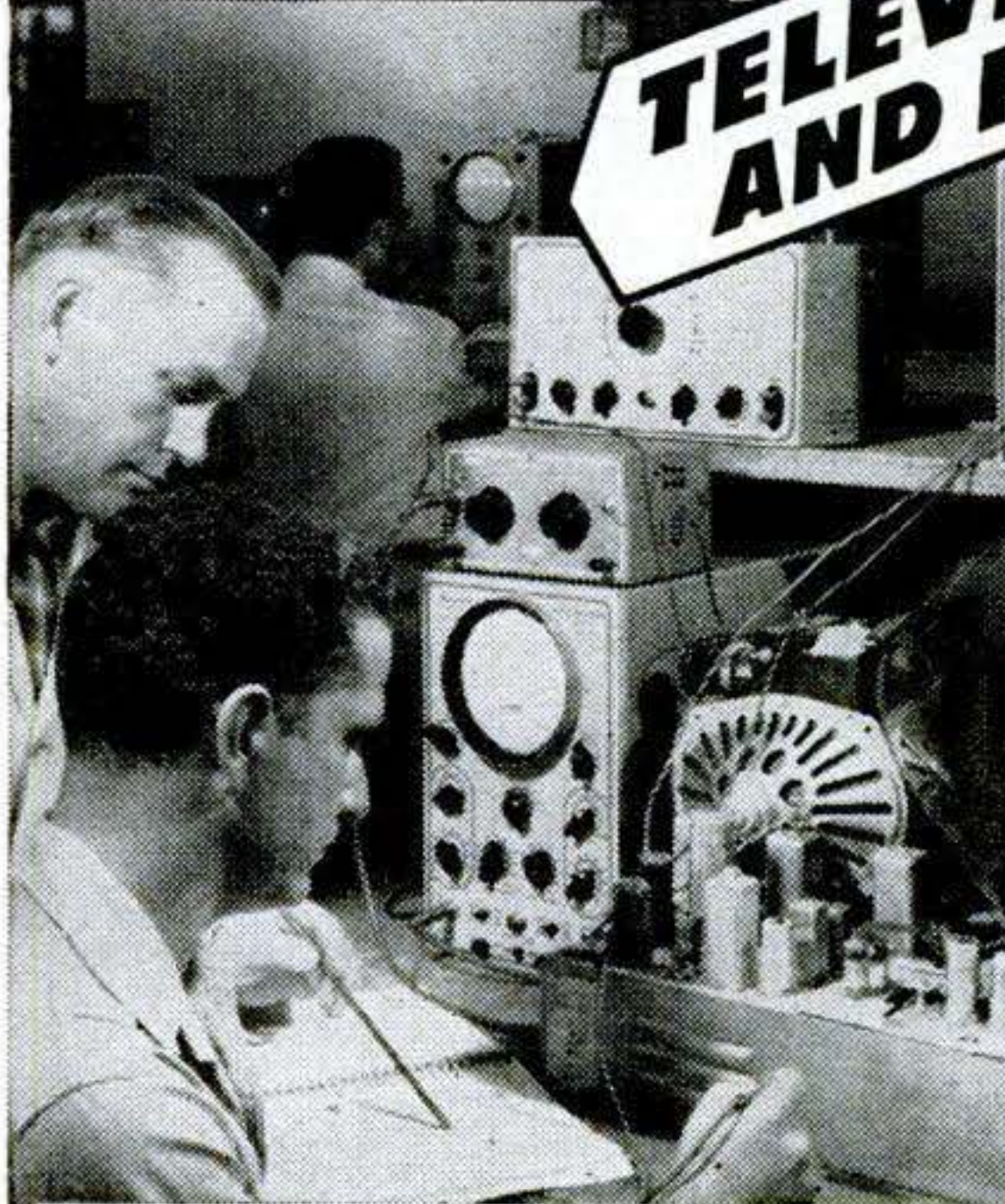

Instructor helping students check the wiring and trace the circuits of television receivers.

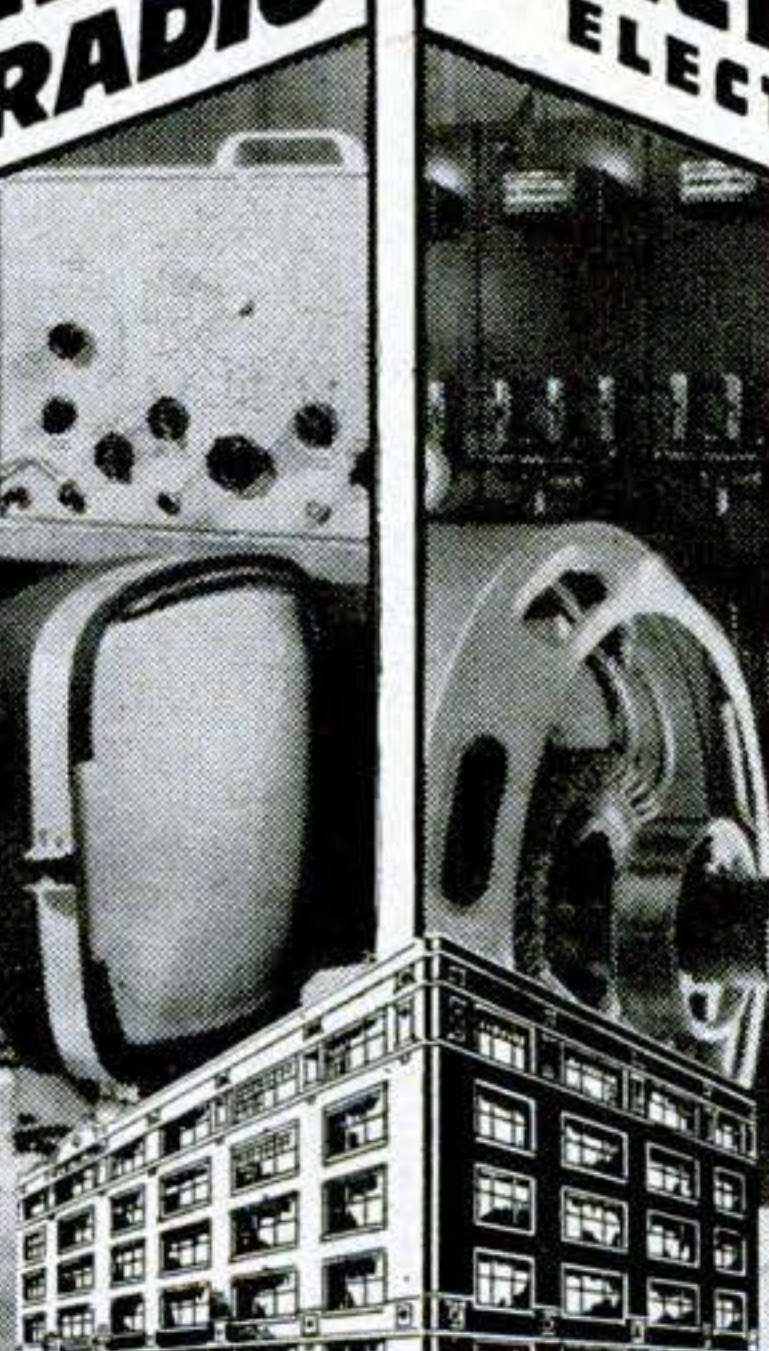

This big fire-proof building is occupied entirely by Coyne.



Instructor explaining operation and testing of a large Motor Generator.

TRAINED YOUNG AND OLDER MEN— URGENTLY NEEDED IN VITAL FIELDS!

ELECTRICITY—RADIO—TELEVISION—ELECTRONICS—VITAL in defense program. Trained men whether 16 or up to 50 needed. **TRAIN QUICKLY** for better rating if drafted—Vital job in industry if not.

TELEVISION-RADIO ELECTRICITY

Here at COYNE you're trained for Television, Testing, Trouble-Shooting on Radio, Public Address, F. M. Sound Units, etc. Many Coyne trained men in good jobs or own well paying Television-Radio businesses of their own.

Big future in Power Plant Work. Motors, Industrial Electronics, Armature Winding, Home and Factory Wiring, Appliances, Refrigeration, Maintenance, Illumination, etc. Lifetime job service to Coyne graduates.

WE TRAIN YOU IN CHICAGO

Our famous Practical-Technical method gives you practical experience on a massive outlay of equipment. Actual shop work plus necessary technical training. You are trained right here in the great Coyne shops. Send for **BIG FREE BOOK**.

**APPROVED
FOR
VETERANS**

START NOW—PAY LATER

Enroll now, pay most of tuition after graduation. **Special plan for men of draft age.** We'll help you get part-time work, if you need it to help pay living costs while at Coyne.

B. W. COOKE, President

COYNE

SCHOOL

**A TECHNICAL TRADE INSTITUTE
CHARTERED NOT FOR PROFIT
Established 1899
500 S. Paulina Dept. 54-73H
Chicago 12, Illinois**

ELECTRICITY ★ TELEVISION ★ RADIO ★ REFRIGERATION ★ ELECTRONICS

LARGEST, OLDEST, BEST EQUIPPED SCHOOL OF ITS KIND IN THE U.S.

Mail Coupon for Big FREE Book!



Whether you prefer Television-Radio or Electricity, train on actual equipment at Coyne. We will send you a Big, fully Illustrated Book. Indicate below which course interests you most. **No salesman will call. Mail coupon TODAY.**

B. W. Cooke, President
COYNE SCHOOL, 500 S. Paulina St.
Dept. 54-73H Chicago 12, Ill.

Send me your **Big Free** book. I am interested in field checked below. This does not obligate me.

TELEVISION-RADIO ELECTRICITY

NAME.....

ADDRESS.....

CITY.....STATE.....

HOW TO FIX ANY PART OF ANY CAR QUICKLY--EASILY--RIGHT!

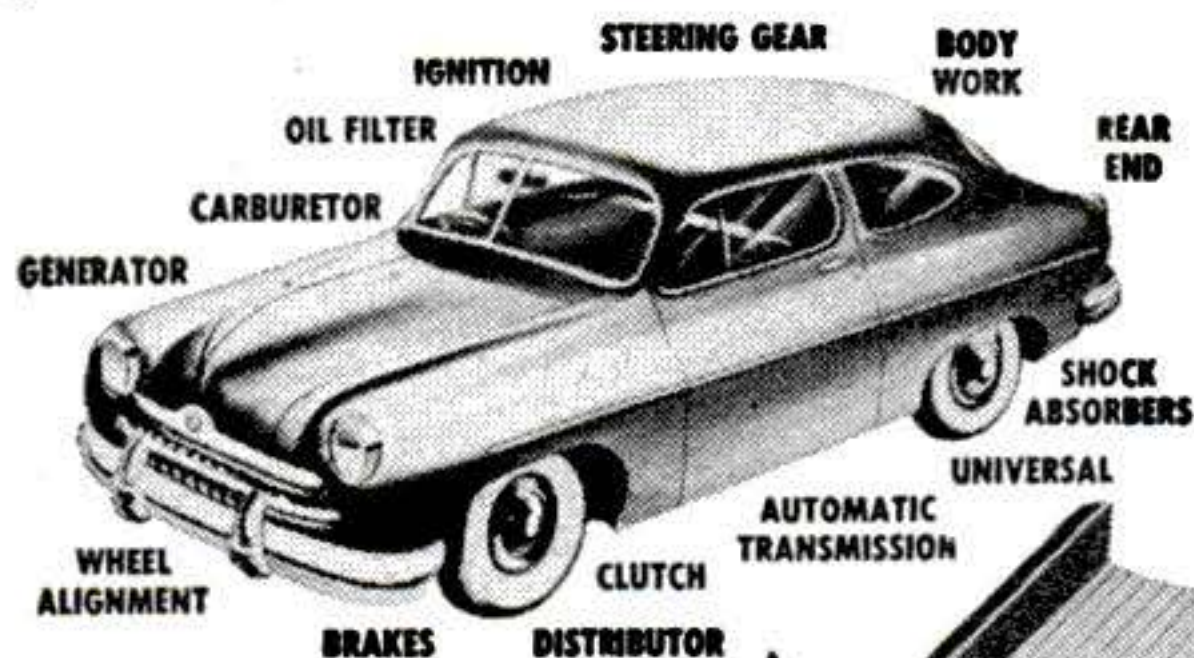

FREE 7-DAY TRIAL



Whether you're a beginner or an expert mechanic—now you can "breeze through" any "fix-it" job from simple carburetor adjustment to complete overhaul. Just look up job in index of MOTOR'S Brand-New 1954 Auto Repair Manual. Follow simple step-by-step directions, clear pictures. Presto—the job is done!

No guesswork! MOTOR'S MANUAL takes you from "scratch"—shows WHERE to start, WHAT tools to use. Covers EVERY job on EVERY car built from 1940 thru 1954!

Everything You Need to Know "Boiled Down" from 140 Official Shop Manuals

NEW, REVISED, ENLARGED, 1954 Edition contains the "meat" from over 140 OFFICIAL shop manuals—simplified for YOU. 22,598 essential repair specifications on over 685 chassis car models. ONE THOUSAND big pages. More than 2,950 "this-is-how" pictures. 225,000 service and repair facts. Leads beginners every step of the way. Time-saving factory repair procedures for experts. Instructions and pictures so clear you CAN'T go wrong. Used by U. S. Army and Navy.

Try Book FREE 7 Days

SEND NO MONEY! Pay postman nothing. Make Manual show you what it's got. Unless you agree this is the greatest time and work saver you've ever seen—return book in 7 days and pay nothing. Mail coupon today to: MOTOR—Book Dept., Desk 2E, 250 W. 55th St., New York 19, N. Y.

Covers 685 Models All These Makes

- | | |
|-----------|------------|
| Buick | Lincoln |
| Cadillac | Mercury |
| Chevrolet | Nash |
| Chrysler | Nash |
| Crosley | Rambler |
| De Soto | Oldsmobile |
| Dodge | Packard |
| Ford | Plymouth |
| Frazer | Pontiac |
| Henry J | Studebaker |
| Hudson | Willys |
| Kaiser | |

Same FREE Offer On MOTOR'S Truck and Tractor Manual

Covers EVERY job on EVERY popular make gasoline truck, tractor made from 1939 thru 1953. FREE 7-Day Trial. Check proper box in coupon.



MAIL COUPON NOW FOR 7-DAY FREE TRIAL

MOTOR BOOK DEPT.
Desk 2E, 250 W. 55th St., New York 19, N. Y.

Rush to me at once (check box opposite book you want):

MOTOR'S New AUTO REPAIR MANUAL. If O.K., I will remit \$1 in 7 days, \$2 monthly for 2 months and a final payment of 95c (plus 35c delivery charges) one month after that. Otherwise I will return the book postpaid in 7 days. (Foreign price, remit \$8 cash with order.)

MOTOR'S New TRUCK & TRACTOR REPAIR MANUAL. If O.K., I will remit \$2 in 7 days, and \$2 monthly for 3 months, plus 35c delivery charges with final payment. Otherwise I will return book postpaid in 7 days. (Foreign price, remit \$10 cash with order.)

Print Name..... Age.....

Address

City..... State.....

Check box and save 35c delivery charge by enclosing WITH coupon entire payment of \$5.95 for Auto Repair Manual (or \$8 for Truck & Tractor Repair Manual.) Same return-refund privilege.

TRY MONTA MOWER
on YOUR OWN LAWN
on Approval!
9 1/2 LBS.

TRIMS AS IT MOWS!
SPECIAL TRIAL OFFER

Save time and labor! Actually "Two-Tools-In-One", the versatile MontaMower is an amazing work saver! Try it on your own lawn, on our Special On Approval Trial Offer! Its live, precision mechanism first gathers, then smoothly cuts a clean 16" swath through grass, dandelions, tall lawn weeds. Cuts right up to walls, fences, trees and under overhanging shrubs... practically eliminates hand trimming! Cuts steep banks easily! Cutting discs are now both Self-Cleaning and Self-Sharpening. Drive shaft mounted on permanently lubricated sealed bearings. Hundreds of thousands in world-wide use. Buy direct from factory and save. Owners Cooperation Plan can repay cost. Write today for full details on limited "On Approval... Trial Offer". Sold Direct Only.

MONTAMOWER DISTRIBUTING CO.
PS-45 Keeler Bldg., GRAND RAPIDS 2, MICH.

PUMP WATER FAST!

DRAIN WASH TUBS, CELLARS, CISTERNS. Famous #7 pumps 2800 GPH. 420 GPH at 75' high or 1600 GPH from 25' well. Sturdy, rustproof Alloy Metal. Six Blade impeller. Uses any 1/2 to 1/2 H.P. Motor. Will not leak or clog. Fits any garden hose. Immediate money back guarantee. Send Check, Money Order, or C.O.D. **\$8 95** IN U.S.

IRRIGATE, FILL TANKS, DRAW WELL WATER. Heavy duty #8 Pumps 7000 GPH. 1000 GPH 75' high — 3000 GPH from 25' well. Rust-proof Alloy Metal. 8 blade impeller. 1" inlet — 1" outlet. Standard Pipe Threaded. Money back guarantee. Send check, Money Order, or C.O.D. **\$11 95** IN U.S.

Free Catalogue — Gear Pumps — Deep and Shallow Well Pumps.

MOORE MANUFACTURING CO.
SWEDSBORO 13 NEW JERSEY

Learn to MOUNT BIRDS

Tan SKINS, make up FURS

Be a Taxidermist. Double your hunting fun. We teach you at Home. Mount Birds, Animals, Fish, Heads, common specimens. Fun and profits. Decorate home and den **MAKE MONEY.** Mount game, tan for others. Big profits in spare time. **WRITE TODAY.** 100 game pictures in **FREE BOOK** Hunters, get your copy. It's **Now Free.** Send post card. State your AGE. **NORTHWESTERN SCHOOL OF TAXIDERMY** Dept. 2605 **Omaha, Nebraska**

High School at Home

Many Finish in 2 Years

No classes. No time wasted going to and from school. Progress as fast as your time and abilities permit. Standard H. S. texts supplied. Thousands enroll each year in this 57-year-old school. Send for **FREE** descriptive booklet.

AMERICAN SCHOOL, Dept. H546
Drexel at 58th St., Chicago 37, Ill.
Without obligation, please send **FREE** descriptive booklet.

Name.....

Address.....

All Electronic Parts
YOURS TO KEEP!

Now!
Work over
300
practical projects
WITH THESE
PARTS...



MULTIMETER

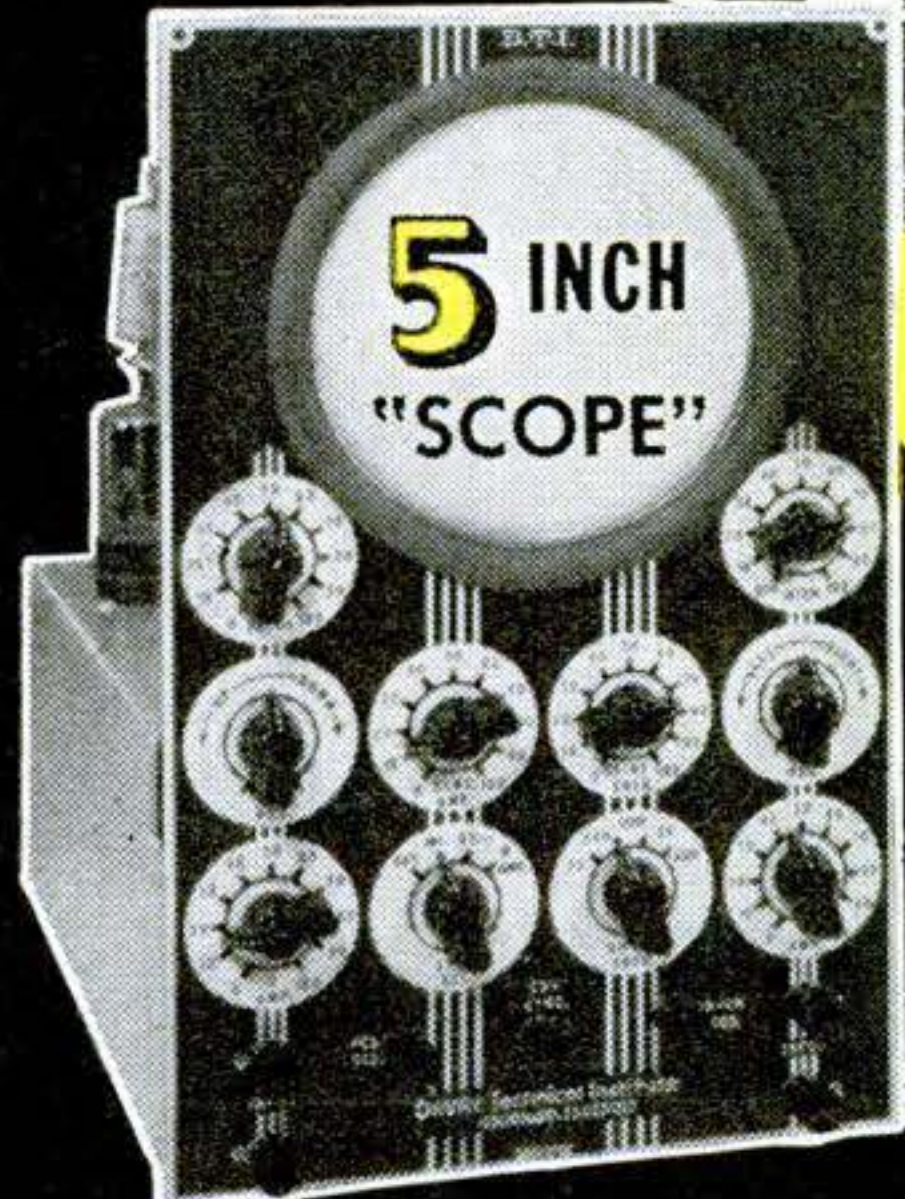

5 INCH
"SCOPE"

.... TO
HELP YOU LEARN

TELEVISION

RADIO-ELECTRONICS Now... at home in spare time you can get BOTH the very training and subsequent Employment Service you need to help you start earning real money in America's thrilling, multi-billion dollar opportunity field of Television-Radio-Electronics. Now that Television is coming to almost every community, here is a chance of a lifetime to prepare to cash in on one of Television's great expansions.

D.T.I.'s amazingly practical home method enables you to set up your own HOME LABORATORY. You get many Electronic parts which you mount on individual bases with spring clip connectors. Tops for experimenting! Add or remove parts in a jiffy. No wasted hours of soldering and unsoldering for each project. You spend *minimum* time to get *maximum* knowledge of important circuits that really work. In fact, you get exactly the same type of basic training equipment used in our Chicago training laboratory—one of the nation's finest.

Build and KEEP This VALUABLE TEST EQUIPMENT

Your home laboratory projects also include building and keeping a versatile 5 inch Oscilloscope and precision Jewel Bearing Multi-Meter. These quality commercial test instruments help you EARN WHILE YOU LEARN and will prove mighty valuable, should you later decide to start your own full time TV-Radio service business. You also build and keep a quality 21 inch TV SET.

D.T.I. Provides EVERYTHING YOU NEED to master TELEVISION

In addition to your home laboratory and easy-to-read lessons, you even use HOME MOVIES—a wonderfully effective and exclusive D.T.I. training advantage. You watch hidden actions... see electrons on the march. Important fundamentals... become "movie clear," helping you learn faster... easier... better.

Full time Residential training in D.T.I.'s great Chicago laboratories also available. MAIL COUPON TODAY for all facts. (If subject to Military Service, you'll especially welcome the information we have for you.)

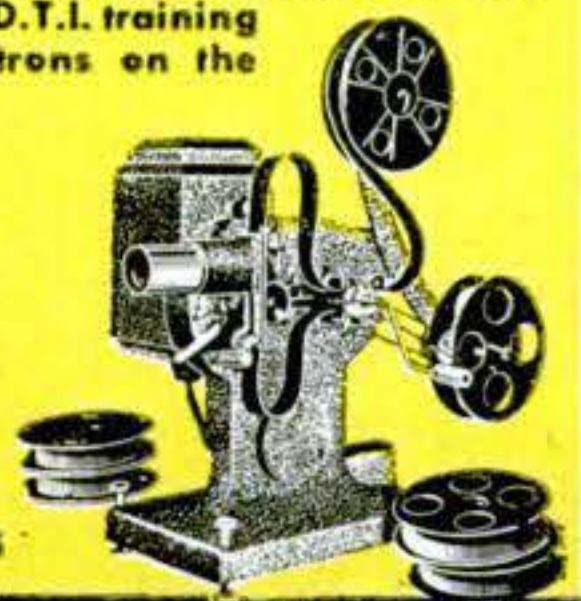

HOME MOVIES

89 WAYS TO EARN MONEY

MAIL COUPON TODAY!

Build and keep this **BIG DTI** Engineered TV set—easily converted to U.H.F. (DTI offers another home training, but without the TV set.)

21 INCH

"ONE OF AMERICA'S FOREMOST TELEVISION TRAINING CENTERS"



DEVRY TECHNICAL INSTITUTE
AFFILIATED WITH
DEFOREST'S TRAINING, INC.
CHICAGO 41, ILLINOIS

DEVRY TECHNICAL INSTITUTE DEPT. PS-5-K
4141 BELMONT AVE., CHICAGO 41, ILL.

I would like your valuable information-packed publication showing how I can get started toward a good job or my own business in Television-Radio-Electronics.

Name _____ Age _____
Street _____ Apt. _____
City _____ Zone _____ State _____

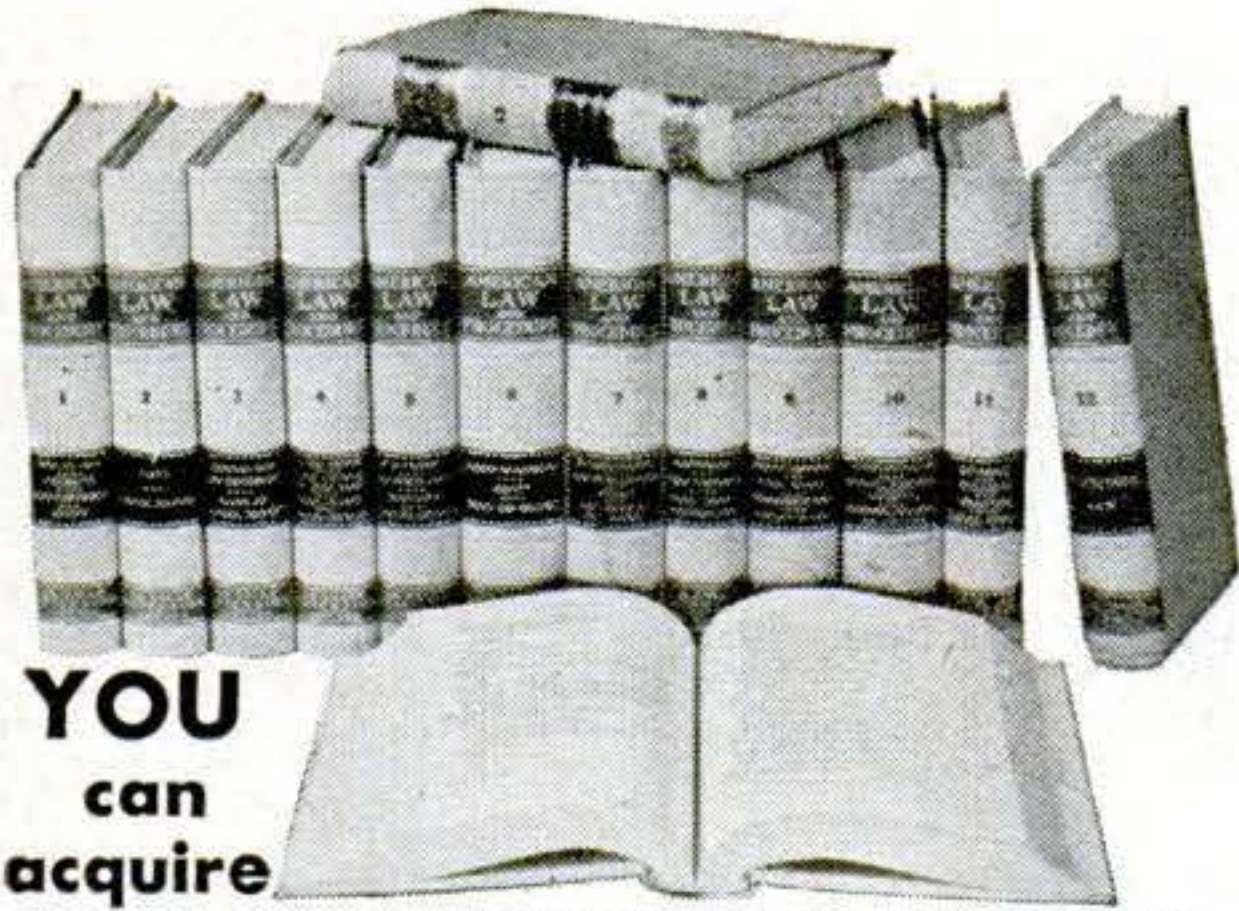

**YOU
can
acquire**

**LAW NIGHTS AT HOME!
LL. B. DEGREE**

LaSalle's famous Law Library—used as reference in many Law libraries and Law offices—has enabled thousands to master Law surprisingly fast, in spare hours at home, for business and professional advancement.

These 14 remarkable volumes, compiled by leading professors and lawyers, cover the whole basic field of Law in condensed, orderly, simplified manner.

You advance rapidly with this great library, plus special lectures furnished. We guide you step-by-step with personalized Problem Method of instruction . . . you *learn by doing*—handling legal problems—not by memorizing rules.

Send for two FREE 48-page booklets, "Law Training for Leadership," and "Evidence," answering questions about Law and its value to you, and telling how LaSalle Law graduates are winning rapid advancement in business and public life. Mail coupon below. No obligation.

**LA SALLE EXTENSION UNIVERSITY
A Correspondence Institution**

417 S. Dearborn St. Dept. 583L Chicago 5, ILL.

Send me your two FREE booklets described above, without obligation.

Name..... Age.....

Street.....

City, Zone & State.....

Inventors

The following are the usual preliminary steps to take toward patent protection.

Make a disclosure of your invention; sign, date and have this document witnessed by two or more people who understand your invention; authorize your registered patent attorney or agent to conduct a preliminary search among previously granted U. S. patents for similar types of invention; secure a report on the probable patentability of your invention and a recommendation of the further course to take.

We shall be glad to send you without obligation our instructive booklet, "Patent Protection for Inventors" and our "Evidence of Invention" disclosure form.

VICTOR J. EVANS & Co. *Merlin M. Evans*
REGISTERED PATENT ATTORNEY
940-E MERLIN BUILDING, WASHINGTON 6, D. C.

INVENTORS

IF YOU WISH TO PROTECT YOUR INVENTION, You should take steps to protect it by a U. S. Patent. Write me for "INVENTION RECORD" FORM

CARL MILLER
REGISTERED PATENT ATTORNEY

WOOLWORTH BLDG., 35th FLOOR, 54C
NEW YORK CITY

INVENTORS

Whether an invention is patentable can be substantially determined by a search of the U. S. Patent records. Without obligation, write for information explaining the steps you should take to secure a patent.

JOHN N. RANDOLPH

Registered Patent Attorney

205 Columbian Building

Washington 1, D. C.



PATENTS

C. A. SNOW & CO.

REGISTERED PATENT ATTORNEYS

WRITE FOR INFORMATION TO

426 SNOW BUILDING, WASHINGTON 1, D. C.



INVENTIONS WANTED

If you want to market, or sell, your invention for cash or royalties, Write for our Free Booklet. Send no drawings. We also welcome hearing from firms, or private capital, wishing to review inventions in any field. We will be glad to send notice of our clients' inventions.

GLOBAL MARKETING SERVICE

1404 Mitchell Street

Dept. SD

Oakland 1, Calif.

INVENTORS

Send for
PATENT INFORMATION
Book and
INVENTOR'S RECORD
without obligation

GUSTAVE MILLER

54-PS WARNER BUILDING
WASHINGTON 4, D. C.

**REGISTERED PATENT
ATTORNEY**

ASSOCIATE EXAMINER
U. S. PAT. OFF. 1922-1929

Patent Attorney & Advisor
U. S. NAVY DEPT. 1930-1947
PATENT LAWYER

**When Writing To Advertisers
Please Mention Popular Science**

INVENTORS

I shall be pleased to furnish you, upon request, with information relative to patent procedure—without any obligation on your part.

PATRICK D. BEAVERS

Registered Patent Attorney

937 Columbian Building, Washington 1, D. C.

Premium Performance! Increased Mileage!

TCP NOW IN CANS!!!

ADD IT TO YOUR GAS YOURSELF AND START SAVING MONEY TODAY!

TCP (Tri-cresyl Phosphate) is the sensational new gasoline additive. Field tests prove that TCP gives more power and increased mileage in *your* car. But until now, you could buy TCP only blended with high-priced *premium* gas. Now you can get TCP *in cans* in concentrated form . . . add it yourself to your favorite brand of *regular* gas . . . get *premium* performance—more mileage, greater power, longer engine life—with lower-cost regular gas and save money on every tankful.

How does TCP give these marvelous results?

These cars were designed to run on regular gas: Chevrolet, Chrysler, De Soto, Dodge, Ford, Hudson, Mercury, Nash, Plymouth, Pontiac, Willys, Kaiser, Buick (Special). Most car owners know a new car soon loses its "pep"—has less power, gives poorer mileage. Expensive high octane "premium" gas is necessary to obtain the same performance which regular gas gave when the car was new. This phenomenon, called "increase in octane requirement", was a mystery to automotive engineers for many years.

U.S. AIR CORPS RESEARCH

During World War II, research by the Air Corps and private industry established that increase in octane requirement results from lead deposits in the cylinder. These deposits cause "pre-ignition"—premature explosion of the gasoline-air mixture before it is ignited by the spark plug. When pre-ignition occurs, the piston is still moving in a direction opposite to that in which the exploding gases have to push it. Thus there is a great loss of power and efficiency—and a great waste of gasoline—not only because the exploding gases have to work against the motion of the piston, but also because the gas-air mixture is not fully compressed when explosion occurs.

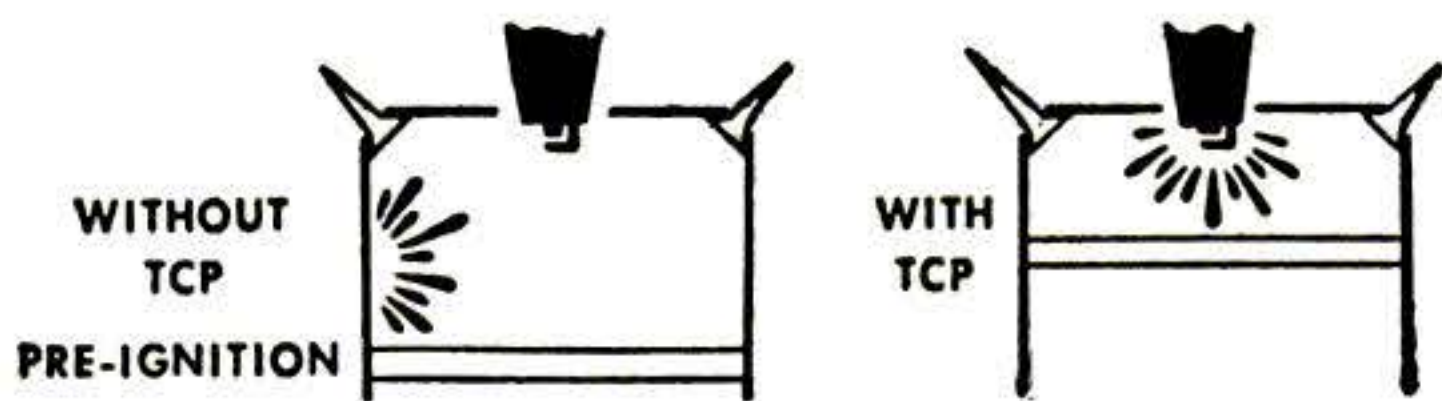

In correct ignition, compression raises the temperature of the gas mixture to a very high point, but never above the temperature at which it explodes. Lead oxides and halides reduce the temperature at which the air-gas mixture explodes, thus causing premature ignition and consequent

QUART CAN—Sufficient for 12 tankfuls of regular gasoline . . . a 3 months supply . . . only \$2.00.



loss of power and gasoline waste. Automotive engineers have now found that cars operated in normal type driving increase from 5 to 15 numbers in octane requirement in a few thousand miles because of the formation of combustion chamber deposits.

TCP eliminates pre-ignition

TCP converts the lead oxides and halides into lead phosphate, an infusible high melting point compound which does not stick to the surfaces of the cylinder. Instead, the microscopic particles are swept out of the cylinder with the exhaust gases.

Field tests with TCP confirmed laboratory findings. In cars operated on ordinary commercial gasoline, pre-ignition became evident shortly before 100 hours and progressed to a severe state at 150 hours. Within a short time after introduction of TCP at the 150 hour mark, pre-ignition ceased completely.

Other advantages of TCP

TCP not only prevents pre-ignition, but is an excellent solvent for gums and resins, which cause sticky valves. Because of its solvent properties, fuel injection systems are kept cleaner and lacquering of engine parts is decreased. For the same reason, use of TCP also reduces deposit of carbon up to 50%. TCP has also proved effective as an upper cylinder lubricant.

Another important result of the removal of harmful lead deposits is a great decrease in spark plug fouling which causes spark plugs to misfire with consequent poor engine performance.

While the use of many fuel additives must be carefully controlled since an excess will produce extremely corrosive products, this is not true of TCP. In fact, an excess of TCP provides better anti-rust protection and upper cylinder lubricating as well as increased cleaning action.

GET IT TODAY!

TCP concentrate *in cans* is now on sale at most automotive supply dealers. If your dealer does not have it yet, send in the coupon below, and begin to get premium performance at *regular gas* prices!



AMERICAN TCP CORPORATION

342 Madison Ave., New York 17, N. Y. PS 5

Please send me quart cans of TCP concentrate at \$2.00 per quart can. Enclosed is check or money order for \$.....

NAME.....

ADDRESS.....

CITY.....STATE.....

Looking for Something?



**FROM BOATS TO
BUILDING MATERIALS
WHATEVER YOU NEED**

**LOOK IN THE
'YELLOW PAGES'
OF YOUR TELEPHONE DIRECTORY**

Does BIG JOB

at small cost

The new improved 1954 CON-SOL All Purpose Power Roller tops even superb performance and dependability of earlier models that are still rolling up an enviable

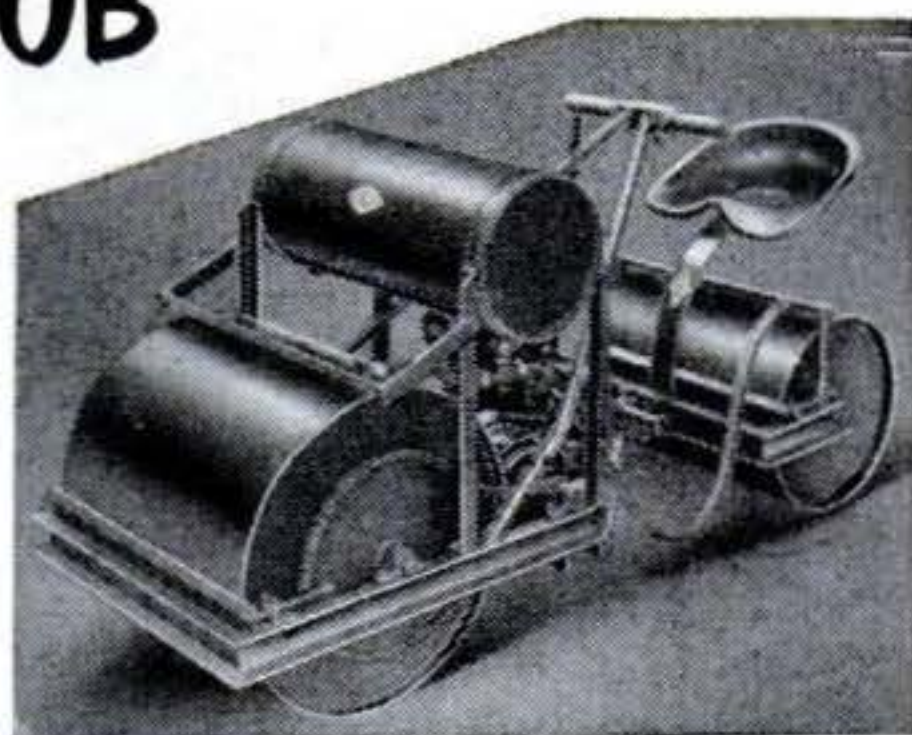

reputation for low cost, top-quality on asphalt and other "hot-top" paving and maintenance work. Equipped with sprinkler tank that wets rollers, preventing sticking of hot asphalt—designed for greater strength, longer life and easier operation with low initial, operating and maintenance costs. Also used for all types of lawn and turf rolling.

Powered by Briggs & Stratton 2½ hp engine, model pictured is adjustable in weight from 375 to 1400 lbs. Lighter weight Standard Model, adjustable to 1200 lbs., also available. Ideal for lawns. Prices start at \$350.00.



Write today for FREE literature to Dept. PS-5R
CONSOLIDATED INDUSTRIES, INC.
WEST CHESHIRE, CONN., U.S.A.

AUTOMATIC

MAKES NEW PROFITS

RETOOTHER

for HAND SAWS

Cuts new teeth in 50 seconds—any size 4 to 16 points. Old teeth fall off as chips. Easy to operate. A perfect job

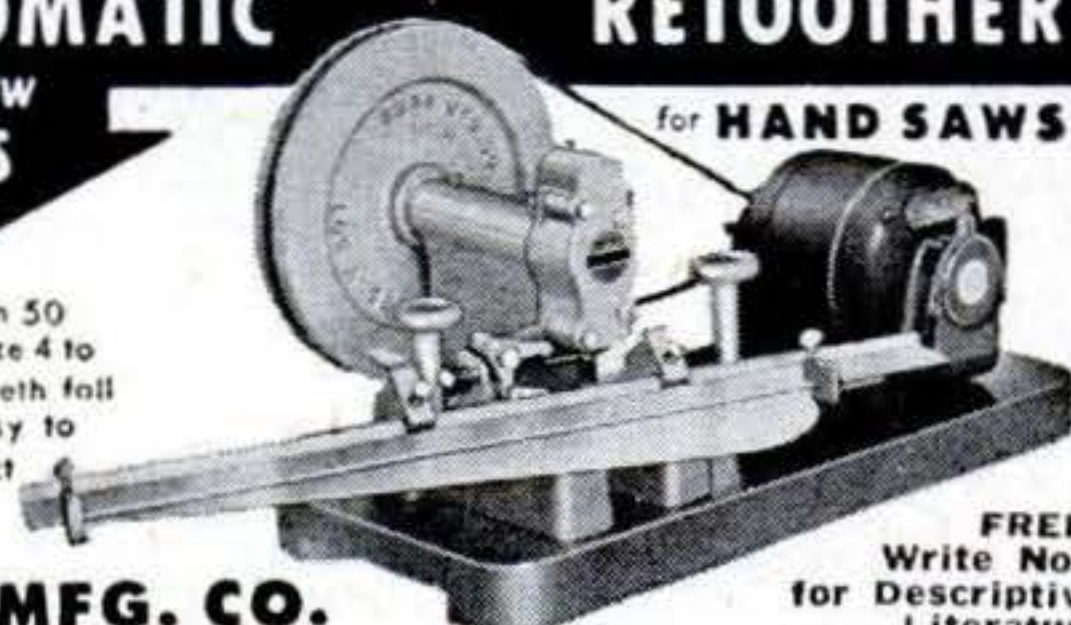

BURR MFG. CO.

8943AA VENICE BLVD. LOS ANGELES 34, CALIFORNIA

FREE!
Write Now
for Descriptive
Literature

EYE GLASSES by MAIL As low as \$1⁹⁵

WRITE for FREE CATALOG with 14 LENS SAMPLE CARD

Thousands of Customers
Est. 1939



QUALITY READING-MAGNIFYING OR BIFOCAL GLASSES FOR FAR AND NEAR
ADVANCE SPECTACLE COMPANY, Inc.
537 S. Dearborn St., Dept. SP-5 Chicago 5, Illinois



TELEVISION OWNERS SAVE ON YOUR REPAIR BILLS

WHEN YOUR SET FAILS OR BECOMES WEAK, CHANGE TUBES YOURSELF!

Why call a repairman when most of your trouble is due to weak, shorted or burned out tubes. TUBE KIT consists of the four most used tubes; comes with directions and an explanation of the trouble that can be cured with each tube.

List \$10.00—Now \$4.98 Each Kit Postpaid

Tube Kit contains:

1 each, tube #1B3, 5U4, 6W4, and 6BG6. Tubes are simple to change. Knowledge of electronics not necessary. Easy directions with kit. Five-day money-back guarantee. Order YOURS today! These tubes may be what your set needs to give your TV new set performance. Better still, have an extra set of tubes on hand for emergency. \$4.98 per kit postpaid, or C.O.D. plus postage.

MULLINS TELEVISION SUPPLY CO.
2158A Mapleview Ave. Dayton 10, Ohio





Weep for poor Willie,
 who thinks he's done fine
 If he gets nothing more
 from car polish - but shine...

So when it starts raining,
 this well-meaning fella
 Has to let his wife drive
 while he holds an umbrella.



But look at Joe Robust!
 His sagacious selection
 Is an easy-on wax
 that gives rock-hard protection!

For Bodygard wax
 holds off nature's barrage
 And his paint job's as safe
 as if in a garage!

(He feels extra breezy, 'cause the job is so easy.)

**MORAL: Use New Liquid Bodygard -
 the first, easy wipe-on wax that
 protects your car with this
 rock-hard finish. Protects 9 times
 longer than skimpy-shine polishes.**

YOU CAN'T SHINE DIRT,
 SO CLEAN YOUR CAR FIRST.

Every car must be cleaned before it's waxed.
 Simoniz Liquid Kleener cleans better, faster.

Copyright 1954 by Simoniz Company

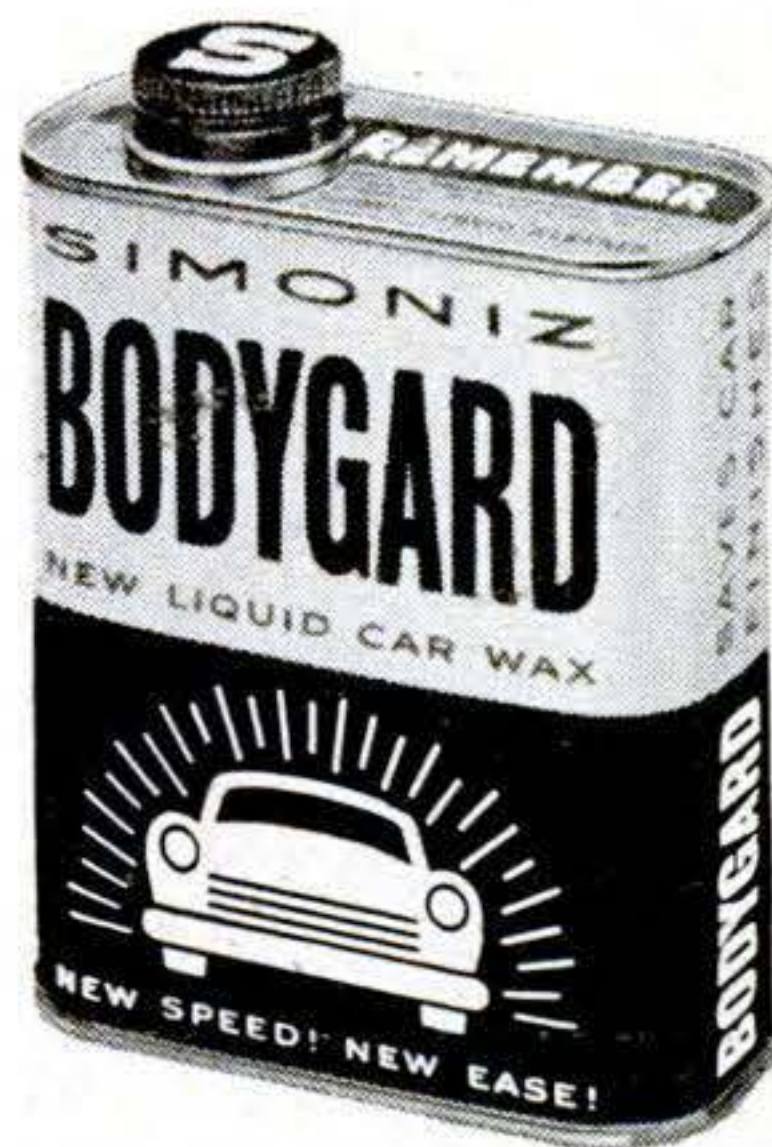

True Simoniz Quality in
 a Liquid Car Wax. **Only 98¢**

AUDELS Carpenters and Builders Guides 4 vols. \$6



Inside Trade Information for Carpenters, Builders, Joiners, Building Mechanics and all Woodworkers. These Guides give you the short-cut instructions that you want—including new methods, ideas, solutions, plans, systems and money saving suggestions. An easy progressive course for the apprentice and student. A practical daily helper and Quick Reference for the master worker. Carpenters everywhere are using these Guides as a Helping Hand to Easier Work, Better Work and Better Pay. To get this assistance for yourself, simply fill in and mail **FREE COUPON** below.

Inside Trade Information On:

How to use the steel square—How to file and set saws—How to build furniture—How to use a mitre box—How to use the chalk line—How to use rules and scales—How to make joints—Carpenters arithmetic—Solving mensuration problems—Estimating strength of timbers—How to set girders and sills—How to frame houses and roofs—How to estimate costs—How to build houses, barns, garages, bungalows, etc.—How to read and draw plans—Drawing up specifications—How to excavate—How to use settings 12, 13 and 17 on the steel square—How to build hoists and scaffolds—skylights—How to build stairs—How to put on interior trim—How to hang doors—How to lath—lay floors—How to paint.

Step up your own skill with the facts and figures of your trade. Audels Mechanics Guides contain Practical Inside Trade Information in a handy form, Fully illustrated and Easy to Understand. Highly Endorsed. Check the book you want for **7 DAYS FREE EXAMINATION**. Send No Money, Nothing to pay Postman.



MAIL ORDER



Check NOW!

You Can Look Over Any Guide In Your Own Home — Start the Easy Payments If Satisfied

MAIL THIS TODAY



AUDEL, Publishers, 49 W. 23 St., NEW YORK 10, N. Y.

Please send me postpaid for **FREE EXAMINATION** books marked (x) below. If I decide to keep them I agree to mail \$1 in 7 Days on each book or set ordered and further mail \$1 monthly on each book or set until I have paid price, otherwise I will return them.

- AUTOMOBILE MECHANICS GUIDE, 1800 Pages \$ 4
- TRUCK & TRACTOR GUIDE, 1299 Pages 4
- DIESEL ENGINE MANUAL, 575 Pages 2
- MACHINISTS HANDY BOOK, 1650 Pages 4
- WELDERS GUIDE, 400 Pages 1
- BLUE PRINT READING, 416 Pages 2
- MATHEMATICS & CALCULATIONS, 700 Pages. 2
- SHEET METAL PATTERN LAYOUTS, 1100 Pages 4
- SHEET METAL WORKERS HANDY BOOK, 388 Pgs. 1
- MECHANICAL DRAWING GUIDE, 160 Pages 1
- MECHANICAL DRAWING & DESIGN, 480 Pages 2
- AIRCRAFT WORKER, 240 Pages 1
- TELEVISION SERVICE MANUAL, 384 Pages 2
- RADIONICS GUIDE, 914 Pages 4
- ELECTRONIC DEVICES, 216 Pages 2
- ELECTRIC MOTOR GUIDE, 1000 Pages 4
- ELECTRIC WIRING DIAGRAMS, 272 Pages 1
- ELECTRICIANS EXAMINATIONS, 250 Pages 1
- ELECTRIC POWER CALCULATIONS, 425 Pages. 2
- HANDY BOOK OF ELECTRICITY, 1440 Pages. 4
- ELECTRIC DICTIONARY, 9000 Terms 2
- ELECTRIC LIBRARY, 7000 Pages (12 Book Set) 18
- MARINE ENGINEERS HANDY BOOK, 1258 Pgs. 4
- SHIPFITTERS HANDY BOOK, 250 Pages 1
- REFRIGERATION & Air Conditioning, 1280 Pgs. 4
- MILLWRIGHTS & MECHANICS GUIDE, 1200 Pgs. 4
- POWER PLANT ENGINEERS GUIDE, 1500 Pages 4
- ENGINEERS & FIREMANS EXAMS, 525 Pages 1
- PUMPS, Hydraulics & Air Compressors, 1658 Pgs. 4
- ENGINEERS LIBRARY (3 Book Set) 9
- MECHANICAL DICTIONARY, 950 Pages 4
- GARDENERS & GROWERS GUIDES (4 Book Set) 6
- CARPENTERS & BUILDERS GUIDES (4 Book Set) 6
- PLUMBERS & Steamfitters Guides (4 Book Set) 6
- MASONS AND BUILDERS GUIDES (4 Book Set) 6
- PAINTERS & DECORATORS MANUAL, 450 Pgs. 2
- HOUSE HEATING GUIDE, 1000 Pages 4
- OIL BURNER GUIDE, 384 Pages 1

Name _____

Address _____

Occupation _____

Employed by _____ \$5

more jobs than graduates

ENGINEERS
Engineering opportunity! If you are interested in these \$1 per hour pay you to write Box D 1 for, including a complete history of science and education.

Demand for our engineering graduates exceeds supply. Effective placement! Study in this world-famed college . . . established 1884. New term starts quarterly. Approved for Korean Vets.

Bach. Sc. degree in 27 months

Bachelor of Science in Mechanical, Civil, Electrical, Chemical, Aeronautical, Radio (Television), Administrative Engineering; Business Administration and Accounting. Also 36-weeks certificate courses in Surveying, Drafting, Secretarial Science. Intensive program: technical fundamentals accented. Small classes: personalized instruction. For earnest, mature students whose time and budget require accelerated courses and modest costs. Preparatory courses.

Beautiful campus in friendly college town. Well-equipped, new and modernized buildings and labs. Enter June, Sept., Jan., March. Write Jean McCarthy, Director of Admissions, for Catalog and View Book.



TRI-STATE COLLEGE

554 College Avenue Angola, Indiana



GIANT 100 POWER DAY & NIGHT TELESCOPE

Steel and brass tubing construction. Ready to use. Two eyepieces. Instructions for use as a helioscope! Extra heavy tripod. \$7.95 fob factory. 400X telescope makers lens kit has brass focusing tube, erector, 5 lenses and instructions. \$3.95 postpaid.

CARL W. JAMER, Dept. S5, MANORVILLE, N.Y.

HAWAIIAN WIGGLER #1

WORLD-FAMOUS FISH-GETTER

Deep runner. No snag-up in pads and brush. Easy to cast. Rubber Hula Skirt acts alive. At your dealer 5/8 oz. or 1/4 oz., \$1.15 each.



FRED ARBOGAST CO. INC. 2315 W. North St., Akron 3, Ohio

FREE WRITE TODAY FOR YOUR BIG FREE ARBOGAST COLOR CATALOG—FULL OF PICTURES OF CATCHES

'How to MAKE MONEY with Simple CARTOONS'



A book everyone who likes to draw should have. It is free; no obligation. Simply address **FREE BOOK**

CARTOONISTS' EXCHANGE

Dept. 195D Pleasant Hill, Ohio

Tool and Die Design Training

\$8,000 to \$15,000 YEARLY INCOME!

ACME training has been fully proved in practice through its fine resident schools. Acme graduates report outstanding promotions, resulting in higher salaries. Progress is sure and easy through Acme's famous "COPE" System. Prepare yourself IN YOUR SPARE TIME for a secure position of responsibility and high earnings, and qualify at a time when you will have every opportunity to rise to a position in the \$8-15,000 per year salary bracket. Be successful—Go Farther Faster!

Approved Under PL550 for Korean Veterans Training

ACME SCHOOL OF DIE DESIGN

Write Correspondence Div., Dept. S, for Information 8 N. JEFFERSON STREET DAYTON 2, OHIO



BIG PROFIT making Concrete Drain Tile

Millions of dollars' worth of drain tile are used every year for farm drainage, building construction, reclamation projects, highways, and other purposes. And the big swing is to concrete tile because it's better and costs less. Sales potentials are BIG.

Concrete drain tile is locally manufactured of local materials, for direct selling to local users or contractors. Useless costs—freight, distribution, breakage—are eliminated. While worth more than clay tile, concrete tile can sell for less and still earn a handsome profit.

Tile made on the Champion Machine are strong and uniform. Truly round. All sizes up to 12" diameter. Easy to make because the Champion is simple to operate.

Get The Champion Facts

Write for the *Champion* book. Tells about concrete drain tile as an outstanding manufacturing opportunity. Describes the machine and outlines liberal payment terms.

CONCRETE EQUIPMENT CO.
521 Ottawa Ave., Holland, Mich.

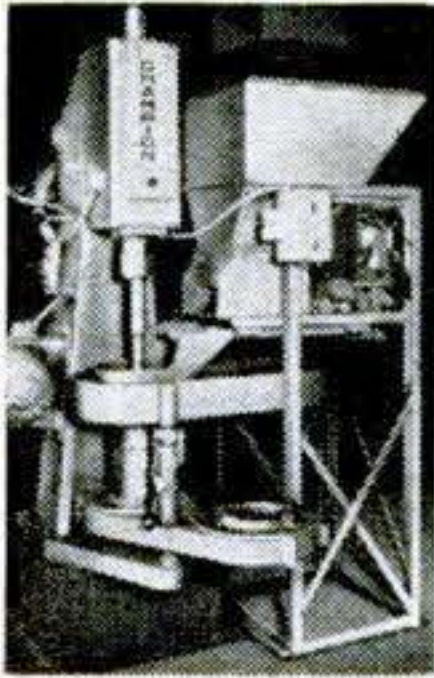
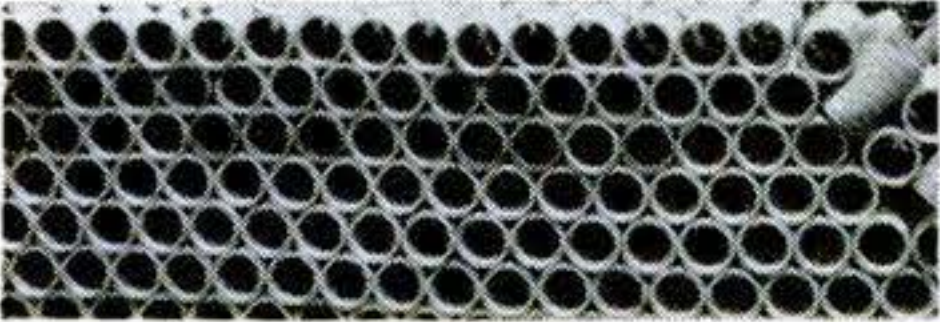

Prints Postal Cards!

FREE Use on 30 Day Trial! Send name today for facts and **FREE** Illustrated Book of unique advertising plans and money-making ideas for your business. Learn how others are boosting sales with post card ads . . . easy with Cardmaster.

Cardmaster Co., 1920 Sunnyside, Dept. 1645, Chicago 40, Ill.



A "GOOD HAND" HELPS YOU SUCCEED!

LEARN TO WRITE WELL

Handwriting quickly improves with our easy-to-understand picture lessons! Put your spare time to good use; send today for **FREE BOOKLET**. "How to Become a Good Penman," or check volumes wanted below at \$1 each: Business Writing Artistic Writing Card Writing Bird & Design Flourishing Engrossing Alphabets. **COMPLETE SET \$4.50.** Ask for price list of penman's supplies.

TAMBLYN SCHOOL of PENMANSHIP
S. A. Ziller, Pres. 438 Ridge Bldg., Kansas City, Mo., USA

Write Your Name
beautifully written, plus special pen-point for shaded writing.
Only 10¢

OUR 53rd YEAR

HYPNOTISM

BE POPULAR • AMAZE • ENTERTAIN

Learn to apply Hypnotism and Auto-suggestion in short time, by training at home, with **GUARANTEED RESULTS — DON'T DELAY.**

Write to America's oldest, most famous Hypnotic school for free information - now - to-day.

JUST FILL IN COUPON AND MAIL

SCHOOL OF APPLIED HYPNOLOGY
Dept. 25
120 Central Park South, N. Y. 19, N. Y.

Please send me Free information:

SENT IN PLAIN WRAPPER

NAME.....

ADDRESS.....

CITY..... STATE.....



Guard NOW against summer overheating

1. Drain out winter-worn anti-freeze and clean with **DU PONT COOLING SYSTEM CLEANSER**

Do it *before* the first summer day can cause overheating! Du Pont Cooling System Cleanser gets rid of rust, scale, grease . . . works as you drive. Thorough, safe, simple.



2. Put in **Du Pont Anti-Rust**
Just pour it in and leave it in!

Just as you pour in anti-freeze for winter, pour in Anti-Rust for summer. Du Pont Anti-Rust protects against the most common causes of overheating. Its special rust-inhibiting action keeps water from rusting in the cooling system. And, at the same time, Anti-Rust keeps out acids and lubricates the water pump—helps prevent squeaking. Simple to use—just pour in liquid Du Pont Anti-Rust and forget it!



ASK ABOUT THE COMPLETE DU PONT SPRING DRAIN-OUT

Includes drain-out, clean-out, adding Du Pont Anti-Rust plus complete cooling system check-up. At garages, car dealers and service stations.

DU PONT NO 7 PRODUCTS
From Chemical Research . . . For Easier Car Care



BETTER THINGS FOR BETTER LIVING . . . THROUGH CHEMISTRY

FREE

GET THE WORLD'S LEADING
TV & RADIO CATALOG

**ALLIED'S 1954
ELECTRONICS BUYING GUIDE**

268
VALUE-
PACKED
PAGES

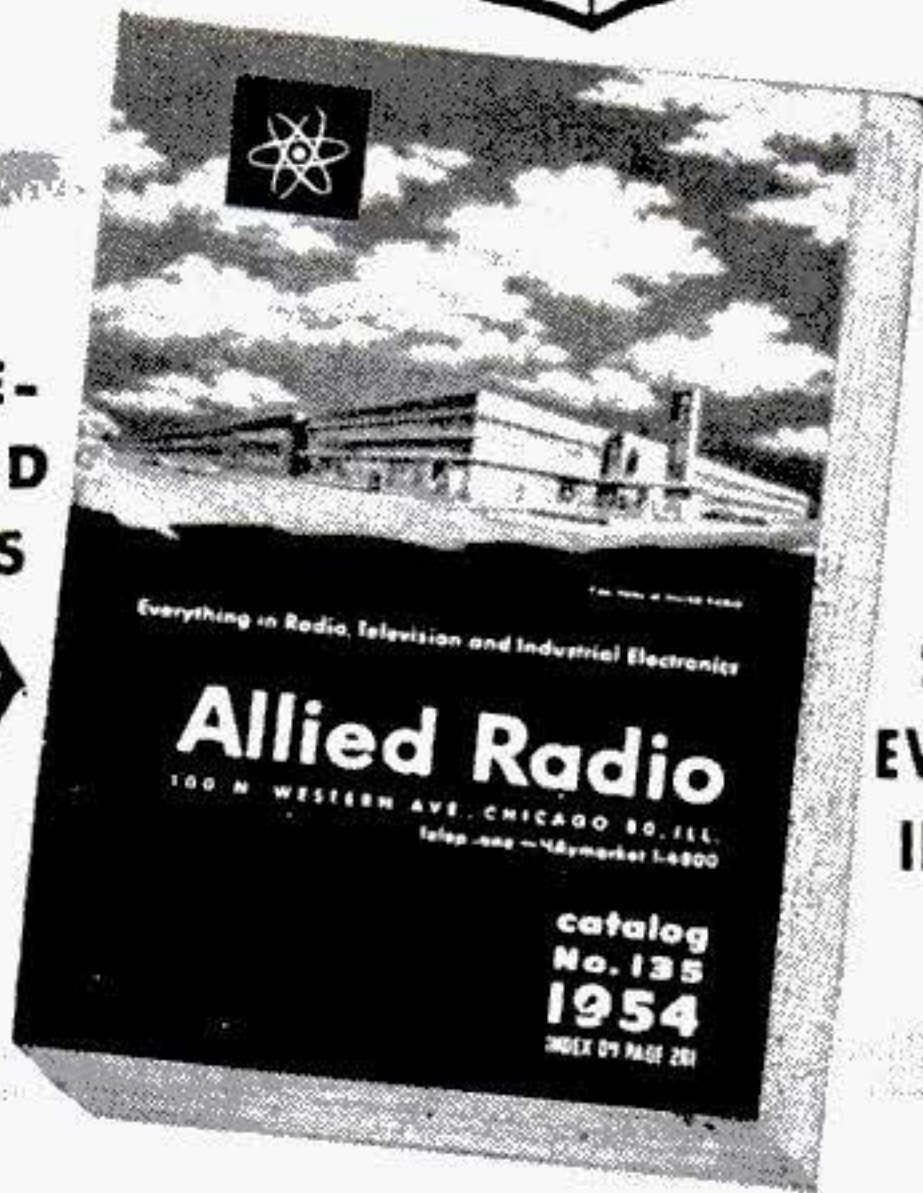

SAVE ON
EVERYTHING
IN TV AND
RADIO

Everything for Experimenters, Builders,
Amateurs, Servicemen, Engineers
and Soundmen...

Get ALLIED's big 268-page
Catalog featuring the world's
largest selections of latest top-
quality electronic equipment
at lowest, money-saving
prices. See the newest in cus-
tom TV chassis, TV accesso-
ries, FM and AM radios, High-
Fidelity sound, Amateur
equipment, P.A. systems,
recorders, test instruments,
builders' kits, industrial elec-
tronic supplies—plus thou-
sands of parts, tubes, tools
and books. Get more for your
money—send today for your
FREE 1954 ALLIED Catalog!

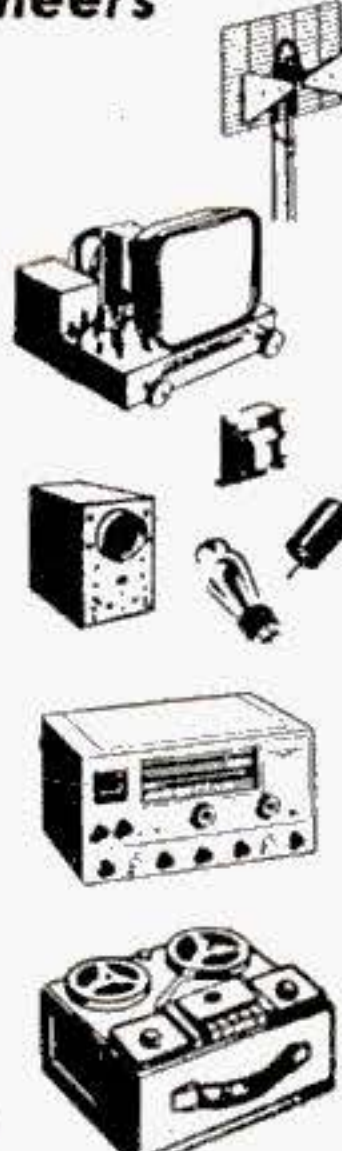

NEW HOME OF ALLIED RADIO

ultra-modern facilities TO SERVE YOU BEST

ALLIED RADIO

**SEND FOR
FREE
CATALOG**

ALLIED RADIO CORP., Dept. 7-EE-4
100 N. Western Ave., Chicago 80, Illinois
 Rush FREE 1954 ALLIED 268-Page Catalog

Name _____

Address _____

City _____

Zone _____

State _____

WHY PAY MORE? Family-safe Partially-used TIRES (NOT RECAPS)

Month After Month, For Years, You See Our Ad.



FREE This Pictured Tire Ash Tray with your name with two or more tires



Car \$3 (20 Mo.) Truck \$11 Tires Guar. Tires

TAKE 10% DISCOUNT Free Tube With Every Tire Goodyear, Firestone, Goodrich, U.S. & Others

AMERICA'S MOST RESPECTED GOLDEN-RULE GUARANTEE FREE REPLACEMENT IF DEFECTIVE
32 Mos. or 50,000 Miles 34 Mos. or 55,000 Miles Tough, Rugged truck Tires 6-8-10-12-14-Ply Tires

600-16 \$5.13	640-15 \$4.84	750-15 \$10.84	32x6(10) \$13.14
600-16(6) 6.64	670-15 5.24	825-15 11.04	750-20 13.24
650-16 5.64	710-15 5.34	750-16(8) 9.34	825-20 17.74
650-16(6) 7.14	760-15 5.84	700-17 8.94	900-20 17.84
700-16 6.24	800-15 6.24	750-17 11.84	1000-20 16.84
700-16(6) 7.24	820-15 6.24	600-20 8.24	1100-20 17.84
750-16(6) 8.34	650-15 5.14	650-20 9.74	1200-20 18.84
550-16 4.44	700-15 5.24	700-20 10.74	1000-22 18.04
550-17 4.44	525-18 4.00	32x6(8) 10.74	1100-22 18.04
475-19 5.34	500-20 4.44		WHITEWALLS \$1 EXTRA

MILITARY GRIP (Not Retreads)
750-20 Super 20 Mos \$12.22 Rugged 34 Mos \$14.44
900-16 Super 20 Mos \$12.22 Rugged 34 Mos \$14.44

MUD-GRIP RETREADS any car \$7 32 Mo. Guar.

"I have personally pinpoint inspected every tire, as if our very future depended on it. There's not 1 tire here I wouldn't use myself. I ask one chance to treat you right." Mort Blatt, Mgr.
—Faithfully serving motorists, hospitals, schools & churches since 1917.

BLATT Phila., Pa., 11th and Spring Garden St.
Miami, Fla., 2827 N.W. 7th Ave.
Order from our nearest store. Send Ck. or M.O. & this ad.
—Thousands of shipments Rushed all over the world.



LEARN TO DANCE \$1.00

Why be a lonely, unpopular wall-flower? Learn all the smart dances from the most modern to the old favorites—at home, in private without teacher, music or partner. So simple even a child can learn quickly. Tap dancing, Waltz, Collegiate, Samba, Rhumba, Jitterbug and many others, including illustrations. Complete course only \$1.00. Also, delightful old square dances with illustrations for \$1.00. Get each Separate or both for \$1.98. If you order both take your choice of FREE-DREAM BOOK or LOVE LETTERS. C.O.D. orders 25c extra and Postage.

Professional taps, toes and heels \$2.98 prepaid or C.O.D. plus shipping charges.
ROLLDEX, P. O. Box 516, Dept. D-85, Safety Harbor, Fla.

EARN WHILE YOU LEARN AT HOME MAKE MONEY 90 WAYS IN PHOTOGRAPHY

If you are OVER 17—good pay, fascinating work await you in photography. Start earning at once as you learn to make money 90 ways with your camera. Our famous, low-cost LEARN-BY-DOING method and INDIVIDUAL guidance train you quickly at home! Write TODAY for FREE catalog. Also Resident Training, 44th Year, GI Approved.
NEW YORK INSTITUTE OF PHOTOGRAPHY
Dept. 5, 10 W. 33 Street New York 1, New York



Secrets of VENTRILOQUISM Now Revealed!



Easy to learn in 60 to 90 days with our Home Study Course. RESULTS GUARANTEED. Make Money! Be Popular! Have Fun! Big Opportunity! Radio, Television, Stage Appearances! For Free Information regarding price and terms, WRITE. You must state your age. Dummy Catalog 25c.
FRED MAHER SCHOOL OF VENTRILOQUISM
Box 36, Studio PS-E Kensington Station Detroit 24, Michigan

POWER MOWERS & KITS

FREE PLANS

LOW FACTORY PRICES DIRECT TO YOU

Build your own quality mower with our LOW COST KITS, Parts, Engines. Free Plans guide you, 3 and 4 Wheel Kits, complete. Parts precision finished, ready to use. Write TODAY for Free Plans, Low Prices, Parts List and Guarantee.

3 & 4 Wheel Model

4 Wheel Direct Drive

America's Finest Power Mowers completely assembled in 3 and 4 wheel models. Belt or direct drive. 18" and 20" sizes. Nationally known make engine. Latest improved features, sturdy construction and money back guarantee fully described in color folder. Write Today.

3-WHEEL KIT NO. T-800

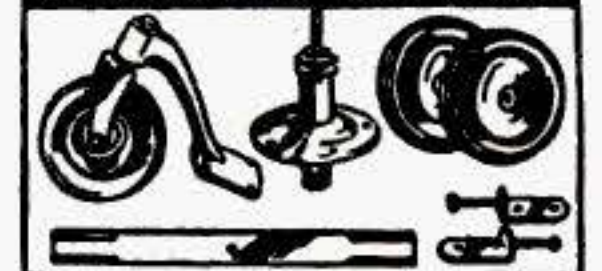

TRIANGLE MANUFACTURING CO., Box S-29, Fort Scott, Kansas

1995 puts power brakes in your car!



AT LAST! THIS WONDERFUL "EXTRA" CAN BE INSTALLED IN YOUR CAR FOR 1/10th THE USUAL COST.

Up to this time, you had to purchase a brand new car to enjoy the wonderful advantages of Power Brakes—and pay up to \$85.00 "EXTRA" for them, too. Now, for the first time, Touch-O-Matic "Million Mile Proven" Power Brakes

SAVE BRAKE LININGS!—SAVE TIRES

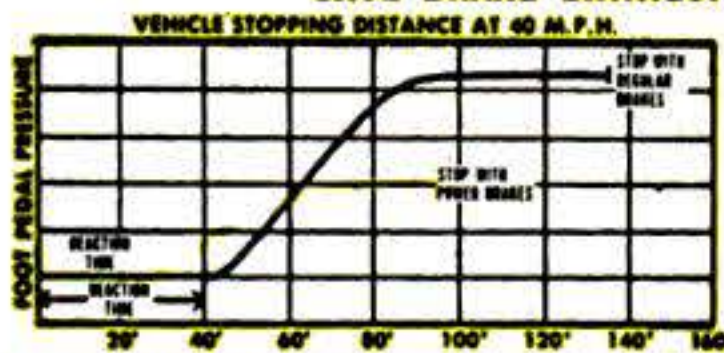

Touch-O-Matic Power Brakes virtually pay for themselves by equalizing braking power on all wheels and reducing tire-wearing skids.

are available to fit any car or truck—and at astonishingly low cost!

POWER BRAKES PUT THE "FUN" BACK IN DRIVING

Power Brakes double braking-power with half the effort. This means that in traffic, or on wet or rough roads, just a touch of your foot brings your car to a soft, smooth "controlled stop." Driving becomes a pleasure, eliminates fatigue... you drive relaxed and refreshed!

DRIVING SAFETY INCREASED 350%

Power Brakes are your insurance against accidents HAPPENING... not just against RESULTS. Simulated graph above illustrates relative foot pressure and distance required to stop a car at 40 MPH (with and without Power Brakes). Power Brakes bring you to a "controlled stop" without skidding!

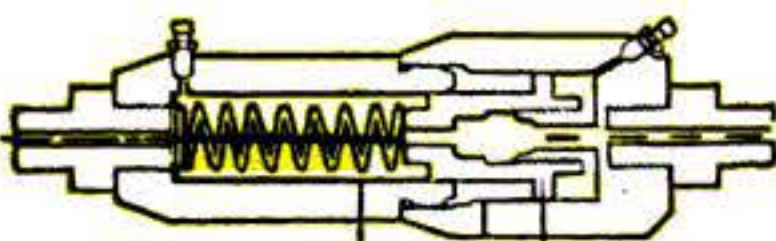

Touch-O-Matic Power Brakes operate on an ingenious double-piston principle which compounds normal hydraulic pressure to generate tremendous braking force using reduced physical effort.

FITS ALL CARS, NEW OR OLD

Yes, Touch-O-Matic Power Brakes can be quickly installed in any car or truck—regardless of make, model or year. That's why they are so reasonably priced. (Most Power Brake manufacturers produce only for one make or line of cars, therefore, their production costs are high.)

INSTALL THEM YOURSELF IN LESS THAN 30 MINUTES

If you can change a tire, you can easily install Touch-O-Matic Power Brakes on your car. All fittings and easy to follow, step-by-step illustrated instructions are enclosed with each Touch-O-Matic Kit. You need only pliers and wrench, (or your garage or gas station will install them for only a few dollars).



ORDER YOUR POWER BRAKE KIT TODAY

If your garage, gas station, or automotive supply store cannot supply, order direct with coupon below. Then put Power Brakes in your car. Try them—use them for 30 days. If you're not absolutely amazed with their performance, your money will be promptly refunded. If you keep them, you're protected by guarantee warranty shown below. Order yours today at this low introductory price!

ATTENTION GARAGES, DEALERS, AUTOMOTIVE ACCESSORY RETAILERS!

Touch-O-Matic Power Brake Kits are available to you for the first time. Add them to your line and increase your business. See your jobber for discounts or write direct c/o Dealer Sales Dept.

Typical installation in late model Mercury takes only 10 minutes

PROTECTED DISTRIBUTOR TERRITORIES OPEN

At last, nationwide distribution is being established on this fine new product. National advertising and publicity to 50 million motorists will soon be launched. Exclusive franchises are now being awarded. Write or wire for complete details to our Mr. Fred Murphy, Sales Mgr.

MILLION-MILE PROVEN

GUARANTEE

Touch-O-Matic Power Brakes are so dependable that similar units are used on jet aircraft. They have also been proven in 3 million miles of driving. Made of finest materials available and rigidly tested before leaving factory, they are fully guaranteed against defective materials and workmanship.

ORDER TODAY AND SAVE!

CONTINENTAL MANUFACTURING PRODUCTS, INC. DEPT. A-5
10418 Venice Blvd. • Culver City, Calif.

Please rush _____ Touch-O-Matic Power Brake Kits at your low introductory price.

Make & Model of car or truck _____ year _____

I enclose \$ _____ (cars, \$19.95; light trucks, \$24.95; 1½ and 2 ton trucks, \$36.75) Send ppd.

I enclose \$5.00 deposit, will pay balance and shipping costs C.O.D.

Name _____

Address _____

City _____ Zone _____ State _____

©1954, Continental Mfg. Products, Inc.

LONG QUART



**SAVES
OIL**

**and
ENGINE
WEAR**

This 100% Pennsylvania motor oil with *THE Tough-Film* stands up under intense heat, resists formation of oil-wasting engine deposits. Your engine stays clean, smooth-running, uses less oil. And because Pennzoil lasts so long, it guards against costly wear caused by acids and friction. Switch to Pennzoil now!

As big a difference as ever!

Most motor oils now contain detergents. A detergent's job is not to lubricate, but to improve conditions under which oil lubricates. Pennzoil, too, contains detergents, but its basic lubricating quality, resulting from superbly refined Pennsylvania crude, still provides an extra margin of safety.

**Sound
your Z
at this sign...**



© 1954, The Pennzoil Co.
Member Penn. Grade Crude Oil Assn., Permit No. 2

**BETTER DEALERS IN EVERY STATE FEATURE
PENNZOIL® MOTOR OILS & LUBRICANTS**

MAKE EXTRA
MONEY

PLASTICS

LEARN
AT HOME

LEARN HOW
TO MAKE
fast-selling
PLASTIC
NOVELTIES
FURNITURE
JEWELRY



SIGNS
TOYS
LAMPS

WRITE
TODAY!

There are RICH OPPORTUNITIES for MEN and WOMEN with "know-how" in Plastics. Interstate's new Plastics course tells and shows how to make hundreds of fast selling items out of Plastics. Gives complete training in fabrication, casting, lamination, molding, internal carving, etc., in simple, easy, step-by-step language and pictures. Plastics and Fabricating Kits for 23 valuable Plastic items come with training at no extra cost. **START A PLASTICS BUSINESS OF YOUR OWN.** No other industry holds such promise for the future. You can make big money manufacturing novelties, toys, signs, etc., in your own home in spare or full time. Don't wait! Learn NOW how Interstate's Plastics Training qualifies you for success in the Plastics field.

PLASTICS AND SUPPLIES FURNISHED
FOR 23 VALUABLE PROJECTS

INTERSTATE TRAINING SERVICE

Dept. C-2-E

Portland 13, Oregon

Sample IMPORTS

FROM FOREIGN LANDS—Exciting, useful sample, products from France, Germany, India, etc., sent to you. Established Import-Export firm offers men or women **FREE** plan for big profit, world-wide, mail-order business at home; or travel abroad. No capital or previous experience needed. Overseas bargains bring high U. S. prices. Write today for **FREE** plan!
Mellinger, Dept. 245, 1717 Westwood, Los Angeles 24, Cal.

REAL ESTATE BE A BROKER

PAYS BIG! SEND FOR FREE, BIG, ILLUSTRATED CATALOG NOW! Graduates report making substantial incomes. Start and run your own business quickly. Men, women of all ages, learn easily. Course covers Sales, Property Management, Appraising, Loans, Mortgages, and related subjects. **STUDY AT HOME** or in classrooms in leading cities. Diploma awarded. Write TODAY for free book! No obligation.

**FREE
BOOK
TELLS
HOW**

Approved for World War II and Korean Veterans
WEAVER SCHOOL OF REAL ESTATE (Est. 1936)
Suite 300 Law Bldg. Dept. PS Kansas City, Mo.

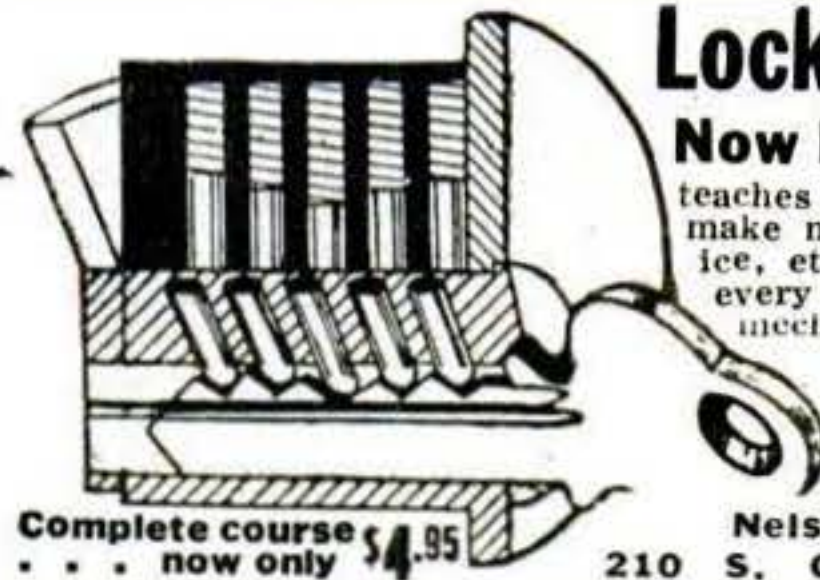

Locksmithing AND KEY MAKING

Now Made Easy! Practical up-to-date course teaches you how to pick locks, de-code, make master keys, repair, install, service, etc. New self-instruction lesson for every handyman, homeowner, carpenter, mechanic, service station operator, fix-it shop, hardware dealer, gunsmith. 53 easy illustrated lessons. Full price only \$4.95, postpaid; or C.O.D. plus postage. Satisfaction or refund guaranteed.

Complete course \$4.95
... now only \$4.95

Nelson-Hall Co., Dept. EW-1
210 S. Clinton St., Chicago 6, Ill.



LEARN MEAT CUTTING

Train quickly in 8 short weeks at Toledo for a bright future with security in the vital meat business. Big pay, full-time jobs—**HAVE A PROFITABLE MARKET OF YOUR OWN!** Pay after graduation. Diploma given. Job help. Thousands of successful graduates. Our 31st year! Send NOW for **FREE** catalog. No obligation. G. I. Approved.
NATIONAL SCHOOL OF MEAT CUTTING, Dept. 51-E, Toledo 4, Ohio

I'll Send You This Handsome SAMPLE CASE - FREE



**and Show You How to Make
Up to \$15.00 in a Day**

WRITE for this **FREE** Tailoring Sample Case packed with 150 beautiful, big-value suit and overcoat fabrics. Take orders from friends, fellow-workers, others, for fine quality, made-to-measure clothes. Pocket big cash profits in advance. Because wearing our suits and over-

coats brings more orders, we make it easy for you to get your own clothes without 1c cost. No experience is needed. **SATISFACTION GUARANTEED.** SEND NO MONEY. Rush your name, address, and age—today!
**J. C. FIELD & SON, INC., Harrison & Throop Sts.
DEPT. K-1720 CHICAGO 7, ILLINOIS**

1000 MILES RECEIVED AT NIGHT!

SKYMASTER PALM SIZE RADIO

Vacuum tube miniature kit covers standard broadcast band 550 to 1600 KC. Hearing aid battery powered. A PERSONAL radio for home, office, camp, etc. This ideal beginner's kit includes photo diagram for easy assembling. ALL PARTS GUARANTEED. Battery plus extra "A" BATTERY, \$1.50. 1500 OHM ALNICO MAGNET powered earphone \$1.45. Flesh-color 1900 ohm HEARING AID EARSET AVAILABLE AT \$4.95. C.O.D. orders acceptable with \$1 deposit within U.S. and possessions.



\$6.75

postpaid

FACTORY-ASSEMBLED

\$8.95

(set only)

PRECISION ELECTRONICS, Dept. J., Placerville, Calif.

SHORTHAND in 6 WEEKS

Famous SPEEDWRITING shorthand. 120 words per minute. No symbols; no machines; uses ABC's. Easiest to learn; write and transcribe. Low cost. 250,000 taught by mail. For business and Civil Service. Typing available. 31st year. Write for FREE booklet to:

Speedwriting
Dept. 2605-4, 55 W. 42 St., New York 36

ALL NYLON Auto Seat Cover!



298

NYLON auto seat cover that is TOUGH! Will Resist Rough Treatment Without Damage. No Installation Problem—No Tacks or Nails Needed. **GUARANTEED TO FIT OR MONEY BACK WITHIN 10 DAYS!** WASHABLE—Dries in One Hour. Split Style for Folding Front Seat and Solid Style for Either Front or Rear Seats. Price **ONLY \$2.98** For Front Split Or Solid Seat and **ONLY \$5.50** for BOTH Front and Rear Seats. Enclose Payment for Prepaid Delivery Or Shipped COD.

MARDO SALES CORP.

Dept. NY-385, 480 Lexington Ave., New York 17, N. Y.

IDEAL LAWNMOWER SHARPENER

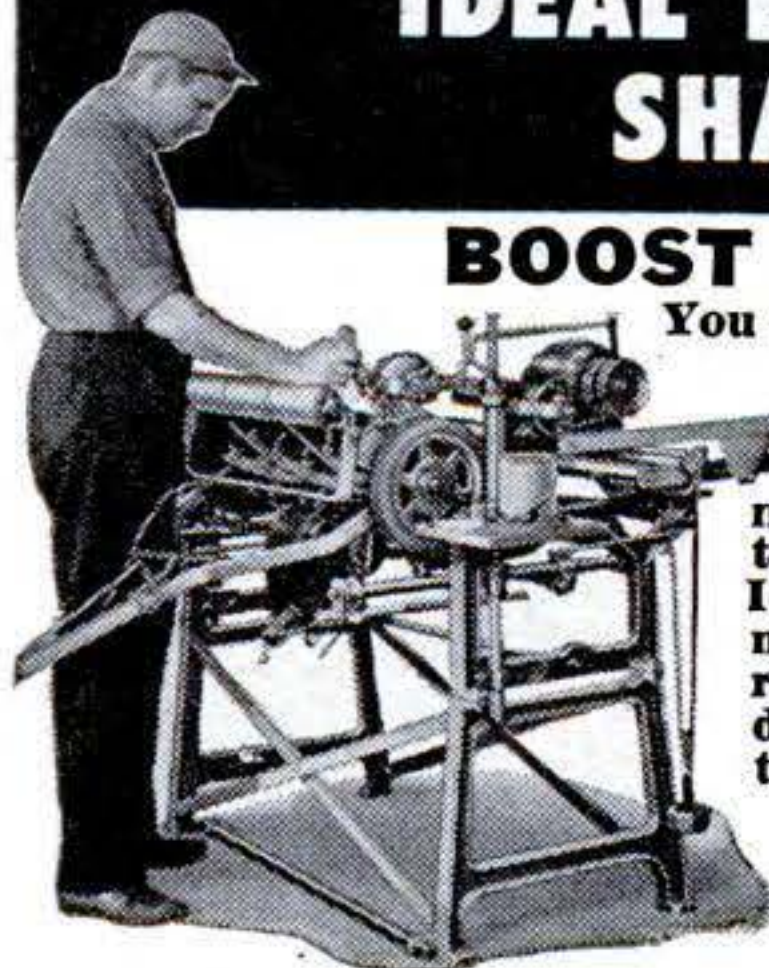

BOOST YOUR INCOME

You can earn extra cash with the Model 300 Ideal Lawnmower Sharpener. Used and recommended by leading manufacturers and service shops, the Ideal has everything you need, nothing else to buy. Grinds reel and bed knife, also reconditions. Get started now in this highly profitable business. Write for catalog today.

The FATE-ROOT HEATH Co.
Dept. PS-5, Plymouth, Ohio

Get into RADIO-TELEVISION ELECTRONICS by Shop-Method Home Training



↑ You also receive this Multitester

Superheterodyne Receiver

GOOD JOBS AWAIT THE TRAINED RADIO-TV TECHNICIAN! Business of Your Own • Broadcasting • Radio Manufacturing, Sales, Service • Telecasting • Television Manufacturing, Sales, Service • Laboratories: Installation, Maintenance of Electronic Equipment • Electrolysis, Call Systems • Theatre Sound Systems, Police Radio • Garages: Auto Radio Sales, Service • Sound Systems, Telephone Companies, Engineering Firms, etc. **WE BRING NATIONAL SCHOOLS TO YOU!** There is a place for you in the great Radio-Television-Electronics industry when you are trained as National Schools will train you at home! OUR METHOD IS PROVED BY THE SUCCESS OF OUR GRADUATES SINCE 1905. **YOU RECEIVE AND KEEP** Signal Generator, T.R.F. Receiver, Audio Oscillator and Superheterodyne Receiver, plus professional Multitester shown above. *No extra charges.* **EARN WHILE YOU LEARN—we show you how!**

APPROVED FOR G. I. TRAINING



FREE RADIO-TV BOOK & SAMPLE LESSON!

MASTER ALL PHASES! Get Master Shop-Method Home Training from an Established Resident Technical Trade School with its own Training Shops, Laboratories, Studios—almost 50 Years of Successful Experience in Training Ambitious Men.

NATIONAL SCHOOLS

Technical Trade Training Since 1905

LOS ANGELES 37, CALIFORNIA

In Canada: 811 West Hastings Street, Vancouver, B. C.

BOTH HOME STUDY AND RESIDENT COURSES OFFERED

MAIL NOW TO OFFICE NEAREST YOU!

(mail in envelope or paste on postal card)

NATIONAL SCHOOLS, Dept. RC-54

4000 S. FIGUEROA STREET
LOS ANGELES 37, CALIF.

OR

323 W. POLK STREET
CHICAGO 7, ILL.

Please rush **FREE BOOK & FREE LESSON**. I understand there is no obligation, no salesman will call.

NAME _____ BIRTHDAY _____ 19__

ADDRESS _____

CITY _____ ZONE _____ STATE _____

Check if interested **ONLY** in Resident training at Los Angeles.

VETERANS: Give date of discharge _____

NOW! Meet the Amazing turtle wax family!

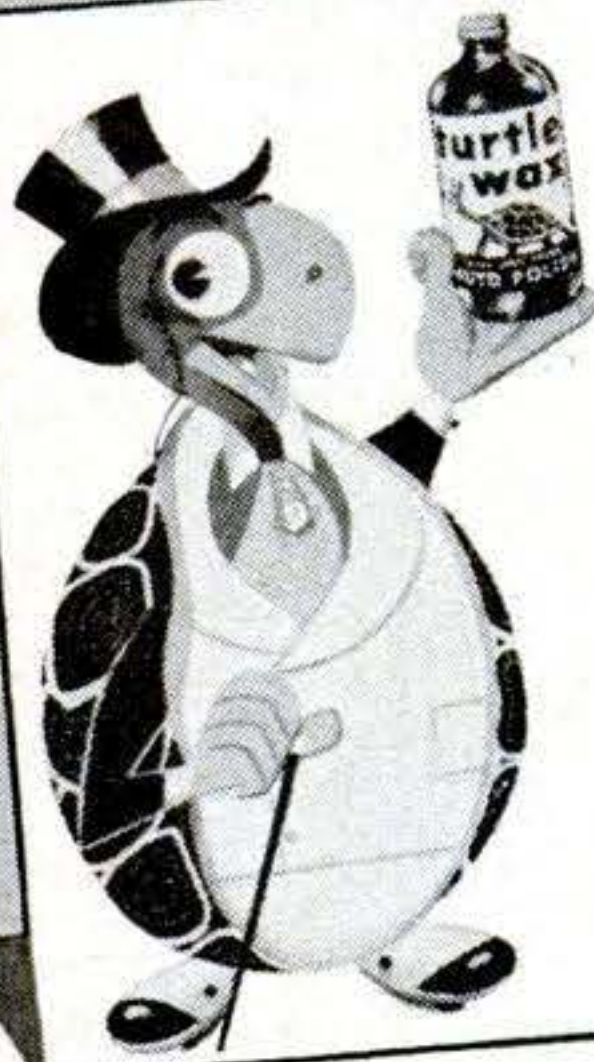

turtle wax AUTO POLISH

TURTLE WAX, the World's Finest Auto Polish! Only TURTLE WAX Cleans, Polishes and PROTECTS your car with a brilliant HARD SHELL FINISH, all in one easy operation! Full year's supply, only \$2 (Fair Traded)

turtle wax FURNITURE POLISH

Now! Transform old furniture into NEW! In minutes, TURTLE WAX Cleans, Polishes and PROTECTS furniture with a rich, lustrous HARD SHELL FINISH. Full year's supply in the new NON-BREAK-ABLE Plastic Squeeze Bottle, only 98¢ (Fair Traded)



tommy turtle BICYCLE POLISH



Tommy Turtle Cleans, Polishes and PROTECTS bicycles with an amazing HARD SHELL FINISH. Removes rust...protects all chrome surfaces. Full year's supply, only 49¢ (Fair Traded)

Only Turtle Wax Products give you a

HARD SHELL FINISH

Available at leading stores everywhere.

© 4-1954 Plastone Co., Inc., Chicago 51, Ill.

DO IT YOURSELF

Remove paint fast, easily, safely from houses, woodwork, boats with the BRAND NEW

LUDLOW ELECTRIC
PAINT REMOVER

Super Glo-Torch

with G.E. Calrod 1000 watt, 115 volt AC-DC tubular heating unit!

ANYONE CAN OPERATE IT! \$10⁹⁵

LUDLOW PRODUCTS CORPORATION
1416 Broadway, Schenectady 6, N. Y.



BEING PUSHED AROUND??



Why take any more nonsense from bullies, wise guys and other pests? The next time they try to act smart—give them the surprise of their lives! It's easy when you know POLICE JIU JITSU! This complete, fully illustrated course comes to you in one volume. The same as taught to police, marines, "G" men, soldiers, sailors and members of the U.S. Coast Guard. By all means, just pin \$1 to this ad and we will send POLICE JIU JITSU! to you postpaid by return mail. Satisfaction guaranteed or your money back.

BOOKS PUBLISHING CO., AMITYVILLE, N. Y.

FREE CRAFT CATALOG



120 PAGES... Craft Supplies, Tools, Designs, Instruction Books from America's Largest, Most Complete Handcraft Stock.

Send for your free copy NOW!

GRIFFIN CRAFT SUPPLIES

5626-B Telegraph Ave. • Oakland 9, Calif.

Also Eshelman SPORT CARS

WORLD'S LOWEST PRICE

70 Miles Per Gal. Holds 1 Adult. Free Literature

RAKES
PLOWS
CULTIVATES
HARROWS
HAULS
SPRAYS
SAWS
DOZER
MOWS
CUTS
ROLLS
TILLS
SNOW PLOW

ESHELMAN

FOR BETTER
LAWNS
and GARDENS

Low as \$69 PLUS TOOLS

1 1/2-3.6 H.P.

Also Power Reverse. Women Can Operate It. Free Catalog. Write: ESHELMAN, Dept. 45 119 Light St., Balto. 2, Md. 333 N. Michigan Ave., Chicago-1, Ill. 7070 Hollywood Blvd., Los Angeles 28, Cal



Find HIDDEN TREASURES

GEIGER COUNTERS (as shown) for Uranium Detection. TREASURE DETECTORS for gold, silver, etc. Lightweight, ultra sensitive. None finer. Also Mineralights for Tungsten.

• INFORMATION FREE •

Detectron Co.

5420 Vineland, North Hollywood, Calif

BUILD-YOURSELF KIT ANODIZED ALUMINUM LIFETIME PICNIC TABLE

You supply the necessary 10" planks, drilled and finished as desired... and this all-aluminum parts kit provides everything else, ready to assemble in minutes, complete with rubber feet, bolts and wing nuts. It's a real savings, direct from factory producing complete, nationally known tables. Will support over one-half ton. Send cash, check or money order. Sorry, no COD's. MONEY BACK GUARANTEE OF SATISFACTION.



ONLY \$17.50

GENERAL EXTRUSIONS, INC.

4041 LAKE PARK RD.

YOUNGSTOWN, OHIO

STOP WASTING GAS

SAVE AS MUCH AS 25%
ON GASOLINE BILLS ALONE
WITH THE **ATOM BUSTER**

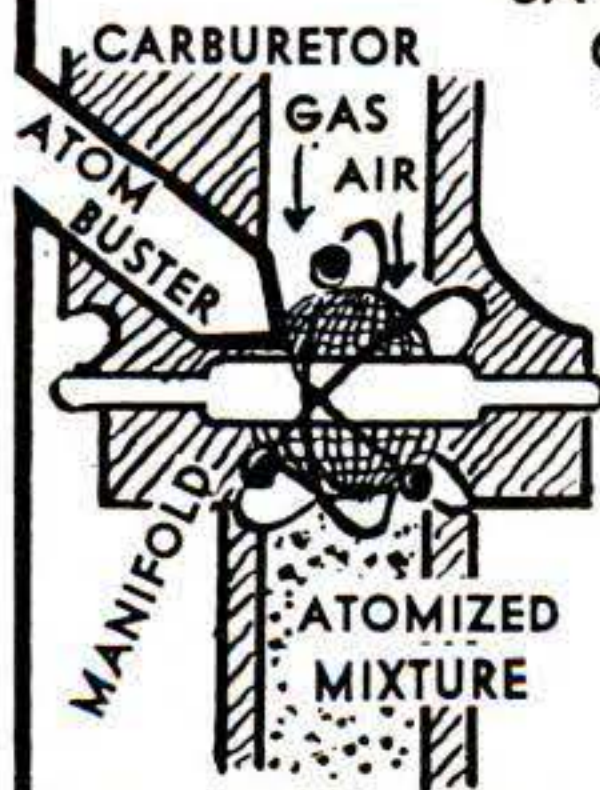

Why pay for gas your car never uses? During every mile you drive, your car blows high-cost, raw, unburnt gasoline out the exhaust. Gas you bought, but never used. That's why the **ATOM BUSTER**, the precision-built, patented atomizer, can pay for itself in one month of normal driving. Simply installed between carburetor and manifold the wire mesh and steel balls churn the mixture of gas and air

into a highly volatile mass of gaseous vapor that's ready to explode with full power. There's no waste! You get greater engine efficiency, more money-saving mileage for your car. You start Big-Savings the minute you install the fully tested and guaranteed **ATOM BUSTER**. If not available at your auto supply store, send check or money order for only \$4.98 direct to manufacturer giving make and model car. **ATOM BUSTER** will be sent Post Paid by return mail.

**ABSOLUTE
SATISFACTION
GUARANTEED**

Desoto Eng. & Mfg. Co.
Dept. PS-4 CLARKSDALE, MISS.

AMAZING NEW POCKET SIZE RADIO

Really Works—Small as a Pack of Cigarettes!



FITS IN ANY POCKET OR PURSE—GETS LOCAL RADIO STATIONS WITH CLEAR BELL-LIKE TONE—NO STATIC OR INTERFERENCE! NEEDS NO TUBES, BATTERIES OR COMPLICATED HOOKUPS! NO AC PLUG INS! Nothing to wear out. Thousands of users—many report years of service. Uses new crystal diode and HI-Q coil. SELF-CONTAINED SPEAKER PHONE. Just the tiny radio to take with you ANYWHERE YOU GO—ON TRIPS, VISITING, ETC.—for real fun and enjoyment—ANYTIME. SEND ONLY \$1.00
(bill, ck., mo.) and pay postman \$3.99 C.O.D. postage or send \$4.99 for p.p. delivery. COMPLETE READY TO LISTEN.
MIDWAY CO., Dept. PPS-5, Kearney, Nebr.

BREED

• TROPICAL FISH •

EARN \$\$\$\$\$ at HOME DURING SPARE TIME. Wonderful new Home-Business opportunity! HELP US FILL HUGE DEMAND from 20 million hobbyists. Some Rare beautiful multi-colored species sold for \$75 PR. AND MORE. It's easy! It's fun! WE SUPPLY EVERYTHING YOU NEED. Write for FREE plan, reprint, folder and all the details. Please state your age.
TROPICAL FISH BREEDERS OF AMERICA, Dept. 3-5, Los Angeles 15, Calif.

NO BETTER RELIEF AT ANY PRICE
for **HEARTBURN**

TUMS

SAFE, FAST, SURE, PLEASANT

STILL ONLY 10¢ A ROLL

BECOME A Mechanical Engineer

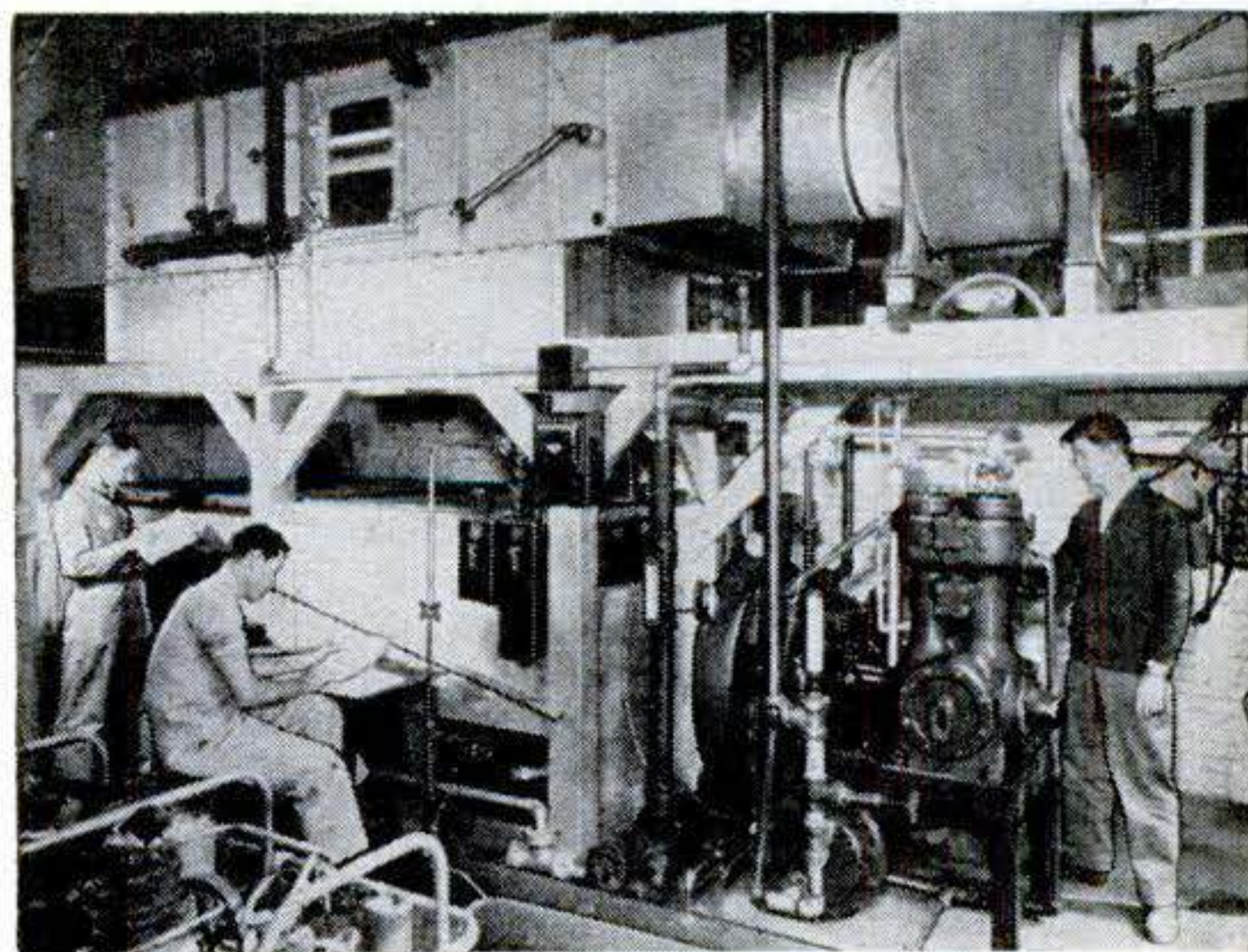

B. S. Degree in 36 months

Mechanical Engineers hold respected, well-paying, and highly interesting jobs in many fields of industry. You can prepare now... for a secure future and a well-paid career as an engineer or engineering technician at the Milwaukee School of Engineering... in one of America's leading industrial centers.

Choose from these courses at the Milwaukee School of Engineering

ENGINEERING 36 months, Bachelor of Science Degree

- Mechanical Engineering with a major in Design, Metal Fabrication or Plant Engineering.
- Electrical Engineering with a major in Electronics or Power.

SERVICE 6 to 12 months

- Electricity ● Heating
- Refrigeration ● Welding

TECHNICIAN 12 to 18 months

- Radio and Television
- Electronics
- Electrical Power
- Mechanical Technician
- Air Conditioning
- Welding

General preparatory course — 3 months.

TERMS OPEN JULY, SEPTEMBER, JANUARY, APRIL
Faculty of specialists. Over 50,000 former students. Annual enrollment from 48 states and 23 overseas countries. *Non-profit. 51st year.* Military, Practical or Academic training evaluated for advanced credit. Approved for Veterans Training. Write for details today.

MILWAUKEE SCHOOL OF ENGINEERING

MS-8

MILWAUKEE SCHOOL OF ENGINEERING
Dept. PS-554, 1025 N. Milwaukee
Milwaukee 1, Wisconsin

Send for free illustrated career booklets Radio-TV
 Mechanical Technology Electrical Technology.

I am interested in _____
(name of course)

Name _____ Age _____

Address _____

City _____ Zone _____ State _____

If veteran, indicate date of discharge _____

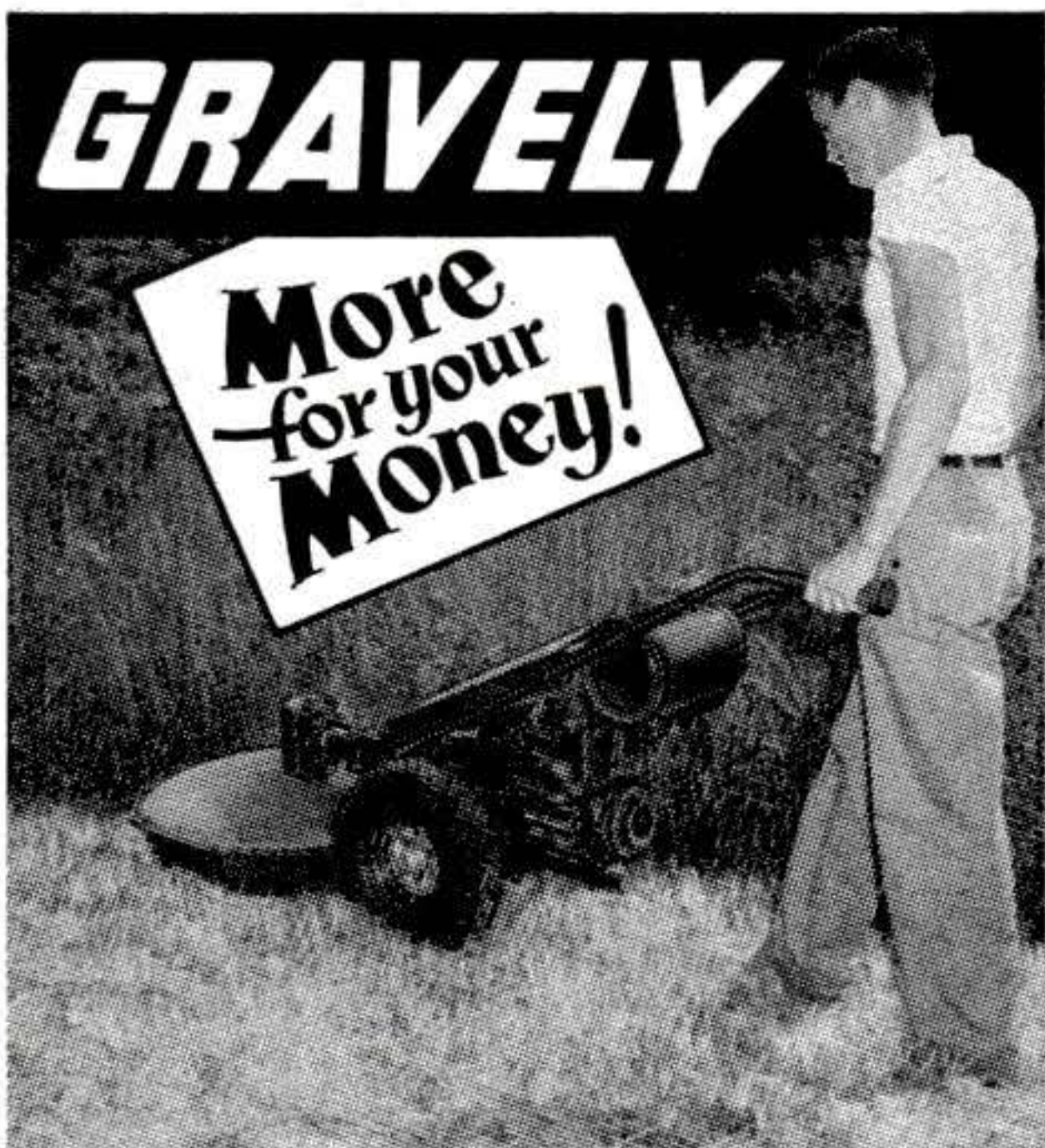

More Power for TOUGH JOBS!

Gravely Rotary Mower attachment makes the toughest mowing jobs *easy*. Lawn or weeds, cut 30-inch swath fast and clean with suction-tip, file sharpened knives.

Gravely does jobs other tractors won't . . . because the 5-HP Gravely has the *extra* power that makes tough jobs easy.

Let us show you the advantages of the Gravely's *extra* power . . . all-gear drive . . . power reverse . . . your choice of 21 tools to do every mowing, gardening or upkeep job . . . *faster, better, easier!*



Write for FREE Booklet
"Power vs Drudgery"

GRAVELY TRACTORS, INC.
BOX 584 DUNBAR, W.VA.



GO PLACES

LEARN ANOTHER

LANGUAGE

EASILY - QUICKLY

IN 20 MINUTES
A DAY

by **LINGUAPHONE**

World's-Standard CONVERSATIONAL METHOD

**FRENCH
SPANISH
ITALIAN
GERMAN
RUSSIAN
JAPANESE
PORTUGUESE**
—any of
29 Lan-
guages

Are interesting job, travel, cultural, armed services' opportunities passing you by because you speak only one tongue? Learn another language **AT HOME** the same, natural, easy way you learned English long before you went to school. **YOU LISTEN**—you hear native men and women speak—you understand—**YOU SPEAK**. Worldwide educational endorsement; over a million home-study students of all ages. **FREE BOOK**, "Passport to a New World of Opportunity," gives fascinating facts. **WRITE TODAY!**

LINGUAPHONE INSTITUTE, 147-05 RCA Building, N. Y. 20, N. Y.

Send me your FREE book. I want to learn . . . language.

Name

Address

City, Zone & State.

BUILD your own TV set

YES, actually build a valuable TV Set right at home. At the same time learn all about installing, repairing, servicing—and get ready for a Big-Pay Job in America's fastest-growing, most exciting industry. The CTI TV Train-at-Home Plan is preparing hundreds for bigger pay TODAY—and a brighter Future TOMORROW. No experience needed. We supply easy-to-understand instructions—made clear with hundreds of charts, diagrams, photos—plus TWENTY KITS of Parts, Professional Equipment and Tools Get a TV Set to ENJOY Get set to ENJOY a TV Future Make money in spare time while taking Course. THOUSANDS SUCCEEDING! So can You Send today for big FREE Book, "You Can Succeed in Television."

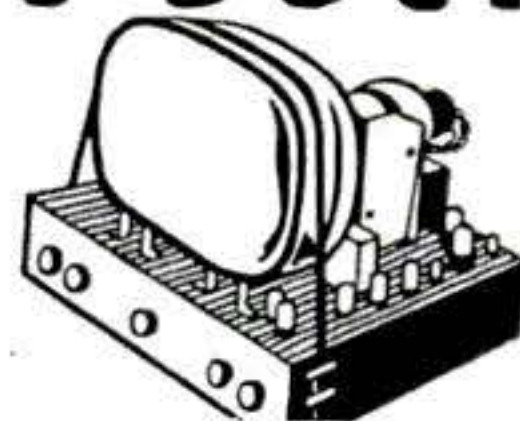

COMMERCIAL TRADES INSTITUTE

Dept. T1-5, 1400 Greenleaf Ave., Chicago 26, Ill.

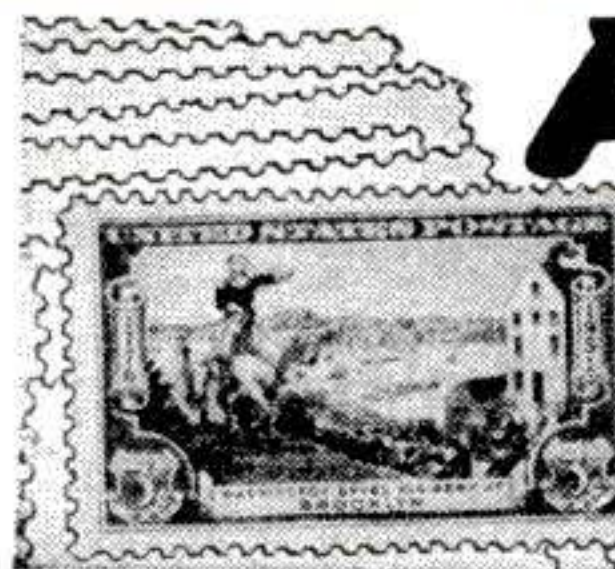

FREE 10 U.S. STAMPS

COLORFUL set of 10 famous historic U. S. stamps—all different—sent FREE to secure names for our mailing list. Each stamp worth real money. We'll also send other interesting offers for your inspection, plus FREE copy of our helpful "How to Collect Stamps." Supply limited. Rush name, address and 10c to help cover actual postage and handling to:
**LITTLETON STAMP CO., Dept. PS-5,
Littleton, N. H.**

CASTING SECRETS REVEALED!

Now you can learn how to make big money by casting thousands of perfect plaques, book ends, figurines, etc., with X.L. rubber molds. **NO EXPERIENCE. VERY LITTLE CAPITAL NEEDED.** X.L. Rubber, Pts. \$2.50; Qts. \$4.00 (postage extra). Molds and enough rubber for three molds, \$1.50 prepaid. U.S. only. Send 25c (refunded with order) for informative catalog (40 pages) describing this wonderful, exciting Profit-making business.

HUGE PROFITS! MORE MONEY!

PLASTIC ARTS STUDIO 3403 S. MADISON, DEPT. 3
MUNCIE, INDIANA

250 POWER



Complete Telescope Lens Kit only \$3.49 postpaid

Conquer Space, Explore the Universe, Planets, Moon Craters, New Stars, etc. Complete Lens Kit consists of 80 inch focal length ground and polished objective lens, eyepiece lenses for 50 POWER, 100 POWER, 150 POWER, 200 POWER, 250 POWER, and all necessary lens fittings. Easy to make from simple step by step instructions. (Tripod and mount not included.) Money back guarantee.

BUSSE SALES CO., Hartford Conn., Dept. PS-21

NO TANKS USED
NEW SIMPLIFIED METHOD

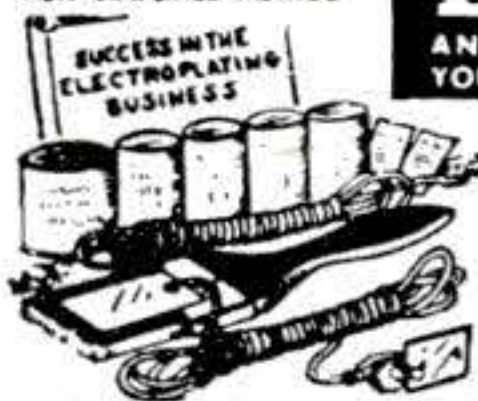

ELECTROPLATE

ANY OBJECT IN HOME, SHOP, GARAGE OR START YOUR OWN WELL PAYING ELECTROPLATING BUSINESS

NOW, using NEW plating kit, it's easy to electroplate any object. Complete kit and instructions on plating Metal and non-metal objects with nickel, copper, chrome, gold, etc. plus full data on obtaining all the business you desire and make **BIG MONEY** full or spare time. **ONLY \$5.95. SEND NO MONEY**—everything sent COD plus postage—OR send \$5.95 now and receive it postpaid. Money back in 7 days if not satisfied. **M. Z. NATIONAL SALES CO., 113-Y West 42 St., N. Y. 36, N. Y.**

Refinish
• TOOLS
• SILVERWARE
• HOUSEHOLD ARTICLES
• JEWELRY
• BABY SHOES
• AUTO PARTS
• ETC.
• like new!

Auxiliary Accelerator LEFT FOOT PEDAL

Auxiliary Accelerator Left Foot Gas Pedal makes driving a pleasure. Permits you to relax, and use left or right foot with equal ease. Fits all cars, either clutch or automatic drive.

Guaranteed for Life of Car on Which Originally Installed

Price \$6.95 Patented Delivered to You Order from R. V. LEHNER, NESS CITY, KANSAS

I have a good proposition for men or women who would like to make an extra \$125.00 a month for spare time



I won't make any fancy promises of \$50.00 a day. I'm not after your money. What I can do is show you a simple plan by which you can pick up extra money every week to help make up for higher taxes and higher living costs.

By Frank W. Strong

I am Sales Manager for a big company making Stainless Steel Waterless Cooking Utensils. By cutting out all other middlemen, and big selling costs we can sell a set of Stainless Steel Cookware for home use for about what it costs some companies to buy it! Others have to add about 5 profits! We



add only our small profit. You add yours—and sell your friends a set equal to \$120.00 to \$180.00 sets sold by other salesmen for only a small part of that cost! Your friends are glad to get such a bargain and they feel that you've done them a real favor! They don't even have to buy a whole set at one time, either. By my Plan they can buy one piece at a time until they accumulate the whole set!

To make an extra \$125.00 a month, you only have to deliver 8 sets and that's easy. Mrs. Montell of Penn. took orders for \$1400.00 worth her first month. Mrs. Wm. Hanchow wrote: "Got my set Saturday—already have 17 customers."

Complete Outfit—Free!

I'll not only be glad to send Free Information, I'll also send you a complete order-taking outfit that you can show to your friends and neighbors. I'll give exact instructions how to get your own 15-Piece Demonstrator Set as a bonus, and how to get orders without making any house-to-house calls. Send your name and address today to Frank W. Strong. Everything I send you is free. No obligation.

CARLTON OF CARROLLTON
2745 High Street - - - Carrollton, Ohio

OWN YOUR OWN BUSINESS!

Repair electrical appliances of friends and neighbors. Service electrical equipment in factories, stores, etc. New Shop Method home training system. Rush name today for FREE BOOK and special form for getting Electronic kit, illustrated instructions on new easy payment plan. Pay us later with your EARNINGS WHILE LEARNING.

CHRISTY TRADES SCHOOL 4804 N. Kedzie Ave. Dept. D-3901, Chicago 25

STUDY AT HOME LAW FREE BOOK!



PREPARE FOR THE BAR

Write today for your copy of our FREE book, "THE LAW-TRAINED MAN," which describes the famous Blackstone home-study course in bar and business law. All needed instruction material furnished including big 16-volume law library. Bachelor of Laws (LL.B.) degree awarded. Moderate tuition; easy monthly terms. Write today.

Blackstone School of Law 225 N. Michigan Ave. Dept. 125, Chicago 1, Illinois
Founded 1890

LEARN DRAFTING HIGHER PAY, BETTER JOB

It's Easy—At Home In Your Spare Time

There is a growing, desperate need for draftsmen—the key men in all industry. CEI can quickly give YOU the necessary technical skill. Bigger income, jobs, and opportunities are yours with a CEI diploma. Thousands have succeeded. So can you! CEI guarantees to train you until you qualify. Write today!

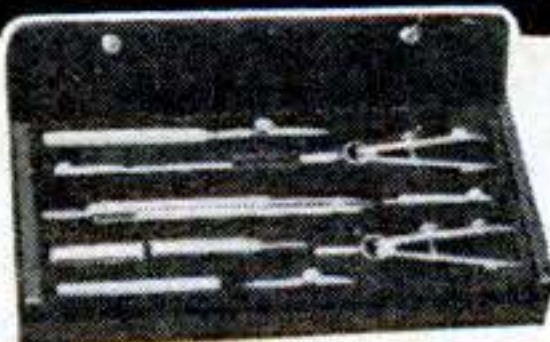

You Get This Professional Set of Instruments at no Extra Cost

Cleveland Engineering Institute Extension Division PS4C 6300 Euclid Avenue, Cleveland 3, Ohio

() Aeronautical () Mechanical
NAME.....
ADDRESS.....
CITY..... STATE.....
No Obligation—No Salesmen

CLEVELAND ENGINEERING INSTITUTE

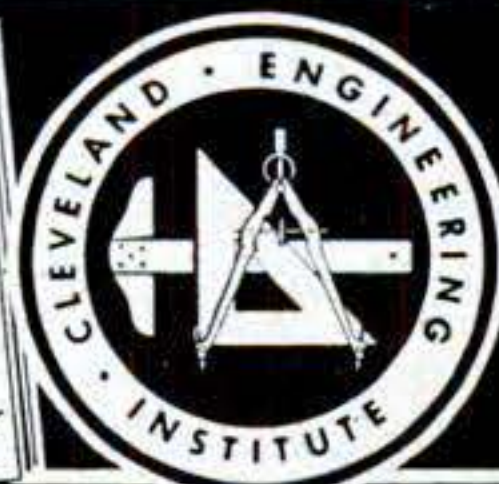

get FREE success book

MECHANICAL



AERONAUTICAL



GET INTO AUTO MECHANICS AND DIESEL!

Shop-Method Home Training

Jobs Like These
Are Open To You as a
Trained Mechanic...Choose
The Field You Like Best!

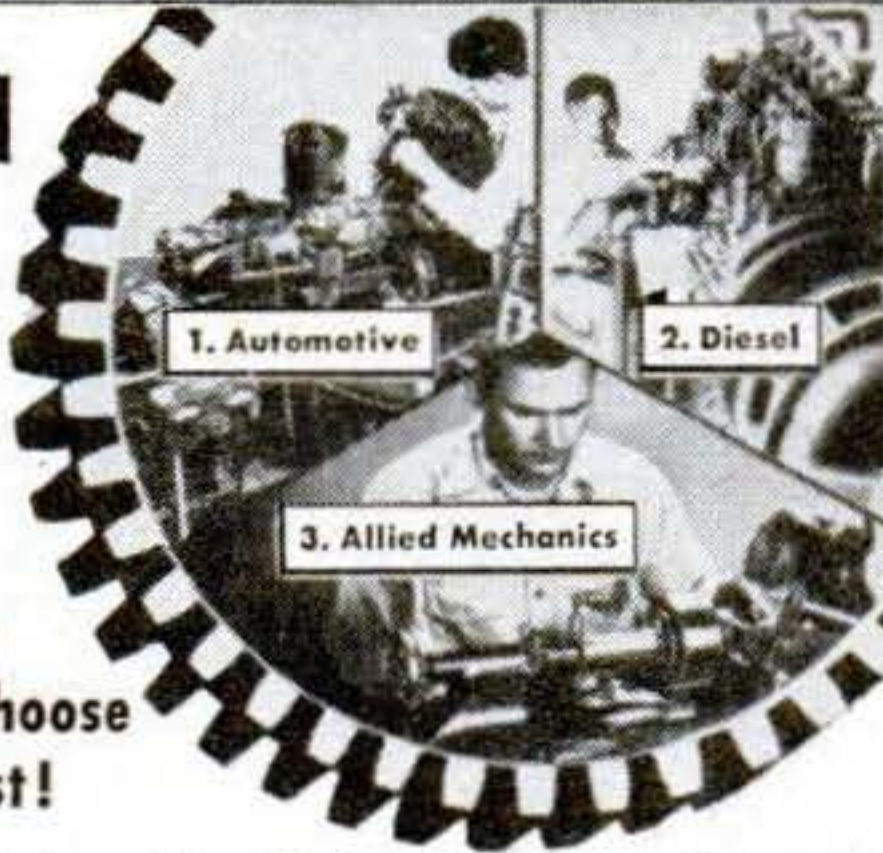

Diesel Fuel Injection • Automotive Motor Tune-up • General Garage Mechanics • Diesel Engine Maintenance • Auto Engine Rebuilding • Auto Elec. Service • Public Utilities • Parts Dealers • Bus & Truck Lines • Contracting & Excavating • Business of Your Own • And MANY other similar openings.

MASTER ALL PHASES! Get Master Shop-Method Home Training from an Established Resident Technical Trade School with its own Training Shops and Laboratories—almost 50 years of Successful Experience in Training Men.

WE BRING NATIONAL SCHOOLS TO YOU!

National Schools trains you for all opportunities in the dynamic, fast-growing Automotive-Diesel and Allied Industries. Pay is good, the future excellent!

EARN WHILE YOU LEARN! Spare Time Work Lessons show you how to earn while you learn...for extra money and experience. You learn by **DOING!**

YOU RECEIVE AND KEEP ALL THIS MATERIAL: Basic Lesson Texts • Diesel Installation, Operation, Maintenance • Diesel Chart Manual • Spare Time Lessons • Thermodynamics • Engine Service Manuals • Engine Repair • Drive Systems.

WE GIVE YOU TOOLS OF YOUR TRADE! Including Drawing Set, Slide Rule, and this all-metal, fully-equipped Tool Kit—all free!



APPROVED FOR G. I. TRAINING

NATIONAL SCHOOLS

Technical Trade Training Since 1905

LOS ANGELES 37, CALIFORNIA

IN CANADA: 811 WEST HASTINGS STREET
VANCOUVER, B. C.

BOTH HOME STUDY AND RESIDENT COURSES OFFERED

**FREE
BOOK &
SAMPLE
LESSON
SHOW
YOU
HOW**



MAIL NOW TO OFFICE NEAREST YOU!

(mail in envelope or paste on postal card)

NATIONAL SCHOOLS, Dept. DC-54

4000 S. FIGUEROA STREET
LOS ANGELES 37, CALIF.

OR

323 W. POLK STREET
CHICAGO 7, ILL.

Please rush **FREE BOOK & FREE LESSON**. I understand there is no obligation, no salesman will call.

NAME _____ BIRTHDAY _____ 19 _____

ADDRESS _____

CITY _____ ZONE _____ STATE _____

Check if interested **ONLY** in Resident training at Los Angeles.

VETERANS: Give date of discharge _____

Shrinks Hemorrhoids Without Surgery

Science Finds Healing Substance That
Relieves Pain—Shrinks Hemorrhoids

Science has found a healing substance that shrinks hemorrhoids, stops pain promptly, ends bleeding—without surgery. Doctors report actual shrinking of hemorrhoids. Sufferers say, "Hemorrhoids have ceased to be a problem." The secret is **Bio-Dyne®**—already widely used for healing injured tissue. This substance is now available in a hemorrhoid ointment called *Preparation H**. Ask your druggist for Preparation H. Money back guarantee. *Trade Mark

BECOME AN EXPERT IN TRAFFIC

Traffic men earn \$4,000 to \$10,000 and up. Thousands of firms need experts on rates, tariffs, regulations. We train you thoroughly in spare time at home for executive traffic jobs. Personal training under traffic authorities. Placement counsel and help. Write for free 48-page book "Traffic Management—the Fast Growing Profession."

**LASALLE Extension University, 417 So. Dearborn St.
A Correspondence Institution, Dept. 583T, Chicago 5, Ill.**

Learn TELEVISION RADIO— ELECTRONICS

TRAIN IN 10 MONTHS OR LESS

Prepare in spare hours for good pay in Television, Radio and Electronics. Train at home with Frank L. Sprayberry, America's outstanding Radio instructor. Big Kits of Equipment furnished. Build testers, sets, etc. Rush name and address for details and 2 **BIG RADIO BOOKS—ALL FREE!** No salesman will call. Write today!

**Sprayberry Academy of Radio, Dept. 55-J
111 N. Canal Chicago 6, Illinois**

LEARN LOCKSMITHING

Learn this fascinating, profitable trade from experts in your spare time at home! Age or physical handicap no disadvantage. Year around, steady income. Full or part time. Practical, illustrated lessons. You can make money even while learning! All materials and special tools supplied without extra charge.

**LOCKSMITHING INSTITUTE, Dept. PS-53
15 PARK AVENUE RUTHERFORD, N. J.**
Lic. by N. J. State Board of Education
Approved for Veterans

WHEELS WHEELS WHEELS

7" Disc Wheel 3/4" Tire 3/8" sleeve	45c ea.
8" Disc Wheel 1 1/8" Tire 1/2" sleeve	70c ea.
7" Disc Wheel 1" Tire 1/2" ball bearing	80c ea.
8" Disc Wheel 1 1/8" Tire 1/2" ball bearing	\$1.00 ea.
6" Disc Wheel 1.50 semi-pneum. Tire 1/2" B.B.	\$1.35 ea.
8" Disc Wheel 2" semi-pneum. T. 1/2" B.B.	\$1.50 ea.
10" Disc Wheel 1.75 semi-pneum. T. 1/2" B.B.	\$1.50 ea.
10" Disc Wheel 2.75 semi-pneum. Tire 5/8" B.B.	\$3.50 ea.
12" Disc Wheel 1.75 semi-pneum. T. 1/2" B.B.	\$1.85 ea.

Above wheel prices includes hub cap. Plus Postage. C.O.D.'s accepted.
AXLES—Sizes 5/16 in., 3/8 in., 1/2 in.—Cut to size—End holes drilled.

**UNITED WHEEL STAMPING CO.
12131 S. PEORIA STREET PS-5 CHICAGO 43, ILLINOIS**

GROW ORCHIDS AT HOME

BIG PROFITS SPARE OR FULL TIME

World's most thrilling hobby—profitable home business. Single Orchid plant may multiply into many—each as valuable as the first. **Successful home grower shows you how!** Raise gorgeous Cattleyas, Cymbidiums, Epidendrums, on living-room table. Big-profit orders come from friends, neighbors, florists, etc.—also Mail Orders. Illustrated secrets of the experts in simple "show-how" language **AND** blooming-size Orchid plants sent at **NO RISK**. Everything you need to start—**for pleasure or profit. FREE**—full details—**SEND NO MONEY**. Write today. **TROPICAL FLOWERLAND, Dept. 25, 4622 Wilshire, Los Angeles 5, Calif.**

YEAR 'ROUND ANY CLIMATE NO EQUIPMENT

NEW INVENTION **REPLATES** by **ELECTROPLATING** RESTORES HOME, AUTO METALS **CHROME-SILVER-GOLD!**

NEW BRILLIANCE WITH SAME PROCESS AS PROFESSIONAL PLATERS

SILVER-CHROME-GOLD



REPLATED, Quickly, Easily
Now—with an amazing new invention, APPL-I-COTER, you plate hundreds of items, using the mild, safe current of 2 flashlight batteries in its handle ALL YOU DO is simply hold disk on applicator to metal, dip brush into solution—and plate as you brush. It's Easy, Quick, Genuine plating.
RESTORE ITEMS LIKE NEW
Replates Silver, Chrome, Nickel, Steel, Gold and Brass—all worn Spots, Stains, "Blisters," Silverware, Trays, Teapots, Rims of Holloware and other items can look like new again with this exclusive Electroplating process. Restore all your valuable Gold jewelry with amazing APPL-I-COTER. The plating you apply becomes an indestructible part of the metal itself!

QUICKLY BUILDS-UP A THICK NEW PLATING WITH EACH APPLICATION.



COMPLETE PLATING KITS:
MET-L-COTE: For Chrome & other white metals... **\$3.95**
SILV-R-COTE: For Silver-plating with pure Silver... **\$3.95**
GOLD-COTE: For Gold Plating... **\$5.95**



BRILLIANT AUTO TRIM — You'll be mighty proud of the Dazzling new finish on your car's bumpers and trim after replating with MET-L-COTE... and remember, each time you electroplate worn areas you build up a lasting layer of coating that tremendously lengthens the life of original trim.

MET-L-COTE is constantly used in leading hospitals, and in doctors and dentists offices to Replate surgical instruments—Also in hotels and restaurants to RESTORE cutlery.

CASH REFUND IF NOT COMPLETELY SATISFIED

EMPIRE MERCHANDISING CO., Dept. JP-5
28 E. First St., Mt. Vernon, N. Y.
Please rush the Complete Plating Kits including Solution, New Pocket Applicator & full simple instructions I have checked below. I enclose full price, sent postpaid, or send C.O.D., plus postage.
 MET-L-COTE—\$3.95 **SILV-R-COTE—\$3.95**
 Combination MET-L-COTE & SILV-R-COTE—\$5.95
 GOLD-COTE—\$5.95
NAME.....
ADDRESS.....
CITY..... STATE.....



A THICKER PLATING WITH EACH COAT!

MET-L-COTE — Replates, Restores worn **CHROME, NICKEL, AUTO TRIM, APPLIANCES, etc.**

SILV-R-COTE — Replates Silver with genuine Sterling.

GOLD-COTE — Replates worn Gold with 24 Karat gold plate. Restores original gold to worn or tarnished valuable jewelry and other Gold Items.

Make money at home Replate jewelry, silver, chrome. Earn up to \$10.00 per hour.

RESTORE YOUR TREASURES-- MAKE THEM VALUABLE AGAIN

Empire Mdsg. Co., 28 E. First St., Mt. Vernon, N. Y.

COMBINATION STETHOSCOPE



SURPLUS—NEVER USED
High Chrome Finish

\$2.95 Postpaid
REGULARLY \$12.00

A professional instrument for detecting delicate mechanism defects.

No C.O.D.'s. Send Check or Money Order to Dept. PS 6

JOB LOT TRADING 53 Vesey St. NYC

PRE-SUMMER SALE

SAVE 20% TO 40%! All United Glasses are Achromatic, Color Corrected. **UNI-COATED*** therefore Sharper, Clearer Crisper! Prices include leather case and straps.

- 10 POWER \$19.95** Palm size yet full 10 6 1/2 Ounce Power. Perfectly balanced. Reg. \$24.95.
- 6 Power \$14.95 7 Power \$16.95
- 5 oz. — 6 oz. —
- 6x30 4x6 in. 15 oz. 390 ft. Field All purpose. Reg. \$34.50 **\$24.95**
- 7x35 5x6 in. 20 oz. 375 ft. Field Very popular. Reg. \$45.50 **\$34.50**
- 7x50 7x7 in. 32 oz. 375 ft. Field Day & Nite Glass. Reg. \$49.50 **\$29.95**
- 8x30 4x5 in. 18 oz. 390 ft. Field Concent'd power. Reg. \$39.50 **\$26.95**
- 12x50 6x7 in. 27 oz. 260 ft. Field Center focus. Reg. \$67.50 **\$47.50**



Use 30 Days At Our Risk. If not satisfied return for full refund. Made in Japan. Add only 10% Fed. tax. Cash orders ppd. C.O.D. include \$2.00 deposit.
United Binocular Co., Dept. ARF-9516
9043 So. Western, Chicago 20, Ill.
DEALERS WANTED! WRITE FOR WHOLESALE CATALOG

UNI-COATED* Internal surfaces vital prisms and front, rear Achromatics are COATED!

Smarter Low-Cost Boating

NOW ONLY 95.— UP



Your steadier, sturdier, streamlined Travel Craft Supreme

FOLBOT
for **EASIER FISHING**
Better Hunting



1 to 4 seaters, paddling, yacht-smart sailing, quieter motoring 1 to 10 HP

ACTION CATALOG

FREE

MAIL coupon to:

FOLBOT CORP. -PS-

Stark Industrial Park, Charleston, S.C.

Name: _____

Address: _____

City: _____ State: _____

The WONDERS of LIQUID PLASTICS

MANUFACTURE WITHOUT TOOLS OR MACHINERY!

EASILY MAKE \$5.00 AN HOUR!

No previous experience or special ability required! NO TOOLS OR MACHINERY required... the entire process is about as easy as pouring water out of a glass! The WONDERS OF LIQUID PLASTICS make all this possible! Many of the products made with our liquid plastics are so beautiful and attractive that we have created an unusual demand for this type of merchandise! That's why we will pay you \$5.00 an hour (materials extra) to make the items shown here and in our catalog for us!

UNLIMITED POSSIBILITIES

Work with LIQUID IVORY, LIQUID GLASS, LIQUID MARBLE, LIQUID EBONY, LIQUID PORCELAIN, LIQUID WOOD, LIQUID GEMSTONE and many other LIQUID PLASTICS and in a matter of minutes turn them into an endless and valuable procession of beautiful imbedded jewelry, novelties, ornaments, statues, bookends, lamps, pensets, lighters, ashtrays, keychains, figurines, curios, SOUVENIRS, art and gift products, fishing lures, BOATS, GADGETS galore, exquisite GEMS! Make gears, tools, dies, forms, handles, dials, knobs, MACHINE PARTS, models of inventions, pistol grips... the list is endless! The only LIMITATION is your IMAGINATION! Liquid Plastics are the blessing of every creative and ambitious person... with these materials ANYONE can create and manufacture by the THOUSANDS and at a tiny fraction of what it would cost by any other method! Just send 25c and we will send you our book, "HOW TO MANUFACTURE WITHOUT TOOLS OR MACHINERY," included with our big 64 page catalog describing all the materials mentioned above; also details of our \$5.00-an-hour offer!

PLASTICAST CO., (Dept. A)
P.O. Box 6737 (Write to either address) Chicago 80, Ill. P.O. Box 987 Palo Alto, Calif.



GEARS



FISHING LURES



PEN SETS



HANDLES KNIVES - DIALS



STATUES FIGURINES



JEWELRY GEMS



NOVELTIES GADGETS



PLASTIC LAMINATING

This remarkable Plastic Laminating Machine will earn \$18.00 an hour right in your kitchen! Big profits laminating Business, Social Security, Identification, Credit CARDS of all kinds, photos, passes, clippings, etc. Price complete (illustrated) \$35.00 plus postage. Others higher. Free literature! **PLASTICAST CO.** (Addresses above)

Paint STRIPES with New "PAINT PEN"!

Makes Straight, Curved or Parallel Lines!

Just fill glass vial with any color paint. Use like a fountain pen to stripe furniture, bikes, autos, model planes, toys, linoleum, wall board. Beautiful, clean, crisp results every time, like professional painters. No experience needed to draw straight, curved, circular or evenly spaced parallel lines. Can't clog or smear. May also be used with glue, tempera, textile paint, or ceramic underglazes. Paints on wood, glass, plastics, metal, fabrics and paper. Lasts a lifetime. Only \$1 postpaid, complete with tip for 1/16 inch stripe. C.O.D.'s plus postage. Used by industry. Order your Paint Striping Tool TODAY!

New! "DOUBLE-STRIP" MODEL Only \$2.95

Newest paint striping invention. Makes DOUBLE stripes — one wide and one narrow or two wide or two narrow at the same time. Or adapt quickly for wide or narrow single stripe. Makes 5 combinations. FREE—Send postcard for complete information... or order now... \$2.95.



\$1.00

DEALERS

Master Paint Striping Tool packed in Display Cartons of 1 dozen. Fast, profitable seller. Write for discounts.

Attention All Home Craftsmen!

New Paint Striping Tool gives "professional" results every time, yet simple and easy to use as a fountain pen. Adjustable guide keeps lines straight as an arrow. Just as easy to make curves or freehand designs. Adds new beauty, finished look to everything you paint. Send \$1 now. **WENDELL MFG. CO., Dept. 2-E** 4234 Lincoln Ave., Chicago 18, Illinois

6 Other Complete Tools

Complete tools for 1/64, 1/32, 3/64, 5/64, 3/32 or 1/8 inch stripes, \$1.50 each. Extra tips 75c ea. COMPLETE KIT with ALL 7 TIPS, \$5.00. (Also 1/4" tip, only \$1.00). All tips interchangeable.

Ball-Bearing SPEED WHEELS

JUVENILE WHEELS (No bearing, solid tires)
5" 45c 6" 65c
7" 75c

(Semi-pneumatic tire, ball bearing)
8x1.25 ... \$1.85 10x1.25 ... \$2.20
8x1.75 ... 1.95 10x1.75 ... 2.30
8x2 2.20 10x2 2.65
12x1.75 \$3.45

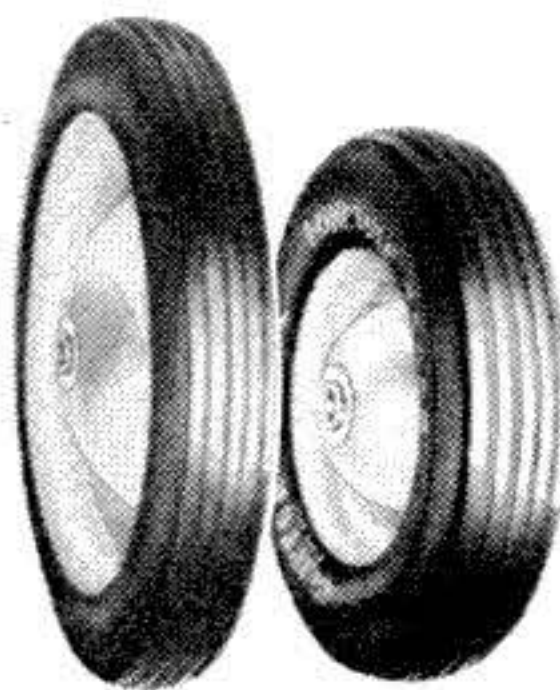

INDUSTRIAL WHEELS

(Lug Base, Semi-Pneumatic tire)
6x2 SW ... \$3.45 10x2.00 ... \$6.10
6x2.00 ... 4.00 10x2.75 ... 5.15
8x2.00 ... 5.20 10x2.75 Pneu. 6.90
8x2.50 ... 5.40 12x2.00 ... 6.90
16x4.00 ... 15.15 12x3.00 ... 9.20
(Smooth Base, Pneumatic tire and tube)
8x3 2 ply \$10.00
10x3.50 2 ply 10.55
12x4 2 ply 14.41
4.00x8 2 ply 13.10
14x4.50 2 ply 15.96

CASTERS—Now Available No c.o.d. orders. Prices F.O.B. our plant.

JIM BROWN TOY COMPANY
1095 HOME AVENUE PS-554 AKRON 10, OHIO

Do FALSE TEETH

Rock, Slide or Slip?

FASTEETH, an improved powder to be sprinkled on upper or lower plates, holds false teeth more firmly in place. Do not slide, slip or rock. No gummy, gooey, pasty taste or feeling. FASTEETH is alkaline (non-acid). Does not sour. Checks "plate odor" (denture breath). Get FASTEETH at any drug counter.



ILLUSTRATED CARTOON BOOKLETS

Men, here are the small illustrated cartoon booklets of comic characters they're talking about. 20, all different, (and other offers) sent for \$1 post-paid. No C.O.D.

GAY SALES, 448-L N. Prior, St. Paul, Minn.

RADIO CONTROL YOUR MODELS

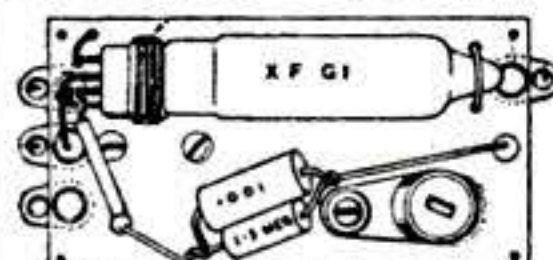

"DELUXE MIDGET 1" RADIO CONTROL, CONSISTS OF LICENSE FREE BAND TRANSMITTING RADIO, A RECEIVING RADIO & A CONTROLLING ESCAPEMENT. LONG RANGE, TO OPERATE MODEL AIRCRAFT, BOAT, & AUTO MODELS. ALL THREE UNITS ABOVE SIMPLE ASSEMBLY WITH OUR PARTS & PLANS \$9.98 DETAILED INFORMATION & RADIO CATALOG - 25c SPECIAL "SUPPLY DIRECTORY" & SUPPLY COUPON, (coupon value \$7.00) ONLY \$1.00

"DELUXE MIDGET 1" RADIO CONTROL \$9.98

RADIOMODELS, BOX 36, DEPT. P BALTIMORE 6, MARYLAND

ANALYZE HANDWRITING

MORE INCOME... MORE PRESTIGE AND MORE SUCCESS!

FASCINATING, uncrowded profession-business, full or spare time. Free illustrated lesson and year-book shows how men and women in home and business find opportunity in analyzing handwriting. Understand People—Make Money. Free lesson and information about amazing opportunities if over 21.

I.G.A.S., Inc., 900 Wilhoit Building, Springfield, Missouri



NOW! USE YOUR WILLYS OR DODGE AS BOTH A 2 and 4 WHEEL DRIVE



Give your 4-wheel drive Willys or Dodge 2-wheel pep, power, speed, extra mileage, passenger car performance—as well as 4-wheel power and traction! Change from 2-wheel to 4-wheel or back in seconds with fingertip control. Warn hubs reduce wear on front axle assembly and front tires, eliminate shimmy, increase gas mileage up to 6 m.p.g. Locking Hub, Willys, \$69.00. Dodge, \$74.00 pr., ppd. Also available: Warn Standard Hub for Willys \$20.00 pr., Dodge \$23.00 pr., Land Rover \$24.00 pr., ppd., and Warn Automatic Hub for Willys \$120.00 pr., ppd. At dealers or direct. Money Back Guarantee.

WARN MFG. CO., Riverton Box 6064-BD, Seattle 88, Wash.

TUBE FREE WITH EVERY TIRE AT NO EXTRA COST
 LOW OVERHEAD—LARGE VOLUME SALES & SMALL PROFITS
 BRING YOU THESE "LOWEST PRICES" WINTER SPECIALS—



WHAT GOOD IS A TIRE WITHOUT A TUBE?
WHY PAY MORE!

20 YEARS AT THIS ADDRESS
 AN ESTABLISHED POLICY OF CAREFUL SELECTION ASSURES YOU, MANY HAPPY MILES. BE WISE—TRY ONE—YOU'LL BUY MORE! WE WELCOME COMPETITION. NO ONE CAN TOUCH OUR QUALITY & PRICE!

GOOD USED TIRES—NOT RECAPS—NOT RETREADS
YOU GET WHAT WE ADVERTISE

EVERYBODY MAY TAKE **20% off** ON EVERY TIRE
20 MONTHS WRITTEN GUARANTEE

600-16	\$3.45	820-15	\$4.85	600-20	\$6.55	32x6(8)	\$8.05
650-16	4.05	700-15	3.85	650-20	7.05	32x6(10)	9.05
700-16	4.35	670-15	3.85	700-20	7.85	900-20	13.25
650-15	3.85	710-15	4.25	750-20	7.85	1000-20	13.25
760-15	4.35	550-17	4.55	825-20	12.85	1100-20	13.25

Specialists in Truck Tires—Selected for Toughest Jobs—Tops in Value

600-16	\$5.15	475-19	\$5.35	700-15(6)	\$8.55	700-20	\$10.75
600-16(6)	6.65	640-15	4.85	750-16(8)	9.35	750-20(10)	16.75
650-16	5.65	670-15	5.25	700-17	7.75	750-20(8)	13.25
650-16(6)	7.15	710-15	5.35	750-17	10.85	825-20	17.75
700-16	6.25	760-15	5.85	750-15	10.85	900-20	17.85
750-16(6)	8.35	800-15	6.25	825-15	11.05	1000-20	16.85
550-18	4.85	820-15	6.25	600-20	8.25	1100-20	17.85
550-17	4.65	550-15	5.25	650-20	9.75	1000-22	18.05
650-15	5.15	670-16	5.05	32x6(8)	10.75	1100-22	20.15
700-15	5.25	700-16(6)	7.15	32x6(10)	13.15	1100-24	20.55

ALL WHITE WALLS \$1.00 EXTRA (Military Treads) 750x20 \$16.75

Thousands of tires shipped all over U. S. A. All tires shipped F.O.B. Phila. Send Check or M.O. with this ad. Dept. 5.
STANDARD 834 N. Broad St., Philadelphia 30, Pa.

FREE

7 Days Use of Practical Book
 "HANDY GUIDE for CAR OWNERS"
 Shows How to Save \$100.00
 or More Yearly on Car Costs!

512 pages of illustrated step-by-step instructions. How to get 2 to 5 MORE miles on every gallon . . . Double Tire Mileage . . . Increase Resale Value of Your Car . . . Get Good Buy in Used Car . . . What to Do In Emergency, and much more! Use book 7 Days FREE. If delighted, remit only \$2.95 plus postage. Or return it and pay nothing. Send No Money. just mail post card to WM. H. WISE & CO., Inc., Dept. 806A, 50 W. 47 St., New York 36.

Some Good Distributor Territories Still Open

LIFE-LONG 10 YEAR BATTERIES

See our ad page 45, March issue of Popular Science. Write, wire or phone Life-Long Battery Mfg. Corporation, Dept. S-5, 11766 West Pico Blvd., Los Angeles, 64.

ENGINEERING DEGREE IN 27 MONTHS

Big Demand for Graduates

AERONAUTICAL, CHEMICAL, CIVIL, ELECTRICAL, MECHANICAL and RADIO ENGINEERING (inc. TV and Electronics).

Hundreds of young men are earning B.S. ENGINEERING DEGREES annually in this recognized institution—year around operation. New terms start quarterly. Many students earn a major part of their college expenses in this large industrial center.

Low tuition. Competent instruction. Thorough, intense, practical program. Modern, well-equipped laboratories including new physics laboratory and modern wind tunnel. Individualized instruction emphasized.

Gov't approved for G.I.'s. Engineering preparatory courses. Students from 48 states and 21 foreign countries. Enter June, September, December, March. Send coupon for free catalog and full information. Enroll now.

SEND COUPON TODAY

INDIANA TECHNICAL COLLEGE

654 E. Washington Boulevard
 Fort Wayne 2, Indiana

Please send me free information on B. S. Engineering degree in 27 months as checked.

- Aeronautical, Chemical, Civil,
 Electrical, Mechanical, Radio-Television.

Name.....
 Address.....

Remodeling BOOM!



Your Big Opportunity TO ENTER

FLOOR SURFACING PROFESSION as YOUR OWN BOSS at BIG PAY!

● Today—twenty million dwelling units thirty years old and more need remodeling and repairs including resurfacing of old and worn floors. Also, new construction continues to boom. This means—a lifetime opportunity to establish yourself in a fine business that pays you well . . . sanding floors with an easy-to-run American machine! Beautiful results . . . make old floors like new! Prospects everywhere want benefits of properly surfaced floors—easier to clean, extends life of floor, increases pride of ownership, makes house more valuable and easier to sell.

Be your own boss—now! Steady year 'round work where profits are limited only by the amount of time you are willing to spend. Unlimited full or part time opportunities. No schooling or special skills required. Only small investment in sander gets you started. Send coupon for "money-making booklet" entitled "Opportunities in Floor Surfacing"—enclose 25c in coin or stamps to cover handling.



AMERICAN

Performance-Proved Machines . . . Nation-Wide Service

SEND!

The American Floor Surfacing Machine Co.
 532 So. St. Clair St.
 Toledo 3, Ohio.

Here is 25c in stamps or coin for booklet "Opportunities in Floor Surfacing," telling me how I can start my own floor sanding business.

Name.....
 Street.....
 City..... State.....

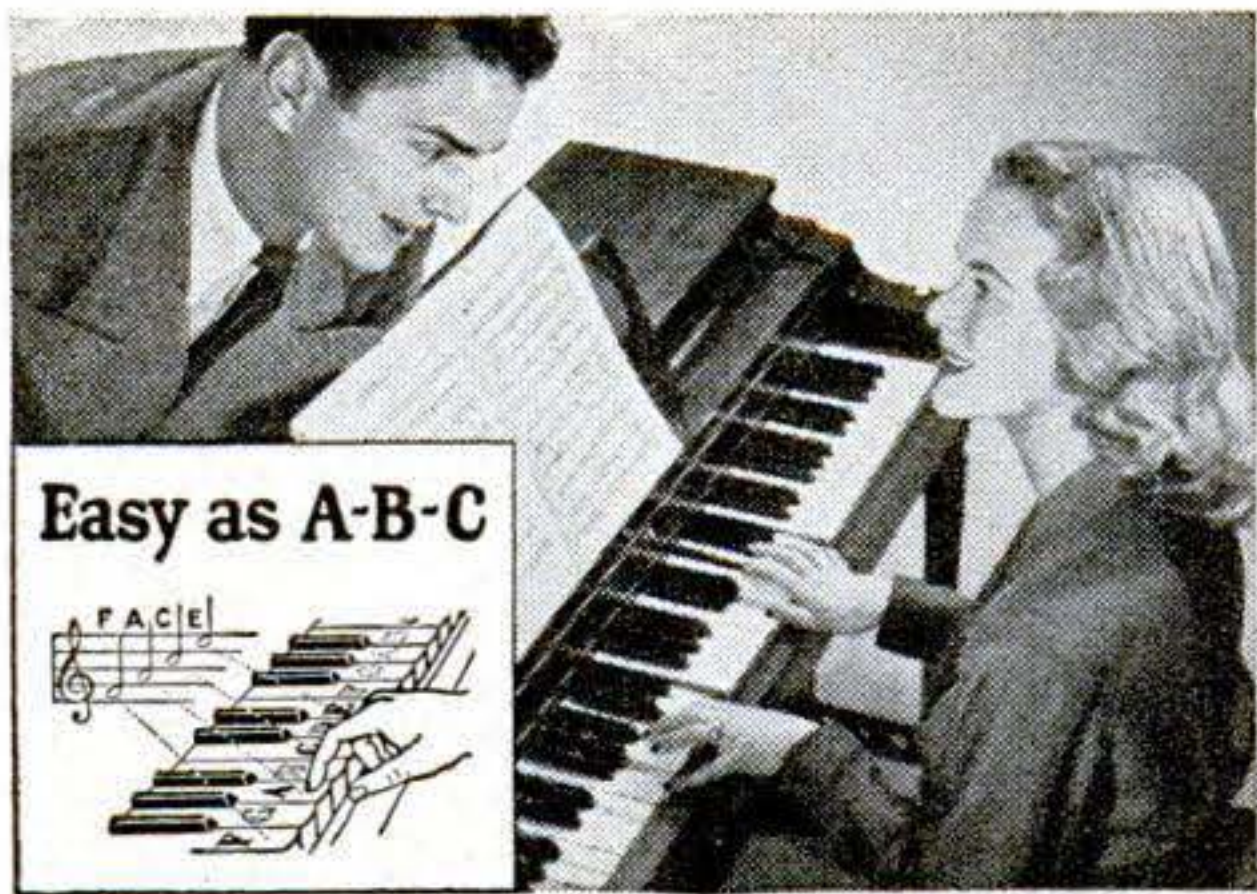

Easy as A-B-C



Be Your Own MUSIC Teacher

LEARN AT HOME THIS QUICK MONEY-SAVING WAY

Simple as A-B-C. Your lessons consist of real selections, instead of tiresome exercises. You read real notes—no "numbers" or trick music. Some of our 900,000 students are band LEADERS. Everything is in print and pictures. First you are told what to do. Then a picture shows you how. Then you play it yourself and hear how it sounds. Soon you are playing your favorite music. Mail coupon for Free Book and Lesson-Sample. Mention your favorite instrument. U.S. School of Music, Studio 155, Port Washington, N.Y.

FREE BOOKLET

U. S. SCHOOL OF MUSIC Studio 155, Port Washington, N. Y. Please send me Free Booklet and Lesson-Sample. I would like to play (Name Instrument).

Instrument..... Have you Instrument?.....

Name..... (Please Print)

Address.....

THIS... 120 PAGE GUIDE FOR AMBITIOUS MEN FREE!

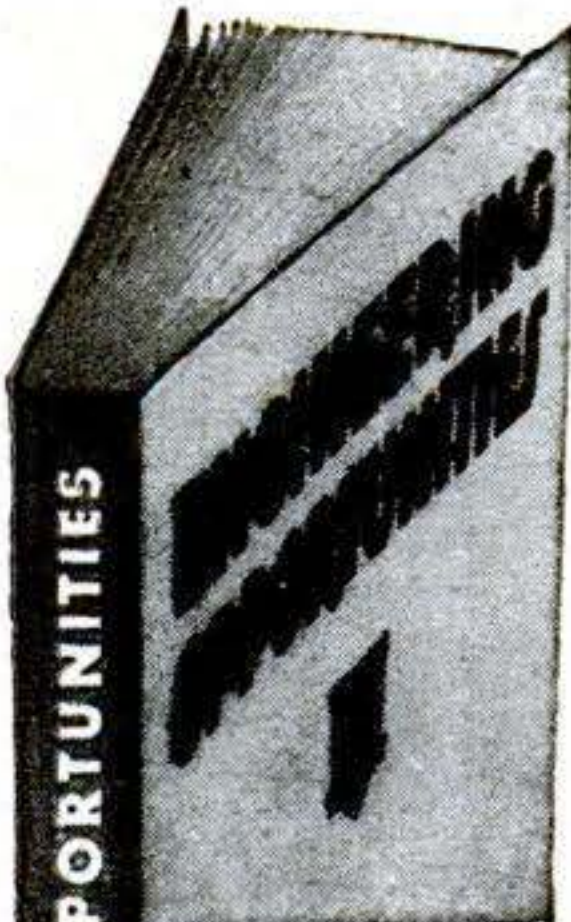

Have you had your copy?

120 pages of guidance to best-paid positions. Up-to-the-minute information for men who want to climb to the top. Tells how to get promotion, security and better pay through home study courses. This handbook "Engineering Opportunities" is free and entirely without obligation. Send the coupon. Make this your big year! Describes over ninety courses including:

Mechanical
Aeronautical
Television
Building

Electrical
Radio
Automobile
A.M.I.Mech.E.

A.F.R.Ae.S.
A.M.I.C.E.
B.S. (Pure
Science)

--- SEND COUPON TODAY ---

Canadian Institute of Science & Technology Limited, 574 Century Building, 412, 5th Street, N.W., Washington, D.C.

Please forward free of cost or obligation your handbook, "ENGINEERING OPPORTUNITIES".

Name.....

Address.....

Course interested in..... Age.....

Canadian Address: Canadian Institute of Science Garden Building, 263 Adelaide St. W., Toronto, Ont.

HOW TO MAKE Your Old Boat NEW

How to build your own FIBERGLASS BOAT

These Two Manuals Tell You How To:
• Protect your old boat permanently with liquid Castoglas • Form resilient plastic skin tougher than steel, lighter than aluminum • Make hulls leak-proof, weather-proof • Lay fiber mat and glass cloth for new boats • Build your own non-rusting, non-corroding tanks, compartments • Repair pipes, etc. • Skid-proof decks • Illustrated step-by-step instructions show how



BOTH FOR 25¢

YOU CAN DO-IT-YOURSELF

easily and save one-half to two-thirds of cost. Send 25c for these two practical books. Satisfaction guaranteed. Limited edition, so order today.

DEALERS: WRITE FOR PROPOSITION

MARINE DIV. DEPT. ME-2 **THE CASTOLITE COMPANY**
Mfg. Chemists—WOODSTOCK, ILL.

MEN PAST 40

Men afflicted with Bladder Trouble, Getting Up Nights, Pains in Back, Hips, Legs, Nervousness, Dizziness, Physical Inability and General Impotency send for our amazing **FREE BOOK** that

tells how you may correct these conditions and have new health and Zest in Life. Write today. No Obligation. Excelsior Institute, Dept. B-5, Excelsior Springs, Mo.

BUILD LUGGAGE AT HOME WE SELL YOUR PRODUCTS!

Only New Home Money-Making Plan in Years!

Make Luggage and cases for traveling, photographers, musicians, salesmen, electronics, tools, portables, 1001 other items. Also repair Luggage. No special equipment needed. BIG Profits. We supply complete instructions—everything. Write for free details and Business Plan. ABARSI CASECRAFT Dept. C10, 805 W. Sunset Blvd., Los Angeles 12, Calif.

\$750 BUILDS 4 ROOMS & BATH!

WHY PAY RENT? For Seven Hundred Fifty Dollars and 30 days of your spare time, you can build yourself this Beautiful Home.



Living room, 11x15. Front bedroom 9x11. Back bedroom 10x12. Kitchen 9x11. Bath 5x8. Hall 3x4. Wind out steel casement windows. Concrete block, stuccoed. Step-by-step illustrated instructions, blueprint and material list. \$1.00 ppd. No C.O.D. Money back guarantee. Economy Home, Box 645, Dept. D, Columbus 16, Ohio

DAN LURIE "America's Most Muscular Man" —on television's "Big Top."



FAMOUS DAN LURIE

BARBELLS

with 4 courses—low factory prices

50 lb. set...\$ 8.48 | 150 lb. set...\$20.48
100 lb. set... 13.98 | 200 lb. set... 25.98

Order by Mail; 50% with order, bal. C.O.D. Extra wts. 13c per lb., F.O.B. plant

DAN LURIE BARBELL CO.

1701-S5 Pitkin Ave. Dept. 470 E. Brooklyn, N. Y.

BUY FROM MANUFACTURER



ATTIC EXHAUST

FANS

\$39.95
F.O.B. N.Y.

28" COMPLETE WITH 1/3 HP MOTOR A.C. 110V STEEL FRAME-TORRINGTON BLADE GUARANTEED 5 Yrs. Nema Rated 8050 C.F.M.

EASY TO INSTALL & ASSEMBLE

If you cannot visit us send for Fan Parts and Electric Motor Catalogue.

For Use in HOMES STORES HOTELS FACTORIES, etc.

Albin Machine Co. 750 6th Ave., N.Y. 10, N.Y. Send Check or Money Order. 425 W. Jefferson Ave., Detroit 26, Mich. C.O.D. send \$5 deposit. 1529 Vine St., Cincinnati 10, Ohio



ITALIAN ACCORDIONS AT LOWEST WHOLESALE PRICES

**5-DAY
FREE
TRIAL**

**"PAY AS
YOU PLAY"**
Small Down Payment
As Little As
\$10 per
month

**DIRECT from
Importer to You!**
SATISFACTION GUARANTEED, or your
money back! NOW you can save up to 50%
by direct purchase from America's leading
distributor of famous genuine ITALIAN
ACCORDIONS. TRADE-INS ACCEPTED.
Send for FREE Illustrated Catalog!

ACCORDION MANUFACTURERS & WHOLESALE OUTLET
2003 West Chicago Ave. Dept. P-54 Chicago 22, Ill.

new! No. 4 HAWAIIAN WIGGLER



WRITE FOR
BIG FREE
CATALOG

Weighted, flexible, weedless spinner
fly—casts like a bullet, sinks quickly,
runs deep. More flash for trolling.
Won't twist line or hang up. 1/4 oz.
or 5/8 oz. — \$1.15 each.

FRED ARBOGAST CO., INC., 2305 W. North St., Akron 3, Ohio

314 STAMPS—25c

Includes Famous GOYA NUDE—
plus FREE Stamp Encyclopedia



Spain's most sensational stamp included in
this imported collection of 314 different, un-
usual stamps from dozens of hard-to-get coun-
tries! You also get black-bordered STALIN
DEATH STAMP; first stamp of U.N.; etc. Also included, FREE,
"Midget Encyclopedia of Stamps." Reg. \$3.00 value—ALL yours for
only 25c with Bargain Approvals. Send 25c today. ASK FOR LOT EH-18
ZENITH CO., 81 Willoughby St., Brooklyn 1, N. Y.

LAW

Men and Women STUDY AT HOME for
Business Success and LARGER PERSONAL
EARNINGS, 44 years expert instruction—
over 114,000 students enrolled. LL.B. De-
gree awarded. All text material furnished.
Easy payment plan. Send for FREE BOOK
—"Law and Executive Guidance"—NOW!

AMERICAN EXTENSION SCHOOL OF LAW
Dept. PS-74, 664 N. Michigan Ave., Chicago 11, Illinois

ELECTRIFY your SEWING MACHINE

NEW LOW PRICE! **\$9.95** 1 YEAR
GUARANTEE

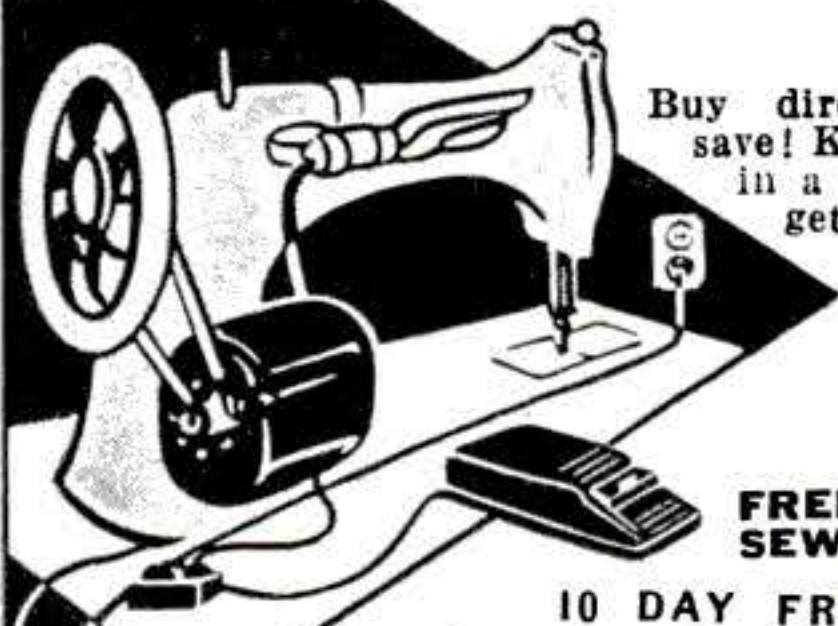

Buy direct from manufacturer and
save! Kit comes fully wired, installed
in a jiffy. Fits all machines! You
get ALL-NEW PARTS

- Motor & Bracket
- AC-DC 115v 60c
- Multi-speed foot con-
trol
- Cord set & block
- Easy instructions
- Steel pulley & belt

FREE . . . reg. \$2.95 chrome
SEWLITE given with every kit.

10 DAY FREE TRIAL—ORDER NOW!

Send no money, pay COD or send money order and we'll
pay postage. Please state whether wheel on your machine
turns toward you or away from you. Shipping wt. 6 lbs.

SENIOR SEWING MACHINE CO.
Box 147 PS 57 Brooklyn 6, N. Y.

FIX CARS!

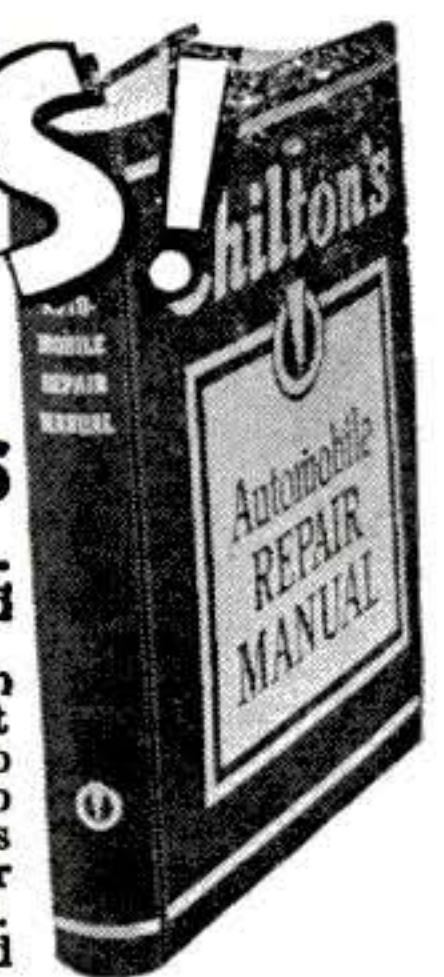

All Makes — All Models

Fix cars easier than you may have thought possible! Train to be a well-paid expert in a field that is clamoring for good men!

Just look up in the giant 752-page Chilton "ALL CARS" Manual the make, model and part of the car you want to repair. It shows what to do . . . exactly how to do it. Covers step-by-step details on specific jobs . . . not a lot of meaningless theory. Widely used in garages, schools and for Army-Navy training. Ideal for teaching beginners. A gold mine of time-saving data for experienced mechanics. Helps you work faster—and better!

MAKES TOUGH JOBS EASY . . . MAKES EASY JOBS A CINCH!

Contains easy-to-understand service details on every model made from 1940 to 1954: BUICK, CADILLAC, CHEVROLET, CHRYSLER, DESOTO, DODGE, FORD, FRAZER, HENRY J., HUDSON, KAISER, LINCOLN, MERCURY, NASH, OLDSMOBILE, PACKARD, PLYMOUTH, PONTIAC, STUDEBAKER, WILLYS—over 1100 models, 350 Quick Check Data Tables and more than 1,800 illustrations explain service operations almost at a glance. Order Chilton "ALL CARS" Manual in coupon. Practice 10 days free!

New Edition

Tops for training beginners! . . . helps experienced mechanics do jobs in minutes instead of hours! Published by Chilton . . . world's largest automotive publishers.

Only \$5.95



FIX CHEVROLETS!

Backed with this 132-page Manual, you'll find it twice as easy to be an expert on Chevrolet repairs! Covers service details on EVERY Chevrolet car made from 1940 to 1954. Complete — accurate — authentic. Dozens of clear illustrations plus 55 page section "General Service and Trouble Shooting." Order Chevrolet Manual in coupon. Money-back guarantee!

Only \$2.75

FIX FORDS!

Handle practically any Ford repair job easier than you may have dreamed! Gives easy step-by-step service instructions on EVERY model from 1940 to 1954 plus 55-page section on "General Service and Trouble Shooting." 144 pages; over 440 illus.; 36 Quick Check Data Tables, etc. Specify Chilton Ford Manual in coupon. Money-back guarantee! . . .

Only \$2.75

FIX PLYMOUTHS! DODGES and DESOTOS!

Here is your master guide to fast, easy service on EVERY Plymouth, Dodge and DeSoto passenger model made between 1940 and 1954. Just look up the job you want to do! 132 pages; over 365 illus.; 53 Quick Check Data Tables plus 55-page section on "General Service and Trouble Shooting." Order Chilton Plymouth Manual in coupon. Money-back guarantee!

Only \$2.75

PRACTICE 10 DAYS FREE!

The Chilton Co., Dept. PS-54
56th & Chestnut Sts., Philadelphia 39, Pa.

Send the big CHILTON "ALL CARS" MANUAL (price \$5.95) for 10-day FREE EXAMINATION. If O.K., I will promptly remit \$1.95 (plus 35c postage); then send \$2 monthly for 2 months. Otherwise, I will return manual postpaid in 10 days and owe you nothing.

Check here to order individual car make manuals

- Chilton "CHEVROLET" Manual, Price \$2.75
- Chilton "FORD" Manual, Price \$2.75
- Chilton "PLYMOUTH-DODGE-DESOTO" Manual, Price \$2.75

NOTE: Individual car make manuals sold for cash with order (we pay postage.) Or, we ship C.O.D. and you pay postman manual price plus post office charges. Specify which method desired. Any manual returnable in 10 days if not satisfactory and we guarantee to refund your \$2.75.

(OUTSIDE U.S.A.—Cash only. Prices: "ALL CARS" Manual, \$6.95; individual manuals \$3.00 each. Same 10-day return privilege with money refunded.)

Name.....
Address.....
City, Zone, State.....

Check the Kind of Body You Want

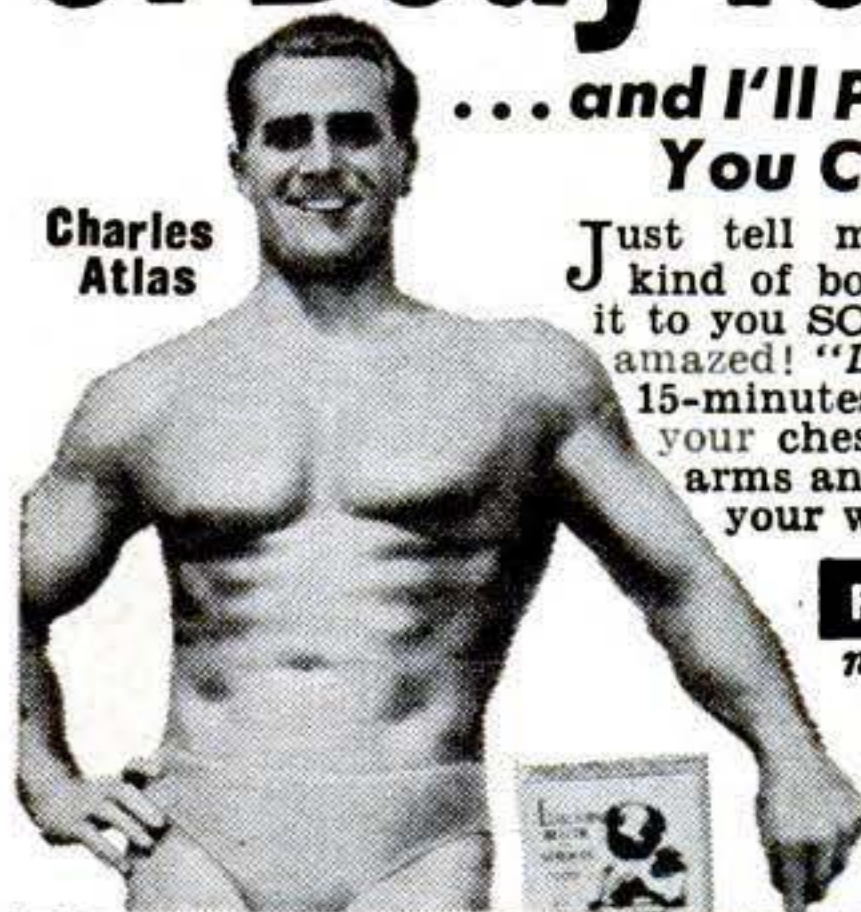

Charles Atlas

... and I'll Prove How EASILY You Can Have It!

Just tell me, in coupon below, the kind of body you want—and I'll give it to you SO FAST your friends will be amazed! "Dynamic Tension," my easy, 15-minutes-a-day method, will make your chest and shoulders bulge... arms and legs surge with power... your whole body feel "alive!"

FREE BOOK 32 pages on how "Dynamic Tension" changed me from a 97-pound weakling into "World's Most Perfectly Developed Man"—and how I'll prove it can change YOU too. Mail coupon NOW!

**CHARLES ATLAS, Dept. 1E,
115 East 23rd St., New York 10, N. Y.**

Dear Charles Atlas: Here's the Kind of Body I want:
(Check as many as you like)

- | | |
|--|--|
| <input type="checkbox"/> More Weight—Solid—in The Right Places | <input type="checkbox"/> Powerful Arms, Legs, Grip |
| <input type="checkbox"/> Broader Chest, Shoulders | <input type="checkbox"/> Slimmer Waist, Hips |
| | <input type="checkbox"/> Better Sleep. More Energy |

Send me absolutely FREE a copy of your famous book "Everlasting Health and Strength"—32 pages, crammed with photographs, answers to vital questions, and valuable advice. No obligation.

NAME _____ AGE _____
(please print or write plainly)

ADDRESS _____

CITY _____ STATE _____



Start As High As
\$3,795.00 A YEAR

MEN—WOMEN

Postoffice Clerks—
Carriers
Railway Postal
Clerks
Stenographers
Accountants
Immigrant
Inspectors
Typists
Customs
Inspectors
Many Other
Early Jobs

Veterans
Get Preference

Mail
**COUPON
TODAY
SURE**

FRANKLIN INSTITUTE
(Not Government Controlled)
Dept. M-80,
Rochester 4, N. Y.

Gentlemen: Rush to me. FREE of charge, list of U. S. Government big pay jobs. Send FREE 36-page book describing salaries, vacations, hours, work, etc. Tell me how to qualify for one of these jobs.

Name

Street

City Age?.....

COUPON



OWN a Business

**\$5 HOURLY Profit . . .
Even if NOW Employed**

Alert dealers average \$5 hourly profit on own service plus \$3 on EACH serviceman. You can profitably operate part time while building a full time business. We locally train and assist you.

Clean and Mothproof, Rugs and Upholstery

Duraclean cleans by absorption! No scrubbing, soaking or shrinkage. Dirt, grease and unsightly spots vanish as if by magic . . . matted pile rises . . . colors revive.

Duraproof protects against moths and carpet-beetle damage. Makes materials resistant to both. Backed by an International Money-Back 4-Year Warranty.

No experience needed. Easy to learn. Quickly established. Nationally advertised Services rendered "in the home." See full-column ad in January McCall's. No Shop Needed. We furnish enough materials to return your TOTAL investment. Territories limited. Write today for FREE booklet explaining details and Easy Terms.

DURACLEAN CO., 4-185 Duraclean Bldg., Deerfield, Ill.

Learn to HYPNOTIZE!

Command others with hypnotic power! Amaze everyone with your new spellbinding technique. New easy to master course teaches you this mystic art, quickly, expertly, professionally. Have subjects at your mercy. Make them obey your every desire. Send for this Valuable Book Now! Just pin \$1 to this ad and "25 lessons in Hypnotism" will be mailed to you postpaid. Satisfaction guaranteed or your money back.

BOOKS PUBLISHING CO., Amityville, N. Y.



TREASURE -- \$10,000

New locator detects metals, valuable minerals and buried treasure. Money-back guarantee of superiority.

Also geiger counters. Govt. reward of \$10,000 for uranium discovery. Write for FREE information.



THE GOLDAK COMPANY
1544 W. GLENOAKS BLVD., GLENDALE 1, CALIF.

make your own Gems 29.50 F.O.B.

The Gem Maker comes complete with all necessary equipment, including a super-charged diamond blade for sawing, and all wheels for grinding, shaping and polishing; also complete instructions. The complete equipment as shown, less motor and belt, for only \$29.50, f.o.b. Burlington, Wisconsin. Write today for information and literature.

B & I MANUFACTURING CO.
Dept. S Burlington, Wis.

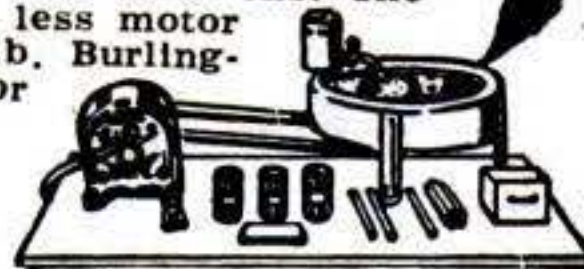

STOP RADIO & TV NOISES INSTANTLY



NEW PATENTED ELECTRONIC INVENTION "CLEAR TONE" filter eliminates noisy interference caused by all motor appliances, autos, oil burners, etc. Simply plug radio or TV cord into filter and filter into wall socket. Enjoy "CLEAR TONE" reception. Try 5 days—MONEY BACK GUARANTEE.

Household Prod., Dept. PS-5, Scarsdale, N. Y.

NEW FALSE PLATE

FROM YOUR OLD ONE IN 18 HOURS

AS LOW AS \$14.95



Send us your old broken, cracked or loose plates and we'll transform them into new lightweight wonder plastic plates. NO IMPRESSIONS needed with our revolutionary method. We use your own old plates. We remake them completely in only 18 hours. Missing teeth carefully matched and replaced. We GUARANTEE TO SATISFY YOU OR REFUND YOUR MONEY.

SEND NO MONEY—Send us your name today and we'll RUSH COMPLETE DETAILS. Begin to enjoy life right now. Clip this Ad; save it and send for free facts.

**CHICAGO DENTAL PLATE LABORATORY • Dept. PS-554
30 N. Dearborn St. • Suite 807 • Chicago 2, Ill.**



FULLY GUARANTEED TIRES COST LESS!

Nationally famous **FIRESTONE, GOOD-RICH, U.S. ROYAL, GOODYEAR,** and other makes. Every tire selected and inspected for your safety.

FREE TUBE ON REQUEST WITH PASSENGER TIRES

WHITE WALLS OR SNOW TIRES \$1 EXTRA

HIGH GRADE TIRES GUARANTEED 12 MONTHS

600x16	4.14	700x16	5.14	32x6(8)	8.84	825x20	14.24
650x16	4.54	670x15	4.74	32x6(10)	10.84	900x20	13.34
650x15	4.34	650x20	7.84	750x20(8)	8.54	1000x20	14.14
700x15	4.64	700x20(8)	8.94	750x20(10)	9.74	1100x20	16.14

AAA PREMIUM GRADE GUARANTEED 18 MONTHS

550x15	5.48	700x15	5.98	760x15	5.58	750x20(10)	14.98
600x16	5.28	700x16	6.78	550x17	5.48	825x20	18.68
600x16(6)	6.58	700x16(6)	7.98	600x20	9.78	900x20	18.98
640x15	5.68	750x16(6)	8.98	650x20	10.88	1000x20	19.98
650x16	5.78	300x15	6.88	700x20	12.88	1000x22	21.98
650x16(6)	6.98	820x15	7.48	32x6(8)	10.48	1100x20	20.98
650x15	5.98	710x15	6.09	32x6(10)	12.48	1100x22	21.98
670x16	6.18	550x18	5.98	750x20(8)	12.98	1100x24	23.98

MILITARY SPECIAL

AA Guaranteed 12 Months—

900x16 10.69 1000x20 19.98

750x20 10.98 1100x20 21.98

AA GUARANTEED 18 MONTHS

900x16 14.98 750x20 16.48

New Tread Guar. 24 Mos.

600x16 8.98

600x16 (6) 9.98

700x15 (6) 15.95

750x20 (8) 24.98

Largest stock of used tires in the East. Thousands of satisfied customers. Write for Free Catalogue. MONEY ORDER OR CHECK WITH ORDER. NO C.O.D.'s

PYRAMID TIRE CO.

1333-35 North 5th St. Dept. S. Phila. 22, Pa.

.22 RIFLE CARBINE STYLE

\$14.95



Exclusive with UNITED

German Precision, simplified, 4 lb. FEATHER-WEIGHT rifle. 34" long. Rugged. 1 screw takedown. Automatic ejector with self adjusting sporting rear sight, blade front sight. HIGHLY POLISHED BOLT ACTION. Blued. Amazingly accurate. Replacement parts easily secured. SHOTS AMERICAN LONGS, SHORTS, LONG RIFLE (regular & hi-powered). 10 DAY NO RISK TRIAL. If dissatisfied return for refund. Transportation collect. C.O.D.'s require \$2 deposit. Mail Orders Only.

State Age. United Arms, 9043 S. Western. NHOB-1455, Chicago 20.

MEN WANTED

Earn \$100 Per Week and up
AUTO DIESEL MECHANICS

Master a trade with a future—learn Auto-Diesel mechanics in our shops. You learn with tools on real equipment. Earn while you learn. Many of our graduates earn \$100 per week and up. No previous experience necessary. Day and night courses. Approved for veterans. Write for free bulletin.

NASHVILLE AUTO-DIESEL COLLEGE

226 7th Ave., N., Dept. 41

Nashville 3, Tenn.

Also ADULT 1 Passenger SPORT CAR WORLD'S LOWEST PRICE. Free Literature

ESHELMAN 70 MILES PER GAL. GAS CHILD'S AUTO WITH MOTOR

Sturdy, Safe for kids 5 to 15 years. Also pulls Mowers, Carts and Power Takeoff drives Pumps, Saws, etc. Write for literature. ESHELMAN, Dept. CM-65, 119 Light St. Balto. 2, Md. 333 N. Michigan Ave., Chicago 1, Ill. 7070 Hollywood Blvd., Los Angeles 28, Cal.



Fastest way to wax a car....
Outshines, outlasts 'em all by far!

ALSOL
THE HARD PASTE
AUTOWAX
WITH THE "RUB"
TAKEN OUT

Wipe on--Wipe off--that's all!



\$2.00
HALF POUND

INSTALL IT

Yourself

and

SAVE!

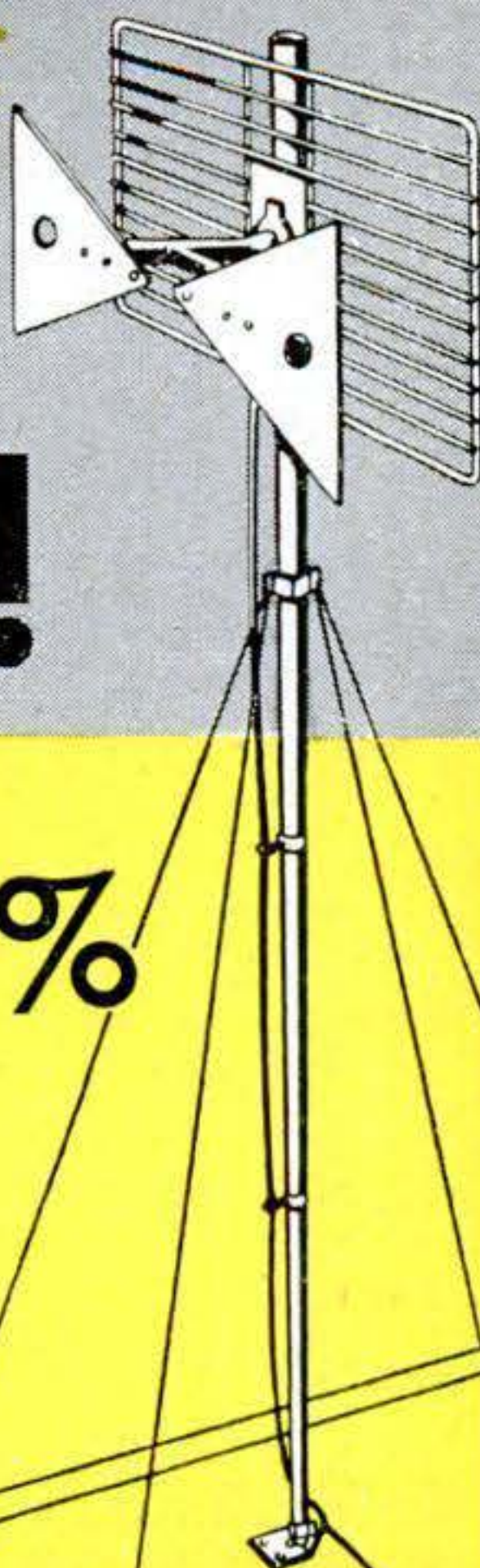

YOU CAN GET
25 to 40%

BETTER RECEPTION
on your present TV Set... any make... and you're ready for **COLOR!**

ANTENNA KITS FROM

Admiral

WORLD'S LARGEST TELEVISION MANUFACTURER

Priced from

\$13.95 LIST

at your **Admiral** dealer

UHF Kits

VHF Kits

All-Channel Kits

Kits contain everything needed...antenna, mast, mast mount, guy wires, insulators, lead-in...down to the last screw-eye. Step-by-step instructions are easy to follow. No experience or special tools needed. High-gain antennas get excellent reception. Finest quality, tested and guaranteed by Admiral. Buy from your Admiral dealer.

AT SERVICE STATIONS, ACCESSORY STORES, GARAGES, HARDWARE AND DEPARTMENT STORES

TRAINED MEN NEEDED

BIG PAY—GOOD FUTURE

- TELEVISION ELECTRONICS
 DIESEL AUTO

WHY WORK FOR LOW PAY or risk being out of a job??? Usually the properly trained man has a steady job... through good times or bad. Even back during DEPRESSION there was a big demand for Bailey Trained men.

In only 5½ to 6 months we can train YOU to enter one of the big pay fields!

No previous experience or special education necessary. With our method of training you do not spend years pouring over books, figures, charts and graphs. You learn by rebuilding, repairing, testing and operating the most modern equipment, under the guidance of experienced, courteous and friendly instructors. This method of training gives you the experience and confidence required to step right into the big pay jobs without spending years as a mechanic's helper.

It's EASIER and COSTS LESS than you may think to get this residence shop training... we help you find part-time jobs while in school—full-time jobs after graduation. Check subject above in which you are interested and mail for complete information.

BAILEY Technical SCHOOLS

Veteran Approved

1632 S. Grand St. Louis 4, Mo.

NAME.....AGE.....
 STREET.....
 TOWN.....ZONE.....STATE.....

FREE!

ANY ONE OF THESE
 HI-FIDELITY RECORDINGS
 (50-15000 Cycles)

BEETHOVEN

"Egmont" and "Coriolanus" Overtures

OR BIZET OR BACH

"Carmen" Suite

Long
 Playing

33 1/3
 R.P.M.

Yes! Yours FREE—any one of these magnificent recordings superbly performed by the celebrated British conductor Walter Goehr and the Netherlands Philharmonic Orchestra. Take any one free—OR you may have ALL THREE records for ONLY \$1!

We make this amazing offer to introduce you to our superb High Fidelity recordings. We will also send you our FREE brochure telling how you can get other brilliant recordings of the world's greatest music—for less than ONE-THIRD the usual retail price!

There are no "strings" attached to this generous offer. But it may have to be withdrawn soon. So rush coupon now!

The Musical Masterpiece Society, Inc.
 Dept. 75, 250 W. 57th St.
 New York 19, N. Y.

Please send L. P. records checked:

- BEETHOVEN BIZET BACH

NOTE: If you check ONE record, it is FREE—simply enclose 25c to help cover cost of special packing, shipping. If you check ALL THREE, enclose \$1. (WE pay postage.)

Also send FREE brochure describing your other fine recordings. No obligation.

Name.....

Address.....

City.....Zone.....State.....

Happy Is The Day When Backache Goes Away

Nagging backache, loss of pep and energy, headaches and dizziness may be due to slowdown of kidney function. Doctors say good kidney function is very important to good health. When some everyday condition, such as stress and strain, causes this important function to slow down, many folks suffer nagging backache—feel miserable. Minor bladder irritations due to cold or wrong diet may cause getting up nights or frequent passages.

Don't neglect your kidneys if these conditions bother you. Try Doan's Pills—a mild diuretic. Used successfully by millions for over 50 years. It's amazing how many times Doan's give happy relief from these discomforts—help the 15 miles of kidney tubes and filters flush out waste. Get Doan's Pills today!



BARBELLS

100
 POUND
 SET
 \$9.80

Extra
 Plates Only
 10c Pound

140-Pound, CHROME DELUXE Barbell-Dumbbell set only \$16.80. This is our feature set and is the finest ever manufactured.

Training with adjustable weight is the BEST way to keep fit; the ONLY way to develop great strength and a perfect body. As the oldest and best equipped barbell company, BUR gives value and prices no one can equal.

SEND FOR FREE CATALOG.

BUR BARBELL CO.

Lyndhurst 5, New Jersey

Build your own JET ENGINE!

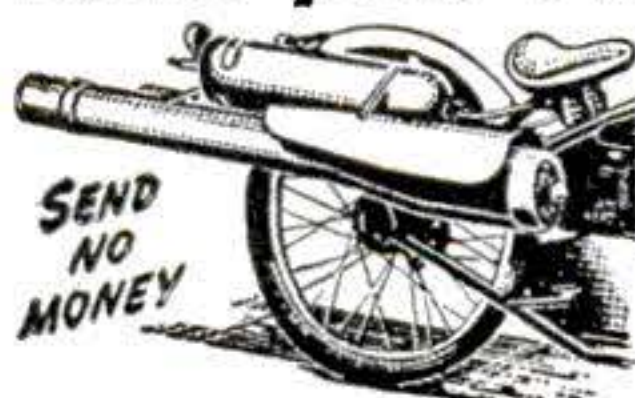

SEND
 NO
 MONEY

Order these plans today

1. JET PROPELLED BICYCLE. Assemble your own. Photo and instructions \$1.00.
2. HOW TO MAKE EXPERIMENTAL JET ENGINES. Seven sheets drawings with information and instructions \$2.95.
3. BOTH OF ABOVE in one order \$3.75. SEND NO MONEY. Order both at once \$3.75 C.O.D. in USA plus c.o.d. postage. Send check or Money Order and we pay postage. Get other information too. Rush Order.

J. HOUSTON MAUPIN, Dept. 66, Tipp City, Ohio

WATCHMAKING

Why spend all your life at dull, backbreaking work? Watchmaking is light, clean, fascinating. Lifelong livelihood. Learn the quick Sweazey way at home or Chicago School. Modern methods, step-by-step. No previous experience needed. Individual training. Start any time. Approved for vets. Send for FREE sample lesson. No obligation. Write!

CHICAGO SCHOOL OF WATCHMAKING

2330 N. Milwaukee Avenue, Dept. 454, Chicago 47, Illinois

WALL STUD FINDER

Don't damage your walls when hanging pictures, etc. Find the stud quickly with this magnetic instrument! Easy to work; points out the place to drive the nail or hook. Handy for detecting nails in tires, too. Simple directions.

Postpaid \$1.00

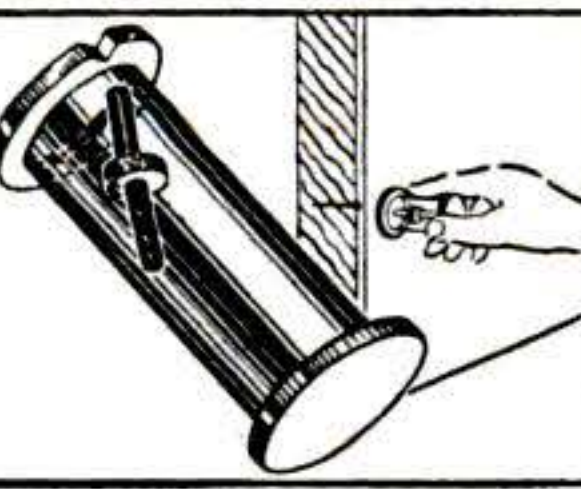

No C.O.D. Guaranteed

ELRON 219 W. Chicago Ave., Dept. 821 Chicago 10, Ill.

WHOLESALE
 HAND & POWER
 TOOL
 CATALOG
 15% to 50%
 DISCOUNT

MAKE EXTRA MONEY

NATIONALLY ADVERTISED HAND & POWER TOOLS

Stanley, Millers Falls, Plumb, Disston, Wiss, and hundreds of others.

Sell Tools Part Time, Full Time. SAVE Money for your Industrial & Institutional Use. NO INVESTMENT REQUIRED. Send \$1. for Dealers Card & 128 page WHOLESALE CATALOG. \$1. refunded on first purchase or returned if you are not 100% satisfied.

SILVO HARDWARE CO.
 Dept. P.S., 108 Market St., Phila. 6, Pa.

Get into.. PLASTIC LAMINATING AT HOME!



THIS MAN ..
... is taking out of the machine a Plastic Sealing Job — ordered by mail — only 11c in material cost brings back \$2.58 in cash by mail. Capacity of machine: **\$25.00 profit per hour of operation.**

Get **ORDERS** and **CASH** from your mailman—do work in **SPARE TIME** at home —or expand into **FULL TIME** business. Send coupon for Free facts about the newest and most fascinating of all home operated businesses. For the first time a simplified machine brings the fabulous profits of **Plastic Sealing** and **Plastic Laminating** within the reach of the small operator. Anyone can learn to operate the machine with a few minutes practice—then with our **Magic Mail Plan** can get mail orders pouring in daily with cash in every envelope. **No canvassing—no selling.** We even

Make \$20 to \$30 a Day by..
MAGIC MAIL PLAN!

supply the circulars you mail to bring back cash and orders. Don't waste a minute. Rush your name. We'll send you **FREE** and postpaid, pictures, prices, details, and all the facts you need to start. Mail coupon or send name on postcard. No charge. Warner Electric Co., 1512 Jarvis Av., Dept. L-9-E, Chicago 26, Illinois

Make Thousands of Beautiful Art Creations
COSTUME JEWELRY • CIGARETTE BOXES
TRAYS • CANDLESTICKS • COASTERS
LAMP BASES • BOOK ENDS...ALL IN
SPARKLING COLORED PLASTIC



WARNER ELECTRIC CO., 1512 Jarvis Av.
L-9-E, Chicago 26, Ill.

At no cost to me, please rush complete details postage prepaid. I am under no obligation.

Name _____
Address _____
City _____ Zone _____ State _____

PLYWOOD BOAT KITS



12 Ft. \$97
14 Ft. \$129
Freight Incl.

Send for free folders on all models as low as \$39.00 freight included

TAFT MARINE WOODCRAFT

Dept. PS 636 39th Ave. N.E. Minneapolis 21, Minn.

Success Requires Training! LEARN AIR CONDITIONING and REFRIGERATION

This great, modern industry is alive with opportunities for trained men. Installation, maintenance and servicing of home and industrial equipment is a well-established, paying trade and business. Now mechanically inclined men can get practical instruction in spare time at home. plus quick shop practice at U.E.I. (founded 1927).

IMPORTANT FACTS FREE — Write today
Find out all about these interesting opportunities without obligation. Send a postcard or short note right now.
UTILITIES ENGINEERING INSTITUTE, Dept. M-7,
2525 SHEFFIELD AVENUE CHICAGO 14, ILLINOIS

MONEY for MEN ALL DATA FREE

THE PLASTEX Industry needs manufacturers on small scale and for big production of Lamp and Clock Stands, Art Goods and Novelties in Plastex and Marble imitation. Experience unnecessary. 1/2c material makes regular 10c store sellers. Rubber moulds furnished for speed production. Small investment brings good returns. We are now placing big chain store orders with manufacturers. Ambitious men have chance for real prosperity. Our Free booklet will interest and benefit you.

PLASTEX INDUSTRIES, Dept. 2, 3400 Third Ave., New York 56, N. Y.

Make Your Own TV REPAIRS!
This Book Can Save You \$50 — \$100 Per Year

Fix 85% of TV troubles, easy as replacing light bulb! Save \$\$\$! New TV REPAIR GUIDE reveals many "trade secrets" on trouble-shooting, tube replacing, antenna adjustment, everything. Makes repairs fun, easy, safe! Includes detailed layout of your TV. Gives Tube prices—prevents overcharging. State set make, model.

MONEY BACK IF NOT WORTH TEN TIMES THE PRICE!
L. S. ENGINEERING, Dept. P-5, Box 4113, North Hollywood, California

60 POWER TELESCOPE \$3.98
VARIABLE EYEPIECE 20x-40x-60x—BRASS BOUND

NEW! Three telescopes in one. 3 different magnifications. 20 power for ultra-bright images with 40 and 60 power for extra long range. Guaranteed to bring distant objects, people, sports events, ships, moon, stars, etc. 60 times as close. Made in U.S.A.

Most powerful for anywhere near the money. 5 Sections. Closes to 1 ft. long. Contains 4 ground and polished lenses. Also used as a powerful compound microscope. Directions included. Mass production enables us to offer this instrument at amazing price of \$3.98 complete. Money back guarantee. We pay postage. Get yours now.

CRITERION CO.
DEPT. PSB-21

331 CHURCH ST.
HARTFORD 3, CONN.

MAIL COUPON NOW

PREPARE FOR BETTER JOB, BIGGER PAY IN SPARE TIME AT HOME

Today, choose the job you want—and prepare for it in time you might otherwise waste. Or if you are already in the work you like best, start training now for quicker promotion and increased pay. During more than 50 years AMERICAN SCHOOL has helped ambitious people to reach higher goals. Check subject that interests you and mail coupon for full information.

AMERICAN SCHOOL, Dept. G546, Drexel at 58th, Chicago 37, Ill.
Without obligation, please send **FREE** and postpaid, full particulars about the subject checked below.

<input type="checkbox"/> Accounting	<input type="checkbox"/> Drafting—Building Trades	<input type="checkbox"/> Plastics Engineering
<input type="checkbox"/> Air Conditioning	<input type="checkbox"/> Drafting—Machine Trades	<input type="checkbox"/> Plumbing—Practical
<input type="checkbox"/> Architecture & Building	<input type="checkbox"/> Electrical Engineering	<input type="checkbox"/> Private Secretary
<input type="checkbox"/> Automotive Technician	<input type="checkbox"/> Electricity—Practical	<input type="checkbox"/> Refrigeration
<input type="checkbox"/> Better Foremanship	<input type="checkbox"/> Electronics—Industrial	<input type="checkbox"/> Retail Merchandising
<input type="checkbox"/> Bookkeeping	<input type="checkbox"/> High School Courses	<input type="checkbox"/> Salesmanship—Outside
<input type="checkbox"/> Business Management	<input type="checkbox"/> Machine Shop Operations	<input type="checkbox"/> Sheet Metal Work
<input type="checkbox"/> Contracting	<input type="checkbox"/> Mathematics & Slide Rule	<input type="checkbox"/> Tool Making
<input type="checkbox"/> Diesel Technician	<input type="checkbox"/> Mechanical Engineering	

NAME.....
HOME ADDRESS.....
CITY.....
STATE.....
AGE.....
OCCUPATION.....

own your own business! earn up to
\$75 A DAY CLEAR PROFIT
 in your back yard or basement!

**MAKE CONCRETE BLOCKS With Amazing New
 LOW PRICED GENERAL BLOCK MACHINE**

**NOW! Big Building Boom
 Profits Within Your Reach**

You don't need much cash to cash in on the building boom! New high speed, low cost General Block Machine produces up to 1,000 concrete blocks a day for homes, factories, buildings, garages. Your profit mark-up is 100% to 150%! Fool-proof, easily operated, sturdy steel machine can make any size from 4" to 12". These superior 3-core blocks meet all building code requirements for foundation, chimney, corner, sash and many other types of blocks. Works indoors or out. Sand, cement and water available anywhere! Simple operating instructions and mixing formulae for cement and cinder blocks supplied **FREE**. Get full details, no obligation!



EXTRA!

Amazing illustrated book gives floor plans for 6 sensational concrete block bungalows. Tells how to lay blocks, lay out building lines, mix concrete, build steps, porch and concrete floors all at great savings. Written by experts. Can save many times the cost of the machine! Get it now! No strings attached.

R. L. T. of
 New York
 City Reports:
 "My General
 Block Machine
**PAID FOR ITSELF IN FIRST
 2 WEEKS!**"

Thousands now in use
 the world over
 Write for **FREE** details
TODAY

**HOW TO
 BUILD
 YOUR OWN
 CONCRETE
 BLOCK
 HOME**
 Only 1 Prepared

**SEND \$1 — Refunded
 if you buy machine!**

GENERAL ENGINES COMPANY
 Dept. S-54, 307 HUNTER STREET, GLOUCESTER, N. J.



**DON'T BE BLINDFOLDED
 by Battery Ballyhoo!**

**LIFE Batteries are
 Guaranteed for the Life of Your Car**

Life is your best battery buy. No tricks or gimmicks are hidden in the unusual LIFE Battery guarantee. A LIFE Battery is guaranteed for the life of your car.

CHECK THESE LIFE BATTERY FEATURES

- ✓ No pro-rated replacement charges
- ✓ Guarantee is good for the life of your car
- ✓ No time limit to guarantee
- ✓ Awarded "Car Life" Seal of Merit



IMPORTANT
 Valuable LIFE Distributor Franchises are available in some key territories. Write, phone or wire Franchise Division.

LIFE BATTERY CORPORATION
 12909 Venice Blvd., Venice 45, Calif.

Regular Price of a
 Slide Rule \$4 and up

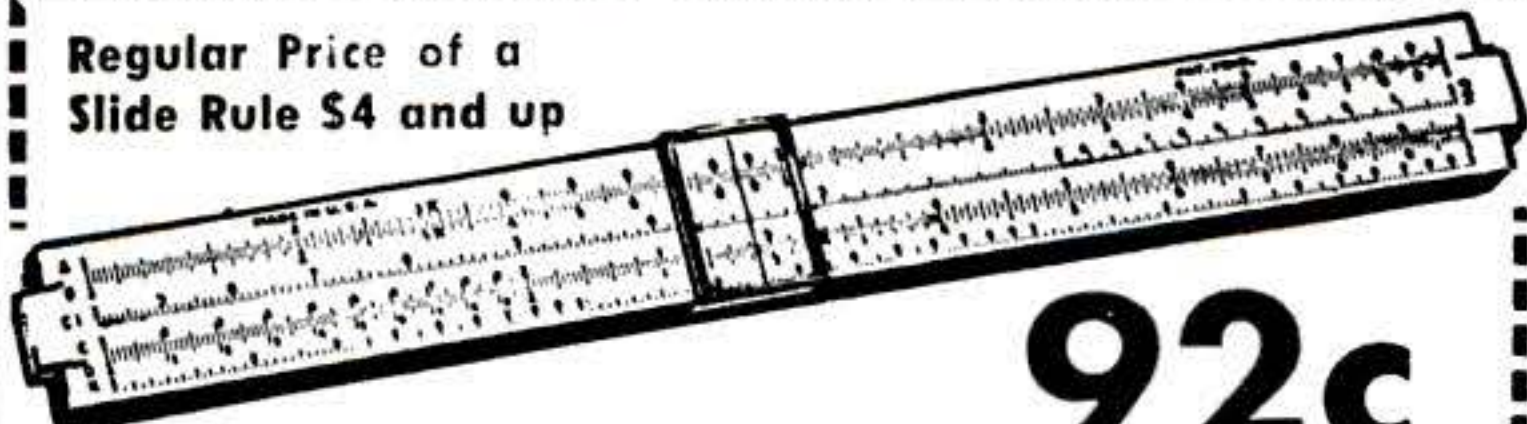

92c

Slide Rule

and this coupon
 Add 8c Postage

If you can use a pencil you can use a slide rule
 For bookkeepers, accountants, salesmen (figuring commissions, cost, etc.), farmers, housewives, etc. For Armed Forces highly important. Men's most useful tool. Easy to calculate instantly. Multiplying, proportions, division, roots, etc. "High Vision" Clear View Slide. Full 10" Rule. A, B, C, D, C1 and K scales.
FREE 28-page instruction book on how to get correct answers instantly without pencil or paper.

Gene Loewy, 545 5th Ave., Dept. 44-P, N.Y. 17
 Limit three rules to each coupon



**Assemble
 Your Own DIVING LUNG**

We furnish the parts and instructions. Complete outfits \$39.95 and \$49.95 Write for descriptive literature

**FREE
 Catalog!**

Underwater swimming equipment. Write today!

**COMPLETE PORTABLE
 OXYGEN RESUSCITATOR**

Ideal for Ambulances, Home Therapy, Clinics, Fire Dept., Police, etc. \$49.95 and \$59.95. Write for literature.

• Air & Oxygen Tank. For Diving Lungs, etc. 295 cu. in. capacity. 1800 psi. Hydro. tested, current dating, ICC3A1800. Reconditioned. Wt. 12 3/4 lb. F.O.B. St. L. \$10.95

Ed. Aguado Trdg. Co., Dept. G, Box 4525 Plaza Sta., St. Louis, Mo.

"I HAVE EARNED \$15.20 AN HOUR"



with Science's New Midget Miracle,
 the Presto Fire Extinguisher,
 says W. F. Wydallis, Ohio



Many others "cleaning up"—so can you! Amazing tiny new extinguisher ends fires fast as 2 seconds. Guaranteed 20 years! Sells for only \$3.98! Write for **FREE** Sales Kit. No obligation. Merlite Industries, Dept. 115, 114 East 32 Street, New York 16, N. Y. (If you want a regular Presto to use as a demonstrator send \$2.50. Money back if you wish.)

**Men and Women Trained at Home For
 Prosperous Business In UPHOLSTERING**

Tools, Supplies, everything necessary to get started sent. Illustrated training shows how—progress rapidly. No previous experience necessary. Make over old furniture, sell for many times cost to you. Establish full or part time money making business. Free booklet explains plan. Send name, address to

COMMERCIAL TRADES INSTITUTE
 1400 Greenleaf, Dept. UI-5 Chicago 26, Ill.



**STRATEX DRAFTING FURNITURE
 FITS TIGHT BUDGETS!**

It costs less to buy the best when you buy direct! Guaranteed Stratex equipment fits any wallet, any space, any requirement — lovely to look at too! Free data.

STRATEX INSTRUMENT CO., INC.
 1861 L HILLHURST, LOS ANGELES 27, CALIF.

RUPTURED

**Modern NON-SURGICAL Treatment Completely
 Heals Most Reducible Ruptures WITHOUT
 SURGERY or Hospitalization**

These Non-Surgical treatments are so certain, that a Lifetime Certificate of Assurance is given. Hundreds have been successfully treated here the past few months. Write today for our **FREE** Book that gives facts that may save you painful and expensive surgery, and tells how non-surgically you may again work, live, play and love and enjoy life in the manner you desire.
Excelsior Hernia Clinic Dept. 3703, Excelsior Springs, Mo.

Sensational Device Tests Eyes



SAVE up to \$15.00 on Glasses!
Big news to the millions of Spectacle Wearers and Prospects. Means Freedom from Outrageous Prices. Sold on Money-back Guarantee.

MAKE BIG MONEY QUICK—FREE SAMPLE KIT!
Show it to friends and others. Let them use it Free and watch their amazement over this Self Testing system. Here is a great new opportunity in a tremendous new field of unlimited possibilities. Spare or full time. No experience needed. Write for Free sample kit.
C. G. Optical Co., Dept. A-230, 20 E. Delaware Pl., Chicago 11, Ill.

MASTER MIND! ||||

Learn Short-Cut Mathematics
Juggle figures, do baffling number tricks. Make people gasp at your marvelous lightning-quick mind. Multiply 4 figures by 4 figures without using old-fashioned multiplication! Big cloth-bound volume: fully illustrated course for self-instruction.

Sharpen up Your Brain Power
Includes worked-out problems, answers, etc. Sensational bargain, only \$2.95, postpaid or COD plus postage. Satisfaction guaranteed or refund. Order this amazing "Short-Cut Mathematics" today!

NELSON-HALL CO., 210 S. Clinton St. Chicago 6, Ill.

\$2.95 Complete

WARNING!

ALL VETERANS DISCHARGED BEFORE AUGUST 20, 1952 must be enrolled and **IN TRAINING** by August 20, 1954, or lose G.I. rights to a free education under NEW G.I. bill. We train you at home to become a trained TV Technician—good pay and a bright future in TV! Time is short. Send for 4 **FREE AIDS** and details!
RADIO-TELEVISION TRAINING ASSOCIATION, Dept. P-5B
52 E. 19th St., New York 3, N. Y.

CAMERA with FLASH



Use indoors, outdoors, day and night. A Nationally accepted, American made Flash Camera. Takes 12—2 1/4" x 2 1/4" pictures on 620 film! Shutter speed 1/50 second! Telescopic view finder. Automatic "hot bulb" ejector. Unbreakable plastic with luxury metal trim. 10 DAY TRIAL. Return for full refund if not thrilled. ADD \$1.00 postage, handling. Rush order. **\$399** Ppd.

UNITED PRODUCTS CO., 90435. Western, Dept. FC-101, Chicago 20.

RAISE CHINCHILLAS MAKE MONEY AT HOME

YOU RAISE THEM—WE BUY THEM!

Small capital can show terrific profits in your spare time! Free booklet explains our new lease plan. Write Dept. 602

CHINCHILLA BREEDERS CORP.

248-02 NORTHERN BLVD., LITTLE NECK, N.Y.



NEW HULL AUTO COMPASSES ARE EASIEST TO INSTALL

• Greater accuracy and a patented, more positive means of compensating against magnetic interference have long kept Hull Auto Compasses first with America's motorists. Now, choice of a new vacuum cup mounting bracket with special adhesive, or the original clamp type, gives greater-than-ever ease of installation.

Write for local dealer's name, free literature

HULL MFG. CO. P.O. Box 246, E5
WARREN, OHIO

Beaconlite \$6.95
Illuminated
STREAMLINE \$4.95
non-illuminated



The Oil Filter with an Engineering Degree!

WIX is at the head of the class in engineering excellence. It also gives you the important fundamentals of simple addition and subtraction. WIX *ADDS* engine protection and maximum oil mileage...when it *SUBTRACTS* all the grit and dirt from oil that can give your engine grief and cost you money.

wix

ENGINEERED FILTRATION

WIX HEVI-DUTY Oil Filter Cartridges far exceed engine manufacturers' specifications and are especially designed for your individual engine. They remove more contaminants without disturbing the valuable detergents in today's heavy duty oils. Ask your Serviceman for WIX and let WIX earn its BS* degree on your car...a high degree of *BETTER SERVICE for YOU!



wix
TRADE MARK REG.

OIL FILTERS • CARTRIDGES

WIX CORPORATION • GASTONIA, N. C.
IN CANADA: WIX ACCESSORIES CORP. LTD., TORONTO

BODY MOLD

SWIM BRIEFS

by **Coronado**

California designed . . . chosen by top athletes and body-builders the world over, to slim hips, display muscles. Finest



fabric; long wearing. Sizes 28 to 36 inch waist.

← #110 Medium Thigh Cut for the active swimmer. 4 elasticized fabrics.

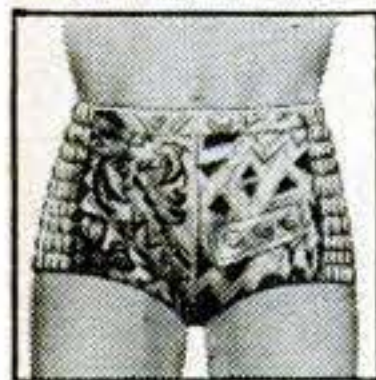

→ #111 Extra-high Thigh displays thigh development. Low-cut for fit. 4 elasticized fabrics.

← #114 Cotton Brief NEW! Elastic-side construction for molded fit. Hawaiian Print.



CORONADO SURF SHOP

627 Eighth Ave., San Diego I, Calif.

Please send me Postpaid (No C.O.D.'s):

Elasticized Fabrics #110 #111

- Nylon—the finest \$7.95
- Lightweight Faille \$5.95
- Leopard Skin \$5.95
- Doeskin Satin Acetate \$4.95
- #114 Cotton Brief \$3.95

Waist Size _____ Give 3 choices

COLORS

- White
- Black
- Red
- Royal Blue
- Green
- Gold
- Light Blue

Name _____

Address _____

City & Zone _____ State _____

Please send your FREE illustrated Brochure

DEPT. P

322 DIFFERENT STAMPS

25¢

With 8 Exciting Topical Groups



This valuable imported collection includes the NEW CROATIA U.P.U. SET of 4, gorgeous Indonesia U.P.U. set, Roosevelt Memorial group including scarce underground issues, United Nations Issue from far off islands, Sports contests from riotous TRIESTE, TRIANGLES GALORE, multicolored BIRDS, ANIMALS, FLOWERS, PLUS HUNDREDS of other fascinating issues. A total of 322 all different stamps cataloging more than \$6.50 for only 25c, to introduce our FAMOUS BARGAIN APPROVALS. Money back if not delighted. FREE: 40-PAGE STAMP DICTIONARY & GUIDE.



STAMPEX CO., 116-RP Nassau St., New York 38, N. Y.

EARN WHILE YOU LEARN



UPHOLSTERY BE YOUR OWN BOSS

"Learn-by-Doing" at home—earn EXTRA CASH in spare time. Get a better job—be your own boss. UTS Course teaches professional furniture upholstery, re-upholstery, slipcovers, drapery making. No experience needed! FREE—ALL tools, frames, materials, fabrics to make 3 beautiful pieces upholstered furniture and slip covers worth over \$239. Write for FREE Illustrated Book. Upholstery Trades School, Dept. CE-1609, 721 Broadway, New York 3, N. Y.

Get into BUSINESS for Yourself!

METALIZING BABY SHOES

AT HOME IN SPARE TIME



Get facts about amazing money-making Warner Success Plan that shows you every easy step in completely charted path to personal independence—with your home as your headquarters . . . This proved and tested Plan is working like magic. It's backed by an old, reliable company . . . And we send it to you on a No-Risk Trial Money Back Guarantee.

QUICK CASH WAITING

Demand for METALIZED Baby Shoes and other keepsakes is growing bigger daily. Our Tested Plan Shows How to Do the Work. How to Bring in the Business, How to Make as much as \$5 an Hour. Spare or full time, big steady profits are waiting for you. Send postcard or mail coupon for FREE Facts. Act NOW! Time is precious.

FREE offer of **COMPLETE MONEY MAKING PLAN**

SEND NO MONEY Just Mail **COUPON**

Ray Brandell, Mgr., Warner Electric Co., 1512 JARVIS AVE., DEPT. 2-E, CHICAGO 26, ILL.

Please rush complete details about your No-Risk Trial Money Back Plan for Metalizing Baby Shoes. Everything you send is FREE and costs me nothing—now or ever.

NAME _____

ADDRESS _____

CITY _____ ZONE _____ STATE _____



HE-MAN VOICE!

STRENGTHEN your voice this tested scientific way. Yes—you may now be able to improve the POWER of your speaking and singing voice . . . in the privacy of your own room! Self-training lessons, mostly silent. No music required.

FREE BOOK Write TODAY for Eugene Feuchtinger's great booklet "How to Develop a Successful Voice." It's absolutely FREE! You must state your age. Booklet mailed postpaid in plain wrapper. No salesman will call. Send your name and age RIGHT NOW! Perfect Voice Institute, 210 S. Clinton St., Studio EW-1, Chicago 6, Ill.

MAKE MONEY VITAMINS-MINERALS at Wholesale! SAVE MONEY

At last—you can SAVE one-half, or more, on your vitamin-mineral needs . . . make easy, extra dollars besides. Write for FREE details.

VITINE CO.

Dept. I 208 Pacific Bldg. Miami 32, Florida

TELEPHONES



Desk Stand Style. Slightly used but in excellent condition. Many Valuable Uses. Inter-House Phones, House to Barn, etc. Loud Speakers, Microphones, Educational Purposes, Toys, etc. Come complete, ready to use with wiring diagrams included.

Two complete for only \$5.00 **\$2.75** Postpaid in U.S.A.

TELEPHONE LAMP KIT—with illustrated instructions for making Desk Telephone Lamp including all parts (harp, nipples, push switch, cord, plug, etc.) . . . \$6.50 Ppd. (Shade is not included).

MICROPHONE, Dept. X1004, 1760 W. Lunt Ave., Chicago 26, Ill.

EXPERIENCED or NOT...

Learn to earn
HIGH PAY
in 12 weeks!

MODERN AUTOMOTIVE DIAGNOSIS TECHNIQUE

is your Stepping Stone to **SUCCESS**

Prepare for a big income—unlimited opportunity in the vast, ever-growing field of modern automotive service—IN 12 WEEKS! SUN, the world's largest manufacturer of scientific automotive test equipment, offers you their MODERN AUTOMOTIVE SERVICE course—the only one of its kind.

YOU TRAIN in Detroit—The Motor City—at the completely-equipped SUN resident school. Your attention is focused on scientific testing—the only way to avoid guesswork servicing cars.

YOU LEARN basic operating principles and maintenance techniques by working on all types of the latest engines, transmissions, brakes, etc.

YOU USE the latest scientific test instruments to observe performance and pin-point trouble.

INVESTIGATE TODAY—take the first step NOW to MORE MONEY, a secure future—and your choice of location when you graduate. Recommended by motor manufacturers. Approved for veterans. Classes scheduled in Detroit Technical Training Center.



611

Sun Electric Corporation, Dept. PS-154
6323 Avondale Ave., Chicago 31, Illinois
Please send free details on MODERN AUTOMOTIVE SERVICE course.

NAME _____
ADDRESS _____
CITY _____ ZONE _____ STATE _____

ALL DETAILS
NO
OBLIGATION

SEND FOR FREE BROCHURE •

DR GRABOW PIPES



GREENSBORO, N. C.

High Power BINOCULARS

FREE 14-PAGE BOOK & CHART

Know the facts! Learn meaning of Power, Field, Coating. Latest data. 33 Models sold on

30 DAY
FREE TRIAL



\$9.95
UP

BUSHNELL'S, P-85 Bushnell Bldg., Pasadena, Calif.

TASOPE PHOTO-ENGRAVING PLANTS



MATERIAL COST
OF THIS CUT 3/4¢
SELLING PRICE
\$1.00 AND UP

Establish your own profitable PHOTO-ENGRAVING business. Make cuts for newspapers, printers, and advertisers. Make etched name plates, plaques etc. Instructions furnished, no experience necessary. Sold direct from factory since 1931. First five hundred cuts sold locally or by mail will pay for plant and pay you well for your time. Write for FREE catalog.

TASOPE DEPT. PS-5, AURORA, MO.

WIN A NEW CAR...

One of 251 BIG PRIZES in Crosman's BIG Contest. TV sets, outboards, radios, cameras. Easy to Win! Senior and Junior Divisions. Ask any sporting goods dealer for FREE entry blank and contest rules.

CROSMAN ARMS CO., FAIRPORT, N. Y., Dept. 46

MAKE YOUR OWN FANS

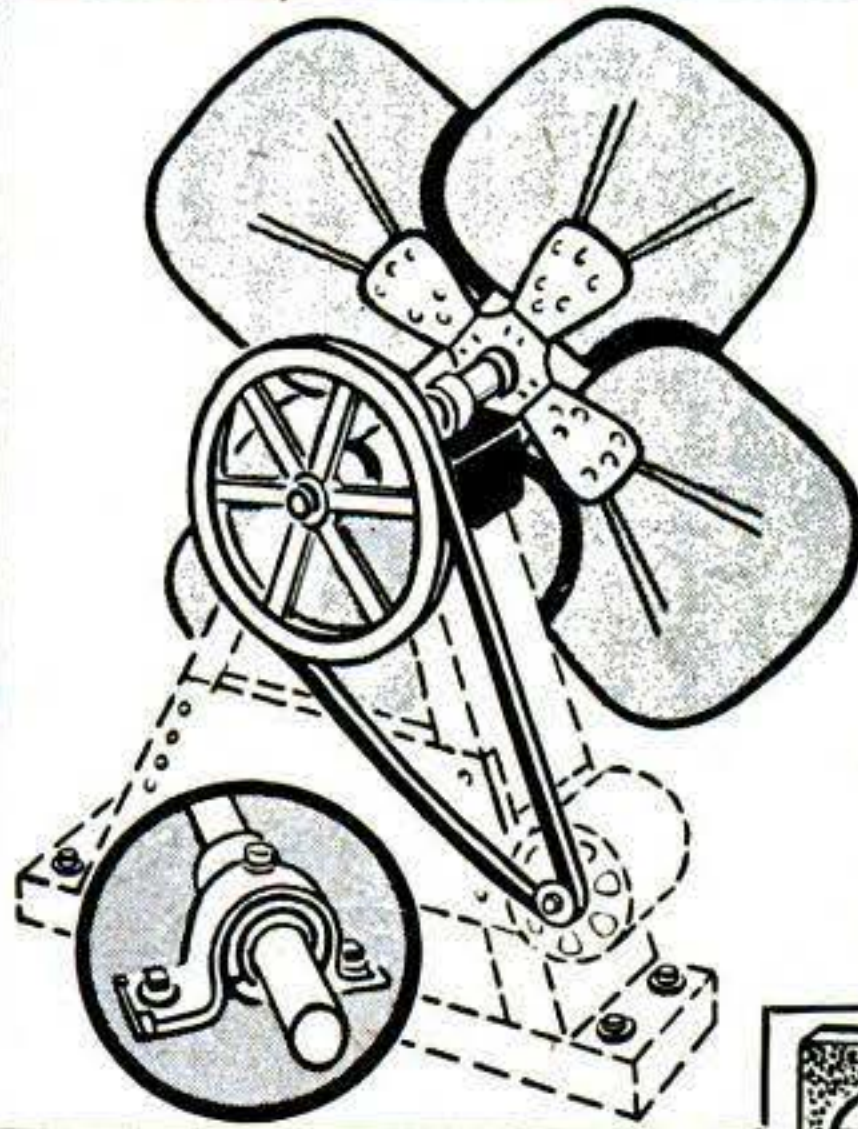

12" REVERSIBLE WINDOW FAN

Adjustable to fit your window. Will cool 1 to 2 rooms.

Regular \$39.95 value

SAVE!
NOW \$29.95

(send 10c for Whlse. Catalogue)
Complete line of fans, parts

MAKE YOUR OWN STAND EXHAUST & ATTIC FAN KITS

Complete with Bronze Bearing driving equipment assembled less stand and motor.

Blade Dia.	For Rooms	Price Ea.	Motor Needed
24"	6	19.95	1/6
30"	7	22.95	1/6
36"	8	29.95	1/4
42"	9	34.95	1/3
48"	12	39.95	1/2

New G.E. 1/3 H.P. Motor

Reg. \$21.95

NOW \$12.75

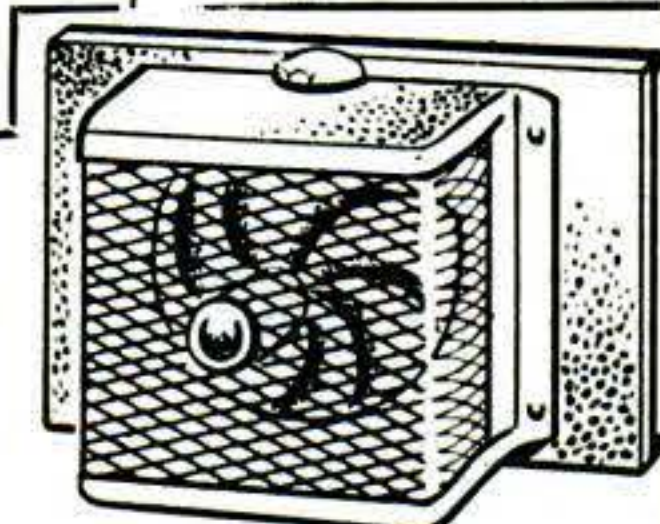

EMECO ELECTRIC

721 W. Randolph Chicago, Ill.

GROW Living MIDGET TREES!

EARN BIG MONEY

- AT HOME
- IN SPARE TIME
- NO EXPERIENCE NEEDED



It's new! Amazing! At last, the secret of growing miniature (MING) trees can be yours. FULL GROWN, dwarf trees—only a few inches high. Beautiful miniature fir, orange, oak, Chinese elm, peach, pine, cypress—any kind! ALL BLOOM and even BEAR FRUIT. All perfect healthy specimens—but miniature in size! Make costly home decorations and expensive centerpieces. (SOLD FOR OVER \$1,500 EACH) Big demand. Costs only pennies—takes only minutes per week. IT'S EASY! Fun! A new fascinating hobby—a new fabulous \$\$\$\$ business. Send for free secret plan details and real seed.

HELP US FILL HUGE DEMAND!

These trees are being demanded by STORES CLUBS • HOTELS • FLORISTS • HOUSEWIVES • INTERIOR DECORATORS • COLLECTORS • HOBBYISTS—A Big Money Opportunity FOR YOU.

FREE! GENUINE SEED AND PLAN!

NATIONAL NURSERY GARDENS, Dept. N5
8463 South Van Ness
Inglewood 4, Calif.

Rush me FREE plan and seed IMMEDIATELY!

Name _____
Address _____ Zone _____
City _____ State _____



**PROFESSIONAL-TYPE ELECTRIC
HAIR CLIPPER**



\$10⁹⁵
At Your Barber,
Beauty Shop or
Dealer's

Removes
Unwanted Hair

Cadet
ELECTRIC HAIR CLIPPER

Saves time and money for the whole family! Has cool-running magnetic motor; fine-tooth blade for close cutting; streamlined plastic case. 110v 60 cycle AC; fully tested by UL. If your barber, beauty shop or dealer cannot supply you, order direct on 10-day money-back guarantee.

ELECTRO TOOL CORPORATION
DEPT. C534-E • RACINE, WISCONSIN

Wherever WATER
comes from ...



**PLUMB IT INTO YOUR
KITCHEN SINK—YOURSELF!**
Model EC-100 — complete
with installation kit
\$39.95

**SATISFACTION
GUARANTEED
IN ANY AREA**

Larger ECWP units available
for Hotels, Restaurants,
Schools, Institutions.
Write for free
illustrated brochure.

**You can be SURE
it's PURE!**

with the sensational NEW
**Electro-Chemical
Water Purifier**

Enjoy Healthful, Crystal-Clear
Water for a lifetime in your home,
trailer, boat — or anywhere!

Chlorine — Objectionable Tastes
— Odors — Colors — Solids
— Dirt — Bacteria and all
suspended matter are
removed by the amazing

Electro-Chemical Water Purifier

If your dealer cannot supply you,
send his name, address and your
check or money-order for \$39.95
Your **ELECTRO-CHEMICAL
WATER PURIFIER** will be sent
you direct — prepaid.

**pro-tech
corporation**
Dept. S-54.
1013 Burbank Blvd.
BURBANK, CALIFORNIA



**INSURED TIRE SERVICE
POPULAR BRANDS**

SPECIAL!
Deduct
10% on
orders for
Two or
More used
tires

FREE INSURANCE POLICY given
with each used tire sold.
We guarantee the amount of
service you pay for.

**YOU CAN'T
LOSE!!**

Tube Given Free with Each Used
Passenger Tire Upon Request

Super Quality — Rugged Performance — 15 Months Insured Service	
600x16 \$3.65	670x15 \$3.95
650x15 3.85	670x16 4.05
650x16 4.25	700x15 3.95
700x16 \$4.45	760x15 4.45
710x15 4.35	820x15 4.95
760x15 4.45	550x17 4.65

Supreme Quality — Nothing Finer — 30 Months Insured Service			
600x16 \$5.25	475x19 \$5.45	700x15 6 \$10.45	700x20 \$12.50
600x16 6 6.75	640x15 4.95	750x16 8 15.95	750x20 8 15.50
650x16 5.75	670x15 5.35	700x17 11.95	750x20 10 17.50
650x16 6 7.25	710x15 5.45	750x17 16.45	825x20 21.50
700x16 6.35	760x15 5.95	750x15 10.95	900x20 19.95
750x16 6 8.45	800x15 6.35	30x5 11.25	1000x20 20.45
550x18 4.95	820x15 6.35	600x20 10.95	1100x20 21.25
550x17 4.75	550x15 5.35	650x20 11.75	1000x22 21.95
650x15 5.25	670x16 5.15	32x6 8 11.95	1100x22 22.75
700x15 5.35	700x16 6 10.25	32x6 10 12.75	1100x24 25.95

Whitewalls \$1.00 extra

**MIDLAND
TIRE SALES**

Speedy shipments on Mail Orders. F.O.B. Chicago.
Insurance Policy sent with each order. Deduct 10%
on orders for 2 or more used tires. Send CHECK or
MONEY ORDER. No COD's.
3701 S. Normal, Dept. SS-19, Chicago 9, Ill.

JITTERBUG • CATCHES MORE FISH

Noisy surface bait. World's best
hooker — day or night. Gurgling,
padding action of the double-
lobed lip makes fish strike hard.
5/8 oz. or 3/8 oz. or 1/4 oz. spin-
ning size \$1.25. Musky size \$2.00.

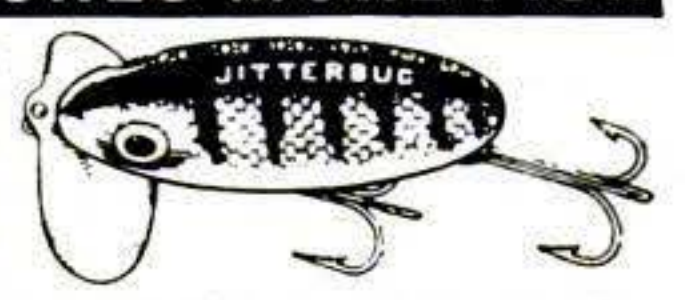

FRED ARBOGAST CO. INC., 2345 W. North St., Akron 3, Ohio

FREE WRITE TODAY FOR YOUR BIG FREE ARBOGAST
COLOR CATALOG — FULL OF PICTURES OF CATCHES

**Free Book on Arthritis
And Rheumatism**

HOW TO AVOID CRIPPLING DEFORMITIES

Explains why drugs and medicines give only temporary relief and
fail to remove the causes; tells all about a specialized non-surgical,
non-medical treatment which has proven successful for the past 35
years. Write for this 44-page FREE BOOK today.

Ball Clinic Dept. 36 Excelsior Springs, Mo.

INVENTOR BARES SECRETS

Successful engineer-inventor strips mystery from in-
vention and science in outstanding document. 25,000
hard-hitting words prove that a college degree
is not necessary to make a fortune in these fields.

Send only \$2.00 or write for free added information
PANORAMIC RESEARCH • 4421 N. 14th St. • Phoenix 43, Arizona

SEND FOR THIS DOCUMENT TODAY!

**Build Your Own AIR CONDITIONERS
AND DEHUMIDIFIERS**

**FROM JUNKED REFRIGERATORS—FOR \$15
FOR HOME OR AUTOMOBILE**

Don't let your family suffer from the heat. Live and ride
in cool comfort. Send 50c for instruction booklet (spec-
ify whether for home or car).

SLACK & CO. DEPT. 60 CHICAGO 18, ILL.
3716A BELMONT



You're Right!

NOBODY LIKES TO ADD & SUBTRACT FRACTIONS

Get a **Fractionator**
"IT ADDS AND SUBTRACTS FRACTIONS"

\$1⁰⁰
POSTPAID
U.S.A.

Direct reading. Answers in Fractions &
Decimal Equivalents. 100% Accurate.
Handles all Engineering Fractions.

Direct Mail Only
Refund if not
Satisfied

DIALS LIKE A TELEPHONE **Chas. E. Wells • Box 25-B • Montrose, Calif.**

WORLD'S GREATEST

CLASSIFIED

OPPORTUNITIES

Here are hundreds of opportunities offered especially to the readers of Popular Science Monthly. Read them. Answer them! You can make and save money.



MAKE MONEY

SAVE MONEY



POPULAR SCIENCE MONTHLY - 353 FOURTH AVE. - NEW YORK CITY 10

Classified Ads only 90c per word per insertion, payable in advance. Minimum ad 10 words. To be included in July issue, copy should be in our office by May 24. No cancellations accepted after May 15th. Address orders to O. K. Kelly, Classified Adv. Mgr.

1 AUTOMOBILES & MIDGET CARS

HI-Mileage-Speed equipment from the world's largest supplier. Dual manifolds, finned heads, electric doors, lowering sets, fuel saver, thousands of items for all cars. Huge catalog 25c (illustrated literature free). Wholesale to garages. Newhouse Automotive Industries, Los Angeles 22.

MODEL T Fords, engines, parts, tires, catalog. Box 381, Williamsport, Penna.

NON-Profit organization offers automobile literature—old, new and foreign; dealer books, service manuals, glossy photographs; free motor magazines. Write today; get on free mailing list. Auto Maniacs, Inc., Stockbridge, Michigan.

FORWARD, neutral, reverse with simple transmission for lawn mowers, sidewalk automobiles, easily built, plans \$1.00. L.W.S., Box 677, Largo, Florida.

FIBERGLAS for Automobile Bodies at half price. Limited Supply. Sample—10c. Crider Plastics, Tongs, Kentucky.

FIBERGLAS automobile bodies. Build your own. Maurice Lannon's Fiberglass "How" book—\$2.50. Information, materials catalog—10c. Gem-O'-Lite, Box 6868A, North Hollywood, Calif.

ANTIQUA Automobile Color Slides, 2x2. Illustrated Catalog Free. Universal Slide Company, Box 779P, Beverly Hills, Calif.

CROSLY Owner? Join with other Crosley owners—in every state—for Crosley parts and info. Crosley Car Owner's Club, 2101 Greenway, Charlotte, N. C.

ANTIQUA Car Catalogue, 300 new listings, price \$1.00, 1323 Jackson Road, Albion, Michigan.

A Better Car For You! New 256-page book, "How To Take Care of Your Car" by famed Popular Science experts shows you easy ways to beat high cost of car care, repair. Over 750 pictures, hundreds of easy instructions on fixing, servicing, saving on gas, more! Guaranteed! Only \$2.49. Popular Science, Dept. 554C, 353 Fourth Avenue, New York 10, New York.

STABILIZE Fords, Mercurys, Lincolns in ten minutes. Write for literature and nearest dealer. \$2.75. B&B Specialty Company, 1718 Hawthorne, Houston 6, Texas.

2 AUTO SUPPLIES & EQUIPMENT

BRUSH Plating Outfits connect to a battery. No tanks or shop required. Free particulars. Gunmetal Co., Ave. K, Decatur, Illinois.

1954 EDITION. It's New! It's Different! Get world's largest Auto Accessory & Parts Catalog and save money. 132 pages. Over 50,000 items, including Hollywood Accessories Hi-Speed Equipment, Rebuilt Engines, all parts and accessories for all cars and trucks. We have that Hard-To-Get part! Jam-packed with bargains. Completely illustrated. Send 25c (refundable). J. C. Whitney, 1919-KB Archer, Chicago 16, Illinois.

NEW And Used Parts At Savings. Complete guaranteed parts service for all models cars and trucks, late or old. Largest in the West. Army parts specialists. No catalog—write for quotations. Fast Mail Order Service. Pioneer Auto and Truck Parts Co., 788 W. 13th Avenue, Denver, Colorado.

CUSTOM accessories headquarters. Electric push button doors—trunks, bull noses, custom grilles, speed dress-up equipment. 40 page catalog hundred photos—25c. Eastern Auto, 3319A South Grand, Los Angeles 7, Calif.

"FORD T" parts—engine and chassis. Parts for other old models too. Special parts made to order. (We buy surplus items). B. S. Wisniewski, Milwaukee 7, Wisconsin.

SAVE your life with amazing new "Torsion-Flex" Sway-Bilizers! Stops sway, skid, slide. Postal brings free illustrated literature, gift offer. Sway-Bilizer, 5434-B Higgins, Chicago 30.

SENSATIONAL Free Trial Offers! Surplus stock of famous Gale Hall automotive instruments, brand new, original cartons! Try at our risk for seven days—then send payment or return merchandise! Professional Compression testers, originally \$10.75, now \$2.98! Engine analysis vacuum gauges, originally \$12.50, now \$4.55! Fuel pump testers, originally \$8.10, now \$3.09! Original Gale Hall motor condition/gasoline economy gauges for permanent dashboard mounting . . . originally \$7.50, now \$2.98! (Add 40c to each price for postage) Order Now! New England Surplus Sales, Dept. PS-5, Newburyport, Mass.

"AUTOMOBILE Accessories", for Free Trial! Write—Neher Industries, LaVerne 6, California.

NEW!! Different! Economy Safety catalog featuring complete national selection of latest improved inventions. Fully illustrated . . . unconditionally guaranteed. Many free, free, send no money offers. 50c refunded on first purchase. Mehren Industries, 8666 West Pico Blvd., Dept. S-3, Los Angeles 35, Calif.

RADIOS custom for 1952-3-4. Fords \$38.90. Free literature. Nordic Radio, Box 582, Evanston, Illinois.

CADILLAC, Buick, Olds, Pontiac. Stop that skip! Install genuine Spark-O-Liner and new breaker plates. New smooth power, top gasoline mileage, 3½ million sold. At all jobbers. Free catalog. Hove, 5606 Clinton Avenue, Minneapolis 19, Minn.

BUY Wholesale, cash or credit. Leopold's, Box 1113-M, Columbus, Ohio.

LACHAPPELLE'S Treatment. (Patented.) Makes any gasoline motor better, even a brand new one. Free data on request. Ferns Products, 8120D Walnut Drive, Los Angeles 1, Calif.

BUY Wholesale nationally advertised auto supplies, thousands other products at big discount. Free "Wholesale Plan." American Buyers', 629-EE Linden, Buffalo 16, N. Y.

CROSLY Parts Supplier, Hydradisc Brake Parts, Marine Conversions, Service, Box 7, Elmont, New York.

AUTO Body repairing made easy. Complete kit \$2.00 postpaid. Guaranteed to save you money. Plastic Metals, 1391 East 33rd, Cleveland, Ohio.

CAR Burning oil? Losing compression? Try Clifford's Compression Seal. \$2 postpaid. Clifford's Engineering, 1329 Seventh, Aurora, Illinois.

ELECTROPLATE autoparts, novelties, mirrors. Easy, inexpensive home processes. Free booklet. Tyco Metals, Box 13231-FC, Houston 19, Texas.

ELIMINATE sticky valves, rings, lifts, restore power. Complete \$2.00. Hoppy, Box 5071, Detroit 26, Mich.

PERRIN end gate locks for Pickup trucks. Braces box, easily installed. Low price. Information free. Engalo, McPherson 1, Kansas. Dealers wanted.

CHEVROLET Owners: Stop tappet noise with Kaye Tappet Silencers. Quality product. Easy to install. Complete set \$5.95. Kaye Products, 2067C So. Layton Blvd., Milwaukee, Wisconsin.

RESTORE that fresh, delightful "New Car Smell" to your automobile. Bottle—50c postpaid. Slack, 3716-A Belmont, Chicago 18, Illinois.

CRUMBLISS Super Coil—literature. Automotive tool catalog. White's, Catawissa 2, Penna.

IONIC Radiator Cleaner!! Proven to clean thoroughly!! Even Inside Engine. Look inside radiator for proof. Free literature. Send \$3.00 for Ion-20 Treatment. Wong Laboratory, Cincinnati 9, Ohio.

HYDRAMATIC Owners prior to '52 models added control available similar to Dual-Range Select third speed at will. Nielson Third Speed Selectors, 1680 N. Western Ave., Los Angeles 27, Calif.

AIR Conditioner. Save \$500.00! Equip your car for \$164.70 with complete kit. Free literature. Slack, 3716-A Belmont, Chicago 18, Illinois.

INCREASE! Gasoline mileage Three to Five more miles per gallon. Guaranteed Gasoline Vaporizer, also Increases Power. Easier starting. \$3.50. Turb-O-Vane, Stockton, Calif.

NEW Tonic to save gas bills, tonic and instructions, \$1.00. T. Wayland, Box 1198, Chico, California.

DOLLARS in the mail for you! Put your ad here and watch orders fill your mailbox. For as little as \$9.00 you can advertise your product or service in the classified opportunities columns of Popular Science Monthly. The July issue closes on May 24. Write today for order blank. O. K. Kelly, Classified Adv. Mgr., Dept. 554, Popular Science Monthly, 353 Fourth Ave., New York 10, N. Y.

3 AUTO TRAILERS

BUILD your own trailer! Plans for all kinds. Illustrated catalog 10c. Jim Dandy, 125-S, Wausau, Wisconsin.

EXCEPTIONAL expanding eight foot trailer. Accommodates family of five. Build yourself. Literature 10c. Fra-Mar Company, Jones Avenue, Wilmington, Mass.

4 MOTORCYCLES, BICYCLES AND SUPPLIES

MIDGET Auto \$45. Villiers motorcycle \$35. Cushman less motor \$25. Whizzer motorbike \$35. Whizzer motor \$5. (Mail-order only). Send 25c for Directory Number 59, listing these and hundreds of other bargains in new and used midget cars, motorscooters, engines, parts, plans for homebuilders, etc. (35c by first class mail). Midget Motors Directory, Athens, Ohio.

SEND for free folder on "How to Build Your Own Motor Scooter." St. Louis Products, Box 24-BF, Normandy 21, Mo.

POPULAR SCIENCE OPPORTUNITIES

RECONDITIONED motorcycles and motors. Chromium accessories. Complete stock Indian parts. Expert rebuilding. Fast service. Indian Motorcycle Sales, Kansas City 27, Mo.

WHIZZER motorbike \$25.00; Doodlebug motorscooter \$35.00; Servicycle \$20.00; Harley Twin \$25.00. Rush 25c (35c first class mail) for catalog #955 listing many other amazing bargains in motors, midget cars, motorscooters, motorbikes, construction plans. Associated, Box 534, Toledo, Ohio.

REBUILT gasoline engines \$17.00 to \$37.00. Cauffiel Motor Industries, Temperance, Michigan.

5 AVIATION

AVIATION Surplus Bargain Catalogue, One Dime. Ort, Thomasville 52, Penna.

600 AVIATION books listed in free catalog! Aero Publishers, 2162-PS Sunset Blvd., Los Angeles 26, California.

WHO to contact for employment in Aviation. Airlines, factories, corporations, cropdusters, etc. Pilots, Mechanics, all others. Experienced and unskilled. U.S. and foreign. Guaranteed reports only \$1.00. Research Services, Box 2904-PS, St. Louis 17, Missouri.

PROPELLERS, plans, kits for air boats, snow sleighs. Immediate delivery. Catalog 25c. Banks-Maxwell, Box 3301G, Ft. Worth, Texas.

6 BATTERIES, GENERATORS, ETC.

EDISON Nickel odorless storage batteries, 12 to 600 ampere hour. Any voltage. Long guarantee. Literature. Hawley Smith Co., Croton Falls 2, New York.

7 ELECTRICAL SUPPLIES & EQUIPMENT

LAMPS—25c brings bargain catalog showing all parts for repairing, building. Contains instructions for electrifying vases, oil lamps, etc. Gyro Lamps, 5402B Clark, Chicago 40.

ELECTRICIAN'S tool for making solderless connections that enables anyone to do "professional-like" jobs. Crimps terminals and connectors. Splices, cuts and strips wire. Shears bolts without damaging threads. Complete kit; Tool, Terminals, Connectors and Insulators, formerly \$5.00, now \$3.95 postpaid. Aircraft Marine Products Inc., 1331-C, American Building, Cincinnati 2, Ohio.

ELECTRIC Pencil: Engraves all Metals, \$1.50. Beyer Mig., 10511-C Springfield, Chicago 43.

TELEPHONE Wire, communication, blasting, signal use. Two-conductor, insulated copper-steel Army Field Wire. Mile reel \$16.00, half-mile \$9.00. Surplus Telephones. Write for Folder. Loris Sales, P.O. Box 1896-A, Sacramento, Calif.

8 WELDING, SOLDERING

"BUILD-UR-OWN" a.c. welder and a.c. power plant with a good used engine and low cost Hobart generator. Welds anywhere and supplies 5KW stand-by power for any emergency. Write Hobartweld, Box P-543, Troy, Ohio.

WELDERS 110V, \$29.50, 220V, \$49, combination \$54. Morris, 1070 Inner Drive, Schenectady, New York.

9 MACHINERY, TOOL SUPPLIES, ETC.

MYERS Sharpening Service. Blake-Tap. Black Diamond. Oliver. Machines. Drills #70-#1; A-Z; 1/32-3/4 @ 10c. 3/4-3" 2-3-4 lip Coretips 25c-\$1.00. Parcel Post. Northfield, Ohio.

TOOL Catalog—Send \$1.00 Refundable. Yuhas, 3350 Theodore, Detroit 11, Mich.

TOOL Post: Turns thousands of different size concave, convex radii 0" to 4" no special tools to grind. Radius Tool, Box 476, St. Louis 12, Mo.

BUILD Your own machine tools. Milling machine castings only \$49.50. 10" shaper \$97.50. Twenty others at low prices. Catalogue 10c. Lewis Machine Tool Co., Los Nietos, California.

SMALL Lathe boring table or backplate castings. Lay Tools, Norcross, Georgia.

ALLEN One Ton Power Bench Type Punch Press, \$97.50. Circular. Allen, Dept. PSB, Clinton, Missouri.

BUILD 10 Terrific Machinist's Tools! Best you've ever seen! Complete drawings, instructions \$2.00. 10 day money back offer. Progressive Tool Designers, 2161C So. 76th Street, Milwaukee 14, Wisconsin.

POWER tools, equipment wholesale prices. Free bulletin. Homecrafters Cooperative, Grand Rapids 6, Michigan.

10 ENGINES, MOTORS, ETC.

WINDING Data, listing 225 motors, single and three phase. \$1.00. Motor Data, Box 7631, Kansas City 28, Mo.

ALTERNATING Current Generators 750 watt \$38.50. 5000 \$185.00. Motors 1 horse \$37.50. 2 \$67.50. 3 \$87.50. Butler, 1885 Milwaukee, Chicago 47.

REBUILT Gasoline Engines, \$17.00 to \$37.00. Cauffiel Motor Industries, Temperance, Michigan.

11 BOATS, OUTBOARD MOTORS

BUILD marine engines with Federal Conversion Kits. Federal Marine Motors, 9011 Cottage Grove Ave., Chicago 19, Ill.

NEW, used rebuilt marine motors. Marine conversions, fittings. Free Catalog. Stokes Marine Supply, Dept. 23, Coldwater, Mich.

OUTBOARD Motor Parts—New—Used for all makes. Send stamp for price quotation, listing parts needed. Outboard Motor Mart, Inc., 229D State Street, Boston, Massachusetts.

MARINE Conversions—Willys to Cadillac. Catalogue and conversion hints free. Barr Marine Products, 2709B Castor Avenue, Philadelphia 34, Pa.

"HOW To Make Your Old Boat New With Liquid Glass" and "How To Build Your Own Fiberglass Boat". These 2 illustrated manuals show step-by-step method. Both for 25c from Marine Div., Dept. ME-102, Castolite, Woodstock, Ill.

FULL size, cut-to-shape Boat Patterns, Blueprints, 7 1/2-38 feet. New 1954 illustrated "Build A Boat" catalog of 50 naval architect-designed Cruisers, Runabouts, Sloops, Skiffs, Outboard Boats, Sailing, Racing, Houseboats, 50c. Marine Hardware Catalog, \$1.50. Bigger, better 1954 "How to Build Boats" book, \$2.50. Polywog Houseboat Plans, \$12. Cleveland Boat Blueprint Co., Dept. A-77, 9400 Steinway, Cleveland 4, Ohio.

SAVE 2/3 Cost. Assemble your own boat. We furnish parts. No experience necessary. Rowboats, Cruisers. Illustrated Catalog 25c. Midwest Boat Company, Menomonee Falls 1, Wisconsin.

RUBBER Boat Bible with Prices 10c. Ort, Thomasville 564, Penna.

GET our big 224 page boat hardware and equipment catalog. Send \$1.00 for cost of handling, refunded with first order. Garland Frasher Marine Sales, 2626 Fifth Ave., Huntington, West Virginia.

BUILD a 21 foot plywood outboard cruiser, also other plans including a sailing catamaran, literature free. Widd Hauber, 2451 18th Avenue, No., St. Petersburg, Fla.

BUY Wholesale nationally advertised outboards, thousands other products at big discount. Free "Wholesale Plan." American Buyers', 628-EE Linden, Buffalo 16, N. Y.

MARINE conversions for Ford and Jeep engines. Catalog 10c. Lehman Manufacturing Co., 972A Broad St., Newark 2, N. J.

AIRPLANE Floats (Pontoons) for Boats. Catalogue 10c. Ort, Thomasville 568, Penna.

FIBERGLAS permanent boat coating. Maurice Lannon's Fiberglass "How" book—\$2.50. Complete catalog—10c. Gem-O-Lite, Box 6868B, North Hollywood, Calif.

FIBERGLAS lifetime boat covering. Average 12 foot boat costs only \$27.50! Free information. Northwest Fibr-Glass Company, 1531 North Morgan, Minneapolis 11, Minnesota.

BUILD Beautiful fiberglass-plastic boats without using molds. New patented method. Write Speedcraft, 2450 Emerson, off Square Lake Road, Pontiac, Michigan.

"AQUA-Cycle"! New! Great! (water bicycle) Build yours home. Be first. Complete plans, simple instructions \$2.98. Koch Engineering, Box 69, New York 28, N.Y.

OUTBOARD Cruisers 15'-17'-20'. Simplified plans for amateurs. Glen Marine—Box 568, Compton, Calif.

FOAM rubber boat mattresses made to order—Free catalog—Perma-Foam, 140-A Main Street, East Orange, New Jersey.

AIR boat plans, kits, supplies. Catalog 25c. Banks-Maxwell, Box 3301J, Ft. Worth, Texas.

KIT. Hardware Catalog. 15c. Boatbuilders Marine, 55-P Sorrento, Allston, Mass.

NONCORROSIVE screws, studs, nuts, washers and specialties reasonably priced. R. Freas, 1012 Maple Street, Conshohocken, Penna.

BOAT Kits, plans and patterns for America's fastest and finest outboard racers, runabouts, hunting skiffs, canoes, and fishing boats. Illustrated literature 25c. Schneider Boat Co., Dept. PS, 1913 West Vliet, Milwaukee 5, Wisconsin.

NEW! Motor-Porter. Outboard Carrier. Factory to you \$14.95 F.O.B. J.B. Sabourin Co., Norton, Mass.

FREE Catalog! Boat Kits, Trailers, Fiberglass. Marine Hardware. Luger Industries Dept. MD, 3207 Fremont South, Minneapolis, Minnesota.

12 BODY-BUILDING COURSES, JIU JITSU & ATHLETIC EQUIPMENT

BUILD Powerful arms, chest, shoulders. 22 exercises. \$1. Fonsad Studio, Box 601-C, 1100 Market Street, Wilmington 99, Del.

BARBELLS. Dumbbells. Exercise equipment Courses. Free booklet. Good Barbell Co., Reading, Penna.

GREAT Strength Easily Obtained. Send \$1 for complete Arm, Chest and Back muscle-building course and apparatus. Noticeable results guaranteed in 7 days or \$1 refunded. Joseph Dryer, Box 5527-H, Chicago 80.

14 FIELD GLASSES, TELESCOPES

FREE Catalogue! Thousands war surplus optical bargains. Lenses, Prisms, Telescopes, Binoculars, etc. Send \$1.00 for 10 Lens Hobbyist Set and Project booklet. G. Jaegers, 691 West Merrick Road, Lynbrook, New York.

WAR Surplus Bargains, Binoculars, Telescopes, Sextants. Millions of Lenses, Prisms, Reticles, Eyepieces, Objectives, etc. Mail 10c for Big "Catalog CN." Send \$1.00 for Stock CN-10-piece Lens Kit and Big Instruction Booklet. Edmund Scientific Corp., Barrington, New Jersey.

SAVE 25%! Get interesting facts. Free 52 page Binocular, Telescope Catalog. \$3.95 to \$250.00! United, 9043 S. Western, A-9016, Chicago 20, Dealers Wanted.

IMPORTERS' amazing prices, binoculars, microscopes, gunsopes. Free trial. Folder, "Binocular Selecting", pricelists free. Dealers wanted. Prentiss Importers, Mercury Bldg., West Los Angeles 25, Calif.

SPECIALISTS. Used, new microscopes. Prepared slides. Supplies. Telescopes. Free illustrated catalog. Nassau Optical, 9 W. Greenwich, Roosevelt, New York.

"DYNA-SCOPE" Sensational new telescope. Send for details. Criterion Co., Hartford, Conn.

BINOCULARS—Telescopes, Microscopes. Terrific values \$3.98 up. Request Free-Money saving catalog. Criterion, Hartford, Conn. Dept. S21.

8X FINDER Scope, \$1.00. "Beginners Astronomy." 25c catalog, kits, supplies. Telescopic Supply, Box 685, Dallas, Texas.

REFLECTOR Telescope Kits from \$6.25. All parts designed and built at our Hoboken factory. Mirror Cells, Diagonals, Focusing Mounts, Tripods, Tubing, Oculars. Fully guaranteed. Free illustrated catalog. Send orders and inquiries to Esco Products, Dept. PS-1, 1428 Willow Avenue, Hoboken, N.J.

GIANT 100X day and night telescope. Completely assembled with two eyepieces. Extra heavy tripod. Steel and brass tube construction. \$7.75. Other telescopes at \$12.00 and \$16.00. 400X telescope makers kit contains brass focusing tube, erector, 5 lenses instructions—\$3.75. Suffolk Science, Riverhead 4, New York.

LOWEST prices all sizes Binoculars, Telescopes, Microscopes 8x30 \$32.00, free catalogue. Joe's Binocular Sales, 4827 Second Street, Detroit 1, Michigan.

POPULAR SCIENCE OPPORTUNITIES

TELESCOPE kits and accessories, mirrors aluminized, ground to order, instructions 10c. Garth Optical, Box 954, G.P.O., N.Y.C. 1, N.Y.

TELESCOPE Making, Astronomical books, free list. Herbert A. Luft, 42-10 82nd Street, Elmhurst 73, New York.

SPACE-Rover Astronomical Telescopes. Precision made, Professionally equipped. Rasmussen-Reece, Amsterdam, New York.

15 SPORTING GOODS, GUNS, FISHING TACKLE, ARCHERY, TRAPPING

180 PROFUSELY illustrated pages, antique pistols, swords, daggers, armor, etc. 50c. Robert Abels, PS860 Lexington Ave., New York 21.

CAST Iron Sinker Molds—for making your own sinkers. Free illustrated booklet. Reading Instrument Co., Box 78, Reading, Pennsylvania.

KNOW when to get the fish. Send 25c—Zodiac Fish Guide—best yet. Morrell, 50 Penna. Elmira, N. Y.

MOLDS for Fisherman's Sinkers, Jigs, Squids, Casting and Spinning Lures. Free Catalogue. Sweet's Molds, Tonawanda 3, New York.

5,000 BARGAINS, firearms, binoculars, war relics, catalog 50c. Smith Museum, Runnemede, N. J.

IMPORTED, Stiletos, Daggers, Throwing, Pocket, Hunting knives, etc. Free catalog. J. D. Clinton, 94 Church, Mt. Clemens 3, Michigan.

BUY Wholesale nationally advertised sporting goods, thousands other products at big discount. Free "Wholesale Plan." American Buyers, 627-EE Linden, Buffalo 16, N. Y.

JAP rifles altering American shells \$6.00, catalog 5c. TP Shop, West Branch 10, Michigan.

SAVE 50% on finest bows, arrows, complete bowhunting outfits, etc. Free Catalog and "How to Hunt with Bow and Arrow" booklet. Send 25c for handling. Malibu Archery, Dept. N-B, 3156 8th Street, Los Angeles 5, California.

"FISH-Master" trip rod catch fish or money back. 6625 15th Avenue, Kenosha, Wisconsin.

TENTS, Complete Line, all purpose, best quality. Send for List. Delano Studios, Suite PS, 31 E. 18th Avenue, Denver 2, Colorado.

5000 COLTS, Flintlocks, Kentuckies, Wheellocks, Antique-Modern Gun Bargains. Catalog only \$.50. Agramonte's, Yonkers 2A, New York.

FLY-Tyers—When tying your own flies, have the best in tools. Catalog 10c. D. H. Thompson, 335 Walnut Avenue, Elgin, Ill.

MAKE over \$100. World famous fishing baits kit \$9.95. Humble, 159 Prichard St., Prichard, Alabama.

FREE Catalog: Flies, Lures, Mustad Hooks, Fly Tying, Lures, Spinner, Rod Making Materials, Nylon Coils. Supreme Mfg. Company, Amarillo, Texas.

SPINNING Lures! 5-polished brass spoons & all fittings you assemble. All for \$1.00. E. L. Wright, Box 115, Fayetteville, New York.

OVER 500 guns, modern, obsolete. List 10c coin. Ed Howe, 26 Main, Coopers Mills, Maine.

SWIMMERS! Send \$3.95 for Imported French Mask. Skin Divers' Catalog 25c. Aquafun, Davenport 5, Iowa.

GOLF clubs, name brands wholesale, Crystal Golf Sales, Crystal, Michigan.

SUBPLANE—Frogman subsurface aquaplane, circular 25c, plans \$2.50. Complete \$78.50. Service Engineering, 7959 Sparling Road, Goodells, Michigan.

16 CAMPING EQUIPMENT & TENTS

TENTS (direct from manufacturer), camping equipment, sleeping bags, air mattresses. Low prices. Send 10c for 72 page illustrated tent-camping equipment—tent maintenance catalogue. Mor-San Sales, 10-21G 50th Avenue, Long Island City 1, New York.

17 DOGS, BIRDS, HAMSTERS, RABBITS & PETS

GUINEA Pigs. Profitable pleasure. Booklet free. Taylors, B426B, Hapeville, Ga.

MAKE Big Money! Raise Chinchilla Rabbits. Cash Markets Supplied. Write Today! Rockhill Ranch, Sellersville 16, Pa.

ORIGINAL Drawing made from favorite photograph of your Dog. Everlasting keepsake. Write for free information. Earle Littlejohn, 201-PS East Earle, Greenville, South Carolina.

RAISE moneymaking Angora, New Zealand Rabbits, Particulars free. White's Rabbitry, Jackson, Michigan.

ST. Bernard puppies! Reg'd! Spring delivery. Details, prices, charming pictures free upon request. Manitou Kennels, Watrous, Sask., Canada.

CHINCHILLAS (no rabbit) easily raised. Profitable. Big future. Terms. Cliff's Chinchillas, Ithaca, Michigan.

CHINCHILLAS Rented, we pay up to \$300.00 each for offspring. Write: R. Rau, R-2, Jeannette 5, Pa.

GROW Mushrooms. Cellar, shed, and outdoors. Spare, full time, year round. We pay \$3.50 lb. We paid Babbitt \$4,165.00 in few weeks. Free Book. Washington Mushroom Ind., Dept. 177, 2954 Admiral Way, Seattle, Washington.

FORTUNES made raising crickets and fishworms sell by mail—complete instructions—\$1.00. Large breeder redworms \$5.00 per 1000. Postpaid. Carter Worm Company, Plains, Georgia.

RAISE Fishworms—Highly profitable! Illustrated booklet explains raising, feeding, marketing, shipping. 25c. Ozark Worm Farm-V, Willow Springs, Missouri.

ALBINO and Golden Hamsters. Cages, supplies. Free Information, Circle S. Hamstery, Box 183, Claymont, Delaware.

HAMSTERS—Golden; young, \$4.00 pair; fully developed, \$5.00 pair. Request prices on rare albinos. Adirondack Hamstery, Prospect 15, New York.

"MONKEYS, Their Training, Care and Feeding." new booklet describing 30 most popular varieties. 25c postpaid includes importers price list. Tropical Hobbyland, 1531 N.W. 27th Ave., Miami, Florida.

19 FARMS, OTHER REAL ESTATE

FARM-Ranch Opportunities. Favorable conditions. Washington, Minnesota, Montana, Idaho, Oregon, North Dakota. Literature, farm descriptions. Specify which state. J. W. Haw, 120 Northern Pacific Ry., St. Paul 1, Minn.

CALIFORNIA Ranch Lands. 50c to \$5 acre minimum bid. Farm-ranch-hunt-fish-retire. 10c brings illustrated land catalog, outline maps. Tax Land Sales, Box 2350BX, Hollywood 28, Calif.

GOVERNMENT Land. Homesteads, Leases. 170,408,160 acres vacant, public land 24 Western States. Information: Area by states, homesteading, lease, 5-a tracts, minerals, latest laws, vet preference, etc. \$1.00. Lands, Box 503, El Reno, Oklahoma.

STROUT Catalog—Mailed Free! Farms, Homes, Businesses, 34 States, Coast-to-Coast. 3240 Bargains described. World's Largest; 54 years Service. Strout Realty, 255-ZB 4th Ave., New York 10, N. Y.

HOUSTON is the fastest growing city in America. Come here Now and profit from its fortune-making future. Beautiful Homesites in desirable Suburb for only \$345—easy terms. Booklet Free. Nathan Wood, Box 413, Houston, Texas.

FLORIDA'S choicest lakefront lots. Excellent fishing—hunting. Eustis-Deland highway. \$10 monthly without interest. Free literature. Roepke's, Eustis, Florida.

SOUTH Carolina Homesites \$235.00. \$8.75 monthly. Development adjoining Lake Greenwood, send 10c Additional information—Bob Hollingsworth, Box 824, Greenwood, South Carolina.

FARMS, houses, businesses wanted. Free information. Toole's, Box 84, Evansville, Indiana.

\$5.00 PER Acre, Missouri Land. Warranty Deed. Free List. John Calvert, Plant City, Florida.

RETIREMENT Homes, nothing down. Gardens, chickens. Details. Perry, Breirhill, Pa.

20 TREES, SHRUBS, ROOTS, HERBS

GINSENG. Goldenseal roots bring \$2.00-\$12.00 pound. Full Information. F. G. Collins, Viola, Iowa.

BONSAI. The secret of dwarfing potted trees. \$1.00 for complete instructions. P. O. Box 58, Yokohama, Japan.

LANDSCAPE—your own. Save.—Send sketch or photograph of your home. R. Paul, 1027 E. Wolfe, N. Braddock, Penna.

GARDENERS, Florists, Clubs. Free samples. Sheill, 29205 Northwestern, Birmingham, Michigan.

21 POULTRY & SUPPLIES

RAISE pheasants on \$100 week plan. Little capital and space can make you independent. Free details. Great Central System, Columbus 6, Kansas.

22 PROFITABLE OCCUPATIONS

DETECTIVES Earn Big Money. Excellent opportunity. Detective Particulars free. Write Wagoner, P-125 W. 86th, N. Y. 24.

"HOW to Make Money With Home Workshop" describes amazing methods used by hundreds of successful craftsmen. Tells what to make. How to sell workshop output spare time. Write at once for details. Craftsman, 115B5 Worth St., NYC.

WANT A Diesel Job? New Opportunities to increase income. Higher Pay. More Money. We can help you Qualify. Tools. Shop method home training. Write today! Diesel, Tractor, Heavy Equipment Division, Interstate Training Service, Dept. B2-E, Portland 13, Oregon.

\$10,800 PROFITS! Your Own Mailorder Business! No Risk! "Success Plan" Free! Treasury, 709 Webster, New Rochelle P-23, New York.

\$500,000 BY mail from home. Free Folder. Publicity, Kalamazoo 65EP, Mich.

\$5000 FROM Half Acre growing Ginseng. crop bought, Particulars 10c. Associated Growers, Sperling, Manitoba.

FOREIGN Employment Construction Work. If interested in foreign projects with high pay, write Foreign Service Bureau, (Dept. P.S.), Metuchen, New Jersey.

FREE! "301 Profitable Small Businesses!" Amazing shoestring plans! Work Home! Start Sparetime! Deumant Surveys, Kenmore 23-S, New York.

ADDRESS advertising postcards. Must have good handwriting. Lindo 504, Watertown, Mass.

WELDING Pays \$\$\$, Learn easily at best equipped school in country. Non-profit School with low cost training. G.I. approved. Write Hobart Trade School, Box P-542, Troy, Ohio.

PRINT without a Printing Press! Amazing New Method! Print colorful signs, banners, cards, posters, glassware—anything at home. Big profits \$ \$ \$ \$ Opportunity! We supply everything. Beautiful Sample, Home-Business Plan Free! Write Screen-Print Company, Los Angeles 15, Calif.

BEGINNERS home mailorder folio. Sources, methods, instructions, 25c. Carnahan Bros., 5582-B Nelson, Cypress, Calif.

TYPISTS! Moneymaking home business. Copyrighted Instructions 50c. Continental Publishers, 1332 So. 61st, Milwaukee 14, Wisconsin.

BUY Wholesale thousands nationally advertised products at big discount. Free "Wholesale Plan." American Buyers, 628-T Linden, Buffalo, New York.

AUCTIONEERING. Home Study Course. Diploma Granted. Auction School, Ft. Smith, Arkansas.

START profitable business service. Become Tax Consultant. Large fees year 'round. Experience unnecessary. Write Union Institute, Lakewood 1-H, N. J.

LEARN a man's work with big pay. Study "How to Operate Excavation Equipment." 150 big pages, illustrated, practical, fascinating. Cloth bound \$2.50, deluxe leatherette \$3.00. Satisfaction guaranteed. North Castle Books, Greenwich 1, Conn.

MUSHROOMS grown boxes, barrels. Manureless process 50c. Spawn \$1.00. Gordens, 553 William, Winnipeg, Manitoba.

GROW Mushrooms. Cellar, shed, and outdoors. Spare, full time, year round. We pay \$3.50 Lb. We paid Babbitt \$4,165 in few weeks. Free Book. Washington Mushroom Ind., Dept. 101, 2954 Admiral Way, Seattle, Wash.

POPULAR SCIENCE OPPORTUNITIES

SET Rhinestone Jewelry. Easy money-maker. Catalog. instructions 25c. Bergen Arts, 128S Main, Hackensack, New Jersey.

FREE Book "505 Odd, Successful Businesses." Work home! Expect "Odd"! Pacific-37C. Oceanside, Calif.

BUILD luggage and cases at home. We sell your products. No special equipment needed. Free details. Casecraft, 805-X10 Sunset Blvd., Los Angeles 12.

SELF-Service-Garage. How to start this profitable business in a small way. Free literature. Box 772-S, Benicia, Calif.

NOVELTY Manufacturing of Ash trays. Book ends, Figurines pays excellent profits. No expensive molds needed. Plastex, Box 167-B, Falls City, Nebraska.

PANNING Gold prospecting catalog, listing maps, mineral books, gold pans, panning lesson free. Old Prospector, Box 729D2, Lodi, California.

DOLLARS in the mail for you! Put your ad here and watch orders fill your mailbox. For as little as \$9.00 you can advertise your product or service in the classified opportunities columns of Popular Science Monthly. The July issue closes on May 24. Write today for order blank. O. K. Kelly, Classified Adv. Mgr., Dept. 554, Popular Science Monthly, 353 Fourth Ave., New York 10, N. Y.

23 BOOKS & MAGAZINES

SPARETIME Profits Taking Subscriptions. All Magazines. Wholesale Catalog Free. Cassell Agency, Westfield 1, N. J.

GOOD Used Books. 50c-\$1.00. Free lists. Editions Dept. FS. Hempstead, New York.

USED Pocket Novels. 8 for \$1.00. Stamp brings list. Trunkat, Glenshaw, Penna.

LAF-A-Lot Joke Book \$1.00. Laf-A-Lot, 1709 Polk Street, Wichita Falls, Texas.

BOOKHUNTERS! All Subjects. Send Wants! Jaher Book Service, 620-K East 178 Street, New York 57.

NATIONAL Geographic Magazines 1888-1952. Any issue. Periodical Service, Box 465-PS, Wilmington, Delaware.

BOOKS. Government Surplus. Instructural and Vocational. Our second large purchase of over 200,000 volumes. About one fifth regular price. Free Catalog. Long's College Book Co., Dept. PS, Columbus 1, Ohio.

ONLY book in existence on Democratic-Scientific Social Engineering. Noncommunist, nonfascist, \$1.50 postpaid. Institute Of Social Engineering, 2623 Lawrence Avenue, Chicago 25, Illinois.

BOOKHUNTERS! Scarce, unusual, miscellaneous books supplied. Atlantic Book Service, 10 Cedar, Charlestown 29, Mass.

ATHEIST books. Catalogue free. Truth Seeker Co., 38 Park Row, New York 8.

"HOW-TO" books—advancement, education, hobbies, health, travel, other subjects. List, 100 titles, 25c. Guidance Associates, 1714 Ocean Parkway, Brooklyn 23, New York. Established 1938.

BOOKS, any subject found. Howard Somers, 188 Scholes Street, Brooklyn 6, New York.

BIG Catalog. 1500 Bargains, send 10c. Books Publishers, Amityville, New York.

24 HYPNOTISM

FREE Illustrated Hypnotism, Selfhypnosis. Catalogue. Write: Hypnotist, 1324 Wilshire, Hollywood 17P, California.

HYPNOTIC Telepathy Amazing New Discovery! Read the minds of others. Complete Course. Clearly written. Only \$2.00. Hypnotic telepathy, Rt. 1, Box 313K, Alexandria, Virginia.

HYPNOSIS guaranteed. International teacher/performer will instruct groups all branches hypnosis/auto-suggestion your location. For group or individual instruction write:—Franchel, Palmyra, New York.

MECHANICAL Hypnotist, new invention causes trances immediately. Instructions, secrets included. \$2.00. Clicke, G.P.O. Box 1312, New York 1.

LEARN Hypnotism. Read—Hypnotic World Magazine, 25c. Pennway, Box 166, Scranton, Penna.

AUTOHYPNOSIS folio. "25 Hypnotism Lessons" and catalogues. 25c. Lloyd Collins, Appalachia, Virginia.

25 MAGIC TRICKS, PUZZLES, ETC.

MAGICIANS, Gamblers books, supplies exposed. Free Catalogue. Book, Box 671, St. Louis 1, Mo.

500 TRICKS. Douglas famous 120-page Catalog, only 10c. Fastest service to magicians for 30 years. Send 10c today. Douglas Magicland, Dept. 2, Dallas, Texas.

FREE Magic & Novelty Catalog, includes 14 wonderful magic tricks fully illustrated and described. Send only 10c to cover cost of mailing. Read all about our Free Gift Offer. Chicago Magic Center, PS-5, 19 W. Randolph Street, Chicago 1, Illinois.

VENTRILOQUISM Easy to learn in 60 to 90 days! Home Study Course! Results Guaranteed. For free information write stating your age. Dummy catalog 25c. Fred Maher School of Ventriloquism, Box 36, Studio PS-5, Kensington Station, Detroit 24, Michigan.

2500 TRICK Catalogue (512-pages), pocket, parlor, stage. World's Finest Magic. Catalogue \$2.00 (dollar trick included free). Kanter's, S-1311 Walnut, Philadelphia 7.

FREE Catalog. Best Magic. Practical Jokes. Top Hat Magic, Evanston 22, Ill.

"VENTRILOQUISM Selftaught"—complete book 25c. Greenview, Box 61-CB, Whitestone 57, New York.

DOLLAR Magic Set Free with Catalog 25c. 4462-PS Germantown, Philadelphia.

"VENTRILLO" Professional Voice Thrower and Catalog 25c! Box 971-PS, Philadelphia.

FIFTY Samples Tricks, Jokes, Novelties. \$1.00! Manufacturers, 1746-PS Market, Philadelphia.

26 COINS & CURRENCY

GET Profit and Pleasure in collecting old coins. Send 10c for 56-page illustrated coin catalog. You'll be delighted with it. Send for it now. B. Max Mehl, 374 Mehl Building, Fort Worth, Texas. Largest rare coin establishment in U. S. Established 54 years.

FREE! Foreign coin banknote and Coin Collectors' Illustrated Catalog to approval service applicants. Send 3c postage. Tatham Coin Co., Springfield-50, Mass.

HAWAIIAN shell money collection, 50c postpaid. Pupuhale, 252 Dewey Way, Honolulu, Hawaii.

OLD Money Wanted. Do you know that Coin Collectors pay up to \$100.00 for certain U. S. Cents? And high premiums for all rare coins? We buy all kinds. Send 4c for Large Coin Folder. May mean much profit to you. Numismatic Co., Dept. 30, Fort Worth, Texas.

WORLD'S Greatest Magazine for coin collectors and wooden nickel 10c. Lawrence Brothers, Anamosa, Iowa.

BRILLIANT Uncirculated \$1/2—Bridgeport, York, Robinson, Iowa, each \$6.95; 1954 Carver Set \$10.00. Fine \$5.00 Gold \$10.95; \$10.00 Gold \$20.95; \$20.00 Gold \$41.95. Fast Service. Giant Bargain Coin Catalogue 35c. Bebee's, 4514 North 30th, Omaha 11, Nebraska.

WANTED—1894-S Dime Pay \$500.00. Certain 1913 nickel \$1,000.00. 1901-S quarter \$20.00 to \$150.00. Hundreds of others. Know their true value. Complete illustrated catalogue 25c. Worthycoin Corporation, (D-301), Boston 8, Mass.

LIST, 3 Coins 10c, 20 Selected \$1.00. Grady Berry, 1705 Cobb Street, Columbia 4, S. C.

JAPANESE Invasion notes for U.S. 1c to \$1,000.00 set \$1.00. 100pp. Catalogue. 25c Shultz, Salt Lake 10, Utah.

100 DIFFERENT Foreign Bills—\$1.00. Free list. Dwight Musser, Dunbar, W. Va.

FOREIGN Coin Collections 50c—\$1—\$2 Each. Descriptive Lists Free. Webb, 2200 Quintara, San Francisco 16, Calif.

UNCIRCULATED Canadian Queen Elizabeth set 1c to \$1.00 for \$3.00. Same 1c to 50c only \$1.50. Six different US Indian-Head Cents for 25c. Price lists of US and foreign stamps and coins free. No approvals sent. Bryson Stamp Co., 612 White, Toledo, Ohio.

INDIANHEAD Cent, U.S. Bargain Lists, 10c. Economy Sales, 160 Dean, Mansfield, Mass.

LARGE cent, 2c, 3c, all for \$1.00. Bargain list included. Delmaco, Box 1123B, Wilmington, Delaware.

SENSATIONAL Grab-Bag! \$4. We Buy! List 10c. Fairway, Rye, New York.

COIN Magazine, 100 pages. Sample 30c. Numismatic, 7320 Milwaukee, Chicago 31.

28 STAMP COLLECTING

FREE—Complete set of Famous Americans, Flags, Parks and Presidentials to approval buyers. Send 5c for 15 of the above stamps plus full particulars. Triboro Stamp Company, 145 Nassau Street, Dept. 205, New York 38, N. Y.

POLAR Bear Triangle; Giant George Washington. Six Colored Ecuador, Arctic Triangle, first American commemorative, Corsica, Devils Island, others. Everything free with approvals. Capital Stamps, Little Rock 10, Ark.

FREE Stamp Collection:—100 different stamps from Europe, Africa, Asia, Scandinavia, Balkans, etc. 3c to approval applicants. Tatham Stamp Co., Springfield 50, Massachusetts.

65 ALL Different U.S. Stamps. Includes 50 yr. olds, commemoratives, airmails and \$5.00 Stamp. Only 10c. Approvals. Willett Co., Box 511-M, Port Chester, New York.

AMAZING Offer! 200 United States stamps—including commemoratives, airmails, high denominations to \$1.00—only 10c to Approval Applicants!! Illustrated Bargain Lists free. Mystic Stamp Co., Dept. 55, Camden, New York.

200 DIFFERENT, including Roosevelt triangle, 10c to approval applicants. S. Avalon Stamp Co., Springfield, Mass.

327 DIFFERENT Stamps 25c! Including early Canada, Newfoundland, British Colonies, Vatican, Red Russia, Hitler Heads, Indian States, Animals, Airmails, French Colonies, Rarities, Unusuals. Every Stamp different. Rare bargain with approvals. Money back guarantee. Niagara Stamp Co., Niagara-on-the-Lake 62, Canada.

ALBUM! Capacity over 1,000 stamps! Only 10c!! Stampmart, Hartford 1, Conn.

12 PACKETS from 12 different countries \$1.00. Mammoth Packet List Free. Econopackets, Box 168, Riverside 22, Calif.

225 STAMPS For Only 10c! This mammoth value includes Airmails, Pictorials; stamps from strange Countries cataloguing up to 25c each! Also approvals. Mystic Stamp Company, Camden 55, New York.

FREE 119 Foreign Stamps including Africa, Australia, Pakistan, China, India, Russia and Scandinavia. Send 10c for postage and handling. With approvals. Niagara Stamp Co., Niagara-on-the-Lake 82, Canada.

WORLDWIDE, 50 all different, absolutely free, just to introduce incomparable approvals. Kent Stamp Company, GPO-Box 87-tz, Brooklyn, New York.

GORGEOUS Flower Triangles, three kinds. Free! Approvals. Olsen, 444 East Hazelwood, Rahway, New Jersey.

"WOW! 153 All Different Germany, 10c" Zeppelins, Semi-Postals, Airmails, High Values, Big Bargain lists and approvals included. Jamestown Stamp, Jamestown 509, New York.

FREE Surprise Packet with approvals. Fahsing, Dept. PS, Atascadero, California.

SAVE Money! Buy stamp packets. Worldwide selection. Bargain lists free. Webb, 2200 Quintara, San Francisco 16, Calif.

FIRST U. N. Set. Among World's Prettiest. Only 10c. Approvals. Welles, Box 1246-V, New York City 8.

300 DIFFERENT given free with approvals. Postage 3c. Windsor Stamps, 8834 S. Cornell Ave., Chicago 17.

50 DIFFERENT Juventute stamps \$1.00. Ernst Schmid, Hauptpostfach 255, Zurich, Switzerland.

FREE—Valuable Illustrated Catalog. Over 1100 special offers, attractive Bargains! Approvals. Kenmore, Milford 9C, N.H.

POPULAR SCIENCE OPPORTUNITIES

FREE "Stamp Finder". Tells at a glance country to which any stamp belongs. 32 pages profusely illustrated. Gargelon. 36, Calais, Maine.

SCARCE colorful Caribbean cover only 10c. List Free. Foreign Cover Service, 4531 N. Ashland, Chicago.

FREE. 4 Germany pictorial Sets Approvals. Pleasure Stamps, 1865A-52nd, Brooklyn 4, New York.

FREE!—New Stamp Book! Tells "How to Collect Stamps", why you will enjoy and profit by this fascinating hobby. Includes complete illustrated listing of United States Postage Stamps; big values in United States and Foreign Packets; low-cost Beginner's Outfits; Clearance Sale Bargains; Special Offers; Albums, Supplies, etc. A gold mine of valuable information! Money-saving prices! 64 pages profusely illustrated, just published by world's largest stamp company. Approvals included. Write today! Harris & Co., 460 Transit Bldg., Boston 17, Mass.

1,000 STAMPS for you to look at—big, attractive approval books of beautiful stamps. Pick and Choose to suit yourself, at 1c to 5c each! Let us show you the economical way to a large, worthwhile collection. Wolverine Stamp Service, Dept. B-24, Fruitport, Michigan.

TERRIFIC Triangles—Frightful Fish, Christ, Volcanoes—African flowers, Giant 50 year Tasmania, "Pearl Harbor" Japanese Philippines, Dead Lands, etc. 3c to approval buyers. Potomac Stampco, Washington 15, D. C.

GIGANTIC Collection Free—Includes Triangles—Early United States—Animals—Commemoratives—British Colonies—High Value Pictorials, etc. Complete Collection plus Big Illustrated Magazine all free. Send 5c for postage. Gray Stamp Company, Dept. PR, Toronto, Canada.

ZOO Parade 10 different bi-colored stamps depicting queer Civet from Liberia, Bay-thighed Diana, Monkey, Sudan Camel, Hedge-Hog, Rabbit, Squirrel, Fox, Finch, Golya, Gulipan including big Triangles, Regular \$1.00 value only 10c to approval applicants. Roseland Stamp Co., Dept. B-34, Spring Lake, Mich.

NUDES Set colorful approvals—10c! Atlas, 2830-P Eisenhower, Racine, Wis.

MINT Five Pound British Colony stamp, guaranteed genuine, face value \$25. Just 25c to introduce our famous approvals. Viking, 11-P Northern Blvd., Great Neck, New York.

ROOSEVELT Giant Triangle, Flowers Triangle, 52 others, 5c. Approvals, Maryland, Arlington-P, Baltimore 15, Md.

TETE-Beche Bi-colored Triangles. A beautiful set of stamps showing Trains—Planes—Boats. This set, worth 50c. This plus 100 other stamps will be sent for only 25c with approvals. Modern Stamp Co., Dept. B-8, Ferrysburg, Mich.

NIGERIA used coronation set free with depression priced approvals. Gobie Approvals, 931-D Emwell, Ferndale 20, Mich.

FREE sample stamp newspaper, valuable information on collecting, special lists. Approvals, Littleton Stamp Co., Littleton A2 New Hampshire.

FREE—105 different British Colonies—Aden to Zanzibar! High Catalog; pictorials. Approvals. Send 10c for mailing. Kenmore, Milford 9T, N. H.

ITALY workers set free with custom made approvals by country. Hall of Stamps, 4327-C Marr, Centerline, Mich.

LOOKING For Bargains? Try our 1c and 2c approvals mounted in books of 1,000. We believe in both quantity and quality. First try will satisfy. Clark Stamp Co., Dept. B-44, Muskegon Heights, Mich.

WILL send approvals only the ones you ask for. Enclose references, please. Sophus Jensen, Coupeville, Washington.

FREE with approvals—Israel, British, French Colonial, Latin American, U.S. packet. Philo, 1463 Drexel, Miami Beach, Florida.

FREE 100 different stamps plus stamp wallet. Postage 10c. Christian, Box 65, Southington, Conn.

MINT plate number box list free. Louis Rosenthal, Levittown, New York.

GREECE—50 selected stamps 20c. Request approvals, Prospect Hill Stampco, Box 51, Somerville 43, Mass.

ALBUM. Outfit, Packet, Supply Catalog. 5c handling, postage. Dahlquist, Omak, Washington.

COLOSSAL Stamp Zoo 10c. Jungle Beasts, Wildlife, Domestic animals—Fifteen different, including Rhinoceros, Elephant, Snake, Tiger, Zabu, Kangaroo, Koalabear, Emu, Kookabura, Bull, Horse—Extraordinary accompanying approvals. Niagara Stamp Company, Niagara-on-the-Lake 52, Canada.

OLD scarce U. S. seconds on approval. Slightly defective, bargain prices. Hearnfeld, Clintonhill Station, Newark 8, N. J.

315 DIFFERENT Foreign stamps including animals, flowers and other tropicals. Airmails Coronation and triangle stamps. 25c with approvals. Hathaway, P.O. Box 145-PS, Garden City, New York.

EXCHANGE Your Duplicate Stamps. Send 100-200 different foreign and 15c. Receive all different. Patterson, 5624 Broadway, Lancaster 12, New York.

UNITED States—58 different including 8 airmails, 15 commemoratives, 10c. Approvals. Sunsets, Box 47, South Gate, Calif.

FREE Sample—Interesting, informative. Illustrated! National Stamp News, Anderson, South Carolina.

50 DIFFERENT Bulgaria 10c! Approvals. Ensign Stamp Company, Dept. S, Berdan Avenue, Paterson 2, New Jersey.

OUR Penny Approvals jammed with Bargains. For better values, try Putnam Stamp Company, Mahopac, New York.

COLORFUL Italy pictorial set Free to approval applicants sending postage. Comanche, Box 7817, Lakewood, Colorado.

SEND 200 Foreign—10c—Receive somebody's 200. Wayside, Livermore, Calif.

START your own Stamp Business. Send for Free book. Donald Shepard, Box 1147, Chicago.

1000 DIFFERENT with approvals \$1.00. Jacobsen, 4395-X Broadway, New York 33, New York.

CHILE 50 different, 10c to approval applicants. Morell, 203 Fenimore Street, Brooklyn 25, New York.

100 FINE pictorial mixture 25c; 500-\$1. Stark's, Novelty, Missouri.

FREE U.S. illustrated bargain catalogue. Rothberg, 44 Bromfield, Boston 8-P, Mass.

BARGAINS galore, low priced approvals. Chur, Box 117, Williamsville 21, N.Y.

COLLECTIONS by countries and world wide at a saving of up to \$2.00 for your dollar. Ask for free list. Approvals include. Frasek Co., White Plains, N. Y.

GREATEST Free Offer—Croatia Exile Government Air Set; gorgeous birds, natural colored triangles. Also albums, supplies. All to our Approval Buyers. Bell Stamp Service, Dept. W-5, Bell, California.

100 JAPAN 10c. All different, with approvals. Gould's, Box 631, San Francisco 1, California.

FREE triangle mint set approvals. L. Hay, 33-51 73 Street, Jackson Heights 72, New York.

FREE!—Big United States Catalog. Valuable guide and check list. Hundreds of illustrations. Approvals. Harrisco., 465 Transit Bldg., Boston 17, Mass.

WANTED To Buy—Stamp Collections, Accumulations, Gold, 62-95S Saunders, Rego Park 74, New York.

FREE, hard to gets, with collectors sets U.S. and foreign \$1.00. Jack O'Brien, R.F.D. #1, Katonah, N. Y.

DEALERS. Also part time. Send for free samples, printed philatelic forms. Thiese, 9320 San Juan Ave., South Gate, Calif.

NEW Zealand triangles. Queen Elizabeth, 10c with approvals. Seminole Stamps, Box 1138-S, Coral Gables 34, Fla.

SEND 100 Different and 25c coin, for 100 Different. Barnes, Box 226-L, Portsmouth, Virginia.

ISRAEL, 25 different for only 25c. Approvals accompany. Dresel, Box 270-K, New York 25, New York.

UNITED States—40 different 10c; 40 different Commemoratives 25c. No approvals. Seidenberg, Appleton 944, Wisconsin.

WONDERFUL Offer Seven complete mint sets only 10c with approvals. Reich (S26), 1033 Lawrence, Chicago 40.

UNITED States approvals. Select copies used. mint. Kingsbury, So. Woodbury 2, Vt.

SENSATIONAL U.S. Confederate States catalogue free. Stone, 45-S Bromfield, Boston 8, Mass.

BEAUTIFUL New Zealand 1943 Elizabeth and Margaret Rose triangles only 10c to approval applicants. George Richie, 1539 Sixth, Alameda, Calif.

250 FOREIGN stamps, 25c to approval applicants. Faith, 1339 1/2 Westminister, Alhambra, Calif.

FREE Congo Flower Set, Approvals. Eagleco, 6916 Roosevelt Boulevard, Philadelphia 49, Penna.

EARLY U.S.! #26 plus 20 nineteenth century! 25c to approval applicants. AAA Stamp Company, Arcade Building, St. Louis 1, Missouri.

44 PICTORIALS—Triangles, bi-colors etc., only 25c! Approvals. Cole, 43-G Rinewalt, Buffalo 21, New York.

30 COMPLETE sets, \$1.00. Approvals. Pinkerton, Box 81-M, Bethlehem, Penna.

CANADA—100 Different, 25c with approvals. Crown Stamps, Box 331, Toronto, Canada.

ARMENIA, Hongkong, Siam, Mongolia, Ukrania, plenty premiums. Free with approvals. Choice Stampco, Box 424, Miami 3, Florid

ARMENIA Pictorials, Value 65c, Free with Approvals. Exotic, Box 755, Miami Beach 39, Fla.

329 DIFFERENT Worldwide Stamps 25c, including Hitler Heads, British Colonies, French Colonies, rarities, unusuals. Everything complete 25c to adults requesting approvals. Canada Stamp Co., 1907 Main St., Dept. 119, Niagara Falls, New York.

MYSTERY Packets Contain Real Value. 50c each. Satisfaction or Refund. LeRoy Stamps, 645 W. 2nd, Winston-Salem, N. C.

25 FINE Mixed with Approvals. A. Klein, 1715 Caton, Brooklyn, New York.

100 DIFFERENT Spain 25c. Penny approvals included. Reed, Box 980, Chicago 90, Illinois.

100 DIFFERENT U.S. Commems. and 300 World-Wide \$1.25. Israel, 50 Different \$1.25. No Approvals. F & S, Box 367, Lindenhurst, New York.

100 DIFFERENT US Commemoratives for \$1.00. 150 Different US Commemoratives for \$2.00. 200 Different US Commemoratives for \$4.00. Price lists of USA and foreign stamps and coins free. No approvals sent with above. Bryson Stamp Co., 612 White, Toledo, Ohio.

GERMANY B257-69, Warplanes, machinegunners, assaultboats; given "Approval Buyers." William Deems, Ravenswood, West Virginia.

LION triangle 28, others 3c. K&S, 303 Clinton Ave., Newark, New Jersey.

PHILIPPINES—20 Different 10c. Approvals. Moffit's, 921 College, Rock Hill, South Carolina.

U.S. illustrated price list—Free. Lush, 6422 Ellsworth, Detroit 38, Michigan.

U.S. approvals, mint used. "Square Deal Teall." 661 Beach, Rochester 12, N.Y.

ANIMALS, Birds, Triangles, Flowers, Butterflies, Fish, Ships, Locomotives, Kings, Dictators, Multicolored, Historical, Geographical, Musical, Battles, Giants, Midgets and over 100 others—only 25c with Approvals. Adults please. Canada Stamp Co., 1907 Main St., Dept. 319, Niagara Falls, New York.

25 COLOMBIA, mystery gift — 10c. Smithco, Box 6618, Kansas City 23, Mo.

TRIANGLE - Diamond - Midget - Giant - Roosevelt - Hitler - Stalin - 3c! Thrifty Company, Silver Spring, Maryland.

FIVE Mint Sets 10c, approvals accompany. Brighton Stamps, Box 97, Rochester 18, New York.

1500 STAMPS \$1.00. Good Variety. World Wide. Many Pictorials. No Approvals follow. Satisfaction Guaranteed. Whalen, 1516 First Ave., Oakland 6, Calif.

HAND drawn covers. Something different. 50c each. Marwin, 88 East Avenue, Bridgeton, New Jersey.

50 DIFFERENT U.S. Commemoratives 25c. Durham, 1021 N. Granger St., Saginaw, Mich.

"MONACO Nudes" 10c with approvals. Royal Stamp Company, Tamaqua 2, Penna.

POPULAR SCIENCE OPPORTUNITIES

UNITED Nations cover free to applicants of U.S. or British Colonial approvals. Alan A. Taylor, Skyland, N. C.

250 STAMP hinges and 25 different Australia 3c with approvals. Jaydee, 218 West Dickinson, Grand Rapids 7, Michigan.

SUPERB Approvals. Stamps 1/3 to 1/2 catalog. P. G. Beals, 125 Tremont St., Boston, Mass.

DOLLARS in the mail for you! Put your ad here and watch orders fill your mailbox. For as little as \$9.00 you can advertise your product or service in the classified opportunities columns of Popular Science Monthly. The July issue closes on May 24. Write today for order blank. O. K. Kelly, Classified Adv. Mgr., Dept. 554, Popular Science Monthly, 353 Fourth Ave., New York 10, N. Y.

29 ANTIQUES, RELICS & INDIAN GOODS

4 FINE Indian Arrowheads \$1.00, notched flint tomahawk \$1.00. List free. Lear's, Glenwood, Arkansas.

WOODEN Indians—5 1/2 feet large. \$325.00. Peter Meindl, Raymond, N. H.

SHARKS teeth fossil relic of ages past \$1 each. Arnold, Box 1107, Arlington 13, Va.

30 MINERALS & PRECIOUS STONES

ATOMIC Trinitite! Send 25c for actual radioactive atomic blast specimen and information on prospecting for tungsten, uranium, mercury with ultra-violet Mineralite. Dept. PS4, Ultra-Violet Products, Inc., South Pasadena, California.

INDUSTRIAL mineral prospecting pays big when you "Hit"! Free instructions. Stratex Instruments, 1861G Hillhurst, Los Angeles 27.

"GENUINE" red Arizona Rubies (Garnets). Send quarter for packet. Bitner's, Box 1025-C, Scottsdale, Arizona.

GENUINE star sapphire 2 carats \$25.00. Genuine star ruby 2 carats \$50.00. Munkey, 21A Queen's Road C, Victoria, Hong Kong.

4 WYO. Jade & Agate cutting specimens \$1.50 p.p.d. Hays, 417 W. 17, Casper, Wyoming.

GEMSTONES. Mineral specimens. Every variety. Lowest prices. Free booklet. Plummer's, 4720 Point Loma Avenue, San Diego 7, Calif.

SAPPHIRE—tourmaline—topaz—garnet—peridot. 5 uncut gem specimens. \$1.00. O'Briens, 1116B Wilcox, Hollywood 38, Cal.

CRETACEOUS Fossils (Exogyra arietina) 2 for 25c, 10 for \$1.00. Hawkins, Route 4, Georgetown, Texas.

GEMCUTTING. Silvercraft authority. Illustrated magazine tells how. Cut rocks, make jewelry. 150 ads illustrating equipment, offering gems for collectors, cutters. Postal brings literature. Lapidary Journal, Drawer D, Palm Desert, Calif.

DIAMONDS Rough. Guaranteed genuine—origin Africa, Brazil. Send \$2.00. House of Diamonds, Box 1119-E, Grand Central Station, New York 17.

GOLD genuine flat Alaskan gold nuggets. Nugget jewelry and collectors. Generous sample covers area size this ad. Airmailed to you \$5.00 guaranteed. Money-order or \$5.00 bill only. Barklow Sourdough Mine, Box 8, Fairbanks, Alaska.

COLLECTORS! Two dollars bring twelve beautiful genuine specimens from gemland Brazil. Three dollars bring perfectly cut ten carat Brazil-topaze. Airmail bills or check. Jean Bach, 413 Praia Icarai, Niteroi, Brazil.

31 HOBBIES, COLLECTIONS

INVENTING can be an interesting and profitable hobby. Write for complete particulars. Institute of American Inventors, Dept. 30-E, 631-E St., N. W., Washington 6, D. C.

ARTISTIC back dated Art Magazines, eight \$1.00 postpaid. Wonderful courses, drawing, painting, cartooning. Free Catalog. Art Book Shop, Arnold 5, Missouri.

UNUSED matchbook covers—100 different \$1.00—36 page catalog 25c—matchcover album \$3.00. Charles Edelman, 1311P East 84, Cleveland 3, Ohio.

60 POPULAR SCIENCE

50 DIFFERENT army embroidered patches \$1. Other bargains. Insignia Mart, 703B Broadway, N. Y. C. 3.

WANTED — Cigarette, tobacco cards. Write Charles Bray, East Bangor, Penna.

WORLD'S smallest bible 50c. Three, \$1.00. Empire's, Box 301, Amesbury 7, Mass.

MILITARY Miniatures: U.S. Marines, American Revolution, Civil War, Custer's Cavalry. Illustrated Catalog 25c. Bussler Miniatures, Dept. E, 59 Russell Park, Quincy 69, Mass.

32 PHOTO FINISHING, PHOTOCOPIES, ETC.

35MM—36 Exp. Develop & Jumbo Print each \$1; Guaranteed Quality—Free Mailer. Flash Photo, Box 36P, Parksville Sta., Brooklyn 4, N. Y.

20 BILLFOLD Size Prints from your favorite negative or picture put on double weight paper for only \$1.00. L. A. Eastman Studio, Bode, Iowa.

TWO Prints each good negative, 8 exposures, 35c; 12 exposures, 50c; reprints, 4c. Mayfair Photo Service, Box 617-A, Toledo 1, Ohio.

OVERSIZE Prints no extra charge. 8-exposure roll, 30c. 12-exposure, 45c. 16-exposure, 55c. Reprints oversize 4c. Finest quality. Mail Order Photo Service, Box 297, Watertown, Wisconsin.

8 JUMBO Prints in Album 30c; 16 exp. 55c; 35mm 20 exp. 85c; 12 exp. roll 45c; 36 exp. \$1.25. Mel's Photo Service, Box 106D, Brooklyn 20, N. Y.

8 EXPOSURE rolls enlarged 50c, Fastest, Finest Service, Camera, Dept. A, Box 280, West Chester, Penna.

ENLARGEMENTS! Eight 5x7's or five 8x10's, \$1.00. Wilart Enlargers, Box 967, Little Rock, Arkansas.

ROLL developed and 4x6 or 3 1/4x4 1/2 oversize glossy velox prints 8 exposures 40c. 12 exposure 60c. 16 exposure 80c. Hagner Photo Service, 1318 West Columbia Avenue, Philadelphia 22, Pa.

SENSATIONALLY New—16 oversize contact prints or 8 plastic bound superpak album jumbo prints with your first roll 25c. Album Studios, Weatherford, Okla.

FREE Flash Exposure Guide for color, B&W. Rush postcard with this ad, name and address. Garden City Photo, Box 237-K, Garden City, New York.

ENLARGEMENTS five 5x7 or three 8x10 50c. Minimum order \$1.00. Photo Finishers, 1729 Grand, St. Paul (5), Minnesota.

35MM specialists—Fine grain developing. 20 exposures—\$.95. 36 exposures \$1.40. Free mailers and prices on others. Tops Photo Service, Lyons, New York.

ENLARGEMENTS Beautifully finished on glossy surface paper, from your favorite negative. Fast Service. Satisfaction Guaranteed. Four 5x7's or two 8x10's, \$1.00. Wall Photo Service, Byars, Okla.

FREE Mailers, 8 contacts 30c, jumbos—40c. 12—45c. Jumbos—55c, reprints—4c. Jumbos 5c. Western Photo PS54, Box 298, San Francisco 1, Calif.

PHOTOSTAMPS! Real, Glossy Photographs in stamp form personalize your greeting cards, stationery, 100 only \$2.00. 50—\$1.00. Send any photo or negative. Fabian's, Box 63, Ottawa, Canada.

33 MOTION PICTURES, SLIDES, SOUND EQUIPMENT

16MM. Sound Projectors—excellent used units, all makes, many models—\$119.95 up—some \$99.95. Dime brings illustrated catalog. Blackhawk Films, 1141 Eastin, Davenport, Iowa.

GUARANTEED Fresh 8mm roll, magazine; 16 mm roll, magazine movie film. Color, b&w. Free catalog. Eso-H, 47th Holly, Kansas City 2, Missouri.

8-16MM Silent-sound films. Complete rental library. All latest subjects. Free catalogue (sample film 10c). Garden Film, 317 West 50th, New York 19.

8MM. Movie Subjects. New 150' films, \$2.98. 50' 8mm. Prevue film, 32-page catalog, 59c. Catalog only, 10c. Blackhawk Films, 1142 Eastin, Davenport, Iowa.

FREE Giant catalog of 8mm & 16mm films for home movie enthusiasts. Films for every occasion. Lee Stann, Dept. PS5, 11 Willard Ave., Mt. Vernon, New York.

MOVIE Camera Film: 8 mm roll \$1.50, 16mm 100' \$3.00. Free processing. Better Films, 742 New Lots, Brooklyn, N. Y.

CLEARANCE Sale of 16mm. sound films. Want a real buy in 16mm. sound films? Take advantage of the I.C.S. 1954 clearance sale of 16mm. sound features, comedies, cartoons, educational films, religious subjects—New, used. Send for our giant list "A" today stating machine you own (make and model). Institutional Cinema Service, Inc., 1560-PS Broadway, New York 36, N. Y.

16MM. Movie Subjects. Dime brings 32-page catalog listing hundreds of titles—new and used—at bargain prices. Blackhawk Films, 1143 Eastin, Davenport, Iowa.

TAPE Recorders, Tapes, Accessories. Unusual Values. Dressner, 624 East 20th Street, New York City 9.

8 & 16 MM Professional National Parks Movies in full color. Reasonable. Ideal Service, 4644 Geary, San Francisco 18, California.

5,000 8-16MM. Silent-Sound Films. International, 2120 Strauss, Brooklyn 12.

RENT 16mm. Sound Feature Pictures—\$3.95, three days, including all postage. 1954 home rental list free. Eastin Pictures, Davenport, Iowa.

34 CAMERAS, PHOTO SUPPLIES

PHOTOGRAPHY For Pleasure or profit. Learn at home. Practical basic training. Long established school. Free booklet. American School of Photography, 835 Diversey Parkway, Dept. 1722, Chicago 14, Ill.

BASS Says: Quality Camera* Since 1910. When in Chicago visit the Camera Cross Roads of the World . . . or write us for your favorite equipment, new or used. Satisfaction Guaranteed. Bass Camera Co., Dept. AG, 179 W. Madison Street, Chicago 2, Illinois.

DISCOUNTS to 40%—cameras, projectors, tape recorders, lenses. Write for individual quotations, no catalogs. Classified Camera, E. 253 E. 94th Street, Brooklyn, New York.

AMAZING Camera Bargains. Send for our free Photohelper price list. Morgan Camera Shop, 6262-B Sunset Blvd., Hollywood 28, Calif.

GOLDE 2x2 Numanumatic projector, 300w blower, \$43.05. Viewlex V-33L, \$44.47. SVE Skyline 300w blower, \$36.92. Original cartons. Free bargain catalogue. Dealer's Mart, 54 Beverly Rd., New Rochelle, N. Y.

FREE Photographic Bargain Book packed with hundreds of fine values in still and movie cameras, lenses and latest accessories, both in new and used. Write now for your free copy to Central Camera Co., Dept. 11E, 230 S. Wabash Ave., Chicago 4 Ill. (Photographic Headquarters Since 1899).

DEJUR 750 projector, case, Spotless \$111.50. New 40x40 screen, \$10.99. Free catalogue. 1001 bargains. Dealer's Mart, 54 Beverly Rd., New Rochelle, N. Y.

NEW Kodak Signet \$69.50 other terrific savings. Free catalog. Camera Shoppe, Box 601-S5, Mount Vernon, New York.

AT Last! 3-D Projection from your 2x2 slides or 8mm and 16mm movies with the new Panoscope Screen. No glasses. No attachments. No gimmicks. 10 day money back trial guarantee. Price \$24.50 postpaid. Dealers Mart, 54 Beverly Rd., Dept. PS5, New Rochelle, N. Y.

20 TO 40% discount everything photographic. Dart, 3812F Atlantic Avenue, Brooklyn 24 New York.

BUY wholesale nationally advertised cameras, photo supplies, thousands other products at big discount. Free "Wholesale Plan." American Buyers', 629-TT Linden, Buffalo 16, N. Y.

BIG photographic outfit camera, complete enlarger, 9 dark room supplies plus chemicals and instructions, \$19.95. All quality materials. Used professionally. Money back guarantee. Humble, 159 Prichard St., Prichard, Alabama.

WHOLESALE Photographic Supplies, Cameras, Films, Projectors, Enlargers. Write for Free Catalog. Capitol Photo Supplies, 2428 Guadalupe, Austin, Texas.

35 MUSIC, SONG WRITERS & RECORDS

WANTED! Poems for musical settings. Write Songwriters' Service, Clifton, N. J.

POPULAR SCIENCE OPPORTUNITIES

POEMS Wanted for musical setting. Send poems. Free Examination. Five Star Music Masters, 646 Beacon Bldg., Boston, Massachusetts.

SONGWRITERS! Protect your poems and songs! Don't mail anywhere! Write for safe procedure! Song Service, 333 W. 56th Dept. P.S., New York 19, N.Y.

SONGPOEMS Wanted. Mail to: Tin Pan Alley, Inc., 1650 Broadway, New York 19, N.Y.

FREE Record of your song—Your words—My melody. Free information. Johnny Mack's Melody Mart, 1094 West 39th Street, Dept. K, Los Angeles 37.

POEMS Wanted for musical setting. Send poems. Free examination. Crown Music Company, 1472-P Broadway, New York City 36.

SONGPOEM Writers—Want Your Songs Published? Get the Inside Facts first. Free Details. Expect Surprise! Melody House, Dept. PS, Box 19007, LaTijera Station, Los Angeles 43, Calif.

POEMS Wanted to be set to music. Free examinations. Send poems. McNeil, Master of Music, 510-PS, S. Alexandria, Los Angeles, California.

ELECTRIC Guitars, amplifiers. Wholesale. Free Catalog. Carvin, P.S., Baldwin Park, California.

SONGWRITERS! Send poems, songs. Music Service, 243 West 72nd St., PS, New York 23.

CRAZY—New records, half-priced, 49c—Free Listings. Paramount, 1801 Ridge, Philadelphia 21, Penna.

SONGWRITERS! Outstanding offer. Ray Hibbeler, C-15, 6808 N. Oleander, Chicago 31.

POPULAR Songs. How to write and sell them. Write for free booklet Successful Songwriting. Gateway Songs, Box 2470, Hollywood 28, California.

VIOLINISTS How To Play Better \$1.00. Prager, 289 Empire, Brooklyn 25, N. Y.

1954 ACCORDIONS — Wholesale. Free catalog. American Accordion Center, PS-5, 5329 Belmont, Chicago.

36 RADIO, TELEVISION, SUPPLIES & EQUIPMENT

BUILD 15 Radios . . . only \$19.95 complete. Learn Radio Construction, Theory, Trouble-shooting. Code, F.C.C. Regulations. Complete Radio Course includes all parts, components, Instruction Books, etc. Free Radio Tester and Soldering Iron. No experience required. Money-Back Guarantee. Order direct or send for descriptive literature. Valuable Radio and TV Guide upon request, free of charge, no obligation. Progressive "Edu-Kits" Inc., 497 Union Ave., Dept. PS-17, Brooklyn 11, New York.

WANT T.V. Radios, Recorders, Hi-Fi, Testers Etc? List of 125 swappers waiting! Send \$1.00 to Lists, 2241 E. Broadway, Muskegon, Michigan.

BUILD Crystal Radios. Sensational Melomite Crystal and detector with instructions and plans—50c postpaid. Satisfaction guaranteed. Allen, 427-PS5, Clinton, Missouri.

NEW TV Catalog Free. Loaded with bargains for TV servicemen, technicians, installers. Finest new TV antennas, Motorless Directronics, Multi-Channel Yagis, UHF Antennas, Converters, Motors, Boosters, Parts, Instruments, hundreds of quality accessories at money-saving prices. Get your catalog now! National Electronics, 4005 Delco Bldg., Cleveland 3, Ohio.

CRYSTAL Radio experimenters. Write Leslie Hulet, R. 4, Lakewood, New Jersey.

MAKE simple powerful distance-getting crystal radio. Works anywhere. Illustrated booklet fifteen cents. Money back guarantee. Francis, Box 5963, Cleveland, Ohio.

BUILD your own top quality TV Set. We supply complete equipment, tools, instructions as part of America's finest Home-Study TV Course. Be a high-paid TV Technician. Install, Repair, Service all makes of sets. Many excellent jobs now open. Or start your own business. Get Full Facts Free. Write: Commercial Trades Institute, Dept. CT1-5, 1400 Greenleaf Ave., Chicago 26, Ill.

MAKE your own television antennas. Instructions 35c. Pfeiffer, 46-09 21 Avenue, Astoria 5, New York.

BUILDER'S Handbook. Plans, Instructions—25c. Alena, Box 24, Astoria 6, N.Y.

FELLOWS—build a subminiature battery radio. plans \$1.00. Box 247M, Pasadena, California.

DIAGRAMS for repairing Radios \$1.00. Television \$2.00. Give make and model. Diagram Service, 672-PS, Hartford, Conn.

15 TESTED One-tube circuits 25c. including "Radiobuilder", catalog. Laboratories, 328-T Fuller, Redwood City, Calif.

F.C.C. Commercial operator license quickly. Grantham, Dept-5, 6064 Hollywood Blvd., Hollywood 28, California.

TRANSISTOR and "Electric Eye" kits. Free bulletin. Electronics, 709 Grove, Buckroe Beach, Virginia.

ERECT your own Television Antenna and save up to \$100.00. Complete U.H.F., V.H.F. instructions \$1.00. All supplies at tremendous savings. List \$25. Stanford T.V. and Appl. Company, P.O. Box 171, Stanford, Illinois.

INEXPENSIVE remote control switch. May turn off television, radio, fans or other electrical appliances at will. \$1.00. G. W. Bowie & Company, Box A, Mountair, N. Mex.

CLEARCO Crystal radio kit \$1.50; pre-assembled \$1.75. Free catalogue. Clearco Crystal Co., Box 1857, Milwaukee, Wis.

LOUDER Crystal radio. Complete kit \$1.00. Mallory, Box 1031-P, Tacoma 1, Washington.

EXPERIMENTERS! Beginners! May issue "Radio Science" 25c. 52 Backman, Westfield, New York.

REPAIR your own TV! Instructions compiled exclusively for your set. Simple as replacing light bulbs. See our ad page 49. Send set name, model number. \$1.00. LS Engineering, Box 4113B, North Hollywood, Calif.

RADIO, television tubes, Antennas, parts. Lowest prices. Free lists. Potter, 1314 McGee, Kansas City 6, Missouri.

AMAZED photoelectric cell transforms light into electrical energy. Only \$1.00. Springfield Enterprises, Box 54-Y, Springfield Gardens 13, New York.

BUILD Crystal radio with screwdriver. Wire, crystals, aerial, earphone, easy instructions, everything needed and book on radio. Money-back guarantee. \$3. James, Box 1281, Lubbock 2, Texas.

COLOR Television! Enjoy 3 color television screen now. Easily attached. No tools needed. Beautiful color tones. Cuts down glare and snow. Send \$1. for size 10", 12" or 14"; \$1.25—17", \$1.50—20"; \$2—21"; \$2.50—24", \$3—27". Prompt shipment. Satisfaction guaranteed. Dealers Opportunity. Zingo Products, Johnstown 9, New York.

DOLLARS in the mail for you! Put your ad here and watch orders fill your mailbox. For as little as \$9.00 you can advertise your product or service in the classified opportunities columns of Popular Science Monthly. The July issue closes on May 24. Write today for order blank. O. K. Kelly, Classified Adv. Mgr., Dept. 554, Popular Science Monthly, 353 Fourth Ave., New York 10, N. Y.

37 BUSINESS OPPORTUNITIES

GOOD Paying Business Silvering mirrors, plating autoparts, reflectors, bicycles, bathroom fixtures, etc., by late methods. No tanks or shop required, outfit furnished. Free Booklet. Gunmetal Co., Ave. E, Decatur, Illinois.

OPERATE profitable mail order business. Write Walter Service, 4159-B East 112th, Cleveland 5, Ohio.

MAKE money addressing envelopes. Our instructions reveal how. Glen Glenway, 5713 Euclid, Cleveland 3, Ohio.

LIVING miniature ("Ming") trees only 10 to 20 inches tall. Grow at Home. Big Profits! Spare time opportunity. Fascinating! Amazing! Write for Free Seed and Plan. National Nursery, Dept. CG, Inglewood 4, California.

ENVELOPES addressed accurately, reasonably. Fast Service. We have capable addressers in your city. Glenway System, 5713-X Euclid, Cleveland 3, Ohio.

NEWEST Spare, Full-Time Business, \$5 to \$10 hour possible. Paint with Suede—the finish with touch and eye-appeal. Beautify auto dashboards, signs, radios, toys, figurines, lamps—100, 1 others. Complete, Step-By-Step Instructions sent for no-risk examination. Free details. Coast 1004-MD, So. Los Angeles St., Los Angeles 15.

IMPORT-Export! Opportunity, profitable, world-wide, mail-order business from home, without capital; or travel abroad. Established World Trader ships instructions for no-risk examination. Experience unnecessary. Free details. Mellinger, 695, Los Angeles 24.

MAKE Money spare or full time, casting Metal Toys and Novelties. Big wholesale and chain store demand for Autos, Soldiers, Ashtrays, Banks, etc., keeps manufacturers busy. Production moulds furnished for up to 100 and more castings per hour. No experience or special place necessary. Write for information and illustrations of patterns needed. Metal Cast Products Co., Dept. E, 1696 Boston Road, New York 60, N. Y.

VENDING Machines—No selling. Operate a route of coin machines and earn amazing profits. 32-page Catalog Free! Parkway Machine Corporation, Dept. 73, 715 Ensor St., Baltimore 2, Maryland.

TROPICAL Fish supplies. Save! Representative your area will supply. Nmoae, Box 4635, Los Angeles 24, California.

RECAST old batteries into new. Latest achievements. Battery Laboratories, Minneapolis.

BREED Rare Tropical Fish at home. Earn Big Money! Learn Secrets! Help fill huge demand. Amazing Opportunity! Free Plan. Tropicals, 1008-G Los Angeles St., Los Angeles 15.

FIX typewriters. Free booklet describes our modern, inexpensive home-study course. Factory methods taught. Write Typewriter, Building 4, Tarentum, Penna.

\$25 WEEKLY working two hours daily at home. Lycke, Box 2471-B, Cleveland 12, Ohio.

BRONZED baby shoe metallizing equipment. New and used. Big selection of metal and onyx mountings. Free catalogue. Hollywood Mounting Supply, 1624-A E. First Street, Los Angeles 33, California.

WE Love our mailman—He leaves over \$1,000.00 monthly in our rural mailbox. My college professor husband drafted a scientific home mailorder method. We bought a Texas ranch, live as we always wanted. Now we sell the "Ranch Mailorder Method." Operates anywhere. Inquire: Eveningshade Ranch, Helotes, Texas.

"INCOME" from local information. No Selling. Write Neherco, LaVerne 6, Calif.

\$500,000 BY mail from home. Free Folder. Publicity, Kalamazoo 65ER, Mich.

SEWING Machine — Repair—Sales — Servicemen needed. "Previous experience unnecessary". Operate home setup. Spare full time. New zigzag machines, motors, parts, etc., supplies. Write today. Taylor Service Co., Hamilton PS-5, Ohio.

AMIDON fittings add to incomes. Amidon Engineering Co., Elyria, Ohio.

THRILLING Profitable Home Business. Make fast-seller chenille monkey trees, dolls, flowers. Terrific holiday demand. Information free. Velva, Bohemia 17, N. Y.

WOMEN! Make Big Money at home. Sew ties for us. It's fun. Earn \$10 day easy. No selling, no experience, no machine necessary. We supply everything. Help us fill huge demand. Exciting details free. Fashion Ties, 2521-X, Manchester, Inglewood 4, California.

MINK Raising information free. Complete. Lake Superior Mink Farm, Superior E E5, Wisconsin.

FREE! "301 Profitable Small Businesses!" Amazing shoestring plans! Work Home! Start Sparetime! Deumant Surveys, Kenmore 28-S, New York.

BOOKKEEPERS, increase earnings operating sensational bookkeeping service. Kern, 4942-B Vineland, No. Hollywood, Calif.

ADDRESS advertising postcards. Must have good handwriting. Lindo 504, Watertown, Mass.

HOW and where to obtain Capital? Free details. Star Service, Wapakoneta, Ohio.

HAVE New York address with mail service \$2 month. 516 Fifth Avenue, Suite 1004, New York.

OWN Your Own Sewing Machine Business. For dealers' illustrated catalog with confidential price lists, send 25c to cover handling and postage. Home Machine Supply 750 Sixth Ave., New York.

POPULAR SCIENCE OPPORTUNITIES

POPCORN and Potato Chip Equipment. LECO. Box 933-B. Springfield, Ohio.

MEXICO! Imports! Curios Wholesale! Giftshop, collector's items! Sample and pricelist 50c! Filmer, 910 Marion, Pharr 10, Texas.

PRINT without a Printing Press! Amazing New Method! Print colorful signs, banners, cards, posters, glassware—anything at home. Big profits \$ \$ \$ \$ Opportunity! We supply everything. Beautiful Sample, Home-Business Plan Free! Write Screen-Print Company, Los Angeles 15, Calif.

EARN extra cash operating sparetime circular mailing service. Moneymaking information furnished. Jennings, 1540 First, Sarasota, Florida.

EXCLUSIVE Franchised Distributor. Amazing crushed Cedar! Applied like paint. Cedarizes closets, chests, drawers. Hardware paint, builders' dealers, contractors large buyers. Low cost, big profit potential! Attractive bags. Write for sample, details. Plant, 90-B Summit Ave., Brookline, Mass.

BE Notary Public. Rate higher. Details Free. Stationers, Helotes, Texas.

FINANCIAL Independence by Mail Order. Details Free. Opportunities Unlimited, Dept. 3, Box 1576, Boston, Mass.

SPECIAL Service: Where to get new, unique, unusual, \$1-\$10 items for mail order. Complete lists with names, addresses of their manufacturers only \$1. New lists compiled monthly. Coral Products Co., 550-B Fifth Avenue, New York 36, N. Y.

START your own "Big Profit" mail order business, at home, sparetime. Instructions 25c. Book \$1.00. How, Wetmore (A), Texas.

MAKE Money At Home as renewal headquarters for all magazines. Liberal commissions. No experience—No capital needed. Supplies furnished. Write for Free Catalog. McGregor Magazine Agency, Dept. 510B, Mount Morris, Illinois.

ADVERTISING book matches—Cash in on big demand—sell Union Label matches. Cuts for all businesses and political parties—Free powerhouse selling kit—low prices—protection guaranteed on repeat orders—Cash commissions. Superior Match Co., Dept. PX-554, 7530 Greenwood, Chicago.

MAKE Perfume, other products—Sell mailorder—Formula Catalogue Free. "International", 6347 Parnell-PS-5, Chicago 21, Illinois.

EARN extra money weekly mailing circulars for advertisers. Complete instructions—25c. Siwaslian, 4317-B Gleane, Elmhurst 73, New York.

OPERATE "Escalator" Mailorder system, selling our products or any products. Fastest, most revolutionary mailorder system known. Write: Selbyco, Decatur 168, Ill.

LIQUID Rubber make flexible molds. Free Sample. Chaney, 1130 E. 16th St., Jacksonville 6, Fla.

REPAIR dolls; learn reweaving; make rubber stamps Catalog of "60 Ideas" Free. Universal, Box 1076-B, Peoria, Ill.

\$200 WEEKLY Reported! No selling. Free booklet. T. J. Surface, Roanoke 4, Va.

START A Buying Service, buy wholesale thousands nationally advertised products. Make big profits selling at sizeable discounts. Postcard brings details. American Buyers', 627-T Linden, Buffalo, N. Y.

WANTED! Home Producers, by manufacturers in our Clearing House Service. Become subcontractor, casting plastic products for these companies. Thousands of easy-to-make items required for consumer-industrial use. Cash in at home, without previous experience. Plastic Service Associates, Dept. 5-PS, East Boston 28, Mass.

MAILORDER Home business using Free Advertising Method. Information free. H. G. Seidel, 7070 Hollywood Blvd., Hollywood 28, California.

EARN \$15,000-\$30,000 Annually. Franchise protected. Guaranteed minimum \$12,500 or money back. Live at home. No merchandise to buy. Self-employed. One of the most exclusive and noncompetitive businesses in United States and Canada. Send for free explanatory booklet. Harrell & Company, Box A-2, Louisville, Illinois.

EARN money! Amazing plans! Easily mastered Details. Bruns, 216-E West Jackson, Chicago 6, Illinois.

START Venetian Blind Laundry. Profitable lifetime business. New machine. Free booklet. F.D. Co., 442 N. Seneca, Wichita 12, Kansas.

NATURAL molding rubber, extra thick. Free sample. Flock, tinsel candle wax. W. Wooley, 115-B Donald, Peoria, Illinois.

FREE Booklet! "Mail Order Confidential." Elson, Box 1631-B, Fargo, No. Dak.

COLOR Concrete with chemicals. Marble—glaze cement benches, pottery. Home—Shop. 10c brings sample, pictures. Hollywood Cementcraft, 8527-S Wonderland, Hollywood 46, California.

1000% PROFIT — plastic laminating photos, licenses etc. No equipment needed! "Home Laminating Kit" 50c. Berea Photo, 232-J, Berea, Ohio.

WHOLESALE Catalog! 25-65% Discounts! Nationally Advertised Appliances, Watches, Typewriters, Cameras, Tools, Toys, Housewares, Phonographs. Consolidated Distributors, Box 1537B, Paterson, New Jersey.

SIX Magic words for financial success. This will make you think. 25c. Jennings Company, 118 Naples, San Francisco 12.

CLOSE-OUT: Mailorder books and fine selling items. List and golden rule book 20c. Persil, 436 N.Y. Avenue, Brooklyn 25, New York.

HOW To Build Your Own Mailorder Business. Copyrighted. 25c. Ballard Service, 425 East Saint Catherine, Louisville 3, Kentucky.

UNLIMITED Earnings! Operating home mailorder business. Sparetime, small capital. Jackson, Newfoundland 7, Kentucky.

SELL To Women By Mail From Your Home—Repeat Order Merchandise. Everything Furnished. Big Profits. Mohawk, 37B Second, Amsterdam, New York.

WHAT'S Your Field Of Interest? Whatever it is, specialized magazines will help you get ahead. Examine current copies of those covering your field through our Easy-to-Get-Acquainted service. Choose from 4,387 covering all fields—business, trades, agricultural, professions, insurance, real estate, music, educational, hobbies, sports, etc. Current List Free. Commercial Engraving Publishing Company, 34S North Ritter, Indianapolis 19, Ind.

GET Newest-Best Merchandise-Book Mail Selling Offers. National, Box 88B, Dorchester 22, Mass.

BREED Parakeets At Home. Sensational Big Profit Opportunity! Free Confidential Details. Parakeets, Box 2127, Inglewood, California.

\$15 AN hour! Become Tax Expert. We train you. Urgently needed. Year 'round. Free details. Union Institute, Lakewood 1-G, New Jersey.

PRINT for Profit at home. Amazing new method prints colorful posters, banners, greeting cards, glassware—anything. Hundreds at time. No press needed. No art. Fantastic profits! Need representative your area immediately! Free home-business plan. Screen-Print, Los Angeles 15, California.

SELL merchandise by mail from your home. Everything supplied. Big profits. Edward Forsythe, 3904 60th Street, Woodside 77, New York.

MAKE Perfumed stationery. Profitable local, mailorder business. Sample free. Rienzi Press, 24-B North 7th, Newark 7, New Jersey.

BIG Money! Start your own Plastic Business at home. Spare or full time. (Also valuable Liquid Marble information.) Free Catalog. Write: Bing Products, PS-553, Watertown 72, Mass.

NATIONALLY advertised appliances, cookware, diamonds, watches, typewriters, etc. Wholesale catalog 50c.—J. J. Davis Co., 30 E. Englewood Avenue, Englewood, New Jersey.

TO \$40.00 weekly. Sparetime, home operated mailorder business. Successful "Beginner's" plan. Everything supplied. Lynn, 10420-C National, Los Angeles 34, Calif.

GROW Mushrooms. Cellar, shed, and outdoors. Spare, full time, year round. We pay \$3.50 lb. We paid Babbitt \$4,165.00 in few weeks. Free Book. Washington Mushroom Ind., Dept. 178, 2954 Admiral Way, Seattle, Washington.

ESTABLISH Profitable Automatic Shoe Shine Route. Proven. Write Jiffy Shine, 1630 South Second Street, Phila. 48, Pa.

MONEY. Typing—Sewing! Details free. Edwards, 3915-PS, 12th, Des Moines 13, Iowa.

SELL by Mail Comic Postcards from Overseas. Write, Goodall, 68 Joost, San Francisco.

MONEY in new greaseless doughnuts. Start in kitchen. No smoke. Sell stores. Free recipes. S. Ray Co., 3605 South 15 Ave., Minneapolis 7, Minn.

EXPORT Business easy made! Substantial income from home. No merchandise buying. Full setup service, includes everything. Hermes Exports, 152R West 42, New York 18.

BUY Wholesale—sell retail Brand Name appliances, watches, etc., Full details—Catalogue 50c. International Sales Co., 175-B Fifth Avenue, New York 10, N. Y.

\$250 WEEK reported! Free book "505 Odd, Successful Businesses." Work home! Expect something Odd! Pacific-36C, Oceanside, California.

NEW Exceptionally profitable plans, ideas for home operated mail business. Rush name. Miller, 1772-R Carlyon Road, East Cleveland 12, Ohio.

ELECTROPLATE autoparts, novelties, mirrors, baby shoes. Easy, inexpensive home processes. Free booklet. Tyco Metals, Box 13231-CQ, Houston 19, Texas.

PLASTERCRAFT molds, liquid rubber, plasters, flocks, candle supplies. Catalog and manual free. Jayhawk Plasters, Blue Rapids, Kansas.

BUILD luggage and cases at home. We sell your products. No special equipment needed. Free details. Casecraft, 805-X9 Sunset Blvd., Los Angeles 12.

HAVE Home Mail Business—Get \$10 Orders In Every Mail—Keep \$8.00. Everything Furnished. Hutchinson, 401C Adams, Dorchester 22, Mass.

MAKE Money Addressing Envelopes. Our instructions state how. Merit Company, PS-983—E. Main, Columbus 5, Ohio.

EARN \$2.00 Hour! I do—making Sandals. Youngs, 1308-PS South First, Arcadia, California.

\$26,500 SALES in two weeks! Amazing radio-mail order method. Free details. Broadcast Service, 1412-V Great Northern Building, Chicago 4, Ill.

\$\$\$ IN personalized baby record books. Sell by mail. Eleven thousand new prospects daily. Use same literature we do. No-Co-Ro, Oakland 6-P, California.

COLORGLAZED Concrete pottery made without molds. Patented method. Cemetery products, novelties, tiles. Basement leak-sealing. Money-making projects. Booklet, details free. Men only. National Potteries, Grand Rapids, "Minnesota."

MAKE Money at home doing easy pleasant work. Everything furnished. Good earnings. Write, Murray's, Box 4006, Mott Park Station, Flint 4, Michigan.

\$1000 A Week Possible With Great Triple Profit Plan. Edikara, Johnstown, Penna.

START your own profitable home mailorder business! We supply everything! Write today! Studio Products, Box 564-"D," Glendale 5, California.

BIG Profits selling used cars. Free details. J. E. Smith, 601 North Willow, Chattanooga 4, Tennessee.

START your own mail business at home in your sparetime with small investment. Proven merchandising methods, no crackpot schemes. Write, Craig, Southern Pines 2, North Carolina.

CASH from trash! Many Methods. (No manufacturing.) Instructions, 25c. Newlon, 505 Cherry, Bonham, Texas.

MAKE Perfumes Other Products, Home, "Carelabs", 1914-PS5, Chouteau, St. Louis 3, Missouri.

UNUSUAL homework opportunity. Spinning angora for us. Men, women, sparetime. Angora House, PSM, Springfield, Ill.

BUY it wholesale. Manufacturers. Distributors. Over 850,000 items. Literature free. Olsen, 1231-B East Third St., Duluth 5, Minnesota.

PARAKEETS—\$400 month profit from 6 pairs. Spare time. Small space. Breeding information free. Zale, 1024B Bellwood, Bellwood, Illinois.

POPULAR SCIENCE OPPORTUNITIES

RAISE crazy waltzing mice. Write for particulars. S. E. Keegan, 7855 Mill Road, Philadelphia 17, Pa.

NEWSPAPERS. Turn them into cash. Eighteen methods. Instructions 50c. Charles Company, 12-ECB, Norwood, Ohio. "SILVERWARE Renewal Service." Start Franchise. Exclusive. NuSilver, 508-PS5-BO, Aurora, Illinois.

\$46 FROM Square Foot Plywood; Jigsaw necessary. Write: Woodart, Bridgewater, Mass.

DEPRESSIONPROOF business—Make tough, Durable Plastic of waste—easily. Makes attractive, resilient floors, walls, built-ins. Stucco. Build for half. Bays Laboratory, Oklahoma City 9.

EXCELLENT business selling imported specialties. Sample merchandise and details \$10. Chesapeake Traders, Box 1107, Arlington 13, Va.

RAISE Earthworms!! Easy! Profitable! First get unusual true story. "An Earthworm Turned His Life." Send dime. Earthmaster System, Dept. 14D, El Monte, Calif.

EXPORT American products to Middle East markets. New ways to import Eastern goods. Write to: A. Majid Shamkani, Margil, Basrah, Iraq.

BECOME Fully Qualified Ordained Minister! Our Ministers Heal, Marry, etc. Send dime for details. Non-sectarian. Order of The Holy Grail, Box 3532, Philadelphia 22, Penna.

TIN-Cans. Turn them into cash. Nine methods. Instructions 50c. Charles Company, 12-ECA, Norwood, Ohio.

EARN money making rhinestone jewelry. Rhinestones 50c gross. Catalog. Ebert, Box B183, East Orange, New Jersey.

BUY Wholesale thousands items. Lists Free. Cottage Industries, Omaha 12, Neb.

MAKE \$100.00 Weekly Mailing Merchandise Catalogs. Bearing your name. Sample catalog. details 25c. Products, 526 Western S., Chicago 12, Illinois.

DOLLARS in the mail for you! Put your ad here and watch orders fill your mailbox. For as little as \$9.00 you can advertise your product or service in the classified opportunities columns of Popular Science Monthly. The July issue closes on May 24. Write today for order blank. O. K. Kelly, Classified Adv. Mgr., Dept. 554, Popular Science Monthly, 353 Fourth Ave., New York 10, N. Y.

38 MONEYMAKING OPPORTUNITIES

SELL Titania gems; \$9.75 carat wholesale. More brilliant than Diamonds. Free catalogue. Diamonite 1404-S Mitchell, Oakland 1, Calif.

DETECTIVES Earn Big Money. Experience unnecessary. Detective Particulars free. Wagoner, P-125 West 86th, N. Y. 24.

MAKE Money addressing Envelopes! Our information reveals how. Only 30c. Business, Dept. 45-E, P. O. Box 2224, St. Louis, Missouri.

SPARETIME Profits Taking Subscriptions. All Magazines, Wholesale Catalog Free. Cassell Agency, Westfield 1, N. J.

\$500.000 BY mail from home. Free Folder. Publicity, Kalamazoo 65EQ, Mich.

1930 **DEPRESSION** forced me to invent my own business—a minimum-cost, high-potential home mailorder. Lucky design paid immediately, over \$1,000 every month since! Over half net! This original design, "Selective Mailorder," is United States Postal Service approved. Now mapped out to guide mailorder operators. Literature free. Eveningshade Ranch, Helotes 15, Texas.

NATIONAL mail order house offers sensational mailing program full or part time. Suppliers Mailing, Buena Park 9, Calif.

FREE! "301 Profitable Small Businesses!" Amazing shoestring plans! Work Home! Start Sparetime! Deumant Surveys, Kenmore 23-S, New York.

ADDRESS advertising postcards. Must have good handwriting. Lindo 504, Watertown, Mass.

MAKE Money At Home as renewal headquarters for all magazines. Liberal commissions. No experience—No capital needed. Supplies furnished. Write for Free Catalog. McGregor Magazine Agency, Dept. 510C, Mount Morris, Illinois.

BUY Wholesale! Thousands Nationally advertised items. Save—Make money! Free Details. Durex Company, Box 672-S, Chicago 90.

MINIATURE Trees. Why pay \$2.00—\$10.00 for growing secrets? Free Details. Tiny Trees 5038 N. Winthrop, Chicago 40.

\$10.800 PROFITS! Your Own Mailorder Business! No risk! "Success Plan" Free! Treasury 709 Webster, New Rochelle PS-23, New York.

FRENCH-Type Perfume Really Sells!! \$1.00 brings \$4.50 facon, details (refundable). Elliott-Stuart, 4616-B Hollywood Blvd., Hollywood 27, Calif.

MILLIONS In Ideas, 20c. Enterprises, P-334 S. Wabash, Rm. 1, Chicago 4, Ill.

\$5.00 **HOUR.** No selling. Details dime. Norval Roland, Langhorne R.D. 4, Penna.

PROFITABLE enterprises. Work home. T. Walker, 3042 Madeline Street, Oakland 2, California.

PRINTING and Office Supplies Wholesale. 20,000 items. Literature free. Royal, Box 368-S, Cleveland 27, Ohio.

\$35 **WEEKLY** addressing envelopes. Instructions \$1, refundable. Adservice, Spring Valley 36, New York.

HOMEWORK! Immediate Commissions! Permanent! Experience Unnecessary! Hirsch, 1301-B Hoe, New York City 59.

EARN Money Evenings, copying and duplicating comic cartoons for advertisers. Adservice, Argyle 2, Wisconsin.

START A Buying Service, buy wholesale thousands nationally advertised products. Make big profits selling at sizeable discounts. Postcard brings details. American Buyers', 630-T Linden, Buffalo, N. Y.

SPARE Time Money plus New Car as encouragement bonus. Amazing 60 gauge nylons 3 pairs guaranteed 3 months. Write Wilkmit, 2045 Wash., Greenfield, Ohio.

EXTRA Money Every Week. I'll send you full-size Blair household products on Free Trial. Show them to friends and neighbors. You can make Big Extra Profits. Write Blair, Dept. 55ME-2, Lynchburg, Va.

FREE Wholesale Catalog! Make Up To 500% Profit! Novelties, gifts, premiums, costume jewelry, wrist watches, housewares, name brand merchandise. No junk, sell to stores or individuals. Write for Catalog No. #PS-5, Heath Distributing Company 506 Broadway, Macon, Georgia.

BREED giant hybrid earthworms. No overhead, 100% profit. Instructions free. Write today. Earthworm Gardens, 15 Peacock Bldg., El Monte, Calif.

CIGARETTES—Roll 200 mild, tasty, guaranteed to please for 75c. Details free. Pete Moberly, Box 882, Owensboro, Ky.

RICKRACK Jewelry. A Profitable Hobby. Instructions, including samples, \$1.00. Homecrafts, Box 46, Paramount, Calif.

BUY Wholesale! Nationally advertised appliances, housewares, cameras, watches, etc. Tremendous discounts. Send postcard. Econ-O-Mart, Box 535-A, Morristown, N.J.

DO It Yourself. Unpainted Novelties. 50% Off. Details 3c stamp. Bishop Novelties, 2729 Lisbon, Milwaukee 8, Wisc.

GET latest money-making opportunities, send 20c. Conrad, Box 301, Seattle, Wash.

MAKE to \$4.50 hour doing common pen lettering. National Artists, 801½-C North Marsalis, Dallas 3, Texas.

Wanted: Typewriter owners. Make handsome profits. Write today. Groves Company, 682 Hastings 3, Nebraska.

START A Buying Service, buy wholesale thousands nationally advertised products. Make big profits selling at sizeable discounts. Postcard brings details. American Buyers', 630-S Linden, Buffalo, N. Y.

GROW Mushrooms. Cellar, shed, and outdoors. Spare full time, year round. We pay \$3.50 lb. We paid Babbitt \$4,165.00 in few weeks. Free Book. Washington Mushroom Ind., Dept. 179, 2954 Admiral Way, Seattle, Washington.

FREE Book "505 Odd Successful Businesses." Work Home! Expect something Odd! Pacific-35C, Oceanside, Calif.

WIN contest money. General Contest Bulletin gives hundreds of tips. Lists current contests and rules. Sample 25c. General Contests, 1609-A East 5th, Duluth, Minnesota.

HOME Business Opportunity—Mailing Literature. All Profit—Orders filled Free. Everything furnished. Genmerco, Box 142-R, Dorchester 24, Mass.

MAKE money at home. Write. Falcon House, Winnebago 4, Illinois.

MAKE Big profits operating mailorder business. Lewis Bartlett, Richland, Ga.

EXTRA Income! Addressing-Mailing advertising literature. Everything furnished! Rush 3c stamp for information. Advertisers, Box 4097-N, San Diego 4, California.

FUTURE Security! Learn Watch-Clock Repairing at home. Inquire. Modern Technical Supply, 55-PS West 42nd Street, New York 36.

PROFITS Guaranteed for sparetime. No investment. Not Mail Order. Canvassing unnecessary. Nothing to make or learn. New plan. Free details. Transamerican, Dept. 60, Box 815, Atlanta 1, Georgia.

START a profitable subscription business in spare time! We need men and women (young or old) as representatives for all leading national magazines. Liberal commissions paid for new and renewal subscriptions. Start earning money in this pleasant work at once! Clip this ad and send with your name and address to: Agency Bureau, Dept. PS, Hearst Magazines, 250 West 55th Street, New York 19, New York.

CAN You Earn \$40 Weekly Addressing Display Postcards? Enclose stamped addressed envelope; write Allen Co., Warsaw, Indiana.

EARN extra dollars with these new formulas: "Glass Polish," "Self Polishing Floor Finish," "Dry Cleaner For Rugs." Detailed instructions supplied for marketing each product. 25c each, 3 for 50c. Main Plan, Box 166, Bridgeport, Conn.

MONEY found. Be our agent in your community. Top quality watches, diamonds, jewelry, etc. at wholesale prices. Amazing profits. Experience unnecessary. Send for Free catalog. Zerah Brothers, 602 Mission Street, Dept. 341, San Francisco 5, California.

CONVINCE Yourself!! Hundreds of ways to make money! Milmac, 724 E. 260, Euclid, Ohio.

MANUFACTURE Rhinestone and Pearl Jewelry at home. Latest creations, tremendous profits, no skill needed. Postcard brings illustrated catalog of settings, stones, etc. A. V. Cutt Co., Inc., 210-H Fifth Ave., New York 10, New York.

DOLLARS in the mail for you! Put your ad here and watch orders fill your mailbox. For as little as \$9.00 you can advertise your product or service in the classified opportunities columns of Popular Science Monthly. The July issue closes on May 24. Write today for order blank. O. K. Kelly, Classified Adv. Mgr., Dept. 554, Popular Science Monthly, 353 Fourth Ave., New York 10, N. Y.

39 FORMULAS, PLANS, ETC.

FORMULAS—All kinds. Latest products. Literature free. Kemico, Park Ridge 15, Ill.

FORMULA Fortunes, 10,000 trade secrets. Authentic 900 page volume, \$3.95 postpaid. Brockway, 1145 High, Topeka 2, Kansas.

FREE Chemicals offer. Profitable specialty manufacturing Formulas. Crotona, 1725 Fulton Avenue, New York 57.

PAYING Formulas \$3.00. Esse Laboratories, 251 Liberty, Harrisburg, Pa. Catalogue.

REMOVE Nickel from Copper, Brass. Simple formula, \$1.00. Odd Shop, Angola, Indiana.

REAL Manufacturing Formulas Lists Free. Cumming, Chemist, Gordon Avenue, Syracuse 4, New York.

ANY Formula \$5.00. Satisfaction guaranteed. Jack, Chemist, 5138 Gainor, Philadelphia 31.

MANUFACTURING Formulas, Household, Cosmetics. Lists Free. Sacco, Box 711, Binghamton, New York.

ANY Formula \$3.00. Catalog — Mfg. Treatise 10c. J. Belfort, 192 N. Clark, Chicago 1.

LABORATORY Tested Formulas. Catalog free. Pont Chemical Company, Terre Haute 1, Indiana.

POPULAR SCIENCE OPPORTUNITIES

FREE Formula Catalog. Anything analyzed \$35.00. Western Chemical. Salem, Ore.

MILLER'S modern manufacturing formulas make fast selling products that get the business and pay! Fifty years supplying the best. Late literature free! Lipscomb Miller, chemist, Tampa, Florida.

40 PLASTICS

PLASTICS home-craft course for Men and Women. Tells and shows how to make hundreds of fast selling plastics products. All plastics and materials for 23 projects included in course. No special tools needed. Course pays for itself. Write for Free booklet. Interstate Training Service, Dept. D2-E, Portland 13, Oregon.

PLEXIGLAS. Lucite. Any size sheets. Square foot (12x12) cost, 1/16", \$1.18; 1/8", \$1.55; 3/16", \$1.90; 1/4", \$2.25. Add 15% for postage. Minimum order \$3.00. Almac Plastics, 600 Broadway, New York City.

PLEXIGLAS sheets—cut to size—clear, all thicknesses—standard outdoor translucent colors. McClarin Plastics, P.O. Box 168B, Hanover, Pa.

LEARN Plastics at home. Complete kit—\$5.98 postpaid. Dime brings sample plastic, three experiments, full details. Plastic Projects, Box 5151, Detroit 35, Mich.

NEW liquid casting plastic. Clear, colors. Preserve flowers, insects, photos permanently. Saw, drill, carve. Send 25c for Castolite Casting Manual and proved Success Plan showing how to make money at home. Castolite, Dept. E-102, Woodstock, Illinois

PLASTIC Sheets, Rods, Tubes; etc. Free List. Plastic Supply Co., 2901 N. Grand Blvd., St. Louis 7, Mo.

NEW "Plexiglas Craftsman Handbook." including material catalog, postpaid \$1.00. Plastic's, Box 1812, Salt Lake City 10, Utah.

FIBERGLAS—resin and lampshade materials included in our complete plastic line. Free catalogue. Van Horn Plastics, 1905 Ingersoll, Des Moines, Iowa.

KELON, clear, dyeable, casting plastic. Pyrocon, bakeable modeling plastic, fun for everyone get your prices, details. Science Now Company, RD 2, Box 107A, Catskill, New York.

FIBERGLAS, Polyester, Plexiglas, Acetate, Vinylite; Casting, coating plastics; Maurice Lannon's Fiberglass "How" book now ready—\$2.50. Fast service, best prices. Catalog—10c. Gem-O'-Lite, Box 6868P, North Hollywood, Calif.

AGENTS—New wonder belt, \$3.00 value. \$1.00 brings one, with details. Cain's, 3022 N. Gale, Indianapolis 18, Indiana.

AMAZING new design plastic for the home craftsman, send for free sample and price list. Bre-Nay Plastics, 394(R) Smith Street, Perth Amboy, New Jersey.

41 CHEMICALS & APPARATUS

NEW Idea Chemical and Apparatus Outfits for Home Experimenting Photo-Scales, Microscopes, Chemicals, Biological and Laboratory Supplies in Small Quantities. Catalog 25c. Established 1931. John H. Winn, 124-B West 23rd Street, New York, N. Y.

ILLUSTRATED Catalog: Chemistry, mineralogy, biology 20c. Tracey Laboratories, Evanston, Illinois.

CHEMICALS, Supplies, Catalog 20c. Laboratory Sales, Box 161-B, Brighton, Mass.

CHEMICALS and apparatus for industrial, analytical and private laboratories. Catalog 25c. Dept. M-26, Biological Supply Co., 1176 Mt. Hope Ave., Rochester 20, N. Y.

AMAZING New Book of Science. Experiments, Formulas and catalogue of Laboratory Supplies. Only 25c. National Scientific Co., Dept. PS5, 2204 W. North Ave., Chicago 47, Illinois.

DO your own analyses and chemical separations. Laboratory analytical ion exchange kit, \$4. Instructions for separating uranium. Rainaway Chemical Company, 800 Delaware, Berkeley, Calif.

42 HELP WANTED

FOREIGN Employment Construction Work. If interested in foreign projects with high pay, write Foreign Service Bureau, (Dept. P.S.), Metuchen, New Jersey.

ADDRESS advertising postcards. Must have good handwriting. Lindo 504, Watertown, Mass.

FOREIGN & Latin American Employment 1954 "Foreign Service Directory" gives Up-To-Minute Facts on Military & Civilian Construction, Government Jobs, Major Oil Listings, Aviation, Transportation, Steamship Lines, Mining, Importers, Exporters, How-When-Where to apply application forms. Hot List Firms Hiring. \$1.00 postpaid. Global Reports, Box 883-S, Hollywood 28, Calif.

ALASKA!! Last American Frontier. \$1.00 brings 1954 Business Directory & Government Map, Military & Civilian Construction; Homestead & Highway facts; Mining, Aviation, Fur Farming, Grazing, Timber. Travel directions. List of firms hiring. How to apply. Alaska Opportunist, Box 92-S, Hollywood 28, Calif.

FOREIGN & Domestic Jobs. High Pay to \$14,000. Fare paid. Alaska, So. Am., U.S., etc. Stamped self-Addressed env. brings reply. Foreign Opportunities, Waseca 2C, Minn.

"INTERNATIONAL Employment Reports!" Who to contact—how to apply for high paying jobs in 38 countries, including U.S., Spain, Alaska, South & Central America, Europe, etc. Listings of employers with contracts (names, addresses, projects. Complete information) who hire skilled, unskilled, professional, supervisory, clerical, laborers, trades, many others. Also best oil, aviation, manufacturing opportunities. Only \$2 (Airmail \$2.25). Includes one year registration and advisory service. We can help you find employment. Only service with unconditional guarantee of satisfaction or money-back. International Reporter, Box 1047-SC, St. Louis 1, Missouri.

FOREIGN Job News and Domestic. Send \$1.00 for World Wide Construction Projects. How-When-Where to apply. Global Reports Monthly, Box 883-Sx, Hollywood 28, Calif.

JOBS in U.S.A. Construction, skilled to \$4.12 hourly. Carpenters, \$3.55. Electricians, \$3.60. Laborers, \$2.40. Civil service openings, \$3,400-\$9,600 yearly. Labor Shortage Areas. Plus, U.S.A., Canada jobs underway, current wages, where to apply. 217 reports this issue. Printed, illustrated, \$2.00. (Airmail, \$2.35). White Pass Reports (CX-01), Box 716, Cody, Wyo.

CALIFORNIA — Employment — California's population increasing over 400,000 yearly—become part of it. Have a job waiting your arrival. Complete listings. \$1.00 Satisfaction-guaranteed. Midcentury, Box 11461, Los Angeles 48, California.

INVESTIGATE Seattle—Unlimited opportunities; Fishing, construction, shipping, Boeings, jobs. Insure family future \$1.00. 40 pages information. Photographs. Westcoast, Box 196, Bellevue, Washington.

JOBS Overseas! Skilled, \$220 weekly. Foremen, \$250. Plus bonuses. Tax free. Transportation, overtime. Four year project. 23 firms seeking construction men, clerks. Spain airbase details. 269 projects, 52 countries. 48 page, printed, plastic-bound manual, applications, everything, \$1. Jobservice (D-1), Box 30, Billings, Montana.

CANADA'S—Three largest cities. Employment and Housing information. Lists \$1.00. Tipton's Service, 5295 East Hastings, Vancouver, B.C., Canada.

FOREIGN jobs, information airmailed \$1.00. Information Service, 902, South San Francisco, California.

INDUSTRIAL Bridgeport, Connecticut. Classifieds Airmailed, \$1. Dunning's PS-1, 1980 Huntington Tpke., Trumbull, Conn.

MEN Wanted for jobs on Foreign, Latin America and Far North projects. Truck drivers, \$3.55 hour. Electricians, \$4.00 hour. Carpenters, \$3.70 hour. Laborers, \$3.00 hour. Clerks, \$3.00 hour. Most all trades wanted. Up to 70-hour week with time and one half for all over 40 hours. Transportation paid. 8 to 24 month contract. Full information of all Firms hiring, living conditions, family accommodation, wages, hours, age, contract requirements, application form, etc., \$1.00. Air mail \$1.24. Foreign Construction Bulletin, Dept. 28, P.O. Box 393, Dallas, Texas.

THOUSANDS of Men needed. Skilled Men to \$8000 year, unskilled \$5000—Women for office and factories—high pay. Act now. Send \$1.00 to Job Application Service, P.O. Box 109, Los Angeles 53, Cal.

"HOW To Get The Job You Want", \$1.00. P. C. Bradley, Box 8271, Houston, Texas.

PERSONS interested in Patent Drafting write International Patent Drafting Service, P. O. Box 134, Dayton 1, Ohio.

MONTREAL—"Help Wanted," question answered. \$1.00 airmailed. Kennedy, 751 Kenaston, Montreal 16, Canada.

FOREIGN Job Listings, application forms, etc. \$1.00. World Wide Listing Service, Box 5234, Chicago 80, Ill.

MEN Wanted now in South America, Alaska, Africa, Australia. \$400 to \$1200 monthly. Travel paid. Complete information and application forms \$1.00 postpaid. Airmail \$1.25. Kemah Company, 3618-B Washington, Houston, Texas.

\$1300.00 MONTHLY for truck drivers, \$1400.00 monthly for carpenters, electricians, plumbers, mechanics, \$1200.00 for clerks and laborers. Replacement hiring now being done. Full information and complete foreign listings, with current information on Spain, Korea, Australia, Alaska & Canada, \$1.00. 25,000 men and women needed for new stateside project! Complete information and other domestic listings, \$1.00. Dept. 4-E, Opportunities Unlimited, 1110 Commerce Bldg., St. Paul, Minnesota.

THOUSANDS of opportunities will be available on the St. Lawrence Seaway Project. Get vital information now, \$2.00. Ellis Enterprises, Box 298, Station-H, Montreal, Canada.

SAN Diego help wanted columns airmailed—\$1.00. Gorman, Box 526, National City, Calif.

DOLLARS in the mail for you! Put your ad here and watch orders fill your mailbox. For as little as \$9.00 you can advertise your product or service in the classified opportunities columns of Popular Science Monthly. The July issue closes on May 24. Write today for order blank. O. K. Kelly, Classified Adv. Mgr., Dept. 554, Popular Science Monthly, 353 Fourth Ave., New York 10, N. Y.

43 AGENTS WANTED

START Your Own Business on credit. Your own boss. 1658 of our Dealers sold \$5,000 to \$27,500 in 1953. We supply stocks, equipment on credit. 200 home necessities. Sales experience unnecessary. Pleasant, profitable business backed by world-wide industry. Write Rawleighs, Dept. E-U-PSC, Freeport, Ill.

NEW Jobs open in selling! Send name, address for five free issues of Opportunity Magazine's money-making guide, listing hundreds of companies who'll pay you well, full or part-time. No experience needed. Opportunity, 28 E. Jackson, Dept. 18, Chicago 4, Illinois.

AGENTS—300% profit selling genuine gold window letters; stores and offices. Free samples. Metallic Sign Letter Co., 431-E North Clark, Chicago.

ABSOLUTELY Free—Sales Kit. Yours for the asking. Send postcard today requesting kit showing new line, belt buckles with your name or personal initials, cap badges, choice 3000 different emblems. Write Hook-Fast, Box 1425PS, Providence, R. I.

BUY Wholesale—25,000 items—Catalog 25c. Matthews, 1472-A8 Broadway, New York City 36.

BIG profits selling ties (\$2.00 values) \$6.50 dozen. Free catalog. Empire Cravats, 611 Broadway, New York 12.

AGENTS—Show America's leading Nationally Advertised line—Novelties, Gifts, Utility Items, 100% profits. Prospects Everywhere. Steady Repeats. Write today for sensational low prices, free literature. Charms & Cain, 407-PS-54 South Dearborn, Chicago 5, Illinois.

GOLD or Silver letters, numbers. Windows, Doors Trucks, 1" to 6". 500% Profits—Free Samples. Atlas-U, 544 West 79th, Chicago 20.

ADDRESS advertising postcards. Must have good handwriting. Lindo 504, Watertown, Mass.

AGENTS—Salesmen: Sell beautiful hand colored plastic enlargements and sensational new personalized photo compacts, rings, bracelets, lockets, etc. Experience unnecessary, 40% advance commissions. We deliver, collect. Wonderful sideline—better full time. Free sample outfit. Novel Portrait Co., 3343 North Ave., Chicago, Ill.

POPULAR SCIENCE OPPORTUNITIES

HAVE you spare time? Terrific lifetime income. International, 61B Roberts, Portland, Maine.

NEW Plastic Mending Tape. Just press on! Repairs clothing instantly. Lightning seller. Samples sent on trial. Kristee 56, Akron, Ohio.

100% PROFIT calling on businesses. Samples \$1.00. P. O. Box 297-PS, Dupon, Ill.

MAN to earn \$150 and up per week. Long needed invention. Advertised worldwide. Prospects are everywhere. Full or part time. Exclusive. No investment. Free samples. Write Red Comet, Inc., Dept. 334-L, Littleton, Colorado.

MAKE Money Introducing World's cutest children's dresses. Big selection, adorable styles. Low prices. Complete display free. Rush name. Harford, Dept. L-6341, Cincinnati 25, Ohio.

CALIFORNIA sweet smelling beads, sensational sellers. Particulars free. Mission, 2328P West Pico, Los Angeles 6, Calif.

EASY handwork makes fast-selling useful articles. Sample free. Sunmade Company, Brockton 64, Mass.

BUY Wholesale thousands nationally advertised products at big discounts. Free "Wholesale Plan." American Buyers', 629-T Linden, Buffalo, New York.

NEED Extra Cash? Get it selling Blair's unusual line of household and food products. Every housewife a prospect. Products sent on Free Trial. Write Blair, Dept. 55ME-1, Lynchburg, Va.

RED Hot! Sell dealers lawnmowers (40% deal). Leads furnished. Rotacut-52, Excelsior Springs, Mo.

BUY Wholesale. Thousands items. Catalog 25c. Refundable. Roselene 4, Independence, Pa.

"FAMOUS Precision Tools, Beat Competition, Make 50%." Mallory, 711 Vine, Los Angeles 38.

CASH in on tremendous demand Low priced burglar Alarm for cars, homes, farm buildings. 286% profit. Unique sample offer. Northwest, PS5, Pukwana, S. Dak.

DISTRIBUTORS, Jobbers, and Salesmen: Get the facts—just the facts on big money maker for service stations, garages, etc. Everybody will buy—build large repeat business. Exclusive territories available. Act fast. Write for free sample and details. John J. Griffin Co., Inc., National Sales Office, Dept. P.S., 4343 Frankford Avenue, Philadelphia 24, Pa.

FREE hosiery! Sensational new way to earn \$3 hour in spare time! Introduce amazing hosiery by giving away free pairs to every man and woman (regardless whether or not final purchase is made) just to prove how good they are! Wonderful luxurious nylon stockings, guaranteed against runs and snags, nationally known—sold coast to coast. New miracle one size two-way stretch men's nylon hose, contains no elastic, yet fits every size foot from 9 to 14! Never sags or droops—clings to foot like second skin—Outlasts several pairs ordinary hose and guaranteed one full year! Money or experience unnecessary. Buy nothing. Deliver nothing. Advance cash plus huge cash bonus to 40%. Your own hose as extra bonus. Special manager plan so you can appoint agents. Nothing like this ever offered before. Samples of stockings and miracle socks with complete money-making outfits free and prepaid. Nothing to pay now or later. Absolutely no obligation. Simply mail postcard with your name and address. Kendex, Babylon 44, New York.

BEAUTIFUL Feather Pictures. 200% Profit! Free sample. Apartado 9036, Mexico 1, D. F.

FREE book "505 Odd, Successful Businesses." Work home! Expect something Odd! Pacific-38C, Oceanside, Calif.

IS \$210 a week worth a postcard to you? Then rush card with name and address for special Free Trial Plan that sells amazing new Automatic Refrigerator Defroster "like hot cakes!" Write to Mr. Lewis, D-Frost-O-Matic Corp., Dept. P-103, 173 W. Madison, Chicago 2, Illinois.

\$1.00 PROFIT selling \$2.95 photo enlargement offer. Allen Studio, Reigler Bldg., Little Rock, Arkansas.

MEMO Blotters-Billfold Secretaries Dynamic advertising mediums. Big commissions. Excellent repeats. Peters Associates, Vandalia, Ohio.

MAKE Extra Money. Sell front door name plates to friends, neighbors. Retail \$1.98—you make \$1.00! Free selling kit. Modern Engraving Co., P.O. Box 194, Boston 14, Mass.

UNUSUAL Invention. Man wanted. Full or part time. Earn \$500 month up. National Company. Exclusive. Prospects everywhere. Free sample outfit. Superior Products, Inc. Dept. 189, 3410 Main, Kansas City, Mo.

FREE Private Labels! Exclusive Sales! Order just 2 dozen bottles VimVite tablets costing \$36.00. Resale value \$72.00. Own your own business! We supply Product—Plan—Literature; you furnish executive management, employing salesmen. Sell radio PI, Stores, Mail Order and others. Terrific Profits! Lifetime Repeats! Details Free. VitaMins, 2908-PSA Beverly, Los Angeles 57.

WHOLESALE Catalog. Appliances, cameras, watches, etc. Pette Company, 1554-PS W. 11th Street, Brooklyn 4, New York City.

44 HIGH-GRADE SALESMEN

AD Matches! Sell Amazing Designs—20, 30, 40 and 240-light book matches. Biggest spot cash commission; every business a prospect. Low prices for high quality. Repeats. Start without experience; men, women; full, part time. Buy Nothing! Sales kit furnished. Match Corp., Dept. PS-53, Chicago 32, Illinois.

ADVERTISING book matches—Cash in on big demand—sell Union label matches. Cuts for all businesses and political parties—Free powerhouse selling kit—low prices—protection guaranteed on repeat orders—Cash commissions. Superior Match Co., Dept. P-554, 7530 Greenwood, Chicago.

45 EDUCATIONAL & INSTRUCTION

USED Correspondence Courses and Books sold and rented. Money back guarantee. Catalog free. (Courses Bought.) Lee Mountain, Pisgah, Alabama.

HIGH School—No Classes. Study at home. Spare time. Diploma awarded. Write for Free catalog. HBA-36, Wayne School, 2527 N. Sheffield, Chicago 14, Ill.

BOOKKEEPERS! Increase your earnings! Operate your own simplified "Dollar-A-Week" Bookkeeping and Tax Service. Full or spare time. Details Free. No obligation. Ellis, Box 203, Cedar Grove, North Carolina.

WANT A Diesel Job? New Opportunities to increase income. Higher Pay. More Money. We can help you Qualify. Tools. Shop method home training. Write today! Diesel, Tractor, Heavy Equipment Division, Interstate Training Service, Dept. B2-E, Portland 13, Oregon.

COMPLETE Your High School at home in spare time with 57-year-old school. Texts furnished. No classes. Diploma. Information booklet free. American School, Dept. X546, Drexel at 58th, Chicago 37, Ill.

BE a Real Estate Broker. Study at home. Write for Free Book today. "G.I. Approved." Weaver School of Real Estate, 301 Law Bldg. Kansas City, Mo.

FINGERPRINTING course, \$12.00. Details. Fingerprinting School, 414 South 10th Street Bessemer, Alabama.

HIGH School diploma at home. Licensed teachers. Approved materials. Southern States Academy, Box 144 PX, Station E, Atlanta, Georgia.

PIANO Tuning Pays. Learn this profitable profession at home. Our Tonometer and mechanical aids make learning easy. No knowledge music necessary. Diploma granted. Largest and oldest school—56th year. G. I. Approved. Write for booklet. Niles Bryant School, 77 Bryant Bldg., Washington 16, D. C.

PRACTICAL Nursing—Learn Easily at Home. Spare Time. Big Demand, good earnings. High School not necessary. Write for free facts. Wayne School, Dept. FH-23, 2525 Sheffield, Chicago 14, Ill.

OPERATE a Collection Agency Business. Very Profitable. Easily learned. Write Cole & Associates, Syracuse 2, New York.

WELDING training pays at Hobart Welding School, Box P-541, Troy, Ohio. VA Contract. Best equipment. Catalog Free.

INCREDIBLE! Become Mental Superman Overnight! Free Booklet! Bijou, Box 1727-VK, Hollywood 28, California.

LEARN Drafting—Write for free booklet, "Drafting Opportunities In Industry." Cesco Industrial Training Services, 1704-B Frederick, Fort Worth 7, Texas.

WHY Don't You Write? Writing short stories, articles on business, sports, hobbies, travel, etc. will enable you to earn extra money. In your spare time at home. We teach you to write the way newspaper men learn—by writing. Free "Writing Aptitude Test" tells whether you possess the fundamental qualities essential to successful writing. Write today! Newspaper Institute of America, Suite #5664-E, One Park Ave. New York 16, N. Y.

BRAIN twisters with answers—\$1.00. John Mullany, 217 Highland Ave., Darby, Penna.

CORRESPONDENCE Courses on Aeronautical Drafting and Engineering. Free Folder. Aero Technical Institute 2162-PS Sunset Blvd., Los Angeles 26, Calif.

MACHINE Shop Blueprint Reading—Train at home. Learn to read blueprints with confidence in ten easy lessons. Write today Belton School, 1059 N. Lawndale, Chicago 51, Illinois.

STUDY by correspondence for Doctor's degree in Psychology, Metaphysics, and Divinity. College of Divine Metaphysics, Dept. P-S, 2811 No. Illinois Street, Indianapolis 8, Indiana.

MEDICAL Laboratory Technicians in great demand. We train you in your own home. Catalogue free. Imperial Technical Institute, Box 973-B, Austin, Texas.

EARN While You Learn Auto And Diesel Mechanics. Master this top paying trade. Many graduates earn \$100 a week and up. Approved for Korean veterans. For free information write Dept. No. 262, Nashville Auto-Diesel College, Nashville 3, Tenn.

SIMPLIFIED method teaches algebra instantly. \$1; guaranteed. Ziemben, 6123 Orchard, Dearborn, Michigan.

LEARN Real Estate Business. Highly profitable. Easily learned, complete home-study Course. Cost surprisingly low. Diploma awarded. Write for free literature. Seavy Realty Institute, 1750-S Colorado, Los Angeles 41, California.

BIG Money Business! Not Knick-knacks nor dime a dozen deal; operate collection agency; own a financial institution. Free booklet. Franklin Credit, Roanoke 7, Va.

WORK For U.S. Gov't! Men-Women. 18-55. Start high as \$316.00 month. Qualify Now! 23,000 jobs open. Experience often unnecessary. Get free 36-page book showing jobs, salaries, requirements, sample tests. Write: Franklin Institute, Dept. N-22, Rochester, N.Y.

CORRECT Your thinking and change your life! Write Bert King, Box 7-A Main Office, Louisville 1, Kentucky, U.S.

HANDWRITING and Character Analysis. Signs-Booklet, \$1.00. Deebee Lucas, 2419 Sunset Boulevard, Los Angeles, Calif.

CHOOSE from eighteen different courses. Drafting, electronics, mathematics, etc. Free literature. Technical Instruction by Correspondence, Box 69, Cambridge 39, Mass.

BECOME a Doctor of Psychology or Metaphysics. Learn secret of contentment, happiness. Win degree of PsD. or MsD. Solve mental worries. Free book. College of Universal Truth, 5038-K Broadway, Chicago.

FREE home study course in basic economics, offered as a public service. Recommended by many leaders. Send postcard for complete information. Henry George School, Dept. P, 50 E. 69th Street, New York 21, New York.

MINISTER'S—laymen's religious courses. Free Bulletin! Midwestern Schools, 517 Merchants Bank Building, Indianapolis, Ind.

GROW Mushrooms. Cellar, shed, and outdoors. Spare, full time, year round. We pay \$3.50 lb. We paid Babbitt \$4,165.00 in few weeks. Free Book. Washington Mushroom Ind., Dept. 180, 2954 Admiral Way, Seattle, Washington.

LEARN mathematics at home. Individualized instructions. NCS, Box 27, St. Johns Station, Brooklyn 13, New York.

PROFITABLE Diamond Facts—Send only \$2.00 includes wholesale catalogue. Jonrue Enterprises, Donora 13, Pa.

POPULAR SCIENCE OPPORTUNITIES

MIRACLES via Subconscious Control. Free Autodynamic Brochure. Box 847, Ocean Park, Calif.

GOVERNMENT Position! Home training for Examination. \$9.95—Refunded if you don't pass. Write. Ozment Instructions. 37-CS-Box 665, St. Louis, Missouri.

EDUCATIONAL books, correspondence courses, bought, sold, rented, catalog. Willard Bayles, 211 Essex, Hackensack, N.J.

POPULAR Piano. Rapid Course. Young Studios. 7051 Middlepointe, Dearborn, Mich.

RECOGNIZED College Degrees through Home Study. Tahoe Colleges, 510 W. Pueblo, Reno, Nevada.

TELEVISION service course. Embraces latest color television technique. Resident training. Midwest's oldest TV School. Veteran approved. Universal Television, 1220 Admiral, Kansas City, Missouri.

STRUCTURAL Drafting. Complete course at once. Lowest rate. Roth Tech., Box 2283, Youngstown, Ohio.

SILK-screen Process Printing. Instructions. Kits. Details Free. Roy Willick, 5026 Escalon, Los Angeles 43.

46 CONTESTS

SURPRIZES Galore!!! Fabulous Home Income Opportunity! Long established contest hdqtrs. Send stamp! National Contest Bulletin, Box 2685-PS, Miami 16, Florida.

CONTESTANTS! Puzzlers! We help you write your entries and work out your puzzles and tiebreakers. Contests, 13 Earl, Red Bank, New Jersey.

47 DETECTIVES

DETECTIVES—Work home—Travel. Experience unnecessary. Detective Particulars free. Write, Wagoner, P-125 West 86th, New York 24

DETECTIVE Training. Phillips Secret Service System, 1917-C North Kenneth, Chicago 39 Ill.

INVESTIGATOR Training. Experience unnecessary. Many opportunities. Send for Free particulars. Also credentials. Exchange Secret Service System, 4360 Broadway, Chicago 13, Illinois.

48 LANGUAGE OUTFITS

IT'S Fun learning a language by Linguaphone. At home, quickly, easily learn to speak French, Spanish, German, Russian, Japanese—29 languages by Linguaphone World's Standard Conversational Method. It's like living in another country. Save time, work, money. Send for Free Book. Linguaphone Institute, 5405 RCA Building, New York 20.

50 BUSINESS SERVICE, INFORMATION, NAME LISTS

MAILING Lists, most any classification. 1000 names \$5.00. 1000 your circulars mailed with ours \$4.00. 5000 your circulars printed and mailed \$12.95. Write Dixie Mailers, King, North Carolina.

3000 MAIL Buyers Names \$2.00. Lucas, 1076z Lake Washington Blvd., Bellevue, Washington.

5000 GUARANTEED Opportunity Seekers \$2.50. Bunn's, 1105 Morning-Glory, Durham, North Carolina.

WOMEN Buyers Names. Any amount \$7.50 1000. Du-Rite, 624 East 17th, Indianapolis 2, Indiana.

LADIES, Gentlemen! Send 10c for sample copy of Collector's & Swapper's Gazette. Hicks Service, Box 7215-PS, Los Angeles 37, California.

BOOKKEEPING Service by mail. Save Money. Write for details. Manuel Torres, Methow, Washington.

CALIFORNIA opportunities Men-Women Typists, office-clerks, salespeople, truck drivers, mechanics—hundreds other jobs. Don't Delay! Send \$1.00 today for information on Who To Contact for Work in California. Franklin Ross, Dept. A, P.O. Box 7, Long Beach, California.

51 SPECIAL SERVICES

LETTERS remailed your choice Brasil—Trinidad—Venezuela—Uruguay—Argentina. \$1.00 Postcards 2 for \$1.00. Szabo, Avenida Atlantica 792, Rio de Janeiro, Brasil, S. A.

66 POPULAR SCIENCE

LETTERS remailed 20c. Literature, samples and golden rule book 30c. Persil, 436 N.Y. Avenue, Brooklyn 25, New York.

NOT Selling? Tell us Product-Talk-Door-Store-Where. One item \$1.00—"Sales-Aids." P. O. Box 1023, Turlock, Calif.

BIBLE Questions answered. Jon. Ferguson, 116-14 141 Street, So. Ozone Park 36, New York.

52 AUTHORS SERVICE

NO luck finding a book publisher? Write for Free Booklet PS. Vantage Press, 120 West 31st, New York.

BEGINNING Writers: Get \$1 to \$20 checks daily writing simple children's stories, articles, poetry in your sparetime. Experience unnecessary. Our instructions reveal how. Details Free. W. Herman, 5927 Euclid, Cleveland 3, Ohio.

HOW To Write short stories, mysteries, articles. Learn at home for career or extra part-time income. Graham Doar sold one story to Post, CBS Radio and NBC-TV. Professional writers show you how. Send today for free lesson. Palmer Institute of Authorship, Desk UM-54, 1680 North Sycamore, Hollywood 28, California.

BOOK Manuscripts Invited—Co-operative publishers since 1925. Meador Press, 324 Newbury St., Boston, Mass.

53 ADVERTISING, AGENCIES, ETC., FOR ADVERTISERS

ADDRESS advertising postcards. Must have good handwriting. Lindo 504, Watertown, Mass.

500 RADIO Stations which accept advertising on commission and 200 Magazines which give Free publicity. Including instructions "How"—\$2.00. Satisfaction guaranteed. Brass, Box 1664-PS-4, Chicago 90.

ADVERTISE: 24 words, 100 Canadian Newspapers \$5.50. Lists Free. Advertising Bureau, 10511-P Springfield, Chicago 43.

BEFORE Advertising—get instructive Ad-Guide and Ratebook, 10c. Ideas developed. Advertisements prepared free. Chicago Advertising Agency (Established 1900), Chicago 4.

FOREMOST Canadian classified outlet. Latest Issue \$1.00. Kennedy, 751 Kenaston, Montreal 16, Canada.

54 CARTOONING, SIGN PAINTING, CHALK TALKS

"HOW To Make Money With Simple Cartoons"—A book everyone who likes to draw should have. It is free; no obligation. Simply address Cartoonists' Exchange, Dept. 195C, Pleasant Hill, Ohio.

SELL your cartoons. 300 markets, subjects desired, rates paid, \$2.00. Monarch Associates, Box 521, Tujunga, Calif.

LEARN Sign Lettering. Copyrighted Code teaches—easy method. Profitable. Complete instructions \$1.00. Lesson Free. Hub Art Center, 84 West Newton Street, Boston, Mass.

CARTOONISTS: Amateur, Professional. Prepare for Animation with Max Fleischer's plan. Write Vera Coleman, 60 East 42nd Street, New York, N. Y.

CHALK Talks. Laugh Producing Program. \$1.00. Illustrated Catalog 10c. Cartoonist Balda, Oshkosh, Wisconsin.

55 TYPEWRITERS & OFFICE MACHINES

TYPEWRITERS. Printing Devices. Office Machines, supplies, appliances. Dixie Graph, King, North Carolina.

TYPEWRITERS \$22.50 up. Adders \$14.25. Meier's, 118 Spruce, Wichita 7, Kan.

TYPEWRITERS. Adders, Duplicators, Addressers, Scales. Inquire, Hammie's, 5529 Master, Philadelphia 31.

56 RUBBER STAMPS & OFFICE SUPPLIES

3 LINES. \$1.00. Fast Service! Catalogue. Johnson Press, Box 6-B, N.Y.C. 26.

57 PRINTING, MULTIGRAPHING, ETC.

BUSINESS. Personal Printing, Catalogs Free. Howprint, 723-S Eunice, Webster Groves 19, Missouri.

ILLUSTRATED Postcards! \$8.90 Thousand. Samples Free! American Devices Company, 164 Montague, Brooklyn 1, N. Y.

PRINT without a Printing Press! Amazing New Method! Print colorful signs, banners, cards, posters, glassware—anything at home. Big profits \$\$\$\$ Opportunity! We supply everything. Beautiful Sample. Home-Business Plan Free! Write Screen-Print Company, Los Angeles 15, Calif.

OFFSET printing, \$6.50-1000. 8½x11, 16 lb. National Letters, 1457 Broadway, New York 36.

MIMEOGRAPHING—Printing. Price list. Samples Free. Robert Bailey, Monterey, Tenn.

JOB Printing—Letterheads—Envelopes—Circulars. Printing, 21 Barclay, Portsmouth, Virginia.

QUALITY Printing: Envelopes, letterheads, statements. Fast Service. Keeling's, Valley City, North Dakota.

DISTINCTIVE Printing. Samples, prices free. McIlvaine, Box 86-PS, Brooklyn 30, New York.

1000 BUSINESS Cards \$2.25. Postpaid. W. Anderson, 1008 Fenwood Drive, Valley Stream, New York.

58 PRINTING OUTFITS, SUPPLIES

DO your own printing. Save money. Simple rules. We supply everything. Print for others; good profit. Raised printing like engraving, too. Have home shop. Details free. Kelsey Presses, V-8, Meriden, Conn.

MAKE Your Own self molding rubber printing cuts. Plexirubber, Argyle (2), Wisconsin.

FREE Booklet "Make Your Own Cuts." Amazing new process. Walp, Box 4308-S, Mobile, Alabama.

PRESSES, Supplies, Paper. Catalog 10c. Custom, Box 211-S, Springfield, Missouri.

DO wonders with world's finest small-cost real printing outfits. Free Booklet shows dozens of ways to enrich your spare time, bank account, doing profitable print jobs. Easy rules, print in 1 day. We supply presses, etc., factory-to-you. Have your own business; do church, club, commercial work, greetings, etc. Craftsmen M'chy Mrs., 533 Atlantic Ave., Boston, Mass.

PRINTING Presses, Type Supplies, Lists 3c. Turnbaugh Service, Loysville, Penna.

59 PATENT ATTORNEYS

C. A. Snow & Co.—S-427, Snow Building, Washington 1, D. C. Registered Patent Attorneys. Write for information.

INVENTORS. For "Invention Record" form, contact Carl Miller, Registered Patent Attorney, Woolworth Building, N. Y.

INVENTORS: Without obligation, write for information explaining the steps you should take to secure a Patent. John N. Randolph, Registered Patent Attorney, 207 Columbian Bldg., Washington 1, D. C.

REGISTERED Patent Attorney offers services. Sanders, 6430 Evans, Chicago 37, Illinois.

INVENTORS: Learn how to protect your invention. Special booklet "Patent Guide for the Inventor" containing detailed information concerning patent protection and procedure together with "Record of Invention" form will be promptly forwarded to you upon request—without obligation. We are registered to practice before the U.S. Patent Office and prepared to serve you in the handling of your patent matters. Clarence A. O'Brien & Harvey Jacobson, Registered Patent Attorneys, 42B-D District National Building, Washington, D. C.

INVENTORS—Send today for booklet "Patent Protection for Inventors" giving detailed patent information and preliminary steps to take toward patent protection, also "Evidence of Invention" form. Victor J. Evans & Co., 941-E Merlin Building, Washington 6, D. C.

INVENTORS—If you believe that you have an invention, you should find out how to protect it. The firm of McMorro, Berman & Davidson is qualified to take the necessary steps for you. Send for copy of our Patent Booklet "How to Protect Your Invention" and "Invention Record" form. No obligation. McMorro, Berman & Davidson, Registered Patent Attorneys, 1437 Victor Building, Washington 1, D. C.

POPULAR SCIENCE OPPORTUNITIES

"INVENTOR'S Guide" and "Record of Invention" free on request. Frank B. Ledermann, 154 Nassau Street, New York City.

PATENTS—Irving L. McCathran, 316 McLachlen Bldg., Washington 1, D. C. Registered Patent Attorney.

INVENTORS: When you are satisfied that you have invented something of value write me, without obligation, for information as to what steps you should take to secure a Patent. Write Patrick D. Beavers, Registered Patent Atty., 938 Columbian Bldg., Washington 1, D. C.

60 FOR INVENTORS

INVENTORS. For "Invention Record" form, contact Carl Miller, Registered Patent Attorney, Woolworth Building, N. Y.

INVENTORS—Send for free patent information book and inventor's record. Registered Patent Attorney, Associate Examiner, Patent Office 1922-1929; Patent Attorney & Advisor, Navy Department 1930-1947. Gustave Miller, 45PSI Warner Building, Washington 4, D. C.

INVENTIONS Promoted. Patented or Unpatented. Established 1911. Write Adam Fisher Company, 5418 Idaho, St. Louis, Mo.

INVENTORS: Without obligation, write for information explaining the steps you should take to secure a Patent on your invention. John N. Randolph, Registered Patent Attorney, 206 Columbian Bldg., Washington 1, D. C.

INVENTORS. If you have an invention for sale, patented or unpatented, write Institute of American Inventors, Dept. 30A, 631-E St., N.W., Washington 4, D. C.

INVENTORS: Learn how to protect your invention. Special booklet "Patent Guide for the Inventor" containing detailed information concerning patent protection and procedure together with "Record of Invention" form will be promptly forwarded to you upon request—without obligation. We are registered to practice before the U. S. Patent Office and prepared to serve you in the handling of your patent matters. Clarence A. O'Brien & Harvey Jacobson, Registered Patent Attorneys, 42A-D District National Building, Washington, D. C.

INVENTORS—If you consider your invention to be something of importance, take steps to protect it with a United States Patent which gives you the right to exclude others from making, using and selling your invention as claimed. "Patent Protection for Inventors" outlines steps to take to secure patent protection. Mailed promptly without obligation. Victor J. Evans & Co., Merlin M. Evans, Registered Patent Attorney, 942-E Merlin Building, Washington 6, D. C.

INVENTORS—If you believe that you have an invention, you should find out how to protect it. The firm of McMorrow, Berman & Davidson is qualified to take the necessary steps for you. Send for copy of our Patent Booklet "How to Protect Your Invention" and "Invention Record" form. No obligation. McMorrow, Berman & Davidson, Registered Patent Attorneys, 1436 Victor Building, Washington 1, D. C.

"INVENTOR'S Guide" and "Record of Invention" free on request. Frank B. Ledermann, 154 Nassau Street, New York 38, New York.

PATENT Searches, \$5.00, including patent copies. Same reliable search as conducted for patent attorneys. Free protection forms, prompt efficient service. Patent Service Institute, 945-B Pennsylvania Avenue, Washington 4, D. C.

MAKE your invention pay. Mine paid over \$750,000.00. My book tells what I learned hard way, inventors should know, avoid, save thousands, help you make fortune. Only \$1.00. Free particulars, and "Invention Record" blank. Inventors Service, P.O. Box 5, Dept. S, Station B, Omaha, Nebraska.

CANADIAN Patent protection necessary! Reputable Attorneys listed. \$1.00. Kennedy, 751 Kenaston, Montreal 16, Canada.

INVENTORS! Electronic design service, magnetic, transistor amplifiers; working models. Box 345, Grand Rapids, Michigan.

INVENTORS: To get the most out of your ideas or inventions, write us. If desirable, we will buy outright, contract on royalty basis, or sell to the proper manufacturers for you. Chisholm Industries, Inc., Box 265, Lynn, Mass.

CASH For your ideas. 280 Manufacturers need inventions, patented or unpatented. List free. Invention Bureau, 208-S Clinton, Oak Park, Illinois.

SEARCHES—Put your patent searches in the hands of a Registered Patent Attorney or Agent as he qualifies to give a worthwhile patentability report. Record of invention form upon request and information on patent protection. Patrick D. Beavers, Registered Patent Attorney, 939 Columbian Bldg., Washington 1, D. C.

PATENT Drawings prepared—International Patent Drafting Service, Box 134, Dayton 1, Ohio.

PATENT Searches \$5.00. 48-hour airmail service. Patent Applications prepared. Invention protection forms free. Write Patent Engineering Service, 711 14th Street, N.W., Washington 5, D. C.

PATENT Searches, including copies of nearest patents, \$5.00. Reports airmailed within 48 hours. Patent Applications prepared. More than 75 registered patent attorneys use my service. For free Record of Invention write Miss Ann Hastings, P.O. Box 176, Washington 4, D. C.

PATENT Searches \$5.00. Reports airmailed in 48 hours. Patent Applications prepared. Free Record of Invention. Write Raymond L. Smith, Patent Searcher, 622 Sheraton Building, Washington 5, D. C.

61 INVENTIONS WANTED

INVENTIONS wanted. Patented; unpatented. Tremendous Manufacturers lists. Global Marketing Service, 1404 Mitchell, Oakland 1, Calif.

INVENTIONS promoted. Patented or Unpatented. Established 1911. Write Adam Fisher Company, 5418 Idaho, St. Louis, Mo.

INVENTORS: Hundreds of manufacturers have requested our assistance in locating marketable new products. Complete information free. Institute of American Inventors, Dept. 30C, 631-E Street, N.W., Washington 4, D. C.

INVENTORS: If your invention is adaptable to our business we will contract on cash or royalty. If not, we will try to place. Free booklet. Kessler Sales Corporation, 75A, Fremont, Ohio.

FREE particulars of guaranteed promotion, also inexpensive patenting. Superior, 240 South Beverly, Beverly Hills, Calif.

MAKE Money With Your Inventions. Leading experts who have marketed famous inventions seek revolutionary items automotive, toy, house-ware, garden, electronics, sporting goods fields. Send no models. Give details regarding search, patent pending, patent. No Fee until invention is sold. New Product Enterprises, 213 N.E. Second Ave., Miami, Florida.

INVENTORS Don't sell your invention Patented or Unpatented until you receive our offer, write Cowgill, Box 298, Marion, O.

INVENTIONS Wanted. Patented or Patent Pending. 23 years experience Promoting Inventions. National Service Bureau, 3122 Meramec, St. Louis 18, Mo.

CASH buyers for ideas and inventions. Write National Inventors Institute, 4097 East 131st Street, Cleveland 5, Ohio.

PROTECTED Inventions Wanted. Industrial Engineering Research Institute, 132 Nassau, New York.

INVENTIONS Wanted. Patented. Pending only. Inventors Patent Exchange, Hartford 1, Conn.

WILL manufacture & merchandise patentable item for Hardware or Household use on royalty. Check patent possibilities, send drawings or model. Murphy Machine Products, Basso Bldg., Detroit 2, Mich.

INVENTIONS Wanted. Patented, unpatented. Send for free form "R." Gilbert Adamec, Patent Broker, 15 Park Row, N. Y.

INVENTIONS. Ideas, financed and promoted. Replies confidential. No obligation. Write McRobbins Sales Co., Box 448, Ravenna, Ohio.

63 MANUFACTURING

SMALL Metal products made to specifications. Any quantity. Walwood Products, Doster, Michigan.

64 MODELS, MODEL SUPPLIES

1954 **CAR** models. 1/25 scale, all metal, chrome trim. Send for catalog. Cars & Hobbies, Dept. PS-17, 2333 Haddon, Chicago.

BUILD Historic ships, vehicles. 50c to \$9.00 kits. Illustrated Catalog 10c. Ideal Models, 19 West 18th Street, New York 11.

SHIP and other scale models. Most complete line in New England. Kits, fittings, plans, books, tools, engines, motors. Illustrated catalog 25c. James Bliss & Co., Inc., Dept. PS54, 342 Atlantic Ave., Boston 10, Mass.

LIVE Steam Locomotive Catalogue 3/4", 1", 1 1/2" scales 25c. Yankee Shop, Box 275-1, Danvers, Mass.

LIVE Steam Engine, 10 1/2" high, ready-to-run, \$5.95 postpaid. Catalog 35c. Merlo Company, 50-18 94th Street, Elmhurst 73, New York.

SHIP and yacht model fittings; blueprints. Send 35c for illustrated catalog #29 listing hundreds of items. A. J. Fisher, 1002-2 Etowah Ave., Royal Oak, Michigan.

MODEL—Hobby Supplies. Prepaid. Send stamp for list. Western, Box 578, Laramie, Wyoming.

STEAM engines, boilers, castings. Catalog 25c. Anton Bohaboy, 2297 Price, Rahway, N. J.

BUILD Model Rockets designed after those demonstrated on G.M.'s Parade of Progress. Complete instructions for simple construction and operation—\$1.00. Model, 980 Wagar, Rocky River, Ohio.

SHIP Models Ltd. Kits, Fittings, Plans. Stuart-Turner Steam Engine Castings. 1954 Catalog 25c. Box 225, Andover, Mass.

65 HOME CRAFTSMAN

"**TOPS**" in everything for Leathercraft. Lowest prices. Genuine "Craftool" stamps. Catalog 10c. Crown Leather Company, 22 Spruce Street, New York 38.

LEATHER, tools, lacing, supplies. Free Catalog. National Handicraft, 199 William St., New York 7.

"**PRACTICAL** Painting, Wood Finishing" shows how to get professional results. Furniture finishing, workshop projects, home decorating. Complete Modern brush and spray methods. Tricks you've never seen. Write Home Craftsman, 115-F Worth St., N. Y. 13.

PLASTICS home-craft course for Men and Women. Tells and shows how to make hundreds of fast selling plastics products. All plastics and materials for 23 projects included in course. No special tools needed. Course pays for itself. Write for Free booklet. Interstate Training Service, Dept. D2-E, Portland 13, Oregon.

LEATHERCRAFT. Tremendous stock of leather, tools, supplies and kits. In leather business over forty years. Send 10c for big catalog. Sax Bros., 1111 No. 3rd, Dept. PS5, Milwaukee 3, Wisconsin.

LEATHERCRAFT. Metal Tooling, Textile Painting, Beadcraft, Shellcraft... many other crafts. Fun, easy, profitable! Free, big, illustrated catalog. Write today. Kit Kraft, Dept. 355, Hollywood 46, Calif.

ASSEMBLE Jewelry, gifts. Free Catalog details. Novelcrafts Co., 25B Adrian Ave., New York 63, New York.

MAKE your own! Assemble America's most beautiful aluminum door canopies and window awnings. The sides are pre-assembled. Save 50%—Factory to you. Free Measuring Chart & literature. Herbert's Aluminum Awnings, Dept. 2, 8974 St. Charles Road, St. Louis 14, Missouri.

VENEERS, Single ply; Walnut, Mahogany, Birch, Oak, Cherry. 8c square foot, minimum 25 feet. Prepaid. No C.O.D.'s. Minnesota Woodworkers Supply, Box 233, Hopkins, Minnesota.

LEATHERCRAFT—56 page catalog with hundreds of projects. Belts, purses, moccasins, kits—easy to make and assemble. For profit or pleasure. Send 25c to MacPherson Leather Co., 140-C South Main, Los Angeles 12, California.

101 **FULL** size patterns. Smart new gifts, novelties, lawn figures, shelves, action windmills, alphabets. Plus "Make Money Jig Sawing" Only \$1.00. Mastercraft 55S, 7041 Olcott, Chicago 31, Illinois.

HOBBYISTS—Rods, sheets—Steel, Brass, Aluminum, Catalogue. Arcy Company, Lynbrook, New York.

LAMP Size cypress knee nipple anchored \$2.00. Cy Products, Dept. 3-H, Lafayette, La.

POPULAR SCIENCE OPPORTUNITIES

GLUE, Packaged at Bulk Prices; animal, casein, resin, liquid. Save up to 60%. Inquire, Minnesota Woodworkers Supply, Box 233, Hopkins, Minnesota.

LEATHER Grab Bag! Direct from tannery. Chock full of beautiful pieces, all sizes, all colors. Have fun, earn money making coin purses, key cases, dozens of other items for gifts or sale. Amazing value, only \$1. No C.O.D.'s. Moneyback guarantee. Dep't. 61, Tannery Outlet, 145 South St., 3rd Floor, Boston, Mass.

GRANDFATHER clocks weight driven movements. Wills Bros., 237 South Ellwood Ave., Baltimore 24, Maryland.

BUY wholesale nationally advertised power, hand tools, thousands other products at big discounts. Free "Wholesale Plan." American Buyers', 630-TT Linden, Buffalo 16, New York.

LEATHERCRAFT. Everything needed by beginners, advanced hobbyists and professional leatherworkers. Largest stock of supplies in U.S. Moderate-priced tooling leathers, top quality calfskins, tools, supplies, kits. Send 10c for Big Catalog. J.C. Larson Co., 820 S. Tripp, Dept. 4054, Chicago 24.

CARVING leather's fun . . . makes money, too! We'll send catalog, then it's up to you. Write Tandy Leather, Box 397-E, Tulsa.

MAHOGANY 1/4"x5 1/2"x36", \$1.25. 1/2"x5 1/2"x36", \$1.50. Brent Wood Service, Box 2913, Brentwood 17, Missouri.

SWISS Musical Movements \$2.00 Each. Music Boxes Repaired. Martin Rogers, 430 Neptune Avenue, Brooklyn 24, New York.

AMAZING Plastic Metal sticks to any surface. Repairs everything. For home, auto, farm. Large can plus bonus gift \$2.00 postpaid. VJDays, 2550 Greenvale, Cleveland, Ohio.

103 NEW jig saw patterns for lawn figures, boats etc. Free ball pen, only \$1.00. Andco, 1488 South, Toledo, Ohio.

SQUAREKNOTTERS: Make belts, handbags, lanyards, dog leashes, etc. Special offer! Beginner's book, catalog and quality cord samples 15c. P. C. Herwig Co., Dept. P41, 39 Henry St., Brooklyn 1, New York.

KNOCKDOWN cedar chest and lumber free price list. Bedford Lumber Company, Shelbyville, Tennessee.

LEATHERCRAFT Tools. Leather Embossing Plates. Craft Accessories. Dies. Catalogue 10c. Louis Jones Engineering Company, 1613 Main, Fort Worth, Texas.

LEATHERCRAFT Supplies. Pre-cut kits, tools, etc., large stock. Catalog 10c, refunded first order. Whitman Saddle Mfg. Co., 1725 Powers Street, D-5, Cincinnati 23, Ohio.

JIGSAW Patterns! Exciting variety for your favorite boy, \$1.00. Pauls Plans, 2233A No. 35th, Milwaukee 8, Wisc.

LEATHERCRAFTERS: Big illustrated catalog of materials, tools, kits, 10c. Art's Leather, 411 Joseph Ave., Rochester 5, N.Y.

SAVE your eyes! Eye-Gard protects on every home power tool job. Fits over prescription glasses. Only \$2.75 postpaid. Order today from E. G. Chase, RFD#2, Huntington, New York.

AWNINGS, cool, ventilated, Aluminum, wood frame, make your own, save, materials average window cost \$5.00. Easily constructed. \$250.00 weekly earnings, making and selling these beautiful awnings. Plans 50c. Coolshade Awnings, P. O. Box #341, Pawtucket, Rhode Island.

MAKE Your Own Furniture! New 256-page book "How to Build and Repair Your Own Furniture" shows you how to save big money making and repairing tables, chairs, bookcases, desks, cabinets, shelves, much more! Step-by-step directions, hundreds of illustrations. Only \$2.49—moneyback guarantee. Popular Science, Dept. 554C, 353 Fourth Avenue, New York 10, N. Y.

DOLLARS in the mail for you! Put your ad here and watch orders fill your mailbox. For as little as \$9.00 you can advertise your product or service in the classified opportunities columns of Popular Science Monthly. The July issue closes on May 24. Write today for order blank. O. K. Kelly, Classified Adv. Mgr., Dept. 554, Popular Science Monthly, 353 Fourth Ave., New York 10, N. Y.

MOULDING for three different 8x10 shadowbox picture frames, samples \$1.50. Hyde, Ohatchee, Alabama.

DO It Yourself. Reynolds Aluminum shipped postpaid. Send 25c for literature. Pacific Tool, Box 86, Paramus, New Jersey.

KNOCKDOWN Cedar Chest. Lumber and Veneers. Free Price List. Giles Co., Brownsboro, Alabama.

"HOBBYISTS - Ceramicists" — Write, draw on glass, Ceramics, minerals with any metal. Instructions, sample \$1.50. Metalrite, 1453 Fairview Rd., NE., Atlanta, Georgia.

66 BUILD IT YOURSELF

LUMBER Core Plywood, 3/4"; Walnut, Mahogany, Birch, Oak, Cherry. Cut exact size, guaranteed first quality. 68c square foot. No C.O.D.'s. Minnesota Woodworkers Supply Box 233, Hopkins, Minnesota.

POWER Mower Kits, free plans, instructions, parts list. Temco Mowers, Springfield 2, Missouri.

PLYWOOD Desk-Table Tops, any size; guaranteed first quality. Walnut, Mahogany, Birch, Oak, Cherry. 3/4"—68c square foot. 1 1/8"—98c. No C.O.D.'s. Minnesota Woodworkers Supply, Box 233, Hopkins, Minnesota.

FANS—Window and Attic—From Kits, Torrington Steel Blades, full size patterns. Catalog Free. Gilliom Power Tools, Dept. 31, Lambert Field, St. Louis 21, Mo.

DIVING, Spearfishing. Exclusive handbook details use construction latest equipment. One dollar. Underwater World, Box 475A, Huntington, New York.

CONSTRUCT 3 Bedroom Ranch House. Large rooms—Fireplace for \$1475. Plans \$1.00—Peter Alan, Box 8, Canarsie, N.Y.

MOTO-Scoot replacement parts, assembly kits. American Moto-Scoot Company, Chicago 25, Ill.

SAVE Closet Space. Portable Shoe Rack; Neat-Pants, Pants Hanger. Full Size Easy to Follow Plans 50c each. Victor Walz, 508 N. Maple, Carlsbad, N. Mex.

BUILDING Economies. 100 items save \$1500.00—cost \$1.00. Ken, Box 635, Island Pond, Vermont.

ELECTROPLATE Baby Shoes. Hardware. Inexpensive process. Write Easy-plater, Box 2939S, Red Lion, Pa.

BUILD a treasure and metal detector. Lightweight, Sensitive, Inexpensive. Complete kits. Free Literature. Dept. H, Electronic Applications, Box 4975, Washington 8, D. C.

BUILD three bedroom rancher—large rooms—fireplace—only \$1200. Plans \$1.00. L. Minkoff, Box 52, Flushing, New York.

ALUMINUM Awnings. Baked Enamel Colors. Easy Installation. Factory to you. Write, All Weather Comfort, Box 10254, Tampa, Florida.

BUILD your own professional Electric Phonograph for 25c. We supply complete instructions and list of materials needed. Kit including parts and cabinet \$7.95. Bonded Electronics, Franklin Square, New York.

BUILD fly trap from scrap lumber. Guaranteed to catch a million flies. Send 50c for Instructions. Mand, 1816 1/2 St. Clair, Racine, Wisconsin.

AIR Conditioner. Save \$400.00! Build your own for home or automobile from junked refrigerator. Instruction Booklet—50c (specify whether for home or automobile). Slack, 3716-A Belmont, Chicago 18, Illinois.

BUILD your own permanent awnings, patios, jalousie windows. Aluminum prefabricated frames. Free details. Russ Smith, 1555 Ridgewood Avenue, Cleveland 7, Ohio.

MODERN Upholstered Chair Plans. Complete building instructions, upholstery and materials suppliers list. Build your own and save over half. Only \$1.00. Guaranteed. Decorator, 4603 W. North Ave., Milwaukee 8, Wisconsin.

CABIN, cottage, hunting lodge, ranch house! Have any one with aid of amazing new book "How To Build Cabins & Ranch Houses"! 256 pages, 207 pictures, 17 different plans—any one worth more than 3 times the low cost of entire book! If not delighted return book for full refund. Send only \$2.49 to Popular Science, Dept. 554C, 353 Fourth Avenue, New York 10, N. Y.

"CONCRETE Block Homes." 32-page booklet on how to build. \$1.00. H. C. Lightfoot, Civil Engineer, Richboro, Penna.

MIDGET Auto Plans, buy our parts \$1.25. R. Smyers, 1141 Elco, Maumee, O.

WINDOWS—Aluminum Combination Storm and Screen. Make your own self-storing combination screen and storm windows for only \$9.95. Save over 50%. Kit includes hardware; all parts factory cut, drilled, mitered—complete except for glass. Easy assembly with only screw driver and pliers. U-Fab-It-Urself, Inc., Dept. PS5A, P. O. Box 209, Worthington, Ohio.

67 OLD GOLD, JEWELRY, WATCHES, ETC.

JEWELRY making. Send 20c for illustrated catalog. Milady-Fair Co., G.P.O. 1328, New York City 1.

HIGHEST Cash Paid For Old Gold. Broken Jewelry, Gold Teeth, Watches, Diamonds, Silverware, Spectacles, Platinum. Free information. Satisfaction Guaranteed. Rose Refiners, Heyworth Bldg., Chicago 2.

FREE Sample pair of Earrings shows you how easy it is to make beautiful costume jewelry. Over 5000 styles listed in New Catalog—25c. Barry's, 179 Ardsley Court, Newark, New Jersey.

AMERICA'S Greatest Watch Values—over 50%—60%—70% discounts. Bulova, Benrus, Elgin, Waltham, etc. Also Diamonds, Jewelry Gifts, practically wholesale. Free Catalog. Maryland Distributors, Dept. C-5, 501 E. Baltimore Street, Baltimore 2, Maryland.

RHINESTONES, jewelry settings, cameos, sequins, beads. Send 10c for illustrated Catalog. J & M Novelties, Dept. CE-4, Griffith, Indiana.

10 SWISS watches \$18.00, catalog 10c. Berkowitz, 1150 Castlehill, New York 62.

"WATCH-Healing", the modern home-study method of watch repairing. Free information. WatchHealing Institute, Box 17715-B, Los Angeles 34, California.

68 TOBACCO & PIPES

PIPE Smokers! Cigar Smokers! Free illustrated catalog offers fabulous savings on choice imported and domestic pipes, cigars, tobaccos, supplies. Write Wally Frank, Dept. 2, 150 Nassau Street, New York 38, N. Y.

69 FOR THE HOME

RETAPE record your Venetian Blinds yourself with a Blin-Kit, information free. Axiom Products Company, Box 8746, Dallas 16, Texas.

TERMITES, \$2.00 for sufficient Pentapak make five gallons solution. Box 7111, Tulsa, Oklahoma.

CESSPOOLS, septic tanks, outdoor toilets cleaned, deodorized. No pumping, digging or moving necessary. Inexpensive. Details. Chemical Cesspool Cleaning Co., Boston 34, Mass.

FOAM rubber furniture cushions—Factory seconds 50% discount. Free catalog. Perma-Foam, 140-A Main Street, East Orange, New Jersey.

ALUMINUM Grilles—Beautifies protects—adjustable all Screen Doors. Free Pamphlet. Tamiami Gift Shops, 3309 - 14 St., Bradenton, Florida.

LANDSCAPE your property, build trellises, arbors, gates, fences, garden screens, outdoor fireplace-barbecue, flagstone walks, beautiful garden furniture, a garden pool, much more! Amazing new "House & Grounds" book even shows how to add a breezeway-carport, terrace, porch or patio! 256 information-packed pages, over 700 pictures. Send only \$2.49 to Popular Science, Dept. 554C, 353 Fourth Avenue, New York 10.

70 OF INTEREST TO WOMEN

NYLONS 14c. Anklets 6c. Socks 9c. Print 17c. Panties 12c. Dresses 50c. Slips 47c. Undershirts 17c. Robes \$1.65. Spreads \$2.65. Jewelry \$1.25. Watches \$3.50. Electric Razors \$2.00. Aspirin \$1.00-1.000. Brushes 9c. Razor Blades 1-1/2c. Pens 8c. Combs 1-1/2c. Complete stock list. Picture Catalogue 25c. Send immediately. Sibert's, Chaucanoga 4, Tennessee.

POPULAR SCIENCE OPPORTUNITIES

ADDRESS advertising postcards. Must have good handwriting. Lindo 504, Watertown, Mass.

HAVE gift shop in your home. Start small. Pleasant, profitable. We show you how. Berth. G.P.O. Box 1480-S, New York 1, New York.

AMAZING hair extractor. Removes eyebrow. Facial hairs painlessly. \$1.00 each. Fiarman, P.O. Box 1969, Chicago 90, Ill.

REGAL Beauty for Garden. Rare. "Hope" Lupin Seeds Grow in any soil magnificent blooms. All colors. Supply limited. 50c P.P. House of Keys, Box 3852, Portland 8, Oregon.

JOIN "work at home" sewing Club crocheting novelties for stores. Mail membership fee \$2.00 (refundable) get Free items. Details for stamp. Homemaker Division, 4042 P. Kimball, Chicago 18.

GROW Mushrooms. Cellar, shed, and outdoors. Spare, full time, year round. We pay \$3.50 lb. We paid Babbitt \$4,165.00 in few weeks. Free Book. Washington Mushroom Ind., Dept. 181, 2954 Admiral Way, Seattle, Washington.

71 FOR SALE MISCELLANEOUS

SWISS Watches from importer \$3.15 up. For resale only. Free catalog. Transworld, 565 5th Avenue, New York 17, N. Y.

FREE 1954 catalog on government surplus bargains from country's largest surplus organization specializing in outdoor, sporting goods, clothing, camping equipment. Tents, rubber boats, tarpaulins, swim fins, hundreds of other items. Rockaway Sales Co., Box PS, Route 46, Rockaway, New Jersey.

BUY Wholesale—Hundreds Nationally advertised products—Watches, Housewares, Jewelry, Appliances, etc.—Save—Make Money—Free Details. National Buying Service, Radio City Station, Dept. S, Box 324, New York City 19, N. Y.

ANYTHING you want from Japan. Unusual products. Catalog and valuable samples \$2.00. Williams Co., C.P.O. Box 89, Tokyo, Japan.

REBUILT—Refinished Vacuum Cleaners. All makes direct from rebuilding factory at wholesale. Catalogue free. Austin Vacuum Cleaner Co., 1108 W. 34, Austin, Texas.

SPECIAL Offer! Miniature sewing machines, not a toy. \$2.50 while supply lasts. Museum Company, 24 Greenleaf Street, Boston 15, Mass.

\$1,000,000 TRUCKS, jeeps, Tools, Mach. etc., being sold by Government annually. For details, Send \$1.00. Surplus, Box 213, East Hartford, Conn.

PATENT Pending, Anchor Cigarette Connectors 30c. Anchor, 14450 Dexter, Detroit.

72 WANTED MISCELLANEOUS

SCRAP Mercury (Quicksilver) containers supplied. Tantalum—Bismuth—Tungsten. Metallurgical Products Co.—Established 1909, 35th & Moore Streets, Philadelphia 45, Pa.

QUICKSILVER, Platinum, Silver, Diamonds. Prompt Payment. Mercury Terminal, Norwood, Massachusetts.

OLD Toy Trick Banks. Big prices. Gordon Grimes, 2000 Marber, Long Beach 15, California.

74 RAZOR BLADES, SHAVERS

100 SUPERIOR double-edge blades. \$1.10. No giveaway gimmicks—just good shaving. Bird, 2413 Madison, Wilmington 2, Del.

INTRODUCTORY Offer—Double Edge Blades 100—\$1.00, 500—\$4.00. Satisfaction Guaranteed. Howard Sales, 3909—13th Avenue, Brooklyn 18, New York.

FREE Gift—100 double-edged razor blades—\$1.00, guaranteed. Baker Sales, 367-9 East 10th Street, New York 9, N. Y.

75 TATTOOING SUPPLIES

TATTOOING Course and Supply Brochures. 25c. Zeis School, 728 Lesley, Rockford, Illinois.

77 TREASURE FINDERS

SEEK Gold, Uranium, Buried Treasure. Latest Super-sensitive detectors. Circulars free. Glen Scientific, Box 151-D, Glen Ellyn, Illinois.

TREASURE—M-Scope Geiger Counters—Mineral Locators. Why buy something inferior when you can buy the best at a lower price? Backed by years of experience. Fully guaranteed by factory. Detects minerals, metals, gold, silver, coins. Payment plan available. Proven superior performance. Free 16 page illustrated booklet. Fisher Research Lab., Inc., Palo Alto, Calif.

GOLD, Silver, Metal Detectors, Geiger Counters for Uranium, Mineralights. Sensational new fully guaranteed models. None Finer. Information Free. Detectron Corp., 5420 Vineland Ave., North Hollywood, California.

TREASURE Hunters! New 11-pound featherweight Model 101 locator for gold, silver and minerals. Money-back guarantee best available. Also Geiger Counters for uranium prospectors. Complete information free. The Goldak Company, 1540 W. Glenoaks Blvd., Glendale 1, Calif.

SELECTIVE metal and mineral detector. Revolutionary design. Distinguishes metals from black magnetic sands. Readily detects metals under salt water. Also Geiger Counters. Free literature. Gardiner Electronics Company, 2018 N. Dayton, Phoenix, Arizona.

FIND Uranium with our Prospectors Maps of Western states showing Radioactive Anomalies detected from Air by AEC. \$5.00 per State, postpaid. Bell, 314 California Bldg., Denver 2, Colorado.

LOCATE Hidden treasure, distinguish minerals from metals with Model 100 Detector. Weighs 5 pounds, extremely sensitive. Factory assembled (\$79.90) or kit form (\$39.90). Free Literature. Dept. G. Electronic Applications, Box 4975, Washington 8, D. C.

78 WATCH REPAIRING

WATCHMAKERS'—Jewelers' complete informative catalogue 20c. Bengal Company, Culver City, California.

WATCH and clock repairing books for hobbyists. Free information. North American, Dept. 24-E, 2330 N. Milwaukee, Chicago 47 Illinois

WATCHMAKERS' Journal for watchmakers, students, hobbyists. \$1.00 year. Sample copy 20c. Box 3218, Daytona Beach, Florida.

79 MISCELLANEOUS

OUTDOOR Toilets, Cesspools, Septic Tanks cleaned, deodorized with amazing, safe, harmless powder. Easy, economical to use. Saves digging, pumping. 150,000 customers guarantee satisfaction. Details Free. Burson Laboratories, Dept. O-53, Chicago 22, Illinois.

HOME study for game warden, fish, park, forestry, wildlife and patrol service. Details free. Write Delmar Institute, A6, Whittier, California.

ADDRESS advertising postcards. Must have good handwriting. Lindo 504, Watertown, Mass.

SOCIAL Security Cards sealed in plastic lifetime protection 25c. Lifetime Plastics, 433 N. Linwood Avenue, Baltimore 24, Md.

YOU may be a missing heir! Find out by reading "The Missing Heir's Key—Family History." Price \$1.00. Family Service, Box 1745, Baton Rouge, Louisiana.

BIG interesting mails three months 25c, year \$1.00. Harvey Teeple, Decatur, Ind.

BUY Wholesale thousands nationally advertised products at big discount. Free "Wholesale Plan." American Buyers', 630-EE Linden, Buffalo, New York.

RECEIVE Magazines, samples, catalogues. Mails from everywhere. Offers, hundreds. Get listed 25c. Rorick, Box 86-M, Cincinnati 26, Ohio.

BILLIONS in Lost, Buried and Sunken Wealth. Documented List Free. Mineral Research, Box 52, Culver City, Calif.

DEVELOP Herculean will-power. Conquer any habit. Scientific instructions \$1.00. Psychogenic Science, Box 402, Canton 1, Ohio.

FULLY Automatic Lighter. Selling for five times less than other lighters. Chrome finish, never before at this low price of \$1.60. Lafayette Sales, 241 Suydam Avenue, Jersey City 4, N.J.

NATURAL Dates, sundried figs, prunes. Raw Ho..ey. Tontz's, Elsinore, Calif.

SURPRISE package. Worthwhile, interesting, unusual. 25c. Hilltop Specialty, Blackwood, New Jersey.

GROW Mushrooms. Cellar, shed, and outdoors. Spare, full time, year round. We pay \$3.50 lb. We paid Babbitt \$4,165.00 in few weeks. Free Book. Washington Mushroom Ind., Dept. 182, 2954 Admiral Way, Seattle, Washington.

RECEIVE mails, magazines, samples. Your name in numerous mailing lists 20c. Greenwood, Box 1116-X, New York 8.

300 BIG Mails guaranteed, samples, offers, plans, propositions, 12 months listing. \$1.00, (refundable). Wright Publications, 2276 Hubbard, Memphis 8, Tenn.

RENTING? Worried? Want a home? Let's build it, we'll help finance different methods. Send \$1.00 for informative folio. United Home Builders Associates, Box 1707, Nokomis Station, Minneapolis 17, Minn.

DOLLARS in the mail for you! Put your ad here and watch orders fill your mailbox. For as little as \$9.00 you can advertise your product or service in the classified opportunities columns of Popular Science Monthly. The July issue closes on May 24. Write today for order blank. O. K. Kelly, Classified Adv. Mgr., Dept. 554, Popular Science Monthly, 353 Fourth Ave., New York 10, N. Y.

80 PERSONAL

DETECTIVE'S Opportunities. Detective particulars free. Write, Wagoner, P-125 West 86th, New York 24.

"HOW Can I Find Out?" You Can! Information confidentially developed. Any matter, person, problem. World-wide. Officially licensed. Established 1922. William Herman, 170 Broadway, New York.

BORROWING by Mail. Loans \$50 to \$600 to employed men and women. Easy, quick. Completely confidential. No endorsers. Repay in convenient monthly payments. Details free in plain envelope. Give occupation. State Finance Co., 323 Securities Bldg., Dept. R-14, Omaha 2, Nebraska.

PSORIASIS Victims: Hopeless? New Discovery! Free Trial offer. Write Pixacol, Box 3583-S, Cleveland, Ohio.

ADDRESS advertising postcards. Must have good handwriting. Lindo 504, Watertown, Mass.

RUPTURED? Something different. Light. Cool. No leg straps. No elastic. No pressure on hips or spine. Inexpensive. Worn by Mechanics, Farmers, Doctors, etc., everywhere. Guaranteed. Write Hand-Lock Products, Dept. P.S., Preston, Ont. Canada. Established 1893.

BORROW By Mail From Postal Finance Co. Employed Men and Women can easily obtain \$50 to \$600 Fast. Entirely By Mail. Repay in small monthly payments. Friends, relatives, employer, tradespeople will not know you are applying for loan. Advise occupation, amount wanted. Postal Finance Co., 200 Keeline Bldg., Dept. 13J, Omaha, Nebraska.

INCREDIBLE! Become Mental Superman Overnight! Free Booklet! Bijou, Box 1727-VK Hollywood 28, California.

BUY vitamins direct. Amazing savings. Catalog free. Matoska, White Bear Lake, Minn.

CHRIST has returned! Free literature. Truth, 21 Lexington, Phoenix, Arizona.

ESOTERIC Curiosa. Rare Adult Books, Manuscripts, Pamphlets, Readers, Booklets; English, French, German. Indicate title, author or subjects desired. Send stamped envelope for reply. Francene, Box PS-1, 949 Broadway, New York 10, New York.

WEAR at our risk! Guaranteed wrist watch with expansion band. Free 5-day trial! If satisfied, \$1 weekly—total \$14. Floral Watch Co., Box 22, Glen Oaks, New York.

HAND Guide. Corrects your Penmanship in 10 hours. Write Perfect Penmanship, Box 665-35P, St. Louis, Missouri.

CHICAGO—Letters remailed 25c. Lasworth, 6055 West Addison Street, Chicago 34, Illinois.

REMAINS one 30c, six \$1.00. Conrad, Box 301, Seattle, Wash.

POPULAR SCIENCE OPPORTUNITIES

MONTREAL—Classifieds, remails, questions answered, \$1.00 each airmailed. Kennedy, 751 Kenaston, Montreal 16, Canada.

LETTERS Rемаiled 25c coin, 5 Virginia Beach Postcards. \$1.00 remailed. Barnes, Box 226-S, Portsmouth, Virginia.

"INTERESTING Mails"—25c keeps your mail box full three months. Bentz Desk-J/58, Chatawa, Mississippi.

4 GERMAN Postcards \$1.00. Castles, Landscapes, State Choice. Evelyn Pinkham, Furstenfeldbruck, Germany, Postlagernd.

"X-RAY Mind." Dangerous power over others. (Details—10c). Krishnar Institute, 1912 Lincoln-Park-West, Dept. PX, Chicago 14.

MEXICAN Law, General Practice Attorney, 1203 Arizona Street, El Paso, Texas.

DANDRUFF? Hair loss? Write: S. Viggiano, 6556 Ladson, Pittsburgh 6, Penna.

REMAILS. Classifieds, 25c, 10 postals \$1.00. Confidential. Mann's, Danville, Virginia.

DRUG Sundries Wholesale. Men, Women. Illustrated list 25c coin. P. P. Ally, 1123 Ellicott, Buffalo 9, N. Y.

BE Rich. Make more money. Financial secrets revealed. Satisfaction Guaranteed. Send \$1. Allen, 6711-H Sunset, Hollywood 28, California.

COEUR Dalene Postmark, Remail 25c, picture folder 25c extra. Jensen, 925 Garden, Coeur Dalene, Idaho.

LETTERS remailed, Corpus Christi postmark 25c. Confidential forwarding service. Felts, 342 Merrill, Corpus Christi, Texas.

ALBUQUERQUE, N. M. Fastest Growing City! Remails, 25c. Questions, Classifieds, \$1.00. Riekeman, 2300PS Kelley Road.

DOLLARS in the mail for you! Put your ad here and watch orders fill your mailbox. For as little as \$9.00 you can advertise your product or service in the classified opportunities columns of Popular Science Monthly. The July issue closes on May 24. Write today for order blank. O. K. Kelly, Classified Adv. Mgr., Dept. 554, Popular Science Monthly, 353 Fourth Ave., New York 10, N. Y.



Here now for 1954

A beauty to see . . . a breeze to move . . . a bargain to own! The HOWARD all-steel insulated mobile home, time-tested from Alaska to Florida, now better by a lifetime of living improvements! For details write: HOWARD Industries, Box 2188—Dept. 36—Saginaw, Mich.

Howard MANSION COACH
HOWARD INDUSTRIES INC., SAGINAW, MICHIGAN

New Money-Maker!

Light-Reflecting CURB-SIDE HOUSE NUMBER *Patented*



A smart-looking house number by day . . . and at night thousands of tiny lenses on each number sparkle and reflect light from auto headlights, street lights, etc., making numbers easy to read on darkest night.

FREE TRIAL Thousands of homes waiting for NiLite Light-Reflecting Curb-side House Number. Amazingly low priced, yet \$40.00 a day and more is easy with unique, effective **FREE TRIAL PLAN** which sells 8 out of 10 homes. We show you how. Territories open. Rush your name and address **TODAY**.

NILITE SIGN CO., 173 W. Madison St., Dept. H-81, Chicago 2, Ill.

Now You Can Do It Yourself

CONFINE DESTRUCTIVE COOKING HEAT, GREASE and STEAM TO YOUR STOVE



It's the Most Important Protection You Can Give Your Expensive Decorations and Furnishings!

Anyone who can use a keyhole saw, hammer and screw-driver can easily install a Vent-A-Hood. Work a miracle in your home! The cooking odors you smell drifting throughout your home are hot, buoyant animal fats or vegetable oils cooling and settling to become a rancid, ruinous film on woodwork, walls and furnishings. Vent-A-Hood consumes Summer's stifling cooking heat and Winter's steamy, greasy cooking vapors before they can touch your home . . . providing real home comfort and saving money year after year. Vent-A-Hood traps cabbage odors which wall or ceiling fans cannot. Vent-A-Hood is complete with simple-to-follow step-by-step instructions.

Write Today! Money Back Guarantee! Write for free Cooking Ventilation Folder, order blank and Vent-A-Hood's detailed, no risk, money back guarantee.



Vent-A-Hood
1911 PLANTATION ROAD DALLAS, TEXAS
HOME COOKING VENTILATION SPECIALISTS

Build Your Outdoor FIREPLACE using the Monett Firebox* with the exclusive "ELEVATOR GRATE"†



Expert cooking's a cinch when you use the Monett Firebox with the exclusive "ELEVATOR GRATE."* No more charring, no more fussing. Any masonry design can be easily built around the Monett Firebox unit.
*Pat. Pending.

Outdoor Fireplace & Equipment Corp.
Kenilworth, N. J.

SEND FOR free DESIGN BULLETIN!

World's Finest Fireboxes for Rugged Outdoor Use

When Writing to Advertisers, Please Mention Popular Science

IT'S A "HIT!"



Order your revolutionary new "HIT" miniature camera today! Greatest value ever offered in a fine imported camera. Low price includes genuine pigskin carrying case, also roll of film.

Smaller than a matchbox! Precision made, easy to use. Additional films 30c per roll or six rolls for \$1.50. Enlarges beautiful 2"x2" prints. Ten exposures per roll. Wonderful gift for young and old.

LOW PRICE OF \$4.95

Shipped C.O.D. plus postage charges. Write today to Hit Sales, P. O. Box 524, Maywood, Illinois.

41 NEW MODELS for 1954

Custom Craft

THE ORIGINAL "PACKAGED"
BOAT KITS

RATED "TOPS" BY THE EXPERTS in
DESIGN, STYLING, PERFORMANCE

See the World's finest, most complete line
before you decide! 41 exciting new models

SEND 25c for BIG, NEW
1954 KIT CATALOG

1954 Catalog PLUS booklet "Boat
Selection, Operation & Maintenance"
\$1.00 (Refundable)

DEALER INQUIRIES INVITED



World's Finest Designs Modern **BOAT PLANS**

With FULL-SIZE PAPER PATTERNS
EASIER TO BUILD, SAVES TIME, MONEY

Over 150 modern plans and patterns with material lists and building procedure. Racing classes, cruisers, inboards, outboards, sailboats, 6 to 36 ft. All materials, fittings, etc. available at "Package" prices. Big savings! Design Catalog tells all!

SEND 35¢ for 1954 DESIGN CATALOG

Design Catalog PLUS boat building handbook, \$1.00

CUSTOM-CRAFT • DEPT. 5 • BUFFALO 7, N. Y.



DIVING EQUIPMENT

HEADQUARTERS

Aqua-Lungs—Recirculating Sets, Sports Diving Masks and Fins, Italian and French importations, Deep-sea Navy surplus (new) Rigs complete for contractors and salvage work. Mask Type Commercial Sets.

World's Largest Stock—Write for Catalog—20c

M. & E. MARINE SUPPLY CO., P. O. Box 601-G, Camden 1, N. J.

Catalog of 3000 Novelties 10c

Send 10c for amazing catalog of novelties, live animals, scientific supplies, hobbies, funmakers, planes & boats, looms, magic tricks, joke articles, unusual seeds, gadget timesavers, cameras, optical goods, projectors, movies, lucky jewelry, religious novelties, disguises, musical instruments, stamps, coins, puzzles, fortune tellers, radios, auto & bike accessories, telescopes, magnifiers, compasses, banks, smokers' gadgets, artists' supplies, printing sets, engines, motors, shockers, knives, billfolds, fireworks, guns, rifles, sports, books, games, plants, etc. Send name, address & 10c to:
JOHNSON SMITH & CO., Dept. 795 Detroit 7, Michigan

Every Fisherman Needs...

FAMOUS **Dayton** ORIGINAL

SNAP ON-SNAP OFF

Fishing FLOATS

AT LEADING DEALERS
in U.S.A. and CANADA!



FIVE STAR TOOL

★ ★ ★ ★ ★

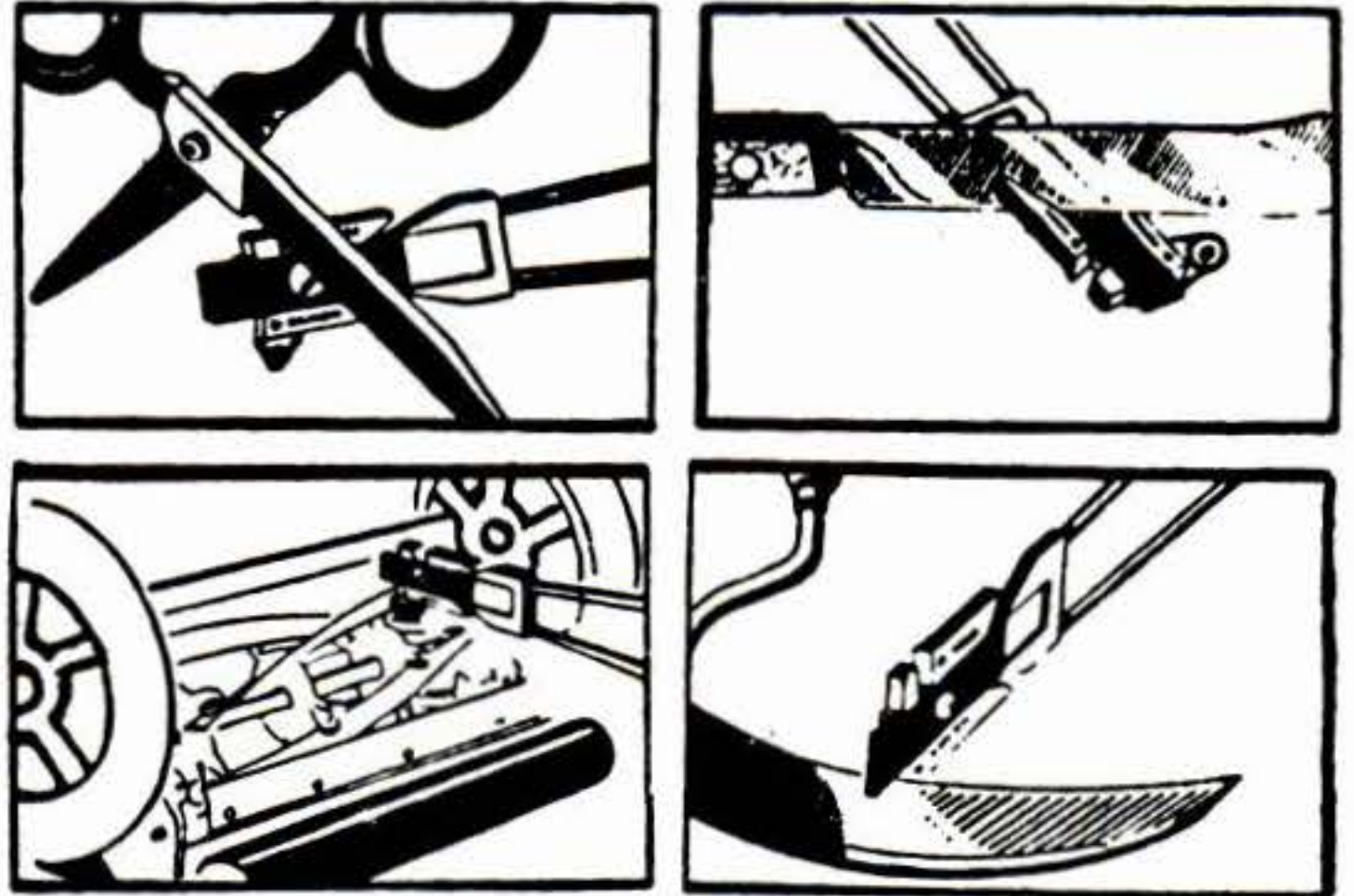

A Successful Mail Order Business Is Based On The Product. We have that product. The Five Star Handy Tool is demonstrated and sold on T.V. for \$1.98. It Sharpens Knives, Scissors, Lawnmowers, Sickles, Scythes, Garden Hoes and Cuts Glass. We have priced these tools very very low because we only want to do business with firms wanting to resell them at a profit. Send \$1.00 for two samples. \$5.00 for a dozen samples. We pay postage. Gross \$48.00—10 Gross lots \$44.00 a Gross, send one third cash Bal. C.O.D. Add 15c per tool for Airmail. Firms wanting to promote this tool on T.V. may rent a Short commercial sound film for \$15.00 made by a fast talking demonstrator who can really cut glass. You can also rent a Sound Projection Machine and set it up in any Farmers Market, Super Market, Woolworths, Grant Stores, Fair, Carnival, etc. You will be amazed how fast you can sell these tools. This is big big business, don't pass it up. People are interested in these tools. Cash in on it.

Mats of illustrations furnished free with orders for 1 gross or more

ALBERT CAHILL STEEL & IRON WORKS

ADAMS AVENUE

TOMS RIVER, NEW JERSEY

ALSO Eshelman SPORT CARS

ESHELMAN BOAT TRAILER

World's Lowest Price ONLY \$79

Easy Load • Easy Haul • Easy Launch

Write for Catalog

Top quality welded steel construction. Shipped complete with Hi-Speed wheels, tires, tubes, hitch, etc. Write

ESHELMAN CO., Dept. BT-95
119 Light St., Balto. 2, Md.; 335 N. Michigan Ave., Chicago 1, Ill.; 7070 Hollywood Blvd., Los Angeles 28, Cal.

70 Miles Per Gal.
Holds 1 Adult
Free Literature.

BENJAMIN SUPER CO₂ GAS CARBINE—\$16.50

NEWEST TARGET

RIFLE—22

IDEAL

FOR

SMALL

GAME

Benjamin CO₂

Gas Pistols

Also Available



ECONOMICAL

SAFE—NON-TOXIC

ACCURATE—CONVENIENT

PRACTICAL Easy to operate—No spring

recoil—No pumping. Uses low cost Soda Cartridges

Cal. .22 Benjamin H-C Pellets and Darts.

WRITE FOR FREE ILLUSTRATED FOLDER OF ALL MODELS

BENJAMIN AIR RIFLES AND BENJAMIN AIR PISTOLS

BENJAMIN AIR RIFLE CO.
852 MARION ST., ST. LOUIS 4, MO. U.S.A.

30 POWER! WHISPER WEIGHT 8½ OUNCES

Newest Pocket Telescope engineered for UNITED to give you sharper, clearer, crisper images and smooth, easy-sliding focusing action. Use indoor, outdoor, vacationing, trips, closeup and long distance viewing. 7" closed, 14½" extended.

NOT A CHEAPLY MADE TOY TELESCOPE. But a precision, all metal, chrome trimmed achromatic masterpiece. Interiors of VITAL front Achromatics are COATED assuring needle sharp viewing! Price includes handsome carrying case. Made in Japan. UNCONDITIONALLY GUARANTEED. Try for 30 days. If not satisfied return for immediate refund. Cash orders postpaid. C.O.D.'s require \$2.00 deposit. UNITED BINOCULAR CO., 9043 S Western Ave., Dept. ARF-9416, Chicago 20, Illinois. Dealers wanted.



\$9.95
Tax Free

ONAN Electric Plants for light and power anywhere!

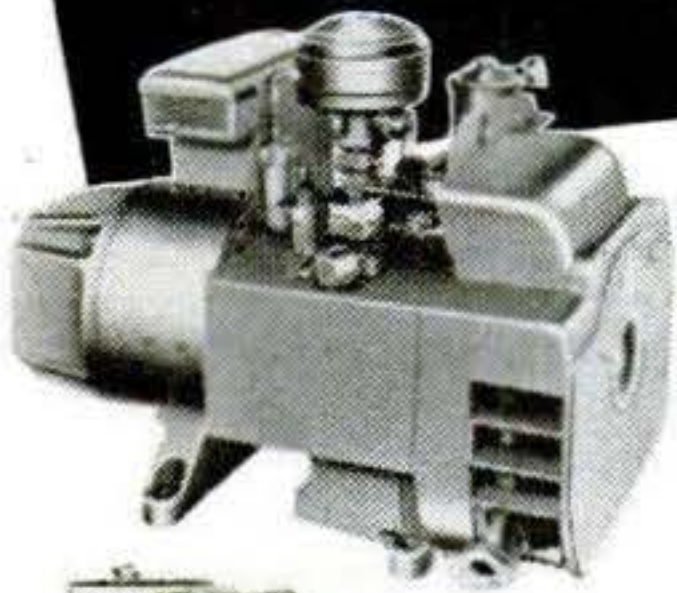

Emergency Power for homes, farms, business
Supply essential current when regular power source is interrupted. Prevents losses and hardships. 1 to 50KW. Gasoline-driven. (Model shown—10CW, 10,000 watts A.C.)



Portable Power for tools, lights
Carry them to any spot for labor-saving, plug-in electric power. Light weight, air-cooled. To 10KW. Gasoline-driven. (Model shown—07AH, 750 watts A.C.)

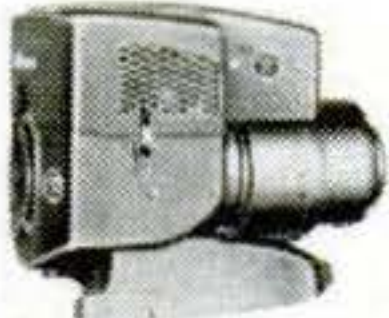

Electricity for cabins, resorts
Bring conveniences of electricity to any remote spot. Use regular 115-volt A.C. appliances and equipment. 400 to 50,000 watts. Gasoline-engine-driven.



Marine Electric Plants
Enjoy electrical conveniences afloat. Install below decks. Compact, smooth-running, quiet. Water-cooled marine design. 400 to 3,000 watts. Gasoline-driven. (Model shown—MKH, 400 to 1,000 watts)

Write for Folder!

D. W. ONAN & SONS INC.

8961 University Ave. S.E., Minneapolis 14, Minn.



OXYGEN REGULATORS

Used Government Surplus

AN 6004-1 and A-12



\$7.50

Cylinder 24x3 3/4 1/2" opening.....	\$2.50
Cylinder 18 1/2x3 3/4 1/2" opening.....	\$2.00
Valve 1/2".....	\$3.00
Tee Fitting.....	\$5.00
Flutter Valves.....	.40 and .50
Mouth Piece.....	.65
Hose2 Ft.....	.40
Clamps15

Terms check or 50% deposit and balance C.O.D.

Pamphlet on Request

M. A. NORDEN SUPPLY COMPANY

273 N. Washington Ave.

Mobile, Ala.

DANGER AHEAD!

It's a life saver — the Delta Flashing Powerlite. Brilliant red flashing top light. Powerful side spotlight — all in one compact unit! 4-way switch. 6-volt battery. Get one! **\$6.75** Less battery, only **6**
Delta Electric Co., Marion, Ind.



Delta FLASHING POWERLITE ELECTRIC LANTERN

NEW 25 CAL. BERETTA BANTAM FEATHERWEIGHT AUTOMATIC
Featherweight BERETTA BANTAM in jewel-like satin Chrome finish. Sensational, improved 9 shot automatic pistol. Fits pocket or purse. **43.50**
Deluxe Chrome with Mother Of Pearl Handles Illus. 37.75
Deluxe Chrome with Black Handles 37.50
Standard Blue Finish with Mother Of Pearl Handles 32.00
Standard Blue Finish with Black Handles 2.80
1 Box 25 Cal. Cartridges (50)
FREE GENUINE LEATHER HOLSTER
Order by Mail - Send only \$10 - Pay balance on del.
GODFREY IMPORT CORP. DEPT. P-5 277 B'WAY, N. Y. C. 7



Earn BIG STEADY MONEY SELL WORK UNIFORMS!

It's easy with TOPPS great "Panoramic" line that spreads out over 3 feet wide! Swatches are king size! Style figures are big, full color—they almost pop off the page! Prospects are everywhere—garages, service stations, factories, etc. Profits are big—one man made \$800 on a single sale! Selection of sizes, fabrics (including DuPont's miracle ORLON), colors, embroidery is unlimited. Start spare time... you'll make it a career! Get the "Panoramic" line FREE. Write TODAY.

TOPPS Dept. 625 - Rochester, Indiana



\$2.95 EACH OR 2 FOR \$5.00!

Genuine Telephone Company Upright Telephone complete with cords, in tested and guaranteed condition with 50 ft. of wire, roll of tape, inter-communication instructions. Tape and wire offer for this month only. Complete line of telephones, dial, magneto, inter-communication etc. Write for free list. All shipments F.O.B.

TELEPHONE ENGINEERING CO.

Dept. 5A4

Simpson, Pa.



WHY SUFFER unnecessarily with the itch

which develops under a plastercast from perspiration? Our new orthopedic scratcher will give relief. Made of stainless steel. Cannot injure skin or cause infection. Follows contour of body. Sterilize-able. \$1.00 postpaid. For rush orders send 12c air mail stamps.

Patent applied for. Dealers and Hospitals write for prices.

"ELDO," Box 147

Bellmore, L. I., N. Y.

SEA LEGS PRICES from \$39.00

QUALITY BOAT KITS

F. O. B. DEFIANCE, OHIO

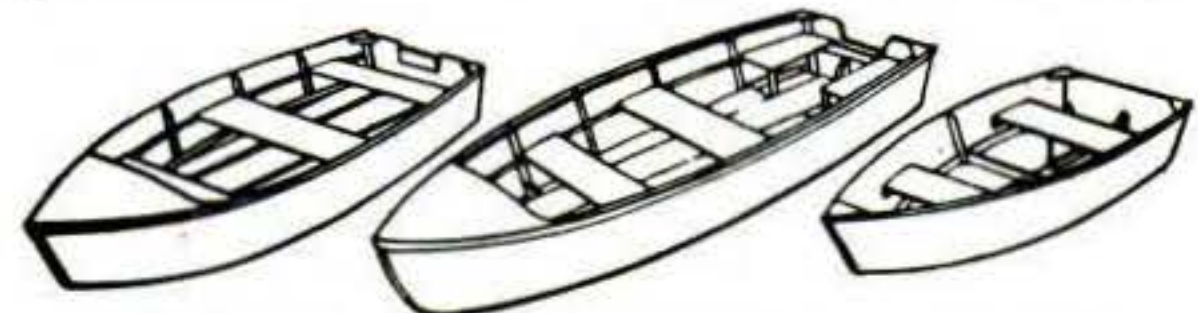

12' UTILITY 14' RUNABOUT 8' SKIFF

WRITE FOR FREE LITERATURE

PENNEY WOODCRAFT INDUSTRIES

1301-09 Ottawa Ave., Dept. 5-P Defiance, Ohio

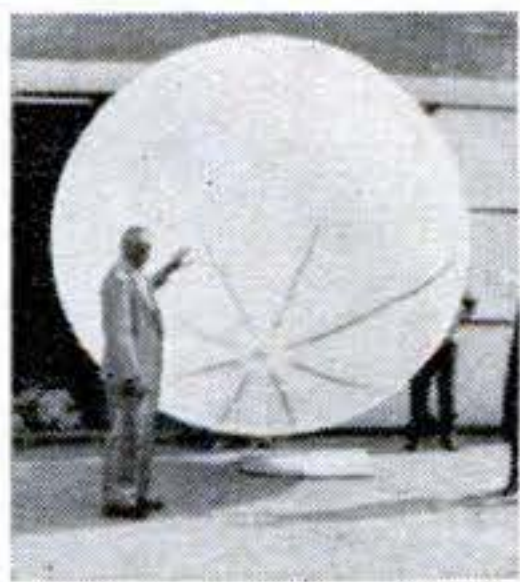

GIANT BALLOONS

Surplus U.S. Gov't. (new—overage) Neoprene weather, target balloons. For **FUN** or **PROFIT**. Great sport in the backyard; or for parties, picnics, dances, fairs. **MONEY-MAKERS**. Use these balloons to attract crowds to civic events, conventions, exhibitions, trade shows. **TERRIFIC** for high school and college **PROMS**. All sizes are approx. inflated sizes. We pay postage on prepaid orders.

18", 3 for 55c
3 ft. dia. 49c—6 ft. dia. 99c
13 ft. dia. \$1.59—20 ft. dia. \$1.95



"Marksman" AIR PISTOL

It's a target pistol but it looks, feels, muzzle loads and cocks like an army .45. You can have fun indoors in rumpus room or basement; or out in the back yard or woods. Make it a test of skill and "outmarksman" your friends. Caliber .177, accurate, high-powered, guaranteed. Complete with free supply of BB's, darts & pellets. Full payment must accompany order. **\$5.95**

EXTRA AMMUNITION AVAILABLE

Darts, 50¢ doz.—BB's, 15¢ for 150—Pellets, \$1.50 for 500
Add 10% for handling & delivery of air pistol and ammunition
Calif. residents please add sales tax on all items

WAR ASSETS DIV. VOLUME SALES CO.

Dept. 5-5-54 3930 Sunset Blvd. Los Angeles 29, Calif.

Authenticast
AMAZING MILITARY MINIATURES!
TANKS - from Govt blueprints!
Every detail reproduced in scale
Miniature models that are the duplicates of the ones used in pre-combat and recognition training
SEND 35c TODAY!
FOR COMPLETE CATALOGUE
COMET METAL PRODUCTS CO., INC.
Richmond Hill 18, N.Y.



RAISE PARAKEETS...

MAKE BIG MONEY AT HOME

Extra income is more important than ever! Turn your spare time and a corner of your garage into a fascinating and profitable hobby. No experience needed. Illustrated booklet **FREE**. Send no money — just name and address.

PARAKEET BREEDERS ASSN. of AMERICA
Dept. 25, 4353 Lovers Lane, Dallas 25, Texas



BUILD YOUR OWN FAN

One-piece cast aluminum propellers for cooling and ventilating.

Size Inches	2 Blade Polished	3 Blade Polished	2 Blade Unpolished	3 Blade Unpolished	Bore Inches
15	\$3.00	\$4.00	\$2.50	\$3.00	1/2, 5/8, 3/4
18	3.75	5.00	3.00	4.00	1/2, 5/8, 3/4
20	4.00	5.50	3.25	4.50	1/2, 5/8, 3/4
24	4.50	6.50	4.00	5.50	1/2, 5/8, 3/4

Write for pamphlet on larger fan blades, wire guards, fan bases, shutters, pillow blocks, exhaust fan frames, etc. Dealers write for discount. Add 10% for packaging and shipping. Shipped C.O.D. or cash with order.
KLOPPENBORG ALUMINUM FDY., Dept. PS-54, Davenport, Iowa

BEAUTIFY YOUR BATHROOM

Now you can have an enclosed bath and **SAVE UP TO \$100.** with the **Do-It-Yourself** glass bathtub enclosures.
5' Width \$89.95 5 1/2' Width \$99.95



These custom units can be self-installed in minutes. You can afford this beautiful glass bathtub enclosure and eliminate messy and costly shower curtains—no more splashing on the floors, no more drafts while bathing or showering. Made of frosted or fluted (indicate choice) 7/32" glass, set in neoprene rubber. Heavy gauge, extruded polished aluminum that won't rust or corrode. Overhead suspension with cadmium plated ball-bearings for easy finger-tip control. Drain holes in bottom guide track allow excess water to run back into the tub. These models for recessed tubs only.

Check the prices of other glass bathtub enclosures and you will realize the tremendous savings with this easily installed unit. **ORDER TODAY** for immediate shipment on money back guarantee. Specify fluted or frosted model and width desired—5' or 5 1/2'. Shipping charges collect. Send check or money order or \$10.00 deposit on all c.o.d.'s. No C.O.D.'s outside of U.S.A.

BATTLE SALES CO.

63 South Parkway

Clinton, New Jersey

for
Extra Speed, Power
Use
Duals or Headers

with

Factory Duplicate

or **DYNATONE**

Deep, Mellow Tone Mufflers



DUALS

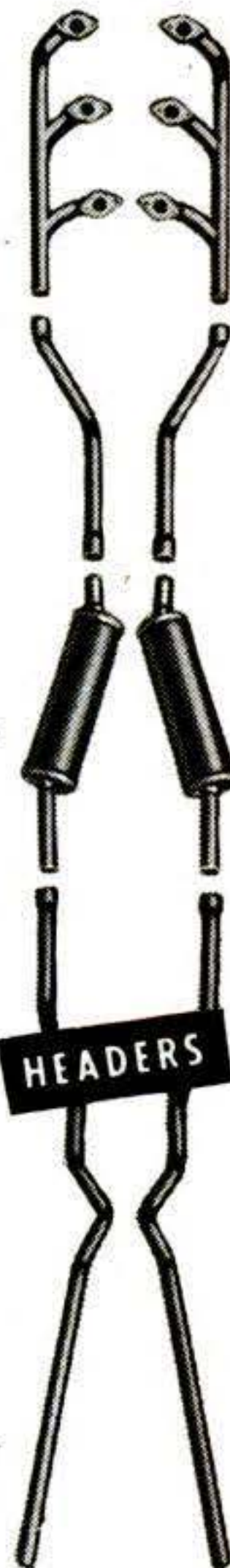

HEADERS

Less back pressure! That's the secret of extra power, speed and gas mileage gained from duals or headers. Available with either factory duplicate type mufflers (made to car specifications or better) or with Dynatone deep, mellow tone mufflers (engineered not packed).

Easy to install—all parts and illustrated instructions are included. Made to permit use of heat riser butterfly. Exhaust pipes have adjustable or rigid flanges and are beaded and sized for trouble-free installation. Tail pipe ends bent to angle of original equipment for balanced appearance. Available for most V-8 engines.

See your dealer or write for details.

The Dynatone Muffler—with the Deep Mellow Tone—is also Available for Single Installation

GOERLICH'S

619 Smith St., Dept. 8-E, Toledo 1, Ohio

MAY 1954 73

BOAT KIT BUILDERS!



Aerojet
INBOARD MARINE
ENGINE

4 cycle—26½ h. p. motor and Vee-drive. Weighs only 220 lbs. drives 12-20 ft. boats ½ m. p. h. to 30 m. p. h. Cuts fuel costs 50% compared to outboards of comparable H. P.

- Vee-drive reverse and reduction drive
- 9 to 1 compression
- 24¾" L x 17½" W x 19½" H.
- Overhead camshaft
- Overhead valves
- 4 hours to install

\$695⁰⁰
State and Federal Taxes extra

WRITE FOR FREE BOOKLET

AEROJET-GENERAL CORPORATION • Cincinnati 14, Ohio

Gentlemen: Send me information on new Aerojet Inboard marine motor, and name of your nearest dealer.

NAME _____
ADDRESS _____
CITY _____ STATE _____

AEROJET-GENERAL CORPORATION • Cincinnati 14, Ohio

SALE-SAVE \$40⁰⁰

PRICE REDUCTION ON FAMOUS NATIONAL POWER MOWERS

18 in. cut — B and S
1.1 H.P. Engine, Chain Drive, Self-propelled, Saber Steel Blades, Ball Bearing Reel.
Reg. \$119.50. Reduced to

\$79⁵⁰

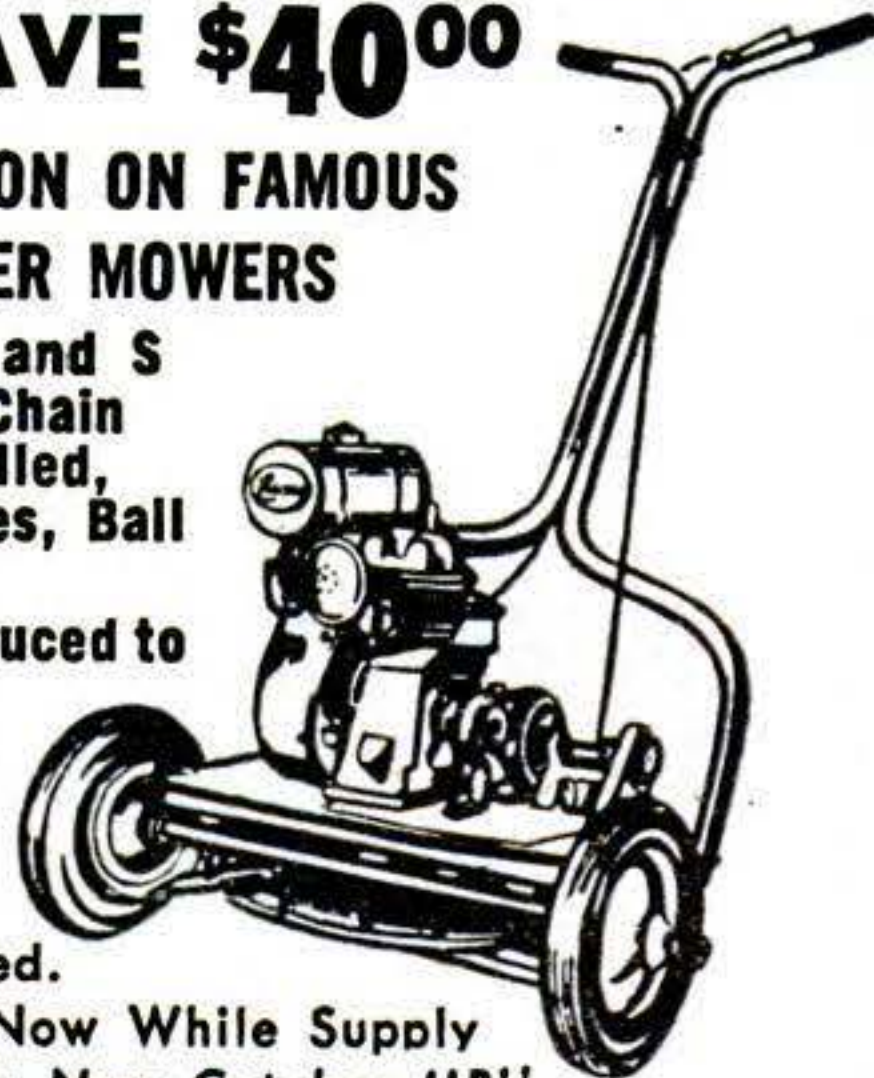

Mail Orders Accepted.
No C.O.D.'s. Buy Now While Supply Lasts. Send for Our New Catalog "B"

NATIONAL FARM EQUIPMENT CO., Inc.
142 GREENE STREET NEW YORK 12, N. Y.

FREE CATALOG OF BOAT KITS

- Assemble your own boat
 - No experience necessary
 - Save 1/2 to 2/3 "factory built" prices
- Models from 39.25 complete

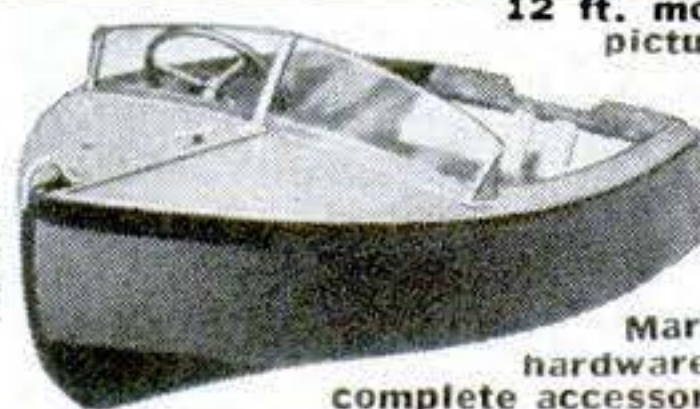

12 ft. model pictured

Marine hardware & complete accessories

Marine Division 3207 FREMONT AVE. SO.
LUGER INDUSTRIES MINNEAPOLIS 8, MINN.

HULA POPPER • GETS BIG BASS

Surface popping lure. Ideal combination of noise, action, casting and hooking qualities. Pops, plunks, jerks, twitches — obeys your slightest wrist command. Rubber Hula Skirt imitates live bug. At your dealer 5/8 oz. or 1/4 oz., \$1.25. Fly rod size, 75c.



FRED ARBOGAST CO. INC., 2355 W. North St., Akron 3, Ohio

FREE WRITE TODAY FOR YOUR BIG FREE ARBOGAST COLOR CATALOG — FULL OF PICTURES OF CATCHES

HOW TOUGH HOW SOFT



CAN WORK GLOVES BE?
WEAR

WOLVERINE PIGSKINS AND SEE!

A NEW PAIR FREE

IF THEY DRY OUT HARD and STIFF

Imagine! Buckskin-soft comfort in work gloves PLUS amazing extra wear that saves money! It's all yours in *Wolverine Pigskins* because Wolverine's exclusive triple-tanning process tans comfort into choicest domestic pighide, but doesn't tan the toughness out! See your dealer and look 'em over.

Try on a pair! And—a new pair free if they dry out hard or stiff, when dried at average warm room temperature.

WOLVERINE SHOE & TANNING CORP. ROCKFORD, MICHIGAN



SAMSON FIBER-GLASS BOWS
THEY DON'T BREAK
THE WHOLE FAMILY CAN USE THE SAME BOW

CATALOG - Fine Bows Arrows Materials 3c
HANDBOOK - Illustrated Instructions on Making & Shooting Archery Tackle 75c

L. E. STEMMLER CO., MANORVILLE, L. I., NEW YORK
Making Bows & Arrows for over 40 years

4 WHITE WALLS \$9.95
100% NATURAL RUBBER

EASY TO PUT ON!

Turn your present black tires into custom white side walls, with these thick, natural rubber WHITE WALLS. Absolute perfection and satisfaction assured. Everything furnished for all four tires. Mail check or money order NOW. Introductory price for complete kit: only \$9.95 postpaid. Sold coast to coast.



Department S

P.O. Box 11758
Wagner Station

CUSTOM SIDEWALLS Los Angeles 47, California

COLOR PRINTS

From Your Transparencies

Electronically controlled for superb results. Rapid service and satisfaction guaranteed.

Prints from any size transparency

ANSCO COLOR
KODACHROME
EKTACHROME

4 x 5	5 x 7	8 x 10
50¢	\$1	\$2

PROCESSING: ANSCO & EKTACHROME
24 hours—Roll Film 120-620, 35 mm,
20 ex mtd. . . . Only \$1.00 roll

COLORFAX LABORATORIES

25c
2 1/4 x 3 1/4

Min. order \$1.
No C.O.D.'s

DEPT. S-54 BOX 3521
Georgetown Sta., Wash. 7, D.C.

STOPS BOAT LEAKS FOREVER

FIBERGLAS NOW PERFECTED FOR PLYWOOD BOATS

Saves Work, Pays for Itself, Do it Yourself

Ideal for Trailers
Station Wagons
Sun Porches

New, improved EV-R-SHIELD Fiberglas is permanent armor protection for decks, cabins, bottoms—for any size boat. Increases speed up to 25%. Stops leaking seams, rotted planks, boat worms. Ends yearly boat hauling, scraping, painting and caulking. Can't waterlog, crack, peel or stretch. Choice of 8 colors or clear. Light, yet gives 5 times tensile strength of steel. Used to make Navy boats, bulletproof vests, etc. Will never deteriorate or rot. Adds years of life to old or weak hulls. Makes boats drier than new.



We challenge you to strip EV-R-SHIELD PermaKote OFF PLYWOOD HULL with hammer & chisel!

FREE! COMPLETE INSTRUCTION KIT.
DEALERS: CASH IN ON BIG MARKET.
Write for our Sales Plan

EV-R-SHIELD PRODUCTS, Dept. P-5, Joppa, Maryland

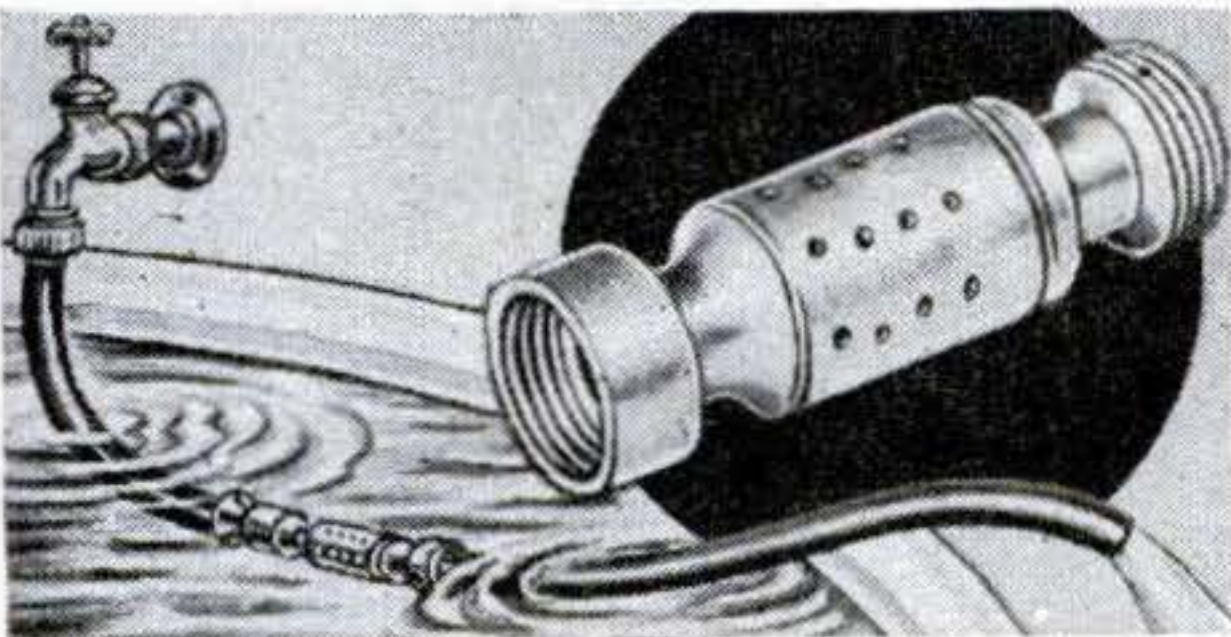

suction drainer pumps 300 gallons of water per hour from flooded cellars, pools, trenches, etc. Just attach with a garden hose to any screw-type faucet. attach another section of hose to the discharge end, turn on the water and it goes to work. Solid brass, non-rusting. Send for Free Novelty Catalog.

NOVELTY MART, 59 E. 8th St., New York, N. Y., Dept 246

ONLY
395

Postpaid

SUCT-DRI

Without electricity or moving parts this suction

Kruger Pistols Wholesale! \$3.00 post paid

.12 CALIBER SINGLE SHOT

.14 MG. POWDER CHARGE

Crafted after famous German Luger design. Not an air or CO₂ gun.

This is a small bore gun that actually shoots .12 caliber lead bullets fired by .14 mg. powder charge. Beautiful gun.. ideal for target shooting. 4" steel barrel. Overall length 8 3/4". This amazingly low price is due to small bore gun design, direct factory-to-you sales. Comes with 50 bullets.

Send for extra bullets or available at stores. Money back if not satisfied. Limited quantity. Send \$3 to

KRUGER CORPORATION
KRUGER BUILDING, BOX 68T, ALHAMBRA, CALIFORNIA
Send . . . Kruger pistols, \$3 ea. \$. . . enclosed (No C.O.D.'s)

NAME CITY
ADDRESS STATE

BLUE-BLACK FINISH..
KNURLED STYRENE STOCK

BUILD 15 RADIOS

AT HOME

ONLY

With the New Improved 1954 Progressive Radio "EDU-KIT"

\$19.95

NOW INCLUDES

SIGNAL TRACER and CODE OSCILLATOR

- Attractively Gift Packed
- Free Soldering Iron
- Absolutely No Knowledge of Radio Necessary
- No Additional Parts Needed
- Excellent Background For Television
- 10-Day Money-Back Guarantee
- School Inquiries Invited
- Sold in 79 Countries



WHAT THE PROGRESSIVE RADIO "EDU-KIT" OFFERS YOU

The "Edu-Kit" offers you a Home Radio Technician Course at a rock-bottom price. You will learn how to identify Radio Symbols and Diagrams; how to build radios, using regular radio schematics; how to wire and solder in a professional manner. You will learn how to operate Receivers, Transmitters, and Audio Amplifiers. You will learn how to service and trouble-shoot radios. You will learn code. You will receive training for F.C.C. license. In brief, you will receive a basic education in Radio exactly like the kind you would expect to receive in a Radio Course costing several hundreds of dollars.

THE KIT FOR EVERYONE

It is not necessary that you have even the slightest background in science or radio. The "Edu-Kit" is used by young and old; by radio schools and clubs; by Armed Forces personnel and Veterans for training and rehabilitation. No instructor is required. Instructions are complete, simple and clear. You cannot make a mistake.

PROGRESSIVE TEACHING METHOD

The "Edu-Kit" uses the principle of "Learn by Doing." Therefore you will build radios, perform jobs, and conduct experiments to illustrate the principles which you learn. You begin by learning the function and theory of each of the radio parts. Then you build a simple radio. Gradually, in a progressive manner, you will find yourself constructing more advanced multi-tube radio sets, and doing work like a professional Radio Technician. The "Edu-Kit" Instruction Books are exceedingly clear in their explanations, photographs and diagrams. These sets operate on 105-125 V. AC/DC. Adapter for 210-250 V. AC/DC available.

The Progressive Radio "EDU-KIT" is Complete

You will receive every part necessary to build fifteen different radio sets. Our kits contain tubes, tube sockets, chassis, variable condensers, electrolytic condensers, mica condensers, paper condensers, resistors, line cords, selenium rectifiers, tie strips, coils, hardware, tubing, Instruction Manuals, etc. A soldering iron is included, as well as an Electrical and Radio Tester. Complete, easy-to-follow instructions are provided. In addition, the "Edu-Kit" now contains lessons for servicing with the Progressive Signal Tracer, F.C.C. instructions, quizzes. The "Edu-Kit" is a complete radio course, down to the smallest detail.

TROUBLE-SHOOTING LESSONS

Trouble-shooting and servicing are included. You will be taught to recognize and repair troubles. You will build and learn to operate a professional Signal Tracer. You receive an Electrical and Radio Tester, and learn to use it for radio repairs. While you are learning in this practical way, you will be able to do many a repair job for your neighbors and friends and charge fees which will far exceed the cost of the "Edu-Kit." Our Consultation Service will help you with any technical problems which you may have.

FREE EXTRAS

- Electrical & Radio Tester
- Electric Soldering Iron
- TV Book
- Radio Trouble-Shooting Guide
- Consultation Service
- Quizzes
- F.C.C. Training.

PROGRESSIVE "EDU-KITS" INC.
497 Union Ave., Dept. PS-517, Brooklyn 11, N. Y.
MAIL TODAY—Order shipped same day received.
10-Day Money-Back Guarantee. INCLUDE ALL FREE EXTRAS.

- RUSH ME the Following—Include all Free Extras:
- "EDU-KIT" Postpaid. I enclose full payment of \$19.95
 - "EDU-KIT" COD—I will pay \$19.95 plus postage
 - Outside USA: "Edu-Kit" Postpaid. Enclose full payment \$20.95
 - Outside USA: 210-250V. AC/DC Adapter. Enclose \$2.50
 - More details on "EDU-KIT" Free—No Obligation
 - FREE Radio-TV Servicing Literature. No Obligation

NAME _____
ADDRESS _____

PROGRESSIVE "EDU-KITS" INC.

497 Union Ave. Dept. PS-517 Brooklyn 11, N. Y.

news & notes

A NEW LIGHT, RUSTPROOF ALLOY has been discovered by Navy scientists. It has many of the qualities of stainless steel, but is much lighter and is made without scarce metals. Called Thermenol, it is an alloy of iron and aluminum plus a little vanadium or molybdenum...Science has finally conquered the starlings. Two Penn State experts discovered that captured birds shrieked a distinctive warning when held and shaken. So they recorded the distress call and played it back in starling-infested areas. Makes an awful noise but it works--the pests go away.

AN AUTOMATIC PILOT FOR TRACTORS lets a farmer set his machine on course and then walk alongside doing other chores. The device is simply a steering wheel containing a built-in clutch that locks the steering gear in any position. Bumps or slopes cannot turn the tractor, but a light touch on the steering wheel can. The Steering-Aid is made by Kosch Manufacturing Co., Columbus, Neb...Wing-mounted rockets--the kind used to help planes take off--stopped a tail spin in a recent trial. Parachutes are usually used for this job by test pilots who must spin new planes before accepting them for the armed forces.

ELEMENTS 99 AND 100 have been added to the periodic table--but who gets credit for the discoveries and the honor of proposing names is somewhat mysterious. First public announcement came from University of California scientists, who reported making No. 99 in a cyclotron and No. 100 in an atomic reactor. They disclaimed credit for the original discovery, however. Apparently AEC scientists had previously created the new elements in the course of secret research.

TV REACHES MORE THAN HALF OF ALL FAMILIES in the U.S. Some 27,500,000 families--58 percent of the total--own

Where the TVs Are

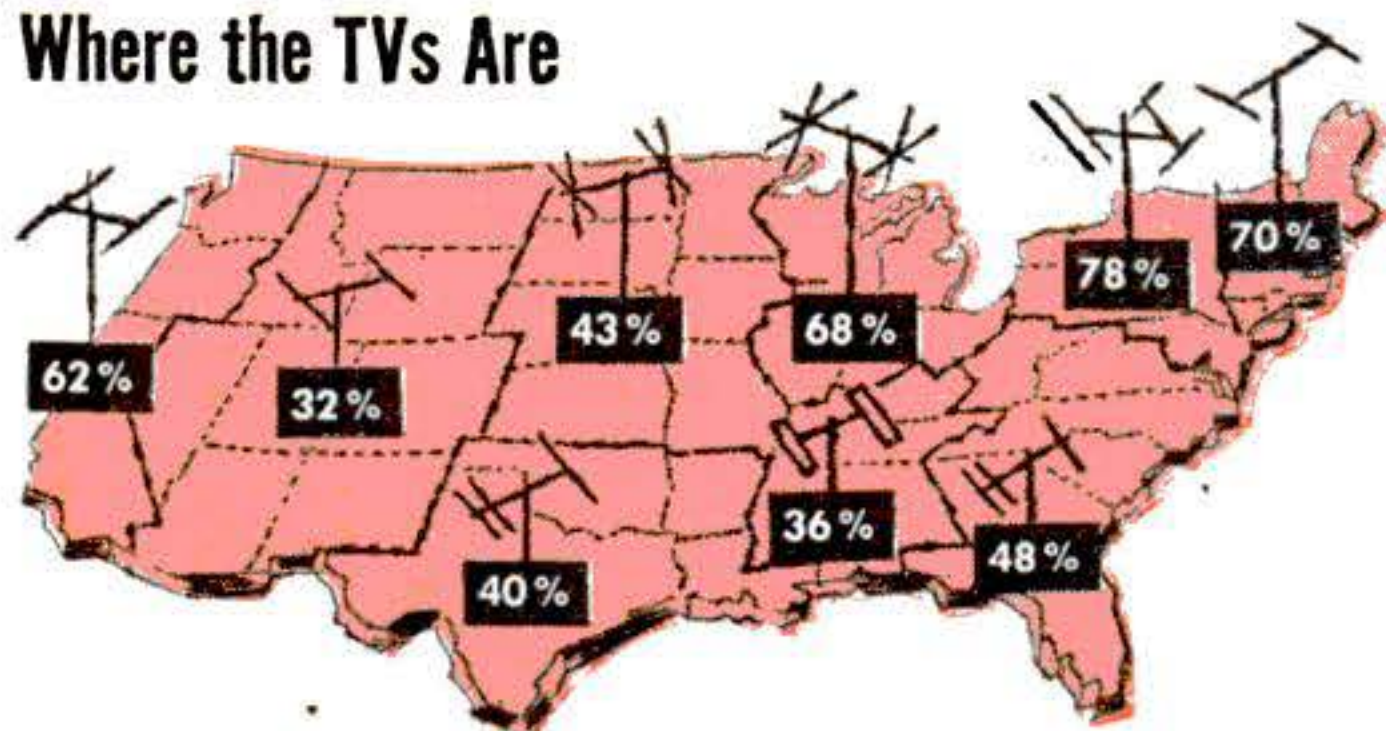

sets. Greatest TV saturation is in New Jersey, where 88 percent of all families have sets, but several other states run close behind. Montana falls at the bottom with five percent. (Chart at left, showing percentages of TV families by geographical area, is based on a Columbia Broadcasting System survey.)

Imagine! *Owning your Own* RANCH HOUSE, CABIN or HIDEAWAY

by the Shore
or in the
Mountains



Only \$2.49
7 Days' FREE Trial!

Amazing NEW Book
Shows You How You Can Build Any
of 27 Different Structures . . .
. . . for Mere Cost of Materials!
256 Pages, 207 Pictures, 23 Chapters!

"How to Build Cabins and Ranch Houses" will slash the cost of your new home! This one great book shows how you can build it yourself at *lowest possible cost* from the foundation to the roof. And it's EASY! Just choose your favorite from the loads of illustrations (complete with floor plans) whether it be cabin, lake cottage, modern ranch house, or mountain retreat. With the aid of this brand-new, money-saving book, you'll complete your house in *record time!*

SIMPLIFIED DETAILS

You don't need professional help when you start building your dream home. Here are simplified, detailed instructions on laying a foundation, building and caulking walls, constructing stairs, laying floor boards, estimating costs. Step-by-step plans on making windows, building fireplaces and chimneys, cutting doors, installing plumbing and lighting. You'll also find out how to beautify your cabin or ranch house, prevent wood decay, build rustic furniture, and speed up the building with many short cuts. Equip your house with all modern conveniences at a fraction of the usual cost!

SEND NO MONEY NOW!

Detach and mail coupon below, then pay postman the low, *bargain* price of \$2.49, plus a few cents postage, when your book arrives. Examine this wonder-book with its 256 pages, 207 illustrations, and sturdy cloth binding for a *full week!* Then, if you don't agree that you'd pay twice as much ordinarily for such a big, jam-packed book, simply return it for refund with NO OBLIGATION! But, HURRY—get your copy while they last!

MAIL ORDER FORM TODAY!

Popular Science Pub. Co., Dept. 554
353 Fourth Avenue, N. Y. 10, N. Y.

Please send my trial copy of "How to Build Cabins and Ranch Houses" today. I'll pay postman \$2.49 (plus postage) on delivery. If not delighted, I may return book within 7 days for full refund.

Name

Address

City..... Zone..... State.....

Check here if you remit now. We pay postage. Same refund guarantee.



Sturdy snow-cabin perfect for one- and two-family living.

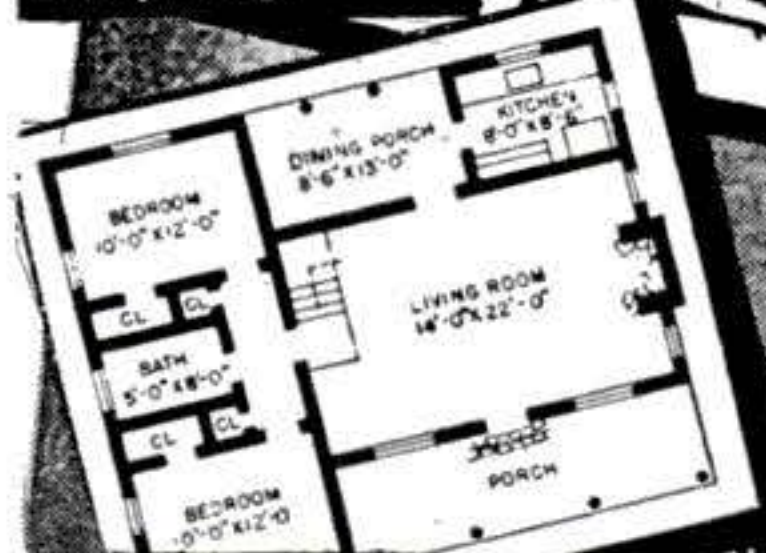

Only 1 of 19 fine floor plans!

You can build roomy wide-porch hideaway at saving of two-thirds or more!



Simple cabin with kitchenette makes ideal summer home.



Complete plans for typical hunting-fishing lodge.

EXTRA!

Make *big* money by building for PROFIT! Valuable section shows you how to *build and sell* roadside stands, gas stations, colorful signboards and more! No complicated, expensive tools needed. This one section *alone* makes this the "Big Opportunity" book of your lifetime!

WHO IS THE SMILING MAN?

CLUES:

1. His children's education is as good as paid for.
2. He's moving into his dream house in 1958.
3. He's going to get \$4 back for every \$3 he invests today, after 10 years.
4. He's helping his country and himself, at one and the same time.

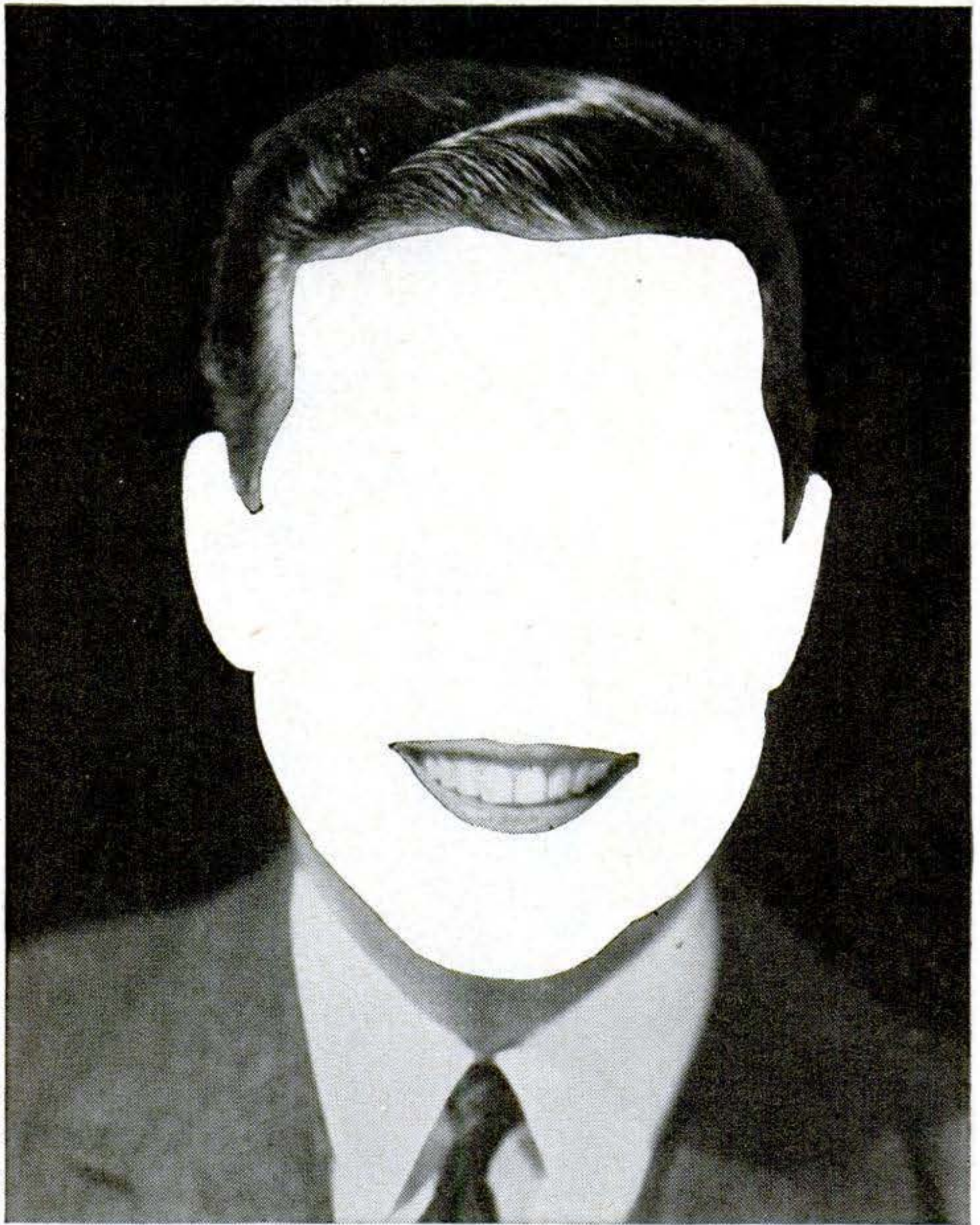

ANSWER: The Smiling Man is the man who invests regularly in U. S. Savings Bonds. What he has done—actually—is to guarantee his own future, to insure the security and happiness of his family.

Every Savings Bond you buy will stretch your smile a little further. They're the wisest investment you can make, today—they pay you back \$4 for \$3 after ten years, and that's a promise by Uncle Sam!

What's more, every dollar you invest in

Savings Bonds is helping to fight inflation over here, helping to maintain democracy over there.

If you draw a salary, enroll in the easy, painless, *automatic* Payroll Savings Plan. Or, if you aren't on a payroll but have a checking account, use the equally convenient Bond-A-Month Plan.

Inquire today about these sure, profitable savings plans. *And watch your smile grow along with your savings!*

AUTOMATIC SAVING IS SURE SAVING — U.S. SAVINGS BONDS



Contributed by this magazine in co-operation with the Magazine Publishers of America as a public service.

Reading time: 3 minutes to learn how to

- cut engine wear up to 38%
- prevent loss of power, compression
- save 15%-25% on oil . . . without ever changing your oil filter

This Gadget is Worth \$320,000,000

...and I Discovered it by Accident!

by Albert Wells

IT ALL STARTED the day I got the bill: \$214.36 for an engine overhaul—and I had only 28,000 miles on the car!

I told my troubles to a neighbor—a lubrication engineer—told him how I'd always changed oil every 1500 miles, changed filters every 5,000 miles. His answer floored me.

"You've been wasting your money," he said. "We've spent millions developing oil additives that keep carbon, gum and abrasives from damaging your engine. Your oil costs about 15¢ more a quart because of those additives. Yet oil filters on the market today are made of rag or paper—they soak up additives like a blotter. The more often you change oil filters the more money you waste!"

"But don't I need a filter to take the impurities out of the oil?" I asked.

He took a deep breath. "This will really shock you. Engine damage is done by abrasives 10 to 40 microns in size (a micron is .000039"). Your oil filter can't take them out because rags or paper can't be packed tight enough without stopping oil flow when the fibers soak up oil and expand."

"Isn't there any kind of filter that does the job it's supposed to do?"

"No, except for the porous bronze filters they're making for supersonic aircraft. And you can't buy a filter like that for your car."

I asked myself: "Why not?" Next day, I tracked down the outfit that was making the filters for aircraft, and got the answer. These porous bronze filters were made by fusing together millions of tiny bronze balls. Non-absorbent, they didn't remove additives, yet they removed abrasives in the 10-to-40 micron danger zone. Could they be made for automobiles? Again, the answer floored me.

LIFETIME FILTER TESTED IN CARS, TRUCKS, BOATS

Test models had already been used in cars and trucks

OPPORTUNITY FOR DEALERS AND DISTRIBUTORS

A dealer and distributor network is now being formed to handle demand generated by advertising and editorial features in national magazines. If you can qualify, you can be first with the most exciting automotive product of this decade, to win new customers and build a substantial business. These valued franchises are not being sold; they are awarded on the basis of ability to grow with us. For complete details, write or wire: Continental Manufacturing Corporation, Dept. FPS-5 Washington Blvd. & Motor Avenue, Culver City, Calif.

©1954



for millions of miles, proving the porous bronze filter: 1. Never needs replacing. 2. Saves the quart of oil thrown away with ordinary filter packs. 3. Increases engine life.

Trouble was, almost the entire production was being absorbed by military and industrial users.

That day I went to work on the biggest job of my life: setting up production of the Lifetime porous bronze permanent filters for cars and trucks (an estimated \$320,000,000 replacement industry).

HOW TO GET A LIFETIME FILTER FOR YOUR CAR

Try the Lifetime filter on your car for 2 weeks: if it isn't all I say, you get your money back; if you keep it, you're through buying filter packs—the Lifetime filter is guaranteed for 10 years, actually will last many times that long.

For complete unit, including case and fittings (install on any car in 10 minutes), send make, year and model of your car and \$12.95 (we pay shipping).

For conversion kit, which replaces your present filter pack with Lifetime bronze, send make and number of filter and \$6.95 (we pay shipping).

Or send only \$2 deposit, pay C.O.D. charges on arrival. But do it today—don't waste another cent on filter pack replacements!

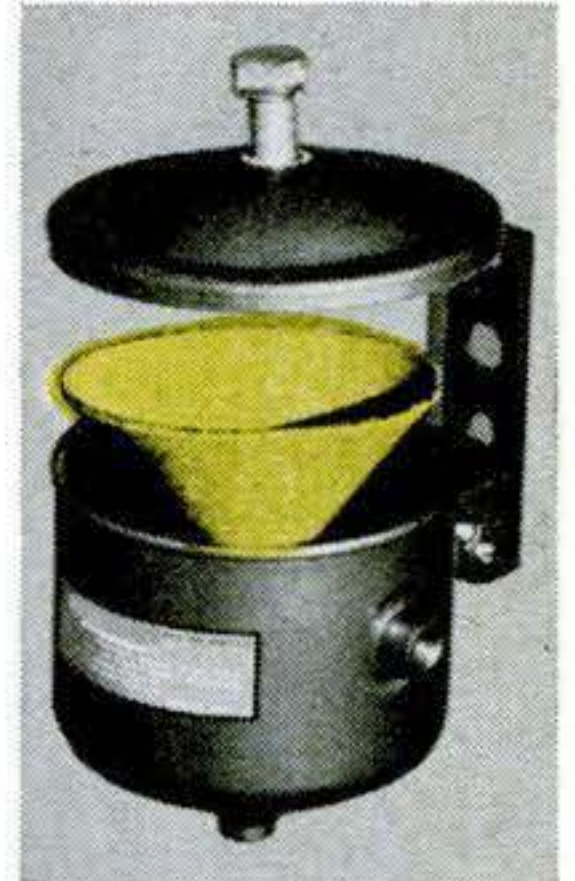

Complete Lifetime Filter; fits any car.



Lifetime Conversion Kit; replaces ordinary packs with permanent bronze element.

Permanent Filter Division, Dept. FPS-5
CONTINENTAL MANUFACTURING CORP.
Washington Blvd. at Motor Ave., Culver City, Calif.

Ship complete unit conversion kit

Make, model, year of car: _____

Present filter make (if known) _____

I enclose \$12.95 for complete unit (\$18.95—chrome)

\$6.95 for conversion kit

\$2.00 deposit; send C.O.D.

Name _____

Address _____

City _____ Zone _____ State _____

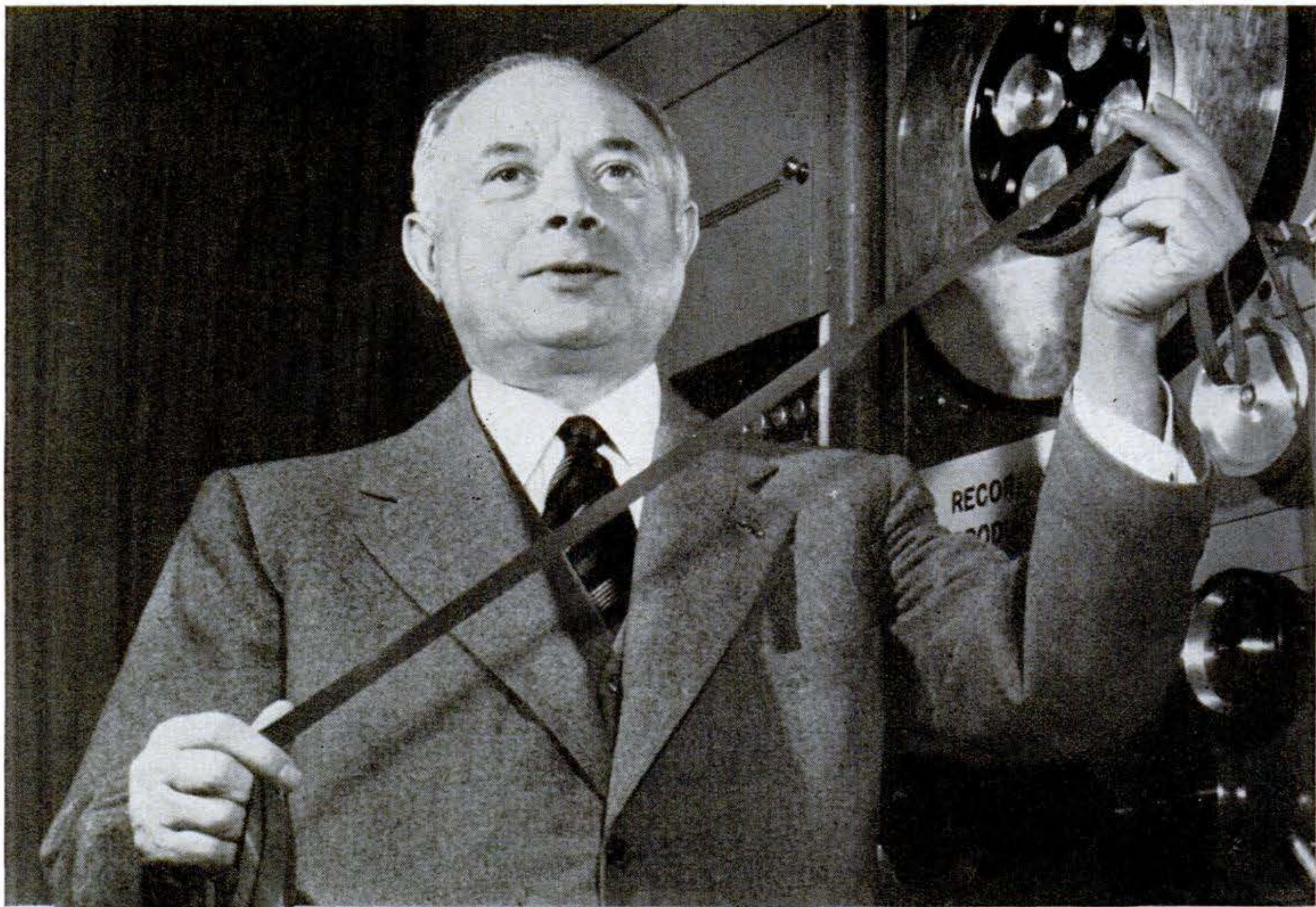

Brig. General David Sarnoff, Chairman of the Board, Radio Corporation of America

Sees No. 1 wish come true!

Television Tape Recording by RCA Opens New Era of Electronic Photography

In 1956, RCA's General Sarnoff will celebrate his 50th year in the field of radio. Looking ahead to that anniversary, in 1951 he asked his family of scientists and researchers for three gifts to mark the occasion: (1) A television tape recorder, (2) An electronic air conditioner, (3) A true amplifier of light.

Gift No. 1—the video tape recorder—has already been successfully demonstrated, two years ahead of time! Both color and black-and-white TV pictures were instantly recorded on magnetic tape without any photographic development or processing.

You can imagine the future importance of this development to television broadcasting, to motion pictures, education, industry and national defense. And you can see its entertainment value to you, in your own home. There the tape equipment could be used for home movies, and—by connecting it to your television set—you could record your favorite TV programs.

Expressing his gratitude for this "gift," General Sarnoff called it the first major step in an era of "electronic photography." He said it was only a matter of time, perhaps two years, before the finishing touches would bring this recording system to commercial reality.

Such achievements as this, stemming from pioneering in research and engineering, make "RCA" an emblem of quality, dependability and progress.

RADIO CORPORATION OF AMERICA

World leader in radio—first in television



Diving Historian Finds Spanish Treasures

The sea bottom off Florida yields relics from pirate ships and sunken galleons.

By Gardner Soule

PHOTOS COURTESY ED LINK

IF YOU stroll into the Smithsonian Institution in Washington, D. C., this summer and ask to see the acting head curator of history, or the curator of military and naval history, you will be told that the 35-year-old scholar who holds those titles is engaged in research.

But you will not find him among the



UNDERSEA TREASURES are found in locations like this one off the Florida keys. Divers

shown here are teen-age sons of Ed Link, skipper and owner of the ship *Sea Diver*.

Undersea, these divers find both adventure and historic treasures.

CORAL-ENCRUSTED Spanish cannon, almost sure sign that a wreck took place nearby, is discovered on sea floor by Mendel Peterson, using diving mask and air hose for breathing.

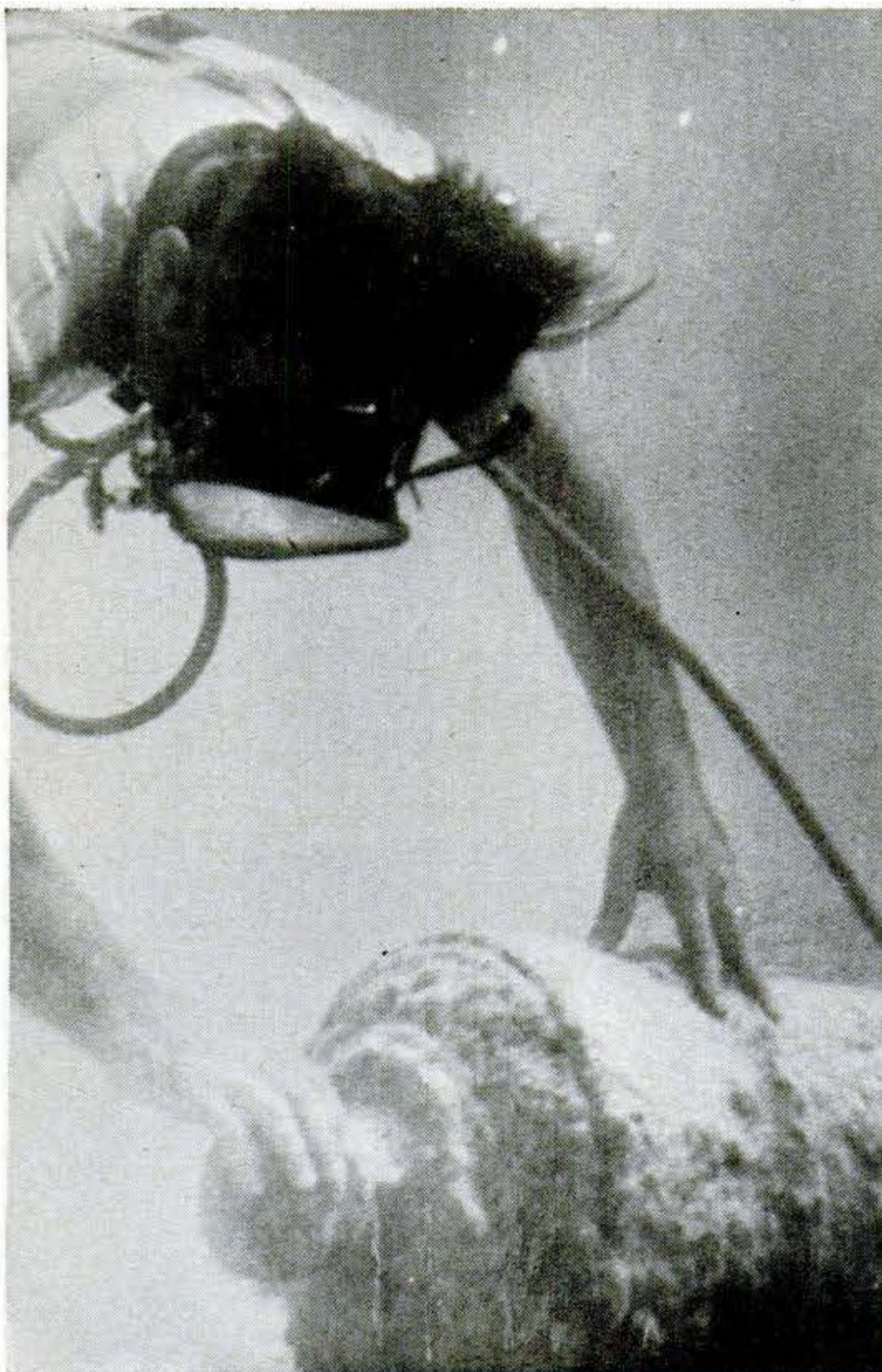

YACHT SEA DIVER, headquarters for these expeditions, is a converted shrimp boat. For diving it has an electric air compressor and an automatic reel to play out and pull in air-

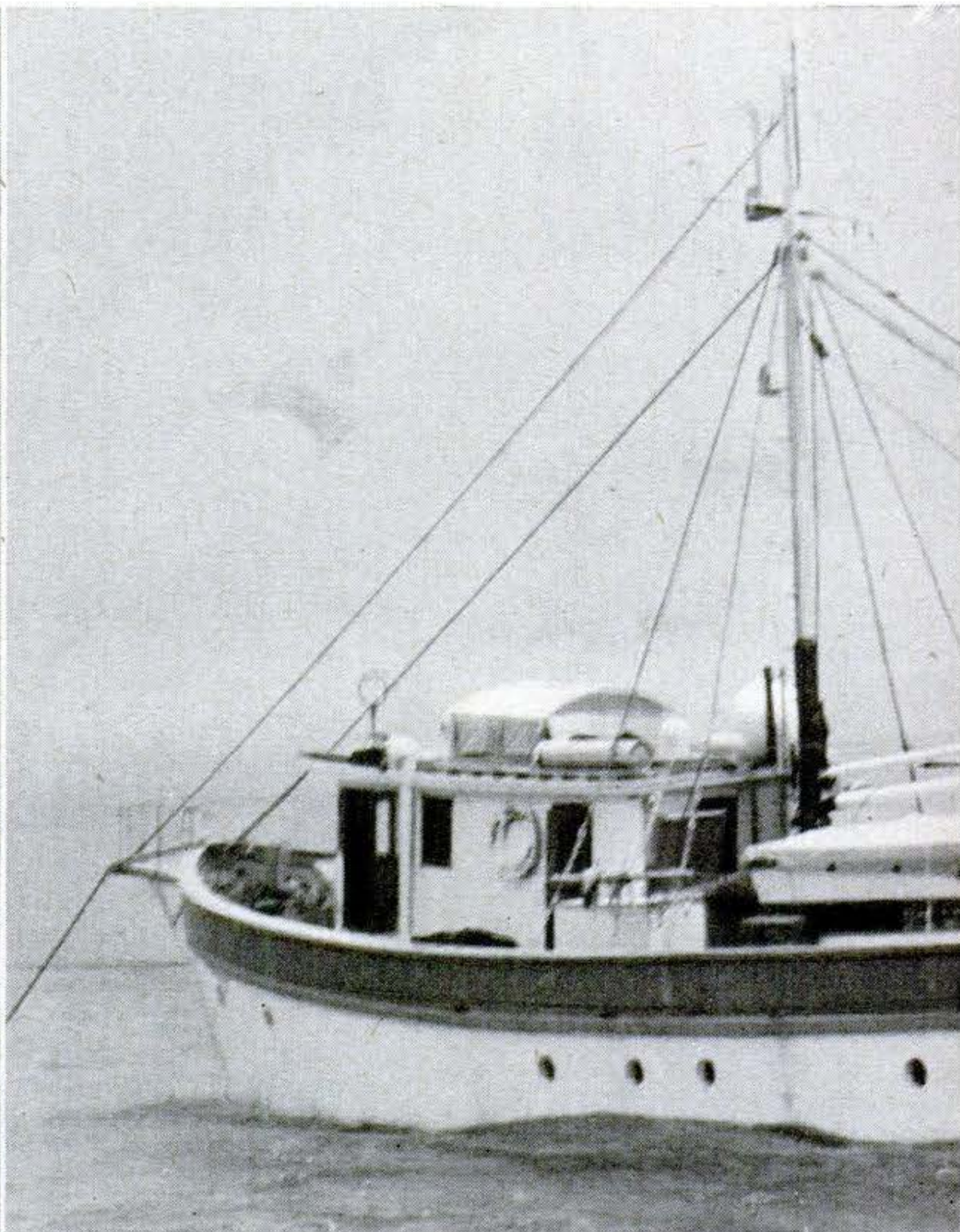

historians delving into the books in the nearby Library of Congress. To consult him, you will need a boat and a diving suit, because he will be strolling among the fish at the bottom of the seas, poking his nose into the wreckage of ships that sank long ago.

Dives for History Off the Florida Keys

Mendel L. Peterson is a diving historian who has brought back many treasures from previous research trips into the water along the Florida keys. Last summer, amid the wreckage of a Spanish ship that went down in 1733, he found a small ax of a type used by boarding parties in the warfare between Spanish, British, colonial and pirate ships more than two centuries ago.

He found bar shot, shaped like dumb-

bells. Fired from a cannon, the bar shot revolved in flight and had a devastating effect on the rigging of a sailing ship.

And in timbers of the vessel, there were many pieces of eight. These are silver coins of dollar size that for centuries have figured in pirate tales. There were also chunks of silver ore and two silver fruit forks, probably from the captain's table.

Peterson says the Florida keys are "one of the richest areas in the world" for wrecks. Vessels of the 1700s had tall masts, were therefore top-heavy, and had to be heavily weighted in the hold to remain upright. Sometimes merchant ships dumped their stone ballast on the beach when they took on silver, gold or other cargoes, and this is why today the Gulf of Mexico and the Car-

breathing hose. Electronic devices invented by Link enable the crew to spot metal objects buried under the ocean floor. Slung aft is a glass-bottomed catamaran.

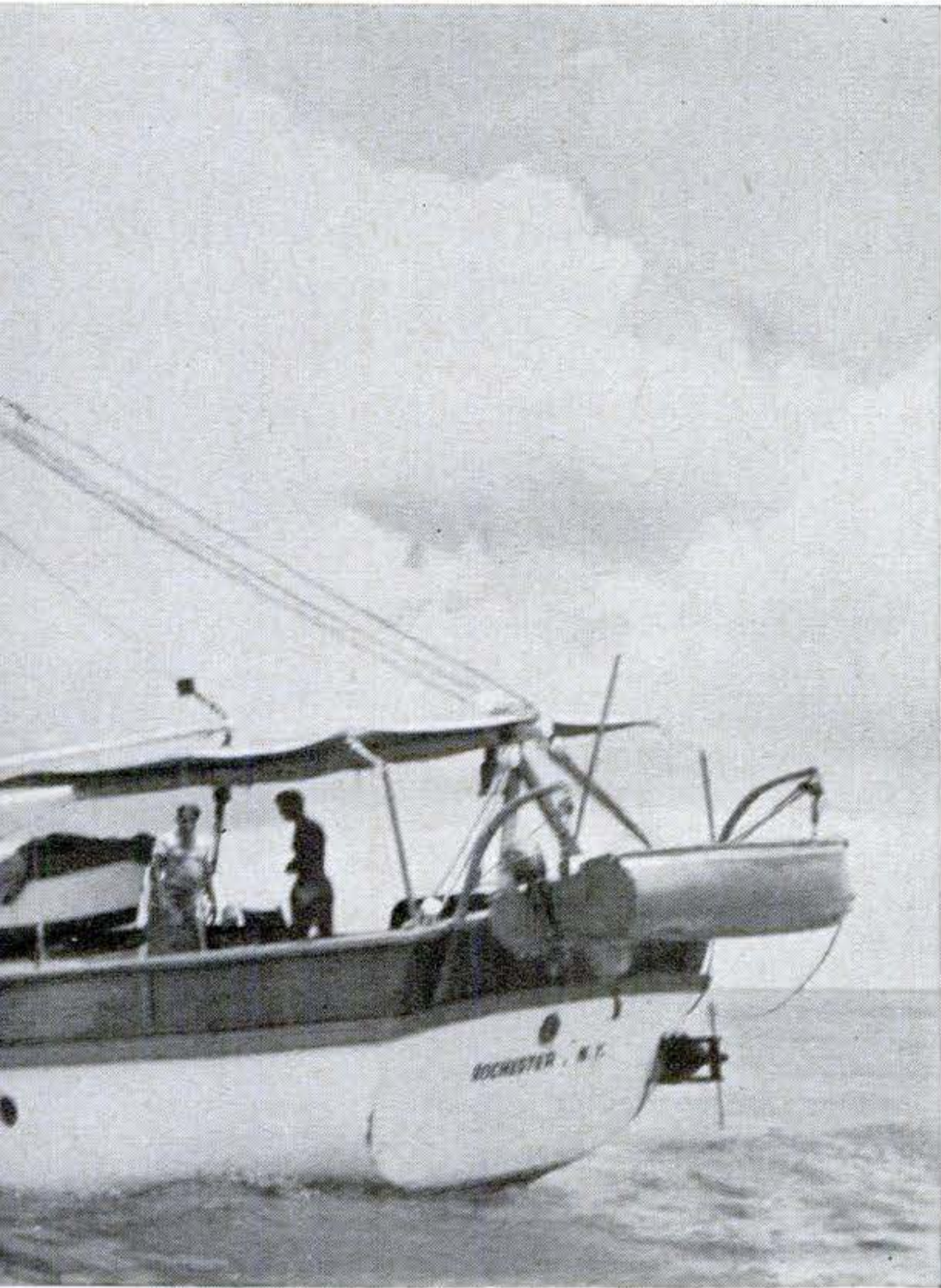

ibbean are ringed with port towns that have cobblestone streets.

For 300 years, until about 1820, Spanish galleons and other vessels took gold, silver and other cargoes from Mexico and other colonies back to Spain. From the Gulf of Mexico, these ships sailed past the long crescent of the Florida keys on the swift Gulf Stream through the Florida Straits into the Atlantic.

As the route of the treasure ships grew in importance, so did the Spaniards' enemies. Warships and privateers invaded the keys—either to protect the ships or to fight them.

In three centuries of treasure shipping, the Spaniards carried gold and silver valued at about eight billion dollars away from the New World. Because of the almost continuous sea warfare, and

ADVENTURE UNDER WATER is recorded by camera like one Ed Link holds in top photo. Reading down, other photos show cannon, grouper fish, shipwrecked anchor winch.

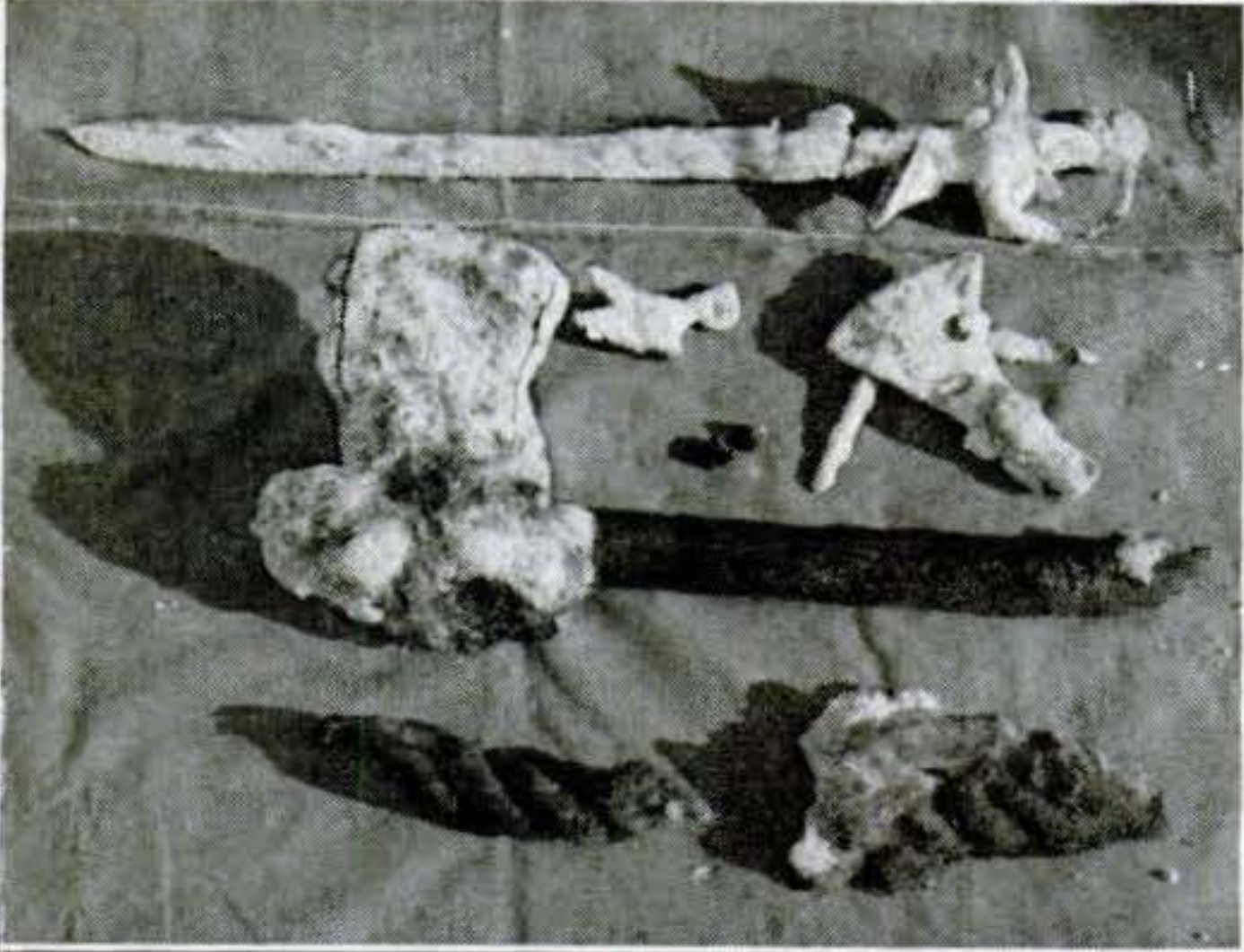
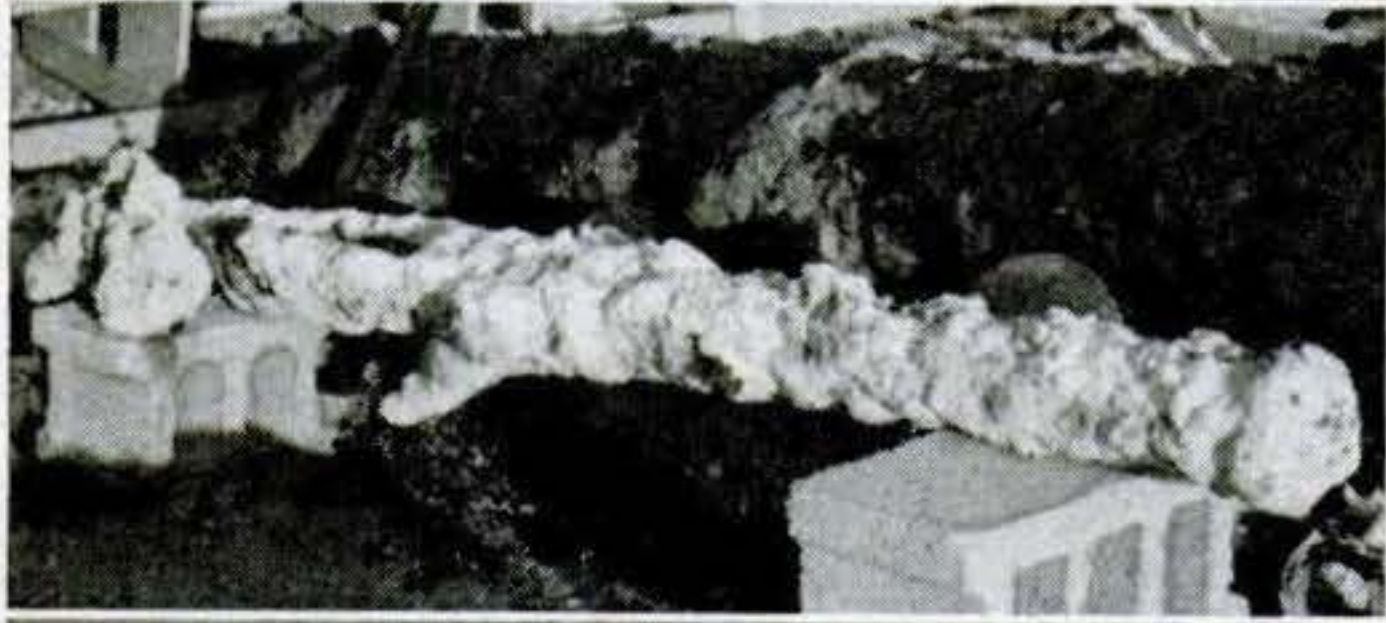

PIECE OF EIGHT (just above) is treasure to divers. Other photos (top to bottom) show old buckles, coral-encrusted cannon, sword and battle-ax dating back to early 1700s.

the hurricanes which dashed ships against the reefs and shores, many treasure ships were lost. So, too, were merchantmen and warships and pirate vessels. Only 20 miles wide in places, the Florida Straits were, says Peterson, "a death trap" in a hurricane.

To find a sunken wreck, however, is not always easy. One way is to spot it as you cruise among the keys. Fishermen, says Peterson, often look down and see anchors or cannon on the sea floor.

Divers Use Shallow-Water Equipment

Once a wreck is spotted, Peterson is likely to sail for it aboard the *Sea Diver*, a 68-ton converted shrimp trawler owned by Ed Link, the man who invented the Link flight trainer, and who skips the treasure-hunting ship himself.

The party tries to anchor as directly over the wreck as possible. This is because they use surface-supplied shallow-water diving equipment (not diving lungs), and they prefer to use only 100 or 150 feet of hose to convey air to a diver.

Their complete diving outfits include sneakers for protection against black sea urchins, the "porcupines" of the sea that love wrecks and whose spines inflict injury; flippers on their feet, for more powerful underwater swimming; a belt with 30 pounds of lead to keep them down; trunks; a jersey or T-shirt that keeps them warm under water; and a face mask to which the air hose is attached. They find face masks more satisfactory than diving helmets.

Crowbars Aid Their Search

"With a helmet on," Peterson says, "you have to keep upright; with a mask you can get in any position."

They sometimes carry crowbars to pry objects from the coral. When they use them to smash sea urchins, white meat comes out and little fish come round and gobble it. Those same fish, two to three inches long, are continually nibbling on Link and Peterson, who feel their bites even less than they feel mosquito bites.

"They seem to be the bravest of all fish," Peterson says. "Even if you wriggle your fingers at them, they'll stand their ground and attack."

Octopuses have never bothered them. The biggest one they have seen was 30 inches long from its body to the tip of a tentacle, and weighed only about one-and-one-half pounds. Link and Peterson have seen barracuda, the up-to-five-foot-long "tigers of the sea," that are more feared than sharks in Florida waters.

Peterson has seen small moray eels—"vicious-looking," he calls them. And he once saw a big sting ray. "Though water magnifies, this one must really have been five feet long," he comments. But neither man has ever been attacked by big fish.

Peterson and his friends, however, take precautions. They always enter the water carefully. No splashes. "Fish may not be aware of it," he says, "but we feel that we are in danger only when we are breaking the water." They also avoid wearing anything shiny. It might attract attention. And if they scrape themselves and start to bleed they come up and let the water clear, because blood attracts fishes.

Underwater Work Is Tiring

"We can stay down, at 40 feet, as much as four hours at a time, though we usually stay only an hour or so," he says, and points out "you get the bends even from a depth of 40 feet if you remain there seven or eight hours."

Although the water supports you, and you have a feeling of lightness on the bottom, Peterson explains, you tire more quickly under water. You move more slowly because of the resistance of the water. Physical exertion, as when carrying 80 pounds of cast iron along the bottom, will wear you out rapidly. You can also get tired blasting sand and coral—to uncover buried items—with a jet of salt water pumped through a hose.

Buttons off uniforms, weapons, ammunition, ballast, pottery, silver figurines—these are a few of the things, besides coins, that Peterson finds on his dives.

[Continued on page 270]



Keeps Radio Under His Hat

THE antenna sticking up from the badge on his cap is the only indication that this Atlantic City, N.J., policeman is in radio contact with headquarters. The four-tube, five-ounce receiver and its speaker are concealed inside the hat.

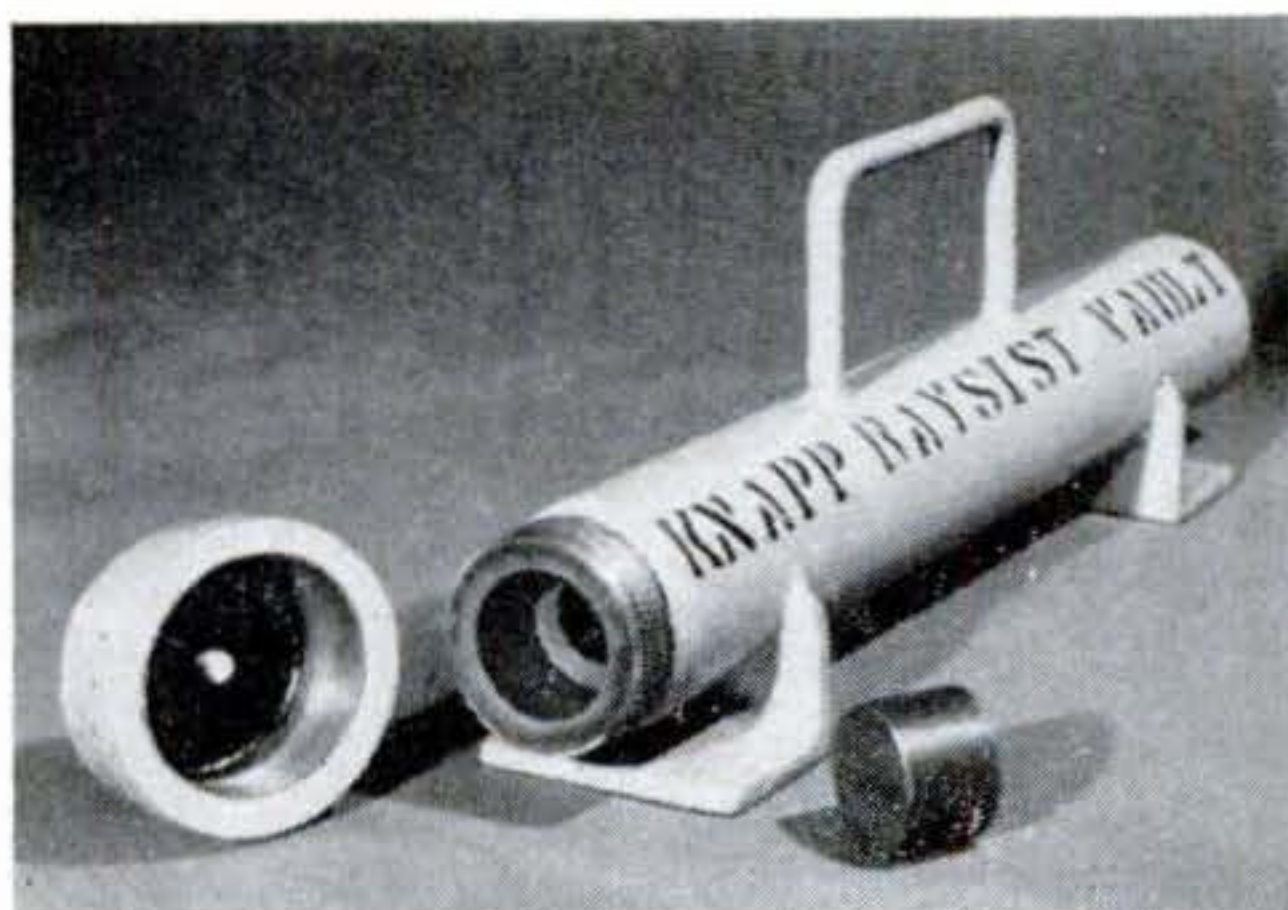

Vault Holds Radiation

THIS tubular container is designed to simplify the shipping and storage of hot radioactive materials. Made of lead-clad steel, the Raysist is said to combine the shielding properties of lead with the great strength of steel.



Refrigerator Door Opens Left or Right

THE picture at left is a double-exposure photo demonstrating the novel feature of a new Philco refrigerator: a door that is hinged on both sides. A large, V-shaped handle is mounted in the center of the door. When you pull on either arm of the V, the hinges on the side of the door nearest your hand are released, while those on the other side hold firm. Both sides can't open at once.

Slimmed-Down TV Set Is Easier to Service

A TABLE television set with a 17-inch screen that is said to be one-third lighter and one-third smaller than conventional TV sets with a screen of the same size has been produced by Crosley. It has a vertical chassis instead of a horizontal one, so all tubes can easily be reached from the back of the receiver. The cabinet, fastened by only a few screws, is easily removed (right).

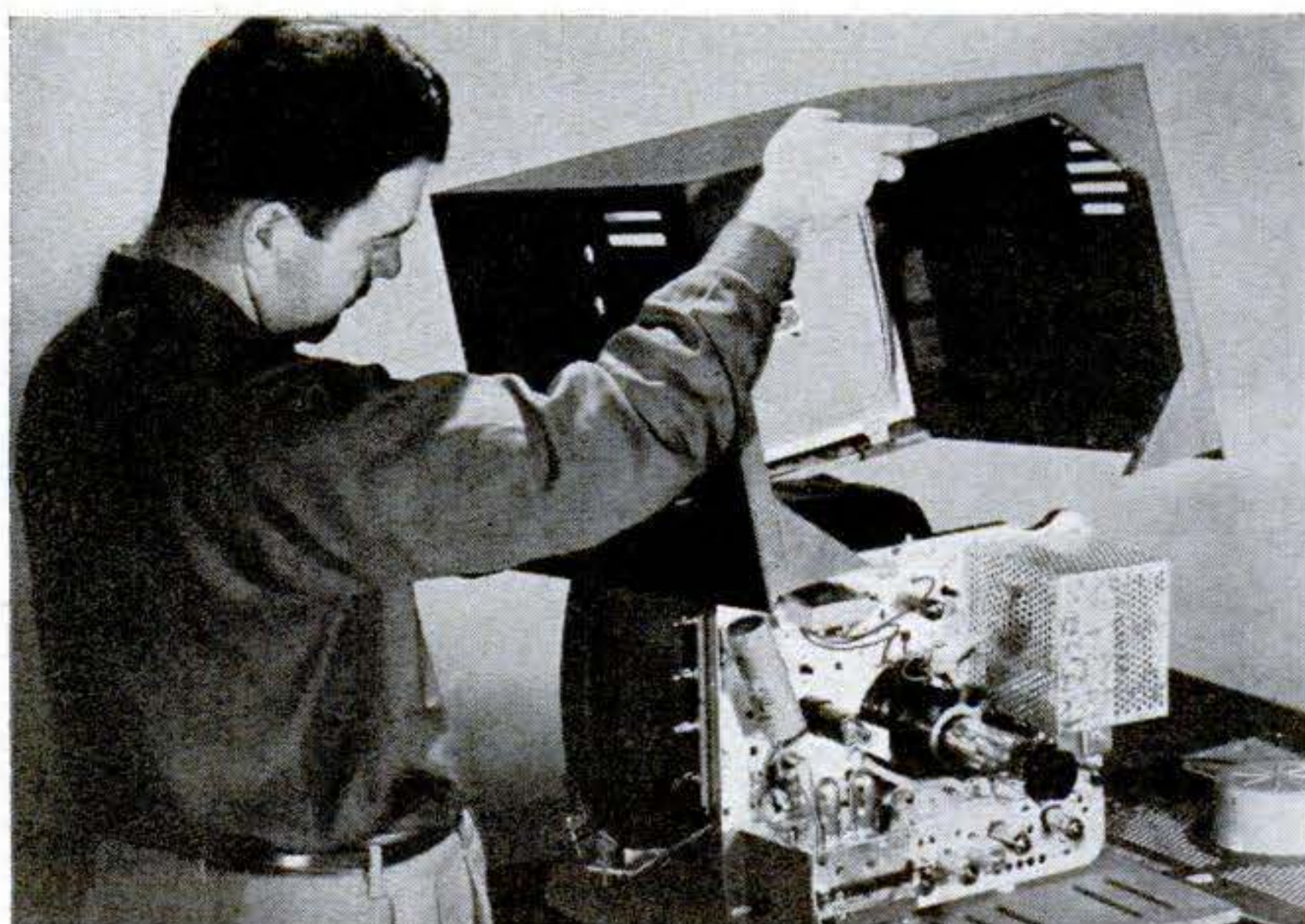

Coin Slipped in the Slot Takes Junior for a TV Ride

YOUNGSTERS, at the drop of a coin, are given a gentle, rhythmic ride while they watch imitation television shows on the screen of the new mechanical entertainment device at the left. It was built by the Scientific Machine Corp., 79 Clifton Place, Brooklyn 38, N. Y.

▶▶▶ Plain, ordinary wheat has been made into building board by Stanley F. Reed, Washington research scientist. He first puffed up whole wheat, then bonded it with plastics and compressed it under heat to make a strong, lightweight material.

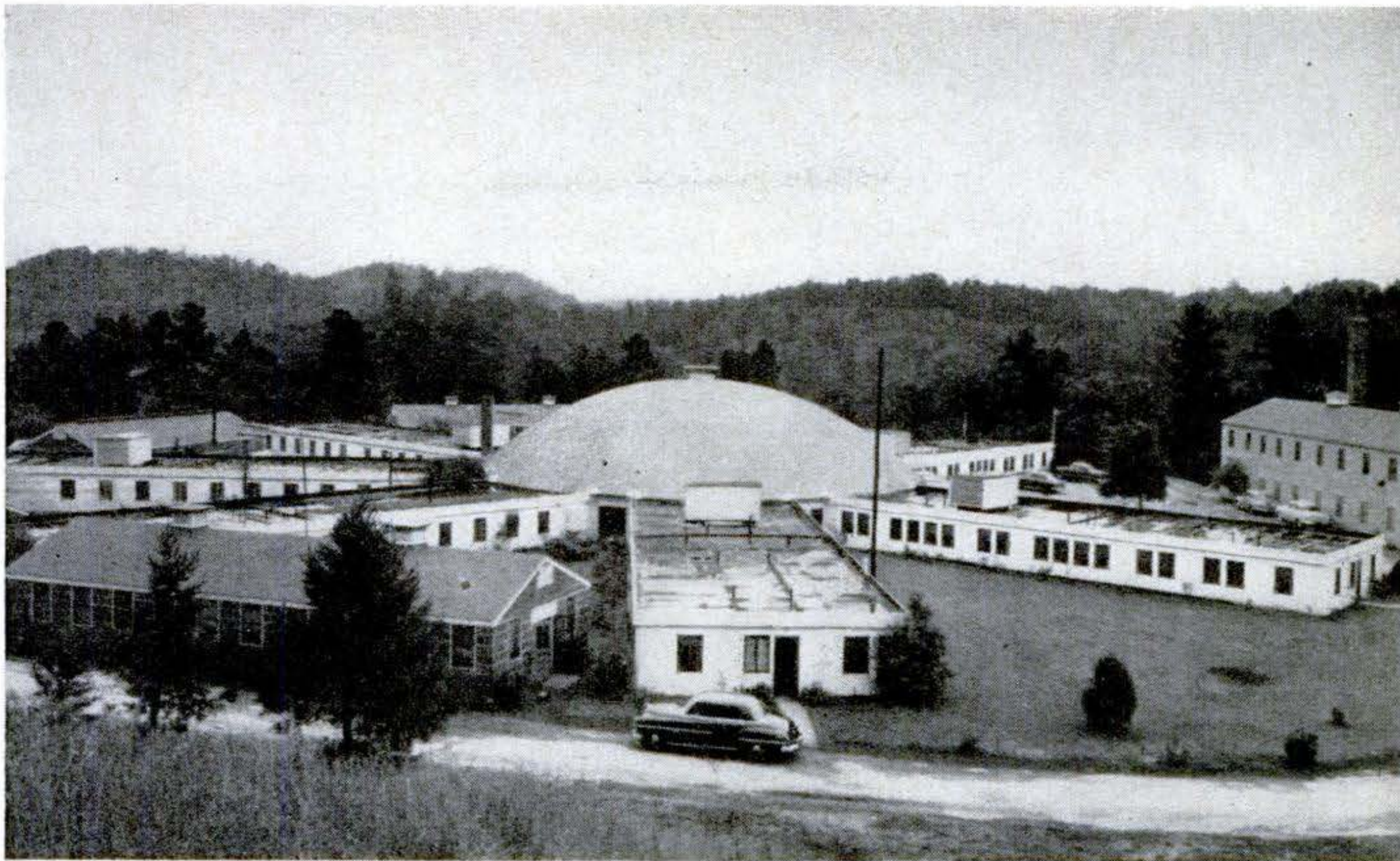

Southern Hospitality Wrapped Up in Air-Conditioned Steel

THIS wheel-shaped cluster of buildings is an all-steel hotel, a summer resort at Toccoa, Ga. Seven steel structures radiate like spokes from a domed auditorium at the hub. Inside, you walk through hallways of steel to reach rooms with walls and ceilings of the same

metal. You sleep in steel beds, dine at steel tables seated in steel chairs, or lounge on upholstery which is stretched over steel frames.

When you go outdoors for a swim, you dive into Lake Louise from a steel pier.

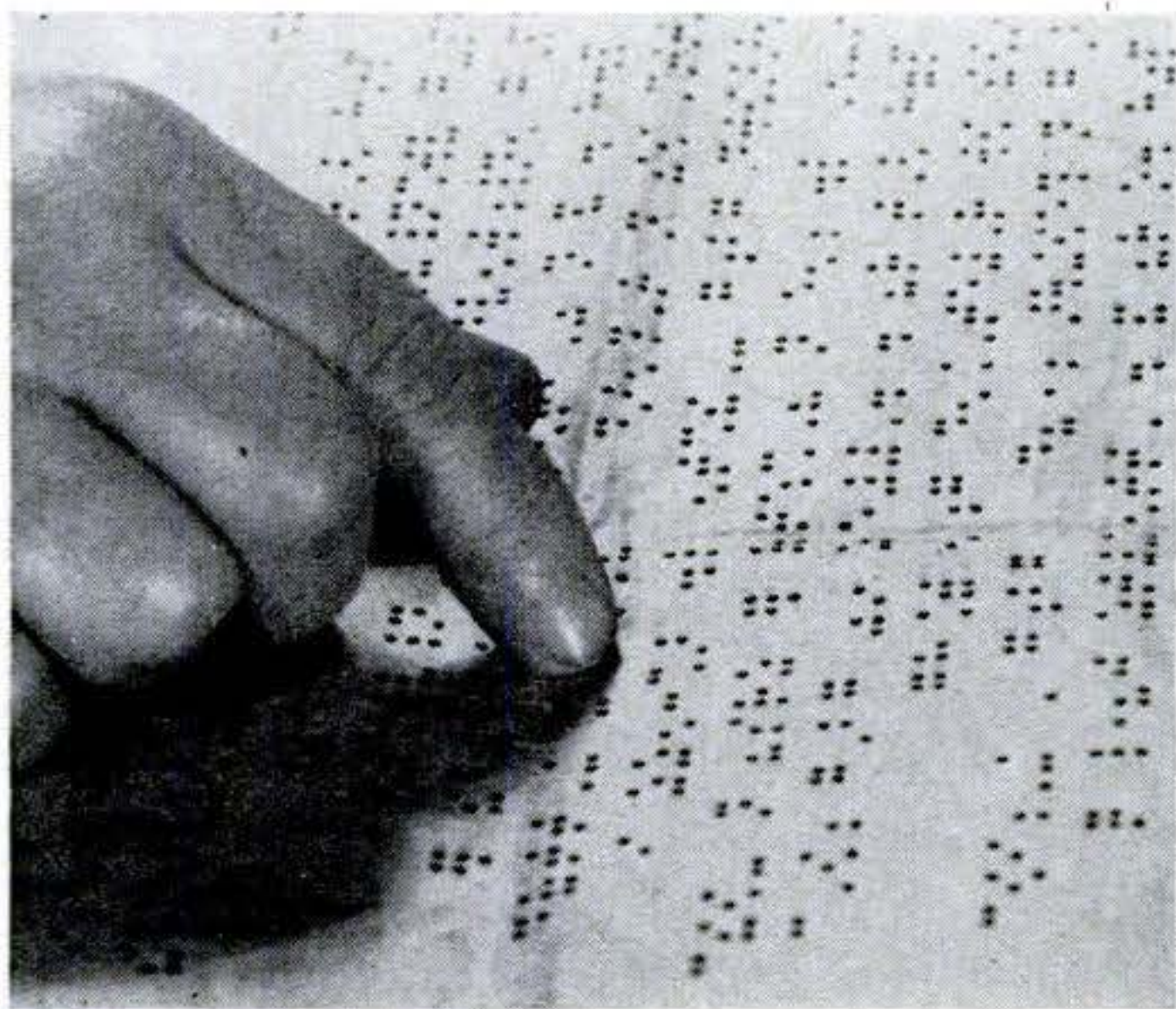

Plastic Dots Print Braille

PRINTING in Braille for the blind is said to be cheaper with a new method being tested in England. Dots of plastic ink are applied to the paper in the form of a thick liquid, then rapidly dried and hardened in a special process. Once dry, the "printing" is said to be practically indestructible, lasting as long as the paper lasts.



Screwdriver Puts MG Together

THIS MG model is astonishingly like the 16-times-larger real thing. A one-piece metal body rides on a steel chassis with front wheels that really steer and rear wheels that move up and down on leaf springs. Above the rear axle is space for a tiny motor. The Chas. Wm. Doepke Mfg. Co., Rossmoyne, Ohio, makes the kit.

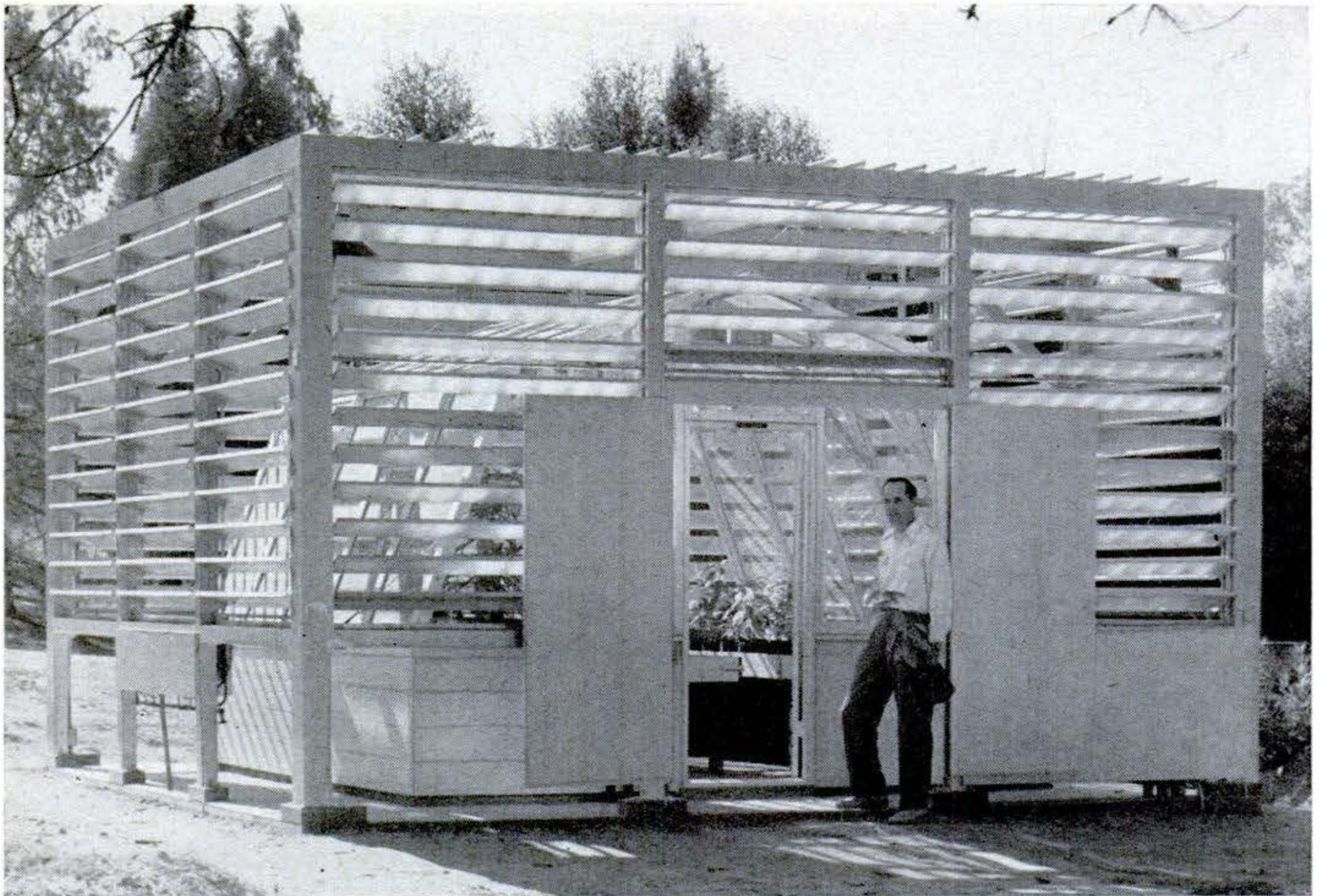

Anti-Bug Bugs Are Battle-Tested in Louvered Laboratory

"Bug eats bug" in this aluminum-shuttered greenhouse, where University of California scientists pit citrus-orchard pests against natural enemies that may replace chemical

sprays. Worked by thermostats, the shutters admit enough sunshine to simulate any climate. The odd lab is called a biotrone, meaning "balance of life."

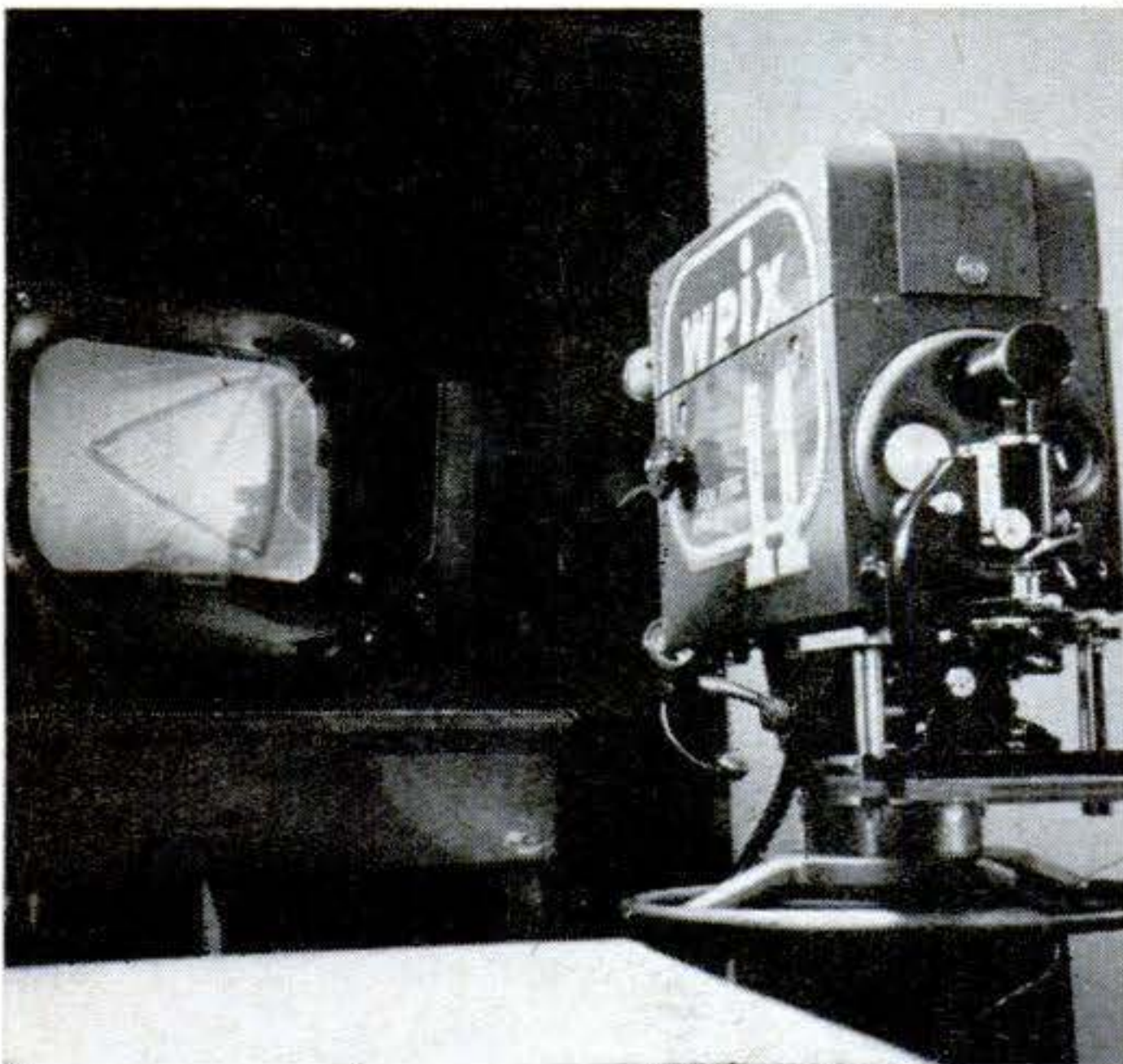

Microscope Wonders Put on TV

A SIMPLE attachment the size and shape of a beer can, containing a right-angle reflecting prism, adapts this TV camera at New York's WPIX to peer through a standard microscope. Here is its view of a diatom, the shell of a one-celled water plant.



Wires in Ceilings Heat Home

STAPLED to ceiling lath as above, before plastering, a new General Electric wire offers electric radiant heating to suit each room. Installation calls for an expert in figuring heat needs, says GE, which sells the wire only to electrical contractors.

CROWDED engine compartments are not jammed up further with a new "coaxial" power-steering unit just announced by the Chrysler Corp. The entire unit, with the exception of the oil pump, fits compactly into the lower part of the steering column.

Designed to replace the bulkier integral unit previously used, the coaxial system has a recirculating-ball nut at the top. This converts rotation of the steering wheel into up-and-down movement within the remainder of the unit. Thus the power piston can be designed to slide within the steering-column housing. At the bottom of the unit, a rack-and-sector gear replaces the old worm and roller.

The coaxial unit retains the characteristics of previous Chrysler units, including a comparatively low threshold of assistance. Over-all steering ratios are dropped to 16.8 to 1 on power-steered cars, compared with 25.8 for manual steering.

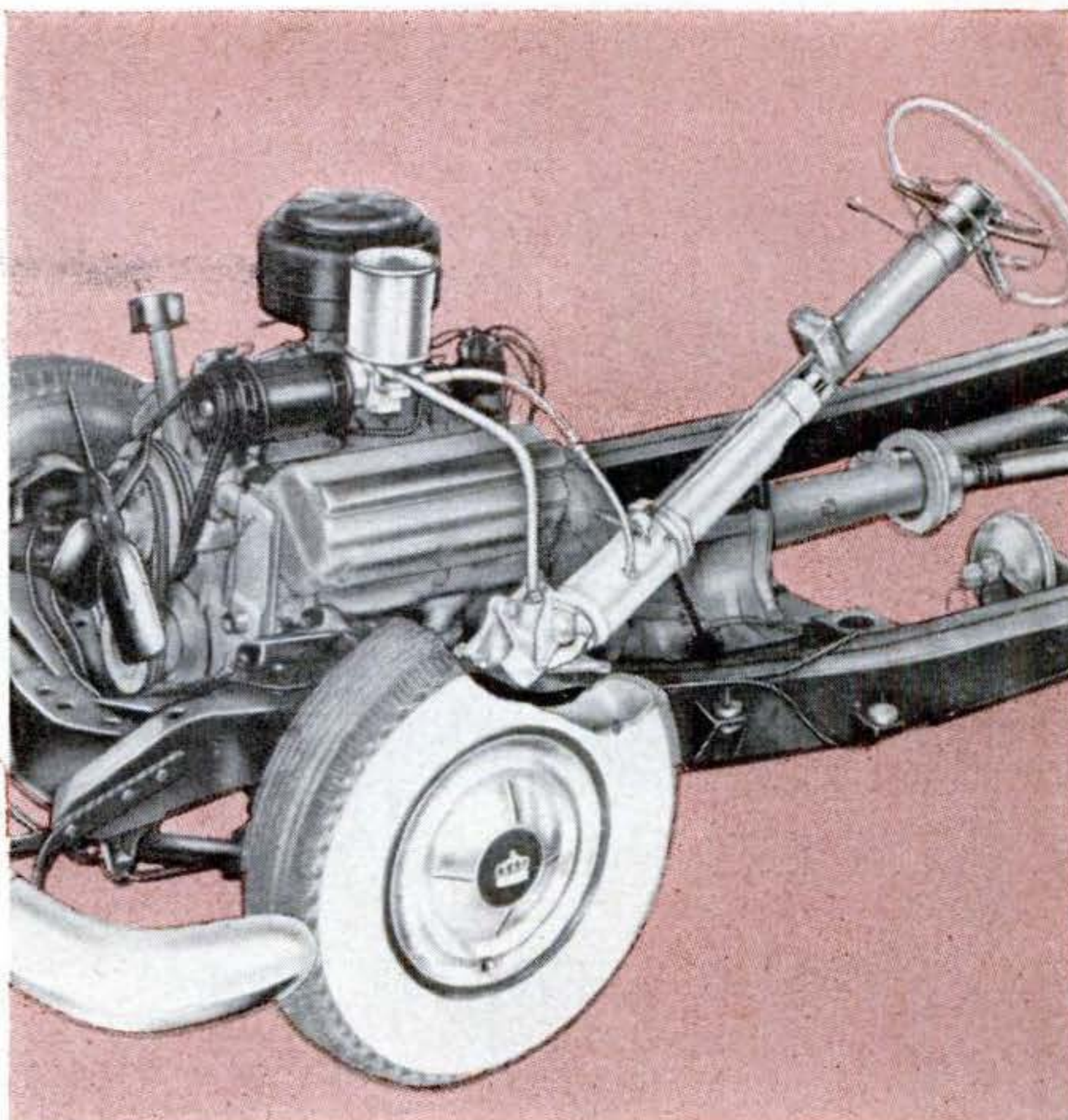

TWO SUB-UNITS make up mechanism: a power unit, around steering-column axis, and an oil-pump-and-reservoir unit.

New Power-Steering Unit Fits Inside Steering Column

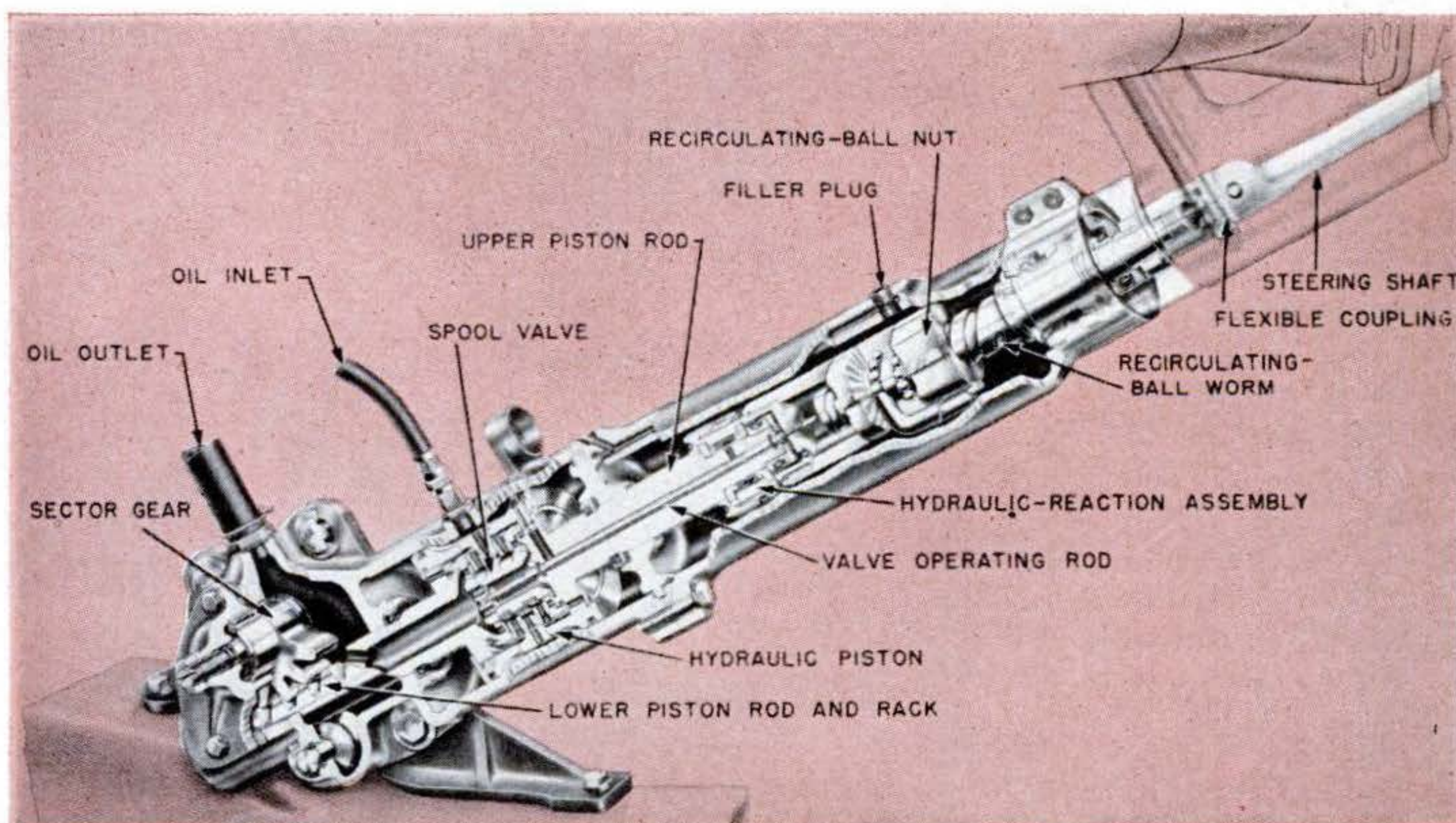

NEAT DESIGN is shown in the cutaway drawing above. Heart of the system is the spool valve

which controls oil flow, and a double-acting piston that produces the axial movement.



Land Yacht Tows Its Own Land Dinghy—Handy for Side Trips

TOWING a 500-pound King Midget roadster, this land yacht reverses a trailer's normal role. That is because the Safari, made by the Saginaw (Mich.) Mfg. Co., is a self-

powered house-on-wheels. It has a bath, lavatory, galley, dinette, four bunks—and an automatic transmission. It also carries an aluminum boat on the roof.



Newest "Growler" Is Ready for Anything

RAILROADERS call diesel locomotives "growlers," for obvious reasons. The growler at the left is a new model, built by American Locomotive. It was designed to be a Jack-of-all-trades. Built for 80-m.p.h. passenger or 65-m.p.h. freight service, it is intended to be equally at home on yard transfer or switching jobs. It has 12 driving wheels and its engine is rated at 2,250 horsepower.

Versatile Pump Speeds Servicing

A THREE-IN-ONE rig developed in Italy makes quick work of service-station jobs. Shown (right) in use in Frankfurt, Germany, it sucks old oil out of a car's crankcase through the oil-gauge slot, then squirts in new; and can also do greasing and waxing.





This Is How Jet Pilots Will Blow Themselves Out of Trouble

THE dummy in this sequence of high-speed shots is making a flying exit from a permanently grounded cockpit to show how a new pilot-ejection seat works. The pilot blows himself out of his plane, seat and all,

by setting off an explosive charge. The seat, developed for the Air Force by Republic Aviation, has a novel feature: At the peak of its trajectory it automatically releases the pilot to make a parachute landing.



Radioactive Tracer Spots Snafu

SUPPOSE mail gets stuck in a mailing tube. How do you find it? Well, if you are the Carborundum Co. of Niagara Falls, you already have fastened a bit of radioactive cobalt to each mailing carrier. When one of the carriers stalls, you track it down with a Geiger counter, as shown above.

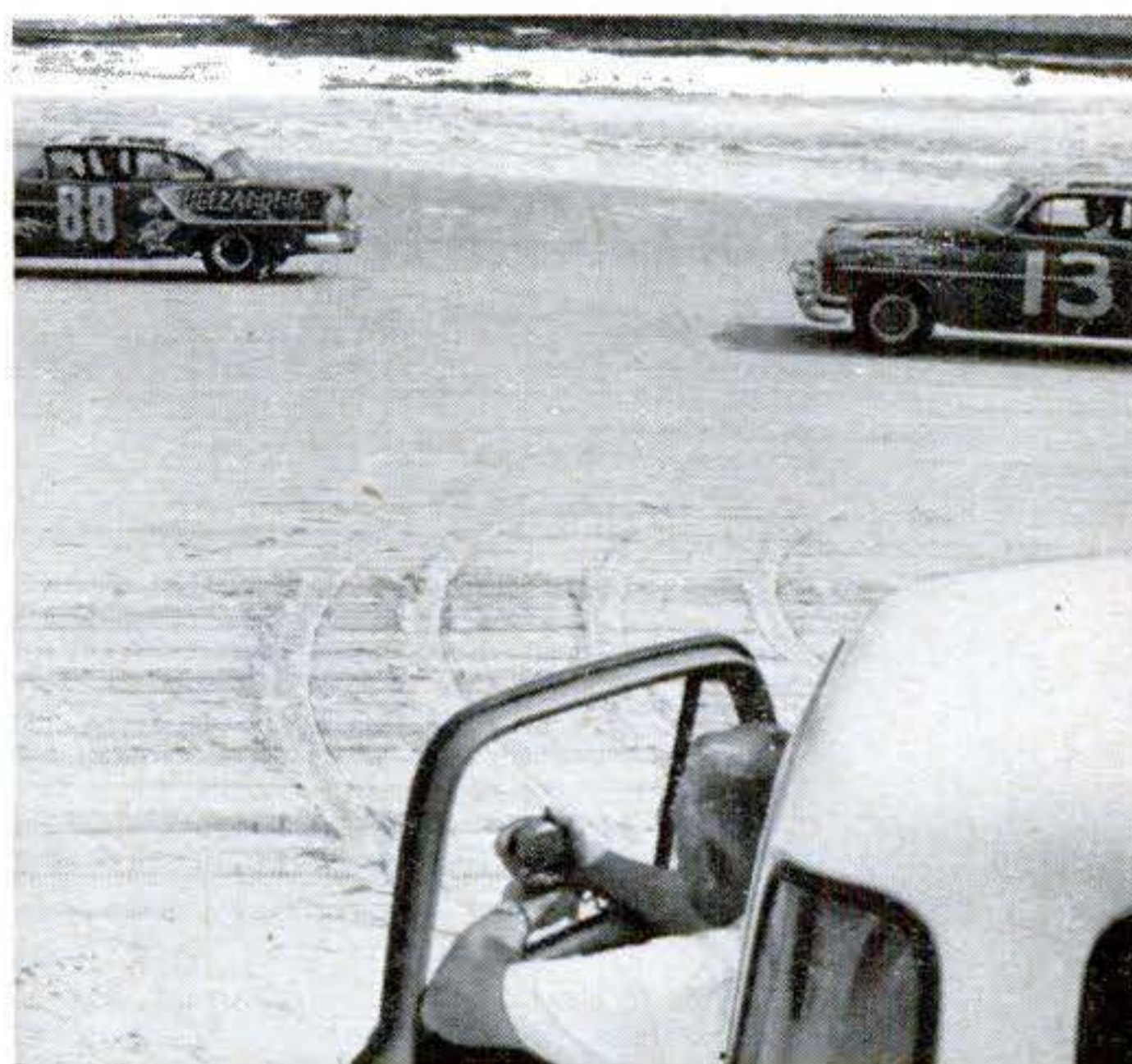

Racer Radio Reports to Pit

DURING a recent stock-car race at Daytona Beach, two drivers were in constant radio communication with their pit truck (above). They were kept informed of their lap, position, time and the track condition. The pit crew, on the other hand, always knew how the fuel was holding out.

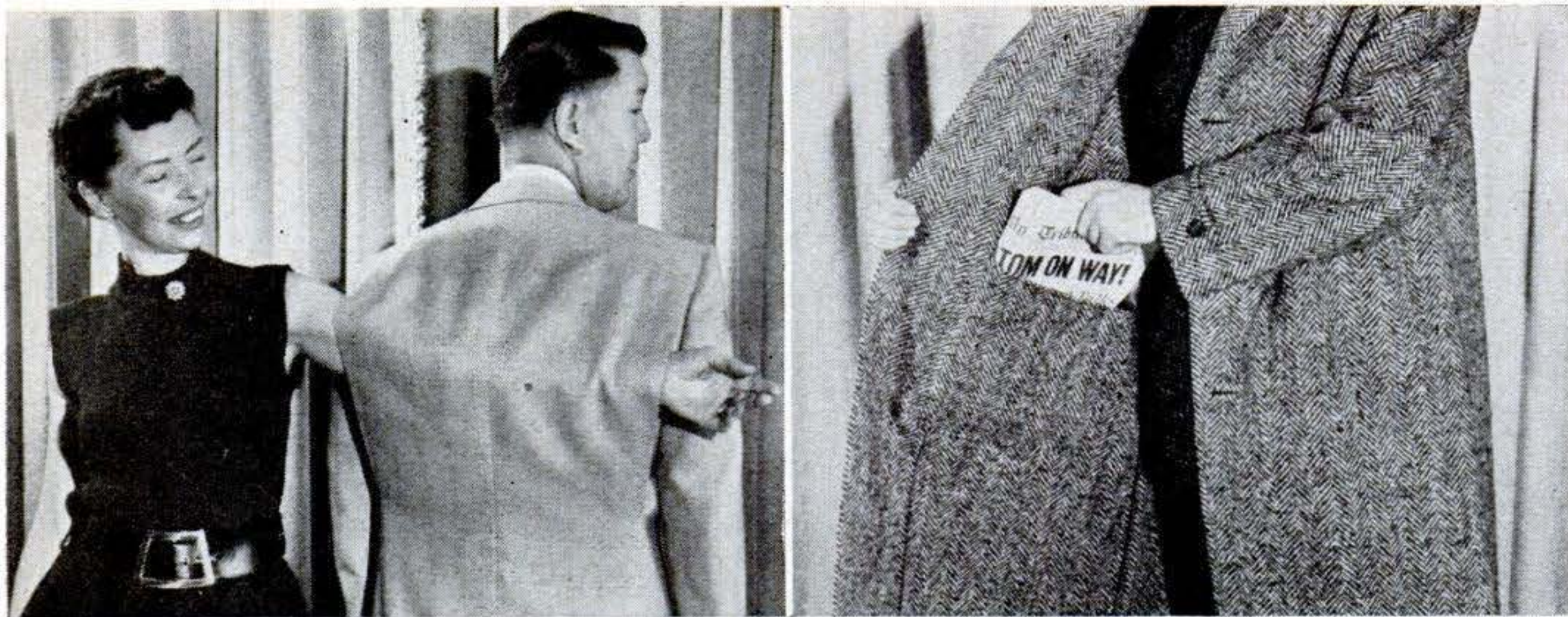

They've Put Vents and Newspaper Pockets in Men's Clothes . . .

MEN may soon be enduring the steamiest summer days with a smile if cross-ventilated sport coats (left, above), introduced at a recent international convention of clothes designers, catch on. The back is simply open

at the sides from the shoulders to the waist. Even more popular, in winter, may be an overcoat (right) which has huge inside pockets for newspapers, and can be rolled into a ball without wrinkling.

. . . And Invented a Fitting Jig

SKIN-TIGHT fits for the gay blades of Paris will be achieved if a certain inventor of the ever-surprising old town has his way. He has produced a "magnetic silhouetter," shown below. The board behind the happy youth in the picture is magnetized. The fitting devices stay wherever the tailor may put them.

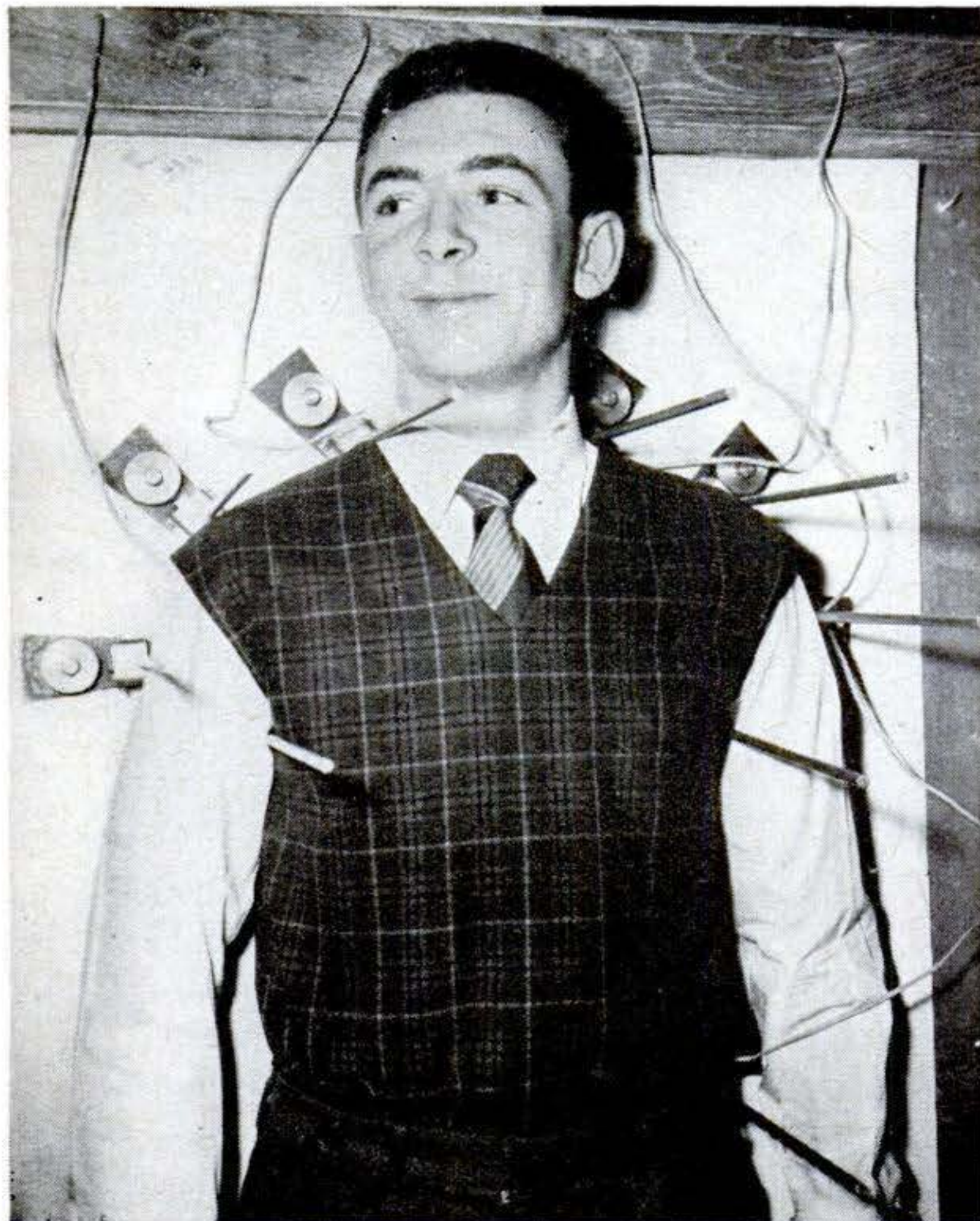

. . . But the Girl Friend Can Now Wear Live Fish!

TINY bowls of water with a live guppy in each have been fashioned into earrings by Kathleen Radel (below) of Rochester, N.Y. Each earring weighs five-eighths of an ounce loaded. Kathleen says, logically, that they'll win attention.



▶▶▶Larger and perhaps luckier fish than the guppies that are confined to earrings are Arctic whitefish, which, scientists report, sleep all winter under five feet of ice.

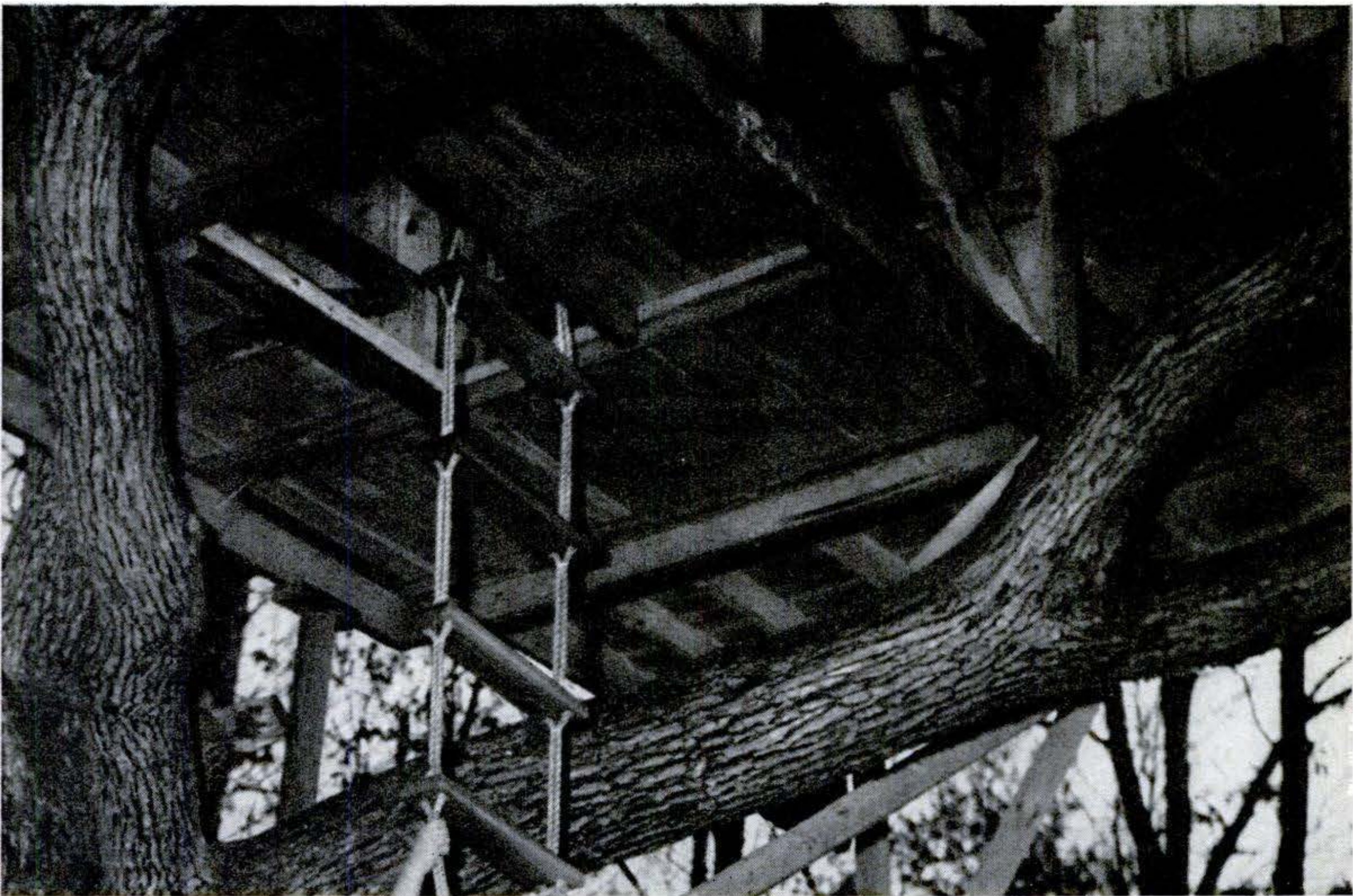

ENTRANCE to the tree house is via rope ladder and trap door. Resting on a foundation of sturdy limbs secured by cables to upper branches, the weather-tight hut is strongly constructed to ride out high winds.

Our Boy Lives in a Tree

Building in the boughs is a custom job—but there are certain basic principles.

By Ruth and Edward Brecher

PRACTICALLY every youngster dreams at some time of living in a tree hut, reachable only by a rope ladder which he can pull up through a trap door to keep out wild animals and parents.

Our seven-year-old fixed on that particular idea with an enthusiasm we found it impossible to ignore. Even though we were busy with our own plans for build-



THE BOUGH of this white oak, nearly horizontal, gave Jeremy the tree-hut idea. Dead and injured limbs were trimmed and stumps sealed with paint before construction began.

ing a summer cottage, we had to take time out for his project.

We bought 70 feet of rough two-by-fours, and nailed together a six-by-eight-foot floor frame. This we hoisted into a white oak tree with sturdy horizontal branches.

What next? We were stumped, but Jeremy's imagination now soared. He planned nothing less than a palace in the boughs, with double-decker bunk, electricity for lighting, cooking and heating, and a variety of refinements which far exceeded our skill or means—until the basic idea loomed up which suddenly made the whole project economically feasible.

Boy's Room Moves to Tree

Even a makeshift shack up there, pieced together somehow from scraps of lumber, would take more time and money than we could afford. But, we suddenly realized, a weather-tight house in the oak tree, in which Jeremy could really live, would enable us to get along with one room less in our own cottage. Jeremy saw that point, too—and we were soon committed to spend on his tree hut what would otherwise have been earmarked for his room.

Tree huts can be as tight



LIMBS are never exactly where you want them; and there are never enough of them to bear the weight. We built up from low branches and dropped cables from high ones.



NATIVE PINE AND FIR were used, much of it green; but there is less warping than in a steam-heated apartment. The substructure was left open to make safety inspection easy.



The usual rules of framing apply to tree huts—but it takes ingenuity to apply them.

and homey as cabins on the ground—and more fun.

The size of the structure was fixed by determining the maximum size that the tree could accommodate. Our original six-by-eight-foot floor frame, we decided, was too small for a livable tree hut but would make a fine porch. A floor frame as big as eight by 10 feet could be fitted in next to and a little above it. To get still more room, the eight-foot walls could be sloped outward, like the walls of a corncrib, to eight by 12 feet at the eaves.

The hut is in part cantilevered out over empty space; and the beams which support the entire weight had to be run at awkward angles determined by the available points of support on the branches.

Continuous ingenuity was required to combine odd-angled sills, joists, rafters and miscellaneous framing members into a rigid structure. Three casement windows, two halves of a double-hung window which could be mounted on hinges and used as casements, and a French door were contributed by neighbors.

We decided on rough boards-and-batten sides, of native pine, as an inexpensive way to get a weather-tight hut, and one which wouldn't look too prettified up in a tree. The battens were shaped with a power saw; all the rest of the tree-hut construction was completed with ordinary hand tools. A colorless wood preservative containing an insect poison and fungicide was used without

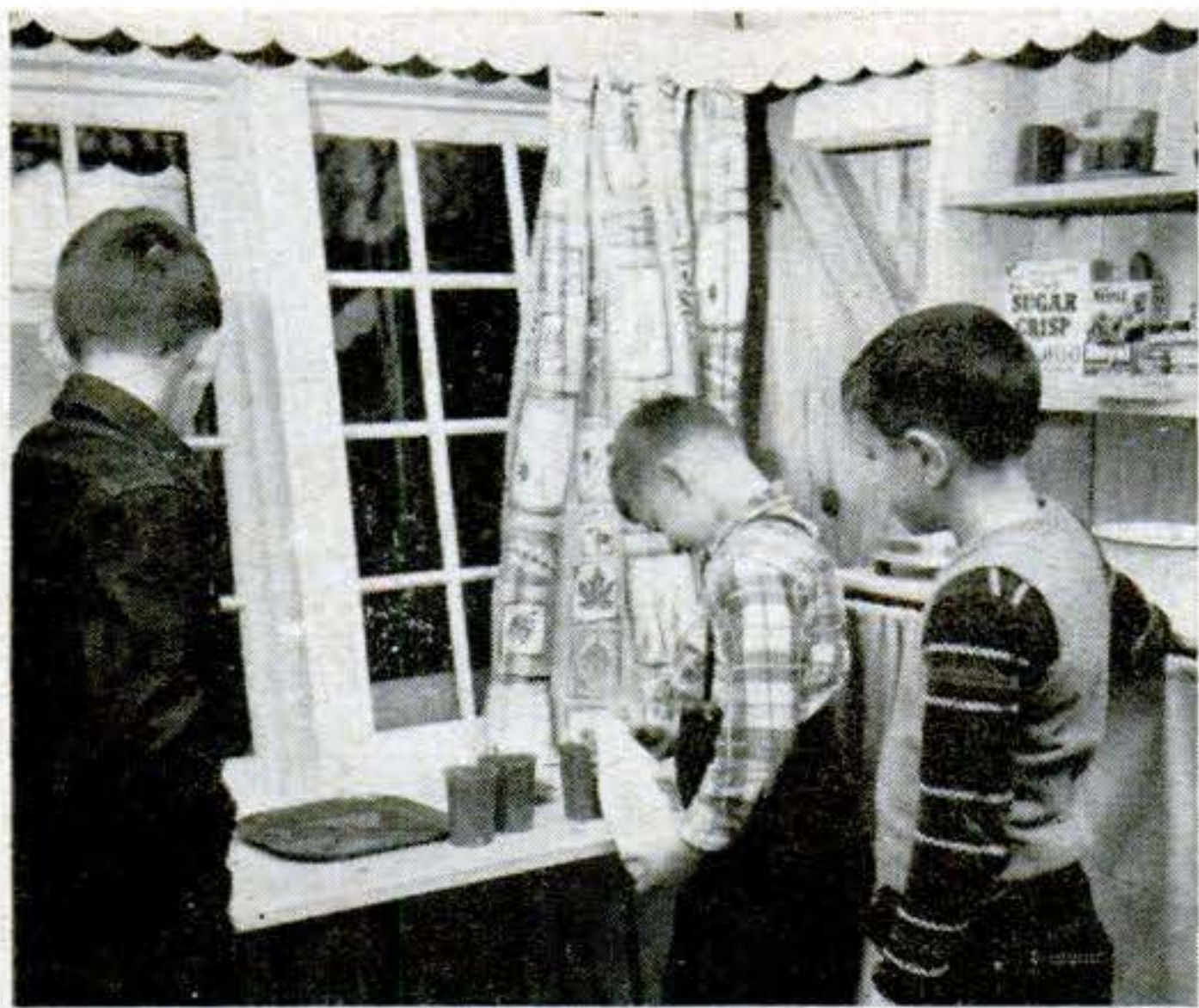

COOKING AND EATING facilities are concentrated in this corner, both to save space and to make it easier to keep things tidy. Lots of shelves is another secret of neatness.



A CHECKER TABLE and the under-window dining and work surface both fold down and out of the way to make room for active games. Sloping walls give a feeling of roominess.



SLEEPING ALL ALONE in a tree house, with the wind sighing and boughs groaning softly in the dark, is pretty spooky for a seven-year-old—but twin bunks take care of that.

paint or stain on all exposed wood surfaces. Fir was used for the flooring and bonded half-lap roofing paper over pine boards completed the external shell.

We had wondered from the beginning how much weight the branches would carry in a high wind, and had come up with no feasible way to test or estimate the maximum permissible load. All we could do was add as many safety features as possible. The branches supporting the tree hut began to sag a bit when the hut was half built, so we suspended them by means of half-inch steel cables and turnbuckles from the upper branches of the same tree. The tree hut continues to sway in the wind, but it now sways with rather than against the cable-linked system of branches. Once a year or so, we expect to make a safety inspection. By readjusting the turnbuckles, we'll be able to re-level the floor and compensate for tree growth.

When *you* build *your* tree hut, the problems you face will no doubt be different. The particular solutions we found are unlikely to fit your tree. But our experience illustrates the importance of keeping building plans flexible so that you can meet new problems as they arise.

Set-Back Upper Bunk Gives More Room

Efficient planning of the interior space available was our next concern. Jeremy wanted a double-decker bunk, and got it. The outward-slanting walls made it possible to set back the upper bunk, so that the lower one could be used as a seat with lessened risk of banging your head on the upper. Room enough for two foot lockers was left under the lower bunk. Bedspring substitutes were rigged of canvas sewn over sawed-off lengths of discarded water pipe. The eight-foot wall afforded room for full-length bunks plus a 14-inch closet; in addition to holding clothes, it holds the four folding chairs whenever Jeremy wants to strip the room for action. The table and the desk are hinged to drop out of the way.

We were a bit diffident about applying for an electrical connection. But the power-company man had to concede that



A boy with a tree hut is never lonely, and treetop adventures keep the gang out of mischief.

he didn't recall a single rule against supplying electricity to tree huts. Thus Jeremy's dream has come true down to the last detail.

The interior room is big enough so that he can easily cook cocoa on his hot plate and serve it to half a dozen friends on a rainy day. On a sunny day, the porch will accommodate several more.

Though Jeremy is only seven, and the

room only eight by 12 feet at the eaves, we tried to build the interior details as nearly full-size as possible, on the theory that this will be Jeremy's home for a dozen summers to come.

"Going to spend your honeymoon up there?" someone asked Jeremy while construction was under way.

"You think you're kidding?" was Jeremy's dead-pan answer.

END

MAY 1954 97

Mercedes-Benz at right has top-hinged doors. With new fuel-injection 240-hp. engine, the car will hit about 170 m.p.h.



Vaughn Super Sports has a new V-8 with overhead cams, weighs only about 1,500 lb., has steel or plastic body.

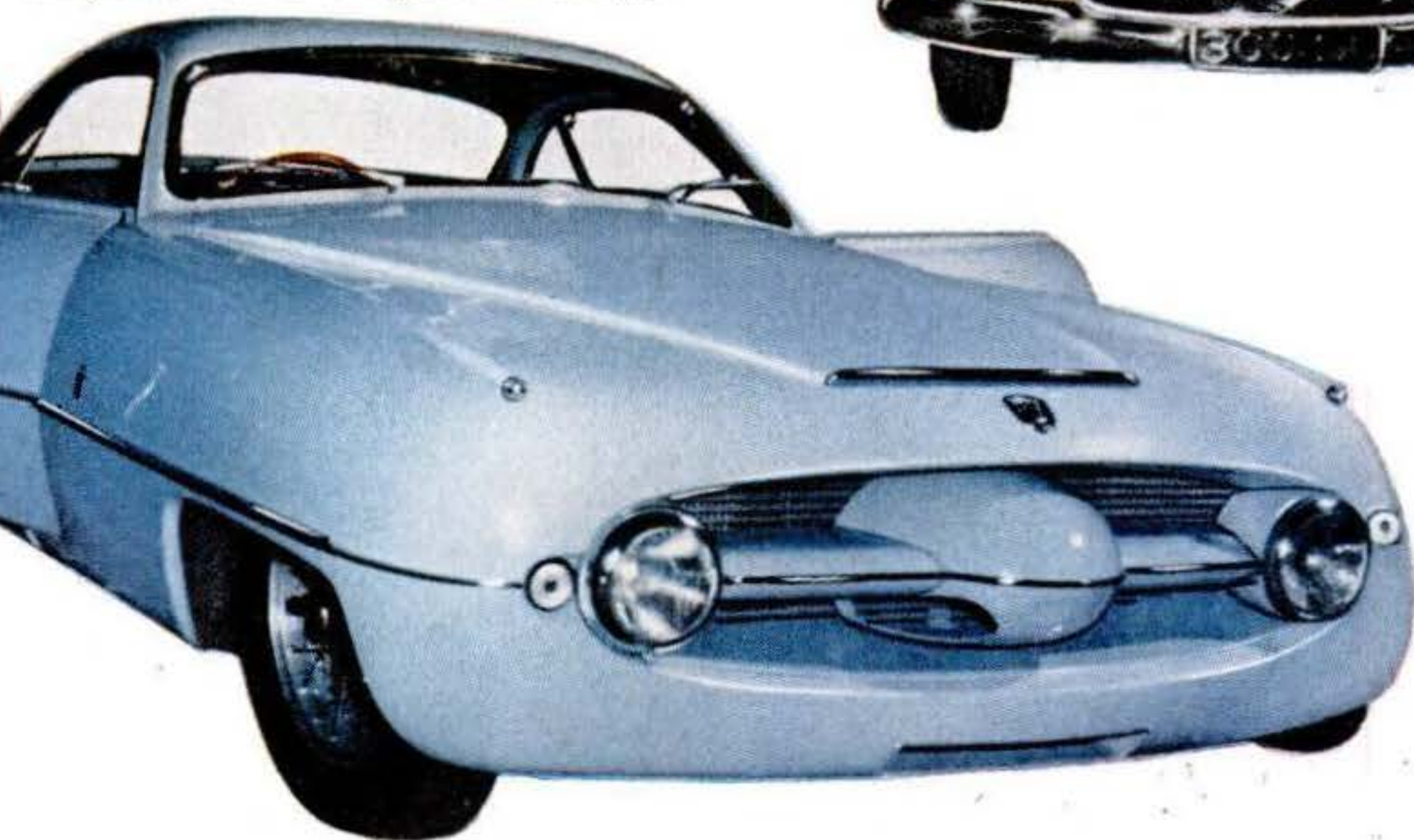

What Is a Sports Car?



Packard gets into act with 275-hp. plastic special that has hit 131 m.p.h.

By Frank Rowsome Jr.

“A CRAMPED, hard-riding vehicle with touchy steering, some aptitude for turns, and a stick shift that needs frequent attention.”

Whoever describes a sports car that way is clearly an unbeliever. But defining a sports car can be tough. Most definitions tell more about the talker than they do about the cars:

“A road car that approaches racing-car performance.”

[Continued on page 262]

98 POPULAR SCIENCE



Rogue is a new plastic-body car with 24-hp. engine in back.

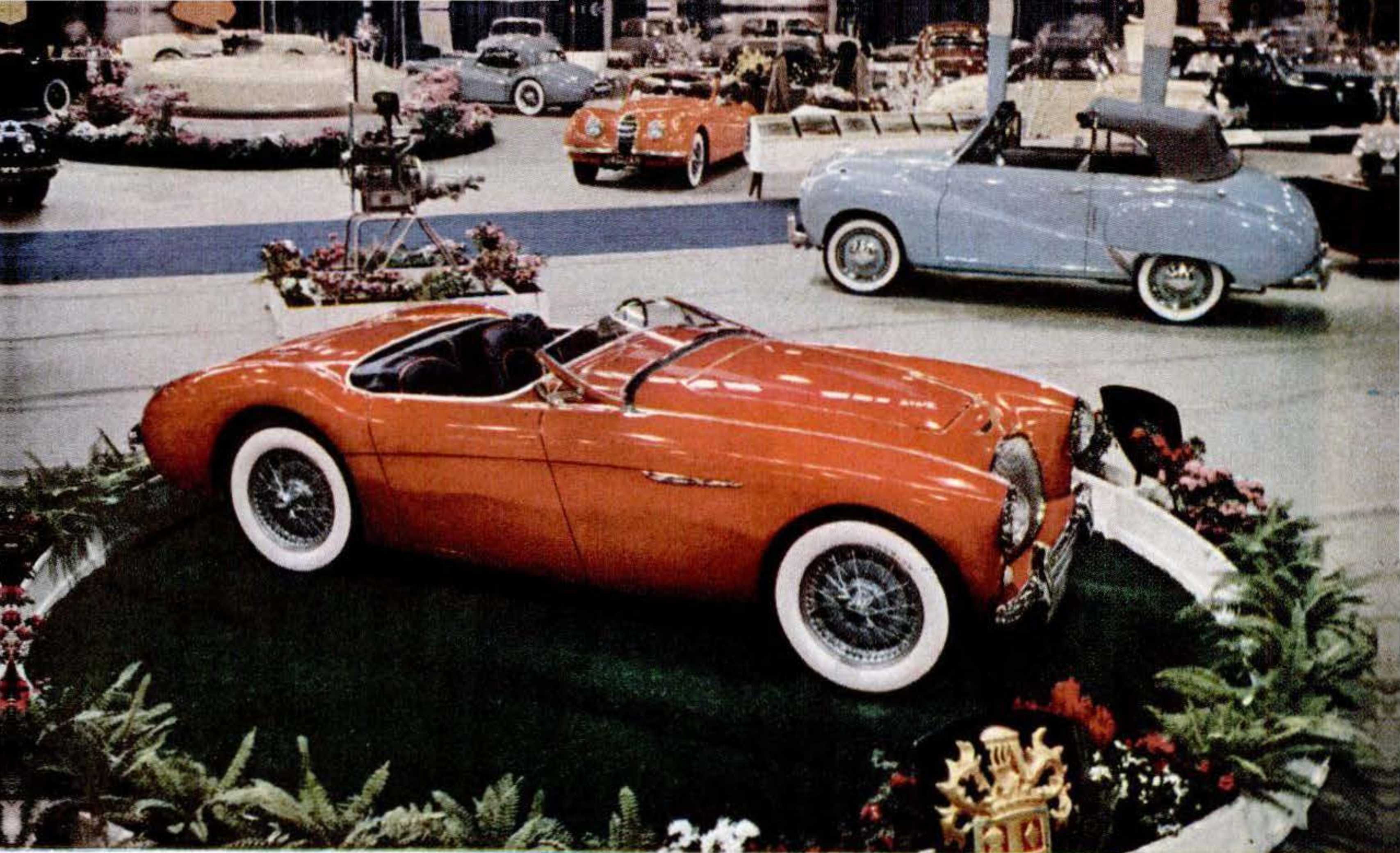

Austin-Healey 100 uses a 90-hp. OHV four-cylinder engine. It gives flashy performance, in part because car weighs 1,200 lb. less than stock U.S. light cars.

Who knows? It's really just a state of mind.

Hudson Italia has a one-of-a-kind Milan body on a 105-inch-wheelbase chassis. Hudson Jet 114-hp. engine drives it. Decision on building for sale is still open.



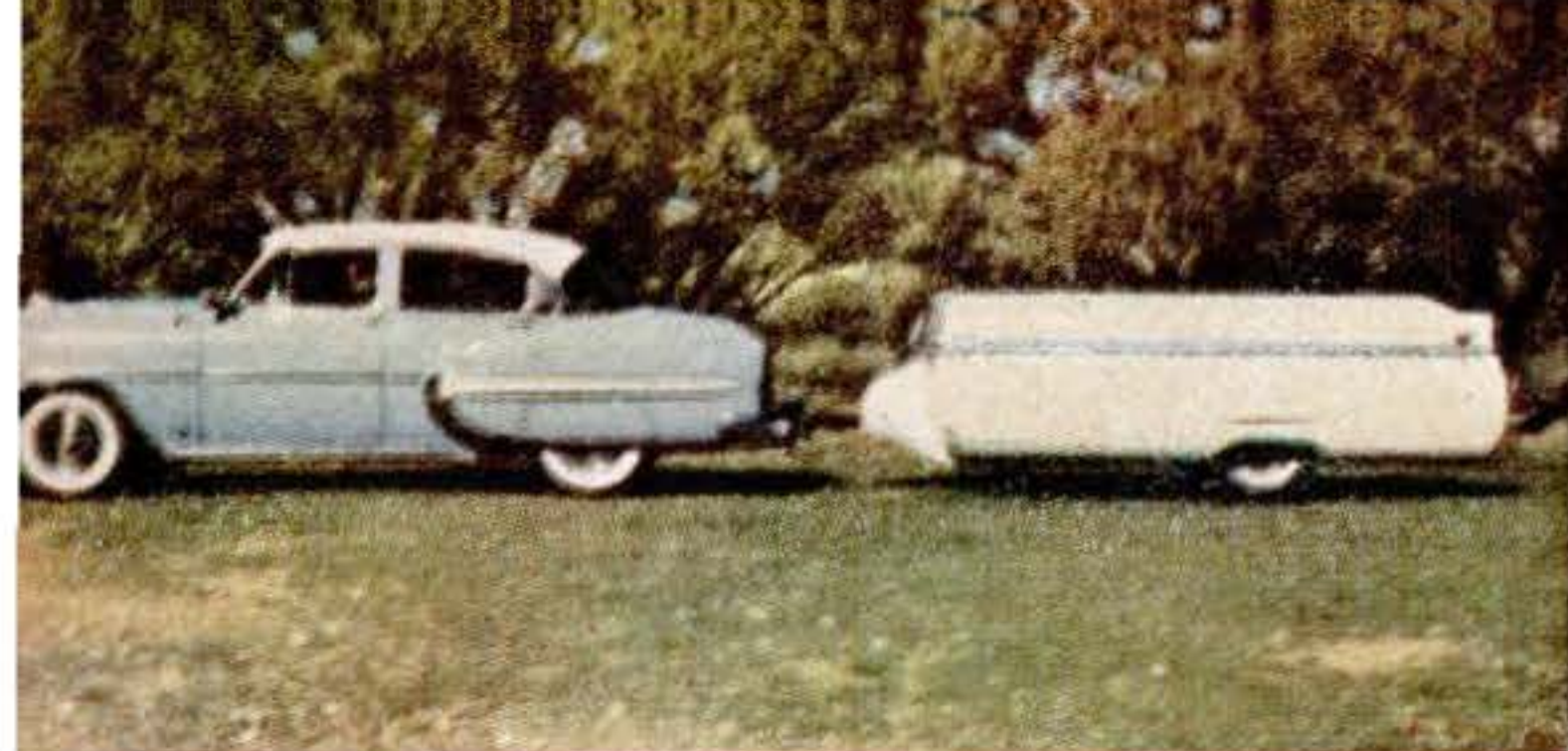

ON THE ROAD, trailer stands four feet high. It is 12 feet long, 82 inches wide.

CRANKING raises the trailer roof to give inside headroom of six feet three inches.

Telescoping Trailer Cranks Up At Night



EXTENSION DRAWER pulls out 39 inches: extra sleeping space for one grownup or two kids.

LARGE WINDOWS in canvas side walls provide interior daylight and cross ventilation.

YOU don't need to haul a full-size house trailer down the highway to enjoy the comforts of home-away-from-home. This sleek new plastic job stands only waist-high for towing but expands to provide full stand-up room as a camping cabin. You just hand-crank the roof up, turning the compact unit into a spacious trailer home with two fixed bunks and storage space.

At 1,100 pounds, about half the weight of a conventional house trailer, it handles easily on the road. The glass-fiber-and-polyester-resin body is said to be dentproof—within reason. The trailer is made by Hille Engineering Corp., Anaheim, Calif., to sell for about \$1,500.

KITCHEN FACILITIES spread across front end of trailer. There's a built-in refrigerator.



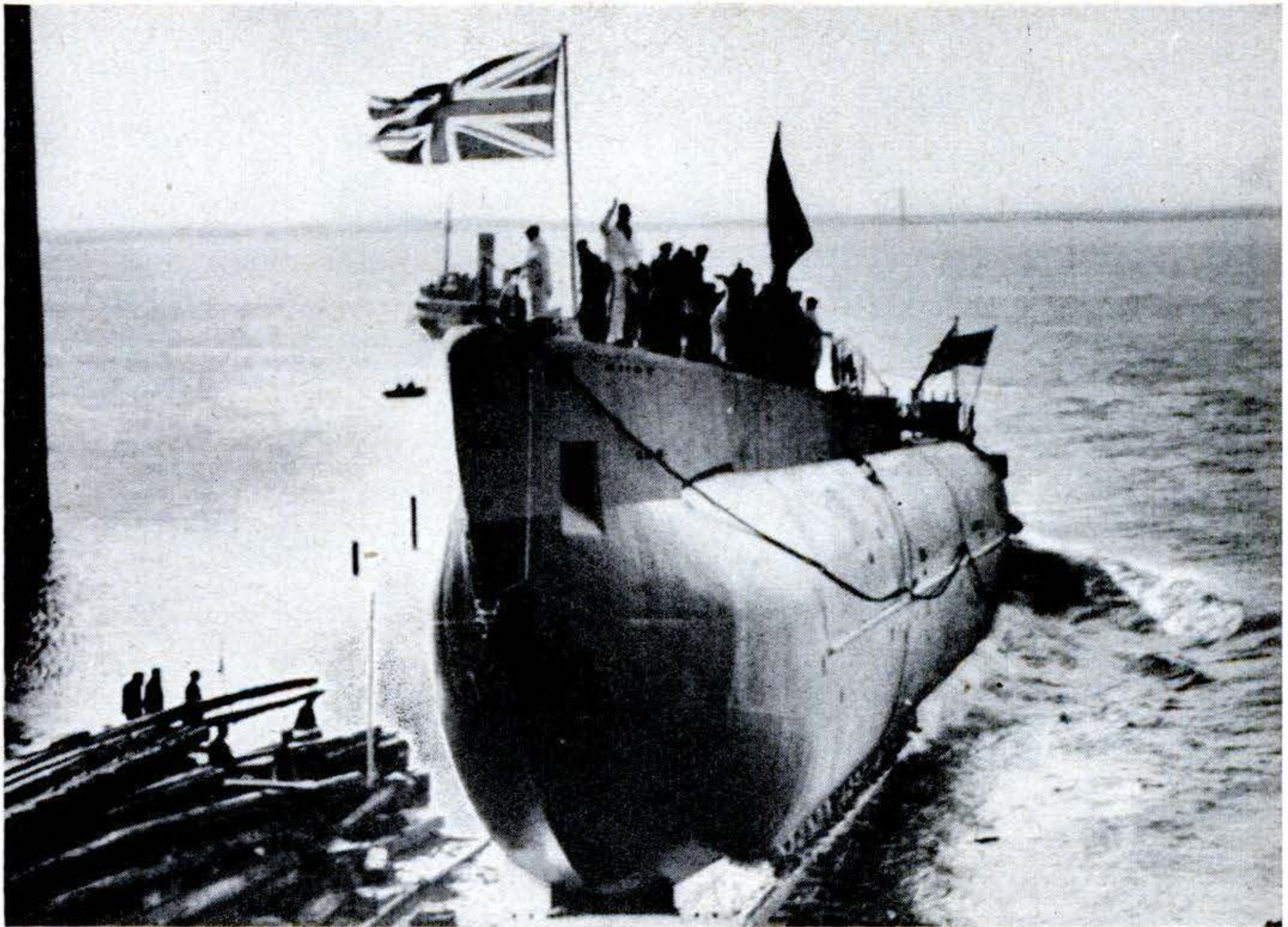

Britain's New Long-Range Submarine Uses Peroxide as Fuel

H.M.S. *Explorer*, the first submarine launched for the Royal Navy since 1948, is powered with hydrogen peroxide. The 225-foot craft was designed for long-range mis-

sions without surfacing. It has a top underwater speed of 23 miles an hour. Hydrogen peroxide has been used by the British as fuel in radio-controlled torpedoes.



Gadgets Aid Camera Hunter

SNEAK boat enables Richard Borden of Boston to cruise among unsuspecting waterfowl as he photographs them for wildlife movie shorts that he sells as television programs. He steers the shallow, electric-powered boat with his feet. Once an otter mistook it for a log and jumped in. At right he is shown with his camera-gun, a movie camera mounted on a rifle stock, that he uses to get tough action shots.

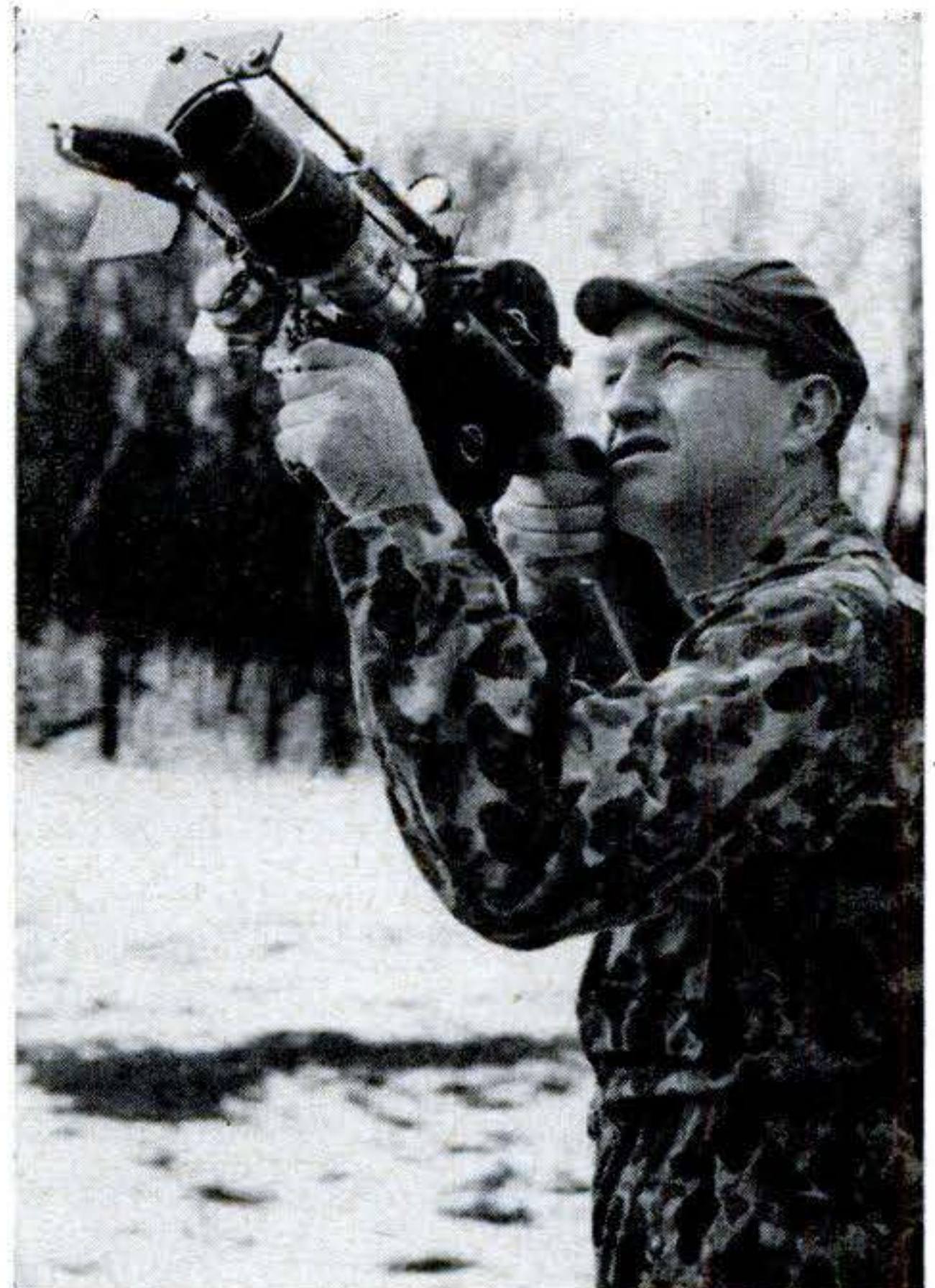

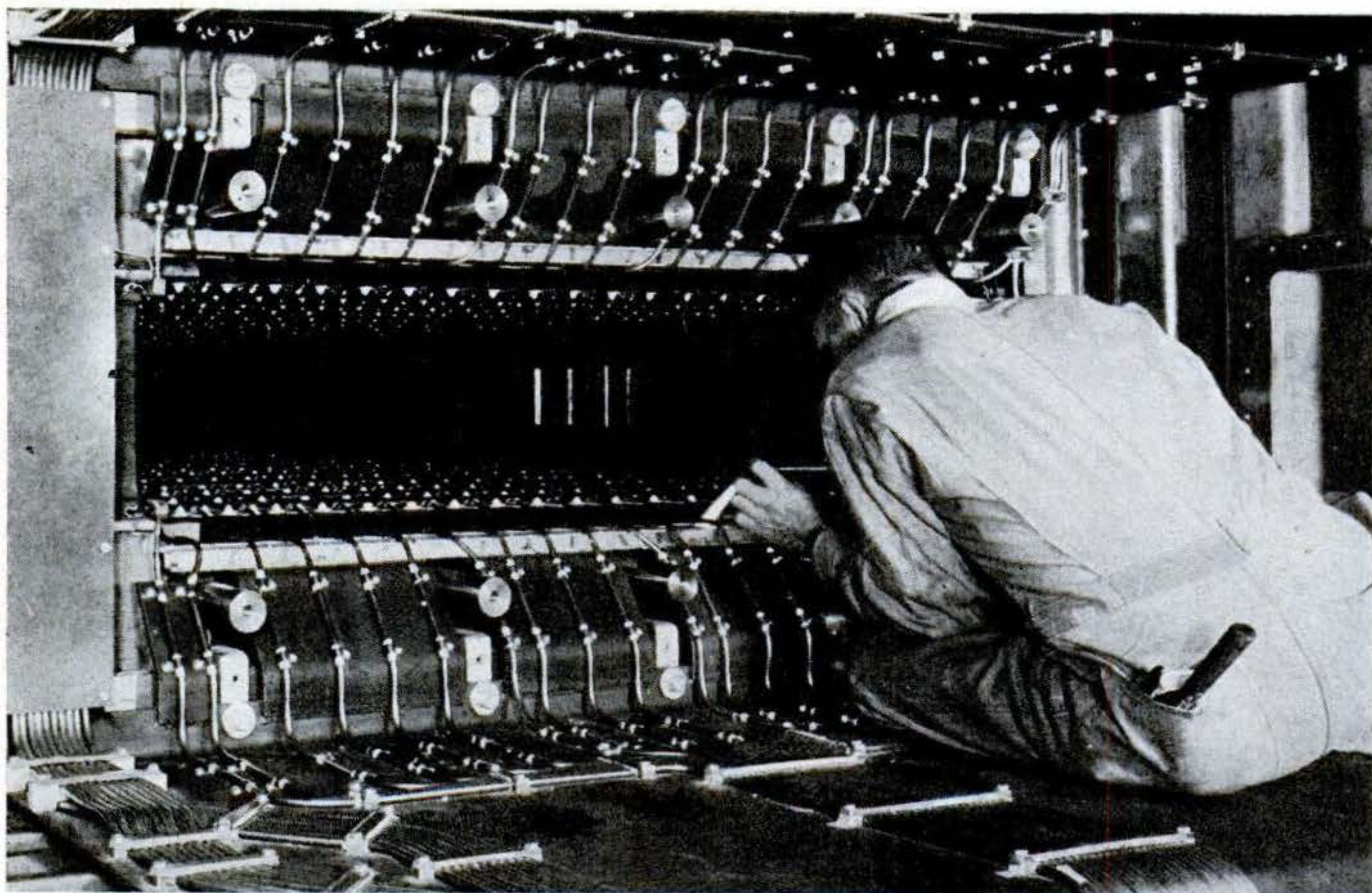

DOWN THAT HOLE will race atom-smashing bullets at 184,400 miles per second. Top and

bottom of raceway are poles of the magnet. In use, this part of the bevatron is a vacuum.

They're socking atoms harder with this

10,000-Ton Cracker for Invisible Nuts

California scientists' new \$9,500,000 tool is pitted against the forces that make the A-bombs powerful.

By Darrell Huff

IN A hollow in a California hillside a large but unpretentious building covers one of the biggest and strangest of all machines. It is 135 feet across, cost \$9,500,000 and contains more than 9,500 tons of iron, 225 miles of wire and 2,400 vacuum tubes. Its 31 vacuum pumps evacuate the equivalent of a seven-room house. What it makes cannot be seen or felt, let alone

sold. This is the bevatron, just completed, the most powerful atom-smasher yet built.

All this money and effort have been spent just to take atoms apart, partly out of plain curiosity and partly because atom-smashing has proved useful—already it has led to better steel, improved cancer treatments, deadlier weapons and new sources of power.

Atoms are all around us. They make up everything in the universe from grass to

stars, but are far too small to be seen individually—it takes 20,000,000 just to span the head of a pin.

Smashing atoms is expensive and complicated because the forces holding the atom together are extremely powerful (that's why an atomic bomb is so destructive). It's as though the atom were a hard nut—so hard that a 10,000-ton cracker would be needed to break the shell.

The strong holding forces can be broken if the atom is hit hard enough by parts of other atoms. Very fast-moving electrons—the lightweight particles that make up most of an atom's volume—can do the job, but naturally the much heavier atomic core can deliver a stronger blow. The core is unbelievably compact; it is so small that if the whole atom were as big as a convention hall, the core would be the size of a fly. Actually, the whole atom is but 1/250,000,000 inch across.

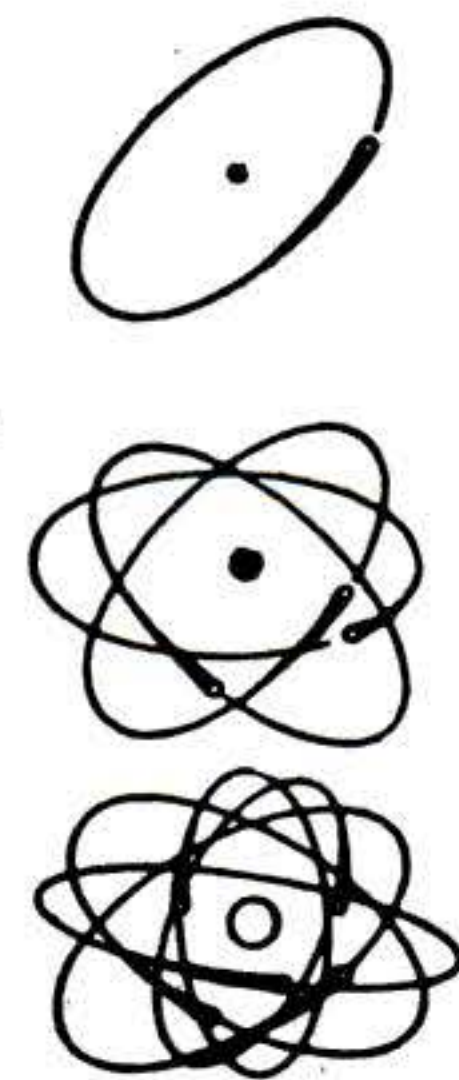

To give atomic parts the high energy that will speed them through a vacuum chamber and strike

the target hard enough to break the target atoms, electrical fields are used. The atomic bullets are electrically charged, and will therefore be attracted by unlike electrical charges and repelled by like charges. When a bullet of one electron charge "falls" through one volt, it gains one electron-volt of energy—just as a one-

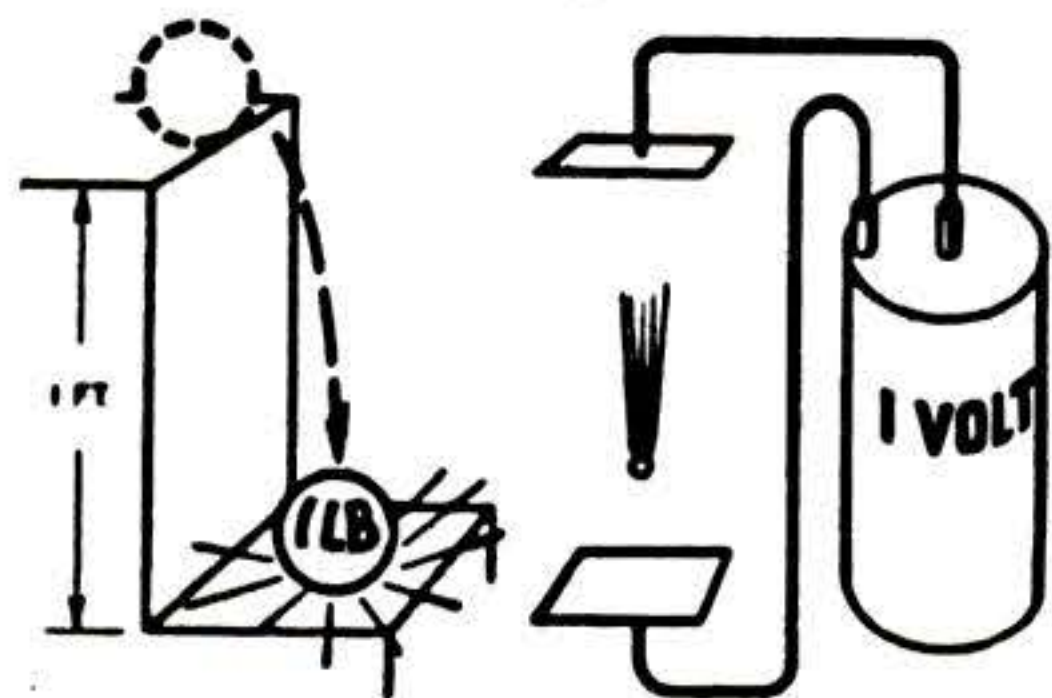

pound weight falling one foot gains one foot-pound of energy.

One electron-volt won't smash any atoms. The first cyclotron generated 80,000 electron-volts. The bevatron will

do better than six *billion* electron-volts. It is so powerful, in fact, that its bullets get a head start in smaller machines and do not enter the bevatron itself until they already have 10 million electron-volts of energy.

To see what happens inside the bevatron imagine a ball tied to a pole. A batter swats the ball, increasing its speed and energy each time it passes by. The beva-

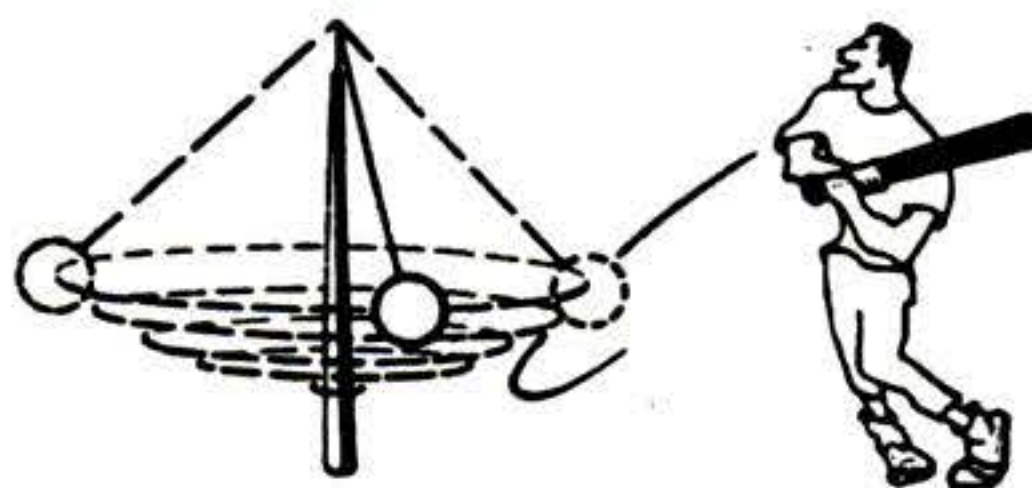

tron's bullets, like the ball, are kept in a circular path, but by a magnet instead of string. This magnet is probably the largest in the world; it can exert a pull of 17,400 tons.

The bevatron's "batter" is an electrode, which paddles the bullets with an electrical wallop once each time around the circle. The wallops are powerful and increasingly fast, finally coming 2,500,000 times a second. It takes only 1.85 seconds for the bullets to reach peak energy and

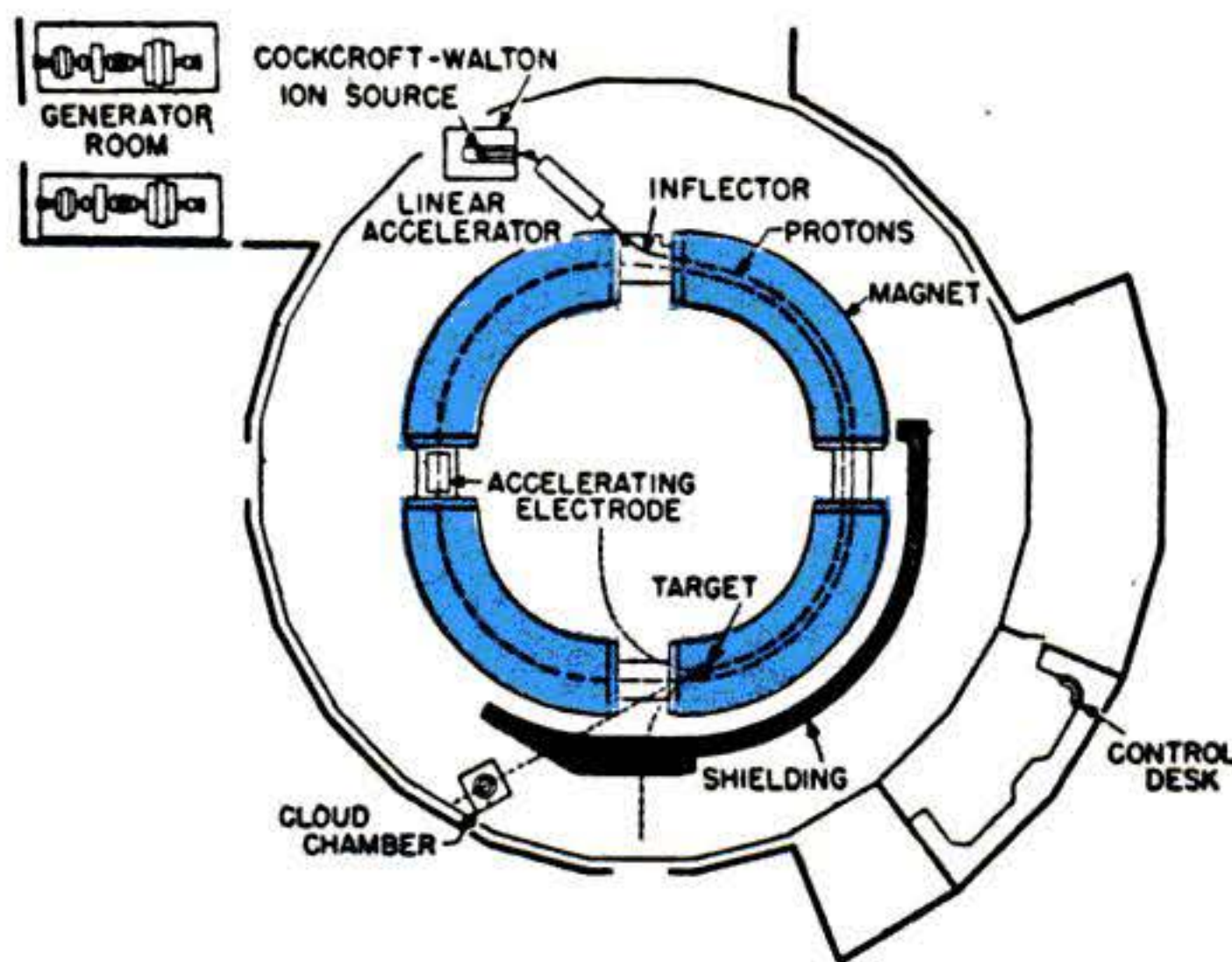

smash into the target—but in that time they have traveled 300,000 miles and attained a speed of 184,400 miles per *second*. That is 99.2 percent of the velocity of light, so fast that the bullets' increased weight—predicted by the Theory of Relativity—must be allowed for.

To see more of this mammoth among atom-smashers, please turn the page.



HAPPY SMILES mark successful tests of newest, most powerful atom-smasher. In fore-

ground is Dr. Ernest O. Lawrence, director of University of California Radiation Lab.

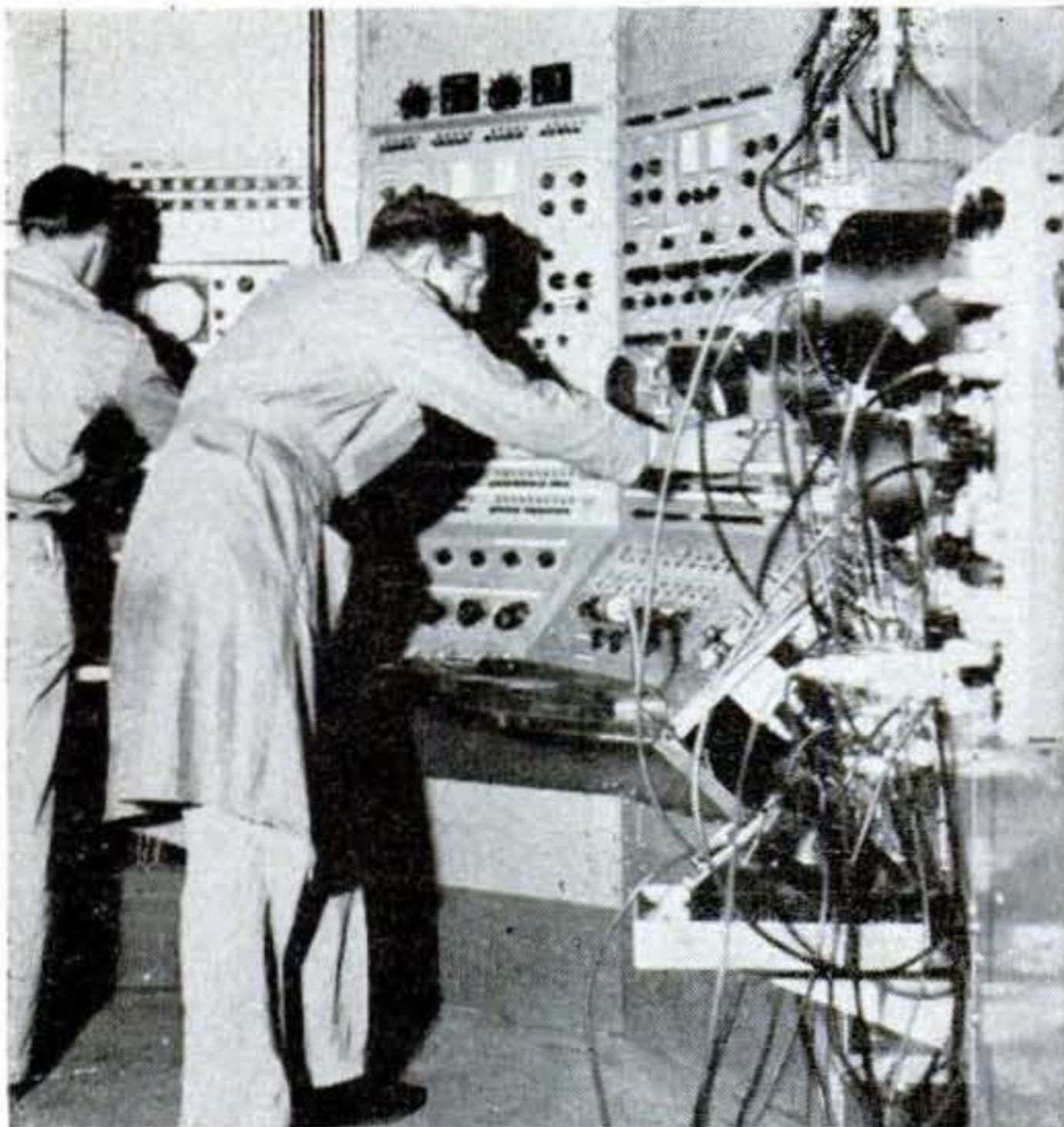

NERVE CENTER FOR A GIANT. Push buttons and a maze of wires here control the entire bevatron—from the huge generators that supply 100,000 kilowatts to circuits that can switch as fast as 2,500,000 times a second.

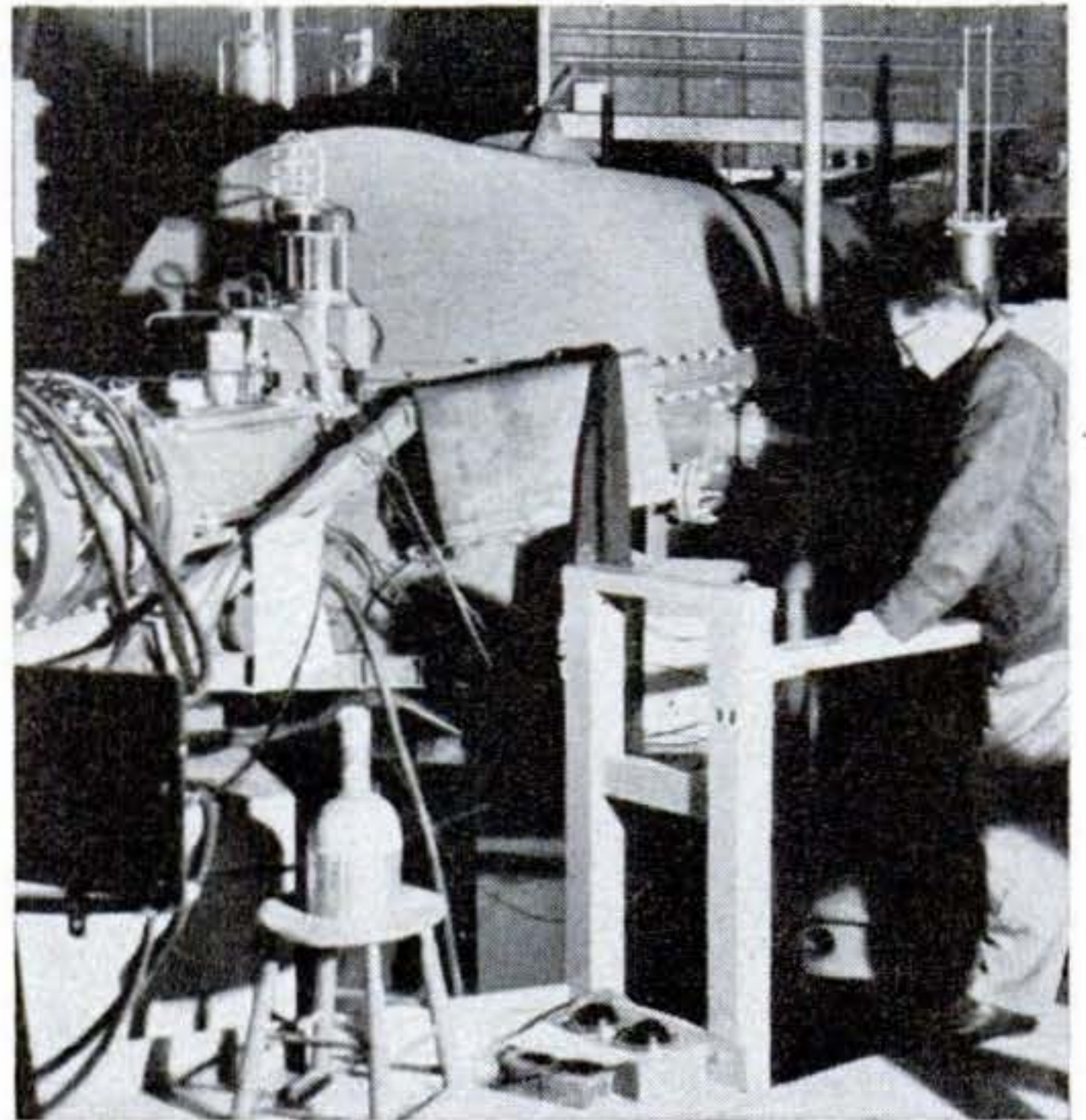

LITTLE ATOM-SMASHERS feed the mammoth bevatron. The tank above is a linear accelerator, one of two devices that give atomic bullets a running start for their 300,000-mile trip that follows in the big machine.

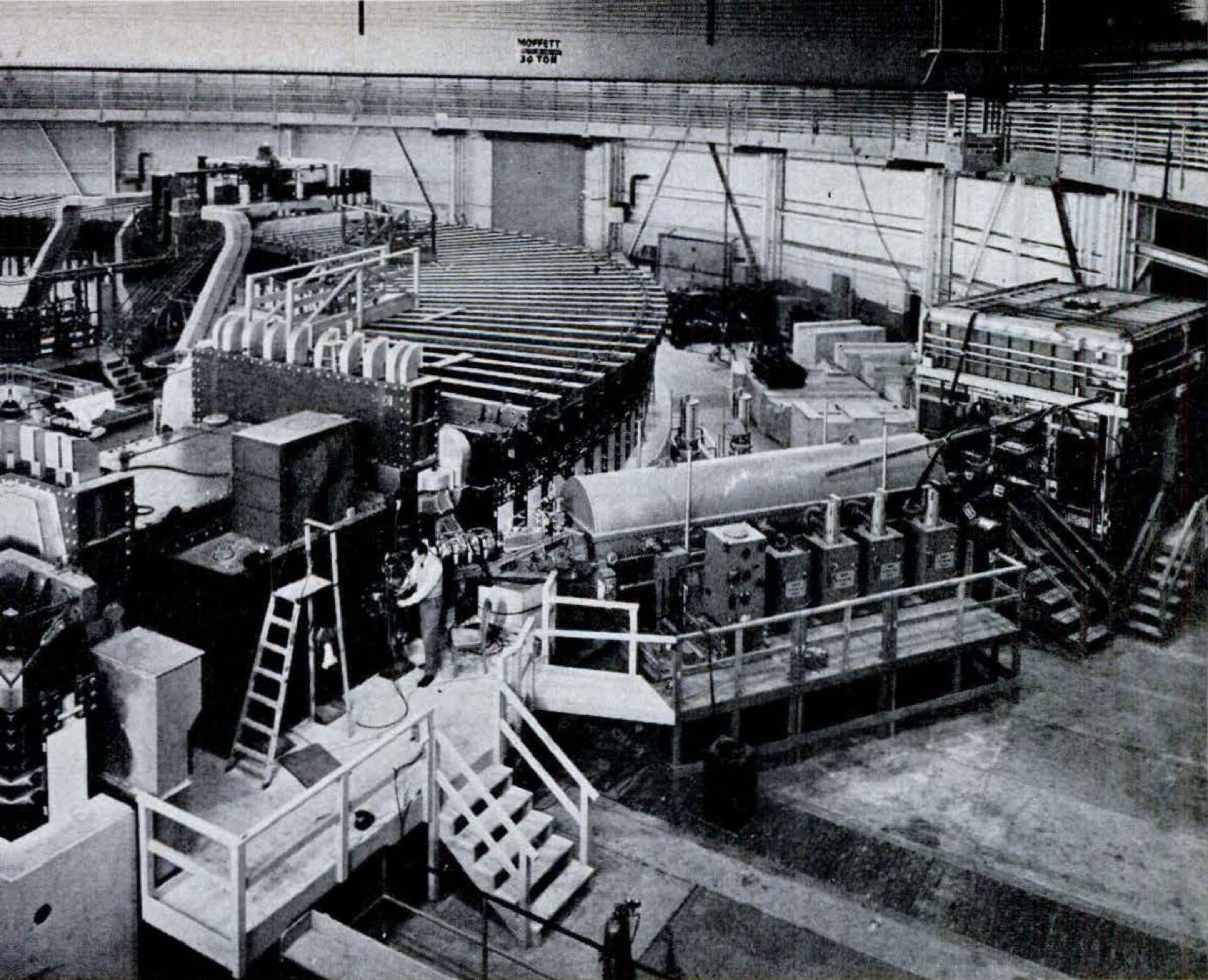

IT TAKES THIS MAMMOTH to smash atoms, which are so small 20,000,000 just span a

pinhead. The tank and box at right center above are bevatron's feeder atom-smashers.



TO CATCH ATOMIC FRAGMENTS broken off in bevatron, world's biggest cloud chamber was built. It is a glass-enclosed box filled with alcohol vapor, which condenses to form a trail along the paths of atomic particles.

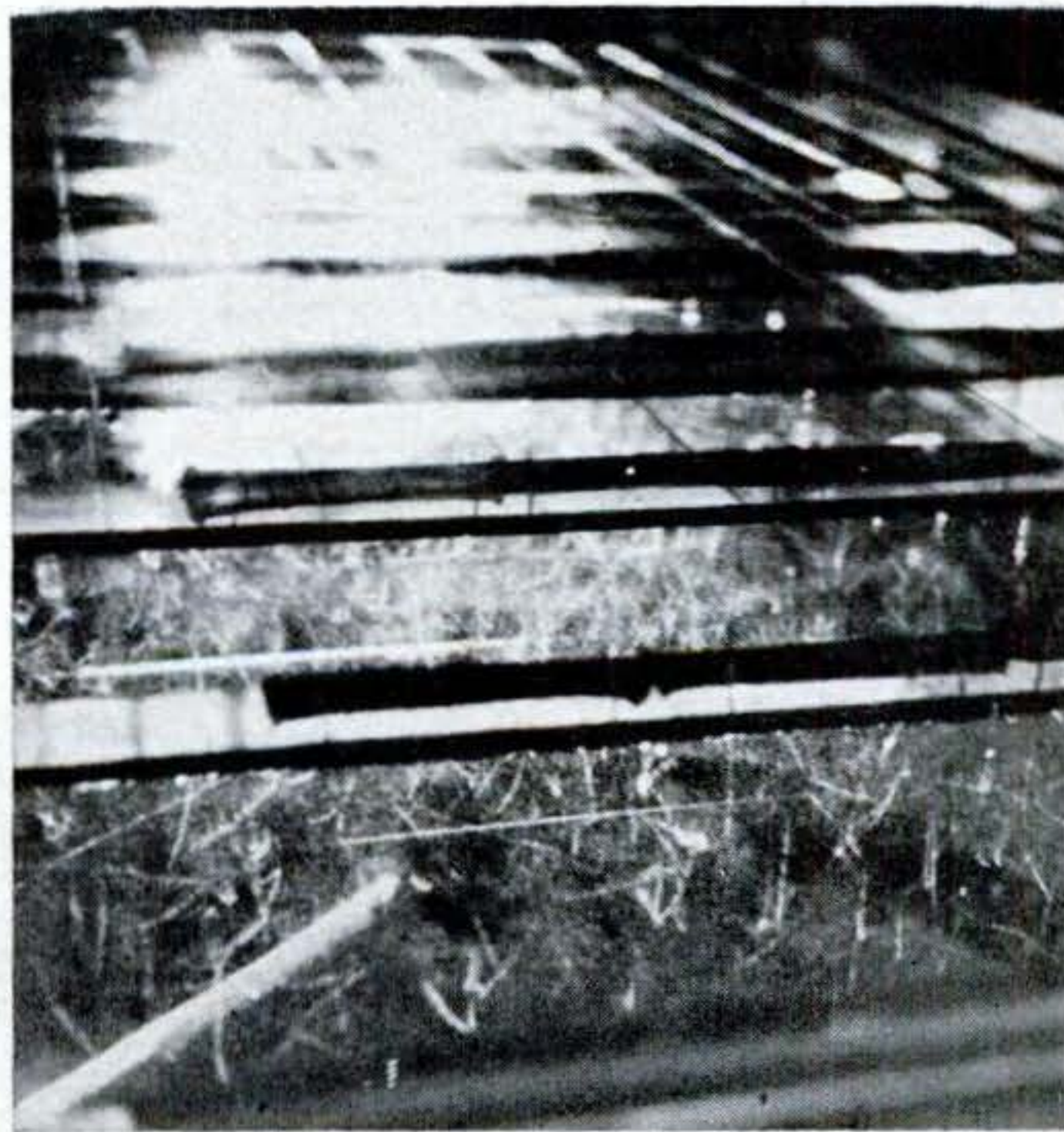

ATOMIC FIREWORKS inside cloud chamber are, in this photo, all caused by cosmic rays. Bevatron will make horizontal tracks like the unusual cosmic-ray streak in foreground. Most cosmic rays leave vertical tracks.

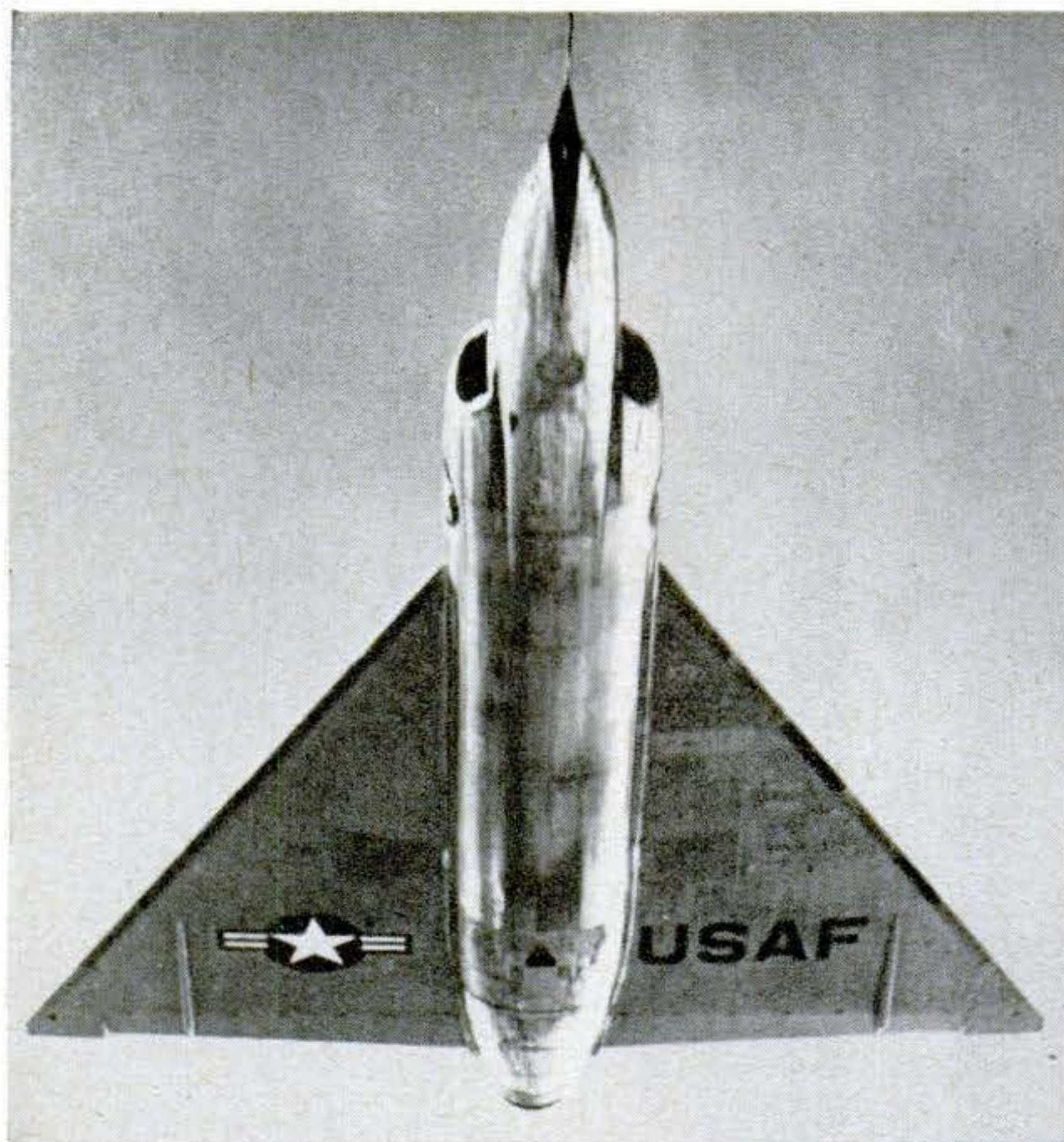

Air Force Tries Out Bat-Shaped Interceptor

IF YOU look straight up and see a mammoth bat streaking by overhead, it may be the Air Force's newest supersonic jet—the F-102 interceptor (left). Convair-built, the all-weather delta-wing plane is now undergoing exhaustive flight tests at Edwards Air Force Base in California.

French Sailplane Carries Its Tails on the Wing

THE sawed-off fuselage of the sailplane below can be shortened still more for road travel by disassembling the nose section. A French glider, the Fauvel AV 36 is said to have skimmed 285 miles in straight flight, averaging 45 miles an hour.

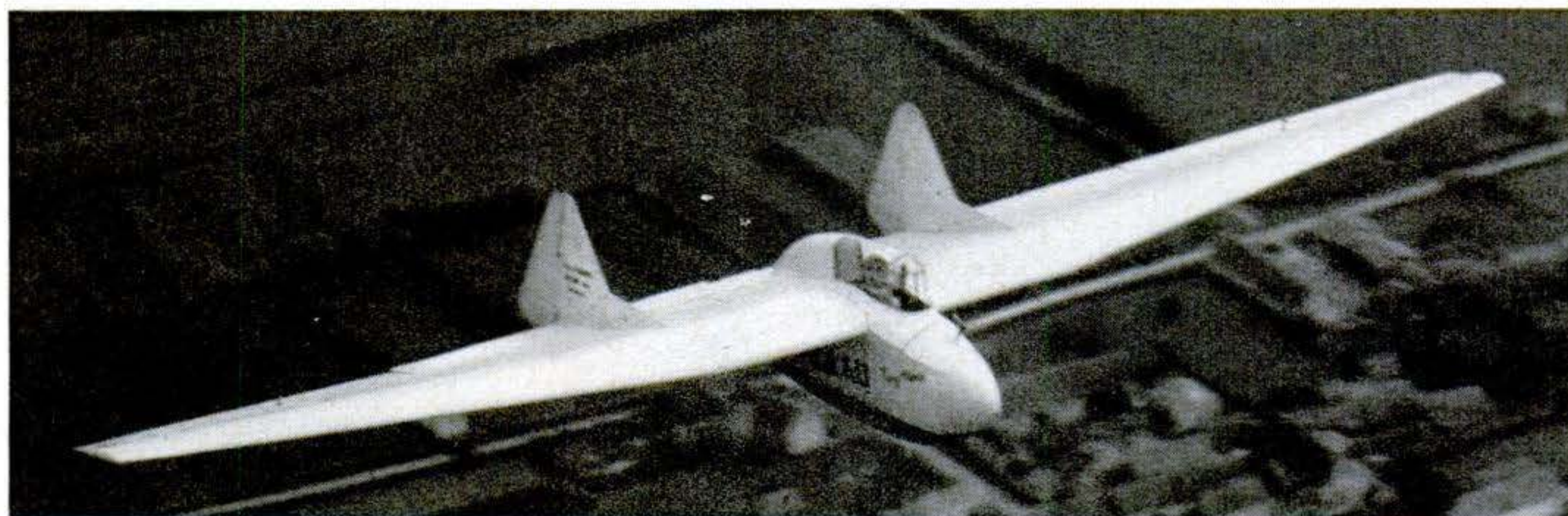

Flying Model Tests Helicopter

IGOR B. BENSON of Raleigh, N.C., built this model to test his helicopter design before building full-scale. The remote-control model is powered by compressed air. A full-size twin is now ready for tougher tests.



Giant Cigarette Tests Planes

SWIRLING smoke hunts air leaks in pressure cockpits at a Chance Vought plant. A flexible tube is packed with tobacco, the giant cigarette is lit and an air hose, serving as lungs, puffs smoke along seams.

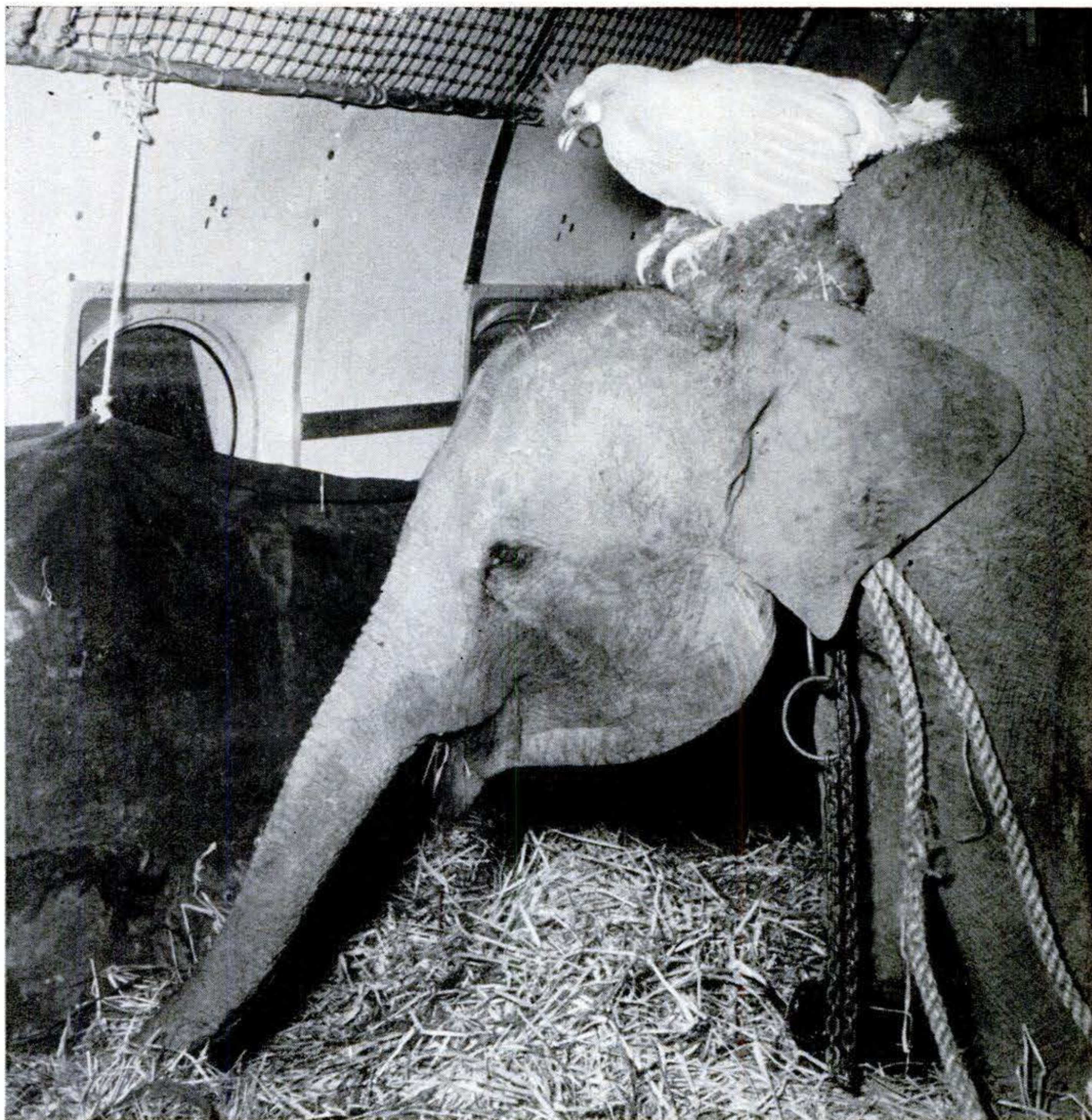

Picture Puzzle: Why Does a Hen Sit on an Elephant's Head?

ANSWER: That hen sitting on Jumbo's head traveled with him in a plane from Siam to New York to keep him from having the jit-

ters. Royal Dutch Airlines has found that animals—like humans—keep calmer in exciting situations if they are not alone.

Jeep Stretched to Haul More

BY CUTTING his Jeep in two and adding to the drive shaft, Luther Oliver of Boone, N.C., stretched it 4½ feet. Then he built it into a full-size pickup with a Jeep's zing for humping over mountain roads.





WILBUR SHAW DRIVES

'Europe's Model A'

The Volkswagen looks like a June bug but works like a mule, goes 30 miles on a gallon and has become one of the world's most popular cars.

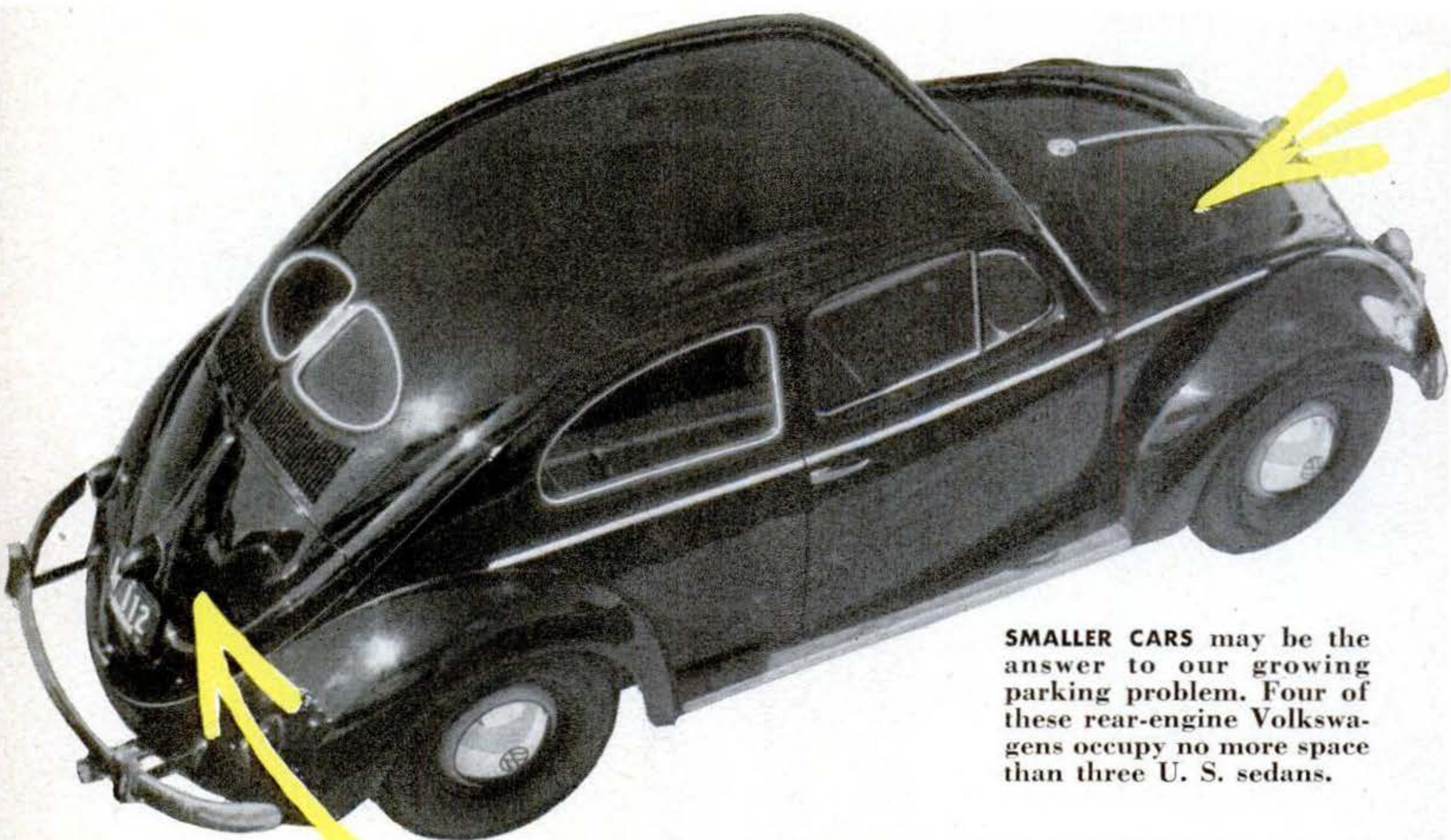

SMALLER CARS may be the answer to our growing parking problem. Four of these rear-engine Volkswagens occupy no more space than three U. S. sedans.

THE VOLKSWAGEN'S ENGINE looks like a toy. But don't smirk—this little aircraft-type power plant develops one hp. for each three-and-a-fraction pounds of engine weight. No U. S. production car will match that. The gearbox has a ratio of 3.6:1 in first gear, 2.07 in second, 1.25 in third and .8 in fourth. The over-all ratio at the rear axle in the fourth gear—"overdrive" to Europeans—is 4.43:1.

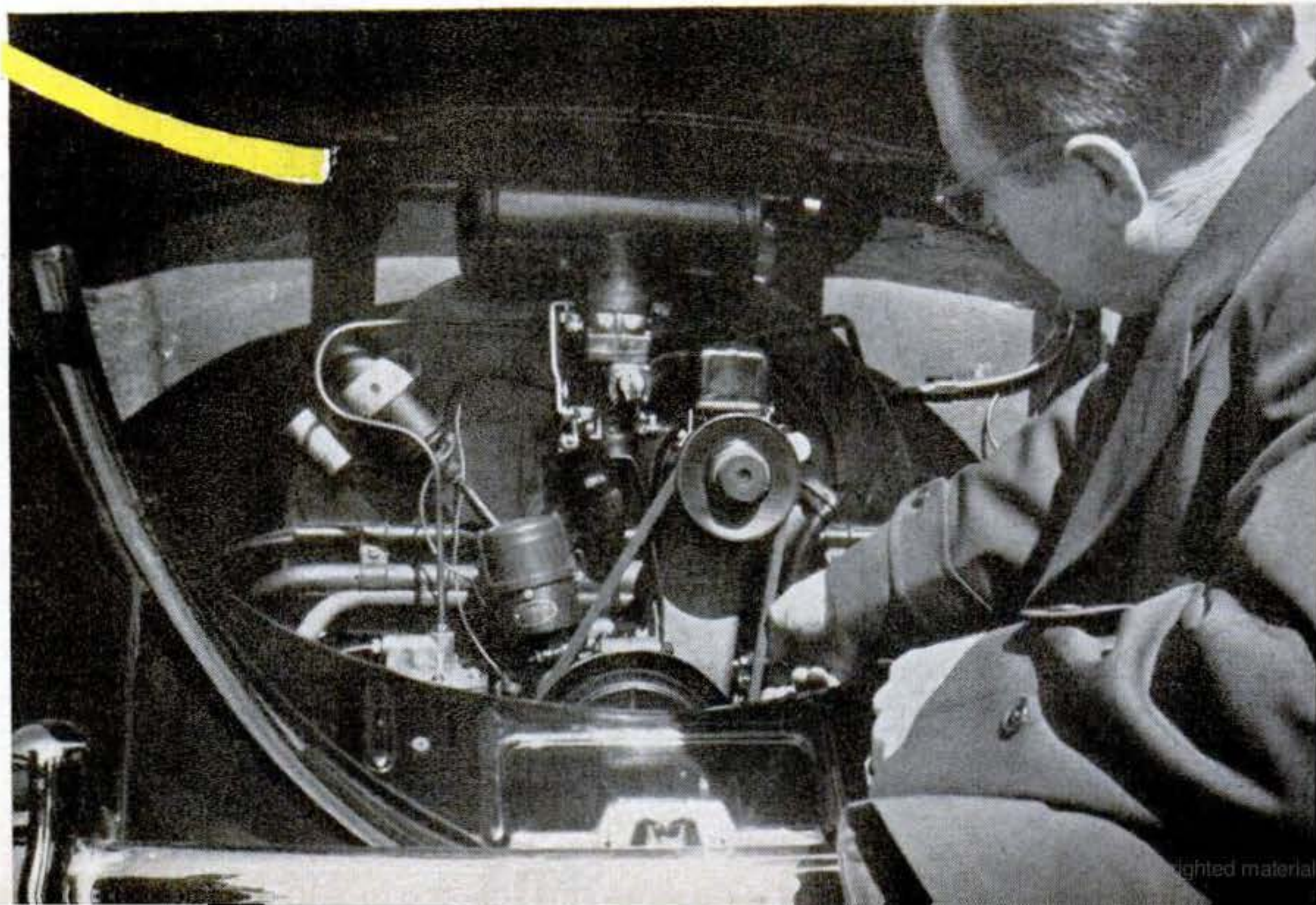

THE PLACE where the engine goes in a U.S. car becomes a compartment for luggage and the fuel tank in the German midget. The tank holds 10½ gallons—enough for 300 miles. There's another small luggage compartment behind the rear seat.

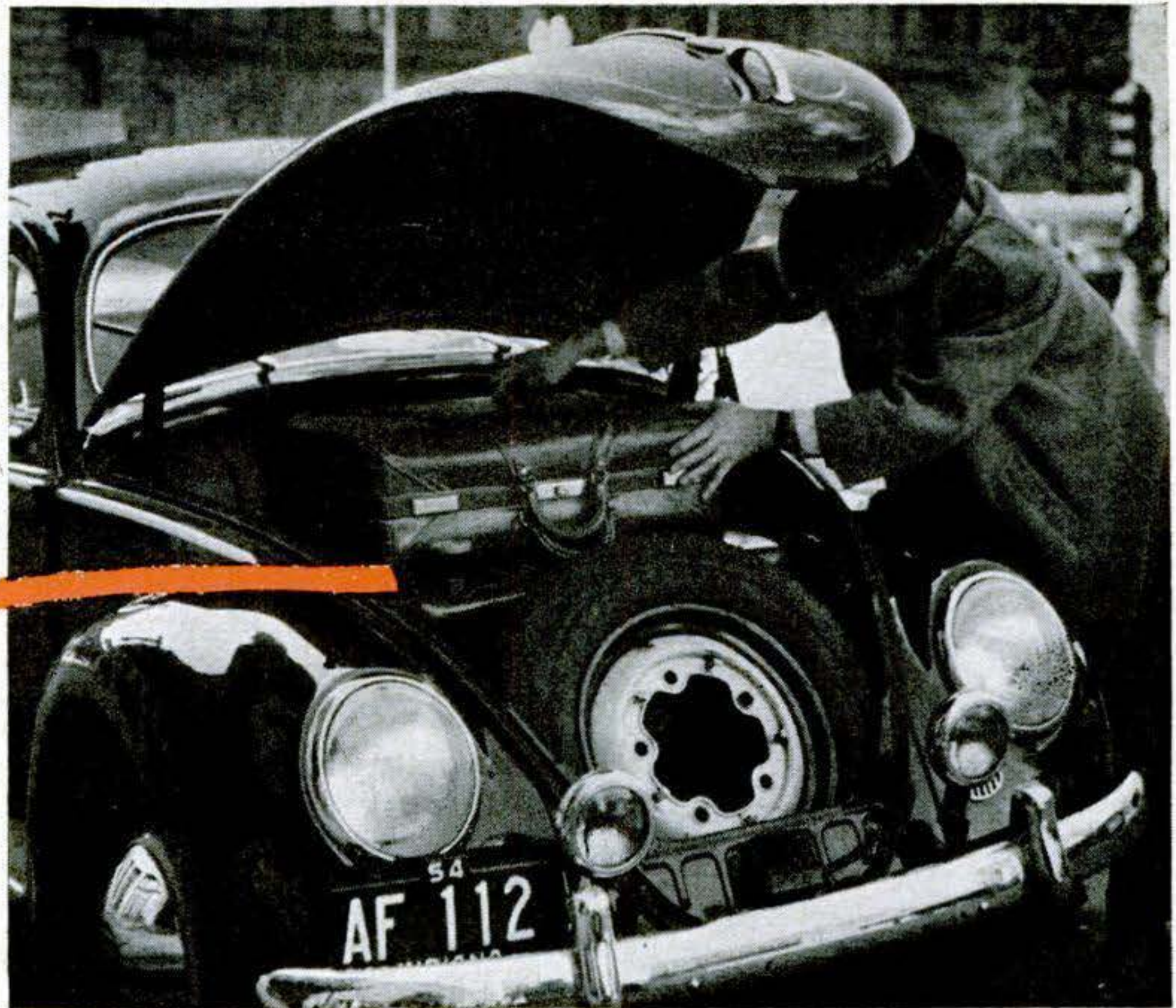

By Wilbur Shaw

President,
Indianapolis Motor Speedway

ON NORTH CAPITOL AVENUE, in my home town, there is an automobile agency that sells what may well be the homeliest car in the world—by U. S. standards, that is. After all, to a Hottentot, no woman is beautiful unless she's got a ring in her nose.

This particular car is not only homely. It's also regarded as one of the world's best, if we are to judge by the number sold each year.

It's well made. It's sure-footed. It runs almost indefinitely without repair. It rides well. And it gets twice as many miles to the gallon as most U. S. cars.

By now you probably know what car I'm talking about. It's the Volkswagen (pronounced "Folks-vahgun"). They don't sell very many copies of this vest-pocket vehicle west of New York's Times Square, and so my Report from the Driver's Seat on this German product will be in the nature of a clinical report.

The Volkswagen ("People's Carriage," in literal translation) hasn't changed much since Dr. Ferdinand Porsche, the brilliant German engineer, designed it clear back before World War II. It's about the same vehicle that Adolf Hitler was fond of calling the People's Car. As

everybody knows, it never became the People's Car. Its engine went to war in the German equivalent of the U. S. jeep, and GIs ran across it all the way from Tobruk to the Elbe.

It did okay, too. That little air-cooled power plant seldom stuttered, whether in Africa's heat or Russia's cold.

After the war, the rubble was swept out of the bombed Volkswagen factory in Wolfsburg, in the British zone of Free Germany, and production was begun again. This time it really was a civilian car.

But it was more than that. It was a symbol of West Germany's industrial recovery. And it was cheap transportation. It turned out to be just what the doctor ordered for Europe, where money was short and petrol was high.

Production: 250,000 a Year

The Volkswagen has been called Europe's Model T. That's an injustice to the car. It's more properly a Model A, mit sauerkraut. Today, after eight years of steadily mounting production, the factory is turning out a quarter of a million cars a year.

To anyone in Kansas City, Kalamazoo

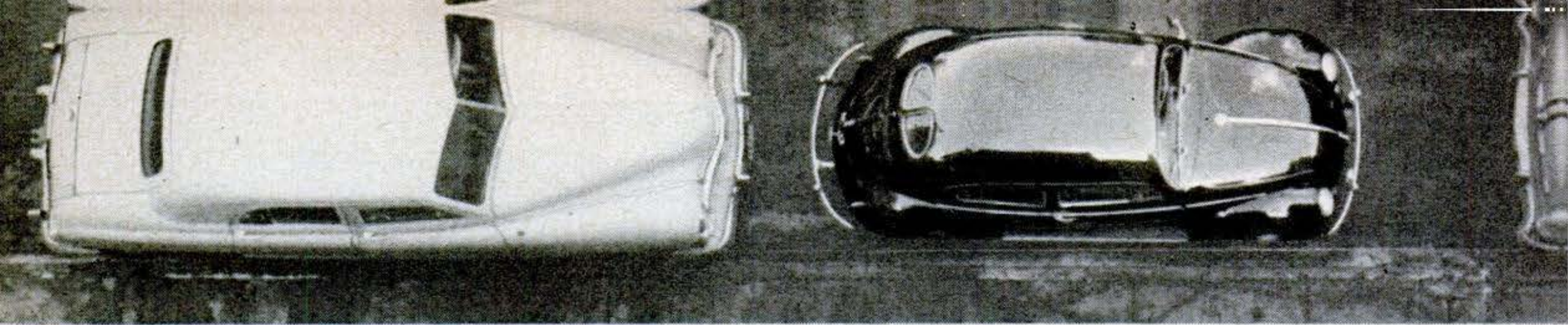

The car can be snugged up against the curb in half the time and three-fourths the space the

or Keokuk, that's a puzzle. Look at the car by a U. S. yardstick: it has less horsepower than a stock American motorcycle. Its top speed is slightly more than 60 miles an hour. It rides pretty well, but does pitch on rough roads due to its short wheelbase. It will seat four, but they need a shoehorn to get in. It costs almost \$1,500 shipside, New York.

Finally . . . well, *look* at it.

When I called Auto Imports, Ltd., in Indianapolis to pick up a Volkswagen loaned me by John Kissling, an insurance man, I asked one of the salesmen what kind of people bought this kind of car.

Not Made for Looks

"I mean," I amplified, trying to get my point across without hurting anybody's feelings, and failing nobly, "a car that looks like this."

He nodded. "It certainly isn't much for looks," he conceded. "But it wasn't made for looks. It's just good, cheap transportation." Then, as an afterthought: "Suppose you drive it and decide for yourself why anybody would buy it."

THE KNOB on top of the floor tunnel turns the heat on and off. The heating system is simple—deflectors duct into the car's interior the air warmed up in cooling the engine. The black box under the right side of the rear seat is the battery. The little car is sprung on transverse torsion bars.

So I drove it. Straight off, I found that comparing it with U. S. cars was plain silly. The Volkswagen wasn't built for this market. The European driver isn't looking for a machine that will burn rubber when the light turns green and will hit 95 going away.

With that in mind, I ran an acceleration on the car. The speedometer was calibrated in kilometers. By my simple algebra, 64 kilometers came out as 40 miles an hour.

From zero to 40, through three of the four gears in the gearbox, took me 18 seconds against a light wind and 16 seconds with the wind—an average of 17.

I shifted gears at 25 and 50 kilometers an hour.

On the Speedway, scene of the annual Indianapolis 500-mile classic, the Volkswagen sort of got lost. It took a good mile for the car to indicate 100 kilometers an hour from a standing start, going downwind. That was about 62½ m.p.h., and as nearly as I could determine that was its top. Against the wind I could manage only 90 kilometers.

But—to repeat—speed wasn't what the

THIS VIEW OF THE BOTTOM of the car, at the rear, shows the engine—the ribbed area—and the exhaust manifold, at the top of the picture. Forward of the engine is the transmission. The two big openings at the sides exhaust the air from a big fan that is used to cool the four-cylinder engine.

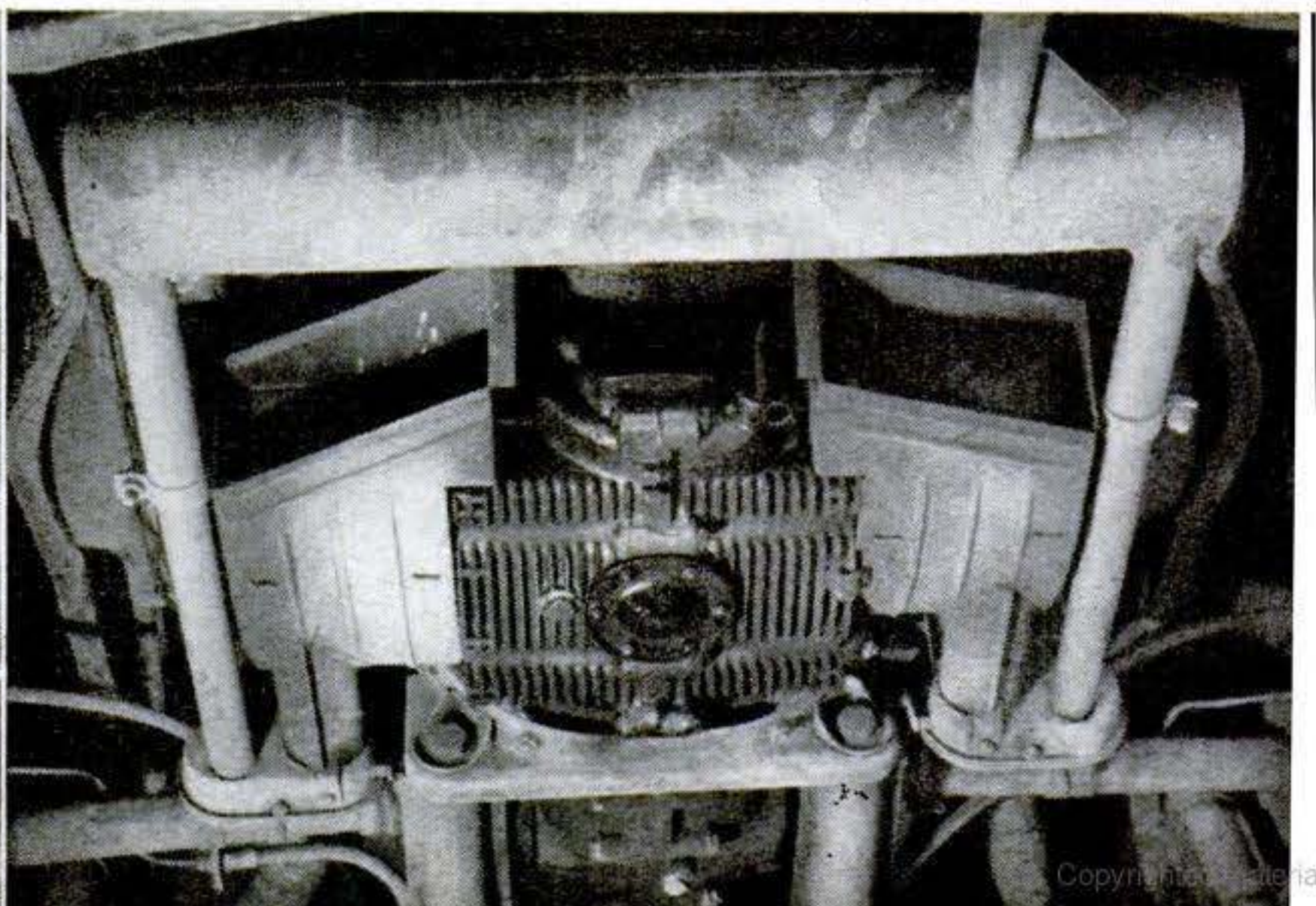
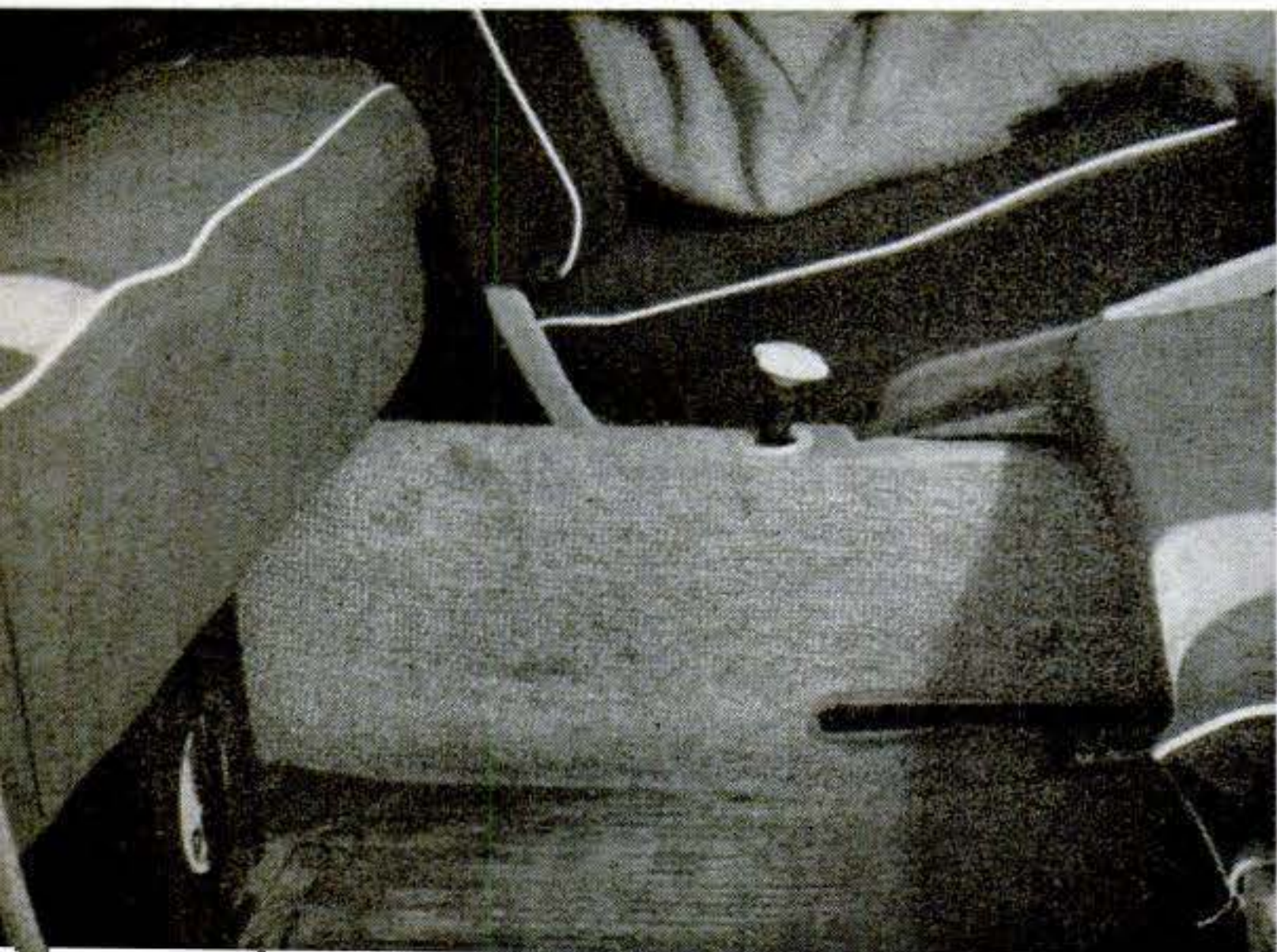

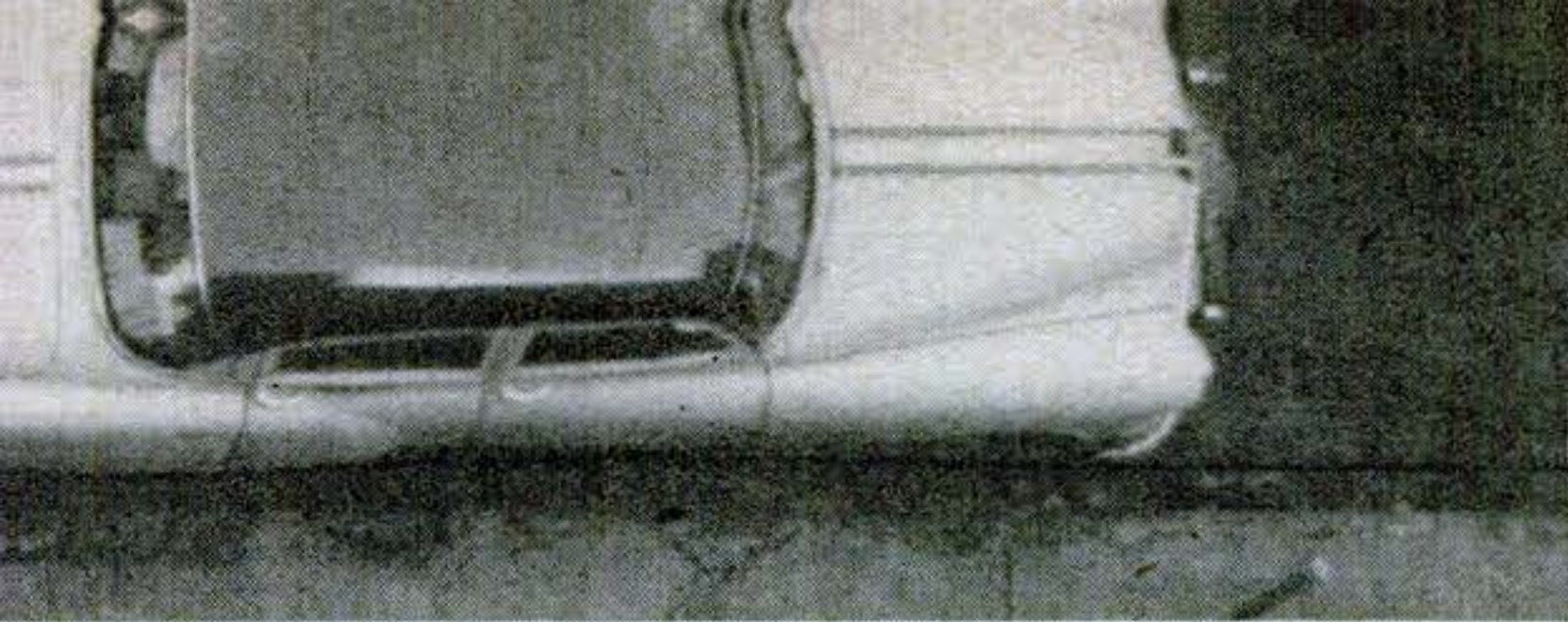

average U.S. six-passenger sedan requires.

car was built for. Do you want economy? It is good for 30 miles to the gallon. A housewife can romp to the grocery store, or make a three-mile detour to say hello to Mamma, and it won't cost more than a few thimblefuls of fuel.

Do you want ease of maneuvering? With "fast steering," requiring little turning of the wheel, the car wound in and out of traffic like a snake. That was partly because of the superb visibility.

Do you want a car that won't change looks like feminine styles? The 1954 Volkswagen is about the same car that the Germans turned out in 1939.

The People's Car probably will never sell in any coarse numbers over here. The U. S. buyer seems to prefer a full-size secondhand car to a new midget from abroad. If our tastes change, the Volkswagen may find a market here.

But nonetheless, for transportation it's a good buy. In token of the fact that it is well built, don't forget that the sturdy, sensational little Porsche—the rear-engine, four-cylinder car that has racked

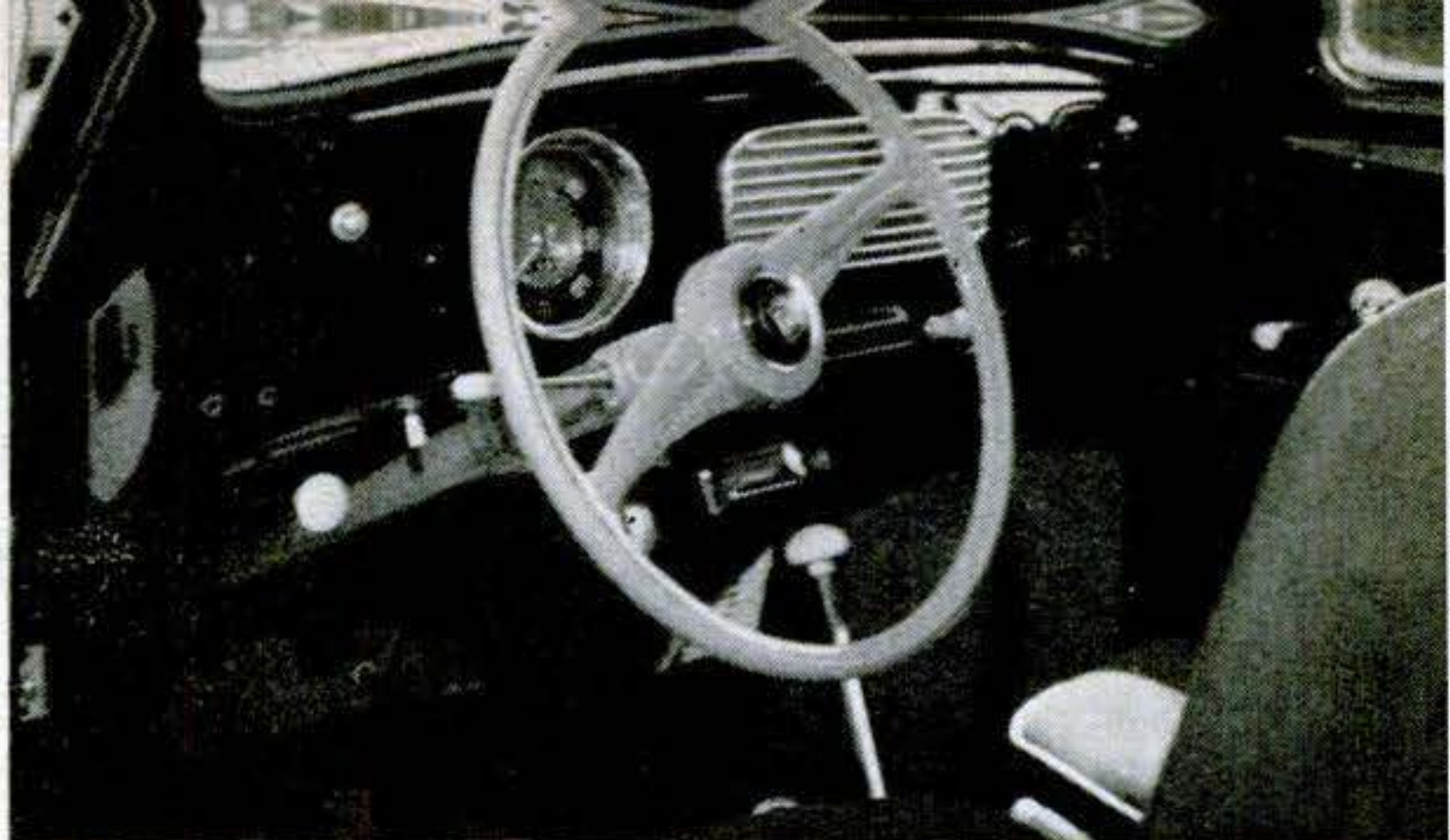

INSTRUMENT PANEL is austere. It contains the starter button, speedometer, light switch, windshield-wiper switch, choke button, radio controls and ignition switch. On the steering column is the European-style signal lever, throwing out a semaphore amidships. The gearshift is of the wand type, anchored in the floor. First gear is where reverse is in U. S. cars. Second, third and fourth follow the U.S. pattern for first, second and high. To shift into reverse gear, you depress the knob on the wand and pull it into what we call first, or low gear.

up an average of 90 miles an hour for 24 hours—is the Volkswagen's descendant. Dr. Porsche used the knowledge he gained in designing the People's Car in building the postwar, faster Porsche.

I said the Volkswagen hadn't changed much. It *has* changed a little. The German engineers evidently have succumbed to the blandishments of added horsepower. The power is up—a whole six hp., from 24 to 30. That's 25 percent more than the car had. Those Germans must have taken a gander at the Detroit newspapers in recent months. **END**

FACTS ON VOLKSWAGEN

Model: 2-door de luxe sedan.

Engine: 4-cyl., horizontally opposed, valve-in-head; 30 hp. at 3,400 r.p.m.; compression ratio, 6.1:1; piston displacement, 72.7 cu. in.; piston travel (in feet per car mile at 20 m.p.h.), 1,303; bore and stroke, 3.03" by 2.52"; crankshaft bearing surface, 15.5 sq. in.; torque, 55 lb.-ft. at 2,200 r.p.m.

Weight: 1,609 lb.; per hp., 53.3 lb.

Transmission: 4-speed manual shift; overall rear-axle ratio, with 1:0.8 fourth gear, 1:4.43.

Steering ratio: 2.4 turns lock to lock; radius of turning circle, 18'.

Effective brake-lining area: 86.6 sq. in.

Springs: transverse torsion bars front and

rear, independent suspension on 4 wheels.

Outside dimensions: height, 59"; overall length with bumpers and guards, 160"; width, 60½"; wheelbase, 94½"; overhang, front 27½", rear 38"; tread, front 50¼", rear 49¾".

Inside dimensions: seat-cushion widths, front (split) 19", rear 52"; leg room (with front seats in mid-position), front 43½", rear 36½"; headroom, front and rear, 35½"; seat height, front 13", rear 16"; vertical distance, steering wheel to seat cushion, with seat in mid-position, 6¾"; front-seat adjustment, horizontal 11", vertical 0".

Tire size: 5.60 by 15.

Price: \$1,495 shipside, New York.

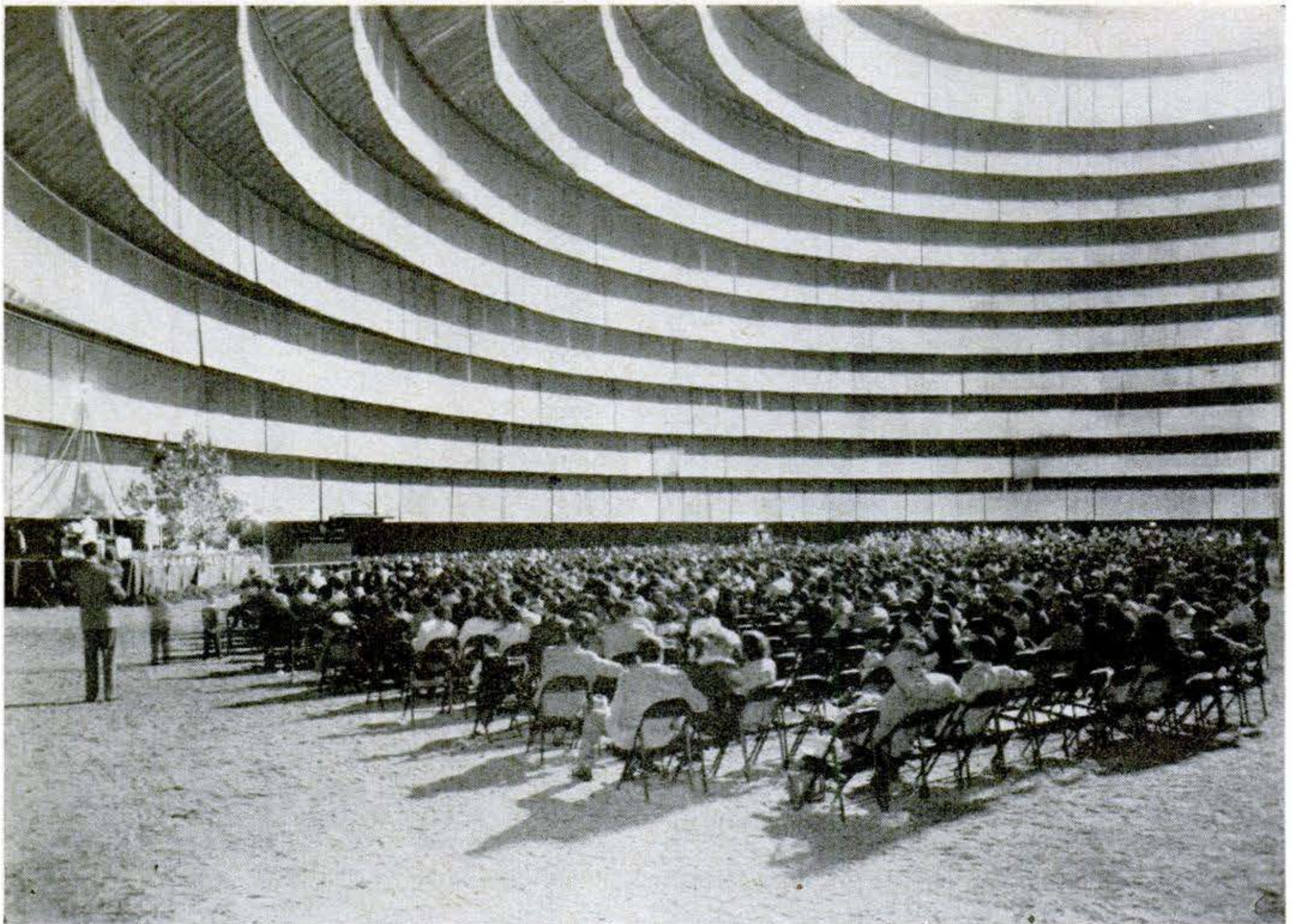

Aluminum Tent Seats 12,000 – Goes Up from the Top Down

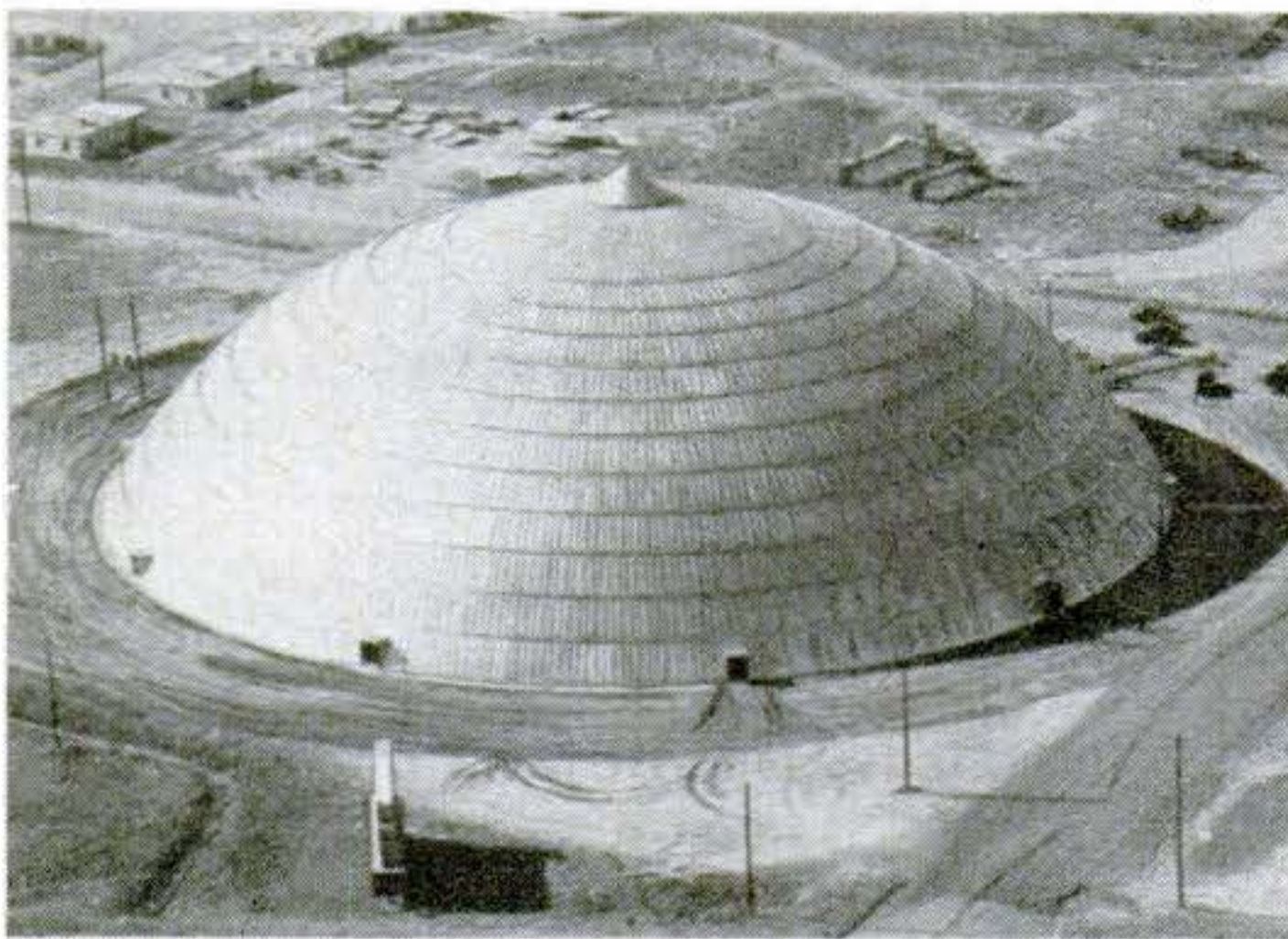

WHEN evangelist Billy Graham wanted something sturdier than a canvas tent for his camp meetings, he got together with R. G. LeTourneau, the road-machinery maker. Thus the semisphere (left) was born. The portable dome—85 feet high, 300 feet across—is raised on a center pole which later can be removed. The coned peak goes up first, then 15 successive rings of aluminum sheets are bolted on. When the last ring is in place, the dome is lowered and anchored in concrete. The rings hanging from the ceiling (above) are for sound control.

They Say Now

DR. G. L. WOLCOTT, BRISTOL-MYERS CO.:
"No one would think of buying and driving an automobile without learning how, but people buy toothbrushes every day without ever learning how to use them."

J. H. KINDELBERGER, CHAIRMAN OF THE BOARD, NORTH AMERICAN AVIATION: *"It would cost 10 billion dollars to put a satellite into space. No, the nation that ac-*

complished it would not rule the world, because you could build a rocket for a few million dollars that would knock it down as soon as it was put there!"

DR. BYRON T. SHAW, U.S. DEPT. OF AGRICULTURE: *"The more efficient you become, the harder it is to become still more efficient. It may not be too difficult for a good runner to cut his time for a mile race from 4½ minutes down to just a few seconds over four minutes. But the four-minute mile has never been run."*

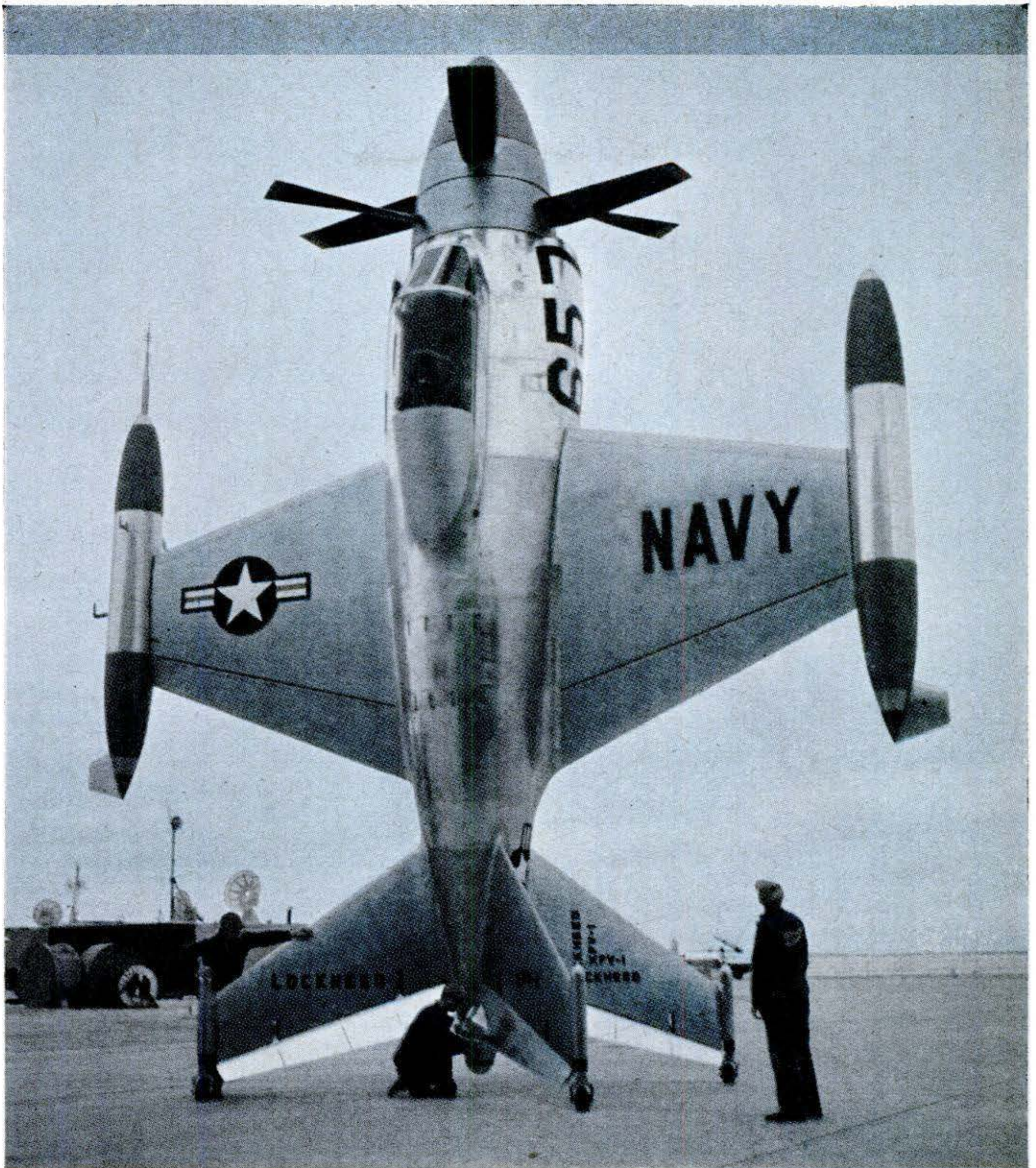

Four-pointed, X-shaped tail is landing gear of Lockheed XFV-1, shown in take-off position.

New U.S. Planes Leap Straight Up

*Standing on their tails,
these "vertiplane" fighters
will take off like rockets.*

TWO new Navy fighter planes designed to take off straight up and land tail down would make almost any ship an aircraft carrier. Poised nose-up on the ground, the 500-m.p.h. experimental Lockheed XFV-1 and Convair

LOCKHEED XFV-1



PILOT climbs a portable ladder (left) to reach cockpit of the Lockheed XFV-1 vertical-take-off, swept-wing fighter. The special mobile platform above permits the plane to be tilted for easier maintenance.

XFV-1 look like spaceships from science fiction.

Power to lift the planes straight up into the sky comes from twin turbojet engines, reported to be of 5,500 horsepower, driving a pair of specially designed, high-speed contra-rotating propellers. Once in the air, the pilot levels off into conventional flight position. For landing, he maneuvers back into the

perpendicular and backs down, hovering in mid-air like a helicopter if necessary. A rotating seat automatically pivots the pilot into the proper position for any attitude into which he puts his plane.

The planes were not designed for use aboard carriers, but for various ship-to-shore missions (termed "secret" by the Navy) where neither flight decks nor land runways are available.

CONVAIR XFY-1 is a delta-wing fighter. It is shown at left in the position in which it takes off and lands. The mobile vehicle below is used to transport the plane on the ground, and to raise and lower it.



CONVAIR XFY-1



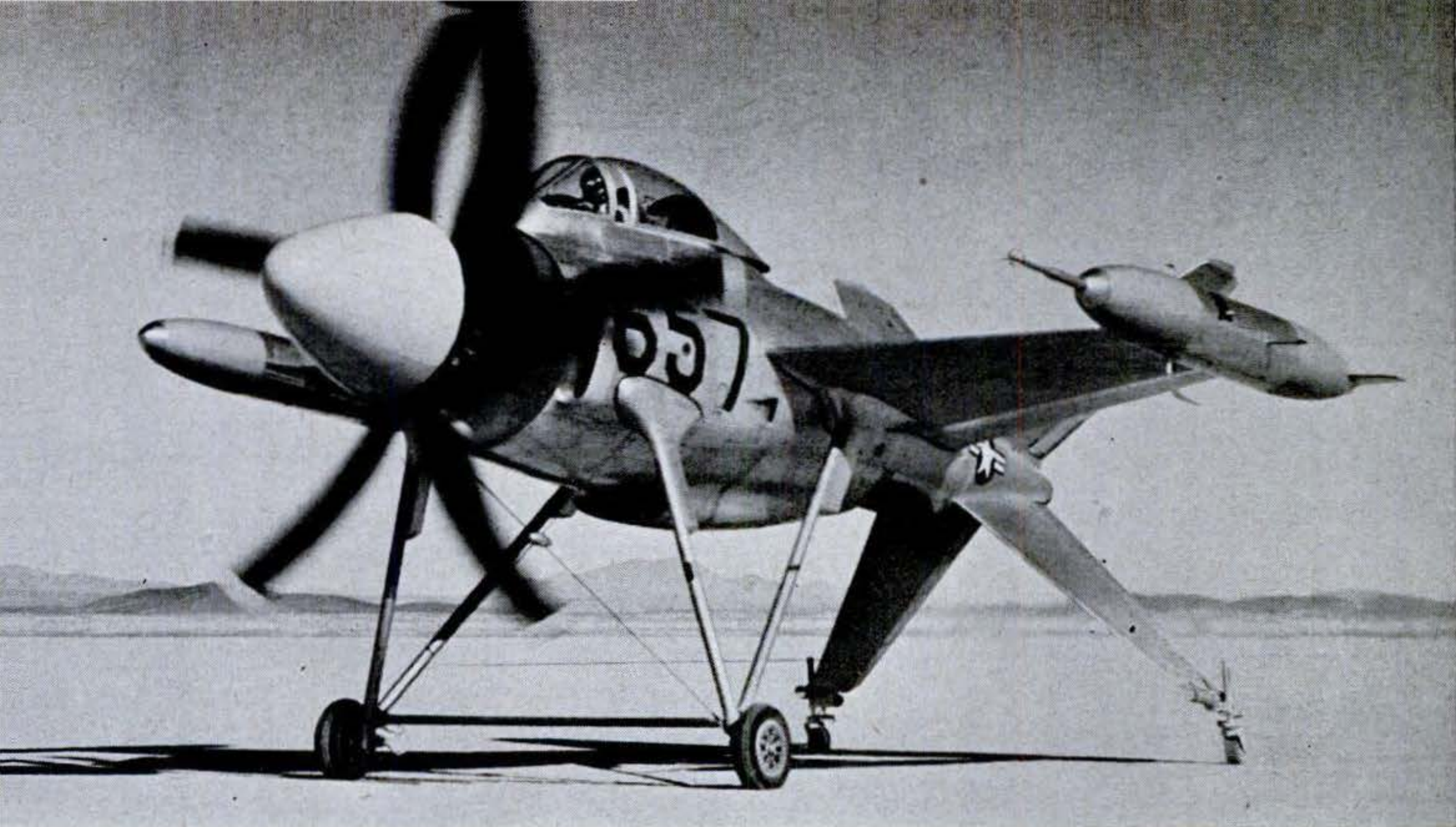

The XFV-1 has auxiliary landing gear also, used for normal take-off during test flights.

The obvious significance of these straight-up planes, however, is that they could be based on practically any type of Navy ship, and, in time of war, even on merchant ships with the addition of a small platform at the stern. Thus a ship could carry its own aerial protection, and a convoy could send up a vast umbrella of fighter cover in a matter of minutes.

Propeller power probably will keep

these pioneer planes below supersonic speeds, but vertical-take-off pure jets are known to be under construction.

These "vertiplanes" are not to be confused with "convertiplanes," which use one system of propulsion to take off and land vertically like a helicopter, and another system for forward flight. For the latest news on convertiplanes, please turn the page.

Seen in normal, level-flight position, Consolidated Vultee's XFY-1 is a fat, stubby job.

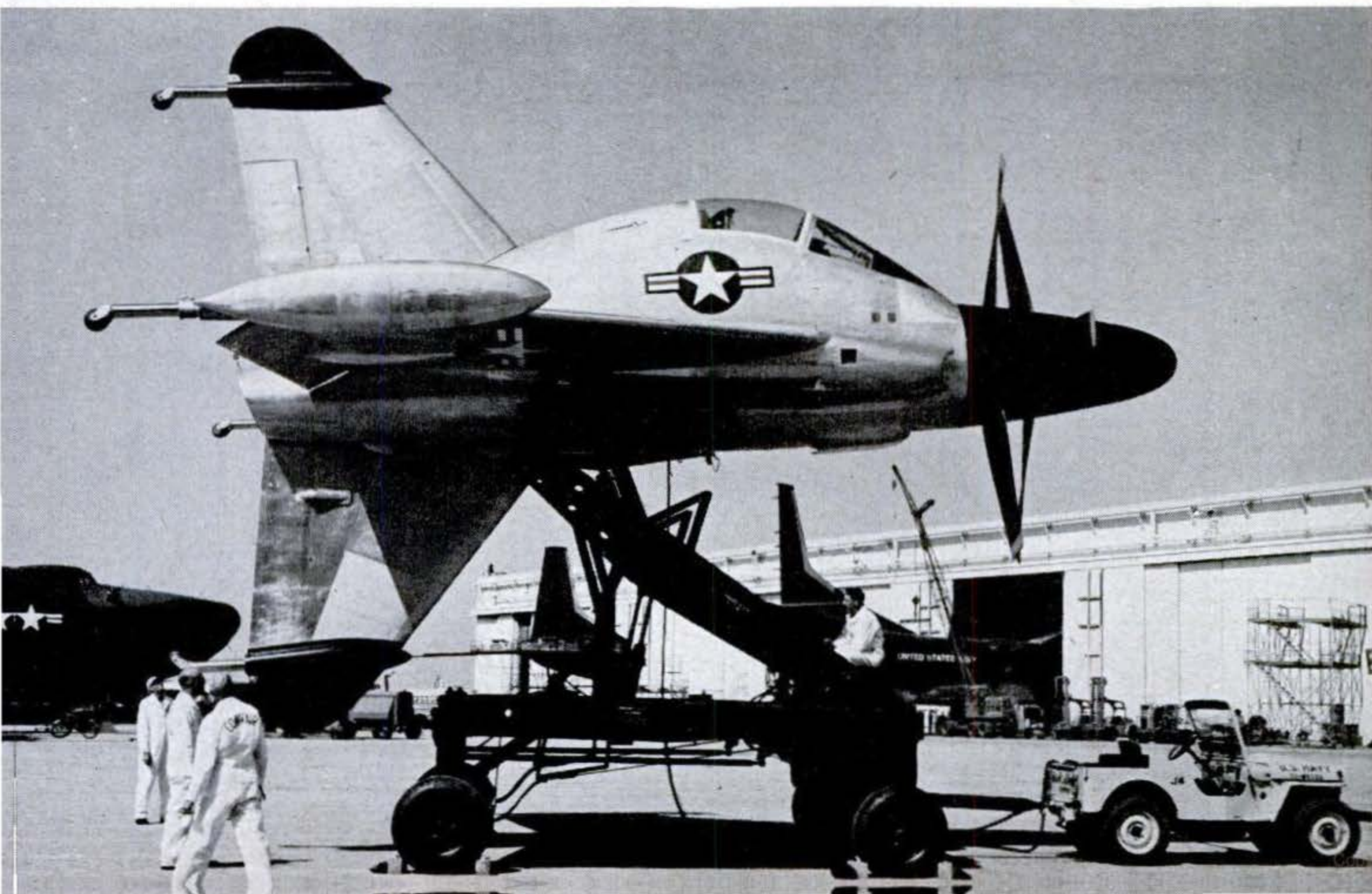

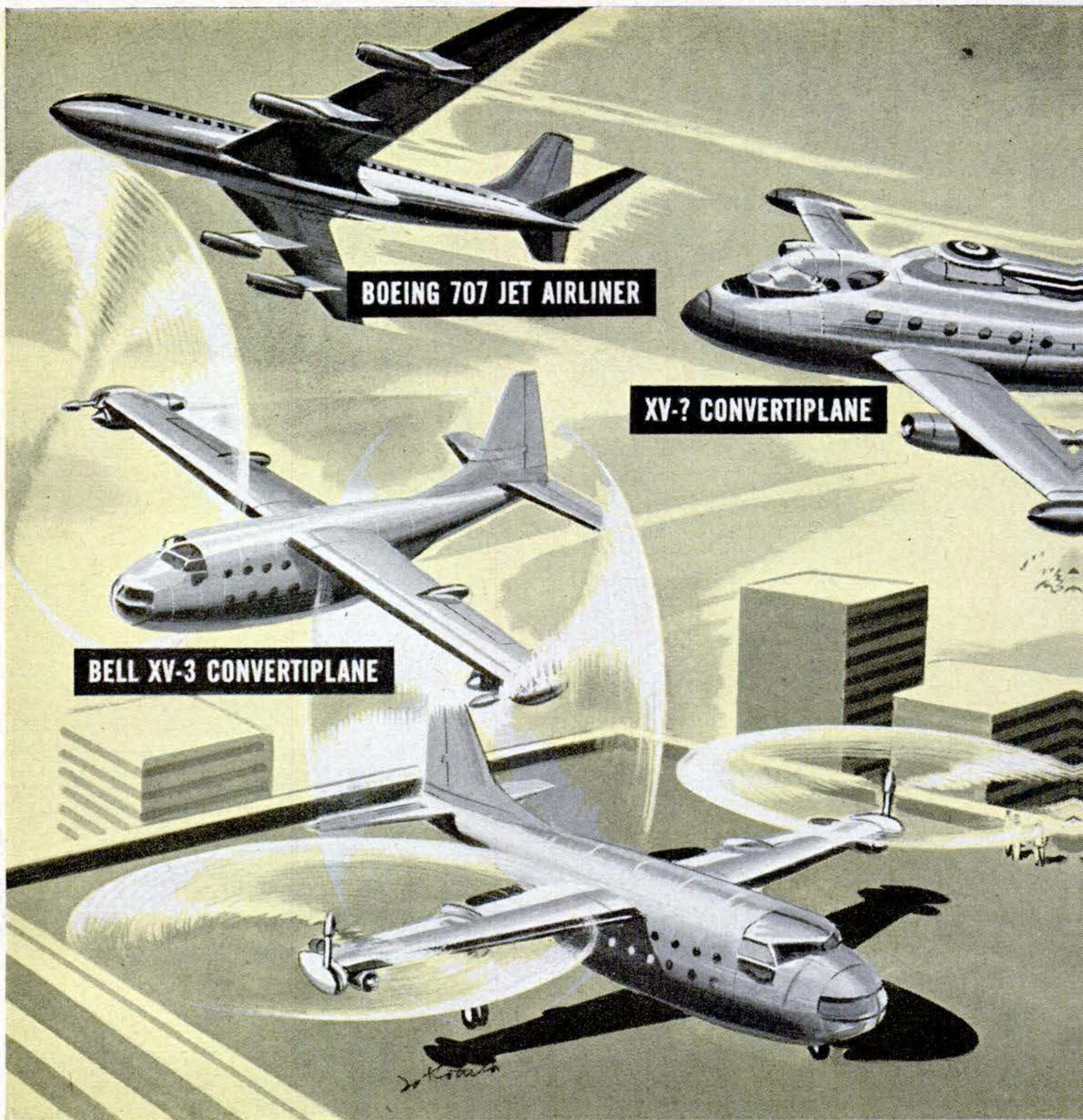

More New Planes Are Coming

ABOVE is an artist's report of dreams come true: five planes that were designers' dreams a few years ago and that you soon will see in flight—some of them this summer.

A recent sensational development is the convertiplane. Not so far back the idea was considered fantastic. Today the military has \$6,000,000 invested in these planes that take off and land like heli-

copters but convert in flight to a faster means of forward propulsion.

McDonnell XV-1 Convertiplane is the farthest along. Now being ground-tested, it is expected to fly this summer. An overhead rotor, with pressure-jet engines at the blade tips, gives it helicopter flight. A rear-of-fuselage propeller goes into action for forward flight.

Bell XV-3 Convertiplane is nearing



HORTON WINGLESS

MCDONNELL XV-1 CONVERTIPLANE

completion. Wing-tip propellers pointing upward serve as helicopter rotors. In forward flight, stubby wings carry the lift as the "rotors" tilt 90 degrees forward to become true propellers.

XV-? Convertiplane is the artist's idea of what the Sikorsky job, still on the drawing boards, may look like. As shown here, overhead rotors, used for helicopter performance, fold up and retract into the fuselage in flight as gas-turbine engines speed it forward.

Boeing 707 Jet Airliner, expected to

fly in August, may be America's answer to the British Comet. The huge jet will carry from 80 to 150 passengers nonstop across the continent (five hours) or from New York to London (seven hours). Cruising speed will be 550 m.p.h.

Horton Wingless is all fuselage—or all wing, if you prefer. At present it is planned as a 10-place executive plane for economical nonstop transcontinental flight at 300 m.p.h. Its designer foresees a mammoth 4,000-troop military version.—*Herbert O. Johansen.*

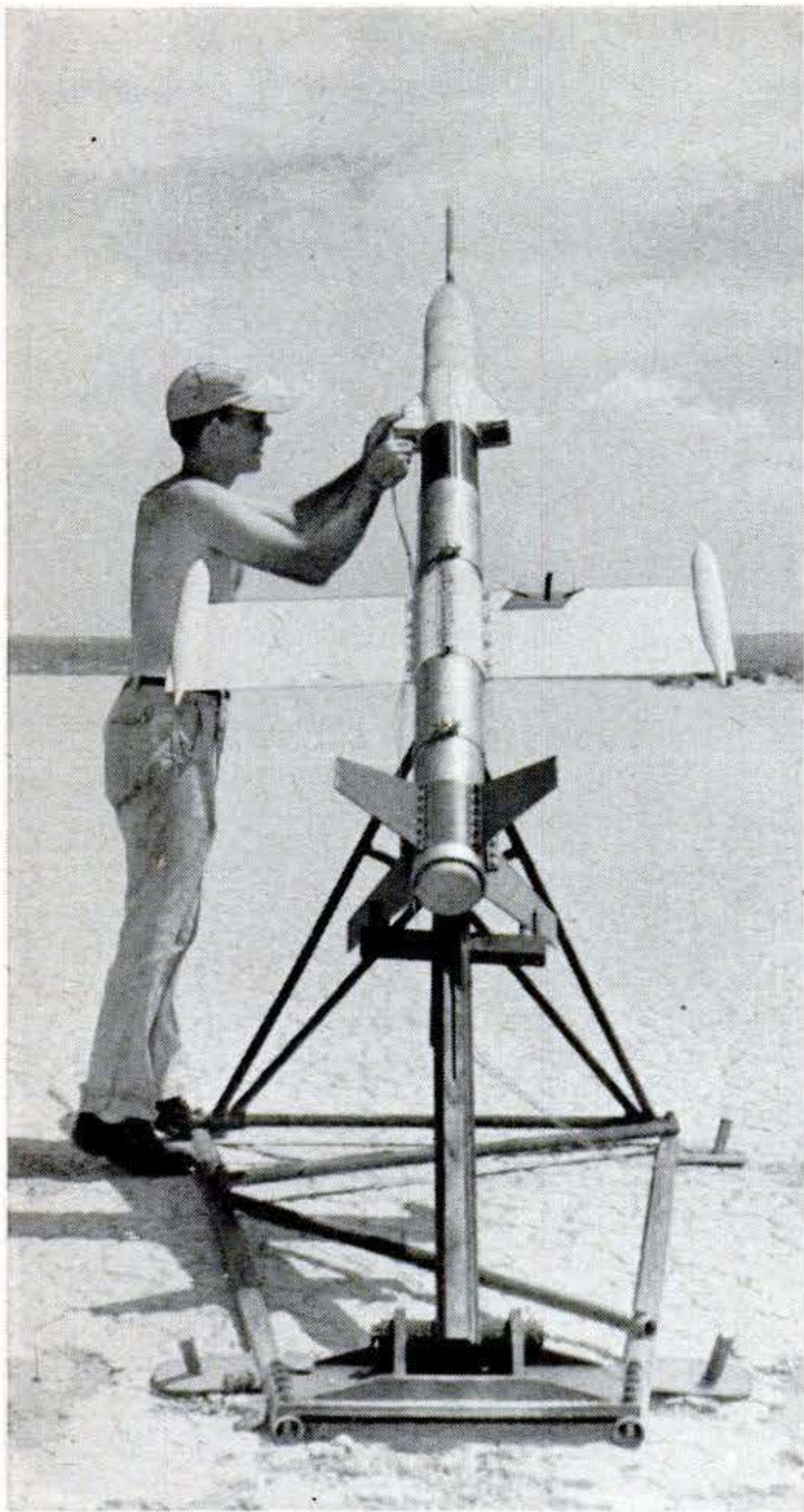

Rocket Hits 1,400 M. P. H. to Test Warplane Wings

FASTER than any combat aircraft are likely to fly soon, a five-inch combat rocket carries a miniature plane wing through the air. Transmitting instruments in the six-foot flying laboratory report the wing's behavior at speeds up to 1,400 m.p.h. Then an automatic parachute lowers the missile gently to earth. About to be launched, at left, is a wing of straight design. This type is expected by Lockheed engineers, conducting the trials, to prove the most efficient for super-high-speed fighters.

Bike Gets Color-Signal Light

THIS multicolor electric safety light automatically shows green when a cyclist is pedaling, amber when he coasts and red when he brakes. Made by Darwin Products, Inc., Chicago 9, it clips to the rear fender. Its control switch goes on the rear-wheel sprocket; the battery case on the frame above the sprocket.

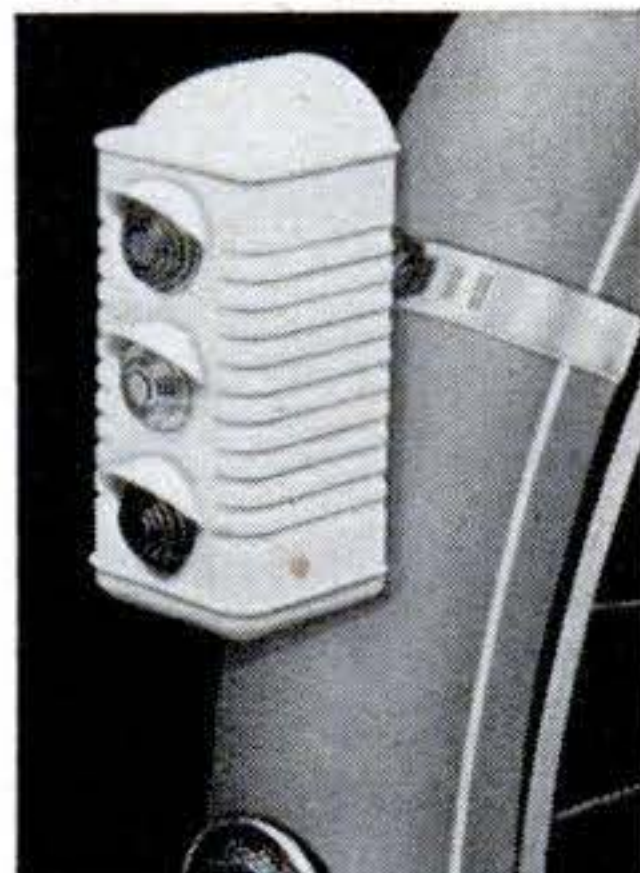

Camera Traps Reckless Drivers

THERE'S no denying traffic violations spotted by the Washington State police car above. As it trails an offender, a 35-mm. movie-or-still camera registers his driving, his license number and the readings of a speedometer dial.

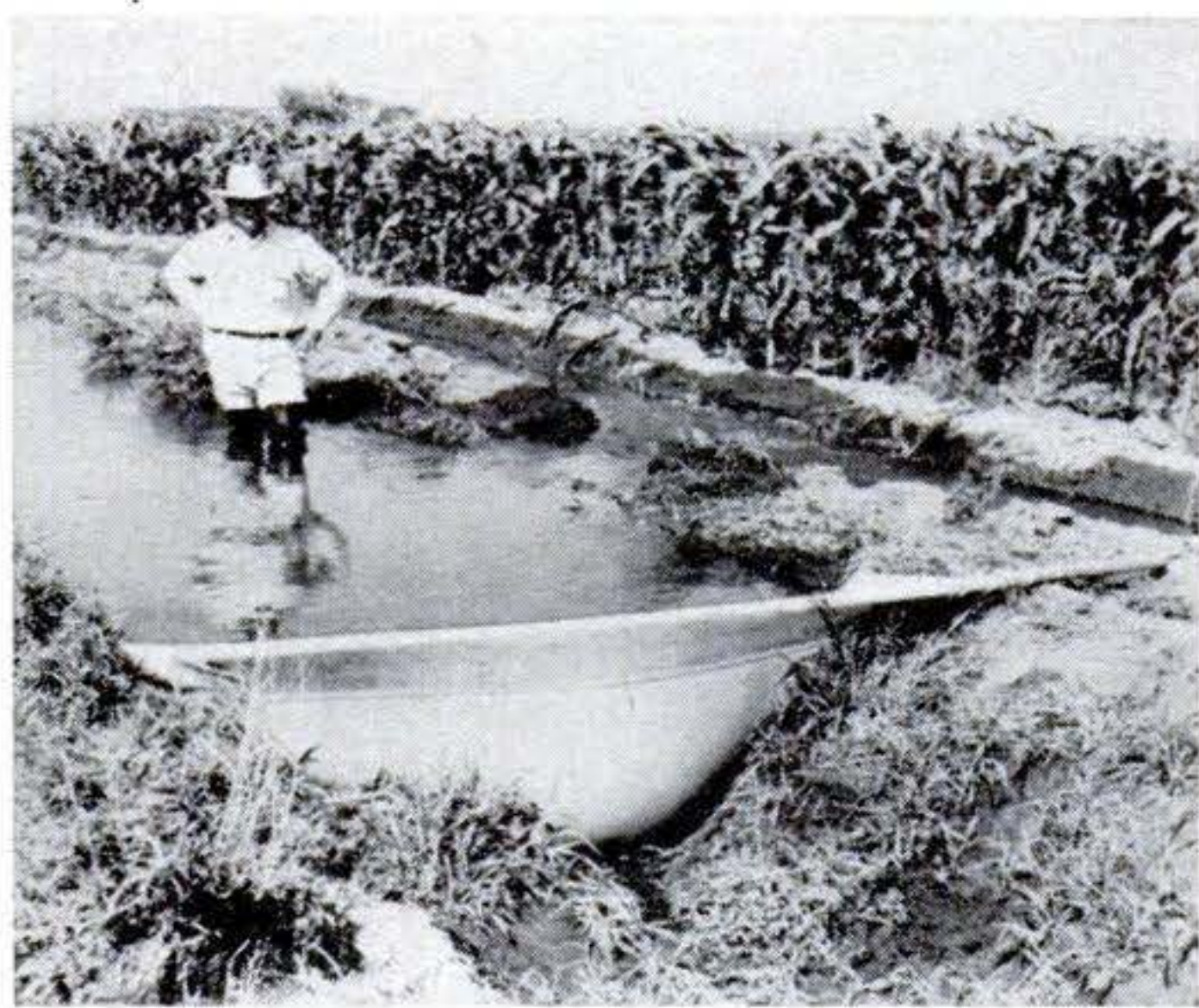

Portable Dam Fits Ditch

THRUST a supporting pole through the looped edge of a plastic sheet, and you have a dam for an irrigation ditch. The water's weight holds the flexible apron in place, as above. Vivid colors of the portable Cozad dams help to spot them from afar.

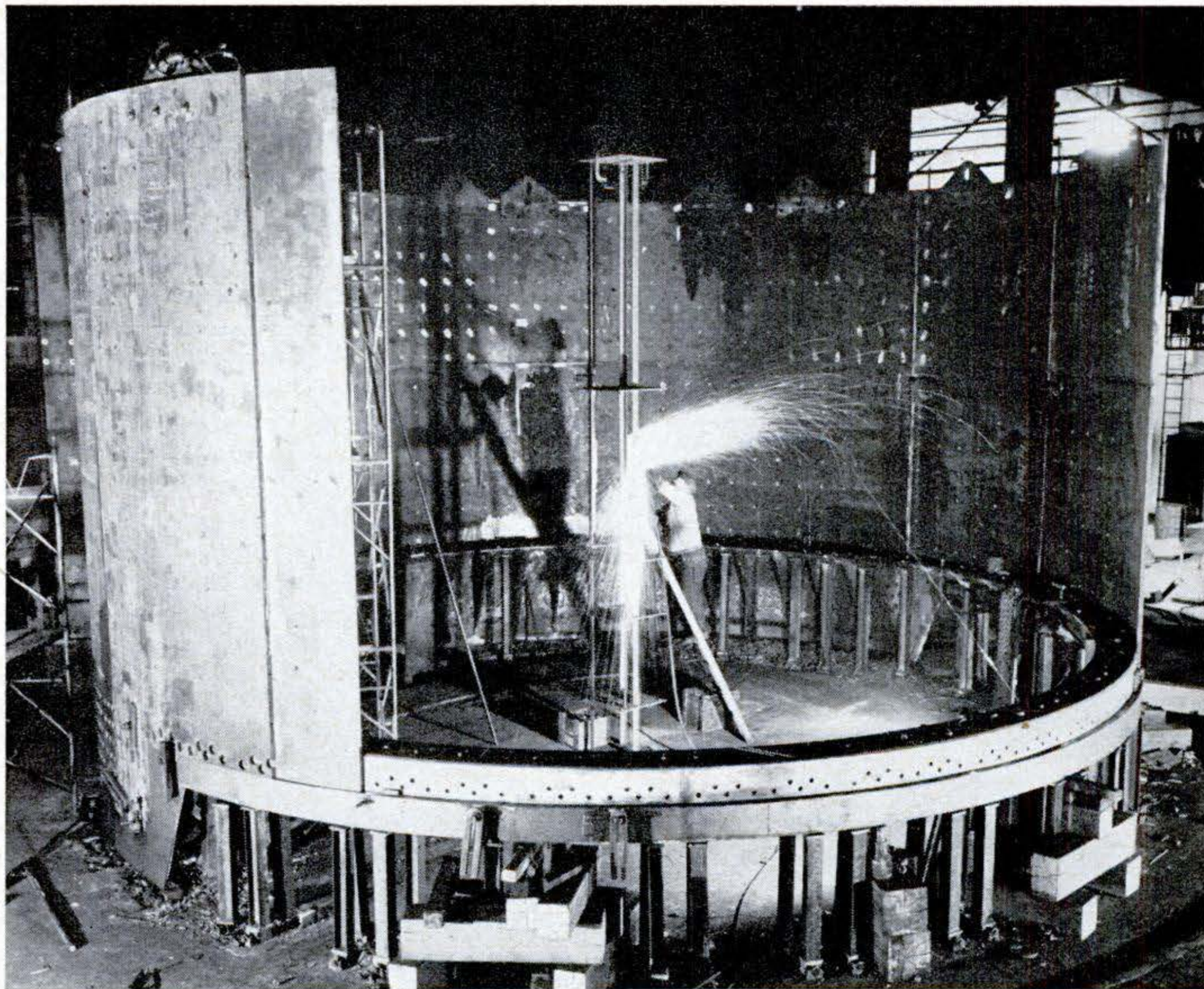

Giant Cutter Ready to Bore New Tube for Tunnel Under River

THE tanklike structure above is the gigantic cutting shield that will soon be boring its way under the Hudson River to make the third tube of New York's Lincoln Tun-

nel. It will be forced through the river bed while mud and rock are removed ahead of it and tunnel sections are erected behind it. American Locomotive Co. built it.

Easy-to-Inflate Play Pool Has Sides That Float

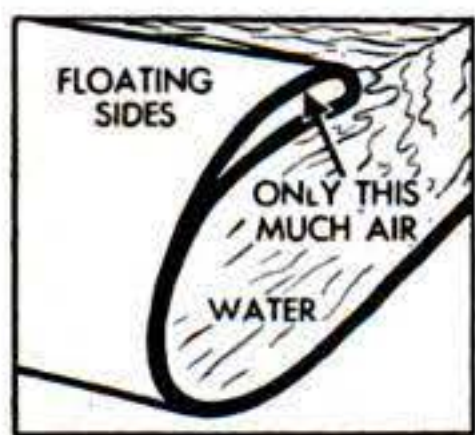

You don't have to pump like crazy or run back and forth to a filling station to inflate this play pond. A few huffs and puffs fill the air space in the rim so that the sides float to dam in water. The pool is made by Goodrich in sizes from three to seven feet in diameter.

▶▶▶ In the interior alone, the average late-model car has more than 250 exposed screws, requiring at least 10 different sizes and varieties of screwdrivers.

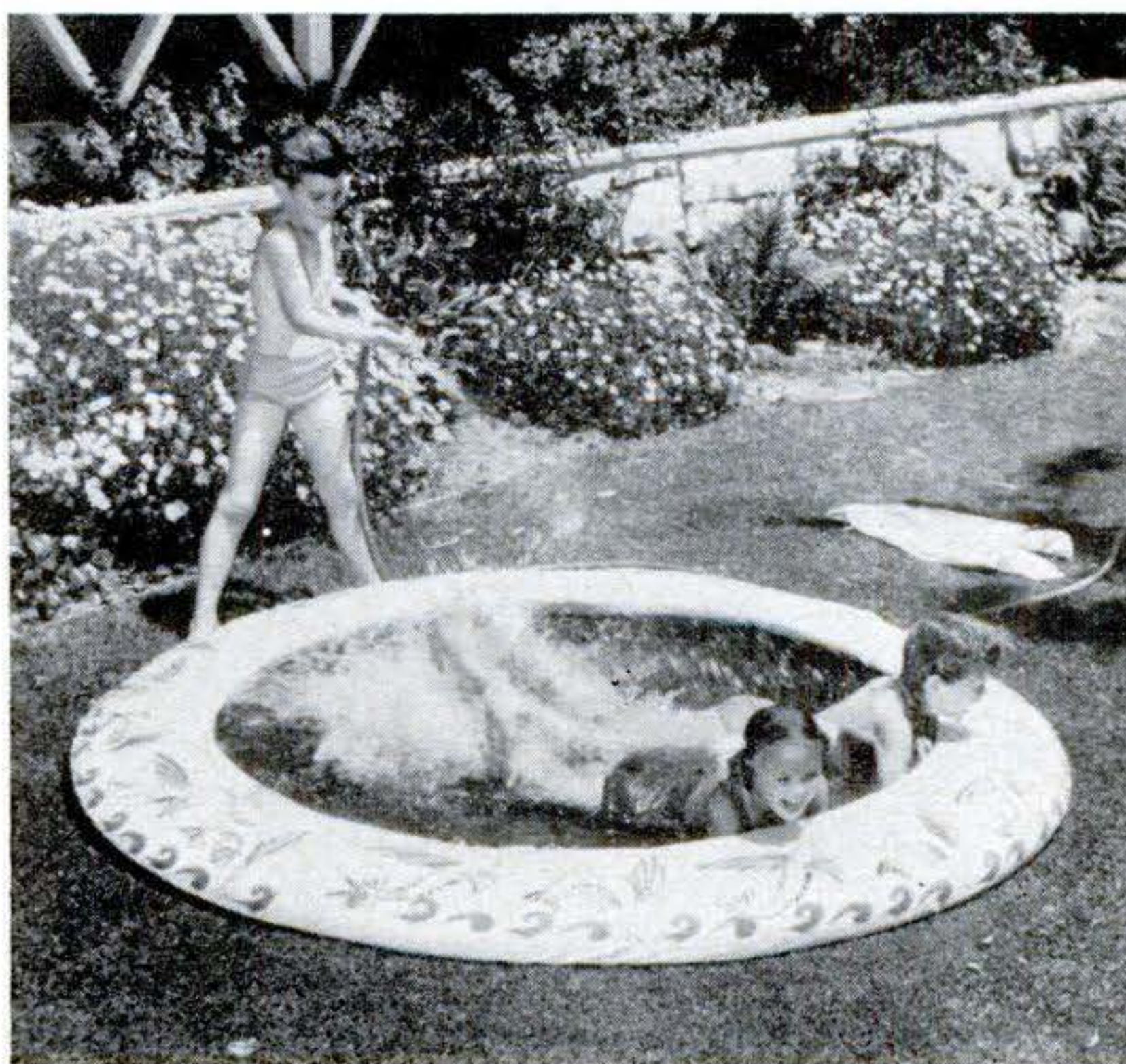

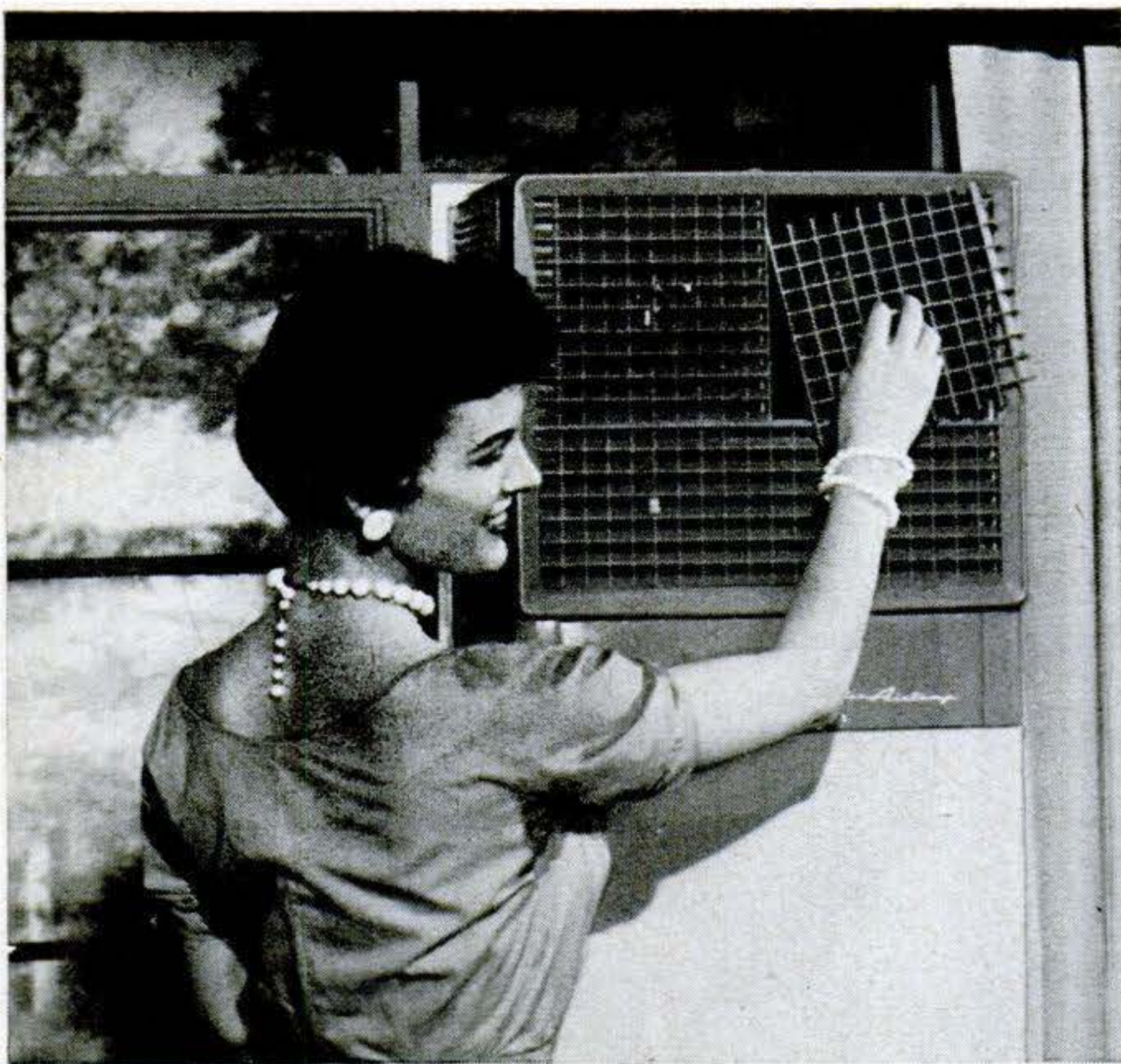

New Air Conditioner Replaces Screen On Casement Window

EVEN if your house has casement windows, you can keep cooler this year with a room air conditioner. One new casement unit (left) is mounted in place of the window screen, using the same screw holes. Flush on the outside, it doesn't interfere with the opening or closing of the window. The unit has adjustable grilles that turn to direct air flow up, down, left or right. It is made by the Airtemp Division of the Chrysler Corp., Dayton.

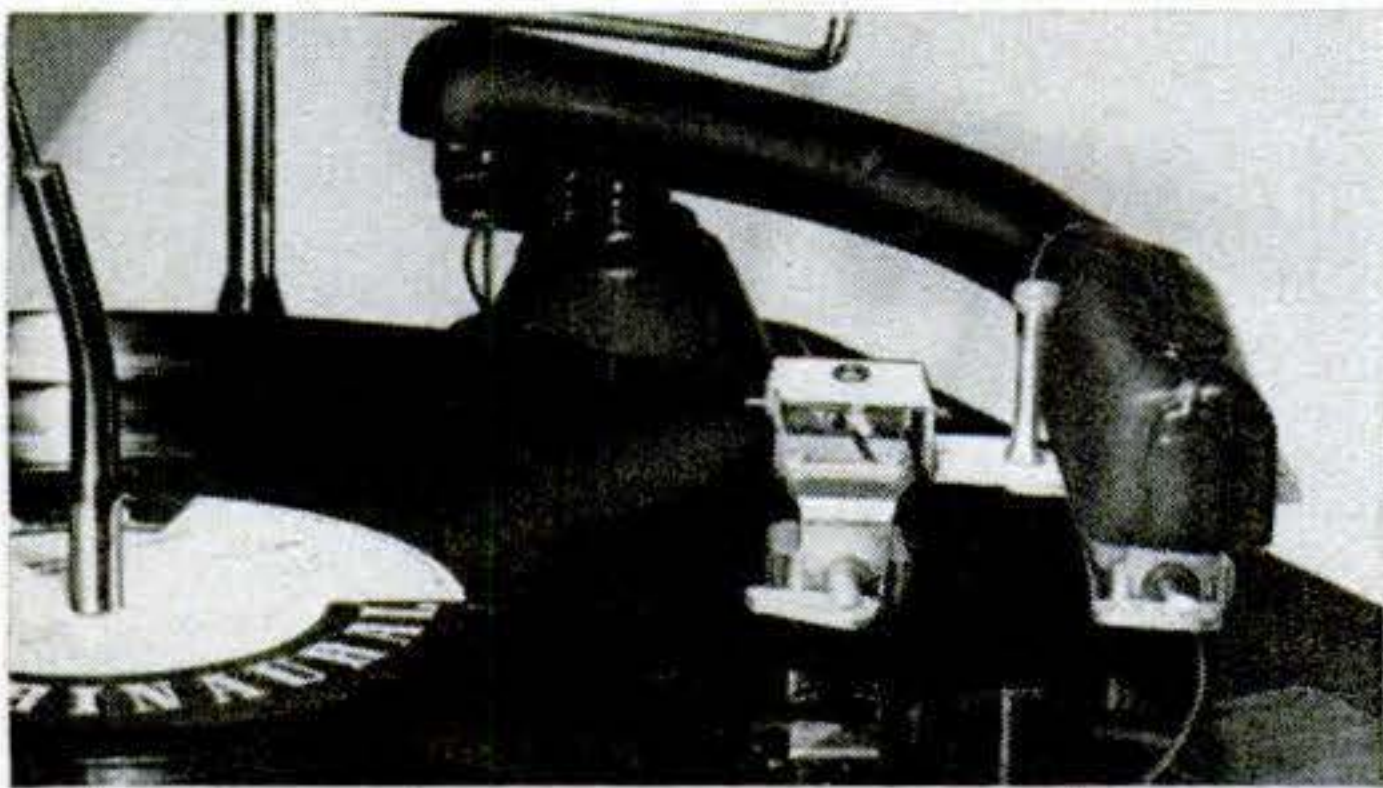

1-D Phonograph Plays 2-Ds

A NEW attachment adapts any phonograph to play binaural "two-dimensional" records. Clipped to the arm, it provides mounting holes for two cartridges. Cook Laboratories, Stamford, Conn., makes it.



Three-Wheeler Is Plastic Job

JUST like many a big sports car, this pedal-operated number has a seamless body of plastic reinforced with Fiberglas. The Inland Mfg. Corp., Buffalo, says it won't dent, warp, chip or come apart.

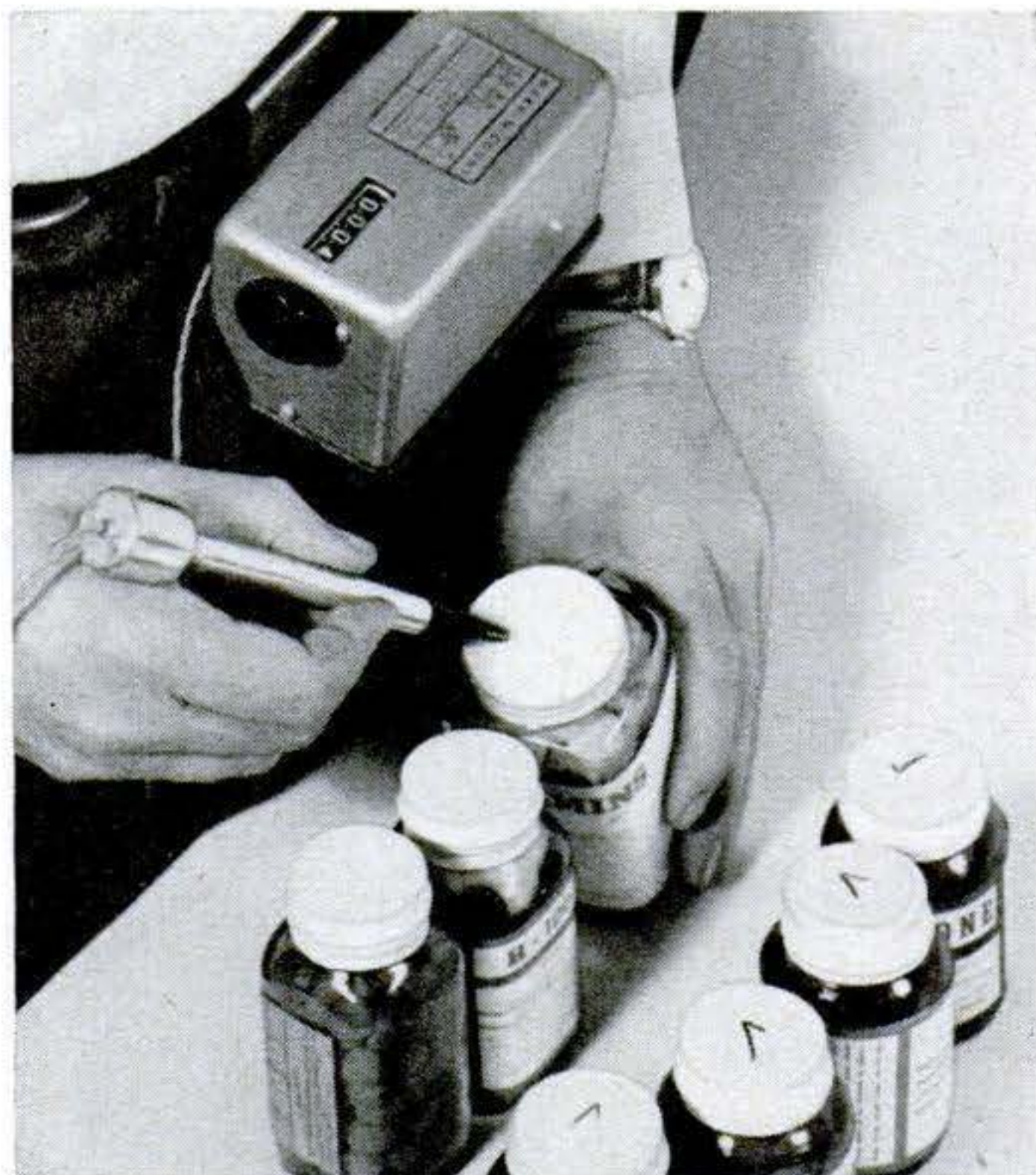

Marker Keeps Count, Too

AN ELECTRIC counter on the belt (above) tots up packages as they're checked off. Various markers are used—one has a rubber tip to count paper sheets. May Engineering Co., No. Hollywood, Calif., is the maker.



An Ape Uses Our Household Tools

Editor's Note:

One of the most fascinating papers presented at the last meeting of the American Association for the Advancement of Science dealt with the differences between men and apes. It was presented by Dr. K. J. Hayes of the Yerkes Laboratories of Primate Biology. He and Mrs. Hayes have raised a chimpanzee like a child in their home.

POPULAR SCIENCE MONTHLY, says Mrs. Hayes, "epitomizes the scope of man's cultural uniqueness." In the article that follows, she describes aspects of the behavior of the chimpanzee in her home that are of special interest to readers of this magazine.

Viki helps anthropologists study man's cultural roots by showing them what can be done without language.

By Cathy Hayes

IN A quiet corner of her home in Orange Park, Fla., sits six-year-old Viki, turning the pages of a copy of POPULAR SCIENCE MONTHLY. To the onlooker, it is clear that she is not reading but merely

looking at the pictures. This is not surprising, since Viki is a chimpanzee.

Born at the Yerkes Laboratories of Primate Biology, Viki has spent her entire life in the home of Dr. Keith J. Hayes, where she has been given the advantages of a human education. She is being reared in this way to determine which of the obvious ape shortcomings are unavoidable and which can be altered by schooling.

Results to date indicate that while Viki probably never will read the words of *POPULAR SCIENCE MONTHLY* or understand the level of technology which it represents, she does share with its human subscribers an interest in tools, plus considerable ability to use them.

At that indefinite past age when man first appeared where only apes had been before, two brand-new skills are commonly thought to have entered the animal kingdom—language and tool-using. These talents in combination are a large part of what anthropologists mean by *culture*—not refinement, as people use the word, but an accumulation of knowledge passed down from generation to generation. Of all the animals, only man has developed culture and civilizations.

Viki Is an Ape of Few Words

But are the apes completely incapable of doing so? It becomes the job of anthropologists and psychologists to boil down the nature of culture, to find out what physical and mental traits are required and which of these actually are exclusively human.

Language seems to be quite beyond the apes. As described in the book, *The Ape in Our House*, Viki learned to speak only a few human words after extensive training, and she seems to understand little of what is said to her. However, tool-using is another story. At an age when the human child becomes aware that there is too much knowledge for him to learn everything, Viki, too, has begun to specialize—in her case on matters of practical science. There may be some significance in the fact that her greatest talent lies in this area of greatest inter-

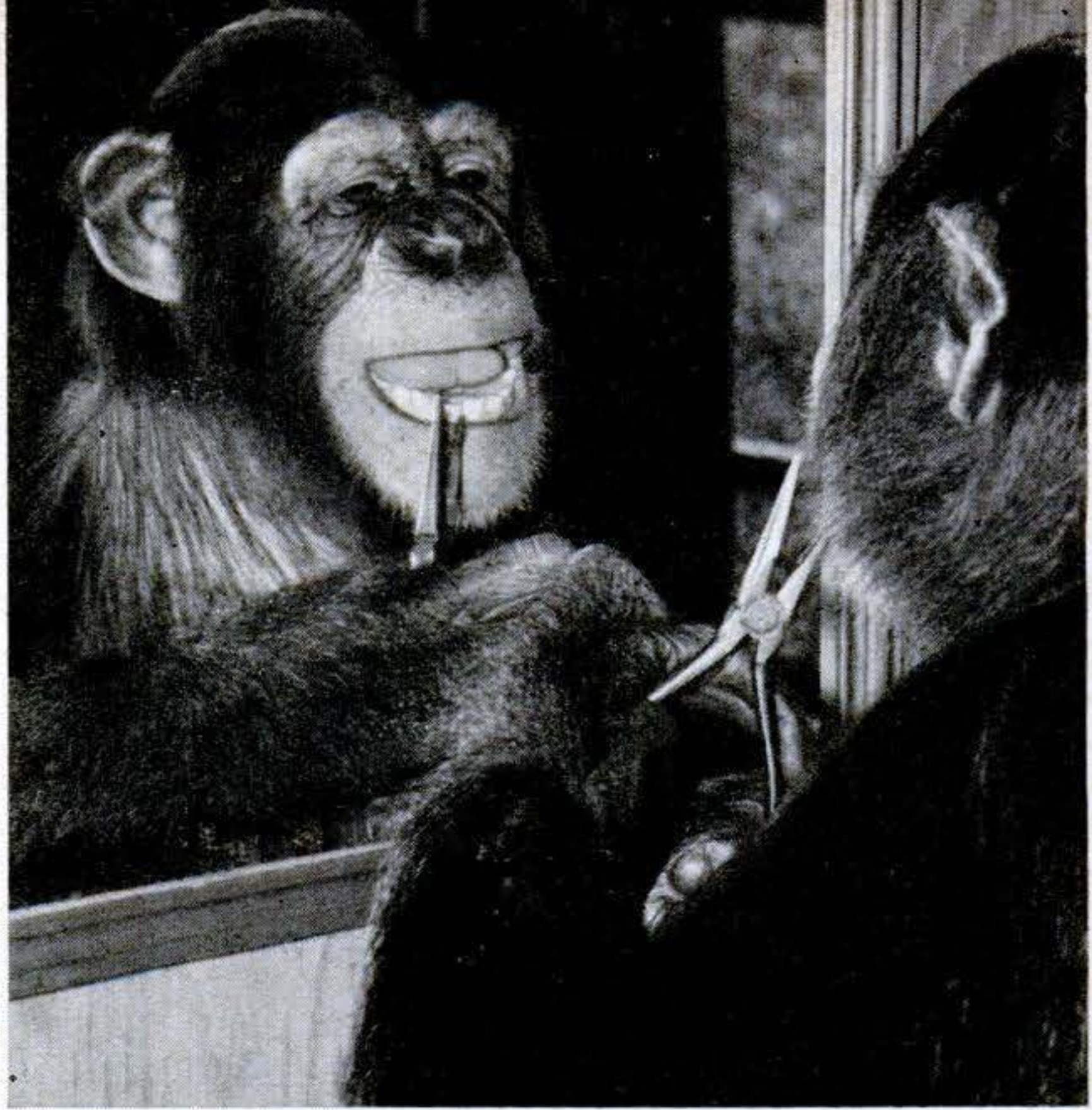

“Well, why not try it?”

A loose baby tooth finally annoyed Viki enough to inspire an idea. She had learned to use pliers. One day she decided to get rid of that old tooth with their help.



“This is the way I hammer.”

Viki has been shown the proper way to handle a hammer, but she still prefers to pound in nails like this. Perhaps she thinks it's better to use *all* of the hammer's head.

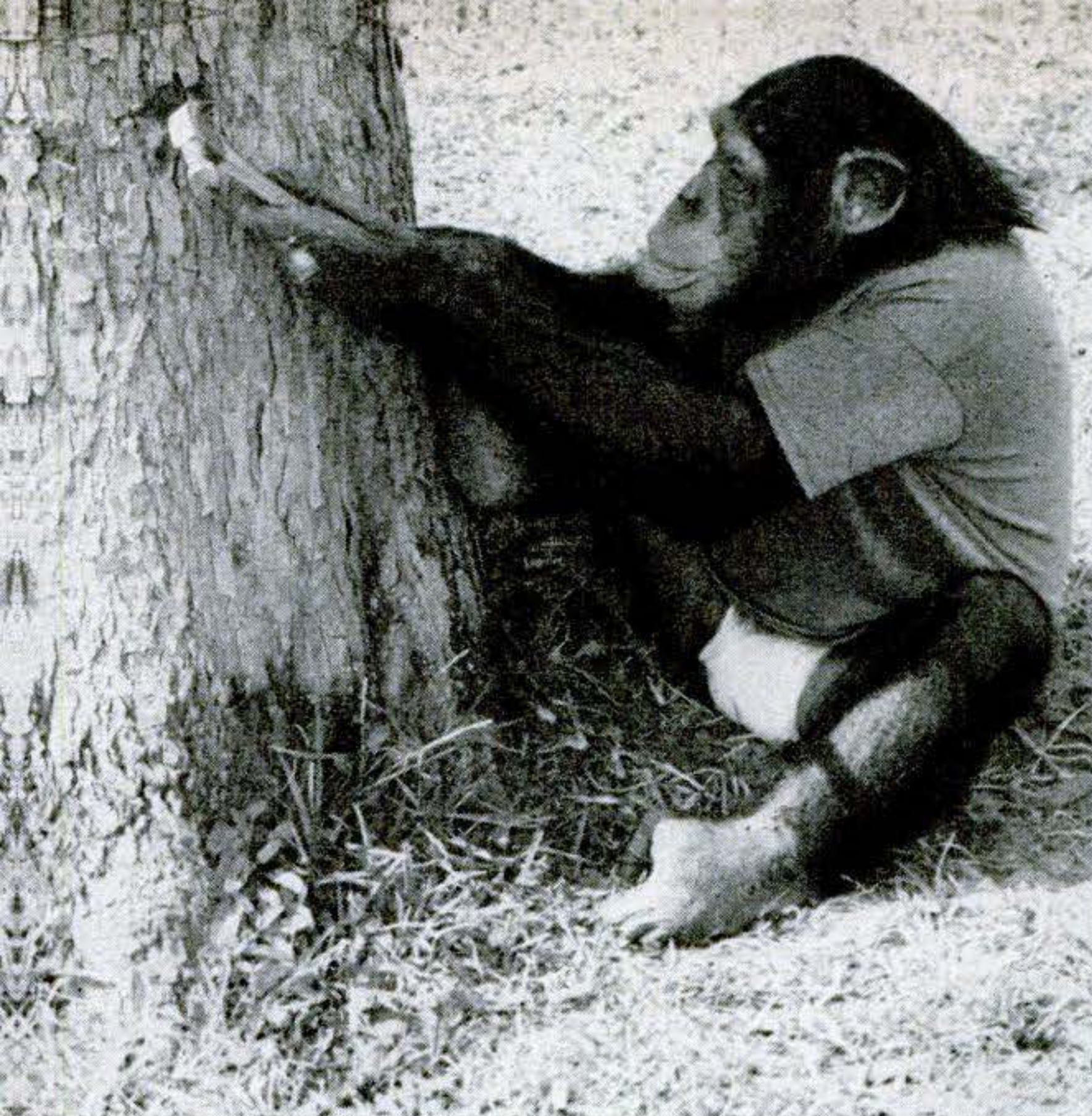

"A foot comes in handy."

Viki hasn't yet learned how to use the leverage available in the head of a hammer. She uses the claw like a hook and then does what comes naturally to an ingenious young ape.



"My, what a lovely noise!"

Her feet are not in as much danger, actually, as they seem to be. Her human teachers report that, though Viki knows how to use a number of tools, she tires of work quickly.



"It's fun, but I don't get it."

She doesn't seem to know what she is doing, but she loves to use a tape measure, as she has seen her mistress do. This is one job for which four hands, or feet, are dandy.



"I'll have it out in a jiffy."

Viki demonstrates her admirable technique with pliers in the process of extracting an alluring loose nail. She can also sort nails, screws and tacks with remarkable ease.

est, while her poorest showing has been in the field of language, which she has never appeared to enjoy.

Maid of All Work

Surrounded by a host of household gadgets undreamed of by her ancestors—or ours of a few centuries back—Viki spends a busy 12-hour day getting into everything. In the kitchen, she raids the refrigerator when thirsty and searches the cutlery drawer for the proper opening tool to use on her prize—canned milk, soft drink or beer. She is Mother's Little Helper, beating eggs for me, juicing oranges and ironing the hankies and napkins. A little work goes a long way with her, however, and she usually leaves a job half done to ride the tank-type vacuum cleaner through the house, like a modern witch on a rocket.



“Now, for a smoke!”

Viki would be a chain smoker if the human members of her family would let her. She knows how to work practically every kind of lighter.

She very much enjoys experimenting with electrical gadgets. Before the age of two, she could operate every lamp and switch in the house. In the summer, she spends her waking hours close to the fan. Once a visitor was trying in vain to turn on this appliance. Again and again he punched the starter button, until Viki came to his rescue. Her eyes ran the length of the cord to the plug, and there was the trouble. It had fallen out, so she plugged it in. “I feel like a darned fool,” said the visitor.

Of all household equipment, the tool chest fascinates Viki most. She figured out for herself the principles involved in some tools. From her earliest childhood, the sound of her hammer has rung like an anvil chorus. She recognized the value of a knife for carving furniture long before her recent love of sharpening pencils. Since prying is her favorite way to take things apart, she has long employed knives and screwdrivers as makeshift crowbars.

With other tools, Viki has required tutoring. While she cannot be given a book to read, or spoken instructions, she readily accepts directions by gesture. In fact, she “asks” for additional demonstrations until she has mastered a tool. The drill, sandpaper and saw fall into this category. Sometimes she imitates actions with little possibility that she understands the purpose.

Friends shower her with gifts that challenge her ability to take things apart. Given a coconut, she applied tooth and nail first, in usual fashion. Then she banged it on the floor. This failing also, she recruited some tools—a hammer and a knife. Finally a human friend demonstrated a hammer-plus-chisel combination, which punctured it. Since then, the chisel idea is her preferred method for breaking up rocks and bricks.

Viki shows much spread of learning from old tools and principles to new ones. She found it a short step from bead-stringing to sewing, for instance. When given a new nutcracker, she thought at first that it could be used like her old, familiar pliers. She held the cracker at the joint and pinched the nut between the tips of the handles. Nothing happened. I gave her a hint by placing her thumb where the nut should go and squeezing gently. She immediately put the nut there and cracked it.

She's Good at Aping

When she looks at a picture of a man touching his ears and is told to “do this,” she touches her ears. Shown a picture of a man sticking out his tongue, she replies in kind. This amounts to a simple form of reading. Later she will be asked to duplicate constructions as shown in drawings, similar to the “Wordless Workshop” feature in *POPULAR SCIENCE*

[Continued on page 272]

Nash Cooler Is All Up Front

A CAR heater, air conditioner and ventilator, all combined in one unit, is available in 1954 Nashes. The most compact system yet designed, according to the manufacturer, all its components are located in the engine compartment. Other air conditioners require machinery in the luggage compartment. The new unit is priced at \$395, including tax.

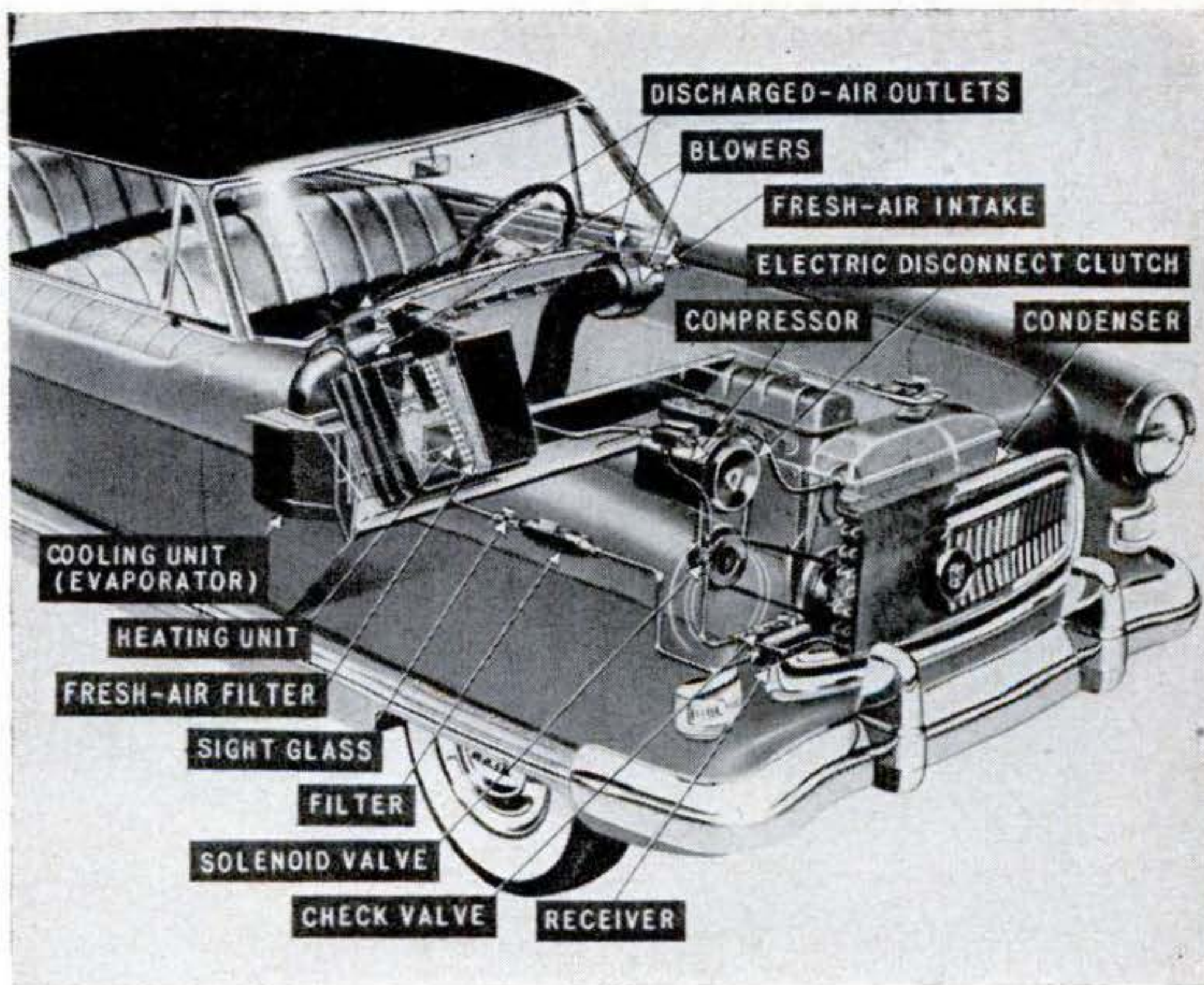

Dream Dodge: A Sport Coupe

A SPORT coupe has been added to Dodge's Firearrow line of experimental cars. Firearrows previously announced have had roadster-type bodies.

Built on a 119-inch wheelbase, the coupe is only 55 inches high and 195 inches long. The windshield as well as the rear window wrap around for visibility.



Luggage Matches Upholstery

SISTER car of the Firearrow, and somewhat resembling it, is Plymouth's new Explorer sport coupe (above), also experimental. Built on a 114-inch wheelbase it features a set of black-and-white luggage (right) that matches the car's upholstery. A between-seats compartment houses maps and also carries an ash tray.

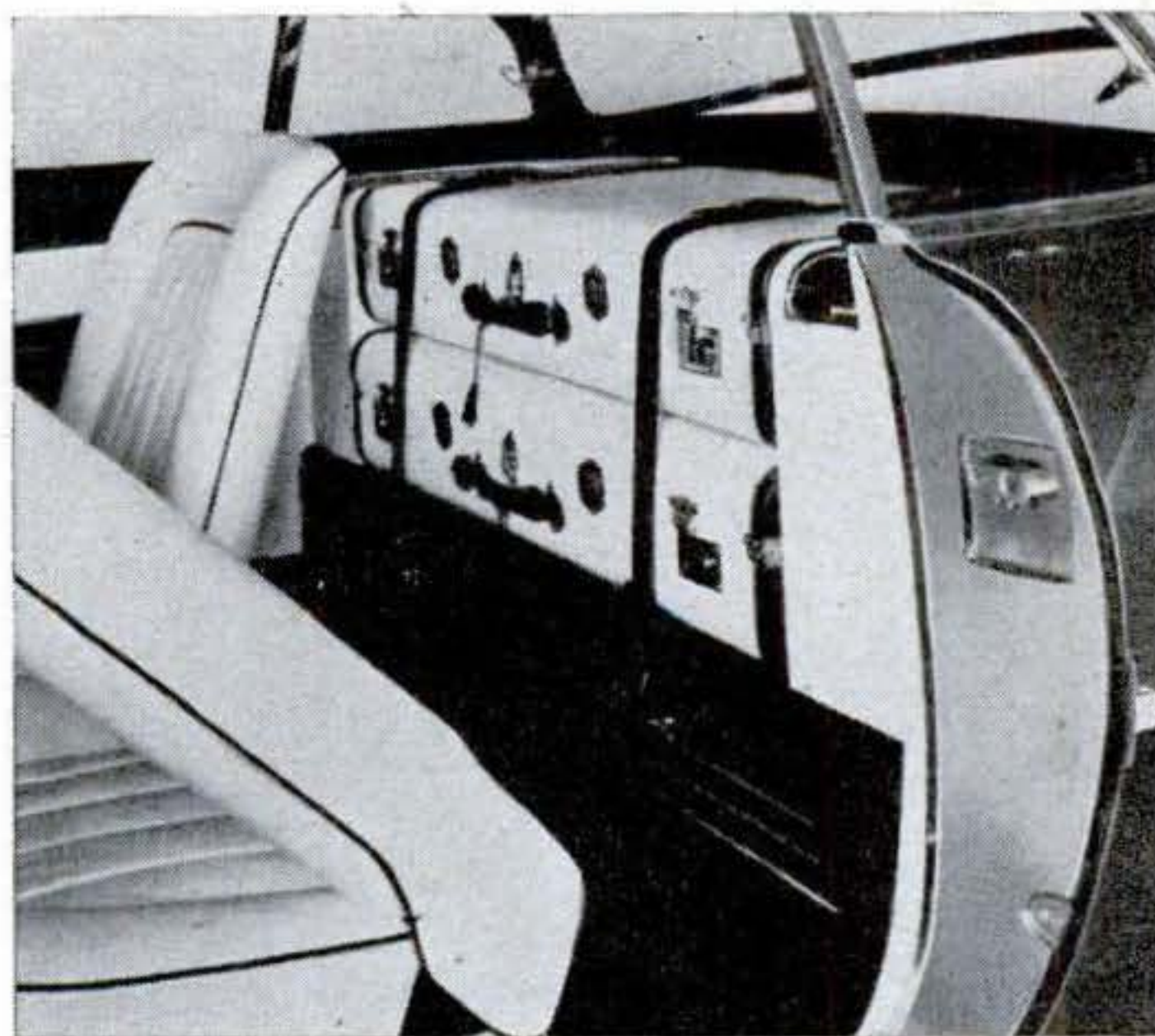

They're Searching For Crops That the Smog Won't Harm



7500-VOLT CHARGE transforms oxygen into ozone in brass tube in case.

SOMETIME during the day, at least 250 days out of the year, the sunny skies over Los Angeles fade, the air thickens, and people and plants find it harder than usual to breathe. The reason for this unpleasant phenomenon is that a layer of hot air at 2,000 feet has trapped the fumes of 3,000,000 cars and the smoke of scores of industries, and has made smog.

The damage that smog does to humans has not yet been reliably estimated. The damage it does to crops in that vicinity, however, was soberly assessed at more than \$500,000 for one recent 72-day period alone.

That brought action. Scientists at the University of California at Riverside have now built smog chambers, shown below, in which they mix ozone and gasoline vapors in any proportions they like and study how this artificial smog affects food plants growing in the chambers.

They are trying to find out which varieties of the valuable plants are best able to take it. If none is especially able to stand up to this man-made smog, the Riverside scientists will try to develop hardier strains of the plants.

Nobody yet has figured out how to develop more smog-resistant humans.

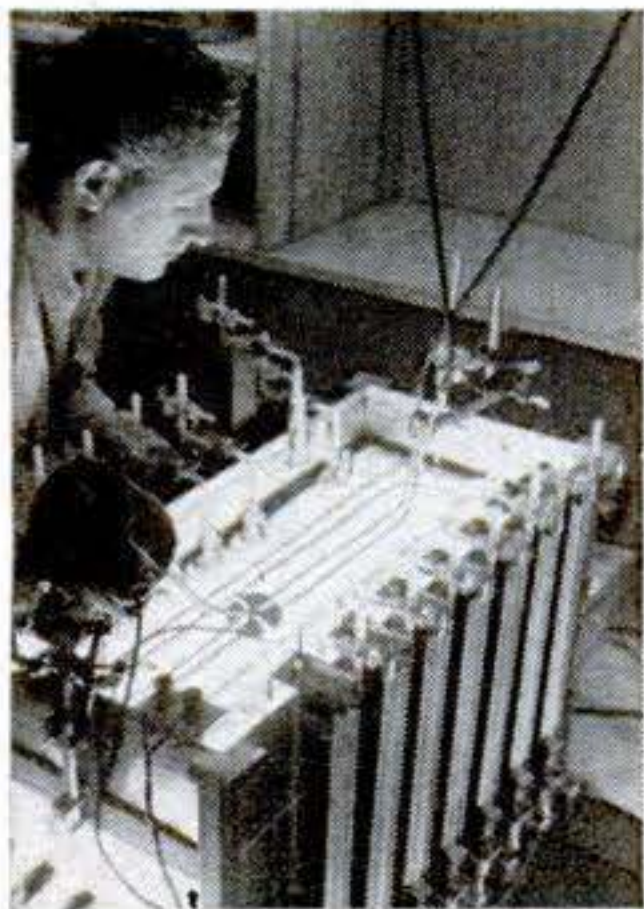

RESPIROMETER (left) measures details of life process (photosynthesis) in which plants exchange oxygen for carbon dioxide.

GLASS-ENCLOSED CHAMBERS, two for ozone, two for smog mixture, test effects of fumes on plant respiration. Towers contain ozone.



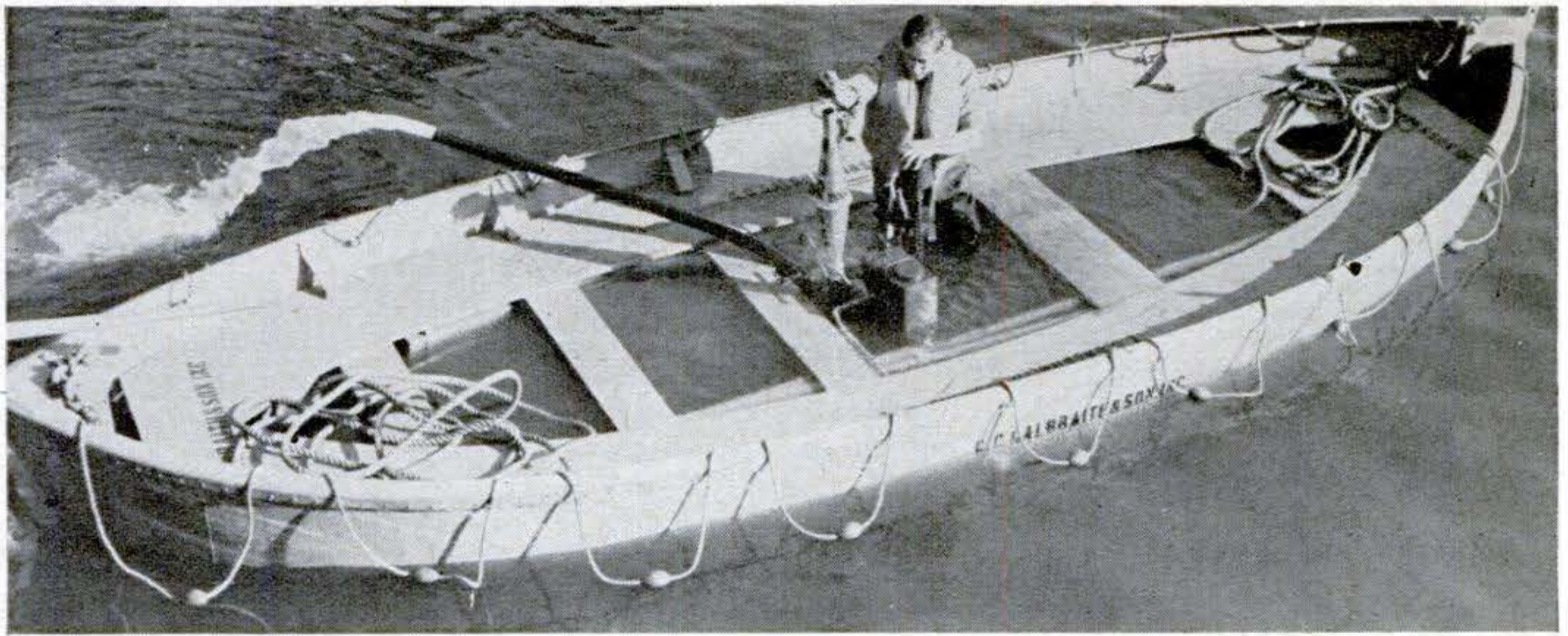

Lifeboat's Motor Starts Under Water

EVEN if submerged in a brimful lifeboat, the little Danish diesel above, breathing through a snorkel, starts briskly and bails out the boat with its rotor pump. Then it turns to its main job of moving the craft. Completely waterproof, the four-cycle Bukh, from Norse Electric Mfg. Co., 55 Water St., NYC, is triggered by a shotgun cartridge.

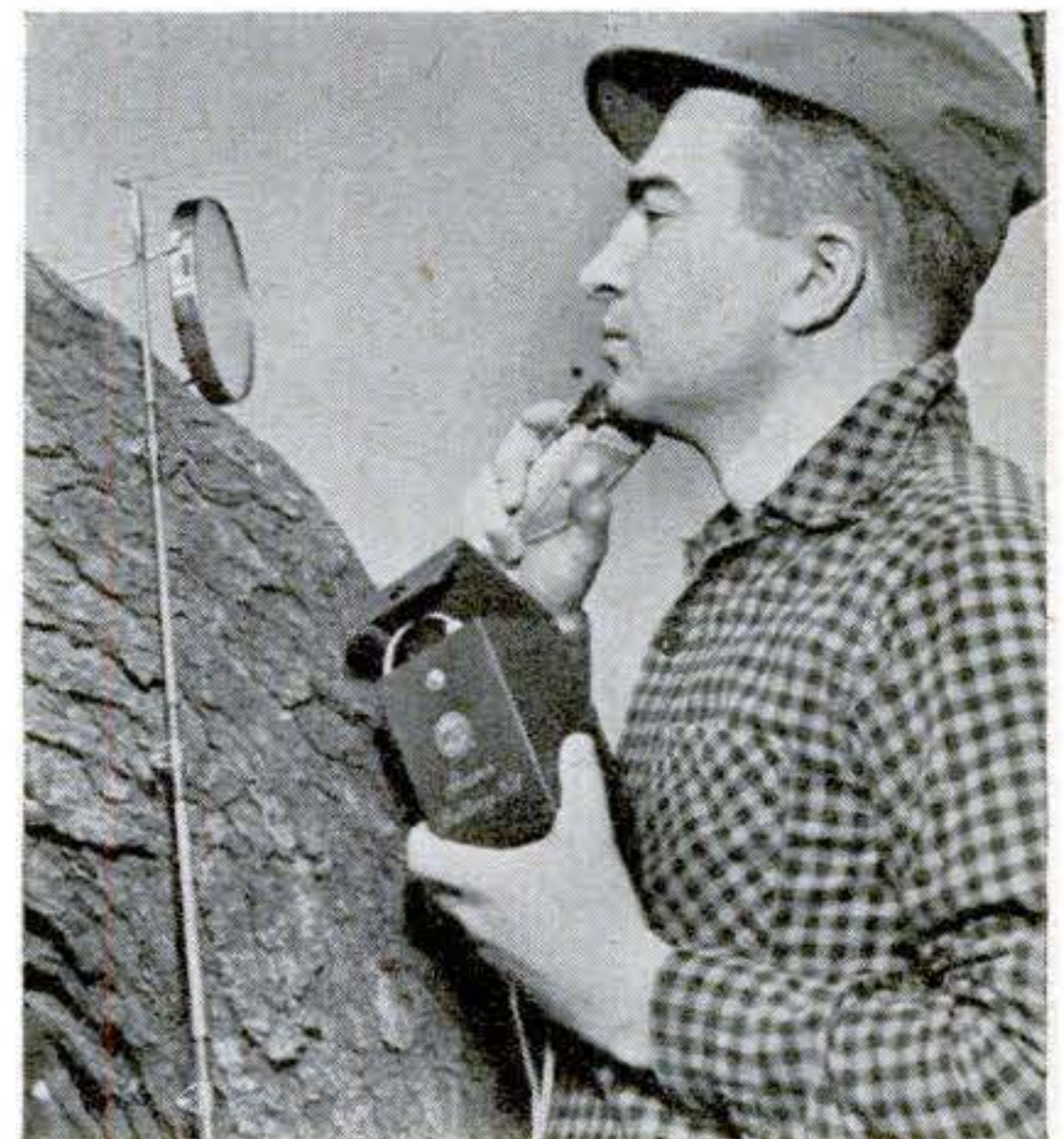

Razor's Buzz Now Heard in the Wilds

THE weekend hunter, fisherman or camper with a city-bred taste for electric razors need no longer fret about going back to blades when he goes back to nature. RCA has brought out this battery kit, into which nearly any AC/DC shaver can be plugged.

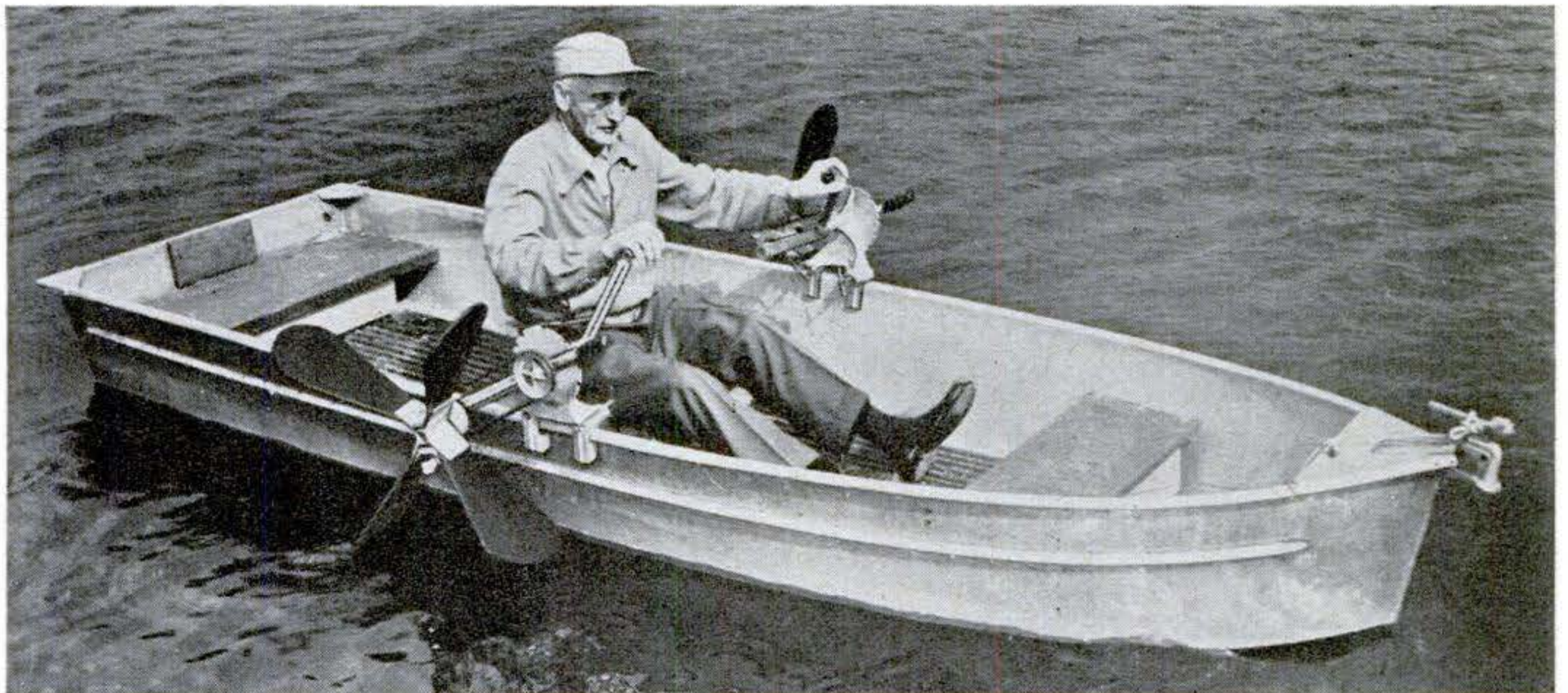

Hand-Cranked Paddle Wheels Put a New Twist into Boating

ANYBODY who has ever noisily, or even painfully, "caught a crab" while rowing will appreciate the soft spot in which the gentleman above finds himself. Cranking comfortably away at two paddle wheels,

which clamp to the sides of almost any small boat, he not only can see where he is going but can slither quietly through shallows and weed beds. Aqua-Oar Corp., Barrington, Ill., makes the equipment.

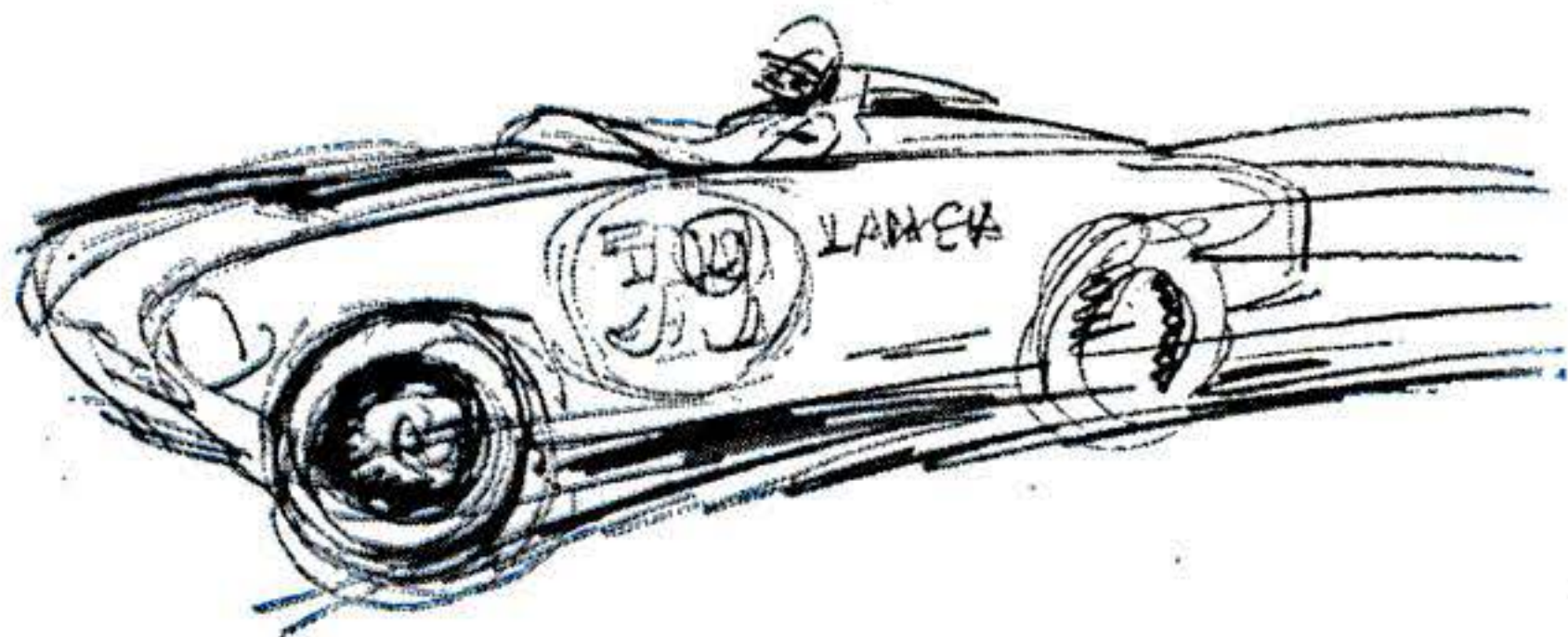

European Racing Invades America

Sebring 12-hour grind gives a bigger variety of thrills than track races.

By Frank Rowsome Jr.

SKETCHES BY RAY QUIGLEY

FOR a little band of dyed-wool enthusiasts, the most exciting 1954 auto race in the U.S. was run recently on an abandoned bomber field near Sebring, Fla. Conducted in the European style, it was as different from the American fashion of identical Offy-powered Kurtises orbiting in a banked loop as anything could be.

Unlike the typical U.S. track race, a constant-speed affair that sometimes tends to have a sedative effect on the onlookers, the European style of sports-car race offers a variety of excitements. Partly, this is because the cars vary widely, ranging from agile little trinkets to enormously powerful locomotives. Partly, it is because the twisty course measures roadability, braking, cornering and acceleration as well as flat-out speed.

The sharklike pros. But especially it is fun to watch because you can stare, fascinated, at the way different drivers drive. Some earnest amateurs—only some-

what better than you or I—careen along with rubbery shrieks and an uncertain lashing of the back end. The real pros, in contrast, drive with a precision that reminds you of championship form in tennis or golf: direct, able and rather sharklike. Over it all is the smell of hot castor oil, the squall of sliding rubber, and the metallic hysteria of engines wound

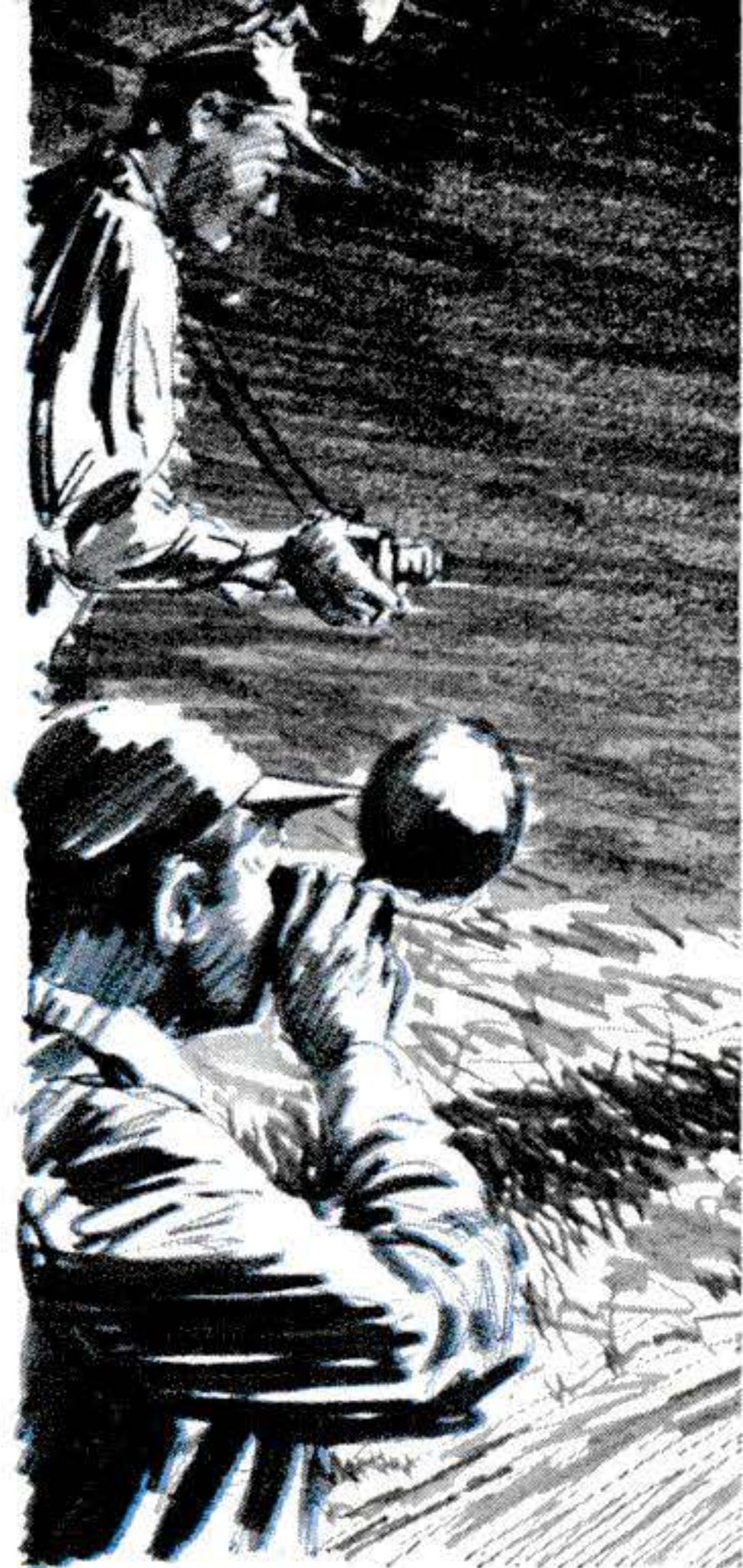

SHARPENING UP
THE TUNE
ON THE CAR
THAT WON

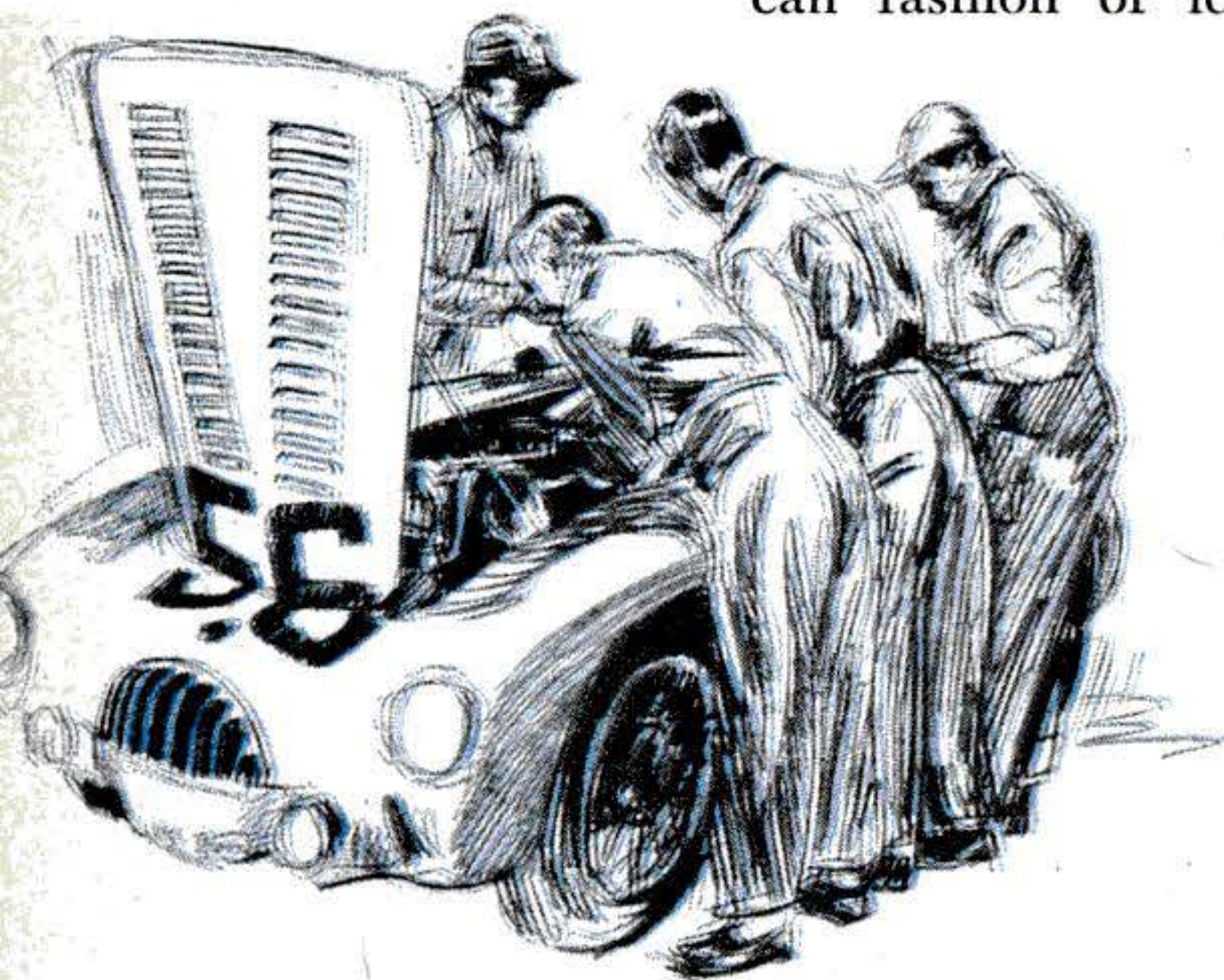



TARUFFI PUSHED THE DEAD CAR MORE THAN A MILE TO THE PITS.

up to the point where their elegant parts threaten to come through the hood in fragments.

The Sebring race, now only four years old, has a pretentious title (Florida International Twelve-Hour Grand Prix of Endurance) and an impressive accreditation. Sanctioned by the *Fédération Internationale de l'Automobile* and by the AAA, it draws factory teams and their hot professional drivers from the big European circuits—unlike most U.S. sports-car races, which are the province of amateurs.

Watching a factory team from Lancia, Ferrari or Aston-Martin, or the even more impressive U.S. stable run by Briggs Cunningham, is a little like watching an armored task force deploying to clean up a nest of squirrel hunters. The big outfits don't necessarily carry the day, racing being a chancy thing, but they certainly cast an ominous shadow over some amateur entrants.

Corkscrew course. At Sebring the course is 5.2 miles long and uses both wide concrete runways and mediocre black-top roads of bare passing width. There are 13 turns, five of them right-angle affairs and two even sharper, including a mean, almost-turnabout 135° hairpin with no banking at all. A couple of "chicanes"—rapidly alternating direction changes—are tossed in for spice. The two concrete



GOGGLES OVER GLASSES





straights, each about seven-eighths of a mile, let fast-accelerating cars wind up to a howling 135. But at several places even the most artfully suspended vehicle must be pulled down to 25 or 30 m.p.h.

Symbol signs at each turn remind drivers of what's coming up. Before each corner 200- and 100-foot markers cue them into the rapid-fire sequence of braking-downshifting-braking-accelerating-upshifting that is involved in a racing turn. This writer, exploring the course in a borrowed Chevrolet sedan, found the 85-m.p.h. lap averages hit during the race inconceivable; the sedan showed the whites of its eyes in fighting for an average 38.

Intricate rules. The race runs from 10 a.m. to 10 p.m. Two drivers per car may spell each other during the long grind. The cars must carry headlights, tail lights, self-starters, horns and rear-view mirrors. The rules are drawn to simulate a long cross-country race: a breakdown away from the pits must be repaired by the



driver alone, using tools and spare parts carried in the car. Pit-stop fixes must also use material carried along, excepting fuel, tires and a few oddments such as might be found at a small rural gas station. Elaborate regulations, suitable for sharpening the wits of Philadelphia lawyers, govern points such as who may work on a car in the pits (two mechanics, plus a gassing man, provided the driver is back of a barrier and no one uses tools or parts not carried in the car, with specified exceptions).

The over-all winner is the car that travels the greatest distance in 12 hours. A second major winner is the one that goes the farthest beyond its individual "Index of Performance" handicap, calculated on engine displacement. A variety

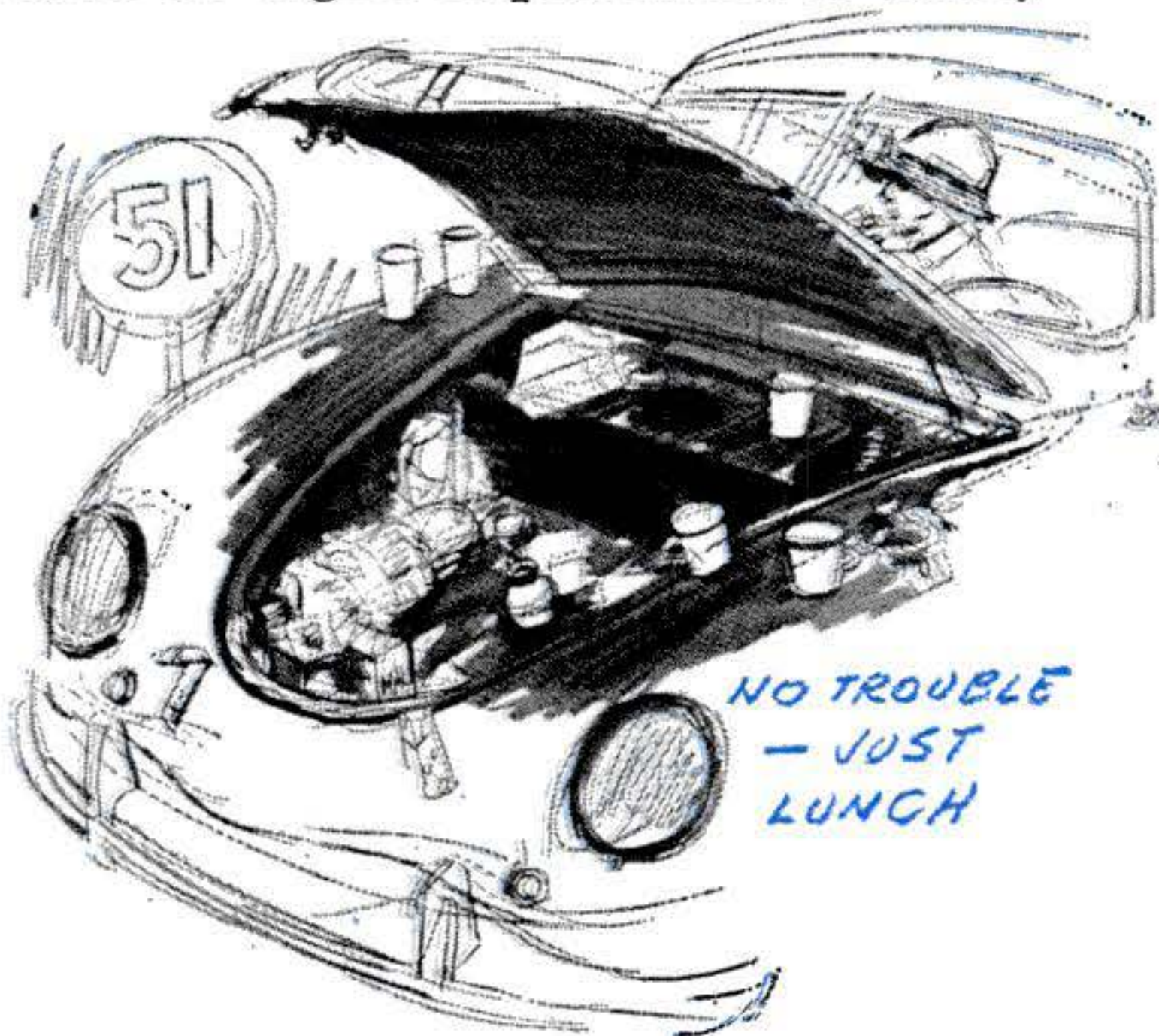

of cups, plates and plaques are awarded; but no one wins cash prizes—just mementos.

Fatigue unlimited. Preparing a car for the race can involve labors so arduous that you get tired just looking on. Take for example the three Excaliburs entered this year by Brooks Stevens, a Milwaukee designer. (This is a U.S.-assembled sports car using a Willys F-head engine hotted up to 135 hp. with a wild cam, three carbs and 8:1 compression, installed in a reworked Henry J chassis.)

The cars were trailer-trucked 1,500 miles to the race in an exhausting Odyssey marked by blizzards, ditching, time pressure, insufficient sleep and faulty



LAST-MINUTE WORK
IN A LEAKY-ROOFED HANGAR

trailer brakes. Then the crew of mechanics and drivers, established in a corner of a great leaky hangar near the course, began five days of concentrated labor. Two of the three cars were given exacting overhauls, piece by piece. The third was literally built, having been trucked down in unassembled bits.

Work went on without interruption as the coffee cartons and sandwich wrappers piled up by the toolboxes. Most of the crew felt lucky to get five hours' sleep out of 24. Late the night before the race the three cars were ready. Then, just hours before the start, when one engine was fired up to sharpen its tune, a rod bearing let go with a sickeningly final clatter. Hasty autopsy showed that a faulty bearing shell had starved the bearing, leaving the crankshaft fatally scored. Still, two were ready. And now . . .

Le Mans start. Fifteen minutes before 10 a.m. on race day, 58 cars are lined up near the pits, pointing outward at 45° as though angle-parked. Each has been anxiously checked over: tools and spares in place and snugged down; oil, water, brake fluid and tires just right; fuel tank topped and sealed (no car may refuel for 20 laps); and everything as right as skill and imagination can make it.

On many cars the preparations involve some picturesque extras. The engine has been carefully warmed before being shut

off; the key is in place and turned on; the shift lever is already in low or second; and the safety belt is laid out as invitingly as a turned-down bed.

Ten seconds before the start the loudspeakers toll off the seconds to zero. When the green flag drops, each driver, lined up across the way from his car, sprints over, jumps in, fastens his belt, drops the clutch, hits the starter and screeches off.

Some of them, mindful that 50 cars jostling wildly in the first turn can create uncontrollable situations, make a fierce effort to be out in front. Others, wary of the perils of precipitousness (it is not unknown for an excited driver to turn his switch off and then try desperately to kindle his engine), prefer to cross at a brisk trot to the cars. Their goal is

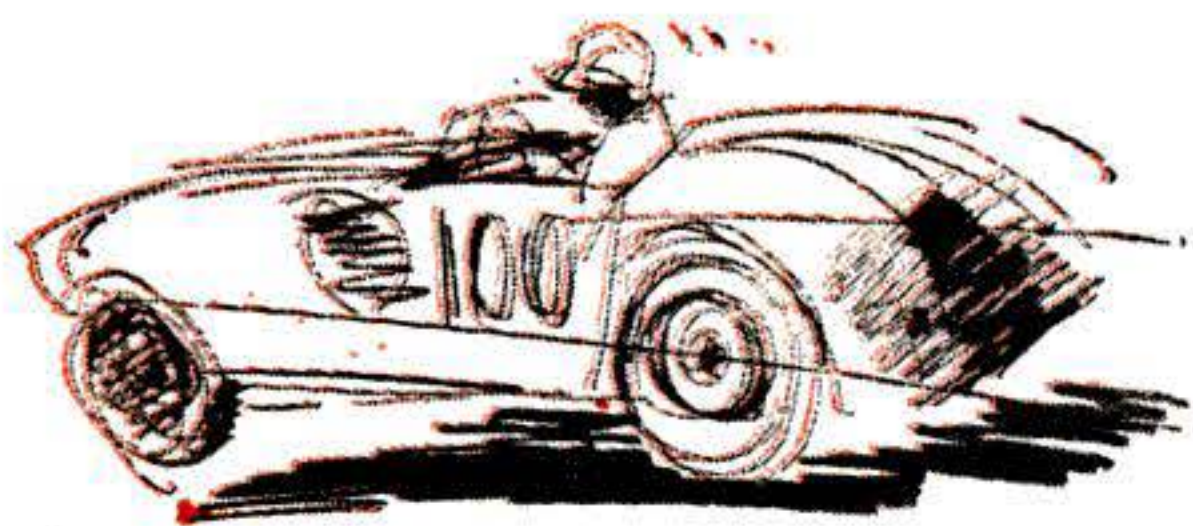

to get away with an unflurried dispatch.

A few drivers, calculating that 15 seconds are a trivial piece of 12 hours, obviously try to amble over but get carried away. A minute or so after the pack has roared away, one Tail-End Charlie finally succeeds in firing up and hares off in a quick-shift crescendo.

The daylight hours. Though cars are soon spread around the course like beads on a string, the field quickly divides into the real goers and the valiant triers. Expertly driven fast cars such as Lancias, Aston-Martins, Ferraris and the Cunningham flash around at blinding speed, tracking as precisely as if on rails, accelerating tremendously on the straights, braking at the last moment when a turn looms. Others, less able or less proficiently handled, travel with a great rumpus and a continuing air of catastrophe narrowly averted.

Once-sleek cars soon have the raffish look of hard-pressed machines. Tailpipes dangle, sides are crumpled by spin-outs, and many cars wear wisps of hay or fragments of orange baskets speared from the course markers. By now the pits are busy as nervous-fingered mechanics change condensers or remove fouled plugs. Hard luck thins out the field: an Excalibur quits when a fuel-tank weld opens up; the hot Aston-Martins, piloted by some of England's best drivers, are out with brake-line and oil-seal failures; a mixed bag of Porsches, Jaguars, Allards and Ferraris come to grief; two of the leading Lancias, driven by champions Ascari and Fangio, die of clutch failure and a broken axle.

As the day wears on, the cars—now reduced by a third—show distinctive personalities. The big Cunningham thunders heavily

around curves with a graceless but potent rumble. Agile little Oscas dart deftly through a chicane with no fuss at all. A Lancia leads the field, mean and businesslike. A big-engined Ferrari continually winds up toward 7,000 revs in a series of appalling screams.

Able drivers, with every inch of the course memorized, give arrogant driving lessons to newer men by passing where they please with contemptuous skill and raspberries from the tailpipe. The Cunningham is abandoned in its pit, a gasket gone and water boiling pathetically from its exhaust. The clutch on the last Excalibur shatters—some pieces come through the bell housing—but the car still motors gamely along, unable to shift gears.

After dark. Once the quick Florida sunset is done, the race becomes more romantic. Waiting in the dark at a turn, you first see the tops of the palms picked out by distant headlights. Quickly this builds up to a scalding white glare amid the shrill of high revs, and then red tail lights streak away into the distance. Because 10 hours and more than 600 miles have trimmed the 58 cars down to 30, a minute or two passes before the far headlights pick up the palms again.

Less than an hour before the finish comes a dramatic climax. A Lancia driven by Piero Taruffi to a tremendous 17-lap lead suddenly dies more than a mile from the pits. Taruffi, a white-haired "hero driver" to thousands of enthusiasts abroad, pantingly pushes his car to its pit and drops exhausted while mechanics diagnose it and other cars flash by, steadily eating up his lead.

They discover the Lancia has a holed oil pan, perhaps from a thrown rod, and

[Continued on page 274]



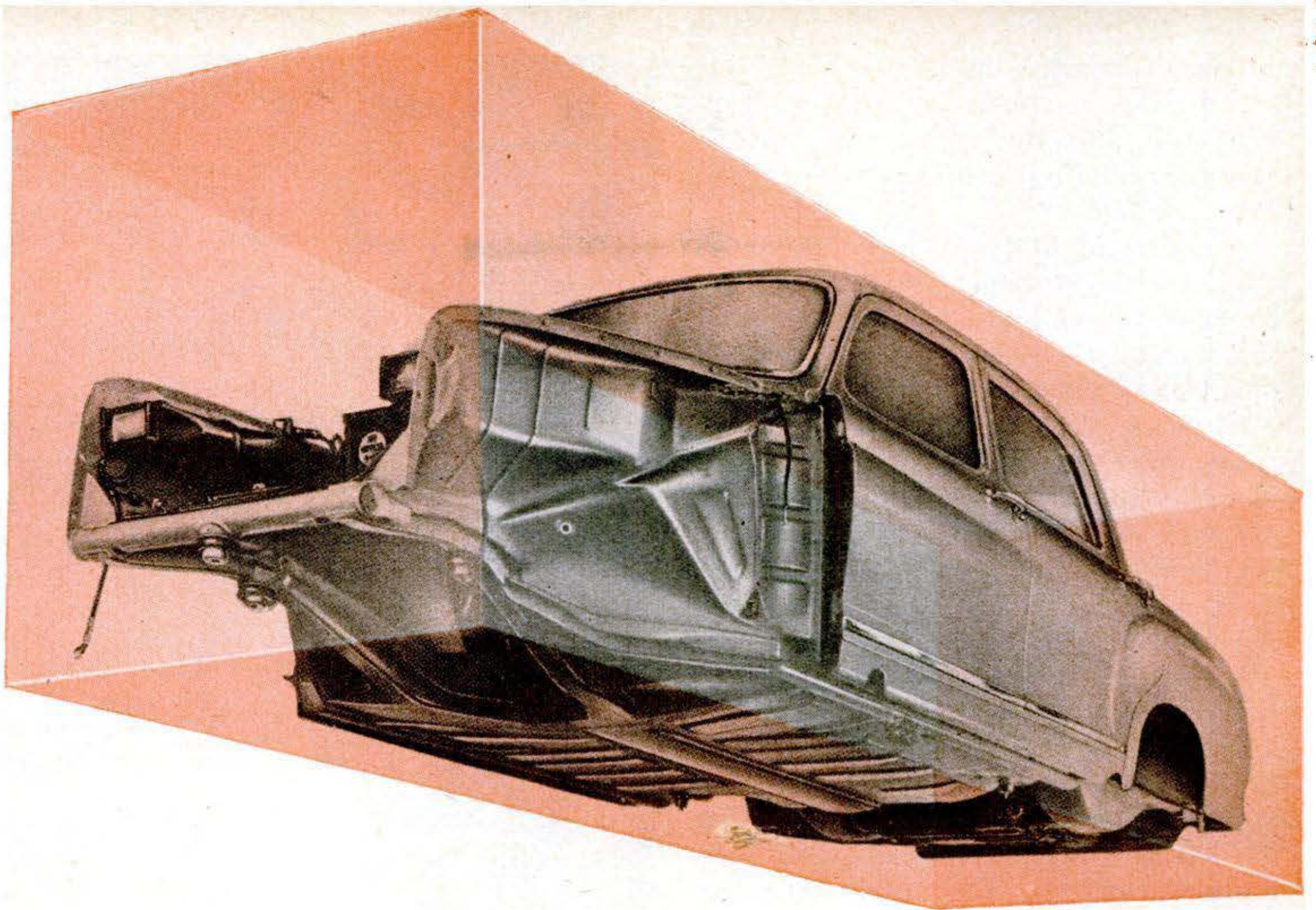

Will All Cars Be "Box" Cars?

U. S. auto makers tend increasingly to do without chassis frames and fasten the engines and running gear directly to the bodies.

By Roger Huntington

THAT old, bulky chassis frame that the American motorist has been riding around on for the last 50 years has about as much future as running boards and updraft carburetors. Detroit is about to whip it out from under you and ditch it for good. Give them five years.

Since the very early days of the automobile, the classic method of construction has been to mount all the major components of the car—engine, running gear and body—on a massive frame base. It has worked very nicely. But is it the final answer? Why not build up the body as a sturdy *box* unit and fasten the engine and running gear directly to it? This would not only eliminate the weight of the frame, but the

rigidity of the whole assembly would be greatly improved by spreading the various structural loads over the body skin.

On a conventional car the frame absorbs most of the jolts from the road through the wheels. The body, mounted on rubber bushings, contributes very little to over-all stiffness. This means a big, heavy frame. With unit construction, the whole body shell—roof, floor, side posts, quarter panels, firewall—is put to work. The result is a more rigid, lighter and less expensive body.

The advantages of unit construction over present layouts are obvious:

More efficient use of material. By eliminating the heavy frame we save on both weight and cost. The average weight reduction seems to be about five percent, or 200 pounds on the average

full-size car. At the pocketbook this could mean maybe 10 cents a pound on first cost, plus the gas savings with a couple of hundred pounds' less weight to drive around.

More rigid body. A very rigid base for steering and suspension systems is vital to good road-holding, handling and ride. A unit body, built on the principle of a truss bridge, has *twice* the torsional and beam stiffness of a conventional frame-body assembly. This shows up in fewer squeaks and rattles.

Crash safety. Experiments in the aviation field have indicated that the passenger's chances in a bad crash or roll-over are improved if the impact is gradually absorbed by crushing sheet metal, rather than trying to overpower the shock with a massive superstructure.

Lower bodies. The rigidity of a conventional channel frame depends a lot on its depth, which, of course, limits how far you can drop the floor. You don't have this problem with a unit body.

Actually, the idea of unit construction is far from new in the auto industry. In the U. S. during the mid-Thirties, the ill-fated Chrysler Airflows first featured a basic unit construction. Later Cord, Lincoln Zephyr and Mercury adopted it. And in 1941 the famous Nash "600" economy car came out with a full unit body.

But there were problems in those days. The one-piece body acted like a huge sounding board for road vibrations. The thin sheet-metal panels under the body corroded rapidly. And it was claimed that body collision repair costs were excessive.

Today the problems have been solved and we're ready to make the switch. Noise level has been reduced by clever use of rubber insulation between body and running gear, sound-insulating material at certain points in the body, and proper design of stiffening ribs in the panels. Corrosion is controlled by the Bonderite process. (This is a chemical spray treatment that converts the metal surface to a nonmetallic phosphate coating that is insoluble in water.) Collision

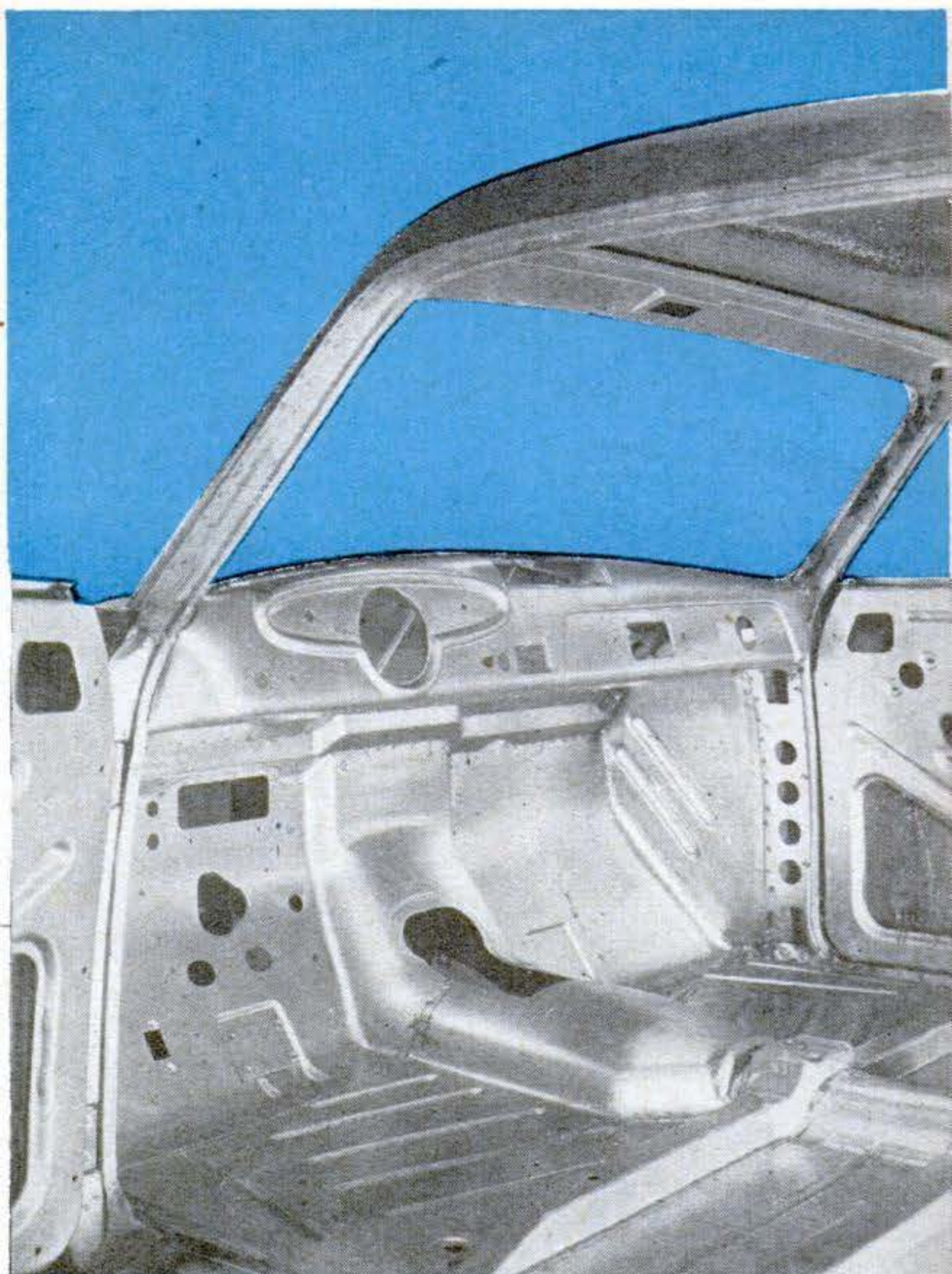

ABOUT 8,000 SPOT WELDS are needed to put together the five main parts of a unitized Aero Willys body. This interior view shows how skillfully the welding job is done.

repair costs are still probably somewhat higher than with a separate body and frame, but the difference is small.

So it looks today as if unit construction has definitely arrived. Hudson went over with their "step-down" models in 1949. All Nash models now feature Airflyte construction. And the new Aero Willys was a natural for it.

In my opinion, the chief factor that is triggering the revolution is not weight, cost, rigidity or safety but simply the styling trend to very low bodies. They've got to lower that floor, and this is the only way they can do it.

Only the tremendous cost of converting production facilities is holding us back. It won't hold us for long. General Motors definitely plans to switch several of its models in 1955, and the rest of the industry will quickly follow.

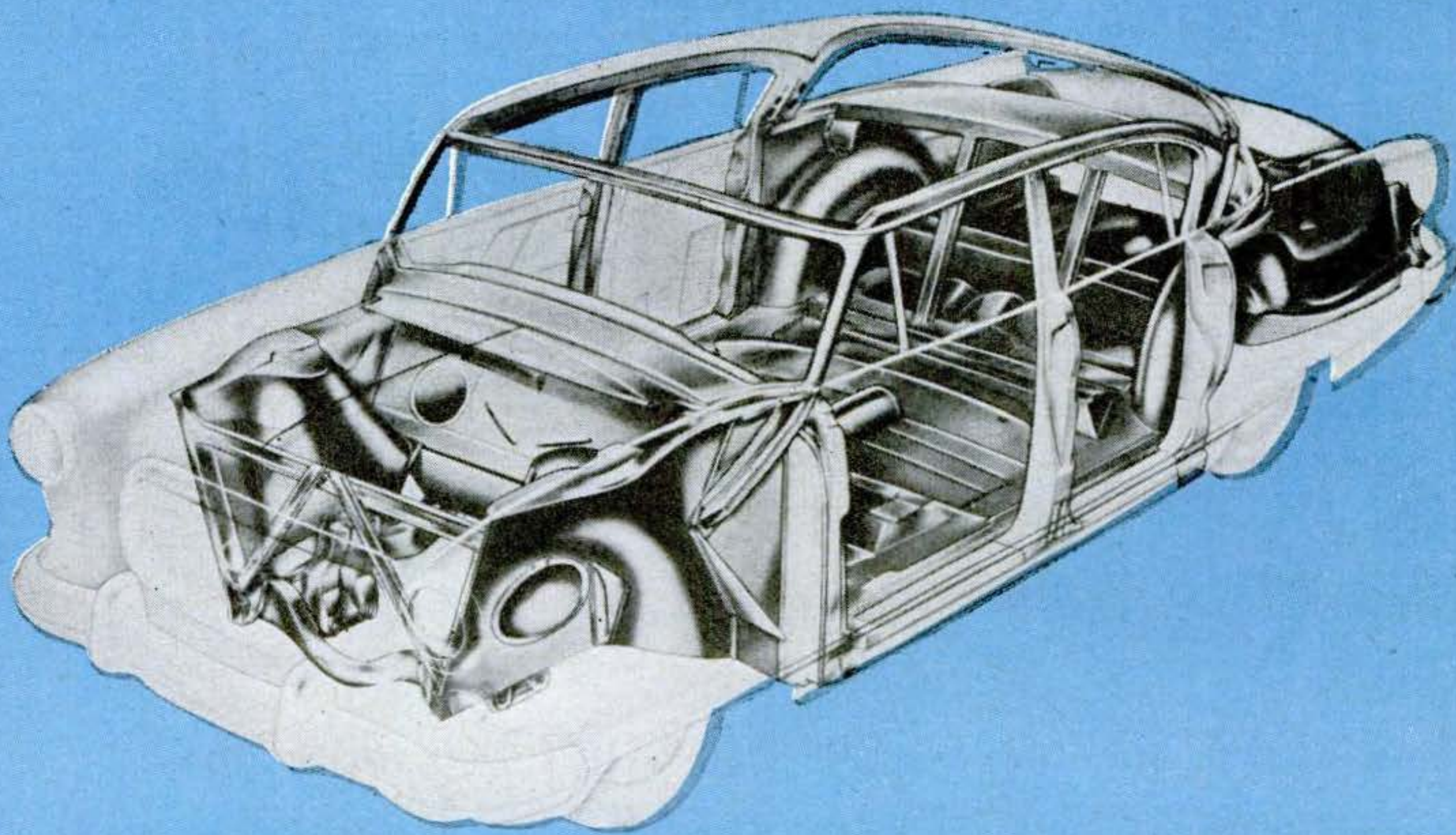
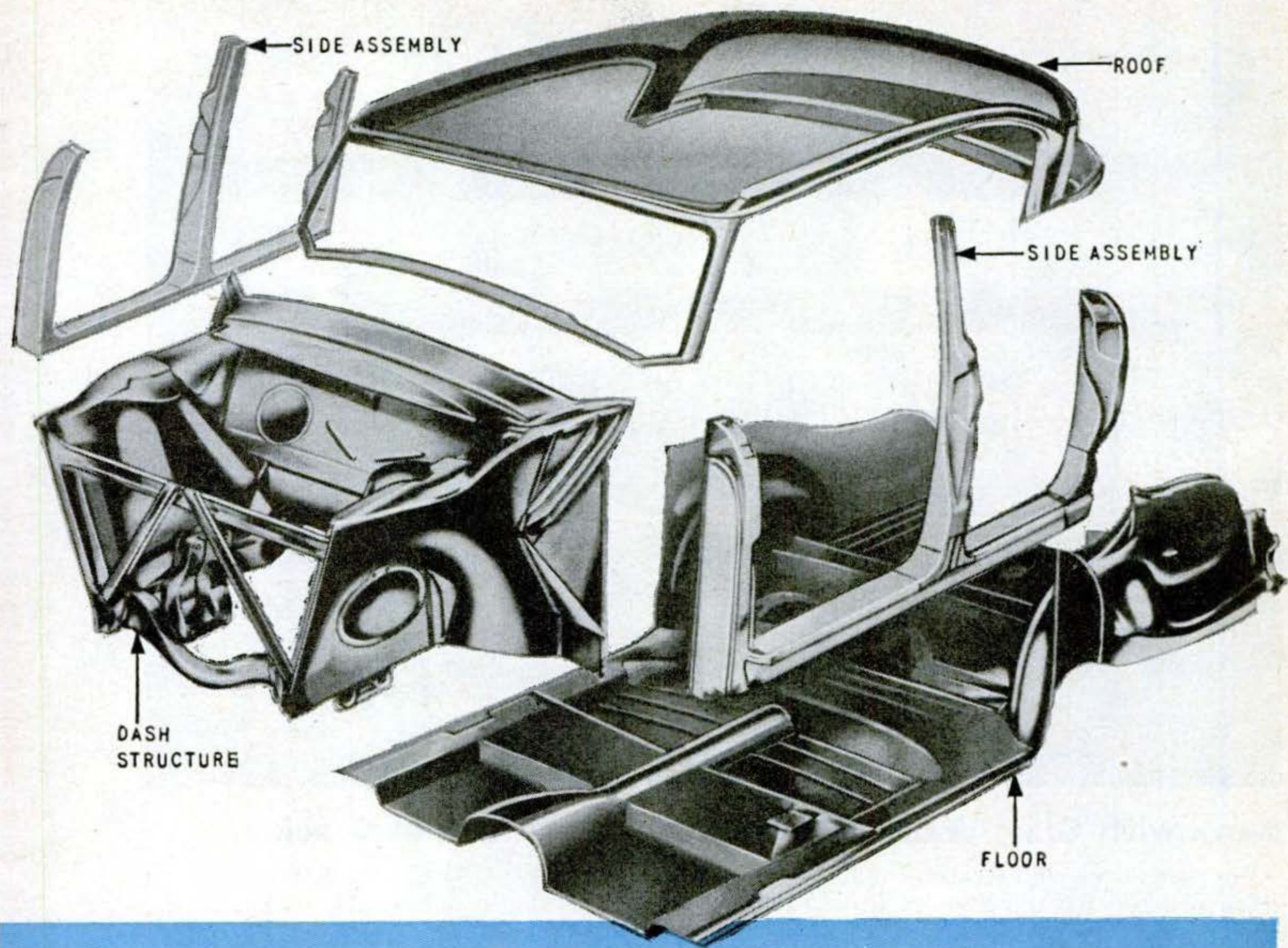

PARTS OF A "BOX" (top) that will soon be welded together to form the skeleton (bottom) of a Nash of Airflyte (unit) construction are: the floor and its bracing; the dash,

including forward bracing to carry engine and front suspension; side assemblies, with door framing and rear fenders; and roof, with front and rear window framing. **END**

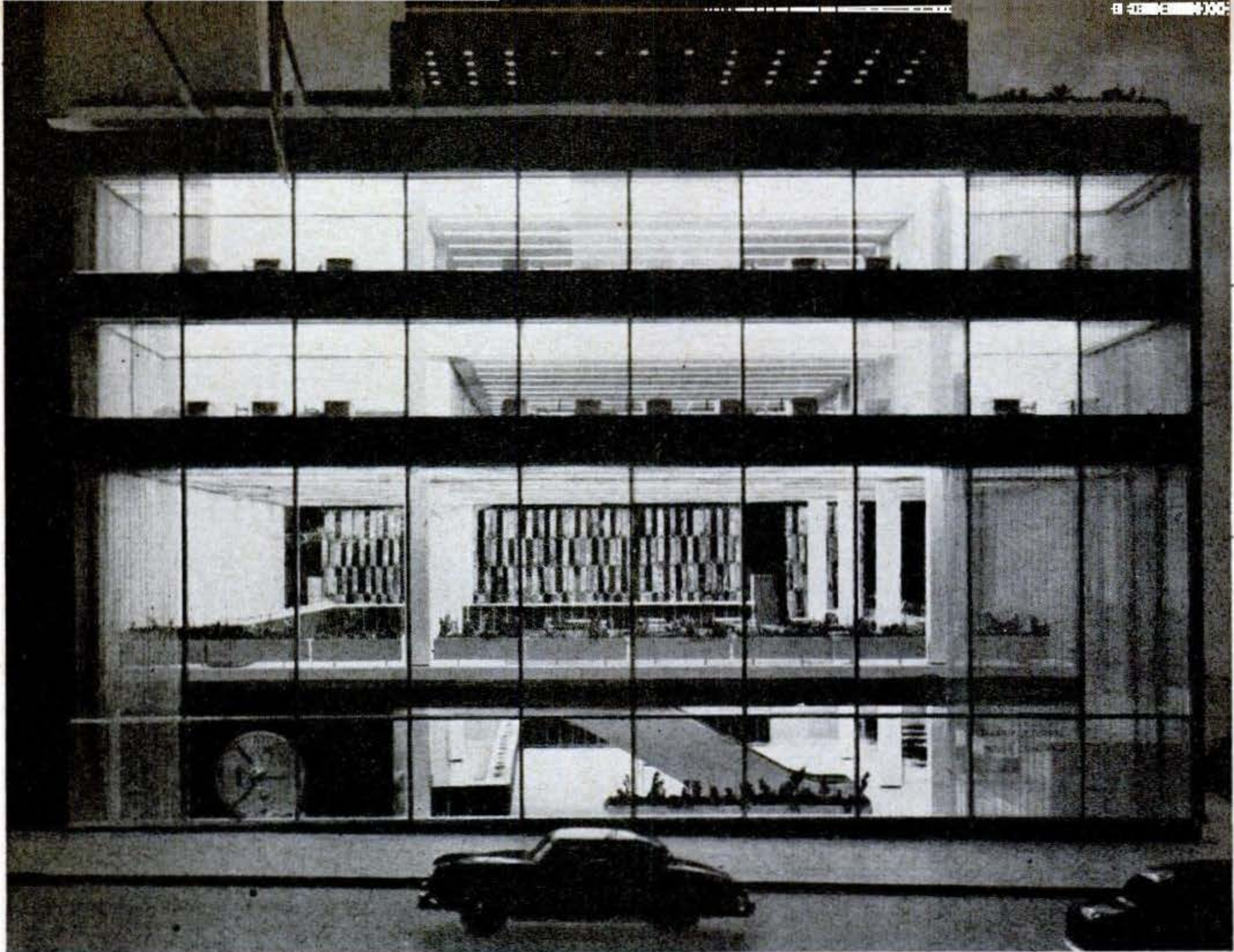

Bank with Glass Walls—Easy to Case but Hard to Crack

NOT a mouse could stir unseen in the new office planned for the Manufacturers Trust Co., New York. Walls of half-inch-thick glass on two sides will leave nothing hidden to view—not even the vault. Instead of be-

ing buried in the basement, it will be set in the 60-foot-high window that forms the Fifth Avenue façade of the bank. Its 30-ton door (shown at lower left on the model above) will be spotlighted day and night.

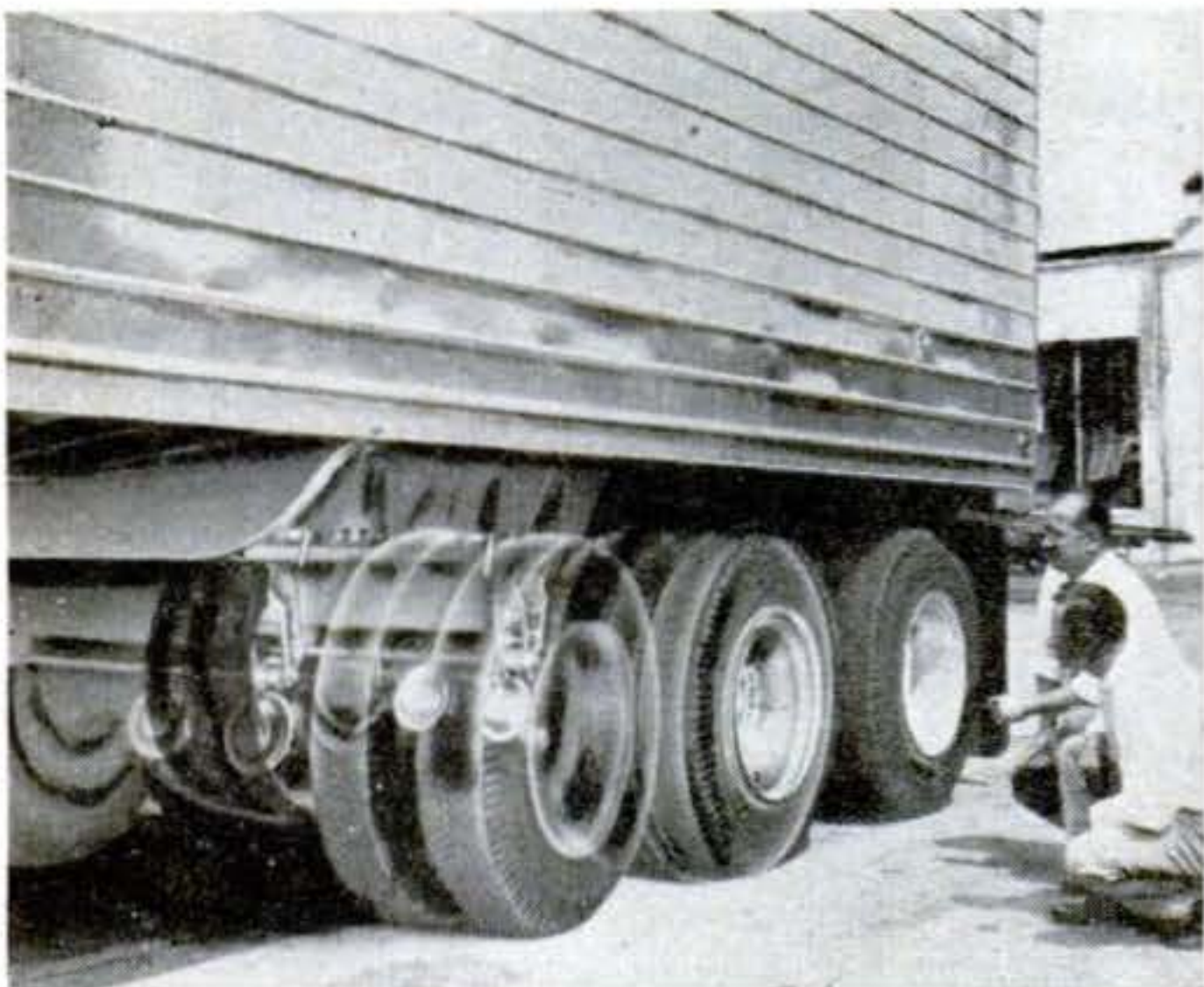

Wheels Shift to Shoulder Load

A NEW shiftable tandem axle suspension for trailers lets the driver lengthen or shorten wheelbase as much as 45 inches. The photo above shows the Trailmobile device in rear position with forward position indicated in phantom outline.



Cab Moves Over for Engine

WITH the engine snuggled alongside him, the driver of this truck sits out in front where the view is good. The Kenworth cab is so narrow he can reach out and clean the windows from the inside. His relief driver sits behind him.

Taming America's Wildest River

Army dam builders are calming the raging Columbia for big ships to ride.

By Richard L. Neuberger



HUNDREDS of miles from the sea-coast, amid the pine forests and sagebrush deserts of the Pacific Northwest, they are getting ready to build

wharves for ships fresh from salt water.

Nobody's nuts. It all makes sense. For one of these days, Army engineers expect to gentle for navigation, with a



TURBULENT FLOOD of the Columbia boils below shaky platforms from which Indians catch salmon in the Celilo Rapids. The Dalles Dam will bury the rapids forever.

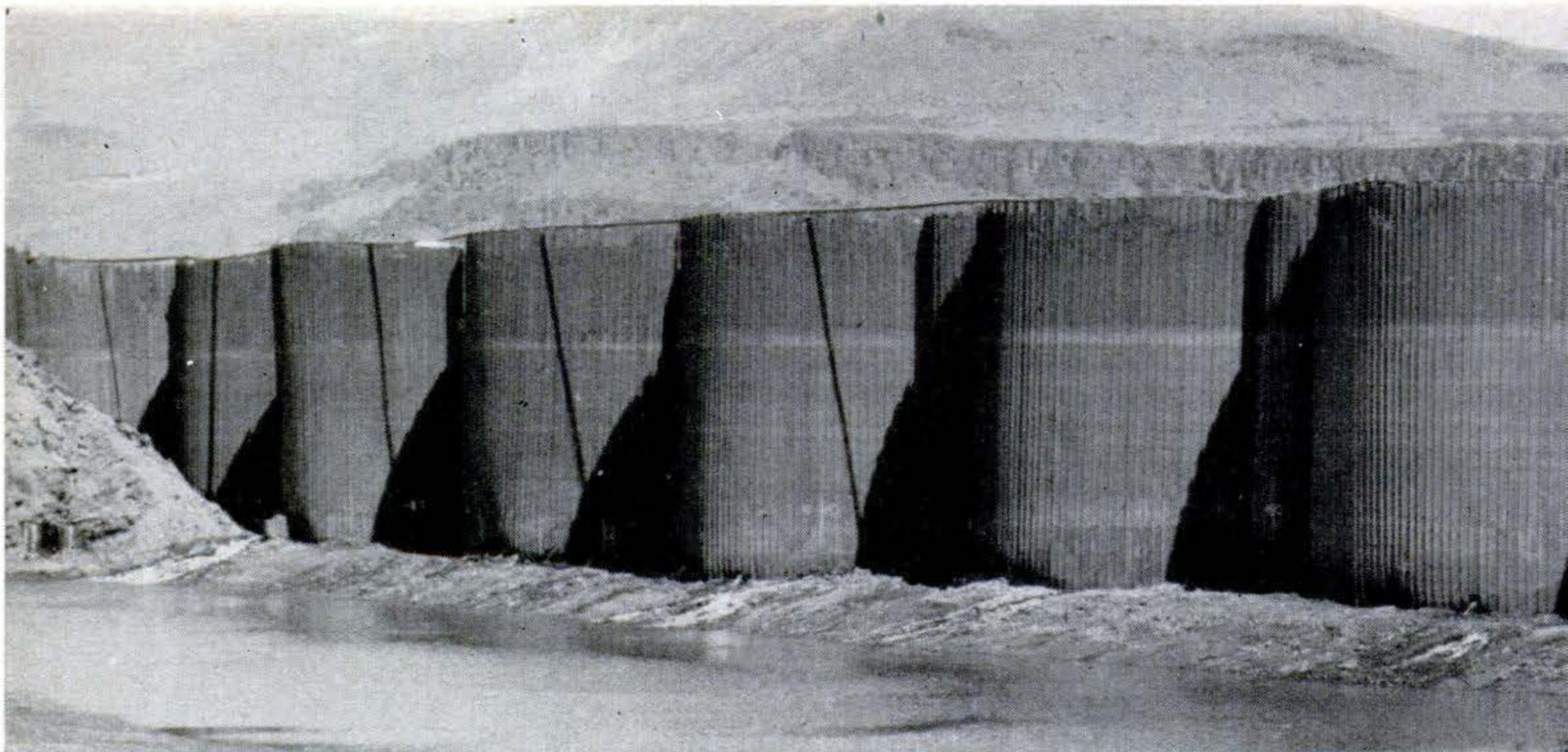

A fortress-like line of huge steel cofferdams holds back the surging river at The Dalles.

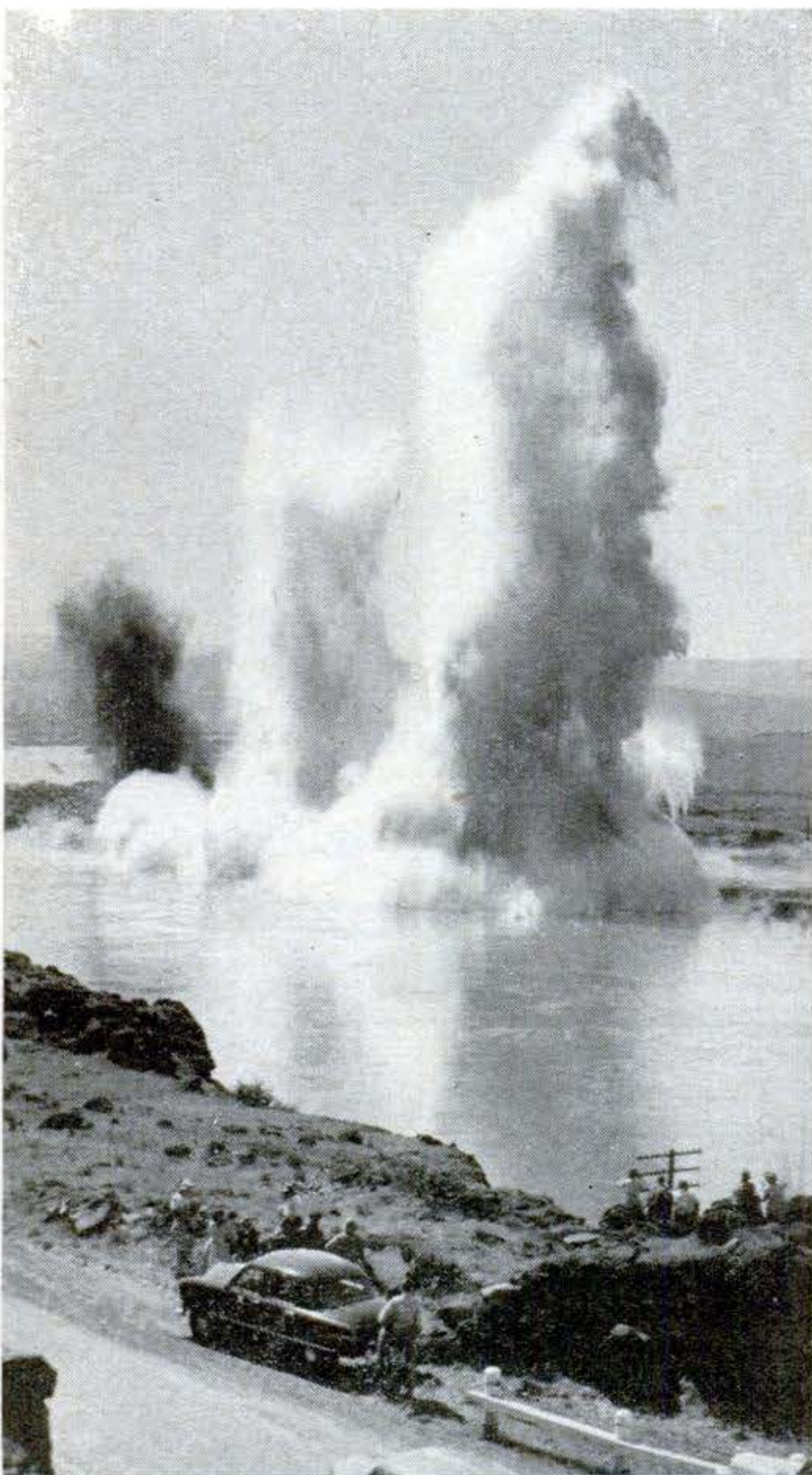

FIRST ROUND in the Army engineers' current wrestling match with the tough, elusive Columbia opened with a rousing dynamite blast at the spot where The Dalles Dam will rise.

strait jacket of steel and concrete, the river that couldn't be tamed—the mighty Columbia.

Much of the work has already been done. The Columbia, potential source of two-fifths of all the hydroelectric power in the entire nation, is becoming a major artery of transportation.

Vessels with blue water in their bilges and salt in their scuppers are riding its breast to breach the great mountain ranges behind the seaboard. The goal of the engineers is 630 miles of navigable water—all the way from the treacherous bar at the river's mouth to Wenatchee, Wash., and, via the tributary Snake River, to Lewiston, Idaho.

From Torrents to Slack Water

Dams are shackling the Columbia. Coast Guard crews are erecting buoys and beacons far inland, in the shadow of mountain precipices, where the river splits the rugged Cascade-Sierra range. Some of the world's biggest dams are catching, and burying beneath cushions of slack water, the hurtling downhill torrent of the Columbia system.

Ever since those frontiersmen, Lewis and Clark, first explored this titan of rivers—with eight times the flow of the Colorado, four times the length of the Hudson—its foaming whirlpools and hid-

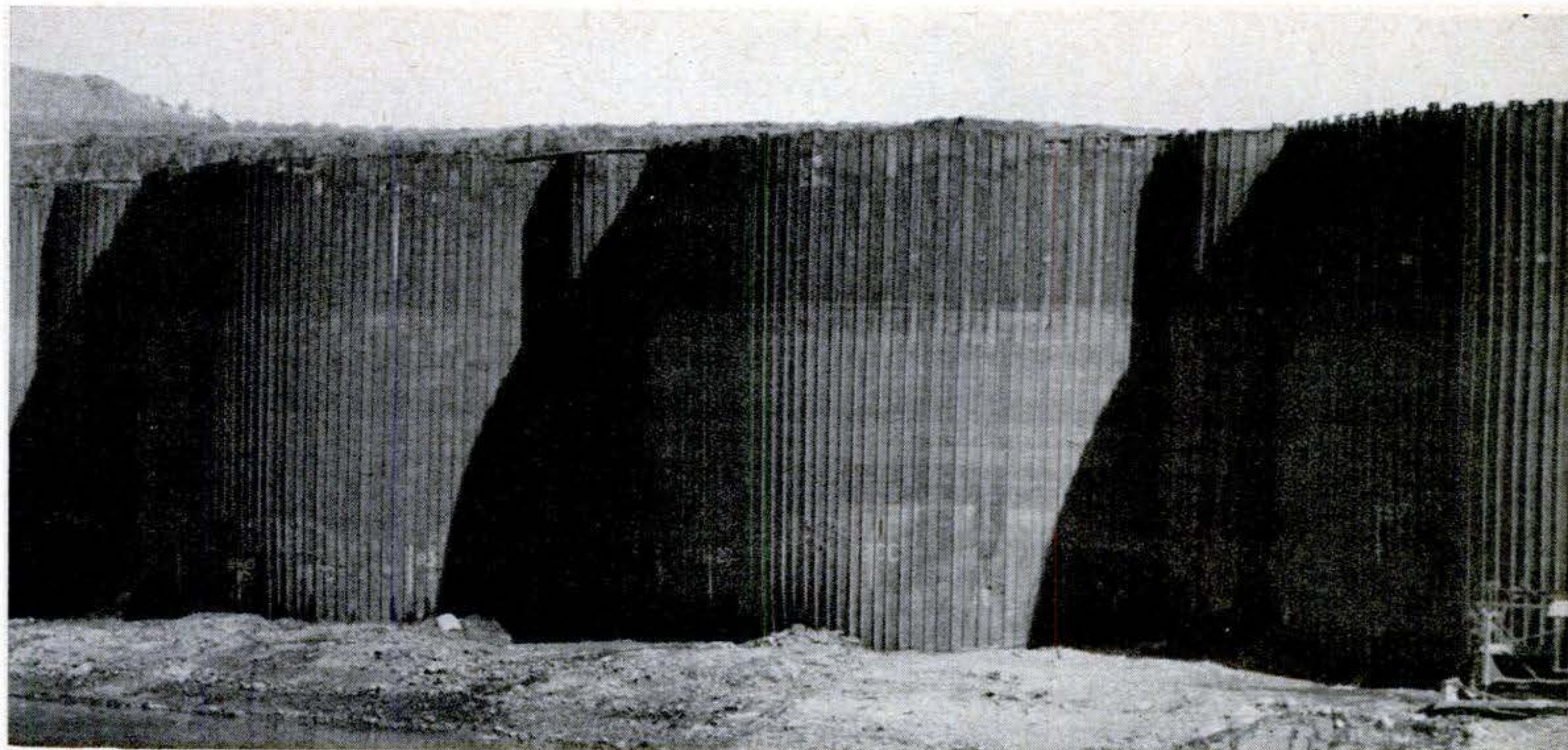

The new concrete dam being built at this point will be more than a mile and a half long.

den rocks have turned boatmen gray.

Long ago, the skipper of the elegant steamboat *Wide West* complained that he had to brave a current "as fast as stampeding buffalo and twice as dangerous."

Putting a Monster to Man's Use

But the harnessing of this maelstrom for low-cost power has accomplished the dual feat of electrifying farms and factories and, at the same time, of sheathing the river's fangs. No longer can the crag-strewn rapids of the Columbia bite into the metal hulls of diesel tugs or rip the planking off stern-wheelers.

Now Bonneville Dam's reservoir has muffled the thunder of Cascade Rapids. And when the new McNary Dam is in full operation, the engineers expect the Columbia to carry some 240 times the freight that it did 17 years ago. That would be 3,600,000 tons.

Above McNary, Ice Harbor Dam, recently authorized by Congress for construction near the union of the Columbia and its principal tributary, the swift Snake River, promises to float even double this load to the very ramparts of the Rocky Mountains.

But ships must have staircases to surmount the dams. This means locks. In one stout hoist, the single chamber of

the McNary lock can heave a ship higher than the three famous steps of the Gatun locks along the Panama Canal. The triple staircase at Gatun lifts a vessel 85 feet. By contrast, the solitary ascension at McNary is 92 feet.

Until the ponderous gates and electric machinery at McNary went to work, the angry ripples of Umatilla Rapids blocked off navigation to all but the most daring operators. Today, the rapids have disappeared.

Other locks are at Bonneville.

Tightest bottleneck on the upper Columbia River has been the nine-mile alley of the Celilo Canal. This by-passes the boiling chutes which the first French-Canadian trappers and traders called The Dalles, meaning a tube or trough.

Diesel tugs of 3,600 champing horsepower must murmur along at a bare crawl. It is threading a needle to push through this narrow passage a chain of stubby oil and grain barges, which measure up to 58 feet wide.

Rapids Transformed into Reservoir

"With a stiff wind whipping across the Columbia," said Lew Russell Sr., general manager of the prosperous Tidewater-Shaver Barge Lines, "a pilot who can keep a 5,000-ton load from nudging the rock banks of the Celilo Canal could

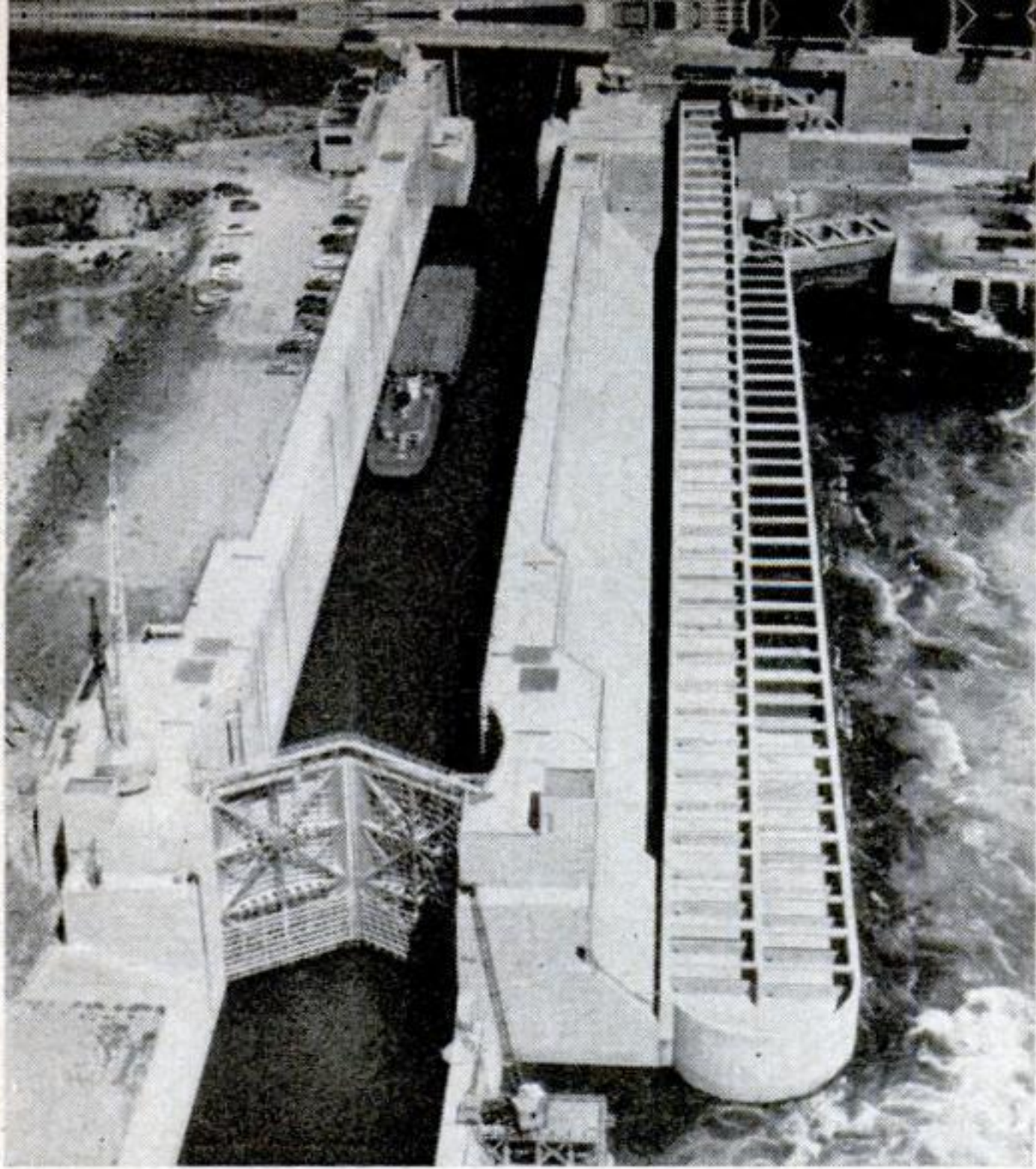

LOFTIEST LOCK in the world is this one at brand-new McNary Dam on the Columbia. Measuring 56,000 square feet in area, it hoists ocean-going tugs and barges 92 feet.

take a corvette through a bowl of consommé without disturbing the noodles.”

But the days of this tortuous cruise are numbered. Already the foundations of The Dalles Dam, a \$348,400,000 project, have been poured onto bedrock.

Behind The Dalles Dam a 25-mile lake will form. It will drown out the canal and rapids at Celilo. Instead of the cramped one-way corridor, river craft will pass the rapids on a limpid reservoir.

Included in the cost of The Dalles Dam is \$23,700,000 which will be paid to the Yakima and Warm Springs tribes as indemnity for loss of their ancestral fishing grounds.

Hellgate will be the site for one of the last dams built to tame the Columbia. Here a strong undertow pulls at tugs and barges. More than one costly craft has foundered on the channel's boulders.

Danger Below

But construction of John Day Dam, already approved by Congress, will add Hellgate to the roster of river hazards that are no more.

All the work to make the Columbia safe for brass propellers and steel prows is not done upstream. The giant river meets the ocean over a bar that shifts

with the tides. It is a fickle entrance, subject to change without notice. Across this bar, the wind often blows with brutal ferocity from the distant Aleutians. The bones of 109 ships, from sailing schooners to luxury liners, litter the Columbia's mouth.

Freighters and tankers frequently draw 32 feet or more, yet the bar lies only 40 feet beneath the surface. When a loaded ship “sounds” in a heavy swell, it may dip to within inches of this perilous bottom.

Jetties have been thrust far out into the salty reaches of the Pacific in an effort to keep the tide from filling up the Columbia's channel. Now a big hopper dredge, with a robust complement of 15 officers and 66 men, churns back and forth over the bar, sucking it to a depth of 42 feet. The bar is 8,000 feet long and 2,600 feet wide.

The Salt-Water Line Moves

Portland, only major city on the Columbia River, has been the dividing line between ocean traffic and fresh-water commerce. Freighters come in over the shifting bar and unload at Portland, 100 miles from the sea. Here, barges take over for a voyage through basalt canyons to points in the Inland Empire.

But now the dividing line is wearing thin. Freighters, right out of salt water, have passed through the Bonneville locks. The still-larger locks at The Dalles Dam and McNary Dam will take ocean commerce far past the glacial backbone of the Cascade Mountains.

Eventually, commerce on the upper Columbia will be through a series of slack-water pools, interrupted only by staircase-like locks. Tugs generating up to 3,600-horsepower can move tows which rival freight trains in length once they no longer have to resist the Columbia's raging current.

Engineering has performed its task well indeed, when the fastest big river on the continent can be made safe for barges and freighters at the same time that it is yoked to turbines and generators.

END

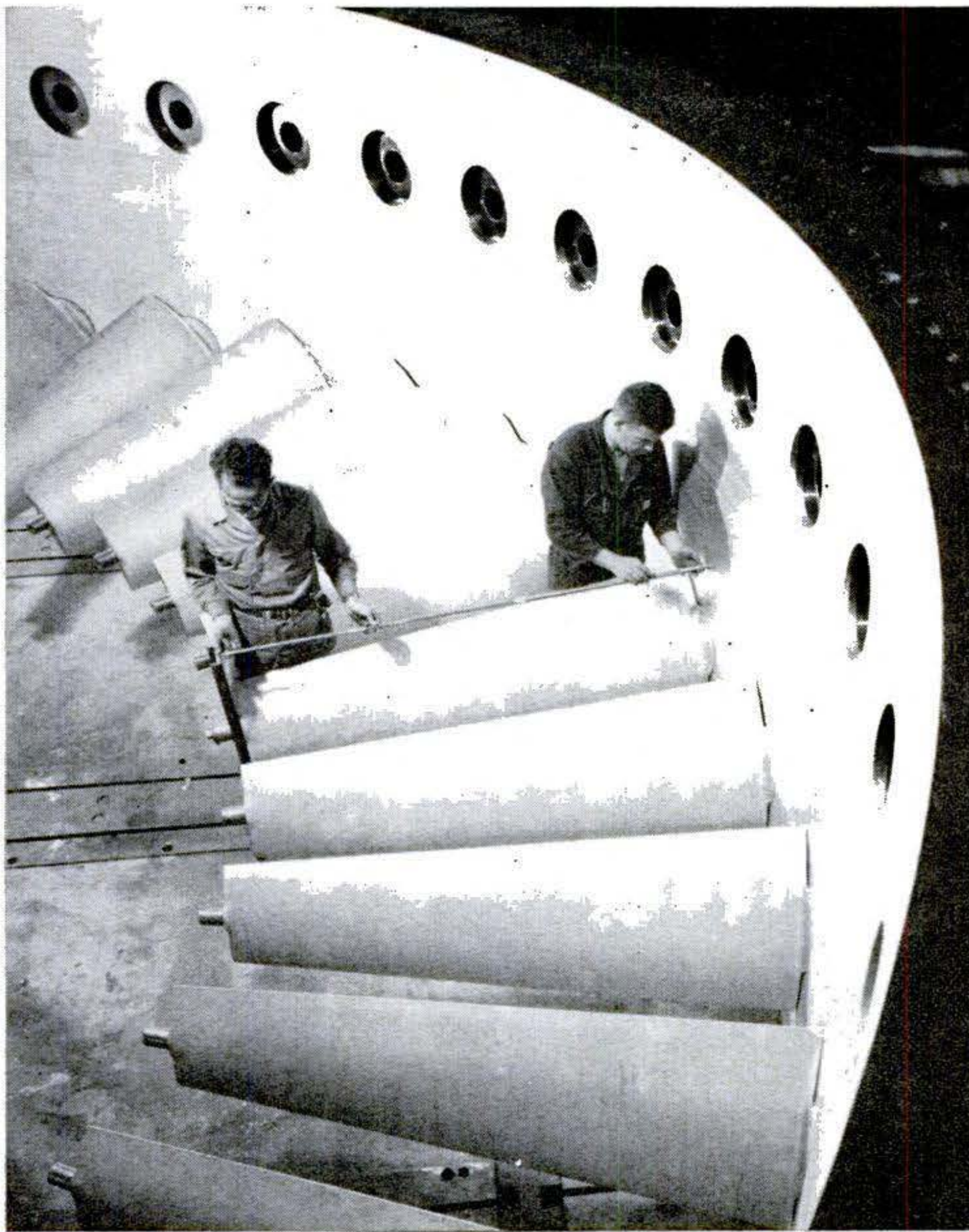

Man-Size Blades Will Stir Gales Of 2,500 M.P.H.

IT TAKES a lot of men in a lot of places to put together a huge wind tunnel. These Westinghouse workers in California are rigging a stator section for one of five giant compressors that will blow up a gale in an Air Force transonic and supersonic tunnel at Tullahoma, Tenn. They are mounting stator blades—each six feet long and weighing two-thirds of a ton—in “portholes” which will be fitted with housings for bearing inserts. Rotor blades will spin at 600 r.p.m. between each two rows of stator blades, creating air speeds up to 2,500 miles an hour. The shaft for the mammoth tunnel weighs 50 tons and is 25 feet long.

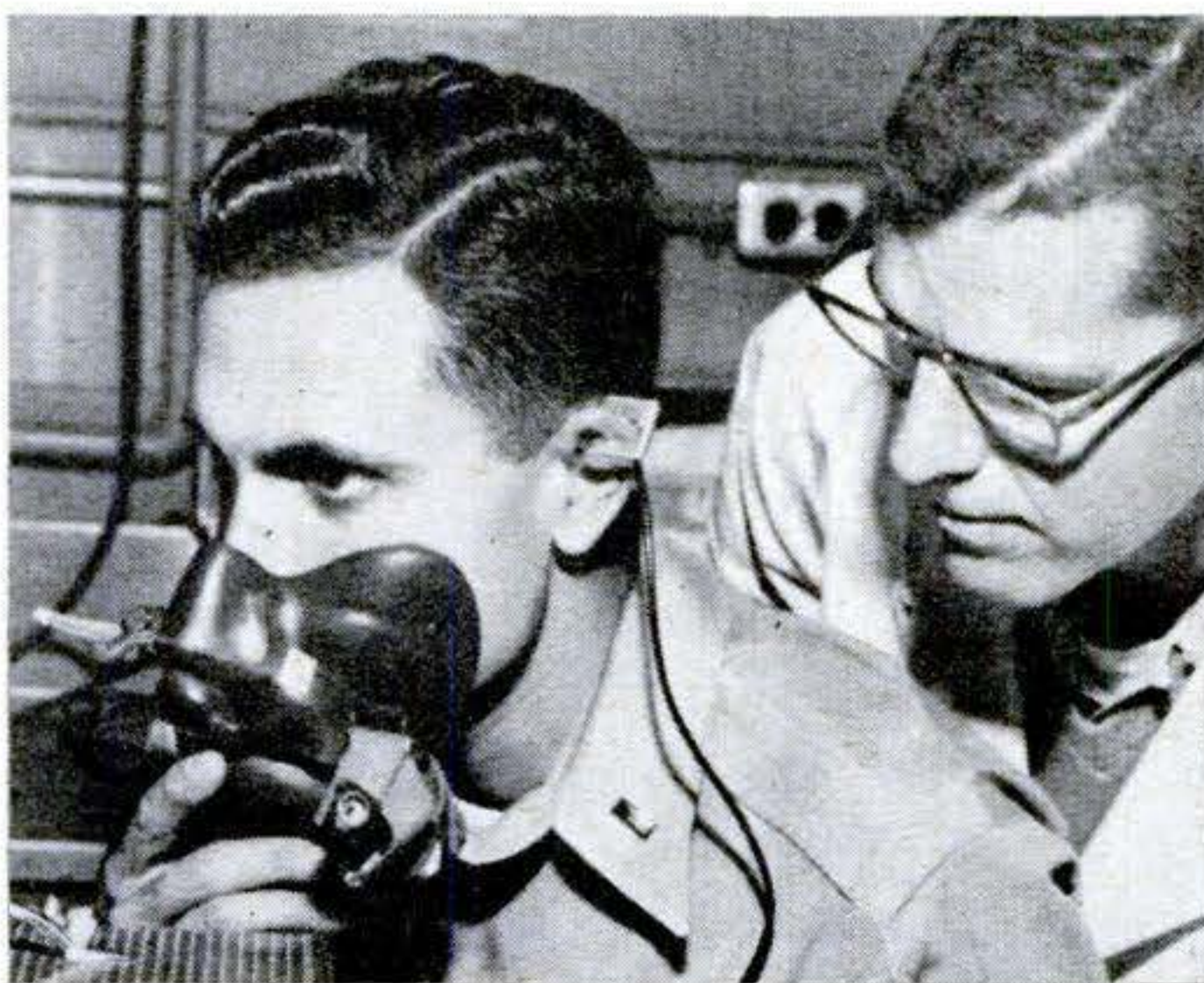

Pilot Gets Electronic Earring

HIGH-FLYING pilots may soon be wearing earrings. The USAF School of Aviation Medicine has devised a photocell that clips to the ear to warn of oxygen lack. As the air gets rarer, the blood gets redder and the cell notes the color change, causing a light to glow on the plane's instrument panel.

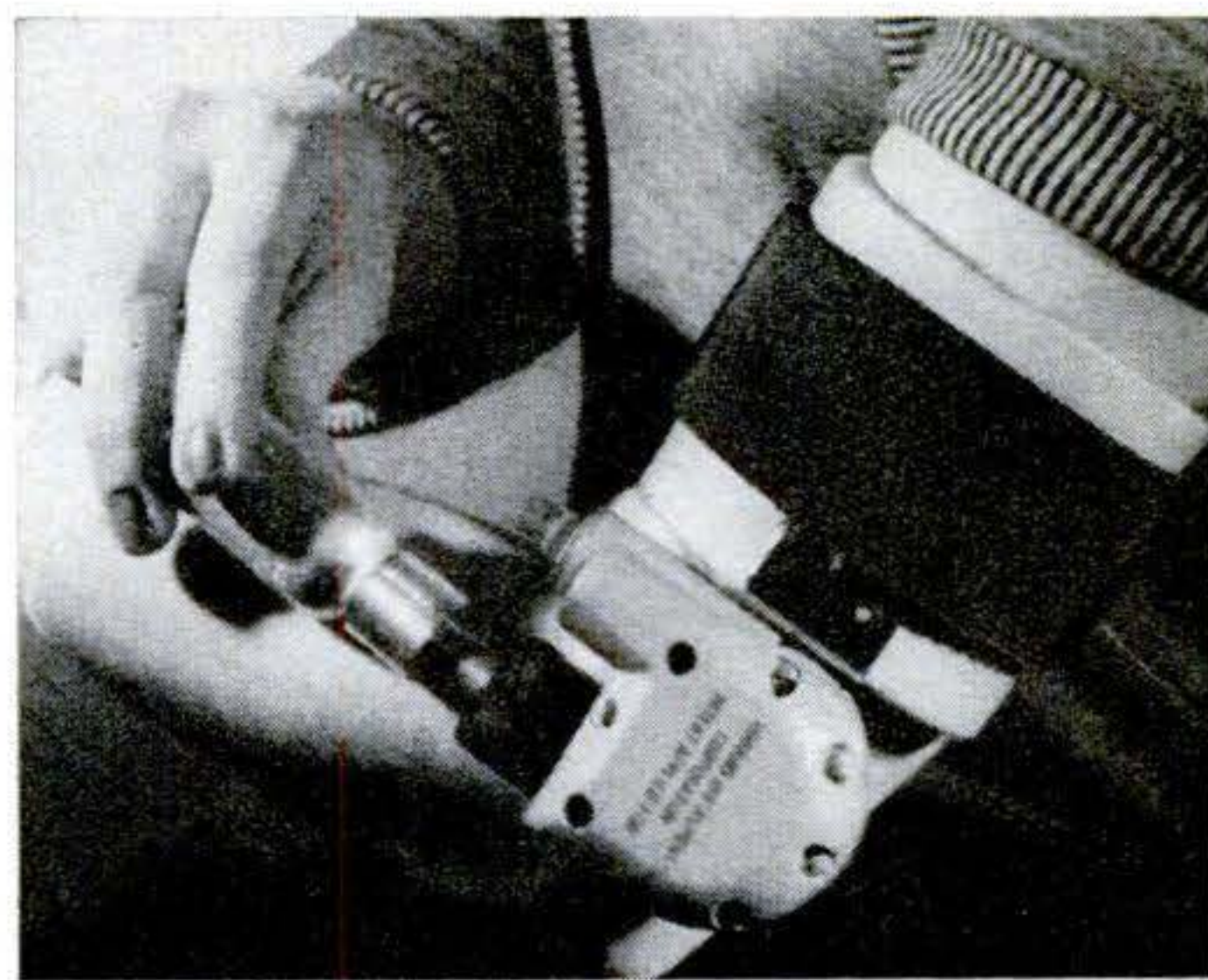

Gas Pressure Stops Bleeding

A GAS cartridge inflates the cufflike tourniquet above to stop bleeding from a cut artery. A twist of the cartridge turns on uniform, constant pressure over a wide area; pushing a button releases it. The new first-aid device is made by Robbins Instrument Corp., Attleboro, Mass.



*A tough, 4-year course separates
men from boys at Uncle Sam's*

Free College for Ship's Officers

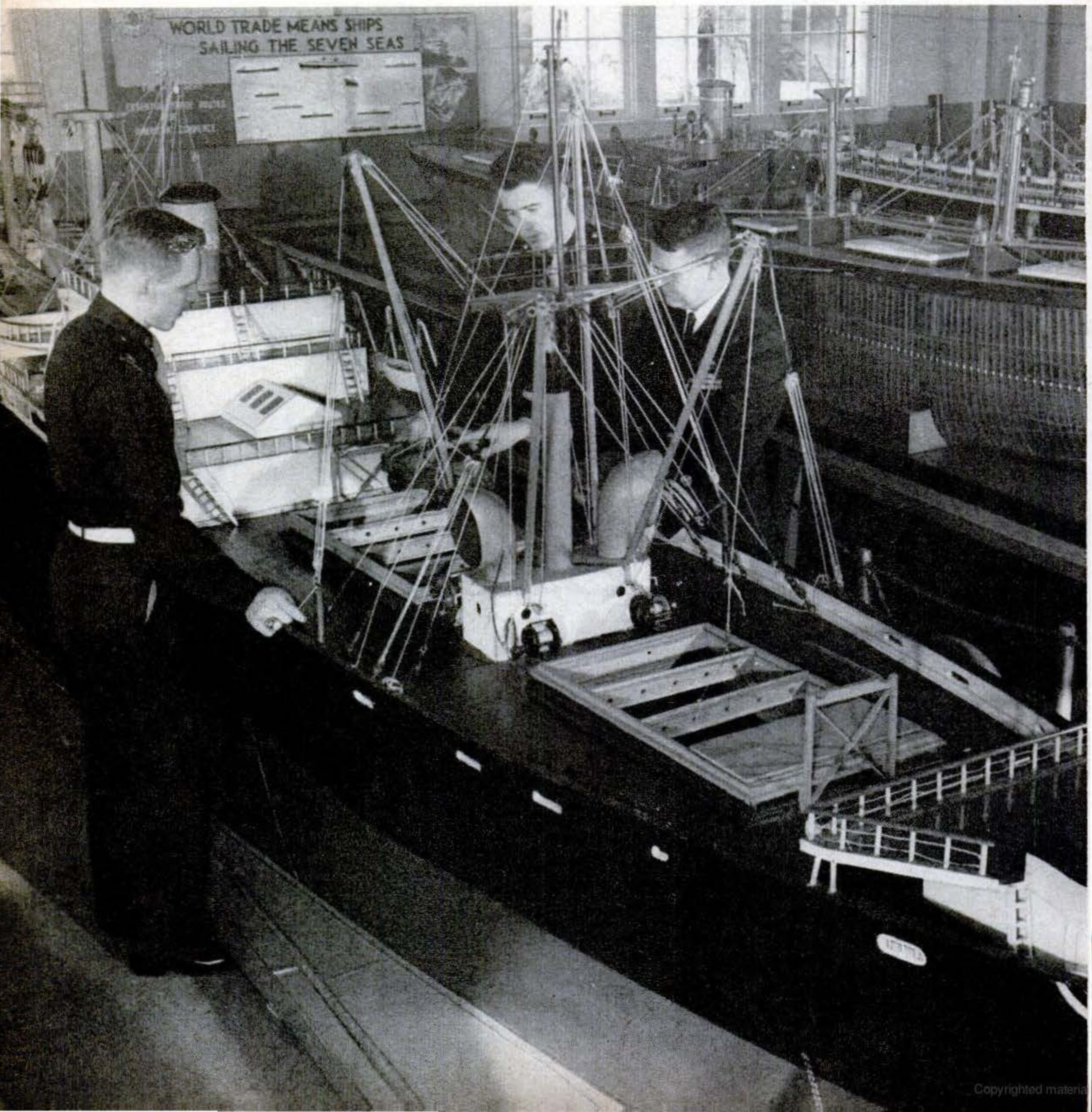

IT'S CLOSE QUARTERS for this Kings Point cadet as he measures the diameter of a crankshaft crankpin on a 400-horsepower marine propulsion engine to see if it is out of round.

CARGO HANDLING in miniature is taught to future deck officers by practice loading of a Liberty ship model (below). Cadets use fishing-reel hand winches to operate the booms.

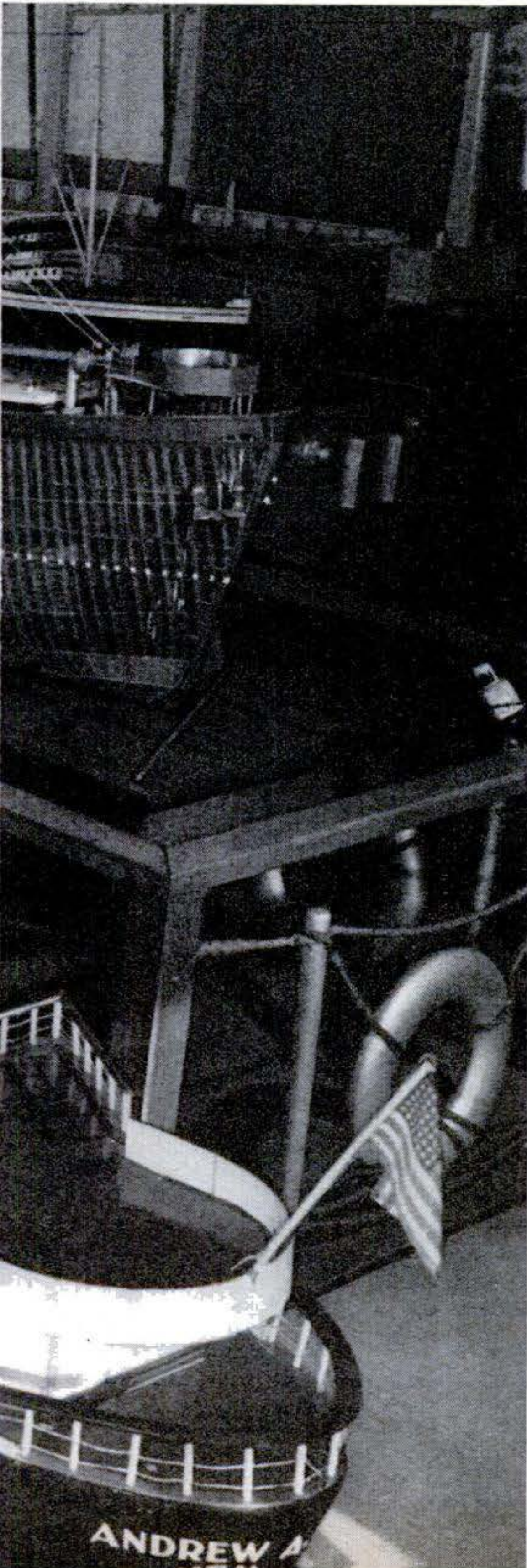
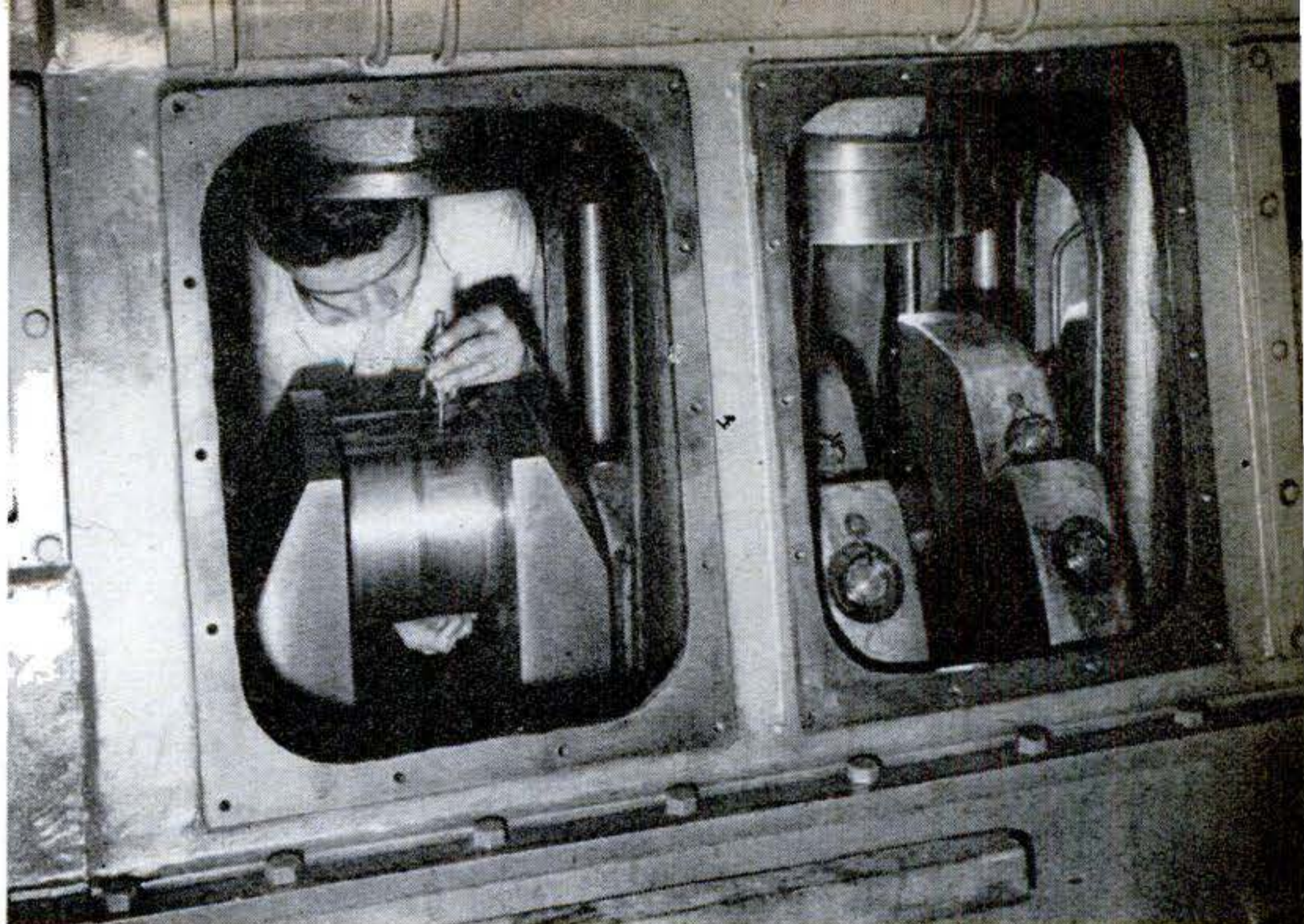

By Phil Gustafson

PHOTOS AND COVER BY W. W. MORRIS

ON A small peninsula jutting off Long Island's Gold Coast lives the best-traveled set of young men in the world. These are not pampered children of New York millionaires who inhabit the rich estates thereabout, but a crowd of hard-muscled young huskies with hands calloused by hard labor.

They compose the upper two classes of the U. S. Merchant Marine Academy situated on Kings Point, a beautiful, wooded promontory about 17 miles from New York, and they pile up all that highly prized travel time because the masterminds at the academy have decided that sending sophomores to sea is the best way in the world to separate the men from the boys.

Because of this decision, some of the lucky young globe-trotters have gone around the world not just once, but two or more times, and the average scholastic sight-seer has sailed some 50,000 miles on three or more seagoing craft.

For Kings Pointers: A Global Pass

Raymond Corkery, 23, of Philadelphia probably had it the best. He not only went around the world twice on luxurious cruise ships of the American President Lines, but crossed the Atlantic twice on American Export's *Independence* and then shuttled between France and England on the U. S. Lines' *American Leader*.

For sheer variety, however, the cruise year of José Reyes, from the Philippines, probably takes the cake. José managed to hit a total of 26 different countries



PINT-SIZE PLANETARIUM acquaints the midshipmen-cadets with the stars they will use in

celestial navigation. The projector also puts the sun, moon and planets in the sky.

on three cargo and passenger ships. Aboard the Matson Lines' *Sonoma*, he swung through the Pacific to Australia. A global tour followed aboard the *President Arthur* of the American President Lines; then a Mediterranean tour via American Export's *SS Excellency*.

But this sort of thing is only an appetizer for the boys who are to be graduated from Kings Point. Along with a degree, they get a permanent globe-trotter's pass that takes them all over the world. For Kings Point is to the merchant marine what Annapolis is to

the Navy. The school takes promising high-school boys with a yen for the sea and in four intensive years turns them into officers to run our cargo and passenger ships.

Kings Point's 68-acre campus was assembled by buying up several estates—made available to the academy at a small fraction of their value. The administration building is the former mansion of Walter P. Chrysler, the automobile magnate, and students now frolic in the blue waters of the former Chrysler swimming pool.

Seventeen other buildings house the laboratories, classrooms, shops and barracks for a current enrollment of 725 students, not counting a class of 190 out at sea this year.

Even Torpedoes Couldn't Sink These 445

Established in 1942, Kings Point was one of the educational war babies which grew up into outsize giants on the hormones of emergency war training. Set up to accommodate 1,200, it shot to a wartime peak of 2,670 and graduated 6,600 wartime officers in accelerated naval



TRICKS of harbor piloting are learned by plotting problems. In foreground is a buoyage trainer with all lighted and unlighted navigation aids that might be found in a harbor.



SHIP MODEL named *Miss Calculation* shows the students what can happen when a vessel is improperly loaded or the cargo shifts. Lead weights simulate any loading condition.

courses—4,500 for the merchant marine and 2,100 who went into the Navy. Kings Point men covered themselves with honors in all Pacific and Atlantic invasions, not to mention the Battle of the Atlantic where 445 of them survived torpedoing and became members of the famous Tin Fish Club.

A Kings Point graduate gets an ensign's commission in the U. S. Naval Reserve and the U. S. Maritime Service as well. If he's in the deck department, he gets a license as third officer of a cargo liner or passenger ship. If he's in engineering, he comes out a licensed third assistant engineer. He also becomes the possessor of a sheepskin which proclaims him to be a bachelor of science.

The majority of the boys who come to the academy are moved by a yen for the sea, but most of them admit that the thing that really attracts them is a chance to make a lot more money than they could get with any comparable college degree.

"The way we have it figured," said Cadet-Midshipman Irving Eldridge of Barrington, R. I., "a Kings Pointer stands to make something like \$7,500 a year, counting overtime, in his first sea job on leaving the academy. With an ordinary engineering degree, about the best he can do is something like \$4,500. Besides, he gets his room and board at sea, plus all his transportation. Add the whole



GYROSCOPES play an important part in navigation. In this lab, cadets learn the operational principles, mechanism and maintenance of the latest gyronavigational devices.

thing together and it's pretty hard to beat."

The average merchant shipmaster will pull down between \$11,000 and \$12,000 in cash, and even though a midshipman can't count on making that for something between six and 10 years, still that's a very good salary for a man from 28 to 32. And plenty of the Kings Point men make it well ahead of the average.

Academy graduates make up a large

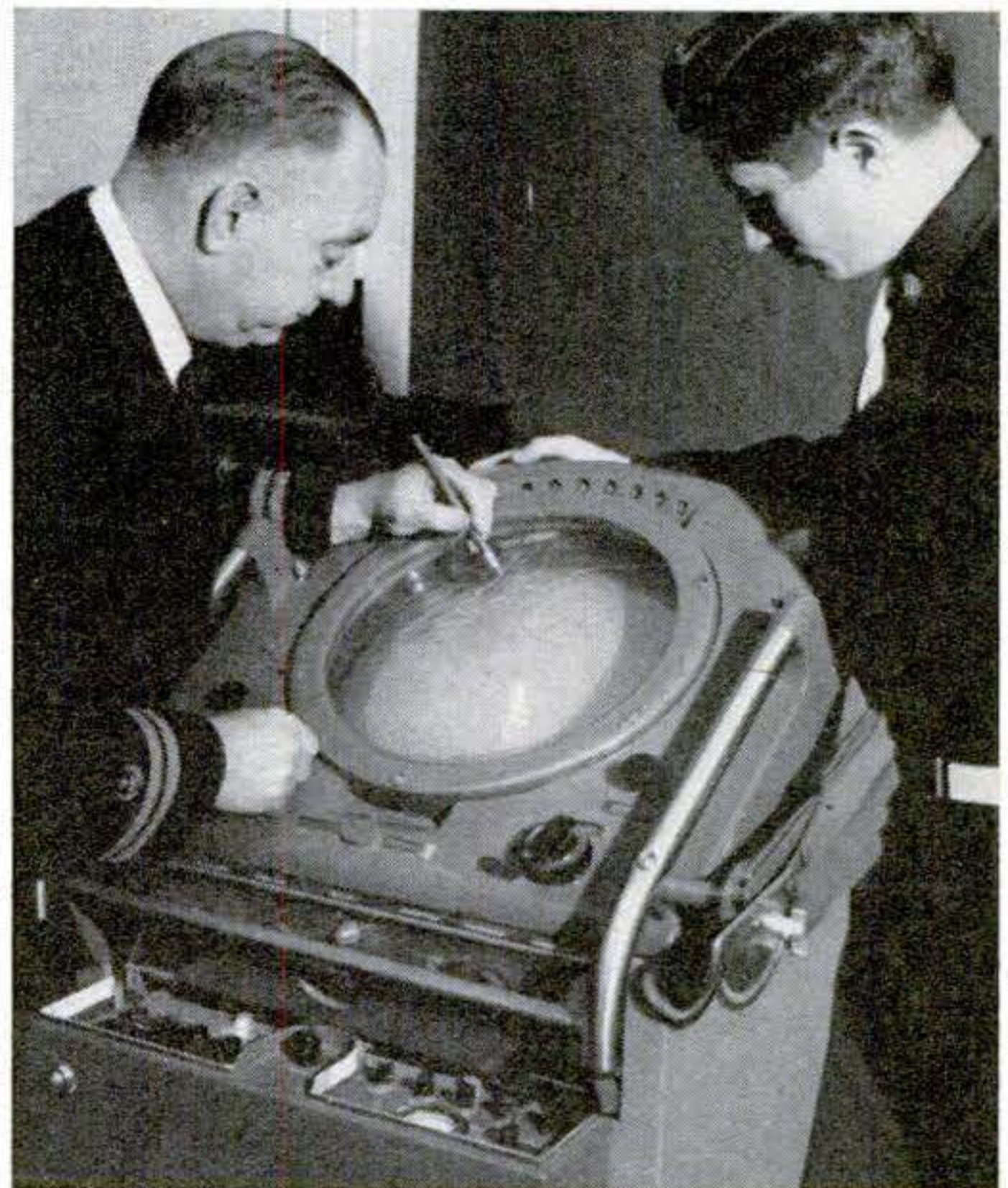

RADAR NAVIGATION is another subject Kings Pointers must master. Here an instructor is interpreting a coast-line picture as it appears on the scope of a marine radar set.

I'd Like
to see them
make...



SELECTOR BUTTONS for drive, low, park and reverse mounted on a steering-column horn ring in cars with automatic transmissions.—*D. W. Taber, Marietta, Ohio.*



AN OUTBOARD MOTOR with a telescoping handle so a skipper could stand up to steer safely through rocky places and narrow channels.—*R. Turley, Pointe aux Trembles, Quebec.*

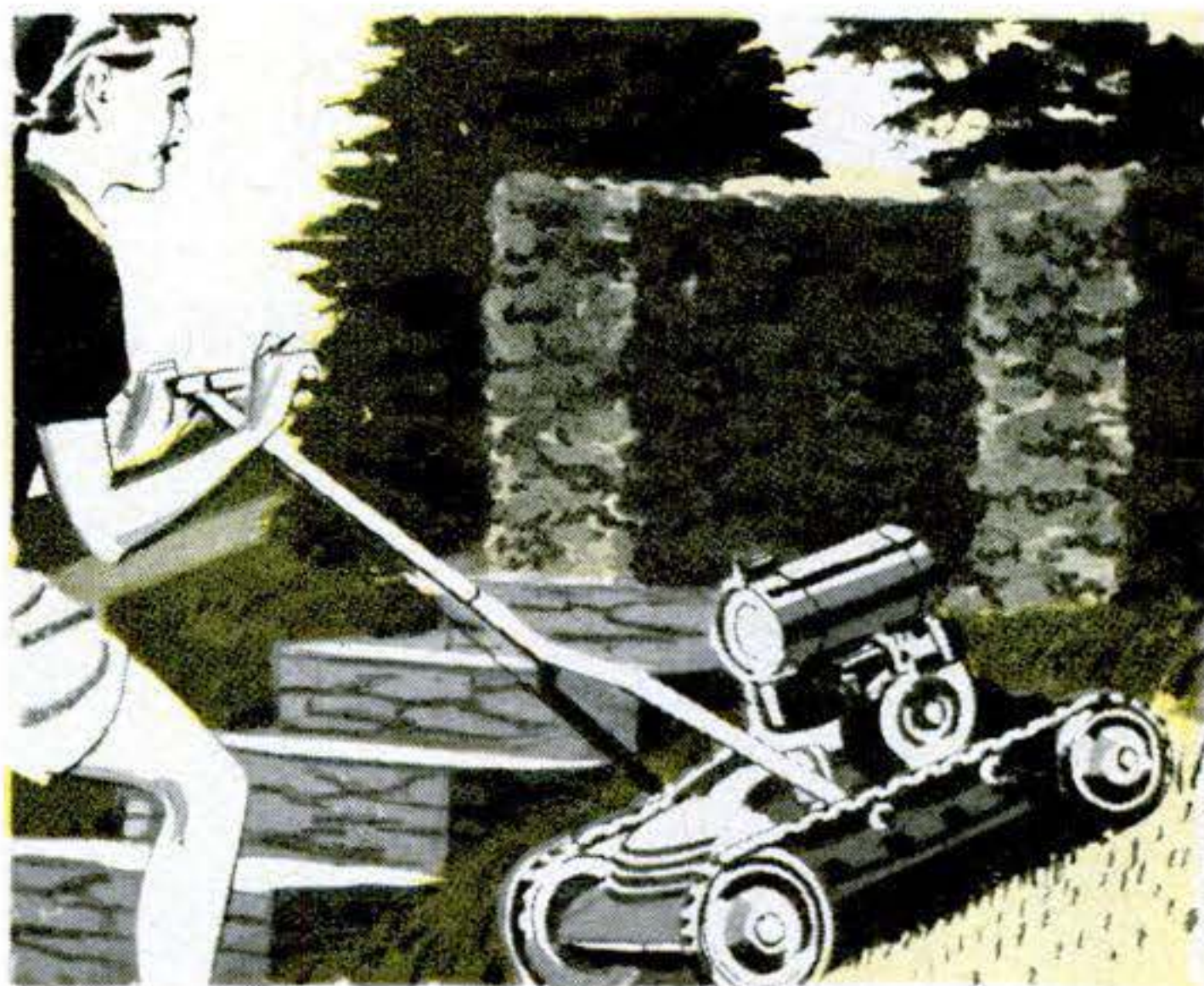

POWER MOWERS, for terrace dwellers, that would run on endless tracks, giving greater traction and requiring only guidance on steep slopes.—*Donel W. Dell, Sheridan, Ind.*



A PAINT SPRAY GUN that would screw directly onto a threaded paint can or onto a collar that would grip and puncture the can.—*R. H. West, Rochelle Park, N. J.*



A SHOE-POLISH DAUBER with a line of bristles on the back that would be narrow enough to get into that tight spot around the sole of the shoe.—*Glen A. Ramsey, Valdese, N. C.*

Everyone has his own pet idea of a gadget he would like to see in general use. The five ideas illustrated above were suggested by PSM readers. What is

YOURS? We will pay \$5 for each one published. Please use government postcards only. Contributions cannot be acknowledged or returned.



Pedals Help Peddle Gasoline

WHEN heavy winds knocked out power lines in Sarnia, Ontario, J. D. Murray rigged up this bicycle-and-belt arrangement to run his gas pumps. He pumped 1,450 gallons by foot power during the 48-hour blackout.



Periscope Shows What Cooks

A PERISCOPE mirror next to the clock on the back panel of this stove lets the cook see just how a roast or pie is doing without opening the oven door. O'Keefe & Merritt, 3700 East Olympic Blvd., Los Angeles, makes the Hi-View range.



Room-Size Model Explains Heart

You can walk inside a huge model heart (left) at Franklin Institute, Philadelphia, and trace the flow of the blood as it is simulated by lighting. A rhythmic thumping makes you think the heart is beating.

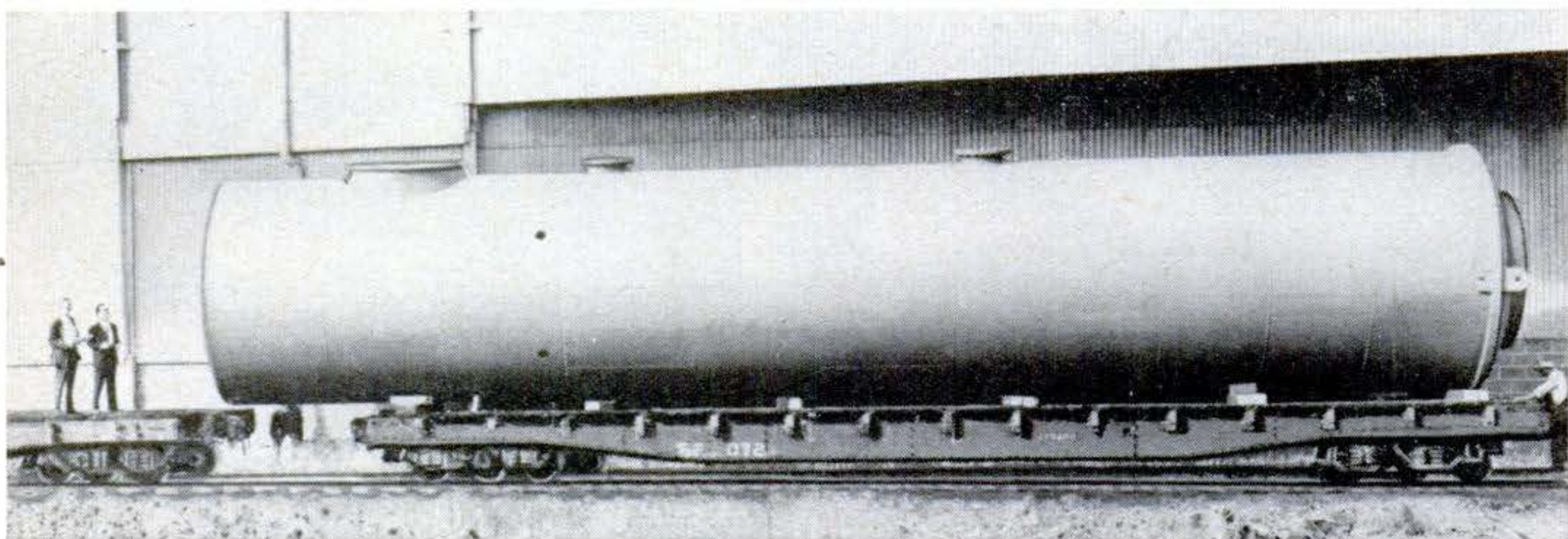

World's Biggest Muffler Will Hush Gas-Turbine Power Plant

PICTURE this flatcar-load scaled down several thousand times and bolted beneath the family car, and you'll see it for what it is—a huge muffler. Twelve feet across and

74 feet long, it tips the scales at 70,000 pounds. Burgess-Manning built it to quiet the exhaust of a 5,000-kilowatt gas turbine at a Midwest power plant.

New Ideas

FROM THE INVENTORS

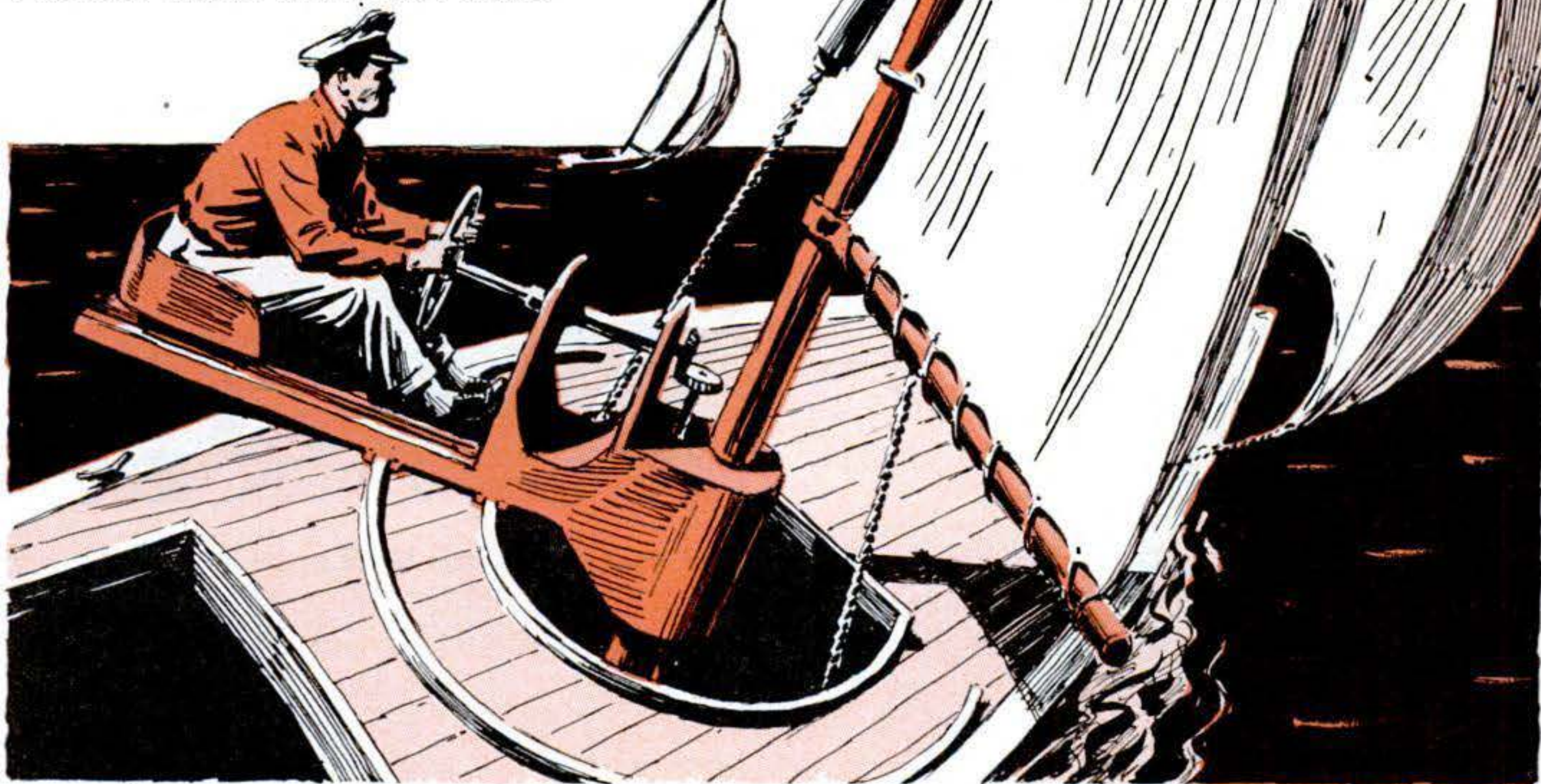

1 Seat to Pivot on Sail. There'd be little danger of this boat heeling too far in a heavy blow, because the helmsman could counterbalance a leaning mast with his own weight. The outrigger seat and tiller would

ride a semicircular rail and would also slide in and out. Seat movement would be partly under the operator's control, but cams would prevent seat and boom from reaching the same spot at the same time.

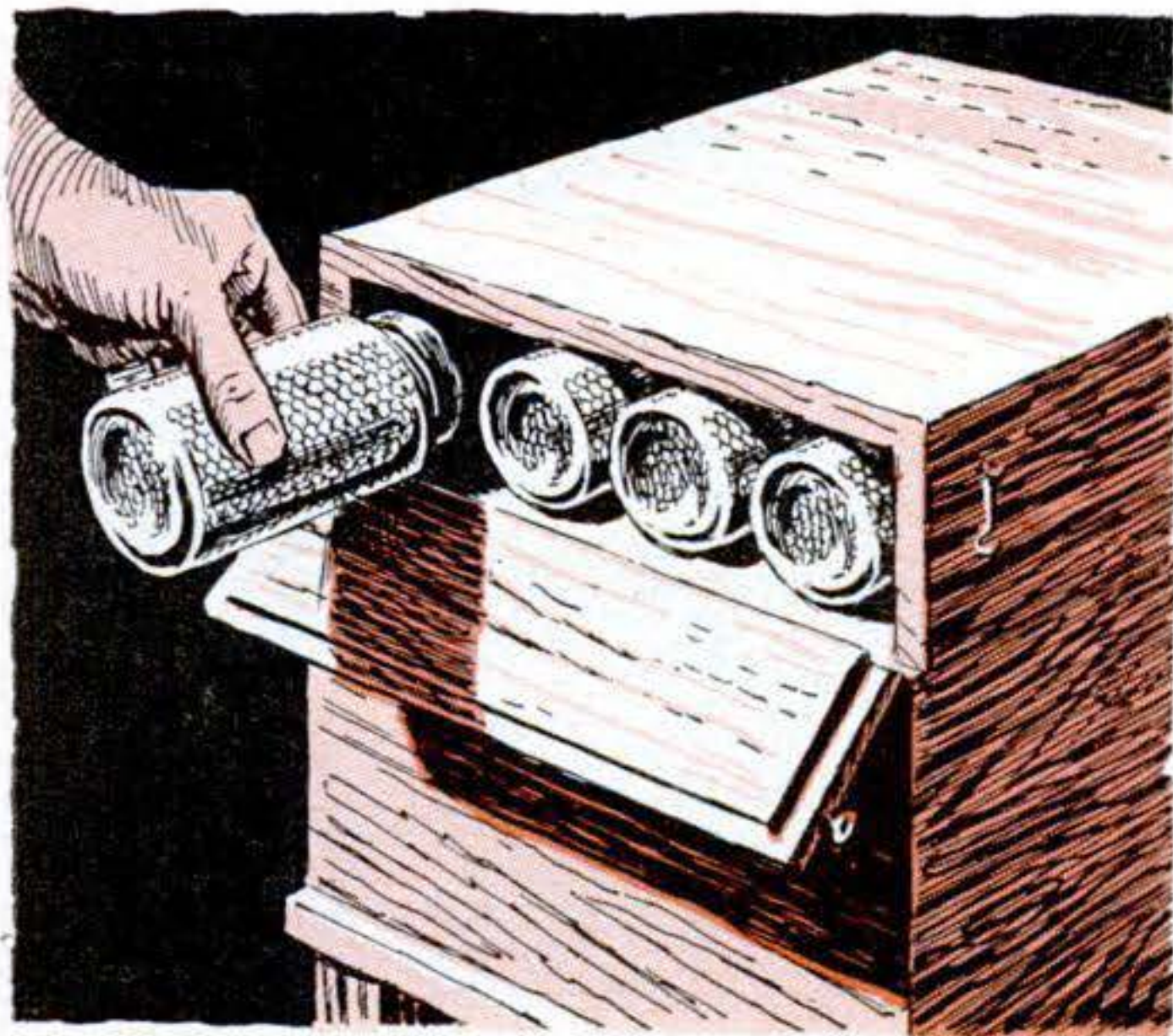

2 Beehive to Foil Stingers. A keeper could not only "rob" this hive in complete safety, but the honey would come out already bottled. Bees would live in the lower section of the stingless hive, but would be able to reach jars in the upper half through narrow passages. Spring doors would close the passages when jars were being removed.

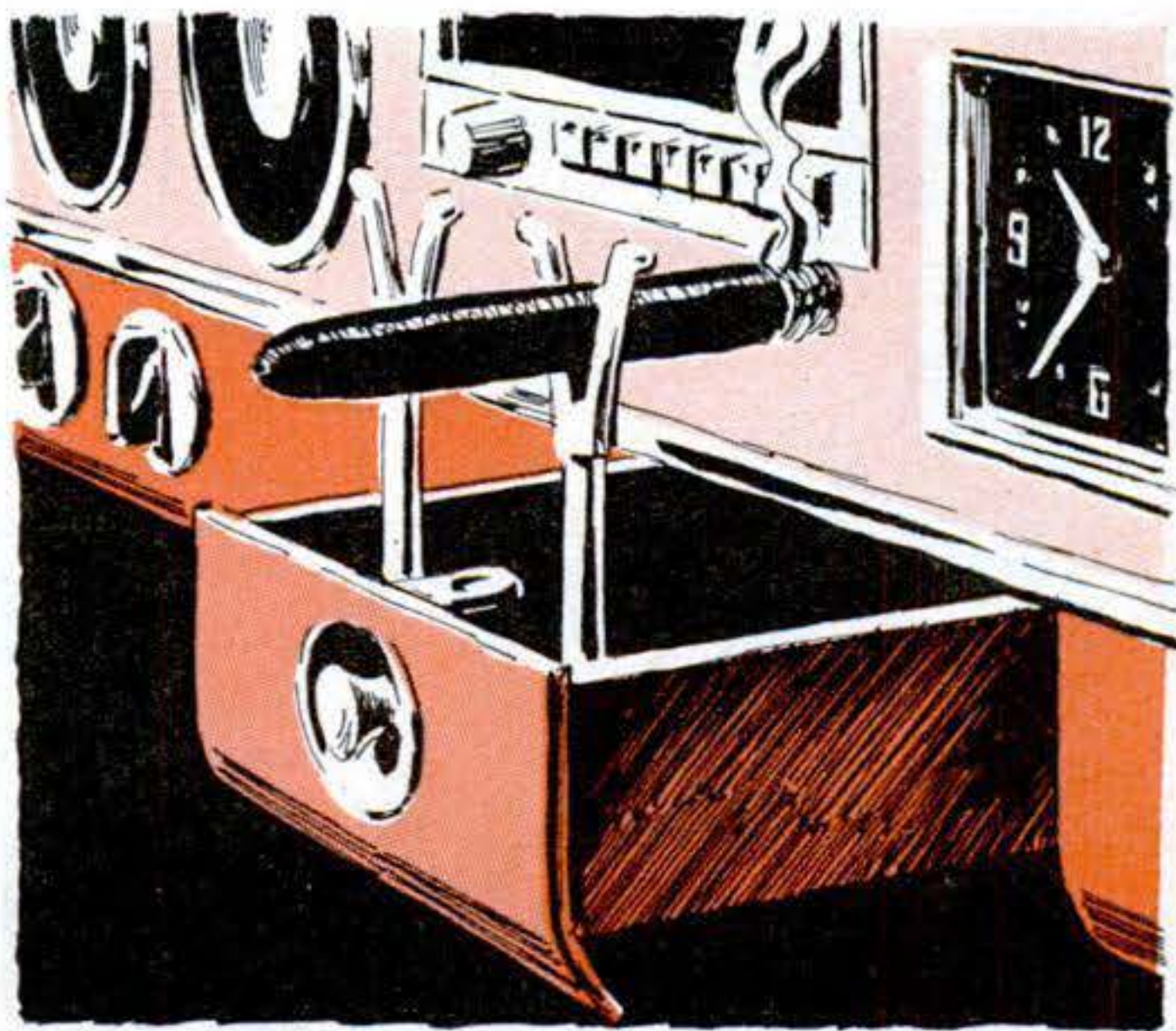

3 Cigar Rest to Fit Car Tray. A holder like this would let you put down a lighted smoke when you needed both hands for car operation. It would clip inside a regular car ash tray, hinge forward so the drawer could be closed in the normal way, and be made luminous so that you wouldn't have to fumble for it in the dark.

Please turn the page for more new ideas.

MAY 1954 149

MORE New Ideas from the Inventors



4 Fulcrum to Vary Claw Leverage. You could pull nails straighter and more easily with a hammer that had this movable head straddling the regular one. Notches and lock pins would permit adjustment of fulcrum angle. The pivot pin would pass through an elongated slot; it would slide backward as the notch setting is changed.

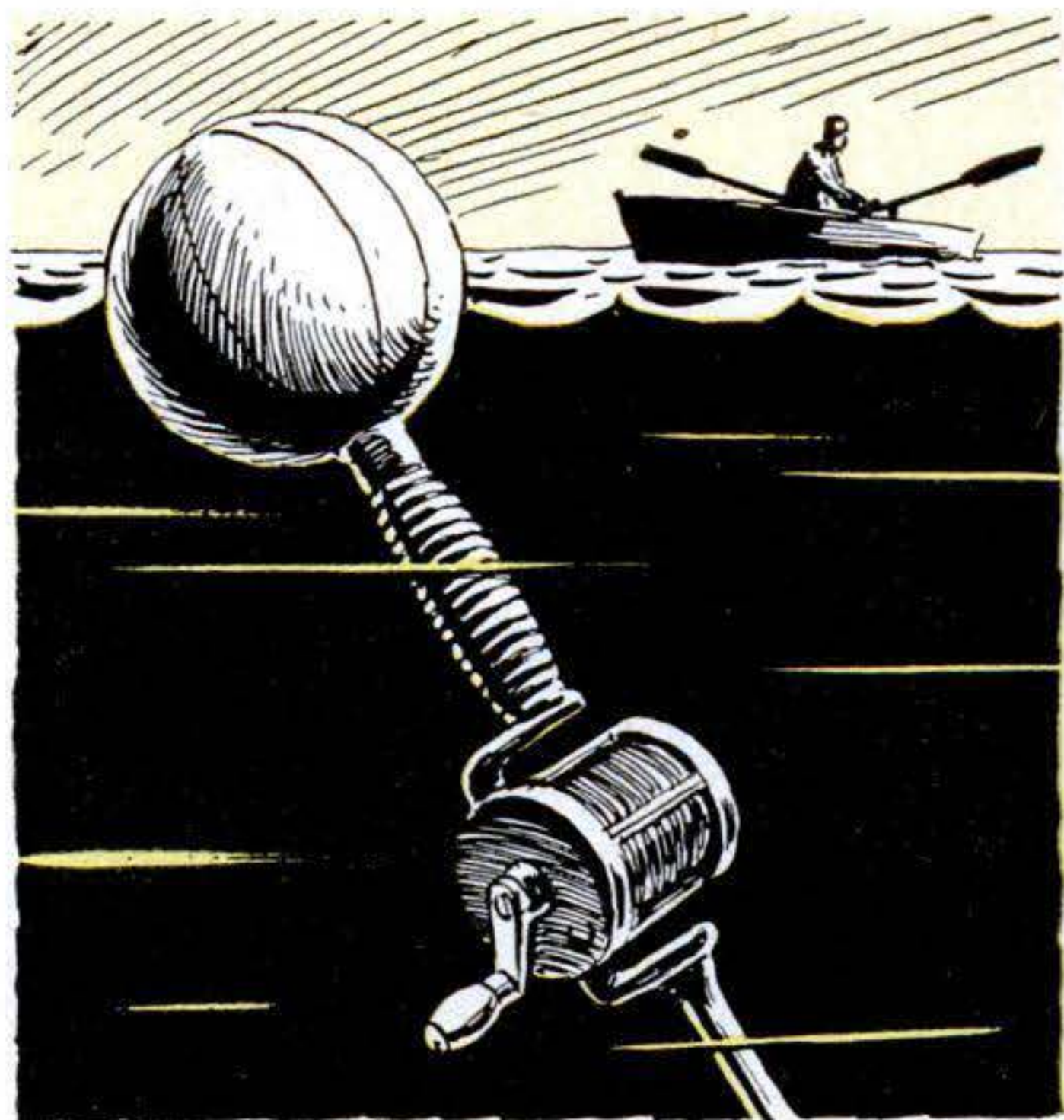

5 Float to Bring Up Lost Rod. Your rod, at least, would never get away if it had this retriever in the handle. A chemical that generates gas when wet would inflate a balloon float. The replaceable cartridge would be sealed against normal moisture. If it sank, however, increased water pressure would open a valve and set off the charge.

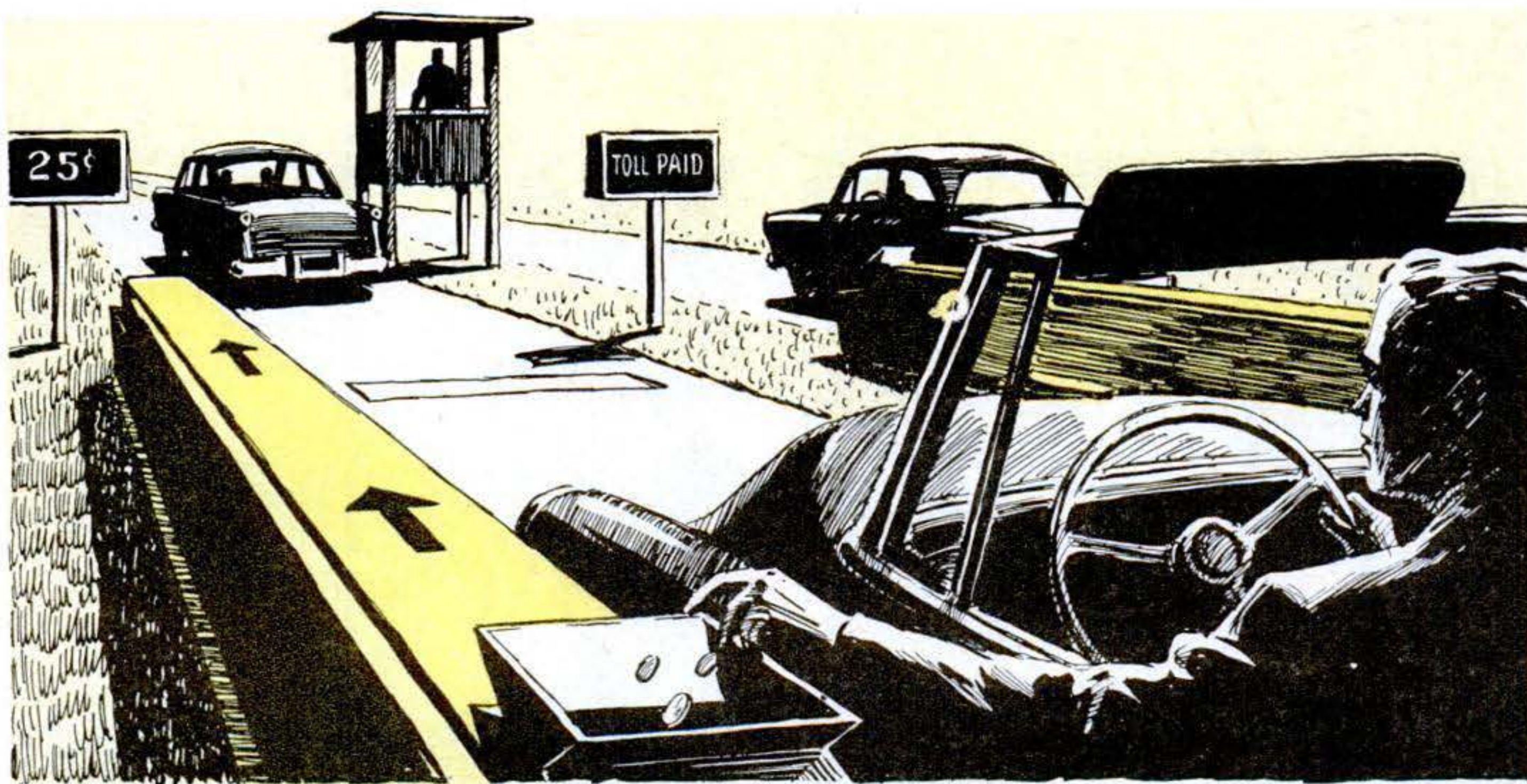

6 Toll Collector to Move with Car. You wouldn't have to come to a full stop to pay your toll at this gate. Collecting troughs would ride along a conveyor at your elbow, so you'd only have to synchronize your speed with theirs. Your money would be funneled immediately into a counting and sorting chute where magnetic and weighing devices would add up the coins and reject

slugs. If the fare were right, a go-ahead would flash on an illuminated sign visible to the driver and to an observer stationed in a control house overlooking all lanes. As the car emerged from the lane it would trip a reset switch. This automatic toll-collection system, says its inventor, would speed traffic flow, eliminate bottlenecks and require fewer attendants and traffic lanes.

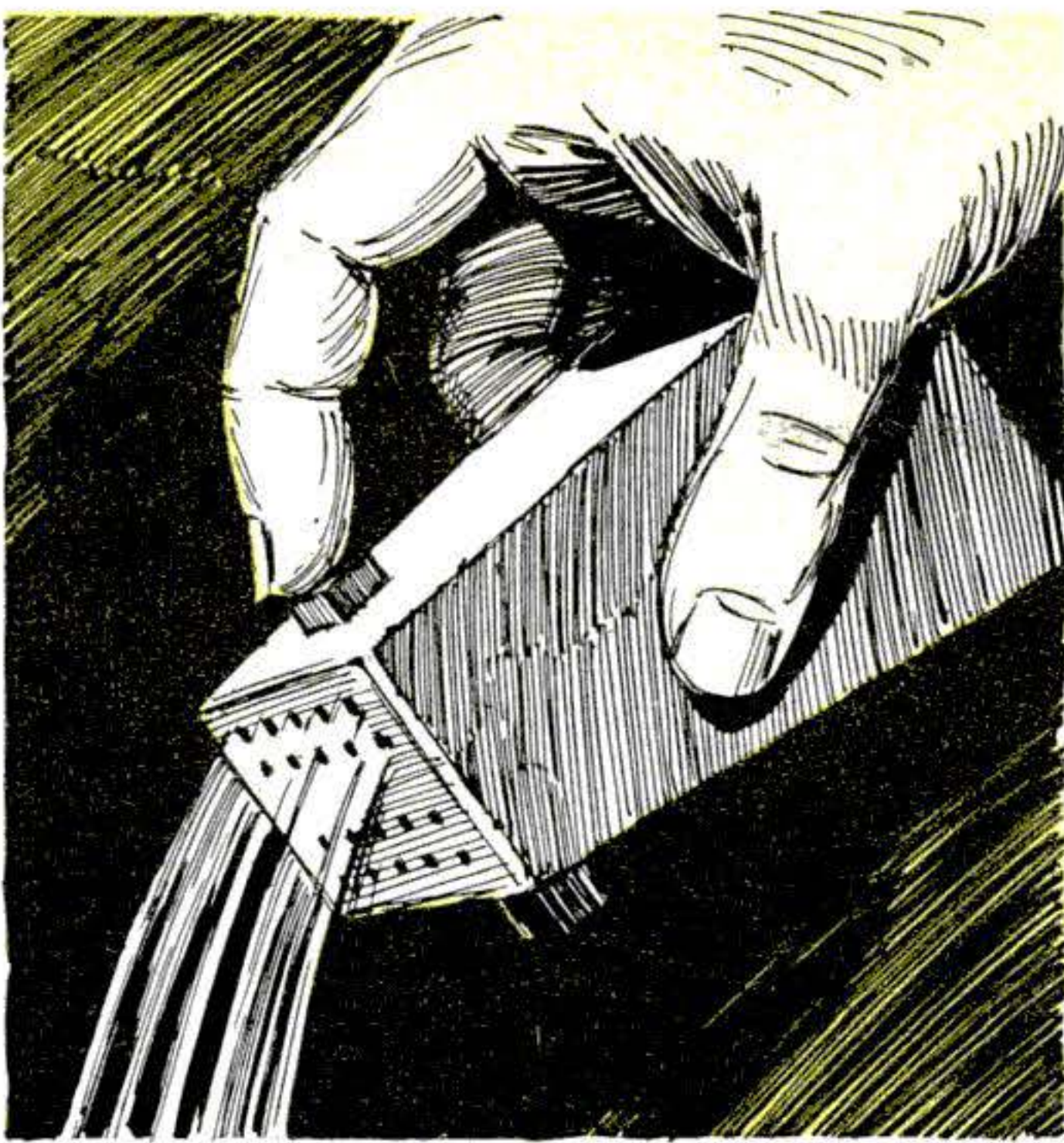

7 Shaker to Serve Salt or Pepper. This combination dispenser would feed salt from one side and pepper from the other. The plastic shell would be divided internally. To shake out either seasoning, you would press a button that would move a closure plate aside. The spring-retracted plates would keep out moisture, prevent spilling.



8 Bricks to Interlock. Even an amateur couldn't lay bricks wrong if they were keyed together by slots and metal T's. These bricks would be double thick, and all except corner ones would be slotted on the ends, top and bottom. The aligning keys would reinforce, not replace the mortar.



9 Ladder to Ease Leg Strain. The folding steps on this folding stepladder would open out to form roomy, comfortable platforms. Higher steps would normally fold back out of bruising contact with your shins, but they could be unfolded when you needed extra, wider tool shelves.

U.S. patents on these inventions have been granted to: 1. L. Sveinsson, Baltimore; 2. C. Garrett, Gainesville, Tex.; 3. A. Smereck, Detroit; 4. R. Johnson, San Jose, Calif.; 5. F. Broady, South Gate, Calif.; 6. J. Stovall Jr., Doylestown, Pa.; 7. A. Esposito, Irvington, N.J., and A. Galantino, Orange, N.J.; 8. C. Lacey, Olivette, Mo.; 9. C. Hansen, Hastings, Mich.



International Harvester TD 24 pulls Nebraska's test car plus a string of tractors in gear.

They Torture Tractors for the Whole World

From India to Brazil, farmers demand of every new model: Has it passed the Nebraska test?

By B. F. Sylvester

AT DAYBREAK, the sky-blue tractor was out on the 2,200-foot oval, humming along at a steady 3½-mile clip. For 10 hours she rolled that way without stopping—35 miles, 80-odd laps around the course. When at last the driver turned off the motor, a small band of observers, who had been waiting like expectant fathers for more than a week, mopped their brows and hurried off to call long-distance.

Test No. 500, a new Fordson Major diesel which had come 5,000 miles from England for just this purpose—testing by the world's most important tractor laboratory, part of the Nebraska College of Agriculture at Lincoln—was over the hump.

As the Fordson rolled off, men busied themselves on the track, readying it for the next test. To L. F. Larsen, engineer in charge, Test No. 500 was merely a part of the day's work.

To Fordson, it was much more. A ship-



At 1½ m.p.h., the behemoth pulled 33,714 pounds, put out a drawbar horsepower of 148.43.



SMALLEST MODEL ever tested was this ½-hp. Choremaster, a walking tractor for garden

work. The mite pulled a 119-pound load, cost its manufacturer \$524 to test.

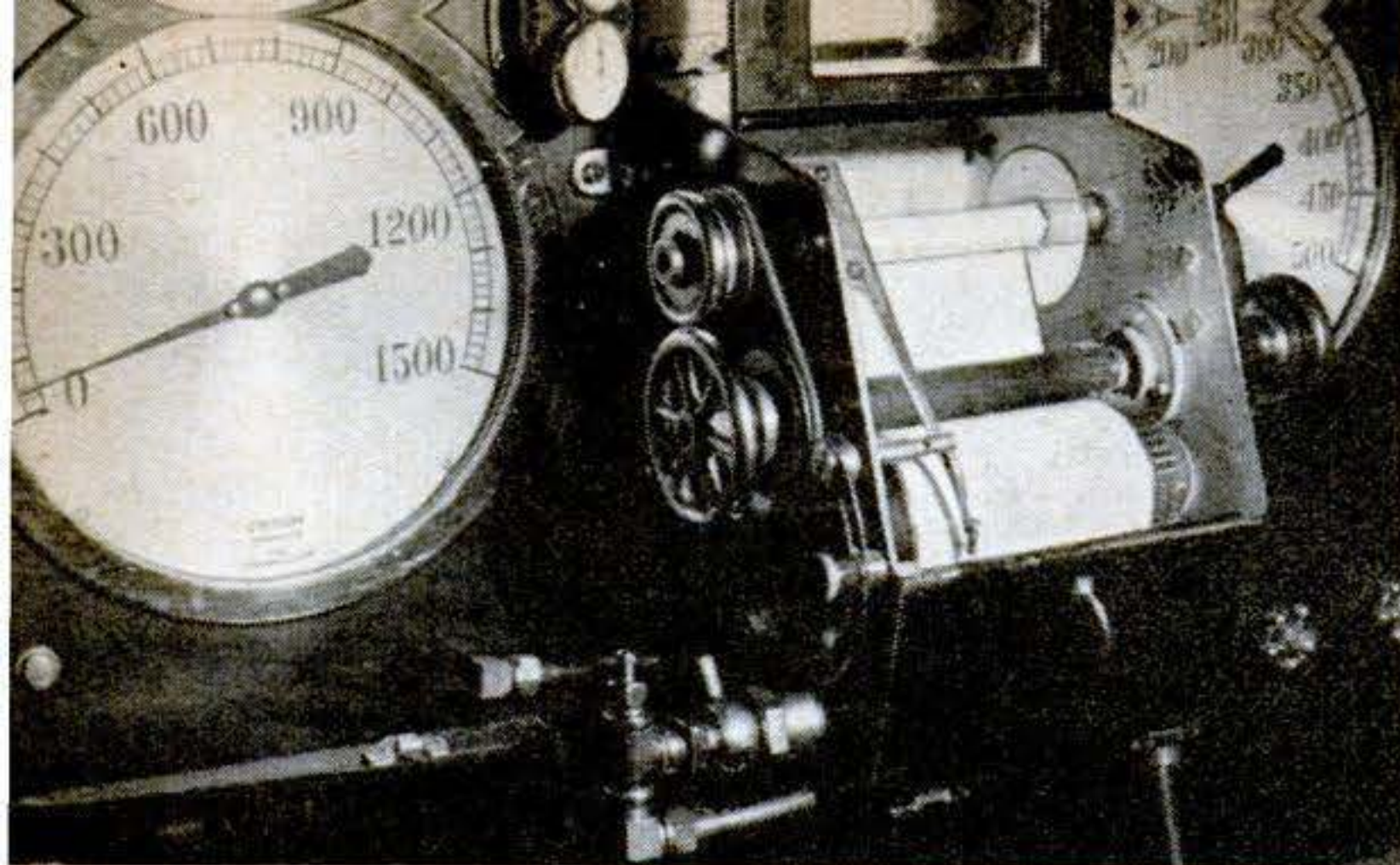

INSIDE VIEW of test car showing devices that record load, horsepower and other aspects of performance. Gauge at left is for large loads, one at right for small loads.

load of other new Fordsons waited at a dock in New Orleans. They could be delivered now. And Fordson dealers all over the world could now assure their customers that their machine had been tested and okayed at the supreme court of tractors. For that is the first thing that tractor buyers all over the world want to know: Was it tested at Nebraska?

For answer, observers from almost every country travel to this sprawling Midwest station. Thousands of others get the station's meticulous reports on tractor performance. In some countries—India, for example, and others in South America—a pass mark by Nebraska is a prerequisite for sale.

Foreign governments are attempting to avoid tractor evils which beset this country about the time of World War I, when power machinery began slowly to dis-

THIS MAZE of wires, wheels and belts is Nebraska's big dynamometer, designed to measure belt horsepower. Rheostats provide resistance to simulate working loads.

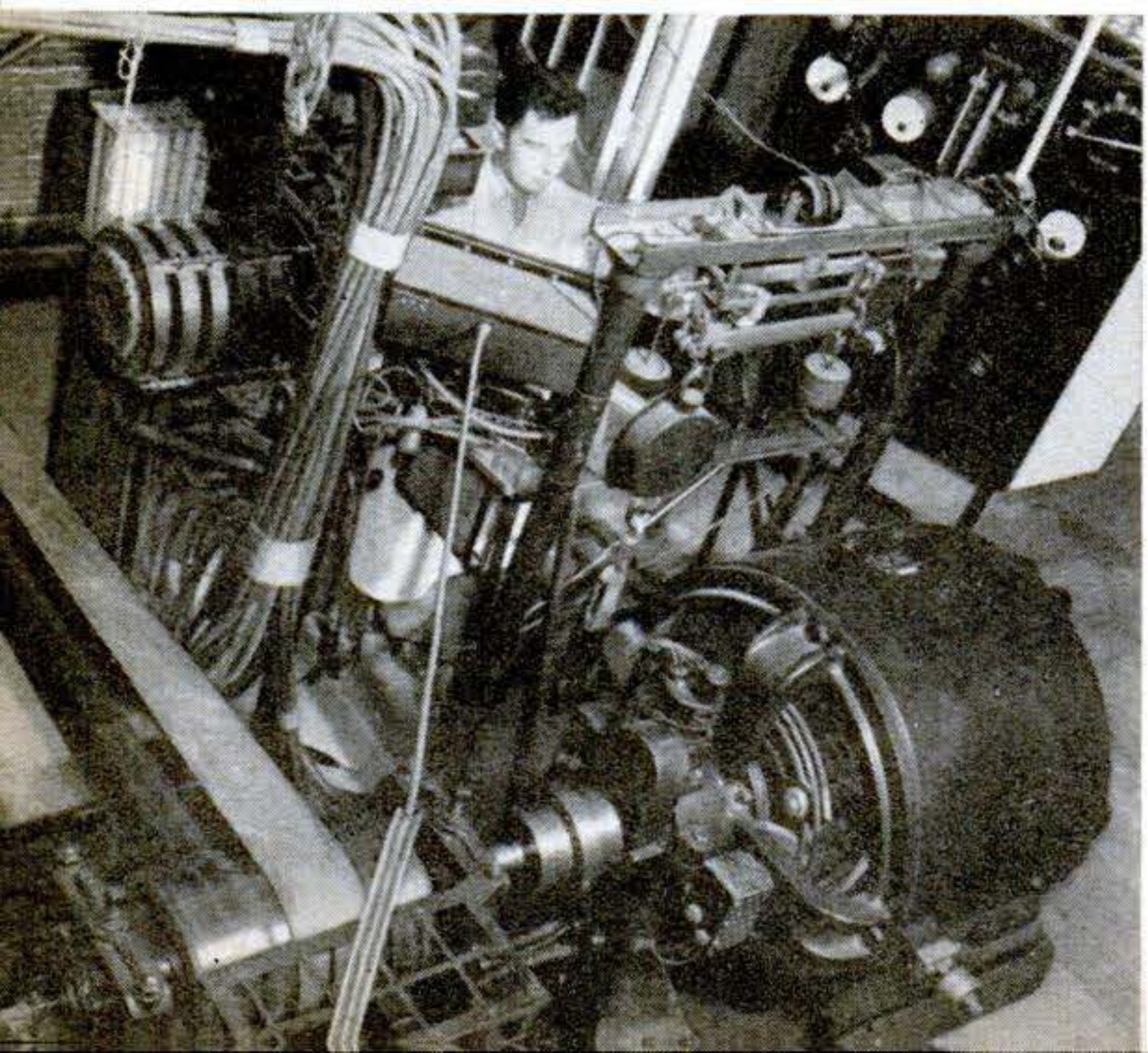

place the horse. In the general turmoil, many factories went out of business and orphan tractors stood in the fields.

One victim was Wilmot F. Crozier of Osceola, Nebr., whose tractor quit cold one day in the middle of his wheat field. Dealer and manufacturer had gone out of business. No service, no parts. Crozier said there ought to be a law, and his neighbors agreed. They elected him to the legislature and, by cracky, he put through a law. No tractor could be sold in Nebraska without prior testing, and provision by the manufacturer for a supply of parts within reasonable shipping distance. Result was the testing laboratory, set up in 1920. Fees, paid by the manufacturers, support the program.

Tests Are Thorough

Tests cover two phases of performance: belt load—the power available for running such equipment as, say, a feed grinder or corn sheller; and drawbar load—pulling power. In addition, careful measurements are made of fuel and lubricating-oil consumption, extra water used for cooling purposes, engine speeds and m.p.h. speeds at different gears and under varying loads, radiator and air temperatures, and wheel slippage. Breakdowns, or necessary repairs or adjustments, are also noted in the final report, as are minor misfunctionings such as lube leakage.

First test of the series calls for a 12-hour warmup period, during which the manufacturer's representatives may make any adjustments they consider necessary. Fussy engineers have been known to take four hours merely to set a carburetor, and in one case 75 hours passed before the factory reps were satisfied that all conditions, including atmospheric, were exactly right. Muggy days are bad for testing, and rain or even excessive humidity (90 percent) will result in postponement.

But the day on which Test 500 was to begin was perfect, weather-wise. The Fordson hummed like a happy top through her 12 hours of limbering-up exercises.

Then fuel lines were attached and the tractor hooked up to the belt. For over an hour, the engine was warmed up before being connected with an electric dynamometer that would keep score.

Now followed a two-hour run at 100 percent of maximum, throttle all the way out and a dynamometer load on the belt to keep the engine turning at the rated (manufacturer's recommended) speed of 1,600 r.p.m.

Next came a rated-load run, with 85 percent of the first dynamometer load being placed on the belt. This is a somewhat better guide to performance since the maximum may not be expected in the field, and not every tractor will attain the exact performance shown on the test.

Then followed six runs of 20 minutes each with varying loads: no load, quarter load, half load, three-quarter load, rated load, and maximum load at full throttle.

Torque tests came next, to determine the horsepower obtained at different engine speeds.

Torque is the twisting effect that turns the axles of the rear wheels.

At 5:30 next morning, the test crew and Fordson reps assembled on the track for the drawbar (coupled-weight) tests, in which the pulling power is measured.

Dynamometer Rides Herd on Fordson

Since, in all, the drawbar tests call for 20 hours of driving and the average speed is about five m.p.h., each tractor covers 100 miles, or about 240 laps. The Fordson was hitched to a dynamometer car full of self-registering instruments, every aspect of performance being tested by gauges and a stylus which makes tracings on sensitized paper. Behind the test car was a tractor in gear, which provided a load of 5,000 pounds.

The machine was tested in each of its six gears for speed, horsepower, slippage,

the load pulled and crankshaft speed.

Daylight the next morning saw the same little group out on the track for the big one: a continuous 10-hour run in one gear with a three-quarter load. Fordson reps chose third gear for this as offering the best balance between horsepower and traction.

Two other tests followed, but by now the worst was behind. Up to this point the tractor had carried ballast, iron weights of 1,292 pounds on each wheel. But now, Test J was run without ballast. Test K, the last one in the series, was run with the smallest tires recommended by the tractor's manufacturer.

That did it. The tractor had performed according to its specifications and claims, and this would be certified to the Nebraska Railway Commission which, in turn, would issue a sale permit. The laboratory does not tag any tractor as good, bad or indifferent. It merely records and publishes its findings on a worldwide mailing list, sending out some 40,000

reports a year to farmers, county agents, teachers of agriculture and others who write in.

There is a dedicated spirit out at the testing station. One crew with two John Deere tractors started at daybreak on a Friday. All day they plugged away, finishing up with the limbering-up tests after dark. Somebody said, "Let's keep going," and they started the belt test. They went all night until 8:30 Saturday morning.

Saturday night looked like a fine night for more belt-testing, so they all came back and ran the test on the second John Deere, until it was finished at 8:30 Sunday morning. Then, because everybody still felt great, they started work on the track, packing it down for the drawbar tests, which would start on Monday. Monday night, they were still at it. END



FIRST TRACTOR tested by the station was this 1920 model, Waterloo Boy. Since then, over 500 models have gone through the rugged program. Three percent failed to qualify.

Pilot of Experimental British Jet Fighter Takes His Turns Lying Down

TO OVERCOME the violent effects of centrifugal force in maneuvering high-speed jet aircraft, British designers are experimenting with putting the pilot in a prone position. In this photo (right), the prone cockpit is in the nose of the plane. Since the machine is an adaptation of a standard Meteor jet, the upright cockpit normally used is still there, just forward of the two engine nacelles.



Machine Shakes Man in Vibration Tests

IN THIS picture (left) it wasn't the camera that moved to produce a double image—it was the man. He is being shaken by a Navy machine to determine the effects of vibration on him. The picture at far left shows him standing on the vibrating platform. Results of the tests will help set safety limits in machine design and devise protective measures.



New Double-Deck Railroad Car Sports a Penthouse Lounge

AN ELECTRIC dumbwaiter connects the upper and lower levels of this dome observation car put into service by the Santa Fe Railway. It gives dome-deck patrons access to a service bar below. Passengers

are protected from discomfort by thermostats, which turn up air conditioning if sun's rays get too hot. The new cars are used on the railroad's Chicago-Los Angeles and Chicago-Oklahoma City runs.

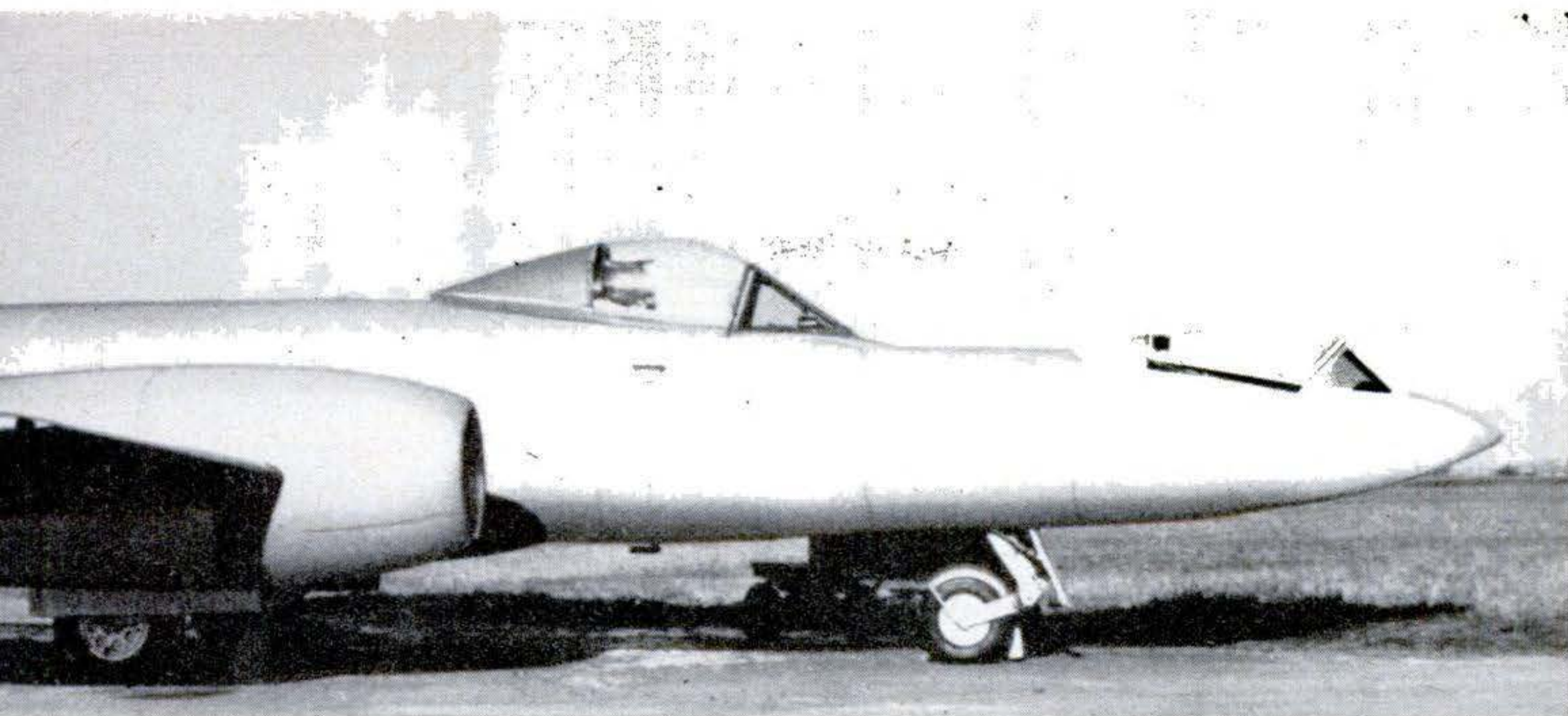

Clock Runs Right Only in a Mirror

EVER see a backward clock? The one shown here has hands that turn the wrong way unless they are seen in a mirror. It's for the benefit of patrons of a Brooklyn, N. Y., bar and grill who most of the time see it only as a reflection in a mirror behind the bar. Left picture shows clock as patrons see it; right one as it really is, with the numerals reversed.

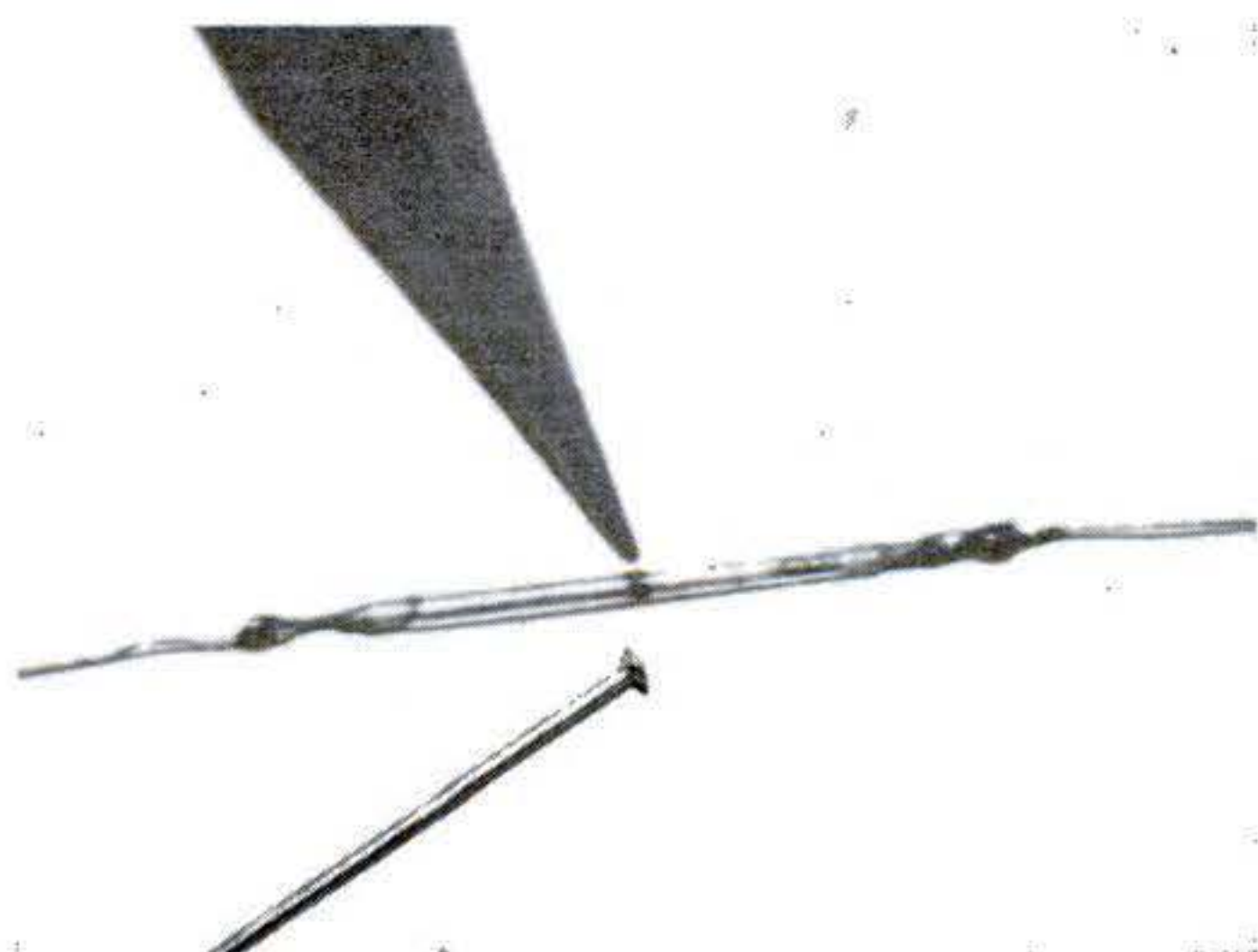
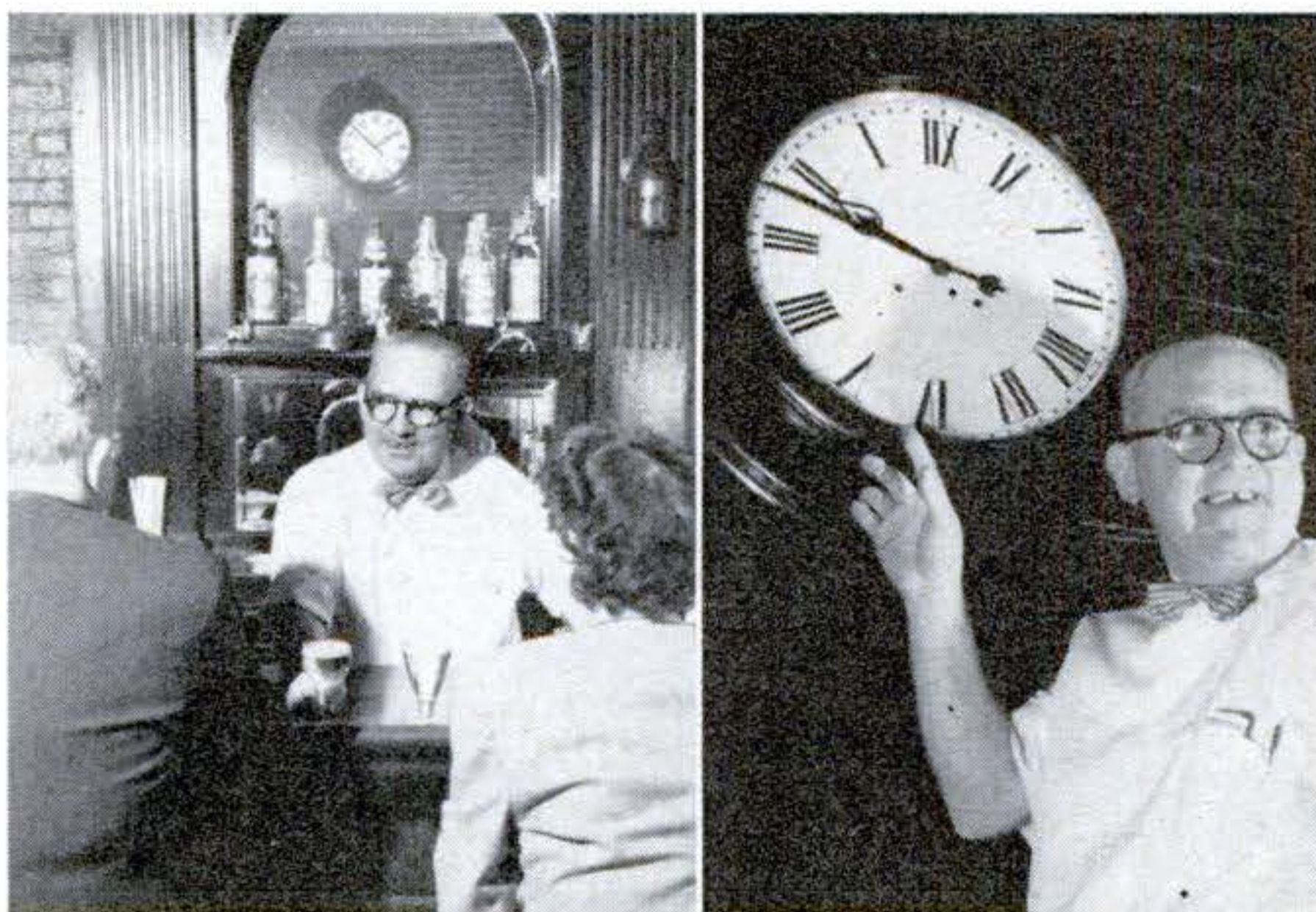

Tiniest Lamp: 1/40 Watt

A PENCIL point and a pin, above, flank the world's smallest neon lamp—an inch long and 1/20 of an inch in diameter. The 1/40-watter, made by Westinghouse, is used in photographing data on guided missiles.

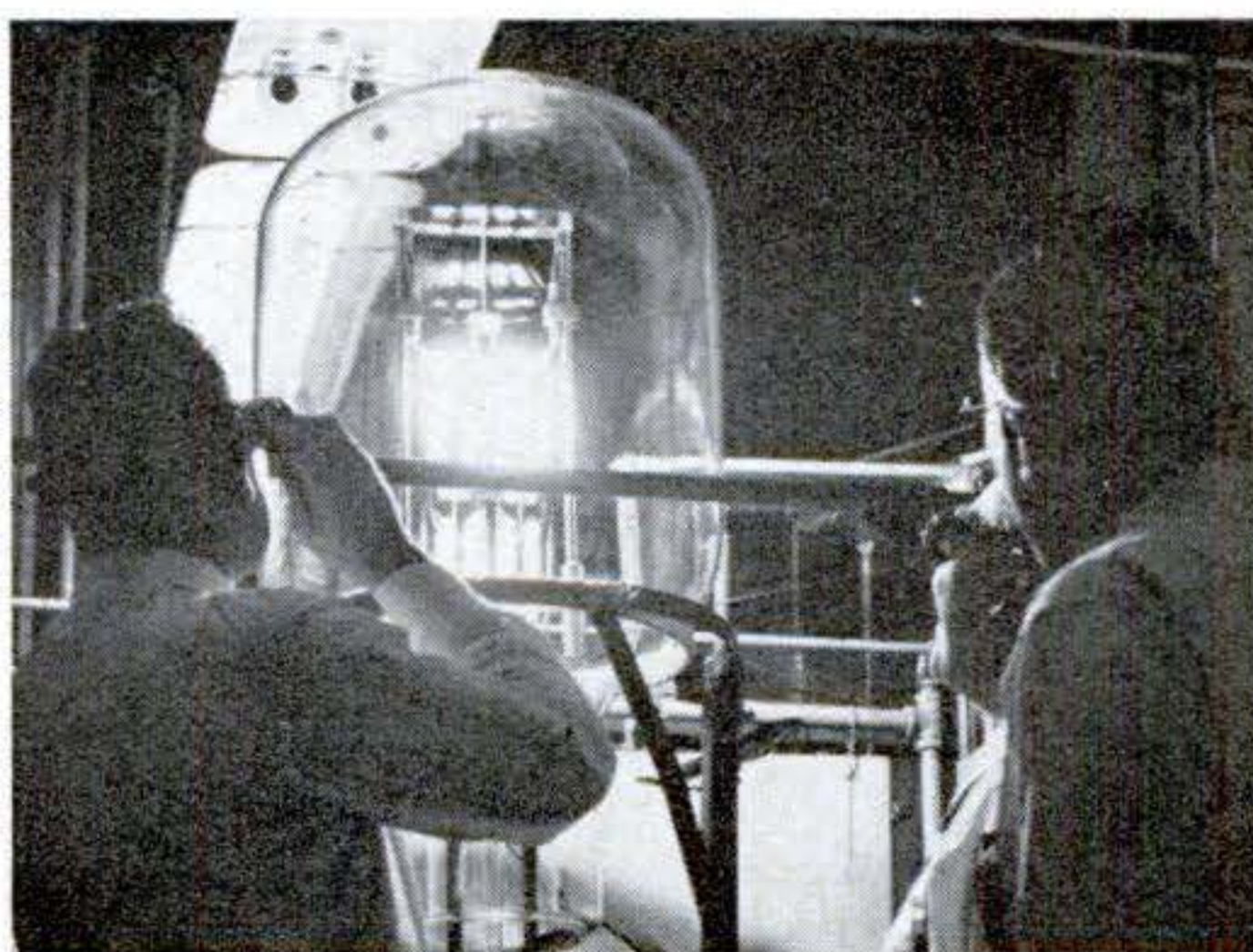

Biggest Lamp: 75,000 Watts

BIGGEST lamp is 38 inches long, 20 inches wide. A 75,000-watter, it must be studied through smoked glasses. GE made it to celebrate the 75th anniversary of Edison's invention of the bulb.

Gus Clears a Traffic Jam

Working to the tune of a hundred angry horns, Gus finds a cure for the bus that wouldn't go to school.

By Martin Bunn

GUS WILSON hung the telephone receiver back on the hook and made a dive for his emergency tool kit. He tossed the kit into the back of his tow truck, jumped in and stepped on the starter button. He was rolling out of the Model Garage even as he yelled to his young helper, Stan Hicks, to take over. Stan ran from the grease rack to gaze after the departing tow truck.

"Golly!" he said. "The town must be afire."

Gus himself wasn't at all sure what was wrong. Sid Price's voice over the telephone had been almost hysterical. Sid was a rather excitable character who ran several buses for charter to ball games, lodge picnics and so forth, and also had a contract to pick up the rural high-school children and bring them into school. Probably, Gus thought, Sid's

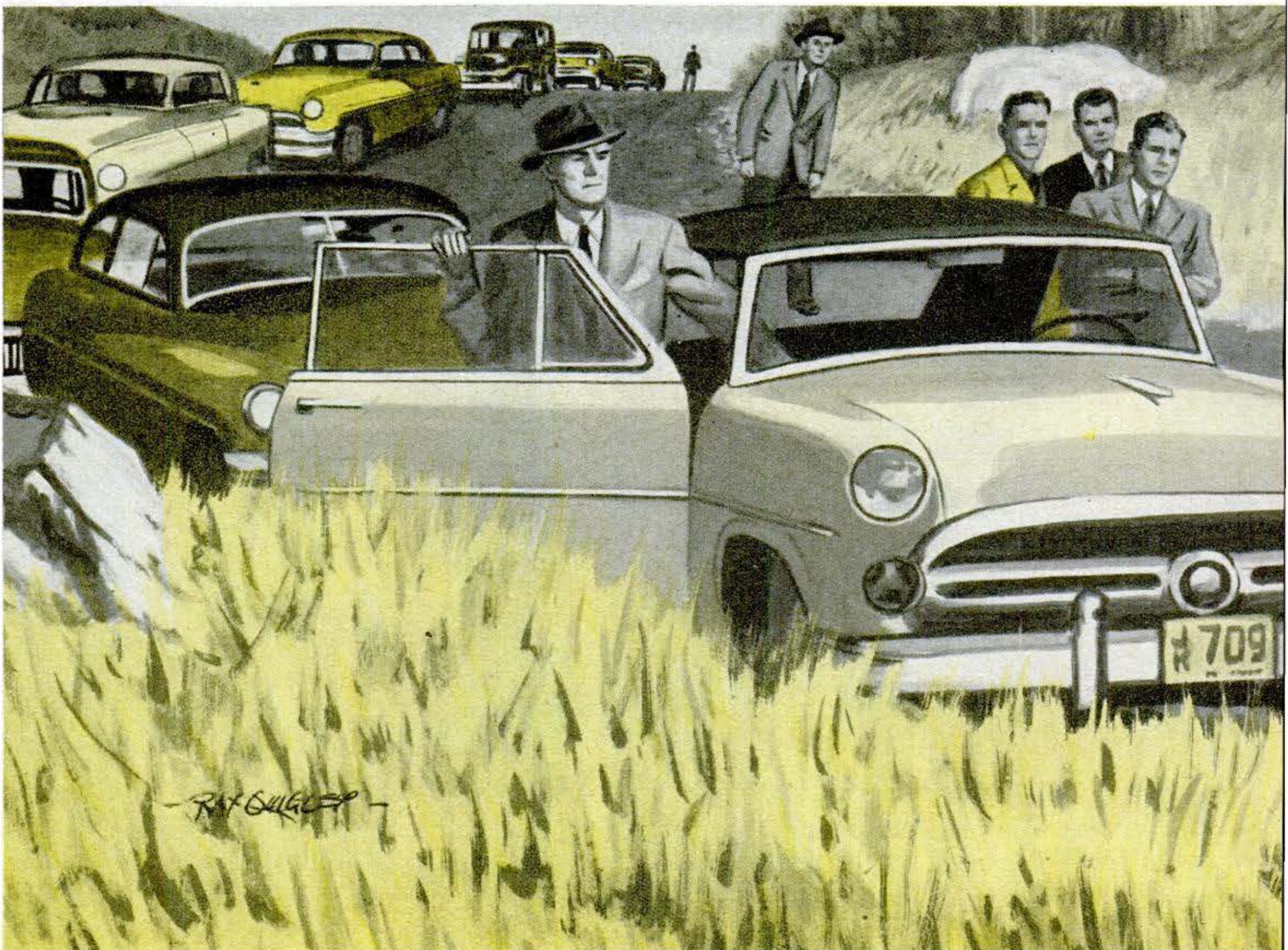

Neither the hydrometer nor voltmeter that Gus put on the battery revealed anything wrong.

school bus had stalled. But that shouldn't be enough to get a man into such a lather.

Gus drove through town and hit the road that led north through open fields, where Sid had converted a large hay barn into a bus shelter and office. Here he ran into the worst traffic jam he'd ever encountered.

Roadblock Stops Gus

Cars headed into town and those going out were stopped solid for a half mile on the narrow pavement, with a ditch on one side and a steep cut bank on the other. There seemed to be some sort of excitement going on in the middle of the traffic jam, before Sid Price's bus barn.

When Gus found that he could drive no farther, he got out, shouldered his tool kit and headed down the line of cars

for the bus yard. As he drew near, he could see that Price's big, yellow school bus was stalled across the road. The forward end almost nudged the bank; the rear end was still partly in the drive, which rose so steeply as to make it impossible to manhandle the vehicle out of the way of traffic. Sid Price was standing by the open front door of the bus, shaking his fist and yelling incoherently at a young man who sat behind the wheel.

Gus recognized Harry Creel, who worked for Price as a combination school-bus driver and all-around maintenance



It was up but could be breaking down under load—that motor had turned over awfully slow.

man. Creel looked hardly old enough to grow a beard, yet he was a married man and Gus had heard there was a baby on the way.

"You're fired!" Price yelled. "Get off the place and stay off."

Creel slid out from under the seat and leaped down, and for a moment it appeared that he was about to attack Price. Gus dropped his tool kit and moved forward to grasp Creel by the arm.

"Take it easy, Harry," he said. "What's the trouble here?"

"He called me a liar," Creel shouted. "Every time this crate won't start in the morning he blames me. It isn't my fault. He told me to put a charge in the battery last night and clean the plugs and points. I did—but he says I didn't."

"Arguing about it won't help," Gus said soothingly. "Let's get to work."

"Every other morning or so," Price told Gus, "this bus won't start. We have to push it out of the yard in gear to start it. I told Creel to charge the battery and tune the motor last night. But no, he was too lazy. Now look at the mess. You're fired, Creel!"

"First thing," Gus interrupted him, "is to get this traffic moving. These folks are on their way to work."

Bus Cannot Be Towed or Cranked

Gus ran his eye over the jam. It would take an hour to make each car back up to a place where they could turn around, so that he could get the tow truck in to the bus. Price's other buses were out, so without wasting a lot of time, towing was out. The school bus would have to be started where it stood.

"Twist her tail, Gus," one of the on-lookers called, "and let's get moving."

Gus knew that there could be no tail-twisting, as this bus had no crank. He

climbed up behind the wheel, flicked the switch and stepped on the starter. The cold, stiff motor turned over slowly.

Gus's eyes went to the ammeter, seeing the make and break of the needle, which told him that the points were juiced and breaking. He got out and lifted the hood. But neither the hydrometer nor voltmeter that Gus put on the battery revealed anything wrong.

The battery was up, but it could be breaking down under load—that motor had turned over awfully slow.

"Get me that hot battery from my truck, Harry," he said, "while I pull this one."

It took but a few minutes to put in the new battery. This turned the motor over a bit livelier, but it still didn't start. Gus jumped out of the cab, jerked the distributor cap, pulled the high-tension wire

from the center socket, held it a quarter inch from the block and snapped the points with his thumb. A blue flame sprang from the wire to the block, with an audible snapping sound. Gus replaced the distributor cap, but not the wire. He again held it a quarter inch from the block, turned to Creel and said, "Step on the starter, Harry."

Creel turned the motor over with the starter. Gus rammed the high-tension wire back in its socket in the center of the distributor cap, pulled paper and pencil from his pocket and scribbled rapidly. He handed the paper to Price.

"Phone Stan Hicks," he told the bus owner, "and tell him to get out here fast with this part."

Gus quickly selected tools from his kit, dived headfirst under the hood. Within a matter of minutes he emerged, greasy-faced but triumphant, with the starter in his hands. Sid Price rushed up.

"Stan says he'll be right out," he said breathlessly. "Hey, what are you doing

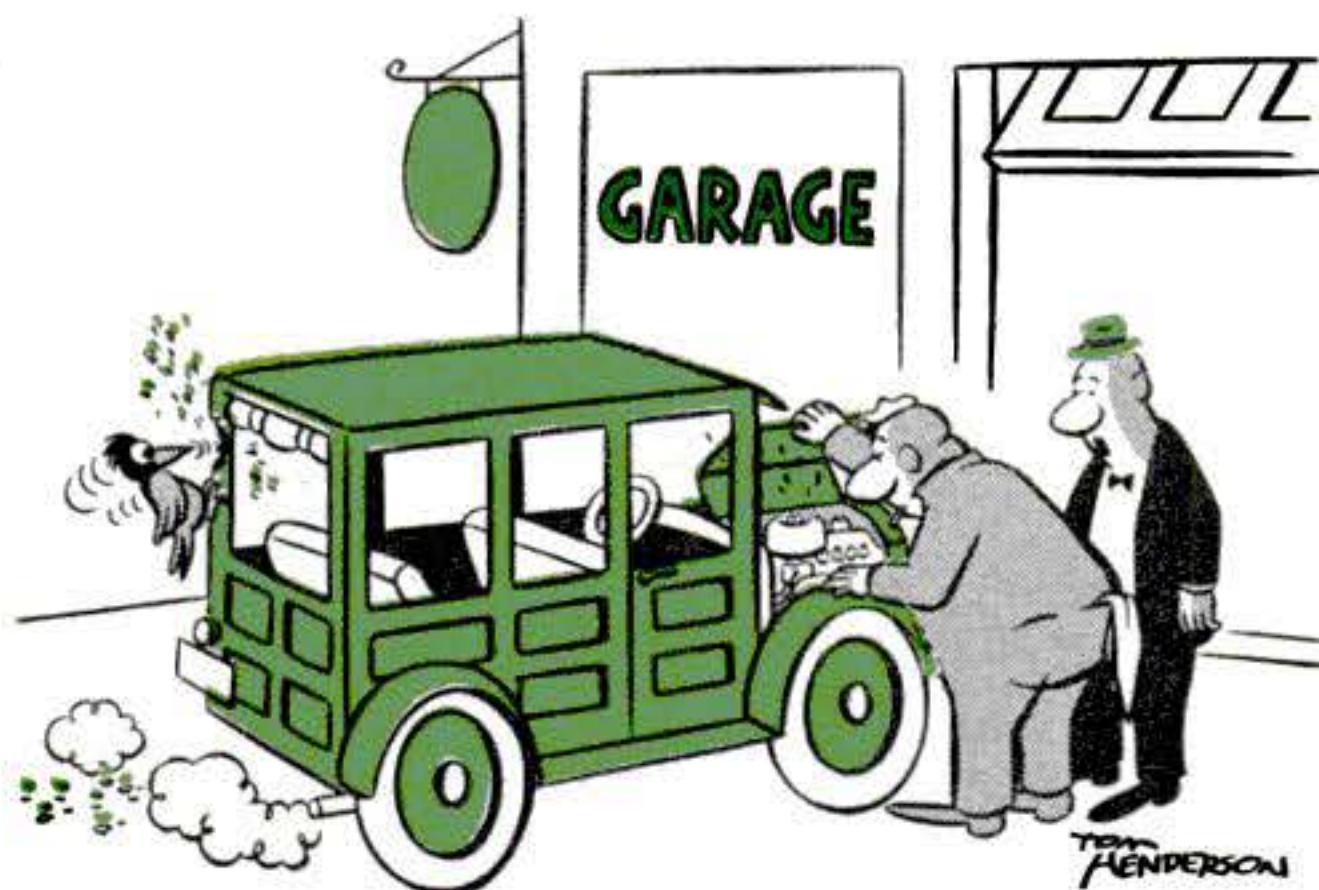

"That's it—that's the knocking sound I mean."

[Continued on page 250]

**MECHANICS
and
HOMEBUILDING**

The Other Fellow's Shop

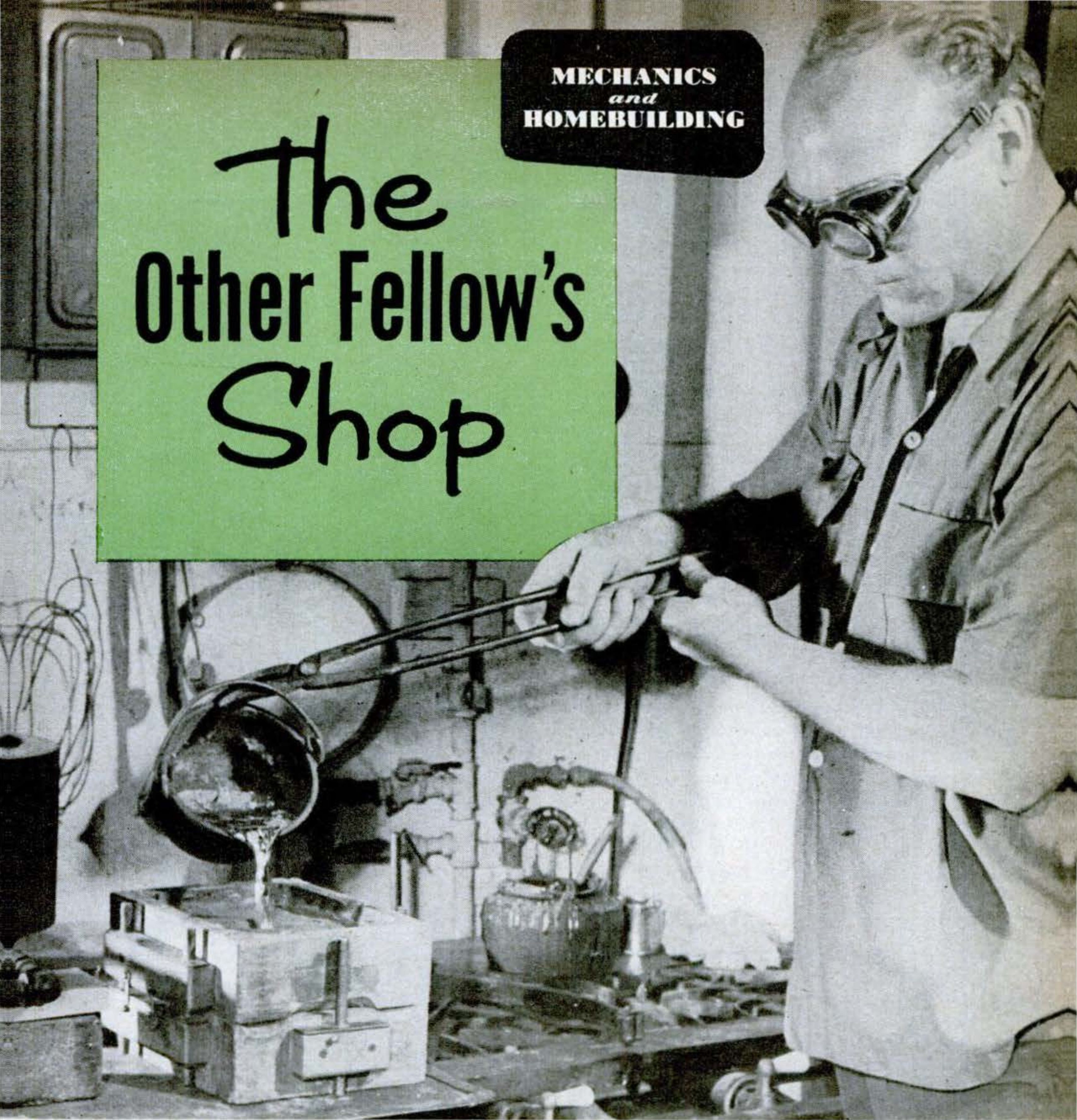

An oversize basement gives this physician-craftsman room for the equipment to ride his model-engineering hobby.

By Harry Walton

HIS hobby is just what the doctor ordered, for Warren G. Lacey, M.D., of Queens Village, N. Y., wrote the prescription himself. Like other doctors, he knows the value of a good hobby. His is model engineering.

It is not an easy one. Most of the models he builds call for castings. Castings require patterns. He makes these of wood, rams up a sand mold around them and pours aluminum or bronze into the mold. Only then is he ready



to start machining, in which fractions of a thousandth count and the slip of a tool can ruin hours' work.

At the Republic Aviation Corp. plant in Farmingdale, where he is Assistant Medical Director, Dr. Lacey's shop know-how comes in handy. He can talk a machinist's own language when telling him how to avoid accidents or favor an injured hand or leg. But that isn't why the doctor picked his hobby. Unlike many enthusiasts, he can tell you the reasons why he chose model engineering:

- Engines have always interested him.
- It is so different from his daily work as to afford a relaxing change.
- It is not too strenuous to continue long after retirement age.
- New challenges are always ahead.

He started with a small lathe. Up to a couple of years ago, his only lathe was a 6" one, bought secondhand in 1940. His next power tool was a drill press. With these two machines, he turned out a four-cylinder

.....

More Americans are spending more time and money on home workshops every day. There's more variety in these shops than in TV shows, and a man's shop is often the most novel and interesting part of his home.

This is the first of a series of articles about outstanding home workshops, from which everyone who has a shop may benefit.

See POPULAR SCIENCE MONTHLY next issue for a peep into another fellow's shop.

.....

gas engine and several flash-steam plants.

Plans for the gas engine were found in an English hobbyists' magazine. The castings had to be cored—cast with cavities for the crankcase, cylinders and water jackets just like a full-size automobile engine. How Dr. Lacey made them is shown in part in the accompanying photos.

Flash-steam plants, perhaps the crankiest of all model engines, call for topnotch machining and precise rationing of water and oil by means of tiny pumps. Dissatisfied with conventional pumps, Dr. Lacey designed some whose output can be adjusted even while they are running.

Like any hobby machinist, he often has to improvise to do a difficult job. For slotting, cutting keyways, and similar shaper jobs, he built a reciprocating ram that bolts onto his lathe. Another rig does indexed

1 Running gear of this 1/2"-scale (2 1/2"-gauge) Pacific locomotive shows precision work. To be driven by live steam, the engine will have Walschaert valve gear (just like a real locomotive's). Cylinders are 1" bore, 1 1/4" stroke. The rods are milled from solid steel.

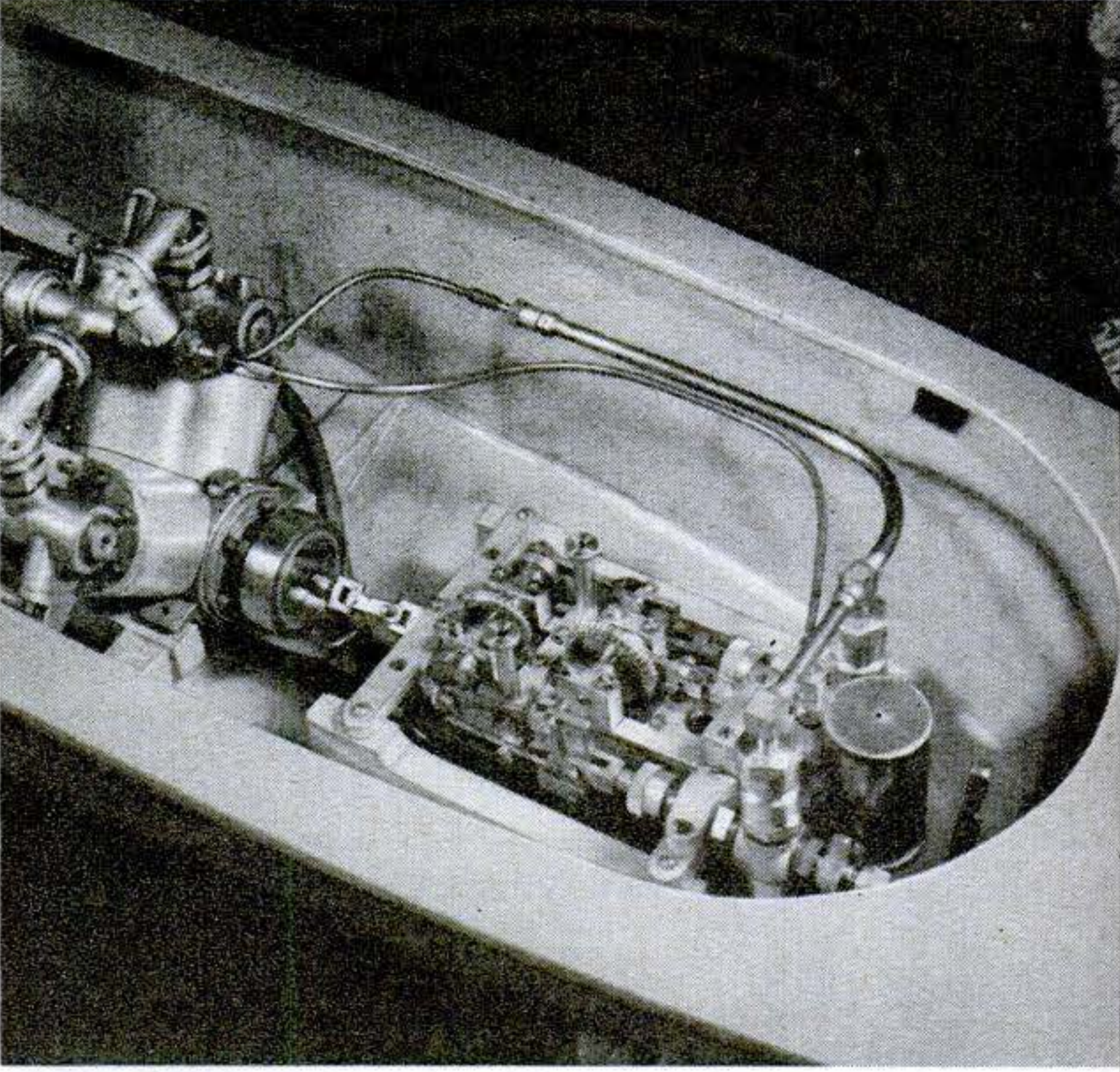
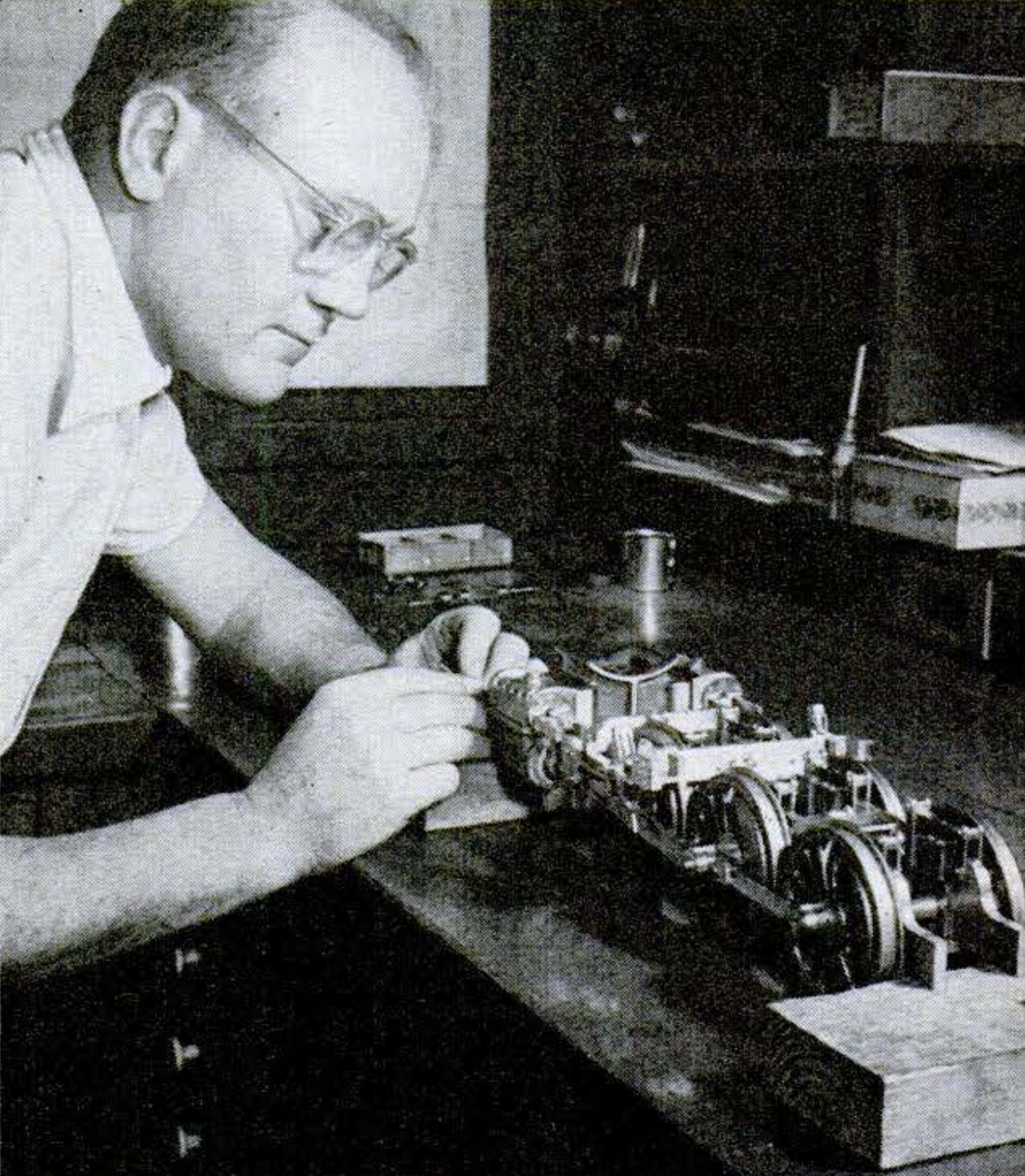

3 Speedboat hull like this is crammed with power plant. Boiler consists of yards of tubing heated by a gasoline blowtorch. Four-cylinder, single-action piston-valve engine is at left above. Oil and water pumps of Lacey's design are to the right of the engine.

2 High ceiling of the Lacey workshop is the result of a mistake when a bulldozer went too deep while excavating for the cellar of the house. A steel girder running its full length instead of Lally columns also gives lots of open floor space. Equipment includes a 6" lathe, a

9" quick-change lathe, power hacksaw, drill press, jig and circular saws, and grinder. The hacksaw rolls under the bench when not needed. Foundry setup includes a gas smelting furnace, with air supplied by an old vacuum cleaner. It melts either bronze or aluminum.

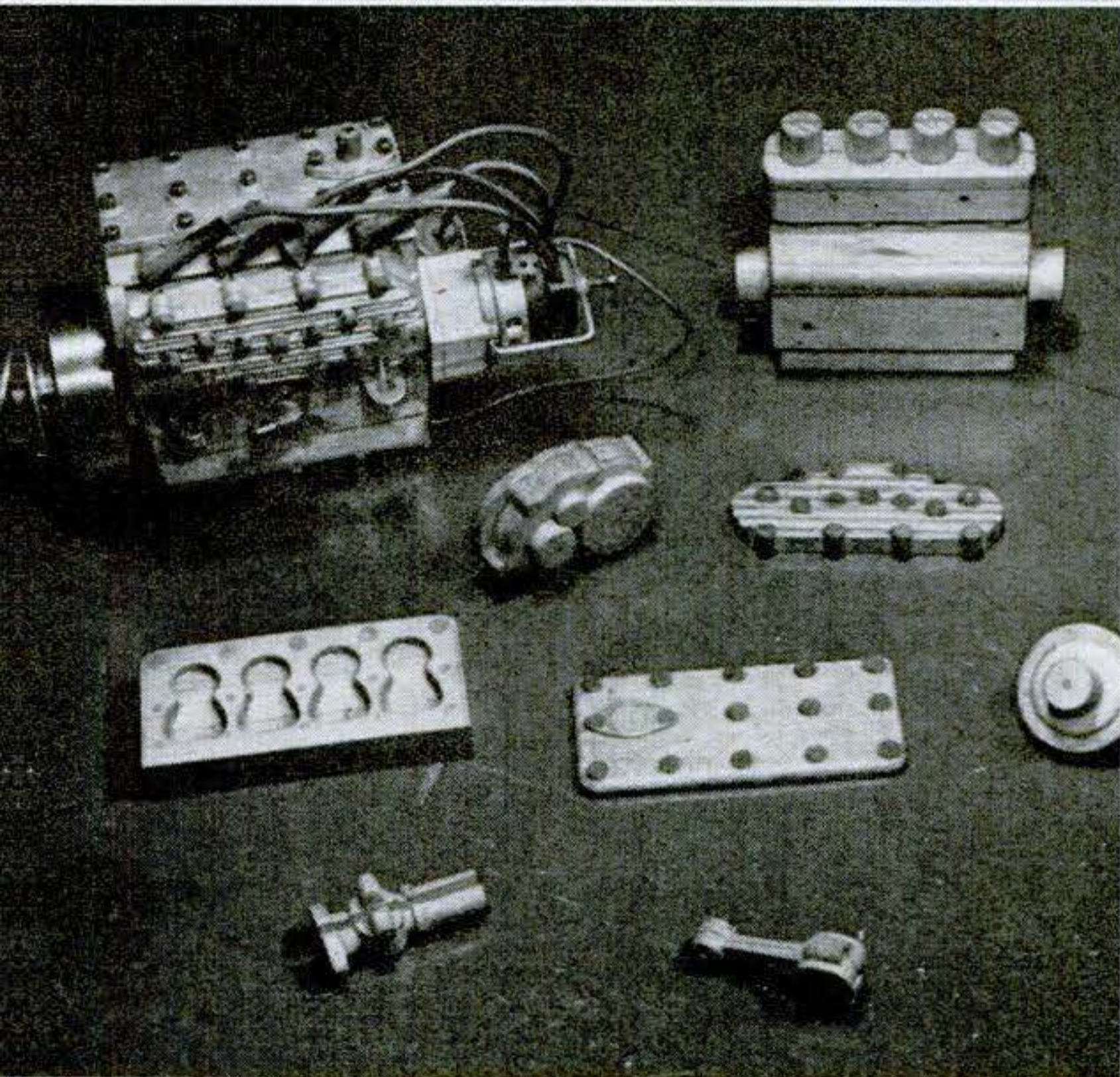
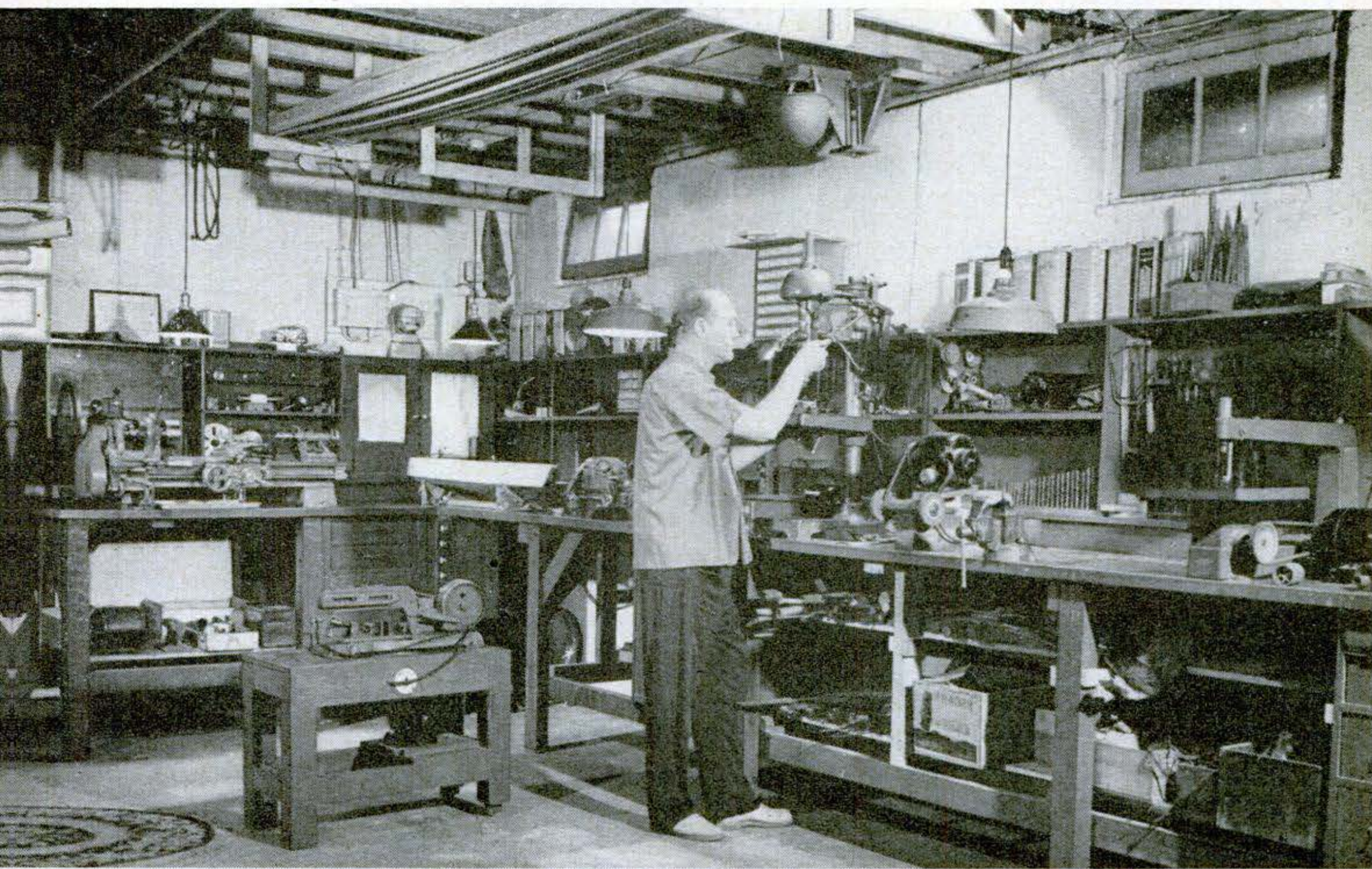

4 Four-cylinder gas engine is another example of fine model engineering. It is a four-cycle, water-cooled, L-head auto type. Alongside it is the core pattern for the engine block. Below them are shown patterns for the head, timing case, rod and other parts.

5 No workshop widow, Mrs. Lacey appreciates her husband's hobby. Coached by him, she even took time out from her work as a freelance statistical consultant to build this model of a vacuum engine from a design that appeared in POPULAR SCIENCE MONTHLY.

6 A core is used in a mold to leave cavities in the casting. Dr. Lacey makes a wood pattern of the core wanted (in two halves for the engine-block core shown). Halves are tacked inside a cardboard box. Then a thick layer of wax is poured on.



7 Patterns are lifted from the hardened wax block, leaving reverse impressions. Core sand, pure silica such as is found on beaches, without organic material, is mixed with varnish and packed into the molds. Careful tamping fills every detail.



8 Turned upside down, the wax block is placed in a pan of water over heat. The wax melts and floats to the surface. When cool, it can be lifted off. Then the sand-core halves are carefully taken out of the water (below), and baked in an oven.

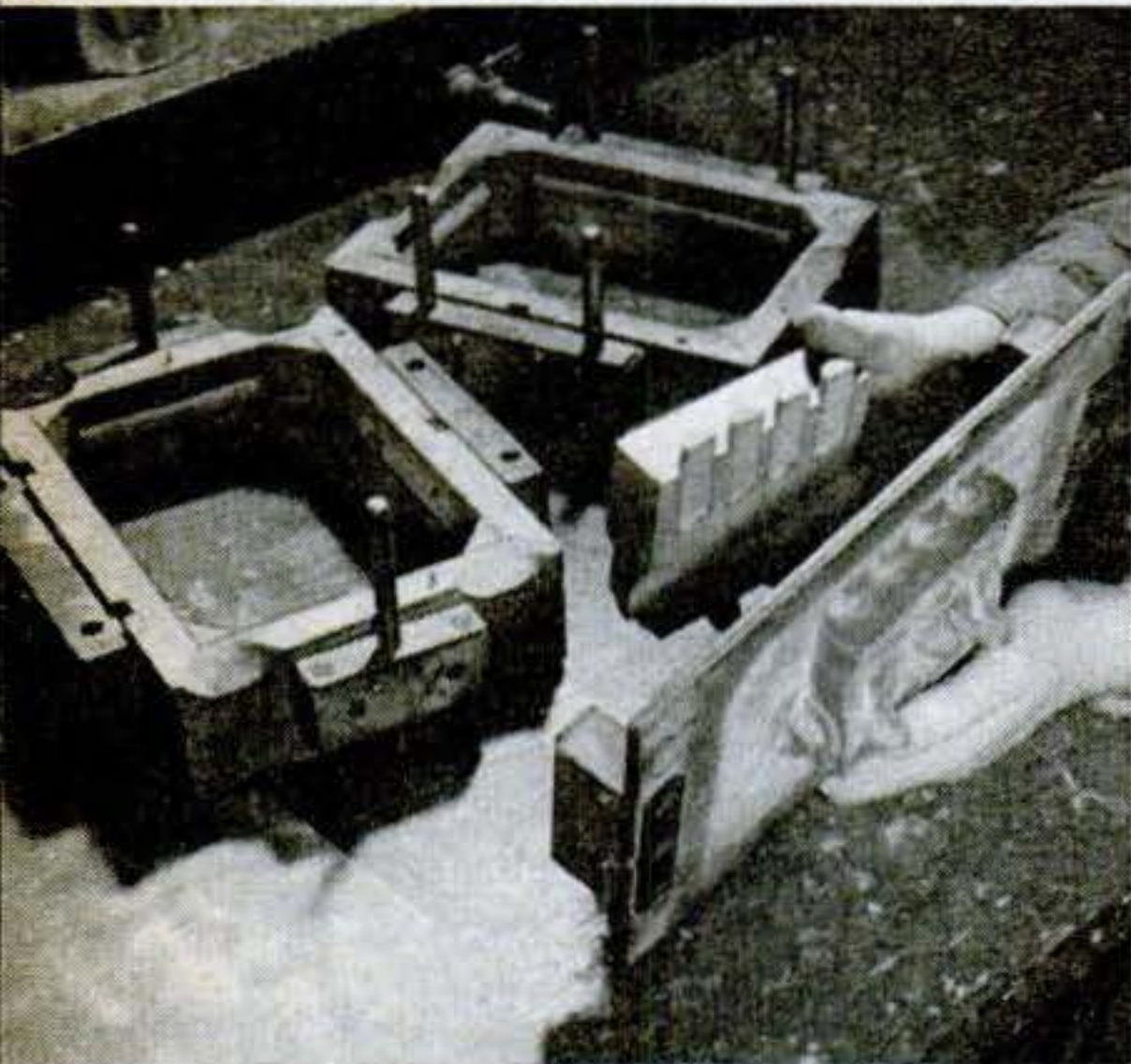
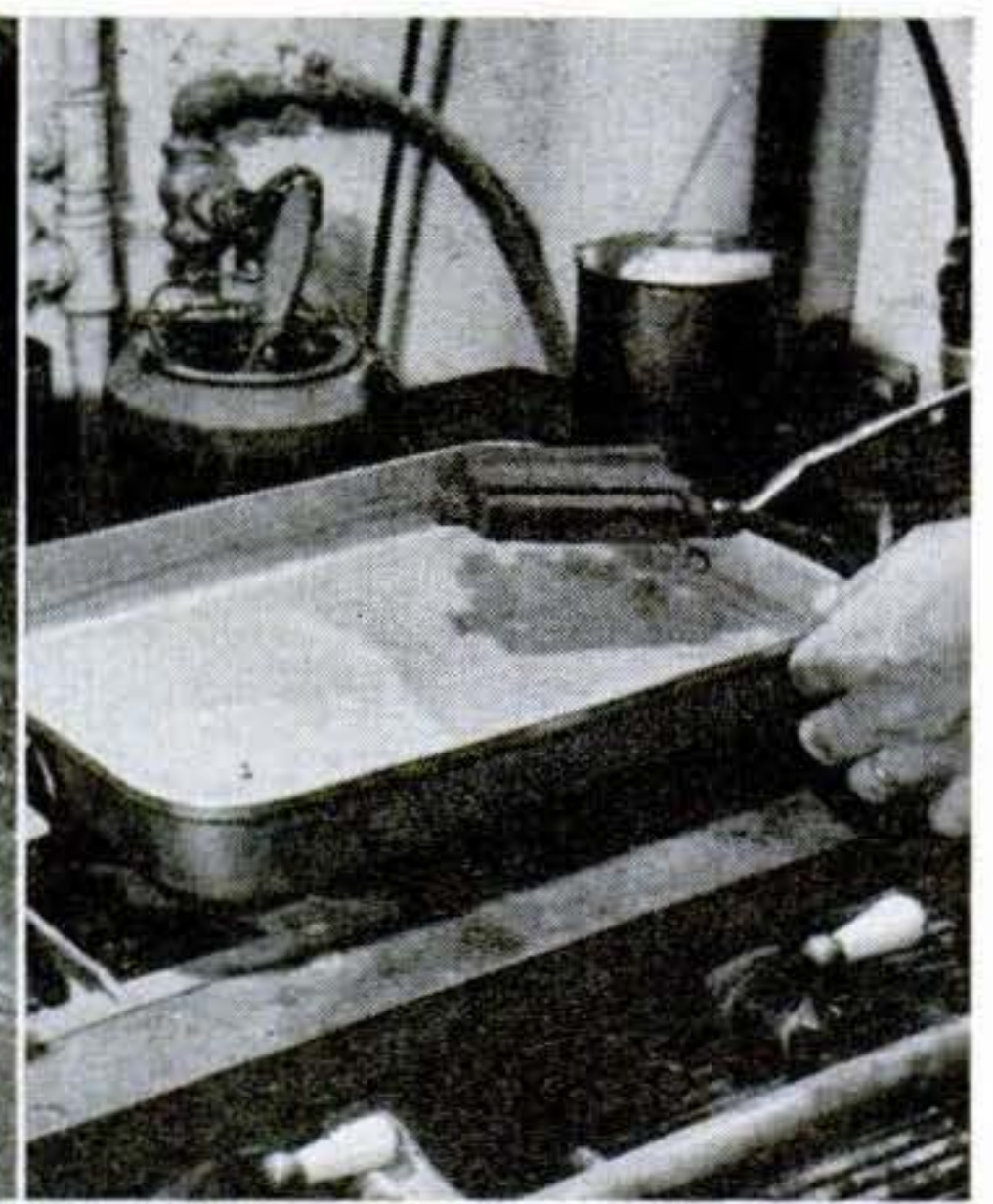

9 Engine-block pattern, split in the middle, is pinned to the two sides of a parting board (above). This is assembled between the two parts of the molding flask shown behind it. Parting sand, a very fine-grained type, is then dusted over it.



10 Molding sand, dampened just enough to pack firmly, is sifted on as shown and rammed to make a firm mold. The flask is then turned over and the other half filled in exactly the same way. Pouring and vent holes are cut in the sand in one half.



11 Separated, the flask reveals a sand impression of the pattern, which is removed. To leave crankcase and cylinders hollow, the core halves are tied together and laid in the mold. Metal flows around, leaving the desired cavities.

milling or radial drilling on the lathe (PSM, Feb. '53, p. 227).

The Lacey workshop is spacious. Sturdy cabinets and a line of workbenches run along most of two walls, with shelves above them. All containers and small-parts drawers are meticulously labeled so that spare time isn't wasted hunting for things. Woodworking equipment is at the opposite end from the two lathes. There is a gas oven for baking cores and a homemade smelting furnace.

The doctor has even scotched that touch-

iest of all workshop problems—the wifely plaint: “You’re always in the cellar.” He has maintained diplomatic relations by putting up shelves and building some furniture for the house. When lady visitors ask his wife that loaded question, “But what does your husband *do* in his workshop?” she can point to kitchen cupboards and two handsome corner cabinets in the dining room.

It's much easier than telling them that the Pacific locomotive he's building will have full Walschaert valve gear. **END**

**WHEN YOU TAKE YOUR VACATION TRIP
THIS SUMMER, YOU'LL HAVE**

MORE FUN For Your Money

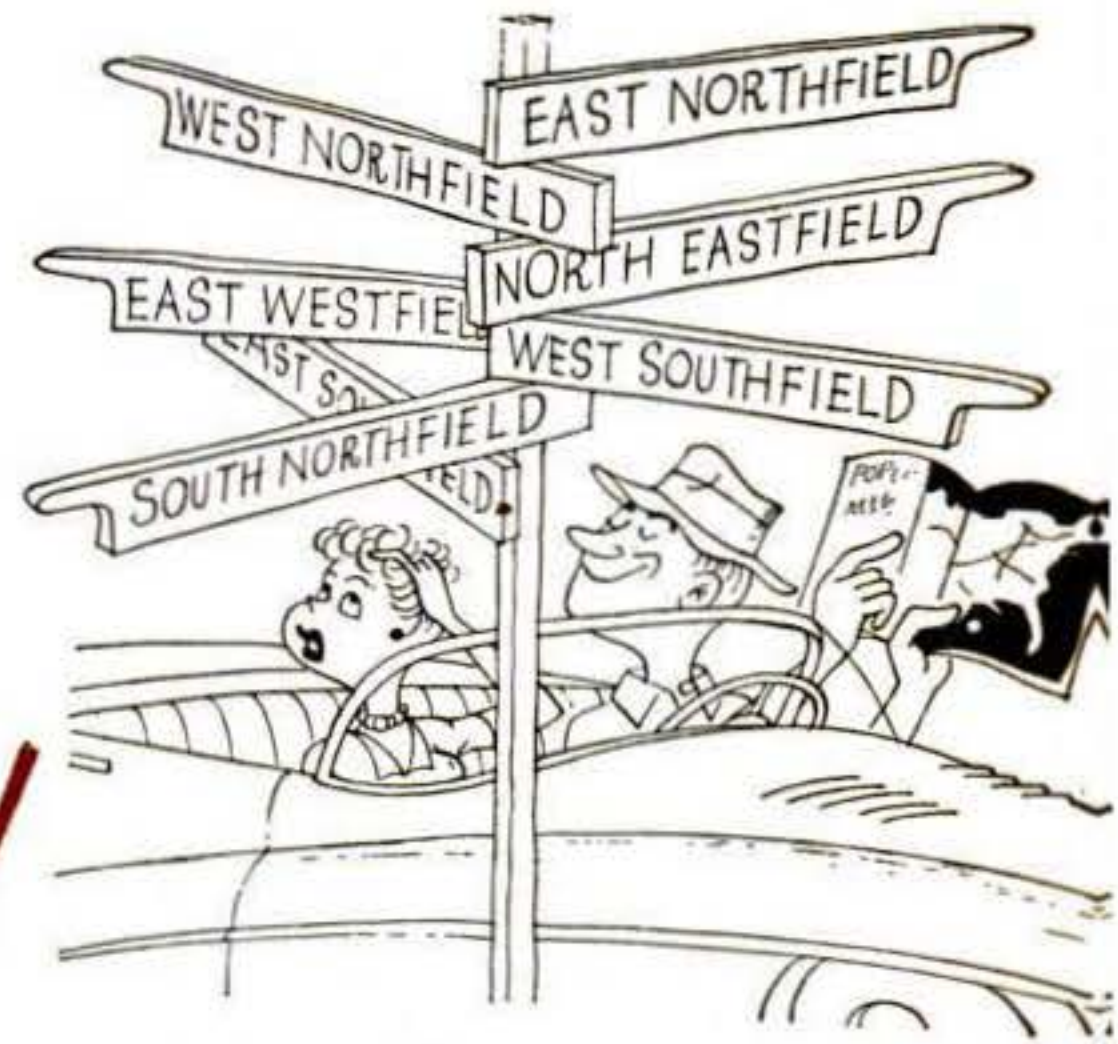

... IF you're hep to the roads, and choose the new super-routes. (See page 166)



*... IF you're equipped to cook outdoors
wherever you may light. (See page 168)*

*... IF you can spot and fix car troubles
before they're serious. (See page 174)*

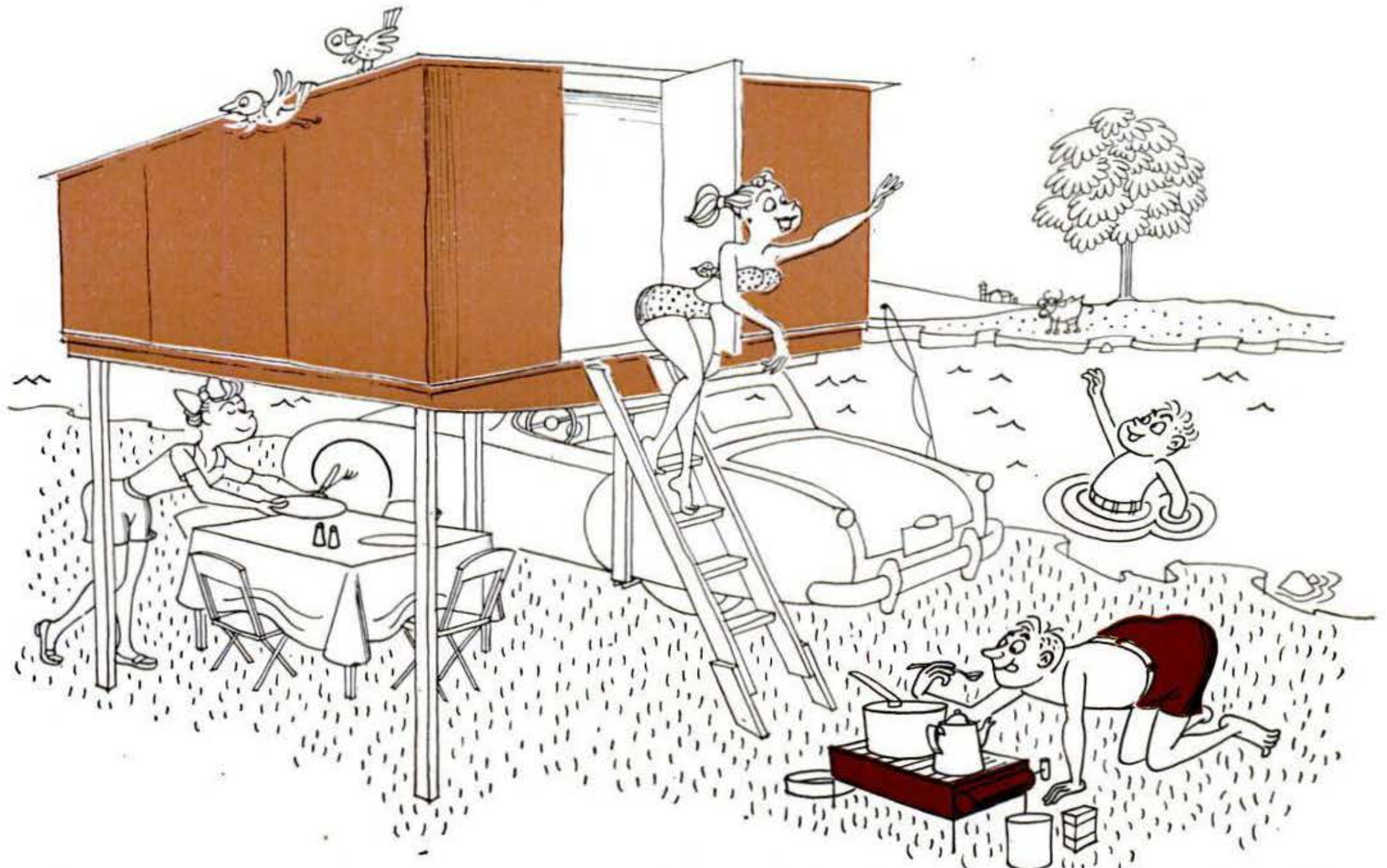

... IF you carry a penthouse with you for easy living anywhere. (See page 169)

**MORE FUN
FOR YOUR MONEY:**

How to Get More Per Day On Your Trip

LIKE the flowers of spring, express highways are bustin' out all over these days to carry you faster and farther on your vacation.

In some sections of the U. S. you will be able to motor 400 miles comfortably between a late breakfast and an early dinner—with an hour's stop for lunch. That's because cruising speeds start at 60 miles an hour and go on up, with nary a red light to grind you to a stop.

Most of these high-speed roads are, of course, toll highways. You pay to ride on them. And most of them, for the present, are in the eastern third of the country. But take a look at the map to the right and see for yourself.

In 26 states there are such multilane turnpikes operating, under construction, authorized by law, or proposed. They extend from Maine's evergreen forests to Florida's evergreen palms, from Long Island's sandy wastes to Washington's Pacific orchards. Right now there are 800 miles of toll highways in operation in 10 states. Before the vacation season ends, 500 miles more will be open. By the time next winter's snows begin sifting down, an additional 700 to 800 miles will have felt the bite of the bulldozer.

For an average charge of a bit more than a cent a mile, you can see more and visit more places in the same time—and do it more safely.

END

Toll Roads: Now and Tomorrow

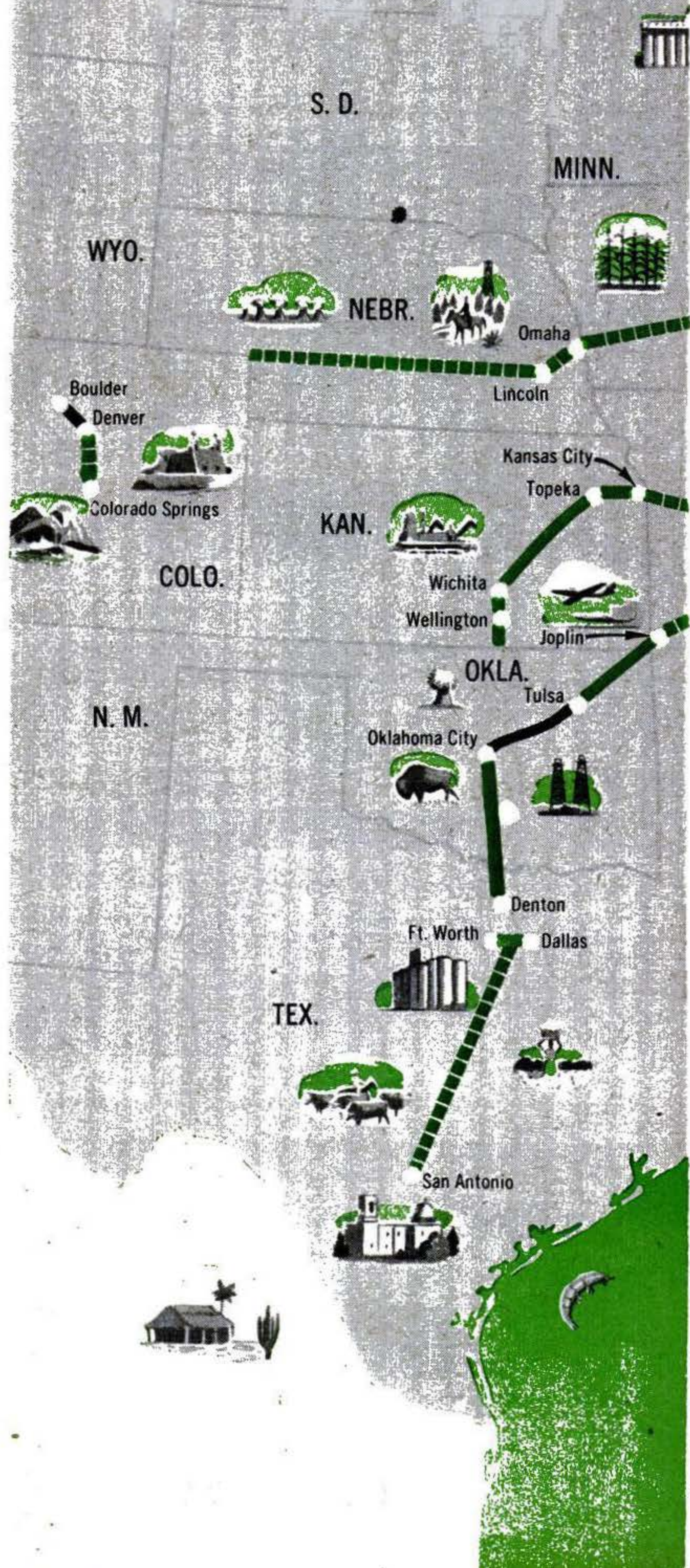

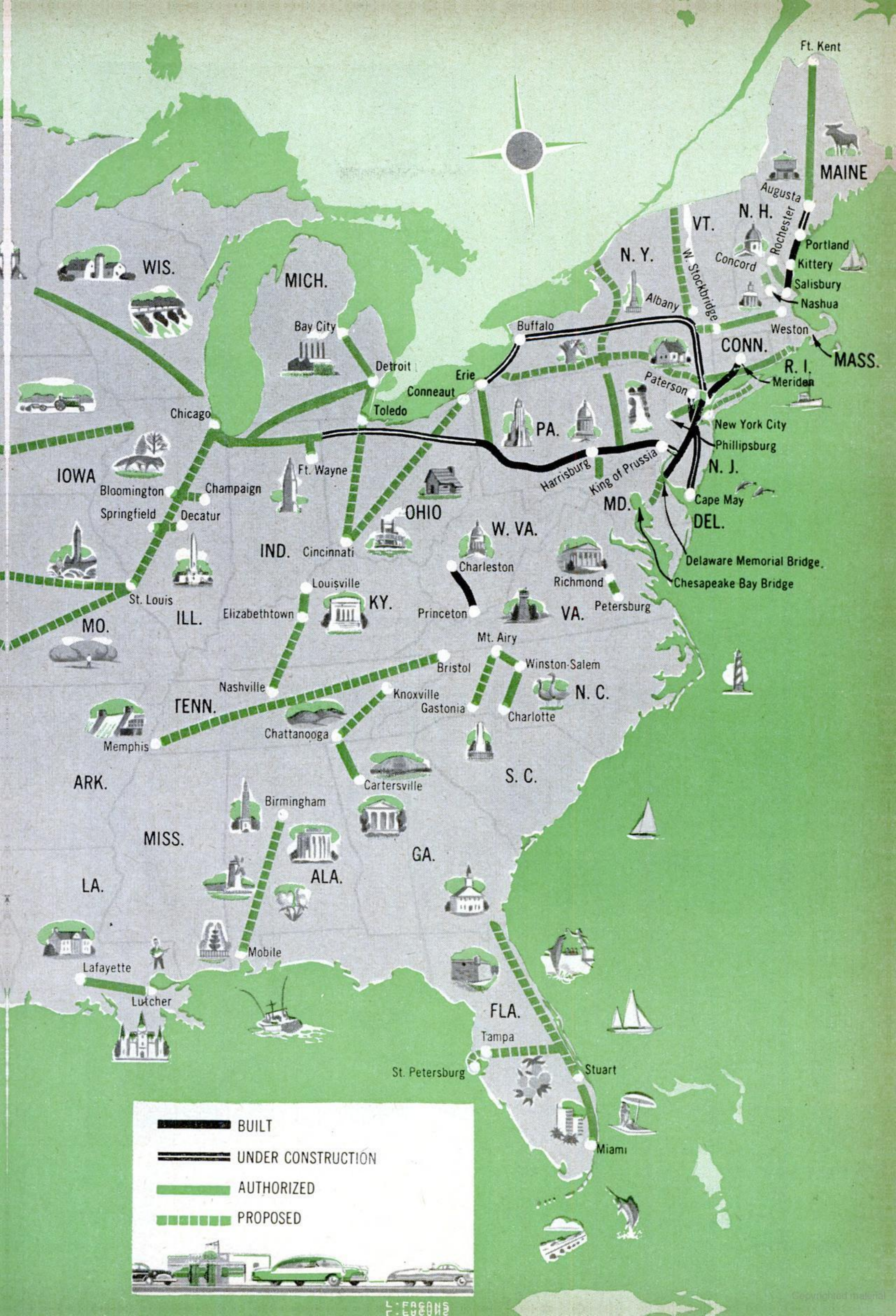

— BUILT
== UNDER CONSTRUCTION
— AUTHORIZED
- - - PROPOSED

**MORE FUN
FOR YOUR MONEY:**

How to Cook By the Road



FIRE MAKIN'S are waiting to be picked along most roads. Small limbs on dry rocks make a good hot bed of coals.

HOT BISCUITS are easy with reflector oven—tin sheet on bolt legs and curved by wire. Logs behind fire aim heat.

NO WAITING FOR BREAKFAST at overnight camps if you keep firewood dry by storing it in a protected spot.

DISHWASHER takes a vacation by lining pots with aluminum foil. Fish need no pan—wrap in foil, set in coals.

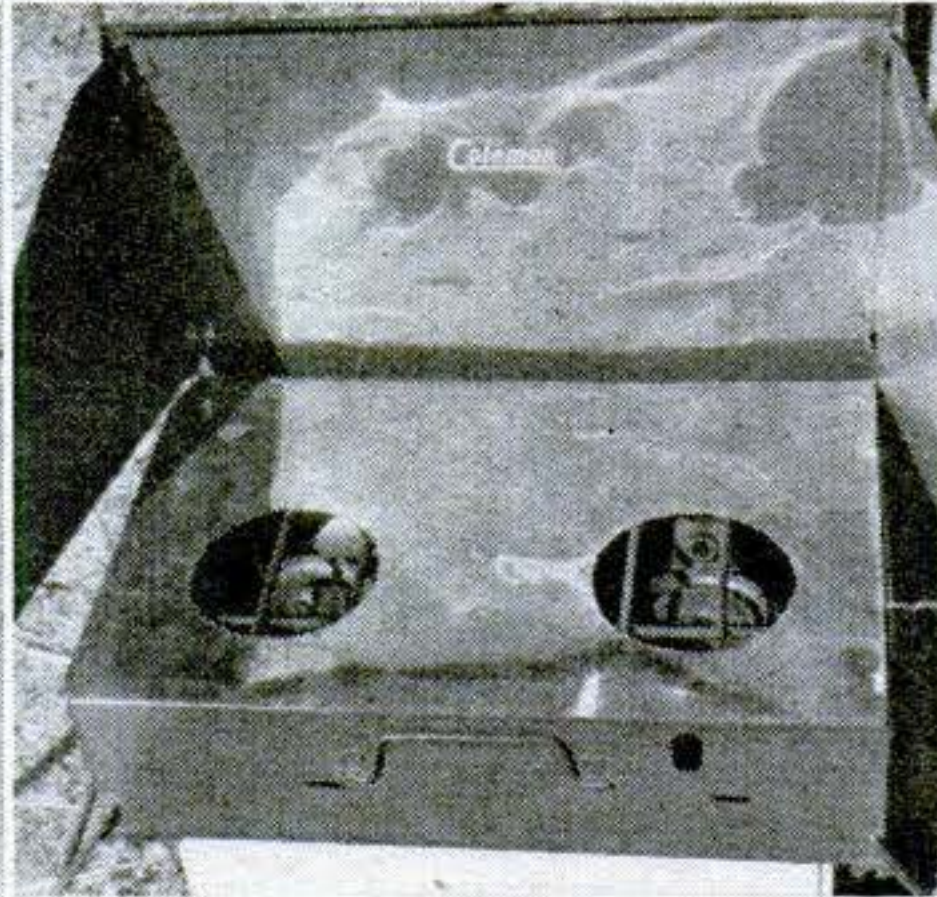
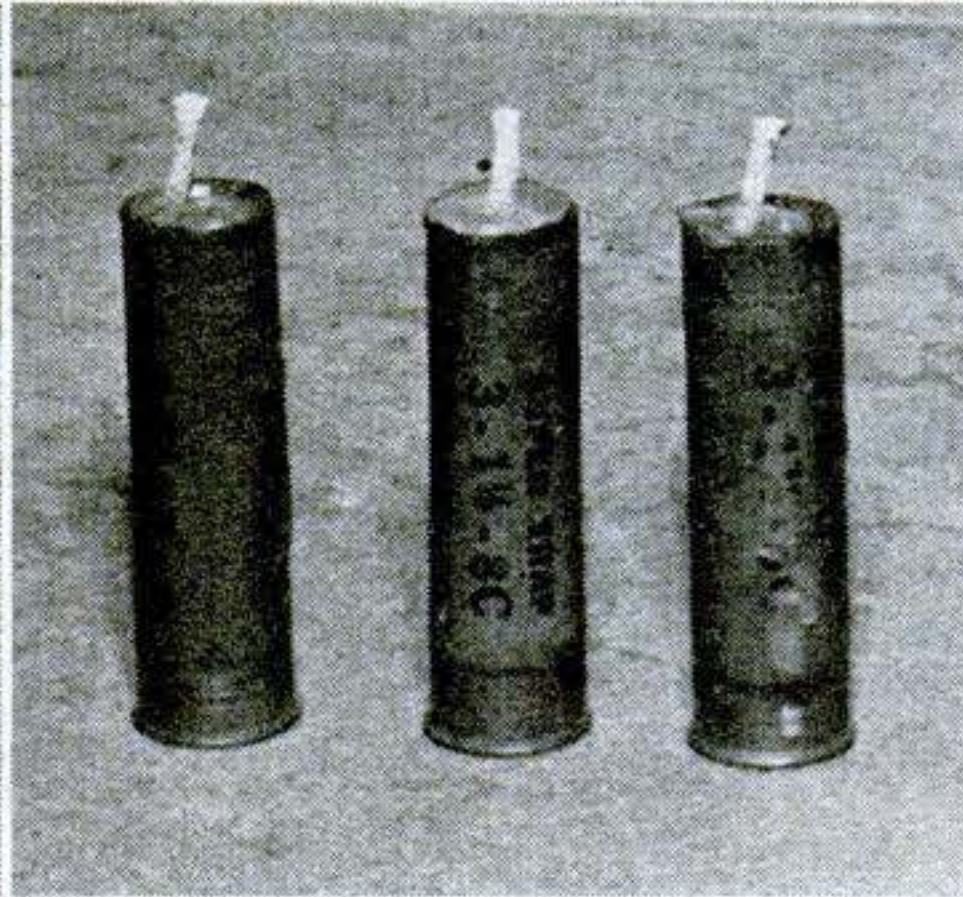
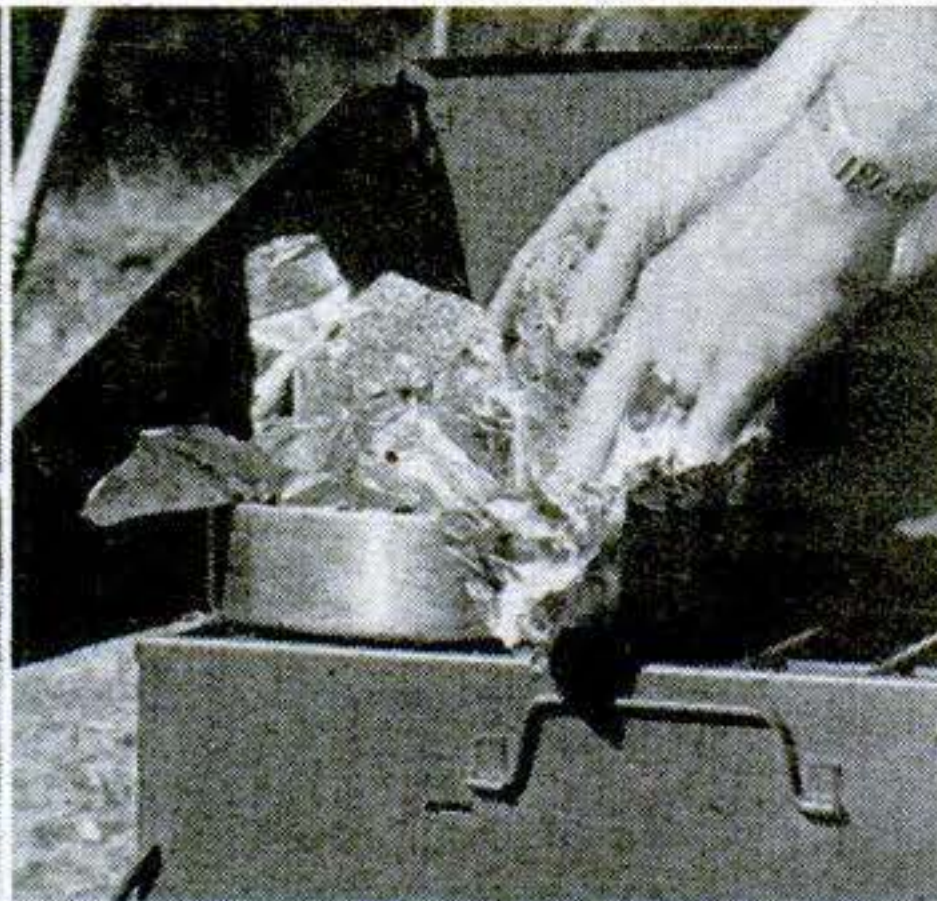

TO HEAT WATER the easy way, hang pail on an improvised crane: a five-foot limb held across a log by a big rock.

PREPARE FOR A RAINY DAY with fire starters—old shotgun shells filled with melted paraffin. String makes wicks.

SHEET-METAL COVER, with holes for burners, will keep camp stove going even in a high wind.—*Shep Shepherd.*

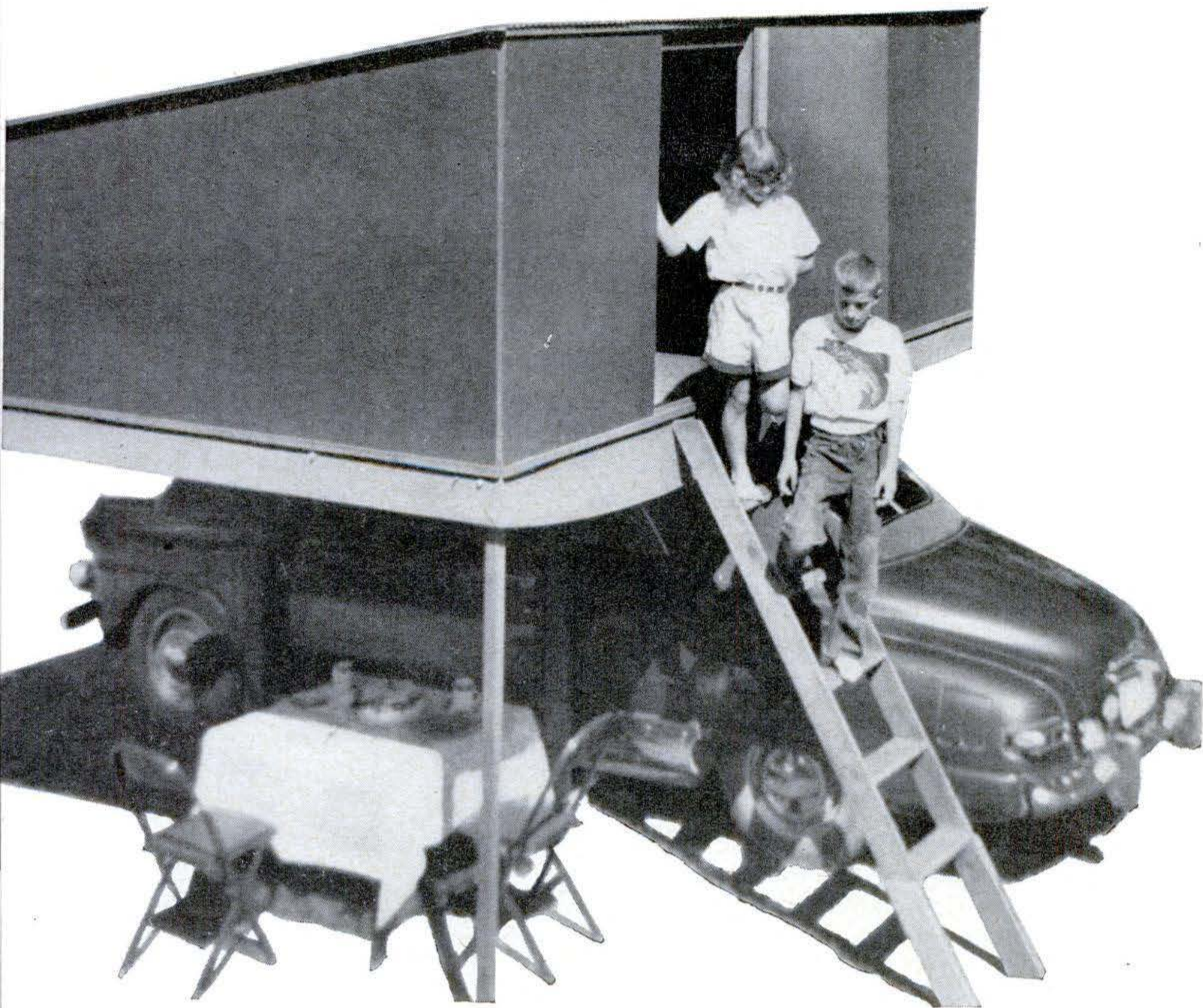

**MORE FUN FOR
YOUR MONEY:**

How to Build a Folding Bedroom

By Joy LaBell

THE four-o'clock hunt for a motel is not for us. When we go touring we carry our own skyroom on top of the car. Closed it looks like a huge old-fashioned trunk. Flip open the "lid," set up the solid walls, bolt on the aluminum roof—and in 20 minutes we have a real

8'-by-12' bedroom with two full-size foam-rubber mattresses. The open "lid" shelters a patio for dining or—with curtains drawn—dressing.

The whole skyroom took about \$75 worth of materials. (It saved us more than that in just one vacation.) It can be taken off by loosening a few bolts.

The box, which forms the floor and

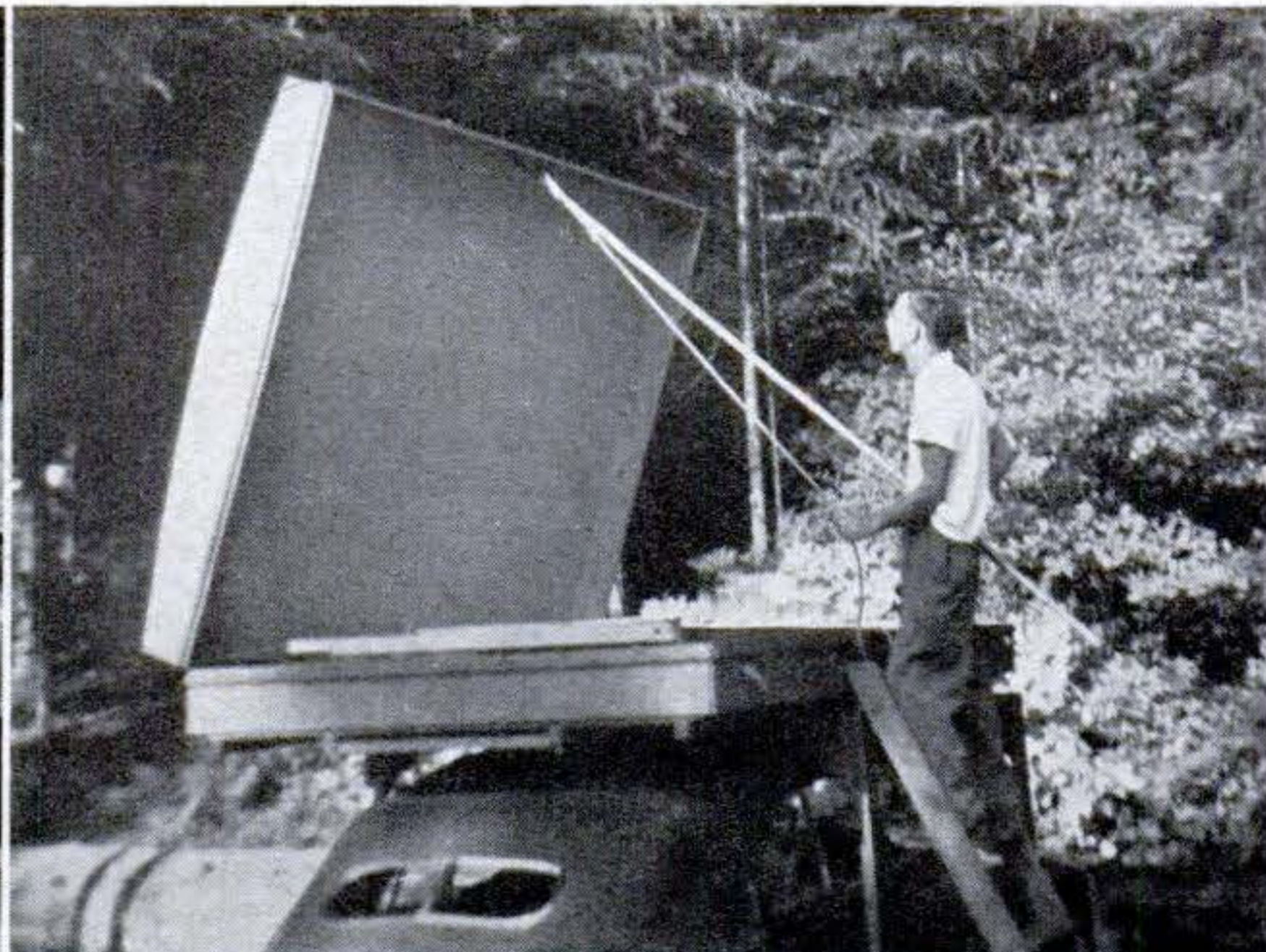
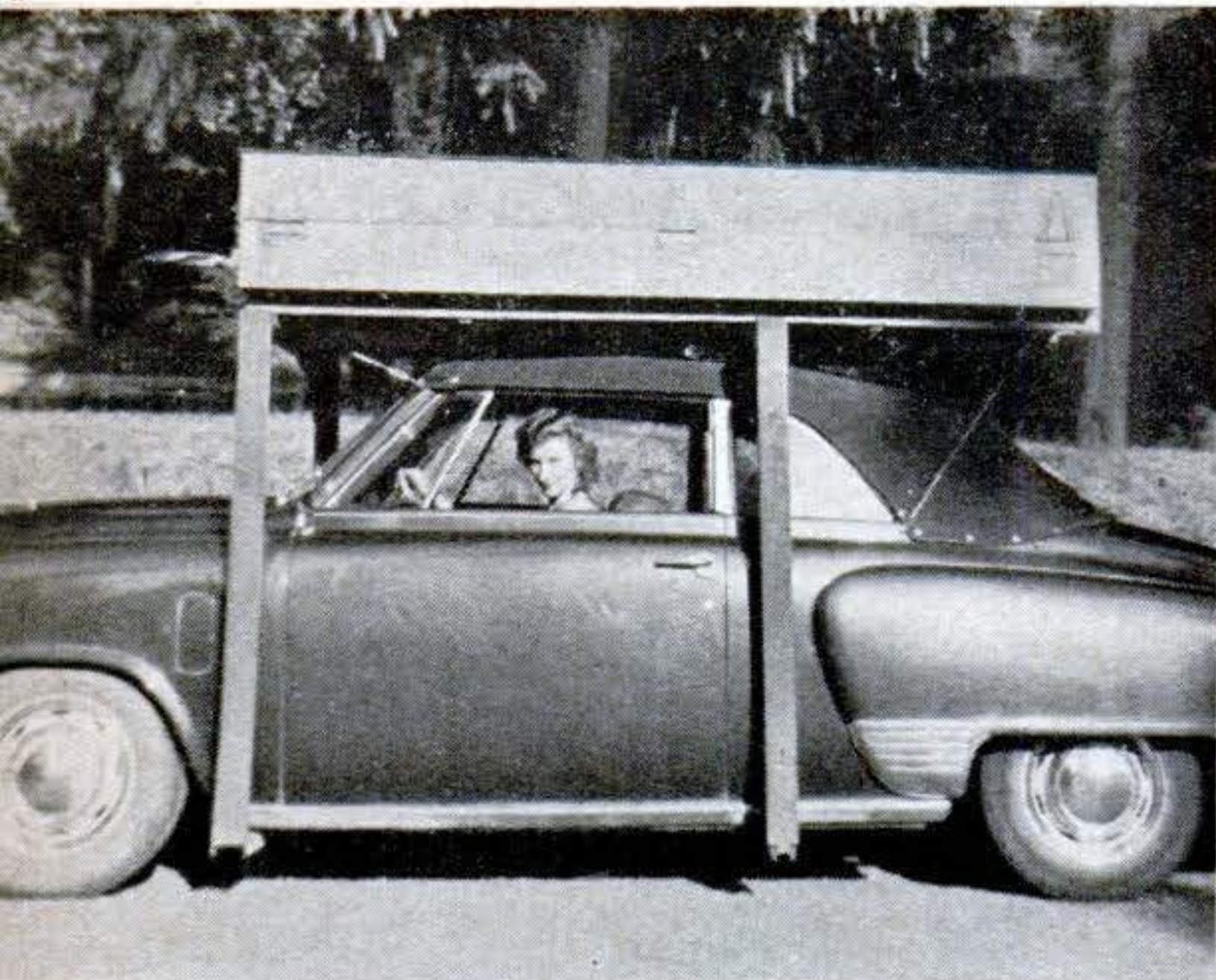

That overgrown suitcase a bedroom? Watch . . . Lid goes up and over with stick, pulley . . .

also stores everything for the road, has $\frac{1}{2}$ " plywood sides and ends with $\frac{1}{4}$ " plywood floors nailed to crosswise ribs. There are five $1\frac{1}{2}$ "-by- $1\frac{1}{2}$ " ribs in the bottom of the box. The top has seven $\frac{3}{4}$ "-by- 3 " ribs cut to make a curved box roof, which is covered with $\frac{1}{8}$ " hardboard.

Sockets $1\frac{1}{2}$ " square, built up from pieces of scrap $\frac{3}{4}$ " stock, are screwed into the box to take the wall corner posts.

The walls are $\frac{1}{8}$ " tempered hardboard. The two identical side walls are capped by grooved lengths of $1\frac{1}{2}$ " by $\frac{3}{4}$ ", glued on. These walls have $\frac{3}{16}$ " holes bored near the edges so that they can be bolted to the corner posts. The end walls are also capped with $1\frac{1}{2}$ "-by- $\frac{3}{4}$ " strips, which hold the bolts for fastening on the roof pieces. The corner posts are a permanent part of the end-wall panels.

The corner posts, 2 " by 2 ", are slanted at the top to match the slant of the side walls and rabbeted at the bottom to fit into the sockets in the box. The door is simply an unframed piece of $\frac{1}{8}$ " hardboard with cabinet hinges and a hasp for a lock. A filler strip built up from $1\frac{1}{2}$ "-by- $\frac{3}{4}$ " stock is bolted to the adjacent corner posts to form a lintel over the door opening.

Supporting framework. Even though my car is a convertible, a fairly simple arrangement fastens the skyroom to it. The box is attached by bolting its crosswise ribs to the lengthwise ribs of the

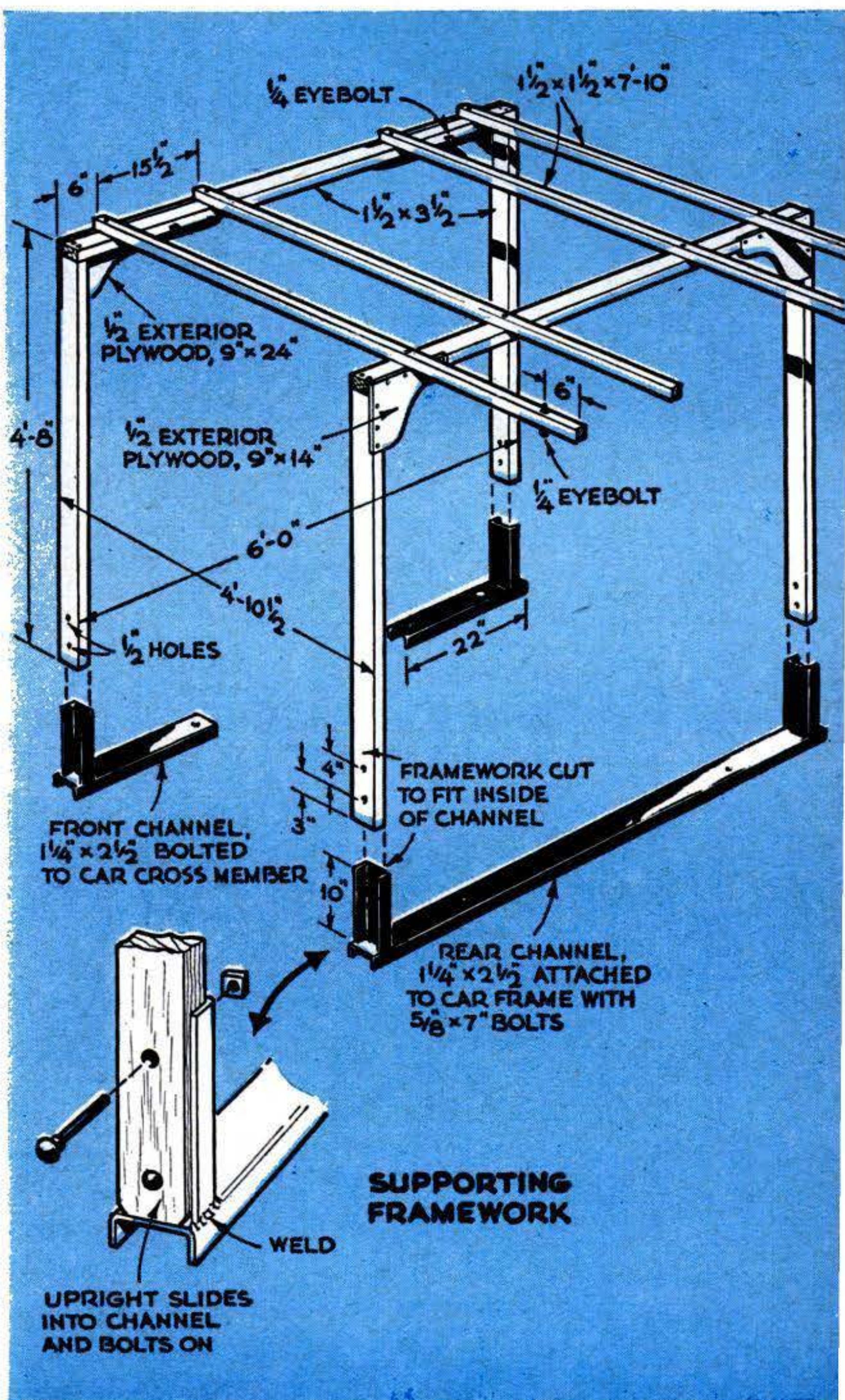



Is gently lowered to rest on two slip-in legs. Walls are next. From stack in the box . . .

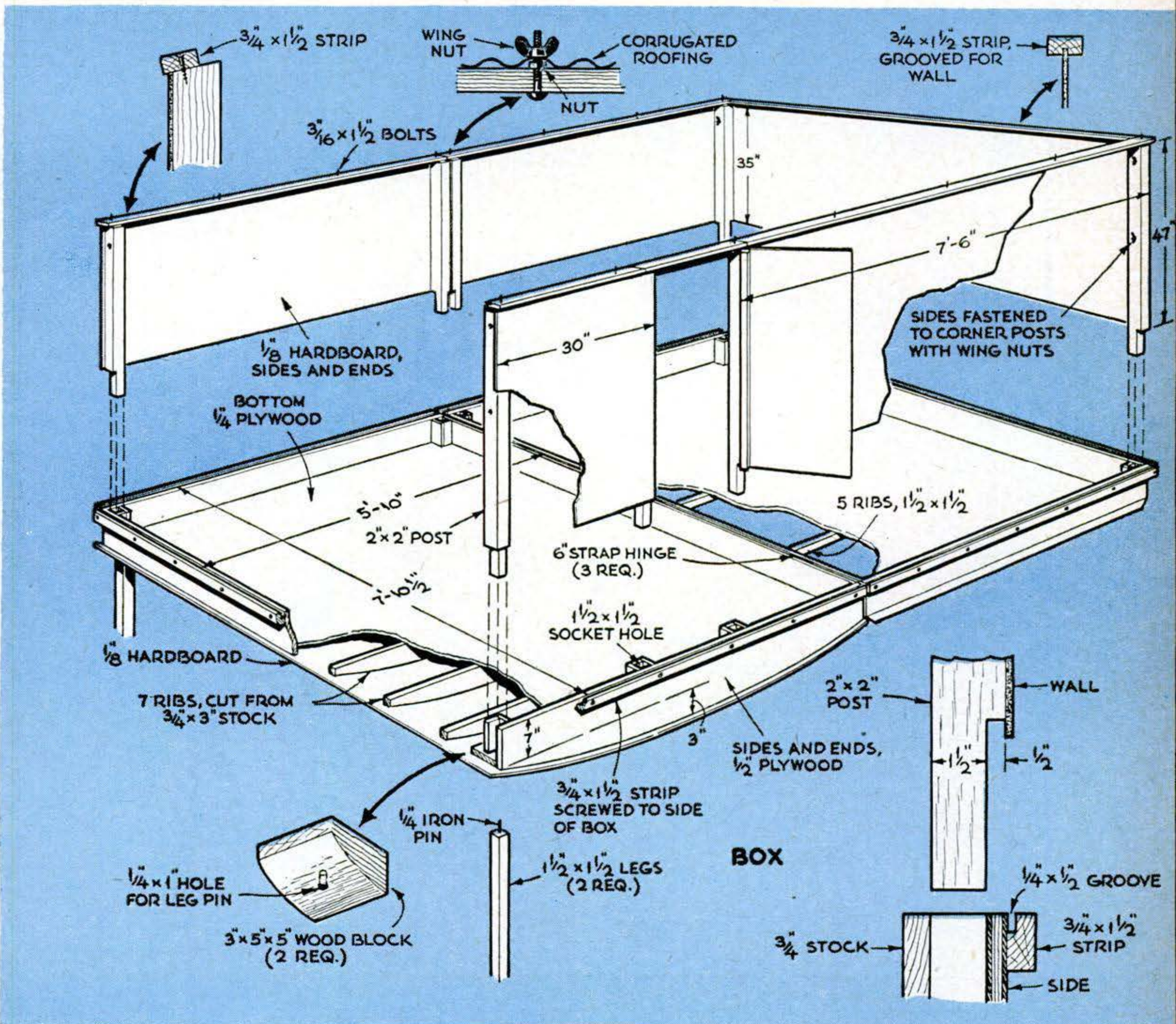

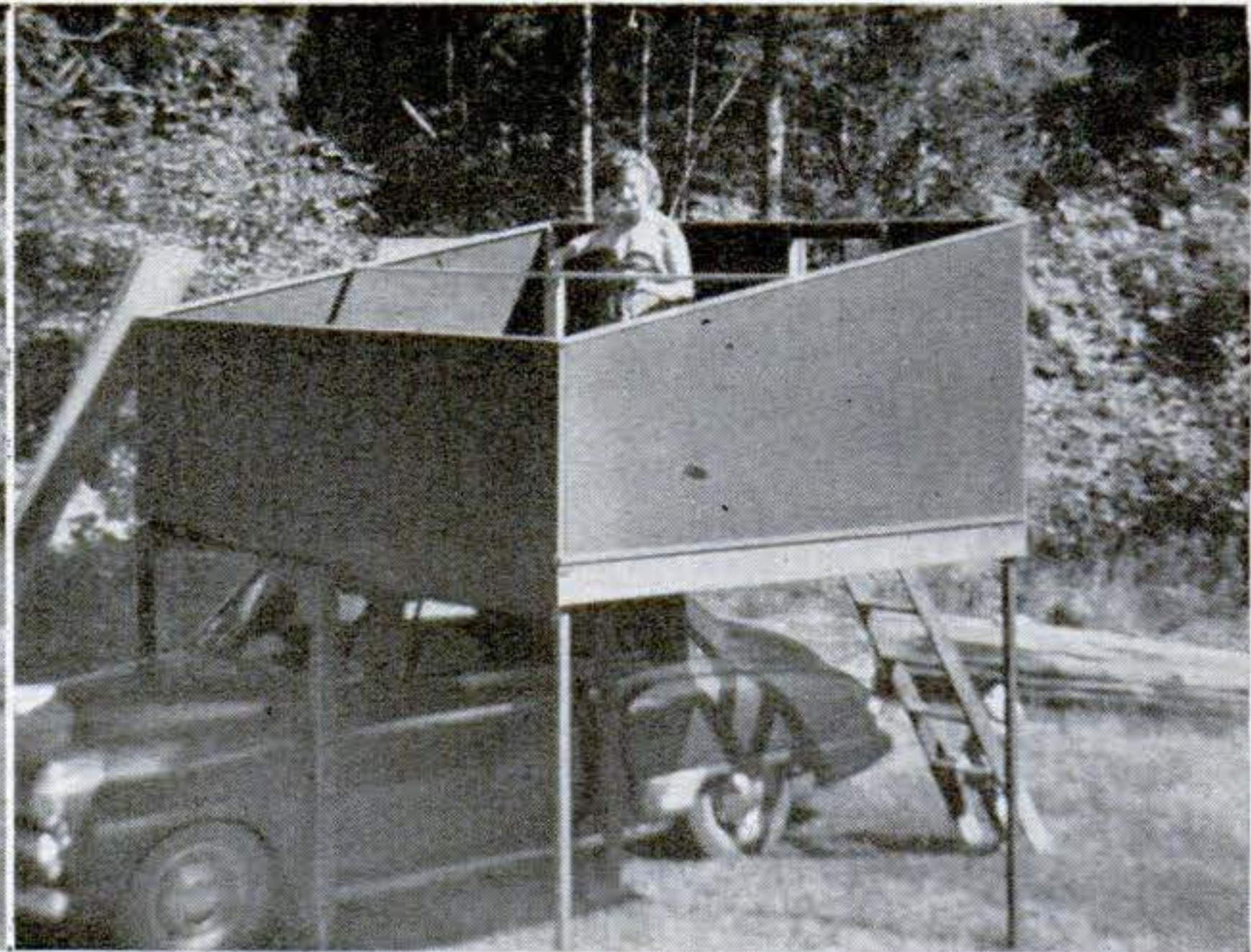

They slip into grooves and sockets on rim.

Bolted-together walls hold roof support . . .

framework. These lengthwise ribs are in turn bolted to two inverted U's. The U's are reinforced with corner braces of $\frac{1}{2}$ " waterproof plywood, glued and screwed into rabbets.

The ends of the U's are cut to fit closely into short uprights of $2\frac{1}{2}$ "-by- $1\frac{1}{4}$ " steel channel, which are welded to horizontal channels bolted to the car chassis. I bolted the rear undercar channel to the

MORE FUN FOR YOUR MONEY:

How to Make...

A Carside Cabana

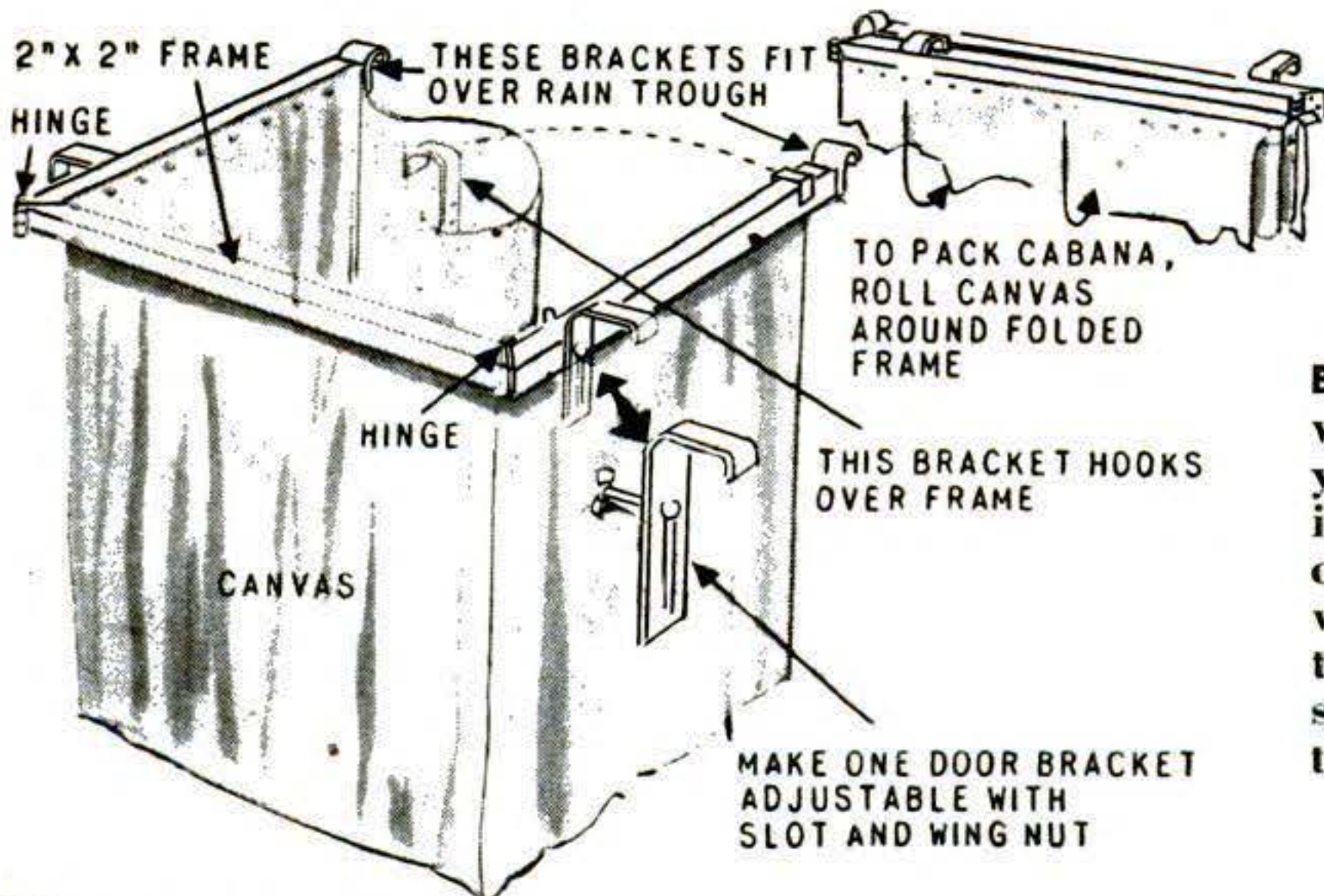
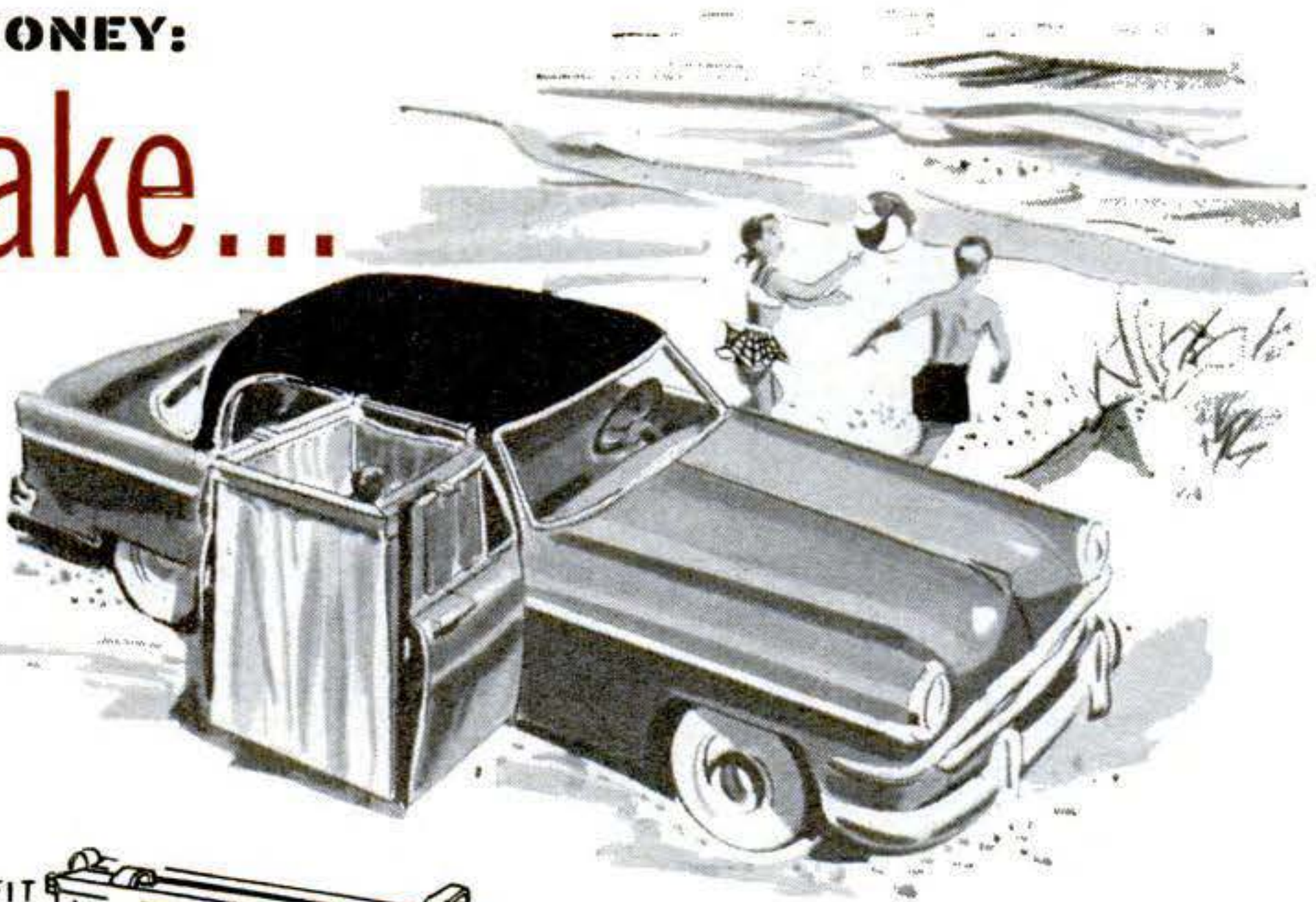

BATHING-SUIT CHANGES at out-of-the-way swim spots are no problem when you unfold this little portable dressing room. It's nothing but a few yards of awning canvas tacked to three wooden arms that hook over the gutter and opened doors of a four-door sedan. The same idea could be adapted to two-door cars by adding one leg.

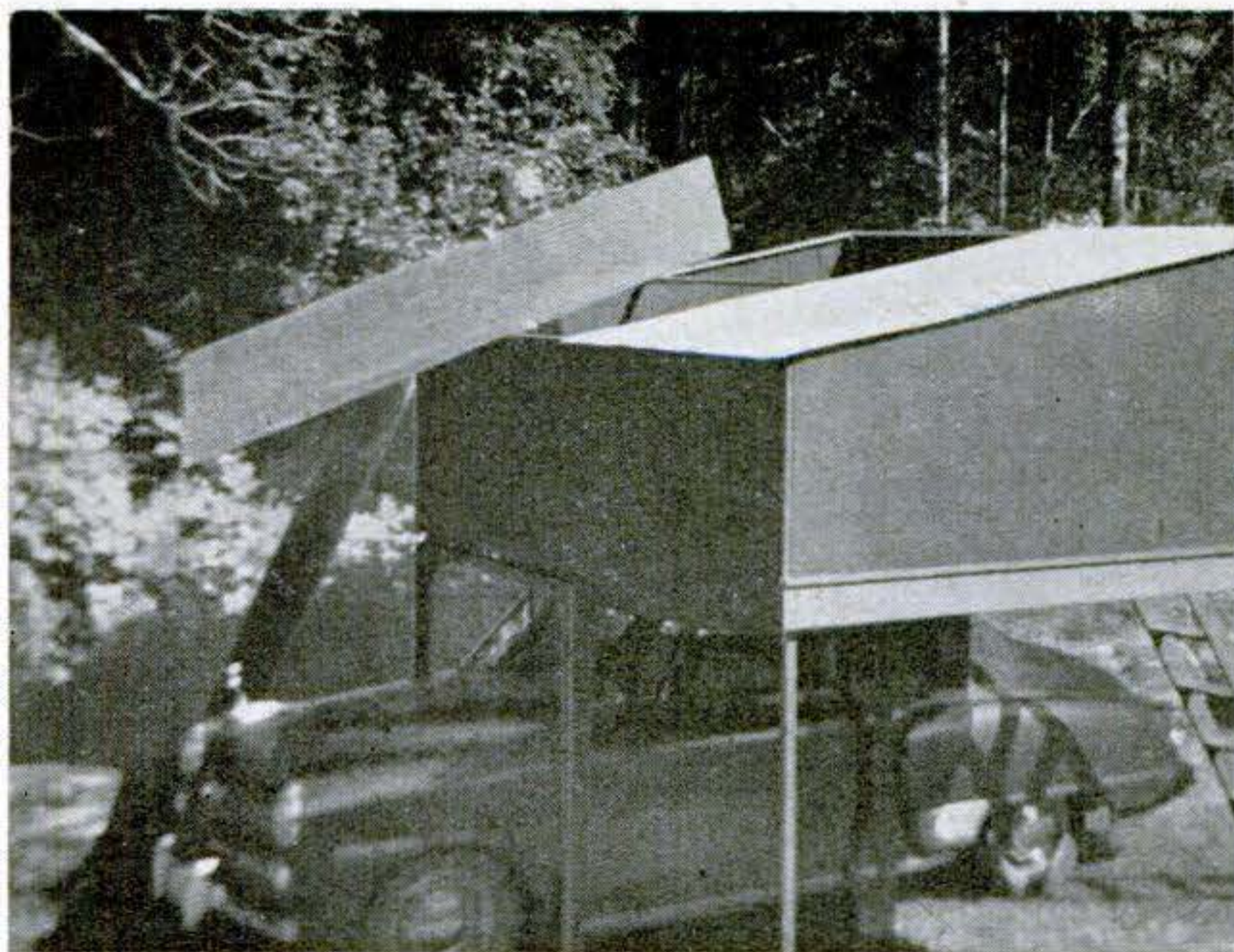

Made from sheets of corrugated aluminum.

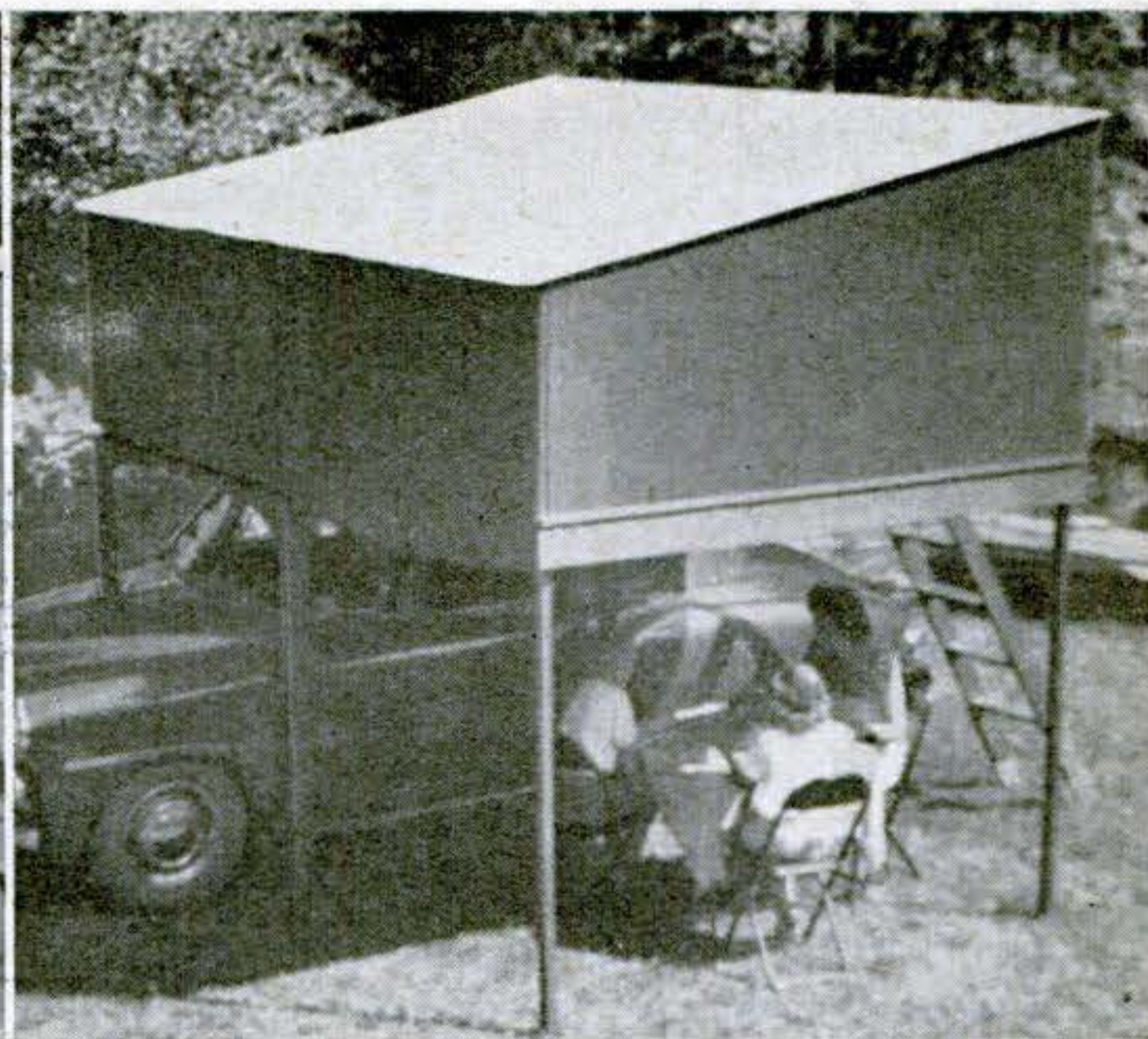

Complete with patio. What's for supper?

car frame, and the front undercar channel to a cross member behind the front wheels. Light steel cable tying the wooden U's to eyebolts in the car body makes the whole structure very rigid.

To support the opened "lid," 1½"-by-1½" legs tipped with ¼" steel pins fit into matching holes in corner blocks in the "lid." A simple ladder, homemade or bought, completes the job. **END**

A Back-Seat Play Table



SPACE FOR CRAYONS, PENCILS, ERASERS, RULER, ETC.

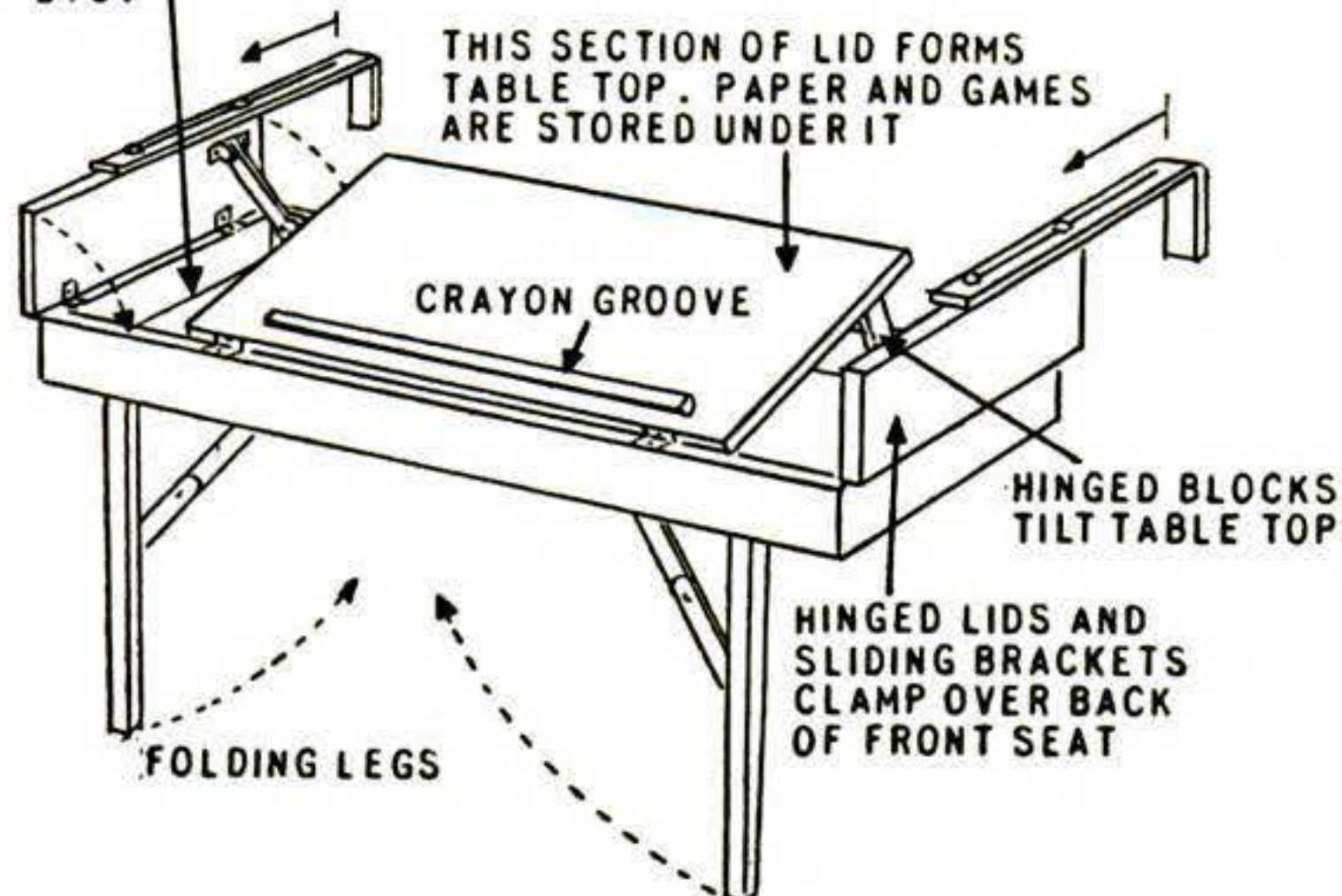

IT TAKES MORE THAN SCENERY to while away a long trip for youngsters. A fun kit, dimensioned for your car, stores varied amusements and, with legs open, provides work space.

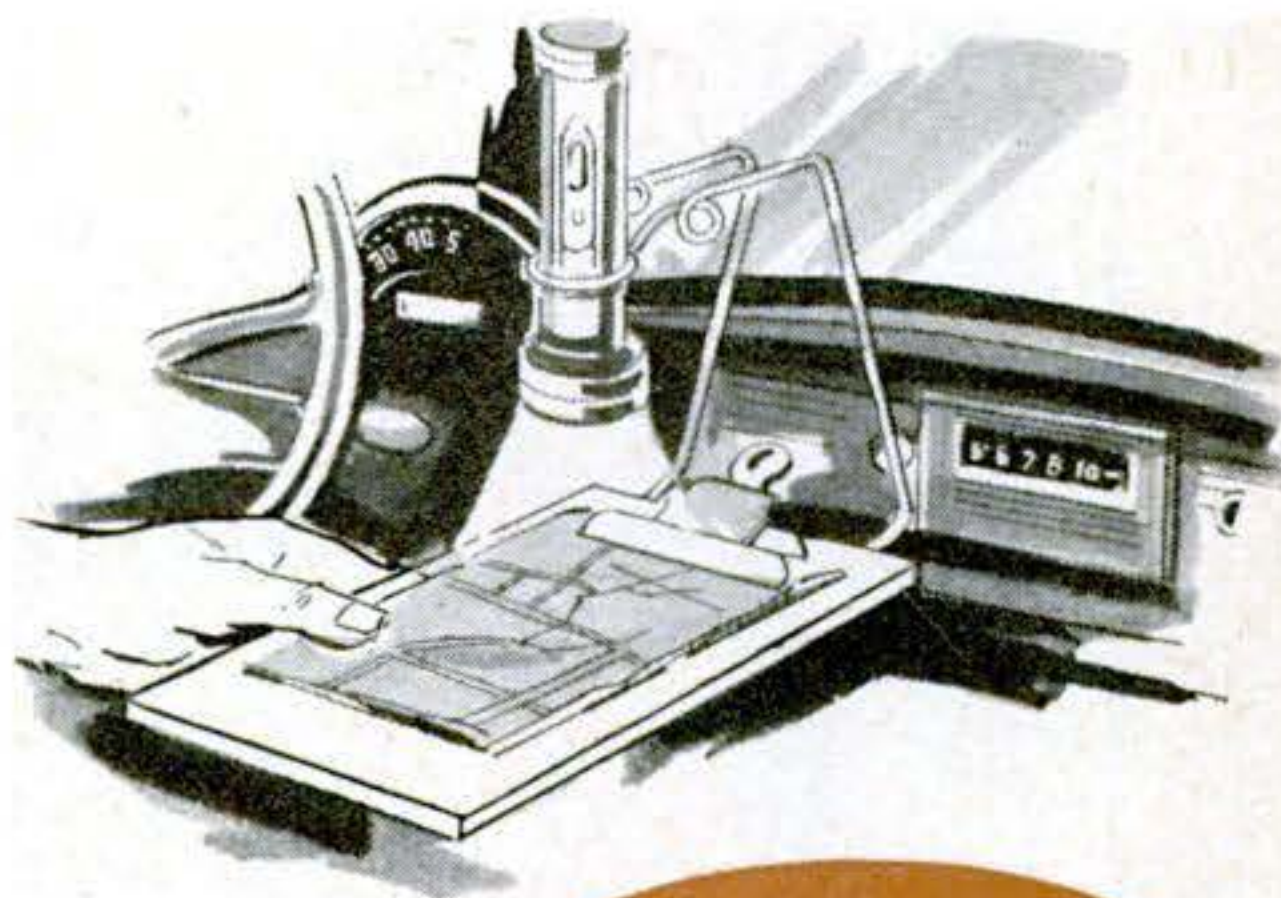

A Lighted Map Board



TO SEE WHERE YOU'RE GOING you need a map light that illuminates the map and not the car floor. Here's an easy one: a piece of coat-hanger wire shaped to hold an ordinary flashlight over a clipboard. The flash slips out if you want it.



Spongy connections indicate hose decay

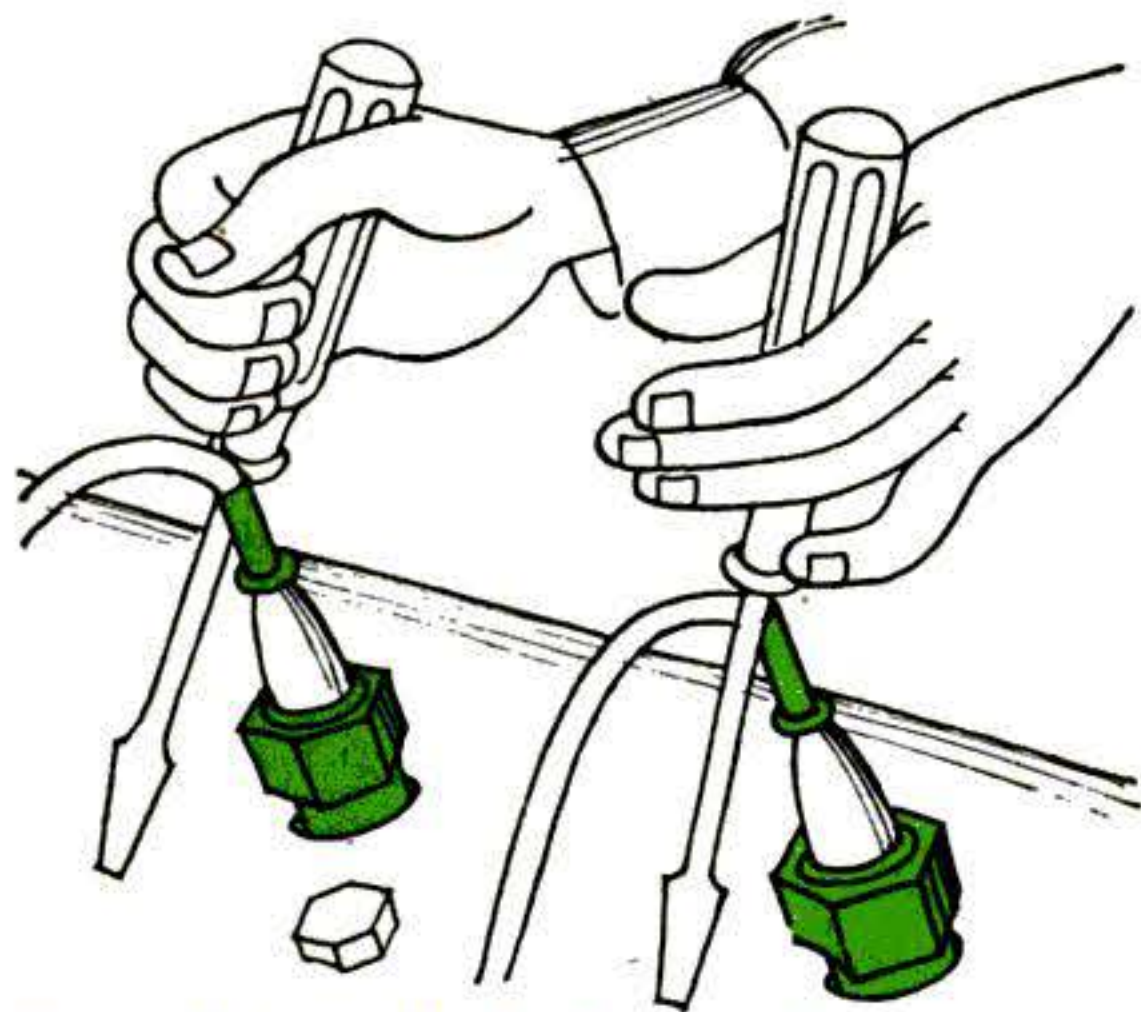

Screwdrivers check plug performance



How to siphon gas without sipping it

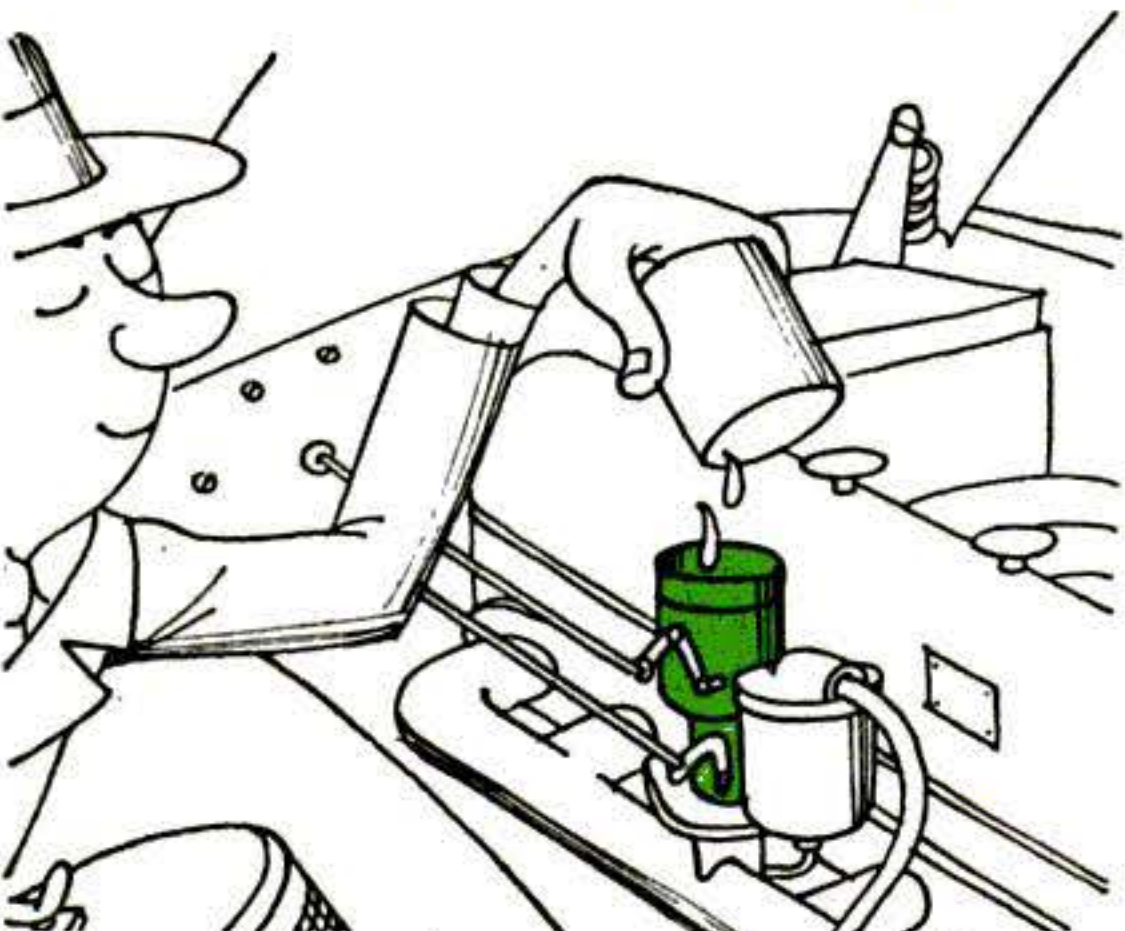

Direct action primes a parched carburetor

MORE FUN FOR YOUR MONEY

How to Escape

By Glen F. Stillwell

WHEN our car overheated on the climb to Clingmans Dome in the Great Smoky Mountains we missed half the scenery worrying about it. We were greatly puzzled because we had flushed the radiator, tightened the fan belt, tuned the motor and greased the chassis before starting out. Nevertheless, other cars were whizzing past while we plugged along nursing a sizzling engine. Then we were encouraged by the unpretentious sign: "Garage."

The lanky mechanic who worked there raised the hood and pinched the hose connections. "They're spongy. Bad sign."

"But they look good on the outside."

"That's the trouble. Hoses wear out on the inside. So do fan belts. Yours looks frayed and greasy where it hits the pulleys."

He was right. The interior of the hose had collapsed and the fan belt had lost much of its resilience. We thought we were all set when he installed new parts, but he detained us for a look at the spark plugs. "Sounds like you've got a miss."

Spotting a Bad Plug

With the engine running, he used two screwdrivers with insulated handles to short the plugs, two at a time. The tips of the screwdrivers were against the cylinder head, the shanks resting against the spark-plug terminals. When he lifted one screwdriver away, the engine picked up noticeably. "That one's all right," he said. "Notice how the engine picks up when I cut it in? On V-8 engines like this one it's hard to locate a bad plug by shorting them out one at a time."

It turned out, too, that the new spark plugs we had installed before starting on the trip were not properly adjusted. "New or old," he said, "spark plugs have to be gapped right before you install 'em. The points on these new ones are set too close. Causes overheating and power loss. Use a wire gauge to set the points."

While we made a note of this, he checked our

oil. Then he crawled under the engine with a wrench. "Just want to make sure that the guy who changed your oil tightened the crankcase plug so it won't leak. Sometimes a guy gets in a hurry and a customer burns out a set of bearings."

"You should move to our town," we told him. "How about taking a look at the carburetor?"

He shook his head. "Don't bother it. Nothing much ever goes wrong with a carburetor, but it's generally blamed for everything from sticking brakes to water in the gas." He closed the hood. "You'd better fill your tank at the next stop. Gas runs short around here this time of year."

Mouth-Powered Vacuum Pump

We paid our bill with thanks and had no more trouble. But after we had filled up with gas we ran across another tourist who wasn't so lucky. However, he knew the trick of siphoning quickly without getting a mouthful.

He used $\frac{1}{4}$ " rubber tube, about 4' long. He stuck one end of it into the tank and blew; he didn't suck. The sound of gasoline gurgling signaled that the tube was in it. Next, holding the tube between thumb and forefinger of the right hand, hand near mouth, he sucked gently but briefly. Then he pinched the hose shut before the gasoline could reach his mouth, lowered the free end of the tube into a clean container and waited a few seconds for the gasoline to start flowing.

This man's car wouldn't start because the fuel pump had lost its vacuum, and we couldn't push him because our bumper didn't match his. But he knew what to do.

He removed the air filter on his carburetor and squirted a little raw gas into the carburetor throat while his wife worked the starter button. The engine came to life with a roar.

The man thanked us and said that if we ever had trouble with a blocked fuel line to disconnect the line at the carburetor and try blowing through it with a tire pump. He told us also that he had trouble starting his car on cold or wet

[\[Continued on page 252\]](#)

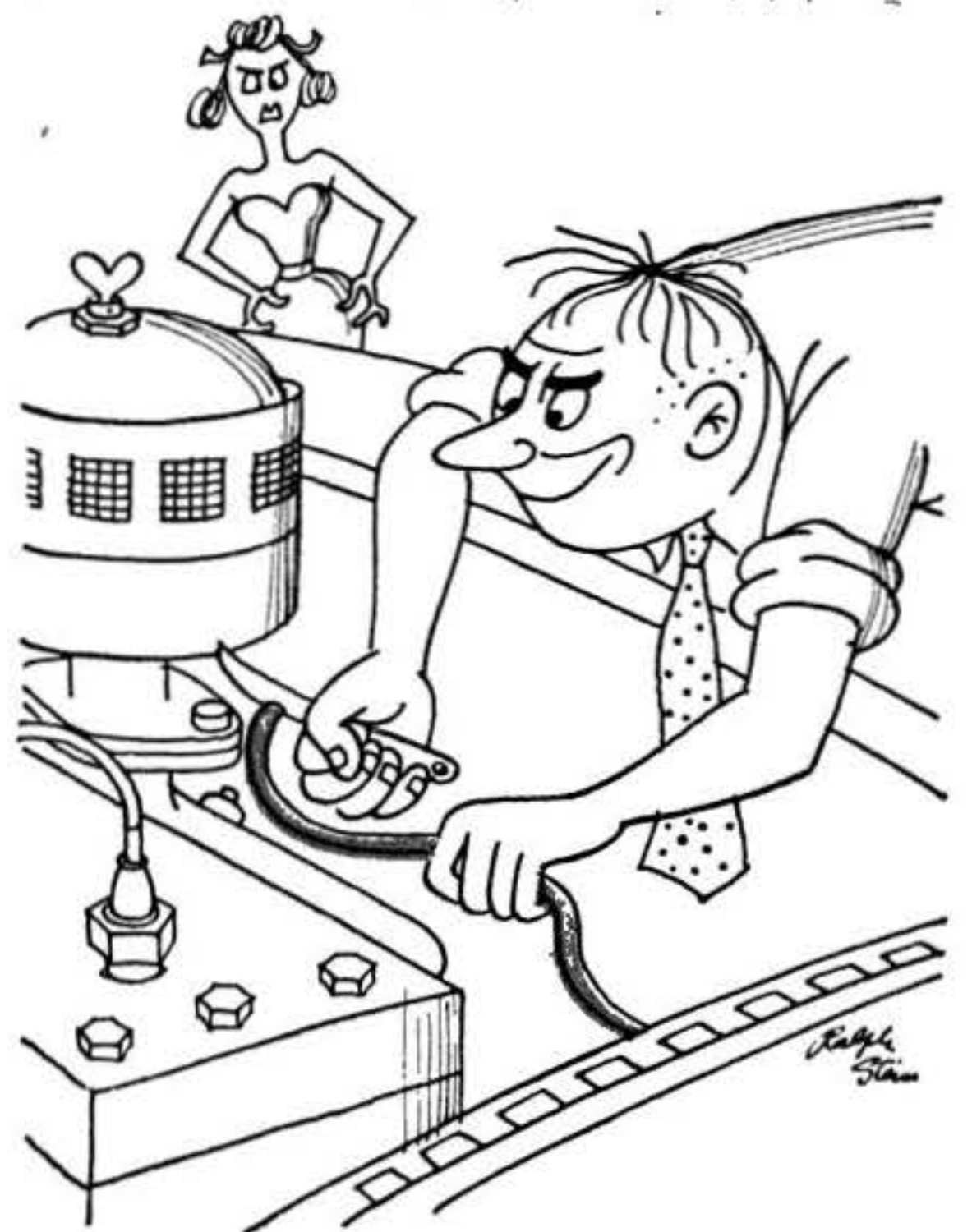

Simple surgery can unplug vapor tubing

What Makes Trouble on a Long Trip

- Thirsty battery*
- Loose wiring*
- Dirty cooling system*
- Faulty spark plugs*
- Defective ignition*
- Dirty fuel system*
- Oil or fuel leaks*
- Faulty brakes*
- Defective steering*
- Slipping fan belt*
- Worn tires*
- Lack of lubrication*
- Gauge or accessory failure*
- Loose bolts or screws*

Your outdoor chores can be easier! Take a look at these

New Yard and Garden Tools

By Sheldon M. Gallager

IT'S hard to tell whether home gardeners are getting lazier or busier.

Powered mowers, tractors and other cultivating equipment are producing a brand-new breed of clean-hands, sport-shirted Saturday farmers who no longer must push,

strain, stoop and sweat in the old way.

But the wide variety of new tools and attachments also enables people to do jobs that they never before would have attempted themselves. So on that score, they're working harder.

In the firm belief that people can appreciate the good earth without getting down



NO NEED TO RAKE with latest mulching mowers. They chop leaves into fine particles, returning vital plant food to soil. Huffman mower at left comes with either gasoline or electric motor, has four pivoted cutter tips that give way if they meet an obstruction, preventing damage.



YOU CAN LOOSEN UP YOUR LAWN at the same time you mow with this Engman aerator. It fits in place of roller, has spikes that punch holes in soil, letting in air, moisture and plant food for better growth.



PORTABLE HAND TILLER at left churns up soil with small whirling blades (below), making it easy to get in and around plants that could not be reached by large cultivators. The electric Rototiller can also be fitted with drilling, grass-cutting, chain-sawing and floor-sanding tools.



SHARP AS A RAZOR, the cutting edge of this new North Wayne sickle is a series of ordinary razor blades, quickly replaceable. It has a blade guard for safety and a folding handle for easy carrying and storage.

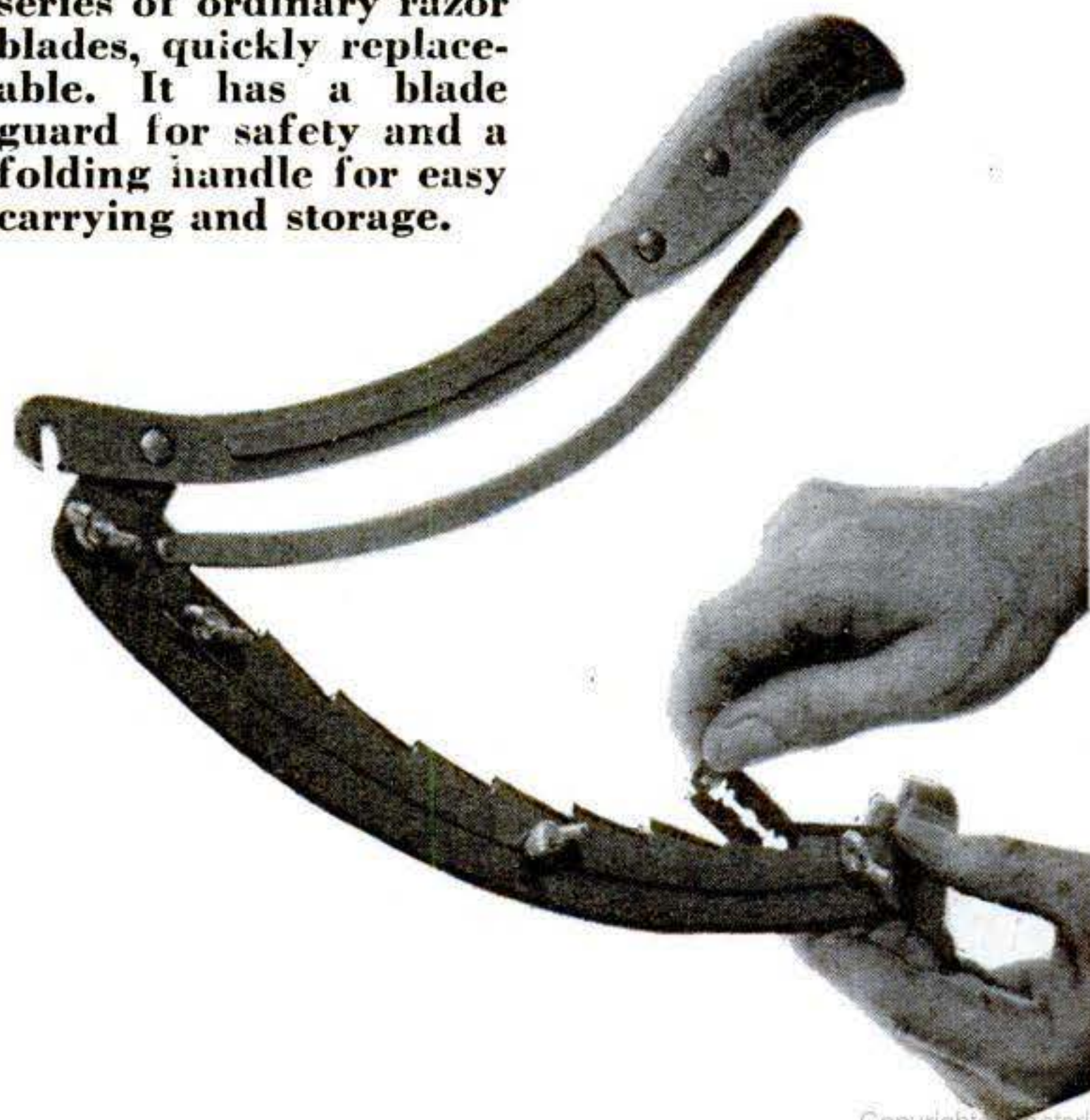

on their hands and knees in it, manufacturers are providing versatile power packages that enable half-acre homesteaders to do a lot of jobs with little effort—mostly standing or sitting.

One such machine, made by the Western Tool & Stamping Co., is simply a motorized seat. You hook on whatever you want, from a disk harrow to Junior's express wagon.

Reel or rotary? Reel-type mowers are supposed to give you a slightly closer cut if you're after a real manicure job. But the rotary models have an edge when it comes to slicing through tall grass. This distinction may not last very long, though, with new



THIS SMALL, PORTABLE gas-driven rig can be taken anywhere for stand-up gardening in hard-to-reach places. Attachments for the Hoffco unit are a lawn edger (below), rotary bush cutter, sickle-bar scythe and chain saw.



DUAL WHEELS, quickly mounted on this 5-hp. Gravely, let it bull right through rough terrain and up steep slopes. Nose drive can be fitted with more than 20 different attachments, including the chain saw above.



BABY TRACTOR is so simple a child can drive it, yet it will haul up to 500-lb. loads and hit 6 m.p.h. Available with a trailer cart to handle light earth-moving chores, the Norbel Pony Tractor can also be hooked up to a mower, a lawn roller or a wagon train full of kids.

MOWER BECOMES WHEELBARROW with this steel box that quickly clips to roller and handle of any hand mower. When not in use, the Jaxon barrow can be hung up out of the way.



Please turn the page for more new tools, and makers' addresses. MAY 1954 177

weed-cutting attachments for reel mowers, such as Cooper makes, and close-cutting blades now on many rotary mowers.

The reels, not requiring power directly, have one big advantage in that they can be pushed or towed by any separate power source, such as a small tractor or cultivator. In fact, the George people make a hitch for their 2-hp. tractor that lets you simply hook on your own hand mower.

Auto-type mufflers to silence mowers to a purr and power-sprayer attachments are two other improvements on the road to making home equipment do more jobs better.

Manufacturers of these garden tools are listed below:
 Cooper Mfg. Co., 409 S. 1st Ave., Marshalltown, Iowa
 Engman Mfg. Co., 1317 Locust St., Des Moines, Iowa
 George Garden Tools, 811 S. Hamilton St., Sullivan, Ill.
 Gravely Tractors, Inc., P.O. Box 25, Dunbar, W. Va.
 Hoffco, Inc., 411 N. 8th St., Richmond, Ind.
 Huffman Mfg. Co., 117 Gilbert Ave., Dayton, Ohio
 Hull Mfg. Co., 1020 W. 53rd St., Wichita, Kan.

Kid power plus horsepower. If you have anything that runs, you'll have to face the fact that it will collect neighborhood kids like a free handout of bubble gum, and you might as well put some of this power to work. Most of the mowing and cultivating units can be reliably run by teen-agers.

Carefully trained, a small boy in combination with a small motor may be one of the best ways to let you do your garden chores from a shaded hammock, sipping a long cool drink and dreaming about new ways to till the north 40. **END**

Jaxon Wire Products, 1705 Probert Road, Jackson, Mich.
Niagara Garden Sifter Co., 1006 Prudential Bldg., Buffalo
Norbel Sales Engineering, 314 S. 12th St., Omaha, Nebr.
North Wayne Tool Co., 62 River St., Oakland, Me.
Rocklin Mfg. Co., Grand Ave. at Jennings St., Sioux City, Iowa
Rototiller, Inc., 9th Ave. at 102nd St., Troy, N. Y.
Sensation Mower, Inc., 7577 Burlington St., Ralston, Nebr.
Western Tool & Stamping Co., 2725 2nd Ave., Des Moines



SOIL SIFTER hooks over end of garden cart or wheelbarrow, letting you screen dirt directly into carrier. Handle on Niagara sifter also forms stand for use on ground.



MULCH OR CATCH—that's the choice you get with this rotary Sensation mower. Cuttings and leaves are channeled either through mulcher or into hook-on catcher for removal.

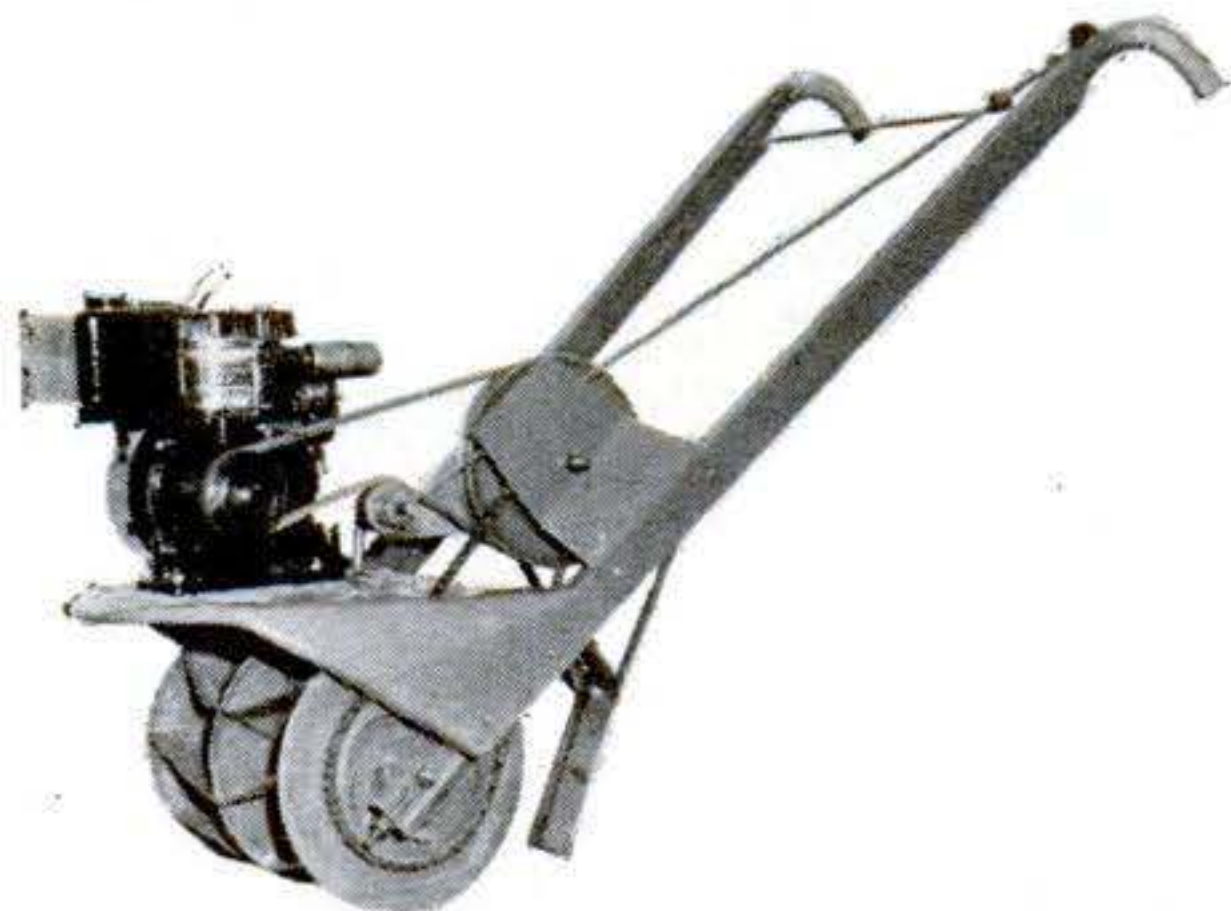

ONE WHEEL does all the work in this powered Hull hoe. Bladed drum acts both as drive wheel and pulverizer to break up earth. It takes plows, other attachments.

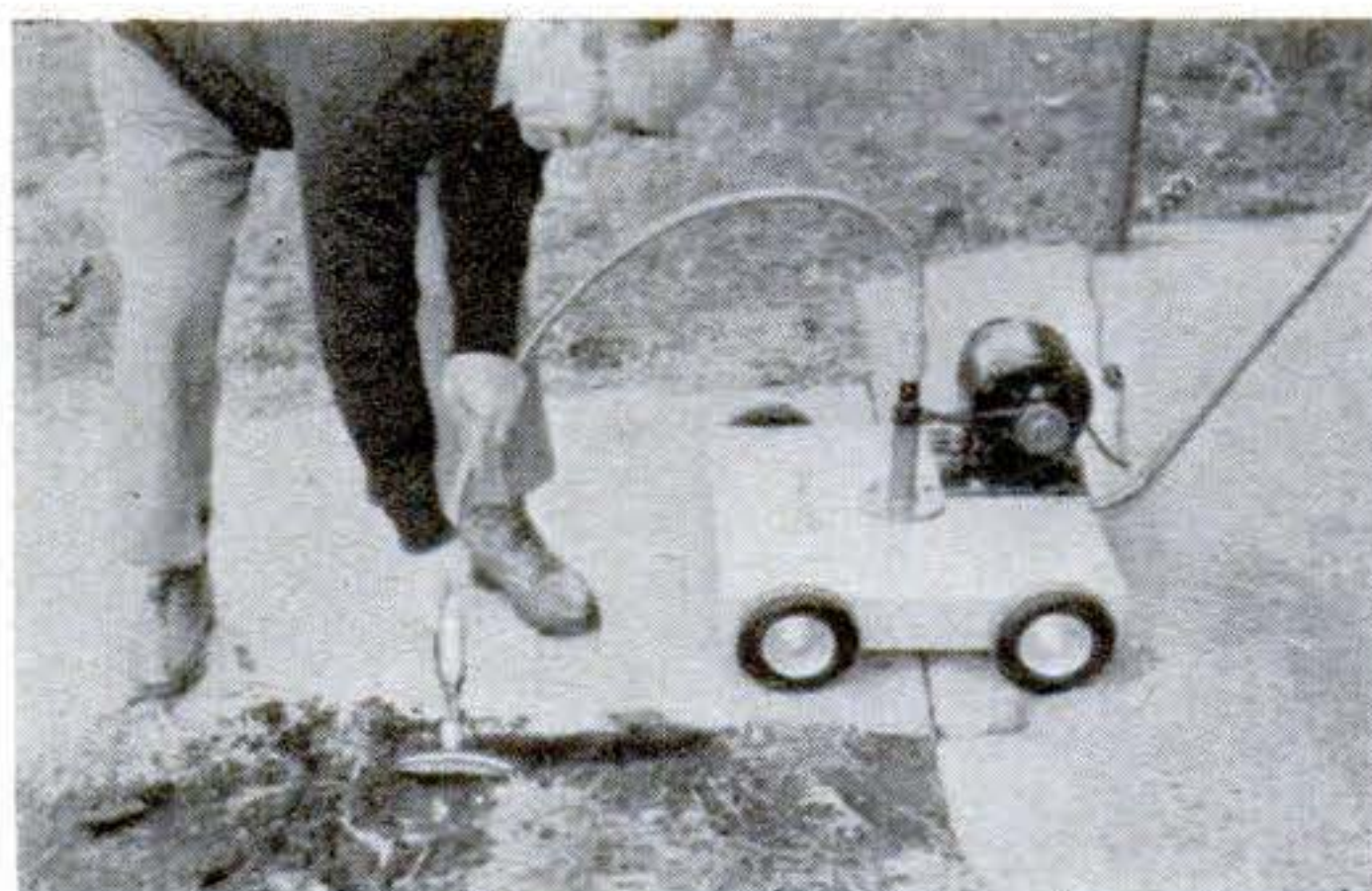

FLEXIBLE SHAFT lets this rotary electric mower also run lawn-edging, hedge-trimming, and car-polishing tools. With other accessories, Rocklin mower becomes a shop tool.

Electric Drill on Shaft Makes the Grain Fly

LIGHT enough for a man to carry easily (it weighs only 24 lb.), this small auger conveyor can move 400 bushels of grain an hour. It is driven by chucking its shaft in an ordinary $\frac{1}{2}$ " electric drill.

Designed primarily for moving grain from wagon to bin, it can also be used to convey grain to a grinder, to fill self-feeders and for other scoop jobs. Developed by the Tri-County Mfg. Co., Taylorville, Ill., the conveyor can be powered with a $\frac{1}{4}$ -hp. electric motor.

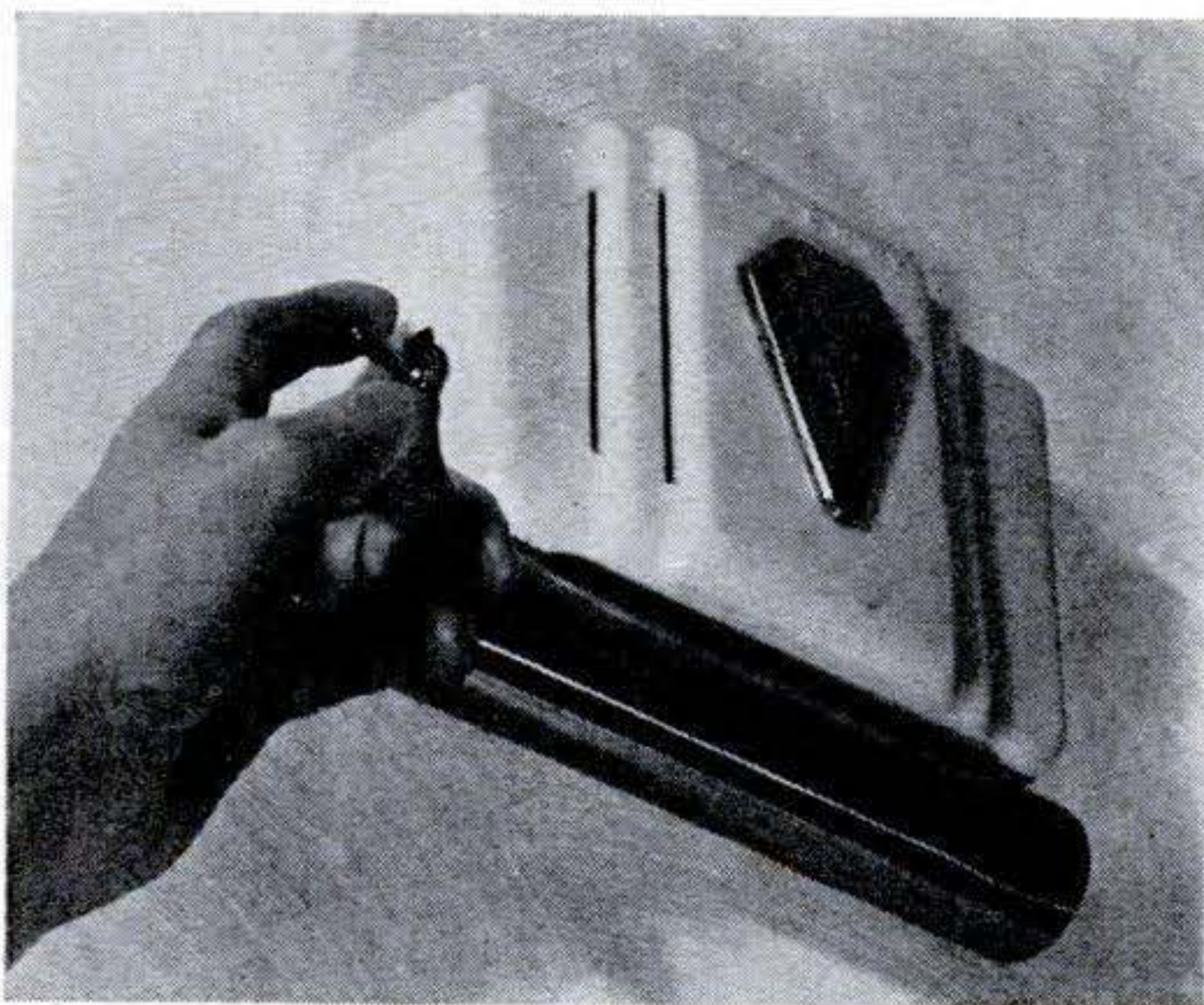
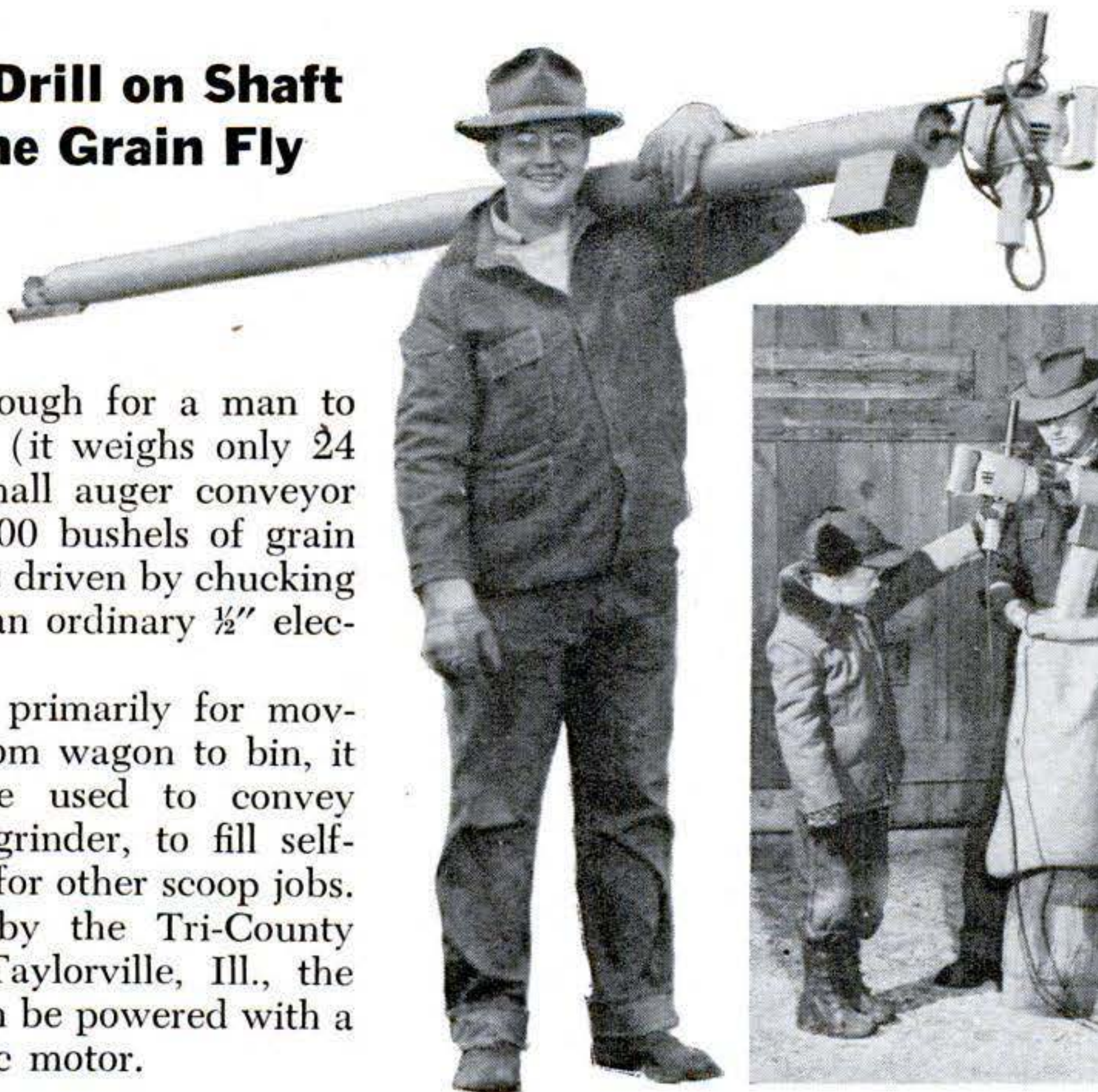

Switch Silences Doorbell

A SWITCH mounted on the side will silence a door chime during sickness—or afternoon naps (if you're that lucky). Wired in series with one wire to the solenoid, an ordinary on-off radio toggle switch will do the trick.—*Karl Greif, Vestal, N.Y.*

Fizz Water Locates a Leak

I HAD an Army canteen with a leak so tiny I couldn't find it. To locate the pinpoint hole, I poured the container half full of soda water, capped it and shook it. When a tell-tale droplet appeared, I marked around it and emptied the canteen for soldering.—*Charles Wilson, Hicksville, N.Y.*

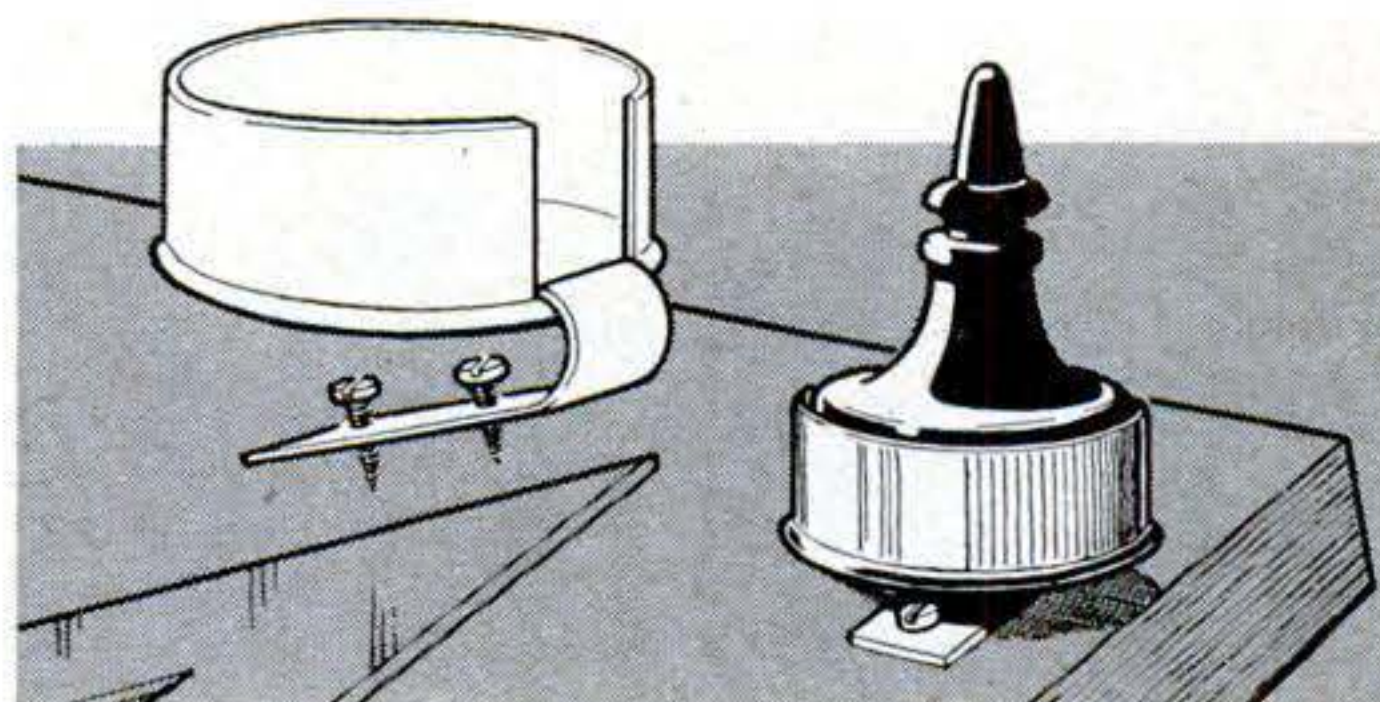

Tin Can Holds Ink Bottle

TO HOLD an ink bottle on a tilted drawing board, cut a frozen juice can as shown and secure it with small wood screws. The flexible tin tab permits adjustment to keep the bottle horizontal at any board angle.—*Norm Jacky, Fond du Lac, Wis.*

Hanging Brackets Hold Shelf

IF YOU hesitate to dig into concrete walls to put up basement shelves, use wooden brackets like this, making them of one-by-twos. A nail into the sill plate will hold the entire bracket, and removal leaves no disfiguring marks on the wall.—*H. A. Johnson, Omaha, Nebr.*

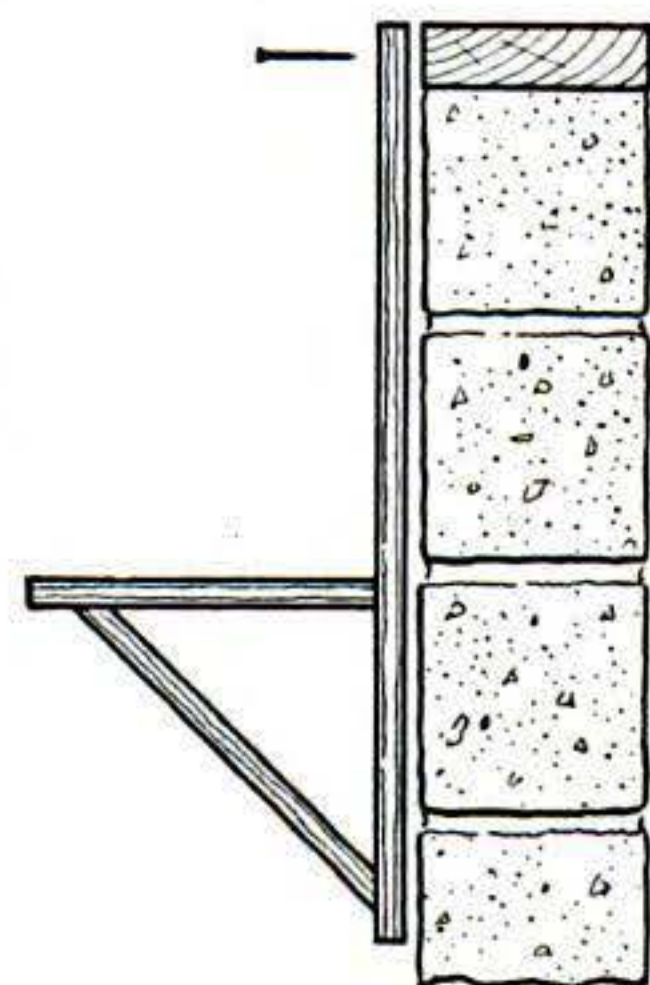

*Whatever you build,
outdoors or in, you'll profit by
this report from the experts on*



TREATING WOOD with suitable preservative can prolong the life of outdoor furniture, play equipment, house and yard accessories. When pieces are too long for the tank, immerse half their length at a time as shown above.

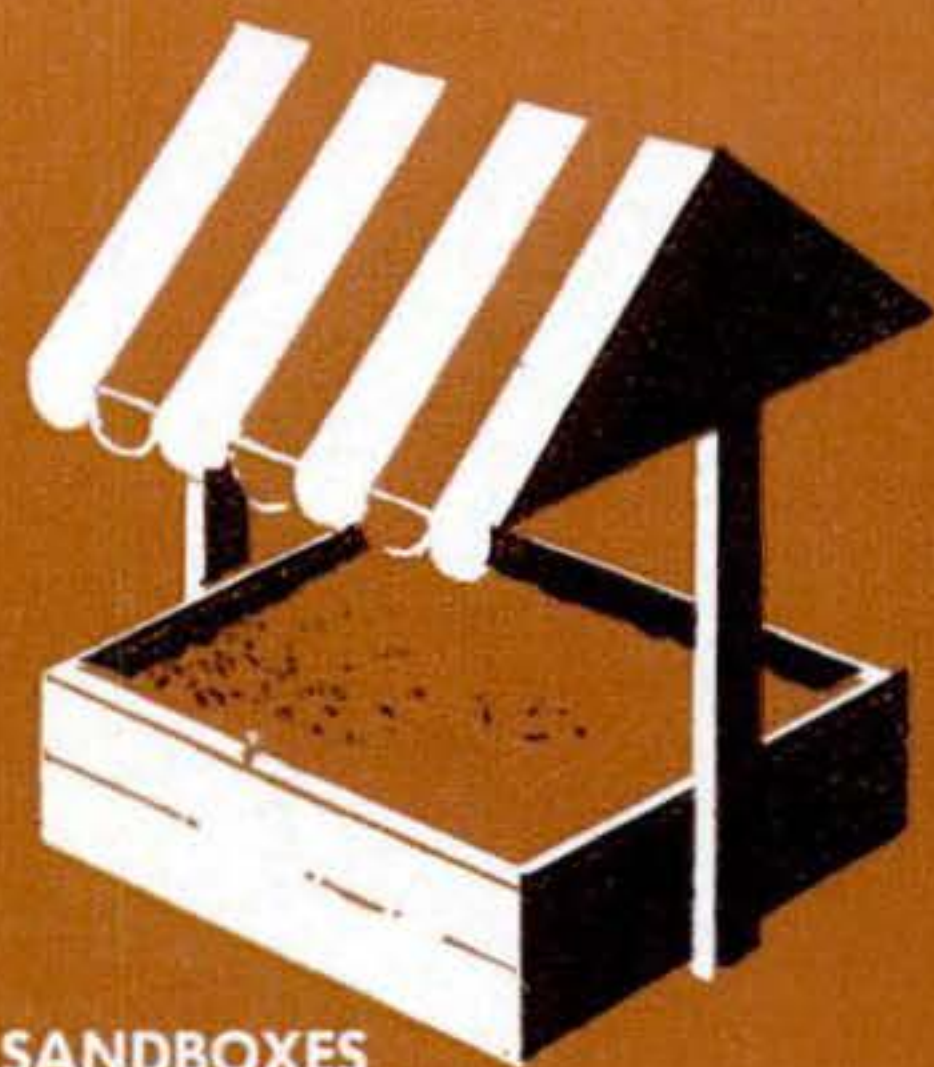

SANDBOXES



BOATS



POSTS AND FENCES

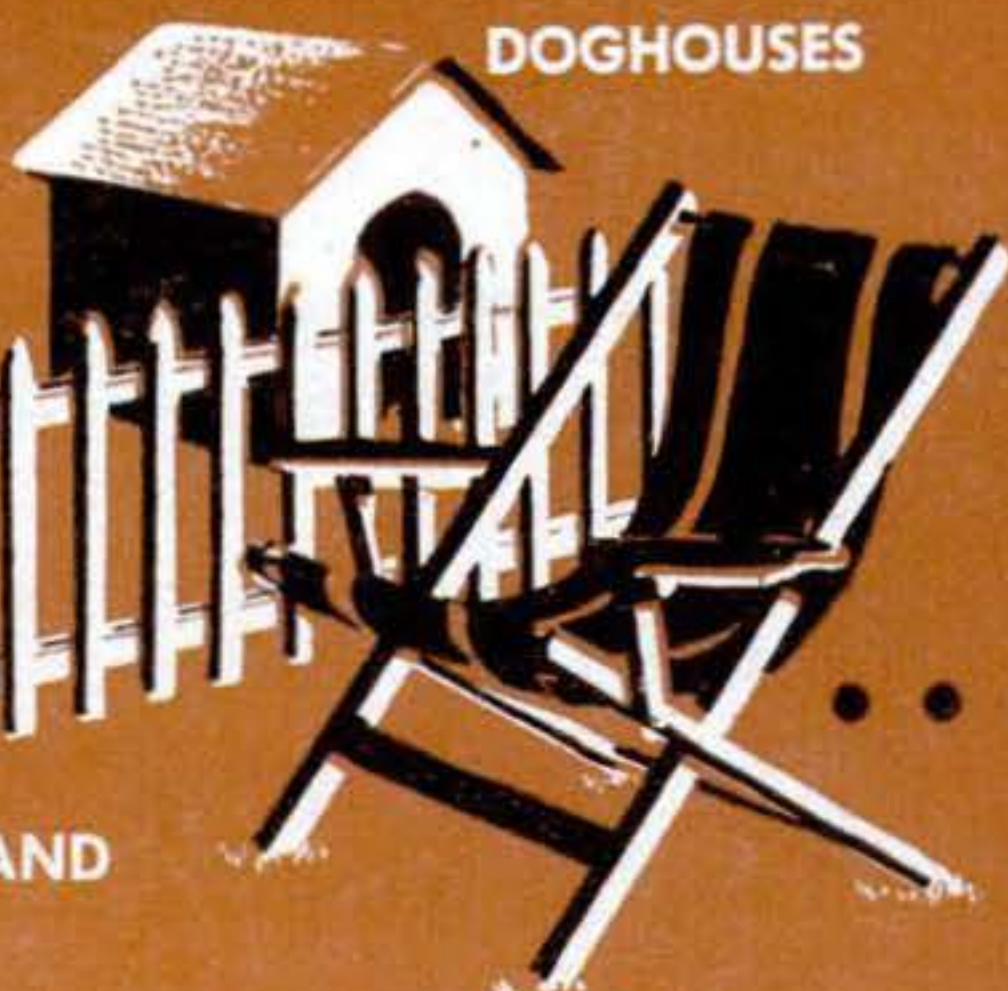

DOGHOUSES

LAWN FURNITURE



PLAYGROUND EQUIPMENT

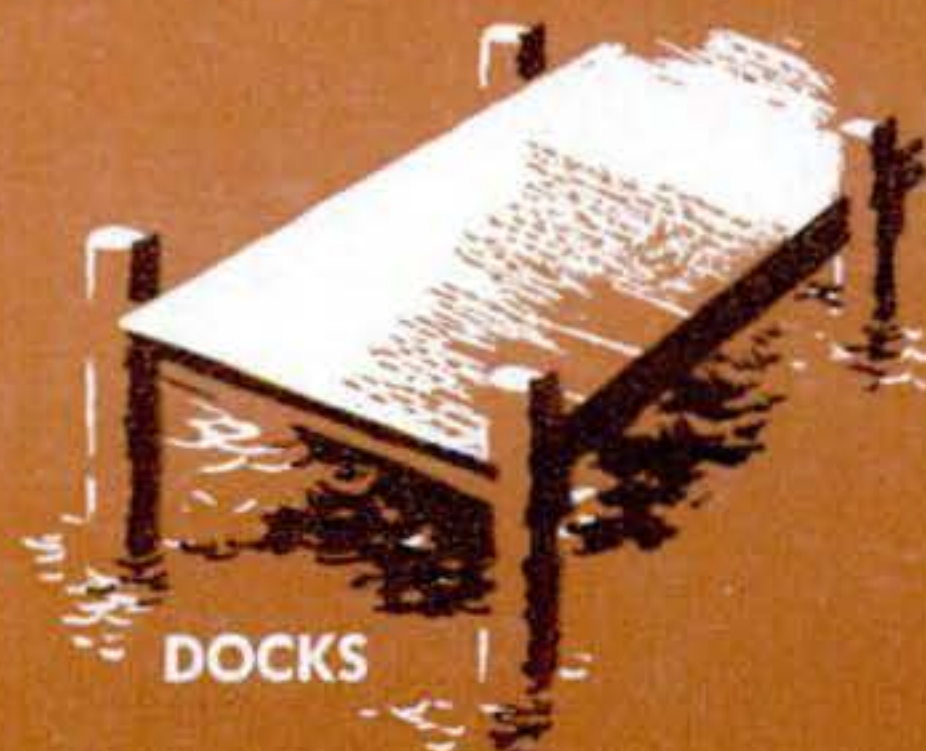

DOCKS

Making Wood Last Longer

By F. A. Strenge

YOU'VE spent good money for lumber, built with loving care, and painted conscientiously. That fence, hotbed, sand-box or lawn chair you've made really does you proud. But there is still a gremlin in the shavings.

How long will it last?

Railroads, and power, telephone and telegraph companies ask that question every time they lay a tie or sink a pole. The right time for you to think about it is while you're sawing wood, boring holes and driving nails.

Why? Because it is then that you can double or treble the life of wood—and anything you're building of it—by protecting it from decay and insect damage.

With modern wood preservatives, this is easier than it sounds. It can be done at home, and for peanuts compared with the cost of repairing or replacing damaged lumber. Nor does the wood have to look as if it had been dipped into a tar barrel.

.....
THE AUTHOR of this article is technical editor at the U.S. Forest Products Laboratory, Madison, Wis., which is making a long-range study of ways to guard wood from decay and insects.

Some preservatives allow it to be painted. You can add oil stains to one type, and so treat and color wood at the same time—a handy dodge for shingles and siding.

When to use preservatives. It would be absurd, of course, to slosh preservative over everything you make of wood. Some things do not need protection and are better without it. Anything made of sound wood and kept dry will stay sound.

But when wood is in contact with the ground, set in water, or where it will get damp or rain-soaked, preservatives are in order. The reason for this is that air and water enable the spores of decay fungi—which are everywhere—to develop and cause rot. Even dry rot is no exception. Its fungi get started in moist locations, and migrate to dry wood, taking water along through a network of porous strands.

Wood deeply immersed in water will not decay because air is lacking. Wooden caskets found in Egypt are still sound after 3,000 years because the air is so dry decay fungi cannot develop. Polar explorers have found

WHERE YOU NEED treated wood. End grain of window casings (below), doors or any other member soaks up moisture that promotes decay. Porch steps and skirtings close to ground (at lower left) are vulnerable not only to rot but also to insect damage. Footings of porch columns, beneath which rain water seeps, are another number-one target for trouble.

Where wooden pieces need protection most

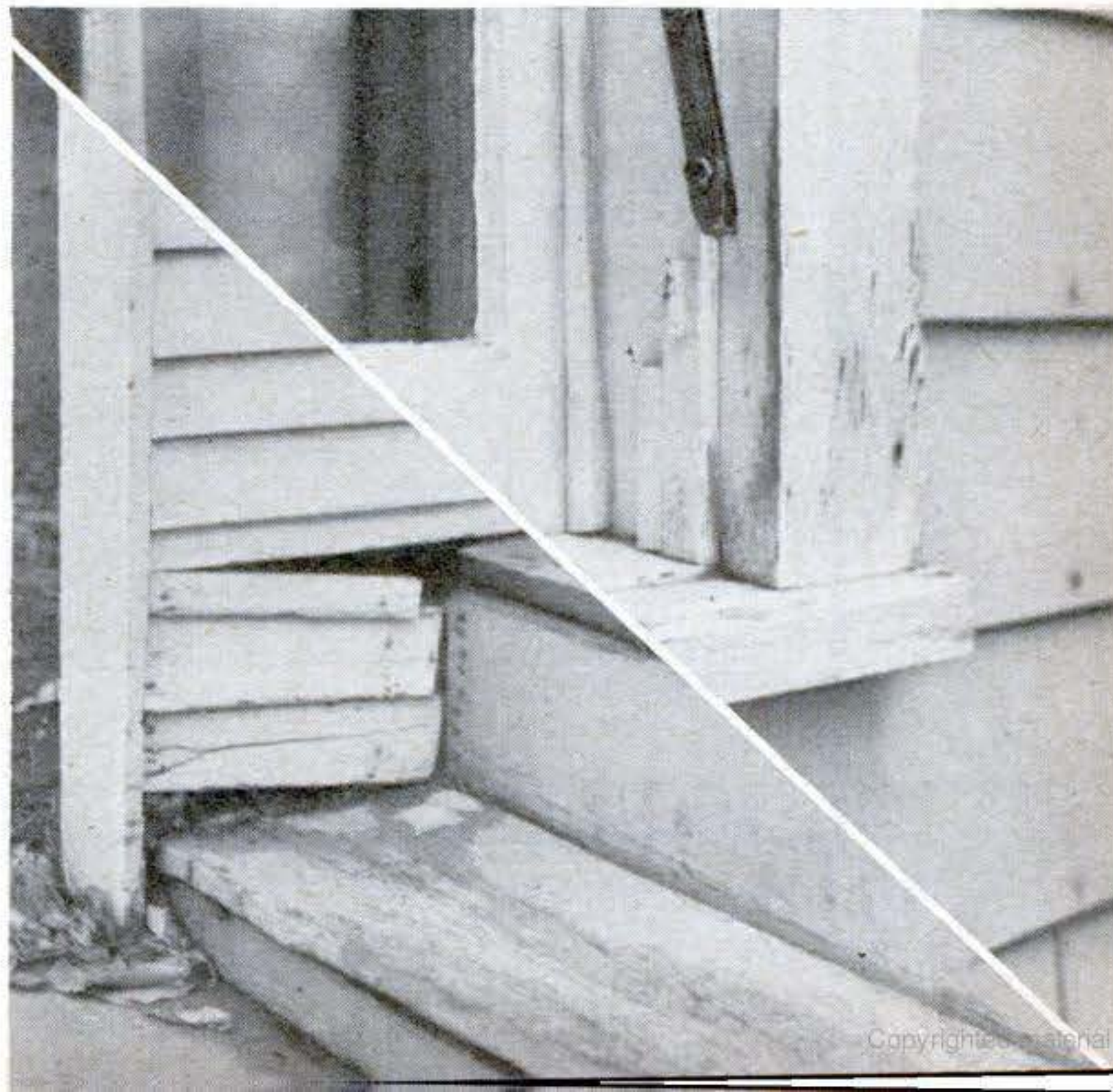
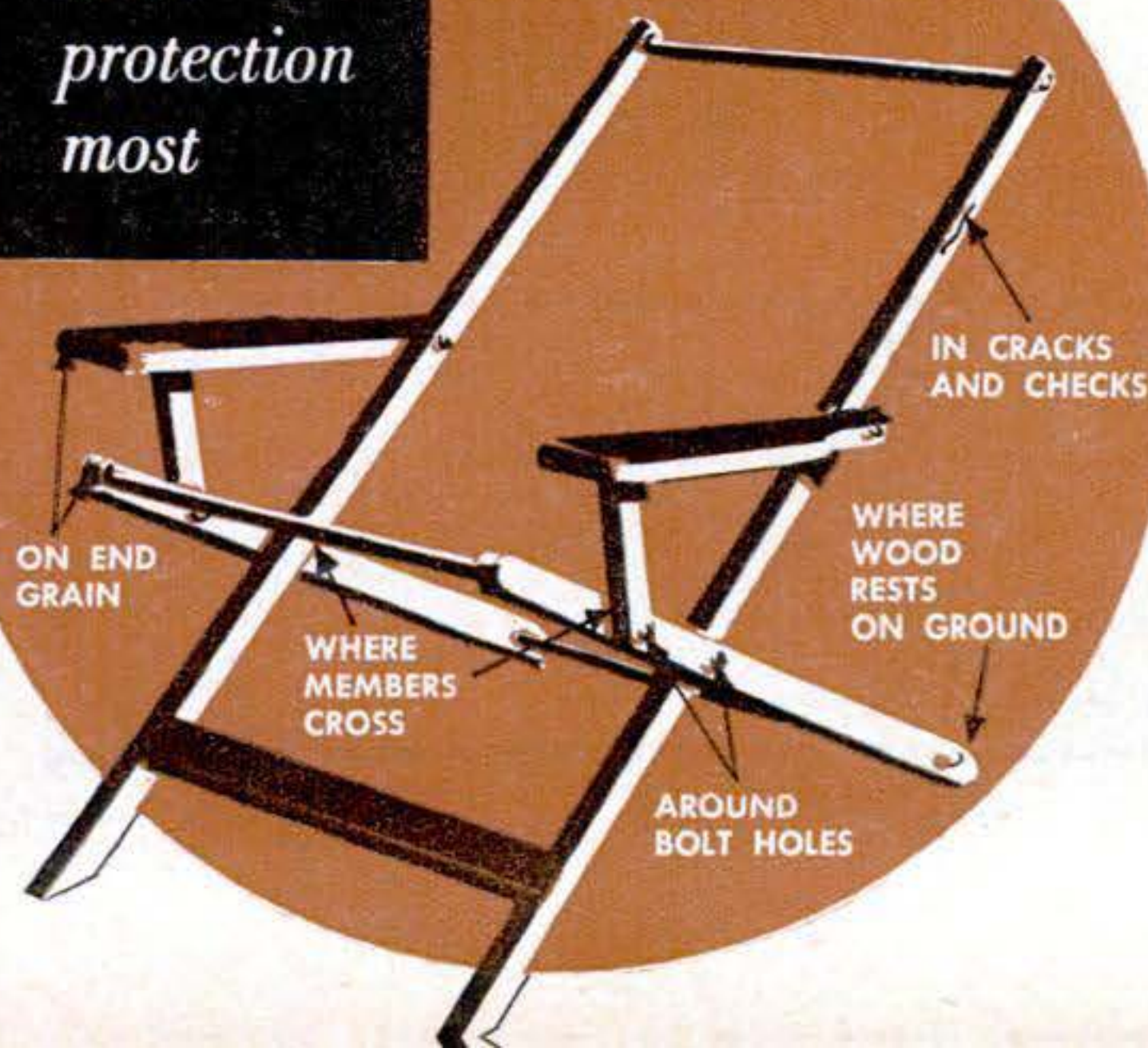

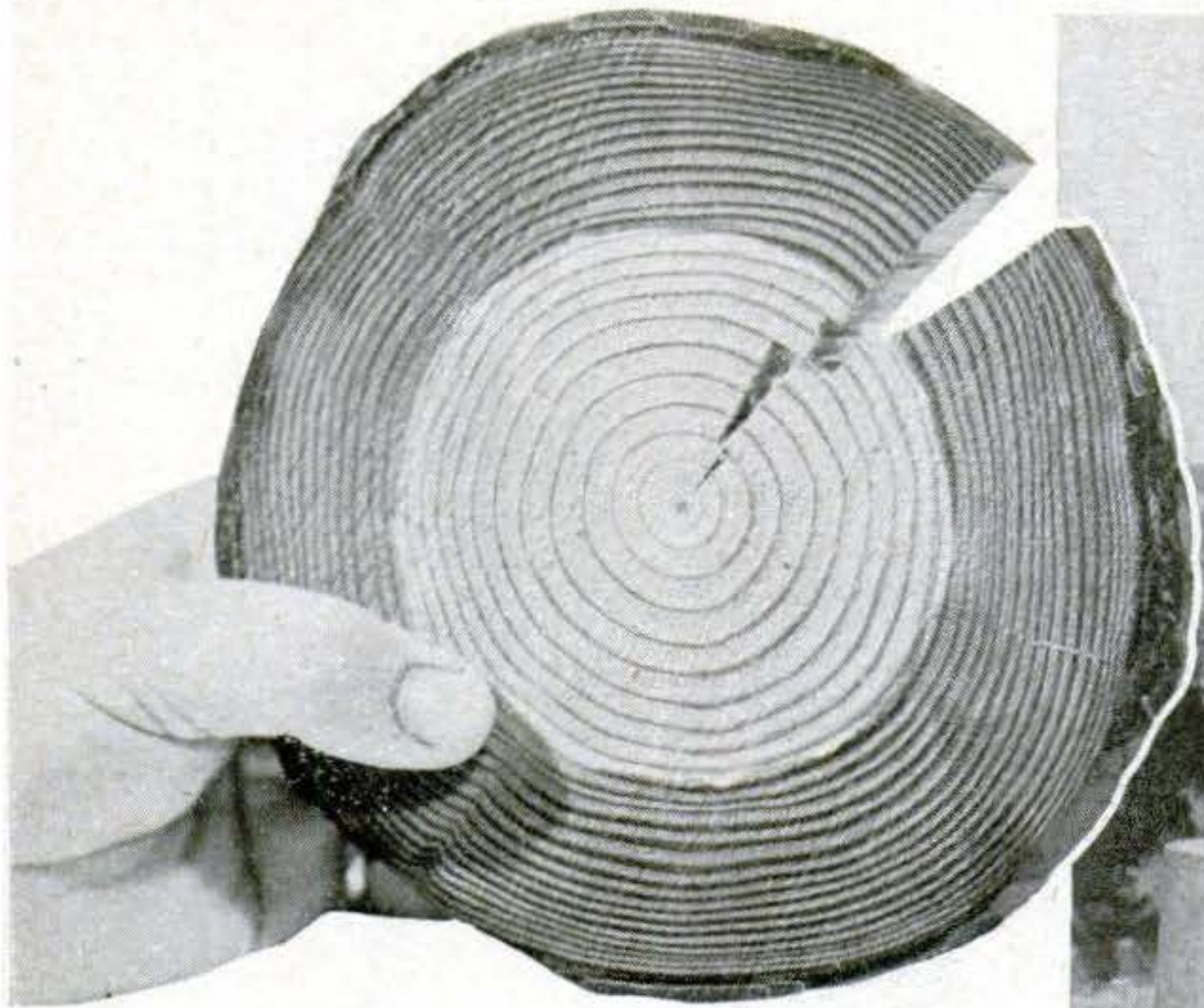

POST SECTION shows sapwood penetrated by double-diffusion process. In a wooden (not metal) barrel stir 18 lb. of copper sulfate into 24 gal. water. In another barrel dissolve 18 lb. of sodium chromate in 26 gal. water. Stand green posts butt down in sulfate for two days (right), then in chromate for one day. Bring water up to level and add 3 lb. of each chemical for each new batch. Add nothing for last three batches. Soak 3, 4 and 7 days respectively, to let solutions work up.

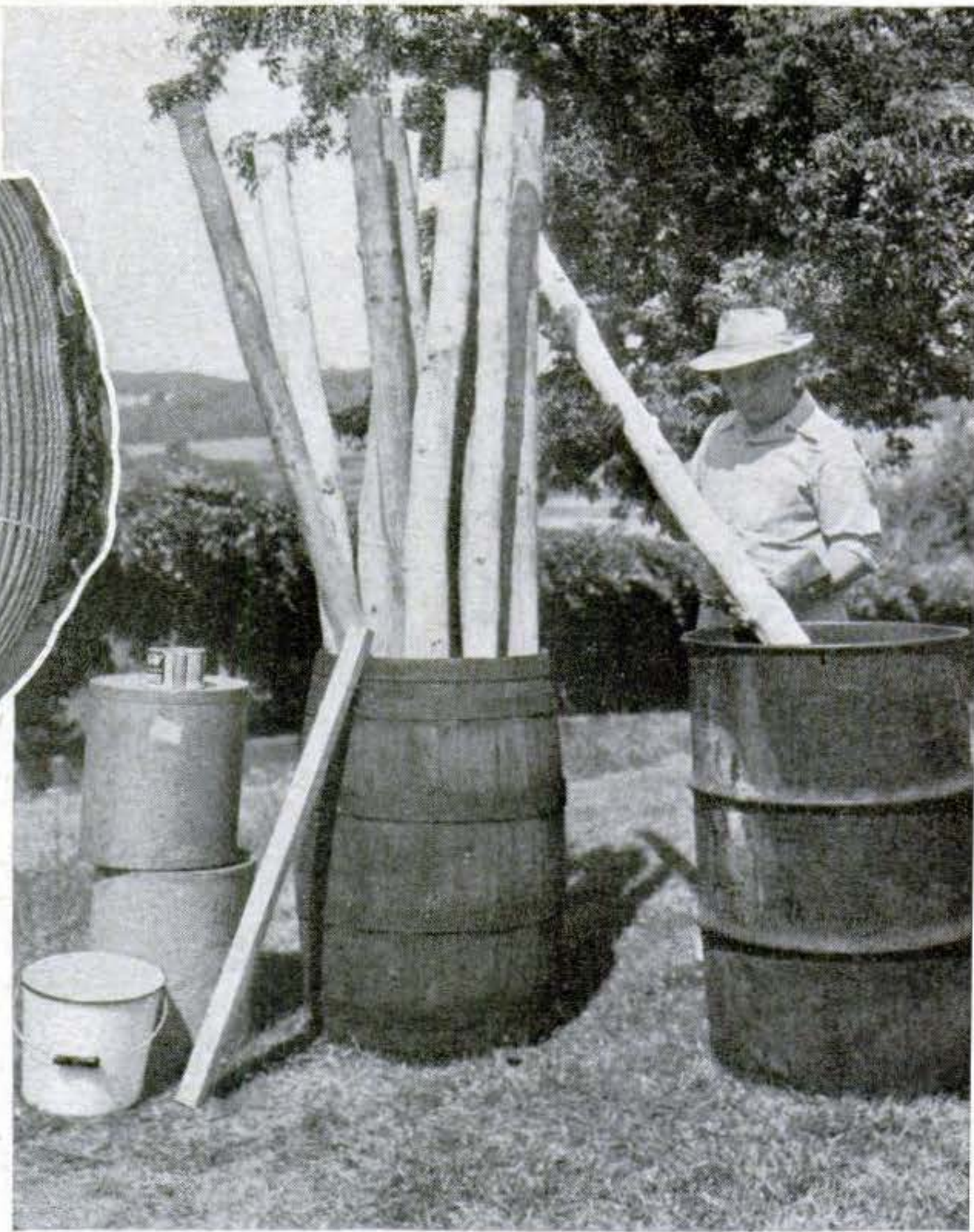

wooden equipment left by previous expeditions sound after decades of exposure—extreme cold prevents decay.

But unless you live in the Sahara or above the Arctic Circle, you may have to protect wood against its natural enemies. Rot is the chief villain, but if termites or marine borers

are lurking about, the right preservative will foil them too.

What are preservatives? Basically, they are poisonous chemicals that prevent decay fungi from attacking wood, and repel insects such as termites, powder-post beetles and carpenter ants.

WOOD PRESERVATIVES (TYPES OF)

PRESERVATIVE	DESCRIPTION	CHARACTERISTICS
COAL-TAR CREOSOTE	Brownish-black heavy oil.	Highly poisonous to decay fungi and insects, including marine borers. Permanent in soil or water, and cheap. Has offensive smell, and bleeds through paint.
ANTHRACENE OIL	Heavier oil than creosote.	Similar to creosote. Costs more but loss by evaporation is less.
WOOD-TAR CREOSOTE	Brownish-black oil.	Less effective than coal-tar creosote but otherwise similar.
PENTACHLOROPHENOL	Available as dry flakes, concentrate or ready-to-use solution.	Effective poison to decay fungi. Free of offensive odor. Flakes not recommended for home use as special equipment is needed. In mineral spirits, does not discolor wood and can be painted over. Will stop decay even if already present. A 5 percent solution (1 pt. concentrate in 2½ gal. of No. 2 fuel oil, for example) is recommended.
COPPER NAPHTHENATE	Available as ready to-use solution or as concentrate for mixing with fuel oil.	Gives good protection against decay and insect damage when solution contains copper metal equivalent of at least .5 percent, but for nonpressure treatment, 1 percent is recommended. Colors wood greenish. May bleed through paint. Follow manufacturer's directions for diluting concentrate.
COPPER SULFATE AND SODIUM CHROMATE	Water-soluble salts.	Used in double-diffusion process, on green wood, these chemicals combine in the wood to form a nonleaching preservative.
WATER-REPELLENT PRESERVATIVES	Generally pentachlorophenol solutions with a water repellent added.	Help keep water out of wood and therefore reduce swelling, checking and shrinking. Can be painted over. Used mainly for treating doors, window sash, framing and other millwork by brushing and dipping. Too costly for posts, fences and timbers.

FOR YOUR POPULAR SCIENCE MONTHLY INFORMATION FILE

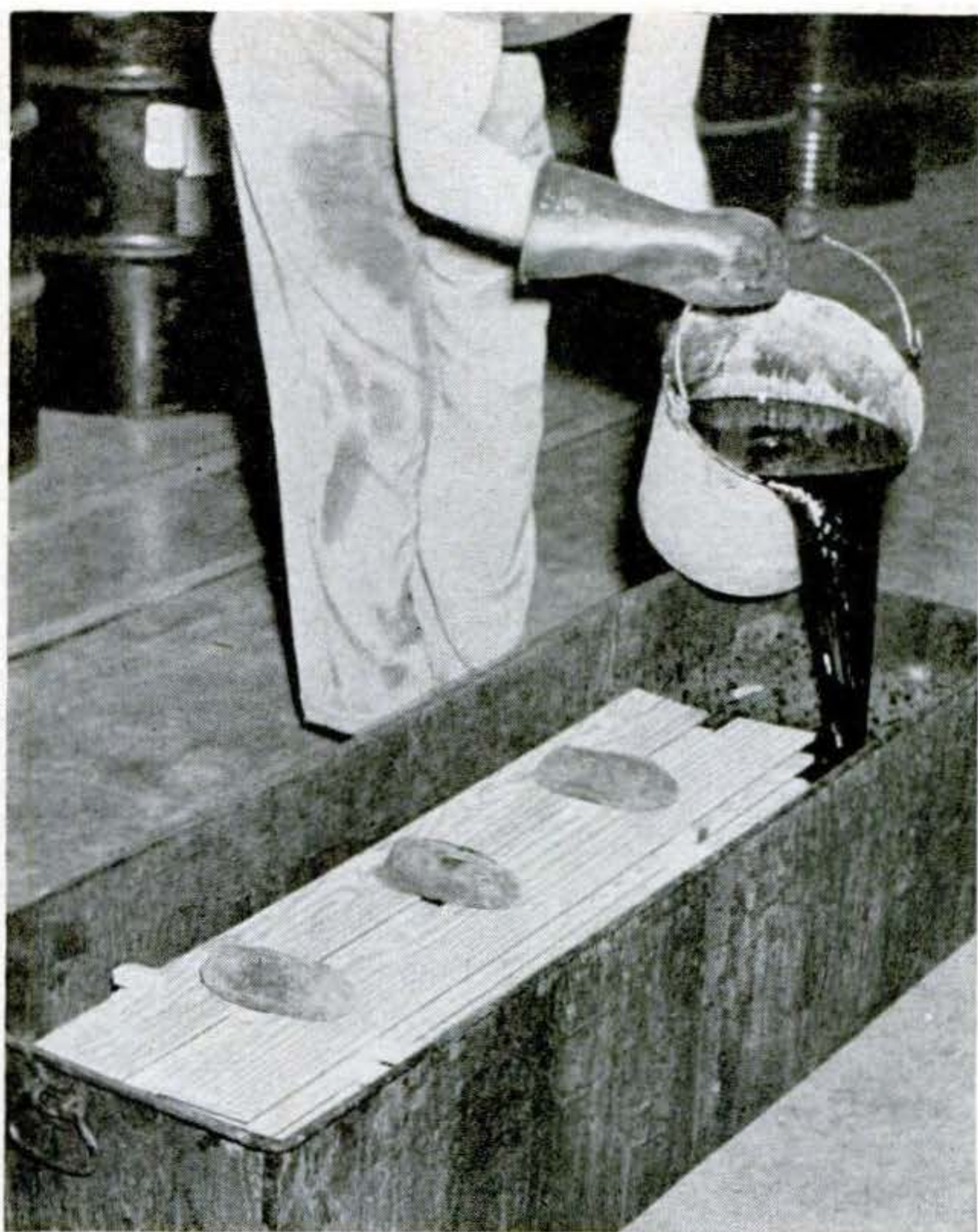

STACK LUMBER for cold soaking in a tank like this, using thin, narrow crosspieces between layers. Weight the top boards with stones or clamp hold-down boards to the tank sides before pouring in the preservative, which must completely cover the wood. Wear rubber gloves and old clothes for the job.

Preservatives are of two kinds—oils such as creosote and anthracene, and water-borne salts like copper sulfate and zinc chloride. (An accompanying box shows the characteristics of each type.)

Preparing wood for treatment. The stock should be clean, dry, free of decay and well-seasoned. All grades of yard lumber down to No. 2 Common usually meet the first two requirements. Seasoning is important because dry wood will soak up more preservative and will not dry and shrink later, whereas poorly seasoned stuff may develop checks that expose untreated wood in which decay can readily start.

The one exception to the use of well-seasoned lumber is in treating fence posts by the double-diffusion process. For this, they should be green.

Whenever possible, do all cutting, planing, boring, and shaping on wood before you treat it. Any such work done afterward will break through the thin shell impregnated

Tanks for home treatment

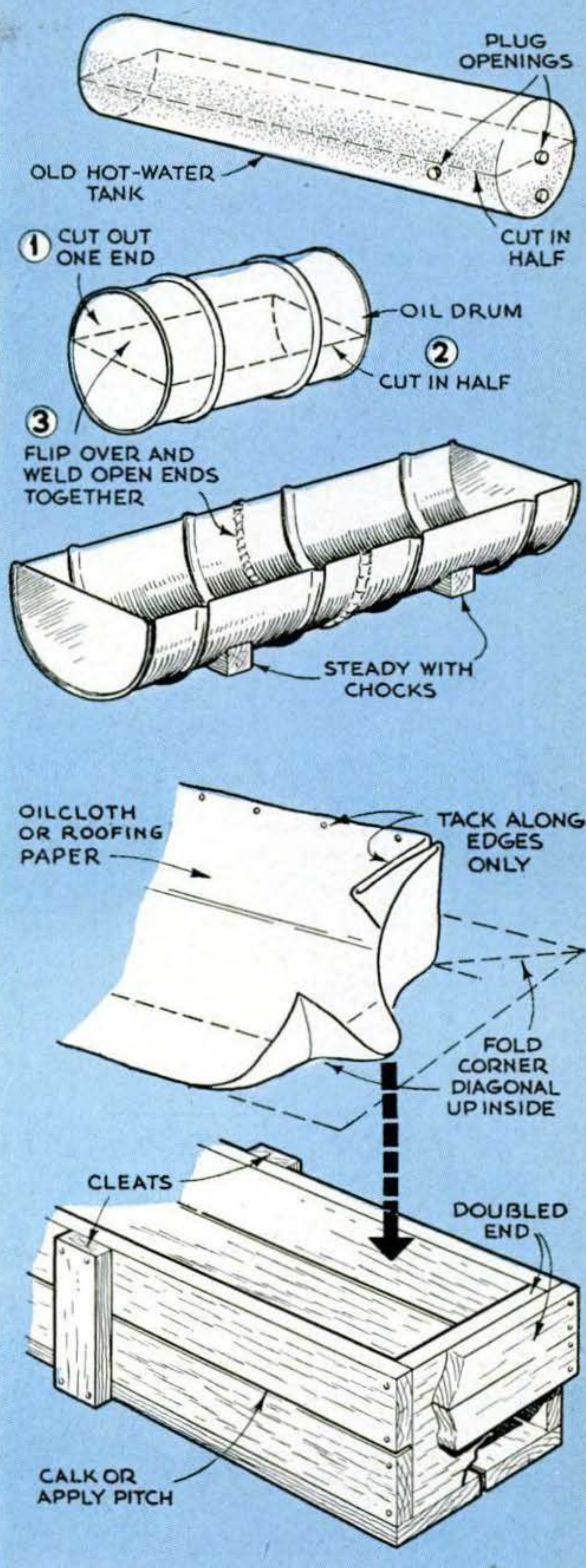

TREATING TANKS can be improvised from old hot-water tanks or oil drums. Wooden tanks should be waterproofed by calking and painting with pitch or roofing compound. A single piece of roofing paper with corners folded up as shown can be tacked inside a wooden tank to hold liquid, but lumber must be handled carefully to avoid tearing such a lining.

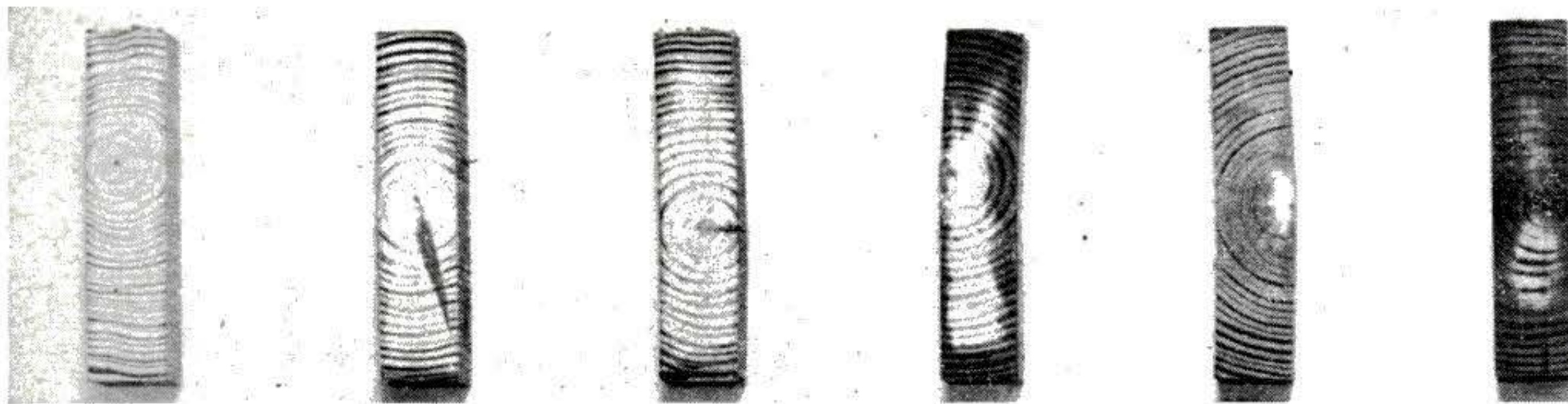

HOW METHODS COMPARE in amount of preservative put into wood. Board sections above were cut after treatment with (left to right) :

three-minute dip, six-hour cold soak, 24-hour cold soak, hot-and-cold bath, commercial vacuum process, pressure process.

with preservative. If you must break the surface after treatment, douse the freshly exposed parts with more preservative.

How wood is treated. Preservatives must penetrate the wood, not merely coat the surface. How you apply them will depend on what method is practical for you.

The most effective way of getting preservative into wood is by a pressure process. Since this calls for complex equipment, it is strictly a commercial proposition. If you can buy pressure-treated wood, by all means do so. Fence posts so treated with creosote are available at many lumberyards. Other kinds of treated lumber are rarely stocked.

Nonpressure treatments you can use at home will give you worthwhile protection. Here they are in order of effectiveness:

Hot-and-cold bath. The best of the non-pressure processes, this calls for immersing the wood in hot preservative (180° to 220°) for one to three hours, and then in cold preservative (100°). The rapid cooling con-

tracts the air in the wood, sucking in preservative. Because of the amount of equipment needed and the fire hazard, it is not very suitable for home use.

Cold soaking. This is the best of the home-treatment methods, requiring no heat, and only a single tank big enough to let the wood be completely immersed. Stack it with thin separators between layers and weight it down or secure it with clamped hold-downs. Then cover with preservative. Two days' soaking will put 70 to 90 percent as much preservative into easily treated species (such as pines and oaks) as a full week's. Small pieces take up more than large ones because relatively more surface is exposed. Tests show that the life of creosote-soaked posts can be tripled. Douglas-fir plywood stakes soaked in a five percent pentachlorophenol solution lasted five years, untreated ones 1.8 years.

Dipping. Much less preservative is tak-

[Continued on page 254]

WOOD PRESERVATIVES (APPLYING)

METHOD	PRESERVATIVE	ADVANTAGES	DISADVANTAGES	TYPICAL USES
Hot-and-Cold Bath	Creosote Copper naphthenate Pentachlorophenol	Most effective Fast	Needs heat Equipment is costly Fire hazard Messy	Posts Timbers in ground Docks, piling
Cold Soak	Creosote Copper naphthenate Pentachlorophenol	Equipment is simple Fairly effective No heat Low cost	Not all woods well-suited	Posts Stakes Porches Docks
Double-Diffusion	Copper sulfate and sodium chromate	Fairly effective Unit cost moderate Simple	Not fully tested Needs green wood	Posts (green)
Dip	Creosote Pentachlorophenol Copper naphthenate Water repellents	Simple, easy Fast Unit cost low	Low effectiveness Limited usefulness	Millwork Seed flats
Brush or Spray	Creosote Copper naphthenate Pentachlorophenol Water repellents	Simple equipment Cheap	Lowest effectiveness Limited usefulness	Millwork already installed Newly exposed areas in treated stock

FOR YOUR POPULAR SCIENCE MONTHLY INFORMATION FILE



New for the Handy Man

1. Masking Tape Brushes on. You can brush this liquid masking tape on a window without even keeping it off the wood. Then you paint right over both tape and wood, score the tape around the edges, and peel off just what sticks to the glass, leaving the window clear of paint.



2. Liquid Rubber Paints, Patches. Brushed on like paint, this liquid neoprene rubber dries to a hard, tough, waterproof coating. As a patch, it seals leaks in practically any material from garden hose to gutters, roofs to boat hulls. It also puts a rust- and rattleproof coating on garbage pails and other metal parts, will waterproof wood, masonry and clothes, and can be used to cover floors and counters.

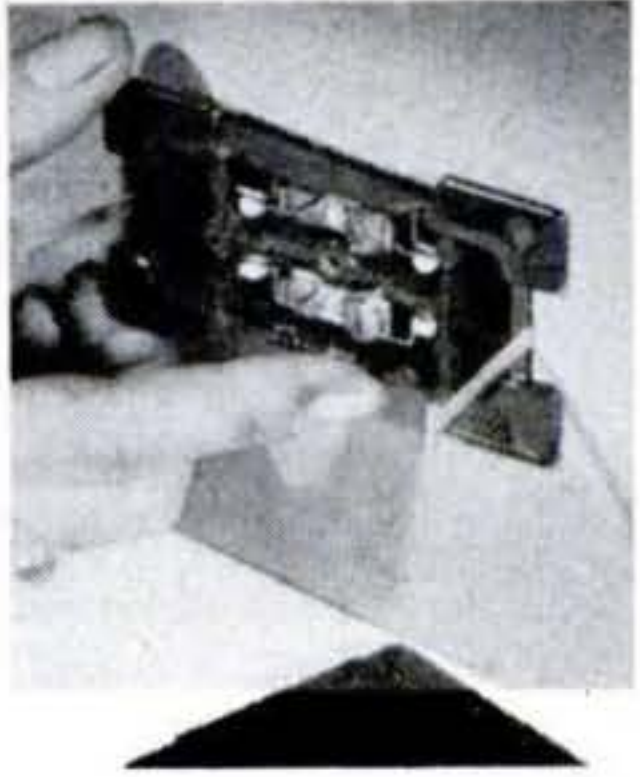

3. Outlet Clips to Wall. You don't need any metal box to install this electrical outlet. The plastic outlet serves as its own insulated box and can be fastened directly to a wall anywhere. A hole is cut,

the cable attached, and the box simply pushed in. Two clips, bent over from the outside, hold it to the wall.

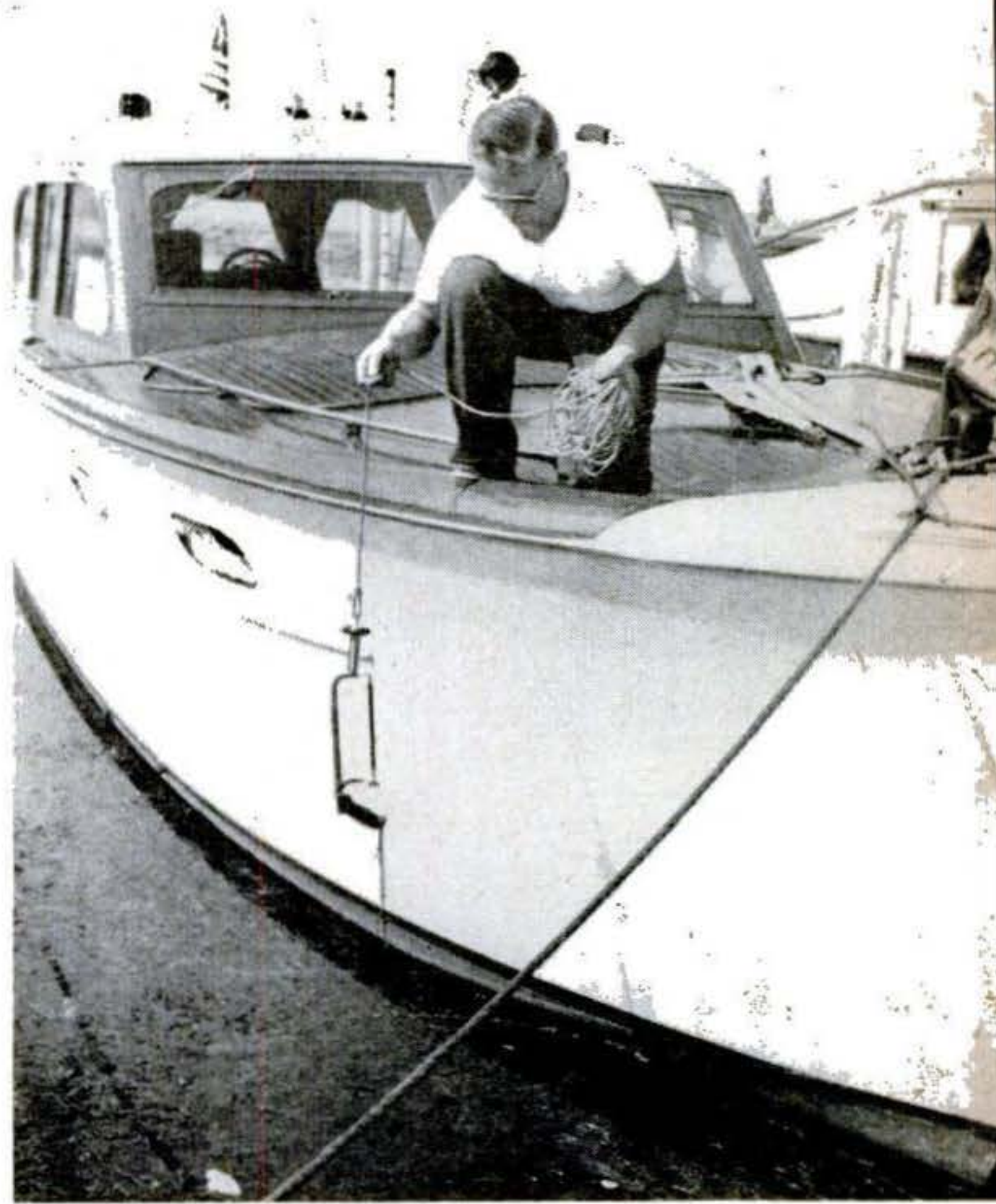

4. Magnet Retrieves Lost Objects. Fishing, but not for fish, this cigar-size pocket magnet will quickly pick up tools dropped overboard and retrieve metal parts lost in pipes, under cars, and behind radiators and other inaccessible places. It has a threaded end for attaching a pipe handle, holes for tying on a cord, and comes with two neoprene rings that can be slipped on to keep it away from pipe walls.

Further information on the products described on this page can be obtained from: 1. Reardon Co., 7501 Page Ave., St. Louis, Mo.; 2. Pro-Chem Co., P.O. Box 1928 Grand Central Station, NYC; 3. Pass & Seymour, Inc., 1302 Milton Ave., Syracuse 9, N.Y.; 4. Eriez Mfg. Co., 7 E. 12th St., Erie, Pa.

Wordless Workshop

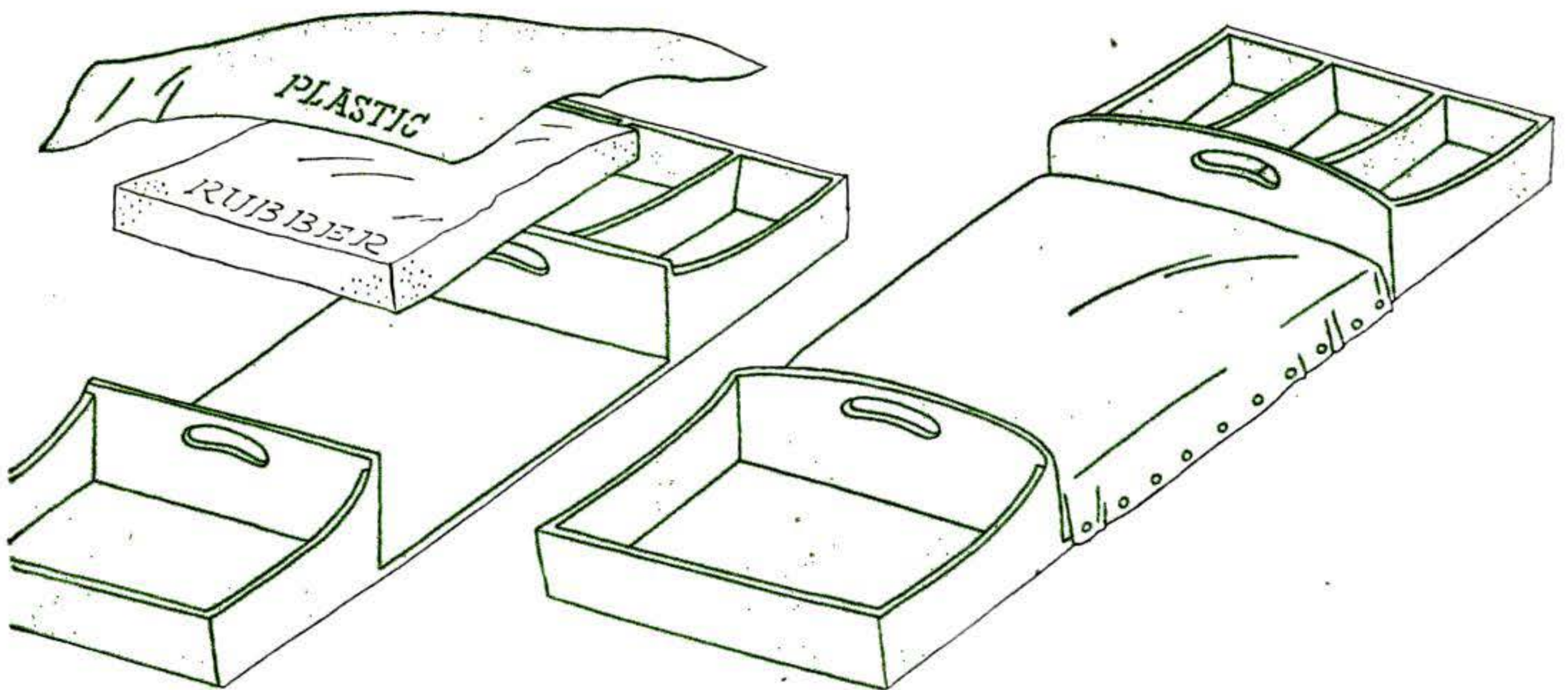
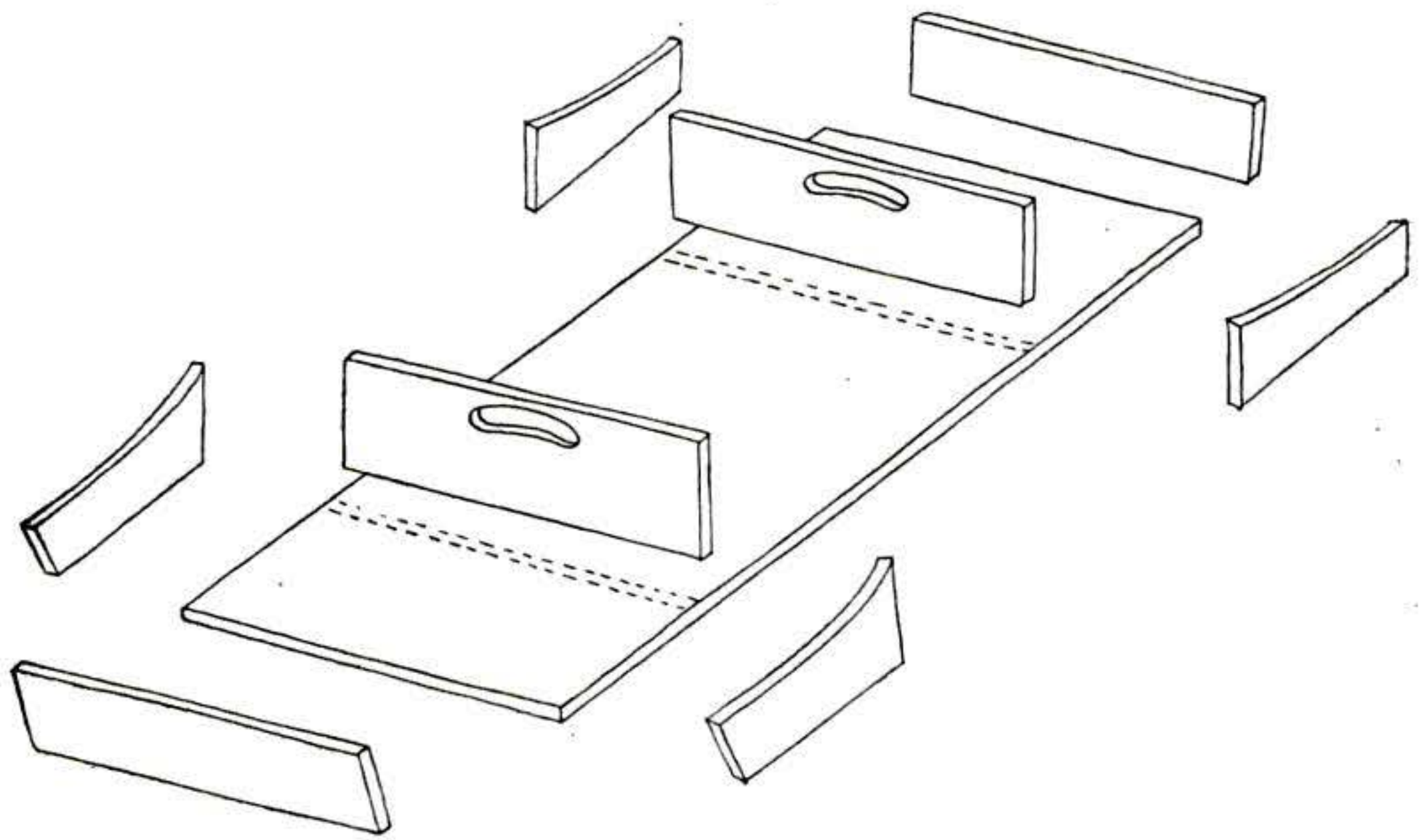

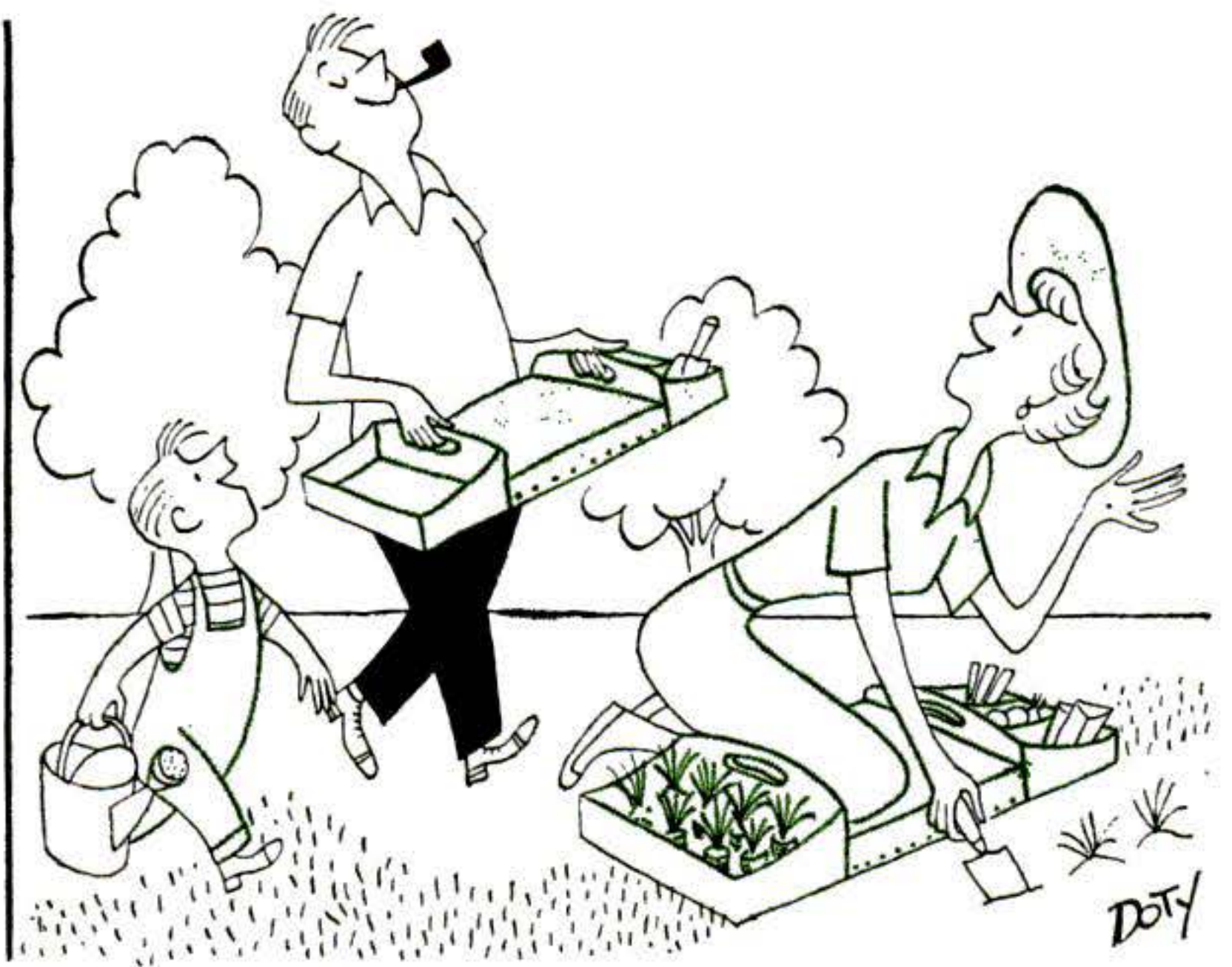
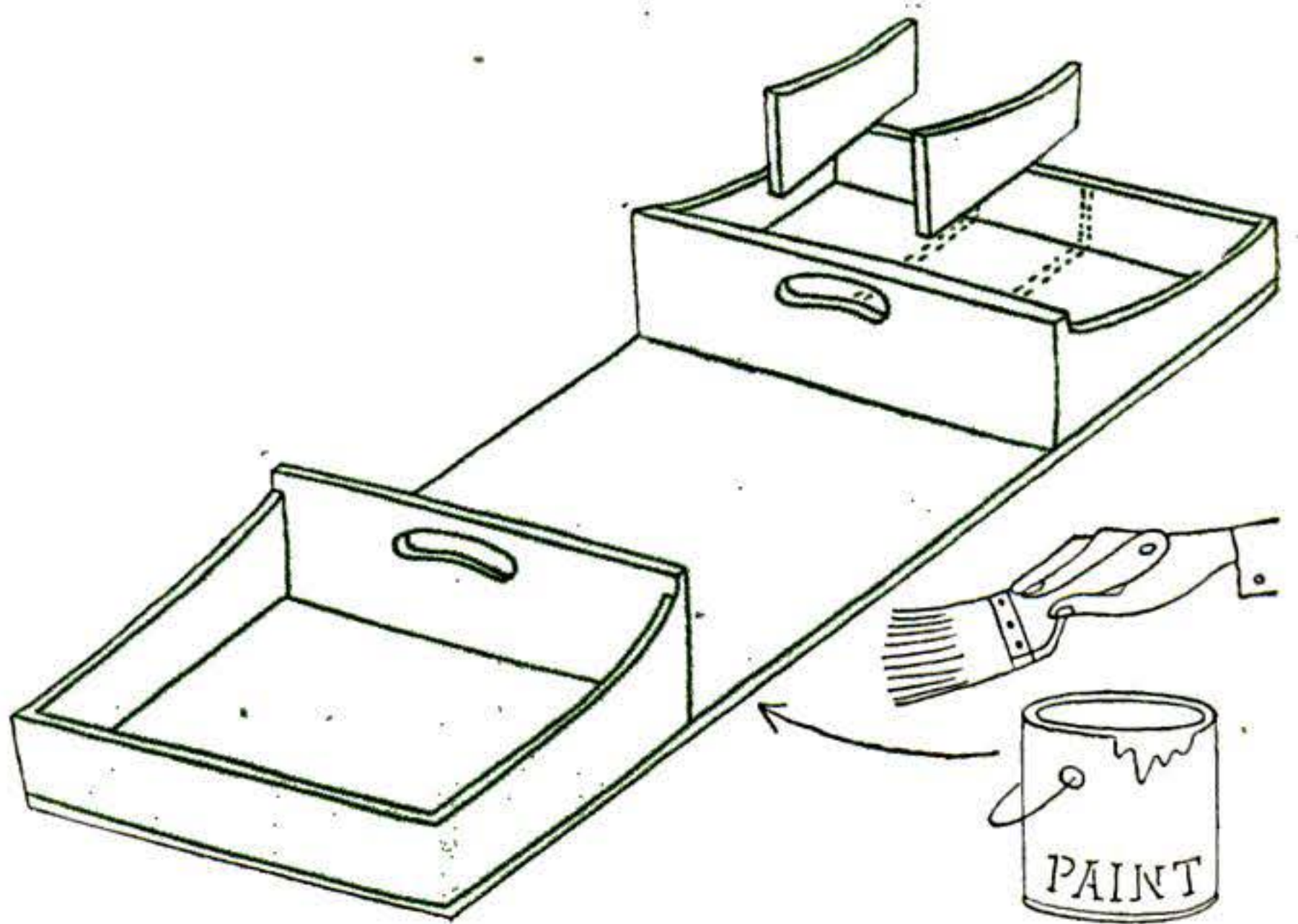
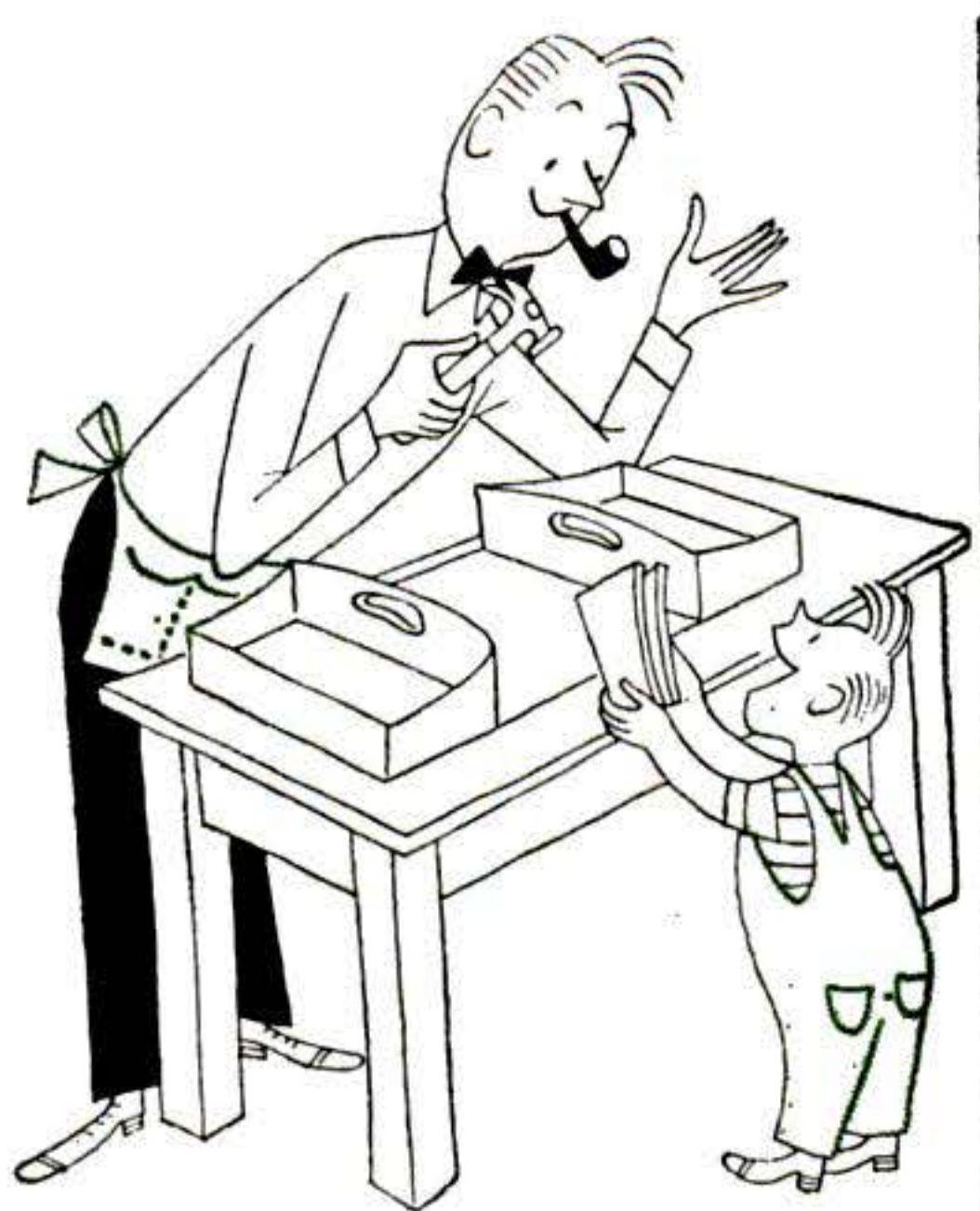
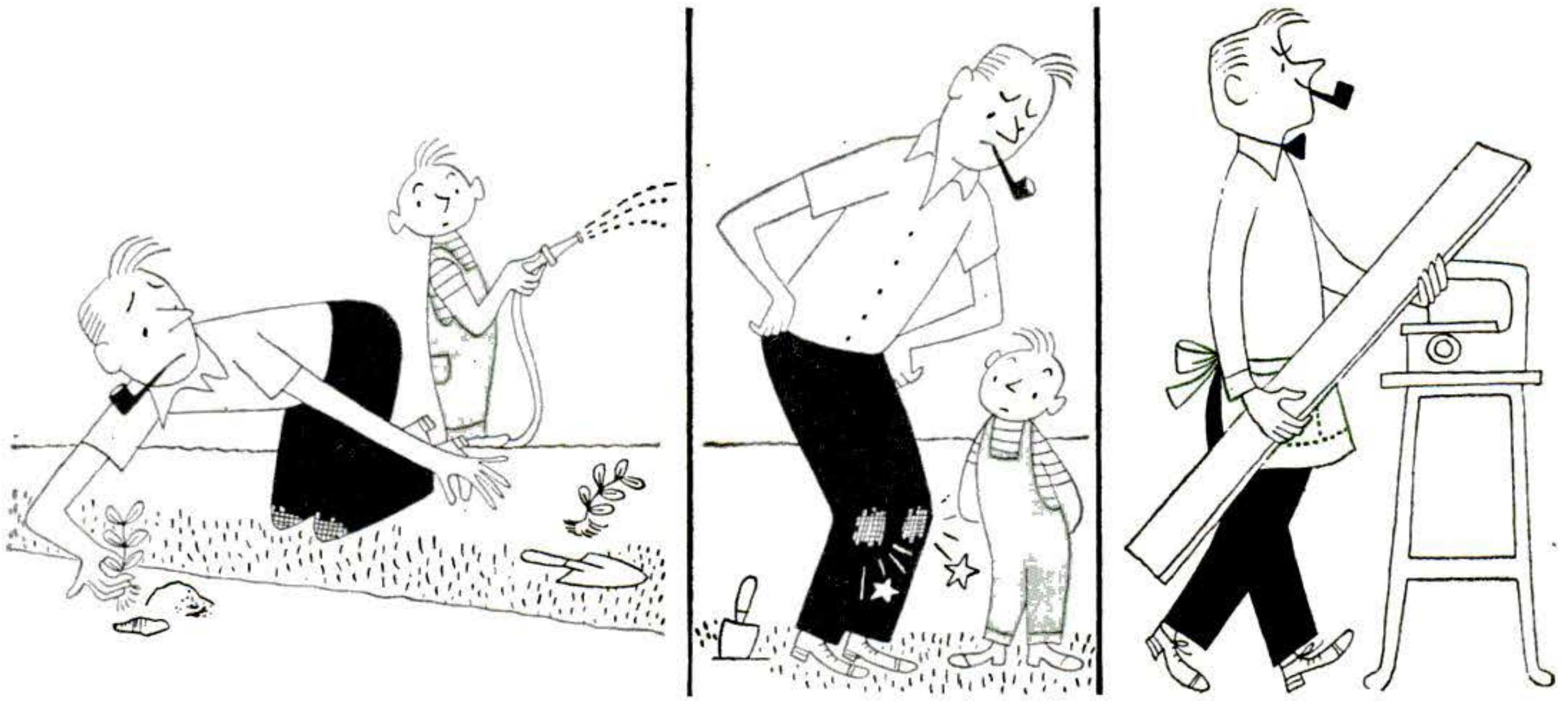

Next Month: A picnic table with a built-in high chair.

MAY 1954 187

Wire-Mesh Strainers Keep Gutters Clean

SLIP-ON strainers made from $\frac{1}{2}$ " wire mesh will keep leaves from clogging gutters, and need no fastening to hold them in place. Cut 5' strips, shape as shown, and force them in so that the top forms a curve that will let leaves slide off. The sections can be easily removed for repairs.—*H. O. Schoenfish, Mountainside, N. J.*



Plastic Serves as Pump Float

DURING a rainy spell in the spring, when it was inadvisable to disturb a basement-ump pump for repairs, a block of plastic foam securely wired to a leaky float ball kept the unit functioning and the basement dry. Plastic foam, porous and filled with air bubbles that make it very buoyant, can be bought at florist shops.

The stuff can also be used for similar emergency repairs on a toilet float.—*David B. Grant, Nashua, N.H.*

DO IT THE EASY WAY

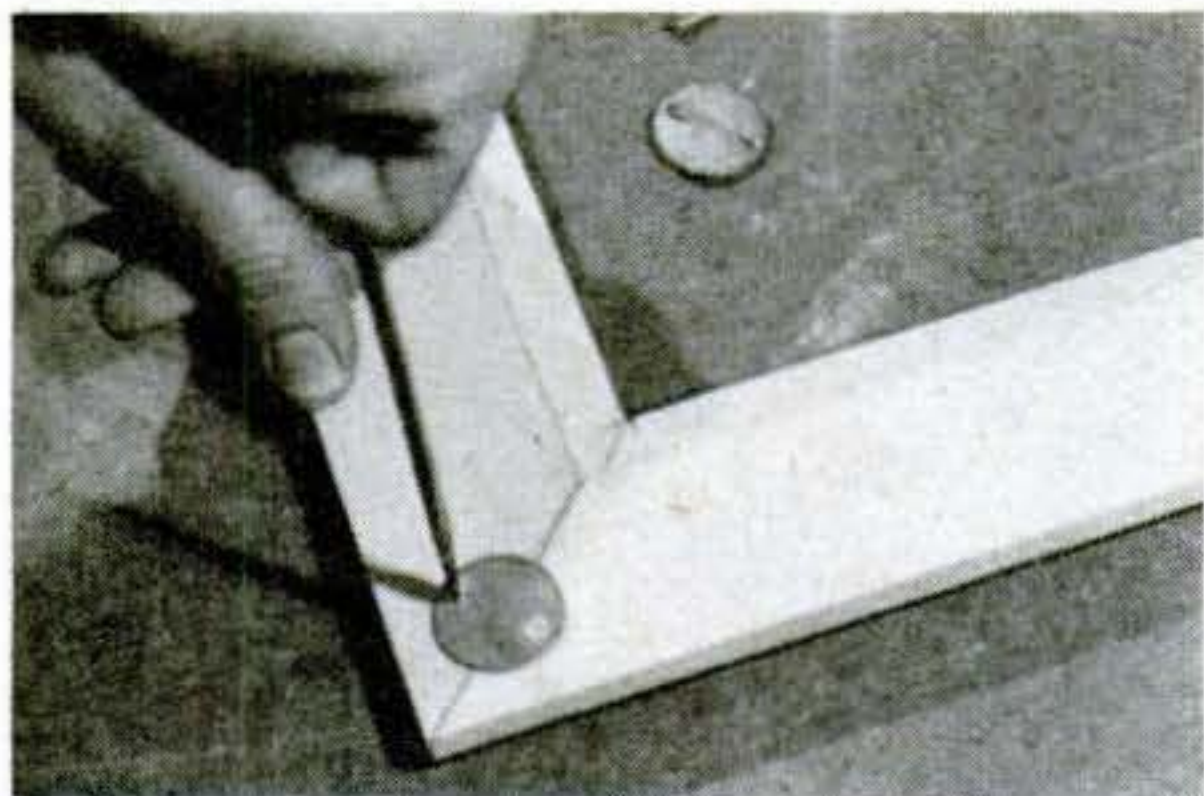

KNOCK-OUT PLUGS, saved from electrical junction boxes, will make emergency mending plates when you need some in a hurry. Drill the metal disks first, and then fasten them on with screws.

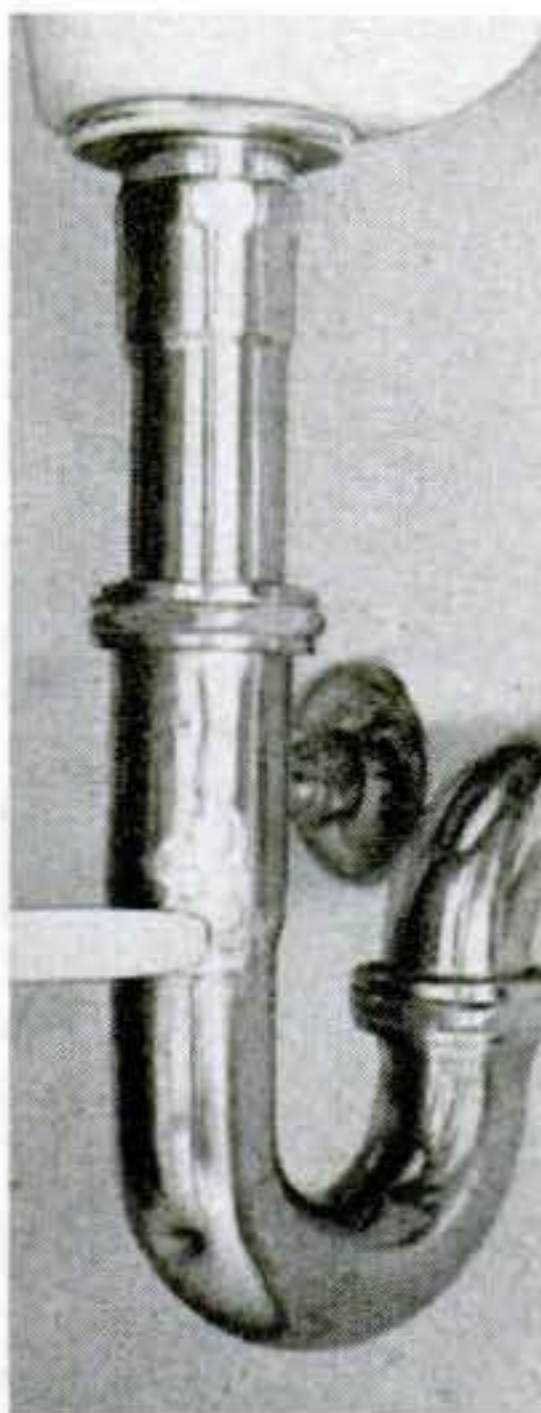

SMALL LEAKS in drain-pipes can be patched with a paste made from cellulose cement and aluminum powder. Dry area thoroughly, then force mixture into crack with knife. Let dry four hours before using pipe.



YOU CAN PROTECT that easily dulled linoleum knife with a small square of $\frac{1}{4}$ " plywood. Slice a niche through the wood and press the knife tip into it.

A DOUBLE WIRE HOOK, bent in the shape of a W, will hold pants creasers on a clothesline and shorten drying time by allowing them to blow freely.

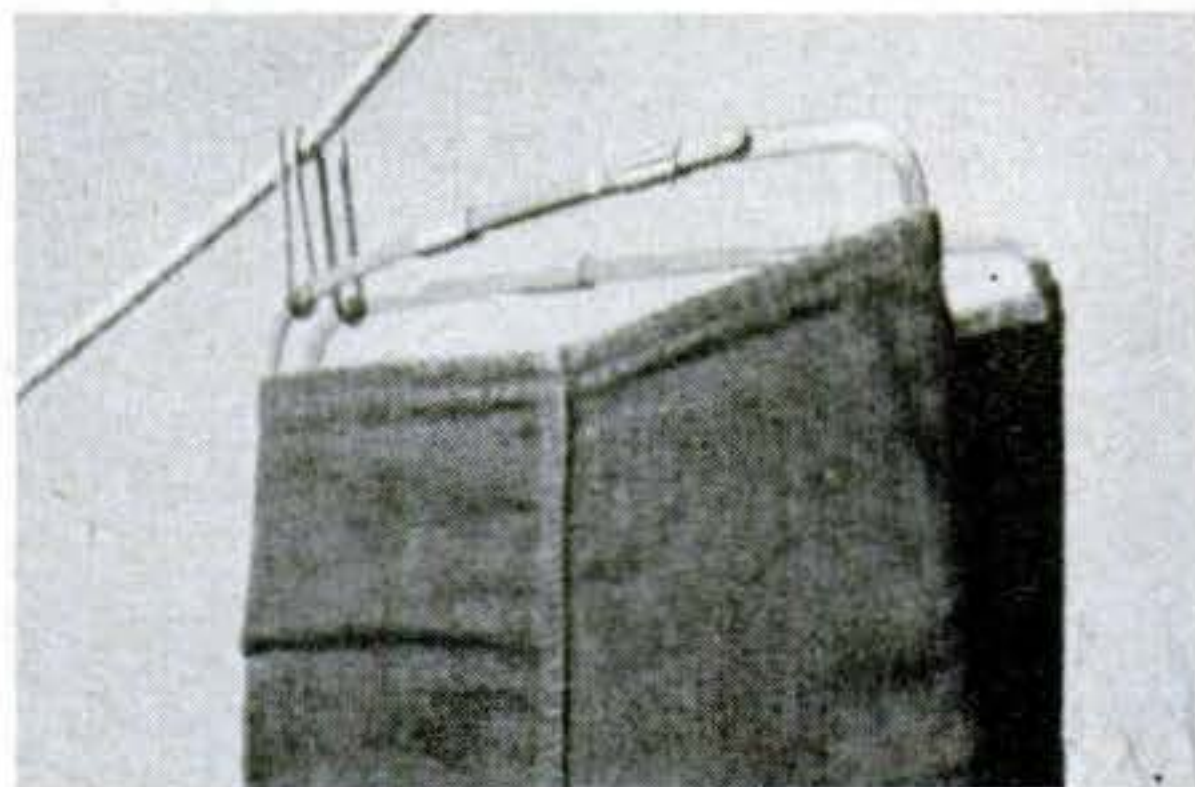

Now YOU Can Have Power Brakes



With this new booster kit, plus an evening's work installing the unit, you can give your postwar car tiptoe stopping power.

By E. F. Lindsley

IF YOU have been thinking that power brakes are strictly for the luxury jobs, you can shift your thoughts now to the ordinary car level. You can install them on your present car if it isn't *too* old, remove them in 10 minutes when you trade, and put them right back on your next wagon. Thus you can spread the initial cost over as many cars as you may own in the next 10 years.

This is possible because the term *power brake* actually means that a source of extra boost has been dropped into the hydraulic system between your foot and the wheel cylinders. If your present brake system is up to snuff, your car is just as well adapted to power brakes as the newest trick on the

showroom floor, allowing for minor details of yearly model changes and improvements. The only thing you lack is something to supply the pressure that you now apply to the hydraulic fluid when you make with the leg muscles. The new Bendix Hydrovac unit will do this for postwar cars.

Leverage vs. Power

Don't kid yourself: it takes power to stop a car. According to Bendix, 70 pounds of foot pressure gives about 400 pounds per square inch in the normal hydraulic system without the booster. Here, the brake pedal is mounted so the push from your foot is crow-barred up through a pretty big leverage before it moves the master-cylinder piston. Conventional, built-in power brakes mount

POWER-BRAKE KIT has been worked out to make home installation practical. At left you

see the main cylinder of the Bendix Hydrovac booster. The writer is studying instructions.

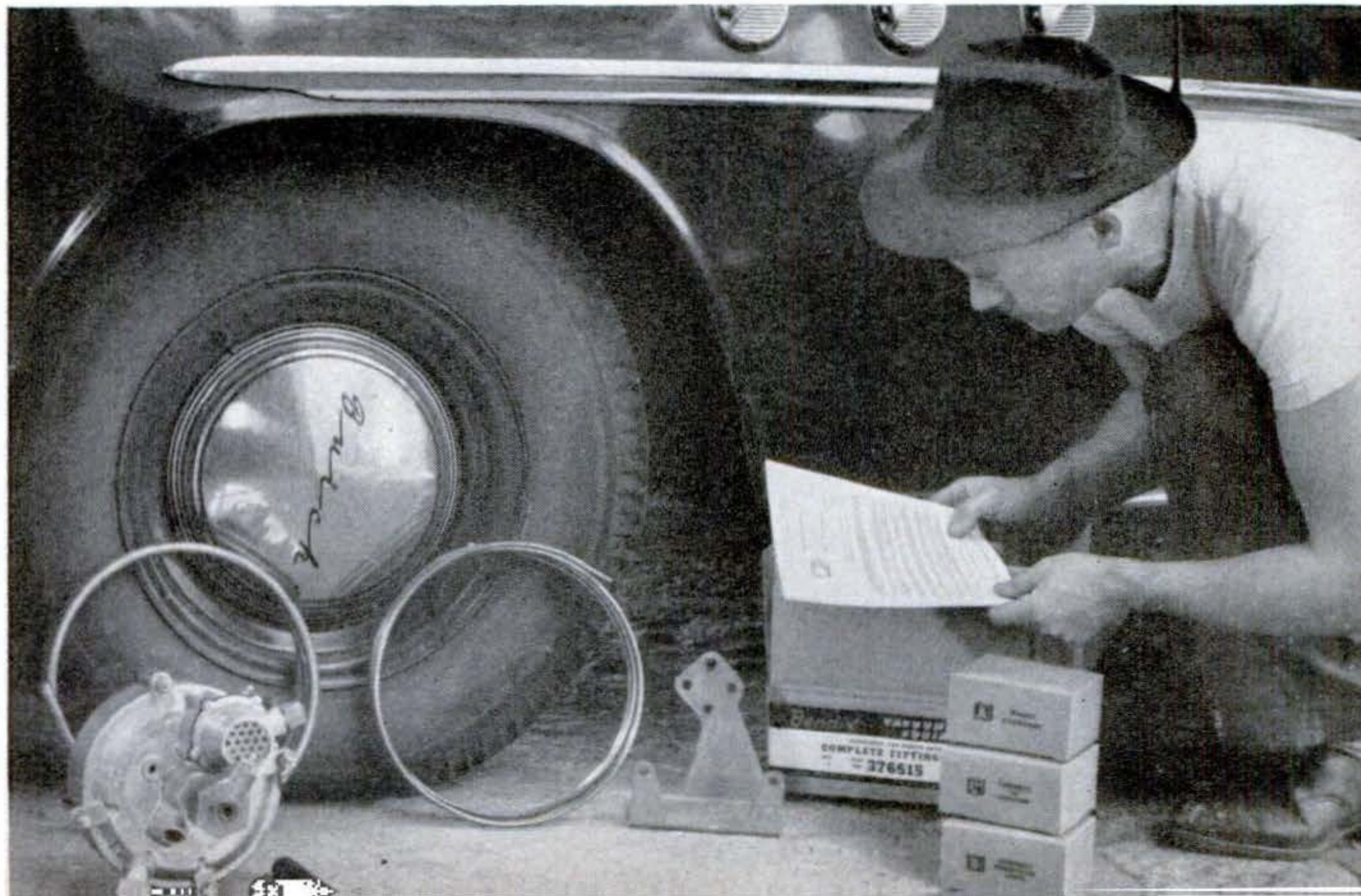



A CONVENIENT LOCATION for the unit in this car was found in the fender well. Holes were

drilled for the cylinder-retaining bracket. This is the only drilling that is required.

the pedal close to the floor and do away with this leverage, figuring of course that the power will take over for the lost leverage.

This is an advantage, according to some, because the driver doesn't lift his foot in going from gas to brake. On the other hand, since the power comes from the engine vacuum, if the engine quits, without the old-fashioned brake-pedal linkage you've got darn few brakes.

When you put on a Hydrovac booster, you retain the original pedal leverage. Even with a stalled engine or a failed power unit, you still have the brakes the car was built with. Admittedly, you have to lift your foot to hit the brake pedal, just as you always have. But the vacuum booster has a 2:1 power ratio and gives out with over 800 pounds to stop your car.

Power Braking Gives Surer Control

My first reaction was an unimpressed "So what?" My leg wasn't knotting in agony from pushing a brake pedal.

The first time I made a traffic stop with the power unit, the car almost did an outside loop on dry pavement. Two days later, I was starting to enjoy the new control I had. Later that week I left on a trip that

racked up 4,000 miles, much of it in the Rockies, and with several days of 800 miles at a stretch. The trip really sold me. Strange roads and schedules that demanded high speeds sometimes brought me into unexpected turns and situations where the amazingly fast and smooth braking was a real lifesaver. Tiptoe pressure is all it takes to ease the car down beautifully.

Fits Anywhere You Can Squeeze It In

Although vacuum-booster cylinders have been familiar to truck operators and mechanics for years, this is the first real passenger-car unit. The Bendix unit will fit any conventional car with conventional hydraulic brakes, will mount and function almost anywhere you can find a nook to hide it, under the hood or elsewhere, and is generally rugged and insensitive to differences in engine size, climate, or the skill of the installer. The makers have packaged it in kit form with the really simple fittings and hardware sorted into well-marked boxes. An evening spent with a drill, screwdriver and adjustable wrench should see power brakes on your car. The flared tubing can easily be made up at any garage.

It is only fair to ask where the additional



SHAPE AND LENGTH of hydraulic tubing for vacuum and hydraulic lines can be found by making templates with soft wire solder. Form copper tubing gently to match solder-wire contours, avoiding sharp bends and flats.

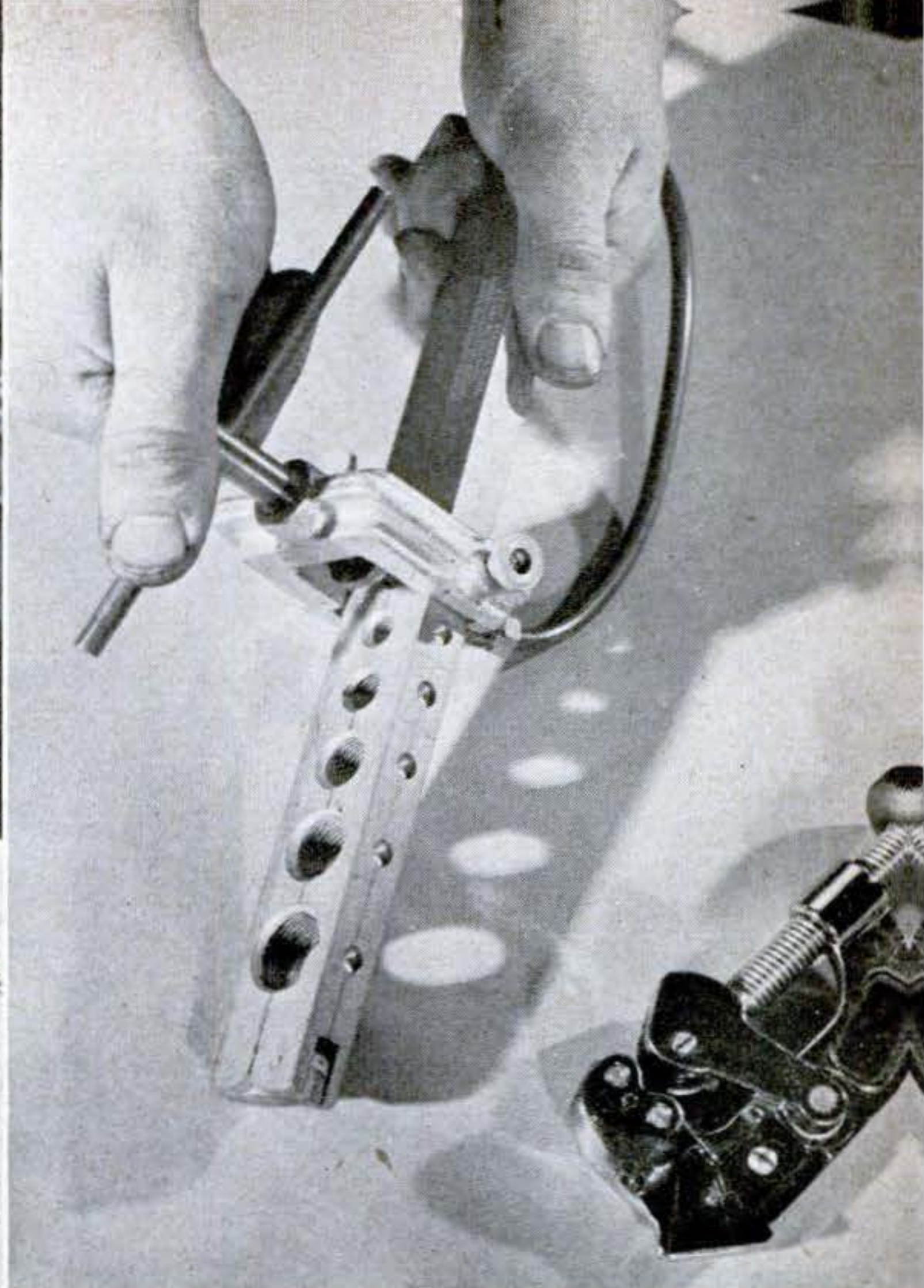

HAVE TUBING FLARED, at a reliable garage, for making the hydraulic connections. Remember, these lines must hold 800 lb. of hydraulic pressure. Failure can be serious. Don't forget to slip fittings on before flaring.

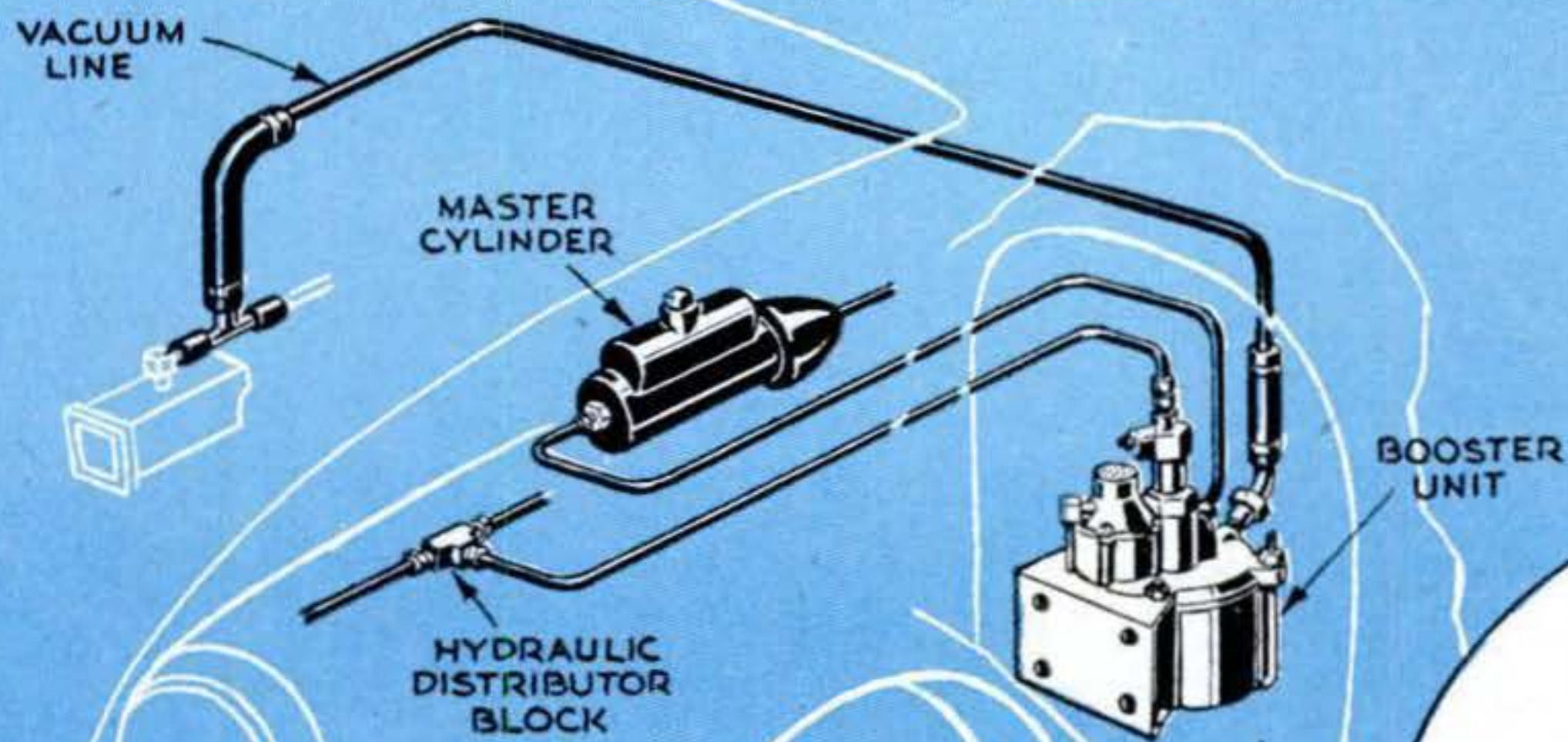

CONNECTIONS to be made in installing a power-brake unit for your car are one vacuum line and hydraulic lines in and out.

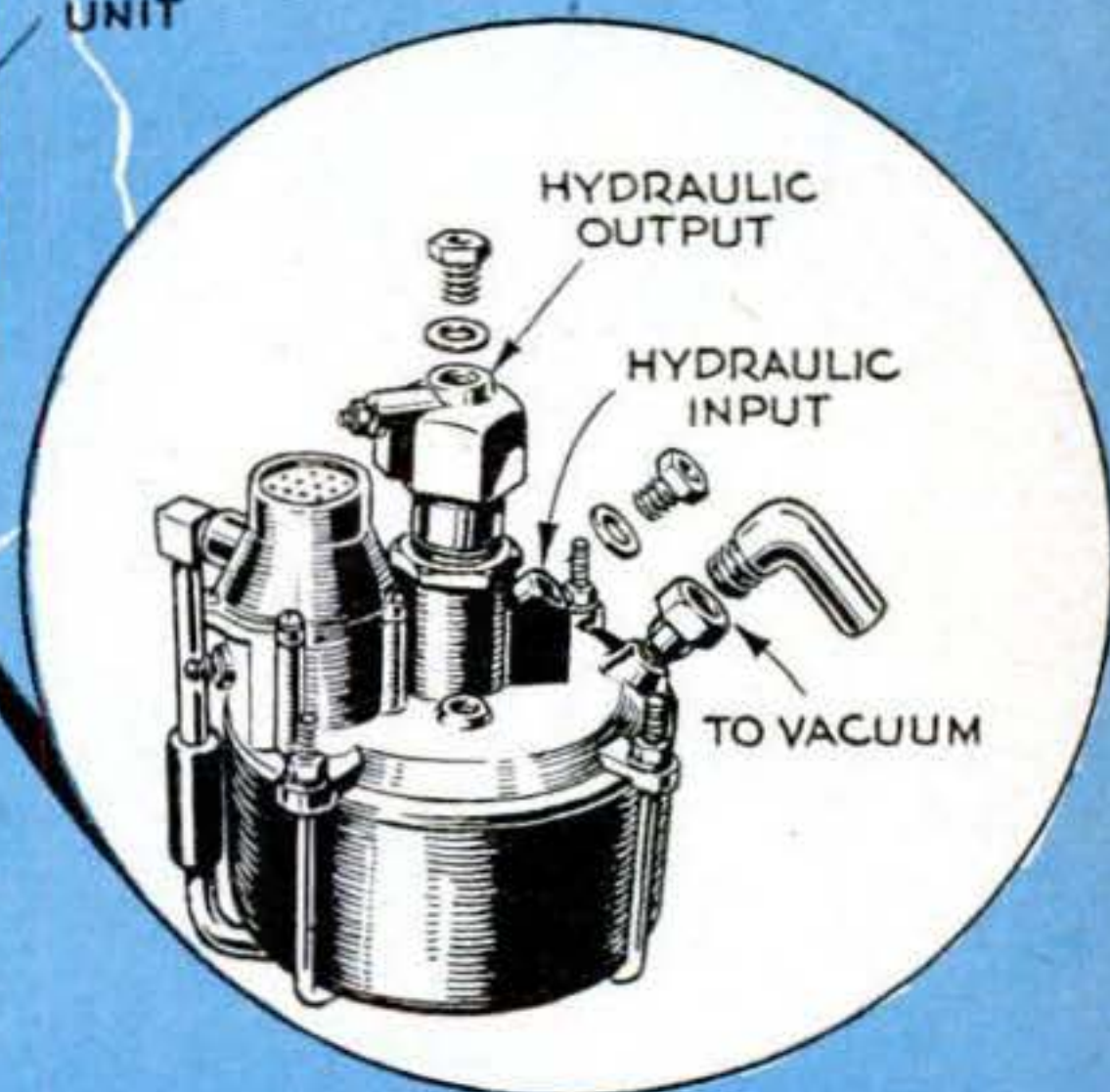

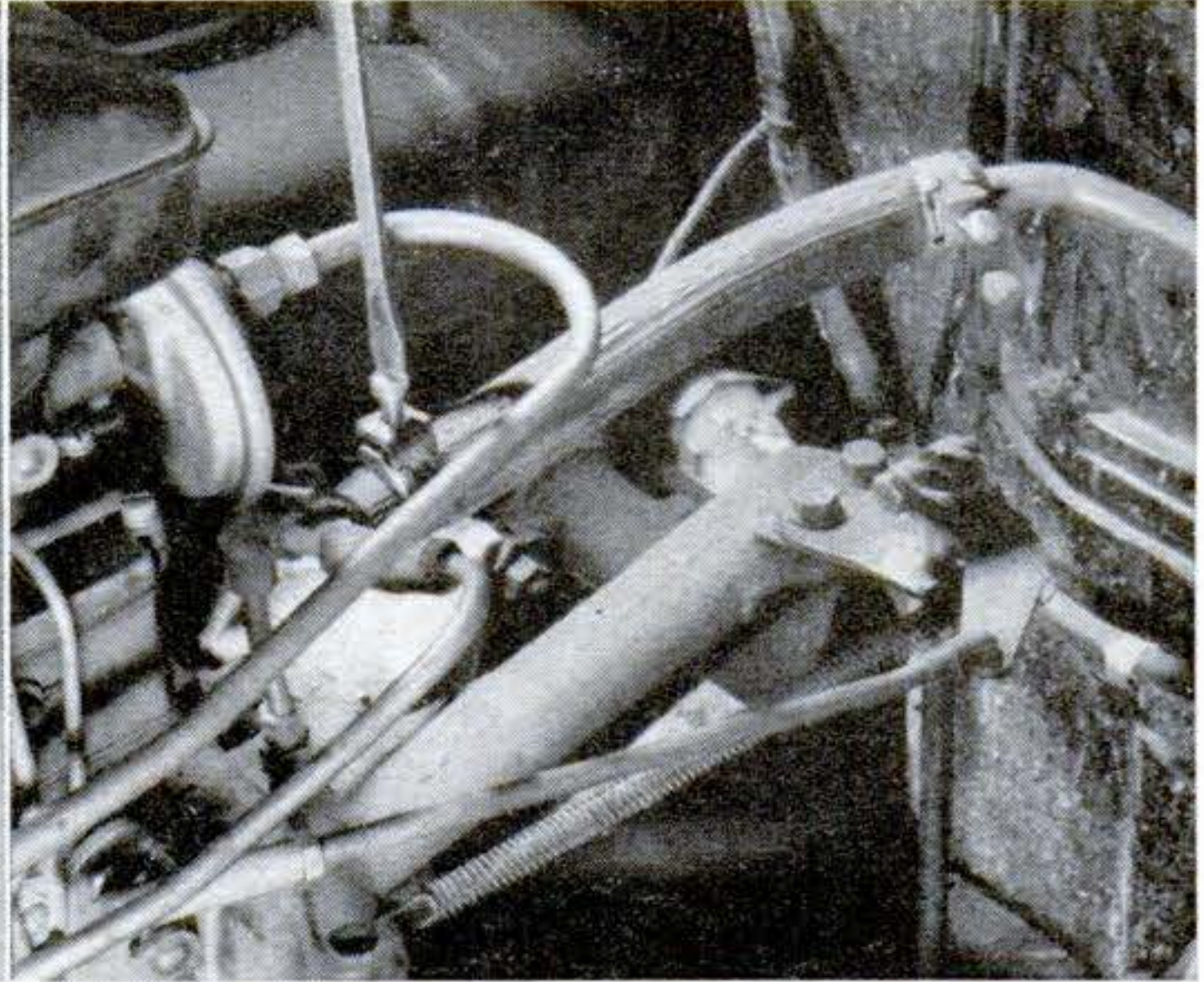
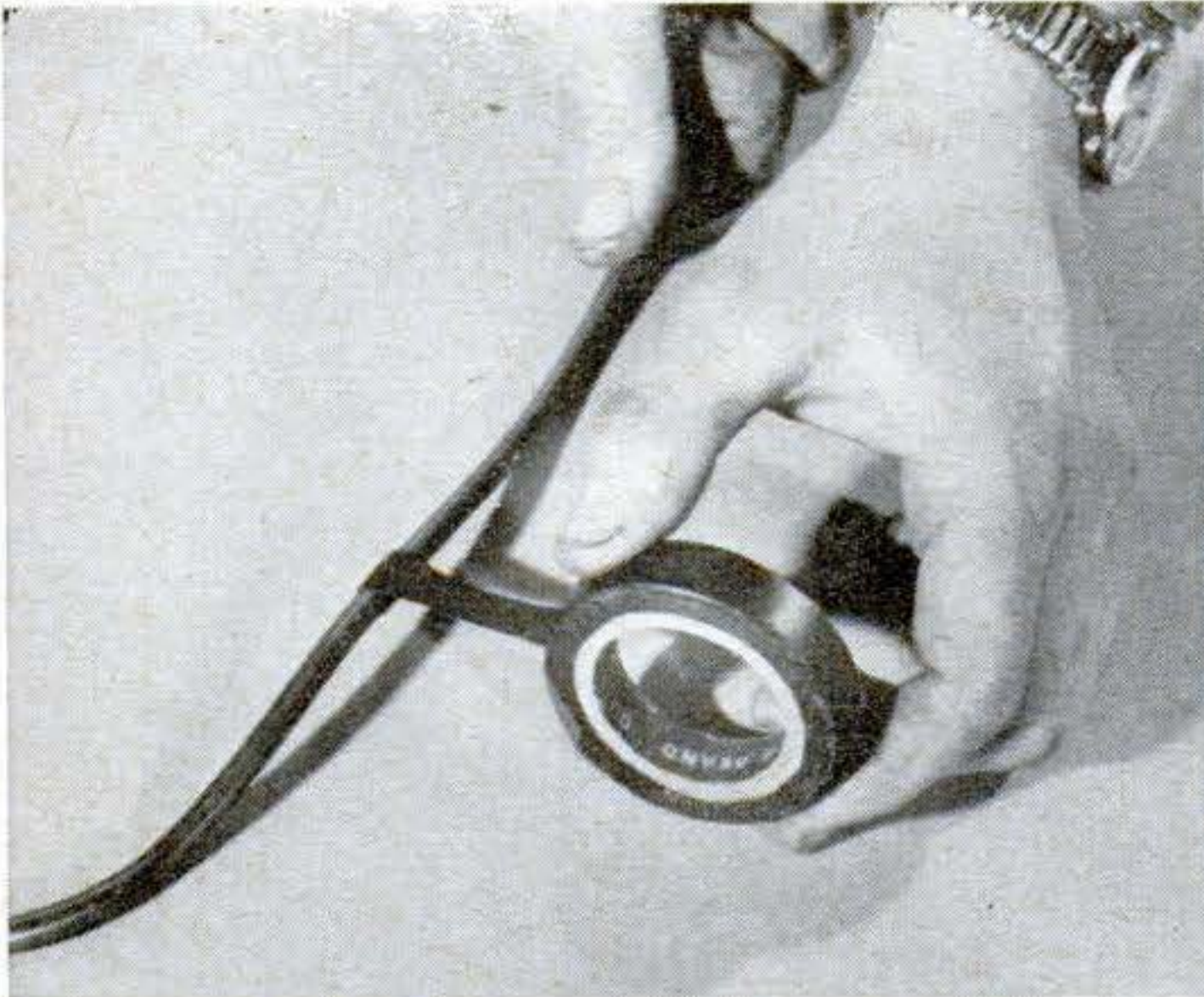

IT IS IMPORTANT that the hydraulic lines be well supported and free from vibration that could cause cracking. Kit contains hold-down clamps. Tape the areas where clamps contact the tubing to prevent metal-to-metal chafing.

INTAKE-MANIFOLD, VACUUM-SOURCE connection is readily made with T fitting and hoses in the kit. Connection must be tight; a leak in vacuum line would reduce effective power of unit, cause poor engine performance.

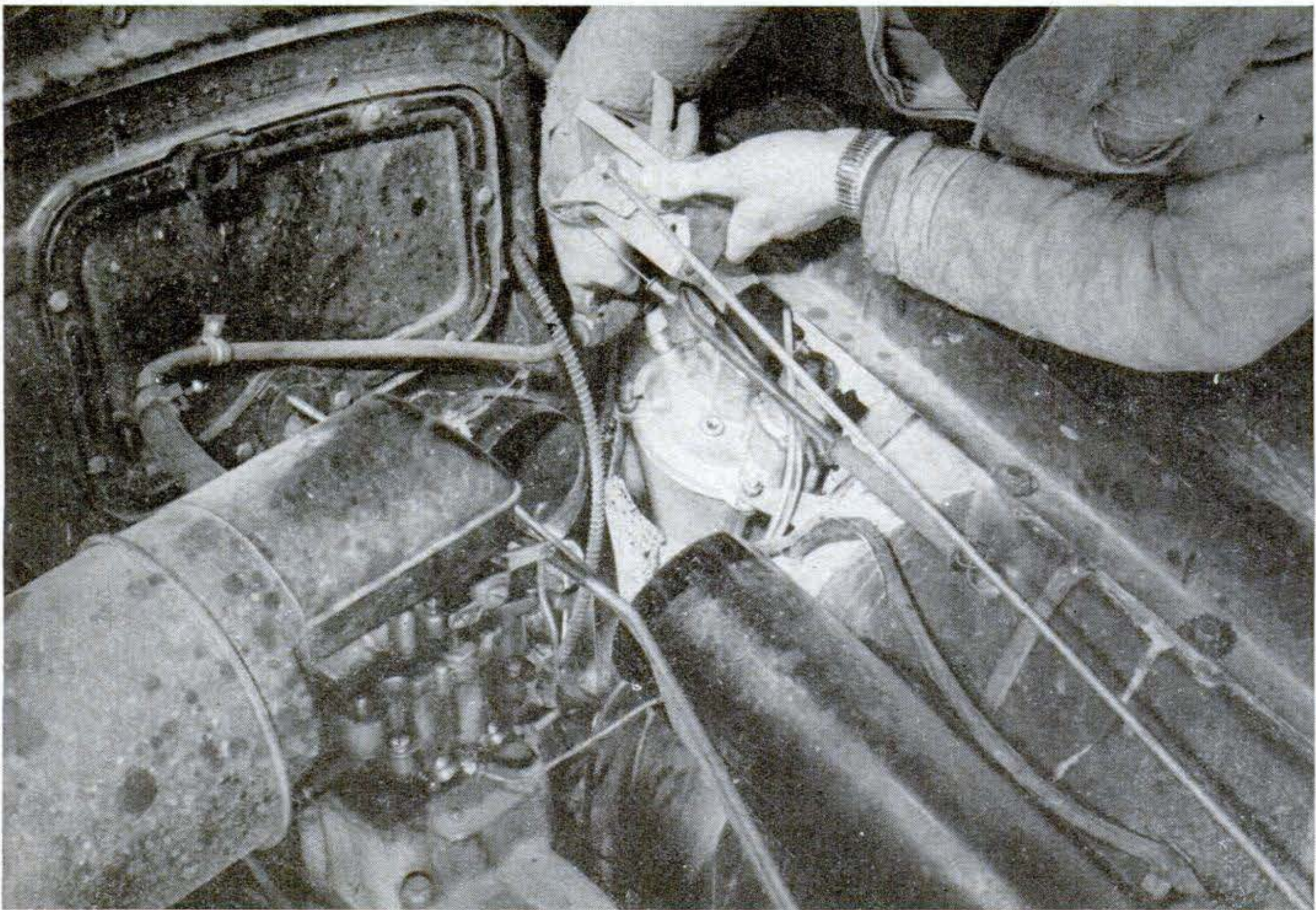

AFTER CONNECTING vacuum line to unit with hose and clamps, you are ready to bleed the system. The instruction sheet will help you

do this if you want to attempt the job yourself, but letting an experienced garageman take over will usually cost you very little.

power comes from to boost the brake pressures up to 800 pounds plus. And why haven't we been using it all the time?

We have. The vacuum windshield wiper has been wheezing with us from the early days. Even at a healthy idle, normal engine vacuum is equivalent to 18 to 20 inches of mercury. Apply this to a diaphragm about

the size of the lid on a one-pound coffee can and you have a force to be reckoned with. Couple that force to a hydraulic master cylinder and you wind up with real power. Because the power comes from the pumping action of the engine, your foot does little more than energize the controlling action of the valves in the power cylinder. **END**

Screen-Door Tips

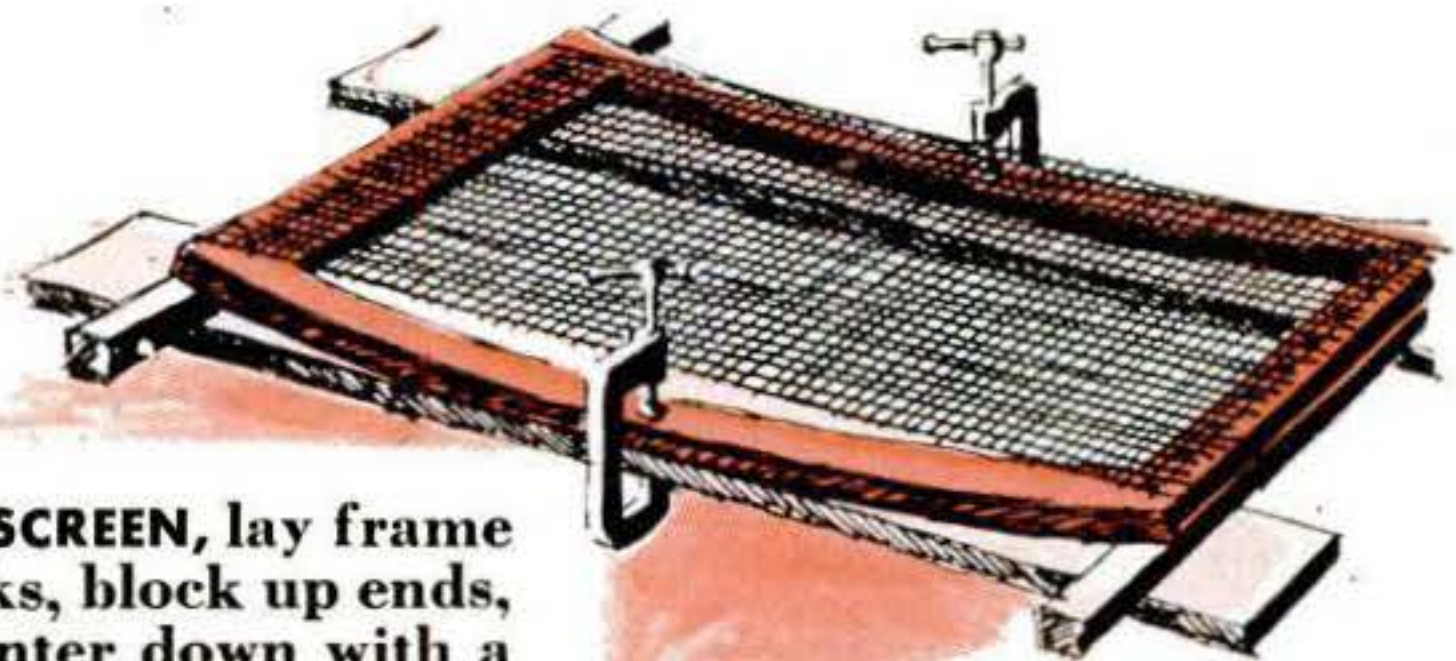

TO REPLACE SCREEN, lay frame across planks, block up ends, and pull center down with a C clamp at each side. Tack on new screen at ends, release clamps, and frame will straighten out, pulling screen taut. Then tack sides.



HOLES CAN BE PATCHED with scraps of screening, "stitched" on with fine wire at edges. Commercial patches that clip on are available.



A TOWEL BAR, painted black, makes a handle that is easily reached by children and adults.

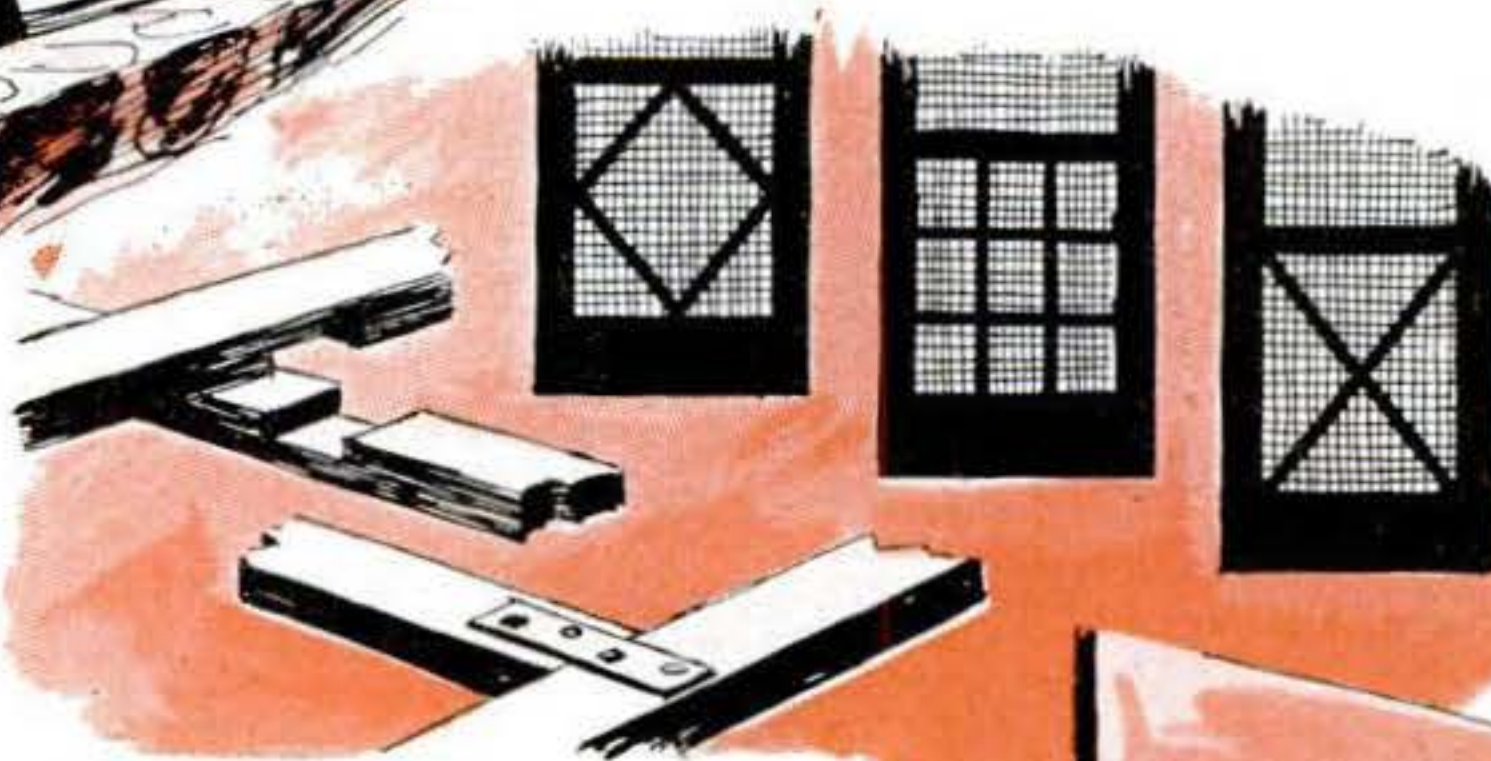

EXTRA CROSSPIECES on lower part of door keep small feet from denting screen, and add decorative touch. Notch strips where they cross; attach with mending plates.



SLIGHTLY WARPED DOOR can be held tight when closed by adding extra spring catches at top and bottom.



REMOVE RUST with wire brush, then paint screen, using scrap of old carpet on wood block. Use varnish on copper, screen paint on galvanized iron.



IF DOOR SAGS, pull it up with diagonal metal brace available at hardware stores.

One Evening Shop Projects

Nothing but dowels and nylon fishline is needed to make these hot-dish and flowerpot mats. Cut dowels to the length of the mat you want. Sand the ends smooth. Then drill four holes in each piece at the same spacing.

Dip the ends of the nylon line in cement to make it stiff for easy threading through the holes. Seal the knots at the ends with dabs of cement. A design can be painted along the edges, if desired, and felt glued to the bottom.



A breeze to make, fans like this are welcome warm-weather party favors, bazaar items or rainy-day projects for children.

Cut the corrugated-cardboard blade to size, rounding the corners. Dip the ends of bamboo splints from a table mat into glue and push them into the corrugations about 2", forming symmetrical groups of two or three. Bind the ends with raffia or cord to form a handle.—*Walter E. Burton, Akron.*

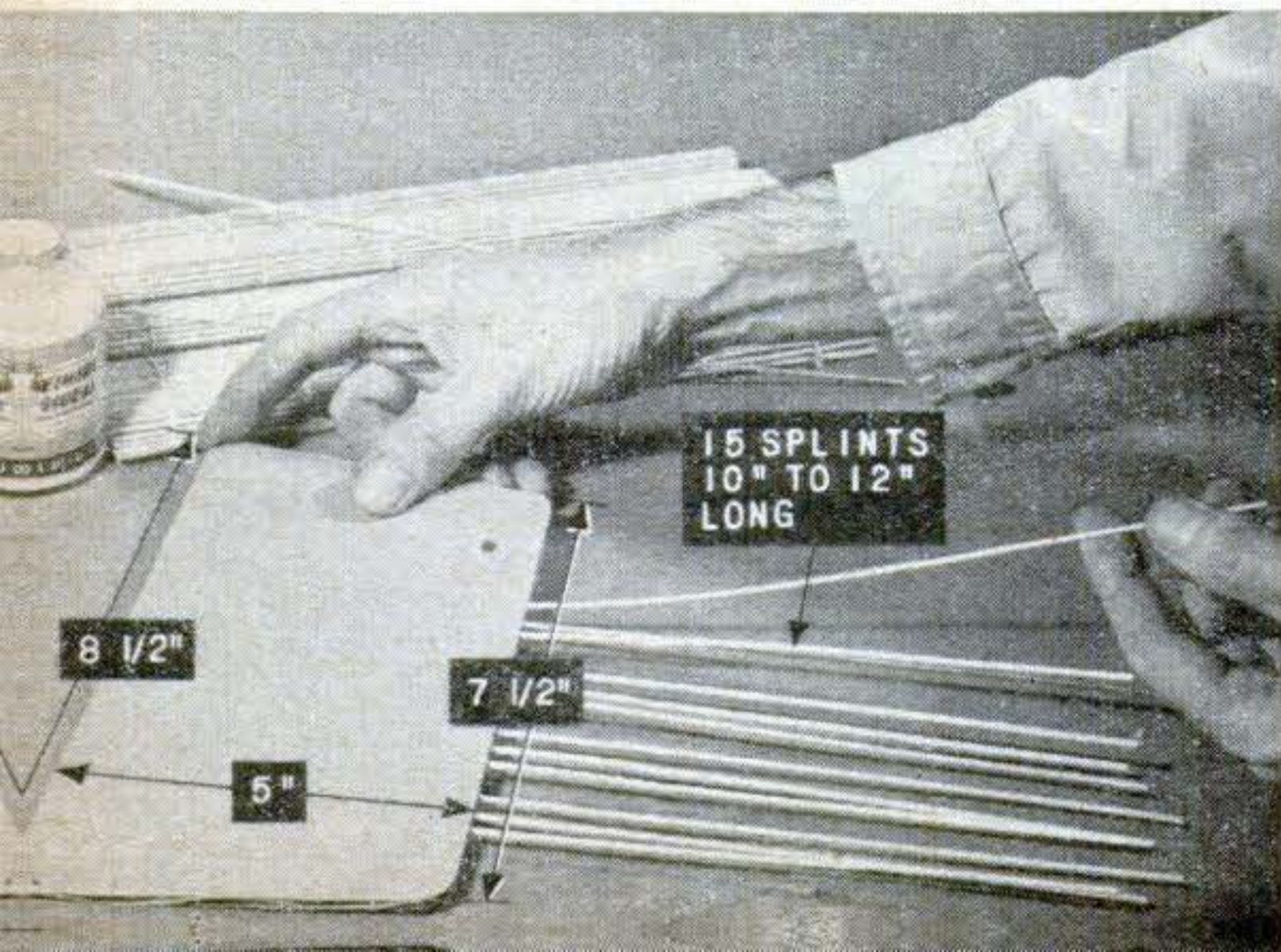

A touch of greenery comes into the living room with this planter lamp. Jigsaw the bracket and back from $\frac{3}{4}$ " stock. Drill matching holes in the two parts for the cord, and gouge a groove down the back. Drill the vertical hole undersize and screw a $\frac{1}{8}$ " pipe nipple into it.

Sand well, rounding all edges. Join the two pieces with glue and one counter-sunk screw. Attach a hanger or drill a slanting hole for mounting. Then shellac or varnish, and wax. Run cord through holes and nipple, which takes a standard socket.—*John G. Voelker, Towson, Md.*

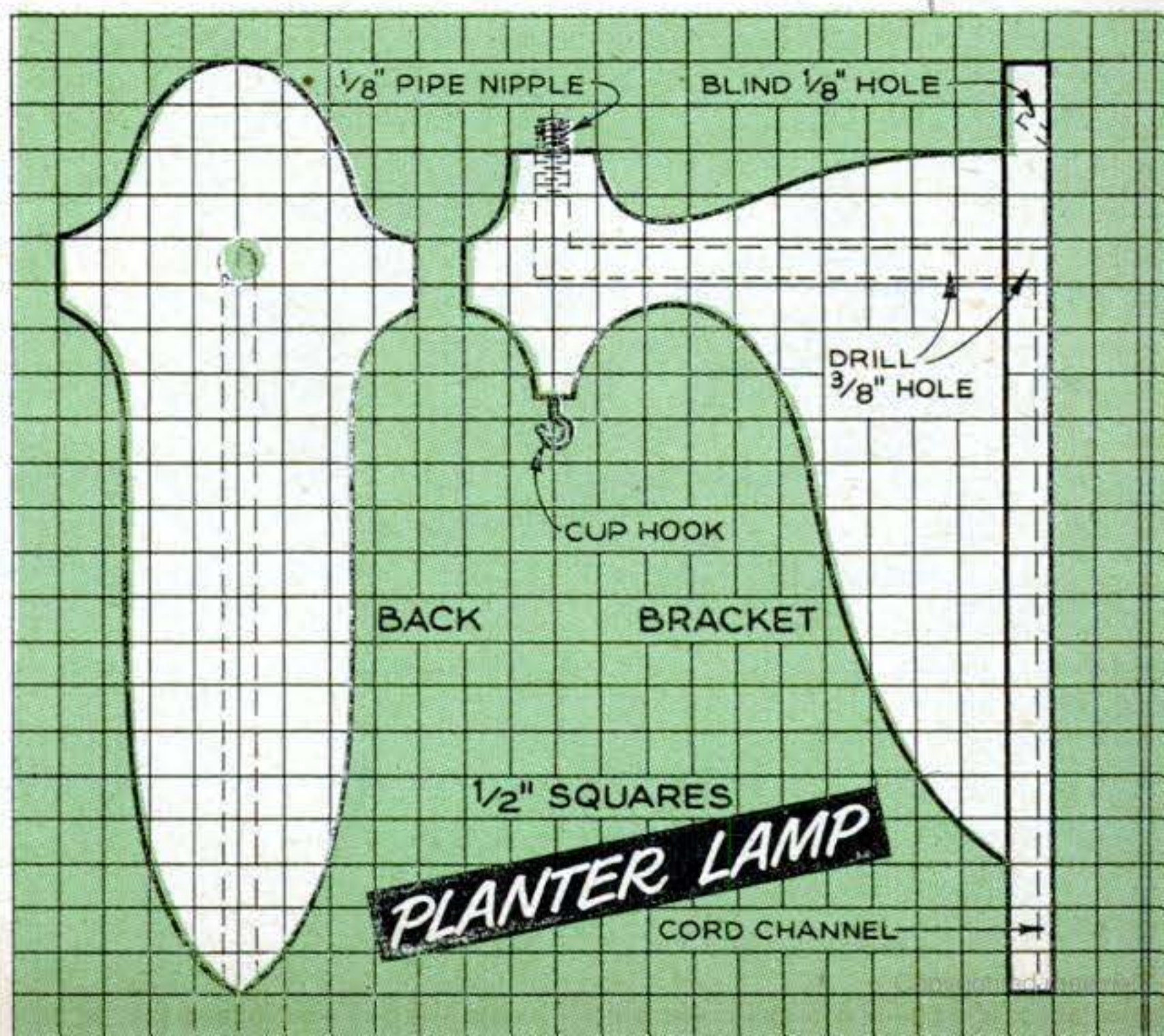

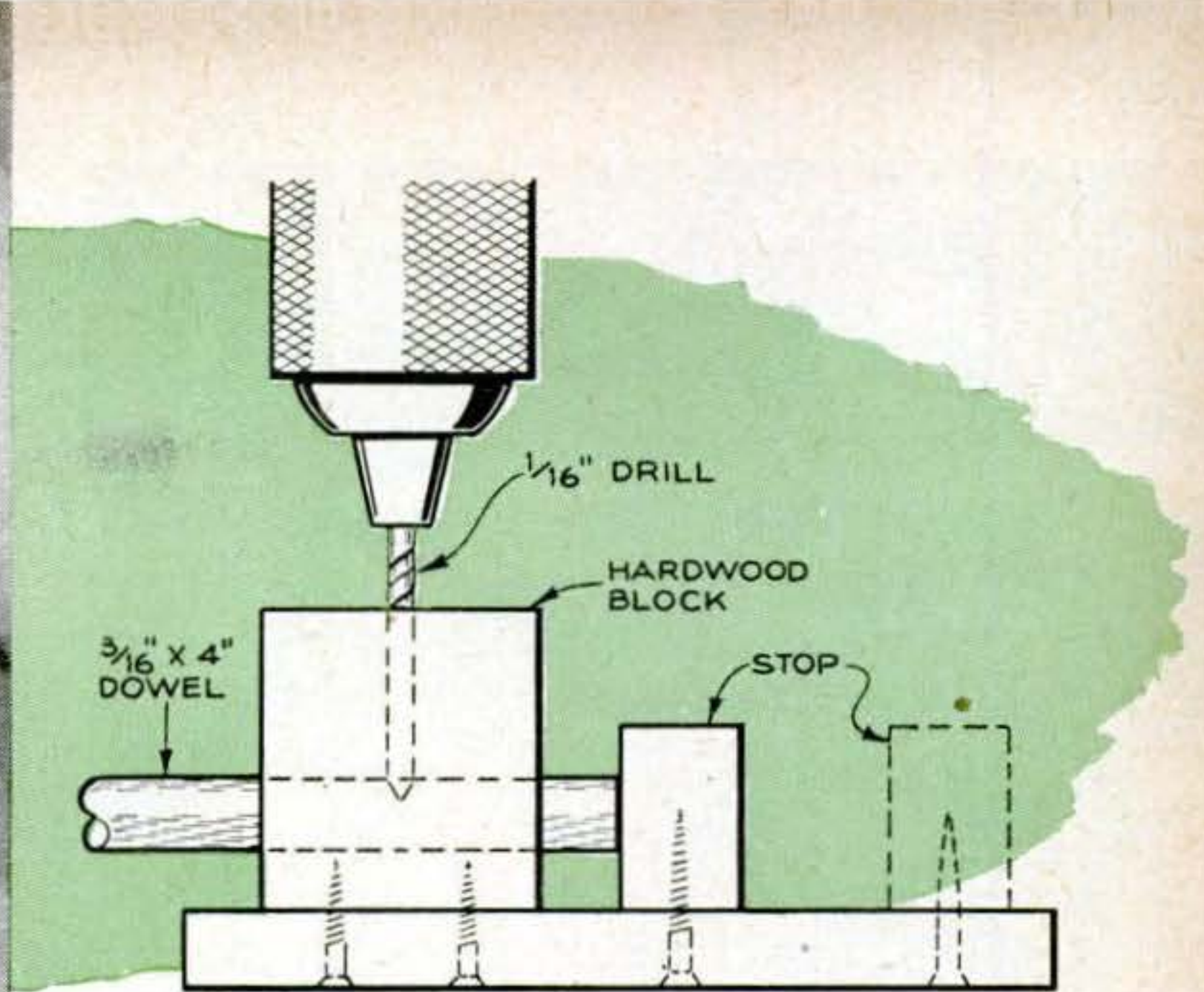
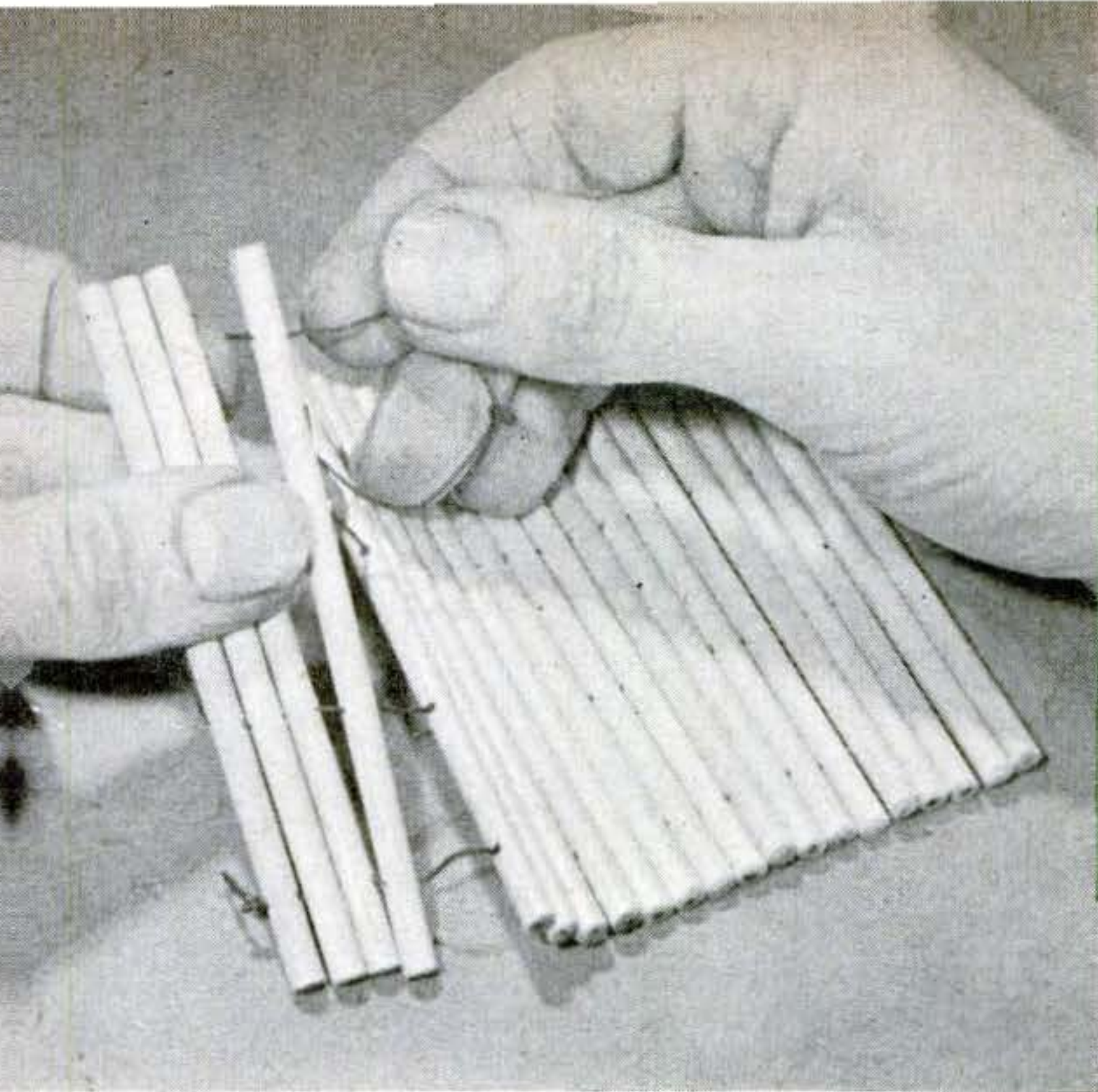

JIG SPACES HOLES right if dowels are all the same length. Drill holes near both ends with the stop close in. Move it away to drill the two inside holes. Thread cord as at left.

Six pairs of pants

can be hung on this space-saving rack which can be folded against the wall. Saw both side plates at one time by tacking two pieces of 1/4" plywood together. Glue and brad them to the back strip with the top bar and brace between. Finish with a hard wax. Mount securely on the wall with a screw through each end of the back strip, using screw anchors in a plastered wall.

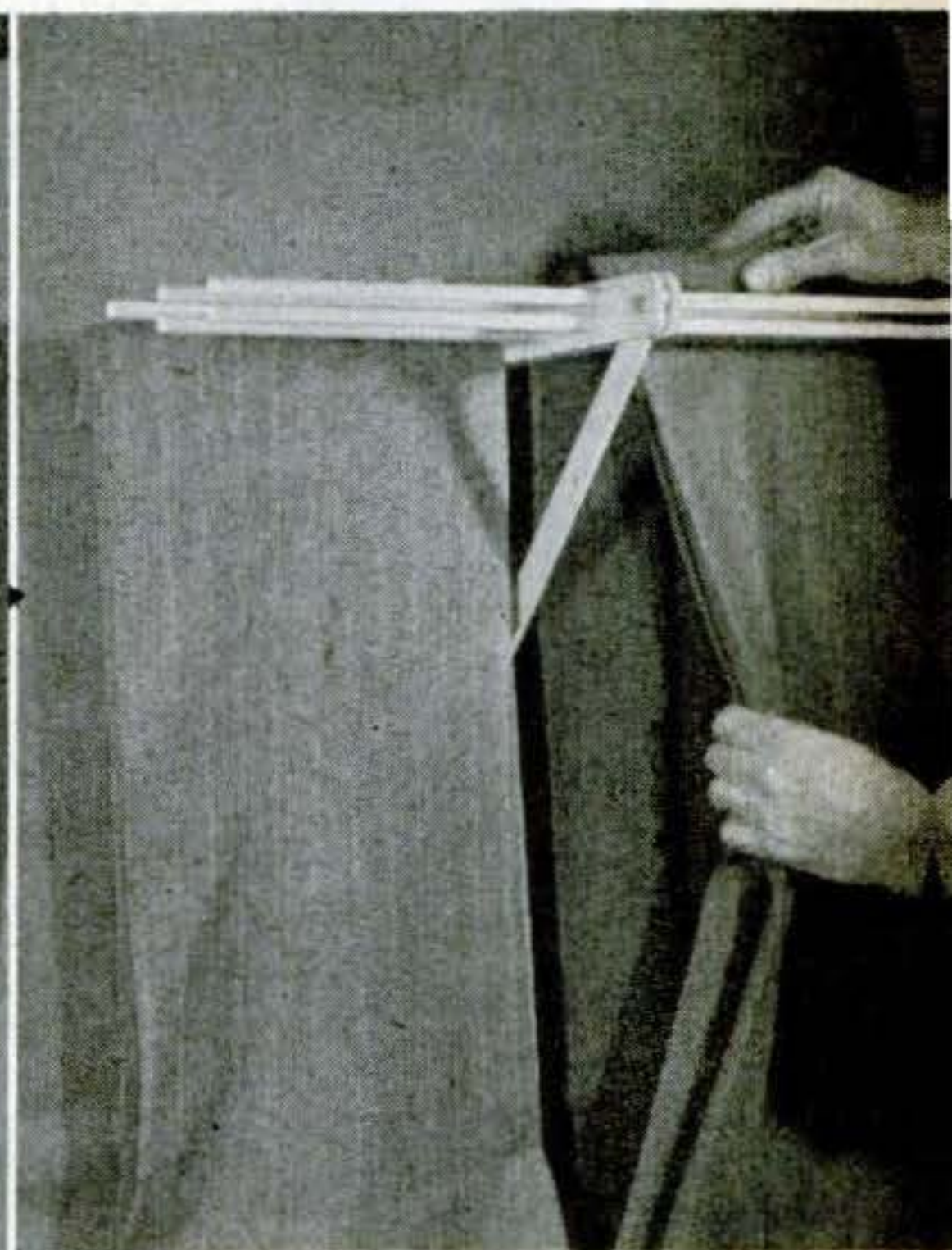
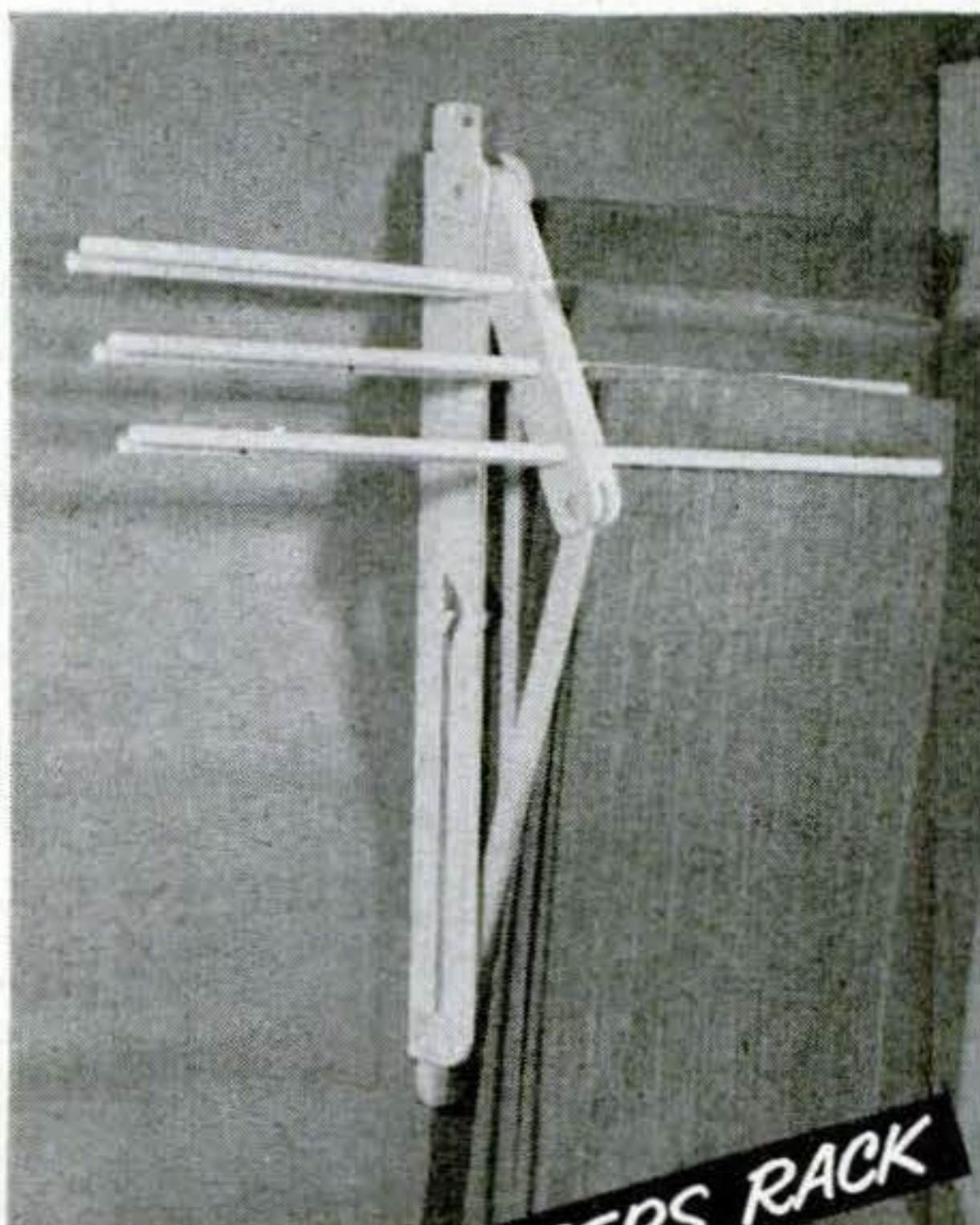

TROUSERS RACK

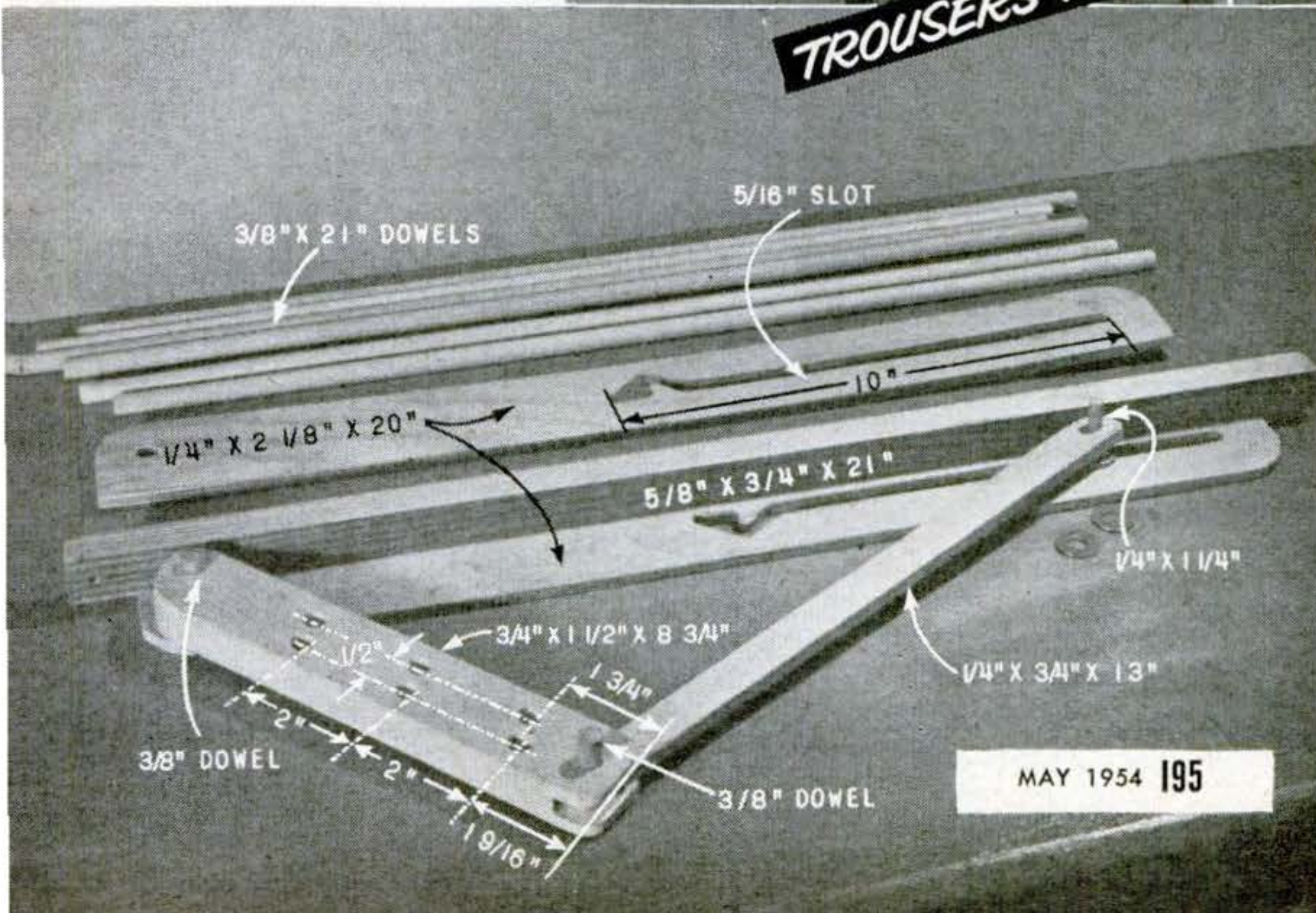

TO HANG trousers, raise top bar until brace drops into a notch cut as in the drawing below. Cuffs go above the paired bars, which should be 3/16" apart.

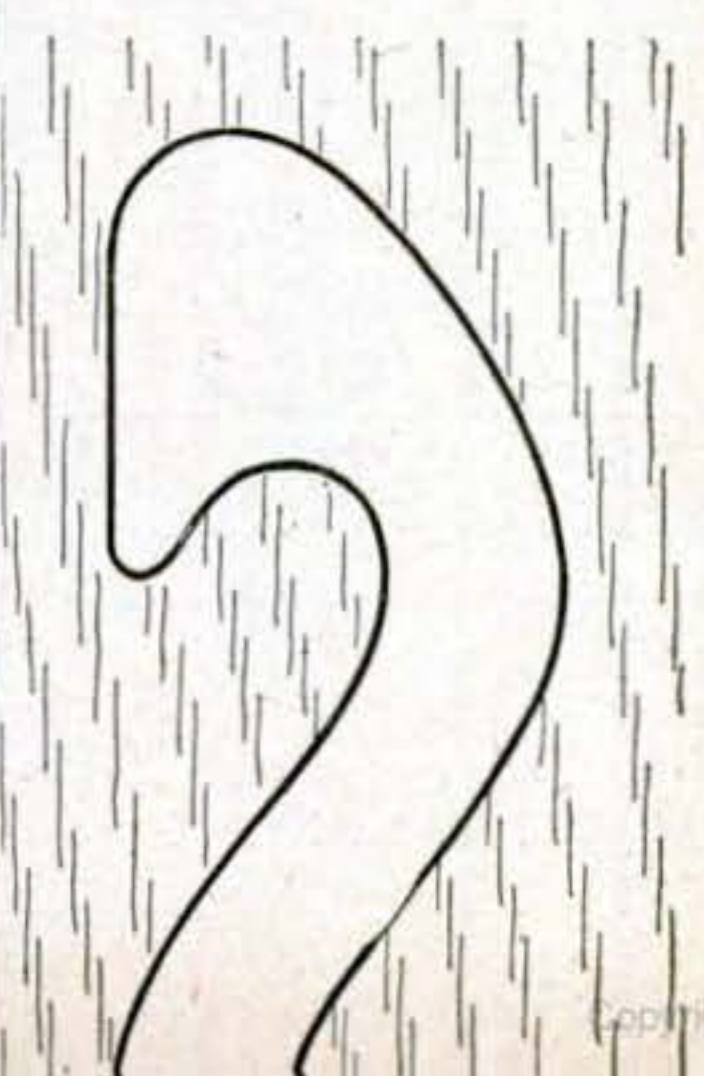

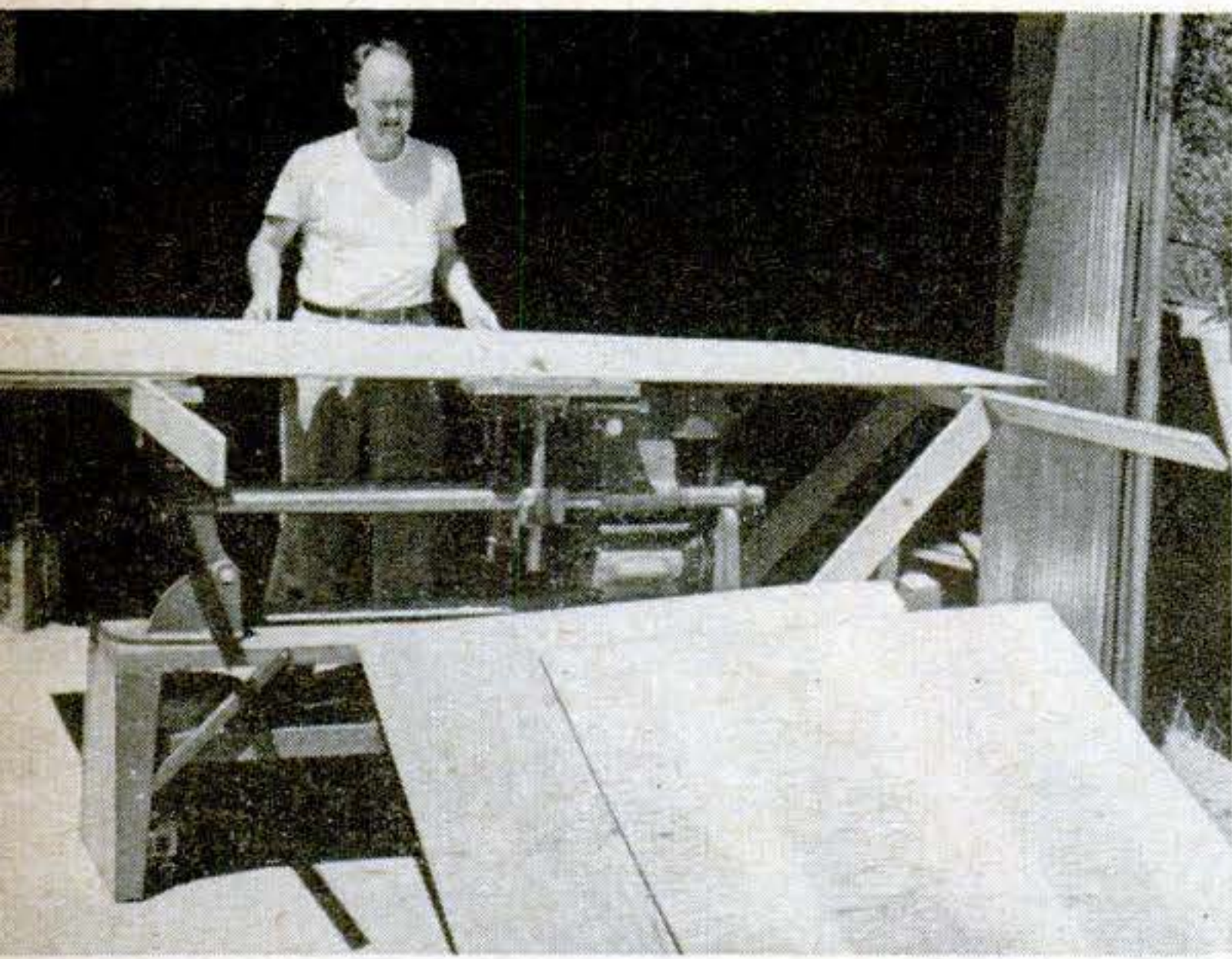

Saw Outriggers Hold Large Panels for One-Man Cutting

ALTHOUGH not elaborate, these extensions for a combination power tool make it possible for one man to cut large panels accurately without help. They are bolted in place.

One extension supports the panel while it is being cut. The other extension is fitted with a fence to guide the panel as well as support it. Settings for cuts of different widths are made by moving the saw table toward the fence or away from it.—*Darrell Huff, Sonoma, Calif.*

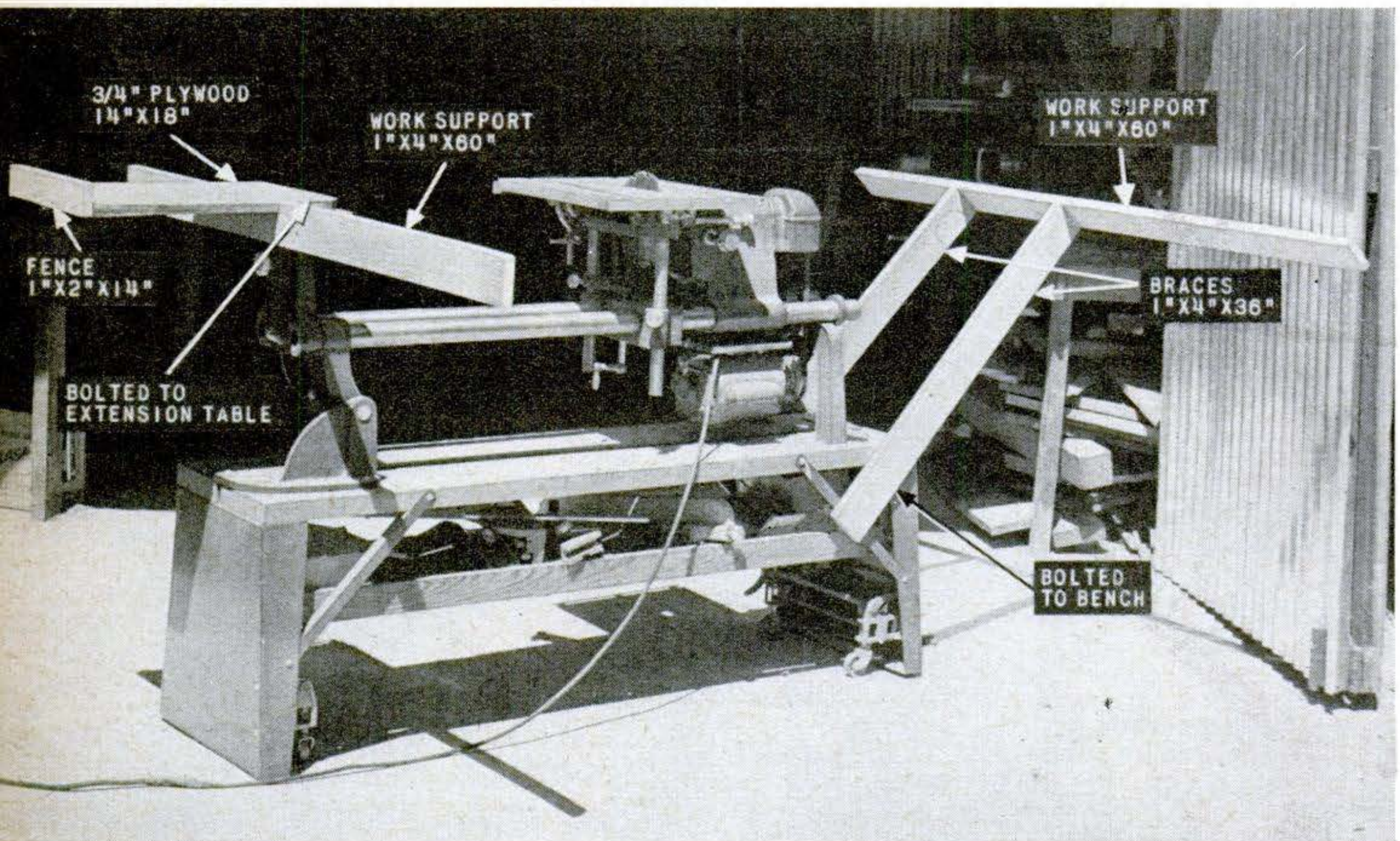

Door Braces Add Beauty, Too

You can add corner braces to a sagging or weakened screen door and still keep them attractive-looking. Scroll-saw the braces from $\frac{3}{4}$ " pine and fasten in place with No. 12 flathead screws, countersunk and puttied over. Cut them so that the grain runs along their length for greatest strength.—*Hi Sibley, Nuevo, Calif.*

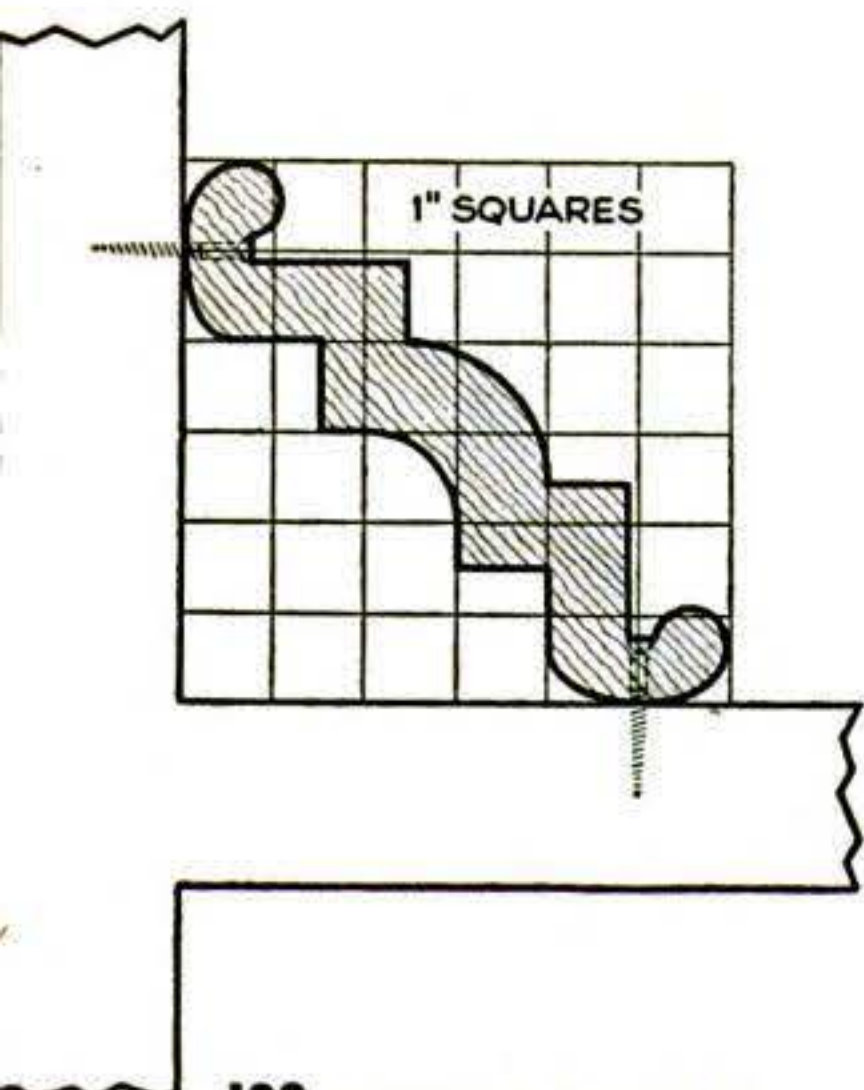

Fishing-Pole Cork Holds Hook

HALF of an ordinary cork taped to a bamboo fishing pole provides a safe, out-of-the-way place to anchor the hook when you wrap the line around the pole. Use a cork of any size, splitting it lengthwise.

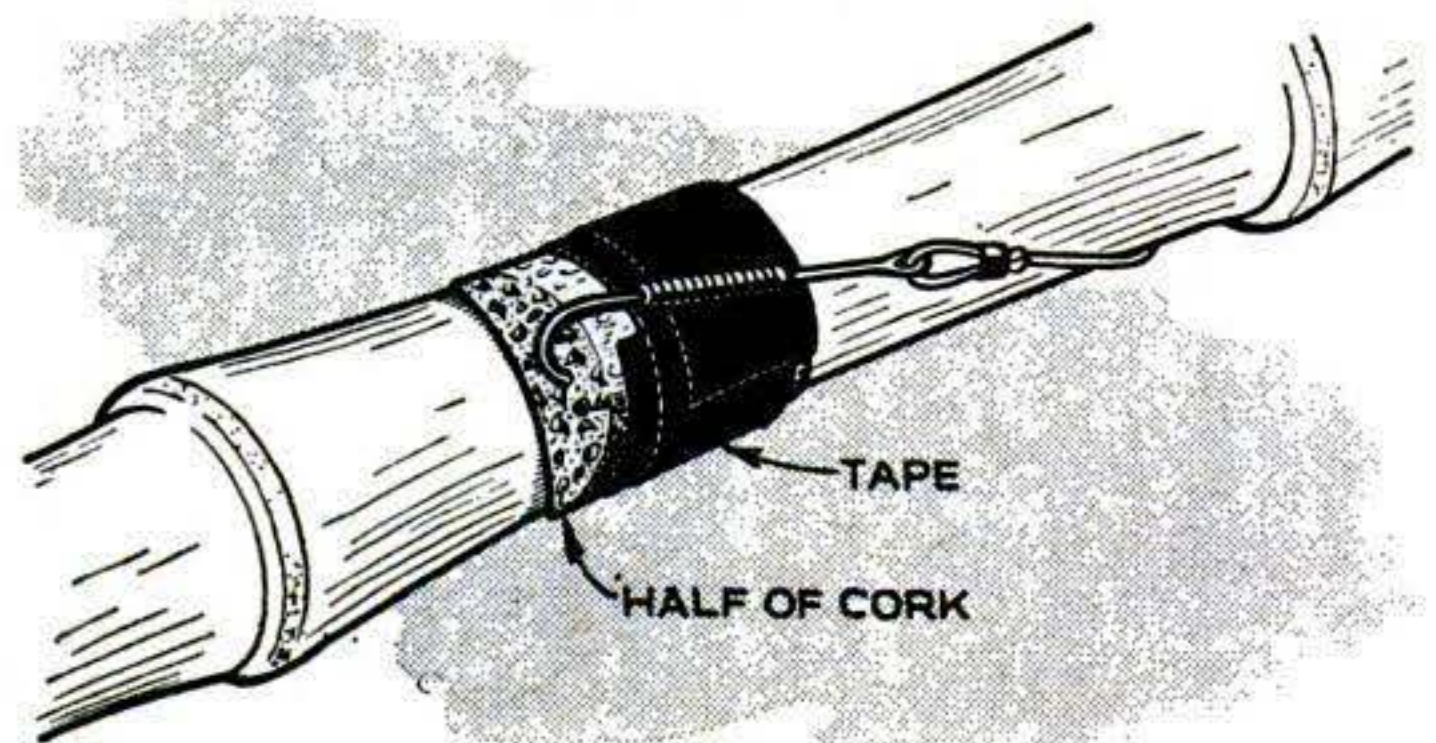

Lazy Susan Made from Scrap

IF YOU never know what to do with those small but beautiful wood scraps, here's a way to turn them into striking trays, lamps, bowls and other decorative projects. The striped lazy susan below was made by ripping narrow strips of dark walnut and wider strips of light maple. The strips were then glued together and turned on a lathe. The pedestal, made of solid stock, fits into an old front-wheel bearing from an auto-repair shop.—*E. M. Grassell, Corvallis, Ore.*

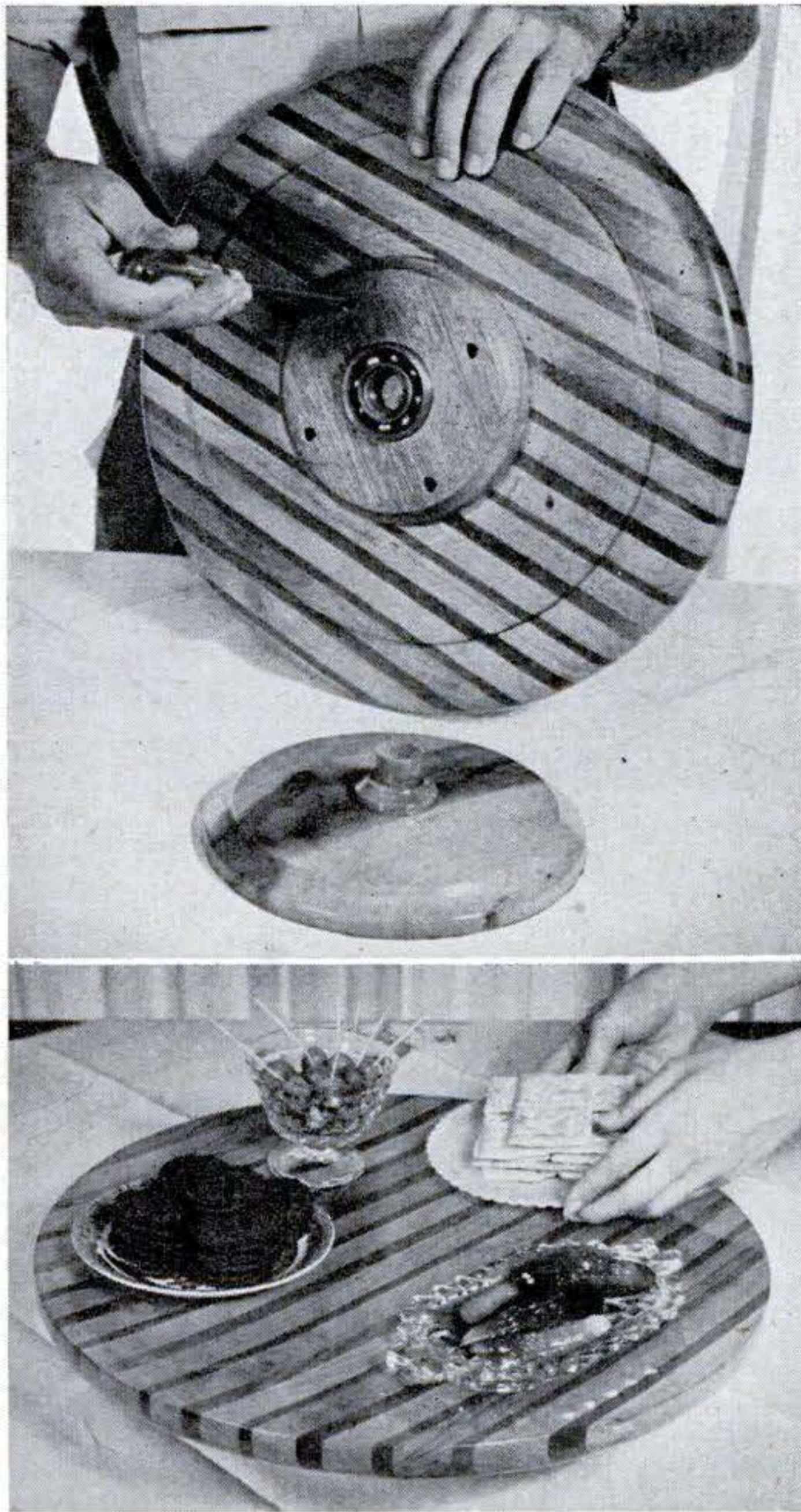

How to Avoid Sail Mildew

SAILS and canvas canopies can be made mildewproof by soaking for eight hours in a solution of $\frac{1}{4}$ lb. of sugar of lead (lead acetate) and $\frac{1}{4}$ lb. of alum for every five gallons of water. This should be effective for at least eight months. But handle the lead acetate carefully; it's a poison.—*Robert D. Simpson, Coconut Grove, Fla.*



Magnet Hunts Hidden Drains

A CONSTRUCTION job called for finding many floor drains hidden under concrete or tiles. Although blueprints showed them, they were often far enough from the indicated spots to require breaking up much of the floor, which cost extra time and work.

The problem was solved with a small Alnico bar magnet, tied to a cord at its midpoint to balance horizontally. Moved over the area $\frac{1}{2}$ " above floor level, it dipped sharply when over the drain. Slow manipulation then made it outline the rim of the drain, which was marked out in chalk.—*Henry Philleo, Framingham, Mass.*



Wire Backing Petproofs Fence

WITH many houses, a fence of the open, rustic kind looks good, but it won't keep in pets or children. You can make an effective barrier by nailing chicken wire to the fence. From a distance the wire is invisible. If you have pets, peg the wire to the ground to prevent their digging under it.—*Bruce C. Vaughan Jr., Springdale, Ark.*

You can turn with the sun this summer on a

Fire-Net Lawn Lounge

A piece of canvas, some awning lacing and metal conduit will make this bouncy job yours.

By Roland Loewen

MY NEW lawn lounge is a steal—a direct-copy of the jump net that firemen use. The same laced construction that keeps the jumper safe gives the lounge a firm yet yielding surface that's ideal for a snooze. The round shape makes it easy for the snoozer to keep in the sun without getting up to turn the lounge.

The frame is $\frac{3}{4}$ " thin-wall conduit from an electrical-supply house. The 6' ring for the top takes two 10' lengths with a little left over. A third goes into the legs. You can use a homemade jig to bend the conduit into a circle, or have a metalworking shop do it for you.

The legs, made of three 30" pieces of conduit, stand a foot high. If you want the lounge to be three or four inches higher, use 40" lengths. Using another jig, the legs can be bent into a hairpin shape, a foot across the top and with a 3"-radius curve at

the bottom. I designed my legs, however, with two 120° angles, made by notching and welding the conduit. Either way, the ends must be welded to the ring, which you can have done for a few dollars.

Finish the frame by sandpapering it and painting it with a good grade of auto enamel. For the top, use #6 duck, 72" wide. If you can't find this width, it is easy—and cheaper—to sew two 36" widths together. I had an

FRAME is made of $\frac{3}{4}$ " conduit. I notched and welded the legs, but they can be bent to a curved shape if the conduit is first filled with sand in order to keep it from wrinkling.

How the ring is formed

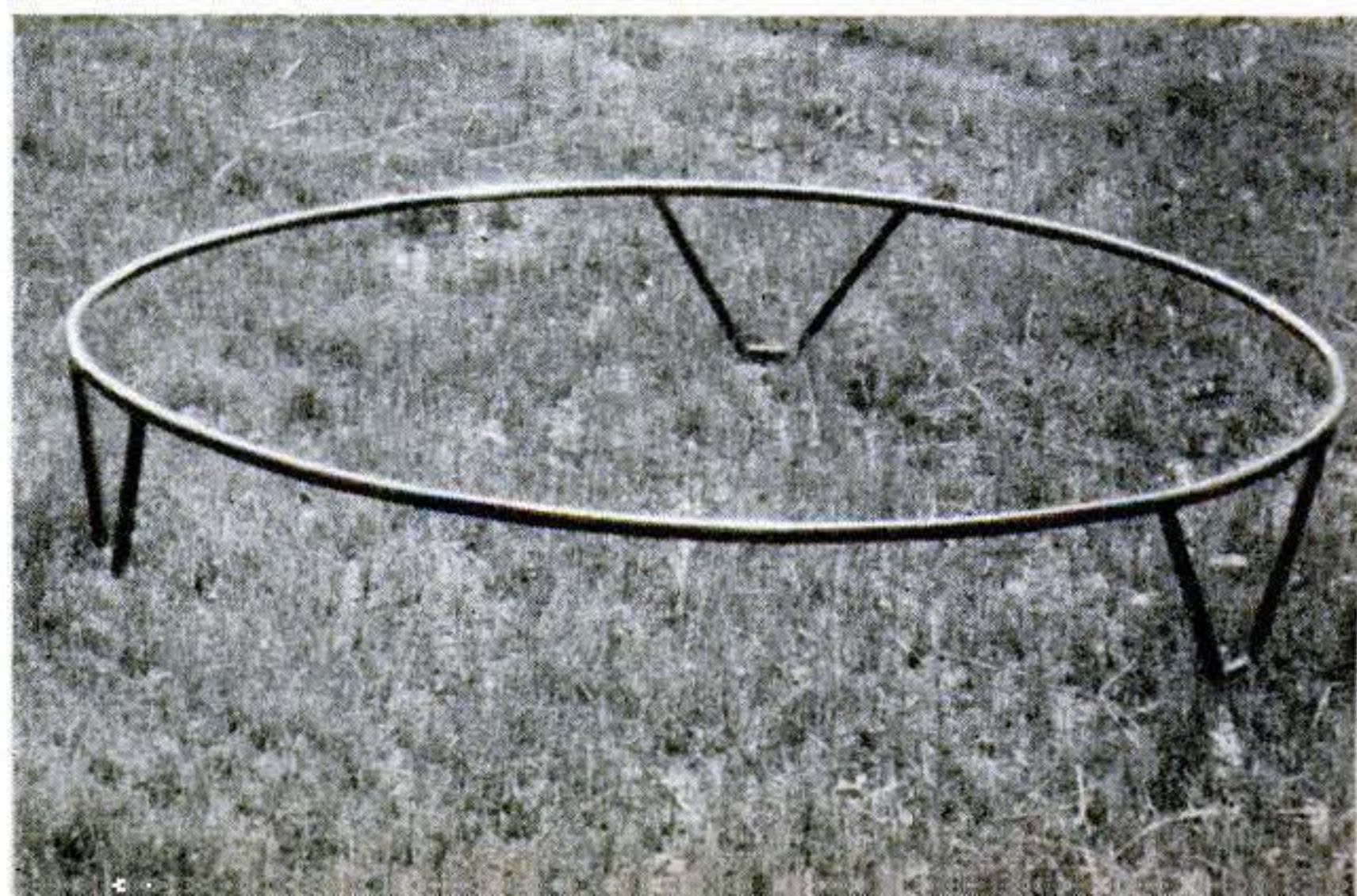
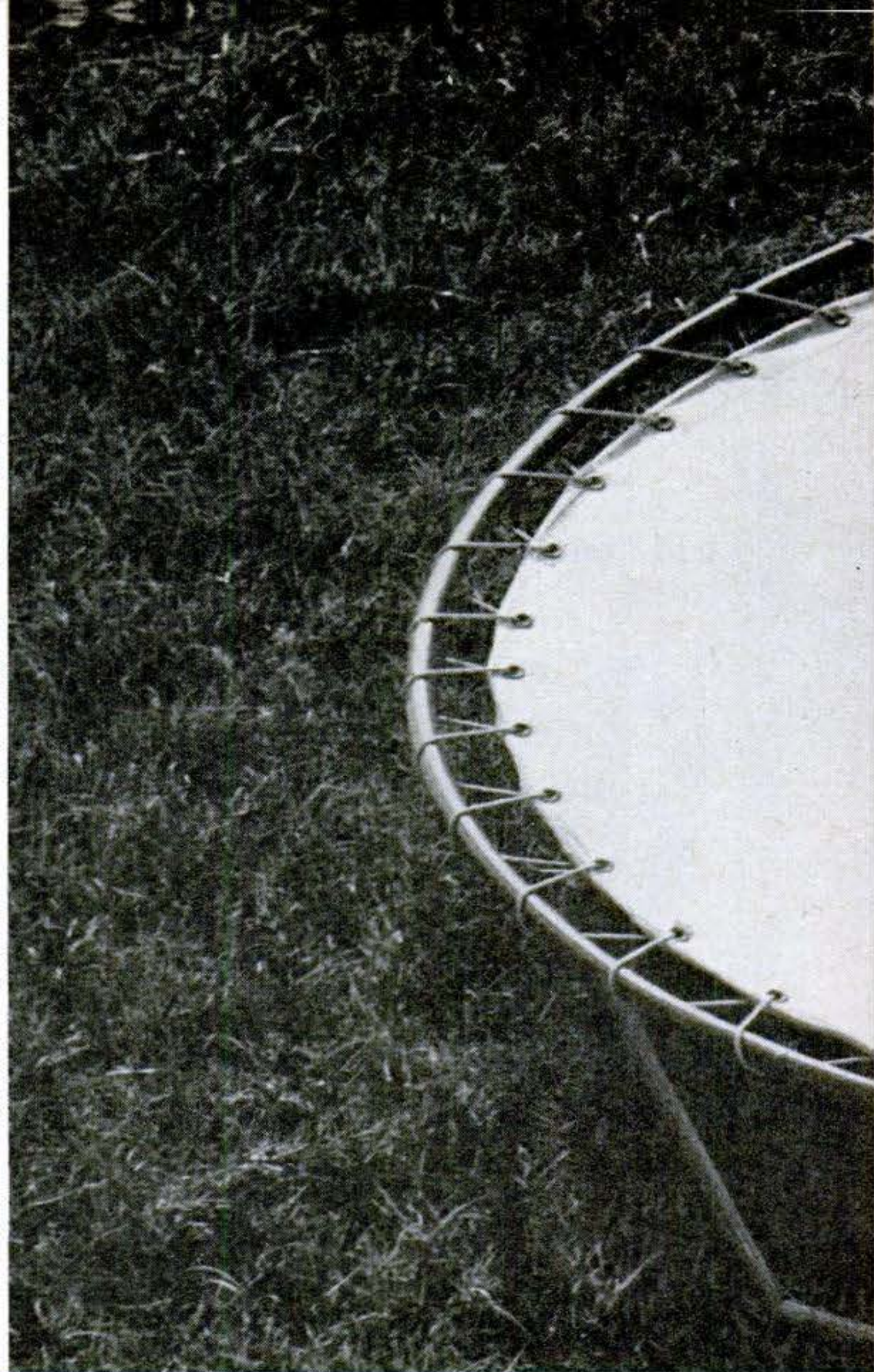

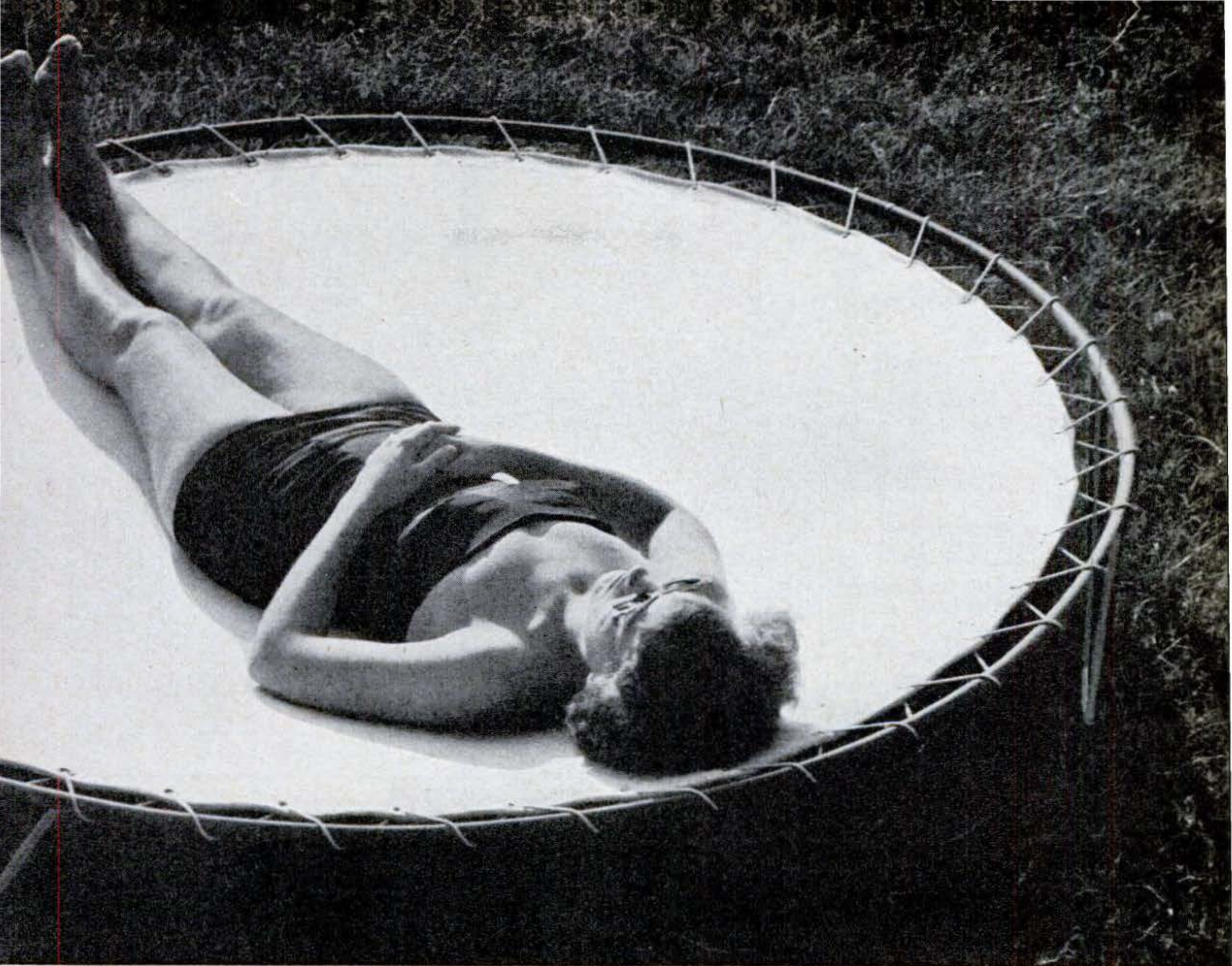

awning maker cut out the 6' circle. He left a 2" hem into which he stitched a rope, and inserted grommets for the lacing every 4". The lacing itself is awning cord.

Another way to make the frame would be to use aluminum tubing with the special fittings described in the February issue of PSM (page 201). In this case, the ring should be made of three lengths, connected with T fittings. The legs are short lengths of

tubing, slip-fitted into the bottom of the Ts. The lower end of each leg must be bent back on itself to make a round tip so that it won't dig into the lawn.

I find the lounge very comfortable—when I can sneak a chance to use it—and its striking shape has attracted a lot of comment. What's more, it is mighty handy to stow away each fall, just by hanging it on a nail in the garage.

BENDING circular frame is easy with wooden jig fastened to bench. Insert one end of conduit between blocks and pull it against the curved channels. Push it along and repeat.

The jig is composed of two curved blocks on a heavy base. Each block is made of two $\frac{3}{4}$ " layers cut to a 3' radius and beveled in at 45° .
(Please turn the page.)

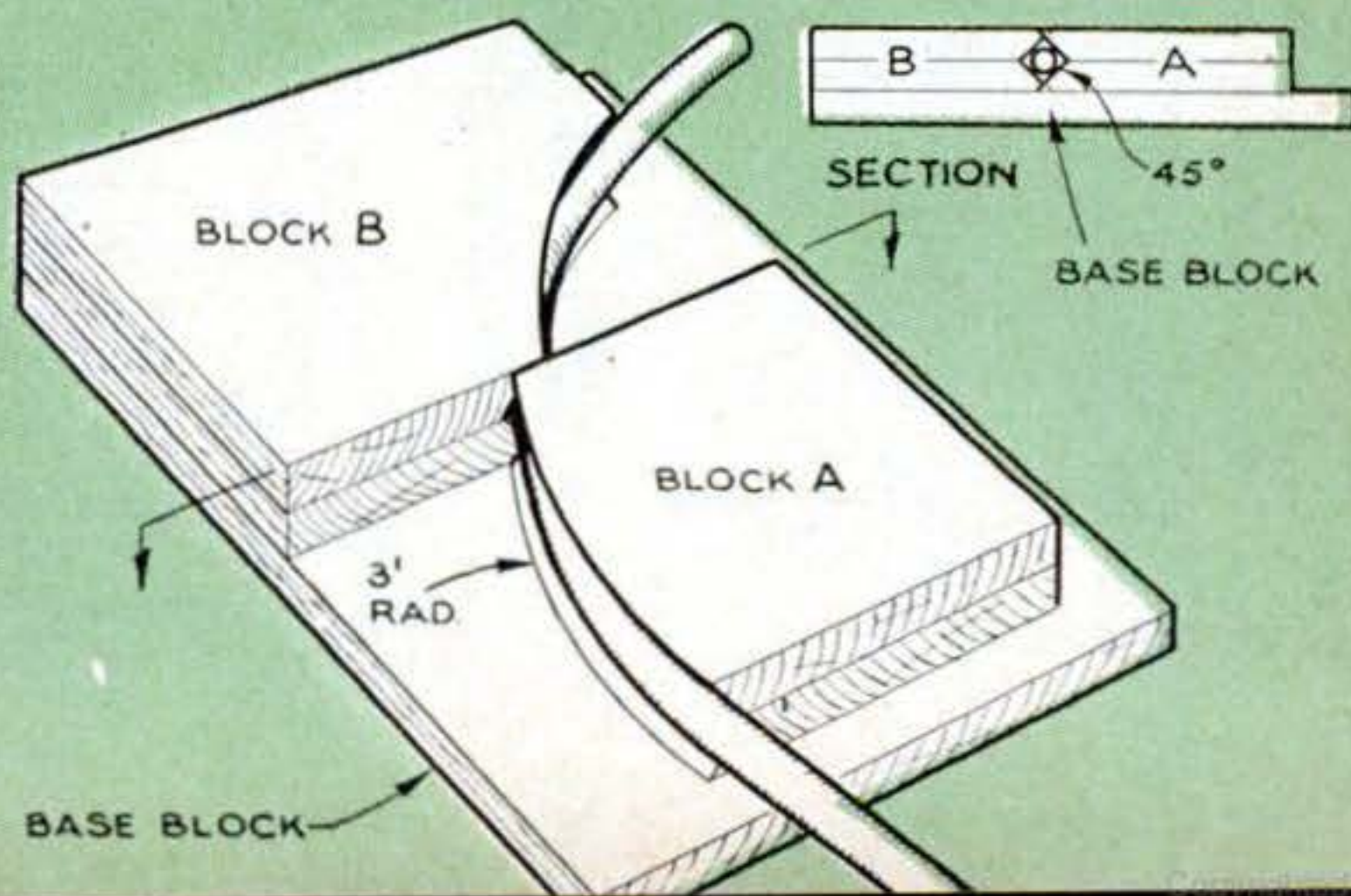
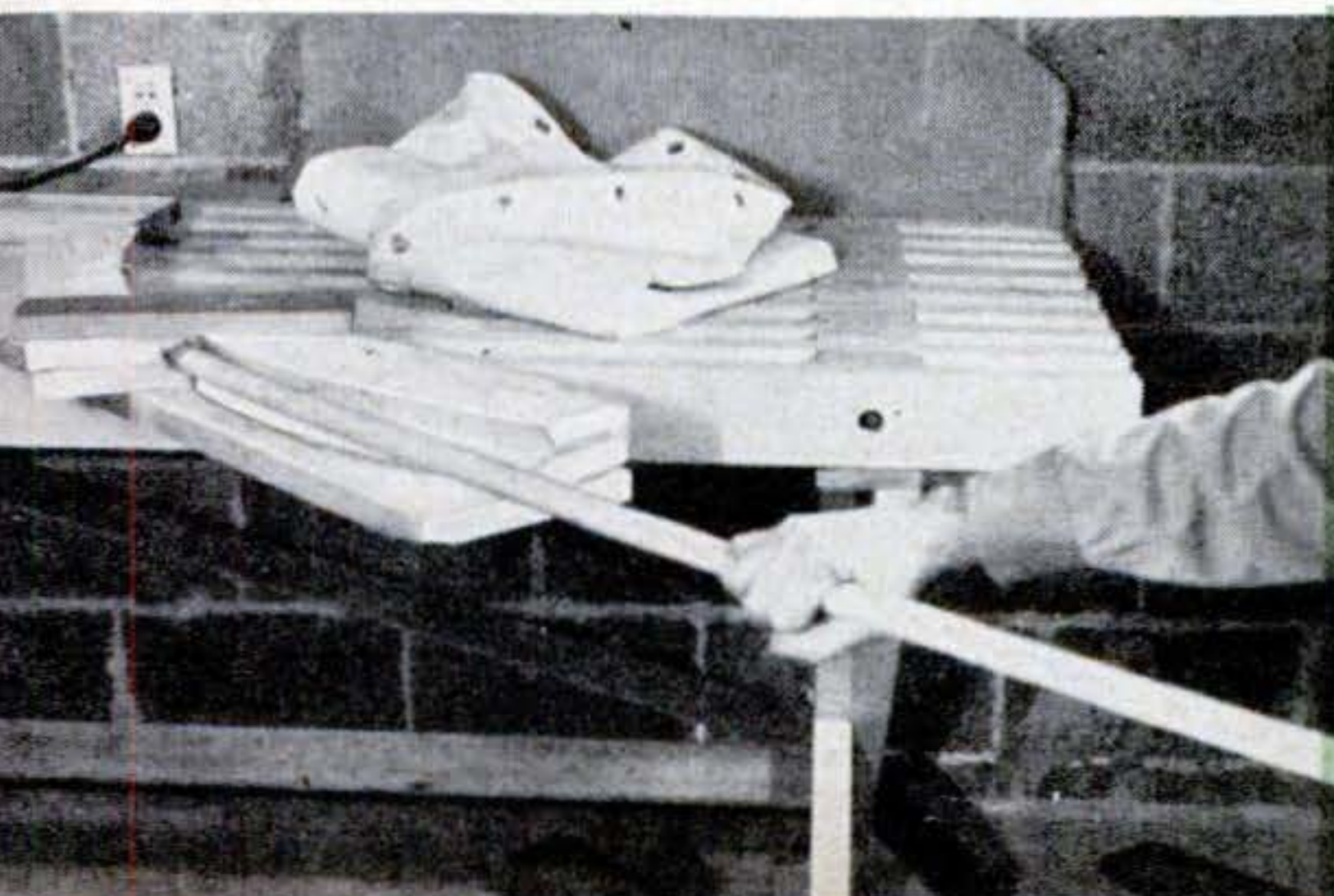

How to cut and notch legs of the fire-net lounge

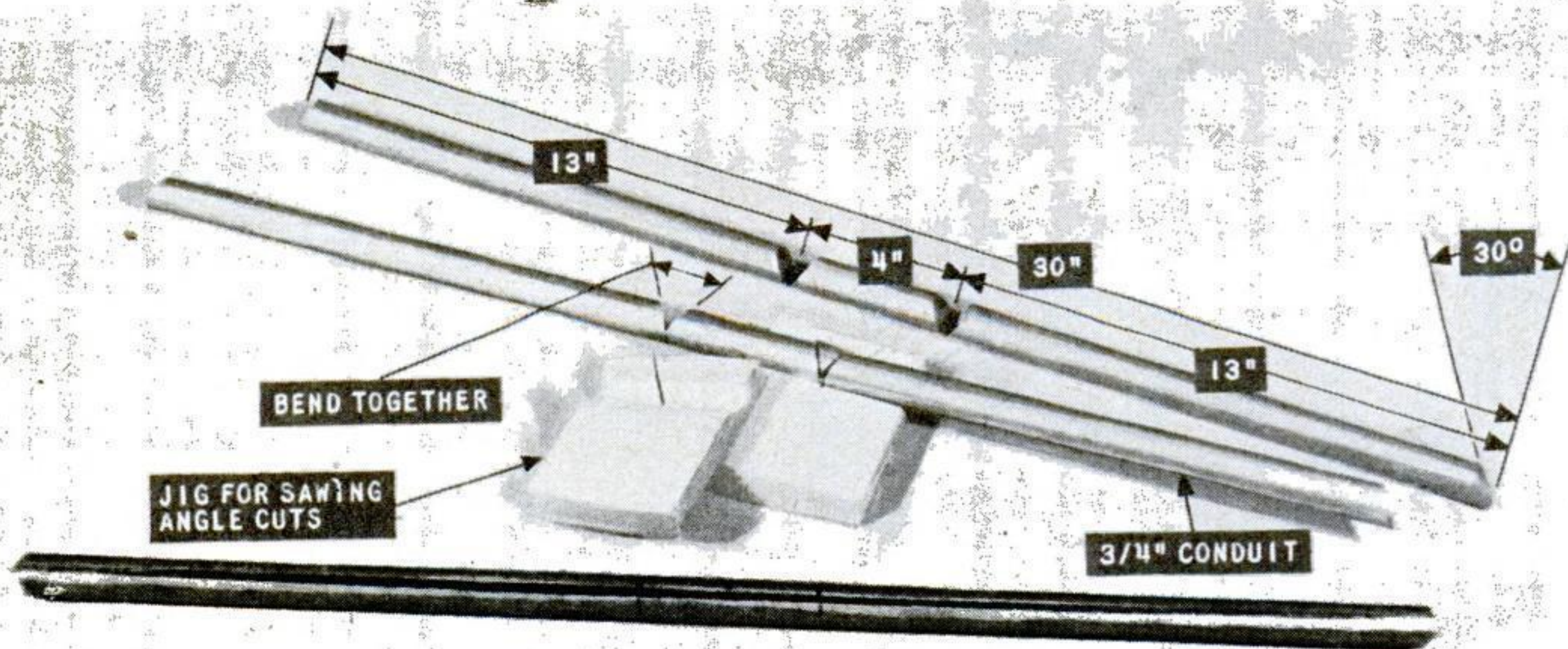

LEG PIECES, marked for notches, are shown above with cutting jig. I made index line, shown on bottom piece, by running a pencil along top of a $\frac{1}{2}$ " board, as at right. When cutting angles I matched this line to a mark on miter so that cuts were aligned. Otherwise legs would have been crooked.

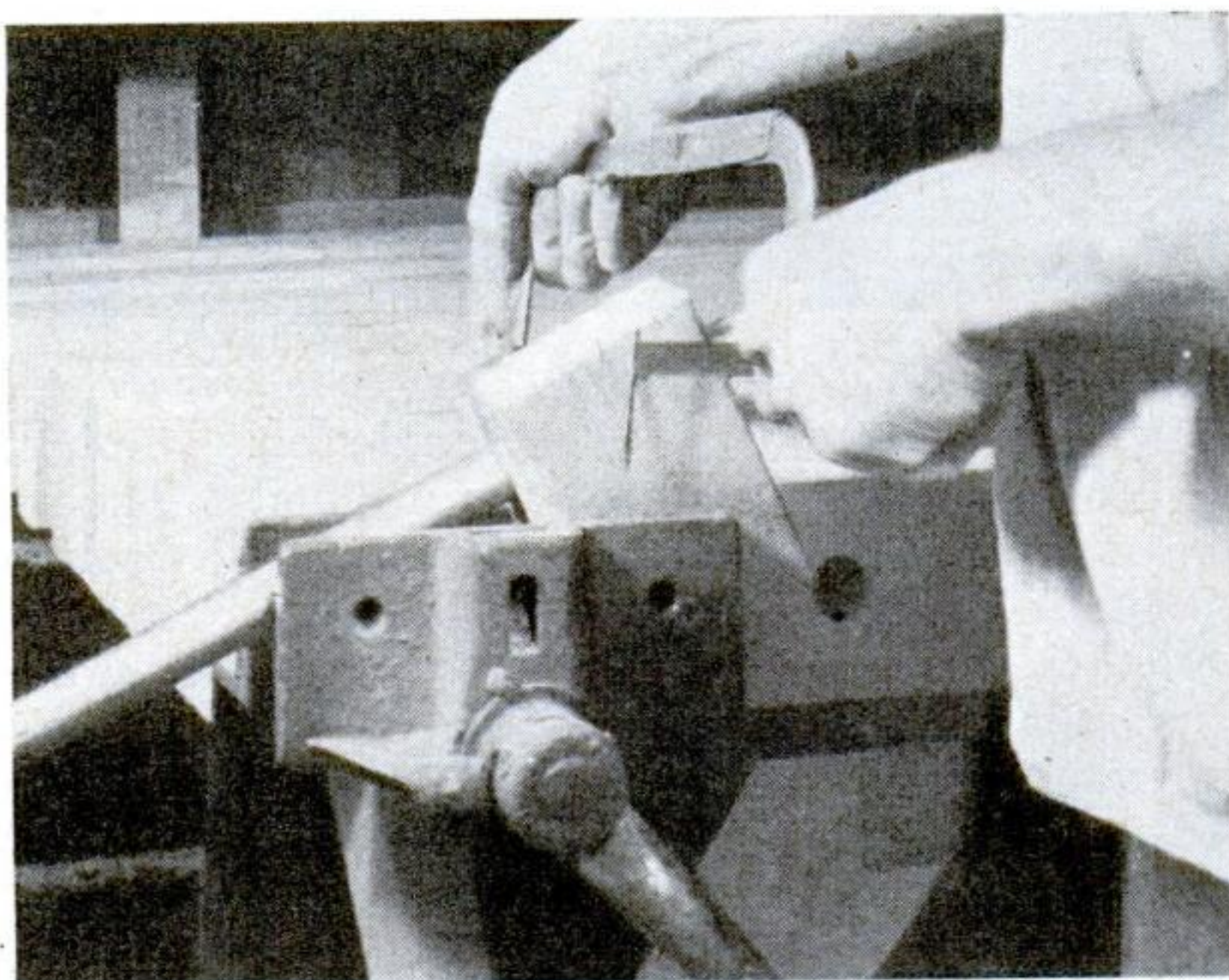
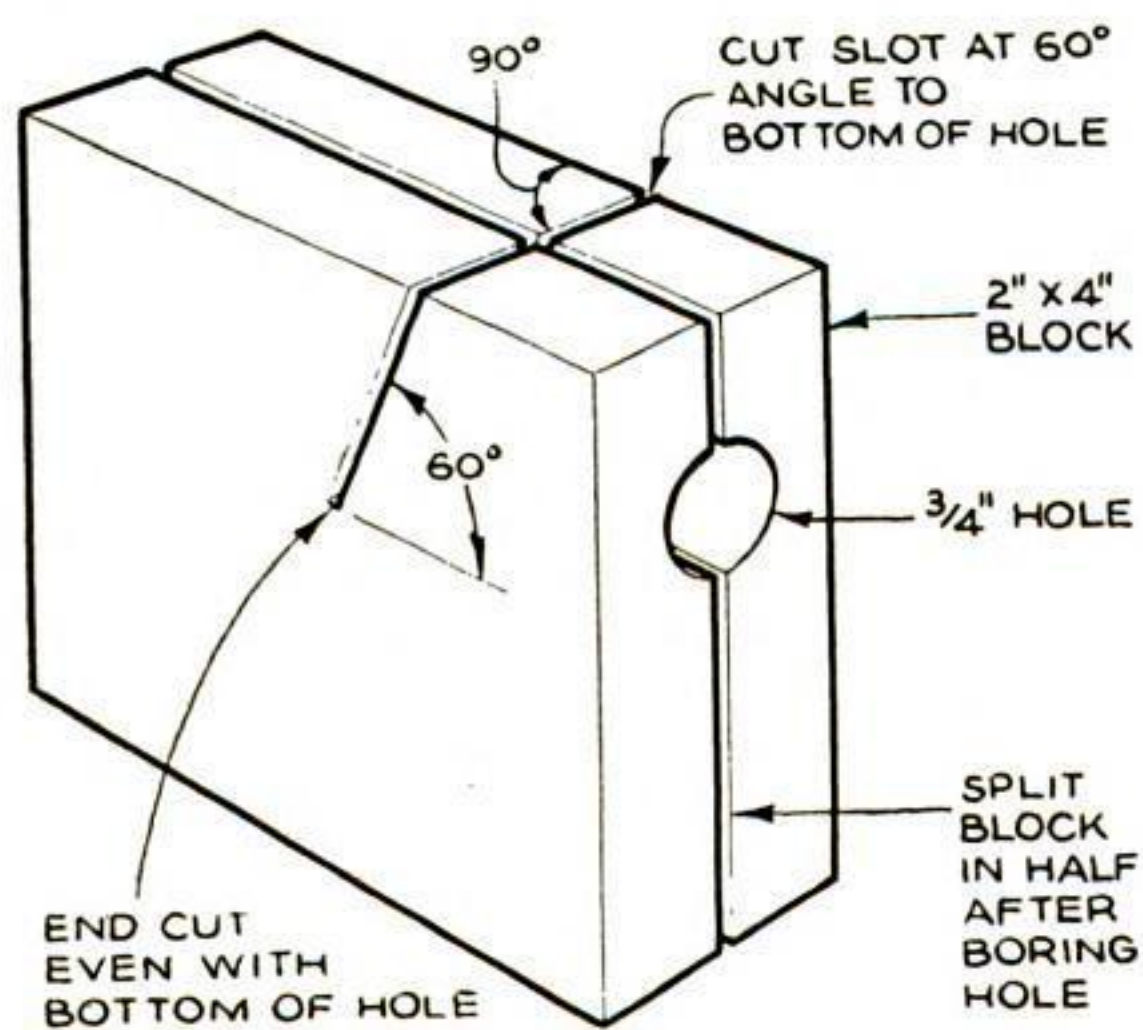
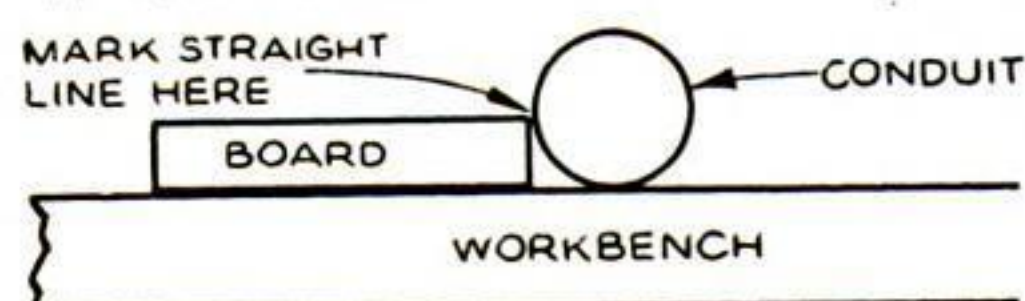

JIG FOR CUTTING 60° angle in leg pieces is made by boring $\frac{3}{4}$ " hole in 2"-by-4" block, hacksawing guide kerf at 60° to top, then sawing block in half endways through the hole.

JIG enables you to cut exact angle each time. Sandwich conduit between the two walls of the $\frac{3}{4}$ " hole, grip in vise, and hacksaw down through precut kerf. Be sure not to saw all the way through conduit when cutting the notches.

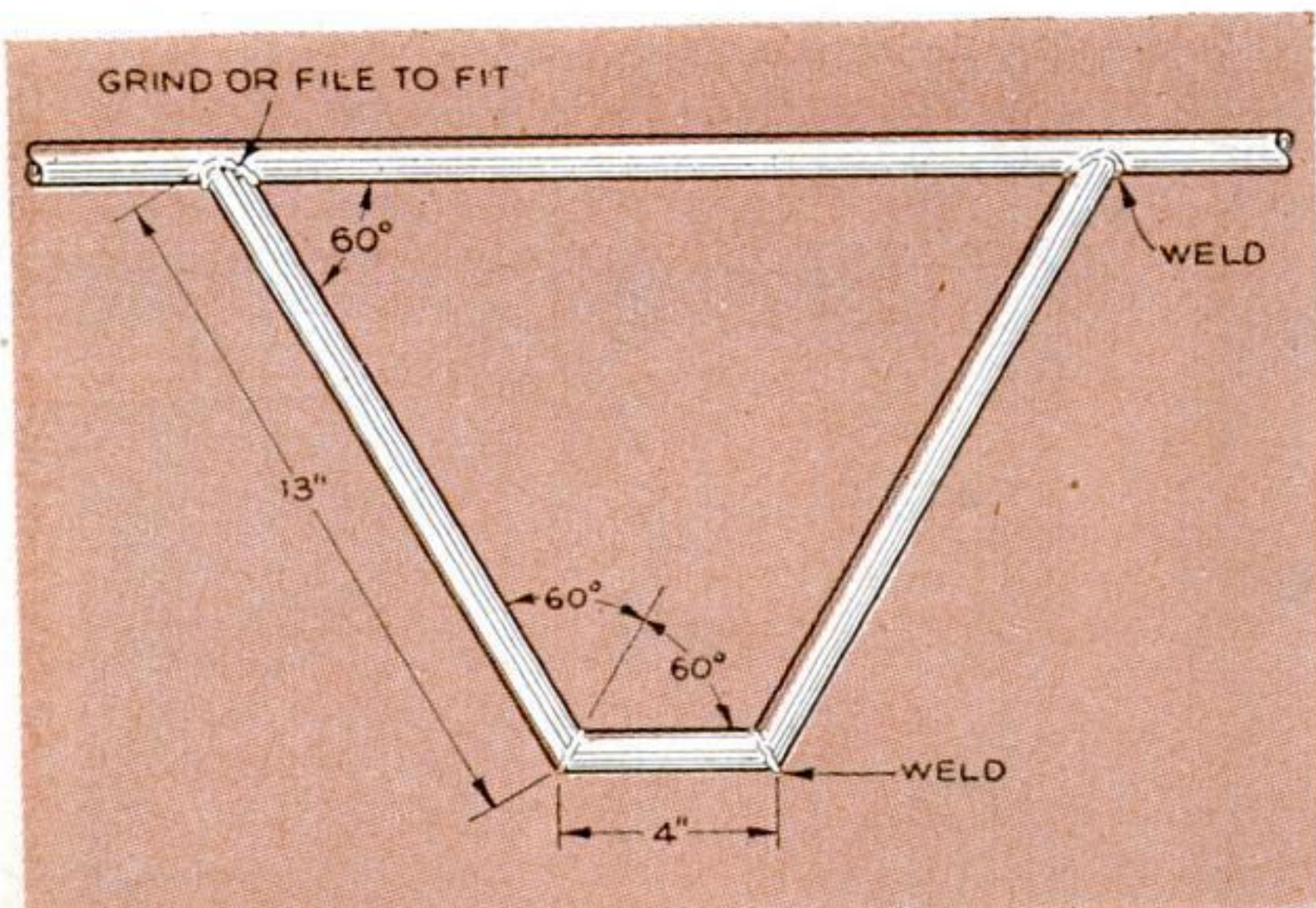

LEG, shown in plan at left, should look like the one above when finished. Notches are welded together; leg ends are filed to fit snugly against ring and then welded to it.

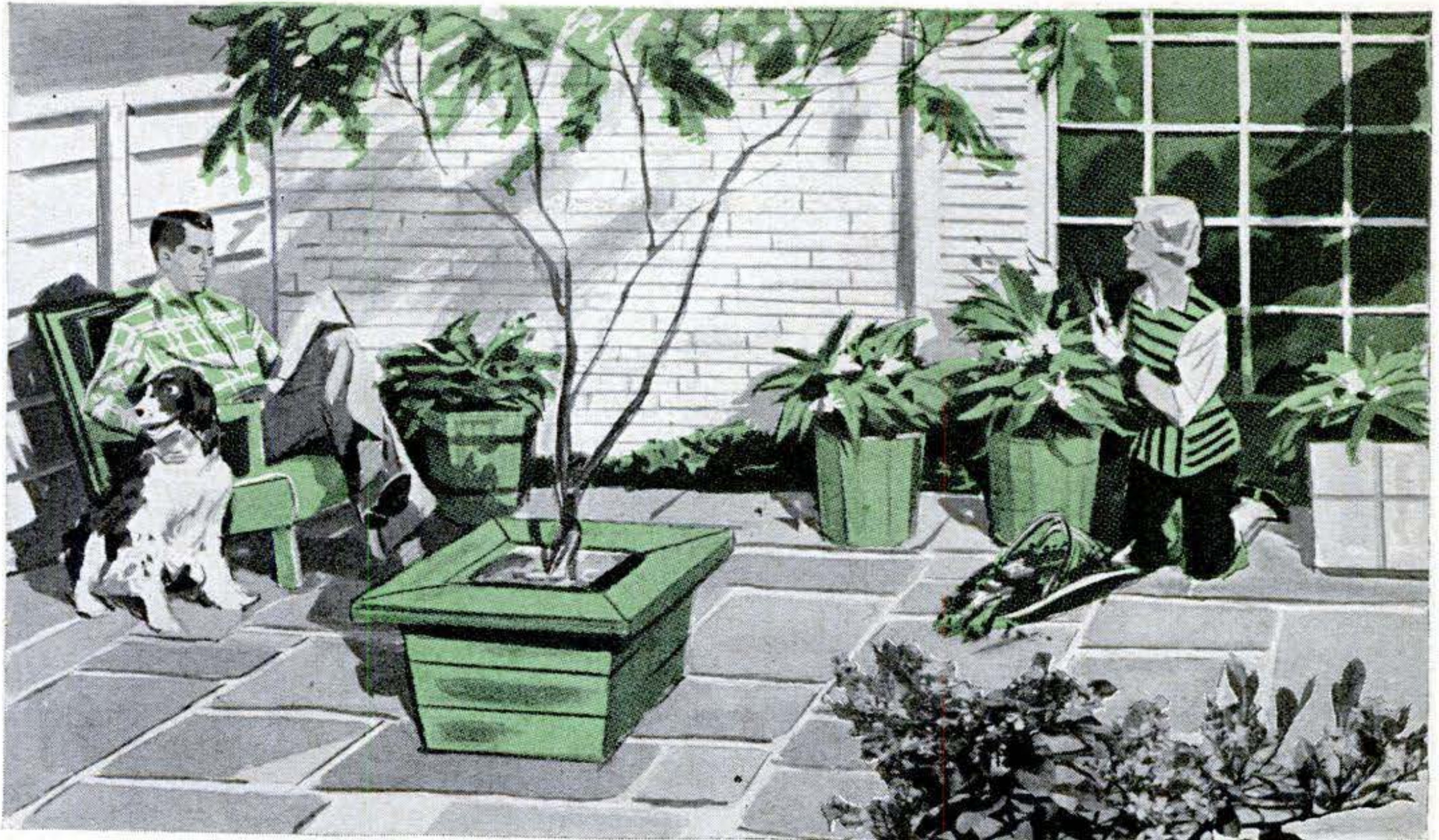

How to Build a Portable Garden

Using quickly made tubs, you can shift plants and shrubs around to create different outdoor effects.

By Jerry Parker

LET'S say you like shop work better than shovel work. Next time your wife suggests a garden session, tell her that you can do great things for home horticulture without leaving your bench. Then make her some plant and flower tubs.

You won't have to sell your wife on the notion. She probably knows something about what hep dibblers call portable gardening. Their system, they say, avoids monotony; you can shift plants to mass colors and create other effects. Shrubs in tubs are less likely prey for insects, too.

The shape of a plant or bush usually determines the size of the tub. A squat bush fits well in a low, square tub; a tapering evergreen requires a tall tub. Since plants

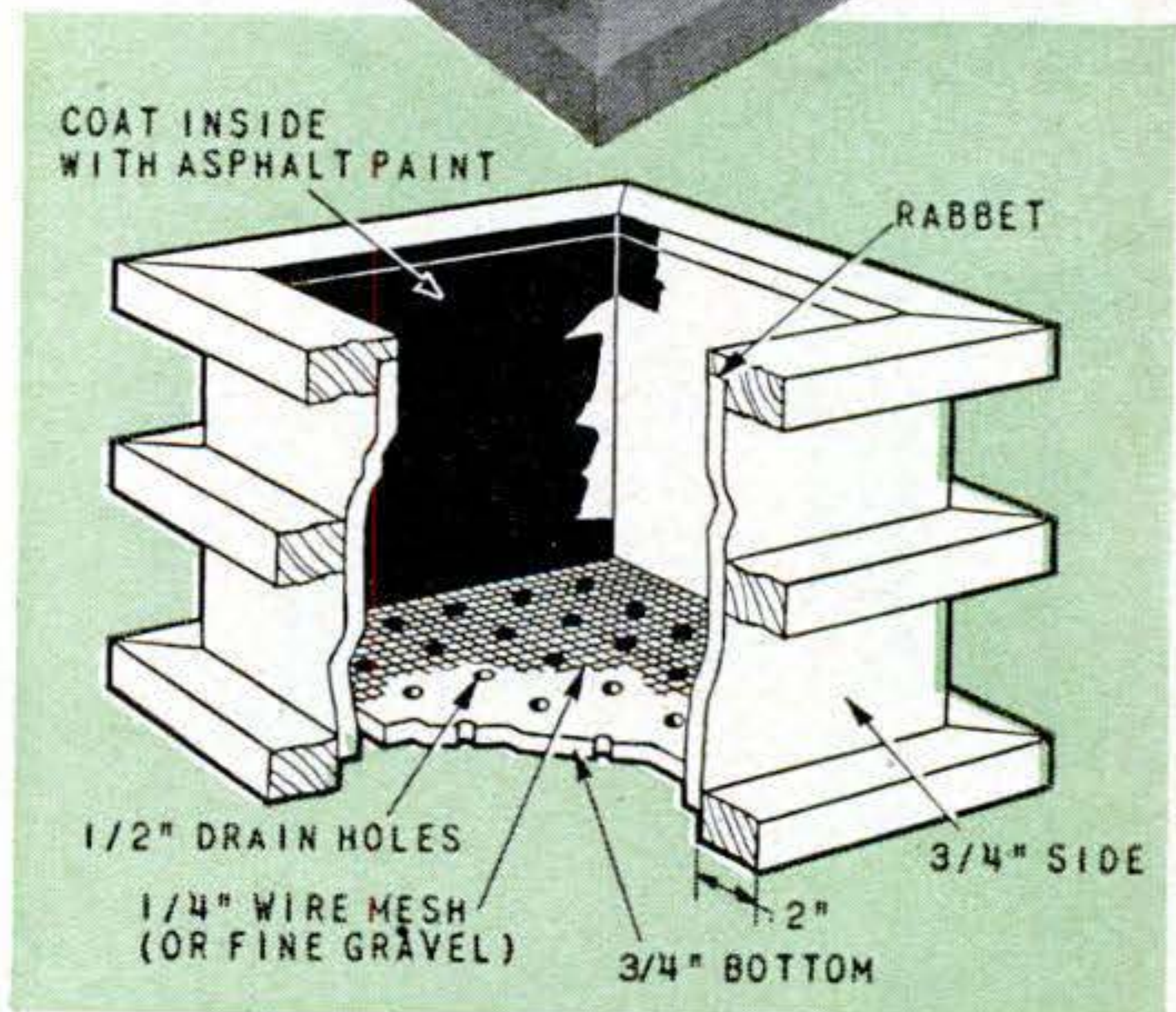

A GOOD-LOOKING TUB like this is easily made of 1" and 2" stock. The base of a tub should always be raised off the ground to improve drainage. Coat the inside with asphalt paint.



A NAIL KEG makes a fine plant tub, just as it is. But paint will give it a longer life.

PLANK TOP on this large tub serves as garden table. Top is redwood tongue-and-groove.

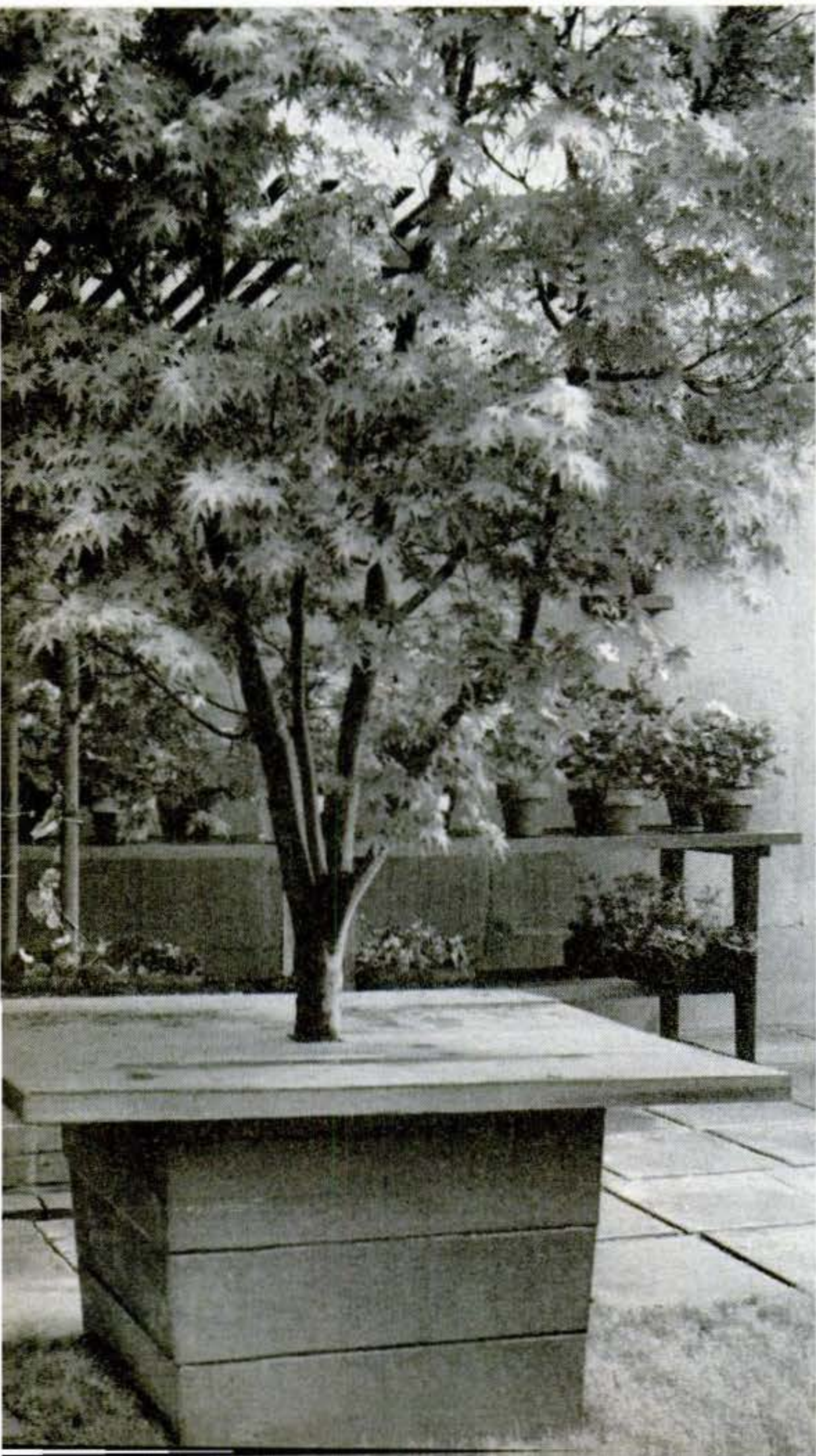

THIS HEXAGONAL TUB was made of clear redwood, bound together with linoleum edging.

need room for their roots, most tubs should be at least 18" deep and some will have to be 24" or more.

Unless you plan to paint or varnish your tubs, make them of redwood, cedar or cypress. They will weather beautifully. Use copper, aluminum or galvanized nails to hold them together. It is also a good idea to keep their bottoms off the ground with cleats.

Drain holes are a must. Half a dozen $\frac{1}{2}$ " holes should do. Put in gravel to keep dirt from clogging the holes or nail $\frac{1}{4}$ " wire mesh over them. The tubs will last longer if they are coated inside with asphalt roofing compound or asphalt paint.

Plant boxes are not easy to heft. You can roll them around, however, on short lengths of 1" water pipe. Or you can build wooden handles right into the tub. (Rope handles

ROUGH LUMBER used here was dressed up with grid design cut into the wide boards. Cleats underneath raise the boxes off the ground.





WOODEN HANDLES built on like this make it possible for two persons to shift the tubs

around in the garden. A skilled craftsman can decorate a tub with his own carvings.

serve almost as well.) Tub's can also be mounted on casters, but the casters must be strong and well greased.

Easy ways to make them. Not much material is needed to make a plant tub, and very often scrap lumber may be utilized. There are also ways to get a plant tub almost ready-made. Wooden barrels cut down to size make fine planters. So do nail kegs.

Another trick is making a tub out of a can. Get a 25-lb. empty lard tin from your grocer and create a wooden "topcoat" for it. Lay out some narrow pieces of wood. They should be the same height as the can.

Wire the pieces together with thin wire at the top and bottom. Stapling makes an easy way to attach the wire to each piece of wood. Twist the ends of the wire together on the inside to hold the "topcoat" intact and slip it over the can.

Flue tiles also make unique plant or flower containers. They have a soft, natural color. Being clay, they are weatherproof. They come in square or round shapes, range from 8" to 21" across and are usually 24" long. They may be used as they are or cut into different sizes with a cold chisel. **END**

Wax Crayon Aids Sign Painting

PAINT creeping along wood grain may give a fuzzy appearance when painting a sign. To avoid this, outline the letters with a wax crayon.—Ken Olin, Marquette, Mich.



A LARD CAN is transformed into a plant tub by wiring together slats cut the same height as the can. Slip the assembly over the can.

FLARING BOX was sandblasted, gilded and immediately rubbed for an unusual finish.



Overnight Drydock:

Boat Shelter Has One-Man Hoist

Here's a rig that you can build to keep a small craft out of the weather and water. You need only readily available materials.

GETTING a boat out of the water will make it last longer and keep it safer from storm damage. With a hoist like this, you can do it singlehanded. Any 14' or 15' outboard utility or runabout can be handled with the rig shown, even with the motor left on.

A frame consisting of three inverted U sections of galvanized-steel pipe is bolted to wooden footings by means of floor flanges. Make the frame high enough to hold the boat well clear of high-water level. The frame shown is 6' above the water. With the dock 10" above the water, you have ample headroom for climbing in or out of the boat. If the bottom slopes, make the frames correspondingly different in height to keep the tops level.

Assemble the U sections, screw the flanges on, and fasten these to the footings with $\frac{1}{4}$ "-by-1" lag screws. Drill $\frac{3}{8}$ " bolt holes below each elbow and in the wooden stringers.

Put the pipe sections and stringers together near the dock site, true up the legs, and nail wooden crosspieces diagonally across the footings for rigidity.

For the hoisting mechanism, get a piece of 2" galvanized pipe slightly longer than frame width. Mount it about midway of the stringers with heavy pipe straps, using shims if necessary to leave it free to turn. Cross members fastened on the stringers with 3" lag screws support the hoisting pulleys. These should be at least 3" in diameter, rated at 200 lb. each, and plated or galvanized.

Hang them from steel straps bent around the supporting pipes, with bolts through the pulley eyes and lock washers under the nuts. Space the pulleys 6" closer than the beam, or 4' apart for a 54" hull.

In line with each pair of pulleys, drill a $\frac{5}{8}$ " hole through the winch pipe. File off all burrs and sharp edges. Thread $\frac{1}{2}$ " marine rope through one hole, wind each part over the pipe a couple of turns in the same direc-

tion, run through a pulley, form a loop, and return around the pipe and through the other hole. One length can be used, the ends tied and the knot pulled close to the pipe, or two lengths and straps as shown.

A wheel at least 42" in diameter is needed to afford enough leverage. The boat is held up by slipping a swivel hook over one spoke.

The canvas top fits over a wooden framework dimensioned to fit the pipe frame. Round off all edges the canvas will touch. Order the material slightly oversize to allow for shrinkage, and with grommets set in 12" apart all around. Lace it on with rope run around hooks screwed into the framework. The endpieces are best cut to size after the top has been installed and allowed to shrink.

—Hal Brown, Binghamton, N.Y.

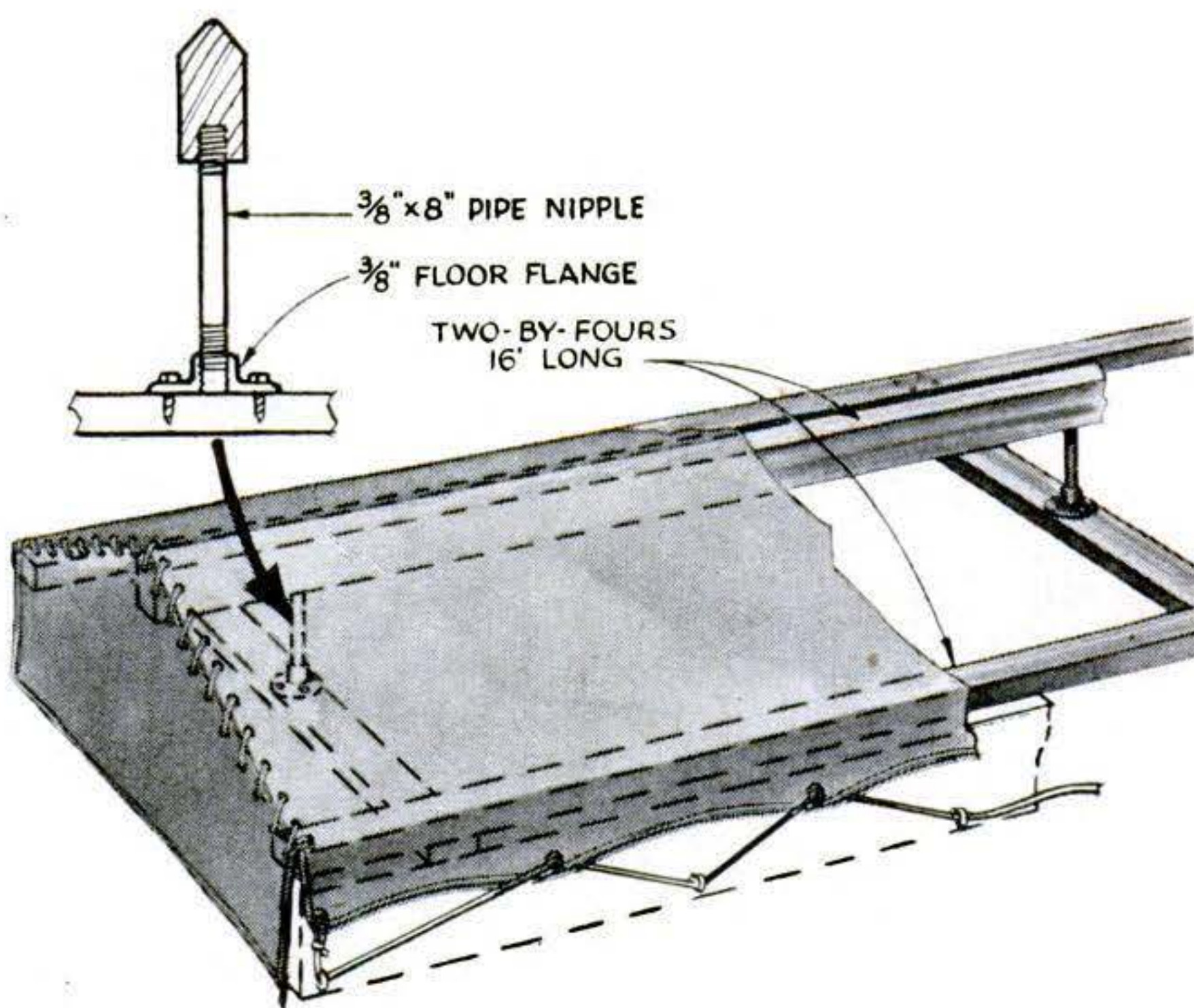

A FRAME WIDTH of 6' 4" will accommodate any boat with a beam ranging from 54" to 60". All dimensions given in this drawing are for such a hull. Cross members cut 6' long and then threaded will give this spacing between the legs because the elbows add length.

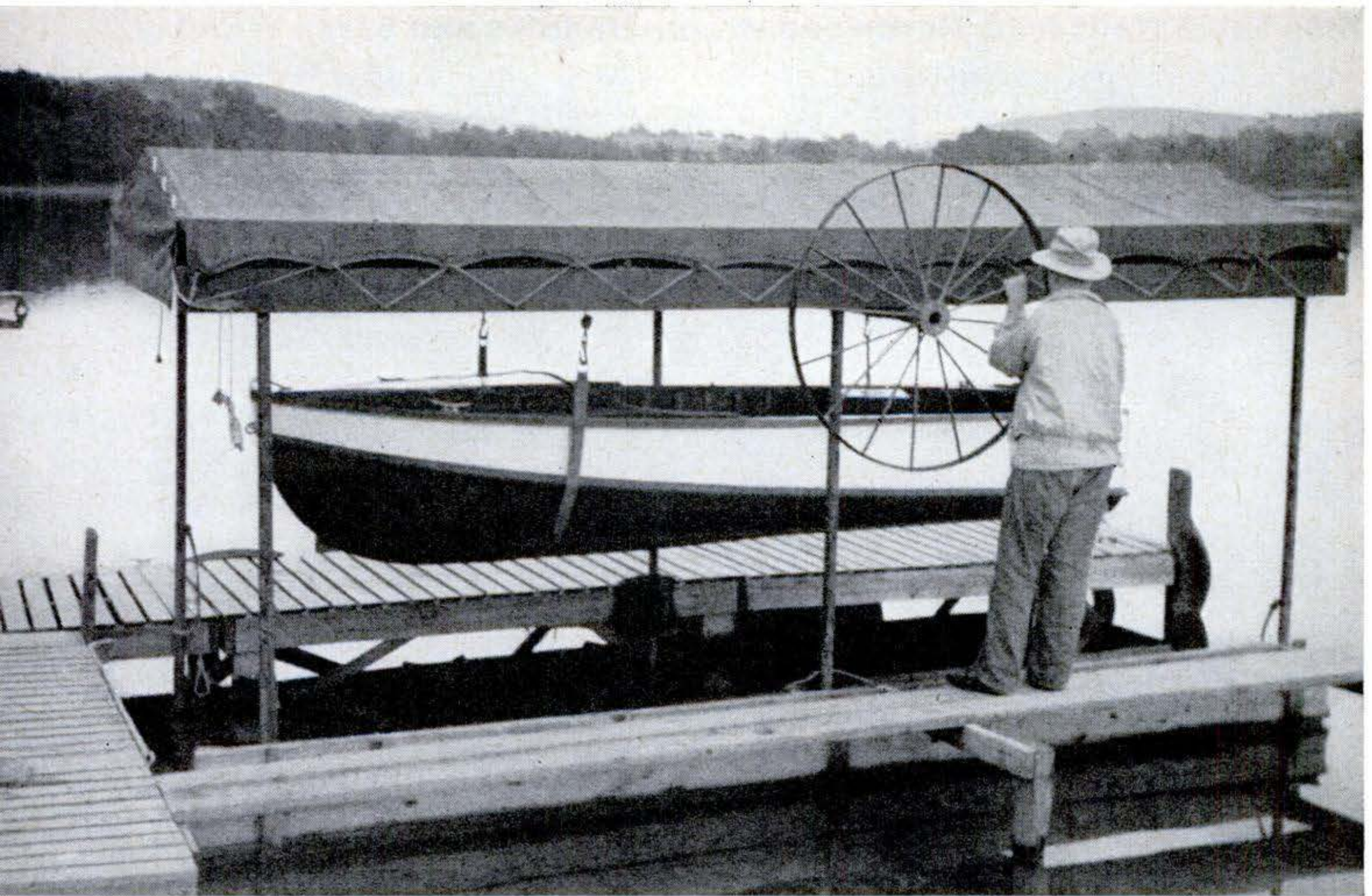

DRYDOCKING A SMALL BOAT is a cinch with a hoist like this. Flat canvas straps with rings to which the hoisting rope is fastened are easier on the paint than rope loops. For this

14' hull, the hoisting pulleys are 6' apart. The 44" wheel is from a hay tedder. Its hub holes were filed to match those in a 2" floor flange screwed on the end of the winch pipe.

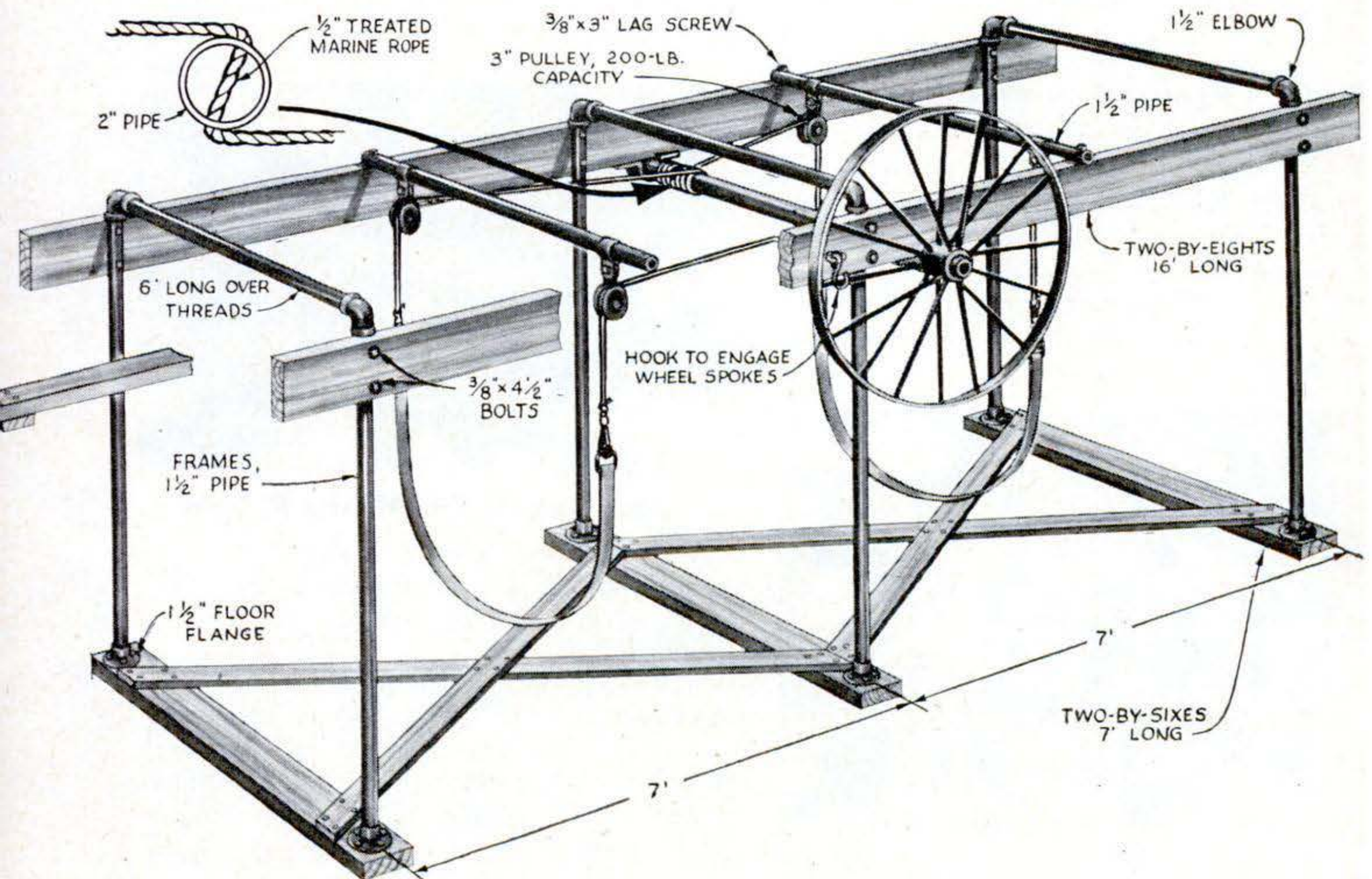

Shop Stool Built from Hardwood Broom Handles and Scrap Wood

You can work more comfortably, and enjoy your hobby more, if you sit down at the bench, lathe or jigsaw. Here is a stool made

from eight mop or broom handles and some scraps of other wood.

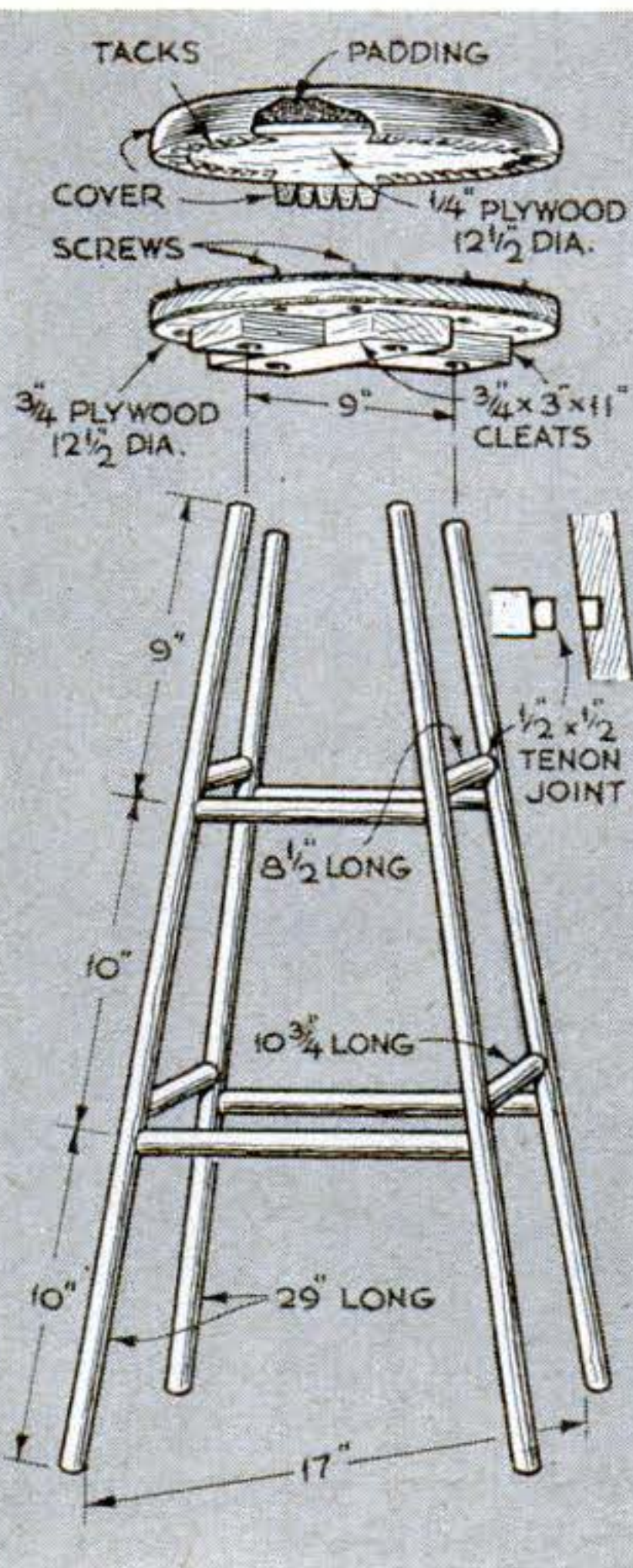

The broom handles should be hardwood rather than fir or pine. Four are needed for the legs and four for the spindles. Drill $\frac{1}{2}$ " holes in the legs at an angle of 83° for the spindle tenons. These can be lathe-turned or formed by rotating the stock against a disk sander faced with coarse paper.

Screw one long and two short cleats to the underside of the $\frac{3}{4}$ " plywood top and bore the four leg holes in them at an 83° outward tilt. Assemble the legs, top and spindles with glue.

Upholster a disk of $\frac{1}{4}$ " plywood by slitting a piece of covering material all around and tacking it over padding as shown. Fasten this to the top with wood screws driven in from beneath.—Harold Jackson, Kankakee, Ill.

Photos Framed in Insulation

PHOTOS can be preserved in practical mounts made of two pieces of reflective aluminum insulation. Cut a picture window in one and assemble the pieces back to back with cellulose cement or dry mounting tissue. Use low heat with the latter to avoid melting the asphalt binder between the layers of insulation.

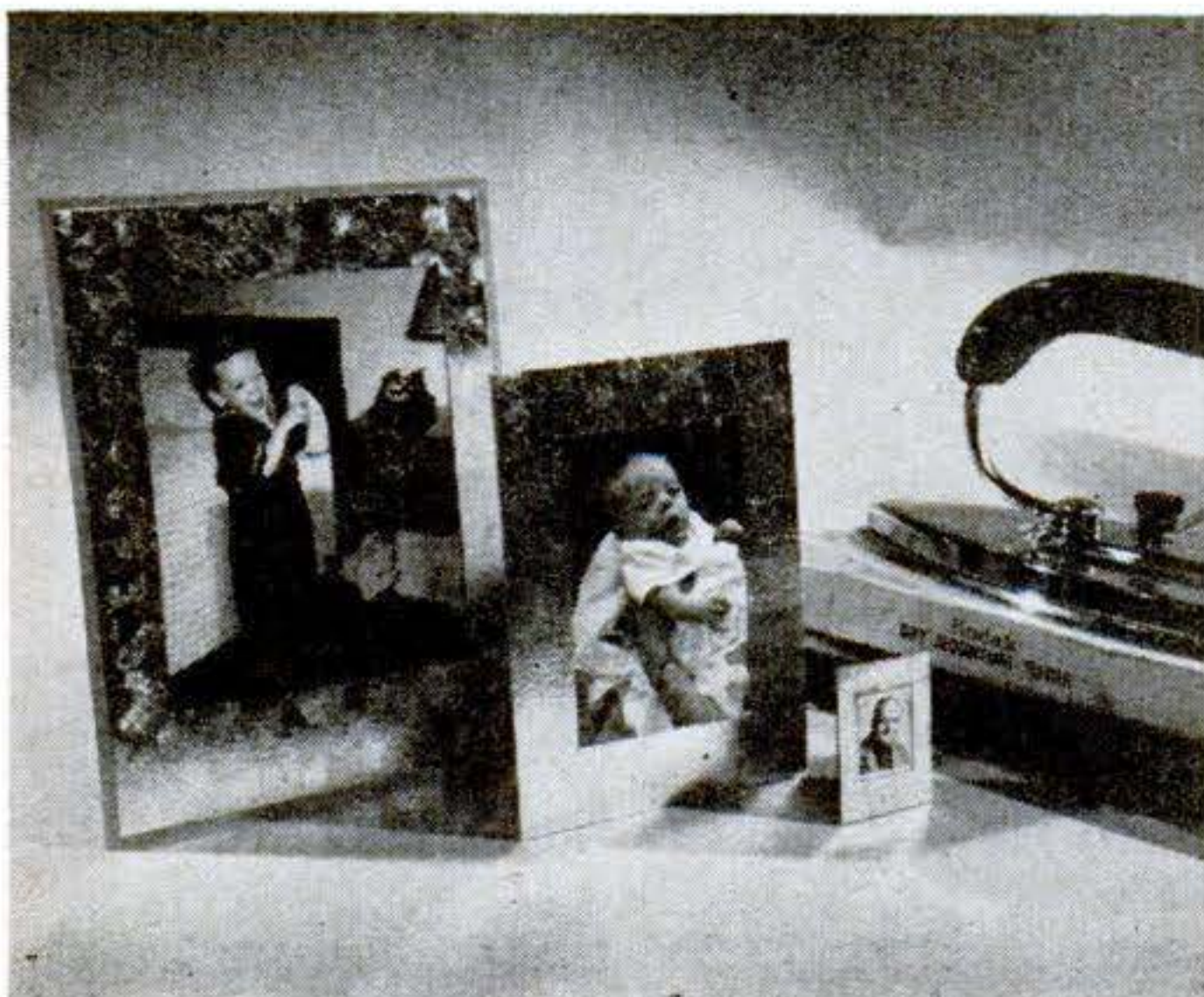

Screen Supports Photo Filter

PHOTOGRAPHIC solutions can be filtered in less time if a cone shaped from plastic window screening is used inside the filter funnel.

Make a paper pattern as at the left above, cut screening to this shape, form it to fit inside the funnel and seal the edges with cellulose cement. The screen holds the filter paper away from the inside of the funnel, allowing solutions to pass through faster.—Ken Murray, Colon, Mich.

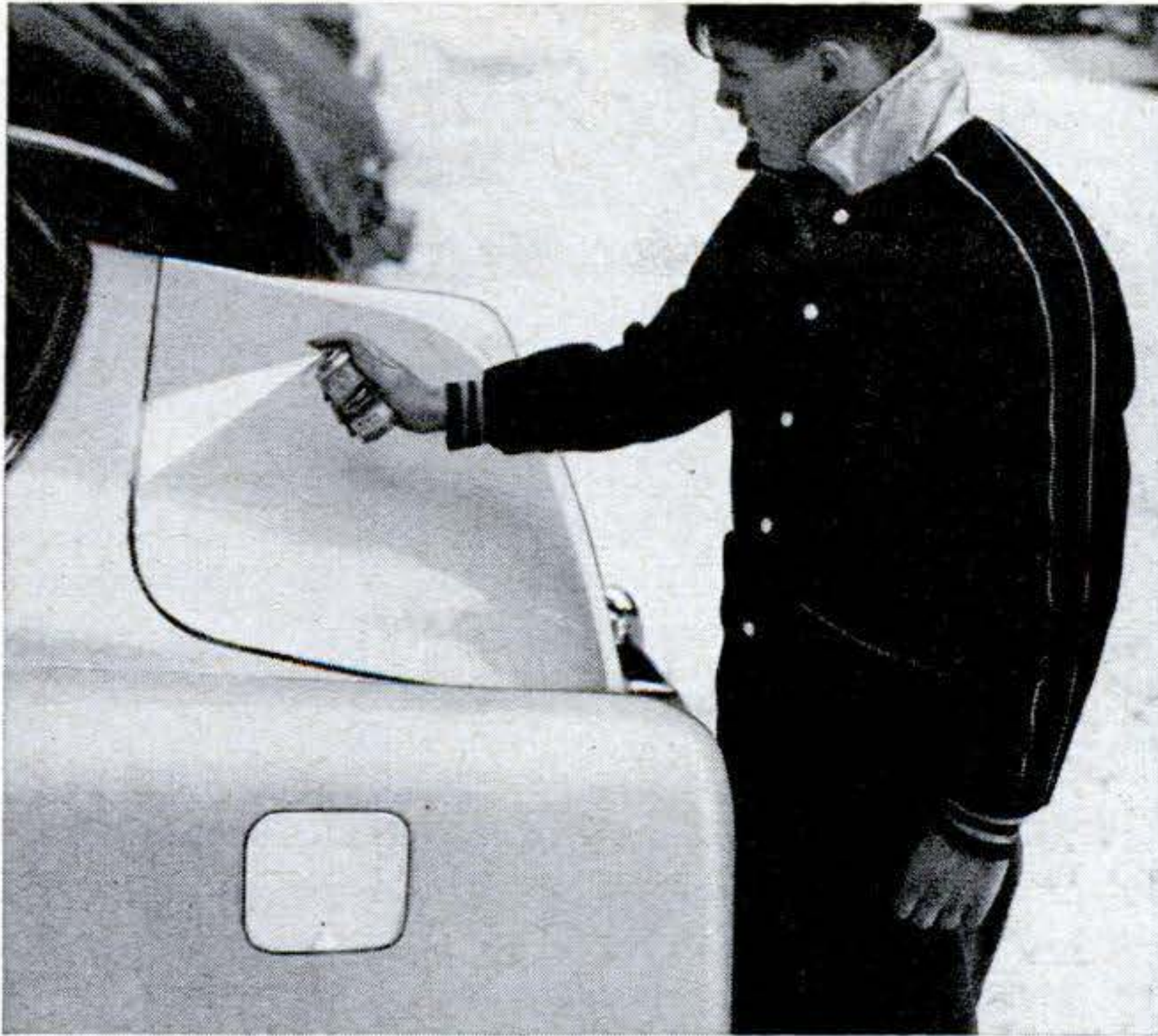

New for Your Car

1. Touch-Up Lacquer in Spray Bomb. Spring car cleaning should include touching up nicks and scratches with paint. Ford, Plymouth and Chevrolet owners can spray over body blemishes with paint bombs packaged in recent colors for these makes.

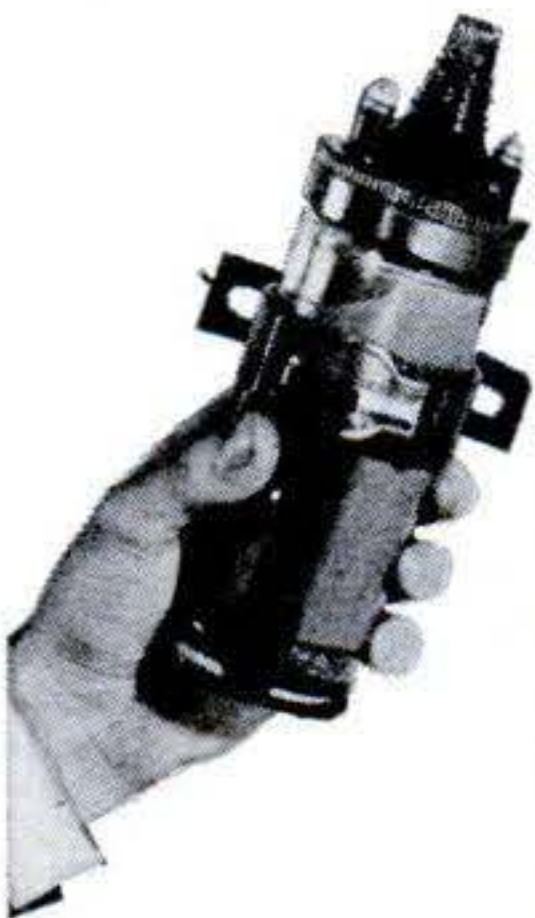

2. Oil Coil Gives 30,000 Volts. A British-made oil-cooled ignition coil now being distributed in the U.S. is said to put out 30,000 volts, more than twice the output of an ordinary coil. The cooling oil is contained in an unbreakable transparent case surrounding the coil.

3. Cleaning Sponge Made of Nylon. A new type of sponge which consists of bonded nylon fibers will help you keep your car cleaner. The maker says it's fine for removing bugs and oil film from the windshield and sprucing up whitewalls.

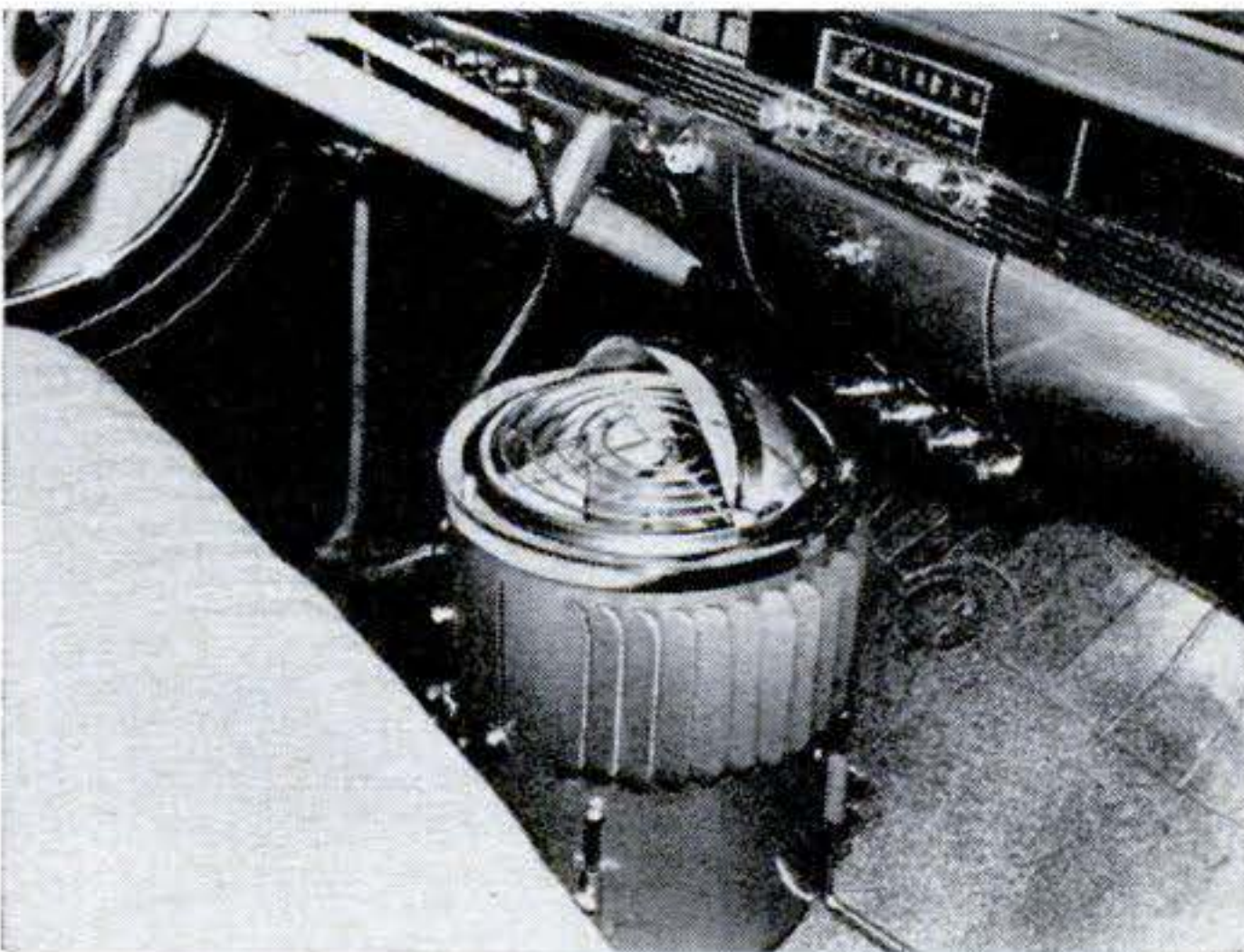

4. Air Cooler Plugs In. If you're going to drive in a hot, dry region this summer, here's an evaporative-type cooler that will keep your car comfortable. It plugs into any standard cigarette-lighter socket. Using an accessory adapter, you can also move it into the house or motel and plug it into a 115-volt circuit. The tank holds 2½ gallons of water. Evaporative coolers are most satisfactory where humidity is low.

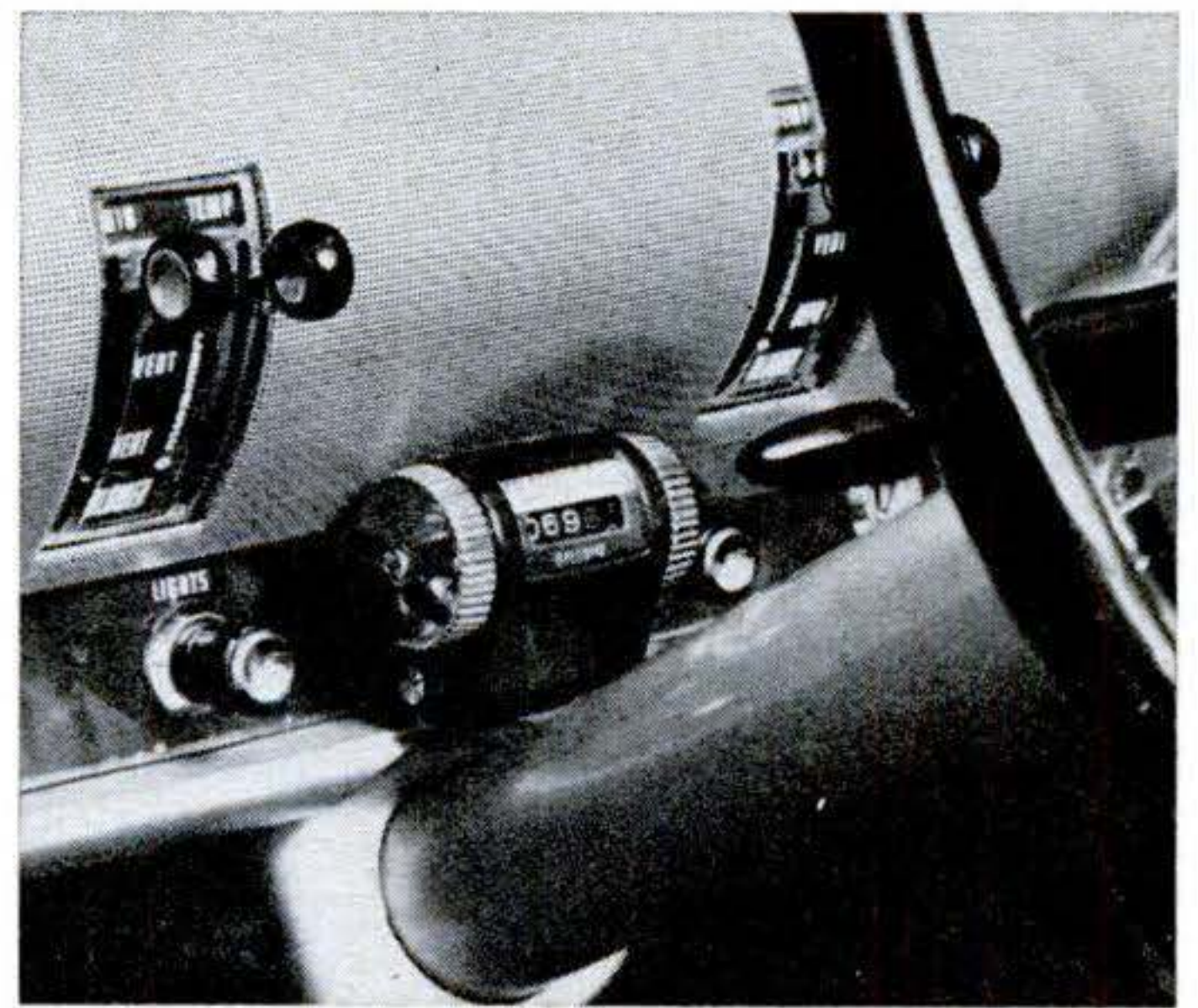

5. Meter Measures Fuel Flow. A new fuel-flow meter will give you a constant check on gas consumption. The meter mounts on the engine between the fuel pump and carburetor, and an electrically operated counter on the instrument panel (above) records the fuel used, in one-hundredths of a gallon, up to 1,000 gallons.

Further information on these products can be obtained from: 1. Auto Paint Products, Inc., 2600 W. North Ave., Milwaukee 5, Wis.; 2. Newhouse Automotive Industries, 5805 E. Beverly Blvd., Los Angeles 22; 3. The Livingston Co., 150 Amity Road, New Haven, Conn.; 4. Frank D. Davison, Inc., 588 Mateo St., Los Angeles 13; 5. McCulloch Motors Corp., 9775 Airport Blvd., Los Angeles 45.

The Saw That Does 'Most Everything

By Devon Francis

AS I stripped the packing case off my new radial-arm power saw in my home workshop, my wife asked, "What will it do?"

"That," I replied, "is what I've got to find out."

This burnished and glistening tool that seemed to have everything except an automatic transmission and power steering was new to me. My table saw, jigsaw, drill press, lathe and sander were old acquaintances. I could attach my chuck or change a blade with my eyes closed.

But a saw with a head that would revolve through a full circle and could be pulled across the work at any angle I desired was

something else again. The fun I was going to have making cuts at compound angles was as far as my thinking went while I was mounting the motor and put tension on the drive belt.

I had a lot to learn. During evenings and weekends for the ensuing month I discovered that the saw would do fancy things that I had always wanted to try. I found, too, that it would do jobs I could do on my old equipment, and do them easier. But there were some jobs it wouldn't do as easily.

The new saw, a Christmas gift, actually was a multipurpose tool. As such, the Shopmaster CU-6000, as it is known, duplicated some of the tools I already owned. I was less interested in its versatility as a drill press,



WITH THE SAW SET for a square cutoff, you can cut practically any length of lumber because the work doesn't have to move. Just stick the end of your board out a window or doorway. The same goes for angle cuts on long pieces. For simple crosscutting, you set the rotatable head and the lifting column on zero. Both have graduated collars. Unlike the operation of a table saw, the feed is with the saw rotation, not against it. This lessens cutting drag and makes it considerably easier to hold the work snug against the fence. The Shopmaster's 16" ram enables the saw to make a pretty wide crosscut.

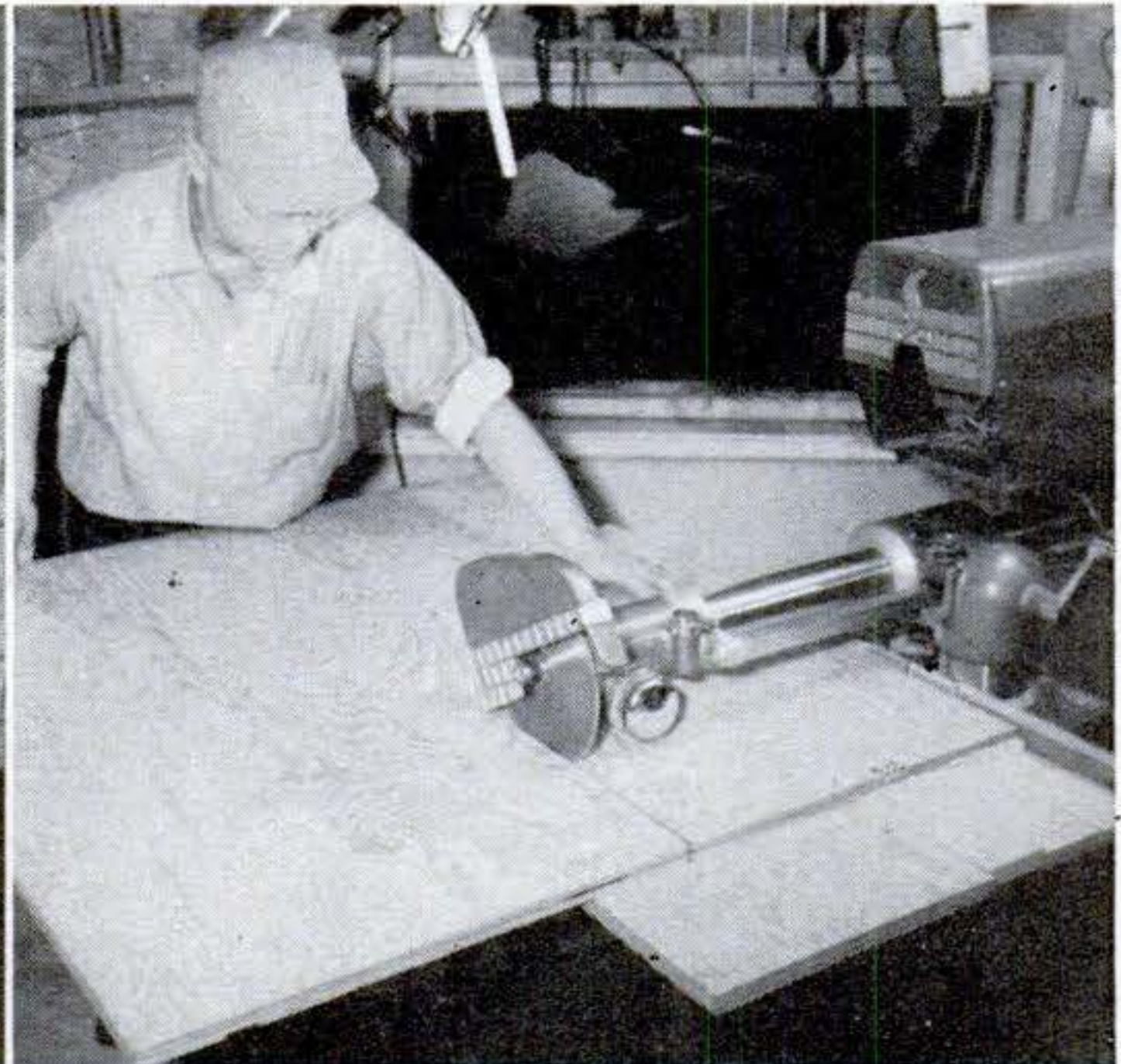

FOR RIPPING, the blade is mounted on the end of the ram. In effect, this makes the ram 2" longer. With the fence moved clear to the rear of the table, you can saw to the center of a 48" panel. For this operation, the saw is locked stationary and the work is fed through it. The guard can be used to hold down the work. Motor rotation must be reversed. Width of the cut is set by moving the ram in or out. A lock holds it. The tool has two other locks. One releases the head for rotation, the other releases the lifting column on which the saw is swung left or right as well as raised or lowered.

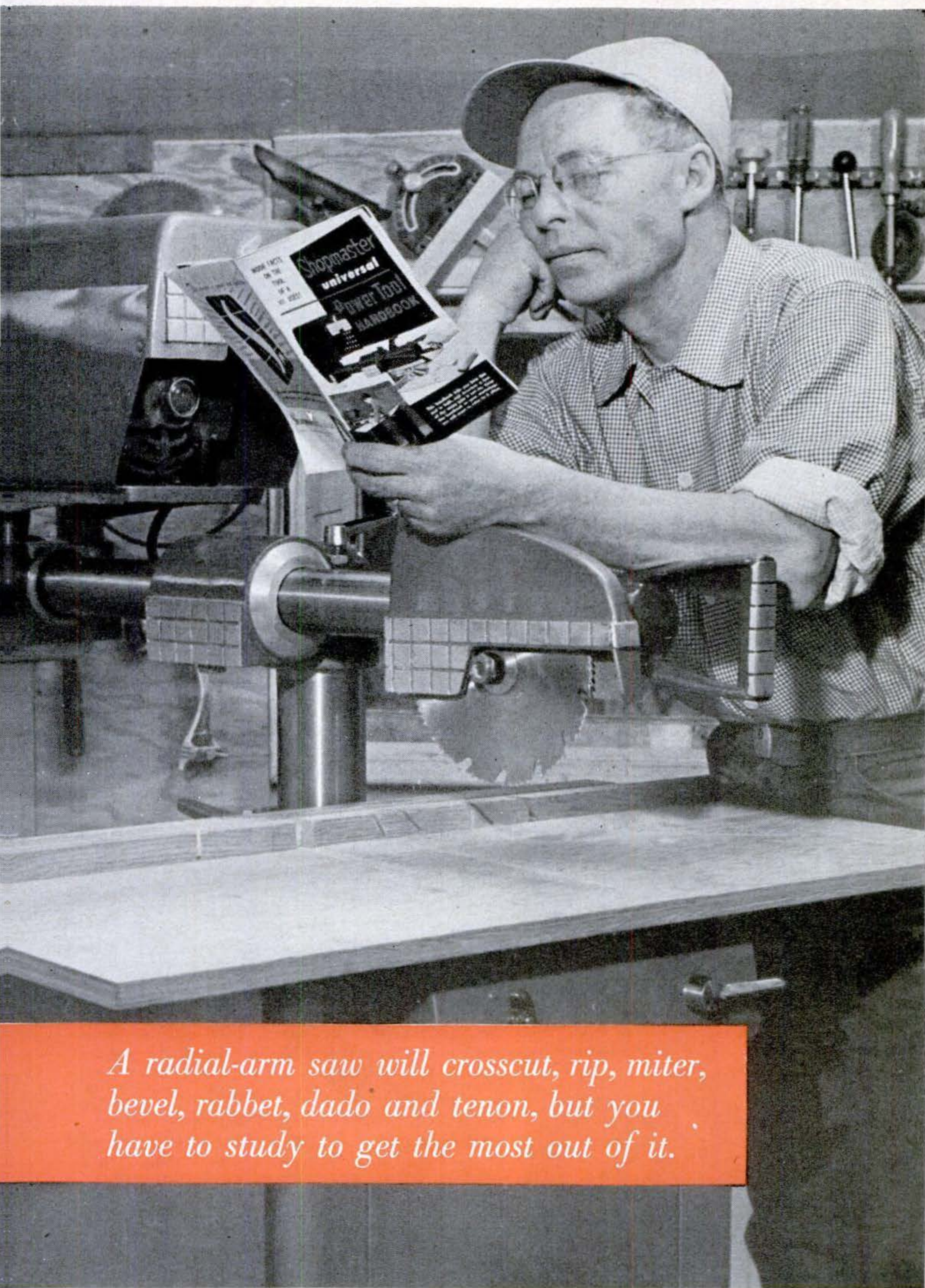

A radial-arm saw will crosscut, rip, miter, bevel, rabbet, dado and tenon, but you have to study to get the most out of it.

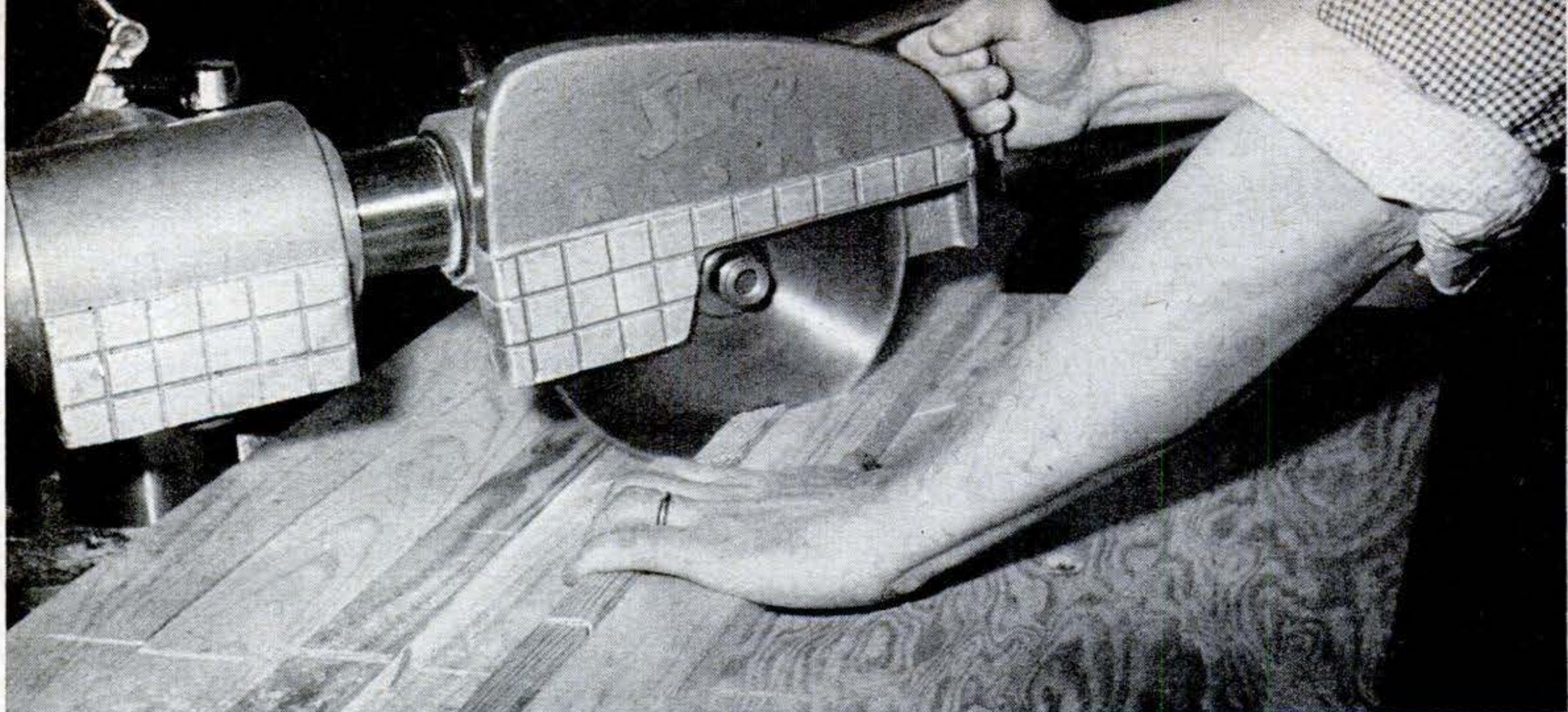

FOR A MITER CUT, you swing the ram to the desired angle and lock it. The saw will miter to either left or right. The big problem of mitering with a table saw is creep—because the blade is going through the work at an angle. There is no creep with a radial-arm

saw because the work can be held tight against the fence with the hand, or even clamped. On all cuts against the table, the blade is positioned where it just scrapes the table top. This picture shows how the fence gradually gets chewed up by the saw.

sander or shaper than I was in what it would chew a piece of raw wood into as a saw.

Would it spline a miter joint? Would it cut a tenon, make a blind dado?

Learning how to use the tool was not simplified by the instruction book I received with it. Shopmaster now has issued a much better instruction manual.

The principles the saw works on are simple. The blade is mounted on a ram, a cylindrical, horizontal member that is pulled toward you for any crosscutting operation.

This particular make of saw has a 16" draw. A bigger, upright cylinder abuts the ram. This is the lifting column, worked by crank, to raise and lower the saw. The ram can be swung to left or right.

Blade Works at Any Angle

The head, containing drive gears turned by a shaft inside the ram, can be rotated a full circle in a plane parallel to the lifting column.

For ripping, the blade can be mounted on the end of the ram, at a right angle to its crosscut position.

The table is wood. The front half, of plywood, is screwed to the metal base. The back half, made of several pieces of dressed wood, is locked in with quick-acting cams. One of the dressed pieces is put on edge to serve as a fence. For most operations, you cut right through the fence. When it gets too chewed up, you simply replace it.

The evening that I installed my saw, I snugged a piece of wood scrap against the fence and pulled the blade through to initiate it. It was a new feeling. I could see that certain kinds of precision cuts were going to be a lot easier. I would be spending less time in front of the TV set watching "I Love Lucy" and more in my workshop. That cabinet for the kitchen was already taking shape in my head.

Then I retired to a chair and began running through the indexes of all the wood-working books I possessed. I looked for one item: "Saws—radial arm." Nothing was

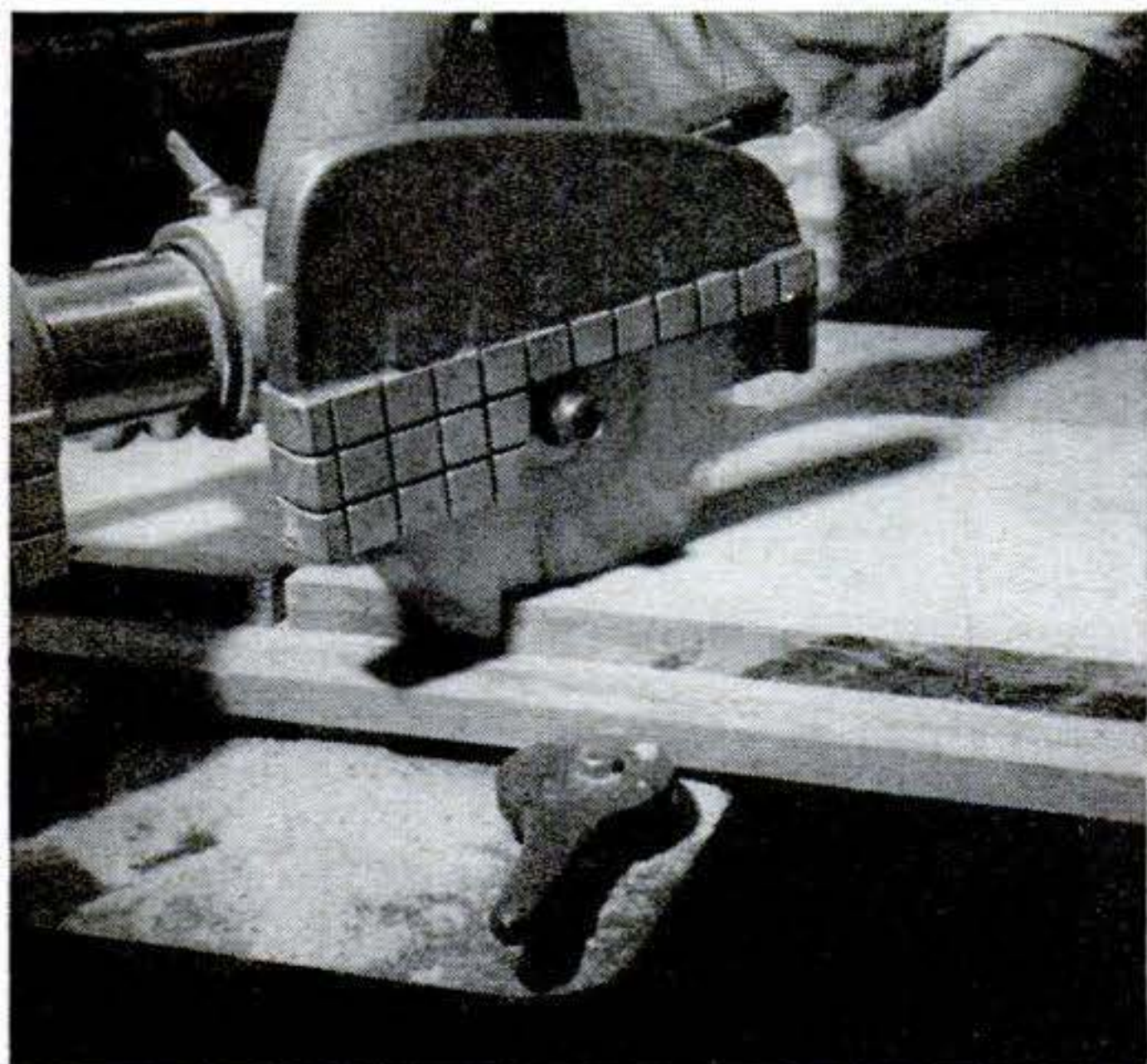

IT'S A CINCH to cut off a panel at an angle with the work held firmly against the fence. On a table saw, of course, this is practically a freehand job. One of the two cam locks securing the free wood stock in the table shows in the foreground of the photo above.

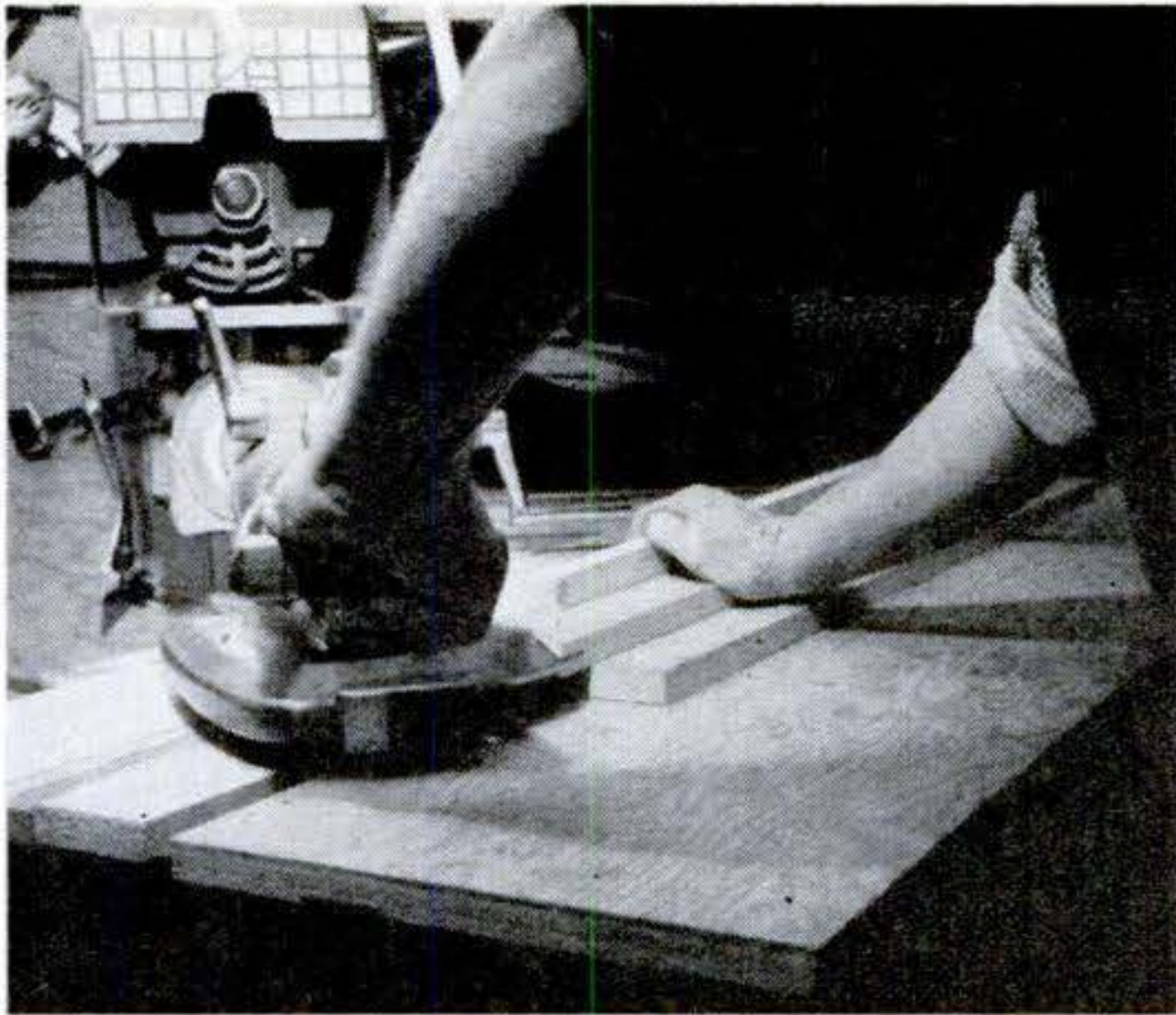

SPLINING A MITER is easy, too. Leave your column set for the same angle as the one you have just used for your miter. Next, move your fence over until one end is in the area of the blade. Now rotate the head until the blade is flat. Make a preliminary cut in the end of the fence. This is to get depth of cut. Build up your work height with a scrap piece of wood, so the nut on the arbor clears the table. Center the spline by raising or lowering the column. Gauge your depth of cut by the cut in the fence, position your work, hold and pull. Presto!—splined miter.

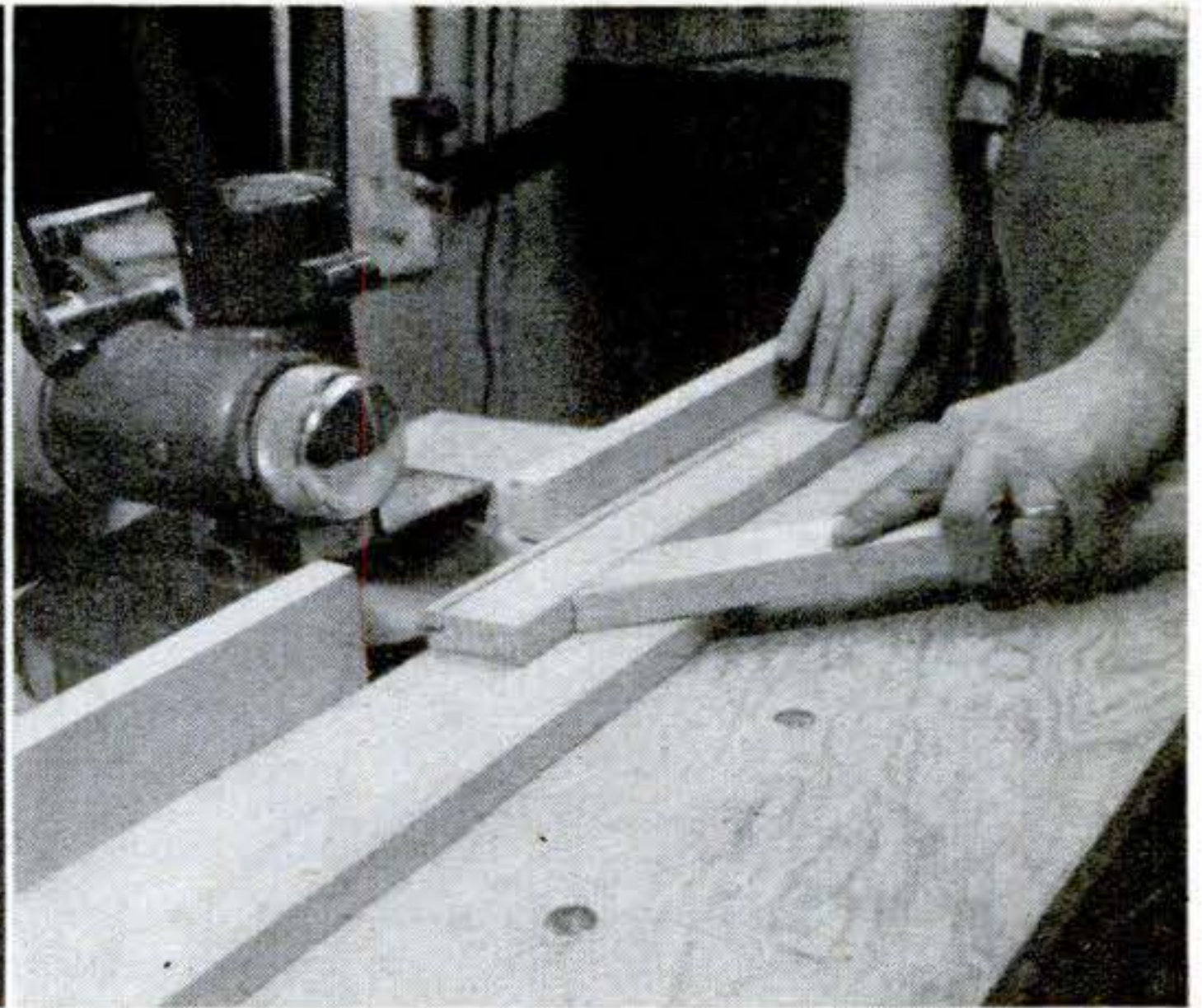

THE RADIAL-ARM SAW will even do jobs that are peculiarly the work of a table saw, such as rabbeting. Chop your fence in two, or use two scraps of dressed wood to leave an opening for the blade. You can rabbet by the two-cut method or with a dado head. In this picture, the work is being run through the blade twice. It's obvious how grooving can be done with the same setup. Generally speaking, where the blade mounting is held rigid and the work moved against it, the table saw is more accurate and convenient. That goes for ripping and grooving, too.

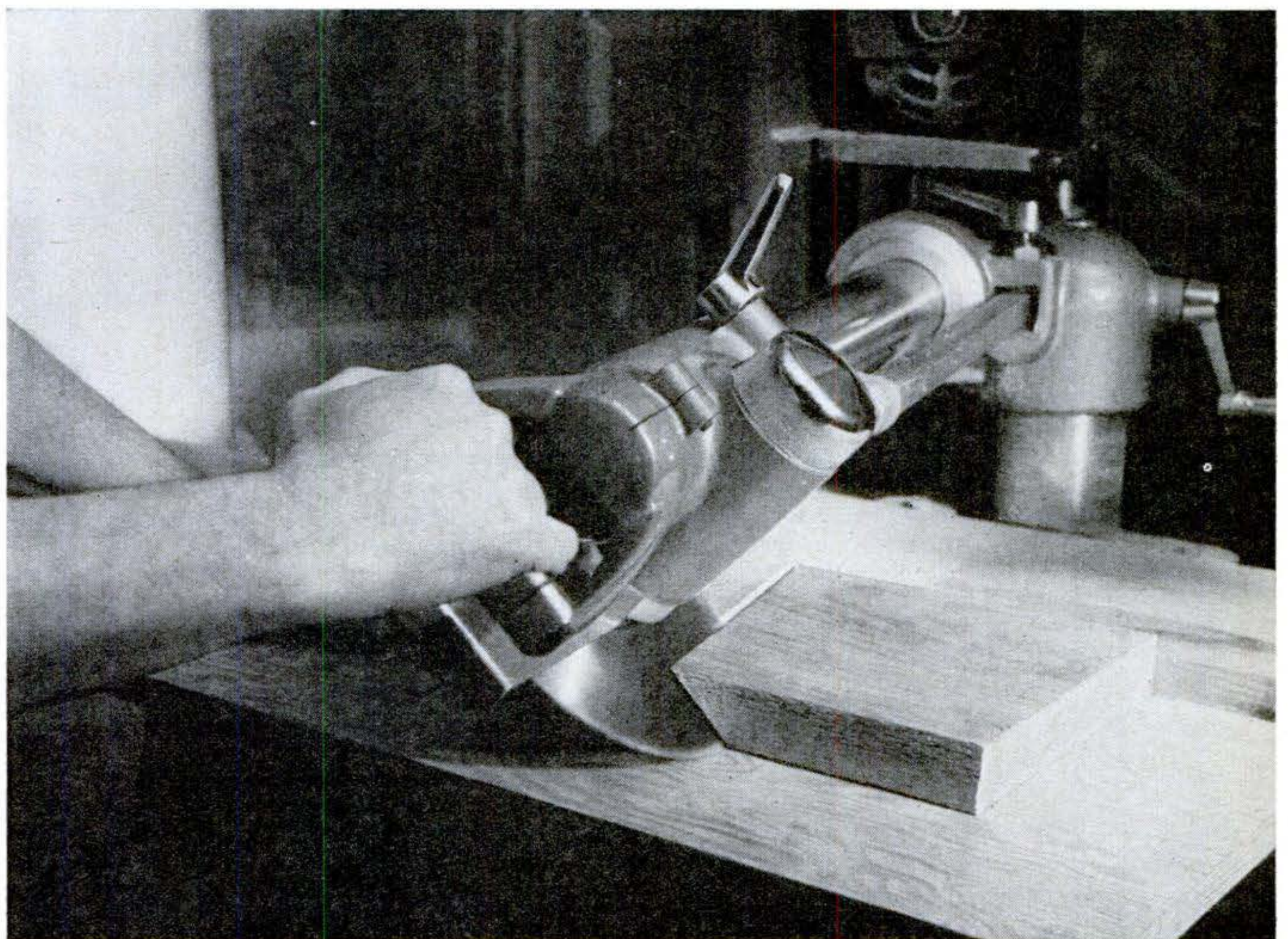

COMPOUND MITERS are one of the biggest joys of a radial-arm saw. They are as easy as a straight cutoff. With a table saw, you

are apt to get into trouble with long pieces. Not here; simply set your angle, rotate the head for the compound cut, lock and pull.

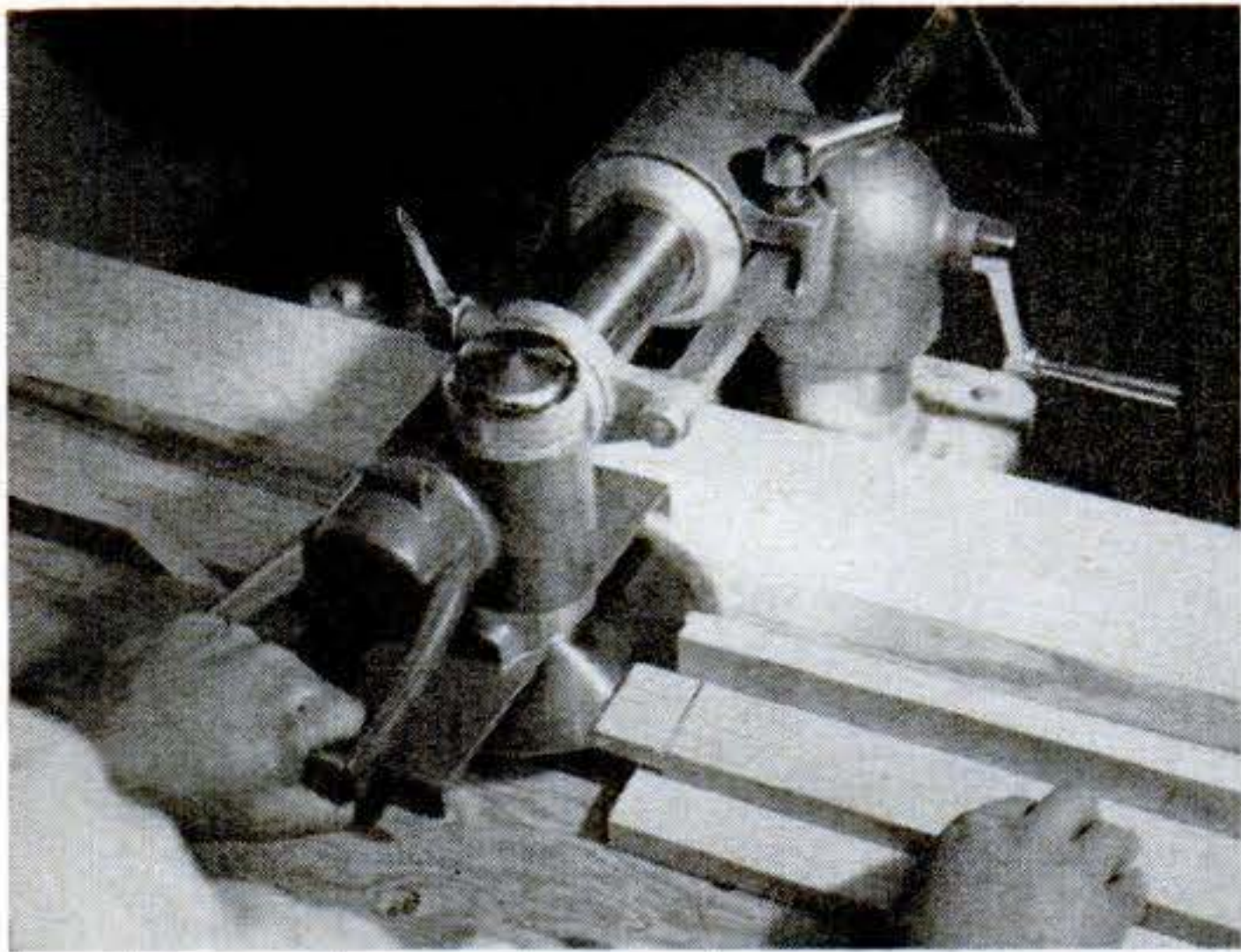

TENONING is done merely by rotating the head 90°. The shoulders are cut by swinging the blade upright, the cheeks with the blade flat. The depth of the cheek cut is determined the same way as for a spline. Both cheeks are made with the same setting; just turn the work over. Thus, any number of pieces can be exactly duplicated. Note that a scrap piece of dressed lumber is again used to bring up the height of the work.

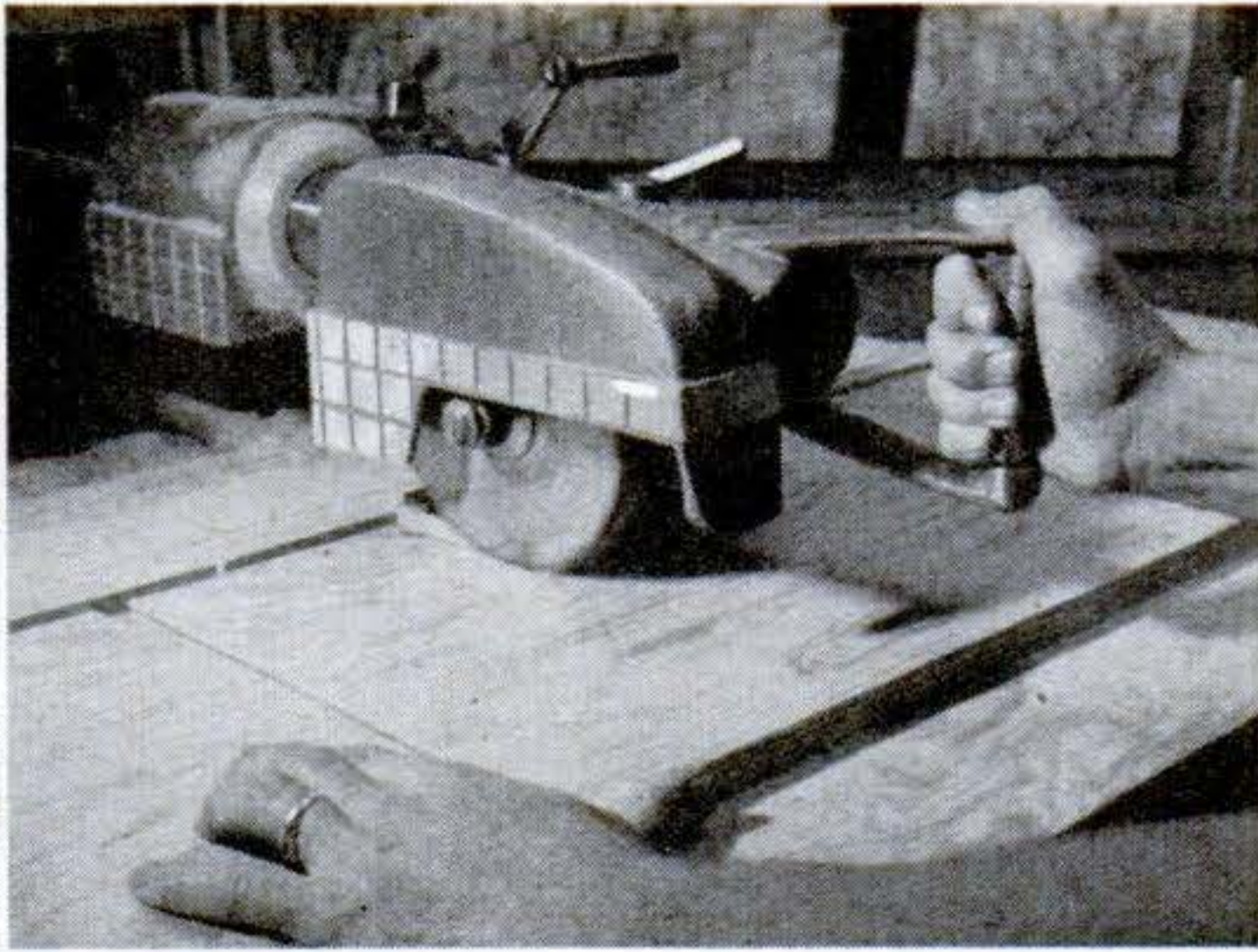

THE BIG ADVANTAGE to dadoing with this saw is that you can tell where to stop your cut. On a table saw, you're blind. Dados at angles and stopped dados are a breeze on the radial-arm saw because you can see where the blade is cutting. A special, wide guard and longer spindle are required for the dado blade. While more of the blade is exposed than on a table saw, you run less chance of nicking a finger: the work is stationary.

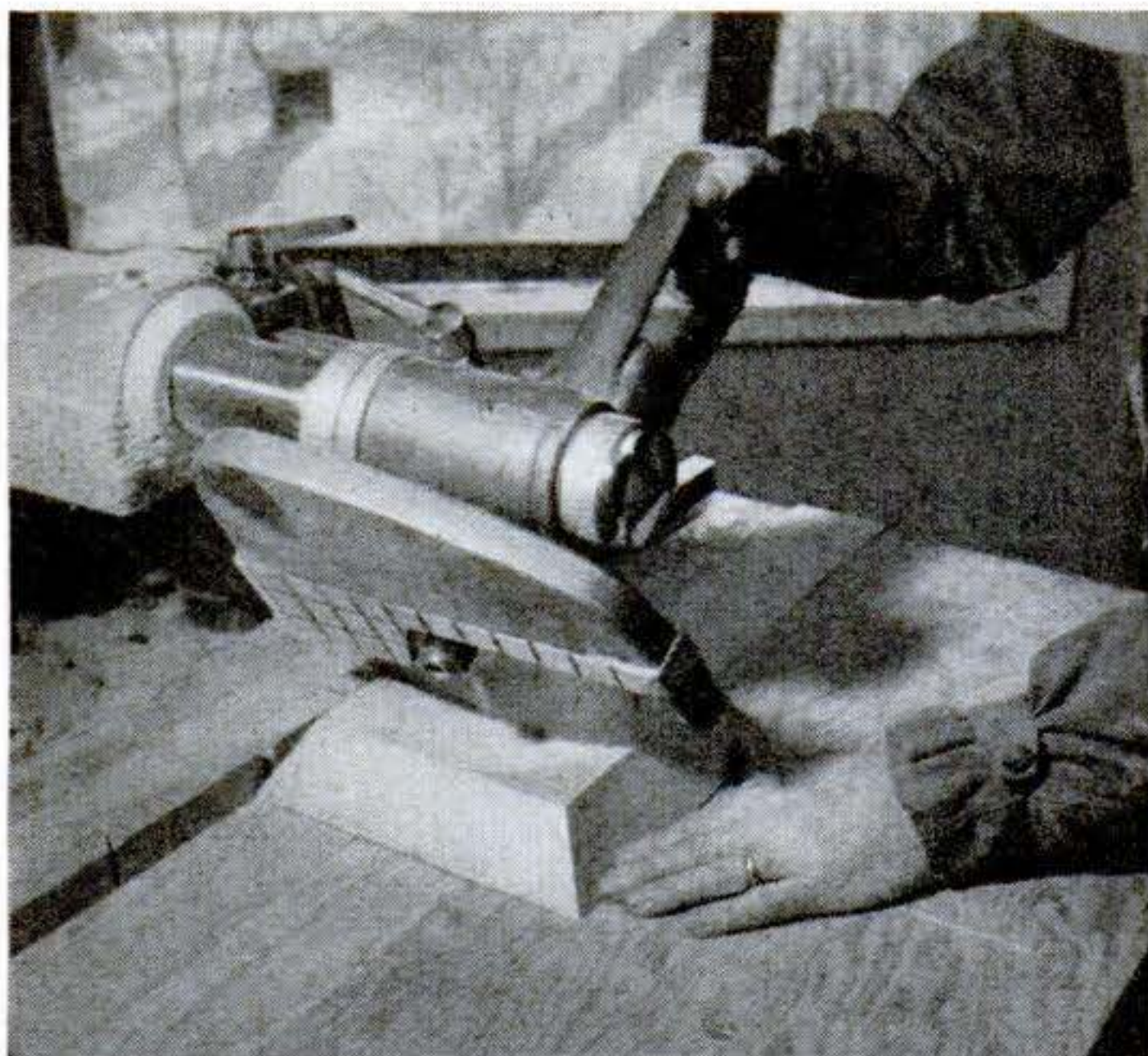

NOVELTY EFFECTS can be achieved with this saw that are impossible on any other type of power saw. Take a bowl. Strictly a stunt, it can be cut because the head swivels. Put your handle on the side, loosen the lock, and rotate the blade back and forth. You lower the blade a bit after each pass. Play it safe, though—switch off the motor between cuts.

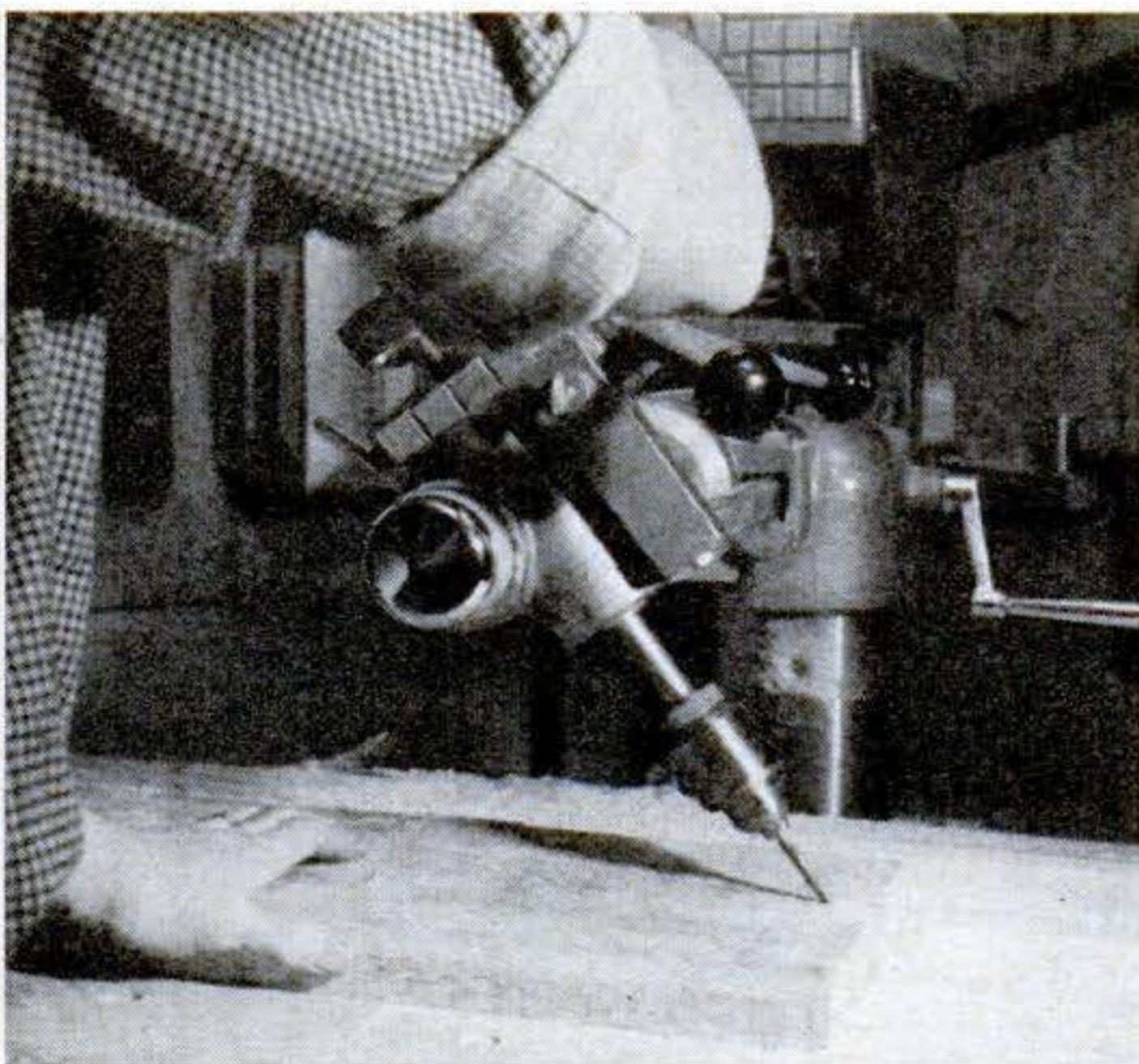

THE SHOPMASTER RADIAL-ARM SAW is a multiple-purpose tool. Here it is being used as an angle drill press. It's also a router and—with attachments—a disk sander, belt sander, face lathe, jointer and shaper. The reversible ¾-hp. motor makes use of accessories easier, as does the design of the handle, which can be switched to a side fitting.

listed. The reason finally dawned on me—the radial-arm saw is an old tool in industry but it's almost brand-new for the home workshop. In fact, DeWalt is the only other company making such a home-workshop tool.

I would have to learn how to use the saw by the cut-and-try method. How I made out is described in the accompanying photographs and captions. END

.....
 • **NEXT MONTH:**

• **Portable Electric Saws** •

• What the handy man and home car-
 • penter wants to know about these
 • will be told in the June issue. The
 • article will show how to use them
 • for both ordinary and fancy jobs.
 •

KEEPING THE

Home

SHIPSHAPE



Unused inches provide enough space for a handy swinging closet like this one. Hinged to the wall, it closes against the equipment next to it and rides open on a ball-type caster.

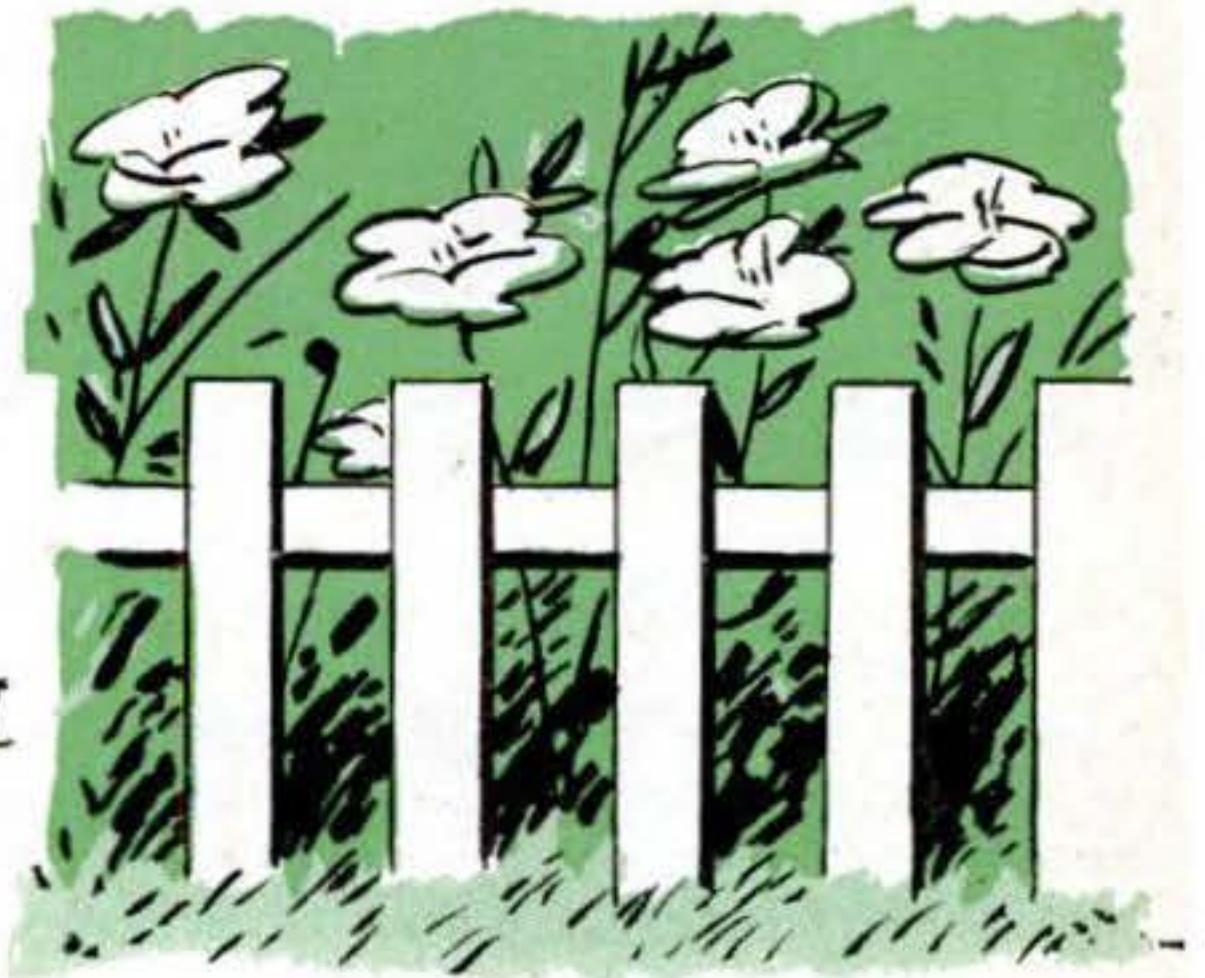

Ready-made pickets for plant fences are right at hand if you have an old wooden Venetian blind lying around. Cut the slats to the desired height and nail to a cross brace.



To store a rolling pin so it won't roll out to meet you every time you open a cupboard drawer, hang it on wooden brackets mounted on a cabinet wall or inside a drawer. Hang it high to leave space below.

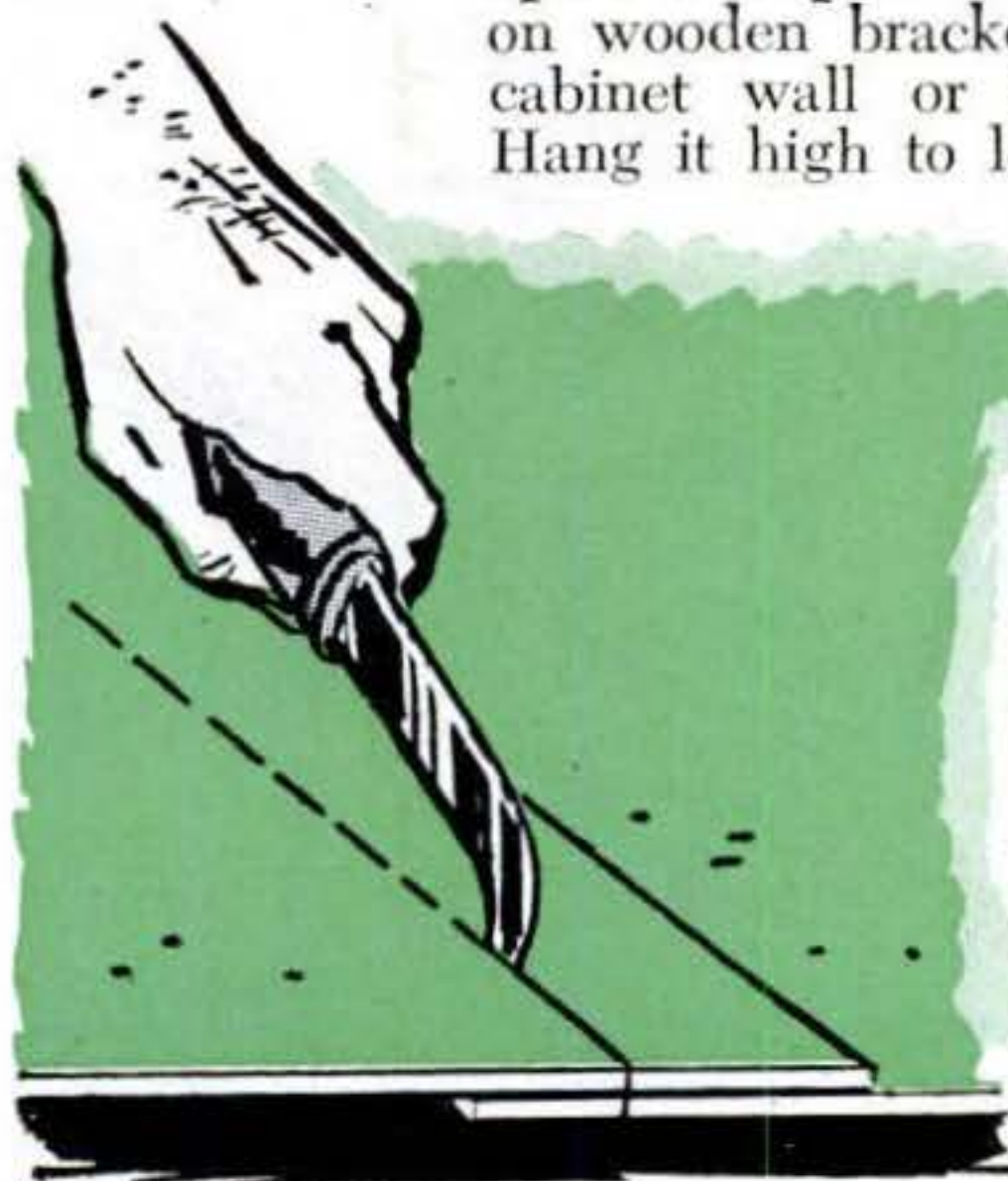

A professional job of linoleum laying calls for perfectly fitting seams. To get two pieces to butt exactly, overlap them an inch or so, then cut through both layers of linoleum at once.



When regluing chairs, try wrapping the tenon ends of the parts with strips of nylon or rayon fabric smeared with glue. This gives a tighter fit and a more lasting joint.

More Home Tips

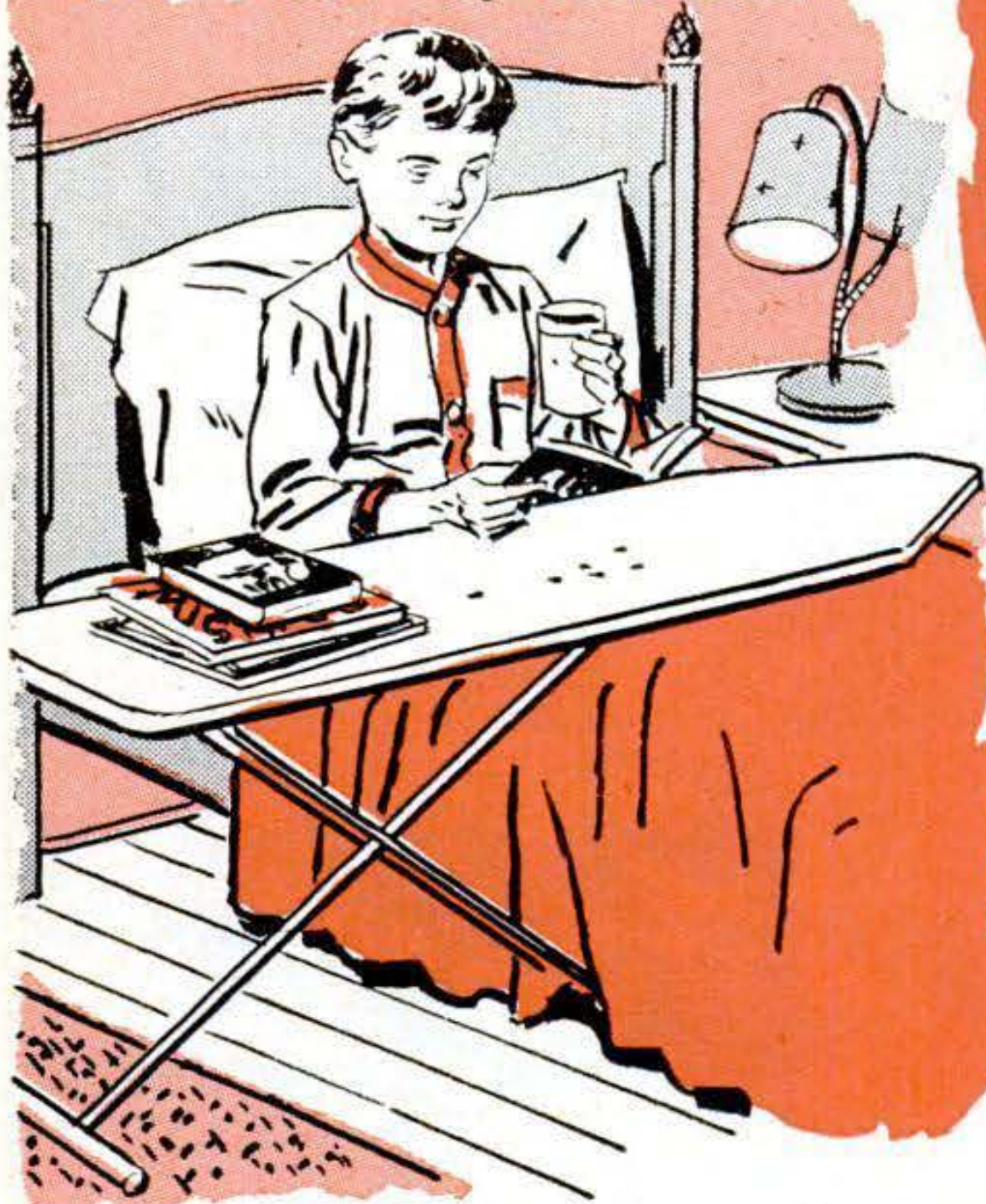

Set up the ironing board when you need a table for bed trays. One that adjusts for height will ride under the bed farther to provide a large surface for hobby equipment, magazines and games for a young convalescent, or Sunday newspapers for weekend slugabeds.

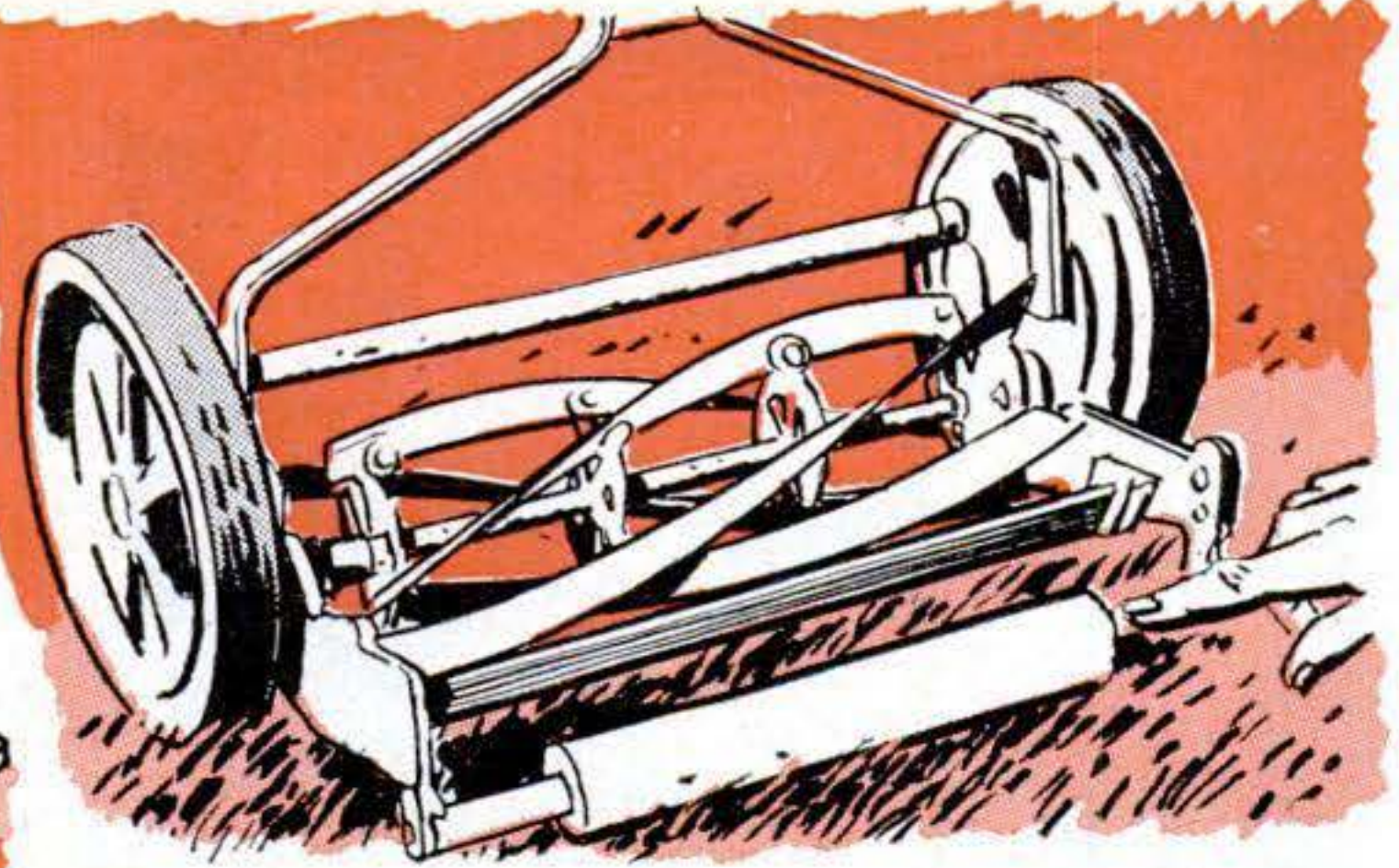

A worn mower roller can be replaced with a roller from an old washing-machine wringer. Drive pieces of $\frac{1}{2}$ " water pipe into the roller ends, cut off to fit, pack with axle grease and mount on the mower.



Before painting a basement, test for dryness by sealing a square foot of cellophane to a wall with adhesive tape and lay a solid rubber mat on the concrete floor. Wait three days. If no moisture is under cellophane, it's okay to paint walls. If underside of mat is dry, you can paint floor.

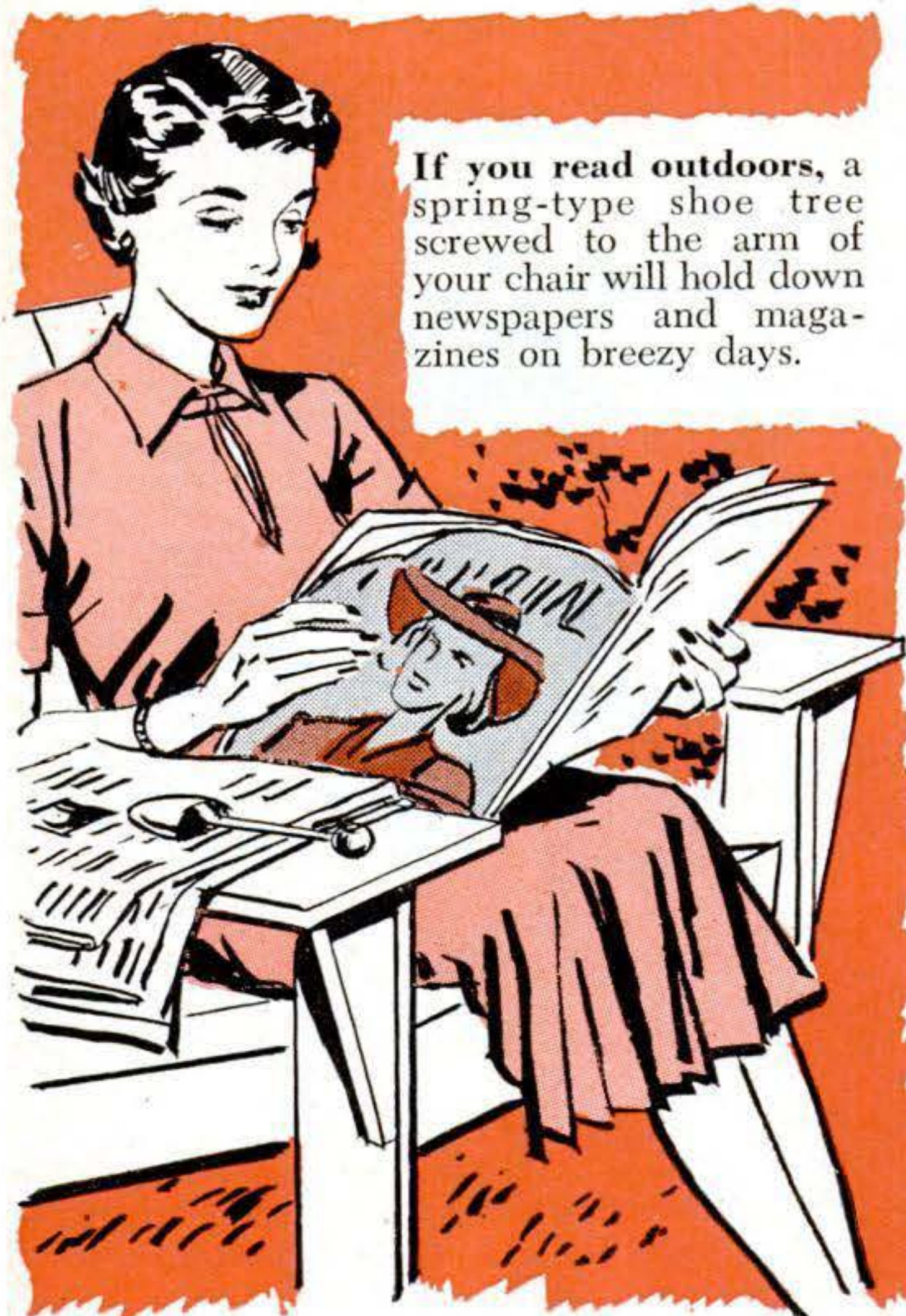

If you read outdoors, a spring-type shoe tree screwed to the arm of your chair will hold down newspapers and magazines on breezy days.

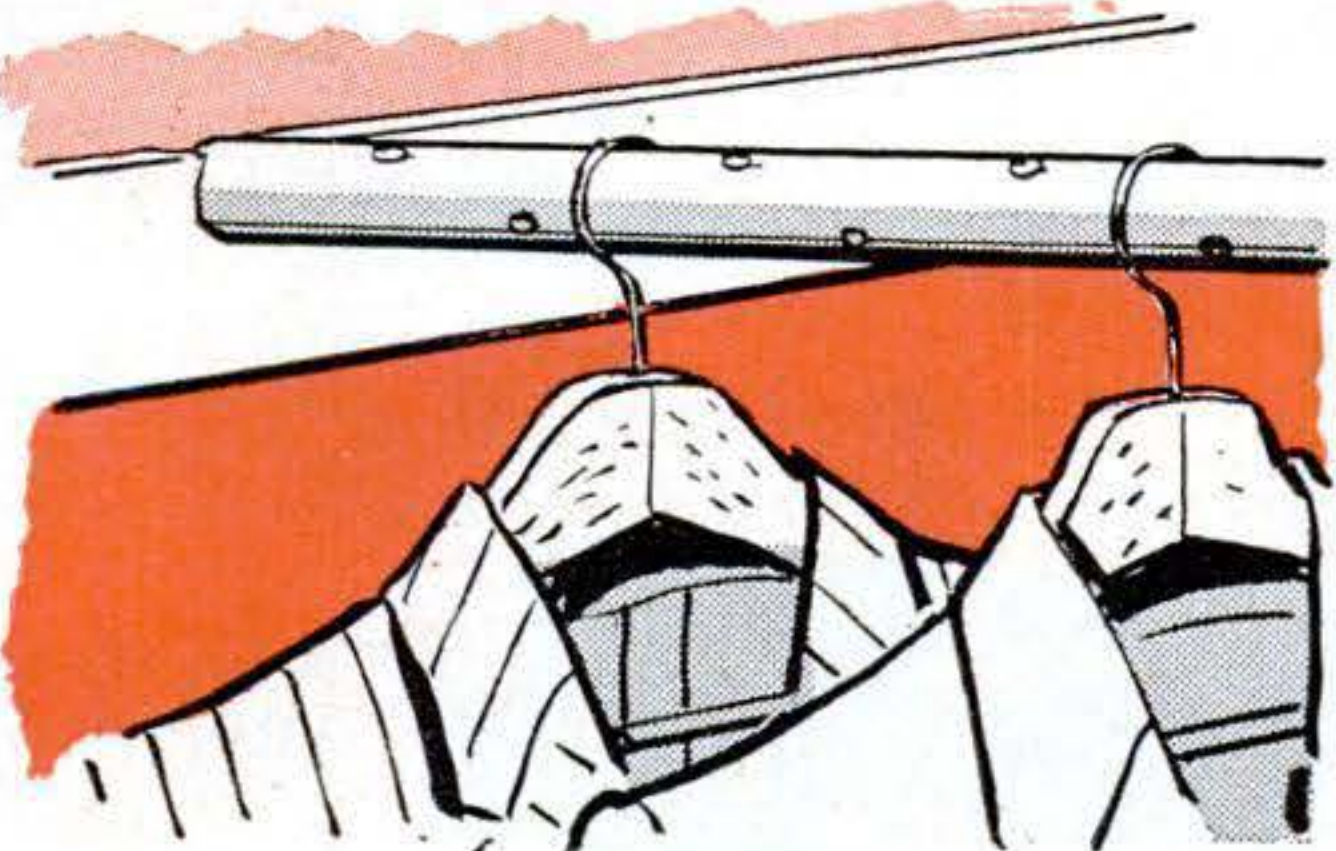

To discourage moths, fit your closets with hollow metal rods drilled with vents and filled with moth balls. An old vacuum-cleaner handle makes a good rod. If it is too short, insert wooden poles at ends.

New Tools

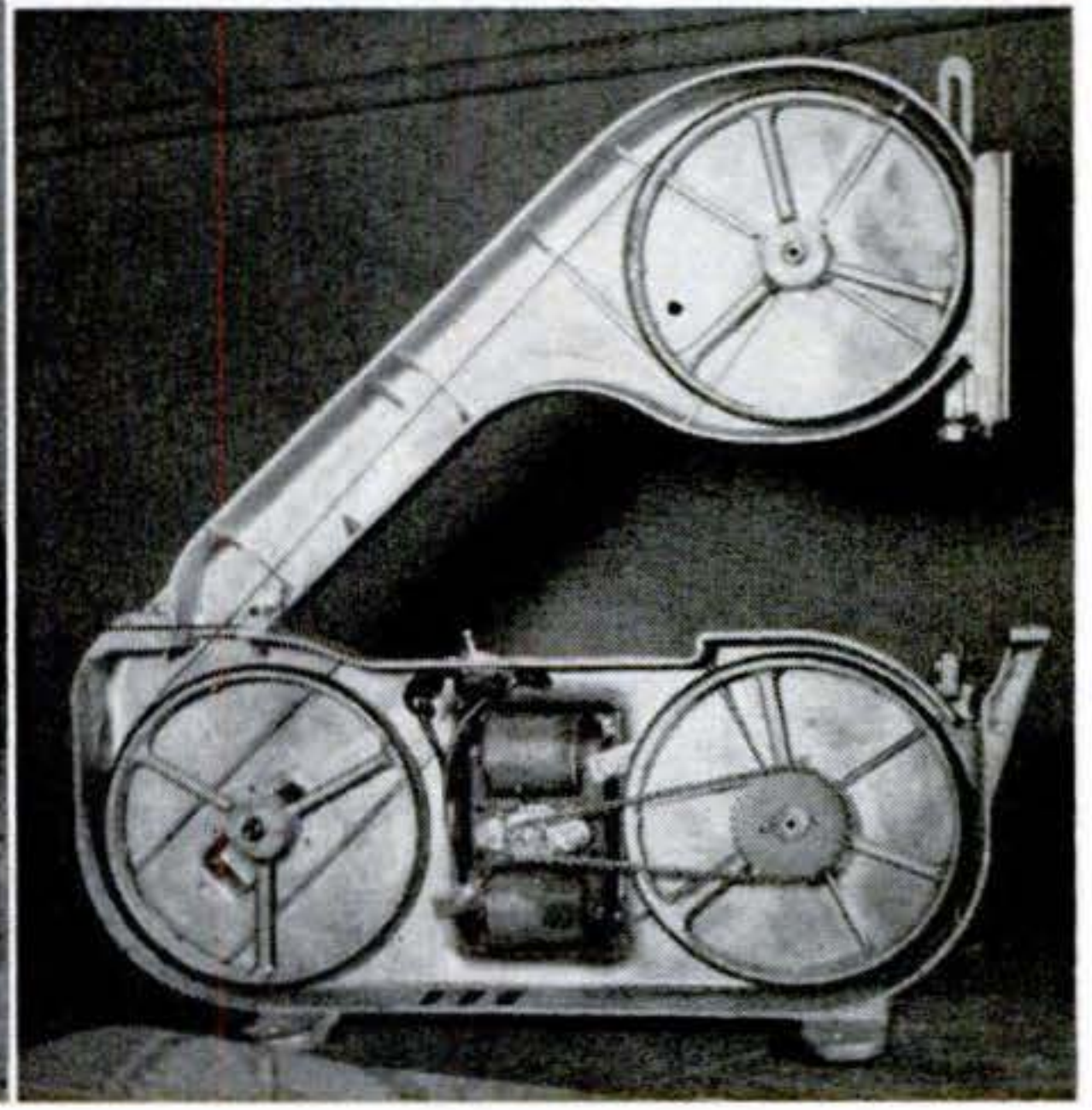

1. Portable Bandsaw Has Its Own Motor. You can carry this lightweight, inexpensive bandsaw anywhere and simply plug it in for on-the-job cutting of wood that is up to several inches thick. A built-in motor chain-

drives the saw through a three-wheel arrangement (right, above) that permits maximum capacity in a minimum of space. The aluminum-and-steel saw has a 12" throat depth and a 10"-square table.

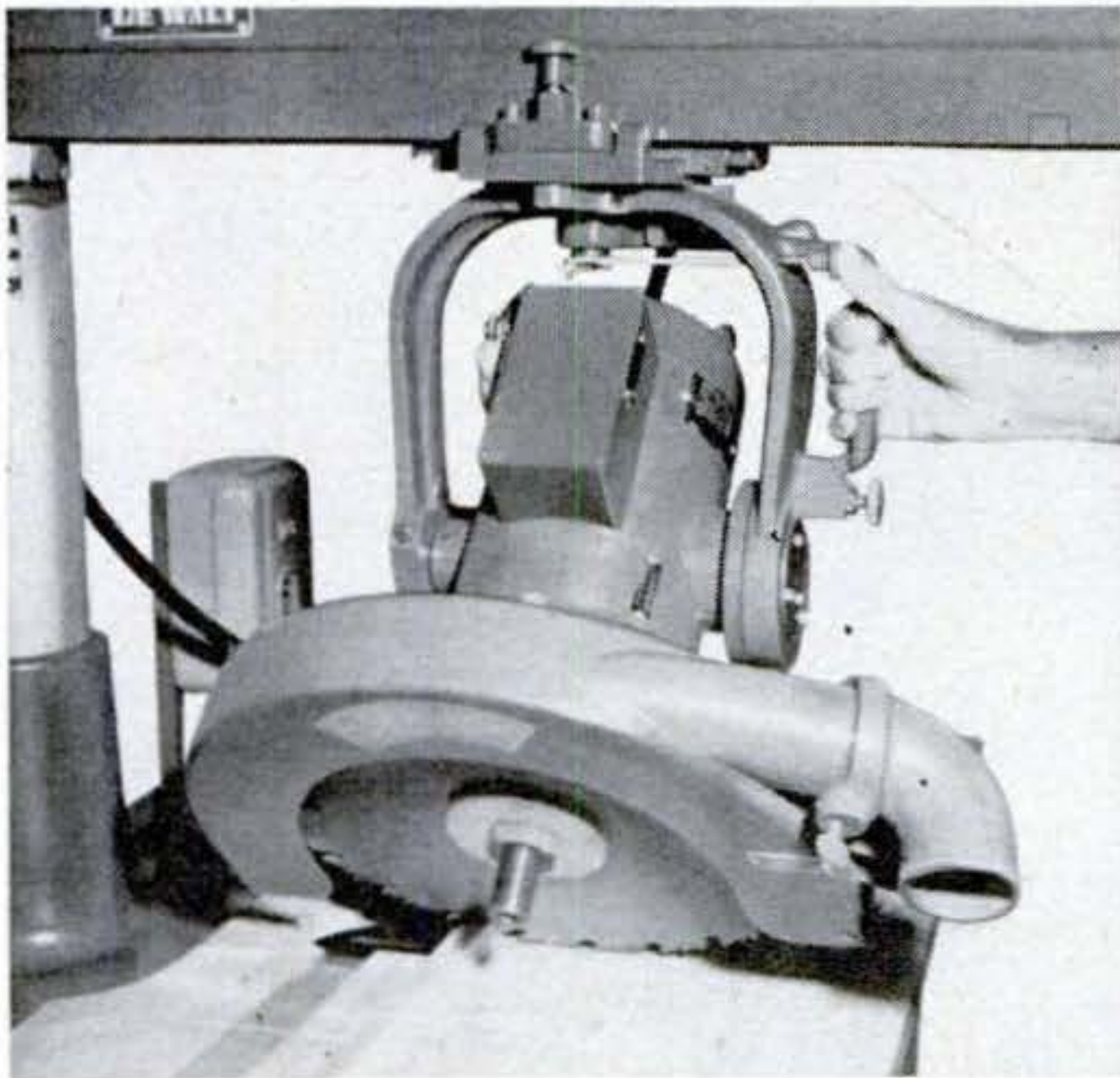

2. Safety Brake Locks Saw. The second you take your thumb off the spring-held plunger on this radial-arm saw, the cutting head automatically locks in the carriage, coming to an instant stop. The brake, designed to prevent trouble in an emergency, also serves as a quick way of locking the blade stationary for use in ripping.

3. Can Sprays Oil. This spray can makes it easy to get light oil in locks, hinges and other hard-to-reach spots. It also sprays a thin coating on guns, garden tools and other metal objects for protection from rust.

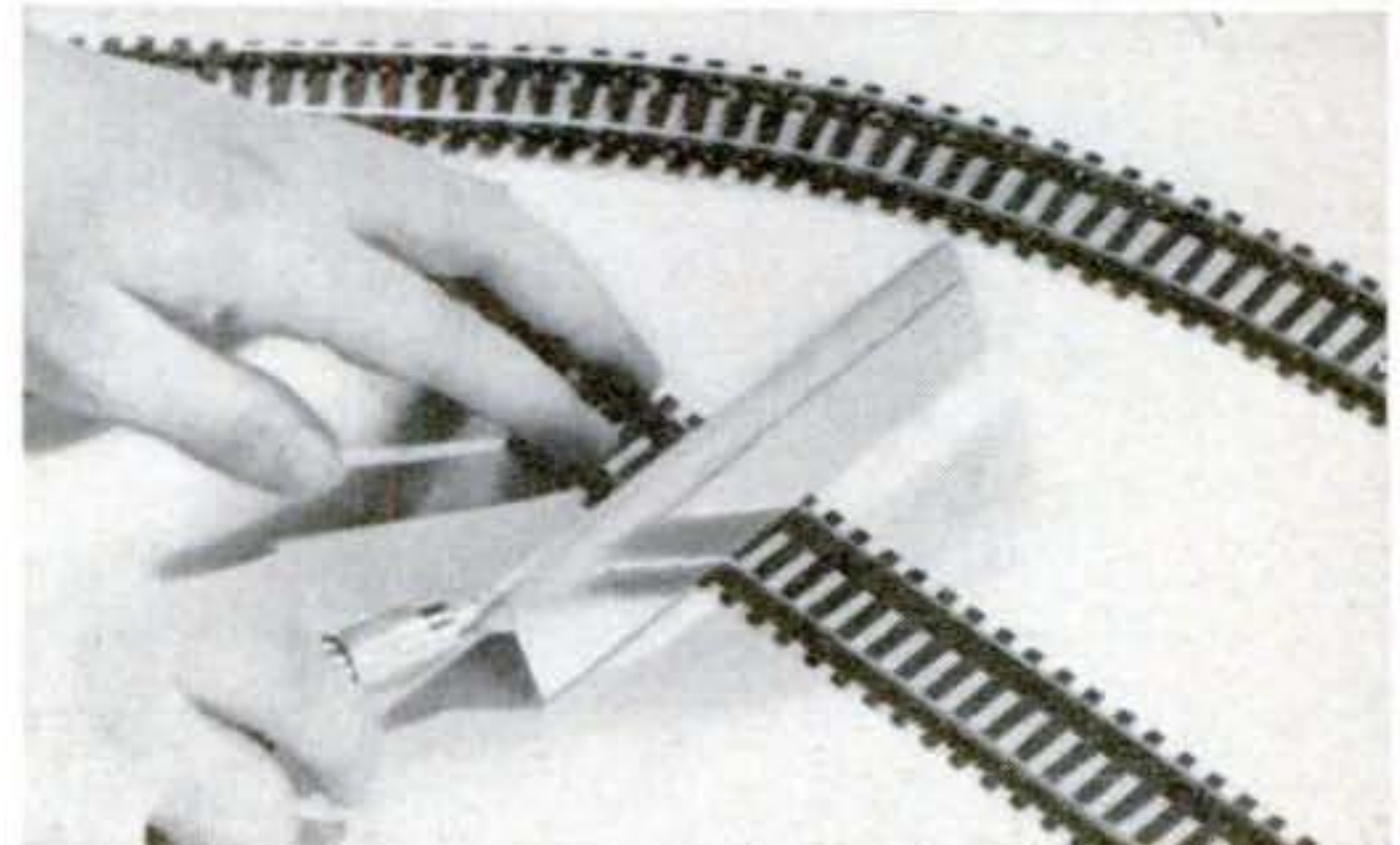

4. Razor Saw Cuts Metal. Tiny saw teeth on this razorlike blade make possible extremely fine cuts in metal, plastic, wood and other materials. The upward-angled handle permits sawing close to a flat surface without barking knuckles. The blade fits in a holder that takes 21 other tools.

Further information on the items described above can be obtained from: 1. Burgess Vibrocrafters, Inc., Old Rand Rd., Grayslake, Ill.; 2. DeWalt, Inc. 3046 Fountain Ave., Lancaster, Pa.; 3. Boyle-Midway, Inc., South Ave. and Hale St., Cranford, N.J.; 4. X-Acto, Inc., 48-41 Van Dam St., L.I.C., N.Y.

Easily Built Control Unit Gives You

Television As You Like It

This safe and simple gadget lowers the boom on commercials, while earphones keep the kids happy watching their own shows.

By Phil Hiner

TO FIND out how you stand in this television era, put a yes or no after each question:

- Is it hard to balance your checkbook or read while the kids are watching TV?
- Ever want to see the fights when your wife is chatting with a friend?
- Feel guilty about looking at late shows because others are asleep?
- Annoyed by the boost in volume that goes with commercials?
- Want to solve all these problems with one master stroke?

For about five bucks' worth of parts and two hours of spare time you can build this remote-volume-control-and-earphone unit. It will let you kill commercials or tone them down, listen with one or more sets of earphones, and adjust the volume on phones or speaker—all without budging from your chair.

With it, children can hear the noisiest horse operas in (to you) complete silence. Stay-ups can enjoy television far into the night without disturbing anyone else in the house.

It's safe and simple. This whole deal is almost as easy to wire as a bridge lamp. The only connections to your TV set are to the voice-coil leads, which are as harmless as a baby chick. The remote-control cable can be run anywhere with perfect safety, and can be room-length if you like.

You will have to buy as many earphones as you have youngsters. (Smartest money you ever spent!) They run from \$1.50 on surplus bargain counters up to several times that, but the cheaper kind will do.

Find voice-coil leads. If yours is a console set, you may not even have to take off the rear panel—the speaker is usually below the chassis, and may be unenclosed. If you have a table set, you will have to take off the rear panel. This will disconnect the

power, but to play safe yank out the plug.

On the loudspeaker frame you will find two terminal lugs with wires to them. The wires may disappear into the chassis, or run to a boxlike gadget mounted on the speaker or close to it. From this unit (the output transformer) a different set of wires will run to the chassis. Leave these and all chassis wiring alone. You want only the speaker leads, the ones to the voice coil.

How to hook them up. Connect a two-foot length of three-wire cable to the socket part of a three-contact connector. Each socket terminal is numbered, and the

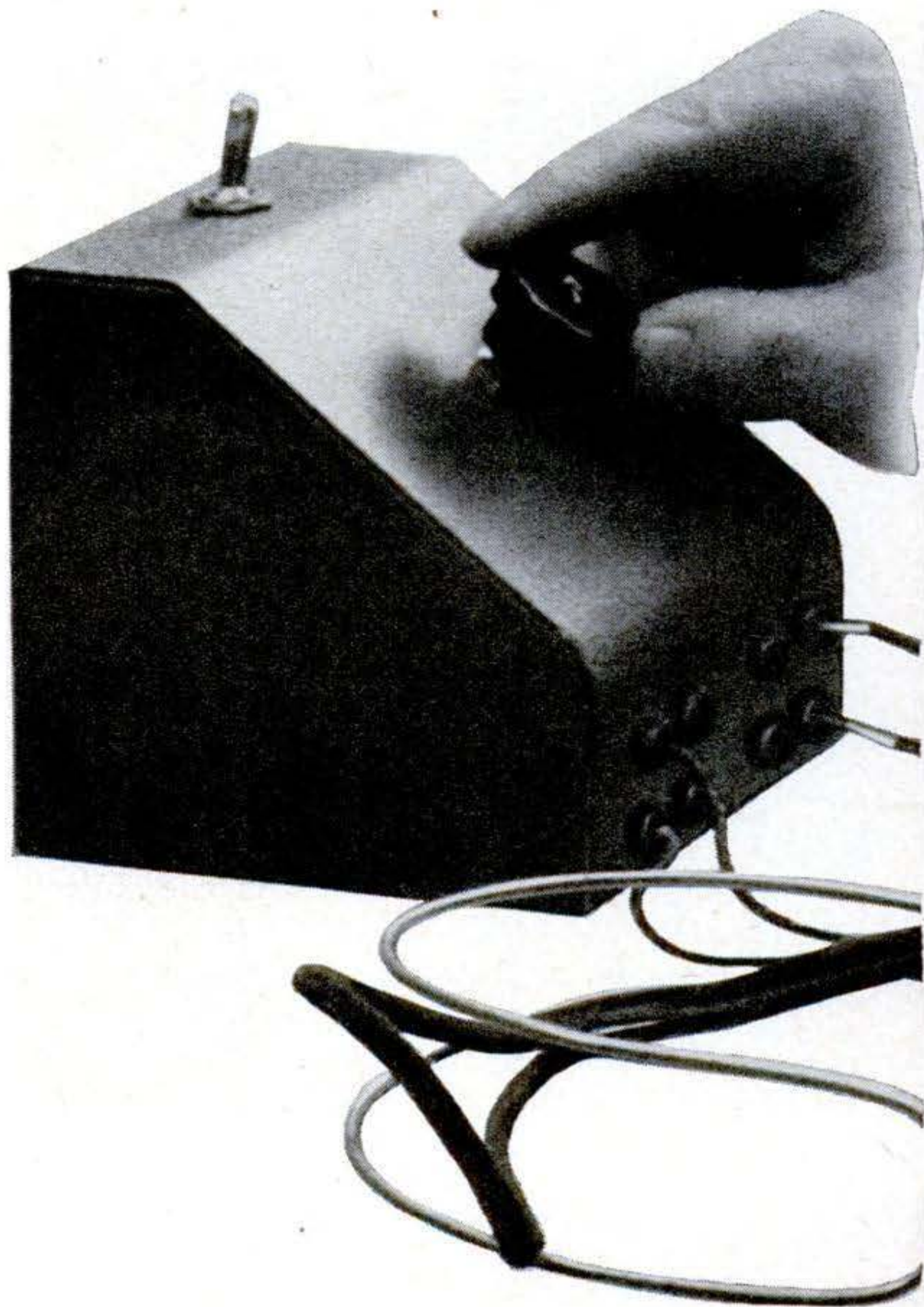



NOBODY IS BOTHERED if the children want to see a rootin'-tootin' Western when Dad and Mother want to read, write or talk. Earphones let the youngsters hear every shot, but the silence is wonderful. For family or company viewing, the unit provides armchair control of loudspeaker volume, letting you tame noisy commercials or cut them out entirely if you wish. Carrying only a harmless current, the connecting cable can be run under rugs or around furniture in complete safety. Although shown here in a small metal cabinet, the unit could just as readily be built into an end table, bookcase or record cabinet, or even into the arm of your favorite viewing chair.

Story *continued on page 220.*

MAY 1954 217

Here's the inside story on Kodak carrying cases

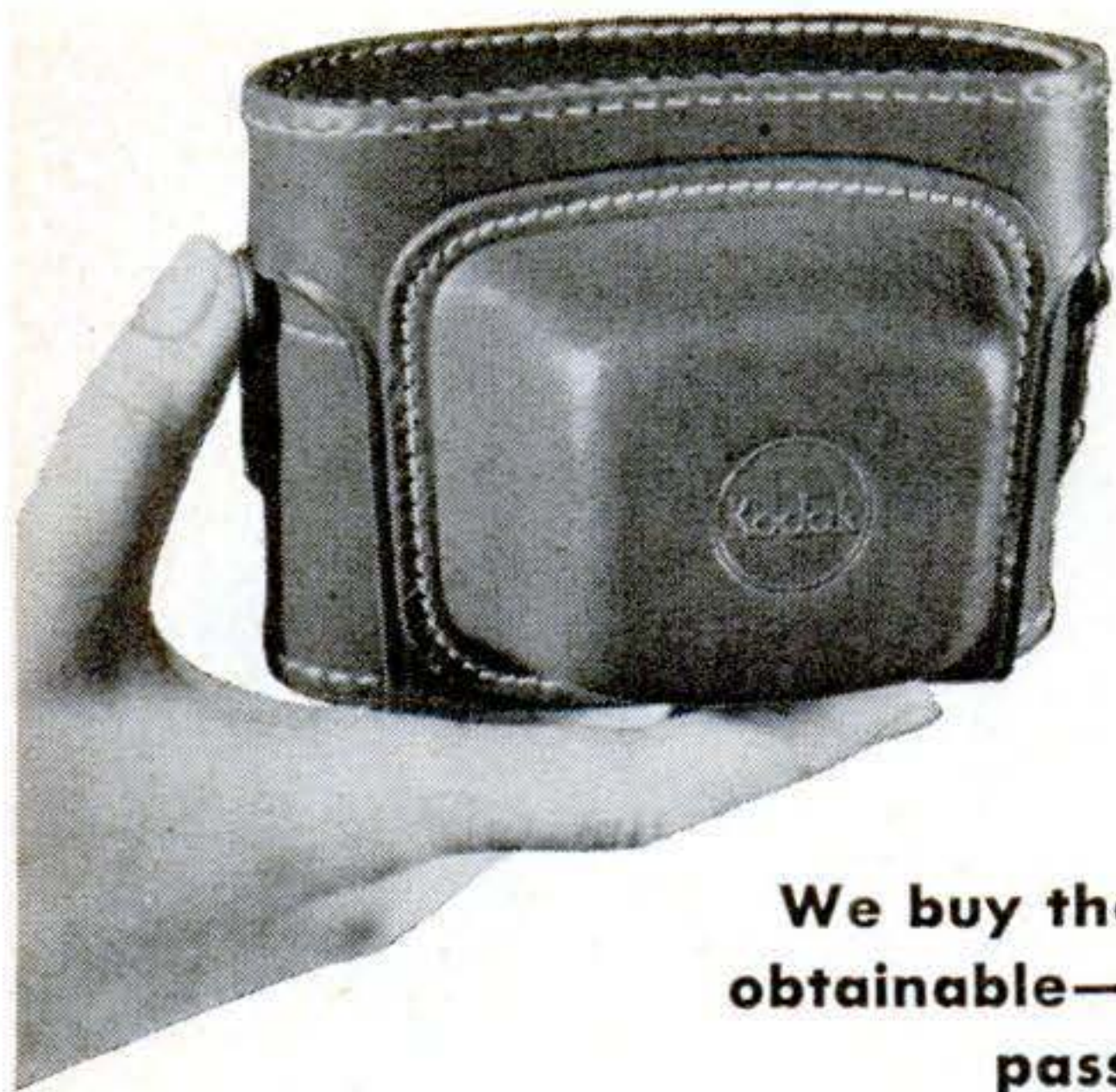

by **A. E. Lechleitner**
Supervising Design Engineer
Eastman Kodak Company



We buy the best top-grain leather obtainable—and even then only 70% passes our inspectors

When people visit our factory, they are surprised to see how particular we are about the quality of our carrying cases.

Here you see the inside story on a camera case (this one is for the Kodak Signet 35

Camera). And opposite are highlights in the production of a "hard" case for a Kodak movie projector. There's a fine Kodak case for nearly every Kodak camera and projector. At Kodak dealers.

Stylists design new models

When Kodak engineers create a new camera, the next step is for stylists to take over and fashion a carrying case. A new case must not only protect; it must also add to operating ease and complement the camera's beauty.

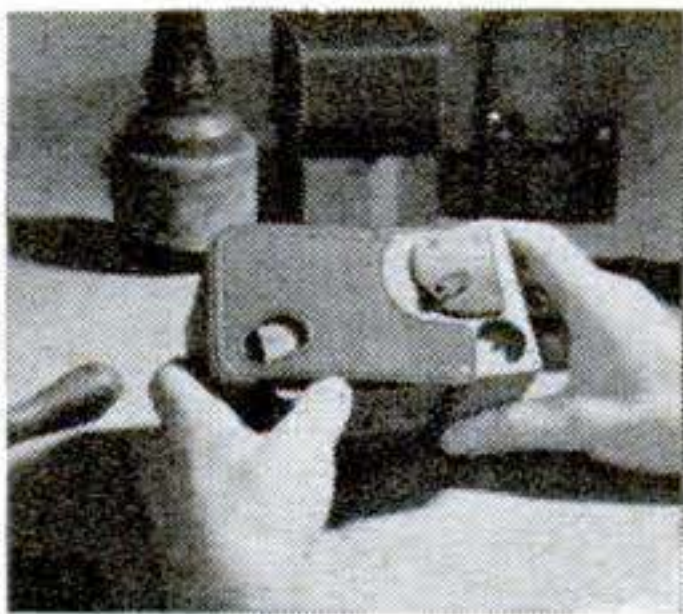

40 operations for average case

It's hard to believe, but a leather case like the one for the Kodak Signet Camera goes through 40 precise manufacturing steps. The final product is unsurpassed for quality and what we call "hidden values."

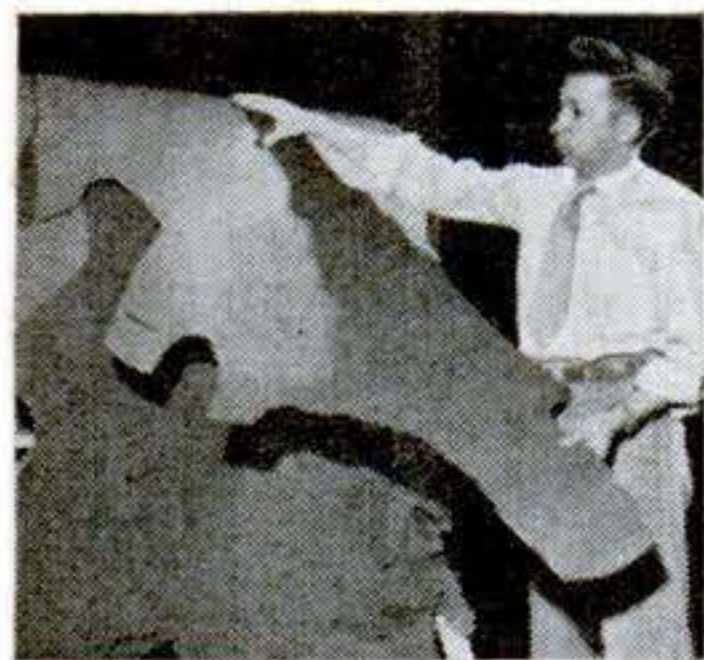

Only top-grain leather

We buy only the best top-grain cowhide. And even then, 30% is rejected in

final tests as not being quite good enough to meet our high standards.

Vegetable-tanned for moisture-proofing

The primary function of a leather case is protection. Each piece of top-grain leather that eventually goes into a Kodak case has been vegetable-tanned. This process interlocks the leather fibers to provide maximum durability. This is the acme of leather processing. We never sand or fill-in cracks either. In the long run these flaws would show up and weaken the whole case.

Many rigorous laboratory tests

Kodak has one of the most extensive research labs for testing leather. There are literally dozens of tests that all leather samples must pass before being accepted for use.

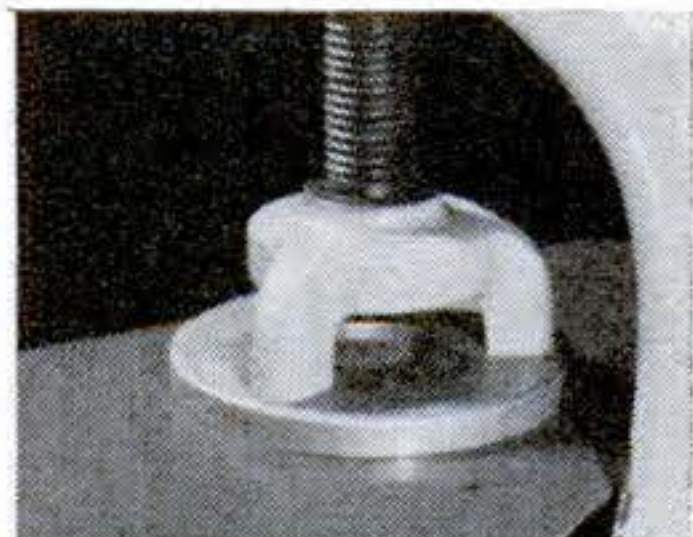

On the right you see the bursting-test machine that subjects the leather to a pressure of several hundred pounds per square inch. We know that leather passing this test will withstand hard knocks and will take plenty of abuse for years.



We also test for ability to withstand flexing in cold weather. The picture at left shows finished leather cases in a refrigerator room where the temperature is 0° F. If the leather shows no cracks after exposure to this test, it passes.

And so it goes. It's a matter of test after test. Sample leather is tested for finish, fading, and aging. At right you see leather cases being tested in an aging oven. Inside this oven, sample cases are left for long periods of time. Terrific heat simulates years and years of deterioration. This severe test subjects a case to the most rigorous conditions it might meet during a lifetime.

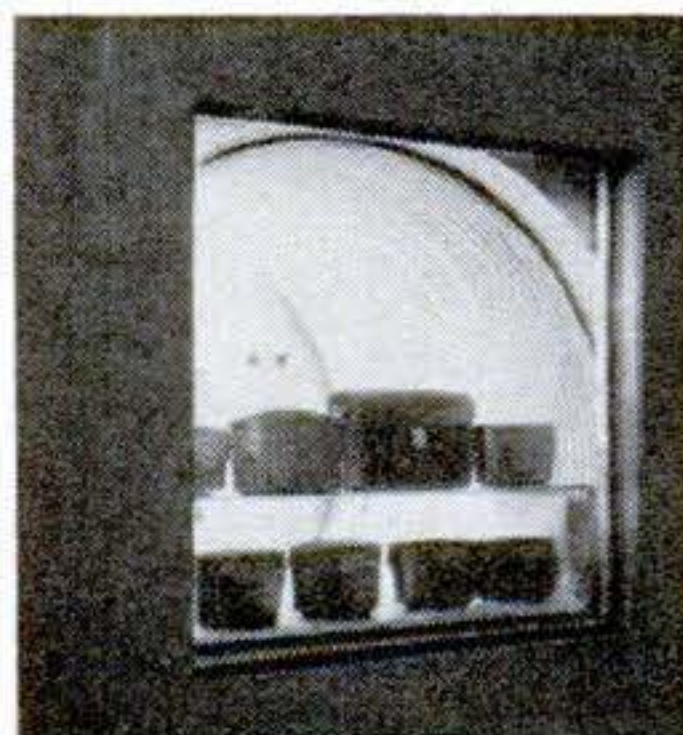

Machines cut leather to perfect pattern

The approved leather is now ready to be cut into bottom, top and side pieces. Precision tools (right) insure a perfect fit for each model.

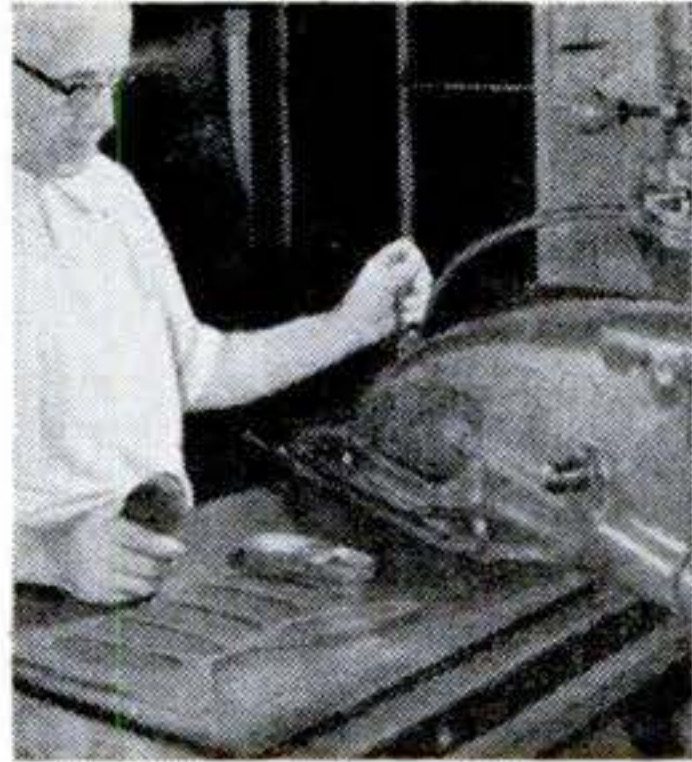

Skilled workers sew with long-staple cotton thread

Durable thread is used for joining the pieces of leather to form the case. Corners are lock-stitched.

Metal reinforcements are rustproof

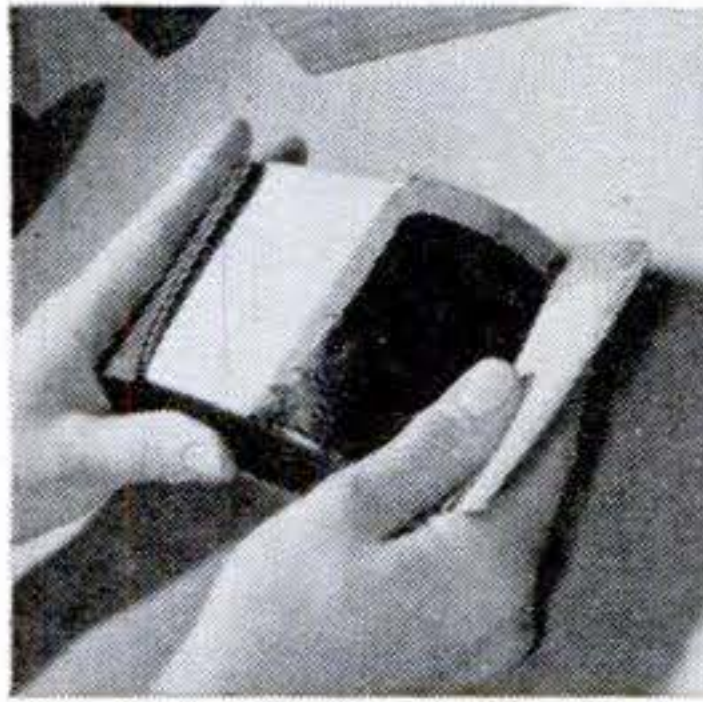

In cases for some camera models we insert metal reinforcing for extra support. This metal is rust-proofed to insure long-lasting protection. And the leather lining is finished smooth for better wear and appearance. Also makes it scuffproof.

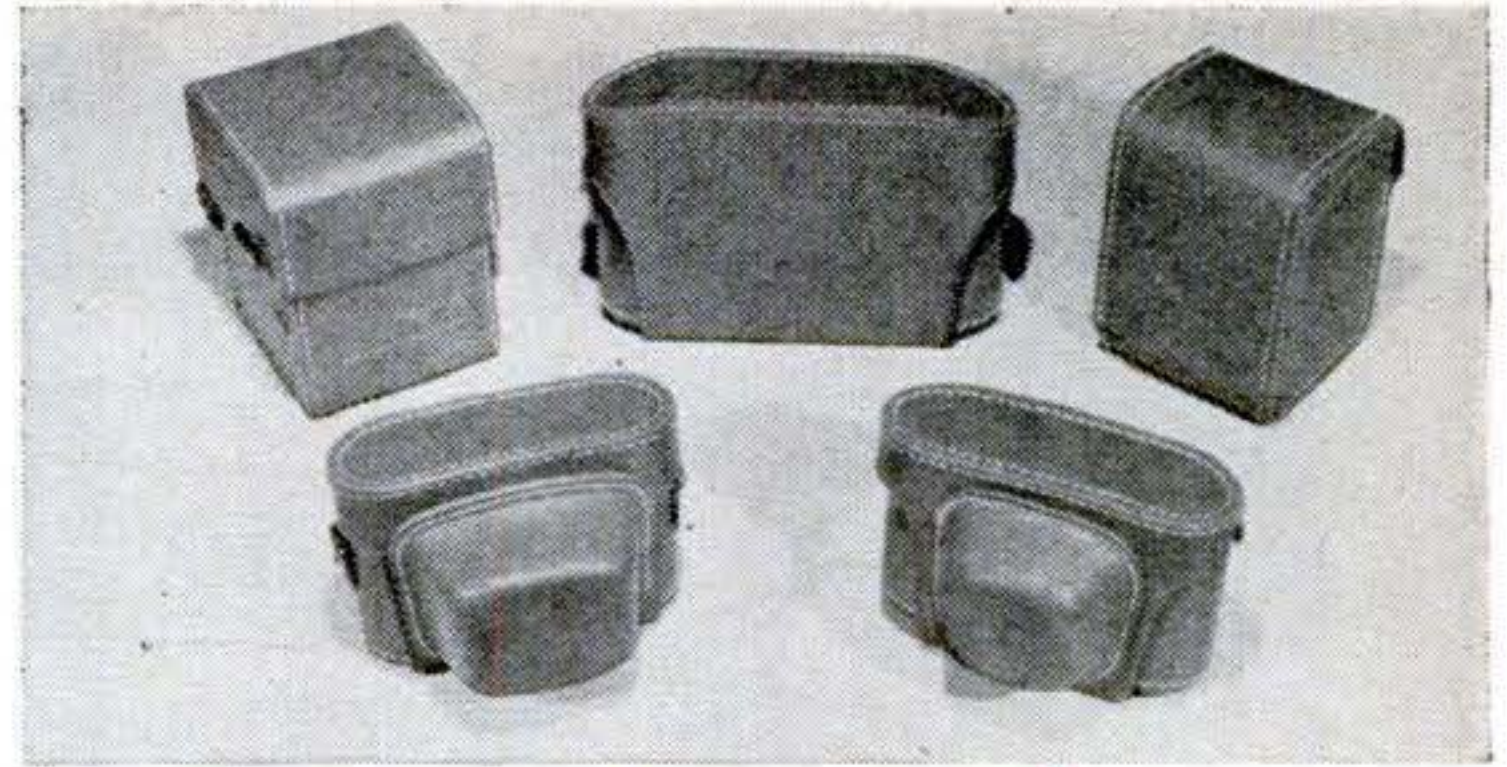

You get top value for your money

As you can see by now, there's no compromise on quality of materials or smartness of design when Kodak makes a carrying case for your camera. Even in our simulated-leather cases for inexpensive models, the materials and workmanship are of the best. These cases also are tested for aging, peeling, fading, cracking.

With all this "to-do" about building a carrying case, you might expect the price to be exorbitantly high. Not at all! Over the years we have been able to introduce new economies all along the line. The end result is absolutely top value in camera cases.

A Kodak "hard" case for projectors will support a 180-pound man

You'll never do it, most likely, but you *could* safely stand on top of our projector cases—those for both movie and slide projectors. They're that strong and rugged. And a good thing too, because optical systems and lamps are fragile at best. They deserve the utmost protection—a Kodak carrying case.



Carefully select materials

Shockproof plywood—and a product called heavy chipboard—are our best materials today for these cases.

Lock corners for long life

The simplest way to make

a box is to take pieces of wood, slap them together, and glue or nail. But that's not the way we do it (see picture above).

Fine-quality hardware

We find customers with cases that are 20 years old and older getting the same good service out of them as when they were first made.

Sanforized® linings won't shrink

Our research lab learned that ordinary cotton lining shrank too much. Now all Kodak hard-case linings are shrinkproof (shrinkage will not exceed 1%).

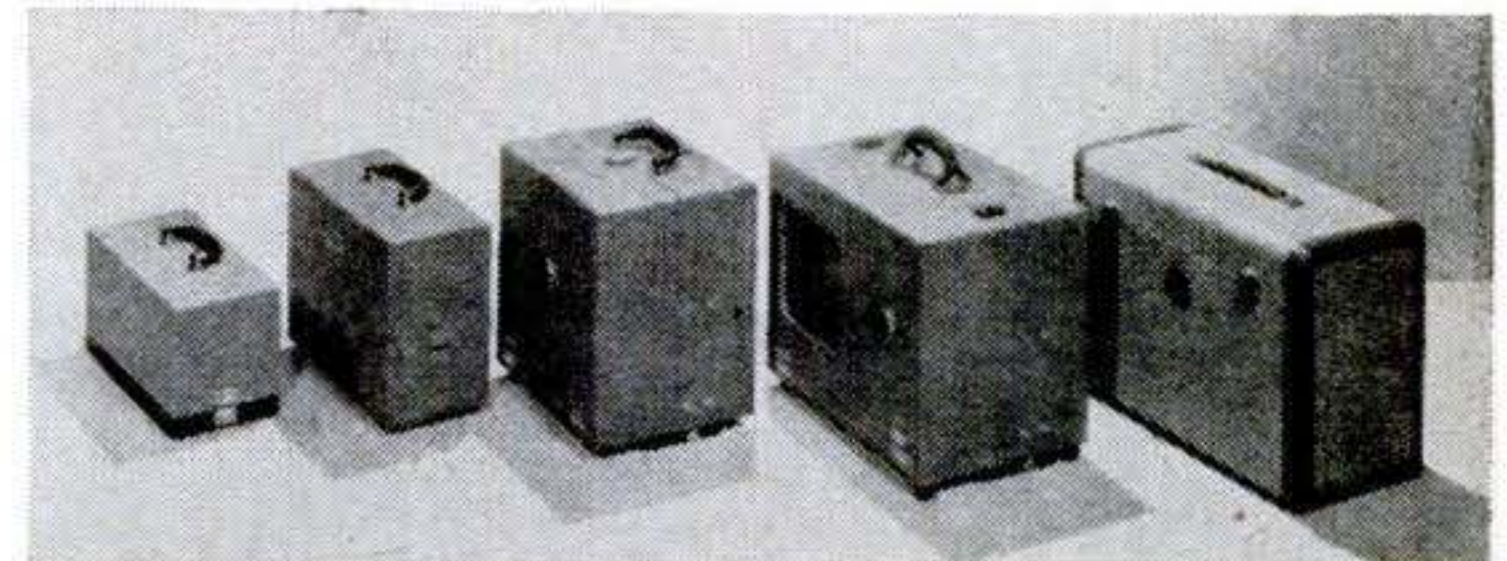
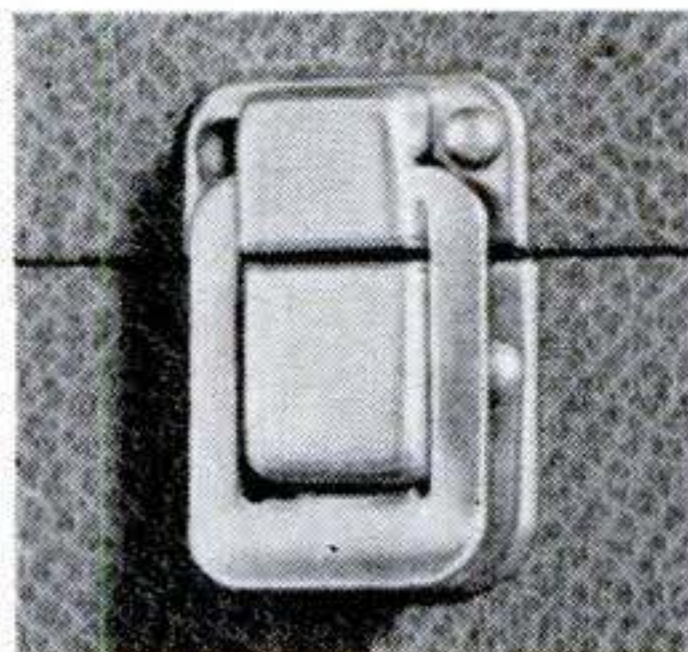

Wide assortment of Kodak hard cases

We make all our own cases for our slide and movie projectors. The next time you're in the market for a projector, check the quality of the cases you see. And when you look at the Kodak cases, remember the inside story of "hidden values."

Eastman Kodak Company

Rochester 4, N.Y.

Kodak
TRADE-MARK

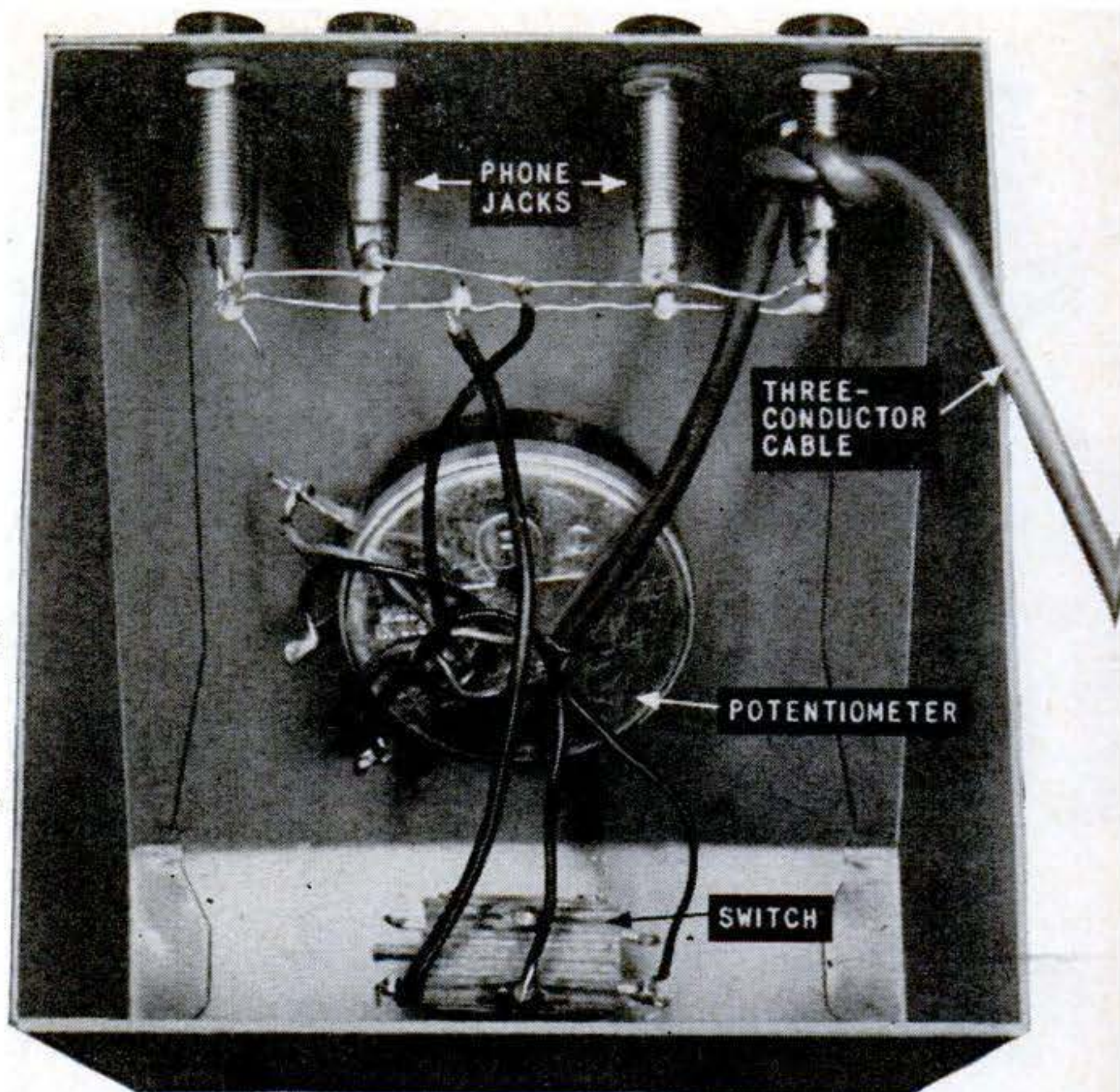
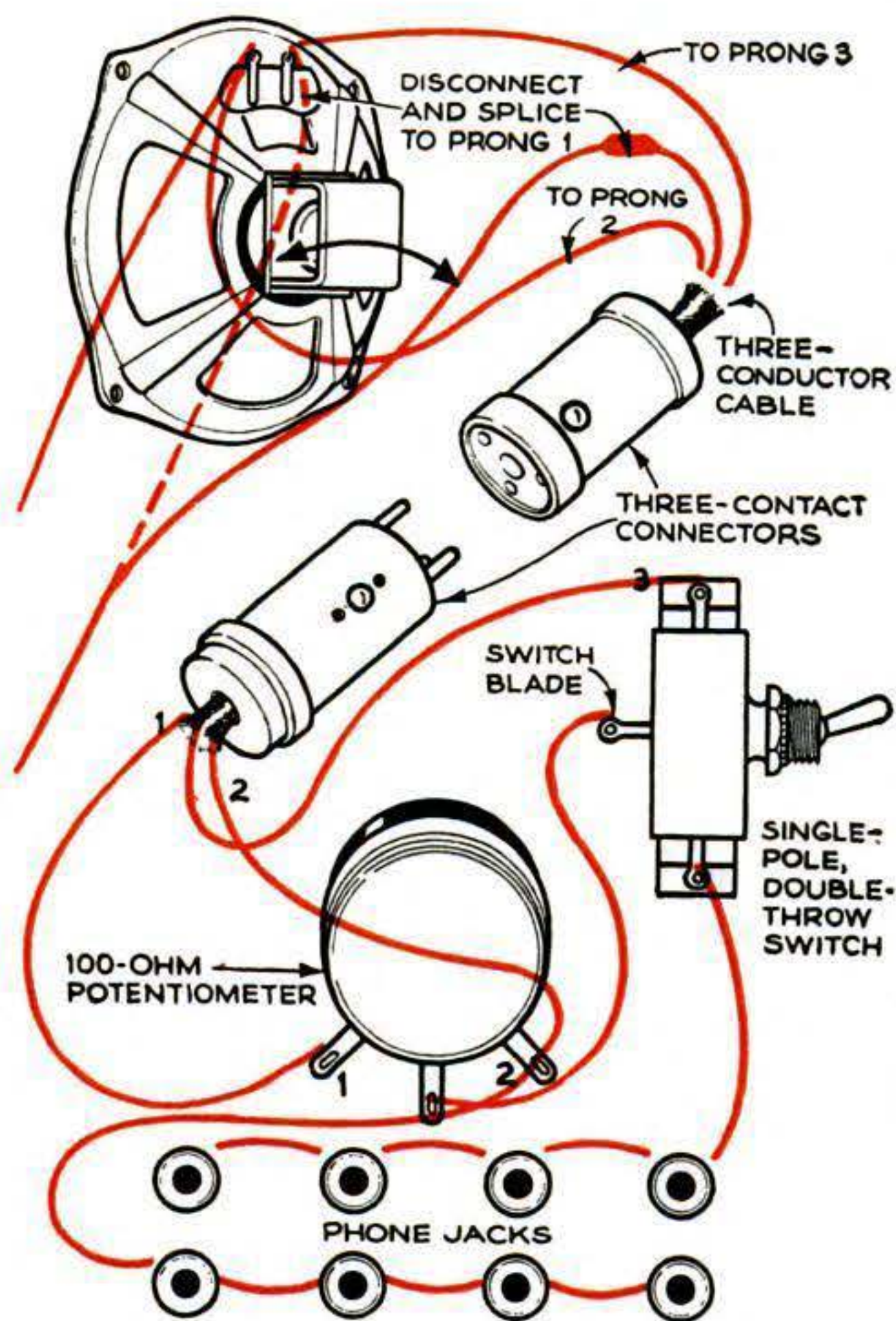

UNIT IS SAFE even if left open, but a wooden bottom can be held in with screws through the sides. Switch shown happens to be a double-pole type, so only one side is connected.

HOW TO FIND VOICE-COIL LEADS

HOOK UP ONLY to wires on speaker frame (arrows). Do not touch those from set to output transformer.

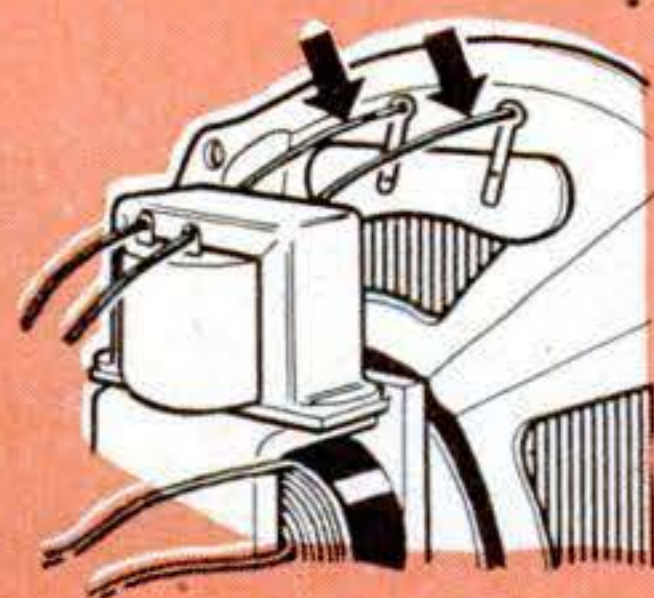
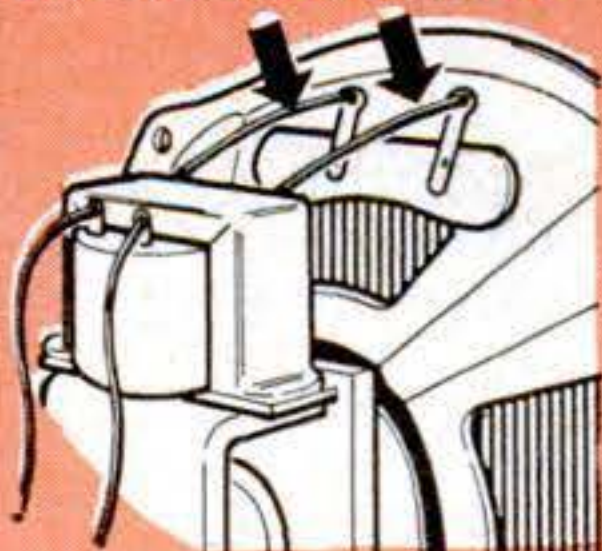

ELECTRODYNAMIC speaker will have two extra wires to its field coil (left). Use only leads indicated by arrows.

wires in the cable are of different colors for easy identification.

Now unsolder one voice-coil lead from its terminal on the speaker. Solder it instead to the cable conductor that goes to socket terminal 1, and tape the splice. To the now-bare speaker terminal, connect the cable wire from terminal 3. To the other speaker lug, solder the wire from terminal 2, leaving on the wire already attached to this terminal.

Building the control box. The remote unit can be put in a small cabinet or even a wooden box, end table or bookshelf. The sloping-panel metal cabinet shown, 4½" on

a side, makes a rugged carry-about unit.

You can use tip jacks, banana jacks or the larger two-contact type, and install as many as you need, fitting the earphone tips with matching plugs.

Solder the three wires of whatever length cable you need to the prongs of the connector plug. Connect the far end of the wire from prong 1 to the left-hand lug of the 100-ohm potentiometer (as seen from the back). Hook the wire from prong 2 to the right-hand lug, to which one row of phone jacks goes. Run wire 3 to an outside lug of the single-pole, double-throw switch.

Connect the other row of phone jacks to the opposite switch lug. Run a short wire from the center or blade terminal of the switch to the middle potentiometer lug.

You've done it. Plug the connector together and turn the TV set to high volume. Throwing the switch on the unit one way should now work the speaker, the other way, the earphones. The potentiometer should control volume either way.

If for any reason you unplug the remote unit, you will have to short connector sockets 1 and 3 to make the speaker work. Buy another connector plug, solder a wire across prongs 1 and 3, and plug it in. **END**

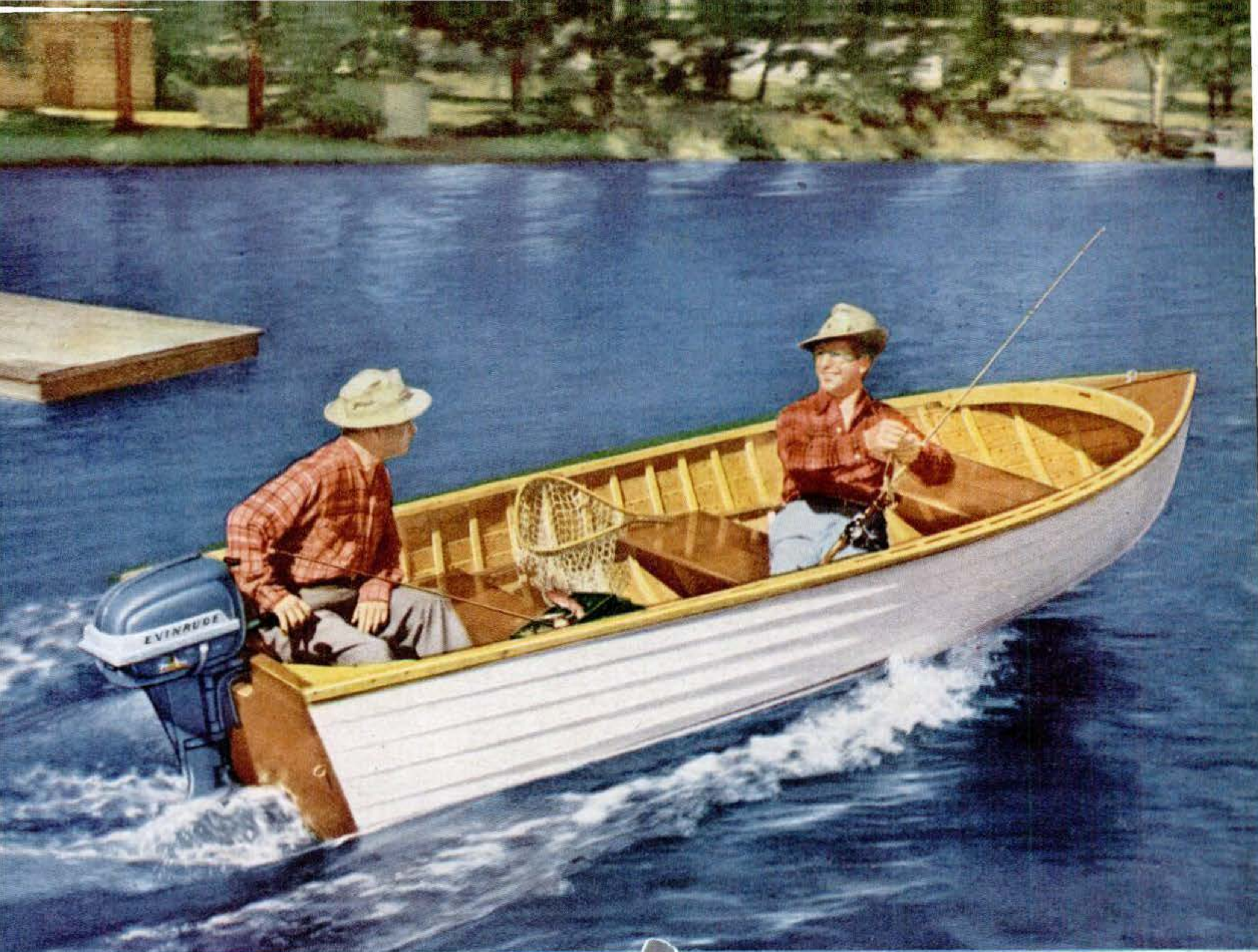

...all's quiet ON THE WATER FRONT!

THERE goes the dawn fishing patrol! But *this time* not a soul was wakened to curse them on their way! The difference is *Whispering Power*, by Evinrude... and light-sleeping cottagers will tell you it's the greatest step forward in outboard design of our time. We'd like you to see, and hear, and *TRY* it—this new, quiet, vibrationless Fleetwin *Aquasonic*... for the *biggest thrill of all* is reserved for the man who holds the steering handle! There's no "wrist tingle"—no dancing tackle box—no hull quiver! And you find you can talk, at last, without letting the world in on your conversation! And there's so *much* more—*big-motor* features like Gearshift, and Cruis-a-Day Tank, and Auto-Lift Hood. And *big-motor* performance that planes your boat! 7.5* horsepower—only 49 pounds!

SEE YOUR EVINRUDE DEALER—he's listed under "Outboard Motors" in the yellow pages of your phone book. Let him show you the complete Evinrude line for '54. Four great motors—smoothest, quietest in each power class—3 to 25 H.P.—the right motor for every boat! For free catalog write EVINRUDE MOTORS, 4355 North 27th Street, Milwaukee 16, Wisconsin.

IN CANADA, Manufactured by Evinrude Motors, Peterborough



*7.5 O.B.C. certified brake H.P. at 4000 R.P.M.



CATALOG FREE! Write for big full-color catalog of the complete Evinrude

Evinrude

quiet

OUTBOARD MOTORS

copyrighted material



STANLEY

Smooth, accurate finishing of rough surfaces is easy with this Stanley 9" Plane. Adjustments for depth of cut, truing blade and cutter opening. 2" wide cutter blade is solid 1-piece tool steel... hardened, tempered, polished. Close-grain cast iron frame. Rosewood handle, knob. (4HR6217) **\$8.29**



WIZARD

Delivers smooth, quiet flow of power longer. Wizard V-belt is perfectly balanced... holds peak efficiency with fewer adjustments. Powerful cable cords, pre-heated in liquid rubber and locked in non-heat-generating cushion stock. Double service jacket. 22" to 100" (2HR1922-88)... **61¢ to \$2.69**



Gives a "piano" finish to rough wood, metal surfaces. Speedway Speedsander ends tiresome hand sanding, polishing. Powerful direct drive ball-bearing motor. "Natural" orbital motion—3450 times a minute! Uses any sheet abrasive. Lightweight aluminum housing. (2HX1140) **\$34.50**

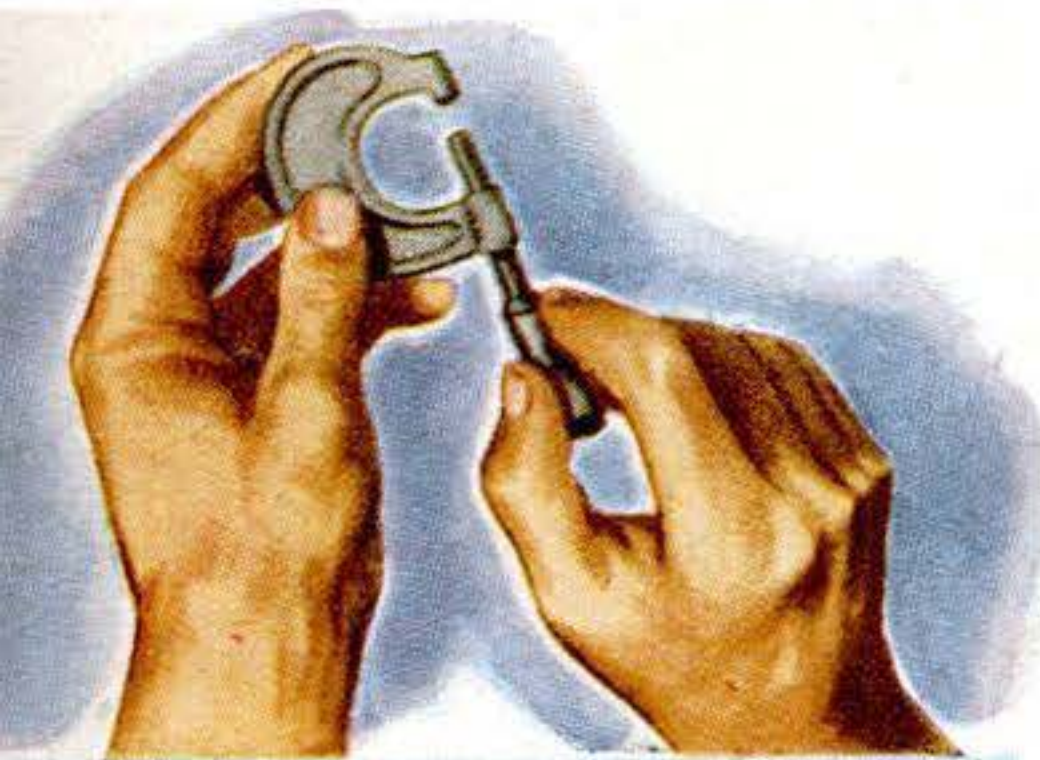

The Pick of America's Finest

Save time, save work... do it



WIZARD

Wizard 8" Tilt-Arbor Saw whizzes through wood up to 2 5/8" thick. Rips, crosscuts, rabbets, bevel cuts to 45° (work stays level). 14" x 17" cast iron table. 1/2" grease-sealed ball bearing arbor. Comb. blade, guard, rip fence, motor rail, pulley, miter gauge, splitter, V-belt. (2H1006).... **\$53.95**



REESE

Designed for maximum protection, years of trouble-free service. Reese Padlock has solid brass body, inside parts... rust and corrosion-resistant. 5-pin tumbler action. Case-hardened steel shackle, 7/8" clearance. 1 1/2" x 3/8" case. Ideal for industrial, school, club, home use. (3HR9910) **\$1.95**



WESTINGHOUSE

For hard-to-start loads on saws, jointers, lathes, other power tools. Westinghouse 1/2 H.P. Capacitor Motor has grease-packed oversize ball bearings for long life, minimum maintenance. Heavy insulated, moisture-resistant windings. Easily reversible. 115 v, 60 cyc. AC, 1725 rpm. (2H1603) **\$38.25**

Choose from over 1,100 professional quality power and



**HOLD-E-ZEE
SCREWDRIVERS**

Makes close quarter work easy. Spring action claws on 4" Hold-E-Zee Screwdriver grip screw head for easy, one-hand starting. Alloy steel blade anchored with new Lok-Blok feature...twist and impact-proof. Shockproof Tenite handle. (HR1403) **79¢**
Others (HR1398-1401-5-6) **41¢ to \$1.22**



Wizard Power Saw Blades, famous Cocker quality (96 yrs. experience). Balanced combination of carbon, chrome, nickel. Precision tempered and tensioned to cut fast and smooth longer without re-sharpening. 1/2 or 5/8" hole. 8" Rip or Crosscut (2HR1023-4) **\$2.49**
8" Combination (2HR1022) **\$2.49**



BERNZ-O-MATIC

No filling, no spilling...no priming, no pumping. Instant lighting Bernz-O-Matic is perfect, easy-to-handle torch for soldering, paint burning, body and fender work, etc. Lightweight—weighs only 2 1/2 lbs. With long-lasting fuel cylinder. (4HR4420) **\$6.95**
Refill cylinder (4HR4421) **\$1.95**

"Do it Yourself" Tools... at **Western Auto**

easier, faster, better... and save

WESTERN AUTO
STORES AND ASSOCIATE STORES

NOTE: Western Auto Associate Dealers own their stores and set their own prices, terms and conditions. Prices may vary due to differences in local conditions. If you do not know the location of your nearest Western Auto Store write Western Auto Supply Co., 2107 Grand, Kansas City, Missouri. (PS54)

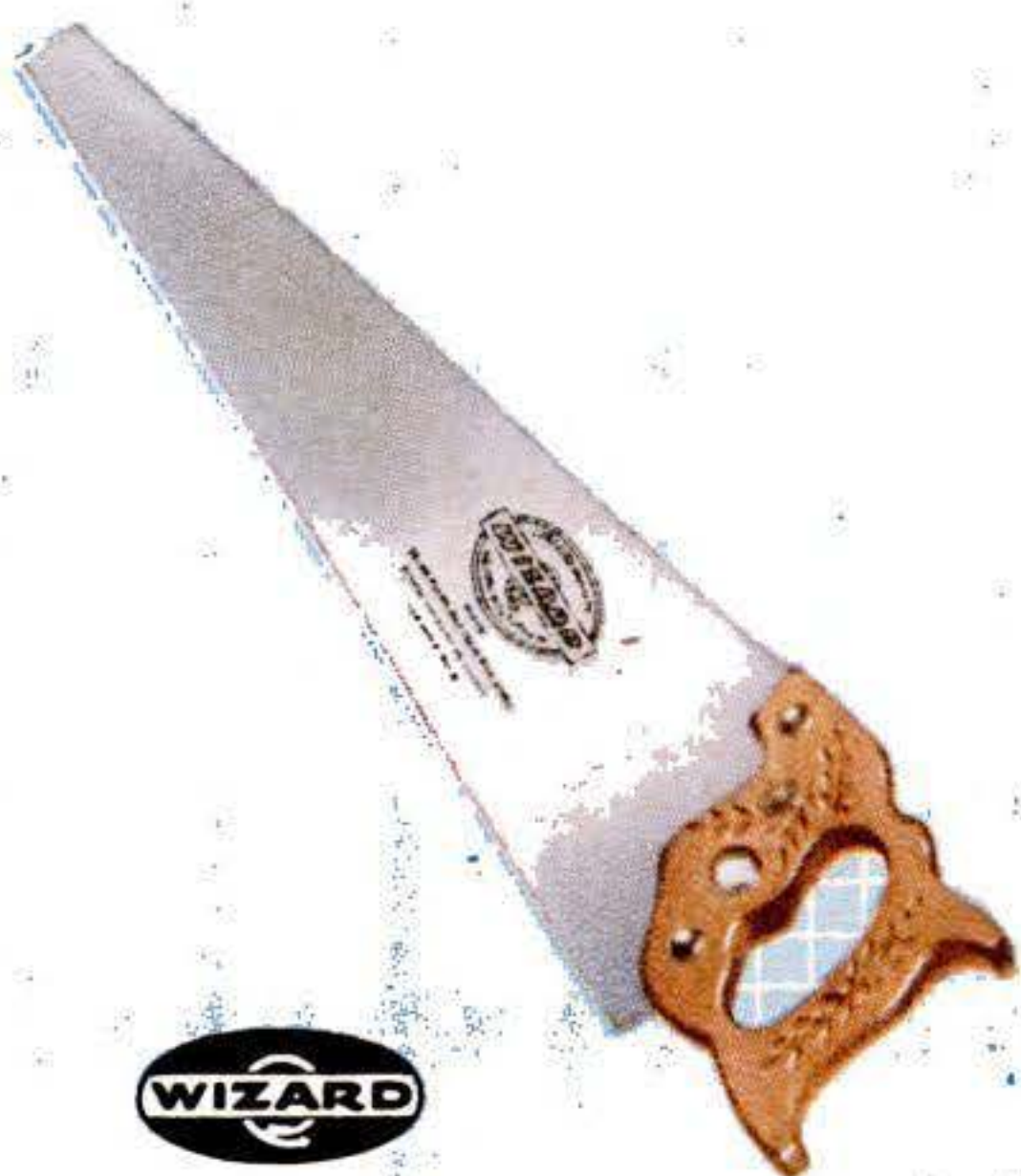

WIZARD

Slices through toughest wood with no binding or buckling. Perfectly balanced Wizard Saw has true double taper... expertly set, bevel-filed teeth. 26" lightweight blade... precision tempered, uniformly hardened from grip to tip. 8 or 10-pt. crosscut, 5 1/2-pt. rip. (4HR6305-6-29) **\$4.10**

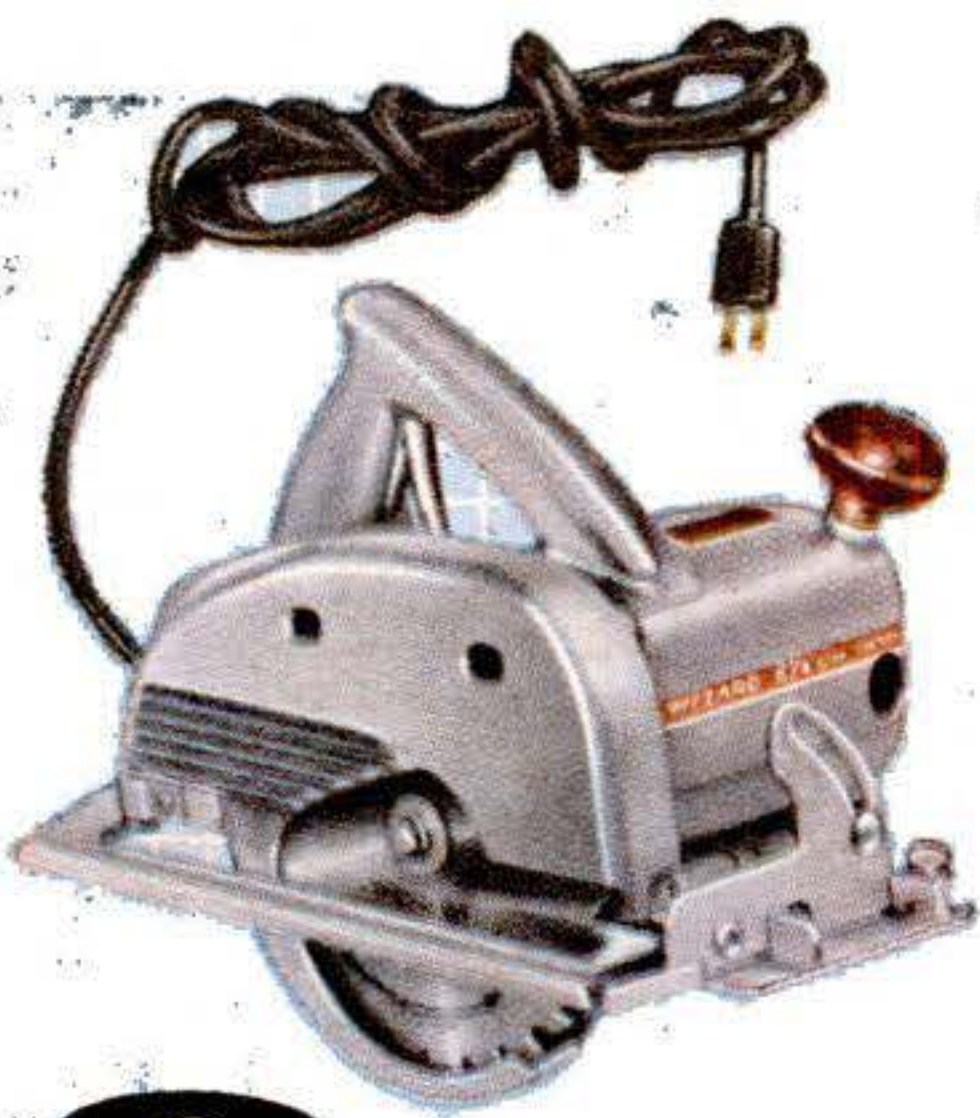

WIZARD

Makes fast work of heavy sawing... saves hours of effort. Wizard Zip-saw has 6 1/4" combination blade... rips or crosscuts to 2 1/8" depth, bevel cuts to 45°. Adjustable rip guide. Precision-cut bronze gears. Lightweight aluminum housing. 110-120 volt, AC-DC motor. (2H1082) **\$36.75**



WIZARD

Whirls through wood, metal, plastic... polishes, grinds, sands. Wizard 1/4" Drill (famous Fairchild quality) does dozens of jobs with just a few accessories. Perfect speed-power balance. Alloy steel-cut gears. Lightweight, cool running. Hand-tite 3-jaw chuck. Finger-tip switch. (2H1379) **\$12.95**

hand tools... see your Western Auto man this week.



SQUAT LAMP like this is fine for sitting around outdoors. Use it indoors, too, or on a porch for nonglare light. The base is cut from one-by-twos; the cylindrical shade is formed from yellow sheet plastic.

How to Install

Outdoor Lights



HANGING LAMP doubles use of picnic table. An octagon of yellow plastic to diffuse light from the bulb gives you your own private nighttime sun. The soft illumination is cheerful and discourages insects.

THERE'S a trace of bat or owl in all of us. Just enough so we like to be outdoors after dark, but not enough so we can get along without any light at all.

You can give full play to the owl in you by wiring your yard. It's surprisingly easy, most of the complications of house wiring being absent from outdoor work.

You can light your yard for some or all of many purposes. You can pinpoint a few handsome spots for a night view of your garden from inside the house. You can illuminate work areas and do your petunia weeding after the sun goes down. You can throw a light fixture over a favorite picnic spot or barbecue and double its usefulness. Or you can merely make the place safer and pleasanter with the simplest of lighting setups.

Perhaps all you'll want to do just now is

New fixtures and cables make it easy to put kilowatts where you want them, for better living under the stars.

By Paul Corey

run wiring to a weatherproof outlet in some strategic spot for use with a lawn mower or other power tools. Once it's there, all you'll need are extension cords and clip-on or stick-in-the-ground fixtures to light up the yard or garden for any party or picnic you plan.

Three easy lighting methods. It is possible, of course, to install permanent lighting outdoors. But it is much more flexible, and certainly a simpler beginning, to use one or more of three other methods.

One of these is the weatherproof outlet. Put in several and you can add whatever lights you need at any time, using simple fixtures sold for the purpose. You can install these permanently when you are ready. Or you can use them plug-in fashion, putting them away between times.

A second method uses overhead wiring. You can buy what is called weatherproof wire and string it up where you want it. At

Here Are Easy Ways to Light the Outdoors



UTILITARIAN LIGHT outside an outbuilding is provided by a simple fixture like this. Conduit serves as the bracket. A switch is placed in easy reach elsewhere, often at the house.



QUICKEST WAY to controlled yard lighting is a porcelain socket on the side of house protected by roof. Add swivel and reflector bulb. Mount socket on an octagon box recessed in wall.



GROUND-LEVEL LAMP comes with a round base for fastening to a building or a spike to stick into ground. Socket is weatherproof if used with an outdoor reflector. Lenses snap on.

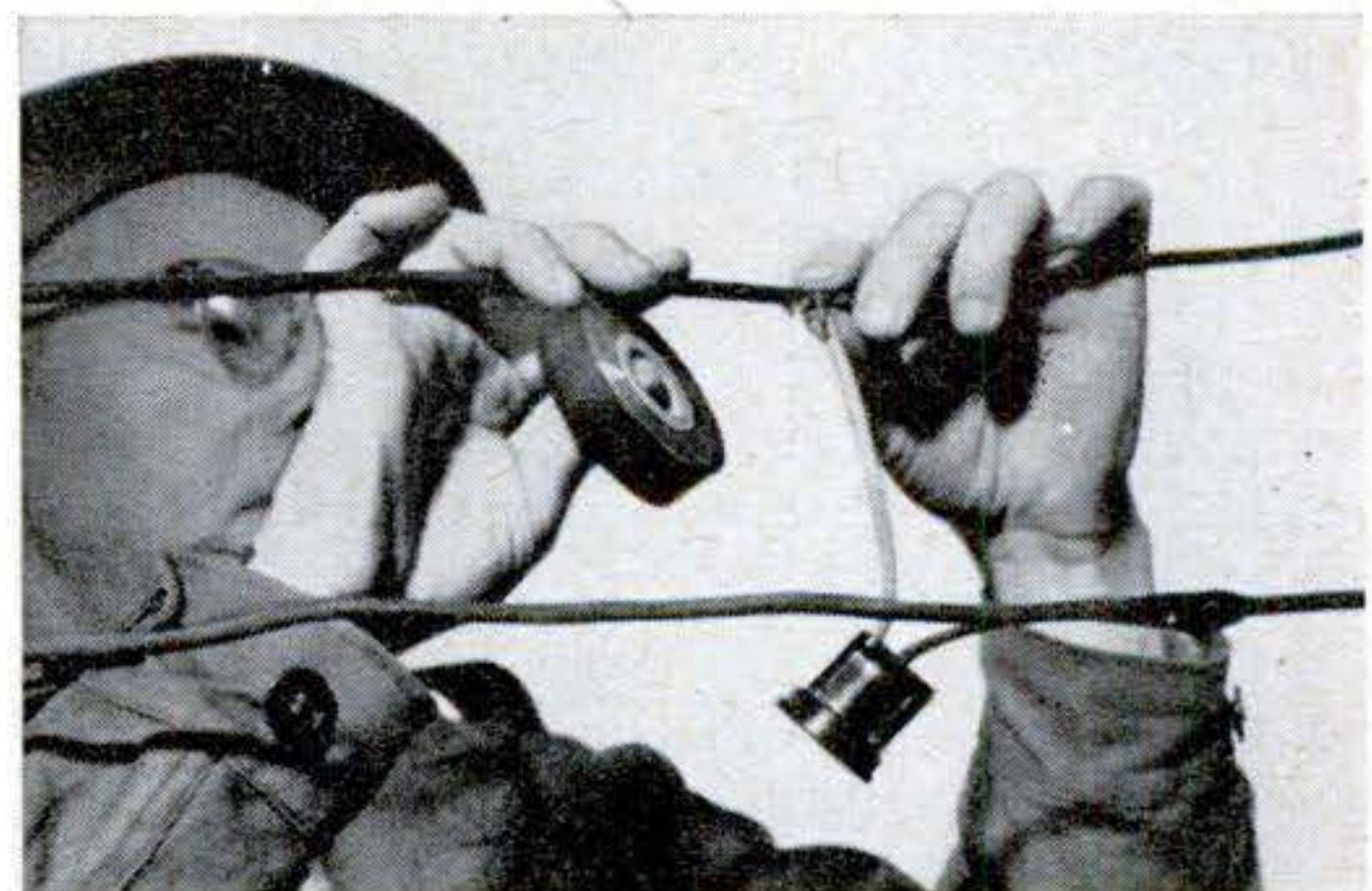

SIMPLEST ALL-WEATHER LIGHTING consists of weatherproof wire and socket tapped in where wanted. Bare the wire, make connection, insulate with plastic electrical tape.

How to Install an Outside Outlet

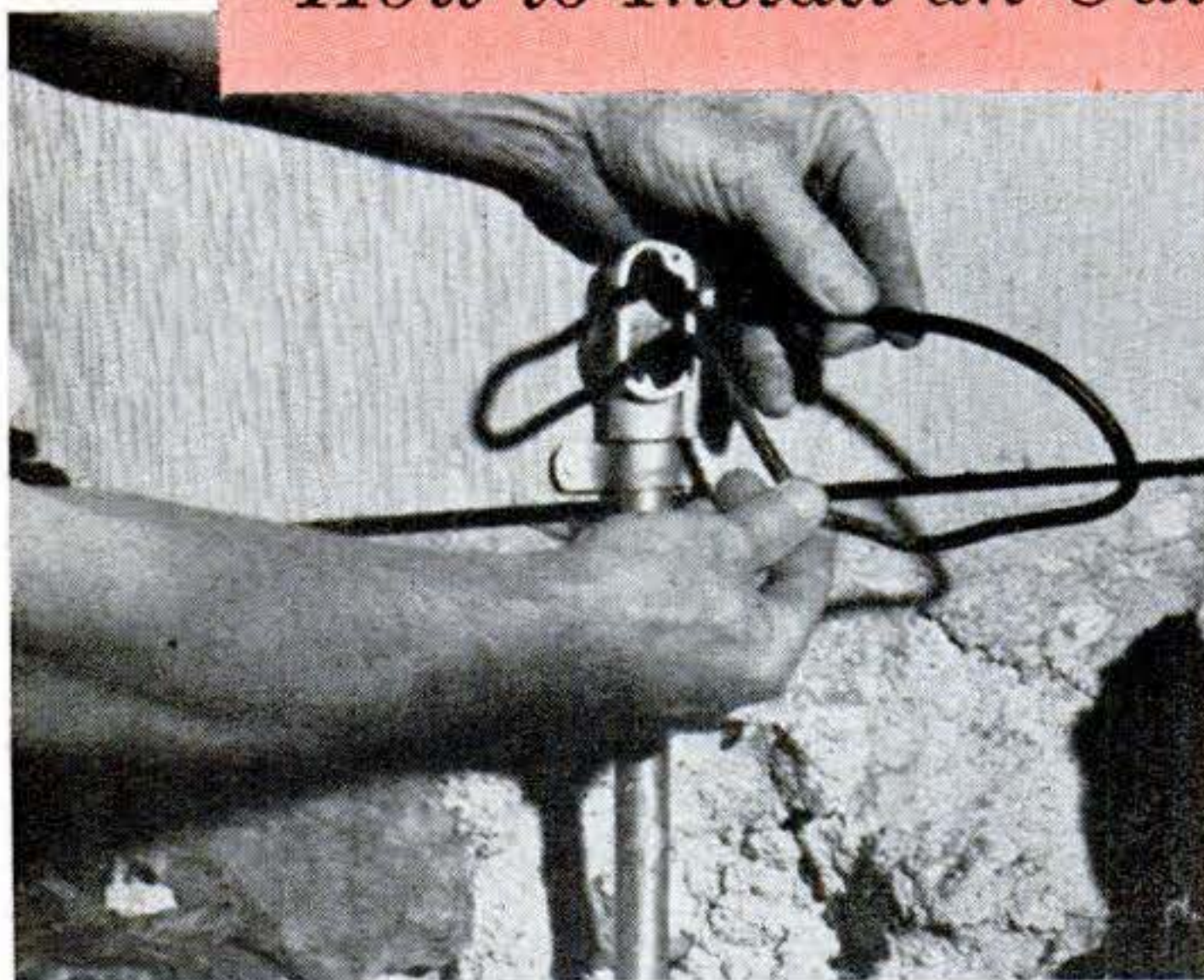

BRING CURRENT OUTSIDE with same kind of cable used for the house wiring, lead it through an entrance ell (above) and splice it to trench cable. The cable should run through conduit until it is well underground.



RUN TRENCH CABLE from entrance ell to point where outlet is wanted. Cable may be put in conduit or, if the local code permits, buried directly in ground. Taping the cable under a board, as shown here, will protect it.

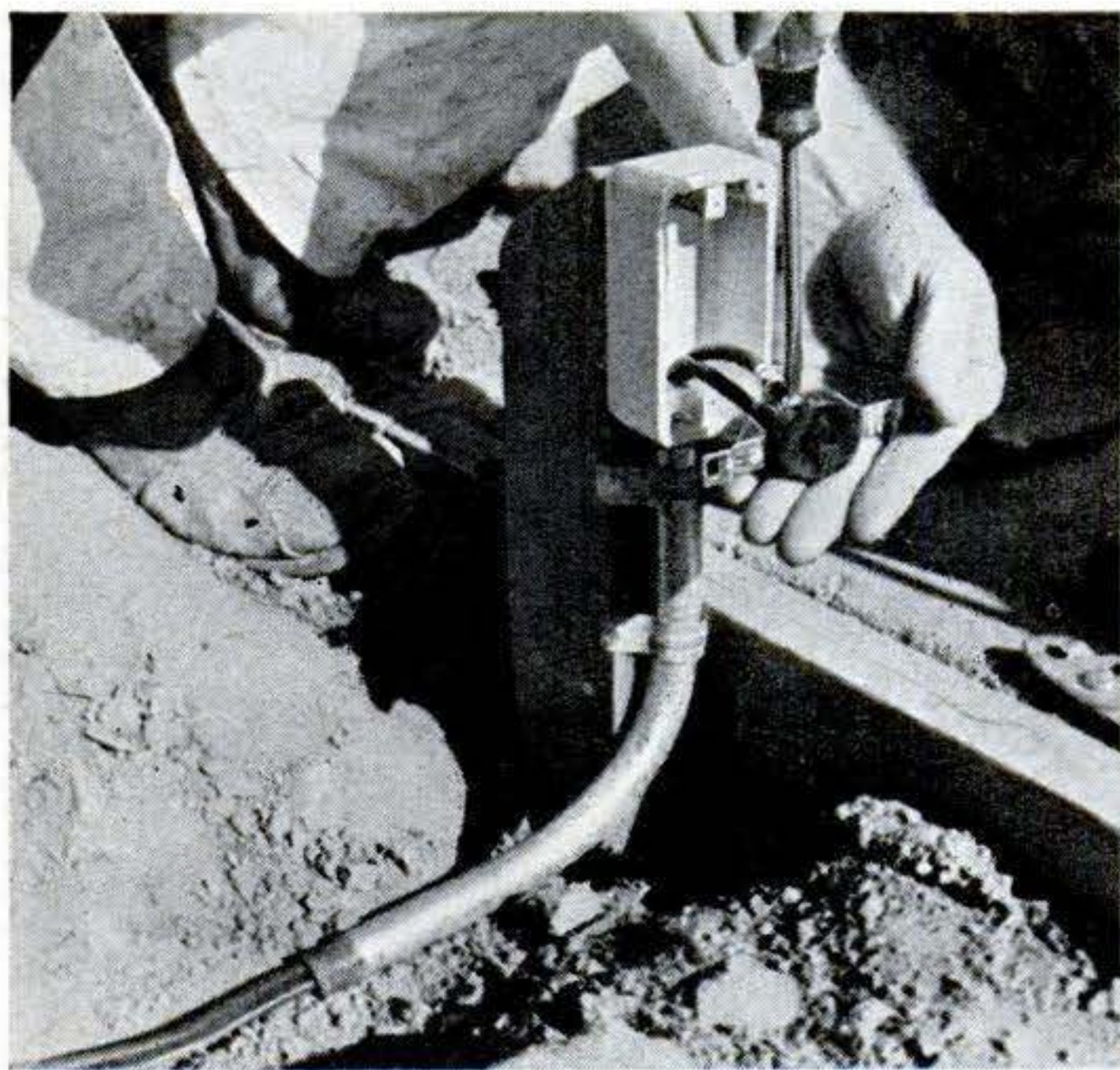

CABLE AGAIN ENTERS CONDUIT before emerging from ground. Connect to surface-mount box and wire in a weatherproof outlet. Neutral wire should be dabbed with white paint or taped as above, for identification.

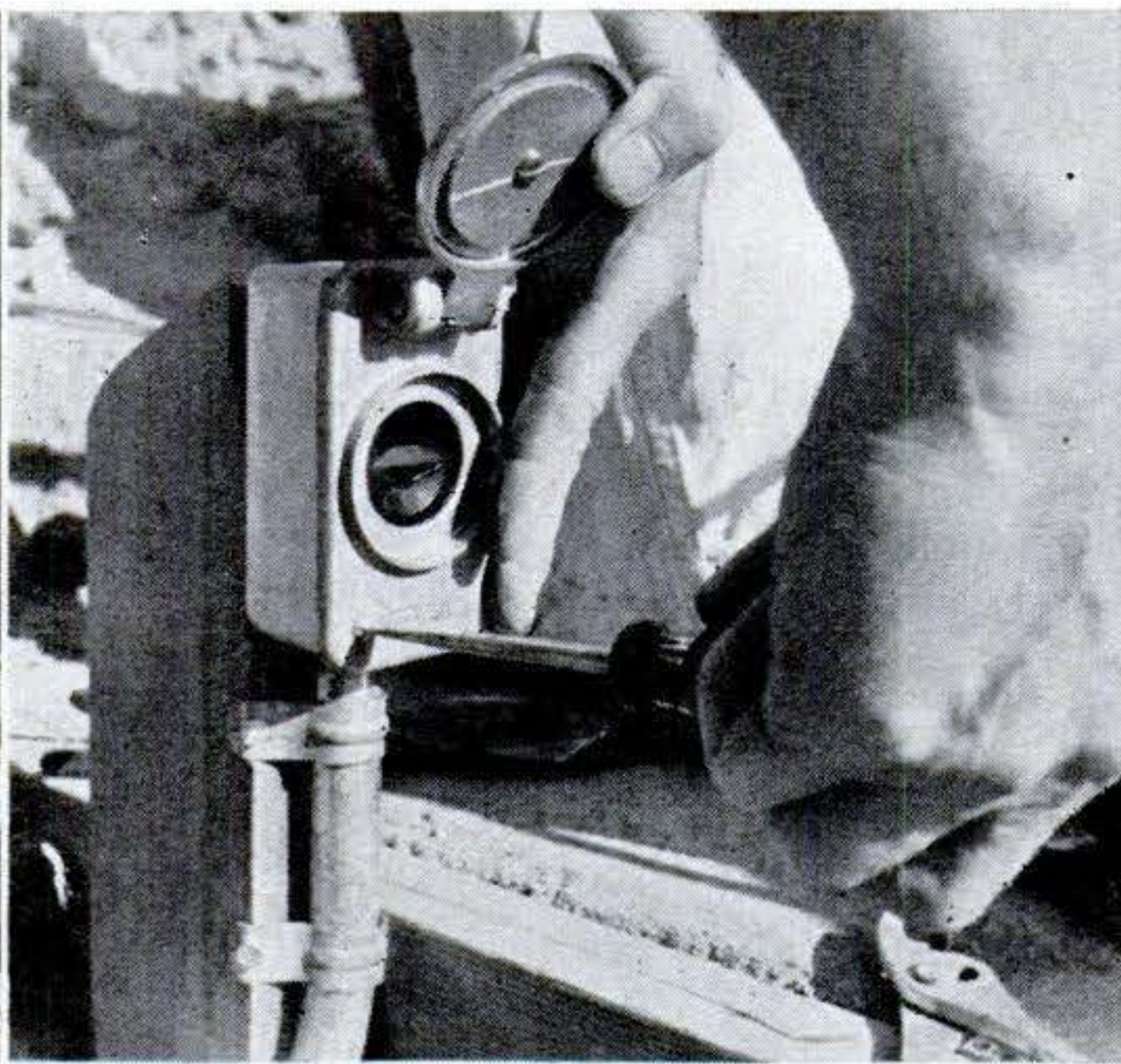

COMPLETE THE JOB by putting on the weather-tight cover, which comes with gasket. Spring-loaded cover snaps down to seal outlet against rain when nothing is plugged in. Fasten conduit to its support with galvanized straps.

any point that a light is called for, strip a bit of insulation and tap in with a weatherproof socket costing about two bits. If you want a lot of lights of this type, try to buy a ready-made string of weatherproof sockets like those used for Christmas lighting in city shopping districts.

Third, and possibly simplest of the lot, is the porcelain socket mounted on the side of the house. Screw a swivel socket into it if you need control of the direction of light.

Use a reflector bulb—either flood or spot type, depending upon how much area your light is to cover. Any installation like this should be kept well under a roof overhang, because it is not waterproof.

However you may wish to arrange your outdoor light and power, you'll be working with a few basic essentials. The first of these is wire, because something has to get that juice to where you want it and do so without shocking anyone (including the city in-

There's Only a Little Work Between You and This Lamppost

spector you may have to deal with in some areas).

First wire or cable you'll need is something to run the circuit from the fusebox, or wherever it now ends, to the point where the outdoor wiring begins. The simplest thing is to use whatever your house is wired with. This may be indoor wire in conduit, steel-armored cable (often called BX), or nonmetallic sheathed cable, such as Romex.

For overhead wiring the standard material is the stuff called "weatherproof." It used to come in copper wire only, but now you can get it in aluminum, too—at half the weight and not much more than half the price.

Types of underground cable. For underground installation, the traditional thing is lead-covered cable containing two conductors. Becoming more popular, because it is somewhat cheaper, is nonmetallic trench cable; it comes as single wires jacketed in tough neoprene. A nonmetallic trench cable containing two wires is also available in some areas. This is somewhat handier to use and is a good bet provided it doesn't cost too much more.

The size wire you'll use depends upon the circuit to which it is to be hooked. You'll normally tap either a 15-amp. circuit, which requires at least No. 14 wire, or a 20-amp. circuit calling for No. 12 conductor. If in doubt, you can't go wrong with No. 12.

This applies to all types of wire and cable with one exception. If you're using weatherproof with an *aluminum* conductor, go one size larger; use No. 12 for a 15-amp. circuit, No. 10 for a 20-amp.

Any of these trench cables may be laid in the ground without protection—except in two cases. If you are in an area covered by electrical codes, your code may require putting the cable in conduit. And if there is any likelihood that anyone will dig into the laid cable, it is safer to put it into conduit anyway.

For any part of your wiring that is going to be exposed, use conduit. You'll find the thin-wall type (called E.M.T.) much easier to use than the heavy conduit, which is similar to water pipe. Just be sure you get

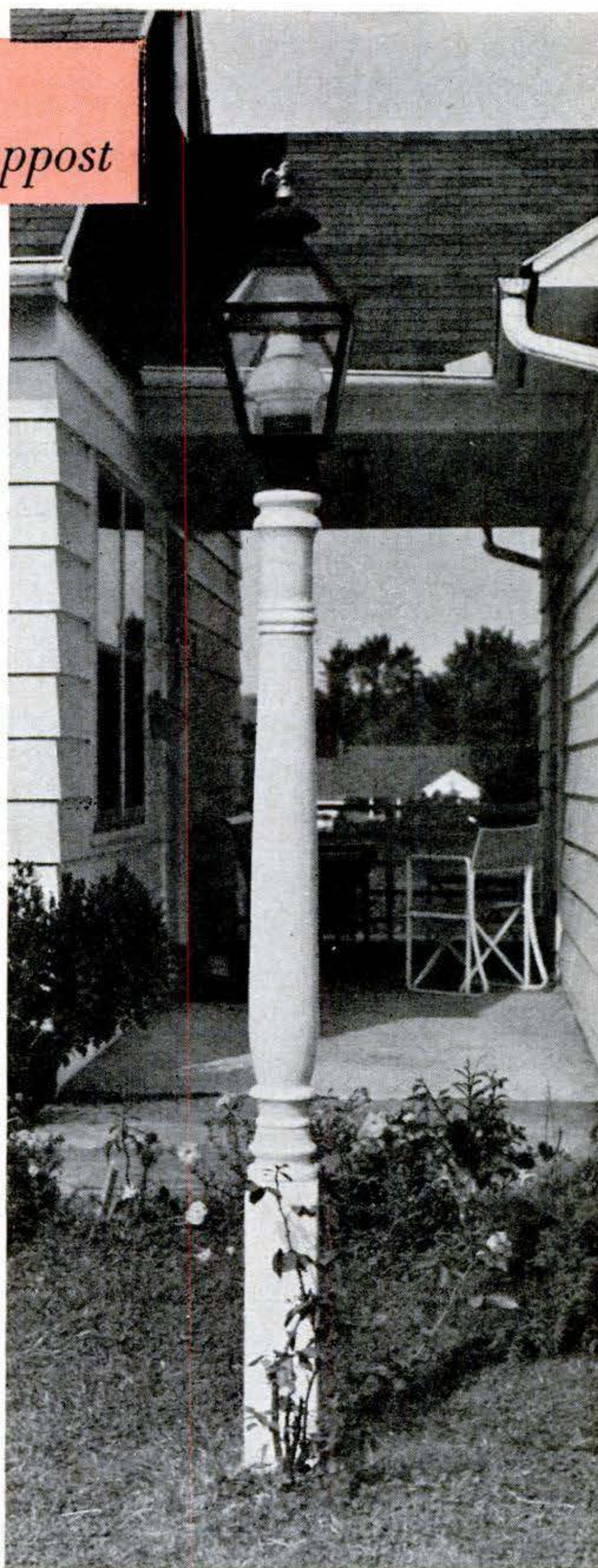

AN OLD PORCH POST salvaged from a junk yard makes a handsome support for a yard lamp. The square block originally on top of this one was sawed off and the diameter reduced enough to suit the lamp chosen. To add height, a 36" piece of timber squared to match was added to the bottom of the post, a splint-type joint being used. After a slot $\frac{3}{4}$ " deep had been cut up one side, the cable was wedged in, and the slot puttied full with water-mix filler. Paint, applied after the post was erected, hid the slot. Use enough lead or vinyl cable to reach from the house to the lamp without splicing.

You Can Have a Handy Outlet in a Lamppost, Too

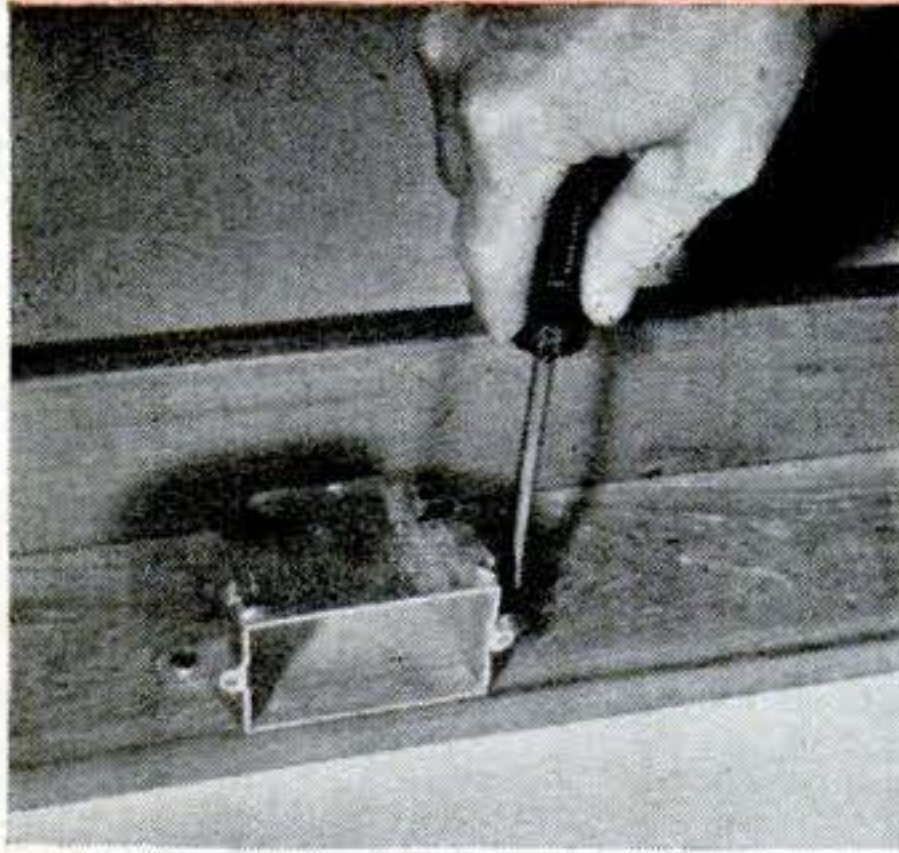

1 TALL LAMP at right begins with four 8' lengths of one-by-fours. Nail two of them together. Mount a standard switch box inside, as shown here, about 24" from the bottom end of one of the boards.

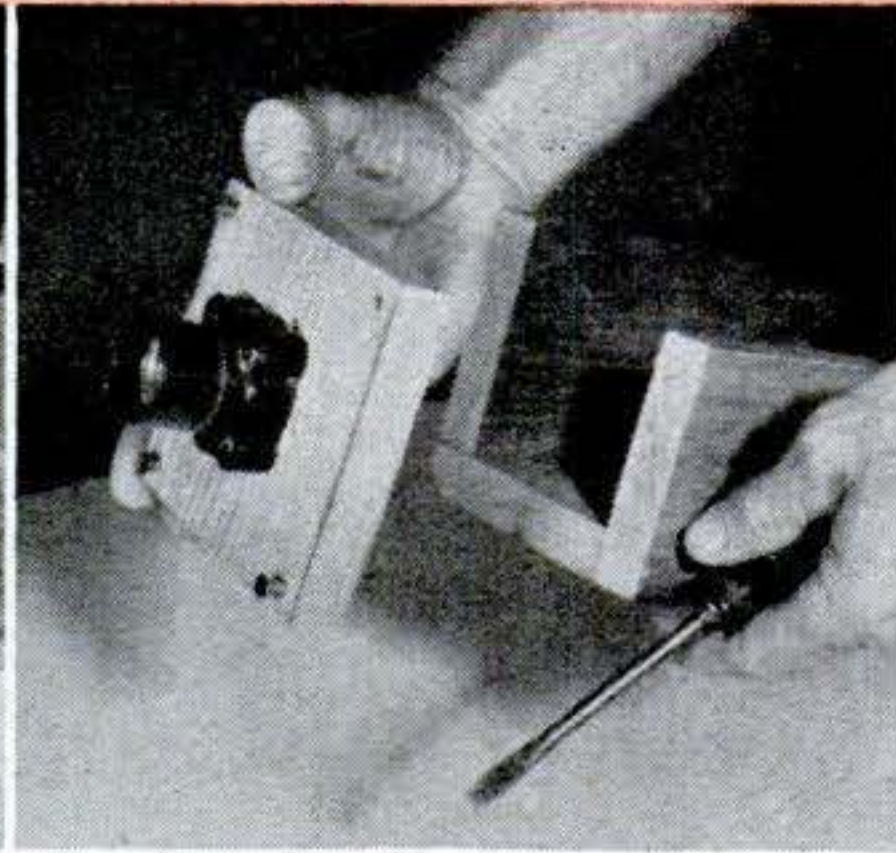

2 NAIL ON THIRD SIDE. Cut a square piece to fit top and mount a socket on it, drilling two small holes to bring wires through. Run wires from socket to box, leaving about 5" of extra wire for connections.

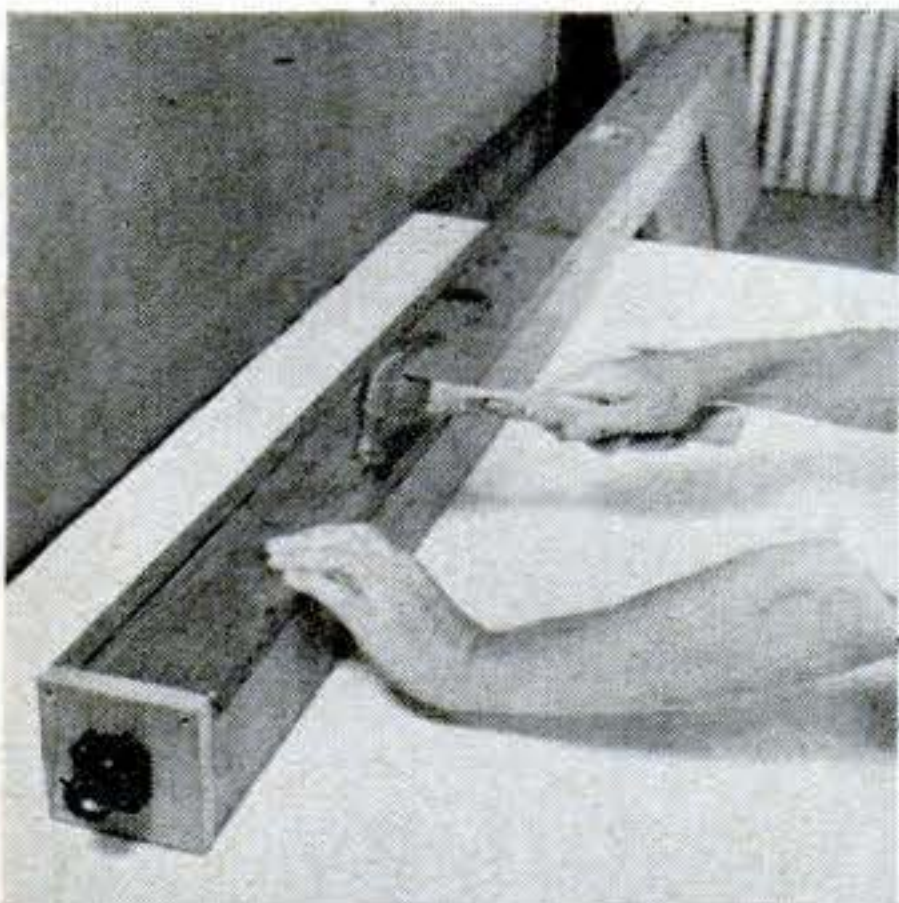

3 NOTCH FOURTH BOARD to fit around the electric box. Then complete the lamppost as shown in photo above and fasten the square bearing the socket securely to the top of the post with four screws.



4 WEATHERPROOF OUTLET goes in the box. Connect it to both socket and wires coming in from the bottom. The latter will ordinarily be trench cable running to a source of power at the house.

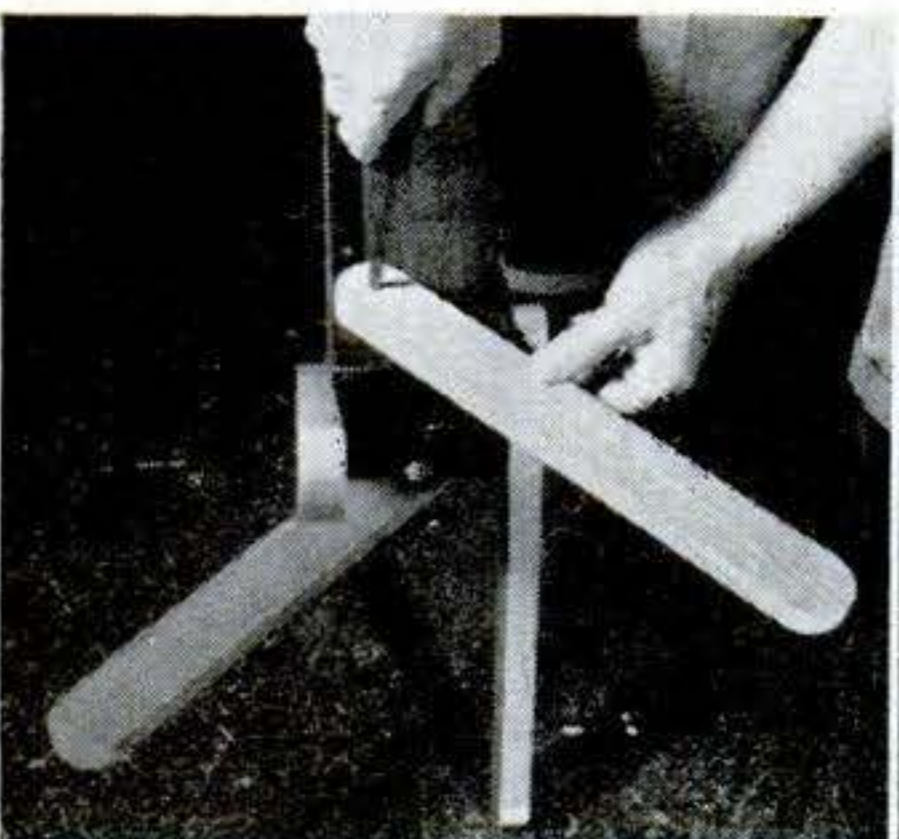
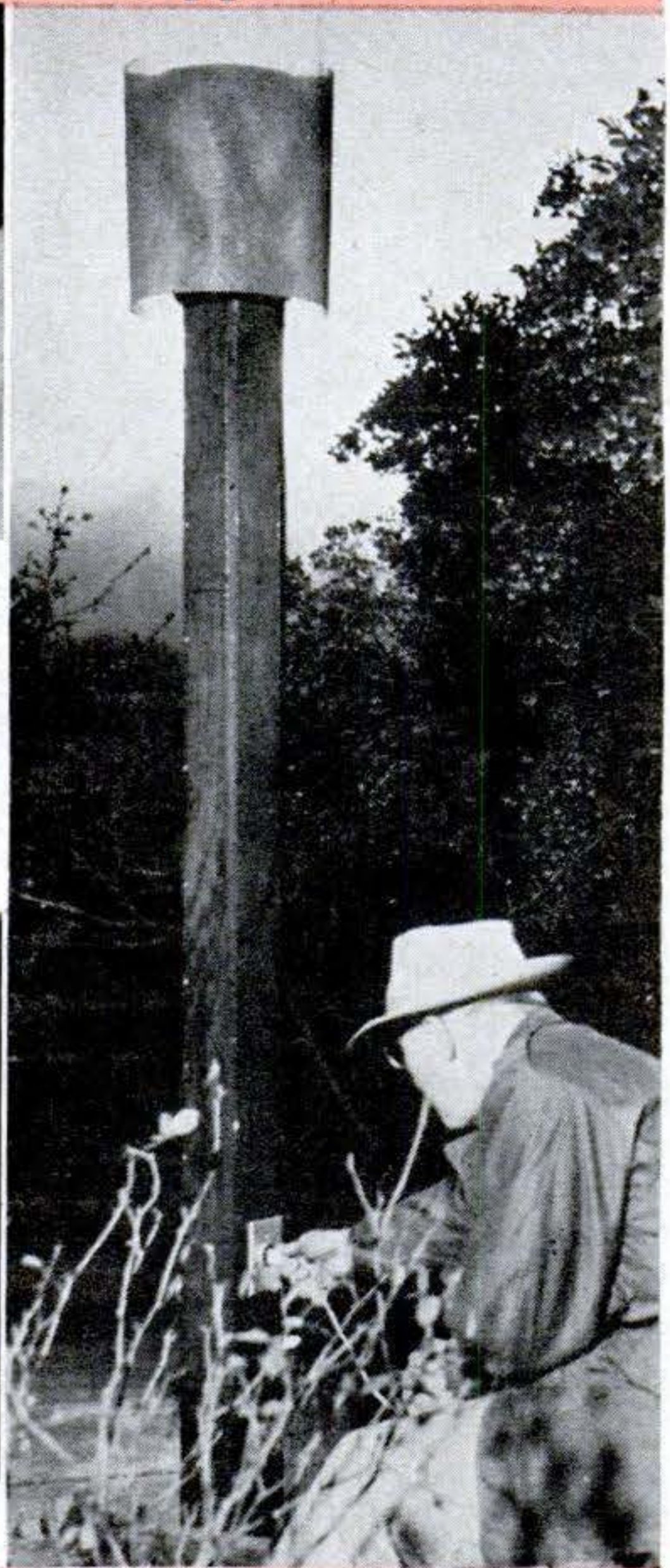

5 BRACKET for shade consists of four 14" lengths of one-by-twos, rounded off. Fasten each to post with only one screw to begin with. Then make a cylindrical plastic shade as seen on the facing page.



6 ADJUST BRACKETS to fit shade and screw them to post. Use rustproof screws to fasten shade to brackets, and secure a pie plate to bracket tops. Plate reflects light, and protects socket from rain.

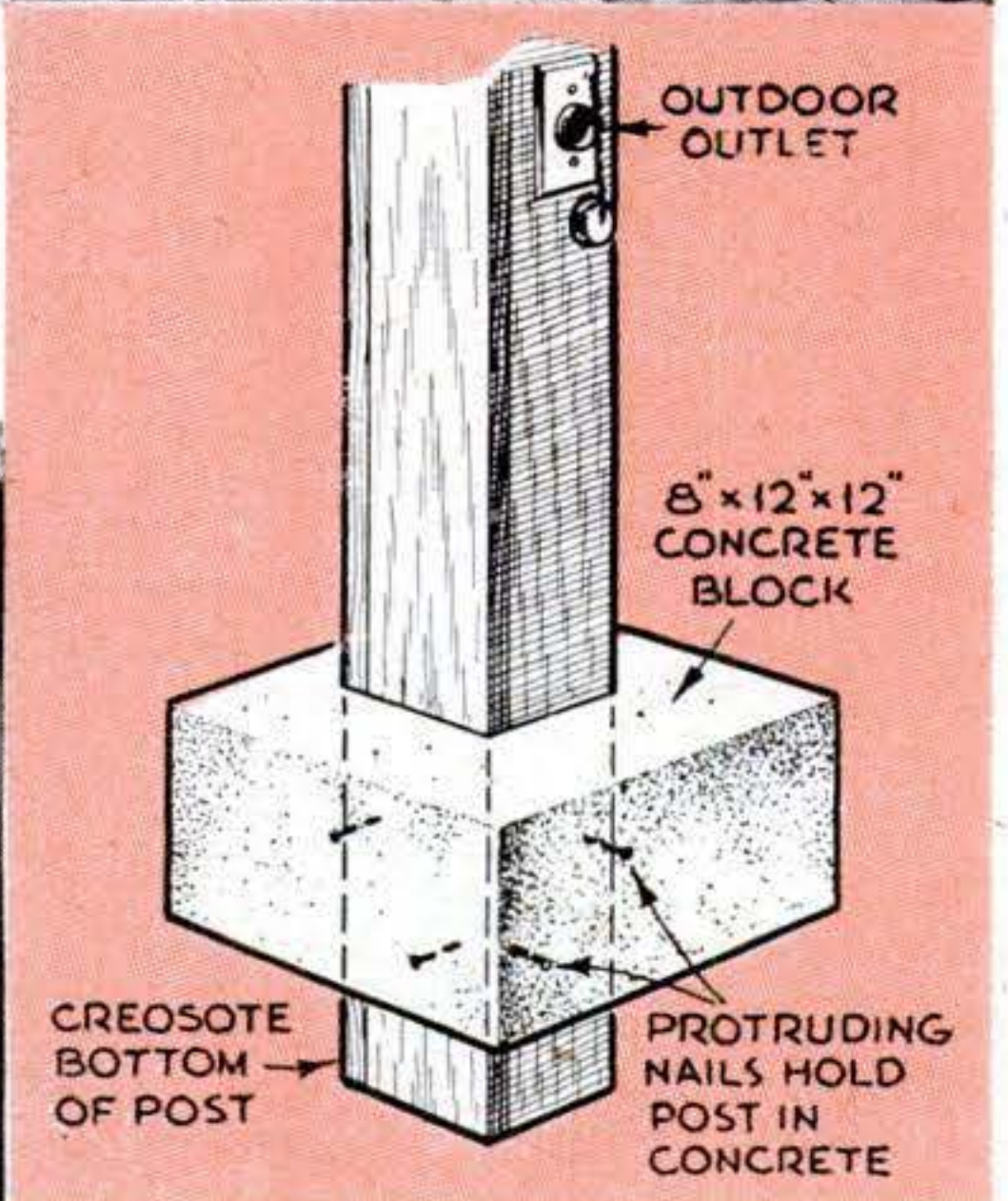

7 SETTING POST in concrete will give it long-lasting rigidity. This can be done as shown in sketch above. Before setting, be sure to coat bottom of post with wood preservative. Completed, you have a source of power in yard, as well as a lamp.



A Modern Yard Lamp Is Easy to Build

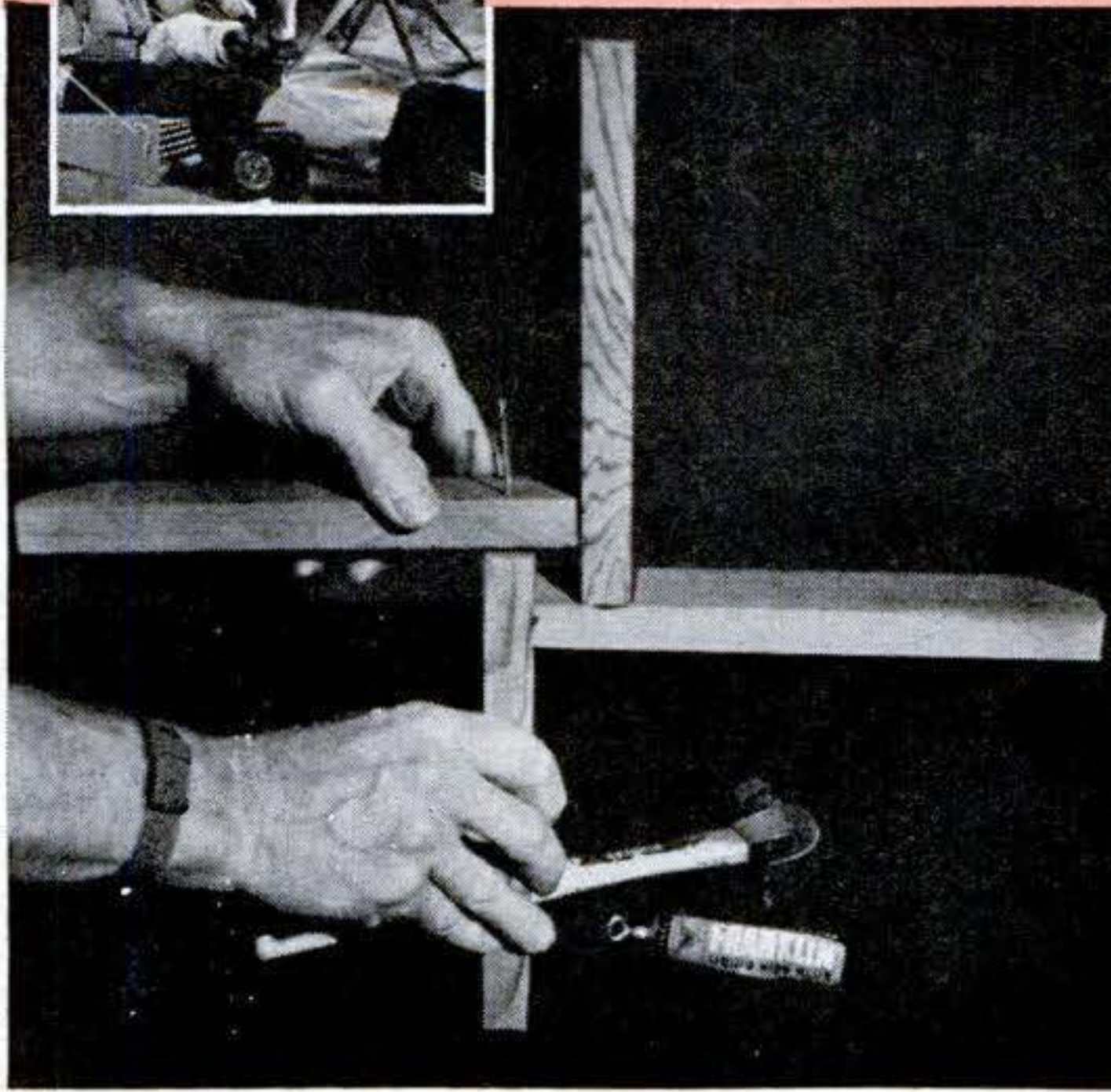

FOUR 9" PIECES of one-by-two stock, with one corner of each rounded, are glued and nailed together like this to make the shade-supporting bracket. Make center gap $\frac{3}{4}$ " square.

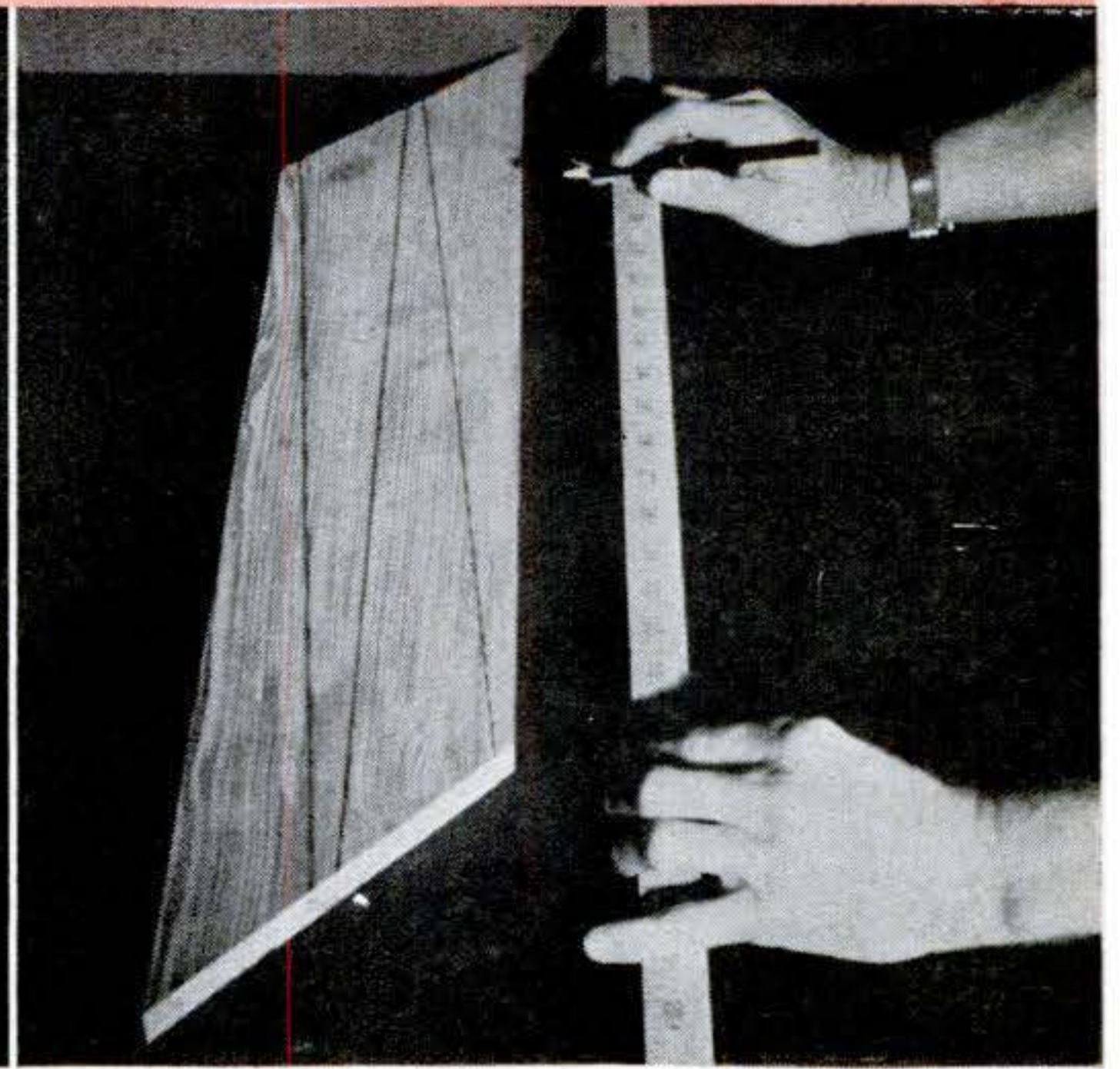

CUT OFF ENDS of a piece of one-by-six at a 45° angle so each long side is 24". Draw a line down the center. Then cut four identical legs, marking so the longer end of each is 3" wide.

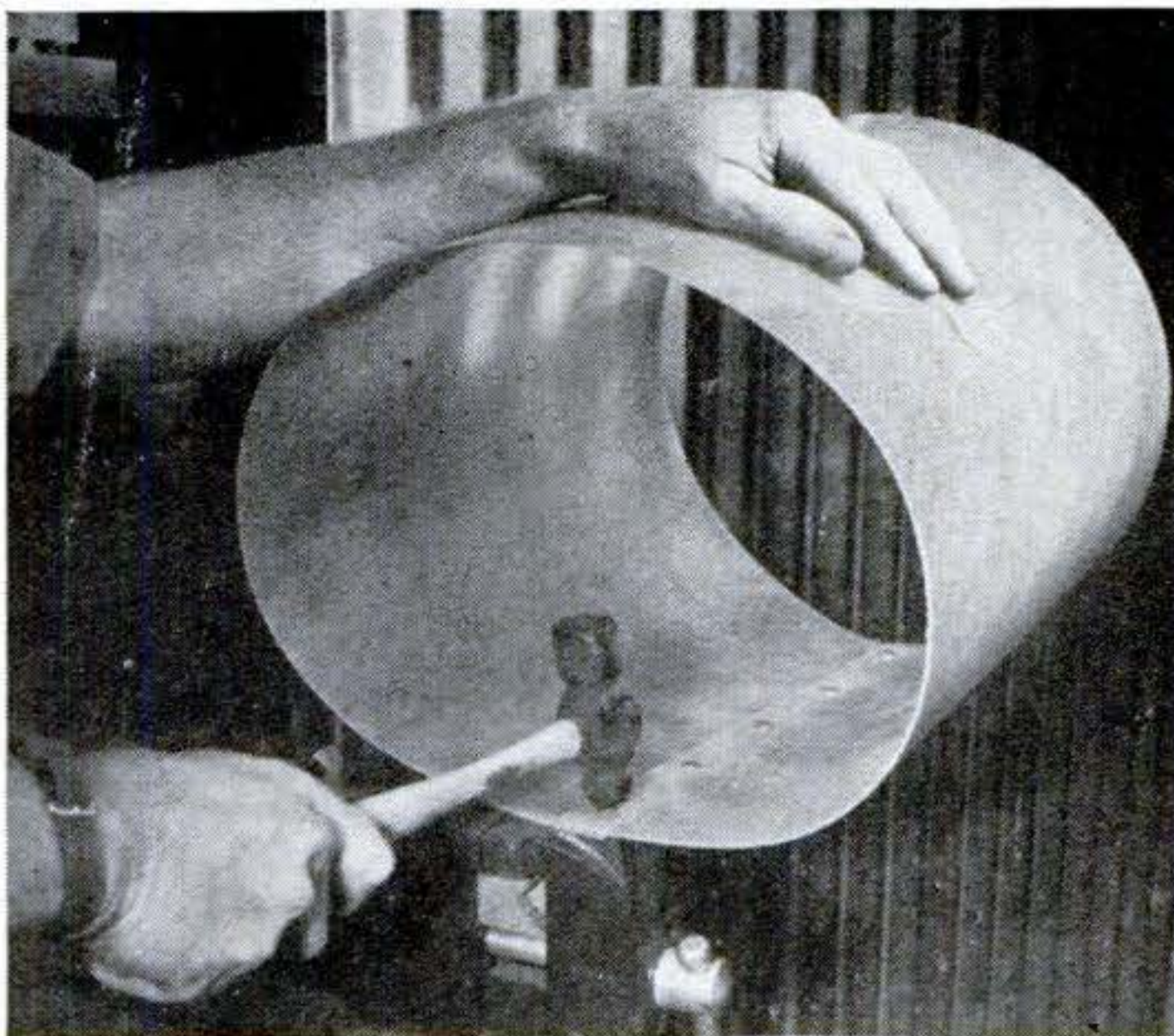

FORM A CYLINDER from a 16"-by-42" piece of plastic (flat yellow Alsynite works nicely and is weatherproof). Fasten the edges together with copper rivets as illustrated above.

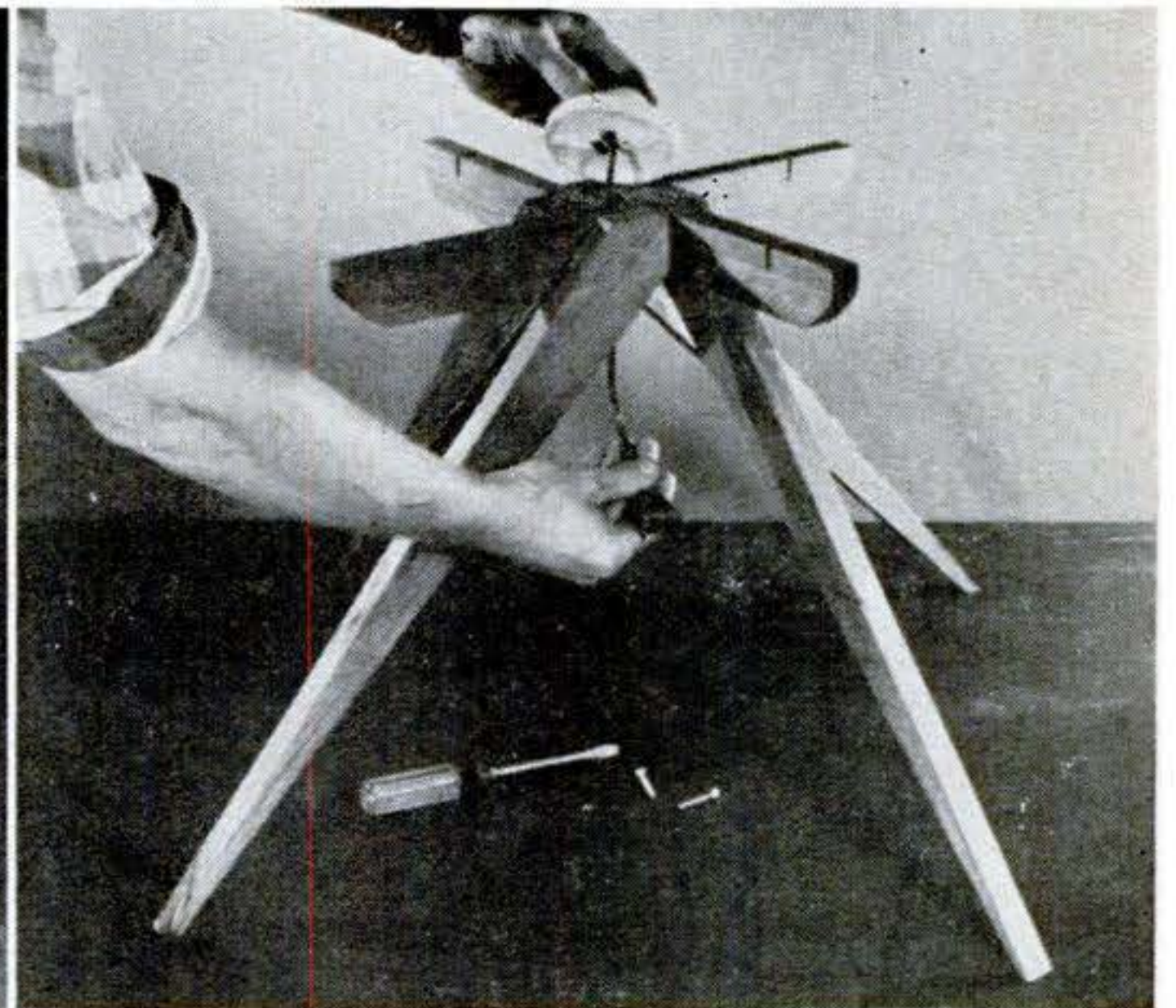

CUT NOTCHES in top to fit cylinder. Attach legs with glue and rust-resisting nails or screws, trimming tops to shape shown. Fasten on a porcelain socket and wire it to plug.

fittings for the kind of conduit you are using. Since you probably won't be using wire larger than No. 12, the smallest conduit— $\frac{1}{2}$ " diameter—is what you'll want.

Installing an outlet. To install an outdoor plug-in, you'll need fittings for both ends. At the house end, you'll need an entrance ell. At the working end, you'll need a weatherproof outlet and a box to put it into. If you recess the box into a post, use an ordinary switch box such as is used in

house wiring. If it isn't to be recessed, get what's called a surface-mount utility box. You'll also need two short pieces of conduit, to protect the wire where it is above ground. Conduit usually comes in 10-foot lengths and costs between 10 and 15 cents a foot.

The lights you can use. You have a good choice of yard lights and outdoor floodlights. One basic type, for yard and barnyard use, has a reflector on an arm. You fasten it to a wall and screw an ordinary 100-



How to Make a Light Diffuser for a Barbecue or Picnic Table

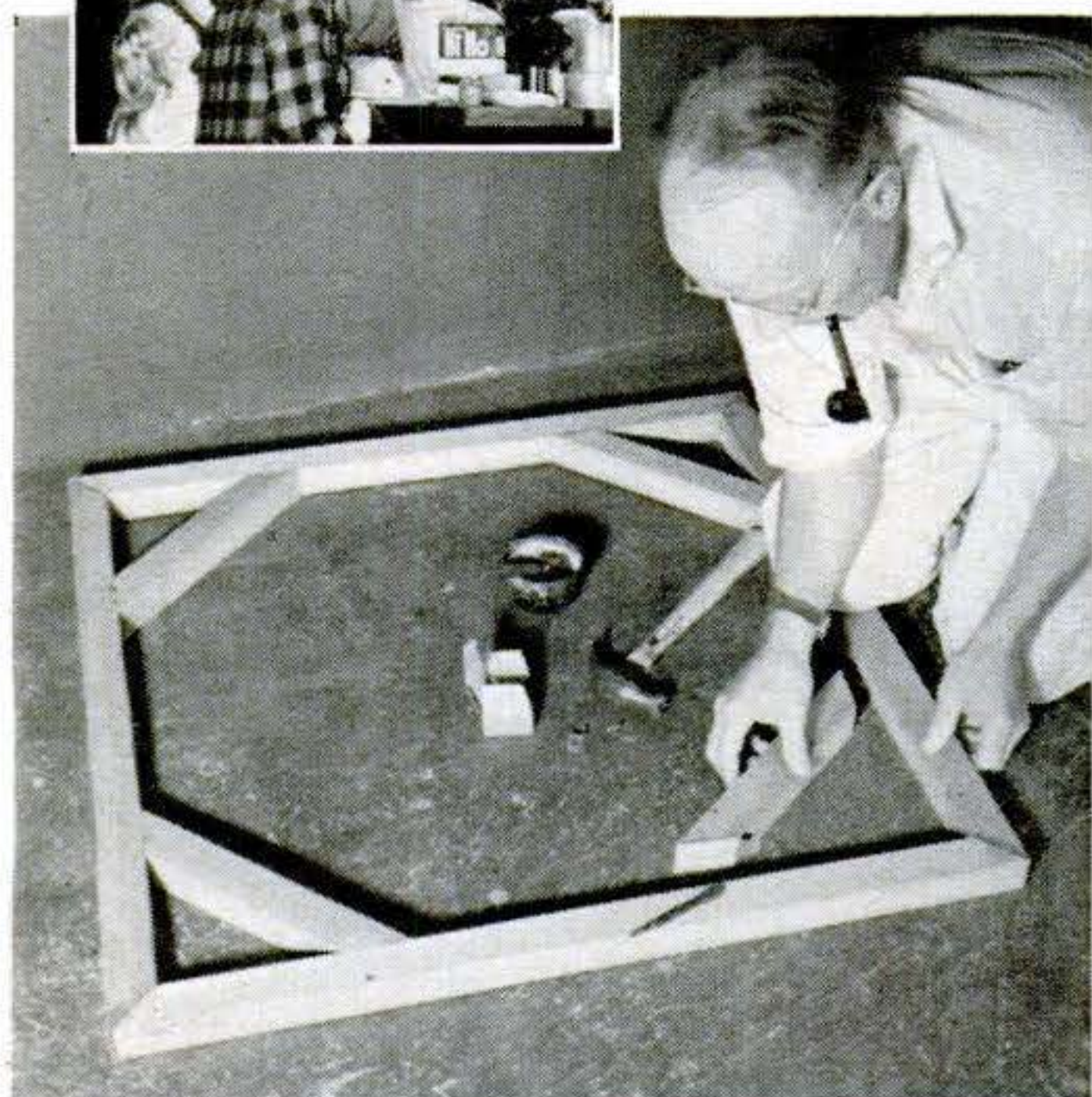

FRAME for picnic-table light diffuser is a 34"-by-34" assembly of two-by-twos (actually about 1 $\frac{3}{4}$ " square). Corner braces, cut off at 45° angle, measure 13" on long sides. Assemble with waterproof glue and rust-resistant hardware. Finish with spar varnish.

to 200-watt bulb into it. It throws light downward.

Other reflectors, usually offered without arms, surround their bulb and concentrate the light. These also are useful for mounting on a building or post.

For use at ground level, the handiest thing is a unit consisting of socket, base and cord. It can be fastened to a wall if you like or it can be stuck into the ground by means of a spike that comes with it. It is weatherproof when used with the bulb for which it is made: the 150-watt outdoor reflector type, either flood for general lighting or spot for concentrating illumination where you want it. You can get one of these units, with bulb, for less than \$4.

There's another dingus you'll get some fun out of—and it will make your outdoor lighting even more spectacular. It's colored glass in a snap-on holder to go with the outdoor reflector bulb. It costs about \$1.50 and you can get it in red, green, blue or amber.

END

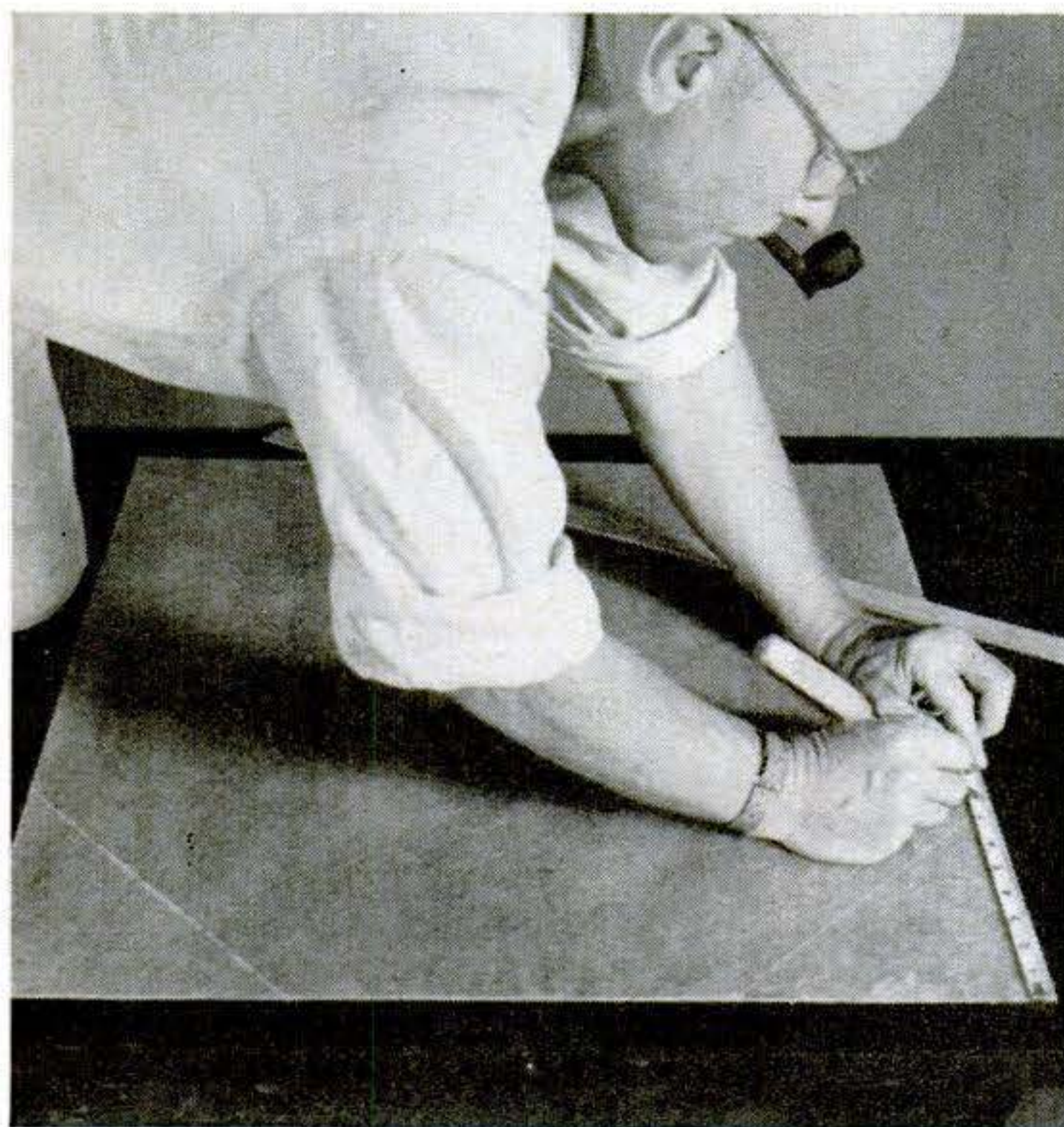

FOR OCTAGONAL DIFFUSER, use a 26" square of yellow or rose-colored structural plastic. (This material is most readily available in 26" widths.) Measure 7 $\frac{5}{8}$ " both ways from each corner, scratch a line between connecting points and cut off the corners.

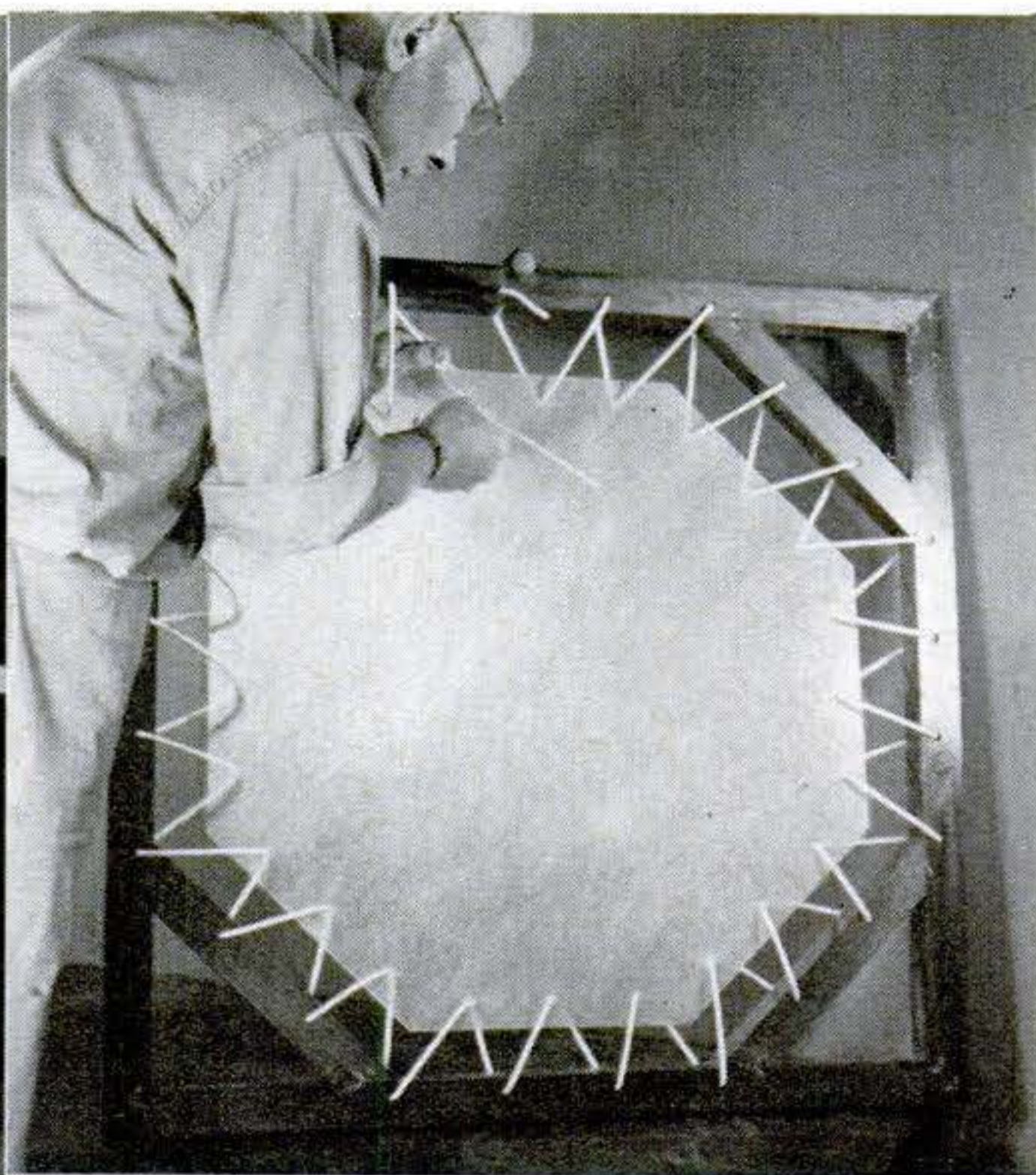

PLASTIC IS SECURED to frame with plastic clothesline. Drill $\frac{1}{4}$ " holes around plastic and frame, lace in the plastic. Hang the diffuser with more line. Use a plain bulb in a weatherproof socket or—better yet—a weatherproof bulb-and-socket combination.

*If you prefer traditional styling
here's a choice of*

Two Outdoor Lamps in the Williamsburg Mode



By Walter E. Burton

WITH street lighting sketchy at best, the colonial home needed gate and porch lamps to light both visitor and homecomer. Today's porch light is a matter of course, but its styling need not be.

If your vacation takes you to Williamsburg, Jamestown, Charlottesville or other

historic spots, you'll see many types of house lanterns worth copying. The originals were of course handmade, so they are naturals for the craftsman to duplicate.

You can build good-looking replicas of such antique lamps from tin-can stock, wire and glass. Standard electric fittings bring them up to date, making them as useful as they are ornamental.

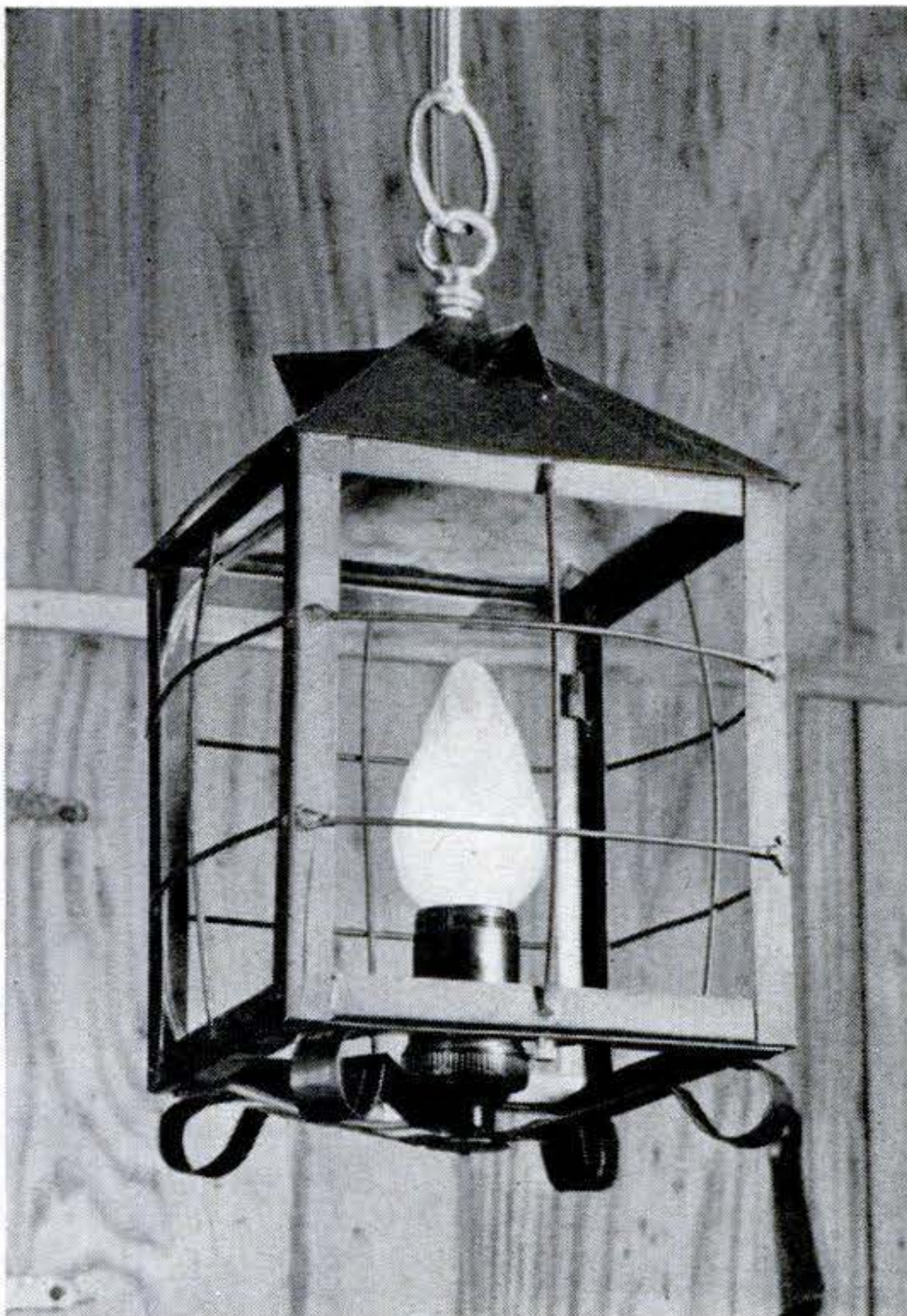

SEEN ON A HOUSE in colonial Williamsburg, the original of this lantern came from a collection. The homemade version above is soldered up of tin-can stock, coat-hanger wire and an old chandelier fitting. Glass panes should be the frosted kind if bulb is in line

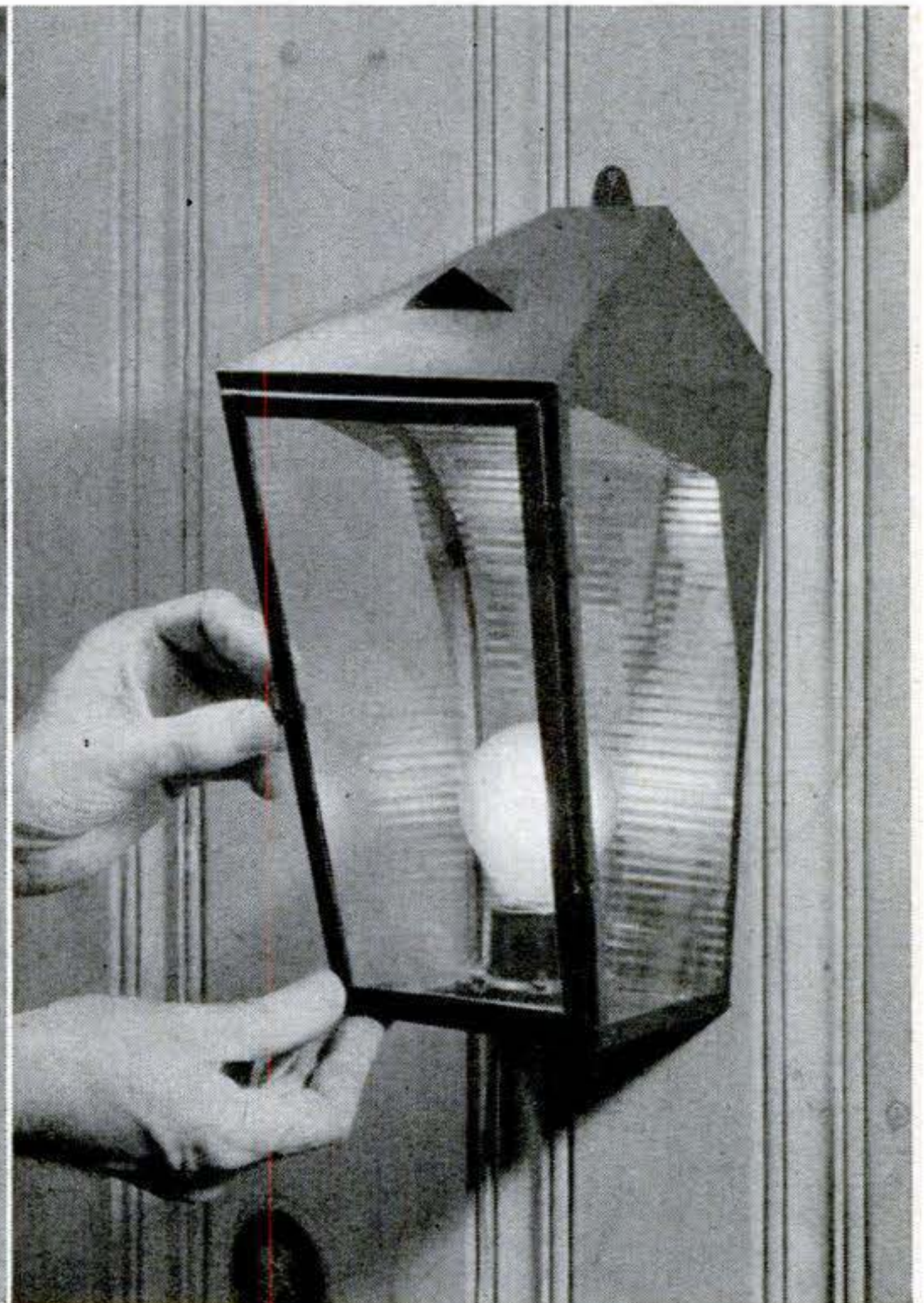

of sight. The wall lamp above is an electrified copy of one on the same house. Its bright tin-plate reflector throws plenty of light. Dull black, bronze or gold stippled on black are all suitable finishes for either lantern. Turn the page for construction details.

How to make the square lantern

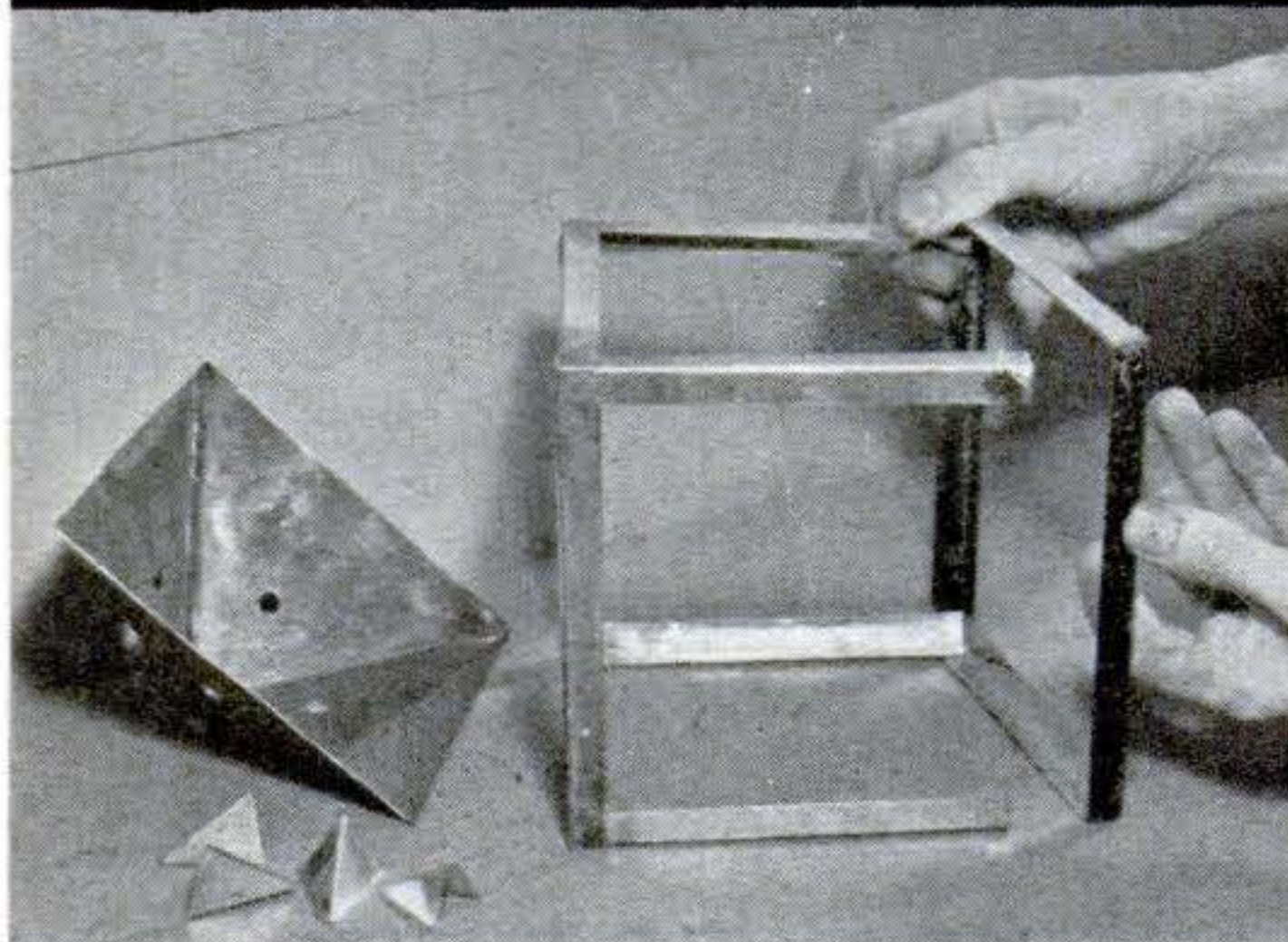

CUT TIN-CAN STOCK into 1" strips. Bend them up to make $\frac{1}{2}$ "-by- $\frac{1}{2}$ " angle. Solder together two $6\frac{1}{4}$ "-by-7" frames, and join them with $6\frac{1}{4}$ " pieces as above to form the body.

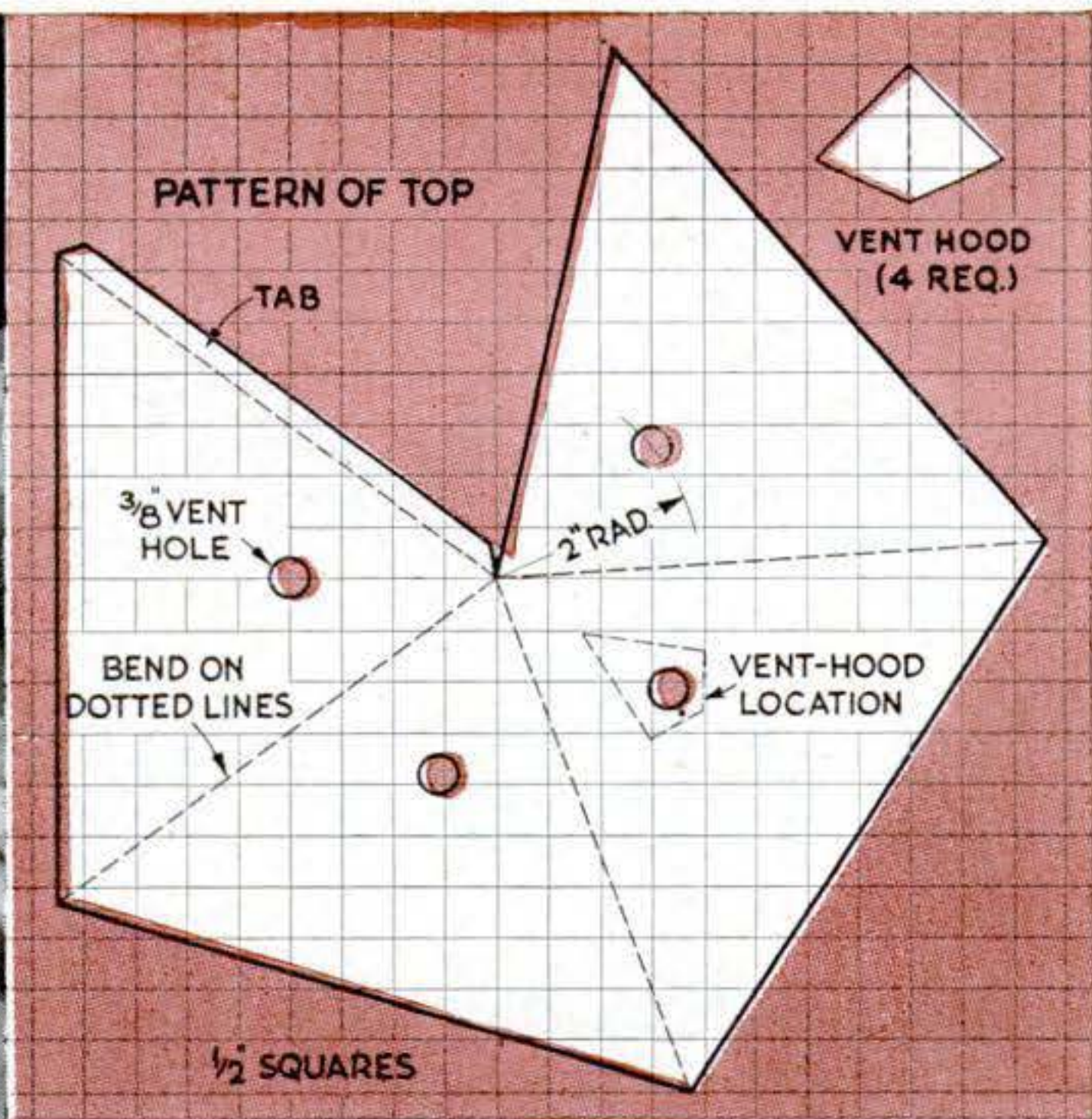

LAY OUT ROOF on squares as above, or cut a cardboard triangle $6\frac{3}{8}$ " long and $4\frac{1}{4}$ " high. Draw around this four times, laying it beside previous outline each time. Add tab shown.

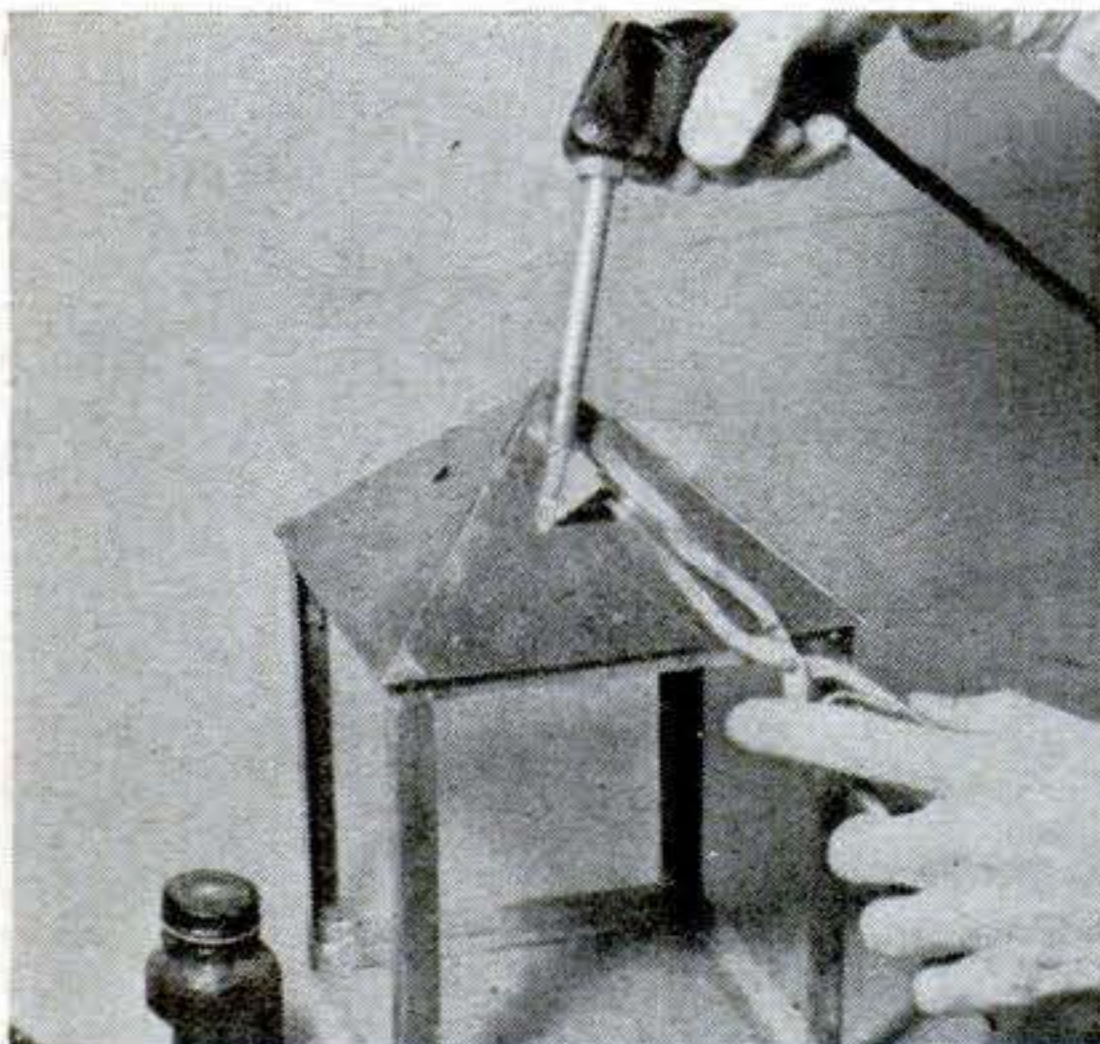

VENT HOLES are 2" from roof peak and in the center of each side. Hoods to keep rain out are small triangles of tin plate, folded in the middle and soldered over the holes.

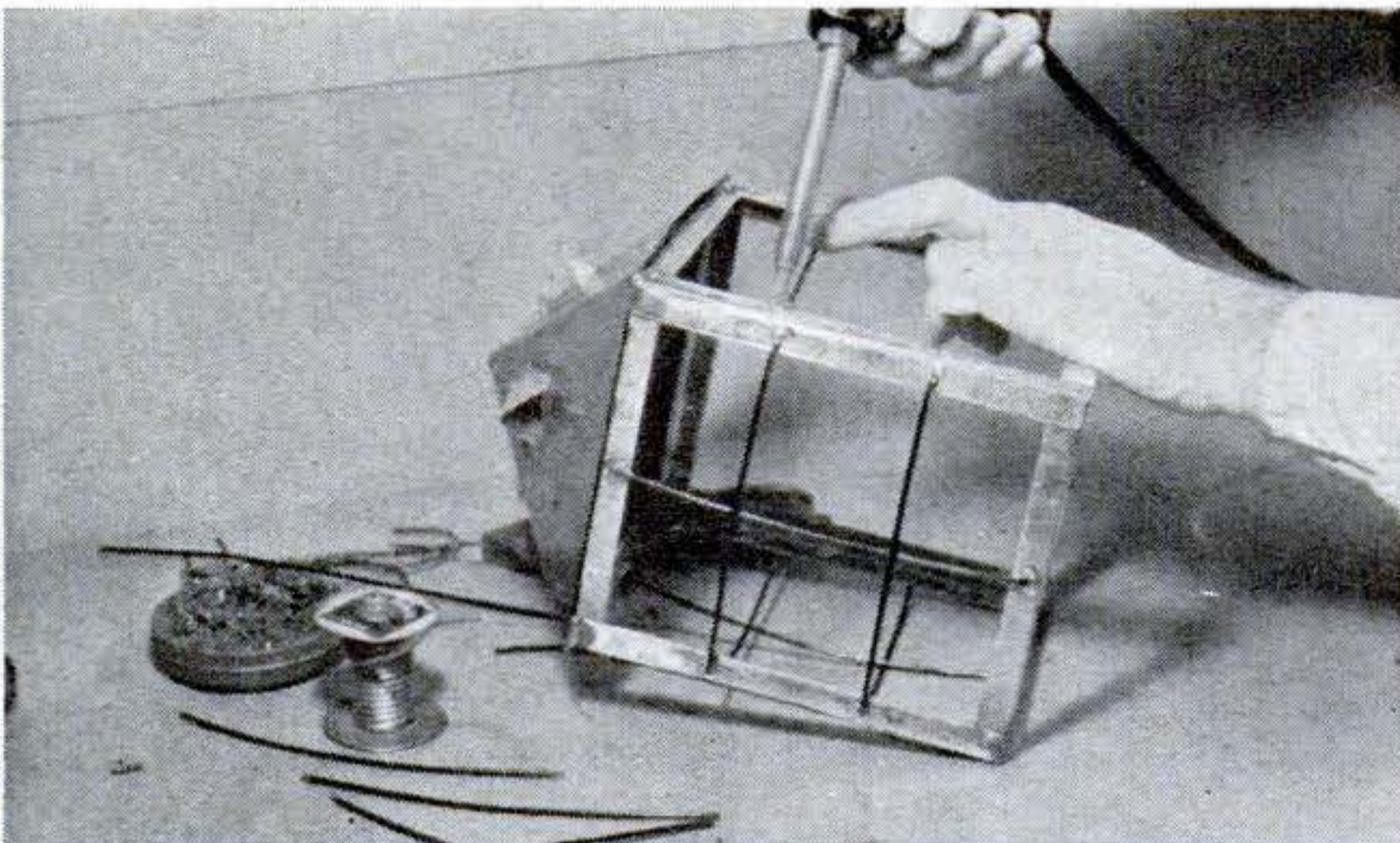

TO SHIELD GLASS and further the colonial effect, solder on guards made of coat-hanger wire. File each end bright, hammer flat, and use acid flux to solder. Wash all joints well.

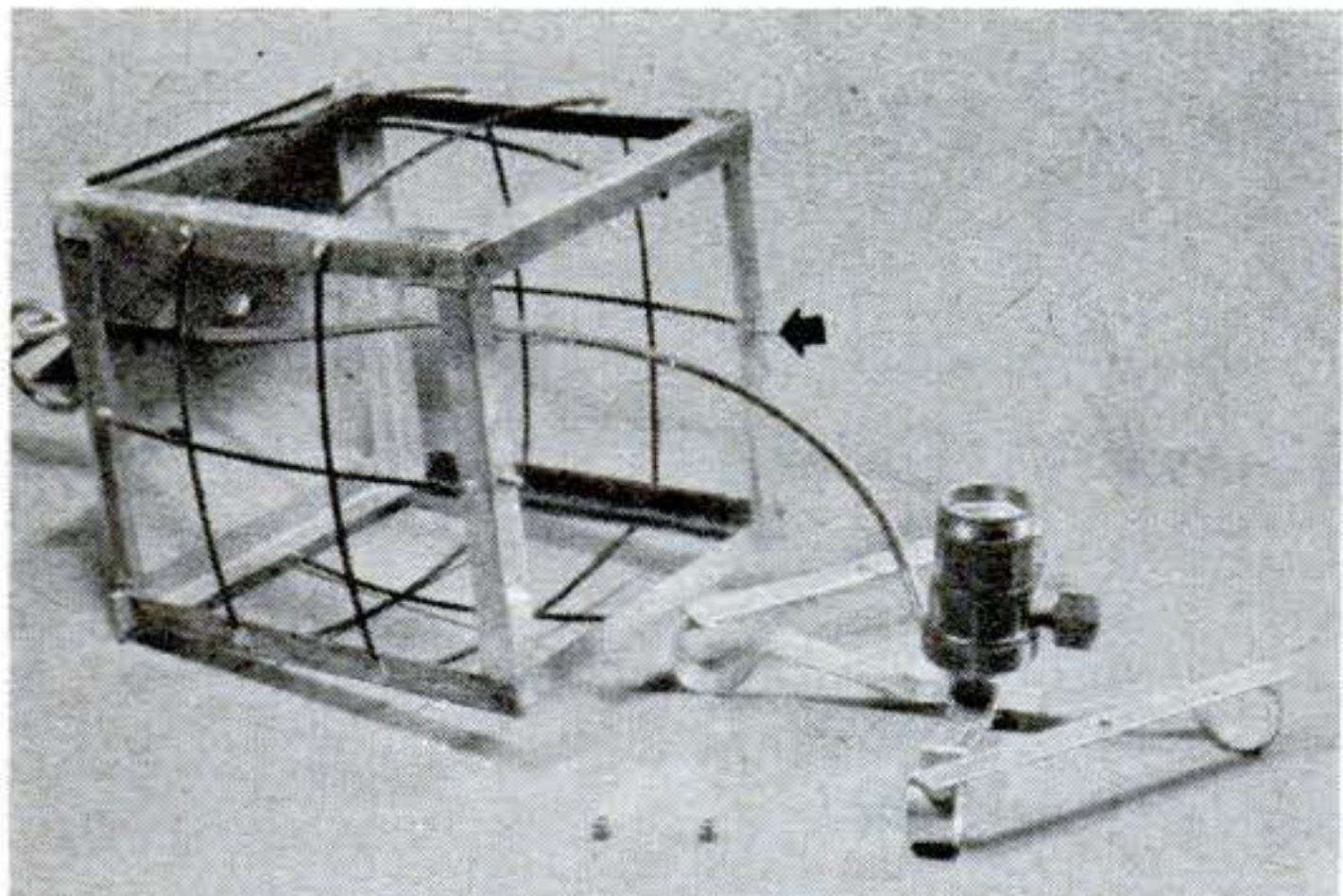

BASE IS REMOVABLE for changing bulb. Make it of twice-folded tin plate. Solder short screws (arrow) into the frame. Drill matching holes in base. Retain with knurled nuts.

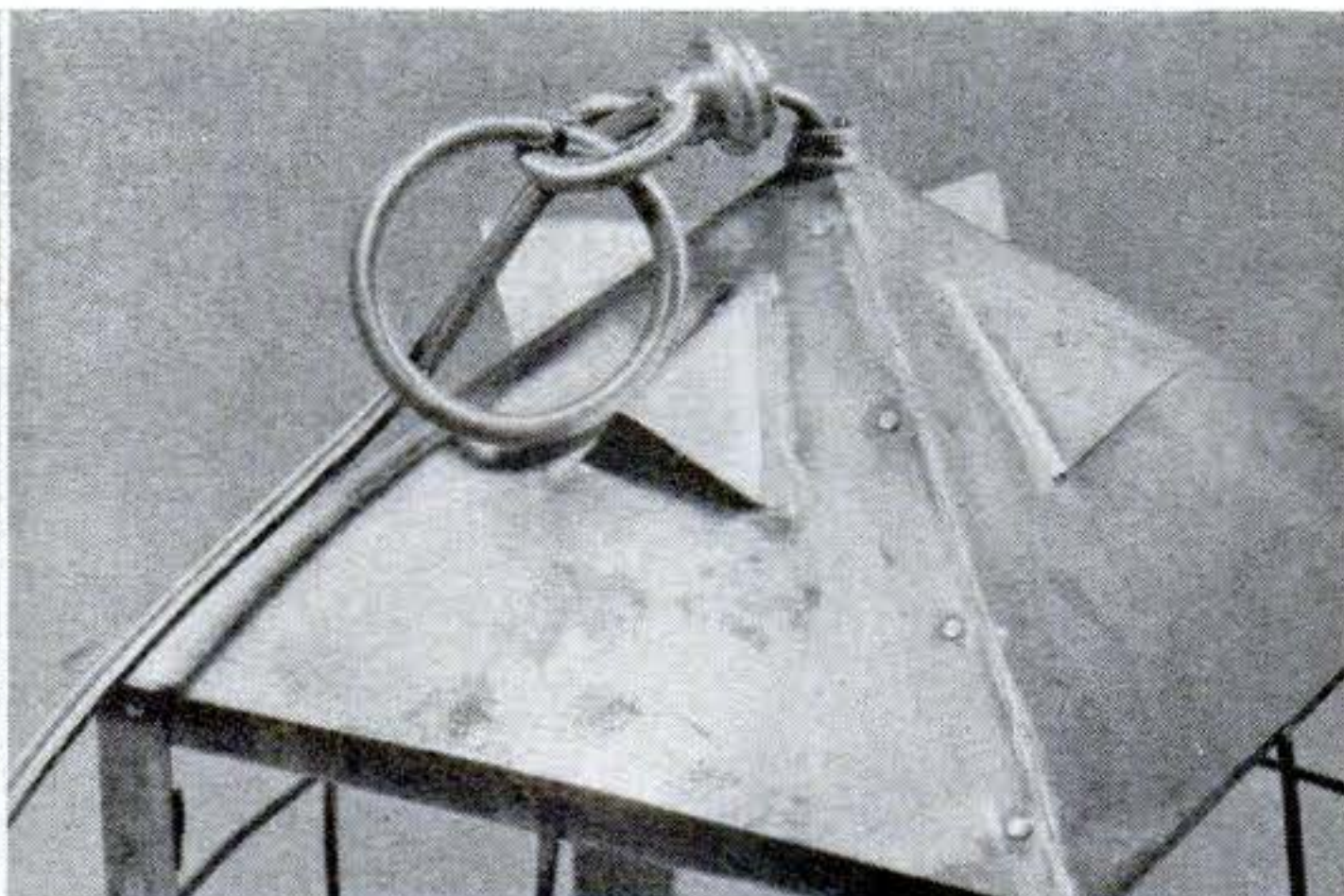

RING FIXTURE, from an old chandelier, screws onto $\frac{1}{8}$ " brass pipe soldered into roof. Cord passes down a corner. Insert panes from bottom and solder in clips to hold them.

PATTERNS
(ONE-THIRD SIZE)

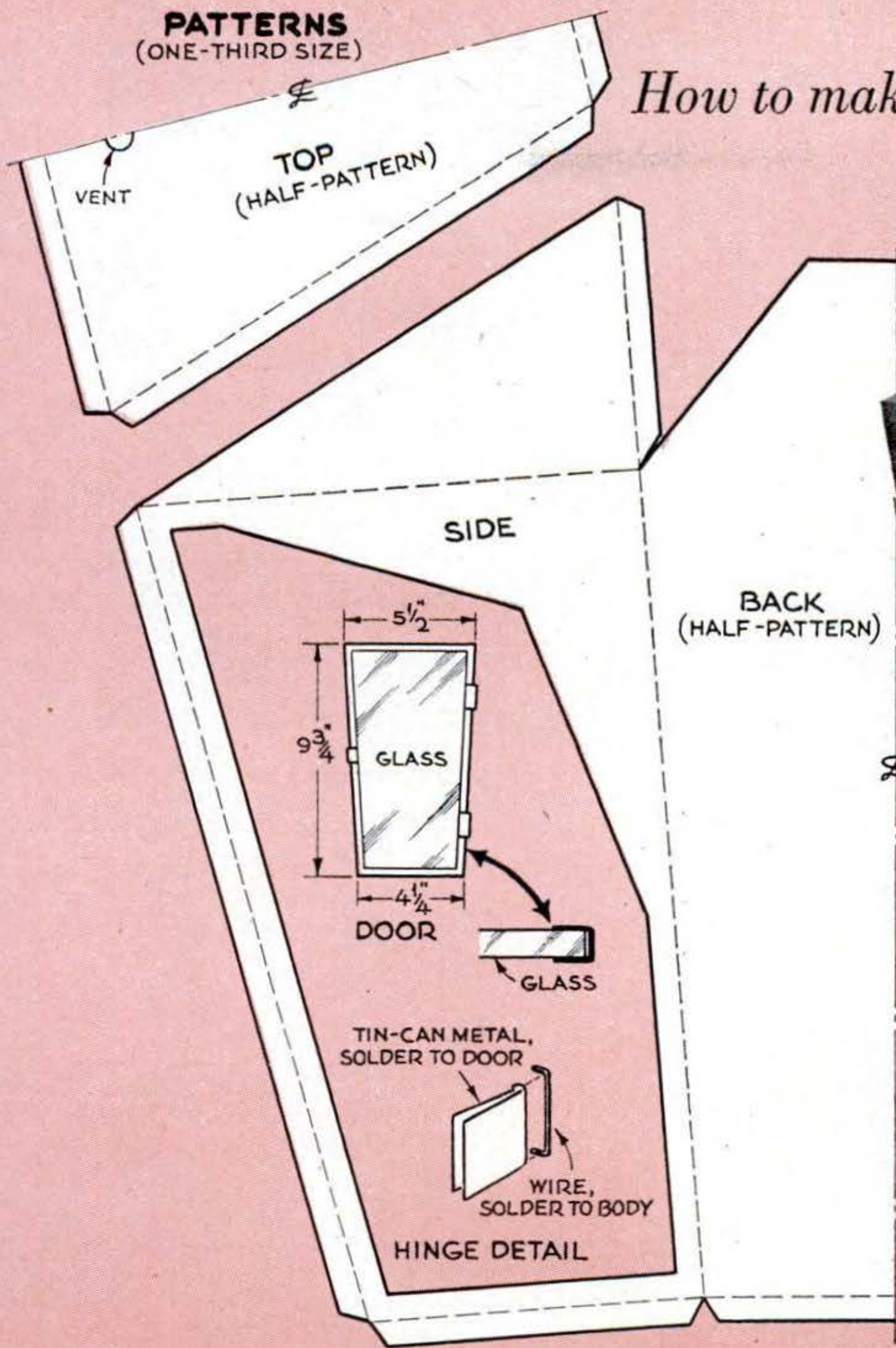

How to make the wall-type lamp

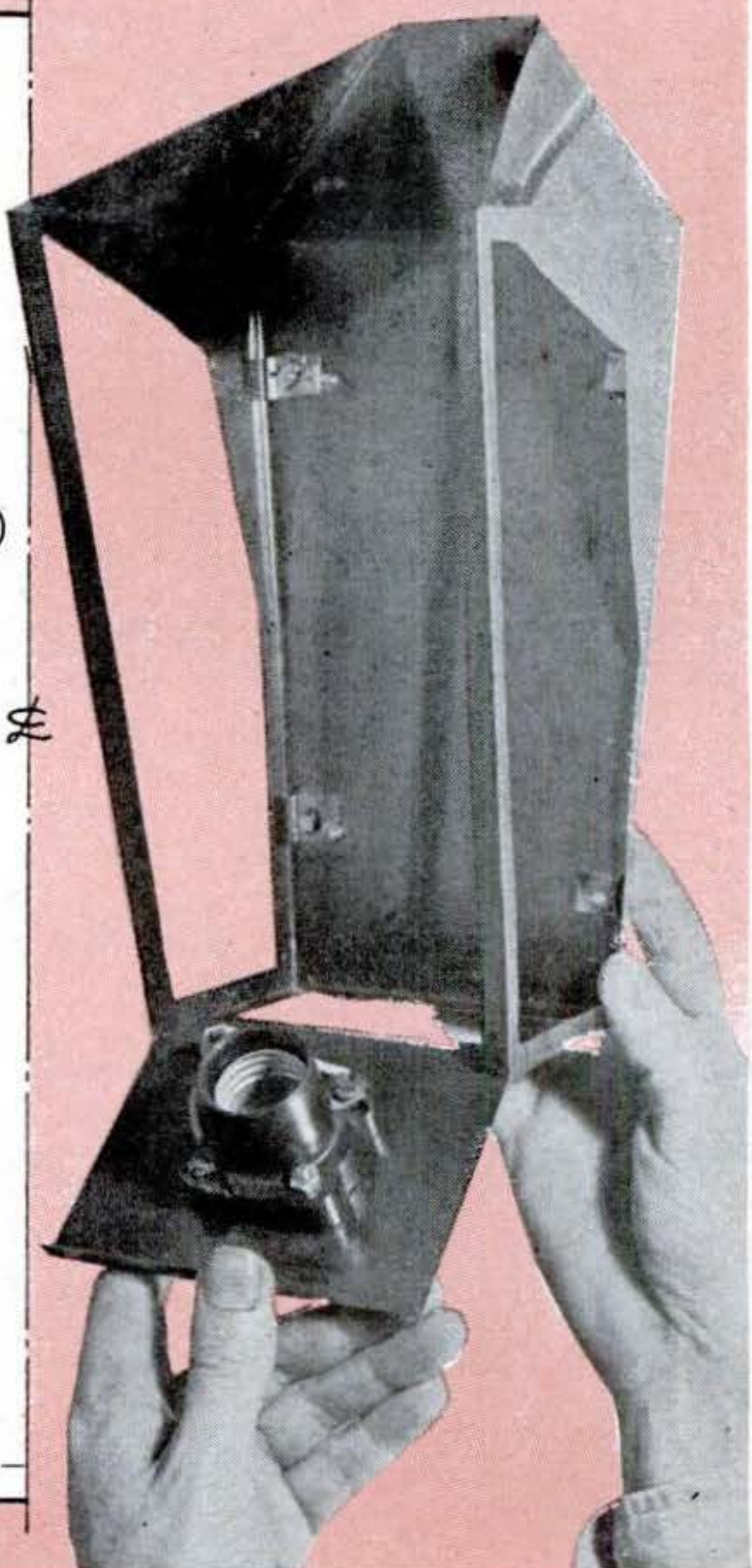

SCALE UP the half-pattern three times the size it is above. Draw it on both sides of a centerline. The flanges on front and bottom edges frame the door and support the lamp-socket base.

THE REFLECTOR may be plain or corrugated tin plate. Lead cord out through a bushing. The socket shown above is suitable only in sheltered spots; it is better to use an outdoor type. **END**

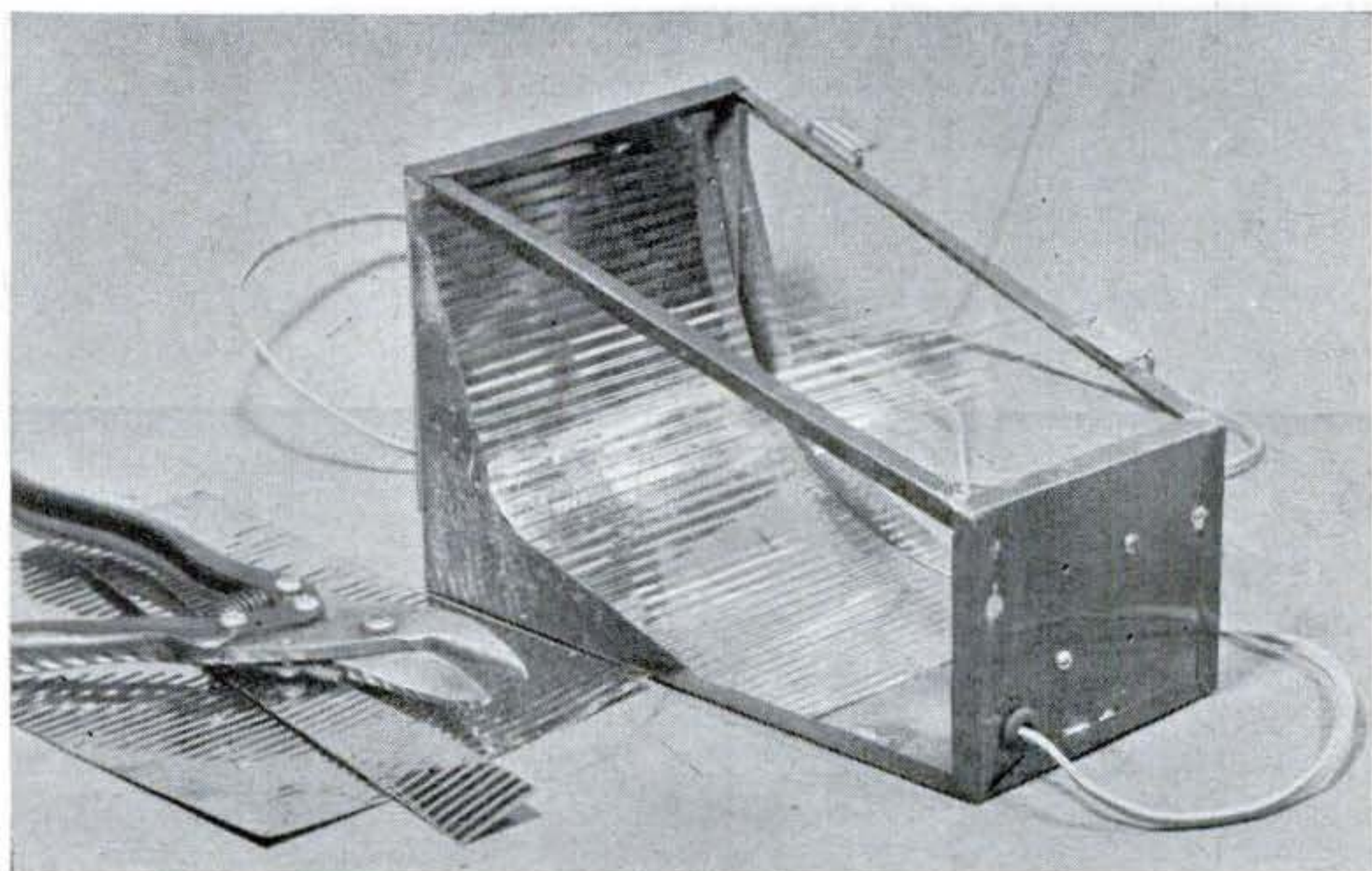

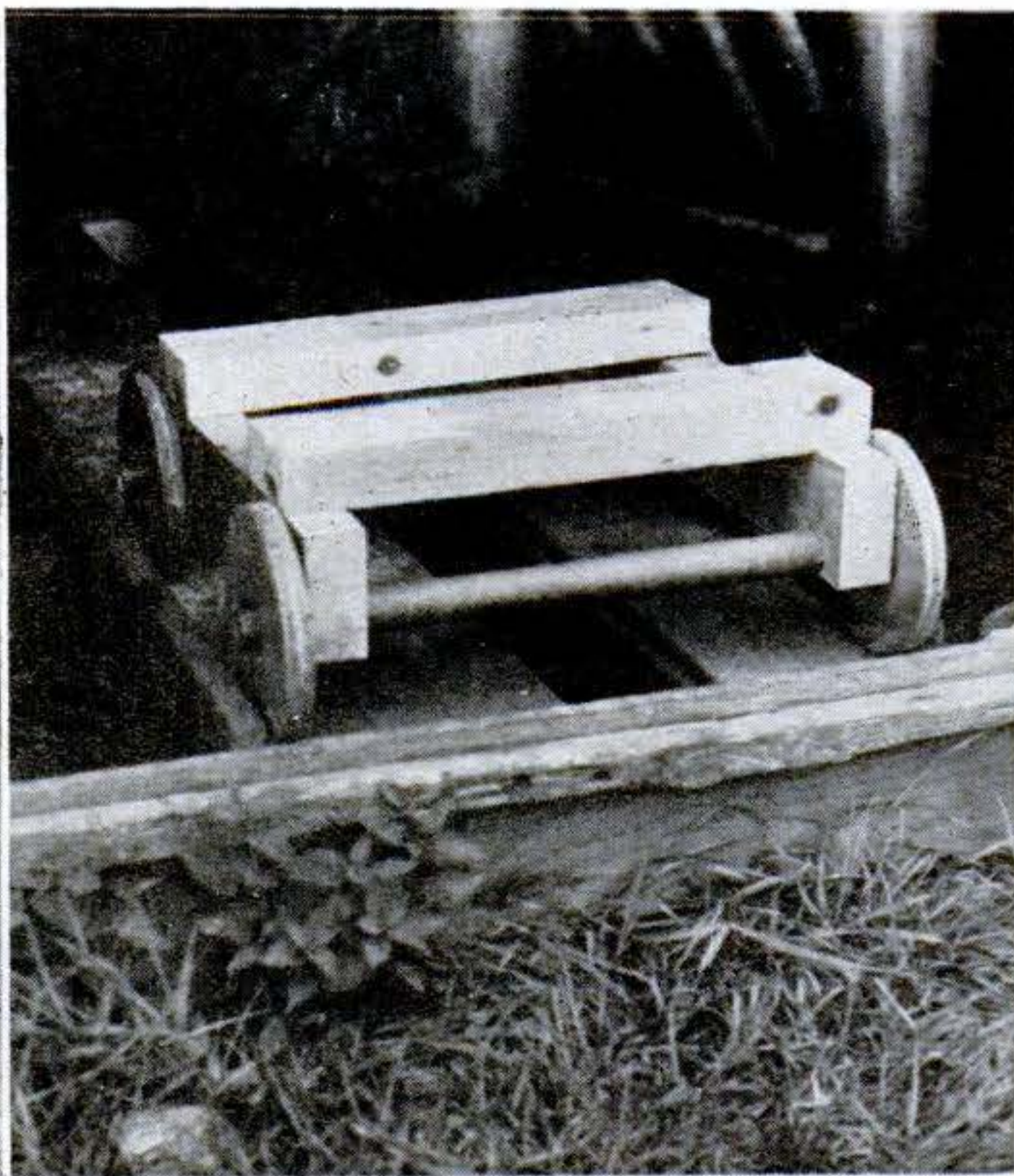

Wood Railway Helps Us Store Our Boat Under Summer Cottage

WE USE a railway-like contraption to store our skiff in the limited space that is available under our summer cottage. We first put down a track of planks with two-by-fours along the outer edges. Then we built a carriage to roll on the planks between the

two-by-four guides. The 6" wheels are $\frac{3}{4}$ " plywood disks pinned on 1" pipe axles. By resting the bow on the carriage, we now just push the boat underneath the house when it comes time to store it away.—*Willard Allphin, Danvers, Mass.*

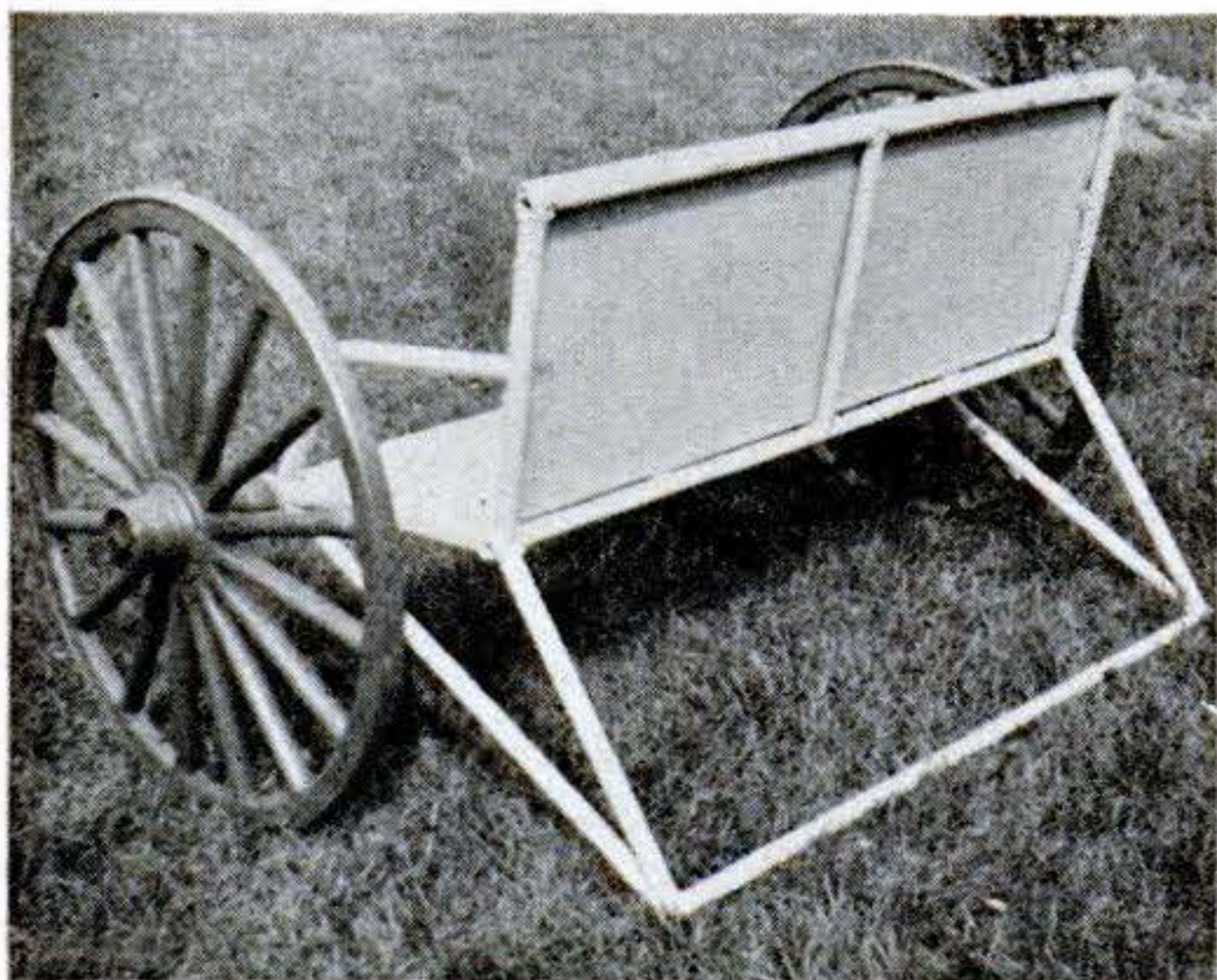

Bench Rolls on Wagon Wheels

Two old wagon wheels, cleaned up and painted, not only decorate this outdoor bench but make it easy to roll around the yard. The frame is $\frac{3}{4}$ " pipe, welded at the joints, but it could be assembled with threaded connectors and bolts to save welding. The rear crossbar that rests on the ground makes a fine handle when wheeling the bench. Seat and back can be sheet metal, waterproof plywood, or even awning material.—*Dick Main, Delaware, Ohio.*

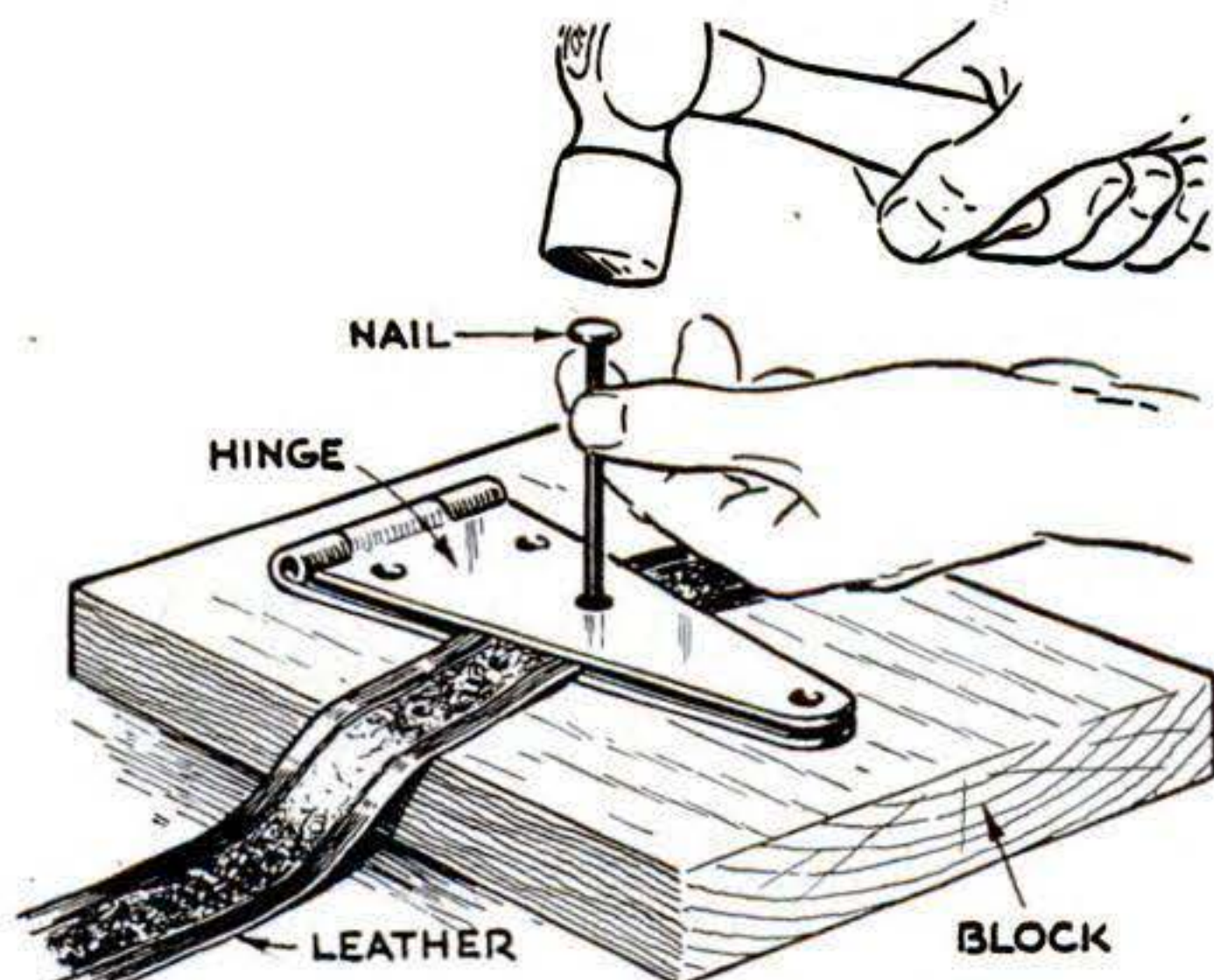

Hinge Makes Leather Punch

AN IMPROVED leather punch can be made from a strap hinge and a block of wood. Fasten one half of the hinge to the wood base with screws, and drill a punching hole into the base through one of the hinge holes not used as a screw-down. The leather then is placed between the folded halves of the hinge with the place to be punched centered with the punching hole. A nail with its end ground square is the punch.—*William B. Eagan, Louisville, Ky.*

NOW IS THE TIME TO INSTALL FULL-FIRING CHAMPION SPARK PLUGS TO TUNE-UP WINTER-WEARY ENGINES!

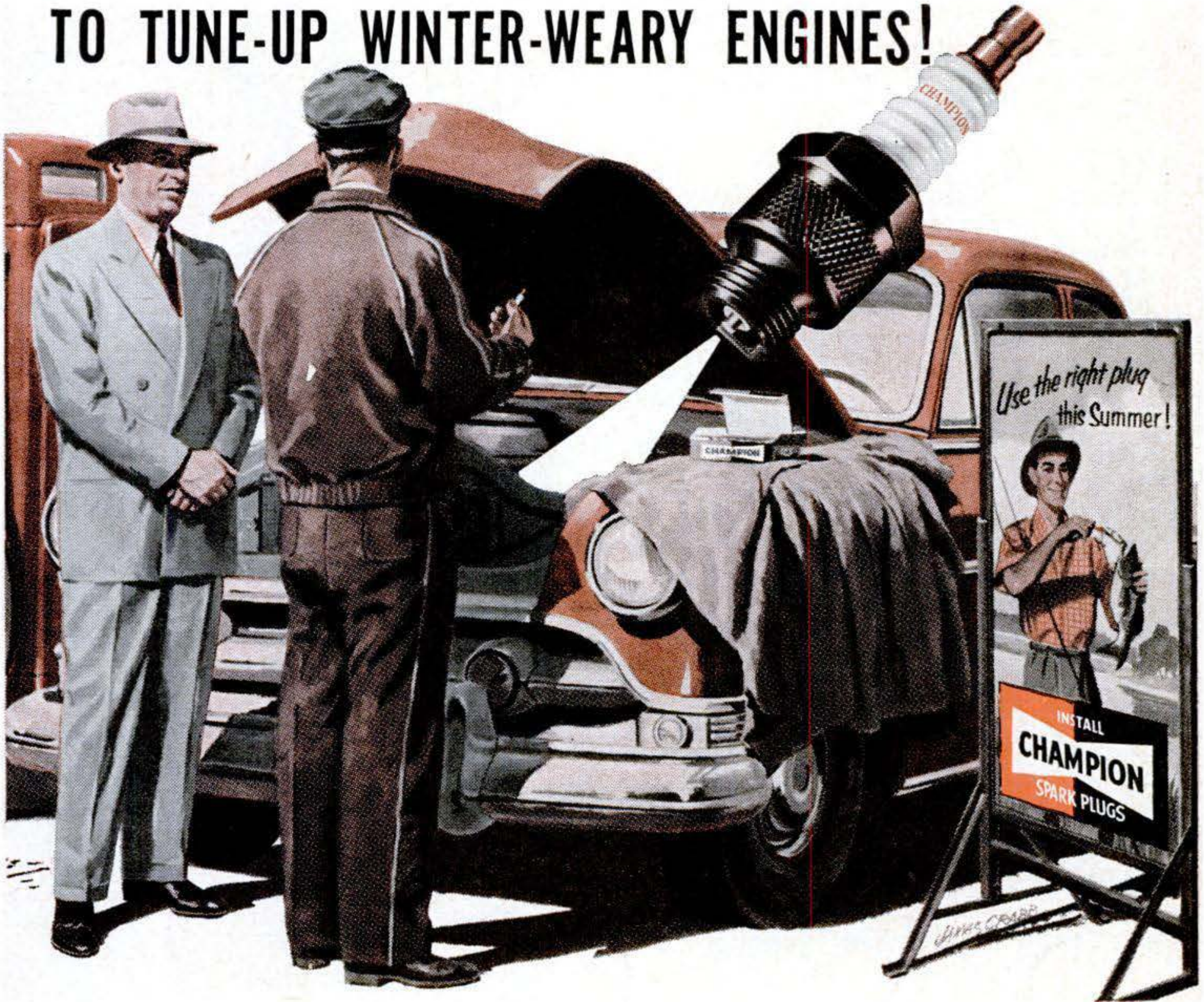

Install new Champions now to offset the damaging effects of limited use or winter storage and help your engine do a first-class job for you this summer.

Quickest, surest way to wake up your engine for increased summer activities is to install a set of new Champion Spark Plugs.

Champion's full-firing spark—delivered through the finest insulator known to ceramic science to special alloy electrodes—turns every drop of gasoline into power. No unburned fuel remains to build up harmful deposits and thin your crankcase oil. That means you can drive longer, and harder this summer and still enjoy better performance and economy.

Now is a mighty good time to see your nearby Champion dealer and start getting all the power you're paying for!

CHAMPION SPARK PLUG COMPANY, TOLEDO 1, OHIO

CRAFTSMEN AT WORK

Dig This Pooch House! Although made of scrap materials, this big doghouse is fancy enough to rate the front yard—and it does at the home of its builder, Bill Pratt of National City, Calif.

Designed to give a Toonerville Trolley effect, the walls slant outward and shutters appear ready to fall off. Copper tubing was put on a trellis to resemble vines.



Water-Jug Town Lights Up. A schooner, waterfront village and two lighthouses were squeezed through the 1" neck of the water jug at left. And because Albert C. Brussee of East Cleveland, Ohio, who made it, is an electrician, the village homes light up and the lighthouses blink on and off. A wire through a hole bored in the bottle carries house current to the display.

Light Boat Rides Car Top. Weighing only 75 lb., the trim little boat below is light enough to ride nicely atop a car when its builder, Edward S. Oliver of Barrington, N.J., heads for the water. The craft will plane at 20 m.p.h. under the power of a single-cylinder 3.6-hp. Mercury. It was built from POPULAR SCIENCE MONTHLY plans.

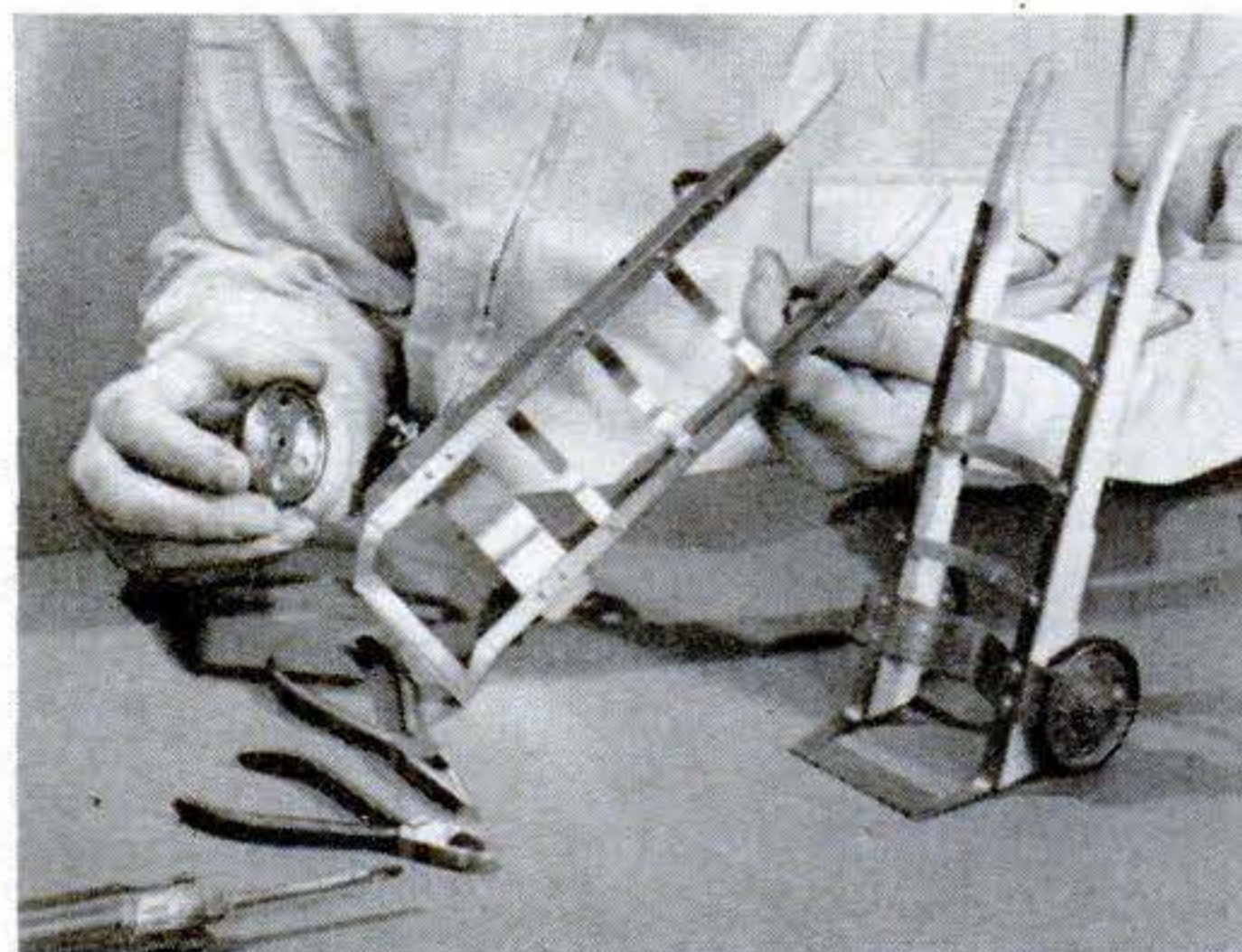
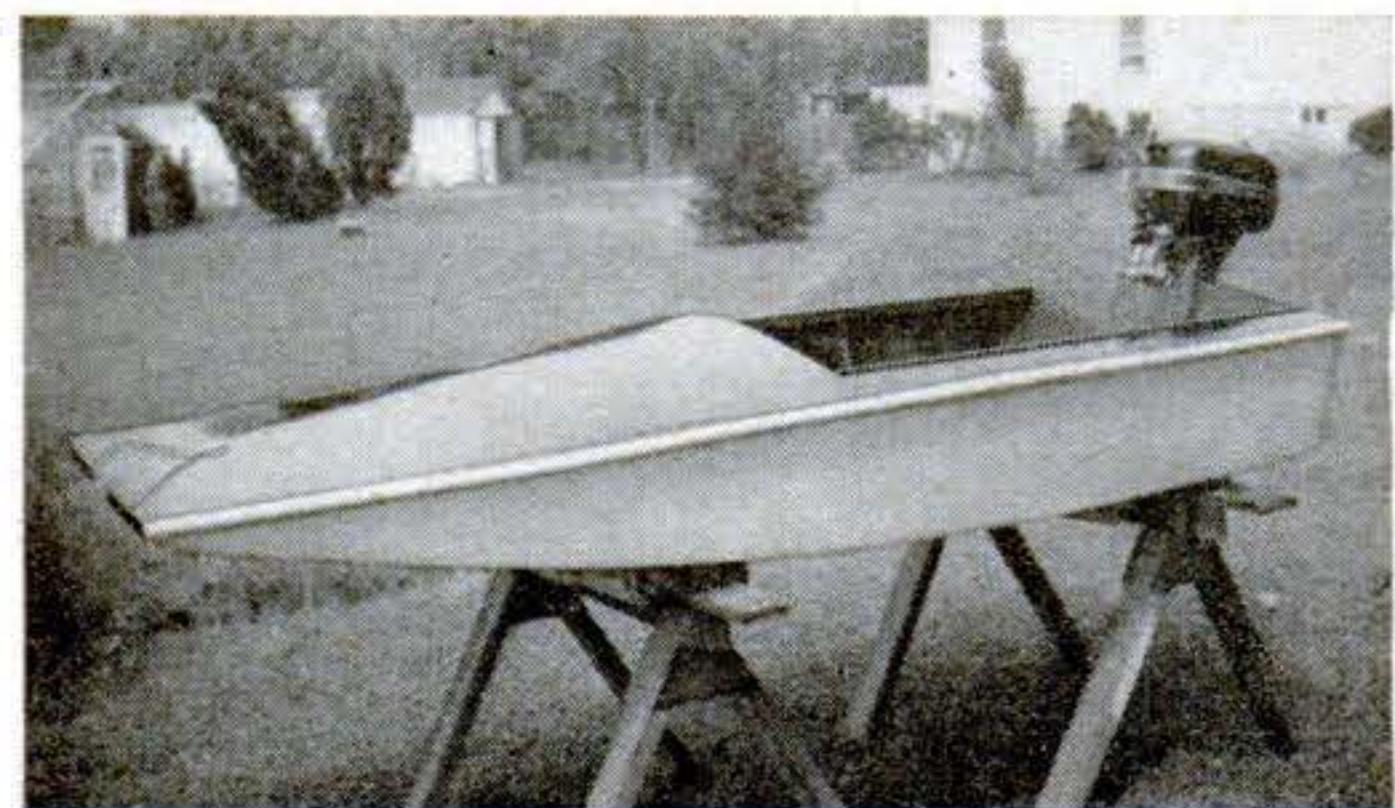

Hand Trucks Fit in Hand. Above are models of the hand trucks Nicholas S. Tranchina of Staten Island, N.Y., uses on his job. He built them of brass, soft wood, and wheels from a radio-supply store.

INTRODUCING...

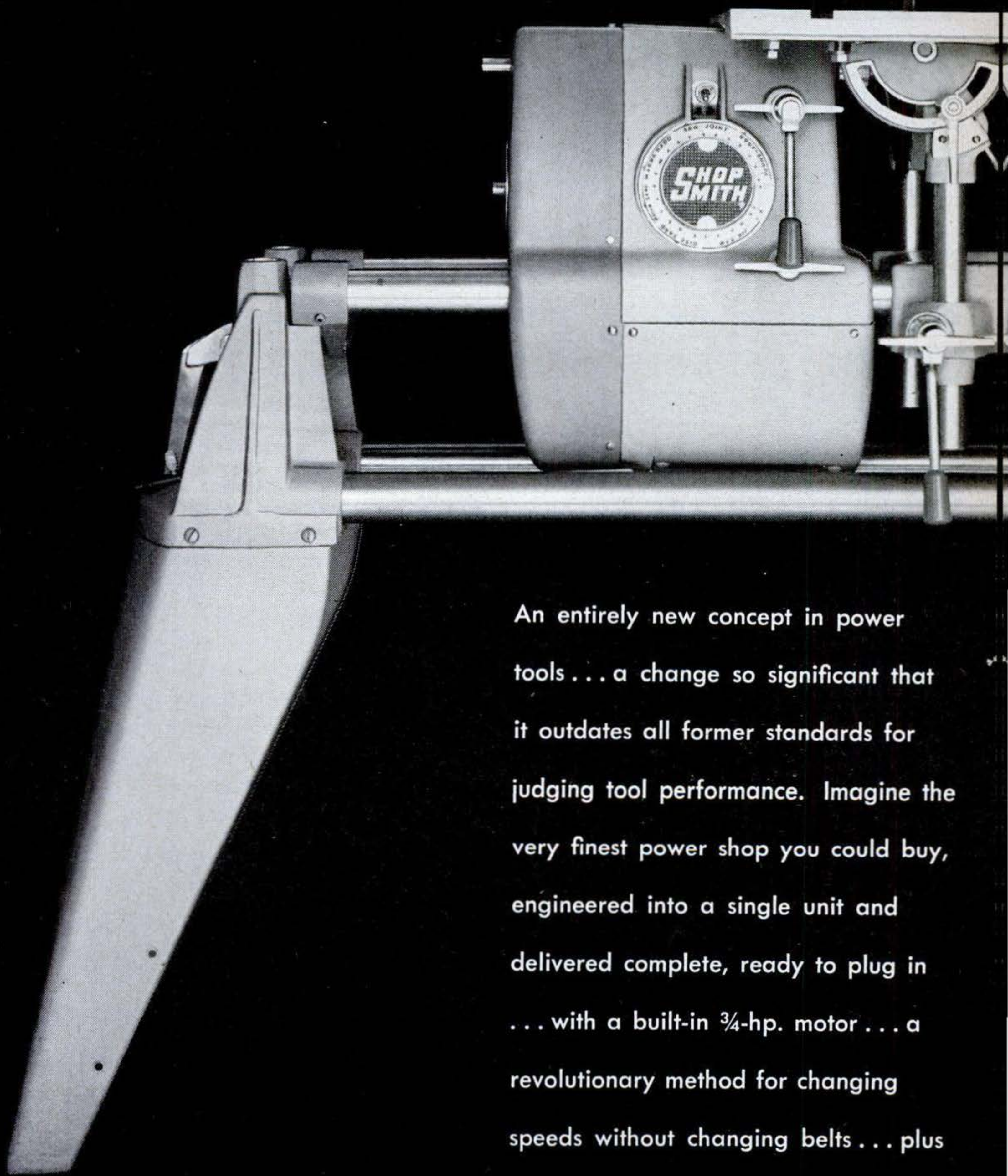

An entirely new concept in power tools . . . a change so significant that it outdates all former standards for judging tool performance. Imagine the very finest power shop you could buy, engineered into a single unit and delivered complete, ready to plug in . . . with a built-in $\frac{3}{4}$ -hp. motor . . . a revolutionary method for changing speeds without changing belts . . . plus many, many more exciting features.

NEW SHOPSMITH

advanced engineering makes it the only power tool to put precision woodworking within the reach of everyone!

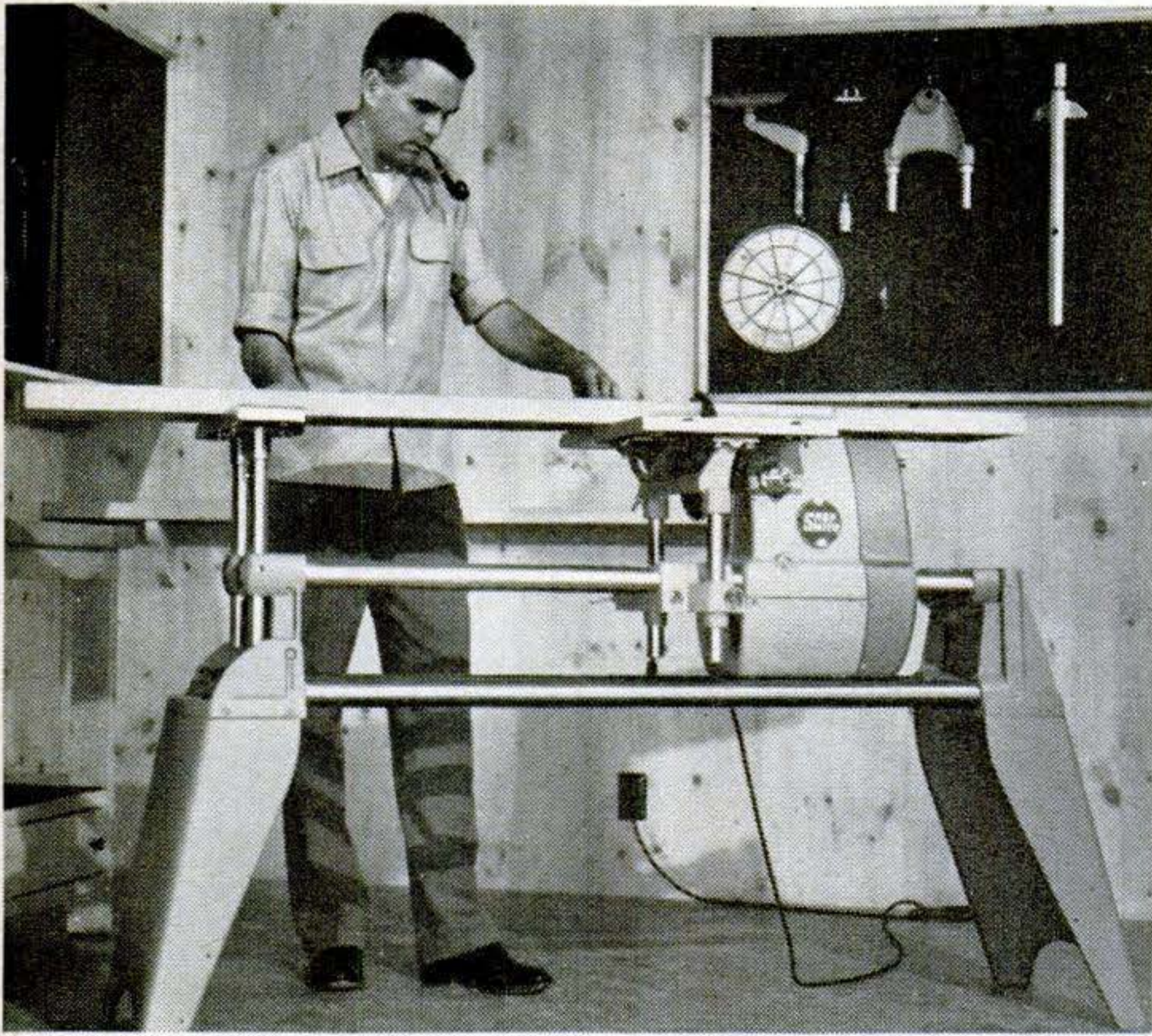

For six years, SHOPSMITH* has been the unchallenged leader in power tools. Over 150,000 owners enthusiastically acclaim the SHOPSMITH principle as the only truly practical basis for multi-tool operation.

And now comes the second great revolution in power tools—an entirely new SHOPSMITH! Here are standards of design you'll recognize as so advanced, you know it will take years to match them—standards of versatility, precision, convenience and safety so new and different, you'll appreciate why SHOPSMITH Mark 5 is the one tool for modern living—why it *alone* is the tool for you and *all* the things you want to do.

*Reg. Trade Mark

SHOPSMITH Mark 5 IS COMPLETE! It's delivered to you ready to plug in. And like your automobile, it comes factory assembled, factory adjusted, factory tested. No bench, motor and switch to buy. No belts, pulleys and wires to attach. No rust worries—rods and tubes are hard-chrome plated! Everything is an integral part of the compact unit *plus* all you need to make it a 9" circular saw, 12" disc sander, 34" wood lathe, 16½" drill press, horizontal drill. The price complete..... **\$269⁵⁰**

SHOPSMITH Mark 5 is built for hairline accuracy!

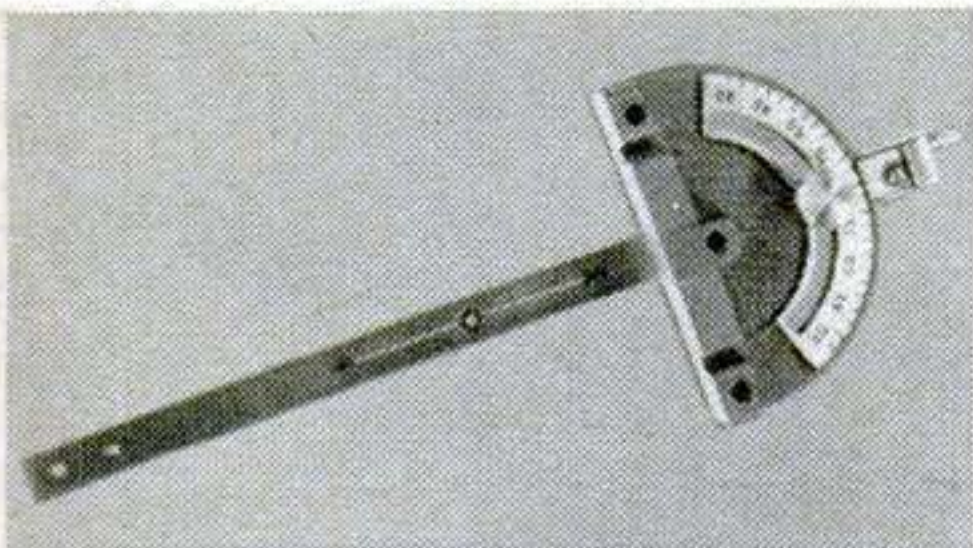

MITER GAUGE. It's accurate to the exact degree of angle. Locks in table slots as handy sanding and drilling jig.



RIP FENCE. Squares and locks front then back with single handle. Easily set off-square for special operations.

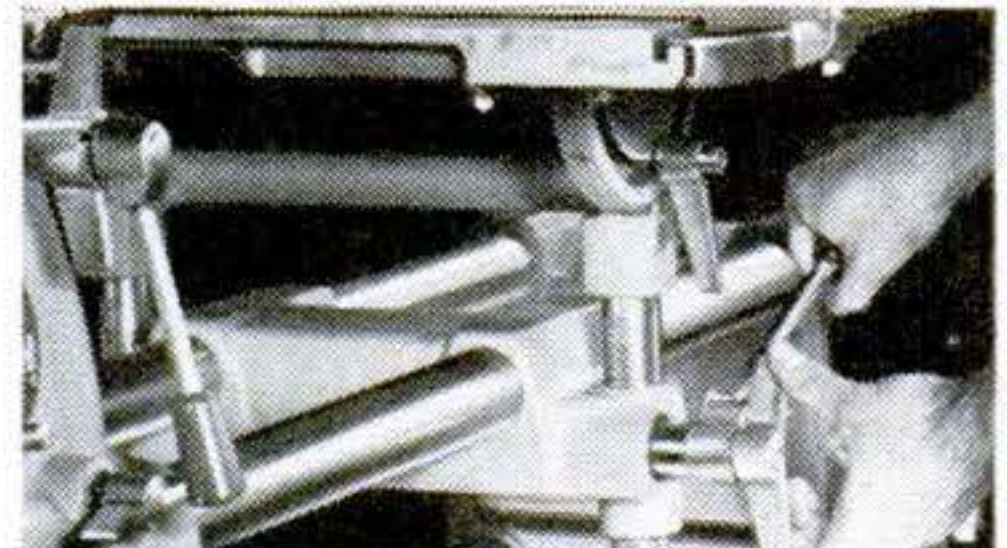
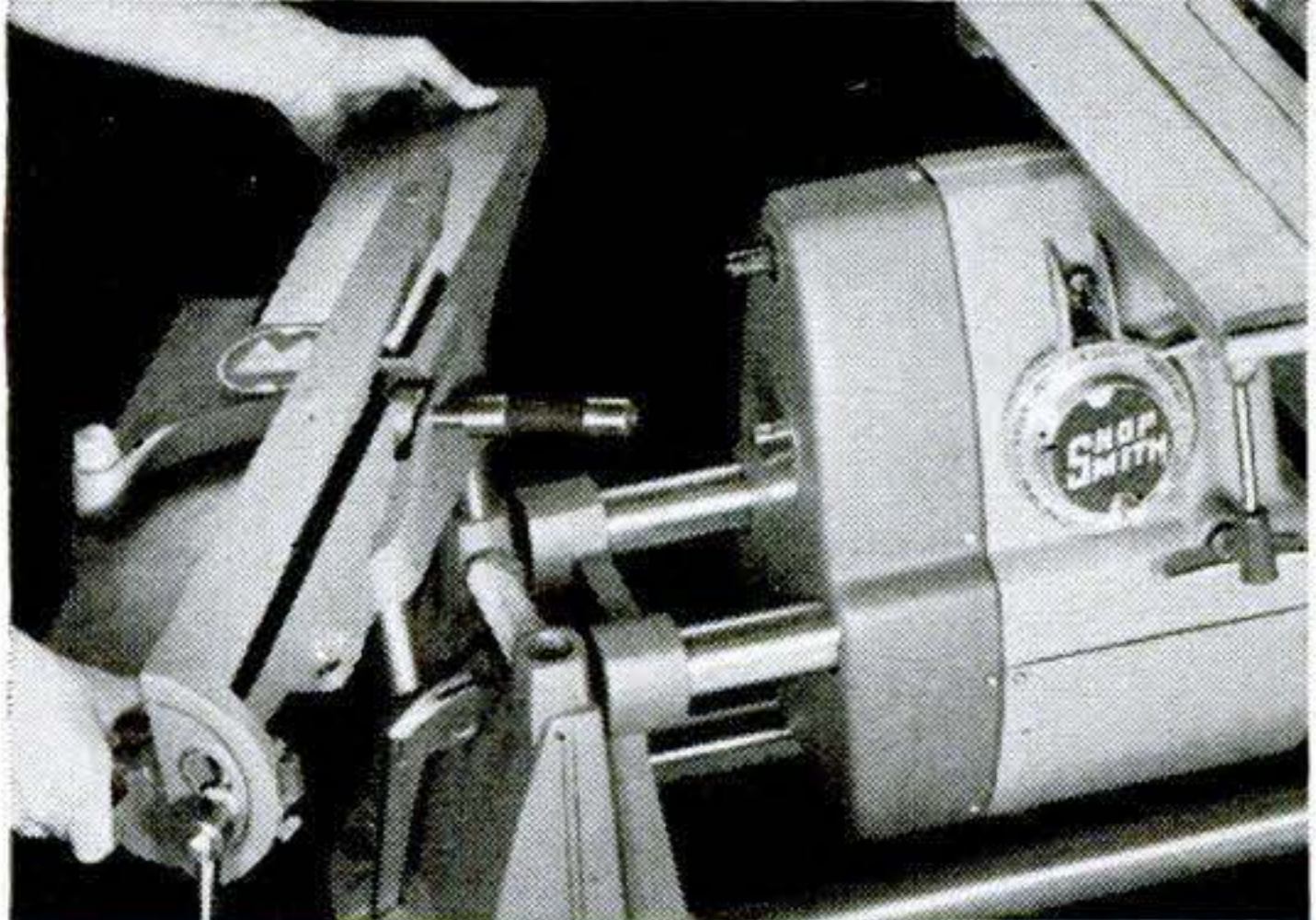

TABLE HEIGHT. Quickly, accurately set by lever-operated double rack and pinion. Faster than other methods.

MARK 5

SHOPSMITH Mark 5 HAS GREATER CAPACITY than any power tool at any price! Its 3/4-hp. motor has ample power for the toughest operations. 9" circular saw cuts 4' x 8' panels in half either way. Lathe has 16 1/2" swing... 12" sanding disc has big 14" x 18 3/8" table... drill press drills to center of 16 1/2" circle... horizontal drill capacity is unlimited!



SHOPSMITH Mark 5 HAS SPEED-DIAL. By itself, Speed-Dial is the most significant power tool advance in years. It automatically selects the correct speed for the job at hand — does it with a twist of the dial. No more guesswork. No more belt changing. No makeshift operations with one-speed or wrong-speed spindles. Simply turn the dial to the place marked saw, jointer, sanding, jig saw, dadoing, etc. —or make infinitely variable settings from 700 to 5200 rpm.

SHOPSMITH Mark 5 IS THE SAFEST TOOL EVER DESIGNED! Belts, pulleys, shafts and motor—they're all completely enclosed! Even the switch is guarded—it can't be bumped ON accidentally, yet it's easily snapped OFF. All control handles are clearly labeled—on both sides!

SHOPSMITH Mark 5 HAS POWER MOUNT. Add a jointer, jigsaw, bandsaw, etc. — with one twist of a handle, one turn of a set screw. Set up useful tool combinations in seconds — saw-jointer, jigsaw-sander, band-saw-sander, lathe-grinder, many others! Power mount tools take no extra floor space — can be operated at optimum speeds.



9" CIRCULAR SAW

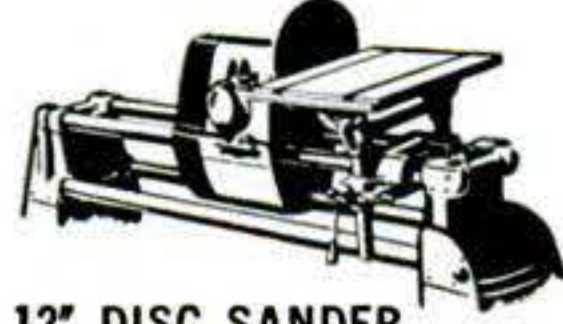

12" DISC SANDER



16 1/2" DRILL PRESS

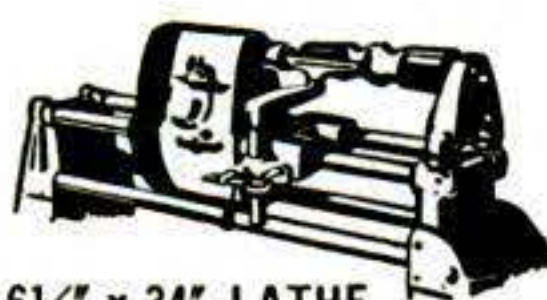

16 1/2" x 34" LATHE



HORIZONTAL DRILL

Premier showing of **SHOPSMITH Mark 5** at leading hardware and department stores, and Montgomery Ward retail stores. **NOW!**



QUILL DEPTH STOP. Simple dial setting: 0-4 1/4". More accurate drilling, saw settings, duplicate sanding.

MAGNA ENGINEERING CORPORATION
 Dept. 261-A, at factory nearest you:
 12819 Coit Rd., Cleveland 8, Ohio, OR
 Menlo Park, California.

I want to know more about the new SHOPSMITH. Please rush me your free, new 20-page catalog with illustrations, data, complete specifications.

Name _____
 Address _____
 City _____ State _____



NEW Shop Ideas

Spring Clips Hold Curves. Use a batch of these spring clips to hold down the line-guiding batten in making a curve on sheet metal or other smooth surface. Less cumbersome and less costly than conventional heavy "ducks," they will stay put on vertical layouts or work that must be moved.

The body and hold-down point is bent from a piece of coat-hanger wire and snapped over a rubber towel-rack suction cup. Points are filed sharp to grip the batten stick. —*Elbert Robberson, Port Washington, N. Y.*

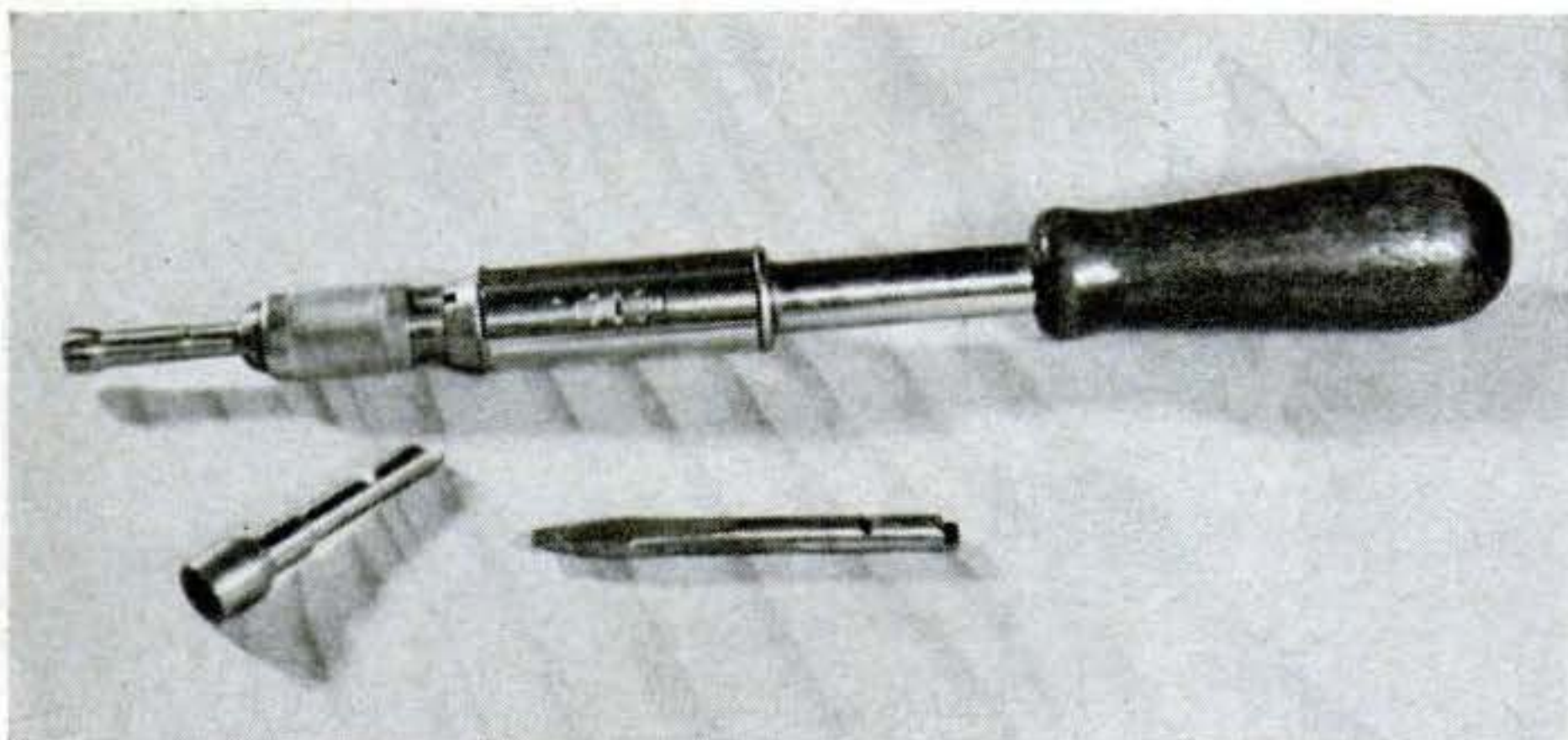
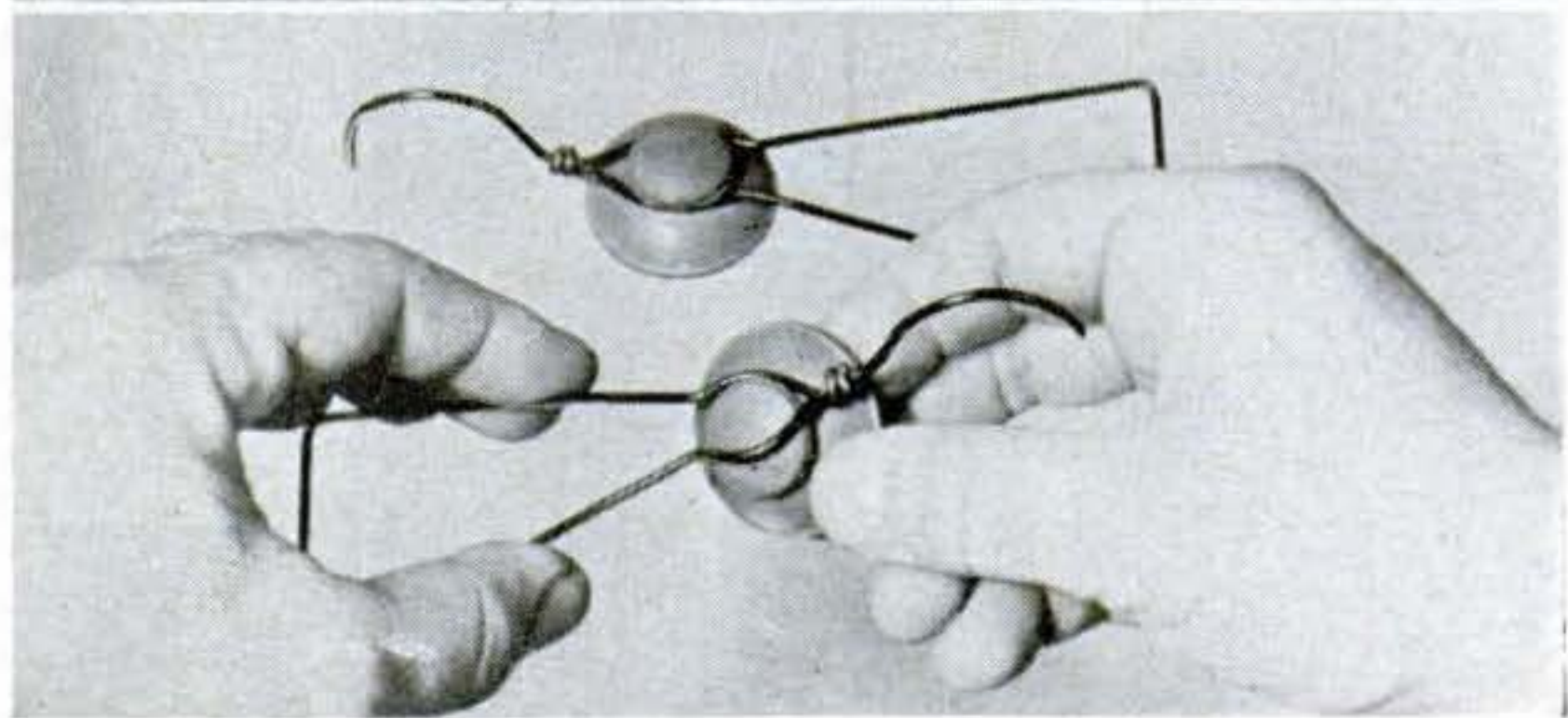
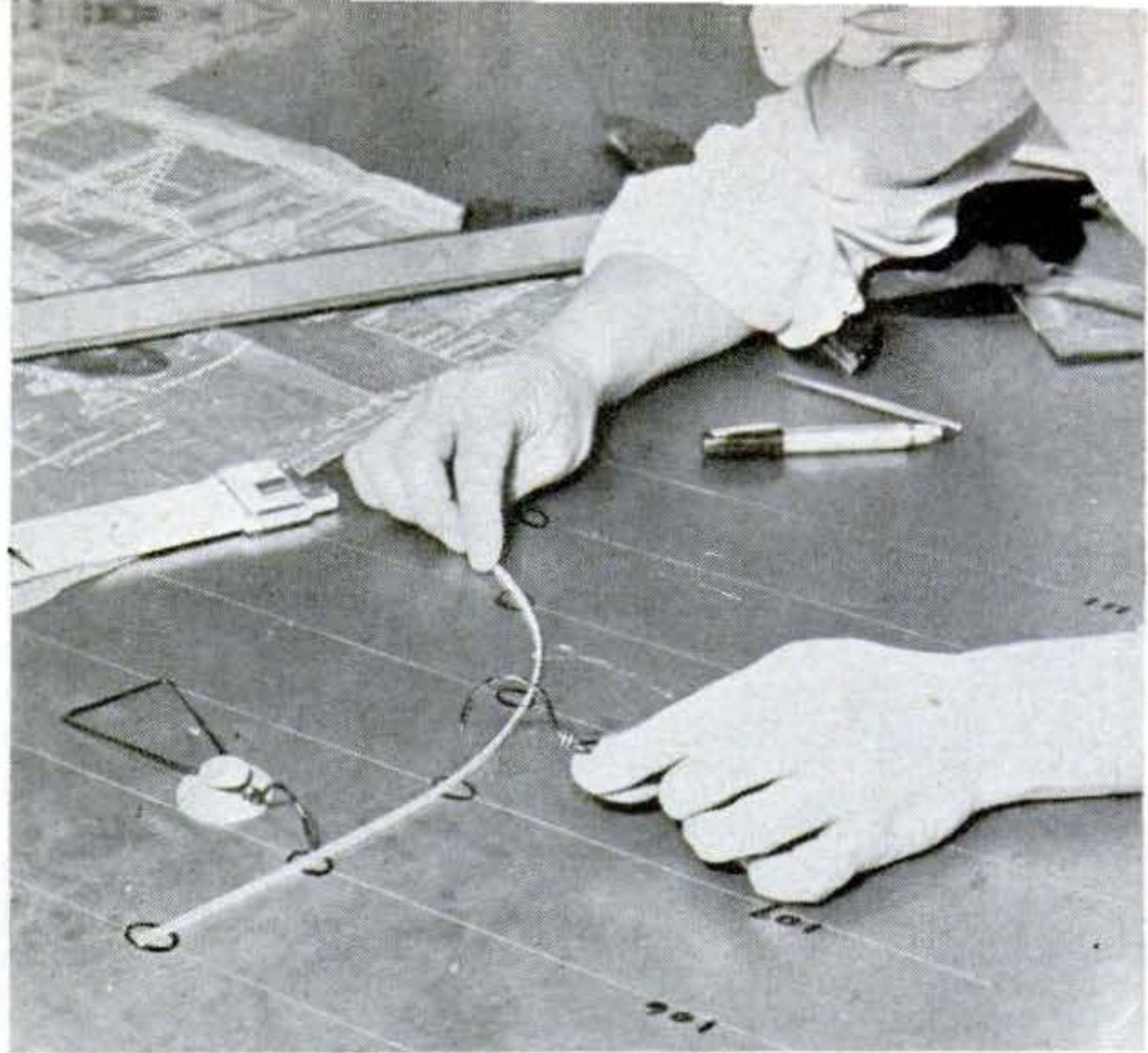

Ratchet Screwdriver Drives Homemade Sockets. Turn down the threaded shanks of an assortment of Allen-head screws and file a V and an offset on the ends to fit and lock in a ratchet screwdriver. The result

will be a fast-acting socket drive for running up nuts on small studs or bolts. Drill out the center of the shank to clear the diameter of the stud as the nut is driven onto it. —*Henry Sevcik, Hawthorne, Calif.*

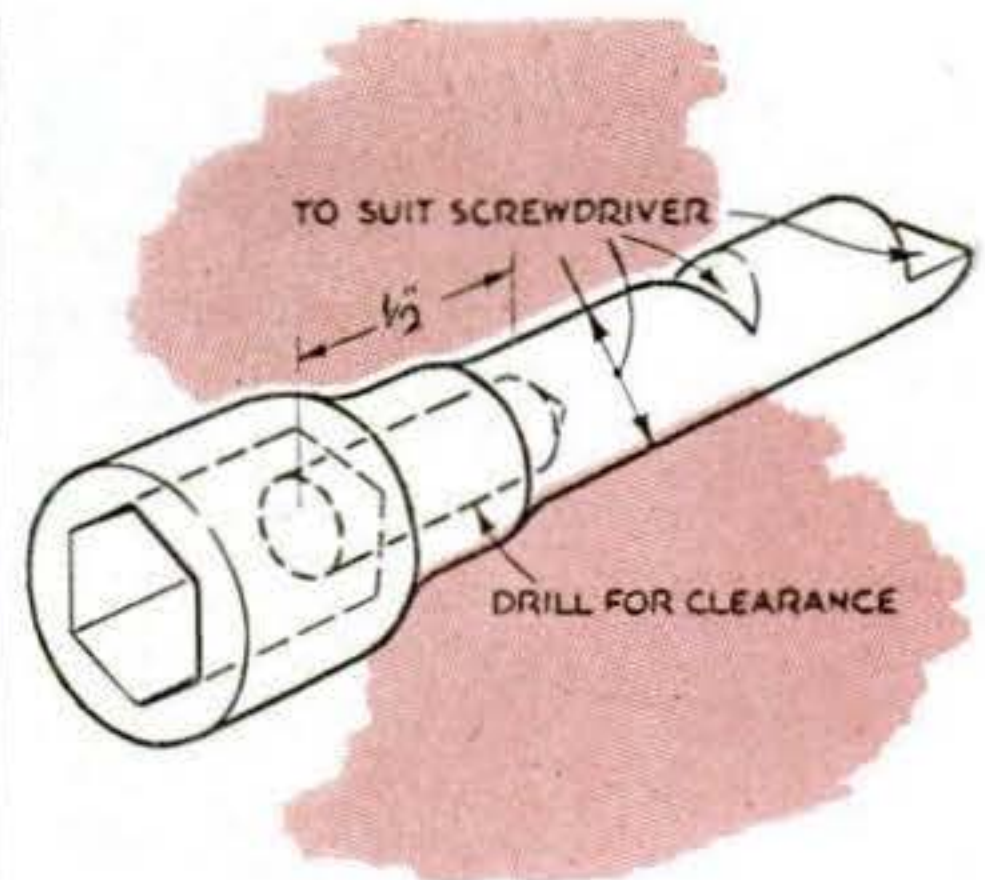

Revolving Lathe Center. A 5/8" steel ball is used as a thrust bearing in this revolving center that permits high-speed turning without overheating the point.

Turn the body from 1"-diameter cold-rolled steel and taper the shank to fit the tailstock ram. Turn the revolving center from 3/8" drill rod and cut a groove to line up with a retaining screw in the body. Oil the tool generously when in use. —*F. W. Shelford, Los Angeles, Calif.*

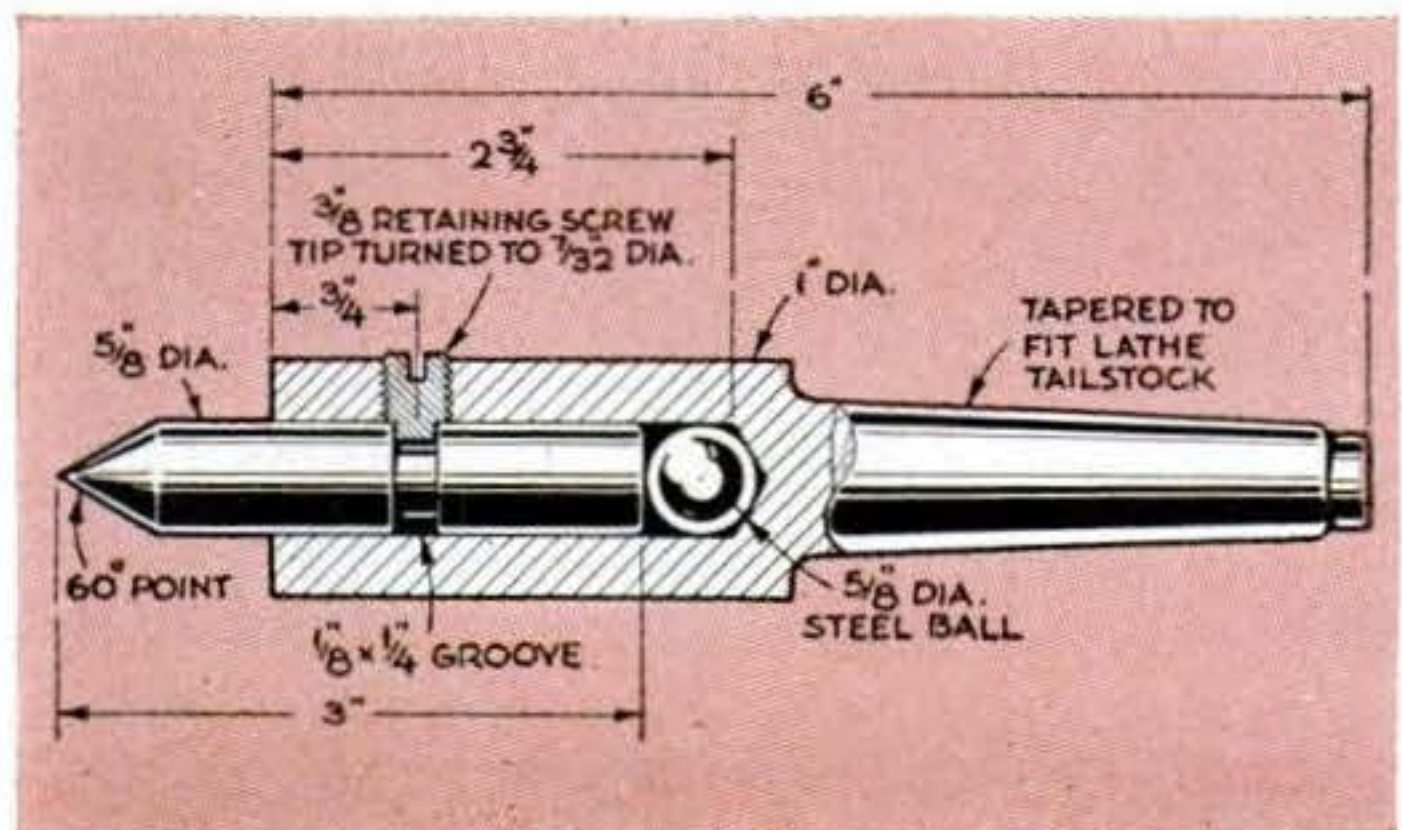

Get Aboard AMERICA'S FASTEST GROWING SPORT!



Mr. and Mrs. America and their children are discovering that their dream boat is at last a reality... thanks to the outboard cruiser! Here is a cruiser to suit average circumstances. Not only is it easy on the budget. It is easy to care for, easy to store, to transport, to service, to operate. No special abilities are required, no unusual facilities. And you can use such a boat on most any waters!

JOHNSON'S contribution to outboard cruising has been exceedingly important. **DEPENDABLE** power, in a portable unit, separate, long range fuel system, remote control of throttle, shift and steering, and now—*electric starting*—all these provide the very basis of the outboard cruising idea. Wherever you look you'll find Johnson Sea-Horses predominantly favored for this great new sport. Ask your Johnson Dealer. Look for his name under "Outboard Motors" in your classified telephone directory.

FREE! The 1954 Sea-Horse Catalog—packed with data on new outboard developments. Write for your copy. Sent free.

JOHNSON MOTORS, 500 Pershing Road, Waukegan, Illinois
In Canada: Mfd. by Johnson Motors, Peterborough

5 GREAT SEA-HORSES FOR 1954

- ELECTRIC STARTING SEA-HORSE 25**—25 hp. The "automatic" outboard \$498.00*
- SEA-HORSE 25**—25 hp. With Ready-Pull starting. \$410.00*
- SEA-HORSE 10**—10 hp. The all-around motor—with terrific getaway. \$297.50*
- SEA-HORSE 5½**—5½ hp. New! "Suspension Drive." It's quiet! \$210.00*
- SEA-HORSE 3**—3 hp. A 32-lb. twin! With amazing Angle-matic Drive. \$145.00
- SHIP-MASTER REMOTE CONTROL**—For "5½," "10," both "25's." From \$29.50

OBC certified brake hp at 4000 rpm.
Prices f.o.b. factory, subject to change.
*Includes Mile-Master Fuel System.



**NEW ELECTRIC STARTING
SEA-HORSE 25**

Johnson
SEA-HORSES
FOR DEPENDABILITY

Quick facts about

Ford's new Ball-Joint Front Suspension

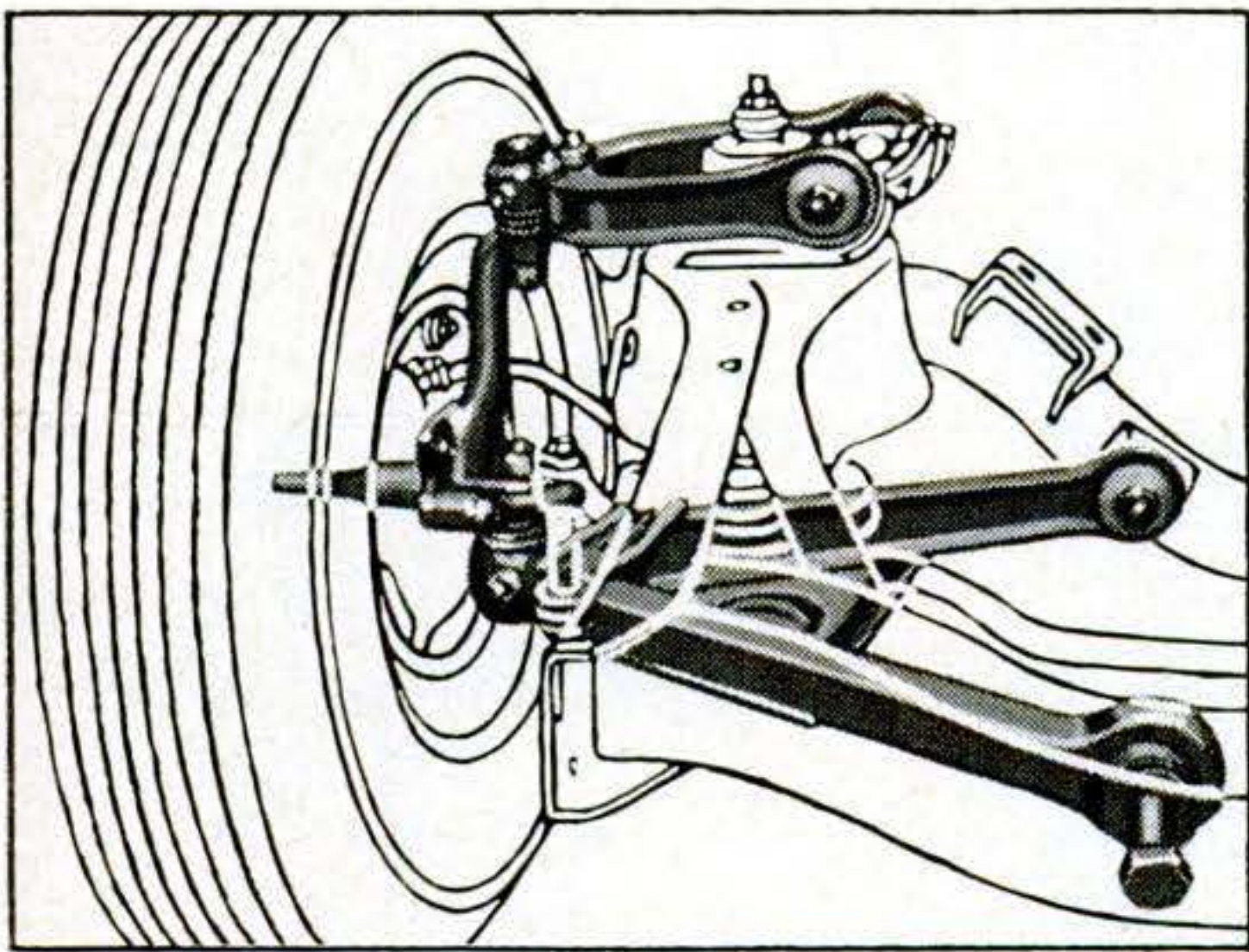

SIMPLER DESIGN

The kingpin on which each front wheel turns right or left in conventional systems has been replaced. Gone, too, are the "hinges" on which the wheel moves up and down. Two simple ball joints now take care of *both* motions.



LONGER LIFE

Ford ball joints (two for each front wheel) are completely sealed against dirt and water by a unique rubber-and-metal shield at each joint. This keeps wear at a minimum . . . aids in retaining that new-car "feel" longer.



It's the greatest riding and steering advance since independent front wheel suspension. It makes all handling easier . . . absorbs road shocks far more effectively . . . keeps wheels in line longer. *And only Ford in the low-price field has it!*

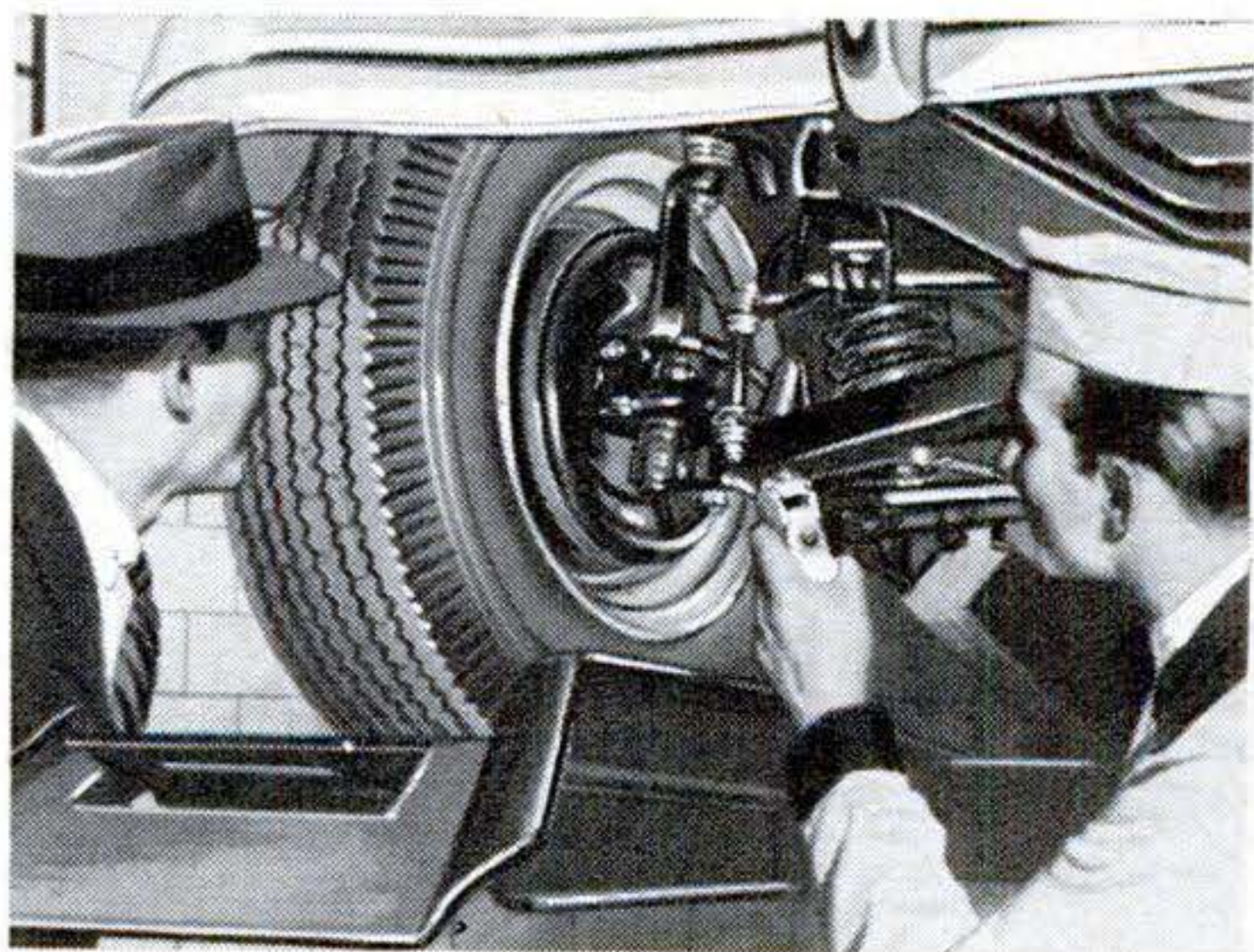
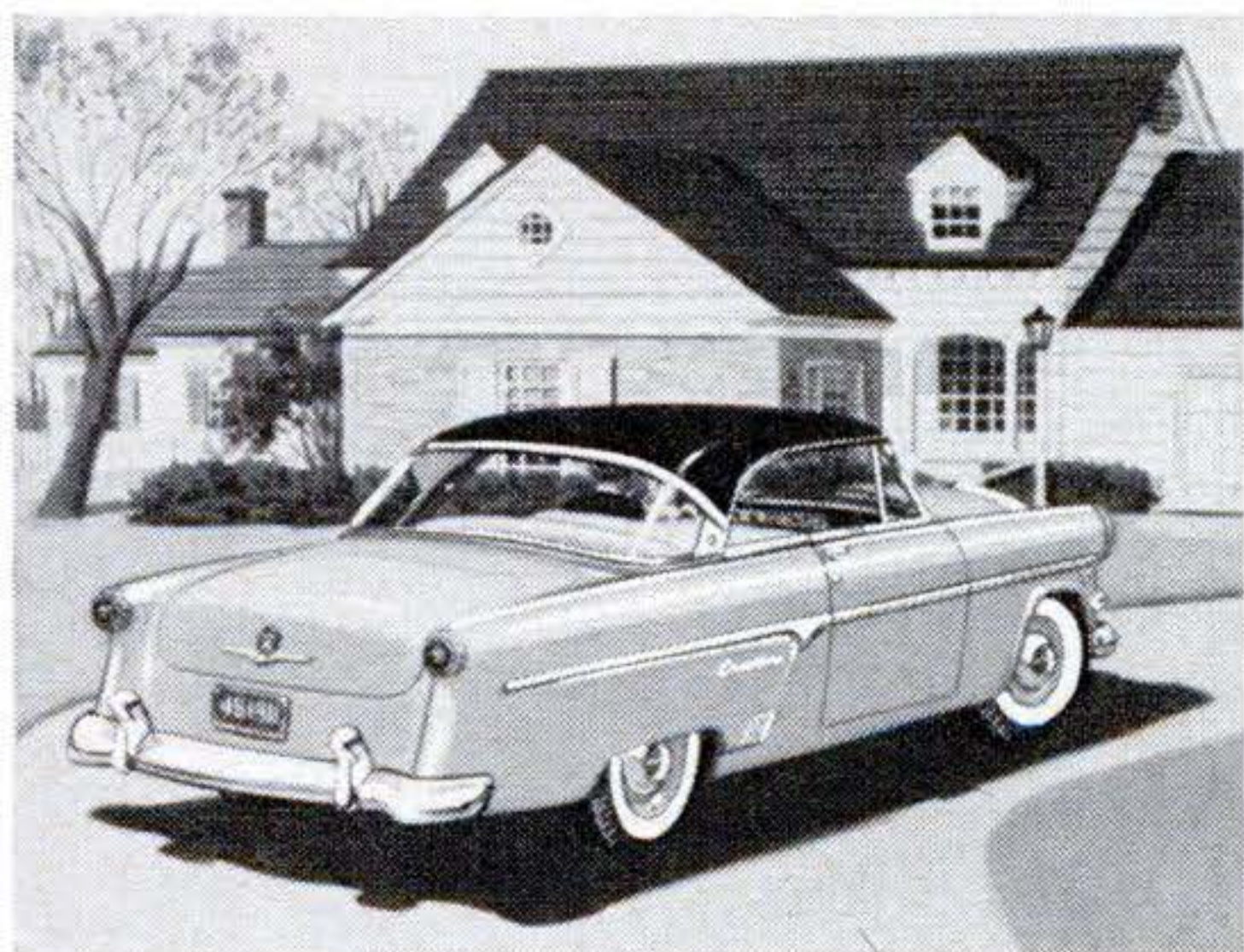

EASIER HANDLING

In steering, each wheel turns on ball joints instead of on a conventional kingpin. Ford ball joints are self-aligning, can't stick or bind. They're spring-loaded, too, to compensate for wear and keep steering consistently easy.

QUICKER SERVICING

Ford's new ball-joint system eliminates 12 of 16 points of wear found in conventional suspensions. Thus, there are only four lubrication points. Rubber bushings at inner ends of control arms insulate chassis from road noises.

IT'S JUST ONE OF FORD'S MANY "WORTH MORE" ADVANCES

Ford's new Ball-Joint Front Suspension, teamed with Ford's all-new chassis, new springs and shock absorbers and hulltight Crestmark Body, brings you the most comfortable ride ever in a low-priced car. And Ford's new 115-h.p. I-block Six and 130-h.p. Y-block V-8 are the most modern engines in the industry!

Your neighborhood Ford Dealer
cordially invites you to Test Drive a

'54 FORD

MORE SHOP TIPS

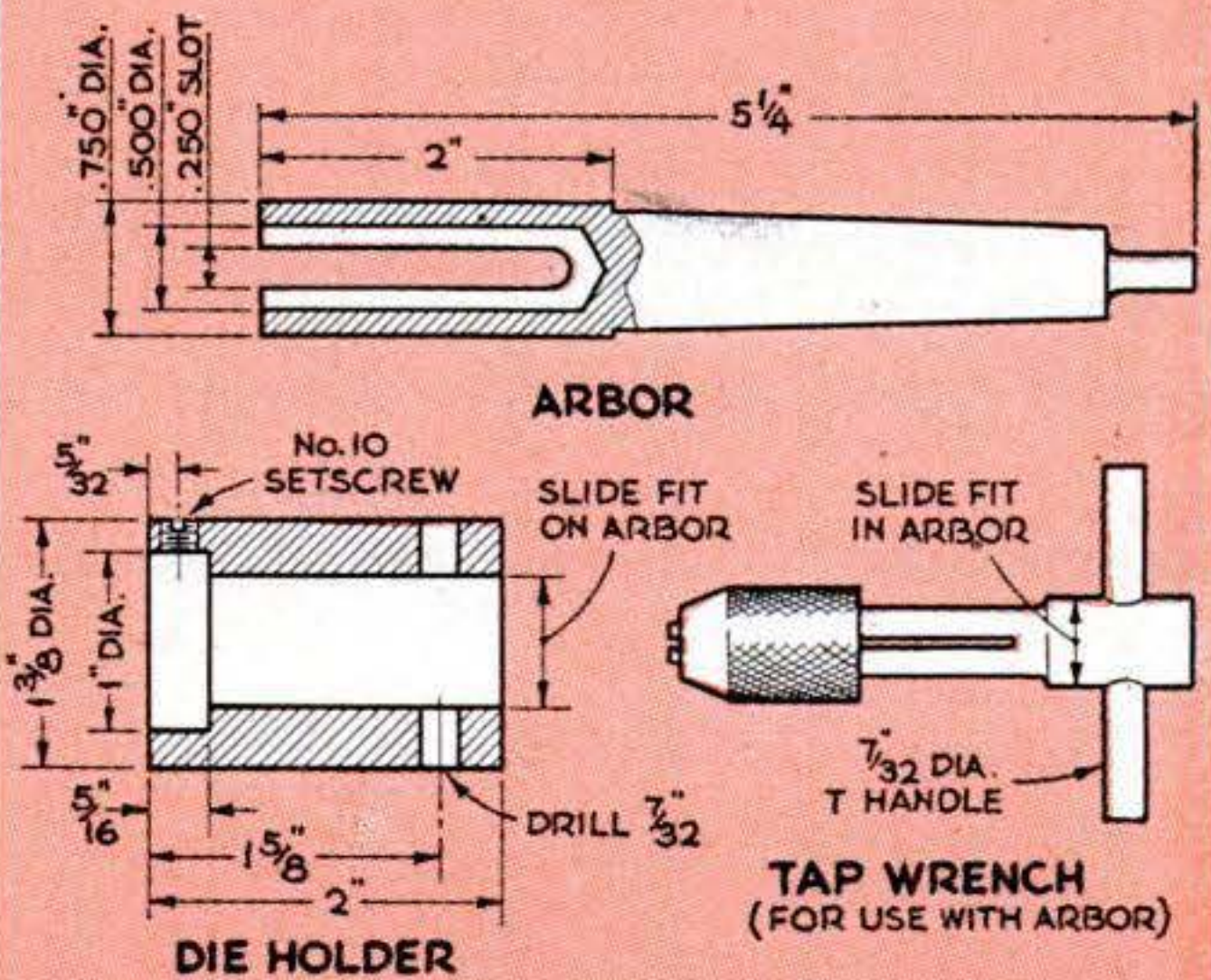
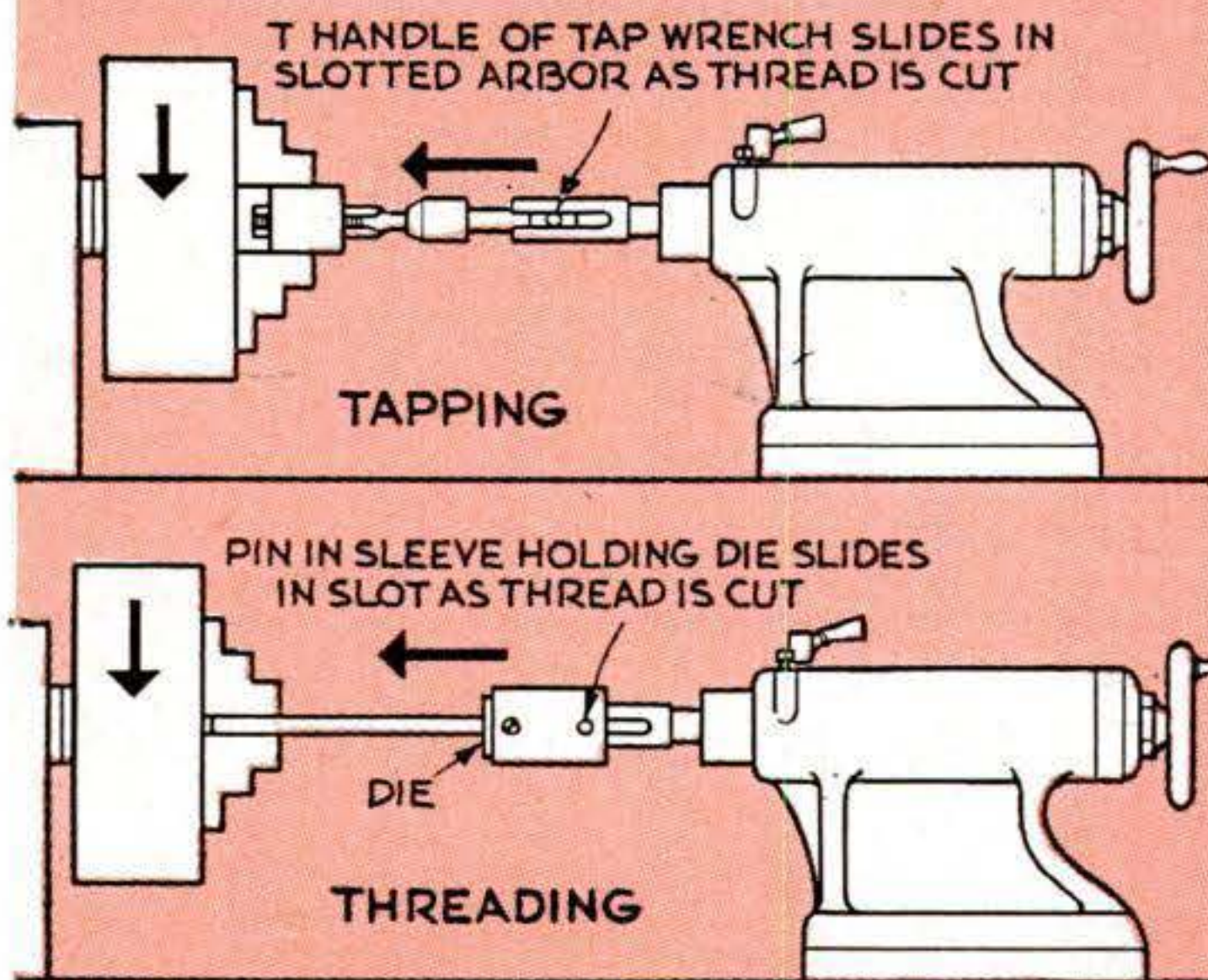

Tailstock Arbor Guides Taps and Dies.

This arbor holds a hand tap wrench for tapping work in a lathe. The special sleeve, turned to fit over it, holds 1"-diameter dies. Slots cut in the side of the arbor lock the handle of the wrench and the pin in the sleeve to keep the tools from twisting.

Turn the arbor from a piece of 3/4" cold-rolled steel rod. Taper the shank to fit the tailstock ram and bore a 1/2" hole about 2" deep in the big end. Cut or mill two 1/4" slots along the bore.

Make the die sleeve from 1 3/8" rod and

bore it to fit easily over the arbor. Bore a 1"-diameter recess in the end to house the dies and drill a 7/32" hole through the other end for a steel pin to keep it from twisting on the arbor.

Taps or dies are started into the work by advancing the tailstock while the lathe rotates slowly in back gear. When the thread is started, the tool will feed itself forward by sliding in the slots. Reversing the lathe will back off the tool as the holder slides back on the arbor.—William C. Pross, Bainbridge, N. Y.

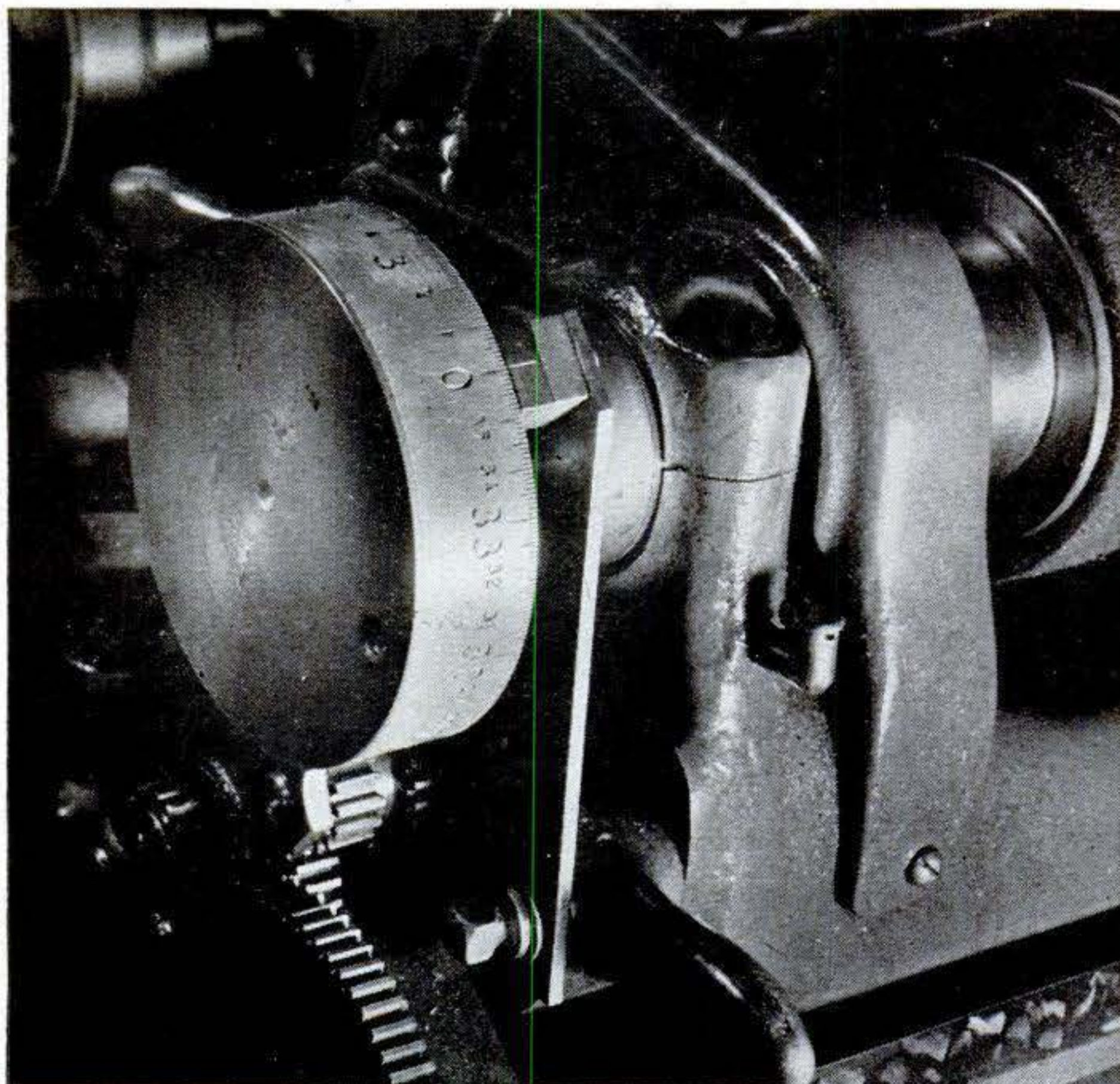

Dividing Head. Work chucked in a lathe can be divided accurately into 360° with this dividing head, made from a graduated ring commonly found in surplus stores. Turn a scrap-iron disk or an oversize pulley to fit tightly in the ring and bore the center for a stub shaft to fit in the headstock spindle. For a firm fit, turn the stub shaft to a tight fit in the spindle bore, then hacksaw two slots along part of its length to give it spring. Rivet a small steel block to a length of strap iron and mount the strap on the reverse-lever lock nut. A wisdom mark stamped in the steel block should line up precisely with the ring graduations.—Joseph Tracy, NYC.

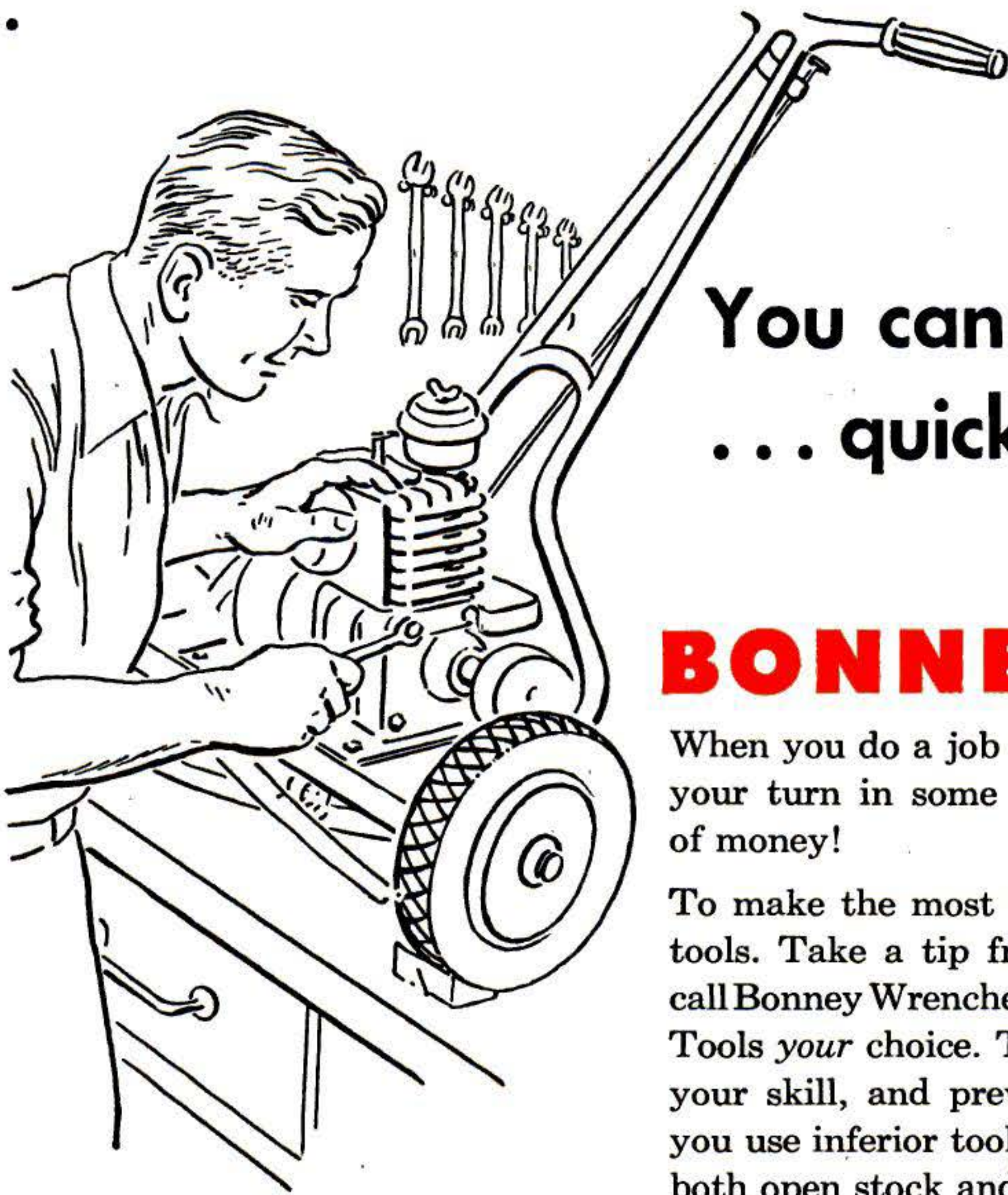

You can do it yourself
 ... quicker and better
 with

BONNEY TOOLS!

When you do a job yourself, you don't have to wait your turn in some busy shop; *and* you save a lot of money!

To make the most of these advantages, use *quality* tools. Take a tip from professional mechanics who call Bonney Wrenches America's finest—make Bonney Tools *your* choice. They help you make the most of your skill, and prevent injuries that happen when you use inferior tools. Bonney Tools are available in both open stock and complete sets. Ask your dealer, or write us direct.



Start your collection of FINE TOOLS with this BONNEY AA8 SOCKET SET!

Here's the most practical basic socket set for home and shop. Contains twelve of the most useful $\frac{1}{2}$ " square-drive double-hex sockets, together with a 15" hinge handle and an 8" cross handle. Helps you make quick work of repairs on lawnmowers and garden tractors, automobiles, washing machines, and other household appliances.

Note! The economy-minded home mechanic or hobbyist will find Bon-E-Con Tools especially suited to *his* requirements. They are tools any man would value at prices anyone can afford. Bon-E-Con Tools carry the same guarantee as Bonney.



BONNEY FORGE & TOOL WORKS, ALLENTOWN, PENNSYLVANIA



Hints FROM THE MODEL GARAGE

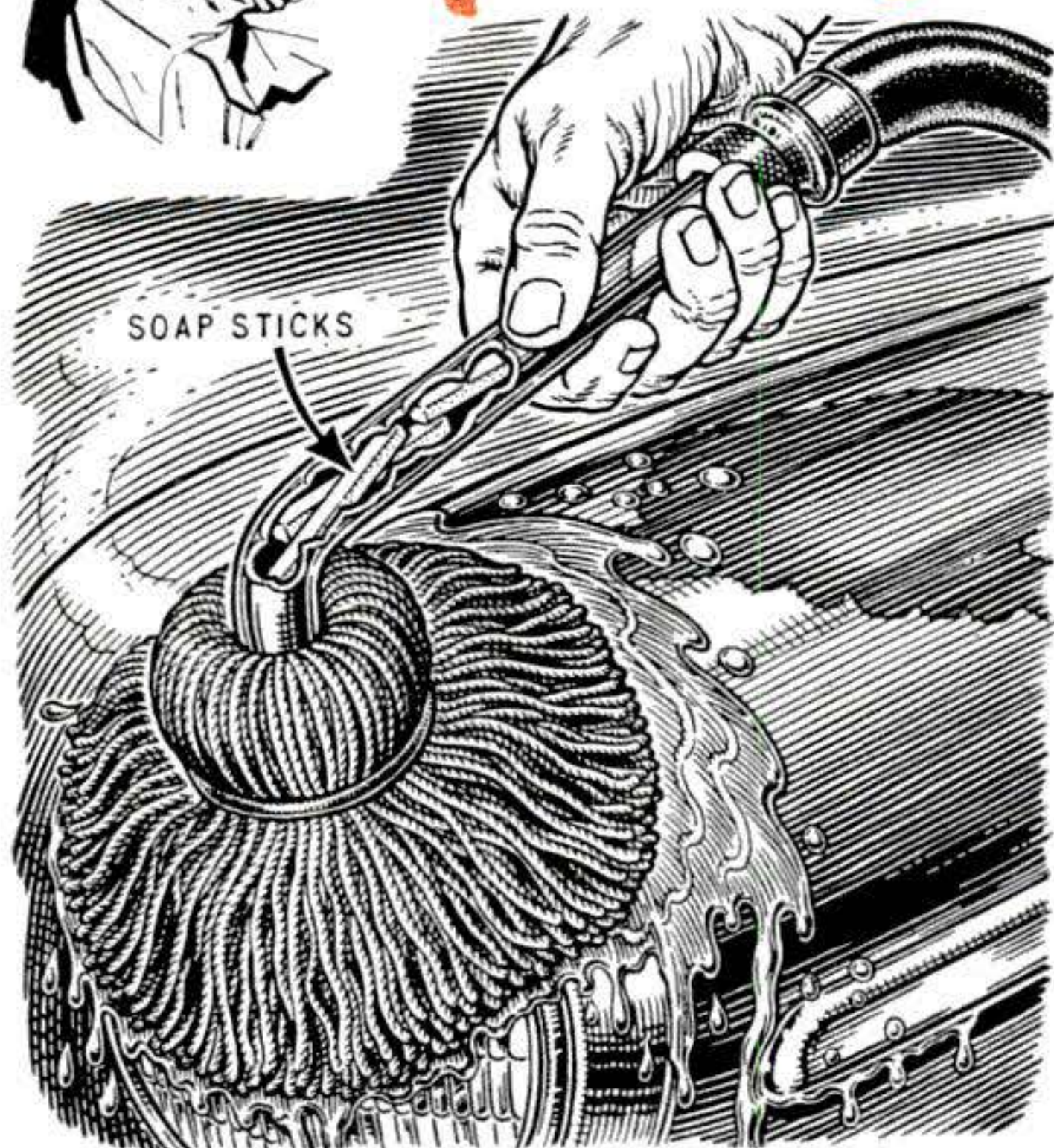

A car-washing mop that attaches to a garden hose can be made to dispense soapy water by filling the hollow handle with soap slivers shaved from a cake. When soap dissolves, clear water will follow for rinsing.

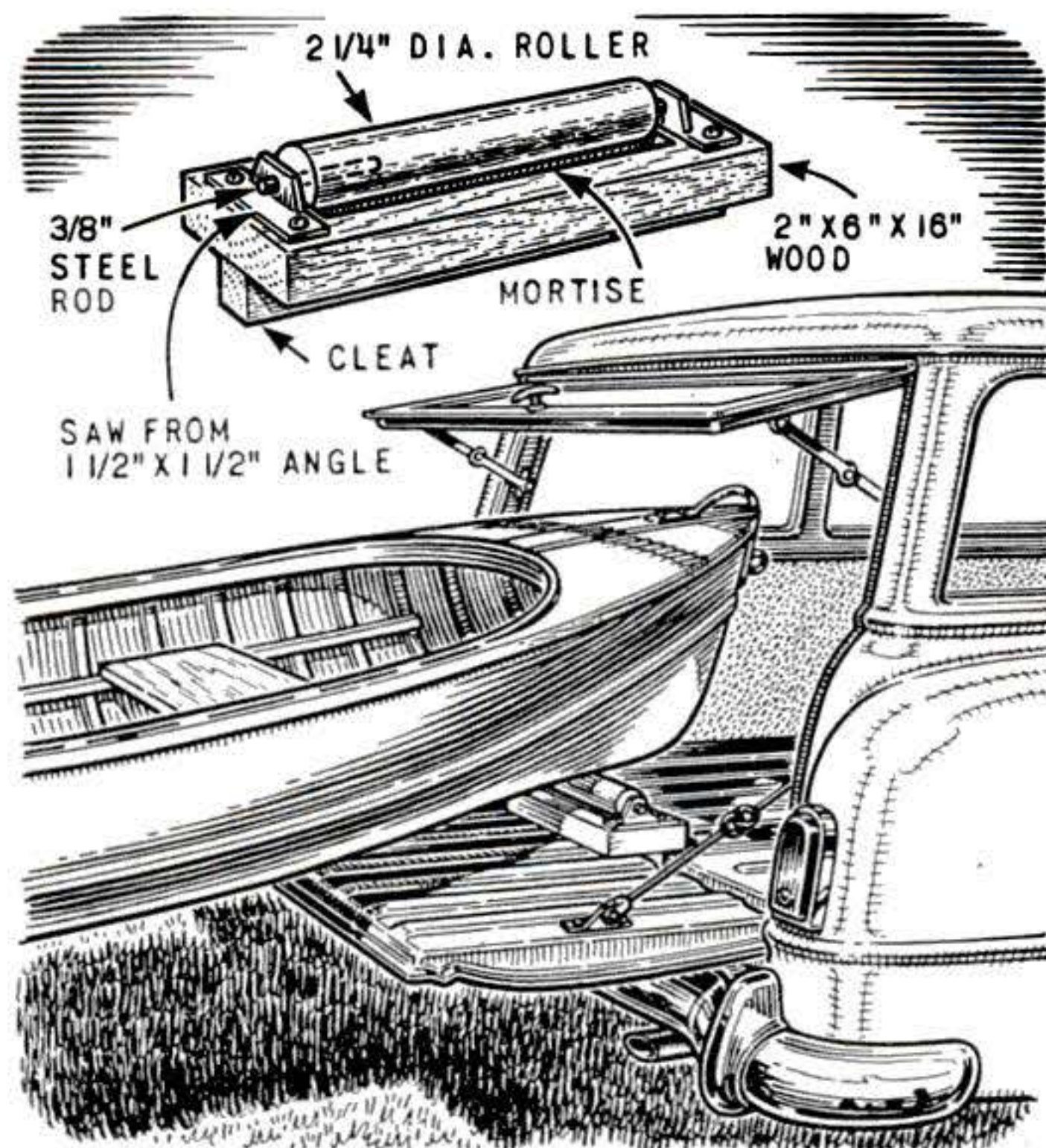

Loading a boat into a station wagon is an easy one-man job with this roller that slips quickly between tailgate and body. The roller can be from an old lawn mower or kitchen rolling pin, mounted as shown.

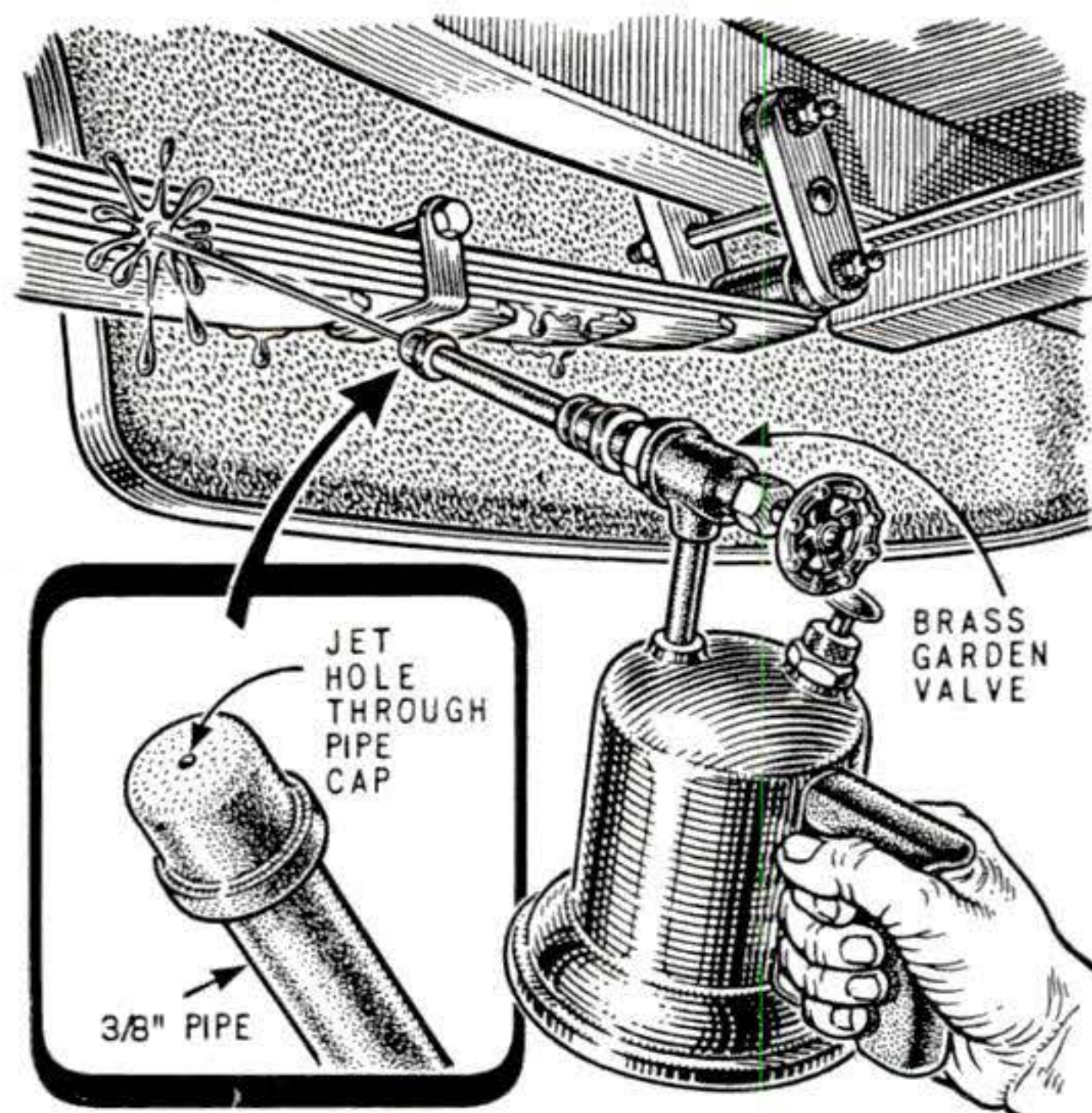

Oiling hard-to-reach spots is easy with this pressure lubricator made from an ordinary blowtorch. Unscrew the burner and screw in the nozzle made from a valve and two lengths of pipe as shown. Pumped up, the rig will squirt oil several feet.

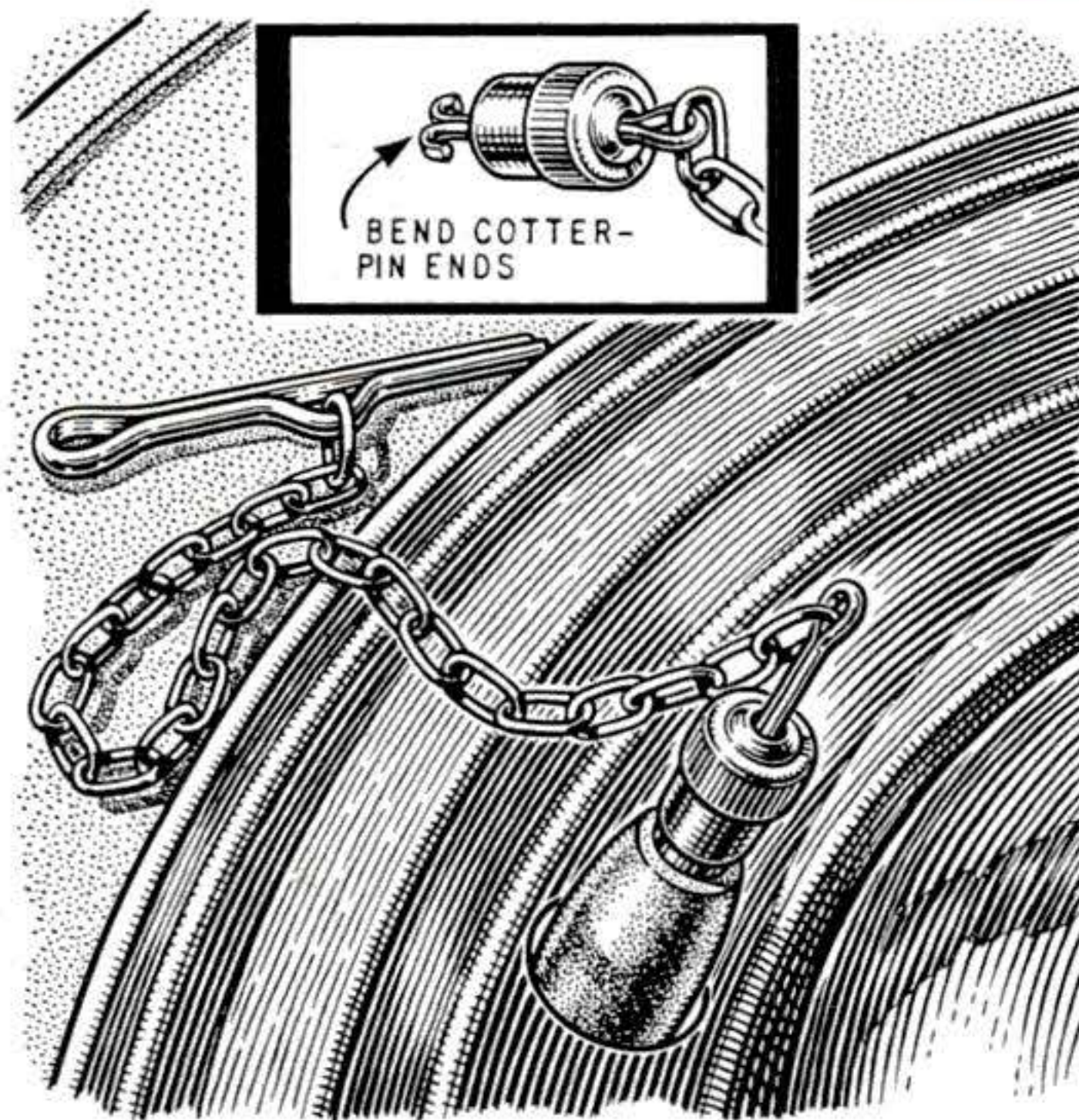

One way of holding a valve stem when mounting a tire is suggested here. Screw on the chained valve cap after inserting the stem through the rim hole. If the stem slips back, the cotter pin on the end of the furnace chain won't let it go too far.

FAMOUS "FIRSTS" in American FIRE PUMPS

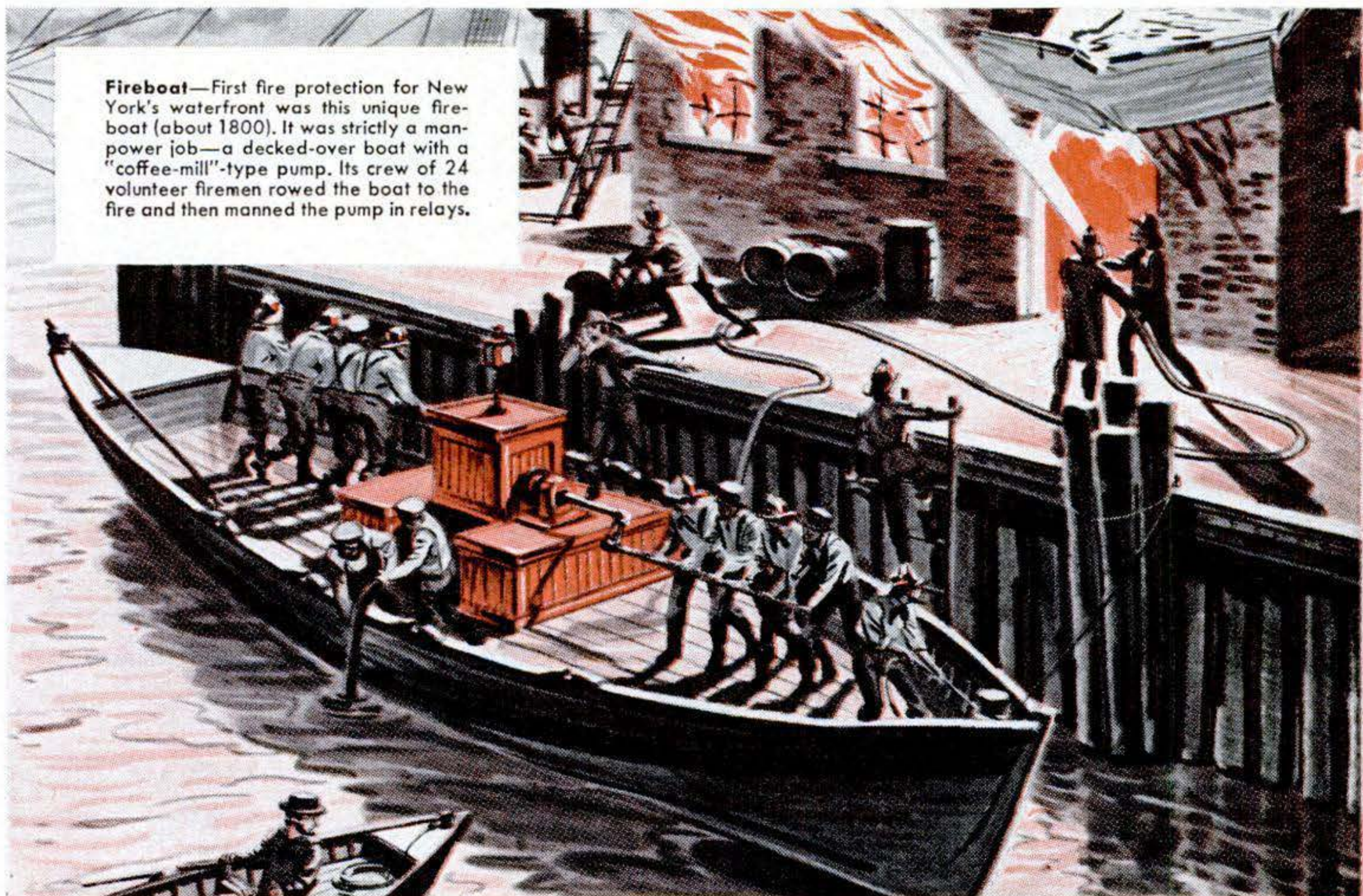

Fireboat—First fire protection for New York's waterfront was this unique fireboat (about 1800). It was strictly a man-power job—a decked-over boat with a "coffee-mill"-type pump. Its crew of 24 volunteer firemen rowed the boat to the fire and then manned the pump in relays.

America's First and Finest **FUEL PUMP**

New York's first fireboat was a major advancement in waterfront fire fighting—just as the AC Fuel Pump was a major advancement in providing automobiles with efficient fuel supply systems.

All the fuel you need—all the time—automatically—through an amazingly long life—that's what America's "first" and "finest" fuel pump has contributed to better motoring for 115 million owners.

Few items of equipment mean so *much* to car operation, yet receive so *little* attention. If your fuel pump is several years old, replace it with a new AC. Insure continued, carefree service.

AC

FUEL PUMPS



Equipment on
9 out of 10 cars
on the road



AC SPARK PLUG DIVISION

GENERAL MOTORS CORPORATION

MORE Hints from the Model Garage



A roll of reflective tape, carried in the glove compartment, will protect you against collision if you're caught with a dead headlight. Strips pasted across the lens will show other motorists which light is out so that they can pass at a safe distance.

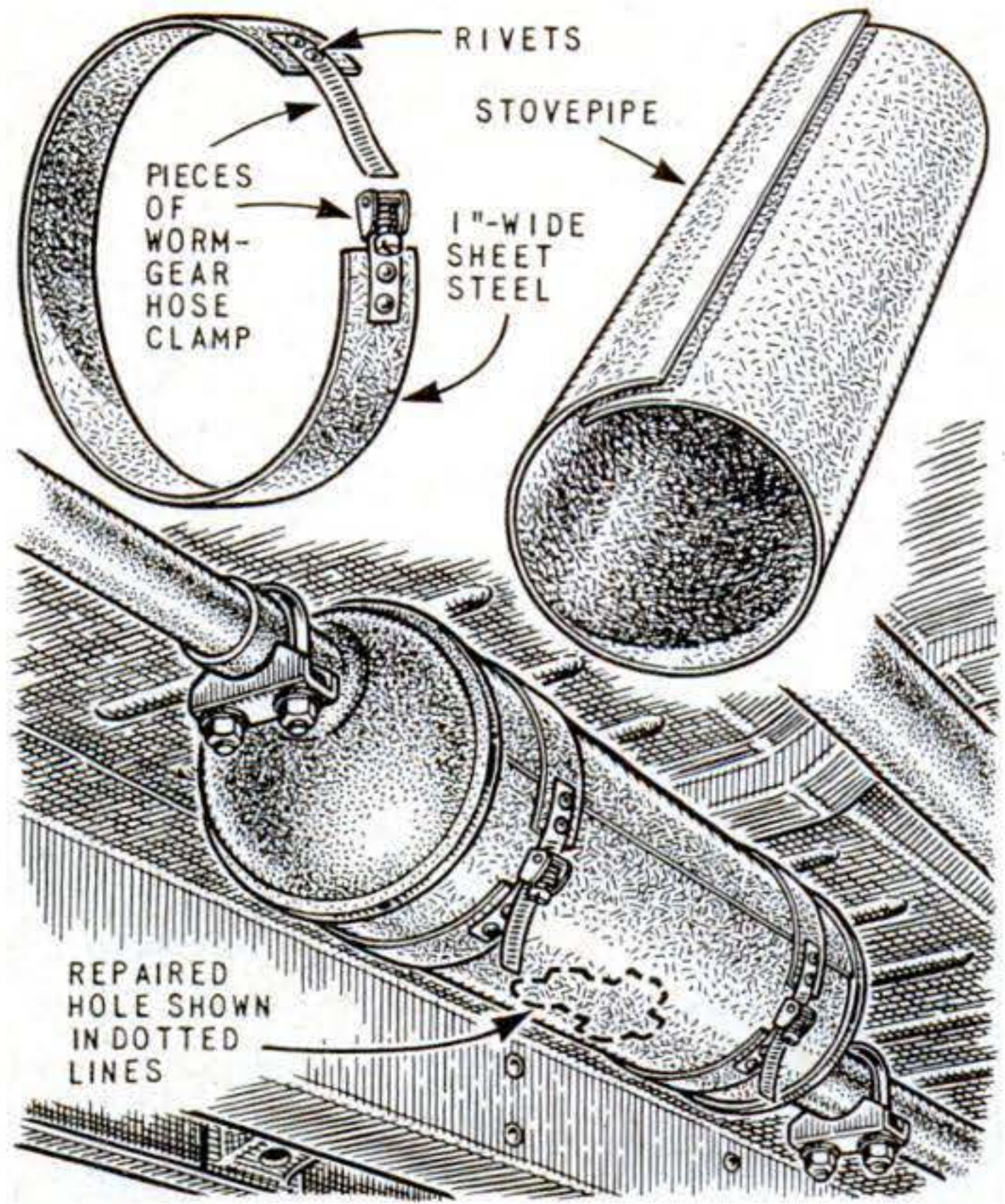

Patch a leaky muffler with a length of stovepipe clamped around it this way. Cut apart two aircraft-type hose clamps and rivet the pieces to two metal bands as shown. Slip the bands around the stovepipe and pull up tight with a screwdriver.

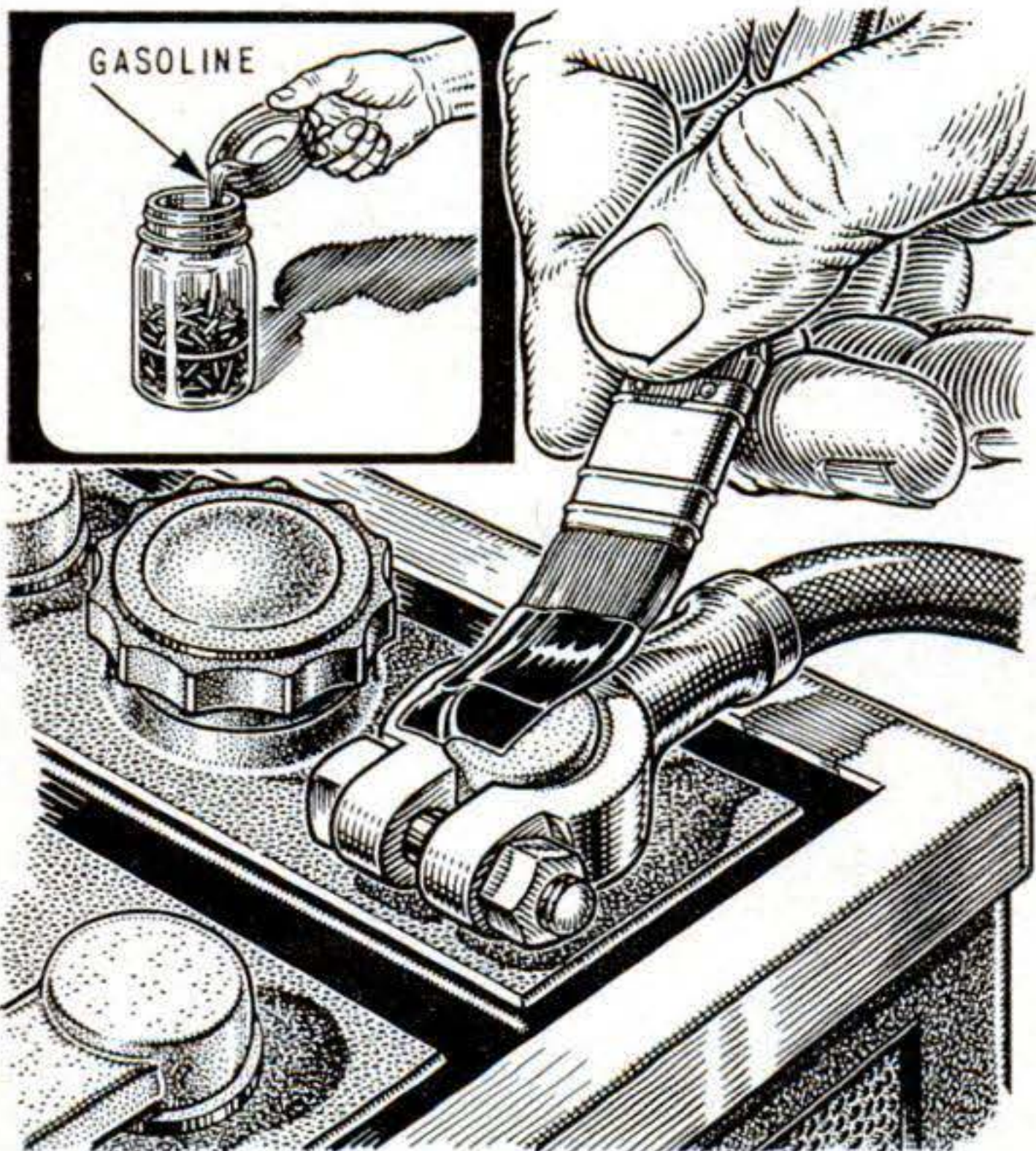

Stop battery corrosion around posts and terminals with a paint made from the pitch of old batteries dissolved in gasoline. The paint can be stored in a closed jar and brushed on whenever the cables have been removed or a new battery is installed.



Tools are kept clean and easy to get at if you store them in an old zipper-type travel case. Folded flat, the case will fit under the front seats of most cars, making the tools quickly accessible without having to unpack a trunk that may be loaded with baggage.



WINDOW VALANCE fashioned from Reynolds *Do-It-Yourself* Aluminum sheet and wood brings beauty to any window. Easi-Bild† Pattern #550, 35c with coupon.

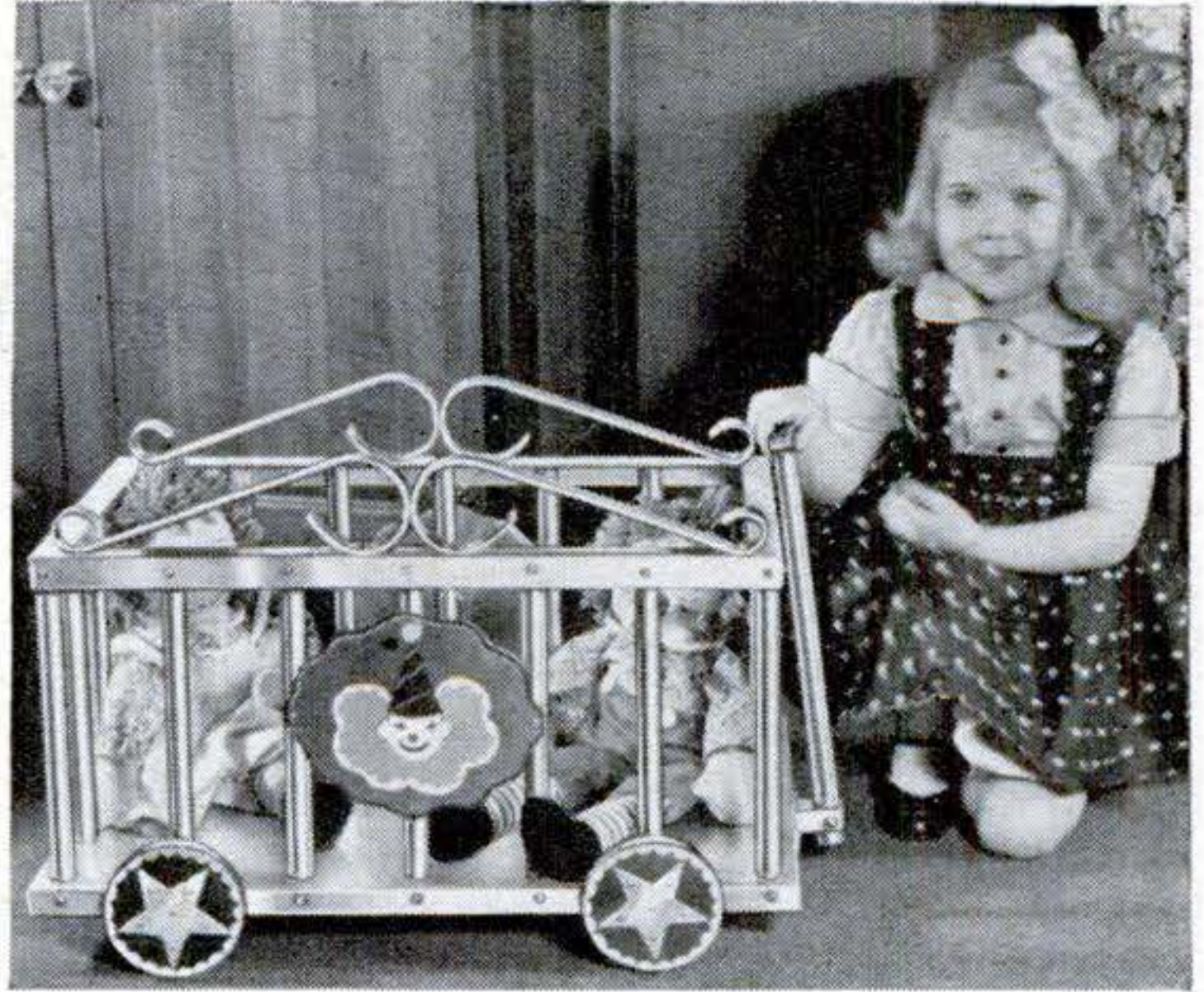

CIRCUS WAGON TOY HOPPER teaches tidiness to tots, is a real joy to Mother. Whip one out this weekend. Reynolds Plan #108, only 25c with coupon.

HOMEMADE MIRACLES IN METAL!

Make these and 101 other projects with amazing

REYNOLDS *DO-IT-YOURSELF** ALUMINUM

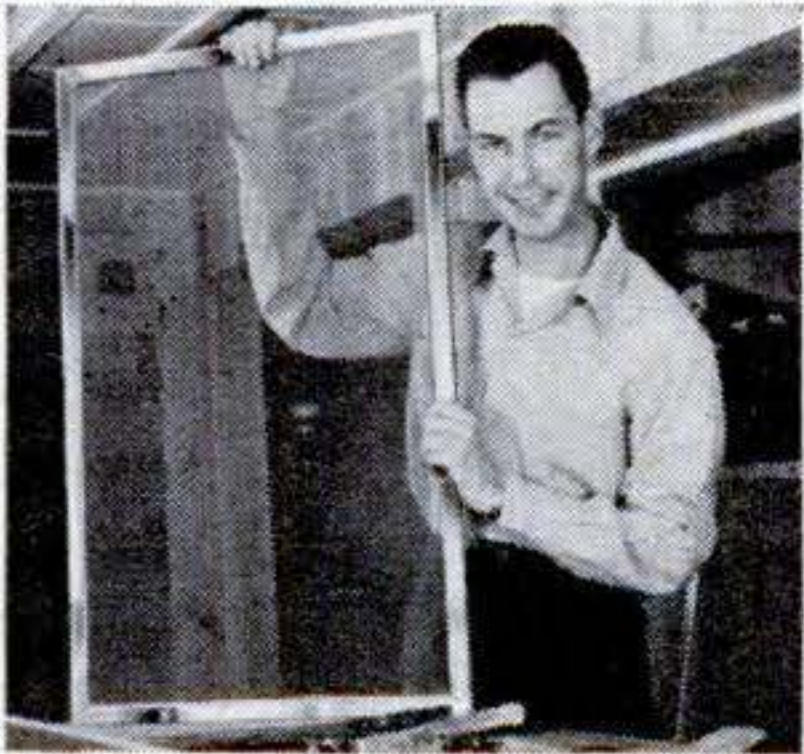

ALUMINUM SCREENS never rust or stain. Make them easily with Reynolds *Do-It-Yourself* Aluminum. Free Folder. See Coupon.

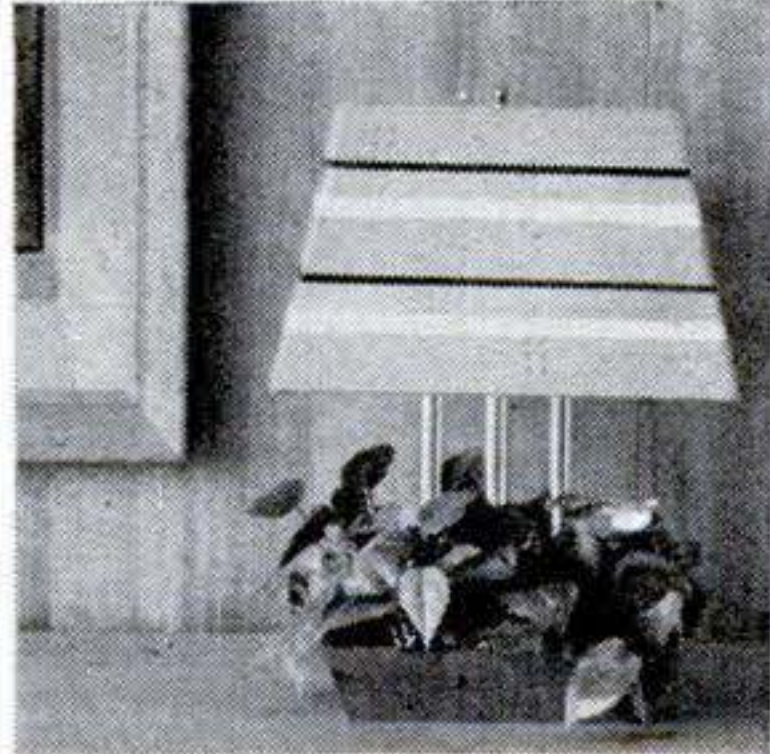

STUNNING PLANTER-LAMP is a simple, inexpensive project. Follow Easi-Bild Pattern #541, 50c with coupon.

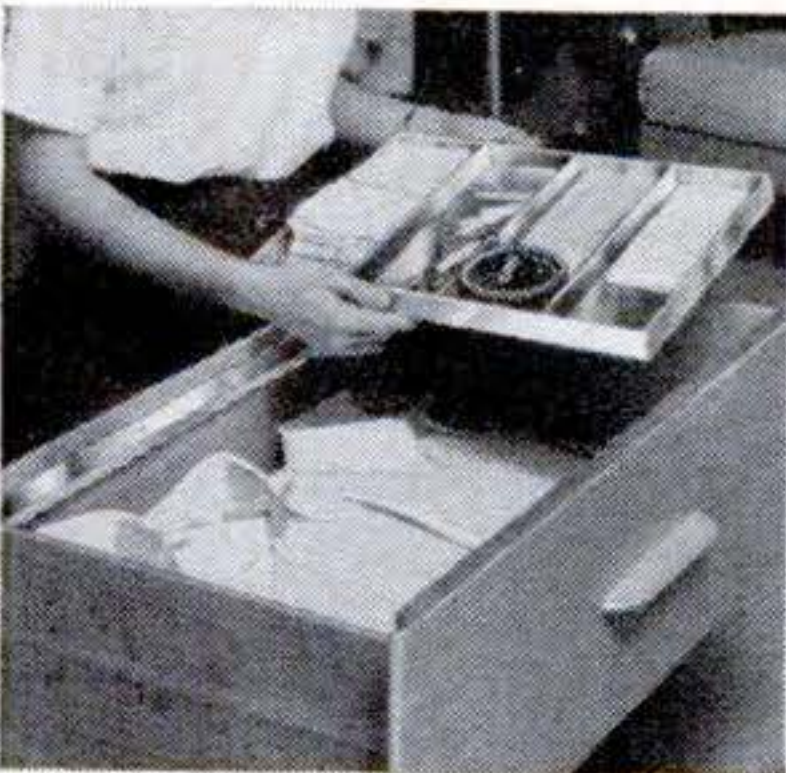

DRAWER-IN-A-DRAWER Handy, sliding "Tray" Drawer. One of ten plans in Reynolds Plan #102, 25c with coupon.



LOOK FOR THIS RACK at your Hardware or Department Store, or Building Supply Dealer.

No special equipment needed . . . use standard hand or power tools

Who says the Age of Miracles is passed? Right in your own home you can now perform *miracles in metal* that will simply amaze you. The secret is Reynolds *Do-It-Yourself* Aluminum. You can saw it, drill it, plane it, joint it just like wood, yet it's far, far easier to use.

There's a form of Reynold's *Do-It-Yourself* Aluminum for almost every project. It comes in sheets, tubes, rods, bars, angles, storm sash and screen sections and handy fasteners. Use only Reynolds *Do-It-Yourself* Aluminum with the special Seal on every piece. Other types of aluminum may harm standard tools.

*T. M. Reynolds Metals Company
†T. M. Reg. Easi-Bild Pattern Company



REYNOLDS METALS COMPANY
2493 South Third Street, Louisville, Ky.

Please send me the following PLANS and free booklets (check as desired). I enclose \$..... in money order or coin (no stamps, please).

- Easi-Bild Pattern #550 for WINDOW VALANCE—35c
- Reynolds Plan #108 for TOY HOPPER—25c
- Reynolds Plan #102 for DRAWER-IN-A-DRAWER (includes plans for nine other projects)—25c
- Instruction Folder for SCREENS, STORM SASH—FREE
- How-To Booklet—FREE
- Easi-Bild Pattern #541 for PLANTER-LAMP—50c

Name.....

Address.....

City..... Zone..... State.....

Reynolds *Do-It-Yourself* Aluminum
is also available in Canada

Gus Clears a Traffic Jam

[Continued from page 160]

with that starter? There's nothing wrong with the starter, Gus. It turned the motor over, didn't it? Trouble's in the motor—I told Creel to—"

"We'll see," Gus said grimly.

Taking a rubber mat from the floor of the bus, he placed it on the road, squatted beside it. Rapidly he unscrewed the long studs that held the body of the starter together. He gripped the front plate and body of the starter so that these wouldn't come apart, and tapped with a light hammer on the rear casting that held the Bendix drive. This came free. He reversed the bell-shaped casting and fitted the end of the armature shaft into the bushing of the casting, feeling it. Then he laid the casting down, small end up, and with a sharp, narrow chisel and a few blows of the hammer neatly cut the bushing out. He came to his feet, seeing Stan Hicks working his way toward him.

"Good boy!" Gus exclaimed as he took a new bushing and small reamer from his hands. "Better get back to the shop, Stan."

A Quick, Simple Job

Swiftly Gus drove the new rear bushing into the casting with a hammer and piece of bronze, ran the reamer through to remove rough edges, and reassembled the starter. Soon it was in place again.

"Try her now, Harry," Gus called.

Creel stepped on the starter. The motor whirled, took hold evenly.

"Back her into the yard until this traffic clears," Gus told Creel. "Then you're on your way."

Sid Price stepped forward to raise a protesting hand. Then he halted uncertainly, looking at Gus.

"Come on into the office," he said. "A cup of hot coffee won't do us any harm about now."

Seated in the office, Gus looked at Price over his steaming cup. Thinking about Creel being fired, and that baby on the way, brought a look of concern to Gus's weathered features.

"The way I get it," he said slowly, "is that you have your major work done here-and there. You hire Creel to drive, grease, wash and do a bit of tuning. The kid never claimed to be a top mechanic, did he?"

"What of it?" Sid Price demanded.

"Takes a good mechanic," Gus said, "with a lot of experience, to know when it's a back bushing of a starter, letting the armature rub the field coils to rob the ignition of juice, that prevents cold starting—and not a weak battery or motor tune."

"I don't know what you're talking about, Gus," Price said wearily, "but maybe I was a bit hasty in firing Creel."

"Maybe you were," Gus told him, and his eyes twinkled. "After all, the battery had been charged apparently, and I noticed the points were newly cleaned and set. Seems like Creel did just what you told him to do. Well, I'll be shoving. Thanks for the coffee."

Gus was halfway across the yard when Price shoved his head out the office door and called to him.

"You got me curious," he said. "How did you know it was the worn starter bushing that was causing the trouble?"

"Easy," Gus told him, smiling. "You had a spark as blue and strong as a pretty girl's eyes when I snapped the points with my thumb. When the starter turned the motor it was yellow, and too weak to jump over the back of a narrow flea. It could have been some other load drag in the starter system, I admit. Let's say I just made a good guess, Sid."

Gus Has Some Afterthoughts

Walking toward the road, where traffic was now moving freely, Gus decided that maybe it hadn't been too much of a guess, at that. Not after he'd fitted the bushing of that rear casting on the end of the armature shaft and felt its wear.

I'll bet, Gus told himself, that the starter armature was scraping the field coils when under cold load, with every turn . . . I wish I'd had time to look. **END**

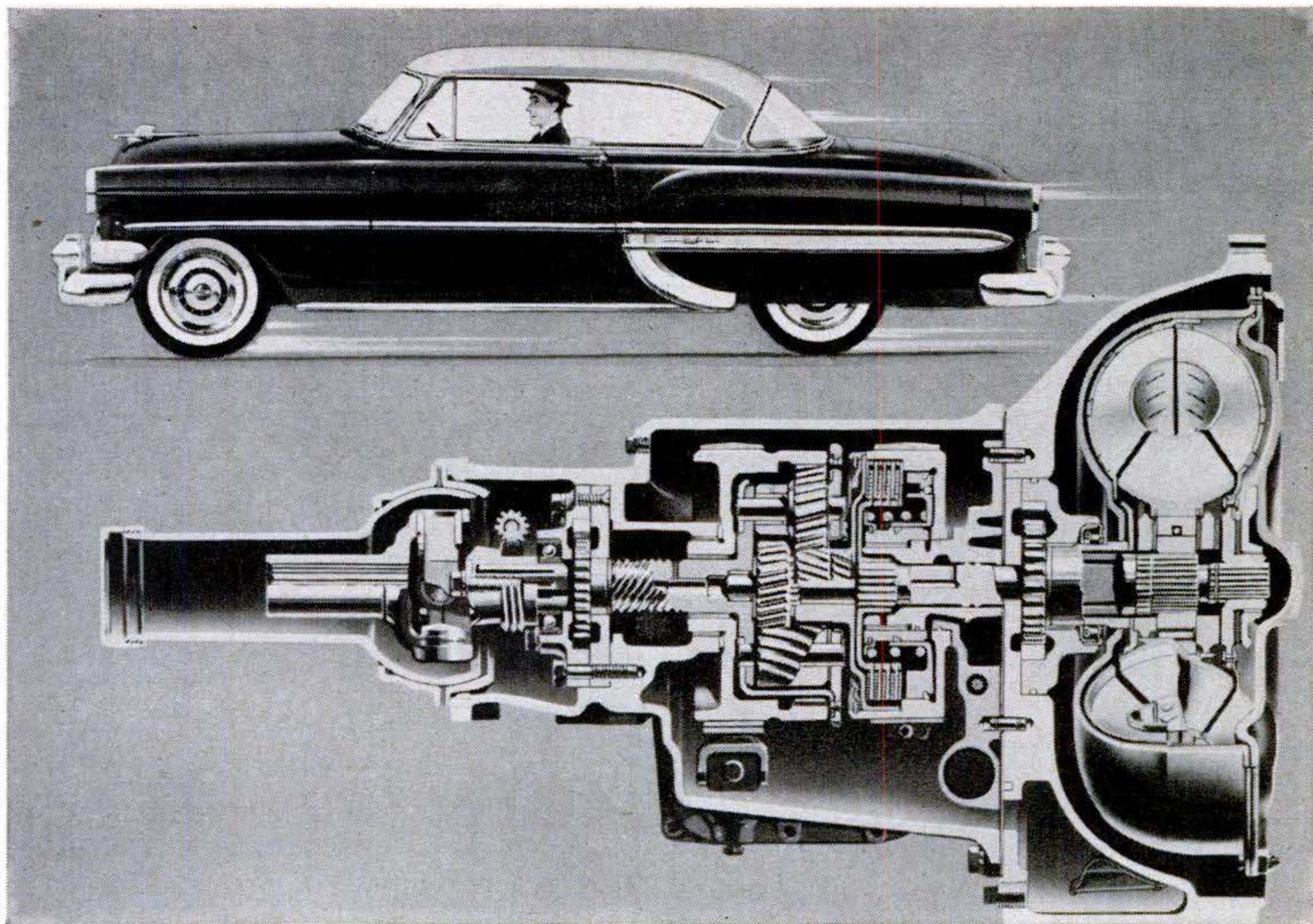

Advanced Chevrolet Engineering brings
LIVELIER, THRIFTIER PERFORMANCE
with a "stepped-up" Automatic Power Team

Thrilling new performance is yours, when you command Chevrolet's stepped-up Automatic Power Team. There has never been a Chevrolet that responded so eagerly to your touch on the accelerator. At the green of "go," its automatic getaway moves you ahead smoothly and positively. The automatic passing range gives you new safety in city traffic. You ease up hills almost as if they weren't there. Yet you obtain this spirited performance with money-saving gas mileage. In one extra-cost option, "Blue-Flame 125" valve-in-head engine, Powerglide automatic transmission and Econ-o-Miser rear axle are teamed to provide the finest, most responsive no-shift driving you have ever experienced in a car of such low cost.

The deep breathing valve-in-head engine—the most powerful Chevrolet passenger car engine ever built—develops 125 horsepower. And its 7.5 to 1 compression ratio, the highest in any leading low-price car, squeezes more work out of gasoline. In the transmission, the highly efficient, three-element hydraulic torque converter makes torque multiplication and cruising oil-smooth. Automatic Low provides swifter, safer getaway and pickup at a touch. Shifts to Low and Reverse are made through planetary gears. The Automatic Power Team is available in every Chevrolet model. See your Chevrolet dealer and try it. Discover how lively yet thrifty a car can be. . . . Chevrolet Division of General Motors, Detroit 2, Michigan.

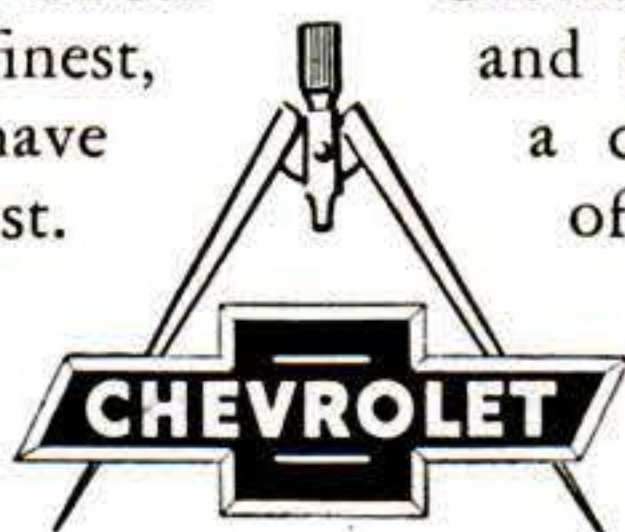

EVER FINER ENGINEERING

EVER FINER CHEVROLETS

Care and Feeding of Engines

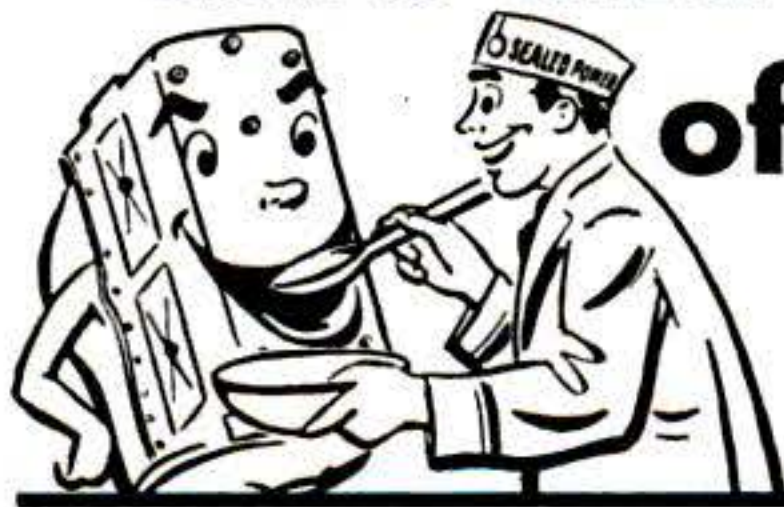

BY
S. P. CORP

ENGINE TUNE-UP

A thorough engine tune-up, to bring all working parts up to standard performance, should follow this order:

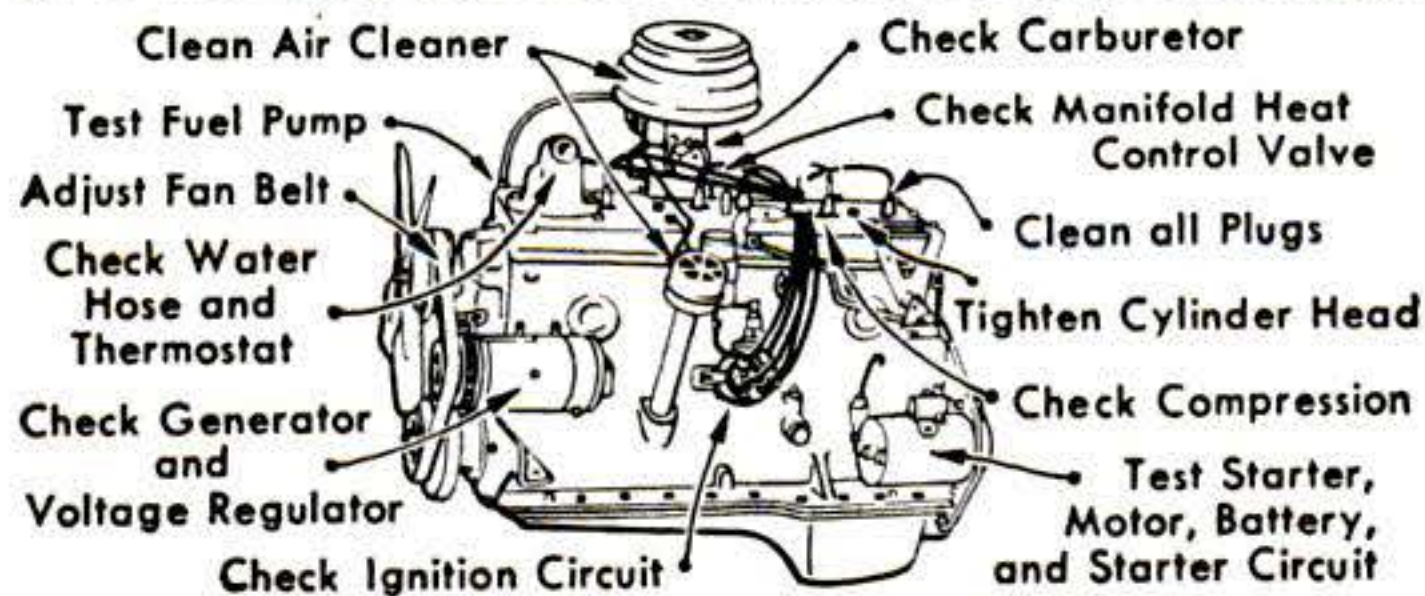

Tighten cylinder head bolts to engine specifications.

Remove spark plugs and test cylinder compression. Reading on first stroke should be 75% of total reading. If not, poor valve operation is indicated. Compression should be equal on each cylinder.

Clean, inspect, adjust spark plugs. Replace any burned or corroded. Check battery cables. Clean, fill, and test battery. Test starting motor circuit for speed of engine turnover and correct current draw.

If **battery** won't stay charged or drinks too much, check charging circuit, adjust fan belt, check generator output and calibrate voltage regulator.

Check ignition system for high resistance through poor connections or burned contacts. Test coil and condenser to see if they are up to specifications.

Test fuel pump. It should deliver 5 to 6 ounces in 15 strokes, or 1 pint in 45 seconds at idle speed.

Clean gasoline filters. Free up and lubricate manifold heat control valve. Clean and refill air cleaner with engine oil.

Check carburetor with vacuum gauge, a tachometer for engine speed, and a combustion meter for correct fuel-and-air mixture. Adjust idle speed to specifications. *This is a must for cars with automatic transmissions.*

Inspect water hose connections and water pump. See that thermostat is assuring correct engine temperature.

Make final road test. Engine should operate smoothly from idle speed to top speed, and accelerate without hesitation, to assure your summer driving pleasure.

FREE MANUAL ON CAR CARE

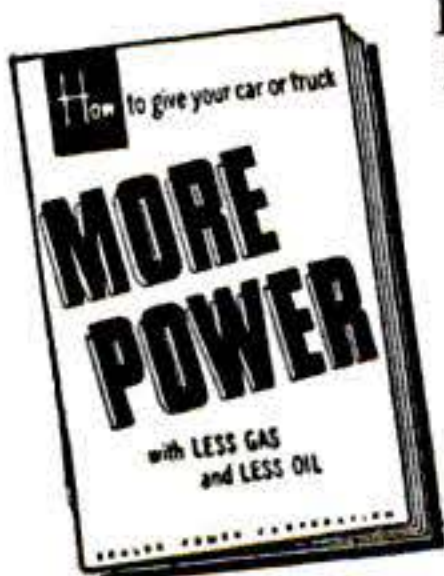

When you re-ring use Sealed Power KromeX Ring Sets, factory-seated for fast break-in and immediate oil control. Top compression ring and side rails of steel oil ring are chrome-faced to fight heat, friction, abrasion, and corrosion. Write for your copy of the illustrated manual, "MORE POWER, Less Gas, Less Oil." It contains many valuable hints on car care. Just address a card to Sealed Power, Dept. H-5, Muskegon, Mich.

Sealed Power

PISTON RINGS

How to Escape Car Troubles

[Continued from page 175]

mornings until he learned the trick of wiping off the spark-plug porcelains with a clean, dry rag before using the starter.

Before starting a trip west we rotated our tires as advised in the car manual; front to rear, left to right, spare to the right rear wheel. Nevertheless we had a flat, miles from a service station.

We hauled out the spare, removed the hub cap of the wheel with the flat and tried to loosen the wheel nuts before we jacked up the wheel. After a fruitless struggle we suddenly realized that while the wheel nuts on the right side had right-hand threads, those on the left side, like many other cars, had left-hand threads (turn counter-clockwise to tighten).

Scissors Snip Repairs Wipers

We hadn't figured on running into heavy rain in the California desert. But that's what happened and we were glad we had checked the windshield wipers before starting west. We were reminded of a friend who hadn't. He spent half a day of his vacation overhauling his wipers only to find, six naughty words later, that the rubber tubing was pinched shut where it was attached to the manifold. He repaired it easily by snipping off a short piece of this end and reattaching it.

Always suspect the obvious trouble. When the engine fails, look for an empty gasoline tank or a broken fuel line. Your overheating problem may be an empty radiator, bad hose connection or broken fan belt. When the electrical system fails, make sure that your battery isn't dead before you overhaul the wiring. Your loss of power might be due to a need of oil. Check at source the four essentials of car operation—gasoline, water, oil and electricity—before digging into the complicated units.

END

Prize Answer

Electrical Examiner: "What's an armature?"
Applicant: "A guy that boxes for nothing."
—Burns and Mixes.

30 YEARS' RESEARCH HAS PERFECTED...

New AMF De Walt "Power Shop" that makes everyone an expert!

Today, AMF De Walt® "Power Shop" is everywhere known and accepted as the *one* really safe, accurate, easy-to-use machine. It's so designed, that working with it, even the inexperienced can *expertly* do everything in home woodworking.

Whether you're modernizing, decorating or repairing your home, AMF De Walt is your best investment. See it demonstrated today. At your De Walt Dealer's or fine hardware and department stores.



\$229 delivered (saw blade and custom-built motor included). EASY TERMS.

Insist on these exclusive extra-value advantages!

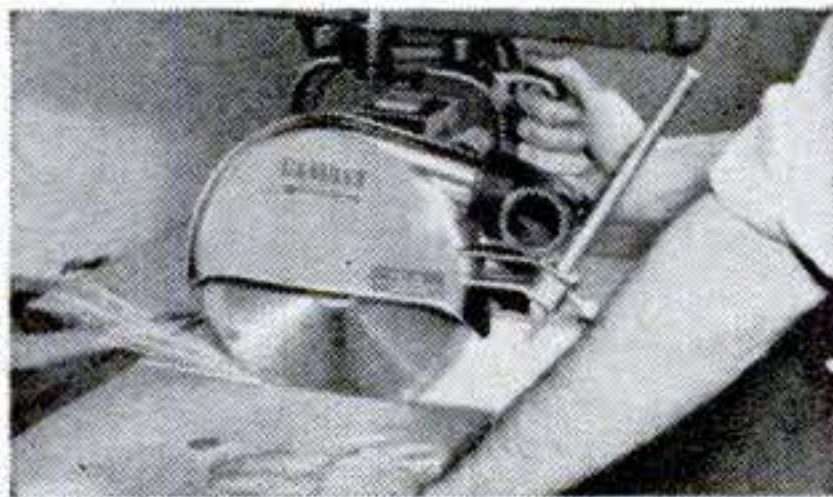

TOP-SIDE CUTTING! No guesswork—no mistakes. You always see the cut because layout marks are visible and easy to follow.



PROFESSIONAL ACCURACY! Calibrated scales for miter, bevel and rip are visible above table. Instantaneous settings!

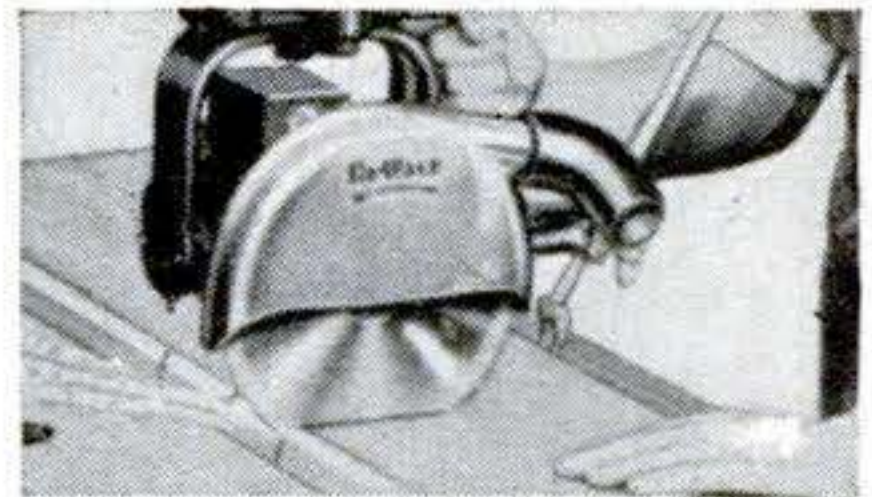

EASY TO USE! You control ball-bearing travel head in radial arm. Moves smoothly, precisely. All cuts perfect—no spoilage.

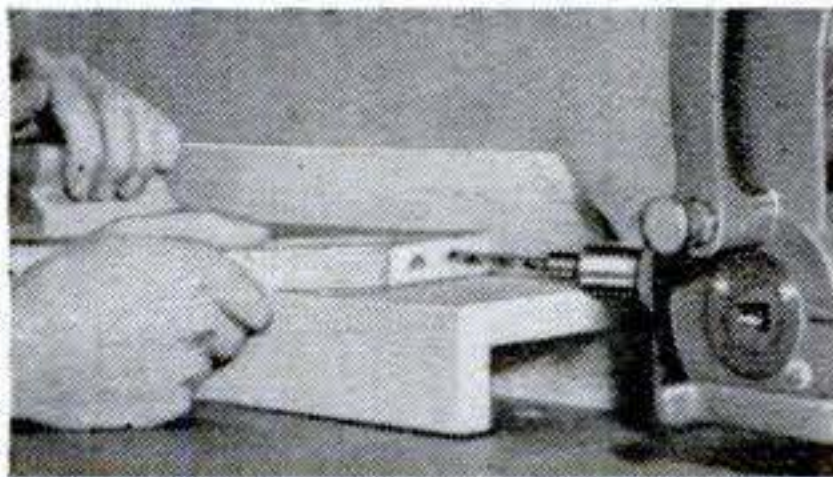

COMPLETE VERSATILITY! One powerful direct-drive motor accommodates 12 tools—gives full "3-D" 360° flexibility.

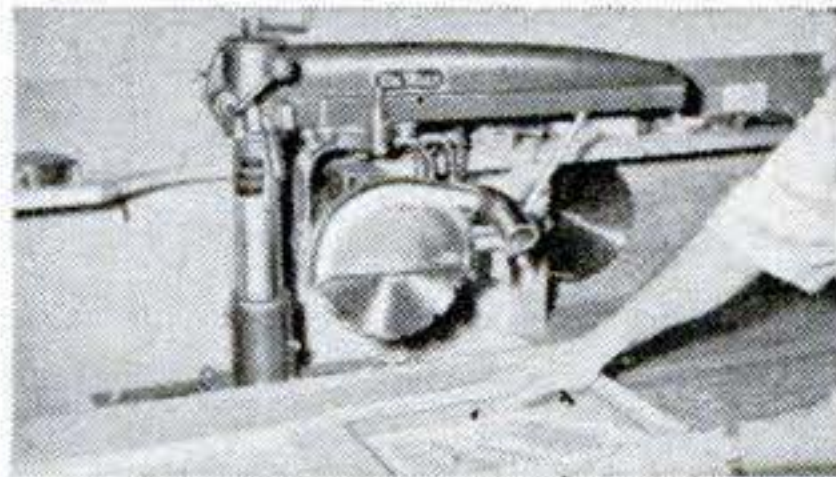

NO FLOOR SPACE NEEDED! Builds into your workbench! When not in use, radial arm swings conveniently out of way.

PLUS BIG CAPACITY and many more extra-value features—all explained in **FREE WOODWORKING BOOKLET**



De Walt Inc.  Lancaster, Pa.



POWER SAWS

IN CANADA:

De Walt Canada Ltd., Guelph, Ontario
Another product of AMF... better by design

Send this coupon today!

AMF De Walt, Dept. PS-54-5, Lancaster, Pa.

Please send me free illustrated booklet showing how your Power Shop makes me a woodworking expert, saves money in my home.

Please send me free blueprint "Building A Home Workbench."

Name _____

Address _____

City _____ Zone _____ State _____



Get Good Performance the way Big Fleets do . . .

DENVER CHICAGO TRUCKING USES FEDERAL-MOGUL ENGINE BEARINGS

As the nation's only common carrier with coast-to-coast authority, Denver Chicago Trucking Company meets every condition of road and weather. That calls for plenty of "muscle" in their truck engines.

Tip-top condition is maintained by a vigilant reconditioning schedule. Denver Chicago uses Federal-Mogul engine bearings for always-dependable heavy-duty service.

Federal-Mogul oil-control bearings have led in the replacement field for 30 years—because of *quality!* Get this quality, next time your car engine is overhauled. It costs no more to get the best—ask your mechanic! Federal-Mogul Service Division of Federal-Mogul Corporation, Detroit 13, Michigan.

for New Power . . .

FEDERAL-MOGUL Oil Control Bearings

BEARING
MANUFACTURERS
TO THE
AUTOMOTIVE
INDUSTRY
SINCE 1899



Making Wood Last Longer

[Continued from page 184]

en up by the wood with this method, for side penetration is only a few hundredths of an inch. Nevertheless, Douglas-fir plywood stakes dipped three minutes in pentachlorophenol lasted 3.3 years. Pine posts dipped in coal-tar creosote lasted 5.6 years against 3.1 for untreated posts. The process is best suited for millwork.

Double diffusion. This dual treatment puts two chemicals into the wood, where they combine to form a nonleaching preservative. The method requires green wood and so is suitable chiefly for posts, rustic fences and the like. Incomplete tests so far indicate it may be better than cold soaking.

Brush or spray. This is the least effective method. Preservative must be flooded on copiously, and at least two coats are recommended. This treatment should be used only for touching up areas newly exposed after other treatment, or where neither soaking nor dipping is practicable. Never mix paint with preservative; neither will do its job well. However, oil stain can be added to water-repellent pentachlorophenol for coloring the wood.

Care of treated wood. Pile freshly treated wood in stacks for drying, with thin separators between layers and adjacent boards in the layers an inch apart. Wood treated with water-borne preservatives must be left to season. If checks appear, douse them with preservative. Do not paint oil-treated wood until it is completely dry.

In handling, remember that only a thin shell of treated wood protects each piece. If you crush or break away that shell, untreated wood is exposed.

Play it safe. Preservatives may irritate the skin, eyes and lungs. Some persons are more sensitive than others, but there is no need to find out how you stand. Wear gloves and goggles, avoid breathing the vapors, and make sure ventilation is adequate. Remember that the solvents are inflammable, like those in paint.

Do not let solutions or freshly treated wood touch valuable plants or shrubs. Treated stakes are safe once they are thoroughly dry. When the job is done, dispose of surplus preservative in a hole in the ground so that children and pets can't get at it. Remember, it's poison! END

NEXT MONTH in Popular Science: How an Oregon professor builds modern furniture out of low-cost materials.



Your Rockwell-built DELTA 14" Drill Press cuts mortises (square holes) quickly and simply with inexpensive Mortising Attachment.

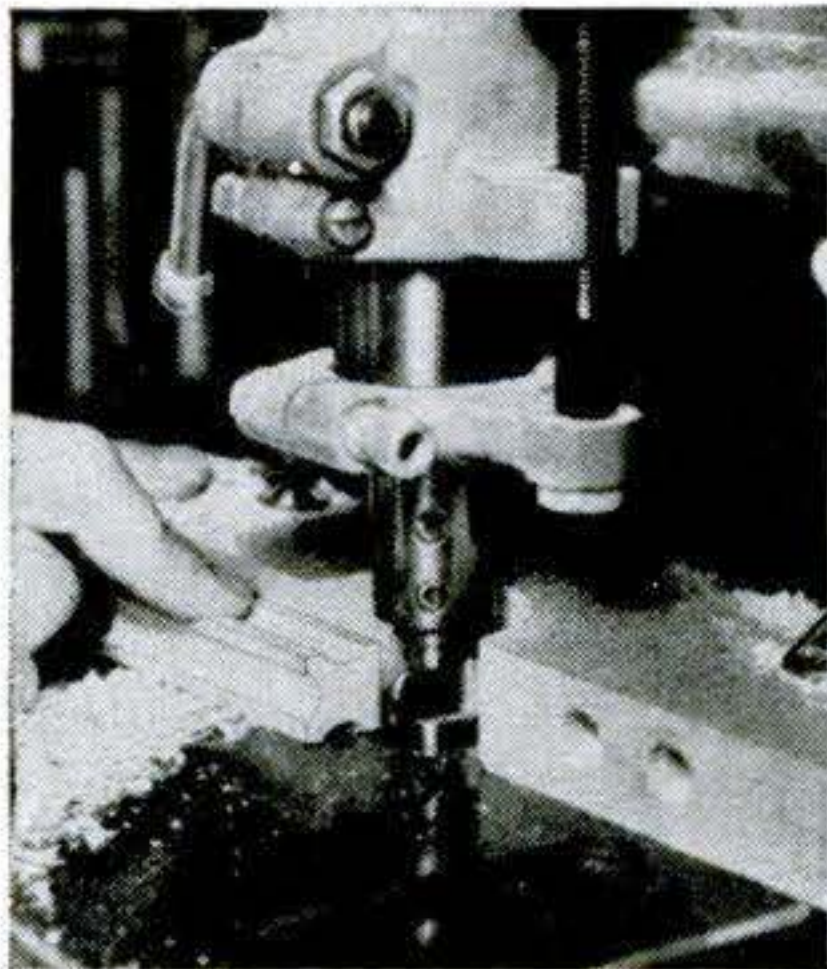

Mount a shaper fence and a shaper cutter bit to your DELTA Drill Press, and you're all set to quickly fashion beautiful mouldings.

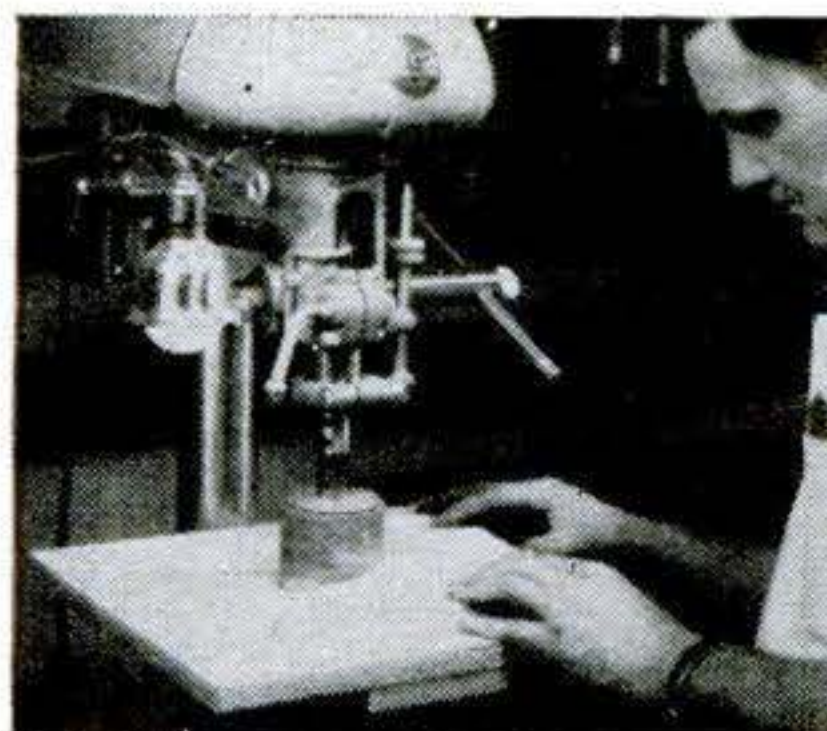

Sanding inside and outside surfaces—even tightest corners—is easy with sanding drums and sleeves. Router bits also available.

EVER COUNT ALL THE JOBS YOU CAN DO on a Rockwell-built DELTA Drill Press?

Fast, accurate drilling in wood and steel is only the beginning—there's almost no end to the jobs a Delta 14" Drill Press will handle in your shop!

For instance, you can cut perfect fitting plugs to make bolts and screws invisible. You can mortise square holes for tight, strong furniture joints. You can shape beautifully curved moulded edges. You can do large area routing or fine inlay work. In fact, the more you use a Delta 14" Drill Press, the more things you'll find you can do with it.

And the more you'll appreciate its full range of speeds, its easy operation, easy to get at controls, and its sensible safety devices.

This Delta 14" Drill Press is the same rugged, fine-quality tool you'll find speeding production and cutting costs in thousands of manufacturing plants—as well as in the finest home workshops. *There's nothing anywhere near its price to compare with it!* See it at your Delta Dealer's today; he's listed in your Classified phone book under "Tools" or "Machinery."

DELTA
MILWAUKEE
 QUALITY POWER TOOLS
 ANOTHER PRODUCT BY
Rockwell



Delta Power Tool Div., Rockwell Manufacturing Co.
 504E North Lexington Avenue, Pittsburgh 8, Pa.
 Please send B-53 Catalog, showing 14" Drill Press.
 Please send Homecraft Catalog.
 Please send 6 issues of Deltagram (mailed bi-monthly) \$1.00 enclosed.

Name _____

Address _____

City _____ Zone _____ State _____

*Even if you
lived in a
rain barrel...*



**Your LUMITE*
saran screening
couldn't stain
sidewalls...
rust or corrode**

Costs ONLY 12¢-13¢ per sq. ft.

(Slightly higher west of the Rockies)

*Registered Trade-mark



LUMITE*

SARAN SCREENING

**LUMITE
DIVISION**

Chicopee Mills, Inc., Dept. PS-41
47 Worth Street, N. Y. 13, N. Y.

Free College for Ship's Officers

[Continued from page 146]

are gratis. Beyond some \$150 to \$165 for incidental costs, the cadet's only expenses are personal ones. Moreover, during his year at sea he makes money; ship-owners pay him \$82.50 a month.

But Uncle Sugar isn't putting out all that largess without asking for something in return.

Candidates for Kings Point have to pass a stiff competitive examination. These exams are given once a year, usually in April, in principal cities throughout the country. Only about a tenth of those who apply make the grade. A rigid Navy physical is the next hurdle for those who do. And a strict state quota system also helps to make things tough. Nevertheless, a plebe class of about 300 finds its way in each year.

The "Happy Hour"—Grunt and Groan

The pace is tough. The boys get up at six o'clock in the morning and keep shuttling between classrooms, mess hall and barracks at a pace slightly under the speed of sound till taps finally stills their aching muscles at 10 o'clock that night. Most students have to put in 25 hours a week in the classrooms, laboratories and shops, but that is just the beginning.

Unless the cadet is out for varsity, he must go in for intramural sports. And then there's the "Happy Hour," a period of enforced calisthenics. He's also expected to get into activities, too—*Polaris*, the academy magazine; *Midships*, the yearbook; *Hear This*, the newspaper; the sailing team, camera club, debating society and what not.

On top of all this, the plebe must contend with all the diabolical disciplines imposed by upperclassmen to purify his soul: dancing attendance on his superiors; waiting on table at mess; keeping his person immaculate and making sure his quarters are policed.

Plebes live for the year at sea. They put up with the pick-and-shovel details, the gibes of upperclassmen and the

[Continued on page 258]

From attic storeroom to cheerful bedroom in just a few days

It's easy to add an extra room in your attic when you finish the walls and ceiling with Armstrong's Temlok® Tile and Plank. Temlok is an attractive fiberboard material that builds, decorates, and insulates in one quick installation.

A special Lok-Bevel joint makes nailing or stapling surprisingly easy. The joint also helps produce a fine finished appearance by hiding nailheads or staples. Both tile and plank are handsomely prefinished.

Remember Temlok can help you turn wasted space into extra living space at remarkably low cost. For full information on Temlok interior finish materials, see your Armstrong lumber dealer.

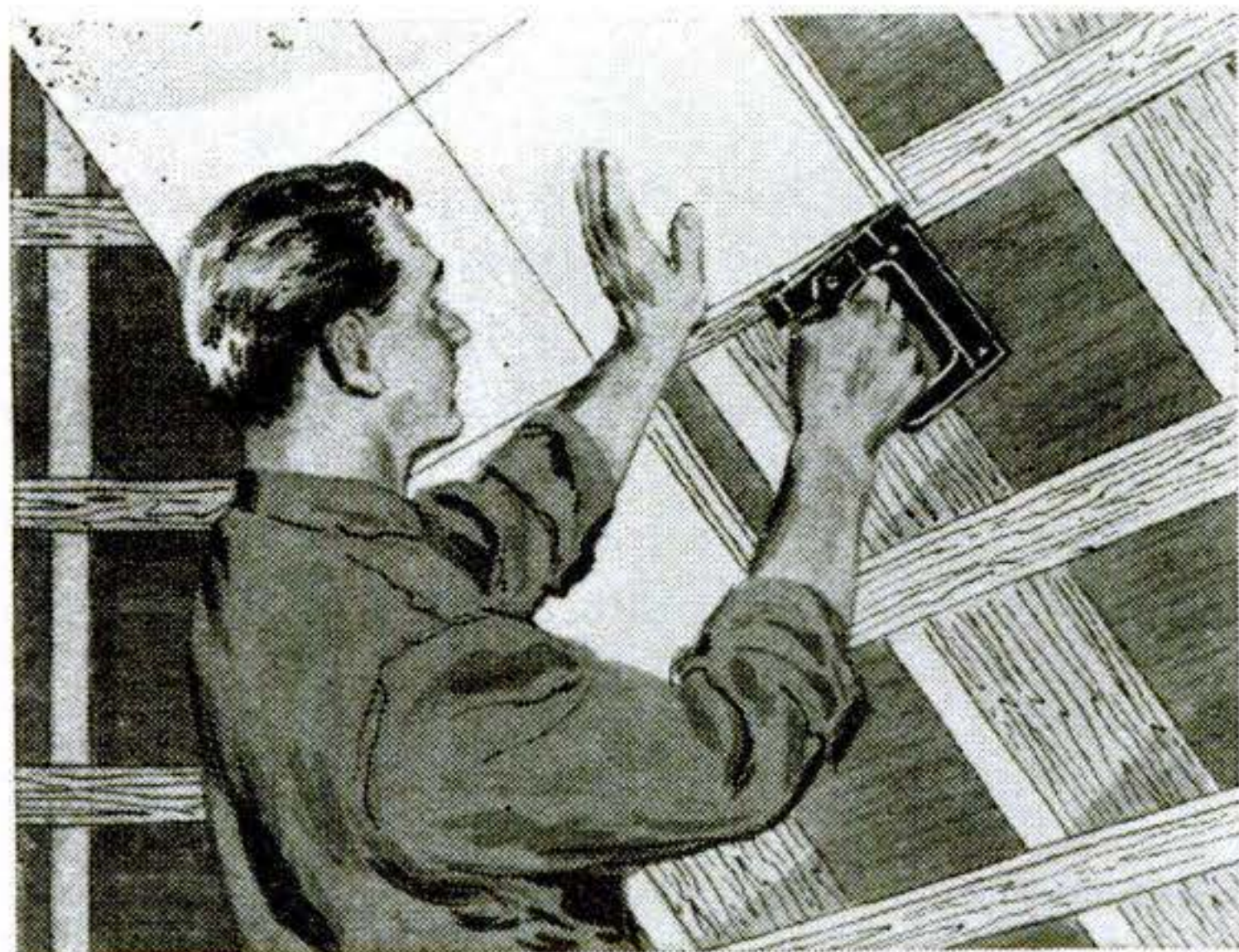

Nail 1" x 3" furring strips on 12" centers to all framing members as a nailing base for Temlok Tile and Plank. Both tile and plank can be nailed or stapled into place easily and quickly.

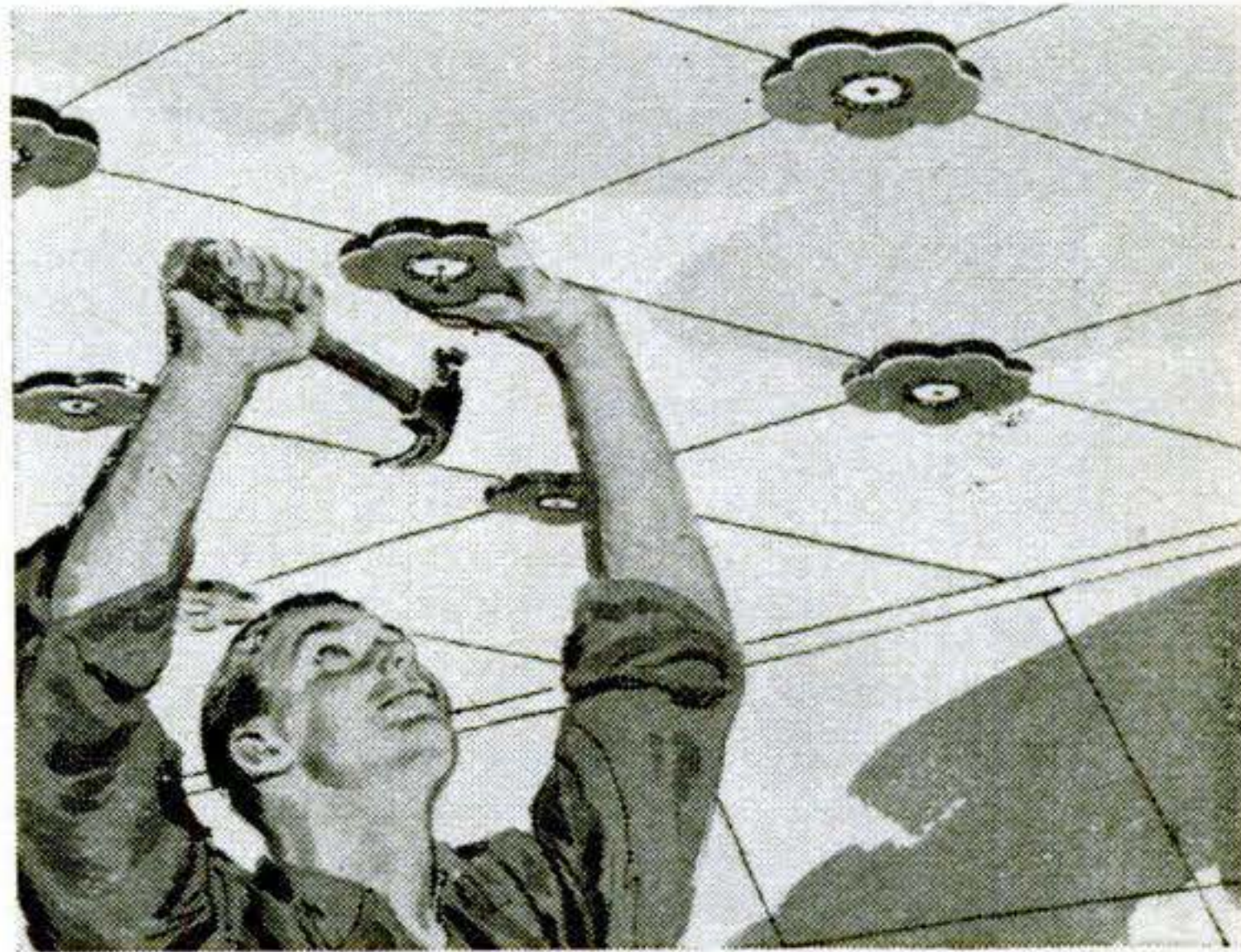

As a decorative touch, rosettes were cut out of wood, painted to match the colorful fabric design, and nailed to the ceiling. Temlok's Lok-Bevel Joint assures you a neat, professional-looking job.

FOR FREE BOOKLET, "New Ways to Remodel Your Home," write Armstrong Cork Company, 3705 Washington Avenue, Lancaster, Penna.

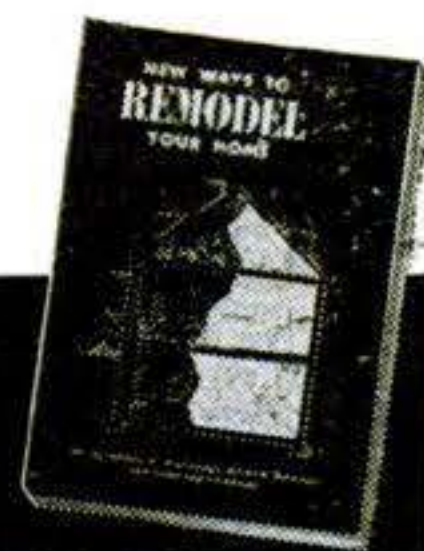

ARMSTRONG'S TEMLOK®

Monowall®

Cushiontone®

Insulating Wool

Hardboards

Counter-top Cement

MAY 1954 257

NOW! Get a Complete Black & Decker Portable Power Shop for only \$49⁹⁵



Complete with B&D Utility 1/4-inch Drill, Tool Board and all these

Accessories: 7 Twist Drills • 3 Auger Bits • Countersink • 1/4-inch Masonry Bit • Paint Mixer • Wire Wheel Brush • Wheel Arbor • Wire Cup Brush • 3-inch Grinding Wheel • Molded Rubber Pad • 3 Sanding Discs • Polishing Bonnet • Can of Electric Wax.



NEW! B&D Screw Driving Attachment

Now you can drive #5 to #9 slotted and Phillips Head wood screws with any 1/4-inch electric drill. Complete attachment, only \$9.95.



NEW! B&D Hole Saws

Cut holes up to 1 1/8-inch diam. with your 1/4" drill, 2 1/2-inch diam. with 1/2" drill, in any material a hacksaw will cut. Hole Saws start at 75c plus mandrel.

NOW you can get the famous Black & Decker Utility 1/4-inch Drill and 23 of the most popular, most useful accessories, all on a handy tool board that you can hang on your basement or workshop wall!

These accessories, hand-picked from Black & Decker's complete line, include just the ones homeowners and hobbyists use most. Each accessory has its own place on the board, so you can select and return them quickly. See and try this new kit at your nearby B&D Utility Dealer. He's listed in phone book Yellow Pages under "Tools-Electric." THE BLACK & DECKER MFG. Co., Dept. H5S, Towson 4, Md.

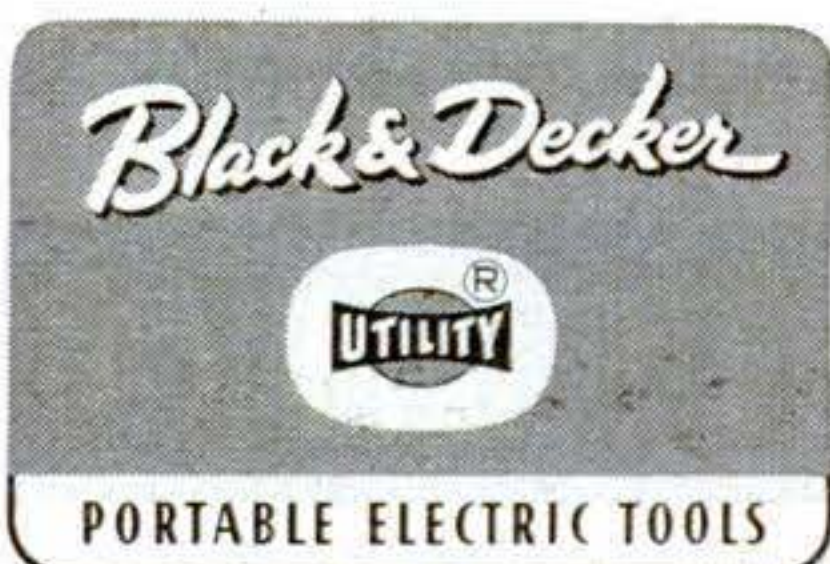

Free College for Ship's Officers

[Continued from page 256]

brain-cracking study schedule in rosy anticipation of that year on the briny deep. But even there they can't escape the long arm of the schoolmaster. There's a correspondence course in navigation, communications, engineering and all the rest of the school's major subjects, with practical applications every day on the bridge or down in engine rooms, plus a 5,000-word thesis at the end.

"Mr. Gadget" Proves His Mettle

Though they're usually dubbed "Mr. Gadget"—a play on the word cadet—and subjected to a good deal of ribbing, many of the cruise kids have proved their mettle in deeds that went into the records.

When some of the new gyro equipment conked out on the shakedown cruise of the USNS *Barrett*, the "Mr. Gadget" of that cruise, Bob Stierton, respectfully asked to have a try. Before long, the reluctant gyro was back in apple-pie order and Bob had a Navy commendation.

The course of study at the academy is divided between deck and engineering departments. In either one of these, the laboratories and shops boast enough gadgets to give a student the impression that he's already out at sea—full-scale boiler rooms, diesel engines, radar sets and even, in the planetarium, a sky.

Cadet's Study Electronic Navigation

The electronics lab boasts gadgets valued at something like a half-million dollars—mostly gifts from the manufacturers. The most impressive of these are huge metal cabinets containing the latest in navigational radar, but the place also abounds in echo-sounding equipment, gyrocompasses and automatic steering devices, as well as complete ship's gear set up to teach students the use of loran, radio direction-finding and other modern navigational techniques.

In the engineering department, the boiler room is an exact duplicate of a

[Continued on page 260]

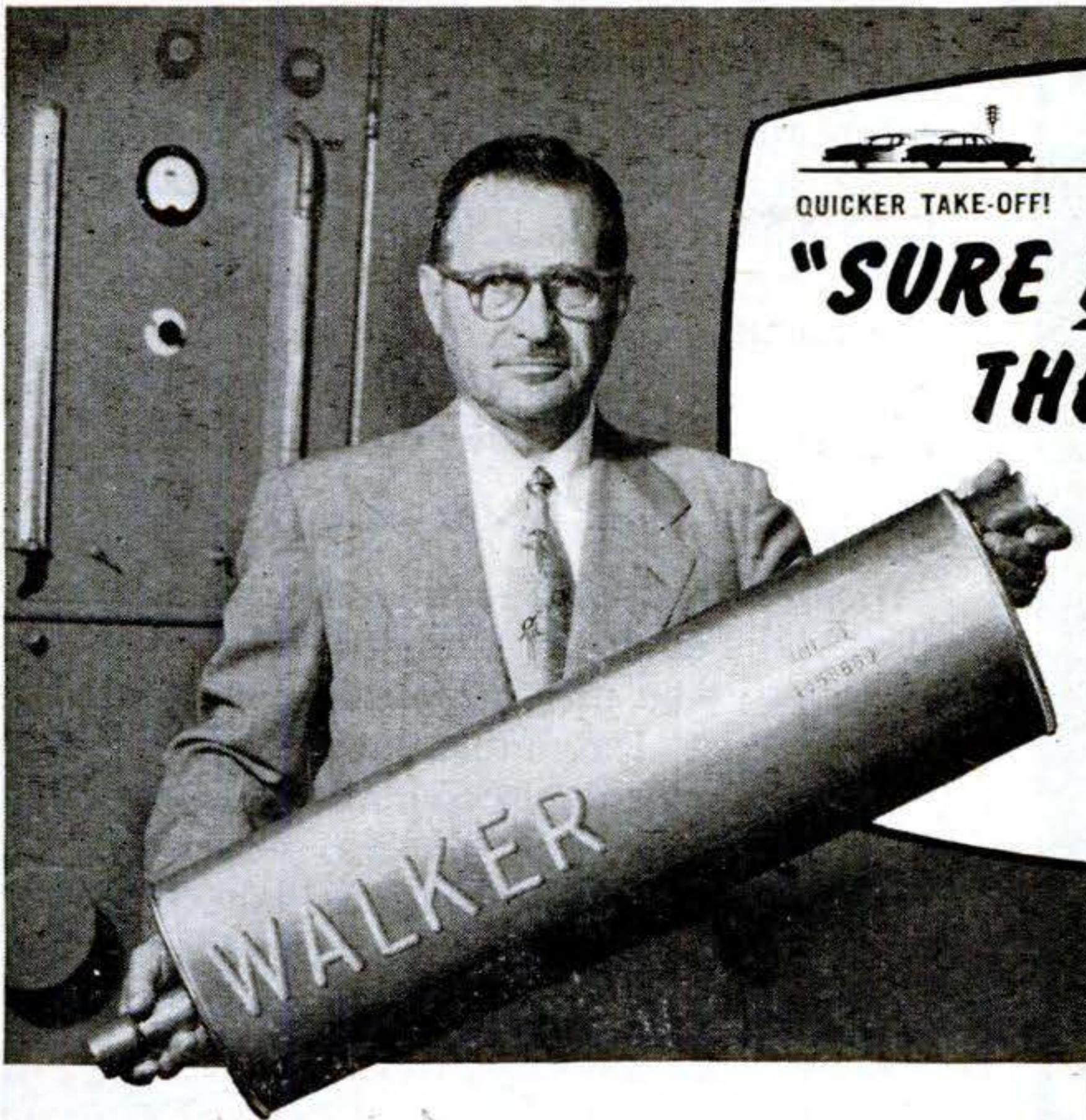

QUICKER TAKE-OFF! FASTER GET-AHEAD! MORE PASSING POWER!

**"SURE DOES BRING OUT
THE GO-FACTOR!"**

SAYS

Wilbur Shaw

President, General Manager
Indianapolis Motor Speedway—
3-time winner 500 Mile Race Classic.

**WALKER "PRECISION TUNING" GIVES YOU
QUICKER TAKE-OFF, FASTER GET-AHEAD
AND MORE PASSING POWER!**

"I think I know engines and what makes them 'tick' . . . what's good for them and what isn't. So I welcomed the opportunity of visiting the Walker plant to see for myself what is being done about exhaust systems for these new passenger car engines.

"I found out that designing and engineering a modern exhaust system takes the finest of laboratory equipment to give it precision performance. But most important—it takes 'know-how' that comes only with years of experience with engines and their exhaust characteristics.

"Now I know *why* Walker 'Precision Tuned' Silencers really do bring out the Go-Factor . . . faster *get-away* at the traffic lights . . . faster *get-ahead* on the straight-away . . . greater power reserves for *safer passing* and hill climbing. I have seen and heard the proof with my own eyes and ears. I have put Walker Silencers through their paces with my own hands . . . and I can say to you in all sincerity—Walker really knows what to do—and they are doing it."

WALKER MANUFACTURING COMPANY OF WISCONSIN • RACINE, WIS.
Exhaust Silencers • Oil Filters • Jacks



"YOU CAN ACTUALLY HEAR THE DIFFERENCE in muffler sounds. Walker Silencers are designed 'right on the button' to eliminate tiring noises . . . the 'blat' and 'bark' that make cars sound cheap and tinny."

"I WAS GREATLY IMPRESSED WITH THE FIRST RULE OF Walker engineering—a *Walker Silencer must quiet an engine properly without increasing its back pressure.* In other words, the exhaust sound must be properly controlled without lowering the engine's established Brake Horsepower Rating."



Now . . . more than ever
WALKER *Precision Tuned* **SILENCERS**

Make the Difference!



ANNOUNCING

AMERICA'S GREATEST
"DO-IT-YOURSELF" SANDER!



ONLY
\$39.95

'900' OFFERS
MORE
THAN ANY
OTHER SANDER
REGARDLESS
OF
PRICE!

The ONLY Portable
with ALL These Features!

- (1) Motor guaranteed against burn-out during ownership or replaced free. (2) Removes more material with less upkeep than any other sander at any price. (3) Over 1000 hours of continuous sanding without breakdown in laboratory endurance trial. (4) Work-Light standard equipment—a Syncro "first" for portable sanders of its type. (5) Vibration-absorbing handle floats in rubber (Pat. Pend.). (6) Easy to use, hand operated, positive paper holding clamps. (7) One hand operation—no jumpy, twisty torque to fight. (8) Most powerful reciprocating sander motor (Pat. AC, Other ented). (9) No oiling—power unit floats in rubber—no cams, bushings, belts or gears to wear out.

Standard
Models: 110-
120 Volt
AC, Other
voltages,
cycles
avail-
able.



No. 504
\$19.95



No. 504-D
Deluxe Sander in
Metal Case: \$22.95

PRESENT, PROSPECTIVE SANDER OWNERS! This new husky '900' SYNCRO is the best portable for home use—costs less than many others! Try this superior, powerful tool on "do-it-yourself" jobs—save many times its cost! Because '900' is so new—and your dealer may be sold out—do this: Send \$39.95 and your dealer's name with coupon—we will ship '900' to you—and see your dealer profits from your purchase. Then—use your '900'—see how it sands better, quicker, easier, smoother one-handed than "bucking" torque-knobbed "two-handed" portables do! If not 100% satisfied—return '900' prepaid, undamaged, within 10 days of receipt—we'll refund \$39.95 promptly! Or write for FREE facts today. (Dealers—See Your Jobber!)

WITH BUILT-IN LIGHT

NEW '900' SYNCRO SANDER

INDUSTRIALLY RATED

Send Coupon for TRIAL ORDER or FREE CIRCULAR:

SYNCRO CORP., Dept. 2-54, OXFORD, MICHIGAN

- TRIAL ORDER: I enclose: () \$39.95 for No. 900—() \$22.95 for No. 504-D—() \$19.95 for No. 504. Send sander postpaid with accessories, on 10 Days Money Back Trial.
- C.O.D. ORDER: I enclose \$5 down. Send model No. with accessories. I will pay balance plus postage, C.O.D. fee on arrival. Same 10 Days Money Back Trial.
- FREE CIRCULAR: Send new free Syncro Sander Circular.

Dealer's Name, Address.....

WRITE YOUR OWN NAME, ADDRESS BELOW!

Free College for Ship's Officers

[Continued from page 258]

boiler room on a Liberty ship, and cadets stand actual boiler-room watches all around the clock. This also serves the useful purpose of producing steam to heat the academy buildings. Elsewhere, other laboratories also sport the equipment you actually find on a ship.

Bearings—and Bearing

Besides producing engineers and deck officers, the course of study at the academy is set up to give a liberal education. Students get a rounded curriculum of English composition, economics, history, languages, chemistry, physics, personnel relations and even international law. The Maritime Service, which runs the academy, wants its officers to be men of education and bearing.

Though many of the academy's graduates go into the Navy and others find jobs aboard the 400 vessels operated by the government's Military Sea Transportation Service, the future for most of the Kings Pointers really lies in the private merchant marine. Currently, this consists of some 1,200 vessels requiring about 18,000 to 20,000 officers, 10 percent of whom are replaced each year.

Advocates of a strong merchant marine point out that a well-trained officer corps is just as important today as a fleet of modern ships. Better and better officers, they say, will be needed to operate increasingly complex equipment on the newer and faster craft. And, as several hundred perspiring midshipmen at Kings Point will attest, you don't become an officer in a day. **END**

Hermits at Home

ONCE upon a time three hermits lived in a cave and spent their days staring at the walls, rarely speaking. One day a horse ran past the cave entrance. Six months later one of the hermits mumbled, "That was a fine brown horse."

Two years later, another of the hermits said, "That wasn't a brown horse. It was white."

A year later, the third hermit got up and stalked toward the entrance of the cave, exclaiming, "If there's going to be this constant bickering, I'm going to leave."—*Wireco Life*.

**DO IT
YOURSELF
WITH...**

Job-designed Upson Panels

There are many Upson Panel styles from which to choose. Each style is job-designed to do its work better, add greater beauty at less cost. Here are a few suggestions.

UPSON ALL WEATHER SHEATHING FOR

GARAGE

Upson All Weather Sheathing is perfect for outside uses such as garage siding. Waterproofed through entire thickness by exclusive Upson *CuraSeal* process; stands up to rain, snow, heat, cold. Adds insulation value, too. See your lumber dealer, insist on Upson.

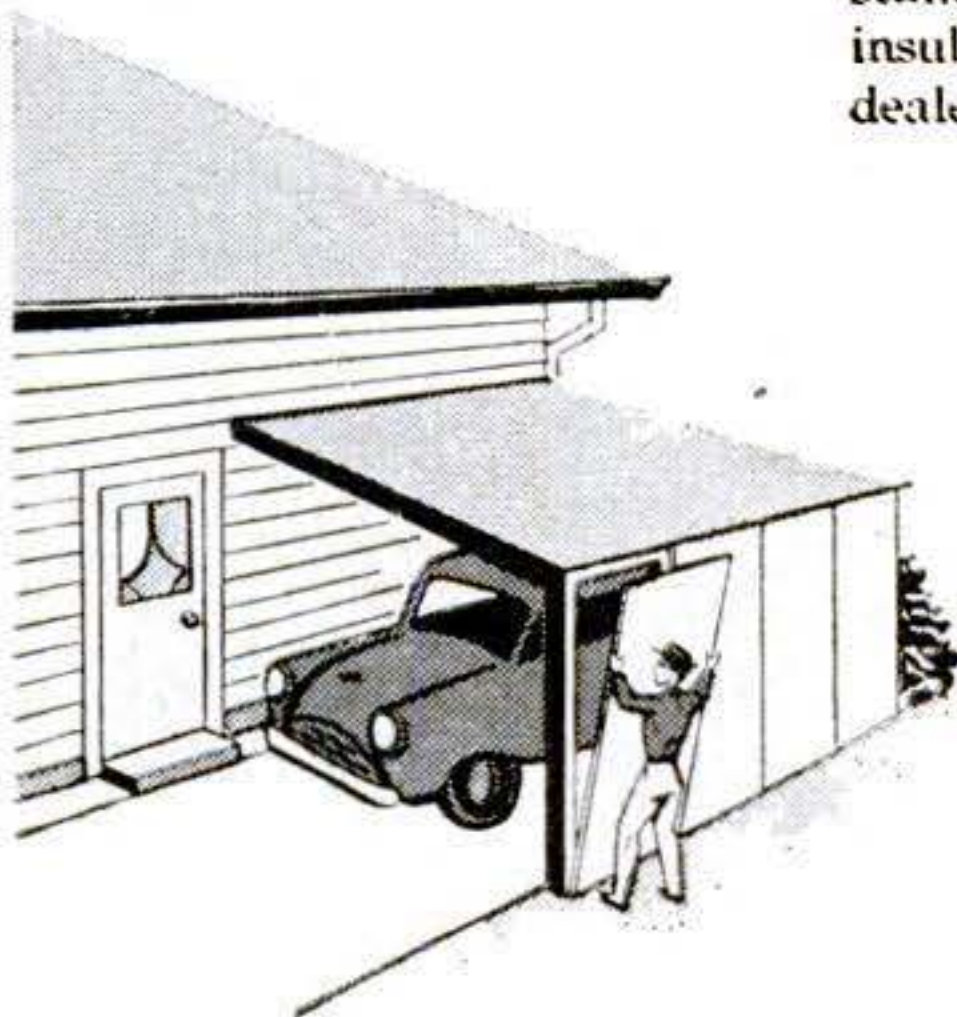
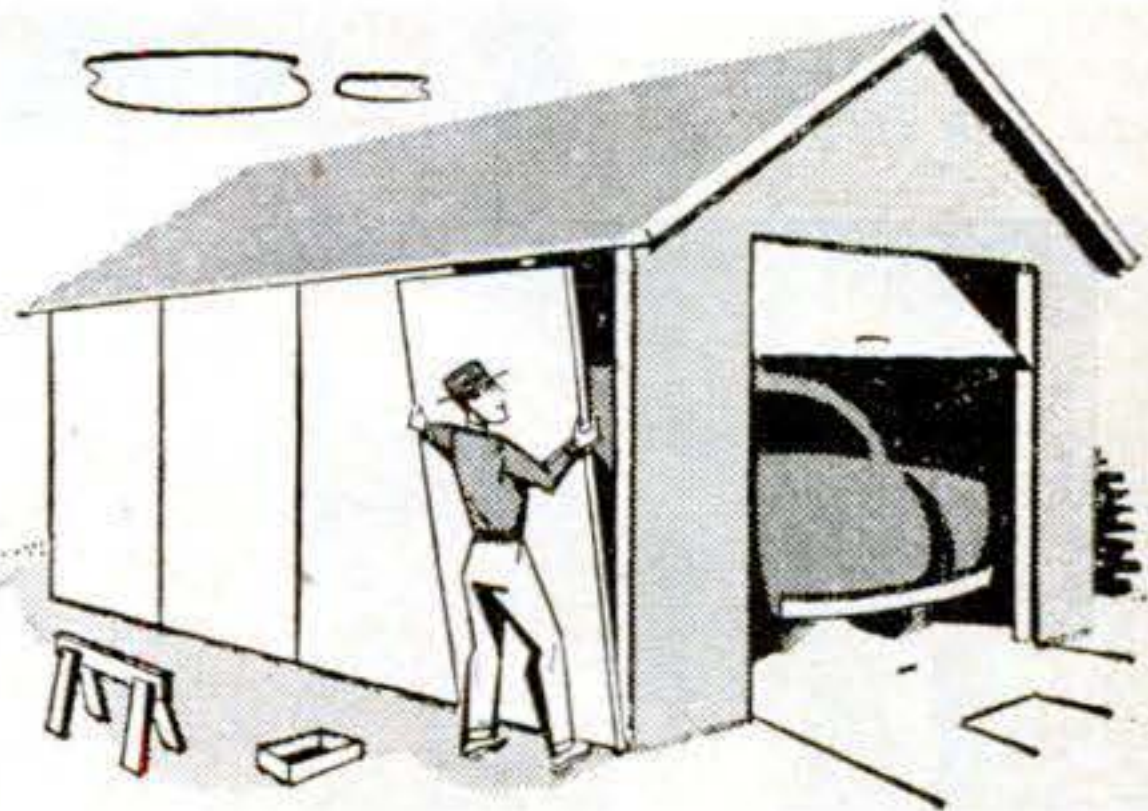

CARPORT

Use super-strong, 6-ply Upson All Weather Sheathing for walls and ceilings of a carport. Costs surprisingly little, yet offers highest quality. Easy to put up too. Nail direct to studs. Doesn't drink paint. Looks good for years.

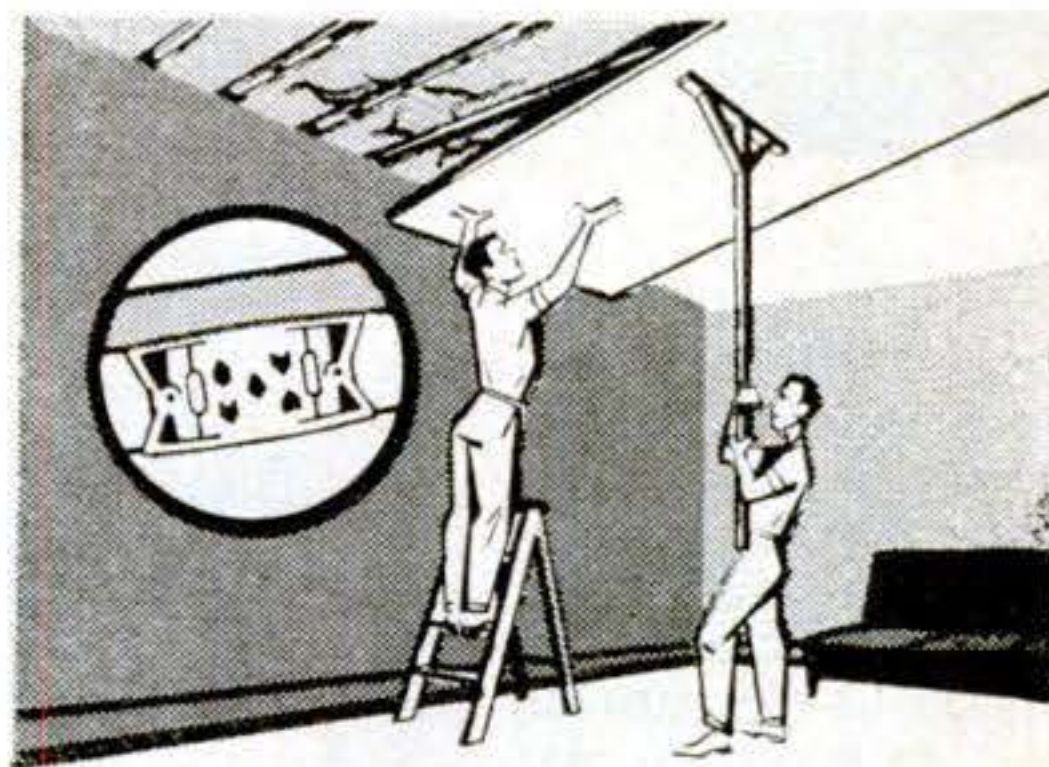

UPSON PEG-IT PANELS FOR WORKSHOP... HANDY, SAVES SPACE

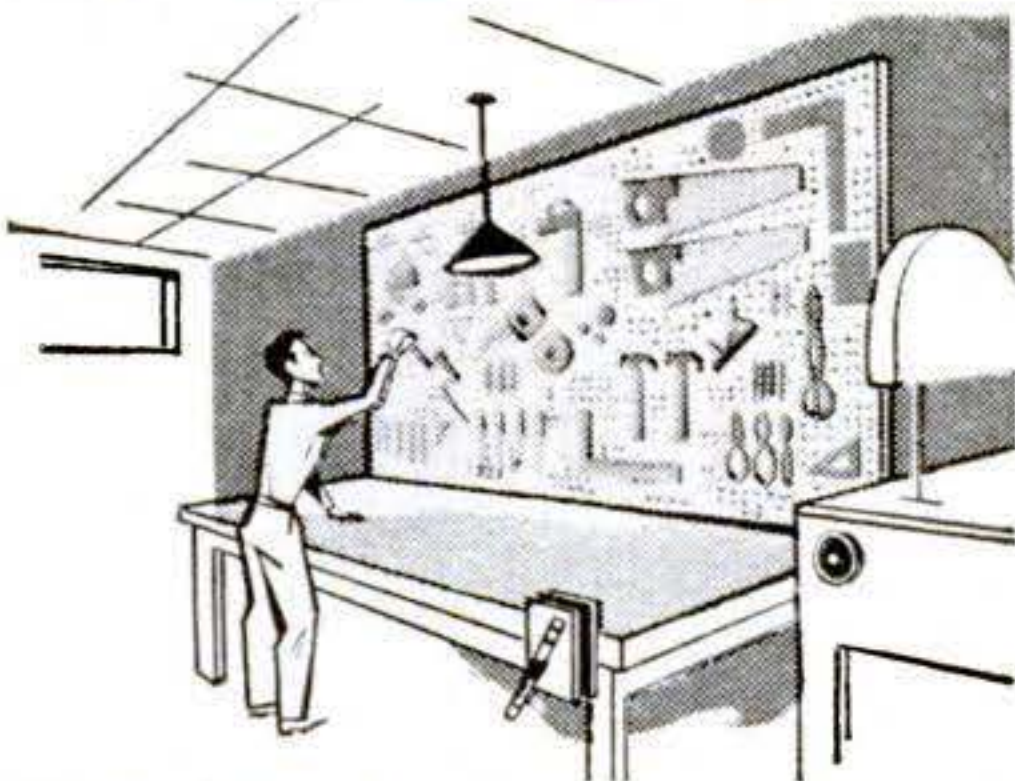

Upson Peg-it Panels are the newest wrinkle in space saving convenience. They change ordinary wall space into storage space like magic. And Upson Peg-it is extra sturdy, holds heavy objects with ease. Comes with lustrous lacquer finish, wipes clean with damp cloth. Strong cleaners won't mar surface. Use Upson Peg-it Panels in your workshop as illustrated or on closet doors, in the kitchen, for a tool rack in your garage. See your lumber dealer. Be sure to ask for Upson Peg-it Panels.

UPSON KUVER-KRAK PANELS FOR CRACKED CEILINGS

Apply crackproof Upson Kuver-Krak Panels on furring strips *right over* your old cracked plaster ceilings. Panels anchored from behind with Floating Fasteners. (See insert). No visible nailholes. Job finished in hours. No dirt. No mess. Permanent Upson Kuver-Krak Panels are a full 1/4" thick, specially designed for ceilings. See lumber dealer, insist on Upson Kuver-Krak Panels. Accept no substitute.

OTHER UPSON PRODUCTS

Strong-Bilt Panels • Ceiling Tiles • Striated Panels
3/8" Panels • Easy-Curve Panels • Cut-out Letters

upson panels
PROVEN QUALITY YOU CAN TRUST



THE UPSON COMPANY, 485 UPSON POINT, LOCKPORT, NEW YORK

Mail coupon
for FREE
details

Please send me FREE details on:

Upson All Weather Sheathing Upson Peg-it Panel
 Upson Kuver-Krak Panels _____
Name of Product

NAME _____

STREET _____

CITY _____ STATE _____

Hints on How to Refinish Furniture

Step 1. Remove old finish—quickly, easily, with fast-acting Strypeeze. Brush on, let it set . . . off comes the old finish. (hint: sprinkle sawdust over Strypeeze. “Roll off” sawdust, Strypeeze and old finish.)

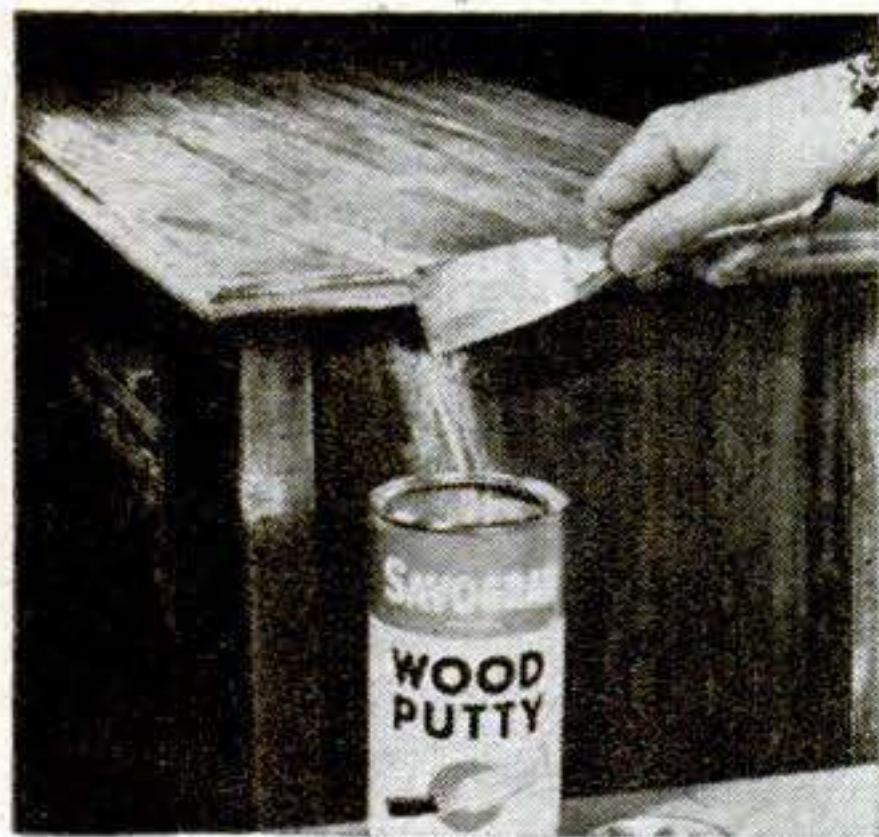
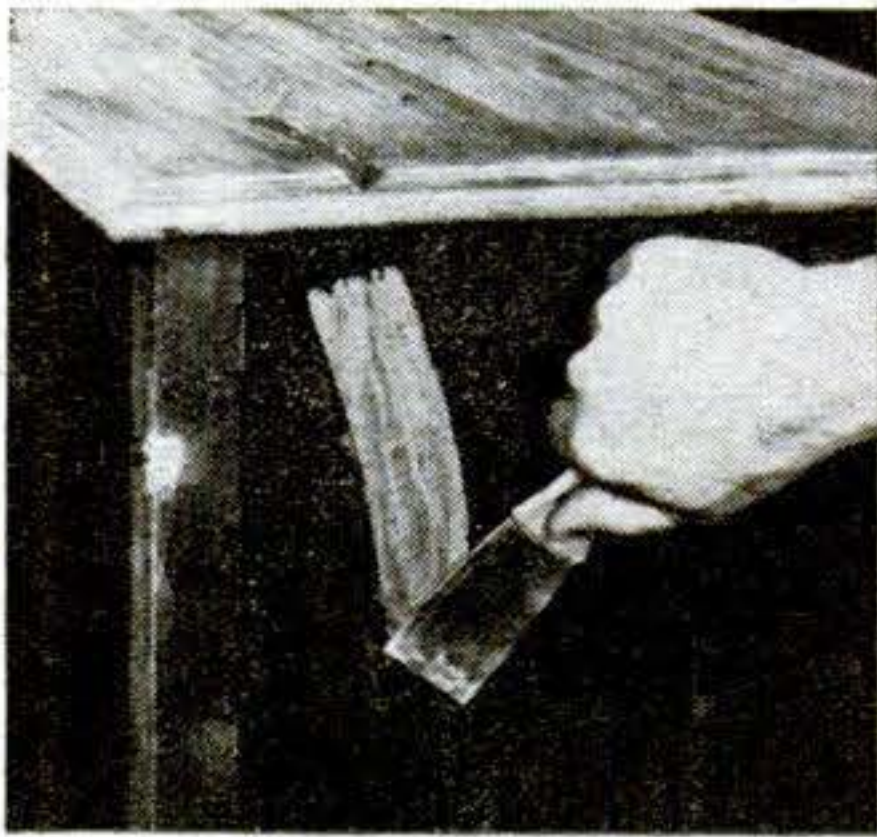

Step 2. Fill all holes, nicks — permanently and simply with Savogran Wood Putty. Tools easily, won't shrink. Now, sand entire surface with 6/0 sandpaper. (For cracks in plaster, use Savogran Crack Filler. It's the original patented quick-hardening water putty.)

Step 3. Refinish—before you start, be sure brush is clean. Savogran Kwikkeeze really cleans varnish brushes. Leaves no specks of old varnish, dirt in brush to mar finish. Apply stain, thinned shellac seal, then spar varnish or dull “rubbed effect” varnish in finishing.

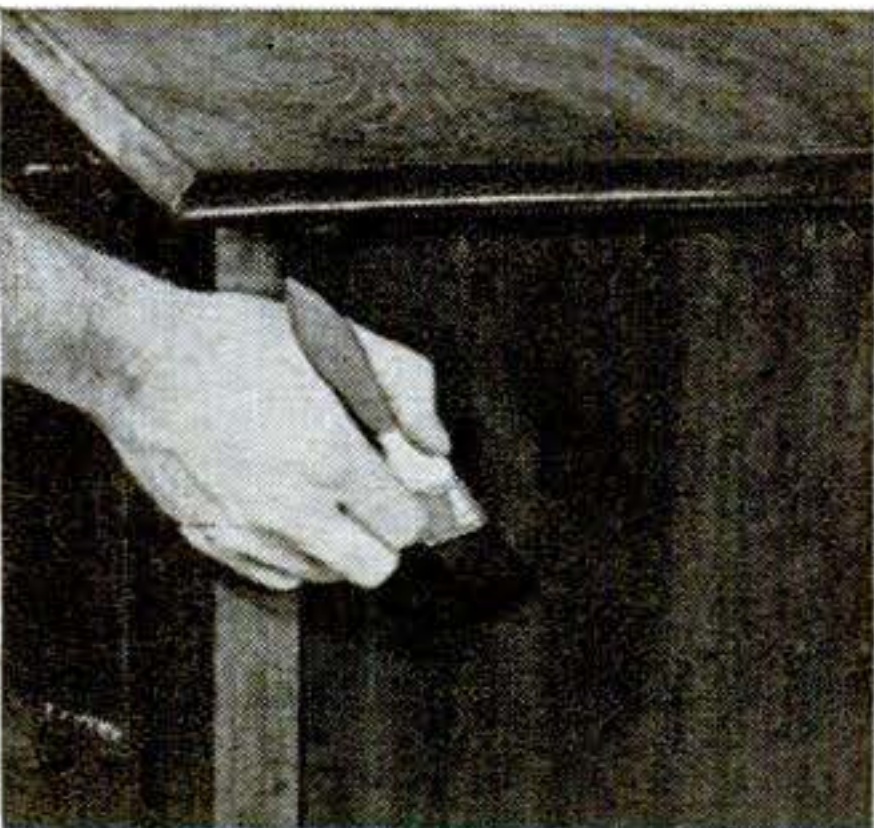

SAVOGRAN

PRODUCTS . . . at better paint & hardware stores
Write for free helpful literature

SAVOGRAN CO., Dept. 50, 25 Huntington Ave., Boston 16, Mass.

What Is a Sports Car?

[Continued from page 98]

“The kind of car that's worn with a beret.”

“A car for the discerning expert driver.”

“A vehicle intended for the display and ventilation of its driver's personality.”

“A mechanized surfboard” (said of an MG TC).

Personality on wheels. A sports car is plainly a state of mind. It is a gasoline-propelled vehicle with a set of characteristics highly prized by its owner. The difficulty in nailing down a definition is that the enthusiasts bicker fiercely over which characteristics. Like cultists elsewhere; they come closer to agreeing what a sports car is *not*. Sample negatives:

“It is not an ordinary stock car, such as peasants drive. It is not a souped-up stock car, such as barbarians drive. And it is not a Detroit show car, devised by manufacturers to befuddle the masses.

“It is not a car for everyone, especially not for the general run of clods (present company excepted, of course, old boy), but one that demands of its driver a certain *fineness* of nature.”

The cultists. An eloquent testimonial to the strength of the sports-car idea is that it has survived association with the *aficionados*. Though now fortunately on the decline, the blown-in-the-bottle Enthusiast can be identified by certain distinguishing traits:

The make of his car is the “marque.” If he is particularly sporting, the car may even be “blown” (supercharged). Club affiliations are evidenced by bright little enameled gewgaws mounted in front on the “badge bar.” He uses his hands like a pilot to describe the “rather sticky” turns he has managed, and he speaks with elaborate casualness of how he almost “spun out.”*

From time to time he attends a “rallye” (pronounced “rally”) where he engages in gentlemanly competitions in parking,

* In contrast to the hot-rodder who, after reworking his engine, may say, “Cripes, she's real goosey!”

[Continued on page 264]

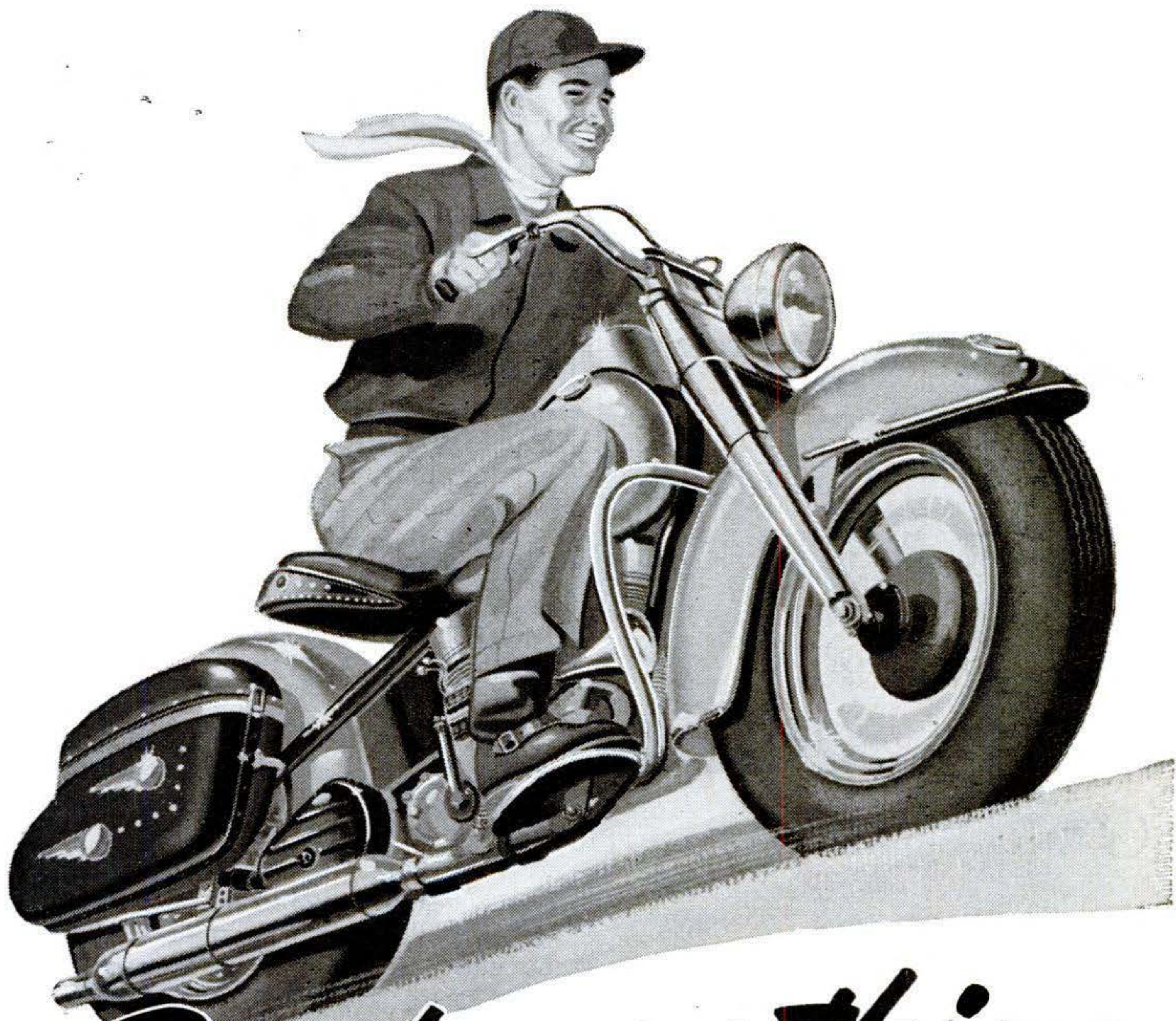

Beats anything
on two wheels!

Harley-Davidson *HYDRA-GLIDE*®



Here's the one motorcycle every rider wants to own . . . truly the undisputed ruler of highways and byways. Yes, the Golden Anniversary 74 OHV beats anything on two wheels. It's powered to *lead* the way to thrilling sport . . . built to *last* for years to come . . . and designed to give you the *most comfortable ride*

in its field. See it! Swing into the saddle on this proud beauty and test ride it at your dealer's today. And ask about his easy pay plans. For your copy of the action packed ENTHUSIAST Magazine and illustrated literature, send 10 cents to Harley-Davidson Motor Company, Dept. PS, Milwaukee 1, Wisconsin.

Pine panel your kitchen!
DO-IT-YOURSELF
 it's easy with Gold Bond
 Fireproof Grainboard!



GIVE your kitchen that warm, cozy pine-paneled look with Gold Bond Gypsum Grainboard. It has all the expensive beauty of fine wood paneling, at a fraction of the cost. Sturdy, fireproof Grainboard is available in two convenient widths—4 ft. panels or handy 16-in. planks...in Knotty Pine, Bleached Walnut and Dark Walnut. It's ideal for finishing off old walls or adding a den or gameroom.



Lightweight and easy to work, Gold Bond Gypsum Grainboard goes up fast—covers large areas at a time. A hammer and knife are the only tools you need. Cuts easier than wood...just score and snap to fit.

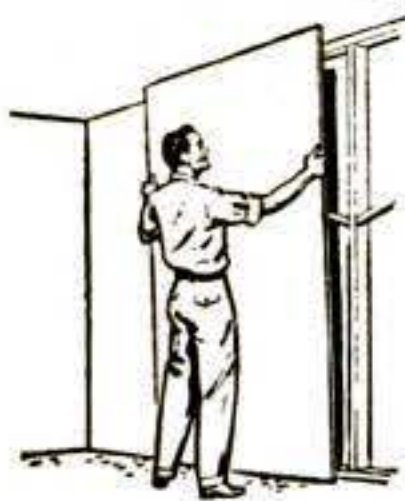

In new construction, Gold Bond Gypsum Grainboard can be nailed to the studs. Or, in remodeling, you can nail it directly to old walls or over furring strips.

Get your **FREE Do-It-Yourself** instruction folder. Send for it today! National Gypsum Company—Buffalo 2, N. Y.

MAIL COUPON TODAY!

NATIONAL GYPSUM COMPANY
 Dept. PS-54, Buffalo 2, N. Y.

Please send me a free copy of your Do-It-Yourself Wallboard Application Folder.

Name.....

Address.....

City..... Zone..... State.....

What Is a Sports Car?

[Continued from page 262]

backing up, map reading, time-distance estimations and, possibly, balloon bursting. He would very much like to own a car with a DOHC engine, for double overhead camshafts are held to be terribly desirable. He has a reverential attitude toward the late Ettore Bugatti, feeling that *Le Patron* was almost unendurably gifted. He is unwilling to recognize that the absence of a gas gauge or of adequate foot room in his car could be thought inconvenient. He is, in short, impossible, in a touchingly human way.

What sports? In searching for a watertight definition, it is well to ponder what objectives are wrapped up in that word *sports*. If you wish to impress the hunt-club set, the muted Oxonian murmur from the tailpipe of an idling Jag may serve. If you are frankly quail-hunting down the main stem, an opulent old Cadillac may really be all you want. If you would like to run with the pack at a rallye, a mint-condition MG might do, though you should be careful it isn't too new (vulgar) or too old (raffish). If really blood-chilling performance is your taste, a Ferrari or Aston-Martin might suit.

Fun is a factor. More definitions will perhaps cast more light:

"A car that's fun to drive."

"A car that responds to skillful handling."

Fun-to-drive looks like a useful touchstone until you inspect it closely. What's fun? And for whom? An antisports-car man could plausibly contend that pounding along in a violent breeze, accompanied by a sense of impending disaster, wouldn't exactly paralyze him with pleasure. A middle-aged sentimentalist could claim that a jaunt in a Model T could be great good fun, but it is difficult to view the Model T as a genuine sports car.

And for a vast number of citizens, the ultimate highway pleasure is to glide potently along in a sedan, making the

[Continued on page 266]

**IT'S
HERE!**

METROPOLITAN

**... A Completely New
and Different Kind of Car!**

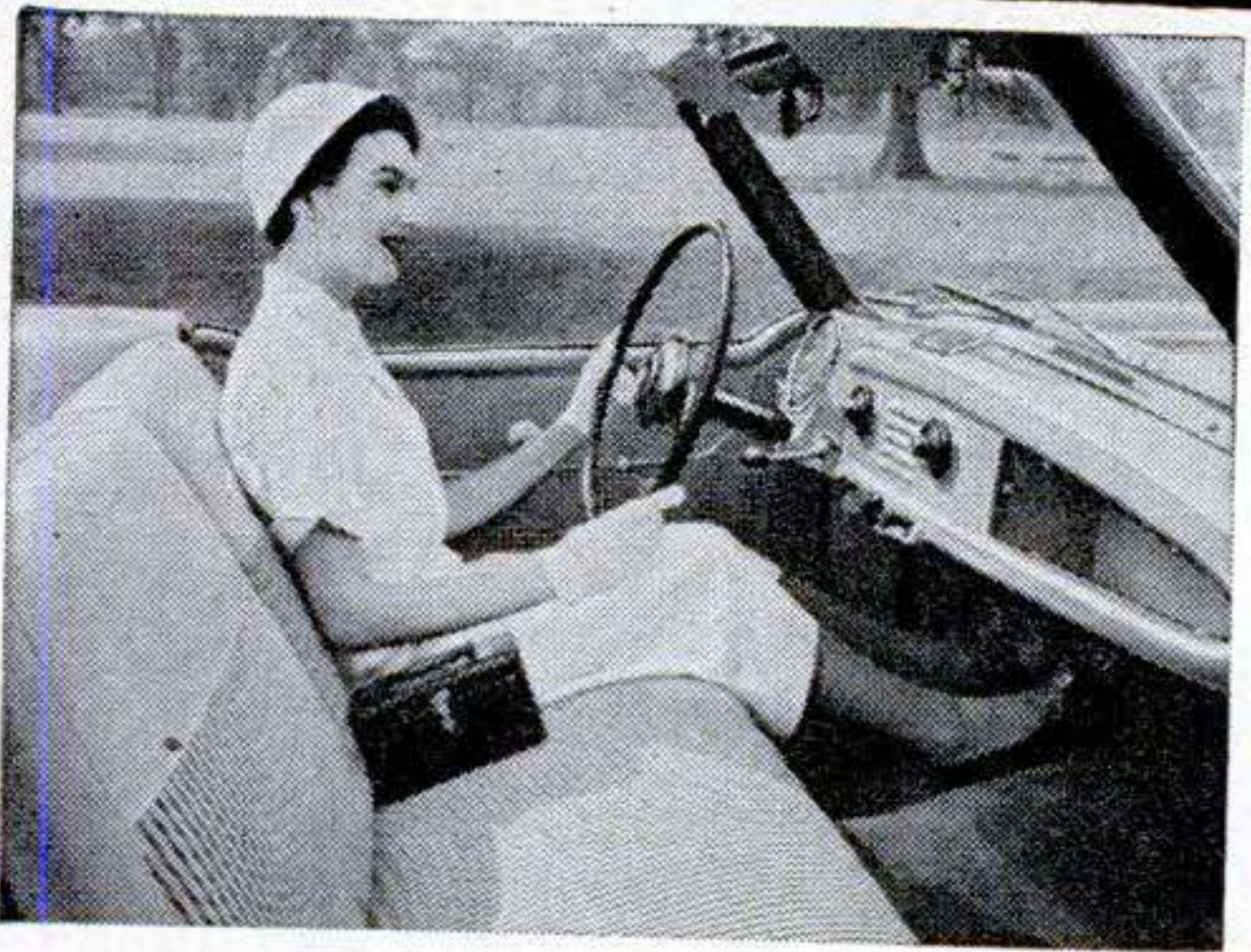
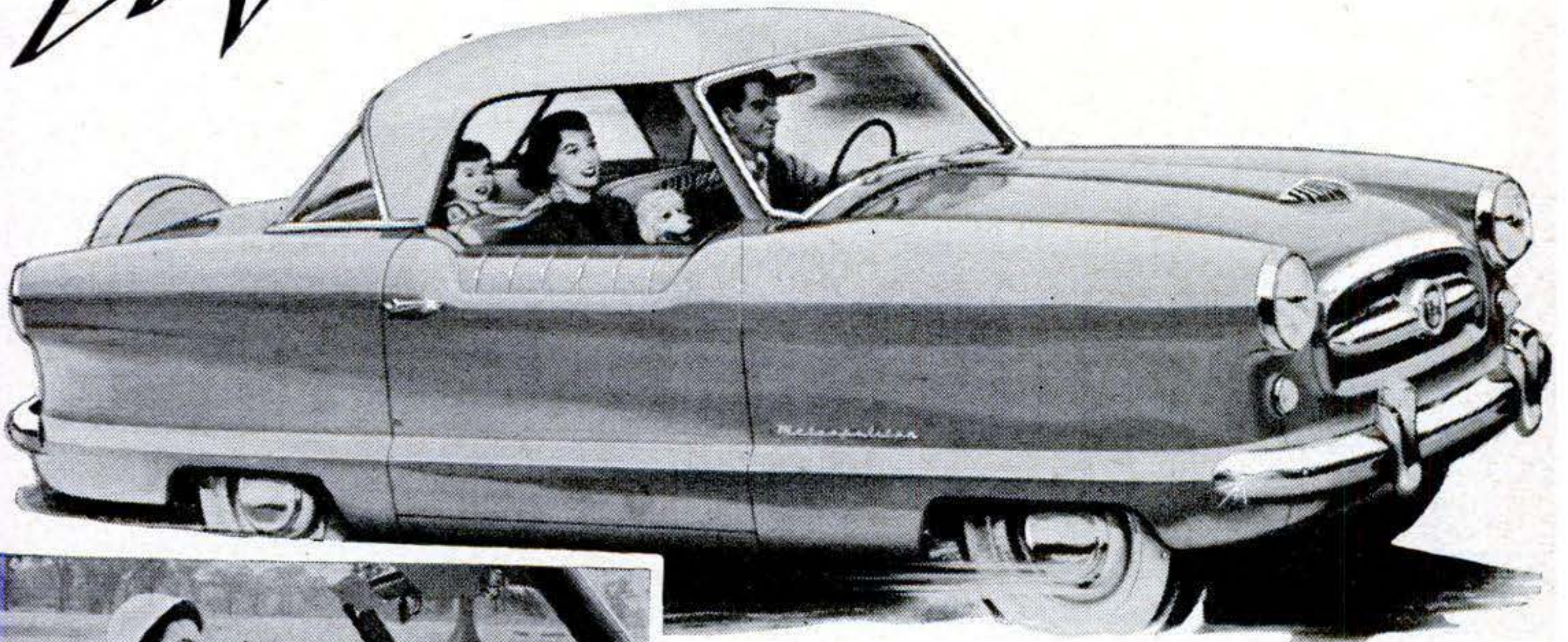

CUSTOM INTERIOR—full-width front seat, upholstered in genuine leather and nylon with foam rubber cushion. Ample leg-room, elbow-room, headroom for the largest passengers.

LIFE-SAVING SAFETY—Nash Unitized Airflyte Construction (shown below) gives you unexcelled sturdiness, freedom from body-bolt squeaks and rattles. Body-and-frame are a single unit for "double lifetime" of service.

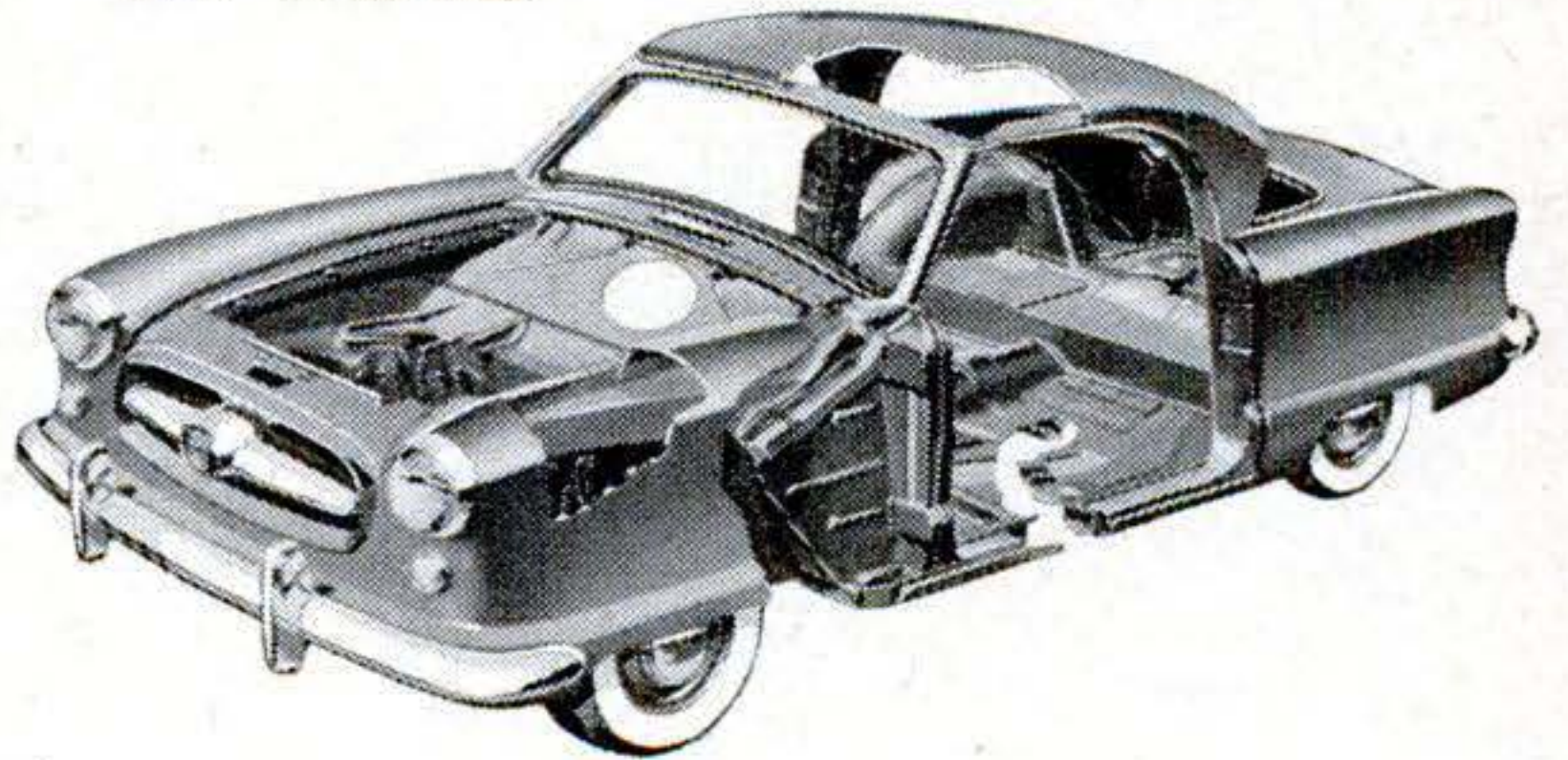

Amazing Facts About the Newest Motor Car in the World . . .

It's a family car . . . practical for small families . . . a truly sensible car for all families. **It's a pleasure car . . .** with world's easiest handling and parking. **It's a business car . . .** giving up to 40 miles a gallon and providing lowest operating costs. Choice of two models . . . Convertible and "Hardtop." Drive a new Metropolitan today at your Nash Dealer's.

Metropolitan

NEWEST MEMBER OF THE

Nash

Airflyte Family

Ambassador • Platemaster • Rambler

Built with a "Double Lifetime" . . . Your Safest Investment
Today . . . Your Soundest Resale Value Tomorrow

MAY 1954 265

Science Speeds Shaving With "Canned Lather"!

That's right! They've invented a gadget that makes shaving faster, easier, more pleasurable! Now you can get rich, creamy lather right out of a can . . . ready to use!

No brush to slow you down . . . no greasy cream to clog your razor. Just push valve . . . out comes lather! That's AERO SHAVE . . . the wonderful new "canned lather" that contains 3 beard-softeners to wilt toughest whiskers in a jiffy . . . *plus soothing lanolin to protect your skin against shaving irritation.*

Get AERO SHAVE Lather Bomb today . . . in the handy metal container with the turret top that won't leak when you travel.

Big Bargain! Aero Shave is the lowest priced "push-button" lather bomb on the market today!

USE "PUSH-BUTTON" LATHER

AERO SHAVE



Also economical King Size—12 oz. only 98¢

New Big Barrel Micrometers Have 7 BIG Features

1. Easy-to-reach ratchet cap. →
2. Big, sensitive direct-feel thimble. →
3. Perfect balance in shorter length. →
4. Non-glare satin-chrome finish. →
5. Easy-to-read markings widely spaced on big barrel. →
6. Rapid reading — big numbers mark every thousandth. →
7. Slip-proof black crackle finish on frame. →

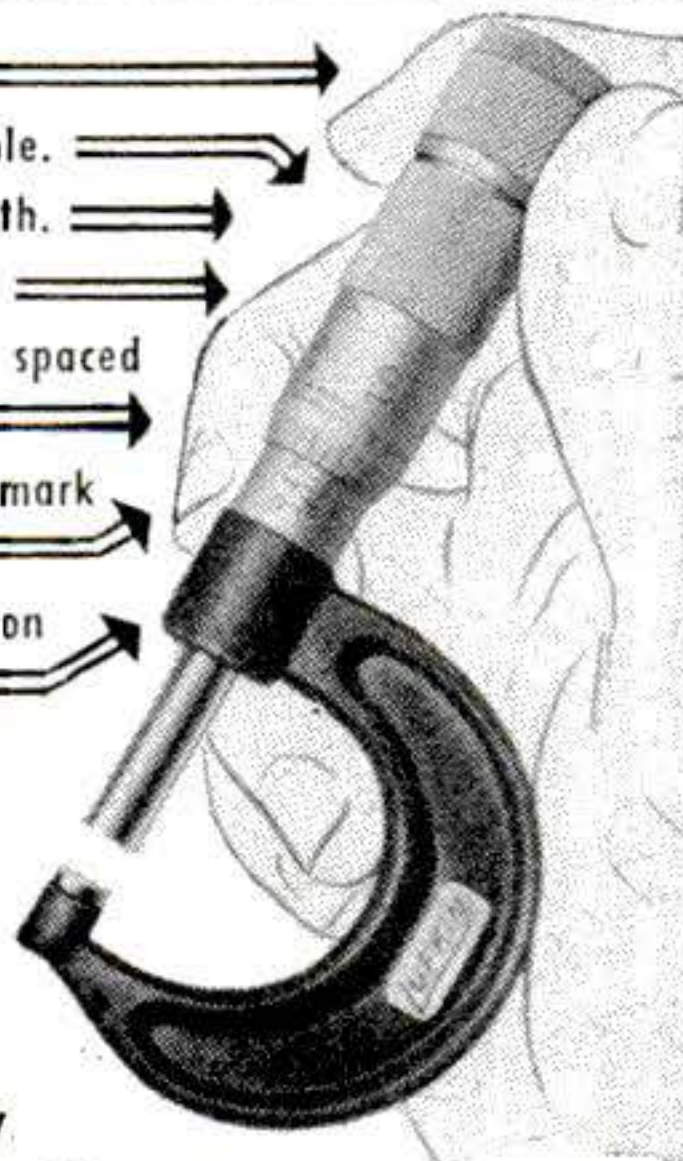

Designed by
LUFKIN

for Faster, Easier,
More Accurate Measurements

Get full information on this and many other new Lufkin time and work-saving precision tools. Send the coupon today.

304 **BUY LUFKIN TAPES • RULES • PRECISION TOOLS AT YOUR HARDWARE OR TOOL STORE**

THE LUFKIN RULE CO., Dept. PS, Saginaw, Michigan
Please send me your Free "New Tools" booklet.

NAME _____
ADDRESS _____
CITY _____ STATE _____

NEW
TOOLS
BOOKLET
FREE

What Is a Sports Car?

[Continued from page 264]

power-operated windows rise and fall.

Still, there's something to it. You have to be remarkably torpid, verging on the reptilian, not to like driving a car that gives a heightened response to your reflexes—one that promptly executes your instructions with precision and agility.

Competition? Here the sports-car gentry are split into several camps. There are those who race, the larger group who don't but like to think about it, and the even larger number to whom a desire to race is as suspect a symptom as collecting old pancakes. Each group, of course, constructs its own definitions accordingly:

"A two- or three-seater not intended for competition."

"No car with wind-up windows can be called a genuine sports car, which is supposed to be suitable for competitions. Any machine that carries extra weight to provide comfort is sacrificing performance for luxury."

"A car that's equally at home with a shopping bag or a crash helmet on its leather seats."

Incidentally, definitions that rigidly specify open cars may be up for revision. In such holy-of-holies as Le Mans and Sebring, and in the unlimited sports category in the Mexican race, enclosed cars have begun to pull out in front. Though frontal areas are larger, aerodynamic drag appears to be less at high speeds. In long races, too, a closed car is easier on its driver, protecting him better than a helmet does from prolonged wind buffeting.

Imports only? For some enthusiasts a car must have crossed the Atlantic to be authentic. They contend that British and continental makers have been expertly producing sports cars for years, while U.S. makers have been crassly grubbing about in mass markets. To some, the notion has such strength that a kind of provincial transference results: if it's imported, it must be good; if it's domestic, it is probably mediocre.

[Continued on page 268]

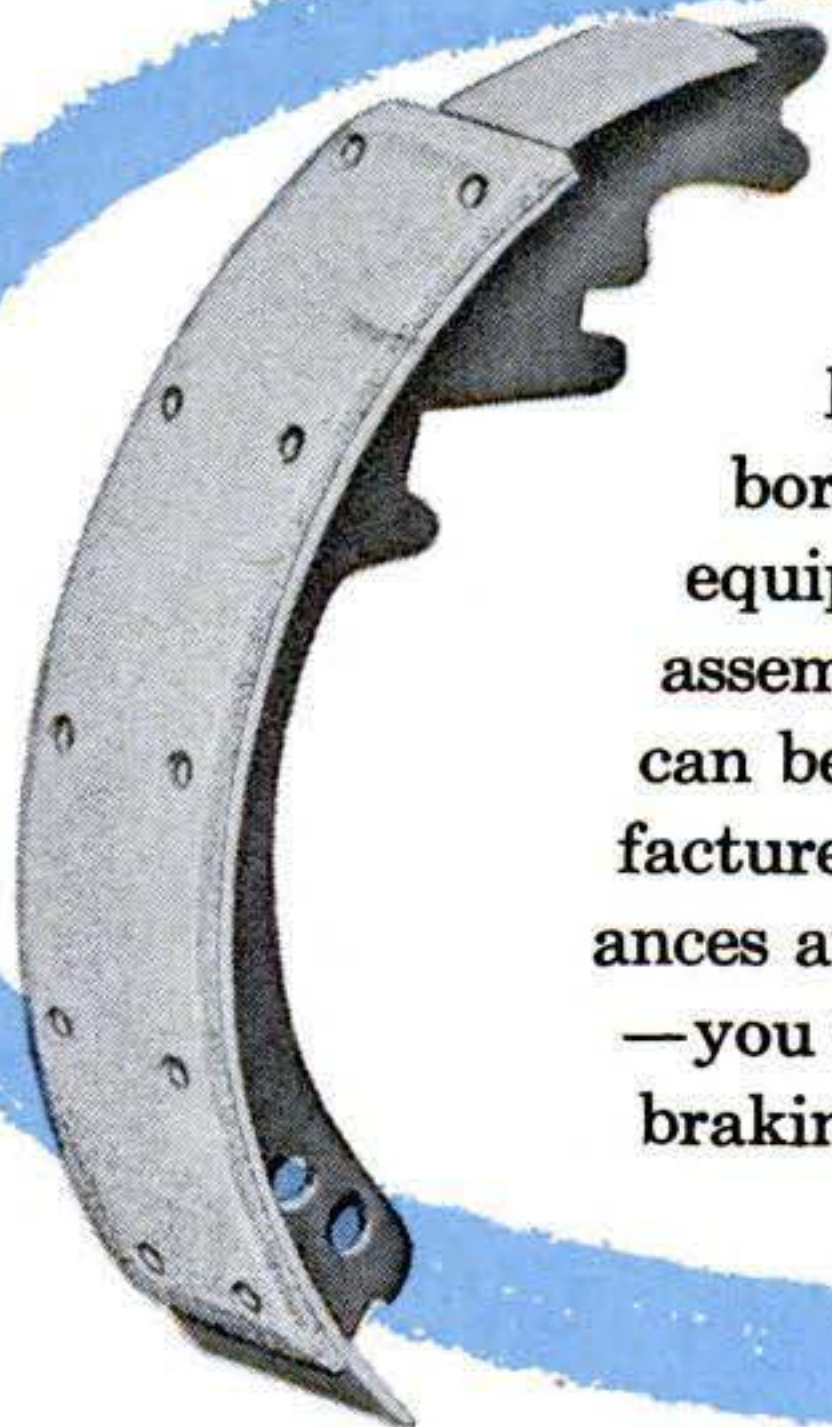

Linings are specially designed and compounded for long life. They are also counter-bored and drilled with precision equipment to provide positive assembly to shoe. Because you can be *sure* that they are manufactured to Ford's close tolerances and rigid specifications—you can be *sure* of top braking efficiency.

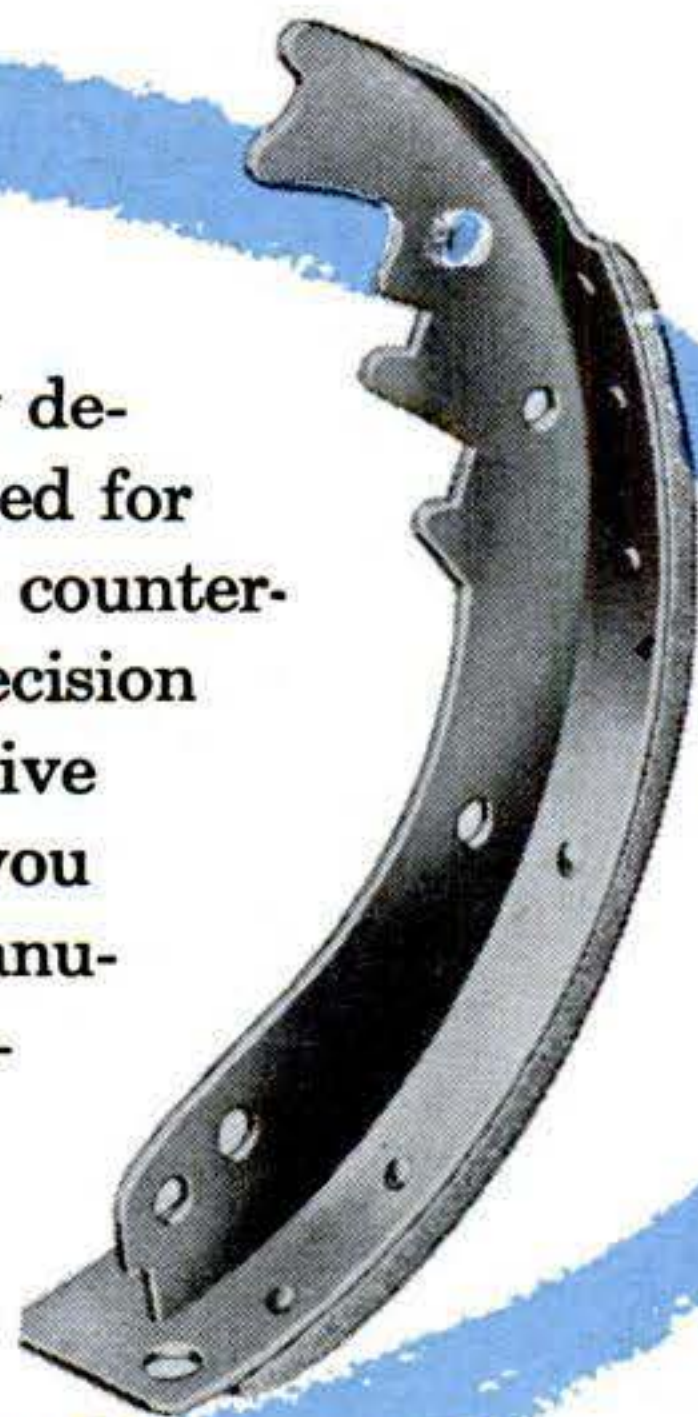

**Get the Brake Lining
that's made right
for your FORD**

**Every single Genuine Ford Part—like the brake lining shown above—is made *right!*
... to the same specifications set by the men who originally built your Ford!**

With fair-weather traffic "just around the corner," it's great to *know* your Ford will stop safely, smoothly, and surely. That's why *now* is the time to have worn brake linings replaced—and with Genuine Ford Brake Linings! They're made of materials specified by the men who built your Ford ... given 3,250 Track Tests before approval for manufacture. And they're made right to work right to last longer in your Ford.

"TRADE" WHERE YOU SEE THIS SIGN



Replace 'em for good



with **NON-STAINING ALCOA SCREENING**

When you repair screens, do a job that will last for years. Do it with screening made from Alcoa® Aluminum. It won't stain or streak your sills and siding. It won't rot, sag or burn.

Hardware stores and building supply yards carry Alcoa Aluminum Screening. Look for the Alcoa label. *Write for Folder that tells easy ways to Replace Screening.* ALUMINUM COMPANY OF AMERICA, 1929-E Alcoa Building, Pittsburgh 19, Penna.

ALCOA 
ALUMINUM
ALUMINUM COMPANY OF AMERICA

this tag
means
quality



What Is a Sports Car?

[Continued from page 266]

(Contrary views have been voiced by Li'l Abner's Al Capp, who lately bought a British car. "Really a wonderful car," says Capp. "I never owned anything quite like it. All sorts of things keep dropping off it—hub caps, wipers, ash trays—all sorts of things. But don't misunderstand me. I don't wish to disparage the car, and everything that does drop off is of the very highest quality, the very best British workmanship.")

U. S. contenders. Transatlantic comparisons don't really settle much. Certainly foreign designers have developed some magnificent machines; and no one with a memory of the Mercer or Stutz, for example, or a familiarity with the Cunningham, can say there have been no native sports cars. Increasing evidence suggests that the native variety may be coming up strong. The Corvette, Kaiser-Darrin and Thunderbird are scheduled for production in some quantities. Each, by reason of a short wheelbase and a curb weight of less than 3,000 pounds, avoids the stigma of being purely a dream car, hoked up for promotional purposes.

If there is to be a resurgence of U.S. sports cars, they will almost certainly differ from their foreign cousins. For a prediction, consider this definition, which was recently made to the Society of Automotive Engineers by Phil Pretz, boss of Ford's Vehicles Testing Department:

"The American sports car [will be] an open two-seater, with all equipment essential to highway driving; with acceleration and top-speed performance a little above that of our current group of high-priced cars; a car which satisfies our desires for fun on the road but does not necessarily fulfill our need for transportation; a car which gives us the feeling of intimate control over a spirited steed—not a sedan chair remotely operated by instructions issued to slaves or servos." END

NEXT MONTH in Popular Science: What safety experts are learning from Oklahoma's high-speed superhighway.

MOST FOR YOUR MONEY!

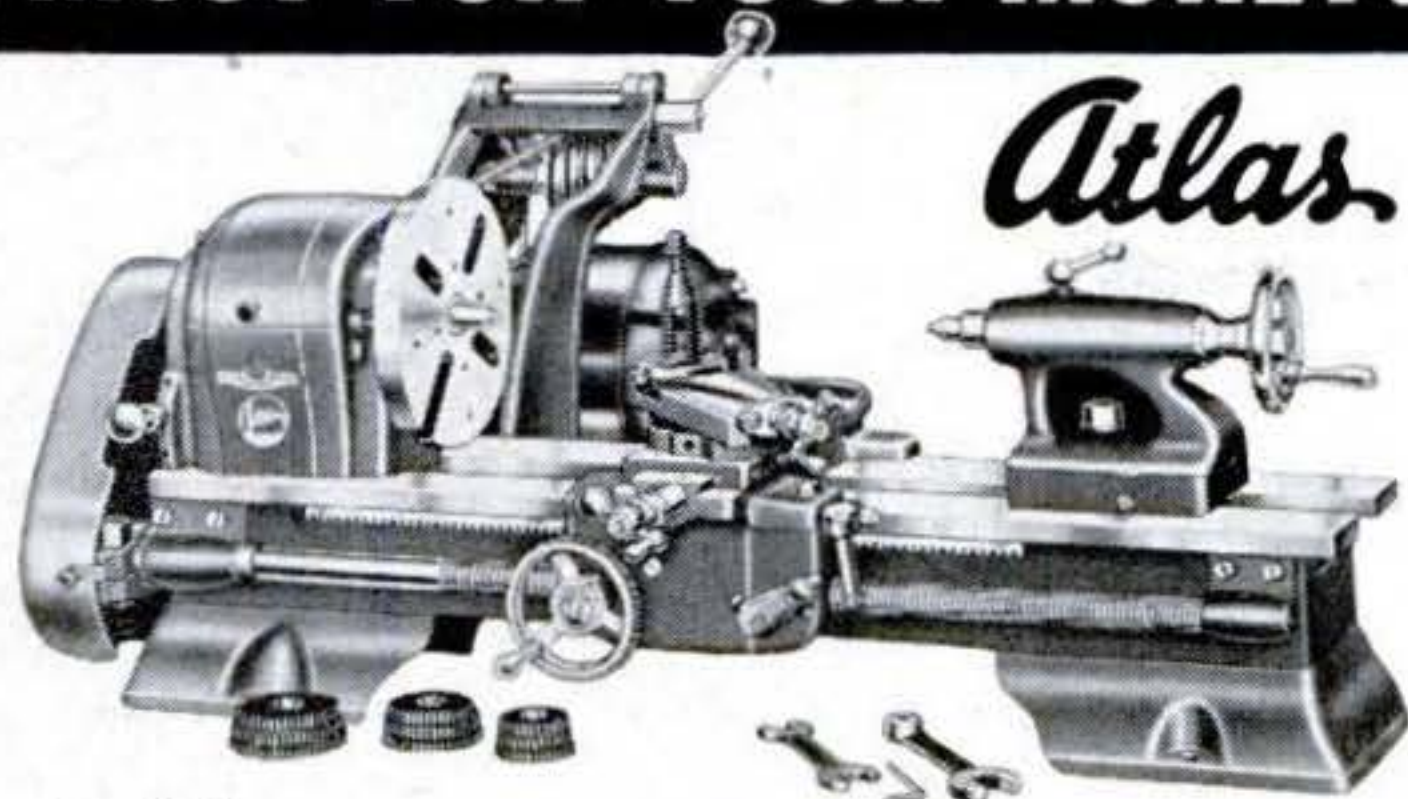

6" PRECISION LATHE

In the low-cost precision lathe field Atlas is first choice for the home shop . . . for development or commercial work! Outstanding features include: Timken tapered roller bearings—quick-change countershaft—V-Belt drive—reversible automatic longitudinal power feed—precision ground bed ways—8 to 96 threading range—16 speeds, 54 to 3225 R.P.M. You can DO so much MORE so much BETTER with an Atlas! See it at your nearest Dealer's, or—

WRITE FOR FREE CATALOG TODAY



Atlas Press Company

Quality Machine Tools Since 1911

ATLAS WOODWORKING POWER TOOLS
ATLAS METALWORKING MACHINE TOOLS
CLAUSING HEAVY DUTY MACHINE TOOLS
525 N. PITCHER ST., KALAMAZOO, MICHIGAN

send for **FREE CATALOG**

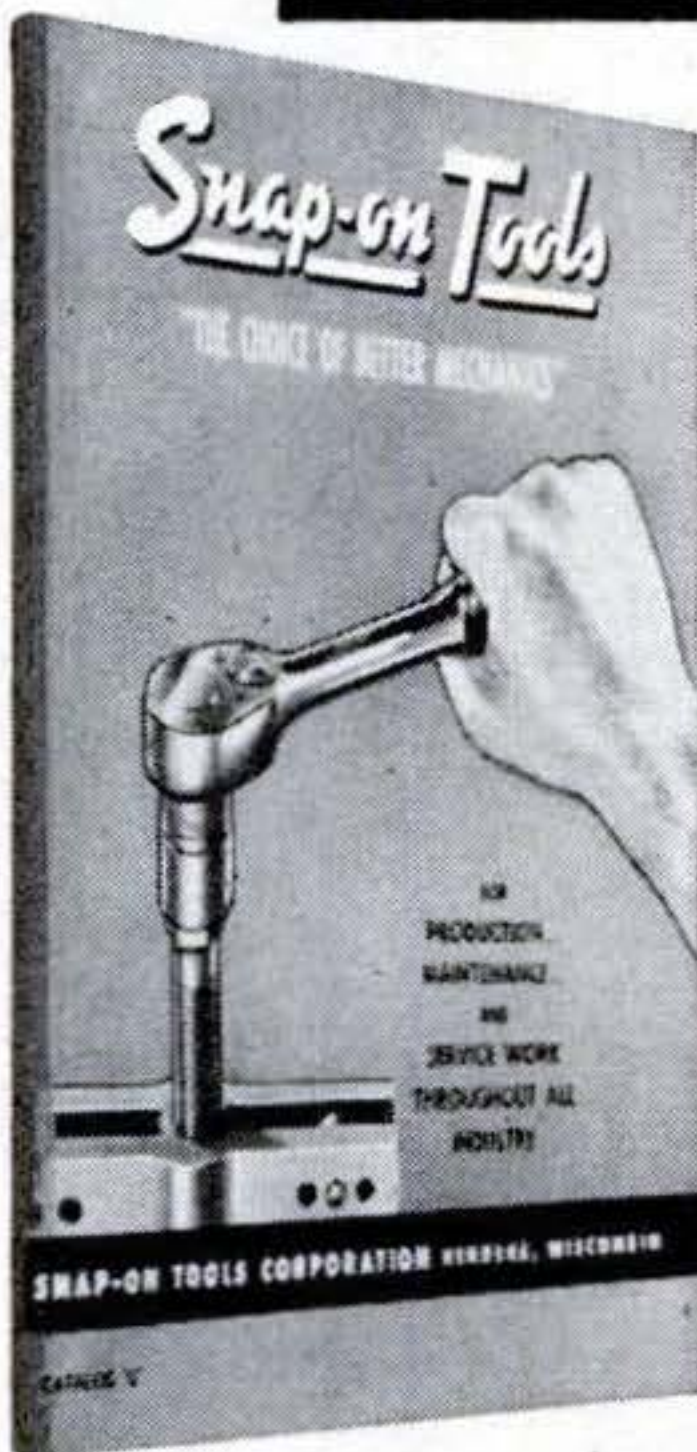

America's Foremost
money-making
MECHANICS' TOOLS

It's easy to own the same "pay-off" tools used and endorsed by America's top-earning mechanics throughout the automotive, aviation and industrial fields! Snap-on tools help you handle every repair job faster, easier, better. And they LAST . . . pay for themselves over and over again! Start building your own tool set now with basic Snap-on units—add others any time. Genuine Snap-on tools are never sold in stores—direct to users only. Mail coupon for free catalog.



Snap-on Tools Corporation

8060-E 28th Ave., Kenosha, Wis.

Send me free catalog. Occupation _____

Name _____

Address _____

City _____ Zone _____ State _____

Save \$89.50
on this Porter-Cable
COMBINATION



USE
Detachable
Motor
in
Combination
with any
of
these tools!

Interchangeable Motor
powers 3 tools . . .
saves cost of 2 motors!

Entire
3-Tools-&-Motor
COMBINATION
ONLY \$104.25



ROUTER
if bought separately,
complete tool... \$49.50

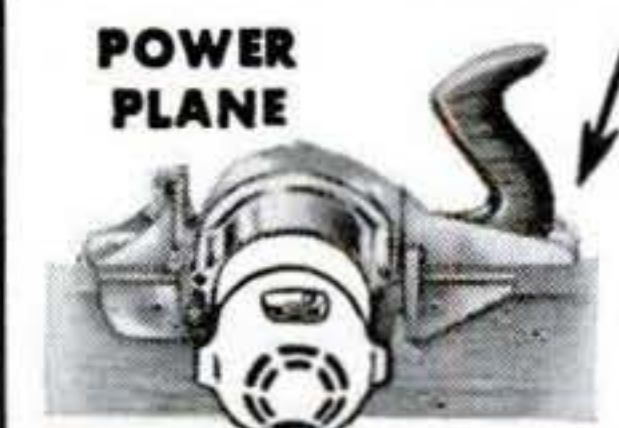

POWER PLANE
if bought separately,
complete tool... \$65.00

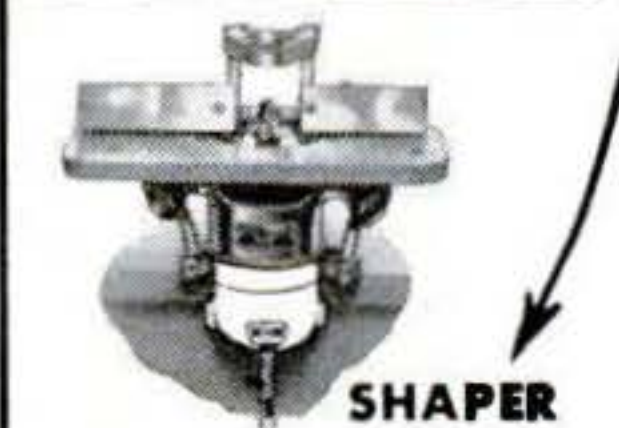

SHAPER
if bought separately,
complete tool... \$79.25

For professional results in home woodworking projects, build your workshop around the tools that professionals use! This Combination gives you ALL three of the most-used professional tools for little more than half the cost of three individually powered tools!

As a **ROUTER**—you can tongue, groove, rabbet, dovetail, do scrollwork, cut contours and beaded edges on wood, composition or plastic.

As a **PLANE**—shave off wood at high speed—take cuts from 1/64" to 3/32" deep—without wave or ripple! Sharpening attachment included.

As a **SHAPER**—makes hundreds of fancy cuts for cabinets, furniture, trim, toys, picture frames, molding, etc.—edges and joints stock of all shapes, sizes!

Buy one complete tool now and add other attachments later, or buy all three now. Either way, you save!

See this great money-saving Combination at your Porter-Cable dealer's. Or mail coupon today for full details.

Total price for
3 complete
tools.....\$193.75

PRICE FOR
COMBINATION \$104.25

YOU SAVE..... \$89.50

Porter-Cable

Quality Electric Tools

PORTER-CABLE Machine Co.

2465 N. Salina St., Syracuse 8, N. Y.

(In Canada: Strongridge, Ltd., London, Ont.)

Send full information on the Porter-Cable Router, Plane and Shaper—also name of nearest dealer.

Name.....

Address.....

City.....County.....State.....

Manufacturers of SPEEDMATIC and GUILD Electric Tools

CHAN NEL LOCK pliers
**The most versatile
 tools on your bench**

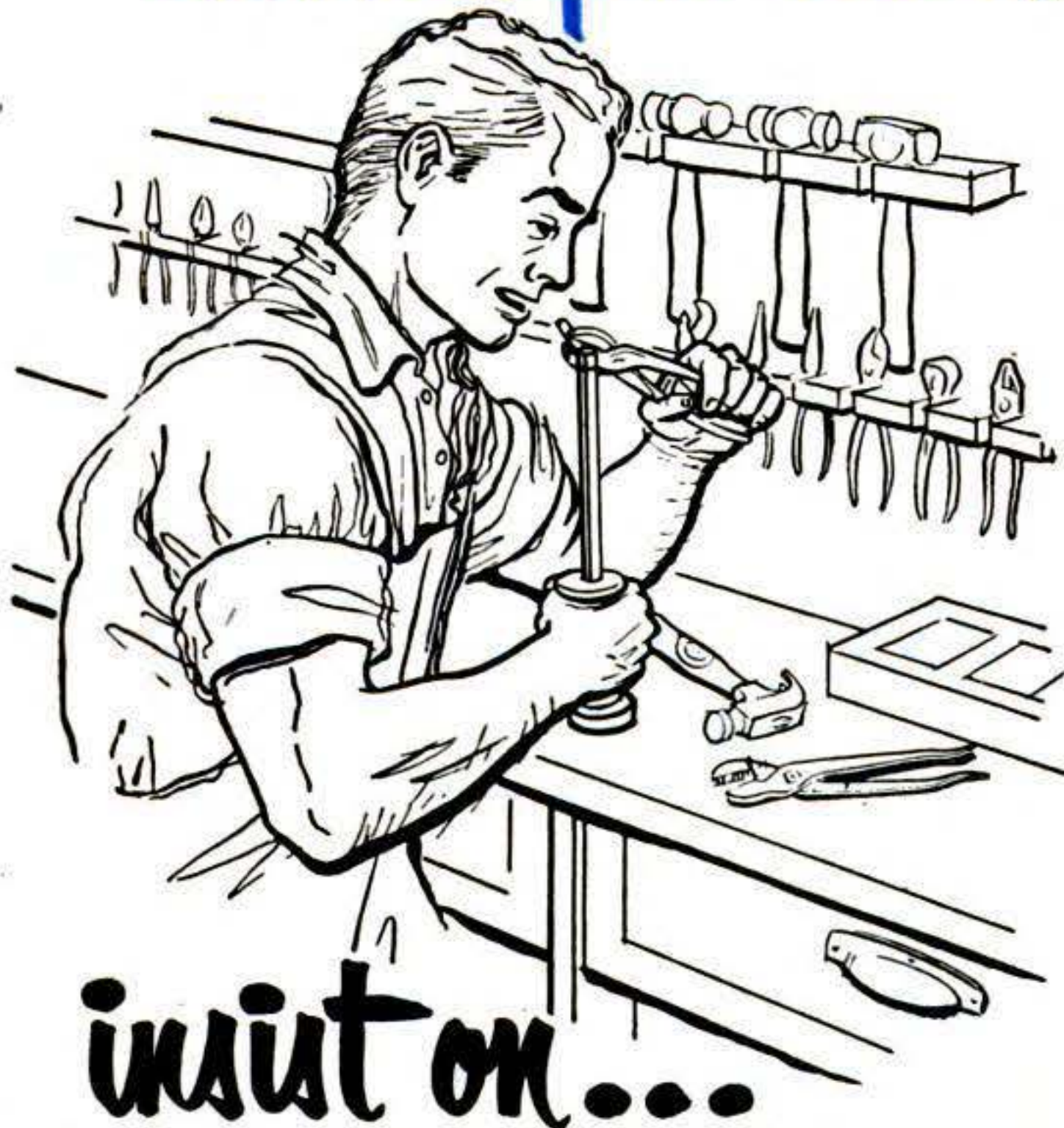

insist on...

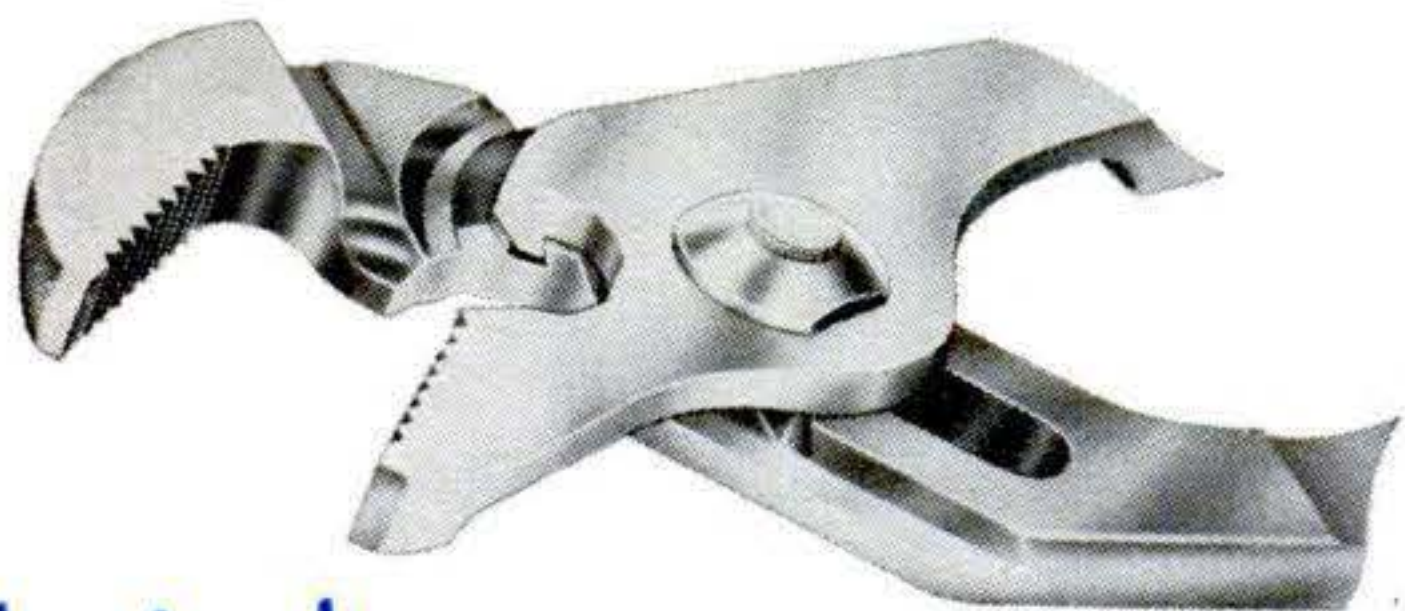

here's why

Look for the Channellock line when you're shopping for hand tools. Channellock pliers offer features that you can't get with other makes. And when you buy a Channellock plier, ask to see the full line—you'll find a style and model to do any job better.



THE PLIER DESIGN THAT OBSOLETE'S ALL OTHERS

CHAMPION DEARMENT TOOL CO. • MEADVILLE, PA.

Diver Finds Spanish Treasures

[Continued from page 85]

He has never found human remains—probably because they have decayed long since. But once he collects a number of objects from a ship, and identifies it, he can usually learn when it sank.

There was, for example, a wreck off Looe Key, about 60 miles above Key West, which yielded such things as clay pipes, cannon balls, jars and bottles of glass, a hammer, lead (used for ballast on warships) and cannons. One cannon, when the coral was pounded off, turned out to bear the insigne of the British crown. Peterson knew that the British named keys after ships that had gone down on them. A check of the name Looe at the Admiralty in London uncovered the story of a British frigate, the *Looe*, that had crashed on the key the night of February 5, 1744. A court-martial in England that knew the reputation of the Florida keys acquitted the *Looe's* captain of negligence.

Doubt That Real Treasure Still Exists

Link and Peterson are inclined to doubt their chances of recovering treasure of great value partly because so many men before them have recovered so much. Most wrecks along the keys were in shallow water, they point out. Survivors were the first to attempt salvage; the Spaniards, they say, had native divers. Next, Indians of the keys, for generations, made a big sideline of recovering loot. Eventually, the Americans took over the business.

But even though many wrecks were fished out long ago, there is evidence that the Spanish survivors, the Indians and the early Americans could only go—as Peterson has up to now—down to depths of about 40 feet. So plans are now under way to dive deeper, starting at about 60 feet. **END**

Modern Youth

YOUTH must be served—but nowadays it's usually in front of the TV set.—*Wall Street Journal*.



Now—caulk cracks and crevices around your home this modern easy way!

DICKS-PONTIUS
WHITE Caulking Compound in a giant tube!

- Dozens of home maintenance uses.
- No gun—no mess! Just squeeze the tube!
- Collapsible tube comes ready-loaded with 1/10 gal. of highest quality, white D-P Caulking Compound.
- Tube has built-in applicator tip—and cap screws over it for storage.

GET IT NOW! On sale at leading hardware, paint and building supplies stores. D-P products are easier to use! Always ask for them by name.

The Dicks-Pontius Company • Dayton, Ohio
 Alexandria, Va. • Decatur, Ga. • Dallas, Texas

The easy way to paint!

Speedy Sprayer

ONLY \$36⁵⁰
 Less motor

Favorite of home owners and craftsmen for 20 years! SPEEDY SPRAYER gives your work that professional paint finish everyone admires. Sprays paint, enamel, varnish, lacquer, etc. . . . 4 to 7 times faster than hand brushing! Lightweight, portable, uses any 1/4 H.P. motor. Improved diaphragm principle assures clean, oil-free air. You'll find dozens of time and money saving uses for SPEEDY SPRAYER, including spraying insecticides 2-4-D and DDT. Complete outfit, without motor, only \$36.50

At leading hardware, lumber, and auto supply dealers.
FREE—write for handy booklet "How to Spray."

W. R. BROWN CORPORATION
 2637 N. Normandy Ave. • Chicago 35, Ill.

Greatest wood-boring tools ever developed

Stay sharp 10 times longer than ordinary power bits

Even cut thru screws and wire nails



Set No. 8006

NEW

DYNO-MITE
HIGH-SPEED POWER BITS

Here's the last word in wood-boring efficiency! "Dyno-Mite" Bits give you all the advantages of the modern flat-blade design that is rapidly replacing conventional auger bits for power drilling. And, in addition, "Dyno-Mite" Bits have high-speed steel blades — stay sharp ten times longer — even cut thru screws and wire nails without damaging their cutting edges!

Yet "Dyno-Mite" Bits cost no more than ordinary tool-steel bits!

Available in 6 diameters, 3/8" to 1", singly or in sets. All with 1/4" shanks. If your dealer cannot supply you, send check or money order for \$6.45 for No. 8006 Set of 6 sizes, postpaid.

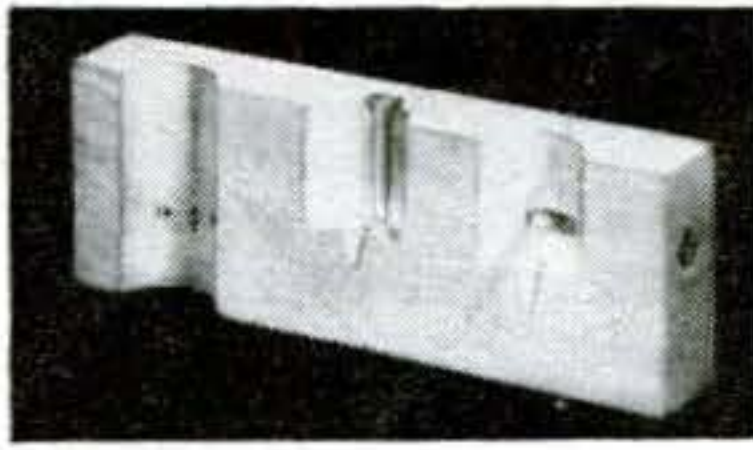

Here's Proof of Amazing Cutting Power. One "Dyno-Mite" Bit, preparing demonstration blocks like the one at left, was still going strong after cutting thru 15 ft. of hard maple, 188 screws, 376 wire nails!

FREE at your hardware store, new Millers Falls Power Tool Catalog — or send 10c to cover mailing and handling.

MILLERS FALLS COMPANY
 Dept. PS-2
 Greenfield, Mass.



The Mark of Superiority

TIPS for the HANDYMAN

ON USING L-O-F SUPER-FINE FIBER-GLASS



Here's a new insulating product of "1001 uses." Wonderfully easy to handle and apply. And so versatile, so effective, you'll find uses for it in a dozen places 'round the house.

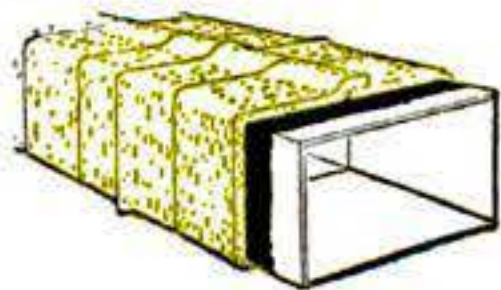

Save fuel by wrapping fire-resistant Super-Fine around your heating ducts! Highly efficient heat insulation. Flexible, lightweight, easy to install.

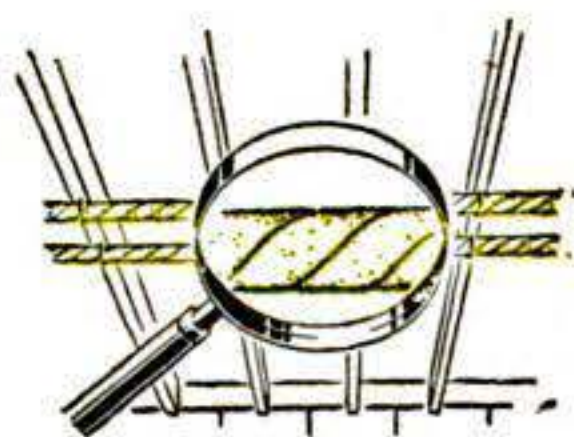

Reduce dripping from cold water pipes. Reduce heat loss from hot water pipes. Spiral wrap them with Super-Fine. Will not mildew or rot.

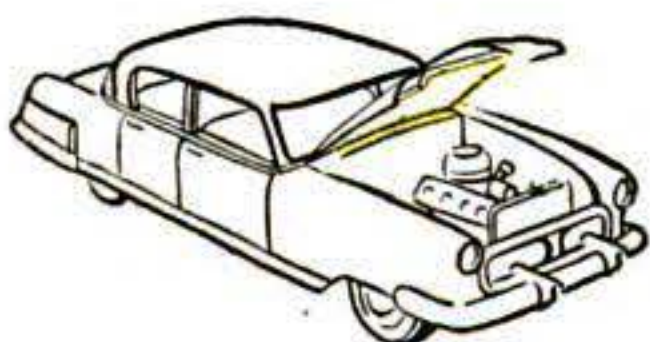

L-O-F Super-Fine installed under the hood of your car reduces airborne noise, tire whine and air-stream whistle.



Sound-insulate your home workshop! L-O-F Super-Fine provides excellent sound absorption. Cuts easily with scissors or knife.

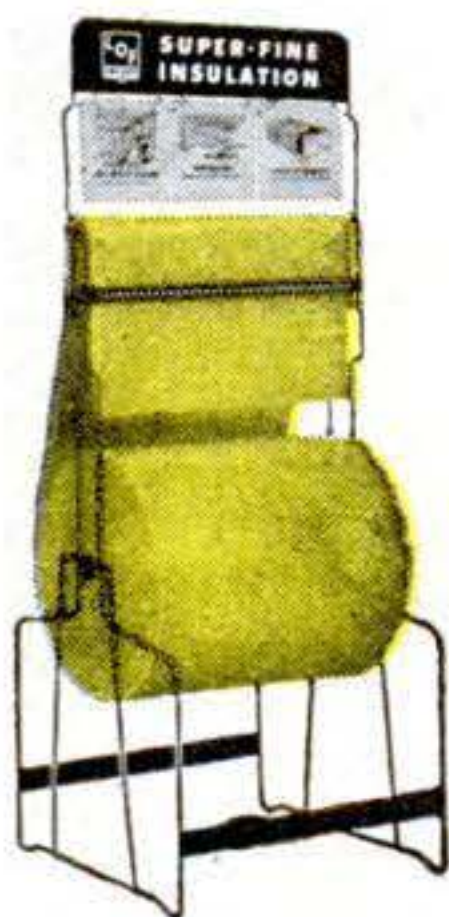

Get L-O-F Super-Fine at your favorite hardware dealer's, where this rack is on display. If your dealer doesn't have it, write Libbey-Owens-Ford, Fiber-Glass Division, 4954 Wayne Building, Toledo 3, Ohio.



FIBER-GLASS

An Ape Uses Our Household Tools

[Continued from page 124]

MONTHLY. This is blueprint reading at an elementary level.

We have been discussing Viki in a modern home complete with tool chest, yet her scientific value may rest in the fact that in some ways modern apes may be regarded as "living fossils." At least they are as close as we can come to observing prehistoric man. One point of similarity is the ape brain, which apparently stabilized at 400 grams in weight while modern man's grew to 1,600 grams.

How does Viki manage the tools available to earliest man?

Only stone tools remain to tell the primitive story. An insight into the birth of these first tools, the eoliths, may be seen in Viki's use of rocks. When on occasion she has broken a rock in two, she has used the sharp edges for cutting, scraping and digging.

She piles her rock treasures in mounds and sometimes sneaks them into the house, concealed in her training panties. Their main use is as hammers and, occasionally, brickbats.

The Primary Tool: Language

Studies of Viki, a twentieth-century chimpanzee, cannot tell us how culture got started or why jungle apes do not have civilizations, but such studies can show which aspects of cultural living are at all possible to apes. Their failures will indicate what earliest man had that apes lack.

The evidence is that apes have sufficient curiosity to experiment, that their brains and bodies are adequate for coping with simple materials, that with experience they can even learn to manipulate the complex tools and techniques of a ready-made culture. They might invent things at a primitive, pre-Stone Age level. But *without language*, they could pass along to the next generation only that small proportion of know-how which can be conveyed by example, gestures and simple pictures.

END

NEXT MONTH in Popular Science: Look what's happened to the house trailer!

REPLACE YOUR OLD WORN
OUT CHUCK WITH A



- ENTIRE CHUCK BODY HARDENED
- JAWS NICKEL CHROME MOLY ALLOY STEEL
- INDIVIDUALLY TESTED FOR ACCURACY
- STURDY ONE PIECE CONSTRUCTION

SOLD BY HARDWARE DEALERS



SUPREME PRODUCTS, INC., 2222 S. Calumet Ave.
Chicago 16, Illinois
The chuck that lives up to its name... SUPREME

**AT LAST! A PRECISION
LEVELING INSTRUMENT
FOR ONLY \$12.95**



Any leveling job is a cinch with LEVELALL. It's speedy... easy... accurate... economical.

For LEVELALL is a 75' transparent plastic tube with shut-off valves, mounting brackets and filled with a special anti-freeze liquid. And here's how it works: fasten tube brackets to forms, etc., snap open the valves and the liquid gives two accurately level points. The job is level... no doubt about it. It's as easy as hanging up your hat.

Now, all alone, you can quickly level points for footings, forms, piping, batter boards, sills, lintels, floors, ceilings, roads, driveways, lawns and all types of construction work without a transit.

Send today for your free copy of "On the Level," a booklet that tells and shows how to use the LEVELALL... better yet, order a Deluxe LEVELALL. Clip and mail the handy coupon now! Money-back satisfaction guaranteed. Dealer inquiries welcome.

LEVELALL

LEVELALL, 81-E Webster St., Rockland, Mass.

Please send free booklet, "On the Level." Mail me Deluxe LEVELALL @ \$12.95 Regular 50' model at \$9.95 Ship postpaid full price enclosed. Ship C.O.D.

Name _____

Street _____

City _____ Zone _____ State _____

IT'S EASY TO
FIX IT YOURSELF
and save money!

**FIX LEAKING,
NOISY TOILETS**
with a
**SEALMASTER[®]
TANK BALL**



Stop those annoying toilet gurgles, save money on water bills. Sealmaster Tank Balls instantly stop water flow after flushing. Sealmaster is a bigger, better tank ball made of the finest quality rubber obtainable.

Fits all valves • Guaranteed 4 years

WITH
FREE
LIFT
WIRE
75c ea.

**STOP DRIPPING,
LEAKY FAUCETS**
with
**SEALMASTER[®]
FAUCET WASHERS**



No need to let faucets drip when it's so easy to stop them. A Sealmaster washer will do the job. Keep an assortment on hand, ready for use whenever you need them.

Assortment of 7 washers, 3 bibb screws

15c PER
BOX



Get SEALMASTER Tank Balls and Washers at Your Hardware Store

**LOOSEN NUTS,
BOLTS, JOINTS**
Stuck by rust or corrosion
with
LIQUID WRENCH[®]



This powerful blend of quick-acting solvents is a product of a thousand uses around the home and workshop. Quickly frees "frozen" joints, cleans and protects fine finishes. It literally "melts the rust away."

3-OZ. CAN 30c

**CLEAN UP AFTER
DIRTY JOBS**
with
**LAN-LIN[®]
WATERLESS
HAND CLEANER**



Just "rub it on... wipe off." Soft, creamy LAN-LIN removes dirt, grease, grime, paint or stains... without water! Rich in Lanolin, it will not dry out skin, helps prevent chapping. Keep a can in your tool chest or glove compartment of your car.

1-LB. CAN 75c



Get LIQUID WRENCH and LAN-LIN at Hardware Stores and Service Stations Everywhere

Free literature on request

RADIATOR SPECIALTY CO. • CHARLOTTE, N.C.

European Racing Invades America

[Continued from page 132]

they work furiously to free the frozen engine. Perhaps Taruffi can push the car on to the finish line, grind it across on the starter motor and salvage a bit of what had just seemed sure triumph.

But time runs out and victory goes to a cat-footed little car that has been tending to business every second. It is an Osca owned by Cunningham and driven by Stirling Moss, a top-ranking Britisher, and Bill Lloyd, an American. It has averaged some 73 m.p.h. for the 12 hours (the expired Lancia had averaged 81), covered about 884 miles, survived threatened brake failure, and solidly won.

Oscas—which are jewel-like and appropriately priced little Italian cars with four-cylinder, double-overhead-camshaft engines of a piffling 89-cu.-in. displacement—carried the day. They took third and fourth place as well, after the surviving Lancia's second, and also won the Index of Performance.

Will it catch on? Less than 15,000 people saw the Sebring race, compared to the 200,000 who will flock to Indianapolis on Memorial Day. This disparity depresses many enthusiasts, who cite the enormous crowds drawn by the early Vanderbilt Cup races, and the huge numbers that see present European races. Hopefully they point out that postwar U. S. road races at Bridgehampton and Watkins Glen have drawn big crowds.

Certain factors stand in the way. One is the need for sure-handed management. A big auto race is not as readily staged as a club picnic. Another difficulty is rumbling subterranean conflict between some sports-car and accrediting groups. Another is the need to find good courses near big population centers that are so arranged that admission can be charged. Another problem is a clannish segment within the sports-car set that views "public spectacles" with distaste.

None of these difficulties seems likely to be permanent. The European style of race is much too good a show. **END**

NEXT MONTH in Popular Science: A colorful who's who of airplane engines.



Service station proprietor, William Vasey, Greenwich, Conn., says: "If your filter's clogged like this, better put in a Purolator Micronic Refill right away!"

**"Right here, in the book that came with your car*, it says—
Change your Oil Filter every 5,000 miles"**

***17 out of 18 leading car makers recommend oil filter changes at least every 5,000 miles, on the average, depending on car and driving conditions.**

Grit and sludge in the oil can ruin any engine . . . run up expensive repair bills. A regularly changed Purolator† Oil Filter traps them and keeps them from damaging delicate engine parts.

If you've driven 5,000 miles since changing your oil filter, it's probably clogged. Install a new Purolator Micronic† Refill—fast! Costs as little as \$1.60. Takes a few minutes. *More car makers specify Purolator than any other oil filter.*

†©Purolator Products, Inc., Rahway, N. J.; Toronto, Canada.

PurOlator

World's finest **OIL FILTER**

"Remember—there's a Purolator engineered for every make of car," says Mr. Vasey. "We recommend them for all the cars we service."



Start Spare Time Business MAKE UP TO \$10 an HOUR

Do-it-yourself
on own house
THEN EASILY SELL
Neighbors & Friends

You Pay Only
\$6.65*

(buy glass & screen
cloth locally)

You Sell For
\$22.00

You Make
Better Than
100%
PROFIT

*28½"x56" redwood win-
dow. Other sizes and alu-
minum slightly higher.

A Few Dealer
Territories
Still Available

Assemble and Install Buckeye Combination STORM WINDOWS

- Factory-To-You In Knock Down Form
- Easy Assembly
- Redwood or Aluminum

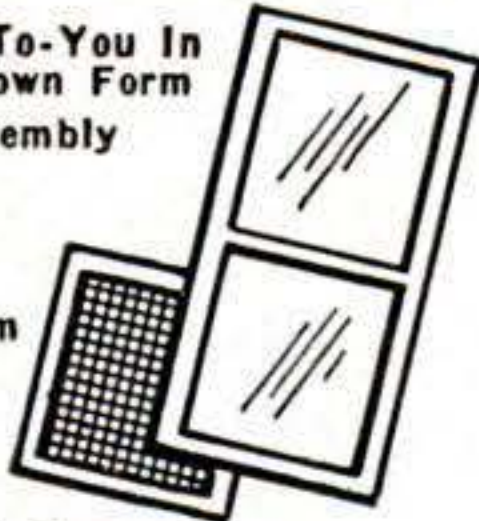

- Glass and Screen Interchangeable
- Each Size Packaged Separately

No get-rich-quick scheme. Sound legitimate business opportunity. No special tools to buy. No big inventory to buy. Order as needed. Thousands sold in past 20 years. Our reputation your guarantee of quality.

Can be FHA Financed
Added to any home for as little as \$5.00 per month. No down payment. See your bank.

WRITE FOR DETAILS TODAY

BUCKEYE SCREEN & WEATHERSTRIP CO.
1378 S. 22nd Street, Columbus, Ohio

NOW—build this practical SWING-UP GARAGE DOOR

at a
major
saving

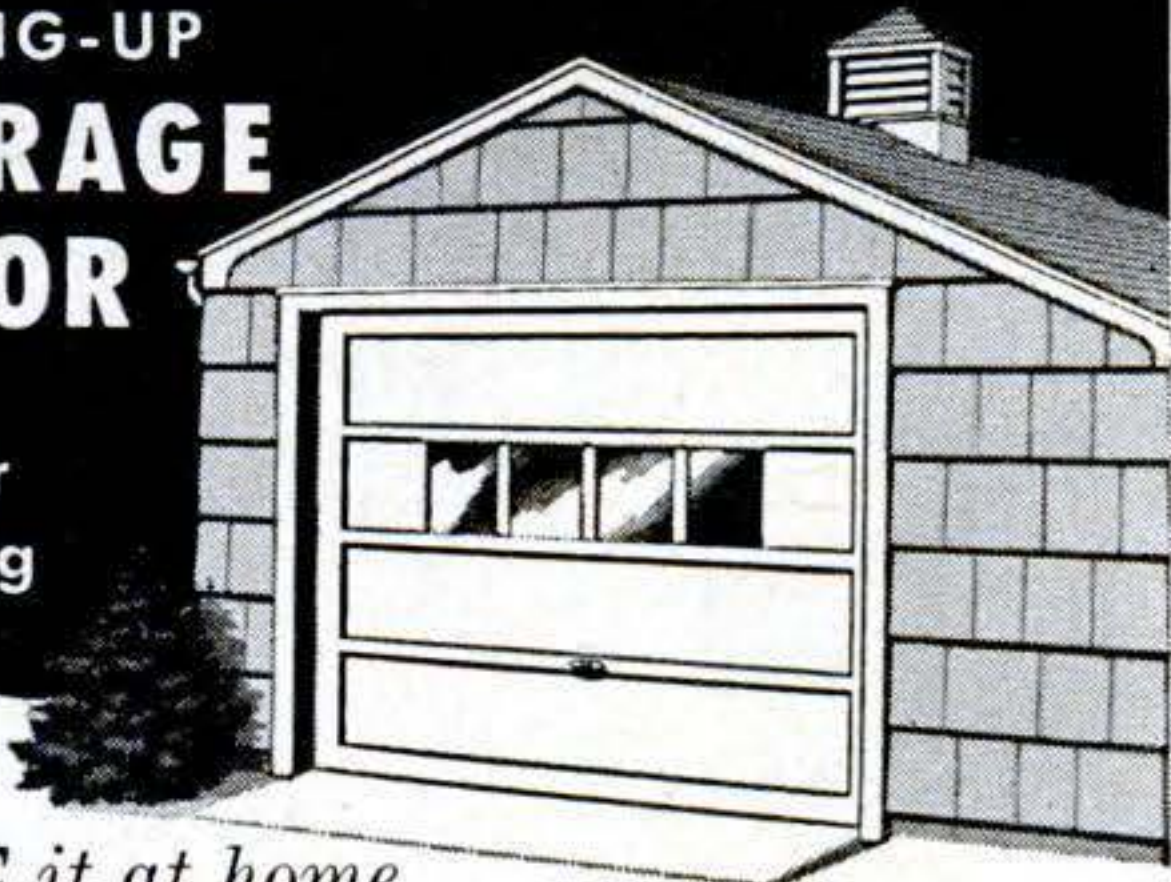

MAKE it at home...
...with **HOMASOTE**

The construction plan for this door is adaptable to openings of many sizes. Light and easy to operate, the door swings up on standard overhead garage door hardware. You build without blueprints! Our Simplified Easi-Bild* Pattern No. 86 shows you how to cut each piece to exact size—specifies all materials required—shows how to assemble and install the finished door.

15/32" Homasote—the oldest and strongest insulating-building board on the market—is the major material used. Weatherproof and permanently crackproof, Homasote saws and nails easier than wood—provides the perfect surface for any paint or stain finish. Homasote is distributed by building materials dealers throughout the United States and in Canada. Send coupon today for pattern and Homasote literature. *T. M. Reg. Easi-Bild Pattern Company

HOMASOTE CO., Dept. 66, Trenton 3, N. J.
I enclose 50¢ for which send me Pattern #86.
NAME.....
ADDRESS.....
CITY.....STATE.....
My lumber dealer is.....

This is "Myth"
—comes in
several colors. →

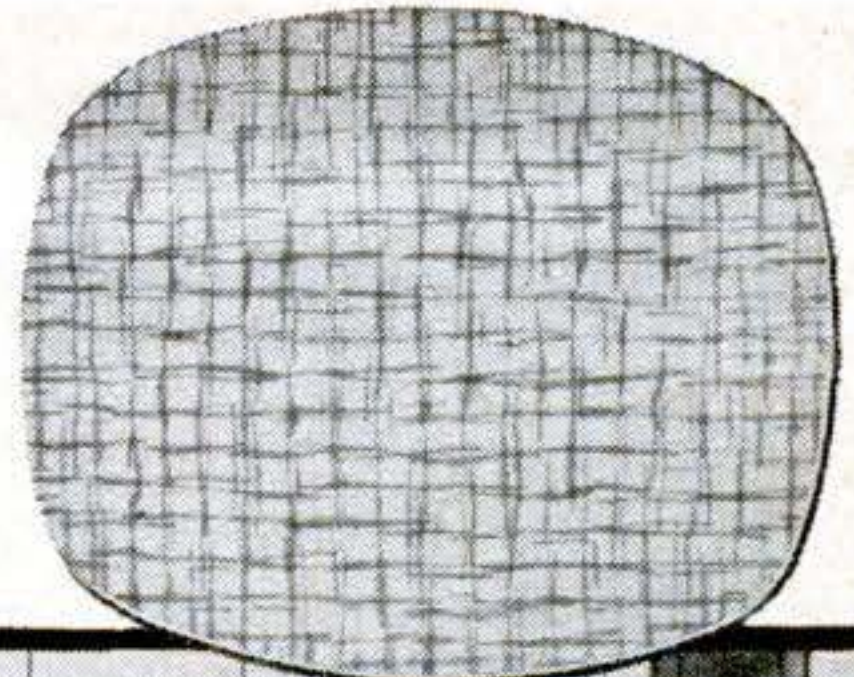

YOU CAN MAKE HER KITCHEN Easier to work in!

Your wife's kitchen is her "workshop." That's where she proudly exhibits her cooking skill. If she could only be rid of the cleaning-up afterwards!

You can put *your* skill to work and reduce her cleaning of work-surfaces to next-to-nothing... by installing St. Regis Panelyte. This smooth, hard surface goes on easily, over the sink, counter and tables.

Your wife will find that it resists all stains from foods, spilled liquids, boiling water, grease.

Patterns are modern, colors lovely. "Easy to Apply" St. Regis Panelyte comes in a special 1/10" thickness you can work with simple hand tools.

See it at your building materials or floor coverings dealer's.



Send for FREE
"Do-It-Yourself"
Booklet

PS-554

St. Regis Paper Company, Panelyte Division
230 Park Avenue, New York 17, N. Y.

Send FREE instruction booklet to:

Name.....

Street.....

City.....Zone.....State.....

**Lighten work
on outside jobs...**



Pointers on painting exterior walls: Make sure surface is dry and temperature between 55° and 90°. Remove loose paint with scraper or wire brush. Fill cracks and holes. Dust thoroughly. Select brush 3" to 5" wide and always...

**Use brushes with bristles of
Du Pont TYNEX nylon**

TRADE-MARK

YOU'LL find "Tynex" nylon bristles pick up a full load of paint every dip and brush it out easily in a uniform coat. Outside or in, brushes bristled with "Tynex" help you get work done fast. "Tynex" bristles simplify brush upkeep, too. They are quickly cleaned by any commercial cleaner and last up to five times longer than other bristles.

Send for free booklet on "How to Choose and Use a Paintbrush Bristled with 'Tynex' Nylon." Write: E. I. du Pont de Nemours & Co. (Inc.), Polychemicals Dept. PM-5, Wilmington, Del.

"Tynex" is the new trade-mark for genuine Du Pont nylon bristles.

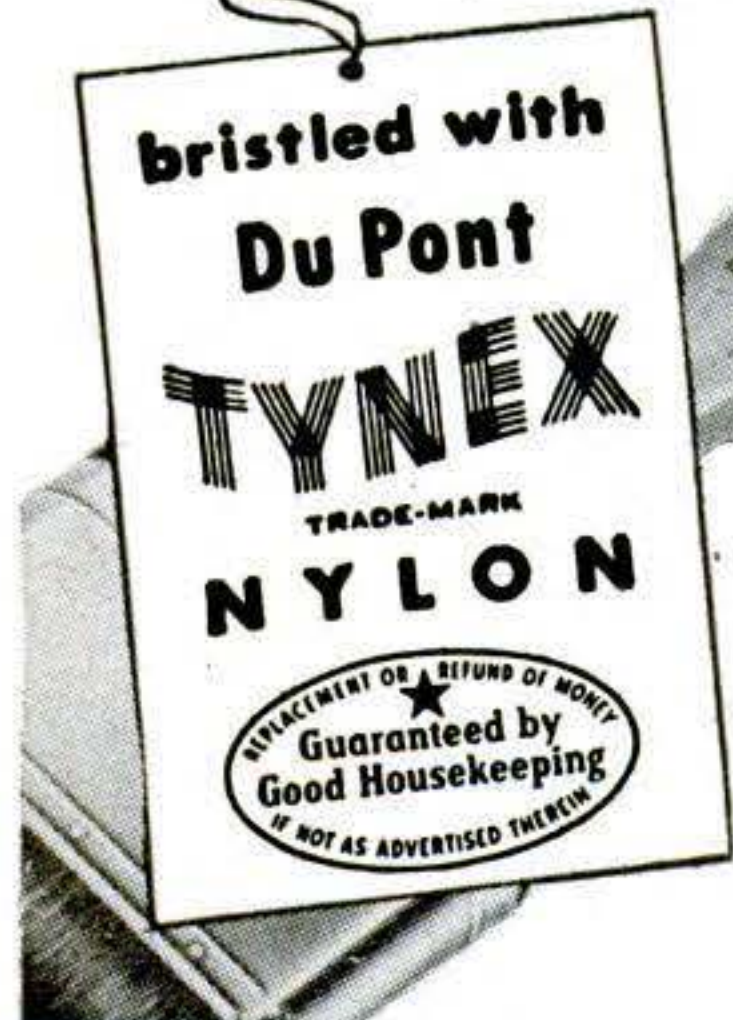

LOOK FOR
"TYNEX"
WHEN YOU
BUY
BRUSHES



Better Things for Better Living
... through Chemistry

DRILL SAW INTERNATIONAL REAM CUT

HI-SPEED COPE SAW DRILL BIT



DRILL. SAW. REAM . . . metal, pipe, wood, plastic, Transite, etc. Use with any electric drill, slow drill press, lathe or milling machine. Drills own starting hole—upper part of bit is used to cut, saw or ream circles, ovals, squares, or scrolls. Easy to operate. Ideal for carpenters, mechanics, electricians, plumbers, hobbyists, many others. Abrasive resistant, high speed steel. Flutes ground from solid. Will withstand severe continuous use without breaking. Resharp-ened at no charge. Takes place of up to \$50 in tools. 1/4" diameter, 2" cutting sections, total length 3 1/2". Available in three types—All Purpose, Wood, Heavy Metal. Specify type needed. Set of 3, \$11.50. Details on request. Shipped same day. Money-back guarantee. Dealer inquiries invited. **ORDER NOW! SEND CASH, CHECK OR MONEY ORDER.**

Manufactured and distributed by
INTERNATIONAL TWIST DRILL CORP
618 Wyandotte, Rm. 695, Kansas City 5, Mo.

only \$3.95 POST PAID

NEW!

OIL MIST SPRAY!

3-IN-ONE's Oil-Spra protects tools with fine mist of oil! Press button for penetrating oil spray! It's so easy to use!



"3-IN-ONE" OIL

DO MORE PLANING JOBS WITH LOW COST BELSAW

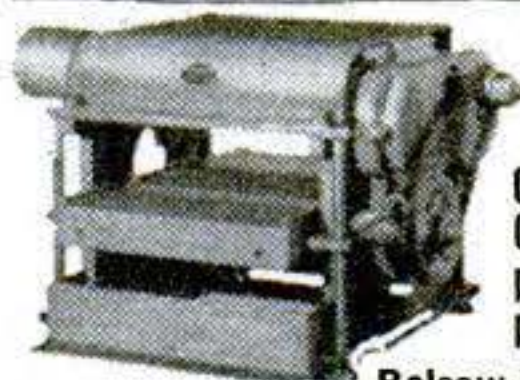

Exclusive **MONEY-MAKING** Features: • Full 12 3/4" x 6" capacity • Power feeds at 24" a minute • Provides for Grinding Knives in the Cutterhead • Attachments for Jointing, Rabbeting, Tongue, Groove, Matching. Convert low cost rough lumber into high priced cabinet finished stock. . . Easy to make flooring and popular patterns. Send today for free literature and prices.

Belsaw Machinery Co., 1024 Field Bldg., Kansas City 11, Mo

LOW DOWN
PAYMENT
EASY
TERMS

CUT COSTS with ALLEN Punch Press

1-Ton Power Bench Type
Powerful, Dependable, Economical

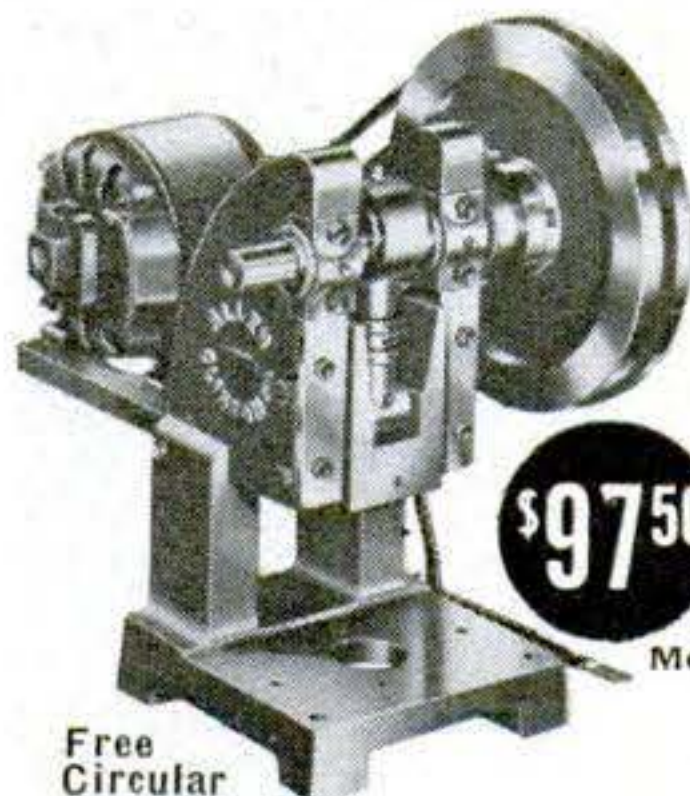

\$97.50

For light work—stamping, forming, riveting, etc.—Metal, fiber or other material.

Overall height 17 1/2" Base size 8 1/2" x 8 1/2" Die bed 5 1/2" x 8 1/2" Ram face 1 1/2" x 3 1/2" Ram stroke 3/4" Positive 3/4" ram adjustment Sturdy, single pin, non-repeat hand lever clutch. V-belt drive. Weight 105 lbs. Requires only 1/4 to 1/2 H.P. Motor.

The machine of a thousand uses! Adequate for many types of work now done on larger presses at greater expense.

Less Motor
30-Day Money-Back Guarantee
Order TODAY. Price \$97.50 F.O.B., Clinton, Mo. (Includes Motor bracket, V-belt, Motor pulley, less motor.)

ALVA F. ALLEN Dept. PS CLINTON, MO.

BRAND NEW

WAR SURPLUS ~ BUY NOW

SHOP by MAIL and SAVE

D. C. GENERATORS

ITEM #176—Type L-3, Rated 25 amps, 24 volts. Manufactured by Leece-Neville Co. Shpg. wt. 30 lbs. Dimensions 12"x6 1/2" x 5 1/2". F.O.B. Chicago **16.50**

ITEM #90—Type P-1, rated 200 Amps.—28 Volts, 2500 RPM. Mfd. by General Electric, Ford, Delco-Remy and Westinghouse. Gov't. Acq. Cost \$300.00. Shpg. wt. 55 lbs. Dimensions 15"x9"x6" F.O.B. Chicago **22.50**

SELF-PRIMING HAND FLUID PUMP WITH STRAINER

ITEM #129—Type D-2—May be used as a boat balling pump, sump pump, barrel pump, fuel transfer pump, for water, oil, gasoline, insecticides, etc. Bronze and aluminum construction. 1/2 in. pipe thread ports. Fine general utility hand pump. Capacity—200 Gal. per hour. Ship. wt. 6 lbs. F.O.B. Chicago **11.95**

BRAND NEW DOUBLE ACTION HYDRAULIC CYLINDERS

ITEM #355 — 2 1/2" bore — 7 1/2" stroke. Mfgd. by Delco-Remy. Clevis mounting. 3/8" pipe thread ports. Will lift 3000 lbs. F.O.B. Chicago **16.00**

ITEM #16-C—1 1/2" bore, 26" stroke. Will lift 1760 lbs. with 1000 lbs. pump pressure. Great for hay loaders, etc. 1" stainless steel piston rod. Postpaid **16.95**

FREE SUMMER EDITION

1954 CATALOG, 52 PAGES, chuck-full of unsurpassed War Surplus Equipment Bargains for farm, home, factory and workshop. Write letter today.

ITEM #371V



SAVE \$30.30 ON THIS Brand New—Pesco HYDRAULIC CONTROL VALVE FOR SAFE, POSITIVE CONTROL OF HYDRAULIC CYLINDERS AND MOTORS—● BUILT-IN RELIEF VALVE—factory set at 1200 P.S.I. ● FOUR-WAY VALVE—to operate one double acting cylinder ● OPEN CENTER—with valve in neutral, cylinder is locked in position and pump is unloaded. ● SPRING RETURN TO NEUTRAL ● FULLY BALANCED PLUNGER ● EASILY STACKED INTO 2, 3, or 4 valve combinations for multiple cylinder operation. ● 8 gal. per min. capacity, at 1500 P.S.I.—3/8" pipe ports. ● CONNECT PUSH RODS TO HANDLE FOR REMOTE CONTROL. ● EASY MOUNTING ● LIST PRICE—\$46.80. ● YOU SAVE \$30.30. ● DIMENSIONS—9"x4 1/2"x2 1/2"—Shpg. Wt.—8 lbs. F.O.B. Chicago **16.50**

VERSATILE

HYDRAULIC CYLINDER **ITEM #41C1C** ● 2" Bore ● 6" Stroke ● Double Acting ● All Steel ● 3/8" Pipe thread ports. Lift capacity 3100 lbs. with 1,000 P.S.I. line pressure. Ship. wt. 12 lbs. Price ea. **12.50** F.O.B. Chicago



ITEM #301



TINY TIM BATTERY CHARGER

Item #301—Model 125 to charge 6 and 12 volt batteries—12 volts—300 Watts; Heavy Duty Generator; Push button self-starter; Sturdy single cylinder air cooled Continental 1.3 H.P. engine; 2 qt. gasoline tank in base; Ammeter; Generator cut-out; Concealed coil, etc.; Speed and charging rate control; Attractive orange finish; Weight 93 lbs.; Length 15 1/2", Width 11 3/4", Height 14 3/4". F.O.B. Chicago **89.00**

BRAND NEW AUTO-LITE 6-VOLT STARTERS & GENERATORS

Convert your hand crank-start gasoline engines, to easy electric starting for very low cost.

ITEM #304 — AUTO-LITE 6-VOLT—Starter P/N-MZ 4101. Dimensions: 11 1/2" x 4 1/2". Ship. Wt. 20 lbs. Each, F.O.B. Chicago **9.95**

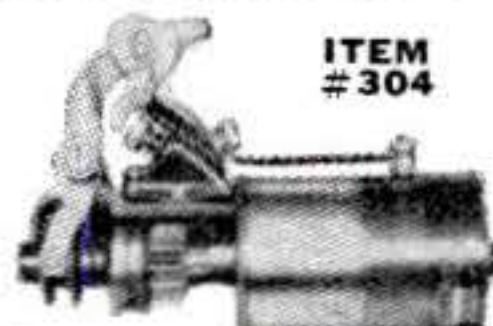

ITEM #305—AUTO-LITE 6-VOLT—Generator 20 Amp.—P/N-GBM 4619.5. Dimensions: 9" x 5". Shipping weight 20 pounds. Each, F.O.B. Chicago **9.95**

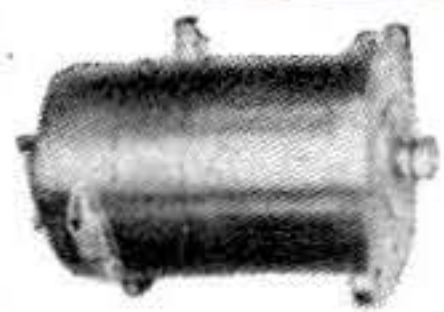

Special Price for Pair.....19.00

PESCO GEAR TYPE HYDRAULIC PUMP



Compact—Powerful—Reliable
ITEM #160—Especially designed for belt drive from fan belt, power take-off, drive pulley, electric motor or small gas engine. Equally suitable for direct coupling. Pedestal type mounting with two bolt holes for 3/8" hold-down bolts. Standard 1/2" pipe thread inlet and outlet ports. Delivers 4.5 GPM at 1000 PSI at 2800 RPM with 3 HP. Will actuate one item #224, 3 1/4" bore, 24" stroke cylinder in 10 seconds. Hardened steel gears turn in dense oilite bronze bearings. Rotation—clockwise facing shaft. Guaranteed trouble-free service. Ship. wt. 6 lbs. F.O.B. Chicago **22.50**

BRAND NEW—GEAR TYPE ALL MANGANESE BRONZE INSECTICIDE PUMP

ITEM #50 — For spraying D. D. T., 2-4D, sulphur compounds, etc. Pressures up to 200 lbs. and 14 gallons per minute—at 1200 R.P.M. Will not rust, pit, foul or freeze up. Use hose or tubing and pipe connection. Weight 15 lbs. Standard 3/4" manganese bronze shaft with keyway. U.S. Gov't. Acquisition Cost \$62.00. NOW ONLY F.O.B. Chicago **15.00**

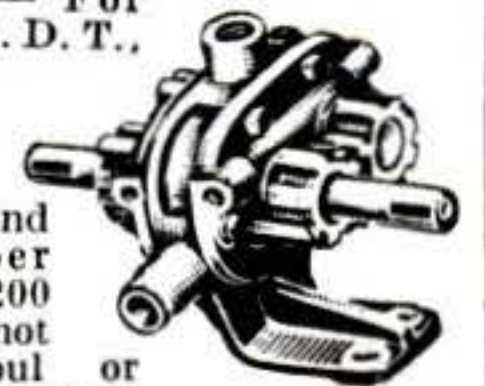

Shatterproof AIR TANK
ITEM #303—use for air compressors, surge tanks, CO-2 tanks, liquid containers, floats, buoys, 24" long—4" diameter—1/2" pipe thread port. Ship. Wt. 10 lbs. F.O.B. Chicago **2.50**

ORDER DIRECT FROM AD SATISFACTION GUARANTEED SEND PAYMENT OR PURCHASE ORDER TODAY
TO PLACE PHONE ORDERS CALL WEBster 9-3793

GROBAN SUPPLY CO. Dept. PS-5
1139 S. WABASH AVE., CHICAGO 5, ILL.

KLEAN-STRIP

"Peels Off Paint"

Heavy-Bodied Klean-Strip also available
The Klean-Strip Co., Inc., Memphis 6, Tenn.

Also Eshelman SPORT CARS WORLD'S LOWEST PRICE 70 Miles Per Gal. Holds 1 Adult. Free Literature



ESHELMAN ROTARY TILLER

ONLY \$99.95 Turns virgin ground into a garden bed in one operation. Replaces plowing, discing, and cultivating. Women can operate it. Also 1 to 8 H.P. POWER MOWERS & RIDING TRACTORS from \$69. Free Catalog. Write: **ESHELMAN CO., Dept. T-45** 119 Light St., Balto. 2, Md., 333 N. Michigan Ave., Chicago 1, Ill. 7070 Hollywood Blvd., Los Angeles 28, Cal.

WISE-GRIP SERVES AS COMPLETE TOOL KIT FOR TEEN-AGE MOTOR SCOOTER OWNER!



WISE-GRIP WRENCH

DOES MORE JOBS EASIER THAN ANY OTHER TOOL!

True stories like this show why Vise-Grip is the **HANDIEST** tool of all! A squeeze of the hand locks these powerful jaws onto work with *Ton-Grip*. Pulls, bends, turns, twists, ratchets, cuts—**WON'T SLIP**. A whole tool kit in one trim tool! At your dealer.

7W, 7" \$2.25
10W, 10" 2.60

Made only by **PETERSEN MFG. CO., DEPT. P-5 DE WITT, NEBR.**

"All my repairs—and there are lots of them—are done with my Vise-Grip. I've even filed the lever tip to use as a screwdriver! At high school I stow my Vise-Grip in my pocket, carry it with me all day for safe keeping. Without it, I couldn't keep my scooter running. What an all-around 'tool kit' it is!" — M. C.

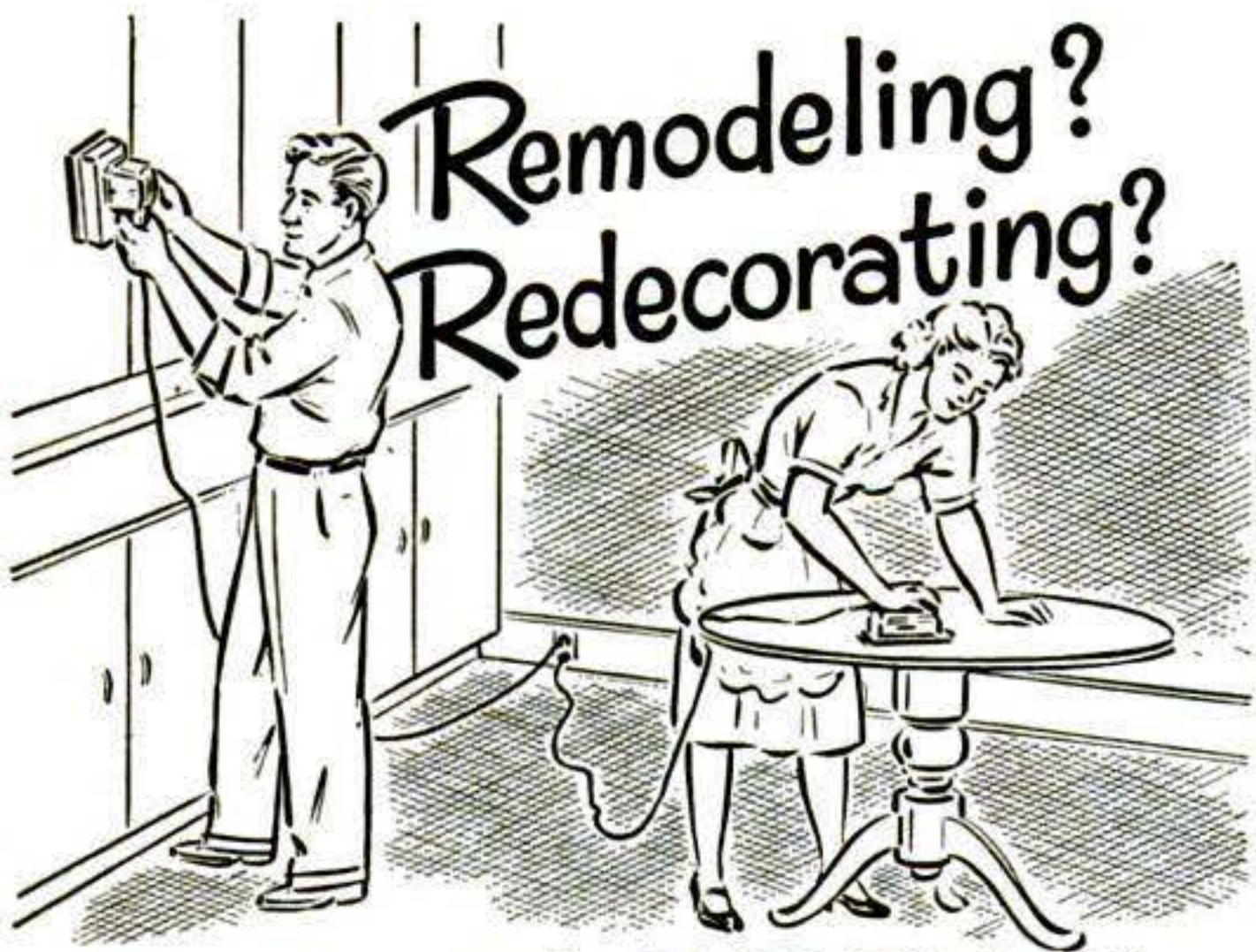

Remodeling? Redecorating?

Do it with DREMEL Straight-Line Action Sanders

For the finest finish sanding, take a tip from the professional craftsmen—insist on Dremel *Straight-Line Action Sanders*. They save you money when you buy them. They save time, labor, and expense when you use them. And they're guaranteed to produce finer finishes because straight-line action sands with-the-grain—prevents cross-grain scratches and orbital swirls. Hobbyist, jack-of-all-work, or professional—there's a Dremel Sander for your needs.

Of the four common sanding actions, only Dremel sands 100% *with-the-grain* — the only guaranteed scratch-free action approved by finishing experts.

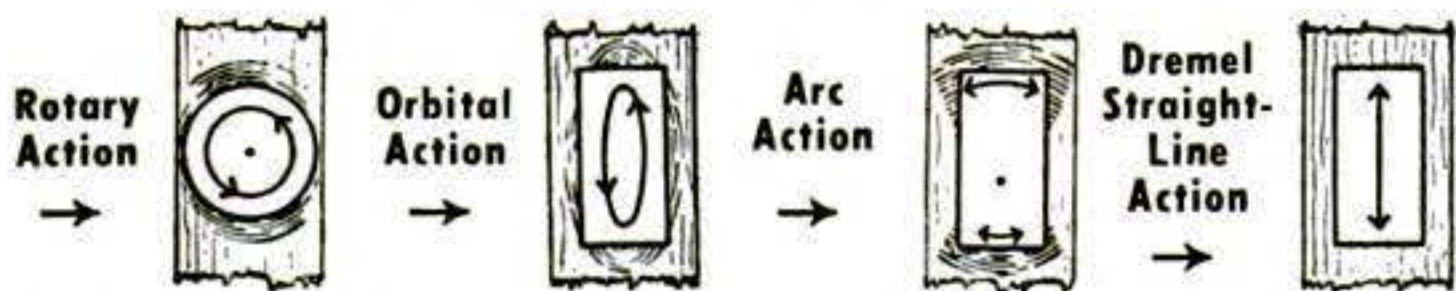

NEW MODEL "53"

This new sander is a real powerhouse, a professional tool at a handyman's price. The first **ROTARY MOTOR (AC)** sander of its kind to have straight line action. Weighs only 5¼ lbs., has 24 sq. in. sanding pad. Out-performs other makes selling for twice as much. Positively the best heavy-duty sander buy on the market. Complete with 2 detachable sanding pads. . . . **\$34.85**

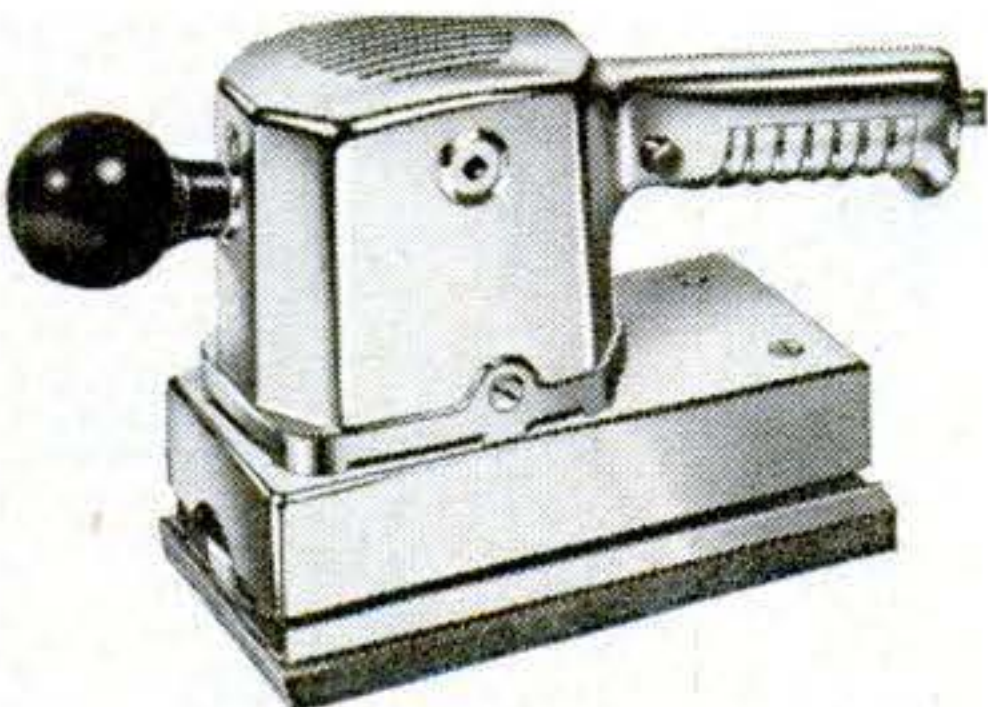

Model "2000" Sander-Polisher

Perfect for small shop, home use. Features Dremel "Straight-Line Action"; high speed reciprocating motor; 14,400 strokes per min.; wt. 5 lb.; 21 sq. in. sanding surface.

Price includes: Sturdy, steel carrying case, Model "2000" Sander-Polisher, 1 polish pad, 25 asst'd abrasives. . . . **\$24.50**

Model "A" Sander-Polisher-Massager

Three tools in one! Lighter capacity for general-purpose use. Features "Straight-Line Action"; high speed reciprocating motor; Wt. 2½ lbs.; 12 sq. in. sanding surface. Complete with 1 polish pad, 1 massage pad, 6 abrasives. . . . **\$14.85**



SEE YOUR DEALER: If he cannot supply, order direct on 5-day trial, money-back guarantee. Remit in full for postpd. shipment; or send \$2. pay postman balance plus postage and COD.

DREMEL MFG. CO., Dept. 124-E, Racine, Wis.



FOR SMOOTHER PAINTING

USE THE FINEST BRUSH

FREE BOOK — "How to Do a Good Paint Job." Send card (and name of your retailer, if you wish) to Baker Brush Co., Inc., 83 Grand St., New York City 13

Brushes by Baker

AMERICA'S FINEST PAINTING TOOLS



AMAZING, PERMANENT MAGNETS—WILL NOT WEAKEN! NON-ELECTRIC Retrieve guns, tackle, tools and other steel items from lake, river, plating tanks, drains or other hard-to-reach spots. Recover drills, taps, etc. from sweepings. Clear alley of harmful tacks, nails. Many other uses. Pays for itself quickly. **GUARANTEED.** Try any magnet one week. Money refunded if you are not well pleased.

No. S-725 (Weighs 54 oz.) Has pull of 225 lbs. on steel block **\$15.00**
 No. S-675 (Weighs 49 oz.) Has pull of 175 lbs. on steel block **\$10.50**
 No. S-650 (Weighs 41 oz.) Has pull of 150 lbs. on steel block **\$ 8.50**
 No. S-500 (Weighs 15 oz.) Has pull of 50 lbs. on steel block **\$ 4.00**
 No. S-30 Hobbyist assortment of six small magnets. . . . **\$ 1.50**

Send Money Order or check. We pay postage. No C.O.D.'s.
MIAMI MAGNET COMPANY, 3240 N.W. 27th Ave., Miami 42, Fla.

POCKET PISTOL

**LIFELIKE—SHOOTS BLANKS
NO POLICE PERMIT NEEDED**

Looks like regular quality pocket pistol. Precision machined of regular gun steel to close tolerances by German gunsmiths. Has six shot magazine, automatic cartridge ejector and full safety catch. Ideal for home protection, sporting events, theatrical performances, dog training, etc. 3½" long. Weighs 9½ oz. **10 DAY NO RISK TRIAL.** If dissatisfied return for refund. C.O.D.'s require \$2.00 deposit.



\$7.95
Ppd.

UNITED ARMS, 9043 S. Western, Dept. BP-101, Chicago 20

Stop Wasting Gas!

If your car, truck or tractor is a "gas hog"
Try a **TUR-B-LIZER** 30 days at **NO RISK**

See why users report up to 6 miles more per gallon. See why carburetor experts call the **TUR-B-LIZER** the best improvement they've seen for trapping raw gasoline your carburetor fails to vaporize. Only \$3.00 for 6-cyl. single manifold **TUR-B-LIZER**, \$4.50 for 8 cyl. or double manifold and easy to install, try it! Money back promptly if not satisfied. Send check or M.O. to—
UNIVERSAL SALES 625 E. State St., Milwaukee, Wis.

Salesmen write for Big Deal

Carpenters' NAILPULLER Pocket size!

Powerful, Easy to Use, Handy as a Hammer!

Satisfaction guaranteed up to tenpenny nails.

POSTPAID U.S. ONLY

\$1.74

No C.O.D. No Stamps.



Only 12" long.

Carpenters' favorite. Convenient in tight places, carries in pocket. Tool steel counteracting jaws driven into wood under nailhead. Double leverage with hammer. All steel, rustproofed.
K-D Mfg. Co., N. Plum St., Lancaster, Pa.

MEMO
Clean the carburetor with GUMOUT and KIT...

Eliminate hard starting, rough idling, stalling, bucking and high gas consumption caused by a dirty, gummed up carburetor.

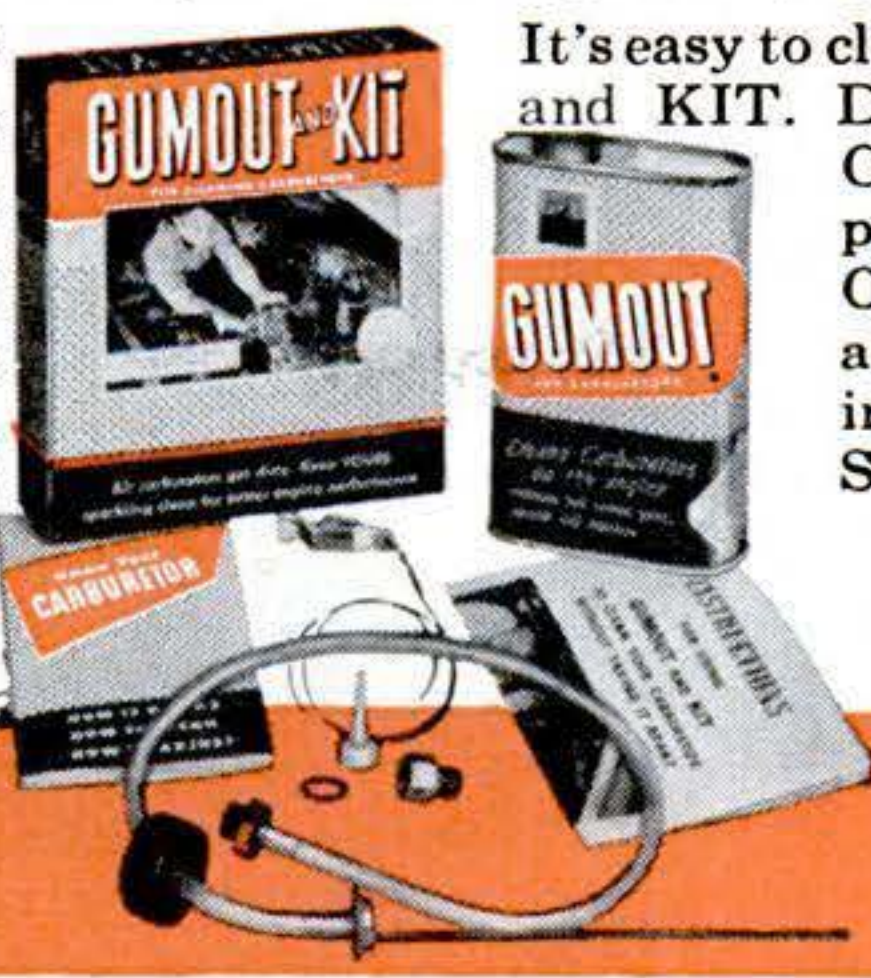

It's easy to clean the carburetor on your car with GUMOUT and KIT. Do it yourself—WITHOUT TAKING THE CARBURETOR OFF THE ENGINE. Engine performance will improve immediately. GUMOUT and KIT includes a pint of GUMOUT and a life-time service kit to feed quick-cleaning GUMOUT directly into the carburetor. Sold by leading AUTO SUPPLY STORES. If local dealer can't supply you, order direct. GUMOUT and KIT, complete, \$3.95 post-paid. GUMOUT refills, \$1.50 per pint can.

GUMOUT DIVISION
 Pennsylvania Refining Company
 2670 Lisbon Road, Cleveland 4, Ohio

GET THE Facts, MAN!
 SEND FOR THE STORY OF THE FINEST SICKLE-BAR MADE



GEORGE
 SELF-PROPELLED
 38" SICKLE BAR
 MOWER
 ONLY \$189⁵⁰ F.O.B.
 ALL BALL BEARING DRIVE
 2 Clutches
 Floating Head

WRITE FOR ILLUSTRATED BROCHURE
 Dept. A GEORGE GARDEN TOOLS • SULLIVAN, ILL.

THIS ONE ALL-PURPOSE HOUSEHOLD CEMENT
 "BONDS ANYTHING TO ANYTHING"



Pliobond
 Amazing quick-setting plastic adhesive makes you an expert "Mr. Fixit". Mends leather, metal, wood, glass, rubber, china, fabric, plaster, paper, plastic. Easy to use. Makes strong permanent flexible bond that won't get brittle. Waterproof. Resists oil, chemicals, etc. Bottle 25c. Handy tube 35c.
 * T.M. Reg. The Goodyear T. & R. Co.
 W. J. RUSCOE CO., AKRON 13, OHIO
 AT DIME AND HARDWARE STORES EVERYWHERE

\$6⁹⁵
DRAINS cellars, cisterns, wash tubs;
IRRIGATES - CIRCULATES - SPRAYS



1,001 USES—HOUSE, GARDEN, FARM
 Original All-Purpose Pump has 2400 GPH capacity. 360 GPH 75' high; or 1500 GPH from 25' well. Use any 1/8 to 3/4 HP motor. Stainless steel shaft. Oil-less bearing. 1" inlet; 3/4" outlet. Motor coupling included.
DOES NOT CLOG OR RUST
 Postpaid if cash with order. (West of Miss. add 50c.) **MONEY BACK GUARANTEE.** Larger Centrifugal Pumps, and Gear Pumps in all sizes.
LABAWCO PUMPS, Belle Mead 3, N. J.

WELD IT YOURSELF!
IN A JIFFY!

Weld, Cut, Braze, Solder IRON, STEEL, BRONZE, BRASS, ALUMINUM & OTHER METALS

Tool and Equipment breakdowns are always annoying and costly. Don't let them bother you. Get a Dynamic Arc Welder. You can do expert work on your very first job. Welders operate from any properly wired 110 V. AC line. Also make your own wrought iron furniture, railings, fences & knick-knacks. Repair fenders, & bodies etc. with the handiest "tool" in your workshop. A Dynamic will pay for its low cost of \$38.50 F.O.B. in both time and money.

DYNAMIC INDUSTRIAL type transformer Arc Welder 75 amp. output for Industrial or Workshop use.

DYNAMIC WELDER CO.
 Dept. D3-E, 1808 S. Federal St. Chicago 16, Ill.

EASY PAY PLAN
 Low down payment. Pay as you weld. Sold on money-back guarantee. Send for details. Complete outfit only
\$38.50
 f.o.b. factory



Free Details and "How to Weld"

POWER BRAKES
 for the car you're driving now!

BUILT AND BACKED BY

Bendix
 AVIATION CORPORATION

WORLD'S LEADING MANUFACTURER OF POWER BRAKES

Available wherever cars are serviced

For Informative Story
 Write for Free Booklet
 "Why Buy Power Brakes"

Address Dept. P
BENDIX PRODUCTS DIVISION
 SOUTH BEND 20, INDIANA

Copyrighted material

Now . . . special low price
IRWIN JIFFY-JOB

auger bit sets

only **\$3.29** 4-bit set

most-used sizes for handyman,
hobbyist, teen-age
woodworkers

Now being featured by thousands of independent hardware dealers. And specially-priced at \$3.29 to make a practical set of 4 Irwin Auger Bits easier than ever to own. Or choose a 6 bit Irwin Jiffy-Job set at only \$4.98, if you wish. Both bring you Irwin's first quality wood-boring tools—America's finest! Bits are held in place by patented spring clips and metal storage panel. And the entire unit is removable for permanent use in home workshop, garage, or wherever you choose.

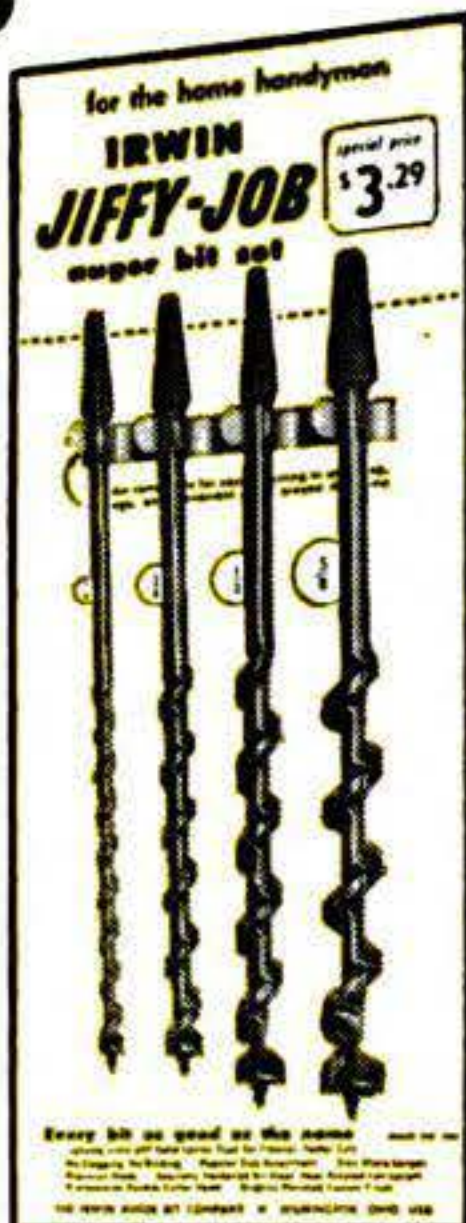

Ask to see Irwin's Jiffy-Job auger bit sets the next time you shop your independent hardware dealer. We suggest that their special price makes them worth a special trip. Either the 4 or 6 bit set will prove a practical investment—whether for your own use, or as a gift. The Irwin Auger Bit Company, at Wilmington, Ohio, since 1885.

IRWIN

the original solid
center auger bit
•
screw drivers
screw driver bits



**Government Surplus
DUPONT NYLON CORDS**

Below Manufacturer's Cost!

Light, strong, durable, quick-drying. Will not rot or mildew. Ideal for indoor or outdoor use. Camping, boating, hunting, clothes-line and venetian blinds. Perfect for tent ropes, light anchors, deer cord, trot lines, crabbing, etc.

OUTWEARS ORDINARY ROPE 10 to 1!

BRAIDED CORD—550 lb. test. White or olive drab, 3/16" dia. 30 & 50 ft. lengths.....**2c** per foot

BRAIDED LINE—1000 lb. test. Olive drab, 1/4" dia. 20, 30, 50, 100 ft. lengths.....**2 1/2c** per foot

NYLON ROPE—225 lb. test. Olive drab, 3 strand, 3/32" dia. 50, 100, 200, 300, 400, 500 ft. hanks....**1c** per foot
Olive drab—3400 lb. test, 7/16" dia. Any length from 20 to 120 ft.....**16c** per foot

NYLON WEB STRAPS with steel buckle. Perfect for luggage straps, car tow-lines, car carrier straps, boat trailer straps.

1" wide—3000 lb. test.....**10c** per foot
1 3/4" wide—6000 lb. test.....**16c** per foot
in 5, 6, 8, 10, 12 ft. lengths

NYLON FISH LINES—25 lb. test. Heat stretched, rubberized, treated. Will not kink, twist, unravel. 300 ft., reg. \$1.....**NOW 50c** per spool

Minimum Order \$1. No C.O.D. Send Check or Money Order **MONEY BACK GUARANTEED**

Illustrated catalog with hundreds of items—**25c**

SCOTT-MITCHELL HOUSE, INC.

Dept. NY-8 611 Broadway, N.Y. 12, N.Y.

5 BIG POWER TOOLS

in ONE

RETAIL PRICE \$125.00
FACTORY TO YOU \$79.95

SUPERSHOP is a PRECISION-BUILT WORKSHOP. 100% ball bearing. All running parts precision ground. Big capacity. Extra rugged. Amazing value. Write for FREE catalog.

BUY ON EASY PAYMENTS

POWER TOOLS, INC. 259 YATES AVENUE, BELOIT, WISCONSIN



ELECTRIC WELDER

AC or DC
110 Volts

The "Little Marvel" all-metal welder. 5-year written guarantee. Welds 1/8" metal or money back. Repairs tanks, tools, fenders, machine parts etc. Complete with everything—rods, unit, eye shield, directions. \$6.45 plus 50c postage. Flame torch accessory for soldering, cutting, brazing \$3.95 complete with carbons, brass rods, flux. Sorry, no C.O.D. Buy direct and save.

ESSAY MFG. CO., Dept. 47, Quincy 69, Mass.

\$6.45 Complete

**SPECIAL OFFER—Only 10¢
50-Page "Tools and Rules" Book**

"The Tools and Rules for Precision Measuring" tells how to make accuracy a habit, shows the methods skilled mechanics use. 100 pictures plus reference tables. Send only one dime. Address Dept. PS.



Only 10¢

THE L. S. STARRETT CO. • ATHOL, MASS., U. S. A.

MORE For Your Money in a SHAW DU-ALL



Low Prices
Walking Tractors \$99.50 up
Riding Tractors \$298.50 up

Improved design, better value in 1 1/2, 2 1/2, 3, 5 H.P. walking tractors. New, low cost, streamlined 2 1/2, 5, 8 H.P. riding tractor. Inexpensive, new 1 1/2 H.P. tiller that pulverizes up to 12 inch swath 6 inches deep, and less. Automotive gears on heavier models. Prices will please you. **FREE CATALOG.** Write today.

SHAW MFG. CO. 5705 Front St., Galesburg, Kans. 66885 N. 4th St., Columbus, Ohio

SOLDERING Simplified

with this revolutionary gun-type iron

HEAVIEST DUTY—Lightest Weight



The streamlined PHILLIPS Flash will do the work of several ordinary type irons—faster, easier, more economically. Instant heating, high or low heat as desired, by control of your "trigger finger". Hot only when actually soldering. Non-tiring, protected gun grip and perfect balance for easy, steady application. Unexcelled for work in close places. Operates from standard storage battery or plug-in with 110-volt transformer. **AT YOUR DEALER or \$2.85 Post-paid.** With HD Transformer \$6.95—Remit with order.

PHILLIPS MANUFACTURING CO., 2816 Aldrich Av. S., Minneapolis 8, Minn.

NEW! Every Electric Drill A Powerful PORTABLE JIG SAW

"ARCO JIG-SAW"
HAS SAME CAPACITY,
CUTS AS FAST AS SAWS
COSTING \$50 & UP!
Does work of Jig,
Keyhole, Coping,
Band, Rip, Crosscut,
Hacksaw.
HAS EXCLUSIVE, BUILT-
IN AIR BLOWER.



At
Better
Hardware
Stores
Everywhere

No. 500
"ARCO JIG-SAW"
\$10.95
complete with blade

Here for the first time is a Portable Jig Saw that attaches in ONE MINUTE to any 1/4" electric drill. It will handle any project from the smallest to the largest, cuts openings without a starting hole. Cuts intricate patterns, circles, etc., in wood, wallboard, plastics, metals.
"ARCO JIG SAW" is a powerful, lightweight tool that is easy to handle because of its Right Angle Drive. Strong Safety-Yoke & Worm Drive Clamp make it a vibration-free unit.

No. 505—Six extra Blades for wood, metals, etc.....\$1.95
BUY THE BEST—see your hardware dealer now! If not available, try "ARCO JIG-SAW" on our 10-DAY MONEY BACK GUARANTEE. Send us check or M.O. (Postpaid). C.O.D.'s—postage extra.

ARROW METAL PRODUCTS CO.

Dept. PS-5, 140 WEST BROADWAY, NEW YORK 13, N.Y.

WOODCRAFTSMEN'S

144 PAGE

ENCYCLOPEDIA

15¢

Bargain book of every conceivable woodworking item and tools. Full of How-To-Do-It information, illustrations, projects and ideas. Domestic and imported woods, panels, matched plywoods, veneers. Multicolored inlay bandings, natural color inlays and overlays. Embossed and picture frames, mouldings, carved ornaments, hundreds of scroll saw patterns. Send for your copy today, the biggest 15c worth ever offered.

CRAFTSMAN WOOD SERVICE CO.
Dept. B-5, 2729 S. Mary Street, Chicago 8, Illinois

PUMP WATER FAST!

DRAIN WASH TUBS, CELLARS, CISTERNS
IRRIGATE—FILL TANKS—DRAW WELL WATER

Pumps 2800 GPH. 420 GPH at 75' High or 1600 GPH from 25' well. Sturdy, Rustproof Alloy Metal. Six Blade Impeller. Uses any 1/8 to 1/2 H P Motor Will not leak or clog Fits any garden hose. Immediate Money Back Guarantee. Send Check, M.O. or C.O.D. **895** IN U.S.

MOORE MANUFACTURING CO.
SWEDESBORO 2 NEW JERSEY

FILE SAWS FOR PROFIT!

BeMaCo RAPID SAW FILER

MAKES SAW FILING EASY.

Opens the door to extra profits. A power driven filer that takes the work out of saw filing. Anyone can operate it. Gives full control to the operator. Priced Right. Write for literature today!

BeMaCo Automatic Saw Set—

Uniformly sets 400 teeth per minute on hand or band saws. Perfect hammer and anvil action. Acclaimed by saw shops across the country.

BEAVER MFG. CO.

Saw Machine Div. 10-5

800 SO. ISIS AVENUE

INGLEWOOD, CALIF.



START
EARNING
TODAY!

WANT BETTER PAINT JOBS?

Use *Pol-mer-ik*
LINSEED OIL



• For years Archer Pol-mer-ik has been the linseed oil chosen by more professional painters than any other for paint reducing and brush conditioning. Pol-mer-ik has been *super-treated* by a special polymerization process which reshuffles the oil molecules so they are interlocked. This gives you a tougher, more durable paint film than ordinary linseed oil. When you reduce your paints with Pol-mer-ik, they brush out easier, level out better, have a smoother, more dirt-resistant surface, and give you a longer-lasting job! Next time you paint, use Archer Pol-mer-ik Linseed Oil. You'll get better results!



BRUSHES OUT
BETTER



TOUGHER
SURFACE



BETTER GLOSS

ARCHER

Pol-mer-ik
LINSEED OIL

PROTECTS MOST ANYTHING



A few of the
101
HANDY USES:

- Preserves tools and handles.
- Refinishes antiques.
- For natural wood finishes.
- Softens stiff putty.

Yes, Archer Pol-mer-ik is a real Handy-Andy helper that saves you time and money by doing the job of a dozen specialized products. The handiest single product in your home!

FREE! 101 Money-Saving Ideas!



Get your copy today. Shortcuts and pointers from the "pro's" based on practical experience. Free! No obligation—just drop us a card today.
ARCHER-DANIELS-MIDLAND CO.,
604 Roanoke Building, Minneapolis, Minnesota

It's easy! DO IT YOURSELF WITH TEENUTS

STEEL THREADS IN WOOD



GARDEN FURNITURE



BATTEN DOORS

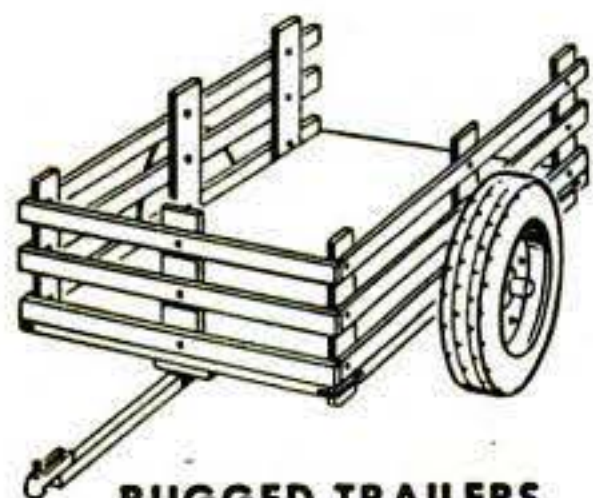

RUGGED TRAILERS



DE-MOUNTABLE
SCREENS AND WINDOWS

TEENUTS fasten anything that's bolted . . . provide flush mounting without counter-boring. Excellent for new work or repairs. Ideal for wood to metal applications and where old screw holes have become useless. Simply drill hole size of TEENUT barrel, hammer home TEENUT and its steel prongs provide rigid, permanent anchorage. Same size hole for bolt. Sizes to fit these standard bolts: 6-32, 8-32, 10-24, 10-32 (4 per card), 1/4-20 (3 per card), 5/16-18, 3/8-16 (2 per card).

AT HARDWARE

COUNTERS EVERYWHERE

15¢ per card



THE **DOT** LINE

3229 South Ashland Ave., Chicago 8, Illinois

282 POPULAR SCIENCE

A third hand
for painters!

WHIZZER
Can and Brush
Holder



NO MORE PAINT DRIP!

Smooth, durable plastic pistol grip, spring steel band holds all quart cans firmly. Brush clip eliminates drips, messy brush handles, smeared hands. Carry paint and brush easily, safely, comfortably, even while climbing ladders. Guaranteed.

If dealer can't supply you, order direct. **\$1.00**
Postpaid

WHIZZER PRODUCTS CO., 342 S. SANFORD, PONTIAC, MICH.

MODERN LAWN MOWER SHARPENER

Service departments of leading Lawn Mower manufacturers use the Modern Lawn Mower Sharpener. One lever moves lawn mower into grinding position. Gasoline and oil remain in engine while sharpening, no dismantling of wheels, roller or handle. The Modern is a precision bed knife grinder—no extra grinder to buy. Imitated but never equaled—Compare before you buy.

If it isn't a Modern it can't be Modern

(Prices subject to change without notice)

MODERN MFG. CO.

160 N. Fair Oaks - Pasadena 1, Calif.

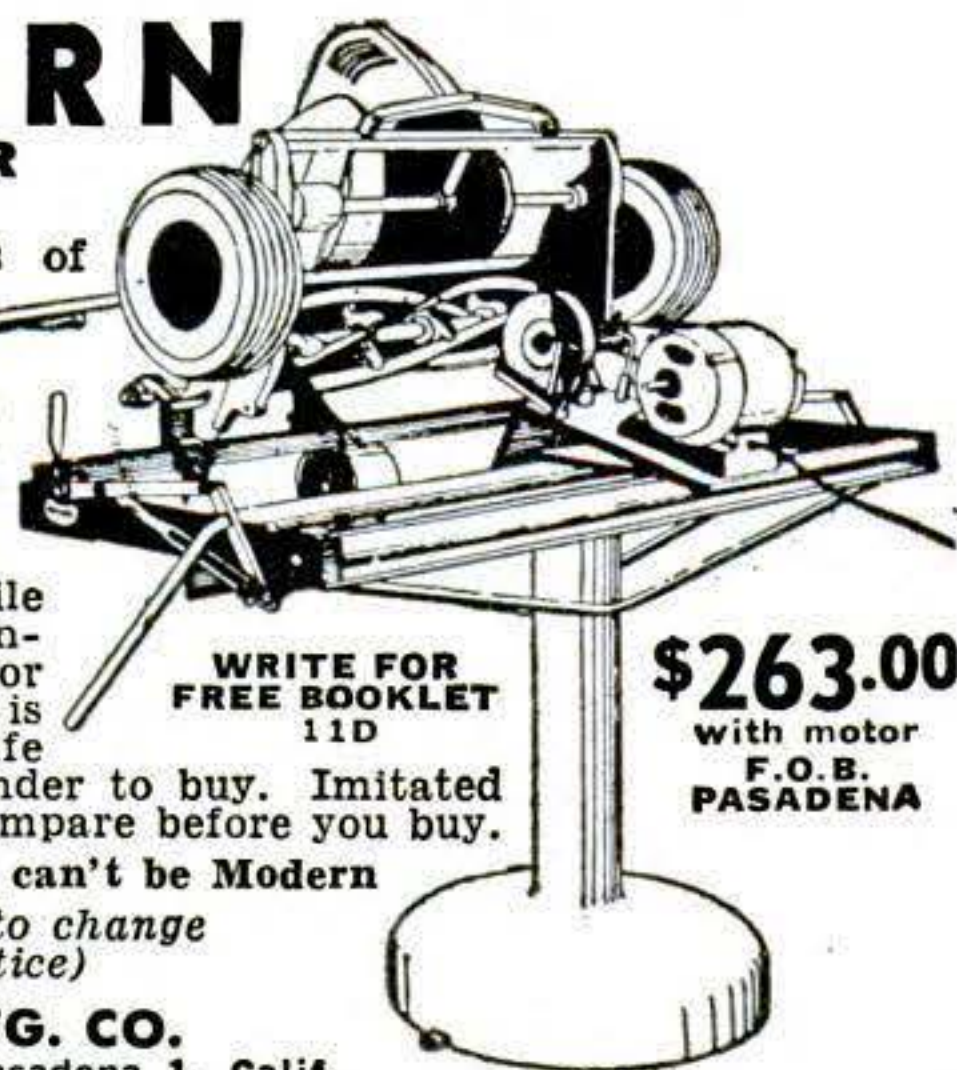

WRITE FOR
FREE BOOKLET
11D

\$263.00
with motor
F.O.B.
PASADENA

SHOPMASTER'S

NEWEST SENSATION

COMBINATION
POWER TOOL



It's a . . . Circle Saw,
Drill Press, Sander,
Router, Shaper, Lathe
All In One

For Complete Information Write Dept. PS-5
1214 S. 3rd St., Minneapolis, Minn.

SHOPMASTER, INC.

Professional Results in PAPER HANGING

In hanging wallpaper, Adhesium helps you match patterns more easily—sizes walls perfectly so paper slips into place smoothly. Added to wallpaper paste, it makes paper grip tighter to wall—helps prevent cracking at seams. Used by professionals for over 50 years. Get Adhesium at paint and hardware stores.

Write for informative leaflet

ADHESIUM®

Colonial Works, 229 Norman Ave., Brooklyn 22, N. Y.

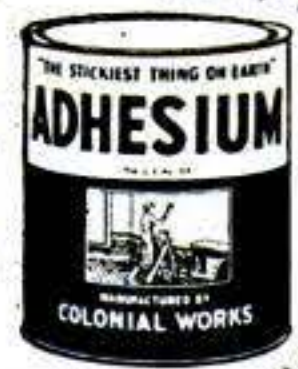

Explore! THE FASCINATING JUNGLE OF THE MICROSCOPE!

Model 800
New "L" design. 75, 150, 300, 600 power as shown. Many accessories available. **\$39.95** postpaid



Model 300
100-200-300 power. Capable of showing you microscopic animals. **\$9.95** postpaid

America's most amazing, fastest growing hobby. Search and explore the green tangled jungle of microscopic plant life, see as many as fifteen kinds of invisible animals in one drop of water, living, darting, swimming, crawling, eating (often each other). Living micro-animals are found in every home in America—in your fish pond, aquarium, flower vase, bird bath, ditch, puddle, nearby brook, or lake. The variety is never-ending. Almost every flower petal, leaf or blade of grass will reveal infinitesimal forms of fragile insect life which are transformed into glistening horny giants by the microscope. Take the first step toward starting your own living micro-zoo, your own micro-museum. Send for the two big free books today.

COLLAR OF SHARP SPIKES
This tiny flea looks like a dragon in armor



WELL SLIDE allows you to keep micro-animals alive when you roam through their invisible tangled habitat with your microscope. Costs **25c.**



LILY ANIMAL is one you will be sure to find. Beautiful but deadly, it sucks smaller swimmers into its flowerlike maw.

MANY CAREERS spring from the microscope. A knowledge of its use is helpful in all of these:
Medicine **Biology** **Agriculture**
Dentistry **Botany** **Agromony**
Pathology **Geology** **Industrial Research**
Nursing **Chemistry**

Dealer Inquiries Invited
Send for information. All microscopes manufactured for us to our own rigid specifications by leading members of the Japanese Optical Industry. Achromatic Optics are interchangeable with all standard U.S. and European makes.



FREE!

This 44 page catalog Research, student and hobby microscopes, accessories, slide making materials, everything you need **PLUS FREE MICRO-MANUAL!** Pages from a micro-explorers' notebook. Where to find living specimens, how to make slides. Completely illustrated. **SEND POSTCARD TODAY**



Model 635
150-300-600 power. Standard equipment in many schools. **\$29.95** postpaid

Heidelberg
20 to 2000 power. Special brochure on request. **\$319.00**



Von Steuben
Medical schools, universities, advanced hobbyists. 25 to 1200 power with accessory lens. **\$89.50**

the AKRON MAIL THIS HANDY COUPON

88 Akron Bldg.
4379 Sunset Boulevard, Los Angeles 27, California

MAIL FREE CATALOG & MICRO MANUAL
Mail Model..... microscope in fitted hardwood cabinet with sample slides—Postpaid at price listed above.
Include.....well slide(s) @ 25c each.
I enclose \$.....(check or M.O.).

Name

Address

City..... State.....

I understand that I may return any instrument within 10 days for full refund if I am not completely satisfied.

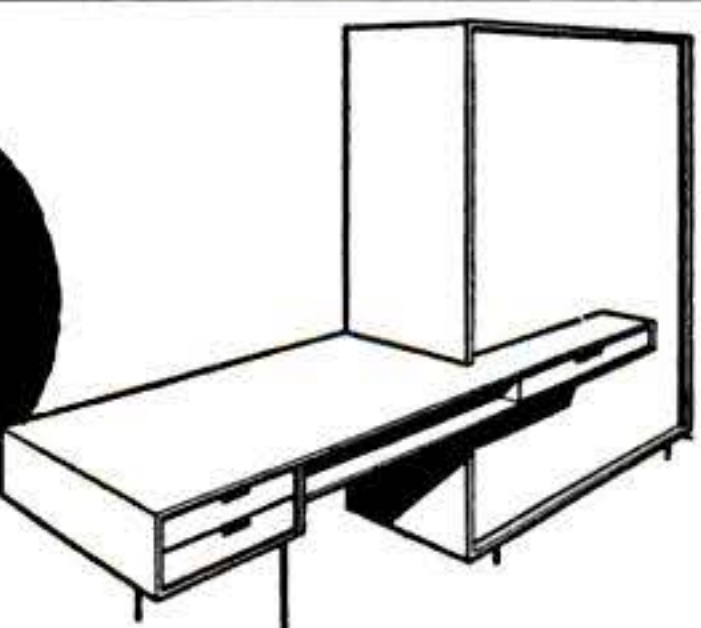

improve your home with MASONITE PRESWOOD®

Build your own room divider!

Save money! Build this room divider-desk with strong, grainless Masonite Presdwood® and plan #AE-295. Works like wood. 33 types and thicknesses at your building materials dealer's.

Send for "Idea Book." Lists free plans.

NATURALLY STRONGER WITH LIGNIN®



MASONITE® CORPORATION
Dept. PS-5, Box 777, Chicago 90, Ill.

Here's a dime to cover expenses of sending "Idea Book" and plan #AE-295.

Name.....

Address.....

Town..... Zone.....

County..... State.....

"Masonite" signifies that Masonite Corporation is the source of the product

Made

\$900
IN SPARE TIME

"I did very well last year with my Foley equipment, filing about 950 saws in my spare time. About \$900 for me." Leo H. Mix, New York.

MAKE UP TO \$3 OR \$4 AN HOUR IN SPARE TIME

With a Foley Automatic Saw Filer you can file hand, band and circular saws better than the most expert hand filer. Cash business—no canvassing. No eyestrain, no experience needed.

FREE BOOK—
"MONEY MAKING FACTS"

shows just how you can start at home in spare time, with small investment, no overhead—and develop into a full-time repair shop. Send coupon today—no salesman will call.

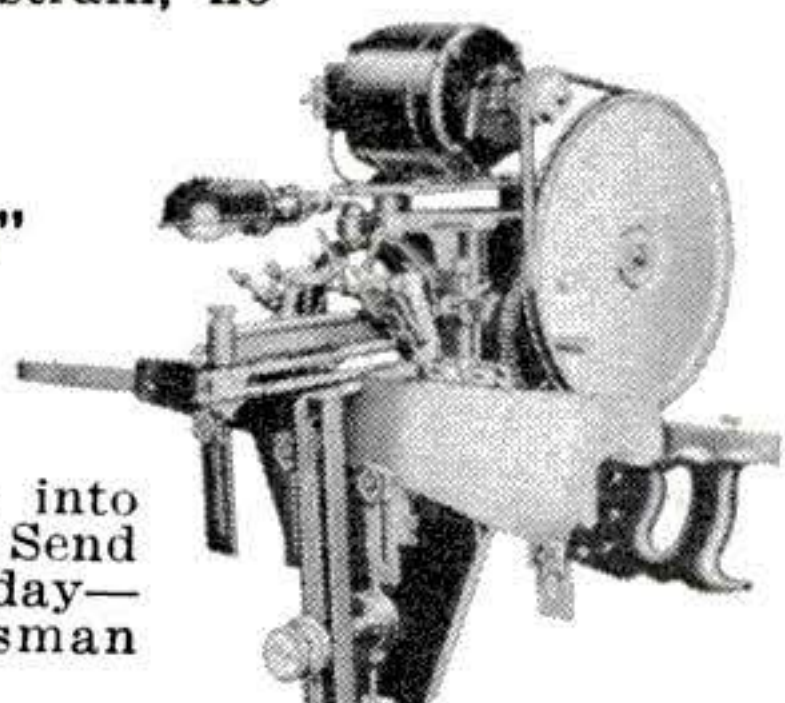

Send Coupon for FREE BOOK

FOLEY MFG. CO.
519-4 Foley Bldg., Minneapolis 18, Minnesota
Send FREE BOOK—"Money Making Facts."

Name.....

Address.....

I'VE TRIED THEM ALL—
THERE'S NOTHING THAT
DOES THE JOB LIKE
PLASTIC WOOD!

Plastic Wood is stronger—resists weather. Sands down to a smooth, hard finish. Professional craftsmen have preferred Plastic Wood for more than 50 years because it takes paint, varnish and other finishes best. Will not chip, crack or peel . . . won't pull away! In cans and tubes.

In natural, white and 8 wood colors.

"PLASTIC WOOD"®

remodeling?

... use

FIR PLYWOOD

Gives you more house for your money. Best for sheathing, siding, paneling, built-ins. For "Plan with Plywood", send 10c to Douglas Fir Plywood Assoc., Tacoma 2, Wash., or see your lumber dealer today!

Buy Only DFPA-Grademarked Panels

BUILD YOUR OWN FURNITURE

IT'S REALLY EASY



With a set of Rogers Project Plans, you can make many attractive useful pieces for your home . . . it's simple with these easy-to-follow plans. Simple, too, using "gorilla grip" Rogers Glue. Its pure, clear, consistency, its superb adhesiveness is your guarantee that Rogers Glue is made only from the finest materials. Special Offer — Only 15c will bring you a full-sized bottle of Rogers Glue — plus a set of these remarkable Project Plans that give illustrations and directions for building furniture, household articles, toys. Mail 15c today to Rogers Isinglass & Glue Co., Gloucester, Mass. Buy Rogers Glue At Your Hardware Store. Once used, you'll never accept a substitute.

"A Ton of Strength in Every Drop"

ROGERS

the best LIQUID FISH GLUE
GLOUCESTER, MASS.



NEW, IMPROVED CALCULATOR FOR WOODWORKERS only 25c

Instantly gives information on lumber, nails, concrete mixes, painting materials, etc. Convenient, simple to read. Just set dial for nail specifications, to convert linear to board feet, find bit sizes for screws, compare characteristics of woods. 6" diameter heavily varnished cardboard. Send 25c, no stamps, please to Greenlee Tool Co., 2125 Columbia Avenue, Rockford, Illinois.

x-acto®

KNIVES • TOOLS
HANDICRAFT KITS

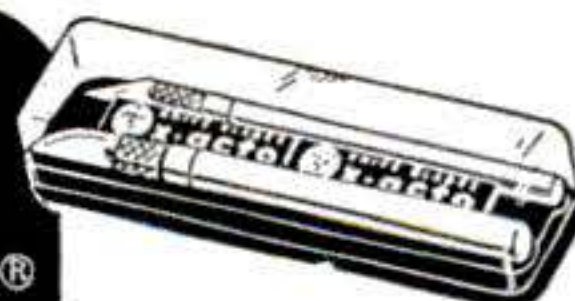

#62
VIZI-DOME KNIFE SET \$2.50

X-ACTO, INC.
48-41 Van Dam St.
Long Island City, N. Y.

Send 20¢ for 28-page Catalog

The book that tells everything about **HOW TO USE PORTABLE POWER TOOLS**

By MAURICE H. REID. Full information on using drills, saws, combo tools, the router-shaper-planer, sander, and many others—includes shortcuts that save time on the job. Over 100 photographs. . . . \$2.95

Order from
THOMAS Y. CROWELL COMPANY, 432 Fourth Ave., N. Y. 16



How to cut glass



Simple instructions make glass cutting sure and easy. Free book tells how, shows in pictures. Limited printing. Free copy is yours if you write now. Send handy coupon today!

FREE

MAIL THIS HANDY COUPON RIGHT AWAY

Red Devil Tools, Irvington 11, N. J.
Please send free copy of Booklet HT-205
"How to Cut Glass."

NAME _____
ADDRESS _____
CITY _____ STATE _____

D.C. ARC WELDER

AT A.C. TRANSFORMER WELDER PRICE

Model LG-200



\$350.00 VALUE

ONLY **\$85.00** f.o.b.

Fully Guaranteed

200 AMP. Powerful, Belt driven welder can't be matched. Pays for itself immediately!

For field and shop use! Ideal for machinery break-downs-in field. Operates at 3000 RPM off any tractor, jeep, truck or 5 Hp electric motor... any engine of 10 HP or more (old auto engine is excellent). Welds anything from Tractor frames to Sheet metal. Make your own special equipment for Farm, Shop or Factory. Does 1,001 jobs! **WELDS, CUTS, BRAZES** steel, cast iron, galvanized, bronze, aluminum, tool steels and stainless steels. Straight or reverse polarity. Welds 1/32 to 1/2" plate, cuts 3/8" plate. Uses 1/16 to 3/16" rods. **COMPARE FEATURES: Brand New!** Compact. Reactor-type series winding for EVEN ARC. Rheostat for pin-point heat control. Large brushes for extra long life. Oversize ball bearings. Air cooled by internal fan. Complete with 2-groove V-belt pulley. **Direct current makes arc striking and welding easier.** Output is 30 to 200 amps. **COMPLETE WITH ACCESSORIES shown,** including \$9850 f.o.b. two 15 ft. cables, plus sample rods (Shpg. wt. 95 lbs.)

SUPPLY LIMITED! IMMEDIATE DELIVERY! ORDER From AD!
FREE CATALOG of Motors and Electrical Equipment
ROBERTS ELECTRIC CO., Dept. 176, 849 W. Grand, Chicago 22, Ill.

3 CU. FT. MIXER 3975

DIRECT FROM MFR.

Fills long felt need for small mixer for concrete, feed, fertilizer, seed and many other materials. Saves 3/4 cost of ready mixed concrete. Pays for itself on first job. Combination belt pulley and crank for hand operation. Also power mixers. Write for circular.

3 Cu. Ft. Drum—Mixes 2 Cu. Ft. Concrete \$39.75
5 Cu. Ft. Drum—Mixes 3 Cu. Ft. Concrete 59.50

FOB Pulaski, N. Y. Cash, Check or M. O. Money back guarantee.

UNITED STATES FORGE AND FOUNDRY CO.
CONSTRUCTION EQUIPMENT DIV. PULASKI, NEW YORK



NEW WAY TO CUT PERFECT GROOVES WITH CIRCLE SAW!



Just dial any of 40 cuts. Parallel, clean, no sanding! Leave on saw for regular cuts. For 1/2, 3/8, 3/4 and 1" arbors. At dealer's or order direct!

Only **\$4.95** per set

WARREN DADO WASHERS CO.

Dept. 45 P.O. Box 98, Detroit 2, Mich.

VARIABLE SPEED HYDRAULIC POWER TRANSMISSION

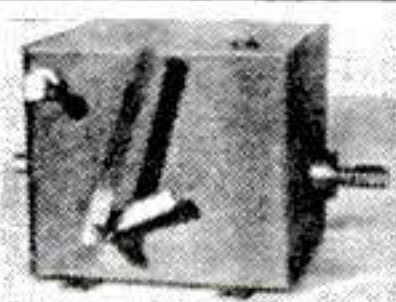

It has Infinite Speeds 0 to 550 Reverse Automatic Overload Protection: Adjustable Torque up to 180 inch pounds, 5/8" Input and Output Shafts. It will handle 1/4 to 1 1/2 H.P. Motor. Case measures 7 1/2" long 7" high 6 1/2" wide. VALUE OVER \$300. Shipping Wt. 25#. On C.O.D. Orders we require a 10% Deposit. **only \$54.50** Fob. Chicago

DIRZUIS MACHINE SHOP "N" 1423-25 52nd Ave., Cicero 50, Ill.

do it faster...better!

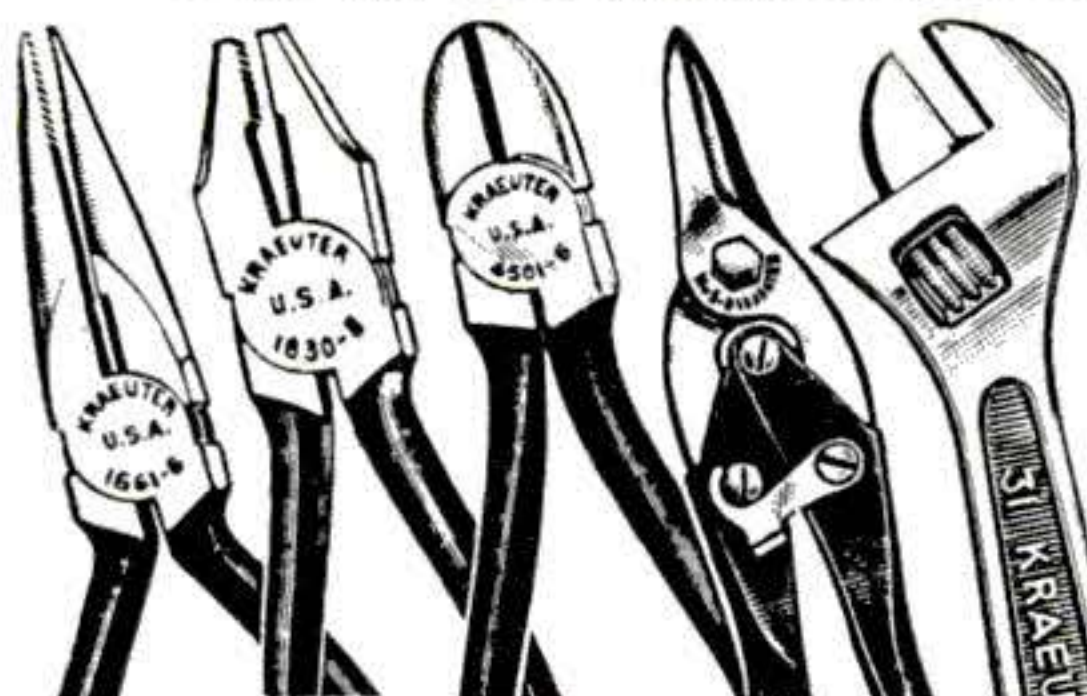

PLIERS,
CHISELS,
PUNCHES,
SNIPS,
ADJUSTABLE
WRENCHES

Buy wherever fine tools are sold in U. S. and Canada.

KRAEUTER

Power to Mow...
Power to Go

WITH **BOLENS**

GREAT *NEW* ROTARY MOWER



YOU JUST GUIDE IT

BOLENS 421A
20 INCH ROTARY
2 1/2 H.P....

- ★ Easy starting with sturdy, long-life recoil starter
- ★ Effortless mowing — powerful engine does the pushing
- ★ All-Safe Design for the All Family Mower

Bolens offer a complete line of both gasoline and electric powered models, with power units and cutting widths to suit every budget and need, from cottage to estate. All as smartly styled as a sports car. 5 other rotary models to choose from!



GRIND-A-LEAF Wonderful, easily attached device pulverizes autumn leaves and distributes them evenly over lawn as fine fertilizer.



MORE POWER FOR YOUR MONEY WITH BOLENS 3 GREAT REEL TYPE MOWERS:
441B 21", 433C 18"
438B 18"



AMERICA'S FINEST OUTDOOR POWER EQUIPMENT

MAIL COUPON TODAY

BOLENS PRODUCTS DIVISION
Food Machinery and Chemical Corporation
267-5 South Park Street
Port Washington, Wisconsin

I am interested in literature on:

- | | |
|---------------------------------------|-------------------------------------|
| <input type="checkbox"/> POWER MOWERS | <input type="checkbox"/> TILLERS |
| <input type="checkbox"/> TRACTORS | <input type="checkbox"/> CHAIN SAWS |

Name _____

Address _____

City _____ Zone _____ State _____

NEW 12-FT. POCKET TAPE MAKES L-O-N-G MEASUREMENTS EASY

made only by **EVANS**

Only
\$1.89*

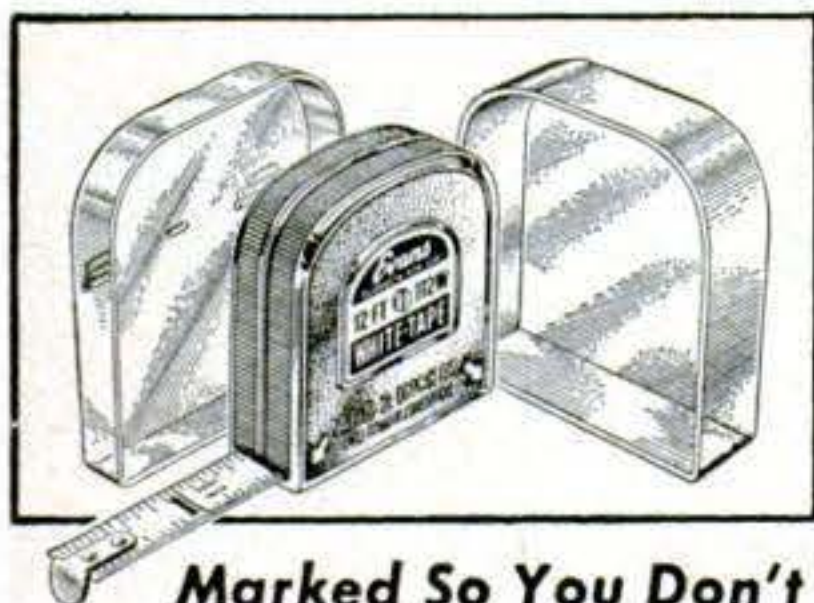

No longer need you make two measurements for 12-ft. jobs as you must do with shorter tapes. Chrome-plated case is no larger. Each EVANS Tape packed in FREE transparent Tenite utility case.

**Marked So You Don't Have To Figure
No Other Tape Is Marked This EVANS Way**

Work in feet and inches?
Read here



Work in inches?
Read here

King-Size 10-Ft. White-Tape

**STANDS UP
STRAIGHT**

For Upright Measurements!

Wider (3/4") heavy-duty blade makes those long upright measurements easy and accurate. Exclusive EVANS double markings, same as 12-ft. pocket tape. FREE belt clip and Tenite utility case with every EVANS King-Size.



Only
\$2.39*

*At hardware stores everywhere.

Prices slightly higher Denver west.

2642

Evans & CO., Elizabeth, N. J.

Makers Of Evans "Long Tapes"—25-50-75-100 Ft.

WAR SURPLUS AND OTHER BARGAINS SAVE UP TO 90%

LOW VOLTAGE CIRCUIT TESTER

Made for U.S. Ordinance. Self-contained device makes complete & rapid check of generator battery circuit. Will check out any 6 or 12 volt system. Garages, mechanics, truck fleet owners, boat & marine mechanics. Guaranteed perfect. Shpg. Wt. 20 lbs. Approx. GOVT. COST \$175. NEW, complete with steel carrying case & instruction book. WHILE THEY LAST—\$29.75



RI GENERATORS — RI Jack & Heintz. Rated 300 Amps. 30 Volts. Wt. 60 lbs. Approx. GOVT. COST \$450. Guaranteed perfect. \$23.50

GEAR HEAD MOTOR

Use to run antenna, open or close doors and windows, Barbicue, displays, etc. Approx. 1 RPM. Set for 140° turning with limit switches that remove for full 360° turning. 1. Amp. 24 volt D.C. 1/2 in. shaft dia. 3" RPM. 1/10 HP motor, micro-switches, reduction gears, mounting brackets — hobbyists! Barber-Coleman. Approx. GOVT. COST \$90. Like new; only \$3.50.

MICROMETERS Chrome plated, precision engineered, carefully tooled to give long life. All new 0-1" cap. \$2.25 ea., 1-2" cap. \$3.50.



PRECISION GROUND SQUARES

Production engineer's Squares. Accuracy guaranteed. Mfd. by Wright & Moore, Sheffield, Eng. Square blades hardened & tempered. Individually packed in wood box. Brand NFW. Fraction of original cost. 2"—\$2.25, 3"—\$2.50, 4"—\$2.75, 5"—\$3, 6"—\$3.25, 8"—\$4.25, 10"—\$6.25, 12"—\$8.25

SENSITIVE ALTIMETER in 10 Ft. Increments. NEW! Famous Pioneer! 0 to 35,000 ft. (inches of Mercury). Tested and inspected in our own instrument lab. Guaranteed perfect. Approx. Govt. Cost \$150. NOW ONLY \$12.95 PREPAID!



MULTI-PURPOSE PUMP & MOTOR

Pump has 3/4" connections, built-in relief valve, adjustable up to 1500 lbs. Max. capacity 6 GPM. 1 1/2 HP, 24-Volt motor, 4000 RPM. Can be used on 12 or 36 Volts. Approx. Govt. Cost \$350. Like new, ONLY \$9.75!



Send 25¢ for big catalog. Bargains for everyone. Check, Money Order or Cash. 25¢ deposit on C.O.D. orders. Prices F.O.B. Culver City, Calif., Unless otherwise stated.

AIRBORNE SALES CO., INC. DEPT. PS554
8501 Stellar Drive, Culver City, Calif.

CATCH 'EM KING-SIZE WITH THE Flatfish



If you want to get away from the minnow plague and hook into lunkers for a change, tie on a Flatfish and go after the king-size fellows that the Flatfish has such an overpowering attraction for. World's largest selling plug. Over 12,500,000 sold. Get it at your tackle dealer's or write for 48-page book with fishing secrets of famous anglers.

HELIN TACKLE CO.

3669 Meldrum

Detroit 7, Mich.

Free
CATALOG

SHEET METAL BRAKES

Angles, flanges, Pittsburgh locks, 24 G. steel, heavier aluminum. Cam locking. mount on bench, truck or floor stand. Truss braced-steel. Express collect. 30". 65 lbs., \$28.50. 36", 75 lbs., \$33.00. 48", 100 lbs., \$48.00. Also 8 ft. size. Floor stand. 22 lbs., \$7.00. 15", capacity 16 gauge, 40 lbs., \$21.50.



IRON BENDER 1/4 x 3, \$9.50. **TUBING BENDER**, 3/4"-1", \$6.00. **SHEARS** 7 x 16 ga. steel, \$14.00; 24" squaring and slitting shear, 24 ga. 16 ga. aluminum, \$38.00. **Hand Bending Brake**, 14", \$6.50. P. Paid.

(Immediate delivery. Order cash or C.O.D., or send for folder)

VYKE BRAKE CO., S-2439 15 St., Denver 11, Colo.

SAVE \$\$ DO-IT-YOURSELF

Make your own projects with Reynolds-Do-It-Yourself Aluminum—Easy to work with ordinary hand tools. Order Now

- ROD—3/8" Dia. x 6' —1.19 per length
- BAR—1/8" x 3/4" x 6' —1.69 per length
- TUBING—1/4" x 1" x 6' —1.98 per length
- TUBING—3/4" O.D. x 6' —1.49 per length
- TUBING—1" O.D. x 6' —1.59 per length
- TUBING—1 1/4" O.D. x 6' —1.98 per length
- PLAIN SHEET—36" x 36" x .020" —2.49 each
- EMBOSSED SHEET—36" x 36" x .020" —2.69 each
- ANGLE—3/4" x 3/4" x 1/2" x 6' —1.59 each
- ANGLE—1" x 1" x 1/16" x 6' —1.89 each
- SCREEN-STORM WINDOW SECTIONS—6' sections—.99 per length

Screen Instructions Furnished With Orders.

Send Check or M.O.—No C.O.D.'s—\$5.00 Orders Postpaid

PACIFIC TOOL CO. BOX 86 PARAMUS, NEW JERSEY

72" FLEXIBLE SHAFT

WOVEN WIRE CORE

USE AS
ELECTRIC
DRILL

REAL BARGAIN — cannot be duplicated for \$15.00. Coupling fits 1/2" or 3/4" motor shaft (state which); other end fits standard chuck. Durable, heavy. Use it for grinding, polishing, buffing, drilling, etc. Chuck for same only \$1.25. Send check or money order and we will ship P.P. prepaid or C.O.D. Plus Postage. Money refunded if not satisfied.

only
\$6.95

L. C. DOWNEY—Dept. P

8004 Traymore Ave.
Phila. 18, Pa.

BUY Direct from Factory!

LIGHT-WEIGHT... handles big and little jobs easily!

Concrete Smoothie

Concrete finisher does beautiful work. Powered by 2 HP gear-reduction Lauson motor. Adaptable to any width. ALL MACHINES GUARANTEED.

\$134.00
F. O. B.

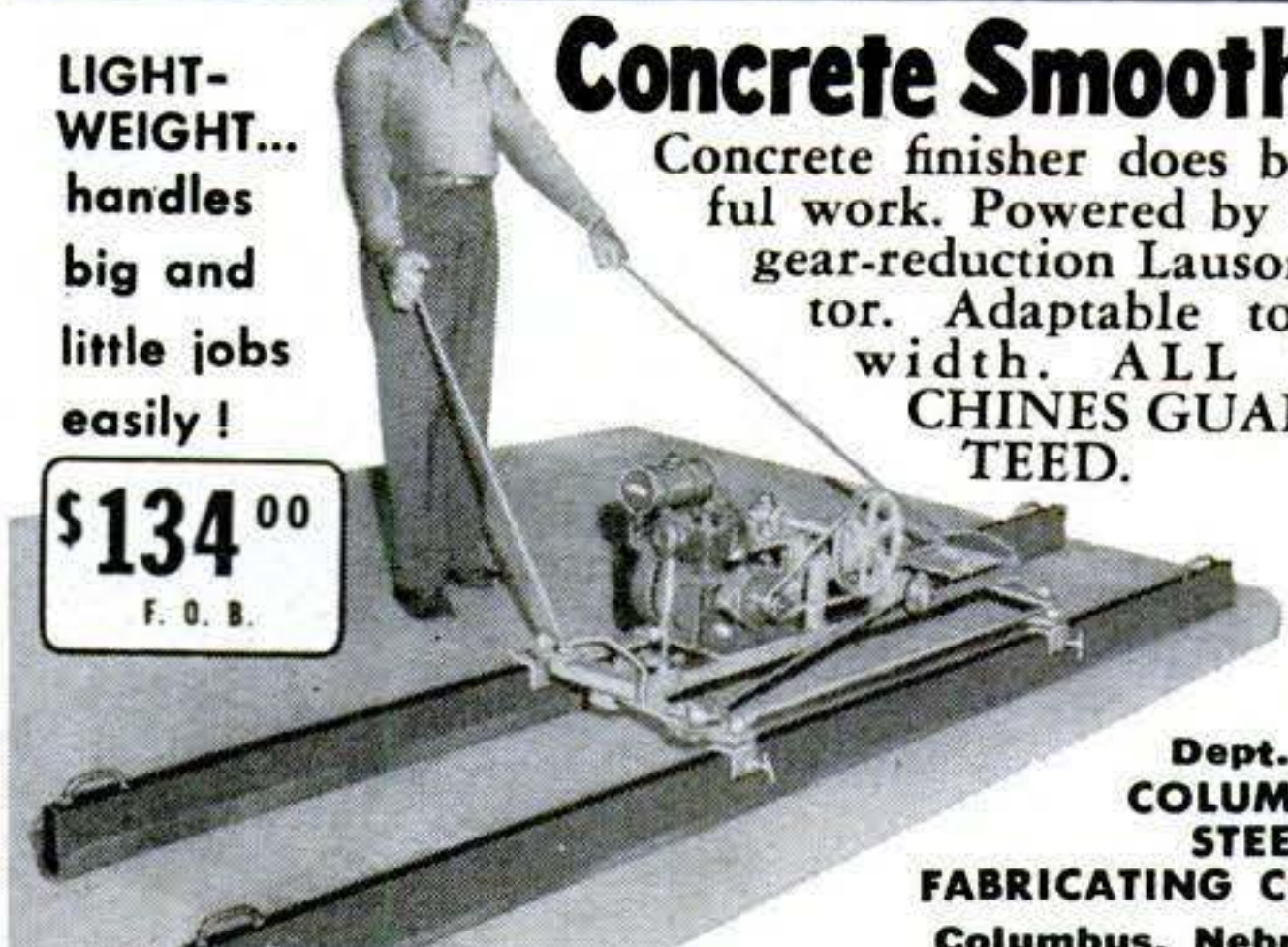

Write
Dept. PS-1
COLUMBUS STEEL FABRICATING CORP.
Columbus, Nebraska

\$40 A DAY BUSINESS

IN YOUR SPARE TIME

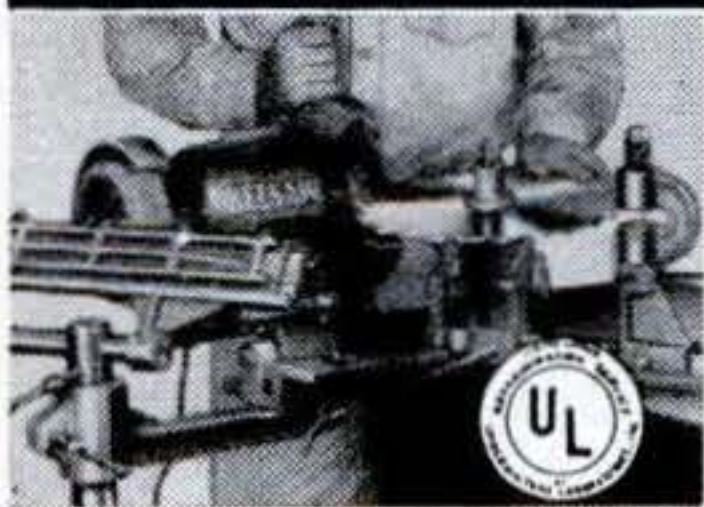

ANDY PHILLIPS SAYS:

"My Belsaw Sharp Smith gives me big profits at low expense — I can run 35 to 40 Circular Saws in an 8-hour day — that makes me \$40 cash."

"I also get BIG EXTRA PROFITS... up to \$4 an hour... by grinding planer and jointer knives — there's always a demand for this kind of work."

You can start this REPEAT CASH business in your own home or garage while you are working at your regular job. Easy to operate, no experience needed. "My BELSAW paid for itself the first month." — H. J. Opie

For as little as \$15 down payment, you can get your BELSAW SHARP SMITH rushed to you.

FREE book tells how

YOU can start making money the very day your BELSAW SHARP SMITH arrives. Hundreds of jobs in your own neighborhood. Send for Free book "Life-Time Security."



BELSAW MACHINERY CO

4407 Field Building

Kansas City 11, Mo.

EARN YOUR OWN KING MIDGET. We want rider agents to demonstrate and sell the World's Lowest Priced Two Passenger Automobile. Fully assembled or bolt together parts. If there is no dealer near you send 25c for detailed literature with wholesale dealers price or \$1 (refunded first order) for this plus actual assembly book and service manual.

MIDGET MOTORS MANUFACTURING CO., ATHENS, OHIO

KING MIDGET AUTOMOBILE



MAKE YOUR OWN

POWER LAWN MOWER

with this DRIVE CUTTER ASSEMBLY
For those who desire to build their own power mower. Complete with 20" blade and double ball-bearing drive. Only \$13.95.



ONLY \$13.95

Send check or M.O. Add 50c to cover handling and shipping.

SEND FOR **FREE** Power Mower Catalog

ATLAS KEEN MOWER

229 Southwest Blvd., Kansas City 8, Mo.

MAXIM SILENCERS

QUIET



LAWN MOWERS
GARDEN TRACTORS

Here it is... a world-famous Maxim Silencer that you can install easily on any power lawn mower or garden tractor powered by a 4-cycle air-cooled engine. Prices postpaid: \$6.00 (1/2"); \$7.25 (3/4"); \$9.00 (1"). If inside diam. of engine exhaust port measures 13/16", order 1/2" silencer; 1-1/6", order 3/4" silencer; 1-15/16", order 1" silencer. Sorry, no C.O.D.'s.

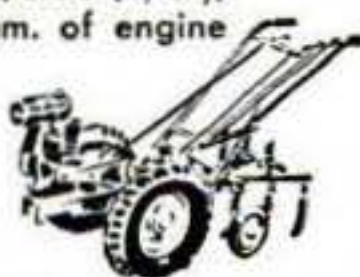

ASK YOUR DEALER OR WRITE DIRECT
THE MAXIM SILENCER COMPANY
122 HOMESTEAD AVE., HARTFORD 1, CONN.

MAKES GOOD, SAFE, INSULATED ELECTRICAL CONNECTIONS

AMP Super CHAMP HAND TOOL



SPLICES!



REPAIRS!



SHEARS BOLTS!

Now you can make completely insulated splices and connections in light cords, house wiring, T-V, appliances, car, etc. Just slip on AMP PRE-INSULATED connector and crimp with SUPER CHAMP tool. That's all there is to it—no fuss, no separate tools, no tape or solder needed!

ONLY \$3.95

A WHOLE ELECTRICAL WORKSHOP IN ONE TOOL!

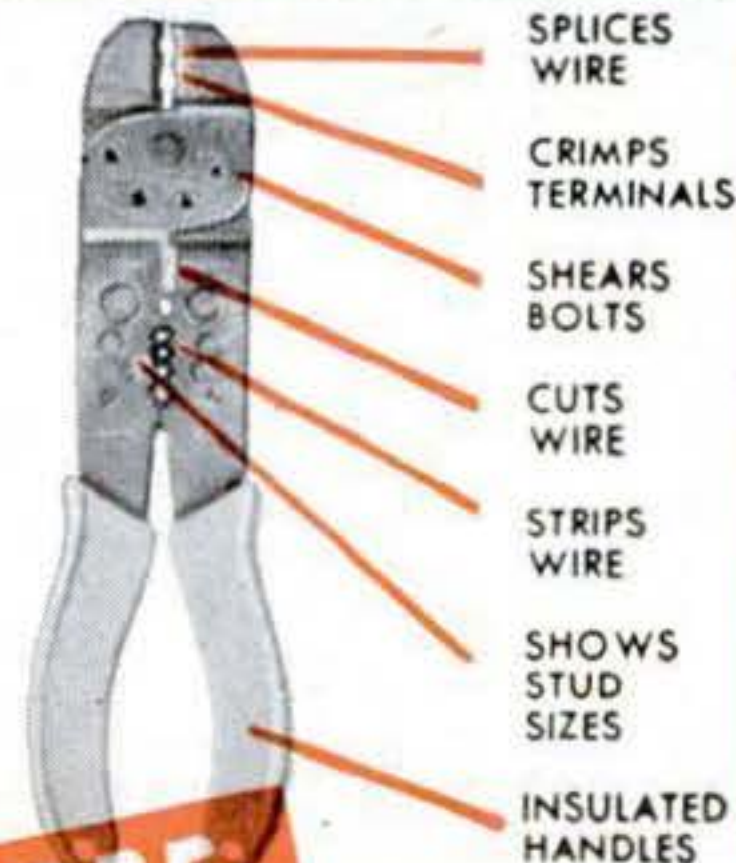

- SPLICES WIRE
- CRIMPS TERMINALS
- SHEARS BOLTS
- CUTS WIRE
- STRIPS WIRE
- SHOWS STUD SIZES
- INSULATED HANDLES

All this in one handy tool. Cuts wire, strips wire, crimps insulated terminals. Shears five popular bolt sizes without damage to threads: #4-40, #6-32, #8-32, #10-32, #10-24. SEND today for the amazing SUPER CHAMP tool—ONLY \$3.95 complete!

© AMP AMP Trade-Mark Reg. U.S. Pat. Off.

FREE OFFER

AIRCRAFT-MARINE PRODUCTS, INC.
Consumer & Dealer Division
1319 American Building, Cincinnati, Ohio

Send this coupon today with \$3.95. Receive your SUPER CHAMP tool with a FREE assortment of insulated TERMINALS & SPLICES.

NAME _____

ADDRESS _____

CITY _____ STATE _____

good going

on a

**Cushman
EAGLE**

**3/4¢ per mile
total operating
cost**

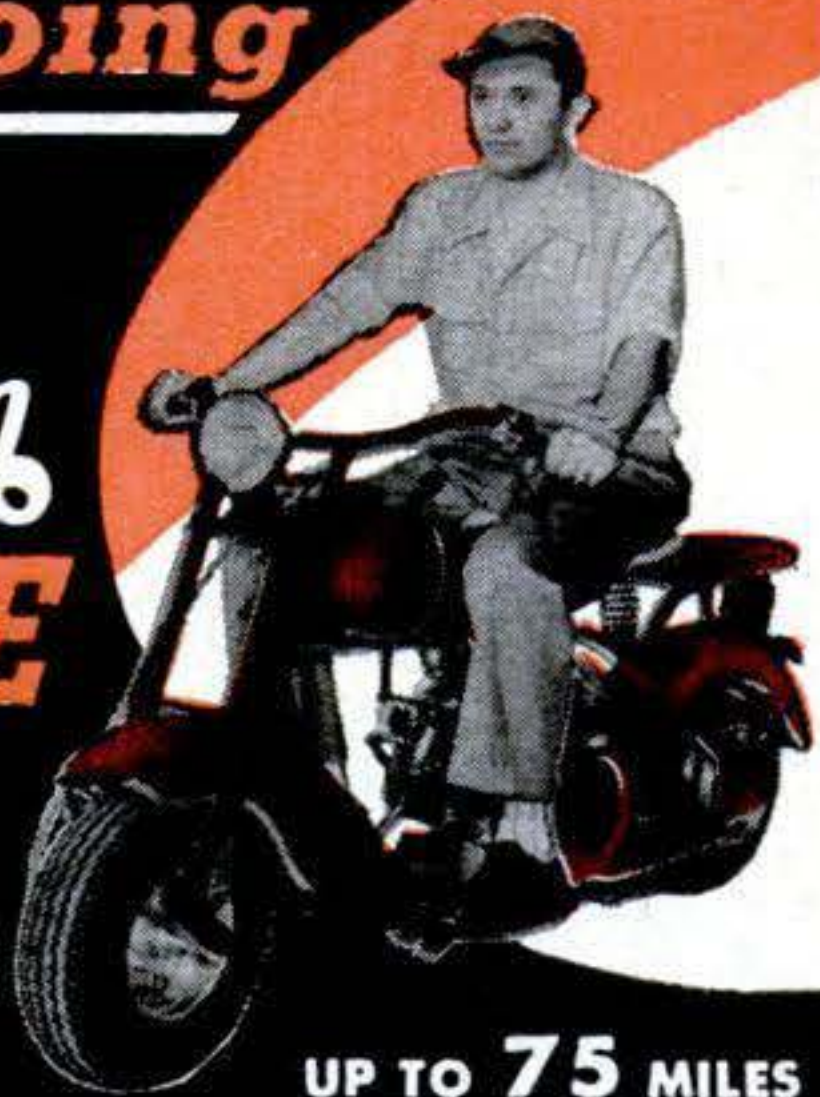

**UP TO 75 MILES
PER GALLON**

You get where you're going faster — cheaper, with the powerful Cushman Eagle. Easy to ride and operate — no parking problems. No money problems either! Pay for your scooter as you earn — as little as \$5.00 a week! Low maintenance, low operating cost. Get ready for fun — get set to GO! See your Cushman dealer. NOW for a FREE demonstration!

send for new **Free illustrated catalog**

CUSHMAN MOTOR WORKS, INC. 913 No. 21st St. Lincoln, Nebr.

Double Savings!

✓ Save on Price ✓ Save on Installation

Duo-Matic

**"Do-It-Yourself"
TRIPLE-TRACK
All-Aluminum
Storm-Screen
Windows**

\$29.95 Value \$15.95

Easily Installed By Anyone!

Lowest price ever for any comparable window! Rugged, all-aluminum construction . . . triple-track design means glass and screen inserts are always in place, ready for immediate use.

At leading lumber and hardware dealers everywhere — or write

the weather-proof co. Dept. PS
1407 E. 40th St., • Cleveland 3, Ohio



REPLACEMENT OR REFUND OF MONEY
Guaranteed by
Good Housekeeping
IF NOT AS ADVERTISED THEREIN

For opening sizes up to and including 29" x 55" double-hung windows. Other sizes slightly higher.

HANDY FOR ALL METAL REPAIRS!

FREE Illustrated Booklet, "Soldering Simplified." Tells you how. Send postcard today.

**KESTER
SOLDER COMPANY**
4254 WRIGHTWOOD AVENUE
CHICAGO 39, ILLINOIS



The QUICK-WAY to SHARPEN CIRCULAR SAWS



Model 6-12P
\$16.50 Postpaid

QUICK-WAY Saw Company
13 Riverside Corning, N.Y.

The complete sharpener, featured in FORTUNE and other leading magazines. Anyone can use . . . guarantees precise grinding and spacing of teeth. Operates on your own power table. Complete with patented Index Plate, facing block for mitre and \$3.00 grinding wheel—no extras needed. Sharpens circular saws up to 12" diameter. Saves time and money. Send check, cash or money order. We pay postage.

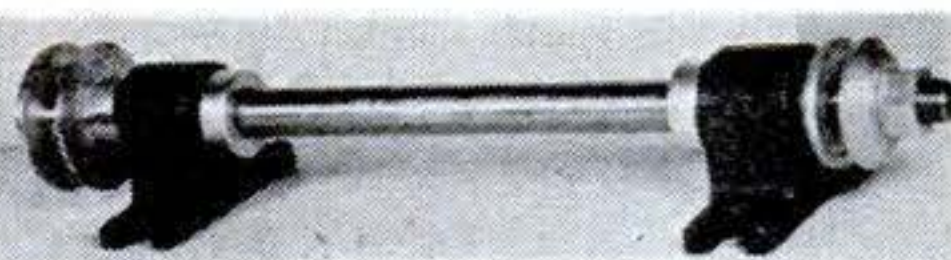

ARBOR SET
Only \$4.85 Post paid

Machined to precision tolerances for use on special machinery, grinders, saws, polishing wheels, sanders, jack shafts, routers, etc. **SATISFACTION GUARANTEED OR MONEY REFUNDED.**

Manufacturer of quality tools for craftsmen. Write for circular on tools and equipment available. **HANDY TOOL INC., P. O. Box 142 S, Tilton, New Hampshire**



GOLD-SILVER-COINS

Easily located with new Lightweight M-Scope Detector. Superior performance, lowest price, monthly payment plan.

FREE LITERATURE
FISHER RESEARCH LAB., INC.
PALO ALTO CALIF.

MACHINED PARTS READY TO ASSEMBLE

DO IT YOURSELF **MODEL 120 FAN KIT** DO IT YOURSELF

- FOR HOME - FARM - SHOP!
- 20" ALUMINUM BLADE WITH STEEL HUB
- 4840 CUBIC FT. OF AIR PER MINUTE
- RUBBER MOUNTED BEARINGS
- COMPLETE V BELT DRIVE
- STEEL FAN SHAFT & COLLARS
- ALL HARDWARE TO ASSEMBLE
- ALL YOU NEED IS ANY 1/4 TO 1/2 HP 1725 RPM MOTOR A SCREW DRIVER AND 20 MINUTES TIME TO ASSEMBLE THIS WONDERFUL HOME OR SHOP FAN KIT **QUALITY AT LOW COST!**

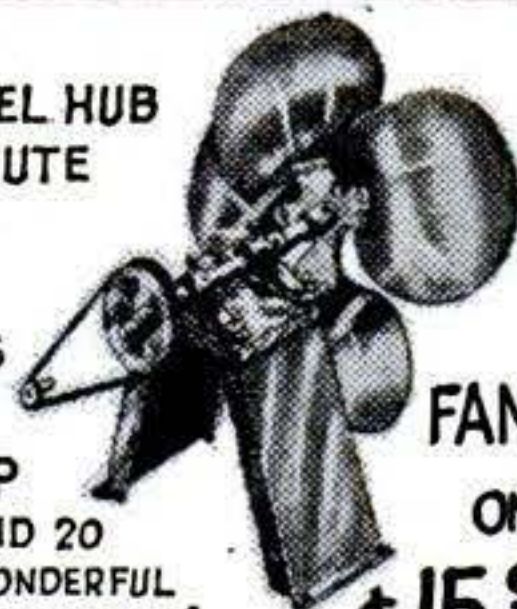

FAN KIT

ONLY \$15.95

28x24x1 1/2 WINDOW KIT BOX \$5.95 Send Check or M.O. F.O.B. Plant - 14 Lbs. (INSTRUCTION SHEET INCLUDED) F.O.B. PLANT 25% Deposit on C.O.D. **DEALER INQUIRIES INVITED**

A. E. BOGG MACHINE & TOOL COMPANY
811 JEFFERSON ST. JEFFERSON CITY, MO

Dept. PS-5

**GIGANTIC
SAVE-TO-70%**

MAIL SALE

**WAR SURPLUS
EXCESS INVENTORY
BANKRUPT STOCK**

POWER PLANTS & GENERATORS

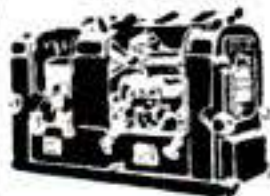

● Army's finest plant, 115-v, 60-c, 3000-4000-w. Size 20"x30"x48". Wt. 600 lbs. 4-cyl. water-cooled self-start eng. Govt. cost over \$4800.00. Prepaid in U.S.A., **\$349.50**

AIR COMPRESSOR UNITS

Paint, clean, for tires, control termites, etc. Build your own.

● **DeLuxe Kit.** Tank, comprsr, gauge, valves, paint gun, regulator, fittings, etc. \$70 value**\$45**

● **Compressors, \$20.** Tanks \$6.79. Press. Switch \$4.95. Gauges (160 lbs.) \$1.89.

● **Air Supply Unit.** Fill at filling station. Holds air indefinitely. **\$15.95**



DC-AC GENERATOR

● Brand new ball brg. G.E. unit, suitable for D-C welder, electroplating, high current battery charging, home emergency plant for lights, etc.

● Generates 200 amps at 30-v D-C. Also furnishes 115-v 800-c A-C at 2000 watts. Marvelous buy! 131 units available. Government cost over \$300. Prepaid to you**\$29.48**

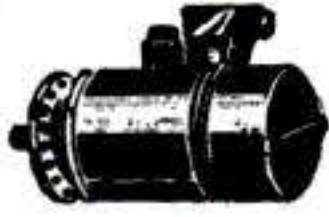

HYD. CYLINDER

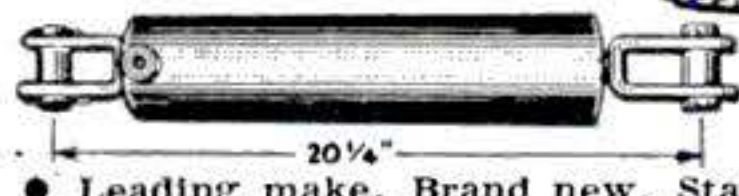

● Leading make. Brand new. Standard unit. 3" bore, 8" stroke, one way, 1" rod, 3/4" inlet. Made for plow Co. that changed to different stroke. will lift 7000 lbs. Guaranteed. Hundreds of uses on farm, industry. Lift plows, arbor press, wagon dumps, dozer, etc. Natl. Advd. \$24.50. SPECIAL. PPD.....**\$11.95**

ORCHARD-ESTATE POWER SPRAYER

Genuine Hydro-Jet pressure pump. 1 1/2 h.p. Clinton engine, 50-gal. steel tank with agitator and 50' hose and hand spray boom. For truck farms, estates, factories, orchards, etc. List over \$200. **\$114.50 Ppd.**



ARMY PARTS CLEANER

● Air-solvent cleaner. Makes dirty greasy parts shiny bright. Wonderful for garages, factories, farm, repair shops.

● Heavy galv. tank 25 x 20 x 20", with valve, hose, hydraulic lid riser. Cost \$100. Ppd. frt. ... **\$29.95**

SPECIAL OF THE MONTH

**Airport or Advertising
GIANT FLOOD LIGHT!**

● Buy of the year! Air Force landing field flood light. Throws wide flat beam of concentrated light for long distance on runway.

● Ideal for private flying field, small airport, contractor, parking lot, estate.

● Makes marvelous flashing adv. lite for entrance or roof top of drive-in, motel, super-market. Attention getter.

● Consists of giant concentrator Fresnal lens, 1250-w, 110-v, hi-intensity bulb, 3' to 12' collapsible steel tripod, expensive shipping trunk, 4 extra bulbs, anchors, etc. Trunk makes wonderful tool chest. Total wt. 140 lbs. Govt. cost, \$280!

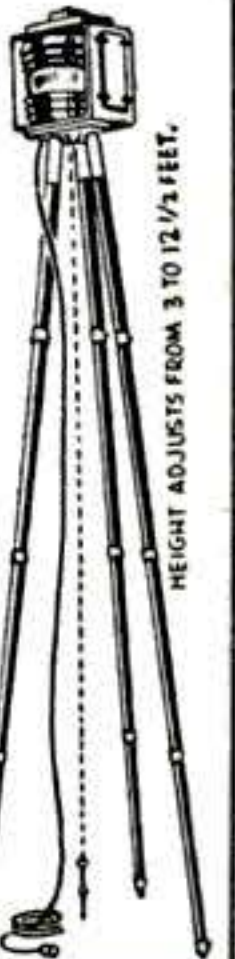

Special Ppd.

\$49.50

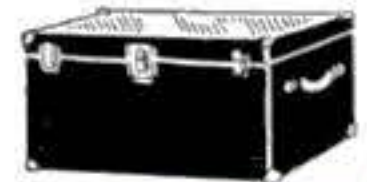

Hundreds other surplus items: pumps, optical, levels, phones, winches, etc.

We pay shipping charges. Send for catalog.

BURDEN SALES COMPANY

827 "O" St.

LINCOLN, NEBR.

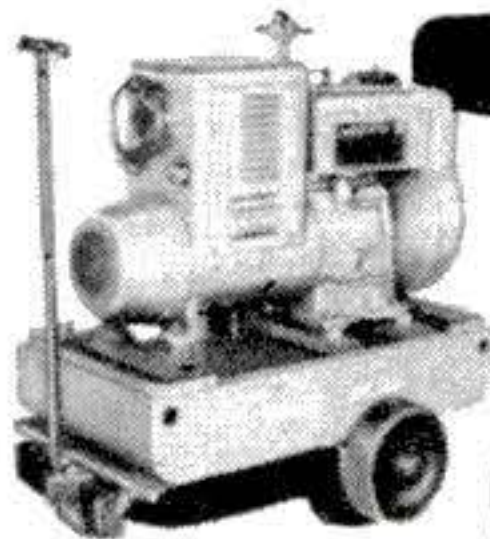

Low Cost "Husky Boy" Welds Anywhere! Earns BIG PROFITS!

Cash in on the profitable outside emergency repair jobs with the **Transformer Type A.C. Welder** lightweight, easily portable, "Husky Boy" 200 amp. arc welder. For in or out of shop welding you'll get years of dependable service at a low investment cost. Wheels and handles available at slight extra cost.

**Air-Cooled
Engine Drive
"Husky Boy"**

"Build Your Own" AC welder, AC power. Operates away from power lines. Ask for details on generator only.

HOBART Brothers Co., Box P-54, Troy, Ohio Phone 21223

"One of the world's largest builders of arc welders."



Mail this Coupon!

Get started now in arc welding and increase your earnings. There's a big demand for welders. Simply check the items below for complete information.

- Hobart "Husky Boy" **FREE**
- Transformer Type AC Welder Welder's Vest
- Hobart Trade School Pocket Guide.

Hobart Bros. Co., Box P-54, Troy, Ohio

See at a glance...



how to...

**SAVE GAS...
CUT REPAIR BILLS**

**with Stewart-Warner
Motor Minder®**

Check Engine Performance As You Drive! Mounted on your dash, this driving gauge and engine analyzer keeps constant check on rings, valves, spark plugs, carburetor, timing. Illuminated dial easily read from any angle. Shows how to get more miles per gallon. Quickly installed.

If your dealer can't supply you, send his name and address, along with your check or money order for \$10.95 to Stewart-Warner. Motor Minder will be sent direct to you prepaid!

Pays For Itself—Fast!

\$10.95

STEWART-WARNER

Instrument Division, Dept. P-54

1840 Diversey Parkway, Chicago 14, Illinois

REJOICE !!

**WITH A MILLION HAPPY FOLKS
WHO ENJOY THIS PRODUCT!**

**OUTSIDE
LUMINALL**

**THE EXTERIOR MASONRY PAINT WITH
EVERYTHING BUILT IN!**

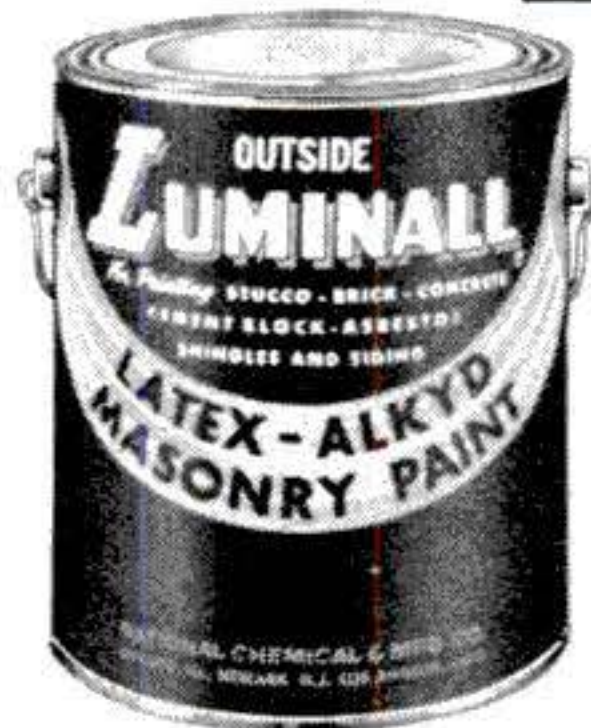

Rich concentrated formula, with Dow latex and alkyd-resin, has everything you need to beautify and protect concrete, brick, stucco, asbestos shingles and siding. Easy to apply! Nothing else to buy! For free 22-chip color chart, write, Dept. PS

Luminall Paints Chicago 9, Illinois

MILLIONS OF HAPPY USERS KNOW THE LUMINALL LABEL IS THE FINEST GUARANTEE IN PAINTS

"HOW I KEEP MY ENGINE TUNED"

by DEB SNYDER

1952 and 1953
I. M. C. A.
Champion



Racing is my business. That's why I'm plenty fussy about my car . . . spend hours tuning it. How do I *keep* it tuned? Easy! I depend on Miracle Power, and believe me, it works so well that I've won the last two I.M.C.A. Championships, taking 58 races out of 67.

I use it in my passenger car, too—in both gas and oil. Here's why: Miracle Power *stops* hydraulic valve lifter noises . . . *fre*es sticking valves . . . *stays on* to lubricate even when heat breaks oil down . . . and gives a better compression seal. And Miracle Power prevents Dry Starting damage, biggest cause of engine wear. Oil can't reach

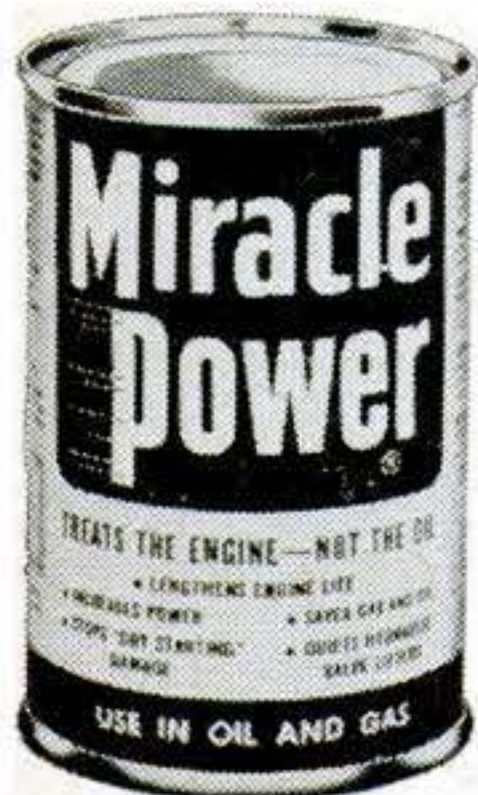

(A blend of super lubricants, including colloidal synthetic graphite in suspension. Treats the engine not the oil.)

all parts during the rough five minutes after starting. But a light tough film of Miracle Power is *always* there preventing dry metal to metal contact! Yes, I know Miracle Power pays off—with extra pep, longer life and less oil consumption.

Miracle Power is made by The AP Parts Corporation over in Toledo, Ohio. They make special lubricants for the Air Force, Navy, engine rebuilders and others. Miracle Power is sold with a money back guarantee through leading car dealers, garages and gas stations. In fact, Ford, Kaiser, and Willys approve Miracle Power for sale through their dealers.

But don't take *my* word. Write The AP Parts Corp. Dept. 811, Toledo for the report of an independent laboratory which road tested Miracle Power for over 33,000 rugged miles—or better yet try it yourself, *today*.

© AP Parts Corp., 1954

WILHOLD

Glu-Bird

**SAVE TIME—25%
SAVE GLUE—DO
NEATER WORK**

**REFILLABLE PLASTIC GLUE GUN
KEEPS THE HANDS CLEAN**

No goopy glue sticks. No hardened brushes. Carry in kit or apron. Can't spill. Keeps glue fresh and clean.

Wilhold—The easiest glue to use for home, hobby and shop uses. Applies white—dries colorless. Odorless. Non-inflammable. Glues wood • tile • formica • paper • china • almost everything. Contains secret Orthonol—Grabs quick; sets fast. Send \$1.00 for Wilhold Glu-Bird, Jr.—P. P. Money Back Guarantee.

ACORN ADHESIVES CO., INC. Los Angeles 31, Calif.
Chicago 44, Ill.

ROTO- HOE

GARDEN TOOLS

*Brings You
the Easy*

NEW and PROVEN WAY to buy POWER EQUIPMENT



Years of experience in perfecting ROTO-HOE plus plenty of "garden testing" by thousands of users, insures your satisfaction. Send for our new free 16-page full color catalog which can save you hundreds of dollars. Look at these ROTO-HOE advantages:

ROTO-HOE complete \$134.

1. Low first cost, complete ROTO-HOE only \$134.
2. Many thousands of satisfied customers.
3. Variety of low cost attachments to do extra jobs.
4. Minimum storage space needed—hang attachments from the garage wall.
5. Low cost replacement parts if ever needed.

You'll want to know more about just what ROTO-HOE and attachments can do to make gardening easier for you. Write today for free color catalog and name of nearby dealer.

START YOUR OWN BUSINESS. There may be an opportunity for you to start your own business selling and servicing ROTO-HOE in your community. Write for full details.

ROTO-HOE & SPRAYER COMPANY

Box 18

Newbury, Ohio

MACHINE SHOP EQUIPMENT

The NEW edition of the famous Center Tool Co. Catalog is now ready! Every workshop owner should have a copy. 240 pages full of illustrations, descriptions, and prices of the latest tools made by best known manufacturers in U.S. You pay the cost of printing, \$1.00. We refund your \$1.00 with your first order of \$25.00 or more. Prompt delivery on most tools. Send check or money order today!

CENTER TOOL CO.
153 Centre St., Dept. D, New York 13

BRONZE FOUNDRY

Schools and Home Workshops

Make your own castings of aluminum, copper, bronze, silver. Foundry sets are available in three sizes including 2400 Deg. F. blast Furnaces, \$22.50; \$29.50; and \$42.00 f.o.b. Kansas City. Free Circular.

KANSAS CITY SPECIALTIES CO. P. O. Box 6022, Dept. S-5
KANSAS CITY, MO.

Also Esheiman **SPORT CARS** WORLD'S LOWEST PRICE 70 Miles Per Gal. Holds 1 Adult. Free Literature

ESHELMAN

FOR Better LAWNS And GARDENS

Women Can Operate it. Free Catalog. Write **ESHELMAN Dept. R-45** 119 Light St., Balto. 2, Md. 333 N. Michigan Ave., Chicago-1, Ill. 7070 Hollywood Blvd., Los Angeles 28, Cal.

RAKES
PLOWS
CULTIVATES
HARROWS
HAULS
SPRAYS
SAWS
DOZER
MOWS
CUTS
ROLLS
TILLS
SNOW PLOW

1 to 8 H.P. Also Walking Tractors Low as \$69

WELD • CUT • BRAZE • SOLDER With

THE SHOBER "JUNIOR" ARC WELDER

Efficient, Inexpensive, Versatile

FOB Factory
Manufactured By

The ideal welder for small shops and portable use. Welds in all positions: flat, vertical, or overhead. Operates on either 110 or 220 volts A.C. Weight 77 lbs. Dimensions 11"x11"x16". Easily carried by one man for use in any remote or difficult place. Will weld all commonly used metals. Used by Contractors, Plumbers, Ornamental Iron Workers, Repairmen and Farmers. Rod Sizes: 1/8, 3/32, 5/64 & 1/16. Fully guaranteed —Factory Tested, \$79.50 Complete*Price includes welding leads, electrode holder, ground clamp, power supply and package of assorted electrodes. Literature available.

SHOBER SALES, INC. 900 West Weber Ave. Stockton, Calif.

General SALVAGE CO. SURPLUS Bargain-SALE! BUY DIRECT FROM THIS AD!

BUILD YOUR OWN ARC WELDER OR LIGHT PLANT



Save \$250 to \$500
\$15.50 used, good cond. Instruc. incl. for Comb. welder & light plant, 200 amps. 28 Volts. Or Brand New Price **\$21.50**
 PRICE F.O.B. K. C., MO.

CONVERTS TO ARC WELDER 200-250 AMP. OR LIGHT PLANT CAP. LOAD 5000 WATTS

Stock No. 711 D. C. Generator R-1 Jack & Heintz, rated 300 Amp. 30 Volts. Gov't cost \$300.00. Instructions for converting to welder or light-plant incl. **\$27.50**

RHEOSTAT #R-27 Heavy duty for regulating the voltage on the converted P-1, R-1, Welder, & A.C.-D.C. type Gen. **\$6.95** post paid

115 V. A. C. GENERATOR

Makes Ideal A.C. Light plant & DC Battery Charger. Stock #511 Mfg. by G.E. Rated 1250 Watts, 400 cy., 10.9 Amps. 115V. A.C. 200 Amps. 30V. D.C. Converts to dependable 115V. A.C. Light plant and D.C. Battery Charger. Gov't cost \$300.00. instructions incl. Used good condition **\$22.50** NEW **\$32.50**

INSECTICIDE PUMP SPRAYER FIRE EXTINGUISHER. Four gallon size includes approx. 3 ft. of high pressure hose with fine mist nozzle. Used, good condition built to give years of heavy duty service. Wt. **\$2.95** ea., add 15 lbs. Price..... **\$2.95** postage

DELCO MOTOR 6 Volt DC. Shaft is 1/4" in dia., 1 1/4" long. Size 5"x3" two mounting studs. 1200-2000 RPM. Price **\$3.50** Post paid

VALUABLE GEARS BARGAIN SPEED REDUCER 5:1 or 10-1 ratio 90 degree angle 1/2" splined shaft 3 mnt. holes rated 2 H.P. **\$6.45** post paid

CUNO OIL FILTER Aircraft type. Filters oil without cartridge replacements. Just turn handle and cartridge is clean. Standard 3/8" inlet and outlet ports. STOP CHANGING OIL. Instructions **\$4.95** post included..... **\$4.95** paid

BEAM ROTATOR MOTOR. Reversible Freeswing geared motor for TV aerials, Ham, FM, etc. Approx. 7 R.P.M. Applicable for 24 V. D.C. and 110V. A.C. instructions incl. Stock #572. O. cost over \$100.00..... **\$12.95**

MAKES IDEAL WINCH HOIST

operates on 12 to 32 Volts. Gives high torque, slow speed and tremendous power. Applicable for pulling or moving heavy loads. Makes ideal winch or heavy duty hoist. For belt or direct drive. Mfg. by Jack & Heintz. O. Cost over \$300.00. Shp. wt. **\$9.95** f.o.b. 55 lbs. Stock #J10..... **\$9.95** KCMo.

BENDIX HYDRAULIC PUMP and MOTOR POWER UNIT. Motor is 1 1/2 H.P. 24V. D.C. and operates on 12 and 32 Volt power. Rated 200 G.P.H. Pressure adjustable up to 1500 P.S.I. Ideal for Hyd. lift trucks, portable loaders, etc. Gov't cost over \$300.00. New.. **\$12.95**

PESCO LARGE VOLUME UTILITY PUMP for Water, Oil, Insecticides, etc. Including built in relief. 400 G.P.H. 1/2" drive spline shaft. 3/4" pipe. Data incl. #6001 **\$7.95**

SELF PRIMING ELECTRIC BLACK & DECKER MOTOR & PUMP UNIT. Ideal for oil burners, Aquarium fluid metering, coolant pressure lubricating, etc. Pump rated 2 G.P.H. Motor rated 1/30HP 1200 R.P.M. For 24 to 32V DC & applicable for 110V AC. Dimensions 7 3/4"x3 1/4"x3 1/4" Data incl. \$50.00 value..... **\$9.95**

THOMPSON MOTOR DRIVEN PUMP. Including built in motor. Applicable for 24V. D.C. & 110V. A.C. Ideal for pumping, fuel, oil, hot water heating circulator, etc. Capacity 300 G.P.H. Instructions incl. #1200..... **\$8.95**

BENDIX VACUUM AIR, GENERAL PURPOSE PUMP For Water, Oil, Insecticides, Air Fluid Pressure or Vacuum or as auto drain case pump. Rated 150 G.P.H. 2000 RPM, 5/8" Pipe ports. Instructions incl. Gov't Cost \$150.00. #548 **\$9.95**

STRATOPOWER CONSTANT DIS-PLACEMENT PUMP For Operating Hydraulic cylinders, motors on tractors, bulldozers, etc. Rated 400 G.P.H. at 3750 RPM. 1250-1400 P.S.I. Has built in relief. #37. \$150.00 value..... **\$17.50**

PESCO OIL HYDRAULIC PUMP. Gear type. Rated .227 cu. in. rev. 198 G.P.H. 1500 P.S.I. Male splined shaft 1 1/16" dia. 3/4" ports. #700..... **\$9.95**

AIR OR OIL HYDRAULIC CYLINDERS Stock #11—Double action 1 1/2" Bore, 6" Stroke, 3/8" Dia. shaft. Clevis mounting base and shaft end. Capacity 1160 lbs. with 1000 P.S.I. **\$8.95** post-input. \$50.00 value... **\$8.95** paid

Stock #17. Double action 1 1/2" bore 9 3/4" stroke 5/8" dia. shaft rated 1850 lbs. with 1000 P.S.I. **\$12.95**

Stock #12 Double action 4" Bore, 10 3/4" stroke, 1-5/16" dia. shaft. Rated 12560 lbs. with 1000 P.S.I. Clevis mounting. O. Gov't cost over \$300.00..... **\$27.50**

FOUR WAY HYDRAULIC VALVE Poppet type Spring loaded pressure balanced Open Center in Neutral position. 1500 P.S.I. 3/8" tube ports. #327..... **\$7.95** post paid

No. 21 FOUR WAY HYDRAULIC VALVE Off at neutral with built in relief valve for limit of cylinder strokes. Control with 3 positions, raise, lower and hold. 1/2" pipe ports. #617..... **\$9.95** post paid

PESCO EQUALIZER VALVE No. 397-D. New For 2 cylinders or 2 systems, will prevent uneven movement due to unbalanced load. Data incl. **\$12.50** post \$75.00 value..... **\$12.50** paid

WEAVER HYDRAULIC HAND PUMP New With Built in Check & relief valve. For oil or Hydraulic Fluid. Rated 2000 P.S.I. data incl. \$75.00 Value. **\$9.95**

HYDRAULIC SOLENOID CONTROL VALVE BENDIX #81560 For remote control & for hyd. cylinders. For 24V. D.C. & applicable for 110V. A.C. 800-1500 P.S.I. Connections are .550"-18thd. \$85.00 value **\$3.95** ea. Data incl. **\$7.50** per pair..

HYDRAULIC PRESSURE GAUGE Range 0 to 2000 P.S.I. Uses 1/8" fittings. **\$3.95** Postpaid

GENERAL SALVAGE CO., 2922 E. 27 St., Dept. 154 Kansas City, Mo.

Wanted: Men who can qualify for free training as Professional Consultants



Part-time: \$2500-\$3200 a year Full-time \$8000 and up

If you are between 25 and 55 years of age and have a sincere interest in new scientific developments, you are eligible for free professional training as an Accredited Nutritional Consultant.

After training, you will be certified to work with physicians and dentists supervising the administration of planned health programs in factories, offices, schools and private groups. You will warehouse for these groups high potency vitamin-mineral formulae as prescribed by your professional associates, and made available at extremely low cost through an ethical non-profit Medical-Dental Foundation.

Because professional men urgently need your services, you will enjoy their respect and esteem while receiving an income equal to or even exceeding theirs.

With your application, enclose \$24.00 (or enclose \$5.00, pay balance and C.O.D. charges on arrival) for the sample professional kit we send for your examination. This kit includes a walnut case with individualized menus indexed according to nutritional and caloric values, specimen copies of professional credentials you will use, and a 120-day supply of high-potency vitamin-mineral formulae (value \$40).

Since this professional kit is not for sale at any price, we request that you return it to us for full refund within 10 days if you decide not to go ahead with your training program.

Only one consultant will be selected for training in each area; we urge you to write us today.

American Foundation for Medical-Dental Science
 (a non-profit corporation)
 Dept. PS-5, 1044 S. Robertson, Los Angeles 35, Calif.

NEW! Giant 1954 Catalog of AUTO PARTS AND Accessories

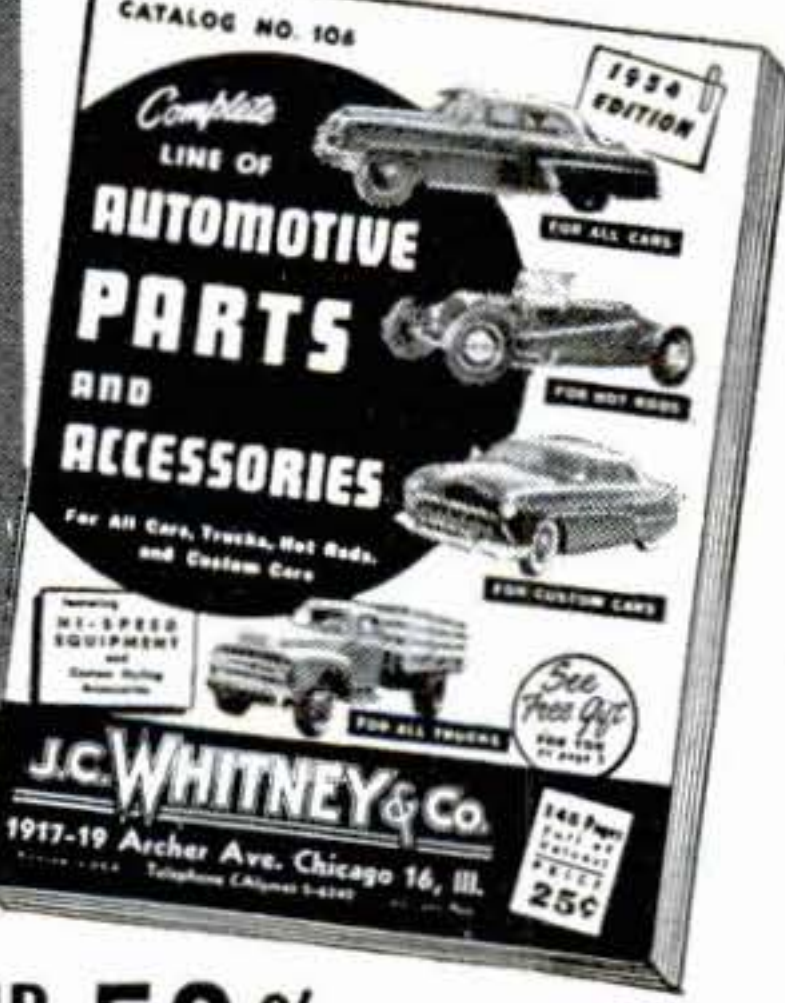

World's Largest Selection—50,000 Items at WHOLESALE PRICES!

YOU SAVE UP TO 50%

Ready now... complete automotive buying guide... everything for your car, truck, custom-styled car, or hot rod... all at rock-bottom wholesale prices! Hard-to-find equipment, parts for cars from 1920 to 1954 models! New HOLLYWOOD ACCESSORIES; HIGH-SPEED PARTS; CUSTOM-STYLING EQUIPMENT!

FREE...valuable Check Chart showing how free if you mail coupon for catalog TODAY with 25c to help pay postage and handling. We credit the 25c on your first \$5-or-more order, so Catalog will then be FREE TO YOU. Fill in and mail Coupon NOW!

148 Pages packed with items like these... all at Wholesale Prices!
 Auto radios — Mufflers, pipes — Engines, parts — Transmissions — Tires, tubes — Tools — Springs, shocks — Ignition parts

J. C. WHITNEY & CO.
 1917 T-5 Archer Ave., Chicago 16, Ill.
 Rush giant 1954 Catalog of auto parts and accessories at wholesale prices. I enclose 25c to cover part of cost, which will be credited to me on my first \$5.00-or-more order.

Name.....
 Address.....
 City..... State.....

The New Improved Model 38-98 DYNAMIC POWER TOOL COMBINATION

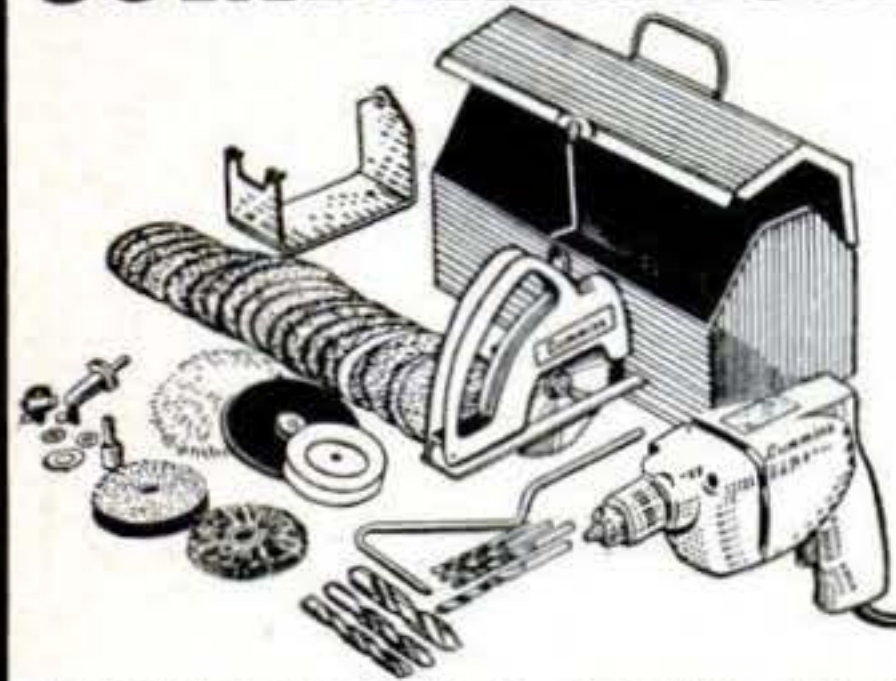

INCLUDES: Cummins 1/4" Pistol-Grip Electric Drill; Cummins Saw Attachment; Combination Saw Blade; Set of Drills; Lambs Wool Bonnet; 13 Sanding Discs; Steel Arbor and Attachments; Cloth Buffing Wheel; Grinding Wheel; Wire Wheel Brush; Steel Paint Mixer; Steel Bench Stand; Portable Steel Carrying Case.

Price of Dynamic Power Tool Combination complete is \$29.95

SHIPPED ON APPROVAL No Money With Order - No C.O.D.

Try it ten days before you buy. If completely satisfied then send \$4.95 and pay balance at rate of \$5.00 per month for 5 months - No Interest or Carrying Charges Added. If not completely satisfied, return to us, no explanation necessary.

KAPNER HARDWARE, INC.
Dept. A-102, 2248 Second Ave., New York 29, N. Y.
Please rush 1 Dynamic Power Tool Combination. I agree to pay \$4.95 within 10 days after receipt and \$5.00 per month thereafter.

Name.....
Address.....
City..... Zone..... State.....

WELD **BRAZE**
SOLDER **CUT**

4WAY
ONLY \$14.75
f.o.b. factory
WELDER
Complete with Twin Carbon Arc Torch and accessories... to handle all metal-craft work.

Acclaimed by thousands of Homeowners, Mechanics and Hobbyists as the welder of 1001 uses. Easily operated from properly wired 110 volt AC or DC line. The ideal gift with a life-long use... Order today on 10 day money back guarantee.

FOUR-WAY WELDER CO., Dept. F3-E
1810 S. Federal St. • Chicago 16, Ill.

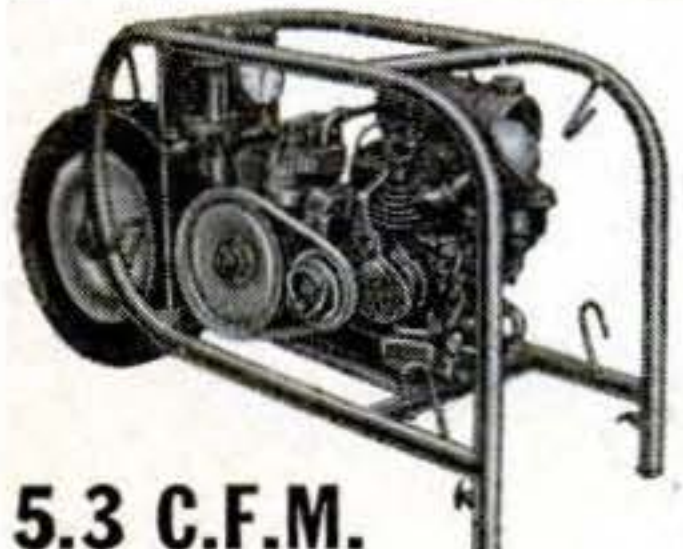

AIR COMPRESSOR

SURPLUS! NEW Gov. Release!
Original Govt. Cost \$350.00
The Finest 2-H.P. TWIN CYLINDER Industrial Unit Ever Built!
\$129.00 fob Fully Guaranteed

5.3 C.F.M. **200 lb. PRESSURE**

Maintains 40 to 65 lb. pressure for CONTINUOUS spraying (no waiting 'til tank keeps building up)

Made by Bendix Westinghouse to rigid specifications. A Buy for Contractor; Factory; Garage; Service Station; Shop; Farm! **PORTABLE!** Two independent air outlets—one for high pressure (up to 200 lbs.)—the other controlled by regulator from 0 to max. Large face gauge. Adjustable Safety valve. Automatic unloader (adjustable up to 200 lbs.) keeps pressure constant without stopping engine. Welded hollow frame acts as air reservoir... assuring large supply of **Oil-Free** air with **Absolutely No Pulsation!** Sprays with material tanks of any size. **Unexcelled for: Spraying; Greasing; Tire Inflation; Blowing out heating and refrigeration lines; Small pneumatic tool operation; insecticide dusting and spraying; Flocking; Undercoating!** Specifications below:

- COMPRESSOR—**
 - Mfg. by BENDIX WESTINGHOUSE
 - Twin cylinder
 - 4 Rings on each piston for added compression capable of pumping 1100 lbs. p.s.i.
 - Forced pressure lubrication assures oil to every moving part
 - Ball bearing construction
 - Capacity 5.3 cu. ft.
- ENGINE—**
 - Mfg. by BRIGGS & STRATTON
 - Kick or rope start
 - 2 H.P., 4-cycle air-cooled
 - Splash lubrication system
 - 2-qt. gas tank
 - Float feed carburetor with adjustable idle speed and automatic governor
 - 3 Piston rings

ALSO AVAILABLE! Same unit with 1 H.P. Electric Motor, Single-phase, 110-220 volts, 60 cy **\$129.00**

IMMEDIATE DELIVERY! SUPPLY LIMITED! ORDER FROM AD
SEND FOR CATALOG OF MOTORS AND ELECTRICAL EQUIPMENT
ROBERTS ELECTRIC CO., Dept. 174, 849 W. Grand, Chicago 22, Ill.

BUILD YOUR OWN POWER TOOLS - TILT/ARBOR SAW

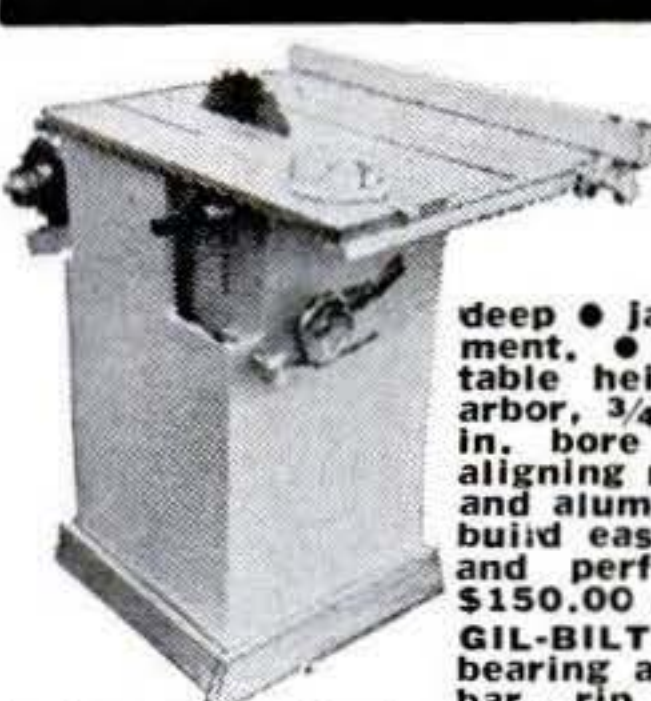

TILT/ARBOR SAW

BANDSAW BELT SANDER
SAVE \$50. OR MORE

- 27 x 28 in. table stays level. Blade tilts full 45 degrees.
- 10 in. blade cuts 3 1/2 in. deep.
- Jackscrew depth adjustment.
- Floor model, 34 in. table height.
- New Departure ball bearing arbor, 3/4 in. precision shaft, ready to run, 5/8 in. bore blades.
- Quick positioning, self-aligning rip fence guide.
- Sturdy wood, steel and aluminum construction.
- No machining—build easily with hand tools only.
- Capacity and performance of floor saws selling for \$150.00 and up!

GIL-BILT Metal Parts Kit, includes Plans, ball-bearing arbor, cast aluminum miter gauge and bar, rip fence guide, machined lock knobs, jackscrew mechanism with 4 1/2 in. handwheel, and all other metal parts (less blade)..... \$22.95
Same Kit with 10" combination blade..... \$25.90
Same Kit with 8" combination blade..... \$24.90
If not satisfied, return Kits in 10 days for refund of purchase price.

For shipments up to 600 miles, add 5%; over 600 add 10%. Amount in excess of actual postage will be refunded.
GIL-BILT Step-by-Step pictorial plans (No blue-print reading required), full scale patterns—actual photographs for above 10" TILT/ARBOR SAW, 8" TILT/TABLE SAW, 12" BAND SAW, 18" BAND SAW, BELT SANDER, SPINDLE SHAPER, \$1.00 each postpaid anywhere in the world or WRITE FOR FREE descriptive catalog.

COMPLETE PLANS only \$1.00 EACH

GILLIOM POWER TOOLS P. O. Box 1-VE, Lambert Field, St. Louis 21, Missouri

WAR SURPLUS GIGANTIC SALE SAVE UP TO 85%

NEW HI-SPEED DRILLS
30 ea. 1/60-1/4 for \$3.25
10 ea. 1/4 -1/2 for \$3.50

IMPORTED SQUARES

2"	1.30	6"	2.25
3"	1.50	8"	3.30
4"	1.67	10"	5.00
5"	2.00	12"	6.60

8 Pce. Combination Set 2" to 12" \$19.95

Check or M.O. 25% Dep. on C.O.D.—F.O.B. L.A.
Metro Precision Tool Co., 1507 S. La Cienega, Los Angeles 35, Cal., Dept. S'

Build Your Own ARC WELDER

D.C. Gen. P.I. 24 V. 200 Amp. Incl. Dia. \$12.50
D.C. Gen. R.I. 30 V. 300 Amp. Incl. Dia. \$21.50 Per. Cond.

Sensitive Altimeter (Pioneer) AN-5761 0-35,000 Condition Perfect \$10.95
Brand New Altimeter 0-10,000 \$6.50 (Send for Cat.)

Send 15c For Catalog or Sent Free With Order



MAKE YOUR OWN FOUNTAINS, LAKES, RIVERS, WINDOW DISPLAYS

With New Miniature Water Pump
Here's real action for window displays, Xmas tree layouts, or the home lab. Pump only 4 3/4" high - 3 1/4" wide. Threaded for pipe, or uses 3/8" rubber tubing. Operates in 1" of water, 110 A.C. 60 Cycle. 1/250th H.P. 50 gals. per hr. Furnished complete—ready to work—your satisfaction absolutely guaranteed or your money back.....
\$9.95 p.p.
Moore Manufacturing Company, Swedesboro 16, N.J.



Dealers or Representatives Needed for nationally advertised line of Spark Plugs — Oil Filters — Auto Specialties — Liberal Proposition — Full or Part Time — Experience Not Necessary — Write Today

ENGINE PRODUCTS MFG. CO.
5801 E. Beverly Blvd., Dept. 170, Los Angeles 22, Calif.

FILE SAWS THE RIGHT WAY

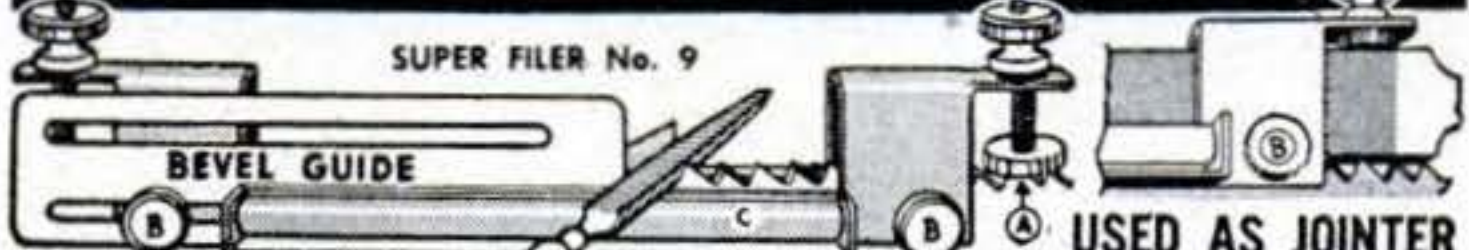

USED AS JOINTER
SO EASY: With this new filing jig and jointer anyone can now sharpen any handsaw like new! When file hits hardened steel rollers teeth are finished and EXACTLY SAME HEIGHT. All teeth cut and saw runs true and smooth. Jig and instructions \$2.95 postpaid. Free literature.

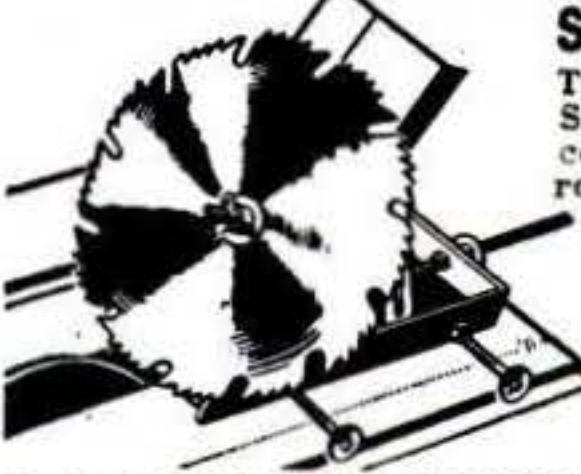

SHARPEN YOUR CIRCULAR SAWS
The RIGHT WAY on your own saw table. Sharpens rip, cutoff, hollow ground and combination blades—8" to 10". Saws stay round with correct bevel. Precision made, easy to use, **GUARANTEED**. Only \$8.95. Includes \$3.00 Grinding wheel. "TRU-CIRCLE" saw set automatically sets teeth at 10° or more \$2.95.

AT DEALERS OR POSTPAID
A. D. McBURNEY, 5908 Hollywood Blvd., Hollywood 28, Cal., Dept. S-41

2500 lb. HOIST



A SURPLUS \$100 VALUE
ONLY 32.50
WITH FRAME

We've sold hundreds of these to garages, machine shops, truckers, boat yards and boat owners, etc. Has a 2500 lb. capacity through a 24 to 1 gear ratio. Had bronze worm gear drive. 18 ft. of high tensile, steel cable, 3/16" in diam. Originally used as Bomb Hoist.

Above Winch comes on a Palley, specially designed and engineered frame. Allows quick & easy universal mount on Truck, Tractor, Jeep, Wall, Beam, etc.



NAVY SURPLUS
PORTABLE WINCH HOIST

LIFTS 1500 POUNDS

Made for U.S. Navy Bur. of Ordnance, as a Bomb Hoist. Has a 21 to 1 gear ratio. 40" tubular arm extension with a 3" pulley on the end. Drum has 12 ft. of 3/16", high tensile strength, steel cable. Handle has a ratchet brake. Ideal for 'swing about', truck or platform loading. Overall length is 48".

27.50



RIGHT ANGLE DRIVE

Has direct 1 to 1 ratio through 90° bevel gears. Drive & take-off shafts are 3/8" diameter. Gears are self-lubricating, hi-speed steel. Ideal for use on power tools, flex drives, etc. Size: 3 1/2" x 2 1/4" x 1 1/4".

2.25



180° OFFSET DRIVE

For use where tremendous power at low take-off RPM is desired. Drives through a chain of 6 gears, rotating on self-lubricating, hi-speed roller bearings. Has an 85 to 1 gear ratio. Take-off shafts are 1 1/4" and 3/8" diameter. USED

6.75

NEW **12.95**



HAND CRANK GEAR BOX

Provides manual power to gear boxes, screw jacks, flexible shafts, etc. Has 9/32" x 12 spline output shaft with 5/8" x 24 thread male fitting. Gear ratio 2.8 to 1.

1.75

- FLEXIBLE DRIVE SHAFTS -

9/32" x 31" - 12 spline . . . 60¢ ea.
9/32" x 32" - 12 spline . . . 65¢ ea.
9/32" x 64" - 12 spline . . . \$1.29 ea.



ARMY D-12 MAGNETIC COMPASS

Originally used as standard navigational equipment on all Army Aircraft. A real War Surplus BARGAIN. Has a rotating verge range ring, calibrated in 1 degree increments from 0 to 360°. Two parallel grid wires for N-S alignment. Ideal for airplane, boat, etc.

12.50

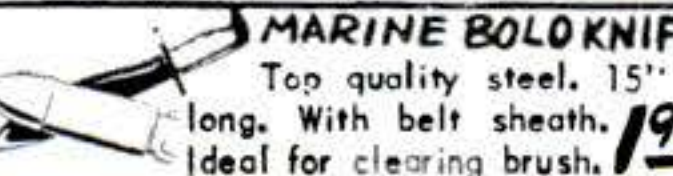

MARINE BOLO KNIFE

Top quality steel. 15" long. With belt sheath. Ideal for clearing brush.

1.98

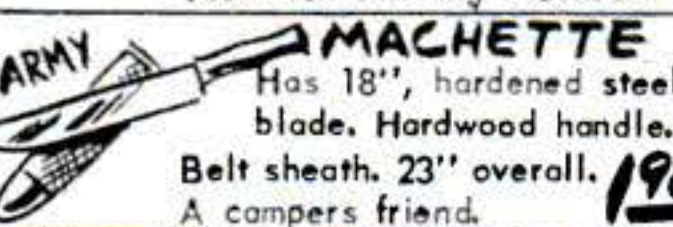

ARMY MACHETTE

Has 18", hardened steel blade. Hardwood handle. Belt sheath. 23" overall. A campers friend.

1.98

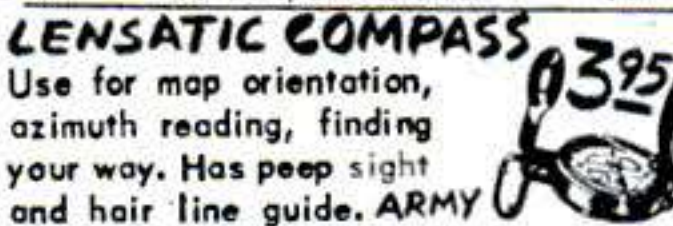

LENSATIC COMPASS

Use for map orientation, azimuth reading, finding your way. Has peep sight and hair line guide. ARMY

3.95

SAVE UP TO 85% ON GOVERNMENT SURPLUS



CENTRIFUGAL PUMP & MOTOR DELIVERS UP TO 700 G.P.H.

Excellent for draining cellars, rock garden waterfalls, fish ponds, sumps, water circulators, evaporative coolers, etc. Powered by the famous G.E. 110 volt, 60 cycle motor. Has 1 inch standard pipe inlet - 3/4" to 1 inch hose outlet.

A Government Surplus Bargain - made to sell for many times our price. Completely reconditioned and ready to run.

A \$20 VALUE **ONLY 7.69**



NOW! BUILD-IT-YOURSELF DIVING LUNG

NOW you can build your own diving lung as described in July 1953 issue of Pop. Science. Kit includes Air Bottles, Pressure Regulator, Hoses, Clamps, Safety Belt (B-14), Shoulder Harness, Valves, Mouth Piece, etc. A \$150.00 VALUE

With 2 bottles (1 hour time) **45.95**

FREE FOLDER

SEND TODAY for FREE

Illustrated Folder on our complete line of Underwater Diving Equipment.

PALLEY SURPLUS FOR DIVING EQUIP.



AN-6004-1 Type DILUTOR DEMAND PRESSURE REGULATOR

Similar to type recommended by the Popular Science Magazine. Gives proper regulation of air flow. While they last . . . NEW

10.95



QUICK RELEASE SAFETY BELT

G.I. SURPLUS CARTRIDGE BELT



OXYGEN TANKS

Shatterproof. Designed to stand pressure of 1800 PSI. Tested and approved. Ready to use.

22 cu. ft. cap. (30 min. limit time) **9.75**

38 cu. ft. cap. 3/4 hrs. under water **12.75**

Palley SPECIAL / Gives up to 1 hour underwater at average depth. Has 15 lb. capacity - 48 cu. ft. Size: 6 1/2" diam. x 23 1/2".

17.95

Cartridge pockets allow for better balancing of ballast weights. **89¢**



NEW CO2 NEPTUNE HARPOON GUN

29.95 VALUE **13.95**

Has JET POWER - Simplest, most efficient underwater gun we know of. Designed for one arm use. Weighs only 27 ounces. Has 13 ft. of 150 lb. test NYLON line on a snag-proof line reel. Positive safety-catch. Rust resistant finish. All-metal body. CO2 CHARGES - Box of 10 charges for above gun. . . . ONLY 98¢

U.S. ARMY SIGNAL CORPS FIELD PHONE

A private phone or intercom system. Easy to operate. Use on Farms, Target Range, Mountains, Forest, or any place portable two-way communication is desired. Gives clear reception up to 15 miles. Uses 2 standard batteries. Has ringing generator, one phone, leather carrying case.



Price each Phone **14.95** System of 2 sets **29.95**

HYDRAULICS

No. 3 - Double Action CYLINDER Lifts or pushes up to 1100 lbs. Has a Bore of 1", Shaft 1/2", Stroke adjustable from 2-1/2" to 4" with internal sleeve stops. Length overall 8-1/2". Will take 1500 PSI continuous - 575 3000 PSI intermittent. **SPECIAL! 5.75**

No. 29 - Double Action Cylinder Gives 20,000 lbs. lift with a 1500 PSI line pressure, or will give 40,000 lbs. thrust on an intermittent 3000 lb. line pressure. Has a 4" bore, 1-1/2" diameter piston shaft. 18 inch stroke. 30-1/2" length. Ideal for presses, road, farm and shop equip. Cost Gov't \$390- **29.95**

Send for CATALOG at right for full details and description of our other Hydraulic Bargains - SAVE up to 85%

WORLD'S MOST AMAZING BARGAIN CATALOG

SAVE UP TO 85% ON WAR SURPLUS

1954 EDITION - 320 PAGES FULLY ILLUSTRATED

Packed with SENSATIONAL VALUES in WAR SURPLUS, FACTORY CLOSE-OUTS and GENERAL MERCHANDISE!

Thousands of items in Hand & Power Tools, Gadgeteers & Hobbyist items of all types, Outdoor and Sporting Equipment, Photo Supplies & Cameras, Hardware, Foam Rubber, Industrial Tools, Precision Instruments, Microscopes, Aircraft Parts, including the LARGEST stock of Hydraulic Cylinders, Valves, Pumps, Motors, Fittings, Tubing, etc. We have on hand over 20,000 cylinders in over 61 sizes and types. Send for your copy TODAY!

SEND 50¢ To cover HANDLING and MAILING COSTS . . . REFUNDED with your first order.

100-200-300 POWER MICROSCOPE

A PALLEY BARGAIN! Has fully ground and polished achromatic lenses. A triple revolving lens turret with 100-200-300 Power objectives. Adjustable plano-sub-stage mirror. All-metal body is built to incline through 90°. Comes in handsome dovetailed hardwood case. Ideal for students, home labs, amateur scientist, schools, etc. This remarkable value for ONLY



9.99

ARMY RIFLESCOPE

Built to rigid gov't specifications. Contains the finest precision, achromatic optics. Has five double-element lenses - fully corrected for color and spherical aberration. 3 power magnification. Dot reticle. Length 9" **9.95**

NOTE: We are now designing a special mount for this scope. WRITE for Details.

SAVE \$800 ON THIS 177 CAL. AIR RIFLE

Take advantage of our Bankrupt Stock BUY! SAVE! Made in Belgium for Hy-Score. Requires no pumping, just cock & fire. Has ALL STEEL, fully rifled barrel, 17 1/2" long. A beautiful natural finish, hardwood stock, Takes .177 caliber pellets or darts. An ideal training rifle for youngsters and excellent for indoor target practice. Overall lgth., 40 1/2". Weight 5 pounds. Quantity limited. **10.95**

NYLON FISHLINE

Strong, lightweight, rotproof and waterproof. Genuine NYLON! 10 lb., 1500 ft. **99¢** 45 lb., 750 ft. **\$2.49**

AIR CORPS RUBBER BOATS

USAF SURPLUS

Made to government specifications. An ideal boat for Fishing or Hunting in river, lake or ocean. Safe, lightweight, easy to pack. Reconditioned and ready to use.

1 MAN **22.95** 5 MAN **59.95**
7 MAN **69.95** 10 MAN **110.00**

COLLAPSIBLE OARS . . . **3.95**
PADDLES **3.95**
HAND AIR PUMP **3.95**

PALLEY SUPPLY CO 2263 E. VERNON AVE., DEPT. PS-5 LOS ANGELES 58, CALIF

Order From This Ad. Pay by M.O. or check. P.O.'s acptd. from D&B firms. 1/2 deposit with C.O.D.'s. All Prices FOB Los Angeles.

How Much Did You Learn?

By **Stanford E. Taylor and Helen Frackenpohl**

Washington Square Reading Center, New York

Now you can sample how much you remember of the useful and interesting information packed into this issue of POPULAR SCIENCE MONTHLY. Answers to the questions are printed just below the quiz. After each answer is a page reference to the article on which the question was based.

1. *The loftiest lock in the world is at McNary Dam, on the*

- a. Snake River
- b. Missouri River
- c. Columbia River

2. *This new type of aircraft, designed for the Navy, is called a*

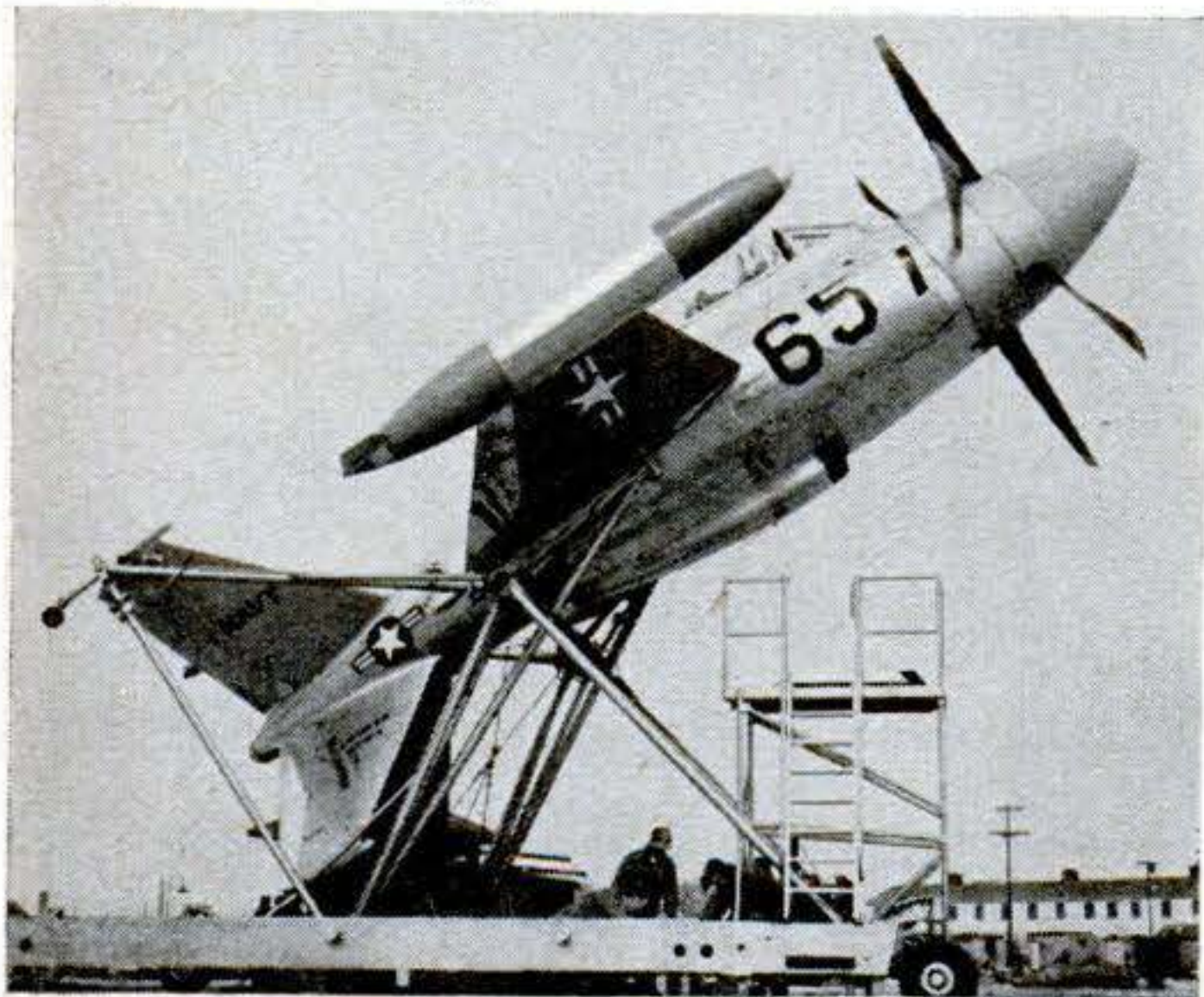

- a. Convertiplane
- b. Vertiplane
- c. Revertiplane

3. *The bevatron is a new*

- a. nuclear particle
- b. atom-smasher
- c. TV broadcasting tube

4. *By the end of this summer, you'll be able to whiz along on*

- a. 800 miles of toll superhighway
- b. 1,100 miles of toll superhighway
- c. 1,300 miles of toll superhighway

5. *To protect your wood fence against decay and insect damage, the best home-treatment method is*

- a. cold soaking
- b. hot-and-cold bath
- c. brushing or spraying

6. *For you, as a car owner and driver, "unit" construction of automobiles would have the advantage of*

- a. lower body-repair costs
- b. neater appearance
- c. better roadability

7. *A dynamometer is used in tractor testing to measure*

- a. fuel consumption
- b. horsepower
- c. temperature

8. *If you want to give your lawn a really close trim, the best machine for you would be a*

- a. reel-type mower
- b. rotary-model mower
- c. dual-blade mower

9. *Their first year out, graduates of Kings Point Merchant Marine Academy stand to make as much as*

- a. \$4,500 a year
- b. \$7,500 a year
- c. \$11,000 a year

10. *The best-selling European car is the little*

- a. MG
- b. Volkswagen
- c. Renault

Answers: 1. c-p. 137; 2. b-p. 113; 3. b-p. 102; 4. c-p. 166; 5. a-p. 180; 6. c-p. 133; 7. b-p. 152; 8. a-p. 176; 9. b-p. 142; 10. b-p. 108.

NEXT MONTH . . .

What You Need to Explore Underwater Playgrounds

Now you, too, can join in America's newest sport, skin diving. A special section in POPULAR SCIENCE MONTHLY for June will show you the equipment you need and tell you how to make it . . . including an easy-to-build beginner's diving outfit.





Here's How A Simple Device INCREASES POWER, PICK-UP, SPEED and PERFORMANCE

up to **10%** and

Assures **ENGINE LIFE**

Up to **300,000 MILES**

A Chemical-Metallurgical Discovery, **MAGNA-POWER OIL DRAIN PLUG**

Neutralizes Corrosive Acids As They Form
In Your Crank-Case



Winthrop A. Johns, originator and manufacturer of Magna-Power crank-case plug, is a graduate of Massachusetts Institute of Technology and a member of the S.A.E. He is shown here with his original test car. "I don't expect to live long enough," he says, "to wear this engine to the first overhaul. At the present rate of wear it will run at least 700,000 miles."

A CHECK TEST. Magna-Power plugs have been subjected to road tests in various passenger cars for periods up to fourteen years. Full scale fleet and passenger car testing began four years ago when about 1,500 test vehicles were started. After 147,000 miles in fourteen years the original test engine shows practically no wear and has the same or more pick-up and power as when new. It uses 1 quart of No. 20 oil in 1,400 miles!

Thanks to the Oil Industry for its multimillion dollar scientific researches and processing improvements, almost any of the leading motor oils today will assure fairly safe protection against FRICTION . . . What most should concern the wise car owner today is PROTECTION AGAINST CORROSIVE ACIDS! That's now proved to be the Major Cause of Engine Wear!

STRONG SULPHURIC ACID—YOUR MOTOR'S WORST ENEMY. Today's motor oils have practically no residual acid. Some are even advertised as alkaline to begin with. But gasoline (or fuel oil) contains about one part per thousand of sulphur. One thousand gallons—enough to drive 15,000 to 20,000 miles—may therefore contain the equivalent of about 5 gallons of good strong sulphuric acid. Also present are substantial amounts of bromine (added to leaded gasolines) and chlorine (with the lead), both acid formers. Despite good engine ventilation these destructive acids, in gas or liquid form, find their way into the oil chamber or crank-case. After the first few thousand miles this cumulative corrosive action begins to take its toll—in loss of power, pick-up, speed and performance.

THE ANSWER TO INNER CORROSION—MAGNESIUM ALLOY ATTRACTS AND NEUTRALIZES THESE ACIDS. It is well known to chemical and metallurgical engineers that magnesium and aluminum in proper combination as an alloy will form a dragnet affinity for acids. To clear all corrosive acids from your crank-case oil, what could be more simple, then, than a special crank-case plug made of this magnesium alloy? **MAGNA-POWER Oil Drain Plug** screws in like your regular plug but the effective alloy metal extends up into the crank-case oil. There, like a potato that draws salt out of water, Magna-Power draws corrosive acids and neutralizes them as they form. (You can see this action for yourself. Drop a MAGNA-POWER into a glass of vinegar or even grapefruit juice and watch the wild effervescent foaming that results.)

YEARS OF ROAD TESTS OVER MILLIONS OF MILES PROVE THE MAGNA-POWER CAN KEEP ENGINES AS POWERFUL AS NEW. As INSURANCE against the need for overhaul for literally hundreds of thousands of miles, no accessory or use of specially made premium motor oils can compare with MAGNA-POWER acid neutralizer drain plugs. Scores of big motor fleets, bus lines, trucking companies and passenger cars have tested them. The enthusiastic letters are available to you at any time.

INSTALL THIS AMAZING ACID NEUTRALIZER NEXT TIME YOU CHANGE OIL—FOR FINEST—LONGEST ENGINE PERFORMANCE. Magna-Power neutralizer is guaranteed to combat corrosion for at least 100,000 miles! Several types are available for all makes and models. It's simple to install—in a matter of seconds—at any time of oil change after your car's original break-in period of 2,000 or 3,000 miles. Stop rust—stop sludge—neutralize acid with this simple device—and "wear-proof" your engine for the life of your car!

ORDER A MAGNA-POWER NOW—ready for Next Oil Change and Remember Our Money-Back Guarantee is Good ANY TIME. Mail the Coupon below—Today!

IT'S LIKE A SACRIFICE HIT!

The magnesium-aluminum alloy is made a part of Magna-Power oil drain plug to stick up into the oil in the crankcase to attract and neutralize any corrosive acids there. It will serve this purpose 100% for many thousands of miles. Each time you change oil have the mechanic examine the alloy part of the plug for any signs of deterioration. Chances are there will be a film of corrosion darkening the surface (scratch it with a piece of metal—a key will do—to the bright under body) or completely covering it if large amounts of corrosive acids have been in your oil. Such signs mean that Magna-Power has taken out the acid action that would have otherwise attacked the vitals of your engine. You can thank Magna-Power for removing these harmful acids and for keeping the abrasive acid products off the working parts of your engine.

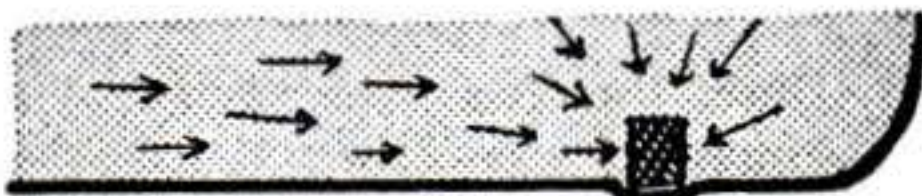

CORROSIVE ACIDS GO FIRST FOR THE MAGNESIUM—BECOME NEUTRALIZED—AND THUS BY-PASS PARTS THEY USUALLY ATTACK

The acids in your engine will eat away those metals that are most easily eaten or attacked. Since magnesium is by far the most easily eaten, acids attack it first and are neutralized or destroyed in the process.

NORMAL DECREASE IN ENGINE POWER COMPARED WITH POWER PROTECTED BY ACID NEUTRALIZER

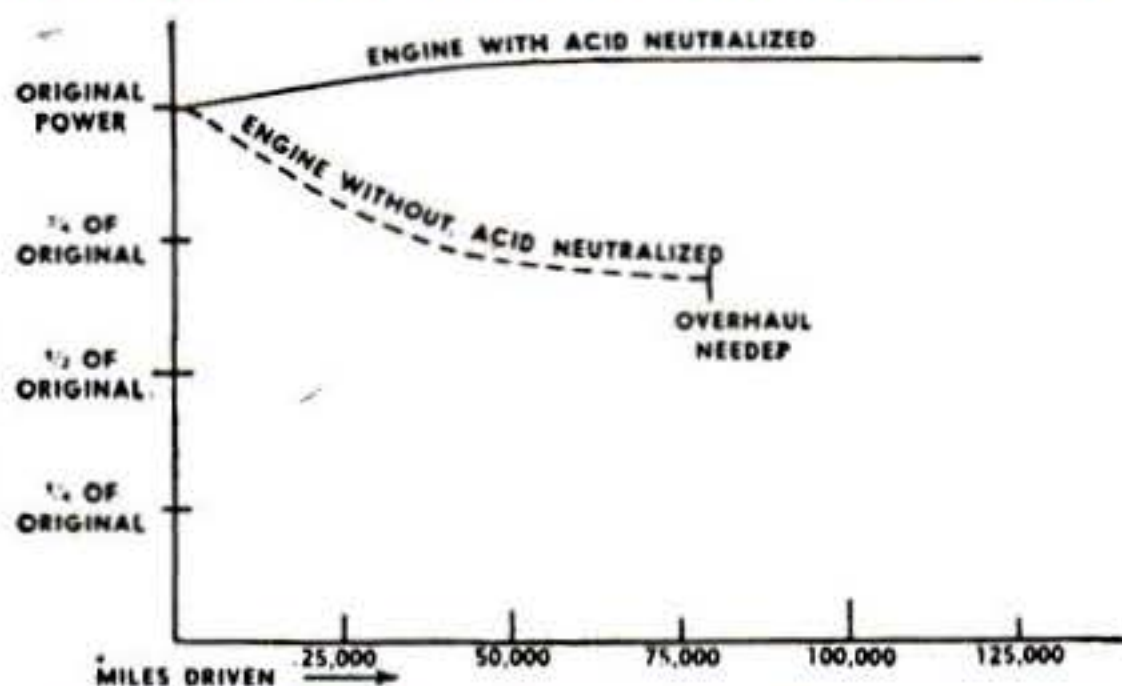

IMPROVE IGNITION—WASTE LESS GAS

Explosion heat and part of the exhaust stroke keep spark plugs hot for only about a quarter of the time. The rest of the time the plugs are cool enough to be affected by the oil. We know this because the type of oil used has a great deal to do with the deposits on and around them. Acids in this oil eat electrodes, attack porcelain and cause short circuiting deposits that keep the spark plug from doing its job. With corrosive acids neutralized they maintain top efficiency for thousands of miles, which saves gasoline.

SATISFACTION GUARANTEED OR MONEY REFUNDED AT ANY TIME

JOHNS MANUFACTURING CO.
Dept. B-5, Dunellen, N.J.

JOHNS MFG. CO., Dept. B-5, Dunellen, N.J.
My car is a (make) (year).
Please send me a MAGNA-POWER acid neutralizer.
I enclose \$2.95. I understand that it is sold with an unconditional guarantee of satisfaction or my money back!

Name
Street
City State

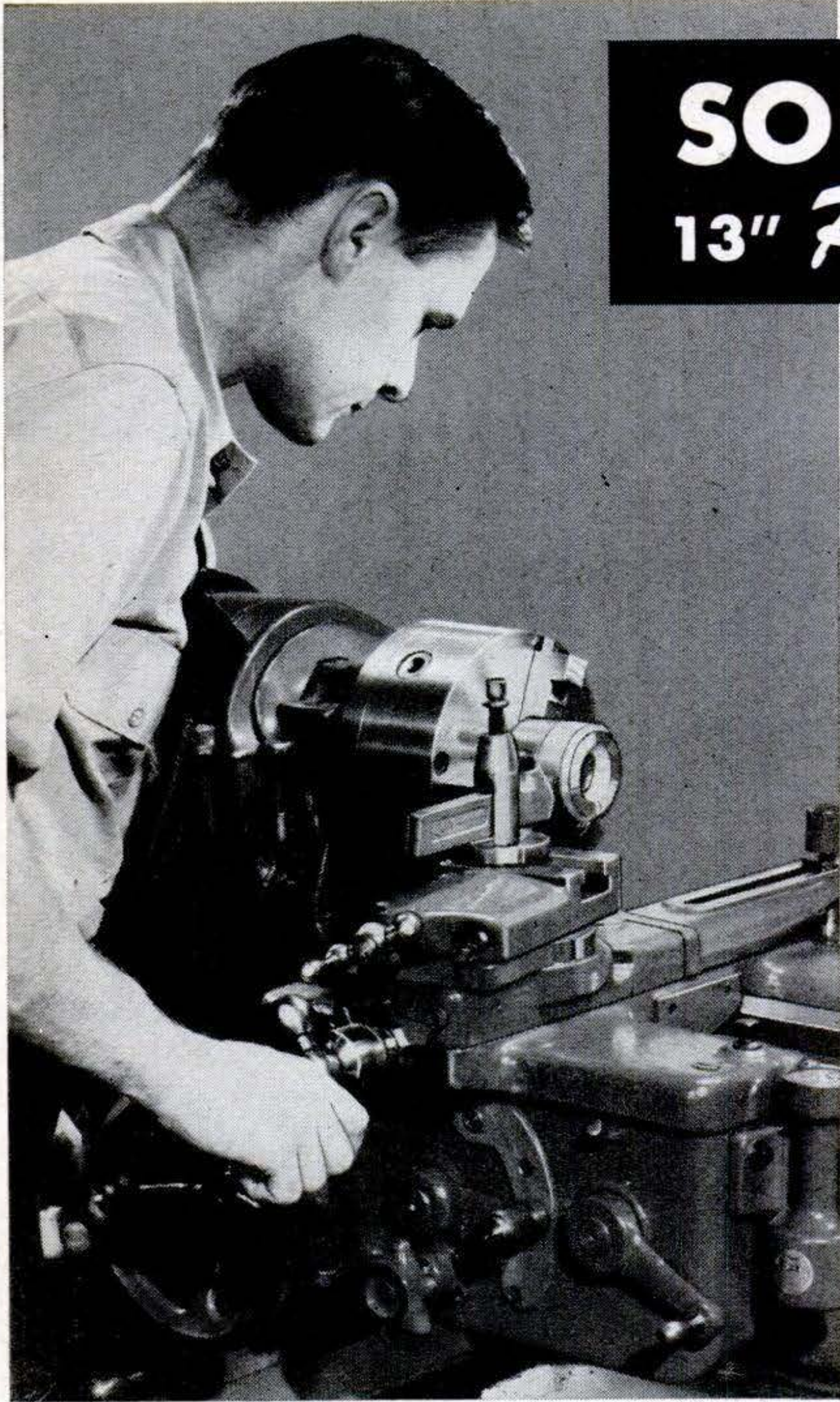

SOUTH BEND

13" Precision Lathes

**for accurate,
low-cost machining**

These lathes are popular in the toolroom, production shop, or wherever varieties of precision parts are machined. Users prefer them for their simplicity and practically effortless handling. Job set-ups and tooling changes are made so quickly and easily that down-time is held to a minimum. A very complete line of attachments simplifies tooling. Send coupon for complete information.

SPECIFICATIONS

Swing — 13 $\frac{1}{8}$ " over bed and saddle wings, 8" over cross slide.

Distances Between Centers — 28 $\frac{1}{4}$ ", 40 $\frac{1}{4}$ ", 52 $\frac{1}{4}$ " maximum.

Collet Capacity — 1" maximum (Collets interchangeable with South Bend 10"-1" Collet, 14 $\frac{1}{2}$ ", 16" and 16-24" lathes).

Spindle Bore — 1 $\frac{3}{8}$ ".

Spindle Speeds — Eight, 40 to 940 r.p.m., approximate.

Power Longitudinal Feeds — 48 R.H. or L.H., .0015" to .0841".

Power Cross Feeds — 48, .0006" to .0315".

Thread Cutting — 48 R.H. or L.H. pitches, 4 to 224 per inch.

Send For This Book!

Every machinist needs "How to Run a Lathe." This helpful handbook contains 128 pages and over 365 illustrations and diagrams on all phases of lathe operation and care. Price postpaid 50 cents.





**Can I get it?
When? How?**



Yes—you can get most any South Bend product immediately from our distributor's stocks in principal cities. Items not stocked, shipped promptly from factory.

Three ways to order:

1. See or telephone nearest distributor.
2. Order by mail from your distributor.
3. If no distributor is nearby, order direct from factory.

South Bend machine tools with accessories may be purchased on convenient terms up to 18 months.

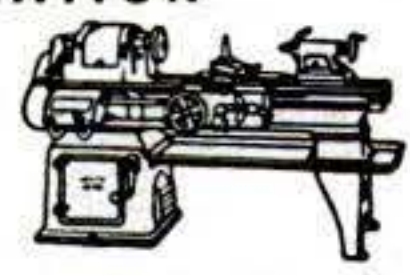
SEND INFORMATION CHECKED:

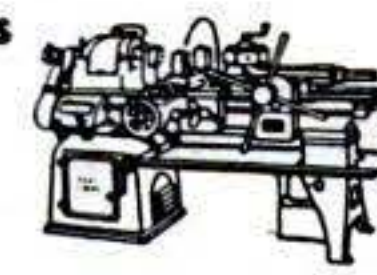
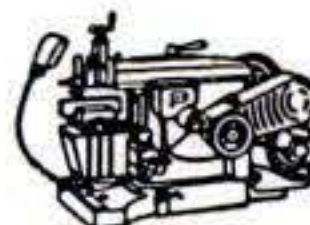
<input type="checkbox"/> 	<input type="checkbox"/> 	<input type="checkbox"/> 	<input type="checkbox"/> TOOL GRINDERS	<input type="checkbox"/> 	<input type="checkbox"/> 
<input type="checkbox"/> 9" and 10" BENCH LATHES	<input type="checkbox"/> 10" to 16-24" FLOOR LATHES	<input type="checkbox"/> DRILL PRESSES		<input type="checkbox"/> 1/2" & 1" Collet TURRET LATHES	<input type="checkbox"/> 7" BENCH SHAPERS

Name _____

Street _____ City & State _____

Building Better Tools Since 1906 • SOUTH BEND LATHE • South Bend 22, Indiana



PORTABLE LIGHT PLANTS



600-700 Watts PUSH BUTTON START
115 v. 60 cyc. AC. Powered by a rugged 2 hp. easy-starting Briggs gas engine. No wiring necessary, just plug in and operate. Plenty of current for any oil burner, freezer, brooder, emergency lights, etc. which require up to 700 watts. Ideal for Civil Defense, Fire Dept., trailers and camps. Complete with Voltmeter and built-in winding to charge 6 v. auto batteries. Item 24. Wt. 75 lbs. Be prepared if war or storm knock out power lines. Reg. \$275. value **\$143.50**

700-800 Watt Plant (Item 44) same as Item 24 but larger engine. **\$169.95**

1000-1200 Watt Plant (Item 45) same as Item 24 but larger generator and engine with 50% greater output. **\$199.50**

1500-1700 Watt Plant (Item 20) similar to Item 24, but has three times more capacity. Wt. 173 lbs. Factory price. **\$279.50**

LITTLE GIANT—350 WATT (Item 273) 115 v. DC 1 1/2 hp. Briggs engine. Perfect for lights, radios, small power tools. Wt. 65 lbs. Factory price. **\$99.75**

BUY DIRECT FROM FACTORY SAVE MIDDLEMAN PROFITS

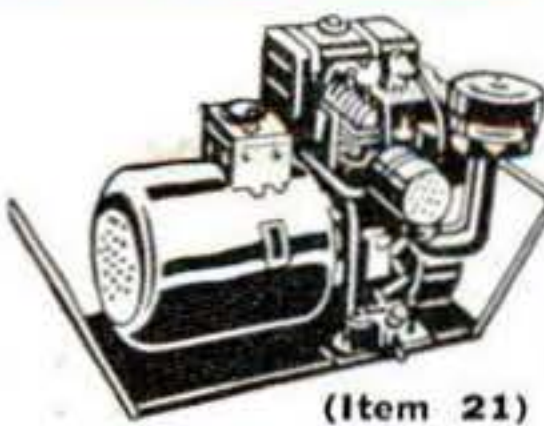

MASTER-LITE 2500 Watt Plant
110/120 v. 60 cyc. AC. A powerful plant, ruggedly constructed and yet designed for easy portability. Can be started by rope or built-in 12 v. electric push button starter. Built-in winding to charge battery. Powered by a big 5.10 HP Briggs engine, complete with all accessories. Includes control box, voltmeter, and handy plug-in power receptacle. An ideal plant for permanent or stand-by service. Wt. 225 lb. Reg. price \$645.00 **\$329.50** (Item 21) Factory Price.

DYNA-POWER 3500 WATT PLANT

Push Button Start
115 v. 60 cyc. AC. Built-in battery charging. Powered by a sturdy 8 hp. air-cooled Wisconsin engine. A powerful plant built for continuous duty, yet compact and portable. Integral positive drive — an exclusive Master Mechanic engineering feature. Includes control box, plug-in power receptacle and voltmeter. Wt. 270 lbs. Factory special. **\$379.50** (Item 23)



FROM FACTORY TO YOU

GIANT 2000-2500 WATT PLANT

110-120 v. 60 cyc. AC. absolutely the best made — exclusive dynamically balanced armature; heavy windings develop up to 5000 watt overload for motor starting. Skid mounted — portable. Powered by an easy starting Briggs or 6 HP Wisconsin engine—complete with all accessories; engine easily disconnected for other uses. Voltmeter, big outlet box, no wiring necessary. Ample current for all purposes. Factory warranty. (Item 31) Wt. 210 lb. Reg. price \$585. Special at. **\$299.50**

Same plant with electric self starter (Item 31a) **\$359.50**

Generator only and control box **\$169.50**



POWER-FLO 3000-3500 WATT

115-230 v. 60 cyc. AC. A rugged power plant for heavy duty use. Duplex power distribution provides both 115 v. and 230 v. output at the same time if desired. Powered by a big 8 HP Wisconsin engine with triple V belt drive. Has built-in overload protection. A dependable plant for either standby or regular service. Equipped with electric self-starter. (Can also be started by rope) and plug-in outlet box. (Item 198) Wt. 310 lbs. Factory price. **\$399.50**

GENERATOR ONLY belt driven **\$239.50**



MASTER GARDENER SELF-PROPELLED

It's a plow
It's a power sickle
It's a cultivator

It's a rotary tiller
It's a bulldozer
It's a lawn mower

Where else can you get a power tool that does so many jobs? Works for you year 'round. Prepares mellowed, deep seed beds without labor. Built-in power take-off to drive pumps, saws, generators, etc. Safety clutch — can't burn out. New gear tread tires assure non-slip drive. The Master Gardener performs better — does more than tractors costing twice as much. Converts in minutes to Tiller, Power Sickle, etc. Basic self-propelled tractor with Briggs **\$119.50**

and Stratton engine. Only **\$42.50**

Rotary Lawn Mower **\$42.50**

Sickle Bar Mower **\$42.50**

Lawn Mower Hitch **\$4.50**

Furrowing Tool **\$8.75** Rotary Tiller **\$42.50**

Cultivator **\$8.75** Disc Harrow **\$15.75**

Snow Blow **\$38.50** Plow **\$15.00**

Freight prepaid to most areas. Easy payment plan available.



52 pc. SOCKET SET Highest quality, guaranteed non-breakable sockets made by Husky. Beautifully matched chrome thin wall alloy absolutely the best. Contains a complete set of 28 sockets in 1/2" drive, 3/8" drive and 1/4" drive, plus all necessary extensions, handles, speeders, reversible ratchets, etc.; all uncond. guaranteed against breakage. A beautiful set of tools that will handle any job; in a big doghouse steel box. Wt. 17 lbs. (Item 205) **\$27.50**

List price \$62.90. Factory special.

44 Pc. SOCKET SET (Item 596) Same unconditionally guaranteed, non-breakable sockets as above. Complete range of 21 sockets from 1/4" thru 7/16" (1/4" drive) & 7/16" thru 1-1/16" (1/2" drive). Two extensions, reversible 1/2" ratchet, 3 drift punches, sliding "T" handle, all angle coupling, 1/2" speeder, 1/4" breaker, 5 pc. high chrome alloy combination wrench set and 8 pc. offset wrench set in big doghouse tool box with ample room for other tools. **\$21.95**

Reg. \$49.50. Wt. 16 lb.

37 Pc. SOCKET SET (Item 59) Contains a complete set of 17 sockets from 1/4" thru 1/2" (1/4" drive) and 7/16" thru 1-1/16" (1/2" drive). 1 extension, reversible 1/2" ratchet, adapter bit, sliding "T" handle, "L" handle, 1/2" speeder, 5 pc. alloy combination wrench set, 8 pc. Allen wrench set and a big doghouse tool box. We challenge anyone to match this value. Easily worth \$41.95. Wt. 14 lbs. **\$16.95**

HEAVY DUTY D-C ARC WELDER

Use as portable or shop welder. Up to 300 amps. Senior model. Made for years of trouble-free, continuous service. Will handle light or heavy jobs. Easily welds up to 3/4" plate using 1/4" rods. Built-in air cooling system. Arc is easy to strike and hold, because of specially designed arc stabilizer. Hi-lo switch and dial control gives wide range of welding heats. Run welder at 2600 rpm. with tractor, jeep or 15 hp. gas engine, or 7 hp. elec. motor. Complete with instructions, guar. and triple V belt or flat pulley. You can pay more, but you can't buy a better welder. Wt. 110 lbs. \$400 value at **\$99.75**

DUAL CONTROL MODEL, same as above but with built-in dual rheostat for low heat soldering, brazing, welding. Special. **\$119.50**

WELDING KIT Two 10 ft. leads, welding helmet, electrode holder, ground clamp. Sold only with welder at **\$10.50**

6000 WATT PLANT PUSH BUTTON START.
115-230 v. 60 cyc. AC. A big, heavy duty plant powered by an air cooled V-type 4-cyl. Wisconsin engine direct drive connected. Plenty of current for ranges, water heaters, oil burners, stokers, pumps, refrigerators, freezers, lights, machinery, etc. Affords both 115 and 230 v. current simultaneously. 18" generator. Ideal for continuous duty where heavy current is needed. Extra heavy winding assures years of trouble-free service. Quiet and smooth running. Complete with duplex power receptacle, power distribution box and voltmeter. Wt. 735 lb. Reg. \$1395. Factory price. **\$899.50**

Model MM50, 5000 Watts, similar plant powered by 2 cyl. Wisconsin engine. **\$795.00**

We make fully automatic controls to operate any of the above light plants. Write for details. We make all sizes up to 25,000 Watts.

EXTENSION CORD

(Item 16a) Heavy duty, made of Buna rubber insulated #14-2 conductor, stranded wire encased in a treated braid jacket. So tough that you can drive over it. Resists oil, grease or water. Extends electricity up to 400 ft. without voltage drop. Complete with heavy rubber plug and outlet. **\$1.99**

(Item 16) 40 ft. 2 1/2 lbs. **\$1.99**

Combination 2-40 ft. and 1-20 ft. (total 100 ft.) (Item 16c) **\$4.95**

NEOPRENE CABLE #14-2 (Item 185) Heavy duty, very flexible, 20 year quality. Wt. 9 lbs. 100 ft. Complete with rubber plug and outlet. A terrific buy at only **\$8.95**

NO. 12-2 POWER CABLE. Very flexible rubber covered, special outside shield for grounding power tools, etc. 50 ft. (Item 199) wt. 8 lbs. **\$6.95.** 100 ft. (Item 200) **\$12.95**

MASTER AIR COMPRESSOR

COMPARE! This is the only compressor built with a **NO RUST** stainless steel tank. Safe up to 500 lbs. (Item 209) High pressure type for large volume of air for heavy duty service. For paint spraying, inflating truck & auto tires, greasing & the hundreds of other jobs done by compressed air. Piston type, 2" bore compressor with built-in air filter. Master built with high strength alloys and precision bearings. Tank, 12"x24", 2100 cu. in. cap. Equipped with automatic switch that starts and stops motor to maintain desired pressure (up to 150 lbs.) and check valve, safety valve, gauge, shut-off valve, 20 ft. air hose and tire chuck. Beautifully balanced on ball bearing wheels and rubber tires. Don't take chances with used or surplus equipment. Our compressors are factory new and are guaranteed **SAFE**. Low factory prices. With 1 1/2 HP., 110 v. AC motor. Reg. \$175. (Item 209p) **\$109.50**



CONDITION-AIRE EXHAUST FANS

Heavy welded frame, pre-drilled for easy mounting—just cut opening and bolt in place. Efficient propeller type blades move huge volume of air quietly and effortlessly. Continuous duty, slow speed motors. Ideal for barns, attics, chicken houses, restaurants, garages, etc. Can be operated manually or with thermostat. Compare our unbeatable factory prices!

Blade	HP	CFM	Wt.	Item	Price
16"	1/12	2925	19 lb.	365a	\$27.95
18"	1/10	3600	27 lb.	365b	\$31.95
20"	1/4	4100	30 lb.	365c	\$39.95

SHUTTERS—open automatically, 16", wt. 10 lb. \$9.00; 18", wt. 12 lb., \$10.25; 20", wt. 14 lb. \$11.25. **THERMOSTATS:** BARN type (range 40°-60°) Wt. 2 lb. \$6.95; ATTIC type (50°-90°) Wt. 2 lb. **\$11.95**



HEATING & VENTILATING FAN

(Item 10) Easily installed in furnace pipes. Forces even heat to all rooms. Over range removes kitchen smoke and odors. Powerful, continuous duty motor, 110-120v. AC. Mount in wall or ceiling to ventilate any area. Quiet, super-efficient fan moves huge volume of air. (400 to 600 CFM).

8" Fan, wt. 5 lb.	\$6.85
9" Fan, wt. 6 lb.	\$7.85
10" Fan, wt. 7 lb.	\$8.85
12" Fan, wt. 8 lb.	\$9.85

HEAVY DUTY FAN. Semi-enclosed motor, suitable for spray booths, restaurant exhausts, poultry houses, etc. 10" Fan, wt. 8 lbs. (Item 10E) **\$11.95**

12" Fan, wt. 10 lbs. (Item 10D) **\$12.95**



AIR COMPRESSOR ACCESSORIES

Pressure Gauge, range 0-160 lbs. 1/4" pipe thread connection 2" face **\$1.50**

Check Valve, solid bronze, 200 lbs. pressure, works in all positions. 1/4" or 3/8" pipe threads, (specify) **\$3.35**

Pressure Regulator, solid brass, std. 1/4" pipe thread, reduces any pressure to a range of 0-50. **\$3.75**

Pop (safety) Valve, adjustable from 0-200 lbs. 1/4" pipe thread. **\$1.40**

SPECIAL . . . All four above. **\$8.95**

Pressure Switch for pumps and compressors, 0-85 lbs., \$5.95; 0-150 lbs. with unloader (3 HP), \$10.95; 0-200 lbs. (5 HP), \$12.95

COMBINATION TYPE SPRAY GUN (Item 223) Precision made, converts in seconds from internal mix (for spraying heavy house or barn paints) to external mix (for spraying fast drying lacquers and synthetic enamels.) Conversion is made simply by changing nozzles and inserting an adaptor plug. Complete with 4 nozzles, including angle nozzles for spraying floors and ceilings. Wt. 4 lbs. **\$12.95**

Heavy Duty Spray Gun Internal mix type for spraying heavy paints. (Item 121) 3 Gal. Tank with 10' air & paint hoses **\$22.50**

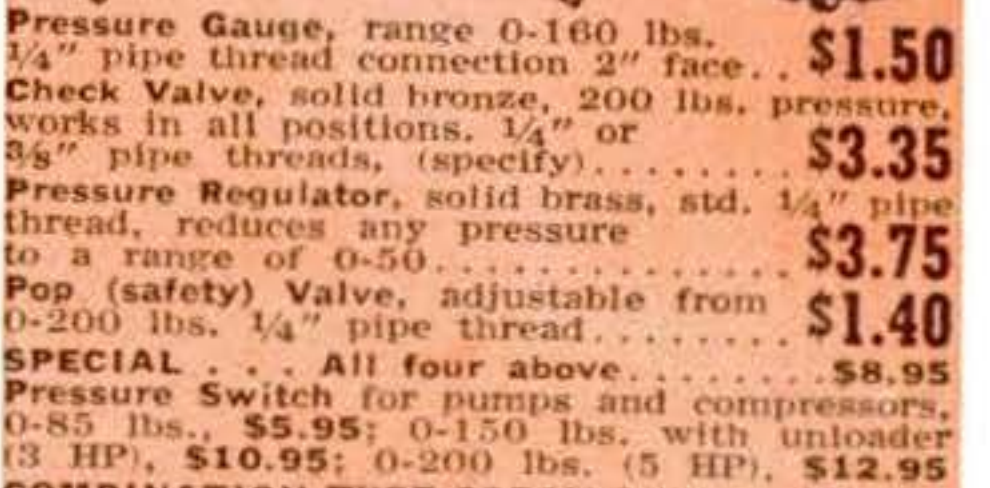

Send check or M.O. Prices f.o.b. Factory. 10 day Money back guarantee. SEND 10c for **BIG 1954 Catalog**

MASTER MECHANIC MFG. CO., DEPT. 231 Burlington, Wis.

Dick Powell and CAMELS

STARTING THEIR 19TH YEAR OF FRIENDSHIP



"Right! Camels have been my steady smoke since 1936! Their fine, full flavor and friendly mildness have always agreed with me... that's why I'm staying with Camels!"

Dick Powell Versatile
director-star of
movies and television

R. J. Reynolds Tobacco Co., Winston-Salem, N. C.

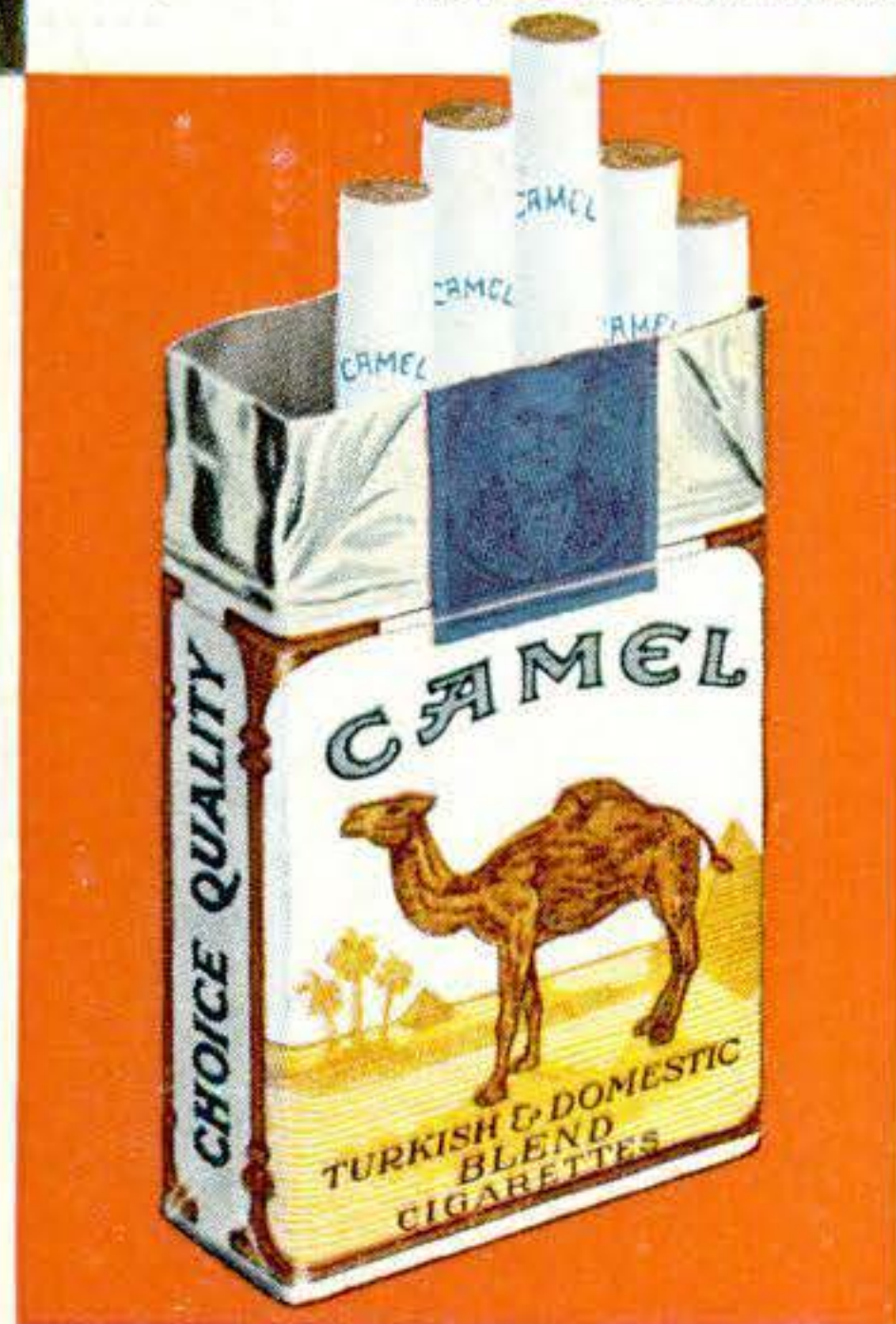

for Mildness - for Flavor **CAMELS**
agree with more people than any other cigarette!

● There's the most reassuring reason in the world why you should smoke Camels. That is — Camels' mildness and flavor *agree with* more people than any other cigarette! Year after year, the pure pleasure in Camels' costly tobaccos wins more and more friends — giving Camels a bigger lead over the 2nd-place brand than ever before! *You* try Camels — see how Camels agree with *you*!

Make your own
30-Day Camel
Test . . . see
what you've
been missing!

