

# POPULAR SCIENCE

November 35c

MONTHLY

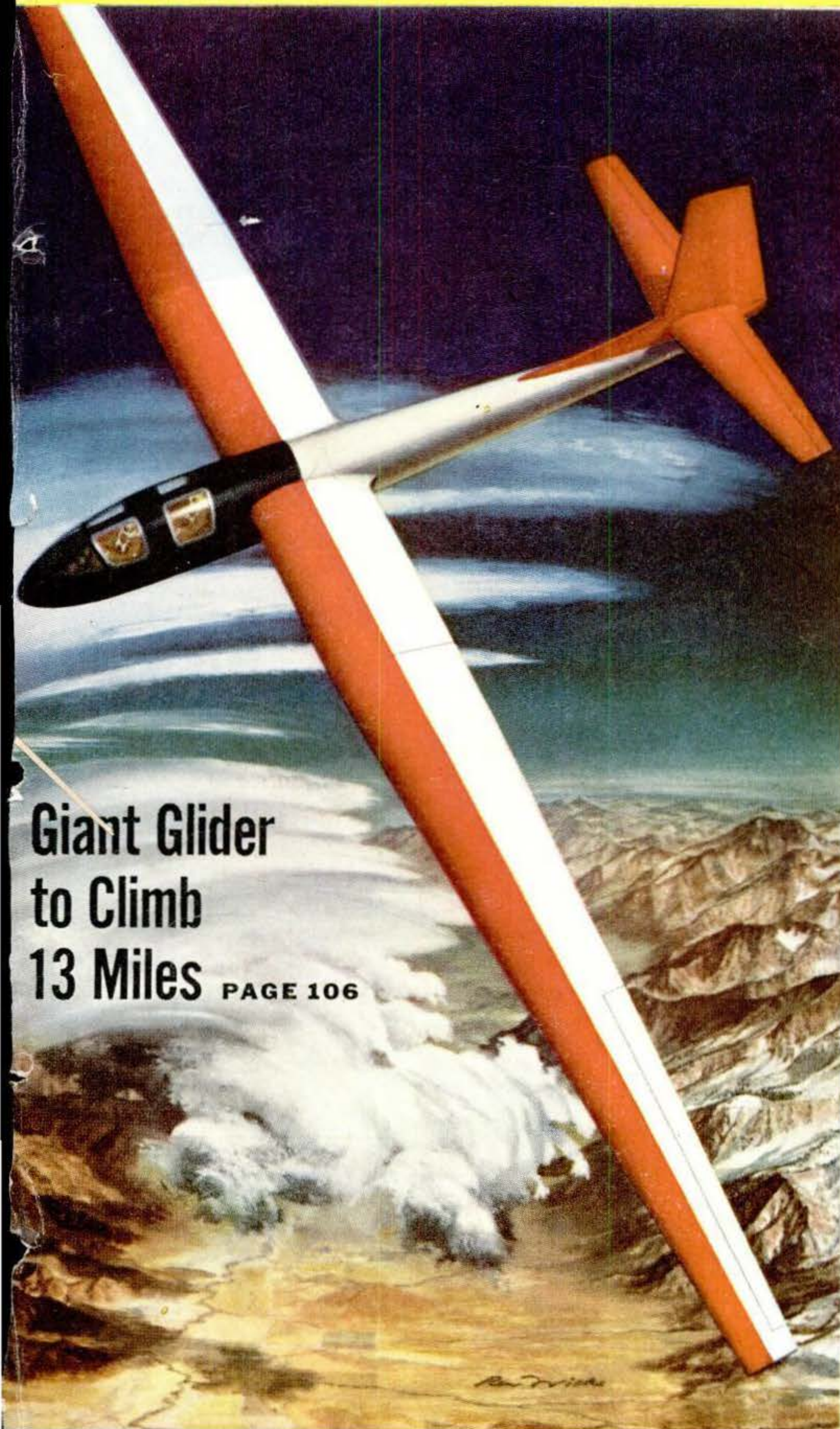

**Giant Glider  
to Climb  
13 Miles** PAGE 106



## WHAT'S NEW IN NEXT YEAR'S CARS

Plymouth • Continental • Dodge  
Pontiac • Chrysler • Packard  
DeSoto • Cadillac • Imperial

—PAGES 110 TO 133

## FUN FURNITURE

How to build double-duty beds,  
tables and chairs —PAGE 169



Copyrighted material





Look what an amateur did with \$49 worth of **FORMICA®**

If you can use simple hand tools, you can resurface worn-out tops or put waste space to work with genuine Formica. You just cut Formica sheets to size with a carpenter's saw and apply it with Contact Bond Cement and a kitchen rolling pin.

From the 70 Formica colors and wood grains this hom craftsman selected Black Oak and Red Linen.



Look in your classified phone book under "plastic" for your nearest Formica dealer.

Send today for free illustrated instruction folder together with actual samples of Formica. Write . . .

**FORMICA**  
4595 Spring Grove Ave.  
Cincinnati 32, Ohio

In Canada: Arnold Banfield & Co. Ltd., Oakville, Ontario

**DEMAND THIS CERTIFICATION**

*This mark certifies genuine*  
REMOVE WITH SOAP AND WATER

Seeing is believing. If this wash-off identification is not on the sheet, it's not FORMICA.

REPLACEMENT OR A REFUND OF MONEY  
Guaranteed by  
Good Housekeeping  
IF NOT AS ADVERTISED THEREIN

Beauty Bonded  
**FORMICA®**  
Laminated Plastic  
Pays in Performance



THIS COMPLETE, SIMPLE, PRACTICAL COURSE FOR SELF-INSTRUCTION WILL QUICKLY GIVE YOU

*a complete mastery of*

# MATHEMATICS

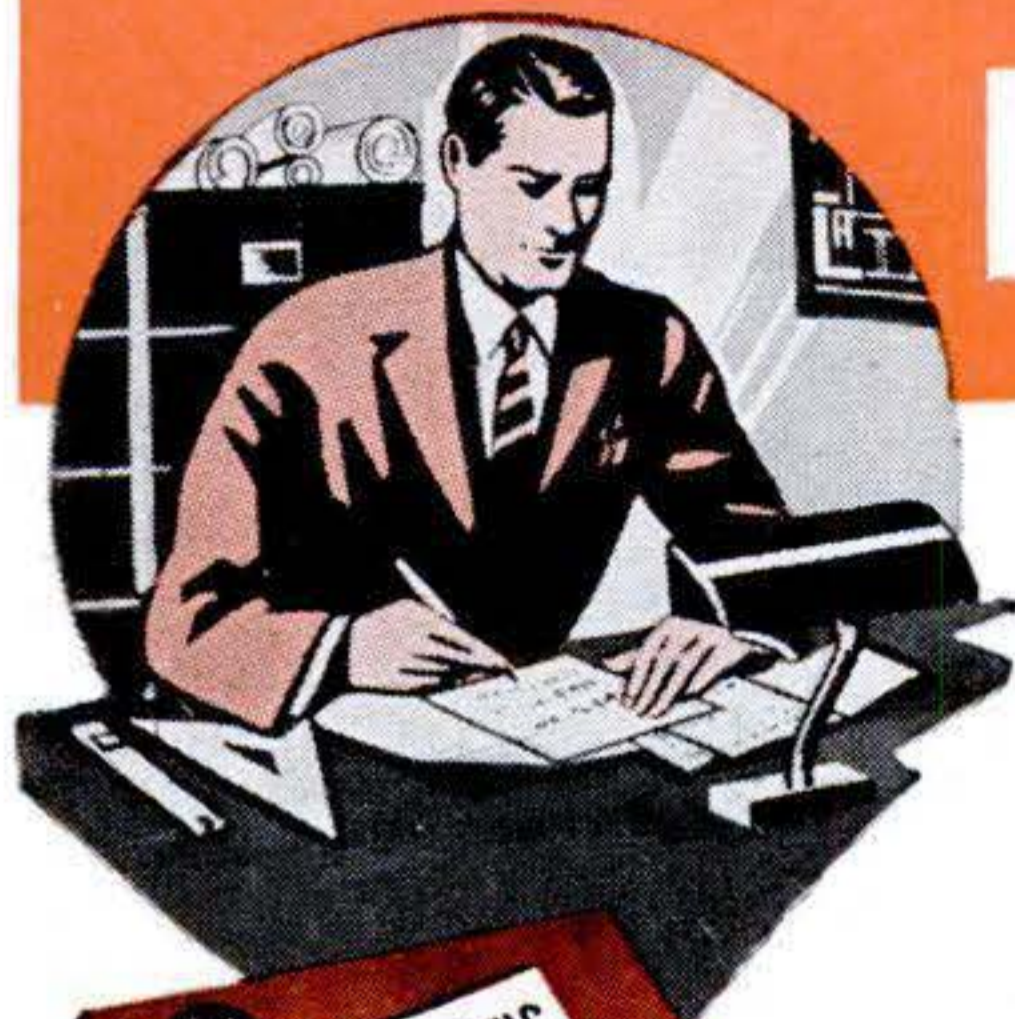

## The Essential Knowledge For the Better Jobs IN ALL BUSINESS AND INDUSTRY

**G**ET a better job—learn mathematics! Mathematics is the basic requirement of all mechanical and scientific work, and of all business and industry based on science. Without this essential knowledge, even the most capable man is left behind while others forge ahead to bigger contracts, more money, better jobs.

You need mathematics to improve, speed up, and check on your work and the work of others. Such basic training is quickly recognized today and gladly paid for. It singles you out from the crowd and gives you an advantage whether it is a matter of a job, a promotion or a contract.

## MATHEMATICS For Self Study

By J. E. Thompson, B.S. in E.E., A.M., Dept. of Mathematics, Pratt Institute  
A COMPLETE COURSE AND REFERENCE LIBRARY

Now, if you will devote *only 10 minutes each day* to this easy home-study course, you can gain all the benefits of a complete training in mathematics. With this practical course, you start right from the beginning with a review of arithmetic that gives you all the special shortcuts that save countless hours of your time. Then, step-by-step, you go into the higher mathematics and learn how simple it all can be when an expert explains it to you. *Every minute you spend on this course will pay you big dividends.*

### An Expert Gives You His Simplified Methods

Mr. Thompson, the author of these books, presents each practical method and problem in the clearest and simplest way possible. He gets right down to the kind of information you need in your daily work.

### Here Are but a Few of the Hundreds of Subjects Explained in this Complete Self-study Course:

**ARITHMETIC:** Starting with a quick review of principles, this book gives you the special calculation methods used in business and industry that are rarely given in ordinary arithmetic books. Above all else this volume shows you how to attain speed and accuracy with fractions and decimals, ratio and proportion, powers and roots, etc. Fundamentals in all computations in engineering and the essential methods for rapid calculation, such as is needed in setting lathes, etc., are made clear and simple. Important business subjects made easy in this book include bank interest, discount, income on securities, payment on mortgages, insurance plans, etc.

**ALGEBRA:** This book makes algebra a live interesting subject. The author starts with simple problems from everyday life that can be solved by arithmetic and algebraic methods. Among

other subjects, this book teaches you all about logarithms—the method of computation that engineers use to save time. It also shows you how to solve problems relating to machines, engines, ships, autos, planes, etc.

**GEOMETRY:** This book gives you the practical, common-sense method for solving all problems in both plane and solid geometry—problems ranging from the simplest distance problems to the geometry of spheres which has applications ranging all the way from the atom to the earth itself. Here you will find all the facts you need to deal with angles, triangles, circles, and the many other geometric figures that are basic to engineering design.

**TRIGONOMETRY:** Practically every problem in machine work, surveying, mechanics, astronomy and navigation is

solved by methods of trigonometry, and this interesting volume makes the methods of solving them clear and easy. The great range of problems in this volume includes those arising in the work of the civil engineer, whether he is surveying land, laying out a road or railroad track or "leveling off" a lawn or tennis court.

**CALCULUS:** This branch of mathematics deals with rate problems and is essential in computation involving objects moving with varying rates of speed. It also enables us to find the most efficient design for any kind of mechanism, engine, or moving vehicle. The practical application of calculus forms much of the foundation for our present world of engineering and mechanics. In each chapter, the author shows you, step by step how to work out practical problems that occur in business and industry.

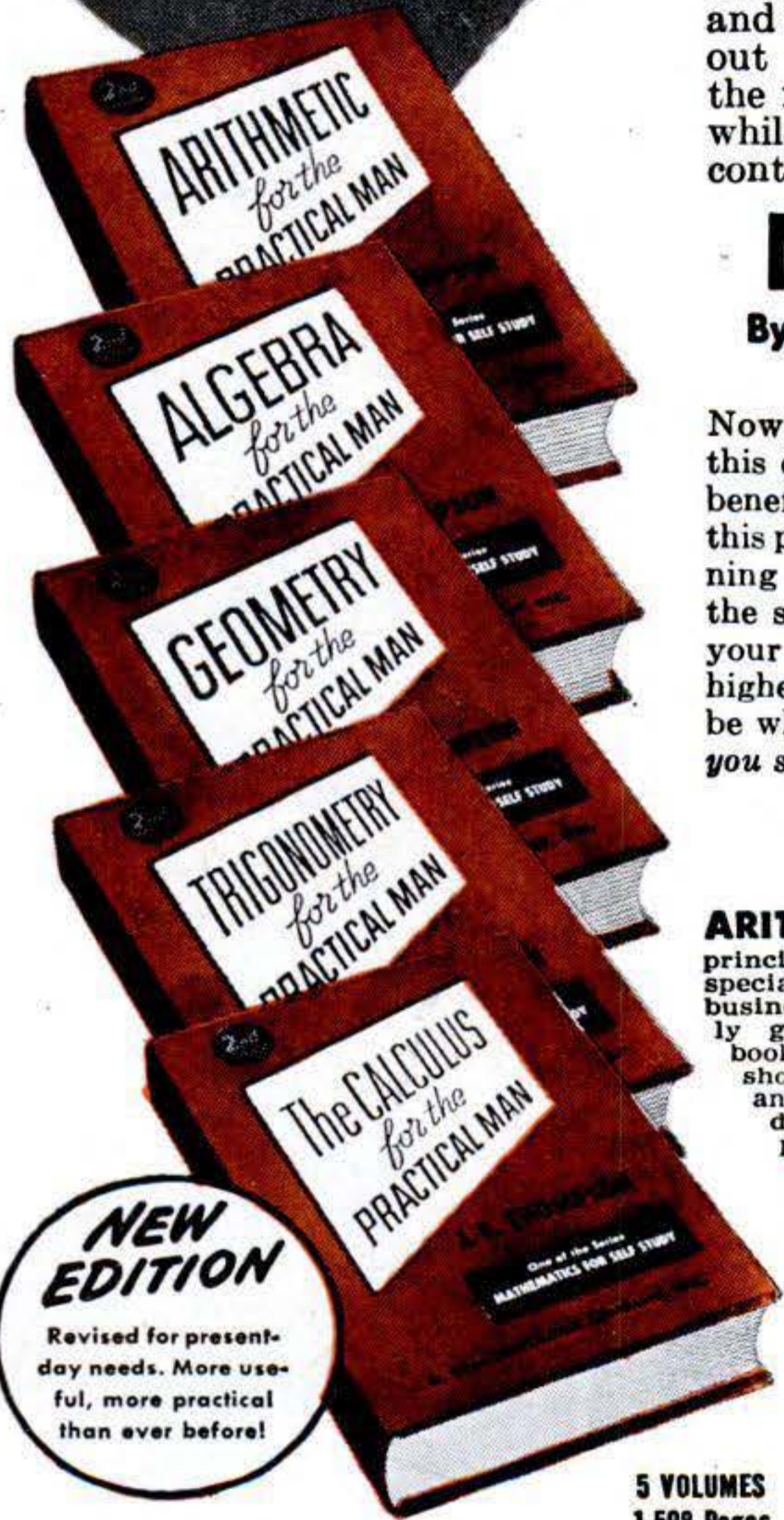

5 VOLUMES  
1,598 Pages  
Illustrated

### Thousands of Jobs Are Waiting for Trained Men

**R**IGHT now, today, trained mechanics and technicians are in urgent demand . . . and in practically ALL OF THESE JOBS a knowledge of mathematics is required.

Remember, mathematics is the foundation of all technical work. Prepare now for one of these better jobs—Learn mathematics by this easy, practical method.

### SEND NO MONEY

Examine These Great Home-Study Books for 10 Days FREE

Send no money now, not a penny! The coupon at right will bring you the complete course in book form for 10 days' trial. Unless you are convinced that it is exactly what you need you may return the books and owe nothing or you may keep them by sending us only \$1.85 down, balance in four monthly payments of \$2.00 each. Take advantage of this opportunity to acquire a complete training in mathematics this simple, inexpensive way.

### MAIL THIS COUPON

D. Van Nostrand Company, Inc., 250 Fourth Ave., New York 3, N. Y.

Send me MATHEMATICS FOR SELF STUDY in 5 volumes. Within 10 days I will either return the books or send you \$1.85 as first payment and \$2.00 per month for four months until the total price of \$9.85, plus a few cents postage, is paid.

(If you send \$9.85 with this coupon, we will pay the postage. Return privilege and refund guaranteed.)

Name.....

Address.....

City.....Zone.....State.....

In Canada: Order from D. Van Nostrand Company, Ltd., 25 Hollinger Road, Toronto, Canada PS-11-55



Founded in 1872,  
Vol. 167: No. 5

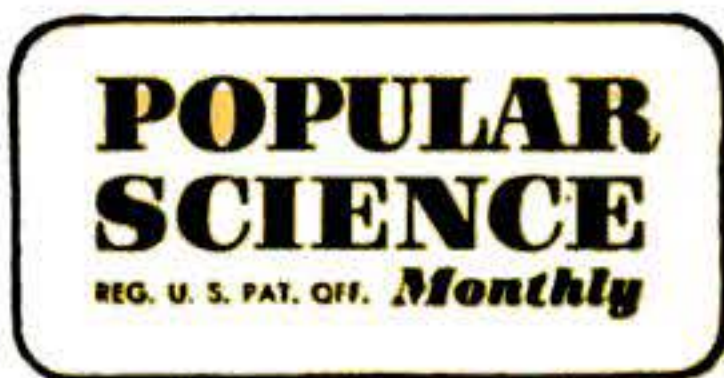

Mechanics and Handicraft  
REG. U. S. PAT. OFF.

America's Leading New-Idea Magazine for 83 Years

NOVEMBER, 1955

.....

Disney Plans TV Trip to the Moon.....	99
Pilots Play Tag with Atomic Clouds.....	102
Table Kiln Fires Enamel on Jewelry.....	103
Giant Glider to Climb 13 Miles.....	106

.....

<b>A Picture Gallery of 1956 Cars.....</b>	<b>110</b>
--	------------

<b>Next Chrysler Line Adopts Push-Button Drive.....</b>	<b>115</b>
---	------------

<b>Year's Hydra-Matic Dampens That Thump.....</b>	<b>119</b>
---	------------

<b>Auto Continental Unveils a Royal Coach.....</b>	<b>122</b>
--	------------

<b>News Packard's Big Engine Spurs Power Race.....</b>	<b>128</b>
--	------------

<b>Highway Hi-Fi Set Plays New 16<sup>2</sup>/<sub>3</sub>-R.P.M. Records....</b>	<b>132</b>
---	------------

.....

Science Closes In on the Common Cold.....	136
---	-----

Pogo Pilot Designs Air-Sea-Land Sedan.....	143
--	-----

Biggest Airlift Moves 7,000 Men.....	148
--------------------------------------	-----

Mexico's New Road Lures Tent Tourists.....	157
--	-----

New High-Bracket Hi-Fis.....	164
------------------------------	-----

Gus Obeys Orders.....	166
-----------------------	-----

Fun Furniture for a Child's Room.....	169
---------------------------------------	-----

How to Build a Good Chair.....	178
--------------------------------	-----

A Sewing Box That You Can Mail.....	184
-------------------------------------	-----

Vacuum-Cleaner Cart Eases Housework.....	188
--	-----

How to Keep Doors Working.....	191
--------------------------------	-----

Repairing an Electric Oven.....	201
---------------------------------	-----

Can You Put It Together Again?.....	203
-------------------------------------	-----

What Steel Is That?.....	209
--------------------------	-----

I Like the Gauges Detroit Left Out.....	214
---	-----

Is Your TV Antenna Worn Out?.....	224
-----------------------------------	-----

Frame Spotlights Prize Photographs.....	229
---	-----

Making and Using an Abacus.....	232
---------------------------------	-----

How We Built a Jigsaw.....	242
----------------------------	-----

(More features and departments are listed on page 4)

**Editor**

VOLTA TORREY

**Managing Editor**

HOWARD ALLAWAY

**Art Editor**

HOWARD C. JENSEN

**Associate Editors**

Alden P. Armagnac, Devon Francis, Martin Mann, Herbert O. Johansen, Sheldon M. Gallager, Henry B. Comstock, Herbert R. Pfister, Stanley Beitler, Frank Dorr, Maryann Smith, Erik H. Arctander.

**Art**

Harry Samuels (Director), Herbert Anthony, Gene Butera, Eric A. Karminski Jr., Henry W. Kazmirowski, Dana B. Rasmussen, Laylen H. Sweet.

**Copy**

Kendall W. Goodwyn (Director), Everett H. Ortner, Georgette Sparks, Ruth Westphal.

**Photography**

W. W. Morris (Director), Hubert Lockett, Orlando Guerra.

**Assistant Managing Editors**

Frank Rowsome Jr.  
Robert P. Stevenson

**Mechanics and Handicraft**

Harry Walton

**Pacific Coast Editor**

Wesley S. Griswold (Los Angeles)

**Editorial Assistants**

Rosa Lee Beeland (Chief),  
Roberta Lester, Louise Levis,  
Roberta Marks.

**Publisher**

GODFREY HAMMOND

**President**

RALPH H. FLYNN

**Advertising Manager**

LEE P. ADAMS

**Circulation Director**

EUGENE WATSON

**ADVERTISING OFFICES:**

NEW YORK—353 Fourth Ave.  
CHICAGO—360 North Michigan Ave.  
DETROIT—820 Book Bldg.  
SAN FRANCISCO—114 Sansome St.  
CLEVELAND—328 Citizens Bldg.  
LOS ANGELES—1127 Wilshire Blvd.  
PORTLAND, ORE.—520 S.W. Sixth Ave.

**EDITORIAL OFFICES:** 353 Fourth Avenue, New York 10, N. Y.

Published monthly at 353 Fourth Avenue, New York 10, N. Y., by Popular Science Publishing Co., Inc., Godfrey Hammond, Chairman of the Board; Ralph H. Flynn, President and Treasurer; Franklin E. Parker Jr., Secretary; Eugene Watson, Vice-President. Second-class mail privileges authorized at New York, N. Y. and Dayton, Ohio. Entered as second-class matter at the Post Office Department, Canada. Printed in U.S.A. Copyright, 1955, by Popular Science Publishing Co., Inc. All rights reserved in the United States, Great Britain, and in all the countries participating in the International Copyright Convention and Pan-American Copyright Convention. Single copy 35c. Subscriptions to United States, its possessions, and Canada, 1 year \$3.40 (2 years \$6.00, 3 years \$8.00). Elsewhere, 1 year \$6.00 (2 years \$11.00, 3 years \$16.00). Four weeks' notice is needed to change a subscriber's address. Please give both old and new addresses, including postal zone numbers.





## **“Feels like a new car now!”**

If years of driving have taken the pep out of your engine...if practically every stop for gas means another quart of oil—it's time for Perfect Circle 2-in-1 Chrome piston rings. They help bring new life to tired engines... restore that *new car feel*.

In Perfect Circle's 2-in-1 Chrome set, BOTH the top and oil rings are plated with thick, solid CHROME—chrome that effectively resists the terrific heat, pressure and friction that result from combustion. The entire area of

piston ring travel gets *complete* protection from wear—more than *doubling* the life of cylinders, pistons and rings. No slow, tedious break-in is necessary...rings are pre-seated at the factory.

Bring top performance back to your car! Enjoy thousands of extra miles of sustained power and positive oil control with Perfect Circles! Perfect Circle Corporation, Hagerstown, Ind.; The Perfect Circle Co., Ltd., Toronto, Ont.

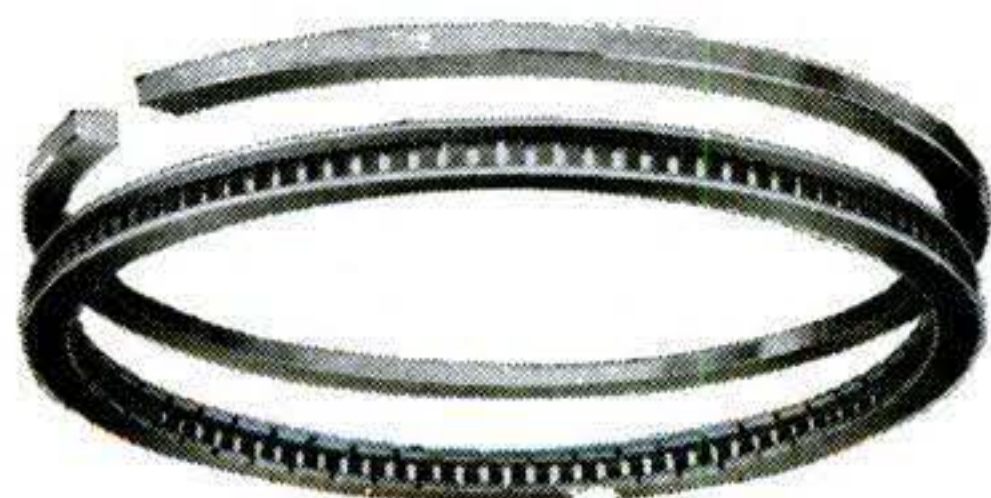

## **PERFECT CIRCLE** 2-in-1 **chrome** piston rings

THE STANDARD OF COMPARISON

NOVEMBER 1955 3



# FAMOUS



# WILLARD

# QUALITY



# ONLY \$11.95

EXCHANGE\*  
GROUP 1

\*In most areas of the U. S.

- Including written guarantee and adjustment policy which protects you anywhere in U. S. and Canada.
- Including competent service by your friendly neighborhood dealer.

**DRIVE A LOT?** Ask your dealer about Willard Batteries with Metalex, the patented grid alloy that has increased Willard guarantees up to a **FULL FOUR YEARS!**

## Willard

Dealers are listed in telephone directories **EVERYWHERE.** Look in the Yellow Pages under "Batteries".

### News and Pictures

<a href="#">Mud Flies in Jeep Jamboree.....</a>	105
<a href="#">New Ways to Tell Time.....</a>	109
<a href="#">Two Engines Run Five-Tonner.....</a>	109
<a href="#">GIs Get Featherweight Radios.....</a>	109
<a href="#">Under Test for Tomorrow's World.....</a>	134
<a href="#">Gas Tanks Get Bouncier.....</a>	140
<a href="#">Turboprop TV Catches Ice Show.....</a>	140
<a href="#">Tiny Eye Blinks Fast.....</a>	140
<a href="#">"Ontos" Packs Six-Gun Punch.....</a>	141
<a href="#">Fire-Support Ship Goes on Sea Trials.....</a>	141
<a href="#">Dream Kitchen Almost Runs Itself.....</a>	144
<a href="#">Direct Line to Fire Headquarters.....</a>	144
<a href="#">Wash Tower Scrubs Big Planes.....</a>	154
<a href="#">Tiny Sub Joins Britain's Navy.....</a>	154
<a href="#">Old Planes Hurtle to Battered Glory....</a>	155
<a href="#">Raft Can Save 20 from Ditched Plane....</a>	156
<a href="#">Television Chassis Tilts Out.....</a>	156
<a href="#">She's Radioactive—Like You.....</a>	156
<a href="#">Folks Too Grasping, Tests Show.....</a>	161
<a href="#">TV Set Flashes Flight Dope.....</a>	161

### Mechanics and Homebuilding

<a href="#">Rubber Block Sands Curves.....</a>	175
<a href="#">Chamfer Sets Molding on Ridge.....</a>	175
<a href="#">You Can Make This Lamp in an Evening..</a>	177
<a href="#">Propped Block Forms Cement Corner....</a>	185
<a href="#">Five Useful Tricks with Screw Eyes.....</a>	190
<a href="#">Cotton Sacking Handy as Drop Cloth....</a>	195
<a href="#">Do It the Easy Way.....</a>	195
<a href="#">Four Accessories for the Living Room....</a>	196
<a href="#">Meat Cans Size Hardware for Picking....</a>	198
<a href="#">Tank Takes Chill Out of Icy Water.....</a>	198
<a href="#">Cartons Form Cement Stepping Stones....</a>	202
<a href="#">Jigsaw Sander Smooths Wood Surfaces....</a>	207
<a href="#">Heavy Wire Makes Long Drill.....</a>	207
<a href="#">Man with Jack Lifts Body Off Truck.....</a>	220
<a href="#">Saw Pusher Protects Fingers.....</a>	220
<a href="#">Seven Unusual Uses for Corks.....</a>	223
<a href="#">Sofa Units Hooked Together.....</a>	230
<a href="#">Five Darkroom Tips.....</a>	231
<a href="#">Paint Roller Made from Spool.....</a>	236
<a href="#">Magnifier Gets a Gooseneck.....</a>	240

### Departments

<a href="#">Letters .....</a>	14
<a href="#">Craftsmen at Work.....</a>	94
<a href="#">Last-Minute News and Notes.....</a>	96
<a href="#">I'd Like to See Them Make.....</a>	104
<a href="#">New Ideas from the Inventors.....</a>	145
<a href="#">New Aids to Living.....</a>	162
<a href="#">New for the Handy Man.....</a>	176
<a href="#">Wordless Workshop.....</a>	186
<a href="#">Keeping the Home Shipshape.....</a>	199
<a href="#">New Tools.....</a>	208
<a href="#">Almanac for Motorists.....</a>	216
<a href="#">Hints from the Model Garage.....</a>	217
<a href="#">New for Your Car.....</a>	219
<a href="#">New Shop Ideas.....</a>	221



# FOR REAL **JOB SECURITY** —GET AN **I.C.S. DIPLOMA**



"You can stop worrying, Jane. My job's secure now! And here's the insurance policy to prove it—my I.C.S. diploma!"

**This feeling of security is probably typical of every I.C.S. graduate. Because—as the job situation gets tighter, the man with I.C.S. training has the advantage.**

Why? Your I.C.S. diploma tells your present employer three important things: (1) You want to make the most of your present job.

(2) You have the training you need for advancement. (3) You look for better ways of doing things *on your own.*

**What you do about your future is up to you. Do nothing and stay at your present job at the same old pay. Or earn an I.C.S. diploma in your spare time for security, promotions, more pay! Your first step is to mark the course that interests you in the coupon below, and mail it to us.**

### Three Free Books

We'll send you three interesting books. The first, "How to Succeed," is a gold mine of helpful tips. Points out many small things in your personality and behavior that can make the difference between success and failure. Second, a book telling you about the opportunities in the field of your choice. Third, sample lesson (Math).

### Costs pennies a day

Many an I.C.S. student has made up the cost of his course in one month with the salary increase his I.C.S. training earned for him. By studying at home in your spare time, you pay yourself many times an hour more than you're now making. (One student reports — "My I.C.S. course was worth \$95 an hour to me.")

**The security of your present job—or the success in finding the new job you've always wanted—is in your hands. Move ahead with I. C. S. training while others stay behind on the routine, small-pay jobs. Remember, your first step to security and success is to mail this coupon. Take a few minutes and do it now. If you put it off, it can cost you your future.**

For Real Job Security—Get an I. C. S. Diploma! I. C. S., Scranton 9, Penna. Member, National Home Study Council

## INTERNATIONAL CORRESPONDENCE SCHOOLS

**ICS**

BOX 81314L, SCRANTON 9, PENNA.

(Partial list of 277 courses)

Without cost or obligation, send me "HOW TO SUCCEED" and the opportunity booklet about the field BEFORE which I have marked X (plus sample lesson):

- |  |   |  |   |   |
|--|---|--|---|---|
| <p><b>ARCHITECTURE and BUILDING CONSTRUCTION</b></p> <ul style="list-style-type: none"> <li><input type="checkbox"/> Air Conditioning—Refrig.</li> <li><input type="checkbox"/> Architecture</li> <li><input type="checkbox"/> Architectural Interior</li> <li><input type="checkbox"/> Building Contractor</li> <li><input type="checkbox"/> Building Maintenance</li> <li><input type="checkbox"/> Carpenter and Mill Work</li> <li><input type="checkbox"/> Estimating</li> <li><input type="checkbox"/> Heating</li> <li><input type="checkbox"/> Painting Contractor</li> <li><input type="checkbox"/> Plumbing</li> <li><input type="checkbox"/> Reading Arch. Blueprints</li> </ul> <p><b>ART</b></p> <ul style="list-style-type: none"> <li><input type="checkbox"/> Cartooning</li> <li><input type="checkbox"/> Commercial Art</li> <li><input type="checkbox"/> Fashion Illustrating</li> <li><input type="checkbox"/> Magazine Illustrating</li> <li><input type="checkbox"/> Show Card and Sign Lettering</li> <li><input type="checkbox"/> Sketching and Painting</li> </ul> <p><b>AUTOMOTIVE</b></p> <ul style="list-style-type: none"> <li><input type="checkbox"/> Auto Body Rebuilding</li> <li><input type="checkbox"/> Auto Elec. Technician</li> <li><input type="checkbox"/> Auto-Engine Tune Up</li> <li><input type="checkbox"/> Automobile</li> </ul> | <p><b>AVIATION</b></p> <ul style="list-style-type: none"> <li><input type="checkbox"/> Aeronautical Engineering Jr.</li> <li><input type="checkbox"/> Aircraft &amp; Engine Mechanic</li> </ul> <p><b>BUSINESS</b></p> <ul style="list-style-type: none"> <li><input type="checkbox"/> Advertising</li> <li><input type="checkbox"/> Bookkeeping and Accounting</li> <li><input type="checkbox"/> Business Administration</li> <li><input type="checkbox"/> Business Correspondence</li> <li><input type="checkbox"/> Public Accounting</li> <li><input type="checkbox"/> Creative Salesmanship</li> <li><input type="checkbox"/> Federal Tax</li> <li><input type="checkbox"/> Letter-writing Improvement</li> <li><input type="checkbox"/> Office Management</li> <li><input type="checkbox"/> Professional Secretary</li> <li><input type="checkbox"/> Retail Business Management</li> <li><input type="checkbox"/> Sales Management</li> <li><input type="checkbox"/> Stenographic-Secretarial</li> <li><input type="checkbox"/> Traffic Management</li> </ul> <p><b>CHEMISTRY</b></p> <ul style="list-style-type: none"> <li><input type="checkbox"/> Analytical Chemistry</li> <li><input type="checkbox"/> Chemical Engineering</li> <li><input type="checkbox"/> Chem. Lab. Technician</li> <li><input type="checkbox"/> General Chemistry</li> <li><input type="checkbox"/> Natural Gas Prod. &amp; Trans.</li> <li><input type="checkbox"/> Petroleum Engineering</li> <li><input type="checkbox"/> Plastics</li> <li><input type="checkbox"/> Pulp and Paper Making</li> </ul> | <p><b>CIVIL, STRUCTURAL ENGINEERING</b></p> <ul style="list-style-type: none"> <li><input type="checkbox"/> Civil Engineering</li> <li><input type="checkbox"/> Construction Engineering</li> <li><input type="checkbox"/> Highway Engineering</li> <li><input type="checkbox"/> Reading Struct. Blueprints</li> <li><input type="checkbox"/> Sanitary Engineering</li> <li><input type="checkbox"/> Structural Engineering</li> <li><input type="checkbox"/> Surveying and Mapping</li> </ul> <p><b>DRAFTING</b></p> <ul style="list-style-type: none"> <li><input type="checkbox"/> Aircraft Drafting</li> <li><input type="checkbox"/> Architectural Drafting</li> <li><input type="checkbox"/> Electrical Drafting</li> <li><input type="checkbox"/> Mechanical Drafting</li> <li><input type="checkbox"/> Mine Surveying and Mapping</li> <li><input type="checkbox"/> Plumbing Drawing and Estimating</li> <li><input type="checkbox"/> Structural Drafting</li> </ul> <p><b>ELECTRICAL</b></p> <ul style="list-style-type: none"> <li><input type="checkbox"/> Electrical Engineering</li> <li><input type="checkbox"/> Electrical Maintenance</li> <li><input type="checkbox"/> Electrician <input type="checkbox"/> Contracting</li> <li><input type="checkbox"/> Lineman</li> </ul> <p><b>HIGH SCHOOL</b></p> <ul style="list-style-type: none"> <li><input type="checkbox"/> Commercial <input type="checkbox"/> Good English</li> <li><input type="checkbox"/> High School Subjects</li> <li><input type="checkbox"/> Mathematics</li> </ul> | <p><b>LEADERSHIP</b></p> <ul style="list-style-type: none"> <li><input type="checkbox"/> Foremanship</li> <li><input type="checkbox"/> Industrial Supervision</li> <li><input type="checkbox"/> Leadership and Organization</li> <li><input type="checkbox"/> Personnel-Labor Relations</li> </ul> <p><b>MECHANICAL AND SHOP</b></p> <ul style="list-style-type: none"> <li><input type="checkbox"/> Gas—Electric Welding</li> <li><input type="checkbox"/> Heat Treatment <input type="checkbox"/> Metallurgy</li> <li><input type="checkbox"/> Industrial Engineering</li> <li><input type="checkbox"/> Industrial Instrumentation</li> <li><input type="checkbox"/> Industrial Supervision</li> <li><input type="checkbox"/> Internal Combustion Engines</li> <li><input type="checkbox"/> Machine Design-Drafting</li> <li><input type="checkbox"/> Machine Shop Inspection</li> <li><input type="checkbox"/> Machine Shop Practice</li> <li><input type="checkbox"/> Mechanical Engineering</li> <li><input type="checkbox"/> Quality Control</li> <li><input type="checkbox"/> Reading Shop Blueprints</li> <li><input type="checkbox"/> Refrigeration</li> <li><input type="checkbox"/> Sheet Metal Worker</li> <li><input type="checkbox"/> Tool Design <input type="checkbox"/> Toolmaking</li> </ul> <p><b>RADIO, TELEVISION</b></p> <ul style="list-style-type: none"> <li><input type="checkbox"/> Industrial Electronics</li> <li><input type="checkbox"/> Practical Radio TV Eng'ng</li> <li><input type="checkbox"/> Radio and TV Servicing</li> <li><input type="checkbox"/> Radio Operating</li> </ul> | <ul style="list-style-type: none"> <li><input type="checkbox"/> Television Technician</li> </ul> <p><b>RAILROAD</b></p> <ul style="list-style-type: none"> <li><input type="checkbox"/> Air Brakes <input type="checkbox"/> Car Inspector</li> <li><input type="checkbox"/> Diesel Locomotive</li> <li><input type="checkbox"/> Locomotive Engineer</li> <li><input type="checkbox"/> Section Foreman</li> </ul> <p><b>STEAM AND DIESEL POWER</b></p> <ul style="list-style-type: none"> <li><input type="checkbox"/> Combustion Engineering</li> <li><input type="checkbox"/> Diesel—Elec. <input type="checkbox"/> Diesel Eng's</li> <li><input type="checkbox"/> Electric Light and Power</li> <li><input type="checkbox"/> Stationary Fireman</li> <li><input type="checkbox"/> Stationary Steam Engineering</li> </ul> <p><b>TEXTILE</b></p> <ul style="list-style-type: none"> <li><input type="checkbox"/> Carding and Spinning</li> <li><input type="checkbox"/> Cotton, Rayon, Woolen Mfg.</li> <li><input type="checkbox"/> Finishing and Dyeing</li> <li><input type="checkbox"/> Loom Fixi'g <input type="checkbox"/> Textile Des'ing</li> <li><input type="checkbox"/> Textile Eng'r'g <input type="checkbox"/> Throwing</li> <li><input type="checkbox"/> Warping and Weaving</li> </ul> <p><b>MISCELLANEOUS</b></p> <ul style="list-style-type: none"> <li><input type="checkbox"/> Domestic Refrigeration</li> <li><input type="checkbox"/> Marine Engineering</li> <li><input type="checkbox"/> Ocean Navigation</li> <li><input type="checkbox"/> Professional Engineering</li> <li><input type="checkbox"/> Short Story Writing</li> <li><input type="checkbox"/> Telephony</li> </ul> |
|--|---|--|---|---|

Name \_\_\_\_\_ Age \_\_\_\_\_ Home Address \_\_\_\_\_

City \_\_\_\_\_ Zone \_\_\_\_\_ State \_\_\_\_\_ Working Hours \_\_\_\_\_ A.M. to P.M. \_\_\_\_\_

Occupation \_\_\_\_\_

Canadian residents send coupon to International Correspondence Schools, Canadian, Ltd., Montreal, Canada. . . . Special tuition rates to members of the U. S. Armed Forces.



# GOING OUT OF AUTO Seat Cover BUSINESS!



A.  
Leopard

We've been serving the public for years with choice, well made auto seat covers—the kind any motorist would be proud to have in his car. We put our heart and soul into this business. We put out the best possible seat covers at the lowest possible price and sold hundreds of thousands. Then trouble set in. Material and labor costs mounted higher and higher. Competition set in too, from big, multi-million dollar outfits who sold on credit. Our profits vanished and so did our capital. So this is "Goodbye" to the business. It's our last seat cover ad to appear in this publication.

## TAKE YOUR CHOICE OF MANY ATTRACTIVE DESIGNS! YOUR CHOICE ONLY \$1

We have complete stocks right now! Many attractive designs! Choice materials such as modern, durable Vinyl—the miracle plastic used in so many 1955 sports cars. Or you may prefer the bright, smooth Nylons or luxury Denims that last and last. No matter your choice, you are sure of the BARGAIN OF A LIFETIME! Imagine it—only \$1 plus postage brings you the luxury and protection of a nationally advertised MOTO-MATIC cover. At this low price you couldn't buy the material ALONE! Yet you get a COMPLETED, carefully tailored seat cover for LESS than the Jobber's WHOLESALE PRICE!

### EASY TO INSTALL WITH NEW ADJUSTOMATIC FEATURE

Moto-Matic Seat Covers slide on or slide off in less than 1 minute! Nothing could be simpler—nothing

SELLING OUT 17,850  
AUTO SEAT COVERS

Values to \$5  
YOUR CHOICE \$

Tough Vinyls, Nylons,  
Denims, Scotch Plaids,  
Leopard & Zebra Prints,  
Candy Stripes, Crystal Tones, etc.

could be faster! All MOTO-MATIC Seat Covers have the famous ADJUSTOMATIC feature. They go on or off so fast, so easily! No pins! No sewing! No tacking! In an instant your car takes on that new, handsome appearance. No matter how soiled or worn out your upholstery is, no matter if you have a '39 Chevy or a '55 Caddy, these magnificent seat covers add new glamour to your car! Your friends will never—but NEVER imagine you paid so little for them.

### THIS AMAZING OFFER IS FOR A SHORT TIME ONLY!

Many thousands of people will be seeing this ad. Our stock will be sold very fast, we hope! So please make your choice at once and rush coupon TODAY. Also make a SECOND choice to protect yourself if we run out of any one design. It's a case of first come, first served. Send only \$1 plus 10c postage for each seat cover chosen. For front and rear, send only \$2.00 plus 20c postage. All sales final. No C.O.D.'s. None sold to dealers. To be fair to all, we cannot accept orders for more than a set of two for front and rear. All orders shipped promptly. NOTE: When these are gone, no more will be available. However, if your order arrives after our stocks are finished, we will return your money AT ONCE! To avoid disappointment, rush your orders today!

## MOTO-MATIC CO.

352 FOURTH AVE., DEPT. 7-M-150, NEW YORK 10, N. Y.

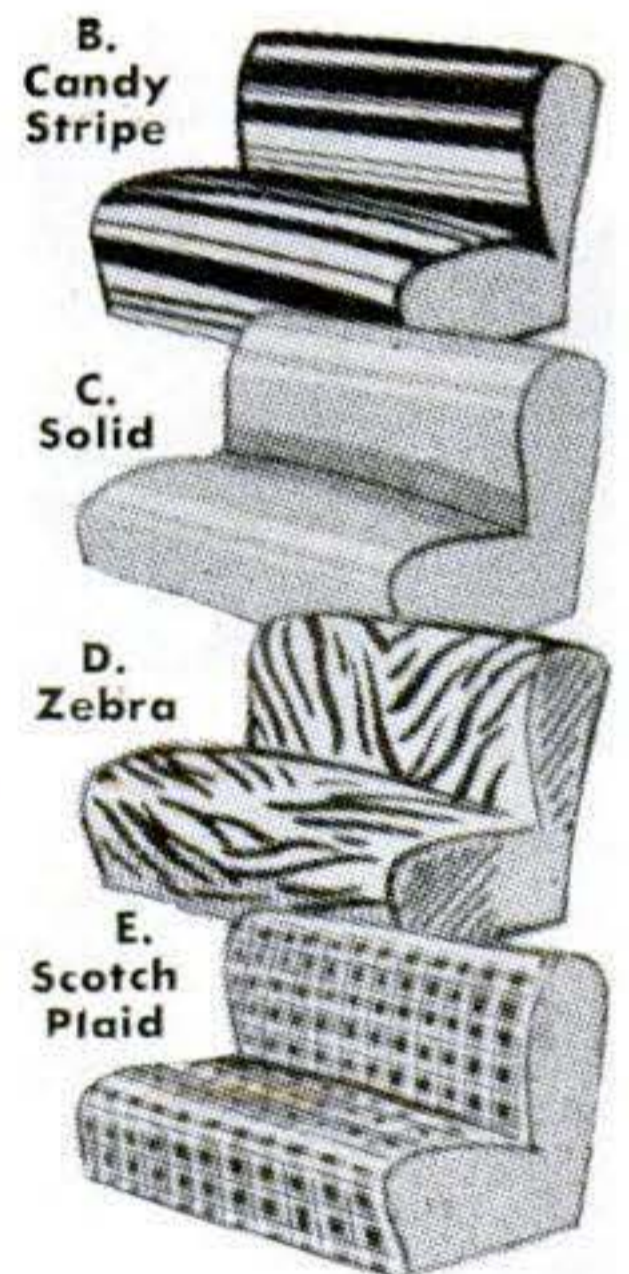

## FREE!

"POCKET TROUBLE SHOOTER" - This booklet lists hundreds of motor troubles and suggests remedies. Your free copy may save you big sums of money on repair bills. Shows how to make your own adjustments—how to avoid excessive repair charges.

## CLIP THIS VALUABLE COUPON—RUSH TODAY!

MOTO-MATIC CO., Dept. 7-M-150  
352 Fourth Ave., New York 10, N. Y.

RUSH ME Seat Cover(s) at \$1 each plus 10c postage. Also send FREE copy of "Pocket Trouble Shooter." I understand that at THIS CLOSE-OUT PRICE, ALL SALES ARE FINAL! (No C.O.D.'s) Payment is enclosed.

A.  Leopard C.  Solid (State color) \*  
B.  Candy Striped \* D.  Zebra E.  Scotch Plaid

NAME \_\_\_\_\_

ADDRESS \_\_\_\_\_

CITY \_\_\_\_\_ STATE \_\_\_\_\_

\*Please state SECOND color choice.







# I WILL TRAIN YOU AT HOME FOR GOOD PAY JOBS IN RADIO-TELEVISION

J. E. SMITH has trained more men for Radio-Television than any other man. OUR 40th YEAR.

## America's Fast Growing Industry Offers You Good Pay—Bright Future—Security

### I TRAINED THESE MEN

 "Started to repair sets six months after enrolling. Earned \$12 to \$15 a week in spare time."—Adam Kramlik, Jr., Sunnyside, Pennsylvania.

 "Up to our necks in Radio-Television work. Four other NRI men work here. Am happy with my work."—Glen Peterson, Bradford, Ont., Canada.

 "Am doing Radio and Television Servicing full time. Now have my own shop. I owe my success to N.R.I."—Curtis Stath, Ft. Madison, Iowa.

 "Am with WCOC. NRI course can't be beat. No trouble passing 1st class Radio-phone license exam."—Jesse W. Parker, Meridian, Mississippi.

 "By the time I graduated I had paid for my course, a car and testing equipment. Can service toughest jobs."—E. J. Streitenberger, New Boston, Ohio.

AVAILABLE TO **VETERANS** UNDER G.I. BILLS

## You Learn by Practicing with Parts I Send

Nothing takes the place of PRACTICAL EXPERIENCE. That's why NRI training is based on LEARNING BY DOING. You use parts I furnish to build many circuits common to Radio and Television. As part of my Communications Course, you build many circuits, including low power transmitter shown at left. You put it "on the air," perform procedures required of broadcast operators. With my Servicing Course you build modern Radio, etc.; use Multitester you build to make money fixing sets in spare time while training. You can stay at home, keep your job, learn Radio-TV in spare time at low cost. Mail coupon for book showing other equipment you build and keep.

### The Tested Way To Better Pay!

Training plus opportunity is the PERFECT COMBINATION for job security, good pay, advancement. In good times, the trained man makes the BETTER PAY, GETS PROMOTED. When jobs are scarce, the trained man enjoys GREATER SECURITY. NRI training can help assure you more of the better things of life.

### Start Soon to Make \$10, \$15 a Week Extra Fixing Sets

Keep your job while training. I start sending you special booklets the day you enroll, that show you how to fix sets. Multitester built with parts I send helps you make \$10, \$15 a week extra fixing sets while training. Many start their own Radio-Television business with spare time earnings.

### My Training Is Up-To-Date

You benefit by my 40 years' experience training men at home. Well illustrated lessons give you basic principles you need. Skillfully developed kits of parts I send (see below) "bring to life" things you learn from lessons.

2 FREE BOOKS SHOW HOW MAIL COUPON



**Television Making Good Jobs, Prosperity**—Even without Television, Radio is bigger than ever. 115 million home and auto Radios are big market for servicing. 3000 broadcasting stations use operators, technicians. Government, Aviation, Police, Ship, Micro-wave Relay, Two-way Radio Communications for buses, taxis, trucks, R. R. are growing fields. Television is moving ahead fast.



About 200 Television stations are now on the air. Hundreds of others being built. Good TV jobs opening up for Technicians, Operators, etc.



25 million homes now have Television sets. Thousands more are being sold every week. Get a job or have your own business selling, installing, servicing.

### Radio-TV Needs Men of Action—Mail Coupon

Without obligating you in any way, I'll send an actual lesson to prove that my training is practical, thorough; 64-page book to show good job opportunities for you in Radio-TV. Terms for NRI training are as low as \$5 a month. Many graduates make more in two weeks than total cost of training. Mail coupon now. J. E. SMITH, President, National Radio Institute, Dept. 5MB, Washington 9, D. C. OUR 40TH YEAR.

### Good for Both—FREE

MR. J. E. SMITH, President, Dept. 5MB  
National Radio Institute, Washington 9, D. C.  
Mail me Sample Lesson and 64-page Book, FREE.  
(No salesman will call. Please write plainly.)

Name.....Age.....

Address.....

City.....Zone.....State.....

**VETS** write in date of discharge .....





# CHRISTMAS GIFT BARGAINS

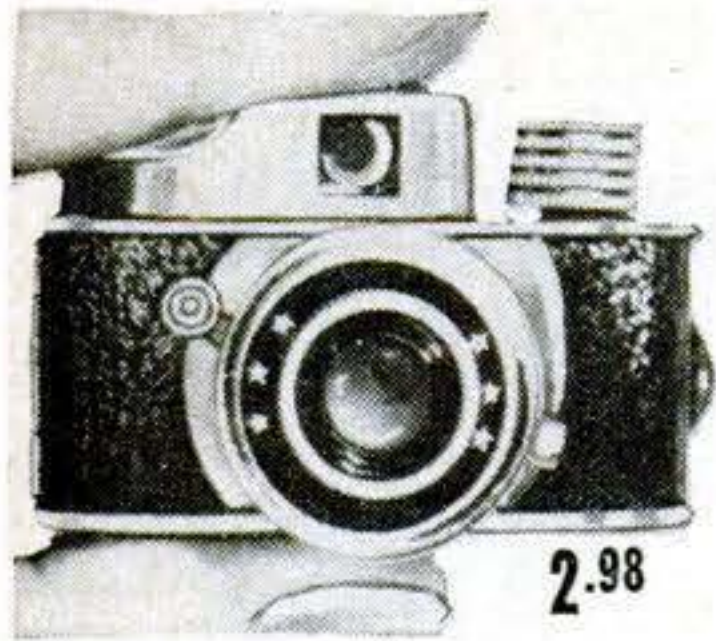

**Midget Spy Camera  
Takes Secret Pictures**

This precision-make camera is tiny—only 2" by 1 1/4"—but it takes unbelievably sharp pictures! Originally designed for espionage and detective work and can be hidden in the palm of your hand. By no means a toy! Sturdy, all-metal, gold plated. Coated lens, speed shutter, professional view-finder. Instant **AND** time setting. Pigskin carrying case and 2 rolls of film included without extra cost. Order several for gifts. **2.98**  
No. 38 .....



**2,500 Area Magnification  
Powerful  
Pocket Microscope**

This new German pocket microscope gives **2,500 TIMES AREA MAGNIFICATION**—yet measures but 2 1/4 inches! Gives giant power and performance. All-metal design—optically ground precision lenses. Easy eyepiece focusing. Lets you see Nature's wonders, hidden beauty—examine liquids, textiles, insects, cells, tissue, smears, etc. Clear, sharp magnification—no distortion ever. 2 slides given with each microscope. **1.98**  
No. 12 .....



**Famous  
SPECTOSCOPES 99c**  
The Binoculars You Wear  
Like Eyeglasses

These internationally famous binocular-spectacles are now being sold at a price that only we, as exclusive importers, can offer. Wear 'em just like eyeglasses—use 'em for close-up or distant viewing. Get clear, magnified images. Ideal for watching sports, TV, plays, opera, public events, etc. Made in West Germany. Precision optical lenses. In ebony finish. Light—only 1 oz. Formerly sold for \$2.98. Order several for gifts. **99c**  
No. 90 .....



For Sportsmen  
**MONARCH**  
**Solingen  
Steel \$3.95**  
**Monarch Hunting Knife**

The man of the family will appreciate this latest model hunting knife, the Monarch, fashioned by famous Korium of West Germany. Solid Solingen surgical steel blade etched with deer scene in 3 colors: handsome stag & chrome handle. Blade is actually sharp enough to shave with! Genuine leather sheath tailored to fit trimly. Hand forged—a knife that will stand up under years of rough use. Sportsmen will really appreciate a gift of this type! **3.95**  
No. 82 .....

## 17-JEWEL AUTOMATIC WATER RESISTANT WATCH



**Runs  
under  
water!**

**24.95**

Completely shock- and water-repellent—this handsome men's watch is selling at an unprecedented low price! Winds itself with the movement of your arm! Hairline sweep second hand—chromed and stainless steel case—17 jewels—Incabloc shock absorber. An accurate, durable timepiece. Formerly sold for up to \$79.00. A modern streamlined design—with the new "thin" look. Fully guaranteed. Good looking gift case included. Supply limited.

No. 238 ..... **24.95**

## Extra Powerful German Telescope

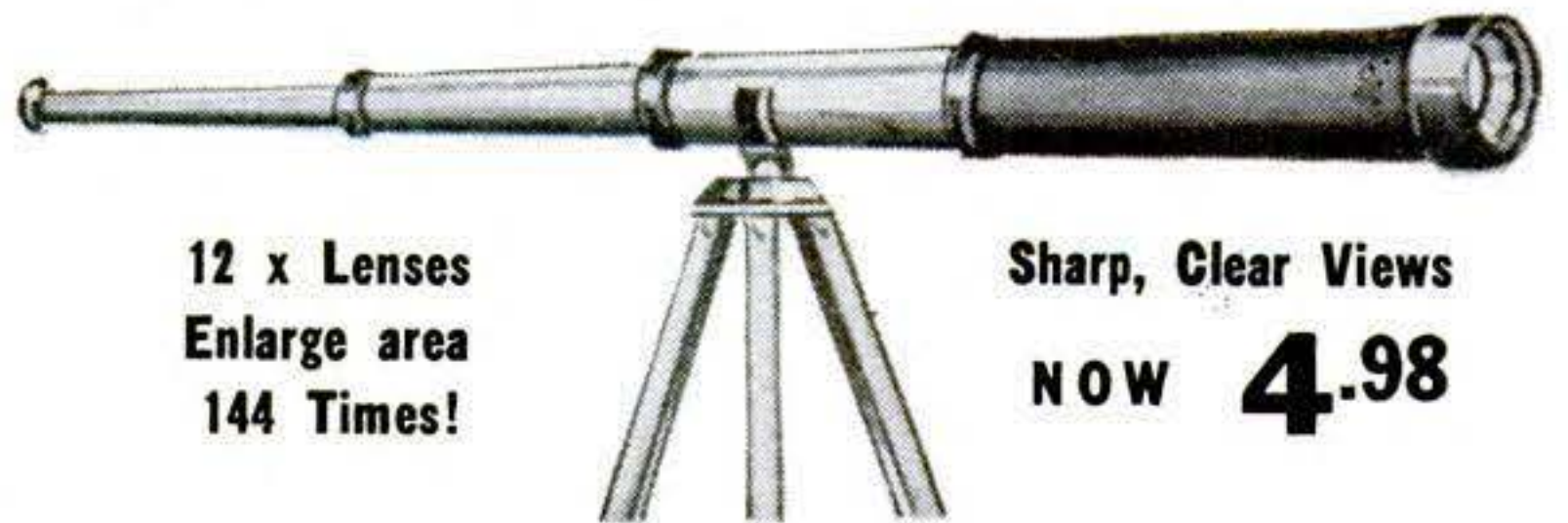

**12 x Lenses  
Enlarge area  
144 Times!**

**Sharp, Clear Views  
NOW 4.98**

The new, amazing **POWERHOUSE TELESCOPE** is the latest triumph of German industry and wizardry! The new 12 X lenses give you 144 times area magnification! Ideal for very great distances, plane and ship spotting, celestial observation, etc. Genuine brass draw tubes and precision manufacture for a lifetime of enjoyment. Comes complete with portable **TRIPOD** for steady viewing. Superb quality and workmanship. A great bargain! Nothing under \$10.00 can beat it. **4.98**  
No. 43—Complete with **TRIPOD**.....

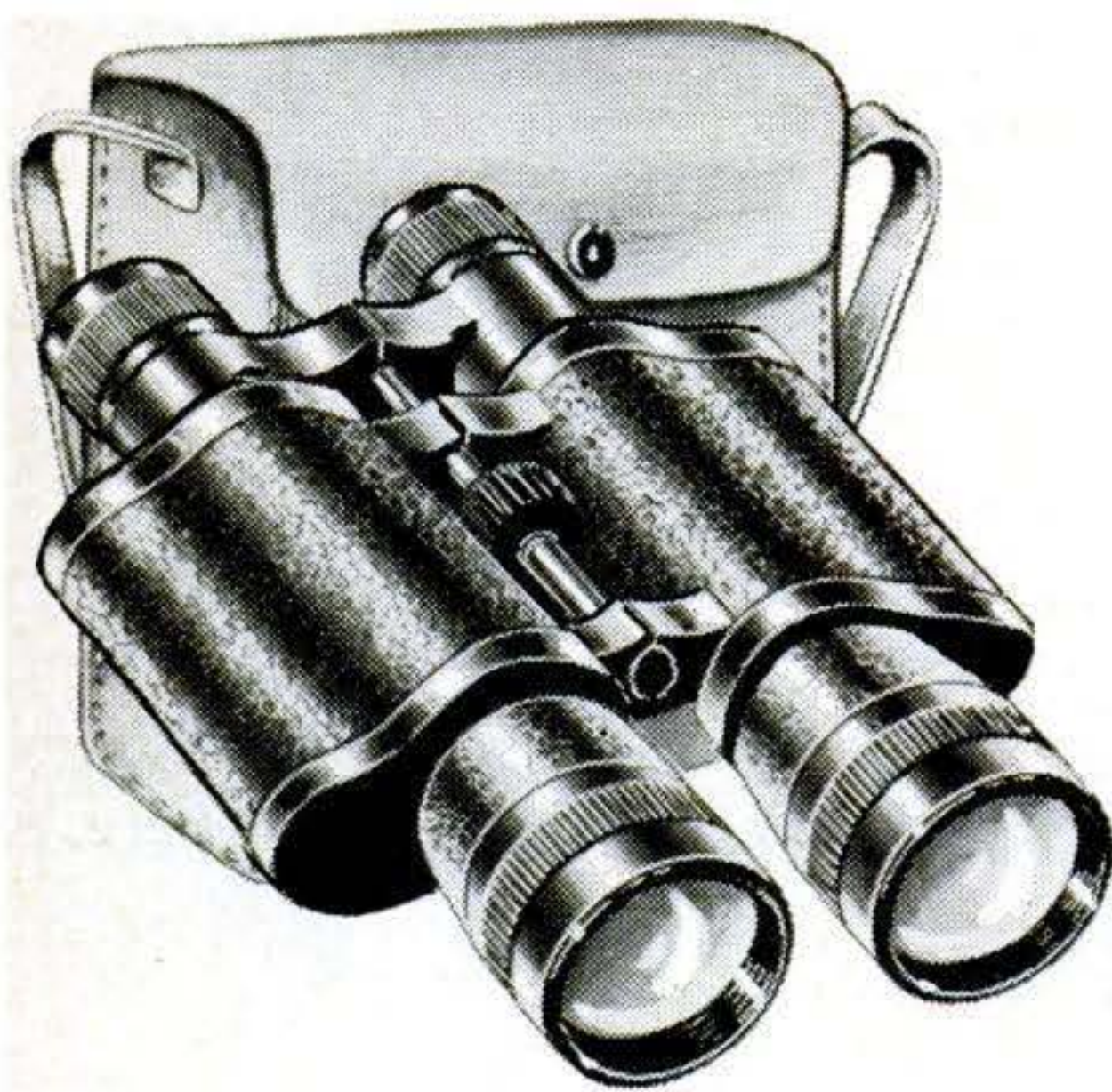

## NEW 1956 MODEL

# 5 x 50

## POWERHOUSE BINOCULARS give 25 times area magnification!

The new 1956 model Powerhouse Binocular is more powerful than ever—lets you see **BETTER**—lets you see farther! A perfect gift for every man, woman, child. West Germany's new, amazing Powerhouse binoculars give extra distance power, better viewing up to 25 miles away! Superb workmanship by century-old German factory. Battleship construction of quality materials and lightweight aluminum. Center focusing. Adjusts to any eye width. Clear, sharp viewing even in moonlight. Precision ground lenses with interior fluoride objective coating . . .

**EXTRA POWER! 4.98**

same as expensive binoculars. Complete with genuine leather case. **4.98**  
No. 66 .....



**Use Coupon on Next Page**





# FROM IMPORTER-TO-YOU!

**FOR HIM!**



**30 Better Shaves  
From 1 Blade**

**SMOOTHER SHAVES TOO!**

Here's an ideal gift for men! They get 30 or more shaves from a single razor blade with this marvelous sharpener! Hones & conditions old and new blades to an unbelievable sharpness. Does it in seconds, too—just whisk the plunger back and forth a few times and you have a blade sharper than one fresh from the factory. Gives the man of the house **BETTER, SMOOTHER** shaving. Made in Western Germany. Save dollars in blades yearly. **No. 3 ..... 1.98**

**Rugged Built  
for  
Boys**



**4.95**

**Boy's Chronograph**

This 4-in-1 imported Swiss Stop Chronograph and wrist watch combined is a perfect Christmas gift for the young man of the family. Gilt finish, double push-button stops, unbreakable crystal, sweep second hand, luminous numerals & hands, sturdy shock resistant case. Measures speeds and distances. Accurate, sturdy, dependable. Gives split-second timing. Fully guaranteed. At this low price it's the watch bargain of the year! **No. 236 ..... 4.95**

**BONNIE BRIDE  
WALKING  
DOLL**

**1.98**



Here's an ideal doll for all-year-round play—she's actually 7 dolls in 1! Her original bridal gown can be changed and you have a choice of 6 other complete outfits to choose from! She walks, turns her head, sits, stands and is washable from head to toe. Not 6, 7 or 8—but 9 INCHES TALL! Plastic body and face looks almost human and her lovely Saran hair is SO natural! Finely detailed features and her trousseau is authentically modeled after latest styles.

**BONNIE BRIDE'S WARDROBE  
6 Outfits—Only \$1. complete**

Includes: Nitegown, Ballerina Dress, Ski Suit, Rain Coat, Hostess Coat.

**No. 54—BONNIE BRIDE WALKING DOLL—1.98—6 extra complete outfits only 1.00 more.....Total—2.98**

**LAST CALL  
AT HALF PRICE!**



**1.98**

**REG. 3.98**

The world famed Black Forest Hunting Knife

Made in Western Germany Solingen Steel 10" Over-all

with LEATHER SCABBARD INCLUDED

Over 75,000 sportsmen paid over 3.98 for this famed hunting knife. It's now yours for only 1.98. Blade is actually sharp enough to shave with! Genuine leather scabbard—**FREE**—is metal-tipped. Tough, rugged Solingen steel. Length: 10". Swell rec room decoration. Send only 1.98 plus 12c postage.

**No. 80 ..... 1.98 (plus 12c)**

**→ → MAIL TODAY → →**

**GIANT PLASTIC PLAYHOUSE**

**ONLY  
98c**

**Big Enough  
for 2 Kids!  
No Tools Needed**



Amazing value! Durable DUPONT flame resist plastic Playhouse sets up in seconds over any card table. No tools needed! Big enough for 2 kids. Keeps kids safe & happy for hours at a time. Windows & door flap open. Looks so realistic! A thrilling toy. Priced so low because it's made in our own factory! **No. 19, sale price, only.....98c**

**SAVE MONEY MAIL NOW!**

**THORESEN'S, Dept. 7-M  
352 Fourth Ave., New York 10, N. Y.**

RUSH the items checked below on 5-day free home trial. If not delighted with the merchandise, I will return it in 5 days for full refund. ( ) Payment enclosed. Send tax & postage paid. ( ) Send C.O.D. I'll pay charges.

- No. 90—Spectoscopes (99c)
- No. 12—Pocket Microscope (1.98)
- No. 38—Spy Camera (2.98)
- No. 54—Bonnie Bride with 7 outfits (2.98)
- No. 66—5 X Powerhouse Binocular & Case (4.98)
- No. 19—Plastic Playhouse (98c)
- No. 3—Honikron Blade Sharpener (1.98)
- No. 236—Boy's Chronograph (4.95)
- No. 43—Telescope & Tripod (4.98)
- No. 82—Monarch Hunting Knife (3.95)
- No. 80—Black Forest Hunting Knife (2.10)
- No. 238—17-Jewel Automatic Watch (24.95)

NAME.....

ADDRESS.....

CITY..... State .....

(Canadians: Order direct from our Canadian plant: Thoresen's, Ltd., 45 St. James St. W., Dept. 7-M, Montreal 1, P. Q. Same prices.)



# "Old Timer" Shows Young Pipe Smoker Reason EDGEWORTH SMOKES COOLEST

## Compare the Cuts of Pipe Tobacco

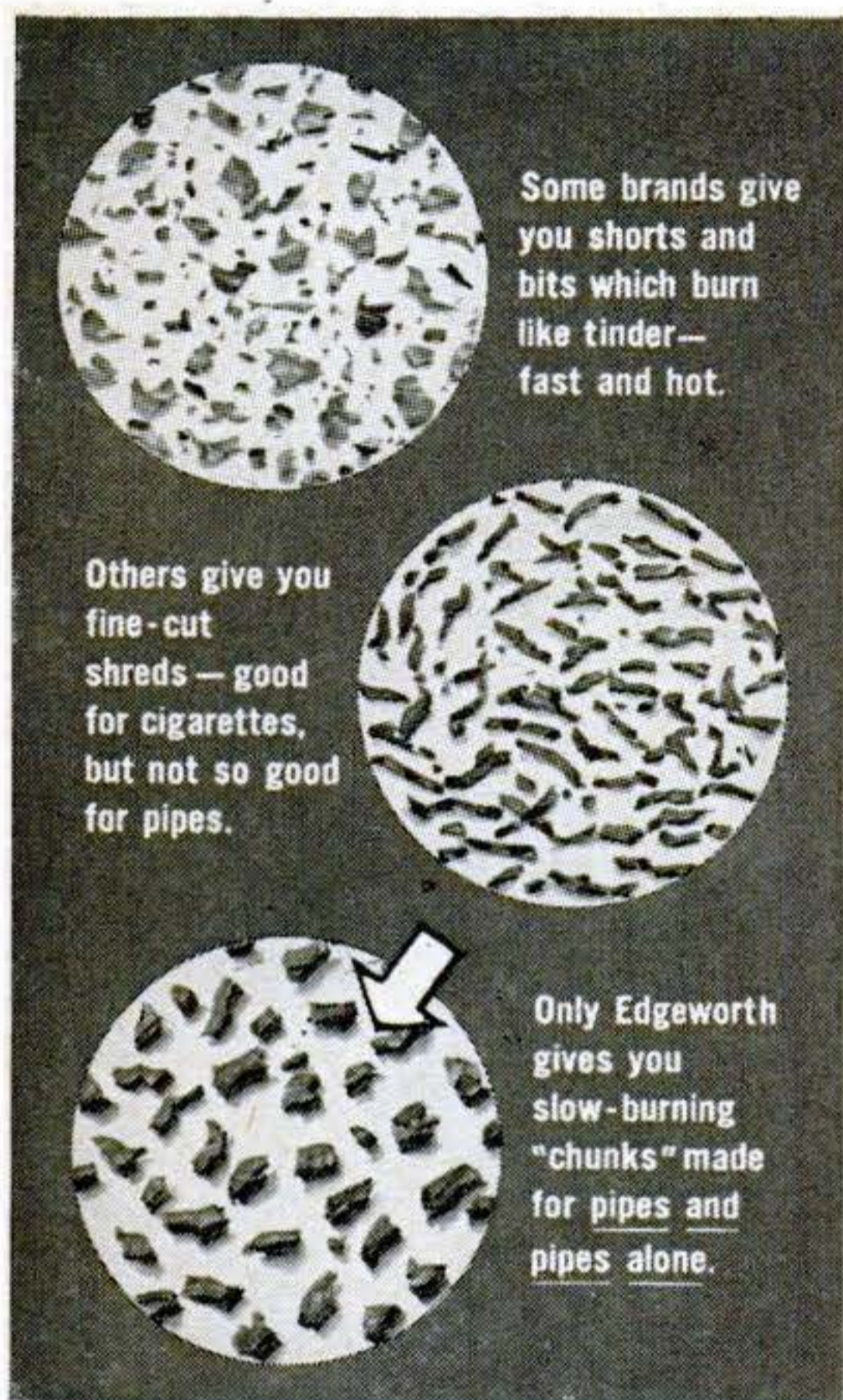

Some brands give you shorts and bits which burn like tinder—fast and hot.

Others give you fine-cut shreds—good for cigarettes, but not so good for pipes.

Only Edgeworth gives you slow-burning "chunks" made for pipes and pipes alone.

**AT YOUR DEALER'S**



### Shows Meaning of "Ready-Rubbed"

Old time smokers knew the secret of cool, even burning. They carefully "hand-rubbed" their tobacco into chunks of just the right size. Now Edgeworth does all this

before the tobacco is packaged. An exclusive process "ready-rubs" Edgeworth into chunks that pack right for a cool smoke without a touch of tongue bite.

## Made Right...Cut Right and Packed Right!

Your true tobacco expert will tell you that white burleys are the world's coolest smoking tobaccos. Edgeworth is a blend of white burleys only—aged for years. It leaves our plant with just the right moisture content for a cool, no-

bite smoke and reaches you in the same condition because only Edgeworth has the Seal-Pak pouch. Air-and-water tight, it promises you fresher tobacco than any other type of pocket pack. No bulky corners in your pocket, either.

### FOR A MILD MIXTURE TRY HOLIDAY

A "custom" blend of five tobaccos selected for mildness and aroma. The only mixture in the Seal-Pak pouch.

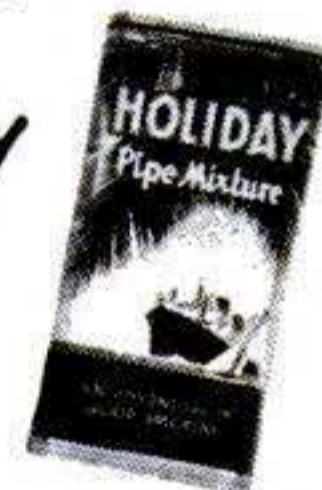

Get this guaranteed "Olde London" Pipe and two full-size pouches of Edgeworth tobacco for only \$1.00. The pipe is fine, hand-rubbed imported briar . . . with genuine hard rubber bit . . . carbonized bowl for cooler smoking. If your dealer is unable to supply you, use this handy order blank.

Name \_\_\_\_\_

Address \_\_\_\_\_

City \_\_\_\_\_ State \_\_\_\_\_

Mail with \$1.00 to "Olde London," Larus & Brother Company, Inc., Richmond, Va.  
Offer Good Only in U. S. A.

PS-11

# Edgeworth

AMERICA'S FINEST PIPE TOBACCO FOR OVER HALF A CENTURY



# 5 reasons why ACCOUNTANCY

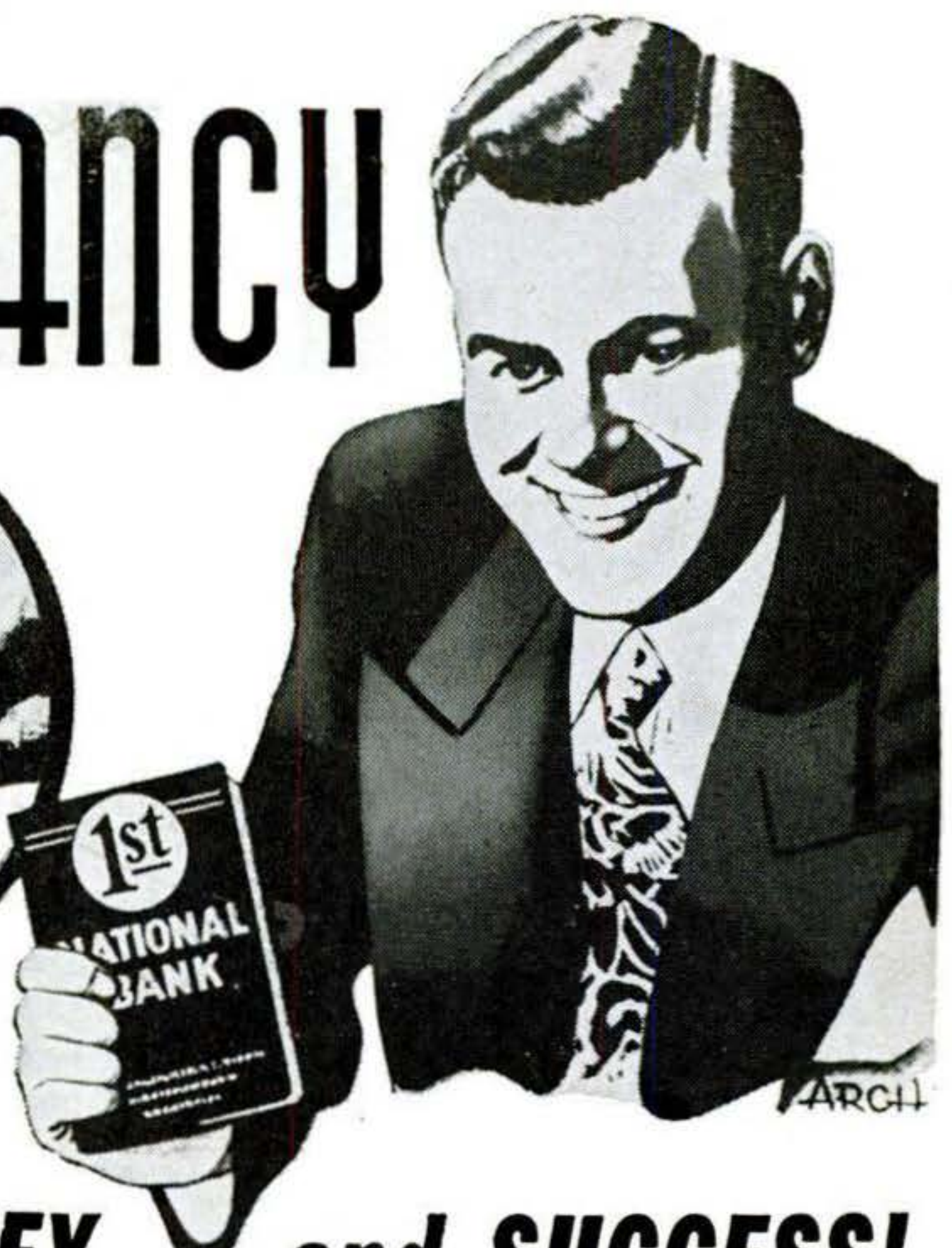

## offers you MORE MONEY... and SUCCESS!

**REASON #1.** If you were an expert accountant right now, chances are you would find yourself among the highest-paid of all professional men and women. Even back in "depression years," surveys showed that accountants earned more on the average than men in other major professions.

**REASON #2.** The demand for accountants is great—everywhere. All businesses must have trained accountants to cope with ever-growing requirements. It's a profession offering wide opportunity—always—to the man who knows.

**REASON #3.** You can fit into any business, anywhere in the country—because accounting principles are universal. Think what this means in terms of security and independence!

**REASON #4.** Accountancy is open to all. Any man or woman of good intelligence, who enjoys figure work and is willing to follow LaSalle's systematic "problem method" plan, can rapidly qualify for a highly profitable, enjoyable lifetime career... and he doesn't have to finish his training before beginning to "cash in."

**REASON #5.** Without losing a day from your present work, you can prepare in spare hours at home, at low cost, under LaSalle's step-by-step "Problem Method" of "learning by doing." This famous plan accounts for LaSalle's remarkable record of having trained nearly 10 per cent of all Certified Public Accountants in the U. S. . . . and of having put many thousands of others into high-paying careers.

Send today for Free Sample Lesson and "Accountancy, the Profession That Pays." Learn about the five great fields of opportunity . . . and LaSalle's time-tested plan for helping men and women to rapid advancement, higher income, greater prestige and professional standing. The coupon below will bring this information to you—without cost or obligation.

**MAIL THE COUPON—NOW**  
Member, National Home Study Council

**GET FREE SAMPLE LESSON**

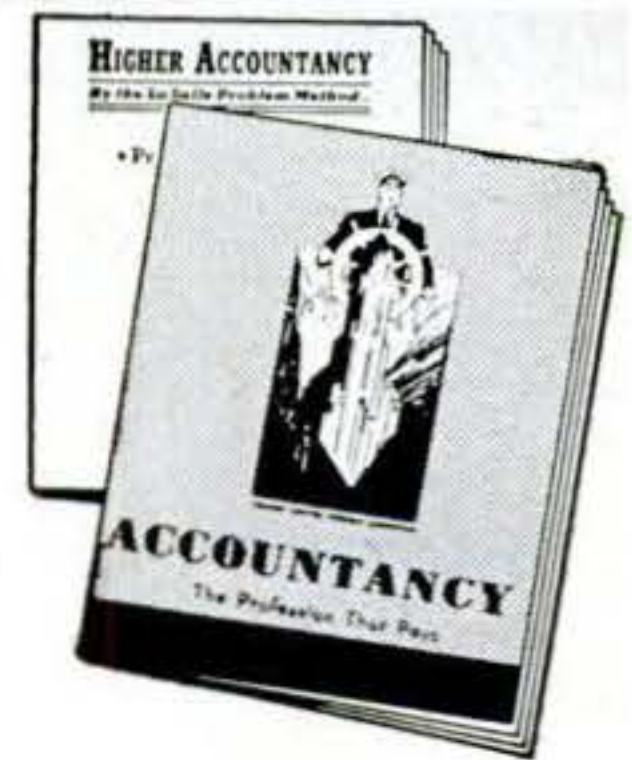

**LASALLE**  
417 S. Dearborn St.,  
CHICAGO 5, ILL.

### LaSalle Extension University

— A Correspondence Institution —

Dept. 1183H, 417 S. Dearborn St., Chicago 5, Ill.

Please send me, free of all cost or obligation, a sample lesson in Accounting . . . also, your 48-page illustrated book, "Accountancy, the Profession That Pays."

Name.....Age.....  
Address.....  
City, Zone, State.....



# Holt's WORLD-FAMOUS Do-It-Yourself Products

**For the Motorist  
and the Home**

**PISTON SEAL—**

For restoring power and compression, stopping piston slap and reducing oil consumption.

**GUN GUM—**

For mending leaky mufflers, sealing pipes and joints.

**BATREPAIR—**

An acid-proof battery weld.

**HOLTWELD—**

For repairing cracked cylinders.

**RADWELD—**

For repairing leaky radiators.

**NO-CRODE—**

For keeping battery terminals clean.

**SUPERTUNE COMPRESSION PRIMER—**

For maintaining top engine tune-up.

**LOY—**

For permanently repairing anything broken, cracked, loose or leaky—metal, wood, glass, plastic, porcelain. It's real metal in a tube.



ORIGINAL

## TRADE MARK Piston Seal

**Restores Power and Compression! Stops Piston Slap! Reduces Oil Consumption! Increases Mileage!**

Good for 10,000 miles of carefree driving. Next best thing to a complete motor overhaul . . . at 1/20 the cost. Today's biggest seller. Millions of tubes have been sold throughout the World during the past 18 years. Undeniably safe for even the finest engines. Endorsed by leading technical automotive experts.



**\$4.95** a tube **POSTPAID** for most cars

Stop Danger of  
Carbon  
Monoxide  
Gas



*Sets like a weld in a few minutes!*

**\$1.69** CAN

No Tools Necessary  
Apply by Hand

*Write for full details*

**At every Auto and Accessory Store  
TREGLOWN CO., Inc., Fanwood 58, N. J.**

Canada: 1366 Greene Ave., Montreal 6 (Prices slightly higher in Canada)

## 80 PROJECTS IN METAL



**you can  
build  
yourself**

Exciting plans of what you can build at home . . . for a few cents.

- |                               |                          |
|-------------------------------|--------------------------|
| <b>Wrought iron furniture</b> | <b>Power tool stands</b> |
| <b>Barbecue grills</b>        | <b>Garden tools</b>      |
| <b>Ornamental iron ware</b>   | <b>Wagons</b>            |
| <b>Flower stands</b>          |                          |

You'll say it's the best dollar you ever invested in do-it-yourself projects.

MAIL COUPON TODAY...OR WRITE DEPT. 3104

Mail To  
**The Lincoln Electric Company  
Cleveland 17, Ohio**

Attached is a dollar. Send my copy of the book, "Selfwelding". 80 Projects in Metal.

Name \_\_\_\_\_

Street \_\_\_\_\_

City \_\_\_\_\_ Zone \_\_\_\_\_ State \_\_\_\_\_

change your portable drill to a  
high power tool with  
**SUPREME VERSAMATIC**



only **\$14.95** ppd.

**REVERSES**  
with a flick of wrist

**BOOSTS POWER • REDUCES SPEED**

Hand Clutch Type Control! With this amazing new attachment on your quarter inch electric drill, you've got a versatile tool for all kinds of heavy jobs. Its 7 to 1 speed reduction steps up power in proportion . . . plenty of drive for big diameter drilling and tapping, and at the lowest speeds needed for such work. It's a power wrench, for running nuts on or off; it's a whiz of a power screwdriver for handling even the largest screws in any number. Useful for every one, and invaluable for the pro. The VERSAMATIC is easy to use, reverses with a flick of the wrist. Rugged planetary gear cuts speed from 7 to 1 forward, 6 to 1 reverse. Comes in complete kit containing slotted screwdriver, Phillips bit, adapter for 1/4 inch socket sets (square drive), wrench pin and 12 page instruction book. Adapter 1/2 inch chuck available at \$7.50 extra.



**6 PRECISION SCREWDRIVERS**

Perfect for jewelers, watchmakers, hobbyists, etc. SIX DIFFERENT SIZES: No. 3, No. 4, No. 5, No. 6, No. 8, No. 10. Knurled body grip assures easy handling. Finest steel and craftsmanship. A hard-to-beat value from Switzerland **\$1.25** ppd.

Send check or M.O. C.O.D. fees extra. **MONEY BACK GUARANTEE**

**Scott-Mitchell House, Inc.,** Dept. SV-9, 611 Broadway, New York 12, N. Y.



**For Good Pay, Interesting Work, Security**

# Learn Electric Appliance Repair AT HOME IN SPARE TIME

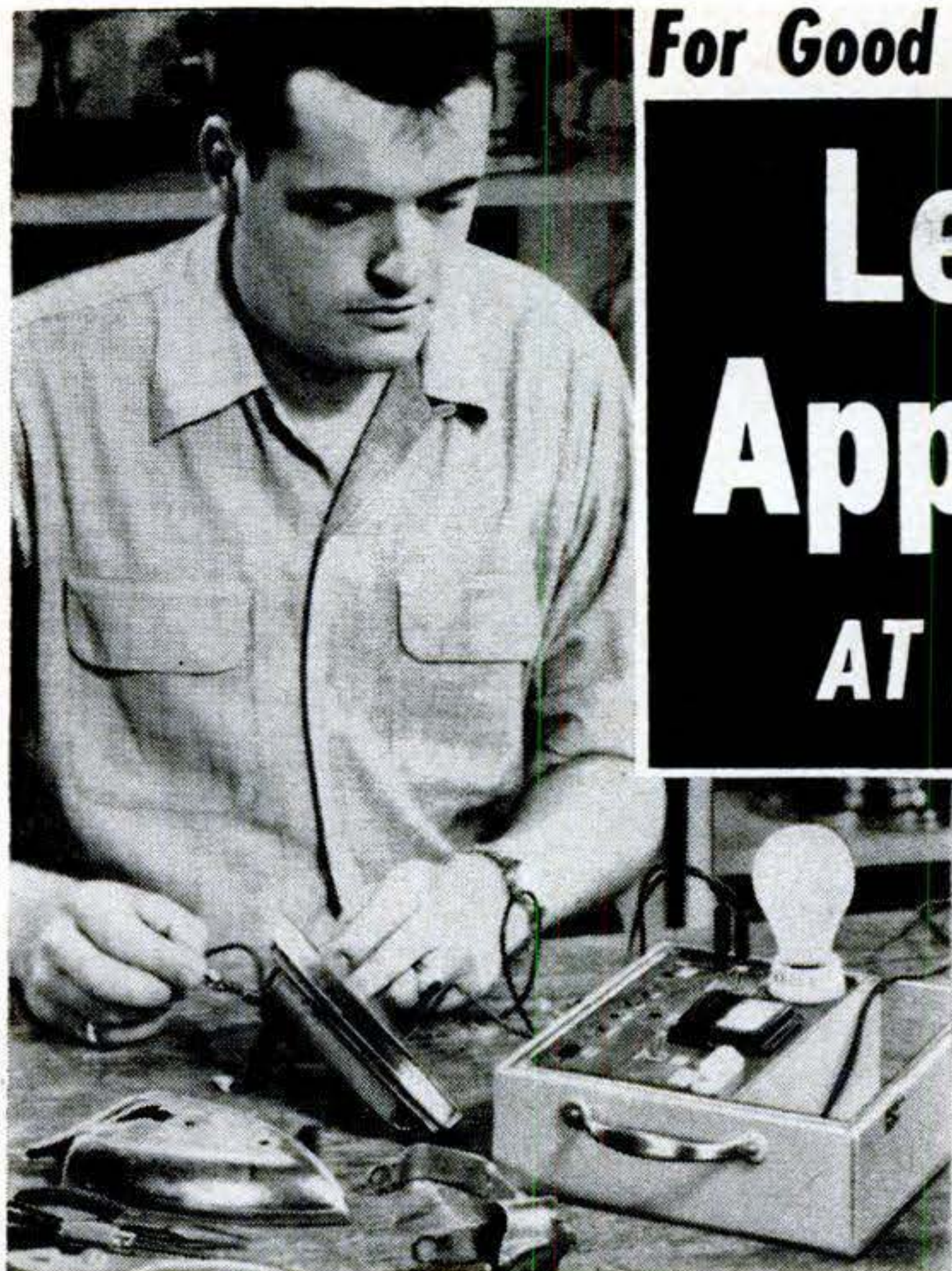

## Pick up \$3, \$4, \$5 an Hour in Spare Time Starting Soon

Start soon to fix electric toasters, clocks, fans, vacuum cleaners, etc. for neighbors and friends. Spare time work done in your basement, garage, or spare room can earn you \$3 to \$5 an hour. See how easy it is to increase your earning power—how you can pay for this training many times over with spare time earnings.

## Learn and Earn With This Appliance Tester You Get

This course includes the parts to build this sturdy portable appliance tester that helps you find electrical defects quickly and easily. You use it to learn and do actual electrical and appliance repair jobs. This multi-use tester helps you start making money soon after your training starts.

## Train Now for Greater Security Low Price — Easy Terms

Today's automatic electrical appliances need expert servicing. The man who knows a good trade like appliance repair has a secure future. Put your spare time to good use. Invest \$2.50 down and \$5.00 a month in a better future. Write Electrical Appliance Training, National Radio Institute, Dept. BM5, Washington 9, D.C.

**B**uild a better future. Get into a field where there is important work and the security that comes from knowing a good trade. The electrical appliance repair business offers OPPORTUNITY FOR YOU. Every wired home today has an average of 8 electrical appliances. Up to 10 million new appliances are sold every year. Owners pay well to keep them in repair and enjoy the convenience they provide. That means there's a fast growing need for trained men.

## Opportunities Increasing For Men Who Know This Profitable Trade

You may want to be your own boss so you can enjoy the profits of your business. Or you may want to qualify for the better job of Service Manager or Supervisor in an Appliance Servicenter. Or perhaps you want to supplement your income doing electrical appliance repairs in your spare time. Opportunity in this growing field is great. Send for free book and see what the Electrical Appliance field offers you!

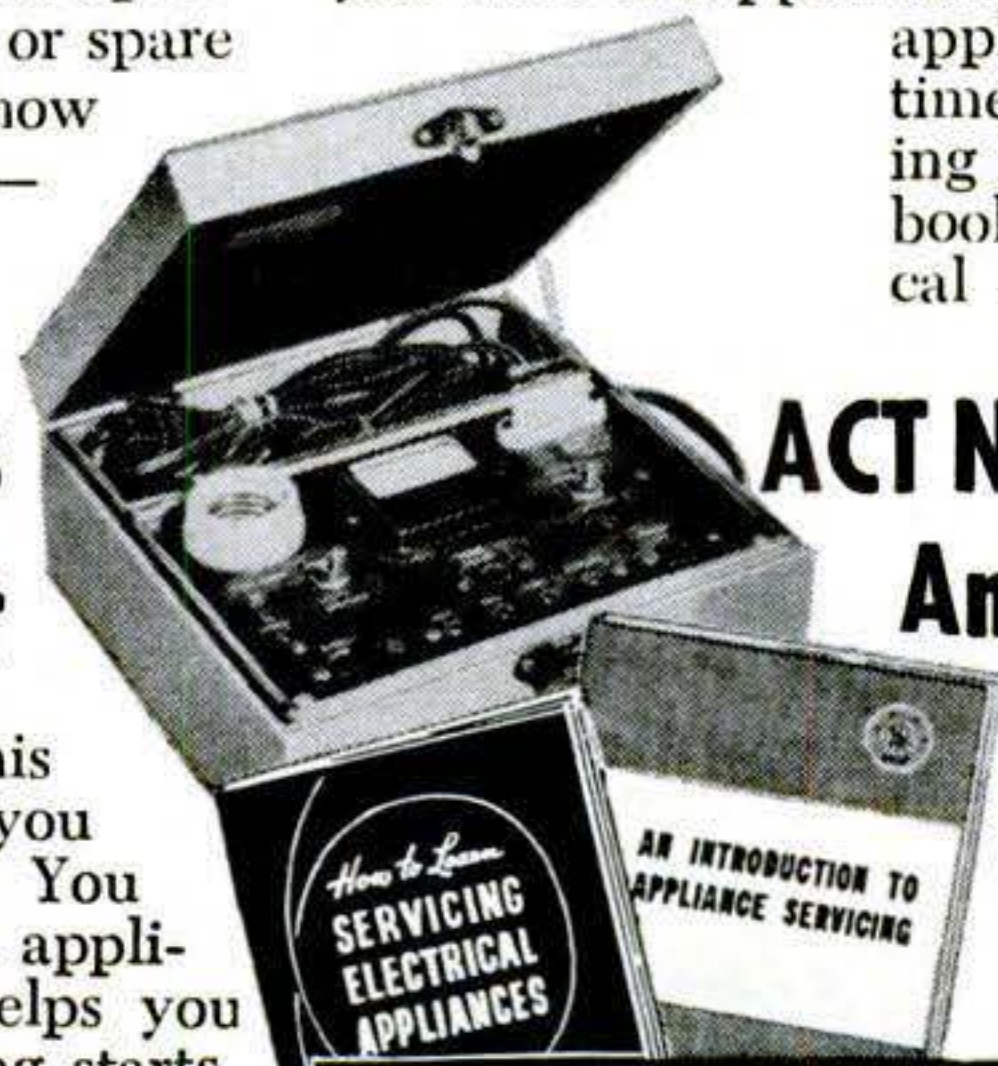

## ACT NOW! Get Free Book And Sample Lesson

Actual lesson proves our method is clear, practical. Book gives facts about Electric Appliance opportunities and details of our training. Act now to make your future more secure.

### MAIL COUPON TODAY

**NATIONAL RADIO INSTITUTE**

Dept. BM5, Washington 9, D. C.

Please send me Electrical Appliance Training Lesson and Book Free. (No salesman will call.)

Name..... Age.....

Address.....

City..... Zone..... State.....

APPROVED MEMBER NATIONAL HOME STUDY COUNCIL



AFTER SHAVING  
**Dims Shine  
 Feels Fine  
 Doesn't Show**

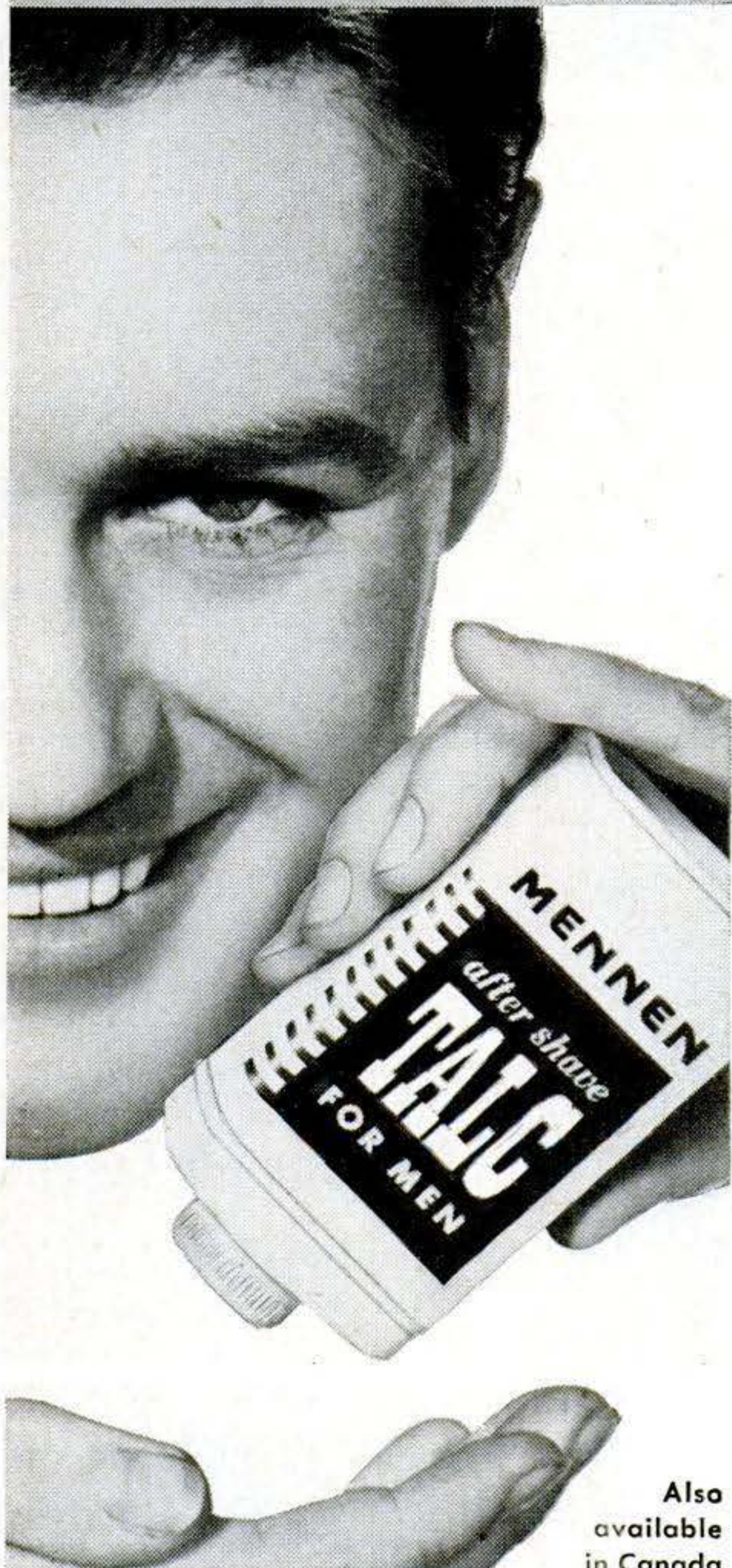

Also  
 available  
 in Canada

Finishing touch for every shave!  
 Neutral tint — crisp scent!

**MENNEN**  
 AFTER-SHAVE TALC  
**FOR MEN**

# Letters



## Accelerator Getting Lonely?

Well, sir, I see by POPULAR SCIENCE that the brake pedal is going the way of the clutch, the stick shift and the tire tube. If Stanley Hemphill has his way ["Out Goes the Brake Pedal," Sept., p. 121], there'll be only one lever jutting out from the floor.

Now all we have to do is get rid of that poor lone pedal. Then we can all stick our



feet out forward (the windshield will push out automatically) and cool our tootsies. And that'll mean an even bigger saving: Cars of the future won't need air conditioning!

J. BEVIN, West Hempstead, N. Y.

## U.S. Tells the World—Through PSM

We would greatly appreciate permission to reprint the article "Atomic Power Plant to Serve New York" [Aug., p. 82]. With your permission, reprints will be sent to our information offices in 81 countries for distribution, translation and possible republication in the foreign press.

WILLIAM E. HUTCHINSON JR.  
 Chief, News and Features Branch  
 U.S. Information Agency

*PSM is naturally proud to let our Government use this story, as we have many others, to tell people abroad of American progress in the peaceful use of atomic energy.*

## He Peeked at GM's V-6

What's this about General Motors' V-6 engine being a deep, dark secret ["Will Detroit Build V-6 Cars?" Aug., p. 65]? Maybe you weren't allowed to look at it, but I saw





# INVENTORS

Learn how to protect your invention. The U. S. Patent Laws provide that any new and useful art, machine, article of manufacture, or composition of matter, or any new and useful improvement thereof, may be patented if the act of invention is involved. Therefore, every inventor with a valuable invention should take advantage of the Patent Laws and proceed for patent protection in order to safeguard his rights.

A patent gives the inventor the exclusive right to prevent others from making, using, or selling the invention claimed in the patent for a period of seventeen years.

The Patent Laws were enacted for the benefit of the inventor to give him protection for the features of his invention which are patentable. These features must be properly and concisely set forth and claimed in a formal application for patent, in order to comply with the requirements of the Patent Laws. For that reason, unless the inventor is familiar with patent matters, he should engage a competent registered patent attorney or agent to represent him. We are registered to practice before the U. S. Patent Office and are prepared to serve you in the handling of your patent matters.

A specially prepared booklet entitled "Patent Guide for the Inventor", containing detailed information with respect to patent protection and procedure, together with a "Record of Invention" form will be promptly forwarded to you without obligation upon request.

**CLARENCE A. O'BRIEN & HARVEY JACOBSON**

*Registered Patent Attorneys*

52-L DISTRICT NATIONAL BUILDING  
WASHINGTON 5, D. C.

NOVEMBER 1955 15





"Your Quaker State sign reminded me to check my oil!"



Super-refined from Pure Pennsylvania Grade Crude Oil, world's finest. Famous for performance, protection, economy! Try it!

**QUAKER STATE OIL REFINING CORP., OIL CITY, PA.**  
Member Pennsylvania Grade Crude Oil Association

it and nobody even asked for my serial number.

When the Motorama was in San Francisco, I simply lifted myself up on the railing that encircled the car and opened the hood and looked in. There it sat: a short V-6 made of unpolished aluminum. Three tubes on each side ran up to the fuel-injection nozzles.

JOHN J. KLINKO

U.S. Navy Patrol Sqdn. 19, San Francisco

### Help for Papa

Some help, please. With Jim, my nine-year-old son supervising, I built that control-line model plane in your August issue [p. 189]. The idea was that I'd build it for him and teach him how to fly it, and then maybe after some practice he could make out on his own. Hunh!

Well, I smashed it into bits the first time out. It didn't even get around the circle once. I spent all one Saturday morning regluing it,



and then smashed it into pieces again. Jim glued it himself the next time. The only successful flights we've had have been with him at the controls.

This is not good for my reputation. Have you got any tips?

JAMES H. WARREN, Boston

*Most fathers will sympathize with Jim Sr.; kids just naturally have faster reflexes than grownups. If the crashes come from too much speed, increase the size of the spoiler disk on the prop, or set the engine extra rich, or wedge a wooden match in the venturi to choke it down. If the trouble is over-controlling, use a smaller control handle or rework the bell crank for less elevator sensitivity.*

### Who Has the Toughest Woodpeckers?

Those pileated woodpeckers that chew up light poles [Sept., p. 163] are just Eastern dudes. If you want to see woodpeckers with bills of carbon steel, come down here to Oklahoma. A few years ago an industrial plant nearby closed up, but left its iron smokestack



# INVENTORS

If you believe that you have an invention, you should find out how to protect it. The first step is to have a search made of the prior pertinent U. S. patents. If a report on this search indicates that the invention appears patentable you can apply for a patent, and the specifications and claims should be prepared.

The firm of McMorrow, Berman & Davidson, with offices in Washington, D. C., is qualified to take the necessary steps for you. We can make a preliminary search on your invention, advise you whether we think it can be patented, and prepare your application for patent.

Unless you are fully familiar with the U. S. Patent Laws, we recommend that you engage the services of a Registered Patent Attorney to protect your interests. The patent laws are *your* laws. A patent gives you the right to prevent others from making, using or selling the invention claimed in your patent for a period of 17 years.

Use these patent laws for your protection. Investigate whether your invention can be patented. If you have what you believe to be an invention, we suggest that you have this firm make a search for you.

*Send for a copy of our Patent Booklet entitled "How To Protect Your Invention," containing information about patent protection and patent procedure. Along with this we will also send you an "Invention Record" form, for your use in writing down and sketching details of your invention. We will mail them promptly. No obligation. They are yours for the asking.*

**McMORROW, BERMAN & DAVIDSON**

*Registered Patent Attorneys*

**PATENTS • COPYRIGHTS • PATENTS**

**142 - L VICTOR BUILDING, WASHINGTON 1, D. C.**



*These great minds were Rosicrucians . . .*



Francis Bacon Benjamin Franklin Isaac Newton

## WHAT SECRET POWER DID THEY POSSESS?

### *Why were these men great?*

How does anyone—man or woman—achieve greatness? Is it not by mastery of the powers within ourselves?

Know the mysterious world within you! At-tune yourself to the wisdom of the ages! Grasp the inner power of your mind! Learn the secrets of a full and peaceful life!

Benjamin Franklin, statesman and inventor . . . Isaac Newton, discoverer of the Law of Gravitation . . . Francis Bacon, philosopher and scientist . . . like many other learned and great men and women . . . were Rosicru-cians. The Rosicrucians (NOT a religious organization) have been in existence for centuries. Today, headquarters of the Rosicrucians send over seven million pieces of mail annually to all parts of the world. Ad-dress: Scribe P.C.H.

**THIS BOOK FREE**



## *The* ROSICRUCIANS

San Jose (AMORC) California, U.S.A.

---SEND THIS COUPON---

Scribe P.C.H.  
The ROSICRUCIANS  
(AMORC)

San Jose, California, U.S.A.

Please send me the *free* book, *The Mastery of Life*, which explains how I may learn to use my faculties and powers of mind.

Name \_\_\_\_\_

Address \_\_\_\_\_

City \_\_\_\_\_

State \_\_\_\_\_

standing. That stack is now pecked full of holes one to three inches across.

DAVID J. EDWARDS, Calvin, Okla.

### **Wordless Gremlins in the Workshop**

In Doty's cartoon [Nov., '54, p. 230], how come the hole in the shirt got burned with the point toward the collar? The previous

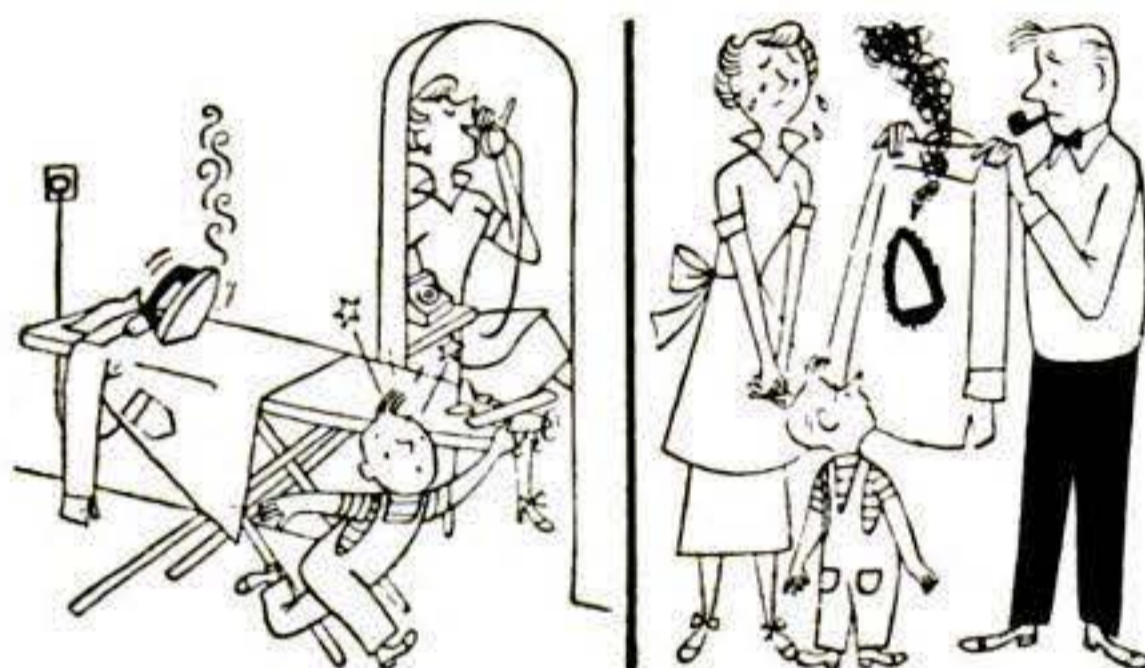

drawing showed the iron pointing in the other direction.

OSCAR C. TRUEBLOOD, Ames, Iowa

*This blooper can only be laid to an excess of artistic license.*

### **They Like Their Fire-Engine Copters**

Thank you very much for sending us the original art work of your August cover [it showed a Bell helicopter fighting a forest fire]. It is a beautiful painting and we are now having it framed to hang in our lobby.

JAMES C. FULLER

Public Relations Director

Bell Aircraft Corp., Fort Worth

### **More Light on Lighting**

In your September issue is an article on building a fluorescent light behind a window cornice [p. 106]. It's a good idea, and I would like to build one, but what is meant by a "feed-through switch"? Also, I would like to know if there is any simple way of locating an electrical wire and snaking it through a small hole in an outside plaster wall after I have attached it to an attic cable. I want to avoid dangling wires from regular outlets in my living room.

A. M. MORONEY, Minneapolis

*A feed-through switch has the power cord running right through it. It is available in the dime stores for lamps. As for your wall problem, you can locate a wire within a few inches by measurement from a room partition that you can spot from the attic. Tie a weighted string to the cable, drop the weight through a hole in the wall plate, drill the plaster and fish for it. The string acts as a leader to the wire.*



# THESE MEN ARE GETTING PRACTICAL TRAINING IN **ELECTRICITY**

—ELECTRONICS

*On Real:*

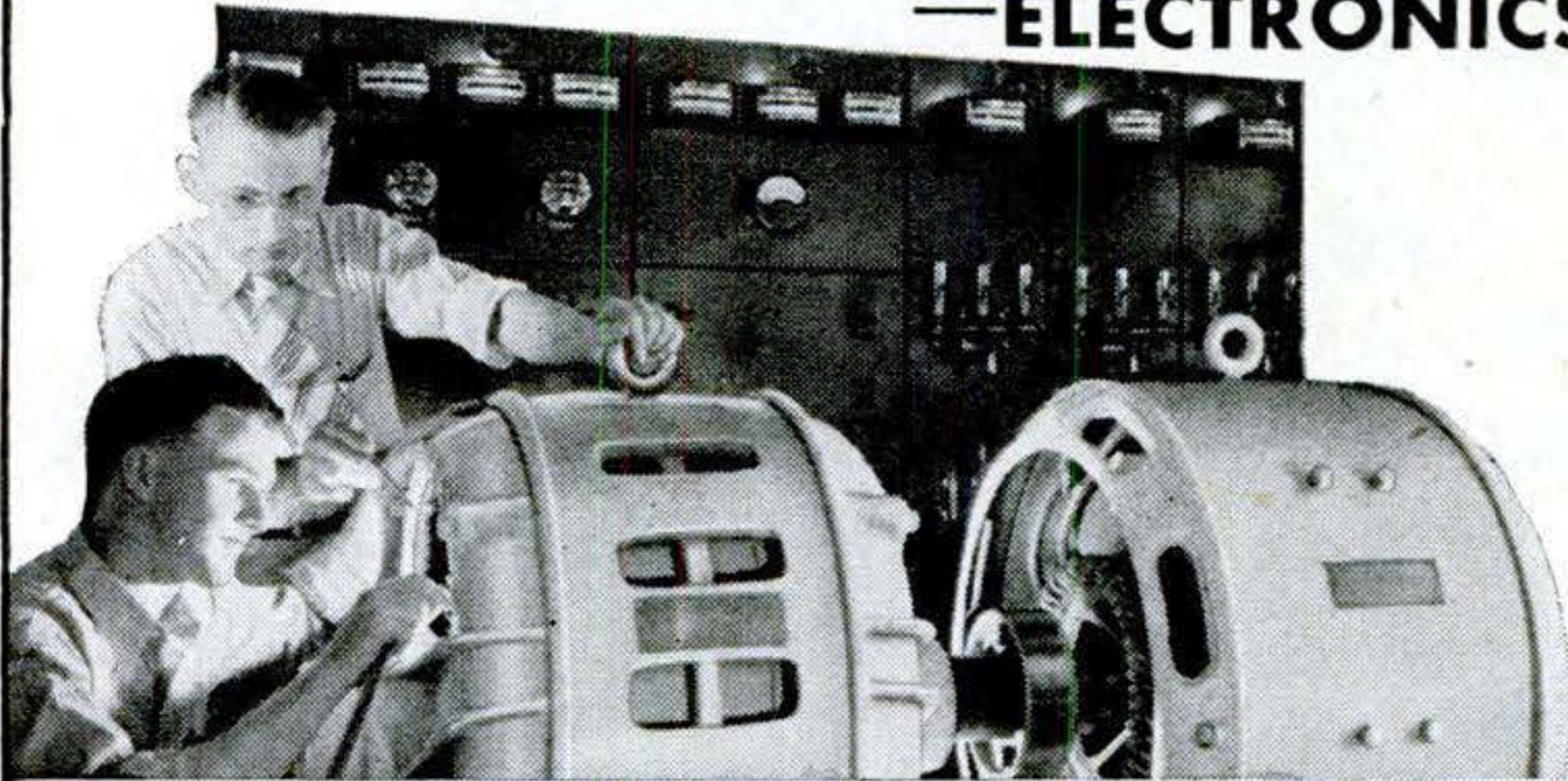

**A.C. and D.C. MOTORS  
GENERATORS  
SWITCHBOARDS  
CONTROLLERS  
WIRING JOBS  
APPLIANCES  
ELECTRONIC UNITS**

*(Shown at left—Instructor explaining operation and testing of a large Motor Generator in our A.C. Department.)*

# AND **TELEVISION-RADIO**

*On Real:*

**TELEVISION SETS  
RADIO RECEIVERS  
F.M.  
(Frequency Modulation)  
ELECTRONICS  
RECORD CHANGERS  
AUTO RADIOS  
PUBLIC ADDRESS Systems**  
*(Right — Instructor helping students check the wiring and trace circuits of television receivers.)*

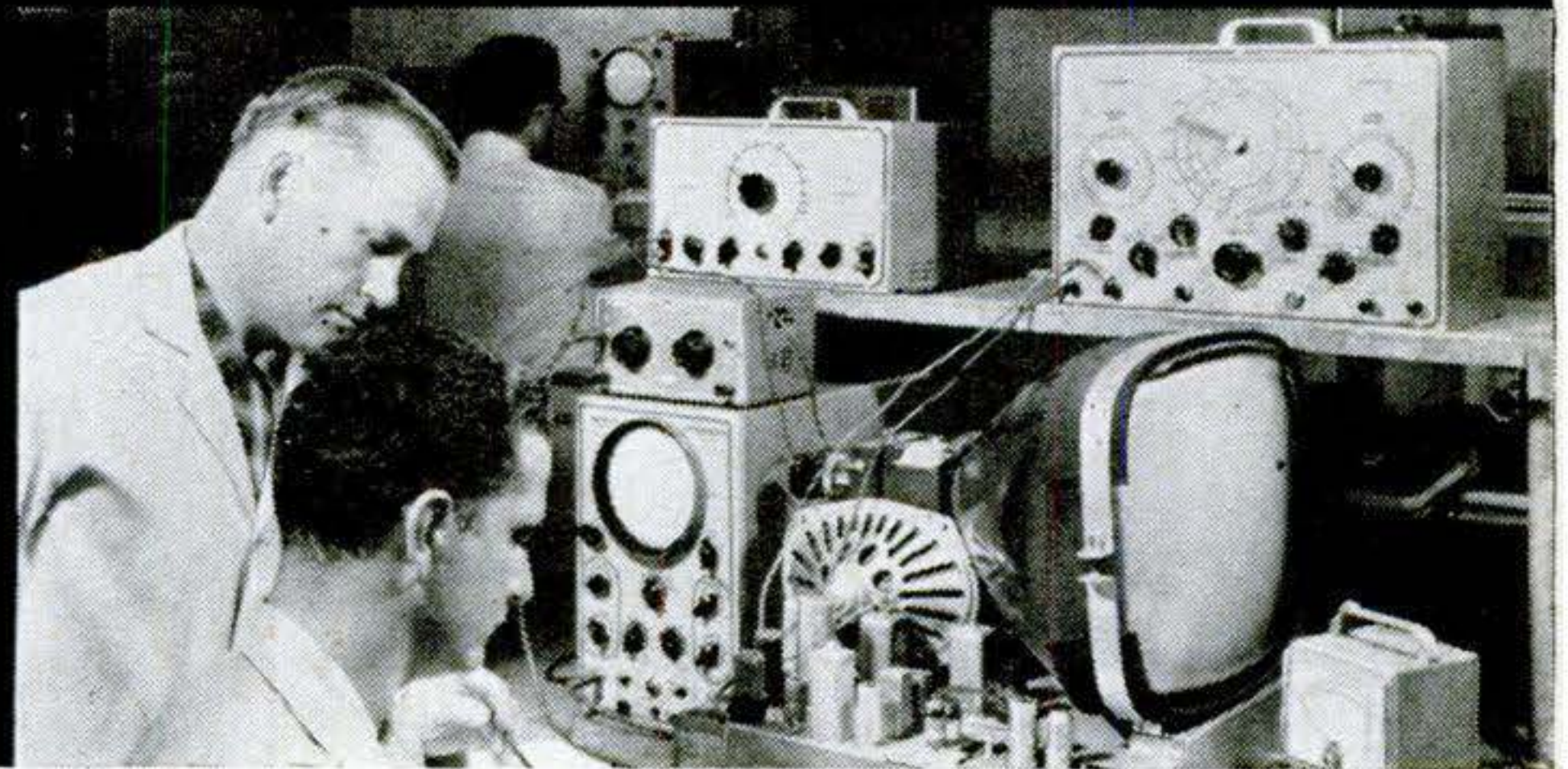

## Train in the great SHOPS of COYNE

**Largest, Oldest, Best Equipped School Of Its Kind In The U. S.**

Whether 17 or up to 45 years of age, prepare for your future now. Don't be satisfied with a "No Future" job. Train the Coyne way for a better job in a field that offers a world of opportunities in the years ahead.

**FINANCE PLAN** Enroll now, pay most of tuition later. Part-time employment service while training, if needed.

**WE TRAIN YOU IN CHICAGO.** At Coyne you learn on real, full-size equipment. Trained instructors show you how, then you do practical jobs yourself. No previous experience or advanced education needed.

**CLIP COUPON NOW** for big new illustrated Coyne book "Guide to Careers in ELECTRICITY and TELEVISION-RADIO". No obligation; no salesman will call. Get vital facts now!

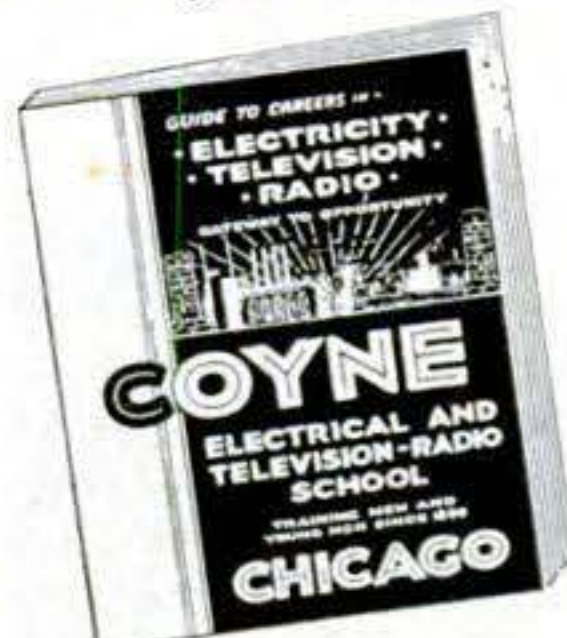

*Mail Coupon for  
Big Free Book*

**APPROVED  
FOR  
VETERANS**

**B. W. COOKE, President  
COYNE ELECTRICAL SCHOOL**

**500 S. Paulina St., Chicago 12, Ill. Dept. 85-73H**

Send **BIG FREE** book and details of your training offer. This does not obligate me and no salesman will call. I am interested in:

ELECTRICITY     TELEVISION-RADIO

NAME.....

ADDRESS.....

CITY.....STATE.....

**B. W. COOKE, Pres. COYNE FOUNDED 1899  
ELECTRICAL SCHOOL**

**A TECHNICAL TRADE INSTITUTE OPERATED NOT FOR PROFIT  
500 S. PAULINA STREET, CHICAGO, Dept. 85-73H  
ELECTRICITY ★ RADIO ★ TELEVISION ★ REFRIGERATION ★ ELECTRONICS**

NOVEMBER 1955 19



**"Do-it-yourself"**

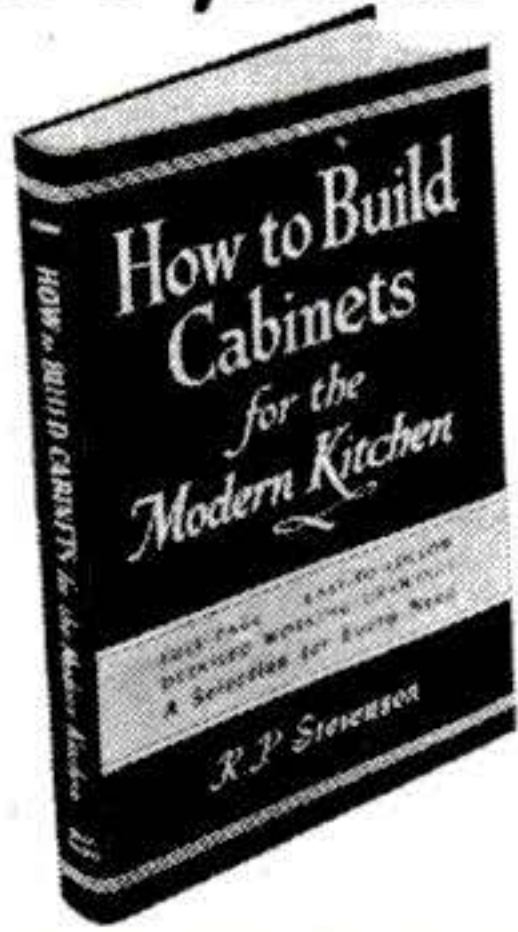

# KITCHEN CABINETS

New book gives step-by-step directions, material lists, building pointers, "show-how" illustrations, for making every type of cabinet for the modern kitchen.

**SAVE \$500 OR MORE**

Now you can SAVE HUNDREDS OF DOLLARS on kitchen cabinets! Build your own with the aid of this great new "do-it-yourself" guide. Tells you everything you need to know. Large, clear drawings show every detail of construction. Easy-to-follow text gives you valuable pointers on how to save work, save on materials, and get a professionally-perfect job.

INCLUDES 70 TYPES OF CABINETS, plus dozens of ideas for ingenious labor-saving, step-saving kitchen units.

**"HOW TO BUILD CABINETS FOR THE MODERN KITCHEN"**

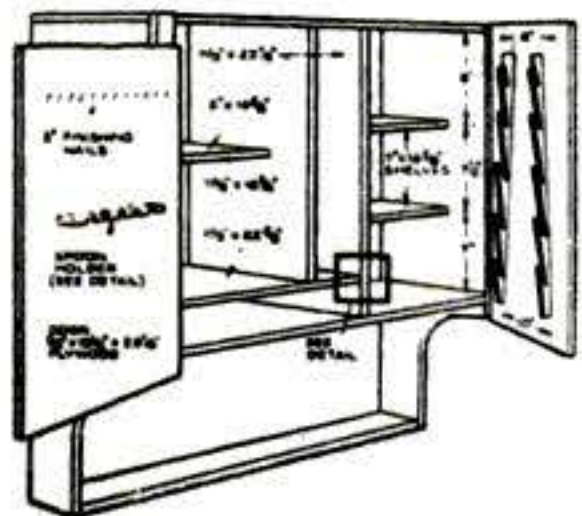

By **ROBT. P. STEVENSON**  
Asst. Managing Editor,  
Popular Science

**TELLS YOU HOW TO BUILD:** Over-Refrigerator Cabinet, Over-the-Range Cabinet, Sliding-Door Cabinet, Adjustable Shelf Cabinet, Mix-Center Wall Cabinet, Over-the-Sink Cabinet, Wall Vegetable Bin, Tool Hanging Cabinet,

Swing-Shelf Cabinet, Combination Sink Cabinet, Tray and Bread Cabinet, Platter Cabinet, Laundry Hamper, Screen-Bottom Vegetable Drawers, Pop-Up Mixer Shelf, Beside-the-Range Towel Rack, Rolling Vegetable Bin, Sink Pull-Out Racks, Revolving Wall Cabinet, Lifting-Counter Cabinet, Pass-Through Serving Center, Canned Goods Storage Cabinet, Storage Wall, Folding Wall Table, Under-the-Counter Table, Curved-Seat Breakfast Nook, Snack Bar, Kitchen Desk, AND MUCH, MUCH MORE! FULLY ILLUSTRATED.

**FREE 10-DAY TRIAL, SEND NO MONEY**

See for yourself how this great new book helps you save money and gives you expert guidance on how to build your own kitchen cabinets. Mail coupon below for free-trial copy. After 10 days' trial, keep it and pay only \$4.95, plus few cents postage. Or return book and owe not a penny. **MAIL COUPON NOW.**

**SIMMONS-BOARDMAN BOOKS, Dept. PS-1155**  
30 Church Street, New York 7, N. Y.

Send me for 10 DAYS' FREE EXAMINATION, "How to Build Cabinets for the Modern Kitchen." I will either return it in 10 days and owe nothing, or send only \$4.95 (plus shipping charge) in full payment.

Name.....

Address.....

City & State.....

**SAVE! Send \$4.95 with this coupon and we will pay postage. Same return and refund privileges.**

## Get this Book and Build

**METAL LOCATORS  
TIMERS  
RECEIVERS  
GEIGER  
COUNTERS**

using

**RAYTHEON  
CK722**

**TRANSISTORS**



**only  
50¢**

All you need to know

is in this new

**RAYTHEON TRANSISTOR APPLICATIONS BOOK**

More than 50 useful, easy-to-make types of transistorized equipment. 116 pages — contains complete wiring diagrams, illustrations, parts lists and procedure information.

Limited supply! — Available through your Raytheon Tube Supplier or send 50¢ to Department S-10.

**RAYTHEON MANUFACTURING COMPANY**

Receiving and Cathode Ray Tube Operations

**55 CHAPEL ST., NEWTON 58, MASSACHUSETTS**

Be a better-educated man

## BE A BETTER MAN

It's a fact. The more education you have the better job you get, the better pay you earn, the better you live. Start now to —



I. C. Lane, B.S., M.A.  
President, National Home Study School

### FINISH YOUR HIGH SCHOOL EDUCATION AT HOME

Complete 4-year course in 2 years or less

No interference with your job or social life. Study in spare time with textbooks and modern study aids I send you.

Special Business, Mathematics, Agriculture, Industrial courses also offered.

Full credit for any high school work completed elsewhere. Start where you left off.

You get standard textbooks, Study Guides, and these *Modern Study Aids* — projector and filmstrips, phonograph and records, complete science laboratory kits.

**NATIONAL HOME STUDY SCHOOL**

50 East 19th Street, New York 3, N. Y.

Chartered by Board of Regents, University of State of N. Y.

Licensed by the State of New York

Send today for my new FREE catalog and sample Home Study Lesson.

**MAIL THIS COUPON TODAY!**

Mr. Leonard C. Lane, President  
NATIONAL HOME STUDY SCHOOL  
Dept. NL-11, 50 East 19th Street, New York 3, N. Y.

Dear Mr. Lane: Please send your new FREE CATALOG with information on High School and special Job-Training courses and FREE SAMPLE LESSON. I understand I am not obligated and no salesman will call.

Print Name \_\_\_\_\_ Age \_\_\_\_\_

Address \_\_\_\_\_

City \_\_\_\_\_ Zone \_\_\_\_\_ State \_\_\_\_\_

**NO SALESMAN WILL CALL!**



# Let this Imported Italian Accordion make **YOU** the center of your Circle

**NOW!** 5 DAYS **FREE TRIAL**  
LOW WHOLESALE PRICE



**Lifetime Guarantee**

Miss Mickey Milin, America's Accordion Queen, playing her new and beautiful S. SOPRANI Moderne



All this is **FREE\***  
**WITH YOUR ACCORDION**

- Home study course of instruction.
  - Your name in chrome letters on instrument.
  - Year's supply of music.
  - A de luxe music stand.
  - Music Portfolio.
  - Life Time Guarantee.
- \* For Limited time only

**EASY TERMS**

**SAVE BUY DIRECT AT WHOLESALE**

Send today for full information and our amazing offer—see, play and hear this superb instrument in your own home—let your friends and family confirm this imported professional model as the accordion of your dreams! Immediate delivery assured from the world's largest selection of leading Italian makes.

## PLAY AS YOU PAY

Leading professionals acclaim our instruments as unsurpassed. "A wonderful surprise, truly an 'artist's instrument'", "In a class by itself for beauty and tone", are typical expressions. Easy to own and play with our FREE lessons. TRY BEFORE YOU BUY—No obligation. Trade-ins accepted.

Get full details of ultra-quality features and our almost unbelievable offer of big discounts to students, professionals, teachers and beginners. Boys and girls learn with ease and make quick progress—playing comes naturally. Children deserve this wholesome outlet leading to desirable associates.

## Read These—Culled from Hundreds

"Words cannot express our delight with the accordion: it is indeed a splendid instrument. Again let us express our heartfelt appreciation for having provided the instrument at such a reduced price. Everyone expresses delight with it. All are utterly amazed at its versatility of tone production. It certainly creates a splendid impression for your company"

Aubrey B Martin,  
Wheeling W Va.

"Received our accordion today- we are pleased with such a wonderful instrument. I have talked to my neighbor who taught accordion for 20 years and he praised this accordion highly as a wonderful instrument."

Theodore M. Swiatek  
Denver, Colorado

"I am writing you from my studio and enclosing a check for down payment on my accordion which I am very pleased with indeed! I thank you for your very generous trade-in allowance on my old accordion. Thank you also for your very courteous letters.

Bill Balduzzi,  
Terre Haute, Ind.

"I like the way you do business trigger action and so courteous."

"My accordion arrived yesterday and am thrilled and happy over the beautiful instrument and pleased with the tone it gives. It is all that you said it was and more."

Mrs. Fred Richter,  
Clear Lake, Wis.



YOU'LL BE PROUD TO OWN THIS S. SOPRANI ACCORDION, PRIDE OF ITALY AND OH HOW YOUR FRIENDS WILL ADMIRE AND COMPLIMENT YOU.

**Mail Today**

ACCORDION MANUFACTURERS & WHOLESALE OUTLET  
2003 W. Chicago Ave., Dept. P-115, Chicago 22, Illinois

Please send me your fully illustrated catalog, amazing low wholesale prices, easy terms on the World's largest selection of super-quality imported Italian accordions

Name \_\_\_\_\_

Address \_\_\_\_\_

City \_\_\_\_\_ Zone \_\_\_\_\_ State \_\_\_\_\_

**ACCORDION MANUFACTURERS & WHOLESALE OUTLET**  
2003 W. Chicago Ave. Dept. P-115 Chicago 22, Ill.



# Build it Yourself!

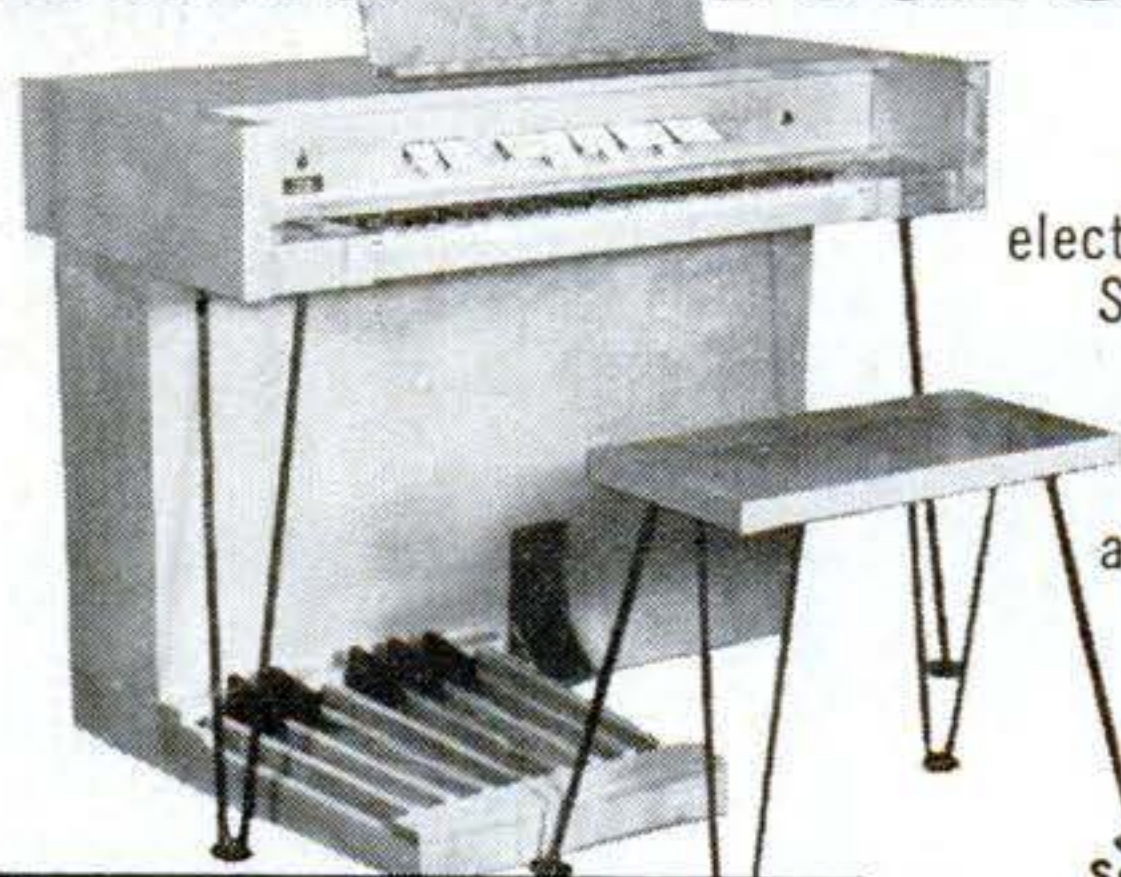

Spinet, two-manual and three-manual electronic organs. Save hundreds of dollars with our easy-to-assemble kits. Designed to sound and look like a pipe organ.

Send \$1.00 for "Organ Builders Manual." Full plans for home, church and concert models. Includes parts catalog.



**ELECTRONIC ORGAN ARTS** Dept. 11  
4878 Eagle Rock Blvd. • Los Angeles 41, Calif.

**LOOK!**



**A MILLION THRILLS!**

High Power **BINOCULARS**

33 Models: \$9.95 to \$125

Free! Catalog & Book  
"How to Select Binoculars"

**BUSHNELL Binoculars**

Dept. P11 43 E. Green  
Pasadena, Calif.

## C O U P O N

**UNIVERSITY LOUDSPEAKERS, INC.** Desk R-1  
80 South Kensico Avenue, White Plains, N.Y.

Gentlemen:

Please send me information about P·S·E (University's Progressive Speaker Expansion plan for High Fidelity speaker systems).

I don't believe that P·S·E can do all you claim for it. According to you P·S·E will solve almost *all* my loudspeaker problems *forever*. That's a bold statement! I hope you can back it up.

You say that *now* I can buy a speaker and *never* worry about it becoming *obsolete*, or *improve* my present system *without discarding* what I have... that University speaker components, enclosures and networks have been so uniquely designed that it's possible to start an excellent basic system, *at low cost*, and add to it later—while enjoying immediate listening satisfaction. This is sensational!

Please send further information; mind you at *no cost* to me; *absolutely free*.

NAME \_\_\_\_\_  
ADDRESS \_\_\_\_\_  
CITY \_\_\_\_\_ STATE \_\_\_\_\_

# AUDELS HOME APPLIANCE SERVICE GUIDE

This HANDY, Practical "How to Do It" book for Electric & Gas Home Appliance Servicemen, Mechanics & Dealers covers Basic Principles, Servicing, Operation & Repairs of Home Appliances. Tells How to Locate Troubles, How to take Appliances Apart, How to Make Repairs, How to Assemble and Connect. Gives up to date testing methods, wiring diagrams and complete data on each appliance.



### IT PAYS TO KNOW HOW TO FIX

Toasters—Pressing Irons—Waffle Bakers—Casseroles—Roasters—Broilers—Coffee Makers—Space Heaters—Water Heaters—Ranges—Home Wiring—Shop Work—Appliance Testing—Fundamental Electricity—Fractional H.P. Motors—Food Mixers—Fans & Blowers—Vacuum Cleaners—Washing Machines—Clothes Dryers

—Ironers—Dishwashers—Garbage Disposers—Refrigeration—Window Air Conditioners—Oil Burners—Drainage Pumps—Gas Ranges, Furnaces & Water Heaters—Bottled Gas Appliances.

A SHOP COMPANION THAT ANSWERS YOUR QUESTIONS.

Easy to read and understand—over 800 pages fully illustrated—with 500 photos and diagrams—1001 Facts. A ready reference.

**\$4 COMPLETE • PAY \$1 A MONTH**  
TO GET THIS SERVICE INFORMATION FOR YOURSELF—FILL IN AND MAIL 7 DAY TRIAL COUPON TODAY.



Step up your own skill with the facts and figures of your trade. Audels Mechanics Guides contain Practical Inside Trade Information in a handy form, Fully illustrated and Easy to Understand. Highly Endorsed. Check the book you want for 7 DAYS FREE EXAMINATION. Send No Money, Nothing to pay Postman.

## MAIL ORDER



**Check NOW!**

You Can Look Over Any Guide In Your Own Home — Start the Easy Payments If Satisfied

**MAIL THIS TODAY**

AUDEL, Publishers, 49 W. 23 St., NEW YORK 10, N. Y.

Please send me postpaid for FREE EXAMINATION books marked (x) below. If I decide to keep them I agree to mail \$1 in 7 Days on each book or set ordered and further mail \$1 monthly on each book or set until I have paid price, otherwise I will return them.

- HOME APPLIANCE SERVICE GUIDE, 800 Pages \$4
- AUTOMOBILE MECHANICS GUIDE, 1664 Pages. 4
- TRUCK & TRACTOR GUIDE, 1299 Pages . . . 4
- DIESEL ENGINE MANUAL, 575 Pages . . . . 2
- MACHINISTS HANDY BOOK, 1650 Pages. . . 4
- WELDERS GUIDE, 400 Pages . . . . . 1
- BLUE PRINT READING, 416 Pages . . . . . 2
- MATHEMATICS & CALCULATIONS, 700 Pages. 2
- SHEET METAL PATTERN LAYOUTS, 1100 Pages 4
- SHEET METAL WORKERS HANDY BOOK, 388 Pgs. 1
- MECHANICAL DRAWING GUIDE, 160 Pages . . 1
- MECHANICAL DRAWING & DESIGN, 480 Pages 2
- AIRCRAFT WORKER, 240 Pages . . . . . 1
- TELEVISION SERVICE MANUAL, 434 Pages . . 2
- RADIOMANS GUIDE, 1040 Pages . . . . . 4
- ELECTRONIC DEVICES, 216 Pages . . . . . 2
- ELECTRIC MOTOR GUIDE, 1000 Pages . . . . 4
- WIRING DIAGRAMS (Light & Power), 272 Pgs. 1
- ELECTRICIANS EXAMINATIONS, 250 Pages . . 1
- ELECTRIC POWER CALCULATIONS, 425 Pages. 2
- HANDY BOOK OF ELECTRICITY, 1440 Pages . . 4
- ELECTRIC DICTIONARY, 9000 Terms . . . . . 2
- ELECTRIC LIBRARY, 7000 Pages (12 Book Set) 18
- SHIPFITTERS HANDY BOOK, 250 Pages . . . . 1
- REFRIGERATION & Air Conditioning, 1280 Pgs. 4
- MILLWRIGHTS & MECHANICS GUIDE, 1200 Pgs. 4
- POWER PLANT ENGINEERS GUIDE, 1500 Pages 4
- ENGINEERS & FIREMANS EXAMS, 525 Pages . 1
- PUMPS, Hydraulics & Air Compressors, 1658 Pgs. 4
- OPERATING ENGINEERS LIBRARY (3 Books) . 9
- MECHANICAL DICTIONARY, 950 Pages . . . . 4
- GARDENERS & GROWERS GUIDES (4 Book Set) 6
- CARPENTERS & BUILDERS GUIDES (4 Book Set) 6
- PLUMBERS & Steamfitters Guides (4 Book Set) 6
- MASONS AND BUILDERS GUIDES (4 Book Set) 6
- PAINTERS & DECORATORS MANUAL, 450 Pgs. 2
- HOUSE HEATING GUIDE, 1000 Pages . . . . 4
- OIL BURNER GUIDE, 384 Pages . . . . . 1

Name \_\_\_\_\_  
Address \_\_\_\_\_  
Occupation \_\_\_\_\_  
Employed by \_\_\_\_\_ \$11



Work over  
**300** projects  
with your  
wonderful HOME  
LABORATORY

Use and keep ALL these units to get  
all-important PRACTICAL EXPERIENCE

MEMBER OF NATIONAL  
HOME STUDY COUNCIL

**21** INCH

Build and keep D.T.I.'s NEW  
2 Unit TV Set—ideal for cus-  
tom installation. (D.T.I. also  
offers home training with-  
out the TV set.)

NOW... at home... get D.T.I.'s  
amazingly effective **NEW** training in

# TELEVISION

**RADIO-ELECTRONICS!** Nothing else like it for providing real LABORATORY-TYPE training at home. Get the kind of thorough, practical experience YOU NEED for the kind of progress YOU WANT in today's tremendous field of Television, Radio and Electronics. Qualify yourself for real money... interesting work... a wonderfully promising future. And when you finish, D.T.I.'s active Employment Service HELPS YOU GET STARTED! Or open your own profitable Television-Radio Service Business.

**NEW!**

Build and keep  
D. T. I.'s new  
VACUUM TUBE  
VOLTMETER...  
one of the most  
useful of all test  
instruments.

**5** INCH  
"SCOPE"

Exclusive  
**HOME  
MOVIES**

help you grasp  
important points  
**FASTER...  
EASIER...  
BETTER.**  
A tremendous  
advantage!

**THOUSANDS OF SUCCESSFUL GRADUATES**

WHY has D.T.I. become one of the largest training organizations of its kind? Because it provides EVERY MAJOR HOME TRAINING AID to help make the subject EASIER to learn... EASIER to remember—the kind of training so helpful for REAL PROGRESS. Students get thorough, up-to-date, practical training that TAKES ADVANTAGE of new and improved training developments: Study the ADVANTAGES shown on this page. Think what they can mean to YOU... to YOUR FUTURE! Or come to D.T.I.'s big Training Laboratories in Chicago. MAIL COUPON TODAY for complete facts—including valuable publication, "89 Ways to Earn Money in Television-Radio-Electronics." Also, valuable information for men subject to MILITARY SERVICE.

"One of America's Foremost Television Training Centers"

**DeVRY**  
**Technical Institute**  
CHICAGO 41, ILLINOIS  
Formerly DeFOREST'S TRAINING, INC.

Remarkable **NEW Styrene  
ELECTRO-LAB\***

Insert pictorial diagram on transparent styrene base. (See insert.) Mount parts to follow pattern—using handy "snap in" fasteners. Eliminates wiring errors. Tops for speedy circuit changes... for providing maximum circuit experience in minimum time. Build and operate scores of interesting projects — such as the electronic circuit shown below.

\*Trademark

PATENTS APPLIED FOR

**MAIL COUPON TODAY**

DeVRY TECHNICAL INSTITUTE  
4141 Belmont Ave., Chicago 41, Ill.  
Dept. PS-11-L

I would like complete facts including "89 Ways to Earn Money in Television-Radio-Electronics."

Name \_\_\_\_\_ Age \_\_\_\_\_

(PLEASE PRINT)

Street \_\_\_\_\_ Apt. \_\_\_\_\_

City \_\_\_\_\_ Zone \_\_\_\_\_ State \_\_\_\_\_

1

D.T.I.'s training is available in Canada.

**89 WAYS  
TO  
EARN  
MONEY  
IN  
TELEVISION  
RADIO  
ELECTRONICS**



# HOW TO FIX ANY CAR

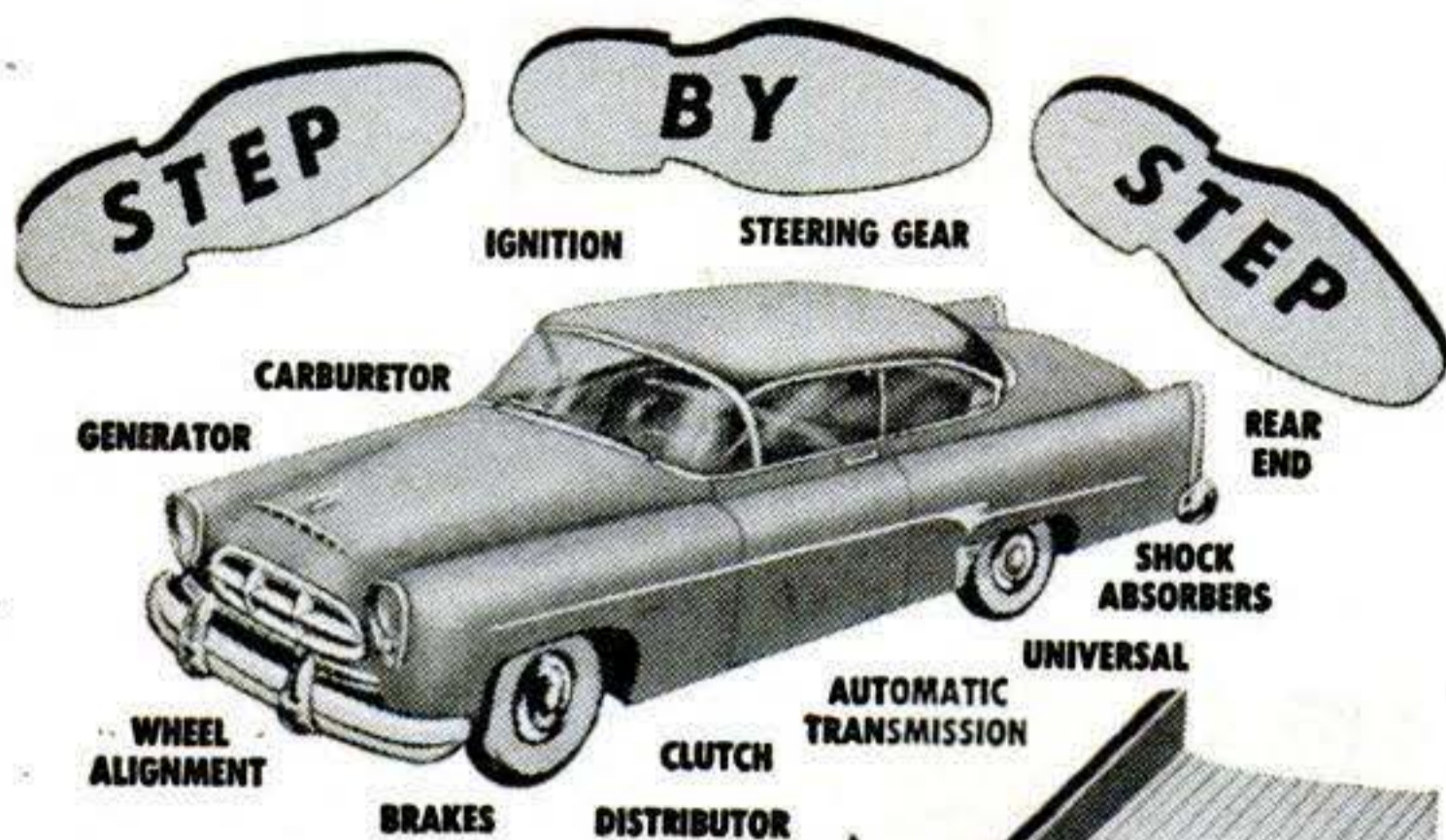

**FREE 7-DAY TRIAL**



ANY tune-up, service or repair job on ANY car can be as easy as A-B-C . . . when factory experts show you how-to-do-it one step at a time. That's why no job's too tough to handle when you've got MOTOR'S brand-new AUTO REPAIR MANUAL at your elbow!

Book "starts from scratch" — tells you WHERE to start, what TOOLS to use—How to remove, repair and replace parts. Whether you're a beginner or an expert mechanic—you can "breeze through" ANY repair on ANY make or model car built from 1940 through 1955!

**Everything You Need to Know in 1000 Big ILLUSTRATED Pages!**  
NEW, REVISED, 1000-Page Edition contains the "meat" from over 160 OFFICIAL shop manuals—simplified for YOU. 23,436 essential repair specifications on over 737 chassis models. More than 2,900 "this-is-how" pictures. 225,000 service and repair facts. Leads beginners every step of the way. Time-saving factory repair procedures for experts. Instructions and pictures so clear you CAN'T go wrong. Used by U. S. Army and Navy. 2,000,000 COPIES SOLD!

Covers 737 Models  
All These Makes  
—1940 thru 1955

- |           |            |
|-----------|------------|
| Buick     | Kaiser     |
| Cadillac  | Lincoln    |
| Chevrolet | Mercury    |
| Chrysler  | Nash       |
| Crosley   | Oldsmobile |
| De Soto   | Packard    |
| Dodge     | Plymouth   |
| Ford      | Pontiac    |
| Frazer    | Studebaker |
| Henry J   | Willys     |
| Hudson    |            |

Try Book FREE 7 Days

SEND NO MONEY! Pay postman nothing. Make Manual PROVE to you what it's got. Unless you agree this is the greatest time and work saver you've ever seen—return book in 7 days and pay nothing. Mail coupon today to: MOTOR Book Dept., Desk 211, 250 W. 55 St., N.Y. 19

Same FREE Offer On MOTOR'S New Truck Repair Manual

Brand new! Covers EVERY job on EVERY popular make gasoline and Diesel truck, made from 1946 thru 1955. FREE 7-Day Trial. Check proper box in coupon.



**MAIL COUPON NOW FOR 7-DAY FREE TRIAL**

**MOTOR BOOK DEPT.**

Desk 211, 250 W. 55th St., New York 19, N. Y.

Rush to me at once (check box opposite book you want):

**MOTOR'S New AUTO REPAIR MANUAL.** If O.K. I will remit \$2 in 7 days, \$2 monthly for 2 months and a final payment of 95c (plus 35c delivery charges) one month after that. Otherwise I will return the book postpaid in 7 days. (Foreign price, remit \$9 cash with order.)

**MOTOR'S New TRUCK REPAIR MANUAL.** If O.K., I will remit \$2 in 7 days and \$2 monthly for 3 months, plus 35c delivery charges with final payment. Otherwise I will return book postpaid in 7 days. (Foreign price, remit \$10 cash with order.)

Print Name..... Age.....

Address .....

City..... State.....

Check box and save 35c delivery charge by enclosing WITH coupon entire payment of \$6.95 for Auto Repair Manual (or \$8 for Truck Repair Manual.) Same return-refund privilege.

**SAVE 75%  
ON**



**WORK CLOTHES!**

SURPLUS STOCK FROM MIDWEST SUPPLY FIRM!  
Terrific values you've got to see to believe!

**SHIRTS 79c**

Made to sell for 2.99! Now Only 4 for \$2.99

What a buy! 4 for the price of one! These shirts, though used, are washed, sterilized and ready for long, tough wear. In blue, tan or green. Send name, address, neck size.

**PANTS to match Unbelievable 99c**

Bargains! Sold for 3.95. Now only . . . .  
Send waist measure and inside leg length. 4 for \$3.75

**COVERALLS . . . wear 'em used and save \$1.95**

plenty! Originally 5.95. Now only . . . .  
Send chest measurement. 3 for \$5.75

**SHOP COATS . . . fully reconditioned. \$1.79**

Take advantage of this rock-bottom price. Send chest measurement. Now only 3 for \$5.00

**SATISFACTION GUARANTEED!** Your money back if you can beat these bargains anywhere! You can't lose so order TODAY for immediate delivery! Pay postman or send money with your order and save postage. \$1.00 deposit on C.O.D. orders.

**GALCO SALES CO. Dept. 2411**  
7120 Harvard Ave. • Cleveland 5, Ohio

## BECOME AN EXPERT IN TRAFFIC

Traffic men earn \$4,000 to \$10,000 and up. Thousands of firms need experts on rates, tariffs, regulations. We train you thoroly in spare time at home for executive traffic jobs. Personal training under traffic authorities. Placement counsel and help. Write for free 48-page book "Traffic Management—the Fast Growing Profession."

**LASALLE Extension University, 417 So. Dearborn St.**  
A Correspondence Institution Dept. 1183T Chicago 5, Ill.

PROFIT from the  
WISDOM of the  
**YOGIS**  
**POWER**



is the secret of success

Banish anxiety, worry, fear and frustration! Take vitality from the air . . . cleanse mind and body of defeatist poison . . . improve voice, posture, self-confidence. Strengthen your spine and nervous system, control your emotions. With these and many more secrets mold your life into a successful pattern with new, DYNAMIC physical and psychological powers!

**STUDENTS SAY:** "I'm self-confident now . . . not self-conscious at all," "no longer neurotic," "calmer, happier, more energetic," "no more tension," "no more headaches or nerves," "wish I'd found this Course years ago."

YOU can start on the road to sure success at our expense. Send coupon for the first lesson, a 26-page booklet covering Deep Relaxation and Dynamic Breathing. It's yours to keep and use!

**Start Your  
All-Around  
Improvement  
TODAY!**

Send the Coupon **YOGA**

**INSIGHT SCHOOL of YOGA 806 Dempster St. Evanston, Ill., Dept. PS-7**

Please send me YOGA Lesson I. (No obligation.)  
I enclose 25c for handling and mailing.

NAME .....

ADDRESS .....

CITY STATE



**GET INTO**

# RADIO-TELEVISION

## ELECTRONICS by Shop-Method Home Training

### GOOD JOBS AWAIT THE TRAINED RADIO-TV TECHNICIAN

There is a place for *you* in the great Radio-Television-Electronics industry when you are trained as National Schools will train you at home!

Trained technicians are in growing demand at good pay—in manufacturing, broadcasting, television, communications, radar, research laboratories, home Radio-TV service, and other branches of the field. National Schools Master Shop-Method Home Training, with newly added lessons and equipment, trains you in your spare time, right in your own home, for these fascinating opportunities. **OUR METHOD IS PROVED BY THE SUCCESS OF NATIONAL SCHOOLS TRAINED MEN, ALL OVER THE WORLD, SINCE 1905.**

### EARN WHILE YOU LEARN

Many National students pay for all or part of their training with spare time earnings. We'll show you how you can do the same! Early in your training, you receive "Spare-time Work" Lessons which will enable you to earn extra money servicing neighbors' and friends' Radio and Television receivers, appliances, etc.



Signal Generator



Audio Oscillator

T. R. F. Receiver

### National Schools Training is All-Embracing

National Schools prepares you for your choice of many job opportunities. Thousands of home, portable, and auto radios are being sold daily—more than ever before. Television is sweeping the country, too. Co-axial cables are now bringing Television to more cities, towns, and farms every day! National Schools' *complete* training program qualifies you in all fields. Read this partial list of opportunities for trained technicians:

- Business of Your Own • Broadcasting
- Radio Manufacturing, Sales, Service • Telecasting
- Television Manufacturing, Sales, Service
- Laboratories: Installation, Maintenance of Electronic Equipment
- Electrolysis, Call Systems
- Garages: Auto Radio Sales, Service
- Sound Systems and Telephone Companies, Engineering Firms
- Theatre Sound Systems, Police Radio
- And scores of other good jobs in many related fields.

### TELEVISION TRAINING

You get a complete series of up-to-the-minute lessons covering all phases of repairing, servicing and construction. The same lesson texts used by resident students in our modern and complete Television broadcast studios, laboratories and classrooms!



## MASTER ALL PHASES!

Get Master Shop-Method Home Training from an Established Practical Resident School with its own Training Shops, Laboratories, Studios — almost 50 Years of Successful Experience in Training Ambitious Men.

**We Bring National Schools To You!**



↑ You also receive this Multitester

Superheterodyne Receiver

### LEARN BY DOING

You receive and keep all the modern equipment shown above, including tubes and valuable, professional quality Multitester. *No extra charges.*

### FREE! RADIO-TV BOOK AND SAMPLE LESSON!

Send today for National Schools' new, illustrated Book of Opportunity in Radio-Television-Electronics, and an actual Sample Lesson. No cost—no obligation. Use the coupon now—we'll answer by return airmail.

**APPROVED FOR VETERANS AND NON-VETERANS**  
Check coupon below

**Both Resident and Home Study Courses Offered!**



## NATIONAL SCHOOLS

LOS ANGELES 37, CALIFORNIA • ESTABLISHED 1905  
IN CANADA: 811W. HASTINGS STREET, VANCOUVER, B.C.

### GET FACTS FASTEST! MAIL TO OFFICE NEAREST YOU!

(mail in envelope or paste on postal card)

**NATIONAL SCHOOLS, Dept. RC-115**

**4000 S. Figueroa Street Los Angeles 37, Calif. or 323 West Polk Street Chicago 7, Ill.**

Send **FREE** Radio-TV Electronics book and **FREE** sample lesson. No obligation, no salesman will call.

NAME \_\_\_\_\_ BIRTHDAY \_\_\_\_\_ 19\_\_

ADDRESS \_\_\_\_\_

CITY \_\_\_\_\_ ZONE \_\_\_\_\_ STATE \_\_\_\_\_



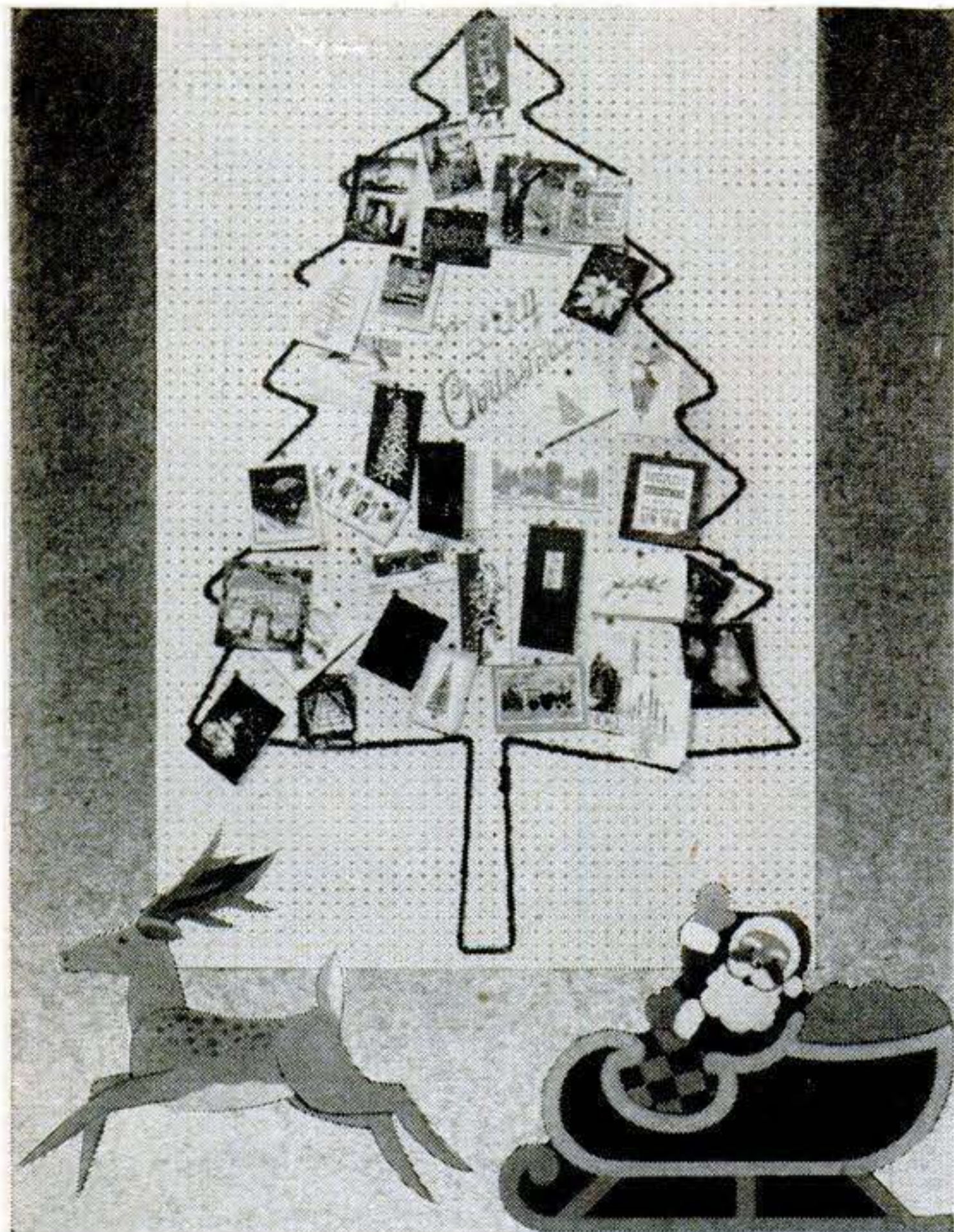

**Christmas decorations—easy with MASONITE PRESWOOD**  
**FREE patterns show how!**

It's fun to make your own Yuletide decorations. And it's easy with strong, rigid Masonite Tempered Presdwood.

These low-cost panels withstand snow and rain. They won't split, splinter or crack. They cut easily with hand or power saw and they take paint beautifully.

Send for your free pattern plan . . . shows how to make the Santa and reindeer, and the Christmas card displayer shown above. Has many other Christmas time ideas, too. You can get Presdwood® at your local lumber dealer's.

Look for this man  He makes the difference

**MASONITE® CORPORATION**  
 MANUFACTURER OF PRESWOOD PANEL PRODUCTS

Dept. PS-11, Box 777, Chicago 90, Ill.  
 Please send me your free pattern plans for Christmas decorations.  
 Name.....  
 Address.....  
 Town.....Zone.....  
 County.....State.....  
 In Canada: Masonite Corporation, Gatineau, Quebec

**CHEMISTRY**



**BIG LABORATORY GIVEN FREE!**

Are you looking for a **WONDERFUL FUTURE** that can start at home right now? The **NATIONAL SCHOOL OF CHEMISTRY** offers a fascinating correspondence course in **PRACTICAL CHEMISTRY** which will give you a wonderful education that can be used almost immediately to increase your income and your position in life, with prospects of a **GLORIOUS FUTURE!** The course is very **THOROUGH**, yet specially prepared to be easy to all regardless of lack of previous training. Very little theory. . . . this is a **PRACTICAL** course with **HUNDREDS** of fascinating **EXPERIMENTS** and valuable **FORMULAS!** Students learn, almost from the start, how to make chemicals and chemical products of commercial value, how to convert wastes into money, etc. **THERE IS A GOLD MINE IN CHEMISTRY!** Why not share in it? We will open your eyes to **GOLDEN OPPORTUNITIES** you've never dreamt of; for this is a **GOLDEN AGE** for those who possess special **KNOWLEDGE!**

An extensive laboratory of chemicals and equipment is included with the course at no extra cost! Just send 25c for your first lesson and **CHEMICAL KIT**; full details will be included. If you send \$1.00 we will send first 5

**FREE!**

lessons and supplies, including "How To Make 100 New Chemicals." Absolutely no obligations! **START YOUR NEW CAREER TODAY!**

**URANIUM TESTER** (ideal for field trips) and **CHEMICAL PUZZLE** (worth \$2.50) both **FREE** with dollar outfit!

**NATIONAL SCHOOL OF CHEMISTRY**  
 POST OFFICE BOX 606-B REDWOOD CITY, CALIFORNIA

**A "GOOD HAND" HELPS YOU SUCCEED!**

**LEARN TO WRITE WELL**

Handwriting quickly improves with our easy-to-understand picture lessons! Put your spare time to good use; send today for **FREE BOOKLET**. "How to Become a Good Penman," or check volumes wanted below at \$1 each:  Business Writing  Artistic Writing  Card Writing  Bird & Design Flourishing  Engrossing Alphabets. **COMPLETE SET \$4.50.** Ask for price list of penman's supplies.

**TAMBLYN SCHOOL of PENMANSHIP**  
 S. A. Ziller, Pres. 438 Ridge Bldg., Kansas City, Mo., USA

**Bar Bells**

**BUY DIRECT FROM FACTORY \$8.95 up**

Write for free booklet and price list

**INDEPENDENT IRON WORKS**  
 2416 East 23rd Street, Dept. "C"  
 Los Angeles 58, Calif.

**more jobs than graduates**

**ENGINEERS**

enging opportunity! If you are interested in these 11 pay you to write Box D 1 including a complete history of science and education.

Demand for our engineering graduates exceeds supply. *Effective placement service!* Study in this world-famed college . . . established 1884. New term starts quarterly. *Approved for veterans.*

**Bach. Sc. degree in 27 months**

Bachelor of Science in Mechanical, Civil, Electrical, Chemical, Aeronautical, Radio (T.V., Electronics), Administrative Engineering; Business Administration and Accounting. Also 36-weeks certificate course in Drafting. *Intensive program: technical fundamentals accented: comprehensive courses.*

*Small classes: personalized instruction. For earnest, mature students whose time and budget require accelerated courses and modest costs. Preparatory courses. Beautiful campus in friendly college town. Well-equipped, new and modernized buildings and labs. Enter Jan., March, June, Sept. Write Jean McCarthy, Director of Admissions, for Catalog, View Book and "Your Career in Engineering or Commerce."*

**TRI-STATE COLLEGE**

5115 College Avenue Angola, Indiana





Cannot channel



Easy to clean



Filters out all dirt



Traps moisture



Never needs replacing



Reduces friction



Rigid double-cone construction



Waterproof



Saves engine repairs



Unconditionally guaranteed



Easy to install



Saves oil



All-metal construction



Built-in acid neutralizer

# Save Oil and Money with the New *Micro* BRONZE

## PERMANENT ALL-METAL FILTER

1. Eliminates Engine Acids
2. Traps Damaging Moisture
3. Filters all the Dirt
4. Reduces Friction
5. Saves the Detergents

U. S. Patent App. No. 464498

**WHY GIVE YOUR ENGINE HALF-WAY PROTECTION?** The Micro Bronze permanent all-metal filter with the built-in acid neutralizer is the world's first filter that guards against all five engine enemies: Acids, abrasives, friction, moisture and sludge.

Made of solid but porous everlasting sintered bronze, the Micro Bronze Filter screens out all particles of dirt and abrasives larger than .00023 inch in size (so small you could put a thousand of them on the head of a pin!). The Micro Bronze positively cannot channel... operates efficiently at all temperatures... never wears out, never needs replacing, merely occasional cleaning.

**SAVES OIL CHANGES... SAVES DETERGENTS.** Your oil is good for at least 10,000 miles with a Micro Bronze Filter. All the valuable additives are saved. You never need buy another replacement pack! Used with modern detergent oils, Micro Bronze will add thousands of miles to engine life, help prevent loss of engine power, save costly oil changes, pack replacements and engine overhauls!

**DOES YOUR PRESENT FILTER PASS THE "ACID" TEST?** If you have a Micro Bronze Filter with the built-in Acid Neutralizer your engine is getting the full protection it needs! In a simple test you can easily make yourself, the Micro Bronze special element completely neutralizes acids in 60 seconds!

**BUILT-IN ACID NEUTRALIZER!**



**THE SINTERED METALS SECRET...** Before World War II, the Germans discovered how to fuse microscopic balls of metal into solid but porous form. Following the war, this secret was made available to American industry and we've developed it for Micro Bronze Filters. This is a magnification of the filter wall.

**NO EXTRA COST FOR FULL FLOW MODELS!**

**FITS EVERY CAR & LIGHT TRUCK.** A Micro Bronze Unit costs only \$6.95, including all full-flow models. Easy to install, never needs changing. Micro Bronze Filter Housing \$9.95 for all cars with no filter equipment (does not include element). Use the easy-order coupon now.

*Micro* BRONZE FILTER CORP.  
11766 W. Pico Blvd., Los Angeles 64, Calif.  
Cable Address: MICRONZE

**FILTERS THE DIRT BUT NOT THE DETERGENTS**

Micro Bronze Filter Corp. Dept. PS-115  
11766 W. Pico Blvd., Los Angeles 64, Calif.

Please ship the following at once

- Conversion unit \$6.95 (including all full-flow models)
- Micro Bronze Housing Unit (Needed where car does not now have filter) \$9.95 (does not include element)

Enclosed is \$\_\_\_\_\_ full price. Factory pays all shipping costs to your door.

MAKE, MODEL & YEAR CAR \_\_\_\_\_

NAME \_\_\_\_\_

ADDRESS \_\_\_\_\_

CITY \_\_\_\_\_ ZONE \_\_\_\_\_ STATE \_\_\_\_\_



Increases engine life



Saves detergents



Unaffected by pressure



Screens out abrasives

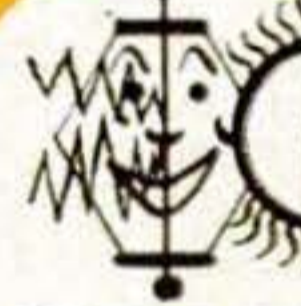

Efficient at all temperatures



Fits all cars



Eliminates acid

### DISTRIBUTORS WANTED

We are receiving orders from all over the world for the amazing Micro Bronze Filter, and are setting up exclusive distributorships to handle our rapidly growing dealer organization. Write, wire or phone.



# Inventors

Take these necessary preliminary steps promptly to protect your invention by applying for a United States patent—

Sketch and describe your invention. Sign, date and have this disclosure witnessed by two people who understand your invention. Have us make a preliminary search among U. S. patents already granted for similar types of invention. We then report to you on the probable patentability of your invention and recommend your further course of action.

Write for our instructive booklet, "Patent Protection for Inventors" and our convenient "Evidence of Invention" disclosure form. No obligation.

**VICTOR J. EVANS & Co.** *Merlin M. Evans*  
REGISTERED PATENT ATTORNEY

140-M MERLIN BUILDING, WASHINGTON 6, D. C.

# INVENTORS

Whether an invention is patentable can be substantially determined by a search of the U. S. Patent records. Without obligation, write for information explaining the steps you should take to secure a patent.

**JOHN N. RANDOLPH**

Registered Patent Attorney

205 Columbian Building Washington 1, D. C.

**PATENTS**  
**C. A. SNOW & CO.**  
REGISTERED PATENT ATTORNEYS  
WRITE FOR INFORMATION TO  
426 SNOW BUILDING, WASHINGTON 1, D. C.

# INVENTORS

I shall be pleased to furnish you, upon request, with information relative to patent procedure—without any obligation on your part.

**PATRICK D. BEAVERS**

Registered Patent Attorney

937 Columbian Building, Washington 1, D. C.

# INVENTORS

Send for  
PATENT INFORMATION  
Book and  
INVENTOR'S RECORD  
without obligation  
**GUSTAVE MILLER**  
115-PS WARNER BUILDING  
WASHINGTON 4, D. C.

REGISTERED PATENT  
ATTORNEY  
ASSOCIATE EXAMINER  
U. S. PAT. OFF. 1922-1929  
Patent Attorney & Advisor  
U. S. NAVY DEPT. 1930-1947  
PATENT LAWYER

# INVENTIONS WANTED

If you want to market, or sell, your invention for cash or royalties, write for our Free Booklet. Send no drawings. We also welcome hearing from firms, or private capital, wishing to review inventions in any field. We will be glad to send notice of our clients' inventions.

GLOBAL MARKETING SERVICE

2420 77th Dept. SD Oakland 5, Calif.

# INVENTORS

PROTECT YOUR INVENTION BY A U. S. PATENT. SEND FOR FREE "INVENTION RECORD" FORM AND "PATENT INFORMATION EVERY INVENTOR SHOULD HAVE".

**CARL MILLER**  
REGISTERED PATENT ATTORNEY

WOOLWORTH BLDG., 35th FLOOR, 115 C  
NEW YORK CITY

When Writing to Advertisers  
Please Mention Popular Science

# Give ME 15 MINUTES A DAY To Prove I Can make YOU a NEW MAN!

That's all I want—just 15 minutes a day to prove I can give you a powerful body of might and muscle—with my quick "Dynamic-Tension" method.

Mail coupon below—and I'll send you, absolutely free, my new

**CHARLES ATLAS, Dept. 1-Y,**  
115 East 23rd Street, New York 10, N. Y.

Send me your Free Book which proves how "Dynamic Tension" can make me a NEW MAN.

Name.....Age.....

Address.....

City.....State.....

book, "Everlasting Health and Strength." Reveals secrets that changed me from a 97-pound weakling to winner of title, "World's Most Perfectly-Developed Man." Shows how I can build you a champion body the same easy way!

I've taken thousands of flabby men and given them powerful muscles, increased measurements, amazing strength, vitality, pep. My natural "Dynamic-Tension" method develops real men!

Send NOW for free copy of my book filled with pictures and body facts. Find out how I can make you the husky, big-muscled NEW MAN you can be! Mail coupon TODAY. **CHARLES ATLAS, Dept. 1-Y, 115 East 23 St., N. Y. 10, N. Y.**

**CHARLES ATLAS, holder of title "World's Most Perfectly-Developed Man."**

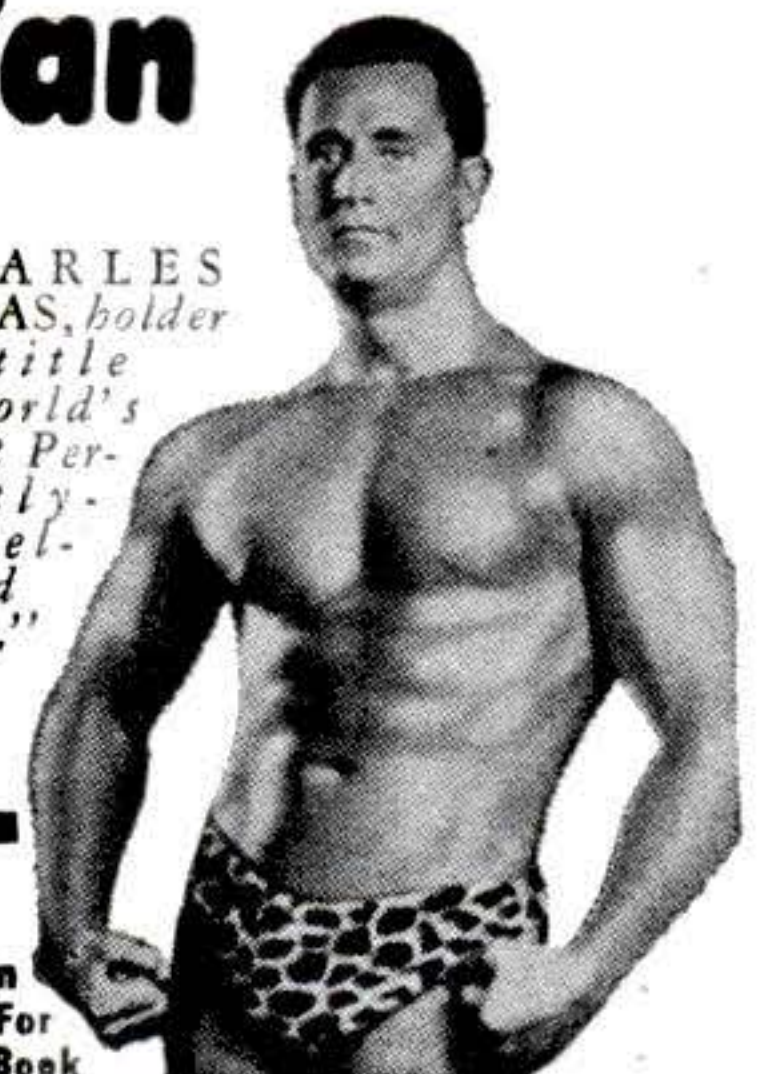

Mail  
Coupon  
Now For  
Free Book



Prepare for a Good Paying Job — Or Your Own Business

Learn **PRACTICAL RADIO-TV**  
with **25 BIG KITS**

of equipment I send you while you train with me . . . for valuable shop bench experience . . .



**17" to 24"  
PICTURE TUBE**

The new Sprayberry Training Television receiver, built and tested in sections.

I now offer this fine modern oscilloscope.

You build this powerful 2 Band superhet radio receiver.

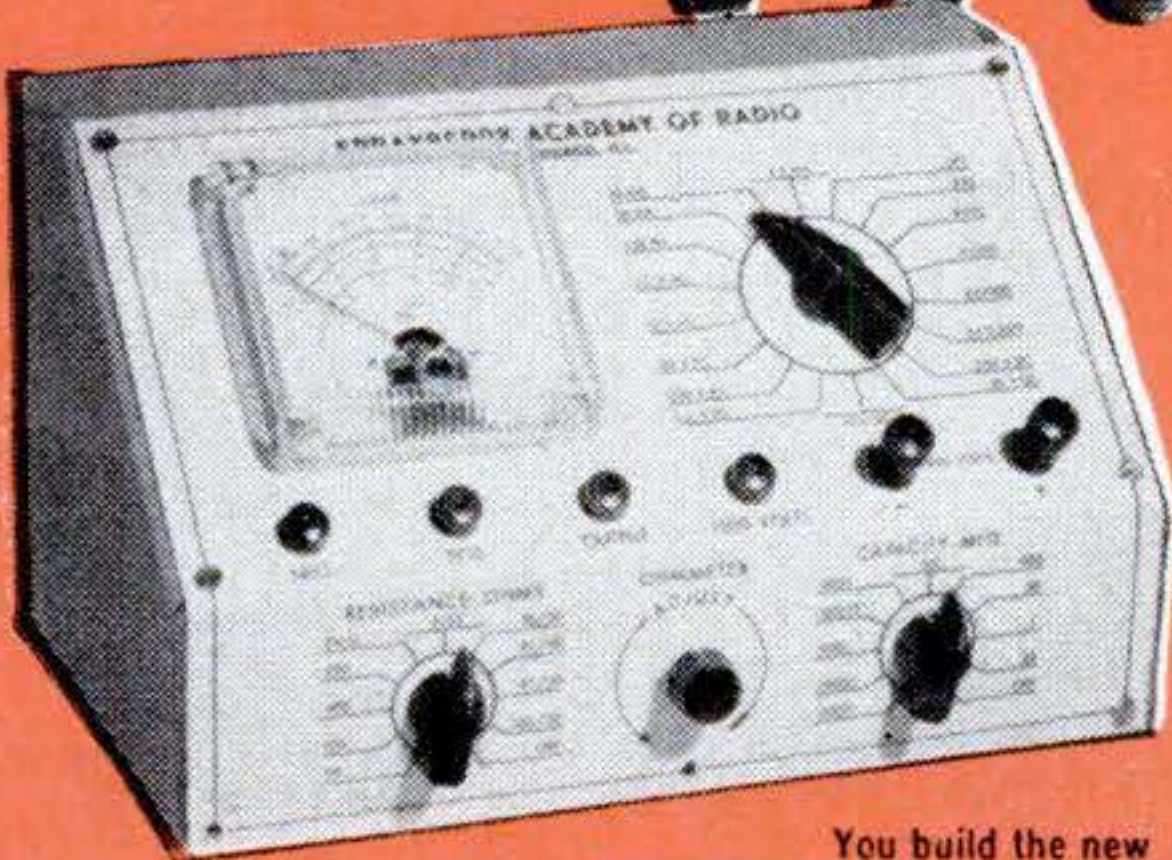
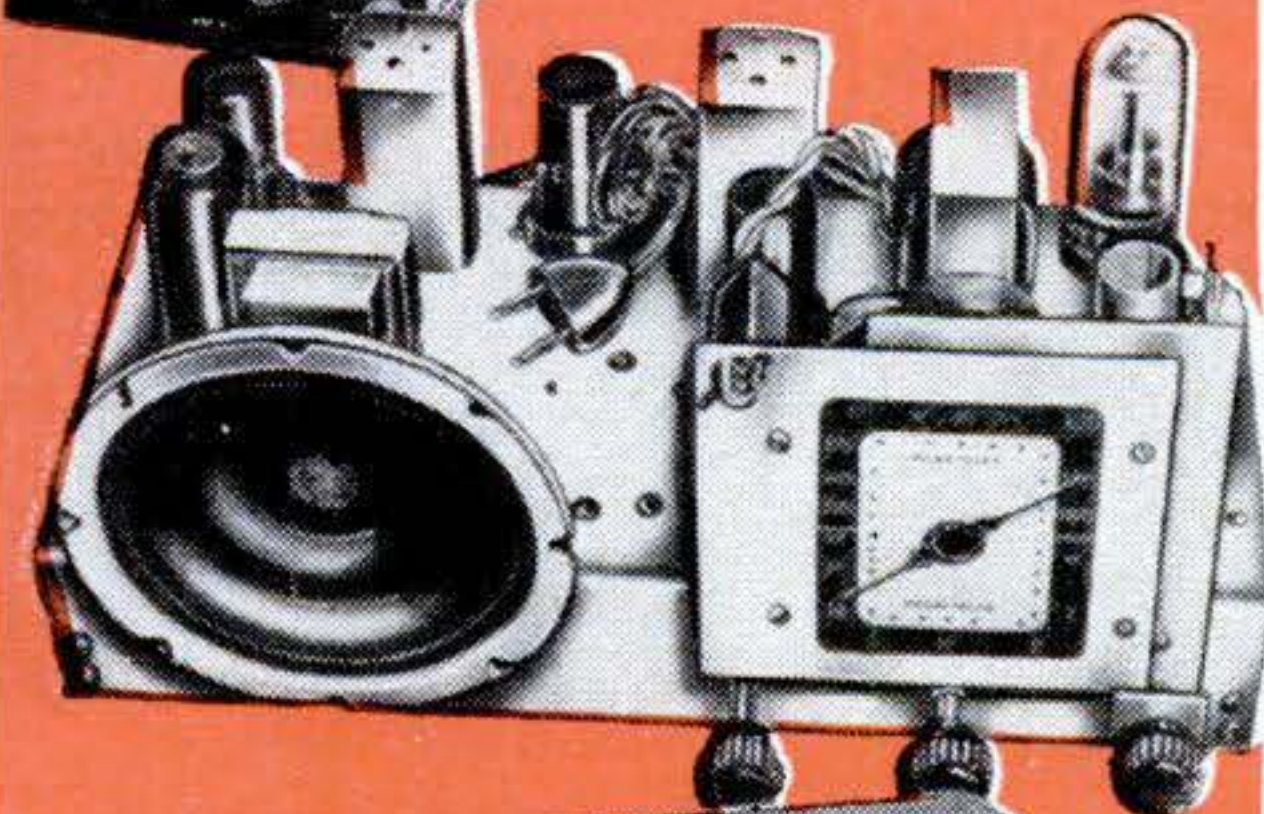

You build the new Sprayberry Tester . . . 18-range Volt-Ohm-Milliammeter readings.

In addition to modern lesson training, I also give you plenty of home practice on actual Radio-Television equipment . . . you will build and use the units shown here plus many more. All this equipment is yours to keep . . . keep everything you need to set up your shop.

**"I Will Train You at Home in  
RADIO-TELEVISION  
on Liberal No Obligation Plan!"**

New Equipment! New Lessons! Enlarged Course! The true facts are yours in my big new catalog . . . **YOURS FREE . . .**

**JUST MAIL COUPON!**



Frank L. Sprayberry  
President, Sprayberry  
Academy of Radio

I can train and prepare you in as little as 10 months to step into the big opportunity Radio-Television service field. Train *without* signing a binding contract . . . without obligating yourself to pay any regular monthly amounts. You train entirely at home in spare hours . . . you train as fast or as slowly as you wish. You'll have your choice of **THREE SPRAYBERRY TRAINING PLANS** . . . planned for both beginners as well as the more experienced man. Get the true facts about the finest most modern Radio-Training available today . . . just mail the coupon for my big new 56 page fact-filled catalog plus sample lesson—both **FREE**.

**Train the Practical Way—with Actual Radio-Television Equipment**

My students do better because I train both the mind and the hands. Sprayberry Training is offered in 25 individual training units, each includes a practice giving kit of parts and equipment . . . all yours to keep. You will gain priceless practical experience building the specially engineered Sprayberry Television Training Receiver, Two-Band Radio Set, Signal Generator, Audio Tester and the new Sprayberry 18 range Multi-Tester, plus other test units. You will have a complete set of Radio-TV test equipment to start your own shop. My lessons are regularly revised and every important new development is covered. My students are completely trained Radio-Television Service Technicians.

**NEWEST DEVELOPMENTS**

Your training covers **UHF, Color Television, FM, Oscilloscope Servicing, High Fidelity Sound and Transistors.**

**See for Yourself . . . Make Your Own Decision  
... Mail Coupon Today!**

The coupon below brings you my big new catalog plus an actual sample Sprayberry Lesson. I invite you to read the facts . . . to see that I actually illustrate every item I include in my training. With the facts in your hands, you will be able to decide. *No salesman will call on you.* The coupon places you under no obligation. Mail it now, today, and get ready for your place in Radio-Television.

**SPRAYBERRY ACADEMY OF RADIO**

111 North Canal Street, Dept. 55-E, Chicago 6, Illinois

**Mail This Coupon For Free Facts and Sample Lesson**



**SPRAYBERRY ACADEMY OF RADIO**  
Dept. 55-E, 111 N. Canal St., Chicago 6, Ill.

Please rush all information on your **ALL-NEW** Radio-Television Training Plan. I understand this does not obligate me and that *no salesman will call upon me.* Include New Catalog and Sample Lesson **FREE**.

Name \_\_\_\_\_ Age \_\_\_\_\_

Address \_\_\_\_\_

City \_\_\_\_\_ Zone \_\_\_\_\_ State \_\_\_\_\_



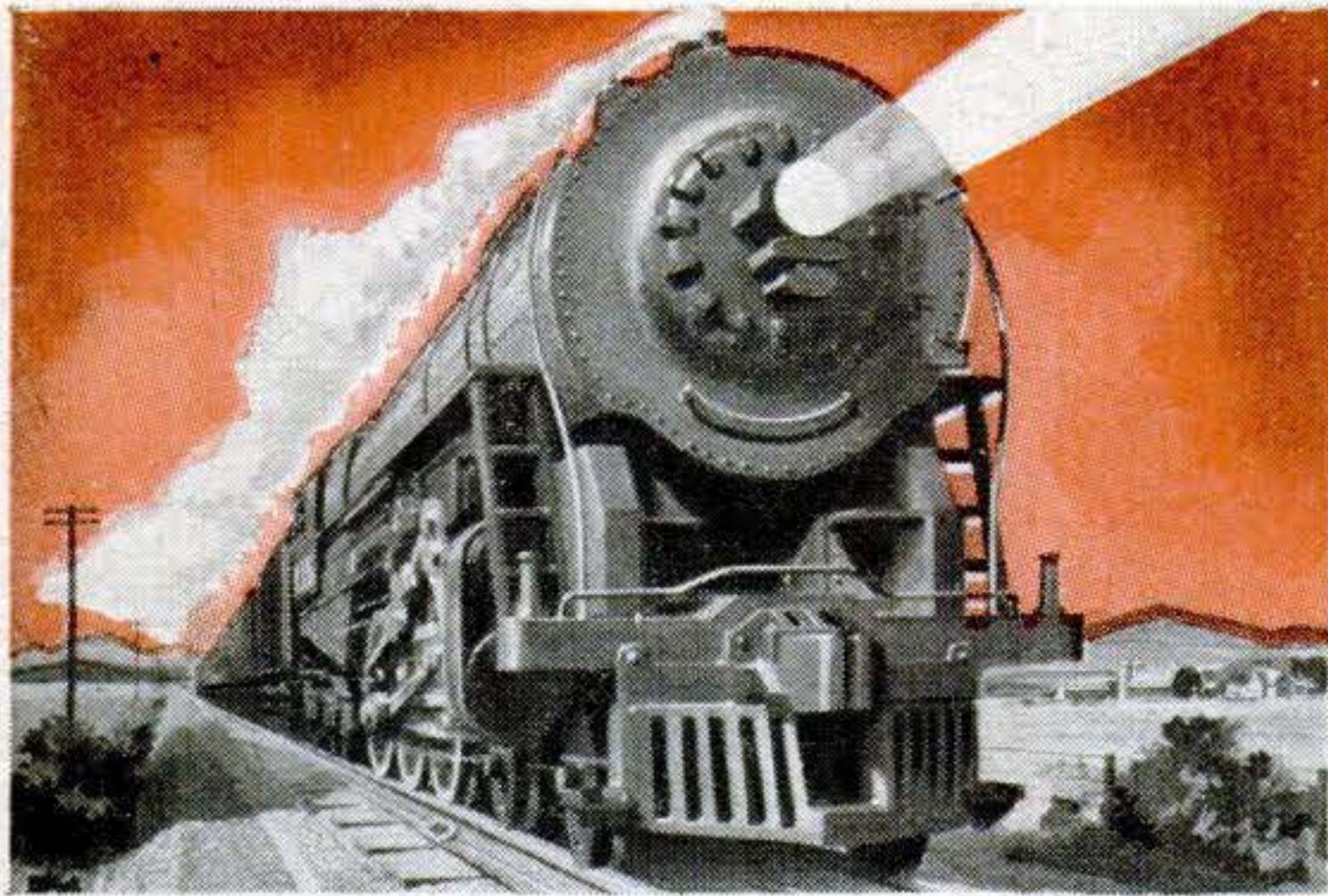

Illustrated: *Mighty American Flyer 4-6-4 "Hudson"*

**NEW FOR '55!** American Flyer No. 5510T "Mountaineer" freight. Complete with smoke, choo-choo, Pull-Mor power, track, transformer. **\$29.95\***

\*Slightly higher Denver and West

**Build your model railroad with Gilbert**

**AMERICAN FLYER**

**...far more realistic than any other!**

Here's a real do-it-yourself hobby! You'll plan layouts, lay track, build scenery, do hundreds of other things. The sure way to realism is with American Flyer. Each train is a scale model; runs on 2-rail track; has puffing smoke and choo-choo, plus many more exclusive features. Choose from all-new American Flyer sets, from \$19.95,\* with transformer and track.

Only **American Flyer** has all these realistic features!

- **Scale-Model Realism!**
- **2-Rail, Flat-Top Track!**
- **Real Smoke and Choo-Choo!**
- **Rugged Pull-Mor Power!**



See Brand-New-For-'55 American Flyer Trains at your dealer's today! Made by A. C. Gilbert, manufacturers of famous Erector Sets

**Send for this DOUBLE-VALUE OFFER!**

192-page book: *How to Build and Operate a Model Railroad*. Hundreds of illustrations. A wealth of ideas on how to plan and build your own railroad.

Brand new full-color American Flyer catalog. Shows you every train; all accessories, too. 44 pages of action and fun.

**Both only 25c—write today**  
(or catalog, only 10¢)

Gilbert Hall of Science, Dept. 25  
Erector Square, New Haven 6, Conn.

- I enclose 25¢. Rush both big train books.  
 I enclose 10¢. Rush catalog.

Name \_\_\_\_\_

Street \_\_\_\_\_

City \_\_\_\_\_ Zone \_\_\_\_\_ State \_\_\_\_\_

T4



**BIG PROFIT making Concrete Drain Tile**

Millions of dollars' worth of drain tile are used every year for farm drainage, building construction, reclamation projects, highways, and other purposes. And the big swing is to concrete tile because it's better and costs less. Sales potentials are BIG.

Concrete drain tile is locally manufactured of local materials, for direct selling to local users or contractors. Useless costs—freight, distribution, breakage—are eliminated. While worth more than clay tile, concrete tile can sell for less and still earn a handsome profit.

Tile made on the Champion Machine are strong and uniform. Truly round. All sizes up to 12" diameter. Easy to make because the Champion is simple to operate.

**Get The Champion Facts**

Write for the *Champion* book. Tells about concrete drain tile as an outstanding manufacturing opportunity. Describes the machine and outlines liberal payment terms.

W. E. DUNN MFG. CO.

521 W. 24th Street, Holland, Mich.

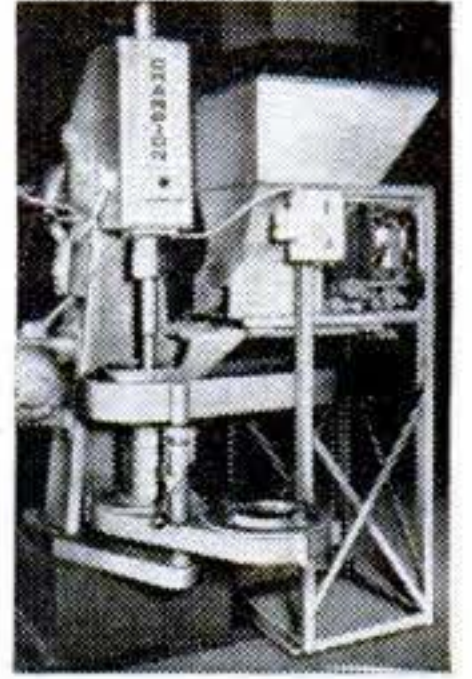
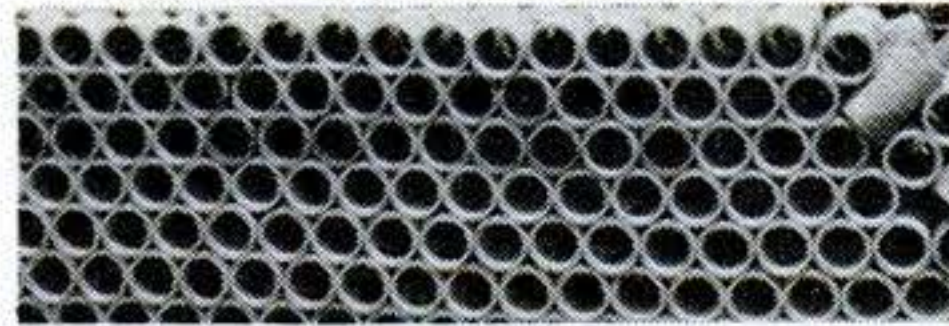

IN CANADA: DUNN MASONRY MACHINERY LIMITED  
972 Dundas Highway, Cooksville, Ont.

**LEARN METALCRAFT**

**and JEWELRY MAKING**

Low Cost Home Training Now Available

Make money. Learn profitable skills and arts of decorative metal and jewelry crafts. Course is complete. Professionally prepared. Easy to master. Special tools and materials furnished.



Write for Free Booklet

**INTERSTATE TRAINING SERVICE**

DEPT. K-2 PORTLAND 13, OREGON

**Secrets of VENTRILOQUISM Now Revealed!**



Easy to learn in 60 to 90 days with our Home Study Course. **RESULTS GUARANTEED.** Make Money! Be Popular! Have Fun! Big Opportunity! Radio, Television, Stage Appearances! For Free Information regarding price and terms, WRITE. You must state your age. Dummy Catalog 25c. **FRED MAHER SCHOOL OF VENTRILOQUISM** Box 36, Studio PS11, Kensington Station Detroit 24, Michigan

**I'll Send You This Handsome SAMPLE CASE - FREE**



**and Show You How to Make Up to \$30.00 in a Day**

Mail coupon for this Free Tailoring Sample Case packed with 150 beautiful, big-value suit and overcoat fabrics. Take orders from friends, fellow-workers, others, for fine quality, made-to-measure clothes. Pocket big cash profits in advance. Because wearing our suits and over-

coats brings more orders, we make it easy for you to get your own clothes without 1c cost. No experience is needed. **SATISFACTION GUARANTEED. SEND NO MONEY.** Just fill out and mail coupon—today!

**STONE-FIELD CORP., 532 South Throop Street DEPT. J-820 CHICAGO 7, ILLINOIS**

**STONE-FIELD CORP., Dept. J-820**  
532 S. Throop St., Chicago 7, Ill.

Dear Sir: I WANT A MADE-TO-MEASURE SUIT TO WEAR AND SHOW, without paying 1c for it. Rush details and Sample Kit of actual fabrics, **ABSOLUTELY FREE.**

NAME \_\_\_\_\_ AGE \_\_\_\_\_

ADDRESS \_\_\_\_\_

CITY \_\_\_\_\_ STATE \_\_\_\_\_



LOWEST PRICES!

AMAZING RECEPTION!

ENTIRELY DIFFERENT!

HIGHEST QUALITY!

NEW!

# SAVE MONEY

## NEW ULTRA-VIDEOSONIC long range TV

### MIDWEST

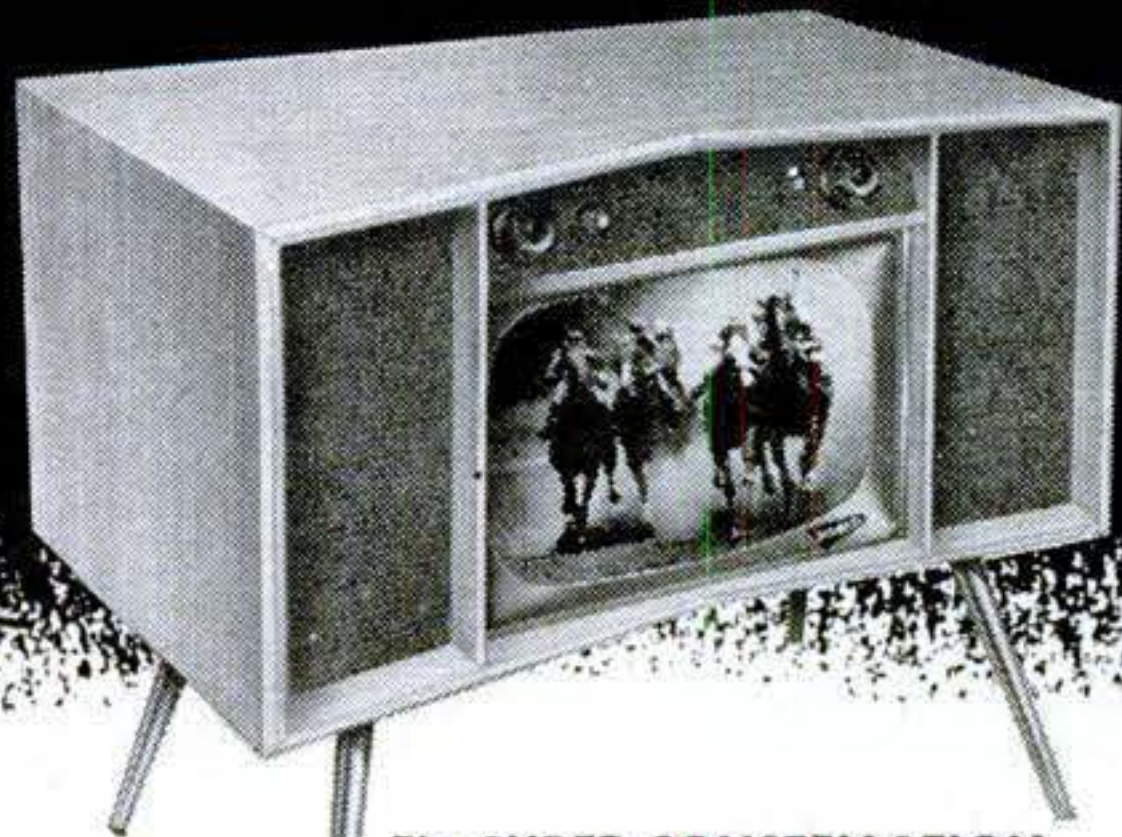

The **SUPER CONSTELLATION**—the most magnificent, unique Low Boy TV you've ever seen. The screen is 21-inch "plus". Unbelievably low price!

## FACTORY-TO-YOU LOW PRICES 30-DAY TRIAL PERIOD



The **CONQUEROR**—the greatest performance ever. Fabulous picture screen is 21-inch "plus". Priced extra low.



The **TOWN & COUNTRY**—long range TV at its best. Famous MIDWEST screen is 21-inch "plus". Sensational low price.

### ONLY MIDWEST DARES TO GIVE YOU A 30-DAY TRIAL

You and you alone are the final judge of MIDWEST quality and performance because we give you the privilege of a *30-day trial right in your home!* If you don't agree with thousands, that here is a TV receiver that meets all our claims for quality, tone and performance, return the set to us. Any money you've paid us will be refunded at once. No other manufacturer has dared to make this offer.

### MAIL COUPON FOR **FREE** 1956 VALUE-PACKED CATALOG OF MIDWEST ULTRA-VIDEOSONIC TV RECEIVERS

We want you to have one—they're absolutely free! Honestly, our catalog is jam-packed with a wealth of information on the new MIDWEST 1956 models, including comprehensive technical data, beautiful illustrations, complete instructions for ordering through the 30-day trial plan and a host of other interesting, informative facts about how to buy the right kind of TV set. Your catalog will show you how MIDWEST sets are specially engineered to deliver day-in, day-out trouble-free performance with the clearest, brightest picture you've ever seen. And wait until you see the beautiful styles and designs, the luxurious finishes that will lend charm and distinction to your home.

**F  
R  
E  
E**



ALL SETS CARRY FAMOUS MIDWEST WARRANTY!

### YOU CAN'T BEAT MIDWEST FACTORY-TO-YOU LOW PRICES ON TV

MIDWEST has no dealers—no retail outlets—no tremendous advertising budget. That's why our prices are lower—much lower! Make us prove it . . . write for our catalog and see for yourself. BUT, while our prices are low, our quality is HIGH. No time, effort, or materials have been spared to produce these magnificent TV receivers. The new MIDWEST 1956 catalog is full of beautiful TV receivers from Table Models to Consoles. Giant, new screens are 21-inch "plus." You'll find one you like at the price you can afford.

### HUNDREDS OF THOUSANDS OF SATISFIED CUSTOMERS

We here at MIDWEST Radio & Television Corporation are proud of the reputation we have built over the last 36 years. Thousands of families have discovered, as we know you will, that MIDWEST is the most honored name in the industry. MIDWEST has always delivered a product of the *highest quality* at a price that everyone can afford.

### YOUR FRIENDS AND NEIGHBORS WILL BE IMPRESSED

When the huge screen, 21-inch "plus", of your new MIDWEST Ultra-Videosonic TV lights up and brings you the clearest, sharpest picture you've ever seen . . . even if you're in the poorest fringe area . . . your friends will be simply amazed. And when the golden tones from the Panasonic speaker floods the room . . . well, that will top it all off, and everyone will know that you own the very best television receiver in the neighborhood, a MIDWEST Ultra-Videosonic TV.

MIDWEST RADIO & TELEVISION CORP., DEPT. B-4  
909 Broadway, Cincinnati 2, Ohio

Send FREE 1956 MIDWEST TV Catalog. No obligation on my part.

NAME \_\_\_\_\_

ADDRESS \_\_\_\_\_

CITY \_\_\_\_\_ STATE \_\_\_\_\_

**MIDWEST**

RADIO & TELEVISION CORP. • DEPT. B-4 • 909 BROADWAY, CINCINNATI 2, OHIO





IF YOU "EAT, SLEEP AND LIVE" CARS...

## TURN YOUR HOBBY INTO A CAREER!

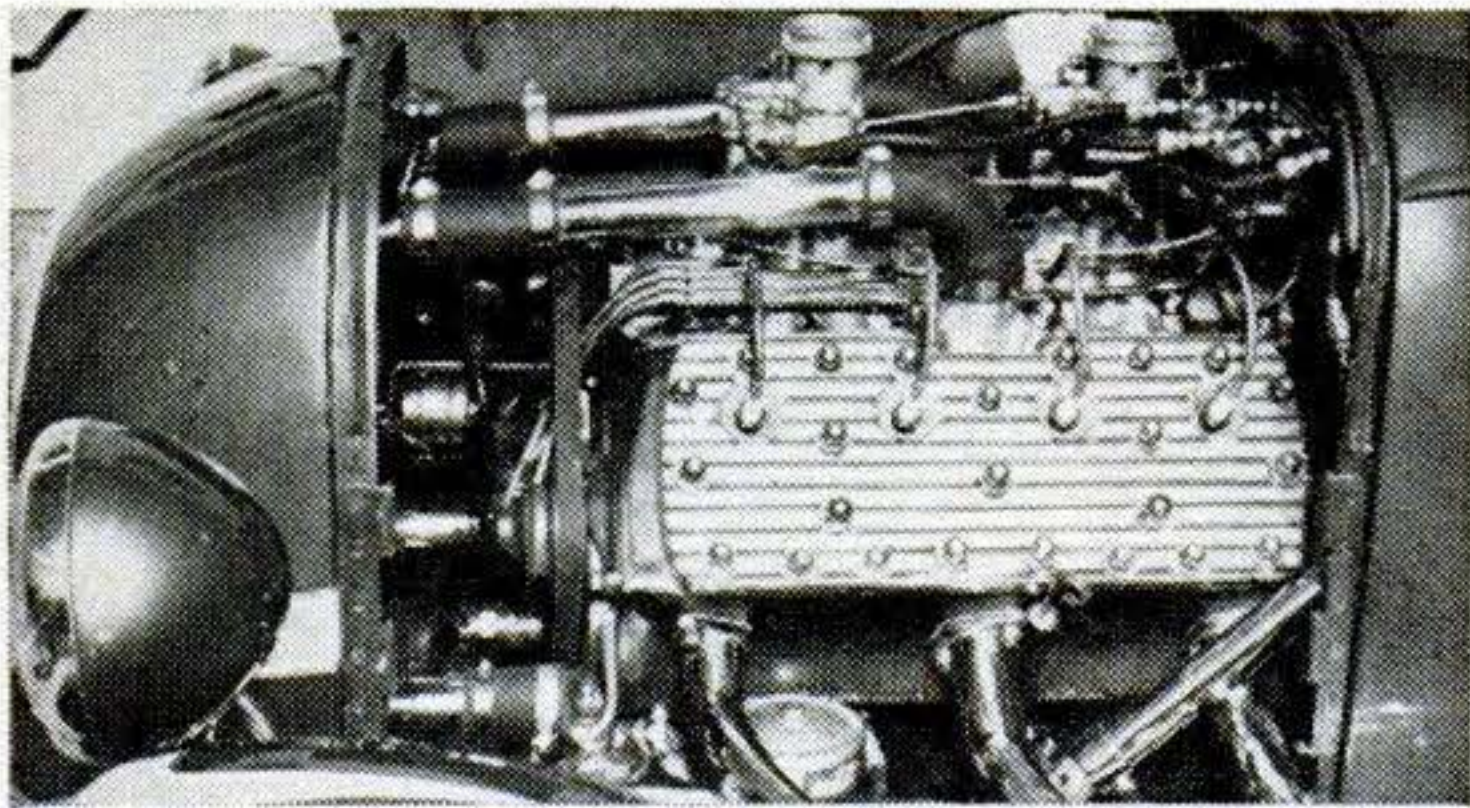

Get America's Big-time, Big-future

# AUTO MECHANICS & DIESEL COURSE

at home in your spare time!

Los Angeles' National Schools, America's automotive Technical Trade School since 1905, now brings its famous resident Shops and Faculty direct to you at home—to prepare you to earn more money, with job security, in today's fast-moving, opportunity-filled Auto Mechanics Industry! Get your home training from the "Car Capital of The World"—America's most auto-minded city, center of Hot Rod and Sports Car activity! Mail coupon right now!

### "SHOP-METHOD" HOME TRAINING!

YOU MASTER ALL PHASES, INCLUDING DIESEL! All lessons fully illustrated. Latest equipment covered.



**THIS SET OF LIFETIME TOOLS IS YOURS!** Also all-metal tool box. Part of your course, yours to keep. **EARN WHILE YOU LEARN!** We show you how to start Spare Time Earnings soon after enrollment.

**ATTENTION MEN OF DRAFT AGE.** Learn how you can achieve higher rating and pay. Mail coupon at once!

**APPROVED FOR G. I. TRAINING.** Both Home Study & Resident Courses Free help with technical and personal problems—Job Placement Service



Send for **FREE FACT-BOOK AND SAMPLE LESSON!**

**NOW! 2 offices to serve you faster! Mail coupon today to one nearest you!**

## NATIONAL SCHOOLS

Technical Trade Training Since 1905

LOS ANGELES 37, CALIFORNIA

IN CANADA: 811 West Hastings Street, Vancouver, B. C.

### MAIL NOW TO OFFICE NEAREST YOU!

(mail in envelope or paste on postal card)

NATIONAL SCHOOLS, Dept. DC-115

4000 S. FIGUEROA STREET  
LOS ANGELES 37, CALIF.

OR

323 WEST POLK STREET  
CHICAGO 7, ILLINOIS

Send **FREE** Auto-Mechanics Book and Sample Lesson. No obligation, no salesman will call.

NAME \_\_\_\_\_ BIRTHDAY \_\_\_\_\_ 19\_\_

ADDRESS \_\_\_\_\_

CITY \_\_\_\_\_ ZONE \_\_\_\_\_ STATE \_\_\_\_\_

Check if interested ONLY in Resident School Training at Los Angeles. **VETERANS:** Give Date of Discharge \_\_\_\_\_

# If Ruptured

For lasting relief your rupture must **BE HELD BACK DAY and NIGHT.**

Consult Your Doctor.



Entirely different

SOFT, FLEXIBLE, and fits neat as a glove. The famous Miller saves you **TIME, MONEY, DISAPPOINTMENT.**

Write for my **FREE** booklet today.

**FRED B. MILLER** Manufacturer  
Dept. P-A Hagerstown, Maryland

## IT'S EASY...

### MAKE MONEY IN PHOTOGRAPHY

If you are over 17—good pay and fascinating work await you in photography! Start making money quickly in sparetime—step into your own studio or exciting career job. **LEARN BY DOING** method trains you at home! Write **TODAY** for **FREE** catalog. Also Resident Training. 46th Year. Approved for Vets.

**NEW YORK INSTITUTE OF PHOTOGRAPHY**  
Dept. 5 10 West 33 Street New York 1, New York

46th YEAR

# LAW

Men and Women **STUDY AT HOME** for Business Success and **LARGER PERSONAL EARNINGS**, 44 years expert instruction—over 114,000 students enrolled. LL.B. Degree awarded. All text material furnished. Easy payment plan. Send for **FREE BOOK**—"Law and Executive Guidance"—**NOW!**

## AMERICAN EXTENSION SCHOOL OF LAW

Dept. D-8, 201 North Wells Street, Chicago 6, Ill.



## BIG BAG of STAMPS

**WHAT TREASURES WILL YOU FIND?** Big cloth bag contains more than 1,000 foreign stamps from over 30 countries in Asia, Africa, Europe etc., mostly still on paper, unpicked, unsorted, just as received from foreign missionaries, banks, etc. Nobody knows what's inside! Worth over \$10 at Catalog prices. Money back guarantee.

Only \$1.00

**H. E. HARRIS & CO.**  
1873 Transit Boston 17, Mass.

WRITE: BREVITYPE INSTITUTE, SAN DIEGO, CALIF., DEPT. 2323

## LEARN THE WORLD'S SIMPLEST, SPEEDIEST SHORTHAND

WRITE FOR FREE LESSONS

**FREE**—please send me typical lessons, details on Brevitype—world's simplest, speediest shorthand—first machine shorthand to eliminate coding. Tell me how I learn Brevitype in 1/2 the time through your personally guided home-study course. Show me how switching to Brevitype, as hundreds have, prepares me for security as a stenographer, secretary, court or hearing reporter here, and abroad, in business or Civil Service—helps me increase my salary 50% to 100%. Include costs and budget plans.

# BREVITYPE SHORTHAND

THE EASY-TO-LEARN MACHINE



Guaranteed by Good Housekeeping  
IF NOT AS ADVERTISED THEREIN

**MODERN:**  
TYPEWRITER KEYBOARD!  
NO CODING! FAST ABC!

THE BREVITYPE MACHINE, WHICH CARRIES THIS SEAL, COMES WITH THIS COURSE



L. C. Lane, B.S., M.A.  
 President, Radio-Television  
 Training Association  
 Executive Director, Pierce  
 School of Radio & Television.

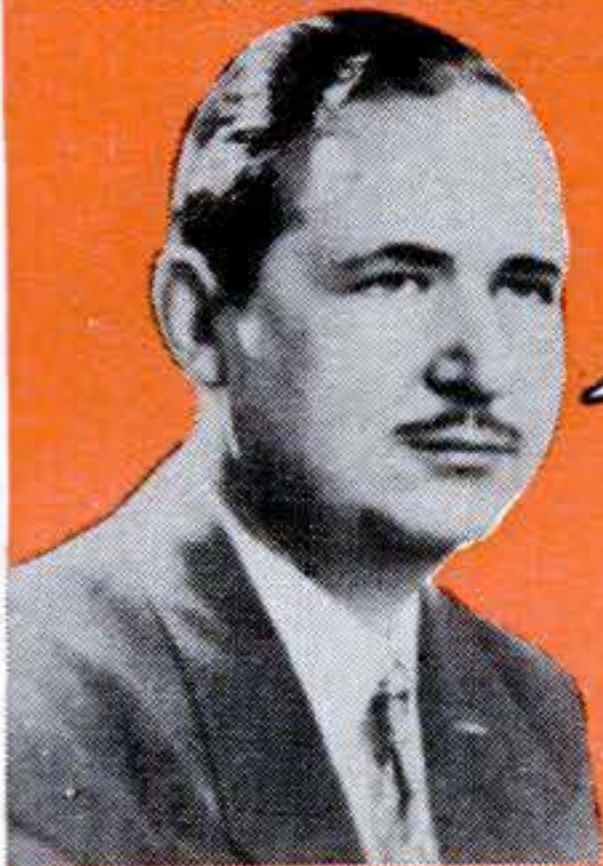

VETERANS - - NON-VETERANS

# Do You Want a BETTER JOB with MORE MONEY?

I will train you AT HOME in your SPARE TIME for a top-pay lifetime job in TELEVISION

The world's leading manufacturers, dealers and service organizations employ men I trained. Even if you've never had any experience in the Television-Radio-Electronics field, you'll recognize most

of the names of just a few of the firms where RTTA-trained men are holding down good jobs with a secure future —

- RCA • SYLVANIA • WESTINGHOUSE  
 BOEING • GENERAL ELECTRIC • LEWY  
 EMERSON • DOUGLAS AIRCRAFT  
 CAPEHART-FARNSWORTH • PHILCO  
 CANADAIR, LTD. • WESTERN ELECTRIC  
 OAK RIDGE NATIONAL LABORATORY  
 AMERICAN AIRLINES • COLUMBIA  
 BELL TELEPHONE • ADMIRAL • DUMONT  
 REDIFFUSION, INC. • BELL AIRCRAFT  
 RAYTHEON • CONVAIR

## LEARN BY DOING

As part of your training I give you the equipment you need to set up your own home laboratory and prepare for a BETTER-PAY TV JOB. You build and keep an Electromagnetic TV RECEIVER designed and engineered to take any size picture tube up to 21-inch. (10-inch tube furnished. Slight extra cost for larger sizes.) . . . also a Super-Het Radio Receiver, AF-RF Signal Generator, Combination Voltmeter-Ammeter-Ohmmeter, C-W Telephone Transmitter, Public Address System, AC-DC Power supply. Everything supplied, including all tubes.



## STUDY NEWEST DEVELOPMENTS

My training covers all the latest developments in the fast-growing Television-Radio-Electronics industry. You learn about FM — RADAR — COLOR TV — TRANSISTORS — PRINTED CIRCUITS, etc.

## CHOOSE FROM THREE COMPLETE COURSES

covering all phases of Radio, FM and TV

1. Radio, FM and Television Technician Course — no previous experience needed.
2. FM-TV Technician Course — previous training or experience in radio required.
3. TV Cameraman and Studio Technician Course — advanced training for men with Radio or TV training or experience.

I can do for you what I did for my hundreds of successful graduates. Many of the men I trained are now their own bosses—making a wonderful living in their own growing business.

You, too, can win a place in the booming Television-Radio-Electronics industry . . . earn big money as a trained TV Technician . . . with my famous "Learn by Doing" home study method.

**FREE!**  
 I'll send you my new 40-page book, "How to Make Money in Television-Radio-Electronics," a Free sample lesson, and other literature showing how and where you can get a top-pay job in Television.



## VETERANS!

My School fully approved to train Veterans under new Korean G. I. Bill. Don't lose your school benefits by waiting too long. Write discharge date on coupon.

## EXTRA TRAINING IN NEW YORK CITY AT NO EXTRA COST!

After you finish your home study training in Course 1 or 2 you can have two weeks, 50 hours, of intensive Lab work on modern electronic equipment at our associate resident school, Pierce School of Radio & Television. THIS EXTRA TRAINING IS YOURS AT NO EXTRA COST WHATSOEVER!

**FCC COACHING COURSE**  
 Important for BETTER-PAY JOBS requiring FCC License! You get this training AT NO EXTRA COST! Top TV jobs go to FCC-licensed technicians.

**EARN WHILE YOU LEARN**  
 Almost from the very start of your course you can earn extra money by repairing sets for friends and neighbors. Many of my students earn up to \$25 a week . . . pay for their entire training with spare time earnings . . . start their own profitable service business.

# Radio Television Training Association

52 EAST 19th STREET • NEW YORK 3, N. Y.

Licensed by the State of New York • Approved for Veteran Training

## MAIL THIS COUPON TODAY!

Mr. Leonard C. Lane, President  
 RADIO-TELEVISION TRAINING ASSOCIATION  
 Dept. P-11C, 52 East 19th Street, New York 3, N. Y.

Dear Mr. Lane: Mail me your NEW FREE BOOK, FREE SAMPLE LESSON, and FREE aids that will show me how I can make BIG MONEY IN TELEVISION. I understand I am under no obligation and no salesman will call.

(PLEASE PRINT PLAINLY)

Name \_\_\_\_\_ Age \_\_\_\_\_

Address \_\_\_\_\_

City \_\_\_\_\_ Zone \_\_\_\_\_ State \_\_\_\_\_

I AM INTERESTED IN:  
 Radio-FM-TV Technician Course  
 FM-TV Technician Course  
 TV Cameraman & Studio Technician Course

**VETERANS!**  
 Write discharge date

## NO SALESMAN WILL CALL!



# TRAPPED NICOTINE

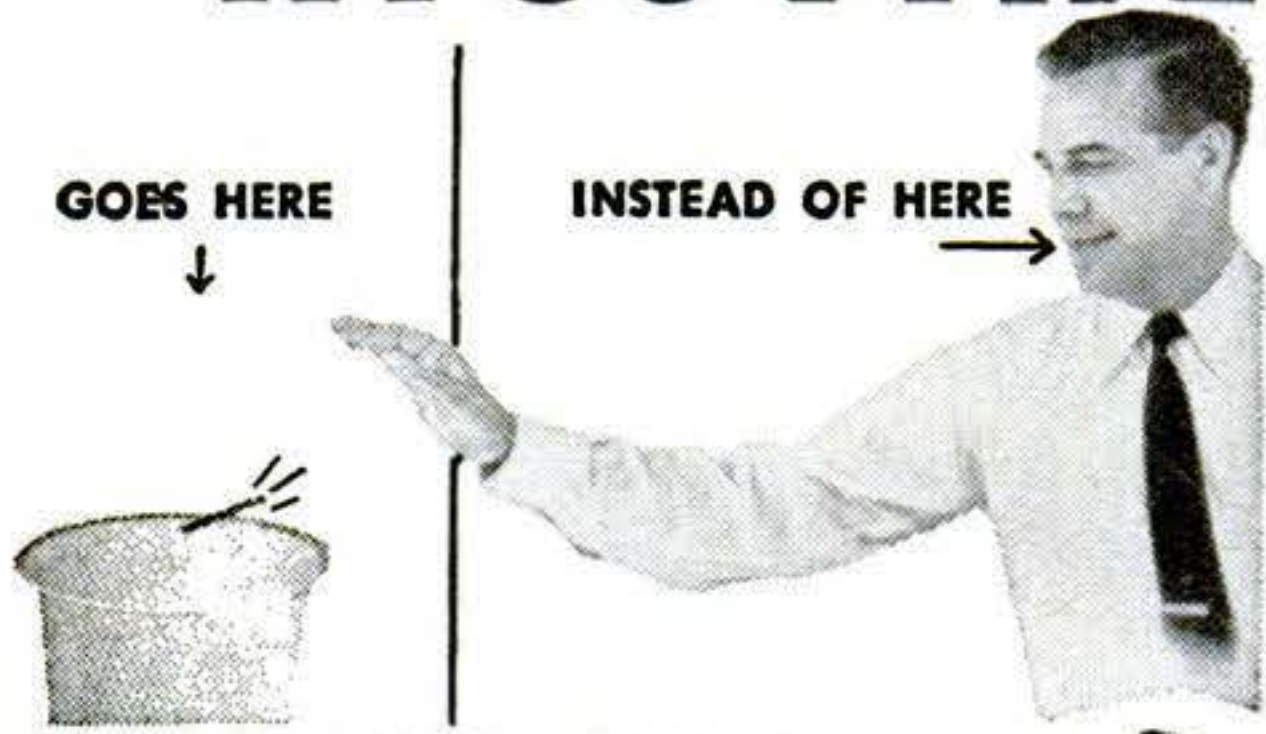

## WHEN YOU SMOKE A MEDICO FILTER PIPE

Nicotine, tars, bitter juices and flakes trapped by Medico's scientific filter never reach your mouth! You throw away all the impurities that Medico's filter traps. Insert a fresh filter and your Medico smokes cooler, cleaner, drier, sweeter. That's why Medico is America's fastest selling pipe! Choose a Medico Filter Pipe today.

**MEDICO Crest**  
**\$3.50**

Other Medico Filter Pipes  
\$1.50 to \$12.50  
Prices higher outside U. S. A.



When filter is discolored, replace with a fresh one—10 for 10¢

For Catalog 12 write MEDICO, 18 E. 54th St. N. Y. 22

# FREE!



A NEW HOME INDUSTRY

OPPORTUNITIES UNLIMITED



GEARS



FISHING LURES



JEWELRY GEMS



HANDLES KNIVES - DIALS



STATUES FIGURINES

Let us show you how extremely easy and PROFITABLE it is to make beautiful and useful things out of LIQUID PLASTIC, LIQUID MARBLE, LIQUID IVORY, LIQUID GLASS, CERAMICS, ETC. . . . as easy as pouring water out of a glass! Make novelties, jewelry, gifts, artware, toys, tools, dies, gadgets, ceramics . . . a million useful things! We supply everything—MATERIALS and INSTRUCTIONS!—Send only 25c for big 64 page catalog of casting materials, molds and accessories and we will include free of extra cost a remarkable book, "THE WONDERS OF LIQUID PLASTICS" . . . that will open your eyes to wonders you never dreamed of! Send 25c today—this may be the lucky coin that will start the most fascinating and profitable phase of your life!

**PLASTICAST COMPANY**

6612 N. Clark St. Dept. PC-107 Chicago 26, Illinois



## BARBELLS

100 POUND SET \$9.80

140-Pound, CHROME DELUXE Barbell-Dumbbell set only \$16.80. This is our feature set and is the finest ever manufactured. Training with adjustable weight is the BEST way to keep fit; the ONLY way to develop great strength and a perfect body. As the oldest and best equipped barbell company, BUR gives value and prices no one can equal.

SEND FOR FREE CATALOG.  
**BUR BARBELL CO.**  
Lyndhurst 5, New Jersey

Extra Plates Only 10c Pound

## 'How to MAKE MONEY with Simple CARTOONS'



A book everyone who likes to draw should have. It is free; no obligation. Simply address

FREE BOOK

**CARTOONISTS' EXCHANGE**

Dept. 1911D, Pleasant Hill, Ohio



REPAIR ANY WATCH

## ... Swiss or American

Unique Sweazy System starts you making repairs right away. Develops your skill step-by-step. Teaches modern methods... professional short cuts. Learn by personal attendance or spare time home study. Approved for veterans. Free Sample Lesson. No obligation. Write today!

**CHICAGO SCHOOL OF WATCHMAKING**  
2330 Milwaukee, Dept. 4115, Chicago 47, Ill.

# Earn over \$800<sup>00</sup> PER MONTH

## DRAFTING

SEND FOR FREE SUCCESS BOOK

RECEIVE THIS SET OF INSTRUMENTS AT NO EXTRA COST

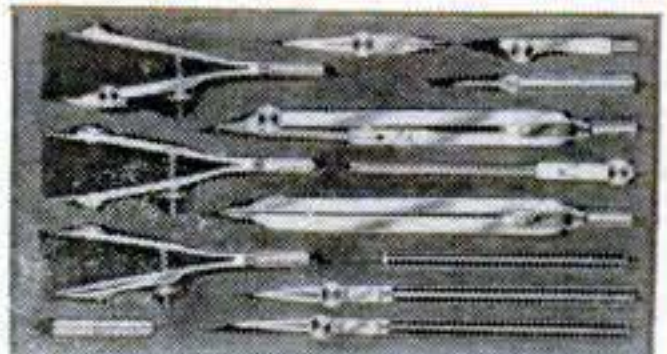

CLEVELAND ENGINEERING INSTITUTE  
DEPT. PS 11E  
6300 Euclid Ave. • Cleveland 3, Ohio



Aeronautical  Mechanical

NAME..... AGE .....

ADDRESS.....

CITY..... STATE.....

No Obliaation — No Salesmen



"MY SALARY HAS INCREASED 50% SINCE GRADUATING FROM C.E.I.", says H. L. ADAMS. ". . . a great part of this advancement and increase in salary I credit to C.E.I. training and to the thoroughness and personal direction of its instructors."

# CLEVELAND ENGINEERING INSTITUTE



# Tune Up, Pep Up, Fix Up ANY CAR!



**NOW! Even beginners can handle practically ANY job on ANY make, model or part!**

TUNE UP, PEP UP, *fix up* ANY automobile . . . even if you've never repaired a car before!

Handle practically any job "slick as a whistle."

A tune up? New rings? Ignition or carburetor troubles? Brake or clutch problems? A valve job? Something wrong with power steering or one of those tricky new automatic transmissions?

Just look up the job you want to do!

This giant, 4 $\frac{3}{4}$  pound CHILTON REPAIR MANUAL tells what to do. Then it shows you step by step just how to do it. No guess work. No lost time. You handle auto repairs easier, faster and better than you may have dreamed.

There's a "secret" to easy auto service and this giant manual is it!

**YOU WON'T MISS**  
with how-to-fix-it data like  
this to guide you!

Chilton covers practically every part of every car on the road today. Gives complete service details on every model of the leading 20 car makes from June 1940 to the present. Over 600 models in all!

Tells how to locate troubles. Shows what work-saving shortcuts to take . . . what adjustments to make . . . what parts to use . . . what mistakes to avoid . . . *even what tools to use.*

"Minor" details, often so puzzling to beginners, are fully explained.

From beginning to end, it's an honest-to-goodness HOW-TO-FIX-IT guide. NOT a "study" book. You use it right at the bench when you've got a car to fix!

Use the CHILTON MANUAL 10 days . . . FREE. If it's not all you expect . . . and more . . . return it postpaid AND DON'T OWE US A PENNY! Send coupon today to: Chilton Co., Dept. PS-115, 56th & Chestnut Sts., Philadelphia 39, Pa.

## GIANT NEW ENLARGED EDITION

BY CHILTON, WORLD'S LARGEST AUTOMOTIVE PUBLISHERS

- 904 Big Pages
- Weighs 4 $\frac{3}{4}$  pounds
- Almost 3,000 clear pictures
- 58 Troubleshooting Charts
- 353 Quick Check Data Tables
- Thousands upon thousands of parts and service specifications

Covers Every Model of These 20 Makes Since 1940:

BUICK	FRAZER	OLDSMOBILE
CADILLAC	HENRY J.	PACKARD
CHEVROLET	HUDSON	PLYMOUTH
CHRYSLER	KAISER	PONTIAC
DE SOTO	LINCOLN	STUDEBAKER
DODGE	MERCURY	WILLYS
FORD	NASH	

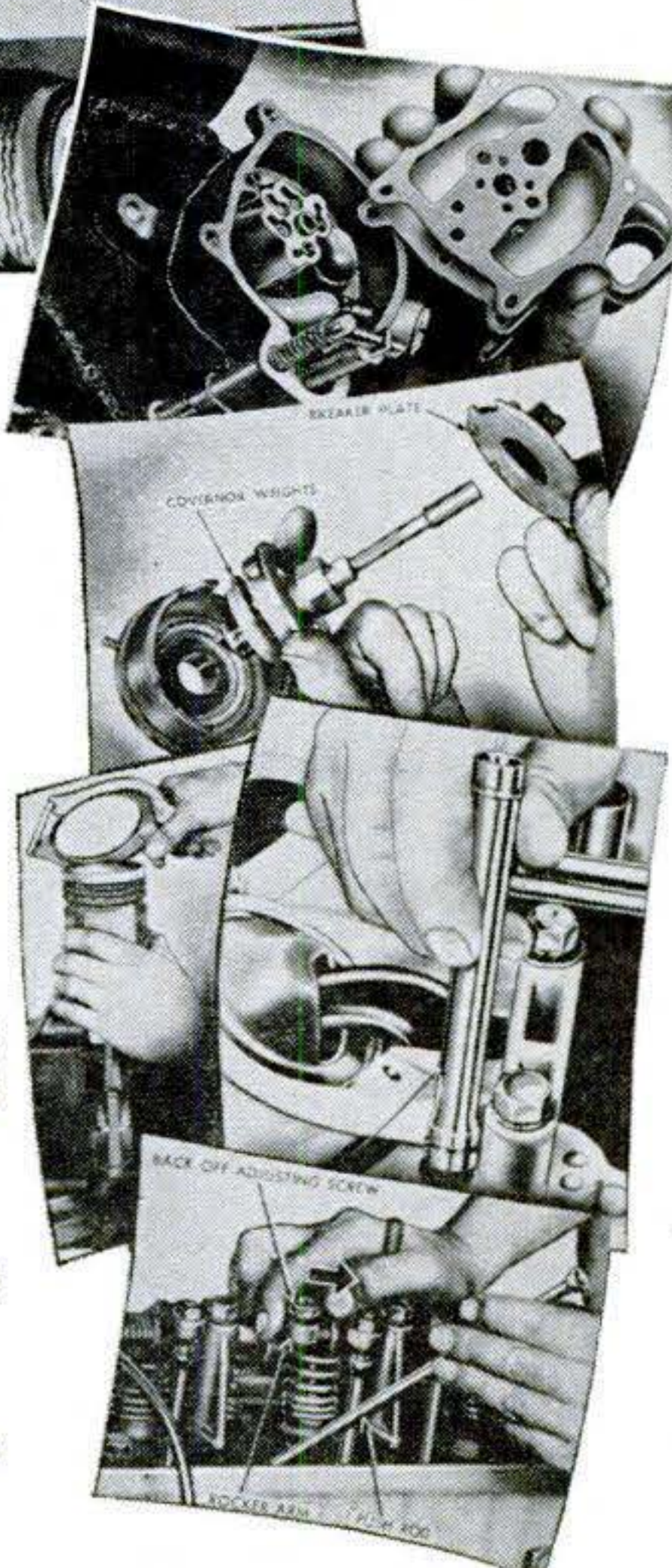

### Read What These Users Say!

**EASY!** "The Chilton how-to-do-it pictures are worth the entire price of the Manual!"

MELVIN WADE, Penna.

(CHILTON BOOKS ARE SOLD BY LEADING BOOK STORES)

**FAST!** "Thanks to my Chilton Manual, I did a job in an hour another mechanic had worked on all day!"

GENE ARNOLD, Iowa



## PRACTICE 10 DAYS FREE!

THE CHILTON CO., Dept. PS-115  
5605 Chestnut St., Philadelphia 39, Pa.

Send me the big 904-page CHILTON "ALL CARS" REPAIR MANUAL (Price \$6.95) for 10-day FREE EXAMINATION. If I like Manual, I will then promptly remit \$1.95 (plus 45¢ postage and handling); then send \$2.50 each month for two months. Otherwise I will return manual postpaid in 10 days and owe you nothing. **SAVE!** Send \$6.95 with order and we pay postage-handling charge. Same return privilege.

Name .....

Address .....

City, Zone, State .....

(OUTSIDE U.S.A.—Price \$8.95 cash with order. 10-day return privilege with money refunded.)



# MEN PAST 40

**Afflicted With Getting Up Nights,  
Pains in Back, Hips, Legs,  
Nervousness, Tiredness.**

If you are a victim of the above symptoms, the trouble may be due to Glandular Inflammation. A constitutional Disease for which it is futile for sufferers to try to treat themselves at home. Medicines that give temporary relief will not remove the cause of your trouble.

Most men, if treatment is taken before malignancy has developed, can be successfully **NON-SURGICALLY** treated for Glandular Inflammation. If the condition is aggravated by lack of treatment, surgery may be the only chance.

## NON-SURGICAL TREATMENTS

The **NON-SURGICAL** treatments afforded at the Excelsior Institute are the result of 20 years research by scientific Technologists and Competent Doctors.

The War brought many new techniques and drugs. These added to the research already accomplished has produced a new type of treatment that is proving of great benefit to man as he advances in years.

The Excelsior Institute is devoted exclusively to the treatment of diseases of men of advancing years. Men from all walks of life and from over 2000 cities and towns have been successfully treated. They found soothing and comforting relief and a new zest in life.

### EXAMINATION AT LOW COST

On your arrival here, Our Doctors who are experienced specialists, make a complete examination. Your condition is frankly explained to you with the cost of treatment you need. Your decision is then made. Treatments are so mild that hospitalization

is not necessary—a considerable saving in expense.

#### RECTAL COLON

Are often associated with Glandular Inflammation. We can treat these for you at the same time.

# FREE ILLUSTRATED BOOK

The Excelsior Institute has published a New **FREE** Book that is fully illustrated and deals with Diseases peculiar to men. Gives excellent factual knowledge and could prove of utmost importance to your future life.

Write for your **FREE** copy today.



Excelsior Institute  
Dept. B-77  
Excelsior Springs, Mo.

Gentlemen: Kindly send me at once your New **FREE** Book on

Diseases peculiar to men. I am.....years old.

Name.....

Address.....

City.....State.....

## NEW! WORLD'S SMALLEST PRECISION 2 SUPER POWER Transistor Radio



- Printed circuit with power pack.
- Plays instantly. No warm-up.
- "impact-resistant" plastic case.

Not a toy! Professionally engineered precision high-powered set, guaranteed to far out-perform any 1 transistor set. Tunes local broadcast stations with clear tone. No "ground" connections or cumbersome aerial wires. Features permeability tuning, diode detection, hermetically sealed transistors. Full size 2" x 3" x 3/4". Smaller than a cigarette pack. Operates months on 2 pen cells. Plays anywhere; at beach, on boat, ball game or golf course. Lets you listen to programs in full privacy. Ideal for Civil Defense receiver. Exclusive =430 printed circuit with power pack shows many hook-ups. Easily assembled by anyone.

Eastern Audio Research Corp.  
P.O. Box 2, Huntington Sta., N.Y.

**COMPLETE RADIO KIT \$12.95**  
ppd.  
Exclusive 8,000 ohm hearing aid ear set \$3.95 ppd.  
Send only \$1. Pay postman balance plus COD charges.

## MONEY for MEN ALL DATA FREE

THE PLASTEX Industry needs manufacturers on small scale and for big production of Lamp and Clock Stands, Art Goods and Novelties in Plastex and Marble imitation. Experience unnecessary. 1/2c material makes regular 10c store sellers. Rubber moulds furnished for speed production. Small investment brings good returns. We are now placing big chain store orders with manufacturers. Ambitious men have chance for real prosperity. Our Free booklet will interest and benefit you.

PLASTEX INDUSTRIES, Dept. 2, 3400 Third Ave., New York 56, N. Y.

## LEARN TO BECOME A GAME WARDEN

or join **FORESTRY, Lookout or Wildlife Services.** Excellent opportunities open! Good pay (\$2,500 to \$10,800 a year), Pleasant Work, Prestige, Real Security, Healthful Working Conditions, and Retirement Income all can be yours. Help us fill huge demand in your area. Make your Love of the outdoors become your business. Learn at home in spare time—Easy! No experience needed! **FREE!** (If over 17 years old.) Complete, Illustrated booklet that tells you everything necessary. **SUPPLY LIMITED**—so send name and address now—today.

HOME STUDY EDUCATORS, Dept. N11, 1036 S. LaBrea, Los Angeles 5, Calif.



## When Writing to Advertisers Please Mention Popular Science



## HANDS TIED?

—because you lack a **HIGH SCHOOL DIPLOMA**

• You can qualify for an American School Diploma *in spare time at home!* If you have left school, write or mail coupon for **FREE** booklet that tells how. No obligation of any kind.

### OUR 58TH YEAR

**AMERICAN SCHOOL, Dept. V846**  
Drexel at 58th, Chicago 37, Illinois

Please send **FREE** High School booklet.

Name.....

Address.....

City & State.....

Canadian Residents: Complete Canadian Course Available. Write American School, 1610 Sherbrooke St. West, Montreal.



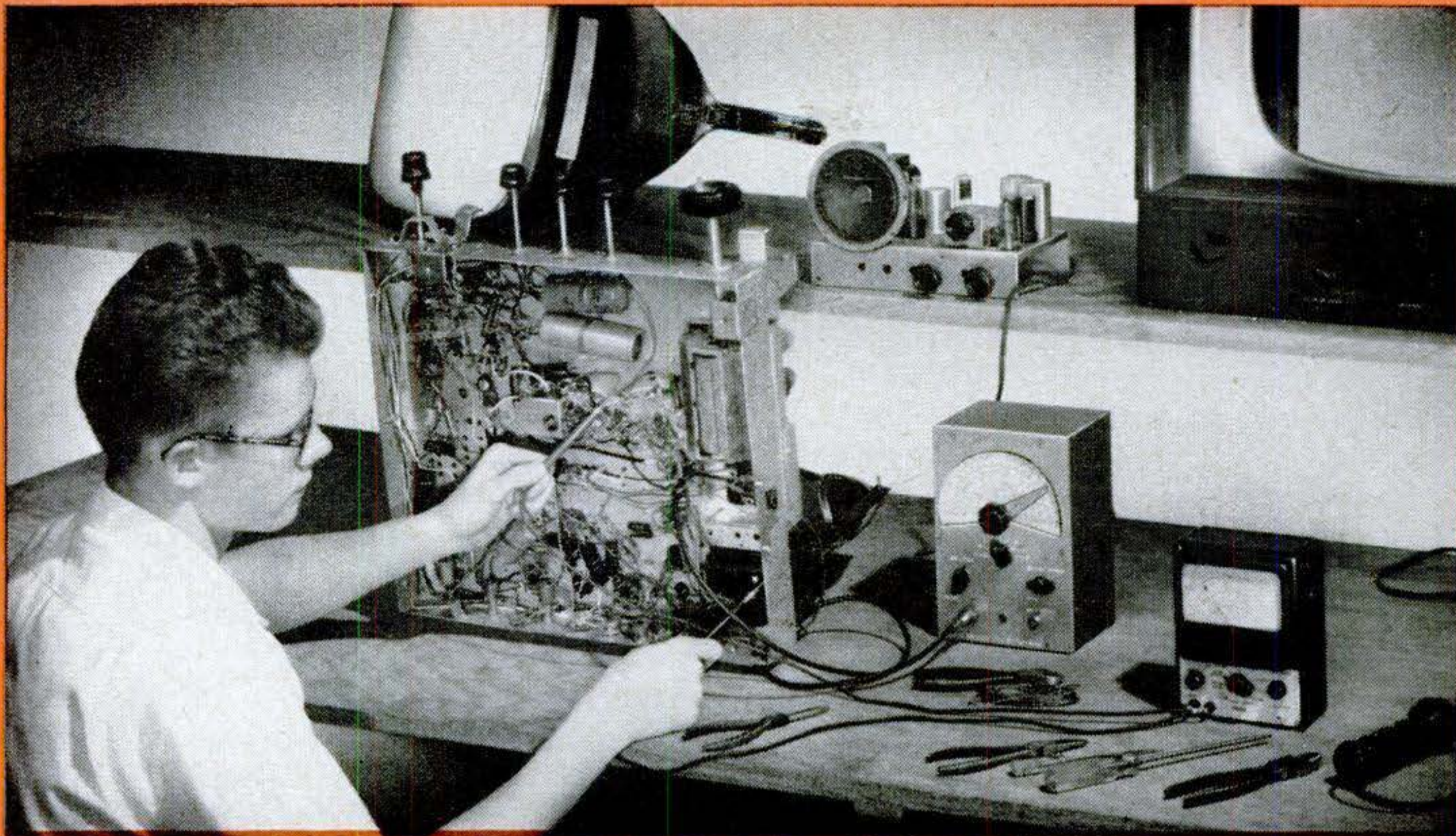

# NOW...RCA trains you at home to be an expert technician in

## RADIO TV ELECTRONICS • TV SERVICING • COLOR TV SERVICING

### NOW THREE HOME STUDY COURSES

... prepared by instructors of RCA Institutes in cooperation with technicians, engineers, and training specialists of RCA. Clearly written ... easy to understand ... the same high caliber instruction as given in resident classrooms of RCA INSTITUTES.

#### ● COURSE I—RADIO-TELEVISION ELECTRONICS

—starts you from the ground up to a solid working knowledge of electronics. Without any previous experience, you get a thorough training in radio theory and servicing techniques for AM, FM, home and car radios ... plus an introduction to the fundamental theory and practices of television.

#### ● COURSE II—TELEVISION SERVICING

—prepares you to advance from radio into the expanding field of television servicing as a well-trained service technician. If you have completed Course I or are now working in the field of radio or TV, Course II will show you the many special techniques of trouble-shooting, aligning, checking, and repairing modern black and white TV sets.

### NEW TV KIT AVAILABLE WITH COURSE II

—there is no better way to learn than by *doing* and RCA Institutes has developed a large-screen TV KIT available to home study students to build while taking Course II. It has the most modern up-to-date circuitry, actually enabling you to apply at home all the latest servicing techniques.

#### ● COURSE III—COLOR TELEVISION SERVICING

—covers all phases of color servicing techniques. It is a practical, down-to-earth course in color theory as well as how-to-do-it servicing procedure. A natural move "up" from Course II or for those now employed in TV.

**SINCE 1909, RCA INSTITUTES** has trained thousands for successful careers in electronics. Many gradu-

ates have established their own paying business. Now this opportunity is available to you at home.

#### "PAY-AS-YOU-LEARN" PLAN

... you pay for one study group at a time, as you progress through the course. Tuition costs are amazingly low. For full details, mail coupon.

**A SERVICE OF RADIO CORPORATION OF AMERICA—RCA INSTITUTES** is licensed by the N. Y. State Education Department ... recommended by radio and television service organizations.

**SEND FOR  
FREE  
CATALOG  
NOW**



RCA Institutes, Inc., Home Study PS-115  
350 West Fourth Street, N.Y. 14, N. Y.

Without obligation, send me FREE CATALOG on Home Study Courses in Radio, Television and Color TV. No salesman will call.

Name \_\_\_\_\_  
Please Print

Address \_\_\_\_\_

City \_\_\_\_\_ Zone \_\_\_\_\_ State \_\_\_\_\_



**RCA INSTITUTES, INC.**

A SERVICE OF RADIO CORPORATION of AMERICA  
350 WEST FOURTH STREET, NEW YORK 14, N.Y.



# DIESEL

## MECHANICS IN DEMAND

Learn to earn big pay in DIESEL in our large, modern equipped Chicago school and shop. No previous experience or training necessary. We help you find living quarters and part time job while in school.

Complete, practical courses taught in the following trades, under the supervision of experienced, expert technicians.

APPROVED FOR CIVILIANS  OR GI'S

### —CHOOSE YOUR TRADE—

CHECK HERE	WEEKS
<input type="checkbox"/> DIESEL MECHANICS	20
<input type="checkbox"/> AUTO MECHANICS	20
<input type="checkbox"/> BODY & FENDER	16 <sup>2</sup> / <sub>3</sub>
<input type="checkbox"/> GAS-ARC WELDING	4-12
<input type="checkbox"/> REFRIGERATION	13 <sup>1</sup> / <sub>2</sub>
<input type="checkbox"/> AIR CONDITIONING	8 <sup>1</sup> / <sub>3</sub>
<input type="checkbox"/> MACHINIST TRADE	30
<input type="checkbox"/> ADVANCED MACHINIST (includes tool & die)	32 <sup>1</sup> / <sub>2</sub>
<input type="checkbox"/> PIANO TUNING & REPAIR	36

### CHOOSE YOUR ENGINEERING COURSE

These courses are intended as terminal education for men who wish to enter the Diesel-Automotive and Refrigeration-Air Conditioning fields as technicians. These courses are designed to prepare men for supervisory positions. Students with a high school education, or equivalent, will be accepted.

<input type="checkbox"/> DIESEL AUTOMOTIVE ENGINEERING	2 years
<input type="checkbox"/> REFRIGERATION & AIR COND. ENGINEERING	18 months

### FREE EMPLOYMENT HELP

Start your career with Greer by checking your interest above and mail coupon for complete information at no obligation.

NAME \_\_\_\_\_ AGE \_\_\_\_\_

STREET \_\_\_\_\_

TOWN \_\_\_\_\_ ZONE \_\_\_\_\_ STATE \_\_\_\_\_

Established 1902—Over 50,000 Graduates  
53 years of continuous trade school experience to guide your training.

**GREER SHOP TRAINING**

Box K, 2238 S. Michigan Ave.  
Chicago 16, Illinois



LOW OVERHEAD-LARGE VOLUME SALES & SMALL PROFITS

BRING YOU THESE "LOWEST PRICES."

EXPERIENCE IS THE BEST TEACHER. AN ESTABLISHED POLICY OF CAREFUL SELECTION ASSURES YOU MANY HAPPY MILES. BE WISE—TRY ONE—YOU'LL BUY MORE! WE WELCOME COMPETITION. NO ONE CAN TOUCH OUR QUALITY & PRICE!

22 YEARS AT THIS ADDRESS.

If you have a car, sooner or later you'll buy from us.

PARTIALLY USED TIRES—NOT RECAPS



**FREE**—If you buy 2 or MORE Passenger 4 ply tires, we give one tire FREE, on Ea. Order, on Request, Does not include W.W. Truck tires-Free Tube.

Specialists in Truck Tires—Selected for Toughest Jobs—Tops in Value

36 MOS.	WRITTEN GUARANTEE	WITH EVERY TIRE
600-16 \$5.35	475-19 \$4.75	700-15 (6) 7.15
600-16 (6) 5.75	640-15 4.25	700-20 \$8.95
650-16 5.75	670-15 5.15	750-16 (8) 10.55
650-16 (6) 6.45	710-15 5.45	700-17 7.85
700-16 5.75	760-15 5.45	750-17 10.35
750-16 (6) 7.55	800-15 5.75	825-15 12.95
550-18 4.55	820-15 5.75	600-20 8.05
550-17 3.75	670-16 5.35	650-20 8.35
650-15 5.35	760-16 7.05	32x6 (8) 11.05
700-15 4.95	700-16 (6) 7.15	32x6 (10) 13.95
		750-15 10.75
		750-20 (10) 15.75
		750-20 (8) 9.85
		825x20 16.65
		900-20 15.55
		1000-20 15.75
		1100-20 17.45
		1100-22 18.95
		1000-22 16.75
		1100-24 23.05

"EXTRA SPECIAL" Some near New all size 4-ply pass. FREE TIRE with 2 or more of these also.—W.W. \$1.00 \$7.65 Extra Factory Tested Tube given. GIANT TIRE SALE EA.



**SNOW TIRES**

\$8.55 Order any 4 Ply Passenger Size Black Wall

FACTORY RETREAD SNOW TIRES and others 30 Mo. Guar.

Thousands of tires shipped all over the U.S.A. All tires shipped F.O.B. Phila. Send Check or M.O. with this ad. Dept. 5, No C.O.D.

STANDARD 834 N. Broad St., Philadelphia 30, Pa.

### BUILD LUGGAGE AT HOME! WE SELL YOUR PRODUCTS!

Only New Home Money-Making Plan in Years!

Make Luggage and cases for traveling, photographers, musicians, salesmen, electronics, tools, portables, 1001 other items. Also repair Luggage. No special equipment needed. BIG Profits. We supply complete instructions, materials—everything. Write for free details and Business Plan. ABARSI CASE-CRAFT, Dept. H, 805 W. Sunset Blvd., Los Angeles 12, Calif.

### CABINET MAKING



LOW COST HOME TRAINING COURSE FOR BEGINNERS & ADVANCED CRAFTSMEN

Make money. Learn skills and secrets of fine woodworking and tool use. Professionally prepared shop method training tells and shows how. Covers everything. Easy to master.

Write for Free Booklet

INTERSTATE TRAINING SERVICE

DEPT. F2, PORTLAND 13, OREGON

### MAKE MORE MONEY IN AVIATION

SAVE 2 YEARS GETTING STARTED

Northrop Institute trains you in Aeronautical Engineering or Aircraft and Engine Mechanics, quickly, thoroughly. Demand for Northrop graduates exceeds supply. Courses approved for

Veterans. WRITE TODAY FOR FREE CATALOG. Give age and veteran status.



MAIL TO

NORTHROP AERONAUTICAL INSTITUTE  
1157 W. Arbor Vitae Street, Inglewood 1, California

### ARTHRITIS?

I have been wonderfully blessed in being restored to active life after being crippled in nearly every joint in my body and with muscular soreness from head to foot. I had Rheumatoid Arthritis and other forms of Rheumatism; hands deformed and my ankles were set.

Limited space prohibits telling you more here! But if you will write me I will reply at once and tell you how I received this wonderful relief!

Mrs. Lela S. Wier

2805 Arbor Hills Drive—70

P. O. Box 2695.

Jackson 7, Mississippi



# HERE'S THE MOST POWERFUL ASTRONO-SCOPE\* WE EVER SOLD UNDER \$10



\*Reg. U. S. Pat. Office

- YOU GET**
- 1—75 Power Telescope
  - 2—Aluminum Tripod
  - 3—Universal Mount
  - 4—108 Page Book "Discover the Stars"

**ALL FOR ONLY**  
**\$9.95**  
COMPLETE POST PAID

A fabulous saving . . . but it's our way of making friends! Yes, here's a rare opportunity to get a genuine Astrono-scope — Criterion's exclusive, powerful 20X, 40X, 75X telescope! It's 3 feet long, is finished in brass, has 4 precision lenses that bring the moon, stars, birds, planets, planes, ships, targets, people — all distant objects — 75 times closer, 75 times clearer and gives you 5,625 times area magnification, the instant you focus it! The Astrono-scope is versatile — can be used as powerful compound microscope. Folds to fit glove compartment of car, brief case, purse, etc. Special introductory price, only \$9.95 . . . and you get FREE all-aluminum tripod with non-skid rubber tips . . . FREE universal mount for steady viewing from any angle . . . FREE 108-page book "Discover the Stars" — not a booklet, but real book! What a value! Supply limited . . . act now! All four beautifully boxed. Money back in full if not 100% enthused! Hurry, send check or money order. We pay shipping charges.

Remember Only We Have The Amazing,  
Powerful 75 Power Astrono-scope That Brings The  
**MOON, STARS, BIRDS, JET PLANES, SHIPS,  
SCENERY, TARGETS, PEOPLE, ANIMALS**  
**EVERYTHING 75 TIMES BIGGER!**  
MAGNIFIES AREA 5,625 TIMES!

**DON'T BE FOOLED** by small power telescopes. For example: 12 power telescopes give you only 144 times area magnification. Our 75 Power Astrono-scope Gives You 5,625 Times Area Magnification.

Remember, It's The Power That Counts!

**CRITERION MFG. CO.**

331 Church St., Dept. PSA-6  
Hartford, Conn.



## CASTING SECRETS REVEALED!

Now you can learn how to make big money by casting thousands of perfect plaques, book ends, figurines, etc., with X.L. rubber molds. **NO EXPERIENCE, VERY LITTLE CAPITAL NEEDED**. X.L., Rubber, Pts. \$2.50; Qts. \$4.00 (postage extra). Molds and enough rubber for three molds, \$1.50 prepaid. U.S. only. Send 25c (refunded with order) for informative catalog (40 pages) describing this wonderful, exciting Profit-making business.

**HUGE PROFITS!  
MORE MONEY!**

**PLASTIC ARTS STUDIO** 3403 S. MADISON, DEPT. 3  
MUNCIE, INDIANA

## LAW FREE BOOK

THE LAW TRAINED MAN

Write today for a FREE copy of illustrated law book, "THE LAW-TRAINED MAN," which shows how to earn the professional Bachelor of Laws (LL.B.) degree through home study of the famous Blackstone Law Course. All necessary books and lessons provided. Moderate cost; convenient monthly terms. Write for FREE law training book today.

**Blackstone School of Law, 225 N. Michigan Ave.**  
Founded 1890 Dept. 128, Chicago 1, Ill.

# Get into.. PLASTIC LAMINATING AT HOME!



**THIS MAN . . .**  
... is taking out of the machine a Plastic Sealing Job — ordered by mail — only 11c in material cost brings back \$2.58 in cash by mail. Capacity of machine: **\$25.00 profit per hour of operation.**

Get **ORDERS** and **CASH** from your mailman—do work in **SPARE TIME** at home — or expand into **FULL TIME** business. Send coupon for Free facts about the newest and most fascinating of all home operated businesses. For the first time a simplified machine brings the fabulous profits of **Plastic Sealing** and **Plastic Laminating** within the reach of the small operator. Anyone can learn to operate the machine with a few minutes practice—then with our **Magic Mail Plan** can get mail orders pouring in daily with cash in every envelope. **No canvassing—no selling.** We even

**Make \$20 to \$30 a Day by..  
MAGIC MAIL PLAN!**

supply the circulars you mail to bring back cash and orders. Don't waste a minute. Rush your name. We'll send you FREE and postpaid, pictures, prices, details, and all the facts you need to start. Mail coupon or send name on postcard. No charge. Warner Electric Co., 1512 Jarvis Av., Dept. L-9-M, Chicago 26, Illinois

**Make Thousands of Beautiful Art Creations**  
**COSTUME JEWELRY • CIGARETTE BOXES  
TRAYS • CANDLESTICKS • COASTERS  
LAMP BASES • BOOK ENDS...ALL IN  
SPARKLING COLORED PLASTIC**



**WARNER ELECTRIC CO., 1512 Jarvis Av.**  
Dept. L-9-M, Chicago 26, Ill.

At no cost to me, please rush complete details postage prepaid. I am under no obligation.

Name \_\_\_\_\_

Address \_\_\_\_\_

City \_\_\_\_\_ Zone \_\_\_\_\_ State \_\_\_\_\_





Easy as A-B-C



# Be Your Own MUSIC Teacher

PLAY ANY INSTRUMENT

LEARN AT HOME THIS QUICK MONEY-SAVING WAY

Simple as A-B-C. Your lessons consist of real selections, instead of tiresome exercises. You read real notes—no "numbers" or trick music. Some of our 900,000 students are band LEADERS. Everything is in print and pictures. First you are told what to do. Then a picture shows you how. Then you play it yourself and hear how it sounds. Soon you are playing your favorite music.

STOP CHEATING YOURSELF OF THESE JOYS!

Popularity! New friends. Gay parties. Good times. Career. Extra Money. Understand, appreciate and converse about music. Learn lives and compositions of modern and great masters . . . Relax! Banish worries and frustrations. Satisfy self-expression, creative urge. Gain self-confidence.

Mail coupon for Free 36-page illustrated book. Mention your favorite instrument. U. S. SCHOOL OF MUSIC, Studio A1511, Port Washington, N. Y.

FREE BOOKLET

U. S. SCHOOL OF MUSIC, Studio A1511  
Port Washington, N. Y.

Please send me your FREE 36-page illustrated book. I would like to play (Name Instrument).

Instrument . . . . . Have you Instrument? . . . . .

Name . . . . . (Print Name)

Address . . . . .

# 30 BOAT PLANS 50¢

## OWN THE "BOAT OF YOUR DREAMS"

You'll find just the boat you want in the BOAT BUILDER'S HANDBOOK. Complete bills of materials, step-by-step instructions, and scores of photos and diagrams, make it easy to build YOUR boat. Each boat is skillfully engineered for fast assembly, specially designed for ease of construction, safety, strength, seaworthiness. Here are the 30 boat plans you get:

- 11-ft. Speedy Class B Racer
- 12-ft. Outboard Hydroplane
- 11-ft. Speed Outboard Runabout
- 14-ft. De Luxe Sports Runabout
- 8-ft. Lightning Fast Hydroplane
- 10-ft. Catamaran
- 12-ft. Multi-Purpose Boat
- 14-ft. Outboard Hydroplane
- 13½-ft. Speedy Inboard Runabout
- 16-ft. Double Cockpit Runabout
- 12½-ft. Outboard Runabout
- 15-ft. Outboard Sports Cruiser
- 18-ft. Luxury Cabin Cruiser
- 16-ft. Inboard Cruiserette
- 15½-ft. Scow Type Cruiserette
- 13-ft. Open Utility Outboard
- 9-ft. Pram
- 9-ft. All-Purpose Dinghy
- 13-ft. V-Bottom Skiff
- 13-ft. Utility Boat
- 14-ft. Flat Bottom Rowboat
- 27½-ft. Auxiliary Cruiser
- 14-ft. Sporty Sailboat
- 12-ft. Inland Scow Racer
- 12-ft. Sailer
- 10-ft. Fold-Up Boat
- 16-ft. Salt Water Fishing Boat
- 14-ft. MacKenzie River Boat
- 10-ft. Canvas Kayak
- 3½-ft. Pint-Sized Sailer



## Build Your Own Boat! It's Easy!

Now you can build your own boat! From an 8 ft. Lightning Hydroplane to a 28-ft. Auxiliary Cruiser, it's easy and it's fun, with the

### BOAT BUILDER'S HANDBOOK

. . . the encyclopedia for the amateur boat builder. Think how proud you'll be when YOUR boat hits the water for the first time!

This big, 192-page handbook gives plans and complete instructions for building 30 Different Boats. Also explains how to make a boat trailer, launching and beaching dolly, boat canopy, motor bracket for canoes, plus a choice collection of handy kinks for boat owners.

Send 50¢ today (No C.O.D.'s) for Vol. 5 this big handbook.

SCIENCE AND MECHANICS MAGAZINE  
450 E. Ohio St., Dept. 1155  
Chicago 11, Illinois



## FULLY GUARANTEED TIRES COST LESS!

Nationally famous FIRESTONE, GOOD-RICH, U.S. ROYAL, GOODYEAR, and other makes. Every tire selected and inspected for your safety.

BUY WITH CONFIDENCE FROM PYRAMID TIRE

WHITE WALL TIRES \$1 EXTRA

HIGH GRADE TIRES GUARANTEED 12 MONTHS							
600x16	4.14	700x16	5.14	32x6(8)	8.84	825x20	14.24
650x16	4.54	670x15	4.74	32x6(10)	10.84	900x20	13.34
650x15	4.34	650x20	7.84	750x20(8)	8.54	1000x20	14.14
700x15	4.64	700x20(8)	8.94	750x20(10)	9.94	1100x20	16.14

AAA PREMIUM GRADE GUARANTEED 18 MONTHS							
590x15	5.48	700x15	5.98	760x15	5.58	750x20(10)	14.98
600x16	5.28	700x16	6.78	550x17	5.48	825x20	18.68
600x16(6)	6.58	700x16(6)	7.98	600x20	9.78	900x20	18.98
640x15	5.68	750x16(6)	8.98	650x20	10.88	1000x20	19.98
650x16	5.78	800x15	6.88	700x20	12.88	1000x22	21.98
650x16(6)	6.98	820x15	7.48	700x17	8.96	1100x20	20.98
650x15	5.98	710x15	6.09	32x6(10)	12.48	700x18	10.98
		550x18	5.98	750x20(8)	12.98	750x17	11.98

MILITARY SPECIAL	AA Guaranteed 12 Months—	New Tread Guar. 24 Mos.
	900x16 10.69   1000x20 19.98	600x16 8.98
	750x20 10.98   1100x20 21.98	600x16 (6) 9.98
	AA GUARANTEED 18 MONTHS	700x15 (6) 15.95
	900x16 14.98   750x20 16.48	750x20 (8) 24.98

Largest stock of used tires in the East. Thousands of satisfied customers. Write for Free Catalogue. MONEY ORDER OR CHECK WITH ORDER. NO C.O.D.'s

**PYRAMID TIRE CO.**  
1333-35 North 5th St. Dept. S, Phila. 22, Pa.

## AMAZING NEW POCKET RADIO



Really Works—Small as a Pack of Cigarettes!  
FITS IN ANY POCKET OR PURSE—GETS LOCAL RADIO STATIONS WITH CLEAR BELL-LIKE TONE—NO STATIC OR INTERFERENCE! NEEDS NO TUBES, BATTERIES OR COMPLICATED HOOKUPS! NO AC PLUG INS! Nothing to wear out. Thousands of users—many report years of service. Uses new crystal diode and HI-Q coil. SELF-CONTAINED SPEAKER PHONE. Just the tiny radio to take with you ANYWHERE YOU GO—ON TRIPS, VISITING, ETC.—for real fun and enjoyment—ANYTIME. SEND ONLY \$1.00 (bill, ck., mo.) and pay postman \$3.99 C.O.D. postage or send \$4.99 for p.p. delivery. COMPLETE READY TO LISTEN. MIDWAY CO., Dept. PPS-11, Kearney, Nebr.

## TASOPE PHOTO-ENGRAVING PLANTS



Establish your own profitable PHOTO-ENGRAVING business. Make cuts for newspapers, printers, and advertisers. Make etched name plates, plaques etc. Instructions furnished, no experience necessary. Sold direct from factory since 1931. First five hundred cuts sold locally or by mail will pay for plant and pay you well for your time. Write for FREE catalog. TASOPE, DEPT. PS-11, AURORA, MO.

## STAMP COLLECTORS 308 DIFFERENT STAMPS 25¢

Including scarce Trieste collection; United Nations Issue. Olympics. Latest wild animal set—in gorgeous multi-color showing the Lynx, Bear, Chamois, Deer, etc. Stamps from riot-torn Trieste are becoming very scarce. These are only part of the big collection of 308 all different foreign stamps Cataloging \$7.00 that you get for only 25¢ to introduce our approvals.

IDEAL STAMP CO., Dept. 3C, P. O. Box 64  
West Farms Station, New York 60, N.Y.

## MAKE \$5 PER HOUR WITHOUT A PRINTING PRESS

**PRINTING** REVOLUTIONARY NEW SCREEN METHOD

PRINT colorful signs, posters, banners, fabrics, wall paper, show cards—ANYTHING! Print on any surface. NO printing press or special equipment is needed with this amazing "approved" new printing secret. 300% profit on nearly every job. Easy to learn —NO EXPERIENCE or art ability necessary. Exceptional opportunity. Complete illustrated detailed plan and colorful sample FREE—Write: SCREEN-PRINT COMPANY Dept. 1B 15127 S. Broadway, Los Angeles 61, Calif.

FREE complete "BIG MONEY" Plan and SAMPLE!

EARN AT HOME SPARE or FULL Time



# "Here's your MOST PRACTICAL way to get an education!"

says I.C.S. graduate **T. W. PUTNAM**  
**Retail Sales Promotion Mgr.**  
**Fresh Milk & Ice Cream Division**  
**Carnation Company**

"From my experience, it appears that the most practical way to get an education is to study with I. C. S.

"First of all, you study alone, with no distraction from others. You lose no time in travel. Your home is your schoolroom.

"Second, you must know your subject—I. C. S. insists on this.

"And third, the lesson you study this evening is put to use the next day, increasing your income, your prestige and your importance to the firm you represent.

"I have recommended I. C. S. to many men. And all those who followed my advice have advanced in position and income."

Will you be next to consider Mr. Putnam's recommendation? Here's the coupon to mark and mail!

**I. C. S.** is the oldest and largest correspondence school. 277 courses. Business, industrial, engineering, academic, high school. Direct, job related. Bedrock facts and theory plus practical application. Complete lesson and answer service. No skimping. Diploma to graduates.

**For Real Job Security—Get an I. C. S. Diploma! I. C. S., Scranton 9, Penna. Member, National Home Study Council**



## 3 FREE BOOKS—

(1) 36-page pocket guide to advancement, a gold mine of information on "How to Succeed." (2) Complete catalog outlining opportunities in your field of interest. (3) Sample lesson demonstrating I. C. S. method. Mail coupon NOW!

## INTERNATIONAL CORRESPONDENCE SCHOOLS

**ICS**

**BOX 91314L, SCRANTON 9, PENNA.**

(Partial list of 277 courses)

Without cost or obligation, send me "HOW TO SUCCEED" and the opportunity booklet about the field BEFORE which I have marked X (plus sample lesson):

- |  |   |  |   |  |
|--|---|--|---|--|
| <p><b>ARCHITECTURE and BUILDING CONSTRUCTION</b></p> <ul style="list-style-type: none"> <li><input type="checkbox"/> Air Conditioning—Refrig.</li> <li><input type="checkbox"/> Architecture</li> <li><input type="checkbox"/> Architectural Interior</li> <li><input type="checkbox"/> Building Contractor</li> <li><input type="checkbox"/> Building Maintenance</li> <li><input type="checkbox"/> Carpenter and Mill Work</li> <li><input type="checkbox"/> Estimating</li> <li><input type="checkbox"/> Heating</li> <li><input type="checkbox"/> Painting Contractor</li> <li><input type="checkbox"/> Plumbing</li> <li><input type="checkbox"/> Reading Arch. Blueprints</li> </ul> <p><b>ART</b></p> <ul style="list-style-type: none"> <li><input type="checkbox"/> Cartooning</li> <li><input type="checkbox"/> Commercial Art</li> <li><input type="checkbox"/> Fashion Illustrating</li> <li><input type="checkbox"/> Magazine Illustrating</li> <li><input type="checkbox"/> Show Card and Sign Lettering</li> <li><input type="checkbox"/> Sketching and Painting</li> </ul> <p><b>AUTOMOTIVE</b></p> <ul style="list-style-type: none"> <li><input type="checkbox"/> Auto Body Rebuilding</li> <li><input type="checkbox"/> Auto Elec. Technician</li> <li><input type="checkbox"/> Auto-Engine Tune Up</li> <li><input type="checkbox"/> Automobile</li> </ul> | <p><b>AVIATION</b></p> <ul style="list-style-type: none"> <li><input type="checkbox"/> Aeronautical Engineering Jr.</li> <li><input type="checkbox"/> Aircraft &amp; Engine Mechanic</li> </ul> <p><b>BUSINESS</b></p> <ul style="list-style-type: none"> <li><input type="checkbox"/> Advertising</li> <li><input type="checkbox"/> Bookkeeping and Accounting</li> <li><input type="checkbox"/> Business Administration</li> <li><input type="checkbox"/> Business Correspondence</li> <li><input type="checkbox"/> Public Accounting</li> <li><input type="checkbox"/> Creative Salesmanship</li> <li><input type="checkbox"/> Federal Tax</li> <li><input type="checkbox"/> Letter-writing Improvement</li> <li><input type="checkbox"/> Office Management</li> <li><input type="checkbox"/> Professional Secretary</li> <li><input type="checkbox"/> Retail Business Management</li> <li><input type="checkbox"/> Sales Management</li> <li><input type="checkbox"/> Stenographic-Secretarial</li> <li><input type="checkbox"/> Traffic Management</li> </ul> <p><b>CHEMISTRY</b></p> <ul style="list-style-type: none"> <li><input type="checkbox"/> Analytical Chemistry</li> <li><input type="checkbox"/> Chemical Engineering</li> <li><input type="checkbox"/> Chem. Lab. Technician</li> <li><input type="checkbox"/> General Chemistry</li> <li><input type="checkbox"/> Natural Gas Prod. &amp; Trans.</li> <li><input type="checkbox"/> Petroleum Engineering</li> <li><input type="checkbox"/> Plastics</li> <li><input type="checkbox"/> Pulp and Paper Making</li> </ul> | <p><b>CIVIL, STRUCTURAL ENGINEERING</b></p> <ul style="list-style-type: none"> <li><input type="checkbox"/> Civil Engineering</li> <li><input type="checkbox"/> Construction Engineering</li> <li><input type="checkbox"/> Highway Engineering</li> <li><input type="checkbox"/> Reading Struct. Blueprints</li> <li><input type="checkbox"/> Sanitary Engineering</li> <li><input type="checkbox"/> Structural Engineering</li> <li><input type="checkbox"/> Surveying and Mapping</li> </ul> <p><b>DRAFTING</b></p> <ul style="list-style-type: none"> <li><input type="checkbox"/> Aircraft Drafting</li> <li><input type="checkbox"/> Architectural Drafting</li> <li><input type="checkbox"/> Electrical Drafting</li> <li><input type="checkbox"/> Mechanical Drafting</li> <li><input type="checkbox"/> Mine Surveying and Mapping</li> <li><input type="checkbox"/> Plumbing Drawing and Estimating</li> <li><input type="checkbox"/> Structural Drafting</li> </ul> <p><b>ELECTRICAL</b></p> <ul style="list-style-type: none"> <li><input type="checkbox"/> Electrical Engineering</li> <li><input type="checkbox"/> Electrical Maintenance</li> <li><input type="checkbox"/> Electrician <input type="checkbox"/> Contracting</li> <li><input type="checkbox"/> Lineman</li> </ul> <p><b>HIGH SCHOOL</b></p> <ul style="list-style-type: none"> <li><input type="checkbox"/> Commercial <input type="checkbox"/> Good English</li> <li><input type="checkbox"/> High School Subjects</li> <li><input type="checkbox"/> Mathematics</li> </ul> | <p><b>LEADERSHIP</b></p> <ul style="list-style-type: none"> <li><input type="checkbox"/> Foremanship</li> <li><input type="checkbox"/> Industrial Supervision</li> <li><input type="checkbox"/> Leadership and Organization</li> <li><input type="checkbox"/> Personnel-Labor Relations</li> </ul> <p><b>MECHANICAL AND SHOP</b></p> <ul style="list-style-type: none"> <li><input type="checkbox"/> Gas—Electric Welding</li> <li><input type="checkbox"/> Heat Treatment <input type="checkbox"/> Metallurgy</li> <li><input type="checkbox"/> Industrial Engineering</li> <li><input type="checkbox"/> Industrial Instrumentation</li> <li><input type="checkbox"/> Industrial Supervision</li> <li><input type="checkbox"/> Internal Combustion Engines</li> <li><input type="checkbox"/> Machine Design-Drafting</li> <li><input type="checkbox"/> Machine Shop Inspection</li> <li><input type="checkbox"/> Machine Shop Practice</li> <li><input type="checkbox"/> Mechanical Engineering</li> <li><input type="checkbox"/> Quality Control</li> <li><input type="checkbox"/> Reading Shop Blueprints</li> <li><input type="checkbox"/> Refrigeration</li> <li><input type="checkbox"/> Sheet Metal Worker</li> <li><input type="checkbox"/> Tool Design <input type="checkbox"/> Toolmaking</li> </ul> <p><b>RADIO, TELEVISION</b></p> <ul style="list-style-type: none"> <li><input type="checkbox"/> Industrial Electronics</li> <li><input type="checkbox"/> Practical Radio TV Eng'ng</li> <li><input type="checkbox"/> Radio and TV Servicing</li> <li><input type="checkbox"/> Radio Operating</li> </ul> | <ul style="list-style-type: none"> <li><input type="checkbox"/> Television Technician</li> </ul> <p><b>RAILROAD</b></p> <ul style="list-style-type: none"> <li><input type="checkbox"/> Air Brakes <input type="checkbox"/> Car Inspector</li> <li><input type="checkbox"/> Diesel Locomotive</li> <li><input type="checkbox"/> Locomotive Engineer</li> <li><input type="checkbox"/> Section Foreman</li> </ul> <p><b>STEAM AND DIESEL POWER</b></p> <ul style="list-style-type: none"> <li><input type="checkbox"/> Combustion Engineering</li> <li><input type="checkbox"/> Diesel—Elec. <input type="checkbox"/> Diesel Eng's</li> <li><input type="checkbox"/> Electric Light and Power</li> <li><input type="checkbox"/> Stationary Fireman</li> <li><input type="checkbox"/> Stationary Steam Engineering</li> </ul> <p><b>TEXTILE</b></p> <ul style="list-style-type: none"> <li><input type="checkbox"/> Carding and Spinning</li> <li><input type="checkbox"/> Cotton, Rayon, Woolen Mfg.</li> <li><input type="checkbox"/> Finishing and Dyeing</li> <li><input type="checkbox"/> Loom Fix'g <input type="checkbox"/> Textile Des'ing</li> <li><input type="checkbox"/> Textile Eng'g <input type="checkbox"/> Throwing</li> <li><input type="checkbox"/> Warping and Weaving</li> </ul> <p><b>MISCELLANEOUS</b></p> <ul style="list-style-type: none"> <li><input type="checkbox"/> Domestic Refrigeration</li> <li><input type="checkbox"/> Marine Engineering</li> <li><input type="checkbox"/> Ocean Navigation</li> <li><input type="checkbox"/> Professional Engineering</li> <li><input type="checkbox"/> Short Story Writing</li> <li><input type="checkbox"/> Telephony</li> </ul> |
|--|---|--|---|--|

Name \_\_\_\_\_ Age \_\_\_\_\_ Home Address \_\_\_\_\_

City \_\_\_\_\_ Zone \_\_\_\_\_ State \_\_\_\_\_ Working Hours \_\_\_\_\_ A.M. to P.M. \_\_\_\_\_

Occupation \_\_\_\_\_

Canadian residents send coupon to International Correspondence Schools, Canadian, Ltd., Montreal, Canada. . . . Special tuition rates to members of the U. S. Armed Forces.



# LINGUAPHONE

MAKES IT EASY TO LISTEN and LEARN to  
*Speak*

**SPANISH** [ New World or European ] • **FRENCH**  
**GERMAN** • **ITALIAN** • **RUSSIAN**  
**MODERN GREEK** — Any of 34 languages available  
for **10 DAY FREE TRIAL**

With LINGUAPHONE—The World's Standard Conversational Method—You Start to SPEAK another language TOMORROW—or IT COSTS YOU NOTHING!

For just 20 Minutes a Day you listen to Linguaphone's life-like recordings. It is easy—AND FUN—to learn another language AT HOME with LINGUAPHONE—the same natural way you learned to speak before you went to school.

Only LINGUAPHONE brings the world's best native language teachers into your home. You hear these men and women speak about everyday matters in their native tongue. YOU understand—you SPEAK correctly as they do. It's like living in another country.

That's why Linguaphone is used 'round the world by educators, governments and business firms. More than a million home-study students of all ages.

### 10-DAY FREE TRIAL

Send today for Free booklet that tells about Linguaphone and how you may obtain a COMPLETE Course-unit in the language you choose on 10-day FREE TRIAL.



Linguaphone Institute. Phone: Circle 7-0830  
T-147-115 Radio City, New York 20, N. Y.  
Please send me your FREE Book about Linguaphone plus details of 10-DAY FREE TRIAL. No obligation, of course.

Language interest .....

Name .....

Address .....

City..... Zone... State.....

Leaders for Over Half a Century in Up-to-Date Modern Language Courses

## How Much Do you Want to Make?

**\$15<sup>20</sup>**  
AN HOUR?



"For every hour I have devoted to PRESTO, I find that I have earned an average of \$15.20 an hour."

William Wydallis, Ohio

**\$37<sup>78</sup>**  
IN 15 MINUTES?



"Friday morning in 15 minutes I had orders for 18 PRESTOS. (Profit \$37.78) By Friday evening 2 dozen were sold and orders taken for a dozen more. I had made a net profit of \$75.56 the first day."

Richard Meade, Ohio

**\$1,000<sup>00</sup>** A MONTH?



"I'm making more than \$1,000 a month with PRESTO—and I haven't touched bottom yet."

Charles Kama, Texas

### Salesmen Rave About "Sell on Sight" PRESTO Fire Extinguisher

Wouldn't you like to make the kind of money these successful men made? Then rush name, address NOW for Sales Kit, amazing money-making plans, full story of "Miracle Midget" super-effective PRESTO Fire Extinguisher everyone needs, wants, BUYS from you at only \$3.98, while you make liberal profit on each one. If you wish, request full-size Demonstrator PRESTO—only \$2.50 plus postage, C.O.D. charges. Or enclose \$2.50 now and we pay postage. Helps get fast orders—may be returned for FREE re-fill as often as you wish. Write TODAY!

Merlite Industries, Presto Division

114 East 32nd St., Dept. 16-B, New York 16, N.Y.

In Canada: Mopa Co., Ltd., 371 Dowd St., Montreal 1, P.Q.



## Piles May Lead to Chronic Ailments

**FREE BOOK—Explains the Cases and Effects**

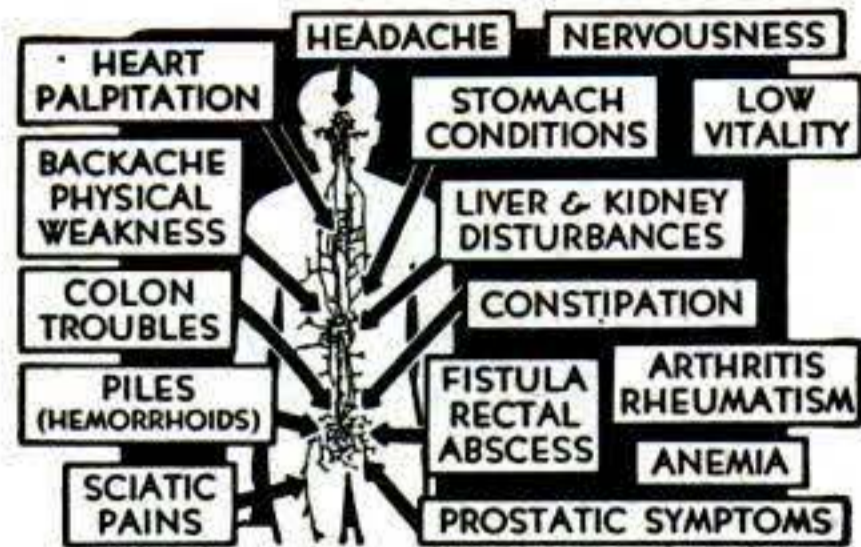

No obligation. Write to Thornton & Minor Hospital, Suite 1149  
911 E. Linwood, Kansas City 9, Mo.

## Watch Repairing Pays Big Money Learn at home



Watch repairers in great demand. Train step-by-step in 10 easy lessons. We furnish all tools and 15 jewel watch and practice movement. Turn spare time into cash. A licensed school. Low cost. Send for FREE book today.

**ILLINOIS SCHOOL OF WATCH REPAIRING**  
2870 Elston Ave., Dept. PS-115, Chicago 18, Ill.

## MAKE CERAMICS IN YOUR KITCHEN

**Make lovely vases, bowls, lamps, trays**

No special skill or equipment needed. New Della Robbia Kit contains Miracle Clay, tools, brushes, 10 glaze colors, illus. instruction book. Clay bakes hard and durable in kitchen oven. Try kit 7 days at our risk. Only \$5.95 post-paid. If not delighted return for full refund. Order from SCULPTURE HOUSE, Dept. A1111, 304 West 42nd Street, New York 36, N. Y.

## GROW MINIATURE TREES

Grow authentic, LIVE dwarf trees!  
Fascinating hobby! Fabulous profit!

**SEND FOR FREE SEED & INFORMATION!**

**MINIATURE NURSERY CLUB**

Dept. KK-11, P. O. Box 8794  
Los Angeles 8, California

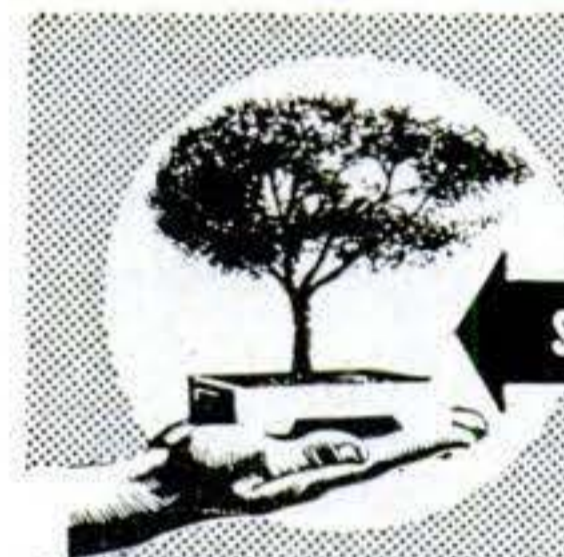

**\$2.95 EACH OR 2 FOR \$5.00!**

Genuine Telephone Company Upright Telephones, complete with cords, in tested and guaranteed condition with 50 ft. of wire, intercommunication instructions. Complete line of telephones and parts, dial, magneto, intercommunication, etc. Write for free list. All shipments F.O.B. Simpson, Pa.



**TELEPHONE ENGINEERING CO.**

Dept. 11A5

Simpson, Pa.

## MAKE MONEY WRITING

*.. short paragraphs!*

You don't have to be a trained author to make money writing. Hundreds now making money every day on short paragraphs. I tell you what to write, where and how to sell; and supply big list of editors who buy from beginners. Lots of small checks in a hurry bring cash that adds up quickly. No tedious study. Write to sell, right away. Send for free facts. **BENSON BARRETT, 1751 Morse Ave., Dept. 86-L, Chicago 26, Ill.**



# TOY DISTRIBUTORS WANTED

FULL OR SPARE TIME

**JUST \$99.50 STARTS YOUR OWN TOY DEPARTMENT CHAIN!**

**GET ON THE TOY WAGON!**

Over 250 million dollars in toys sold every day! Get your share of this tremendous volume by starting your own chain of Toy Departments **right now!** More than 35 million children under 15 constantly demand — and get, toys. These children and their millions of parents are YOUR toy customers!

**"MOMMY BUY ME A TOY!"**

This is the cry of every child — each and every time they see a toy. No mother, father or grandparent can say "NO" when their children ask for TOYTOWN high quality Toys — priced from 9¢ to 99¢! Everybody can afford them — everybody buys them!

**TOYTOWN CAROUSELS DO ALL THE WORK!**

Put the remarkable TOYTOWN "Silent Salesman" CAROUSEL to work for you 7 days a week — right now! Placed in Food Stores, Drug Stores, Beauty Shops, Laundramats — wherever people stop or shop — colorful TOYTOWN CAROUSELS are powerful and irresistible magnets. TOYTOWN Toys sell on sight! All YOU do is count profits — NET PROFITS.

**TOYTOWN TOYS GUARANTEED TO SELL!** That's right! You get a 100% iron-clad written guarantee... any slow-selling Toy, or toys left unsold after holiday seasons can be returned for a Free-Exchange. Dollar-for-Dollar! You can't lose! You must make money!

**SPARE TIME BUSINESS — FULL TIME PROFITS** Start with a single TOYTOWN CAROUSEL... it takes just 10 minutes, once each week to service. Simply replace Toys sold with new Toys... collect your money from the store owner. It's strictly a consignment and cash business — as simple as that. Yes... you can build a chain of TOY DEPARTMENTS — 5, 10 even 50 TOYTOWN CAROUSELS on your profits alone!

**DISTRIBUTORS BEING APPOINTED NOW** This is no get-rich-quick scheme but a sound opportunity for YOU to build a secure future with IMMEDIATE PROFITS! We are not interested in your financial resources or initial investment. We are interested in your reliability and desire to expand on your profits. If you are sincerely interested in a full or part-time business opportunity, mail the coupon immediately for complete detailed information. Include age, background and personal references. NO OBLIGATION WHATEVER!



YOU GET FREE "THE TOY BUSINESS AND YOU" SAMPLE GIVE-AWAY TOY COLOR PHOTO OF TOYTOWN CAROUSEL other FASCINATING INFORMATION

**IMMEDIATE ALL-YEAR INCOME**

Amen Industries, Inc., Toytown Div. — PSB  
14620 Arminta St., Panorama City, Calif.

Name \_\_\_\_\_  
Address \_\_\_\_\_  
City \_\_\_\_\_ State \_\_\_\_\_

**"TOOK IN \$217 FIRST 10 DAYS"**

Some make more, some less  
We help you to start Your Own All-Year Business

**Make Big Money!** With our easily operated, highly efficient wall washer, Chas. Stelle took in \$217 gross in first ten days. E. L. Goss took in more than \$10,000 in one year. E. C. Taber wrote, "I made \$400 gross in two weeks." And no wonder — this machine washes walls 6 times faster and better than by hand. **Your Money-making Opportunity.** Enjoy independence — freedom from bosses, layoffs. Customers everywhere — homes, offices, schools, etc. Expenses low, profits high. No shop necessary; operate from home. Can start spare time until your full time is available.



Lose no time. Get all facts without obligation

**FREE BOOK! MAIL COUPON TODAY!**

• **VON SCHRADER MFG. CO.**  
• E 11 "W" PL., Racine, Wisconsin  
• Send at once (no obligation) your **FREE** booklet containing information about your  
• **WALL WASHING MACHINE** and how I can start my own permanent, profitable business.  
• Name \_\_\_\_\_  
• Address \_\_\_\_\_  
• City \_\_\_\_\_ Zone \_\_\_\_\_ State \_\_\_\_\_

Learn **ELECTRIC APPLIANCE REPAIR** IN YOUR Spare Time at Home



**START YOUR OWN BUSINESS**

**WITH A POTENTIAL MARKET OF 50,000,000 CUSTOMERS** New shop-method, home training system gives you electrical know-how that used to take years to learn. Learn at home by building valuable testing kits, repairing your own and neighbor's appliances. It is not unusual for appliance repairmen to charge on the basis of \$5.00-\$6.00 an hour. **FREE ILLUSTRATED BOOK** Shows you how you learn every phase of electrical appliance. How to make money while you learn. Write today for your **FREE** copy.

**CHRISTY TRADES SCHOOL INC., Dept. D-5701**  
4804 North Kedzie Ave. Chicago 25



# DRAFTSMEN



**CASH BIG  
PAY CHECKS!**

Train Now for  
more success,  
greater security

**LEARN AT HOME IN SPARE TIME  
(or at college in Chicago)**

Check the want ads in any newspaper—SEE the big-pay opportunities open to you as a draftsman. What's more, you can learn this well-paid, prestige profession at home—quickly, easily! No special talent needed. Get complete, step-by-step Chicago Tech lessons in the mail, spend a few pleasant hours studying each week. In a short time you'll be a well-trained draftsman, ready to take your pick of many good jobs. Act now!



**FREE INFORMATION—MAIL COUPON TODAY!**  
Get **FREE TRIAL LESSON** plus information about C.T.C. practical training. Learn what successful Chicago Tech graduates say about high pay and opportunities in drafting. No charge, or obligation.

## CHICAGO TECHNICAL COLLEGE

P-223 Tech Bldg., 2000 So. Michigan Ave.  
Chicago 16, Illinois

Mail me **FREE Lesson** with information about big opportunities in **DRAFTING**.

Name.....Age.....

Address.....

City.....Zone.....State.....

## ENGINEERING DEGREE IN 27 MONTHS

**BIG DEMAND  
FOR GRADUATES**

**AERONAUTICAL, CHEMICAL, CIVIL, ELECTRICAL, MECHANICAL and ELECTRONIC ENGINEERING (Inc. Radio and TV)**

Hundreds of young men are earning **B.S. ENGINEERING DEGREES** annually in this recognized institution—year around operation. New terms start quarterly. Many students earn a major part of their college expenses in this large industrial center.

Low tuition. Competent instruction. Thorough, intense, practical program. Modern, well-equipped laboratories including new physics laboratory and modern wind tunnel. Individualized instruction emphasized.

Government approved for G.I.'s. Engineering preparatory courses. Students from 48 states and 21 foreign countries. Enter December, March, June, Sept. Send coupon for free catalog and full information. Enroll now.

## INDIANA TECHNICAL COLLEGE

6115 E. Washington Boulevard, Fort Wayne 2, Indiana

Please send me free information on B. S. Engineering degree in 27 months as checked.

- Aeronautical  Chemical  Civil  
 Electrical  Mechanical  Electronics

Name.....

Address.....

## SCIENTIFIC CRIME DETECTION



**There's a Thrill in Bringing  
a Crook to Justice.**

**A Steady Pay Profession  
Good Times or Bad.**

We have taught thousands this exciting, profitable, pleasant profession. Let us teach you, too, *in your own home*. Learn

Finger Printing, Firearms Identification, Police Photography and Criminal Investigation thoroughly, quickly and at small cost.

**Over 800 of All U. S. Bureaus**

of Identification employ students or graduates of I. A. S. You, too, can fit yourself to fill a responsible crime detection job with good pay and steady employment. But don't delay—get the details now. Let us show you how easily and completely I can prepare you for this fascinating work, during spare time, in your own home. You may pay as you learn. Write today, stating age. No salesman will call.

(A Correspondence School Since 1916)

**Be A  
FINGER  
PRINT  
Expert**

**FREE!!!**  
Send for Thrilling  
"BLUE BOOK  
OF CRIME"

**INSTITUTE OF APPLIED SCIENCE**

1920 Sunnyside Ave., Dept. 1368, Chicago 40, Ill.

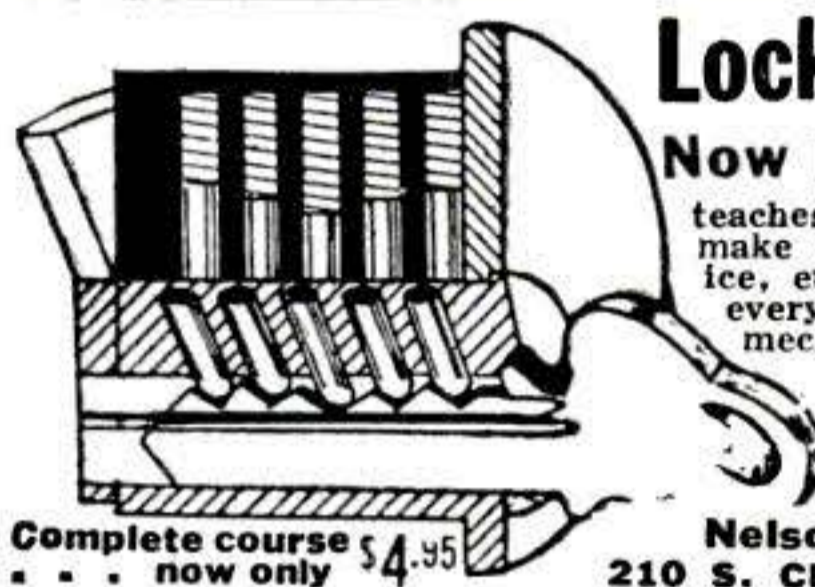

## Locksmithing AND KEY MAKING

**Now Made Easy!** Practical up-to-date course

teaches you how to pick locks, de-code, make master keys, repair, install, service, etc. New self-instruction lesson for every handyman, homeowner, carpenter, mechanic, service station operator, fix-it shop, hardware dealer, gunsmith. 53 easy illustrated lessons. Full price only \$4.95, postpaid; or C.O.D. plus postage. Satisfaction or refund guaranteed.

Complete course \$4.95  
now only \$4.95

**Nelson-Hall Co., Dept. LV-1**  
210 S. Clinton St., Chicago 6, Ill.

## Turn Concrete Into Gold! BUILDING BLOCKS

Cash in on the building boom. Make superior concrete blocks. No special skill required. Low cost concrete vibration block machine operates indoors or out in little space. Simple foolproof 3 step operation makes 1000 blocks per day. We help you start. Write for **FREE** facts.



**GENERAL ENGINES CO., INC.**

Dept. S-115 Route 130, Thorofare, New Jersey

## LEARN ACCOUNTING Business Administration



Bookkeeping, secretarial and allied subjects at home in your spare time or attend nationally approved resident school. Write for **FREE Success Book** giving complete details on courses, plans, rates and employment opportunities. G.I. approved.

Member National Home Study Council

**BUSINESS UNIVERSITY AND  
EXTENSION SCHOOL, Dept. B.**  
629 W. Main St., Oklahoma City 2, Okla.

## ? DENTURE BROKEN ?

**Fix-It-Yourself**

Save time and money on dental plate repairs with a professional repair kit for home use. Comes complete with easy to read step-by-step illustrated directions . . . Satisfaction guaranteed or money refunded.

**\$3.25 postpaid**

**DENTURE REPAIR KIT CO.**

Box 187 Daly City, Calif.

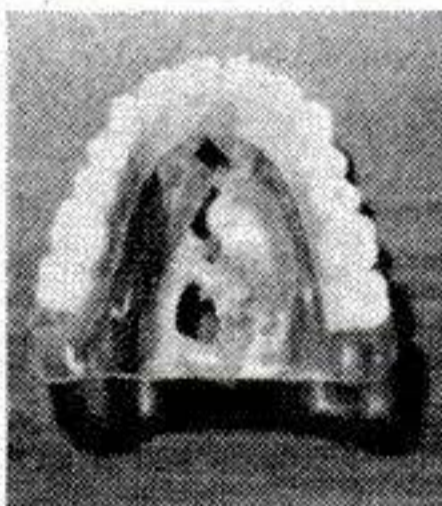

Clip & Save  
This Ad



## URANIUM = \$\$\$

**CASH-IN ON GOVERNMENT BONUSES!  
OVER \$4,000,000 ALREADY PAID!**

Learn how a U.A.C. Geiger or Scintillation Counter can find Uranium \$\$\$ for you.. All counters **UNCONDITIONALLY GUARANTEED**; AEC Evaluated; tested & approved by our scientific laboratory. Write for free maps, techniques, details on extra-sensitive lightweight instruments from \$24.95. Pay as little as \$5. down!

**UNIVERSAL ATOMICS CORPORATION**  
Dept. P11, 19 E. 48th St., New York 17, N. Y.





**HERE'S YOUR  
CHANCE TO  
BE A**

## HARLEY-DAVIDSON DEALER

Right now a few very desirable dealer franchises are available for selling and servicing world-famous Harley-Davidson pleasure, police and commercial motorcycles. These openings offer unusual opportunities to get into a stable, profitable, and successful business.

If you are now in business, or if you want to get into one of your own, write us and tell us all about yourself . . . including business background, previous motorcycle experience (if any), age, and how much money you can invest. You'll receive a prompt reply outlining our factory-dealer relationship and factory co-operation including our extensive national advertising support.

Write — **MR. J. G. KILBERT, Sales Manager**  
**HARLEY-DAVIDSON MOTOR CO.**  
MILWAUKEE 1, WISCONSIN



## Home Training in Underwater SKIN AND LUNG DIVING

Train for fast developing opportunities in this great new sport. More and more big money will be earned by qualified divers. Training program by outstanding authority. Write at once for free information.

### DIVEMASTER

U.A.S. Corporation, Dept. PS-11,  
5637 W. 63rd Place, Chicago 38, Ill.

## REAL ESTATE BE A BROKER

**PAYS BIG! SEND FOR FREE, BIG, ILLUSTRATED CATALOG NOW!** Graduates report making substantial incomes. Start and run your own business quickly. Men, women of all ages, learn easily. Course covers Sales, Property Management, Appraising, Loans, Mortgages, and related subjects. **STUDY AT HOME** or in classrooms in leading cities. Diploma awarded. Write TODAY for free book! No obligation.

**FREE  
BOOK  
TELLS  
HOW**

Approved for World War II and Korean Veterans  
**WEAVER SCHOOL OF REAL ESTATE (Est. 1936)**  
2020S Grand Ave. Kansas City, Mo.



**MEN!** TRAIN NOW FOR  
A BIG PAY FUTURE IN  
**DIESEL**  
& SCIENTIFIC MOTOR TUNE-UP

- Diesel Construction
- Diesel Engine Repairman
- Diesel Operator
- Industrial Maintenance
- Auto Engine Rebuilding
- Bus & Truck Maintenance

Go places with **DIESEL!** Farms, factories and power plants, trains, ships, trucks, busses all use **DIESEL POWER.** . . . all need **DIESEL-trained men!** You can start your **DIESEL** training at home, in spare time, with tested, proved **U E I** training. Course includes practical work on Diesel engines under skilled instructors. You learn the operation, maintenance servicing of all types of Diesel engines, **PLUS Scientific Motor Tune-up.**  
**ACT NOW!** If you have mechanical ability, **you'll like Diesel!** High School diploma not necessary. Write now for **Free book "EARNING POWER in DIESEL."** Act Today!

### UTILITIES ENGINEERING INSTITUTE

2521 Sheffield Ave., Dept. DM-42, Chicago 14, Ill. (Founded 1927)

**free!**

## ALLIED'S SPECIAL 100-PAGE HI-FI CATALOG



Your guide to an easy understanding of Hi-Fi—plus the world's largest selection of Hi-Fi systems and components . . .

## send for "this is high fidelity"

The **FREE** book that shows you how to **SAVE MONEY** on your home music system

### DO IT YOURSELF

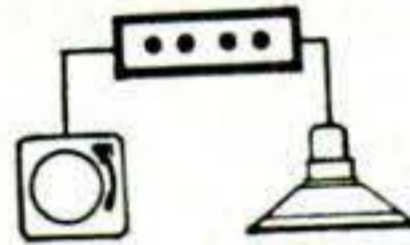

units just plug in



Install in your own fine cabinetry, in book shelves or in built-in wall

Here is the leading guide to an easy understanding of Hi-Fi. It's invaluable if you're planning a home music system. Shows you how to select a custom system to satisfy your own listening desires at lowest cost. Tells you what to look for in complete systems and individual units. Shows many handsome, practical do-it-yourself installation ideas. Offers you the world's largest selection of complete systems as well as individual amplifiers, tuners, changers, speakers, enclosures, tape recorders and accessories from which to make your money-saving choice. Before you make your selections you'll want to refer to this invaluable, informative **ALLIED HI-FI** book. Write for it today—it's **FREE.**

**FREE  
HI-FI BOOK**

**ALLIED RADIO**  
*America's Hi-Fi Center*

**ALLIED RADIO CORP., Dept. Z-115**  
100 N. Western Ave., Chicago 80, Ill.

Send **FREE** 100-Page Hi-Fi Book

Name \_\_\_\_\_

Address \_\_\_\_\_

City \_\_\_\_\_ Zone \_\_\_\_\_ State \_\_\_\_\_



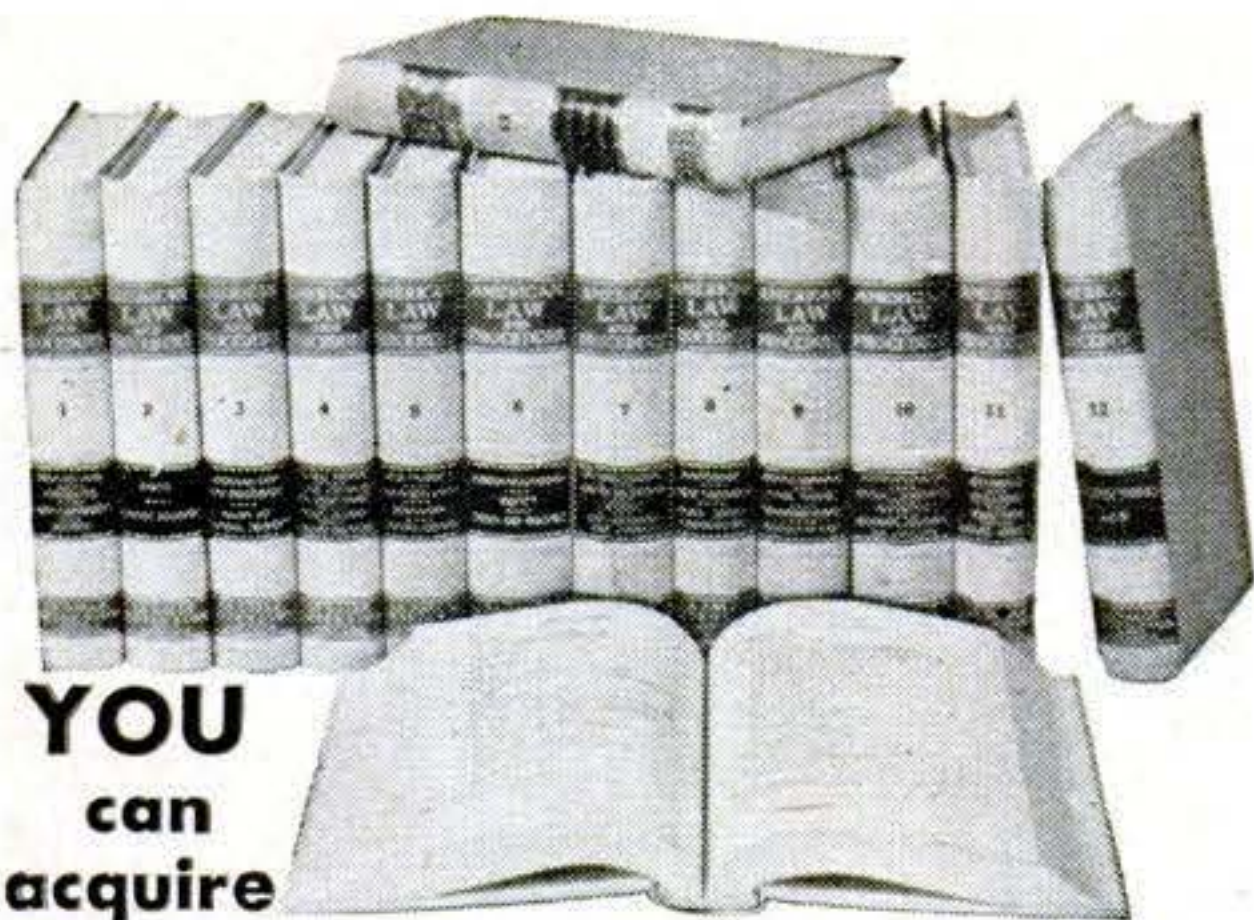

**YOU  
can  
acquire**

**LAW NIGHTS AT HOME!  
L. B. DEGREE**

LaSalle's famous Law Library—used as reference in many Law libraries and Law offices—has enabled thousands to master Law surprisingly fast, in spare hours at home, for business and professional advancement.

These 14 remarkable volumes, compiled by leading professors and lawyers, cover the whole basic field of Law in condensed, orderly, simplified manner.

You advance rapidly with this great library, plus special lectures furnished. We guide you step-by-step with personalized Problem Method of instruction . . . you *learn by doing*—handling legal problems—not by memorizing rules.

Send for two FREE 48-page booklets, "Law Training for Leadership," and "Evidence," answering questions about Law and its value to you, and telling how LaSalle Law graduates are winning rapid advancement in business and public life. Mail coupon below. No obligation.

**LA SALLE EXTENSION UNIVERSITY  
A Correspondence Institution**

417 S. Dearborn St. Dept. 1183L Chicago 5, Ill.

Send me your two FREE booklets described above, without obligation.

Name \_\_\_\_\_ Age \_\_\_\_\_  
Street \_\_\_\_\_  
City, Zone & State \_\_\_\_\_



**\$35,000  
REWARD  
FOR  
URANIUM**

Here's your chance to "cash in!" Over \$2,500,000 in Government Bonuses have been paid for URANIUM discoveries in the past 2 years. Currently \$150,000 a month is paid to people just like you.

Precision Geiger Counters and Scintillators are the finest instruments made for URANIUM prospecting. These highly sensitive instruments are compact, lightweight and ruggedly built for field use. Prices start at \$29.95.

CONTACT YOUR NEAREST DEALER or write direct to factory for FREE 12-PAGE CATALOG, describing URANIUM and Metal detectors.

PROSPECTORS



RELY ON . . .

**PRECISION RADIATION INSTRUMENTS, INC.**

4223 PS W. Jefferson Blvd., Los Angeles 16, Calif.

WORLD'S LARGEST MANUFACTURER OF RADIATION INSTRUMENTS



**Happy Is The Day  
When Backache  
Goes Away**

Nagging backache, headache, or muscular aches and pains may come on with over-exertion, emotional upsets or day to day stress and strain. And folks who eat and drink unwisely sometimes suffer mild bladder irritation . . . with that restless, uncomfortable feeling.

If you are miserable and worn out because of these discomforts, Doan's Pills often help by their pain relieving action, by their soothing effect to ease bladder irritation, and by their mild diuretic action through the kidneys—tending to increase the output of the 15 miles of kidney tubes.

So if nagging backache makes you feel dragged-out, miserable . . . with restless, sleepless nights . . . don't wait . . . try Doan's Pills . . . get the same happy relief millions have enjoyed for over 60 years. Get Doan's Pills today!

**500 Treasured "Pirate" STAMPS**

Get this big "Treasure Chest" of 500 prized stamps from such pirate strongholds as the Bahamas, Barbados, Haiti, Madagascar, etc. All different! Total catalog value guaranteed to be at least \$10.00! 13 special stamps FREE if you act quickly. Other offers included for your inspection. Send your name and address with only 35c and this ad NOW to: LITTLETON STAMP CO., Dept. PS-11, Littleton, New Hampshire.

**FOR ONLY  
35c AND  
THIS AD**

**BIG MONEY FIELD  
Learn OIL HEATING  
INSTALLATION — SERVICE — REPAIR**

Use your spare time to advantage. Learn a trade paying big dividends. Easy to start your own business. Course includes steam, hot water and warm air systems. Write for catalog.

**LINCOLN INSTITUTE**

Dept. PSA 472 Market St. Newark 5, N.J.



**LEARN TV** the practical way..

Assemble a TRANSVISION TV KIT in easy stages. Pay as you wire—only \$15 for Starting Package #1. Learn while building a superb 17" to 27" screen TV Set with latest features. Ideal for Fringe Areas, adaptable to UHF. Easy — no instruments or technical knowledge required. Free Catalog describes 8 great TRANSVISION TV KITS.

Write today to Educational Dept. at—

TRANSVISION, INC., Dept. PS, NEW ROCHELLE, N. Y.



**earn as TAX EXPERT**

**\$15 HOUR** Our students earn as much as \$3,000 in 3 short months preparing income tax returns in spare time—also operate lucrative Business Tax Service yielding steady monthly fees of \$10-\$50 per client, year round. Enjoy professional standing in dignified home-office business. No experience necessary. We train you at home and help you start. Write today

for free literature. No agent will call. Approved by N.J. Dept. of Education. UNION INSTITUTE OF TAX TRAINING, 68-70 Hudson St., Hoboken 10D, N.J.



START AS HIGH AS \$4,525.00 A YEAR

Prepare NOW for next exams

**MEN—WOMEN** Thousands of appointments being made. 36-page Book FREE.  
Mail Coupon Today. SURE.

COUPON / **FRANKLIN INSTITUTE** (Not Gov't. Controlled) Dept. J-90, Rochester 4, N. Y.  
Sirs: Rush FREE: (1) 36-page book with list of U. S. Gov't. Jobs; (2) Tell me how to qualify.

Name.....Age....  
Address.....



# America Discovers the Lifelong Battery



Sintered Plates for greater power reserve, longer life.



Capillary Separators keep plates moist and active at all times.



Mild Type Electrolyte No strong acids to corrode inside of battery.

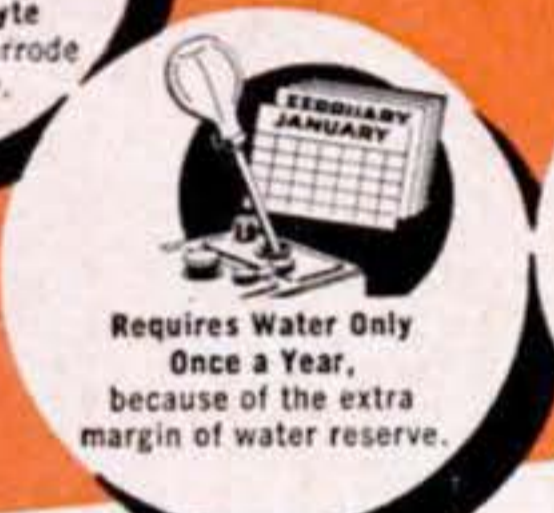

Requires Water Only Once a Year, because of the extra margin of water reserve.



Galvic Cell Shield prevents accidental damage to plates.



New High-Impact Type Case: Larger capacity, greater strength and resistance to chemicals.



New Type Condenser Vent Caps Preserve water supply by condensing vapors.

\*U. S. PAT. APP. NO. 408439

## 10 YEAR BONDED FACTORY GUARANTEE

The Longest & Strongest Battery Guarantee Ever Issued  
The LIFE-LONG BATTERY is guaranteed for more years than any battery on the market. The ten-year bonded guarantee is issued and backed by the factory and is honored by any one of LIFE-LONG's 20,000 dealers throughout the United States. As a further protection to the buyer, the factory ten-year guarantee is bonded by a state licensed escrow company. The LIFE-LONG ten-year guarantee features free replacement and remains in effect no matter how many times the battery is transferred from car to car. Every LIFE-LONG BATTERY carries a serial number which is permanently registered at the factory for your protection.



## \$1,000 REWARD

for anyone who proves a LIFE-LONG BATTERY will not recuperate within 60 seconds after complete rapid discharge. This reward money is on deposit at the Bank of America.

## NEW TYPE BATTERY NOW AVAILABLE FOR AUTOMOTIVE USE

LIFE-LONG BATTERIES, with the revolutionary new sintered plates, were originally designed for commercial and industrial use in submarines, locomotives, steamships and large stationary engines, but American "know how" and mass production methods have reduced their costs to the level of ordinary batteries, making them available to the motoring public.

## USED ALL OVER THE WORLD

First sold in Europe, tens of thousands of LIFE-LONG Bonded 10-Year BATTERIES are in daily use throughout the world. To date not one failure has been reported! LIFE-LONG BATTERIES have been tested and approved by hundreds of large corporations, utility companies, police and fire departments, U.S. and foreign governments. Many large firms, including original equipment manufacturers, are switching to LIFE-LONG as old-type batteries fail. Where safety is essential—in signal beacons, hospital emergency lighting, standby telephone electric supply systems—you find LIFE-LONG BATTERIES.

## LIFE-LONG BATTERY STARTS TEST ENGINE 606,969 TIMES IN TORTURE TEST

In "torture tests" conducted by an authorized member of the American Council of Commercial Laboratories, a LIFE-LONG BATTERY started a test engine over and over again—day in and day out, without pause, for more than a year. After making 606,969 starts, the battery finally was worn down! No other battery can equal this record! This LIFE-LONG BATTERY was no different than the one you can buy for your car. It is good for at least a half a million starts—the equivalent of starting your car thirty times a day for fifty years.

## Proved Superior by Laboratory and Road Tests

- S.A.E. TEST:** Life-Long Battery is 100% more efficient than required by S. A. E. Overcharge Test.
- R. P. M. TEST:** Life-Long spins your engine at least 20% faster, gives you easier, quicker starts.
- COLD TEST:** Life-Long performs efficiently after "soaking" at 70° below zero for 24 hours.
- CAPACITY TEST:** Life-Long has 40% greater reserve capacity than ordinary batteries.
- LIGHT METER TEST:** Your lights are 50% brighter with a Life-Long.
- LIFE CYCLE TEST:** Life-Long produces an incredible 606,969 cycles.

## SAVE \$70.00 OR MORE!

A LIFE-LONG 10-YEAR BATTERY actually costs less than an ordinary battery—saves you \$70 or more! On a yearly basis, LIFE-LONG costs you only \$3.00 a year while a so-called "first quality" three-year battery costs you \$10. Thus LIFE-LONG gives you a direct saving of \$70.00 over its ten-year warranty period.

**OPPORTUNITY FOR DISTRIBUTORS** • Many choice territories are still available. All territories are awarded on an exclusive basis—protected by a written franchise. No charge for franchise. Write, wire, or phone today. Cable: Lifelong.

ALL 6-VOLT LIFE-LONG AUTO BATTERIES \$29.95

ALL 12-VOLT LIFE-LONG AUTO BATTERIES \$34.95

Complete line of Industrial, Commercial, Marine, Motorcycle and Aircraft Batteries.

LIFE-LONG BATTERY MFG. CORP. DEPT. PS-115  
11766 West Pico Blvd., Los Angeles 64, California

Please ship Life-Long  6 volt automotive battery (\$29.95 including tax)  
Battery, 10-year guarantee:  12 volt automotive battery (\$34.95 including tax)

for \_\_\_\_\_  
Make & Model, Year of Car \_\_\_\_\_  
Cash, check or money order enclosed. Life-Long pays all delivery costs to your door.

Name \_\_\_\_\_  
Address \_\_\_\_\_  
City \_\_\_\_\_ Zone \_\_\_\_\_ State \_\_\_\_\_

LIFE-LONG BATTERY MFG. CORP.  
11766 WEST PICO BOULEVARD, LOS ANGELES 64, CALIFORNIA



# Become an Electrical Engineer

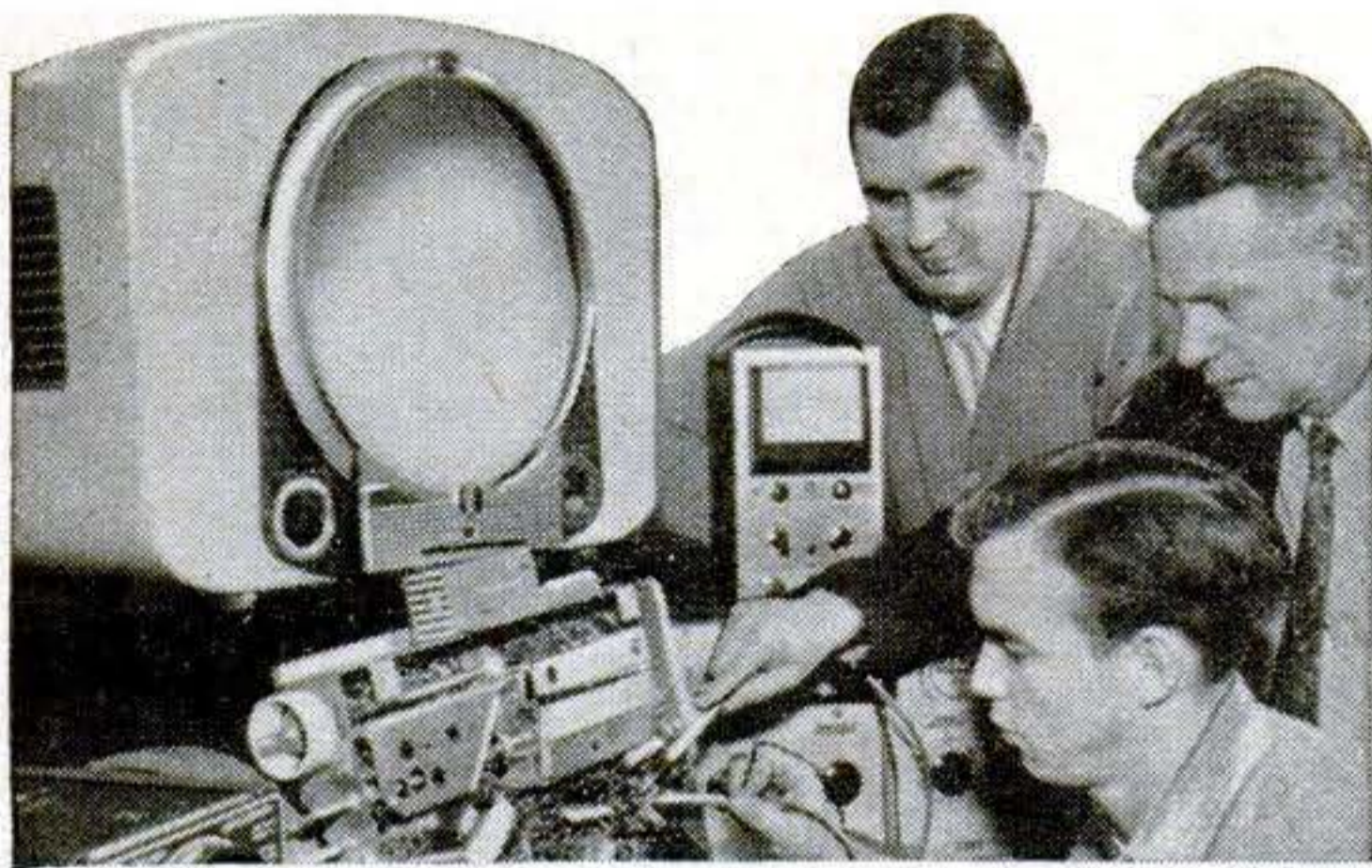

**Major in Electronics or Power  
BS Degree in 36 months**

Prepare now for a career as an electrical engineer or engineering technician—and take advantage of the many opportunities in these expanding fields.

You can save a year by optional year 'round study. At MSOE previous military, academic, or practical training may be evaluated for advanced credit.

## Enter Radio and Television — courses 12 to 18 months

You can be a radio technician in 12 months. In an additional 6-months you can become a radio-television technician with Associate in Applied Science degree. Color television instruction is included in this program.

These technician courses may form the first third of the program leading to a degree in Electrical Engineering. Twenty-one subjects in electronics, electronic engineering and electronic design are included in these courses.

Courses also offered: radio-television service (12 mos.); electrical service (6 mos.); general preparatory (3 mos.).

**Terms — January, April, July, Sept.**

Faculty of specialists. 50,000 former students — annual enrollment from 48 states, 23 foreign countries. Non-profit institution. 51st year. Courses approved for veterans. Residence courses only.

MS-6B



## MILWAUKEE SCHOOL OF ENGINEERING

MILWAUKEE SCHOOL OF ENGINEERING  
Dept. PS-1155, 1025 N. Milwaukee Street  
Milwaukee 1, Wisconsin

Send FREE illustrated booklets  
 Career in Electrical Engineering,  
 Career in Radio-Television.

I am interested in \_\_\_\_\_  
(name of course)

Name \_\_\_\_\_ Age \_\_\_\_\_

Address \_\_\_\_\_

City \_\_\_\_\_ Zone \_\_\_\_\_ State \_\_\_\_\_

If veteran, indicate date of discharge \_\_\_\_\_

## Famous 15 and 17 Jewel BULOVA WATCHES \$16.95 PLUS TAX

PRACTICALLY WHOLESALE TO YOU



**LIFETIME SERVICE GUARANTEE**

**WHY PAY  
\$59.50  
SAVE \$42.55**

Also Choice Of  
• BENRUS  
• GRUEN  
• ELGIN or  
• WALTHAM  
WATCHES

You get these unredeemed SERVICE guaranteed Bulova and other movement in latest style Yellow Gold Cases at this sensationally low price because we bought out huge surplus stocks of leading New York and Md. jewelers. Order now while they last. Specify make preferred and whether men's or ladies! Only \$16.95 plus \$1.70 tax.

**Free Trial Offer! Wear At Our Risk!  
Money back guarantee in 10 days  
if not delighted!**

**SEND ONLY  
\$1 with order.**  
Pay balance  
C.O.D. plus postage. Or enclose  
\$16.95 plus \$1.70

**LIFETIME SERVICE  
GUARANTEED  
17 Jewel Swiss  
WRIST WATCH**

Worn by Army, Navy & Marines. Thousands sold for \$55 under O.P.A.

**\$14.95 Plus \$1.50 tax**  
New Incablock,  
Shock-Protected  
Water & Dust Tight

tax, we pay postage. Handsome Expansion Band with orders at no extra cost.

**Maryland Distributors, Dept. 681**

501 E. Baltimore St., Baltimore 2, Md.  
Write for Free Watch and Diamond Ring  
Catalog—Practically Wholesale Prices.

**AIR MAIL XMAS DELIVERY GUARANTEED**

## SEWS LEATHER

**AND TOUGH TEXTILES LIKE A MACHINE**

With SPEEDY STITCHER Automatic Sewing Awl, anyone can quickly and skillfully sew or repair anything made of LEATHER, CANVAS, NYLON, PLASTIC, or other heavy materials. Sews firm, even lock-stitches like a machine. Gets into hard-to-reach places. Specially made for heavy duty sewing on LUGGAGE, FOOTWEAR, RUGS, AWNINGS, SAILS, SADDLERY, UPHOLSTERY, OVER-ALLS, AUTOTOPS, SPORTS GEAR, and other tough sewing jobs. Here's the handiest tool you'll ever own. Will save you many times its small cost. Comes ready for instant use . . . complete with bobbin of waxed thread and 3 different types of diamond-pointed needles. Easy-to-follow directions will make you an expert in minutes. Extra needles and waxed-thread always available. Save money, send \$1.98 for postpaid delivery. If C.O.D., \$1.98 plus postage. **MONEY BACK GUARANTEE.**



**SPORTSMAN'S POST**

366 Madison Ave., Dept. A-226, New York 17

**1.98 ONLY**

## Malayan THROWING DAGGER

**SPECIAL! \$1.00**  
postpaid

**MALAYAN HUNTING KNIFE**  
used for killing game.  
Exciting target sport.  
Easy to learn! Fun  
indoors or out-  
doors!

**EASY TO  
THROW!**

Balanced to Stick

Fun,  
Thrills,  
Excitement!

Learn this Sport! Easy to throw accurately with our clear instructions. Beautiful, heavy-duty 10" knife. Tempered steel. Tough, rawhide-bound handle. Rare souvenir, unusual bargain. At sporting goods dealers or send \$1.00 to  
**S & R RESEARCH, Box 62A, San Gabriel, Calif.**



**TRANSFER LIQUIDS  
QUICKLY, EASILY  
Automatically**

## NEW SELF-STARTING SIPHON PUMP

Here's a safer, faster way to transfer liquids, without messing up the job. This new NEOPRENE SIPHON PUMP safely handles many acids and corrosive liquids. No metal parts. Plastic valves are acid-resistant. No need to apply to mouth. Squeezing bulb starts fast pumping-action. Doctors, chemists, technicians use for laboratory work. Now widely used in homes and industry. You'll find 101 uses for it. Gets into hard-to-reach places. Just what is needed to empty aquariums, clogged sinks, drain traps, tanks, window-wells, boats, small flooded areas, transfer gas from car to power equipment, outboard motors, etc. Instantly ready for emergency use. Have it when you need it by ordering NEOPRENE SIPHON PUMP now. Send cash, money order, check for postpaid delivery. C.O.D., postal charges extra. **MONEY BACK GUARANTEE.**

**MERIDIAN CO. Dept. T-181  
366 Madison Ave. New York 17**

Over  
5 ft. long

**\$3.00  
ppd.**

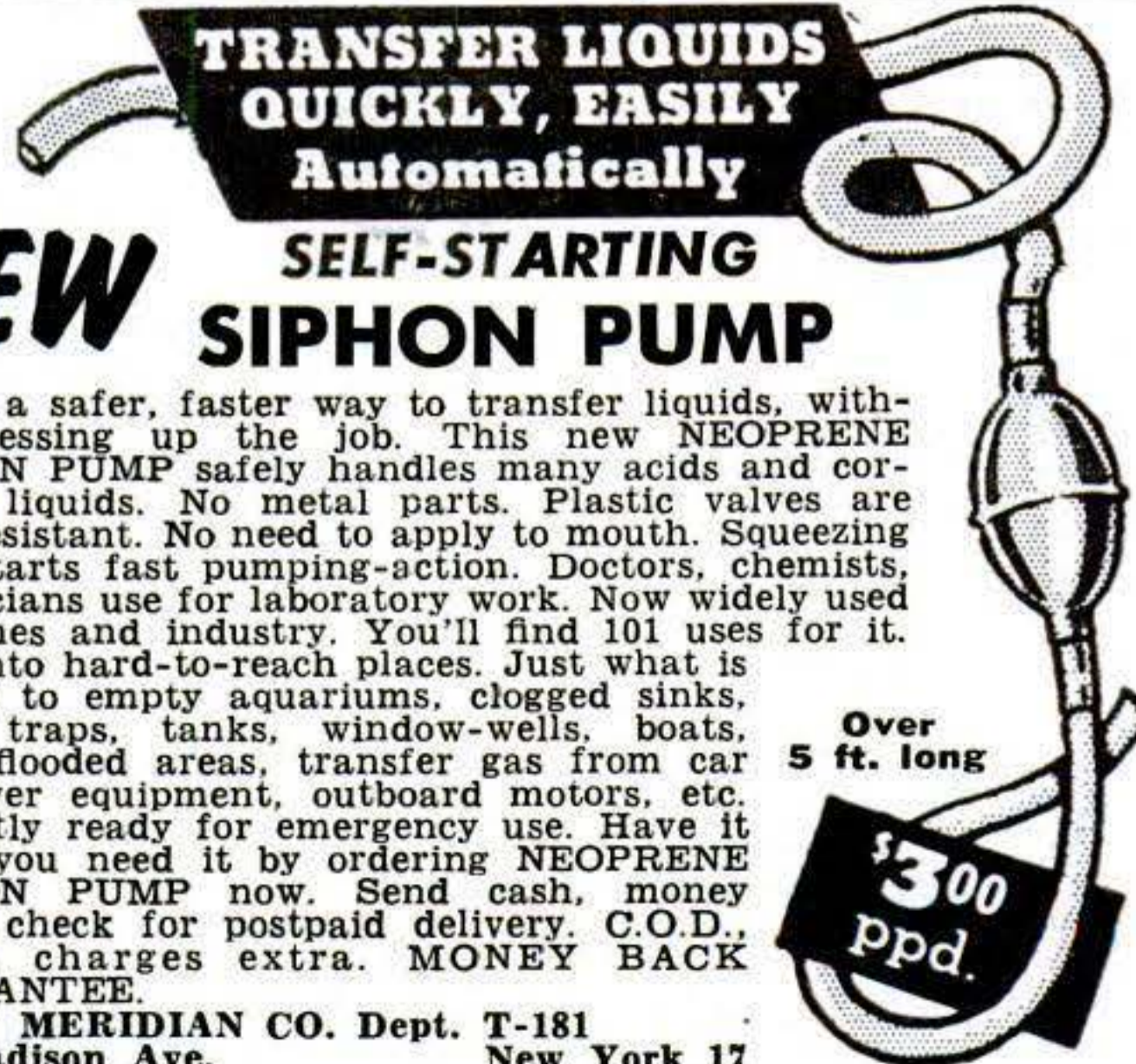



THE POPULAR SCIENCE



# Christmas

## GIFT MART

*Jot down your suggestions on this Popular Science Family Memo:*

**T**his year simplify your Christmas shopping and make sure you get the gifts you want.

Check the following pages of the Christmas Gift Mart carefully for gift ideas. Jot down those you want for **YOURSELF**. And since there are suggestions for everyone, list the presents for the whole family on the handy Memo on this page. If you're in doubt, let the others in the family browse through the Gift Mart and jot down the gifts **THEY** want themselves.

These well-placed hints will cut out your shopping headaches and insure a truly Merry Christmas for you this year.



**SAVE ON XMAS GIFTS** **BUY FROM IMPORTER**

**A COMPLETE CAMP KIT!** **NEW**

**Special 12 Pc. SPORTSMAN'S KNIFE**

IDEAL GIFT FOR FATHER, SON OR FRIEND...

4 5/8" GENUINE BONE HANDLE

WITH COWHIDE HOLSTER

**Only 4.95** WITH HOLSTER

Eliminates 12 Individual Items from Pack or Tool Kit

Here is the Perfect, Combination Knife-Tool for every Outdoor Sportsman, Hunter, Camper, Fisherman, Boy Scout, Ranger, Rancher, etc. Think of it! 11, Fine quality Steel Tools, precision made to fold easily into the heavy bone covered body. In one neat, compact unit you have (1) a regular knife, (2) a fork, (3) a spoon, (4) a draw-knife, (5) a bone-saw and fish-scaler, (6) scissors, (7) a can and bottle opener, (8) a cork-screw, (9) awl punch, (10) a screwdriver and (11) a metal file. All this PLUS a genuine leather, belt holster.

**BUILD-IT YOURSELF** **SPECIAL FOR XMAS**

**12 inch ELECTRIC BOAT KIT** with ELECTRIC MOTOR & SPOTLIGHT

Here is a genuine electric motor driven speedboat that will make many a young sailor happier this Xmas. The hardwood hull and deck are already completed (excepting paint) and is ready for final assembly. Included in this complete kit is an electric motor, flexible coupling, drive shaft with propeller, adjustable rudder, windshield, electric spotlight, and other accessories and hardware. Can be finished and ready for launching in one hour. Motor and spotlight operate on 2 standard flashlight batteries. Order now — Xmas delivery assured to Dec. 15.

**3.95** INCL. MOTOR

**AMAZING - NEWLY DESIGNED** **60 TO 450X MICROSCOPE**

**FEATURING 60, 120, 150, 180, 300 AND 450 POWER MAGNIFICATION**

**NEWLY DEVELOPED - Self-Contained SUB-STAGE LIGHT ELIMINATES NEED FOR EXTERNAL LIGHT SOURCE**

Take advantage of our tremendous foreign purchase. Ideal for use by Amateur Scientist, Student, in Home Laboratory for study of insects, plant life, etc.

**CHECK THESE FEATURES**

- 1- Triple, revolving turret with 10X, 20X, 30X precision ground & polished lenses.
- 2- Two interchangeable eyepieces, 6X and 15X with precision ground and polished lenses.
- 3- SIX MAGNIFICATIONS for all purposes - 60X, 120X, 150X, 180X, 300X and 450X.
- 4- NEW! Sub-stage with SELF-CONTAINED LIGHT. No external light source needed.
- 5- Large sub-stage mirror for use with external light sources.
- 6- All Metal Body - inclines through 90 degrees.
- 7- Special Hardwood Case and 3 glass slides.

FREE with MICROSCOPE - **Only 12.95** INCLUDING DISSECT SET

8 Pc. DISSECTING SET with hardwood case. Has Scalpel, Scissors, Tweezers, etc.

**SATISFACTION GUARANTEED OR MONEY BACK**

ORDER TODAY for Xmas Delivery - Pay by Money Order or Check. 1/2 deposit with C.O.D.'s. All prices F.O.B. Los Angeles.

**Palley SUPPLY CO.** 2263 E. VERNON AVE., DEPT. PS-11 LOS ANGELES 58, CALIF.

**TERRIFIC Sale!**

**BRAND NEW 16 X 50**

**Now \$39.95**

These "whisper weight" 16 Power binoculars regularly sell for \$69.50. However, volume Christmas purchases have greatly reduced our costs and we are, for THIS CHRISTMAS SALE ONLY, passing on this saving of almost \$30.00 to you. Perfectly balanced and therefore Easy to Hold and Easy to Focus. Water-Dust resistant, 2" wide objectives assure greater illumination and brighter, sharper images. 7" high! Weighs only 27 ounces! An ideal gift for those who want Power!!

**RETURN IMMEDIATELY AFTER CHRISTMAS FOR REFUND IN FULL**

**GUARANTEE!** We know UNITED GIFT glasses will please even the most discriminating person. To prove our belief, we will accept all binoculars advertised here for a full refund if returned immediately after Christmas!

Same day AIR MAIL SHIPMENT Add \$3.00. Made in Japan. Leather case, straps included. Add 10% Fed. tax. Cash orders prepaid. C.O.D.'s require \$2.00 deposit. UNITED BINOCULAR CO., Dept. ARF-2216, 9043 S. Western Ave., Chicago 20. DEALERS WANTED.

**Ideal Christmas Gift For Any Man**

**WELD BRAZE 4WAY**

**SOLDER CUT**

**ONLY \$14.75** f.o.b. factory

**WELDER**

Complete with Twin Carbon Arc Torch and accessories... to handle all metal-craft work.

Acclaimed by thousands of Homeowners, Mechanics and Hobbyists as the welder of 1001 uses. Easily operated from properly wired 110 volt AC or DC line. The ideal gift with a life-long use... Order today on 10 day money back guarantee.

**FOUR-WAY WELDER CO., Dept. F3-M**  
1810 S. Federal St. • Chicago 16, Ill.

**.22 MATCH PISTOLS**

**BRAND NEW \$19.95** full price

**Automatic ejection**

Limited sale of fine .22 single action, match designed target pistols. Crafted like famous American .22's by precision craftsmen. Manufactured by large sporting goods firm. Its accuracy is matched only by its handsome appearance. Floating bolt action, automatic recoil ejection for rapid load and fire. 5" rifled barrel. Shoots .22 long rifles, longs, and shorts. Metal is beautifully blued with rust-proof finish. Checkered tenite grips with thumb rest. Notched, adjustable sight. Fast, easy take-down. Outshoots most \$60 pistols. We believe this pistol is one of the finest target guns ever designed. First time ever offered to the American public—a real firearm bargain. 10-day free trial with 100% satisfaction guaranteed or money refunded. Matched pair for \$37.95. Add \$3 for suede leather holster. Shipped F.O.B. San Gabriel. Adults only. State age.

**TO ORDER, send \$19.95 in check, cash, or money order to: WHOLESALE IMPORT CO., Box 4-G, San Gabriel, California.**



YOU can find over 100 PRACTICAL USES and have LOTS OF FUN with

# 5 in 1 Miracle Projector

## Electric Enlarger and Copy Maker

### Magnify & Project

Stamps, coins, puzzles, clippings, maps, science specimens, plans, etc. Examine magnified details. Project on paper and sketch copies, large or small. Easier reading for weak eyes.

Magnifying Reader for Small Detail & Print



### Amazingly Useful Invention

Home Fun—Schools—Salesmen—Clubs—Artists—Teachers—Shops—Sign Makers—Doctors—Classroom—Scientists—Students—Money Maker—Photographers—Experiments—Lab workers—Printers—Painters—Etc., etc., etc.

HIGH FIDELITY, TRUE VIEW, FULL COLOR

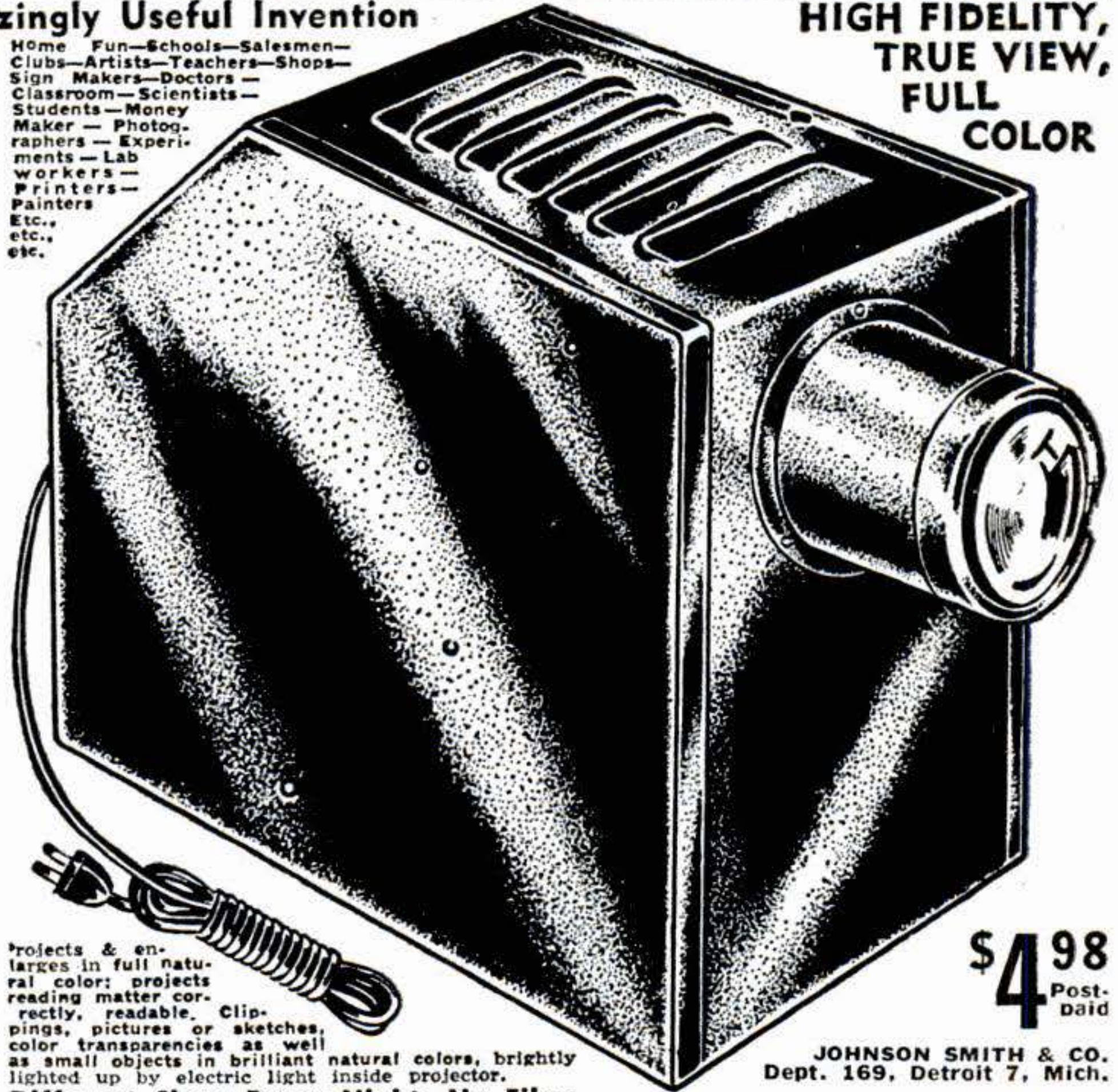

\$4.98 Postpaid

JOHNSON SMITH & CO. Dept. 169, Detroit 7, Mich.

### Learn to Draw & Sketch Signs, Cartoons, Pictures Easily

#### Posters, Lettering, Comics, Objects

Project sketches, pictures, objects, etc. on drawing paper. Sketch over with pen, pencil, colors, etc. Easy to make any kind of cartoons, drawings, signs, etc. either large or small. Make cartoons from pictures. Easy to do; no skill, no practise.



Large or Small

#### Copy Any Picture or Object

Project and focus it large or small. Make enlargements of plans or drawings. You'll be surprised how many practical and entertaining uses you can make. Advertising posters, cartoon sketches of friends, etc., etc., etc.

Projecting posters, cartoon sketches of friends, etc., etc., etc.

### Natural Moving Pictures

#### Projecting Microscope Gives Live Show

Put ants, insects, flies & other bugs or animated objects under glass & let them walk around. See them in action greatly enlarged and magnified. MOVING on screen. Amazing, real-life scientific motion pictures. Like having a projecting microscope.



### Make Photo Enlargements and Copies Without Negatives!

#### Use Any Photo or Picture

Direct positive photo enlargements and prints without negatives using Eastman direct positive paper. Use any black & white or color picture, colored transparency, etc. Easy to do; excellent results. No complicated dark room equipment. Makes correct copy (same as original), large or small. Also useful for making copies of important papers, plans, documents, stamps, sketches, maps, etc., etc. EASY, FUN, USEFUL, PROFITABLE.



Make copies of important papers, plans, documents, stamps, sketches, maps, etc., etc. EASY, FUN, USEFUL, PROFITABLE.

### Picture Enlarger and Projector

#### Project 3-Dimension Pictures



Put on your own show by projecting snapshots, pictures, post cards, photos, comics, clippings, etc. on wall or screen. Fine for school, clubs, talks, home shows, telling about your trip, salesmen, etc. Full color, correct projection, entirely readable & correct. Special device enables you to project real 3-dimension or stereoscopic pictures. Startling, life-like.

### Make Money---Machine Pays for Itself

Many ways to make money. Make photo enlargements, photo copies, give shows, make sketches and drawings and advertising signs, etc. Easy to do—the machine does the work.

Projects & enlarges in full natural color; projects reading matter correctly, readable. Clippings, pictures or sketches, color transparencies as well as small objects in brilliant natural colors, brightly lighted up by electric light inside projector.

#### Different Show Every Night; No Films

to Buy; No More Expense; Sports, Girl Beauties, Comics, Etc. Your favorite or COMIC PICTURES from papers & magazines. Enlarge action pictures. Project snapshots of your girl, family trip. Project and read comic strips to kids. Large pictures projected in full color! Educational, Scientific; Real Life Action! Live ants, flies, bugs and small animals can be projected on screen; watch them in real life action, fighting, eating, playing. Great for amateur scientist experimenter and camera fan.

#### Make Signs, Sketches, Posters, Cartoons, Lettering, Etc. Quick! Easy! In Black

& White or Full Color; From Clippings or Copy; Large or Small Posters and signs for clubs, stores, dances. Easy to make, large or small. Project picture or rough sketch right on blank drawing paper. Using pen, pencil or colors, sketch OVER PROJECTED PICTURE. Project photos and make funny, life-like cartoons or sketches. Amazing & practical. Be a good artist, even though you never did it before! Lettering and signs easy to do.

#### Magnifies Stamps, Specimens, Objects for Close Examination; Reader for Weak Eyes

Collectors can enlarge objects. Examine in greatly magnified detail. MAGNIFIES ABOUT 50 AREAS. Make photo enlargements direct from objects! Enlarges small type, maps, etc., projecting it for easy reading.

#### Photo Enlarger; Makes Photo Prints, Photo Copies, Etc.—No Negatives

Uses Eastman direct positive paper. Correct true-image photos, large or small, from any photo; or even from color prints & color transparencies. Photo enlargements, copies, etc., done cheaply, quickly, easily. 8x10-in. enlargement costs 12c; sell up to \$1.00. NO NEGATIVES. Made by projecting picture on direct positive printing paper. Duplicate copies of blueprints, diagrams, papers, large or small.

#### 3-Dimension Stereoscopic Pictures

By special process you can project 3-dimensional pictures and see in startling, life-like realism, so real you expect to reach out and touch them! Project beautiful girl pictures, travel scenes, etc.

#### No Skill—No Experience—Fun All Year Round

Low-priced instrument that quickly pays for itself. No experience and no skill to operate. Just plug into any 110-volt AC-DC standard home socket. Years of entertainment and practical uses for every member of the family. Lasts indefinitely; nothing to wear out, so only cost is low price of MIRACLE PROJECTOR. Schools, shops, offices, artists, etc., all find many uses for it. Project almost anywhere—even on table. No screen necessary—any blank wall or white paper will do. Wonderful for classroom, clubs and salesmen.

#### Electric, Optically Ground Double Lens, Enameled Steel Construction

Complete except for lamp bulb; use any household 60 to 100 watt lamp bulb. Steel construction, handsomely enameled in brilliant colors. Easy carrying. 7 1/2-in. high, 10-in. long. Optically ground and polished lenses; slide focusing so you can PROJECT FROM VARIOUS DISTANCES to make picture large or small. Takes pictures up to 3 1/4 x 4 inches. With illustrated instruction booklet, views, etc. (2 for \$9.45; 3 for \$13.95). COMPLETE. CASH PRICE ONLY... EACH

What Users Say: Artist & Signmaker: "Valuable aid; enables anyone to do all kinds of art work without training." Photographer: "Many uses; money maker and money saver." Teacher & Lecturer: "Makes talks ten times more interesting; Teaches faster, more fun." Collector: "Magnifies & illuminates specimens for easy study."

Powerful Optical Instrument

100 Times Area Magnification

Johnson Smith Co., Dept. 169, Detroit 7, Mich. (Since 1914 America's Leading Novelty House)

Rush \_\_\_\_\_ Projectors Each \$4.98 Postpaid  
Enclosed is \$ \_\_\_\_\_ Special: 2 for \$9.45  
3 for \$13.95

Name \_\_\_\_\_

Address \_\_\_\_\_

(Sorry, No C.O.D.'s at This Cash Price)



## AMERICAN MACHINE & TOOL CO. MODEL CHANGEOVER SALE SAVE \$800 ON THIS TILT ARBOR SAW

All year a great buy at regular price of \$24.95—this 8-inch Plana Centric Tilt Arbor Power Saw is a spectacular bargain at \$16.95 during model changeover period. This big saving is possible by our patented construction, our manufacturing facilities, and our distribution methods. Top-quality saw features the original Plana Centric Patented Ball-Bearing Floating Drive, Patented Plana Centric Cradle suspension, and Plana Centric Patented Rip Fence that locks front and rear against the table surface. Every part in this fine saw is manufactured in our own factories. All cast iron and steel construction. Cross-cuts, rips, bevels, mitres, dados, cuts compound angles. Massive cast mitre gauge. Heavy steel base fastens to any workbench. Uses any standard 1/4 or 1/2 h.p. motor. INCLUDED: 8" Simonds Combination Blade at no extra charge. We start soon on 1956 models. During model changeover you can have this fine 1955 at a saving of \$8.00. Send check, M.O. or sent C.O.D.



NOW  
\$16.95

### LOOK AT ALL THESE SPECIAL FEATURES:

- Blade tilts, table stays level. Blade adjusts to any angle up to 50°.
- Single Hand Wheel Control. Tilts and tightens blade with a twist of the wrist. Blade rises and lowers; cuts from 0" to 2 1/4".
- Precision-ground cast iron table. Perfect flatness resists nicking and wear.
- Self-aligning rip fence. Adjustable to lie parallel to blade or give clearance either way.
- Patented Motor Mount takes

any standard 1/4 or 1/2 h.p. motor. Motor rides on ball bearing rollers. Keeps belt tight, transmits full power.

• Heavy long-lasting, all-metal construction. Built for a lifetime. Shipping weight 25 lbs.

### FAMOUS AMERICAN IRONCLAD GUARANTEE

Try any Plana Centric power tool for ten days. If, for any reason, you are dissatisfied, return the merchandise for full and complete refund—no questions asked. This famous guarantee has been offered on sales of more than 3 1/2 million power tools, and it has never been violated.

WRITE FOR FREE CATALOG  
Big bargains in home workshop power tools

All power tools sent express collect

AMERICAN MACHINE & TOOL COMPANY  
ROYERSFORD 16, PA.

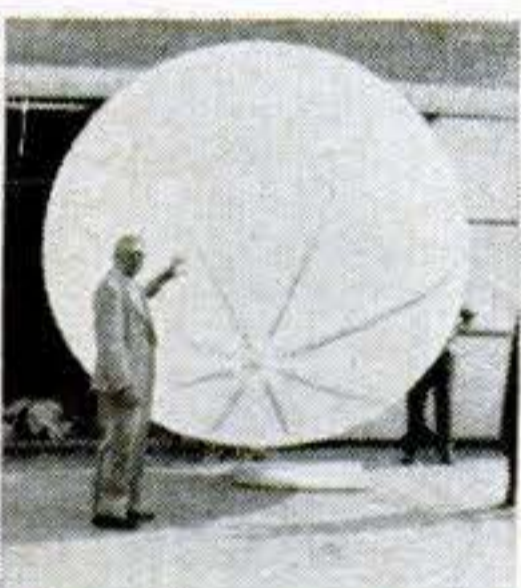

### GIANT BALLOONS 49¢

They're really BIG—surplus U.S. Govt. (new overage) Neoprene weather, target balloons, GREAT FUN in the backyard: at parties, picnics, dances, fairs. TERRIFIC for high school and college PROMS. They attract BIG CROWDS to business openings, civic events, conventions, exhibitions, trade shows. ORDER TODAY! Approx. inflated sizes:

18 in. dia., 3 for 70¢  
3 ft. dia., 49¢—5 ft. dia., 99¢  
10 ft. dia., \$1.59—13 ft. dia., \$1.95  
15 ft. dia., \$2.50

Postage paid on prepaid orders.  
Calif. residents please add sales tax.

VOLUME SALES CO., War Assets Div.  
Dept. PS 1155 3930 Sunset Blvd., Los Angeles 29, Calif.

Choose "out of the ordinary"

Christmas Gifts from

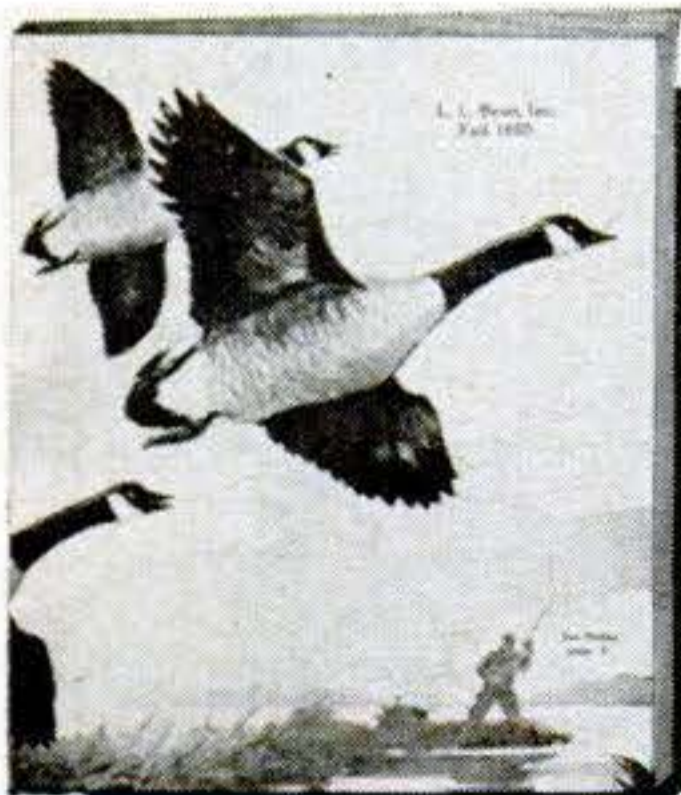

### Bean's Free Catalog

Fully illustrated, 104 pages, showing Hunting Footwear, Clothing, and one hundred and twenty other leather and canvas specialties of our own manufacture for campers and hunters.

L. L. Bean, Inc., 357 Main St., Freeport, Maine  
Mfrs. Hunting and Camping Specialties

## .22 cal Dueling Pistols Special \$19.95

NEW

shoots longs, shorts, long rifles

Matched pair \$37.95

target-hunting-defense

SINGLE SHOT



1776  
FLINTLOCK  
style

Perfect Balance - Precision Shooting

This unique .22 pistol combines the antique beauty of fine 17th Century firing pieces with all the advantages of a safe, modern weapon.

Early American style used by buccaneers, pirates, infamous men skilled in the art of dueling. In Hamilton vs Aaron Burr duel a similar gun was used. Finely crafted weapon with a beautifully polished Southern Magnolia hardwood stock, with etched brass side plates. 6" blued steel rifled barrel. Extremely accurate. A gun which belongs as much on the firing range or hunting trip as in a fine gun collection. Uses standard .22 cal. ammunition. Has opening breech action for fast firing. A real firearm bargain. Similar guns have sold for as much as \$75. Limited sale. 10-day free trial with 100% satisfaction guaranteed or your money refunded. Shipped F.O.B. San Gabriel. Adults only. State age. TO ORDER send \$19.95 in check, cash, or money order. Matched pair \$37.95. WHOLESALE IMPORT CO., Box 82-V San Gabriel, California.

STUDENTS • ARTISTS • DRAFTSMEN • ARCHITECTS • ENGINEERS • CONTRACTORS • SALESMEN

## DRAFTETTE CUTS DRAWING TIME IN HALF, IMPROVES ACCURACY—NEATNESS

Speeds up sketches of any kind! A precision-accurate portable drafting machine that clips on any tablet, sketch pad, notebook. Covers area to 11" x 17". Eliminates need for ruler, protractor, T square, triangle. Compact, lightweight, made of sturdy anodized aluminum. Carry in pocket, briefcase, etc. Last a lifetime. Order Now! Cash, Ch., M.O., postpaid. . . .

\$3.95

Dealer jobs invited.  
BAUMBACH ENGIN. CO. Dept. PS-511—10147 Halbrent San Fernando, California

## NEW BENJAMIN SUPER CO2 GAS CARBINE—\$16.50

HI-LO (2 Stage) Jet Power  
Cal. .177 or .22

RIFLED  
Shoots  
Pellets  
& Darts



IDEAL FOR

TARGET & SMALL GAME

SAFE—ECONOMICAL—ACCURATE

CONVENIENT—PRACTICAL—NON TOXIC

EASY TO OPERATE—NO PUMPING—NO FLINCHING.

Get 40 SHOTS from each 10¢ STANDARD SIZE CO2

(Soda) CARTRIDGE Up to 3/4" penetration.

Ask your DEALER for DEMONSTRATION.

BENJAMIN AIR RIFLE CO.

852 MARION ST., ST. LOUIS 4, MO., U.S.A.

FREE Folder

New Benjamin .177 or .22 CO2 ROCKET Gas Pistol with HI-LO JET POWER.....\$15.00



Shower HER with GIFTS!

SHE'LL ADORE YOU...

if you buy her those thrilling gifts from Frederick's! Send 10¢ today (please no stamps!) for a big, beautiful new catalog—filled with pretty lingerie, hose, Hollywood fashions, blouses, sweaters. Pretty pictures.

Copyright 1955

FREDERICK'S OF HOLLYWOOD  
Dept. C-144 5430 Hollywood Blvd., Hollywood 27, Calif.



# First Choice of Hobbyists— new Gilbert HO Trains!

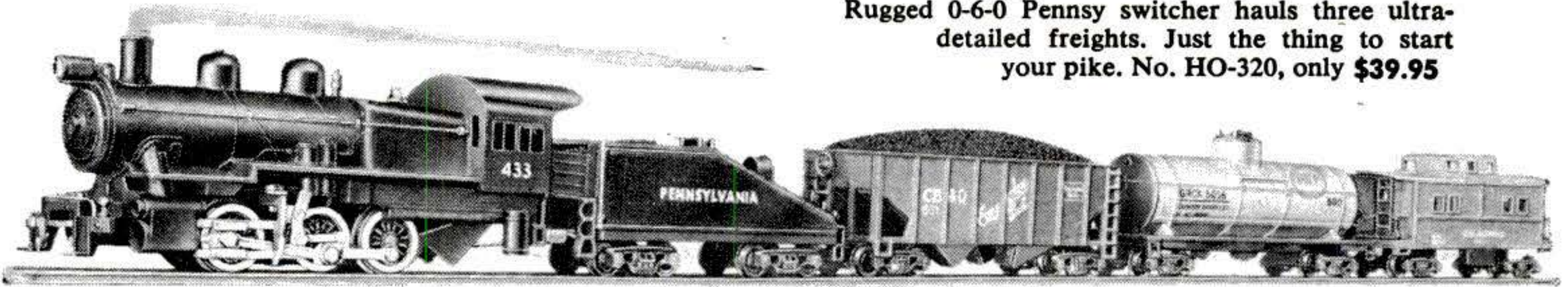

Rugged 0-6-0 Pennsy switcher hauls three ultra-detailed freights. Just the thing to start your pike. No. HO-320, only \$39.95

Here's Why!  
Only Gilbert HO  
has all this!

- real puffing smoke
- timed choo-choo sounds
- NMRA developed couplers
- 2-radius track (15" and 18")
- live spring trucks
- authentic painted cars
- accurate 9/64" scale

America's top do-it-yourself hobby: planning, building and running your own model railroad. Do it better with the best—Gilbert HO trains.

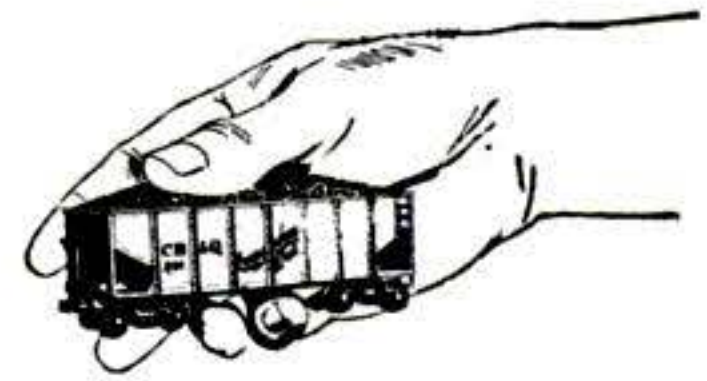

Send for FREE  
Gilbert HO Catalog!

The A. C. Gilbert Company, Dept. F-11  
New Haven 6, Connecticut

Please rush FREE Gilbert HO Catalog.

Name \_\_\_\_\_

Street \_\_\_\_\_

City \_\_\_\_\_

Zone \_\_\_\_\_ State \_\_\_\_\_



- ★ Antique furniture
- ★ Mend toys
- ★ Bend tubing
- ★ Make jewelry

## BERNZ O MATIC<sup>®</sup> TORCH SET

New Bernz-O-Matic Torch Set Makes Every Job Easy

500° hotter than a blowtorch! Instant-lighting propane torch includes pencil burner for making jewelry, antiquing, furniture—utility burner for bending tubing, copper sweat fitting—flame spreader for burning paint—soldering tip for mending toys, electrical repairs. Disposable cylinder—no fuel to spill. Great gift to ask for—or give to another workshop fan.

AT ALL GOOD HARDWARE STORES

Reg. \$12.60 only \$8.88 complete

OTTO BERNZ CO., INC., 280-90 Lyell Ave., Rochester 6, N. Y.

## I OFFER THESE Unbeatable Bargains



This one I think is a WOW... worth \$50.00 in anyone's money! **\$29.95**  
Tax and Postpaid

All-purpose 7 x 35 binoculars for spectators, hunters, nature-lovers, boat owners. Brings objects 7 times closer. Dust-proof, individual focus. Coated optics for brilliant, clear image. Lightweight. Leather carrying case and straps included.

This ELECTRIC MICROSCOPE is a terrific gift for students and hobbyists. **\$10.95** Postpaid

Built-in battery electric light unit gives light when you need it. 3-turret nose gives finger-tip choice of 100, 200 or 300 power. See new worlds under your nose. Fascinating! Entertaining! Hinged wood carrying case and 3 slides included.

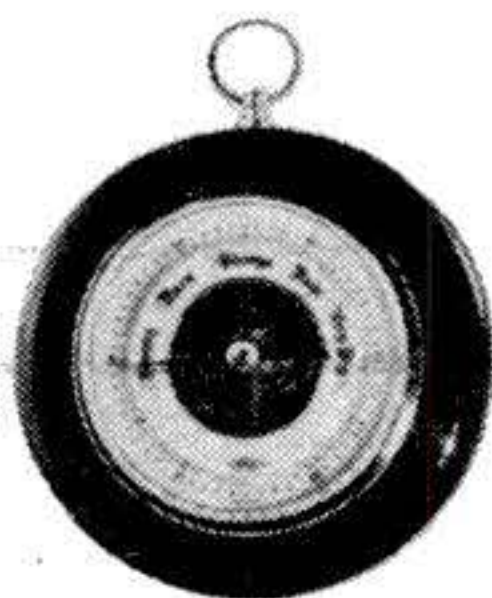
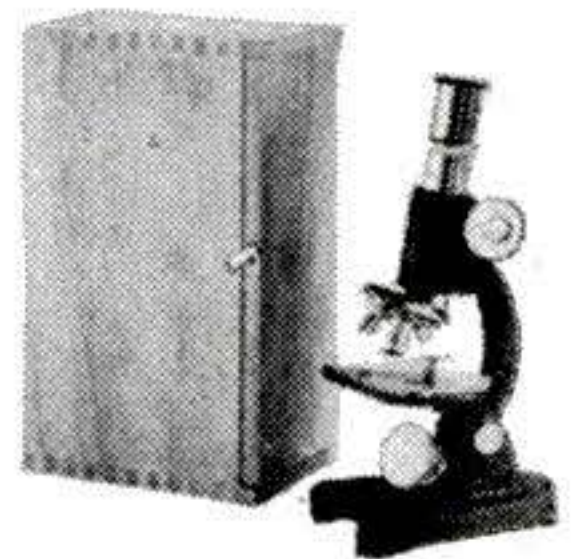

The superb... and I mean SUPERB...workmanship makes this a **\$7.50** great buy! Postpaid

Predict the weather 8 to 24 hours in advance. Don't confuse this with similar cheaper barometers. Finest quality imported polished movement is as accurate as domestic movements at twice the price! Handsome cherry finish frame, heavy brass bezel. 5 inches in diameter.

Satisfaction guaranteed.

**JOSEPH SALES CO.**

1740 East 12th Street  
(Room 506)  
CLEVELAND 14, OHIO



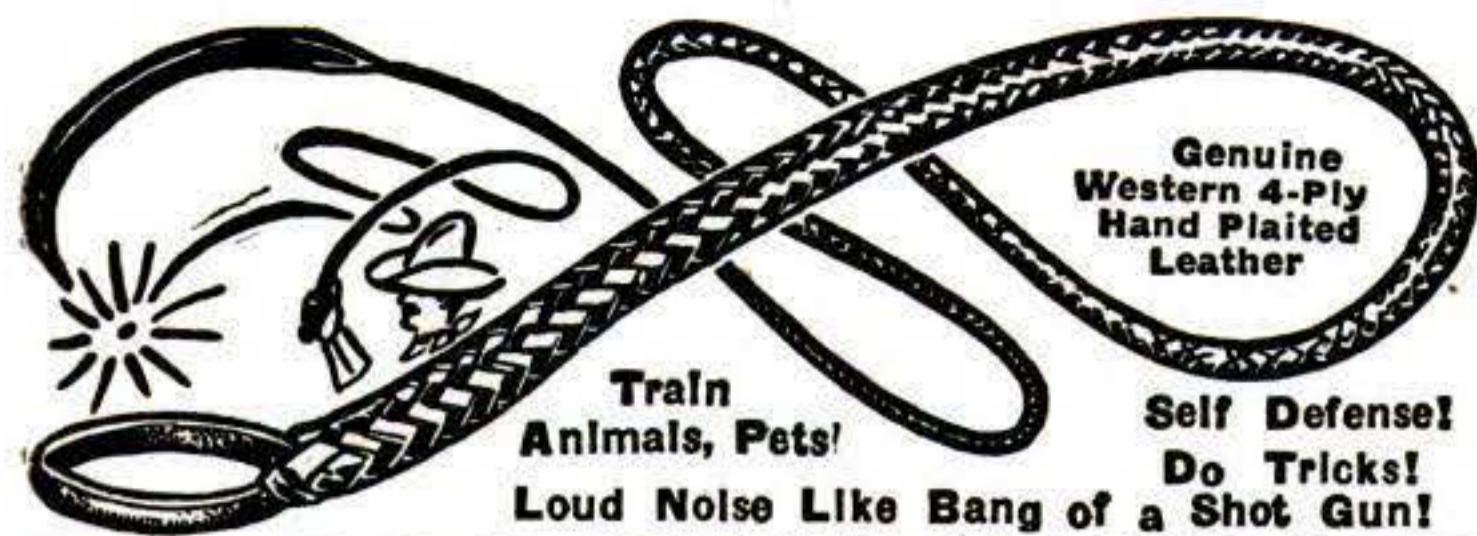

Genuine Western 4-Ply Hand Plaited Leather

Train Animals, Pets! Self Defense! Do Tricks! Loud Noise Like Bang of a Shot Gun!

## PLAITED LEATHER BIG BULL WHIP

Experts knock ashes off cigaret, gun out of hand, yank people off feet, etc. Used by trainers, ranchmen, etc. Grip lightly (pressure is on loop), then crack or coil; snake out or back; overhand, underhand, side-arm. Neat's oil finished for pliability & long life. "Cracker" or tongue on end. Solid grip handle with loop.

6-ft. Whip \$1.98; 8-ft. Whip \$2.69; JOHNSON SMITH & CO., Dept. 169, Detroit 7, Michigan



### Precision Miniature Camera

Less than half size of regular cigaret package! Take everywhere! Take surprise, candid & regular pictures. Weighs 2 1/2-ounces. Solid, all metal construction with leather lined body, chrome trim. Enclosed eye-level view finder. Single action, 1/25th second or time shutter. Precision ground lens. Takes 1 1/2 x 1/2-inch pictures per roll. Standard 16 mm. film. Fine enlargements from negatives. Low film cost. Spools can be used to load with 16 mm. Kodachrome color movie film.

Take indoor or night pictures by use of flash or flood unit (not supplied). Beauty in looks & performance. Precision made. Camera Only \$1.98. Camera with Pigskin Leather Ever-Ready Case & Strap \$2.50. Film 20c per roll. 6 rolls \$1.00. Case only 75c. JOHNSON SMITH CO., Dept. 169, Detroit 7, Michigan.

## Catalog of 3000 Novelties 10c

Send 10c for amazing catalog of novelties, live animals, scientific supplies, hobbies, funmakers, planes & boats, looms, magic tricks, joke articles, unusual seeds, gadget time savers, cameras, optical goods, projectors, movies, lucky jewelry, religious novelties, disguises, musical instruments, stamps, coins, puzzles, fortune tellers, radios, auto & bike accessories, telescopes, magnifiers, compasses, banks, smokers' gadgets, artists' supplies, printing sets, engines, motors, shockers, knives, billfolds, fireworks, guns, rifles, sports, books, games, plants, etc. Send name, address & 10c to:

JOHNSON SMITH & CO., Dept. 169 Detroit 7, Michigan



Comic! Naughty

### Jackass Cigaret Dispenser USEFUL XMAS GIFT

Nod head, up goes tail, out comes cigaret! Great laugh producer & practical cigaret dispenser. Surprise & amuse friends with funny, useful gift. Holds 10 cigarets. Attractively made of wood. Hill Billy Mose sitting on naughty jackass with case of corn liquor. Moveable head & tail. Colorfully finished. Great for den, office, etc. Gift box, 7 1/2-in. high. Get several. (3 for \$2.35; 6 for \$4.35; 12 for \$8.35; 25 for \$16.35; 100 for \$59.50) EACH POSTPAID ONLY 85c

Johnson Smith Co., Dept. 169, Detroit 7, Mich.



### Have Fun, Entertainment... IMPROVE YOUR SHOOTING SKILL WITH THE EXCITING NEW BENJAMIN TARGET PRACTICE OUTFIT

The Real "McCoy" of Home Shooting Sets!

Now you can enjoy hours of Target Shooting with the new BENJAMIN TARGET PRACTICE OUTFIT. Contains all the gear you need for setting up a Pistol Range in Basement or Outdoors, including the Famous BENJAMIN SUPER CO<sub>2</sub> ROCKET GAS PISTOL with 2-Stage HI-LO JET POWER for shooting BENJAMIN H-C PELLETS, bulls-eye Bell Target, 100 Paper Target Inserts, 5 Standard Size CO<sub>2</sub> (Soda) Cartridges, Sample Supply of BENJAMIN H-C PELLETS, and Instruction Sheet. A PERFECT GIFT! No. 262-T BENJAMIN TARGET PRACTICE OUTFIT, Cal. .22.....\$17.95 No. 267-T BENJAMIN TARGET PRACTICE OUTFIT, Cal. .177.....\$17.95

OUTFIT with Cal. .177 or .22 CO<sub>2</sub> ROCKET \$17.95 Gas Pistol

SENSATIONAL NEW

### BENJAMIN SUPER CO<sub>2</sub> ROCKET GAS PISTOL with 2-Stage HI-LO JET POWER PISTOL ONLY \$15.00

HARD HITTING - ACCURATE - ECONOMICAL SAFE - CONVENIENT - PRACTICAL - NON TOXIC

EASY TO OPERATE - NO PUMPING - NO FLINCHING. Get 50 SHOTS from each 10c STANDARD SIZE CO<sub>2</sub> (Soda) CARTRIDGE. Up to 3/4" penetration. RIFLED - Shoots .177 or .22 Benjamin H-C Pellets and Darts. For TARGET and SMALL GAME.

BENJAMIN AIR RIFLE CO., 811 BARRY ST., ST. LOUIS 4, MO., U.S.A.



Single Shot

Benjamin CO<sub>2</sub> CARBINE Rifle with HI-LO Jet Power \$16.50

FREE FOLDER

## CUCKOO CLOCK

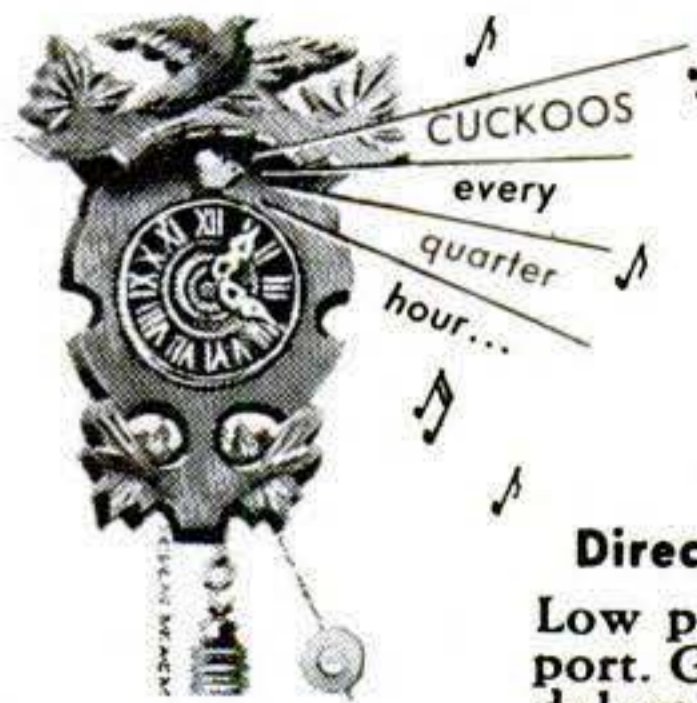

from GERMAN BLACK FOREST

Now \$3<sup>95</sup> only

postpaid... duty-free

Direct to you from EUROPE

Low price only by direct import. German weight and pendulum CUCKOO CLOCK.

Excellent timekeeper. Cuckoos every quarter hour. HAND CARVED. Antique walnut finish. Shipped direct from Free Europe with strange foreign stamps. Order as gifts, too. (Not more than one addressed to the same person.) Send only \$3.95 each. No COD's. Postman collects 15c foreign packet fee which can't be prepaid. Money-back guarantee. Order today.

SEVEN SEAS IMPORTS, Dept. E24B 1717 Westwood Blvd., Los Angeles 24, California

## BRAND NEW BLUE-STEEL

.22 cal. Blank Cartridge German AUTOMATIC, Clipload. 6 shot Repeater.

NO PERMIT REQUIRED

Latest model, not a clearance item. Gun is fully automatic, has positive safety catch, self ejecting clip. Adjustable firing spring. Machined with all the care and precision of West Germany's finest gunsmiths. Ideal for sporting events, theatrical performances, etc., 4" long, perfectly balanced. Satisfaction guaranteed. Send check or money order and save C.O.D. charges.



\$7.95

BIG THREE Inc., Dept. PS-11, 1109 Sixth Ave., New York 36, N.Y.

postpaid

## SHOOT "BAZOOK" HI-POWER SLING GUN!

TOPS FOR HUNTING AND TARGET FUN

SHOOTS EVERYTHING - Arrows, nails, steel balls, pebbles, mud, etc. PISTOL ACCURATE, RIFLE FAST for small game.



Patented

\$1.50 ppd. No C.O.D.

SAFE INDOOR with soft clay balls.

THICK gum rubber sling, hardw'd barrel.

GUARANTEED. Extra rubber & ammo. incl'd.

(500 STEEL BALLS \$1)

'SHOOT BAZOOK' - You'll like it. Quick deliv'ry.

ORDER NOW UMACO MFG. CO., P.O. Box 4133, H. LONG BEACH, CALIF.

Also Adult Size Cars for Golfers Airports Industry Light Delivery

## ESHELMAN 70 MILES PER GAL. GAS CHILD'S AUTO WITH MOTOR

STURDY, SAFE FOR KIDS. Commended by "Parents Magazine" Write for FREE Catalog.

Shipping Points: Baltimore, Reno, Chicago ESHELMAN CO., Dept. MC-411 109 Light Street Baltimore 2, Md.



2 H.P.

Pat. Pend.

## Sub-Machine Gun Style .22 BRAND NEW - single shot

100 SHELL STOWAGE FOR CARRYING EXTRA CARTRIDGES



\$19.95

AUTOMATIC EJECTION We believe this to be the first time that this type of firearm has been offered to the general public. Only a limited quantity of these fine, single action Sub-Machine Gun style Rifles. Crafted like famous guns used by troops and law enforcement agencies. Its accuracy is matched only by its handsome and unique appearance. Features floating bolt action with automatic recoil ejection for rapid load and fire. (Shoots .22 long Rifles only.) Has 18" barrel with deep blued finish, beautiful hardwood stock, built-in stowage case holds 100 cartridges. Has finger-fitting double hand grips. Fast, easy take-down. Notched, adjustable rear sight. A real firearm bargain. Ten days free trial with 100% satisfaction guaranteed or money refunded. Shipped F.O.B. San Gabriel. Adults only. State age.

TO ORDER, send \$19.95 in check, cash, or money order to: WHOLESALE IMPORT CO., Box 15-F, San Gabriel, California.



# Make SURE, SAFE INSULATED ELECTRICAL CONNECTIONS

The New

## SUPER **ChAMP** Hand Tool

The ONE Tool for ALL Wire Sizes used in Home Wiring, Appliances, Automobiles.

DOES ALL THESE THINGS BESIDES

**CRIMPS** Solderless Terminals and Connectors without solder or tape for safe connections.

**CUTS** Wire, making clean, sharp cut through Insulation and Conductor.

**STRIPS** Wire sizes #22-#10. Gauges assure proper length for sure, safe crimp.

**SHEARS** Bolts and screws without damaging threads — no filing or hack sawing.

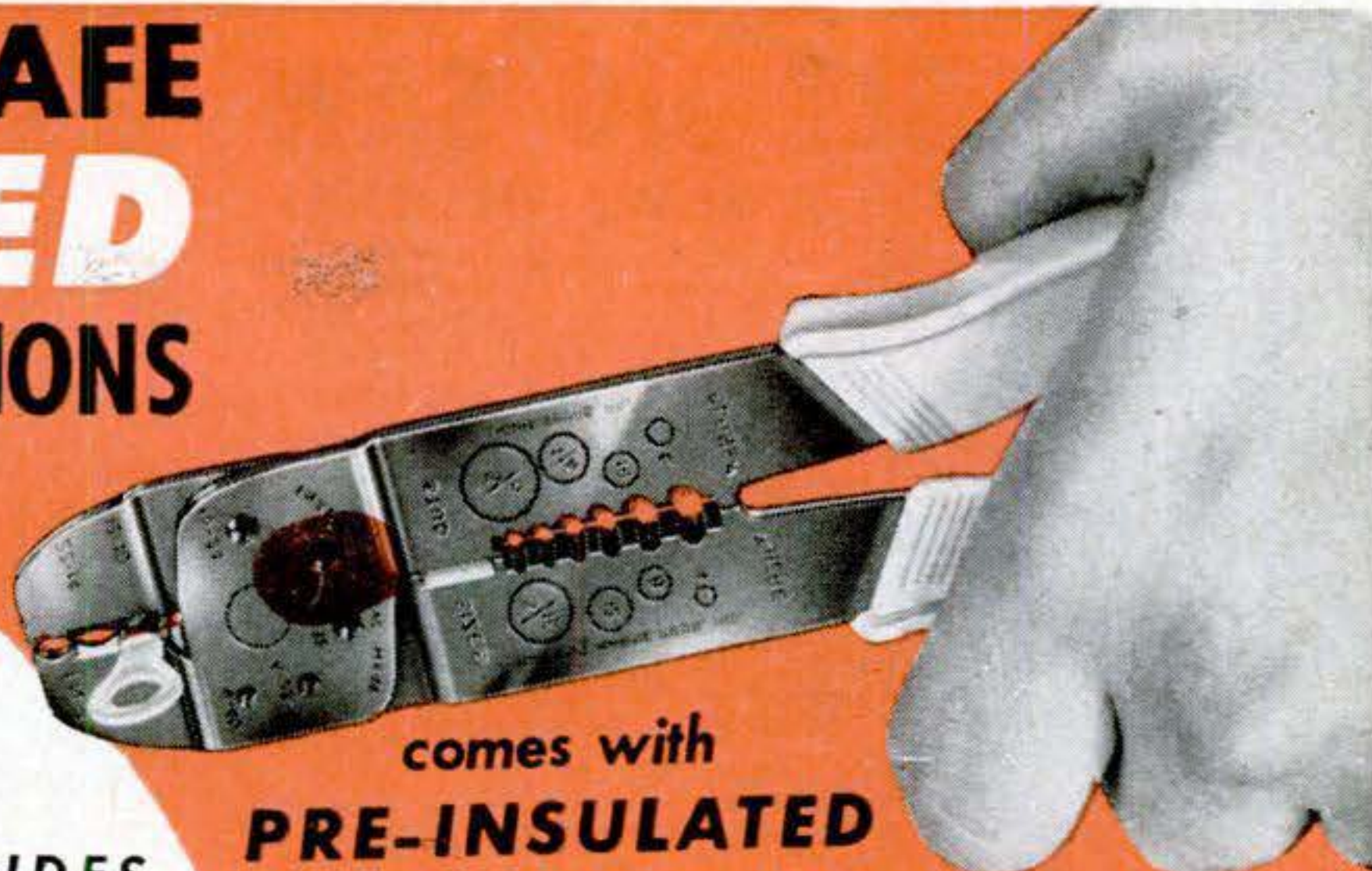

comes with  
**PRE-INSULATED**



**FREE with Each TOOL**

**ORDER DIRECT — USE COUPON**

Only  
**\$3.95**

Post Paid

Satisfaction guaranteed or money back. Send check or money order for \$3.95. (Ohio residents add 12c sales tax.)

T. W. Berger, Inc.  
National Distributor Consumers and Dealers  
**AIRCRAFT-MARINE PRODUCTS, Inc.**  
1319-N American Bldg., Cincinnati 2, Ohio

T. W. Berger, Inc.  
National Distributor Champ Tool  
1319-N American Bldg., Cincinnati 2, Ohio  
Send me post paid the new super Champ Hand Tool. I am enclosing \$3.95. (Ohio residents add 12c sales tax.)

check  money order

NAME .....

ADDRESS .....

CITY.....ZONE.....STATE.....

## NEW ENAMEL-ON-COPPER IDEA BOOK

Now you can enjoy this fascinating craft! Create jewelry, ash trays, bowls, etc. Copper Shop Idea Book gives complete description of processes and techniques for exciting creative results—lists hundreds of ready-to-fire copper items. As America's leading source of enameling supplies Copper Shop will provide at low cost everything you need. Book costs 25c—refunded on your first purchase. Send for your copy today!

**THE COPPER SHOP**  
DIV. OF IMMERMANN & SONS  
1812 E. 13th St. Dept. N-82  
CLEVELAND 14, OHIO



The gift  
that says ...

"Best Wishes"  
ALL YEAR... FOR YEARS  
**HULL AUTO COMPASS**  
NOW ALSO IN  
NEW CAR COLORS

*Beaconlite*  
ILLUMINATED \$6.95  
*Streamline*  
NON-ILLUMINATED \$4.95



The famous, fine instrument name in Auto Compasses.  
At better dealers everywhere. Write for literature.

**HULL MFG. CO. P. O. Box 246, E-11, WARREN, OHIO**

## CUT ANY SIZE-ANY SHAPE - **SPEARHEAD** CUTTER

with the  
★Accurately cuts circles from 1/4" to 6" . . . odd shapes, straight pieces any size. ★Quickly, easily cuts gaskets, discs, washers, shims, patterns — from leather, rubber, asbestos, or any pliable sheet material. ★In use the world over . . . by some of the largest companies.

Long lasting blades of tempered steel. Durable cutting pad included.

**COMPLETE:**

Model A-14 Cutter, pivot pins, blades, cutting pad.

ONLY **14.50**

Postpaid  
Send Check or Money Order . . . Satisfaction Guaranteed.

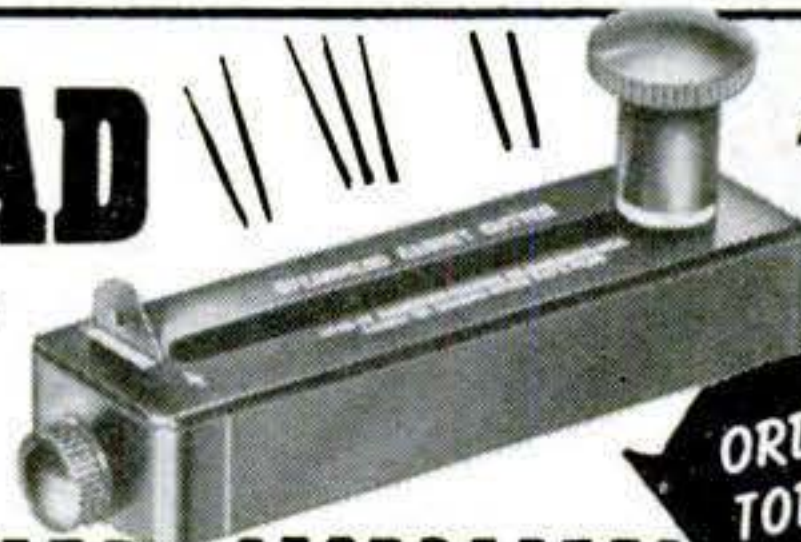

**ORDER TODAY**

**ZIMMERMAN PACKING CO.**  
CINCINNATI 12, OHIO

Send me the Spearhead Cutter, including blades, pivot pins, and cutting pad. My \$14.50 is enclosed.

NAME .....

ADDRESS .....

CITY.....STATE.....

I'm sending  check -  money order.

**Zimmerman**  
PACKING CO. CINCINNATI 12, OHIO



# THE NEW DALTON Model D-500 ELECTRIC PORTABLE JIG SAW

## 7 SAWS IN ONE!

does the work of a RIP...  
CROSS CUT... COPING...  
JIG... SCROLL... BAND  
and KEYHOLE SAW  
CUTS ANY MATERIAL!  
SAWS ANY SHAPE!

RIPS and CROSS CUTS 2x4's

Makes fast, smooth cuts...  
no jumping or chattering. Has  
the capacity to rip and cross  
cut 2 x 4's. The only other similar  
type device on the market that can  
match this amazing performance costs  
almost three times as much!

Specially built Dayton motor assures  
smooth, steady cutting. A built-in com-  
pressor blows sawdust away from guide  
line.

### SPECIFICATIONS

• 4 to 1 gear reduction. • All gears hardened steel.  
• Motor exposed for cool running. • Oilite bronze bear-  
ings. • Air is pumped from top down through the center  
section, cooling unit as well as blowing sawdust from line.

IT CUTS wood — plastics — metals —  
composition boards — hard rubber and  
others.

IT SAWS circles — curves — straight  
lines — intricate designs.

Complete with 5  
different blades

**\$48<sup>00</sup>**

**SHIPPED ON APPROVAL  
NO MONEY WITH ORDER — NO C. O. D.**

Try it ten days before  
you buy. If completely  
satisfied then send \$15.00  
and pay balance at rate  
of \$11.00 per month for  
3 months — **No Interest  
or Finance Charges  
Added.** If not completely  
satisfied, return to us, no  
explanation necessary.

**KAPNER HARDWARE, INC.**  
Dept. A-149, 452 East Tremont Ave.,  
New York 57, N. Y.  
Please rush one D-500 Jig Saw. I agree  
to pay \$15.00 within 10 days after re-  
ceipt and \$11 per month thereafter.

Name \_\_\_\_\_  
Address \_\_\_\_\_  
City \_\_\_\_\_ Zone \_\_\_\_\_ State \_\_\_\_\_

# FREE! MINT BRITISH AFRICAN STAMPS

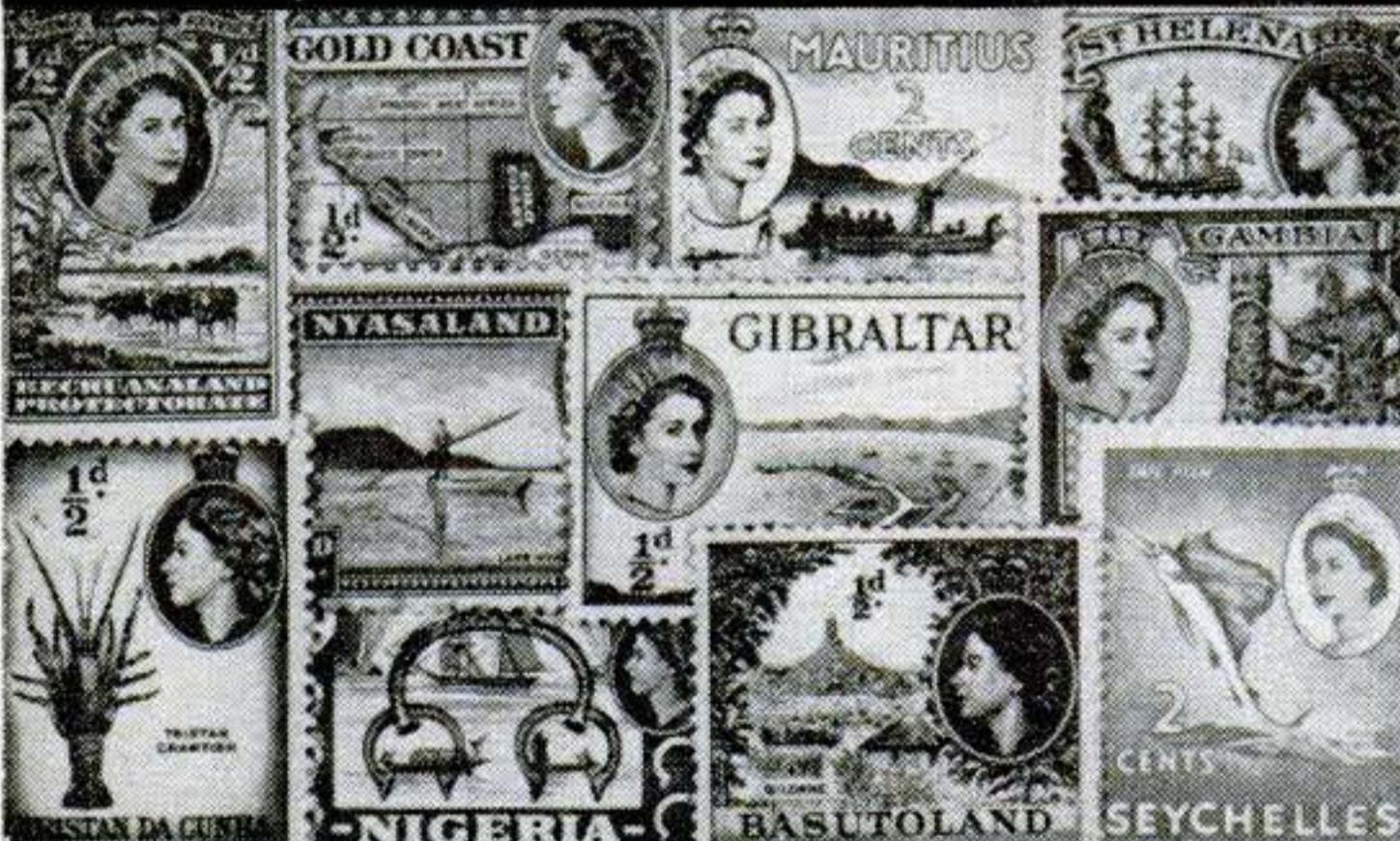

Rush coupon today. Exciting offer! Newest issue Elizabeth II stamps — all mint, all different, all yours, — absolutely FREE! Scarce, beautiful, 2-color stamps from obscure African countries — Nigeria, Basutoland, Gambia, St. Helena — many others! And MORE — free copy helpful "Stamp Collector's Guide" — free color reproduction and story World's Rarest Stamp — free 1/2 penny Falkland Island stamp. Other valuable offers for your free inspection. Limited offer, so rush coupon today! If coupon has been clipped, rush to GARCELON STAMP CO., Dept. PS11B, Calais, Maine.

**GARCELON STAMP CO., DEPT. PS11B, Calais, Maine**  
Rush FREE mint British African Stamps and other offers.  
(PLEASE PRINT)

NAME \_\_\_\_\_  
ADDRESS \_\_\_\_\_  
CITY \_\_\_\_\_ STATE \_\_\_\_\_

# We're sorry...

that we have not had the production to supply all the demand for Life-Time 50,000 Mile Spark Plugs. New equipment and greatly accelerated production enable us now to make immediate delivery. If you have ordered and your check has been returned, please place your order again. Life-Time Spark Plug Sets may be ordered from this advertisement. We will postpay at regular retail price. Specify make, model and year of car. Set of 6, \$7.14; set of 8, \$9.52.

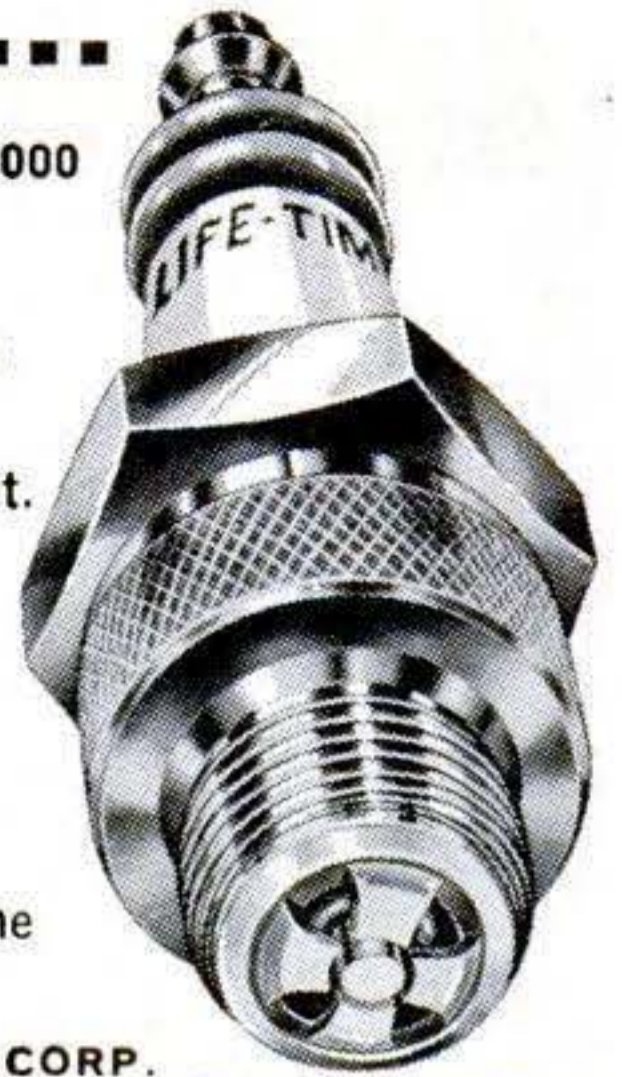

### DISTRIBUTORSHIPS

Some additional distributorships are now available. If you have already written us regarding your area, please contact us again. If you have not written before, please send us an outline of your previous business experience and qualifications.

**CONTINENTAL MANUFACTURING CORP.**  
Washington Blvd. at Motor Ave. Culver City 111, California

695

## HEAVY OIL-IMP-BALL BEARINGS PUMPS MILLIONS OF GALS.



IRRIGATE, SPRAY, DRAIN OR FILL ANYTHING  
— ANYWHERE! Will not Rust, Clog, or Leak. Patented Seal. Pumps 2800 gph. 420 gph. at 75' high or 1600 gph from 25' well. Six blade impeller. Threaded for pipe. 3/4" inlet, 1/2" outlet. Use 1/8 to 3/4 hp motor  
Heavier 2800gph 8.95 Heavier 7500gph 11.95  
7500 gph 9.95

Check. MO or COD—Money Back Guarantee

FREE Literature—Comparison Charts  
**U.A.T. MFG. & ENG. CO. HICKSVILLE 273, NEW YORK**

# Save on Gov't Real Estate

Buy Direct from Government, Surplus Homes, Islands, Farms, Land, etc. Listings \$1.00. Send now & save \$.

## THE ABACUS PRESS

Dept. A, Box 169MMM E, Hartford 8, Conn.



*Find* **URANIUM!!**

GEIGER COUNTERS for uranium detection. All models and sizes — from low-cost, portable to super-sensitive airborne units. Prices start at \$37.50. Also TREASURE DETECTORS and MINERALITES. \* **FREE INFORMATION** \*

*Detectron* CORP.  
5528 Vineland, North Hollywood, Calif.

# Free Book on Arthritis And Rheumatism

## HOW TO AVOID CRIPPLING DEFORMITIES

Explains why drugs and medicines give only temporary relief and fail to remove the causes; tells all about a specialized non-surgical, non-medical treatment which has proven successful for the past 36 years. Write for this 44-page FREE BOOK today.

Ball Clinic Dept. 36 Excelsior Springs, Mo.

**EARN EXTRA MONEY**



**IT'S EASY TO LEARN LEATHERCRAFT**

... the fascinating hobby that turns spare time into profit and pleasure. Learn this easy way to MAKE EXTRA MONEY. Make all kinds of handtooled Leather goods. Tandy has everything for Leathercraft.

WRITE FOR **FREE CATALOG**

**Tandy** "NATIONWIDE—A TANDY STORE NEAR YOU"  
**LEATHER CO. P. O. BOX 791-RE FORT WORTH, TEXAS**



# LAFAYETTE'S BARGAIN SALE!

## MINIATURE CRYSTAL MICROPHONE

Here's a typical Lafayette special for the experimenter, student or dealer. An extremely sensitive and small crystal microphone used in hearing aids and other small apparatus. Can be used as lapel mike—miniature transmitter mike for concealed locations.

MS-108  
Net 1.95

## TIMER-SWITCH SALE 3.95

Automatically turns on radio, television sets, toasters, coffee-makers, etc.—at any pre-set time within 12 hour period; also tells time. Requires 3 1/2" diameter round hole. Depth behind dial face 2 1/4". Shpg. wt. 1 1/2 lbs. MS-62, for 110V/60 Cy AC.



## 3 LENS TURRET MICROSCOPE 100X-200X-300X

100X-200X-300X, full 8" high, precision built. Triple position turret hold 3 achromatic color-corrected objectives. Complete with fitted wood carrying case. Shpg. wt. 4 1/2 lbs.



F-10 ..... Net 4.95

## PRECISION DRAFTING SET



11 Pieces — Fitted Felt-Lined Case. Made in Germany, of heavy brass, nickel plated and polished. Instruments include 5 1/8" compass with pencil and pen points and lengthening bar. 5 1/8" Divider, three 3 3/4" sidewheel bow dividers with needle point, pen point and pencil point. 5" Ruling pen, extra handle for pen or pencil, capsule with extra leads. Your money back—if this set is not worth twice our price!

F-13 ..... NET 2.59

## TELEPHONE PICK-UP FOR RECORDING TELEPHONE CONVERSATIONS

Induction telephone pickup. Telephone conversations can now be picked up with no tapping of wires or special telephone circuits. Connect the leads of any medium gain audio amplifier, or directly to any tape disc or wire recorder.

MS-16 ..... 2.95

## REMOTE CONTROL FOR SILENT TV VIEWING



- For Hard-of-Hearing
- For Late Listening

One or two people can both see or hear the program with the loud speaker cut-off. The hard-of-hearing can listen to radio or TV without turning the volume so high that others can't stand the noise. Comes complete with miniature phone and 20 ft. of cable. Shpg. wt. 3 lbs.

MS-125 ..... Net 6.50

## LAFAYETTE GEIGER COUNTER KIT WITH HIGH SENSITIVITY VICTOREEN TUBE 1B85

Lafayette Geiger Counter Kit with High Sensitivity Victoreen 1B85 tube, makes this one of the most outstanding kit buys in the country. This tube is used only in the most expensive equipment. Easy to build, at only a fraction of the price, of commercial instruments of this type. Just turn it on, flip the high voltage switch and listen to the clicks. Kit includes all parts, tube, carrying case, 22 1/2" and 1 1/2" volt Batteries. Complete instructions for quick assembly. Shpg. wt., 1 1/2 lbs.



KT-75 ..... Net 14.95

## 2 TRANSISTOR POCKET RADIO KIT



Packed into a 2 1/2" x 3 1/2" x 1 1/4" plastic case. This Two Transistor plus crystal diode radio kit offers many surprises, utilizing a regenerative detector circuit with transformer coupled audio stage, gives you high gain and excellent selectivity. Pulls in distant stations with ease with more than ample earphone volume. Kit comes complete with two transistors, crystal diode, loopstick, Argonne transistor audio transformer, resistors, condensers, plastic case, etc. Including schematic and instructions.

KT-68 Complete kit with Miniature Dynamic Earphones ..... Net 13.75  
Less Earphones ..... Net 11.80

## IMPORTED BINOCULARS



All have coated lenses — clamped in prisms — light weight all metal bodies. Complete with case and straps.

F-182	— 6x, 15	I.F. ....	NET 10.75
F-105	— 8x, 30	I.F. ....	NET 17.95
F-15	— 7x, 35	I.F. ....	NET 17.95
F-183	— 7x, 35	C.F. ....	NET 20.95
F-103	— 7x, 50	I.F. ....	NET 21.50
F-164	— 7x, 50	C.F. ....	NET 24.95
F-117	— 10x, 35	C.F. ....	NET 23.95
F-104	— 12x, 50	I.F. ....	NET 27.95
F-118	— 16x, 50	C.F. ....	NET 31.50
F-185	— 20x, 50	C.F. ....	NET 37.50

FULLY GUARANTEED FOR 6 MOS. AGAINST MECHANICAL AND OPTICAL DEFECTS.

ADD 10% FED. TAX TO PRICES

send for **FREE CATALOG**

132 page, electronic buying Guide, Transistors, radio, TV, Hi-Fidelity, Drafting supplies, microscopes, chock full of buys at great savings. Write today for **FREE COPY**.

LAFAYETTE RADIO Dept. KK 100 - 6th Avenue, New York 13, N. Y. ENCLOSE POSTAGE WITH ORDERS

## LEARN PLASTICS



### COMPLETE LOW COST SHOP METHOD HOME TRAINING NOW AVAILABLE

Get in on Big Money opportunities in Plastic molding, casting, forming, carving, etc. Earn as you learn with Interstate's professionally prepared course. All plastic materials furnished.

WRITE FOR FREE BOOKLET

### INTERSTATE TRAINING SERVICE

DEPT. C-2, PORTLAND 13, OREGON

## BUILD YOUR OWN MIDGET ROADSTER \$25 BUILDS BODY & FRAME



BUILD A PONY ROADSTER or Pick-Up in few spare hours. Uses 2 hp engine, 450 lb. loads, 70 m.p.gal., plenty of speed. Designed for VERY LOW-COST assembly from PARTS BOUGHT IN YOUR NEIGHBORHOOD. Use home tools. Great for kids, sturdy utility car. COMPLETE step-by-step plans. 17 large-size pages. 30 "show-how" photos. Body templates, complete material and parts-list. ONLY \$1.95 POST-PAID. Satisfied or money back.

PONY PLANS, DEPT. 3B, 7641 TEXHOMA AVE., NORTHRIDGE, CALIF.

# LEARN MEAT CUTTING AT NATIONAL Pay After Graduation



The steady dependable trade of Meat Cutting taught easily in 8 short weeks. You LEARN BY DOING under actual meat market conditions in big modern school at Toledo.

For beginners or men with experience. Get a Profitable store of your own. Remember, PEOPLE MUST EAT! Big pay jobs. Free employment help. Thousands of successful graduates.

Buying, cutting, percentage, pricing, advertising, selling, etc. A complete retail meat education. National School established over 30 years. Get National training NOW. Pay your tuition in easy weekly payments

after you graduate. Get all the facts. Send coupon for FREE 52 page school catalog—TODAY. G.I. Approved.

National School of Meat Cutting, Inc.  
Dept. 51-X, Toledo 4, Ohio

Send me your FREE school catalog on National Training at Toledo in Meat Cutting, Meat Merchandising and Self Service Meats. No obligation. No salesman will call.

Name.....Age.....

Address.....

City.....State.....

Approved for training Korean Veterans



**MAKE  
BIG PAY  
OR OWN A  
BUSINESS**



*Learn*  
**AIR**

# CONDITIONING & REFRIGERATION

Now you can break into the fast-growing, well-paid field of Air Conditioning & Refrigeration in months... now you can get practical experience as you learn! CTI's new Shop-Method plan trains you at home in spare time—trains you so thoroughly that you can begin repairing and installing units within weeks after you enroll—for pay. Get into this big, uncrowded field—and work for top pay or go into business. Mail coupon and we'll send you eye-opener facts.

## NEW! 23 BIG PRACTICAL TRAINING KITS



Look what you get!—A motor, compressor, testing gauges, controls, a complete refrigeration hi-side; mechanic's tools and supplies! You get on the job training in your own home. You build and keep an air conditioner, freezer, refrigerator or milk cooler. You get more—learn more—earn more—the CTI way.

MAIL COUPON TODAY FOR NEW FREE BOOK

### COMMERCIAL TRADES INSTITUTE

1400 Greenleaf Ave., Chicago 26, Ill. Dept. R-112

Send me your big FREE book which tells me how I can train at home to make big money in Air Conditioning & Refrigeration.

Name \_\_\_\_\_ Age \_\_\_\_\_

Address \_\_\_\_\_

City \_\_\_\_\_ Zone \_\_\_\_\_ State \_\_\_\_\_

MEMBER: NATIONAL HOME STUDY COUNCIL

## You Can Be a Local Manufacturer of CAVITEX

### SUPERFINE MASONRY

Local production explains why Cavitex can offer so much in quality for so little money, yet is so generous in profit potentials. It's a case of streamlined manufacturing—processing local materials for local building—cutting out the high costs of freight and distribution.

Cavitex creates new standards of beauty—in size, proportion and color. "Puts emphasis on the horizontal." Cored-out design for lighter weight and greater insulation values. Available in 8-inch and 4-inch.

Hundreds of territories are available to men looking for a local manufacturing enterprise. Franchise privileges. Responsible operators can obtain basic equipment on attractive rental terms. The Cavitex industry is sponsored by a million-dollar company backgrounded by fifty years of experience and reputation. Write or wire at once for "Opportunity, Unlimited" and tentative reservation of territory.



**W.E. DUNN MFG. CO.**

410 W. 24 St., Holland, Mich.

In Canada

Dunn Masonry Machinery, Ltd.  
842 Dundas Highway  
Cooksville, Ont.

X-6

## OWN Your Own Business



# \$5 per hour

Clean and Mothproof rugs and upholstery "in the home," office, institution. If now employed you can operate in spare time and build a permanent full-time business. Alert dealers can gross \$5 hourly profit on own service plus \$3 on EACH serviceman. We locally train and assist you right

in your town. Easy to learn—quickly established. **DURACLEAN** cleans by absorption. No scrubbing, soaking or shrinkage. Dirt and grease vanish... matted pile rises... colors revive. Furnishings used again same day.

**DURAPROOF** makes fabrics resistant to moths and carpet beetles. Your service backed by an International Money Back 6 Year Warranty.

We furnish enough material to return your total investment. Easy terms. Send for FREE booklet TODAY.

**DURACLEAN CO.**

Duraclean Bldg., 5-18N Deerfield, Ill.

## Buy U. S. Defense Bonds



## He's alive ... and you helped

People still die from tuberculosis—this year one American every twenty-seven minutes!

Yet the money which you give for Christmas Seals has helped to save thousands of lives.

Christmas Seals fight tuberculosis year-round—through education, case finding, patient rehabilitation, and research.

Make Christmas Seals a part of your holiday giving, today.



Buy and use  
**Christmas Seals**



**INSURED TIRE SERVICE POPULAR BRANDS**

**FREE** INSURANCE POLICY given with each used tire sold. We guarantee the amount of service you pay for. NOWHERE CAN SUCH QUALITY BE FOUND AT SUCH LOW PRICE!

**SPECIAL! Deduct 10% on orders for Two or More used tires**

**YOU CAN'T LOSE!!**

**GOODYEAR SUBURBANITE TYPE SNOW TIRES**  
New Tire Guarantee—Factory Rebuilt  
BEST WINTER TRACTION OF ALL!

670x15	\$9.95	710x15	650x16	\$10.90
600x16		760x15	650x15	

Super Quality		Rugged Performance		15 Months Insured Service	
600x16	\$3.65	670x15	\$3.95	700x16	\$4.45
650x15	3.85	670x16	4.05	710x15	4.35
650x16	4.25	700x15	3.95	760x15	4.45
550x17				550x17	4.65

Supreme Quality		Nothing Finer		30 Months Insured Service	
600x16	\$5.25	475x19	\$5.45	700x15(6)	\$10.45
600x16(6)	6.75	640x15	4.95	750x16(8)	15.95
650x16	5.75	670x15	5.35	700x17	11.95
650x16(6)	7.25	710x15	5.45	750x17	16.45
700x16	6.35	760x15	5.95	750x15	10.95
750x16(6)	8.45	800x15	6.35	30x5	11.25
550x18	4.95	820x15	6.35	600x20	10.95
550x17	4.75	550x15	5.35	650x20	11.75
650x15	5.25	670x16	5.15	32x6(8)	11.95
700x15	5.35	700x16(6)	10.25	32x6(10)	12.75
				1100x24	25.95

Whitewalls \$1.00 extra.

**MIDLAND TIRE SALES**  
Speedy shipments on Mail Orders. F.O.B. Chicago. Insurance policy sent with each order. Deduct 10% on orders for 2 or more used tires. Send CHECK or MONEY ORDER.—No COD's.  
3701 S. Normal, Dept. 55-37, Chicago 9, Ill.

**EYE GLASSES by MAIL As low as \$1.95**

WRITE for FREE CATALOG with 14 LENS SAMPLE CARD  
Thousands of Customers  
Est. 1939



QUALITY READING-MAGNIFYING OR BIFOCAL GLASSES FOR FAR AND NEAR

**ADVANCE SPECTACLE COMPANY, Inc.**  
537 S. Dearborn St., Dept. SP-11 Chicago 5, Illinois

**make your own Gems 29.50 F.O.B.**

The Gem Maker comes complete with all necessary equipment, including a super-charged diamond blade for sawing, and all wheels for grinding, shaping and polishing; also complete instructions. The complete equipment as shown, less motor and belt, for only \$29.50, f.o.b. Burlington, Wisconsin. Write today for information and literature.

**B & I MANUFACTURING CO.**  
Dept. S Burlington, Wis.



**\$5 CASH AN HOUR!**

sharpening circular saws, planer and jointer knives in your home or garage... spare time. No experience needed. Hundreds of jobs in your neighborhood... no canvassing... no selling. Only \$15 down brings you this money-maker. Write today to:

**BELSAW MACHINERY CO., 1676 Field Bldg., Kansas City 11, Mo.**

Write today for **FREE BOOK**



**EARN EXTRA MONEY GROWING MIDGET TREES!**

AT HOME • SPARE TIME • FOR FUN AND PROFITS!

It's New! Amazing! FULL GROWN living dwarf trees—only 12 INCHES HIGH! Elm orange, oak, cypress—any kind! All BLOOM and even BEAR FRUIT. Perfect, healthy specimens, but miniature! Make costly home decorations and beautiful expensive centerpieces (sold for over \$1,500 each). It's Fun! A new fascinating artistic HOBBY — a new SSSSSS HOME BUSINESS! Real seed and sensational new growing plan details. BOTH ABSOLUTELY FREE!

**FREE! GENUINE SEED AND PLAN**

**NATIONAL NURSERY GARDENS, Dept. N-11**  
8463 SOUTH VAN NESS, INGLEWOOD 4, CALIFORNIA



**I SHOW YOU HOW TO MAKE MONEY AT ONCE**

**START YOUR OWN BUSINESS IN 2 WEEKS— AT HOME IN SPARE TIME**



**PLATE Baby Shoes IN BRONZE AND COLORED PEARL**

MILLIONS OF NEW PROSPECTS EVERY YEAR



Now is the time to cash in on this big-paying, easy-to-operate, year-round business and you need no experience. MATERIALS COST YOU ONLY 50c—YOU GET \$6.00! With many actual "show-how" illustrations and step-by-step instructions, YOU can start earning money at once in one week. Working only a few hours you can make more money than many people make working an entire week.

**IMMEDIATE RESULTS**

- Big Income
- Huge Demand
- Sales Plan
- Future Security
- Your Own Business

We will send you full details absolutely free.

**FREE! MONEY MAKING PLAN**  
Full Details Without Obligation  
**MAIL COUPON TODAY!**

**KIKTAVI COMPANY, Dept. S-5511**  
11029 S. Vermont, Los Angeles 44, Calif.

**KIKTAVI COMPANY, Dept. S-5511**  
11029 S. Vermont, Los Angeles 44, Calif.

Send me FREE details of your MONEY MAKING PLAN, without obligation.

NAME \_\_\_\_\_

STREET \_\_\_\_\_

CITY \_\_\_\_\_ ZONE \_\_\_\_\_ STATE \_\_\_\_\_



# MEN - WOMEN! Paint it with Suede

SPRAY ON  
RAINBOW COLORS

for PROFIT and Pleasure..



**FLOK-KRAFT**  
Flok-Kraft Covers:  
Plaster, Fabric,  
Wood, Metal, Plastic,  
Rubber - any surface!

**A SENSATIONAL NEW HOME BUSINESS!**  
A NEW INDUSTRY...  
A NEW MIRACLE FINISH!!  
**MAKE \$500 to \$1000 PER HOUR and more!**

## Read What Others Say About Flok-Kraft

"... pleased with your course and I'm being swamped with work to do." W.F., Pa.

"Got \$52.50 for those 7 trunk interiors for about 4 hours work. \$7.50 per trunk." J.O., Mo.

"Received the flok-kraft outfit and everyone that saw it is very enthused. I only had it about thirty minutes and got an order for a hundred dollar job." Mr. C. H. Maryland.

## YOURS TO EXAMINE WITHOUT RISK!!

Complete instructions, starting kit of materials, equipment-complete, full details on how you can start your own business, spare or full time—EVERYTHING sent you to EXAMINE AT OUR RISK!

**FLOK-KRAFT and DEFENSE**  
Flok-Kraft offers a way to big extra money, assisting defense manufacturers in many lines as well as filling a big demand on the home front.

### PROFESSIONAL SECRETS CAN BE YOURS

At last, secrets of this amazing miracle finish can be yours! Huge profits waiting to be tapped in tremendous new field. Flok-Kraft gives a velvety, luxurious surface to radios, lamps, toys, signs, store displays, figurines, auto dash boards—a thousand and one items to be seen on every hand easily and quickly beautified, enriched, increased in value with Flok-Kraft. Make old objects beautiful—saleable, make new things worth much more with this soft, rich covering that can be applied to any surface, even if old or worn.

### YOU CAN LEARN IN A FEW DAYS

Make to \$5.00—yes! even \$10.00 and more per hour. Fully detailed Flok-Kraft instructions—complete and easy to understand—every point explained—shows you how to start on the road to big money, full or spare time.

**WE FURNISH EVERYTHING YOU NEED TO START**  
You also get complete Flok-Kraft kit of materials and equipment that enables you to start at once. Add to your income from your regular job or begin to build a successful business of your own and do it all, right in a corner of your basement, garage, service porch, kitchen or living-room.

**GRASP THIS LIFETIME OPPORTUNITY TODAY**  
I'll arrange to send you the complete outfit—everything you need to start—for leisurely, no-risk examination right in your own home. You owe it to yourself to investigate. Fill out and mail the coupon below for FREE details, Sample, Plan, etc. Do it today! Everything I send you now is FREE of charge and post-paid. Airmail is faster.

COAST INDUSTRIES, Dept. 11  
Los Angeles 61, Calif.

SEND NO MONEY!  
JUST YOUR  
NAME AND  
ADDRESS



NELS IRWIN  
Director of  
Instruction

**FREE!**  
Booklet,  
Sample,  
Plan!



COAST INDUSTRIES, Dept. 11  
Los Angeles 61, California

Gentlemen: Please rush me FREE details, sample, etc., I understand that everything you send is free and that I'll be under no obligation now or ever.

NAME \_\_\_\_\_ STREET \_\_\_\_\_ CITY \_\_\_\_\_ STATE \_\_\_\_\_

# SAVE MONEY



## BUILD YOUR OWN CABIN, RANCH HOUSE OR HIDEAWAY

For the Cost of Materials Alone!

Here's an amazing new book that shows you how to build your own cabin, lake cottage, modern ranch house, or mountain retreat at *lowest possible cost!* In all, you have 27 different, easy-to-follow plans to choose from.

### SIMPLIFIED DETAILS

You don't need expensive professional help when you have "How to Build Cabins and Ranch Houses" at your side. This brand-new book gives you 256 pages of step-by-step instructions and hundreds of "show-how" illustrations to help you lay the foundation, build and caulk walls, construct stairs, lay floor boards, estimate costs. You'll find detailed plans that show you how to make windows, build fireplaces and chimneys, cut doors, install plumbing and lighting. You'll also learn how to prevent wood decay, build rustic furniture and lots more! It's truly a home builder's "dream book."

### SEND NO MONEY NOW!

Detach and mail coupon below. When book arrives, pay postman the low, bargain price of only \$2.49 (plus postage). Examine it for a *full week at our risk!* Then, if you don't agree you would ordinarily pay twice the price for such a big, jam-packed book, simply return it for prompt refund. But HURRY—get your copy while they last!

## MAIL COUPON TODAY

POPULAR SCIENCE PUB. CO., Dept. 1155  
353 Fourth Avenue, New York 10, N. Y.

Please send me a trial copy of "How to Build Cabins and Ranch Houses" today. I'll pay postman \$2.49 (plus postage) on delivery. If not delighted, I may return book within 7 days for full refund.

#617Z

Name.....

Address.....

City..... Zone..... State.....

Check here if you remit now. We pay postage. Same refund guarantee.



**Do YOU Want to Qualify for  
A BETTER JOB AT BIGGER PAY?**



# CLIMB TO SUCCESS!

## in Spare Time at Home

• Jobs are calling—calling to those who want more responsible jobs, in bigger pay brackets, with increasing chances for promotion—and who have the ambition to devote some of their spare time to acquiring necessary knowledge and skill. As little as just a few hours a week, in time you can easily spare, *can* produce surprising results in lifting you up to higher and higher levels of employment, income and security—even eventually to management positions or a business of your own. In the coupon below are listed some of the large number of training opportunities offered by AMERICAN SCHOOL—now in its 58th year. Check the one that interests you most and fill in your name and address. Or if you prefer some other career, write the subject in the margin. Then mail the coupon without delay.

—-FULL INFORMATION...NO COST...NO OBLIGATION—-—

**AMERICAN SCHOOL, Dept. G346, Drexel at 58th, Chicago 37, Ill.**

Without obligation, please send FREE and postpaid, full particulars about the subject checked below.

- |  |   |   |
|--|---|---|
| <input type="checkbox"/> Accounting              | <input type="checkbox"/> Diesel Technician          | <input type="checkbox"/> Mechanical Engineering |
| <input type="checkbox"/> Apprenticeship Courses  | <input type="checkbox"/> Drafting—Building Trades   | <input type="checkbox"/> Mechanical Technology  |
| <input type="checkbox"/> Architecture & Building | <input type="checkbox"/> Drafting—Machine Trades    | <input type="checkbox"/> Metalworking Courses   |
| <input type="checkbox"/> Automotive Technician   | <input type="checkbox"/> Electrical Engineering     | <input type="checkbox"/> Plumbing—Practical     |
| <input type="checkbox"/> Better Foremanship      | <input type="checkbox"/> Electricity—Practical      | <input type="checkbox"/> Private Secretary      |
| <input type="checkbox"/> Bookkeeping             | <input type="checkbox"/> Electronics—Industrial     | <input type="checkbox"/> Retail Merchandising   |
| <input type="checkbox"/> Business Management     | <input type="checkbox"/> <b>HIGH SCHOOL COURSES</b> | <input type="checkbox"/> Salesmanship—Outside   |
| <input type="checkbox"/> Civil Engineering       | <input type="checkbox"/> Machine Shop Operations    | <input type="checkbox"/> Sheet Metal Work       |
| <input type="checkbox"/> Contracting             | <input type="checkbox"/> Mathematics & Slide Rule   | <input type="checkbox"/> Tool Making            |

Name \_\_\_\_\_ Occupation \_\_\_\_\_

Home Address \_\_\_\_\_ Age \_\_\_\_\_

City \_\_\_\_\_ State \_\_\_\_\_

Canadian Residents: Write American School, 1610 Sherbrooke St., West, Montreal

## FASTEST KNOWN SKIN RELIEF!

Many doctors  
report results  
in 1 to 3 days  
with *new*  
**Cuticura**  
method



Want *faster relief* from pimples, rashes, other externally caused skin irritations? Wash skin thoroughly twice daily with superfatted, mildly medicated CUTICURA SOAP. Apply CUTICURA MEDICATED LIQUID frequently. You'll get *instant relief* from discomfort—*faster healing aid*—with this sensational new greaseless, fast-drying, "invisible" antiseptic. Buy at druggists. Soap, only 25¢. Liquid, 60¢, or send 10¢ to cover mailing costs for generous sample of both. Write today to CUTICURA, Dept. 15K, Malden 48, Mass.

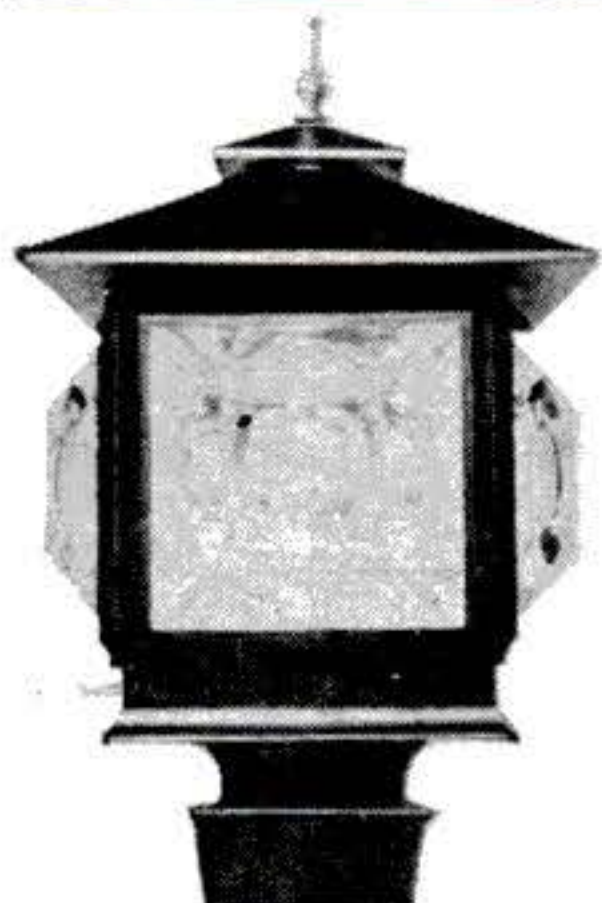

Colonial: 18x10x10  
delivered postpaid  
only \$13.95



Ranch: 16x12x12  
delivered postpaid  
only \$12.95

**POST LAMPS**  
SAVE \$25.00

## DO IT WITH DOOLEY!

Don't do it yourself; do it with me! Lots of good buys and good ideas for home workshops.

These Post Lamps would retail for near \$40. Cast aluminum, machine-fitted, ready to assemble and install. UL approved sockets. Hinged lids. Complete, easy-to-follow instructions included.

**Dooley** 2350 Curry Street P115  
Long Beach 5, California

**FREE CATALOG**  
Projects, Power &  
Hand Tools, Hinges  
Latches, etc.

Please print your name, address and order here.  
Send Cash, Check or M. O. (no C.O.D.'s)

**SAVE TODAY!**



# TENSE NERVOUS HEADACHES

## call for STRONGER Yet SAFER ANACIN

**Won't Upset The Stomach**

Anacin® not only gives *stronger, faster* relief from pain of headache, but is also *safer*. Won't upset the stomach and has no bad effects. You see, Anacin is like a doctor's prescription. That is, Anacin contains not just one but a *combination* of medically proven, active ingredients. Scientific research has proved *no single drug* can give such strong yet safe relief as Anacin. *Buy Anacin Tablets today!*

## Shrinks Hemorrhoids New Way Without Surgery

**Science Finds Healing Substance That Relieves Pain—Shrinks Hemorrhoids**

For the first time science has found a new healing substance with the astonishing ability to shrink hemorrhoids and to relieve pain — without surgery.

In case after case, while gently relieving pain, actual reduction (shrinkage) took place.

Most amazing of all — results were so thorough that sufferers made astonishing statements like "Piles have ceased to be a problem!"

The secret is a new healing substance (Bio-Dyne\*)—discovery of a world-famous research institute.

This substance is now available in *suppository* or *ointment* form under the name *Preparation H.\** Ask for it at all drug counters—money back guarantee. \*Reg. U. S. Pat. Off.

## Free! 75 ORIENTALS



Brought to you from the farthest ends of the earth—these exotic valuable genuine **Stamps** of the Orient! 75 all-different from Borneo, Siam, China, Japan, Hong Kong, Malaya, Sarawak, Singapore,—and other exciting mysterious lands of the Far East. **EXTRA!** Free booklet, bargain lists, fascinating offers for your free examination. Send 10c for mailing expenses. Supplies limited. **Act NOW!**

**USE THIS HANDY COUPON**

JAMESTOWN STAMP CO., D-11PS101, Jamestown, N.Y.  
RUSH my FREE Collection of 75 Orientals & other offers. I enclose 10c for cost of mailing.

Name .....

Street .....

City ..... State .....

DEUTSCHES REICH

## 205 GERMANY only 25¢



This fabulous collection contains **Scarce Stamps** nearly 100 years old; giant and midget stamps; Hitler & blood-red swastikas; battle scenes; inflation issues with pre-war face of millions of dollars; Peace, Music & Religious stamps; birds, animals, sports, airmails—205 all different, worth \$4.22 at Catalog prices! **PLUS** free booklet, bargain lists and other offers for your free consideration. All for only 25c. Send **TODAY!**

Falcon Stamp Co., D-11PS300F, Falconer, N.Y.



**YOURS FREE!**

**VUER-PROJECTOR & Full Color Slide Kit—Authentic \$4.95 Value!**

## If You're Interested In BREEDING TROPICAL FISH For Profit & Pleasure

This handsome, precision-viewing instrument and color slides are yours **FREE**—just for showing your interest in Tropical Fish Breeding! See gorgeous BETTAS, colorful TETRAS, exotic ANGEL FISH, etc., in the vibrant beauty of full color! Convince yourself Tropical Fish Breeding is the *profitable, easy-to-start* home business for you! Breed them in your living room, spare-room, *anywhere*. *Success is assured because we'll buy every fish you produce!* No experience or costly equipment needed. Start spare-time, on a "shoe-string"... build a \$10,000 home business! Investigate!

Write today for **FREE** details on "Profit-Proven" Success Plan & Vuer! (If under 17, ask for plan A.)

TROPICAL FISH BREEDERS OF AMERICA  
Dept. C-11  
Los Angeles 61, Calif.

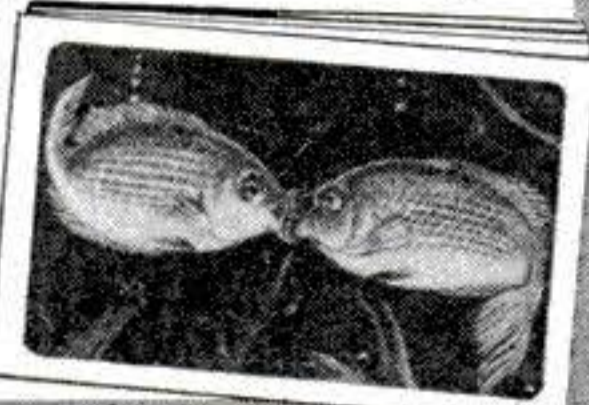

## RUPTURED

**BE FREE FROM TRUSS SLAVERY**

NOW there is a new modern **Non-Surgical** treatment that permanently corrects rupture. These **Non-Surgical** treatments are so certain, that a Lifetime Certificate of Assurance is given. Write today for our **FREE** Book that gives facts that may save you painful and expensive surgery, and tells **how non-surgically** you may again work, live, play and love and enjoy life in the manner you desire. There is no obligation. **Excelsior Hernia Clinic Dept. 3705 Excelsior Springs, Mo.**

## HOW TO DOUBLE YOUR SALARY!

**FREE LESSON**

**MAKE BIG MONEY** with your **NATURAL COMMON SENSE** in a high paying, prestige job. Our graduates **PROVE** that you can more than double or triple your salary. Industry desperately needs trained men. Men like you have saved business millions of **\$\$\$\$** every year. **IEC** can train you for this wide open field of **TIME STUDY**. Your pay is excellent. Your future secure. Wonderful chances for promotion. Write today for your **FREE LESSON**. **NO** salesman will call. **FREE JOB** help for students. Indicate whether you want home-study or Chicago resident training. If you choose, you may send only \$2.00 to take special **IEC** aptitude test.

**INDUSTRIAL ENGINEERING COLLEGE** 3309-J W. WASHINGTON CHICAGO 24, ILL.



## STAMMERING

may be overcome by re-education of vocal muscles and speech mechanism. Scientific Home Method for adults and children by **EX-STAMMERER** based on physiology of speech leads to **FLUENT SPEECH**.

Write: Dept. PS-2, **VOCAL METHODS**  
P.O. Box 5123 San Antonio, Texas

## When Writing to Advertisers Please Mention Popular Science

## Need an extra \$1,000, \$2,000, or more? Make it with an IDEAL LAWNMOWER SHARPENER

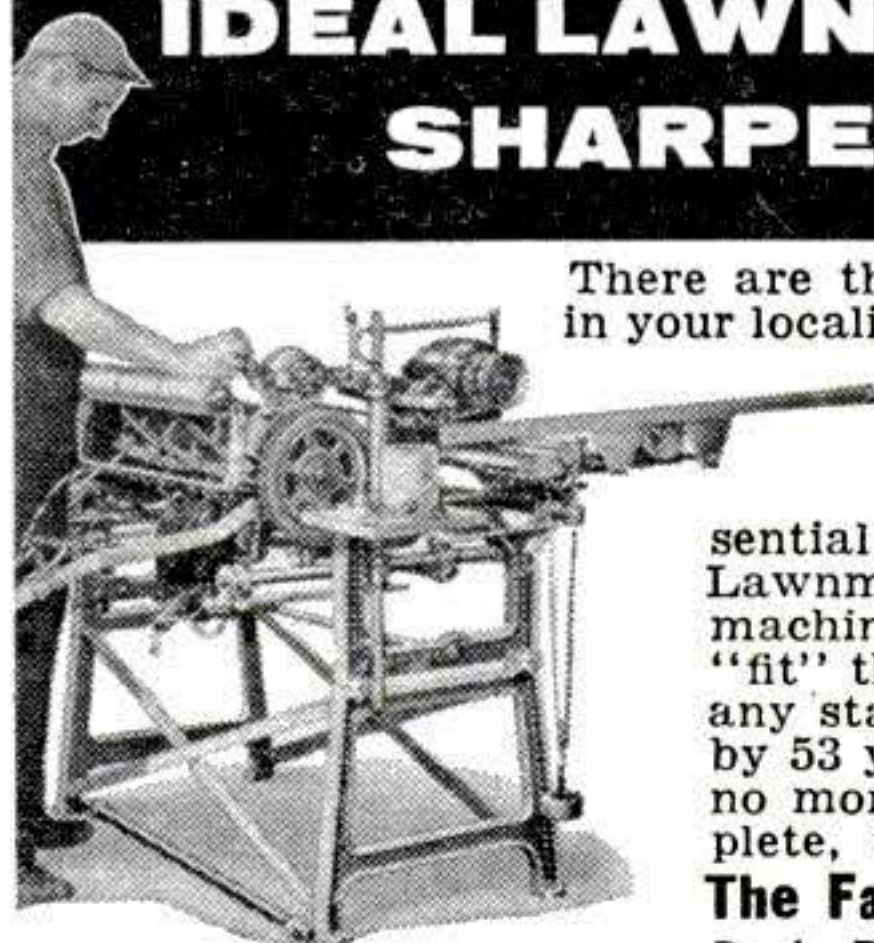

There are thousands of lawnmowers in your locality; Average \$1,000 profit per 250 mowers with customer satisfaction and repeat business assured. Provide this essential service with an **Ideal®** Lawnmower Sharpener, the only machine that grinds the reel to "fit" the bed knife. Compare by any standard. The **Ideal**, backed by 53 years of experience, costs no more. Write today for complete, free catalog.

The **Fate-Root-Heath Company**, Dept. PS-11, Plymouth, Ohio



# HOBBIES FOR Profit



CASTING



GLASS ETCH

**HAVE FUN!  
MAKE BIG MONEY!  
WE SHOW YOU HOW!**

Enjoy hobbies that make money! Make beautiful and UNUSUAL items for the home and business. Make exquisite jewelry, ceramics, without a kiln, toys, dolls, puppets, tools, Planters, embedded Plastics, Metal Enamelling, etc. Learn Jewelry Making, Wirecraft, Photocraft, Woodcraft, Metalcraft, Leathercraft, Mold Making, Bait Making, Gemcraft, Plastic Laminating, Lampcraft, Feathercraft, Basket Weaving, etc. Over 1000 Golden Opportunities! Send 25c for giant-sized catalog giving full facts on all these Hobbies.

**HOBBIES FOR PROFIT**

6612 N. Clark Street  
Dept. HP-104, Chicago 26, Illinois



MOLDING



PLASTER

**Now is the time to  
change your oil and filter.**

**\$1.00 STARTS YOU IN YOUR OWN \$75,000 BUSINESS!**

Operate Profitable Home Mail Order Business. Everything Included. Big Profits—No Stock To Carry—We Deliver! Your \$1.00 brings 6 self-mailing 32 pg., 4 color catalogs, picturing \$75,000 Nat. Adv. Watches, silverware, jewelry, etc. Details & Price Sheets. (5,000 @ 5c ea.)  
DIRECT DIST. Dept. 11A, Box 5, N.Y.C. 36, N.Y.

**BUY WHOLESALE  
25,000 ITEMS—CATALOG 25c**

B. MATTHEWS, 1480-W2 BROADWAY, N.Y.C., N.Y.

**EXCLUSIVE DOUBLE-BEARING  
HEAVY DUTY PUMPS**

**IRRIGATE - DRAIN - CIRCULATE - SPRAY**  
Up to 7,500 GPH; 1,000 GPH 60' high; or 3,000 GPH from 25' well. Use 1/4 to 1 HP motor. 1 1/4" inlet; 1" outlet. Stainless shaft. TYPEX—\$10.95  
2 oil-less bronze bearings. Won't rust.

TYPE XB—Ball bearing model. \$12.95  
Best for belt drives. . . . .

Postpaid if cash with order. (West of Miss. add 50c)

**MONEY BACK GUARANTEE**  
Centrifugal and Gear Pumps in All Sizes

**LABAWCO PUMPS** Belle Mead 4A, N. J.



**ELECTRIFY your SEWING MACHINE**

**NEW LOW PRICE! \$9.95 90 DAY GUARANTEE**



Buy direct from manufacturer and save! Kit comes fully wired, installed in a jiffy. Fits all machines! You get ALL-NEW PARTS

- Motor & Bracket
- AC-DC 115v 60c
- Multi-speed foot control
- Cord set & block
- Easy instructions
- Steel pulley & belt

**ONE MONTH SPECIAL: Reg. \$7.95 Pinking Shears Only \$1.00 with kit!**

**10 DAY FREE TRIAL—ORDER NOW! FREE—REG. \$2.95 SEWLITE GIVEN WITH KIT!**

Send no money, pay COD or send money order and we'll pay postage. Please state whether wheel on your machine turns toward you or away from you. Shipping wt. 6 lbs.

**SENIOR SEWING MACHINE CO.**

Box 142

PS 02

Brooklyn 6, N. Y.

# BUILD 16 PRINTED CIRCUIT and METAL CHASSIS RADIO CIRCUITS

With the New Deluxe 1956 Progressive Radio "EDU-KIT"

**ONLY \$19.95**  
Complete

**NOW INCLUDES  
RECEIVER, TRANSMITTER,  
SIGNAL TRACER, CODE  
OSCILLATOR, SIGNAL  
INJECTOR CIRCUITS**



- Attractively Gift Packaged
- Free Soldering Iron
- Absolutely No Knowledge of Radio Necessary
- No Additional Parts Needed
- Excellent Background For Television
- 30-day Money-Back Guarantee
- School Inquiries Invited
- Used in 79 Countries
- Learn High Fidelity

## WHAT THE "EDU-KIT" OFFERS YOU

You will learn how to identify Radio Symbols and Diagrams; how to build radios, using regular radio schematics; how to wire and solder in a professional manner. You will learn proper chassis layout. You will learn printed circuitry. You will learn the basic principles involved in radio reception, transmission and audio amplification. You will learn how to service and trouble-shoot radios. You will learn code. You will receive instructions for F.C.C. Novice license. In brief you will receive a practical basic education in Radio, worth many times the small price you pay.

### THE KIT FOR EVERYONE

It is not necessary that you have even the slightest background in science or radio. The "Edu-Kit" is used by young and old; by radio schools and clubs; by Armed Forces personnel and Veterans. No instructor is required. Instructions are complete, simple and clear.

### PROGRESSIVE TEACHING METHOD

The "Edu-Kit" uses the principle of "Learn by Doing." Therefore you will build radios, perform jobs, and conduct experiments to illustrate the principles which you learn. You begin by learning the function and theory of each of the radio parts. Then you build a simple radio. Gradually, in a progressive manner, you will find yourself constructing more advanced multi-tube radio sets, and doing work like a professional Radio Technician. The "Edu-Kit" Instruction Books are exceedingly clear in their explanation, illustrations and diagrams. These sets operate on 105-125 V. AC/DC. For use in foreign countries having 210-250 volt source, an adapter for 210-250 V. AC/DC is available.

### The Progressive Radio "EDU-KIT" is Complete

You will receive every part necessary to build sixteen different radio circuits. The "Edu-Kit" contains all tubes, tube sockets, variable, electrolytic and paper condensers, resistors, tie strips, coils, hardware, tubing, Instruction Manuals, printed circuit materials, etc. No solder or hook-up wire included. A soldering iron is included, as well as Electrical and Radio Tester. Complete, easy-to-follow instructions are provided. All parts are guaranteed, brand new, carefully selected and matched. In addition, the "Edu-Kit" now contains lessons for servicing with the Progressive Signal Tracer and Signal Injector, High Fidelity, F.C.C. Novice instructions, quizzes.

### TROUBLE-SHOOTING LESSONS

Trouble-shooting and servicing are included. You will learn how to recognize and repair troubles. You will build and learn to operate a professional Signal Tracer and a Signal Injector. You will receive an Electrical and Radio Tester, and learn to use it for radio repairs. While you are learning in this practical way, you will be able to do many a repair job for your neighbors and friends and charge fees which will far exceed the cost of the "Edu-Kit."

## FREE EXTRAS

- ELECTRICAL & RADIO TESTER • SOLDERING IRON
  - HI-FI GUIDE • TV BOOK • QUIZZES
  - CONSULTATION SERVICE • TESTER INSTRUCTION MANUAL
- PROGRESSIVE "EDU-KITS" INC., 497 Union Av., Brooklyn 11, N.Y.

MAIL TODAY—Order shipped same day received.  
30-Day Money-Back Guarantee. INCLUDE ALL FREE EXTRAS

"EDU-KIT" Postpaid. I enclose full payment of \$19.95

"EDU-KIT" COD—I will pay \$19.95 plus postage (USA only)

Outside USA: Enclose \$20.95. "Edu-Kit" sent postpaid

Outside USA: 210-250V. AC/DC Adapter. Enclose \$2.50

More details on "EDU-KIT" Free—No Obligation

FREE Radio-TV Servicing Literature. No obligation

NAME \_\_\_\_\_

ADDRESS \_\_\_\_\_

PROGRESSIVE "EDU-KITS" INC.  
Room 535 A, Progressive Building

497 UNION AVE.  
Brooklyn 11, N. Y.



**EARN UP TO \$5 AN HOUR SPARE TIME WHILE TRAINING FOR A FULL-TIME JOB**



Thousands of mechanics are needed! They earn big pay, enjoy lifetime security. *Learn at home in months the new, easy CTI Shop-Method way.* In weeks, you can repair cars for friends, or work spare time in a shop—get *practical experience and earn extra dollars!*

**I TRAIN YOU AT HOME IN AUTO MECHANICS**



**I Send Tools and Tune-up Kit**

You start on repair jobs quick. I send you a set of mechanic's tools and a trouble-shooting



R. C. Anderson Tune-Up Kit. Kit includes Compression Tester, Ignition Timing Light, Vacuum Gauge & Fuel Pump Tester—a CTI exclusive!

**PLUS DIESEL OR BODY REPAIR**

Full training on Automatic Transmissions included. You also get Diesel or Body-Fender Repair instruction if desired. I send *more kits, more training.* Act now.

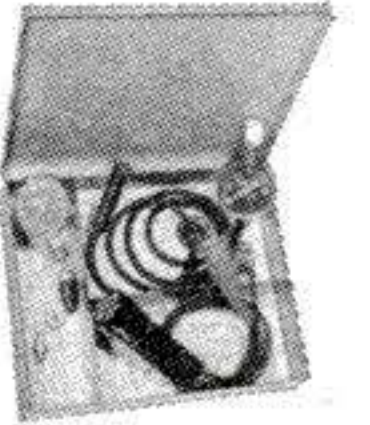

**FREE BOOK—MAIL COUPON**

**COMMERCIAL TRADES INSTITUTE**

1400 Greenleaf Ave., Chicago 26, Ill. Dept. A-114

Send me your new, big FREE book which tells me how I can train at home to make big money in the automotive field.

Name \_\_\_\_\_ Age \_\_\_\_\_

Address \_\_\_\_\_

City \_\_\_\_\_ Zone \_\_\_\_\_ State \_\_\_\_\_

MEMBER: NATIONAL HOME STUDY COUNCIL

**INSTALL YOUR OWN INTER-ROOM OR HOUSE TO BARN TELEPHONE SERVICE!**

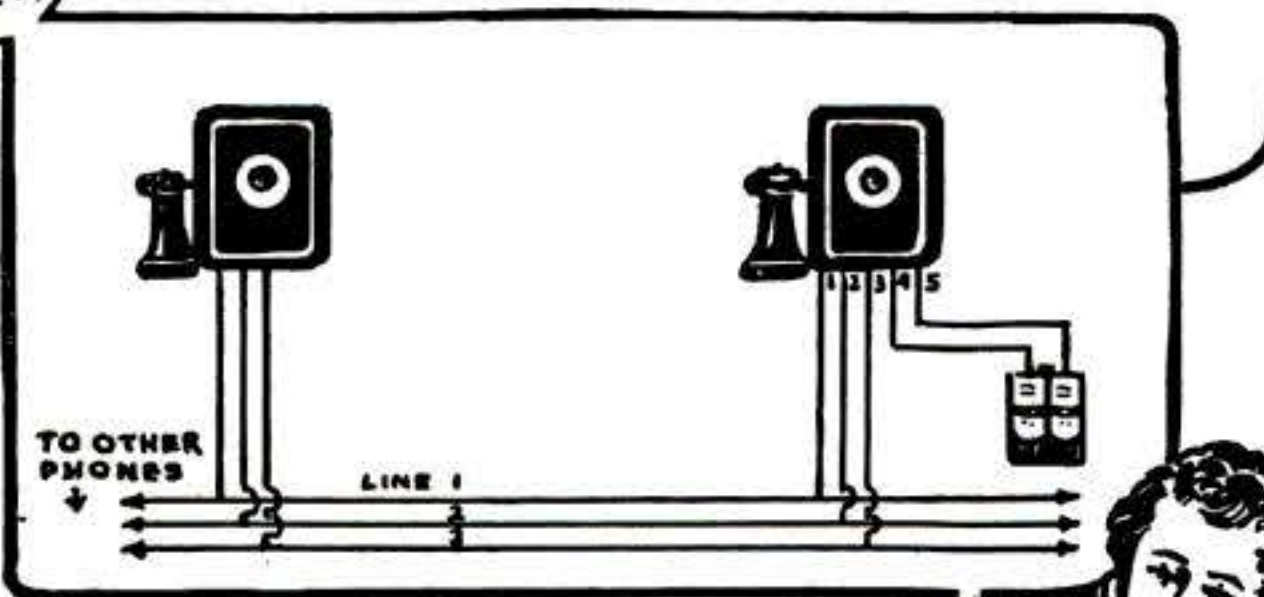

Genuine dependable Telephones not toys. Save unlimited steps—communicate upstairs to down, out to the garage, barn or where ever you would like around your place.

Complete Wall Phone with bell and signal button for battery operation—\$5.50 each, Two for \$10.00 postpaid in the U.S.A.

Rush order today or send for FREE illustrated literature.

**TELEPHONE REPAIR (Microphone Division)**  
1760 Lunt Ave., Dept. X-2804, Chicago 26, Illinois.

**Tells How You Can Learn to**

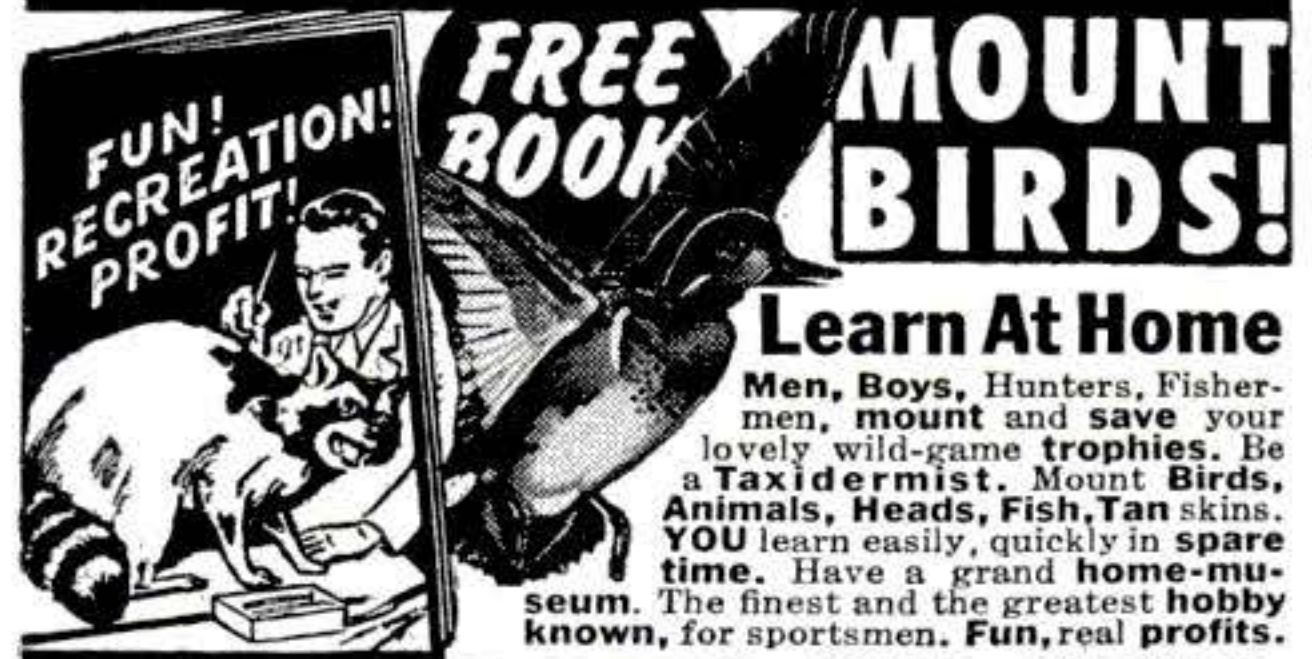

**Learn At Home**

Men, Boys, Hunters, Fishermen, mount and save your lovely wild-game trophies. Be a Taxidermist. Mount Birds, Animals, Heads, Fish, Tan skins. YOU learn easily, quickly in spare time. Have a grand home-museum. The finest and the greatest hobby known, for sportsmen. Fun, real profits.

**FREE BOOK**

Yes, FREE. Beautiful strange, valuable Book, telling all about Taxidermy. Contains over 100 beautiful game-pictures. And it's yours FREE, if you rush your request. You can mount all kinds of wild-game, and common specimens too. We can positively TEACH YOU. So GRASP this opportunity. RUSH letter or postal for this amazing FREE BOOK. Don't delay. State your AGE. N. W. SCHOOL OF TAXIDERMY, 2611 Elwood Bldg., Omaha 2, Neb.

**Build your own GAS TURBINE ENGINE!**

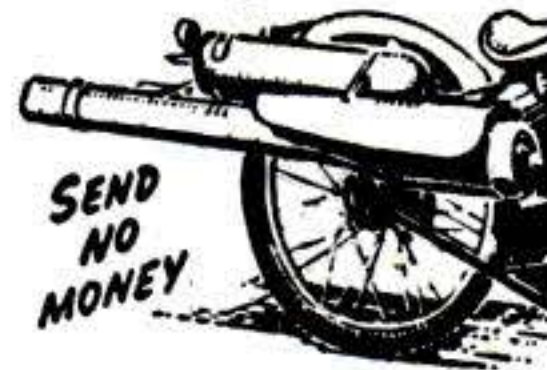

**Order these plans today**

GAS TURBINE ENGINES. Two engines in one plan. Quick easy to make. No special tools, material. Instructions and seventeen sheets drawings, complete \$9.95 C.O.D. We pay C.O.D. postage. Or send money and we will also include drawings of patent automobile turbine engine. Money back ten day guarantee. Get other information too. Write, "Ship C.O.D." Print name. Rush order.

J. HOUSTON MAUPIN, Dept. 68, Tipp City, Ohio



**SEND FOR THIS FREE!**

Make money. Know how to break and train horses. Write today for this book FREE, together with special offer of a course in Animal Breeding. If you are interested in Gaiting and Riding the saddle horse, check here ( ) Do it today—now.

**BEERY SCHOOL OF HORSEMANSHIP**  
Dept. 5811 Pleasant Hill, Ohio

**WHEELS WHEELS WHEELS**

- 7" Disc Wheel 3/4" Tire 3/8" sleeve.....45c ea.
  - 8" Disc Wheel 1 1/8" Tire 1/2" sleeve.....70c ea.
  - 7" Disc Wheel 1" Tire 1/2" ball bearing.....80c ea.
  - 8" Disc Wheel 1 1/8" Tire 1/2" ball bearing.....\$1.00 ea.
  - 6" Disc Wheel 1.50 semi-pneum. Tire 1/2" B.B.....\$1.35 ea.
  - 8" Disc Wheel 2" semi-pneum. T. 1/2" B.B.....\$1.50 ea.
  - 10" Disc Wheel 1.75 semi-pneum. T. 1/2" B.B.....\$1.50 ea.
  - 10" Disc Wheel 2.75 semi-pneum. Tire 5/8" B.B.....\$3.50 ea.
  - 12" Disc Wheel 1.75 semi-pneum. T. 1/2" B.B.....\$1.85 ea.
- Above wheel prices includes hub cap. Plus Postage. C.O.D.'s accepted. AXLES—Sizes 5/16 in., 3/8 in., 1/2 in.—Cut to size—End holes drilled.

**UNITED WHEEL STAMPING CO.**  
12131 S. PEORIA STREET PS-11 CHICAGO 43, ILLINOIS

**25 Yulecards**  
\$1.00 plus 35¢ postage



Personal Photo Christmas Cards, including envelopes, from your own negative.

**FREE SAMPLE** ... send snapshot negative for free sample Deluxe Yulecard. Include 6¢ stamps for handling. Negative returned with sample. No obligation. Satisfaction guaranteed. Write today **YULECARDS,\***

Dept. 31, Quincy 69, Mass. \*Div. Mail-N-Save \*T.M. Reg.

**BE A CLAIM INVESTIGATOR**



**INVESTIGATE ACCIDENTS!** Many earning \$750 to \$1000 a month. Thousands of insurance companies, airlines, steamship lines and Government Offices need Claim Investigators. Also big opportunities for your own spare time business. We train you at home. National Placement Service FREE of extra charge. Bill King writes: "Your course has paid off for me with large earnings. You can quote me—your Adjuster Training Course is worth many times the cost." Write TODAY for FREE book.

**UNIVERSAL SCHOOLS**  
University Park, Dept. PS-11, Box 8202 Dallas 5, Texas



**CONSTIPATED?**  
 Avoid the Danger  
 Of Neglect.  
 Get This  
**FREE BOOK**



**RECTAL AND COLONIC  
 DISORDERS**  
 and  
 Associated Ailments

Constipation, colitis and rectal disorders like piles and fistula are often associated, and one may lead to another. Get the facts. Learn what delay may mean. Write for 130-page **FREE** book today. McCleary Clinic and Hospital, 1171 Elms Blvd., Excelsior Springs, Mo.

NO TANKS USED  
 NEW SIMPLIFIED METHOD



**ELECTROPLATE**

ANY OBJECT IN HOME, SHOP, GARAGE OR START YOUR OWN WELL PAYING ELECTROPLATING BUSINESS.

NOW, using **NEW** plating kit, it's easy to electroplate any object. Complete kit and instructions on plating metal and non-metal objects, with nickel, copper, chrome, gold, etc., plus full data on obtaining all the business you desire and make **BIG MONEY** full or spare time. **ONLY \$5.95.** SEND NO MONEY—everything sent C.O.D. plus postage—OR send \$5.95

now and receive it postpaid. Money back in 7 days if not satisfied. M. Z. SALES CO., Dept. PS-20, 113 W. 42 St., New York 36, N. Y.

**\$14,839 in 1 Year  
 SERVICING RADIATORS**



—**REX RYAN**, Bloomfield, Iowa  
 Hundreds earning \$8,000-\$20,000 a year servicing auto-truck-tractor radiators! New Inland equipment makes work easy, insures finest professional workmanship. "Pays-for-itself" financing available. \$100 training course included free by world's largest radiator servicing equipment manufacturer.

WRITE for free folder "Want a business of your own?"  
**INLAND MFG. COMPANY** Dept. PS-11  
 1108 Jackson St., Omaha 8, Nebr.

HAVE FUN! MAKE YOURSELF A FINE  
**GRANDFATHER CLOCK**



The simple, sensible Red-i-Kut way as thousands have since 1916. Save \$500 to \$700! SHOP TESTED PLANS "SPIRIT OF THE CENTURY" Narrow waist 83" tall or stately straight side "SPIRIT OF AMERICA." Amazingly EASY-to-FOLLOW photopack PLANS and life size patterns tell all—plus **CLOCK MOVEMENT BROCHURE** of heavy brass weight Westminster, tube chime, movements, gorgeous moving moon dials. Precision-bilt weight movements as low as \$43! Famous sure-fit RED-I-KUT 3/4" solid mahogany kits. Send \$1.00 today. Both plans \$1.50 NOW. . . . you'll be delighted.

KUEMPFL CHIME CLOCK CO. Kuempel Bldg. F, Minneapolis 16, Minn.

**SHORTHAND in**

Famous SPEEDWRITING shorthand. 120 words per minute. No symbols; no machines; uses ABC's. Easiest to learn, write and transcribe. Lowest cost. 300,000 taught by mail. For business and Civil Service. Typing available. 33rd year. Write for FREE booklet to: **SCHOOL OF**

**6  
 WEEKS**

**Speedwriting**  
 Dept. 2611-5, 55 W. 42 St., New York 36

**free!**

**1956  
 ALLIED**

**ELECTRONIC  
 SUPPLY  
 CATALOG**

**324  
 value-packed  
 pages**

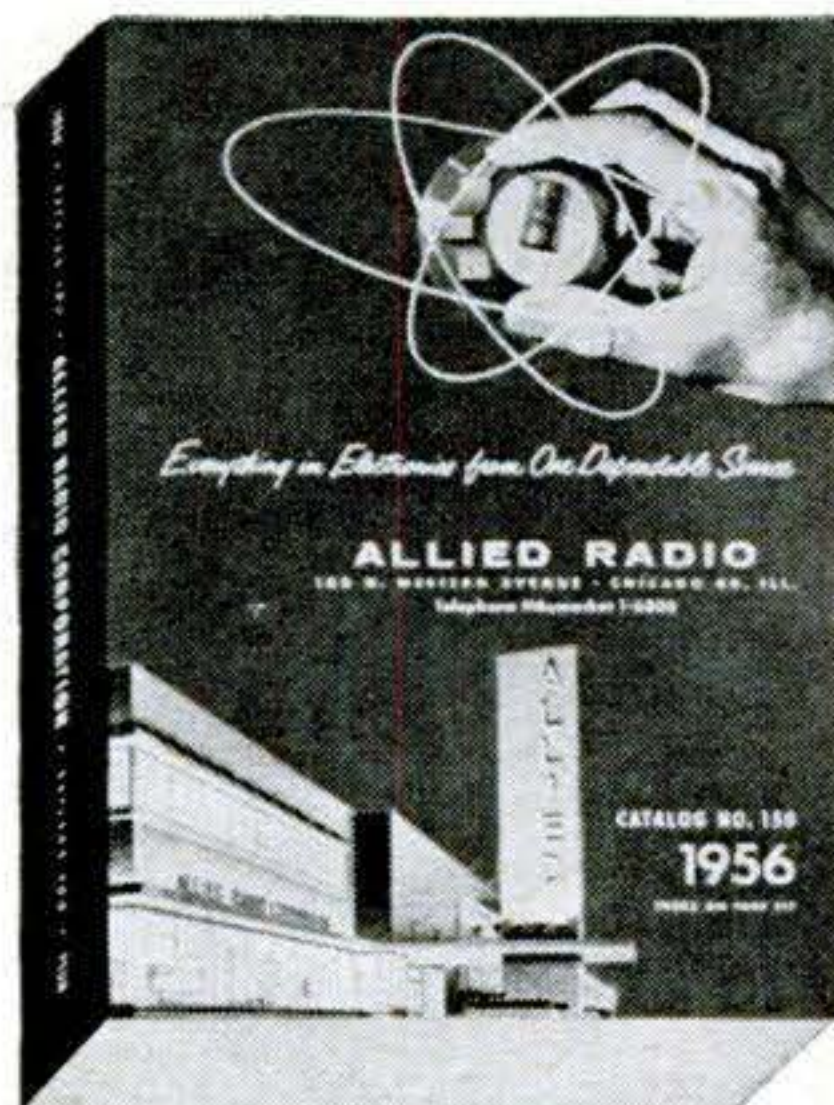

Save on Everything  
 in TV and Radio  
 Parts & Equipment



Everything for Experimenters,  
 Builders, Amateurs, Servicemen,  
 Engineers & Hi-Fi Specialists

Send for ALLIED's big 324-page value-packed guide to *everything* in TV, Radio and Electronics! Select from the world's largest stocks of High Fidelity systems and components; recorders and phono equipment; TV tubes, antennas and accessories; Amateur station equipment and supplies; P.A. systems; test instruments; latest build-your-own kits; industrial electronic supplies—plus *everything* in electronic parts, tubes, transistors, tools and books. Save on everything in Electronics—send today for your **FREE 1956 ALLIED Catalog.**

Everything in Electronics  
 From One Reliable Source

send for it **FREE  
 CATALOG**

**ALLIED RADIO**

ALLIED RADIO CORP., Dept. 7-L-5  
 100 N. Western Ave., Chicago 80, Ill.  
 Rush FREE 1956 ALLIED 324-Page Catalog

Name \_\_\_\_\_

Address \_\_\_\_\_

City \_\_\_\_\_ Zone \_\_\_\_\_ State \_\_\_\_\_



# IN YOUR CAR RADIATOR... GUARANTEED TO STOP RUST!

**WATER STAYS  
CRYSTAL CLEAR  
FOR OVER  
ONE YEAR**

Just one can of  
MAC'S NO. 13 re-  
moves rust and scale  
...prevents costly  
repairs. Get MAC'S  
NO. 13 today.



**AT SERVICE  
STATIONS EVERYWHERE**

**MAC'S SUPER GLOSS CO., INC.**  
Los Angeles 42, California

**"WE'RE LOOKING FOR PEOPLE  
WHO LIKE TO DRAW"** ... says  
Norman Rockwell, one of America's  
12 Most Famous Artists. If you like  
to draw, you may have talent to be-  
come a successful artist, spare or full  
time. Find out for sure with our scien-  
tific, 8-page **Free Art Talent Test**.  
Thousands paid \$1 to take it.  
Get it FREE. No obligation.  
Send your name, address, age  
to: Famous Artists Schools,  
Dept. 11-Y, Westport, Conn.



## PLASTIC SANDWICH MACHINE PAYS BIG MONEY

**EARN \$18<sup>00</sup> AN HOUR  
UP TO \$18<sup>00</sup> AN HOUR**



Laminate  
social security  
cards, identi-  
fication cards,  
photographs,  
etc.

This new re-  
markable  
**PLASTIC  
SANDWICH  
MACHINE** does a permanent,  
beautiful, professional, protective, plas-  
tic lamination job in exactly four min-  
utes time! Amazing earnings possible  
in your own home or shop, permanently  
sandwiching **PHOTOS** and **CARDS** of  
all kinds, clippings, diplomas, etc., be-  
tween sheets of clear plastic. Laminat-  
ing machines from \$35.00 up. Rush  
name for FREE sample and illustrated  
literature.

**PLASTIC SANDWICH MACHINE CO.**  
6612 N. Clark St., Dept. LM-203, Chicago 26, Ill.



\$2.00, dozen only \$5.00). Sorry, no C.O.D.'s.  
(20 ft. balls \$2.00 each.)

Dealer Inquiries Invited

**NOVEL MFG., 33 2nd Ave., Dept. G-1273, New York 3, N. Y.**

## GIANT BALLS

Great fun for Kids  
and Grownups. In-  
flates to a Giant **59c**  
3 to 6 feet. Use  
anywhere. Made of genuine neo-  
prene rubber for extra durability.  
Can be painted to carry your  
message! Terrific for attracting  
crowds at fairs, openings, school  
games, gas station, etc.  
Government surplus, never used,  
sold at a fraction of original cost.  
59c each. (2 for \$1.00, 5 for

## HIGH BLOOD PRESSURE?



A Home Blood Pressure Gauge now tests your  
pressure at home as often as you wish! That's  
how to avoid unexpected strokes, heart and  
kidney damage, insomnia, headaches, etc. Full  
particulars on how to test pressure and what  
to do for your condition are included with this  
dependable mercury gauge. It is simply con-  
structed so it can be operated alone and it ac-  
tually pays for itself in less than a week. Free  
descriptive circular sent on request.

**THE STANDARD UNIT** ..... \$5.98 postpaid  
Or C.O.D. plus postage. Contains everything that  
is needed, including functional stethoscope.

**THE DELUXE UNIT** ..... \$9.23 postpaid  
Or C.O.D. plus postage. Same outfit as standard  
unit, but includes genuine professional stethoscope.

**JOY SPECIALTY COMPANY,**  
Scientific Instrument Dept. G

2320-G W. Hubbard Street

Chicago 12, Ill.



## OVERLOAD SPRINGS

**\$9.95 Per Pair  
postpaid**  
2000 LB. SIZE  
\$11.95

For cars and trucks. Front  
and rear. Gives 2000 lbs. ex-  
tra capacity for all 1/2, 3/4,  
and 1 ton trucks; 500 or 1000  
lbs. extra for all cars. Easily  
installed. Guaranteed. State  
make, model. Dealers wanted.

**BRINKMAN MANUFACTURING CO.**  
2315 Clay Dept. 6-N Topeka, Kansas

## Success-Winning VOICE

### WHO LISTENS TO YOU?

You Can Have a Voice  
that Commands Attention!

Do people listen when you talk—are they impressed favorably so that they  
have greater confidence in you—friendliness toward you? Find out about  
amazing method that makes it possible for you to have a trained voice.  
Just a few minutes of your spare time in your own home can work won-  
ders! A man with an untrained voice is handicapped in many ways. **Make  
the most of yourself** by having a voice that leaves the best possible im-  
pression. Write today for remarkable FREE booklet "How to Develop a  
Successful Voice." Mailed postpaid in plain wrapper. State age. **Perfect  
Voice Institute, 210 S. Clinton St., Studio LV-1, Chicago 6, Ill.**

## FREE BOOK

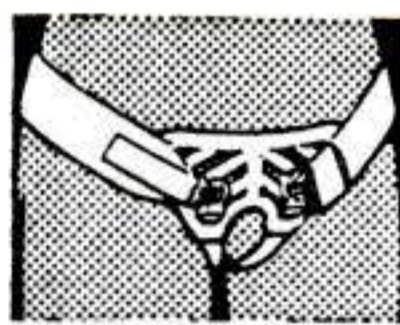

### ON RUPTURE CARE

Contains much helpful in-  
formation. Shows how thou-  
sands have been helped by  
the comfortable, safe WEB  
Truss. Write today to:

**WEB TRUSS CO. Dept. PS-11 HAGERSTOWN, MD:**

## When Writing to Advertisers Please Mention Popular Science

## BUILD, FLY HELICOPTER!

No license required. You, too, can build  
and fly the **GYRO-GLIDER**, world-famous  
helicopter glider. Simple Plans and Kits avail-  
able now. Order Three-View drawings and specs  
for \$1.00 TODAY.  
**BENSEN AIRCRAFT CORP., Dept. PS-11  
P. O. Box 2621, Raleigh, N. C.**

Greatest Thrill in Flying **SEND \$1** Name ..... Address .....  
City ..... State .....



*America's Great Diamond Values*

**OUT OF PAWN...**

SAVE UP TO 50% and more

Diamonds from Estates, Banks, and Unredeemed pledges



**GENUINE DIAMONDS**

VALUES FROM \$10 TO \$10,000

**TOP QUALITY**

Send for Brand New 36 PAGE **FREE ILLUSTRATED CATALOG**

Over 100,000 satisfied customers have bought their diamonds from Berman's.

**MONEY-BACK GUARANTEE**      **ALL DIAMONDS RESET IN BRAND NEW MODERN MOUNTINGS**

Our Reference: Your own bank or any mercantile agency

**Berman's Diamond Loan Bank**  
Dept. PS—BERMAN BLDG., BALTO. 1, MD.

**NEW! PERSONAL POCKET RADIO**



**LISTEN WHILE YOU WALK, RIDE, WORK!**

**Slips in any pocket—Wt. only 9 ozs. Size 2 3/4" x 4 3/4" x 1 1/8". Beautiful Black Gold plastic case. NO TOOKUPS—NO WIRES—NO PLUG-INS!** Self contained with 150 hour life flashlight batteries. (Available anywhere) and **BUILT-IN ANTENNA!**

**GUARANTEED RECEPTION OF RADIO STATIONS TO 50 miles—up to 1500 miles for powerful stations!** Has new Patented Super-regenerative Duotriode tube and transformer audio stages for sharp selectivity and sensitivity! Easy to use top controls (while walking). Almost invisible plastic foam personal earplug lets you alone listen while you walk, visit, work, ride or sleep—anytime—anywhere. Money Back guarantee—1 year service guarantee.

**SEND ONLY \$5.00** (Ck, Mo) and pay postman \$14.95 plus postage on delivery or send \$19.95 for postpaid delivery. Get YOUR TINYTONE REAL pocket radio now and be ready to listen to Civil Defense alarms, news, music, sports, etc. on a moment's notice. Not a Kit or plaything! Shipped complete with batteries—Ready to listen! Order now—today.

**WESTERN RADIO      Dept. APS-11      Kearney, Nebraska**

MEN WANTED

Earn \$100 Per Week and up

AUTO DIESEL MECHANICS

Master a trade with a future—learn Auto-Diesel mechanics in our shops. You learn with tools on real equipment. Earn while you learn. Many of our graduates earn \$100 per week and up. No previous experience necessary. Day and night courses. Approved for veterans. Write for free bulletin.

**NASHVILLE AUTO-DIESEL COLLEGE**

226 7th Ave., N., Dept. 41      Nashville 3, Tenn.

There's **BIG MONEY** In Your Future With **ELECTROPLATING!!**



Yes, Genuine Electroplating Offers You Year Round Added Income and Financial Security

Here's a fascinating and profitable trade that can be developed from part time effort right from your home. Help fill the tremendous need that exists for electroplaters.

Free yourself from worry -- Write today for price list and literature on complete home workshops, easy-to-follow instructions, prepared plating solutions, chemicals and anodes for all types of plating.

RAMYR MANUFACTURING CO.

Dept. E16 · 1624 East First Street · Los Angeles 33, California



## Floor Surfacing Contractors **NEEDED!**

- ★ **BIG PAY**
- ★ **FULL or PART TIME**
- ★ **AGE No Barrier**
- ★ **Minimum Investment**

Highly Respected Profession Offers You Unusual Opportunity to **BE YOUR OWN BOSS**

Thousands of men of all ages have found financial security and happiness in a phase of the building and remodeling industry that has become as necessary as the hammer and nails. The pay scale is high for those who are willing to work; many earn \$50 a day and more. No great physical stamina required—men from 18 to 80, even with physical handicaps, enjoy this pleasant year 'round indoor work where earnings are limited only by the amount of time you devote to it. The American Floor Surfacing Machine Co., a 50-year-old pioneer firm and leader in the industry, shows you how to quickly make good in this stable business. No schooling, no special talent or skills required. Only small investment in sander gets you started. Send coupon for "money-making booklet" entitled "Opportunities in Floor Surfacing"—enclose 25c in coin or stamps to cover handling.



# AMERICAN FLOOR MACHINES

SEND ↓

The American Floor Surfacing Machine Co.  
532 So. St. Clair St.  
Toledo 3, Ohio

Here is 25c in stamps or coin for booklet "Opportunities in Floor Surfacing", telling me how I can start my own floor sanding business.

Name.....

Street.....

City..... State.....



# FREE

# 1956 CATALOG

## WORLD RADIO LABORATORIES

"The World's Largest Distributor of Amateur Radio Equipment"

Jam packed with bargains — everything in Radio, TV, and Hi Fi — for Handyman, Ham, Experimenter or Serviceman!

- Pay Only 10% Down
- Easy Terms
- Liberal Trade-Ins
- Save Over 50% on Recond. Equipment
- Over 800 Guaranteed Reconditioned Items



### WORLD RADIO LABORATORIES

3415 W. Broadway — Council Bluffs, Iowa  
Leo I. Meyerson PERSONALIZED SERVICE

#### MAIL HANDY COUPON

WORLD RADIO LABORATORIES, INC. PS 11  
3415 W. Broadway — Council Bluffs, Iowa

- Free 1956 Catalog       Recond. Eq't. List  
 3'x4' U. S. Radio Map 25c

NAME \_\_\_\_\_

ADDRESS \_\_\_\_\_

CITY \_\_\_\_\_ STATE \_\_\_\_\_

## BARGAINS

LISTS EVERY MONTH HUNDREDS OF TERRIFIC BUYS IN—

- BANKRUPT, Closeout, Surplus Goods
- New & UNUSUAL items.
- WHOLESALE ITEMS • BELOW WHOLESALE • Sources of 100,000 items wholesale.
- Rare Money-Makers opportunities.

HUNDREDS of TERRIFIC offers in Toys, Books, Household goods, Jewelry, Greeting cards, etc. . . . SAMPLE BARGAINS— • Famous \$16.00 Perfume at 60c. • 50c boxes Everyday, Xmas cards, 7c box. • \$1.00 toys, 20c • \$1.95 silk ties, 12 1/2c • Pencils, 99c gross • \$17.50 talking dolls at \$7.50! PLUS MANY, MANY OTHERS!! BIG SPECIAL ISSUE NOW OUT! Subscribe NOW! BARGAINS let you BUY BETTER, CHEAPER, NEWER things for yourself or for resale at TREMENDOUS PROFITS.

**\$1.00** Buys 6 Big issues—1 Yr. \$2.00. Reg. Price \$3.00 year. Spec. Limited time offer to get 10,000 new subscribers. The only magazine of its kind published!

TOWER PRESS INC., P. O. Box 591-DL, Lynn, Mass.

## HYPNOTISM

BE POPULAR • AMAZE • ENTERTAIN

Learn to apply Hypnotism and Auto-suggestion in short time, by training at home, with **GUARANTEED RESULTS — DON'T DELAY.**

Write to America's oldest, most famous Hypnotic school for free information - now - today.

JUST  
FILL  
IN  
COUPON  
AND  
MAIL

SCHOOL OF APPLIED HYPNOLOGY  
Dept. 211  
120 Central Park South, N. Y. 19, N. Y.

Please send me Free information:

SENT IN  
PLAIN  
WRAPPER

NAME.....

ADDRESS.....

CITY..... STATE.....

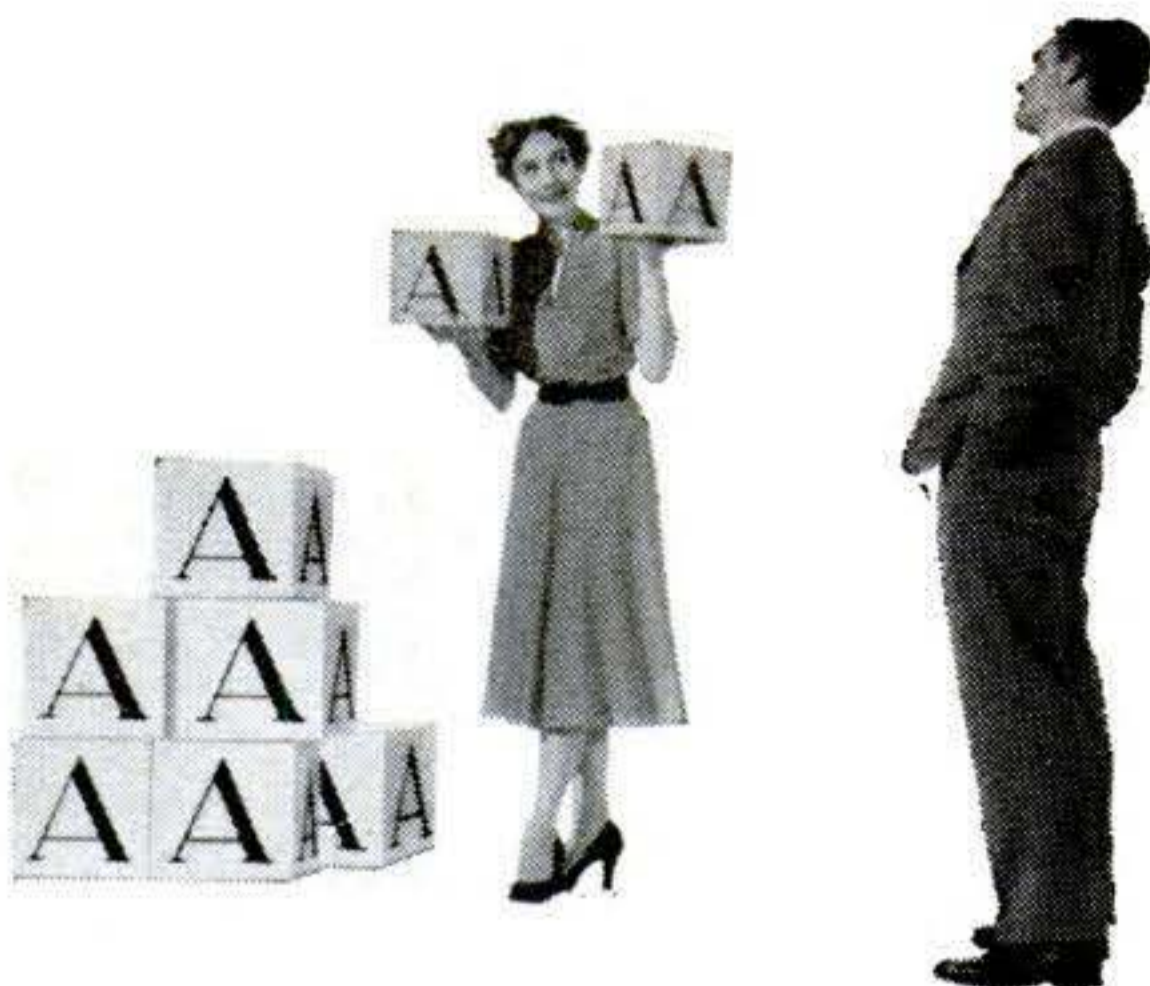

# ALWAYS THE SAME

...today, tomorrow  
and tomorrow

Stable as the alphabet! Go out today and buy any product of any good manufacturer's brand...ask for the same thing tomorrow, or weeks from now... match 'em up, and they're uniformly good, or better.

This uniformity is no accident. Every manufacturer works hard at it because he knows that only *unfailing goodness* will keep you buying his product. So he's mighty sure never to let quality slip. If he changes his product at all, you can bet it's a change for the better.

This goes for everything from a *bobby pin* to an automobile—just another reason for staying with your favorite brands for years and years.

*For news of the goods that are always good, read the ads in this magazine.*

### BRAND NAMES FOUNDATION

INCORPORATED

A NON-PROFIT EDUCATIONAL FOUNDATION  
437 Fifth Avenue, New York 16, New York

WANT UNIFORMITY? PATRONIZE THE DEALER WHO PROVIDES YOUR FAVORITE BRANDS





men ... be TALLER!

THE ORIGINAL AND GENUINE  
**ELEVATORS**<sup>®</sup>  
TRADE MARK  
WEIGHT-INCREASING SHOES  
"YOUR PERSONAL PEDESTAL"  
\* TRADE MARK OF STONE-TARLOW CO., INC.

Step up in "ELEVATORS" and others will look UP to you. The moment you slip on these height increasing shoes you add almost 2 inches to your height. The shoes look no different, but you'll see an amazing difference in your appearance. Be sure, be smart, be taller!

For FREE Booklet and Dealer's name write to:  
**STONE-TARLOW CO., INC., DEPT. PS-11-55, BROCKTON 68, MASS.**

**NEW! Giant AUTOMOTIVE CATALOG**

1956 Edition! Everything for car, truck, custom-styled car, hot rod ... at **LOWEST PRICES!**

Save up to 50% on all parts, accessories! Only complete automotive buying guide...50,000 items...148 pages! Thousands of **hard-to-find parts**; equipment, parts for 1920 to 1956 models; **Hollywood accessories** never before offered; **hi-speed parts**. Send your name and address and 25c (refundable with first \$5.00 order) to:

**J. C. Whitney & Co., 1917 Archer, Dept. T-11, Chicago 16, Ill.**



**DR. GRABOW PIPES**



GREENSBORO, N. C.

\$1.50 TO \$5.00

**LEARN LOCKSMITHING**

Learn this fascinating, profitable trade from experts in your spare time at home! Age or physical handicap no disadvantage. Year around, steady income. Full or part time. Practical, illustrated lessons. You can make money even while learning! All materials and special tools supplied without extra charge.

Send for **FREE BOOKLET**

**LOCKSMITHING INSTITUTE, Dept. PS-71**  
15 PARK AVENUE RUTHERFORD, N. J.  
Lic. by N. J. State Board of Education  
Approved for Veterans

**EVERYBODY LOVES THE SMELL OF A BRAND NEW CAR**

Now ... Amazing New Odorless Duplicates the Refreshing Fragrance of a New Car. Actually Makes Your Car Smell Brand New Again! Also Eliminates Stale, Unpleasant Odors. Send Today for Handy Spray Bottle. Money Back Guarantee!

**\$1** Post paid

**CENTRE PRODUCTS, GARWOOD, N.J.**



**TRAINED MEN NEEDED**

**BIG PAY—GOOD FUTURE**

- TELEVISION
- DIESEL
- ELECTRONICS
- AUTO

WHY WORK FOR LOW PAY or risk being out of a job??? Usually the properly trained man has a steady job... through good times or bad. Even back during DEPRESSION there was a big demand for Bailey Trained men.

In only 5½ to 6 months we can train YOU to enter one of the big pay fields!

No previous experience or special education necessary. With our method of training you do not spend years pouring over books, figures, charts and graphs. You learn by rebuilding, repairing, testing and operating the most modern equipment, under the guidance of experienced, courteous and friendly instructors. This method of training gives you the experience and confidence required to step right into the big pay jobs without spending years as a mechanic's helper.

It's EASIER and COSTS LESS than you may think to get this residence shop training... we help you find part-time jobs while in school—full-time jobs after graduation. Check subject above in which you are interested and mail for complete information.

**BAILEY Technical SCHOOLS**

Veteran Approved

1632 S. Grand St. Louis 4, Mo.

NAME.....AGE.....  
STREET.....  
TOWN.....ZONE.....STATE.....

**Paint STRIPES with New "PAINT PEN"!**

**Straight, Curved or Parallel Lines**

Use like a fountain pen with any color paint to stripe furniture, bikes, autos, model planes, toys, linoleum, wall board. Beautiful clean, crisp results every time. Can't clog or smear. Also use with glue, tempera, textile paint or ceramic under glaze. Paints on wood, glass, plastic, metals, fabrics and paper. Tool complete with tip for 1/16" stripe only \$1.00 post-paid. Other complete tools with following tips, 1/64", 1/32", 3/64", 5/64", 3/32", 1/8"—\$1.50 each. Extra tips 75c each. Entire kit with tool and 7 tips—\$5.00. A 1/4" tip only \$1 each. COD's postage collect.

**New! "DOUBLE-STRIP" 5 Way Combination Model only \$2.95**

Double Stripes— one wide and one narrow or two wide or two narrow at the same time.

**FREE**— Send postcard for complete information **\$2.95**—or ORDER NOW...



\$1.00

**DEALERS:** Master Paint Stripping Tool in display cartons of 1 doz. FAST, Profitable seller. Write for discounts.

**HOME CRAFTSMEN!** New Paint Stripping Tool gives "professional" results every time, simple, easy to use. Send \$1.00 now

**MANUFACTURERS:** Write today for information about industrial and production stripping tools.

**WENDELL MFG. CO., Dept. 211**  
4234 Lincoln Ave., Chicago 18, Ill.



**FAMILY SAFE, PARTIALLY USED TIRES.** Check my Golden Rule Guarantee! "The BLATT NAME famous in tires for 40 years". Only BLATT offers a "FREE REPLACEMENT" guarantee! Any other guarantee is USELESS where you must pay for the months service you've received. I replace FREE instantly ANY defective tire within 36 mos.

**CHOOSE YOUR FAVORITE BRAND** **GOOD YEAR** **Firestone**

These are not Recaps—not cheap grade tires. We are selling thousands in our retail store at higher prices!

**36 MONTH GUARANTEE & FREE FACTORY-TESTED TUBE**

600-16 \$5.20	670-15 \$5.10	700-20 \$8.90	600-16(6) \$5.60
650-16 5.60	710-15 5.30	750-20 9.80	650-16(6) 6.40
700-16 5.70	760-15 5.30	825-20 16.50	700-16(6) 7.00
640-15 4.80	800-15 5.60	900-20 15.50	700-15(6) 7.80

700-15 4.90	820-15 5.60	1000-20 17.20	700-17 7.80
600-20 7.90	650-20 8.20	1100-20 17.20	750-17 9.90
WHITEWALLS \$1.00 EXTRA	1000-22 16.20	750-16 7.50	

**MARVIN BLATT 609** Spring Garden St. Philadelphia, Pa.

**MILITARY MUD-GRIP TIRES**  
AA Guar. 20 Mos. AAA 38 Months  
900-16 \$9.50 900-16 \$13.90  
750-20 12.90 750-20 17.30

WHY LOSE TIME! JUST ORDER!

**FREE**

This pictured tire Ash Tray Given with 2 or more tires!

**SPECIAL! TIRES RELEASED BY CO ADJUSTERS!** If a tire falls in 36 months, I charge you nothing. Just slightly used. Any car size. World's top tire value. (White-walls \$1 extra.) And tube FREE. **\$7.50**

**SNOW-TIRES** **GOODYEAR SUBURBANITE** type & others—any car. Factory retreads & Partially used. 26 Mos. Guar. Free Tube **\$7.77**

Send Check or M.O. & this ad for instant shipment. FOB Phila. I personally select your tires—as if my future depended on it. Thousands of tires shipped the world over. Read that top line again.



# Go after the **BIG MONEY**

in

*From the  
Low  
Low  
Low*

## Repair and Maintenance

Keeping industrial and domestic electrical machinery "going"—that's a big-pay job for thousands of men—big today—and ever-growing, in this electrical age! Get into this promising line—grow with it into bigger opportunities and get really worthwhile pay. Let this big, practical, Electrical Maintenance and Repair Library show you how—as it has hundreds of other men.

**5 volumes 2112 pages 1801 illustrations**  
Starts at beginning, and takes you step-by-step through every phase of connecting, altering, testing, repairing all types of equipment. How to install motors, generators, rewind motors; inspect, repair starters; locate trouble, test induction motors, and MUCH MORE! One entire volume crammed with troubleshooting charts. Simple diagrams make everything crystal-clear. Gives best on-the-job practices of experts. Will help to put you in big-pay class and rate you an EXPERT electrical worker.

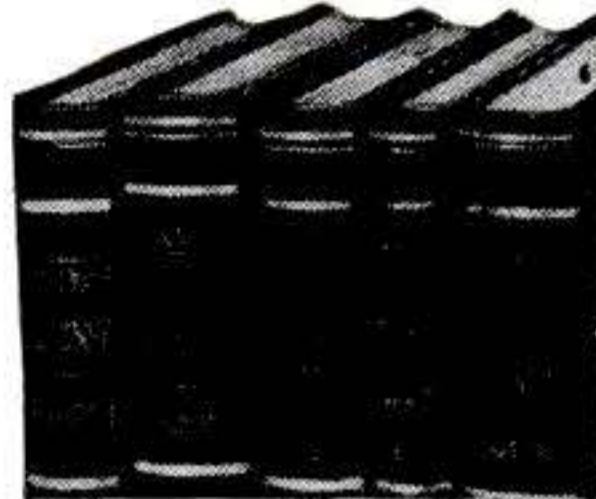

**FREE  
10-DAY TRIAL**  
Send no money. Just mail coupon. Easy payments.

McGraw-Hill Book Co., Dept. PS-11  
327 West 41st St., New York 18, N. Y.

Send me for FREE 10-Days' Examination the Electrical Maintenance and Repair Library. If not satisfied I will return books. Otherwise, I will send \$4.50, plus delivery costs, and then \$4.00 a month for 5 months, until total of \$24.50 is paid.

Name \_\_\_\_\_

Home Address \_\_\_\_\_

City & State \_\_\_\_\_ PS-11

WE PAY DELIVERY COST if you enclose \$4.50 first payment WITH coupon. Same return privilege for full refund.

# LEARN UPHOLSTERY

in your spare time  
run your own  
business  
AT HOME



FREE TOOLS WITH COURSE!

**FREE BOOK**  
with sample lessons

with course

**YOU MAKE  
SLIPPER  
CHAIR**



**CLUB  
CHAIR**



**OTTOMAN**

with  
**SLIP COVERS**  
Yours to Keep  
or Sell

### BE YOUR OWN BOSS

Earn more from the start! Set up your own profitable business, in your own home, enjoy steady income, independence for life—in the booming field of Custom Furniture Upholstery. Right off you start learning with tools, complete frames, fabrics and materials, included FREE with your UTS course. You learn skilled professional custom upholstery, reupholstery, furniture finishing, repair, how to make beautiful slip covers, window cornices, cushions and draperies. EARN WHILE YOU LEARN, in your spare time . . . the UTS easy way.

**FREE illustrated book, with sample lessons.**

Get ready for well-paid job, big profits, from steady work, as your own boss, running your own business. Mail coupon NOW! Training in N.Y. school also available.

**APPROVED FOR VETERAN TRAINING**

**UPHOLSTERY TRADES SCHOOL**  
Dept. DS-1610, 721 B'way, N. Y. 3, N. Y.

Send me free book "Your New Way to a Successful Career." No obligation—no salesman will call.

Home Study  N.Y. School Training

Name \_\_\_\_\_

Address \_\_\_\_\_

City \_\_\_\_\_ Zone \_\_\_\_\_ State \_\_\_\_\_

Check if Korean Veteran

# Home Operators Use New Rubber Stamp Machine for Big Profits!

**Gives Men and Women Everywhere—  
Even in Small Communities—Chance to  
MAKE \$9.20 AN HOUR**



The multi-million dollar Rubber Stamp business is now being taken over by small home operators throughout the U.S. Men and women who operate this inexpensive machine can turn out large numbers of Rubber Stamps with special wording of all kinds. Material costing only 27c makes a stamp that sells for \$1.80. The machine is easy for anyone to operate. It molds as many as six Rubber Stamps at a time, each with different wording such as names, addresses, notices, stock numbers, prices and other "copy" needed by offices, factories, and individuals. At full capacity, it can earn as much as **\$9.20 an hour for the operator!** You don't need experience to get into this big profit business at home. We supply everything, including complete instructions and eight ways to get orders for stamps coming in fast. Start making up to \$9.20 in one hour right away. We'll mail full particulars FREE and no salesman will call. Be first in your locality. Rush name, address today to **Rubber Stamp Div., 1512 Jarvis Avenue, Dept. R-3-M, Chicago 26, Illinois**

# Personal RADIO



**POCKET  
SIZE**

Amazing new midget radio. Slips into purse or coat pocket. Imagine... music, news, sports . . . right in the palm of your hand! Plays indoors or out. "Tunes in" local broadcasts. Gives clear reception. **Uses No Tubes, No Batteries or Electric "Plug-Ins"**. Has new diode that eliminates them all FOREVER! A self-contained radio in attractive case with built-in speaker phone. Durably built to give long service. Not a toy, but a practical tiny radio for real fun and enjoyment. This COMPLETE READY-TO-LISTEN RADIO sent postpaid for only \$4.95. Order yours today. No C.O.D.s. By mail only from:

**NAFICO, Dept. R-12, Box 5, Sta. E, TOLEDO 9, OHIO**

# Don't Neglect Slipping

# FALSE TEETH

Do false teeth drop, slip or wobble when you talk, eat, laugh or sneeze? Don't be annoyed and embarrassed by such handicaps. FASTEETH, an alkaline (non-acid) powder to sprinkle on your plates, keeps false teeth more firmly set. Gives confident feeling of security and added comfort. No gummy, gooey, pasty taste or feeling. Get FASTEETH today at any drug counter.

# FIND URANIUM!!!

Prospecting made easy with Goldak's new U-238C triple-action geiger counter! Also famous line of metal locators, from \$49.50  
Send 25c for radioactive uranium sample!  
FREE DETAILS. Dealer Inquiries Welcome.

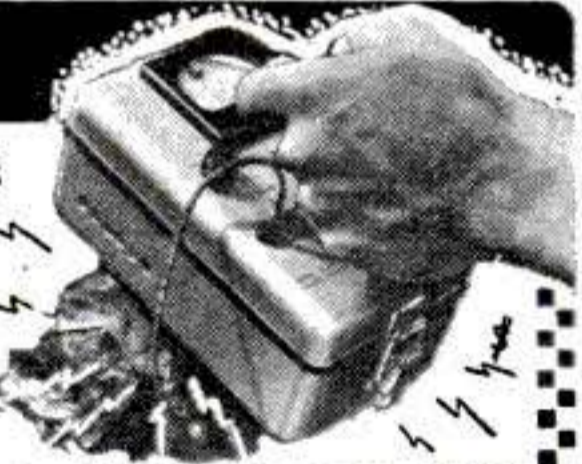

**GOLDAK COMPANY 1544 W. Glenoaks Blvd., Glendale, Calif.**

# JEEP OWNERS

**STA. WAGONS • JEEPSTERS • PICK-UPS!**

Take full advantage of 4-wheel drive by installing a Ford V-8 engine—MORE POWER—means less shifting, better traction at lower speeds, greater safety, plenty of power in high. All this is now possible by using our F-J adapter plate. Conversion Kit \$43.25 incl. FED. TAX. Write for free details or send check or M.O. for prepaid delivery. Order now for early shipment. Please indicate year of engine you will use and whether 2 or 4 wheel-drive.

**HOOSIER MACHINE PRODUCTS CO.**  
314 S.E. 6th St. Pendleton, Oregon

# HIGH WAGES!

Are being paid to Operators of Bulldozers, Draglines, Back Hoes, Earthmovers and Motor Graders, Contractors want our Graduates Learn these skills NOW

National School of Heavy Equipment Operation  
P.O. Box 8243-A4, Charlotte, N. C.  
Please send me your School Catalog FREE

Name \_\_\_\_\_ Address \_\_\_\_\_  
City \_\_\_\_\_ State \_\_\_\_\_



# New FALSE PLATE

for OLD  
IN 24 HOURS

Low As Only  
**\$15.95**



Wonderful New Scientific Method Transforms OLD, LOOSE, Cracked or Chipped Plates into LUSTROUS BEAUTY-PINK DUPONT PLASTIC PLATES

## MONEY BACK GUARANTEE

Why envy beautiful false teeth of others? We will transform your old, loose, cracked or chipped plate into a beautiful new, lightweight DuPont Beauty-Pink Plastic Plate, using your own teeth. All missing and broken teeth matched and replaced. Your cost amazingly low; actually save many dollars. No impression needed under our new scientific False Plate Method. 24-Hour Service.

**SEND NO MONEY** Enjoy life again, and save money on beautiful, new, natural-looking plastic plate. Rush name, address for full details sent FREE. If your plate is loose, we show you how to make it comfortable, tight-fitting before duplication. West Dental Laboratory, 127 N. Dearborn St., Dept. G-34, Chicago 2, Ill.

## It's EASY to play The MUSICAL SAW



the Glass-O-Phone the Jazz-O-Nette,  
Musical-Pitchfork, Flute-O-Phone

If you can whistle or hum a tune, you can play these remarkable Novelty Instruments. They are played entirely by ear. Low priced. Write for FREE literature. **MUSSEHL & WESTPHAL, Est. 1921**  
12 FORT ST., FORT ATKINSON, WISCONSIN

**FREE!** 60 APPROVED EXERCISES, 68 PHOTOS  
with FAMOUS DAN LURIE



LOW  
DIRECT  
PRICE

## BARBELLS

50 lb. set \$ 8.48 | 150 lb. set \$20.48  
100 lb. set \$13.98 | 200 lb. set \$25.98

SEND FOR FREE CATALOG

Order by mail—50% with order Balance  
COD. Extra WTS. 13c lb. FOB Plant.

**DAN LURIE BARBELL CO.**

52-S11 Bristol St., Dept. 570L, Brooklyn 12, N.Y.  
SEE DAN ON T V "BIG TOP" SHOW

## FREE-U.S. STAMPS

U. S. 1943 Bi-Colored Flag of Occupied Nations (as illustrated) Airmails, Commemoratives, Regular Issues, included in this collection of 25 selected, all different, genuine U. S. Stamps. PLUS VALUABLE U. S. \$5.00 STAMP. Everything for 10c to cover mailing expenses. Approvals included. Act at once.



**WILLETT CO., 141 E. Main St., Dept. 606, Mount Kisco, N.Y.**

## Super Powerful All Channel TV RECEPTION IN ALL DIRECTIONS

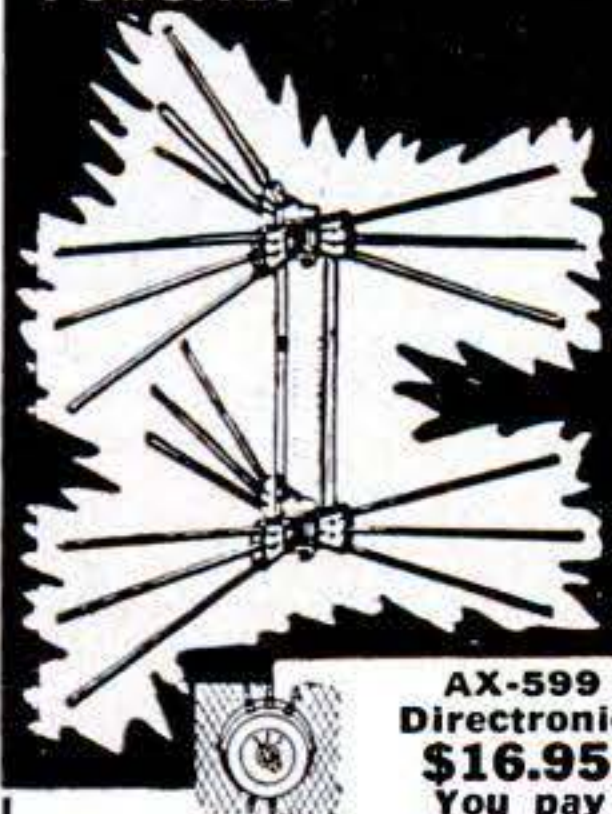

### Rocket DIRECTRONIC MOTORLESS TV ANTENNA

360° Electronically Switched Beam

- No Motors
- No Roof Orientation
- No Electric Power
- No Ghosts
- Flick of Switch Clears Picture Instantly

In the city or in an ultra-fringe area, the Directronic will out-perform ordinary antennas. Only the Motorless 360° Directronic TV Antenna offers "around the compass" reception WITHOUT Rotors. Clarity of picture will amaze, it's so bright, so sharply defined. AX-599 "Serviceman's Array" contains Hi-Pac molded insulator of extremely high tensile strength, 18 hi-tensile aluminum alloy elements, 1 set connecting stubs (3). Universal U-Clamps for masts to 1 1/2". Directronic Beam Selector, 75' Tri-X Cable. 25% deposit on C.O.D.

AX-599  
Directronic  
**\$16.95**  
You pay  
postage

orders, please. Money Back Guarantee.

**NATIONAL ELECTRONICS OF CLEVELAND**  
6608 EUCLID AVE., DEPT. S-11 CLEVELAND 3, OHIO

# MEN-WOMEN GROW ORCHIDS

IN YOUR  
LIVING ROOM!



Any Climate - Maine to California

YEAR 'ROUND No Equipment Needed

**BIG PROFITS** SPARE OR FULL TIME

Fill your home with gorgeous Orchids. Huge purple Cattleyas, exquisite Cymbidiums - dozens of others! Many grow without soil, getting food from the air. White Orchids, yellows, greens, every rainbow color. No equipment needed. Start on table or window ledge.

**SUCCESSFUL HOME GROWER SHOWS YOU HOW!** Complete instructions show you step-by-step how he and his wife started with a few plants and developed a big-profit home-business - grew an Orchid collection now worth a fortune. Learn how orchids multiply, how one plant may become many, each as valuable as the first. No big investment or overhead. Takes but a few minutes a week.



Orchids have rewarded me richly - thanks to Tropical Flowerland.  
S. V. SMART - Colorado

Big-profit orders for plants and flowers come from individuals, florists, hotels, clubs, etc. Year 'round gift. Millions sold by Mail-Order.

**COMPLETE INSTRUCTIONS AND BLOOMING-SIZE ORCHID PLANT SENT FOR YOU TO EXAMINE AT HOME WITHOUT RISK.** Secrets of the experts in simple language, jam-packed with "show-how" drawings, magnificent full-color pictures of Orchids. Send No Money! Write NOW for your FREE FACTS that show you how to learn to grow Orchids at home. Airmail is quicker.

**TROPICAL FLOWERLAND, Dept. 2B**

4622 Wilshire Blvd., Los Angeles 5, Calif.

12-Star  
UTILITY PANTS  
With Shirts to Match  
**ARE  
A BETTER  
BUY**



Work comes easier  
when you "tool up"  
in comfort clothes

THERE'S more joy in any job when you slip into the relaxing ease of an Anvil matching suit. Stoop, reach, bend, twist—in any position there's comfortable freedom for action. Made of tough twills in choice of colors. Non-shrink waistband, foot-deep, double-lined safety pockets; every point of strain especially reinforced. Try out Anvil Brand for new satisfaction.

**ANVIL BRAND FACTORIES** HIGH POINT, N. C.



not everyone does as well, but E. O. Lockin, who started a business of his own, reports...

for 12 months I've averaged  
**\$800 PER MONTH**  
**INCOME** —  
 most of it clear profit for me!

● Many men have discovered how to be independent, to be free of bosses and layoffs. L. A. Eagles grossed more than \$200 his first week. Others report gross up to \$12,000 per year. How much you make depends largely on you. You need no special skill, no large investment!

**No shop necessary.** Our ELECTRIC RUG WASHER cleans rugs, carpets right on floor... helps to show their natural color, beauty. So efficient and safe, used by largest hotels and railroads.

You take no risk. Machines fully guaranteed. Write for full information including how to make big profits in YOUR OWN business.



MAIL COUPON TODAY FOR FREE BOOK

VON SCHRADER MFG. CO., E11 "R" PL, Racine, Wis.

Without obligation, send your FREE booklet containing information about your ELECTRIC RUG WASHER and how I can start my own permanent, profitable business.

Name \_\_\_\_\_

Address \_\_\_\_\_

City \_\_\_\_\_ Zone \_\_\_\_\_ State \_\_\_\_\_

FREE TO NEW MEMBERS...

# IMPORTS

FROM FOREIGN LANDS

NOW! EASY TO START YOUR OWN BIG-PROFIT IMPORT-EXPORT BUSINESS AT HOME!

**FREE** to new members of the International Traders Guild—many unusual, useful products from France, India, Germany and other foreign lands, and trade bulletins listing hundreds of import bargains. World trade boom offers new, big-money opportunities for men and women! Now you can import at low foreign prices for buyers in your locality at high U. S. prices.

**BUY-SELL, WORLD-WIDE, WITHOUT CAPITAL** Big profits possible, no investment in goods. Operate a world-wide mail-order business from home, spare or full-time. Also, for your own use, big savings on clothes, tools, gems, antiques, watches, cameras, china, silk, toys, etc. (see examples at left). No matter where you live World Trade can be carried on—in small towns or large cities, anywhere. World travel opportunities. Established World Trader shows you how. Teaches you quickly at home.

**START AT ONCE-IMPORT PROFITABLE ITEMS** Complete training includes many exciting im-

ports that come to you from 'round the world AT NO EXTRA COST. Go after big profits NOW—importing and exporting. No previous experience is required. 2000 members in 42 countries. 7th successful year. Free details, write Now. Airmail reaches us overnight.

"Business good... importing paintings... selling to gift shops." — C. Renick, Penn.

Mrs. M. G. Bowman — Her entire import of beaded purses from India bought by large department store.

The MELLINGER CO., Exporters-Importers, Dept. E24B 1717 Westwood Blvd., Los Angeles 24, Calif.



## "THE MAGIC OF LIGHT"

Read how one of the most famous Physics experiments has been incorrectly interpreted for over 70 years; how in this experiment, which is the cornerstone of the Theory of Relativity, such eminent personalities as Michelson and Albert Einstein were misled by the behavior of light rays. This clear and simple presentation involves only elementary algebra and geometry. 20 illustrations. \$1.00.

THE MANDS COMPANY

Box 177

Franklin, Michigan

## NOW! Practical Home Course in AUTOMATIC TRANSMISSION

FREE loan of automatic transmissions while you learn at home! Demand for specialists is terrific! Real big money in this field. Learn from experts in spare time. Easy to understand, illustrated lessons plus FREE use of Hydramatic, Dynaflo and Fordomatic transmissions. You can start making money. Send for FREE BOOKLET.

LINCOLN TECHNICAL INSTITUTE

Dept. PS-1, 472 Market St.

Newark 5, N. J.

## SKYSCOPE

The 3 1/2" dia. reflector, astronomical telescope 100% American made. Completely mounted. Used by schools and universities for over 15 years. Unconditionally guaranteed. \$29.75. Descriptive literature on request.

THE SKYSCOPE CO., Inc.  
 475-Y Fifth Ave., N. Y. 17, N. Y.

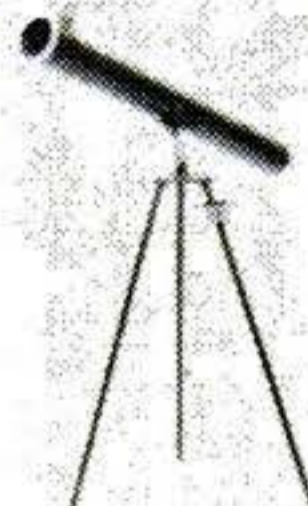

\$35,000 BONUS OFFERED BY THE U. S. GOVERNMENT FOR URANIUM

FREE BOOKLET! "HOW TO MAKE MONEY PROSPECTING FOR URANIUM"

Tells where to look, how to stake claims, how to sell, equipment needed—plus many other facts to help you cash-in on rich Uranium rewards. (Please enclose 10¢ for postage & handling.)

U.S. GEIGER CO. Dept. PS11 195 Sackett St., B'KLYN 31, N.Y.



## BUY IT WHOLESALE!

GET UP TO 40% OFF

Start a Buying Service at Home, SPARETIME. GET BIG-NAME MERCHANDISE FOR SELF AND CLIENTS UP TO 40% LESS THAN REG. PRICE. SALES EASY, AS YOU CAN GIVE SIZEABLE DISCOUNTS, STILL MAKE FAT COMMISSIONS. Post Card brings FREE COPY "The Wholesale Plan".

FREE! "THE WHOLESALE PLAN"

American Buyers Service

HERTEL STATION, DEPT. PS BUFFALO 16, N. Y.

## AMAZING NEW 2 OZ. CIVIL DEFENSE RADIO

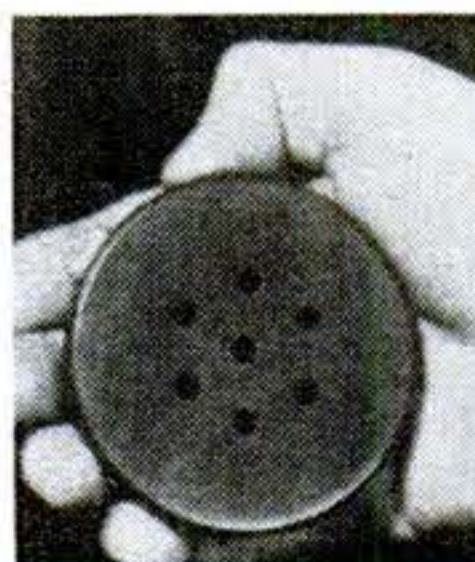

**NEW TUBELESS POCKET SIZE RADIO** NEWLY DEVELOPED BUILT-IN SPEAKER MECHANISM SENSATIONAL—OVER 30,000 SETS SOLD—NO TUBES, BATTERIES OR ELECTRICITY. Uses worlds finest signal detector—Super-Sensitive Germanium Diode Rectifier—developed for Radar, performs at a high level of efficiency. Nothing to burn out or run down; should last for years. Gets local radio stations with amazing clearness—many users report reception up to several hundred miles. War may stop production so order today to make sure of delivery. RADIO COMPLETE READY TO LISTEN. 1 ounce antenna included. Rush check, cash or money order TODAY. No C.O.D.'s—\$7.95 each —2 for \$15. Civil defense instructions included. SOUTHERN SPECIALTIES General Delivery, Miami, Florida PS-11



**WORLD'S GREATEST**

**CLASSIFIED**

# OPPORTUNITIES

Here are hundreds of opportunities offered especially to the readers of Popular Science Monthly. Read them. Answer them! You can make and save money.



MAKE MONEY

SAVE MONEY



**POPULAR SCIENCE MONTHLY — 353 FOURTH AVE. — NEW YORK CITY 10**

Classified Ads only 90c per word insertion, payable in advance. Minimum ad 10 words. To be included in January issue, copy should be in our office by November 25. No cancellations accepted after November 15th. Address orders to O. K. Kelly, Classified Adv. Mgr.

## 1 AUTOMOBILES & MIDGET CARS

**CROSLY Owners?** Join Crosley Club, Big discount on Parts. Write—Crosley Club, Bedford, RD2, Penna.

**FREE** motor magazines; automobile literature, old, new and foreign; glossy photos, dealer books, shop manuals. Offered with non-profit organization. Write today; get on free mailing list. Auto Maniacs, Inc., Stockbridge, Michigan.

**AUTOMOBILE** booklet, "How To Drive," 25c. Ringer's Auto School, Box 702, Lynn, Massachusetts.

**ANTIQU** Automobile color slides, 2x2. Illustrated catalog Free. Universal, Box 779P, Beverly Hills, Calif.

## 2 AUTO SUPPLIES & EQUIPMENT

**NEW** And Used Parts At Savings Complete guaranteed parts service for all models cars and trucks—1924 and later. Largest in the West. Army parts specialists. No catalog—Write for quotations. Fast Mail Order Service. Pioneer Auto and Truck Parts Co., 788 W. 13th Avenue, Denver, Colorado.

**AUTO** Accessory & Parts Catalog. 1956 edition—All New! 164 pages. Save up to 50%—over 50,000 items, including Hollywood Accessories, Hi-Speed Equipment, Rebuilt Engines, all parts and accessories for all cars and trucks! Hard-To-Get parts! Send 25c (refundable). J. C. Whitney, 1919-PS Archer, Chicago 16, Illinois.

**FREE** Discount catalog—Speed, power, custom equipment. Almquist Engineering, Milford 3, Pennsylvania.

**BUY** Wholesale nationally advertised auto supplies, thousands other products at big discount. Free "Wholesale Plan," American Buyers', Hertel Station, Buffalo 16-S, N. Y.

**LATEST** Custom accessories . . . Items not in stores. New low prices. Continental tire kits, push-button doors, trunks, etc. New illustrated catalog . . . biggest ever, 25c. Eastern Auto, 3319-D South Grand, Los Angeles 7, California.

**FORD T** Parts?—Try best source Old Car parts anywhere. Wisniewski, Milwaukee 7, Wisconsin.

**AMAZING** Fybrglass! Repair Anything! Save time—money on hundreds of car, home repairs. Kit "A" (144 sq. in.) \$1.98; Kit "B" (432 sq. in.) \$4.95 post-paid. At your auto store, or order direct. Illustrated booklet, 10c to cover handling. Schramm, 5434-B Higgins, Chicago 30.

**"PLEASE** Clean My Windshield." New gas cap and vent window decal remind station attendants who often neglect. 50c each. Order today. Jac-D-Cal, 682 Cecil, Louisville 11, Kentucky.

**BUY** Surplus Cars, Jeeps, Auto Parts: Direct from Government. Bulletin \$1.00. Box 1842P. Hartford 1, Conn.

**LACHAPELLE'S** Motor Treatment. For a better car longer, \$3.00 postpaid. Ferns Products, Box 71827, Los Angeles 1, California.

## USE THIS HANDY INDEX TO FIND WHAT YOU WANT

Advertising, Agencies for Advertisers . . .	53
Agents Wanted . . .	43
Antiques, Relics & Indian Goods . . .	29
Authors Service . . .	52
Auto Supplies & Equipment . . .	2
Auto Trailers . . .	3
Automobiles & Midget Cars . . .	1
Aviation . . .	5
Batteries, Generators, Etc. . . . .	6
Boats, Outboard Motors . . . . .	11
Body-Building Courses, Jiu Jitsu, Etc. . .	12
Books & Magazines . . . . .	23
Build It Yourself . . . . .	66
Business Opportunities . . . . .	37
Business Service, Information, Name Lists . . . . .	50
Cameras, Photo Supplies . . . . .	34
Camping Equipment & Tents . . . . .	16
Cartooning, Sign Painting, Chalk Talks . .	54
Chemistry & Physics . . . . .	41
Claim Investigators . . . . .	37A
Coins & Currency . . . . .	26
Contests . . . . .	46
Detectives . . . . .	47
Dogs, Birds, Hamsters & Pets . . . . .	17
Drawing Supplies & Equipment . . . . .	76
Educational & Instruction . . . . .	45
Electrical Supplies & Equipment . . . . .	7
Engines, Motors, Etc. . . . .	10
Farms, Other Real Estate . . . . .	19
Field Glasses, Telescopes . . . . .	14
For Inventors . . . . .	60
For Sale Miscellaneous . . . . .	71
For the Home . . . . .	69
Formulas, Plans, Etc. . . . .	39
Frog Raising . . . . .	18
Games & Entertainment . . . . .	24A
Geiger Counters, Treasure Finders . . . . .	77
Help Wanted . . . . .	42
High-grade Salesmen . . . . .	44
Hobbies, Collections . . . . .	31
Home Craftsman . . . . .	65
Hypnotism . . . . .	24
Inventions Wanted . . . . .	61
Language Outfits . . . . .	48
Machinery, Tool Supplies, Etc. . . . .	9
Magic Tricks, Puzzles, Etc. . . . .	25
Manufacturing . . . . .	63
Minerals & Precious Stones . . . . .	30
Miscellaneous . . . . .	79
Models, Model Supplies . . . . .	64
Moneymaking Opportunities . . . . .	38
Motion Pictures, Slides, Sound Equip. . .	33
Motorcycles, Bicycles & Supplies . . . . .	4
Music, Song Writers & Records . . . . .	35
Of Interest To Women . . . . .	70
Old Gold, Jewelry, Watches . . . . .	67
Old Stamps Wanted . . . . .	27
Patent Attorneys . . . . .	59
Patents For Sale . . . . .	62
Personal . . . . .	80
Photo Finishing, Photocopies, Etc. . . . .	32
Plastics . . . . .	40
Plays, Stories, Etc. . . . .	49
Poultry & Supplies . . . . .	21
Printing, Multigraphing, Etc. . . . .	57
Printing Outfits, Supplies . . . . .	58
Profitable Occupations . . . . .	22
Radio, TV, Supplies & Equipment . . . . .	36
Razor Blades, Shavers . . . . .	74
Rubber Stamps & Office Supplies . . . . .	56
Special Services . . . . .	51
Sporting Goods, Guns, Fishing Tackle, Etc. . . . .	15
Stamp Collecting . . . . .	28
Tattooing Supplies . . . . .	75
Taxidermy . . . . .	13
Tobacco & Pipes . . . . .	68
Trees, Shrubs, Roots & Herbs . . . . .	20
Typewriters & Office Machines . . . . .	55
Wanted to Buy . . . . .	72
Watch Repairing . . . . .	78
Wearing Apparel . . . . .	73
Welding, Soldering . . . . .	8

**JEEP Owners—V8 Power.** Read Jeep Owners ad. Page 70.

**DISCARDED** GM71-110 Injector Parts Wanted. Bonus on HV. Mayer, 7120 Carnegie, Cleveland 3, Ohio.

**RADIOS'** Custom for 1952-3-4-5-6 Fords \$38.90. Free literature Nordic Radio, Box 582, Evanston, Illinois.

**ELECTROPLATE** autoparts, novelties, mirrors. Easy, inexpensive home processes. Free booklet. Tyco Metals, Box 13231-FC, Houston 19, Texas.

**FOOT** Horn Switch, accelerator design, chrome finish, self cleaning contact points, wiring included. Wholesale \$1.00. Rite-o-way Products, 17886 Hull, Detroit 3.

**SUPERCHARGE** your motor for Outstanding Performance and Economy with sensational Superjet Carburetor Valve. Money back guarantee. Only \$3.95 Ppd. Ericson Products, 11365 Matteson Avenue, Dept. PS-11, Los Angeles 66, California.

**CAR** Burning oil? Losing compression? Try Clifford's Compression Seal, Tube \$2 postpaid. Clifford's Engineering, 452 Claim, Aurora, Illinois.

**"AUTO-Polish,"** wholesale! Gallon \$3.00. Guaranteed Superior. Box 3095, Riverside, California.

**WHY** Die? Free auto safety belt literature. Lifesaving Products Company, Box 8076 Northgate Station, Seattle, Wash.

**BALANCE** two front wheels yourself. Weights and copyrighted instructions \$3.50 postpaid. Hiddenglen Company, French Gulch, California.

**HYDRA-Matics** and Fordomatic transmission parts, new and rebuilt. 75% off on most parts. Fully guaranteed. Send for quotations. Transco, Box PS-1892, 221 West 41st Street, New York City 36.

**END** Foggy Car Windows with X-One. Applied with cloth, X-One "Steamproofs" glass, allowing you safer driving, clearer vision in snow, rain, fog. X-One could save your Life. Stick form—plastic container; carry in pocket, glove compartment. Rush \$1.00 to: Morrow Sales, 20638 Lorain, Fairview Park 26, Ohio.

**MOTORIST** save gasoline by Vacuumating overrich mixtures. Fits all cars. For free particulars write Vacuumatic, Dept. 2123, Wauwatosa, Wis.

**IT'S** New Coiltenna. For car radios. Brings twice as many stations, twice as strong with less static. Installs on your present antenna in minutes. No special tools needed. Send \$3.95 and Diameter of your present antenna to Ekmar Products, 1211 Mohawk Lane, St. Joseph, Michigan. Sorry no C.O.D.'s. Dealer inquiries invited.

**TAPPET** noises in Fords, Chevrolets and Mercurys stopped with our silencers. Literature, Kaye Products, 2067C S. Layton Blvd., Milwaukee 15, Wisconsin.

**SENSATIONAL** GE-Subzero Automobile Engine Heater starts coldest cars, trucks, tractors immediately. Special \$3.95 (regularly \$8.95). Order for yourself, sell others locally and mailorder. Huge profits. Terrific quantity discounts. Act Now! Wisniewski Inc., Milwaukee 7, Wisconsin.



# POPULAR SCIENCE OPPORTUNITIES

## 3 AUTO TRAILERS

**BUILD** your own trailer! Plans for all kinds. Illustrated catalog 10c. Jim Dandy, 125-S. Wausau, Wisconsin.

**EXCEPTIONAL** Expanding eight foot trailer. Accommodates family of five. Build Yourself—literature, 10c. Framar Company, Wilmington, Mass.

**PICKUP** Canopies. Trailer blueprints. Literature 10c. Comstock Trailers, Parsons, Kansas.

## 4 MOTORCYCLES, BICYCLES AND SUPPLIES

**RECONDITIONED** Motorcycles and motors. Chromium accessories. Complete stock Indian parts. Expert rebuilding. Fast service. Indian Motorcycle Sales, Kansas City 27, Missouri.

**MOTORBIKE** engine \$7.50, Cushman motorscooter \$30. Midget car, less engine \$16. Engines \$5 up. (Mailorder only). Send 25c (35c for first class mail) for new Directory-catalogue Number 68 listing the above and hundreds of other bargains in new and used midget cars, motorscooters, homebuilders parts, plans, etc. Midget Motors Directory, Athens, Ohio.

**PARTS**—accessories. Motorcycles, Bicycles. Catalog 35c. Bunico, 146, Covington, Virginia.

## 5 AVIATION

**AVIATION** surplus bargain catalog. One dime. Box 22F2, Thomasville, Penna.

**BUILD** A man carrying Helicopter Jet Engine Yourself! "Practical Ram Jet Design" \$1.00, "Practical Pulse Jet Design" \$1.00. Also Centrifugal Propulsion Details \$1.00, Money Back Guarantee, Decker Engine Works, Plasterco, Virginia.

**HELICOPTERS** 1 and 3 man aviation marvels. Construct own. Instructions \$3.50, \$6.00, respectively. Mayberry Aircraft, Box 343, St. Clair Shores, Michigan.

**BUILD** a fast, safe airboat or snow sleigh from your 65-200 H.P. aircraft engine. Propellers, Plans, Supplies. Satisfaction guaranteed. 48 page catalog 25c. Banks-Maxwell Co., Box 3301G, Ft. Worth 5, Texas.

**BUILD** Ram-Jet and Pulse-Jet. Ideal for helicopter. Detailed blueprints—\$2.50 each. Satisfaction guaranteed. Vincent Rose, 219B Lytton Ave., Pittsburgh 13, Pa.

## 6 BATTERIES, GENERATORS, ETC.

**EDISON** Nickel Storage Batteries. Any voltage, any amperage. Unconditionally guaranteed. Power Plants, Generators, Motors. Literature. Hawley Smith Co., Croton Falls 2, New York.

## 7 ELECTRICAL SUPPLIES & EQUIPMENT

**ELECTRIC** Pencil: Engraves all Metals. \$1.50. Beyer Mfg., 10511-C Springfield, Chicago 43.

**ELECTROPLATING** equipment, anodes and solutions for all types of plating. Instructions. Assemble your own plater and save. Free Catalog. Ramyr, Dept. E-2, 1624 East First Street, Los Angeles 33, California.

**NEW 1955** Lamp Parts Catalog showing everything you need to make and repair most types of lamps. Everything at lowest wholesale prices. Send only 25c today for both catalog and wholesale price list. Gearon Co., Dept. 503-A11, 27 S. Desplaines, Chicago 6, Ill.

**WONDERFUL** flasher device makes Christmas lights flash. Many other uses. \$1.00. Cornell Appliances, 809 Bryant, Kalamazoo, Michigan.

**TELEPHONE** Transmitter. Hand set type. Suitable for inter-house phones, speakers or any communication purpose. Delivered two for \$1.00. No C.O.D.'s. Telephones, Dept. C-226, 1760 Lunt, Chicago 26.

**LAMPS**—25c brings bargain catalog showing all parts for repairing, building. Contains instructions for electrifying vases, oil lamps, etc. Gyro Lamps, 5402B Clark, Chicago 40.

**PENNIES** for switches, foot, bench, hand. Contacts and plans 25c. Venners, Box 116, Clyde, Ohio.

## 8 WELDING, SOLDERING

**"BUILD-UR-OWN"** a.c. welder and a.c. power plant with a good used engine and low cost Hobart generator. Welds anywhere and supplies 5KW stand-by power for any emergency. Write Hobartweld, Box P-1153, Troy, Ohio.

**NEW**, timesaving oxy-acetylene outfit welds, cuts, heats, brazes. Just change tips. Light, compact, portable. Thrifty to operate, ruggedly built. Complete outfit and instructions, only \$76.50. Special economy plan for supplying gas cylinders. Write for free literature: Dept. S, Linde Air Products Company, 30 East 42nd Street, New York 17, New York.

**BUY** Welding supplies direct from manufacturer. Cable, welding rods, helmets, etc. Portable arc-welders and kits at tremendous savings. Free factory catalog! LeJay 23, Minneapolis, Minnesota.

**ACETYLENE** Welding outfits new \$49.00; used \$29.00; Arcwelders \$56.50. Eagle Welding, Dept. 42, 5085 Broadway, Chicago 40, Ill.

**WELDERS**, 110/220, Welds 1/2". \$39.50. Morris, 1070 Inner Drive, Schenectady, New York.

**A. C. Welders**, four sizes, lowest prices. Free Literature. Holgerson Co., Canton, Kansas.

## 9 MACHINERY, TOOL SUPPLIES, ETC.

**ALLEN** Two Ton Power Bench Type Punch Press. \$97.50. Circular. Allen, Dept. PSB, Clinton, Missouri.

**AIR** Compressor. Build yourself. Circular 10c. Little Machines, Hamilton, Mich.

**"CRAFTSMAN"** Practical new invented plastic rubber Case For Your 1" 2" 3" Micrometer prevents damage, scratches, Grit. Satisfaction guaranteed. When ordering, please give outline on paper. 1" \$1.00, 2" \$1.25, 3" \$2.00. Micro Safe, 46 Oakview Drive, Dayton 9, Ohio.

**MILLING** Attachment, South Bend. Atlas 9", 10" lathes. Castings, stock, instructions \$7.50 postpaid. Literature: Floyd McGuckin, 314 Monroe, Ridgewood, N. J.

**TAILSTOCK** power feed. Try on money back guarantee. 9" lathes \$3.00. B & D Mfg. Co., 143-20 Franklin Ave., Flushing, Long Island, New York.

**JEEP** Owners—V8 Power. Read Jeep Owners ad. Page 70.

**MILLING** Machine: New. Accurate \$149.50. Southern Machine Tool Company, Conyers 4, Georgia.

**BIG** Factory Catalog! Buy direct—Save Middleman's profits; hundreds of labor saving tools and equipment—tremendous savings. Send 10c. Master Mechanic Mfg. Dept. CL-96, Burlington, Wisconsin.

## 10 ENGINES, MOTORS, ETC.

**WINDING** Data, listing 225 motors, single and three phase. \$1.00. Motor Data, Box 7631, Kansas City 28, Mo.

**REWIND** Motors yourself. Complete instructions \$1.00. Lewis Mfg., Howell 11, Michigan.

**REWIND** Motors yourself, make extra profits. Instruction manual \$1.00. Modern, 507 West 75th, Kansas City 14, Missouri.

**A.C. Generators** 750 watt \$42.50. Twin cylinder compressors with 1/3 horse \$22.00. Motors 1 horse \$38.50. Butler, 1885 Milwaukee, Chicago 47.

**ELECTRICAL** repair men, motor winding and testing catalog Free. Motor Industries, Quincy, Illinois.

**MOTORS**, 1/4 HP, General Electric \$7.50, 1/2 HP Wagner \$14.50. Send M.O. Rebuilt sizes to 5 hp. A.C. Motors, 3101 N. 32nd Street, Philadelphia 32, Pa.

## 11 BOATS, OUTBOARD MOTORS

**AIRPLANE** floats, pontoons. Rubber boats. Catalog 10c. Box 22F6, Thomasville, Penna.

**NEW**, used rebuilt marine motors. Marine conversions, fittings. Free Catalog. Stokes Marine Supply, Dept. 23, Coldwater, Mich.

**OUTBOARD** Motor Parts—New—Used for all makes. Send stamp for price quotation, listing parts needed. Outboard Motor Mart, Inc., 229D State Street, Boston, Massachusetts.

**FREE** Catalog! Boat Kits, Trailers, Fiberglass, Marine Hardware. Luger Industries, Dept. K, 4452 Nicollet, Minneapolis, Minnesota.

**FULL** size, cut-to-shape Boat Patterns, Blueprints. 7 1/2-38 feet. New 1955 illustrated "Build A Boat" catalog of 50 naval architect-designed Cruisers, Runabouts, Sloops, Skiffs, Outboard Boats, Sailing, Racing, Houseboats, 50c. Small Boat Hardware Catalog, \$1.50. Bigger, better 1955 "How to Build Boats" book, \$2.50. Cleveland Boat Blueprint Co., Dept. A-77, Box 1651, Cleveland 4, Ohio.

**BUY** Wholesale nationally advertised outboards, thousands other products at big discount. Free "Wholesale Plan." American Buyers', Hertel Station, Buffalo 16-T, N. Y.

**BOAT** Plans, Patterns, Frame Kits, Modern inboards and outboards 11'-22' for amateur builders. State requirements or send 40c for complete Catalog. Glen Marine, Box 568, Compton, California.

**MARINE** conversions for Ford and Jeep engines. Catalog 25c. Lehman Manufacturing Co., 972A Broad St., Newark 2, N. J.

**BOAT** Plans: Welded steel, wood, plywood. Outboards, Inboards, cruisers, sail. Free literature, please specify type. John B. Clark, N.A., Box 51, Bay Village, Ohio.

## 12 BODY-BUILDING COURSES, JIU JITSU & ATHLETIC EQUIPMENT

**BUILD** powerful arms, chest, shoulders! 22 exercises, \$1. Fonsad, Box 601-C, 1100 Market, Wilmington 99, Delaware.

**MEN'S** Athletic Supporters. Comfortable Form-Fitting Pouch. S-M-L \$1.00. Poly Shop, Box 3203, Ft. Worth 5, Texas.

**100 TRICK** Knockouts for self defense \$1.—1c each. Priest, Box 251, Evanston 2, Illinois.

**LEARN** handbalancing quickly. Fun, builds muscles. Write. Power, 923 W. Vine, Kalamazoo, Michigan.

**PUSHED** around? Why take nonsense from Bullies. Give them the surprise of their lives. Easy when you know Police Jiu Jitsu. Complete fully illustrated course in one volume same as taught police and armed forces. Send \$1 now for Police Jiu Jitsu postpaid. Satisfaction guaranteed. Books Publishing Company, Amityville 2, New York.

**BARBELLS**, Dumbbells, Exercise equipment Courses. Free booklet. Good Barbell Co., Reading, Penna.

## 14 FIELD GLASSES, TELESCOPES

**FREE** Catalogue! Thousands war surplus optical bargains, Lenses, Prisms, Telescopes, Binoculars, etc. Send \$1.00 for 10 Lens Hobbyist Set and Project booklet. G. Jaegers, 691 West Merrick Road, Lynbrook, New York.

**IMPORTERS'** amazing prices Precision Binoculars, 22 models. Free trial. Folder, "Binocular Selecting," catalog free. Prentiss Importers, Mercury Bldg., West Los Angeles 25, Calif.

**REFLECTOR** Telescope Kits \$6.25 (3") to \$175, (12"). Mirrors, Cells, Focusing Mounts, Tripods, Eye-Systems. Anything, everything in telescopes. Free Illustrated Catalog. Also ready to use telescopes from \$25. to \$176. Inquiries to Esco Products, 1428 Willow Ave., Dept. PSM-11, Hoboken, N. J. Sales Showroom, 166 Church St., N.Y.C.



# POPULAR SCIENCE OPPORTUNITIES

**BUILD** your own Reflector Telescope. Complete kit: Mirrors, Eyepieces, Tripod, all other accessories. Request free illustrated literature. Criterion Manufacturing, Dept. KP-13, Hartford, Connecticut.

**DYNASCOPE**—Sensational New Reflector Telescope. Send for details. Criterion Company, Dept. DS-18, Hartford, Connecticut.

**WAR** Surplus bargains! Millions of lenses, instruments, telescopes, binoculars, components and complete line of astronomical telescope items. World's greatest optical market place! Send only \$1.00 for beginner's 10-lens kit and big instruction booklet Stock 2-CN. Write for catalog-CN Free! Edmund Scientific Corp., Barrington, New Jersey.

**REFLECTING** Telescopes, completely assembled. 60X. \$29.75. Guaranteed Observatory clearness. Free information. Skyscope, 475 Fifth Avenue, New York 17.

**6 THUMBS** on each hand? Even you can assemble our Telescope Kits from our easy instructions. Enjoy the heavens with a high precision telescope assembled in less than an hour. You'll like our complete line of telescopes, microscopes and accessories, biological stains, etc. Send for free catalog T of finest quality and newest design astronomical kits or free Catalog M of microscopes. Optical Engineering Co., 164-19 Northern Boulevard, Dept. PS, Flushing, New York.

**SPECIALISTS!** Used microscopes & accessories. Unusual slides. Supplies. Catalog Free. Research Scientific Supplies, 60 Wall St., New York 5.

**UNITED** Binoculars. Ideal Christmas Gifts. \$3.95 to \$250.00. Free 56 page Binocular-Telescope Catalog. United, 9043 S. Western, A-1116, Chicago 20. Dealers Wanted.

**BINOCULAR** specialists, all makes repaired. Authorized Bausch Lomb, Zeiss, Hensoldt, and Bushnell dealer. Tele-Optics, 5514 Lawrence, Chicago 30.

**TELESCOPES, Microscopes, binoculars,** past quarter century. Comprehensive scientific instrument catalog \$1.00. None free. Dollar deductible from orders. Harry Ross, 70 West Broadway, New York, N. Y.

**ASTRONOMICAL** Books, Star-Atlases, free list. Herbert Luft, 42-10 82nd Street, Elmhurst 73, New York.

**MAKE 6" Telescope reflector.** Glass, abrasives, instructions—\$10.50. F. Cameron, Box 65, Inwood 96, New York.

**BINOCULARS, telescopes, microscopes.** Terrific values \$3.98 up. Request free money-saving catalog. Criterion, Dept. S36, Hartford, Connecticut.

**400X TELESCOPE** easily made. Kit includes focusing tube, erector, five finished lenses and building instructions—\$3.75. Giant astronomical telescope completely assembled with tripod—\$15.00. Free information. Suffolk Science, Mattituck 4, New York.

I can save you money on binoculars, microscopes and barometers. Send for free information about 7-power binoculars at \$29.95, triple turret electric microscopes at \$10.95 and finest German barometers at \$7.50. Joseph Sales Company, Room 507, 1740 East 12th Street, Cleveland 14, Ohio.

## 15 SPORTING GOODS, GUNS, FISHING TACKLE, ARCHERY, TRAPPING

**180 PROFUSELY** illustrated pages, antique pistols, swords, daggers, armors, etc. 50c. Robert Abels, PS860 Lexington Ave., New York 21.

**SWIMMERS!** Send \$3.95 for Imported French Mask. Catalog of Skin Divers' Equipment and Books 25c. Aquafun P-S, Davenport, Iowa.

**FREE Fishing Catalog—148 Pages, Over 3,500 Hard To Find Fishing Specialties.** Netcraft Company, Dept. PS1, Toledo 13, Ohio.

**BUY Wholesale** nationally advertised sporting goods, thousands other products at big discount. Free "Wholesale Plan." American Buyers', Hertel Station, Buffalo 16-U, N. Y.

**BOWHUNTING** Secrets Free! New book "How to Hunt with Bow"—100's tips outwitting big, small game, bowfishing. Revealing "How to Choose Bow" facts, Bargain Catalog included. Save 50% finest tackle. All 3 Free! Malibu Archery, 1036-NNO LaBrea, Los Angeles 19, California.

**FISHERMEN**—Make your own sinkers with our molds. Free illustrated booklet. Reading Instrument Co., Box 78, Reading, Pa.

**5,000 BARGAINS,** firearms, binoculars, war relics, catalog 50c. Smith Museum, Runnemede, N. J.

**FLY-Makers!** 1955 free catalog. D. H. Thompson, 335 Walnut Avenue, Elgin, Ill.

**MOLDS** for Fisherman's Sinkers. Jigs, Squids, Casting and Spinning Lures. Free Catalogue. Sweet's Molds, Tonawanda 3, New York.

**JAP** rifles altering American shells \$6.00, Jap shells \$3.65, catalog 5c. TP Shop, West Branch 10, Michigan.

**SEND** for free ammunition list from America's foremost ammunition house. All types including Jap, German, Italian, etc. Philip Jay Medicus, 18 Fletcher St., New York 38, New York.

**MANY** Modern, Antique guns. List 10c coin. Ed Howe, 26 Main, Coopers Mills, Maine.

**GUNS!!** Sportsmen's Gun Gifts!! Bargain Catalog 50c—Antique, Modern Arms, Armour, Rarities. Agramonte's, 201 Warburton, Yonkers 2A, New York.

**ARCHER'S** Free New Illustrated Catalog—Pride Archery Company, RFD#1, Danbury, Connecticut.

**PORTABLE** Duck Blinds—Strong 4x5 Ft. Natural Tule Mats. \$3.00 each. Two for \$5.00 delivered. Peacock P. S., 915 Bryant, San Francisco, California.

**JEEP** Owners—V8 Power. Read Jeep Owners ad. Page 70.

**DIVING** Catalog 30c. Deductible first purchase. Florida Frogman, Miami 43, Fla.

**SAMPLE:** 25c copy of "The Archers' Magazine." Send 10c: 1200 Walnut Street, Philadelphia 7, Pennsylvania.

**AUTHENTIC** Primitive weapon reproductions. Spears, Lances, Shields, Cross-Bows, Hatchets, etc. Colorful. Deadly. Decorative. Write Primitive Weapons, Pevely, Missouri.

**BUY Wholesale!** Guns, Fishing, Sporting Goods. Save 66-2/3%! Free Catalogs. National Buyers Service, Box 426FC, Oakland, California.

**PHOTOMURALS**—your negative—30X40—\$7.50. Shribers, 1920 Beaver, Pittsburgh 33, Pa.

## 16 CAMPING EQUIPMENT & TENTS

**TENTS, camping equipment.** Send 10c for 100 page tent, camping equipment 1955 catalogue-handbook. Morsan, 10-21G 50th Avenue, Long Island City 1, New York.

## 17 DOGS, BIRDS, HAMSTERS, RABBITS & PETS

**MAKE Big Money!** Raise Chinchilla Rabbits. Cash Markets Supplied. Write Today! Rockhill Ranch, Sellersville 16, Pa.

**RAISE** moneymaking Angora, New Zealand Rabbits. Particulars free. White's Rabbitry, Jackson, Michigan.

**HAMSTERS**—golden; young, \$3.00 pair; fully developed, \$4.00 pair. Adirondack Hamstery, Prospect 123, New York.

**RAISE** Mink: Free booklet, pen plans, inside "secrets," feed, care. Mink are money makers. Investigate today. Lawrence Molgard, Brigham City 13, Utah.

**CHINCHILLAS** Closing out \$100 to \$200 Pair. Bright's Chinchillas, 2312 N. 38 Street, Kansas City, Kansas.

**NATURALISTS** Catalog 15c. Hamsters \$4.75 trio. Quivira Specialties, Topeka 10, Kansas.

**MAKE Big Money** raising Chinchillas for us. Free catalog. Keeney Brothers, New Freedom 9, Penna.

**PUREBRED** Chinchilla and New Zealand Rabbits. Write—Wilson's Rabbitry, Greer, South Carolina.

**HAMSTERS**—The New Empress Strain. Guaranteed to produce. Free Details. Anderson's Hamstery, 35G Oneida, Pontiac, Michigan.

**GROW** Mushrooms. Cellar, shed, and outdoors. Spare, full time, year round. We pay \$3.50 lb. We paid Babbitt \$4.165.00 in few weeks. Free Book. Washington Mushroom Ind., Dept. 177, 2954 Admiral Way, Seattle, Washington.

**HUNTERS.** Finest hunting hounds. Reasonable. Trial. Free list, pictures. Okaw River Kennel, Cowden C-42, Illinois.

**ANGORAS, Chinchillas**—World's most profitable rabbits! Catalog free. Grinsteads, Edwardsville, Illinois.

## 18 FROG RAISING

"FROG Raising!" Get ready now for next spawn. New book tells how. Folder 10c. Broel- B, Box 506, New Orleans 1, Louisiana.

## 19 FARMS, OTHER REAL ESTATE

**SEE** our ad on page 56. The Abacus Press.

**FLORIDA**—Nice homesites, \$245 at \$10 Monthly. Folder Free. Winfree Vernor, DeLand, Florida.

**HOMESITES \$400** — Convenient payments. California's finest garden section. On Morro Bay's scenic shores. Wonderful fishing, boating, bathing. Fertile soil, softest water, temperate climate, congenial community. Free literature. Richard Otto, Department P, San Luis Obispo, Calif.

**FLORIDA**—Beautiful Retirement Homesites near Gulf Coast. Finest Fishing, Hunting. \$250 and up at \$10 Monthly. Write William Mathews, P. O. Box 1406, Asheville, N. C.

**CALIFORNIA** farm and ranch lands. \$15 to \$35 acre. Homesites \$395. Easy terms. Free Catalog. Pacific Tax Sales, 1621-B Cahuenga, Hollywood 28, California.

**STROUT** Catalog—Mailed Free! Farms, Homes, Businesses, 36 States. Coast-to-Coast. 2,914 Bargains described. World's Largest; 55 Years Service. Strout Realty, 255-ZB 4th Avenue, New York 10, N. Y.

**FLORIDA** Waterfront homesites on famous Saint John's River \$50.00 front foot. Also inland lakefront five miles from River, \$195.00—\$995.00. Specify which literature. Easy monthly payments. Pine Lakes, Eustis, Florida.

**FLORIDA.** Several 5 acre tracts, grand climate and location. Near Gulf Mexico. For Fishing, boating, bathing. Priced at \$985.00, \$20.00 down, \$20.00 month. Information write G. B. Potterfield, Owner, Union Bldg., Dept. X, Charleston, W. Va.

**FLORIDA** Winter Garden Farms—your best investment for retirement or vacation place. 5 acres—10 acres—20 acres. Low Prices—Easy Terms. High—Dry—Beautifully Wooded. Near Panama City, famous pleasure resort. World's most beautiful beaches. Grow fruits, berries, vegetables, money-making Tung Trees. Tung oil makes world's finest paint products. We plant and service your grove. Brochure Free. Douglas Wood, Fountain, Florida.

**FLORIDA** Lakefront homesites near Ocala Forest. Excellent fishing-hunting. \$10.00 monthly without interest. Complete price \$195.00—\$995.00. Literature. Grace Parker, Paisley, Florida.

**VILLAGE** homes, nothing down. List. Industries encouraged. Buildings waiting. Perry, Breirhill, Penna.

**NOTARIZED** deed in your name or blank for gift. Square foot Texas ranch. Oil leased \$1.00. Hilco Sales, Box 71, Kerrville, Texas.

## 20 TREES, SHRUBS, ROOTS, HERBS

**PEACH** Trees 19c. Catalog. Globe Nurseries, Dept. 655, McMinnville, Tenn.



# POPULAR SCIENCE OPPORTUNITIES

**TREES And Shrubs**—Raise your own from seed for shade, windbreak, snow fence, ornament, erosion control, etc. For free planting guide—price list, write Woodlot Seed Company, Norway 46, Mich.

## 21 POULTRY & SUPPLIES

**POULTRY Farmers**—Broiler Growers—Turkey Raisers read the new American Poultry Journal for latest ideas and greater profits. 12 months, 50c. Special offer, 4 years, \$1.00. American Poultry Journal, 182 North Wabash, Chicago.

**RAISE pheasants** on \$100 week plan. Little capital and space can make you independent. Free details. Great Central System, Columbus 6, Kansas.

## 22 PROFITABLE OCCUPATIONS

**"HOW to Make Money With Home Workshop"** describes amazing methods used by hundreds of successful craftsmen. Tells what to make. How to sell workshop output spare time. Write at once for details. Craftsman, 115B11 Worth St., NYC.

**\$5000 FROM Half Acre** growing Ginseng, crop bought. Particulars 10c. Associated Growers, Sperling, Manitoba.

**HOME Workers!** Spare time—full time. Assemble luggage and cases with our complete illustrated step-by-step instructions. We sell your product—supply everything. Manufacturing representative needed in your area immediately. Unlimited profits possible. Investigate at our risk. Free details. Casecraft, 807-H Sunset, Los Angeles 12, Calif.

**MAKE Money** writing short paragraphs! No tedious study. I tell you what to write, where and how to sell; and supply list of editors buying from beginners. Many small checks add up quickly. Write to sell, right away. Send for free facts. Benson Barrett, 1751 Morse, Dept. C-86-L, Chicago 26.

**BUY Wholesale** thousands nationally advertised products at big discount. Free "Wholesale Plan." American Buyers. Hertel Station, Buffalo 16-M, New York.

**WELDING Pays \$\$\$.** Learn easily at best equipped school in country. Non-profit school with low cost training. G.I. approved. Write Hobart Trade School, Box P-1152, Troy, Ohio.

**DETECTIVES Earn Big Money.** Excellent opportunity. Detective Particulars free. Write, Wagoner, P-125 West 86th, New York 24.

**BE a Mason.** No experience necessary. Special tool and instructions. Send \$2.98—guaranteed. Brickerblock, 2290 Ashland Avenue, Toledo, Ohio.

**WHOLESALE Catalog!** 30-80% Discounts! Appliances, Musical Instruments, Typewriters, Phonographs, Watches, Jewelry, Recorders, Housewares, etc. Consolidated Distributors, 21-19 Lafayette, Paterson 15, New Jersey.

**TYPISTS**—Profitable home business. Complete copyrighted information 50c. Gaunt, 827-S Irving, Chicago 13.

**\$10. HOURLY.** Spare time. At home. Prepare tax returns. Simple, complete course. Details free. Box 2204, Hobbs, New Mexico.

**WATER**—Find new sources of water and sites for drainage. Send \$1.00 for booklet. 114 South Fourth, Hamburg, Penna.

**EARN \$40 weekly** addressing envelopes. Instructions \$1. Berckun, 2763 Linden, Knoxville, Tennessee.

**MAKE new greaseless doughnuts** in kitchen. Sell stores. Free recipes. Samuel Ray, 3605 South 15th, Minneapolis 7.

**FREE Folio "Up to \$45,000; Unlimited Vacations."** No merchandise, equipment. Unknown! Work home—sparetime! Haylings—S14, Carlsbad, Calif.

**GROW Mushrooms.** Cellar, shed, and outdoors. Spare, full time, year round. We pay \$3.50 lb. We paid Babbitt \$4,165 in few weeks. Free Book. Washington Mushroom Ind., Dept. 101, 2954 Admiral Way, Seattle, Washington.

## 76 POPULAR SCIENCE

**"YOU Can Own A Business";** New manual tells how; write now for free details. Phillips of California, 2700-B Piedmont Avenue, Berkeley, Calif.

**FREE Book "505 Odd, Successful Businesses."** Work home! Expect "Odd"! Pacific—37C, Oceanside, Calif.

**PROFIT** from our research-home work-proven Moneymakers during 1955, 10 plans for \$1.00. Surveys, Box 12, Des Moines, Iowa.

**MUSHROOM Spawn** plus complete instructions various processes. \$1.00. Christenross, 641 S. 19th, Newark 3, New Jersey.

**\$200 WEEKLY** Cleaning Venetian Blinds. Free book. Burt, 2434B, Wichita 13, Kansas.

**MANUFACTURE!** Sell products right away. Complete instructions on approval. Free "Manufacturing Plan." Jarry, 268-CH, New York 5.

## 23 BOOKS & MAGAZINES

**SOCIALIST Books.** Catalog, literature. Free. New York Labor News Company, Dept. F, 61 Cliff Street, New York 38, N.Y.

**SPARETIME Profits Taking Subscriptions.** All Magazines. Wholesale Catalog Free. Cassell Publishers, Westfield, N. J.

**NATIONAL Geographic Magazines** 1888-1952. Any issue. Periodical Service. Box 465-PS, Wilmington, Delaware.

**BOOKHUNTERS!** All Subjects. Send Wants! Jaher Book Service, 183 Hazelwood Drive, Westbury, New York.

**SENSISM: The Philosophy of the West,** By Charles Smith. Reversing Plato and Descartes, the author formulates a philosophy appropriate to the Atomic age. Two volumes (approximately 1,700 pages). \$10. Truth Seeker Co., 38 Park Row, New York 8, N. Y.

**BOOKS, Government surplus.** Bargain prices. Free catalog listing 50 other free catalogs. Instructional, educational, vocational subjects. Millions of volumes, new and used. Books bought. Est. 1902. Long's College Book Co., Dept. PS, Columbus 1, Ohio.

**BOOK Catalog,** 1000 interesting titles, send 10c. Books Publishing Company, Amityville 2, New York.

**OLD Books Wanted.** Will Pay up to \$2,500.00 for "Alice's Adventures in Wonderland," original edition, and large cash prices for other Old Books, Poems, Bibles, Almanacs, Newspapers, Deeds, Letters, Documents, Etc. Send 10c for large informative folder. The Book Mart, PS-983 E. Main, Columbus 5, Ohio.

**BRITISH books**—All Subjects. Catalog 10c. Wants solicited. Transbooks, Box 22-PSA, Brooklyn 26, N.Y.

## 24 HYPNOTISM

**FREE Illustrated Hypnotism.** Selfhypnosis. Catalogue. Write: Hypnotist, 1324 Wilshire, Hollywood 17P, California.

**HYPNOTISM!** Party Demonstrations. Neige Diehl, Post Office Box 2002, Seattle, Washington.

**BECOME Hypnotist, Mindreader, Superman.** Write today! Success School, Sparta 1, Michigan.

**HYPNOTISM**—professional calibre correspondence course. Question coupons included, permitting specified number of questions on each lesson answered personally by author—a practicing physician. Send One Dollar for first lesson to: Dr. Frank Carter, Box 97, CGS-G, Miami 33, Florida. Money Back, if dissatisfied.

**HYPNOTISM/Autosuggestion** our only business—failures sell gadgets. Complete professional copyrighted course modern guaranteed techniques. Details dime: Hollywood School, 6252 Woodman, Van Nuys, Calif.

**FREE literature; Hypnotism, Autohypnosis, Mechanical hypnosis.** Revealed by scientists. Hypni, Box 6097, Oklahoma City, Oklahoma.

**EX-Ray mind.** Hypnotize, one glance. Guaranteed. \$3.00. Wamsteker, Ottery, Cape, South Africa.

**EFFORTLESSLY** overpower others! 78 rpm record, "Trance Tutor," teaches hypnotist's spellbinding words. \$2.98. B. Grauer, 210-P Fifth Avenue, New York 10.

**MASTER Hypnotism** in 25 Lessons, complete easily learned fascinating course in one volume. \$1 postpaid in plain wrapper. Satisfaction or dollar refunded. Books Publishing Co., Amityville 2, New York.

**HYPNOTIZE Successfully!** Learn easy, fast, modern methods—including secret nerve pressure technique (Guaranteed harmless)! Complete illustrated course \$1.00. H. Fowler, 1252 Dahlia Lane, Waukegan, N. Y.

**"MECHANICAL Hypnotist,"** new "Pocket-Size" invention causes trance simply, quickly. Also 32 page book—Command others. Stop Harmful Habits, instantaneous Hypnosis . . . \$1.98 (Guaranteed). Post-Way, PS-11, 30 East 20, New York City 3.

**STUDY Hypnotism!** Amazing illustrated lessons. Big 280-page treatise jam-packed with fascinating information. Simple understandable language you'll enjoy. Full price only \$2.95 postpaid—or C. O. D. Plus Postage. Satisfaction or refund guaranteed. Order "Hypnotism" today. Nelson Company, 210 South Clinton, Dept. 2LV-1, Chicago 6.

**AUTOHYPNOSIS, Hypnotism Books,** courses, Suggestion Records, Free Catalogs. Speedy Mailers, Appalachia, Virginia.

## 25 MAGIC TRICKS, PUZZLES, ETC.

**3100 NOVELTIES, Tricks, Jokes, Gadgets, Funmakers, Hobbies.** Catalog 10c. Johnson-Smith, D102, Detroit 7.

**BEST magic.** Joker's novelties. Lower prices. Catalog 10c. Top Hat, Evanston 13, Illinois.

**FREE: Gamblers winnings exposed, Slot, Pinball, Dice, Racing.** Purchase 10c catalog. Book, Box 671, St. Louis 1, Missouri.

**500 TRICKS,** Douglas famous Catalog, 10c. Fastest magic service for 30 years. Douglas Magicland, Dept. 2, Dallas, Texas.

**PROFESSIONAL Catalog.** 175 pages. 25c. Williams, 900 Plymouth, Ellwood City, Penna.

**"VENTRILOQUISM Selftaught"**—complete book 25c. Greenview, Box 61-CB, Whitestone 57, New York.

**TRICKS**—magic. Big catalog 10c. Jasper Joke Shop, 804 So. Wesley, Oak Park, Ill.

**SENSATIONAL Magician's Wand** (Vanishes Handkerchief!) 25c, catalog included. Box 1352-PS, Philadelphia 5.

**"VENTRILLO"** Professional Voice Thrower and Catalog 25c! Box 971-PS, Philadelphia, 5.

**FRANKENSTEIN Mask** (rubber) \$1.00. Gigantic feet \$1.00. 1746-PS Market, Philadelphia 3.

**SMOKEBOMBS** 25c, 7 for \$1.00. (Terrific!) 4463-PS Greene, Philadelphia 44.

**DOLLAR Magic Set Free with Catalog** 25c. 4462-PS Germantown, Philadelphia.

## 26 COINS & CURRENCY

**\$3,000.00 FOR 1913 Liberty Head Nickel.** Dimes 1894-S, 1895-O, 1916-D. Quarters 1827, 1896-S, 1901-S, 1913-S, 1923-S, we pay \$5.00 to \$1,500.00. Certain dates—Lincoln Cents, \$60.00. Indianheads, \$60.00. Large Cents, \$500.00. Eagle Cents, \$200.00. 2c Pieces, \$45.00. 3c Pieces, \$60.00. Half-dimes, \$500.00. Shield Nickels, \$100.00. Old Dimes, \$300.00. 1875 Canadian Quarter, \$50.00. Hundreds of others worth \$5.00—\$500.00. Wanted—Half Dollars, Dollars, Gold Coins, Paper Money, etc. Know their true value. Our large illustrated Guarantee Buying-Selling Catalogue, giving complete allcoin information—send \$1.00. Purchase catalogue before sending coins. Catalogue money refundable. Worthycoin Corporation, Leaders Numismatic Quotations (K-109-C), Boston 8, Massachusetts.

**GET Profit and Pleasure** in collecting old coins. Send 10c for 56-page illustrated coin catalog. You'll be delighted with it. Send for it now. B. Max Mehl, 374 Mehl Building, Fort Worth, Texas. Largest rare coin establishment in U. S. Established 55 years.



# POPULAR SCIENCE OPPORTUNITIES

**FREE!** Foreign coin banknote and Coin Collectors' Illustrated Catalog to approval service applicants. Send 3c postage. Tatham Coin Co., Springfield-50, Mass.

**COIN Magazine**, 100 pages. Sample 30c. Numismatic, 7320 Milwaukee, Chicago 31.

**INDIAN Cent** with bargain lists 10c. Hutchinson, 3463 "I" Street, Philadelphia 34, Penna.

**FOREIGN Coin Bargains**. List Free. Lyle Andrews, Box 677, Sumner, Wash.

**WORLD'S** greatest magazine for coin collectors and wooden nickel 10c. Lawrence Brothers, Anamosa, Iowa.

**COINS** bought and sold. Catalog 15c. Brunk, 3530 Osceola, Chicago 34.

**TEN** Different Liberty Nickels \$1.00. Sayers, 1000 East Unaka, Johnson City, Tennessee.

**MORGAN Dollars**; 1878-79-80-81-82 uncirculated \$2.00 ea. Illustrated coin catalogue 25c. Shultz, Salt Lake 10, Utah.

**FREE!** Bargain lists. United States Coins. Economy Sales, 158 Dean, Mansfield, Mass.

**SCARCE** uncirculated 1955S cents. 15c. 1955S dimes, 40c. Price list 10c. Ps Landon, Box 836, Denver 1, Colorado.

**FAMOUS** Beautiful sets—Tahiti, Iceland, Columbia, Libya, Malaya, \$1.00 each, all Five \$4.35. Retail Guidebook \$1.75; Giant Catalog 35c. Bebee's, 4514 North 30th, Omaha 11, Nebraska.

**EIGHT** different Liberty Nickels \$1.00. Five different Canadian Large Cents 50c. Six different U. S. Indian Cents 25c. Our price list of U. S. and foreign coins included with order. Bryson Stamp Company, 612 White, Toledo 5, Ohio.

**16 PAGE** U.S. Coin List 10c. Stone Coins, 192-S Washington, Boston 8, Mass.

## 28 STAMP COLLECTING

**200 DIFFERENT**, including Roosevelt triangle, 10c to approval applicants. S. Avalon Stamp Co., Springfield, Mass.

**"WOW!"** 153 All Different Germany, 10c" Zeppelins, Semi-Postals, Airmails, High Values. Big Bargain lists and approvals included. Jamestown Stamp, Jamestown 509, New York.

**TWO \$5.00** US stamps plus 20 different, 10c with US approvals. Irwin Stamp Co., Box 1109, Brooklyn 30, New York.

**WEIRD** Diamond Shape Coffee Stamps, lovely Flower Triangle. First American Big Commemorative. Greenland Idol Dancer, etc. Free with approvals. Capital Stamps, Little Rock 10, Arkansas.

**AMAZING Offer!** 200 U.S. stamps—including commemoratives, airmails, high denominations to \$1.00—only 10c to Approval Applicants!! Illustrated Bargain Lists free. Mystic Stamp Co., Dept. 55, Camden, New York.

**300 DIFF.** World wide 25c. Plus surprise packet. Mammoth packet list free. Econopackets, Box 168, Riverside 22, Calif.

**FREE!!** Giant Catalog Offering thousands of bargains sent with beautiful approvals. Jamestown Stamp Co., Jamestown 613, New York.

**ADD 10,000** different stamps of the World to your collection for less than 1/2c each. \$5. down, \$4.25 month brings you book of 1000 each month for ten months. I. Huppert, 1972 East 18th Street, Brooklyn 29, New York.

**50 DIFFERENT** U.S. 5c with bargain approvals, lists. Bookman, Box 8245-S, Madeira Beach, Fla.

**FREE—Valuable U.S.A.!** (1) Scarce genuine stamp picturing first U.S.A., issued in 1847! (2) Big collection 30 all-different U.S.; ancient 19th century, valuable \$5 stamp, etc. (3) Packet gorgeous Commemoratives. (4) Large illustrated U.S. catalog; 64-page, four-color Collectors' Guide; other unusual offers. Everything for only 10c covering mailing costs! Harrisco, 1061 Transit Bldg., Boston 17, Mass.

**NUDE**, pioneer, animals packet (with approvals)—10c. Atlas, Eisenhower, Racine, Wisconsin.

**U.S. Classics—Over 50 Yrs. Old.** 15 Selected oldtimers. Missing in biggest collections. All 15 at less than 1c each. 10c with approvals. Jaro, Box 246-P, New York 8.

**WORLDWIDE**, 50 all different, absolutely free, just to introduce our incomparable approvals. Kent Stamp Company, GPO Box 87, Brooklyn, New York.

**FREE—Complete set of Famous Americans**, Flags, Parks and Presidentials to approval buyers. Send 5c for 15 of the above stamps plus full particulars. Triboro Stamp Company, 145 Nassau Street, Dept. 211, New York 38, N. Y.

**FREE Stamp Collection:—100 different stamps** from Europe, Africa, Asia, Scandinavia, Balkans, etc. 3c to approval applicants. Tatham Stamp Co., Springfield 50, Massachusetts.

**225 STAMPS** For only 10c! This mammoth value includes Airmails, Pictorials; stamps from strange Countries cataloguing up to 25c each! Also Approvals. Mystic Stamp Company, Camden 55, N. Y.

**100 DIFF.** Latin America 25c. Packet list Free. Econopackets, Box 168, Riverside 22, Calif.

**GERMAN** Peace Dove set free. Approvals. George Richie, 1539 Sixth, Alameda, California.

**FIRST U. N. Set.** Among World's Prettiest. Only 10c. Approvals. Welles, Box 1246-V, New York City 8.

**FREE! Catalog!** About stamps. Illustrated. Free! The Stampmart, Hartford 1, Conn.

**126 DIFFERENT**, includes triangle, diamond, airmails, Old U.S., British Colonies, animals, others: 10c with approvals. Cactus Stamps, Desert Springs 40, California.

**FREE!!** U.S. Price catalogue (Order today). New-Way Stamp, Lawrence, Massachusetts.

**ECONOMICAL** 1/2-1-2c Approvals, 22,000 varieties available. Dresel, Box 270-T, New York 25, New York.

**GIANT** Approvals Thousands Different! 1 and 2c. Wahl's Stamp Exchange, 7008K Farragut, Chicago 31, Ill.

**CORONATIONS**, Triangles, Animals, Sports, Free with Approvals. Exotic, Box 482-S, Coral Gables 34, Florida.

**PICTORIAL** Angola, Mozambique, Hungary, a beautiful assortment of stamps, 3 sets depicting wildlife in color, plus 100 attractive stamps. 10c to approval applicants. Modern Stamp Co., Dept. B-1, Ferrysburg, Mich.

**BRITISH** West Indies. Quality Approvals. Rahmer, Box 123S, Rome, N. Y.

**GREATEST** Premium! World-wide collection! Over 1000 Different Stamps from Aden, Nigeria, Corea, Macao, other exotic lands. Includes triangles, airmails, sport, animal, ship, map stamps. Catalog value over \$25.00. This exciting collection Given to approval customers. Request approvals, details, today. Odd Stamps Co., Dept. B-1, Box 31, Redondo Beach, Calif.

**FREE!—Red China**, 25 all different unused. Fine approvals. Meeker, 2951P Masasoit, San Diego 17, Calif.

**GIGANTIC** Collection Free—Includes Triangles—Early United States—Animals—Commemoratives—British Colonies—High Value Pictorials, etc. Complete Collection plus Big Illustrated Magazine all free. Send 5c for postage. Gray Stamp Company, Dept. PR, Toronto, Canada.

**50 DIFFERENT** Bulgaria 10c! Approvals. Ensign Stamp Company, Dept. S, Berdan Avenue, Paterson 2, New Jersey.

**WHY Pay More?** Pick stamps from our large collections. 2c each. Just as purchased. Be first. Premiums given. U.S. also available. Roseland Stamp Co., Dept. B-35, Spring Lake, Mich.

**FREE** sample stamp newspaper, information on collecting, special lists. Approvals. Littleton Stamp Co., Littleton A2, New Hampshire.

**U.S. Stamps! Coins! Discounts!** Unistate, 730-D North Lexington, St. Paul 4, Minnesota.

**ROOSEVELT** Greece, Pope Triangle, Greenland, Israel, 51 others, 5c. Approvals. Longhorn, Box 3068-P, Lubbock, Tex.

**312 MIXED** U.S. only 10c to "Gold Nugget Approval" applicants! Nothing like them. Kessel's, Box 6116, Tucson, Arizona.

**FABULOUS** Collection—Large U.S. Commemoratives. Only 10c. Approvals. Raymax, 39-X Maiden Lane, NYC 38.

**FREE—Pope triangle**, 25 others different. Approvals. Ellarsons, 611 Centre, Dallas 8, Texas.

**AUSTRALIA—Fifty** different exciting commemoratives, Animals, Kings, Queens. This valuable Australian Collection only 10c with approvals. Viking, Great Neck 5, N. Y.

**PAYING** High Prices for approvals? Try ours at 1c and 2c in books of 1,000. Special offers and U.S. available. Clark Stamp Co., Dept. B-45, Muskegon Heights, Mich.

**FREE—Muscat, Victoria!** Tru-val-u Approvals. Brunning, Donaldsen Avenue, Rutherford, New Jersey.

**BE Smart—Stop** paying high retail prices—Approvals at wholesale. Write for details. Bargain Stamps, Redlands, Calif.

**FREE! Set** Flower Triangles, Rhineland, Anchal, Others. Approvals. Delton Page, Box 201P, East Paterson, New Jersey.

**FREE Sample—Interesting, informative, illustrated!** National Stamp News, Anderson, South Carolina.

**PENNY** Approvals by Country. Hoerning, 9013 W. 57, Merriam, Kansas.

**FREE U. S.** illustrated bargain catalogue. Rothberg, Box 60, Boston 1, Mass.

**50,000 STAMP** grab-bags, 25c each. Anderson, Box 1, Reading, Pennsylvania.

**VALUES** ignored 2c approvals. Mount Vernon Stamps, Box 28, Uniontown, Pennsylvania.

**100 JAPAN** 10c. All different with approvals. Gould's, Box 631, San Francisco 1, California.

**225 DIFFERENT** 10c Approvals, Hay, 33-51 73 Street, Jackson Hgts., New York.

**1500 STAMPS** \$1.00. Good variety. On and off paper worldwide. Many Pictorials. No approvals follow. Satisfaction guaranteed. Whalen, 1435 1st Ave., Oakland 6, California.

**14,000 DIFFERENT** yours on our streamlined, systematic Club plan for only 50c weekly. Big shipment every two weeks. Details free. Sjoquist, Box 217, Valley Stream 70, New York.

**ILLUSTRATED** Album, Hinges, Gauge, Detector, Fifty Stamps, Two Sets, \$1. Chile Stamp. All 10c. Approvals. Corneta, 228 West 25th, New York 1.

**100 DIFFERENT** Finland 25c with approvals. Corzine Stamps, 19620 Lamont, Detroit 34, Michigan.

**300 DIFFERENT** given free with approvals. Postage 3c. Particulars. Windsor Stamps, 8834 Cornell Ave., Chicago 17.

**1000 FINE** Mixed U.S. Stamps 25c. Wright, 201 Mealey, Hagerstown 2, Md.

**25 EGYPT** free, stamp appreciated, approvals. Bellet Stamps, Hazel Park, Mich.

**CENTRAL** America packet, valuable surprise Bonus, 25c. McEvoy, Farmville, Virginia.

**150 DIFFERENT** used United States Commemoratives—\$1.00. Wright, 363 McKinley, Stratford, Conn.

**UNITED** States. \$1.00 buys 20 early stamps including #26, #145, #146, #211, #234. Approvals accompany. Whiton Paine, Westport 12, Conn.

**30 DIFFERENT** commemoratives. 1893 up. 10c U.S. Approvals. K & B, Box 5, Brooklyn 14, N.Y.



# POPULAR SCIENCE OPPORTUNITIES

100 DIFFERENT Foreign, pictorials, commemoratives, 10 cents. Approvals. Chartier, George St., North Haven, Conn.

BRITISH Colonial collection-Hivalues, Commemoratives. Free to approval buyers. Pleasure Stamps, 1865A-52nd, Brooklyn 4, New York.

BIG stamp finder and catalog, only 15c to approval applicants. Itasca Stamp Exchange, Box # 758, Itasca, Illinois.

CANADA, 1954 issues, Queens, wildlife, commemoratives including scarce 15c Gannet, 11 Var. only 20c with attractive approvals. Rheume, 6591 11th Avenue, Montreal, Canada.

FRANCE 427-50, 22 mint stamps honoring Marshal Petain, hero and traitor, 25c with colorful half catalog approvals. Adults only. Kingsway Stamps, Dept. 15, Fulton, Maryland.

FAROUK 27 different better Egypt 10c with approvals. Excello Stamp Company, Box 489, Red Bank, New Jersey.

ZEPPELIN set free with approvals. Variety Stamps, 57-S Circuit, Newton Highlands 61, Mass.

50 COUNTRIES! Stamp packet from 50 Countries for 10c to approval applicants. Quality Stamps, 178 Sweet, Buffalo 12, New York.

OLD scarce U. S. seconds on approval. Slightly defective, bargain prices. Hearnfeld, Clintonhill Station, Newark 8, N. J.

WONDERFUL Offer Seven complete mint sets only 10c with approvals. Reich (S26), 1033 Lawrence, Chicago 40.

THOUSANDS of Exciting Stamps, All Different, Yours for 1c, 2c each. Fill your Album for Pennies! Big Collection Sent for Free Examination. Cole, 43-G Rinewalt, Buffalo 21, New York.

INSTRUCTIVE book on Stamp Collecting plus 50 different foreign stamps only 10c with approvals. Pot-O'-Gold, Litchfield, Conn.

PONY Express plus 49 Different Stamps 10c to Approval Applicants. Tippet, 1118 Clay, Pelham Manor, New York.

100 FOREIGN, 20 U.S. Commemoratives, 10c. Approvals. Weckerling, Box 442P, La Feria, Texas.

OVER 3,900 sold. 30 Different Beautiful Airmails 10c. Selected Approvals. Morrison, Milmont Park, Pennsylvania.

SPECIAL Offer! 15 beautiful, complete foreign sets, 10c. Approvals. Farmer, 6919 Camrose, Los Angeles 28.

BEST Buy. Five Brilliant Beautiful Sets Twenty-Five Cents Coin. Approvals. Langfords, 53 Durham Road, San Anselmo, California.

FREE. United States Plate Block List. Simmyco, Box 63, Mattapan 26, Mass.

FABULOUS United States Commemorative collection—31 different 10c. Approvals. White, 516-W Avenue L, Brooklyn 30, New York.

100 DIFFERENT Spain 25c. Penny approvals included. Reed, Box 980, Chicago 90, Illinois.

FREE Worldwide Collection;—157 different stamps. Many large Pictorials and Commemoratives from Saar, Belgium, France, Turkey, etc. 10c to Approval Applicants. Knight Stamp Company, 656 Rogers Avenue, Brooklyn 26, New York.

1000 DIFFERENT. 50c Approvals. Ouellette, Box 66S, Flint, Fall River, Mass.

AMAZING Savings: Picture Stamps by the thousands. Choose Choice ones for Pennies. Approvals Postpaid Both Ways. Costs nothing to Try us. The Elders—2500 El Venado Dr., Puente, California.

111 DIFFERENT Worldwide, 10c. Approvals. Roy Farr, 88 Maple, Hamilton, Canada.

VALUABLE Surprise Packet!! Different approvals. Send 10c. The O. & P. Company, Box 618, Lexington, Kentucky.

GIANT Stamp Zoo Free! Fifteen different including rhinoceros, elephant, snake, tiger, zebu, kangaroo, koalabear, kookabura, bull, horse—with approvals. Send 10c for postage and handling. Lincoln Stamp Co., St. Catharines, 519, Ontario.

200 DIFFERENT Including Macau, Rhodesia, Mauritius. 10c to approval applicants. Evden, Box 128, Valley Stream 42, New York.

CIPEX souvenir sheet plus 25 different U.S., 10c. Approvals accompany. Village Stamps, 90-39B 214 Street, Queens Village 28, New York.

SUPERIOR worldwide mission mixture. Amazing variety! Half pound only \$1.50. Ray Nielsen, 4545A Harvard, Montreal 28, Canada.

PENNY Approvals jammed with Bargains. For better values, try Putnam Stamp Company, Mahopac, New York.

135 DIFFERENT U.S. commemoratives \$1.00 request approvals. Harold Holub, 18 East 198th Street, New York 68, N. Y.

CHINA! Spruce up your collection with these fascinating stamps. 100 Different 10c, 200 25c, 300 50c. Oriental Approvals. Fred Kunkel, 146 Dunbar, Long Branch, New Jersey.

CORONATIONS. 10 different only 10c with approvals. Seminole Stamps, Box 1138-S, Coral Gables 34, Florida.

19th CENTURY U.S. 41 different \$1.00: Approval books by countries. Charles Chase, 152 Court St., Portsmouth, N.H.

1000 DIFFERENT 85c with approvals. Golden's 6721 Eastwood, Philadelphia 49, Pennsylvania.

SOUVENIR Sheet Russia 1937 10c with approvals. Kingman Stamps, 30 Empire, Yonkers 4, New York.

RHODESIA—30 Different 25c. Worldwide Approvals. Moffat's, 740 Milton, Rock Hill 26, South Carolina.

QUALITY U.S. mixture, 2 lb. \$1.00. Clift, 1040 N. Irving, Scranton 10, Pennsylvania.

ESTONIA Carrier Pigeon Set Free. Approvals. Canyon Stamps, Box 808, San Fernando, California.

ISRAEL—25 Different—25c. Value \$1.00. Limited supply. With Approvals. Yokum, Box 1327, San Antonio, Texas.

FREE U.S. catalogue. Contains almost 1,000 illustrations; over 10,000 delightful bargains. Stone, 192-S Washington, Boston 8, Mass.

500 WORLDWIDE 50c. Handsome approvals. Attractive premiums. Faith, 1225 Campbell, Alhambra, California.

OVER 200 Different better stamps. Beautiful triangle set, pictorials, 10c. Approvals. Greene, 43-01 46th St., Long Island City 4, N.Y.

50 DIFFERENT U.S. Commemoratives 25c. Durham, 1071 North Granger, Saginaw, Michigan.

FREE stamp album! Serious approval applicants sending postage. Adventure. Buckland, Connecticut.

200 DIFFERENT 10c with bargain Approvals. Ideal, Box 210, Brooklyn 11, N. Y.

SUPER grabbags. U.S. or foreign, 10c. Monjar, Fairmount, Cincinnati 14, Ohio.

FREE—German War Issues B200-91, cataloging \$9.62. to approval buyers. Details 10c. Royal Stamp Company, Tamaqua 2, Penna.

SENSATIONAL Stamp bargains. U.S. Foreign. Write Universal Services, Clayton 5-X, Missouri.

ASTONISHING Gift, 40 US with superior approvals. Send 5c for postage. Sparta, Box 1082, Rochester, New York.

COMPLETE Country for only 30c. Tokelau Islands #1-4. Personalized approval service only if requested. Livingstonville Stamp Company, Middleburg 3, New York.

EXCITING "Strange countries" packet. Free with approvals! Saxon, Vista, Calif.

FIRST UN. Mint—10c. Approvals. Gatewood, Box 346, Winston-Salem, N. C.

UNBELIEVABLE! Africa, Asia, Latin America, set Triangles. Also 100 different 10c with approvals. Bennett, Candor 2, New York.

ATTRACTIVE 1c approvals you will enjoy. Bonder, Ellenville, New York.

## 29 ANTIQUES, RELICS & INDIAN GOODS

STAYSCHUNeyedentiefekayschun—Illinois. Selling 600 historical firearms, 30,000 prehistoric, stoneage Indian Relics, Collectors Cartridges, Confederate Money, Coins—Revolutionary, Civil, Indian-Wars Flintlocks, Muskatoons, Swords, Bayonets, Bullet Molds, Powder Flasks—Blunderbusses, Pepperboxes, Kentucky Rifles, Winchesters, Buffalo-Stagecoach Carbines, Frontiers, Derringer, Duelling Pistols, Matchlocks. — Arrowheads, Tomahawks, Bannerstones, Gempoints, Spearheads.—Steer-Deer-Buffalo Horns, Mounted Pheasants, Quails, Squirrels, Deerheads.—Agates, Fossils, Mineral Specimen, Lapidary Supplies. —Daguerreotypes, Gold Dollars, Bo-wood, Blo-horns, Violin Wood. —Send 35c for profusely illustrated catalog. Heike, Zipperton, Wenona, Illinois.

ARROWS: Thirty, assorted colors \$5.00. Book-Relic Catalog 25c. Tilton Relics, Topeka 10, Kansas.

4 FINE Arrowheads \$1.00. Spearhead \$1.00. List free. Lear's, Glenwood, Ark.

4 FINE Indian Arrowheads \$1.00. Beautiful Drill \$1.00. List Free. Arrowhead, Box 5283, Indianapolis 1, Indiana.

MAKE your own claw necklace with our perfect imitation Bear and Eagle Claws, 4 sizes of each. Free price list. Also used as mailers. Sauvage Trading Post, RFD #2, Torrington, Conn.

## 30 MINERALS & PRECIOUS STONES

ROCKHOUNDS! Trips every issue. Subscribe! Dollar: "Prospector's Gazette," Bellflower 51, California.

400,000,000 YEAR old Ordovician fossils. Five different classified \$1.00. Don MacKenzie, Northfield, Minn.

MINERALS and Seashells from Coney Island. 25c. Potential Radio, 446 Crown Street, Brooklyn, N. Y.

URANIUM Ore Samples (Carnotite). \$1. Mineral Specimens, P.O. Box 86, Golden, Colorado.

LARGEST gem and mineral magazine tells how to have profitable fun with rocks, gems, jewelry. Monthly, \$3.00 year. Sample 25c. Gems & Minerals, Dept. S11, Palmdale, Calif.

BEAUTIFUL Herkimer Diamonds. (Double terminated quartz crystals).  $\frac{3}{8}$ " length 3 for \$1.00 Postpaid. Smaller and larger sizes available. Marilyn L. Fahs, R.D. #5, York, Penna.

24 BEAUTIFUL Boxed and Identified Minerals with Ten Square Inches Slabbed Agate \$2.50, add postage. Gemco, Eisner Avenue, Sheboygan, Wisconsin.

HANDBOOKS for rockhounds. Free list. Minub—Box 3114, Station "A", Spokane 17, Washington.

GEMSTONES. Mineral specimens. Geiger Counters, uranium samples. Every variety. Lowest prices. Free booklet. Plummer's, 4720 Point Loma Avenue, San Diego 7, Calif.

SAPPHIRE, Topaz, tourmaline, garnet, peridot. Five uncut gem specimens, \$1.00. Ten polished gems, baroque shaped, \$1.00. Free big bargain list jewelry, gems, profitable, easy, do it yourself projects. O'Brien's, 1116B Wilcox, Hollywood 38, California.

GEMCUTTING — Silvercraft. Illustrated Magazine tells how to cut gems, make jewelry. 150 ads illustrating equipment, gems for collectors, cutters. Free literature. Lapidary Journal, Del Mar 1, Calif.

TEN New Mexico Minerals \$1.50, Six Fluorescents \$1.00, Fools Gold 25c. Hartson, Winston 5, New Mexico.

## 31 HOBBIES, COLLECTIONS

FREE! Leathercraft catalog. Do-It-Yourself! Tandy Leather, Box 397BH, Tulsa, Okla.



# POPULAR SCIENCE OPPORTUNITIES

50 ARMY Insignia \$1. Insignia Mart, 703B Broadway, New York 3, N. Y.

INVENTING can be an interesting and profitable hobby. Write for complete particulars. Institute of American Inventors, Dept. 30-E, 631-E St., N. W., Washington 6, D. C.

NAZI Genuine emblem and catalog 25c; 37 different American emblems \$1.00. Insignia Club, 550-B Fifth Ave., N. Y.

65 ASSORTED Army Patches, Insignias, Ribbons, \$1.00. Surprise included. LHGCO, 19 East 16th Street, New York City 3.

PINK Dogwood Trees. 2 Ft. \$1.98 Each, 3 for \$5.00. Globe Nurseries, Dept. 656, McMinnville, Tenn.

MILITARY Miniatures: U.S. Marines, American Revolution, Civil War, Custer's Cavalry. Illustrated Catalog 25c. Bussler Miniatures, Dept. E, 40 Howe Street, Quincy 69, Mass.

GROW giant crystals. Free booklet. Crystocraft Company, Box 35, College Station, Texas.

BUTTONS — guaranteed five million years old. Unique, serviceable card of four. One dollar postpaid. Canadian Rockcraft, Swastika, Ontario.

MILITARY miniatures, insignia catalog 25c, miniature flag catalog and sample \$1.00. Griffen and Gray (A-1), 72-05 67th Street, Glendale 27, N. Y.

WANTED — Cigarette, tobacco cards. Write Charles Bray, East Bangor, Penna.

NAZI Medals, Ribbons, Flags, Daggers. Big Introductory Packet \$1.00. Illustrated Lists. Medcrafts, 1923 34th Street, S. W. Calgary 3, Canada.

UNUSED matchbook covers—100 different \$1.00—36 page catalog 25c—matchcover album \$3.00. Charles Edelman, 1311P East 84, Cleveland 3, Ohio.

COLOR Slides, 2X2, Trains, Fire Engines, Antique Automobiles, etc. Illustrated Catalog Free. Universal, Box 779J, Beverly Hills, California.

HOBBYISTS-Naturalists. View wonders of beautiful Gulf of Mexico. \$1.00 brings sample water, sand, shell, Brazosport Laboratories, Clute, Texas.

HISTORICAL documents—reproductions—\$1.00 each. Howard Sawyer, 5813 Benton Hgts., Balto. 6, Maryland.

## 32 PHOTO FINISHING, PHOTOCOPIES, ETC.

12 EXPOSURE rolls 39c, jumbo prints. Guaranteed work, one day service. Lincoln Studios, Dept. L, Box 13, Lincoln, Nebr.

4 X 6 OR 3 1/4 X 4 1/2 oversize glossy prints. 8 exposures 40c, 12 exposures 60c, 16 exposures 80c. Hagner, 1318 West Columbia Avenue, Philadelphia 22, Penna.

FREE Film! Write for mailers. Vets, Box 37PS, Montalvo, California.

PHOTOGRAPHY For Pleasure or profit. Learn at home. Practical basic training. Long established school. Free booklet. American School of Photography, 835 Diversey Parkway, Dept. 1746, Chicago 14.

SPECIAL Introductory offer 8 Jumbos 25c, 12-35c. Western Photo, PS-115, Box 298, San Francisco 1, Calif.

PARTICULAR? Custom Finishing Guaranteed. 8 Jumbos 35c. 12-50c. Special! 35mm 36 exposures \$1.10. Free Mailer. Flash-Foto, Box 36H, Brooklyn 4, N. Y.

SURPRISE gift with first roll developed. 8 jumbo superpak album prints or 16 contact prints 40c. 12 exposure roll 50c. Certificate for 3-5x7 enlargements. Dept. B-14, Owl Photo Co., Weatherford, Okla.

PORTRAITS! "Personalize" friends, yourself—Colorfully. No obligation approvals! Send photograph, \$1.00 (refundable): Dorsetfoto, Ojai, California.

HIGHEST Quality, fastest service, rock bottom prices. Write Professional Developers, Pevely, Missouri.

ROLL Developed and 5x7 glossy prints. 8 exposure 80c; 12 exposure \$1.20. Hagner, Dept. B, 1318 West Columbia, Philadelphia 22, Pennsylvania.

## 33 MOTION PICTURES, SLIDES SOUND EQUIPMENT

MOVIE Camera Film 8 mm roll \$1.50. 16mm 100' \$3.00. Free processing. Better Films, 742 New Lots, Brooklyn, N. Y.

5,000 8-16MM. Silent-Sound Films. International. 2120 Strauss, Brooklyn 12.

TAPE Recorders, Tapes, Accessories. Unusual Values, Dressner, Box 66, Peter Stuyvesant Station, New York 9.

SAVE 50%! Guaranteed-fresh color, b&w movie film! 8mm, 16mm. Free catalog! Eso-H, 47th Holly, Kansas City 12, Mo.

FREE! Blackhawk's big sale catalog new and used 16mm, 8mm. films; 2"x2" color slides; used 16mm. sound projectors. Biggest stock in USA. Blackhawk Films, 1201 Eastin, Davenport, Iowa.

MOVIE-Makers! Save 50% on your 8-16mm film and Do-It-Yourself processing equipment. Free Catalog. Superior Bulk Film Co., 448 N. Wells, Chicago 10.

KEYSTONE Kops. Charlie Chaplin, Tom Mix. Famous Early Movies. 8mm, 16mm. Film Classic, 1611 North LaBrea, Hollywood 28, California.

TAPE Recorders, tapes; wholesale prices. Korstan, 215 E. 88, New York City 28.

SHENANDOAH Valley, National Park. 2 x 2 Kodachromes, originals, 24 mailed, you select 12 for \$3.50. C. T. Chapman, Luray, Virginia.

16MM Sound Films. Sale and exchange. Bedner, 5300 South Talman, Chicago.

BEAUTIFUL Color Slides and Movies. Sample 10c. Eddings, Corning R-3, New York.

THRILL to slides processed from your favorite pictures or negatives. For trial write Thirty-five Slides, Box 279-S, Green Mountain Falls, Colorado.

HUGE listings, color, B&W sports, comedies, travel, musicals, etc. Catalog 15c. Turke Films, 423 S. Lincoln, Hinsdale 1, Illinois.

TAPE Recorders! Wholesale! Free catalog! Towers, 935 North 40th, Philadelphia 4.

FEATURE Film Rentals. \$3.95. Sale on used prints. Write "Sound Films", Box 262, Chicopee, Mass.

MOVIES; Movies; Movies;—8 & 16mm B&W and Color. Free List sent in plain sealed envelope. M. George, 14226 Haynes Street, Van Nuys, California.

8 OR 16MM films \$2.98 each. Free list. Specify sound or silent. Corey PS, 556 Aldine, Chicago 13.

## 34 CAMERAS, PHOTO SUPPLIES

BASS Says: Quality Cameras Since 1910. When in Chicago visit the Camera Cross Roads of the World . . . or write us for your favorite equipment, new or used. Satisfaction Guaranteed. Bass Camera Co., Dept. AG, 179 W. Madison Street, Chicago 2, Illinois.

BUY wholesale nationally advertised cameras, photo supplies, thousands other products at big discount. Free "Wholesale Plan." American Buyer's, Hertel Station, Buffalo 16-P, N. Y.

PHOTOGRAPHY For Pleasure or profit. Learn at home. Practical basic training. Long established school. Free booklet. American School of Photography, 835 Diversey Parkway, Dept. 1726, Chicago 14.

MAKE Money with your camera. Sure market for pictures. Complete details including list buyers, plans of operation. \$1.00. McKinley, Box 334, Hayward, Calif.

NEW Argus C-3 Outfit \$48.90. Westinghouse Steam iron \$12.90. Terrific discounts Photo equipment appliances. Free Catalog. Mailers Mart, Box 135-P2, New Rochelle, New York.

FREE! Free! Free! Central Camera Co., Photographic Headquarters since 1899, saves you money on all photographic equipment. Send for Central Camera Co.'s Free Photographic Bargain List today: Central Camera Co., Dept. 11-C, 230 S. Wabash, Chicago 4, Ill.

20 TO 50% Discount everything photographic, giftware. Free catalogue. Dart, 3812F Atlantic Avenue, Brooklyn 24, N. Y.

## 35 MUSICAL INSTRUMENTS, SONG WRITERS & RECORDS

ACCORDIONS—Direct from importer—save 50% and more! Free trial. Lifetime guarantee. Trades accepted. Free Catalog. Write Accordion Outlet, Dept. 115-P, 2003 Chicago, Chicago 22, Illinois.

WANTED! Poems for musical settings. Write Songwriters' Service, Clifton, N. J.

SONGWRITERS! Protect your poems and songs! Don't mail anywhere! Write for safe procedure! Song Service, 333 W. 56th, Dept. P.S., New York 19, N. Y.

POEMS Wanted for New Songs. Send poems. Immediate consideration. Crown Music Company, 1472-P Broadway, New York City 36.

POEMS needed for new songs. Send poems for free examination, details. Immediate consideration. Songcrafters, 2724 Arcade Station, Nashville, Tenn.

SONGWRITERS: Large recording company wants new songs. Royalty basis. National sales, promotion if selected. No charge for melodies. Send songs, song poems. Music Makers, Dept. G-15, Box 2507, Hollywood, California.

POEMS—Urgently needed to set to music! Write clever poems, catchy rhymes. Achieve Fame, Money in popular music field! Send sample poems. Free evaluation. TinPan Alley, 1650 Broadway (Dept. F), New York 19.

FREE Records of your song—Your words—My Melody. Free information. Johnny Mack's Melody Mart, 1094 West 39th Street, Dept. K, Los Angeles 37.

SONGS—Poems wanted. Good opportunity. Hollywood Tunemiths, 1609 Vista Del Mar, Dept. N, Hollywood, California.

POEMS Wanted for musical setting by America's Largest Songwriters Organization. Immediate consideration. Five Star Music Masters, 646 Beacon Bldg., Boston.

WHOLESALE Catalog! 30-80% Discounts! Appliances, Musical Instruments, Typewriters, Phonographs, Watches, Jewelry, Recorders, Housewares, etc. Consolidated Distributors, 21-81 Lafayette, Paterson 15, New Jersey.

SONGWRITERS! Send poems, songs. Music Service, 243 West 72nd St., PS, New York 23.

SONGWRITERS! Outstanding, amazing offer. Hibbeler, C-15, 6808 Oleander, Chicago 31, Illinois.

PHONOGRAPH Records Cheap. Catalogue. Paramount, SC-313 East Market, Wilkes-Barre, Pennsylvania.

POPULAR Songs. How to write and sell them. Write for free booklet Successful Songwriting. Gateway Songs, Box 2470, Hollywood 28, California.

ELECTRIC Guitars, amplifiers, parts, wholesale. Free catalog. Carvin, PS 287, Covina, California.

TO \$50 for poems! 220 markets. Hobbies, 1603-A Sun Valley, Austin, Minnesota.

SWISS Music box movements \$2.50. Lutts, 705 Plaza, Ontario, Calif.

BUILD electric steel guitar. Easy, inexpensive. Plans, patterns. 25c. Gibbons, Grandfield, Oklahoma.

SONGWRITERS: Free details—Melody \$5.00. Paramount, 1944 Linwood, Toledo, Ohio.

1955 ACCORDIONS — Wholesale. Free catalog. American Accordion Center, PS-11, 5329 Belmont, Chicago.

## 36 RADIO, TELEVISION, SUPPLIES & EQUIPMENT

MAKE Simple, Tubeless, Batteryless. Distance-Getting radio. Genuine Melomite crystal, Detector. Illustrated instructions. 50c postpaid. Allen, 427-PS5, Clinton, Mo.



# POPULAR SCIENCE OPPORTUNITIES

**BUILD 15 Radio Circuits at Home—** Progressive Radio "Edu-Kit" only \$19.95 complete. Free Electric Soldering Iron and Radio Tester with "Edu-Kit." No radio background required. 30-Day unconditional money back guarantee. Order direct or send for free descriptive literature—no obligation. Valuable Radio & TV Repair Guide sent on request—no charge, no obligation. Progressive "Edu-Kits" Inc., Room 35-A, Progressive Building, 497 Union Avenue, Brooklyn 11, New York.

**REPAIR your own TV.** Instructions compiled exclusively for your set. Simple as replacing light bulb. Send set name, chassis, model number. \$2.00. LS Engineering Co., Box 4113-PS-11, North Hollywood, California.

**TV Trade-In Sets.** Philco, R.C.A., Emerson, others. List available. 10"—\$17. 12" to 17"—\$20 up. Washtek Service Co., Dept. S, 956 Southern Blvd., Bronx, New York.

**FREE 324 Page 1956 Television—Radio—Hi-Fi—Electronics Catalog!** World's largest stocks, lowest prices. Everything for experimenters, builders, amateurs, servicemen. Latest build-your-own kits, Hi-Fi, phonos, recorders, P.A., TV accessories. Thousands of parts, tubes, test instruments, tools and books. Write for Free copy! Allied Radio Corp., 100 N. Western Ave., Dept. 31-L-5, Chicago 80, Illinois.

**ENJOY F-M Music from your television** only \$1.00. Tool and instructions. Box 247M, Pasadena, California.

**ALL parts to build "Loopstick" Germanium Diode Radio.** Finest, most sensitive yet designed. Complete with instructions \$2.95 postpaid. TV Sales, P.O. Box 44, Yonkers, New York.

**BUILD Cigarette Radios, 4 plans, \$1.00.** Cook, 4003 Roosevelt, Midland, Texas.

**NEW Raytheon Transistor Applications Book—116 pages—contains complete how-to-do-it information for building over 50 types of transistorized equipment—metal locators, receivers, timers, geiger counters, etc. Only 50c.** Send to Department S-11, Raytheon Manufacturing Company, Receiving and Cathode Ray Tube Operations, 55 Chapel Street, Newton 58, Mass.

**BUILD amazing midget match box radio, post card radio, many others. 50c complete.** Wire, clips, crystal, etc. D&Q, P.O. Box 59, Bellflower, California.

**NEW! Printed circuit television antenna, smaller than a transistor. Only \$1.98 Postpaid.** Ekeradio, 646 North Fair Oaks, Pasadena, Calif.

**CRYSTAL Radio Experimenters.** Write Leslie Hulet, 305 Hope, Lakewood, New Jersey.

**GEIGER Counter and Metal Detector Kits.** Inexpensive. Educational. Free Literature. Electronic Applications, 5024 Lee Highway, Arlington 7, Virginia.

**GOV'T Surplus meters, TBY's, radar, transmitters, parts.** List 5c. Meshna, 5805 Lynn, Malden 48, Mass.

**RADIO—TV job? FCC license training—correspondence or residence.** Classes held in Hollywood and Washington. Beginners get first class commercial license in 3 months. Write Grantham School, Dept. 5X, 737 11th Street, NW, Washington, D.C.

**24 PAGE Plans "20 Crystal Sets" (SW record 5800 miles) 25c—Catalog.** Laboratories, 328-T Fuller, Redwood City, Calif.

**TAPE recorders, accessories.** Best buys. Boynton Studio, 10P Pennsylvania, Yonkers, New York.

**SUN Battery \$2.50 Free details.** Strong, 601H El Centro, South Pasadena, Calif.

**REPAIR Diagrams Radio \$1.00, Television \$2.00.** Give Make, Model, Diagrams, Box 672-PS, Hartford 1, Conn.

**NEW germanium diode, variable condenser crystal radio kit \$2.95; Phone \$1.75; New catalogue.** Clearco Crystal Company, Box 1857, Milwaukee, Wisconsin.

**WALKIE-Talkie.** Build wireless two-way portable radiophone for less than \$10.00. Plans 50c. Springfield Enterprises, Box 54-A11, Springfield Gardens 13, New York.

**EARN Estimated \$2,000.00 Giant Radio Package \$2.00.** Master Kit Company, Box 206, Belleville, Ontario.

**KITS.** Crystal Radio 50c. Personal Radio including tube—\$2.00. Cozzo, 2059 60th Street, Brooklyn 4, New York.

**GUARANTEED simplified TV Trouble Shooter** automatically locates faulty tubes. \$1.00. Stern, Box 42, Hillside, New Jersey.

## 37 BUSINESS OPPORTUNITIES

**START A Buying Service,** buy wholesale thousands nationally advertised products. Make big profits selling at sizeable discounts. Postcard brings details. American Buyers', Hertel Station, Buffalo 16-N, N. Y.

**ENVELOPES** addressed accurately, reasonably. Fast service. We have capable addressers in your city. Glenway System, 5713 Euclid, Cleveland 3, Ohio.

**"MAKE Perfumes",** other products—Sell mailorder—Catalog Free. International, 6347 Parnell-PS-11, Chicago 21, Illinois.

**IMPORT-Export!** Opportunity, profitable, world-wide, mail-order business from home, without capital; or travel abroad. Established World Trader ships instructions for no-risk examination. Experience unnecessary. Free details. Melinger, E691, Los Angeles 24.

**MEN Wanted—Build Luggage And Cases At Home.** We sell your products—supply complete instructions, materials, everything. No special equipment needed. Free details. Cascraft, 805-H Sunset, Los Angeles 12, Calif.

**WE Love our mailman.** He leaves over \$1,000.00 monthly in our rural mailbox. My college professor husband drafted a scientific home mailorder method. We bought a Texas ranch, live as we always wanted. Now we sell the "Ranch Mailorder Method." Operates anywhere. Inquire: Eveningshade Ranch, Helotes, Texas.

**\$1,000 MONTHLY** possible in collection agency business. Free details. Write Cole Associates, Syracuse 2, New York.

**GROW Orchids at home—profitable—fascinating.** Year 'round, Maine to California. No Greenhouse. Gorgeous Cattleyas, Cymbidiums, etc. Successful home grower shows you how. Free—full details. Flowerland, 4622 Wilshire, Los Angeles 5.

**OPERATE profitable mail order business.** Write Walter Service, 4159-B East 112th, Cleveland 5, Ohio.

**VENDING Machines—No Selling.** Operate a route of coin machines and earn amazing profits. 32-page Catalog Free! Parkway Machine Corporation, Dept. 73, 715 Ensor St., Baltimore 2, Maryland.

**\$25 WEEKLY** working two hours daily at home. Lycke, Box 2471-B, Cleveland 12, Ohio.

**BRONZE Baby Shoes.** Instructions, Equipment and mountings for genuine electroplated process. Free catalog. Hollywood Bronze Supply, Dept. B-1, 1624 East First Street, Los Angeles 33, California.

**MEN.—Income from local information.** No selling. Neherco, LaVerne 6, California.

**NEWEST Spare, Full-Time Home Business.** \$5 to \$10 hour possible. Paint with suede—the finish with touch and eye-appeal. Beautify auto dashboards, signs, radios, toys, figurines, lamps—1001 others. Complete. Step-By-Step Instructions sent for no-risk examination. Free details. Coast, Los Angeles 61.

**BE appointed state notary public now.** Write—Stationers, Helotes, Texas.

**YOUR Own name brand business.** No investment; no inventory. Part time or full time. Sell famous brands of appliances, housewares, silverware, radios, vacuum cleaners, lamps, tools, clocks, watches, jewelry, etc., etc., over 1,000 items. Join thousands of successful independent dealers. Send for Free catalog and dealer price list. H. B. Davis Corp., Dept. F, 145 W. 15 St., New York City.

**FIX Typewriters** Inexpensive home course teaches Factory Secrets. Free Booklet. Write. Typewriter, Tarentum 2, Pennsylvania.

**\$200 WEEKLY** Cleaning Venetian Blinds. Free book. Burt, 2434B, Wichita 13, Kansas.

**\$1,000 MONTHLY,** home, mailorder, free advertising method. Revealing information. Seidel, 6000-BK Sunset, Los Angeles 28.

**LIQUID Rubber** makes flexible molds. Free Sample. Chaney, 1130 E. 16th St., Jacksonville 6, Fla.

**GOOD paying business** silvering mirrors, plating articles in the shop and home by late method. No tanks or shop required. Free booklet. Gunmetal Co., Avenue E, Decatur, Illinois.

**WANT To Make Big Money At Home?** \$5 profit in an hour possible with Invisible Reweaving. Make tears, holes disappear from clothing, fabrics. Steady year-round demand from cleaners, laundries, homes. Details Free. Fabricon, 8338-S Prairie, Chicago 19, Illinois.

**LEARN Sewing Machine Repair.** How to make "Big Money" at home sparetime. New machines—"Everything"—Supplied. Write Taylor Service, Box 2126, San Bernardino, California.

**BREED Rare Tropical Fish at home.** Earn Big Money! Learn Secrets! Help fill huge demand. Amazing Opportunity! Free Plan. Tropical Fish Breeders, Los Angeles 61, Calif.

**MINK Raising** information free. Complete. Lake Superior Mink Farm, Superior E E5, Wisconsin.

**\$70 WEEKLY—Home, spare time.** Simplified mail bookkeeping. Immediate income—easy! Auditax, 34757DW, Los Angeles 34.

**MAKE Big money in your spare time!** Sell nationally advertised brand name merchandise. Appliances, cookware, housewares, watches, jewelry, dry goods, clothing, sporting goods, toys, gifts, etc. Build a profitable repeat business. Send for Free 124 page illustrated color catalog with separate confidential cost sheet. Merit Home Products, Dept. PS-11, 107 Manhattan Ave., Brooklyn 6, N. Y.

**OPERATE Profitable magazine subscription service.** Earn Big Christmas Profits. New telephone plan. Handle renewals for all magazines. No experience or investment. Rush name; McGregor Agency, Dept. 500-B, Mount Morris, Illinois.

**\$3.75 HOURLY** Minimum, evenings. Preparing tax returns—simplified! Auditax, 34757DW, Los Angeles 34.

**NO Investment! No inventory!** Your own merchandising business! Sell nationally advertised products right out of the brand new Rake Catalog. Biggest Price Advantage ever! Sensational Profits! Write for your Free copy Today! Rake Company, 708-P Sansom Street, Philadelphia 6, Pennsylvania.

**MINIATURE Trees.** Why pay \$2.00—\$10.00 for growing secrets? Free details. Tiny Trees, Box 3084-S, Chicago 54.

**SAWDUST** Turn it into cash. Fortynine methods. Instructions \$1.00. Sawdust Institute, Box 155, Islington, Ontario, Canada.

**METALIZE Baby Shoes, jewelry, gifts.** Free Catalog. Kiklavi, Box 73136, Los Angeles 3.

**POPCORN and Potato Chip Equipment.** Eakins, Box 933-B5, Springfield, Ohio.

**WE'VE Got a highly unusual deal** for you on a new line of Fire Extinguishers. This is a new company, but you'll recognize the men behind it (who have had more than 20 years experience in this field), when you write to us—and it might pay you well to airmail us today. The "Fire King" Company, Inc., Dept. 14, Littleton, Colorado.

**HOW and where to obtain Capital?** Free details. Star Service, Wapakoneta, Ohio.

**SAVE 30-80% Nationally Advertised Brands.** For information, Riley Products, 3115 King St., Alexandria, Virginia.

**GO Into Business For Yourself—Sell** nationally popular name brand items of Jewelry, Watches, Appliances, Housewares, Toys, Gifts, Premiums, Prizes. No Investment—No Inventory. Send \$1.00 now for Big New Catalog. Confidential price list. Refund on First order. Halen, Inc., 125 Fifth Avenue, Dept. PS, New York, N. Y.



# POPULAR SCIENCE OPPORTUNITIES

**STRANGE "Dry" Window Cleaner.** Sells like wild. Replaces messy rags, liquids. Simply glide over glass. Samples sent on trial. Kristee 114, Akron, Ohio.

**NEED Cash? For "Know-how & where"** Write Business Service, 202 Bank Bldg., Cole Camp, Mo.

**OIL Millionaire.** How to become one. Write Texas Oil Associates, Box 486-B, Wichita Falls, Texas.

**WHOLESALE—Get the big merchandise**—furniture, appliances, TV's, clothing, tools, auto accessories—most anything. Save half. Literature free. Associated Wholesalers Service, 1016-D So. Starr, Burlington, Iowa.

**CAPITAL Easily Obtained.** Unlimited sources of money. Millions now available for your immediate use. Any purpose. How and Where, information free. Act quickly! Write today! Advance Service, Box 1377-P, Miami 8, Florida.

**ISLAND Mats.** 6 for \$1.00—Wholesale. Krueger Agencies, Box 54, Auckland, New Zealand.

**WHOLESALE Catalog—25c.** Pictures \$75,000 Merchandise. Worldwide, Box 12-D11, NYC 60.

**OPERATE cafe, diner.** Start with minor investment. Guides reveal every step. Write for free booklet "Cafe Business." School of Restaurant Arts, BU411, Fremont, Ohio.

**YOU for President of your own collection Office.** Free details. Franklin Credit, Roanoke (7), Virginia.

**WHOLESALE Catalog!** 30-80% Discounts! Appliances, Musical Instruments, Typewriters, Phonographs, Watches, Jewelry, Recorders, Housewares, etc. Consolidated Distributors, 21-15 Lafayette, Paterson 15, New Jersey.

**THRILLING Profitable Home Business.** Make fast-seller chenille monkey trees, dolls, flowers. Terrific holiday demand. Information free. Velva, Bohemia 17, N.Y.

**BIG Profits Raising Fishworms and Crickets.** Free Literature. Carter Worm Company, Plains, Georgia.

**HOW to get the Job you want \$1.00.** Burl Stilwell, 1129 W. Bell, Houston 19, Texas.

**FRANCHISES make profits!** Become exclusive franchised distributor, agency operator. Nationwide opportunities. Information rushed. National Franchise Reports, R-528, 333 North Michigan, Chicago 1.

**PLASTERCRAFT molds, liquid rubber, plasters, flocks, candle supplies.** Catalog and manual free. Jayhawk Plasters, Blue Rapids, Kansas.

**WANTED! Home Producers, by manufacturers in our Clearing House Service.** Become subcontractor, casting plastic products for these companies. Thousands of easy-to-make items required for consumer-industrial use. Cash in at home, without previous experience. Plastic Service Associates, Dept. 11-PS, East Boston 28, Massachusetts.

**HIGHEST commissions all magazines.** Free catalog, supplies, prizes exclusive services. Subscription Service Company, Dept. D, Box 2070, Birmingham, Alabama.

**FREE! Complete Mailorder Business!** Terrific Profits! No Investment! Vita-Mins, 2908PS Beverly, Los Angeles 57.

**EARN Up To \$2000.00 monthly** with spare or full time route of automatic 3 in 1 Hot Drink Merchandisers using Maxwell House Coffee, Bakers Chocolate, Tender-leaf Tea, in your community. We train you. \$1190.00 starts you. Write Superior, 4555-BG East Warren, Denver, Colorado.

**LEARN modern sign painting—Commercial lettering.** Anyone can be successful. Earn \$40.00-\$160.00 per week, spare time. Sign Instruction, Box 187B, No. Chicago, Illinois.

**"MAILORDER Laws and Regulations."** Discusses federal, state, local licenses, taxes, legal requirements governing mail-order businesses. Play safe. Order today. Only \$1.00. Tasker, 105 East Custis Avenue, Alexandria, Virginia.

**TIN-Cans.** Turn them into cash. Thirty methods. Instructions 50c. Charles Company, 12-EXC, Norwood, Ohio.

**ESTABLISH Automatic shoe shine route.** Jiffy Shine, 1630 South Second, Phila. 48, Penna.

**LEARN "Mechanical Secrets," "Money Schemes," "Advertising Stunts,"** Servicing Sewing Machines. Almost Free. Purdy's, 207-P, Weatherford, Texas.

**TELEVISION Mail Order Cuts Your Selling Cost.** Write Telesales, 24K, New York City 19.

**NEWSPAPERS.** Turn them into cash. Eighteen methods. Instructions 50c. Charles Company, 12-EXD, Norwood, Ohio.

**ADVERTISING book matches—Cash in on big demand—sell Union Label matches.** Cuts for all businesses and political parties—Free powerhouse selling kit—low prices—protection guaranteed on repeat orders—Cash Commissions. Superior Match Co., Dept. PX-1155, 7530 Greenwood, Chicago.

**BECOME A game warden, professional hunter!** Join forestry, park, fishery services. Good pay! Opportunities open! Free!—revealing "Select-Job Chart," details, job-getting secrets. Write Home-Study Educators, 1036-NNR LaBrea, Los Angeles 19, California.

**DOLLARS: Baby record books, Kitty Kat shoes, My Baby's Album,** eleven thousand new prospects daily, sold by mail, use our literature. No-Co-Ro, Oakland 6, California

**ELECTROPLATE autoparts, novelties, mirrors, baby shoes.** Easy, inexpensive home processes. Free booklet. Tyco Metals, Box 13231-CQ, Houston 19, Texas.

**MONEY in new greaseless doughnuts.** Start in kitchen. No smoke. Sell stores. Free recipes. S. Ray Co., 3605 South 15 Ave., Minneapolis 7, Minn.

**\$250 WEEK cleaning venetian blinds.** Patented Machinery. Free literature. Robinson, 7213A, Indianapolis 1, Indiana.

**\$5.00 HOURLY bronzing baby shoes!** Mountings! Foster, 1520 Ardmore, Chicago.

**NATURAL molding rubber, extra thick.** Free sample. W. Wooley, 115-B, Donald, Peoria, Illinois.

**MAKE money helping others out of debt,** stop garnishments, save jobs, re-establish credit. Details. Borum S6, 411 West Walnut, Kalamazoo 42, Michigan.

**MONEYMAKING mailorder business plan, free.** Write: George Lenhoff, Lincoln 1, Nebraska.

**A MONTHLY repeat business which you can operate in your own community.** For free details write Grask, Dept. B-202, P. O. Box 494, McKeesport, Penn.

**"STARTING a Business in Twelve Essential Steps" Save Money!** Avoid Complications! Succeed! \$1.00—Knowho, Box 218, Ware, Massachusetts.

**PROFITABLE Home Collection Office.** Experience unnecessary. Details. Fern, 411 West Walnut, Kalamazoo 42, Michigan.

**OPPORTUNITY To earn \$15,000 or more annually.** Business of your own. Self-employed. Franchise protected and guaranteed. Live at home. No merchandise to buy. One of the most exclusive and non-competitive businesses in United States and Canada. Send for free explanatory booklet. Harrell & Company, Box 8-D, Louisville, Illinois.

**GROW Mushrooms.** Cellar, shed, and outdoors. Spare, full time, year round. We pay \$3.50 lb. We paid Babbitt \$4,165.00 in few weeks. Free Book. Washington Mushroom Ind., Dept. 178, 2954 Admiral Way, Seattle, Washington.

**TO \$50.00 weekly.** Sparetime, home operated mailorder business. Successful "Beginner's" plan. Everything supplied. Lynn, 10420-C National, Los Angeles 34.

**SAVE 20% to 50%.** Buy wholesale! Nationally advertised merchandise. Free details! Beecher Sales, Box 2161-E, Cincinnati 1, Ohio.

**HAVE Home Mail Business—Get \$10 Orders in Every Mail—Keep \$8.00.** Everything furnished. Hutchinson, Box 87-C, Dorchester 22, Mass.

**ADDRESS Envelopes at Home.** Leon Duquette, 97-A Snow, Fitchburg, Mass.

**\$250 WEEK reported!** Free book "505 Odd, Successful Businesses." Work home! Expect something Odd! Pacific-36C, Oceanside, California.

**BIG interesting opportunity mails.** Three months 25c. Hemmel, 44 Vanderburg Ave., Rutherford, N. J.

**BUILD your business on building plastics.** Easily made at home. Enormous profits. Bays Laboratory, Oklahoma City 9.

**MAILERS! We do mailing and addressing;** pen—typewriter! Perry, Box 5, Iron River, Michigan.

**LIQUID marble.** Beautiful permanent floors. Formula, instructions, supply sources. 50 cents. Jos. Thompson, 1021 Mohegan, Pontiac, Mich.

**AGENCIES wanted, self-help books, courses.** Please send sample and proposition to Mail Sales Company, Lakemba, Sydney, Australia. (25 years this address).

**AFTER 11 years of business I have the true Formula Of Success.** Yours plus 6 money making plans. Money Back if not the true Formula. Send preference; travel, indoors, etc. and \$1.00. McConaghy, 3806 Nile, San Diego 4, California.

**MAKE Perfume other products sell mailorder.** "Carelabs," 1914 Chouteau-PS115, St. Louis 3, Missouri.

**TV Rental is profitable.** Literature free. Alpha Television Rental, 1106 Clayton Austin 5, Texas.

**BUY Wholesale 550,000 products.** Literature Free. Carter, Box 6011-E, Chicago 80.

**STARTLING Mail-Order profits possible!** Write Universal Services, Clayton 5-S, Missouri.

**LIQUID Marble—Brushed, sprayed!** Mold novelties, tile. Particulars free. Marbleizing Service, Edwardsville, Illinois.

**\$46 FROM Square Foot of Plywood;** Jigsaw necessary. Details Free; Woodarts, PS-15, Bridgewater, Mass.

**HOW to make a fortune with White Mice.** Laboratory Industries, P.O. Box 614, Pottstown, Pennsylvania.

**\$26,500 SALES in two weeks!** Amazing radio-mail order method. Free details. Broadcast Service, 1412-L Great Northern Building, Chicago 4, Ill.

**WHOLESALE Name Brands illustrated catalog 50c.** Refundable first order. Distributors, Box 106, Hudson, New York.

**HOW and where to obtain money.** Many ways to use your time to make big money. How I started with \$28 and built assets over half million dollars. Complete information postpaid \$2.00. Money-back guarantee. Particulars free. Business Consultants, 5853 N.E. 2nd Avenue, Dept. "D," Miami 37, Florida.

**COLORGLAZED Concrete pottery made without molds.** Patented method. Cemetery products, novelties, tiles. Basement leak-sealing. Money-making projects. Booklet, details free. Men only. National Potteries, Grand Rapids, "Minnesota."

**WANT Up to \$100.00 weekly deposited in your mail box?** Details Free! Smith, 2798-S Ladera, San Bernardino, Calif.

**I MAKE \$25.00 per day cleaning upholstery and rugs.** No equipment. Send \$1.00 for material and instructions. Money-back guarantee. Russ Knight, 2537 North 29th St., Phoenix, Arizona.

**EARN \$2.00 Hourly,** making and selling Sandals! Youngs, 1308-PS, South First, Arcadia, California.

**"EVERYBODY Likes Candy."** Make professionally home. (Our 45th Year.) Ragsdale Candies, East Orange, N. J.

**WHOLESALE! Appliances, toys, bicycles, aluminumware.** To 500% profit. Picture catalog 10c. Supply, 205 North 22nd Birmingham 4, Alabama.

**\$16.00 PER pound,** spinning Angora wool at home. Angora House, PSM, Springfield, Illinois.

**MAILORDER, money, money, Guaranteed plans, Huge profits.** Information free. Johnson, Dell Rapids, South Dakota.



# POPULAR SCIENCE OPPORTUNITIES

**SPARETIME** mailorder business. Profits \$500.00 monthly. Synacron, Box 102, 67 Poplar, Boston 14, Mass.

\$35,000.00 **BONUS** offered by U.S. Government—Fortunes being made in Uranium! Free Booklet Shows "How to Make Money Prospecting for Uranium." Please enclose 10c for handling, postage. Geiger Company, 195-PS11b Sackett Street, Brooklyn 31, New York.

\$15,000.00 Typewriting lists. Paid in advance. Excitingly new, different opportunity! Particulars and \$1. Instruction, Free! P. Economy, Rowley, Mass.

**PRINT for Profit** at home. Amazing new method prints colorful posters, banners, greeting cards, glassware—anything. Hundreds at time. No press needed. No art. Fantastic profits! Need representative your area immediately! Free home-business plan. Screen-Print, Dept. PS-11, Los Angeles 61, California.

**BUY it wholesale.** Manufacturers. Distributors. Over 850,000 items. Literature free. Olsen 1231-B East Third, Duluth 5, Minnesota.

**FREE Folio** "Up to \$45,000; Unlimited Vacations." No merchandise, equipment. Unknown! Work home—sparetime! Haylings-S15, Carlsbad, Calif.

## 37A CLAIM INVESTIGATORS

**INVESTIGATE Accidents**—Many Earn \$750 to \$1000 monthly. Thousands of insurance companies, airlines, and steamship lines need Claim Investigators. We train you at home spare time. Placement counsel and help. Free book—Now! Universal Schools, Dept. B-11, Box 8202, Dallas 5, Texas.

## 38 MONEYMAKING OPPORTUNITIES

**MAKE money** addressing envelopes sparetime. Glenway, 5713 Euclid, Cleveland 3, Ohio.

**MAN Wanted**—Are you dissatisfied with your work? Would you like a business of your own? If so, write Rawleigh's, Dept. K-GG-PSC, Freeport, Illinois.

**WIN contest money.** General Contest Bulletin gives hundreds of tips. Lists current contests and rules. Sample 25c. General Contests, 1609-A East 5th, Duluth, Minnesota.

**START A Buying Service,** buy wholesale thousands nationally advertised products. Make big profits selling at sizeable discounts. Postcard brings details. American Buyers', Hertel Station, Buffalo 16-O, N. Y.

**SELL Titania Gems;** far more brilliant than diamonds. Catalog free. Diamonite, 2420 77th, Oakland 5, California.

**EARN At Home**—we help you. Free details. Maxwell, Dept. 83-11, Cleveland 14, Ohio.

**SCHOOL Seniors**—Sell Classmates America's most beautiful Graduation Name Cards. Largest selection. Highest commission. Outsell all others. Free sample kit. Printcraft, Dept. P, 1509 Maple Street, Scranton 5, Penna.

**MAKE Spare Time Money** preparing and mailing sales literature. Adams Surveys, 3513-AS Sunset Blvd., Los Angeles 26, California.

**DETECTIVES**—Work home—Travel. Experience unnecessary. Detective Particulars free. Write. Wagoner, P-125 West 86th, New York 24.

**MAKE Money At Home** as renewal headquarters for all magazines. Big Christmas Sales profits now. Liberal commissions. Supplies furnished. Write for Free Catalog. McGregor Magazine Agency, Dept. 510-C, Mount Morris, Illinois.

**VENDING Machines**—No Selling. Operate a route of coin machines and earn amazing profits. 32-page catalog free. Parkway Machine Corporation, Dept. 16, 715 Ensor St., Baltimore 2, Maryland.

**FREE Toy catalog** and wholesale prices. Arro Sales Co., 1261P Brinton Rd., Pittsburgh 21, Penna.

**HUSBAND-Wife.** Successful in mail order business. Details free. Chas. S. Edwards, Box 2427A, Dallas 21, Texas.

**NEW Comedy,** religious, general 7" x 11" signs. 7c, retail 50c. 15 samples, \$1.00. Lowy, 812 Broadway, Dept. 904, New York 3.

**EARN At Home** with assignment we send. \$20-\$50 weekly possible. Other self employment offers listed. Free details. Maxwell, Dept. 44-11, Cleveland 14, Ohio.

**HOUSEWIVES!** \$200.00 for Xmas!! Rush \$1.00 for Samples and Easy Sales Plan! "Talking Toys"! Box 892-P, Hollywood 28, California.

22,000 **SMART,** close-mouthed ordinary American folks make really big money in a unique way. Internal Revenue Department reports. Send for eye-opening free folder. Fontel, Dept. 6, 210 Fifth Avenue, New York 10, New York.

**INFORMATION** Worth Dollars. Yours for Quarter. Wolfe, 8106D South Park, Chicago 19.

**FREE Book** "505 Odd Successful Businesses." Work Home! Expect something Odd! Pacific-35C, Oceanside, Calif.

**SELL "Lady Luck"** wallet charms for men. Unusual, exotic. One look sells them! Sample, wholesale plan \$1.00. Refundable. Malemart, Box 568, Danville, Illinois.

**BUY Wholesale!** 30-50% Discount! Name Brand Television, Refrigerators, Water Heaters, Radios, Electric Housewares, Power Tools, etc. Catalog 25c. Marpat Distributors, Box 1485, Milwaukee, Wisconsin.

\$25 **WEEKLY** possible, sparetime, preparing mail for advertisers. Temple Company, Muncie 7, Indiana.

**SPARETIME Profits** Taking Subscriptions. All Magazines. Wholesale Catalog Free. Cassell Publishers, Westfield, N. J.

**WHOLESALE Catalog!** 30-80% Discounts! Appliances, Musical Instruments, Typewriters, Phonographs, Watches, Jewelry, Recorders, Housewares, etc. Consolidated Distributors, 21-17 Lafayette, Paterson 15, New Jersey.

**PRINTING and Office Supplies** wholesale. 20,000 items. Literature free. Royal, Box 368-S, Cleveland 27, Ohio.

**LEARN Technical Metaphysics** and insure your future. Easy, inexpensive correspondence course. Simplest method known. Diploma. Write: Premier College of Technical Metaphysics, 2532 McKenzie St., Vancouver 8, B.C., Canada.

**AMATEUR Artists,** cartoonists. Turn your art ability into money. Hamilton, Box 4-PSK, Astoria 5, New York.

**SELL yourself.** Sell neighbors, Aluminum Awnings, Baked enamel Colors, any size. Factory prices! Write Groff—Box 10254, Tampa, Florida.

**DOLLARS In Modern Baby Record Books,** Baby Shoe Kits. Liebig Industries, Beaver Dam 57, Wisconsin.

**METAL Castings,** Art Hardware Machine. Write Box 124, Lynwood, California.

\$19,000 **SALES** in two months. Sensational Mailorder Method actually works. Details Free. Carter's, Box 261, Gainesville, Georgia.

\$50.00 **THOUSAND** possible, addressing envelopes at home, sparetime. (Instructions 50c Refundable). Fisher-B, Box 9243, Houston, Texas.

**SELL Merchandise** by mail. Everything supplied. Big profits. Details Free. Stull's Buying Service, 621 Adams Ave., Scranton, Pa.

**PIANO Tuning Pays.** Learn this profitable profession at home easily with patented Tonometer and mechanical aids. No knowledge music necessary. Diploma granted. Write for booklet. Niles Bryant School, 3731 Stockton Blvd., Dept. S, Sacramento 20, Calif.

**OPERATE "Escalator"** Mailorder System, selling our products or any products. Most revolutionary mailorder system known. Postcard. Selbyco, Decatur 174, Illinois.

**MONEY maker**—Goldmine of ideas—trade secrets—etc. \$1.00. Willbanks, Box 246, Chamblee, Georgia.

**GROW Mushrooms.** Cellar, shed, and outdoors. Spare, full time, year round. We pay \$3.50 lb. We paid Babbitt \$4,165.00 in few weeks. Free Book. Washington Mushroom Ind., Dept. 179, 2954 Admiral Way, Seattle, Washington.

**WANTED:** Typewriter owners. Make handsome profits. Write today, Groves Company, 682 Hastings 3, Nebraska.

**EXTRA money** addressing mailing postcards. Gul, 2419 Thomas, Chicago 22, Illinois.

**BUY wholesale.** Fifty-seven free catalogs. Thousands items. Econ-O-Mart, 8 Perry Street, Whippany, New Jersey.

**WHOLESALE,** Nationally Advertised Brands. 25c Brings Catalog and Price List. Natel Sales, 411 Paulison, Passaic, New Jersey.

**EARN \$50.00 Daily** making mats, shoes and mud guards from old tires. S and S Patents Inc., 1307 North Clark St., Chicago 10, Illinois.

**MAKE money** with your typewriter!! Write Barnett Company, Box 6555, Cleveland, Ohio.

**MAIL Order Business**—Your opportunity. "How to Build Your Own Mail Order Business." Beginner's Idea-Book tells "How." 25c postpaid. Satisfaction guaranteed. Schroeder Enterprises, P. O. Box 108, Jasper, Indiana.

**HOMEWORKERS** Wanted Painting Novelties. Good Earnings. N. Roland, R.R. #1, Vincentown, New Jersey.

\$13.50 **PER Thousand.** Home addressing. No selling. Details for stamp. Service, Box 37215, Los Angeles 37.

**EXCEPTIONALLY Profitable** Home Mailorder Business Plans. Lewis Bartlett, Richland, Georgia.

\$35.00 **WEEKLY** addressing envelopes. Instructions \$1.00 Refundable. Adservice, Spring Valley, New York.

**INFORMATION** worth dollars. Yours for quarter. Wolfe, 8106 S. Park, Chicago, Illinois.

**MAKE Money** at home mailing cards—circulars—featuring fast-selling merchandise. Everything furnished. Orders filled for you. The Wm. F. Liska Company, 102 Birchwood Avenue, Cranford, New Jersey.

**FREE details.** Home addressing offer. Descriptive literature 1000 valuable tips, all needs wholesale. Nelson Sales, Elkhorn, Nebraska.

**EXPORT-Import!** Opportunities unlimited! Full or part time. Compiled from successful experience, complete instructions tell how, where, whom to contact for immediate possibilities, \$2.00 Postpaid. G. A. Neander, 237 S. Torrence Street, Dayton 3, Ohio.

**SIMPLY Mail Magazines** and watch orders fill your Mailbox. 50% Commission! Send 25c for unique plan and sample. Maxted Book Agency, Western Springs, Illinois.

**MANY Money Making Methods** and Ideas for only one quarter. Casper, 915 Washington, Jacksonville, Texas.

**ADDRESS Envelopes** at Home. \$50.00 weekly possible, National Industries, Box 155, Boston 26, Massachusetts. (Mattapan Sta.)

\$200 **WEEKLY** Cleaning Venetian Blinds. Free book. Burt, 2434B, Wichita 13, Kansas.

**PROFITABLE Hobby** adds to your income and pleasure. Operate home Mail Order Business. Write Publicity, Box 727B, Kalamazoo, Michigan.

**CLOSEOUT 50,000 GE Subzero Automobile Engine Heaters.** Listed \$8.95, sample \$3.95. Terrific quantity discounts. Illustrated literature and mailorder plans. (\$1.00) (Refundable first order). Wisnieski, Milwaukee 7, Wisconsin.

\$1,000. **MONTHLY** possible raising earthworms! Backyard, garage, basement. Complete illustrated booklet explains raising, feeding, packing, marketing. 25c postpaid! Ozark Worm Farm-V, Willow Springs, Mo



# POPULAR SCIENCE OPPORTUNITIES

1c DOUBLED daily thirty days is \$10.-737,418.24. Copyrighted "doubling up plan", sample printed matter, and your right to use in your locality, \$3.00 postpaid. Ashburn Enterprise, Box A187, Ashburn, Georgia.

**MANUFACTURING** — Selling instructions, guidance. Free Booklet. Jarry Associates, 268-CN, New York 5.

**FREE** Folio "Up to \$45,000; Unlimited Vacations." No merchandise, equipment. Unknown! Work home—sparetime! Haylings—S16, Carlsbad, Calif.

**BUY Wholesale!** Save 66-2/3%! Appliances, Furniture, Jewelry, Toys, Sporting Goods, Tools. Free Catalogs. National Buyers Service, Box 426FB, Oakland, Calif.

**SAVE** buying nationally advertised merchandise. Catalog 50c. D'Auria Sales, Box 355S, Jackson, Michigan.

**JEWELRY** manufacturing at home without special tools or training. Professional results from the beginning. Make tremendous profits selling to your friends, stores, etc. Great variety of beautiful rhinestone, pearl and moonstone creations to select from. Small investment with all merchandise unconditionally guaranteed. You have started your own business when you send 25c for our fully illustrated catalog and other literature. A. V. Cutt Company, Inc., 210-H Fifth Avenue, New York 10, New York.

**BIG** profits, selling ties (\$2.00 value) \$6.50 dozen. Free catalog. Empire Cravats, 611-PS Broadway, New York 12.

"**TIMELY** Tips." Paulding 2, Ohio, publishes moneymaking opportunities, formulas, ideas, monthly 25c. 31st year, \$2.00.

## 39 FORMULAS, PLANS, ETC.

**FORMULAS**—All kinds. Latest products. Literature free. Kemico, Park Ridge 15, Ill.

**FREE** Formula Catalog. Anything Analyzed \$35.00. Western Chemical, Salem, Oregon.

**MODERN** formulas for today's fastest selling big-profit products. Literature free! Miller, Chemist, 1517-A, Tampa, Florida.

**ANY** Formula \$3.00. Catalog—Mfg. Treatise 10c. J. Belfort, 192 North Clark, Chicago 1.

## 40 PLASTICS

**PLASTICS** home-craft course for Men and Women. Tells and shows how to make hundreds of fast selling plastics products. All plastics and materials for 23 projects included in course. No special tools needed. Course pays for itself. Write for Free booklet. Interstate Training Service, Dept. D-2-M, Portland 13, Oregon.

**LAMINATING** Supplies. Price List Free. Solomson, 46 Cornhill, Boston 8, Mass.

**PLEXIGLAS**—Cut to size—Clear—Any thickness—Colors—Rods—Tubing. McClarin Plastics, P. O. Box 168B, Hanover, Pa.

**PLEXIGLAS**, Lucite. Square foot cost. 1/16"—\$1.15, 1/8"—\$1.52, 3/16"—\$1.86, 1/4"—\$2.21, 3/8"—\$3.28, 1/2"—\$4.38. Colors add 10%. Send 15¢ for postage. Aristocrat Plastics, 23-25 Sussex Avenue, Newark, N.J.

**PLEXIGLAS**, Fiberglass, Polyester, Acetate. Unique wholesale-retail catalog—15c. Gem-O-Lite, Box 686S, North Hollywood, California.

**NEW** Liquid Casting Plastic, clear, colors. Embed real flowers, insects, photos, coins. Saw, drill, carve. Send 25c for handbook "How to Cast with Liquid Plastic" and proved success plan showing how to make money at home. Castolite, Dept. M-102, Woodstock, Illinois.

## 41 CHEMISTRY & PHYSICS

**CHEMISTRY** for beginners. Systematic, Fascinating. All ages. First lesson 25c. Also formulas. Trade secrets. Expert advice on all plastics. Parkway Laboratory, R #1, McKees Rocks, Pa.

**EXPERIMENTERS** Supplies Catalog: 20c. Hagenow Laboratories, 2414 Clarks, Manitowoc, Wisconsin.

**NEW** idea chemical and apparatus outfits for home experimenting. Photo-scales, microscopes, chemicals, biologicals, and laboratory supplies in small quantities. Catalog 25c. Established 1931. John H. Winn, 124B West 23rd St., New York, N.Y.

**ILLUSTRATED** Catalog: Chemistry, mineralogy, biology 20c. Tracey Laboratories, Evanston, Illinois.

**AMAZING** New Book of Science, Experiments, Formulas and catalogue of Laboratory Supplies. Only 25c. National Scientific Co., Dept. PS-11, 2204 W. North Ave., Chicago 47, Illinois.

**CHEMICALS** and apparatus for industrial, analytical and private laboratories. Catalog 25c. Dept. M-26, Biological Supply Co., 1176 Mt. Hope Ave., Rochester 20, N.Y.

**HYDROGEN**—from common household chemicals. Inflate toy balloons, etc. Instructions—\$1.00. Hough, 638 Rice St., Springfield, Ohio.

**CHEMICALS**, Supplies, Catalog 25c. Laboratory Sales, Box 161-B, Brighton, Mass.

## 42 HELP WANTED

**OVERSEAS**, Latin American, Alaska, Canada Employment. Originator 1955 "Foreign Service Directory" Up-To-Minute Report on Military & Civilian Construction; Oil Companies; Aviation; Transportation; Steamship; Mining; Government Job Info. How-When-Where to apply. Listing Firms Hiring. \$1.00. Global Reports, Box 883-S, Hollywood 28, Calif.

**MIAMI**, Jacksonville, Or Atlanta Business and Employment Opportunities Newspaper Section Airmailed \$1.00 Each. Or three for \$2.25. Letter remailed 25c. B. Duca, 1260 120th St., Yukon, Florida.

**EARN** to \$1500 Monthly. Many Jobs Available. Work in Fabulous South America, The Islands, Africa, USA, etc. All Trades. Labor, Clerical, Truck Drivers, Mechanics, Engineers, etc. Tax Free Earnings. Chance to Travel. Fare paid if hired. Make and Save a fortune. Application Forms. Free Information. Write Dept. 76D, National Employment Information, 1020 Broad, Newark, New Jersey.

**AIR** Force Academy under construction, Colorado Springs booming. Help wanted columns airmailed. \$1.00. Opportunities, 511 N. Hancock, Colorado Springs, Colorado.

**LOS** Angeles—Help Wanted Columns airmailed 50c. 1924-12 Cloverfield, Santa Monica, California.

"**FOREIGN**, Alaskan, USA, Jobs!" Million Americans Employed Overseas! Opportunities Galore. Latest copyrighted Reports. Who to contact for Highest Paying Jobs. To \$1500.00 Monthly. Laborers—Trades—Truck Drivers—Equipment Operators—Helpers—Clerical—Engineers—Many Others. Over 52 countries—St. Lawrence Project, Spain, Latin America, Northern Projects, Europe, Pacific, Etc. Year Registration—Advisory Service. Application forms. Unconditional Money-Back Guarantee. Act today. Only \$2.00. Airmailed \$2.25. (COD's Accepted.) International Reporter, St. Louis 1-S, Missouri.

**MIAMI** jobs. Complete classified Section Airmailed \$1.00. Letters remailed Miami \$2.25. Postcards \$1.00. Grace Gainer, Box #726, No. Miami, Florida.

**INDUSTRIAL** Houston employment section airmailed \$1.00, remails 25c. Morgan, 5306 Bell, Houston, Texas.

**OPPORTUNITIES** — California, Texas. Current job listings rushed to you airmail. Any state—Any major city, \$1.00: Classified, Dept. A, P.O. Box 923, Taylor, Texas.

**LOS** Angeles area booming, help wanted columns air mailed \$1.00. Mansfield, 2306 Thorton, Burbank, California.

## 43 AGENTS WANTED

**YOUR** own business—Suits \$1.50; Overcoats 65c; Mackinaws 35c; Shoes 12 1/2c; Ladies' Coats 30c; Dresses 15c. Enormous profits. Catalog Free. Nathan Portnoy Associates, 605 West 12th Place, Chicago 7.

**BEAUTIFUL** Feather Pictures. 200% Profit! Free sample. Apartado 9036, Mexico 1. D. F.

**ABSOLUTELY** Free—Sales Kit. Increase your income. Send postcard today requesting kit showing new line, belt buckles with your name or personal initials, cap badges, tie clasps, choice 3000 different emblems. Hook-Fast, Box 1425PS, Providence, R.I.

**AGENTS**—300% profit selling genuine gold window letters; stores and offices. Free samples. Metallic Sign Letter Co., 431-E North Clark, Chicago.

**GOLD** or Silver letters, numbers. Windows, Doors, Trucks. 1" to 6". 500% Profits—Free Samples. Atlas-U, 544 West 79th, Chicago 20.

**START** Your Own Business On Credit. Your own boss. 1135 of our Dealers sold \$5,000 to \$30,000 in 1954. We supply stocks, equipment on credit. 200 home necessities. Sales experience unnecessary. Pleasant profitable business backed by world-wide industry. Write Rawleigh's, Dept. K-U-PSC, Freeport, Illinois.

**NEW** Jobs open in selling! Send name, address for five free issues of Opportunity Magazine's money-making guide, listing hundreds of companies who'll pay you well, full or part-time. No experience needed. Opportunity, 850 N. Dearborn, Dept. 18, Chicago, Illinois.

**BUY** Wholesale thousands nationally advertised products at big discounts. Free "Wholesale Plan." American Buyers', Hertel Station, Buffalo 16-L, N. Y.

**TREMENDOUS** profits! Every man, woman and child a customer. Suits \$1.50, Pants 35c, Dresses 20c, Shoes 20c. Operate from store, home, car. Free catalog. Superior, 1250-B Jefferson, Chicago 7.

**GET** New Shirt Outfit Free: make \$90.00 weekly on 5 average orders a day. Famous quality Made-To-Measure dress and sport shirts at \$3.95 up sell fast to all men. No experience needed. Full or part time. Write: Packard Shirt Company, Dept. 139, Terre Haute, Indiana.

**WANTED:** Men interested in making up to \$15,000 a year. Exclusive line of personalized articles. No investment. Free information and sales kit. Write Hook-Fast, Box 480 (PS), Roanoke, Virginia.

**BIG** Money making opportunity. Exclusive line work uniforms, jackets, pants, shirts, coveralls. Advertising embroidered. Every business prospect. Outfit Free. Master Div., 584 Water, Ligonier, Indiana.

**GOLDMINE** Of 600 money-makers. Copy Free. Specialty Salesman Magazine, Desk 6, 307 N. Michigan, Chicago 1.

**WOMEN**, Men, Make Money Spare Time plus New Car as Bonus for Encouragement. Amazing hosiery Guaranteed to wear without holes, snags, and runs, or replaced Free. For example, lovely 60 gauge nylons Guaranteed for as long as 1 1/4 years, or replaced Free. Write, Wilknit, 20511 Washington, Greenfield, Ohio.

**MAKE** Money at home as headquarters for all magazines. Earn Big Christmas Profits. Liberal commissions. No experience—no capital needed. Supplies furnished. Write McGregor Magazine Agency, Dept. 510-A, Mount Morris, Illinois.

**BE** Your own boss! No investment—No inventory. Big real profitmaking wholesale catalog Free! Dept. PS, Jay Norris, 487 Broadway, N.Y.C., N. Y.

**BUY** Wholesale—25,000 items—Catalog 25c. Matthews, 1472-A2 Broadway, New York City 36.

**COMPLETE** Full Line of First Quality Gift Wrapping Supplies, Christmas and Greeting Cards. Highest Profits. Valuable Premiums. Walt's House of Cards, 208 S. Lamar, Amarillo, Texas.

"**FOG-Stop**" Windshield Cloth. Instantly removes blurry Mist, Frost, Sleet, Snow. Stops windshield fogging. Samples sent on trial. Kristee 79, Akron, Ohio.

**MEN!** Make \$1000 a month with 3-second demonstration of powerful, midget Presto Fire Extinguisher to homes, offices, factories, car owners, garages, farms, etc. New chemical beats expensive extinguishers. Merlite, 114 E. 32nd, Dept. 50-B, New York 16.



# POPULAR SCIENCE OPPORTUNITIES

**150% PROFIT** selling 500 Name and Address Labels. Retail, \$1.00. You keep 60c profit. Free selling kit. Bruce, Box 71-T, Boston 1, Mass.

**YOU** Can make a fortune with miracle discovery liquid cloth. Mends everything from boats to finest hosiery. Dries soft, durable elastic texture. Sells so fast production increased 34 times already. It's sensational! Bard's Products, Dept. O, Evanston, Illinois.

**AGENTS—Salesmen:** Sell beautiful hand colored plastic enlargements and sensational new personalized photo compacts, rings, bracelets, lockets, etc. Experience unnecessary. 40% advance commissions. We deliver, collect. Wonderful sideline—better full time. Free sample outfit. Novel Portrait Co., 3343 North Ave., Chicago, Ill.

**\$8,000 PROFIT** a year—from just one sale a day! Keep/Safe, only full-sized personal safe sold direct, lets you offer low-cost fire and theft protection that all homeowners, farmers and businessmen need—and less than 5% have! \$73.95 sale means \$26.45 profit, plus big bonus. No competition. Exclusive territory. Full details from manufacturer. John D. Brush & Co., 576 West Ave., Rochester, N. Y.

**EARN Big Money—Manufacture Better Mousetrap—Disposability Assures reorders—\$1.00 brings complete plans—Dispos-O-Mouser, Box 2693, Dept. PS115, Sacramento, California.**

**WHY** work for peanuts? \$16.95 profit per unit possible with amazing new Alarm-O-Safe. Sells itself. No experience needed. Free Sales Kit. Merlite-Alarm, Dept. A-5111, 114 East 32nd St., New York 16.

**SPARE** or full time top earnings selling America's largest low-priced line Business Printing and Advertising Specialties to every retail store and business. Big advance commissions. Complete order-winning sales kit Free. National Press, North Chicago 2, Illinois.

**NEW** Plastic mending tape. Just press on! Repairs clothing immediately. Lightning seller. Samples sent on trial. Kristee 77, Akron, Ohio.

**BIG** profit repeater—Low cost Chamois. Babrok Imports, PS4, Hudson Falls, N. Y.

**CALIFORNIA** sweet smelling beads, sensational sellers. Particulars free. Mission, 2328 P West Pico, Los Angeles 6, Calif.

**BIG** money! Buy Wholesale, sell retail. Dresses, children's wear, family apparel. Lowest factory prices. No stock to carry. No samples to buy. Big sales Kit with actual fabrics Free. C. E. Israel, Dept. P-6704, Cincinnati 25, Ohio.

**PRINTING!** Highest quality. Big profits. Free wholesale pricelist, supplies, details. Napco, 2337-PS Bath Avenue, Brooklyn 14.

**WHOLESALE** Catalogue! Appliances, cameras, watches! Anelag Industries, Rochester 3, Wisconsin.

**MAKE** products—sell mailorder—Catalog free—"Imisco", 6347 Parnell, Chicago 21, Illinois.

**\$20. DAILY.** Free nameplate and selling kit. Easy seller. Universal, Box 25, Cambridge 39, Mass.

**WHOLESALE** Catalog! Housewares, appliances, watches. Postcard.—Selbyco, Decatur 274, Illinois.

**EASY** handwork makes fast-selling articles. Sample free. Sunmade Company, Brockton 64, Massachusetts.

**DAY-Glo** Letters, Samples. Edward Cook, 51 Martin Avenue, Saratoga Springs, New York.

**MONEY-Making Opportunity!** Take big profit orders for world famous Patented Varieties Fruit Trees. Also Flowering Shrubs, Roses, Vines. Big Sales outfit Free. Stark Bro's, Desk 30156, Louisiana, Missouri.

**FREE** book "505 Odd, Successful Businesses." Work home! Expect something Odd! Pacific-38C, Oceanside, Calif.

**REAL** Diamond Rings. Sell Direct. Make big middleman's profit. No investment. Experience unnecessary. Free catalog, details. Gleamlight, 111-Q No. Columbus, Mount Vernon, New York.

**\$1.00 PROFIT** selling \$2.95 photo enlargement offer. Allen Studio, Reigler Bldg., Little Rock, Arkansas.

**SPRAY—**Can fire extinguisher. Sell \$2.00 you make \$1.50. Eleven other profitable pressurized spray can products. Amazing sellers, repeaters. Free literature. Strobel Aerosol Co., 2412-DD, Market, Louisville, Ky.

**WILL** you wear new suits and topcoats without one penny cost and agree to show them to friends? You can make up to \$30.00 in a day even in spare time, without canvassing. Pioneer Tailoring Company, Congress & Throop Sts., Dept. K-1226, Chicago 7, Illinois.

**MAKE** Extra Money. Sell front door name plates to friends, neighbors. Retail \$1.98—you make \$1.00! Free selling kit. Modern Engraving Co., P.O. Box 194, Boston 14, Mass.

**BEAUTIFUL** Feather Bird Christmas Folders. From Mexico. Send 25c for samples and price list. The Tradewinds Co., Box 254, Wilder, Vermont.

**BUY** Wholesale 550,000 Products. Literature Free. Carter, Box 6011-F, Chicago 80.

**EARRINGS.** Ocean and River pearl. Genuine. River freshwater pearl. Dozen. \$4.50. \$6.00. \$6.75. \$8.50. \$9.00. \$10.50. \$12.00. Ocean pearl—Dozen \$10.50. \$12.00. \$13.50. Wholesale only. Jos. Fleischman, 211 Linda, Tampa 4, Florida.

**EARN \$30 A Day!** Sell Dab-It, amazing pocket-size, stick-form, "no ring" spot remover. Works like magic! Guaranteed! M & M, S-1, 842 Third Avenue, New York 22.

**SCHOOL** Seniors. Be popular with classmates. Have spending money galore. Details free. Craftcards, Box 235-M, Pittsburgh 19, Penna.

**AUTO** compass—Magnetic. Thousands sold. Dealers. Premium Users. Free sample offer. Smith Agency—52, Excelsior Springs, Mo.

**BE** In your own business—Buy wholesale—Big profits—Get Free nationally famous name brand mdse. catalog. Dept. PS, Normandy Distributing Corp., 133 Fifth Ave., N.Y.C., N. Y.

**A steady** moneymaker—Good repeat business—Sell Embossed Business Cards. Our Standardized high quality production gives you a low price and good profits. Write W. A. Dalgligh Co., 1831 Ashland, St. Paul 4P, Minnesota.

**\$200 WEEKLY** Cleaning Venetian Blinds. Free book. Burt, 2434B, Wichita 13, Kansas.

**EARN \$200 a Week & Up!** Amazing profits are yours selling Seal-Tite, miracle puncture-proofing discovery! \$1.98 tube stops flats forever. Sure-fire appeal to America's 50,000,000 motorists! Complete sales kit Free on request. M & M, S-2, 842 Third Avenue, New York 22.

**SALESMEN!** Cloisonne, Damascene, Ivory! Details free. Ohga, 44, Yabasi, Sigakenkusatu, Japan.

**BUY** Wholesale! 100,000 Name Brand Products! Save 66-2/3%! Big profits selling others spare time! Free Catalogs. National Buyers Service, Box 426FE, Oakland, California.

**CASH** in on tremendous demand for new low priced burglar alarm for cars, homes, stores. Unique sample offer—Northwest Electric Co., 424-N Main, Mitchell, South Dakota.

## 44 HIGH-GRADE SALESMEN

**AD** Matches! Sell amazing designs—10, 20, 30, 40, and 240-light book matches. Bigger spot cash commissions; every business a prospect. Low prices for high quality. Repeats. Start without experience; men, women; full, part time. Buy nothing! Sales kit furnished. Match Corp., Dept. PS-71, Chicago 32, Illinois.

**MEN!** Make \$1000 a month with 3-second demonstration of powerful, midget Presto Fire Extinguisher to homes, offices, factories, car owners, garages, farms, etc. New chemical beats expensive extinguishers. Merlite, 114 E. 32nd, Dept. 50-B, New York 16.

**ADVERTISING** book matches—Cash in on big demand—sell Union label matches. Cuts for all businesses and political parties—Free powerhouse selling kit—low prices—protection guaranteed on repeat orders—Cash commissions. Superior Match Co., Dept. P-1155, 7530 Greenwood, Chicago.

## 45 EDUCATIONAL & INSTRUCTION

**BOOKKEEPERS!** Increase your earnings! Operate your own simplified "Dollar-A-Week" Bookkeeping and Tax Service. Full or spare time. Details Free. No obligation. Ellis, Box 203, Cedar Grove, North Carolina.

**USED** Correspondence Courses and Books sold and rented. Money back guarantee. Catalog free. (Courses Bought.) Lee Mountain, Pisgah, Alabama.

**BE** a Real Estate Broker. Study at Home. Write for Free book today. GI approved. Weaver School of Real Estate, 2018R Grand, Kansas City, Mo.

**COMPLETE** Your High School at home in spare time with 58-year-old school. Texts furnished. No classes. Diploma. Information booklet free. American School, Dept. X846, Drexel at 58th, Chicago 37, Illinois.

**AUCTIONEERING!** Be an auctioneer. Earn big money. Term soon. Free catalog. Kansas City Auction School, Box 6808 PS, Kansas City, Missouri.

**STUDY** For Doctor's degree of Psychology, Metaphysics and Divinity. Correspondence courses only. College of Divine Metaphysics, Dept. P-S, 2811 North Illinois, Indianapolis 8, Ind.

**BECOME** A Real Estate Broker or Salesman. Complete home study course. Free information. Kansas City Realty School, Box 6808PS, Kansas City, Missouri.

**FREE** home study course in basic economics offered as a public service. Recommended by many leaders. Send postcard for complete information. Henry George School, Dept. P, 50 E. 69th Street, New York 21, New York.

**WANT** A Diesel Job? New Opportunities to increase income. Higher Pay, More Money. We can help you Qualify. Tools. Shop method home training. Write today! Diesel, Tractor, Heavy Equipment Division. Interstate Training Service, Dept. B-2, Portland 13, Oregon.

**EARN** While You Learn Auto And Diesel Mechanics. Master this top paying trade. Many graduates earn \$100 a week and up. Approved for Korean veterans. For free information write Dept. No. 262, Nashville Auto-Diesel College, Nashville 3, Tenn.

**WELDING** training pays at Hobart Welding School, Box P-1151, Troy, Ohio. VA contract. Best equipment. Catalog free.

**QUALIFY** for college equivalency degrees. Increase opportunities for promotions, better pay. No courses. Bulletin 10c. Cramwell Institute, Adams 7, Mass.

**HIGH** School—No Classes. Study at home. Spare Time. Diploma awarded. Write for Free Catalog HBA-49. Wayne School, 2527 Sheffield, Chicago 14, Illinois.

**LEARN** successful Small Business Management Methods by mail. write Alex Page, Box 1806, Miami 10, Florida.

**MEDICAL** Laboratory Technicians in great demand. We train you in your own home. Catalogue free. Imperial Technical Institute, Box 973-B, Austin, Texas.

**WANTED:** More new writers for TV-radio, magazines, business publications, motion pictures. Learn at home for extra income or exciting full time career. Many students earn while learning. Professional instruction. Send today for free lesson and book. Palmer Institute of Authorship, Desk UM-115, 1680 N. Sycamore, Hollywood 28, California.



# POPULAR SCIENCE OPPORTUNITIES

**ENGINEERING** Degrees earned through Extension Division. American College of Engineering, Box 27724 (A), Hollywood 27, Calif.

**BLUEPRINT** Reading for machine and building trades. Train at home. Learn to read blueprints with confidence in 10 easy lessons. Earn more pay. Literature free. Belton School, 1059-A North Lawndale, Chicago 51, Ill.

A Pleasing Dynamic Singing and Speaking Voice can be Yours! Use Canfield Self-Training Voco-Records. Thrilling Details! 2018-C-Fifth Avenue South, Minneapolis 4, Minnesota.

**USED** Correspondence Courses and Educational books bought, sold, rented. Catalog free. Educational Exchange, Menlo, Georgia.

**LEARN** Basic Algebra, Details Free, CSAM, P. O. Box 251, Elmwood 10, Conn.

**HOW** to write, sell advertising. Van Buskirk, 825 East Harrison, Danville, Ill.

**COLLEGE** degrees—Independent study. Keep employed. Brentwood College, Box 19-721, Los Angeles 19.

**GROW** Mushrooms. Cellar, shed, and outdoors. Spare, full time, year round. We pay \$3.50 lb. We paid Babbitt \$4,165.00 in few weeks. Free Book. Washington Mushroom Ind., Dept. 180, 2954 Admiral Way, Seattle, Washington.

**EARN** Degree—orthodox home study religious courses. Free literature. Bible School, 517 Merchants Bank Bldg., Indianapolis, Ind.

**PHYSICAL** Therapy and Massage—We Train You At Home. Earn Big Profits from your own Private Practice or Work with Hospitals and Doctors. Free Catalog. National Institute, Desk 3, 159 East Ontario, Chicago 11.

**PIANO** Tuning pays. Big money in spare time. Learn at home in 30 days. No musical knowledge necessary. Phonograph, records, tools and instructions furnished. Free catalog. Capital Tuning School, 16 Southwest Second, Fort Lauderdale, Fla.

**EDUCATIONAL** books, correspondence courses, bought, sold, rented. Free Catalog. Willard Bayles, 211 Essex, Hackensack, New Jersey.

**CAR** Owners—Save hundreds of dollars. Unique "Know Your Car" home study course teaches trouble shooting and how to make repairs. Anyone can learn. Free Booklet. Roberts Technical and Trade Schools, 343 East 63rd St., New York, N.Y.

**BECOME** a Doctor of Psychology, Divinity or Philosophy in Metaphysics. Learn the secret of contentment, happiness. Write for Free Booklet. Correspondence Courses only. College of Universal Truth, 5038-K Broadway, Chicago.

**MEDICAL** Laboratory Technicians in big demand by hospitals and physicians. We train you at home. Free catalog. Century College, Desk 2, 960 Montana Street, Chicago 14.

**ANALYZE** Handwriting. Earn up to \$10 an hour spare time, teaching, counseling, TV, other fascinating fields. We need men, women Now to prepare for Tremendous opportunities in growing, uncrowded field. Trial lesson with All the details free. Give age. IGAS, Inc., 509 Wilhoit Building, Springfield 4, Missouri.

**TUNE** Pianos spare time. Learn quickly. Inexpensive home course. Write Stafford, 708A Rawlings, Carbondale, Illinois.

**YOU** can train for U.S. Civil Service tests! Men—Women earn more. Steady work. Pass next exams. Many jobs open. Experience often unnecessary. Free 36-page book shows requirements, salaries, sample coaching. Write: Franklin Institute, Dept. K-22, Rochester, N.Y.

**EARN** college degree. Remain employed. Fremont College, 915-S Grandview St., Los Angeles 6, Calif.

**HOME** Study Courses leading to Diplomas. Minister, Divinity, Psychology, Therapy, Philosophy. Western Schools, 746 24th Street, San Diego 2, Calif.

**TRANSFORM** yourself via subconscious dynamics. Free Amazing Brochure. Box 847 (A-11), Ocean Park, Calif.

**HOME** Study course, drugless therapy. Free literature. Inst. of Drugless Therapy, Tama, Iowa.

## 46 CONTESTS

**WIN** Contests!! Revealing Course!! Complete! Easy! Just \$1.00. Stevens, 2543 Welsford, Columbus 21, Ohio.

**PRIZE** Contests provide Fabulous and Confidential Home Income Opportunity! Here's How and Where to Win Your Share! Send stamp! National Contest Bulletin, Box 2685-PS, Miami 16, Florida.

**WIN** Contests. We Help You. Contests, 166 Catherine, Red Bank, New Jersey.

## 47 DETECTIVES

**DETECTIVE** Training. Phillips Secret Service System, 1917-C North Kenneth, Chicago 39 Ill

**DETECTIVES.** Work Home—Travel. Free particulars and badge. Exchange Secret Service System, 4554 Broadway, Chicago 40.

**DETECTIVES—Work home—Travel.** Experience unnecessary. Detective Particulars free. Write Wagoner, P-125 West 86th, New York 24.

**LEARN** Civil and criminal investigation at home. Earn steady good pay. Institute Applied Science, 1920 Sunnyside, Dept. 338, Chicago 40, Ill.

## 50 BUSINESS SERVICE, INFORMATION, NAME LISTS

**GUARANTEED** mailing lists many classifications opportunity seekers, farmers, ministers, school teachers, many others. Price lists write Ken-West Distributors, 7-T South Harlem Street, Worcester 4, Mass.

**5000 LATEST** Buyers of \$3.00 Mailorder System, on labels, \$1.00 per 100. Make a test. Selbyco, Decatur 374, Illinois.

**SELL** New Mothers thru mail. 500 Names \$2.00. Other Texas Lists available. Box 371, Austin Texas.

**MAILING** Lists! Unlimited Coverage. Bulletins Free. Mailtrader, Box 643, Ann Arbor, Mich.

## 51 SPECIAL SERVICES

**CIRCULAR** saws, 10" or under, machine sharpened \$1.25 postpaid. Bartoli Sharpening, Cedar St., Westville Grove, N.J.

**ADDRESSING—Mailing** Service. Write or call collect. M. Favini, 80 Snow Street, Fitchburg, Massachusetts, Tel. 3-9012.

**MEXICO** remails 25c each. Tip o' Texas Traders, P.O. Box 831, Harlingen, Texas.

## 52 AUTHORS SERVICE

**NO** luck finding a book publisher? Write for Free Booklet PS. Vantage Press, 120 West 31st, New York.

**WANTED:** Book manuscripts—all subjects considered. Greenwich Book Pub. (Attn. Mr. Ibsen). 489 Fifth Ave., N.Y.C.

"TIPS For Beginning Writers." Free Booklet! Career Aids, Southampton, N. Y.

## 53 ADVERTISING, AGENCIES, ETC., FOR ADVERTISERS

**ADVERTISE:** 24 words, 100 Canadian Newspapers \$5.50. Lists Free. Advertising Bureau, 10511-P Springfield, Chicago 43.

**ADVERTISE—24** words, 20 big newspapers, \$30.00. Newspaper, magazine, rate-book 10c. Chicago Advertising Agency, Chicago 4.

**PRODUCTS** publicized free. Details 25c. Red Kerce, PS-642, Tallahassee, Fla.

**35 WORD** ad. 21,000 Bulletins, Printed Mailed \$2.80. Write. Direct Publishers, Conshohocken, Penna.

## 54 CARTOONING, SIGN PAINTING, CHALK TALKS

"**HOW** To Make Money With Simple Cartoons"—A book everyone who likes to draw should have. It is free; no obligation. Simply address Cartoonists' Exchange, Dept. 1911C, Pleasant Hill, Ohio.

**SHO'CARD** Sign Painting! Home Instruction.—Clarke, 2507-C Ari. Blvd., Arlington 1, Va.

**LEARN** sign painting, showcard lettering at home. Particulars free. Bolger, 148 Concord, River Edge, New Jersey.

**CARTOONIST:** Amateur, Professional. Prepare for animation with Max Fleischer's plan. Write Vera Coleman, 60 East 42nd Street, New York, N. Y.

**PROFITABLE** lettering is no trick, it's Know-How! Moneyback guarantee. Ken Hobbs, P.S. 10, Fitzgerald, Ga.

**PAINT** Signs with Master patterns. Set 1 1/4" to 12" high, with supplies, \$2.00, sample free. Eyerly, P-583, Newton, Iowa.

**PAINT** your own signs! Patterns, instructions, \$2.00. Signs, 1737 Sherman, Springfield, Missouri.

**YOU** can Entertain with Chalk Talks. Catalog 10c. Cartoonist Balda, Oshkosh, Wisconsin.

## 55 TYPEWRITERS & OFFICE MACHINES

**GOV'T** Surplus typewriters \$19 up. Picture list 5c. Meshna, 580S Lynn, Malden 48, Mass.

## 56 RUBBER STAMPS & OFFICE SUPPLIES

**3 LINES,** \$1.00. Fast Service, Catalogue, Johnson, 443 McDonough, Brooklyn 33, New York.

**3 LINES** \$1.00 cash. Price list. Carlton's, 3007 Wharton, Philadelphia 46, Penna.

**SELL** stamps yourself. Fast, complete, quality manufacturing service. Handy Stamps, Bellevue, Texas.

## 57 PRINTING MULTIGRAPHING, ETC.

**ATTRACTIVELY** boxed personal stationery. Name, address printed 150 sheets, 100 envelopes, 50 correspondence cards. All for \$2.95 postpaid. Charles Schuler, 319-A West 48th Street, New York 36, N.Y.

**BUSINESS** Printing. Illustrated Catalog Free. Howprint, 723-W Eunice, Webster Groves 19, Missouri.

**QUALITY** printing. Booklets, publications, catalogs, stationery. Free catalog. Adams Printers, 30 West Washington, Chicago 2, Illinois.

**OFFSET** printing, \$6.50-1000. 8 1/2"x11, 16 lb. National Letters, 1457 Broadway, New York 36.

**SENSIBLY** Priced Business Printing. Special! 250 8 1/2"x11" letterheads, bond, and 250 #10 heavyweight envelopes, \$5.95. Postpaid, guaranteed. Free samples, quotations. Sparks Co., Box 4096, Austin 51, Texas.

**HIGHEST** quality mimeographing free samples, price lists. Ken-West Distributors, 7-T South Harlem Street, Worcester 4, Mass.

**QUALITY** Mimeographing, printing. Free catalog. Currier, PSM, New Lebanon Center, N. Y.

**QUALITY** printing—reasonable. List—samples free. Allen, 216 W. Jackson, Chicago.

**\$1.00,** 100 ENVELOPES or letterheads, Postpaid. Poor Boy PS, Box 1055, Little Rock, Arkansas.

**JOB** Printing—Letterheads—Envelopes—Circulars. Printing, 21-S Barclay, Portsmouth, Virginia.



# POPULAR SCIENCE OPPORTUNITIES

1,000 ENGRAVED Business Cards \$3.50 Postpaid. Over 25 Type Styles. Samples sent Free. House of Farrell, P. O. Box 452, Buffalo 5, New York.

200 BUSINESS Cards \$1.00, Postpaid. Artcraft, 95-28 Roosevelt, Jackson Heights 72, New York.

FREE Catalog. Letterpress Printing. D & M Press, Sebastopol, California.

FINEST Artistic printing 500—8½x11 letterheads \$5. Catalog rushed. Steinbergen Press, GPO Box 291B, New York City.

PRINTING you'll be proud to use. Sensible prices. Samples free. Starks Printery, 2926(B) Jerome Street, Dallas 23, Texas.

PRINTING. Free estimates. Send copy. Berliner, 3581 Milwaukee, Chicago, Illinois.

## 58 PRINTING OUTFITS, SUPPLIES

DO your own printing. Save money. Simple rules. We supply everything. Print for others; good profit. Raised printing like engraving too. Have home shop. Details free. Kelsey Presses. V-8, Meriden, Conn.

PRESSES, Supplies, Paper. Catalog 10c. Custom, Box 211-S, Springfield, Missouri.

MAKE your own self-molding rubber stamps and printing cuts. Plexirubber, Argyle 2, Wisconsin.

PRINTING presses, type, supplies. Lists 3c. Turnbaugh Service, Mounted Route, Mechanicsburg, Pennsylvania.

## 59 PATENT ATTORNEYS

REGISTERED Patent Attorney offers services. Sanders, 6430 Evans, Chicago 37, Illinois.

INVENTION Record form free and "Patent Information Every Inventor Should Have". Carl Miller, Registered Patent Attorney, Woolworth Building, New York.

INVENTORS—Send today for instructive booklet "Patent Protection for Inventors" giving detailed patent information and outlining preliminary steps to take toward patent protection,—also "Evidence of Invention" form. Victor J. Evans & Co., 141-M Merlin Building, Washington 6, D. C.

INVENTORS: Without obligation, write for information explaining the steps you should take to secure a Patent. John Randolph, Registered Patent Attorney, 207 Columbian Bldg., Washington 1, D. C.

C. A. Snow & Co.—S-427, Snow Building, Washington 1, D. C. Registered Patent Attorneys. Write for information.

INVENTORS: Learn how to protect your invention. Unless the inventor is familiar with patent matters, he should engage a competent registered patent attorney or agent to represent him. We are registered to practice before the U. S. Patent Office and prepared to serve you in handling your patent matters. "Patent Guide for the Inventor" containing detailed information concerning patent protection and procedure with "Record of Invention" form will be forwarded to you upon request—without obligation. Clarence A. O'Brien & Harvey Jacobson, Registered Patent Attorneys, 52B-K District National Building, Washington, D. C.

INVENTORS—If you believe you have an invention you should find out how to protect it. The firm of McMorrow, Berman & Davidson with offices in Washington, D. C., is qualified to take the necessary steps for you. Send for copy of our Patent Booklet "How to Protect Your Invention." We will also send you an "Invention Record" form. No obligation. They are yours for the asking. McMorrow, Berman & Davidson, Registered Patent Attorneys, 143-E Victor Building, Washington 1, D. C.

WRITE for free invention record forms. No obligation. Frank J. Renaud, Registered Patent Attorney, 1311 G Street Northwest, Washington 5, D. C.

"INVENTOR'S Guide" and "Record of Invention" free on request. Frank B. Ledermann, 154 Nassau Street, New York City.

INVENTORS: When you are satisfied that you have invented something of value write me, without obligation, for information as to what steps you should take to secure a Patent. Write Patrick D. Beavers, Registered Patent Atty., 938 Columbian Bldg., Washington 1, D. C.

PATENTS—Irving L. McCathran, 316 McLachlen Bldg., Washington 1, D. C. Registered Patent Attorney.

## 60 FOR INVENTORS

INVENTORS, if you have an invention for sale, patented or unpatented, write Institute of American Inventors, Dept. 30A, 631-E St., N.W., Washington 4, D. C.

INVENTORS: Without obligation, write for information explaining the steps you should take to secure a Patent on your invention. John Randolph, Registered Patent Attorney, 206 Columbian Bldg., Washington 1, D. C.

INVENTION Record form free and "Patent Information Every Inventor Should Have." Carl Miller, Registered Patent Attorney, Woolworth Building, New York.

INVENTORS—Send for free patent information book and inventor's record. Registered Patent Attorney, Associate Examiner, Patent Office 1922-1929; Patent Attorney & Advisor, Navy Department 1930-1947, Gustave Miller, 115PSI Warner Building, Washington 4, D. C.

INVENTORS—This firm is registered to practice before the United States Patent Office and available to assist you in the preparation and prosecution of your patent application. "Patent Protection for Inventors" booklet containing detailed information and steps to take toward patent protection sent promptly upon request. No obligation. Victor J. Evans & Co., 142-M Merlin Building, Washington 6, D. C.

INVENTIONS Promoted. Patented or unpatented. A-1 service for inventors since 1911. Write Adam Fisher Co., 5418 Idaho, St. Louis, Mo.

INVENTORS: Learn how to protect your invention. Unless the inventor is familiar with patent matters, he should engage a competent registered patent attorney or agent to represent him. We are registered to practice before the U. S. Patent Office and prepared to serve you in handling your patent matters. "Patent Guide for the Inventor" containing detailed information concerning patent protection and procedure with "Record of Invention" form will be forwarded to you upon request—without obligation. Clarence A. O'Brien & Harvey Jacobson, Registered Patent Attorneys, 52A-K District National Building, Washington, D. C.

"INVENTOR'S Guide" and "Record of Invention" free on request. Frank B. Ledermann, 154 Nassau Street, New York 38, New York.

PROMOTION at its very best at Superior, 338-342 North Rodeo, Beverly Hills, California.

SEARCHES—Put your patent searches in the hands of a Registered Patent Attorney or Agent as he qualifies to give a worthwhile patentability report. Record of invention form upon request and information on patent protection. Patrick D. Beavers, Registered Patent Attorney, 939 Columbian Bldg., Washington 1, D. C.

INVENTORS: Profit from copyrighted "One Inventor's Experience" or money back. Send \$1. R. E. McLean, 5703-B South Benton, Kansas City 30, Missouri.

SUCCESSFUL inventors use our fast action plan to protect, market, test, search, patent, and sell their inventions. No investment until proven salable. Free details. Dynavolt Company, 3310 Huntington, Newport News, Virginia.

PATENT Searches, including copies of nearest patents, \$5.00. Reports airmailed within 48 hours. More than 100 registered patent attorneys use my service. For Free invention protection forms, write Miss Ann Hastings, P.O. Box 176, Washington 4, D. C.

FREE Patent Booklet and Record of Invention on request. H. Lawrence Blasius, 15 Park Row, New York City.

PATENT Searches \$5.00. 48-hour service. Free Invention Protection forms. Write Raymond L. Smith, Patent Searcher, 622 Sheraton Building, Washington 5, D. C.

PATENT Searches \$5.00. 48-hour airmail service. Invention Protection forms free. Write Patent Engineering Service, 711 14th Street, N.W., Washington 5, D. C.

## 61 INVENTIONS WANTED

INVENTIONS wanted. Patented; unpatented. Tremendous Manufacturers lists. Global Marketing Service, 2420 77th, Oakland 5, Calif.

INVENTORS: Hundreds of manufacturers have requested our assistance in locating marketable new products. Complete information free. Institute of American Inventors, Dept. 30C, 631-E Street, N.W., Washington 4, D. C.

INVENTORS: If your invention is adaptable to promoting we will contract on cash or royalty. If not, we will attempt selling it for you. Special booklet free. Kessler Corporation, 711, Fremont, Ohio.

INVENTORS Don't sell your invention Patented or Unpatented until you receive our offer, write Cowgill, Box 298, Marion, O.

INVENTIONS Wanted. Patented or Patent Pending. 24 years experience Promoting Inventions. National Service Bureau, 3122 Meramec, St. Louis 18, Mo.

ATTENTION Inventors. Sell your invention through the pages of: Gadgets, Patents & Invention News. Write Inventors' Service Bureau, 847 F Roscoe, Chicago 13, Illinois.

INVENTIONS wanted. Patented; unpatented. Outstanding manufacturer lists. Full particulars free. Superior, 338-342 North Rodeo, Beverly Hills, Calif.

INVENTORS—see us first! United Inventors and Scientists of America (Non-Profit Corporation), 2712½ W. 7th St., Los Angeles, California.

CASH Buyers for ideas and inventions. Write National Inventors Institute, 457 Munsey Building, Washington 4, D. C., or 4097 East 131st St., Cleveland 5, Ohio.

INVENTIONS wanted. Patented; Unpatented. Free Booklet. Its Worth Getting Our Offer. Wulco Patent Association Ltd., D-106 550 Fifth Avenue, New York 36, N. Y.

AMERICA's Largest housewares, Children and novelty Manufacturer wishes to purchase for outright sale or royalty basis, patented or unpatented items in these fields. E.Z. Por Manufacturing Co., 4514 N. Broadway, Chicago 40, Ill.

PROMOTION, Financing, searching, patenting. Complete inventors service since 1930 brings results. Free invention analysis. Inventors Project Engineers, 188 West Randolph, Chicago 1.

INVENTIONS wanted now by my Manufacturer-Clients. Patented, Unpatented. Send for Free Form "R". Adams, Patent Broker, 80 Wall Street, New York City.

## 62 PATENTS FOR SALE

PATENT 2,708,286 Adjustable Magic Gate Hinge. Makes gate self-closing. Raises free end as gate opens in either direction. Tollak Tolleison, Bonilla, South Dakota.

PAT. 2,698,210 gasoline engine oil anti-sludging device. Royalties.



# POPULAR SCIENCE OPPORTUNITIES

PENDING patent for sale. Cigarette Filter royalties. William Butler, Em. 2-2686, 547 Lowell Street, Pittsburgh 6, Pa.

## 63 MANUFACTURING

DESIGNING, Manufacturing, Machinery, Parts, Models. Henry, Engineer, 2136 East Monmouth, Philadelphia 34, Pa.

MANUFACTURERS, Businessmen: Complete understandable instructions "How to Choose, Manufacture, Sell Products Right-away, Manage, Finance Enterprises Successfully." Sent on approval! Confidential guidance. Free Booklet. Jarry Associates, Box 268-CS, New York 5.

## 64 MODELS, MODEL SUPPLIES

SHIP and yacht model fittings; blueprints. Send 35c for illustrated catalog #29 listing hundreds of items. A. J. Fisher, 1002-2 Etowah Ave., Royal Oak, Michigan.

SHIP and other scale models. Most complete line in New England. Kits, fittings, plans, books, tools, engines, motors. Illustrated catalog 25c. James Bliss & Co., Inc., Dept. PS, 342 Atlantic Ave., Boston 10, Mass.

1955 CAR Models, 1/25 scale, all metal chrome trim. Send for catalog! Cars & Hobbies, Dept. PS-14, 2333 Haddon, Chicago.

SHIP Models and yacht supplies. Complete. Large 68 page catalogue 50c. William Wild, 510 East 11 St., New York City 9.

MODEL Railroads, HO and O, over 850 cast metal items illustrated, catalog only 10c. Selley, 744 Clay, Winter Park 6, Florida.

GEARS and model supplies for the inventor. Send 10c for catalog. Pierce Model Works, Tinley Park, Ill.

POWER Models. Unusual steam, gasoline and traction engines, fittings, metals. Anniversary catalog 50c. Charles Cole, Ventura, California.

LIVE Steam castings and supplies. Catalog 25c. Yankee Shop, Box 275, Danvers, Massachusetts.

MODEL Steam Plant (English) ready for assembly; Engine \$16.00, Boiler \$18.00, accessories. Literature: Floyd McGuckin, 314 Monroe, Ridgewood, New Jersey.

WORKING Steam Models, Tractors, Locomotives, Stationary, Engines, Boilers, Fittings, Materials, Castings, Prints. 1956 Catalog-Manual \$1.00. Tiny Power, Corvallis, Oregon.

"ST" Steam engine castings, fittings, boat plans catalog 15c. Ship Models Ltd., 186 Summer, Andover, Mass.

STEAM engines, boilers, castings. Catalog 25c. Anton Bohaboy, 2297 Price, Rahway, N. J.

## 65 HOME CRAFTSMAN

ALL Crafts, Supplies. Large Free Catalog. National Handicraft, 199 William St., New York 38.

PLASTICS home-craft course for Men and Women. Tells and shows how to make hundreds of fast selling plastics products. All plastics and material for 23 projects included in course. No special tools needed. Course pays for itself. Write for Free booklet. Interstate Training Service, Dept. D-2-M, Portland 13, Oregon.

LEATHERCRAFT. Send 10c for new 60-page catalog of tools, supplies, kits. Including metalcrafts, enameling, ceramics, all other crafts. Complete stock. Reasonable. Since 1910. Sax Bros., Dept. PS-11, 1111 N. 3rd, Milwaukee, Wis.

BUY wholesale nationally advertised power, hand tools, thousands other products at big discounts. Free "Wholesale Plan." American Buyers', Hertel Station, Buffalo 16-R, New York.

MAGIC "Velcoat" sprays fur or velvet finish on any article. Multiplies value. Refinishes shoes, bags, toys, pictures, like new. 6-Color kit \$4.95. Single color \$1.00. Literature free. Velcoat, Box 5172-PC, Tulsa 16, Okla.

FREE "Do-It-Yourself" Leathercraft Catalog. Tandy Leather Company, Box 791-011, Fort Worth, Texas.

LEATHERCRAFT, metal enameling, beadcraft, shellcraft, metal tooling, textile painting, many other crafts. Free big illustrated catalog. Kit Kraft, Dept. 3211, Studio City 1, California.

GENUINE Glo-Candle wax for candle making. Interesting. Profitable. Write for price list. Valuable instructive book 10c. Mar-Ro, Box 675-PS, McPherson, Kansas.

FREE! Large Complete Leathercraft Catalog. J.C. Larson Co., 820 S. Tripp, Dept. 5652, Chicago 24.

WOODWORKING for home craftsmen. Twenty-two manuals. Over 1,000 pages, 75 training projects. Only complete home training program available. Carefully written, profusely illustrated. Covers everything in cabinet making from wood selection to final finishing. Complete instruction in care and use of all hand and power tools. Prepared by manual training instructors. Write for free booklet. Interstate Training Service, Dept. G-2-M, Portland 13, Oregon.

JOLLY Life Size Santa in three Dimensional effect. 5'-3" high. Easy to make. No tracing required. Just mount and Paint. Only \$1.00. Mastercraft 1111S, 7041 Olcott, Chicago 31, Illinois.

"Practical—Violin—Making" With Patterns—\$1.00 Supplies. Chelsea Fraser, 2025 Stark, Saginaw, Mich.

FULL size plans and directions. Maple Leaf wall plaques. 50c—ideal gift item. F & S Speciality Co., Box 275, Philadelphia 5, Penna.

VIOLINMAKERS. Amateurs, Professionals. Fine tone European Wood. Complete materials, tools, instructions, patterns. Illustrated Catalogue 10c. Premier Violin Supplies, Division SVP, 430 South Broadway, Los Angeles 13, California.

SQUAREKNOTTERS: Make belts, handbags, lanyards, dog leashes, etc. Special offer! Beginner's book, catalog and quality cord samples 15c. P. C. Herwig Co., Dept. 71-P7, 39 Henry St., Brooklyn 1, New York.

FURNITURE. Build your own with our legs. Frames and parts. Free catalog. Phillips Furniture Company, East Peoria 6, Illinois.

JIGSAW, bandsaw owners, extra profits. Fun. Free details, Dept. B, Nu-Art, Box 2235, Boston.

KNOCKDOWN cedar chest and lumber free price list. Bedford Lumber Company, Shelbyville, Tennessee.

LAMP size Cypress Knee, with nipple installed \$2.00. Cy Products, Dept. 3-M, Lafayette, Louisiana.

SEWING Machines. Portable, Console, or head only. Build cabinet yourself. Ideal Christmas gift. Importers' low prices. Kochan, 4002 E. 54th Street, Cleveland 5, Ohio.

STYLECRAFT sure fire hits. "Pretraced" leather kits. Handbags, Billfolds, Filigree Belts, over fifty other projects. Patterns on leather. Why trace? Just carve, assemble and lace. Large assortment "Pre-carved" kits also available. Send 25c for catalog, free folder. Refunded first order. Apache Leather Company, 2804 E. Washington St., Phoenix, Arizona.

LEATHERCRAFT Supplies, Illustrated catalog 10c. Arts Leather, 411 Joseph Avenue, Rochester 5, New York.

BAROMETER Movements. Make own case. Free information. Abtek, 1075 Third Avenue, New York 21.

SENSATIONAL. Rope making machine, manilla, cotton, hair, nylon silk, rope sample, illustrated literature, \$1.00. 9133 East Whitmore, Rosmead, Calif.

## 66 BUILD IT YOURSELF

GEIGER Counter and Metal Detector Kits. Inexpensive. Educational. Free Literature. Electronic Applications, 5024 Lee Hwy., Arlington 7, Va.

FURNITURE . . . Wrought iron legs and frames! You assemble . . . Free catalogue. Phillips Furniture, East Peoria 6, Illinois.

COMEDY patterns for children's rooms. \$1.00. Bronze Portraits, 309 Lowden Street, Pawtucket, R. I.

FREE Catalog metalworking projects. Picnic table, swing-glider set. Utility carts. Tru-Part Mfg. Corp., 196 East 9th, St. Paul, Minnesota.

BUILD inexpensive Concrete blockmaker. Motor-Hand. Make 500 blocks daily. Write. Clyde Lee, Mountain View-1, Oklahoma.

KIDS: 7-70, build bird houses. Complete kits, even the nails. Send \$1.00. Kid Kraft Kits, 427 State Bank, LaCrosse, Wisconsin.

GRANDFATHER clock shoptested plan, dollar—thousands built. Kuempel Klox, Minneapolis 16.

WROUGHT Iron Legs, 3/8" Rod, Sets of Four, 6" \$4.00, 12" and 16" \$5.00, 22" and 28" \$6.00. Postpaid. Guaranteed. Waken Supply, Box 32, Orangeburg, N. Y.

## 67 OLD GOLD, JEWELRY, WATCHES, ETC.

COSTUME Jewelry supplies. Catalog and Samples. 35c. Largest line in America. Milady-Fair Co., G.P.O. Box 1328, New York City 1.

HIGHEST Cash For Old Gold, Broken Jewelry, Gold Teeth, Watches, Diamonds, Silverware, Spectacles, Platinum. Free information. Rose Refiners, Heyworth Bldg., Chicago 2.

MAKE your own costume jewelry and save money. It's easy. Free sample earrings. Over 5,000 styles in new catalog, 25c. Barry's, 204 Ardsley Court, Newark 2, New Jersey.

RHINESTONES, Jewelry Settings, Copper Enameling. Sample Earring Kit and Catalog 25c. J & M Novelties, Dept. CM-3, Griffith, Indiana.

MAKE Gemstone jewelry for profit. Free catalog. Sierra Gems, 16230 Orchard Ave., Gardena, Calif.

BANKRUPT auction goods; Klondike Novelty jewelry findings assorted, beads, Pearls, Jewels, 5 lb. lots \$7.50; Sample \$2.00 lb. Merchandise, 19-B East 16th St., New York City 3.

USED and new watches. \$2 up. Free List. Southern Watches, Gray, Georgia.

10 SWISS watches \$18.00, catalog 10c. Berkowitz, 1150 Castlehill, New York 62.

TOP cash by return mail for your gold, silver, platinum in any form. Satisfaction guaranteed. Information free. Noble Metals Company, Box 1113, Santa Monica, California.

WHOLESALE Watch catalog. Write Clear-Vue, 1237 Knott Building, Dayton, Ohio.

EARRINGS, genuine amethyst baroques \$2.25. Free price list on bracelet and necklace kits. Reed's, 4930 Palo Alto Avenue, SE, Albuquerque, New Mexico.

## 68 TOBACCO & PIPES

PIPE Smokers! Cigar Smokers! Free illustrated catalog offers fabulous savings on choice imported and domestic pipes, cigars, tobaccos, supplies. Write Wally Frank, Dept. 26, 150 Nassau Street, New York 38, N. Y.

CUSTOM pipes, pipe making. Supplies. Tools. Instructions. Walter Miller, Germantown, Ohio.

## 69 FOR THE HOME

UNUSUAL Hand carved wooden novelties. Italian imports. Music, lights. Gaines, 5105 Mulford-PS, Skokie, Illinois.

AFRAID of Fire? Protect your Family from fire with automatic home Plug-Alarm. Just plugs in any AC outlet. No wires or batteries. Sounds loudly in case of fire. Uses no electricity except when alarm sounds. Size 2 3/4"x3". Dielectric plastic case. Money back guarantee. \$6.95 prepaid. No C.O.D.'s. Send for free literature. Karday Associates, Dept. S, 220 Fifth Avenue, New York, N. Y.



# POPULAR SCIENCE OPPORTUNITIES

**FOAM rubber furniture cushions**—Factory seconds 50% discount. Free catalog. Perma-Foam, 429a Central Ave., East Orange, New Jersey.

**DAILY weather**—forecast. Precise. Cash-order \$1.00. Box 8107, Philadelphia 1, Penna.

**HEAT your home or business** for almost nothing. Thousands satisfied. Valuable free information. Henault, R.F.D. #1, White River Junction, Vermont.

## 70 OF INTEREST TO WOMEN

**MAKE money** addressing envelopes sparetime. Glenway, 5713 Euclid, Cleveland 3, Ohio.

**WANT To Make Big Money At Home?** \$5 profit in an hour possible with Invisible Reweaving. Make tears, holes disappear from clothing, fabrics. Steady year-round demand from cleaners, laundries, homes. Details Free. Fabricon, 8336-S Prairie, Chicago 19, Illinois.

**FREE**—Big New Wholesale Catalog! Up to 50% saving for you, family, friends on nationally-known gifts, jewelry, toys, appliances, Christmas cards, etc. Also make money selling part time! Write: Evergreen Studios, Box 846-G, Chicago 42, Illinois.

**GOOD Money in Weaving.** Weave rugs at home for neighbors on \$69.50 Union Loom. Thousands doing it. Booklet free. Union Looms, 154 Post St., Boonville, N.Y.

**SEW?** Home-workers needed, spare time. No charge for materials. Write Adco, 561, Bastrop, Louisiana.

**EARN sparetime money** doing mailing work at home. Kentco, Patterson Block, Muncie 7, Indiana.

**DRESSES 24c; Shoes 39c; Men's suits, \$4.95; Trousers \$1.20.** Better used clothing, free catalog. Transworld, 164T Christopher, Brooklyn 12, N. Y.

**FREE! 50-Piece tableware set.** For details, write: Orlando Nafziger, 3566-A Dimond Ave., Oakland 2, Calif.

**SEW Ready Cut Products for Fun and Pleasure.** Earn \$50. Easy. Eschin, Box 4227, San Francisco, California.

**GROW Mushrooms.** Cellar, shed, and outdoors. Spare, full time, year round. We pay \$3.50 lb. We paid Babbitt \$4,165.00 in few weeks. Free Book. Washington Mushroom Ind., Dept. 181, 2954 Admiral Way, Seattle, Washington.

**MAGNIFICENT stainless steel tableware.** Factory prices, introductory offer, catalog, 10c. Factory Representative, 5125 Annette, Baton Rouge 5, La.

**UNUSUAL opportunity** to buy nationally advertised products wholesale! Large illustrated catalog. Write, Ila Rose, Bascom 6, Ohio.

## 71 FOR SALE MISCELLANEOUS

**DIAMONDS.** Not chips not Zircons but genuine diamonds. Guaranteed. Price \$5.00 each. Write Gamco, 114 Thaw Place, Sistersville, West Virginia.

## 72 WANTED TO BUY

**SCRAP Mercury (Quicksilver)** containers supplied. Tantalum—Bismuth—Tungsten. Metallurgical Products Co.—Established 1909, 35th & Moore Streets, Philadelphia 45, Pa.

**QUICKSILVER.** Sterling, Silver Solders, precious metals. Mercury Terminal, Norwood, Massachusetts.

## 73 WEARING APPAREL

**BUY clothing and jewelry** at wholesale prices. Send for catalog. Merchandise, Dept. S, Bronx 59, New York.

**MENS stretch Nylon socks.** 6 pairs asstd. colors, postpaid, \$2.50. Satisfaction guaranteed. Christmas coming. Nylons, Chehalls, Washington.

## 74 RAZOR BLADES, SHAVERS

**BLADES**—100 for \$1.00. Microsharpened. Guaranteed smooth shaves. Double-edge. Practical gift. Bardin, Box 821, Chicago 90, Ill.

125 "DON Juan" double edge blades \$1.00, Thousand \$6.00. Guaranteed. Johnson's, 605 Wells, St. Paul 1, Minn.

## 75 TATTOOING SUPPLIES

**TATTOOING** Outfits, licensed course. Brochures 25c. Zeis, 728 Leslie, Rockford, Illinois.

## 77 GEIGER COUNTERS & TREASURE FINDERS

**GOLD, Silver, Metal Detectors, Geiger Counters for Uranium, Mineralights.** Sensational new fully guaranteed models. None Finer. Information Free. Detectron Corp., 5528 Vineland Ave., North Hollywood, California.

**SELECTIVE metal and mineral detector.** Revolutionary design. Distinguishes metals from black magnetic sands. Readily detects metals under salt water. Also Geiger Counters. Free literature. Gardiner Electronics Company, 2545 E. Indian School Rd., Phoenix, Arizona.

**AMAZING triple-action Geiger Counter U-238C,** combines audio, neon flasher, meter. Guaranteed best available. Also metal detectors and Scintillation counters from \$49.50. For radioactive uranium sample send 25c to Goldak Company, 1540 W. Glenoaks Blvd., Glendale, California.

**GEIGER Counters, Metal Detectors, Ultra-Violet Mineralights**—from \$29.50 up. Write for Free catalogs. The Radiac Co., Inc., 489 Fifth Ave., Dept. 11-PS, New York 17, N. Y.

**GEOLOGY, Lapidary Books.** Free list. Gazette Publisher, Airport Station, Los Angeles 45.

**URANIUM, Gold, silver treasure.** New, power-packed, highly sensitive Metal Detectors, Geiger Counters and Mineralights, Kit and Assembled Models from \$12.50. Lightest weight, guaranteed, free literature. Electronic Applications, 5024 Lee Highway, Arlington 7, Va.

**GOLD And silver indicators.** Price \$30. Box 51, Plant City, Florida.

**ROCKET Mk 11 Nucloton.** 6 times as sensitive as a Geiger counter. Only \$37.50 Complete. Uses 2 supersensitive 1B85 tubes. Weighs less than 3 lbs. Plug-in probe available. 10 day trial period. 1 year guarantee. Write today for free catalogue. Webster Electric Mfg. Co., Dept. A, 3834 Clarke Street, Oakland 9, Calif.

**LEARN Mineralogy at home.** Diploma course. Fortunes now being made in Uranium and other minerals. Free catalog. Mineral Science Institute, Desk 3, 159 East Ontario, Chicago 11.

**URANIUM Finding made easy!** Completely transistorized Geiger Counters. Extra sensitive. Lightweight. Scientifically engineered. Unconditionally guaranteed. Also complete line prospecting instruments from \$19.95. Write for free information, maps, techniques. Universal Atomic Corp., Dept. PS11, 19 East 48th Street, New York City.

**GEIGER Counter**—Powered single flashlight battery! \$22.50. Carson, 316 Lee, Iowa City, Iowa.

**"HOW To Make Money Prospecting for Uranium."** Free booklet. Send 10c for handling, postage. Geiger Co., 195-PS11a Sackett Street, Brooklyn 31, N. Y.

## 78 WATCH REPAIRING

**WATCHMAKERS'**—Jewelers' Supplies, Instructions. Catalog 20c. Bengal Company, Culver City, California.

**WATCH and clock repairing books.** Free information. North American, Dept. 25-K, 2320 N. Milwaukee, Chicago 47, Illinois.

**WATCHMAKERS' Journal** contains instructive articles on watch repairing. \$1. year. Sample copy 20c. Dean Company, Box 3218-A, Daytona Beach, Fla.

**USED and new watches.** \$2 up. Free List. Southern Watches, Gray, Georgia.

## 79 MISCELLANEOUS

**BIG interesting mails** three months 25c. year \$1.00. Harvey Teeple, Decatur, Ind.

**BUY Wholesale** thousands nationally advertised products at big discount. Free "Wholesale Plan." American Buyers', Hertel Station, Buffalo 16-V, New York.

**WAR Surplus Bargains!** New government releases arrive constantly. Save Up To 80%. Blankets, boots, coats, tents, wearing apparel. Send for Free War Surplus Catalog. Sioux Falls Surplus Store, Sioux Falls, South Dakota.

**FORESTRY,** game warden, park, fish hatchery, patrol and wildlife conservation jobs pay well. Prepare now. Write Delmar Institute N6, Whittier, Calif.

**DOUBLE your income!** It's easy! Just send for two Free booklets (60c value) . . . "Treasure Hunting For Fun and Profit" and "How to Be a Successful Uranium Prospector." Others have made fortunes. Here's your chance. Time Payment Plan available. Send for Free booklets today! Fisher Research Laboratory, Inc., Dept. 6, 1961 University Avenue, Palo Alto, Calif.

**WOULD you like a painting done** especially for you? \$27.50 for 16x20. Money back guarantee. Richcreek, 745 Alamanda Way So., St. Petersburg, Florida.

**WHOLESALE Catalog!** 30-80% Discounts! Appliances, Musical Instruments, Typewriters, Phonographs, Watches, Jewelry, Recorders, Housewares, etc. Consolidated Distributors, 21-18 Lafayette, Paterson 15, New Jersey.

**THOUSANDS Nationally Advertised Brand Name products**—discounts to 80%. Meder, 550-PS Fifth Avenue, New York 36.

**ARTIFICIAL Human Eyes**—Assortment mailed you from world's largest, finest selection imported glass and all-plastic unbreakable eyes. Write for free booklet and color chart. Established 1906. Denver Optic Company, 1014 University Bldg., Denver 2, Colo.

**URANIUM Prospectors Club** now accepting applications for membership. Grubstaking, Leasing, Anomaly Reports. Trial membership \$3.00. UPC, 5 Beekman St., New York 38, N. Y.

**RECEIVE mails, magazines, samples.** Your name in numerous mailing lists 25c. Greenwood, Box 1116-X, New York City 8.

**WHAT'S your hobby?** Be it cars, reducing, stamps! Specify with 25c for joker's novelty. Stommel, Box 104, Detroit 31, Michigan.

**GROW Mushrooms.** Cellar, shed, and outdoors. Spare, full time, year round. We pay \$3.50 lb. We paid Babbitt \$4,165.00 in few weeks. Free Book. Washington Mushroom Ind., Dept. 182, 2954 Admiral Way, Seattle, Washington.

**CATALOG of the most efficient cesspool and drain cleaning equipment.** Mail 50c to learn how to fix that faulty cesspool, clogged waste pipe or drain. Free advice on how to do-it-yourself. Send details of your particular problem. Electric Sewer Cleaning Company, Boston 34, Massachusetts.

**300 BIG Mails guaranteed.** Samples, offers, plans, propositions, 12 months listings, \$1.00 (refundable). Wright Publications, 2276 Hubbard, Memphis 8, Tenn.

**RECEIVE Magazines, samples, catalogs.** Mails from everywhere. Offers, hundreds. Get listed 25c. Rorick, Box 86-M, Cincinnati 26, Ohio.

**FLORIDA classifieds airmailed \$1.00.** Nye, 2201 N.W. 22nd St., Fort Lauderdale, Florida.

**FREE offer**—1955 Edition describing over 10,000 different samples, pamphlets, films, books, stamps, posters, comic books, etc. offered by Government and Industry. Worth thousands to home craftsmen, housewives, expectant parents, teachers, students, hobbyists, etc. Send \$1.00 or request information. Free Offers, Box 102, Brooklyn 19, N. Y.

**SURPRISE Pack 25c.** Columbia Mailers, Dept. Box 644, Springdale, Connecticut.

**SCIENCE removes, prevents, rust, corrosion, tarnish; formulas, instructions** 50c. Wallingford, 1260 South Third, Champaign, Illinois.



# POPULAR SCIENCE OPPORTUNITIES

**LADDERSHOE**—stand at ease on ladder rounds. Money back guarantee. \$1.95 pair cash. J.I.B. Company, RD 1, Locke, New York.

**SURPRISE** your wife, family, friends and yourself with gifts from Japan on Christmas, birthdays, happy occasions. Lots of fun. Pearl necklace \$7.00, ring \$3.00, colored porcelain necklace \$4.00, ear-ring \$2.00, toys \$1.00 each, other novelties as requested, postage included. We also, solicit exchange of goods between Americans and Japanese. Fee—\$1.00. Send Government or American Express Money Orders. Clarence Yamagata, Room 202, Naka 7 Building, Marunouchi, Tokyo, Japan. Will confirm each order.

**CIGARETTES** — Roll Mild, Tasty. Guaranteed, 10c pack. Facts free. Pete Moberly, Box 791, Owensboro, Kentucky.

**COMPLETE Creeper Kit**, \$4.50 plus postage, one dollar with order balance on delivery, Hickory Frame, Swirl Type Casters. P.M. Childers & Co., Lake City, Florida.

**LIFETIME 3" ring magnet**, weighs 1/2 lb. \$1.00 postpaid. Colonial Specialties, P.O. Box 241 Uptown, Kingston, N. Y.

## 80 PERSONAL

**"HOW Can I Find Out?"** You Can! Information confidentially developed. Any matter, person, problem. World-wide. Officially licensed. Established 1922. William Herman, 170 Broadway, New York.

**PROFIT! Prestige!** Publish a magazine under your own name! Only \$3.25 per month! Sample, details 5c! Filmer, 910 Marion, Pharr 17, Texas.

**CHRIST'S return past!** Free literature. Truth, 21 Lexington, Phoenix, Arizona.

**PSORIASIS Victims: Hopeless? New Discovery!** Free Trial Offer. Write Pixacol, Box 3583-S, Cleveland, Ohio.

**LATEST Methods** treating piles, fistula, colon-stomach disorders. Write for free book. McCleary Clinic and Hospital, E-144, Excelsior Springs, Mo.

**REMAILS From Beautiful Florida** 25c. \$3.00 Monthly. H. Duca, 1260 120th St., Yukon (Jacksonville), Florida.

**"RULE Others With Thoughts."** Full course. (Sensational exercises.) \$2. Delmar Wisdom, 846 Sunnyside, Chicago 40.

**DETECTIVE'S Opportunities.** Detective particulars free. Write. Wagoner, P-125 West 86th. New York 24.

**BORROWING** By mail. Loans \$50 to \$600 to employed men and women. Easy, quick. Completely confidential. No endorsers. Repay in convenient monthly payments. Details free in plain envelope. Give occupation. State Finance Co., 323 Securities Bldg., Dept. M-227, Omaha 2, Nebr.

**ECZEMA Rash? Discouraged? Moz-E** brings results! Trial offer. Write to: Moz-E, 1644-A Compton, Cleveland 18, Ohio.

**BORROW** By Mail From Postal Finance Co. Employed Men and Women can easily obtain \$50 to \$600 Fast, Entirely By Mail. Repay in small monthly payments. Friends, relatives, employer, tradespeople will not know you are applying for loan. Advise occupation, amount wanted. Postal Finance Company, 200 Keeline Bldg., Dept. 13X, Omaha, Nebraska.

**WHAT Is Your "I.Q.?"** Take reliable intelligence test. Approved, scientific. Confidential report by mail. Free information. University Test Bureau, Desk A-3, Box 401, Palo Alto, California.

**REMAILING**—25c. Pocket Rubber Stamp \$1.00. Royal Views, Box 3201-PS, Denver 18, Colo.

**JOIN Dancer's** corresponding club! 25c. Book develops rhythm, coordination; teaches all dances, \$1.00. Castle, 158 Smith, Brooklyn.

**LOWEST** wholesale prices are yours. Catalog directory \$.50. Johnson's, 3262-V Medina, Ft. Worth.

**ARTHRITIS** relief from soy beans. Not a drug or medicine. Nueblings-S, Sickler-ville, New Jersey.

**LETTERS** Remailed 25c. Eloise Enterprise, Box 1297, Miami 8, Florida.

**TELEVISION** Program reminder. Quick glance tells time, channel of your favorite programs. Good for season. Mail 25c. Tee-Vee-Tyme, 5208 Longton, Dept. 1, Cleveland 24, Ohio.

**REMAIL** service from "Deep in the Heart of Texas". 25c Each. Also fabulous Houston classified ads \$1.00 Airmailed. Remail, Box 371, Austin, Texas.

**\$3.00 BIBLE** Study Text—Lessons \$1.00, refundable. Hinkles, Dayton, Virginia.

**MEXICAN** Law, General Practice Attorney, Apartado 79, Juarez, Chih, Mexico.

**SATISFY** Your desires. Enjoy unexpected power. Discover hidden personality! "Chart-Yourself" — \$1.00 (refundable): Dorservice, Ojai, California.

**DON'T** fear Hell. Valuable information \$1.00. Hanlan, 1322 W. Speedway, Tucson, Arizona.

**POPULARITY** overnight. Read character at sight as artists do models. Exciting secrets revealed. Rush \$1.00. Pricketts Hy-life Studios, Bar Harbor, Maine.



## LEFAX TECHNICAL DATA BOOKS

POCKET SIZE • LOOSE LEAF

Printed on loose leaf, 6 hole, 6 3/4" x 3 3/4" bond paper, each book contains about 140 pages of technical data, condensed, accurate, essential, for student, engineer, technical worker, business man. **\$1.25** each

- |                    |                  |                        |                               |
|--------------------|------------------|------------------------|-------------------------------|
| Architecture       | Surveying        | Mech'l Drawing         | Metallurgy                    |
| Home Heating       | Surveying Tables | Machine Design         | Hydraulics                    |
| Illumination       | Highway Eng'g.   | Machinist's Data       | Radio                         |
| Electrician's Data | General Math     | Mech. of Materials     | Television & FM               |
| Builder's Data     | Math Tables      | Pwr. Trans. Mach.      | Electricity, AC               |
| Lumber Data        | Physics          | Thermo. Tbls. & Charts | Electricity, DC               |
| Air Conditioning   | Trig-Log Tables  | Phys. & Thermo. Data   | AC Motors & Gen'trs.          |
| Building Constr.   | Gen'l Chemistry  | Metals                 | Transformers, Relays & Meters |
| Reinf. Concrete    | Chemical Tables  |                        |                               |
| Piping Data        | Analytic Chem.   |                        |                               |

Write for FREE catalogs (2000 listings). See how helpful LEFAX can be to you. Send \$1.25 book, or \$6 for any five books to

**LEFAX PUBLISHERS, Dept. PS-7, PHILADELPHIA 7, PA.**

Protect your home against power interruptions with an...

## ONAN Emergency ELECTRIC PLANT

Provides dependable standby electricity for heating system, pumps, freezer, lights, appliances. Keeps home safe, livable. Automatic start and stop. Find out how little it costs!

Write for Folder!

**D. W. ONAN & SONS, INC.**  
3339 University Ave. S. E., Minneapolis 14, Minnesota

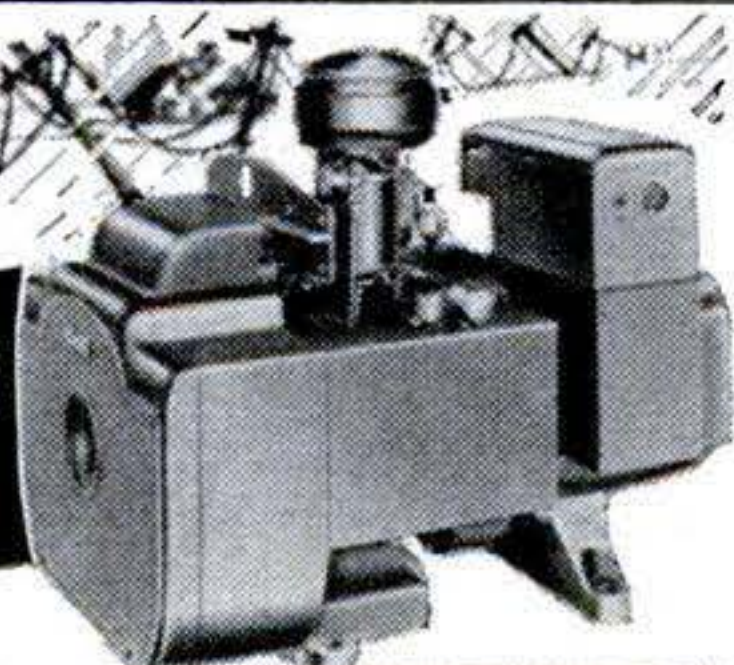

### A SIZE FOR EVERY NEED

400 to 75,000 watts. Compact, quiet-running, easy to install. Gasoline engine powered.

**SKI KIT**  
\$18.00  
SAVE 1/2

## IDEAL CHRISTMAS GIFT

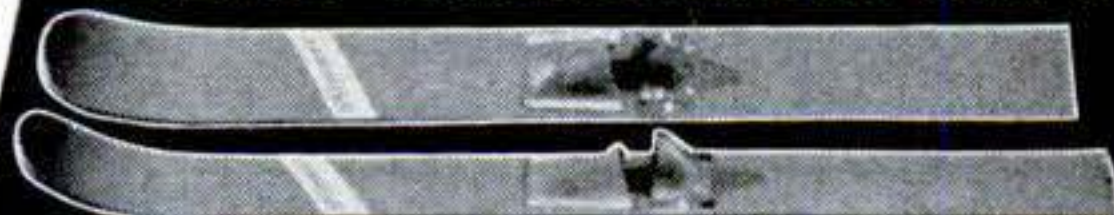

Simply assemble and finish our new water ski kit and you have a pair of skis worth twice the price of the kit. Skis are 7 ply moulded plywood, 67 1/2" long, 7" wide, 9/16" thick. Sturdy rubber foot pieces. All parts plus instructions included—\$18.00. Order from your Michigan dealer or MICHIGAN WHEEL CO., Dept. PS-1111, Grand Rapids, Mich. C.O.D. orders accepted.

## LOOK! UNUSUAL XMAS GIFT!



Makes a Car **BELLOW** like a Bull

## THE New Kattle Kaller AUTO HORN

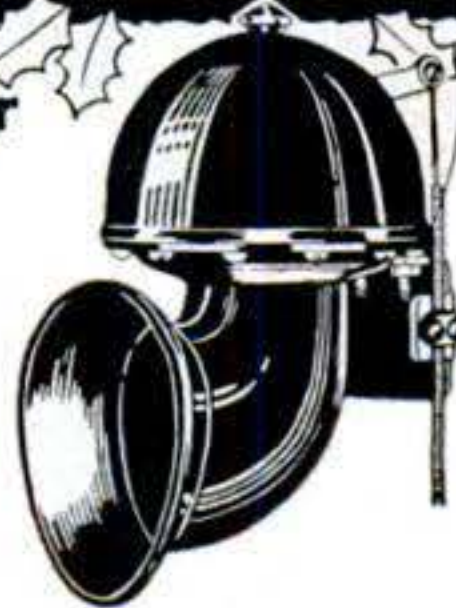

Completely different novelty horn. Sounds just like a lonesome bull. Imitates any cattle sound. Actually used by ranchers to call cattle. Makes low gentle tone, or roars full blast. Makes pedestrians smile. Variable tone control located on steering column.

If your dealer can't supply you, order direct and send us his name. Send check, M.O., C.O.D. Money back if not satisfied.

- Really gets attention!
- Easily installed under hood
- Fits any Car or Truck

**Special Introductory Offer**  
**\$10.95** Post Paid  
(\$2 below reg. list)

**KATTLE KALLER DIV., 1953 So. 20th St., Omaha, Nebr.**





# GUNS

12 MODELS

"AUTHENTIC REPLICAS"

START YOUR COLLECTION TODAY!

Colt Cobra .38

Newest firearm in Colt line. Compact in design. Used by detectives and police officers throughout USA where quick action is paramount. Six shot.

One of the most versatile weapons ever made. Carried by officers as side-arm. Semi-automatic. Could be fitted to special stock and used as rifle.

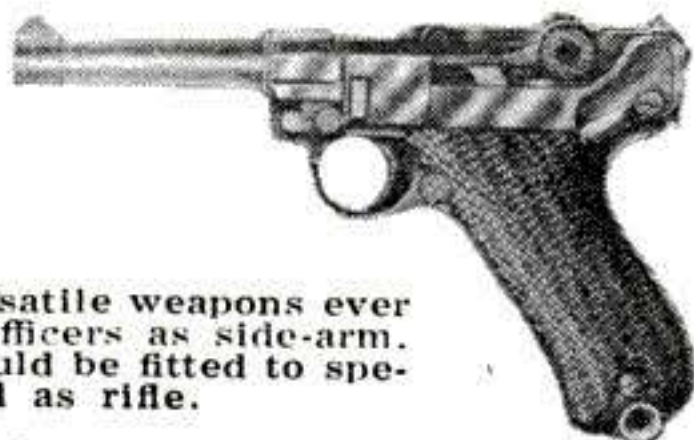

German 9MM Luger

**COLLECTION INCLUDES:**

- Reproduced in Actual Size, Design and Balance.
- Made of Solid Cast Aluminum
- Finished in Gun Metal Black
- "He-Man" Trophies for Den, Rumpus Room, Cabin, Etc.

- Russian Tokarev
- German Luger
- Czechoslovakian Pistol
- Italian Brevettata
- German Mauser
- Japanese Nambu
- Spanish Moxley
- Belgium Automatic
- German P-38
- Frontier .44 Colt
- Colt .45 Automatic
- Colt Cobra .38

ONLY \$2<sup>00</sup> each POSTPAID

Canada Orders Not Accepted

SEND 10c IN COIN

MAIL TODAY! (Please Print)

FOR ILLUSTRATED FOLDER

**LYTLE NOVELTY CO.**

2656-S Fashion Avenue, Long Beach 10, California

Enclosed is \$.....(No Stamps or COD's). Please send by return mail the guns I have listed:

NAME.....

ADDRESS.....

City & Zone.....State.....

(In California add 3% Sales Tax)

**250 POWER . . . .**

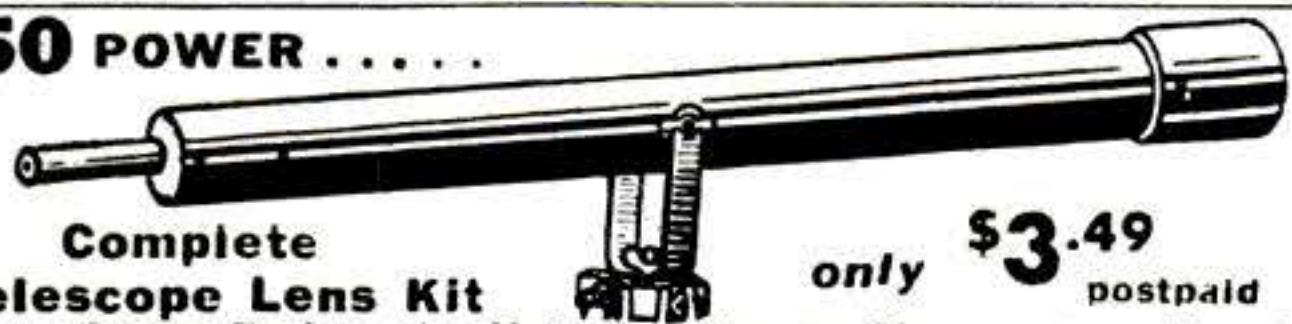

Complete Telescope Lens Kit only \$3.49 postpaid

Conquer Space, Explore the Universe, Planets, Moon craters, New Stars, etc. Complete Lens Kit consists of 80 inch focal length ground and polished objective lens, eyepiece lenses for 50 POWER, 100 POWER, 150 POWER, 200 POWER, 250 POWER, and all necessary lens fittings. Easy to make from simple step by step instructions. (Tripod and mount not included.) Money back guarantee.

**BUSSE SALES CO., Hartford, Conn., Dept. PS37**

**ELECTRIC MOTORS—POWER KITS MAKE WONDERFUL XMAS GIFTS**

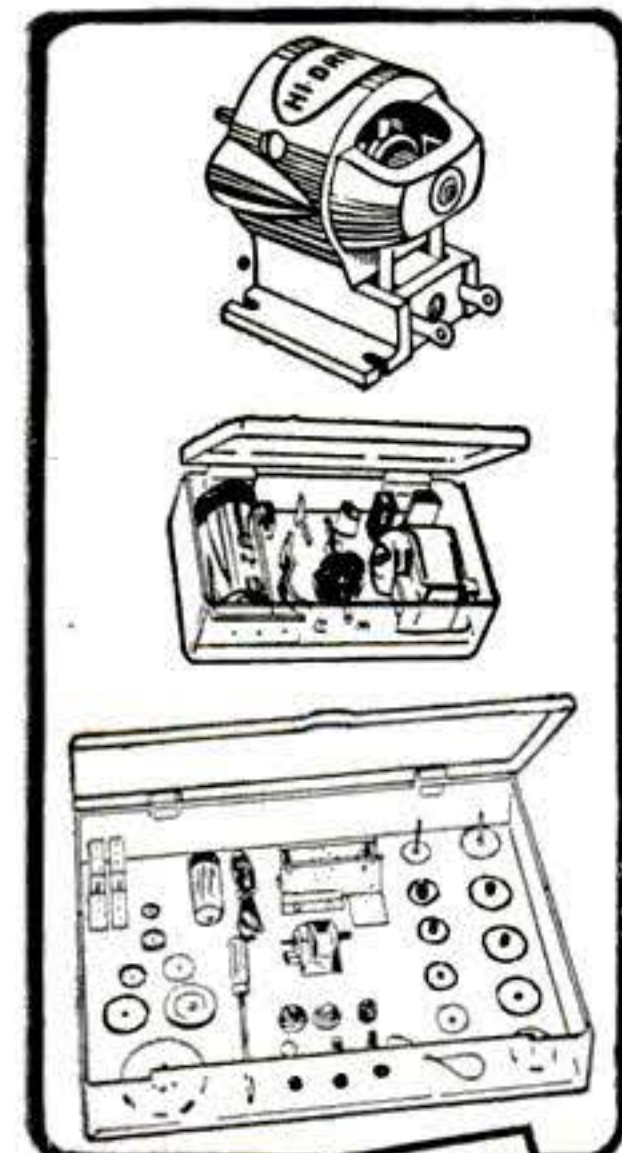

Give Wilson's battery-operated motors and power accessories this Xmas. Keep your boy busy for months developing new educational projects with these exciting items. Read this list of Wilson's gifts for boys and hobbyists of all ages—and MAIL YOUR ORDER TODAY.

- \*No. 7-100 Hi-Drive Motor, 1 1/2-3V .....\$2.00
- \*No. 8-100 Same for 3-6V.....\$2.50
- No. 3-100 Tiny Atom Motor, 1 1/2-3V .....\$2.00
- For higher voltages.....\$2.50
- No. 96 Steel frame motor with gear, pinions, pulley, worm \$4.00
- \*No. 3113 Tiny Atom motor assembly kit with many acc. \$3.00
- No. 1300 Small accessories kit \$1.00
- No. 3700 Large accessories kit \$3.00
- No. 4000 DeLuxe accessories kit with motor.....\$5.00
- \*No. 700 Super-Power kit with motor, speed reducer, all accessories .....\$10.00
- No. 88 Kit of 8 pulleys—2 belts \$2.00
- No. 3000 Vari-speed gear unit \$4.00
- \*Item illustrated. Ask for FREE Cat.

All Wilson's motors have Permanent Alnico Magnets.

Remit with order and we pay postage in U.S.A. No C.O.D. Add 3% Sales Tax for delivery in Ohio. Write Dept. PS



For quick delivery see your local dealer — or order direct

**WILSON'S OF CLEVELAND**

425 Lakeside Ave., N.W. • Cleveland 13, Ohio

# SAVE UP TO 74% ON FURNITURE...

Do Your Own

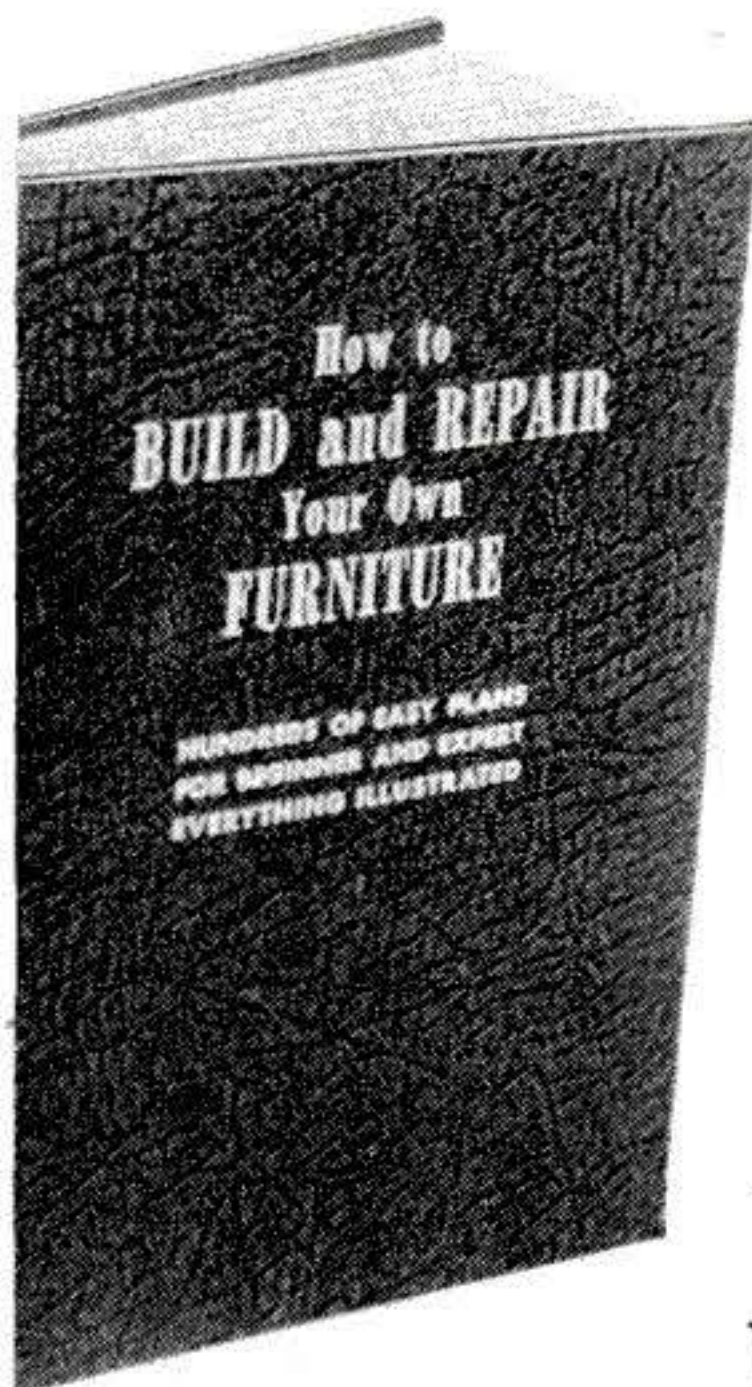

- ★ REPAIR
- ★ BUILDING
- ★ DECORATING
- ★ MODERNIZING
- ★ GLUING
- ★ REFINISHING
- ★ OVERHAULING
- ★ PAINTING
- ★ MAINTENANCE
- ★ REUPHOLSTERING

## SIMPLIFIED DETAILS IN NEW BOOK

With "How to Build and Repair Your Own Furniture", new 256-page "how-to" book, you'll be able to own that furniture you've always wanted—and make your present furniture look brand-new! Popular Science Editors have poured all their knowledge and skills of home furnishing into one great book written especially for men who want to furnish their homes handsomely—at little cost! Detailed, easy-to-follow photos and directions make it easy!

**BUILD FURNITURE FOR EVERY ROOM IN YOUR HOUSE!**

You can make coffee tables, chairs, desks, lamps, book-cases, kitchen equipment, consoles, cabinets, children's furniture, plastic furniture, cabinets—for all types of decorating—period or modern! Most of the 163 simplified projects can be done with simple tools found in any home!

**SEND NO MONEY NOW!**

Just mail coupon below with your name and address and pay postman the low, low price of \$2.49 (plus postage) on delivery. After 7 days free trial, if not satisfied, return book for money back. But hurry, supply is limited!

**MAIL FREE-TRIAL ORDER FORM TODAY!**

**POPULAR SCIENCE PUBLISHING CO., Dept. 1155**  
353 Fourth Avenue, New York 10, N. Y.

Please rush my copy of "How to Build and Repair Your Own Furniture" in edition checked below. When postman delivers my copy, I'll pay low price indicated, plus postage. If not completely satisfied, I may return book within 7 days for full refund.

- Regular Edition, bound in handsome Linen Finish Kivar, Only \$2.49 #96
- Deluxe Edition, Stamped in Silver Color, bound in Red Duotone Kivar, Only \$2.99 #7017

NAME \_\_\_\_\_ (Please print plainly)

ADDRESS \_\_\_\_\_

CITY & ZONE \_\_\_\_\_ STATE \_\_\_\_\_

Check here if you remit now. We pay postage. Same return guarantee.



## Amazing Invention WUERTH TUBE-SAVER



**COMPLETELY AUTOMATIC.** For old and new sets. Easily plugged in. Lasts for life. 150 to 400 watts, 117 volts AC-DC. Mail Order Send check or M.O.

**\$7.95** prepaid Saves TV, Hi-Fi & Picture Tubes.  
**HAROLD H. POWELL COMPANY**

2102 Market St. Dept. C-3 Philadelphia 3, Pa.

**Lengthens Life of All Tubes Up to 7 Times!**

TUBE-SAVER'S Thermal Cushion Action protects tube filaments and cathodes from destructive high power surges every time set is turned on. Cuts costly service calls. Virtually eliminates burned-out tubes. Arrests untimely breakdowns of expensive parts.

<b>RADIO CONTROL YOUR MODEL</b>		<b>PLANES BOATS CARS</b>
"CUSTOM MIDGET" RADIO	ONLY \$9.98	DETAILED INFORMATION & RADIO CATALOGUE 25c
LICENSE FREE BAND		SPECIAL "SUPPLY SOURCE DIRECTORY" & \$7.00 SUPPLY COUPON \$1.00
OPERATES SAME AS \$50.00 SETS. INCLUDES LONG RANGE TRANSMITTER RADIO, RECEIVER RADIO AND CONTROL ACTUATOR ALL 3 EASY ASSEMBLY WITH OUR PARTS AND PLANS \$9.98. PLANS ALONE \$1.		BOOK "RADIO CONTROL OF MODEL AIRCRAFT" CONTAINS 14 PLANS \$3.98
		RADIO CONTROL GARAGE DOOR DETAILS \$1.00
RADIOMODELS BOX 36 DEPT. P5 BALTIMORE 6, MARYLAND		

**ONLY \$495** Freight included **FREE FOLDER**

18 FT. CRUISER

**BOAT KITS**

12 Models as low as \$39.95 (freight included). Fiberglass boat covering kits, marine supplies, etc. Free folders.

**TAFT MARINE WOODCRAFT**  
Dept. PS-11, 636-39th Ave. N.E., Minneapolis 21, Minn.

**FULL SIZE MODEL KITS!**

**\$5.95**

Complete, improved detail, easy to finish. The original kit. Wood with process for gun metal finish. ORDER THESE MODELS DIRECT. Ideal for den or game room.

THE ORIGINAL — Improved!

NEW illustrated catalog of 9 models. For Catalog, Send 10¢ to:

**O'BRIEN GUNCRAFT (C) P.O. BOX 657 MADISON, WIS.**

**SOCK-O**

**SUPER SLINGSHOT**

**SILENT • RIFLE FAST • POWERFUL • ACCURATE**

Great for small game and target shooting! 45 pound pull. Big, sturdy stock. Lively raw rubber. Sweet shooting. Free! 50 Sock-O "cannon balls", extra rubber and target. Sent by return mail. Guaranteed. Every sling fully tested. No COD's please.

**SOCK-O, 7000 Melrose, Los Angeles 38, Calif.**

**WARN HUBS** PATENTED

**AUTOMATICALLY FREE-WHEEL 4-W.Ds. IN 2-WHEEL DRIVE**

Free-wheeling 2-wheel drive stops front end drag! Cuts front end repairs 50% or more. saves gas, tires; gives amazing pep, performance, handling ease to 4 W.Ds! Warn Automatics engage or disengage front power train as you shift into 4-wheel drive, or out for fast, economical free-wheeling 2-wheel drive use. Automatics only also permit high speed driving in 4-wheel drive. Warn Automatic and Locking models for Willys factory approved, sold only by Willys dealers worldwide. Over 70,000 sets in use around the world. Models for other 4 W. Ds. at dealers or write:

**RUGGED DESIGN PROVEN IN USE**

**WARN MFG. CO., Riverton Box 6064 -B7, Seattle 88, Wash.**

## "SPORTERS"



that are great sport to use

Light, streamlined. Long barrels. Smooth actions. Open sights. Monte Carlo stocks with cheek piece. Receivers grooved for scope mounting. Molded finger grips. Quality throughout.

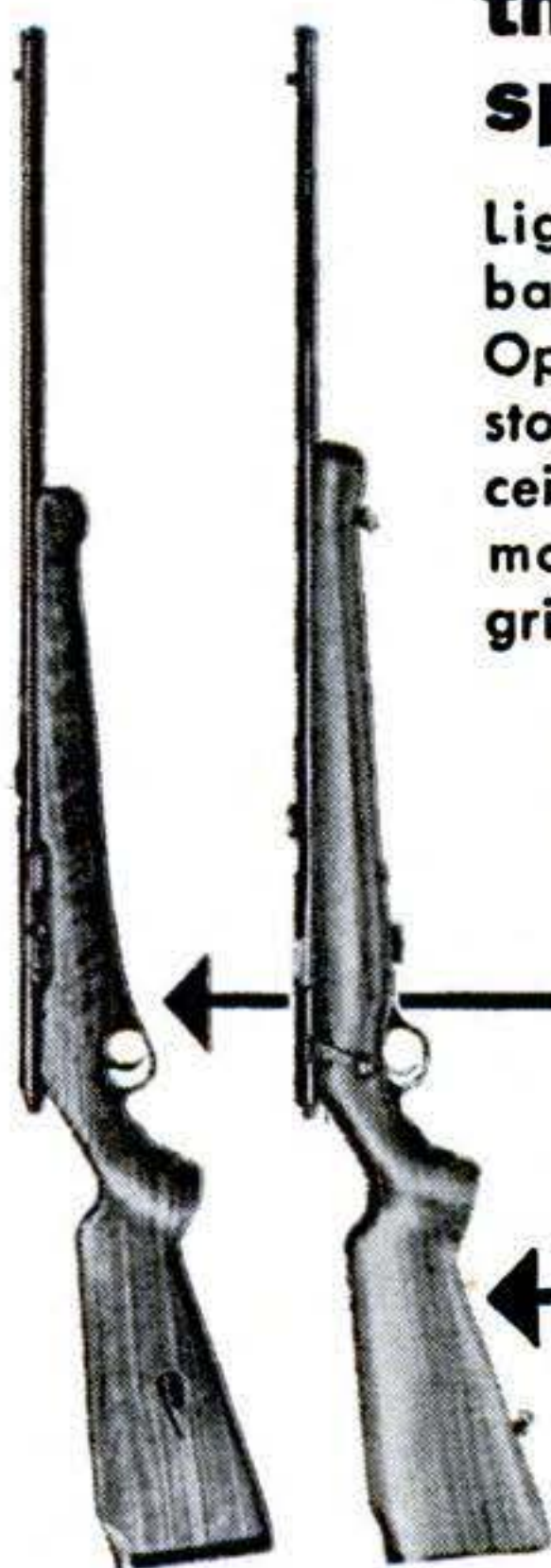

**Model No. 151K** 22 cal. Auto 15 shots. Straight line feed through stock. **\$31.95**

**Model No. 140K** 22 cal. 7-shot clip feed, bolt action.. **\$24.95**

\$1.00 higher west of Rockies

**YOUR MOSSBERG DEALER WILL BE GLAD TO SHOW YOU THESE FINE MODELS**

Send for **FREE** catalog

**O. F. MOSSBERG & SONS, INC.**  
56511 St. John St.  
New Haven 5, Conn.



Also Eshelman 2 Pass. SPORT CARS 1/5 the Cost of Any other Auto. 70 Miles Per Gal. Free Literature.

**ESHELMAN CAR SNOW PLOW**  
CLEARS ROADS & DRIVEWAYS

**\$39.95 COMPLETE**

Bolts on to car or truck in 2 minutes without tools. Clears snow 16" deep and 72" wide. Lightweight and sturdy. Order now, or write for free catalog.

**ESHELMAN, Dept. SP-411**  
109 Light St., Baltimore 2, Md.  
SHIPPING POINTS: Balto., Chicago, Reno

**POWERFUL!**

Man, here's **light!** 1/4-mile beam — 15,000 beam candle power. Compact, easy to carry, built to last! Uses two 6-volt batteries. See your dealer. **\$6.50** less batts.

**DELTA ELECTRIC CO., Marion, Ind.**

**Delta POWER-KING ELECTRIC LANTERN**



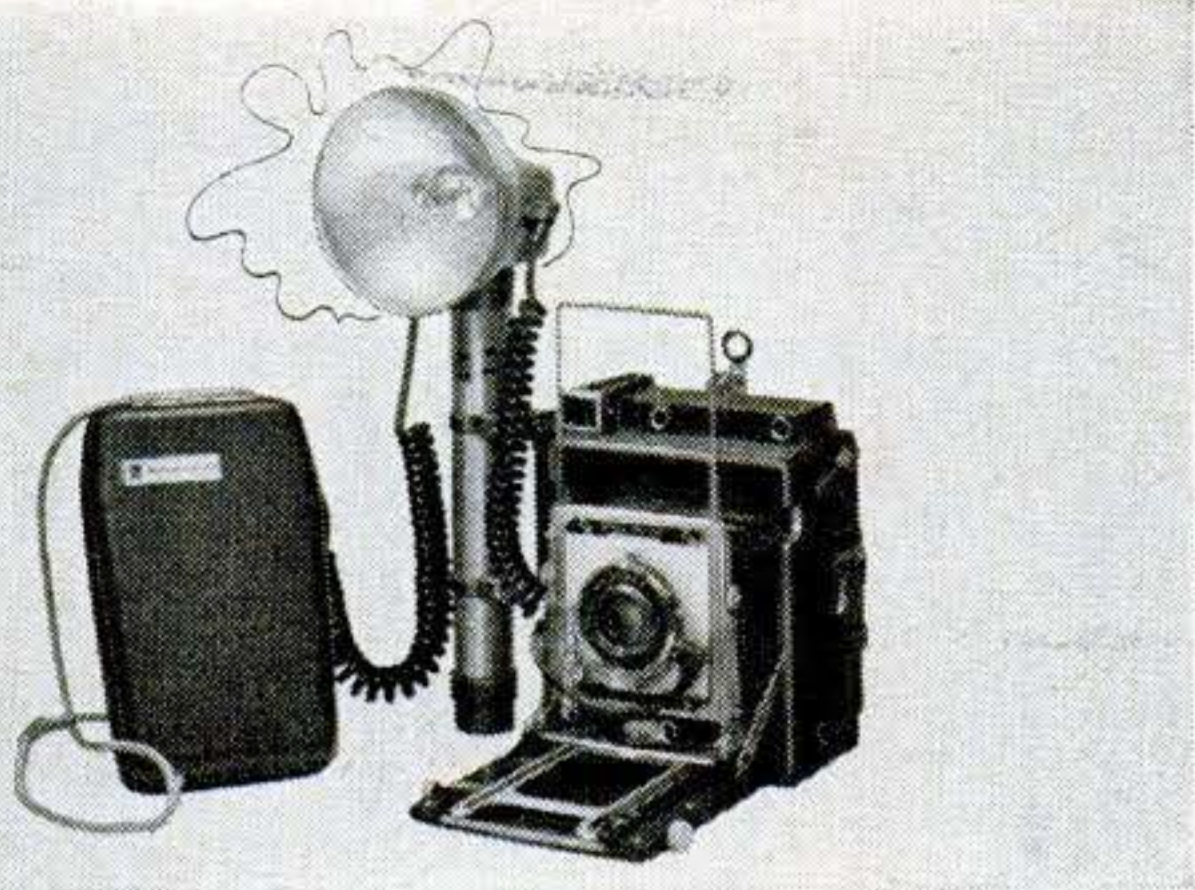

## Get Sure-Fire Shots with STROBOFLASH and PACEMAKER GRAPHIC®!

An ideal combination for any photographer who wants exceptional results at lowest possible cost! Professionals choose Stroboflash-equipped Pacemaker Graphics because no other equipment is so easy or inexpensive to use, yet gives such superior results. By eliminating the need for flash bulbs, Stroboflash reduces illumination cost to as little as one cent a shot! Three portable models: Stroboflash I is extremely light weight . . . battery pack fits easily into coat pocket; Stroboflash II is more powerful, has economical, long battery life; Stroboflash III gives maximum light output, plus portability . . . excellent for color. Write for free folder to Dept. PS-115, Graflex, Inc., Rochester 8, N. Y.

## GRAFLEX® Prize-Winning Cameras

Do you work all day with

# COLD FEET?

NOW,

at last, a new, modern, low priced electric foot warmer that will keep you healthy, happy and comfortable



Help prevent colds with...  
**ELECTRO MAT**

Check stand cashiers, secretaries, assembly line workers, housewives, office workers, theatre cashiers, machine operators, telephone operators, and many others throughout the country are now singing the praises of the Electro Mat. There is no further need to work all day with cold feet. Many colds, causing absenteeism and irritability, can be directly traced to cold feet. *Safe and Economical*

Size 14" x 21"  
light-weight  
portable

Consumes less power than a 75 watt light bulb. Mail your check or money order today for **ONLY**

**\$7.95**

prepaid

### PETERSON RUBBER MAT CO.

5508 No. Halifax Rd., Dept. PS-12, Arcadia, Calif.

Please send me \_\_\_ Electro Mats at \$7.95 each  
**IMPORTANT SAVING.**

If 6 or more ordered, price is only \$6.95 each.

C.O.D. Enclose \$1.00 deposit with order  
 Prepaid

Name \_\_\_\_\_

Address \_\_\_\_\_

City \_\_\_\_\_ State \_\_\_\_\_

PLEASE PRINT CLEARLY

## Kruger Pistol *Bargain* \$3.00 post paid

.12 CALIBER SINGLE SHOT

.14 MG. POWDER CHARGE

Crafted after famous German Luger design. Not an air or CO<sub>2</sub> gun.

This is a small bore gun that actually shoots .12 caliber lead bullets fired by light 14 mg. powder charge. Beautiful gun . . . swell for target shooting. 4" steel barrel in knurled styrene stock. Overall length 8¾ inches. This amazingly low price due to ball and cap design. Direct factory-to-you-sales. Comes with 50 bullets. Send for extra bullets or available at stores.

Money back if not satisfied. Limited quantity. Delivered free.

Send \$3 cash, check or money order to **KRUGER CORP**

KRUGER BUILDING, BOX E-709, ALHAMBRA, CALIFORNIA

## Sensational FOG-STOP Windshield Cloth



**Amazing Discovery!** Autoists wild over new FOG-STOP Windshield Cleaner. Simply glide over windshield chemically-treated Mitt—at once glass sparkles crystal clear. Blurry mist, frost, sleet, snow disappear like magic. Stops fogging. *Sells like wild!*

**SAMPLES FOR AGENTS** Sample offer sent immediately to all who send name at once. Hurry. Postcard will do. **SEND NO MONEY—just your name.**

**KRISTEE CO., Dept. 701, AKRON 8, OHIO**

## SAVE MONEY ON U S GOV'T SURPLUS

Buy surplus direct from US Government. These are samples of the savings that can be made. Life boat \$12.00. Grinder \$4.69. Shaper \$15. Dump truck \$76.77. Tractor \$75.00. Typewriter \$7.51. Freezer \$50. Spray painter \$15.25. Motor \$4. Hunting, fishing, camping, sporting Equip, jeep, boat, tools. Hundreds others may be purchased at tremendous savings through our Bulletin "Surplus Sales." Price \$1.00. **The Abacus Press, Box 169AAA, Dept. 5, East Hdfd. 8, Conn.**



*Auxiliary Accelerator...*

### LEFT FOOT PEDAL

Step on the gas with either foot with equal ease. Drive relaxed.

Guaranteed for the life of the car—

which originally installed on. **FITS ALL CARS.**

**PRICE \$6.95** Paid. **ORDER FROM**  
Delivered to You **R. V. LEHNER, Ness City, Kansas**

## What Every Mason Wants



We have Important Masonic books for Blue Lodge, Chapter, Commandery, Scottish Rite, and Shrine.

**OUR RITUALS ARE USED THE WORLD OVER**

Send for free catalog of books and rituals for Masons, Odd Fellows, Knights of Pythias, Knights of Columbus, etc. **EZRA A. COOK, Publisher, P. O. 796, 11D Chicago 90, Ill.**

See the Greatest Show on Earth with this

## GIANT ASTRONOMICAL TELESCOPE

**\$15.00**  
FULL PRICE



Delivered ready for use. Has 45X, 75X and 100 power individually mounted eyepieces with brass focusing tube plus sun projector lens for observing sun spots and solar storms. Steel telescope tube 50 in. long. Rigid 6 ft. tripod adjustable to any height. Steel forked mounting with closely machined aluminum tripod head assembly assures extra fine adjustments. This professional type instrument provides full power with clear vision at all times. See the moons of Jupiter, our own moon, planets, milky way, double stars, star clusters, etc. All for only \$15.00 FOB Mattituck. Sent express. COD orders require \$5.00 deposit. Satisfaction guaranteed. 200X and 400X eyepieces available at \$2.00 ea.

**SUFFOLK SCIENCE SERVICE**  
Dept. ATP-11 **MATTITUCK, N. Y.**



## NEW! PRINTED CIRCUIT Transistor Radio

Pocket size—works anywhere

- Features P-N-P Junction Transistor
- Permeability tuning, Diode detection
- Printed circuit eliminates extra wires
- Batteries last for months
- Expensive hearing aid headset included
- Furnished complete, nothing else to buy



**\$9.95**  
Only **9** Postpaid  
in kit form  
or wired and tested  
for only \$12.95

Here is a powerful, completely portable radio, employing the latest type of transistor audio amplification and printed circuitry. Tiny size, only 2 3/8" x 3 1/2" x 3/4" fits in pocket or purse. Uses so little current, batteries last for months. Kit can be assembled by anyone with just a soldering iron. Or furnished complete and tested, ready to use. Guaranteed to work. Comes complete with plastic case, batteries, headset, all parts. Nothing else to buy. Send for yours, today!

Send no money. Just pay postman \$9.95 plus C.O.D. charges, or send check or money order for \$9.95 and we pay postage.

TRADYNE, INC., 11 W. MONUMENT AVE., DAYTON 2, OHIO DEPT.S-2

## TREMENDOUS Profits with Hagen's Exclusive



100% PROTECTION

### TEAR GAS PENCIL!

This Tear-Gas Pencil discharges smothering clouds of tear gas to instantly stop, stun and incapacitate the most vicious man or beast, an effective substitute for dangerous firearms; leaves no permanent injury. No selling experience needed. Handle as a profitable sideline . . . soon you'll sell it full time. Start now! Send \$4.25 for complete demonstrating kit of Automatic Tear Gas Pencil, 10 demonstrators & 3 Powerful Tear Gas Cartridges. Not sold to minors.

HAGEN SUPPLY CORP., Dept. P-115, St. Paul 4 Minn

## PUT YOURSELF IN BUSINESS

With Our Newest, Biggest NAME BRAND MERCHANDISE Housewares, gifts, jewelry, power tools, tableware, appliances, watches, etc. No investment. BE READY FOR THE XMAS RUSH!

Write today to, Dept. L-2  
ROBEL SALES 487 B'WAY  
N. Y. 13, N. Y.

FREE JUST OUT

NEW '56 Jumbo Catalog. Bigger than ever. Imprint space for your name, plus private price list too. Fully illustrated.

Plenty Of Profit . . . Simple To Sell

## REAL ESTATE BE A BROKER

PAYS BIG! SEND FOR FREE, BIG, ILLUSTRATED CATALOG NOW! Graduates report making substantial incomes. Start and run your own business quickly. Men, women of all ages, learn easily. Course covers Sales, Property Management, Appraising, Loans, Mortgages, and related subjects. STUDY AT HOME or in classrooms in leading cities. Diploma awarded. Write TODAY for free book! No obligation.

FREE BOOK TELLS HOW

Approved for World War II and Korean Veterans  
WEAVER SCHOOL OF REAL ESTATE (Est. 1936)  
2022A Grand Avenue Kansas City, Mo.

## FREE BOAT KIT CATALOG

Write:

8' to 14' Models from \$39.95

- Assemble your own boat incl. freight
- No experience necessary
- Save 1/2 to 2/3 "factory built" prices



12 ft. Runabout Pictured

Marine Hardware, Trailers, Fiberglass

DEPT. A 4452 NICOLLET AVE.  
LUGER INDUSTRIES MINNEAPOLIS 9, MINN.

# ride for pennies . . . save dollars with the New 1956 HARLEY-DAVIDSON HUMMER

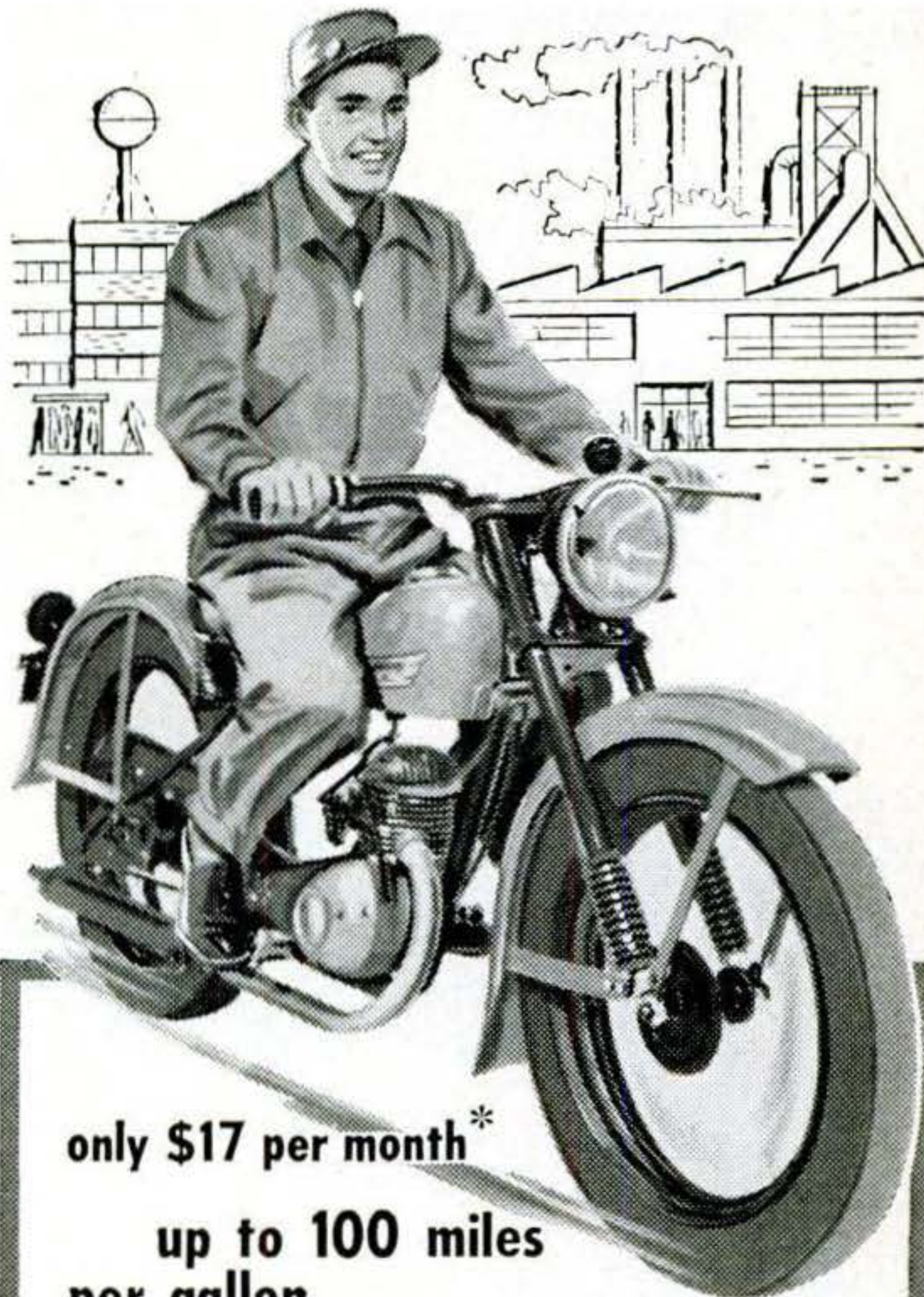

only \$17 per month\*

up to 100 miles  
per gallon

You can buy and ride the Harley-Davidson Hummer for little more than the change in your pocket. And what an easy answer to your get-to-work problem. With a Hummer you leave home later . . . get back sooner. In and out of heavy traffic in a jiffy. No parking worries with a Hummer either. Try it . . . ride it — at your Harley-Davidson dealer today. Or, write us for FREE literature.

\*After minimum down payment, includes fire, theft, collision insurance; Federal tax; freight and carrying charge.

HARLEY-DAVIDSON MOTOR CO.  
DEPT. PS., MILWAUKEE 1, WISCONSIN



## CRAFTSMEN AT WORK

### Aquarium Is Moving Picture.

A real-life underwater scene hangs on the wall of Herbert Berg's home in Chicago. Two angel fish swim among plants in a 12-by-20-inch plastic tank that protrudes only 2½ inches from the wall. The tank, with molding around it, sits on a shelf. A tubular lamp provides the light and warmth.



**School Desk Serves as Phone Stand.** An old-fashioned school desk makes a swell telephone desk-bench for Frank Regur of Hemet, Calif., and his family. He mounted the desk on redwood four-by-fours to bring it up to a comfortable height for adults.

**Bike-Trike Is Shopping Combo.** By attaching the rear of a child's chain-drive tricycle to a 26-inch bike frame, C. A. Cole of Graham, Ala., constructed this three-wheel shopping cart. Bicycle wheels were fitted onto the long tricycle axle. He built the basket out of metal railing with rods set into holes bored in the wooden floor.

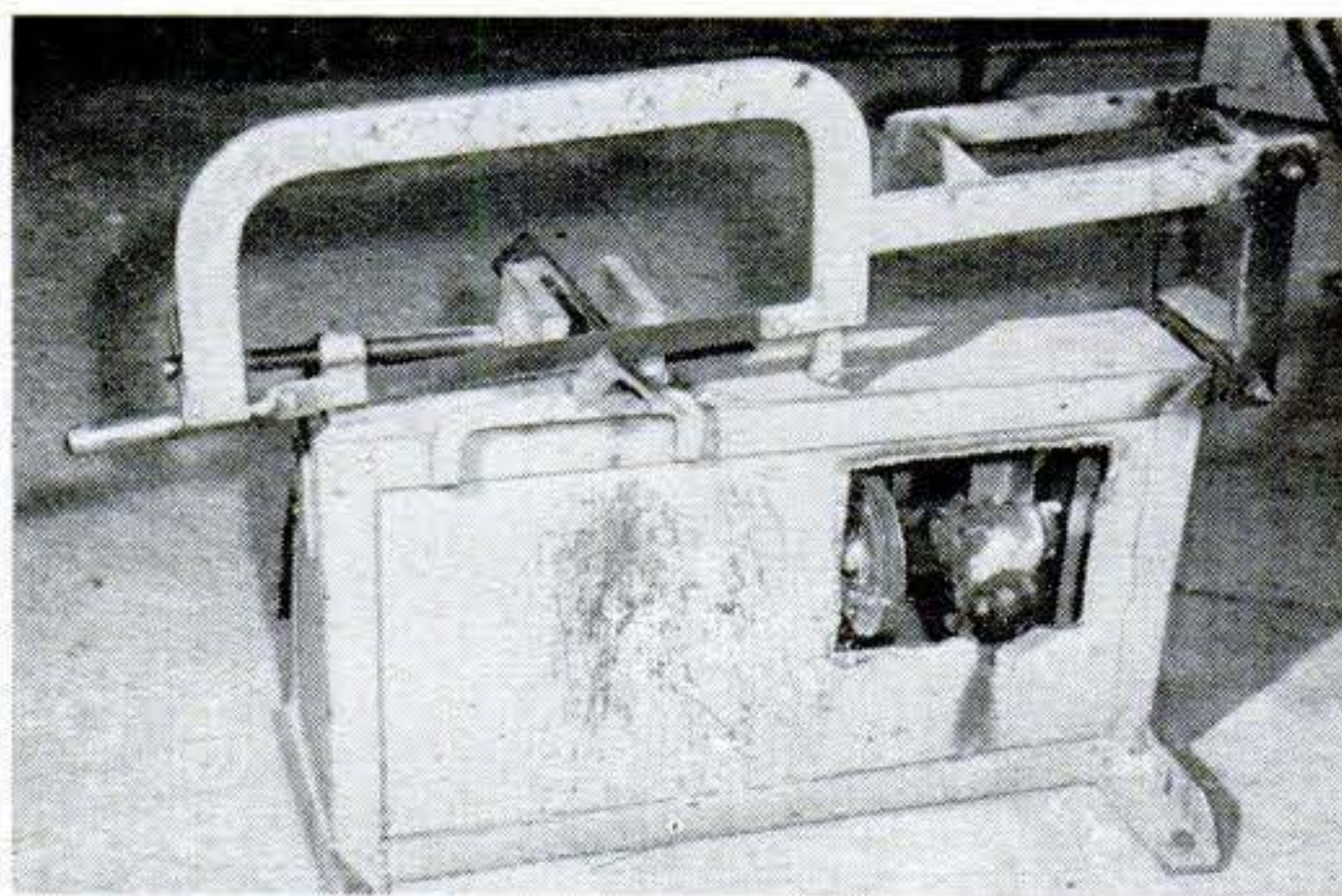

**Motor Drives Hacksaw.** Using scrap parts from his welding shop, Carl Sayre of San Jacinto, Calif., built a heavy-duty hacksaw run by a motor-driven walking beam. An old refrigerator motor was connected through V pulleys to a truck steering-gear worm. A crank at the rear of the worm rotates to pivot the walking beam. The saw rides free on a roller after cutting through the stock.

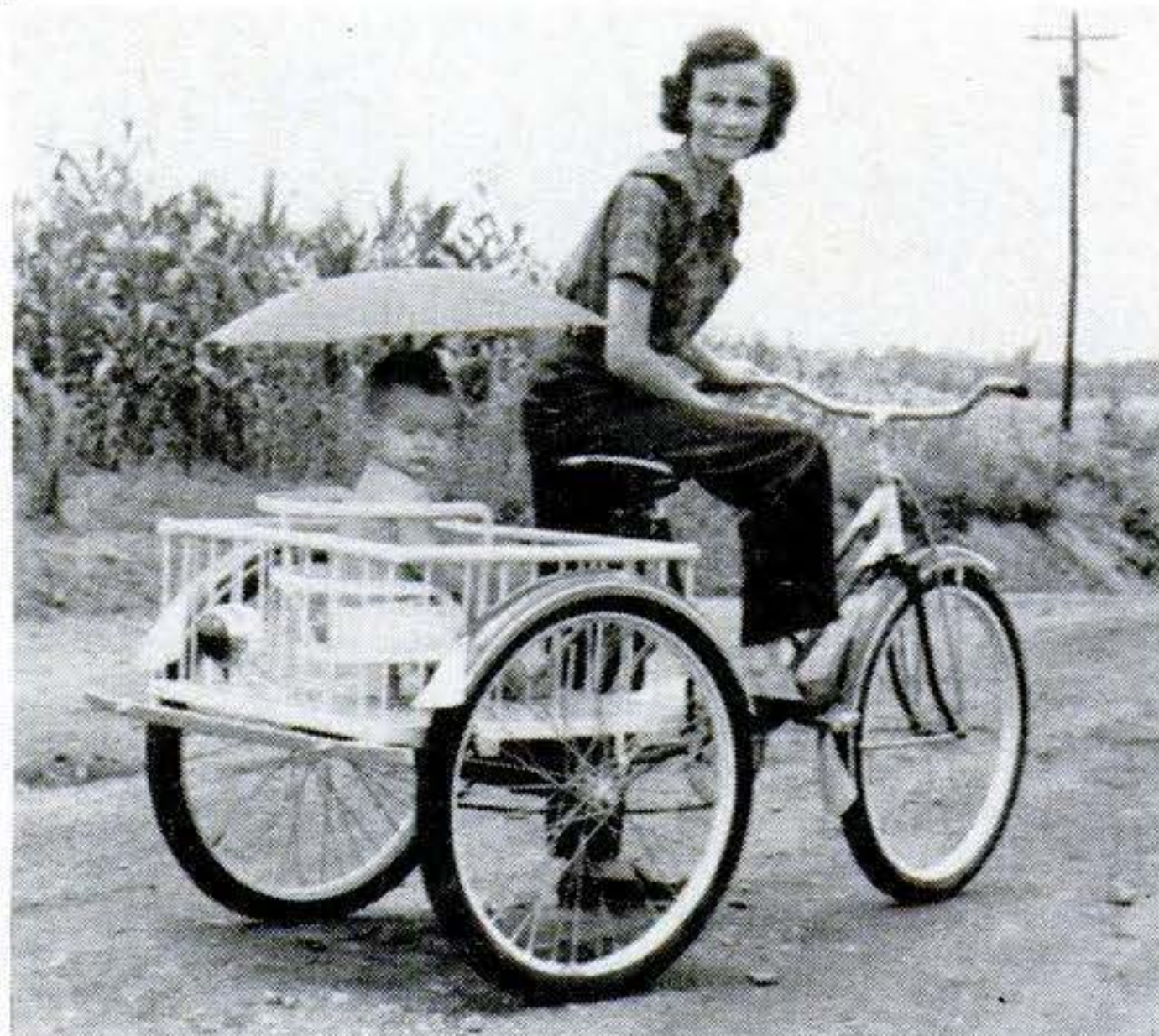







news & notes

DENTISTS OF THE FUTURE MAY FREEZE YOUR MOUTH BEFORE THEY FILL YOUR CAVITIES. Dr. Robert J. Eustice of Biloxi, Miss., reports successful use of a cold air stream as a local anesthetic. (Dermatologists have been using a cold spray to anesthetize skin during operations for several years, are now experimenting with the refrigerant Freon.)...ULTRASONICS MAY CURE KIDNEY STONES, a report from Yale says. Doctors are working on a way of breaking up the stones, without surgery, using high-frequency sound vibrations.

JEEPS MAY HIT THE DRAG STRIP SOON, Detroit rumor says. The word is that Willys will bring out a hot-rod job in full, fancy colors...ALL-BLACK CARS WILL COME BACK IN FAVOR, predicts R.C. Somerville, Dodge vice-president. But they'll have "shocking" color accessories and interior trim...CAR OWNERS WILL MAKE THEIR OWN BODY REPAIRS ON PLASTIC CARS OF THE FUTURE, plastics expert Stanley S. Wulc told the Society of Automotive Engineers. Repairs, even after serious collisions, will be do-it-yourself jobs.

ENGINEERS ARE NOW "LAUNCHING" BRIDGES. In a system developed by U.S. Steel, bridges are assembled on one side of a river and rolled over by means of a "launching

nose." Sections of the bridge are bolted to the nose, which is pushed across (upper drawing, left) until it engages rollers on the opposite side. When the whole bridge is across (lower drawing), the nose is detached to be used again...THE WORLD'S TELEVISION STATIONS

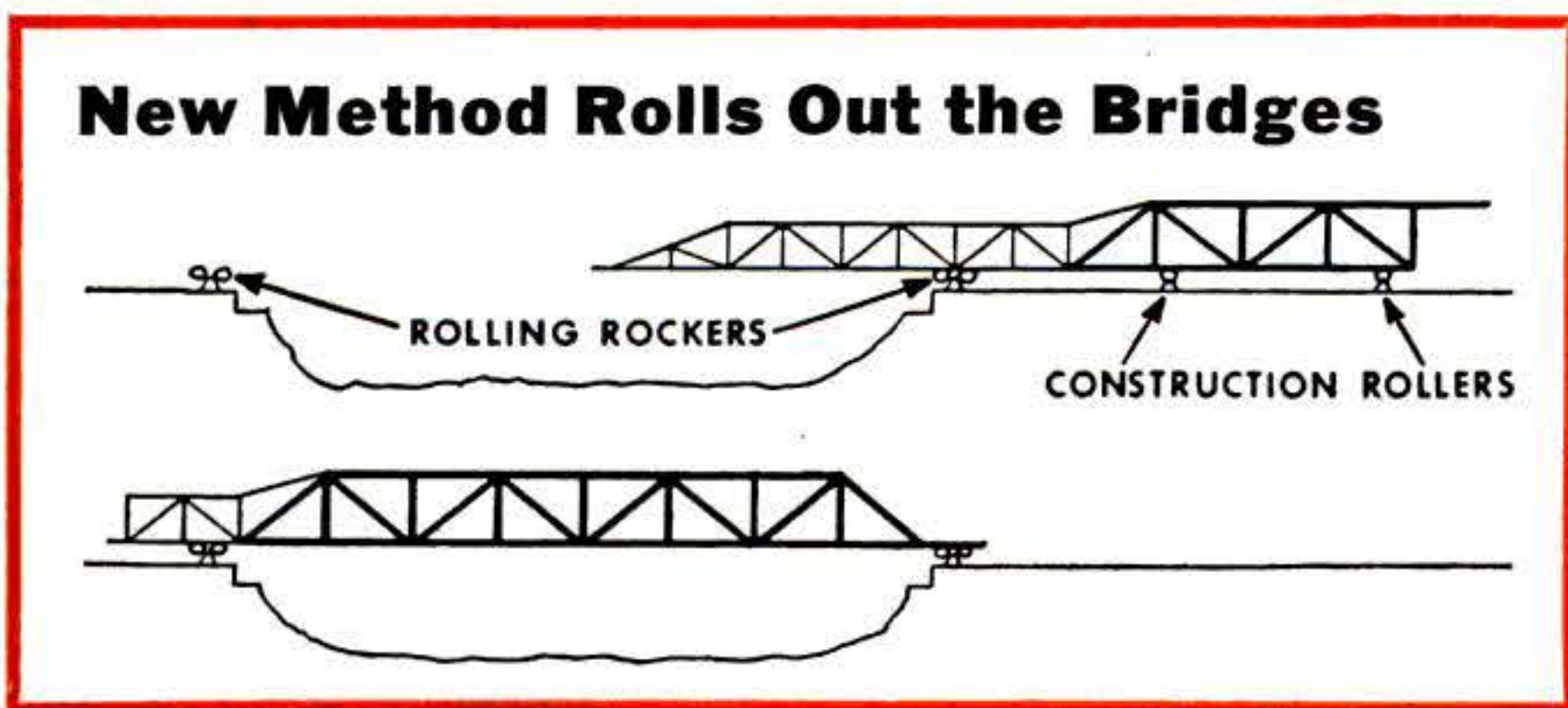

HAVE TRIPLED IN NUMBER IN THE LAST TWO YEARS. There are now 570 stations in 38 countries.

LIGHT FROM A SINGLE FIREFLY MAY BE ENOUGH TO SNAP PICTURES BY SOME DAY, predicts Kodak vice-president Donald McMaster. Film speeds, getting faster all the time, may reach that point in 75 years...NEW SPECIES OF PLANTS, CREATED BY ATOMIC RADIATION, MAY HELP FEED A HUNGRY WORLD, two Swedish scientists say. Radiation can induce beneficial hereditary changes.





spectacular beauty...  
dazzling performance  
the fabulous new Evinrude

*Lark*



**CHALLENGING NEW CONCEPT** in outboard design . . . the Evinrude Lark . . . headliner for '56! A truly custom motor that lends added distinction to the handsomest runabout. Crisp, dynamic lines that plainly proclaim superb performance . . . *and it's there* At your finger tips. Breath-taking getaway when you give the word to 30 tautly eager horsepower. *Commanding* power so wonderfully quiet and smooth that riding is like sailing. *Obedient* power that spins life at the touch of a button. And *thrifty* power as well . . . with the new Cruis-Throttle that gives you up to 20% more miles per gallon. See your Evinrude Dealer—look for his name under "Outboard Motors" in your phone book. For free catalog, write **EVINRUDE MOTORS, 4135 North 27th Street, Milwaukee 16, Wisconsin.**

*free!*

Big, full-color catalog of the complete Evinrude line for 1956. Now *nine* great models with smooth, quiet Whispering Power. Three brilliant "Thirties." New electric starting Fastwin. New Fisherman and Sportwin. With revolutionary new Eas-A-Matic starting on five models! Write for catalog today!

A Division of Outboard, Marine and Mfg. Co.  
In Canada: Mfd. by Evinrude Motors, Peterborough



**Evinrude**

*Pioneers in quiet Outboard Motors*



**NEW  
1956  
MODEL**

# POWER TOOLS

CRISP DESIGN . . . MORE EFFICIENCY . . . MODERN COLOR STYLING

See these 1956 advance models of America's most modern line of power tools at your hardware now. Write for Free Syncro Power Tool Catalog, Sanding Handbook.

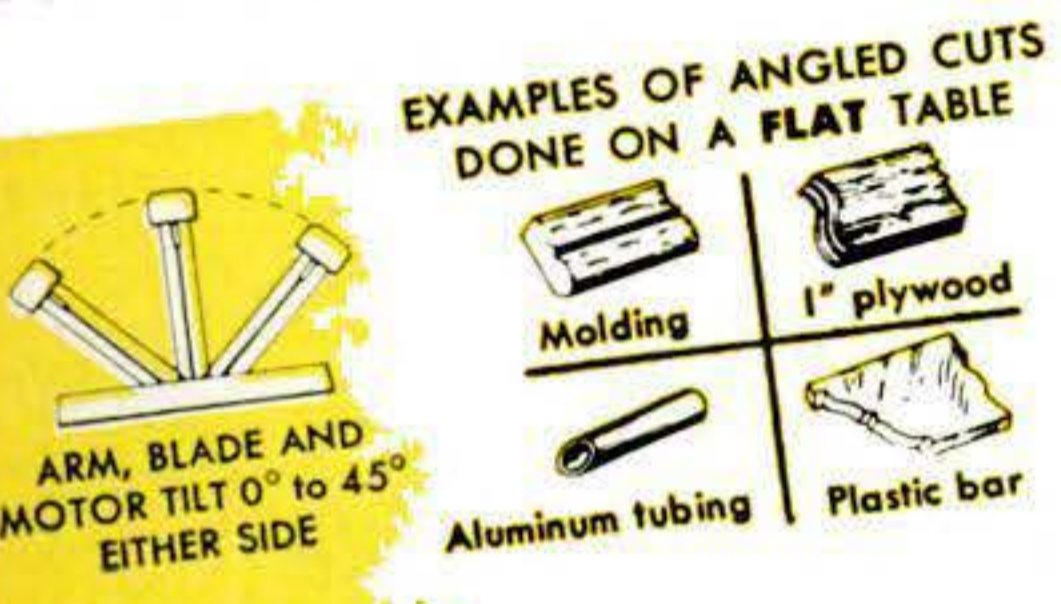

SYNCRO POWER UNITS  
**GUARANTEED**  
AGAINST BURN-OUT DURING  
YOUR OWNERSHIP OR  
REPLACED FREE!

## ANNOUNCING THE **ONLY** TILTING ARBOR JIG SAW

Now . . . all others are old fashioned! Because, on new syncro model 2500, your work remains flat while making angled cuts. Blade, arm and motor tilt together 0° to 45° to either side. Just "dial" for angled cuts. Modernize your shop with the *only* tilt arbor jig saw! Comes ready to use—no bolting down. 65 lbs., cast semi-steel. 20-in. throat, 80 sq. in. table. Use heavy duty "2500" for big projects. See at hardwares, write for catalog, price.



Precision-ground table is always level for greater control—easier, more accurate sawing . . .

## AMERICA'S ONLY \*MULTI-MOTION SANDERS



MODEL 900-D and 900

*\*Almost all wood grain is naturally crooked and irregular. Only Syncro exclusive "Multi-Motion" sanding pad action can sand with such grain and completely finish the whole surface.*

### Model 900-D DeLuxe Sander Kit

Heavy duty sander. Outsands, outlasts others. Easy to handle. No "jumping". With metal case, polish pad, 48 assorted sandpapers. *Model 900 Heavy Duty Sander* comes without sight-saving work lamp or metal case.

### Model 504 Finish Sander Kit

Light. Powerful. Easiest for vertical use. In metal case, sandpapers, polish pad.

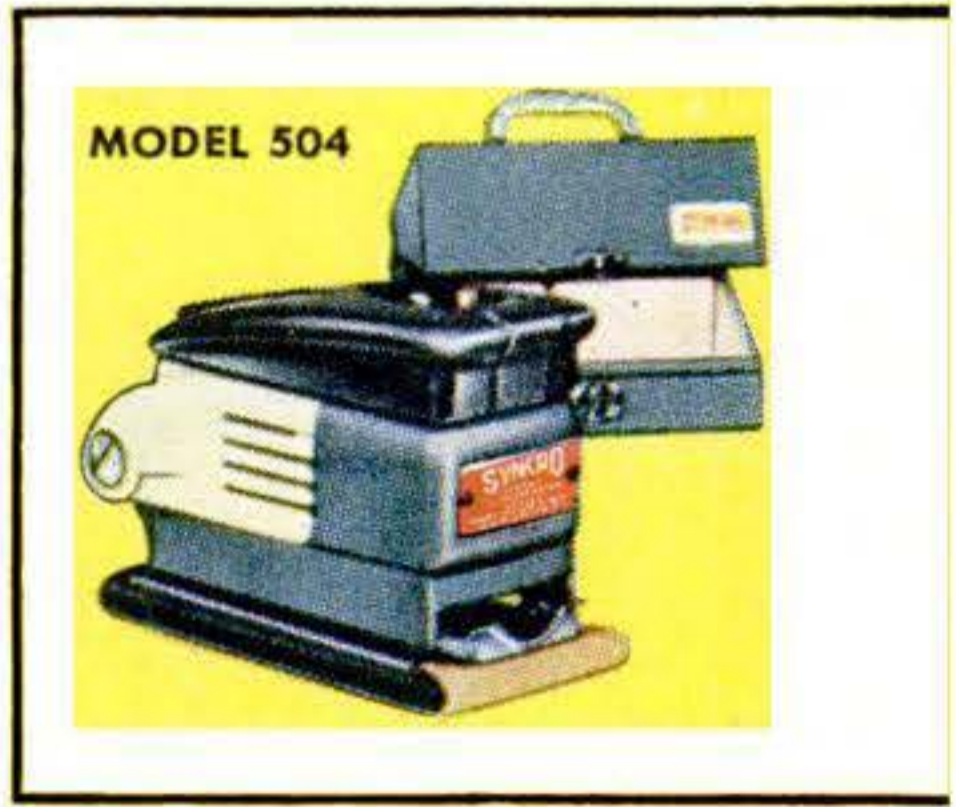

MODEL 504



Model 208

### Family Jig Saw

Basic power tool for Dad! Safest for children. Full 15" throat. 10' x 10" table. For projects and recreation.

**Remember:**  
More Syncro-made jig saws sold than any other self-powered make!

*Don't buy trouble - buy*  
**SYNCRO**  
SAWS AND SANDERS

**FREE**  
Valuable Sanding Handbook, Catalog. Write.





# Disney Plans TV Trip to the Moon

**F**AR bigger and more elaborate than the "flying basketball" with which the U.S. plans to dip its toe into outer space a couple of years from now, is the space station from which Walt Disney intends to take his TV watchers on an inspection trip to the moon some Wednesday evening in December. The "Disneyland" (ABC-TV) program that night will be called "Man and the Moon." It will consist of a film with both live action and



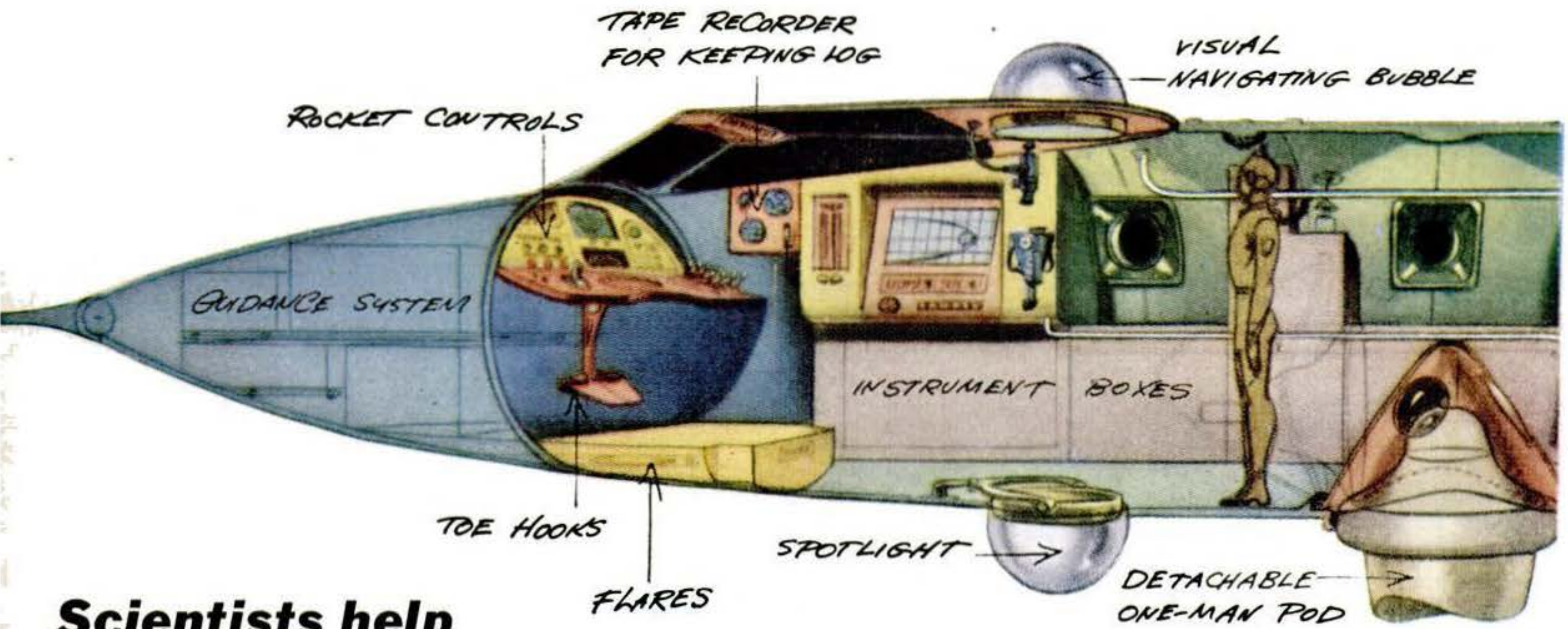

## Scientists help artists design spaceship

Rocket dreamed up for Disney's TV show

animation, and its theme will be an imaginary, two-stage journey to within 60 miles of our biggest natural satellite, customarily 240,000 miles away.

The imagination will be based on a high degree of probability, for Dr. Werner von Braun, chief of the Guided Missile Development Division of the Army's Red Stone Arsenal, and rocket experts Dr. Heinz Haber and Willy Ley were technical advisers for "Man and the Moon." Scenes pertaining to the filming are shown here.—Wesley S. Griswold.

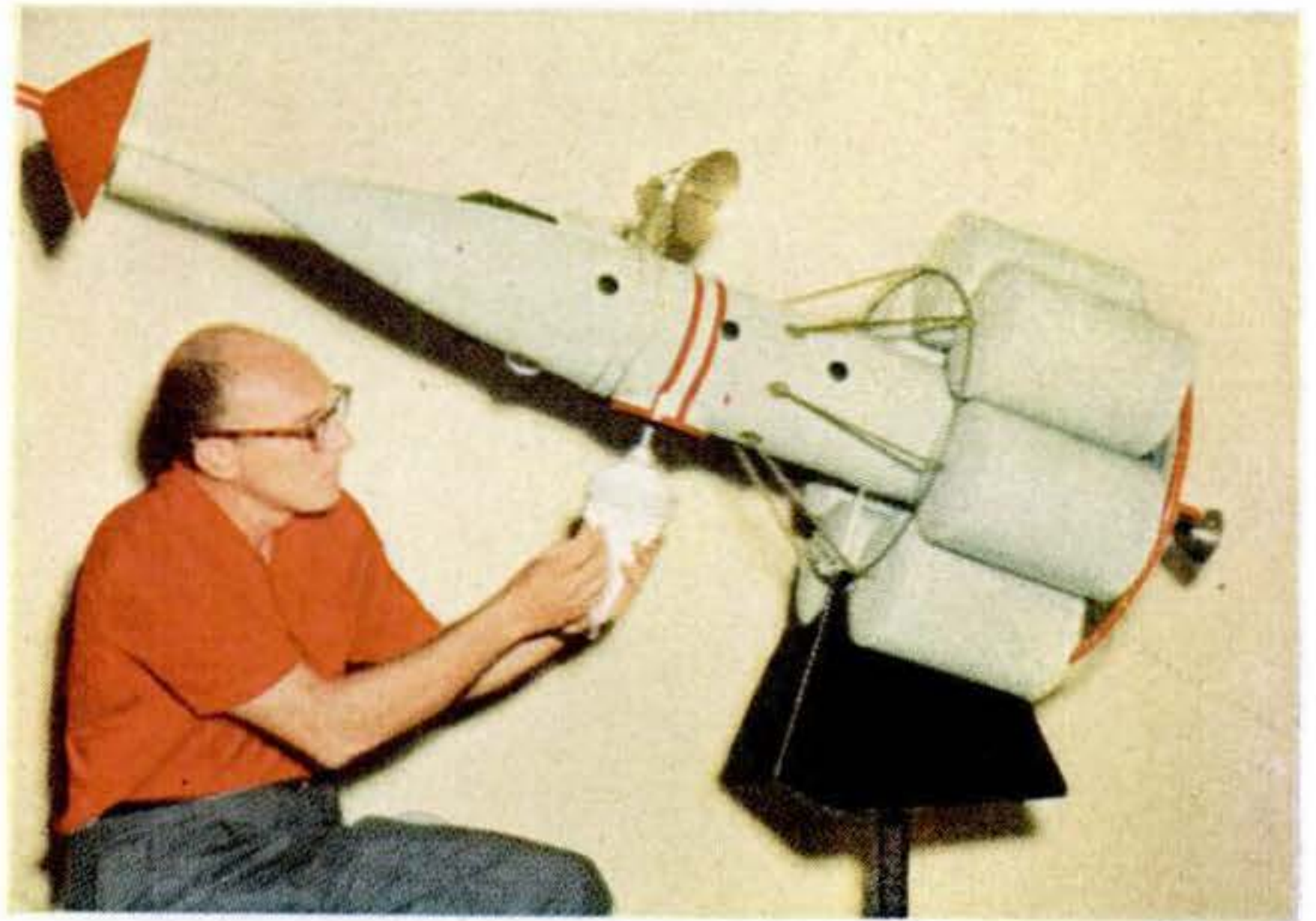

No-gravity is a problem (below) as a man is stuffed into a detachable pod (above) for





RADAR NAVIGATING INSTRUMENTS

HANDRAILS

FUEL TANKS

TOE HOOKS

AIR REPURIFIER

would be 53 feet long and carry four men.

# Part-Time Fan Cuts Car Noise

SOME 400 Midwest motorists are driving around these days in cars whose fans have been doctored to shut off when they get up to a speed of around 40 m.p.h.

The doctoring was done by a Franklin, Ind., car dealer and mechanic. Pete Keeling, who gets his patented Kee-Darr fan cutouts made by a local machine shop and installs them himself at a total cost of about \$40.

At highway speeds, Keeling explains, enough air blows through a

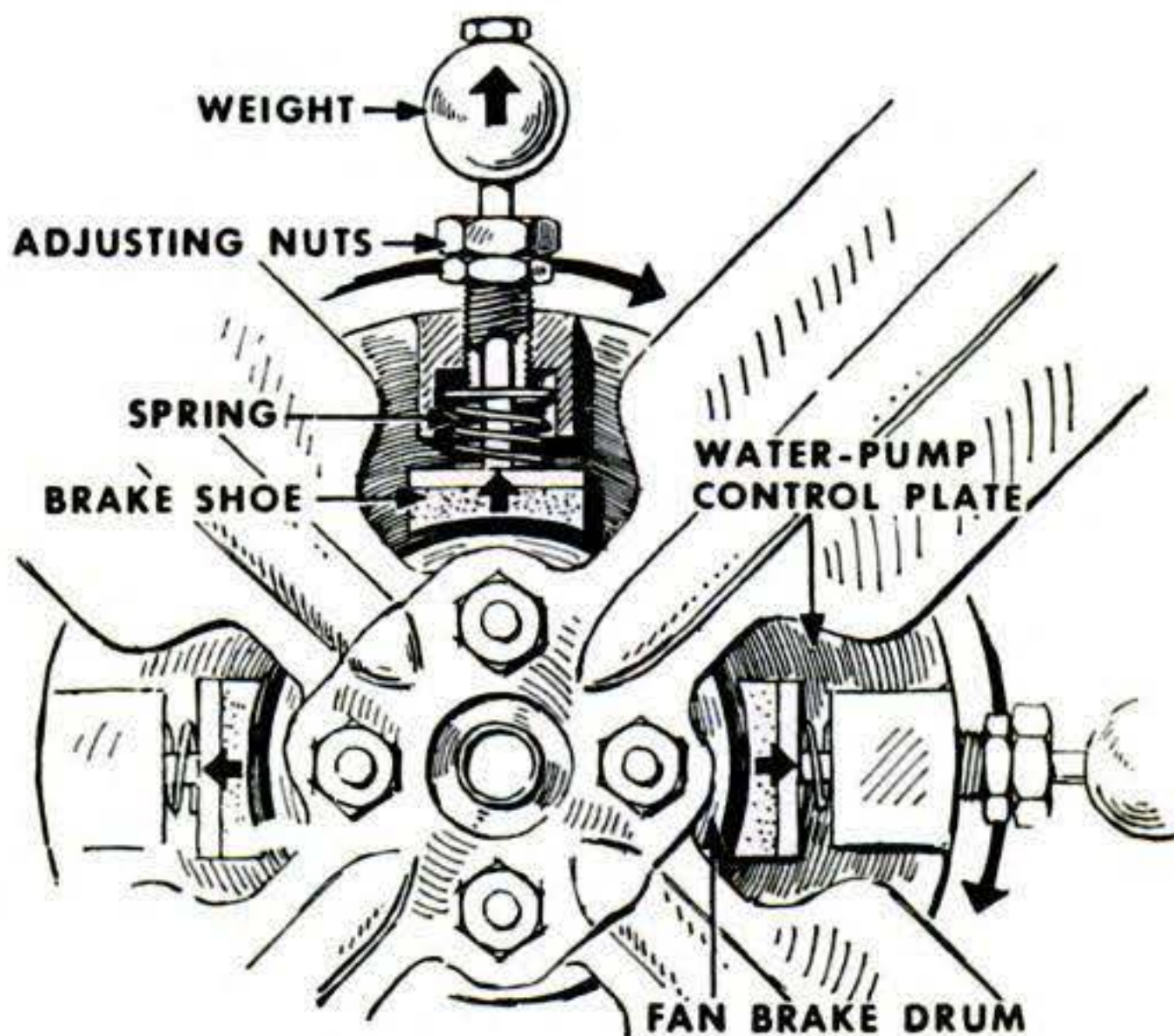

car's radiator to keep the engine cool, so long as the water pump keeps going. Keeping the fan chewing at the air stream only wastes gas and makes unnecessary noise.

Keeling's kit, which fits most 1954 and '55 cars, disconnects the fan when the engine hits 2,000 r.p.m. (about 40 m.p.h.), but keeps it spinning at slower speeds. The fan blades are attached to a brake drum that can spin free on the water-pump shaft. Fastened to the shaft is a control plate carrying four brake shoes. At low speeds the shoes grip the drum, and the fan turns with the pump. At high speeds, centrifugal force pulls the brake shoes outward, releasing the fan—and, Keeling says, saving six to 16 hp.

a side trip to the permanent space station.

**THE SPACE STATION**, shown in the model below, is wheel-shaped, 200 feet across, and houses 50 men. Small rocket motors set it twirling slowly to create artificial gravity inside.

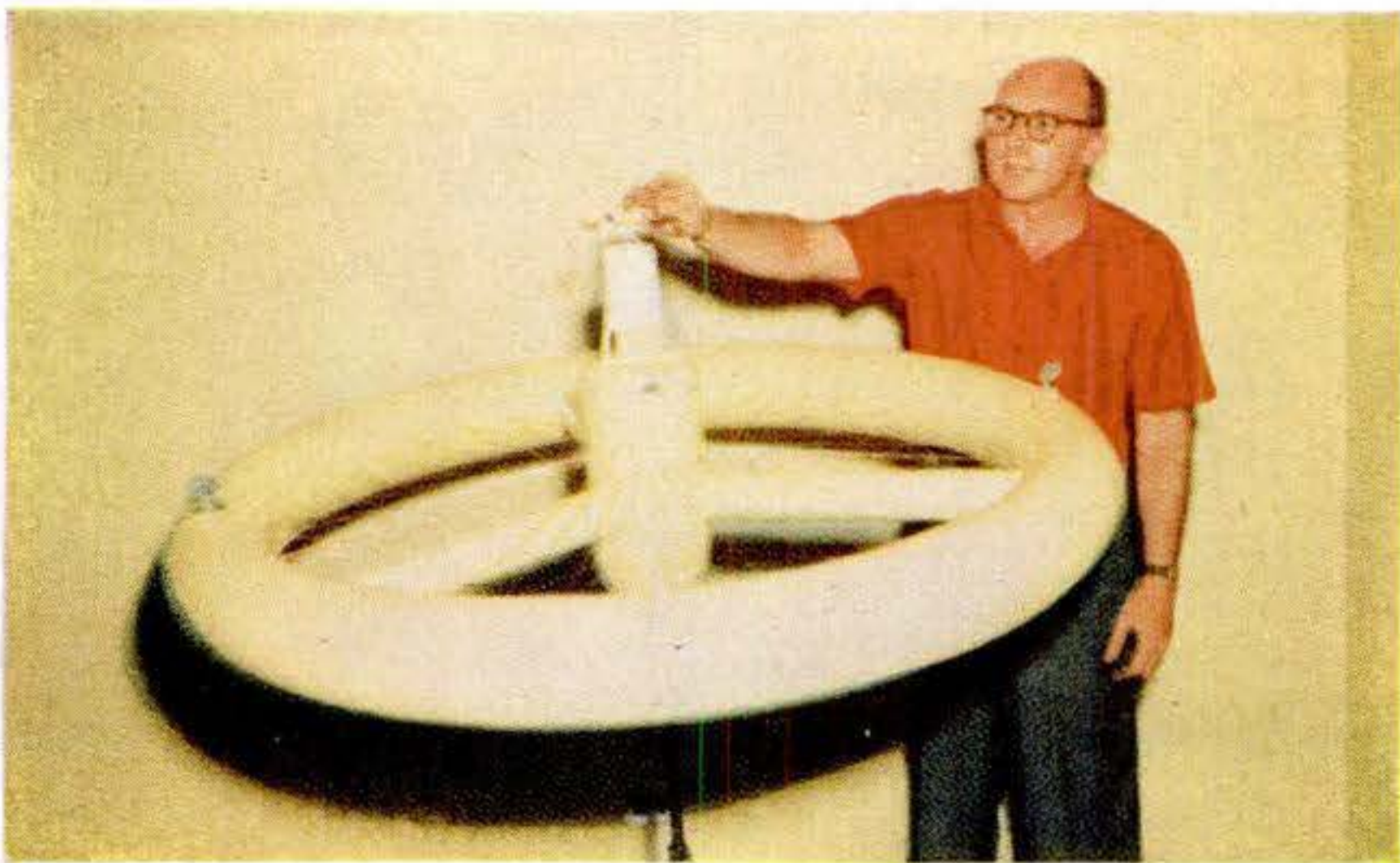



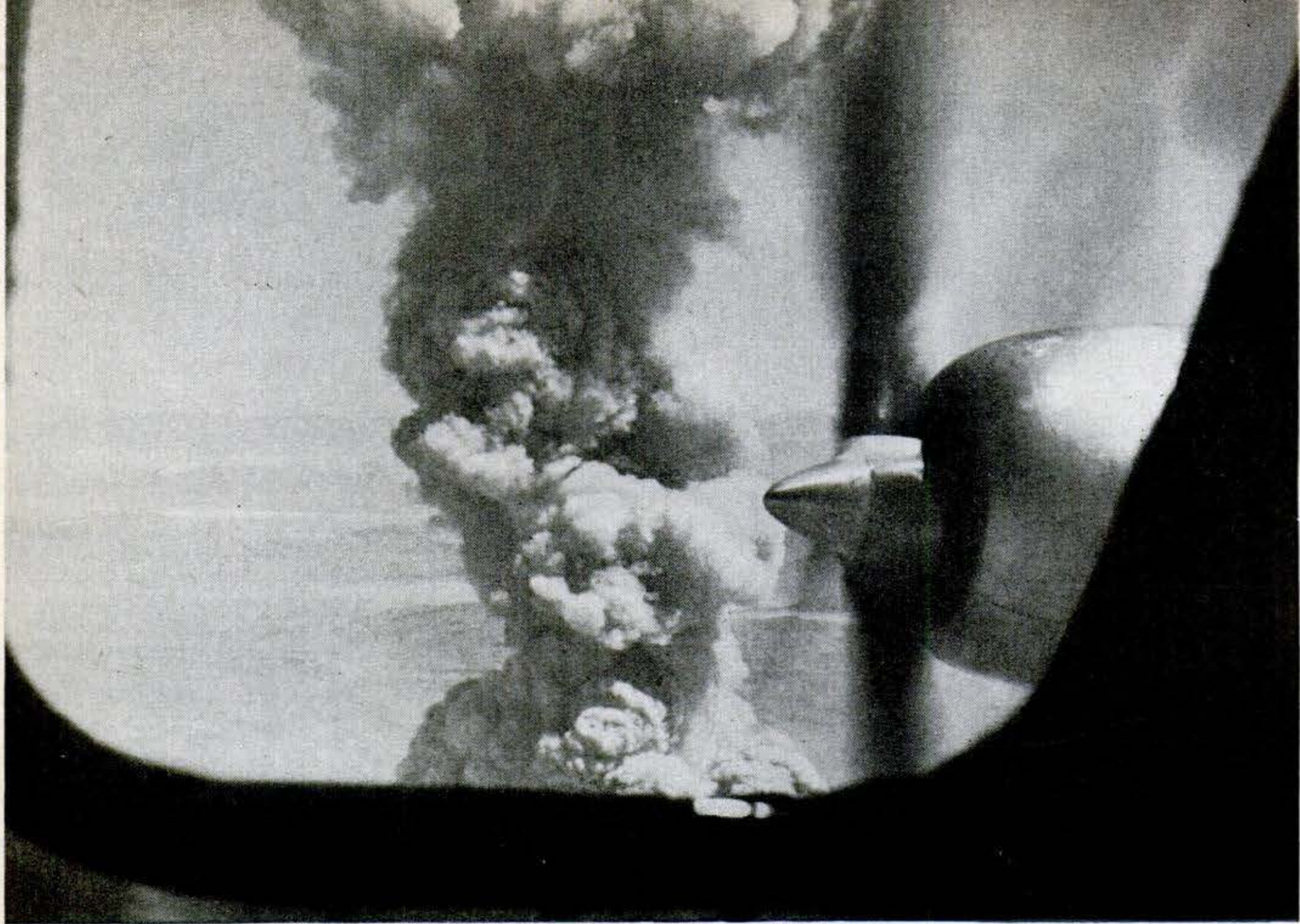

## Pilots Play Tag with Atomic Clouds

**F**LYING through atomic clouds is the awesome job of a group of pilots and crewmen of the Air Force Special Weapons Center in New Mexico. Minutes after a test bomb explodes, a jet whams through the mushroom's cap to trap radioactive samples for study by scientists. As the mushroom disperses, a C-47 buzzes by at 500 feet to measure ground fallout levels. Next, "cloud hunters" in

bombers head upstairs to track the drifting nuclear cloud and warn the test center if the mass begins moving toward airline routes or cities.

Men in the sampling planes pick up more radiation than trackers because they must fly through the atomic cloud itself. But even this exposure is far below the allowed limit and a post-flight shower washes away any lingering contamination.



**GIANT STEP**, from cockpit to platform of a forklift truck, keeps pilot from touching radioactive skin of plane after flight. Truck backs off before lowering the pilot to the ground.



**HOT PLANE** gets cooled off as ground crews in protective clothing hose it down with special decontamination spray. After 24 hours on the ramp, the craft is again safe for flying.



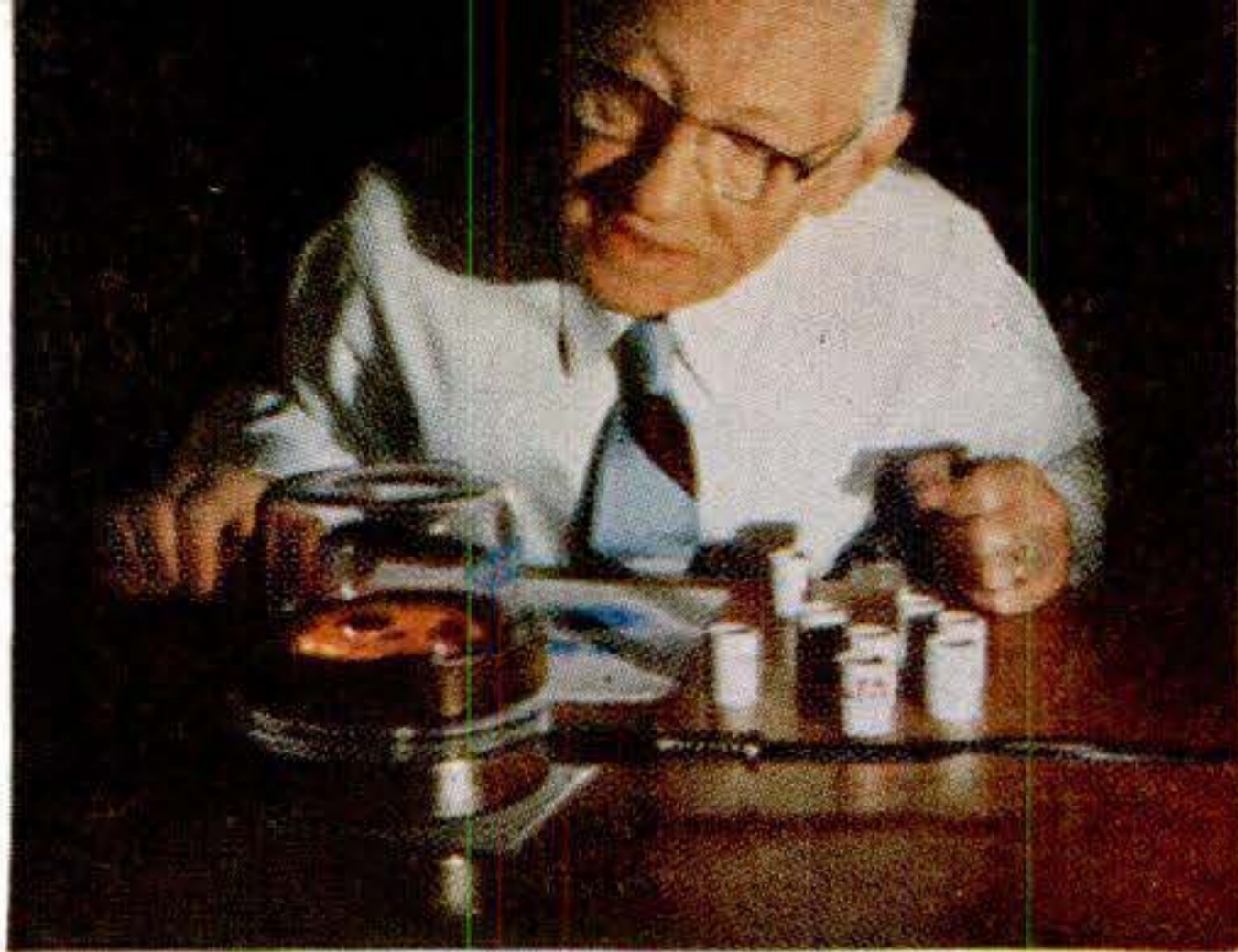

# Table Kiln Fires Enamel On Jewelry

**A**N EXPERT made the enameled pieces in one of these photos, a beginner those in the other picture. Can you tell which is which?

Such speedy skill is made possible by a small, portable, glass-domed kiln that plugs into any electric outlet and might be taken for a coffee pot if you didn't look twice. Because you can actually see the enamels fuse during the firing, mistakes are quickly corrected, and a beginner can soon learn to turn out professional-looking enameled pieces.

The "kitchen-table" kiln is made by The Craftint Mfg. Co., 1615 Collamer Ave., Cleveland, Ohio, and sells for about \$8.



**GLASS-HARD BEAUTY** results from fusing powdered enamels on a copper or silver base under heat. The striking earrings and brooches above are the first pieces fired by Mrs. Elizabeth Wagner of White Plains, N.Y. You can draw your own designs or trace them. Pleasing random effects are made by dusting on different colors or fusing glass threads or beads into a coating of cement which holds them in place.



**ENAMELED PIECES** make excellent gifts as well as hobby projects. Blanks of various shapes for tie clips, cuff links, earrings and other jewelry can be bought ready to enamel, or you can cut your own from sheet metal. A kit including kiln, blanks, enamels and tools is available for about \$15. Earrings at left were made by A. H. Edgerton, expert craftsman and inventor of the kiln.



# I'd Like to see them make...

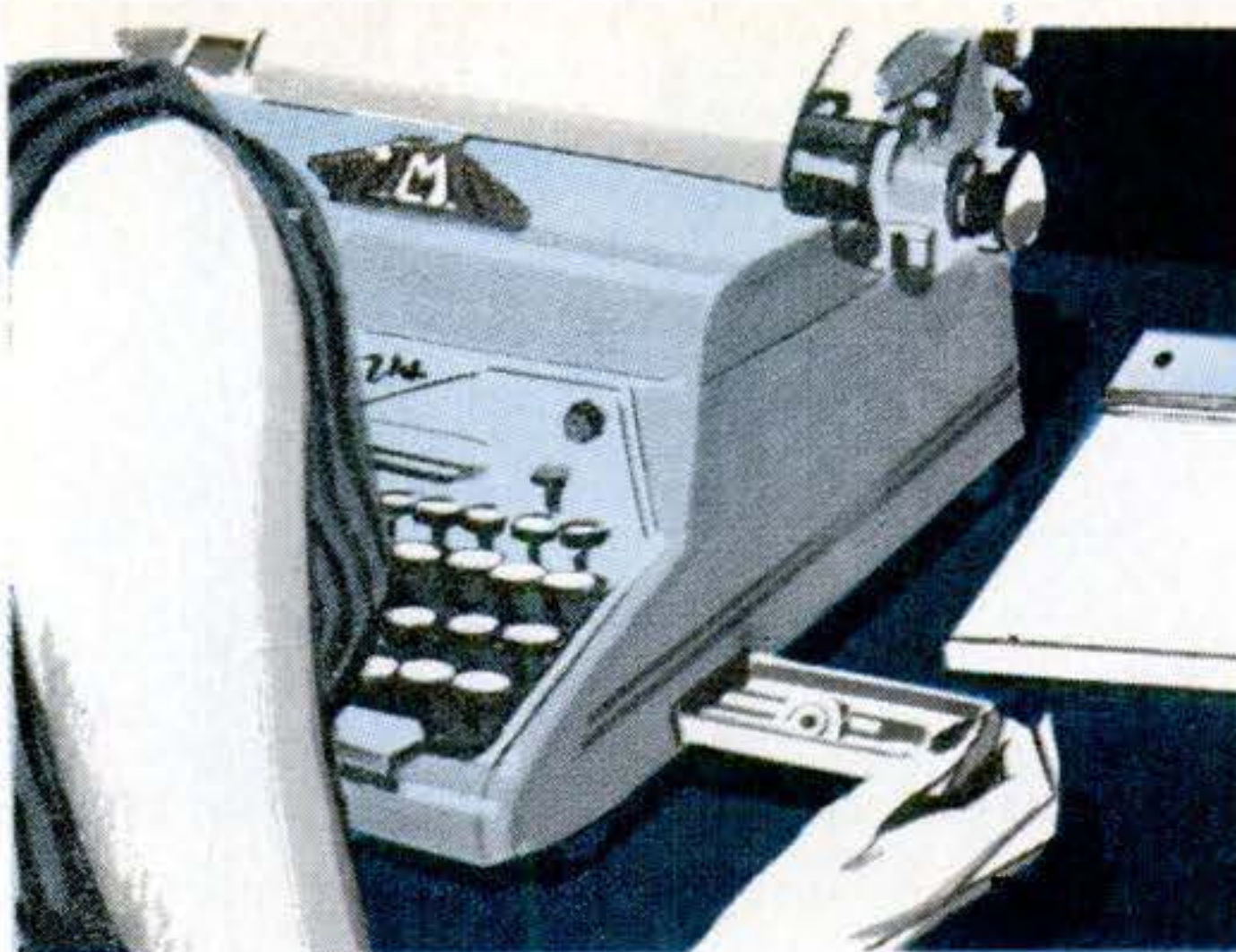

**A TYPEWRITER WITH A BUILT-IN DRAWER** or with a box having a lift-up lid fitted to one side. It would be handy for pencils and erasers.—*Mrs. Edith Pritchard, Los Angeles.*

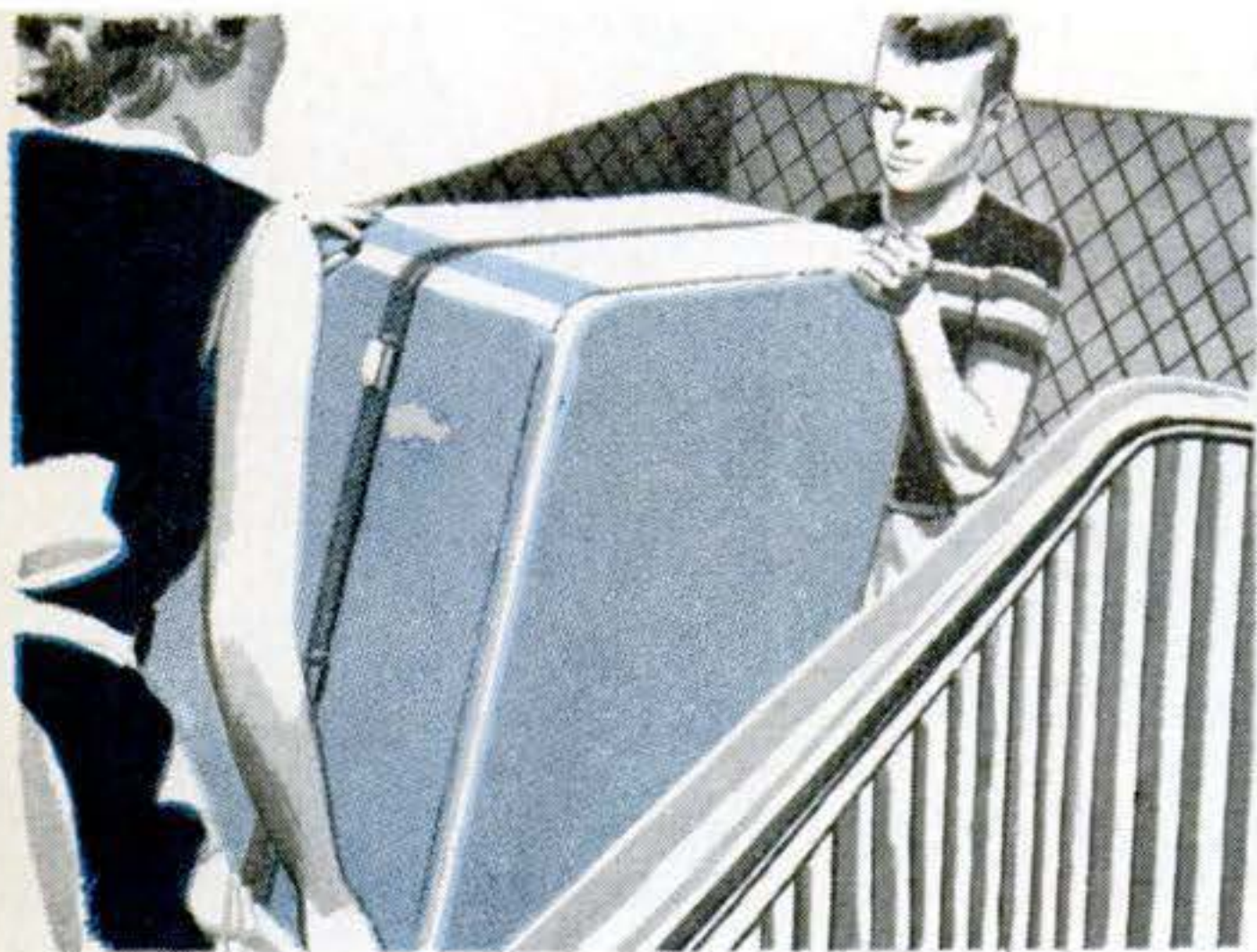

**BED SPRINGS THAT FOLD IN HALF.** It would be easier to move them through doorways, into narrow halls, or around sharp bends in stairways.—*Mrs. R. Darnell, Rockford, Ill.*

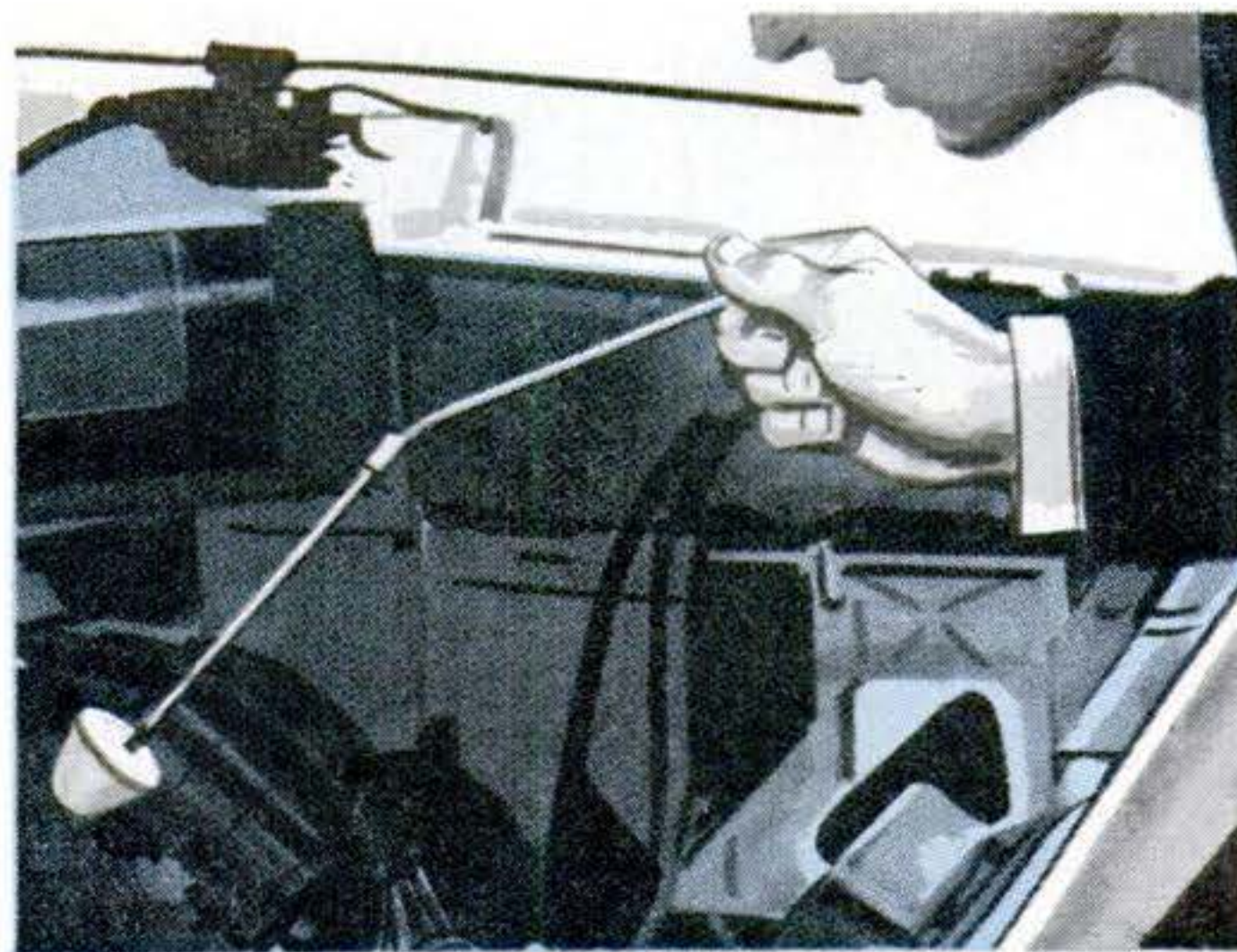

**FUNNEL-SHAPED DIP-STICK HOLDERS** on cars. A flaring tube end would make it easy to replace the oil stick without blind fumbling and poking around.—*R. G. Knox, Tulalake, Calif.*



**A HOT-PLATE TURNTABLE** on electric mixers. You'd switch it on when cooking foods that need constant stirring, such as lemon-pie filling.—*John Bainbridge, Old Forge, Pa.*



**BACK-ZIPPED BABY SHOES.** They'd go on easier and require no lacing—a real chore when you're working with a squirming youngster.—*H. Neibert, Davenport, Iowa.*

Everyone has his own pet idea of a gadget that he would like to see in general use. The five illustrated above were suggested by POPULAR SCIENCE MONTHLY readers. What

is yours? We will pay \$5 for each one published. Please use Government postcards only. Write name and address clearly. Contributions cannot be acknowledged or returned.





## Mud Flies in Jeep Jamboree

**R**RACING war-surplus jeeps through mud and rough stuff is the sport of 40 Yakima (Wash.) Ridgerunners. Ex-G.I.s started the club five years ago.

At their third annual Jeep Rodeo (above), contestants start off two abreast

through the mud, fly through the air in a broad jump, and plow fender-deep into a water splash. Modified engines have split exhaust headers, are bored out .80", ported and relieved; fitted with semi- or ¾-race cams. Compression: 7.5-8.5 to one.



**WINNER OF MUD RACE** grins wearily through several layers of muck after a grueling event.



**LOSER OF JALOPY RACE** also loses his car when it gets shoved over a cliff in the finale.



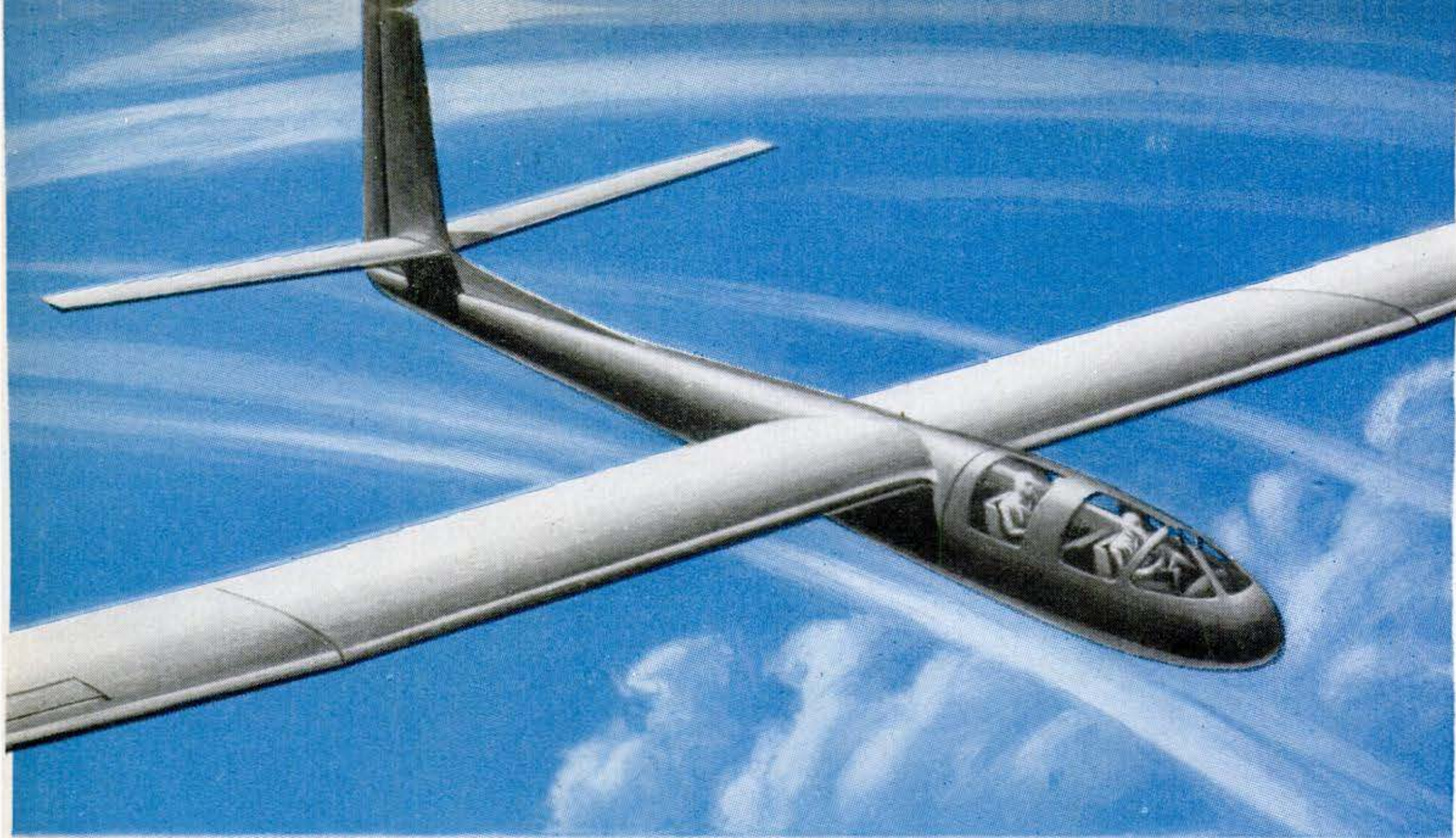

**WINGS LONGER THAN AN AIRLINER'S** are proposed for big space glider. It would be built

stronger than the average fighter plane. Detachable cabin (shown in cutaway at right above)

# Giant Glider to

**Scientists plan to float in space for hours in an engineless craft. They'll get up there riding a treacherous wave of mountain wind.**

**T**HE new way to explore space is in a glider. Conventional airplanes can't fly high enough; rockets run out of fuel in a few seconds; balloons are difficult to control.

But big, rugged gliders, riding a remarkable wind that blows upward to great heights, could soar for hours on the edge of space more than 13 miles above the earth. This is miles above the practical ceiling for airplanes, whose engines need air to operate.

**Such a space glider** may be built by the Air Force. Plans for a giant sailplane—a hefty craft stronger than most fighters, with a two-man detachable cabin and wings longer than those on a DC-7 passenger liner—have been prepared for the air arm's Geophysics Research Division. The ship was designed by a group of engineers guided by Victor M. Sau-

dek, Los Angeles aeronautical designer, and Dr. W. B. Klemperer, Douglas Aircraft researcher.

About the only resemblance between this space glider and sailplanes flown at sporting meets would be its lack of an engine. It would be big and heavy, weighing a ton and a half. One design submitted to the Air Force calls for a fuselage 43 feet long, wings spanning 120 feet and a rudder 15 feet high.

**The capsule cabin**, big enough for two men and 650 pounds of instruments, would have a big parachute. If things went haywire up where space begins, the crew could jettison their sealed cabin and chute down inside it to altitudes where they could safely bail out of the cabin. A detachable cabin has more prosaic advantages, too: It could be wheeled into a heated hangar for servicing; and it



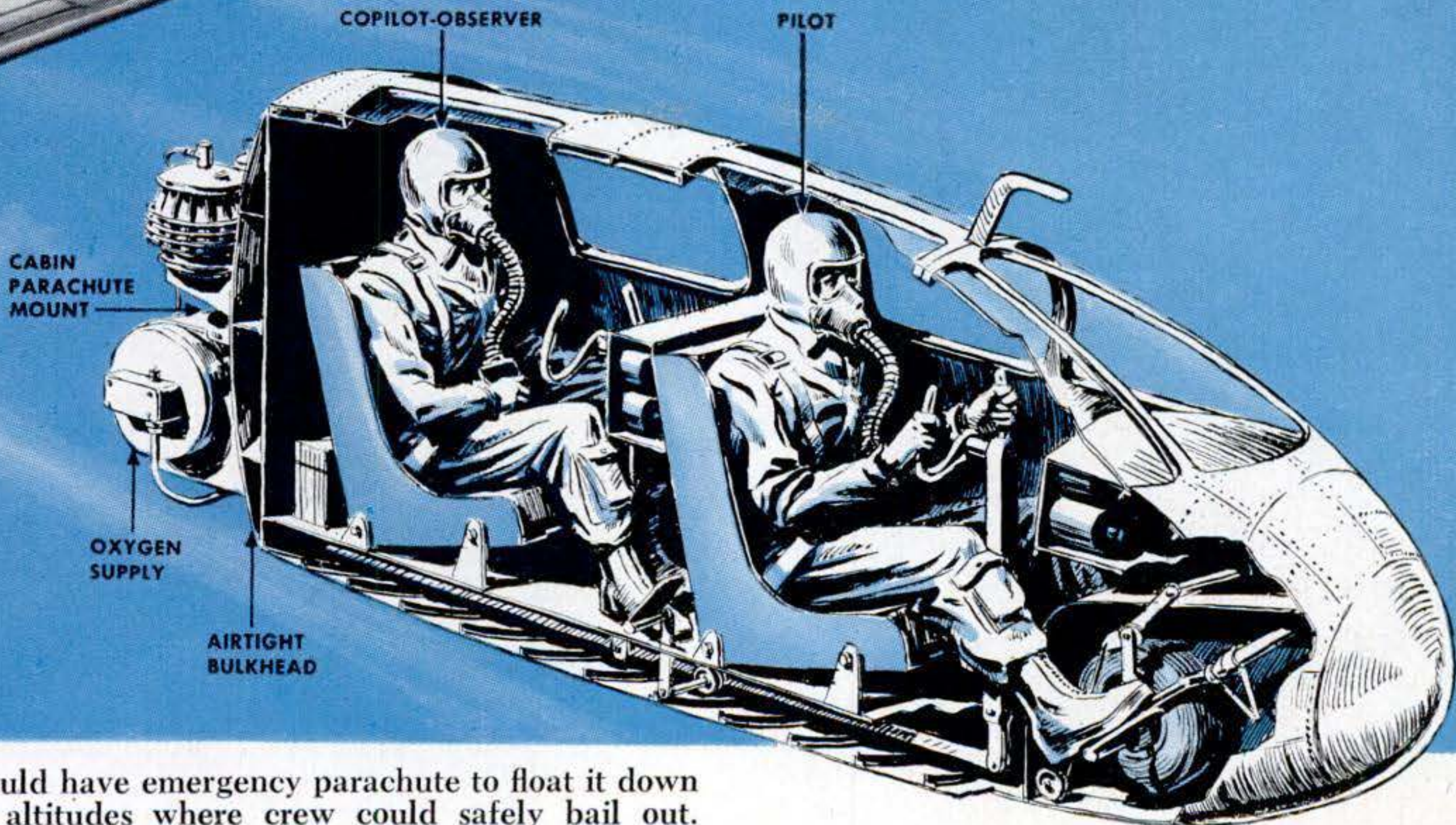

would have emergency parachute to float it down to altitudes where crew could safely bail out.

# Climb 13 Miles

could be exchanged for another cabin with an entirely different set of equipment which would suit it for some other type of air mission.

The cabin would be sealed airtight and pressurized with air from liquid oxygen tanks so that the crew could fly with masks off even at 13 miles altitude.

**LENS-SHAPED CLOUDS MARK AIR WAVE** that could float glider into space. Lee wave is formed when wind pours down over mountains (right in photo below), then rebounds high over valley.

The crew would still have to wear pressure suits, for if the cabin's pressurization should fail at top altitude, the very low outside pressure there would literally make the fliers' blood boil and they would be killed. Their suits, gloves and boots would be heated to shield them from the numbing chill of outside

**ANATOMY OF A LEE WAVE** is clearly revealed in sketch, which shows a vertical cross section of a very strong one. Probing sailplane rode these updrafts above 40,000 feet.

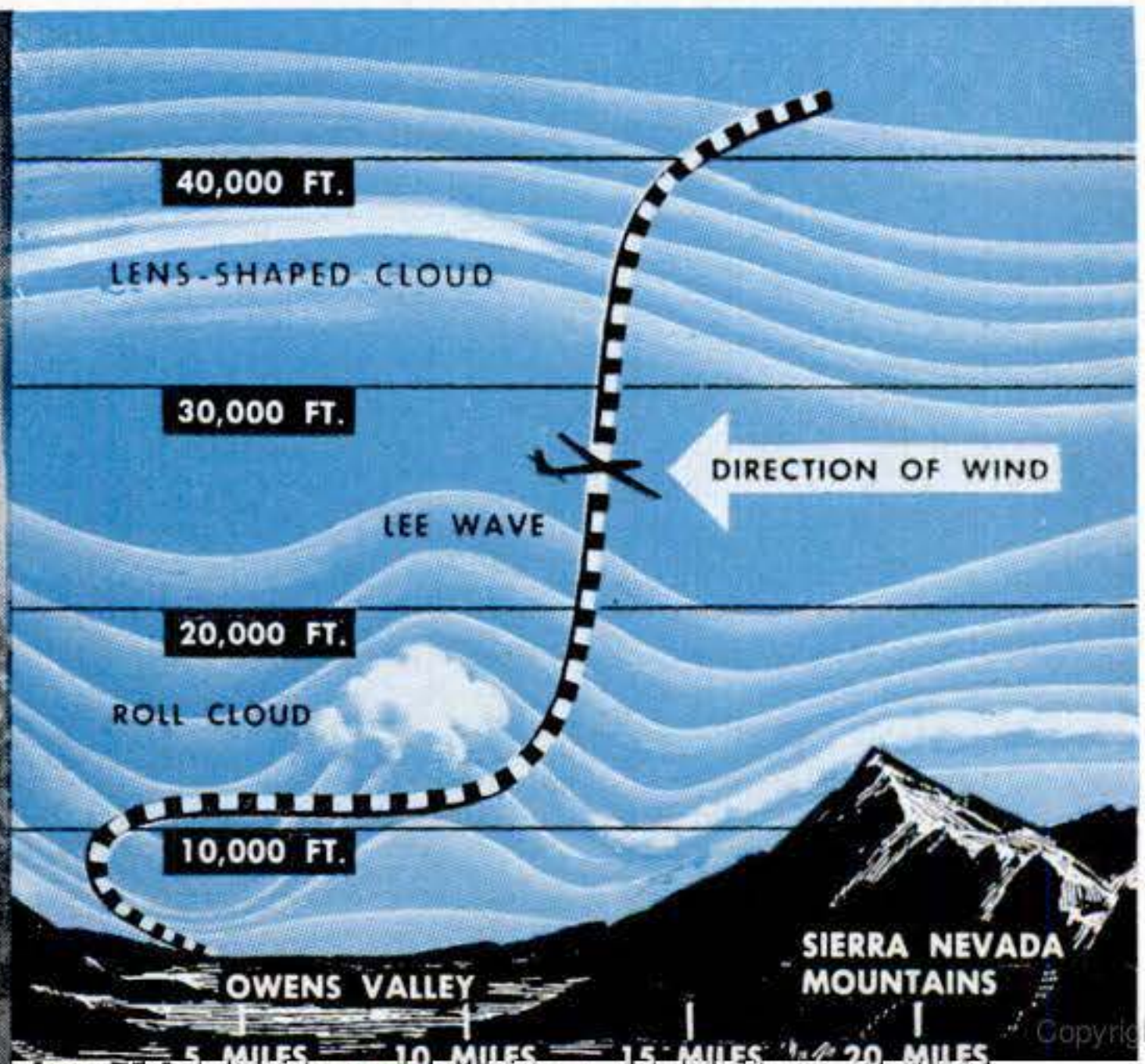
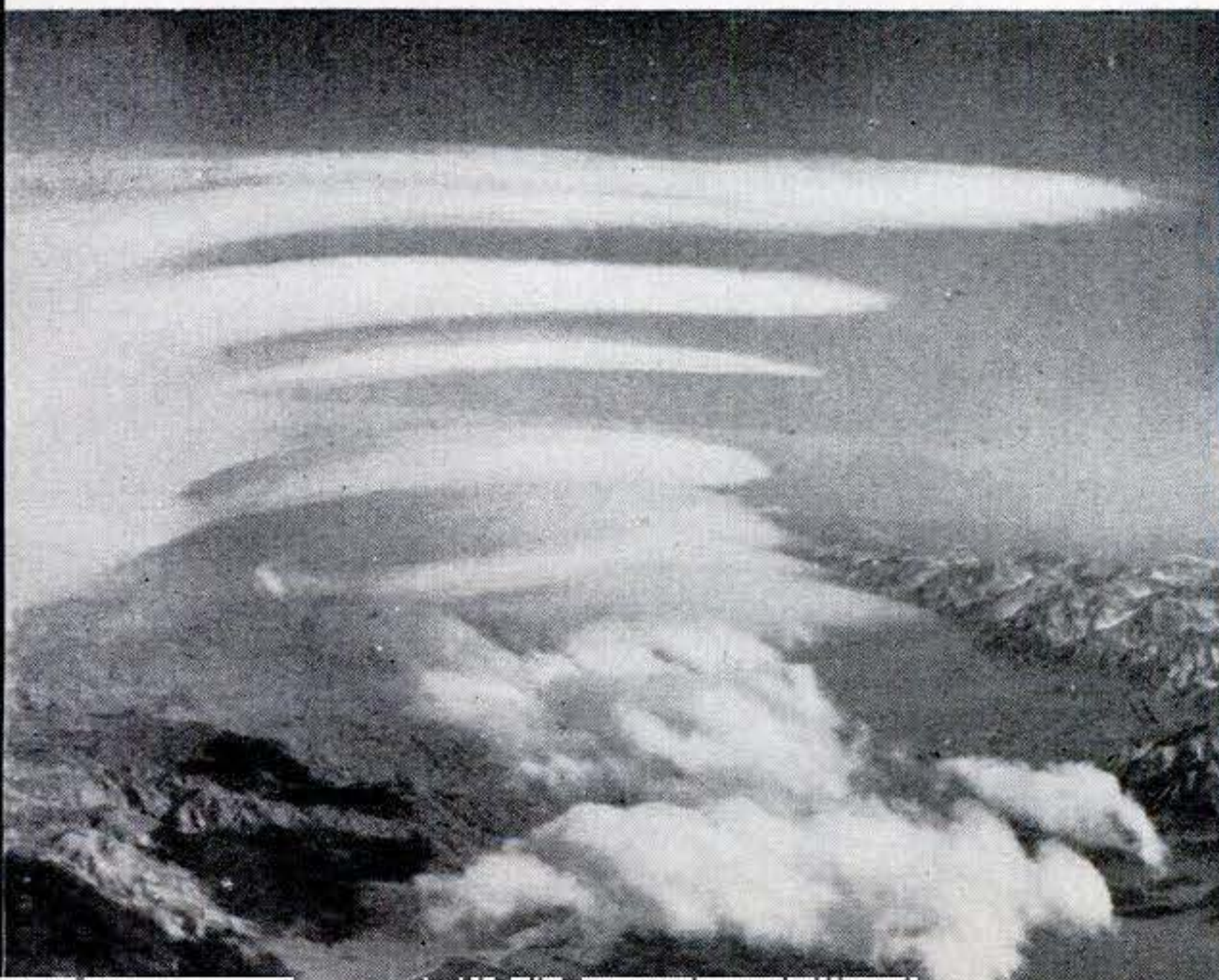





**LIKE RUNNING INTO A TRUCK** is the way glider pilot Laurence Edgar describes turbulent blast of lee wave that tore him out of safety harness and shot him through cockpit canopy. Force of shock made him momentarily feel heavy as a Cadillac. The glider itself was wrecked.

temperatures as low as 112 degrees below zero.

Electricity is to be supplied by storage batteries supplemented by a wind-driven generator. The generator would be used when the glider was being towed or was descending, but would be retracted during normal flight to reduce drag.

**Designed to be twice as strong** as an airliner, the big glider would stand up under forces 10 to 12 times gravitational pull, and greater loads momentarily. Even fighter planes are generally built to take only forces nine times gravity.

**MOCK-UP OF SPACE-GLIDER CABIN** is shown below. Ship is designed to carry on high-altitude exploration started by University of California at Los Angeles and the Air Force.



Such massive strength is required because of mighty, often turbulent air currents the glider may encounter on its climb up into space. It would be towed aloft by an airplane and released into the strong updrafts of a "lee wave"—a powerful upflowing wind that would carry it into the lower reaches of space in two to four hours. The craft could then "take off" for as much as four hours of exploration before descending.

**This lee wave**, which could lift a heavy glider 13 miles, is one of the most startling discoveries of the past few years' probing into the mysterious ocean of air we inhabit. The wave is created whenever a strong wind meets a steep mountain ridge head-on. The wind flows over the mountain tops like water over a dam, dashing down into the valley on the far side. As it falls, the air is compressed and heated so that it expands again. This makes it bounce above the valley and rush faster and faster to heights far above the mountain top. Updrafts in such a lee wave, and downdrafts when it plunges earthward again, may hit mile-a-minute speeds.

Often moisture will condense along the crest of the wave, forming unusual lens-shaped clouds. These clouds have been seen as high as 19 miles in the air.

A glider has already flown to 44,255

*[Continued on page 256]*





## Designers Dream Up New Ways to Tell Time

**Y**OU'D never have to wind the experimental timepiece shown at left. It snaps on the telephone and keeps itself wound by the motion of the dial mechanism. Three calls a day are enough to keep it ticking.

It was one of several timepieces of the future exhibited by Elgin at the National Jewelry Show. Strictly in the dream class was a nonworking solar watch designed to capture the sun's rays and convert them into electrical energy which would run the tiny wheels and gears. Some other Elgin watches—working models—are shown below.



**TELE-DIAL WATCH** tells hour in window. Black line moving around dial shows minutes.



**FROGMAN'S WATCH** registers depth as diver descends. Water enters tube, moving indicator.

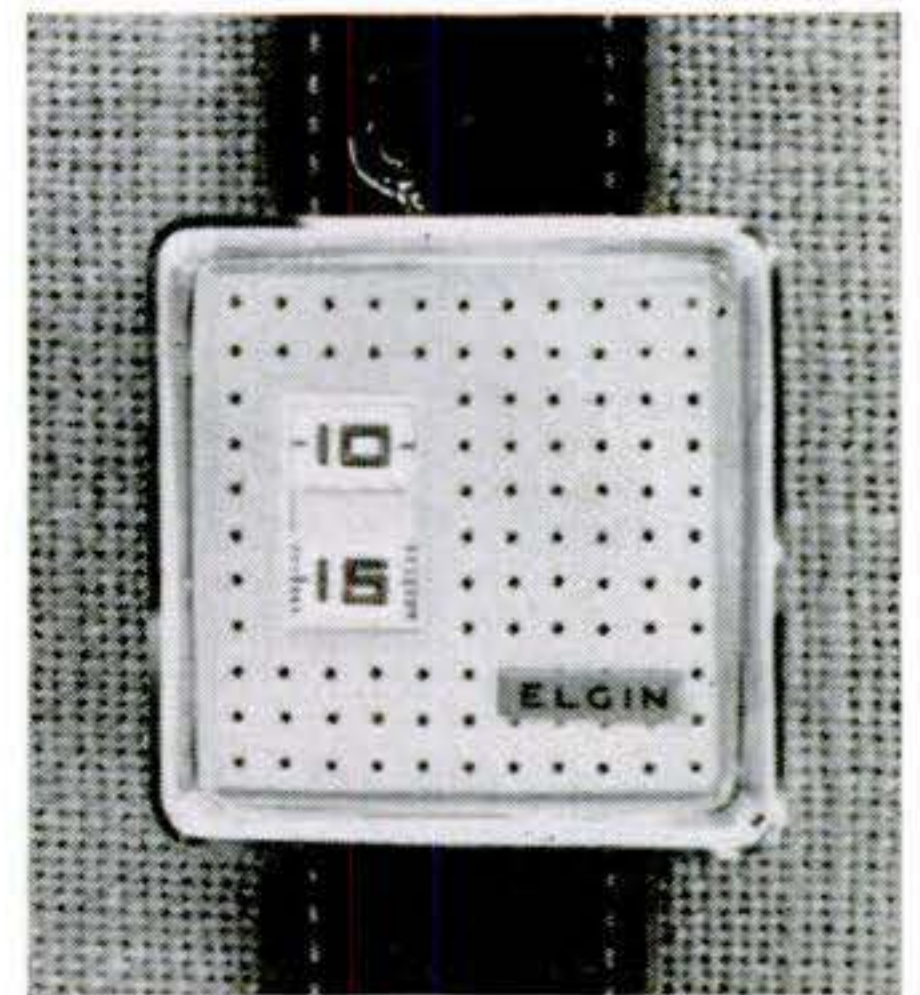

**DIRECT-READING WATCH** has twin ports in which hours and minutes roll into view.



### Two Engines Run Five-Tonner

TWIN engines turn out 180 hp. to drive this cross-country truck at 50 m.p.h. Power goes back to a transfer case at the chassis' center, and then forward and to the rear to balloon-tired wheels. Nicholas Straussler & Co., London, built the big vehicle.



### GIs Get Featherweight Radios

THAT'S a radio receiver strapped to the helmet of the infantryman above. About as big as a king-size pack of cigarettes, it weighs only nine ounces. The Army has a new "transceiver," too, that sends and receives messages. It weighs less than a pound.



# A Gallery of 1956 Cars

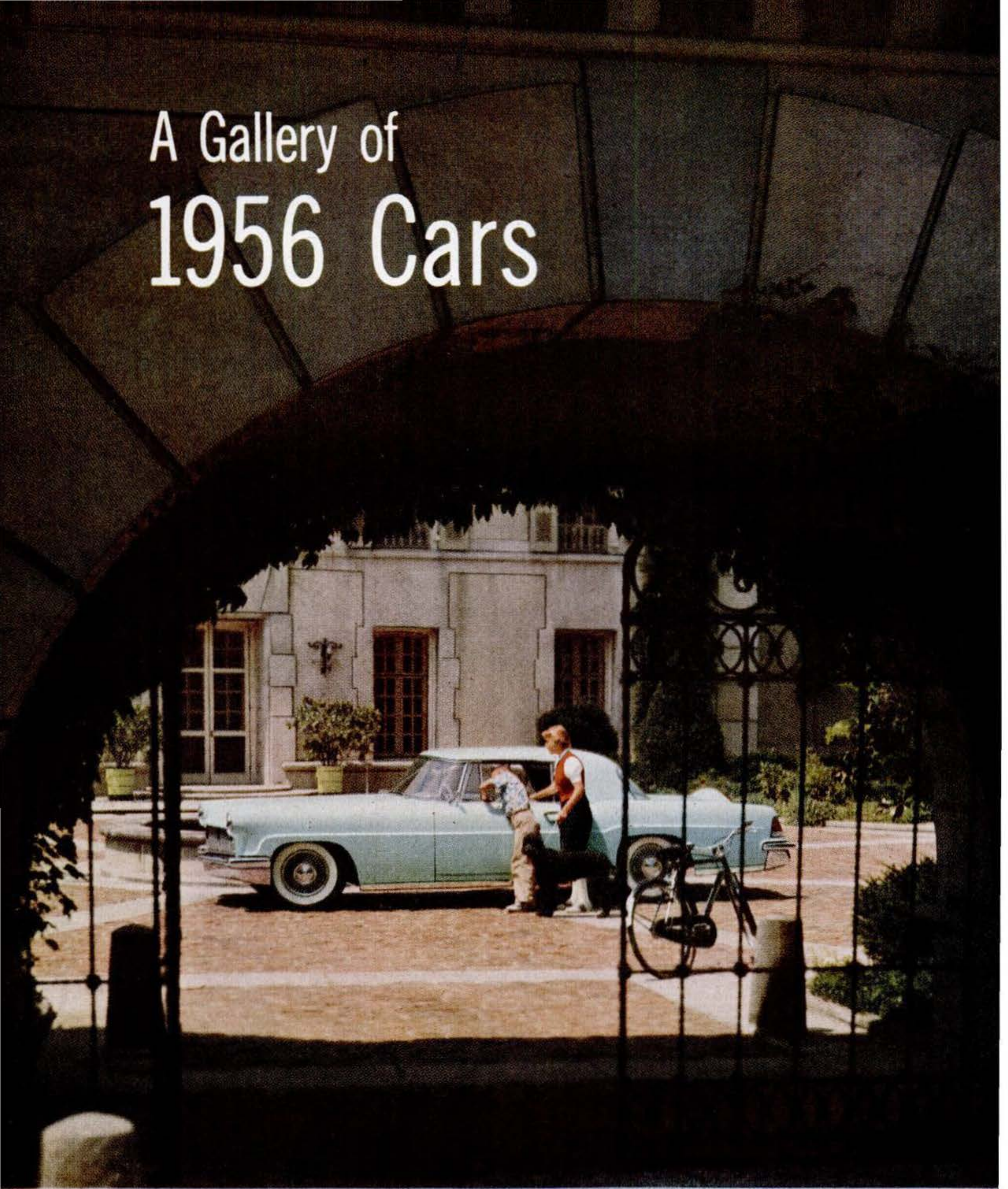

## Continental

A new car—at \$2 a pound

**A BUNDLE OF HAUTEUR** molded into sheet metal, the Continental Mark II is a revival of a masterpiece of automobile styling that first appeared as a production model in 1940. It vanished in 1948. The new Continental is 56 inches high and a bit more than 18 feet long. It's elegant. It's stridently conservative. It's also America's most expensive car. Got \$10,000? For full details, see page 122.



# Imperial

Those tail-light eggs  
are bigger yet

**PACED BY THE SNOOTY IMPERIAL**, Chrysler Corp. vehicles for '56 sport completely redesigned rear ends. The aft running lights on this car, appropriately pedestaled, have grown. Behind those new wheel plates is a new type of brake that—the company says—ought to give the owner up to 60,000 miles without relining. There's more power, of course. For more on the whole Chrysler line, see page 115.



# Chrysler

Now hash marks  
on the fenders

**ONLY A SHADE LESS SNOOTY** is the Chrysler New Yorker. Any sergeant will respect those chrome strips on the fenders. Added rear overhang makes the car three inches longer.

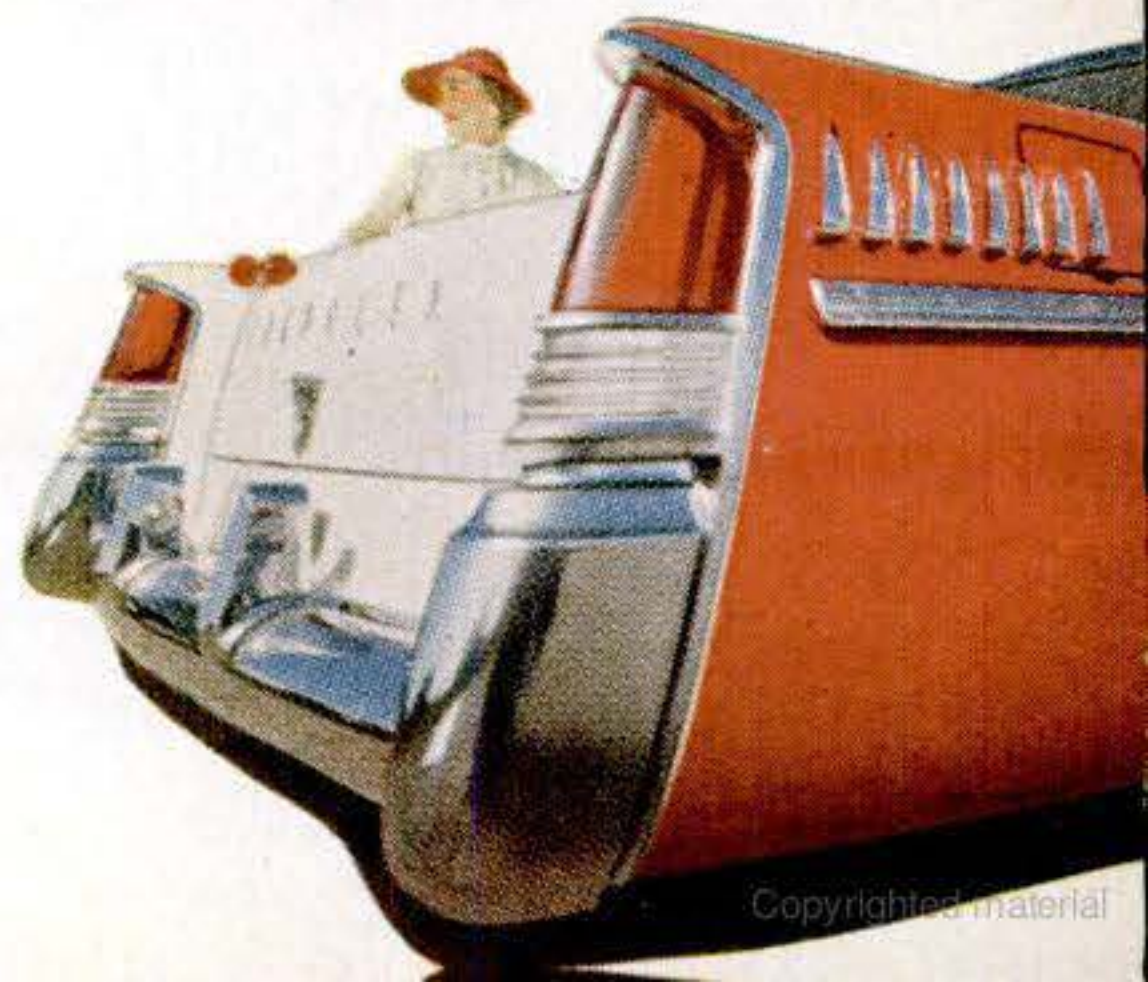





# Dodge

Fins soar and upholstery breathes

**FINS ON THE DODGE** are king-size. Like those on all other Chrysler Corp. cars, they can well close the book on this trend in styling. Shown here in the convertible version, the Dodge also has seat fabrics that "breathe"—the pattern is in bas-relief. For added gas mileage, the hemispherical cylinder head has been replaced with a "polysphere." Hotter plugs of a new design help. Protruding further into the fuel-burning area, they permit leaner mixtures.

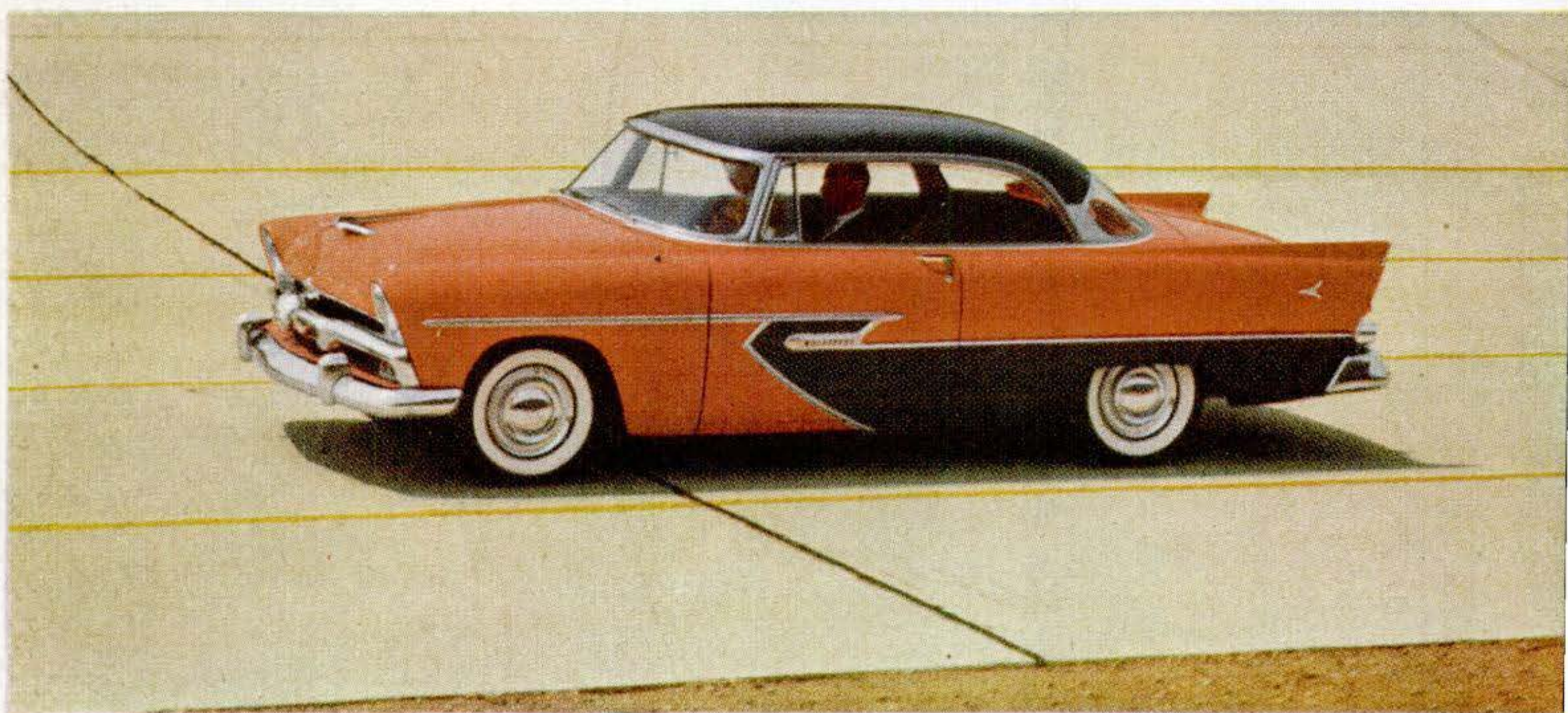

# Plymouth

Tail styled for Air Age



**THE SIMILARITY** in rear-end styling between Plymouth and a jet plane is purely intentional. Emphasizing safety, the new cars have stouter door catches, a dished-rim steering wheel, optional padding in the driver compartment, and extra seat anchorages.



# DeSoto

Twin light clusters  
tell the tail

**GOING DODGE ONE BETTER**, DeSoto has *three* (instead of two) lights in clusters under each of its awning-like fender tips. The top bulb is for stop and turn, the middle one for backing up. The bottom one is a running light. The grille, minus DeSoto's traditional "teeth," is a marked improvement. As on the Imperial and Chrysler, a gasoline-fired heater, providing warmth for the car's occupants in one minute, is optional equipment.

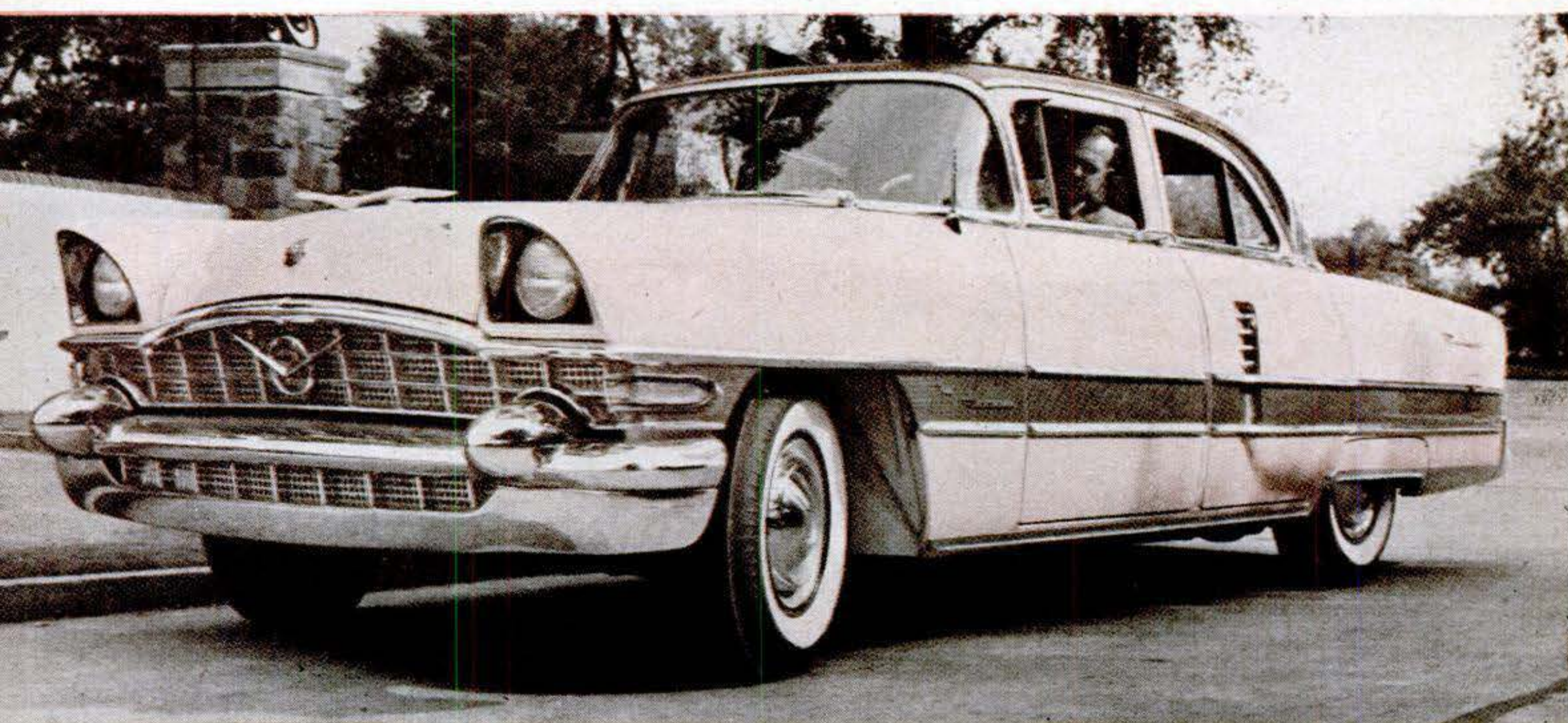

# Packard

Slicker and quicker,  
with punchboard control

**FULL-LENGTH STRIPE** suggests flashy performance of new Packard Patrician, powered by Detroit's biggest engine. Push buttons (right) select transmission range. For more, see page 128.

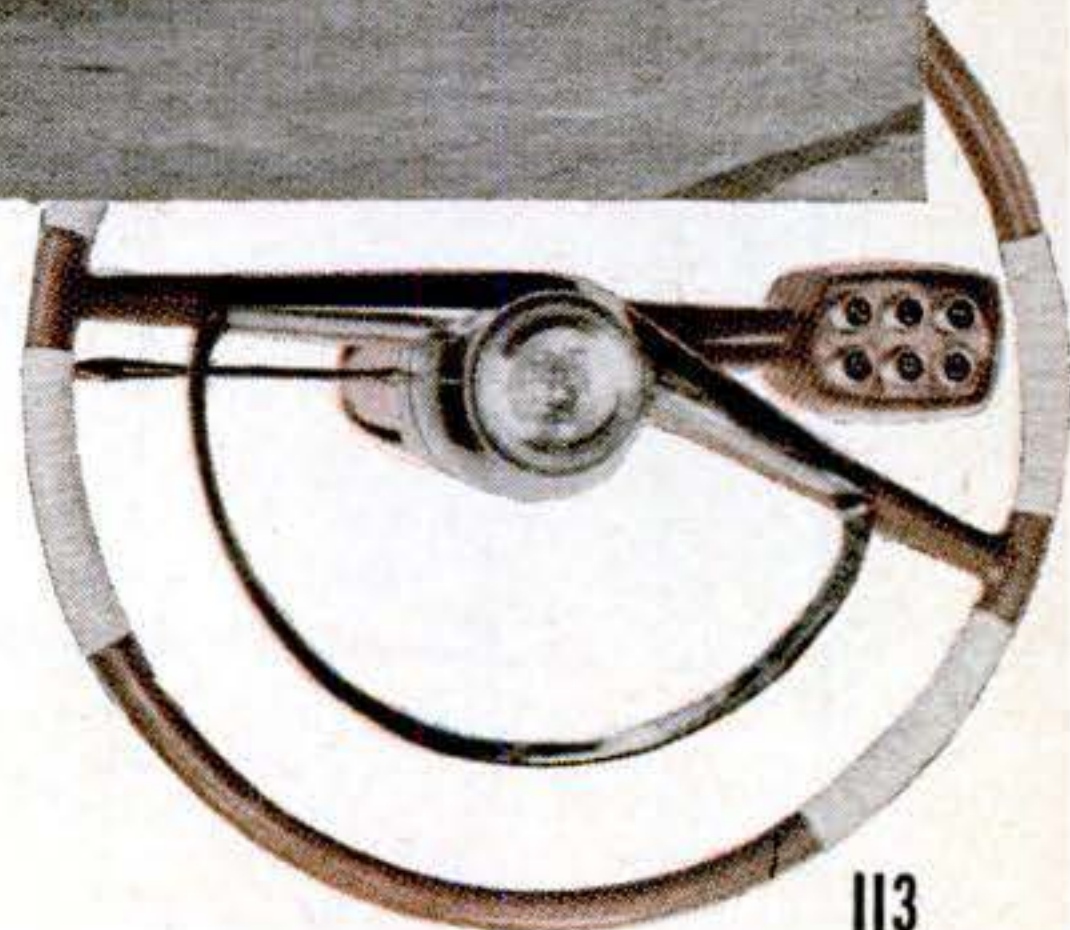



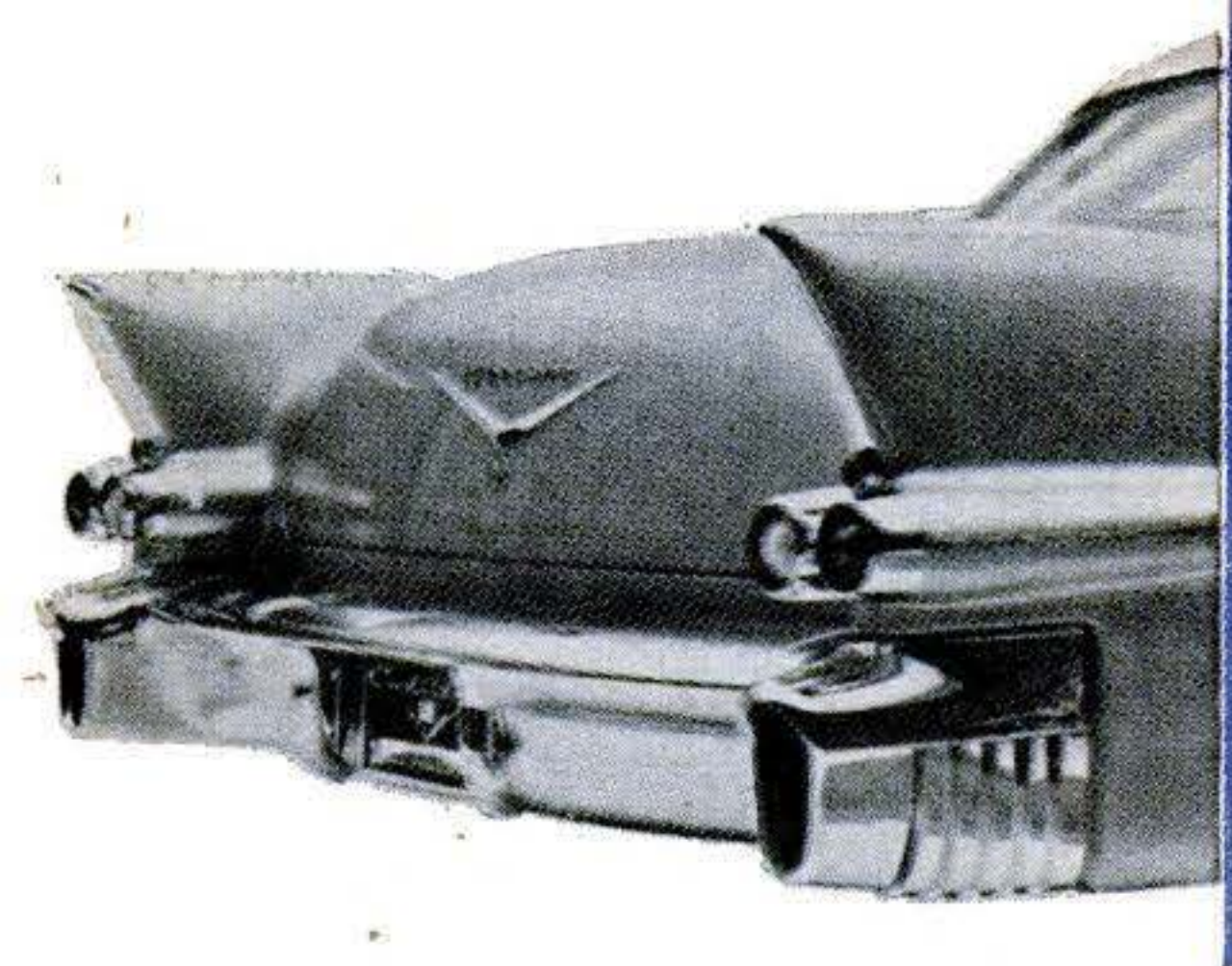

## Cadillac Big-finned Eldorado gets a hard top

**WITH 305 HP. UNDER THE HOOD,** the Eldorado now comes in a hardtop version. The grille—surprise!—is cast aluminum, given a golden color by a dye process. Exhaust ports snaked through the bumper have a louvered effect. For more about both cars here, see page 119.

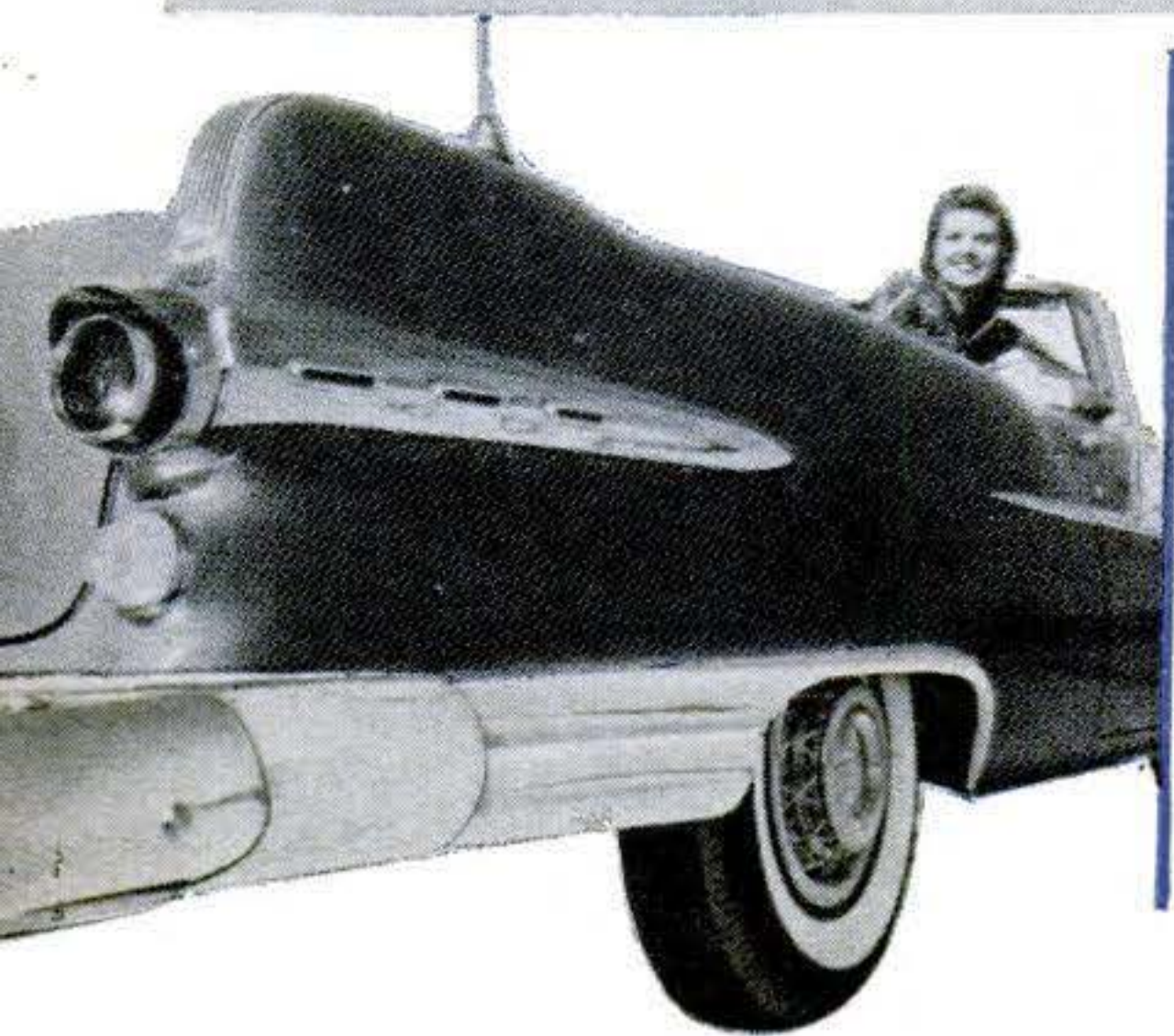
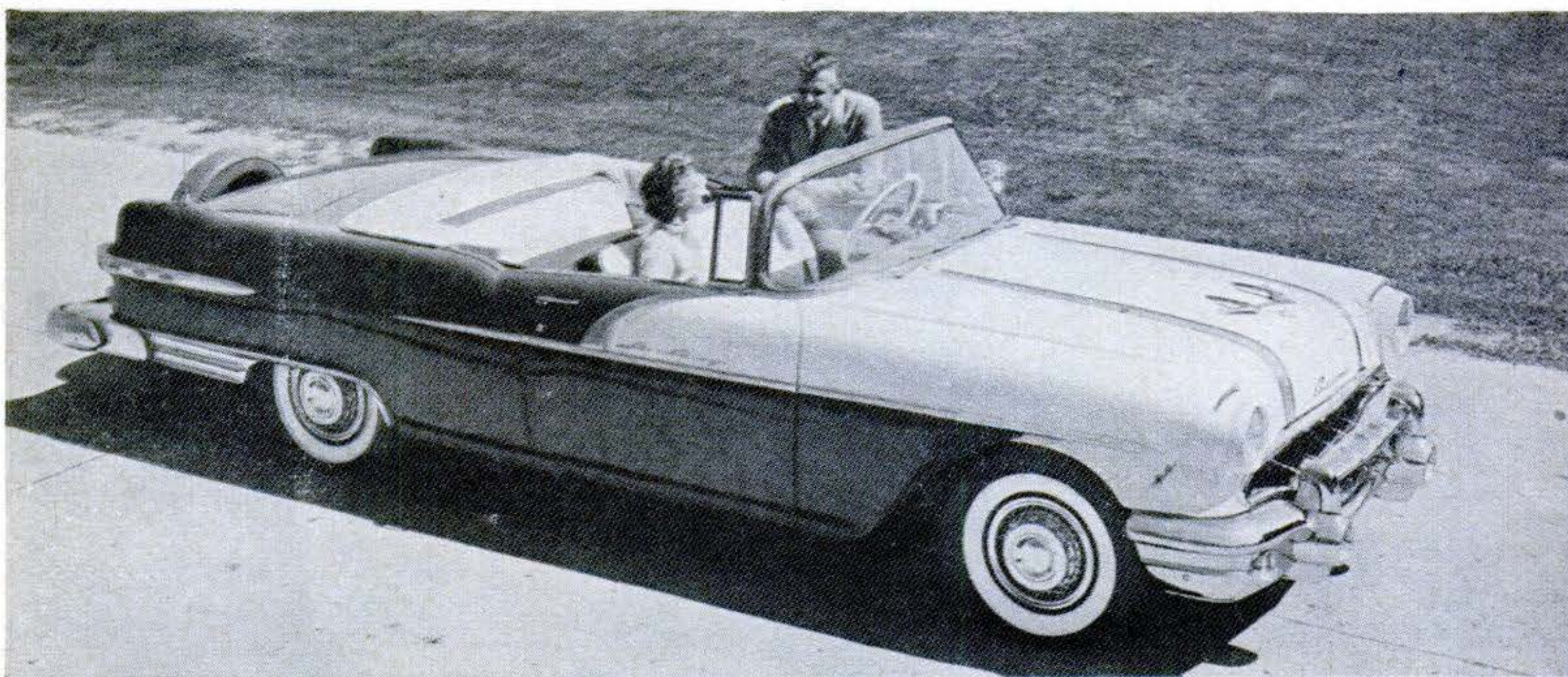
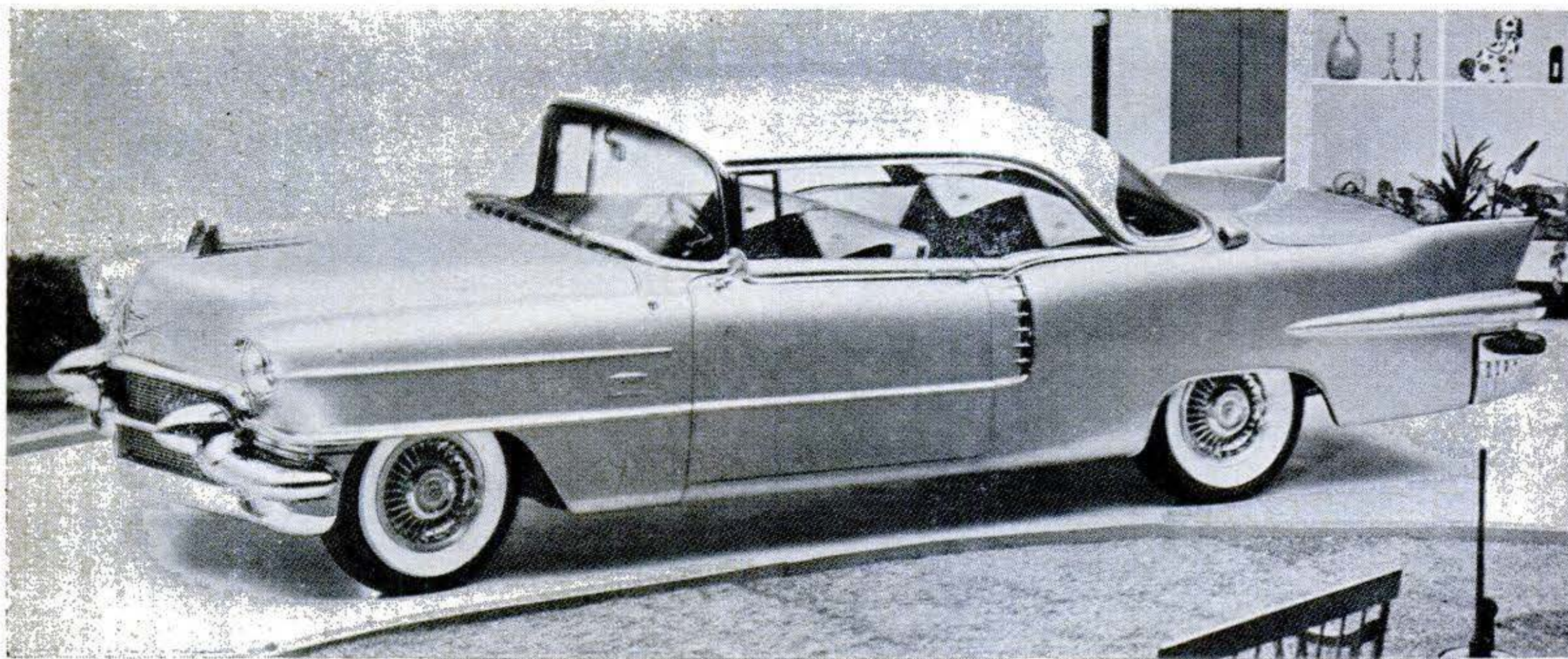

## Pontiac Silver streaks blend into sheet metal

**AND WITH 227 HORSES IN ITS TOP LINE,** Pontiac has changed its two-tone trim, depressed its silver-streak trademarks into the sheet metal, enlarged the tail lamps and put wind splits on the rear fenders. Even the instrument panel now comes in two colors. Pontiac also is introducing a four-door hardtop model for '56.



# Chrysler Adopts Push-Button Drive

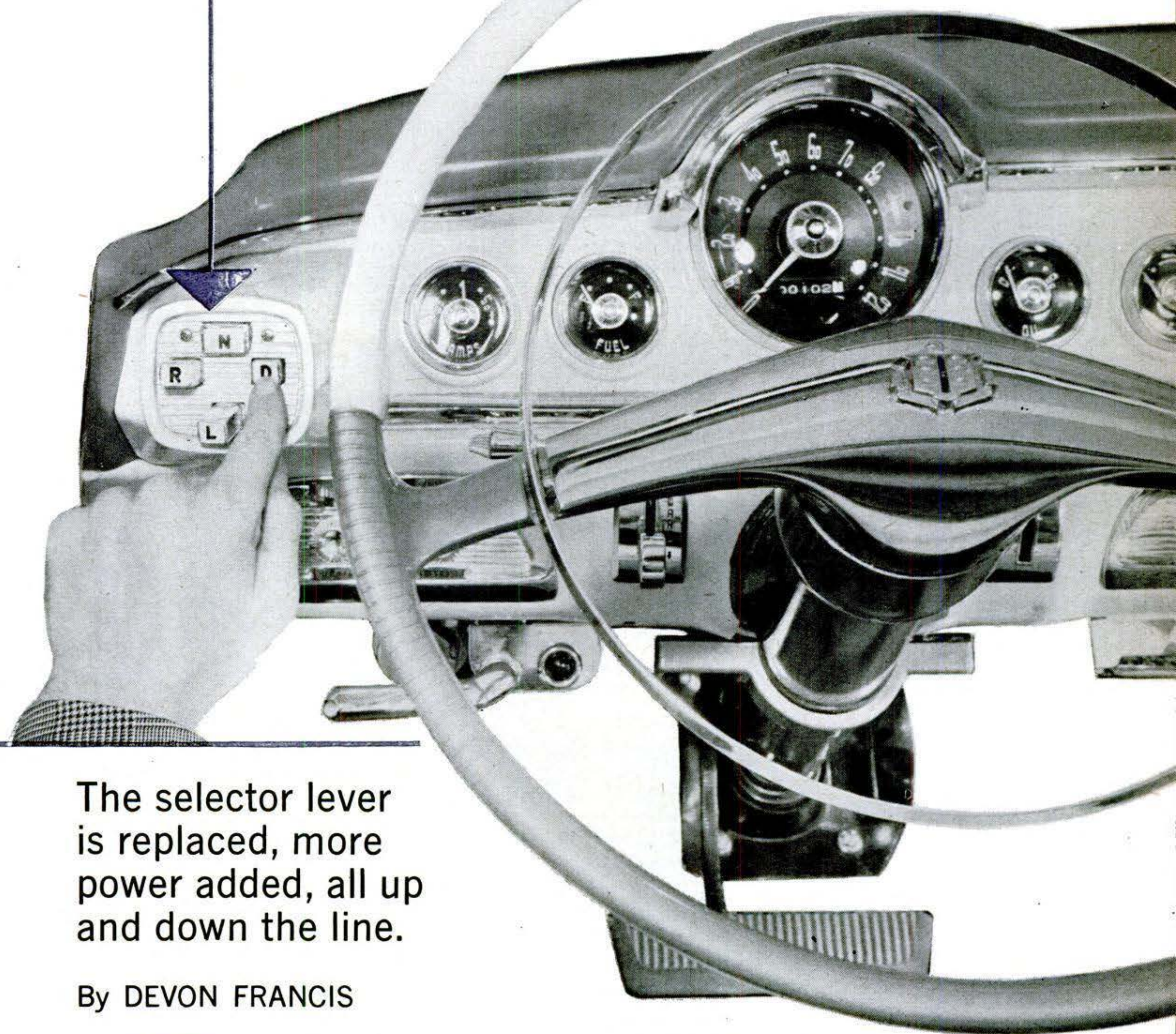

The selector lever is replaced, more power added, all up and down the line.

By DEVON FRANCIS

**F**RIEND of mine got into a new Dodge the other day, and sat there bewildered. He fumbled. He searched. He shook his head.

"Okay," he sighed finally, "I give up. What makes it go?"

What bothered him was the absence of

a selector lever for the automatic transmission. It wasn't on the steering column. It wasn't on the instrument panel, where it had reposed in the 1955 cars.

It wasn't anywhere, in fact. For the '56 Dodge—along with all the rest of the Chrysler Corp. cars fitted with automatic



## How push buttons work transmission in Chrysler-line cars for 1956

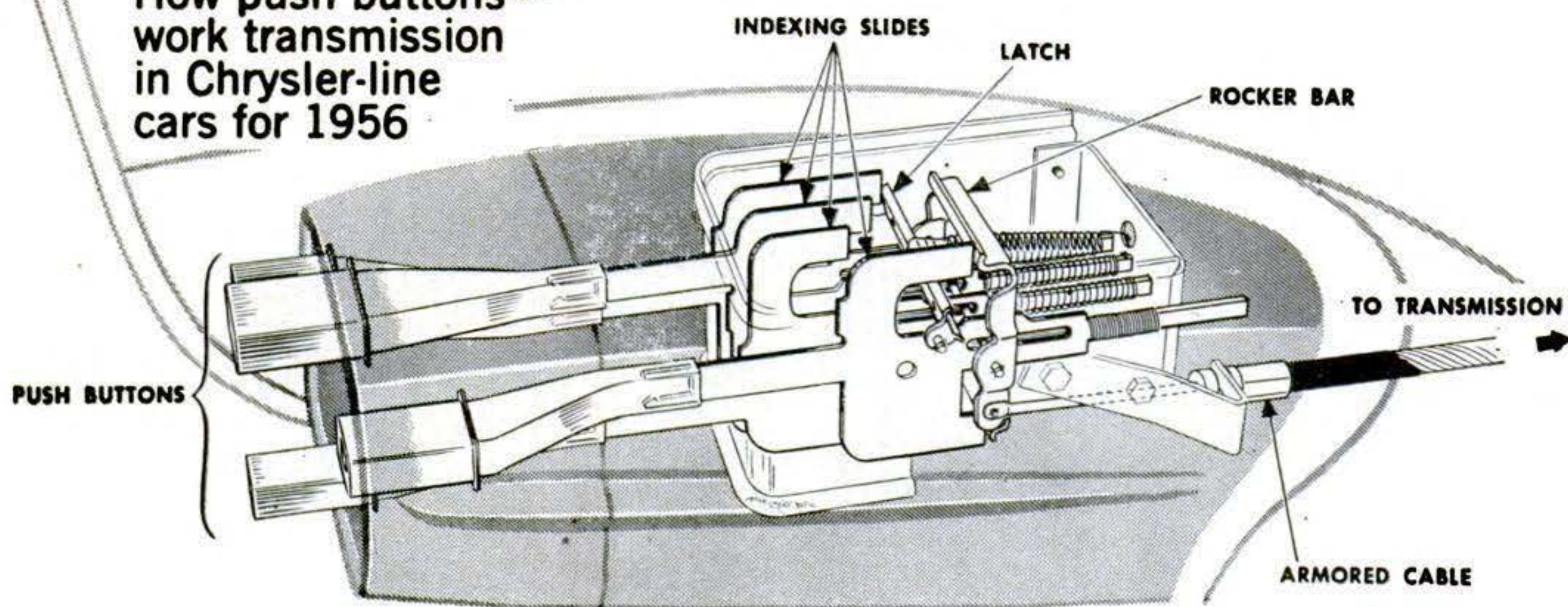

**FOUR BUTTONS AND A CABLE** take the place of the selector lever and customary linkage to the automatic transmission. Pushing a button shoves an indexing slide against a hinged, spring-loaded rocker bar to which the cable is attached. Since the slides are of different lengths, the cable is pulled a different distance—depending on the button pushed—to

open and close ports in the transmission valve for Neutral, Drive, Reverse or Low. A cutout in each slide hooks to a latch, locking the rocker bar in position. A ramp releases it when another button is pushed. Above 10 m.p.h., hydraulic pressure in the transmission control system moves a piston to keep the selector valve from engaging reverse gear.

drives—has gone to push buttons. They are on the panel at the left of the steering wheel, projecting from a little box. To go, you push a button and step on the gas.

**Push-button driving** (an idea shared for '56 with Packard, see p. 128) wasn't the only rabbit that Chrysler pulled out of the hat when its five flavors of cars were announced last month. It wasn't the trickiest, either. That title went hands down this time to an automobile record player (see p. 132).

This is an off year, as they say of elections not involving the Presidency, for the parent Chrysler company and its divisions. Detroit usually scraps its models only once every three or four years and starts new ones from scratch. Most things were new in Imperials, Chryslers, Dodges, DeSotos and Plymouths for '55. It's touch-up year in '56—like fresh paint here and there on your house.

Nonetheless, the changes are considerable. Dodge and its sister cars are bracketing push buttons with a series of developments designed for greater safety.

**Take brakes.** The Imperial, built for the lorgnette and squash-rackets trade, has a new type. The Crown Imperial began mounting disk brakes in 1949, and a

more conventional brake now replaces it.

The nub of the change is the shoes. Most brake drums tend to anger in hard braking. They heat and distort and get out of round. That leaves only the toes and heels of the shoes in contact with the drums. So it takes longer to stop.

**The new shoes float.** They have no fixed anchors. The full area of the lining remains in contact with the drum.

The engineering people behind the chromed portals of the Chrysler research labs on Detroit's Oakland Avenue venture the opinion that the linings of the new brakes will last more than twice as long as those of other designs. Chrysler and DeSoto '56 models also have this new kind of brake.

Dodge and Plymouth power brakes have undergone surgery, too: a matter of changing the design of the power assist. If the engine stops and the vacuum power for the brakes dribbles away through repeated pedal applications, the power unit is automatically divorced from the linkage train. That means you don't have to strain your leg muscles to reach the drums *through* a dead power unit. Power-off braking is easier.

Finally, that floor hole is gone; the pedal swings from an underdash hinge.



Better gas mileage was the goal of engineers in changing rocker arms, plugs and shape of cylinder heads

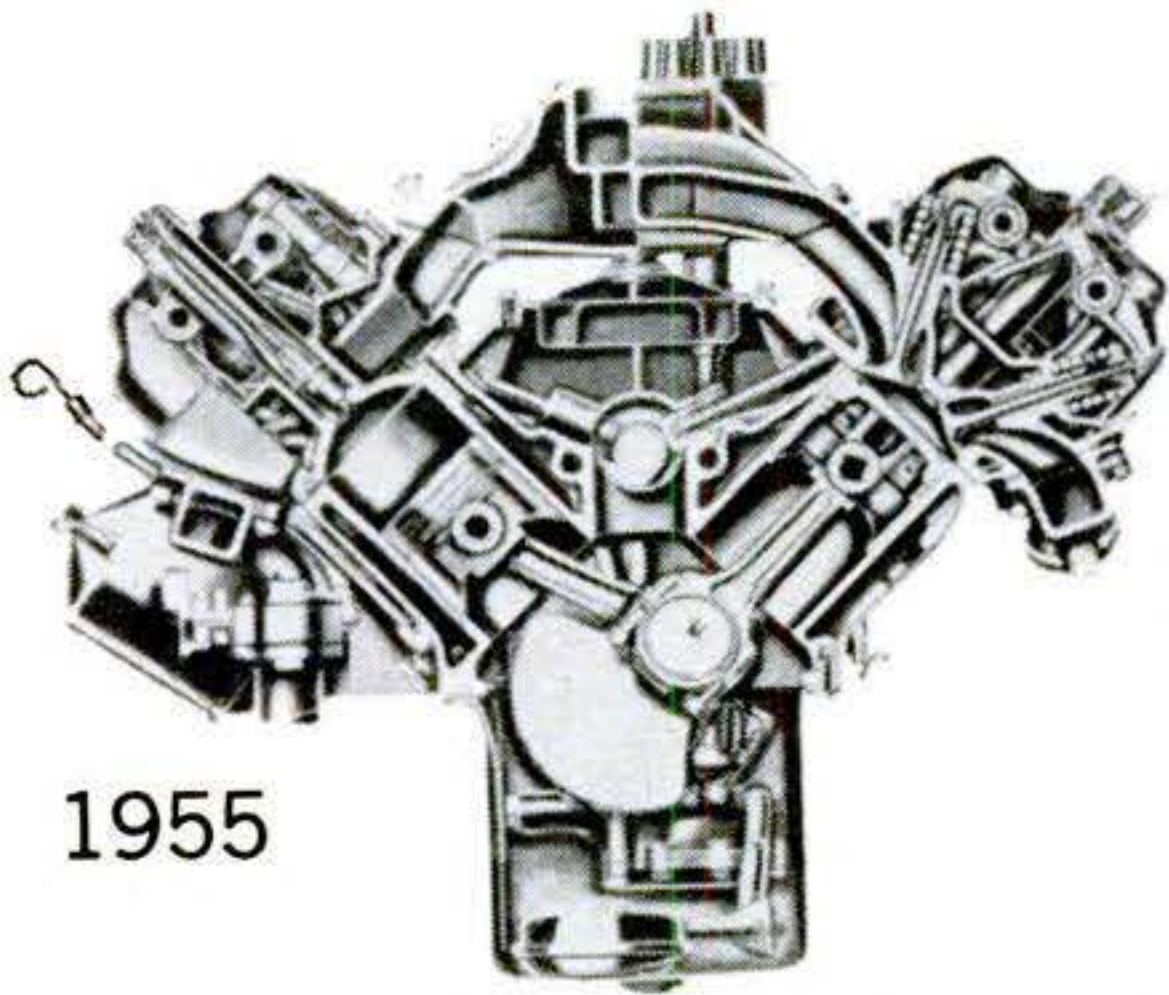

1955

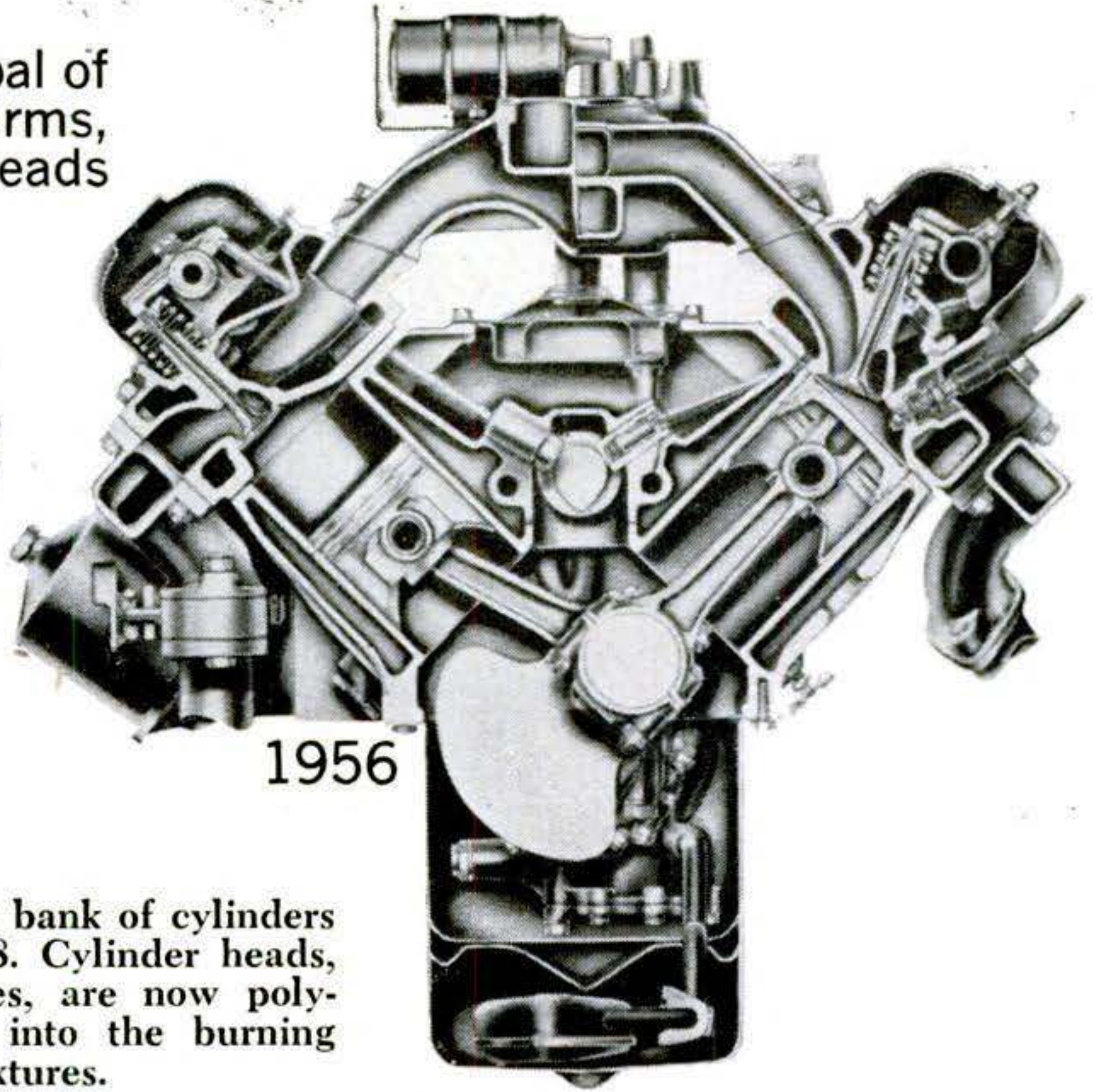

1956

**A SINGLE ROCKER-ARM SHAFT** for each bank of cylinders replaces twin shafts in the Dodge V-8. Cylinder heads, as also in the new Plymouth engines, are now polyspheres. Spark plugs project farther into the burning area to permit the use of leaner fuel mixtures.

**Take door latches.** Detroit's sheet-metal curtain has been lifted at last on the distasteful subject of designing cars for the health of their occupants. (See "Detroit Prepares to Stress Safety," PSM, Aug. p. 88.) Manufacturers now concede that trees and bridge abutments are astonishingly immovable. Last fall, one

company fashioned a safety door latch that didn't reach production; the top brass shrank from the implication that their cars might be dangerous.

Chrysler Corp. latches for '56 are designed specifically to help doors resist that impulse to fly open in a smack-up. The idea is to keep you and your passen-

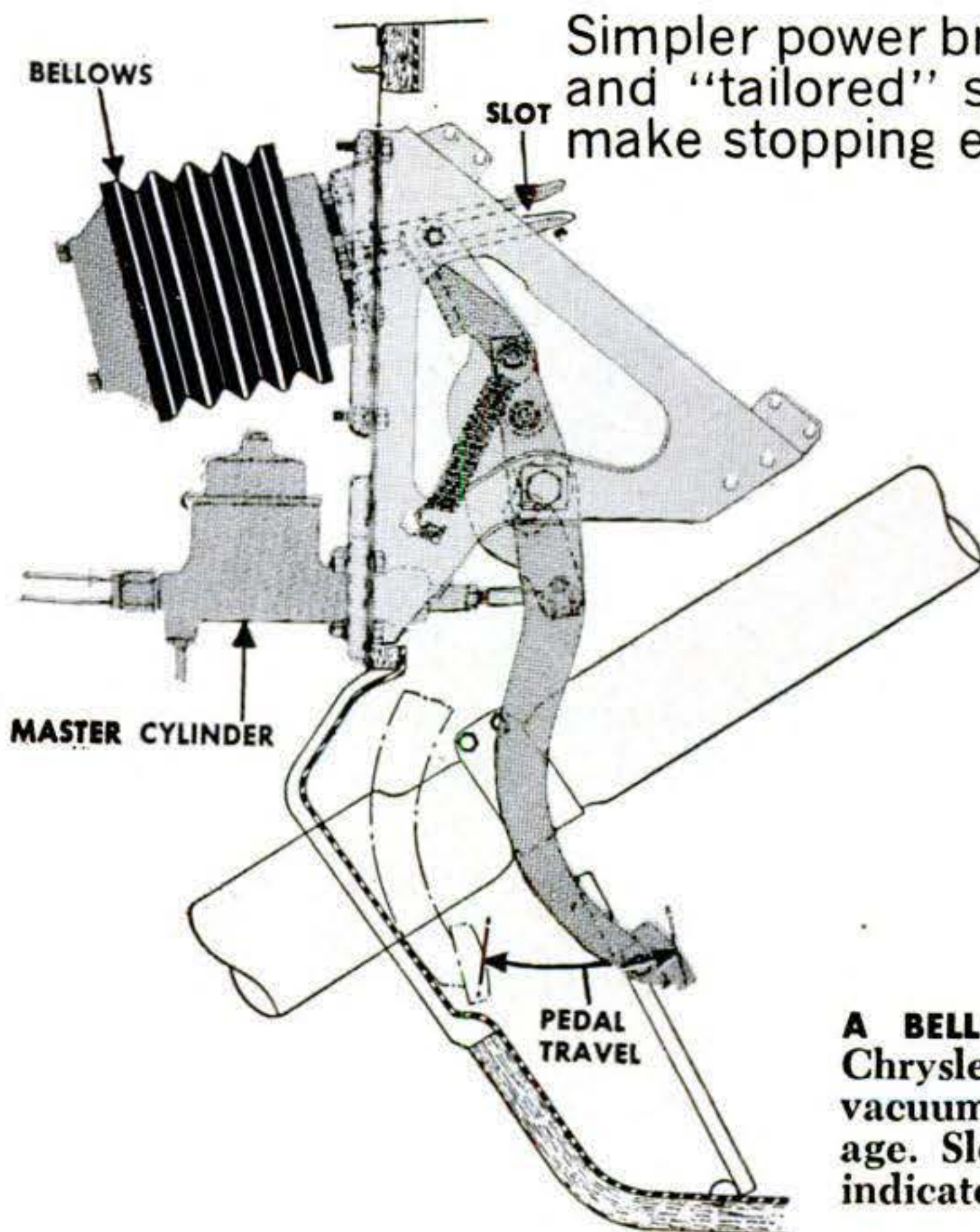

Simpler power brakes and "tailored" shoes make stopping easier

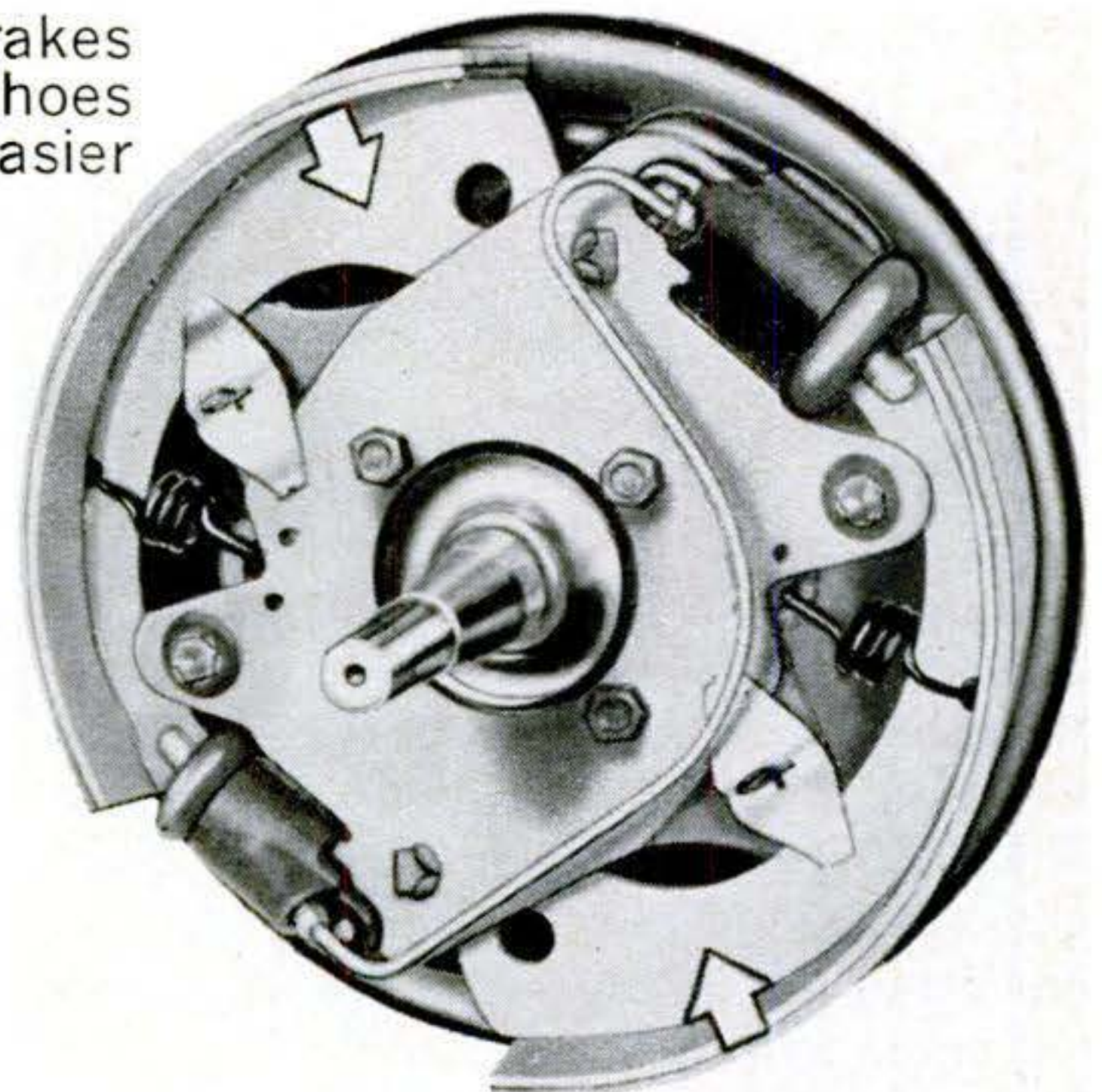

**A BELLOWS IS THE HEART** of a new power unit for Chrysler Corp.'s power brakes (left). Collapsed by vacuum, it pushes a piston to supplement pedal leverage. Slot divorces it from pedal if vacuum fails. Arrows indicate new shoes (right) on Chryslers and DeSotos.



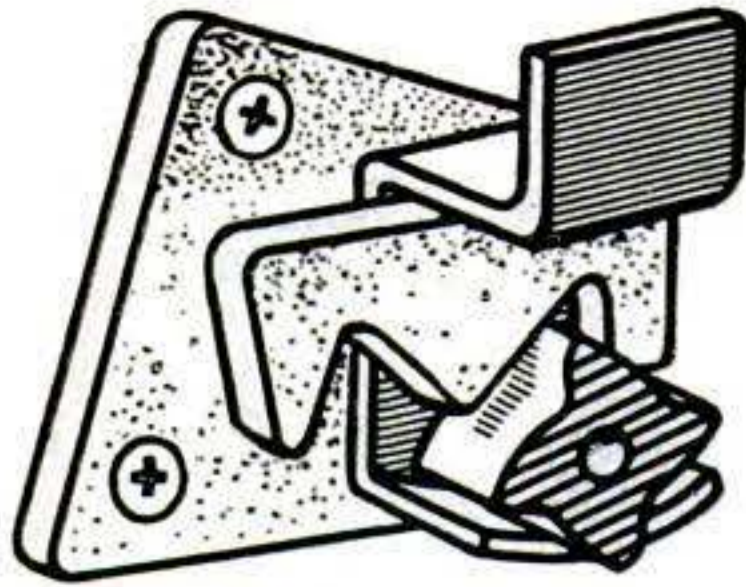
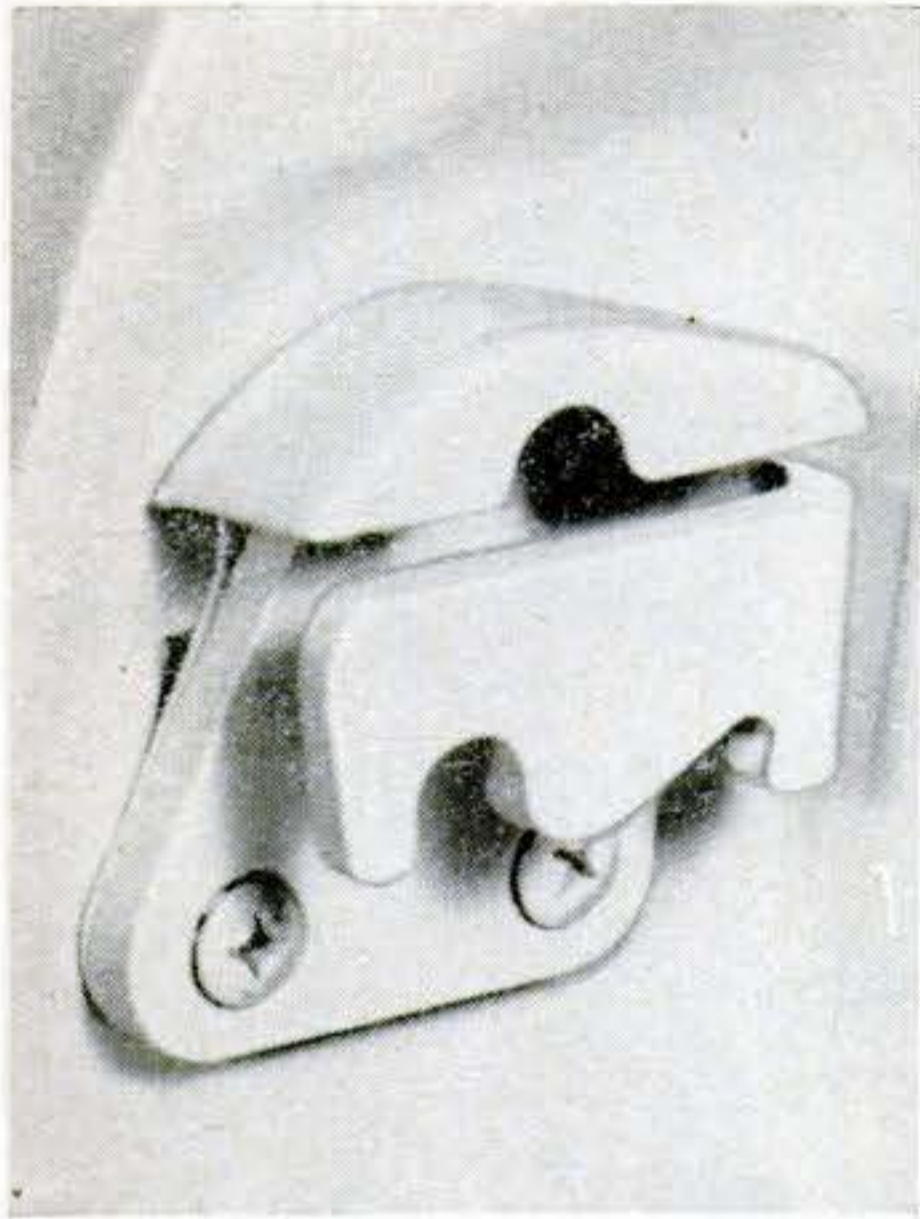

**STRIKER PLATE** on Chrysler's safety door latch (left) is anchored half an inch from the door post instead of flush, with an "eyebrow" above it to protect clothing. That arrangement, plus a strap guard (arrow, right) around the toothed rotor, keeps the two (above) from springing apart in a crash.

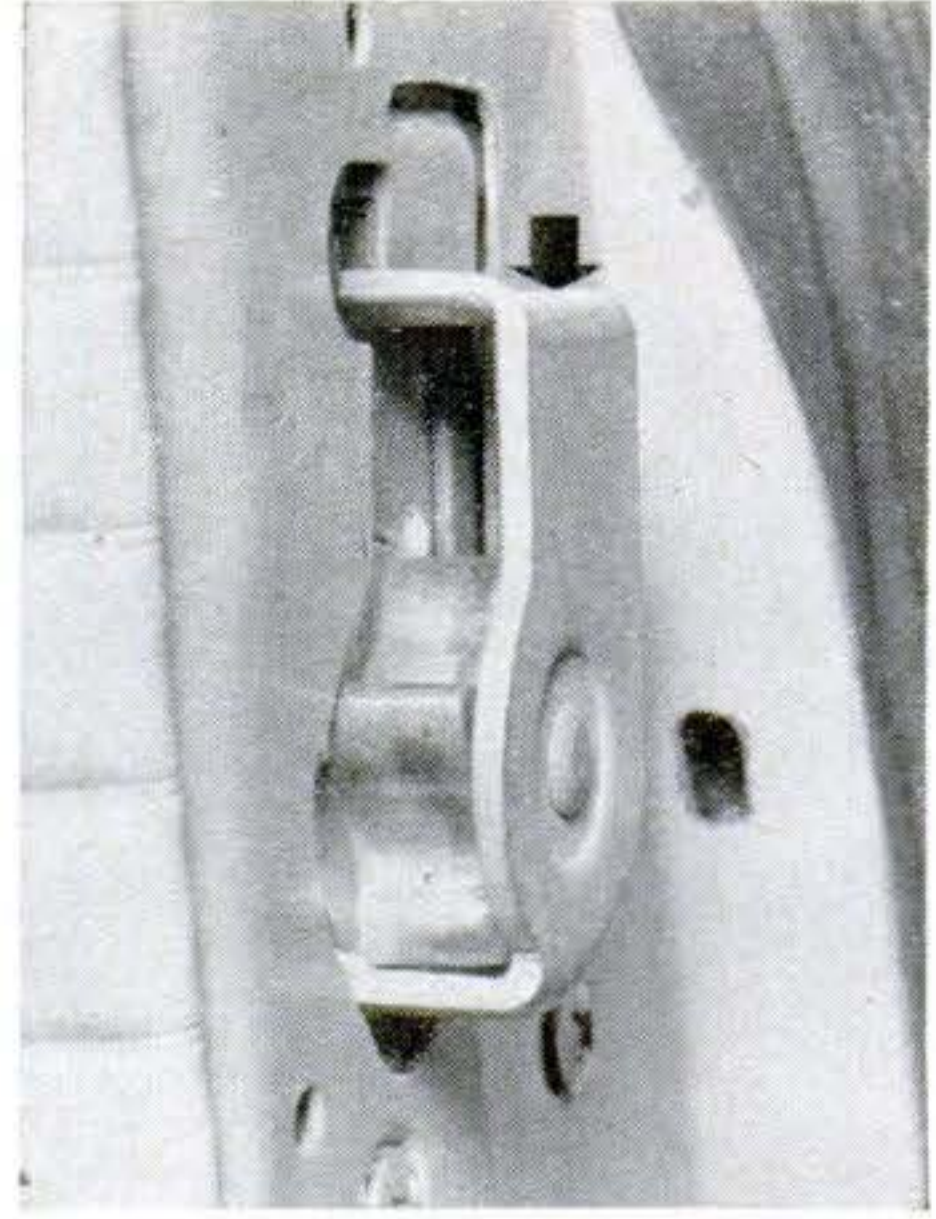

gers aboard when impact inertia sets in.

**Take seats**—anchored better to a reinforced floor. Take a dished steering wheel—designed to prevent impalement of the driver on the steering column. Take padding—made of an energy absorbing material, for places like the top of the windshield, so people can hit their noggins without fracture. The padding is optional. And, of course, take seat belts—an optional item in Chrysler Corp. cars since last spring.

The Imperial's new modified Hotchkiss drive, designed to reduce sway in turning a corner, probably can be classified as a safety item, too.

Other changes in the company's stable of vehicles are those common to the industry. All the cars wear new rear fenders—known in the die shops as "quarter panels"—for Detroit's version of the Dior look. It's a surprising refurbishment for an off year. Most manufacturers are content to move some chrome around.

**Horsepowers hit escalator.** In the horsepower race, the biggest of the Plymouth engines, with power pack, delivers 200 horsepower.

The biggest Dodge is at 230 hp., up 37. The biggest DeSoto is at 255, up 55. The biggest Chrysler is at 280, up 30. The Imperial's power matches that under the Chrysler's hood.

For the record, Dodge's horsepower today is more than twice what it was just five years ago.

What these horsepower increases mean to performance is reflected in comparative figures for getaway when the light turns green, and for passing.

Dodge's 1953 Coronet equipped with a torque-converter transmission, first of this brand of car to adopt a V-8 engine, jumped from a standing start to 60 m.p.h. in 15½ seconds. The 1956 Dodge, similarly equipped, does it in 12.2.

It took the 1953 Dodge 8½ seconds to pass another car going 60 m.p.h. The 1956 Dodge has cut it down to 6 2/3 seconds.

For those who think that power is a latter-day fetish, however, be it remembered that the 1936 Duesenberg could have widened its fenders and taken flight on its 265 horses.

But the Duesy didn't have those lovely push buttons.

END

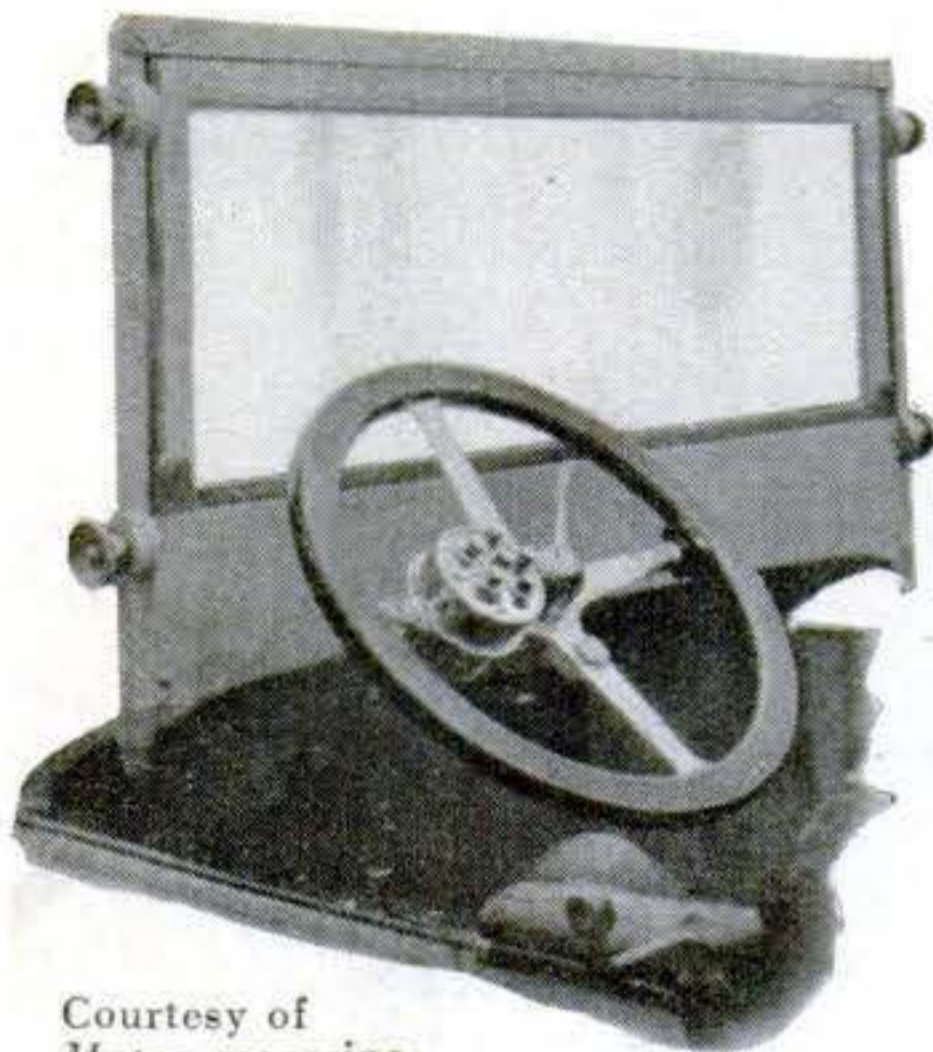

Courtesy of Motor magazine

**HISTORICAL NOTE:** Push-button driving isn't new. In this 1913 S. G. V., six buttons shifted gears by solenoid for four forward speeds, reverse and neutral.



# Hydra-Matic Dampens That Thump

Cadillac-Pontiac transmission now rivals torque converter.

**A**BOUT four years ago General Motors began fiddling around with an idea for improving the Hydra-Matic drive on its Oldsmobile, Pontiac

and Cadillac cars. The transmission had zip. It was miserly with gas. But every time the gears shifted, it thumped.

The payoff on GM's research came last



**NEW HYDRA-MATIC** substitutes little fluid coupling (shown at right, posed above transmission case) for friction clutch to smooth out gear changes. It fills or empties in  $2/5$  second. One-way clutch (above, with inner race) replaces the sometimes-troublesome bands that used to switch planetary gear ratios.

**HEAT EXCHANGER** (arrow) cools transmission oil. Unit's weight in Pontiac version remains the same—225 pounds.

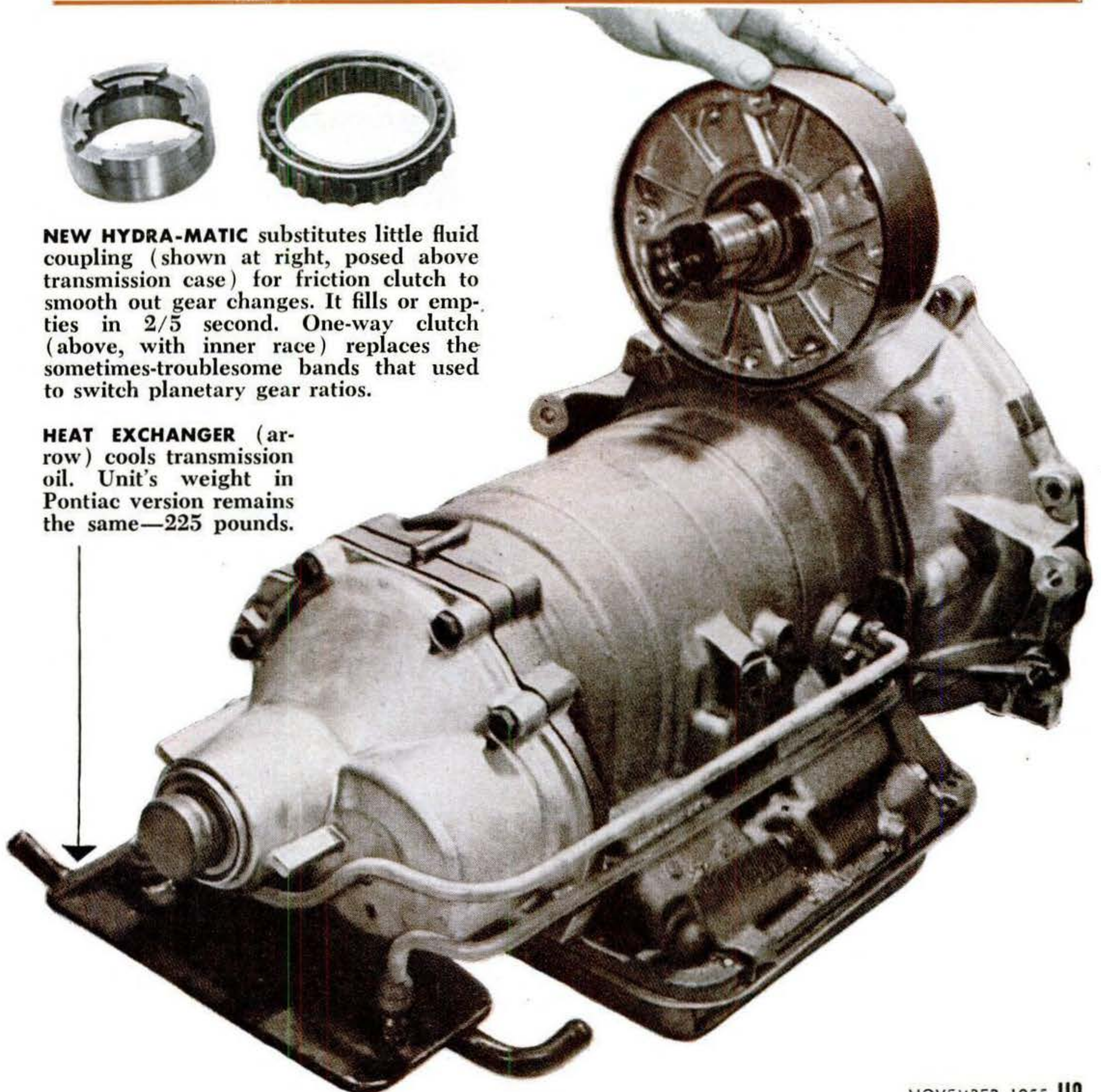



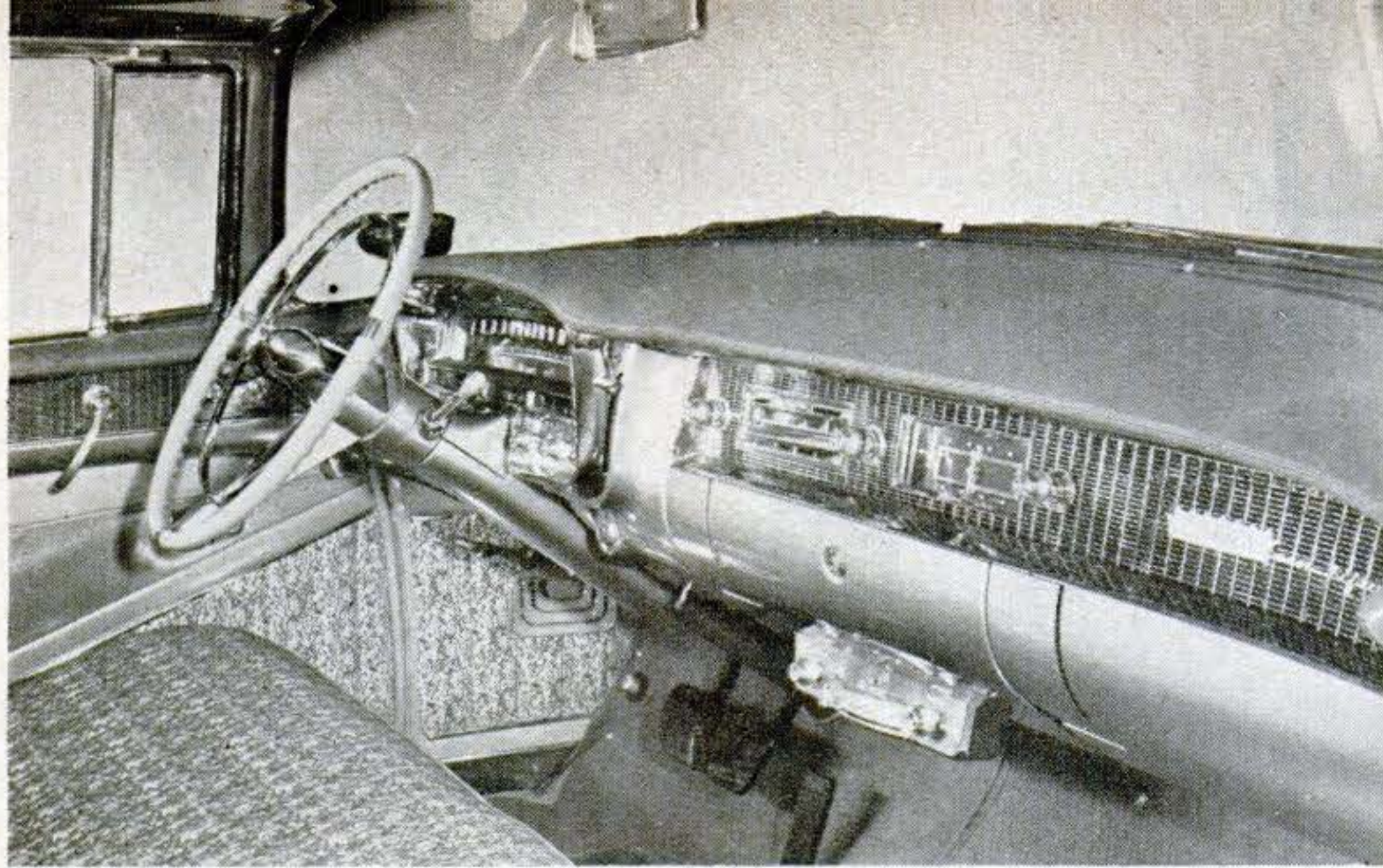

Caddy's cockpit has three-spoke wheel, center glove box

**ASH TRAYS AND LIGHTERS** are duplicated at each side of panel, knobs and escutcheon redesigned. Script on right dates car as a '56. Rear-view mirror is wider, and electric window buttons require no contortion. Lowered brake pedal is now pendant type.

month when the shrouds were stripped from the 1956 Pontiacs and Cadillacs. The almost-new transmission wasn't the only change in these two vehicles by any means—we'll come to the others in a moment—but it was unquestionably the most spectacular change.

**Major surgery** has been performed on the Hydra-Matic. It still has zip. It's still miserly with gas. But most of the thump is gone. It's the biggest change in this particular transmission in 15 years.

For smoothness, the Hydra-Matic for the first time can give the torque-converter transmission (used in most other cars, including the Chevrolet, Ford and Plymouth) a run for its money.

To do this, the engineers had to throw out some hardware and add new pieces. To see what they did and why, it's necessary to take a second gander at how a Hydra-Matic works.

Its guts are gears, as contrasted to torque-converter transmissions consisting of gears *and* a hydraulic torque-multiplication system.

Torque multiplication is mumbo jumbo for slowing r.p.m. on the rear axle and speeding the engine. That provides more push at the rear wheels when the light turns green. With ordinary first-second-third shift transmissions, this is done by hand. With Hydra-Matics and torque converters, it's done automatically.

**The gear drive of the Hydra-Matic**, embodied in two sets of planetaries borrowed from Ford's old Model T, has been a source of sublime satisfaction to the engineers from the beginning. True, it

did thump a bit in shifting from first through successive gears. It thumped going down on deceleration, and that last thump—from second to first gear—was the most annoying of all. Everybody in the car involuntarily curtsied as it neared a stop.

This unhappy fault seemed inherent in the design. Road speeds governed the shift points. The rate of rotation of the rear wheels dictated, within limits, the points where a car would plaster a person against the seat or, slowing down, make him nod like a puppet.

**The trouble lay** in a brace of friction clutches that acted something like the foot-operated clutch on a manual-shift car. The gears shifted. And there was that thump. It was the Hydra-Matic's thumps, in fact, that led to the development of the torque converter. The torque converter didn't have the zip. It used more gas. But compared with the Hydra-Matic, it was silk-smooth.

It was the Hydra-Matic's thumps that caused the designers to interpose a fluid coupling between engine and transmission soon after its invention. This coupling, softening the eye-teeth jar and letting the engine idle in gear, is nothing more than Chrysler's old Fluid Drive (see "Auto Transmissions that Shift for Themselves," PSM, Dec. '45, p. 142).

The champions of Hydra-Matic (their enthusiasm can be equated roughly with that of Brooklyn Dodger fans) have said all along that sure, there were thumps, but a Cadillac with Hydra-Matic could go farther on a gallon of gas than a Chev-



## Pontiac convertible's interior features white-on-black trim

**KNOBS IN WHITE PLASTIC** make controls easy to see. Decorative plates on instrument panel are brushed aluminum, recessed in black. Cigarette lighter, at left of glove compartment, is nearer driver. New to Pontiac is signal-seeking radio—optional equipment.

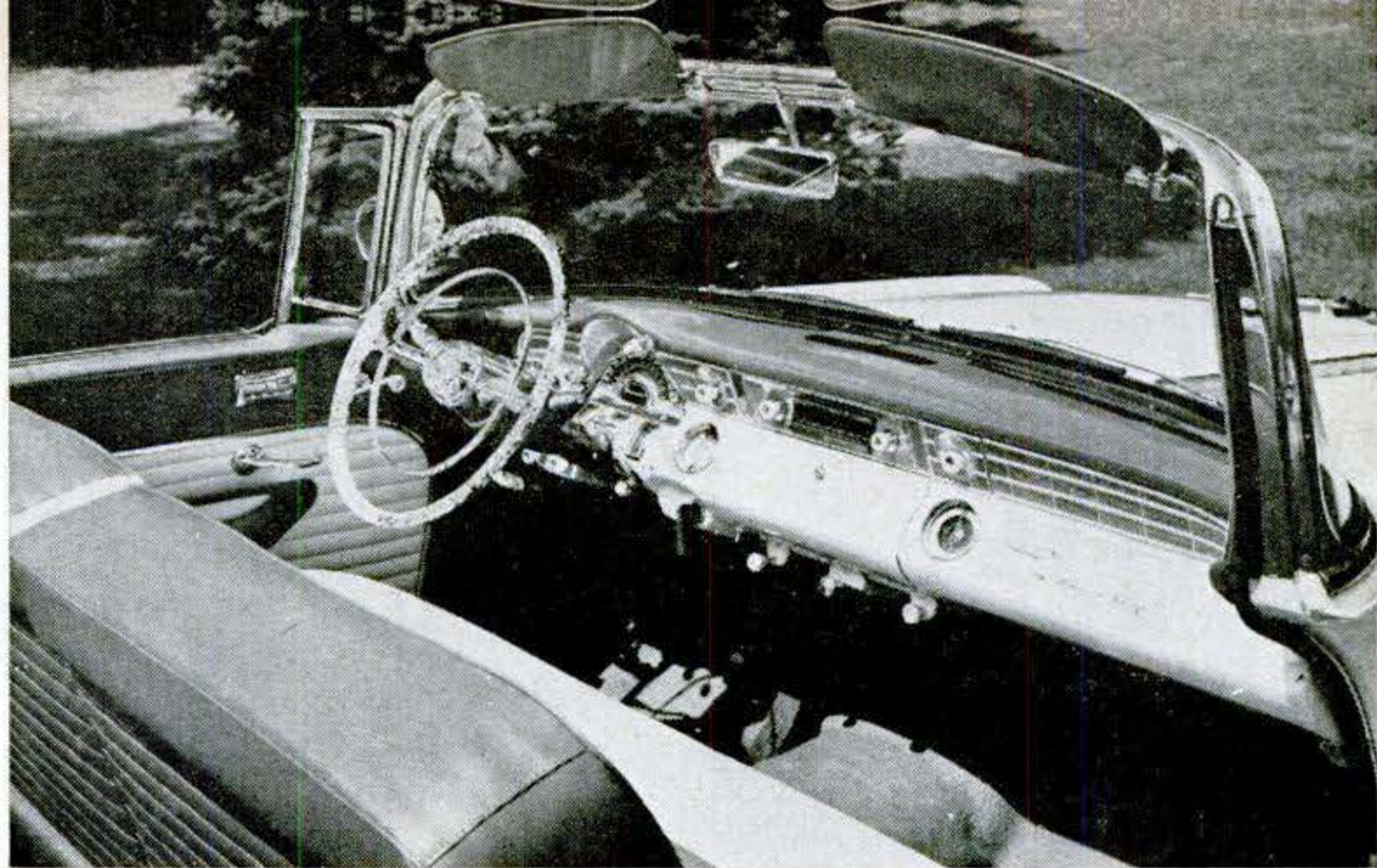

rolet with torque converter. That's true.

Now, finally, they have found a curative for the thumps. In principle, the solution was simple. They reached into the innards of the thing and scissored out one of the two friction clutches. In its place they put a fluid coupling.

This second fluid coupling is small. It's quite tricky. When oil is valved in, the coupling freezes the front planetary while the other planetary multiplies the torque. When oil is valved out, the front planetary performs its part of the legerdemain in the gear-shifting operation.

Filling or emptying the coupling requires a mere fraction of a second.

The coupling freezes the unit only between the Hydra-Matic's first and second gears, and between third and fourth. Between second and third, that remaining friction clutch freezes the rear planetary, and there you do get a thump. It's tiny, though, and just about what you get in a torque converter with a gear assist, that in the Buick excepted.

(Buick has its own way of doing things—no thump at all. We'll tell you about that next month.)

The only reason the engineers didn't replace the second friction clutch with a little fluid coupling was that there

was no room for it. Even as it is, they had to immerse the front planetary in the big fluid coupling to save space.

*Exorcising the thumps* is by no means all that has been done to the '56 Hydra-Matic. From the beginning, gear changes in this transmission have been made with bands that seized and stilled the sun gear or the ring gear on the planetaries—even as Henry Ford did with his pedals on the toeboard. The ad-

justment on the bands, comparable to those external-contracting brake bands of yesteryear, was critical. They got worn. They slipped. That made them wear worse.

So now they've taken the bands out. In their place are two one-way (or overrunning) clutches—exactly the

same thing that makes a coaster-brake bicycle freewheel. They are so foolproof that Pontiac, for one, has advised its dealers that it won't have to bother with adjustments on them. Experimental cars have been driven as much as 70,000 miles without a transmission tear-down.

*There are other modifications.* Most important is one that has to do with a dead spot, around 25-m.p.h. road speed, that has afflicted Hydra-Matics when they went into fourth gear at light throt-

[Continued on page 260]

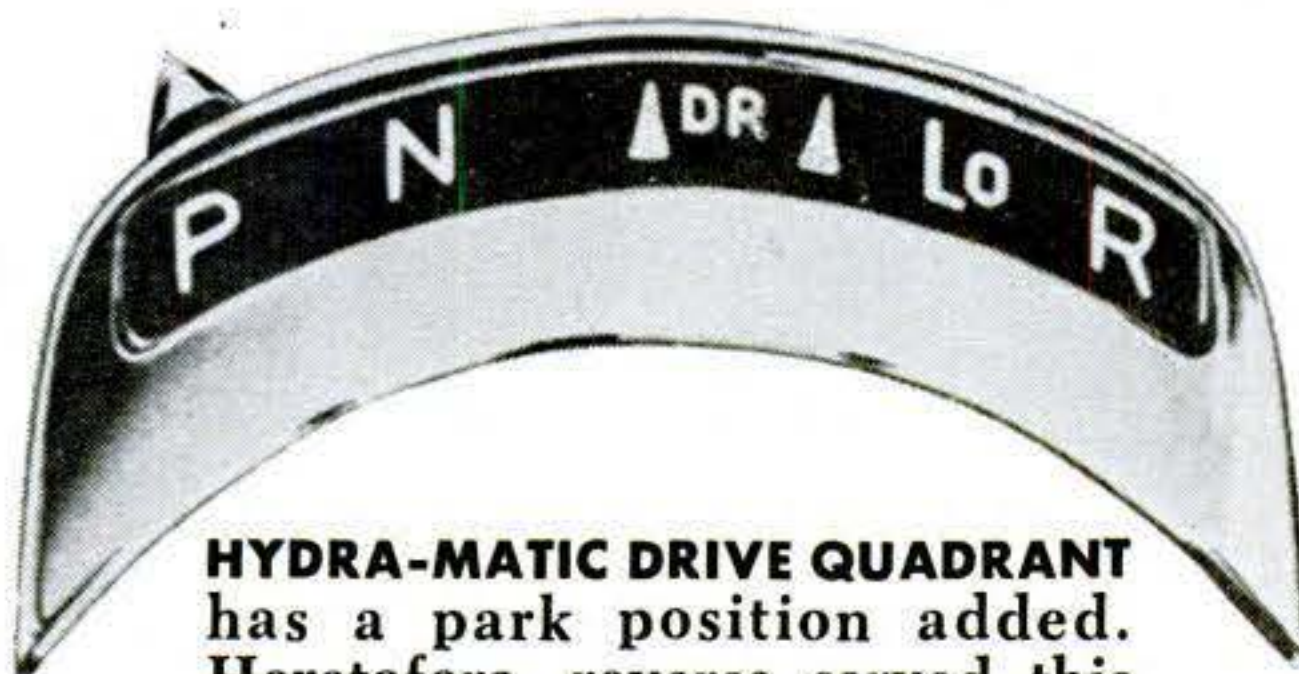

**HYDRA-MATIC DRIVE QUADRANT** has a park position added. Heretofore, reverse served this purpose. The car can now be braked firmly on a hill and the engine started in "park" instead of only in neutral. Left arrow is for normal driving; right one locks out fourth gear for mountain climbing or city driving.



# Continental Unveils A Royal Coach for Four

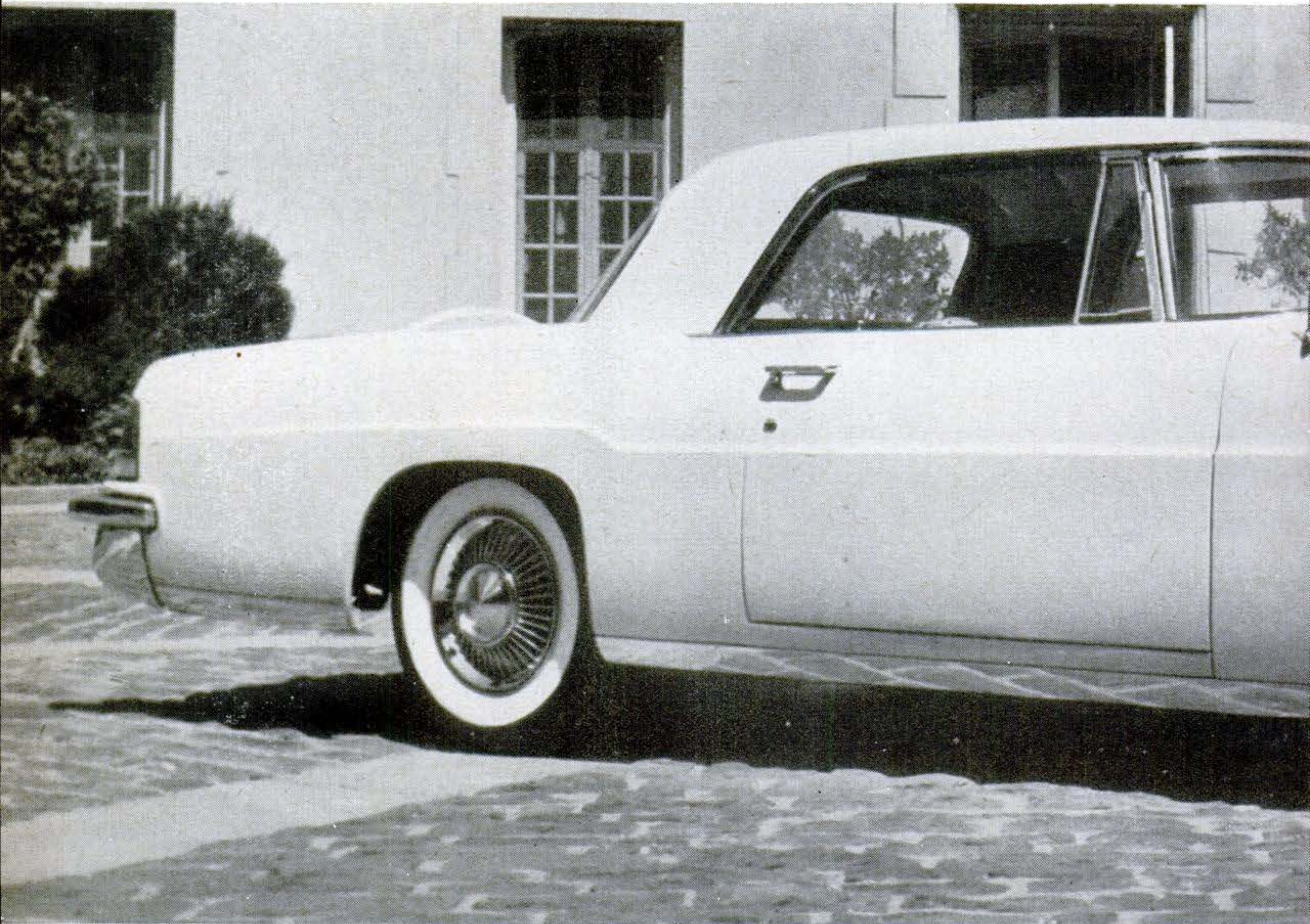

By KENNETH WYLIE

**W**ITH a wave of its wand, Ford's Continental Division has finally brought forth a glittering bundle of automotive hauteur, the Mark II. Though plainly a car born under a star, the company took no chances; it bolted

a specially made star right to the hood.

From the chaste grille, a handsome honeycomb that sniffs the road winds, back 18 feet to the armor-massive rear bumper, the Continental is as sleek as a suite at the Waldorf and as conspicuously simple as the Washington Monument. Yet every niche and stitch of the car is full of tricks:

**Goodies galore.** Each passenger has



Staggeringly lush, Mark II is the stuff that dreams are made on. It's also a good car.

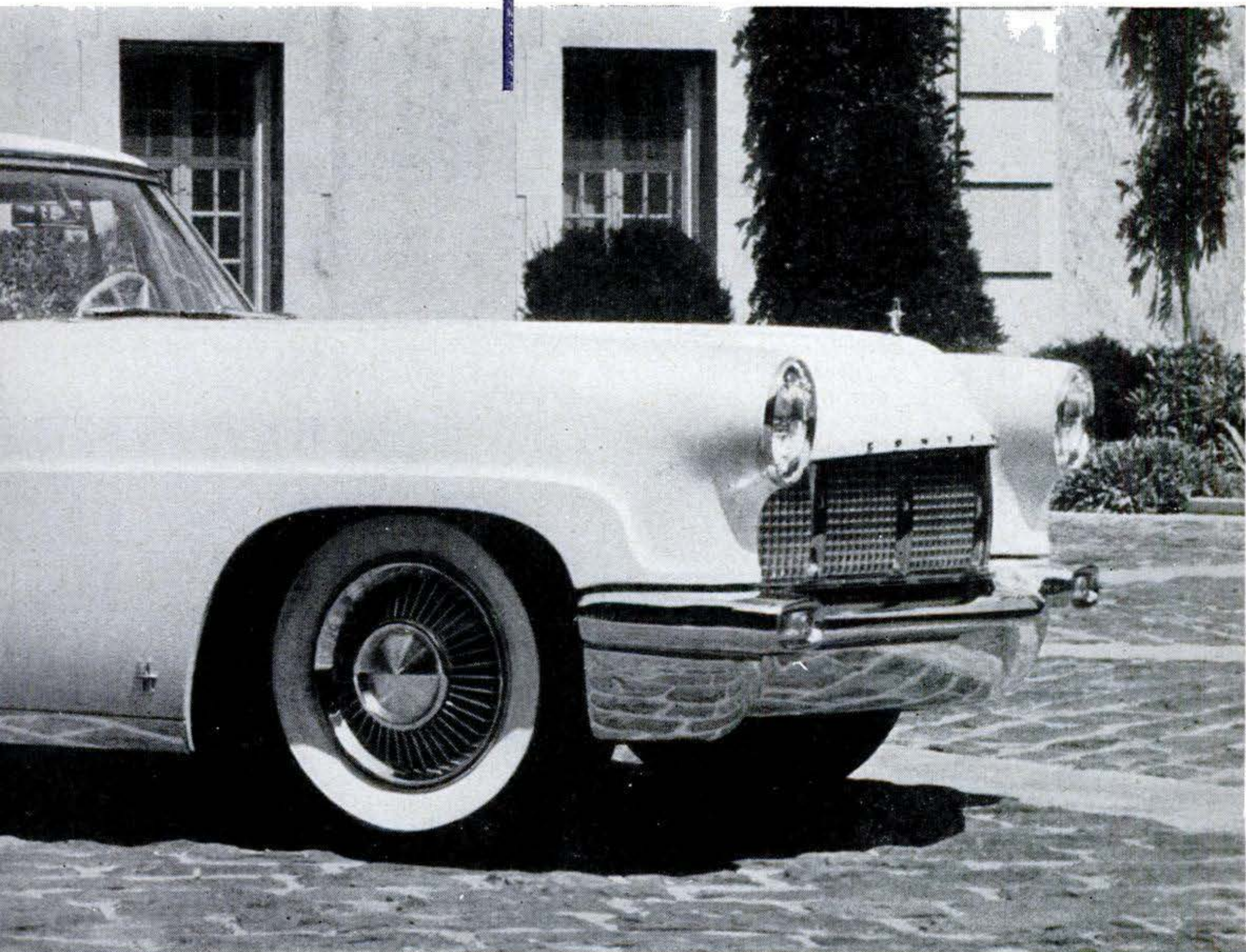

his own cigar lighter and ash tray (a person so rich as to smoke two cigars at once will have to make do somehow). Touching a hidden button beneath the back bumper causes the left tail light to glide aside like a secret panel in the Duke's library, revealing the gas filler cap. The hood release has the feel of a safe handle. Underneath, three automatic lights illumine the engine's brushed

brightwork. The door to the glove compartment is spring-balanced, saving you the chore of easing it down, and the vent panes in the windows are motorized to eliminate a further source of fatigue. The driver's seat can be button-fingered into as many positions as a six-year-old at church. And that stellar hood ornament is no chromy bauble but an investment casting of stainless steel, like the inlays





**HONESTY AT ALL COSTS** was the word passed the designers. So the spare had to be under the lid bulge that tradition dictated. It's not as awkward with luggage as it looks. Not quite.

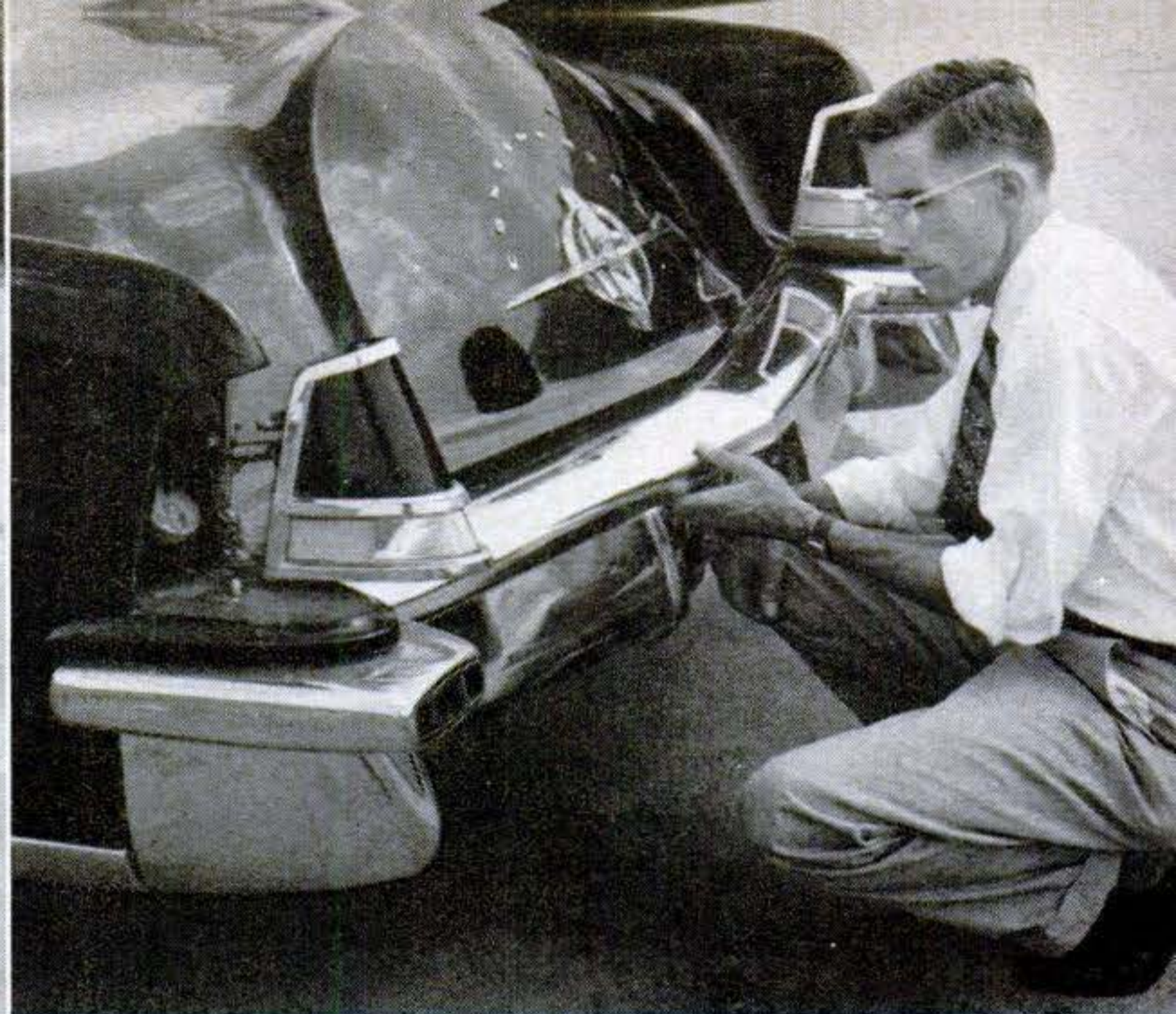

**TOUCH A BUTTON** (my left hand shows area) and the left tail light does a peculiar shuffle, ending up in this disjointed state. Nestling in the exposed cavity is the gasoline filler.

## Mark II has sleek elegance in details as well as in lines

**HONEYCOMB** in door breathes gently warmed air on rear-seat passenger's tootsies, in case his circulatory system has been weakened by rich living. Note quality of fitting and finish.



in a Commissar's teeth. The price for these and other princely comforts is \$9,800 to \$9,900. This includes the spare tire and almost every conceivable accessory except air conditioning, for which you still pay extra.

**That spare.** Since the nakedly visible spare was almost a trademark of the

**NEST OF BUTTONS** lies conveniently at the driver's hand. The handle is the door release, which works with silky ease. The interiors are designed to have "a sartorial splendor."

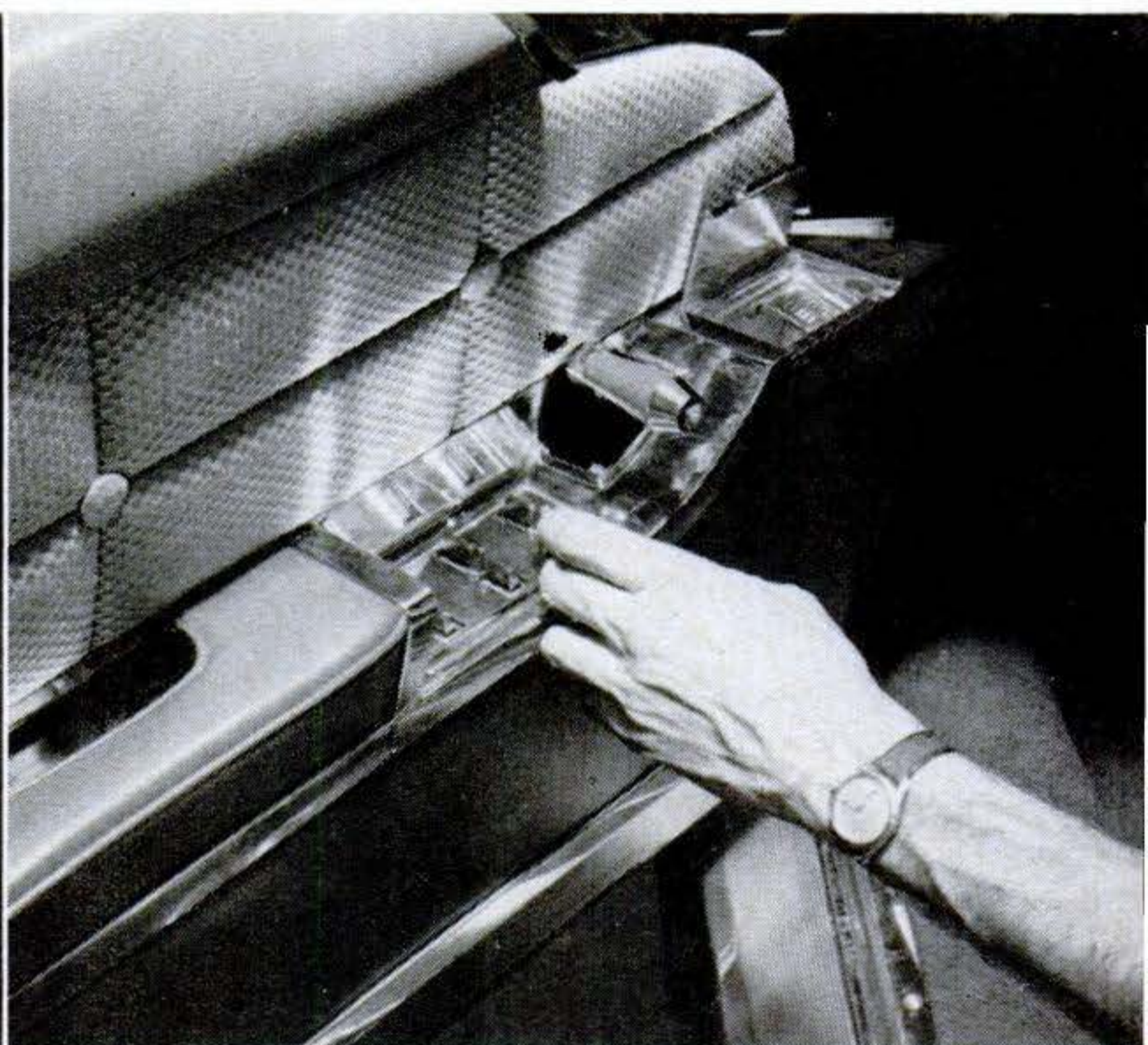

earlier, Mark I Continental (1940-'48), some reminder of it was essential. The reminder is a kind of inverted pouch stamped in the rear deck, which rises from the sheet metal as distinctively as a big, streamlined wart on a pretty woman. Raise the deck lid and you'll find the leatherette-booted wheel itself



leaning inside, its bottom fitting a well in the trunk floor.

Some critics will complain that this spare-tire blip on Mark II's sylphy lines is a superfluous flourish. Others will contend that it is a touch of identity, like a Rolls radiator. Still others will argue that, esthetics aside, it is an awkward place to locate the spare. Swinging a fly-rod case past it won't exhaust you, but anything heavier may involve standing at one side of the trunk, planting your feet well apart, and handing the luggage to George.

Carpeting in both the trunk and front (it's identical) is the kind you want to run barefoot through. All-wool,  $\frac{3}{4}$ -inch thick, and rubber-backed, it's almost deep enough to lose keys and change in. Merely touching a brogan to it makes you feel that the world is, after all, a pretty good place.

**Come for a ride.** You enter Mark II via a gaping door and then step down to the floor slung between the frame rails. This helps give the car its snaky center of gravity, and permits a roof line only four feet eight inches off the ground. Inside it is not cramped but distinctly intimate. There are 59.6 inches of hip room in front and 56.9 in back—plenty for four passengers but little, considering the high shaft tunnel, for any more. No matter: this isn't a bus for hauling the youngsters to school, but a personal car for elegant, adult motoring.

The seats that embrace you may be covered with Scotch cowhide, specially obtained from a district where the cows are of noted amiability. (Continental people explain that this isn't pure fancifulness; gloomy or irritable cows poke each other with horns, slightly marring the leather.) Or the seats can be covered with nylon, broadcloth or a quilted fabric called matelassé. Or any combination of leather and fabric, or any material the customer elects, including a combination of his favorite tweed and her cocktail sheath.

**Machinery, too.** Everything is powered or automatic in Mark II—brakes,

[Continued on page 264]



**LORDLY ENGINE ROOM** is well stocked with able machinery. De luxe touches include special rocker-arm covers, twin air-induction system and great amounts of sound-absorbing matting.

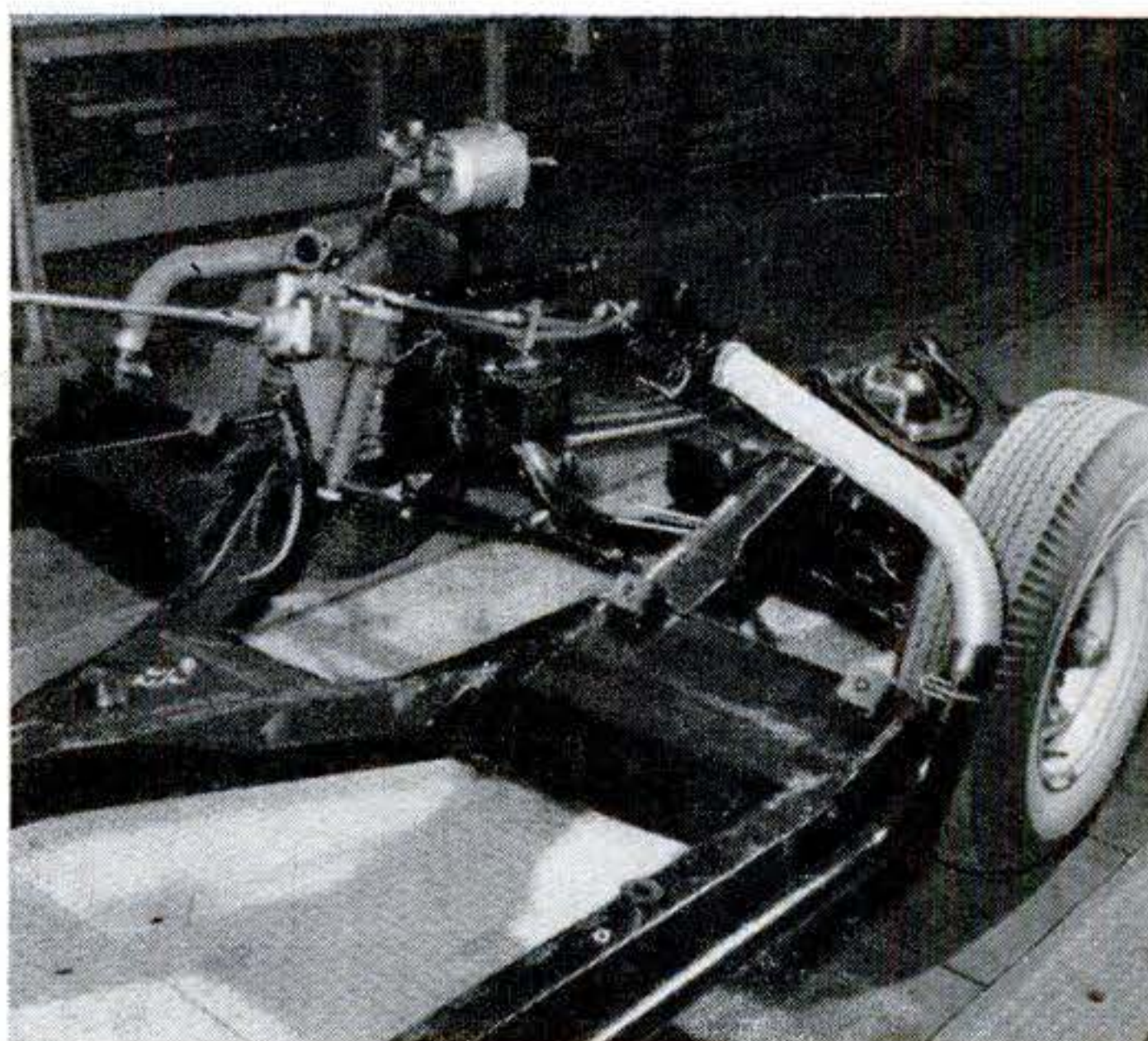

**BEEFY AND LOW**, special chassis has heavy box and tube cross members by rear of engine. The twin exhaust pipes run outside to clear the dished floor pan. Wheelbase is 126 inches.

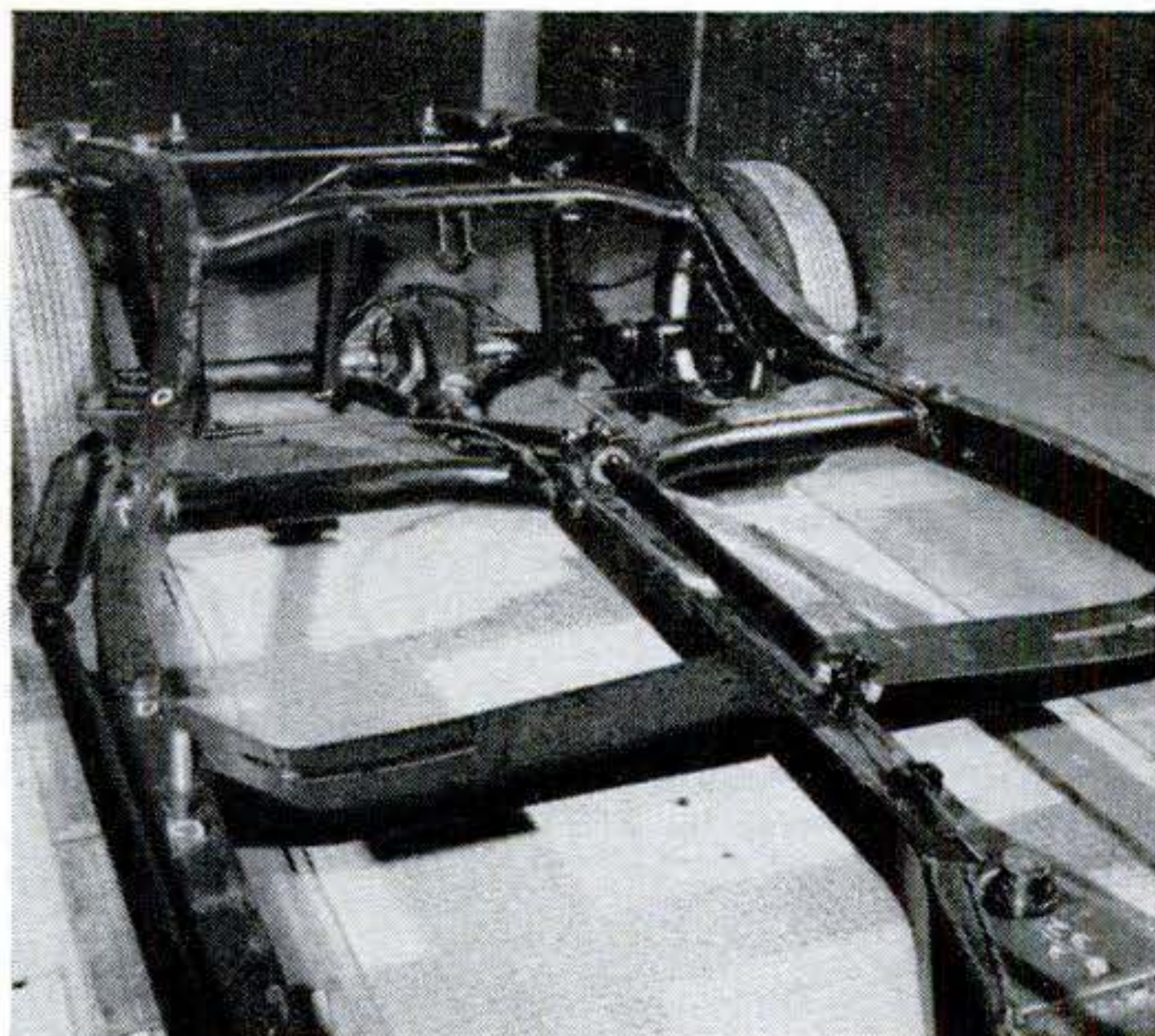

**SPINE** carries drive shaft on top. In rear a crossover pipe joins the two exhaust systems to minimize tailpipe talk. Four big apertures in the frame give riders room in the low car.



# Making the Mark II: Why It



THESE pictures, taken by PSM at Continental's jewel-box new plant (left), help explain why the car is so costly. Its components are expensive to begin with, but the Mark II price tag could be nearly halved if these parts were slammed together on a high-volume line.

The big cost arises from careful selection and painstaking hand assembly to finicky standards. Into the plant there flows a stream of Continental parts; a

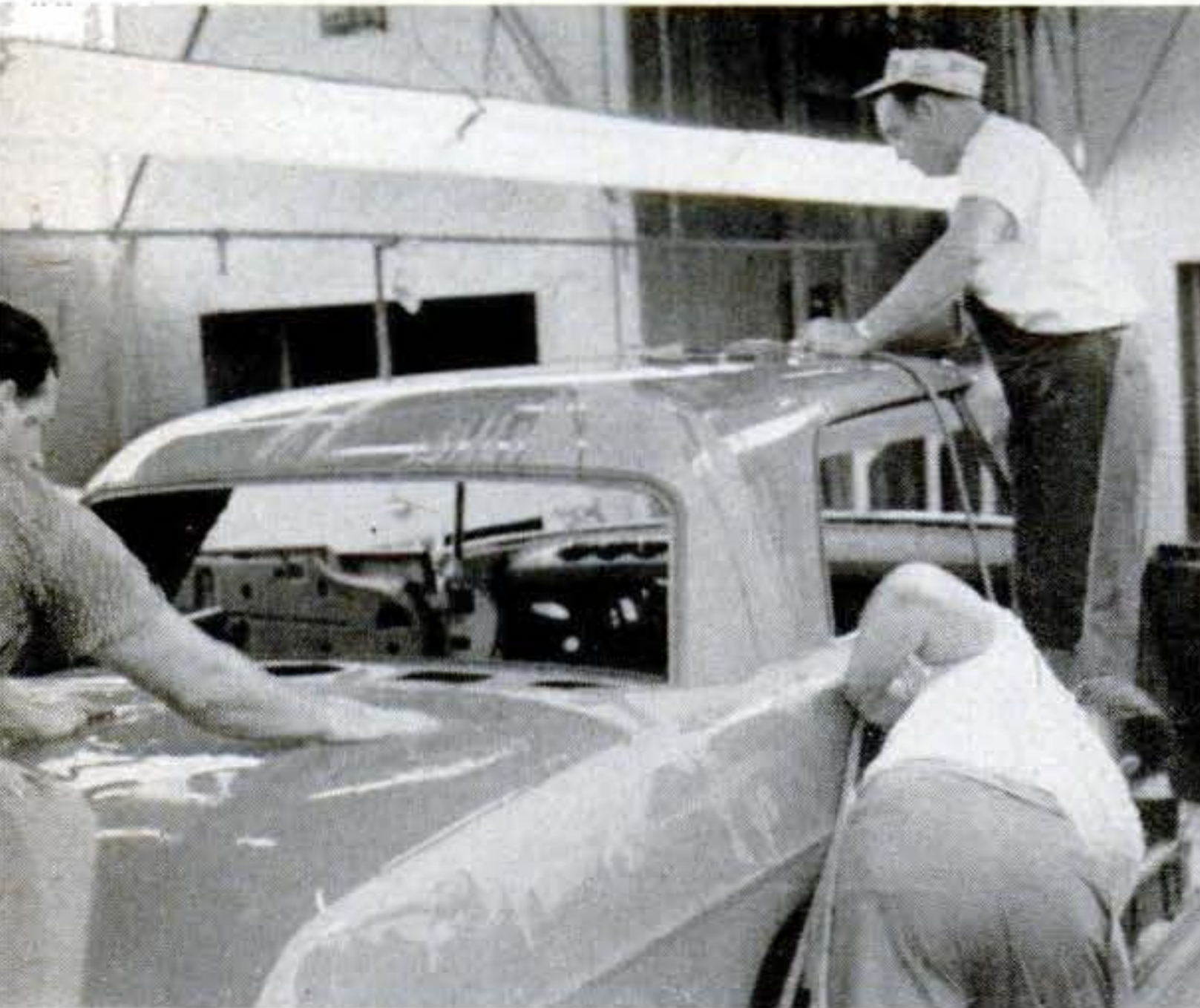

**2 WET SANDING** carries primer coat. Every inner and outer metal surface is coated, including those later invisible. The entire body is wet-sanded at two different stages.

**6 NO HURRY.** A lone craftsman here patiently fiddles with a minor detail. The general rule in the plant is that it's much more important to get it right than to get it done.



**3 FOUR DOUBLE COATS** of colored lacquer are sprayed on top of two gray surfacer coats, which are on top of two red primer coats. Each of the double lacquer coats is also oil-sanded.

**7 ENGINES** aren't installed until they pass a rigid set of tests. All major nuts and bolts are hand-torqued; all moving parts are balanced individually and then together.

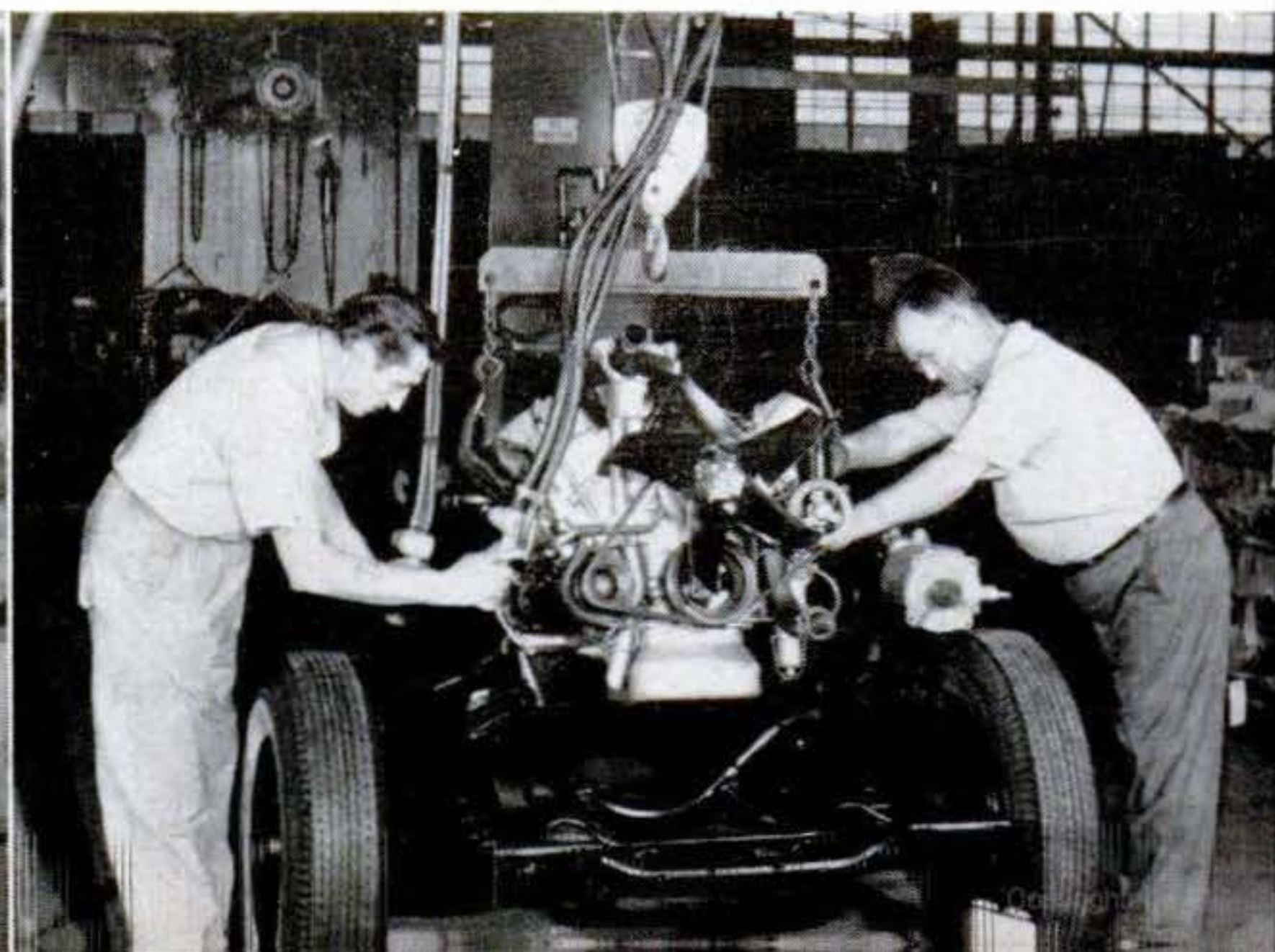
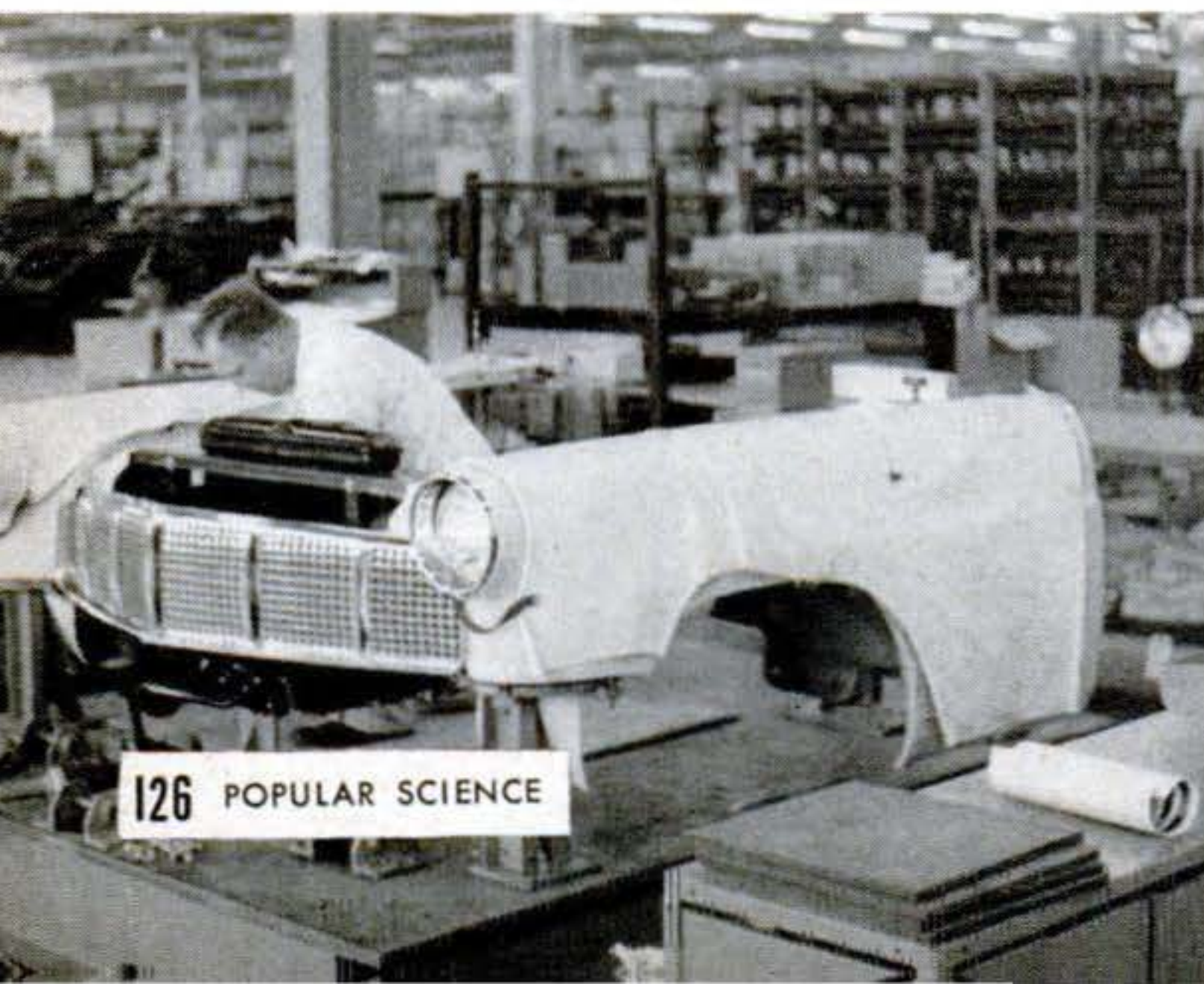



# Costs \$10,000

smaller stream flows *back* to suppliers—parts rejected because they just miss meeting quality standards.

Across wax-sheen concrete floors, Continental's 225 plant employees pick and choose, file and grind, ease and polish until they finish a 2½-ton vehicle that the inspectors will accept.

"Our system," says manufacturing chief Norm Crisman, "is the reason why, with Continental, every car is like the one you make for the big boss."



**1 TRIAL MARRIAGE.** Body parts are assembled "in the white"—unpainted—and fitted to a tolerance of .025 inch. When right they are keyed for later identical reassembly.

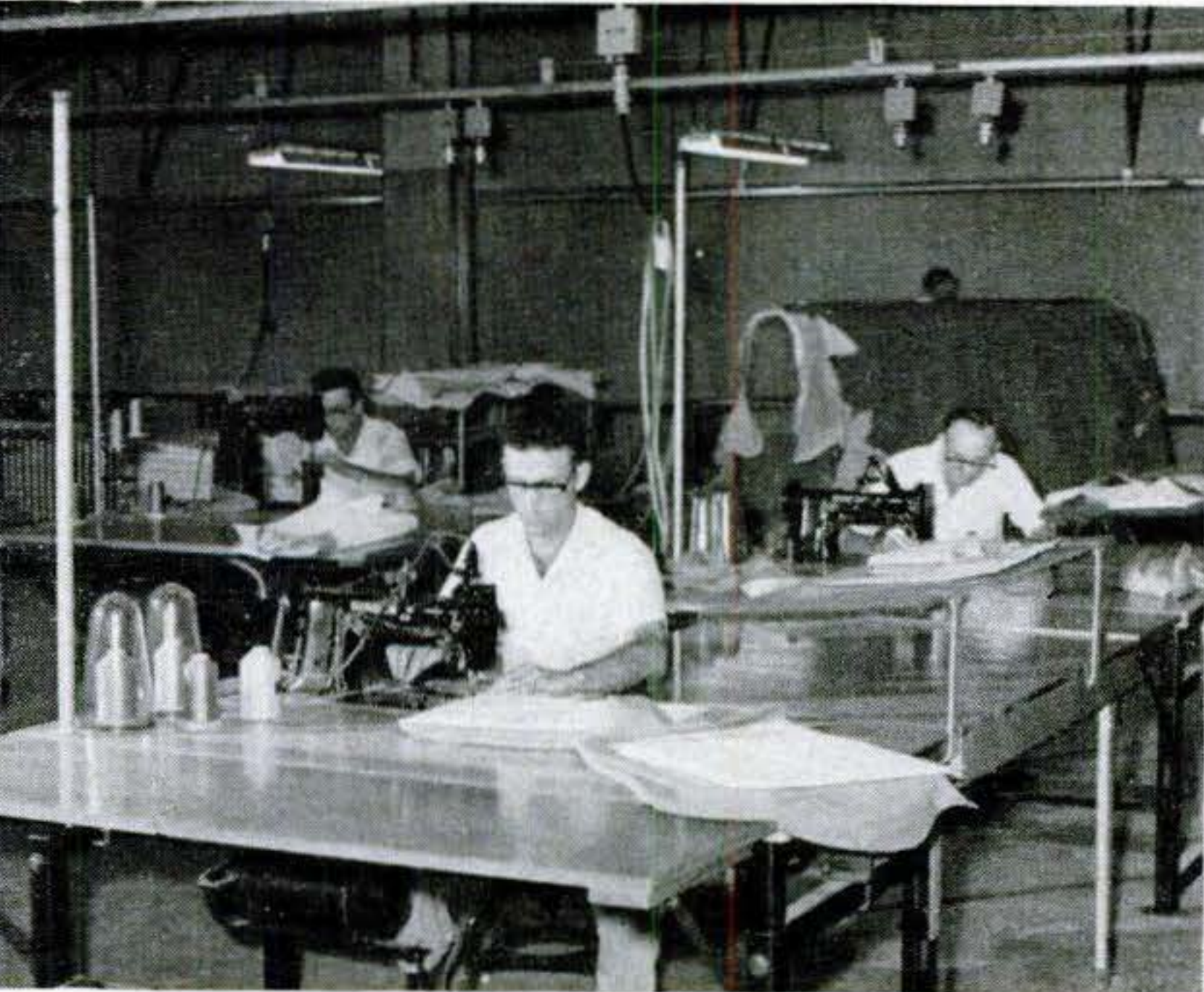

**4 SKILLED UPHOLSTERERS** sew up individual interior fabrics or fabric-and-cowhide combinations for each car. Or the customer may supply his own material for Continental to use.

**8 DYNAMOMETER RUNS** are used both to make sure engine and power train have been built right and to sharpen tuning to a keen edge. The car needs no "preparation" before delivery.

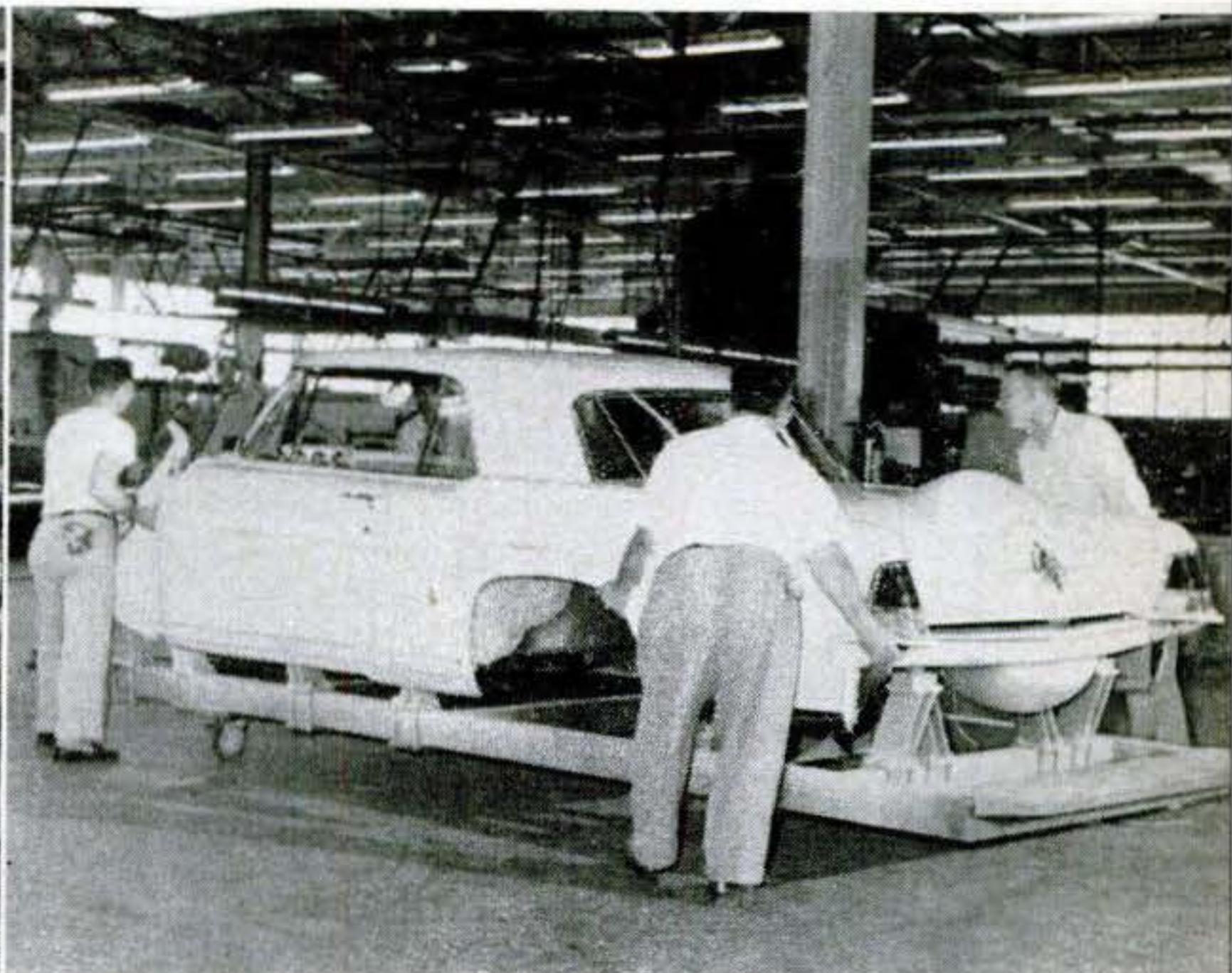

**5 GENTLY DOLLIED** up to final assembly is a body on which a crew of six may have worked 60 hours. Cars are built by small teams, not by running a production-line gantlet.

**9 IS IT REALLY DONE?** The plant won't let a car go until it has been waxed and polished three times, oil and oil filter replaced, and everybody's happy about its details. **END**

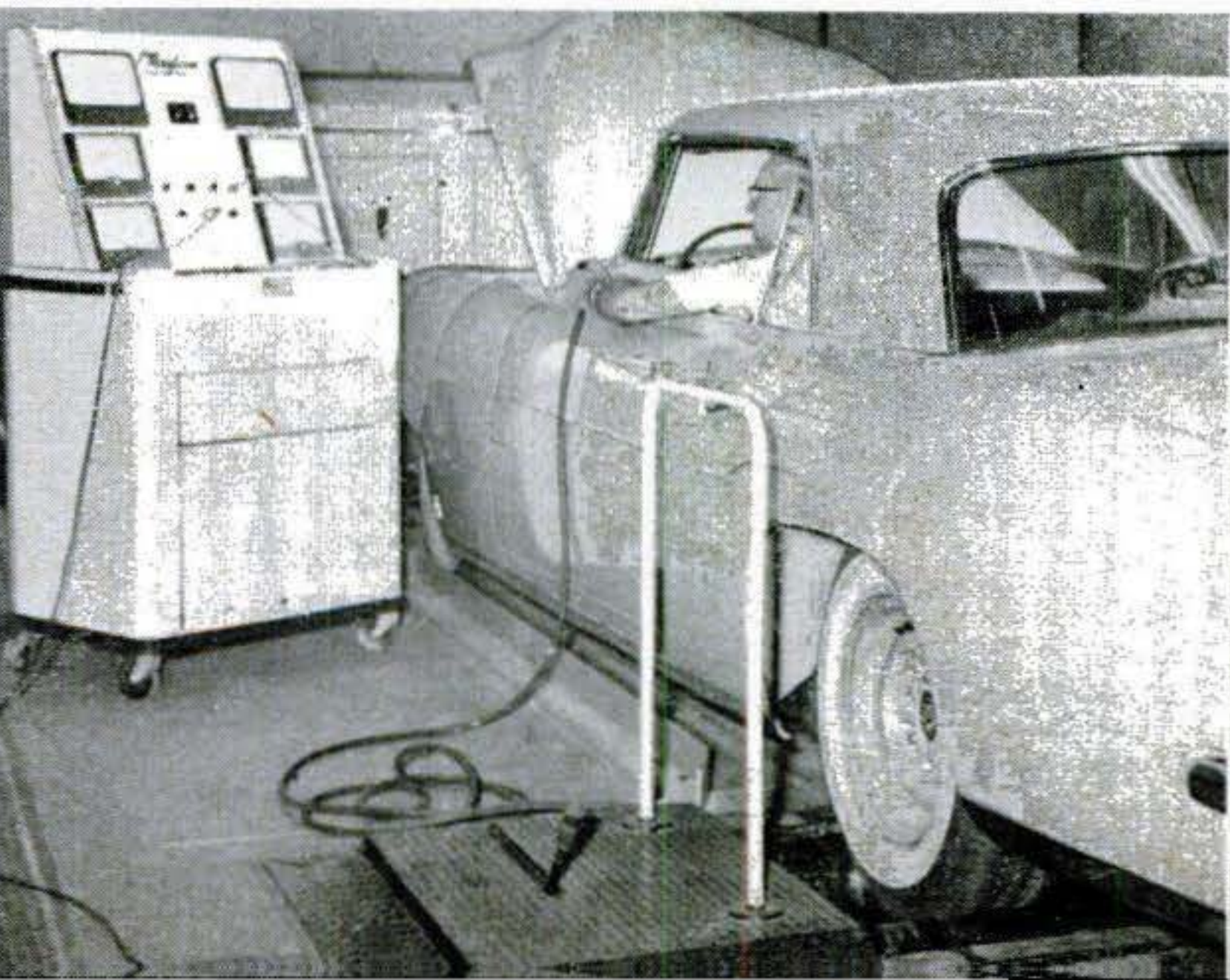



# Packard's Big Engine

374-cubic-inch job is out in front with a mighty 310 hp. You control it with automatic push buttons on a keyboard.

By EDWARD D. FALES JR.

**Y**OU are about to drive the new Packard Patrician around the 2½-mile test track at Utica, Mich. You're a little excited because this isn't just billed as a 290-310 hp. engine: it's the *biggest* U.S. production-car engine (374 cubic inches). And you're going to control it by playing Packard's new "driver's piano."

This is a little console of six push buttons sticking out from the steering post and nerved electrically to the transmission system. Push D and you work up through a two-stage torque converter into direct drive. Push H and you have push torque conversion throughout—from zero up.

They hand you the '56 Patrician—a slick piece of class. Nothing gaudy. It's got a long-low-wide look. The tail bea-

cons flare like northern lights when you toe the wider '56 brake pedal.

There are three men with you in this four-door family packet on a 127-inch wheelbase. You stop at the track gate

**THAT HOOD HIDES** what Packard calls the biggest engine in the industry. The four-door Patrician's lights have longer eaves. Grille and ornament are new; bombs are farther apart for that wide, low look.

**THIS MAN-SIZED V-8** has been given the job. Outwardly it looks much the same as the '55, but inwardly it's got bigger cylinders, elliptical firing chambers, a shorter stroke and longer spark plugs. The valves are quieter.

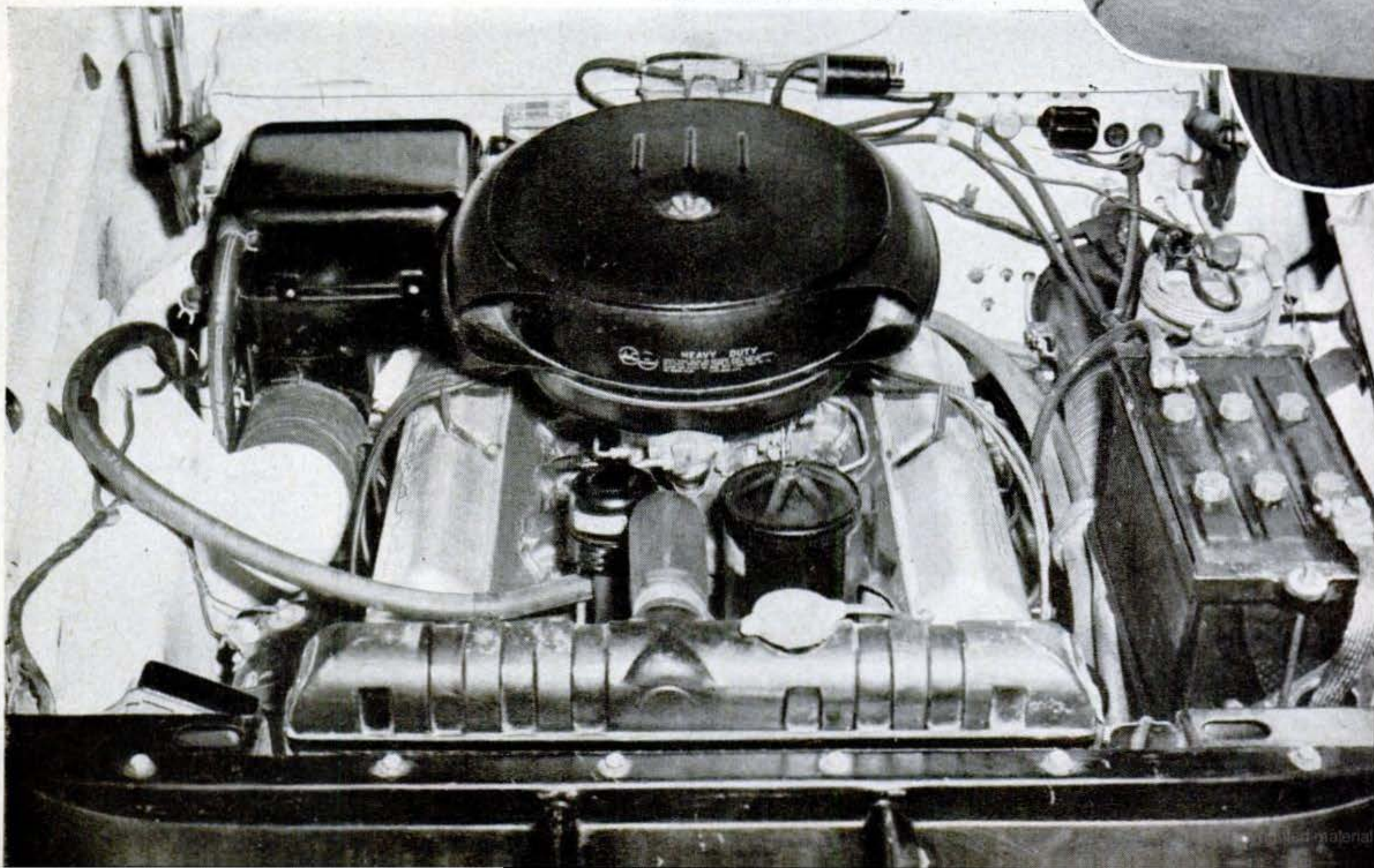



# Spurs New Power Race

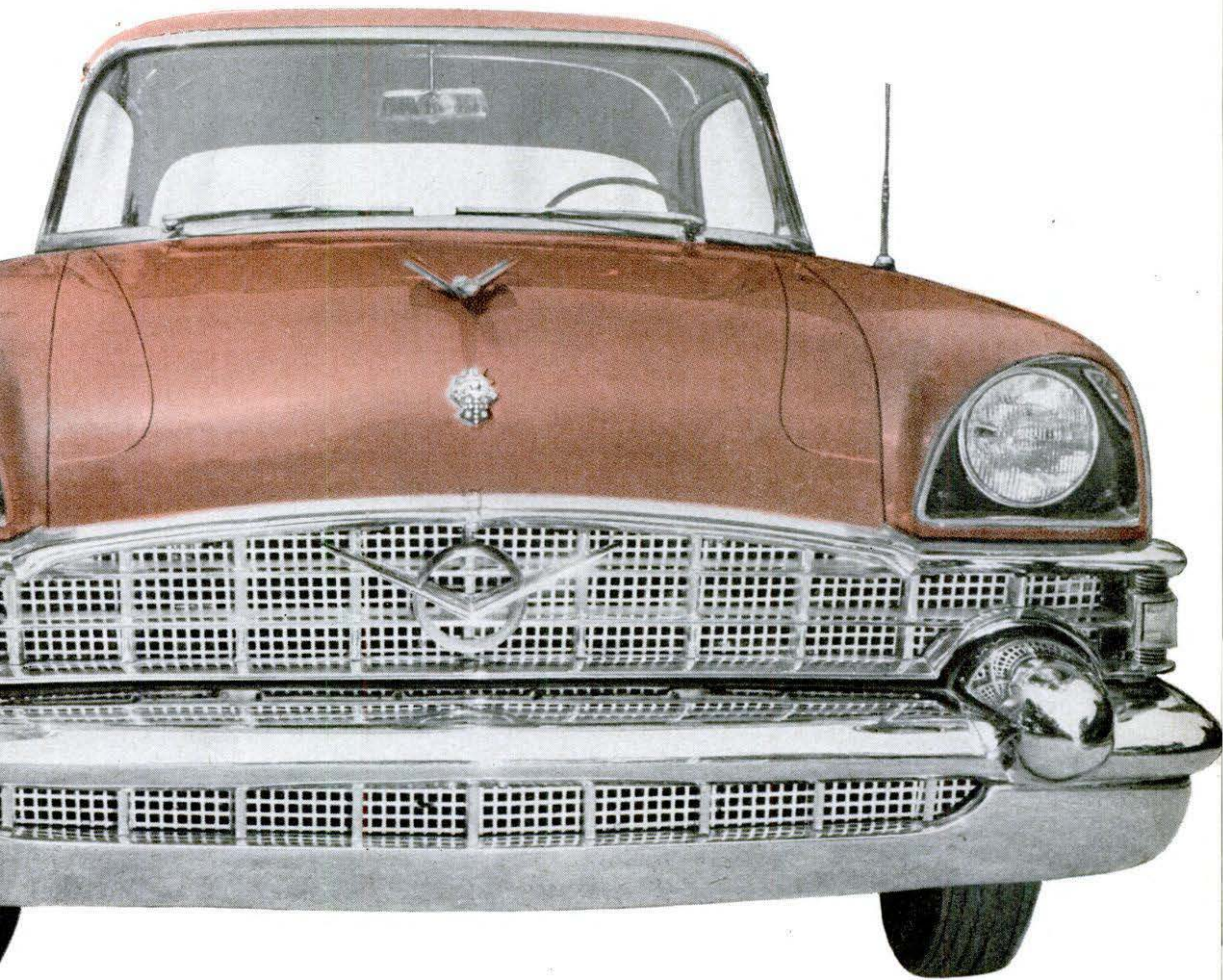

while three other '56 Packard products go by at 100 m.p.h.: first a "400" hardtop convertible, then the '56 Clipper (the medium-price "hot car" with a 270-hp. V-8), and finally up around 115 comes the \$6,200 Caribbean.

**Now the track's clear.** You punch D on the piano and gun the engine. A servomotor shifts you into drive. You plan to ease into the first turn at 60-65. But, whoa! What are you doing at 90?

Now you see why Packard's bright young men are grinning over their planning boards this year. They claim:

- *Fastest getaway* (still to be proved).
- *Horsepower* in the highest brackets (290 plus, and the Packard Caribbean is billed at 310).
- *Torque* that soars to a potent 405 foot-pounds in the Caribbean, Patrician and "400."
- *Highest compression ratio*—10 to 1.
- *Biggest cylinders*—4 $\frac{1}{8}$ -inch bore (up from four inches in 1955) and a shorter, 3 $\frac{1}{2}$ -inch stroke.
- A new "self-locking" differential that automatically throws torque to the slow wheel when one wheel spins madly. Re-





**COMING ROUND A HARD TURN** in soft, deep ruts, the author let the front wheels get untracked, got ready to wrestle back to the road but found no loss of balance or control.

sult: you now get 50-50 drive instead of 90-10 when one wheel is in the snow.

With all this scat, why didn't you *know* you were taking off? Here, frankly, is something that pains the engineers. They want you to get a *jolt* when you gun it.

**But this car gets away** like an arrow from a bow. In the 50-75 passing range, where acceleration counts most, it just lifts its tail and goes. You're arrow level.

This is due to the 26 feet of torsion bars that Packard put in for 1955 and has now made available all through the line.

If you use the new 2.87 rear axle, you'll get overdrive economy and still have a terrific kickdown and a torque curve that has backbone right up to 80.

**What a test shows.** You've been scating around this track for an hour. And you've noted: no tire squeal on sharp turns . . . no wandering . . . a rear mirror that (like some others) gives you a hopelessly inadequate 300-foot view . . . a steering handgrip that's *really* comfortable.

With three passengers, 100 m.p.h. is enough for you—though a "400" with a

test pilot at the wheel scoots past you on the high wall with three gents aboard.

"She's doing 105 and only loafing," says a test driver in your car.

**And in that remark** lies the real '56 Packard story.

A while back, shirt-sleeved Packard brain-trusters found themselves on a spot.

Other designers were trimming weight. Engines would be small but oh so strong. They'd go right up to 250 hp.

Then and there, the engineers made up their minds:

- The hp. race wouldn't stop at 250.
- It would take BIG engines to stand the gaff.

- Then they made a third decision: "We'll make block and crank big so that when the time comes, we'll be ready."

Buzzing curves at 95 you realize the time is here and the big block and crank are taking it in stride. There's hardly a sound. You're chatting with the boys in the back seat. The dial goes on up to 120. But what do you want with two miles a minute? You hold her down and get that "just loafing" feel.

How did they get the extra Wheaties into the same engine that in 1955 was rated 260 hp. with 352 displacement?

**The big block,** says Packard, lets the bore go up from 4 to 4½-inches and still leaves room for plenty of water. (It's this, Packard says, that's kept it from having a single cracked V-8 block.)

The new engine keeps the same rods, cylinder heads, bearings and four-barrel carburetor. Crank's a little huskier but basically the same. Only inside the block do changes show, and in the rings and

## \$6,200 two-masted Caribbean has even Detroit whistling

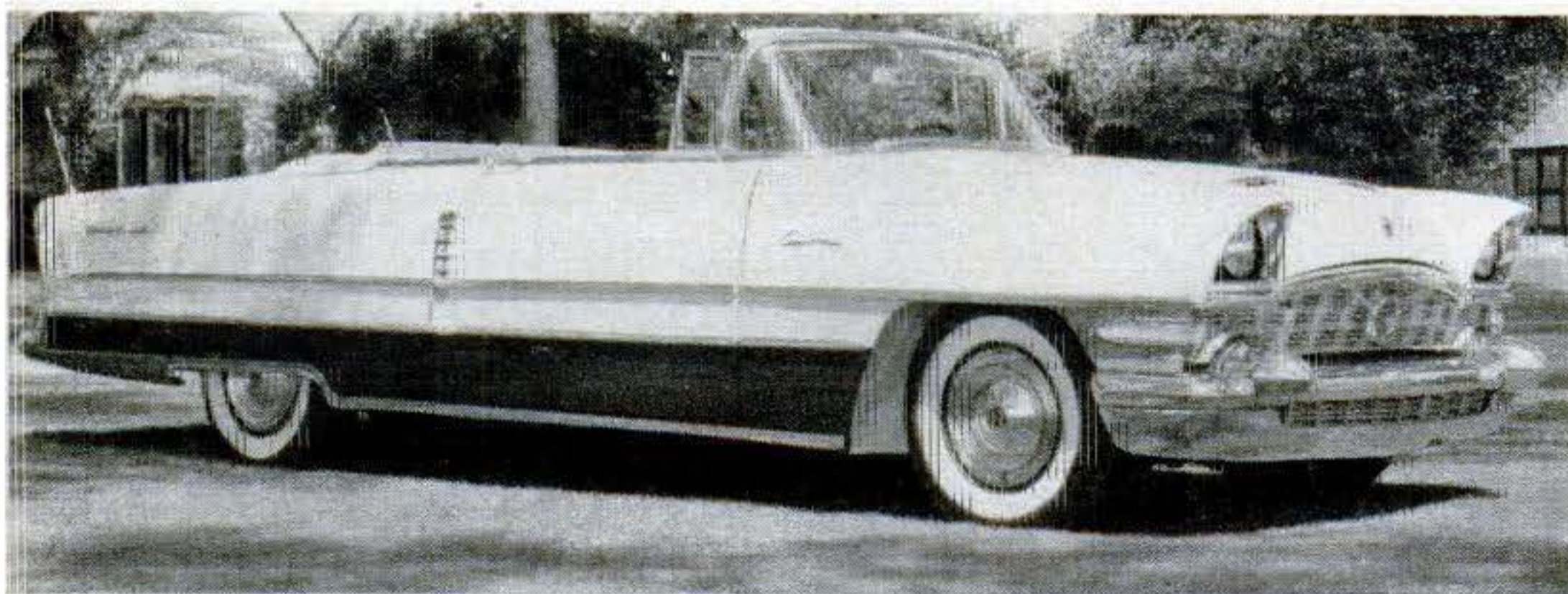

**'56 CARIBBEAN:** This is the luxury car in which the V-8 breaks through the 300-hp. barrier with 10 to spare stashed under its gleaming bonnet. There are twin radio masts aft. Besides the convertible shown, there'll be a hardtop. New automatic push-button drive control will be standard.





**FOUR-WAY TOGGLE SWITCH** replaces seat-control buttons. Just flip the lever the way you want the seat to go.



**TOUGHER, THICKER** new crash pad tops a rich gold dash panel. Glove box has a new lip to keep things from tumbling out.



**FLICK OF THE WRIST** changes Caribbean's "sofa" from daytime leather to plush brocade fabric for evening elegance.

## Elegance and push-button ease mark new Packard line

**"TURN THE MEDALLION"** latch is easy to turn when you want to snap the trunk lid open. It's a new feature in '56.

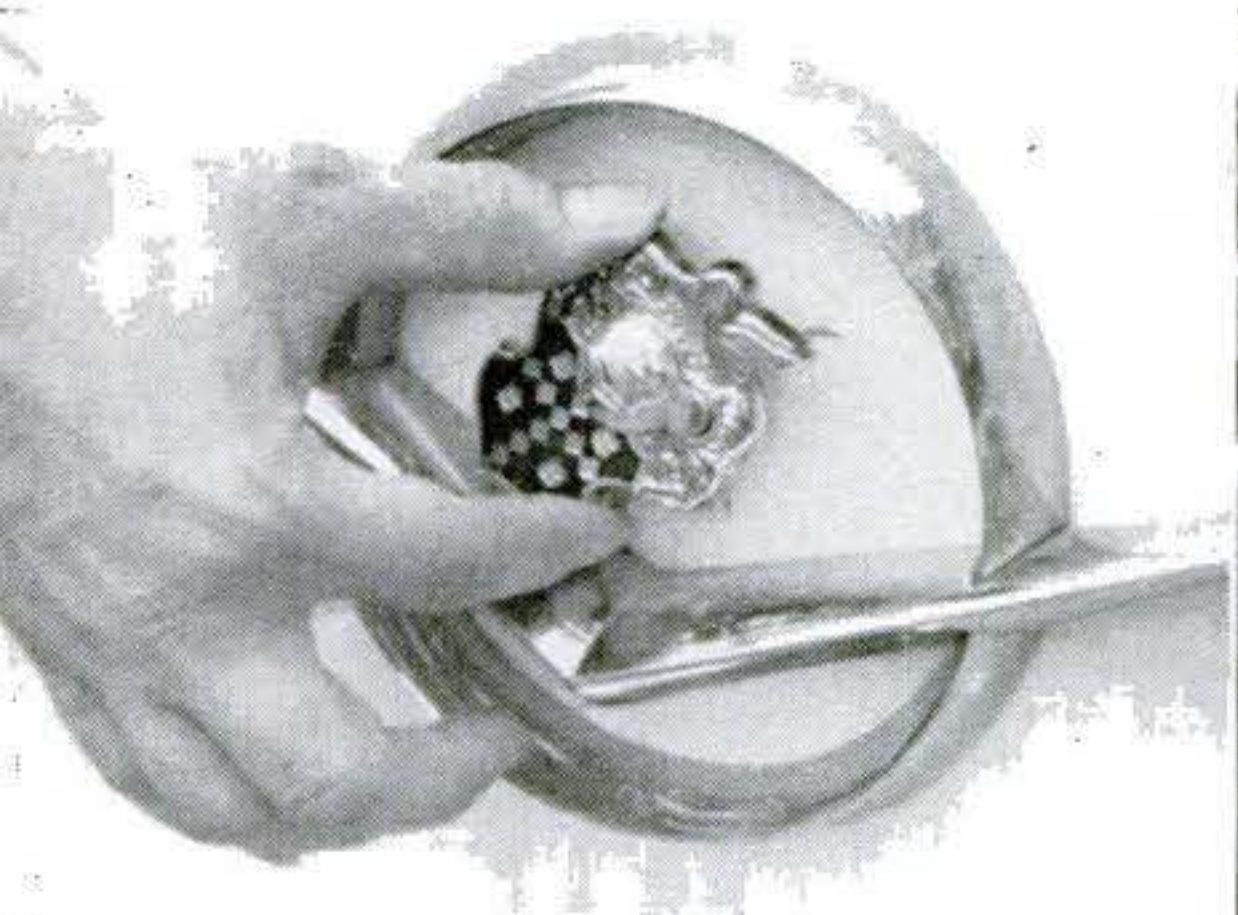

**HEADLIGHTS** are sinking in deeper and deeper. Eaves or hoods have been extended another five inches forward in '56.

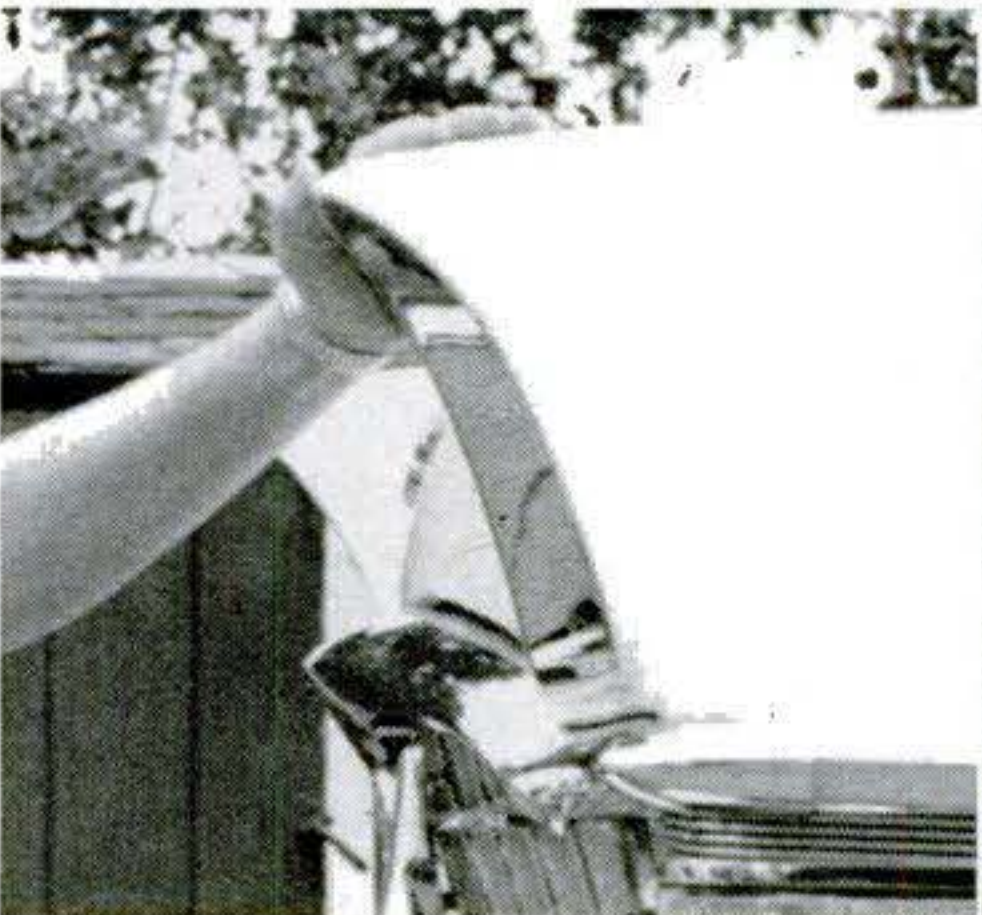

**SWEEP-SECOND HAND** on the electric clock serves no practical purpose beyond helping time your starts and passes.

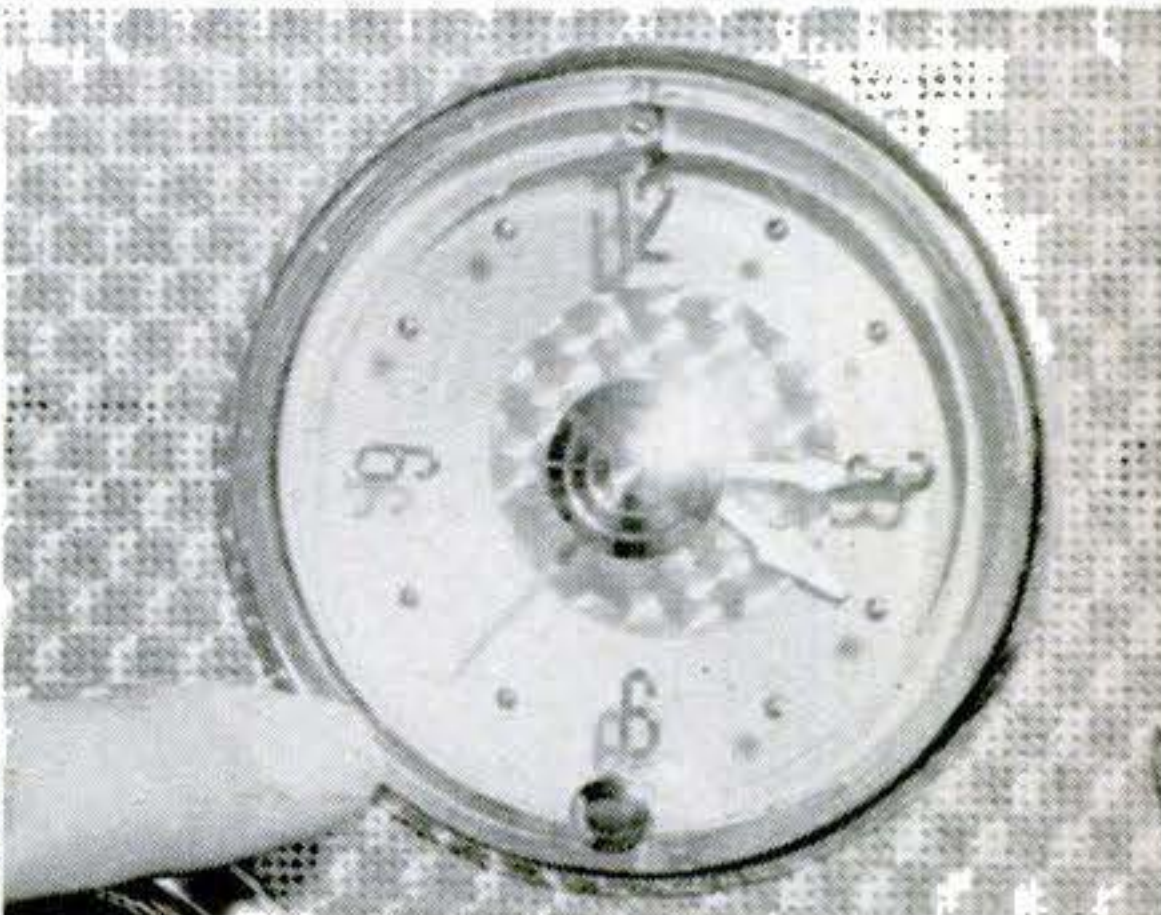

carb. Pistons are sturdier, valve stems wider ( $\frac{3}{8}$  inch). Valves lift .024 inch higher. Manifold passages are wide and husky, and valves are two inches.

Packard says it gets away with 10-to-1 compression by going to an elliptical fire chamber and a "long reach spark." Business end of each plug is up on a pedestal where it gets a real scouring.

Packard also sent its four-barrel carb

into surgery. A couple years ago drivers who didn't start in low beefed about a "flat spot." Even though they mashed their feet right down into the carburetor, they strangled their starts. To fix this asthma, the venturis have been changed. And a nerve from the throttle now refuses to let the secondary throttle open and spoil everything until your engine has enough speed to accept it! **END**

## Clipper will be sold as a separate line, not as a Packard

**352-CUBIC-INCH V-8** powers the "hot" Clipper line, which is to Packard what Oldsmobile is to GM. Test pilots say Clipper's top speed this year is up 10 m.p.h. to 116. Frame has been beefed up like Packard's '55. Result: there are fewer body noises. Fishmouth tail lights are new.

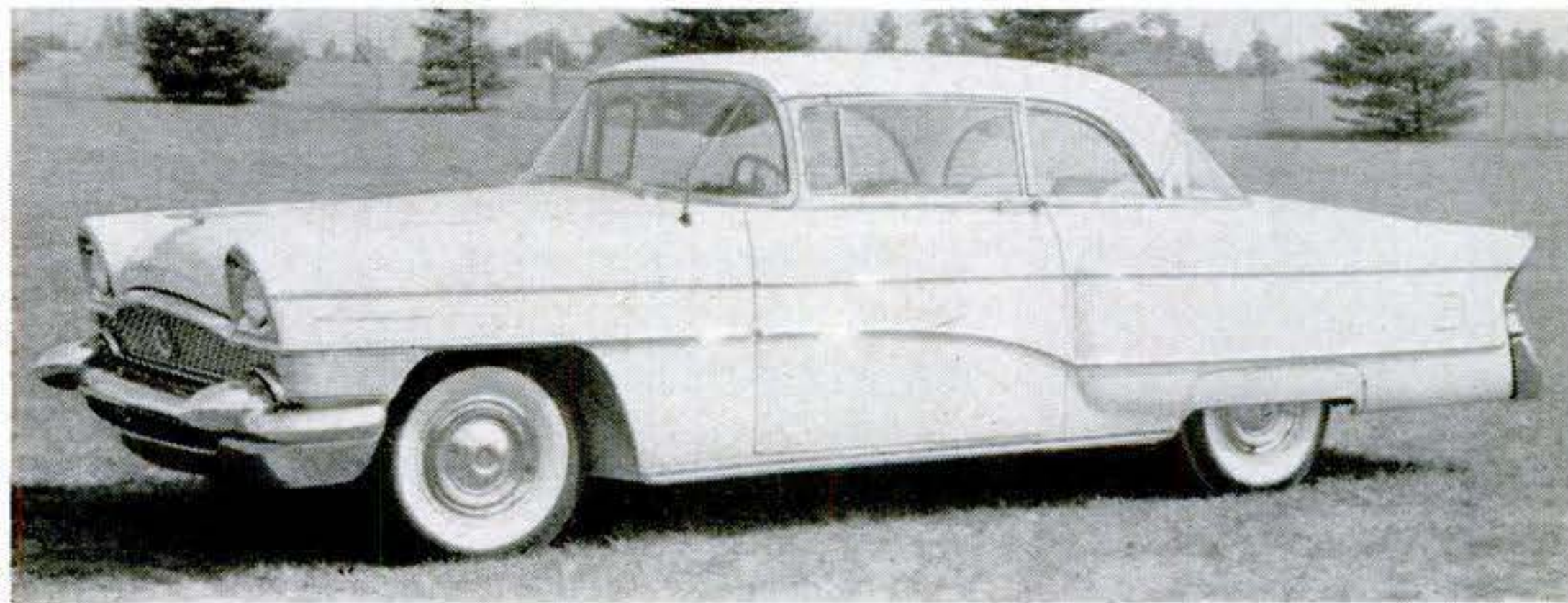



Bumps won't shake the platter that spins in '56 Chrysler-built cars.

# Highway Hi-Fi Plays

## New $16\frac{2}{3}$ -R.P.M. Records

By MARTIN MANN

**Y**OU'RE tooling your '56 Dodge along the Turnpike way past bedtime. Even the radio's passionate pleadings for the newest miracle toothpaste can't keep you awake. So you reach over, switch a knob to PHONO, and put on a record. The one with cymbals that nobody could doze through.

This automobile phonograph is the cutest toy for cars since windshield squirters. Highway Hi-Fi, Chrysler calls it. It is an ingenious little record player in a neat case slung under the dash to play through the radio, and will be available as an extra on all of the Chrysler Corporation's 1956 cars. The price will be about the same as a car radio.

**One-hand, no-look operation.** You play records with no more fuss than it takes to work the radio—an obvious safety requirement. Press a button and the door flops open. Pull out the turntable as far as it will go, pick a record from the stack underneath and push it against stops on the turntable—it drops right over the spindle. Press a lever on the tone arm and move the arm until it stops. When you let go, the needle drops into the first groove and the music starts.

No reworking of a home player, the new unit was designed for cars, from



**AS EASY TO WORK AS RADIO**, auto phonograph has stops at back to guide record over spindle. You needn't look.

the record grooves up, by Columbia Broadcasting System and Chrysler engineers. The discs, a mere seven inches across, can play for a full hour on one side. That's because they spin at the unconventional speed of  $16\frac{2}{3}$  r.p.m. and have extra fine grooves, one-third the thickness of a human hair. The needle is a skinny .0003 inch across—a regular LP record uses one three times its size.

**The player keeps right on** making music, up and down hills, over bumps and around tight corners. Chrysler claims it shrugs off almost any jolt that won't send the car to the nearest garage. A Dodge engineer rode me over curbs with the phonograph going—it didn't miss a beat. And I listened to an unmounted unit playing beautifully while it was tilted almost on its side.

The ruggedness that makes the music go on no matter how you drive is built into every part. The turntable base, for example, is a heavy metal casting—plenty of inertia to make it just want to sit still. It rests on three  $1\frac{3}{4}$ -inch-thick neoprene rubber sponges, which can soak up big bumps.

**The tone arm** is also engineered to hug the groove and ignore distracting bumps. It swings easily when pulled slowly by the record grooves, but holds

[\[Continued on page 270\]](#)





**PRESS LEVER ON TONE ARM**, swing arm till it stops, let go, and needle drops into first record groove.

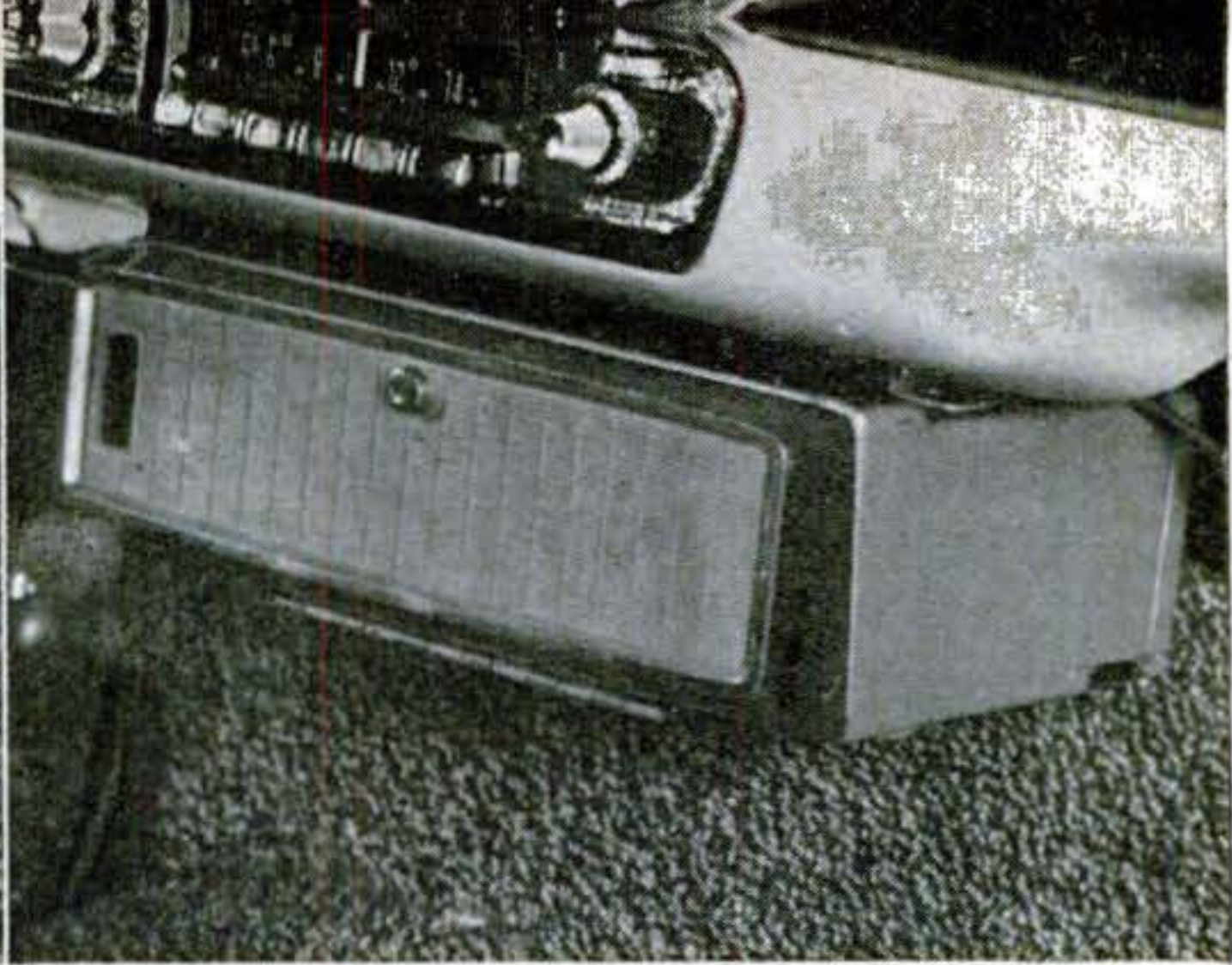

**CLOSE IT UP AND LISTEN TO MUSIC.** Slow speed makes one side of small disc play for an hour.

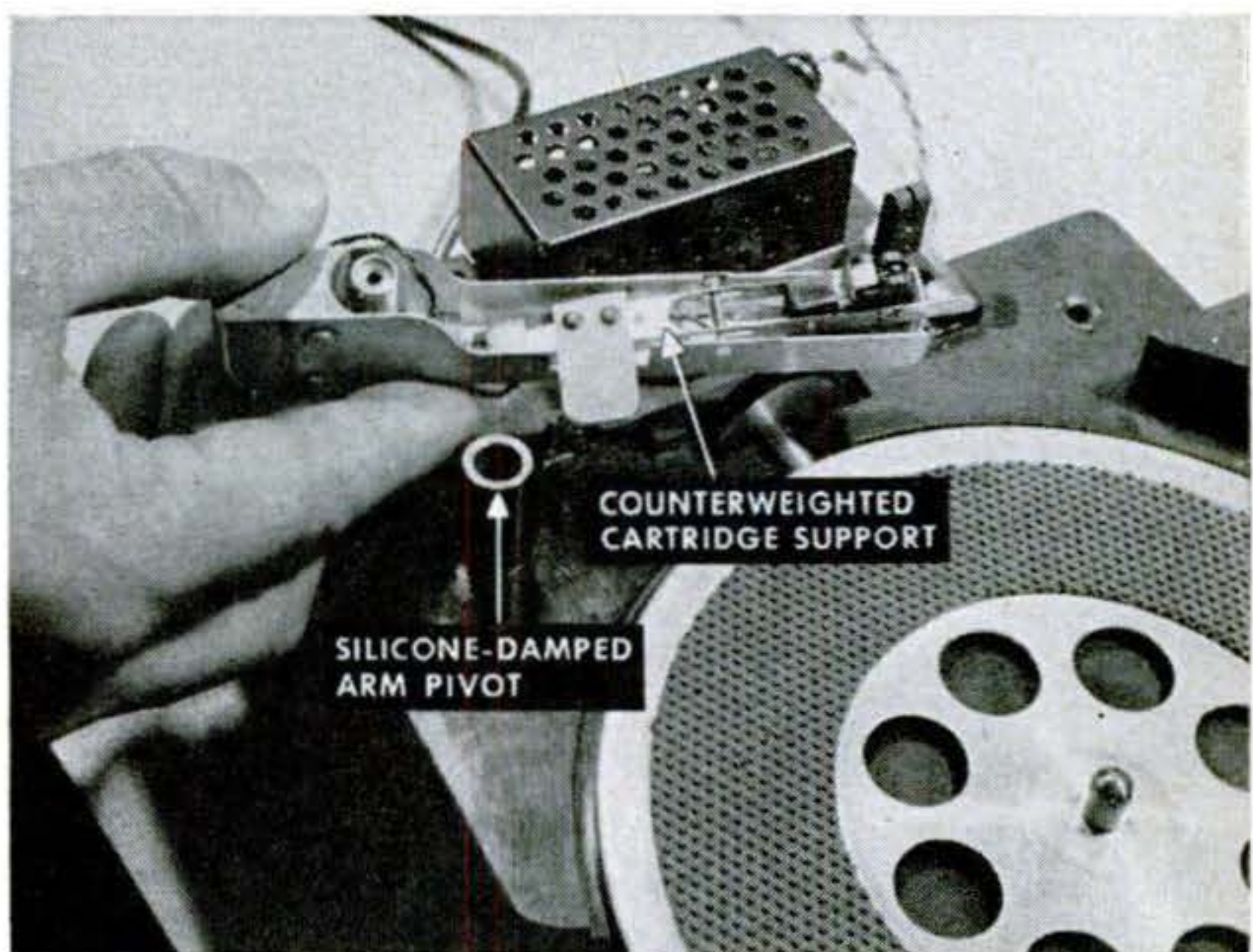

**DESIGNED FOR BUMPS**, unit plays on rough roads, around tight curves. Tone-arm pivot, containing silicone fluid, resists sudden forces yet gives to gentle pull of groove. Cartridge weight is fully counterbalanced.

**YOU'D HAVE TO DRIVE UP A WALL** to make the needle skip a groove. The player was making good music when tilted for this photo by Dr. Peter Goldmark, Columbia Broadcasting System research chief. The new unit is an optional accessory for Dodge and other Chrysler cars.





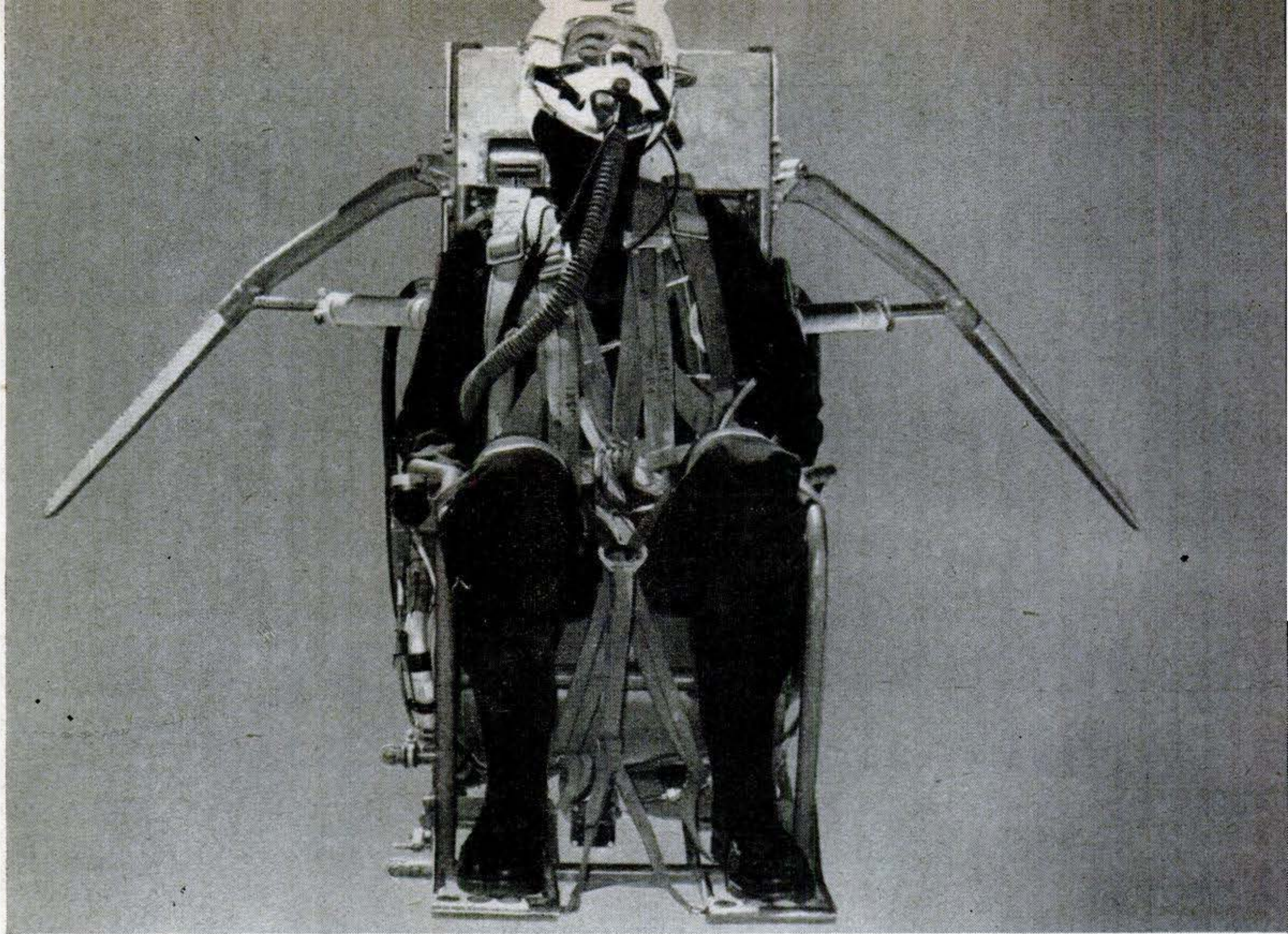

**Downward Ejection Seat:** In case of bail-out, the pilot of Douglas Aircraft's new X-3 will be hurled *downward* out of his fighter. Reason: at advanced speeds the force re-

quired to shoot the pilot *up* out of the plane's path is beyond human endurance. Fins stabilize the seat down to 15,000 feet, after which a parachute takes over.

***New machines, new methods, new theories, go***

## Under Test for Tomorrow's World

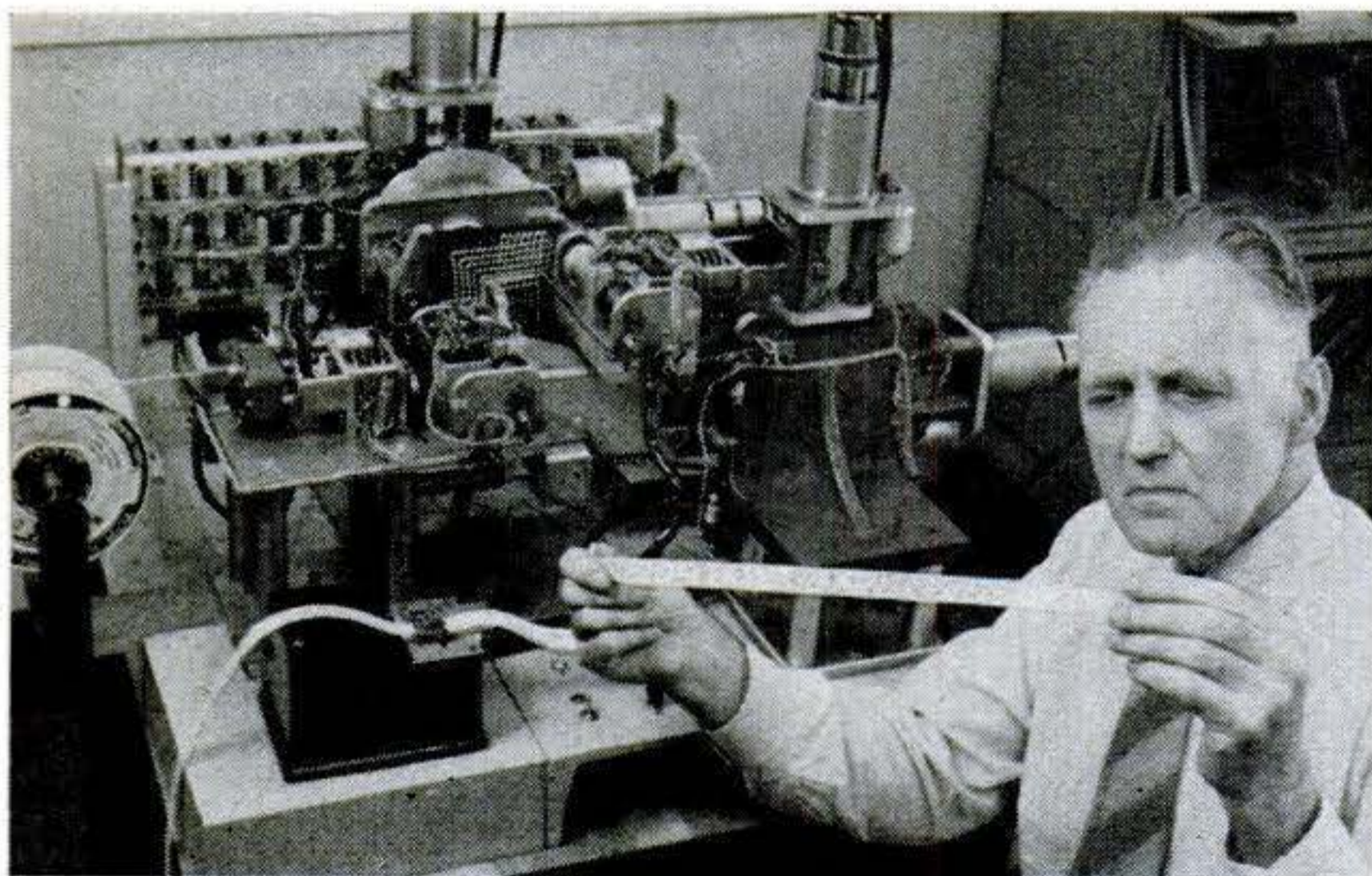

**Circuit Weaver:** A first cousin of the loom, this Bell Labs machine gets its orders from a punched tape, and delivers a complex electrical circuit with solderless wrapped con-

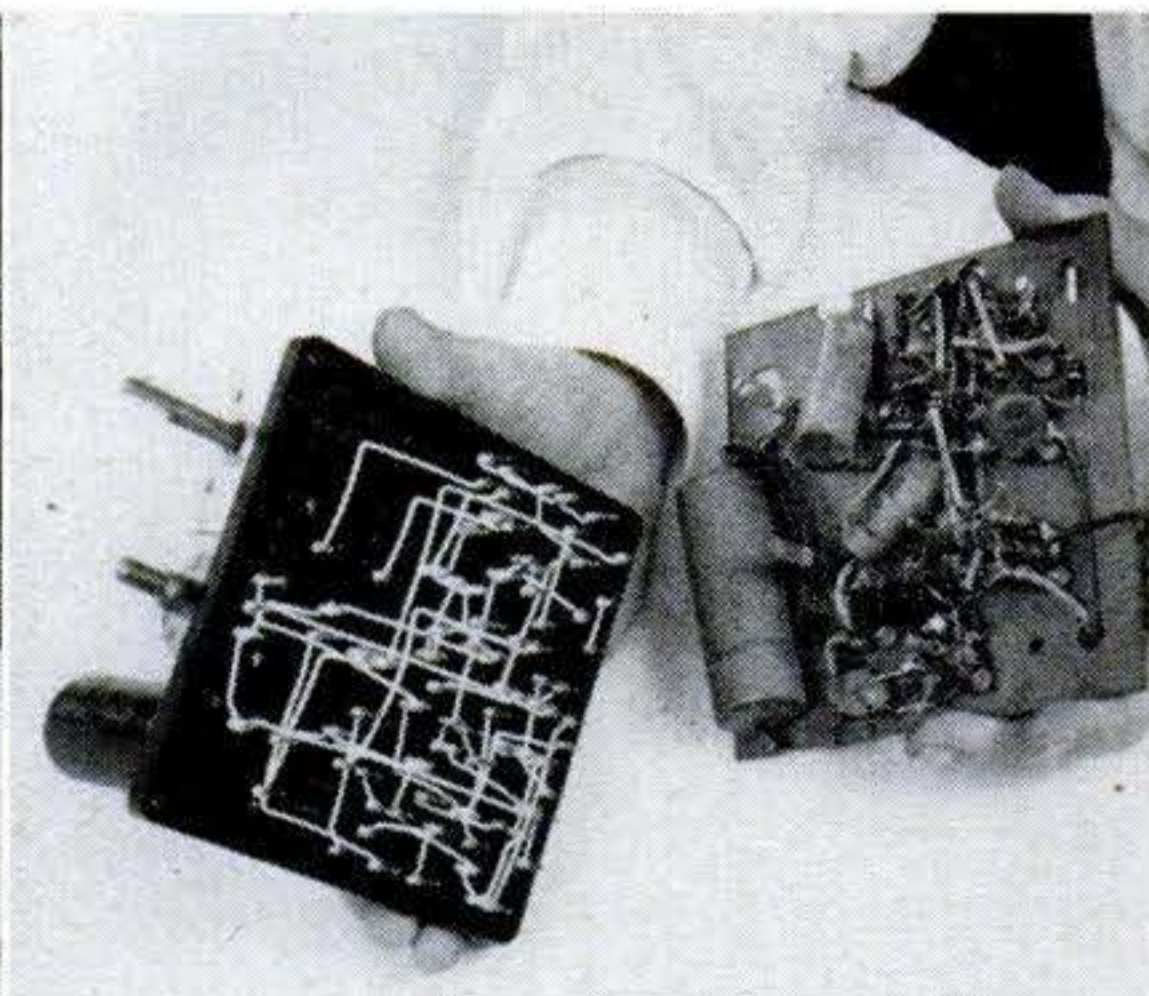

nections. The circuit at left above, for a five-tube radio receiver, was made by Bell's "M-4"; the circuit at the right was wired by ordinary soldering methods.



**Plane Cage:** Using a metal-tipped plastic probe, this Boeing engineer is measuring the charge on a model plane set in a 20,000-volt electrostatic cage.

Static electricity generated by a plane's metal skin can do strange things to delicate electronic instruments. Test readings here will help designers figure out where to locate antennas, sometimes more than 50 of them, on high-speed bombers.



**Tornado Chamber:** What causes a tornado? In a glass chamber at New York University, Prof. James E. Miller uses swirling currents of air, steam and flame to find out. To create a tornado, he shoots jets of air at a spiraling column of steam.

Much is known about hurricanes from pilots flying through them; but tornadoes arise so suddenly and roar so violently that on-the-spot study is impossible.

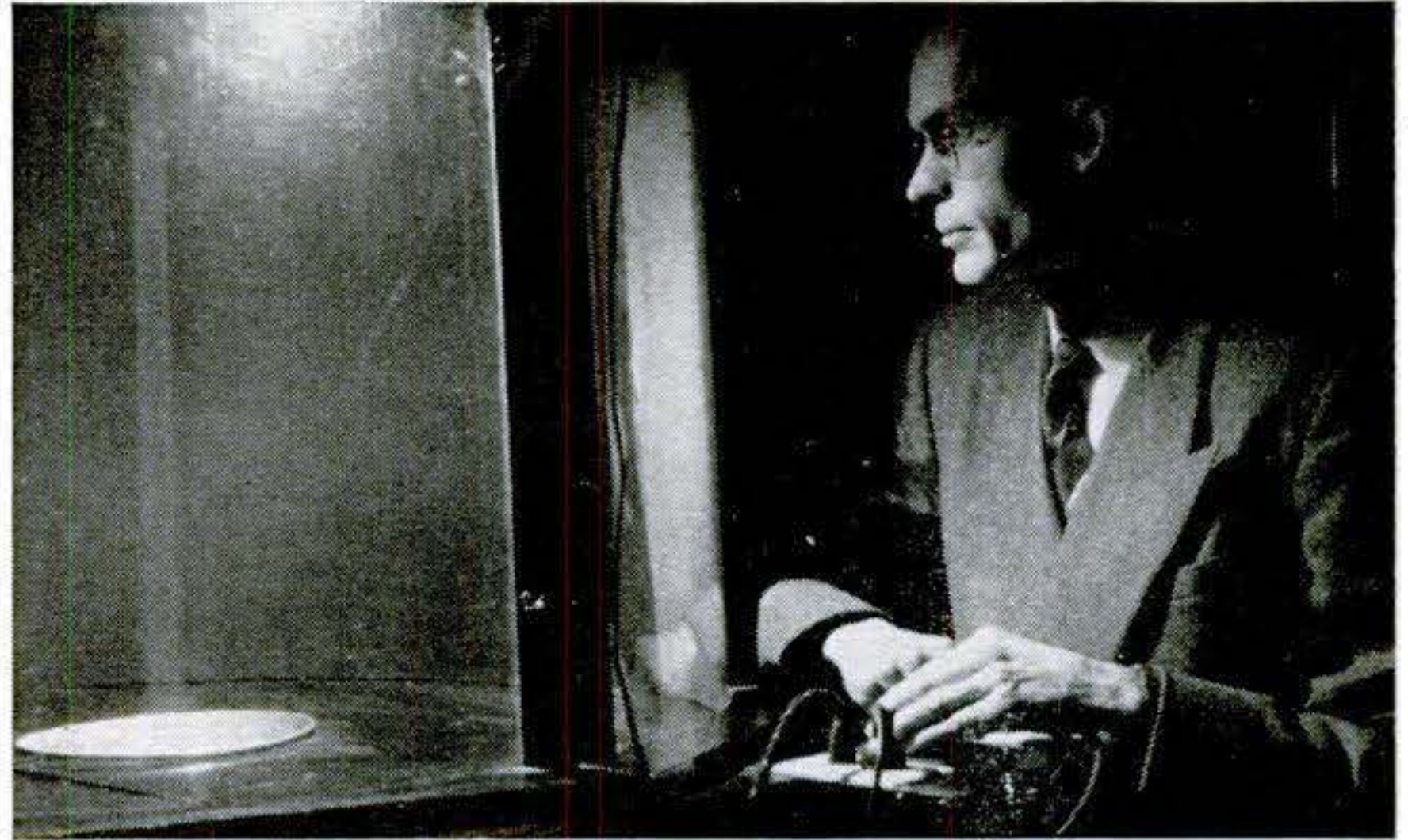

**Lab Concert:** The squeal that comes out of this technician's cello bow will determine whether the turbine wheel under test, part of a Fairchild turbojet engine, will be accepted or rejected.

If the natural sound frequency of a particular blade corresponds to the frequency of forces that may affect it, such as aerodynamic disturbances, the blade will vibrate and interfere with the operation of the power plant.

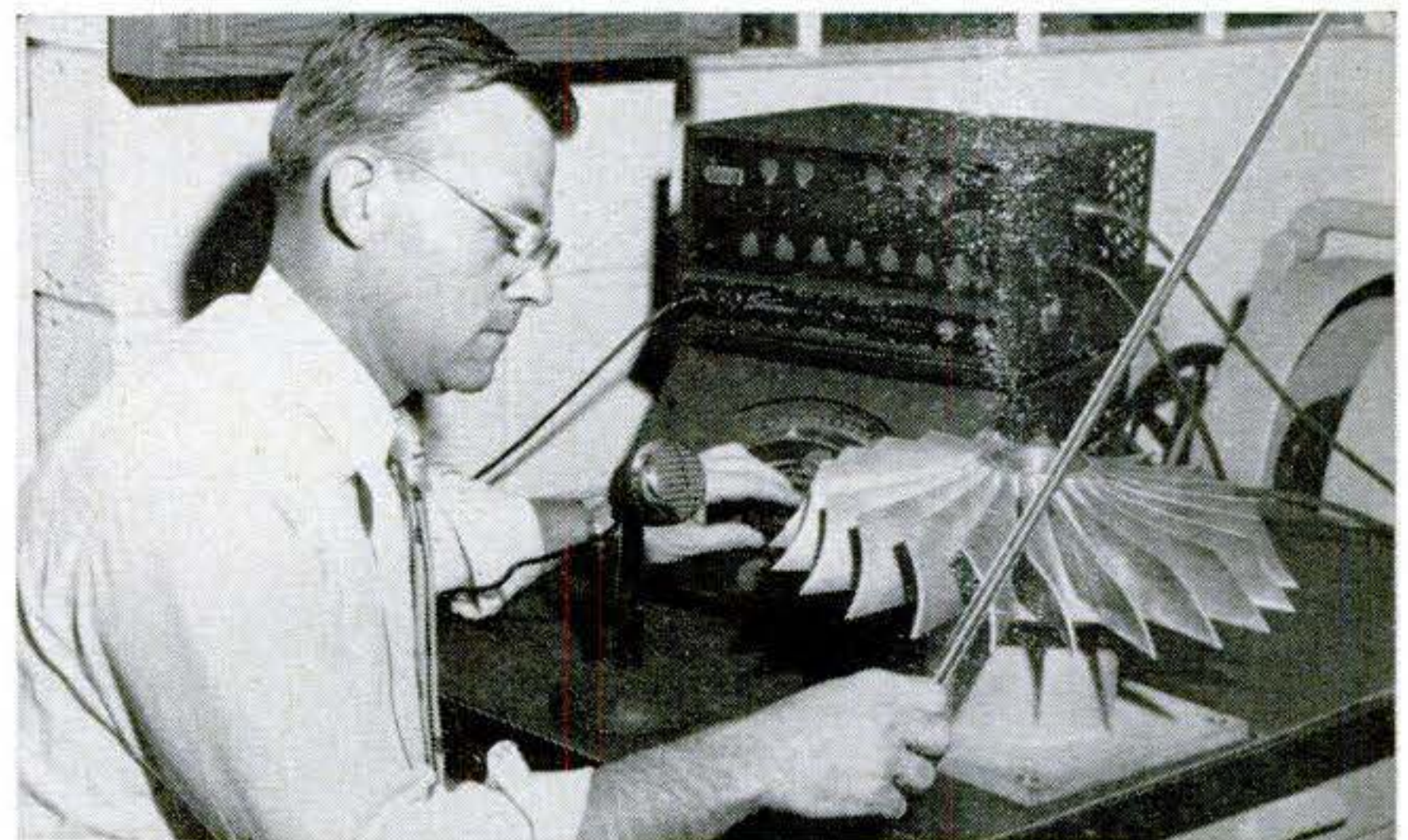

**Standardized Cockpit:** Here's what Lockheed's new turboprop transport, the Electra, will look like up in the pilot's "office."

It's a mock-up of aviation's first standardized cockpit. Instruments and controls are laid out in accordance with recommendations by a committee of aviation experts, so that pilots will be able to go from plane to plane, safely and without any need for expensive transitional training.

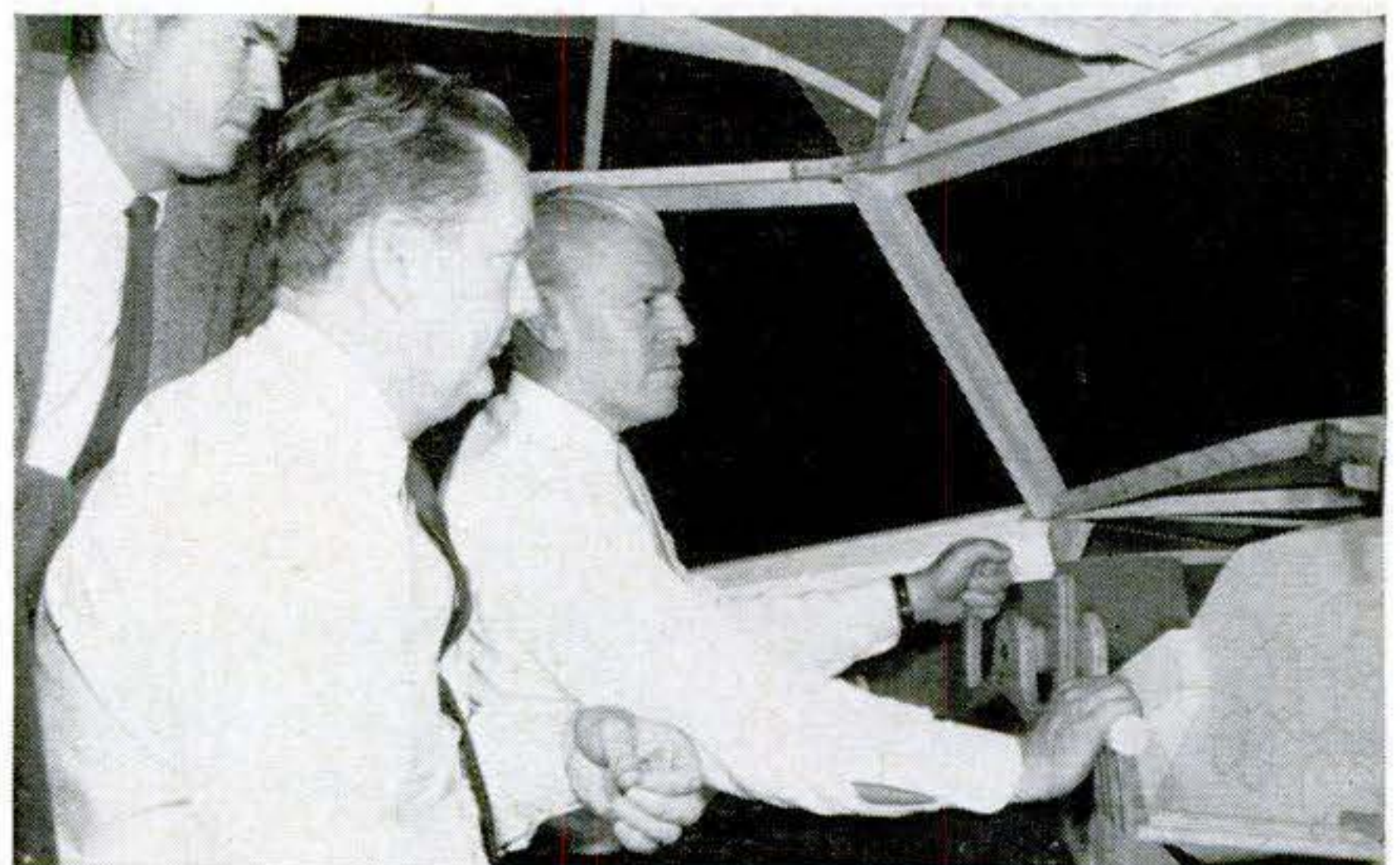



# Science Closes In on the

By Herbert Yahraes

**H**URRICANE CONNIE had roared and poured its way across Frederick County, Maryland, the night before, and now—on a hot Sunday afternoon—Bob Huebner was out checking up on the damage it had done to his Hidden Valley Farm.

Bob is more formally known as Robert J. Huebner, M. D., chief of the Virus and Rickettsial Diseases Section of the National Microbiological Institute. He is one of the world's outstanding virus hunters.

Bob's first interest this Sunday afternoon, however, was his corn. Some of it was still standing—eight and nine feet tall—but much of it lay on the ground. The ears, not yet ripe, would fatten woodchucks instead of Angus cattle.

**Bob looked at it** and turned away. A visitor suggested that sometimes he must get pretty discouraged.

"No," said the doctor. "I have a theory about discouragement. As long as you are able to do something about changing a situation, you don't get discouraged."

Bob, besides his spare-time farming, has been doing a great deal about one of the most discouraging problems facing the medical profession: the cause and prevention of the common cold and related ailments. This block of diseases attacks the average person perhaps five times a year and costs Americans at least two billion dollars annually. Yet medical science until recently had got almost nowhere in its fight against them.

**Breakthrough at last.** Now, largely because of Huebner and his associates, science has finally made a breakthrough in its long fight against the infections that knock a lot of us out every fall and winter—and sometimes summer and spring

## Virus Hunters at Work

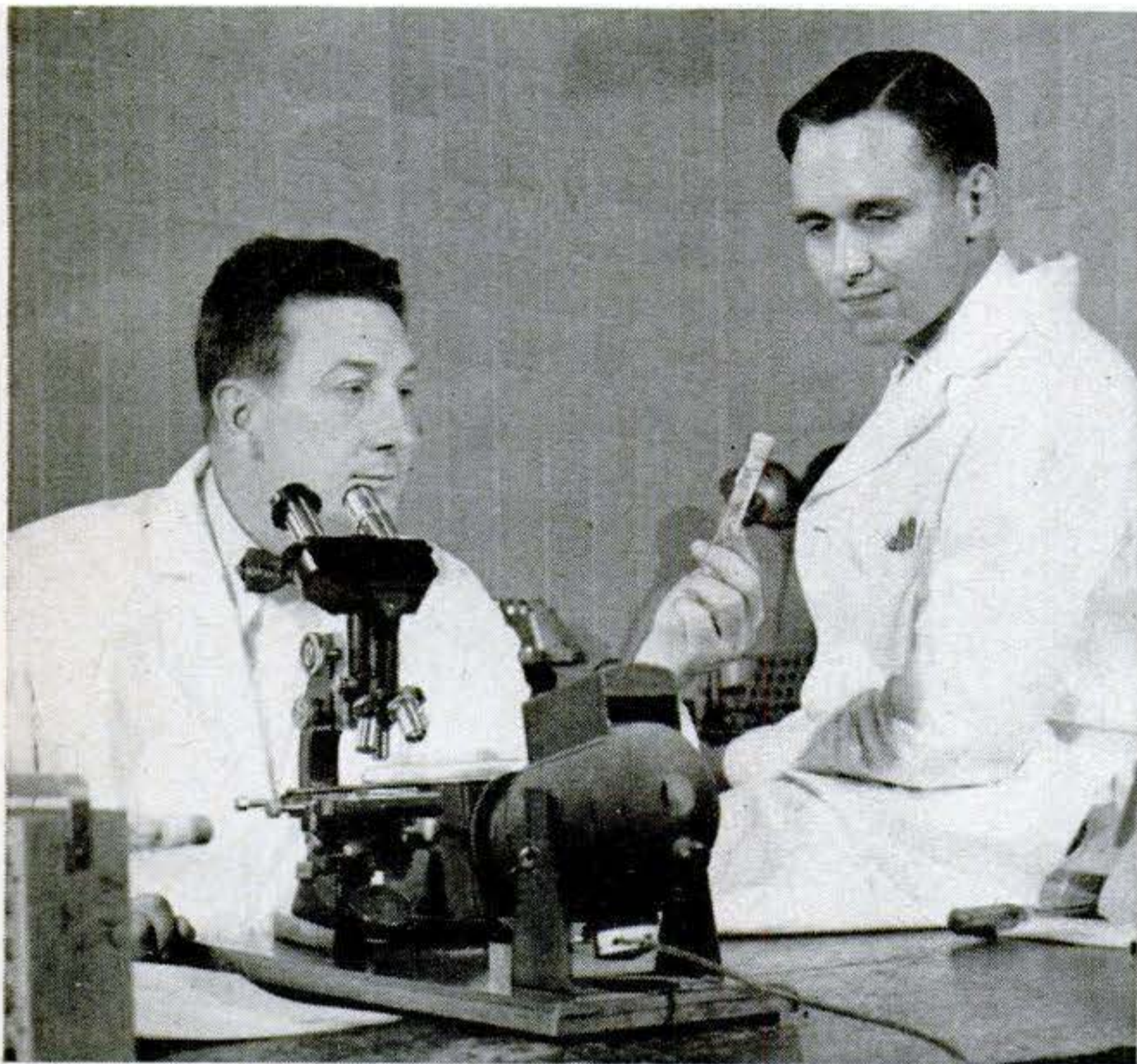

*Dr. Bob Huebner (left) discusses with Dr. Wallace P. Rowe the artificial growth in human tissue of a newly discovered cold virus.*



**Using convicts as human guinea pigs, a team of doctors headed by a part-time farmer is working on a vaccine like the Salk polio shots.**

# Common Cold

as well—with sore throats, runny noses, fever and a general wretchedness. He and his team have trapped a whole family of new viruses responsible for many of the illnesses called “a cold” or “a touch of grippe.” Further, they have developed a vaccine against one of the family’s worst members.

A tragic case of scrub typhus turned the young doctor, recently out of St. Louis University medical school, into a virus hunter. Scrub typhus was one of our big problems in the South Pacific during World War II, and one of the men working on it in 1944, when Huebner returned from serving as medical officer aboard a Coast Guard ship in the Alaska area, was an old acquaintance from medical school, Dick Henderson.

Huebner dropped in to see him at the National Institutes of Health, outside Washington, D. C., and then went on to apply for a research position for himself—preferably in physiology. Nothing was open.

*A few months later* Henderson caught scrub typhus and died. Huebner was offered his job of research in rickettsial diseases: ailments caused by organisms larger than viruses but smaller than bacteria. “Big viruses,” Huebner calls them. The young doctor had no interest and little training in viruses, but he did have three children (now he has eight) and he did want to get into research.

After two years at NIH, and attacks of Q fever and typhus, he decided that the work offered neither fun nor future. But just then an epidemic of a mysterious disease causing rash and fever struck New York City. Huebner got the assignment to look into it.

Within three months he tracked down the agent, a rickettsia, causing the new disease, and with Charles Pomerantz, a New York City exterminator, discovered that the agent was transmitted by mites that were living on mice.

*This was detective work,* and Huebner loved it. Just three years after he had decided the field held no future, Huebner was made chief of his department.

The scene now shifts to the Maryland State Reformatory at Hagerstown, Md. It is 1953, and Huebner has quietly started a virus hunt potentially more important than any of

## Raising “Cold Bugs” in the Laboratory

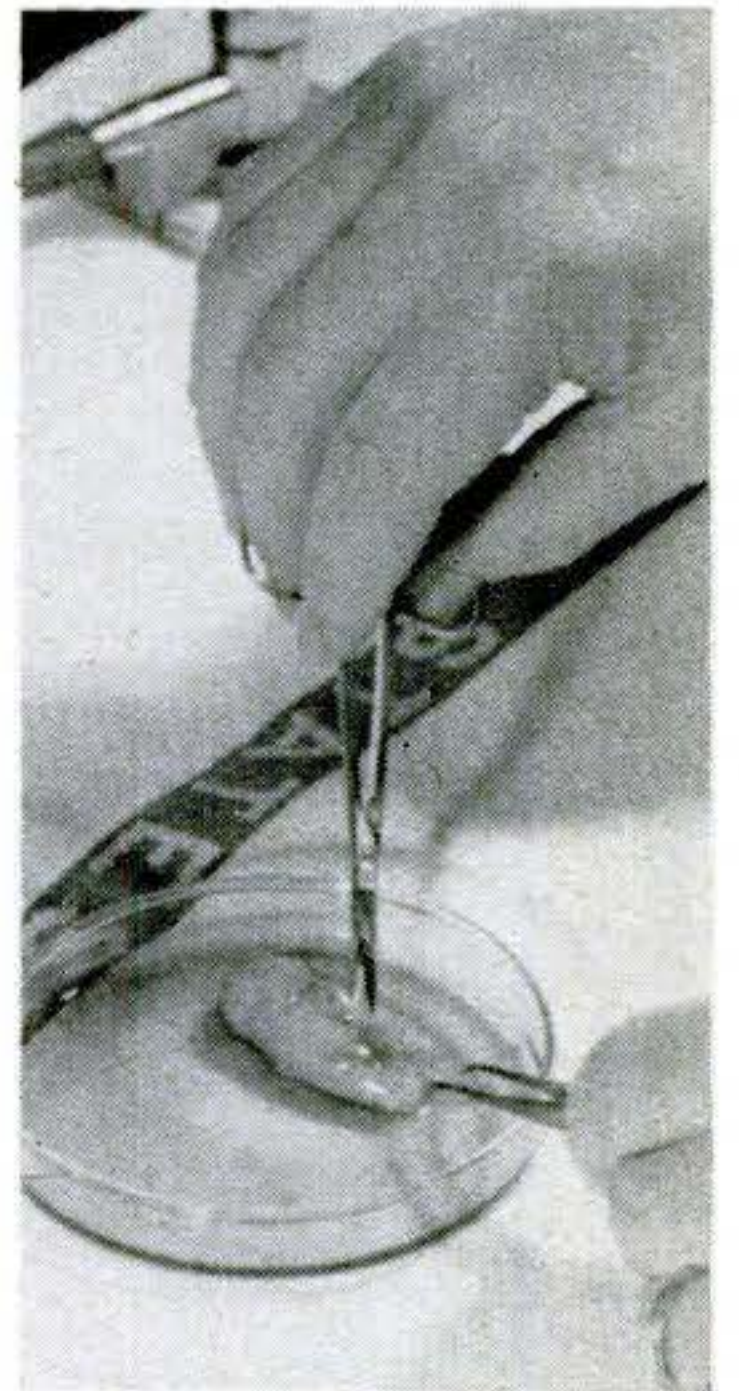

*Human tissue is cut into bits to provide a soil bed in which viruses now can be grown in test tubes for study and to make vaccines.*

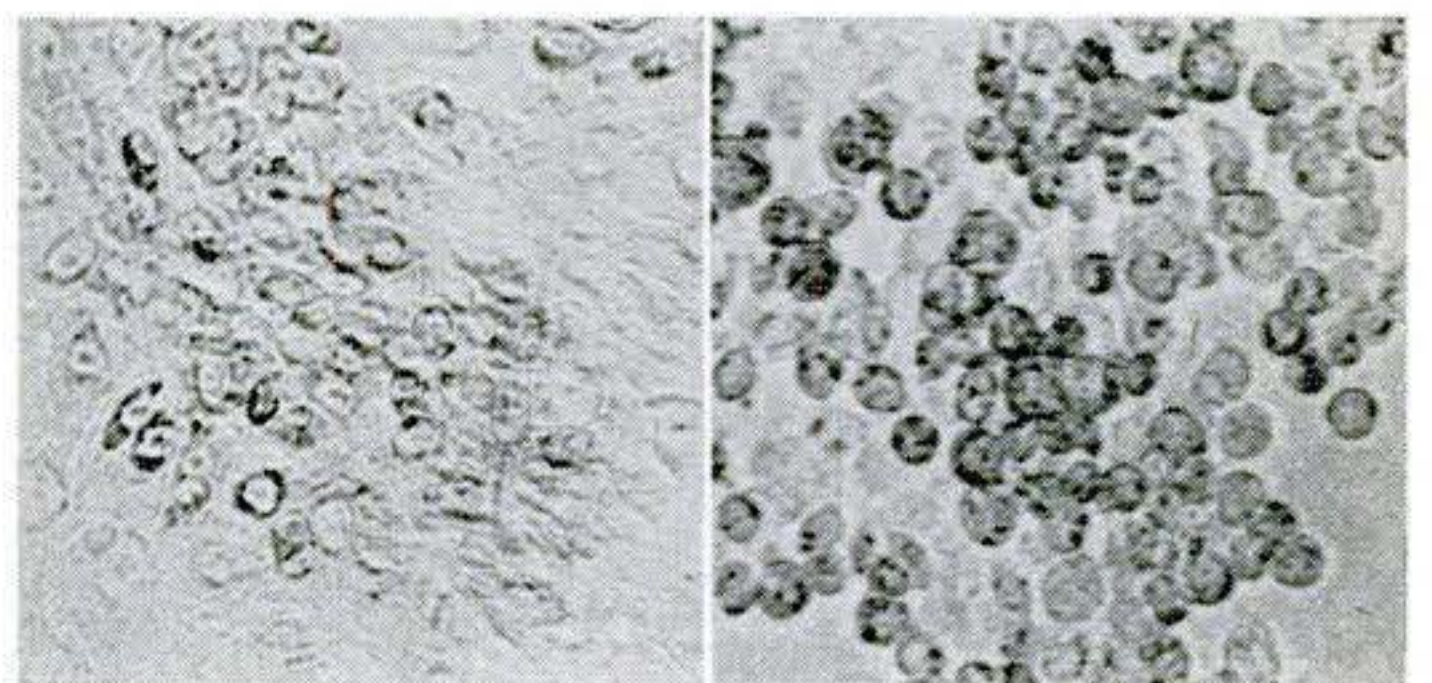

*Tissue cells are seen in microscope before (left) and after being attacked by cold viruses.*



## One Step Toward a Cold Vaccine

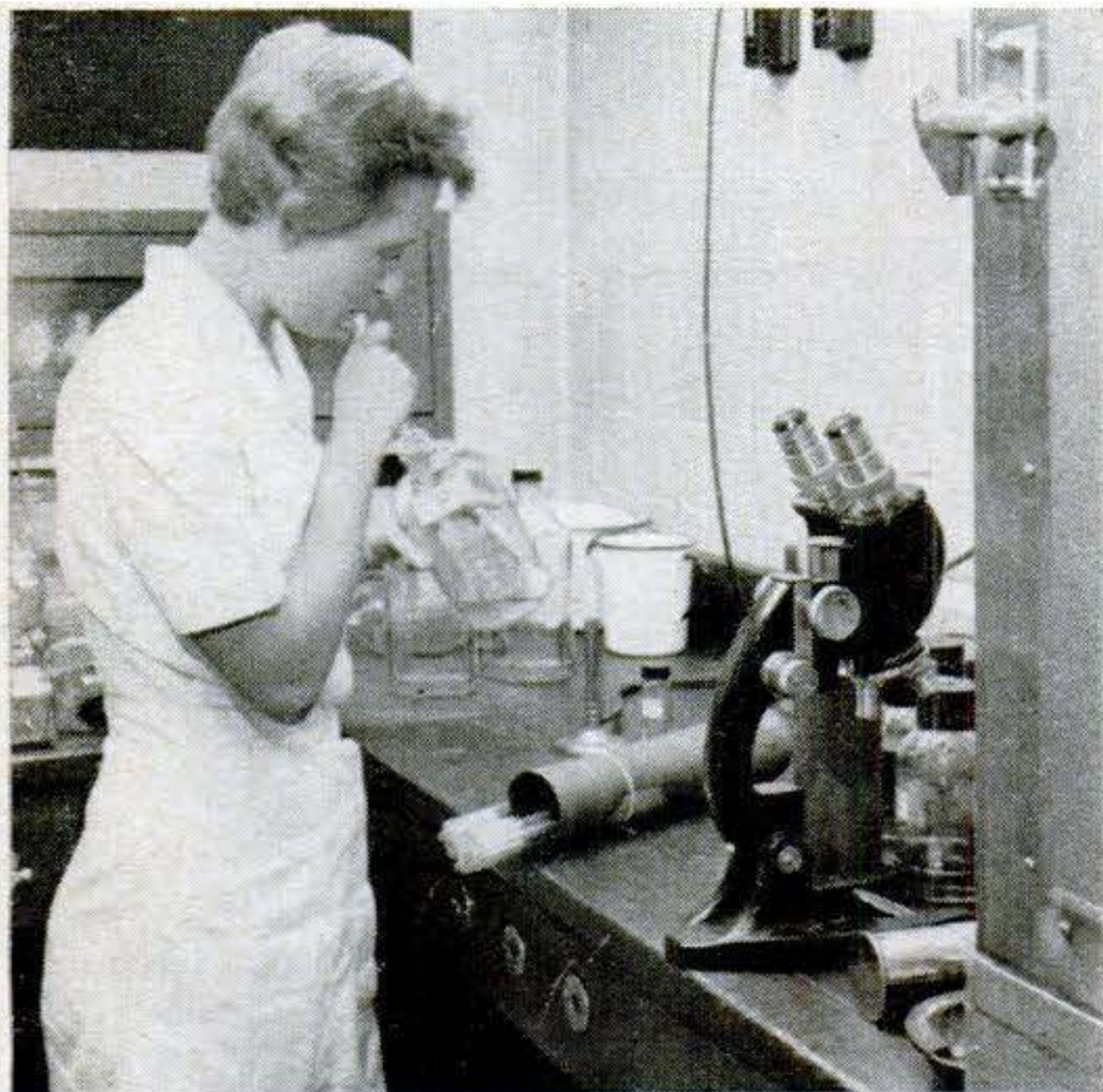

*Laboratory worker removes APC viruses from bottle in which they were grown on human tissue. The viruses can then be killed with formaldehyde to make a vaccine of the kind Dr. Salk developed for polio.*

his earlier ones. This time—working with Dr. Thomas G. Ward of Johns Hopkins, a veteran in the field—he is gunning for the common cold.

Into the nose of a healthy reformatory inmate, one of Huebner's associates drops a little material from the nose of a young man with a cold. The man with the cold is a sailor at the Bainbridge, Md., naval training station. The inmate is listed simply as G. B., aged 23. He and his fellows have volunteered to serve as guinea pigs in a new effort to pass a common cold through half a dozen groups of persons—to make sure that it is a common cold—and then to grow the virus.

Earlier investigators had shown that nasal secretions from people with colds do contain a virus. Diluted and filtered through porcelain to remove everything larger than viruses, this nasal material could give healthy volunteers a cold. But attempts to grow the virus outside the human body so that it could be studied had failed.

***New method of cultivation.*** Now you put human or animal cells (a piece of kidney tissue, for example) in a test tube containing a nutrient solution that enables them to live and multiply. Then you introduce the virus. If the cells are

the kind it can grow on, it will grow on them in the test tube as well as it can in the body.

This is the famous tissue-culture technique that won Dr. John Enders of Harvard a Nobel prize and enabled Dr. Jonas Salk to grow the viruses used in his polio vaccine.

For his supporting tissue, Huebner and his lab associate, Dr. Wallace P. Rowe, had collected adenoids removed from children in Washington hospitals, had washed them in a germicidal solution to kill bacteria, and had prepared cultures. Then an odd thing happened. The tissue in many of the cultures began disintegrating as if attacked by a virus.

***Checking and rechecking,*** Huebner discovered that the test tubes did indeed contain a virus: a new kind of virus, one that had been in the adenoids to begin with. There were two forms of it. He called them adenoid-degenerating virus, types 1 and 2.

It was on July 13, a short time after these finds, that G. B. was given his cold. Three days later he was sneezing and had a runny nose. The investigators washed out his nose, filtered the material, kept some of it for examination, and used the rest to infect other volunteers.

Now another odd thing happened. Instead of catching an



ordinary, uncomplicated cold, G. B.'s successors came down with fever, sore throat and mild conjunctivitis (an eyelid inflammation commonly called "pink eye") or some combination of these ailments. And their nasal secretions, as well as G. B.'s, yielded a virus almost exactly like the two found in the disintegrating adenoids.

Huebner renamed the new family adenoidal-pharyngeal-conjunctival virus (APC) and designated the newest member as type 3.

It was all very well to discover a new virus, but the important thing was to learn what disease it caused, if any. You could give it to a human volunteer, of course, but you didn't like to do that until you were pretty sure what it would do. That meant finding it under natural conditions.

**Hunted new epidemics.** Huebner and his associates in the anti-cold investigation let it be known that they were interested in studying "virus" epidemics of unknown cause, and in the summer of 1954 a physician from the Georgetown University of Medicine pointed to one that had broken out in Alexandria, Va., and nearby Fairfax County.

An NIH team hurried into the field. Besides Huebner and Rowe, the team included Dr. Joseph A. Bell, one of the nation's top epidemiologists, Dr. Robert H. Parrott, and Dr. Joseph I. Engler.

The investigators studied almost 400 sick people in their homes and took throat or eye swabs from more than 100. Most of the patients were children, but adults of all ages were included. Some had sore throat, some conjunctivitis, some fever, some had all three. That made no difference. In the great majority Dr. Huebner and his research group found the APC-3 virus.

The doctors concluded that this virus is responsible for a good many cases of "the common cold." Where APC-3 is at work, they suggested that the ailment be called pharyngoconjunctival fever.

But the symptoms are not very clear-cut. Your sore throat may be pharyngoconjunctival fever, or it may be some other type of cold. To tell for sure, the doctor would have to isolate the virus, and by that time you would be well.

But APC-3 is not just of scientific interest. Once you have isolated a disease-causing virus and can grow it in the laboratory, you can probably develop a vaccine against it. That's what Huebner and his team seem to have done.

## Scientist at Home



*Dr. Huebner, one of the world's great medical detectives, examines hurricane-battered corn on his Maryland farm.*



*The virus hunter poses proudly with Mrs. Huebner, an ex-nurse, and their eight children, ages one to 14.*

**[Continued on page 278]**





### Gas Tanks Get Bouncier

TANKS like this one, of synthetic rubber reinforced with nylon, will carry fuel for the new 100-passenger Britannia airliner. Flexible tanks, say British experts, are less likely than rigid tanks to burst and catch fire in a crash or forced landing.



### Turboprop TV Catches Ice Show

A SPRAYING device (lower picture) helped ice up a Bristol Proteus turboprop engine during flight tests, while engineers watched the effect on its performance by means of a TV camera mounted in an engine nacelle. What they saw is shown in the top picture.

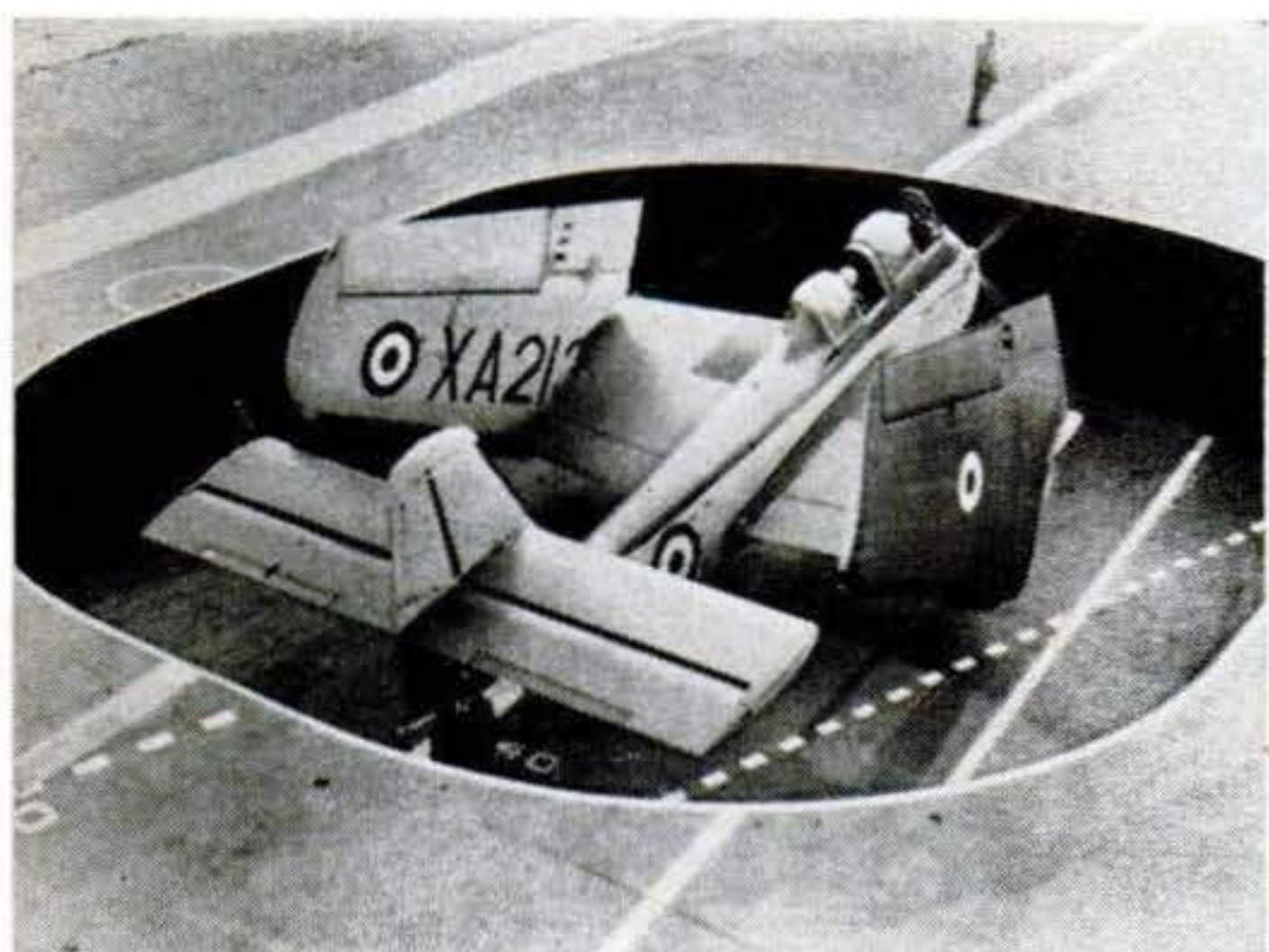

### British Try Cut-Rate Fighter

AN ECONOMY plane, the British Seamew (left) costs only two-thirds as much as comparable antisubmarine fighters. It can take off from the smallest merchant ships or air strips. The plane is shown being lowered into a hangar under a carrier deck.

### Tiny Eye Blinks Fast

THE Bolsey 8 (below) is the smallest movie camera in the world, says the Finetta Company of Goslar, Germany. It weighs 13 ounces and holds 22 feet of 8-mm. film. Its shutter blinks at speeds ranging all the way from 1/40 to 1/600 of a second for either serial or single shots.

### Stove Burns Up Odors

RAISE the top of this electric stove and you'll see an Oxycoil—a coil of fine wire coated with a chemical catalyst. What's it do? Oxy-Catalyst of Wayne, Pa., says it lowers the point at which smoke, grease and odorous substances will burn. The result is odorless cooking.

### Tote TV Is Here

TELEVISION men have finally done what everybody knew they would: made a self-powered portable set. This one, by Ecko, London, England, has a nine-inch screen and works by either battery or house current. It weighs 30 pounds, costs about \$168.







### **'Ontos' Packs Six-Gun Punch to Support Marine Landings**

MARINES hitting the beaches on future amphibious landings will have a brand-new weapon to give them close-in fire support. It's Ontos (Greek for "the thing"), and it's

made up of six 105-mm. recoilless guns mounted on a lightly armored antitank vehicle. Allis-Chalmers, La Porte, Ind., will make the leatherneck beach-busters.

### **Carronade, New Inshore Fire-Support Ship, Goes on Sea Trials**

THERE'S not much aft on the USS *Carronade*, but the foredeck bristles with the rifles and rocket throwers it needs for its mission: inshore fire support. Vessels like

this one will replace the World War II rocket-firing landing ships, which have previously contributed fiery support to troops during amphibious assault operations.

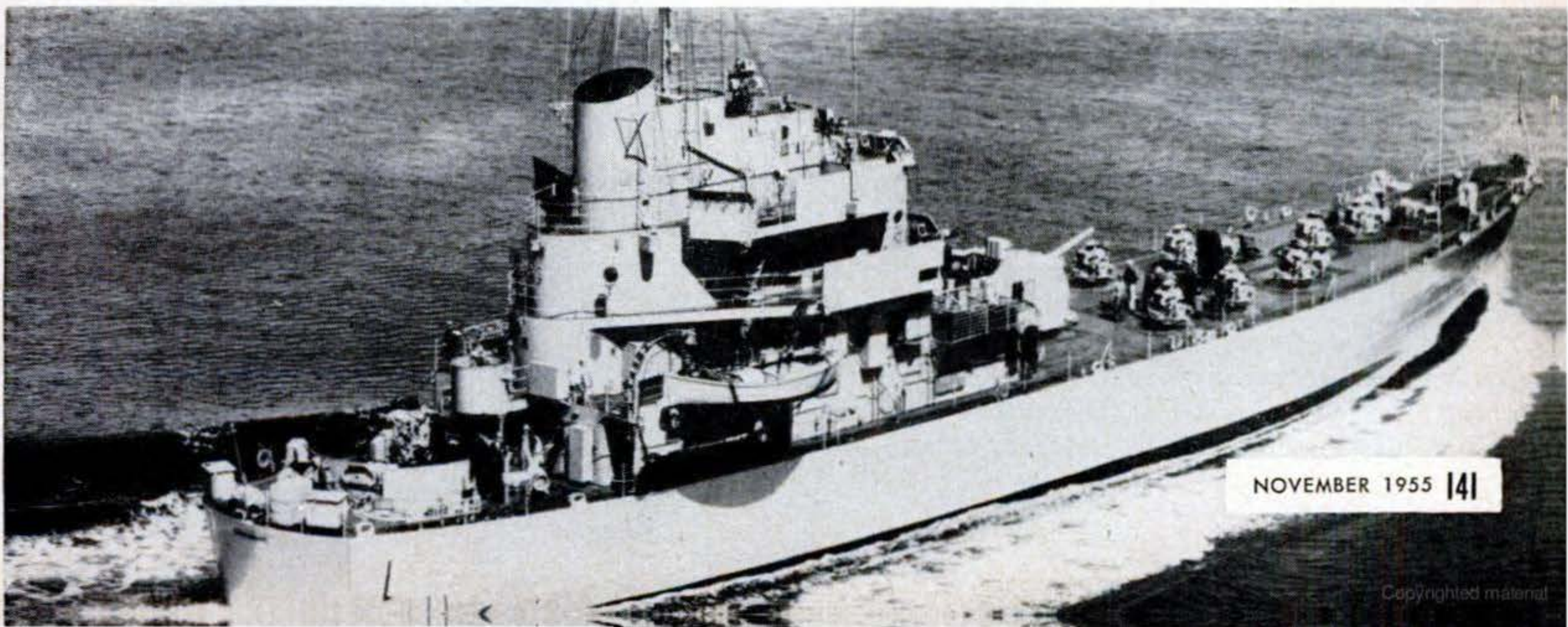



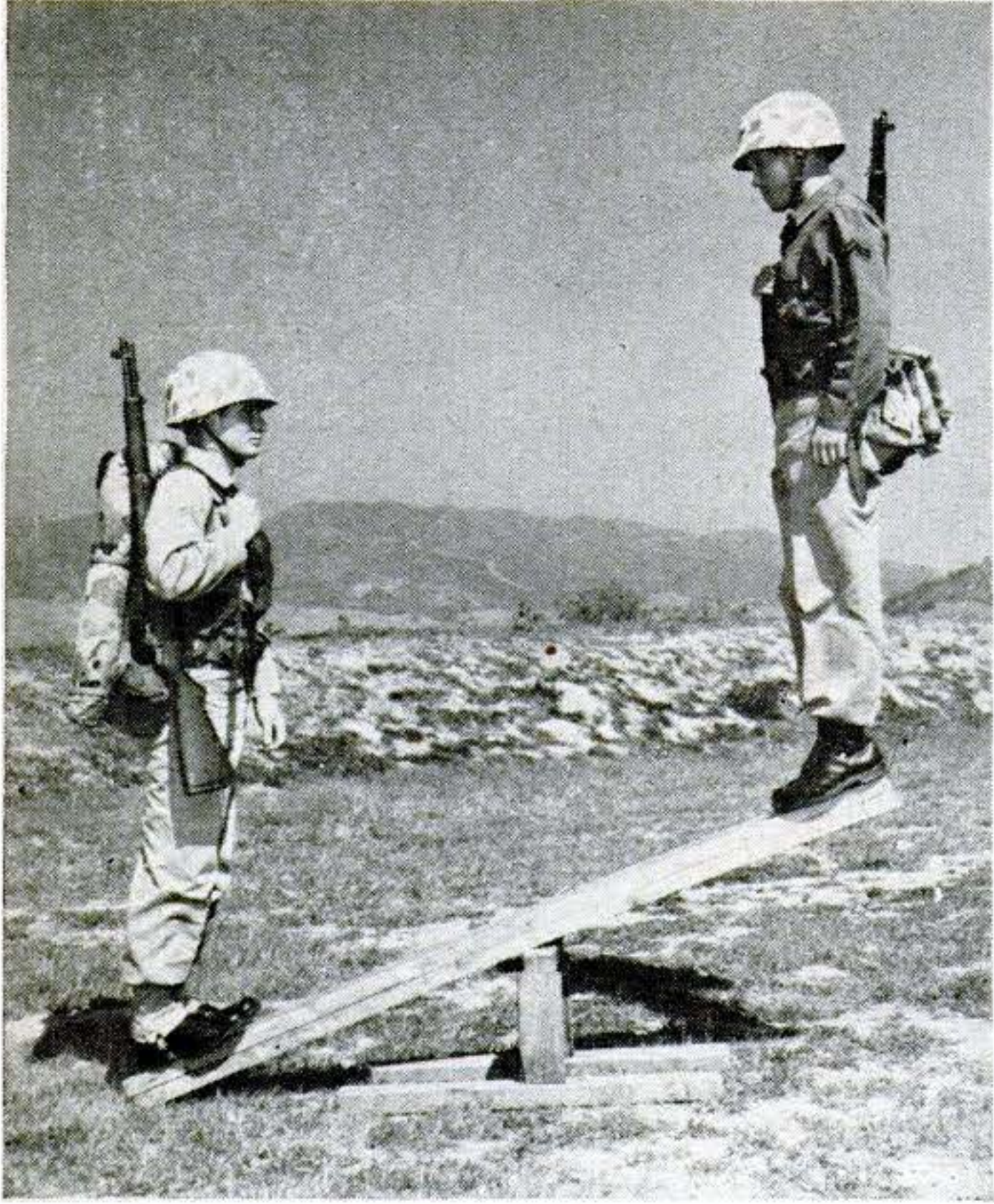

### Marines Try Lightweight Pack

BECAUSE ground troops may ride into their next war in helicopters, the Marine Corps is trying out lighter combat packs. Low man on the seesaw above is weighted down with the 58 pounds of gear carried ashore by assault marines in World War II. High man (same weight stripped) carries an experimental pack weighing only 18 pounds.



### Flying President Gets Copter

THIS Bell executive copter can carry three in its plush cabin. It's painted in the national colors of Colombia, and will be flown by Gen. Gustavo Rojas Pinilla, president of the country. The craft has a speed of 100 m.p.h., a range of 200 miles and a high enough ceiling (14,800 feet) to churn over most Andean peaks with ease.



### Fenders Snap Back After Bumps

ENGLISH truckers are experimenting with fenders that bounce back into shape when crumpled or dented under impact. Lighter and cheaper than steel fenders, they're made of rubber and coated with a flexible paint that matches the color of the truck body and gives the fenders a glossy finish.

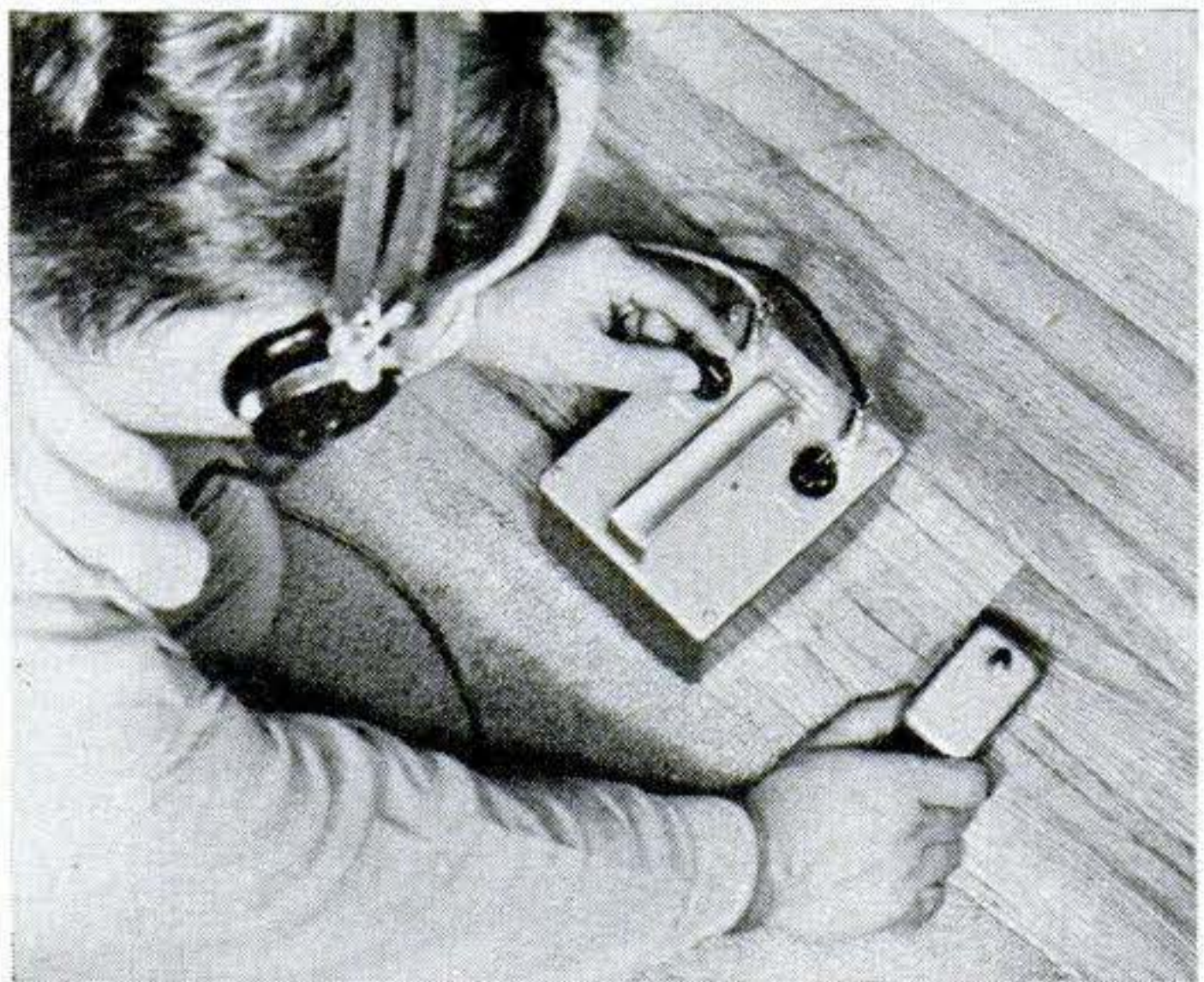

### Stethoscope Tunes in Termites

Now exterminators can "tune in" on termites with an electronic instrument devised by a University of California at Los Angeles entomologist. A needle-like probe pushed into the wood picks up the noise of the destructive insects at work. Craig Electronics, Los Angeles, sells the detector.





Four passengers are no squeeze in the roomy cabin of Coleman's delta-wing pusher plane.

## Pogo Pilot Designs Air-Sea-Land Sedan

THE novel private plane shown in these sketches was designed by J.F. "Skeets" Coleman, test pilot of the Navy's vertical-takeoff "Pogo" fighter. A prototype is now being built at Del Mar, Calif. Although a 215-horsepower engine will

push the 2,500-pound Aeromarine at better than 200 miles an hour in flight, the pilot will have to be satisfied with a 50-mile top when driving it as an automobile. The delta-wing shape offers exceptional stability in the air.

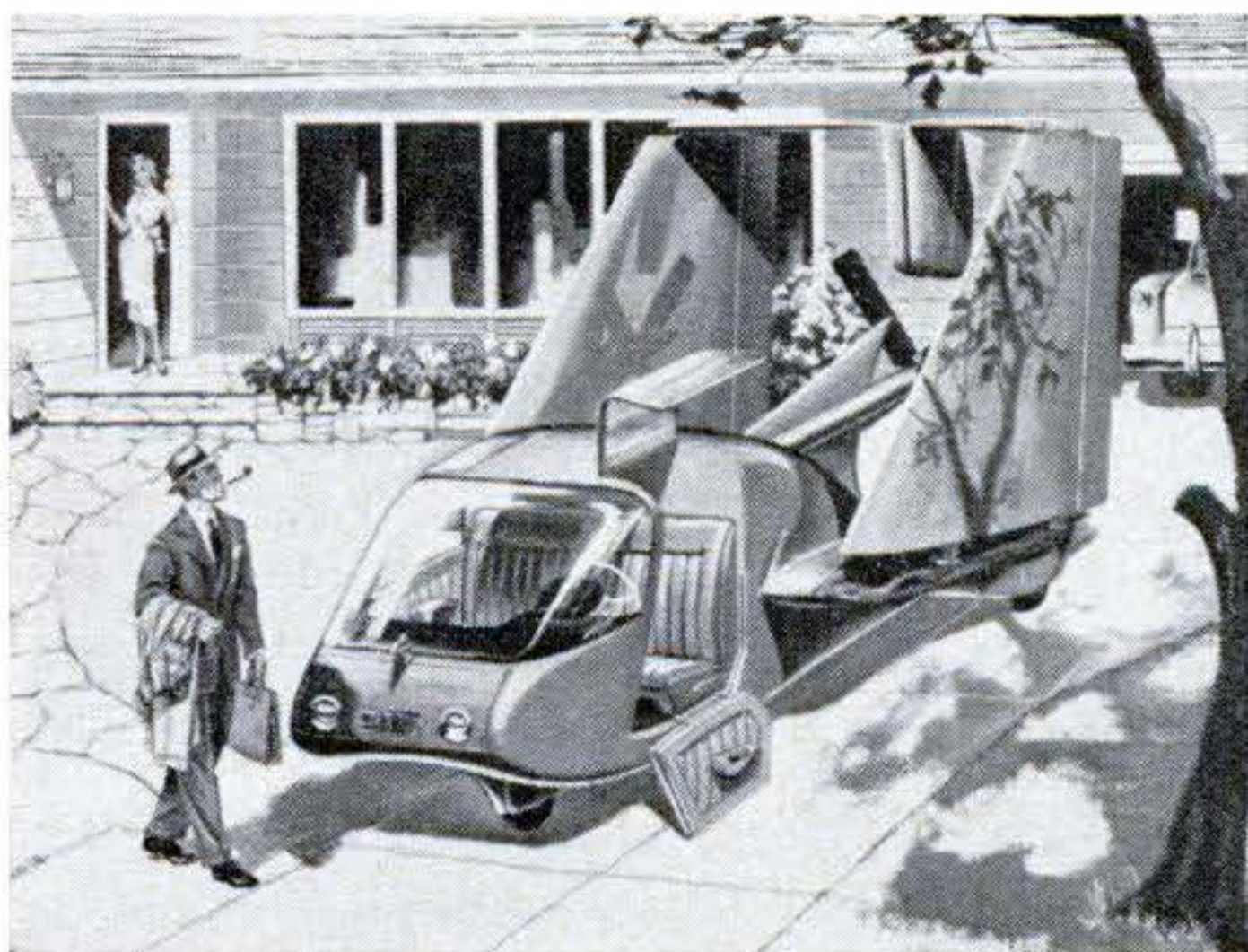

**WINGS FOLDED**, the Aeromarine becomes a car, as shown above. Power is fed to the two rear wheels of the tricycle landing gear, and the front wheel is steerable. For water landings and takeoffs (right), there will be a hydro-ski mounted under the plane's watertight hull. Both ski and wheels will retract in flight.







## Dream Kitchen—No Bend, No Stretch—Almost Runs Itself

THERE'S no bending or stretching in General Motors' Kitchen of Tomorrow: The housewife waves her hand to answer the phone, touches a control bar to raise or lower refrigerator doors, pushes heavy objects around the room on a tray hanging from tracks on the ceiling. The desk (right) is her intercom center. On the swiveling TV screen she sees, by means of cameras mounted about the house, what's going on in other rooms.



## Fire-Alarm Phone Gives Direct Line to Headquarters

THIS young lady is using a new kind of emergency phone to put a call straight through to the fire department without dialing or waiting for an operator. The new system of getting a direct line to your fire chief was developed by Bell Telephone Laboratories. It is expected soon to replace the old fire-alarm boxes in Indianapolis, Miami, Syracuse, Omaha and Sioux Falls.

When you lift the receiver, a light flashes on a console at fire headquarters, giving them the location of the phone; and an automatic recorder begins to take down your message. The same phone can be used to get the police, too. All you do to get at the phone is to fling back the spring door of the aluminum housing. The door is painted bright red.



# New Ideas

FROM THE INVENTORS



**1 Cot to Form Its Own Tent.** Lighter and less bulky than a separate cot and tent, this enclosed bed would serve campers who like to sleep under cover off the

ground. Flap windows—covered with insect netting in season—would provide protection as well as ventilation. Equipment could be stored in the cot during the day.

**2 Clock to Tell When It's Wrong.** If a nighttime power shutoff stopped this lighted-dial electric clock, you'd know it even in the dark. A current failure would trip a switch. When current came on, a colored bulb would glow until the hands were reset.

**3 Ash Tray to Douse Stubs.** You wouldn't have to worry about smoldering cigarette butts if you had this ash tray in your car. A fire-extinguisher cartridge in the tray would squirt the cigarette tip when you pressed it down on the crushing pan.

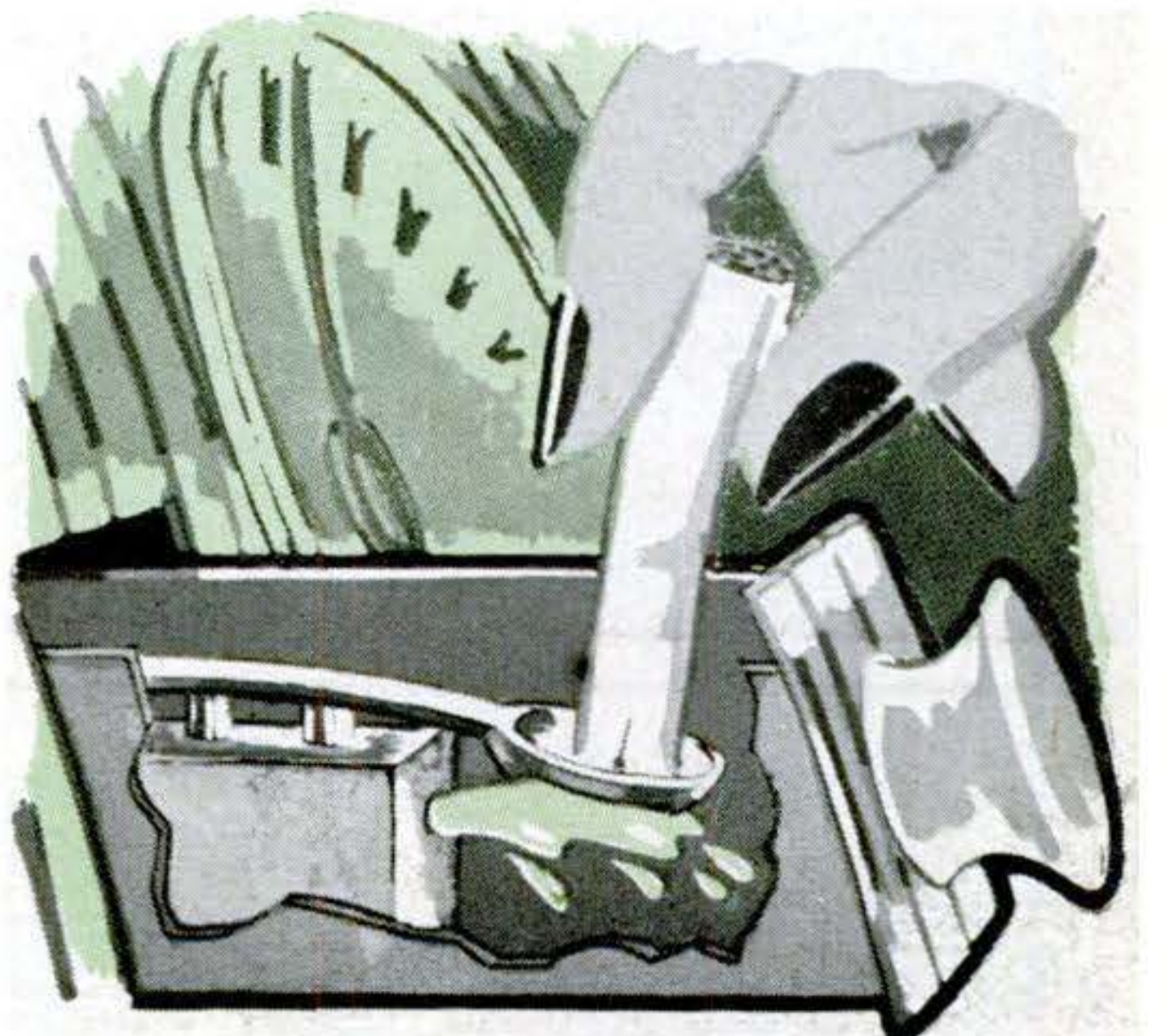

Please turn the page for more new ideas

NOVEMBER 1955 145



## ***MORE*** New Ideas from the Inventors



**4 Valve Cap to Warn of Low Tires.** This GM-assigned patent valve cap would tell you at a glance when a tire needed air. It would screw onto a valve stem, and tires could be inflated while it was in place. If pressure dropped, a calibrated spring would expand and let a colored indicator move into view behind a transparent window.



**5 Hanger to Straighten Picture.** This pendulum-type bracket would automatically straighten a picture or mirror that got joggled out of line. Attached rigidly to the picture frame's back, the bracket would be hung loosely on the wall from a single nail or screw. The pivoted bracket's centered weight would level it and the picture.

**7 Shell to Speed Air Rescue.** Planes that can travel farther and faster than helicopters might take part in rescue operations with the aid of this man-carrying sphere and its hook-tipped pick up pole. The buoyant capsule would have a hatch large enough to admit a man and could carry heater,

radio or other needed equipment. Whether the sphere were dropped at sea or parachuted to earth, its weighted base would cause the pole to slant upward. A spread-out line lowered from a plane would sweep over the pole to engage the hook. The shell could then be hoisted to safety.

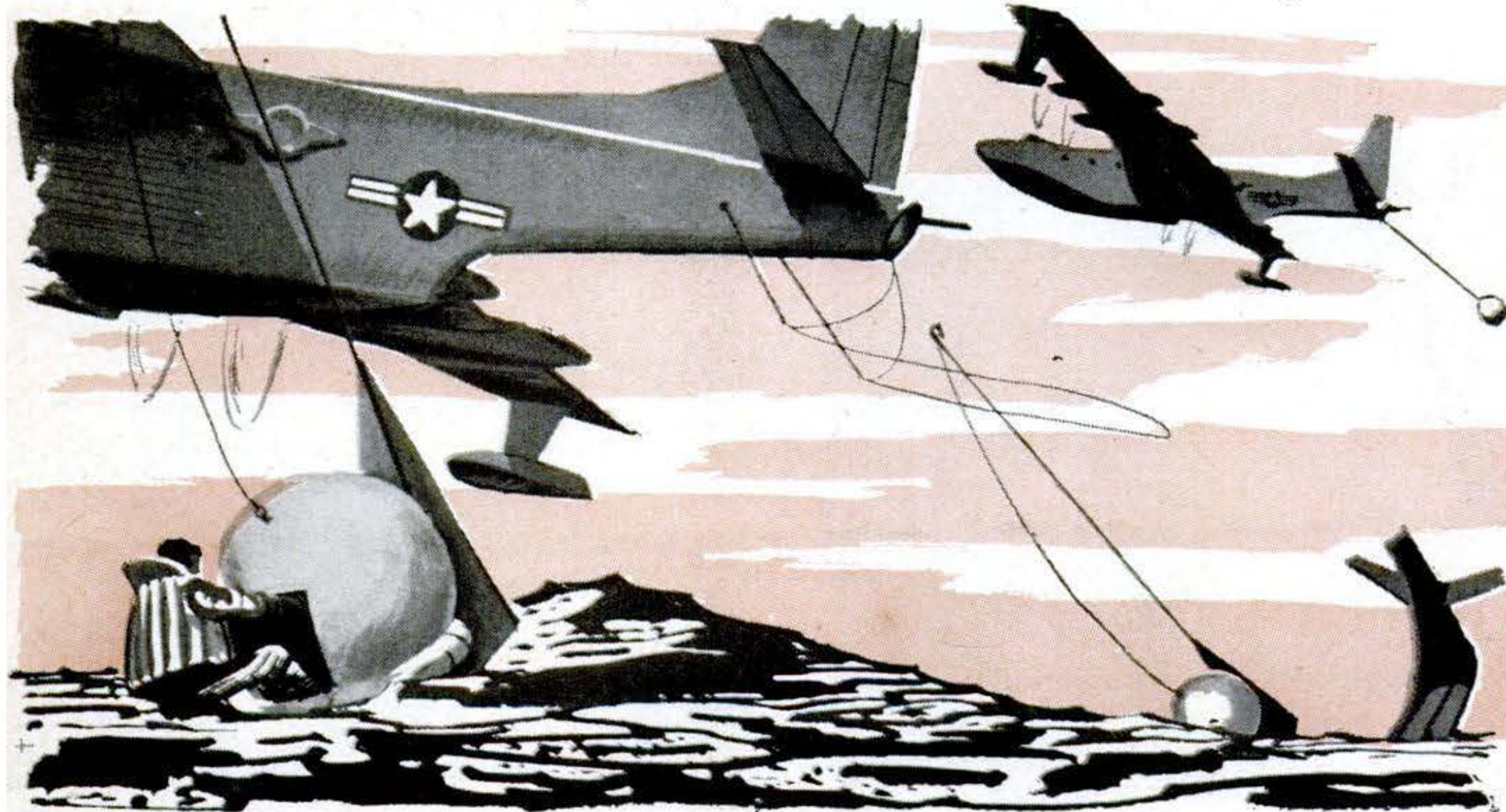





**6 Tray to Mind the Phone.** Do you ever wonder if a call you were expecting came in while you were away from the phone? This tender might set your mind at rest. You'd place a bell-in-phone handset alongside it, and balance the pointer. If the phone rings, the vibration would move the pointer. The tender would double as an ash tray.

**8 Razor to Lather Your Beard.** After being dipped in the suds, this razor attachment would roll a coat of lather onto your face. You'd then flick the roller to a lower position and shave as usual. It's claimed the roller would improve your shave by stretching the skin ahead of the blade.

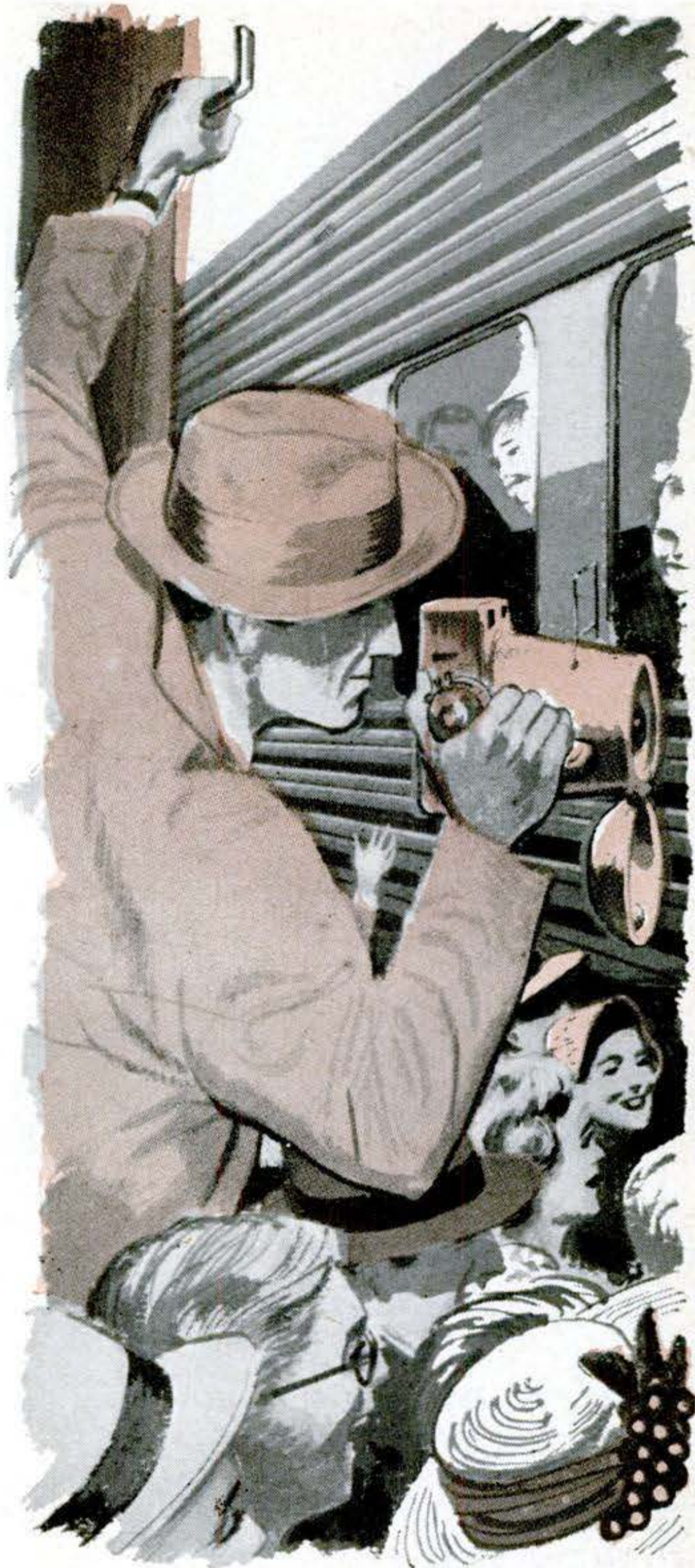
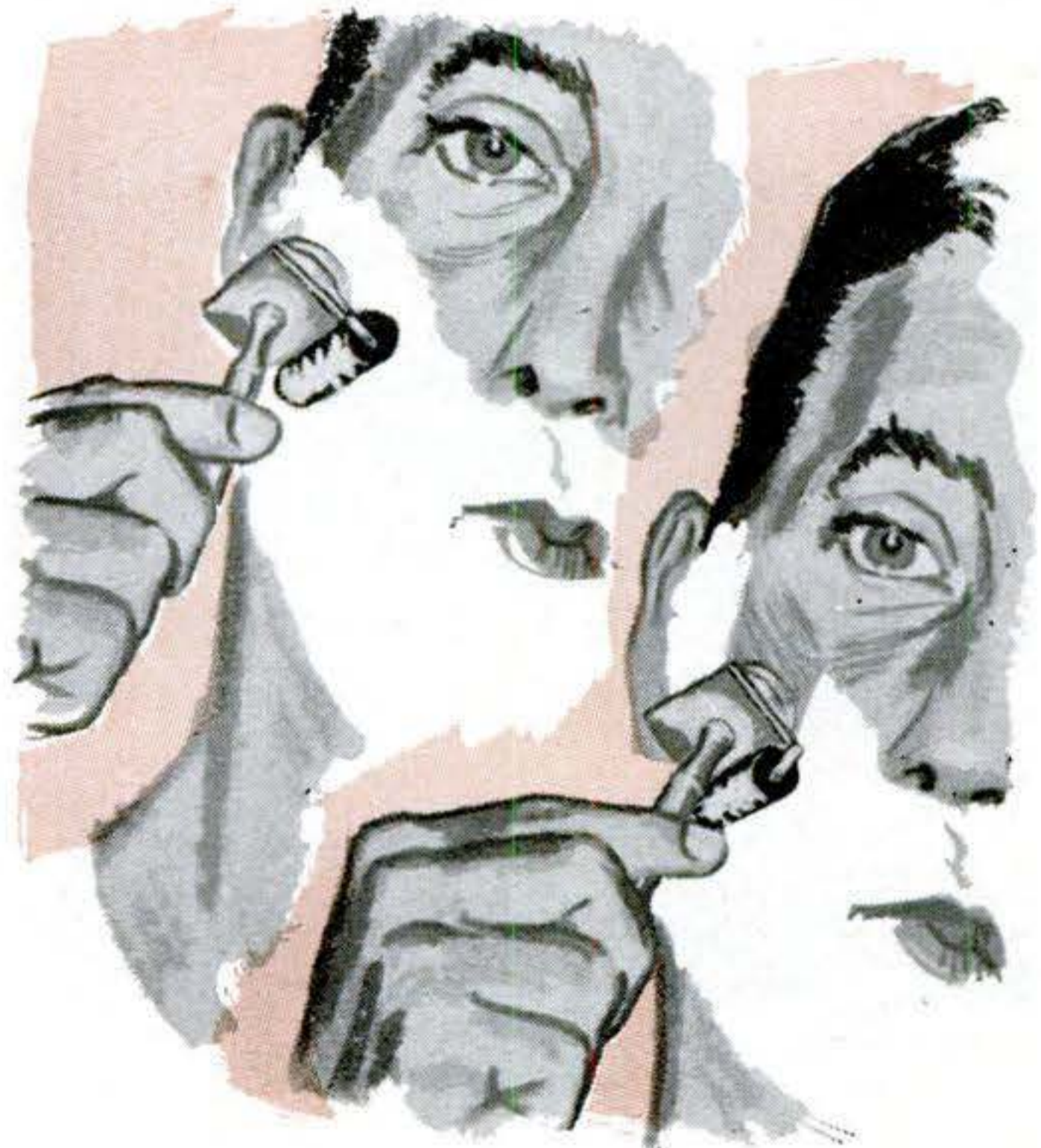

**9 One-Hand Grip to Control Camera.** A photographer could get his picture with this camera even if he had to climb a pole to do it. He could steady himself with one hand to shoot over a crowd or other obstruction, since he'd only need one to hold this box by its grip. Dials and releases near his thumb adjust speed, focus and exposure, and set off the shutter and flash.

*U.S. patents on these inventions have been granted to: 1. A. B. Butterworth, Newport News, Va.; 2. T. Coonradt, Owego, and F. K. Freundorfer, Endicott, N.Y.; 3. R. S. Haner, Coeur d'Alene, Idaho; 4. E. F. Riesing, Dayton, Ohio; 5. W. P. Halvorsen, Red Wing, Minn.; 6. G. O. Erickson, Inglewood, Calif.; 7. R. B. Cotton, Wilmington, Del., and D. B. Doolittle, Media, Pa.; 8. F. Schallgruber, Bogota, Colombia; 9. J. H. Kindelberger, Pacific Palisades, Calif.*





Mammoth C-124 Globemaster was home for these 90 paratroopers during 9,000-mile, 50-hour

# Biggest Airlift

**PSM photo-reporter takes you on one of the 43 huge flying troopships that moved 7,000 men 18,000 miles in 10 days.**

**By W. W. Morris**

PHOTOS BY THE AUTHOR

I'VE been traveling with an army that moves in an airplane's belly.

As a guest of the Army and the Air Force, I was able to take part in the biggest airborne movement of troops in military annals: the peacetime transfer of more than 7,000 paratroopers and their equipment over a round-trip route that covered better than 18,000 miles between the U.S. and Japan. The object of the mission was to airlift 3,800 "Red

Devils" of the 508th Airborne Regimental Combat Team to Japan and to ferry home 3,200 men of the 187th ARCT, which the 508th was replacing. The 187th—known as the Angels from Hell—had recently completed five years of duty in the Far East, including combat in the Korean War.

A steady stream of big Globemaster C-124s, each carrying approximately 90 men and seven tons of their gear, leap-frogged across the Pacific both ways to complete the entire transfer in 10 days.

*The big, whalelike planes began tak-*

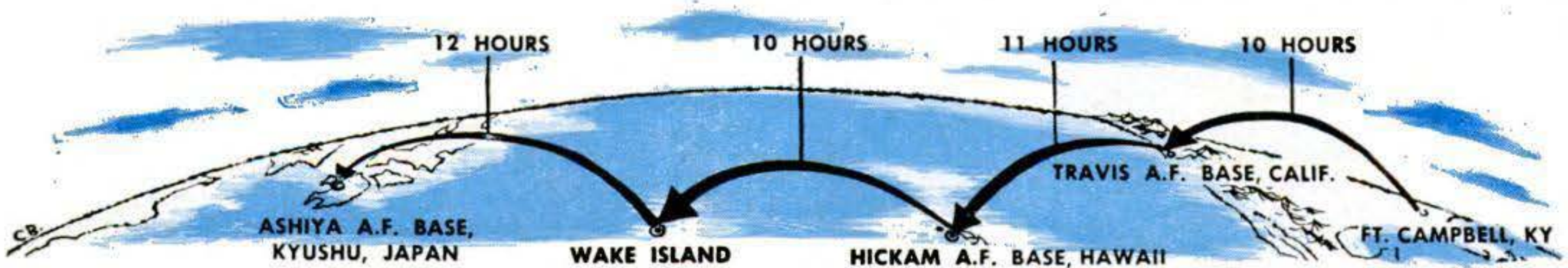



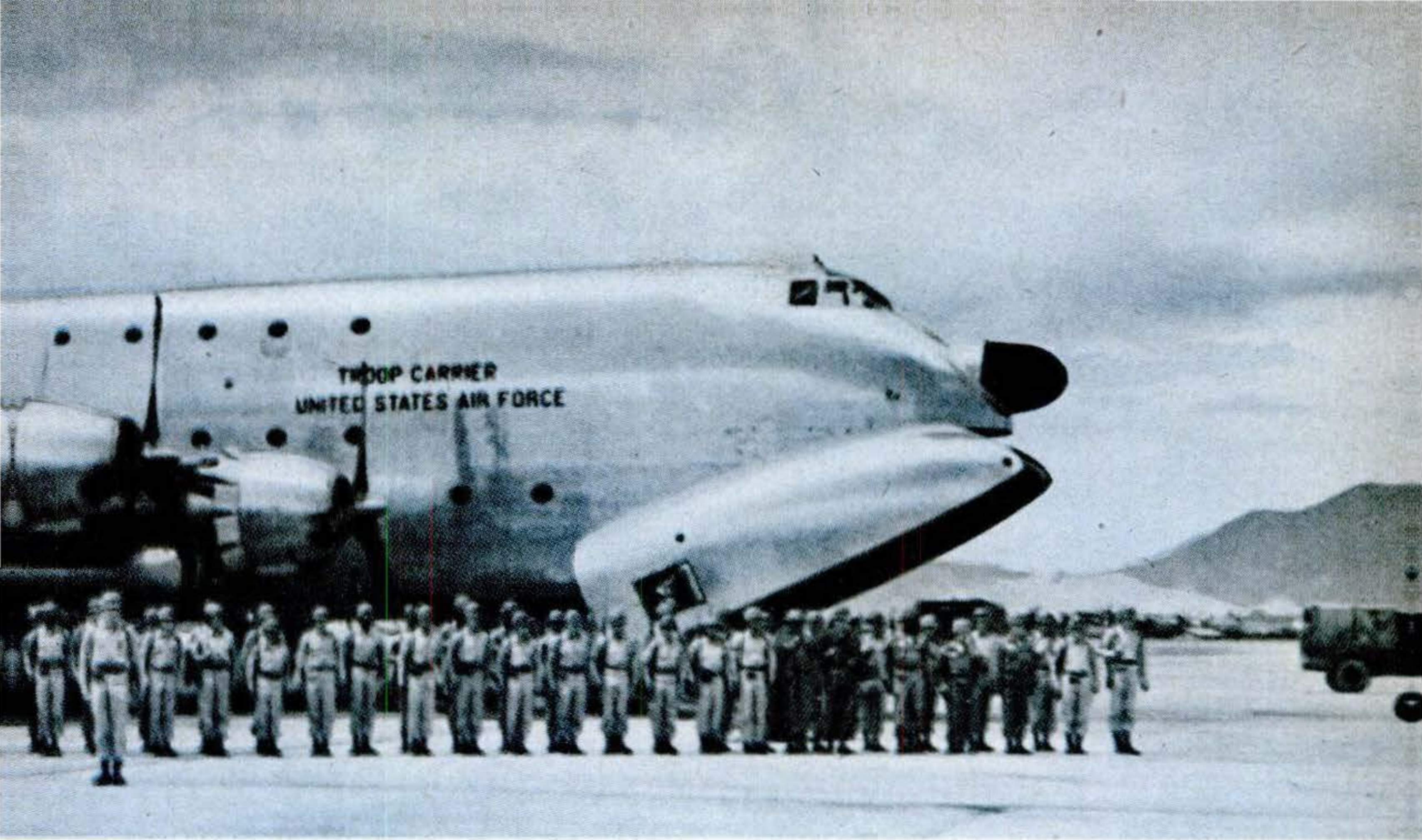

flight from Kentucky to Japan. The map at bottom of the opposite page shows two-way air route. After a hot meal at one of three brief stopovers, men boarded plane carrying in-flight lunches.





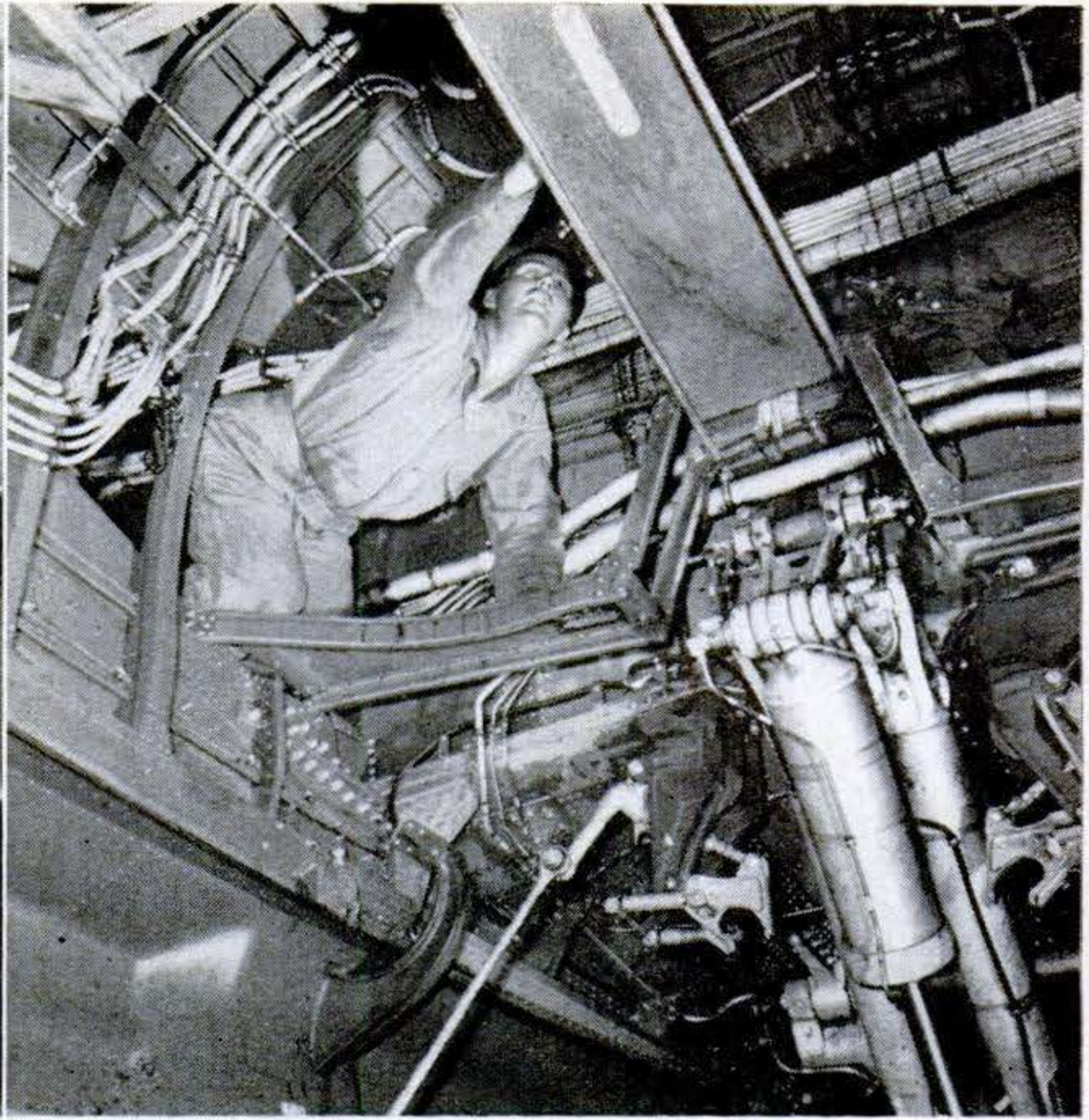
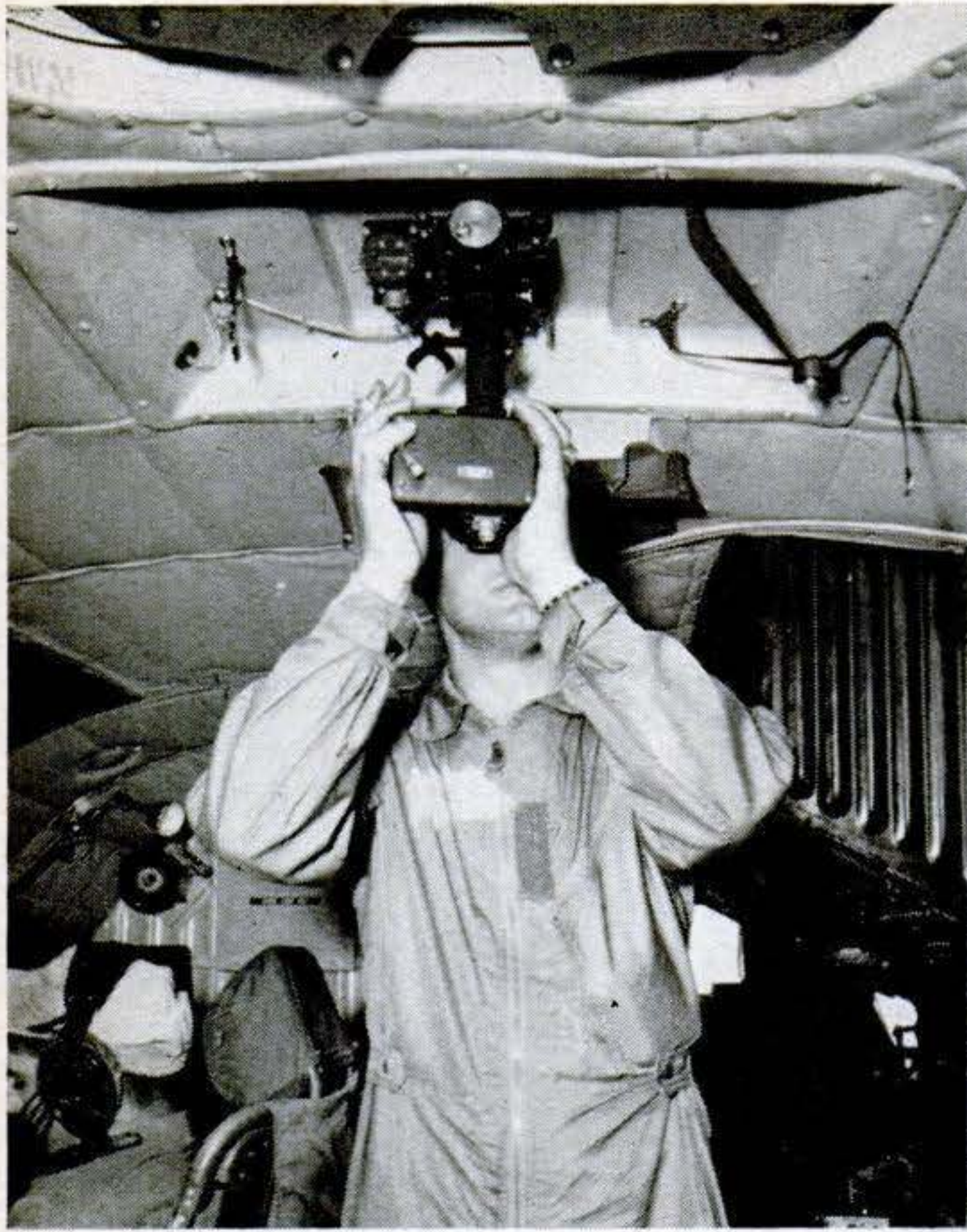

**NAVIGATOR** took frequent celestial observations during flights over the vast Pacific. Airborne radar warned pilot to skirt turbulences; surface ships provided radio checks.

**TUNNELS** extending into the wings enable engineer to crawl out and service faulty engines in flight. Electronic engine analyzers automatically detect and locate trouble.

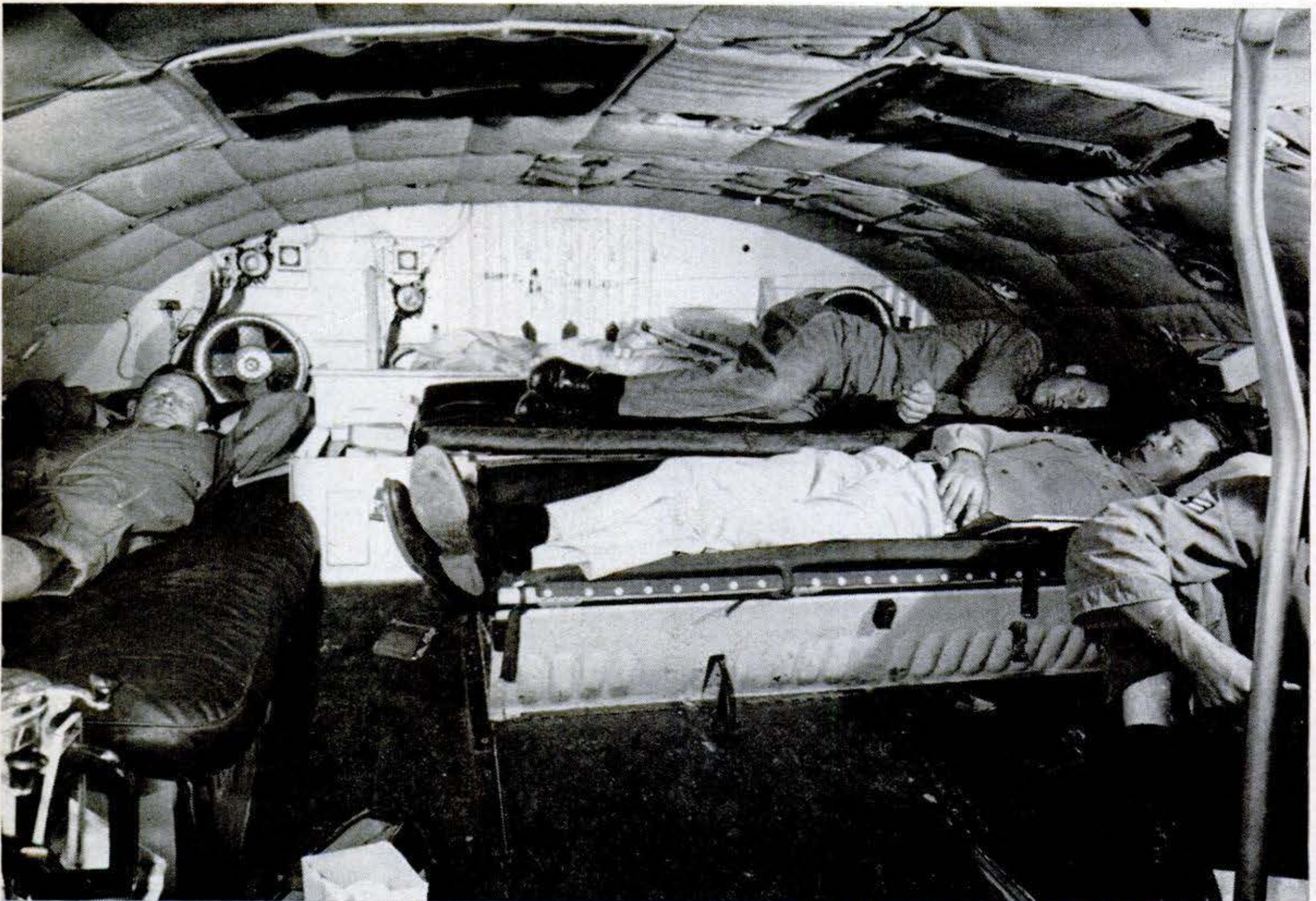

Three bunks at rear of flight deck give crew members a chance of forty winks on long hops.



ing off from the airfield at Fort Campbell, Ky., at just one minute past midnight on G-Day. From then on, a plane took off every two hours and landed in Japan approximately 50 hours later. With time out for fueling stops in California and Hawaii and Wake Island, the actual flying time from the Kentucky airfield to Japan was about 43 hours.

I was in the fifth Globemaster to roar down the runway. It was exactly 8 a.m. As the pilot banked the big ship and circled the field before heading for Travis Air Force Base in California, our first fueling stop 10 hours away, I looked out of one of the porthole-like windows. Down on one of the long runways I could see the long line of 38 other Globemasters waiting their turn to load and take off at two-hour intervals.

Once in the air, the men soon had peeled off their summer uniforms and put on fatigues. As the air miles ticked off at about 210 an hour, they played cards, they read, and they napped, stretched out on the floor or curled up on the bucket seats. Many spent an hour or more buffing their paraboos and polishing brass belt buckles and insignia.

**This polishing routine** had me a bit puzzled until just before we landed, on time, at Travis Air Force Base. Shedding their rumpled fatigues, the men put on their summer uniforms again. When they deplaned, and formed up to march to the mess hall for a hot meal, they were as trim as any bunch of paratroopers I'd ever seen in spite of a 10-hour plane ride. There wasn't a wrinkled uniform, a scuffed boot, or a dull piece of brass on the whole lot. As one sergeant put it when I kidded him about the "spit-and-polish" routine, "Who ever heard of a wrinkled paratrooper? Man, we even have creases in our pants after we make a combat jump."

**Two hours later**, we were in the air again with a new flight crew guiding our big Globemaster toward Hickam Air Force Base in Hawaii. Being a nighttime flight that wouldn't put us down on the islands until early morning, the men lost little time changing into their fatigues



**HELMETS BECAME BASINS** for washing and shaving in spruce-up spurts before each landing.



**CARD PLAYING** helped pass the time for many. Others read and some just slept or talked.



**BOOTS AND BRASS** were polished to a mirror finish during long hours over the Pacific.





Slow Japanese train took men to new bases.

again and bedding down. Some liked the floor, some preferred the bucket seats. The trick of sleeping safely on the bucket seats, I found out by experience, was to hook one arm through the webbing at the back of the seats to keep from falling off, or being thrown off if the plane lurched or bounced.

Not being too tired, I climbed upstairs to the Globemaster's broad flight deck. Of the ship's seven-man crew—pilot, co-



On overnight pass, soldiers visited Tokyo.



Paratroopers grouped around the lead Globe-

pilot, navigator, flight engineer, crew chief, radioman, and loadmaster—the pilots, the flight engineer and the navigator were the busiest. The loadmaster, having done his job of seeing that the big plane was loaded properly to keep the center of balance within safe limits, was taking some "sack time" in one of the bunks behind the flight deck.

Long before Hawaii was sighted the next morning, the men were up, shaving, and dressing. When we landed at Hickam, they were a spruced-up gang ready for the greetings of the hula girls who were on hand to welcome us.

**Another two-hour stop** and we were on our way to Wake Island. This time we not only had another new crew, but a different Globemaster as well. Our new ship had just been given a complete maintenance check so that it would be ready for the last two legs of our trip. Our original plane, in turn, would be given a complete going-over and be ready as a replacement for some one of the 38 Globemasters that were following the same route behind us.

Some 10 hours later we landed on historic Wake Island, and after another short stopover for food, fuel, and a new flight crew, we were off for our final

[\[Continued on page 252\]](#)





master at Itazuke Air Force Base in Japan were the first to take off for flight to U.S.



Back home after a 9,000-mile flight, the paratroopers put on a mass demonstration jump.



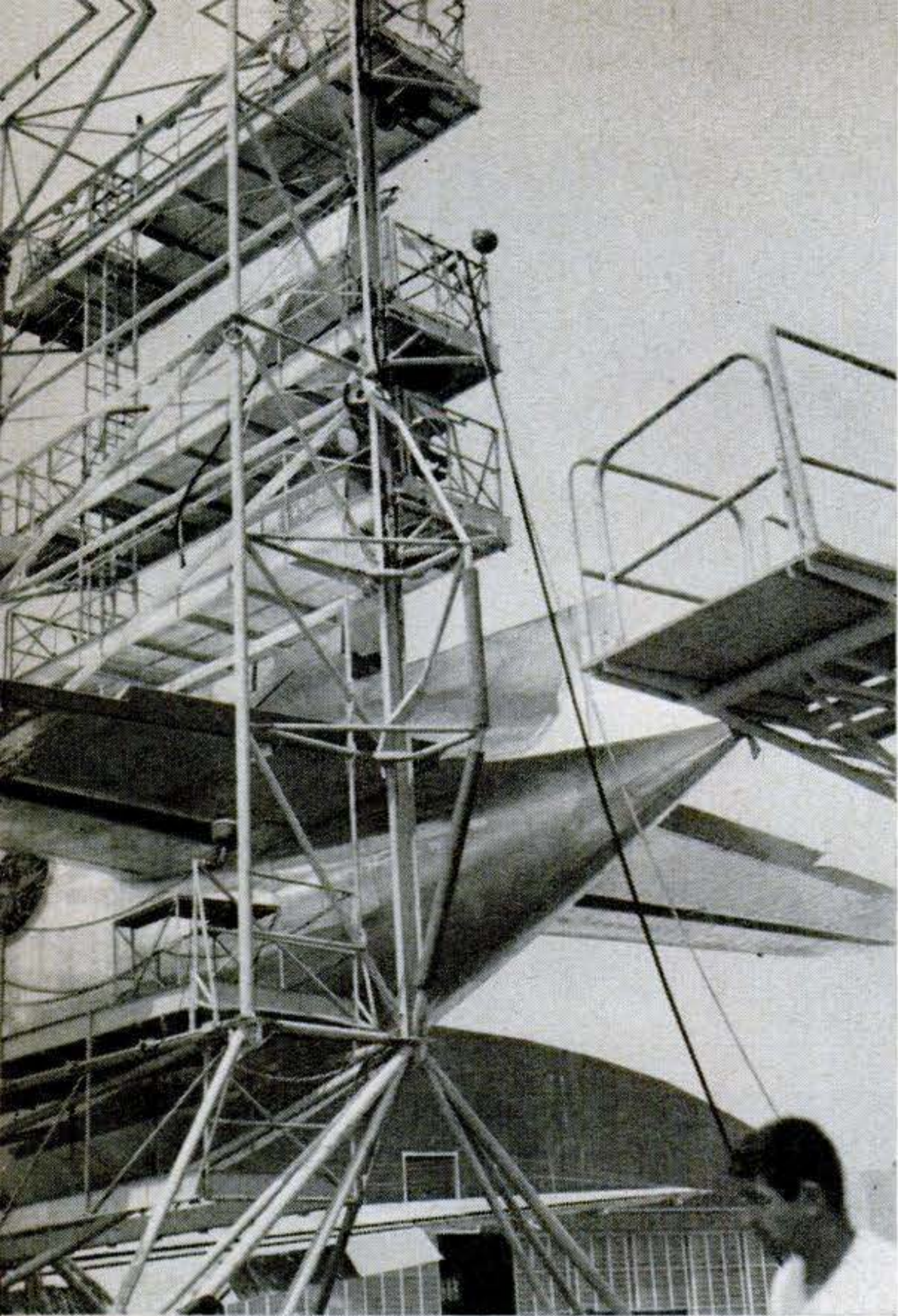

## Wash Tower Scrubs Big Planes

How do they wash a plane? At Norton Air Force Base, Calif., a giant mobile washing dock stands ready to scrub aerial giants like this C-124 when they come in for periodic checkups. Norton runs the largest aircraft hospital in the world. After the bath, the plane moves on to the repair hangars for an engine overhaul and structural checkup.



## Tiny Sub Joins Britain's Navy

THIS baby is one of the British Navy's new Shrimp Class submarines. Four of the 54-foot midgets have been built so far. The *Stickleback* is powered by a diesel-electric engine and is manned by a crew of only five specially trained submariners: the captain, first lieutenant, engineer, engine-room mechanic and an electrician's mate.

## They Say Now . . . about space travel

DARRELL C. ROMICK, GOODYEAR AIRCRAFT CORPORATION: "Space flight is now at a point corresponding to that of aeronautical science in the opening years of the twentieth century."

PROF. MARTIN SUMMERFIELD, EDITOR, JET PROPULSION (journal of the American Rocket Society): "The first launchings [of U. S. satellites] may well take place from an established long-range proving ground such as that off the Florida coast."

DR. R. TOUSEY, U.S. NAVAL RESEARCH

LABORATORY: "The satellite should be easily visible with a binocular when the sun is more than five degrees below the horizon . . . The satellite will cross the field of the 7 x 50 binocular in five seconds, if it is at 200 miles altitude. Therefore, a sharp watch must be maintained."

J. GORDON VAETH, OFFICE OF NAVAL RESEARCH (in *200 Miles Up*, a book on rocket exploration of the upper air): "A very genuine possibility exists that the moon and other celestial bodies may be radioactive as a result of direct bombardment by primary cosmic radiation . . . [This] should be thoroughly investigated before any lunar expedition or interplanetary flight is undertaken."





## Old Planes Hurtle to Battered Glory

**O**LD aircraft come to a shattered but useful end at the Ravenna (Ohio) Arsenal of the National Advisory Committee for Aeronautics. Scientists have deliberately crashed 37 service-wearied planes in testing how passengers can

survive crack-ups. In the Lodestar above, six dummies in the cabin carry sensitive instruments which will register the results of test on both conventional and shock-absorbing seats. In pictures below, the plane is being crashed at 110 m.p.h.

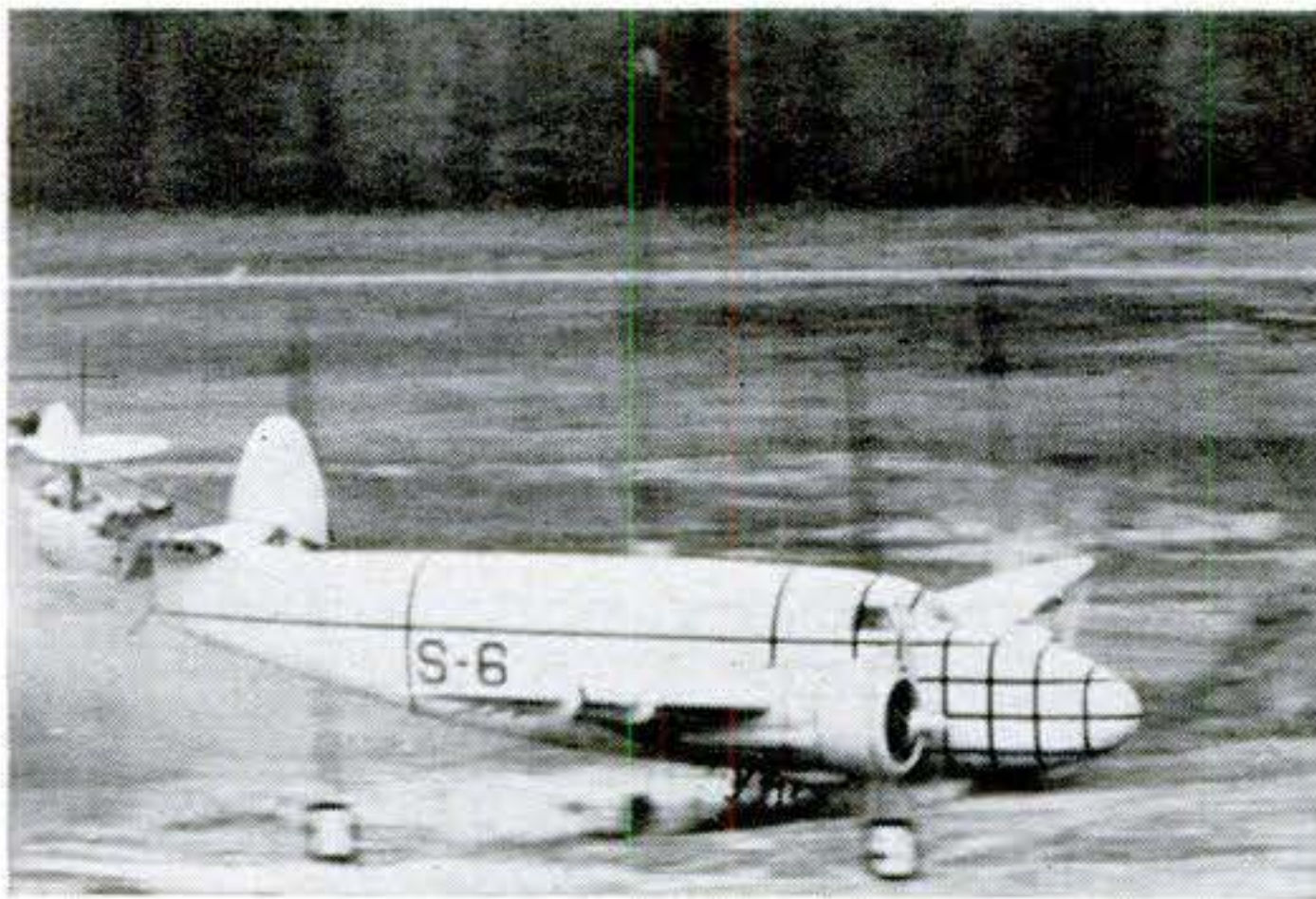

Lodestar speeds toward earthen barrier . . .

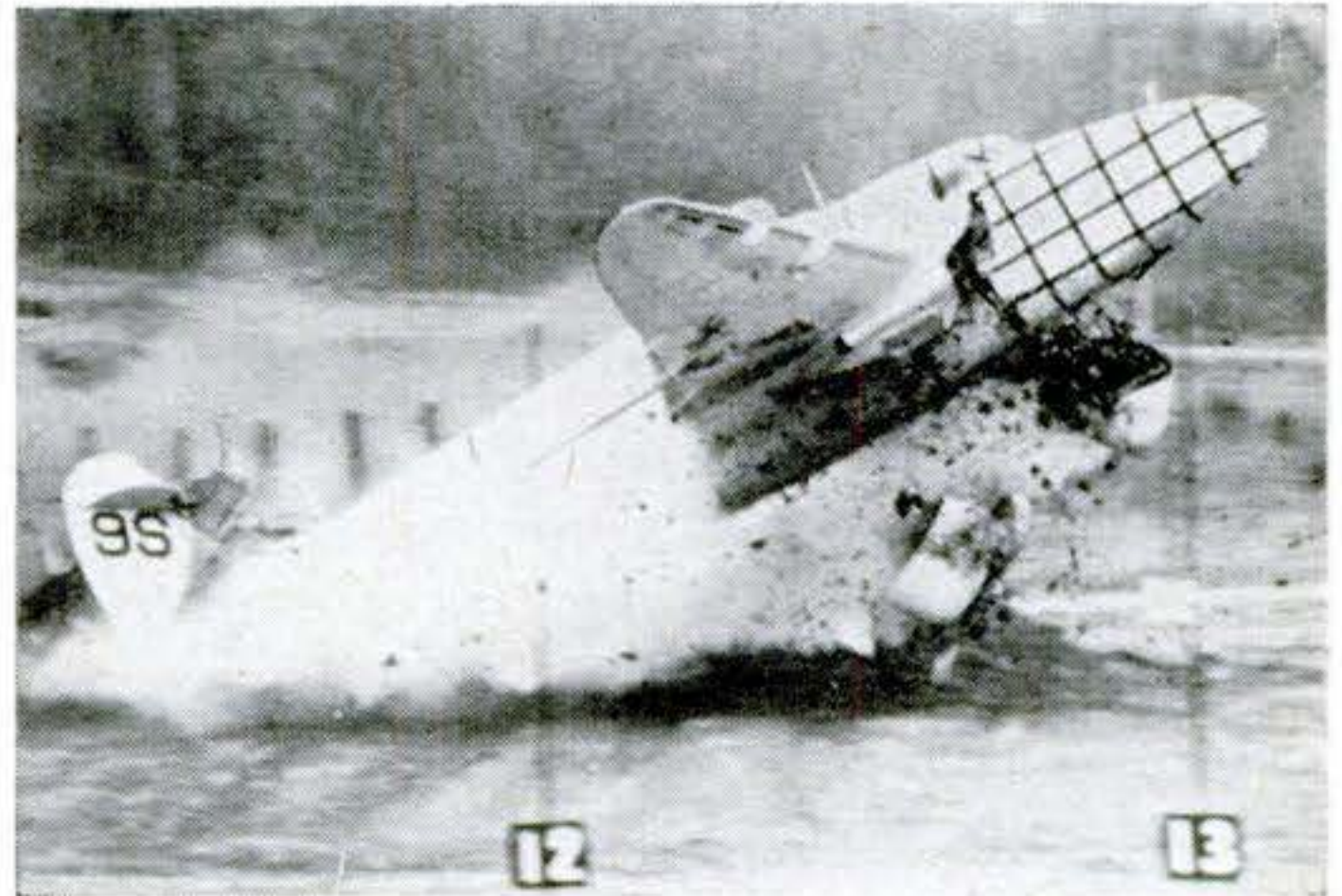

. . . hits, and is hurled up in the air . . .

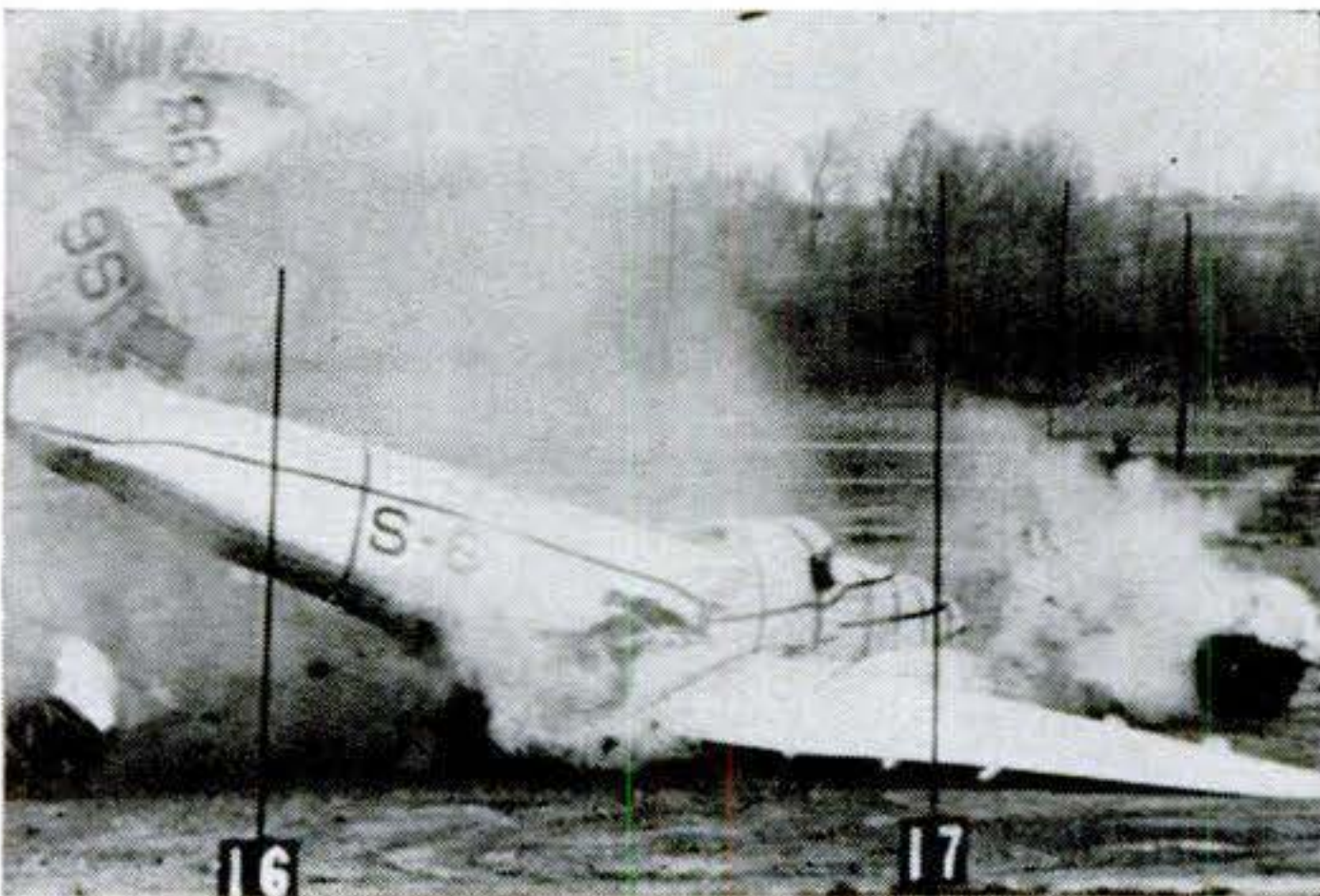

. . . drops, as fuselage starts to break up . . .

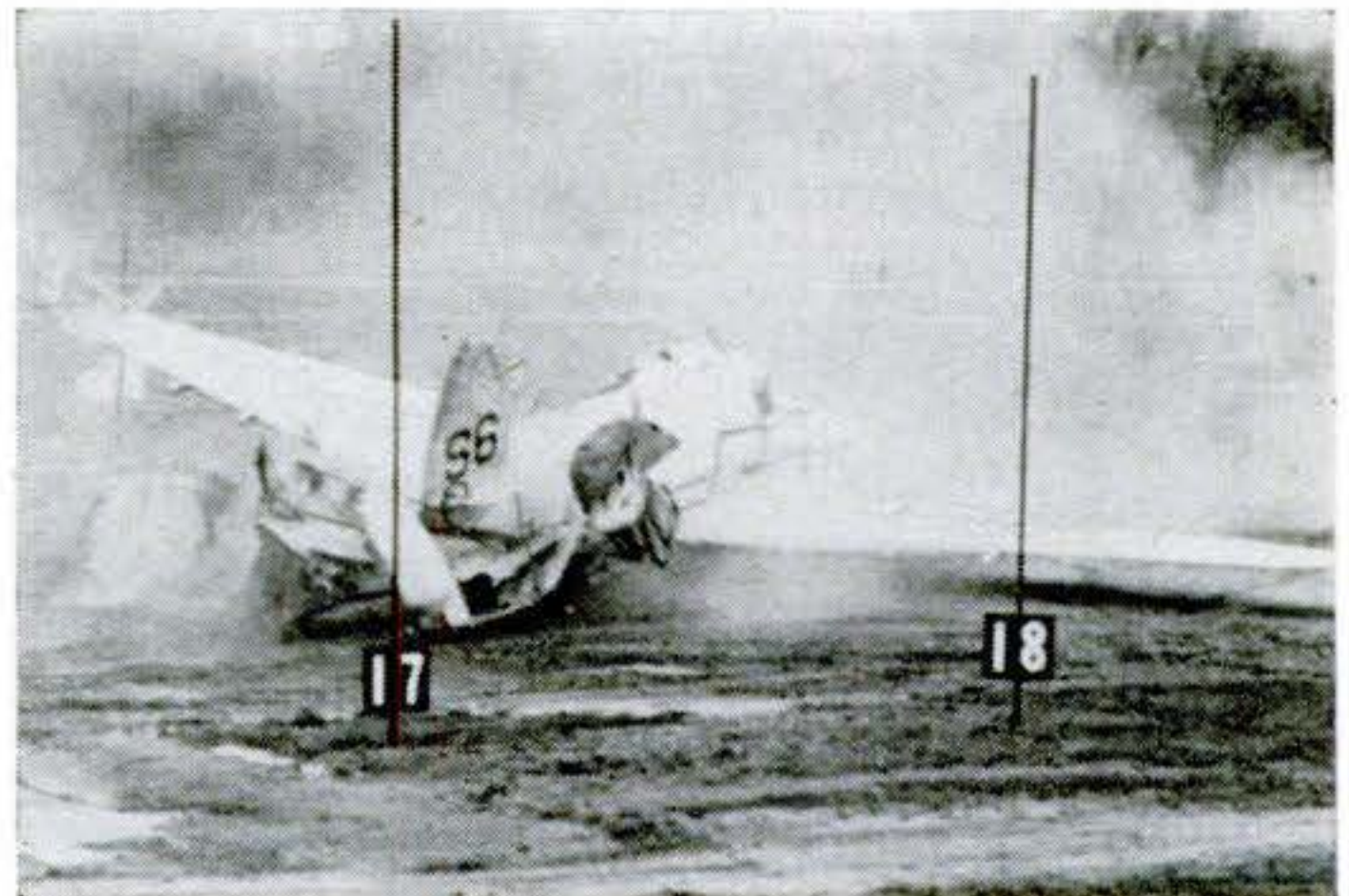

. . . then settles to earth, its last job done.





## Lightweight Life Raft Can Save 20 from Ditched Plane

THE inflatable raft above has 20 people aboard; but it's so light, says its maker, Pan Avion, Miami, that a single stewardess could heave it into the sea from a plane. The raft,

made of sectional compartments, comes with a light that automatically flashes when it hits the water, a sea anchor and standard survival gear. The raft floats on either side.

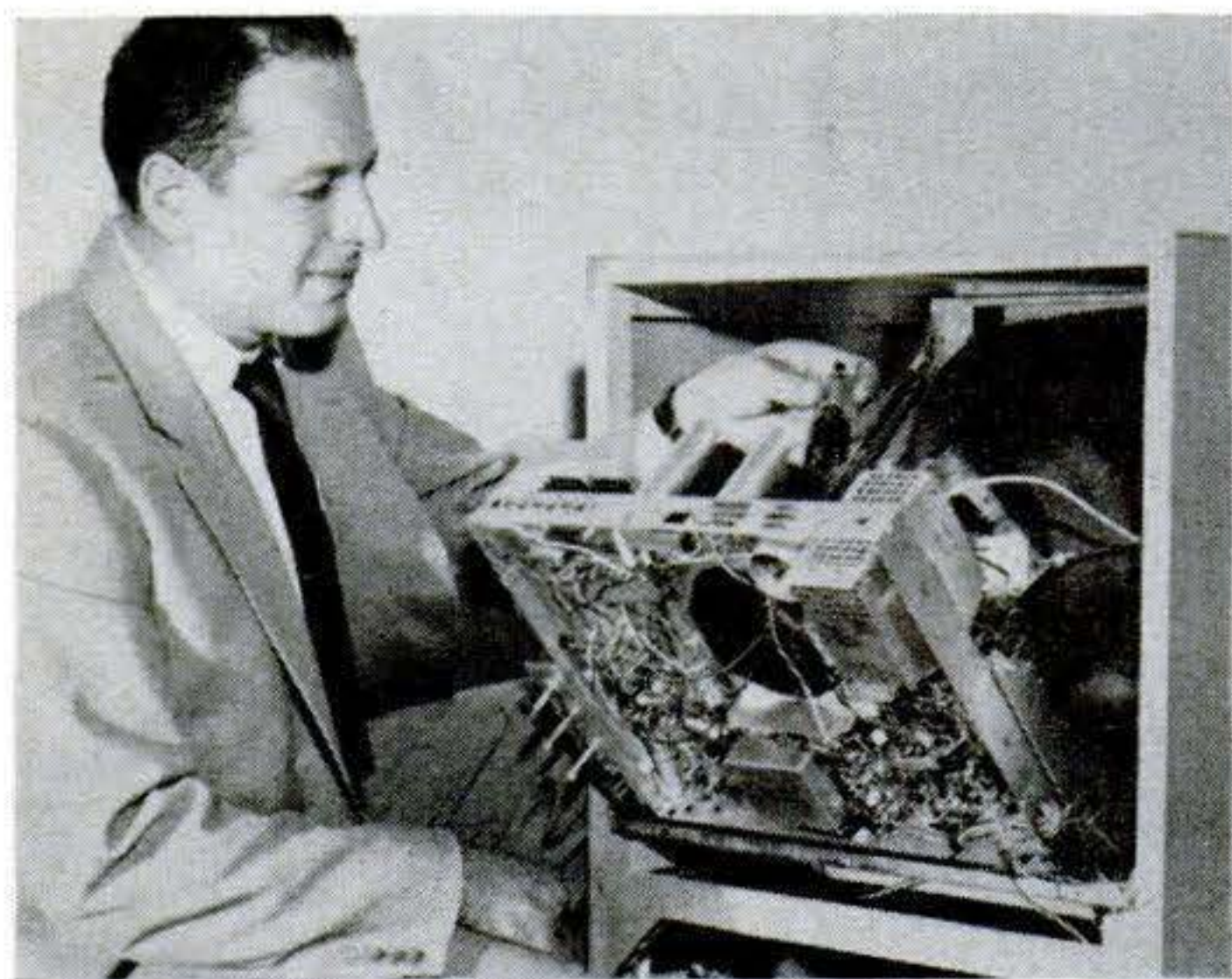

## Television Chassis Tilts Out

PULL back the vertical chassis of this new CBS-Columbia TV set and it will automatically lock at a 45-degree angle for on-the-spot servicing. Advantage: TV repairmen can work deep inside without dismantling the set, and thus can handle many routine servicing jobs right in your own house.

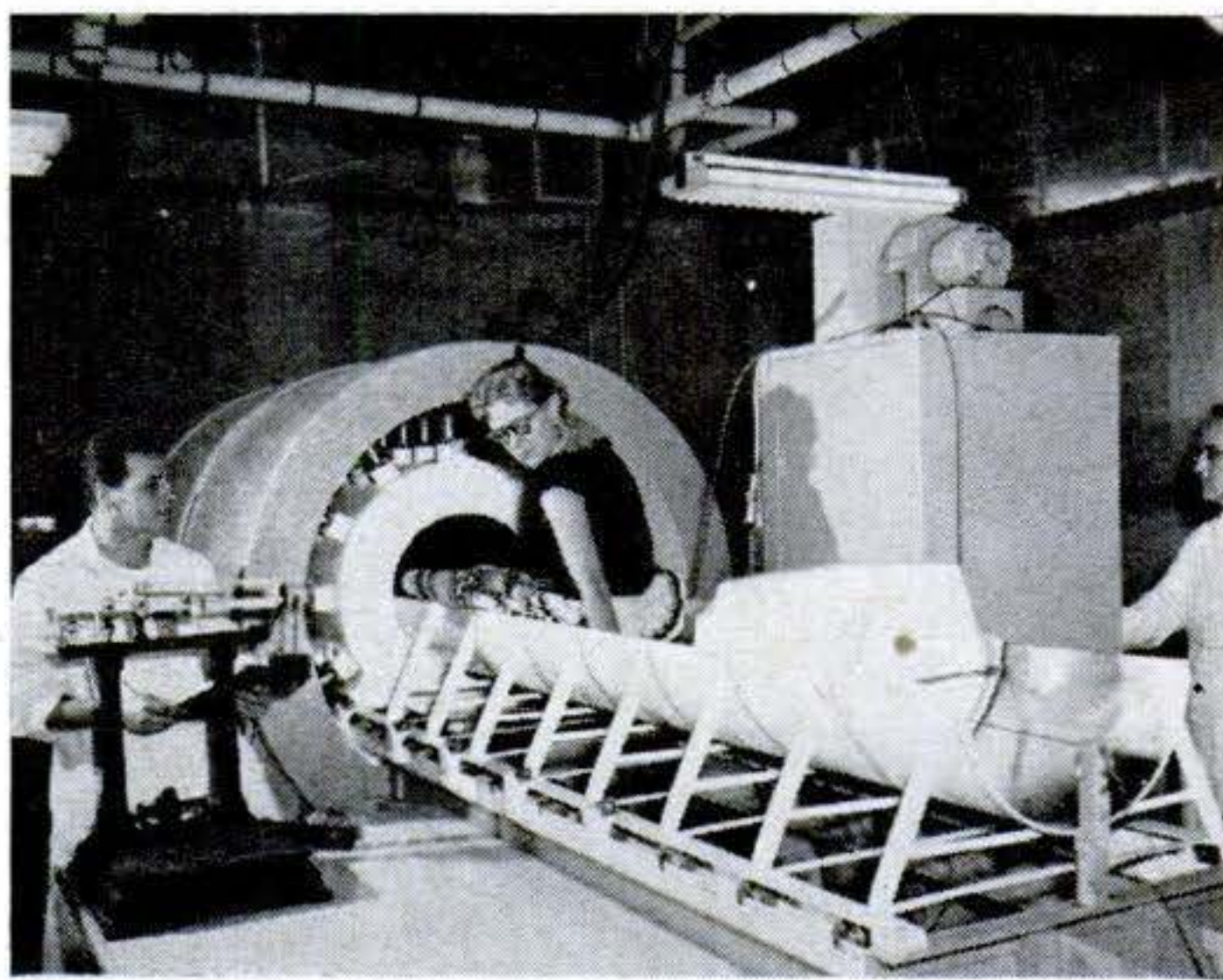

## She's Radioactive—Like You

THE young lady in this picture is about to have her radioactivity measured. Technicians will slide her into a new "body counter," which was developed by the University of California's Los Alamos, N.M., scientific laboratory. Every human being is a little bit radioactive, say the scientists.



## It'll Mow the Jungle

THIS 60-ton jungle destroyer travels on the largest rubber tires in the world—they're 10 feet high and four feet thick. With its blade raised, the vehicle uproots heavy trees and underbrush with push-button ease. R. G. Le-Tourneau, Longview, Tex., built the Tree Crasher for land-clearing operations.









**SYSTEMATIC STOWAGE** tucked all this into the trailer—with room left for souvenirs picked up on the way. Surplus duffel bags proved to be the most sensible kind of luggage.

ico 15—is the newest major travel route in our hemisphere—and the most exciting tourist news in a long time. Until a year or so ago, it was usable only for a driver willing to gamble on the weather and to put up with jolting, tire-tearing, 20-m.p.h. gravel.

Driving it now is just like home. There's nothing but your own reluctance to miss the sights that keeps you from driving any stretch of it at the legal speed of 100 *kilometros* (62 miles) an hour. It's all paving and it's all good,

**RESORTS ALONG WEST COAST ROUTE** are uncrowded, and the weather is warm enough for ocean bathing even in mid-winter. This beach-umbrella house at Mazatlan is made of thatch.

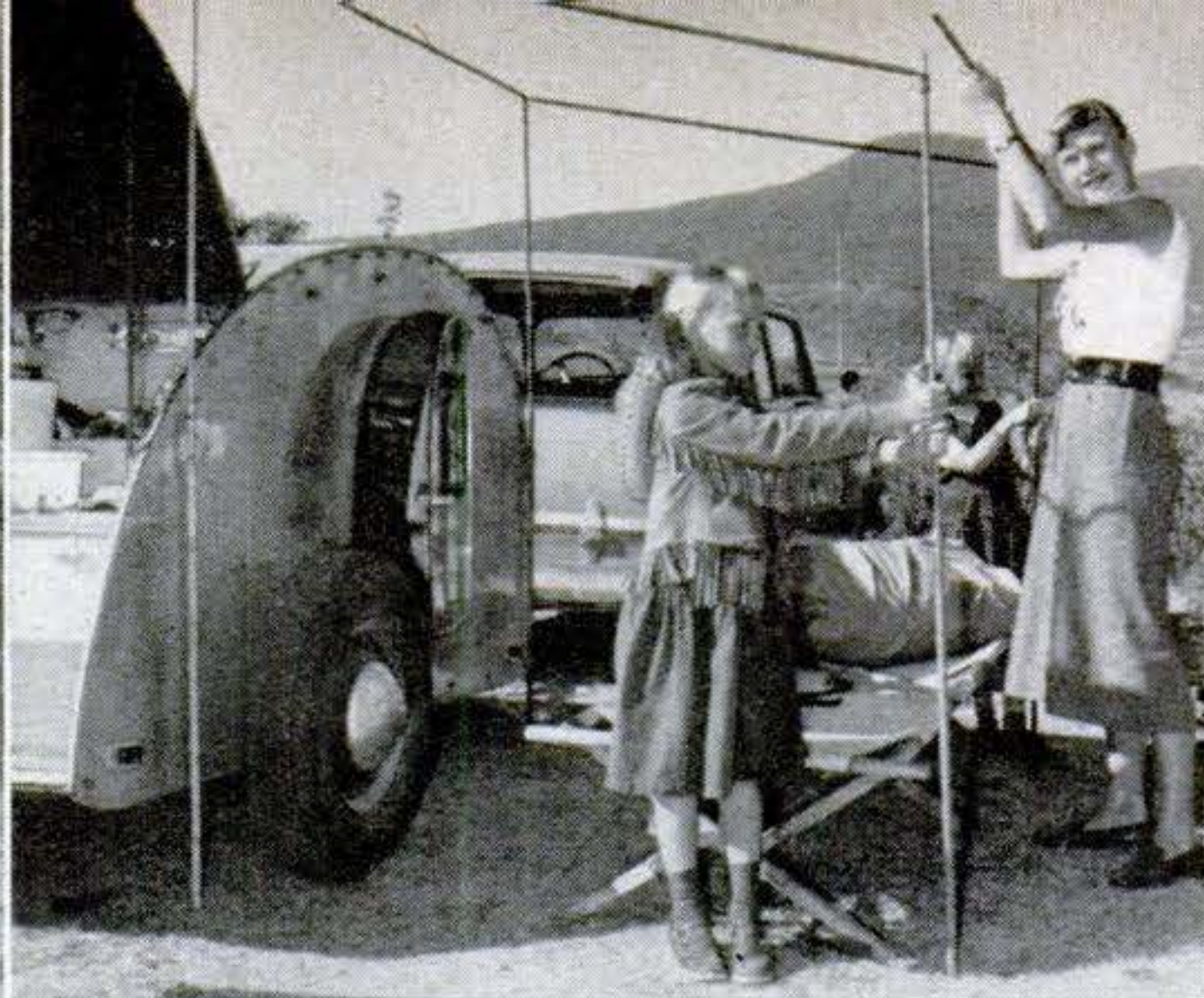

**PUTTING UP TENT** for the night was a pipe. Eyebolts on the side of trailer hold the poles at left rigid. Ends of crosspieces are hammered flat and drilled to fit over nipples.

from Nogales on the Arizona border to Mexico City. And most of it hasn't seen many tourists so far.

***It will; it's too good to miss.*** After Nogales you come to Hermosillo, a city whose name says it is pretty—and it's right. You reach the coast at Guaymas, where the waterfront is lovely and the deep-sea fishing ranks with the best in the world.

You continue south through the most progressive part of the nation, agricultural Sonora, helped by mechanization and irrigation. Stop at the four-block market in Ciudad Obregon, but don't load up with purchases; this is only the beginning, and before you're finished, packing space in both car and trailer will be at a premium.

At Mazatlan you're back on the Pacific. Fishing, views, beaches and lively Mexican life make this destination itself enough for a trip if your time is limited.

But the road goes on, through un-touristy Tepic to modern Guadalajara, Mexico's second city and metropolis of the west. You have a choice of side trips: to San Blas on 24 miles of paving cut through brilliant tropical jungle to the sea; to Tequila, near Guadalajara, from which one of the Mexicans' popular drinks takes its name.

From Guadalajara, all Mexico is open to you.

***Camping in Mexico*** now is not only do-it-yourself but find-it-yourself. You keep your eyes open as you drive, wait-



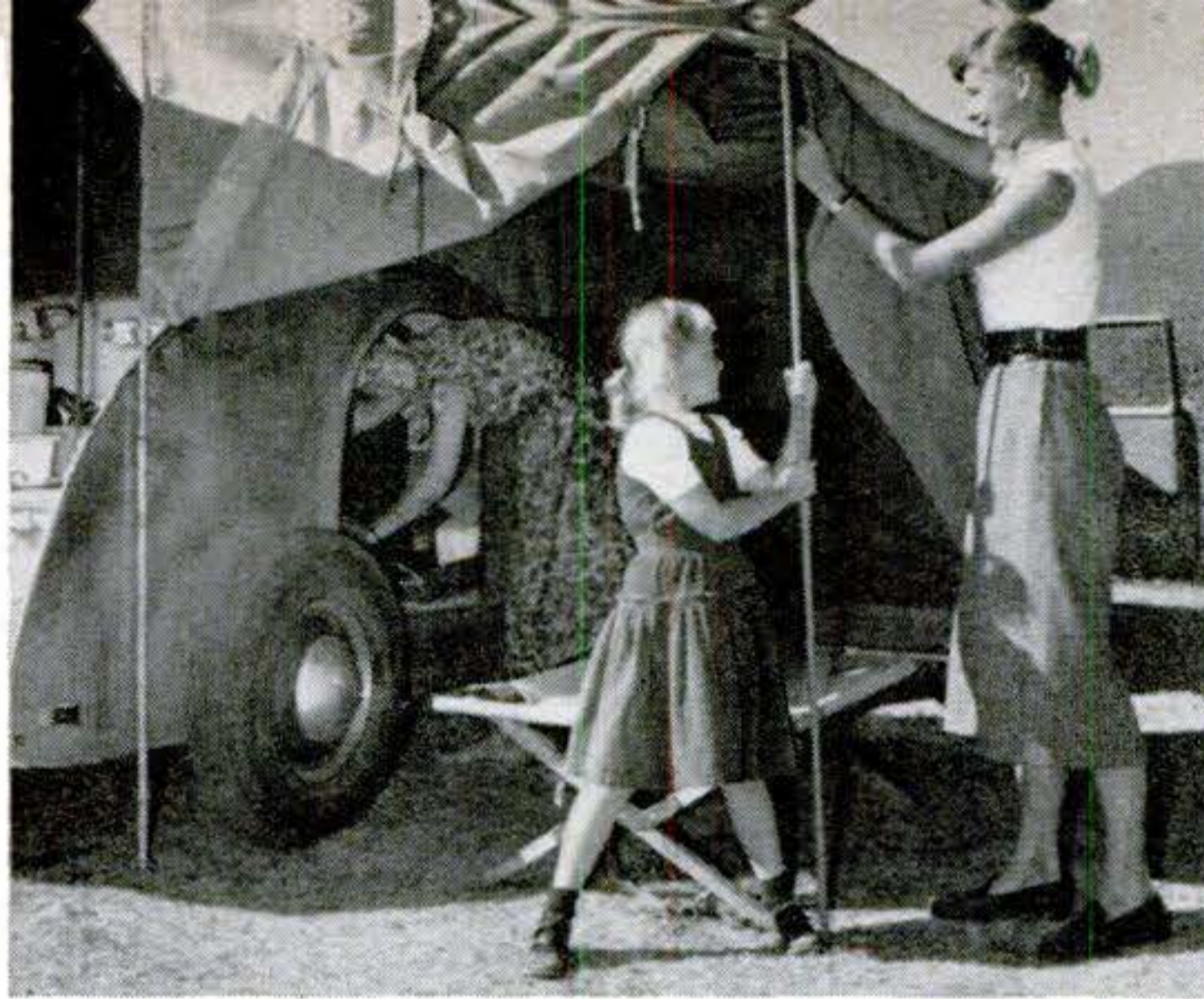

**CANVAS SLIPS OVER PIPE FRAME** to make a four-sided box shelter. One side is cut to fit the curved top of the trailer and buttons to it with grommets. The front has a zipper-closing door.



**FOLDING COT SERVES AS A BENCH** for evening camp gatherings before it becomes a bed. In semi-desert country like this, the nights are comfortably cool and crystal clear.

ing for time of day and the right place to coincide. Then you pull off the road into whatever kind of seclusion you've spotted, and there you pitch your tent. You may be in a semi-desert in Sonora, on the beach near Mazatlan or among evergreens in the gentle mountains south of Lake Patzcuaro.

Wherever you are, the predictable weather of Mexico is in your favor. In the rainy season of summer, you know the water will come down at the same time each day, with sun before and after, and you can be prepared. In winter you can count on perfect sunny weather every day.

**Gasoline stations** are far apart. And you have to keep an eye on the condition of your oil, tires and battery yourself. As the man in the station looks at it, you asked for *gasolina*, so that's what you get. He probably will not pry into the health of your battery, which he regards as your own business.

If you start out with thin tires and insist on exploring gravel side roads, as we did, you may have to replace a tire or two. We did. Your new tire will be made in Mexico, it will be six ply whether you like it or not and the price will be at about the U.S. level.

Most U.S. auto insurance drops dead when you cross the border, so buy some from a Mexican company right away. It isn't cheap, so buy just for the time you'll need it.

*It's hard to get lost* on Mexican high-

ways; they just go on and on with few paved side roads. But watch closely for tiny *Transito* arrows when you're going through town. If you miss, though, there'll be plenty of local citizens glad to point your way—even before you ask. They know a tourist when they see one.

Such danger points as narrow bridges, curves, grades and populated areas are well marked. For a good distance on both sides of the border, warning signs come as twins, in English and Spanish.

One you'll meet soon and often says

**MEXICO DEMANDS A CAMERA** to record its colorful variety of places and people. This interior of a cathedral at Chapala was shot without flash (1/25 at f/3.5), using Tri-X film.







**CAMPING EQUIPMENT CAN PAY OFF** even when not camping. We cooked in our trailer kitchen while stopping at this Lake Patzcuaro cottage to catch up on laundry, baths and schoolwork.

*Cuidado con el Ganado.* That translates "Watch Out for Livestock," but what it mostly means to the tourist is don't drive at night. Cows, burros, horses and goats wander the roads, and even the best driver can be ambushed by an animal after dark. Besides, you'll see so little if you drive at night that you might as well have stayed at home.

Most camping rules for Mexico are the same as for anywhere else: good light, warm sleeping facilities, refrigeration, some way to cook quickly. We met these needs with the rig you see in our pictures—station wagon, teardrop trailer and button-on tent. For lights we used a hookup to the car battery plus the usual gasoline lantern. Similar lanterns are widely used in Mexico, so there's no problem about fuel or mantles.

Water is probably the biggest problem. The only kind that can be relied upon as safe is the kind that comes in

bottles, and this is to be found only in fair-sized cities. To camp comfortably you should figure on carrying about two gallons per person and make sure your supply is replenished daily. Otherwise you may wind up as we did more than once, brushing your teeth with bottled mineral water.

Ice is widely available in Mexico and it's cheap. But don't put it in your drinks. It is made from water you wouldn't drink, and freezing doesn't purify it.

Some kind of icebox, or at least an insulated bag, is good to have. Keep it filled with bottled drinks, which are safe, cheap and much easier to find than pure water.

You'll find splendid grocery stores in the cities, but they won't carry all the things you're used to. Stock up in advance on canned soups if you like them; and try to keep your moving pantry well supplied since distances are long on the West Coast route. Powdered milk is probably the most important single item to keep on hand.

**Handy to have.** Here are some other things we're glad we took—or wished we had:

*Sponge cloths*, in different colors for identification, for washing faces and dishes.

*Pressure cooker*, for tough but well-flavored Mexican beef and for quick water purification at high altitudes.

*Big water bag* that hung on the outside of the car, taking up no storage space and keeping the water cool.

*Aluminum foil* and foil pie plates for cooking.

*Salt* in miniature shakers—less mess if they spill.

*Child's broom*, a 50-cent item for cleaning camp, car and even clothes:

*Short shovel* from surplus store, for garbage and latrine duty, camp leveling, emergencies, kids' beach play.

*Hatchet and tool kit* (including screwdriver, hammer, wrench, scissors and pliers) for equipment repair.

*Plastic dishpan* of flexible variety. Useful for washing dishes, clothes, car and

[\[Continued on page 254\]](#)



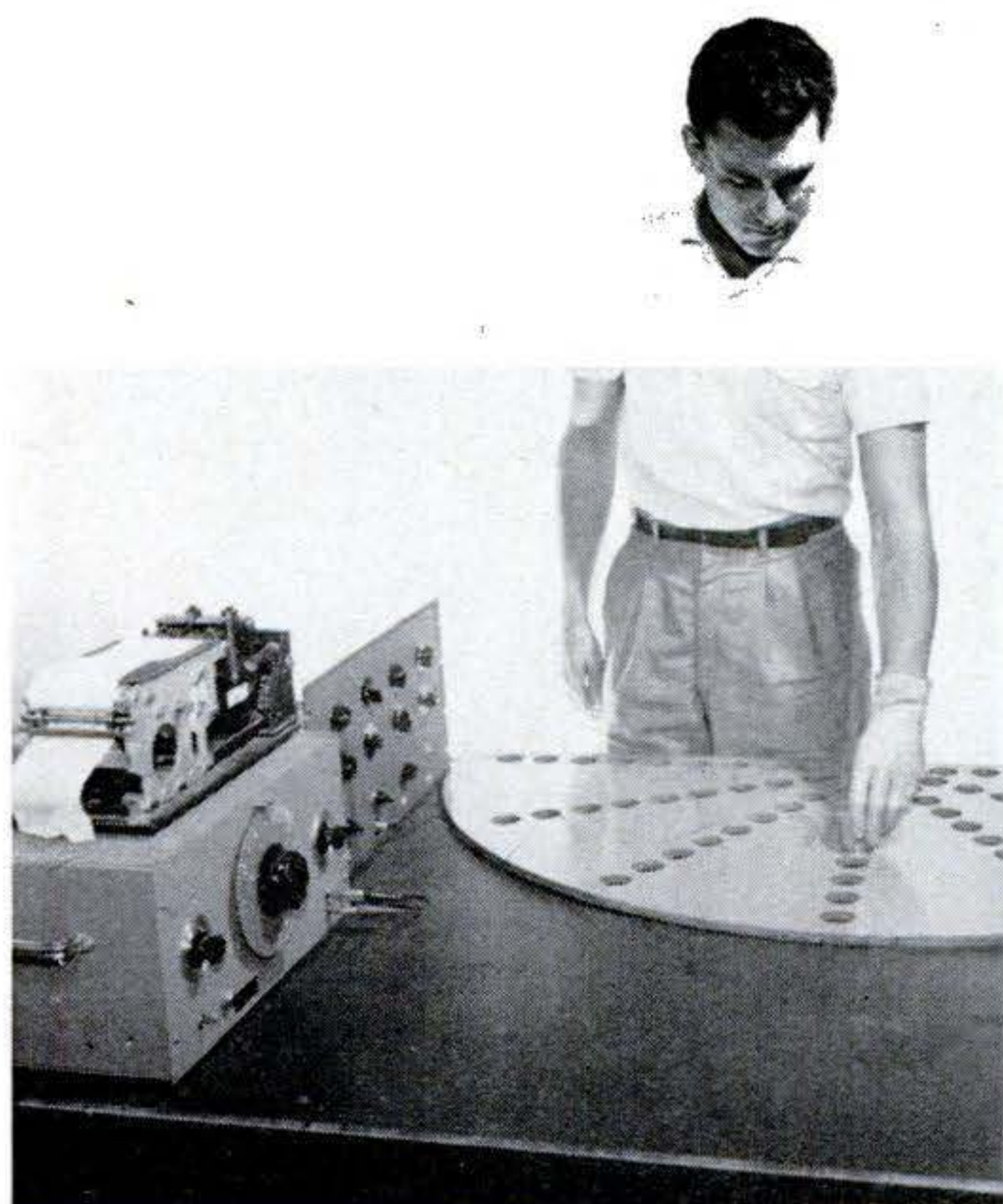

### Folks Too Grasping, Tests Show

How hard do you grip something to pick it up? Too hard, say engineers at the University of California at Los Angeles. Tests with the setup above show that workmen picking up parts relax somewhat after the first grab but still waste grip force. Gloves increase the energy expended in grasping, as does picking up an object at arm's length.



### 50-Pound Boat Hits Five Knots

A THOUSAND hours of work went into this model freighter built by Charles Mooney of Columbus, Ohio. Radio-controlled, it is powered by a 20-amp. wet-cell battery and two linked toy-train motors. It has two forward speeds and one reverse, and can attain a maximum speed of about five knots.

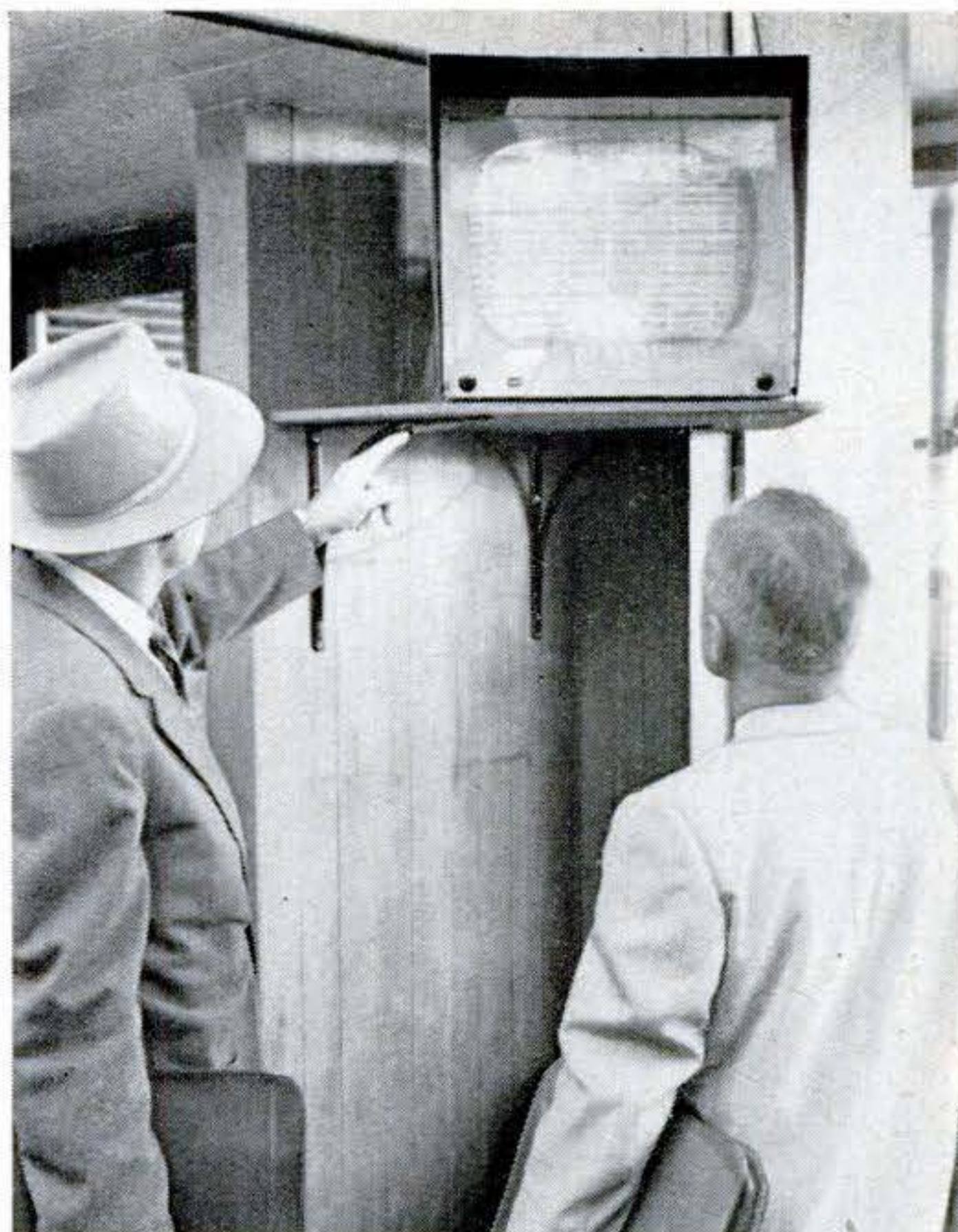

### TV Set Flashes Flight Dope

FOUR closed-circuit TV sets spotted around the terminal at the Portland (Ore.) Airport give passengers and officials flight information. Arrivals and departures of United Airlines planes are posted on a large panel in the dispatch office. A TV camera, focused on the panel, transmits pictures via coaxial cable to the four receivers in the building.

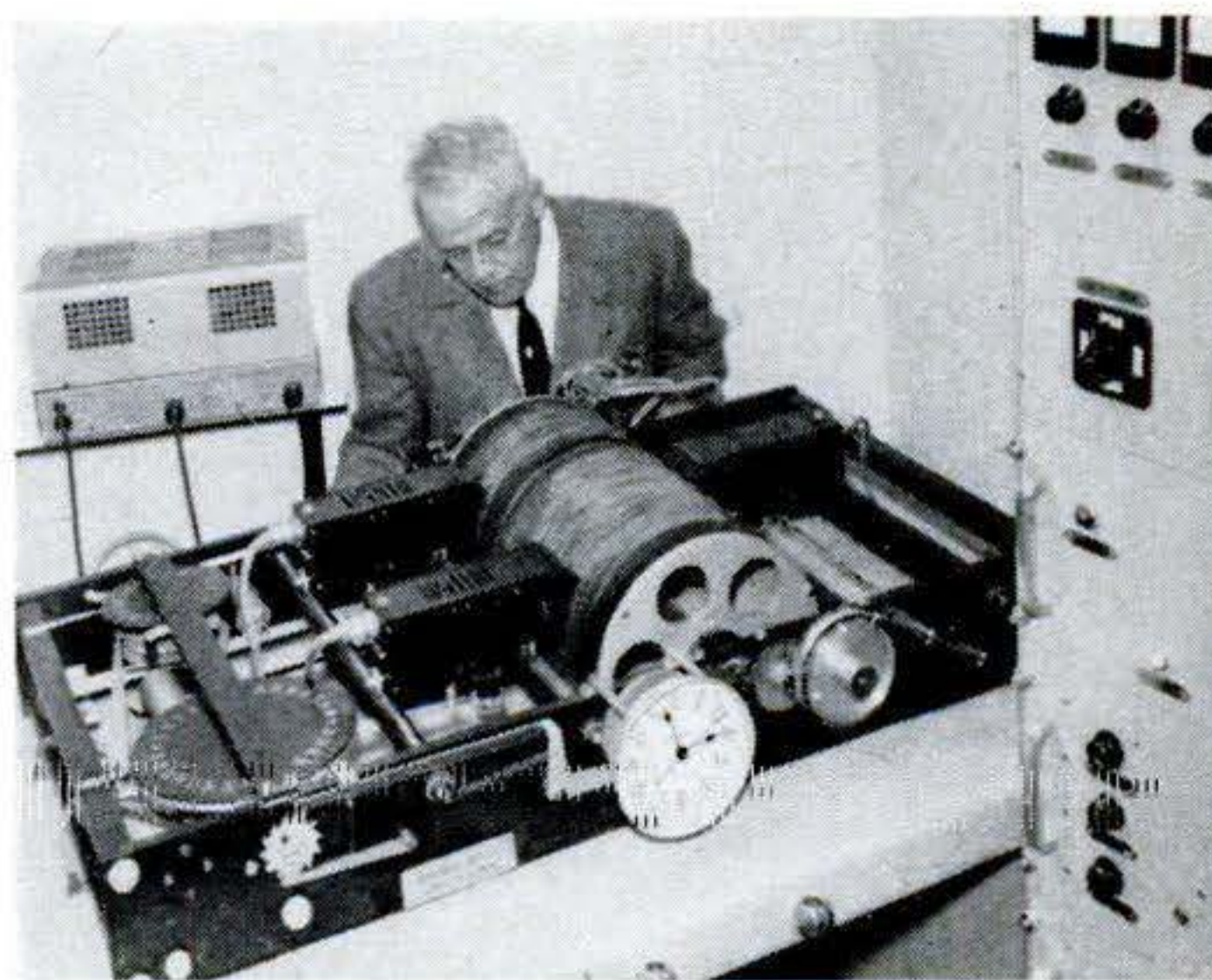

### This Clock Really Tells Time

THIS clock at the Dominion Observatory in Ottawa not only keeps time but also broadcasts it each minute. The voice is on a sound track cut on a strip of 35-mm. film and mounted on a revolving drum. Exciter lamps and photocells keep the voice announcements booming out—right to the second.



# New Aids to Living...



**Foil Broiler:** Deep corrugations and high sides of the aluminum Broil-A-Foil catch dripping fat and prevent spattering. It's large enough to hold a four-pound steak or six to eight chops, and strong enough to be washed, if you wish, for re-use. Trays come packed five in a box.

**Touch-Control Clock:** The mere touch of a finger sets the alarm of the Touché at night or turns it off in the morning. The same touch turns the concealed dial light on (as the alarm is set) or off. The clock will be on the market soon.

*Further information about the products described on these pages can be obtained from the following sources: FOIL BROILER: Manhattan Products Co., 331 Madison Ave., NYC; ROLLING VACUUM CLEANER: General Electric Co., Bridgeport, Conn.; TOUCH-CONTROL CLOCK: General Electric-Telechron, Ashland, Mass.; ROTARY OIL-STONE: Wulff Mfg. Co., Ontarioville, Ill.; DISPENSING BRUSH: Golden Rule Enterprises, 115 W. 57th St., NYC; FIRE ALARM: Cronin-Staples Mfg. Corp., 1514 Park St., Houston, Tex.; IRON-HANDLE SUITCASE: Ann Louise Sales, 215 Ste. Marie St., Manchester, N.H.; BLOW-UP SPATS: Benjamin H. Weiss, Inc., 259 W. 30th St., NYC.*



**Rolling Vacuum Cleaner:** Big, rubber-tired wheels take the Roll-Easy vacuum anywhere—up or down stairs or in a full circle. It can be guided with the hose or with a steering handle made by fitting the cleaning wand into a plug-in hole on the canister. A foot control on one wheel turns the cleaner on or off when you touch it lightly with the tip of your shoe. The cord, nonkinking, is detachable for easier storing.

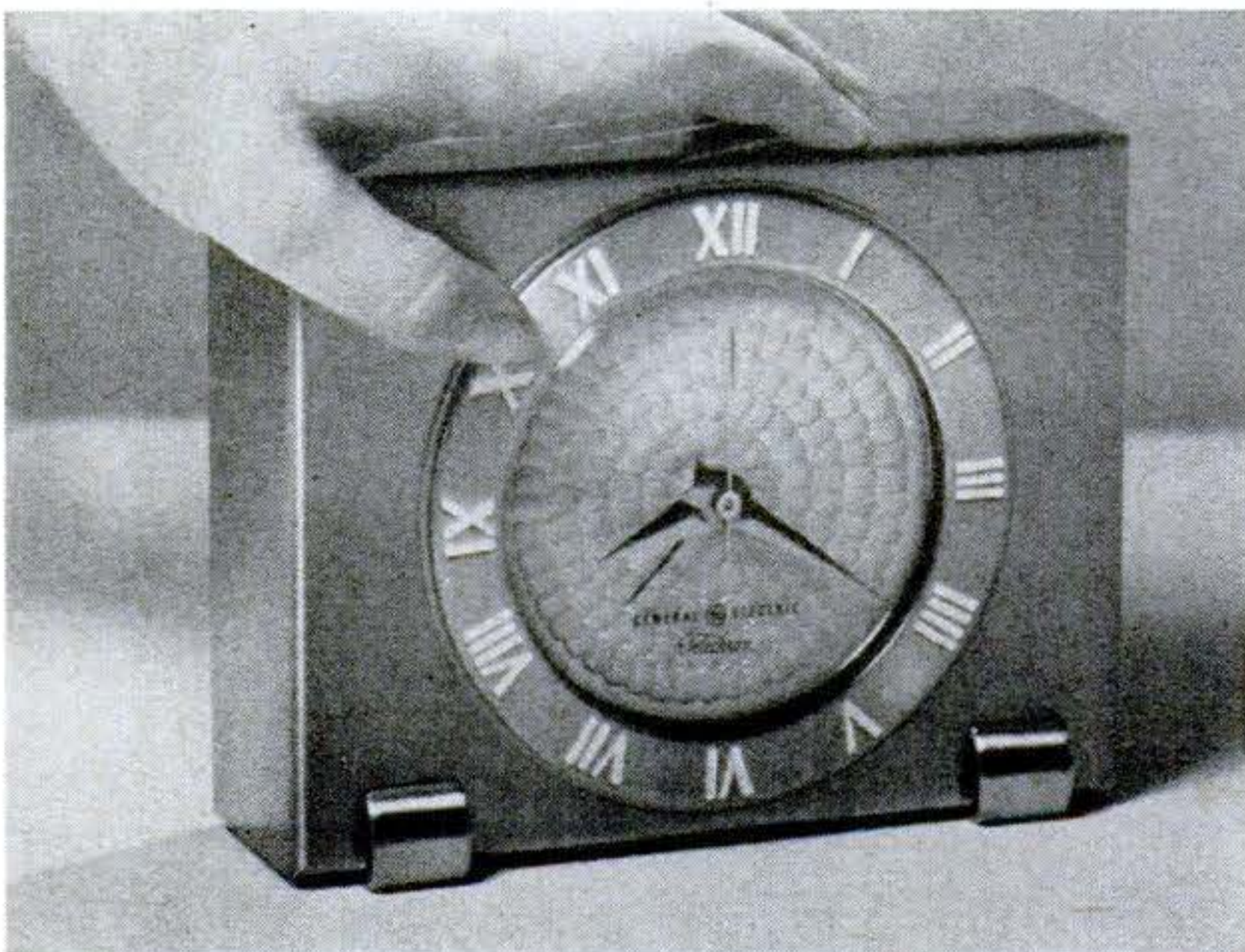



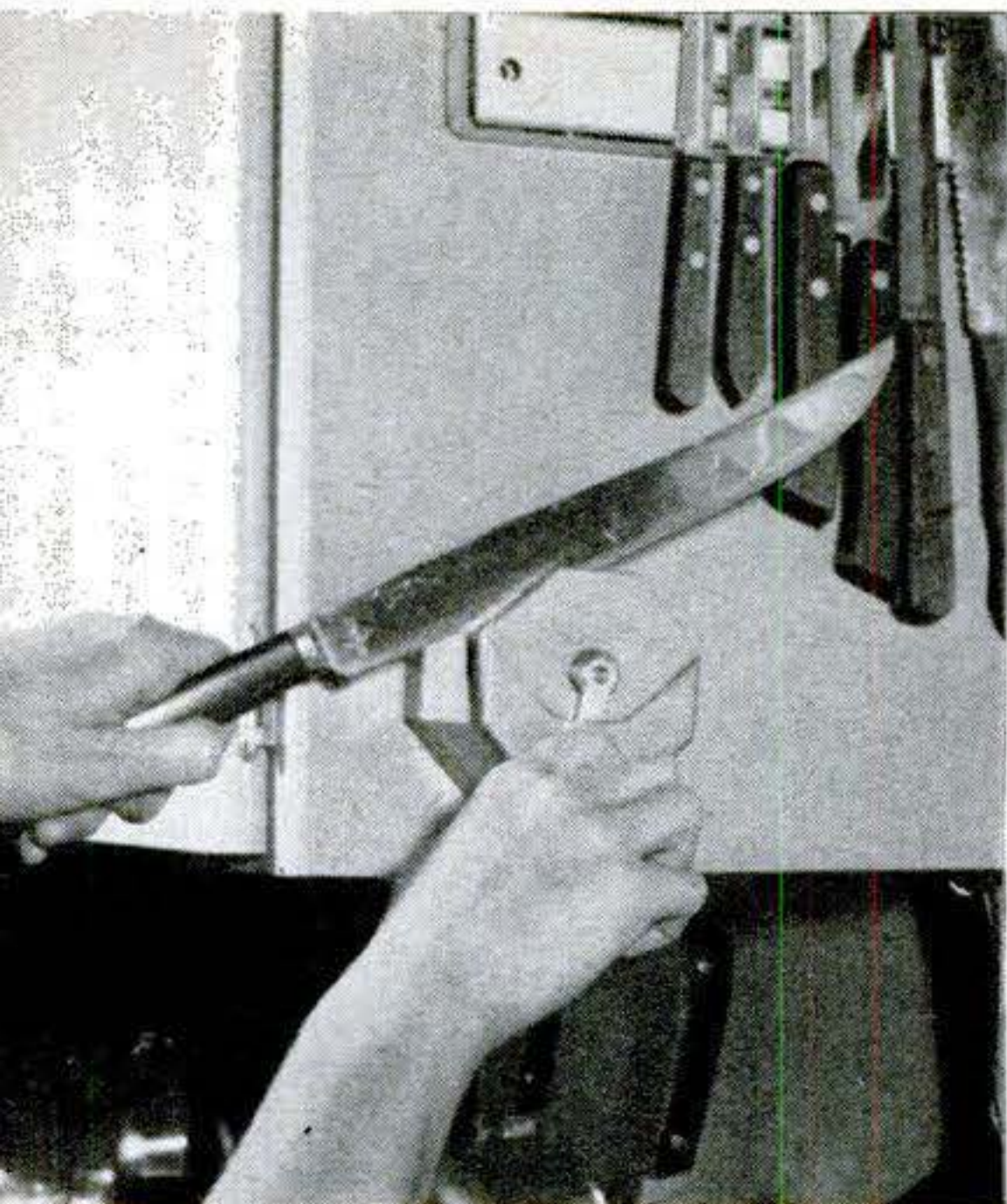

**Rotary Oilstone:** Hollow-ground knives are sharpened by the Hone-Rite in a bath of oil to give them a razor edge. Guide slots hold the blade of your knife at a preset angle against a small crank-turned corundum oilstone suspended in a pool of oil.



**Dispensing Brush:** Lather foams up into the bristles when you turn the bottom of the Magic-Wheel handle. It holds enough shaving cream for about 100 latherings. To refill it, squeeze in your favorite cream from the tube. Handle is plastic, bristles nylon.



**Fire Alarm:** A shrill whistle that should wake even a sound sleeper is built into the Chief. At 156° F., a fusible plug melts and releases a fire-deterrent gas that swirls through the horn. The signal can be heard 500 feet away from the detector, says its maker.

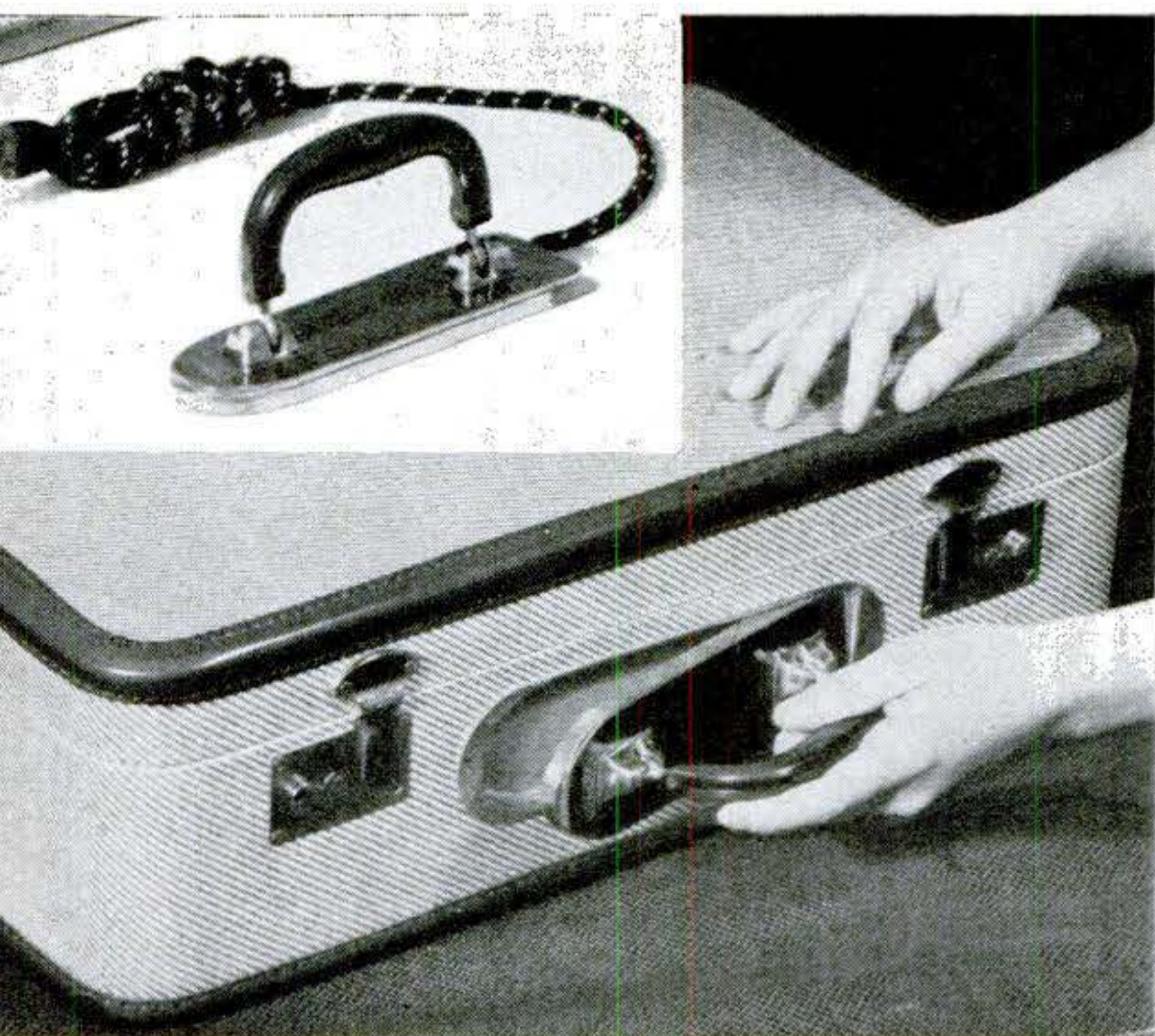

**Iron-Handle Suitcase:** You'll never go unpressed with this Iro-Case—the handle comes right out to double as a traveling iron. When you arrive at your destination, slip the iron out of its niche, turn the 21-inch case on its side to serve as an ironing board and you're all set to go to work on those wrinkles. The smooth, flat top of the AC-DC iron can be engraved with your name and address.



**Blow-Up Spats:** These Ankleons make ski boots and skating shoes fit like custom-built jobs. Air pressure fills up excess space so that even loose-fitting footwear hugs the heel and gives you air-cushioned comfort. You never have to adjust shoelaces. The little pump fits into your pocket so you can tighten them up any time with a few squirts of air. The air cushion helps keep your ankles warm, too.





**EVERYTHING BUT THE KITCHEN SINK** is in this super de luxe job, biggest of a new line of phonographs introduced by the Bell & Howell camera firm. All components, including three

speakers (two woofers and a tweeter), are housed in this handsome cabinet, which has a rigid "spine" across the back to prevent reverberation of sound. Price: Nearly \$2,000.

**PHONOGRAPHS IMPORTED FROM EUROPE** are gaining popularity here. Below is a Norelco made by Philips in Holland. It has FM and eight-band AM radio, three speakers, sells for about \$1,000.

**SEPARATE SPEAKER CABINET** of RCA Mark I houses 15-inch woofer, five-incher for middle





# High-Bracket Hi-Fis

## Do Everything but Dance

**Y**OU don't have to be an engineer to get a hi-fi system now—you can buy good ones ready to play. But a look at the controls may send you hunting for

an electronics handbook. Some have more knobs than a radar set. Here are a few of the newest hi-fis, fully assembled in fancy cabinets (at fancy prices).

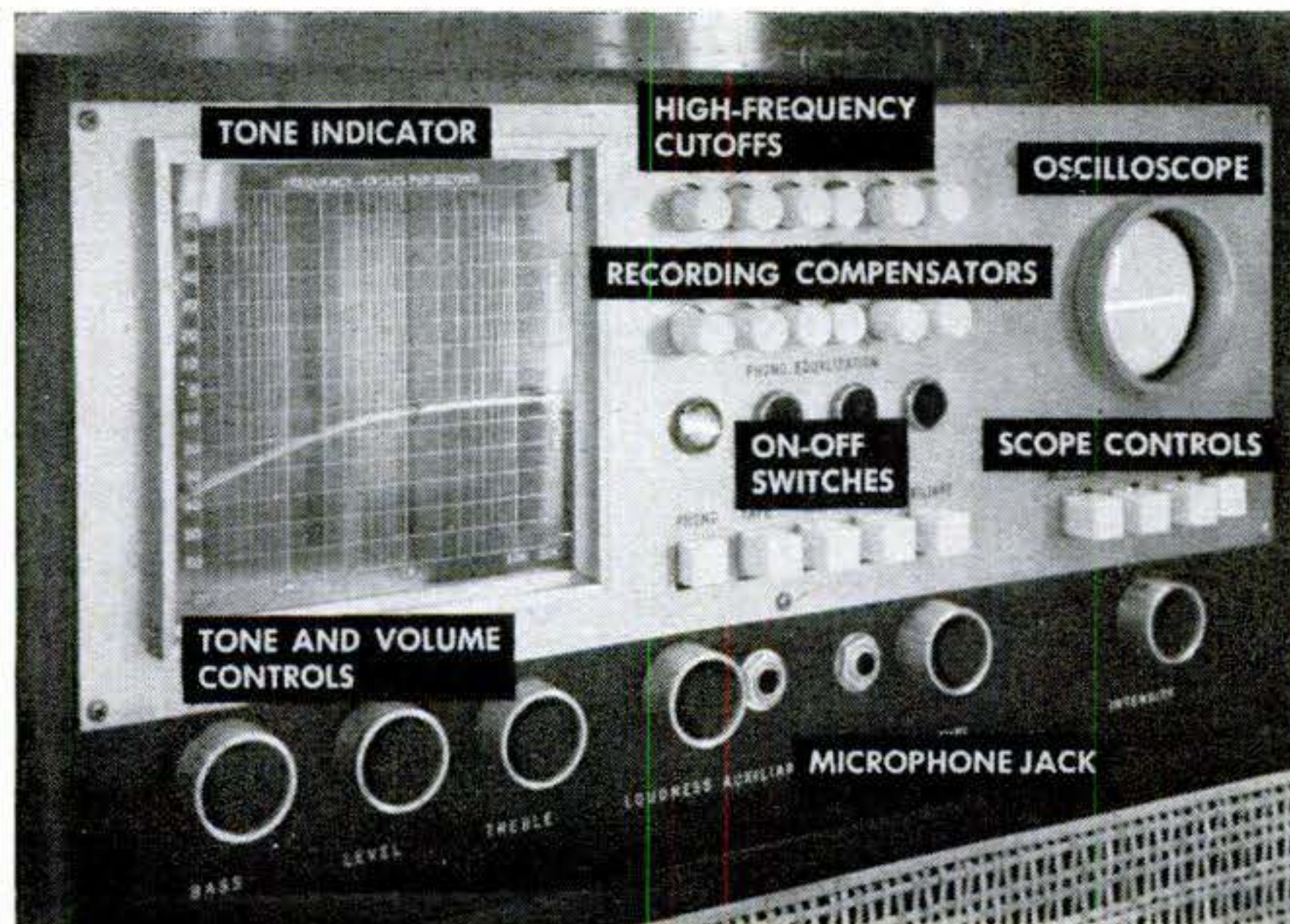

**IT WON'T TAKE OFF**, though you may wish for a co-pilot. Complex panel includes oscilloscope, and visual tone control that shows graphically how you've adjusted all those knobs.

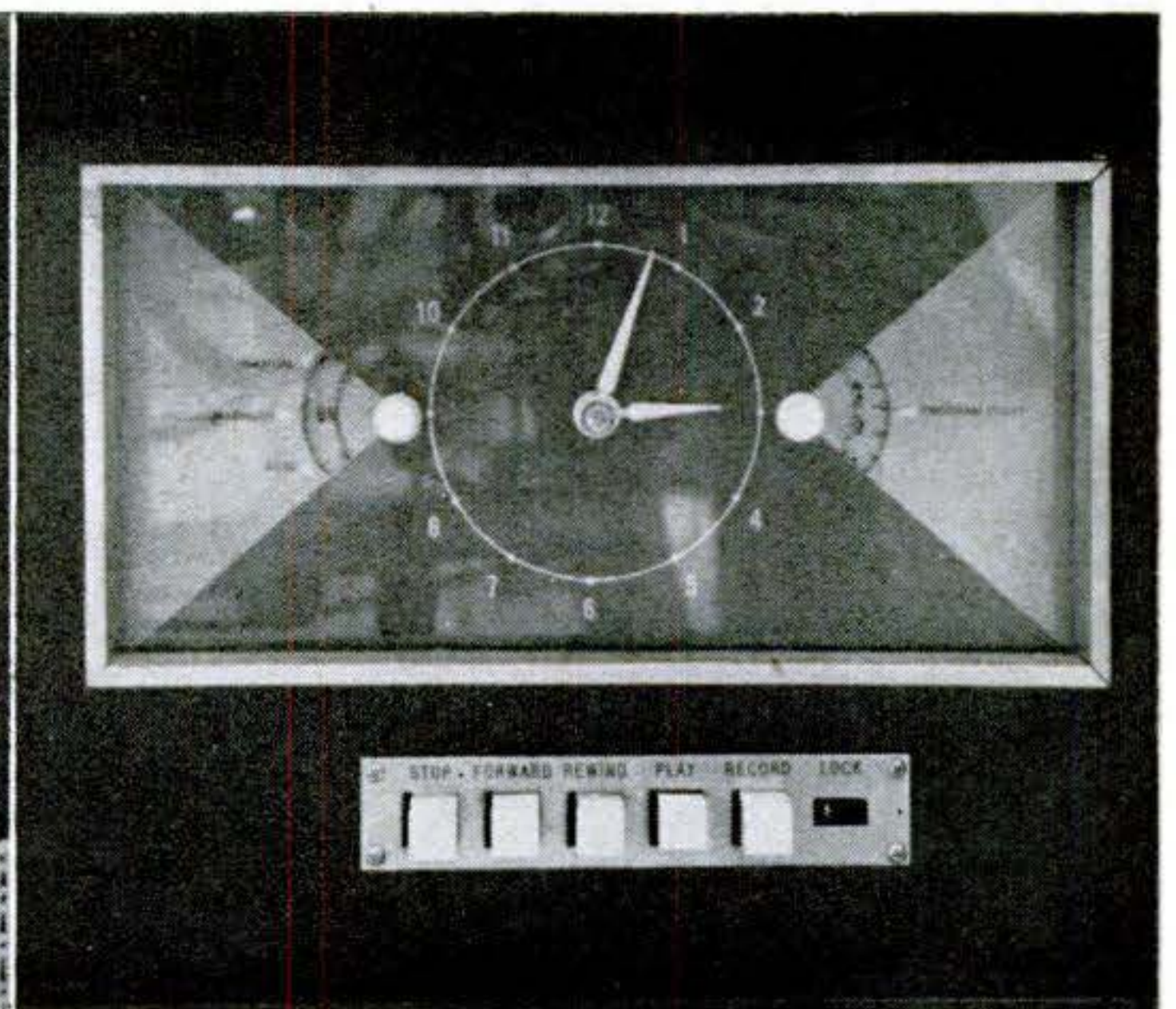

**CLOCK**, like ones on clock radios, automatically turns tape recorder and radio on and off at pre-set times so you can record shows you might otherwise miss. It tells time, too.

tones, two tweeters. Set uses 20 tubes, one transistor, has AM-FM radio, recorder. Price: \$1,600.

**ELECTROSTATIC SPEAKER** that distributes high tones uniformly around room is used by Philco. Changer handles 14 LP records and affords five hours of continuous music. Price: About \$750.

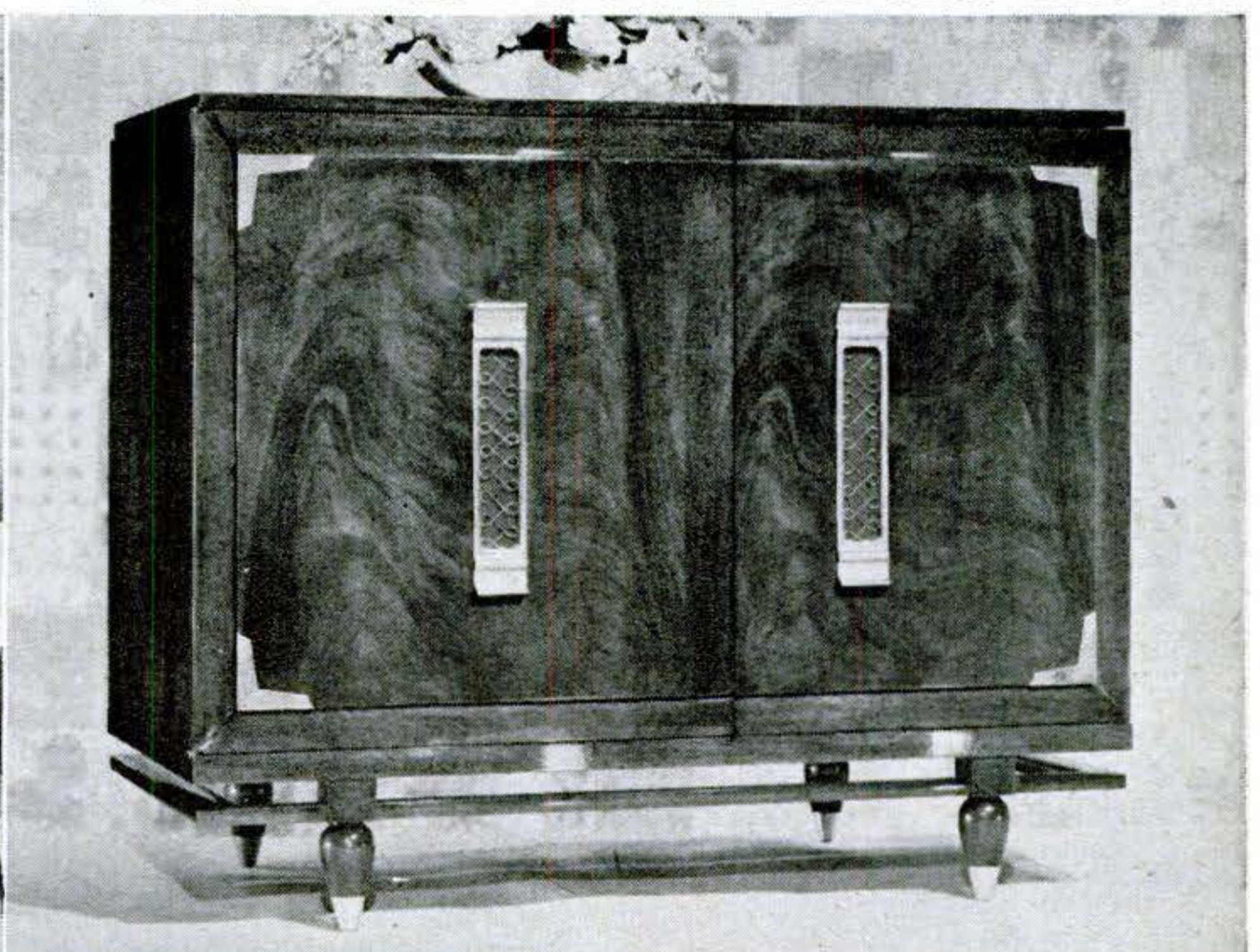



"I know what  
I want . . ."



"I ain't going to stand for  
any tinkering around . . ."

## GUS

By Martin Bunn

"**H**OW much would you charge," Silas Barnstable inquired suspiciously of Gus Wilson, proprietor of the Model Garage, "to put a new clutch in my Ford?"

Gus, who was engaged in putting the usual two gallons of gas in Barnstable's dilapidated Ford, could hardly believe his ears. Silas, well known as the town tightwad, usually scrounged worn parts from a junk yard, and either tried to fix his car himself or hired some teen-age kid to do it for him.

"It's about time," Gus said, hanging up the hose, "that you did something about that chatter when you shift gears. Every time you shift, you're in danger of being thrown out of the rig."

"None of your sarcastic remarks," Silas snapped, peering angrily over the tops of his glasses. "What'll you charge to put in a clutch?"

"Depends," Gus told him, "on what's required. I can't give you a flat price until I check over the job."

"Oh, no you don't," Silas said warily. "I'm on to how you garage fellers work. You poke around and hem and haw, and make believe a lot of things need fixing that don't. Time you get done you've chalked up a bill that's worth more'n the car."

Gus was tempted to tell the stingy





"It's none o' your business . . ."



"I was to get new parts . . ."

## OBEYS ORDERS

old coot that it wouldn't take much of a bill to be worth more than his third-hand Ford. But he refrained from doing so. He made the mistake of trying to reason with Barnstable, making him more suspicious than ever.

"It's this way, Silas," he explained. "You think that you need a new clutch, and from the way your car acts, undoubtedly you do. But I can't be sure until I check it out. This Ford has gone over a hundred thousand miles—loose and worn universal joint, transmission bearings, drive bushings, and even loose truss rods could be causing your chatter when shifting. Even if you do need a clutch overhaul, the price would depend on how many parts I had to put into it."

"Quit beating around the bush," Silas demanded. "Nobody works on my car until I know what it will cost me. If you won't give me a straight answer, I'll take my business somewhere else."

"All right," Gus said wearily. "A clutch overhaul it is. I'll put in an exchange disk, facing and pressure plate, and it will cost you 28 dollars."

**B**ARNSTABLE rose up in his seat like a hooked salmon.

"What d'ya mean—28 dollars!" he yelled. "That's highway robbery."

The cantankerous old codger shifted into low, roared the motor with a clattering of pistons, lifted his foot from

the clutch. The car leaped from the gas pumps with a shuddering and chattering that threatened to shake off its dilapidated, flapping fenders.

"Take his business somewhere else," Stan Hicks said, coming from the grease rack. "I wish he would."

"It takes all kinds to make a world," Gus said amiably. "We might even miss the old man if he didn't come around at least once in awhile."

"Why?" Stan queried. "Occasionally he buys two gallons of gas. In the meantime he fills his leaky radiator and tires with our water and air every day. When he needs oil, he dips it from our waste barrel for free. Most of the bolts and nuts in his old jalopy he filched from our junk box."

"Kind of ingenious character, isn't he?" Gus chuckled. "I wonder who he'll find to put in a clutch for less than 28 dollars?"

Gus didn't have long to wonder. Barnstable made the rounds of the town's garages, and then showed back at the Model Garage, as cantankerous as he ever was.

"I've decided," he



"I'll test it myself."



told Gus, "to let you fix my clutch. But mind you, I'll have my eye on you every minute. So don't try slipping in any beat-up parts."

"I won't," Gus promised. "But you'd better let me check the car over first. It might save you..."

"NOW," Barnstable warned, "don't start trying to hornswoggle me again. I know what I want—just see that you give it to me."

"You're the doctor," Gus said grimly. "Back the car under the chain hoist, Stan—I'll get right to work on it."

Gus hooked the back of the chassis to a split chain, hoisted the rear end high. He got under on a creeper, and lay there awhile, looking up at the bottom of the old Ford.

The clutch, he thought, would really have to work smooth on this baby when he was finished with it to make her take off without any chattering.

"I'll bet every bearing, gear and bushing between clutch and rear wheels could stand replacing," he muttered half aloud.

GUS's mind went back to depression days, when junk heaps in this condition had been common. He grunted as he began to unhook spring, universal joint and other connections.

He backed the rear assembly out from under, put a jack under the rear of the engine, and removed the transmission. He removed the flywheel housing, pricked the flywheel and clutch cover, and eased the pressure-plate tension off carefully by backing off the studs all the way around. Then he removed them and took out the pressure plate and facing disk for closer inspection.

He carried the parts to the bench, with Barnstable trotting at his heels like a suspicious terrier.

"Hm," Gus grunted, wiping a slight bit of moisture from the edges of the parts and smelling it. "You've been squirting gas in here recently."

"It's none o' your business," Barnstable said belligerently. "I'll do as I please with my car."

Gus had a mental picture of Barnstable running around trying to beat down his price, and failing. Then, as a last resort before coming back to Gus, he had squirted gasoline into the clutch in an attempt to wash out grease to stop his chatter. The humorous thing about

this was that there was no grease on the clutch facings.

Gus began to inspect the pressure plate and disk carefully for cracks, burns, warpage and adjustment of pressure-plate springs.

"Now look here, Gus," Barnstable protested. "I was to get new parts. I ain't

going to stand for any tinkering around on these old..."

"All right," Gus interrupted, and moved to draw out an exchange pressure plate and a lined disk from his store in the stock room.

Gus worked systematically to install the parts. In spite of the fact that Silas had insisted that his trouble was caused by a bad clutch, Gus kept his eye open for other easily visible defects, such as loose truss rods and transmission out of line. Gus intended to road-test the completed car, but Barnstable got in it and drove out.

"I'll test it myself," he announced testily as he left with a lurch.

"BROTHER!" Stan Hicks chortled, "I never expected to see the day when Silas Barnstable would pay for a first-class job of repair."

Gus poked thoughtfully at a gob of grease that had leaked onto the floor

[Continued on page 246]



"Well, I wondered where you were gonna find room for that hitchhiker."





**Here's something new:**

## **Fun Furniture for a Child's Room**

**Two Western designers created it to appeal to young imaginations. It's useful, too—and you can build it.**

**T**RYING to put himself in a child's place, a San Francisco architect took a thoughtful look at the furnishings that youngsters have to live with. At first they seemed pretty good.

But soon, from his newly adopted viewpoint, the architect saw that they lacked something important.

They just weren't fun.

Why, he wondered, couldn't beds, toy





**PLAY CONFERENCE** is only one of many uses for this sturdy table and chair set. Triangular chairs fit neatly under the table when not doing duty as forts or trenches. Slots make them easy to handle. When it is laid on its side, the table becomes a doll cradle.



chests, tables and chairs serve their purpose—and be springboards for youthful imaginations besides?

From that idea were born the pieces shown here. Designed by John Garden Campbell and his partner Worley Wong, they were shown at the Golden Jubilee Exhibit sponsored by the Douglas Fir Plywood Association at Portland, Ore., last summer. Kids took to them at once.

“The imagination of a child is a great deal more active and alive than his or-

dinary surroundings encourage,” says Campbell.

**Operation Imagination.** The bunk beds, for instance, aren’t just to sleep in. The steps can become firemen’s ladders, Jack’s beanstalk, or the limbs of an apple tree such as Dad climbed as a kid.

Shallow rooflike structures (Campbell calls them tumblers) serve as tricycle ramps. Two tied together become a tent or garage; three, set on edge, are a spaceship or a submarine conning tower.





**STACKED TOY CABINETS** become cliffs or skyscrapers; in single tiers, store counters or cowboy corrals. End compartments house trailer trucks. Middle one has door on each side (it's fun to pass things through or, with an accomplice, to make them disappear).



Toy-storage boxes make fine frontier forts (or, in a quieter vein, store counters). Two doors in each open on the same compartment—handy when play calls for a ticket window or ship's porthole.

The husky four-seat play table has a broad, nontipping base. But it can be turned on its side for fun. The triangular chairs snug in under the table when not used as king-size building blocks.

**Keep them simple.** The designers specify plain, solid colors except for a

couple of rings painted around the holes in one tumbler.

"The usual stuff in stores," says Campbell, "allows for no imaginal play. If it is a car, it's a car; if a train, it's a train, usually with too many gaudily painted details. Don't overdo decoration—youthful imagery can draw in the right props faster than you can shake a brush."

You can build these pieces from inexpensive fir plywood in time for Christmas. Glued joints assembled with screws



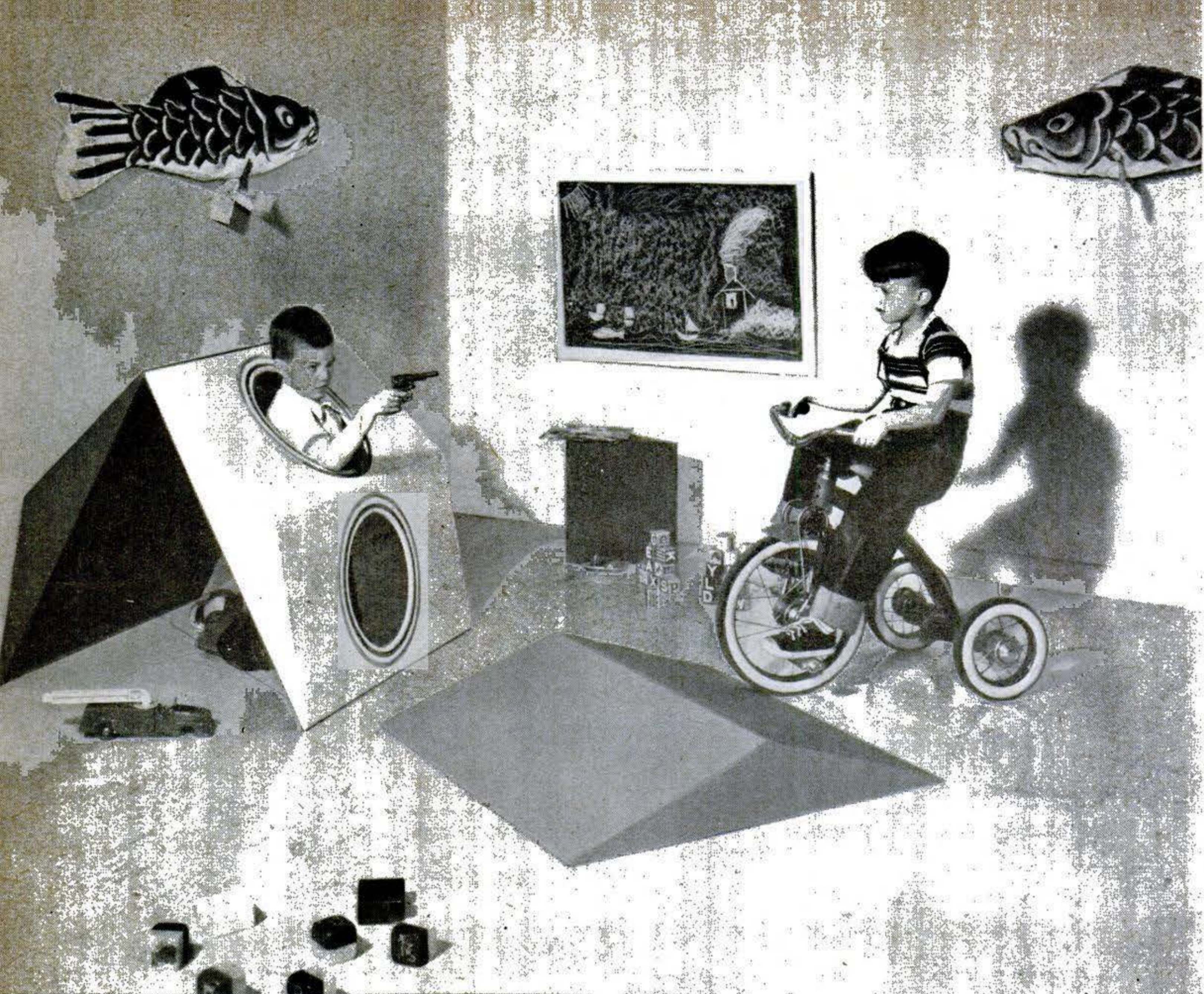

**KIDS GET ACTION** with these low ramps, whether it's swooping down them on a tricycle or defending a fort (which doubles as a tent or a garage). Set three units on edge, tie on a triangular cover, and youngsters can take off for space or a deep dive under the sea.

or nails make construction easy. Counter-sink or set such fasteners, fill over them, and sand smooth. Apply resin sealer to close the grain and two coats of enamel.

**Toy boxes.** Three parts can be cut in pairs: the top and bottom, the large side-pieces, and the two partitions. If you groove the latter for the shelf, be sure to slide it in before you nail on the sides (or, instead of grooves, you can use cleats nailed to the partitions).

Apply glue to all joints and assemble them with finishing nails, setting them below the surface. Cut doors  $\frac{1}{8}$ " smaller each way than their openings. Piano-type (continuous) hinges are recommended, but cabinet hinges will do. In-

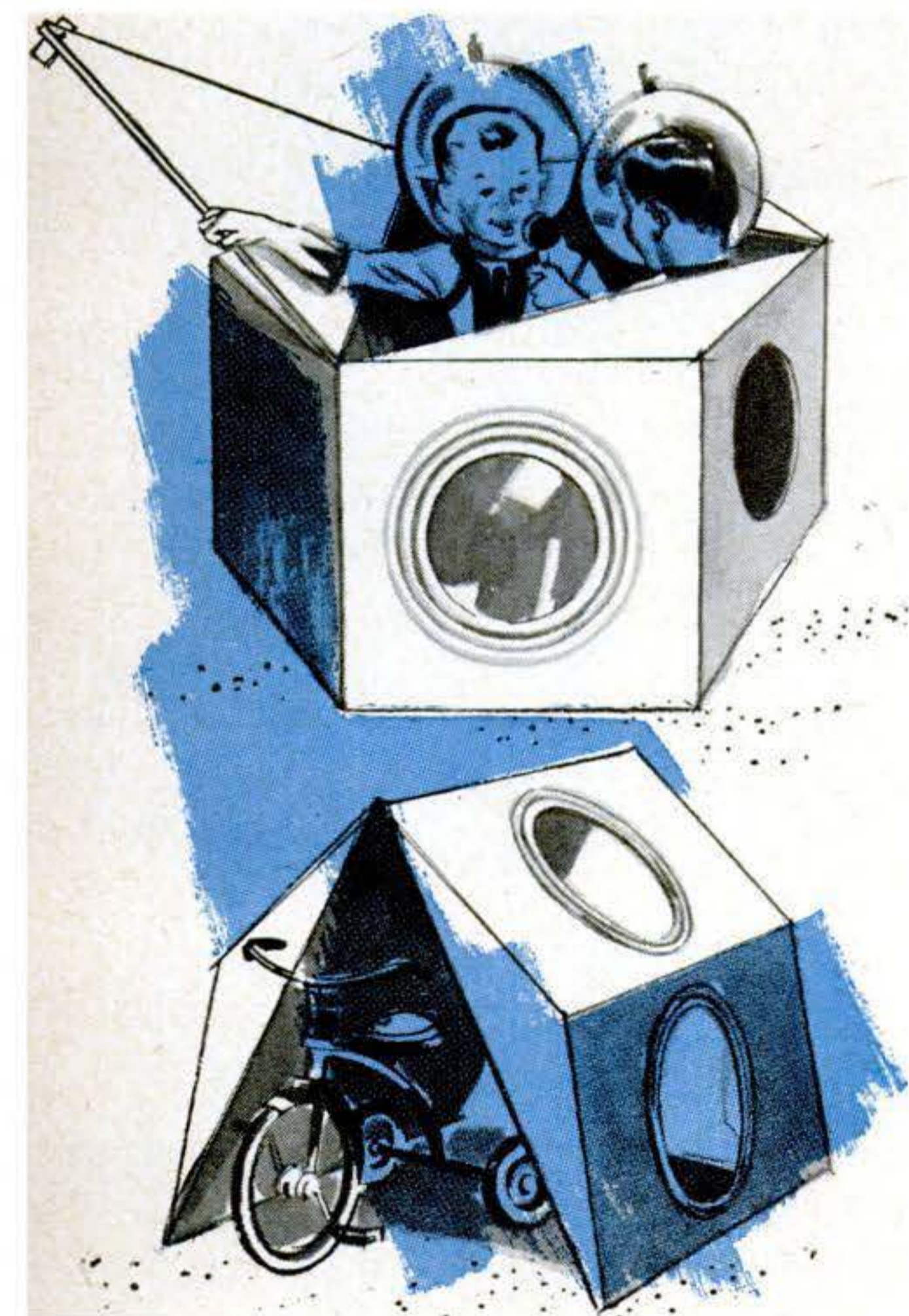



**TOY CABINETS** should be strong enough to take a lot of pushing around, so make them of  $\frac{3}{4}$ " plywood. The shelf is shown set into grooves, but can be fastened to cleats screwed to the inner partition walls. Cut the two front doors so that both overlap the partition between them by about  $\frac{3}{8}$ ". Be sure to fill holes in the plywood edges before finishing.

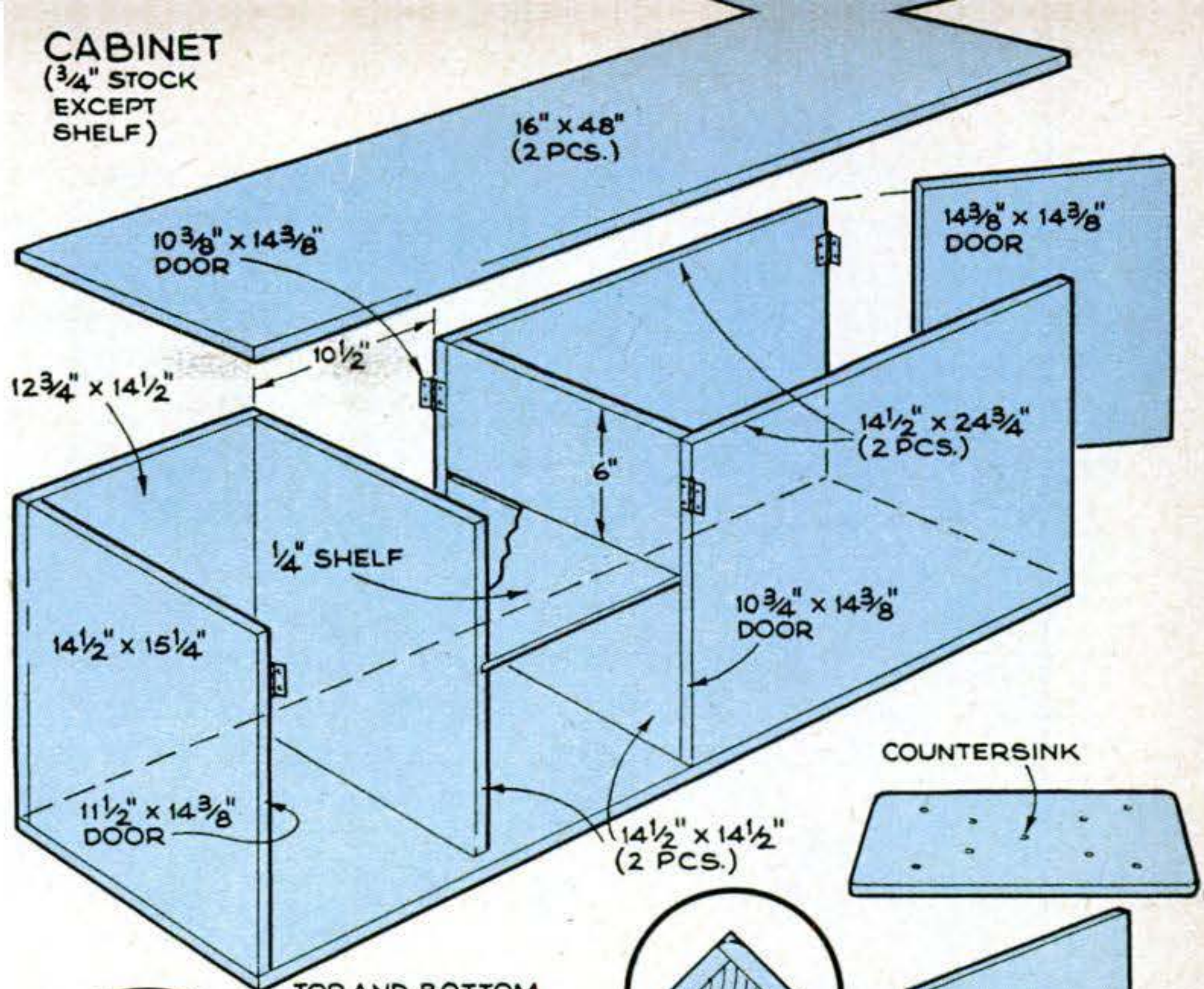

**TUMBLER RAMP**  
( $\frac{3}{8}$ " EXTERIOR PLYWOOD)

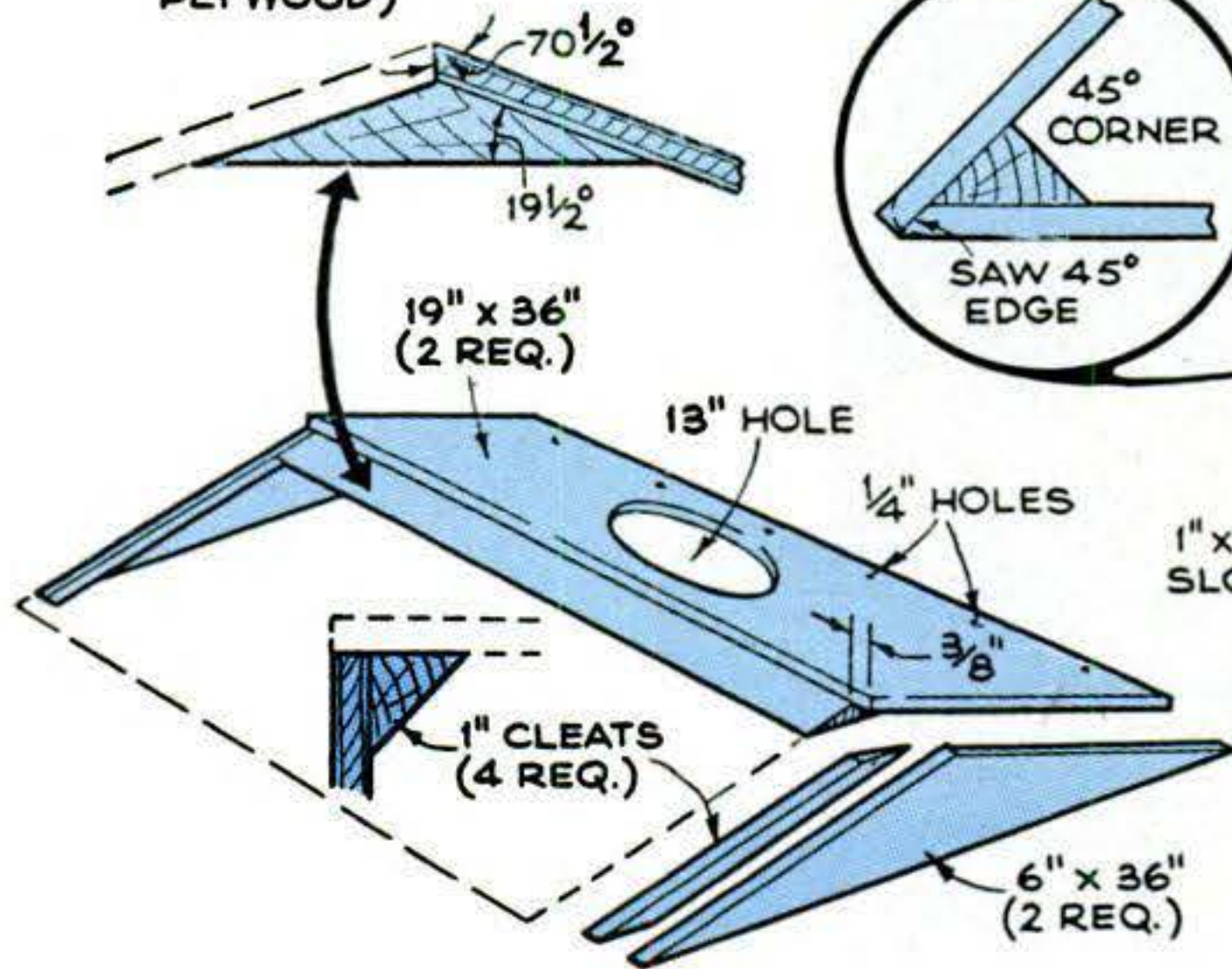

TOP AND BOTTOM  
 $\frac{1}{2}$ " PLYWOOD  
 $13\frac{1}{4}$ " x  $18\frac{3}{4}$ "

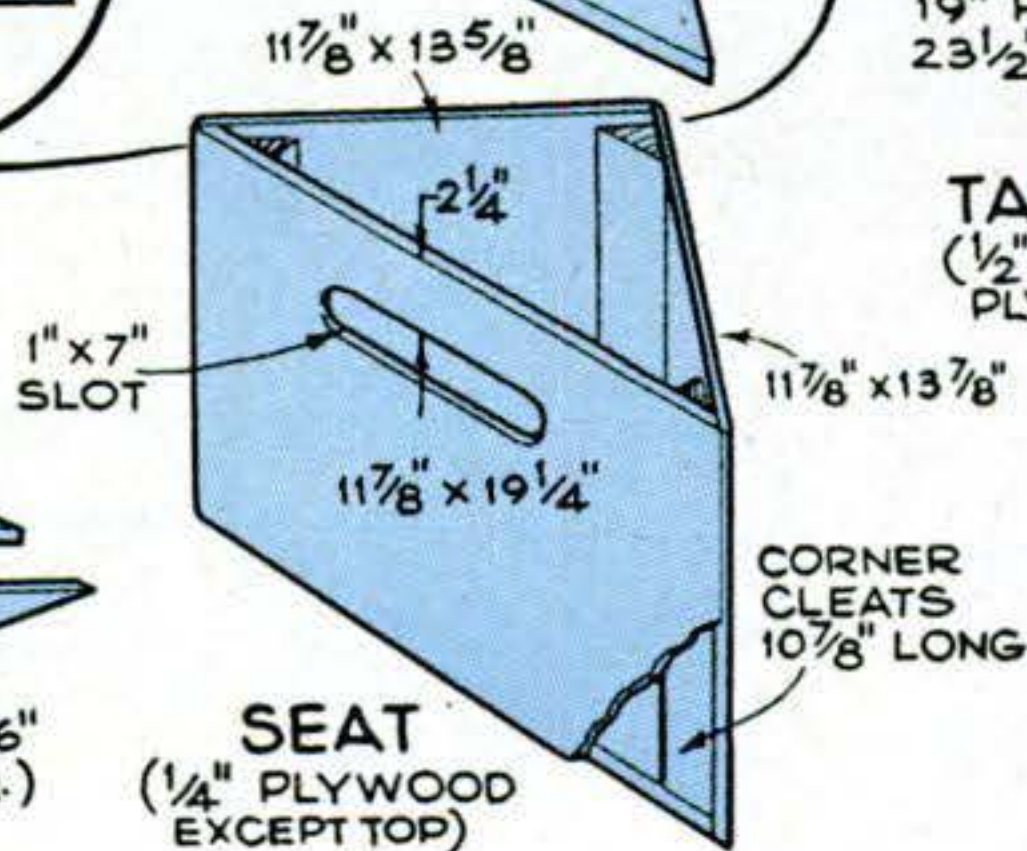
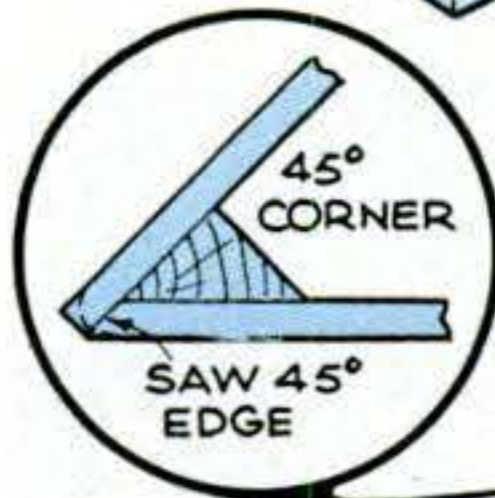

UPRIGHTS  
19" HIGH  
23 1/2" WIDE

**TABLE**  
( $\frac{1}{2}$ " FIR PLYWOOD)

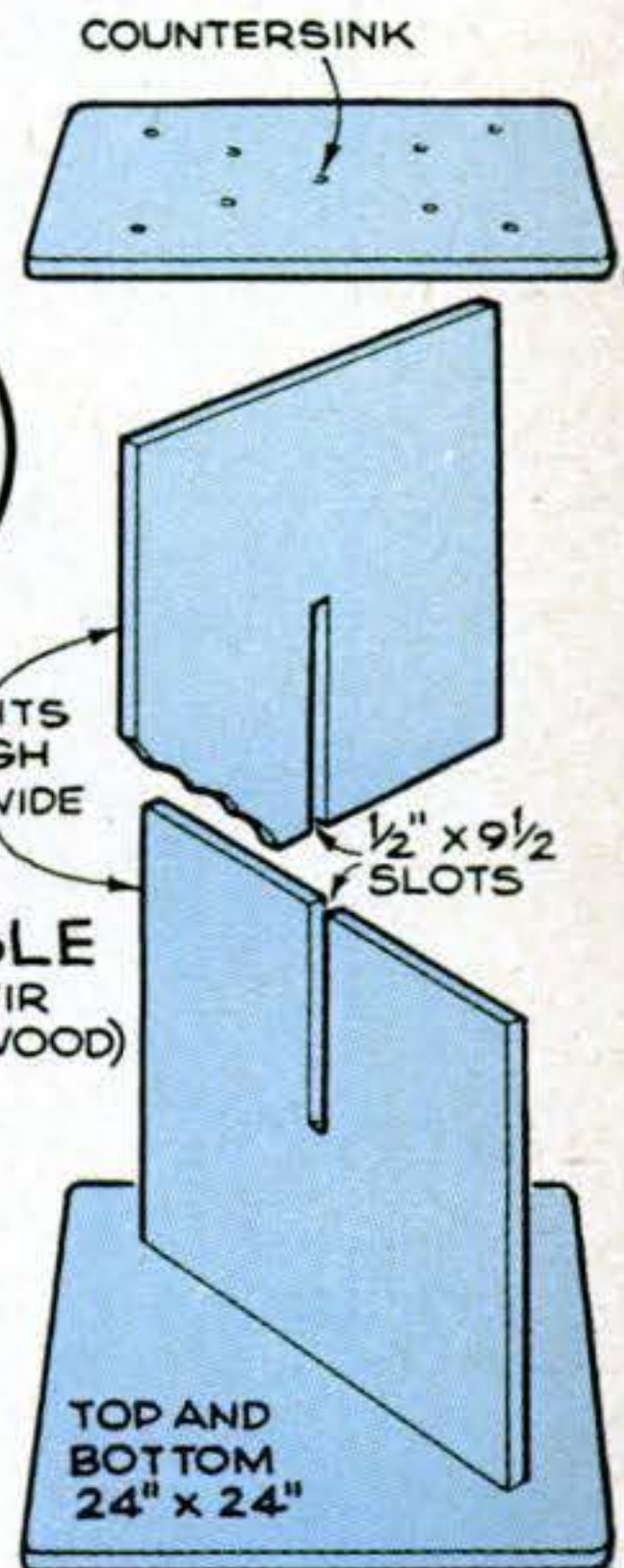

**WATCH YOUR ANGLES** to make good joints along the ridge. Set endpieces in flush with edges of the short panels. Cut "portholes" in one ramp.

**TO ASSEMBLE CHAIRS**, nail the slotted panel to the bottom and to two 45° cleats. Then add the short sides and the 90° cleat.

stall catches to keep the doors shut and gliders to make the boxes easy to slide.

**Table and chairs.** Cut the table top and base as nearly 24" square as you can get from a 4' panel. The table uprights are also one size. Be careful to cut the slots along the shorter (vertical) dimension. Lay out diagonals on the top and base before rounding the corners. Drill and countersink four holes on each for screws to go into the uprights.

Chair height is held to 11 7/8" so that four pieces can be cut across the width of a 4' sheet. Saw the short edges of the large side at 45°. Bore 1" holes at the ends of the slot and cut between.

One of the short sides is longer than

the other, which it overlaps at the 90° corner as shown in the drawing. Rip a two-by-two on the diagonal and use one piece as the cleat in this corner. Rip the other piece in half again to make 45° cleats for the other corners.

Cut all corner cleats 1" shorter than the height of the sidepieces so that the top and bottom, cut from 1/2" plywood, will drop in flush. Assemble with glue and six-penny finishing nails. Round off the corners with sandpaper after the glue has set.

**Tumbler ramps.** Better make these of exterior plywood—the kids will haul them outdoors at times. Saw one long edge of each panel at 70 1/2° to join along the ridge



piece. In the middle of both panels for one ramp (assuming you make two or three ramps) cut a 13" hole.

Make the ridge piece from a one-by-six. Rip a  $19\frac{1}{2}^\circ$  bevel from each edge. Cut this piece short so that the end-pieces set in flush with the panel edges.

Rip the triangular side cleats from 1" stock, cutting both ends at an angle to fit. Glue and nail all joints. Drill  $\frac{1}{4}$ " holes 6" apart along both outer edges so that the units can be tied together.

**Bunk beds.** Cut all parts except the rails and cleats from  $\frac{1}{2}$ " plywood. The foot end is a whole 3'-by-6' panel. Lay out ladder holes beginning  $1\frac{1}{2}$ " from the top and 10" from the bottom, spacing them 6" apart except the second from the top.

You can cut these with a saber saw

or electric-drill attachment or by boring holes at opposite corners of each and cutting out the middle with a keyhole saw.

The mattress panels are cut from 4'-by-8' sheets. Rip a  $\frac{1}{2}$ "-by- $\frac{1}{2}$ " groove in 2"-by-4" stock; then cut two 36" end rails and four 79 $\frac{1}{4}$ " side rails. For the front rails of the mattress frames, rip stock 2" wide and rabbet it as in the drawing.

Before gluing and screwing the frames around the mattress panels, notch the side rails from beneath to take  $1\frac{5}{8}$ "-square cleats. Glue and screw these on the side uprights 16" and 61" from the bottom. To the foot end fasten similar 36" cleats at the same heights.

Bore holes through the rails and cleats. Use carriage bolts with wing nuts to assemble the beds, and you'll be able to take them down for moving or storage. END

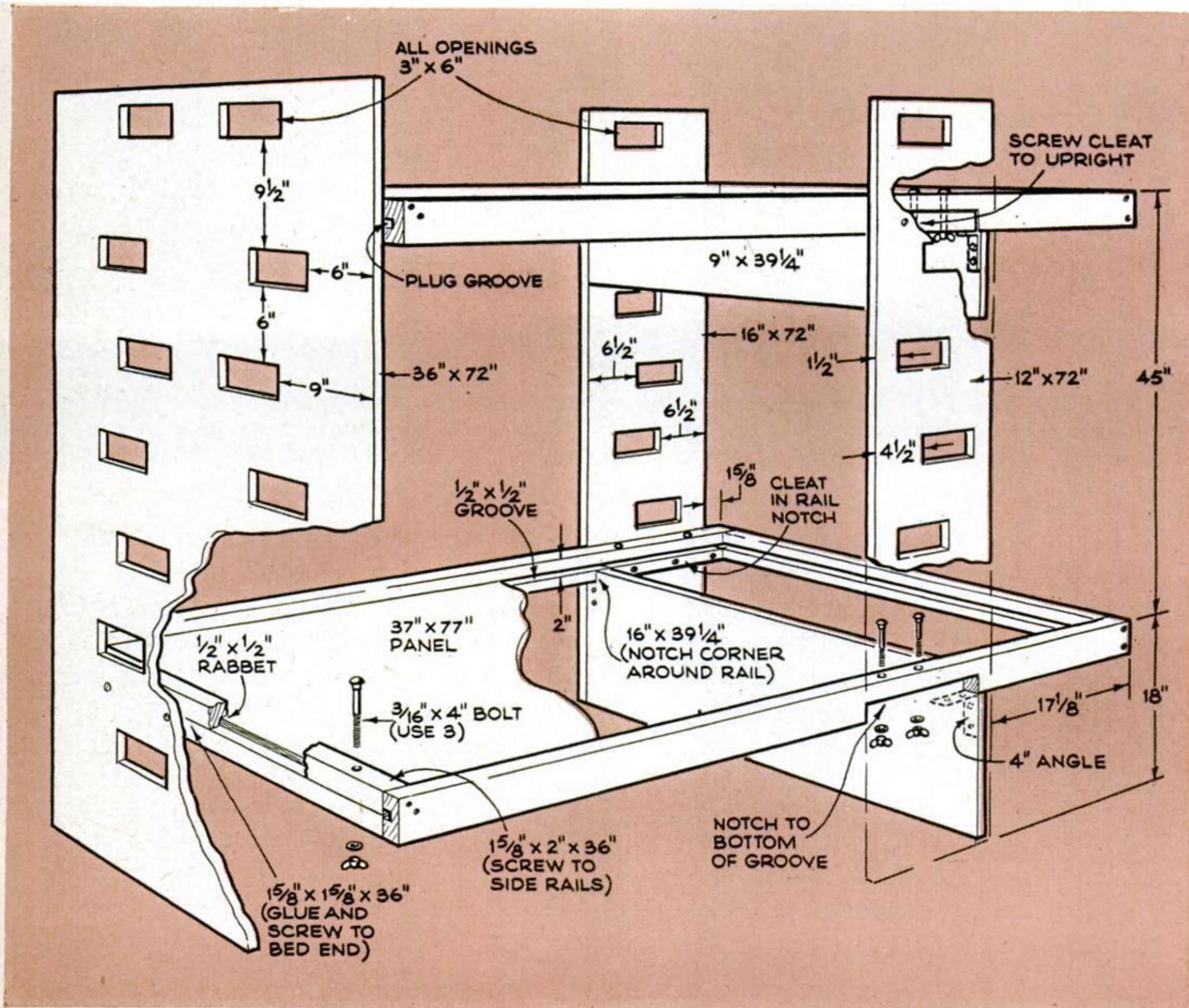

**STAIRWAY TO ADVENTURE.** A welcome take-off to dreamland, these steps may lead to a spaceship, the bridge of a carrier, or even a secret cavern in the cliffs of "Planet X." Make the

top and the bottom mattress frames alike. Two cross panels join the front edge of the 16" upright at one corner with the rear edge of the 12" upright, which is set forward.



## Move Speaker to Help Sound

PLACING a speaker near the audience may improve the sound of 16-mm. movies by cutting down reverberations. In extreme cases, try putting it right down in the audience. —C. L. Anderson, Burlingame, Calif.

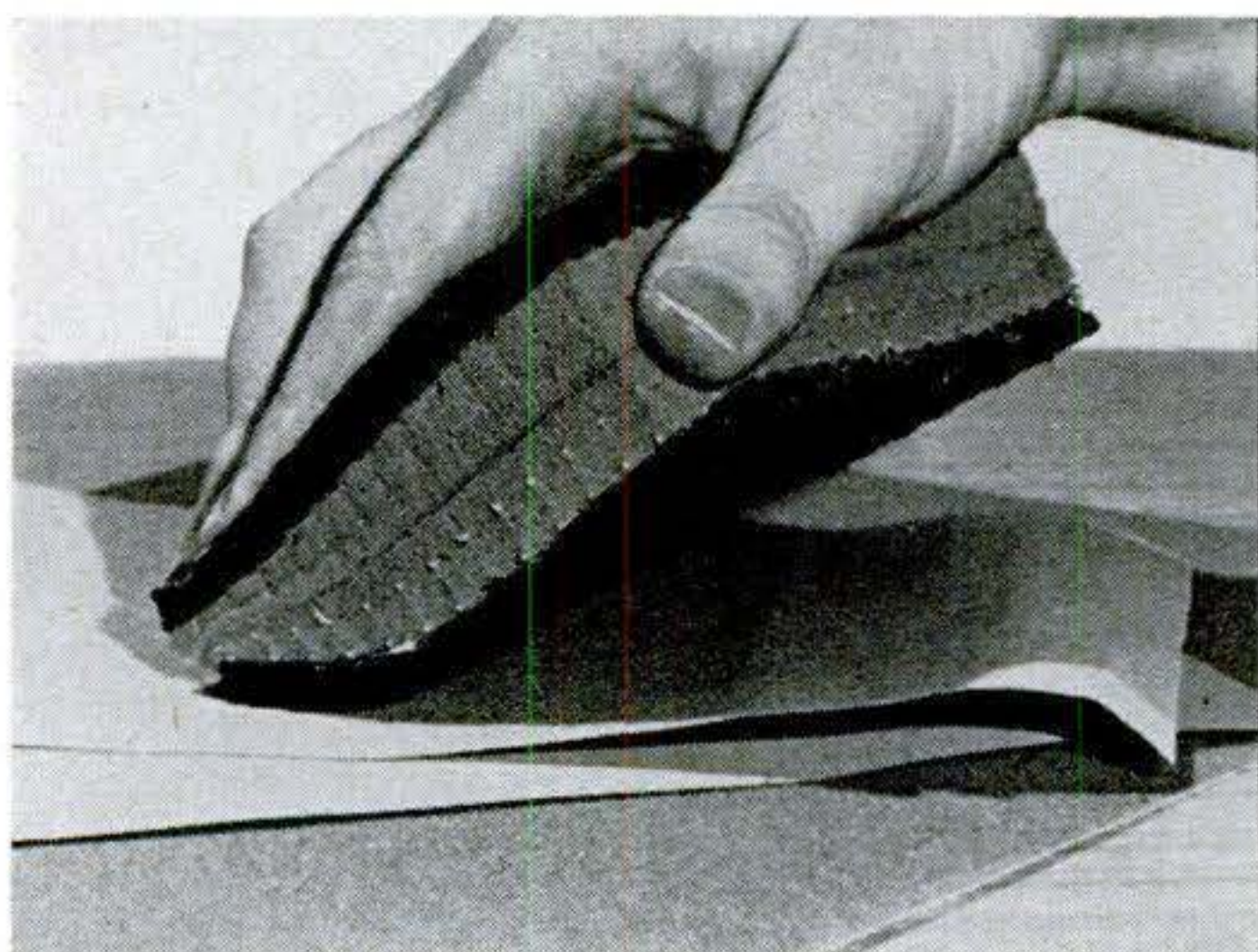
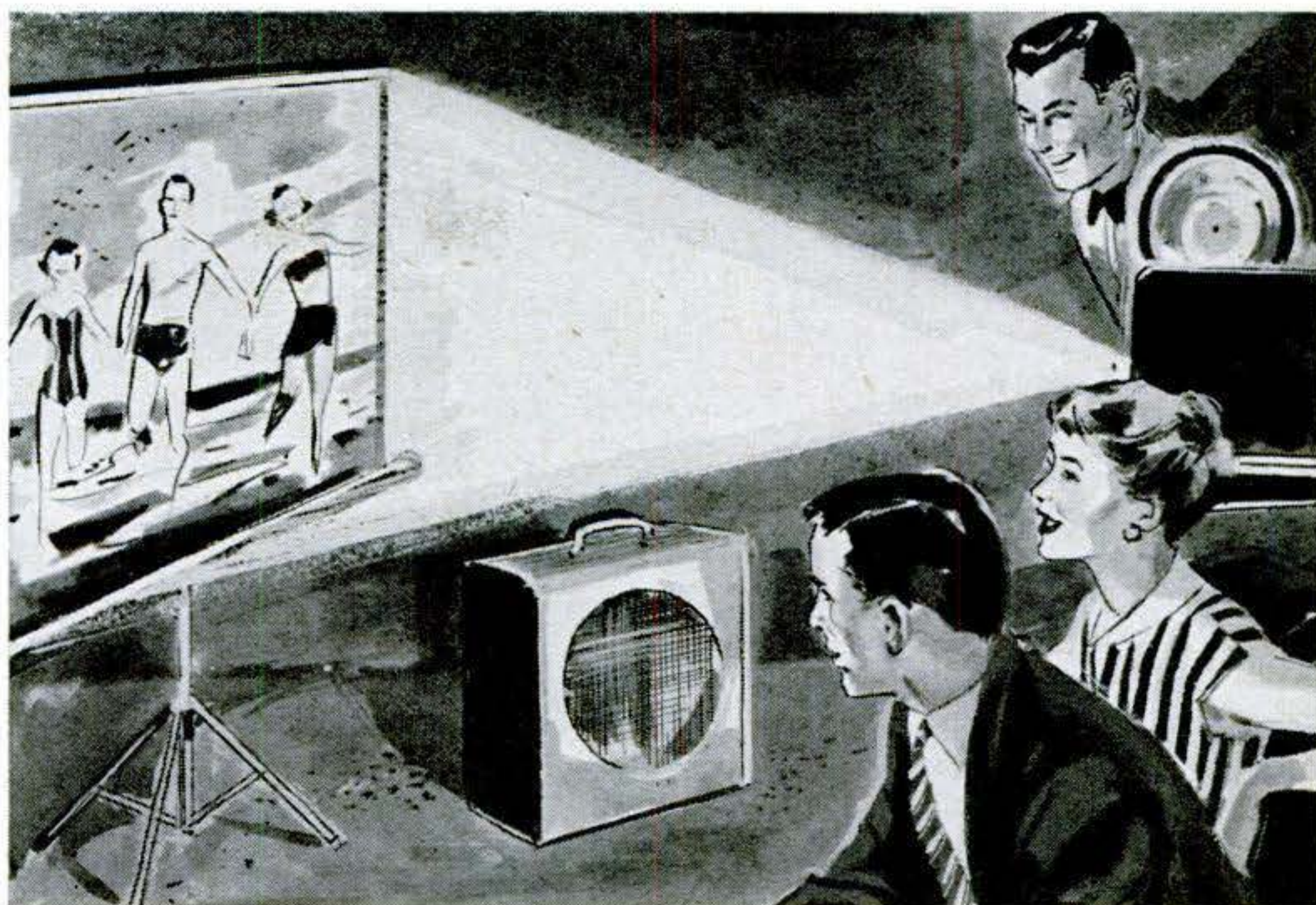

## Rubber Block Sands Curves

Two small pieces cut from an old rubber kneeling pad make a flexible contour-sanding block. Glue the pieces together back to back with ordinary rubber cement.

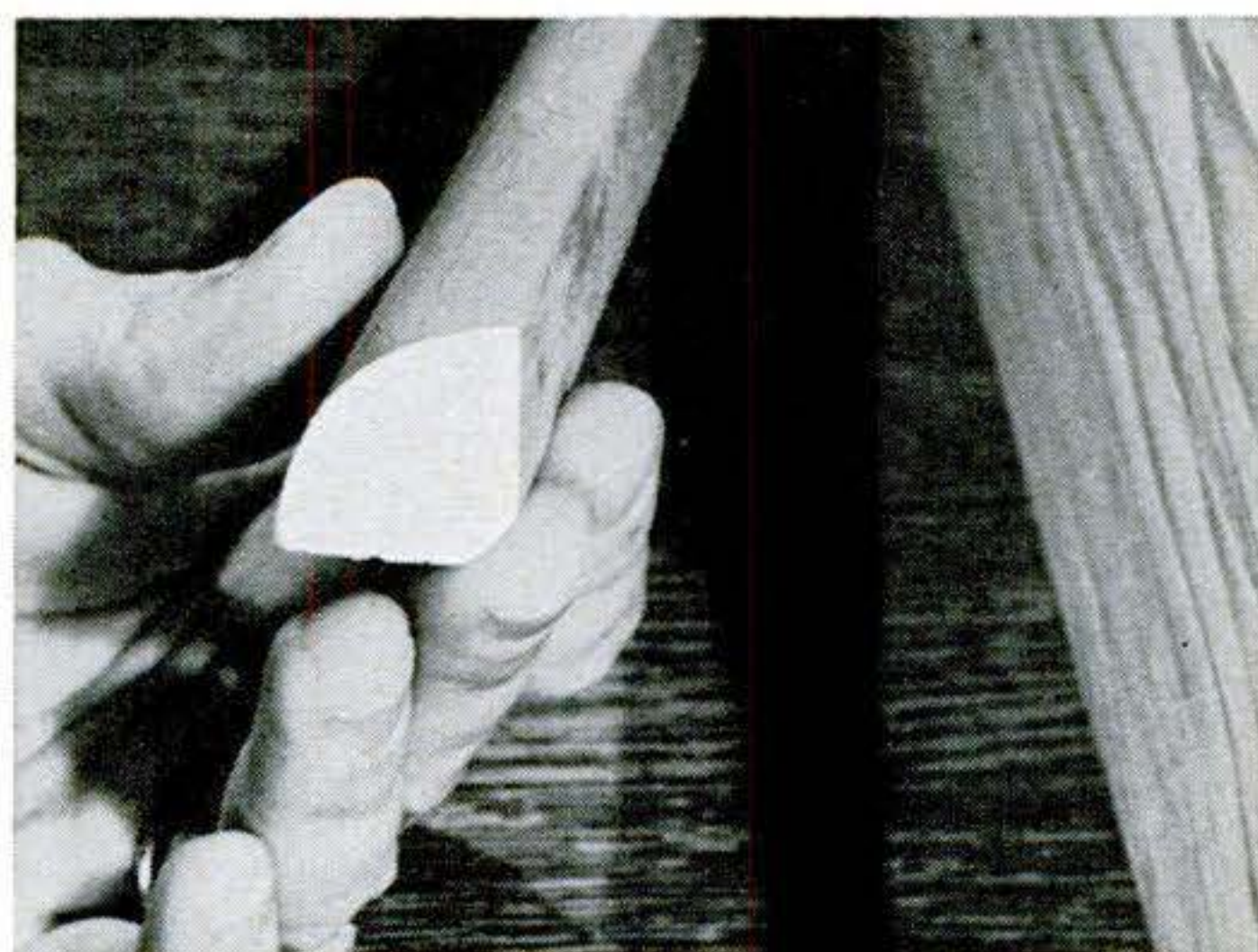

## Chamfer Sets Molding on Ridge

FLOOR-SANDING machines usually skip edges, leaving little ridges near the baseboards. To fit new molding over such a bulge, chamfer the inner corner of the stock.

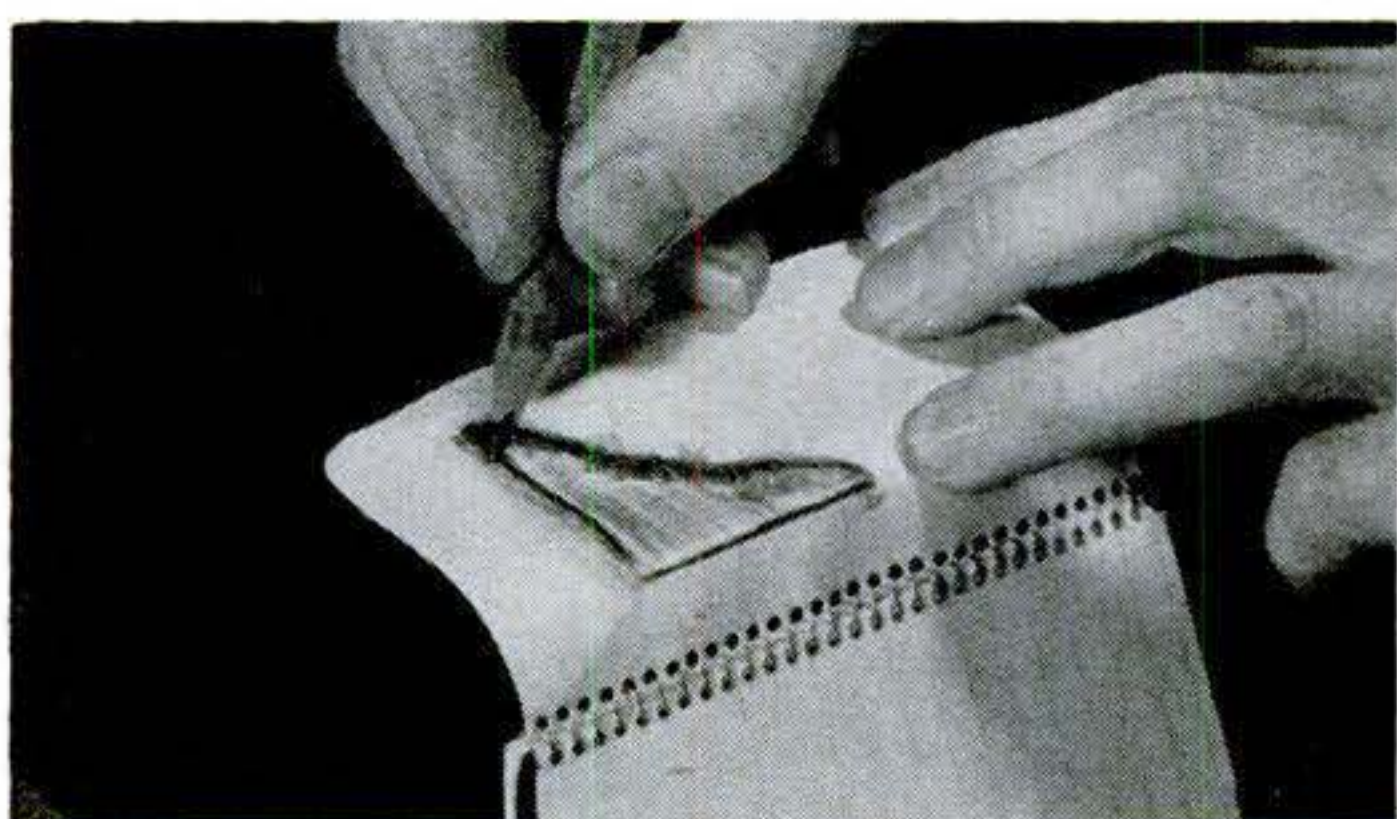

## Rubbing Helps Match Fitting

MATCHING a fitting is easy if you have an exact pencil rubbing to take with you. Lay a piece of paper on the fitting and rub over it with a soft pencil. —Walter E. Burton, Akron, Ohio.

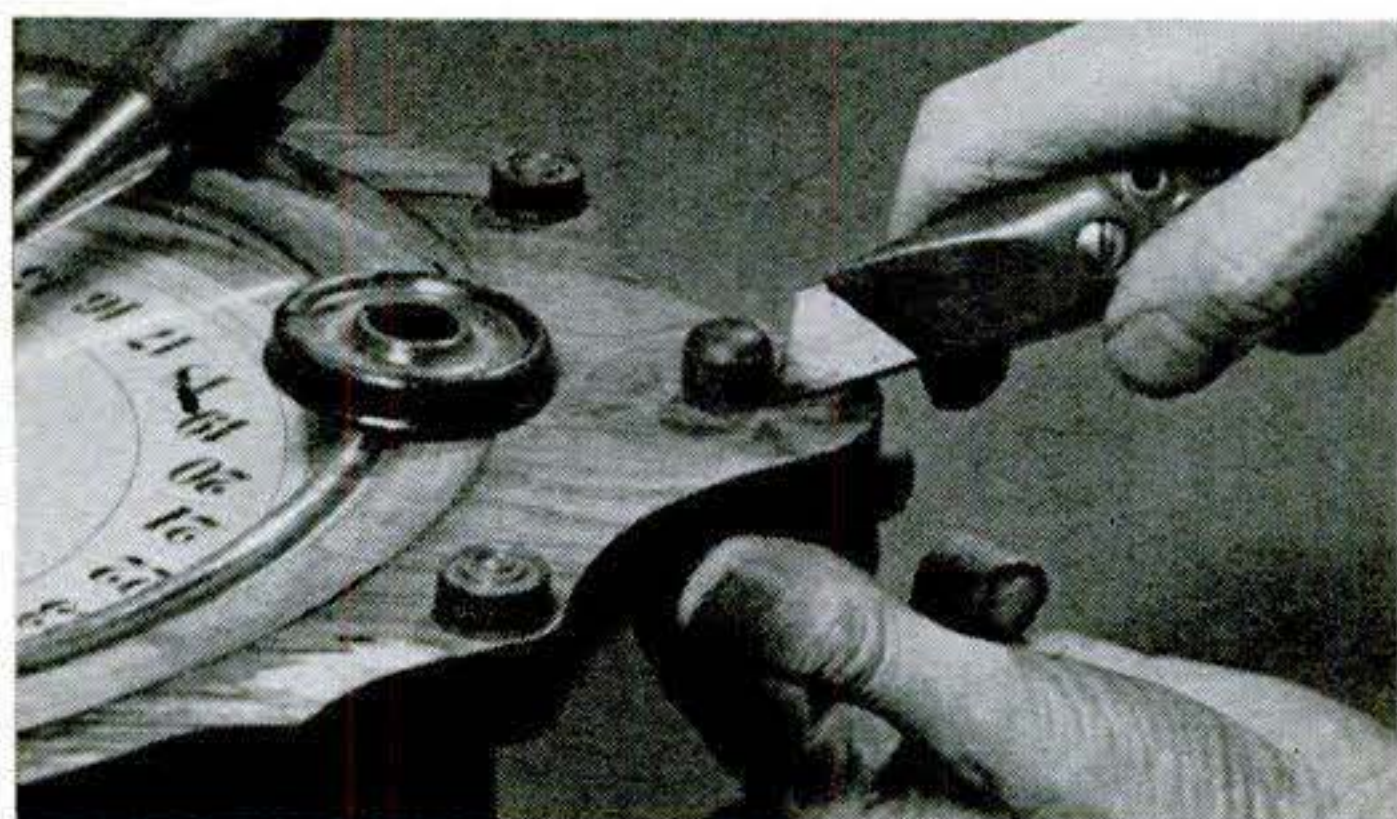

## Old Veneer Repairs Itself

TINY bits of veneer needed to patch an old clock or antique can be cut from under a button, molding or other decoration on the same piece. Be sure to cut away only as much as the decoration covers.



# New for the Handy Man

## 1. Marble Table Is Precut.

Screw the legs into a composition-wood base (inset), lay on the marble slab and you have a marble-top coffee table, 22" by 41" by 15". The legs come in various wood finishes or in brass, and extend either flared or straight.

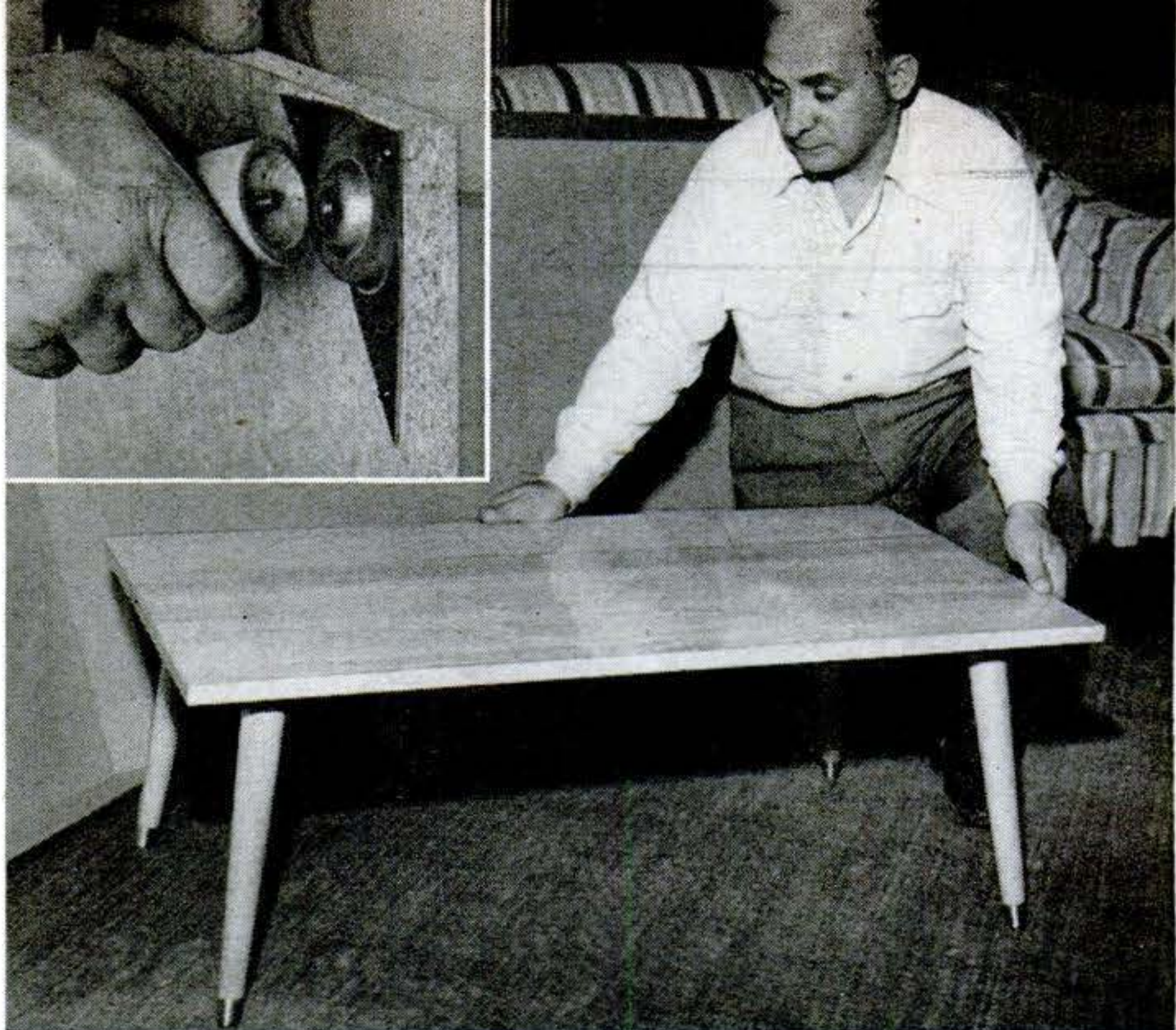

## 2. Tape Holster Fits on Belt.

Save wear on your pockets by carrying a fabric or steel tape in a lightweight holster that slips on your belt. The holders take 1/2"-by-8' and 3/4"-by-10' tapes. They're made of cowhide and riveted for extra strength. The opening makes it easy to pull the tape out for immediate use.



## 4. Putty Fits Sash.

The triangular opening of this tube releases putty shaped to fit right into the angle between a window sash and the glass. It holds 150" of putty and comes separately or with a kit that includes the putty knife and glazier's points.



## 3. Storm-Sash Catch Lets in Air.

Flip open this storm-window catch and it pushes out the sash for a breath of air, yet braces it securely against winds. Closed, it holds the window tightly under tension, like a trunk latch. An extra half bracket is included for a screen sash so that it can be used with the same sill section.



## 5. Kit Reproduces Colonial Table.

For the first time, Colonial Williamsburg offers a kit from which you can build an exact facsimile of an 18th-century table that was once used in the Wythe House there. The table has a maple base and pine top. It is 24" high, 22" wide and 16 1/2" deep. It comes ready for assembling and finishing.

Further information on the products shown on this page can be obtained from: 1. Fred. Rolla Marble Works, 1251 Riverside Dr., Los Angeles; 2. Bauer-Lee & Co., 140 E. Montecito, Sierra Madre, Calif.; 3. Treco Products Co., Inc., Bayport, Minn.; 4. Goodell Co., Main St., Antrim, N. H.; 5. Colonial Williamsburg Craft House, Williamsburg, Va.



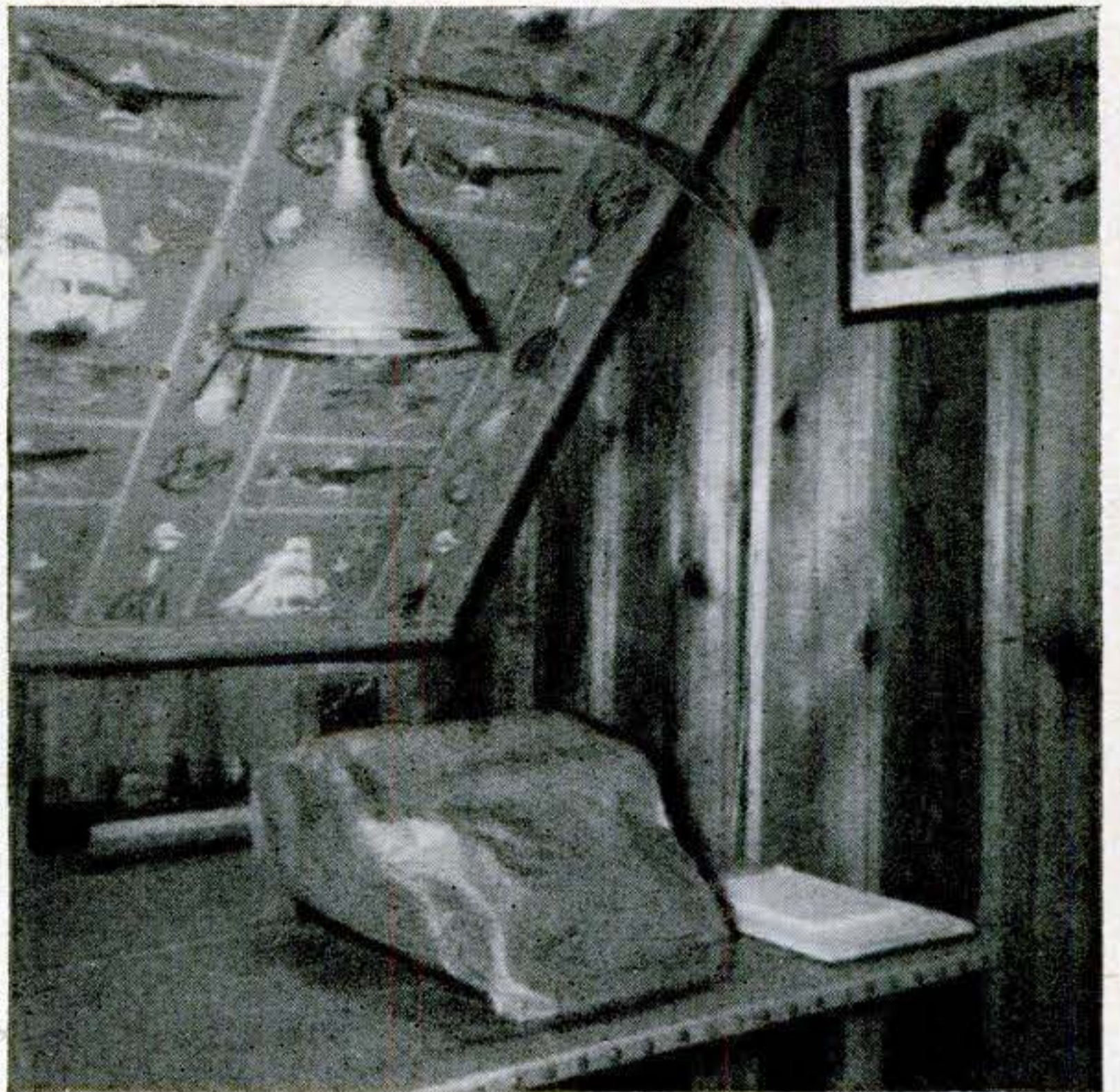
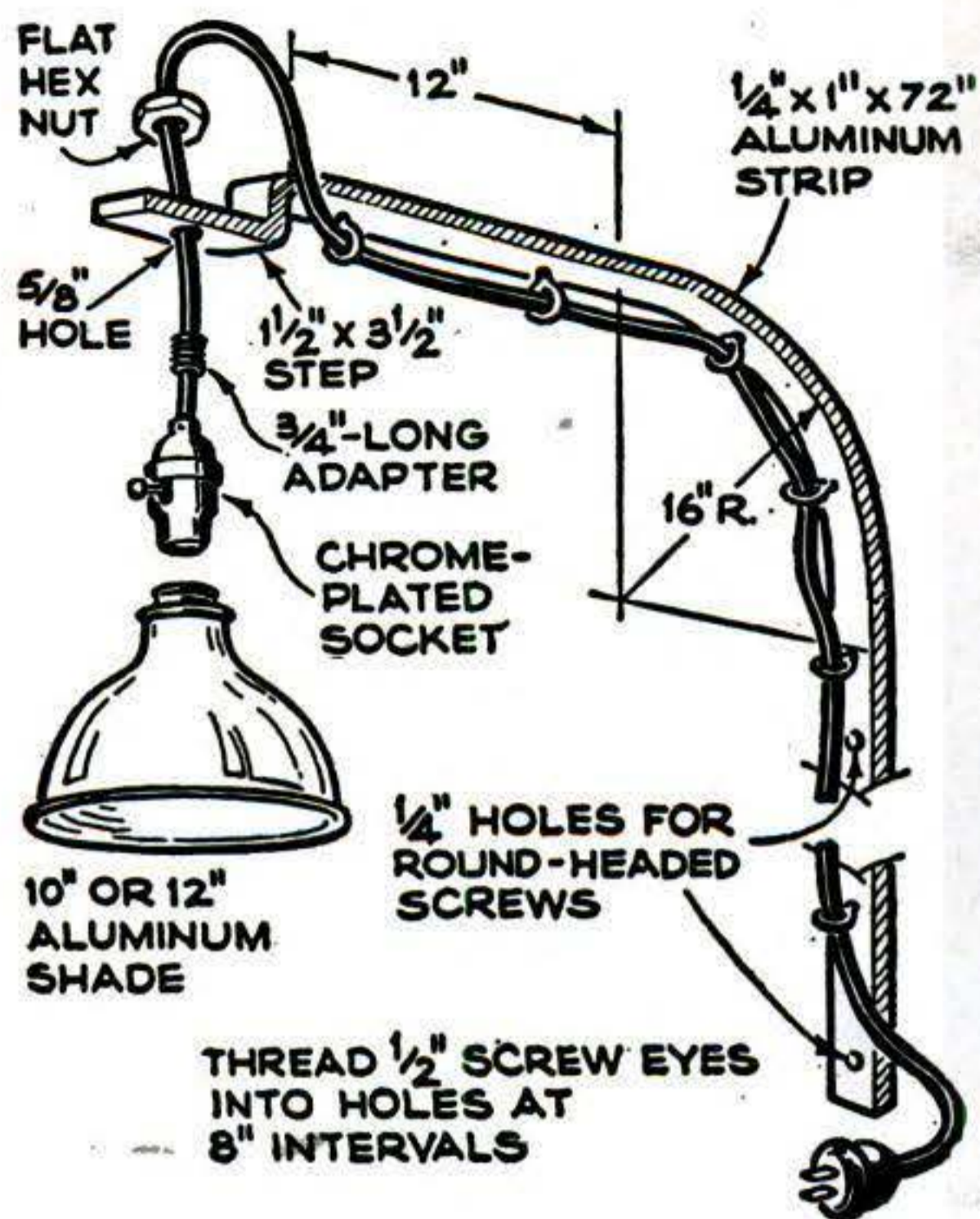

## You Can Make This Overhead Aluminum Lamp in an Evening

A STRIP of aluminum, a light socket and an old photo reflector make this attractive study lamp for a den or child's room. Bend the bracket from a 6' length of  $\frac{1}{4}$ "-by-1" aluminum. Drill seven undersize holes for  $\frac{1}{2}$ " screw eyes at 8" intervals, starting 1" back from the step that supports the socket. Thread the screw eyes into the soft metal, then back them out and file off the tips so that they will not project beyond the metal when they are reinserted.

Drill a  $\frac{5}{8}$ " hole through the center of the step for a  $\frac{3}{8}$ " pipe nipple. Thread half of the

nipple into the socket, pass the other half through the hole in the step, and secure it with a flat, hexagonal nut. Thread the cord through the screw eyes and down through the nipple to the terminals in the lamp socket. Use a chrome-plated socket, to harmonize with the aluminum bracket and the photo reflector.

Fasten the bracket to the wall with round-head screws passed through  $\frac{1}{4}$ " holes drilled through the aluminum. For a firm grip in plaster walls, use small toggle bolts.—*Wyeth Kidwell, Willoughby, Ohio.*

## Painted Screen Shows Figures

You can form neat figures for house numbers by filling in spaces in ordinary wire window screen with opaque lacquer or paint. Placed in front of a light-colored background or illuminated panel, the painted-in screen numbers will show up brilliantly.

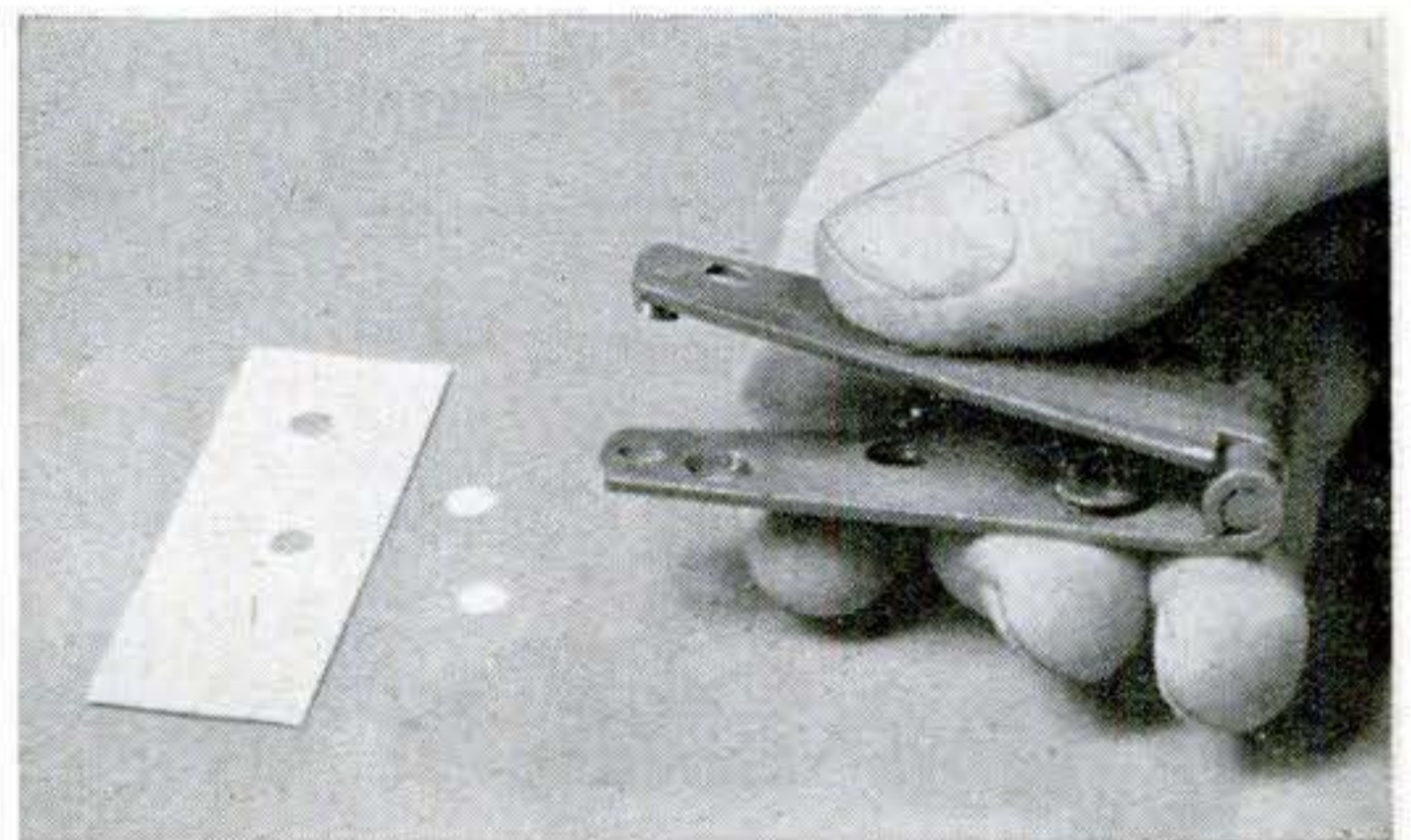
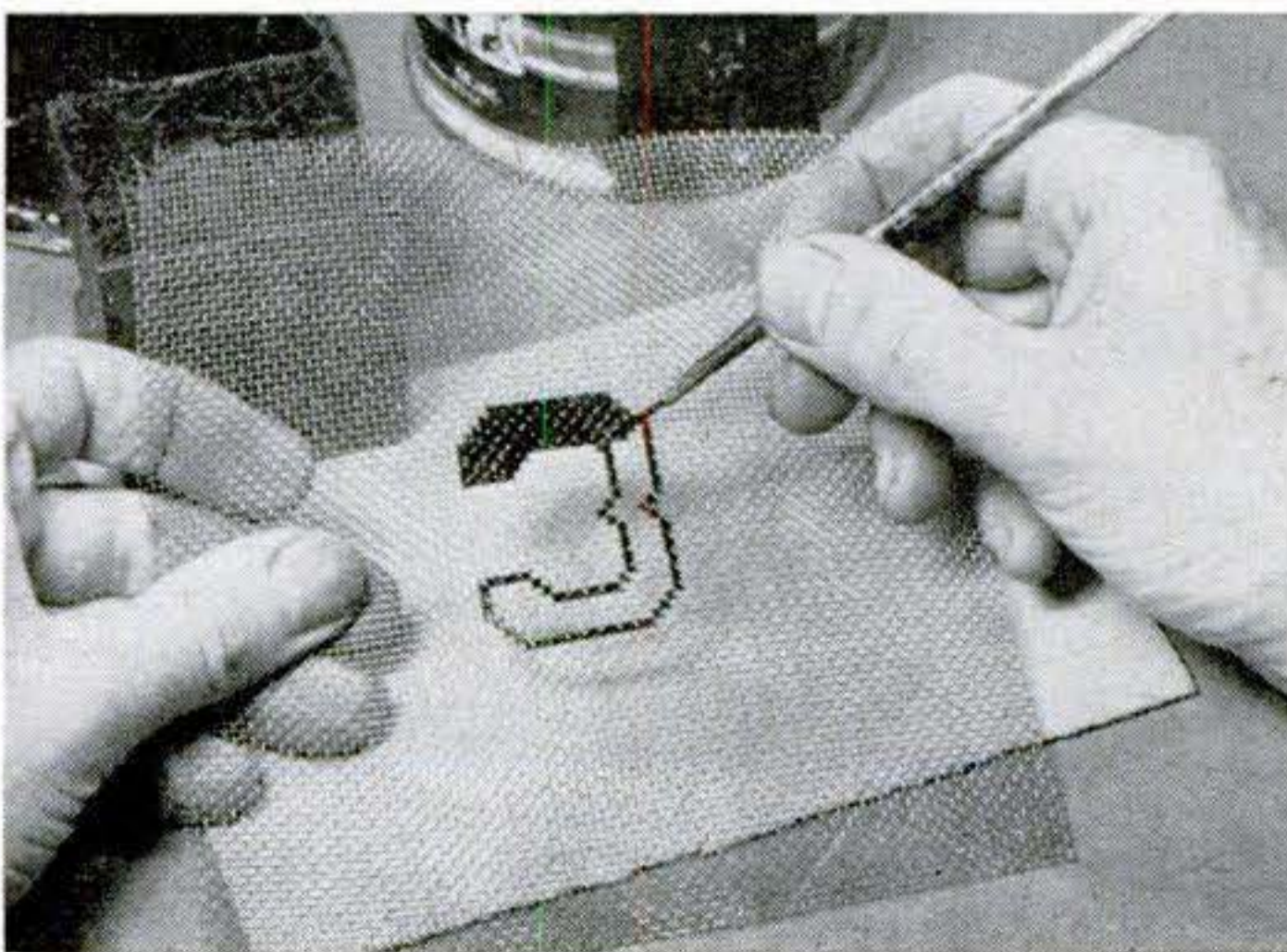

## Strap Hinge Packs a Punch

MAKE YOUR OWN eyelet punch from a strap hinge. Drill holes through the tips of both leaves and drive a piece of drill rod tightly in one. Hammer the hinge loops to pinch the looseness out of them. To form self-opening jaws, rivet a short compression spring to one leaf. File the remaining hole smooth.—*Walter E. Burton, Akron, Ohio.*





# How to build

*A top designer shows you how to combine  
new cabinetmaking tricks with old, for  
furniture your family will treasure.*

**By Frank Dorr**





# good furniture

**I**N THE picture above you see a dining room of superior furniture—the kind that stores unblushingly tag at \$1,000 or more. But you can build these pieces with home shop tools.

Created especially for POPULAR SCIENCE MONTHLY by an outstanding young designer-craftsman, Martin Stan Buchner\* of Whippany, N. J., the table, chairs

and server show what makes good furniture good.

They look good. Their spare, light style is today's classic, carrying forward the great heritage of Early American and Shaker furniture makers. They will make

\*Martin Stan Buchner, winner of many design awards, is a founder and leading member of the New Jersey Designer-Craftsmen, a group fostering good contemporary design. His Buchner Co., furniture designers, is at Route 10, Whippany, N.J.



a proud display in any home of taste—already the PSM server has been exhibited at the Museum of Art in Newark, N. J.

They are structurally good, built solid for practical everyday use by you and your children and possibly your children's children. The chairs fit you. The table holds rock-steady while you carve the roast. The server, with unique doors that glide at a touch, is efficiently compartmented for dining needs.

The PSM furniture meets one more requirement: construction that knowing amateurs can duplicate. Buchner built these pieces with power tools common to most well-equipped home shops. He used a bandsaw, table saw, drill press and portable drill, plus ordinary hand tools.

**Take the chair,** which is detailed here. (We'll tell you how to make the table and server in following issues.)

The chair back is curved—for comfort and appearance but even more for

**Chair-making starts with these drawings**

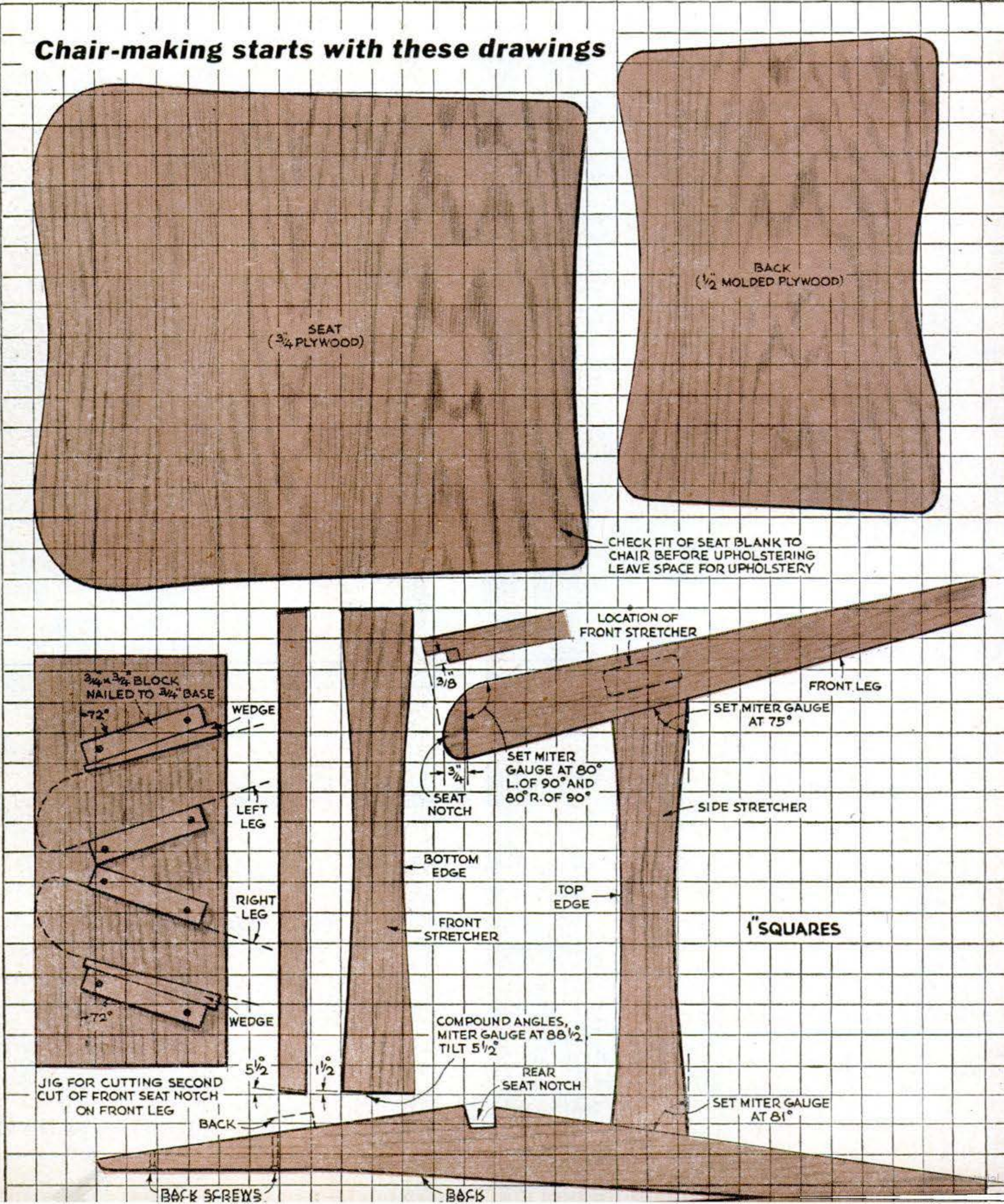



strength. It is so strong that it is joined to the uprights by just four screws.

You mold this shape yourself, using a simple technique—borrowed from the aircraft industry—as new as the chair design itself. It will prove useful for many other shop projects.

You start with  $\frac{1}{8}$ " three-ply plywood (which bends readily), glue four blanks together, and clamp this sandwich in a jig Buchner has devised (shown in the photos and drawing below). The result

is homemade  $\frac{1}{2}$ " plywood, curved to the shape you want.

The  $\frac{1}{8}$ " plywood is widely available in a variety of woods. However, if you can't find just what you want to match the solid legs and stretchers, you can add veneer facings to the chair back. You do this in the same way and with the same jig as shown for veneer-face plywood. It will take more time, though, and calls for careful handling of the delicate veneer.

Take a close look at the chair seat and

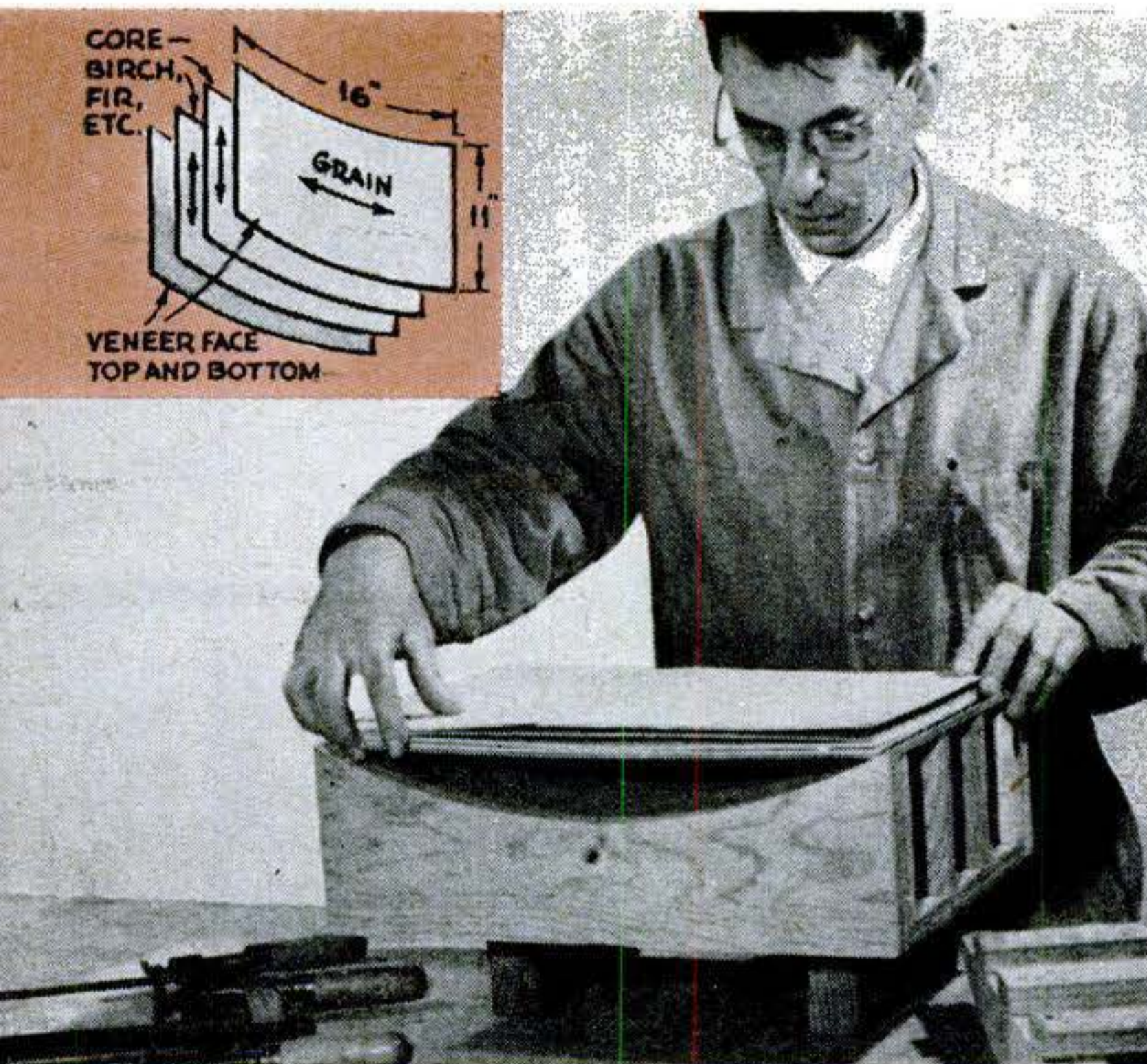

**HERE'S HOW YOU MOLD PLYWOOD:** Cut  $\frac{1}{8}$ "-plywood blanks oversize. Apply resin glue (such as Weldwood or Cascamite) to the surfaces with a notched spreader. Stack the blanks with the grain of the outer veneers running in

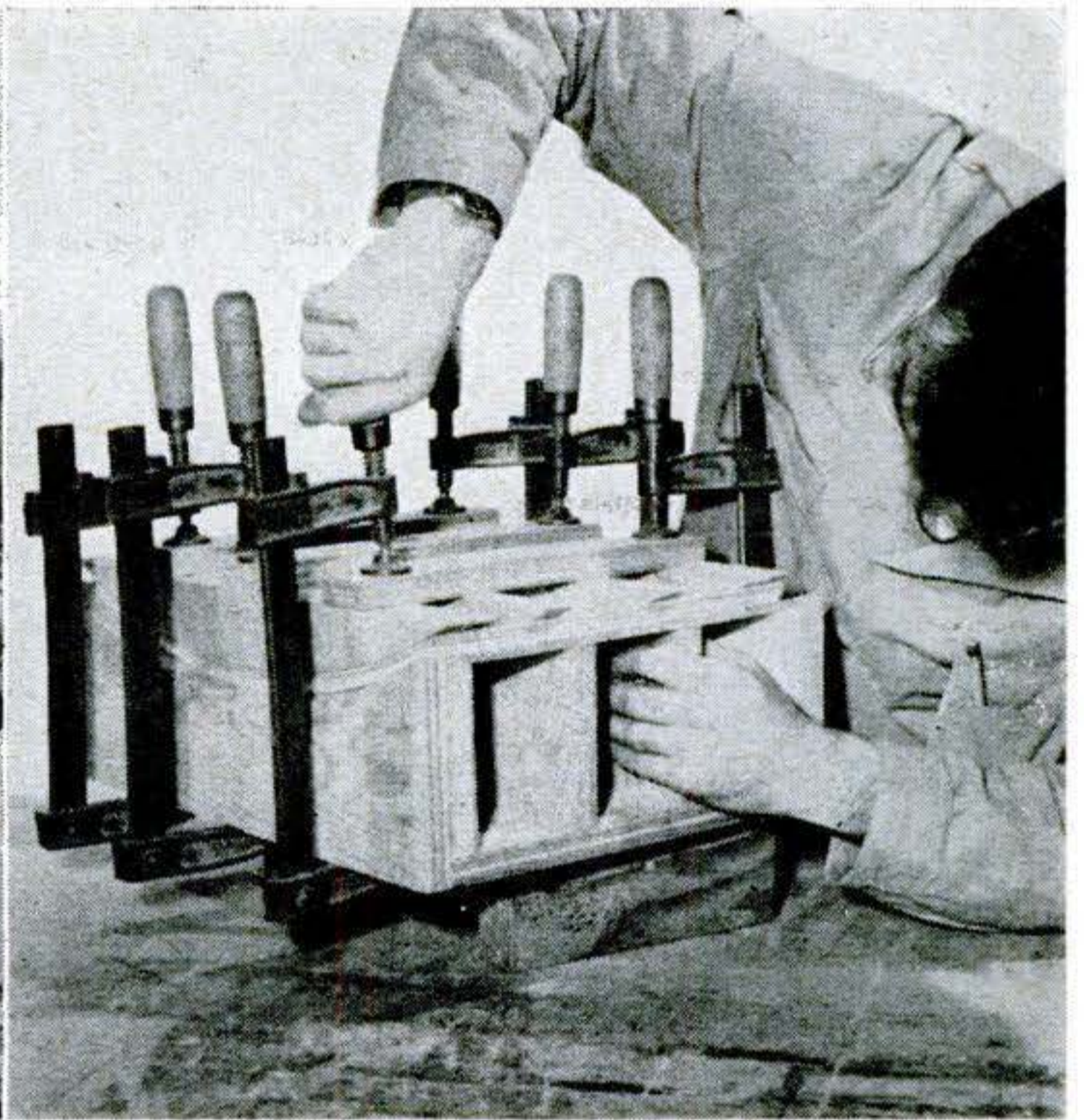

line with the desired curve, and the grain of the inner blanks at right angles. Sandwich the assembly between two protective sheets of scrap plywood and clamp it in a bowed jig overnight. Once the glue sets, the shape is permanent.

**JIG FOR THE CHAIR BACK** is made from  $\frac{3}{4}$ " plywood scraps. For mating curves, stack and nail uprights together and make one bandsaw cut.

**LAY THE CHAIR-BACK PATTERN** on the concave face of the molded plywood to trace the outline. Use a medium-fine jigsaw blade for the cut.

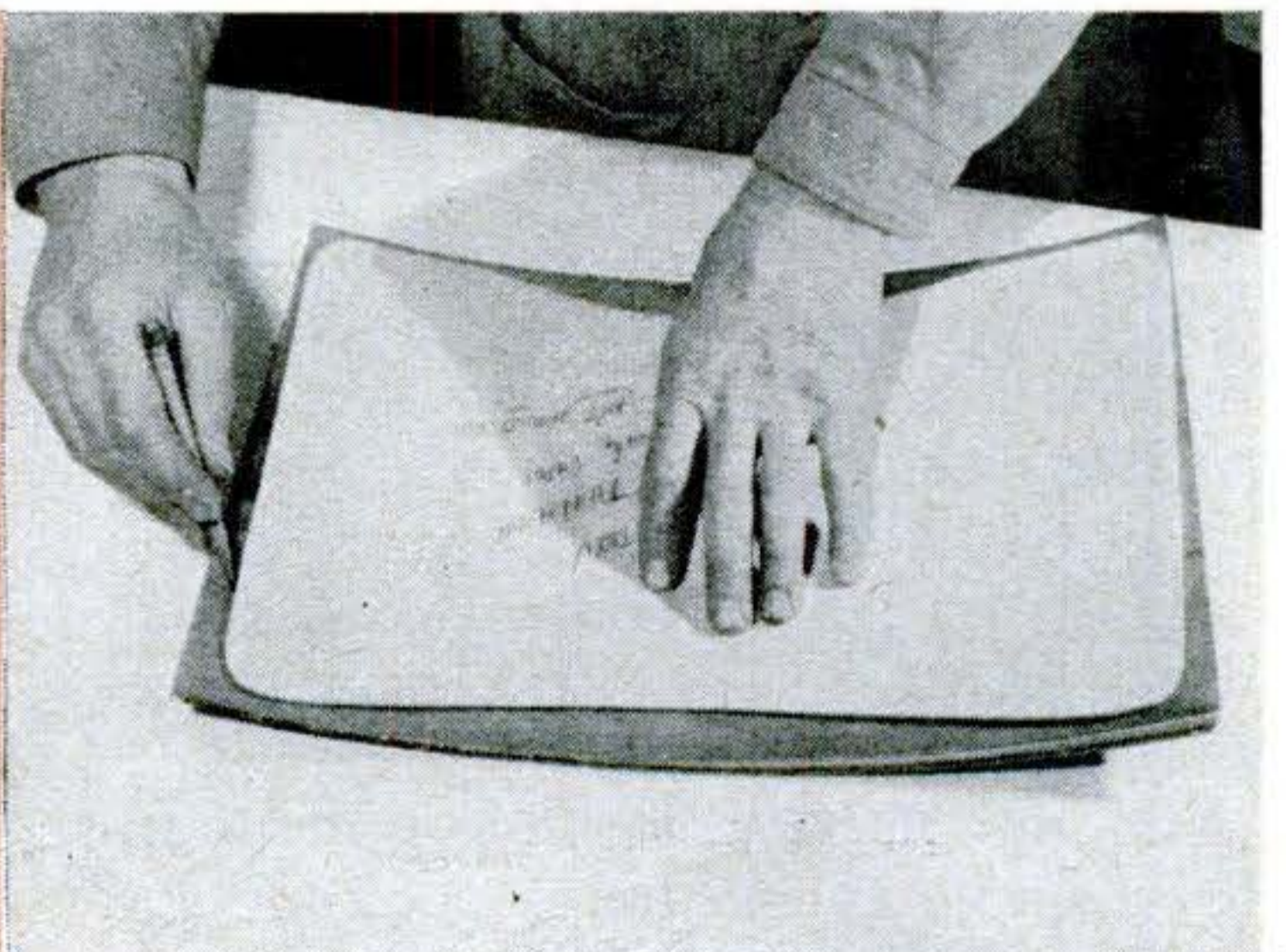
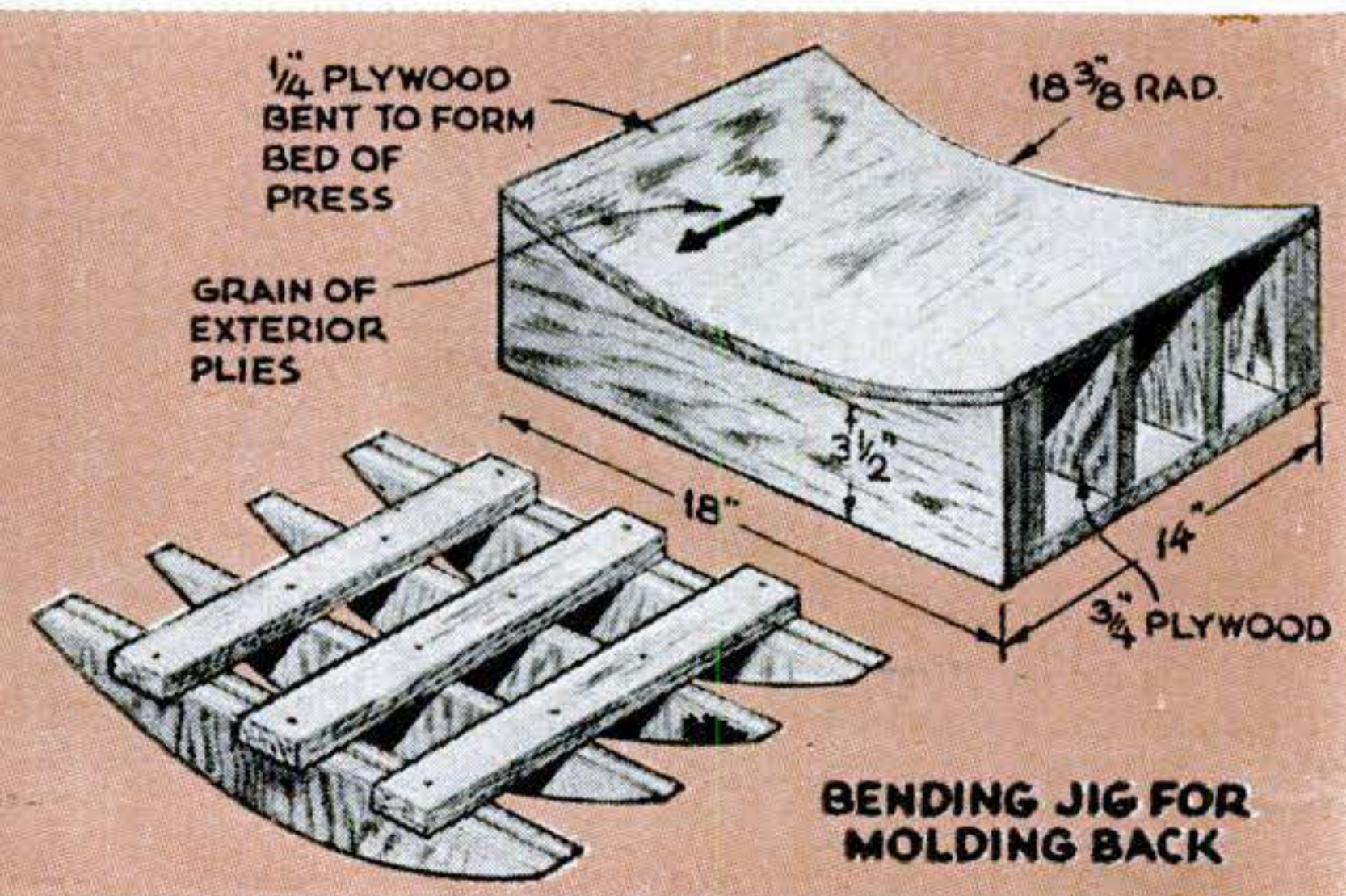





**1 MAKE LEGS AND STRETCHERS** by first tracing patterns on hardwood stock dressed to  $\frac{7}{8}$ ". Make stretchers  $\frac{1}{2}$ " longer than the pattern at each end. You need four board feet per chair.

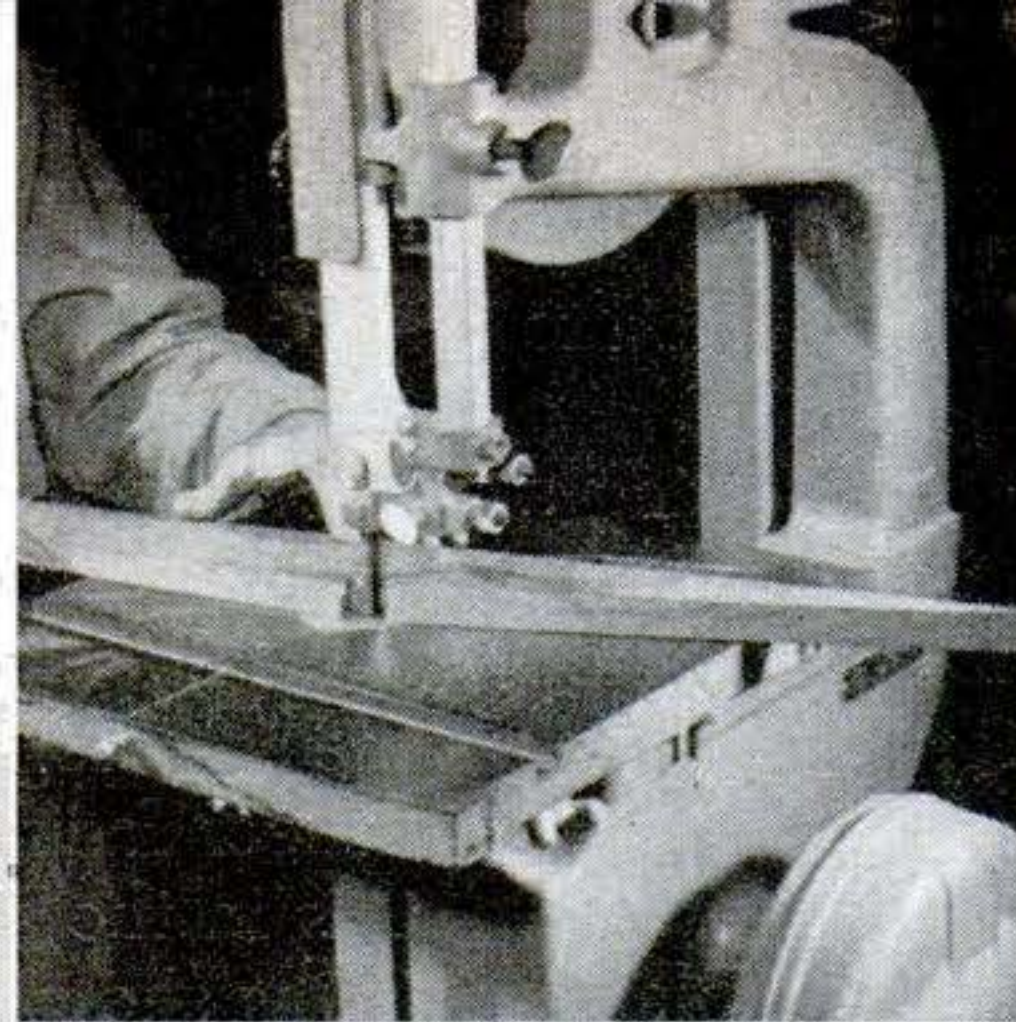

**2 BANDSAW LEGS** carefully to shape, notching back legs to take the seat. Blanks for the stretchers are sawed straight on all sides at this time. The angles and curves come later.

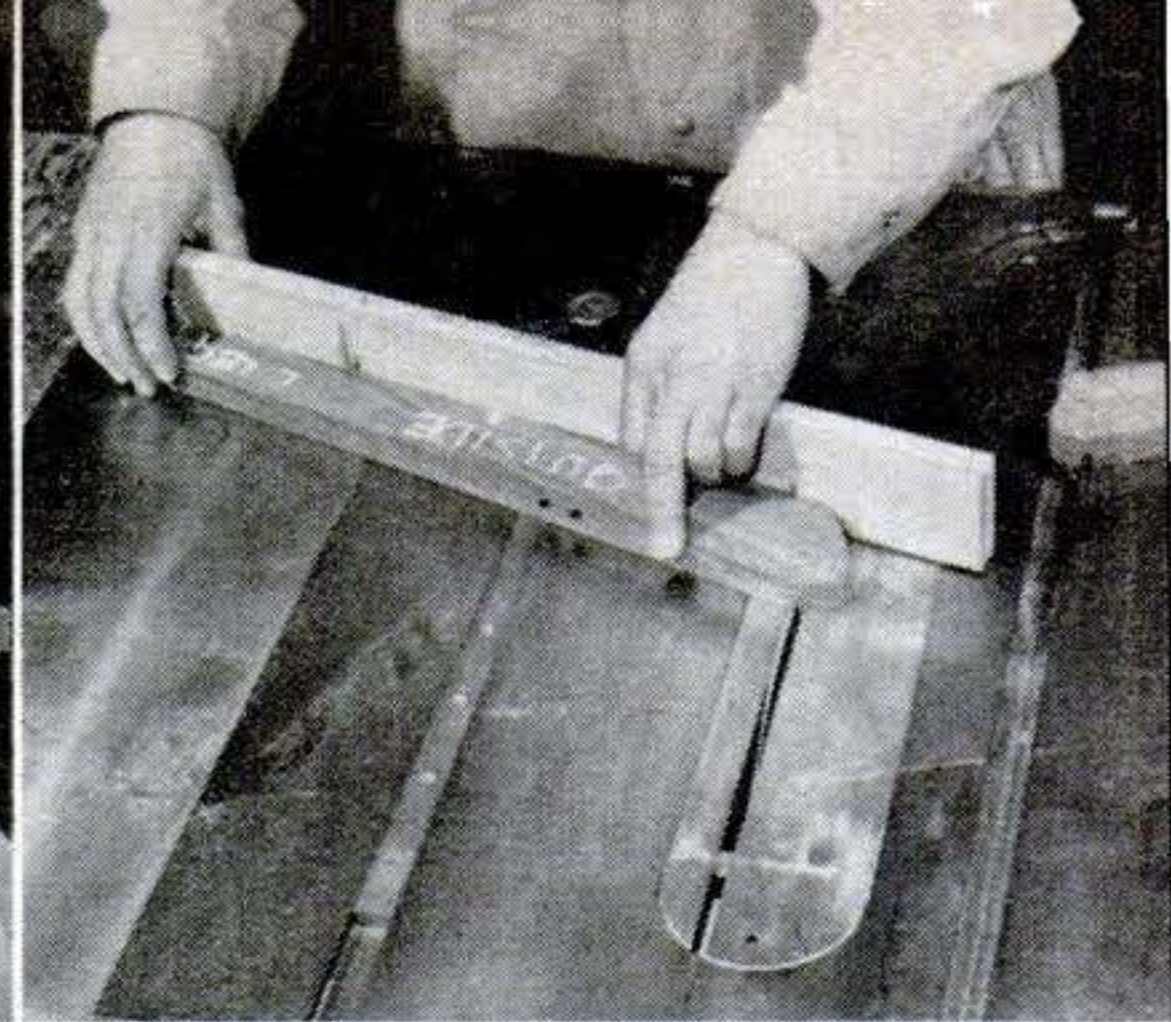

**3 FIRST CUT FOR SEAT NOTCH** in front legs is taken on saw table with miter gauge at  $80^\circ$  right of  $90^\circ$  for left leg, and left of  $90^\circ$  for right. Measure in  $\frac{3}{4}$ " and cut  $\frac{3}{8}$ " deep.

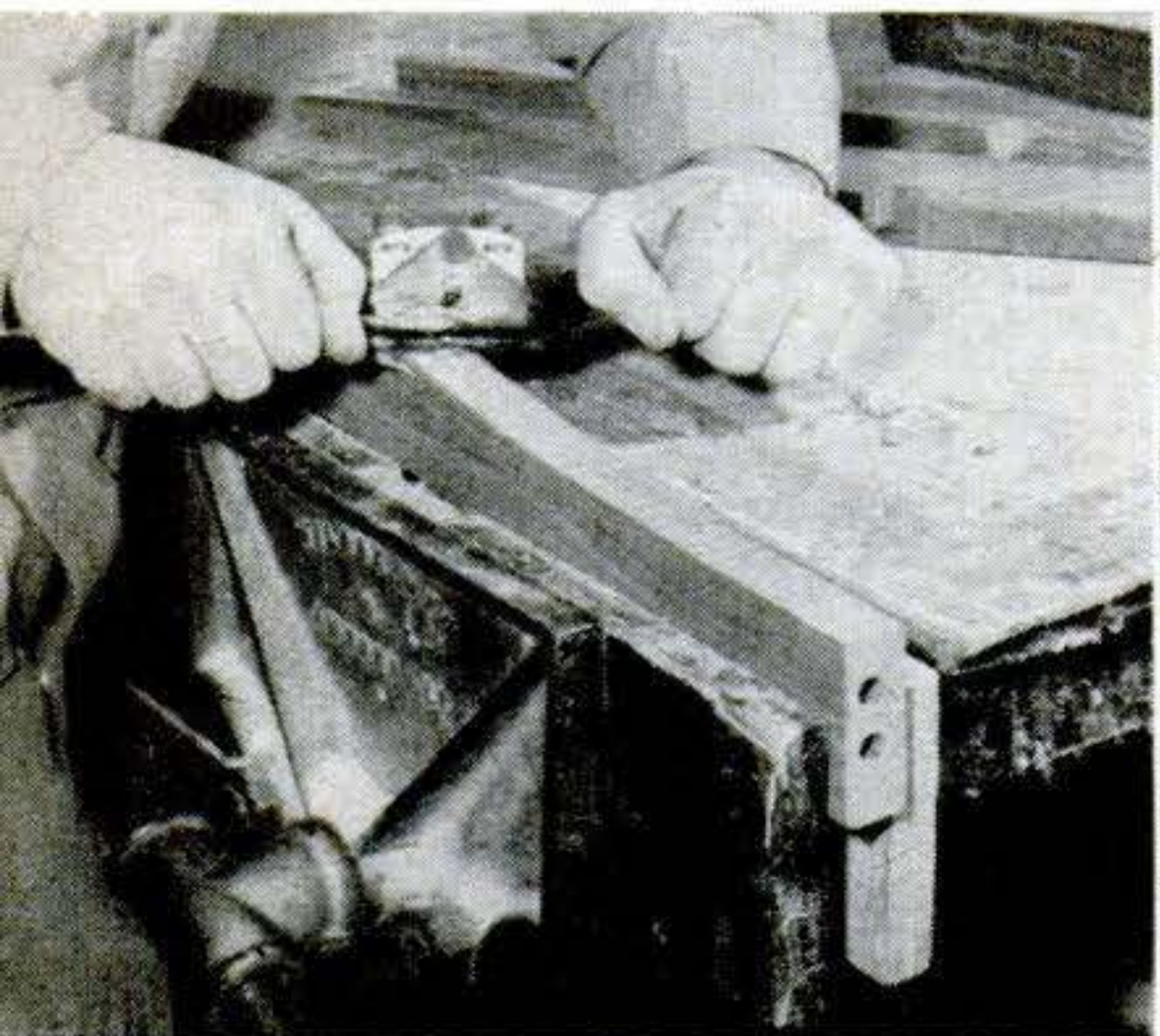

**7 SPOKESHAVE** cleans up curves on the legs and stretchers after the tops and bottoms of the stretchers have been carefully bandsawed to the contours shown in the plan.



**8 START ASSEMBLY** by laying out parts for dowel-hole locations. You'll need guide lines only on the face if you use a doweling jig (foreground) to center holes in the thickness.

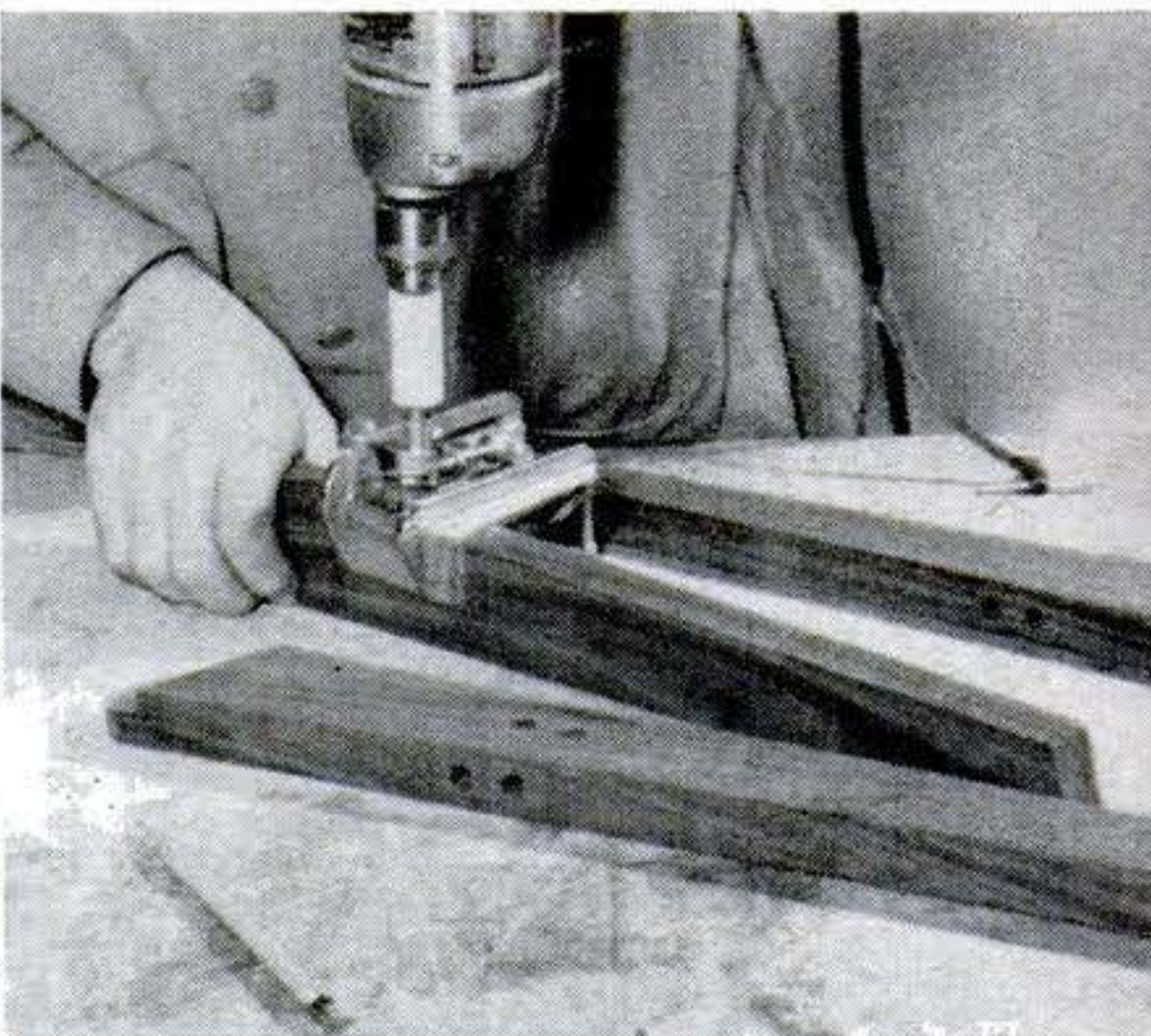

**9 WITH BIT STOPPED** to control depth, holes are drilled for  $\frac{3}{8}$ " spiral wood dowels. Some doweling jigs have a depth-gauge attachment. Here a wood stop is used on the bit.

you'll discover another of Buchner's slick schemes for making topnotch construction easier. Usually a side-chair seat is a light plank supported on frame pieces. For the PSM chair, Buchner eliminated the separate framing and made the seat of sturdy  $\frac{3}{4}$ " plywood. It not only holds you but helps hold the chair together as well.

*The leg stretchers* are thick at the ends, giving the secure appearance of a doweled joint. They are doweled, either blind or clear through the legs. The centers of the stretchers do not need thickness for strength and so they are thinned, adding to the piece's look of lean gracefulness.

The front stretcher requires compound-angles on its ends. You can cut one end

with the saw tilted to  $5\frac{1}{2}^\circ$  and the miter gauge at  $88\frac{1}{2}^\circ$ . The other end is cut in either of two ways. If your miter-gauge extension is as long as 16" or more on the other side of the blade, just flop the work over and saw from that side. Otherwise, you can reset the miter gauge to the other side of  $90^\circ$  and turn the work end for end while keeping the same face up.

*The wood you use*—each chair requires about six dollars' worth of solid stock and plywood—determines the final effect. Walnut, maple, birch, oak, ash, mahogany, chestnut or hickory are all suitable.

When you have finished the last stroke of hand rubbing, you will have furniture to show off—and live with.



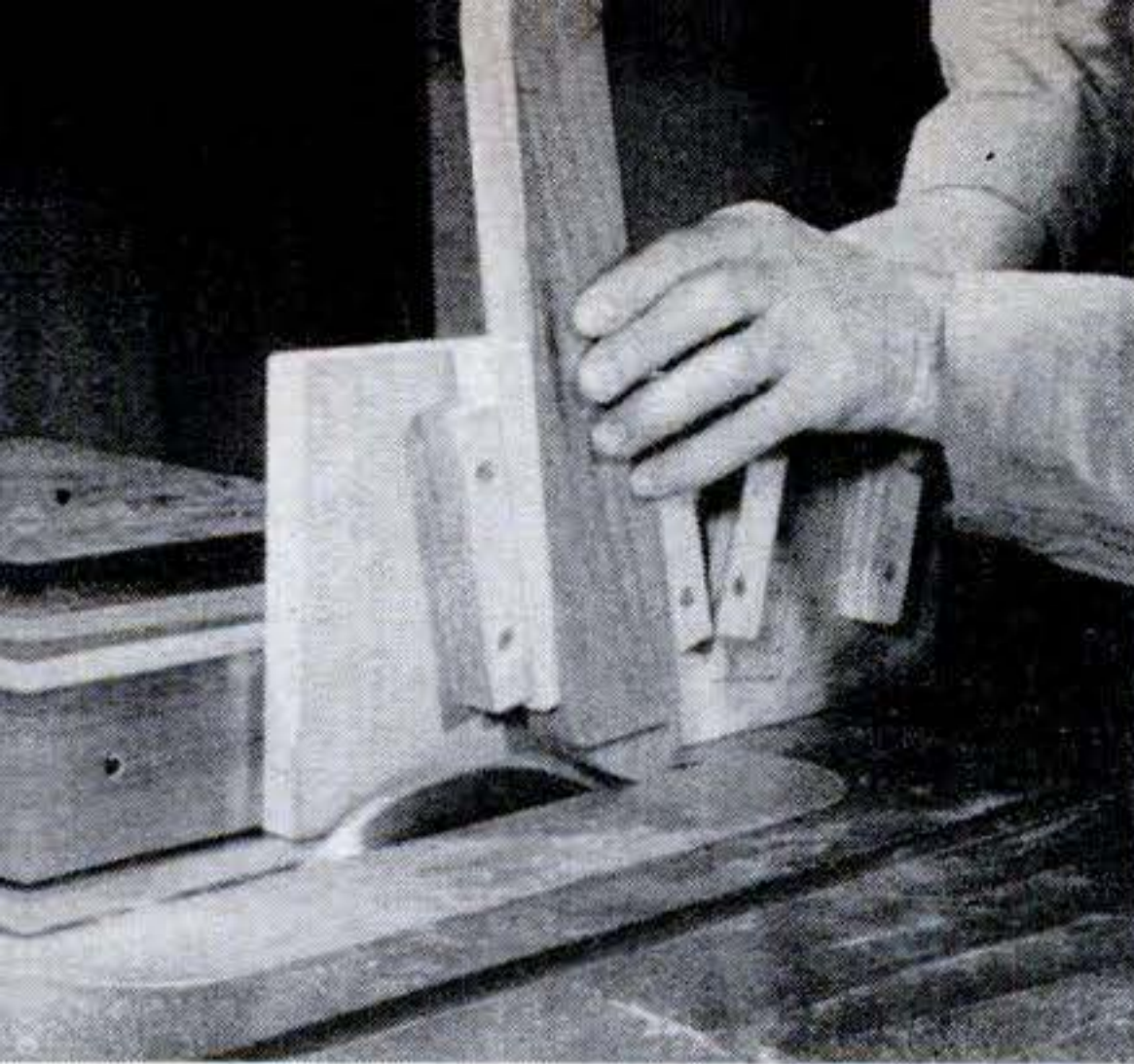

**4 TO MAKE SECOND CUT** you need a special jig. Hold left leg upright in forward position. Right leg goes between rear cleats. Cut is  $\frac{3}{4}$ " deep and  $\frac{3}{8}$ " in from inside face.

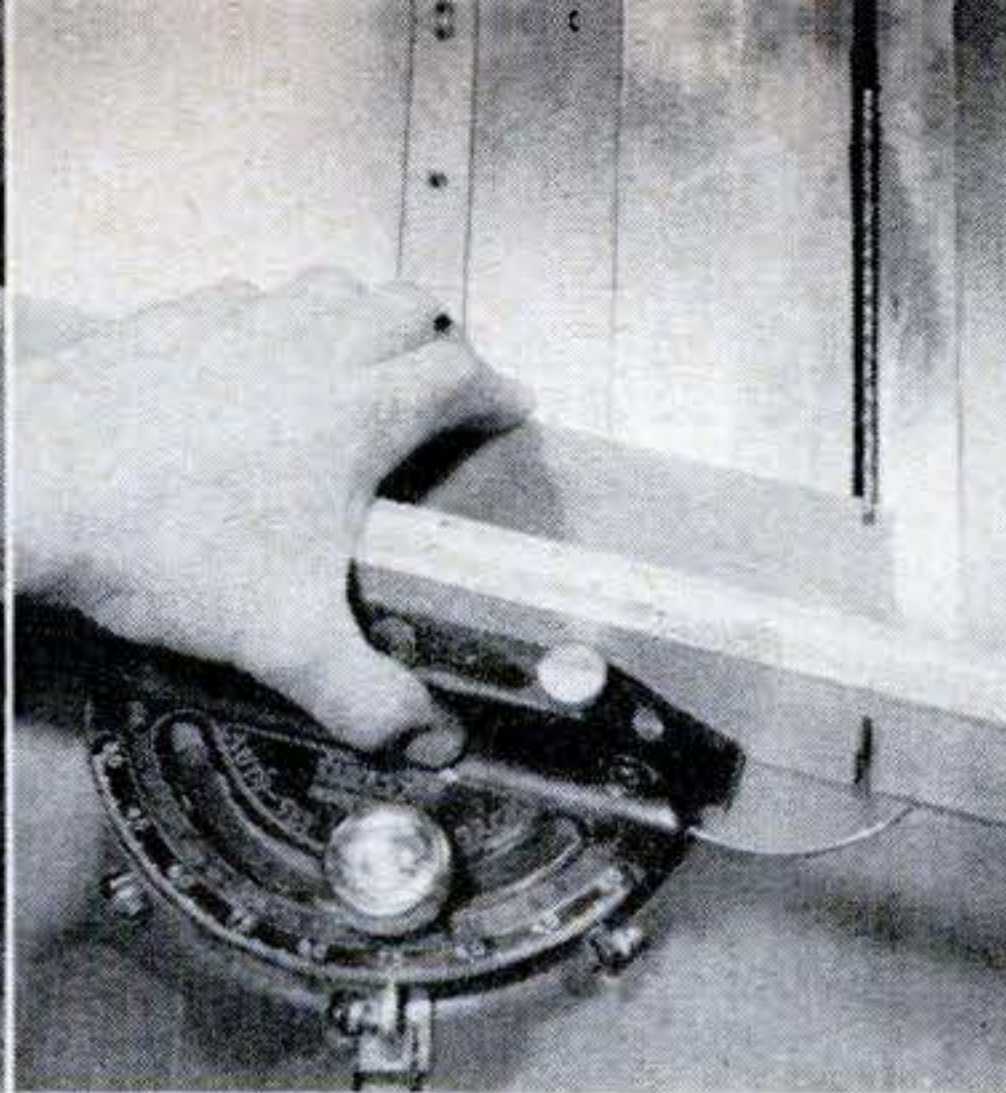

**5 SIDE STRETCHERS** are cut with the miter gauge set at  $75^\circ$  for the forward end, and  $81^\circ$  for the back. Saw all of the front ends first; then reset the gauge for the other cuts.

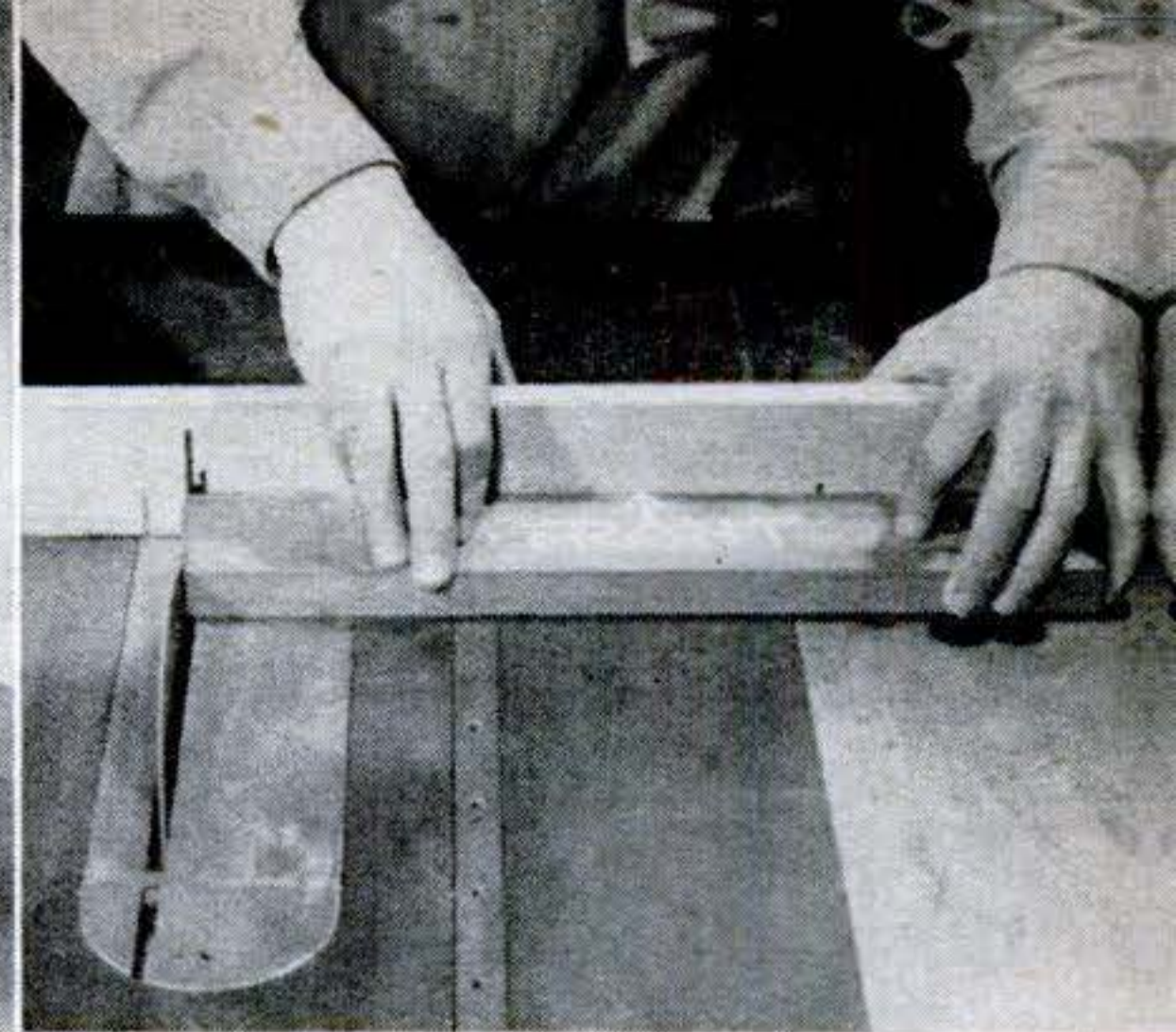

**6 FOR COMPOUND ANGLE** of front stretcher, you tilt the saw arbor  $5\frac{1}{2}^\circ$  and set the miter gauge at  $88\frac{1}{2}^\circ$ . Flop the stock for a second cut from the other side of the blade.

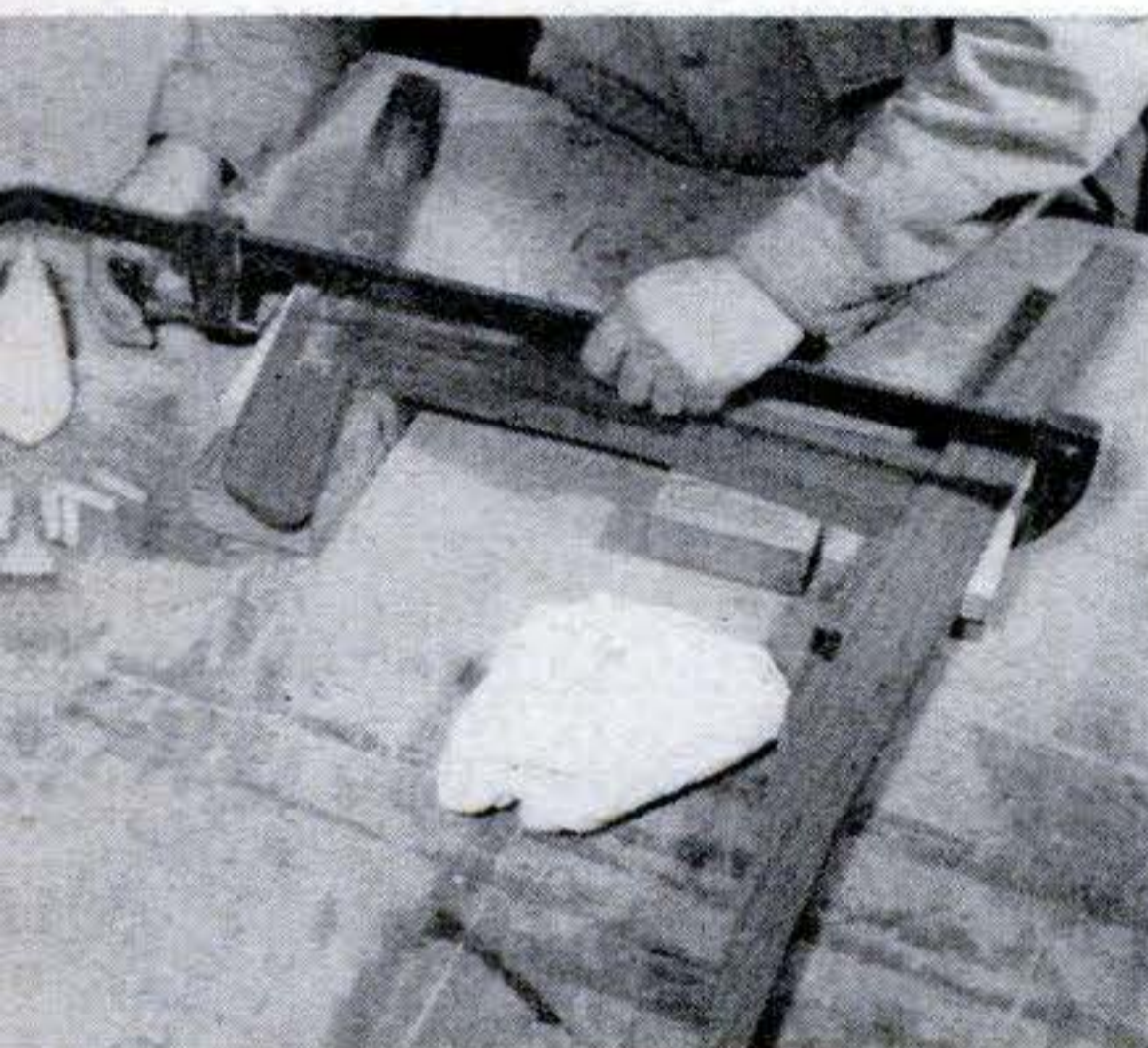

**10 SIDE ASSEMBLIES** are glued up first as separate units. Give the parts a trial assembly before applying cabinetmaker's resin glue and clamping. This will assure well-fitting joints.

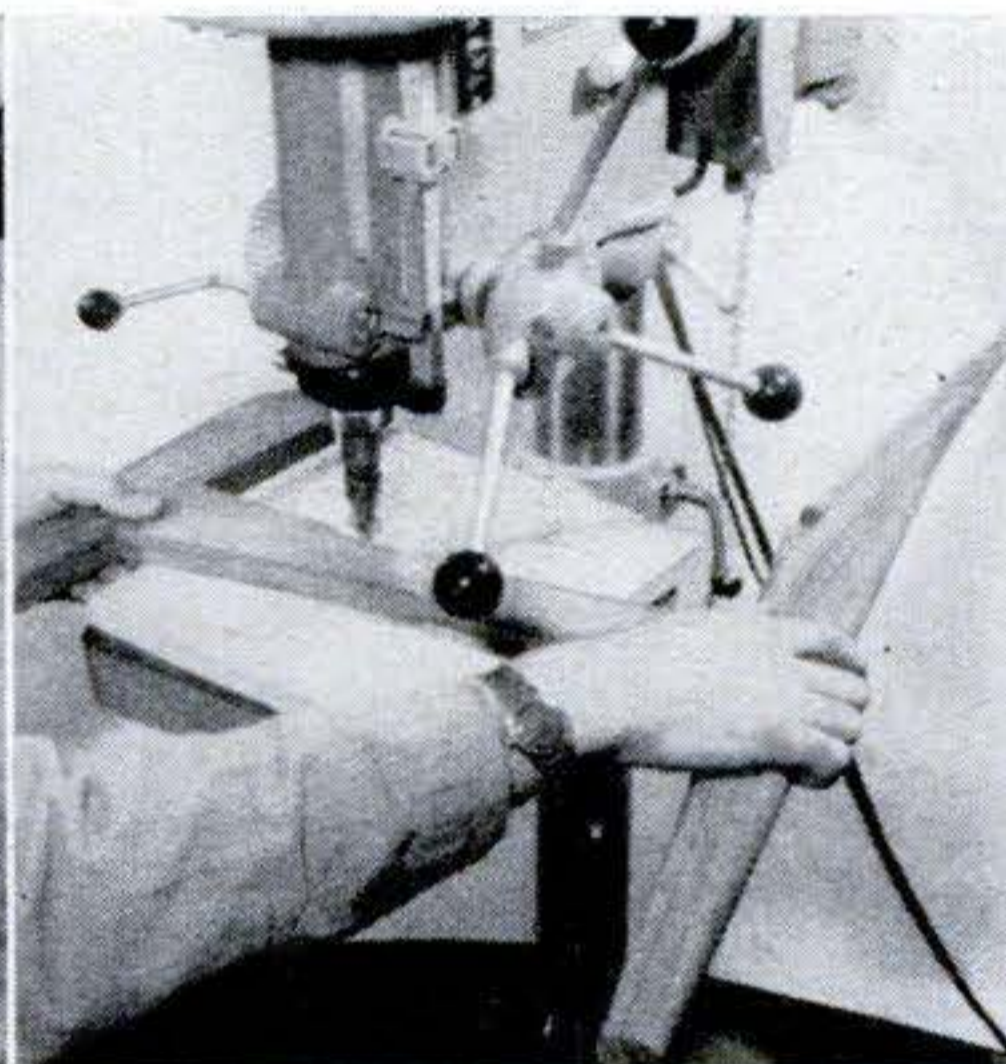

**11 ROUND SHARP CORNERS** on side units and front stretcher in drill press, using a pilot-tip rounding-over bit with  $\frac{3}{8}$ " radius and, as a safety measure, a shaperbit collet as well.

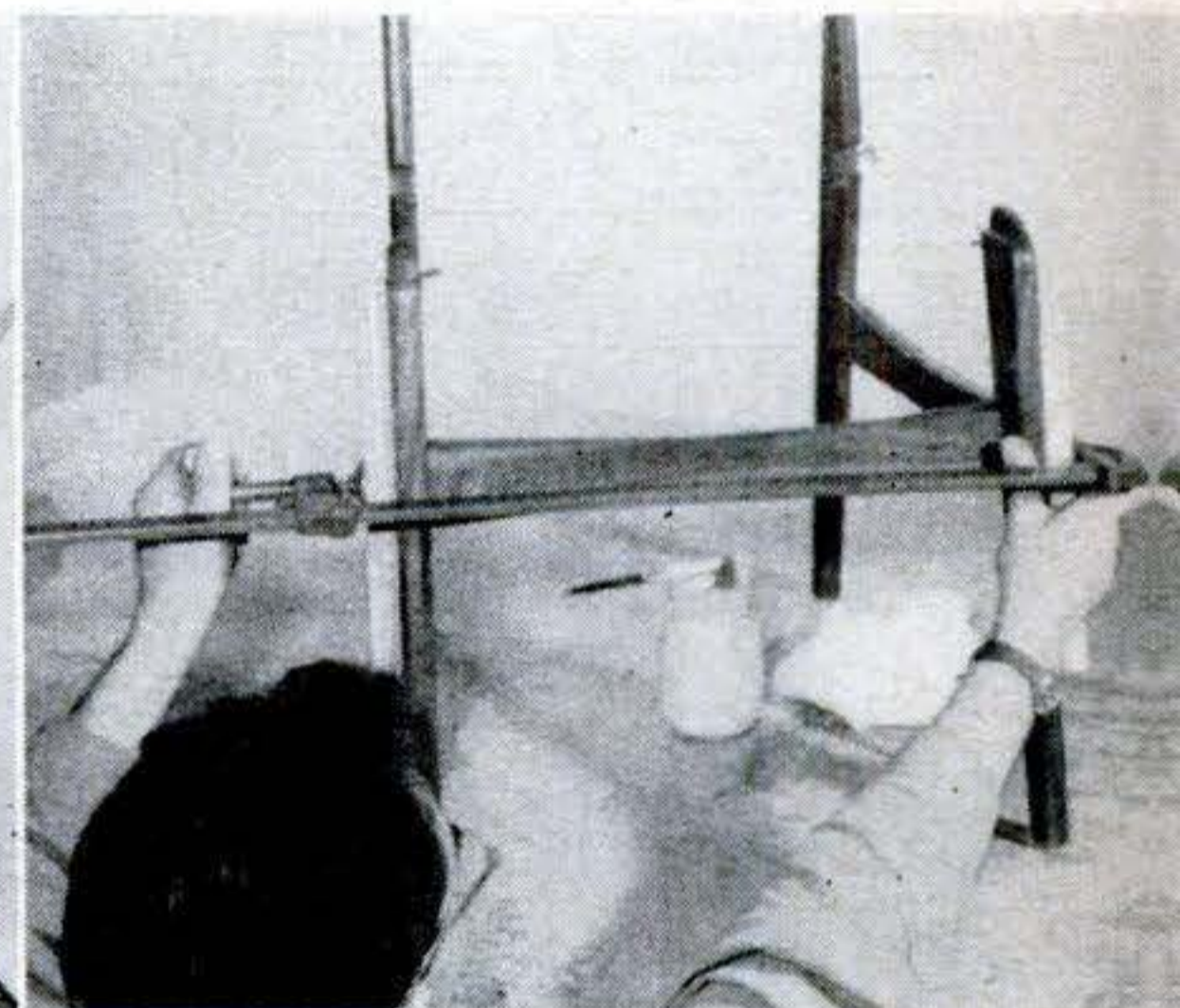

**12 FRONT STRETCHER** is glued in place next. Check alignment carefully when clamping glued joint. The screw eyes just below the seat notches are used to attach the upholstered seat.

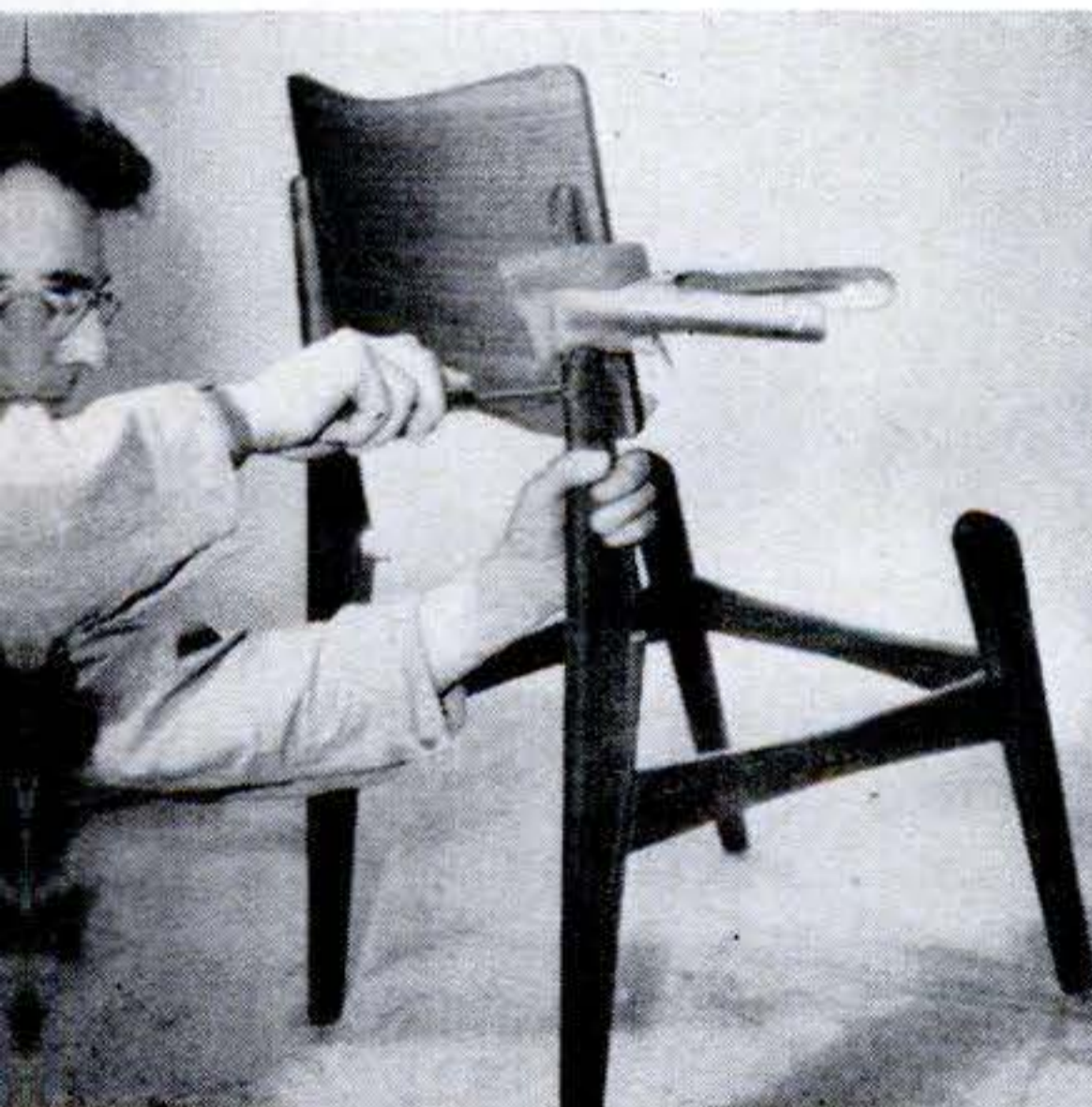

**13 INSTALL BACK** with screws driven through the back legs. Plug the screw holes or use oval-head cross-slot screws. Sand the assembly well and apply finish of your choice.

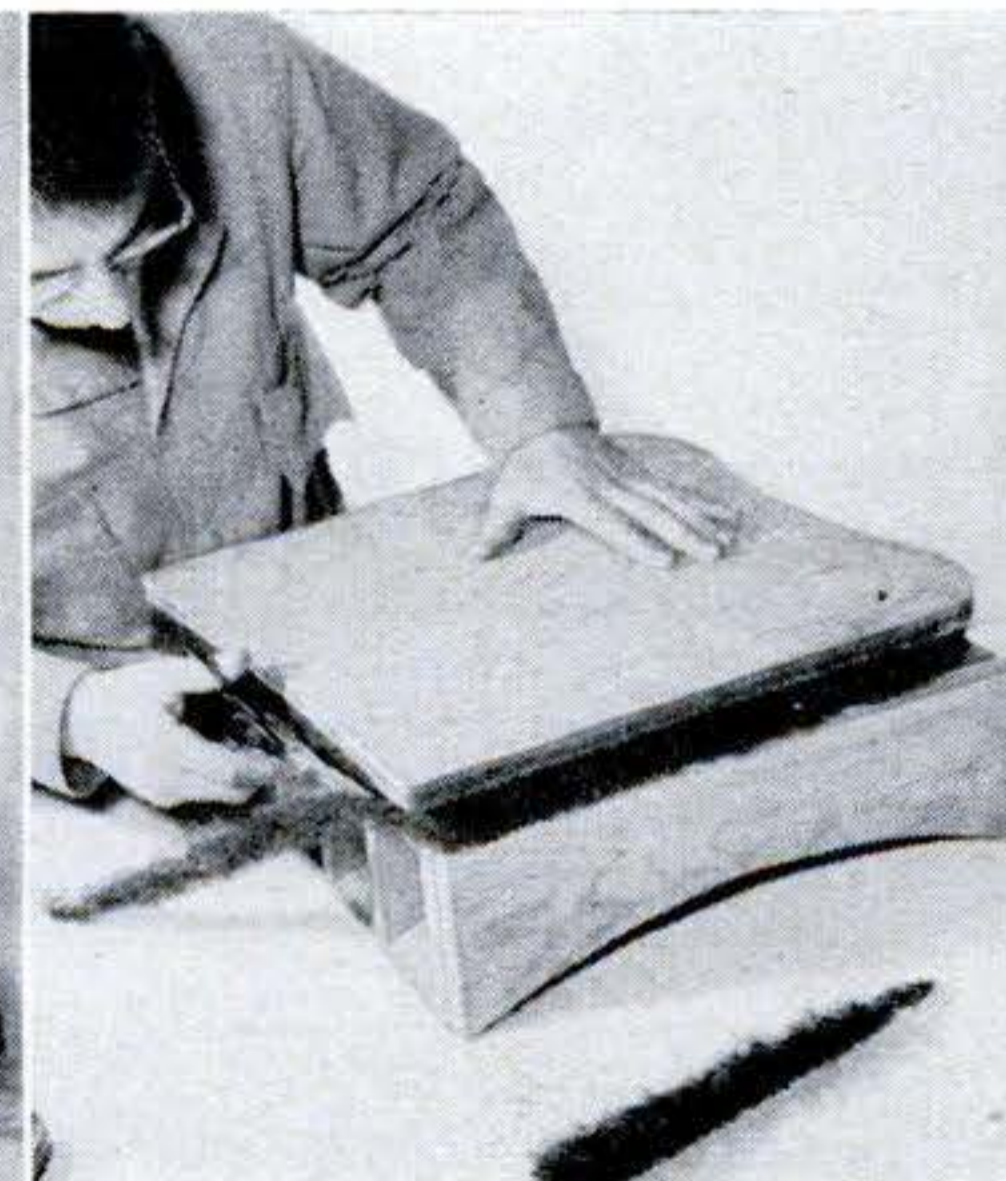

**14 BANDSAW SEAT TO SHAPE** from  $\frac{3}{4}$ " plywood and cover with foam rubber or rubber-covered hair. Stretch upholstery fabric tightly over filler and tack or staple underneath.



**15 AFTER COVERING BOTTOM** with muslin, seat is slipped into notches and fastened with screws through screw eyes in the legs. This makes removal for reupholstering easy. **END**



# How to build A Sewing Box

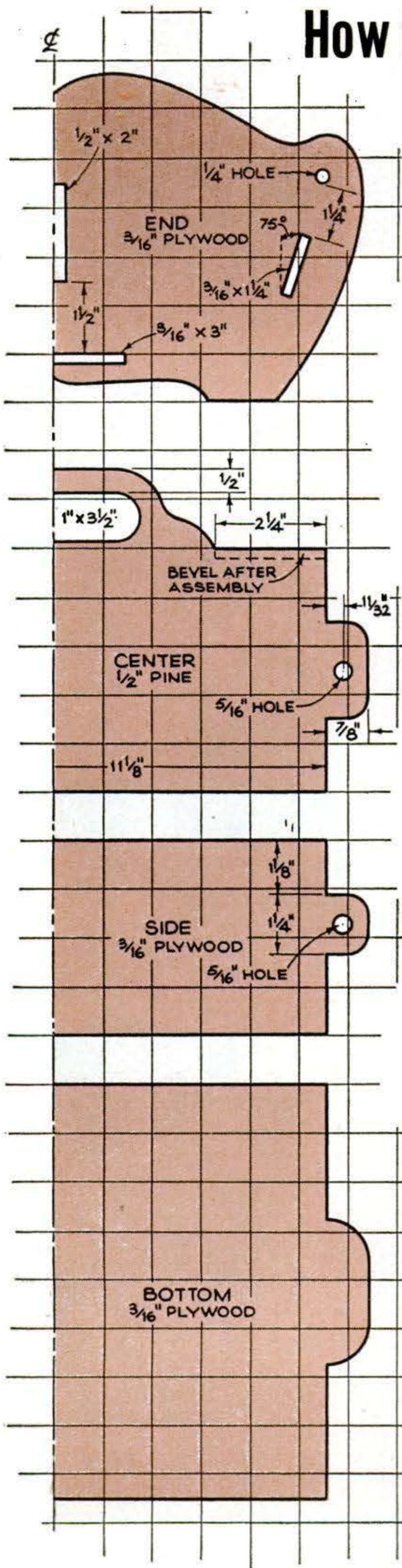

**E**VER think of building a practical gift that you could put in an envelope and mail? Here's one. Knocked down, this useful sewing box slips into an 11" by 14" envelope. The recipient can assemble it in minutes by springing a  $\frac{1}{4}$ "-by-11 $\frac{1}{2}$ " dowel through holes in protruding tabs at each end.

Except for the center partition, which is best made of  $\frac{1}{2}$ " wood stock, the parts might all be cut from  $\frac{3}{16}$ " hardwood-veneer plywood. After transferring the patterns, cut the parts with a jigsaw or coping saw and sand them smooth. Fold coarse sandpaper over the corner of a small block of wood and rub it along the pivoting edge of each cover piece to cut a V groove. Glue a

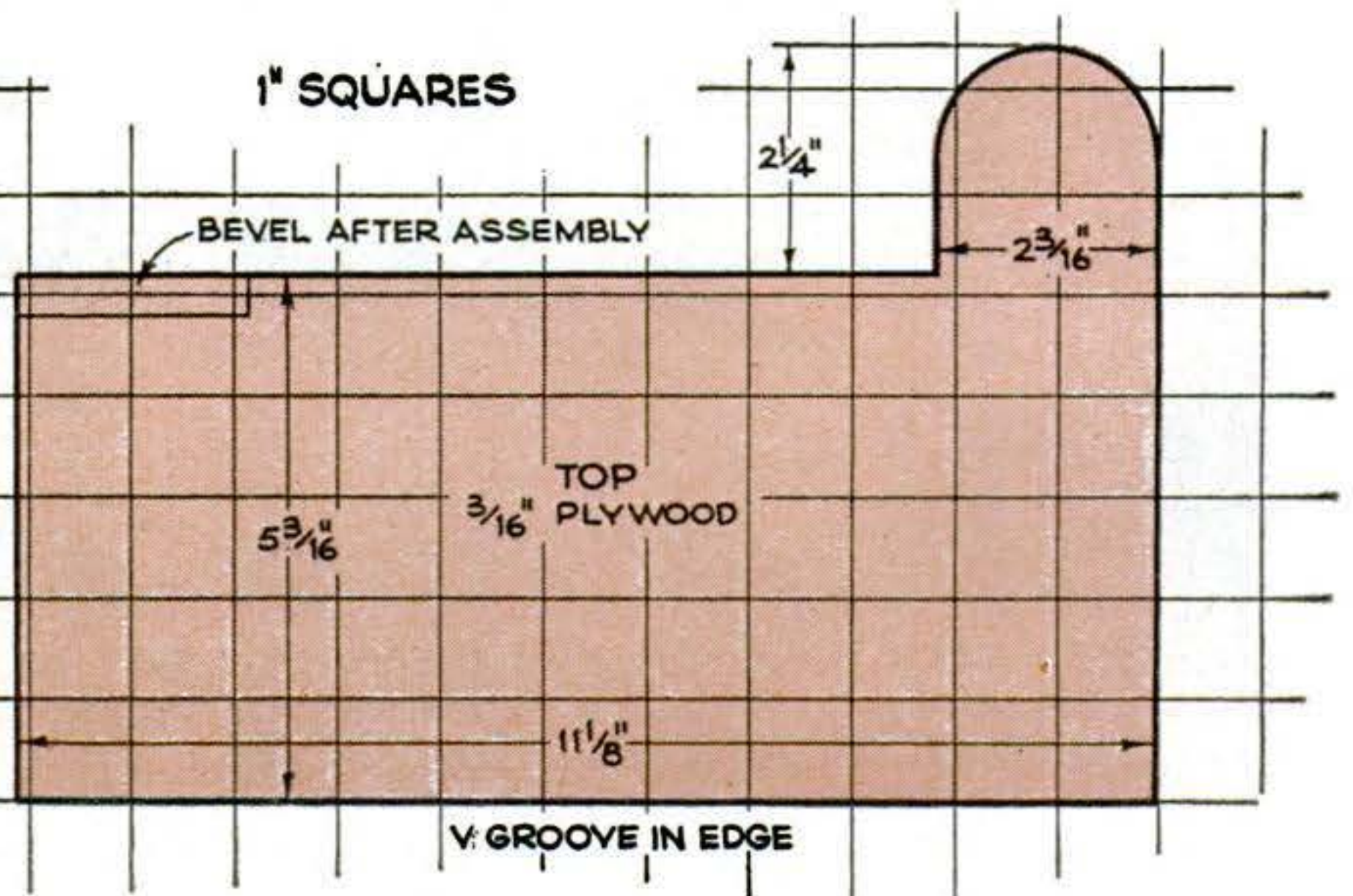



# You Can Mail

12" length of  $\frac{1}{4}$ " dowel into each groove, leaving  $\frac{7}{16}$ " projecting at each end for pivoting.

Assemble the dividers, sides and covers on one end first, and secure the tabs with a dowel. Then press the other end over the tabs and cover pivots, and thread the second dowel through holes in the tabs.

Bevel the top edge of the divider at each side of the handle to provide a flat surface for the cover tabs. Also bevel a part of the edge of each cover in line with the lifting tab on the opposite cover so both will lie flat when they are closed.

Finish with shellac or clear lacquer. Rub the final coat with steel wool, and apply wax.—*Kenneth Olin, Marquette, Mich.*

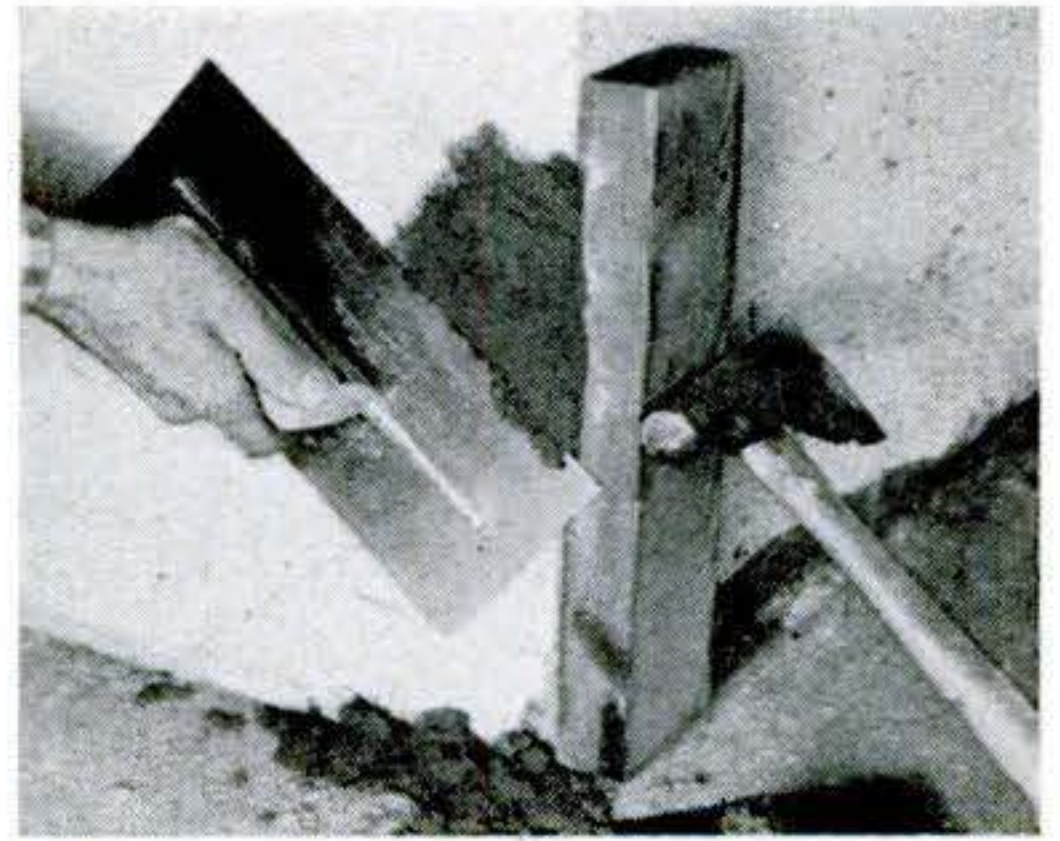

## Propped Block Forms Cement Corner

You can patch a damaged cement corner true and square by propping a block against one side to serve as a form. Wet the break thoroughly and fill it from the open side with a ready-mix patching cement. Trowel it flush with the wall and block edge, and leave the form in place until the mortar has become firmly set.—*A. L. Phelps, Azusa, Calif.*

## Wire Hangers Strengthen Concrete

WIRE coat hangers make fine reinforcing rods for small concrete jobs. When you pour regular shapes, just criss-cross them in the form. To reinforce odd shapes, like stepping stones, turn the hooks inward and bend the wires to the shape you want, then pour cement over them.—*Bill Copeland, Sarasota, Fla.*

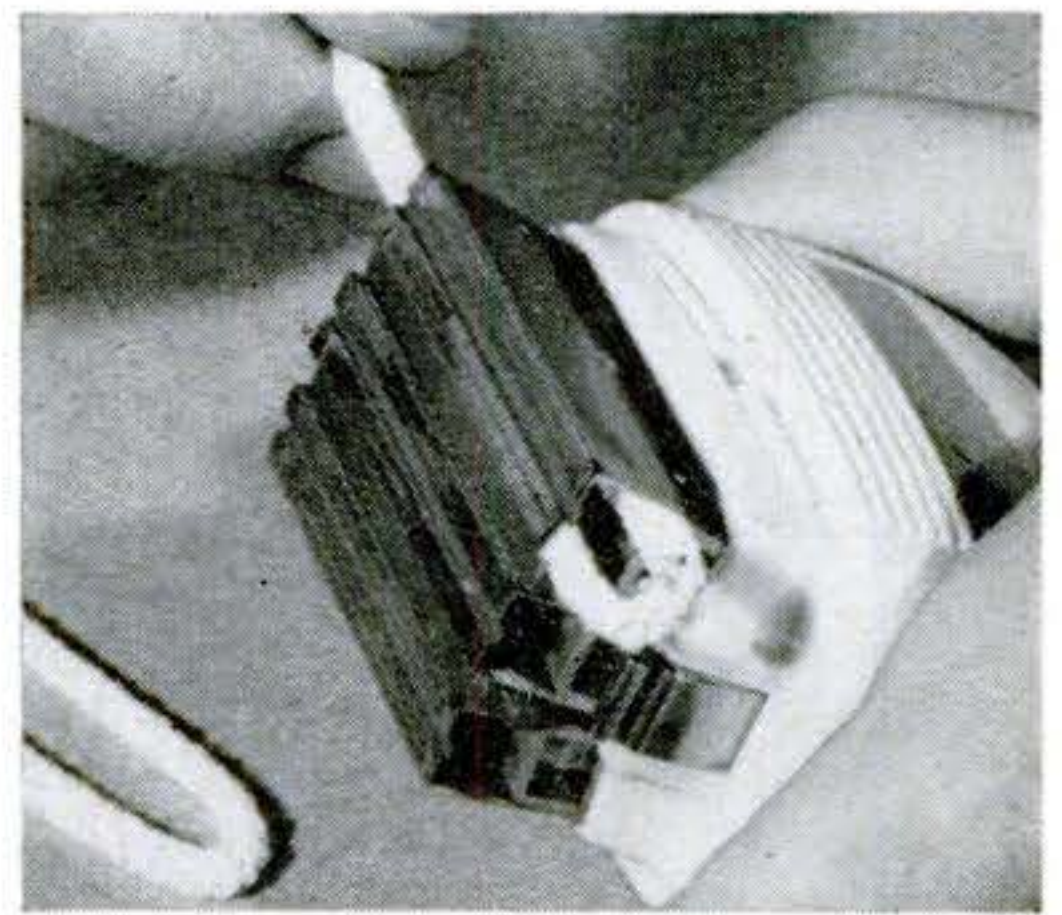

## Pipe Cleaner Cleans Razor

LOST the cleaning brush for your electric razor? A pipe cleaner makes a fine substitute. It gets out the embedded dirt without damaging the cutters.

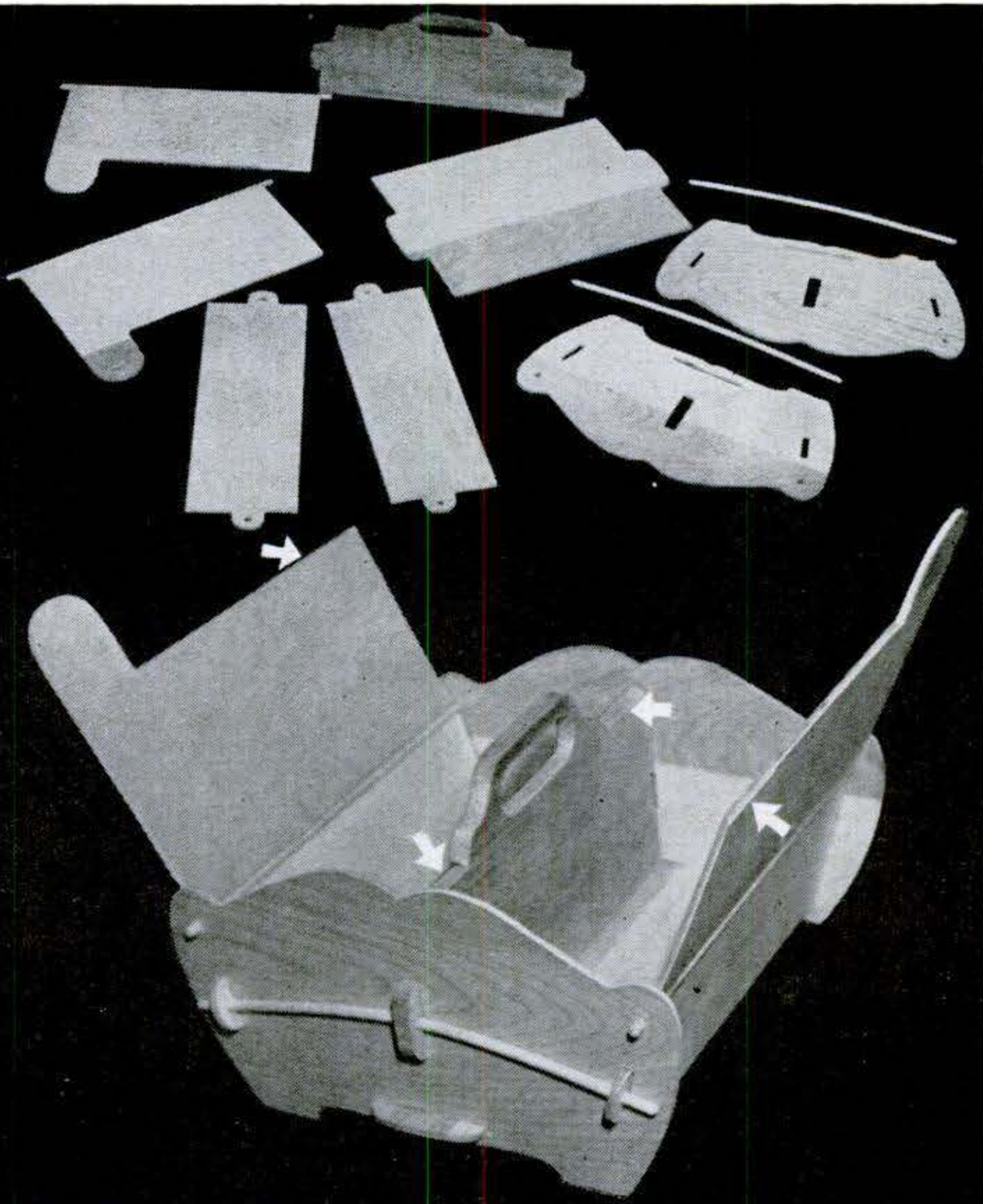

**THE PARTS GO TOGETHER** like an interlocking puzzle. The two dowels at right above lock the completed assembly, which has two spacious compartments. Arrows show the bevels that permit covers to close tightly.



By Roy Doty

# Wordless Workshop

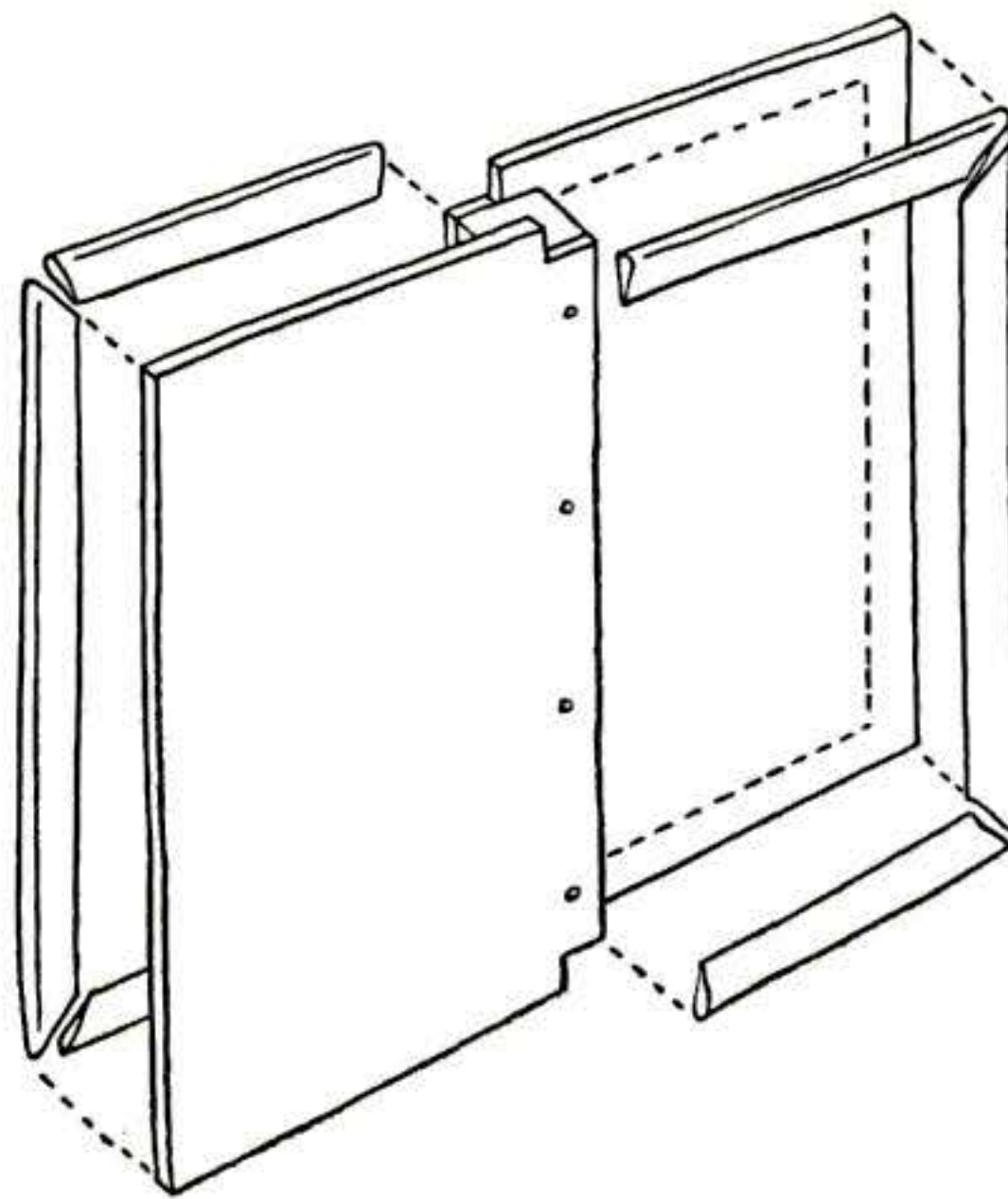
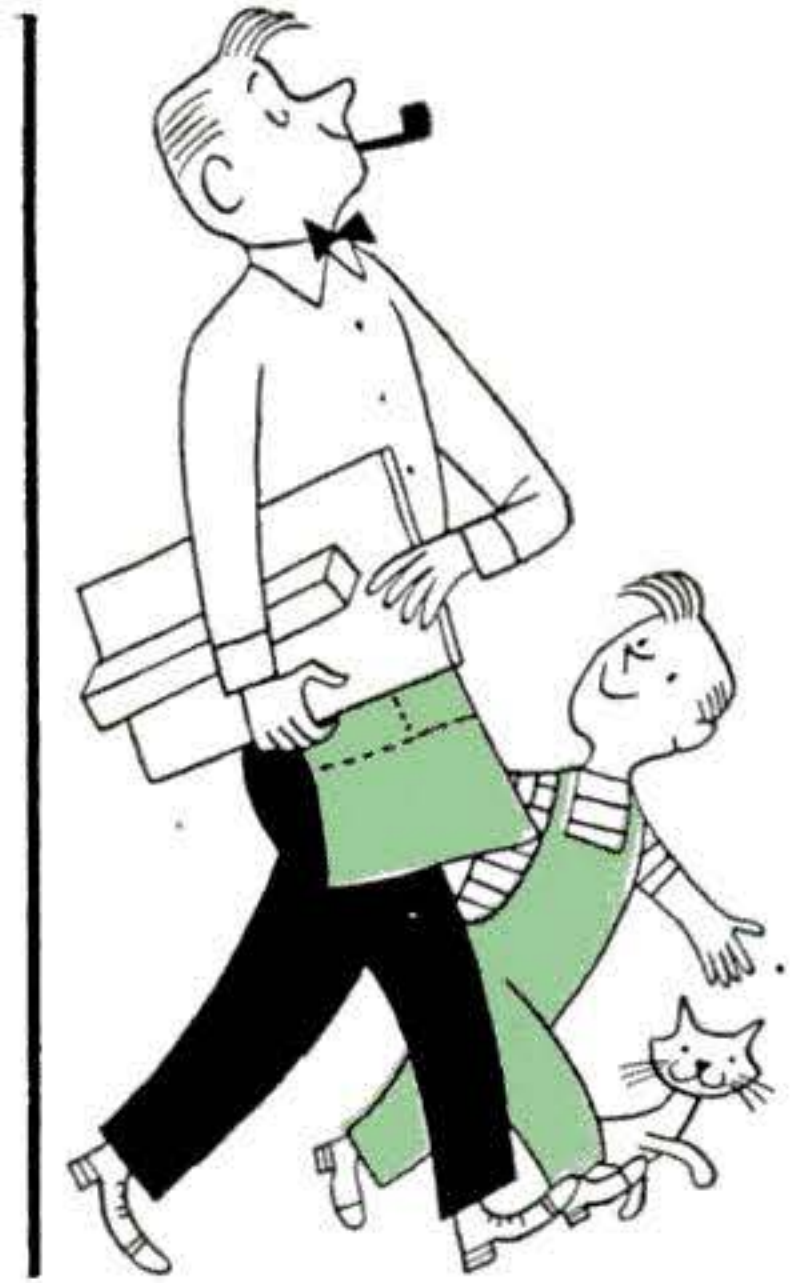
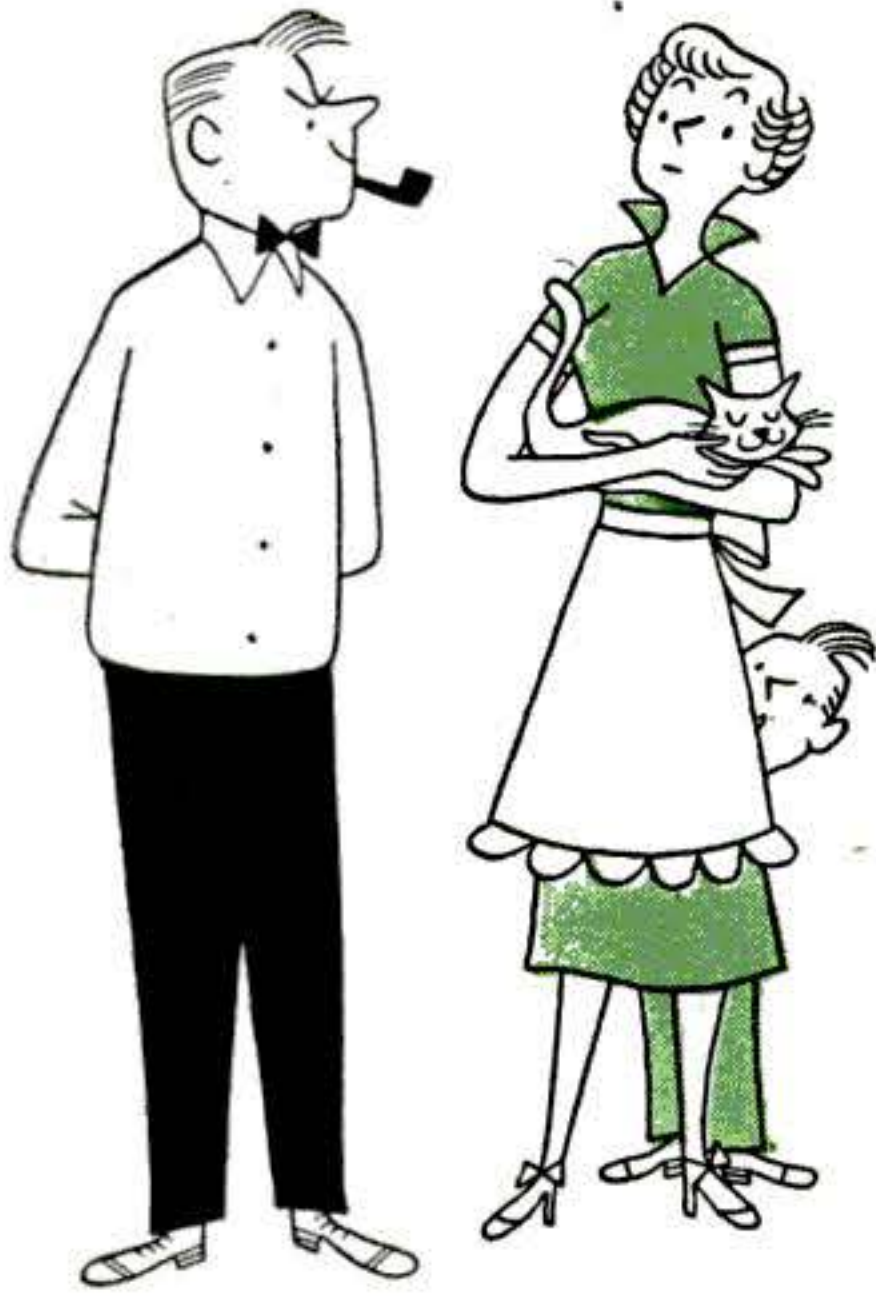
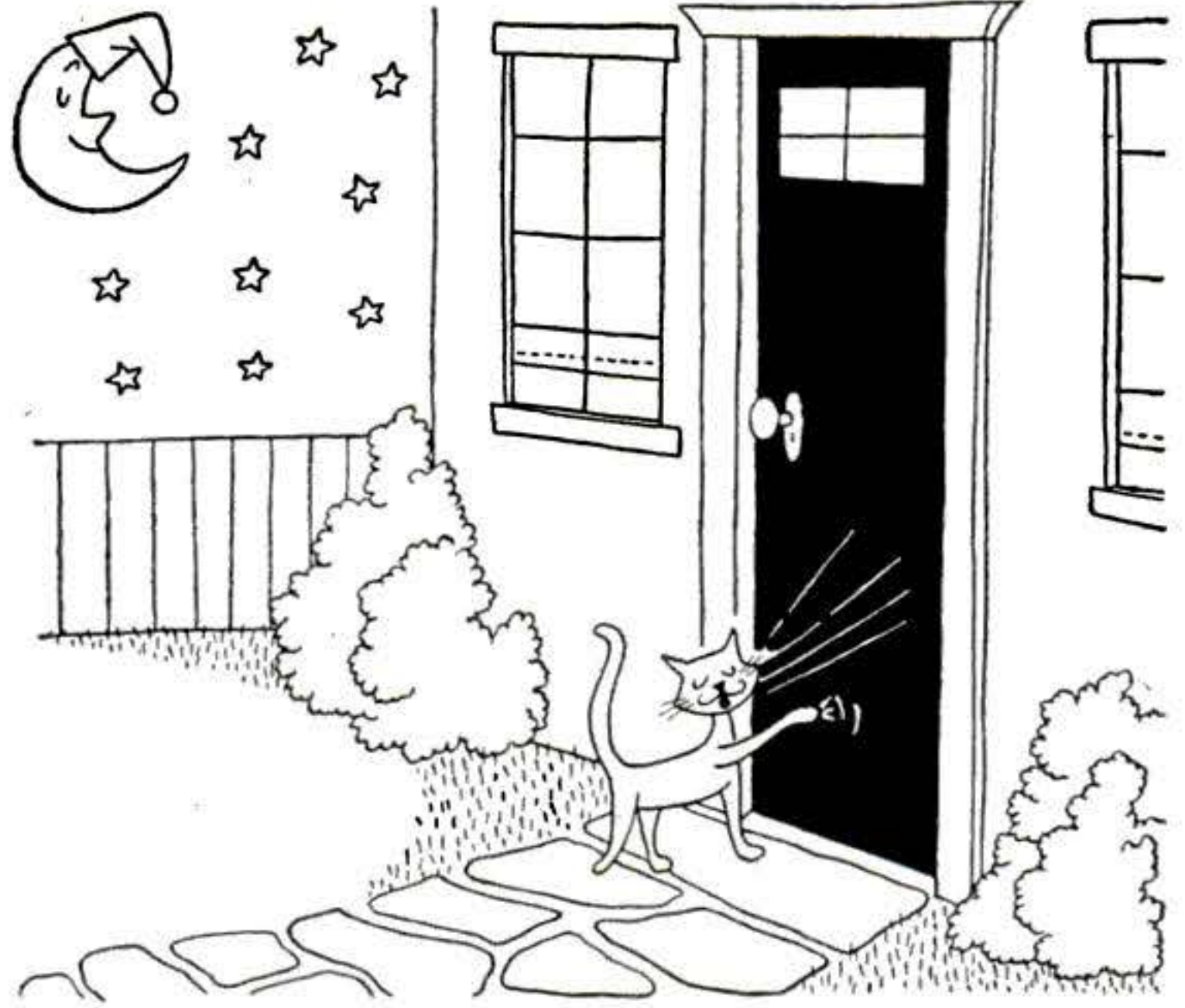



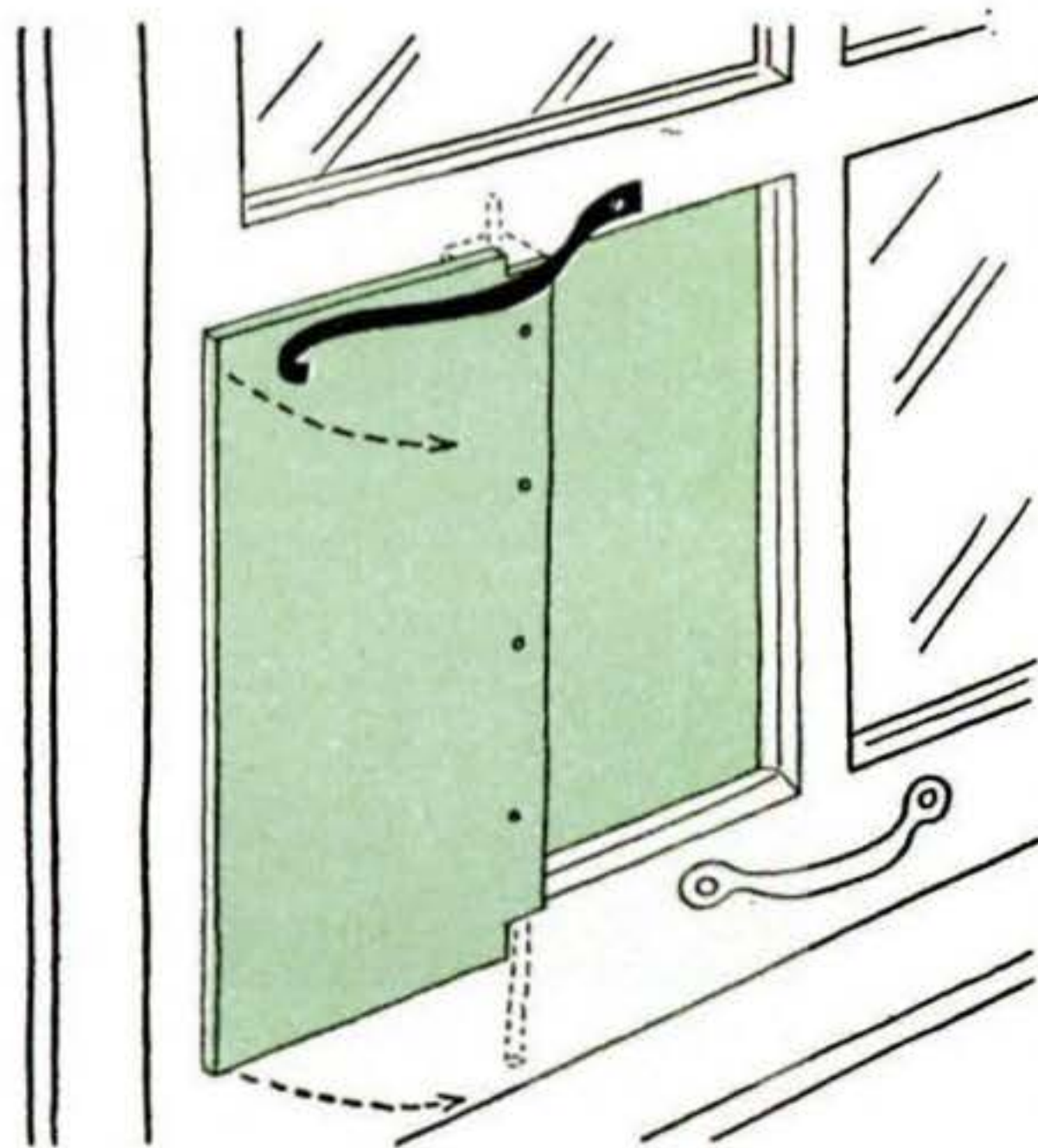
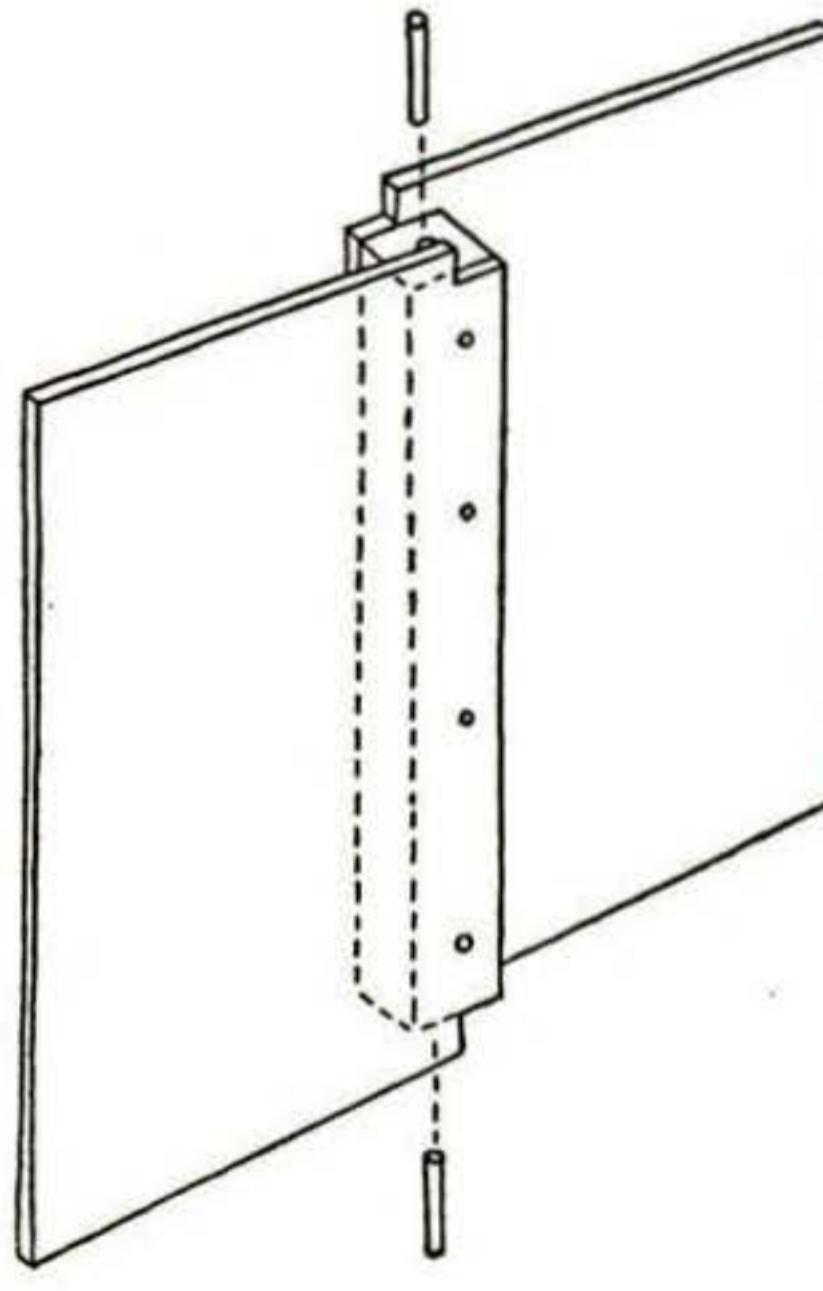
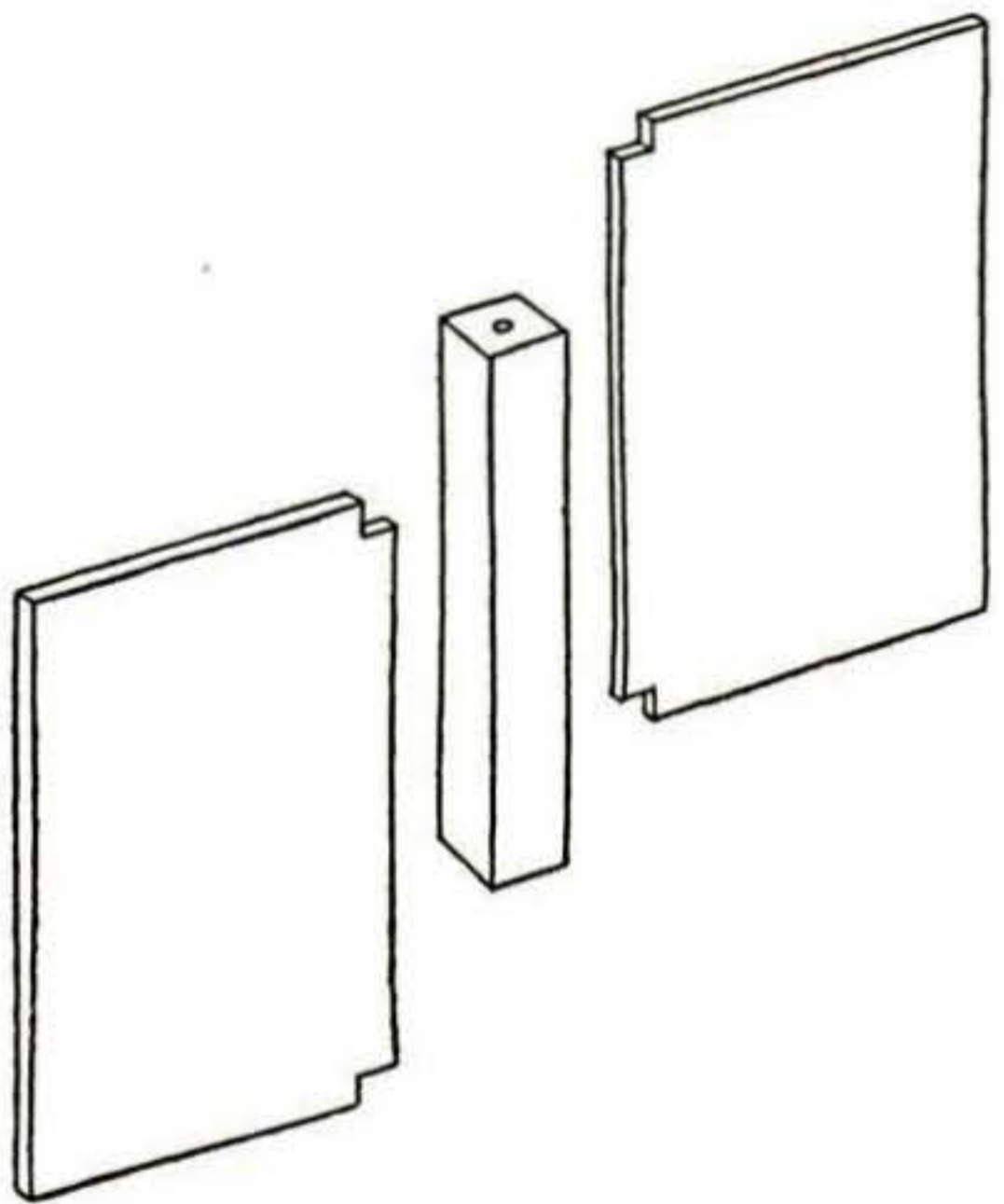

**Next Month: A doorstep shoe cleaner that scrapes and brushes**

NOVEMBER 1955 187



# Vacuum-Cleaner Cart

**This silent mother's helper rolls to work with all cleaning needs.**

**N**OTHING is left behind when a housewife sets out with this cart to clean house. It has a place for everything—vacuum cleaner, hose, two extension tubes, six brushes, dust cloths, a sprayer and several bottled cleaners. It is made of the hardware store aluminum that you can cut with woodworking tools.

Two accessory boxes are bent up from light embossed sheet aluminum. Cut this to the pattern shown, but before bending to shape, fold over the exposed edges. You can make a jig for doing this by cutting a kerf  $\frac{1}{4}$ " deep in the edge of a piece

of 1" wood. Insert the sheet metal, bend over as far as you can, and finish the fold by pounding with a mallet.

The open rear corners of the larger box are closed by riveting both edges inside angle strips fastened to the rear corners of the frame. Fasten the front of the box to a piece of angle riveted crosswise to the frame. The  $\frac{1}{8}$ "-by- $\frac{3}{4}$ " flat trim strip around the top of this box supports the handle brackets and brush hangers.

Floor a part of the frame with sheet aluminum to hold the vacuum cleaner. Pieces of thick rubber weather stripping cemented to the floor under the cleaner will cut down vibration and drumming.

Lay out a full-size pattern for the han-

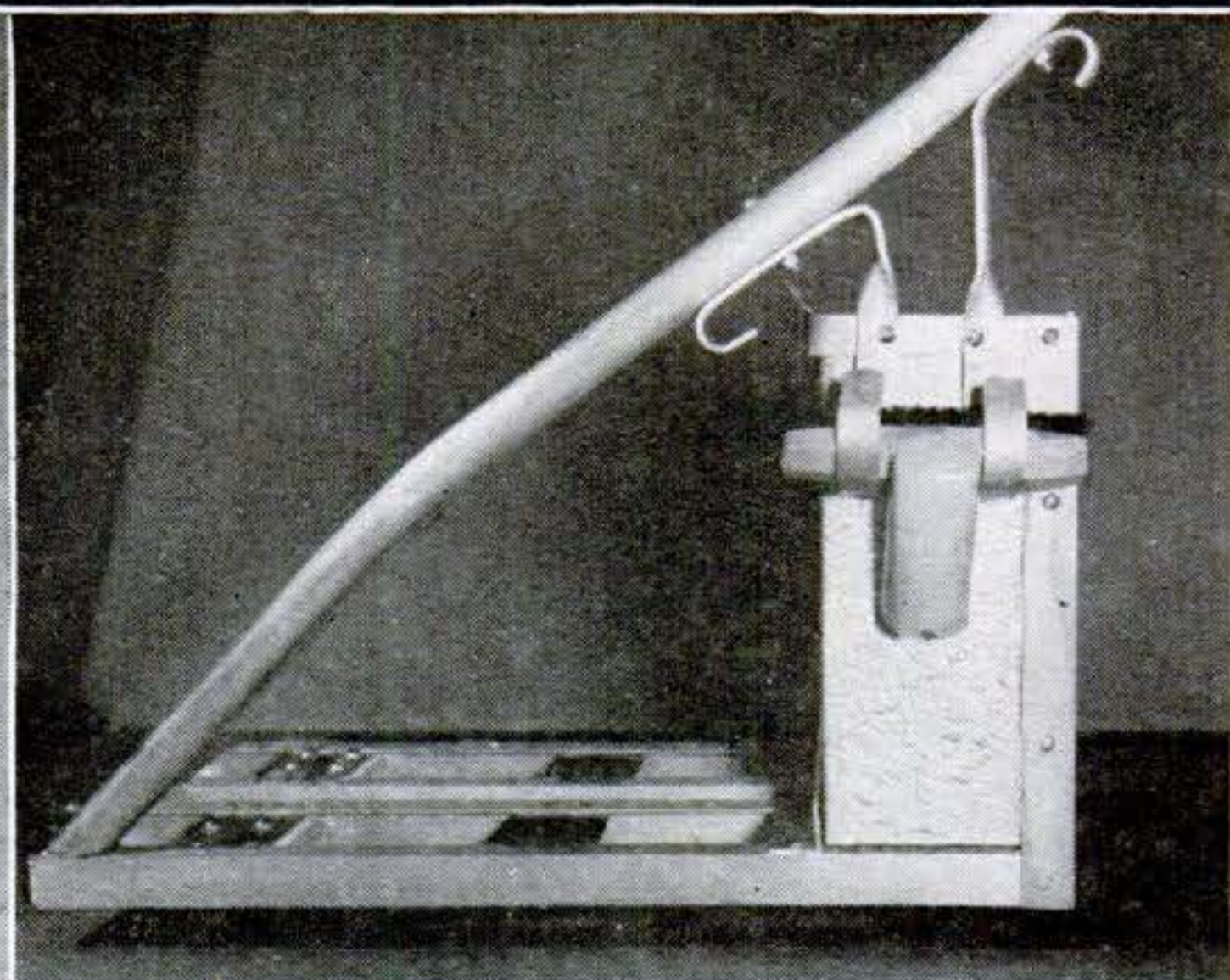
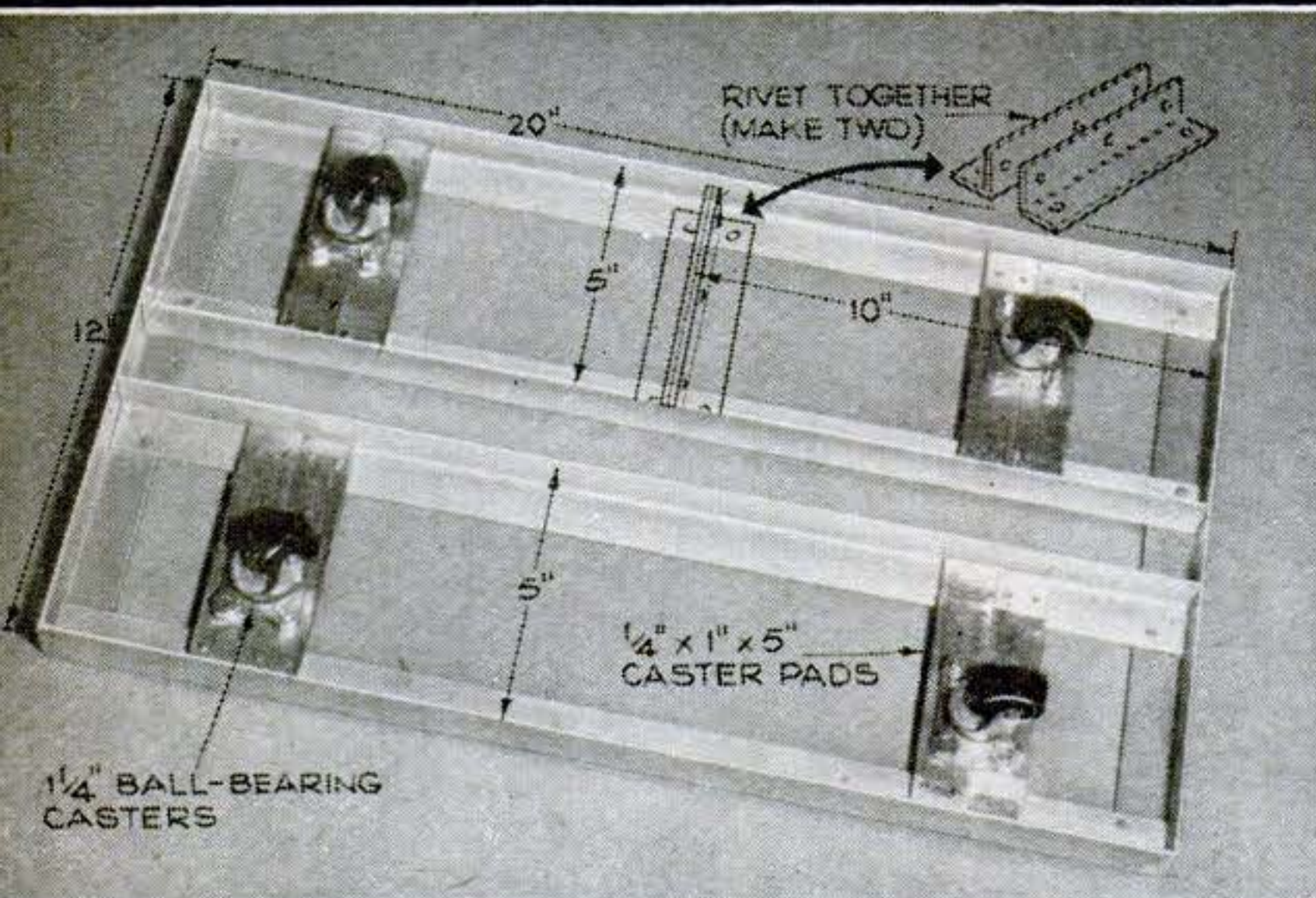

**OVERLAP ENDS** of 1"-by-1" aluminum angle and drive two  $\frac{1}{8}$ " rivets in each joint. Rivet 5" lengths back to back as center stiffeners. Attach caster pads 3" from ends. Mount  $\frac{1}{4}$ " ball-bearing casters with  $\frac{1}{4}$ " bolts and nuts.

**RIVET ANGLE UPRIGHTS** 10" long to the rear frame corners and a 12" length across the frame  $4\frac{1}{2}$ " away. Mount the rear box between these. Shape brackets to suit the handles, rolling up the lower ends to hold brushes as shown.

**FRONT ACCESSORY BOX** holds the upholstery nozzle, crevice tool, sprayer and furniture oil or window-cleaning fluid. A retaining strip riveted to the upper corners is fitted with loops for the nozzle and the crevice tool.

**BOLT TWO HANGERS** to rear box rim to hold a long brush. The lower brush holder is angle stock, bolted to the vertical corner pieces, with two short upturned strips riveted on. Shape hangers to fit each brush individually.

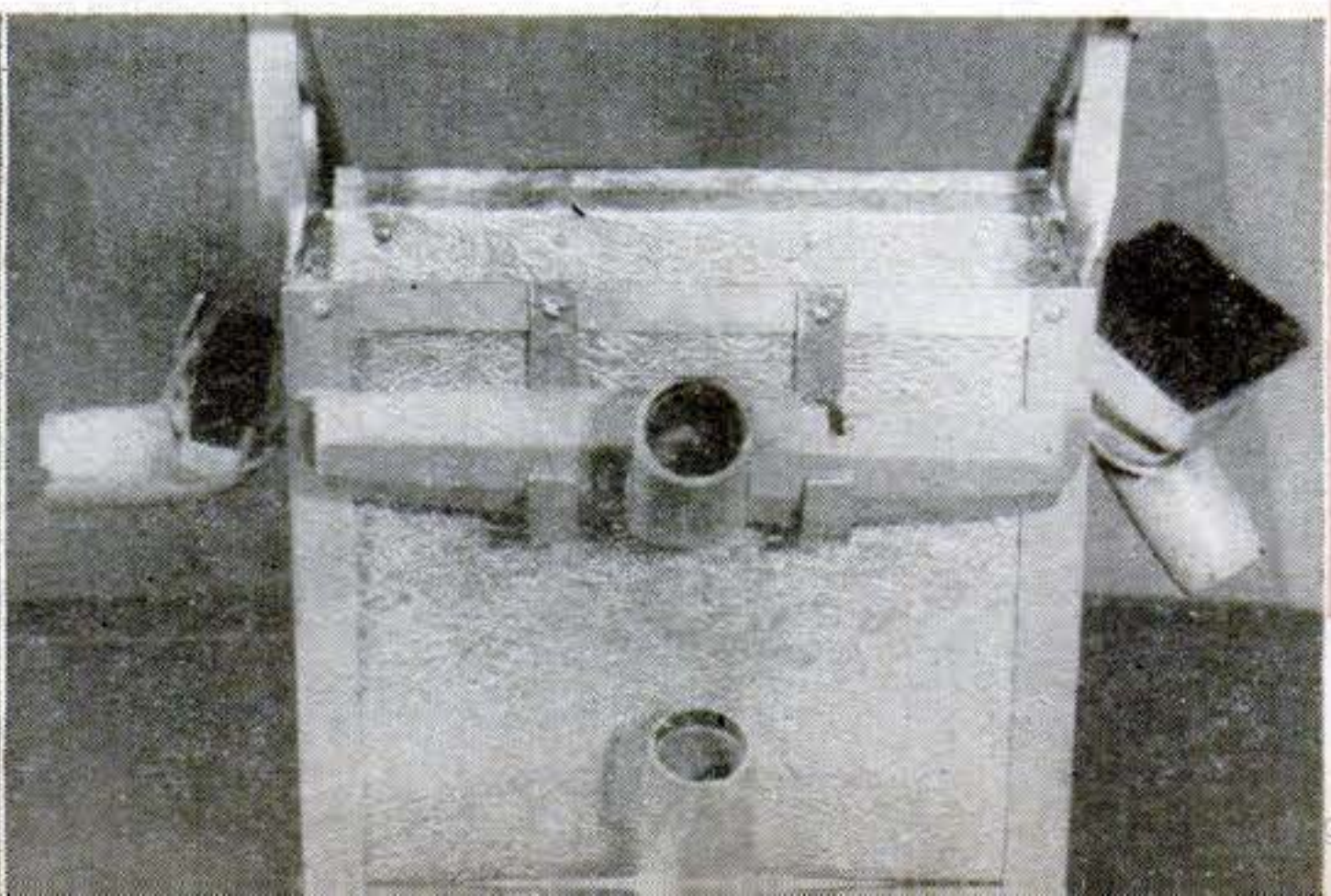
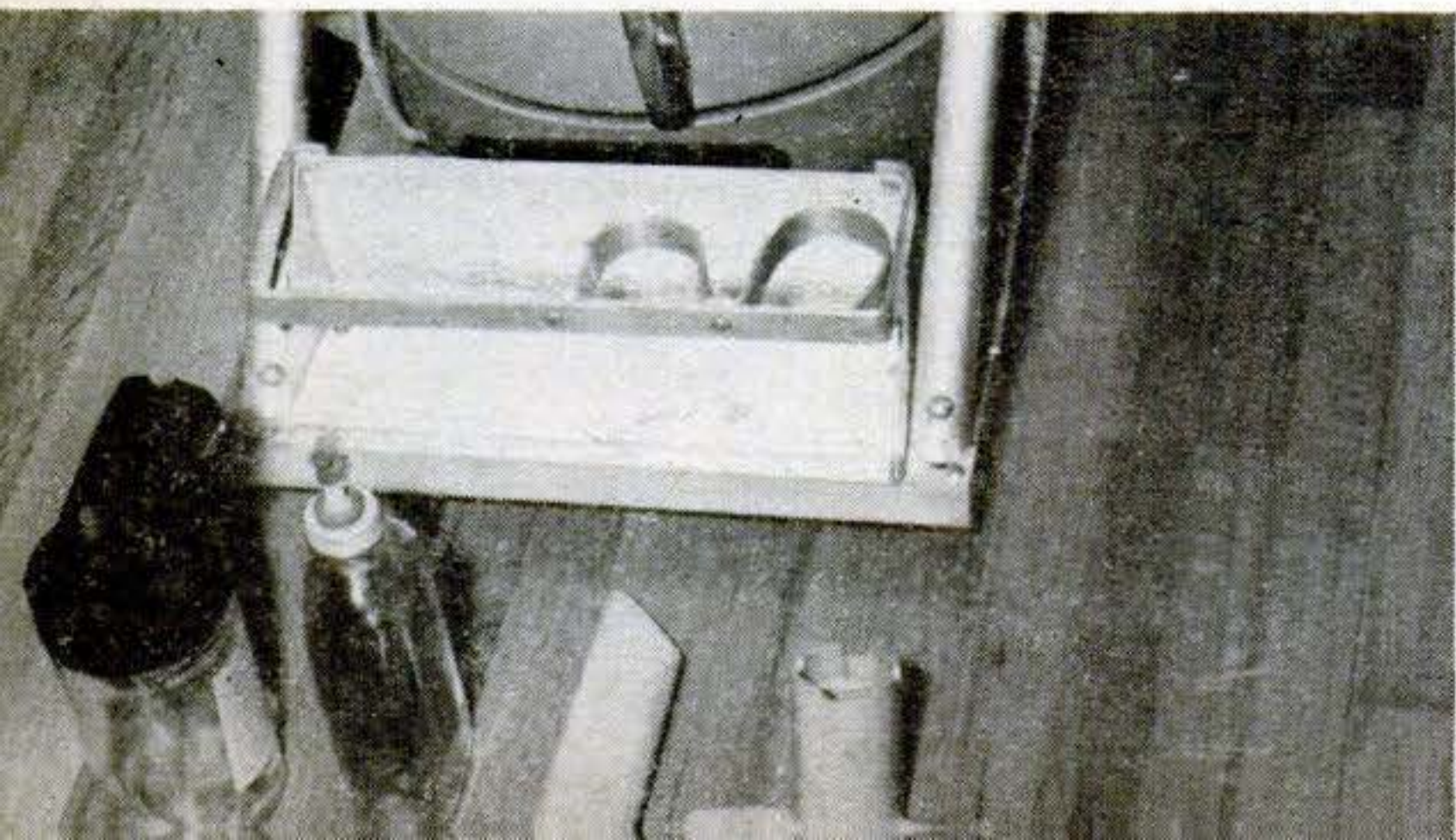



# Eases Housework

dles to help you shape both alike. Wood blocks bolted to a solid bench top make a bending jig. For best results, fill the tubing with sand and plug both ends.

To make the twist in the handle brackets, clamp  $\frac{1}{8}$ "-by- $\frac{3}{4}$ " aluminum strip in the vise 6" from one end, grasp it with a monkey wrench 2" above the vise jaws, and turn it 90°. Lock two square-head bolts close together in a vise, clamp the heads firmly together, and insert the stock between shanks for bending the scrolls.

Shape wooden hand grips with a rasp or on a power sander. Cut the towel bar overlength and spring it into  $\frac{3}{8}$ " holes drilled in the inner wall of each handle. —L. H. Houck, Jefferson City, Mo.

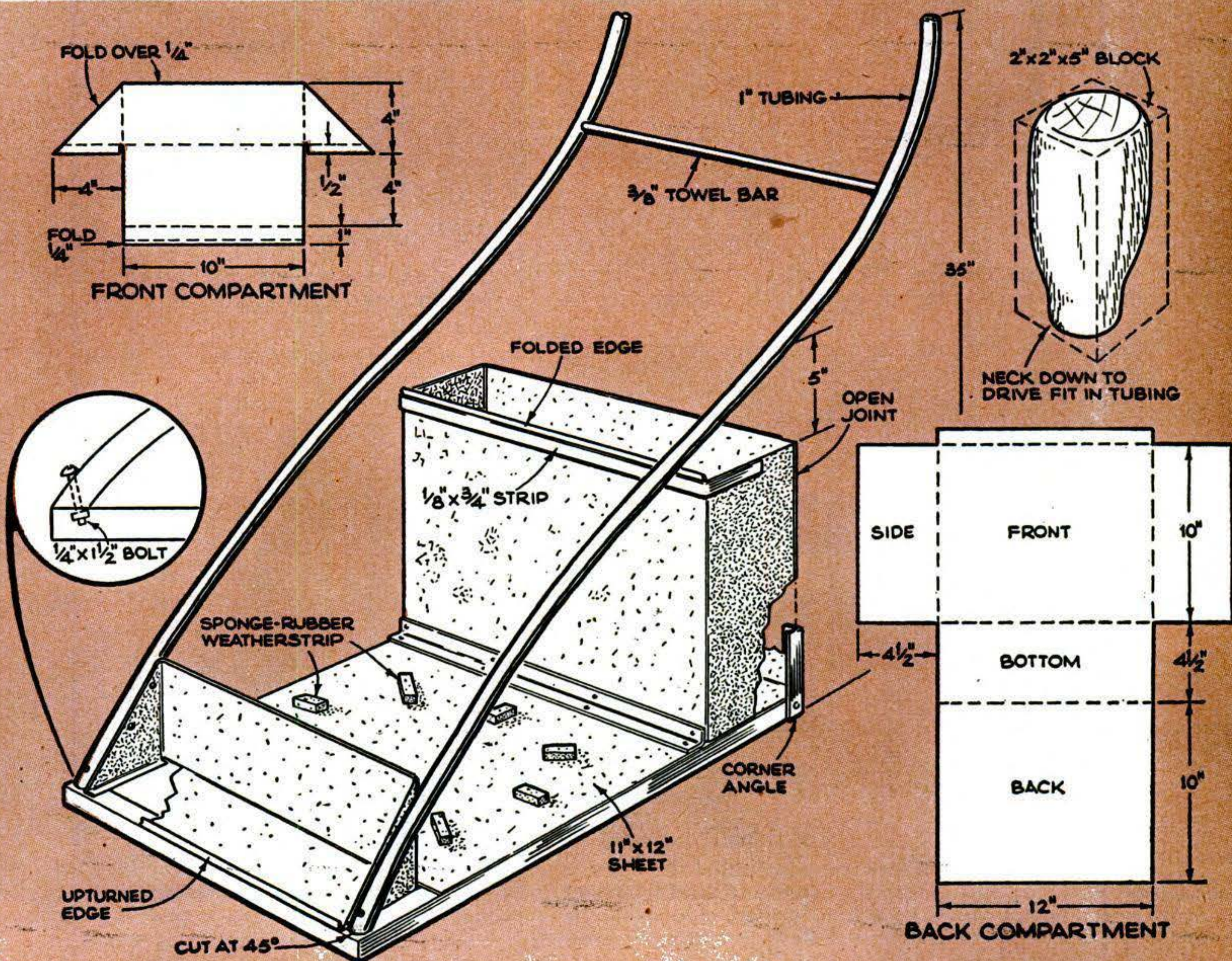
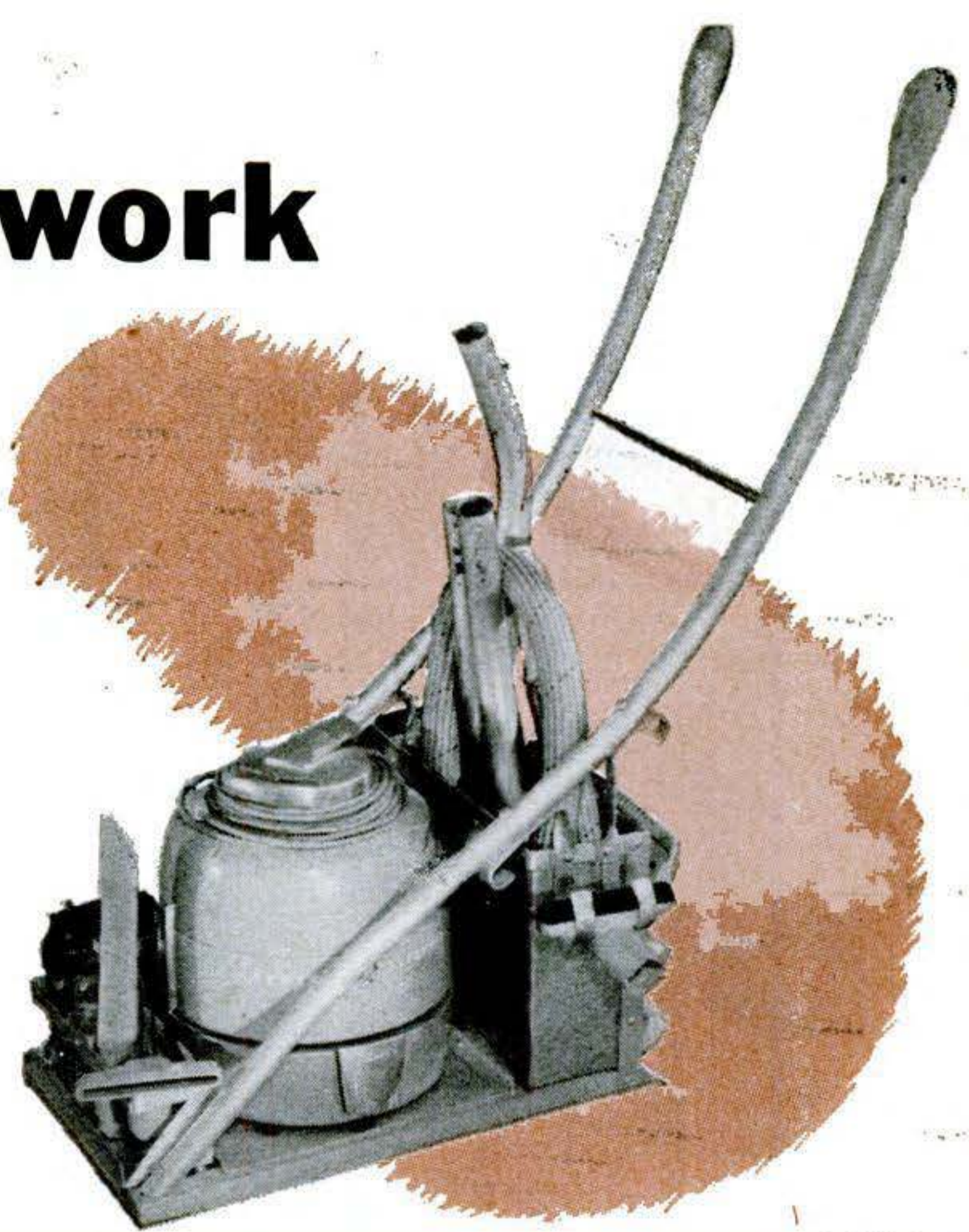



# 5 USEFUL TRICKS WITH Screw Eyes

**A RACK FOR SMALL TOOLS** is made by arranging screw eyes in vertical pairs as you see at the right.

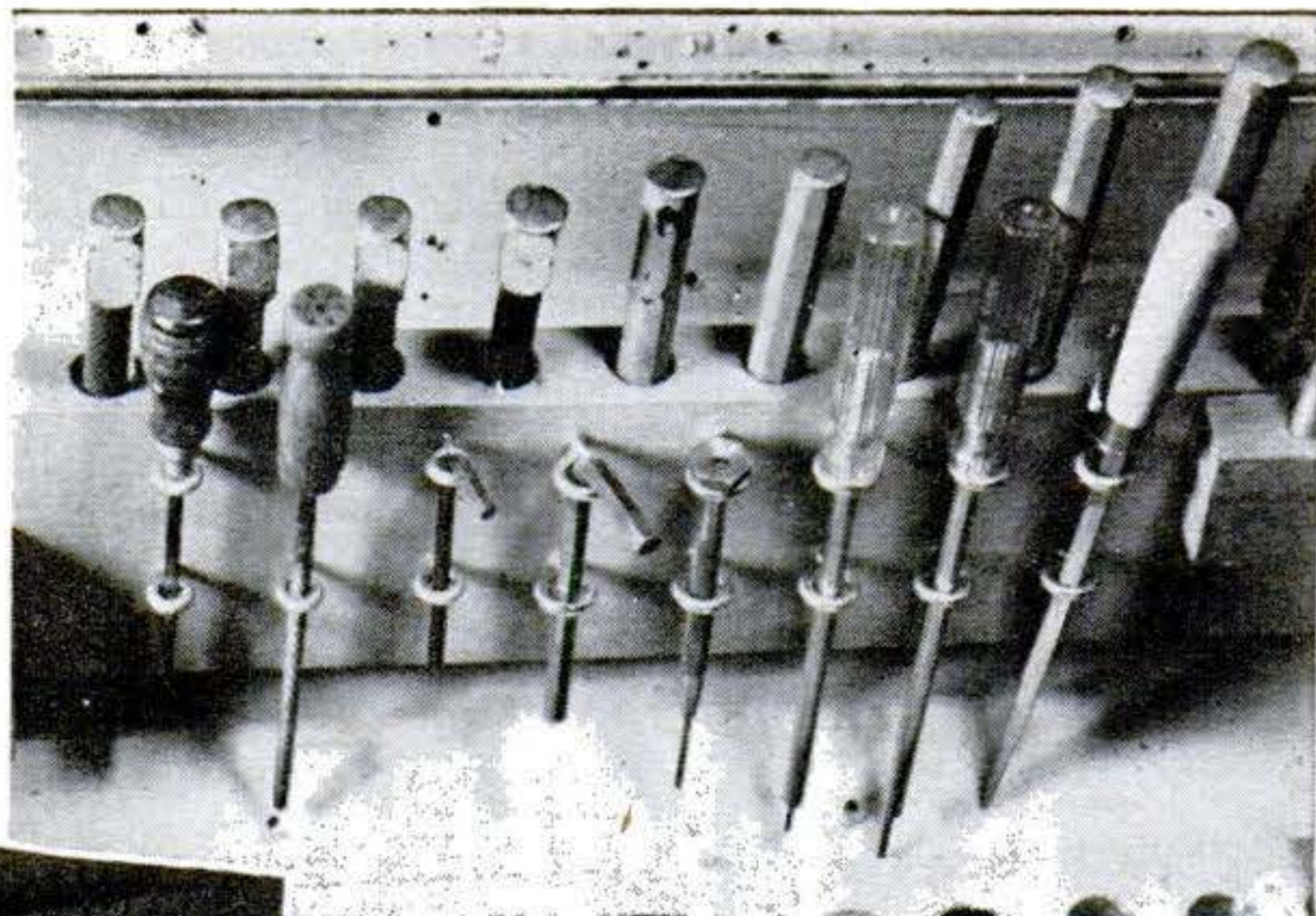

**THE STRIKING FEET** on this small cabinet are simply four large screw eyes turned into the bottom.

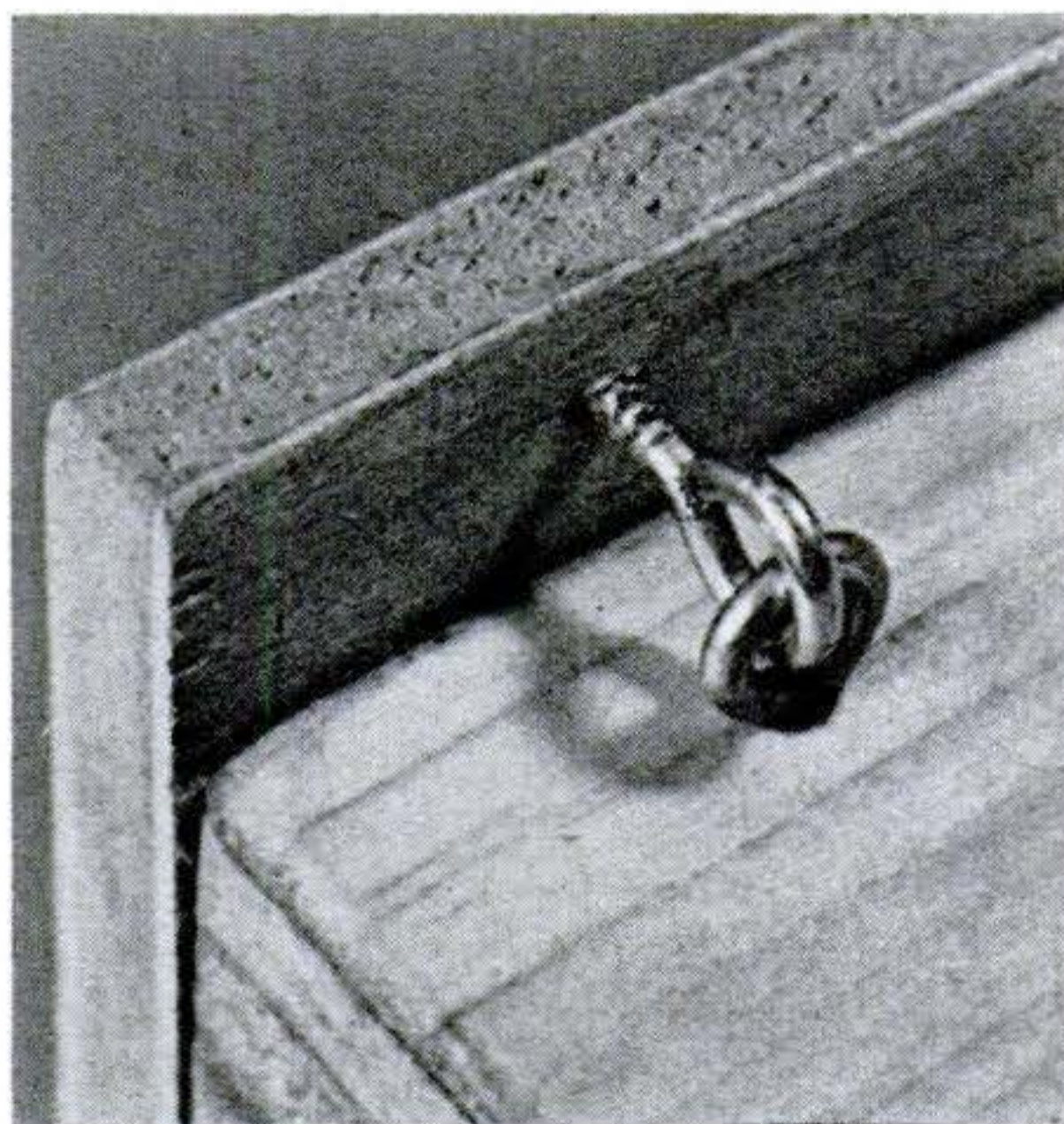

**A HINGE** suitable for light construction consists of two interlocked screw eyes, installed as shown above. Spread one screw eye apart to assemble hinge.

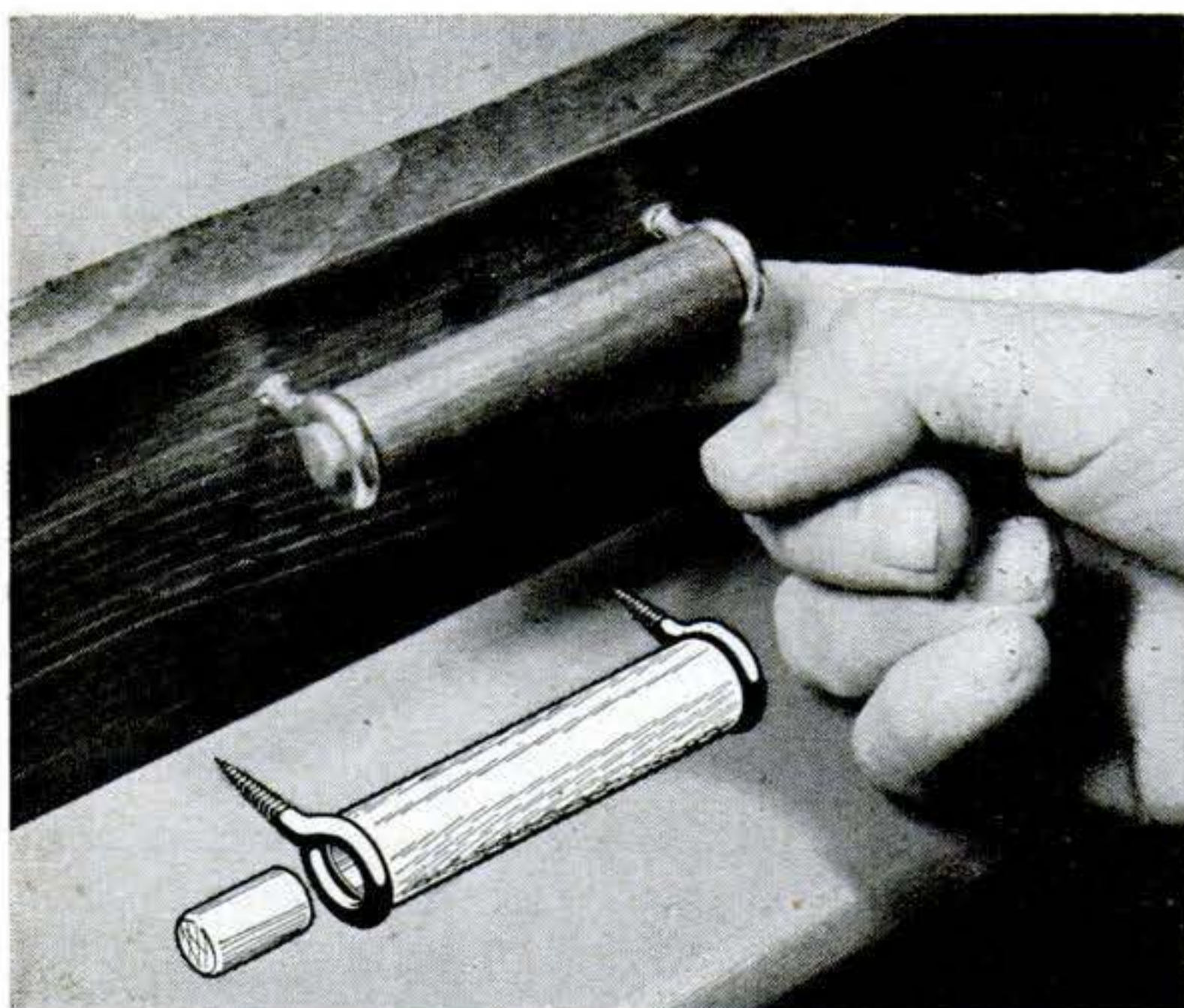

**PEOPLE WILL WONDER** how you assembled this drawer pull until you show them the secret—a short length of smaller dowel glued in a hole drilled in one handle end. The other end is turned down to fit. Use screw eyes with an inside diameter of  $\frac{3}{8}$ ".

**NEED A SHAFT BEARING** for an experimental setup? Select a screw eye to suit the diameter of the shaft.

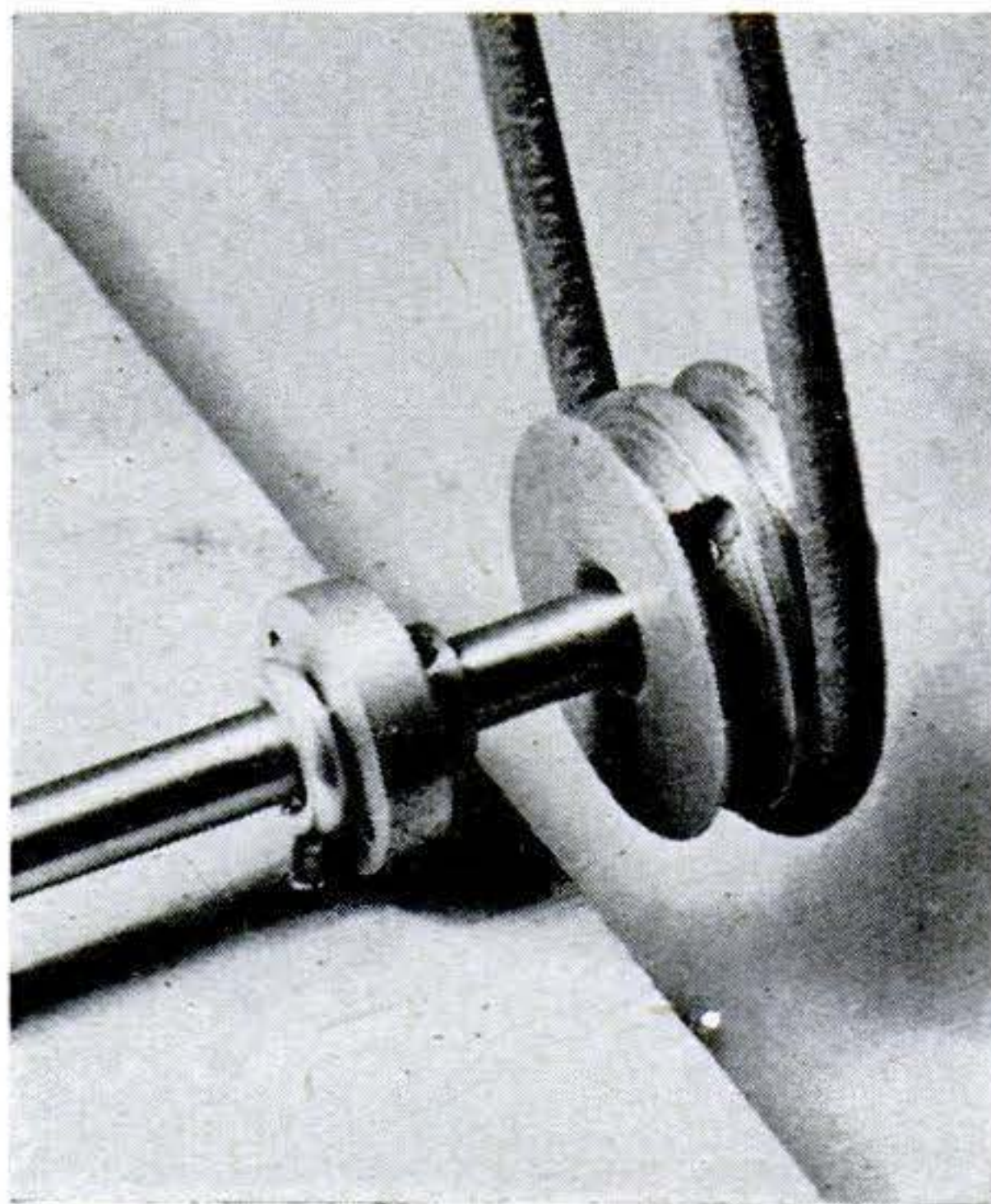



# How to Keep Doors Working

By Charles Adams

**A** DOOR that sticks, drags, binds or rattles is as common as a leaky faucet—and once you know what to look for, the solution is just as simple.

You can eliminate most troubles with a screwdriver, plane or a piece of cardboard. But be sure before you act.

A quick first look at a sticking door may suggest that it needs planing. But a second may show that the hinges are loose. A third may tell you that the hinges won't hold until you plug the screw holes first. And a fourth may show that you need a slight bevel on the back edge—the real cause of the trouble all along.

**Silencing rattles.** A door rattles only when it's loose at the latch and is free to flutter.

You can prevent this by resetting the stop strip on the latch side of the jamb. Move the top and bottom edges about  $1/16''$  toward the door, but keep the middle portion bowed about  $1/16''$  away from the door. When

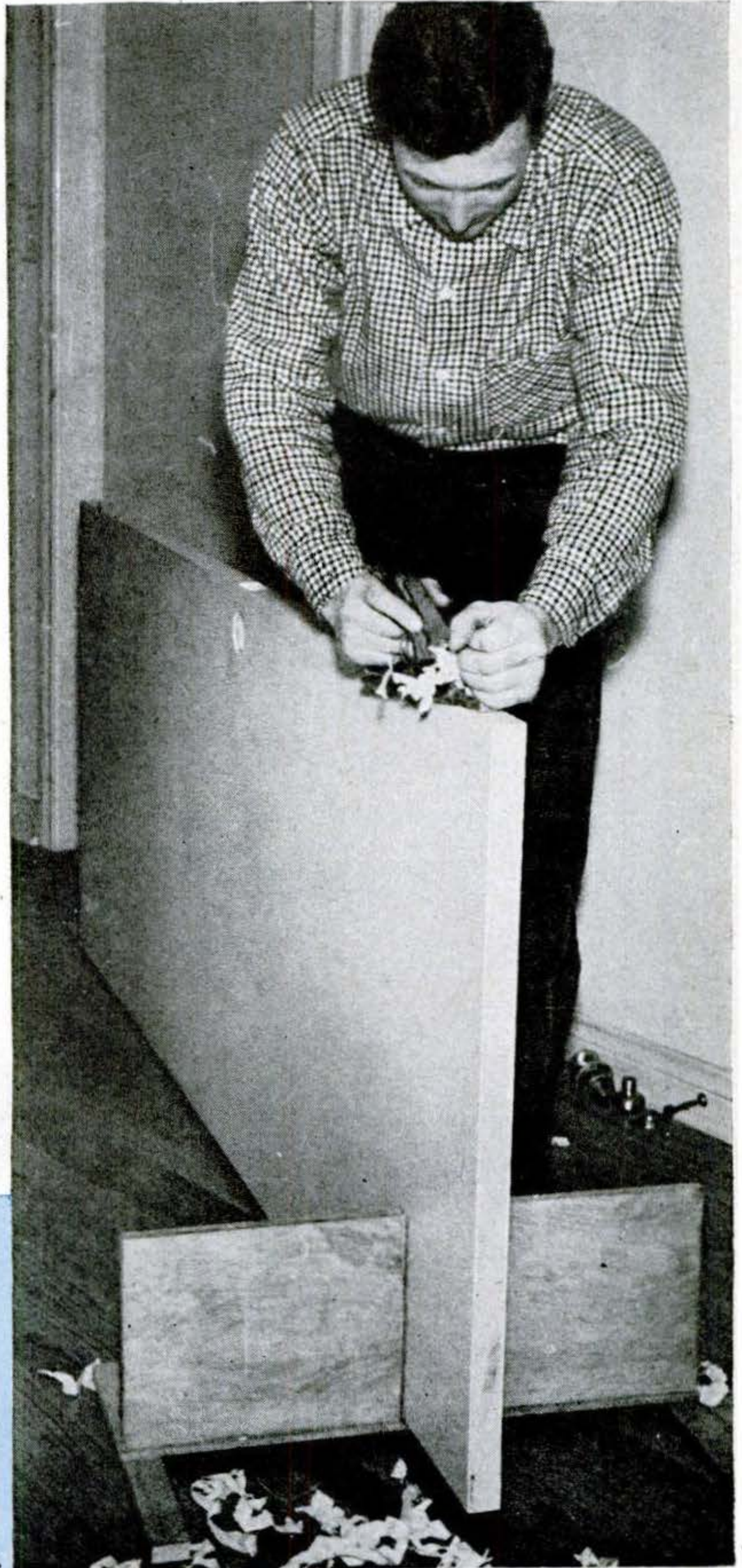
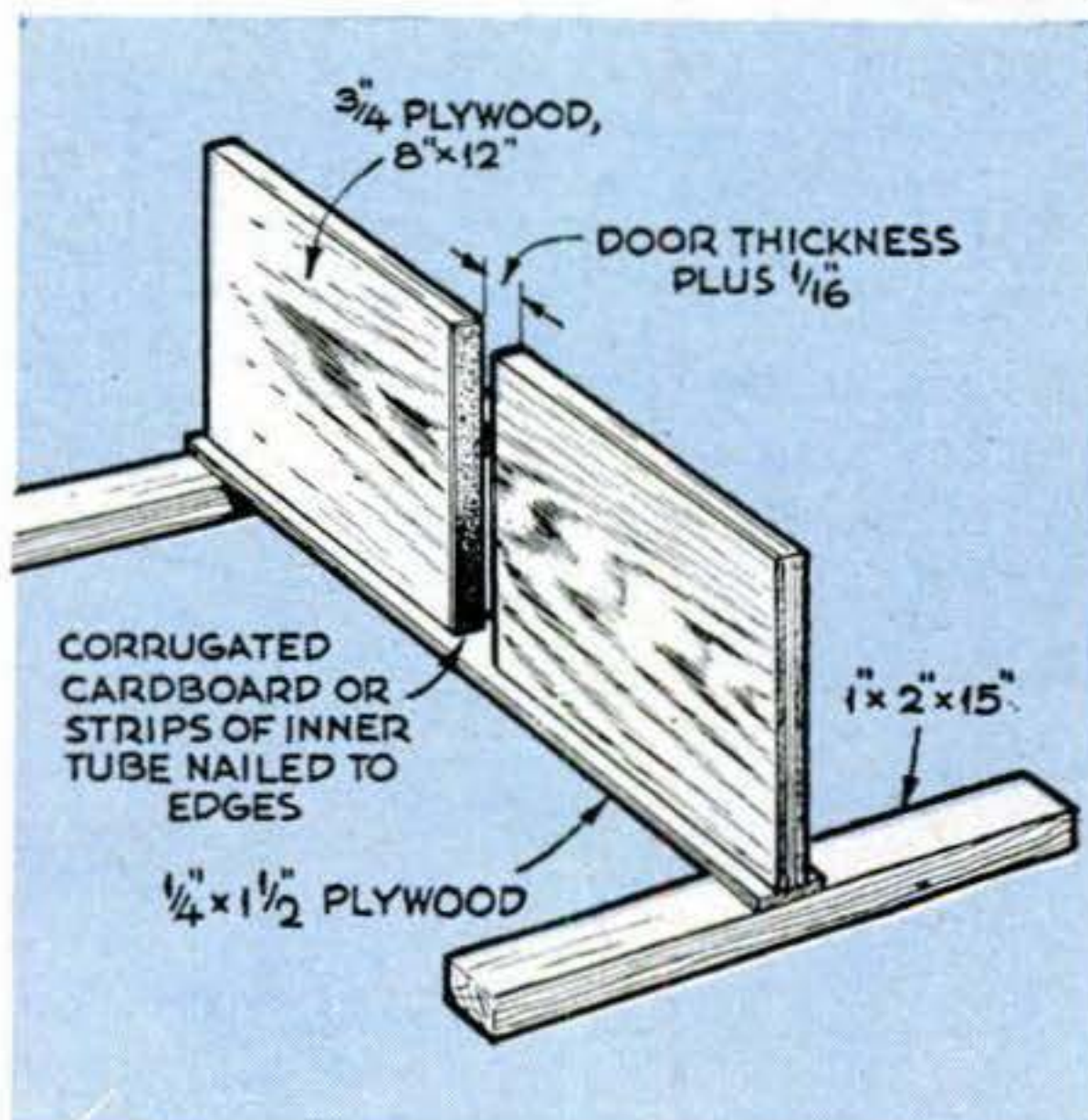

**A DOOR VISE** to hold a door on edge for planing, mortising and other fitting is a useful addition to a home shop. When you rest the door in the slot, the thin strip at the bottom sags, pinching the door tightly between the two sidepieces.





STOP STRIP TOUCHES DOOR AT TOP AND BOTTOM ON LOCK EDGE

$\frac{1}{16}$ " SPACE BETWEEN STOP AND DOOR EDGE



**TO CLEAR A CARPET**, trim off the bottom of the door like this. Set a compass to the carpet thickness plus  $\frac{1}{8}$ " , then run the compass along the floor, marking a pencil line on the door

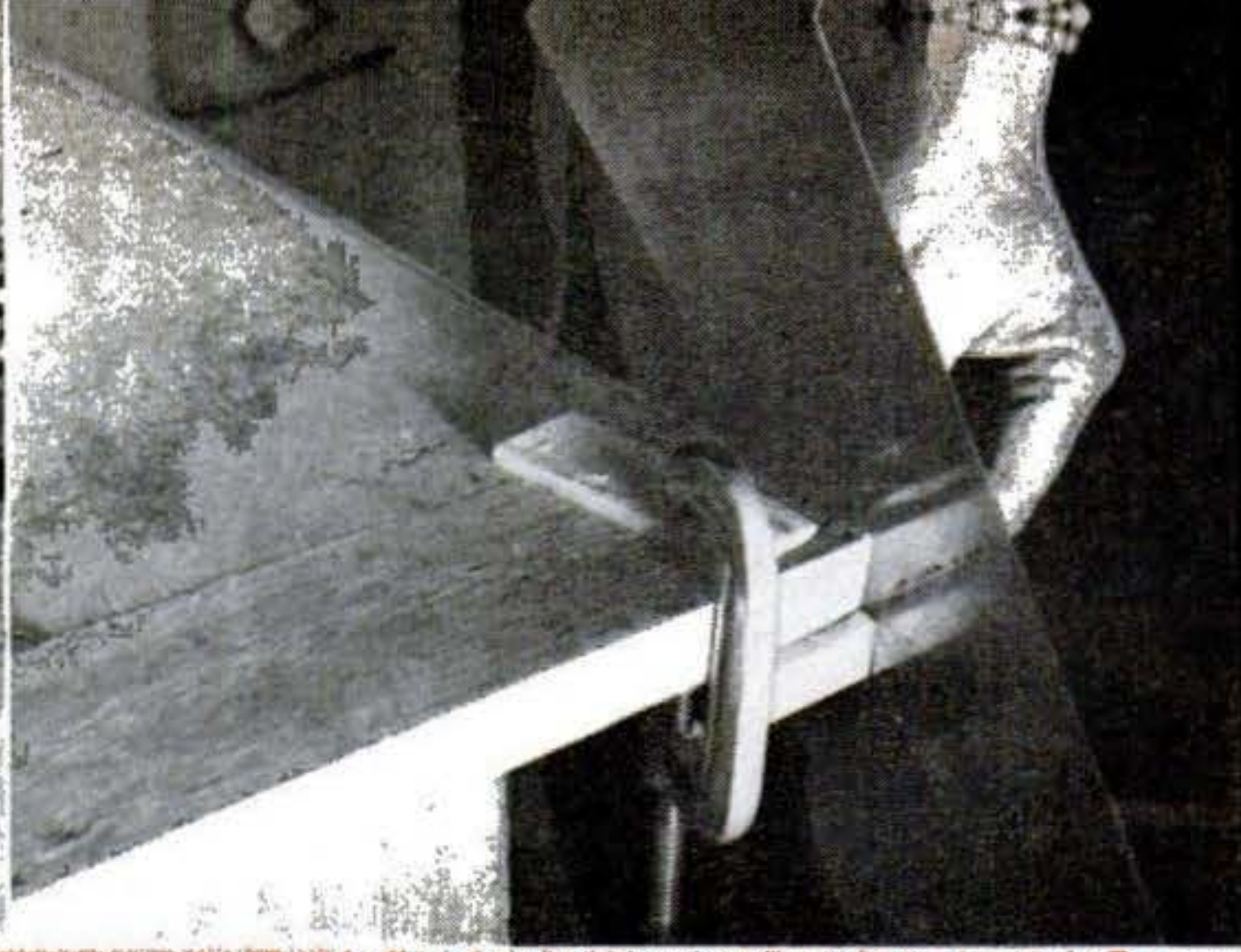

(above left). Clamp a board across the bottom so you saw through both board and door at the same time (right). This helps guide the saw and prevents splintering any end grain.

**A DOOR WON'T RATTLE** if you set the stop strip so it touches the door at the top and bottom but is bowed  $\frac{1}{16}$ " away from the door at the center. Slight bend in door against strip puts it under tension, holding latch bolt firmly. When painting a doorstop use a "dry brush" so that successive coats won't build up and cause the door to bind.

**DOORS THAT SHRINK** can be built back to shape by gluing and screwing thin strips to the edges. On the hinge side, avoid putting screws where hinges go. Sand strips flush, putty cracks, and repaint the area for an invisible fix.

the door is closed, it bends slightly against the bowed strip until the latch bolt falls in place; then it is held snugly under tension so that it can't rattle.

For a temporary fix, you can glue small pads of felt or cardboard to the top and bottom edges, which create the same effect as bowing the strip. But it's best to make the repair permanent.

Whenever you reset a stop strip, run a knife blade down along each edge to break the paint joint. This will make the strip easier to remove and keep it from tearing off surrounding paint.

Pry the strip off gently with a thin, wide blade—a screwdriver will just chew up the soft wood. One trick is to insert a putty knife first, and then drive a small wedge under it. Nail the strip back on at new points, patching the old nail holes that have worked loose.

**The cardboard test.** You can quickly find out how well a door is fitting by running a piece of post card or other thin cardboard all around between the door and the jamb. Mark the spots that bind, for future planing.

But before you slash, first make sure that the hinges are tight—you can never put back the wood you take off. Loose hinges often cause binding and dragging by letting the door sag away from the jamb.

If the hinge screws won't hold tight, whittle tapered wood plugs and glue and drive them into the oversize holes. If





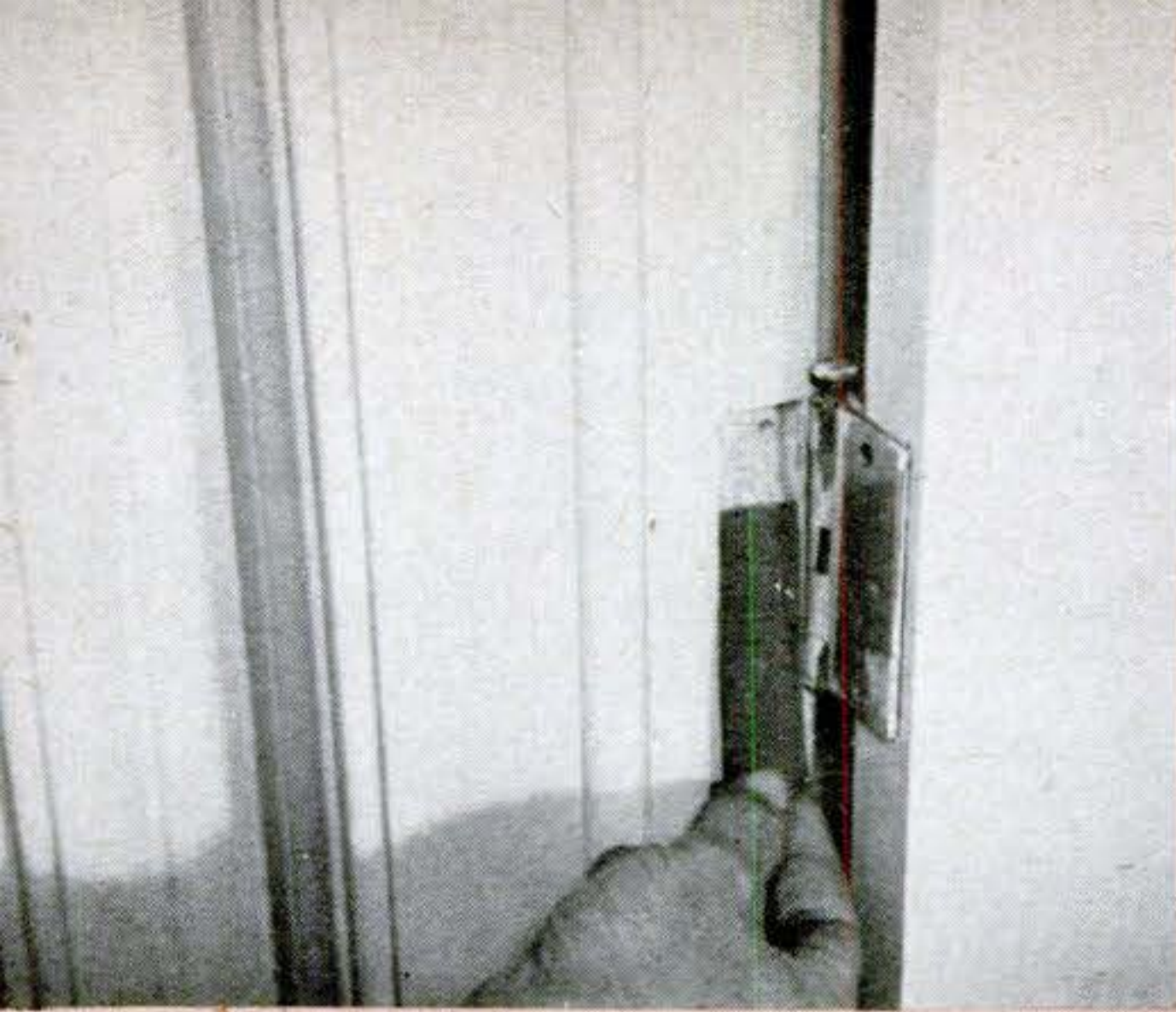

**SHIMMING OUT HINGES** helps set a door plumb, relieving sag or drag. You can slip small pieces of cardboard, felt or linoleum under a hinge without removing the door, as shown above.

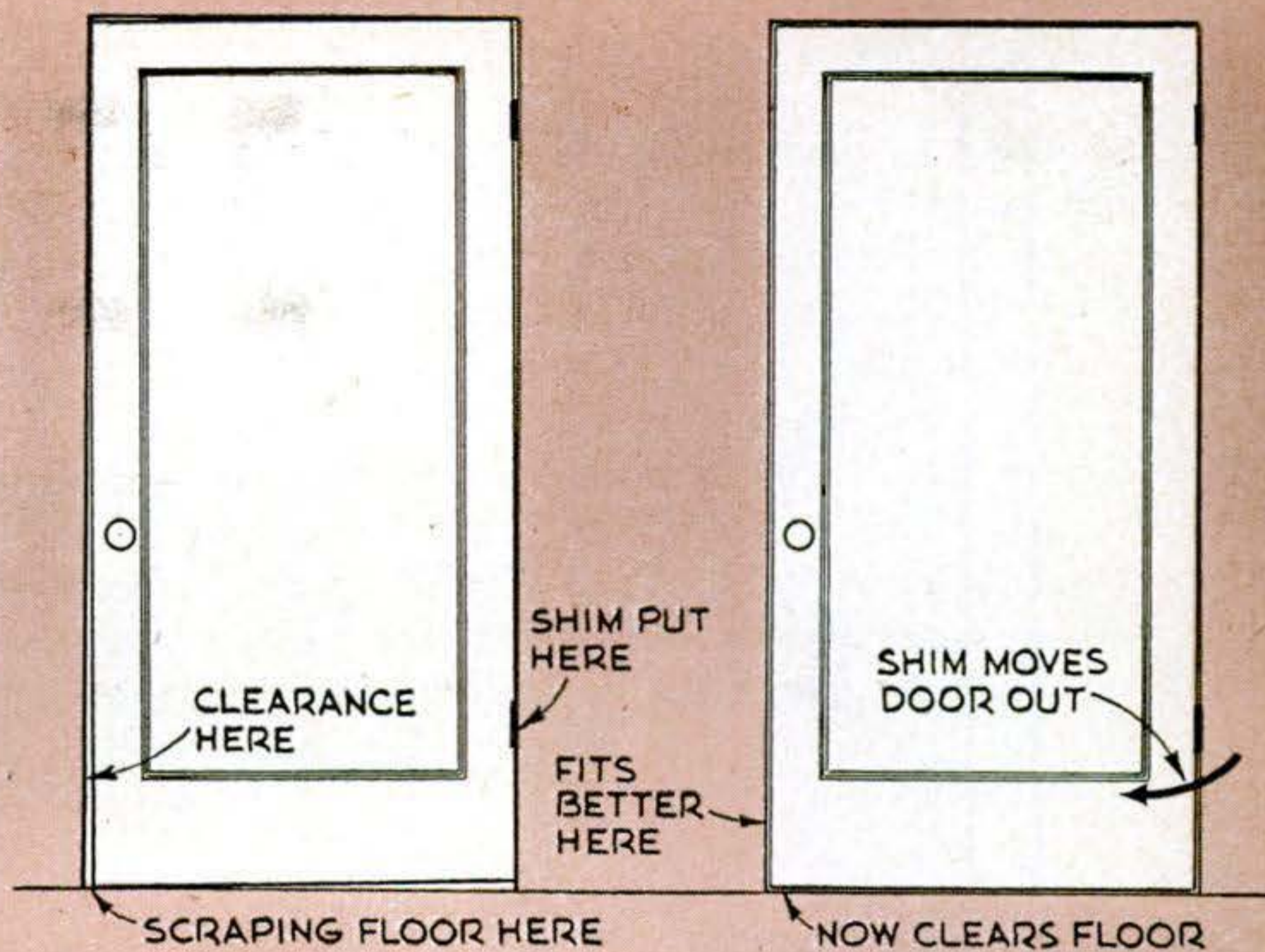

previous plugs haven't held, it's best to bore out the old holes with a  $\frac{3}{8}$ " or  $\frac{1}{2}$ " bit as deeply as you have wood to drill into, then glue in hardwood dowels of the same diameter.

**Drive screws in tight.** A screwdriver bit in a brace will give you all the leverage you need to turn up the screws tight. Screws driven halfway in with a hammer first are a major cause of loose hinges and sagging doors. Dab a bit of paraffin or soap on the screws if the going gets tough, but don't do it if you don't have to—you want the screws to be as tight as you can get them.

While you're checking the hinges, also test their clearance with the cardboard. Any bind between the door and the jamb, or between the hinge leaves themselves, will spring the hinges and eventually loosen the screws.

A heavy door that is sagging may be pulled back in place by adding a third hinge in the middle. With the door closed, mark the top and bottom of the new hinge on both the door and the jamb, then take down the door and cut a mortise that matches the original ones.

**The cardboard cure.** A door that binds at the top or bottom can often be corrected by adding a cardboard shim under one of the hinges. Slipping a piece between the lower hinge and the mortise sets the door out a bit, having the effect of raising the lower edge. Shimming out the top hinge lowers the upper edge.

You can also shim out a door that has shrunk, leaving too big a crack between door and jamb. In this case, use cardboard or linoleum scraps depending upon the thickness needed, and place them under both hinges.

**Call to surgery.** A door that still binds after you've checked the hinges requires more drastic attention.

High spots on the door's edge can be planed or sanded off without removing the door. Jam it part way open with a rubber stop or with a piece of thin plywood blocked up on one side to form a spring wedge.

In humid weather, take off just enough to let the door close without scraping—it will shrink back a bit as the air dries. On doors that have stiles, bevel the corners with a rasp to  $1/16$ " more than you plan to take off, so that the plane won't splinter the end grain.

If you plane down the edge near the latch, you'll have to remove the lock, then set it farther in when you replace it. You can do this by enlarging the lock mortise with a rasp so that the lock can be pushed in toward the hinge side of the door (the escutcheon plate will conceal the oversize hole). Then remortise the edge so that the latch plate will lie flush with the newly planed surface.

If you have a lot to plane off (more than the escutcheon plate will safely cover), you can remove the door and take the excess off the hinge edge instead



of at the latch side. You then need only to deepen the hinge mortises (mark their locations first in case you plane them off entirely) and rehang the door.

**Doors that won't close.** When you have to heave your hip into a door to get it to latch, it means that the door is hitting the stop strip before the latch bolt reaches the opening in the strike plate. Some carpenters move the strike plate out, but it's easier to file the front edge of the latch opening so that the bolt drops in sooner.

Check first, though, to make sure that the stop strip is correctly located (it should bring the face of the door flush with the edge of the jamb). If it's set too far forward, it will keep the door from closing flush, and enlarging the latch hole may invite rattles if you later move the strip back. So set the stop first, then file if you have to.

Filing is an even bigger help on sagging doors where the latch bolt has

dropped below the latch hole. In this case, file the lower edge of the latch hole until the bolt falls in place.

A door that keeps popping open is binding against the jamb on the hinge side. Run a pencil line down the back of the door 1/16" in from the hinge edge. Then plane a bevel along the edge to the depth of the pencil line, maintaining the angle as carefully as you can. This makes the door slightly narrower at the back, relieving the bind.

**House settling.** A door that can't be cured by minor refitting is probably the victim of a house that is settling, throwing the door out of alignment. It may act up so long as the house continues to settle (mostly during the first five years).

Fortunately, carpenters provide a simple built-in adjustment that permits you to realign your doors even while the house is settling around them. The door jamb is nailed to the wall frame through wood shims, never to the wall directly. By removing the jamb and adjusting the thickness of the shims, you can reset the jamb so that it is level and plumb. The door should then fit perfectly, even if the wall itself isn't level and plumb. END

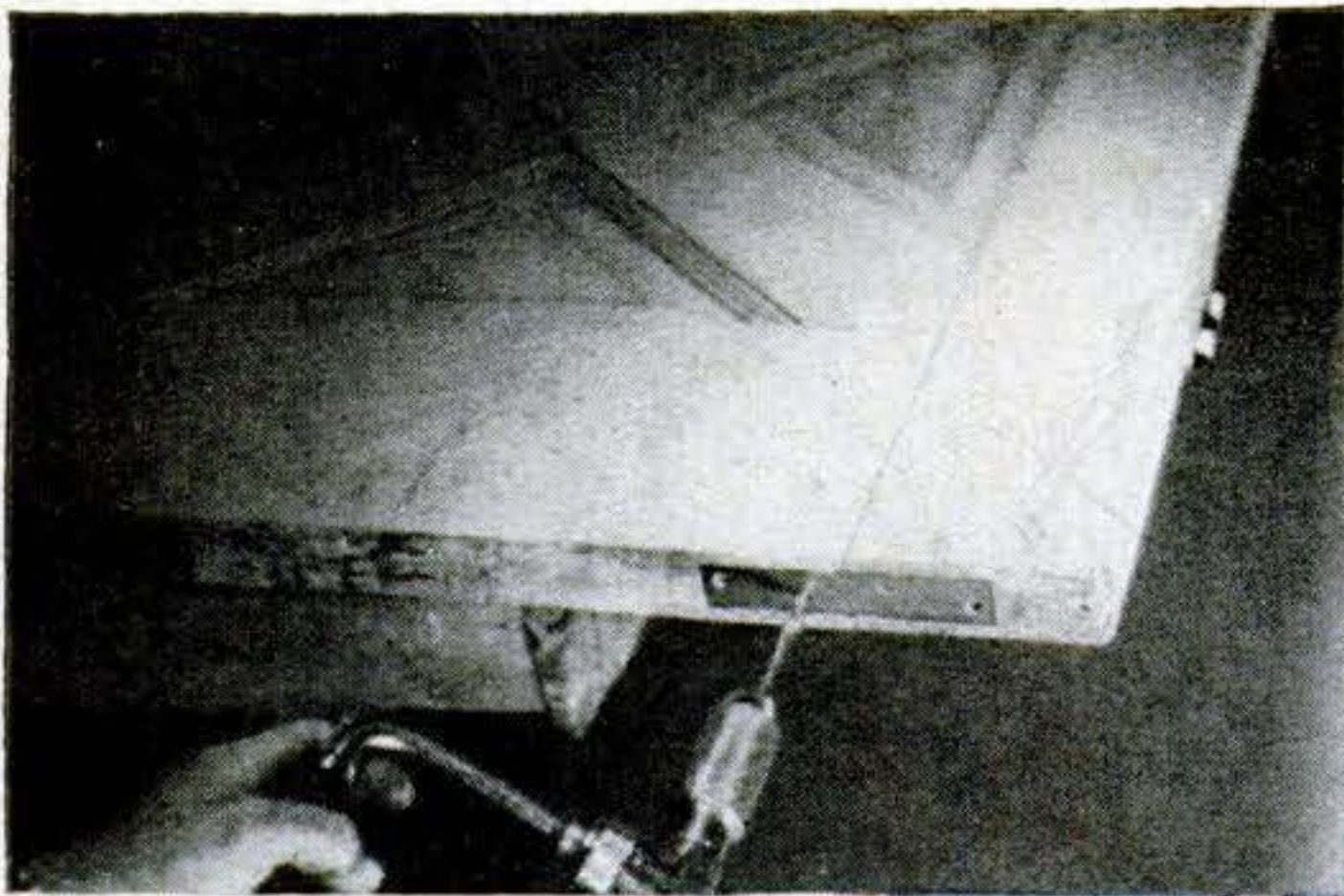

**DOORS THAT COME APART** can be hammered back together, and then reinforced with metal mending plates. On good doors, mortise the plates into edges so they won't show; where looks don't matter, screw flat angles to the door face.

**SEVERE SETTLING** or sagging can be corrected by adding one or two inexpensive jack posts, available at hardware stores, to raise the floor. Place them under existing beams, and screw them up very gradually over several weeks to avoid sudden strain on wood and plaster. You can also strengthen door frames with metal corner braces.

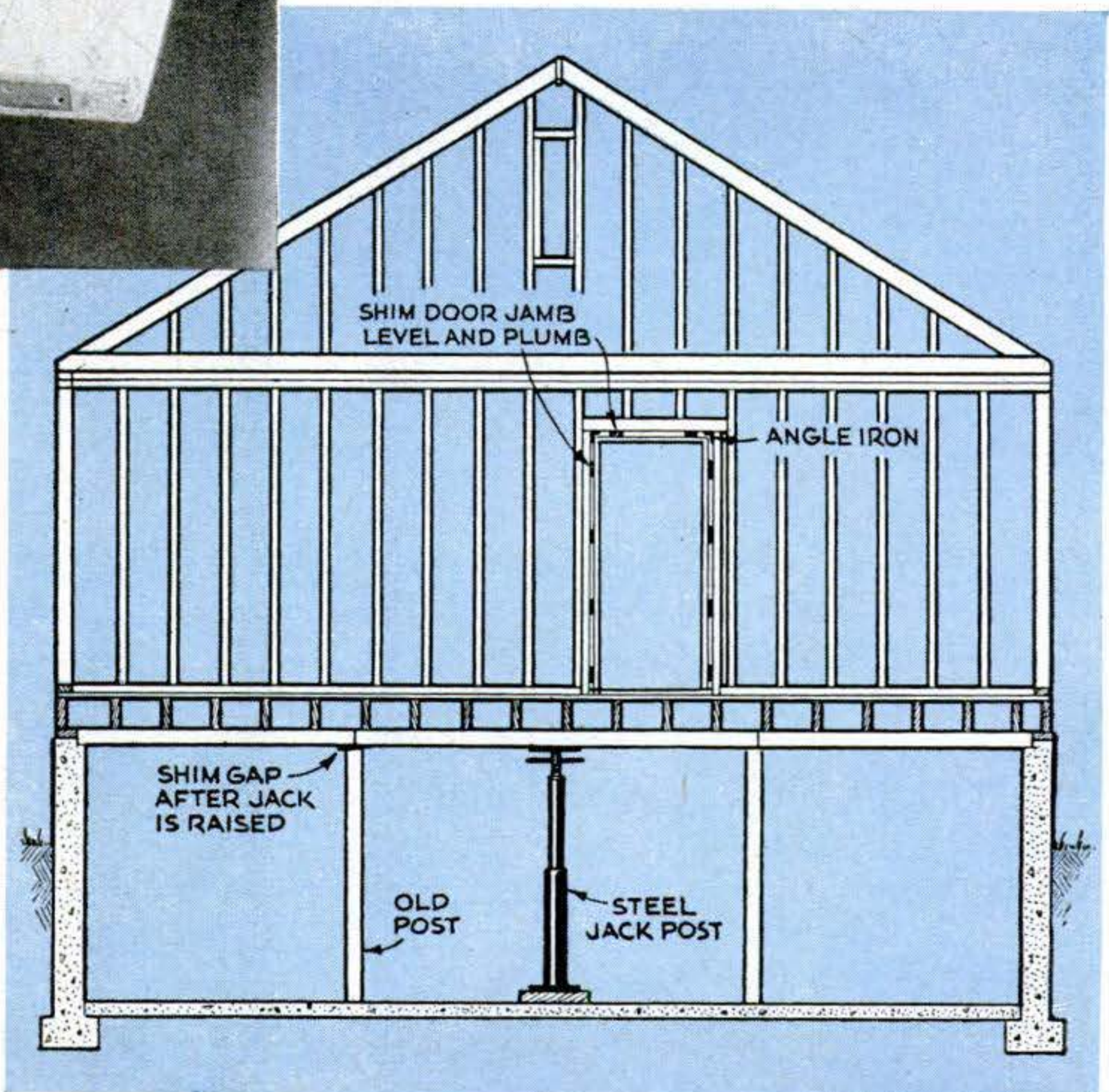



## Cotton Sacking Is Handy As a Drop Cloth

SEVERAL strips of cotton sacking a yard wide by three yards long come in handy for covering floors, furniture and walls on inside paint jobs. The inexpensive sacking gives as much protection as regular canvas drop cloths, and the strips can be spread or arranged more easily in narrow hallways and other quarters where space is limited.—A. B. Kennerly, College Station, Texas.



## DO IT THE EASY WAY



**TO INFLATE BALLOONS** for a party, wedge the vacuum-cleaner hose into a kitchen funnel, slip the balloon over the neck, and operate the cleaner as a blower.

**UNSTICK OLD DECALS** with sticky cellophane tape. Press the tape down firmly and lift it and the decal off.

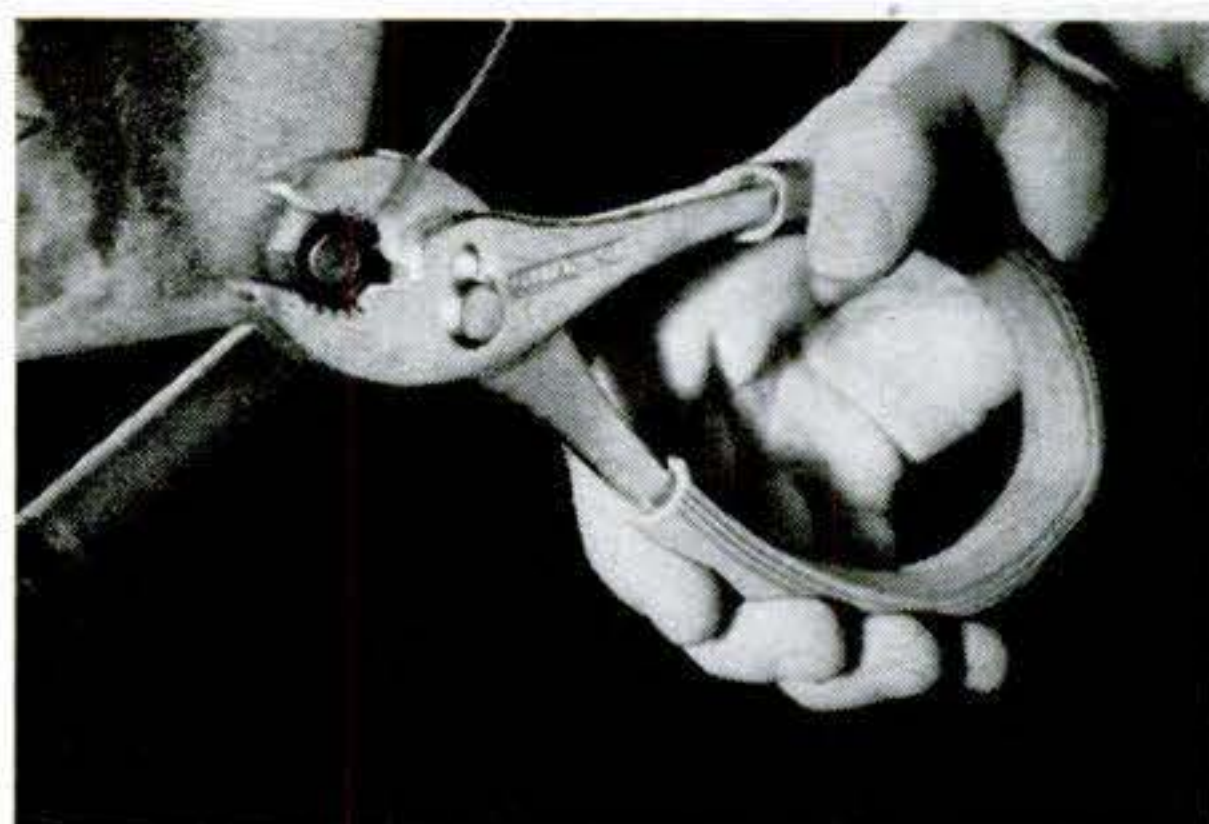
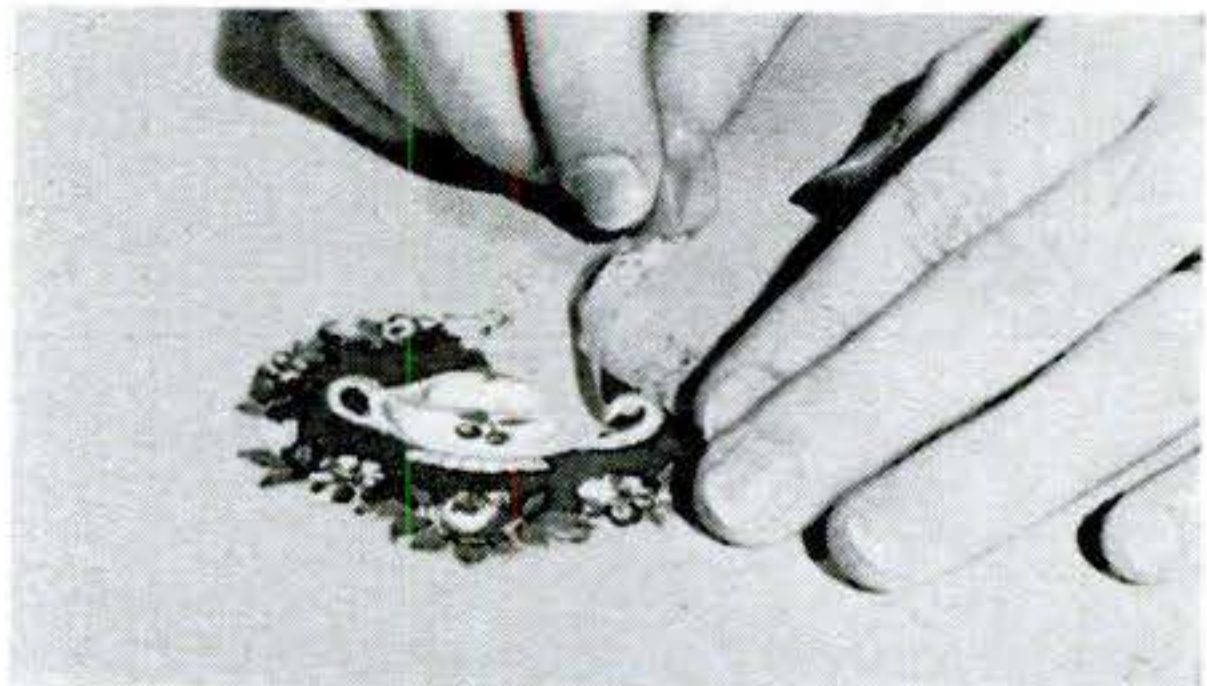

**RUBBER TUBING** slipped over both handles gives quick open-and-close action when you use a pair of pliers as a wrench.

**DRY SOAP** rubbed in the track helps you raise or lower a binding window.

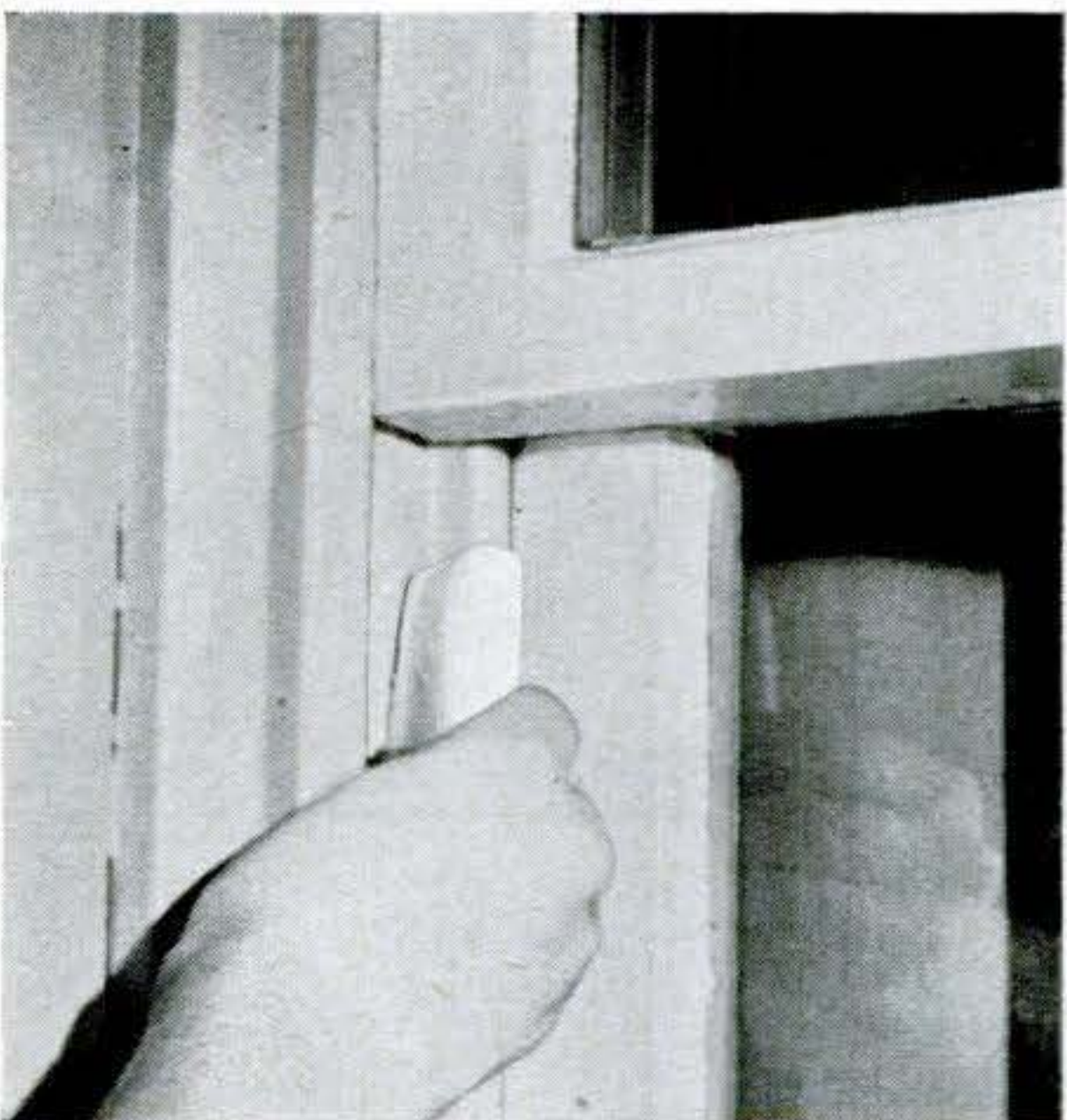



# Four Accessories for the

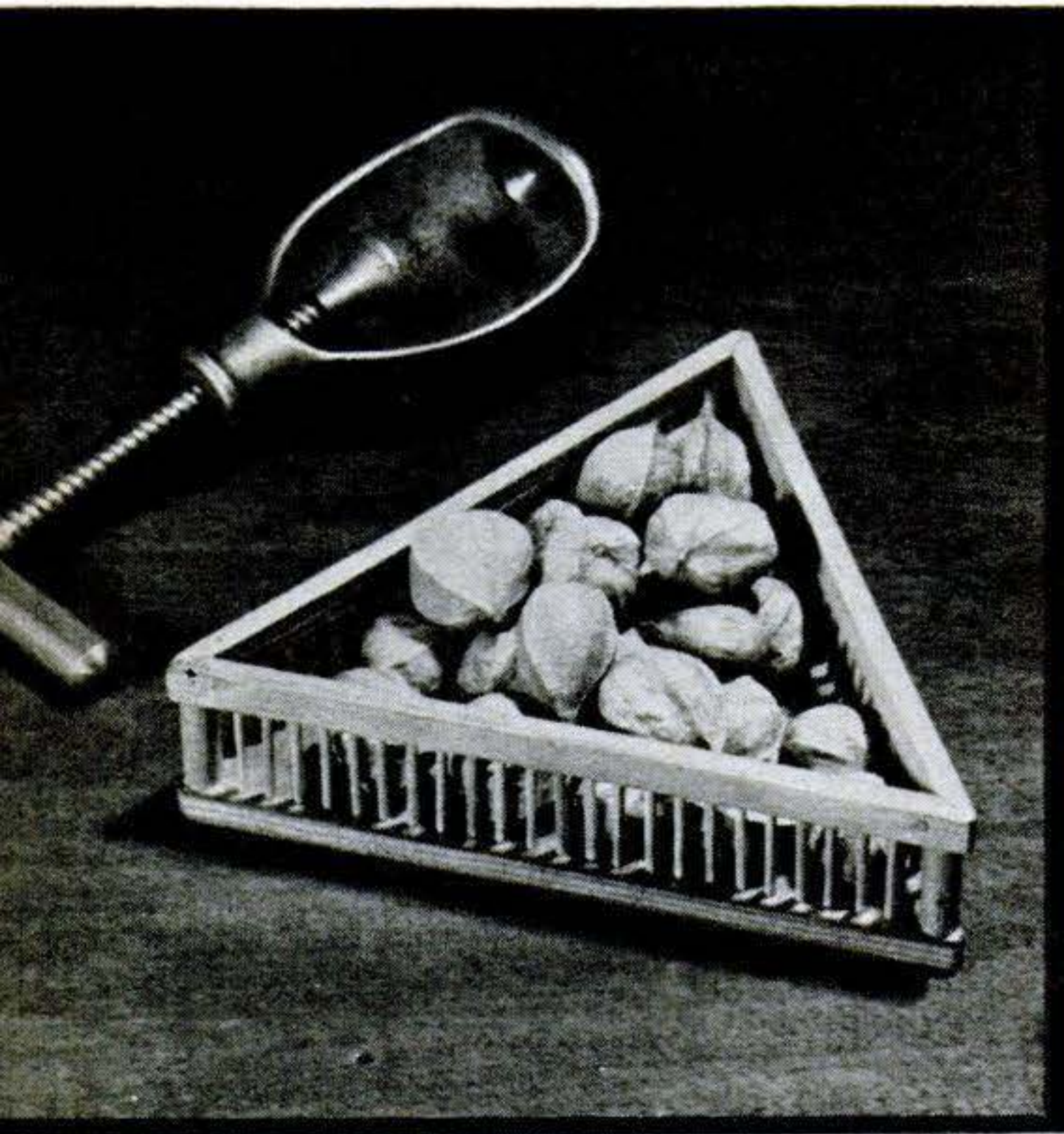

**1** This triangular nut tray has a hardwood-plywood base, round bamboo spindles, and hardwood top rails. After shaping the two  $5\frac{1}{2}$ " equilateral triangles, one solid and the other of strips, clamp them together and invert them. Drill holes through the plywood and halfway through the rail strips. Glue and brad  $\frac{1}{4}$ " corner dowels between the triangles, then drive in the bamboo sticks. Finish the tray with stain and wax, or apply two coats of clear lacquer.

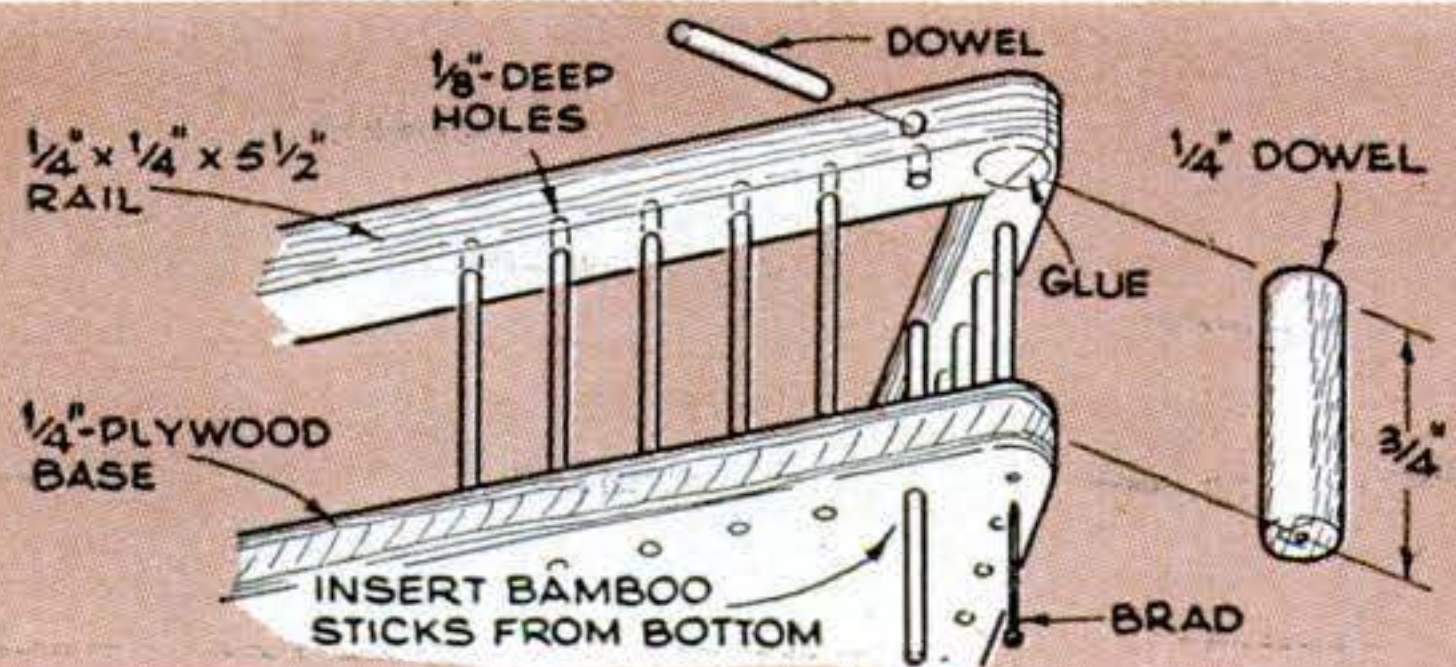

**2** Tailored to fit in a corner, this wastebasket is just right for a small room. Cut the triangular bottom from plywood and the sides from plain or textured hardboard. Drill holes for the rawhide shoelaces that bind the sides together, and for the escutcheon pins that fasten the sides to the bottom.

Glue and nail the sides to the bottom. Run off triangular, corner-reinforcing strips from  $\frac{3}{4}$ " stock, as shown in the detail drawing. Then tie the corners temporarily with cord and glue in the strips. Finally, thread in the rawhide, shoe style, crisscrossing the laces and then knotting the ends securely.

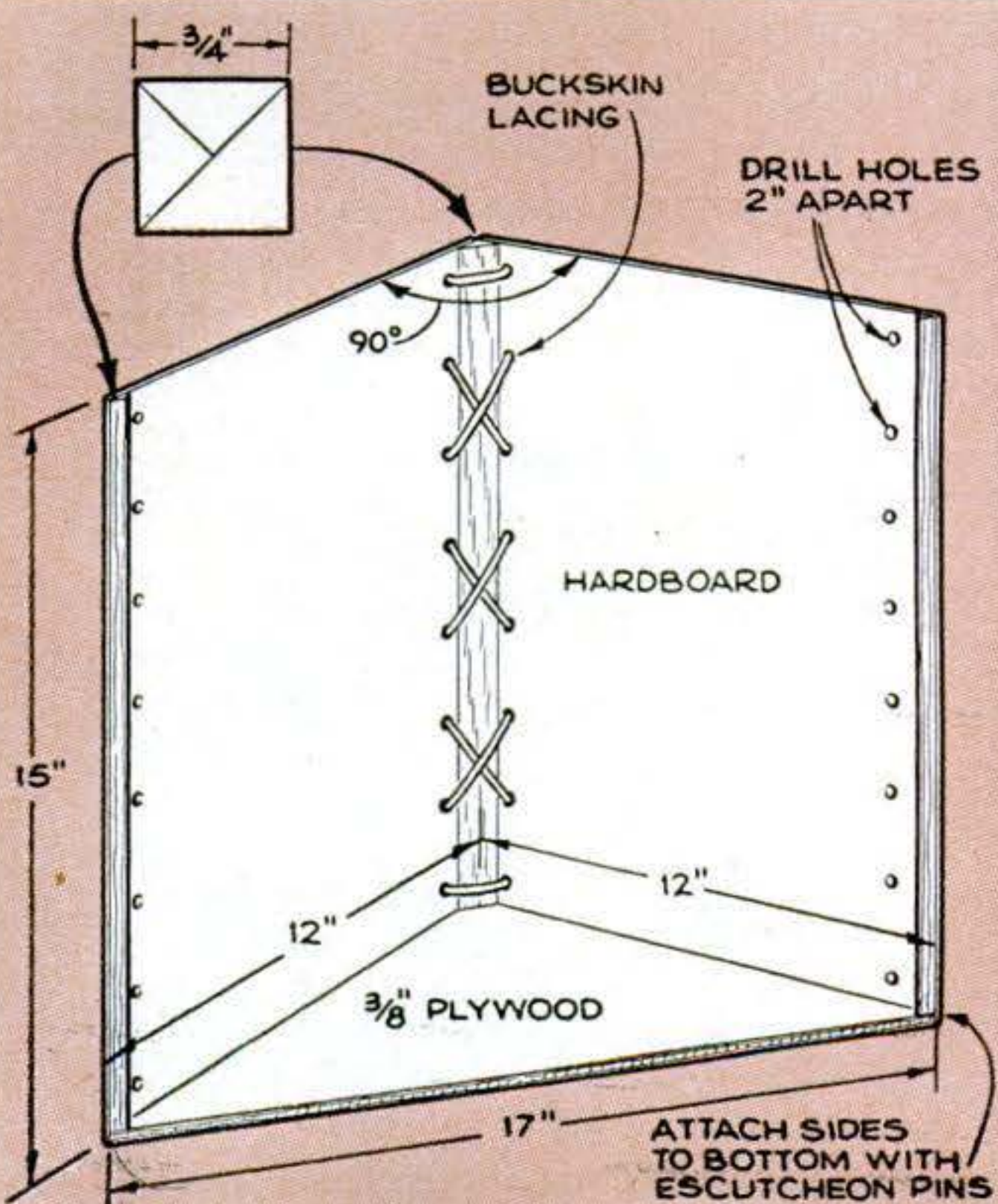
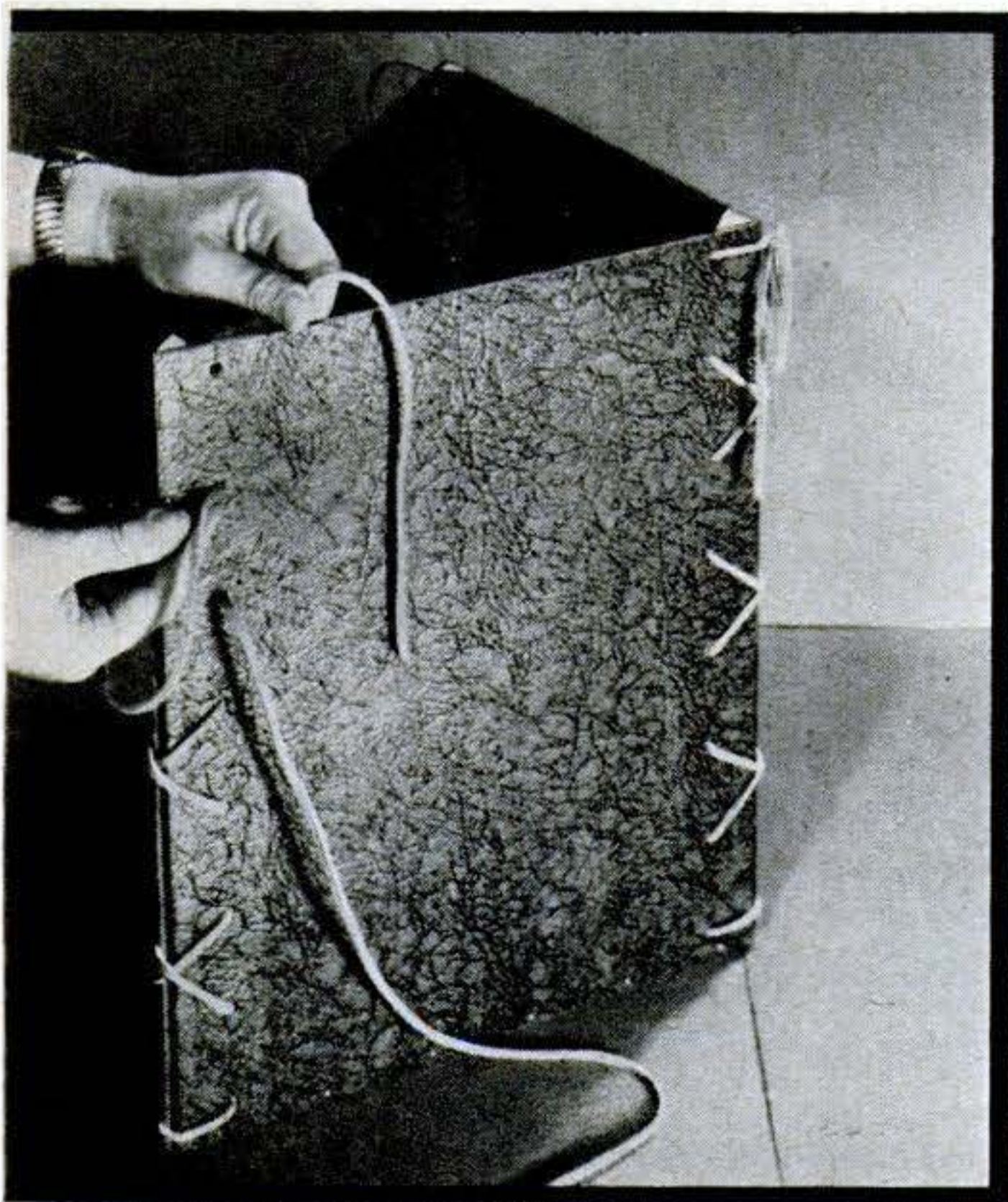



# Living Room

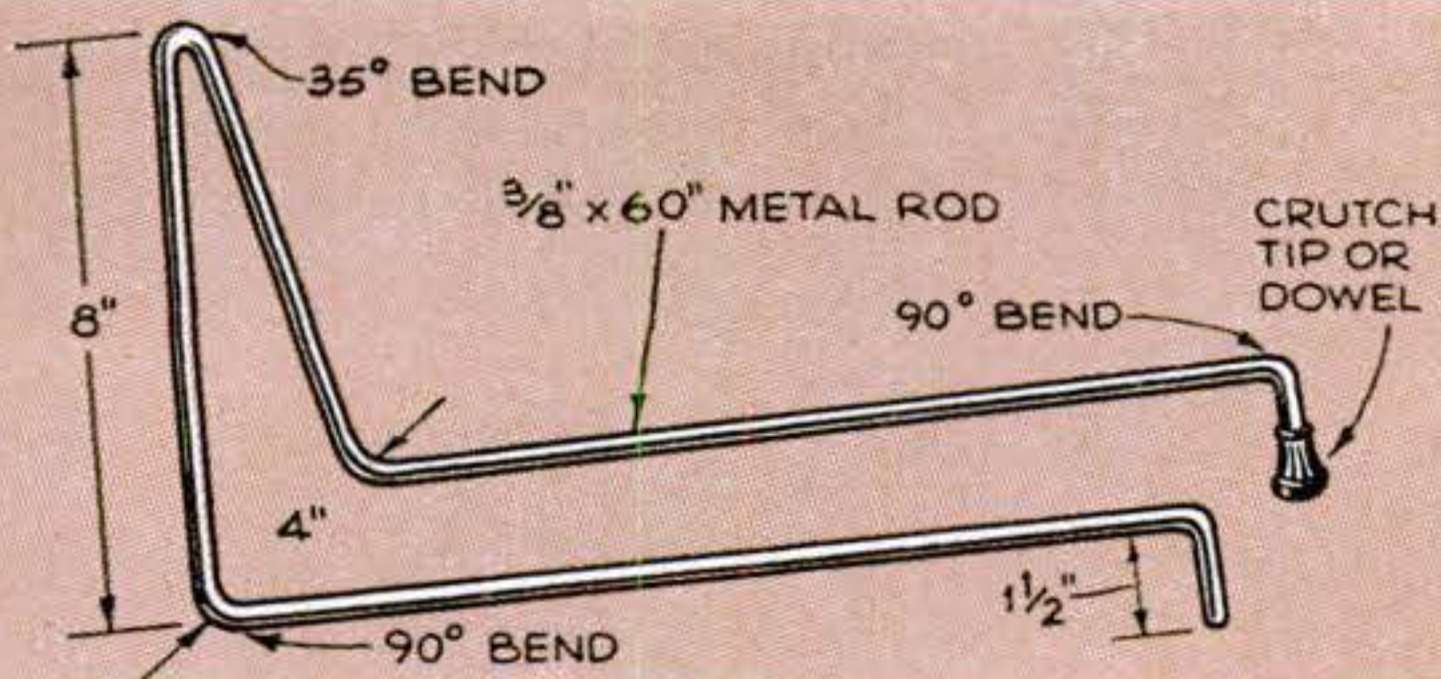

**3 Smart book irons** like these can be made of  $\frac{3}{8}$ " brass, aluminum or steel rod. Bend a  $35^\circ$  angle at the center of a 5' rod, and make two  $90^\circ$  bends on each leg of the resulting "U" to form the L-shaped book cradle and the legs. Polish brass or aluminum with fine steel wool, and brush on a protective coat of clear lacquer. If you use steel, apply flat-black enamel. Crutch tips, or  $\frac{5}{8}$ " dowels drilled out to make cups, form the feet.



**4 A copy of this antique** Colonial doll cradle makes a novel container for gourds or fruit. All parts can be cut from  $\frac{3}{4}$ " clear-pine stock. Bevel the edges of the cradle floor and the bottom edges of the slanting sides and ends. Cut rabbets in the ends of the sidepieces so that they will lap the endpieces.

Assemble the miniature-cradle parts with glue and brads, taking care to nail on the rockers before adding the sides. Hand-rub the cradle with wax for an attractive natural-wood finish.

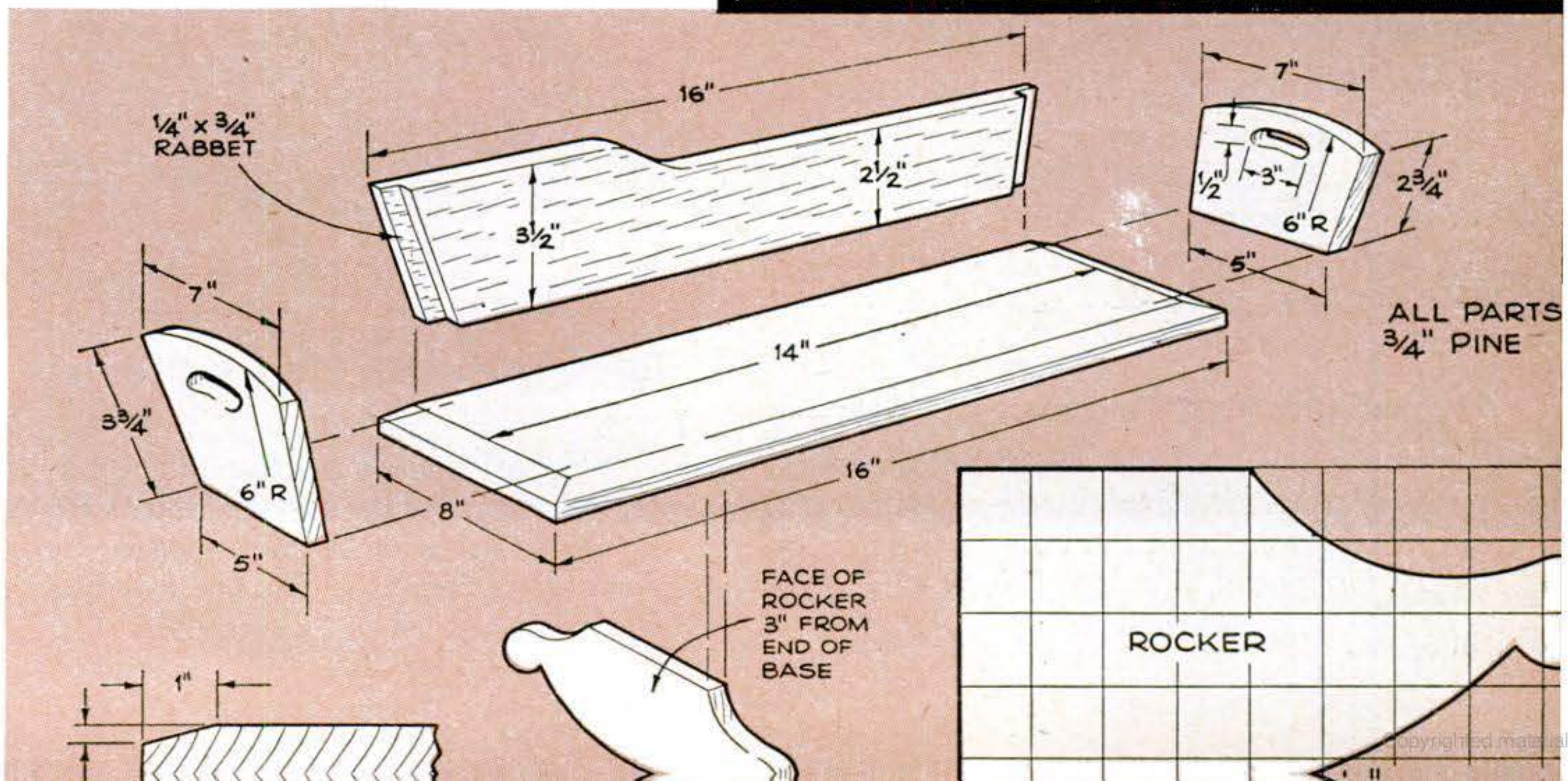
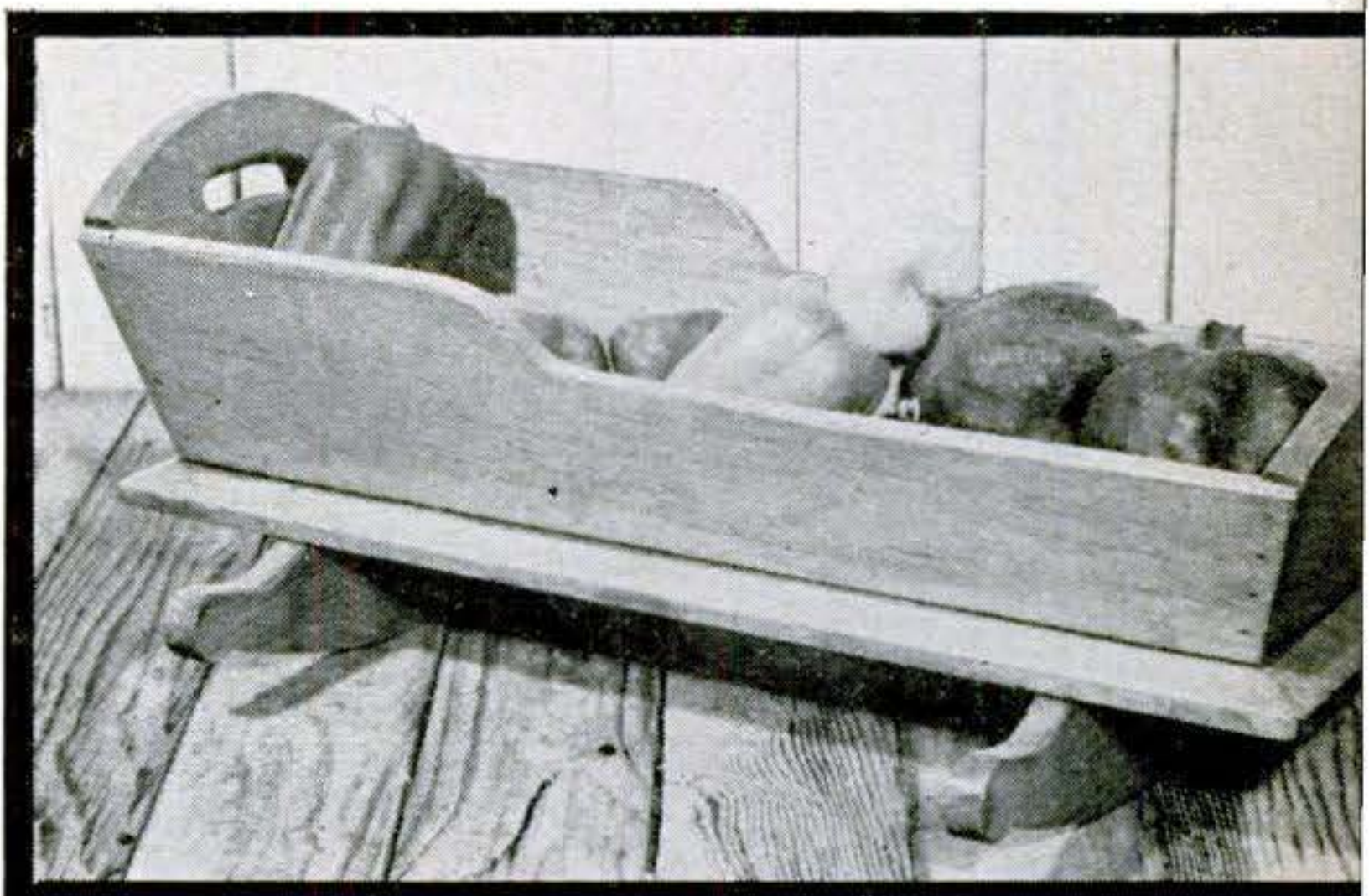



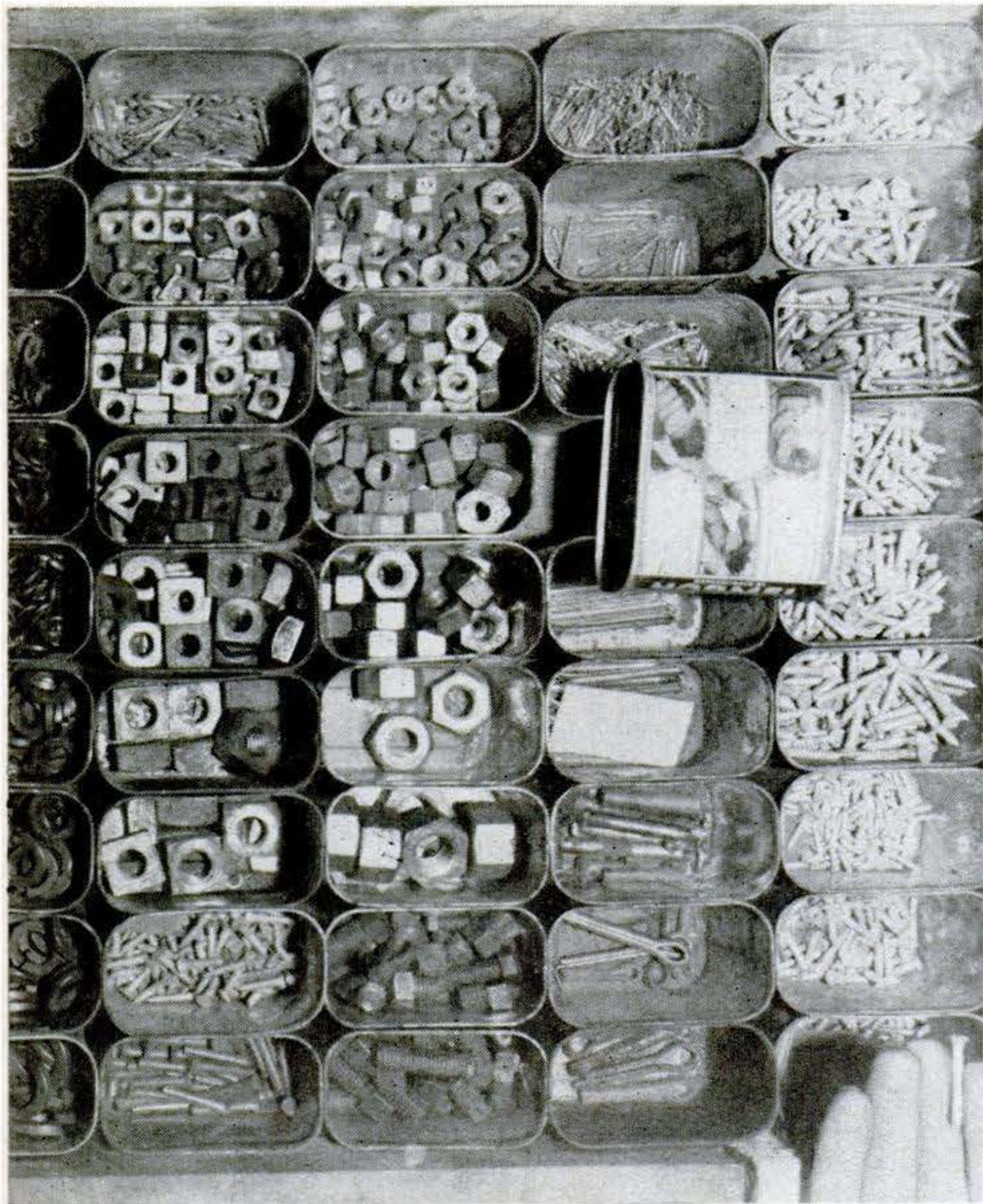

## Meat Cans Size Hardware For Easy Picking

A DRAWER full of discarded luncheon meat cans will hold most of the small hardware you need around the workshop. My drawer (top view, left) holds 45 of these cans.—*Ken Hadenfeldt, Storm Lake, Iowa.*

## Tank Takes Chill Out of Icy Water

COLD water is icy in our neighborhood, so I installed a 30-gallon, galvanized tempering tank to take off some of the chill before it goes into the water heater. A removable pan fitted beneath the tank stand catches condensed moisture. We now use less fuel since heating the water takes less time.—*W. H. Schroeder, Milwaukee.*

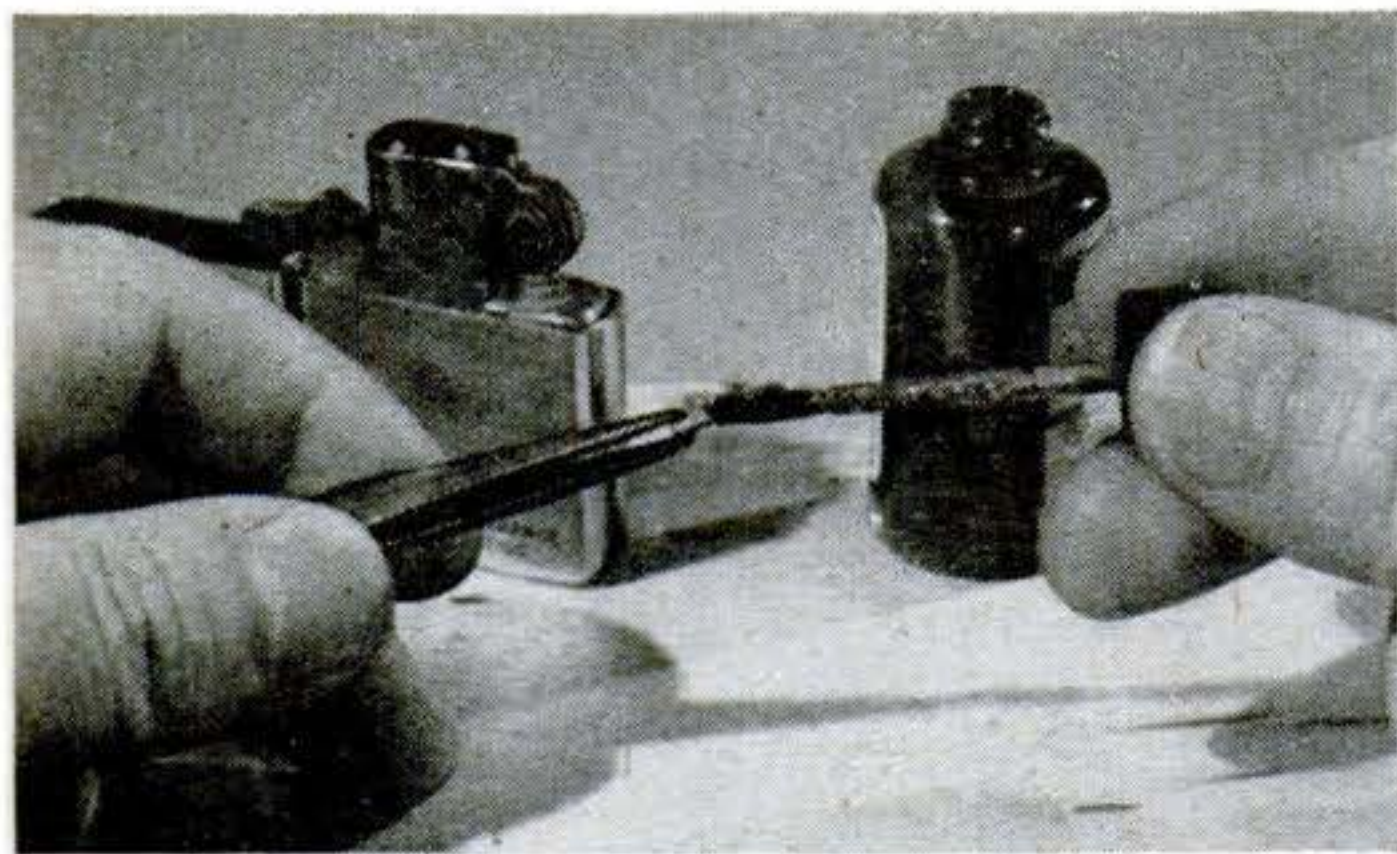

## Mark Warns It's Time to Change

COAT one end of your lighter flint with red nail polish. When the color shows up underneath the cigarette-lighter wheel, you will know that the time has come to replace the flint.—*Ken Murray, Colon, Mich.*

## Aluminum Foil Protects Work

SEVERAL layers of aluminum foil wrapped or taped around an area being soldered will protect the work from the heat of the iron.—*Roy H. Copperud, Stockton, Calif.*

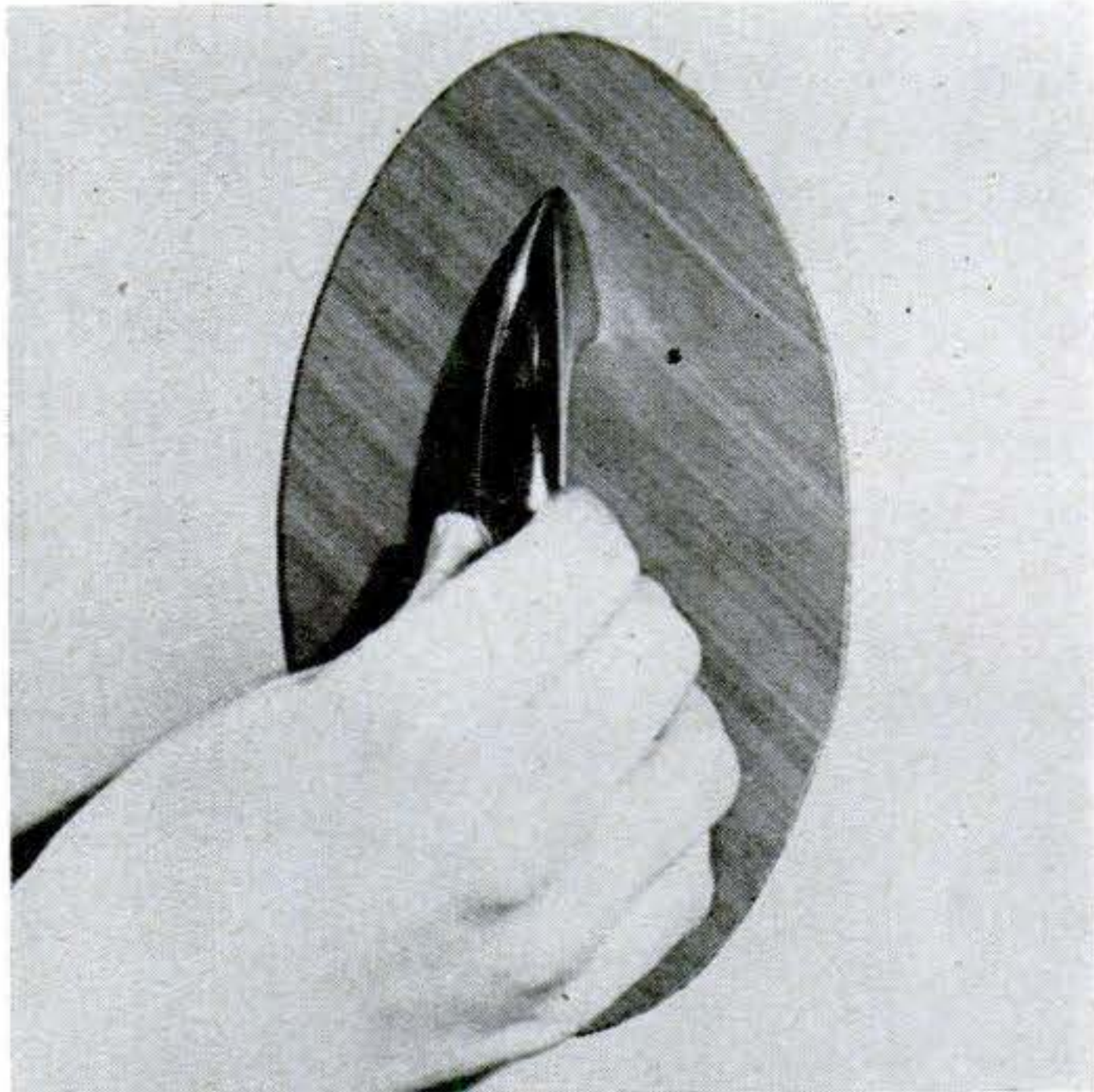

## Linoleum Keeps Doors Clean

LINOLEUM scraps cut square, round or oval (as above) make attractive finger guards for cabinet doors. The easy-to-clean surface of the linoleum will match the floors and will keep finger smudges off the woodwork.





**A HAMPER IN THE ROOM** will encourage small fry to be tidy. A new cover on the frame of a discarded garment bag makes a hanging closet hamper. A zipper at the bottom makes it easier to empty.

# KEEPING THE Home SHIPSHAPE

**IRKED BY SOGGY SOAP?** Slice through a cellulose sponge and make a thin pad to fit the soap well. Rinse it out now and then to keep it from sudsing up.

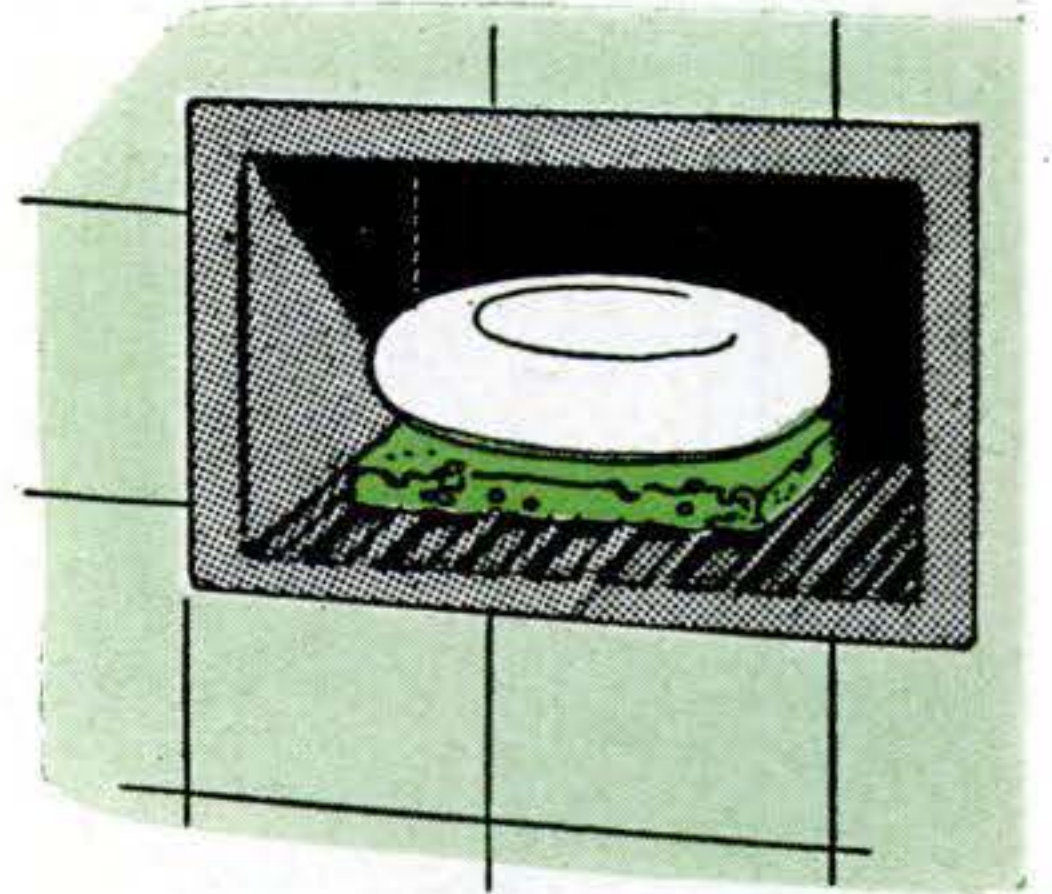

**A LAMPSHADE FRAME** makes a revolving holder for cooking utensils. Screw the frame under a shelf, placing washers on both sides of the hole for bearings.



**A SLIPPERY BOTTLE** of hair tonic, shampoo or shaving lotion won't slide through wet fingers if a rubber band is snapped around the smooth glass just where you grip the bottle with your hand.

**Please turn the page for more home tips**

NOVEMBER 1955 199



## More Home Tips



**DELIVERY WINDOW** in a back door makes it possible for you to take in packages without admitting wintry blasts. To install one, remove one or more panes and hinge a framed glass panel in the opening. A cupboard latch will hold the window shut.

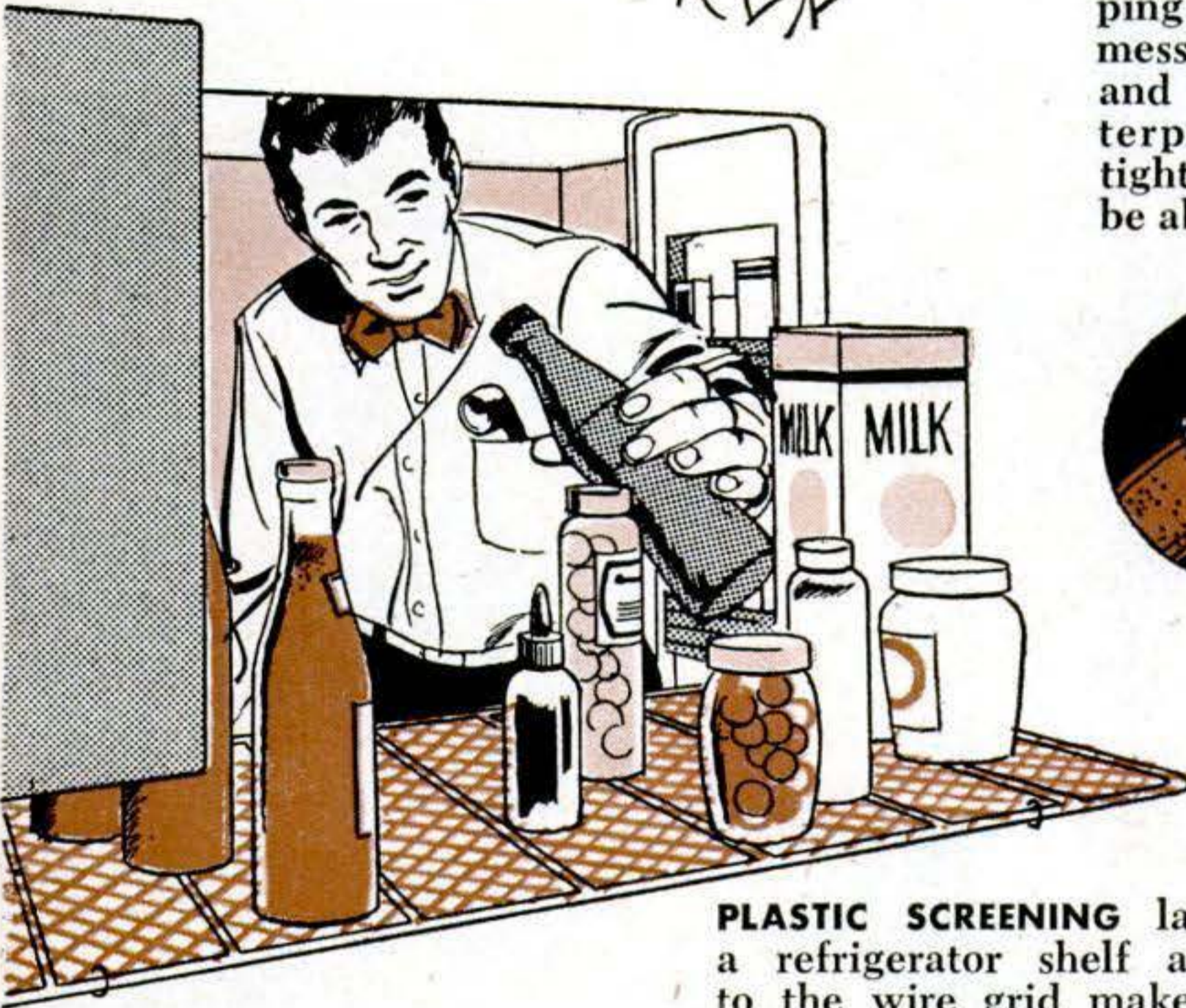

**PLASTIC SCREENING** laid over a refrigerator shelf and tied to the wire grid makes a tip-proof surface for small jars and bottles. The holes allow plenty of air circulation.



**SPLASHPROOF FLOWERPOTS** are made by spreading a layer of marbles on top of the earth. They'll let water in but keep the wet soil from splattering around.

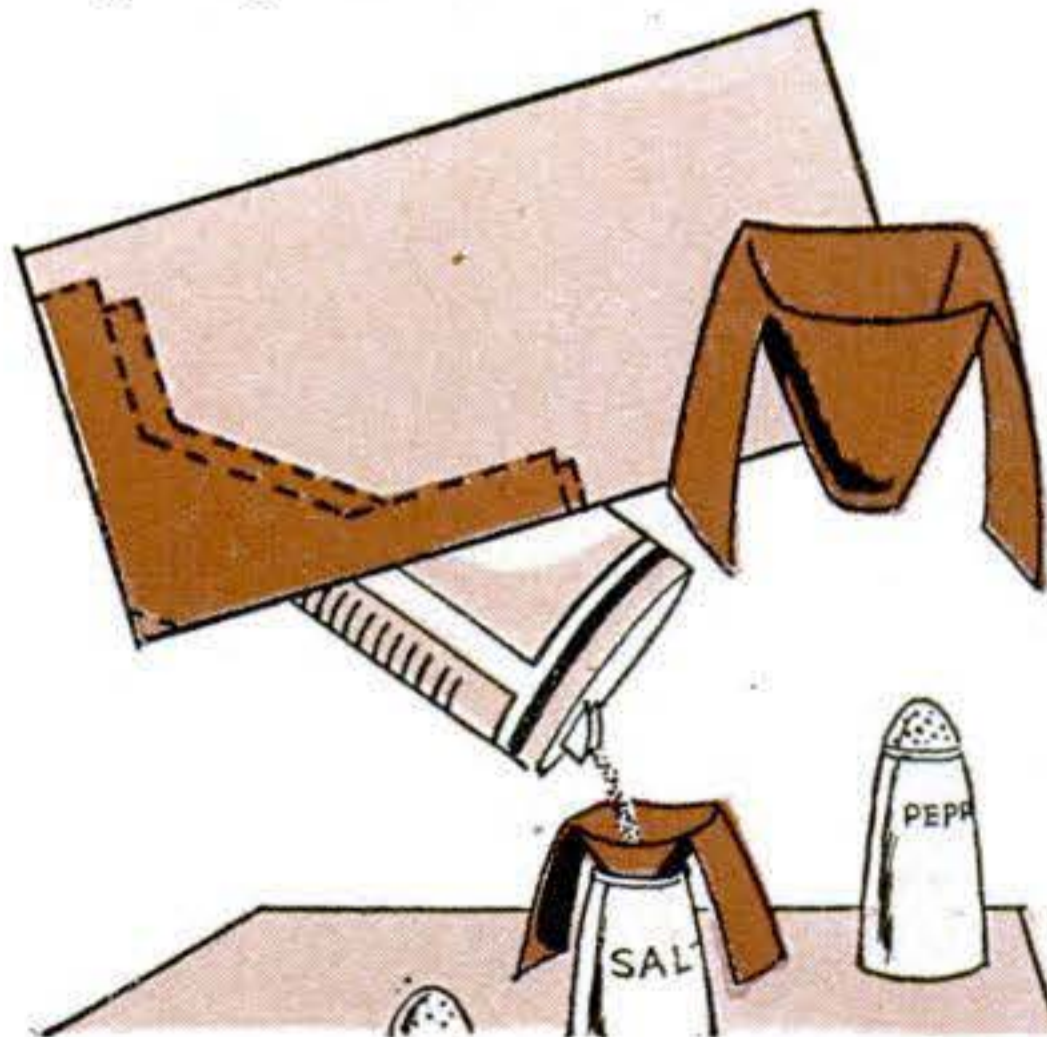

**CUT CORNERS** from envelopes to make small funnels for filling salt and pepper shakers. If cut as shown, so that the arms can be bent down, you'll have a self-seating funnel that will hold itself open.

**WRAP YOUR WATCH** in plastic food wrapping when you tackle messy jobs. The works and case will be waterproof and dust-tight, but you will still be able to tell the time.



**FOOD-CLOGGED STRAINERS** come clean in a jiffy when you scrub them with a vegetable brush. The stiff bristles work through the mesh so that it can be easily flushed clean under the tap.



# How to Repair an Electric Oven

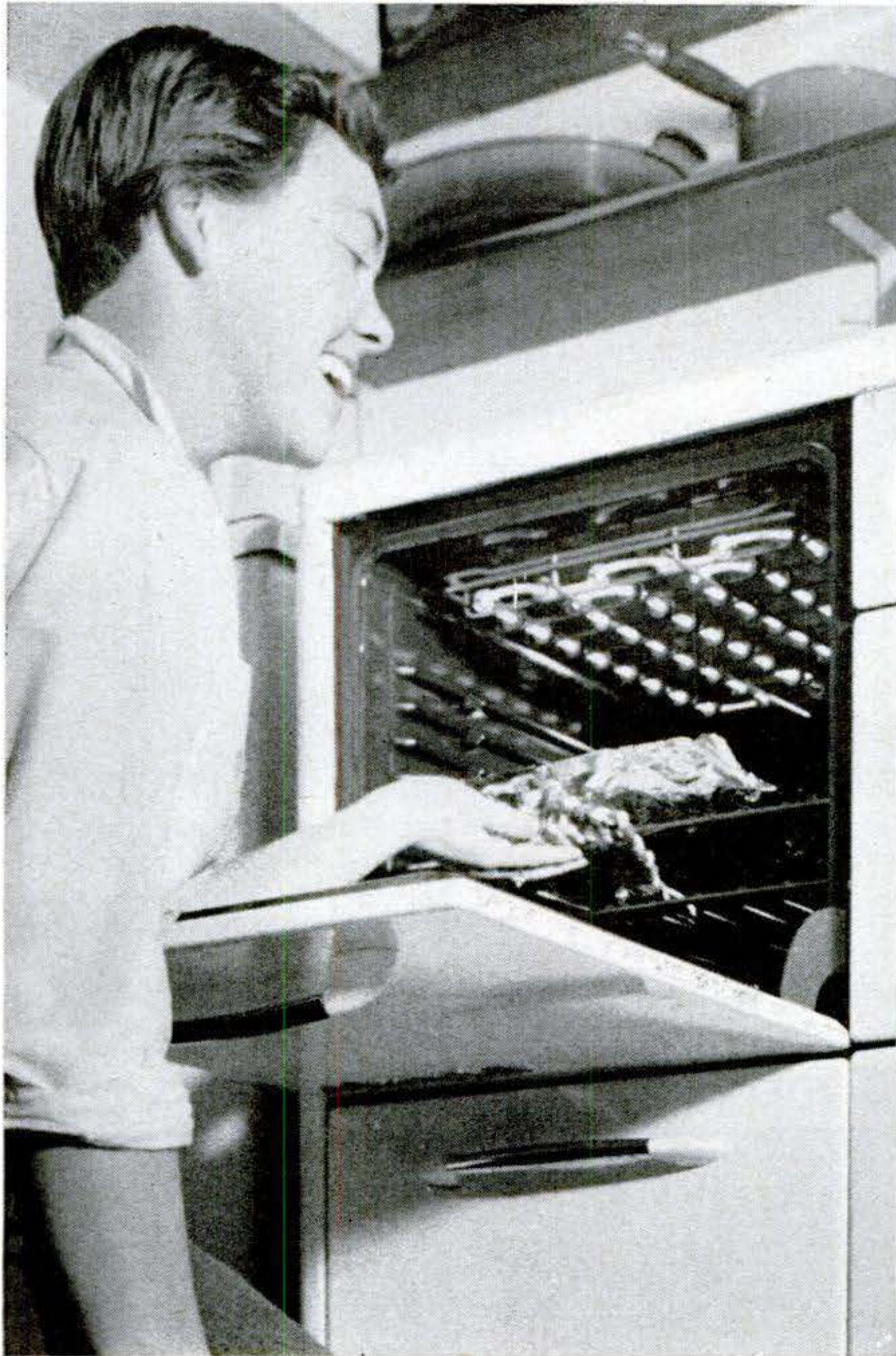

**B**URNED-OUT coils for electric ranges or other resistance-type heaters cost little to replace if *you* put in the new ones. You can buy the coils for a dollar or so, and by knowing the tricks you can do a fast, neat job.

Most oven and broiler elements unplug from the rear and pull out like sliding racks. Elements in heaters and other equipment can be removed by loosening the mounting screws.

To find out how much new coil to buy, either take the unit to your dealer or give him the wattage, marked on the unit, and the diameter of the coil. He'll cut you off the correct amount of wire. You can then stretch it out to fit your particular unit, as shown in the photos.—*Darrell Huff, Sonoma, Calif.*

**1 TO FIND LENGTH OF COIL** that you need, string cord through insulators after removing old coil. Make a sketch (lower left) so you won't forget the winding path that the wire takes.

**2 STRAIGHTEN OUT** a couple of inches at each end of new coil for fastening to binding posts. To keep coil from kinking, insert an awl or ice pick and unwind it. (*Please turn the page.*)

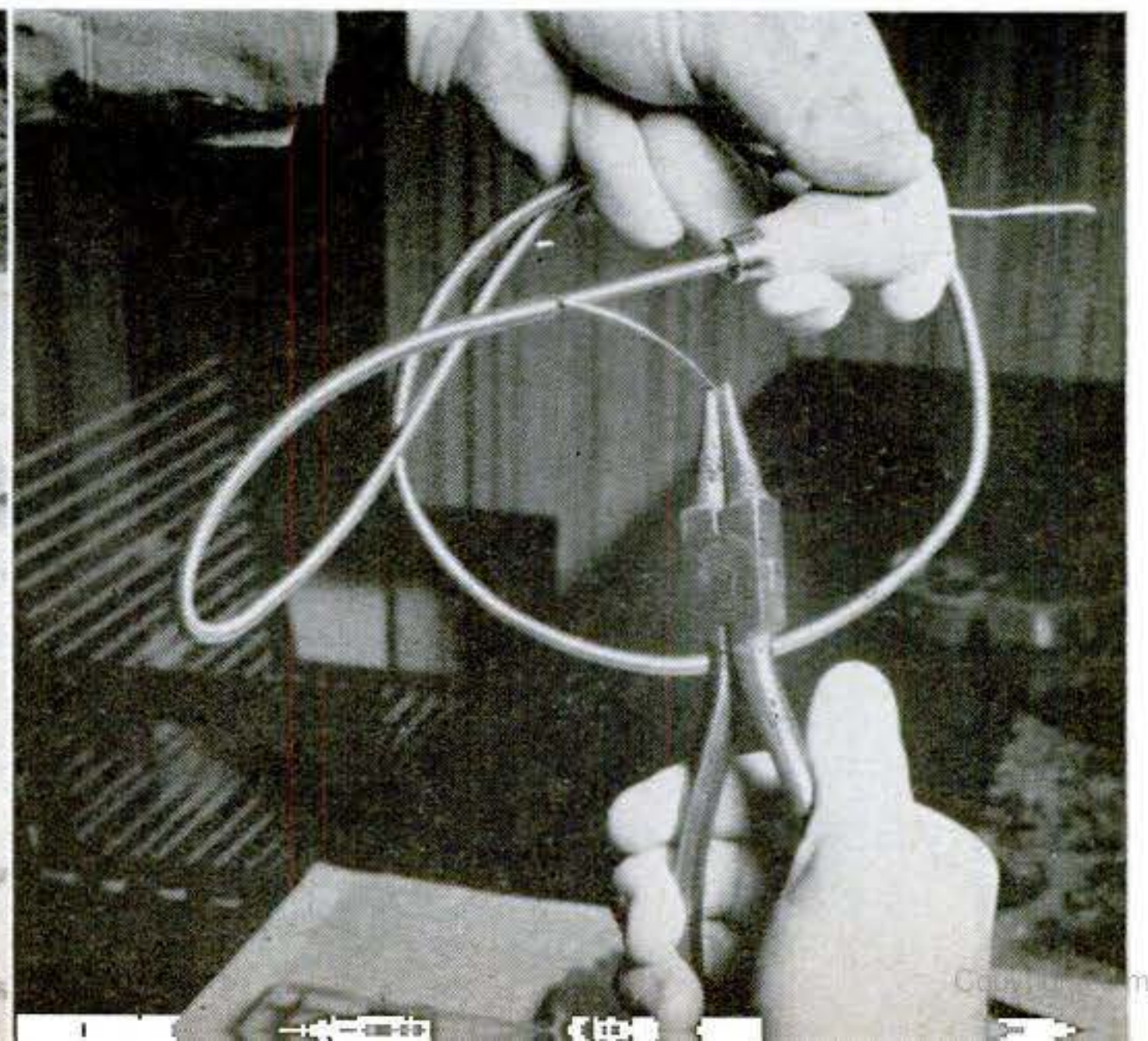
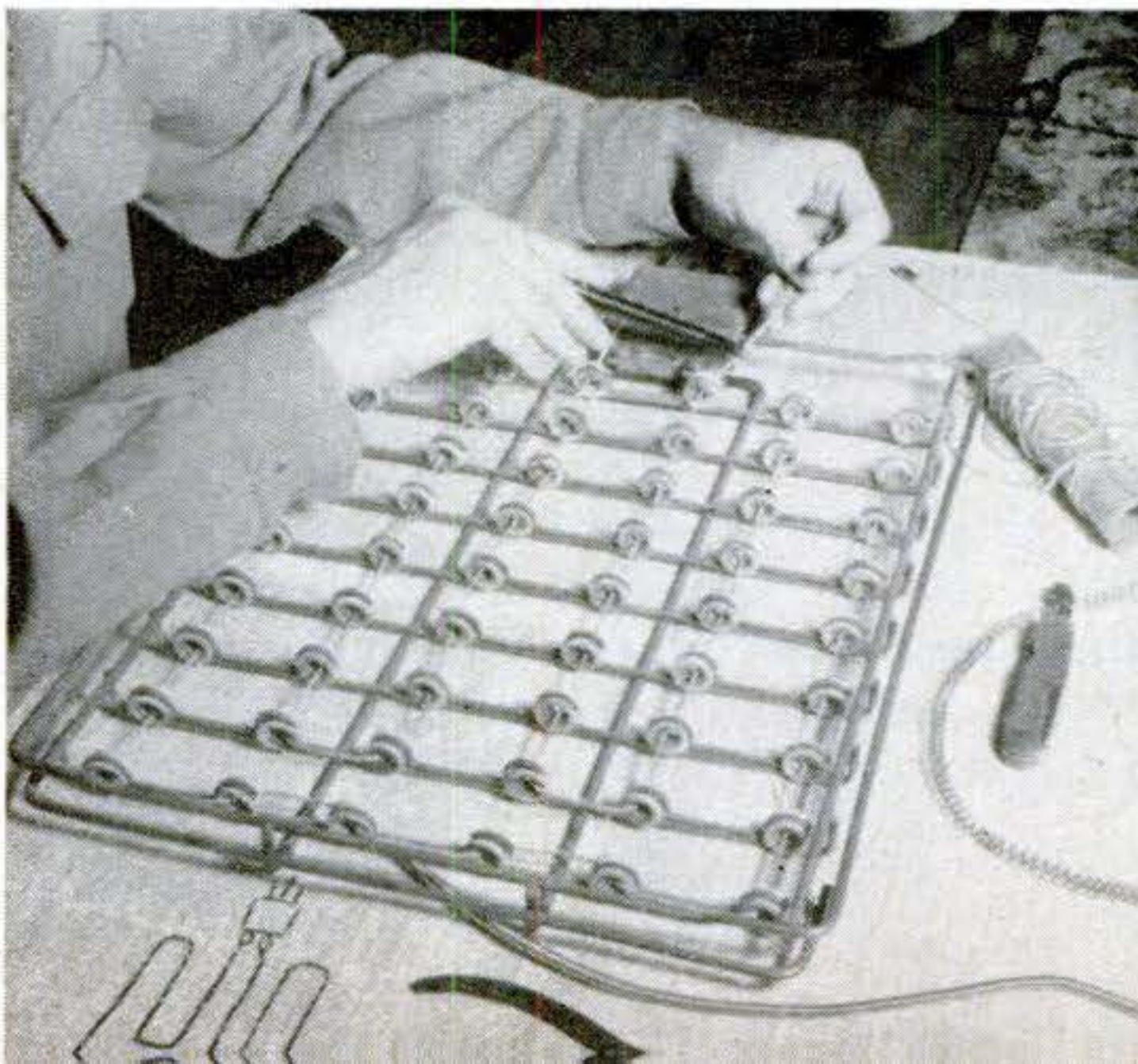





**3 CLAMP COIL IN VISE** and pre-stretch to match length of cord you used for measuring. If you thread coil without pre-stretching, it will stretch unevenly, causing uneven heating.

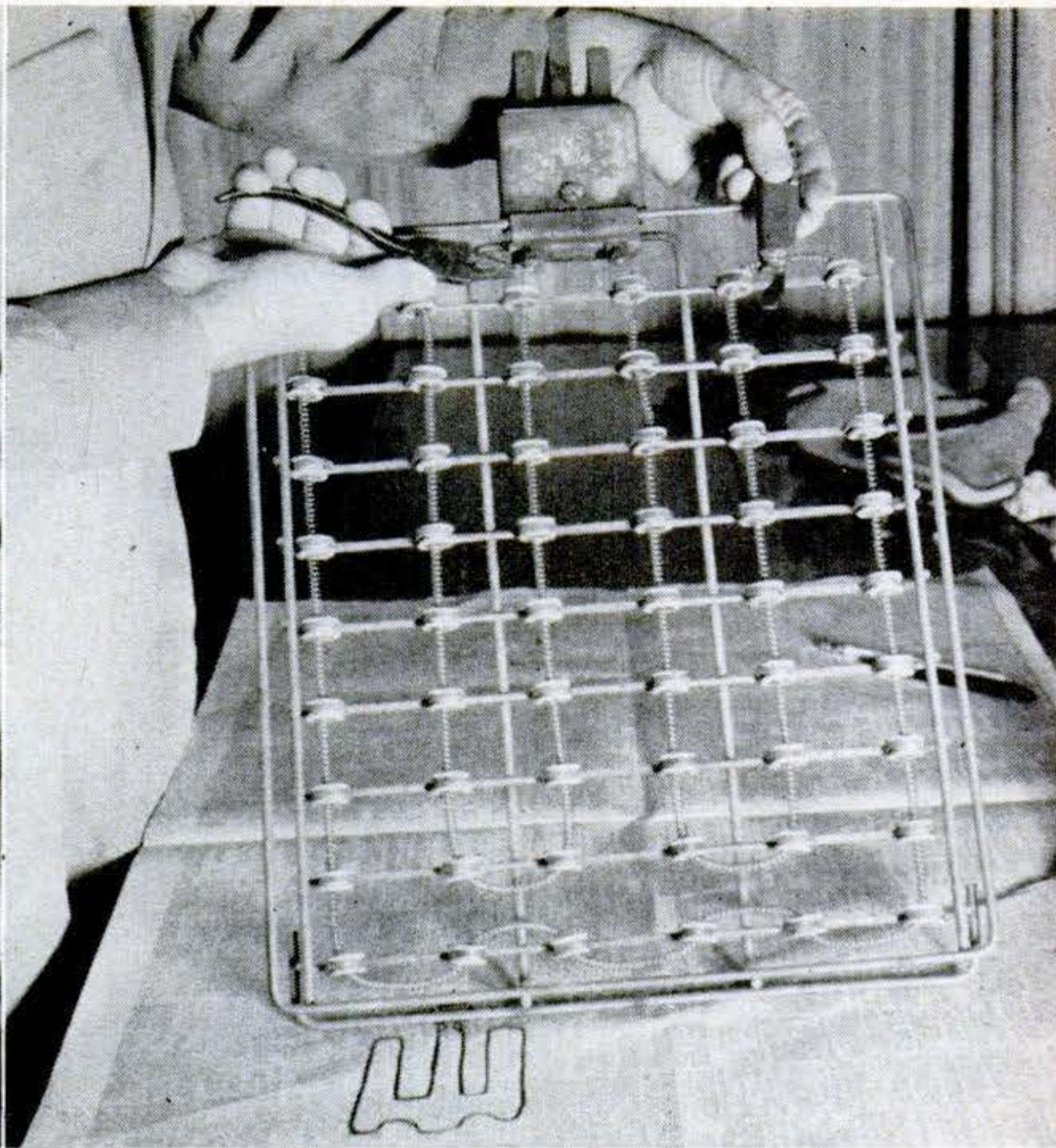

**4 NEW COIL IS STRUNG** through insulators, following sketch plan. Bend loops in ends of wire and screw to terminals. (Replace cracked or charred insulators before stringing coil.)

## Cartons Form Left-Over Concrete into Stepping Stones

WHEN you do a concrete job, you may end up with some left-over mix. To keep it from going to waste—and to solve your disposal problem—round up some cardboard cartons. Pour about 2" of mix into each and trowel the top. When the concrete sets, peel off the cartons. You'll have a supply of mixed-size stepping stones that will store compactly until you have enough to lay a walk.—*Warren Bohlman, Chicago.*

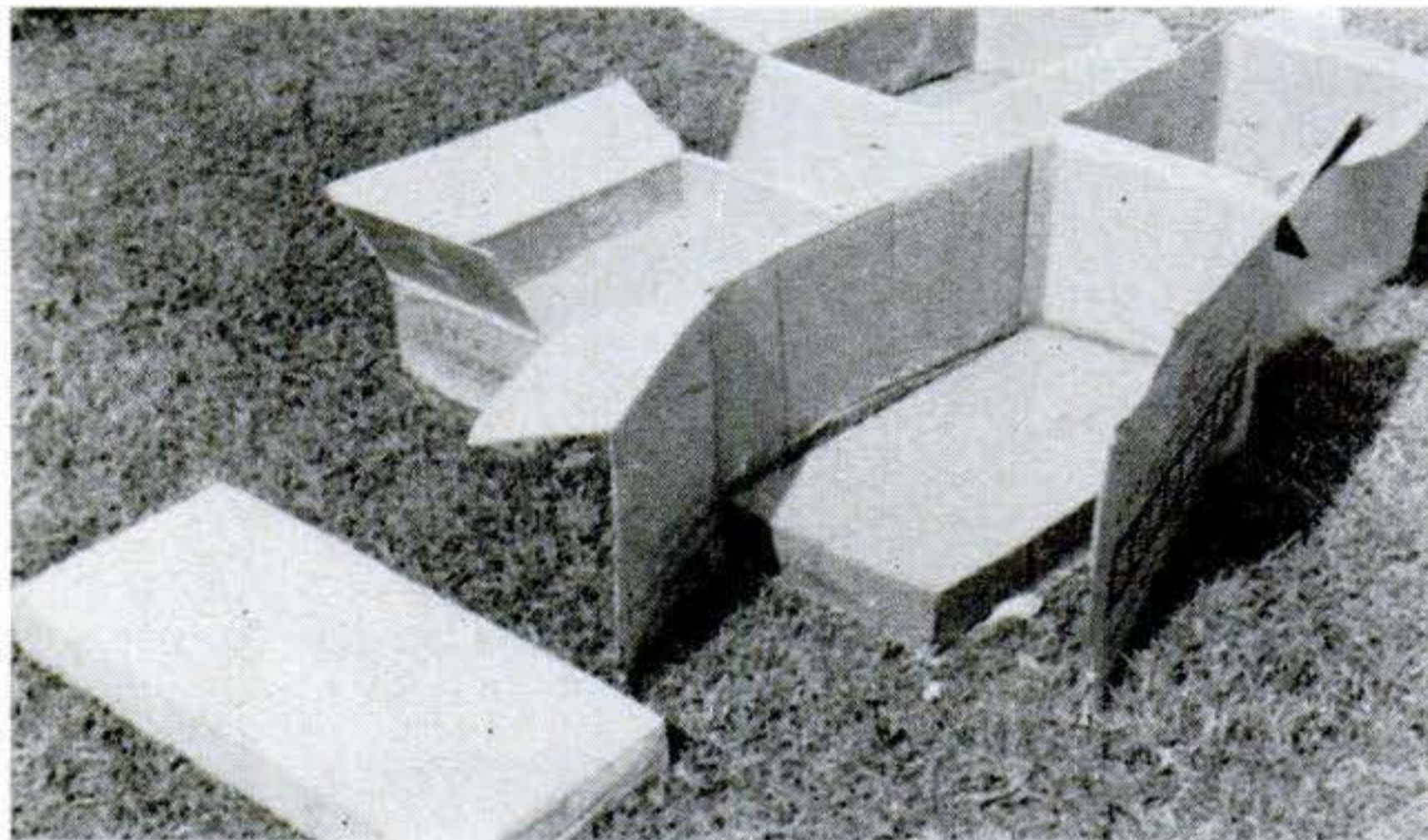

## Coffee Can Marks Fuel-Oil Inlet and Keeps It from Freezing



OIL INLETS that stick up in the lawn get no protection from water, mud and falling leaves. Cold weather may freeze the plug, and in any season grit settling in the recess at the edge of the cap can get into the oil line when the cap is removed. To eliminate these nuisances—and make a half-hidden inlet less of a toe-catcher—cover it with a coffee can.—*Frank A. Javor, North Bergen, N.J.*



**You can take anything apart, but**



# Can You Put It Together Again?

**By  
Henry B. Comstock**

**T**HE other night, a friend of mine invited me to see some stereo slides. Thrown on a five-foot screen, the first one looked like an aerial view of the battleship *Missouri*, with her topside blown away.

"Wife's electric steam iron," my friend explained. "My boy started to take it apart a week ago, to find a short. I stopped him. Made him shoot this picture with the housing off. That boy is going to learn to put things back together right."

Of course my friend was carrying it to extremes. But he had a right to. During World War II his job was laying out gun-sight assembly-line procedures for Rosie-the-Riveter's kid sisters.

With exploded drawings, simple coding and an orderly work pattern, he taught youngsters who couldn't wire an electric light socket to handle precision

jobs that would stump a watchmaker.

"Unless a machine or appliance is deliberately designed so that it can't be tampered with," he says, "the easiest part of the repair job should be the re-assembly."

It makes sense, the way he tells it. Today most manufacturers are pulling for the customer who does his own repair work. They've stopped thinking of him as an all-thumbs jerk. If they don't toss a repair and replacement-parts manual in the carton with their product, you can generally get one by asking—for the price of a three-cent stamp.

Even with a manual at your fingertips, first study the assembly carefully before you take screwdriver and wrench in hand. Then follow through with the reassembly kinks that this expert passed along to me. You'll find them described on the next three pages.



### 3 ways to keep track of small parts



**MACHINE SCREWS**, washers, nuts and other small parts won't roll off your worktable if you lay them on a sheet of corrugated cardboard.

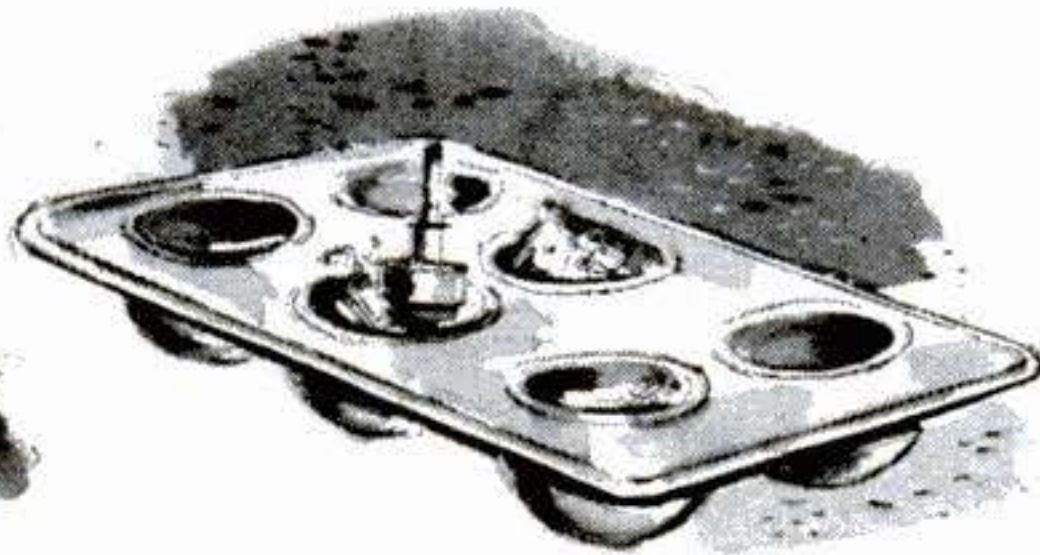

**MUFFIN PANS** or egg cartons make good sorting trays. Fishing the right parts out of their rounded, cup-shaped receptacles is quick and easy.

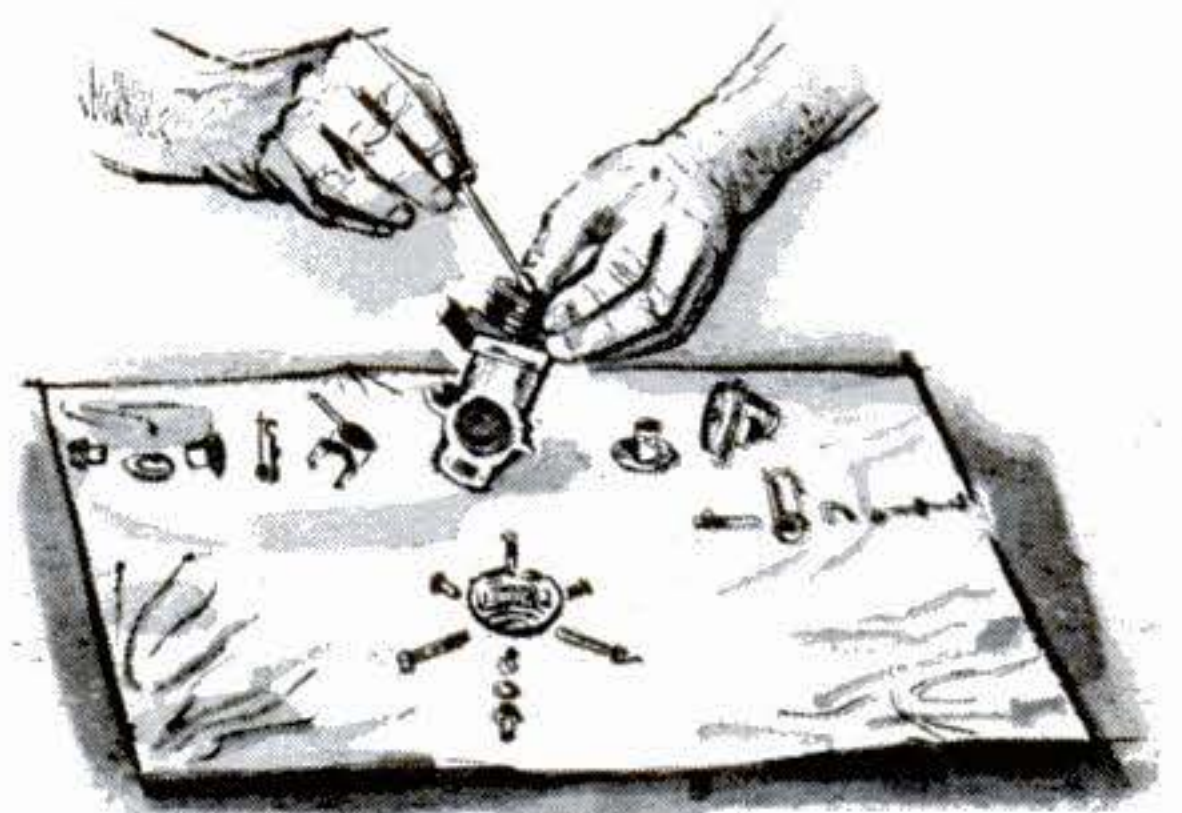

**THERE'S NO HIDE-AND-SEEK** when you use this jeweler's trick. Lay out parts on a strip of felt—schematically, if you like—and they'll stay in place.

### These simple kinks identify motor leads

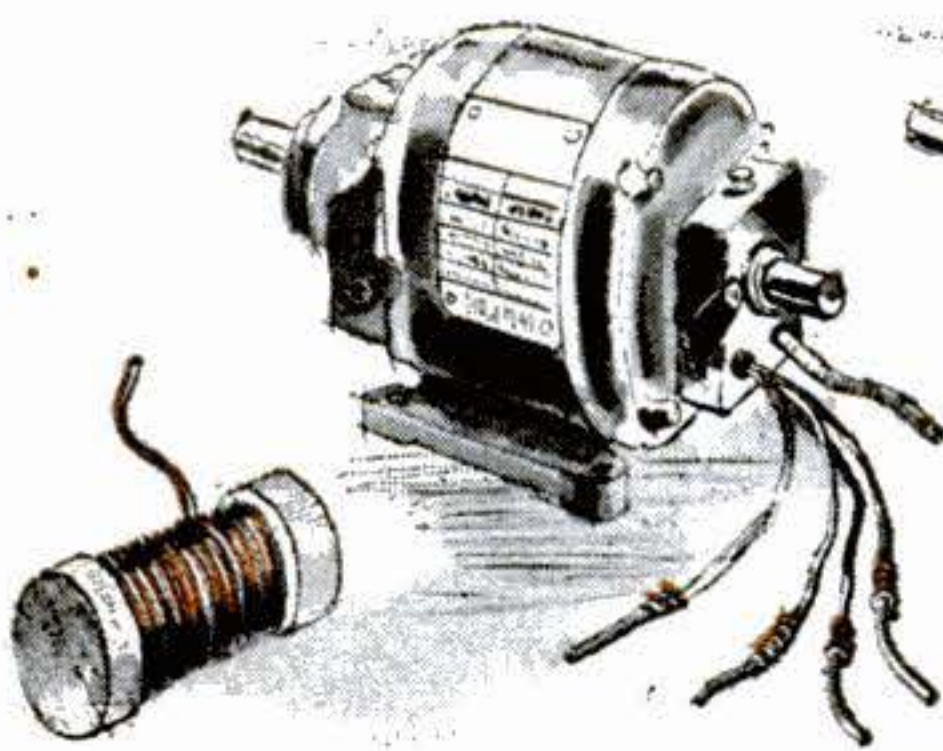

**FOR GREASEPROOF CODING**, twist a different number of turns of stiff wire around each lead. Tape a code chart on the motor frame for identification.

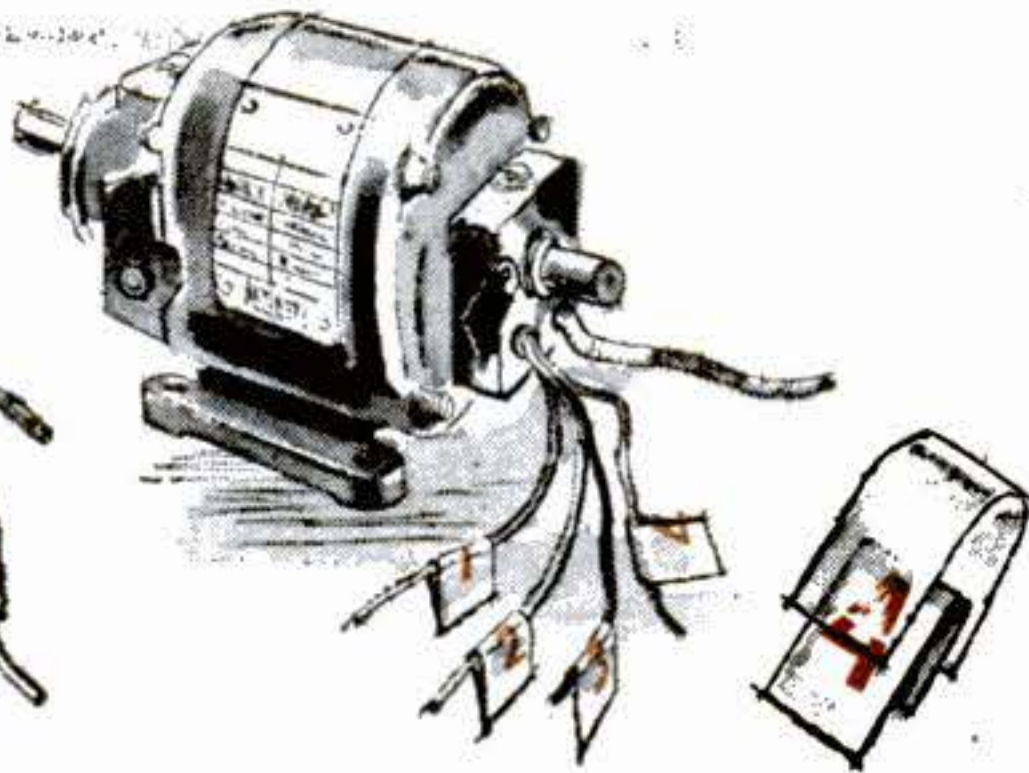

**USE CELLULOSE TAPE** for temporary marking. Wrap the tape around the leads and sandwich numbered tabs of paper between the ends of the tape.

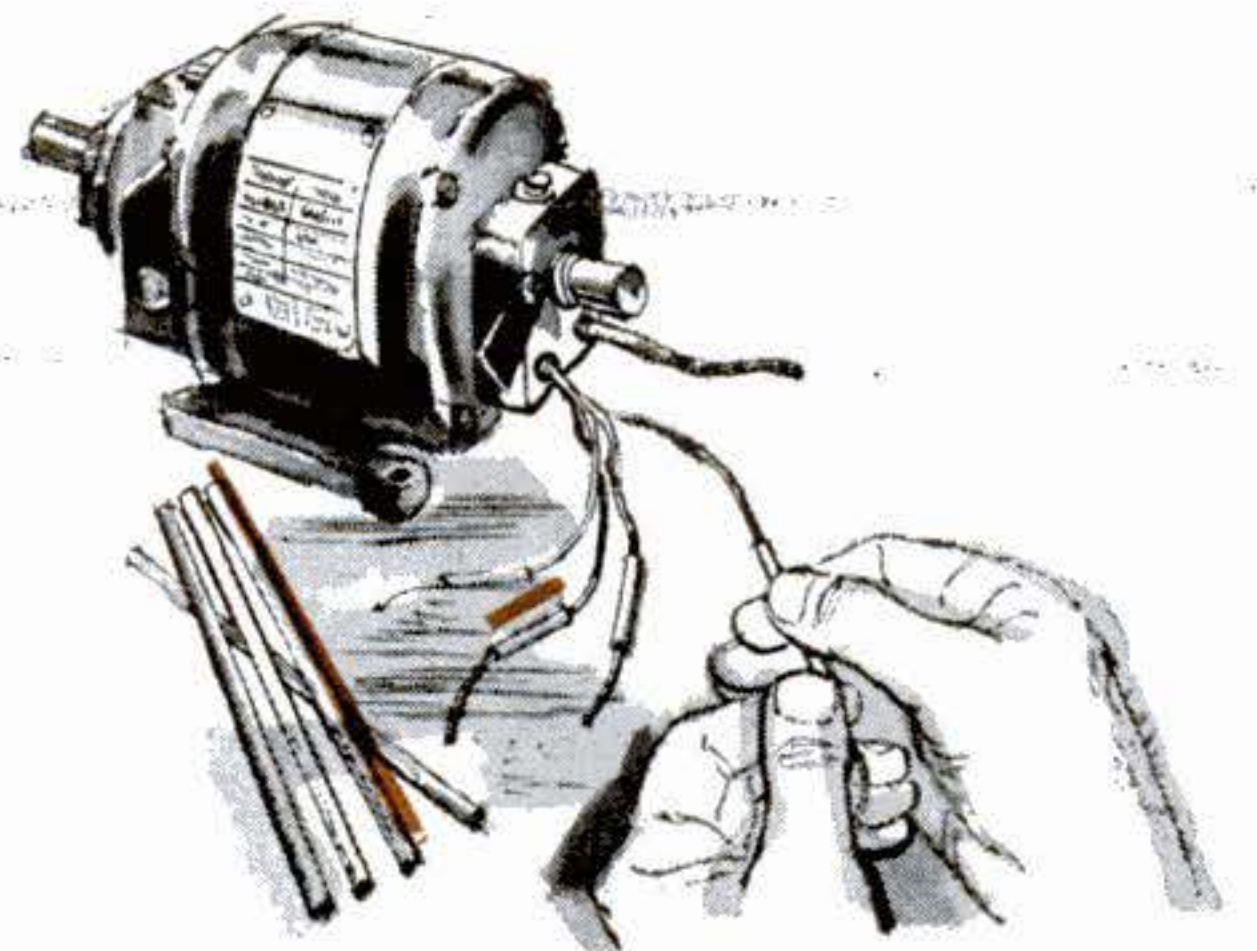

**OLD PROS USE THIS ONE.** Slip sleeves of different-colored "spaghetti" tubing over leads. Bending the wire ends keeps the sleeves from coming off.

### Scribe and punch marks make realigning easy

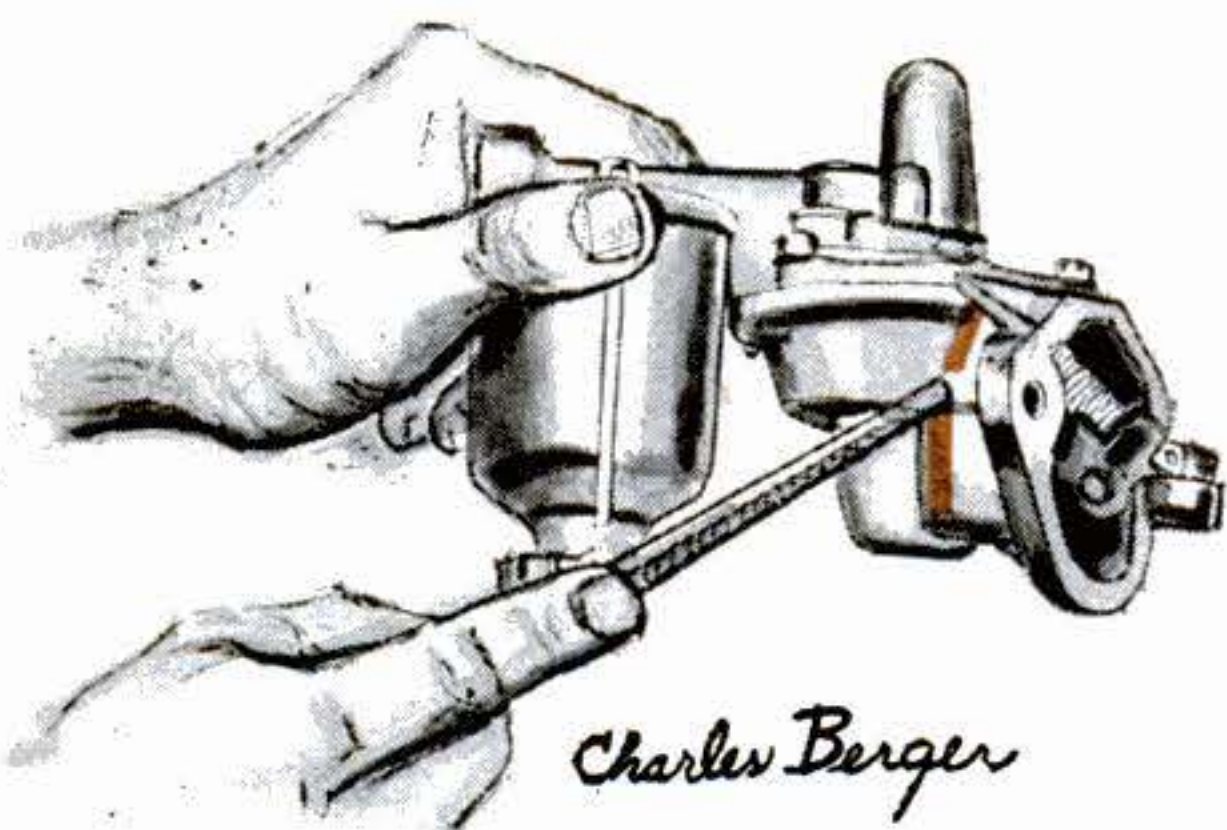

**BEFORE PARTING** two sections of a housing, scratch across adjacent faces with a file. Then realign the file marks for a perfect reassembly job.

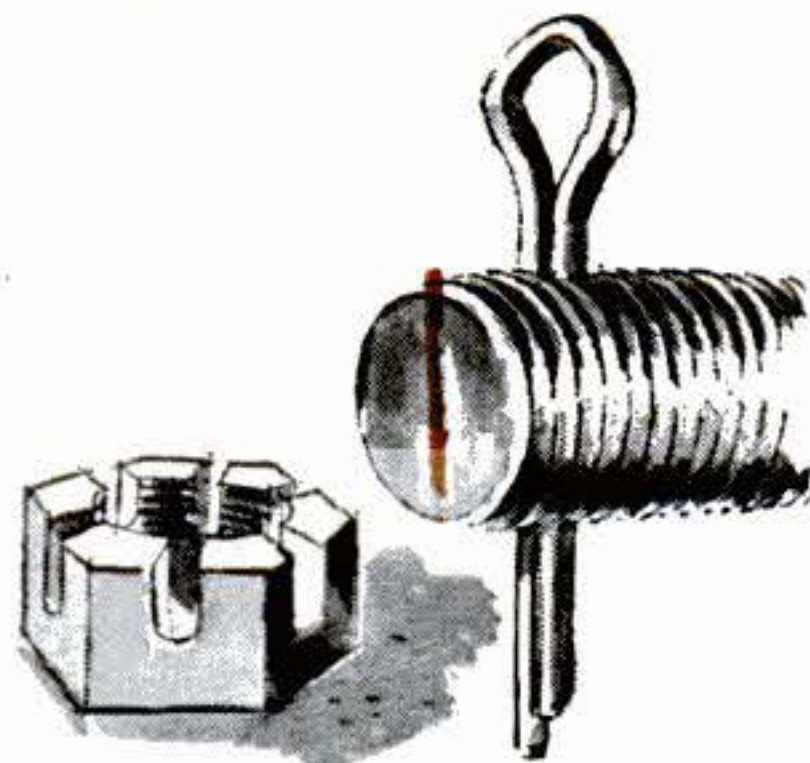

**WHY PROBE** for a cotter-pin hole when a light file mark across the end of the bolt will allow you to check the cotter pin's alignment at a glance?

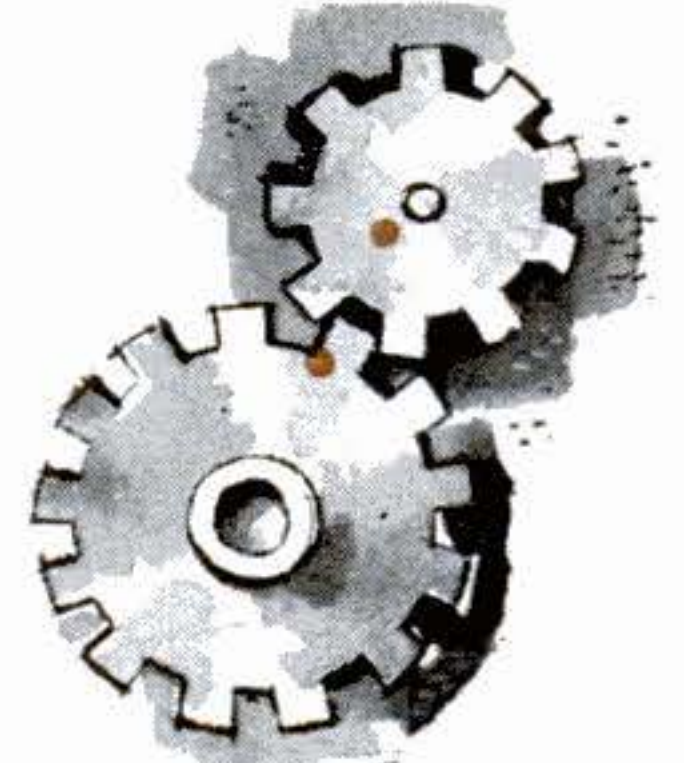

**USE PUNCH PRICKS** for neat, permanent marking, but not on cast or brittle metals that might break. Dots, here, show how the timing gears should mesh.



## Grease-pencil indexing is fast

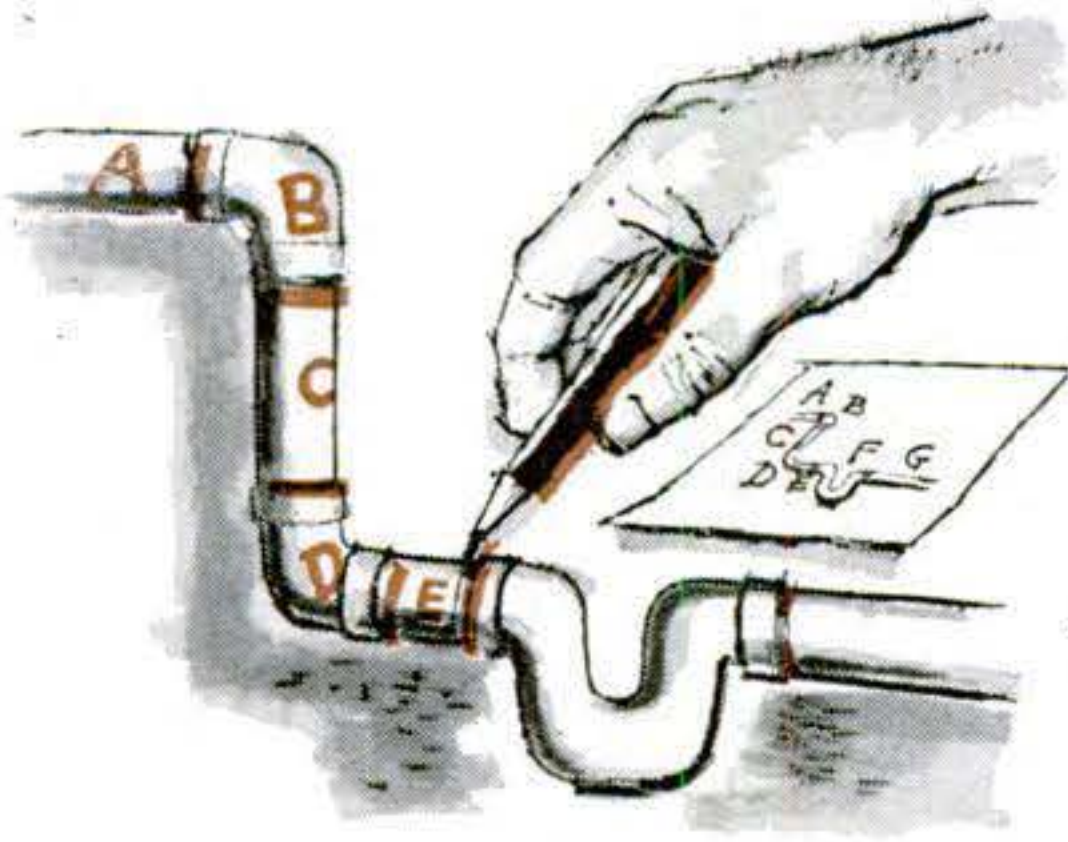

**PIPE CONNECTIONS** may be too long or short when you reassemble them if you don't mark the depth of threaded joints. Index parts in proper order.

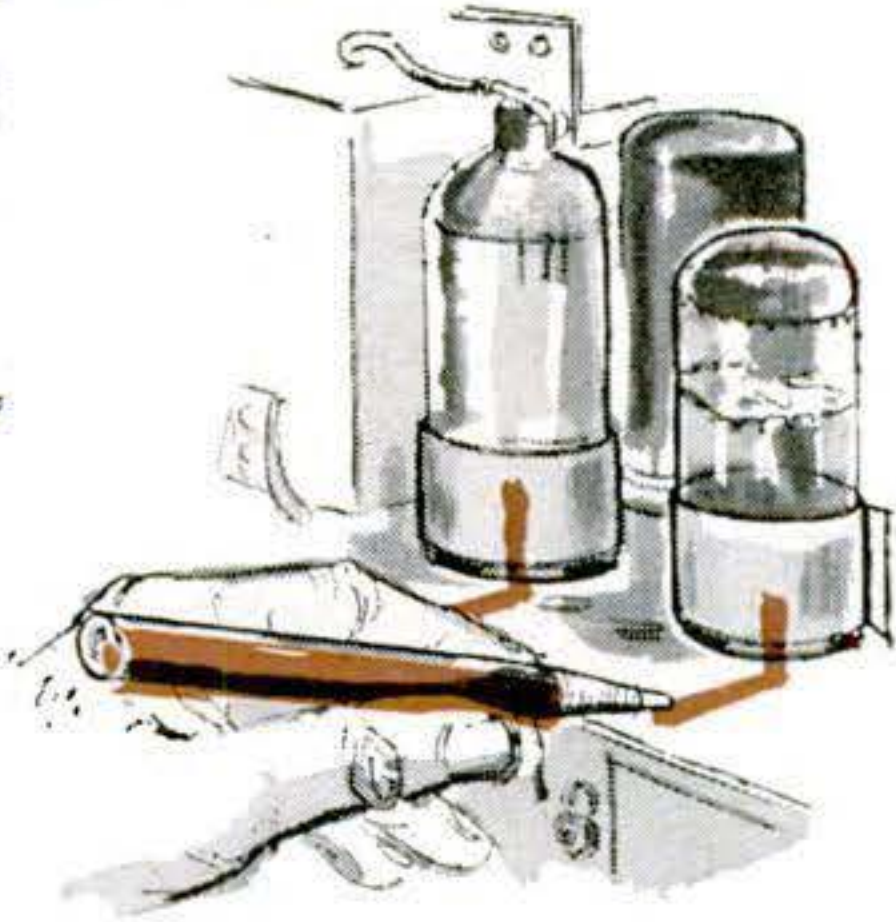

**FOR QUICK REPLACEMENT**, mark the position of tubes in their sockets. Adhesive tape on glass or wires (right) makes a good surface to make guide mark on.

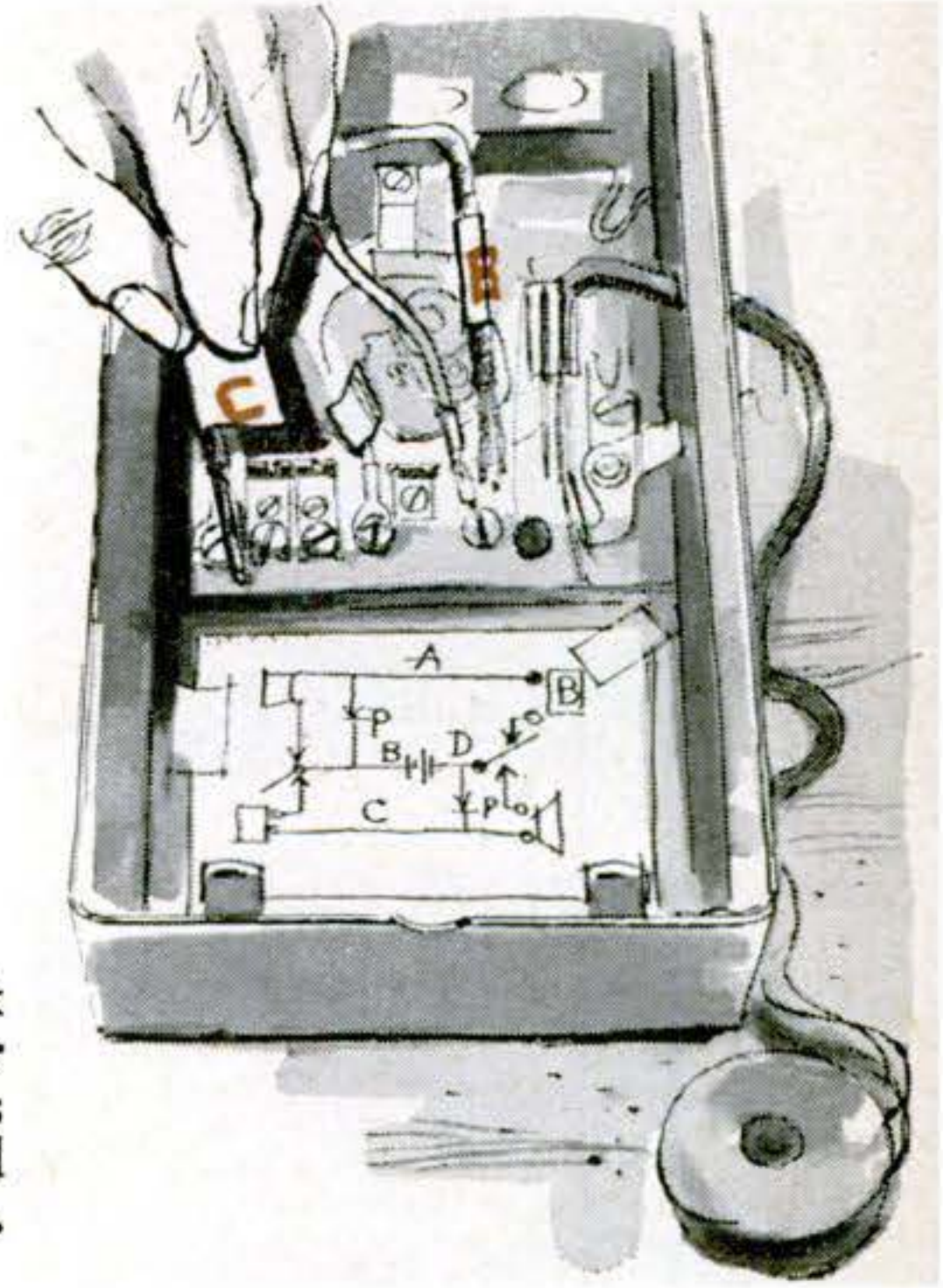

## 2 color-coding tips



**NAIL-POLISH BOTTLES** are handy for holding different-colored enamels used to code wires.

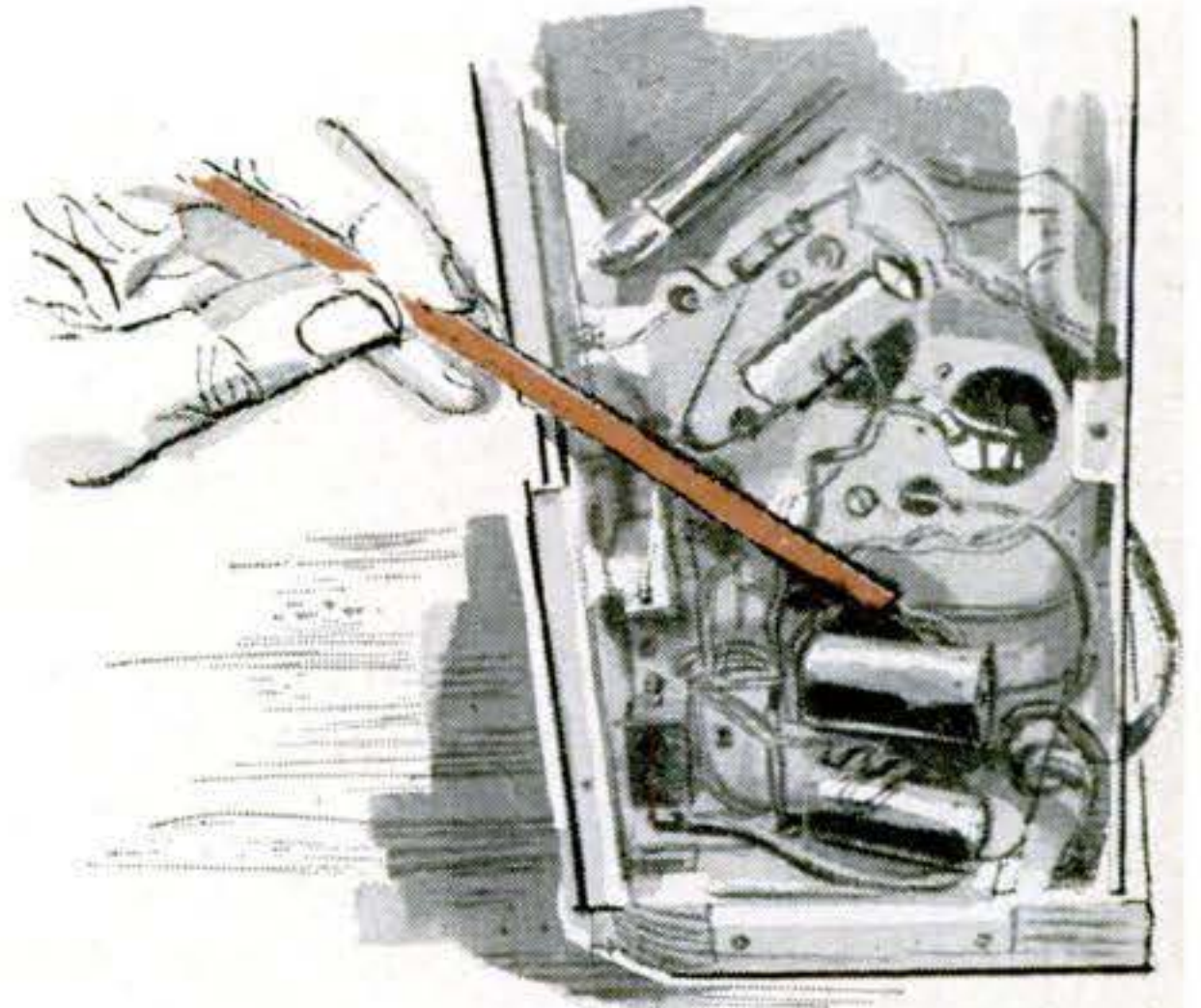

**CIRCUITS ARE COLOR-CODED** for identification. Use the same colors when replacing wires.

## Hole-sorting identifies parts

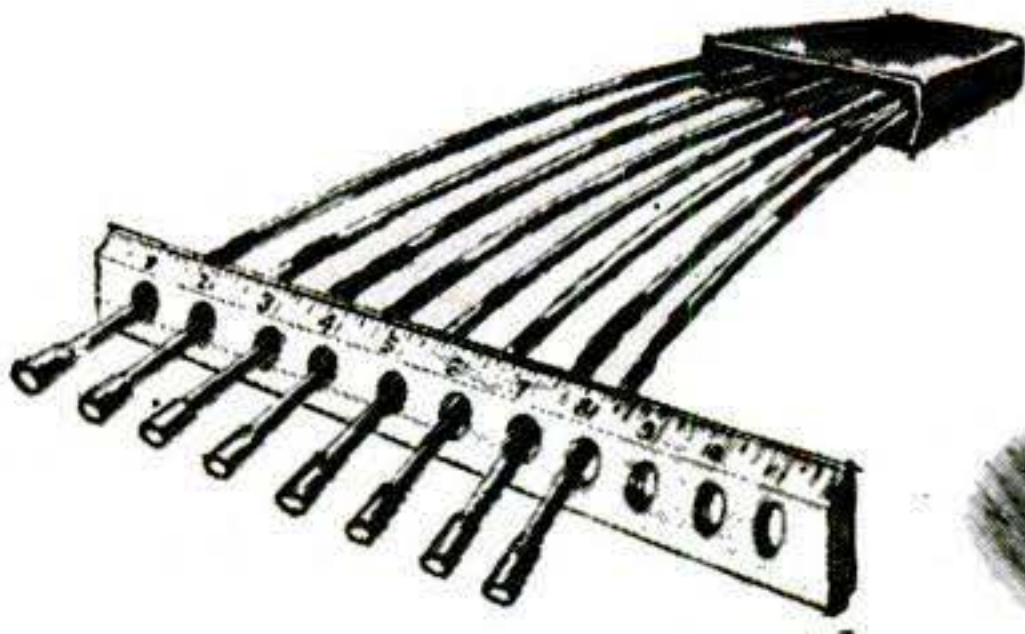

**ONE-FOOT RULE**, with a hole drilled under each inch mark, keeps disconnected spark-plug or other complicated wires in proper order for replacement.

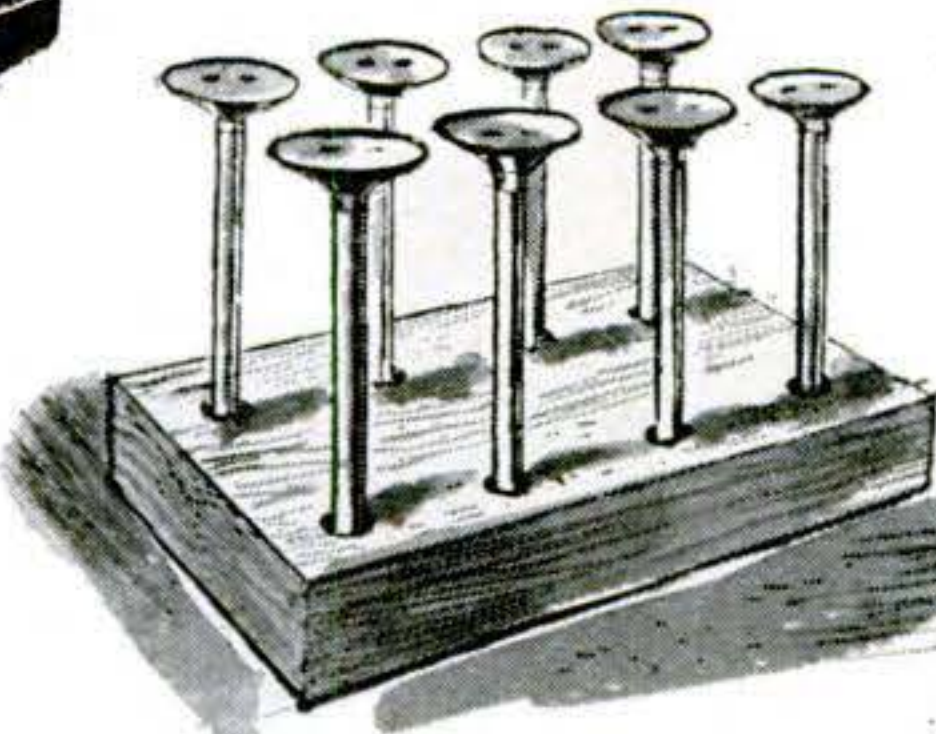

**REMEMBER** this valve-indexing trick? Wood block drilled part way through has many other uses, including a heads-up holder for gear-train parts.

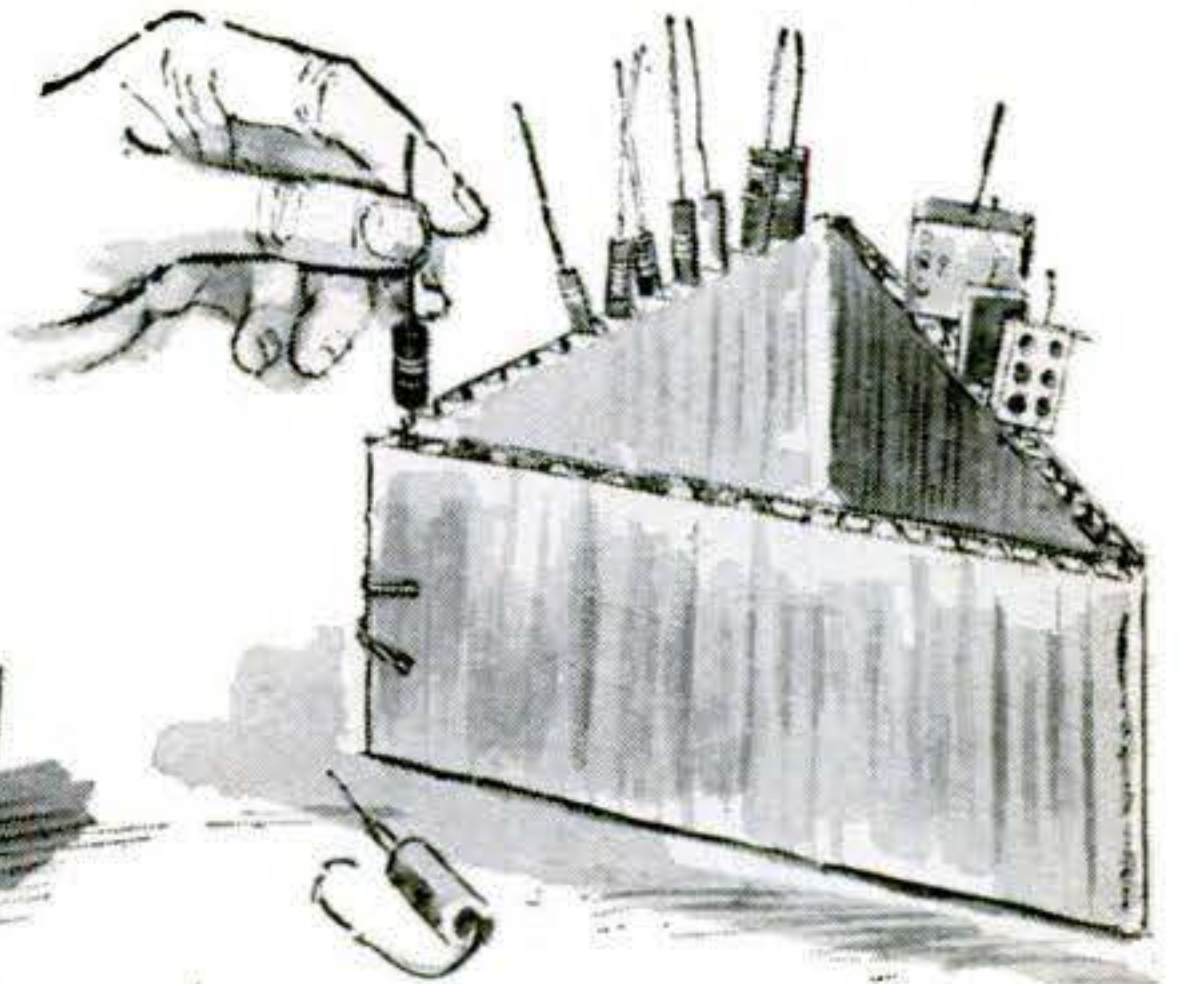

**TRIANGLE** of corrugated cardboard, with the ends wired together, makes a handy stand for holding radio components inserted in the right order.



## 5 ways to remember what goes where

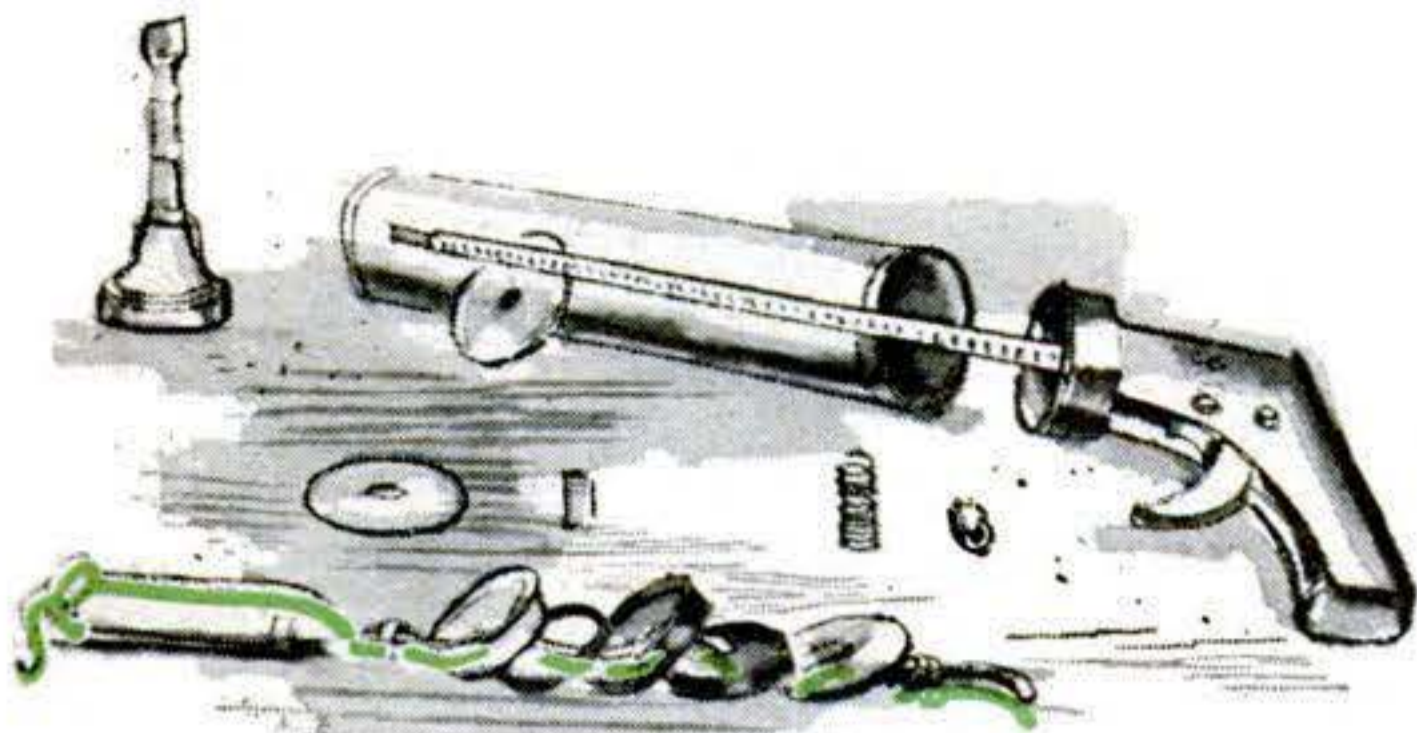

**THREAD A STRING** through a train of parts, such as the washers, disks and plungers of this calking gun. Knot the string at the ends.

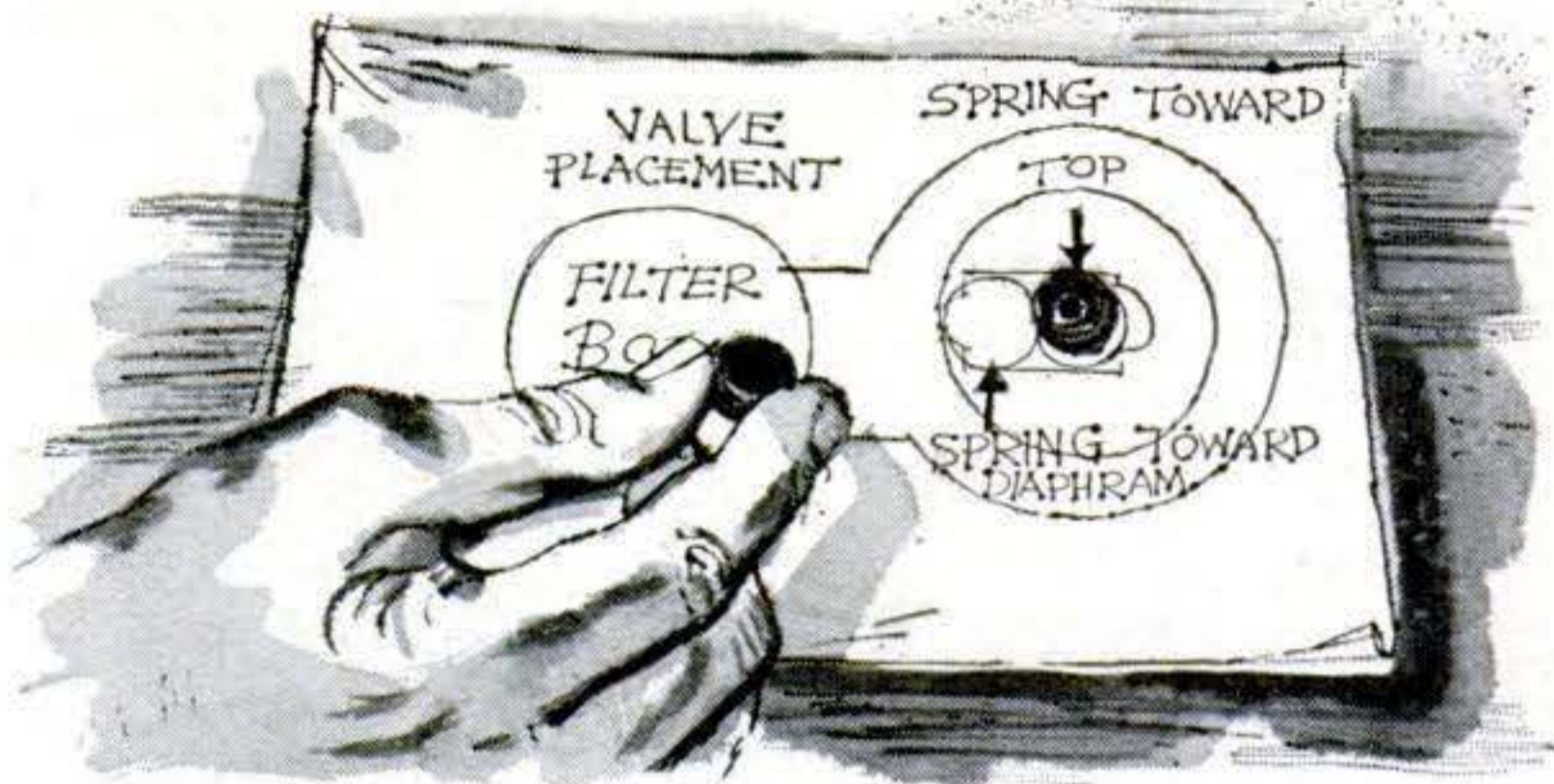

**LAY PARTS** at their correct locations on a full-size diagram of an assembly. Make the diagram when you first take the mechanism apart.

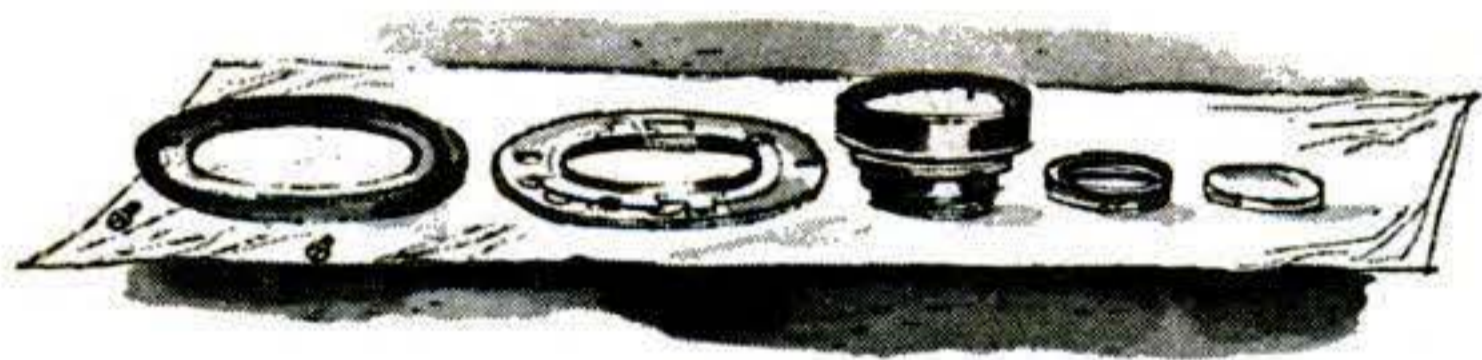

**YOU CAN ADAPT** this orderly, in-line layout of lens-mount parts to many assembly jobs.

**FOR COMPLEX PROJECTS**, arrange parts schematically, like those of steam iron at right.

**HERE'S A VARIATION** of string sorting. Place parts in sequence on a threaded shaft.

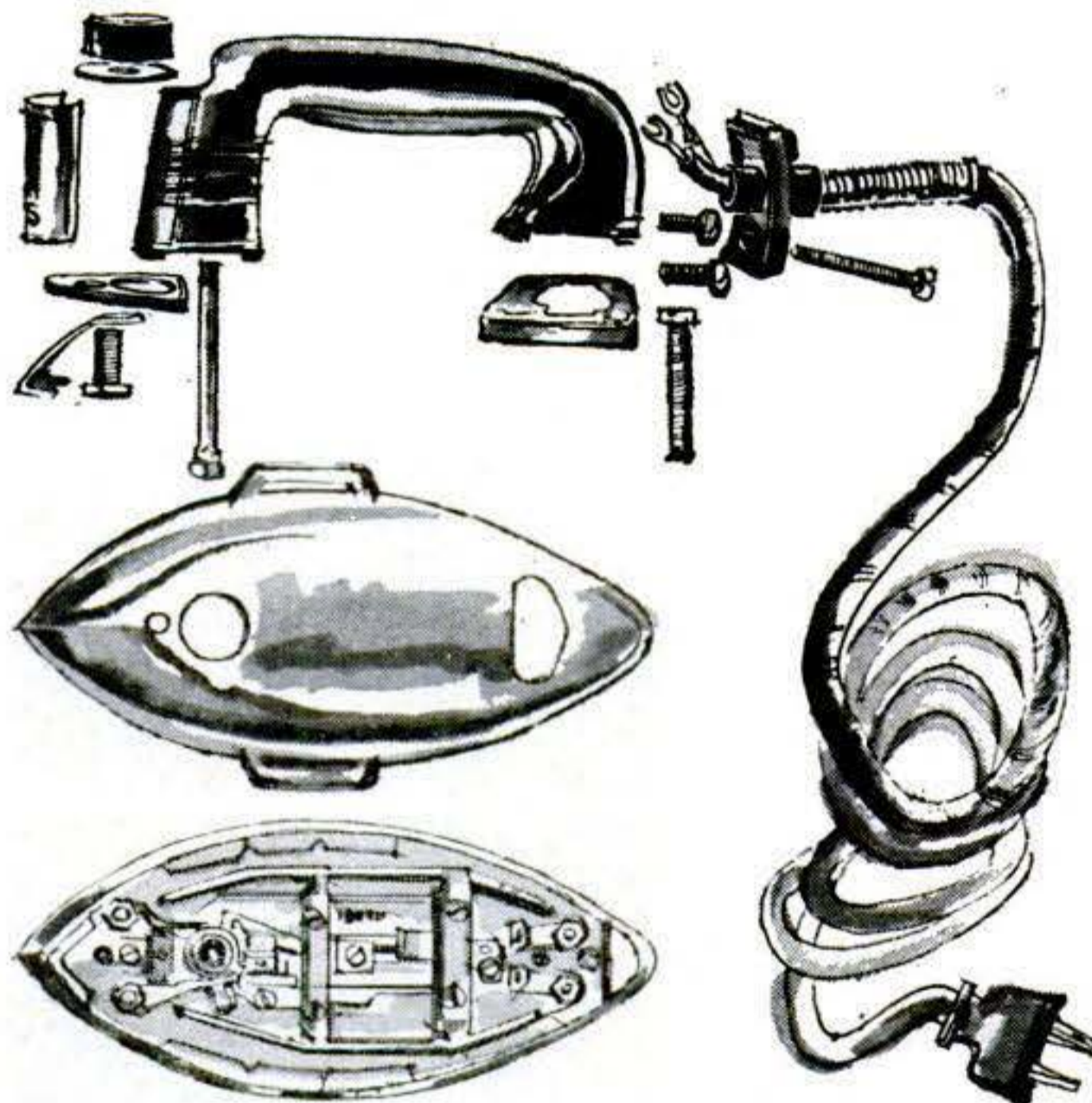
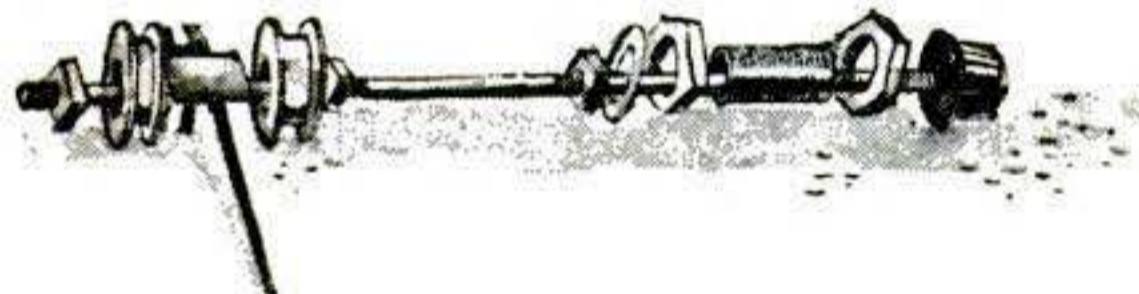

## Use these reference marks for repeat performances

**CLIP OFF** the upper right-hand corners of slide mounts inverted for projection and you'll always know how to feed the slides into the machine.

**TO MARK A REEL** of recording tape where Junior starts his "Flight of the Bumble Bee," lay a paper match on the tape and then rewind the reel.

**A WAX-CRAYON MARK** on a long-play record will let you find your favorite selection any time you want it, and without harming the recording.

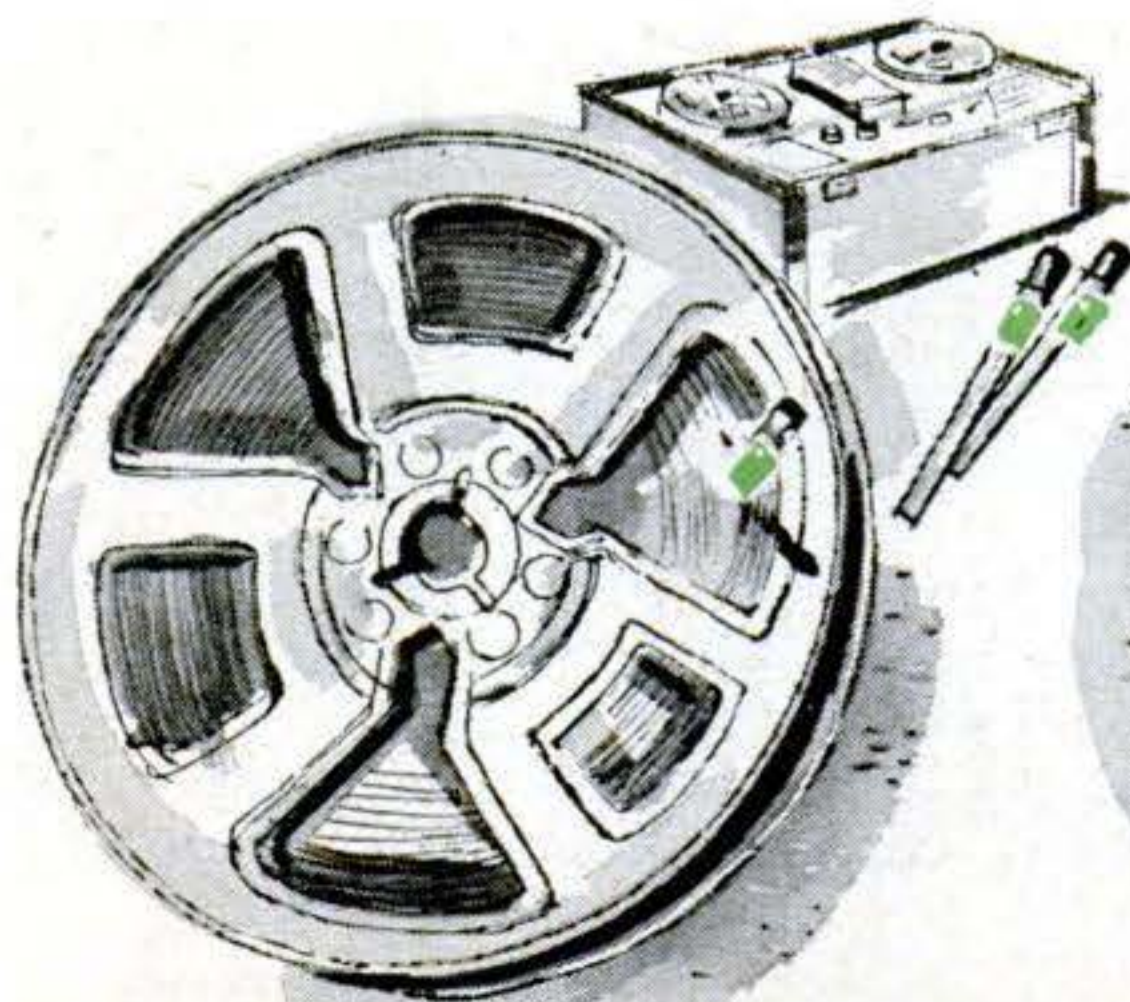
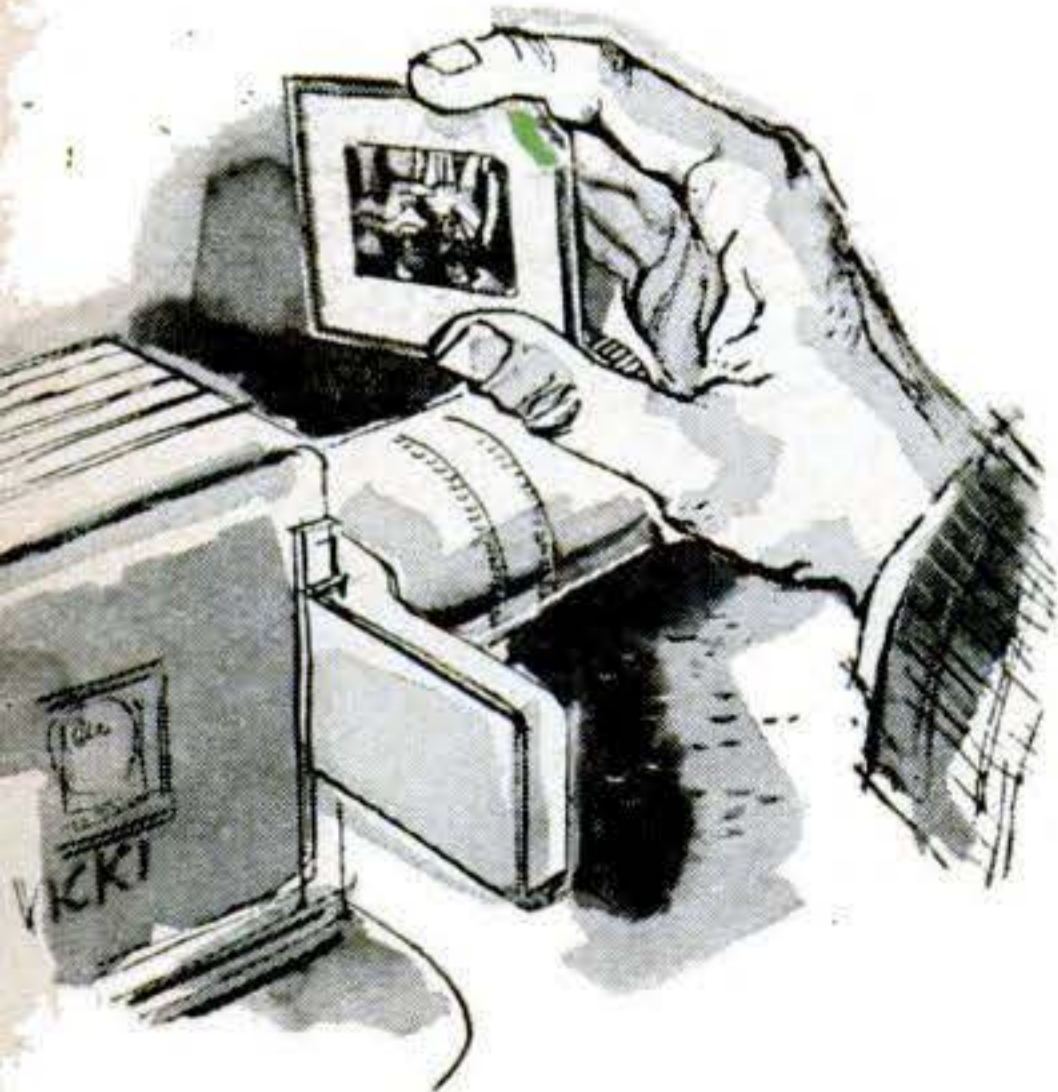



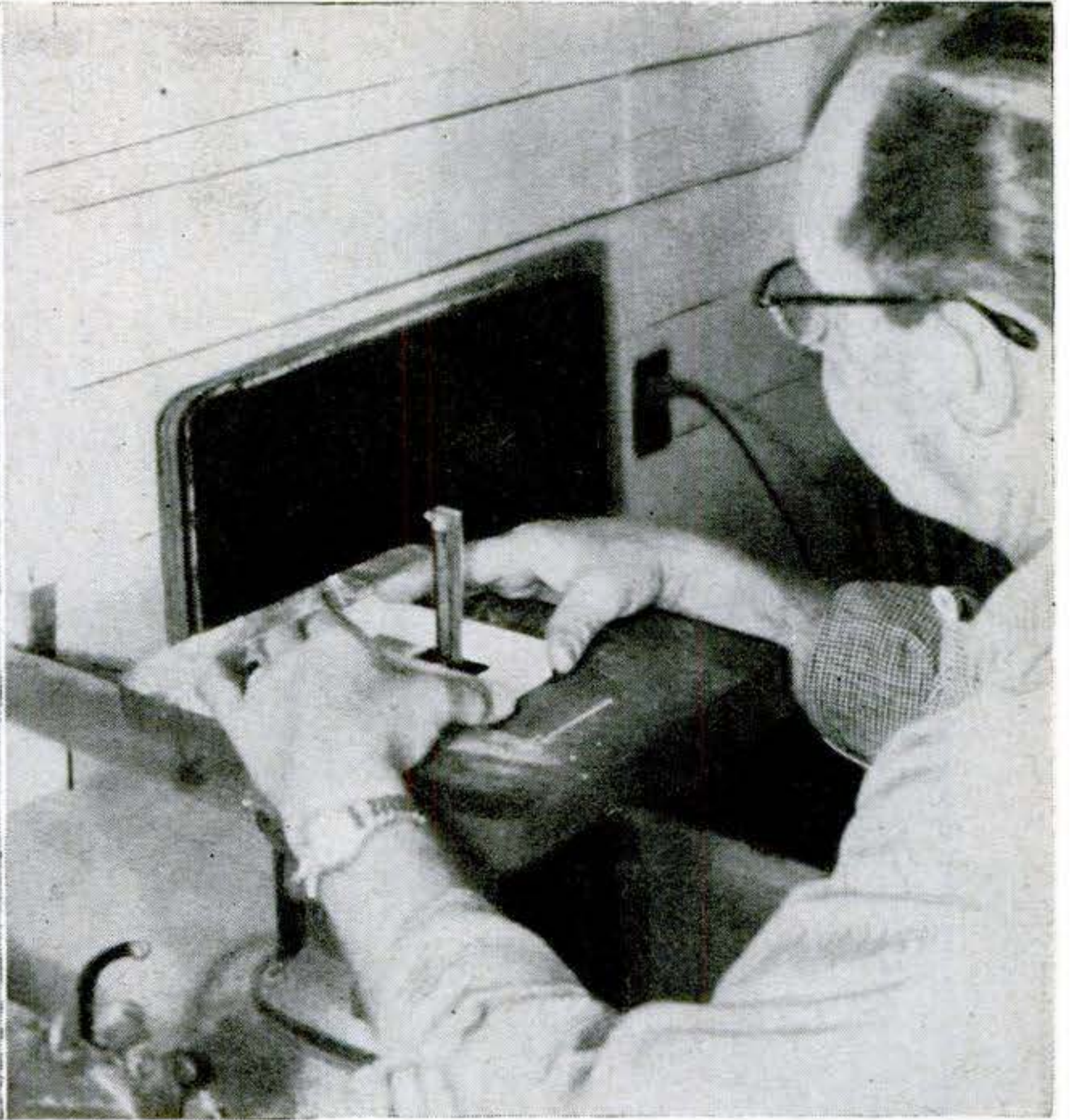
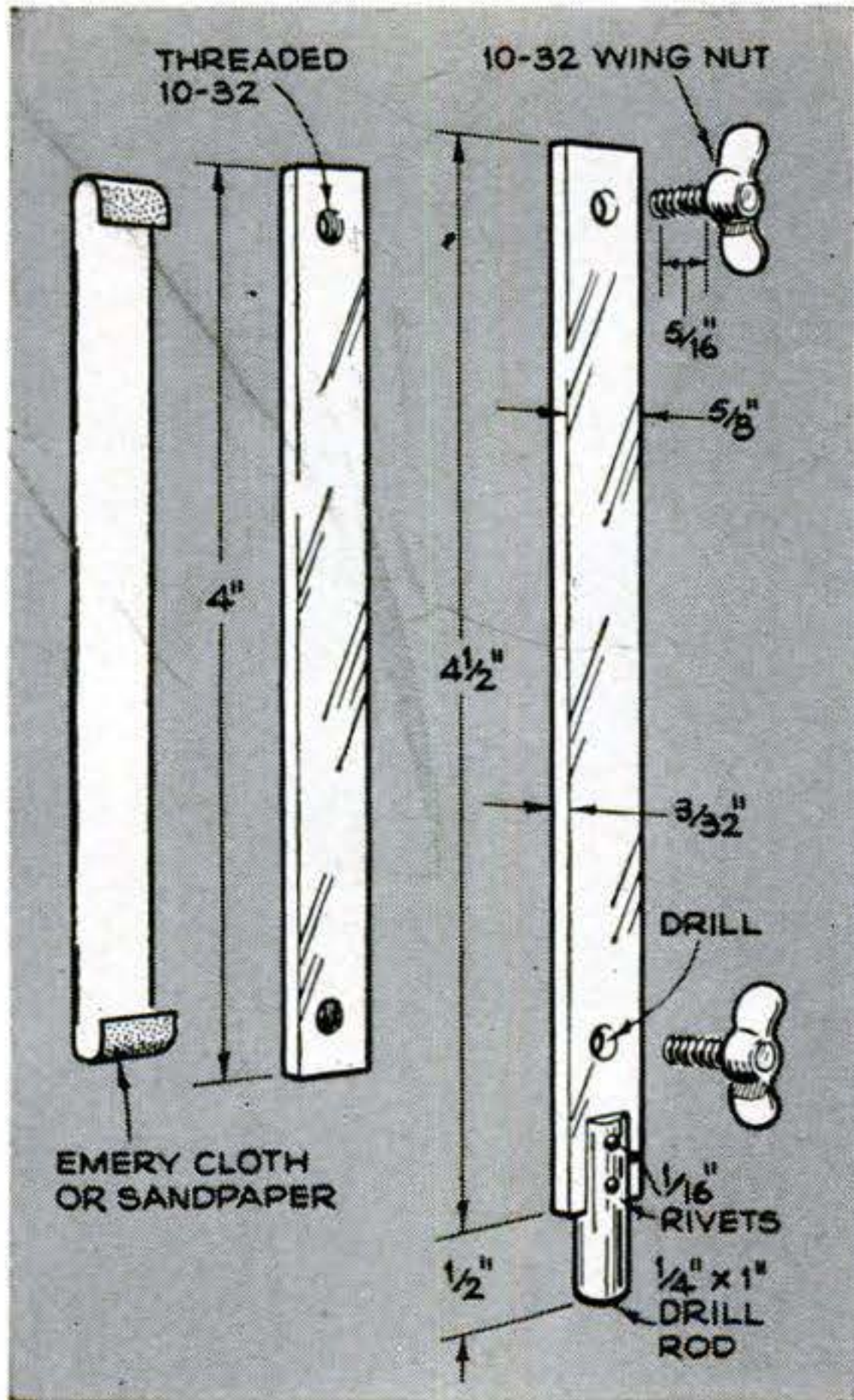

## Jigsaw Sander Smooths Straight, Inside Wood Surfaces

STRIPS of sandpaper clamped to the face of this sanding plate (left) will make short work of sanding inside edges.

Hacksaw a slot  $\frac{1}{2}$ " deep in one end of a 1" piece of  $\frac{1}{4}$ " drill rod, and rivet a  $4\frac{1}{2}$ " strip of  $\frac{3}{32}$ "-by- $\frac{5}{8}$ " flat steel to it. Drill clearance holes for two 10-32 wing bolts. Cut a 4" length of  $\frac{3}{32}$ "-by- $\frac{5}{8}$ " steel for the

sanding plate, and tap two 10-32 holes for the wing bolts. Fold the ends of a  $\frac{5}{8}$ "-wide strip of sandpaper over the sanding plate and clamp it by tightening the wing bolts. Chuck the shank in the jigsaw with its center insert removed, and run it at medium speed to keep from burning the stock you're working on.—Dick Hutchinson, San Gabriel, Calif.

## Bottle Cap Saves Chisel Handle

A BOTTLE cap tacked or nailed to the top of your wood chisel will help keep the handle from mushrooming or splintering under the impact of repeated hammer blows.

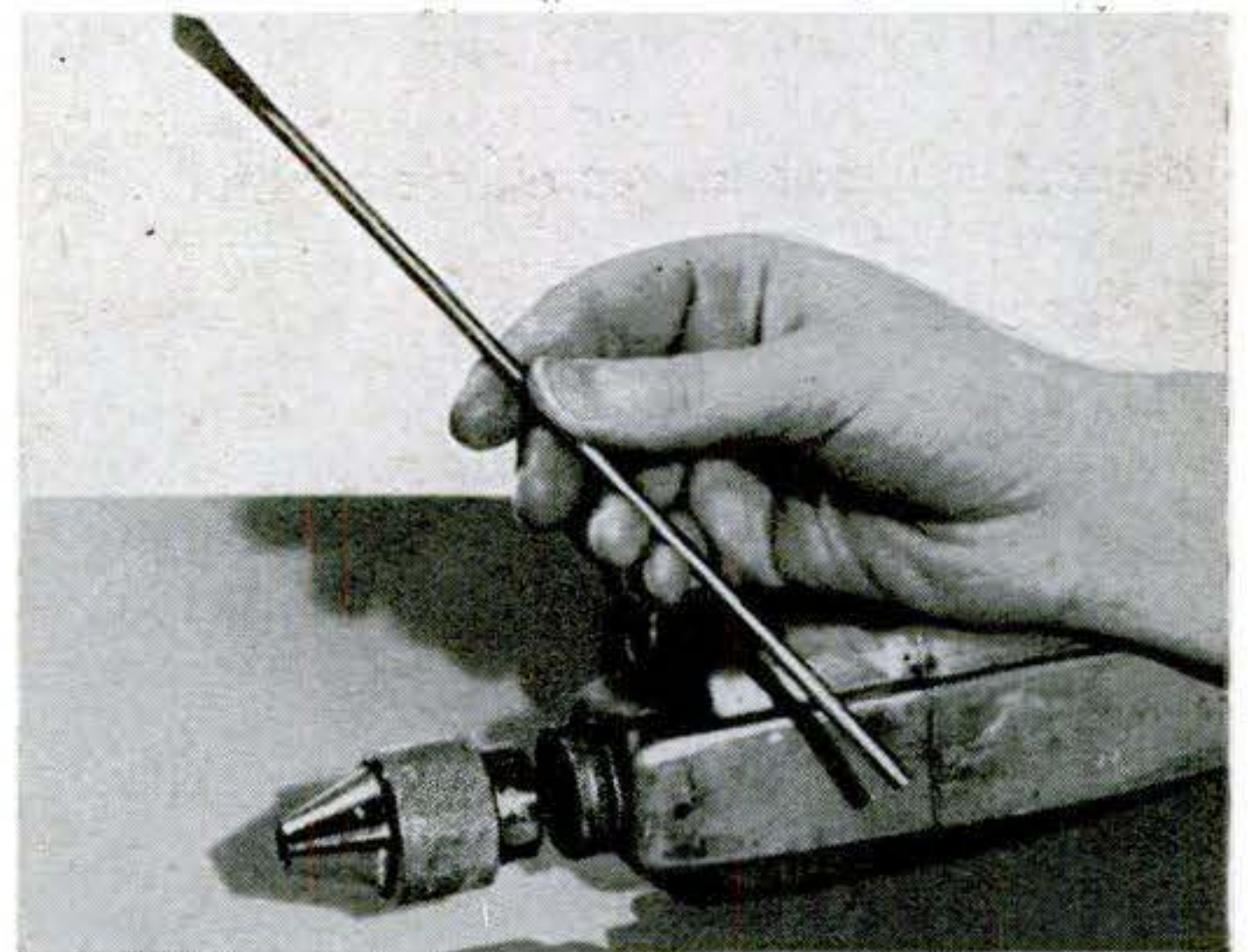
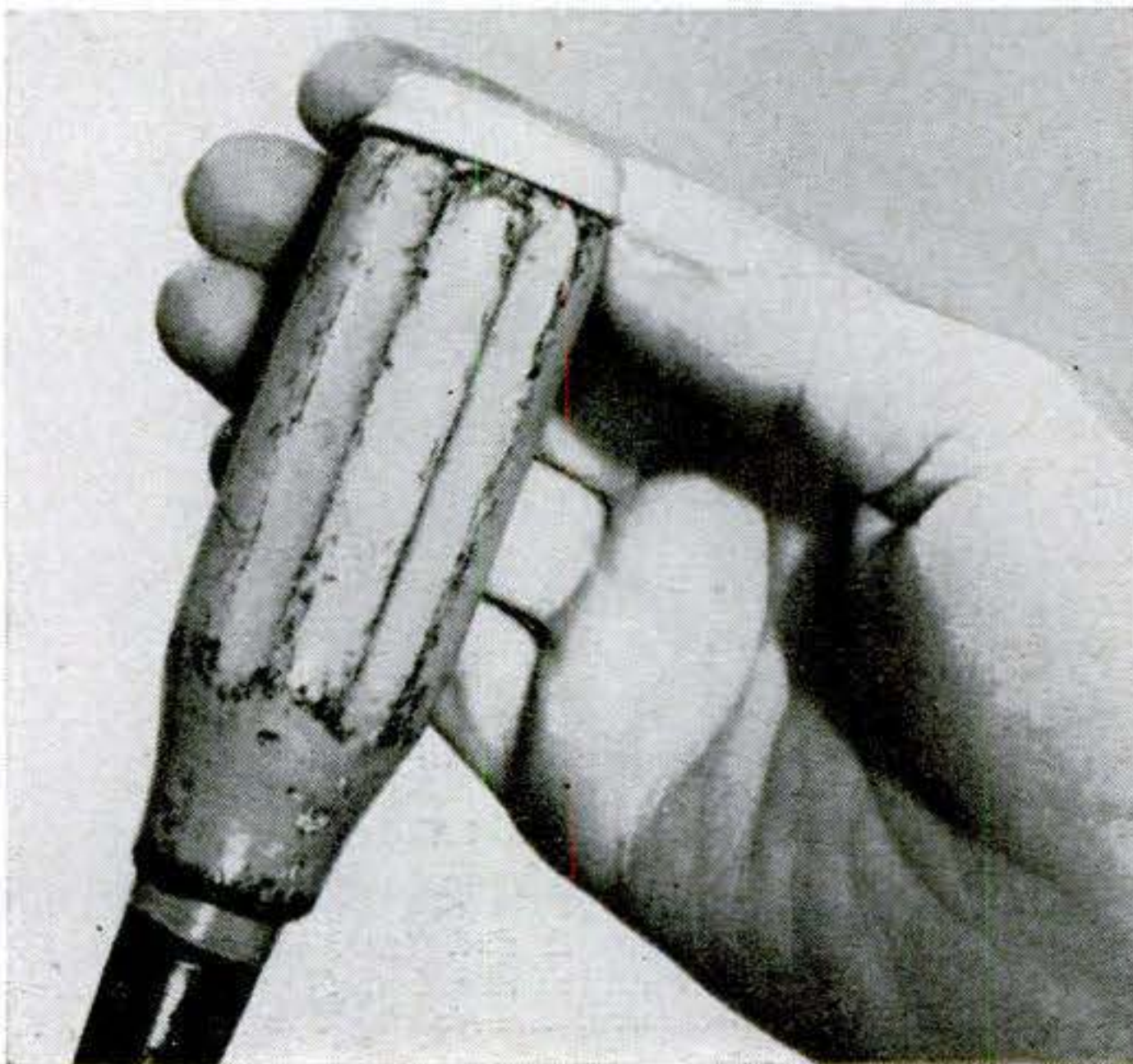

## Heavy Wire Makes Long Drill

You can improvise a long drill from a piece of heavy steel wire or solid curtain rod. Flatten one end, file it to a spear point and bevel the back edges, away from direction of turn. Use the drill with light pressure.—Frank A. Javor, North Bergen, N. J.



# New Tools

**1. Jaws Lock on Wrench.** The jaws on this wrench won't slip out of adjustment if you push up a locking plunger. It grips the adjustment sleeve, keeping it set while you start a bolt or nut on its way out. To release the jaws, just push the plunger down. The Superjustable comes in 6" to 12" sizes and is made of chrome alloy.

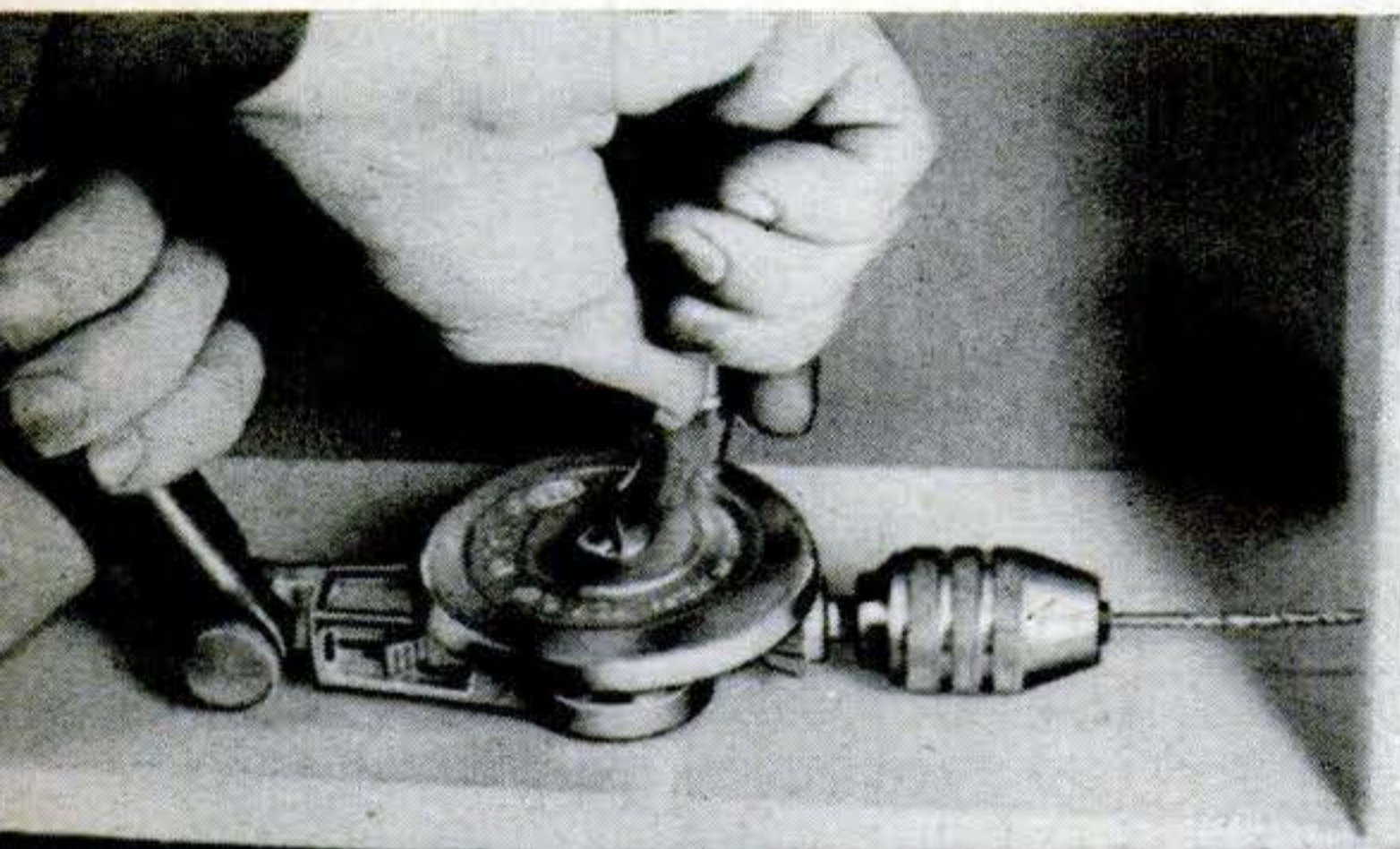
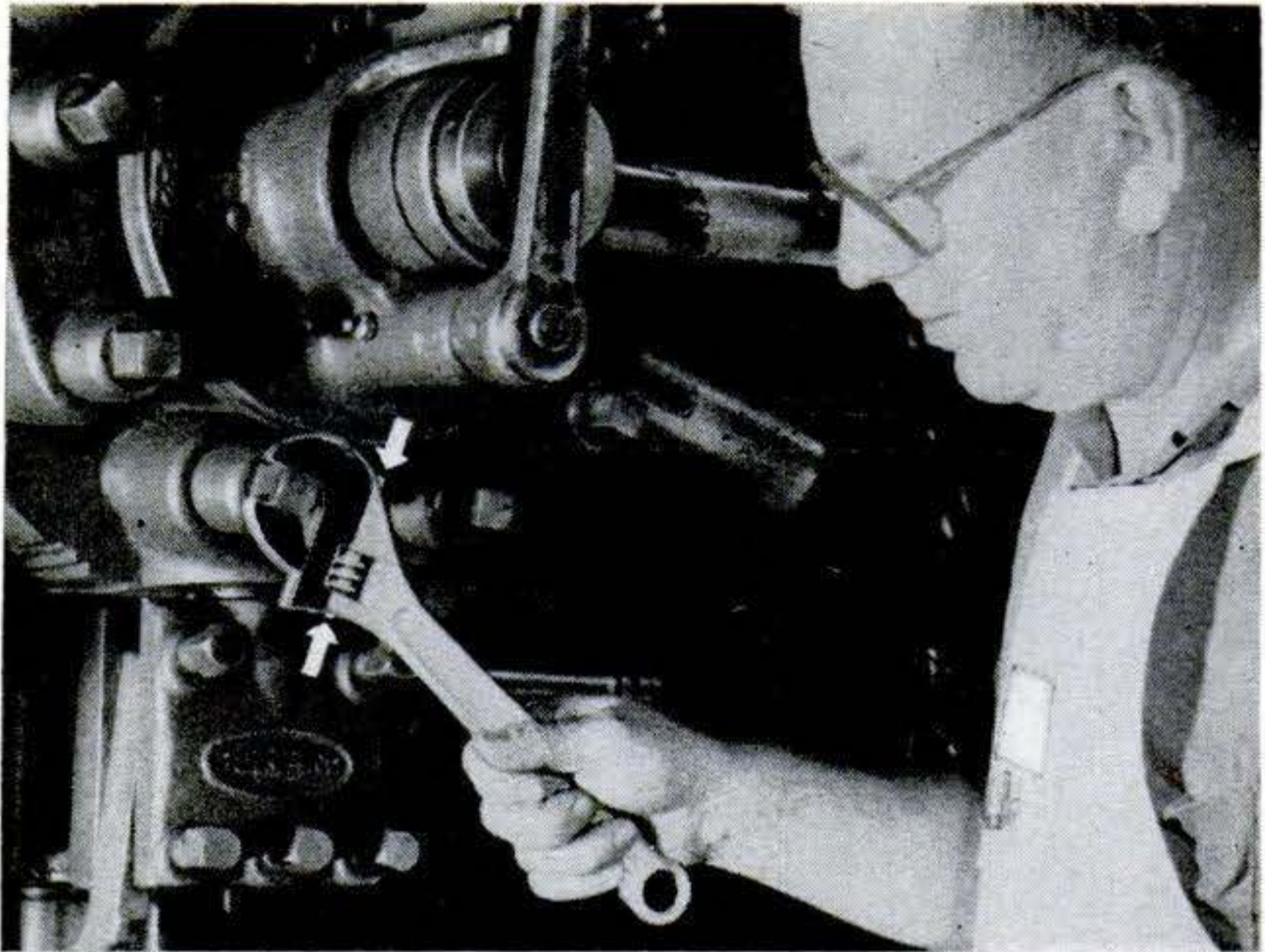

**2. Drill Gets into Corners.** Chuck and handle of this drill twist into snakelike shapes so you can drill in the narrowest places. With the handle at right angles to the chuck, the drill takes up half the space of a regular hand drill. The chuck rubber-necks in a 270° arc, handle 180°. A flip of the spring lock changes chuck positions. The All-Angle drill takes up to ¼" bits, which can be stored in the hollow handle.

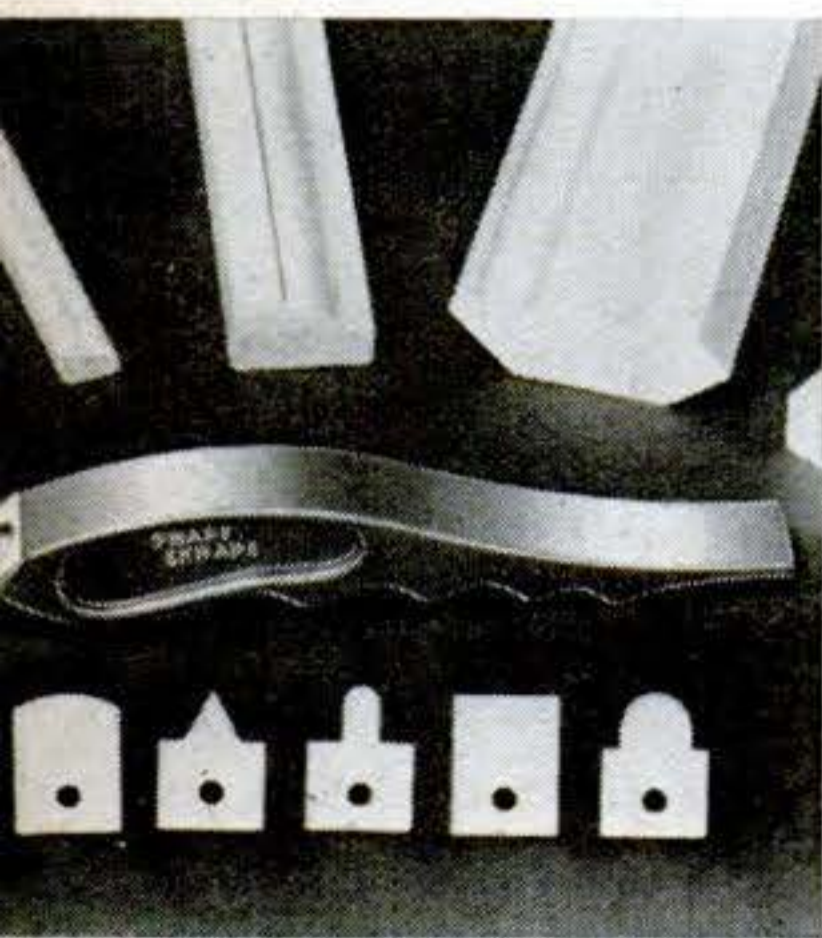

**3. Scraper Works on Curves, Odd Shapes.** Six specially designed scraping blades skin the old finish off moldings, picture frames, windows, antiques and odd-shaped pieces. The Shape-Skrape blades, made of steel, screw onto a molded handle.

**4. Tubing Bender Pre-Sets Angle.** Set the dial (0° to 180°), bring down the lever, and your tube is bent to the desired shape. The bender forms hard or soft tubing: copper, steel, aluminum and thin-wall conduit. Each Blue Dot bender handles only a single size tubing, ⅛" to ½" O. D.

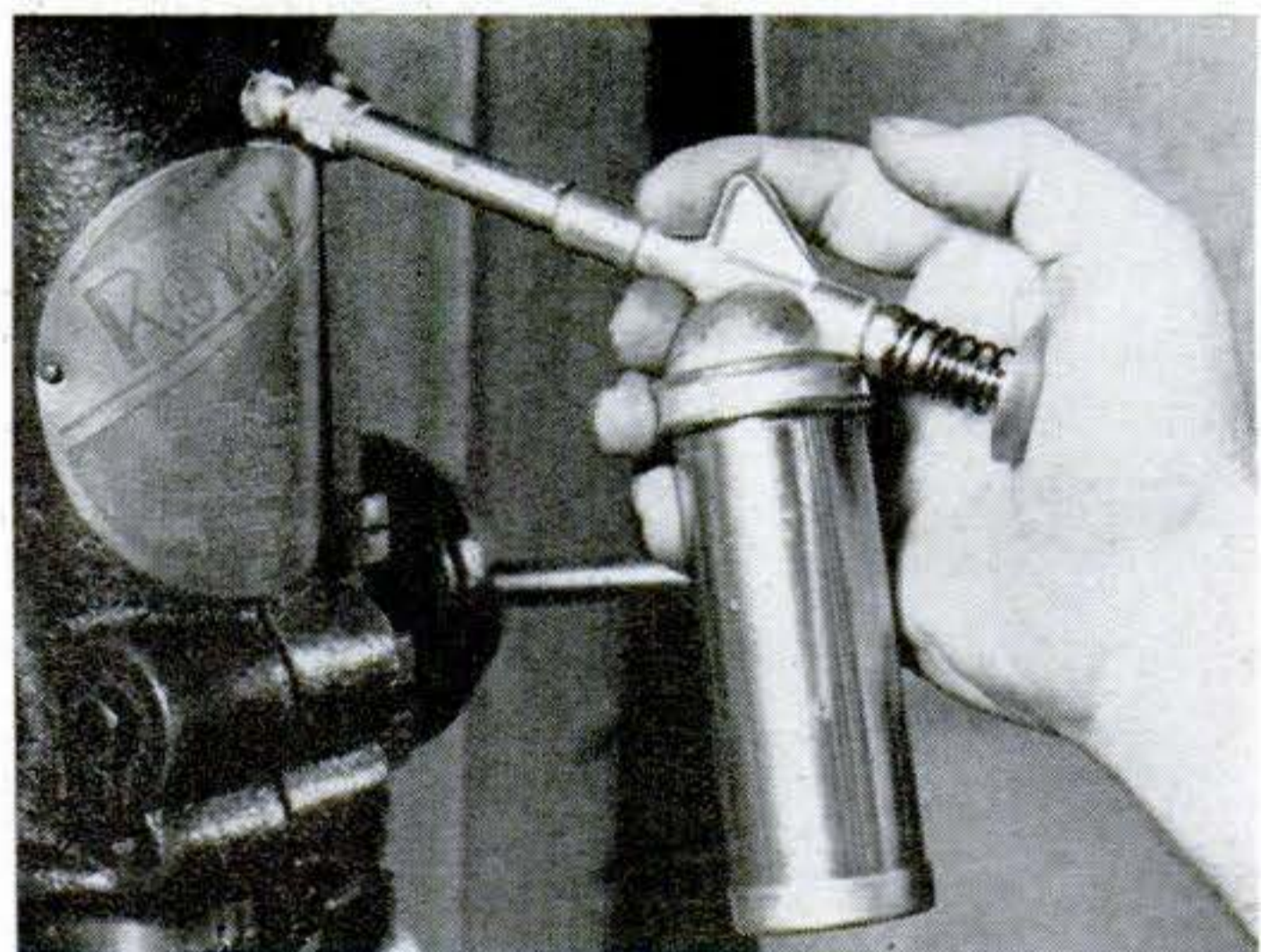
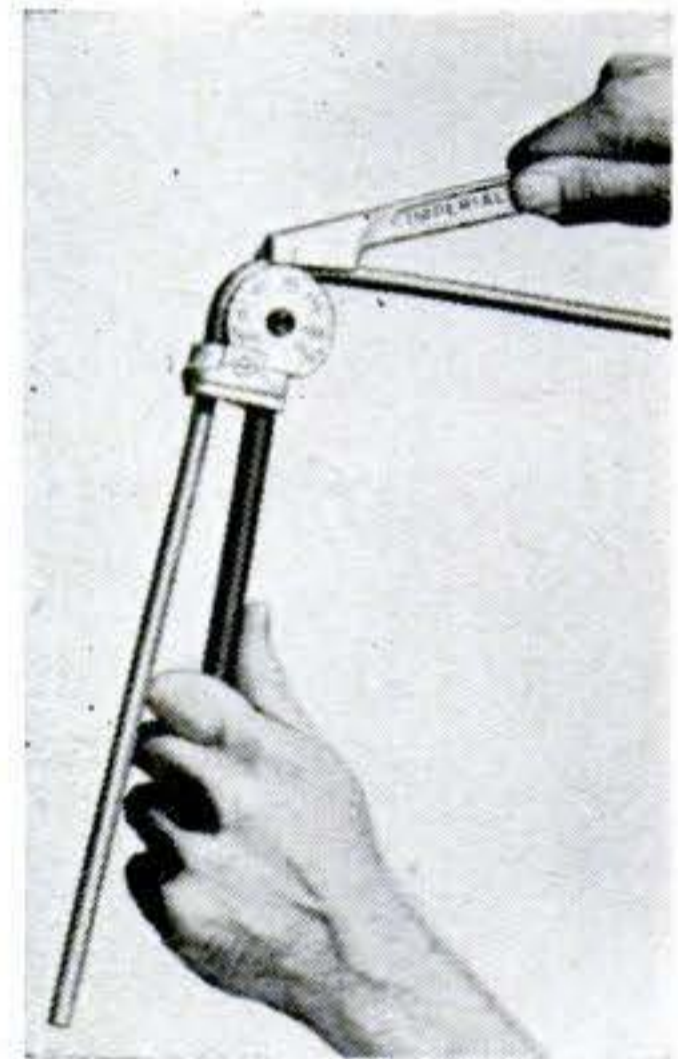

**5. Small Grease Gun Lubes Big Jobs.** Imitating big brother, this 4-oz. grease gun makes lubricating workshop or other equipment easier. Little Lube can be used for pressure greasing or ordinary jobs. A coupler and needle adapter are available.

Further information on the tools shown on this page can be obtained from: 1. J. H. Williams & Co., 400 Vulcan St., Buffalo 7, N.Y.; 2. P & C Hand Forged Tool Co., P. O. Box 5926, Portland 22, Ore.; 3. Adams Products Co., 119 Ann St., Hartford 3, Conn.; 4. The Imperial Brass Mfg. Co., 1200 W. Harrison St., Chicago 7; 5. Universal Lubricating Systems, Inc., 747 Allegheny Ave., Oakmont, Pa.





# What Steel Is That?

**All of it looks pretty much alike, but there are simple tests that will help you pick out the type best suited to the job.**

**By John Burroughs**

**W**HEN the man in the machine shop said I could help myself, I fished the piece of steel out of the scrap barrel. It was a bar about  $\frac{3}{8}$ " thick,  $1\frac{1}{4}$ " wide and 10" long—just the right size for the blade of the sheath knife I wanted to make. I put it in my pocket and went home happier than a pack-rat with a new penny.

But then I began to wonder what kind of steel it was. Suppose I heat-treated it, fitted grips and worked down the cutting edge—only to find that I had

wasted all my work on the wrong stock.

That evening I chased over to ask Dutch Morgan whether the bar would make a civilized knife. I found him in his basement, inching the flame of his blowtorch along an old clock mainspring.

"Making a cookie cutter," our best tool-and-die man admitted sheepishly. "Betty's invited the girls in her club to a get-together, and she thought it would be ducky to serve cookies shaped like the club emblem. I'm softening up this spring so I can bend it to outline. Then I'll solder it to a backing plate."

I showed Dutch my piece of steel. "Is





## These tests tell you what steel you're using

**FILE TEST.** Mild steel files easily, tempered tool steel is fairly hard to file, and hardened, high-carbon steel can't be filed. Between the first two types are medium carbon steel and annealed (softened) tool steel. The difference in the two cannot be detected by the file test.

**HARDABILITY TEST.** To find out whether fairly easily filed stock is medium carbon steel or annealed, high-carbon tool steel, heat a sample until it glows bright red, and then plunge it into a can of oil. If it comes out file-hard, you've got yourself a chunk of tool steel.

this the stuff they use for cutlery?"

Dutch ran his thumb along one edge of the bar. "Ground stock," he said. "It's probably a piece of electric-furnace tool steel. Run-of-the-mill machine steel wouldn't have a ground finish."

**What the sparks can tell.** Loosening a screw, he removed the guard from his grinder and switched on the motor. Touching the stock to the top of the wheel, he studied the shower of sparks that streamed out horizontally.

"That's what I thought," he nodded. "It's a low-alloy chrome-vanadium tool steel. About point/90 or 1-point 10 carbon. Yeah, it'll make you a good knife."

I was impressed. "You mean you can tell all that from the sparks?"

"It doesn't give you a complete analysis," he admitted. "But it's a quick way to tell one steel from another. Here, try it. As a start, look for sparks that break up in bursts. The more bursts, the more carbon content."

I did as he suggested, taking experimental grinds at the tool steel, a nail, the end of a file, and the blade of my pocket knife. "The fireworks sure are different," I admitted.

**The hardening test.** "Want to whack a half inch off your ground stock and try

hardening it in oil?" Dutch asked me.

While I went at the bar with a hacksaw, Dutch brought a can of oil from his garage, and pumped up the blowtorch. Propping the bit of metal I'd cut off on a firebrick, we heated it red-hot. With his pliers, Dutch snatched it up and dunked it in the oil. When it had cooled he wiped it off and tossed it to me.

"Try scratching that bottle on the bench," he said. Sure enough, the steel scratched the glass.

"It works," I admitted, "but I don't see why. How come only high-carbon steels harden? Where does the carbon get in the act?"

**"It forms hard carbides** when you quench the stock. Any steel with more than 70 points of carbon will turn file-hard."

"Points?"

"That's just a convenient way to express the carbon content. A point is one-hundredth of one percent. The whole deal is a little like making fudge. How a batch of steel turns out depends on what you throw in the pot, how you cook it and how you cool it. It's either soft and gooey—tough, you'd say—or it's hard and brittle."

Now that I came to think of it, I didn't





**SCRATCH TEST.** Draw a corner of the hardened sample across a piece of glass. Fully hardened, high-carbon steel will leave scratches in the surface. This kind must be worked while annealed, then hardened and, finally, re-heated at about 400° to relieve internal strains.

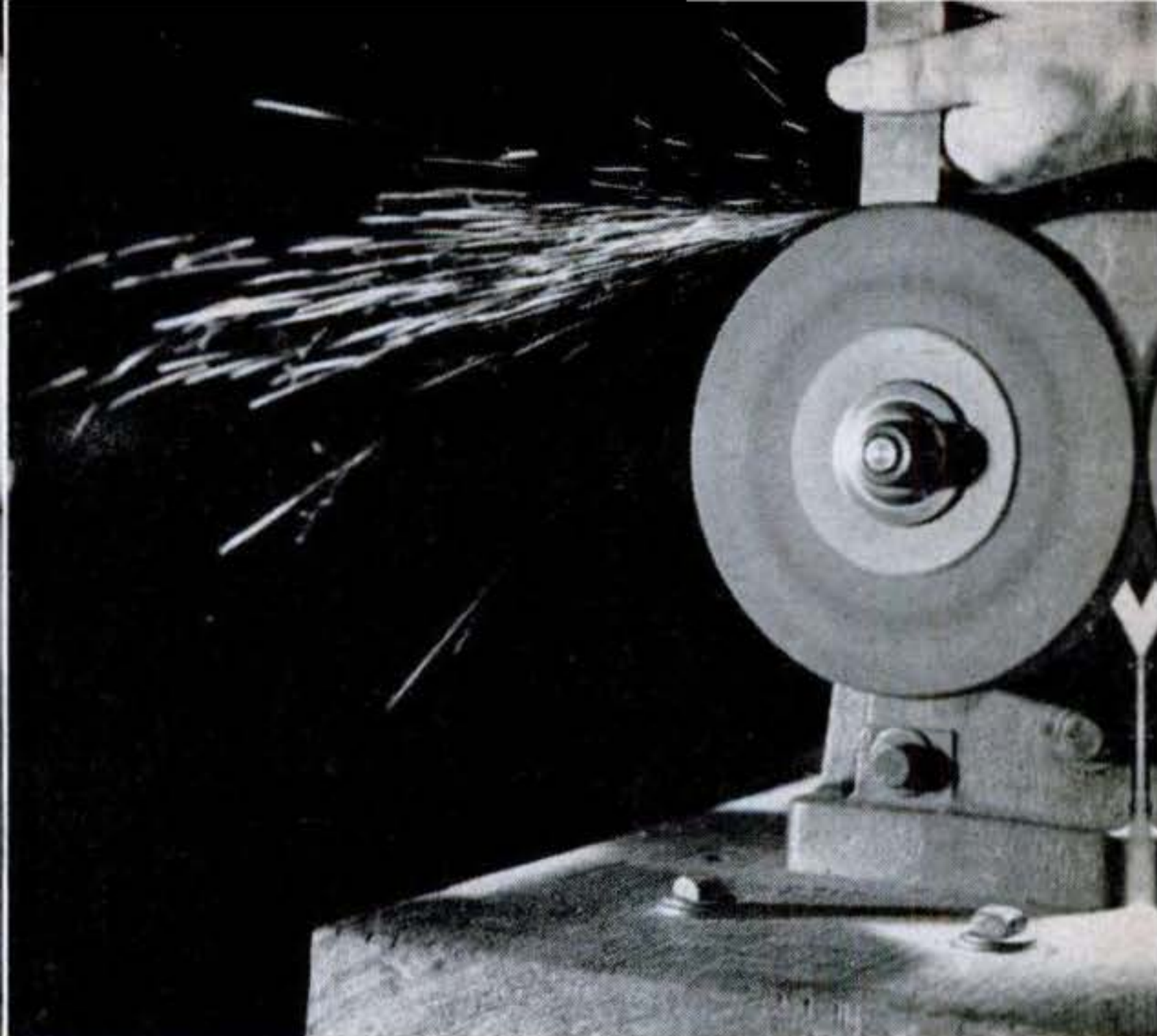

**SPARK TEST.** Touch the stock to a grinding wheel and study the shower of sparks in subdued light. Their pattern will tell you the approximate carbon content, whether the steel is alloyed, and with what. Typical spark patterns are shown in the drawings below.

**MILD STEEL** throws off strong, light-yellow lines ending in brilliant, white, orange-tipped tongues. Interspersed with the lines are a few simple carbon bursts.

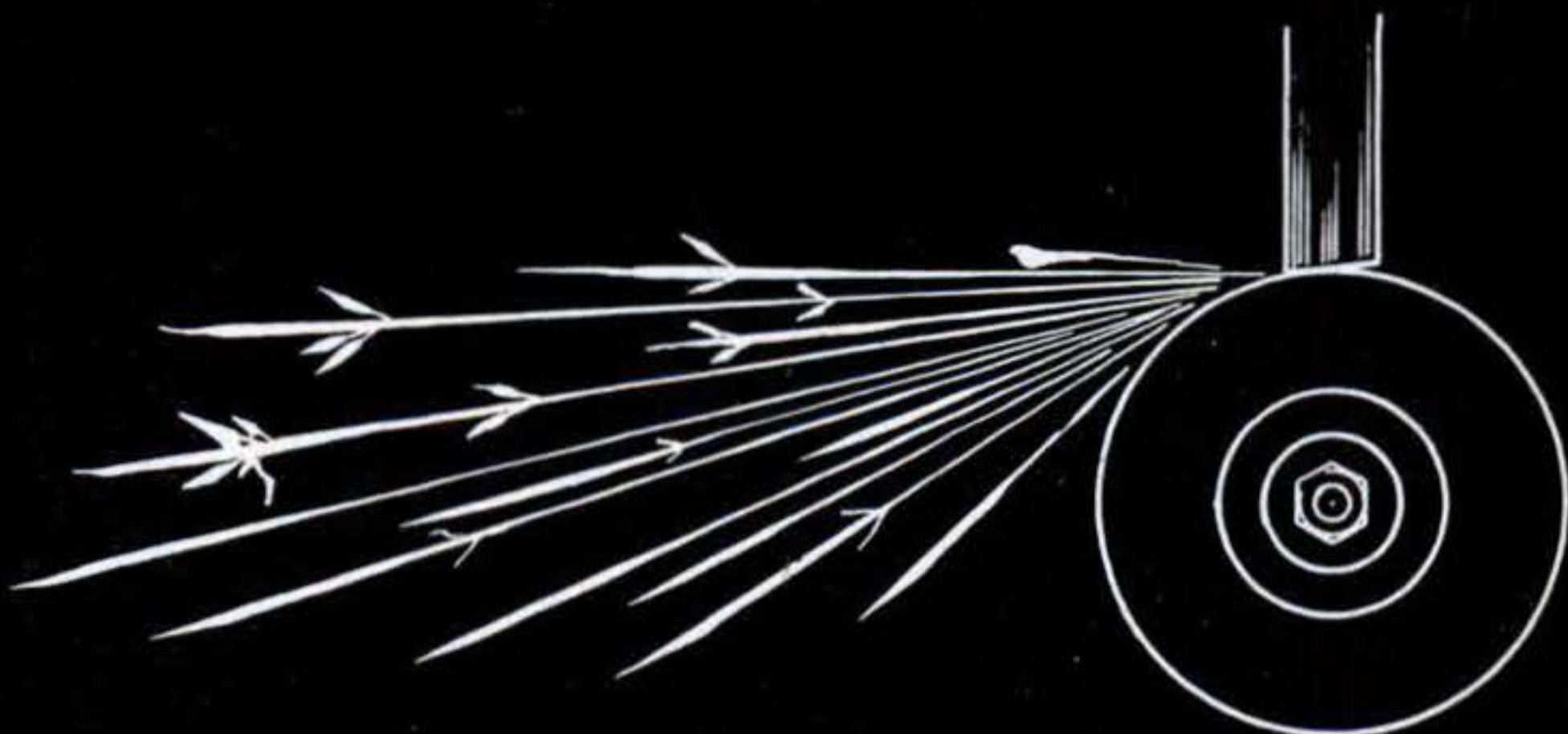

**HIGH-CARBON TOOL STEEL** sparkles with fine, feathery bursts. The more plentiful and complex the bursts, the higher the carbon content. Neither hardening nor annealing changes the pattern.

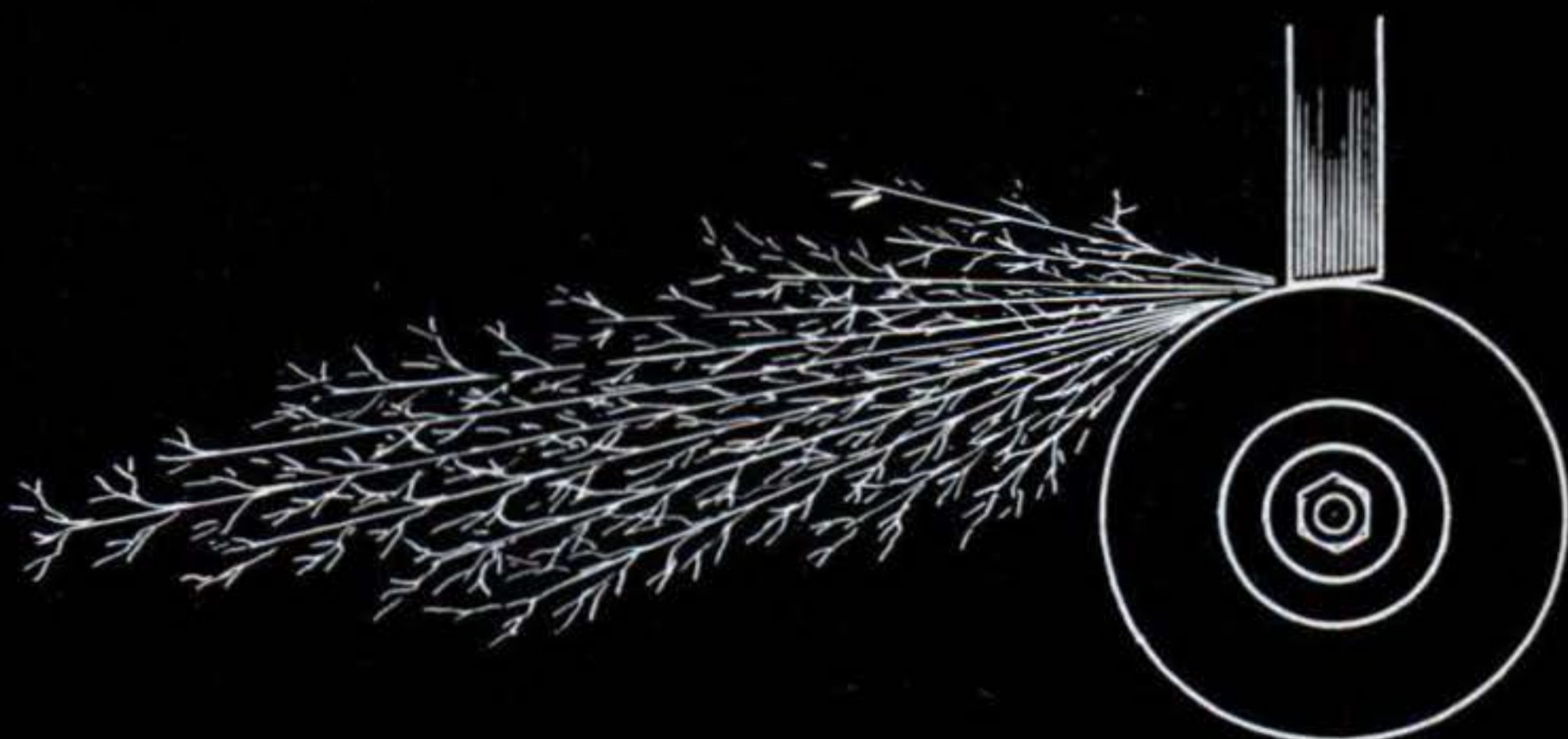

**LOW-ALLOY STEEL** is identified by disjointed orange lines, with some carbon bursts which the alloying metals tend to suppress. Forked tongues at the end of the spark stream identify nickel; long dark-yellow lines, chrome; very bright sparks with increased spray around the wheel, manganese; and red-brown lines with bright-orange tongues, tungsten.

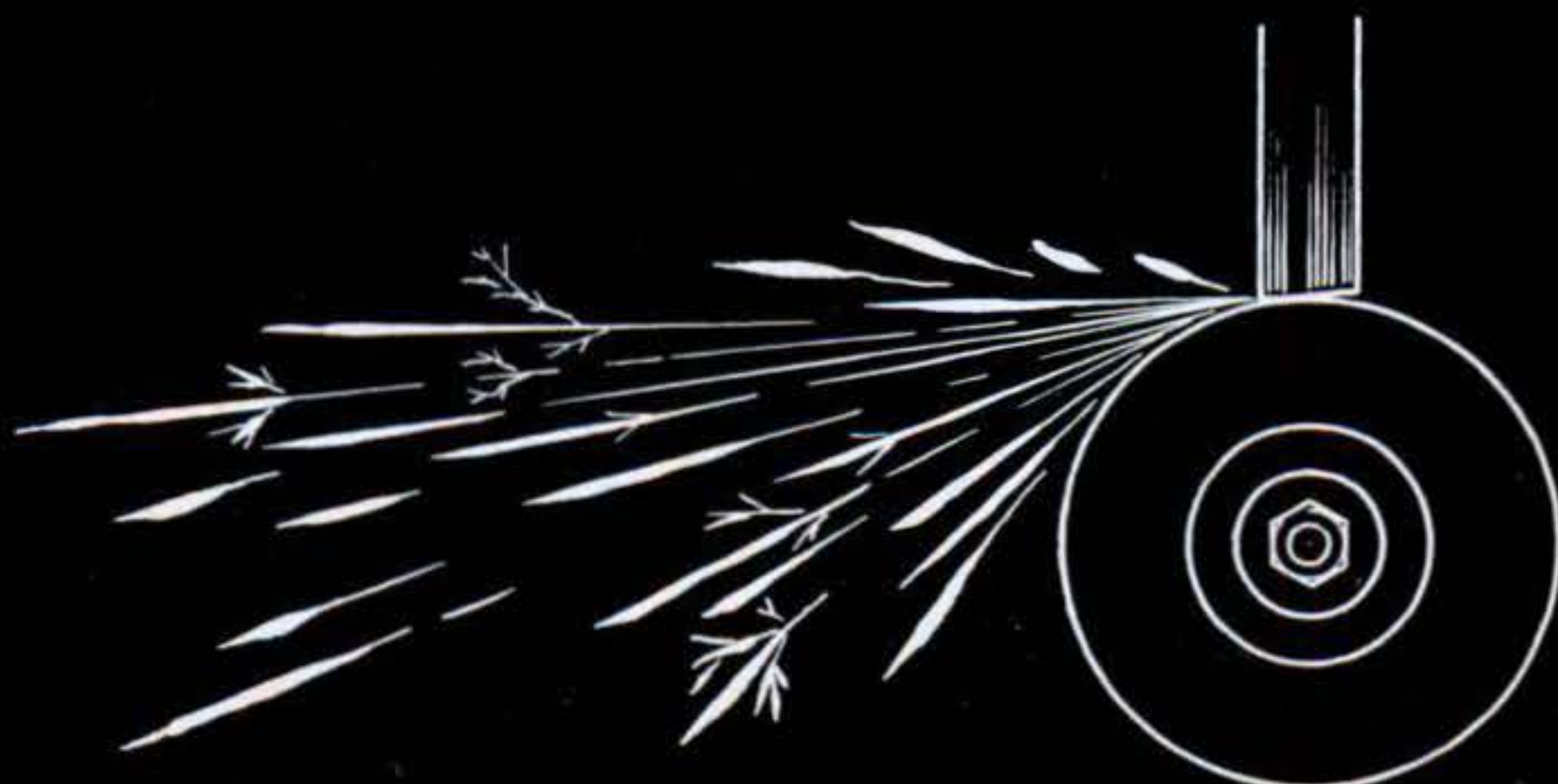



## Typical jobs for various steels



**HOT-ROLLED MILD STEEL** is too low in carbon content to harden when heated. Tough, it can be twisted or bent; welds easily. Use it for assemblies like this decorative stair rail.

know anything about iron or steel making. So I pumped Dutch on that, too.

"It's like this," he explained. "First you fire up some iron ore, coke and limestone, and pretty soon molten iron runs out at the bottom. If you pour it into molds, it becomes cast iron.

"Back there at the blast furnace," Dutch went on, "your hot iron picked up carbon from the coke. Dissolved it, like water dissolves sugar. There's about four percent carbon in cast iron, making it crystalline and brittle."

"What about steel?"

"I'm coming to that. Suppose you put your cast iron in another furnace and burn out the carbon. Throwing in some iron oxide does it, or you can speed the process by bubbling compressed oxygen up through the metal. The impurities in the iron combine chemically with the slag, and when you run out the batch it's relatively carbon-free iron. Just a trace left in it—about one-tenth of one percent. That's mild steel."

"How about tool steel?" I asked.

"Simply add some carbon to your mild steel. Melt it up again and toss in a little ground anthracite coal, maybe, or a small piece of cast iron. Say you want some

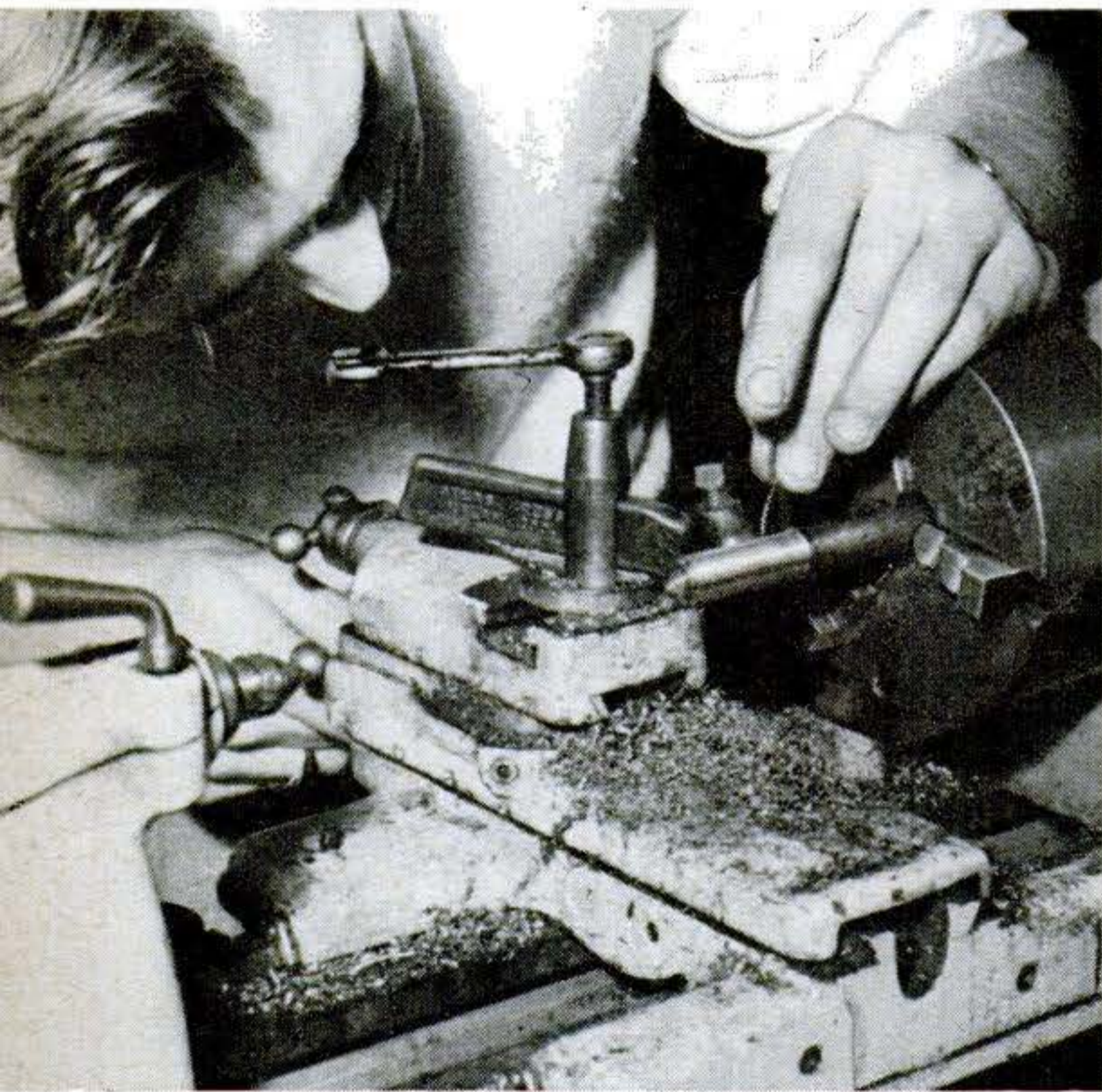

**COLD-ROLLED MACHINE STEEL**, which comes in bars, rods and plate, is good for shafting and structural parts. Rolling it cold toughens this low-carbon steel and gives it a smooth finish.

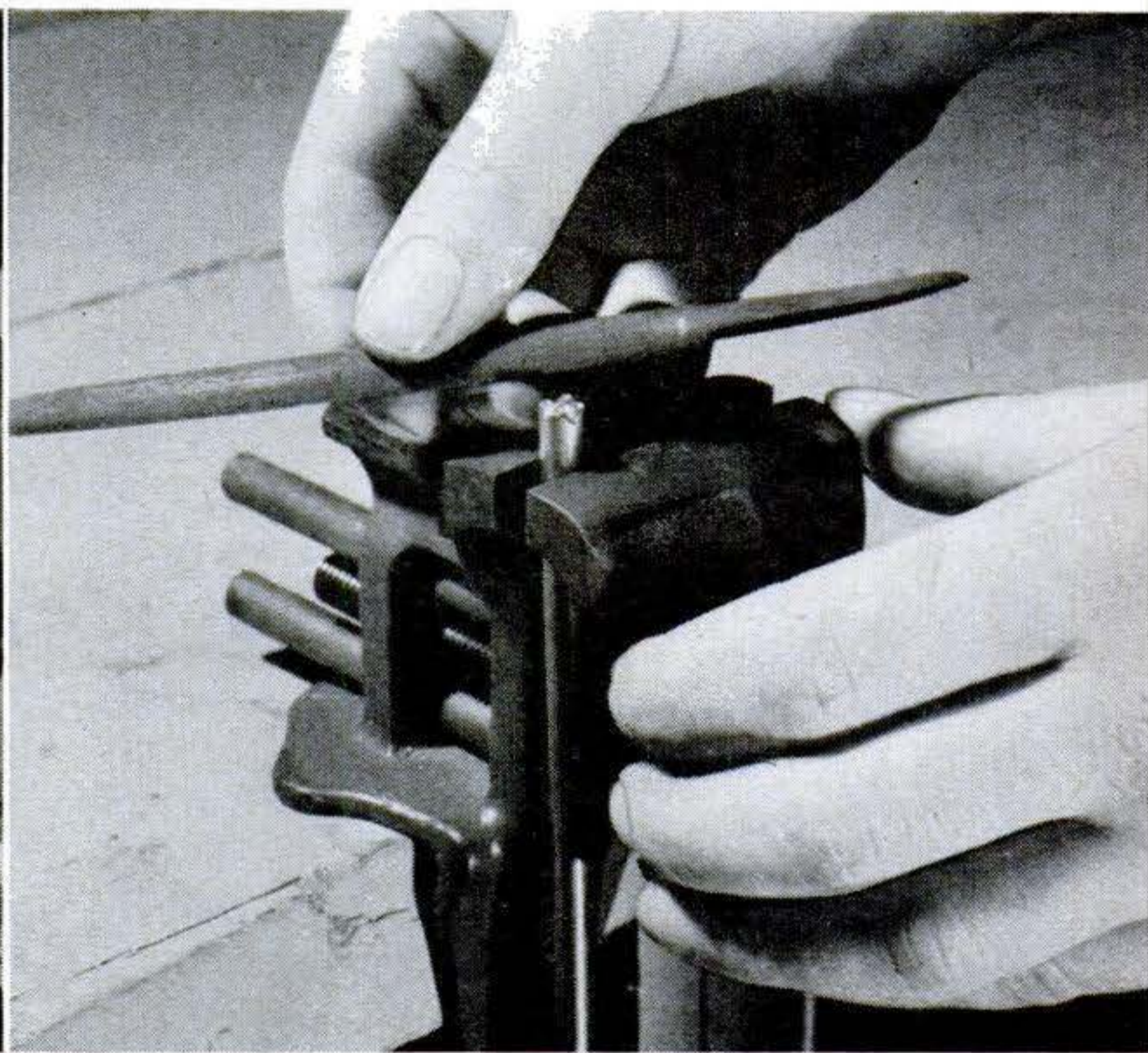

**HIGH-CARBON STEEL** can be worked with comparative ease when annealed. This is the stock you use for making special tools like this star-tipped punch, lathe-tool bits or knives.



steel for cold chisels; then you increase the carbon content to eight-tenths of one per cent—80-point steel, that is. Up the steel to 130 points and you can make razor blades of it. But you don't want to go much higher than that. If you do, your steel will be almost as brittle as cast iron again."

"While I'm making steel," I said, "why don't I stir in something to alloy it?"

"**Alloy steels** are a little tougher than plain carbon steels, and they're easier to harden."

"How come?"

"Because you can give them a slower quench. Plain carbon steels have to be quenched in water or brine in a hurry, to cool them fast enough to form hard carbides. Drastic quenching sets up strains in the metal which can warp or crack it. But if you use a steel with a little chrome or nickel in it, you can harden the tool in warm oil."

"I've read about 'oil-hardening steel' somewhere," I said.

Dutch nodded. "That's a definition for low-alloy steels, just as plain carbon steel is sometimes called water-hardening steel. Then there's another group of steels containing about four percent chrome called air-hardening steel. Just letting them cool in air hardens them."

"Stainless steel is a chrome alloy, too, isn't it?"

"It's a high-alloy steel," Dutch said, "with anywhere from 11 to 27 percent chrome. Good enough for kitchen knives, though a butcher wouldn't use one."

"Getting back to knives," I said, "you told me this ground stock of mine is low-alloy tool steel. Then I quench it in oil?"

"**Can be oven-tempered.**" "You're learning fast," Dutch grinned. "It'll probably quench out file-hard. Then temper it at about 400° to relieve strains in the metal. Safest way is to put it in your kitchen oven for a couple of hours. If you use a torch it may get too hot, and before you know it you've got a spring instead of a blade."

While we'd been talking, Dutch had finished shaping the spring for his cookie cutter. Setting it on the backing plate, he flowed solder around the joint with his torch and trued the cutting edge on his sanding disk. We went upstairs and his wife looked it over approvingly.

"Thanks, Hon," she said, "but what took you so long?"

My sheath knife? It turned out fine. As I always say, if you want a thing done right, first find out how to do it from somebody who's smarter than a treeful of owls. Then do it yourself. END

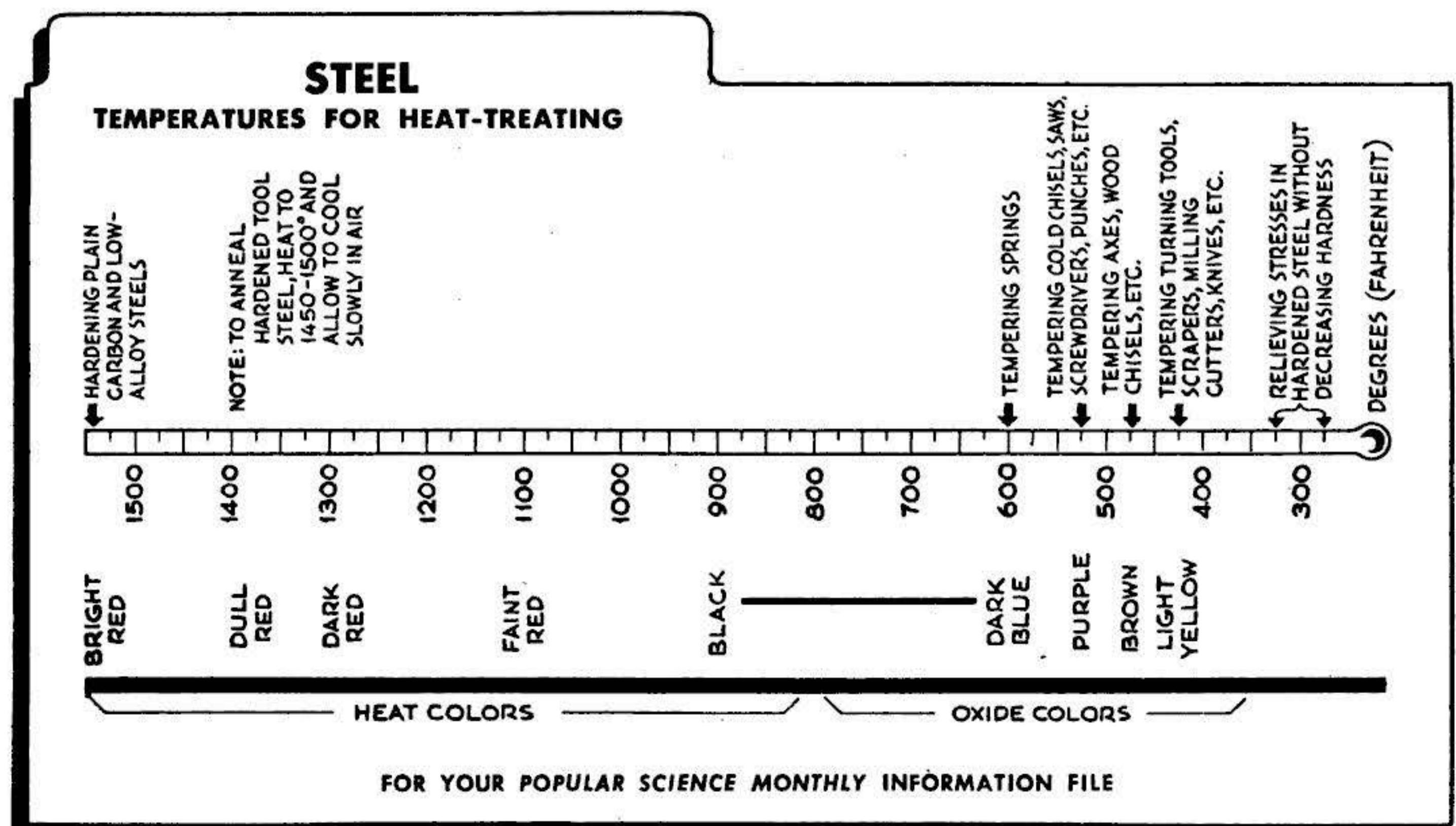



# I Like the Gauges Detroit Left Out

**An ammeter and oil gauge help you drive. It's easy to sub them for those new red blink-out indicators.**

**By Phil McCafferty**

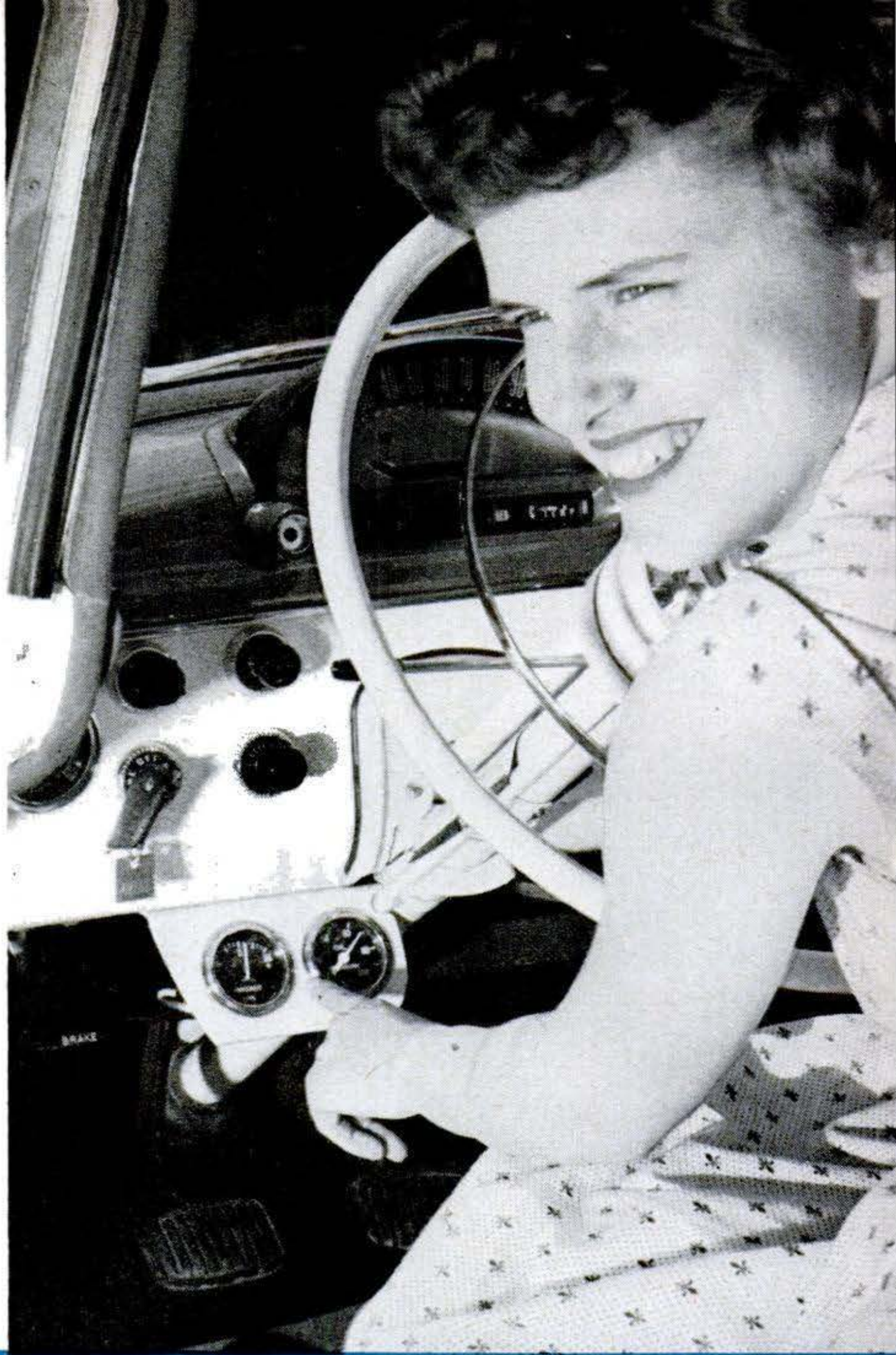

**WHAT YOU'LL NEED** to equip a new car with an oil gauge and ammeter is suggested at the left. The instruments can be mounted on an aluminum panel, marked and cut as outlined, painted and then mounted under the dash as above.

**T**HE red lights that are appearing on the instrument panels of new cars to tell what is going on in the electrical and lubricating systems are great, I suppose, for those who don't know what a generator or oil pump is—and care even less.

But, from the day I drove my new car off the dealer's floor I didn't feel at ease. Sure, it's just like the book says. When the red lights go out,



the generator is working and you have oil pressure. But to me it's like driving in a soupy fog. You know the road is ahead. But just exactly *where* is it?

Suppose you have your lights, heater and radio on, drawing some 30 amperes from the battery. Suppose at the same time the generator is only producing 20 amps. The "GEN" light would be complacently off.

**You would be in trouble.** But you would not know a thing about it until the starter solenoid gave off a hollow click the next time that you tried to start the car.

My operator's manual says that the "OIL" light goes out when pressure reaches 14 pounds per square inch. That's fine. But I've always liked to know just how much oil pressure I have. I'd hate to drive faster than 20 m.p.h. to the nearest garage (with any of the new V-8 engines) with only 15 to 16 pounds of oil pressure. Falling oil pressure is a sure sign of trouble.

**But, I now know a lot more** about what is taking place under the hood of my car—and feel a lot more at ease. I bought an oil-pressure gauge and an ammeter and installed them myself. The whole outfit cost about \$10. That was for

new stuff. You can do the job for a lot less by getting your gauges from a junk yard.

As soon as I hooked up the ammeter I learned that my generator was overcharging most of the time. Rather than work over the voltage regulator myself, I took the car back to the dealer. He fixed it and told me what I knew—that it was a good thing I brought it in when I did or I'd have soon been buying a new armature—or complete generator.

**Mounting the gauges.** Some cars have room for the instruments on the dash. A circle cutter or hole saw mounted in a hand or electric drill works well for cutting the holes.

If you decide, as I did, to put the gauges under the dash, make a cardboard pattern for the mounting bracket. Bend and trim it to fit where you wish, then transfer the shape on 20-gauge (18 to 24 gauge will do fine) sheet metal or aluminum. Bend the bracket to shape after the holes are cut. Attach the bracket with sheet-metal screws.

A neat-looking paint job can be had by using touch-up paint, available from the dealer. I sanded the metal smooth and brushed on one coat of touch-up paint. When dry, I sanded the paint

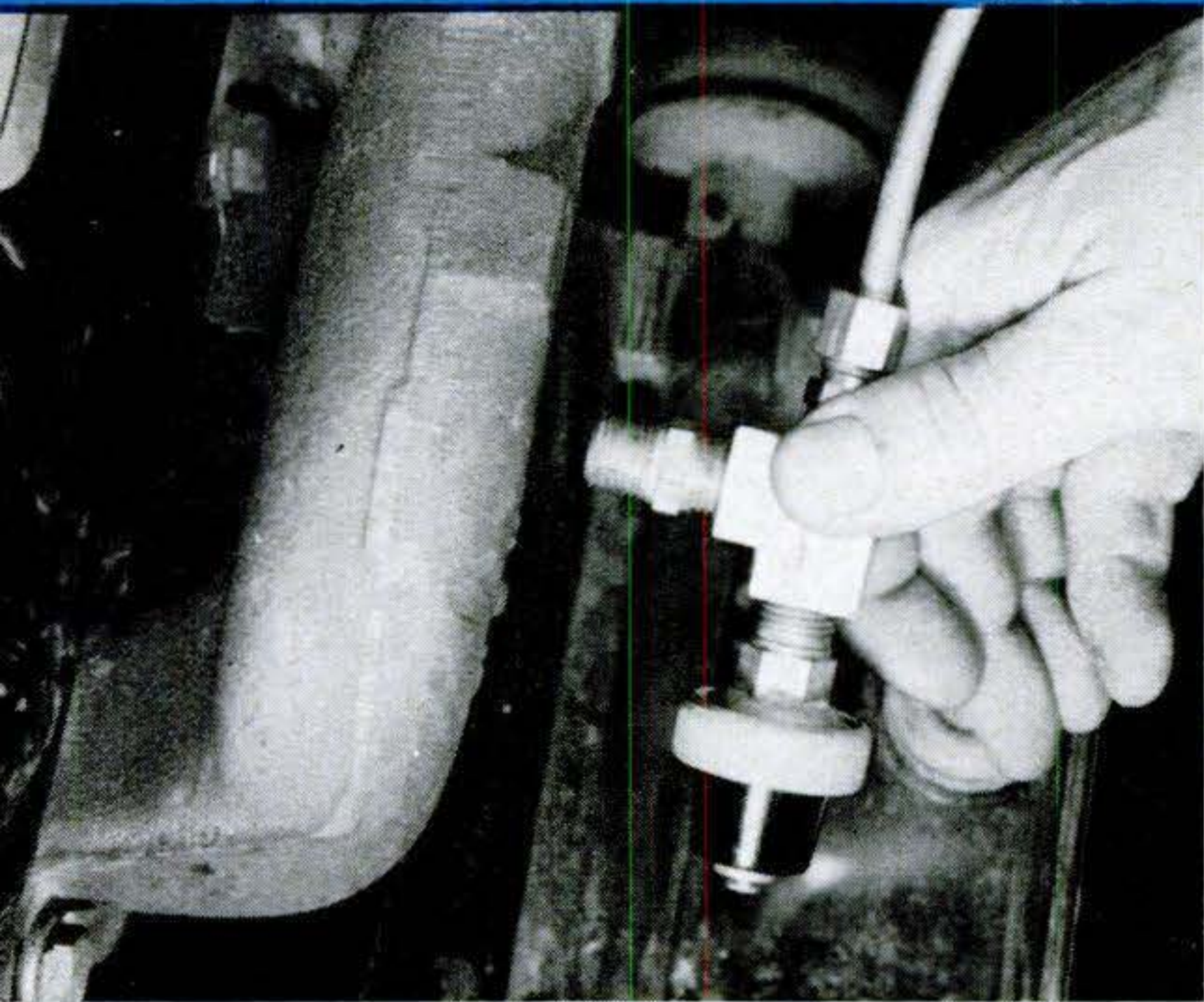

**TEE FITTING** enables you to use both oil indicator light and gauge. Check system for leaks with engine running. If an electric oil gauge is used, screw the sending unit into the tee.



**A BULB SOCKET** soldered on back of the metal panel lights the gauges that the writer installed. Connected in parallel with dash light, the lamp shines through slots in the gauges.



# ALMANAC FOR MOTORISTS

Pithy proverbs, provident counsel and omens and portents of interest to horseless-carriage operators.

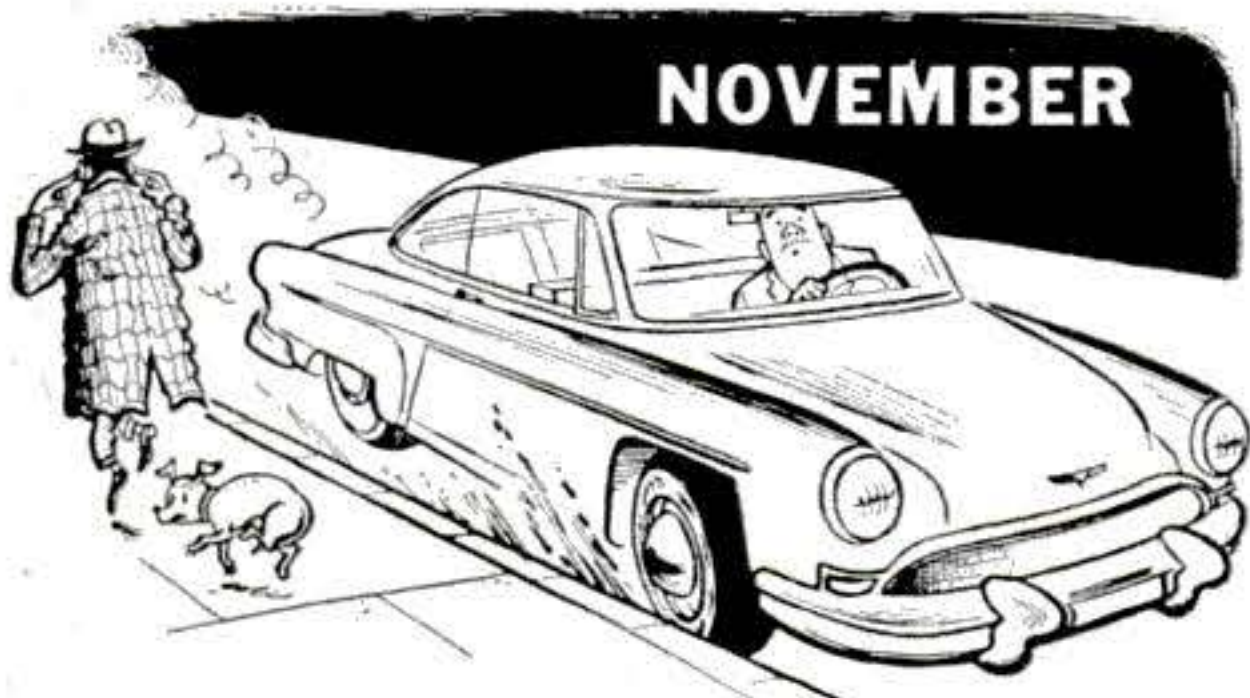

▶▶**Curbs and tires** have an inherently hostile relationship, like cats and dogs. If you don't want to be let down, stay friendly with your tires whenever you park.

▶▶**Is the weather** growing nippy where you live? Don't forget to reset the accelerator-pump link on the side of the carburetor to its cold-weather position.

▶▶**On the subject of weather**, ice is fine for skating but a genuine nuisance in the bowl of a fuel pump. We don't mean to nag, but it won't take you three minutes to drain it.

▶▶**Brake wear**, a creepingly gradual affair, is sometimes masked by a driver's unconscious ability to adapt to failing brakes by tramping harder on the pedal. Next time you take the wheel, make a point of seeing just how good your stopping power is.



▶▶**When a seemingly healthy battery** turns up its toes, make sure that the heavy-current terminals are tight. Under the high starter drain, a poor connection may imitate a dying battery.

▶▶**Study the mirror-using habits** of a good driver and you'll discover why he never gets surprised from behind. The mirror receives a frequent, flicking glance, and there's always a quick check just before he changes lanes.

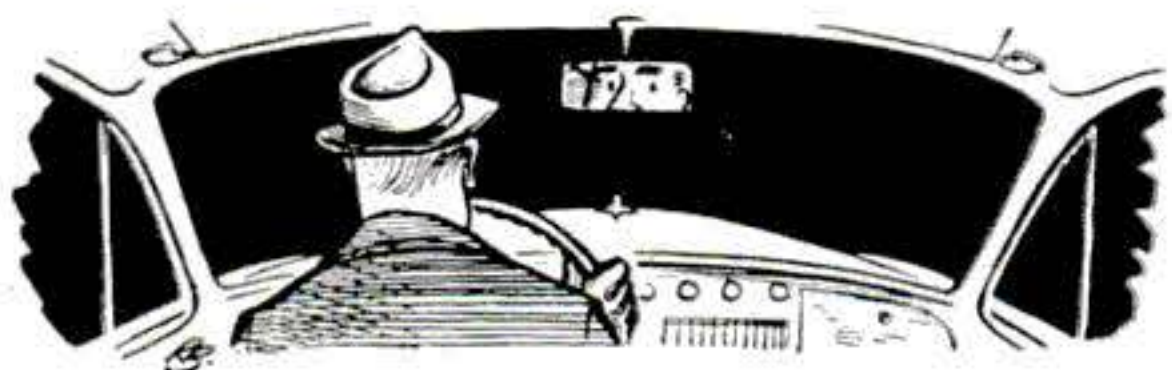

smooth with very fine sandpaper and applied a finish coat of paint. This coat was rubbed smooth with rubbing compound and waxed. It looks like part of the dash now.

**Connecting the ammeter.** For an honest picture of the condition of the electrical system, you'll want the ammeter to be hooked between the battery and all the equipment except the starter. The hot wire runs from a terminal on the starter solenoid to the light or ignition switch (in all the cases I know of).

Open this wire between its start and the first connection. Hook the ammeter in series with this line. Solder all connections. If the severed line is too short, splice in lengths of wire equal in size to the existing wire. If the ammeter shows "charge" instead of "discharge" when the headlights are turned on, reverse the ammeter leads. (I've stated it this way because it is probably the least confusing. Battery polarities are different in some makes of cars, and some ammeter connections are not marked "positive" and "negative" so you may have to experiment to find out which is which.)

**Hooking up the oil gauge.** The little red bulb marked "OIL" on the dash is hooked between the ignition switch and a sending unit on the engine block. When the engine is not running the diaphragm in the sending unit is grounded, turning the light on. When oil under pressure forces the diaphragm out, it is no longer grounded, turning the light off.

Remove the sending unit from the block. I decided to leave my little red light hooked up, so I bought a brass tee, screwed it into the block and ran copper tubing from one side of the tee to the oil gauge. In the other side of the tee I screwed the indicator-light sending unit, hooked up in the normal way.

If you decide to use an electric oil gauge, screw the gauge sending unit into one side of the tee and the indicator sending unit into the other. If it is desired to have the gauge only, screw either the tubing or the gauge sending unit directly into the block where the indicator unit was attached.

END





# Hints FROM THE MODEL GARAGE



**Clean headlights** are as important as a clean windshield when driving at night. Even though yours may look clean, tests have proven that a single day's accumulation of dirt on headlight lenses can reduce their effectiveness by as much as half.

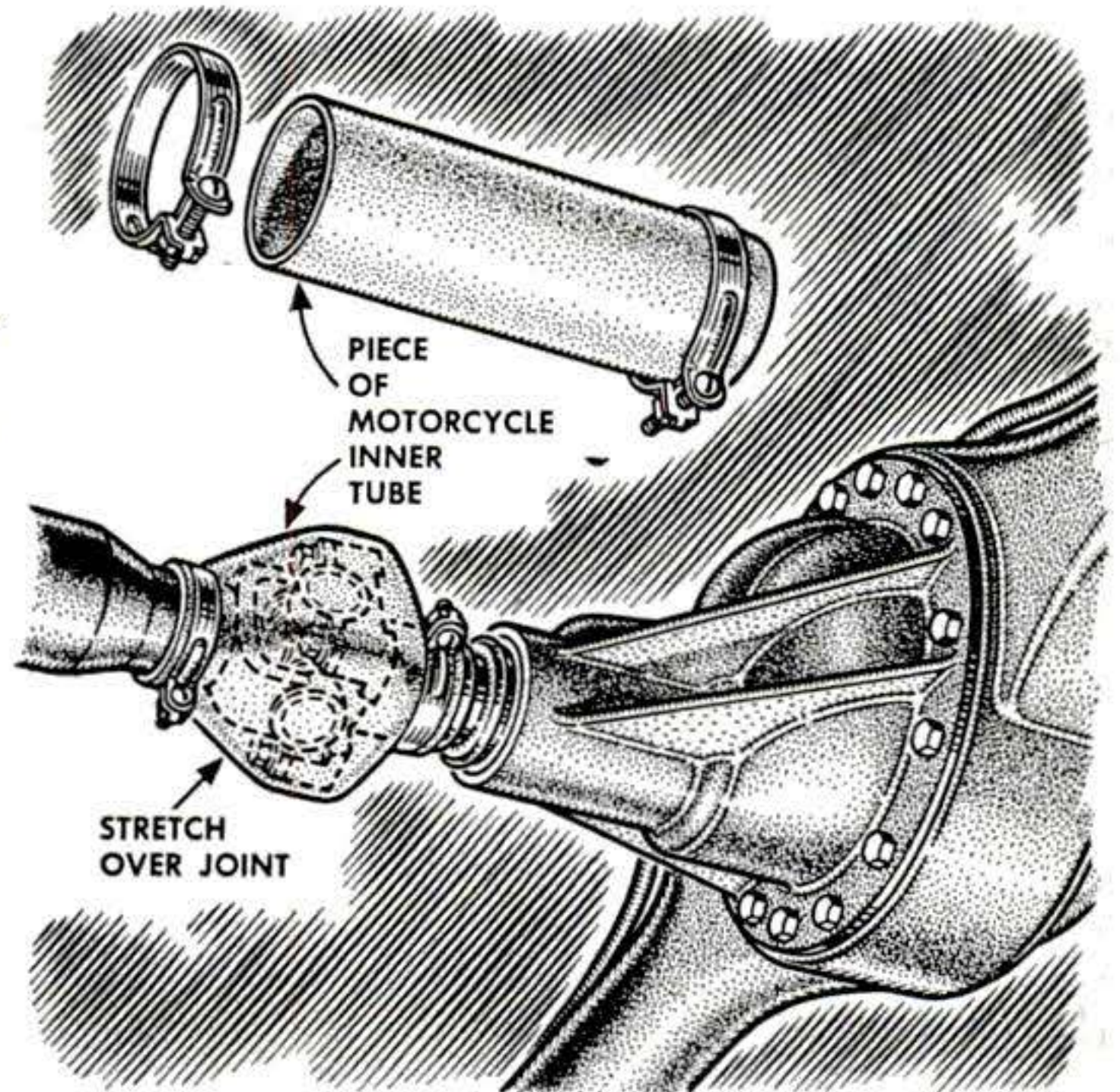

**Universal joints** will stay free of dirt and mud with these protective covers. Cut pieces about 10" long from a small-size inner tube and have your garageman slip them on the next time you have the bearings packed. Close the tube ends with hose clamps.

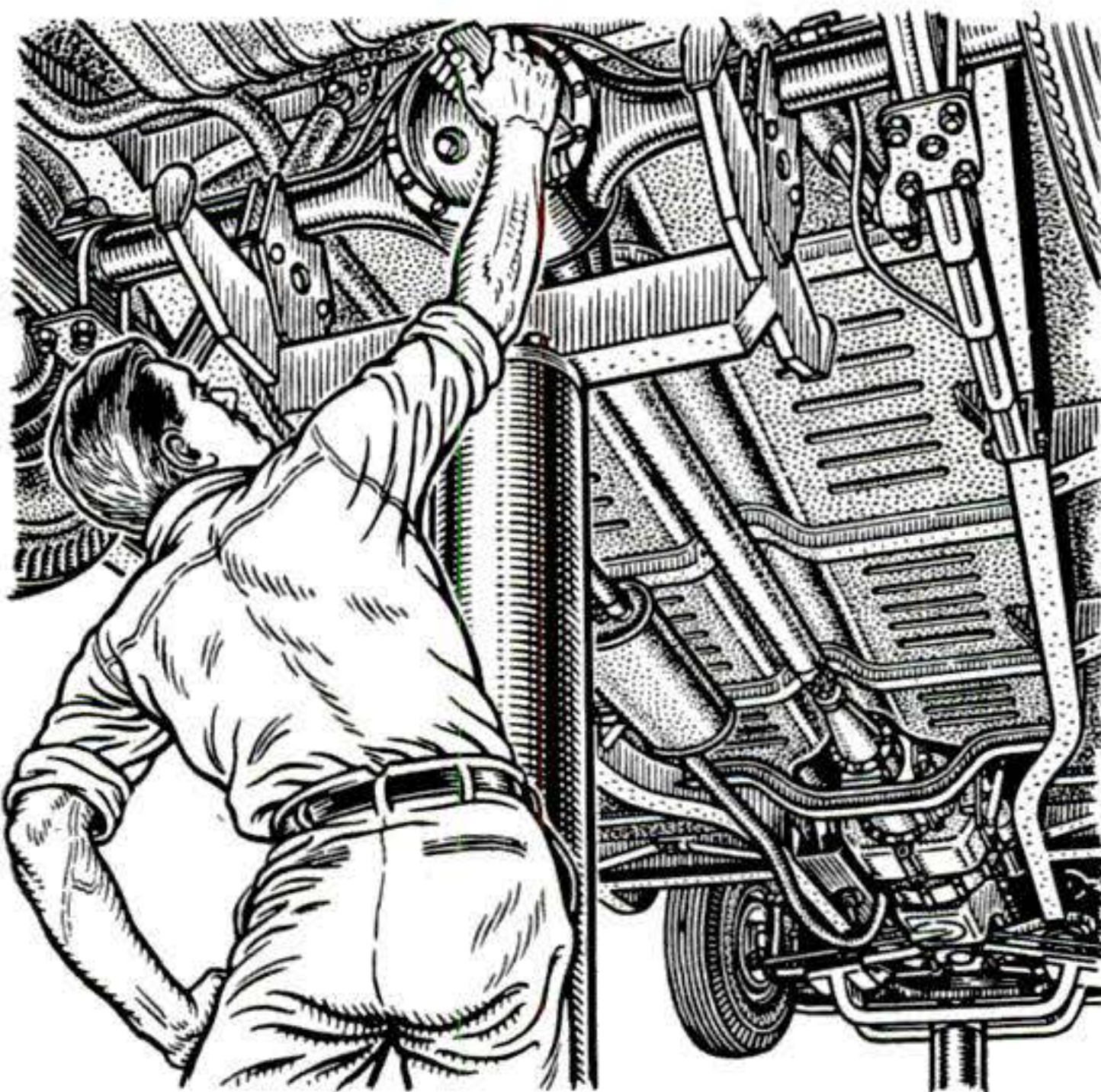

**Running gear will run cooler** if steam-cleaned or brushed with solvent once a year. A coating of grease and dirt on the rear axle, transmission and oil pan keeps the heat in, thinning out the lubricants and reducing their efficiency considerably.

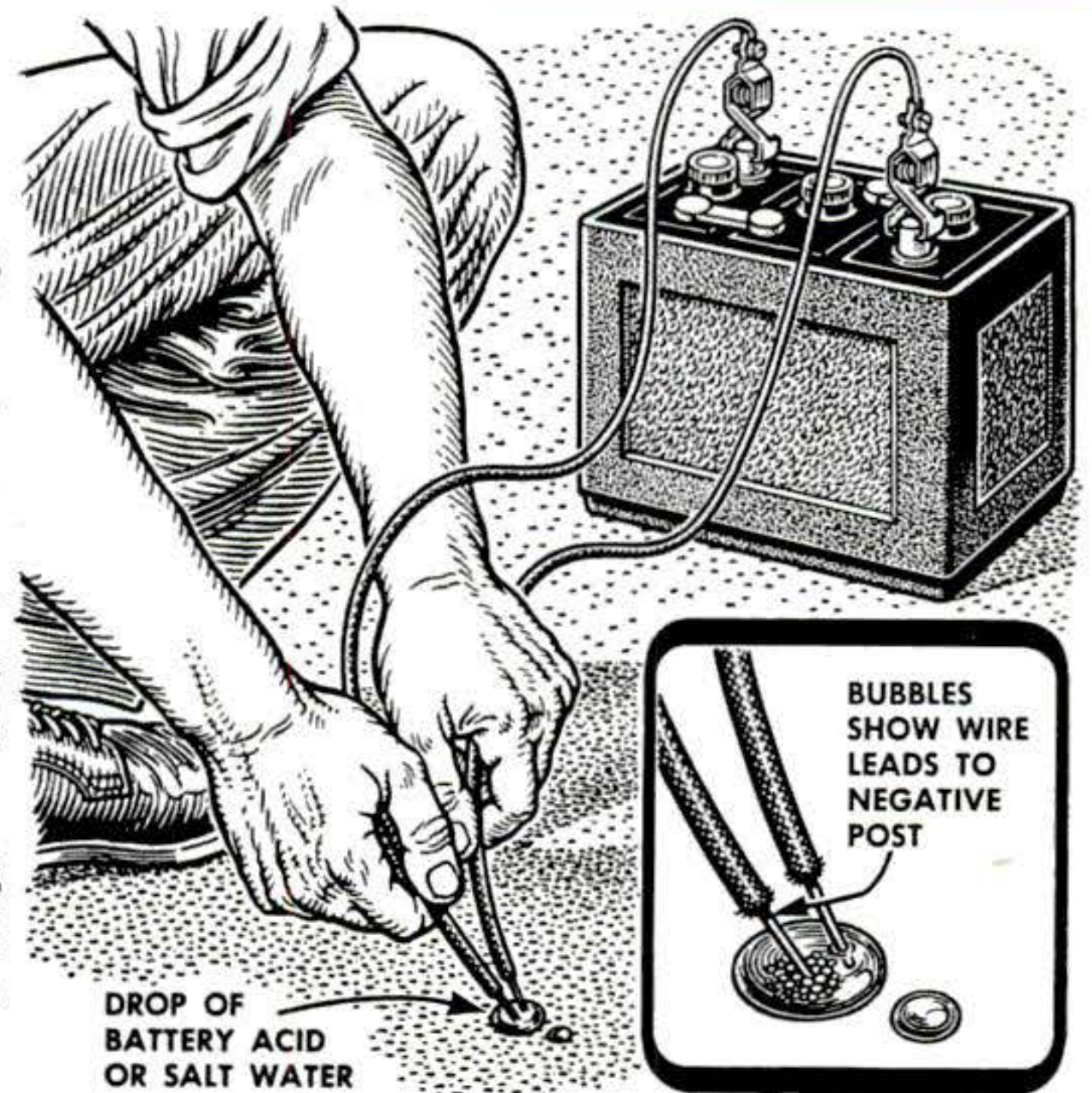

**If the terminal marks** on a battery are worn, attach two wires to it and hold their ends in a drop of battery acid, salt water or saliva. Move the wires close together and bubbles will form around the one that leads to the battery's negative terminal.

**Please turn the page for more auto hints**

NOVEMBER 1955 217



**MORE Hints from the Model Garage**

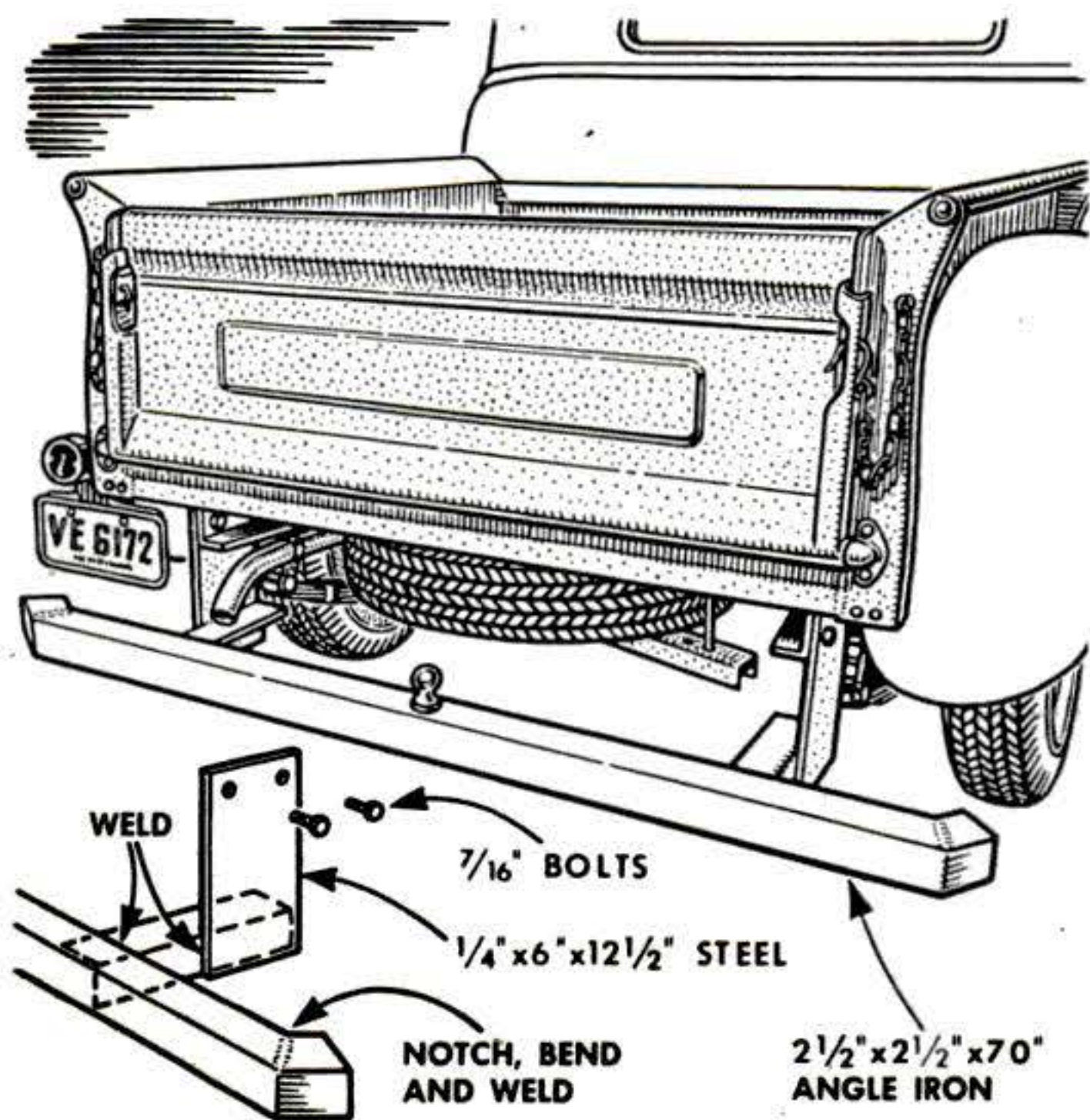

**This welded angle-iron bumper** doubles as a trailer hitch and rear step for a light pickup truck. The assembly was welded to  $\frac{1}{4}$ " steel plates bolted to the truck's frame. The ends were shaped by cutting a V notch, bending the angle, and then welding the joint. A ball hitch for a trailer was mounted in the center of the bumper.

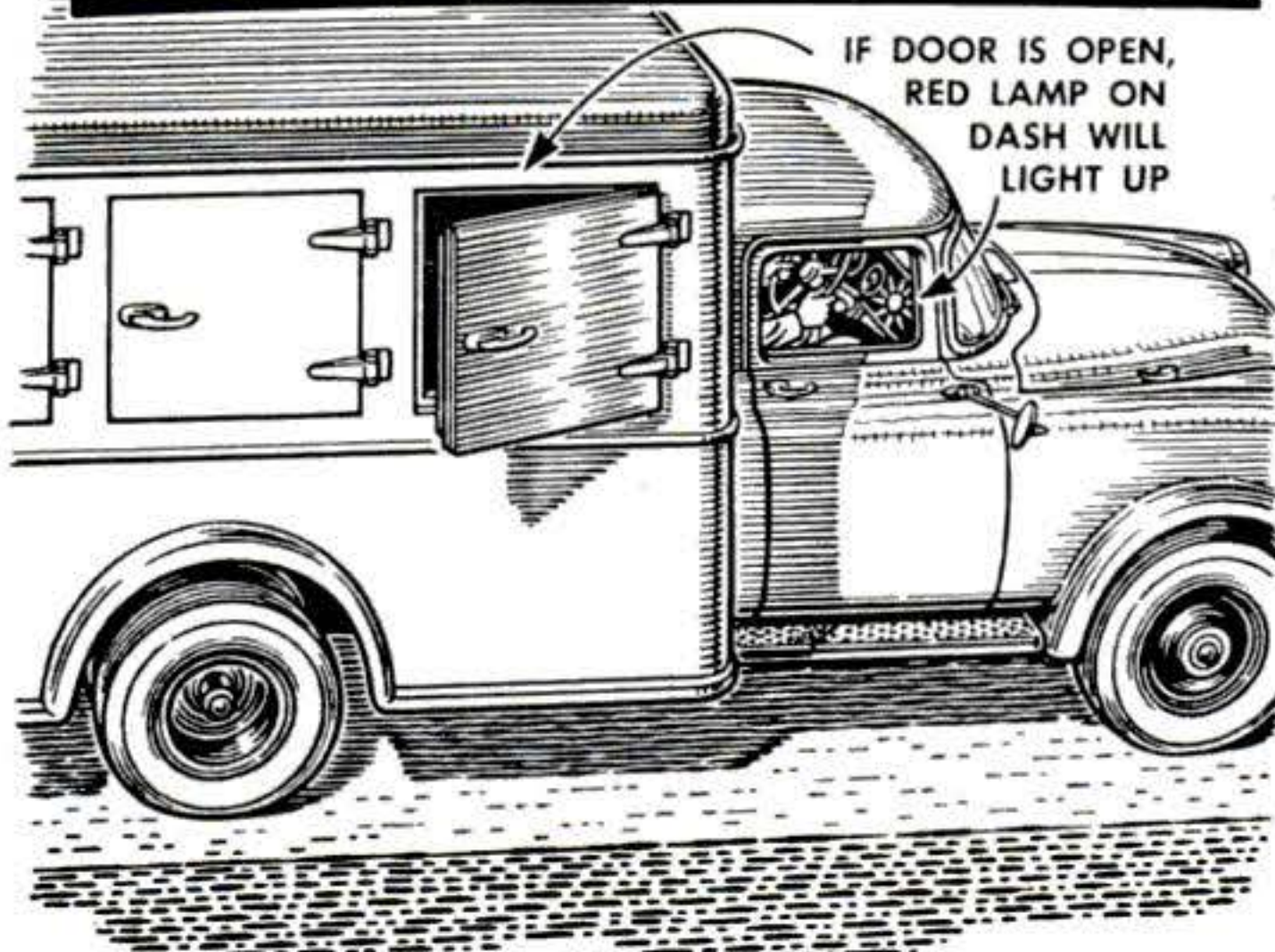
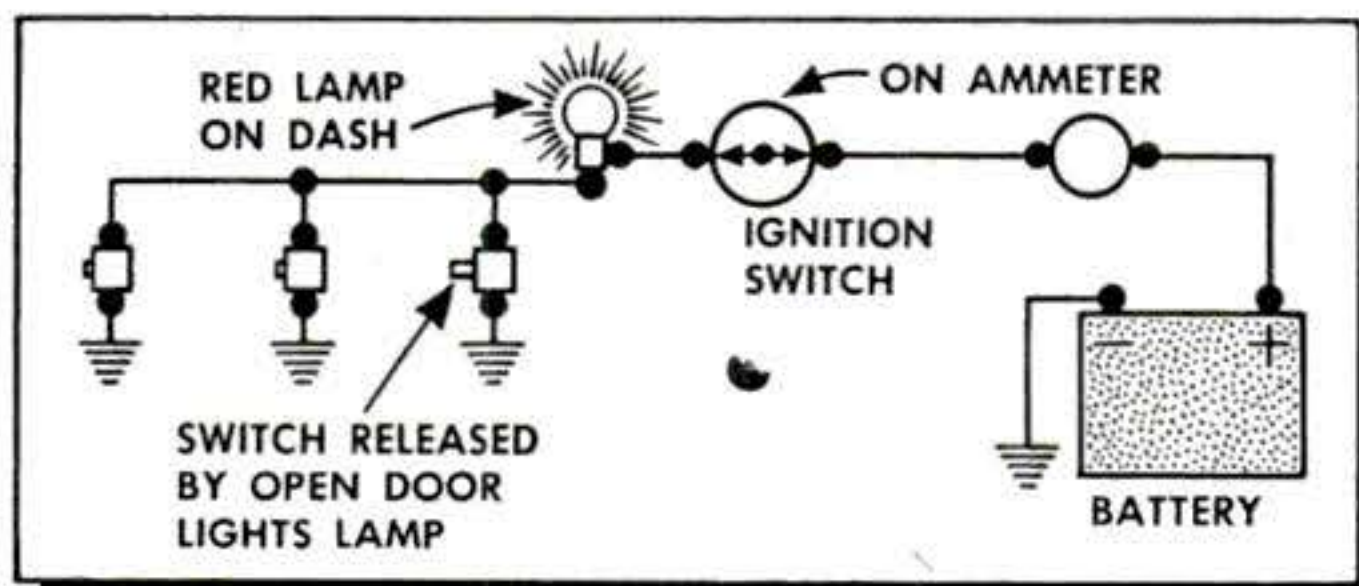

**Truck owners** may save a costly lawsuit by mounting an indicator light on the dash to tell when a van or freezer door is swinging open. Install a push-button switch (the type used on passenger-car doors) on each door and wire them through the ignition switch so that the light won't go on while the truck is being loaded.

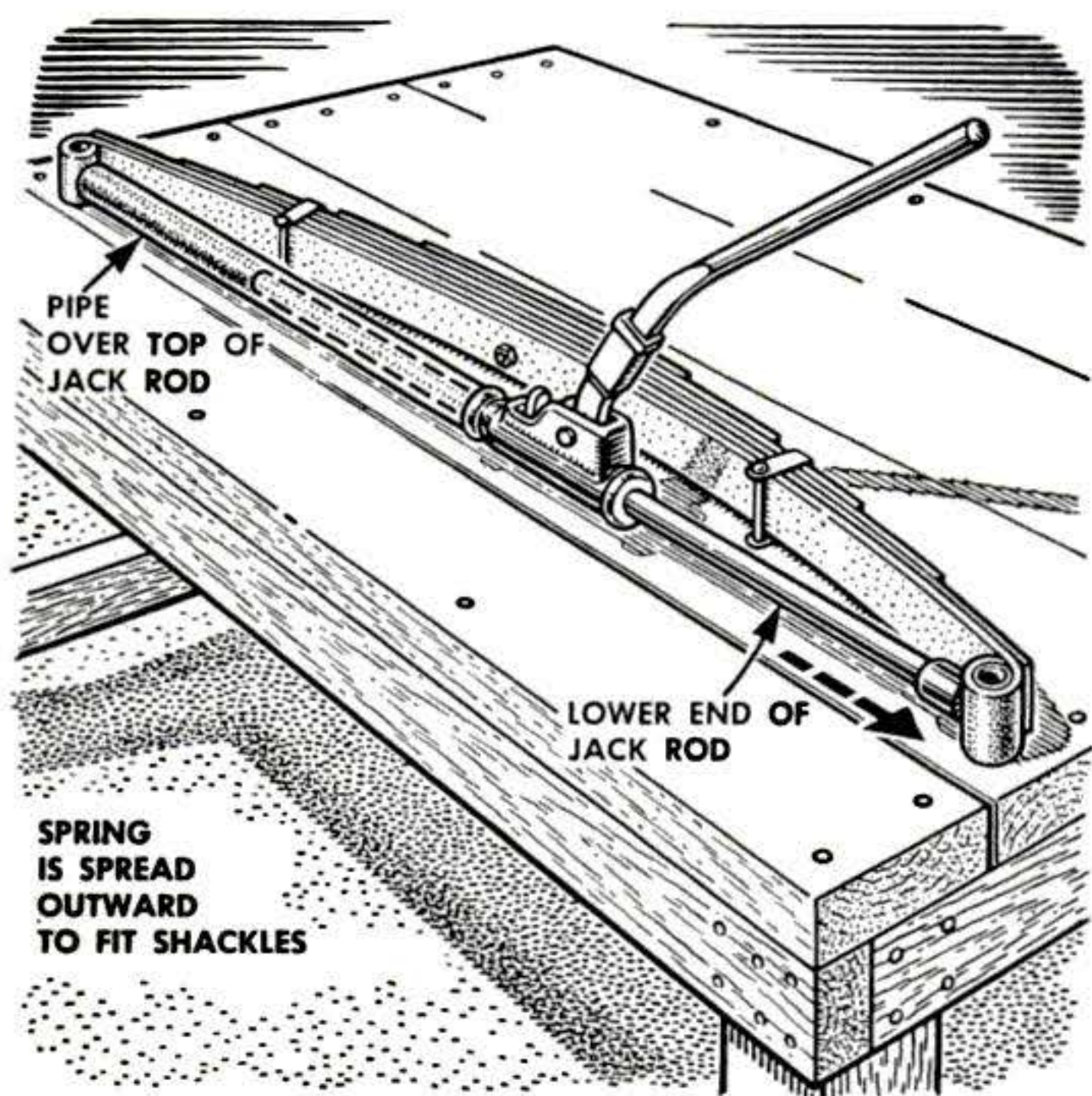

**Leaf springs** can be installed easily by spreading their ends outward with a bumper jack to line up the eyes with the shackle holes. Slip a length of pipe over the top half of the jack bar and work the ratchet against it.

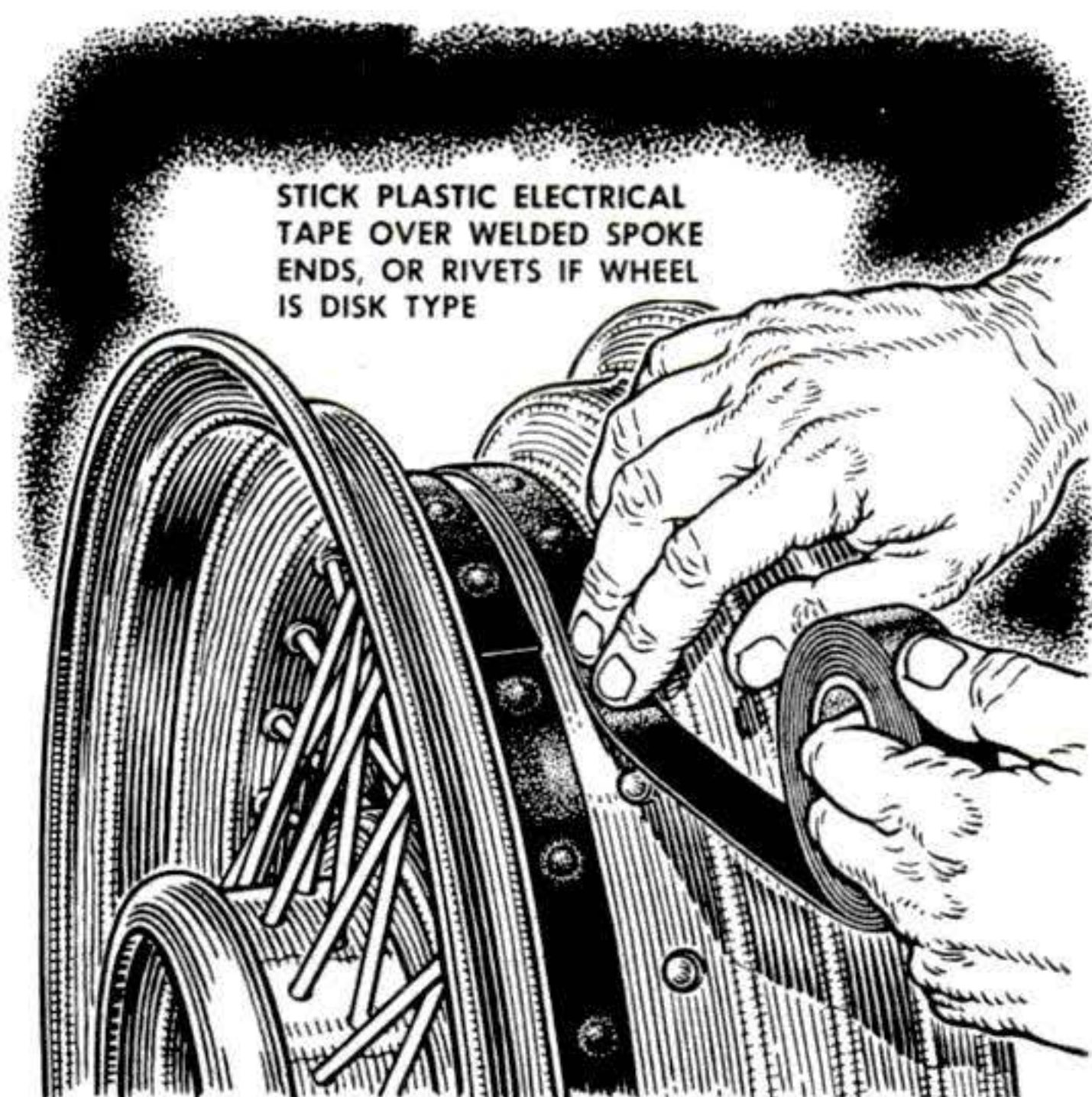

**When mounting tubeless tires** on standard rims, seal the heads of the rivets or spokes with plastic electrical tape to prevent possible air leaks. Clean the rim, and apply the tape evenly to avoid throwing the wheel out of balance.





# New for Your Car

**1. Disks Color Tires.** Sidewalls take on new color with rubber disks that glue onto the tires. Kolorwalls come in white, blue, green, yellow or pink for 15" or 16" tires. A kit includes four or five disks, cement, abrasive, applicator, roller and complete instructions for their use.

**2. Preheater Warms Engine.** An electric heating unit that fits into the cooling system keeps an engine ready for quick starts

regardless of outside temperature. It shuts itself off when engine operating temperature is reached. Hooking up is simple: hoses from the unit's outlet and intake connect to the car heater line and radiator drain. Uni-Flex, 3" in diameter by 8½" high, can be installed in any position, uses AC or DC.



**4. Arm Rest Doubles as Food Box.** Lift the lid of the portable Thermo arm rest and there's an insulated compartment to keep food hot or cold. It's covered with imitation alligator hide, weighs three pounds.



**3. Oil Cups Shield Battery Posts.** These enclosed terminals slip over conventional battery posts, hold heavy oil which prevents corrosion or sulfate from forming. The terminals require eye-lug cable connections.

**5. Gauge Measures Car's Efficiency.**

Working on the inertia theory, liquid level in the tube rocks back and forth in response to your car's running performance. Continuous readings indicate such things as road horsepower, acceleration and hill-climbing ability. Gauge attaches inside windshield.

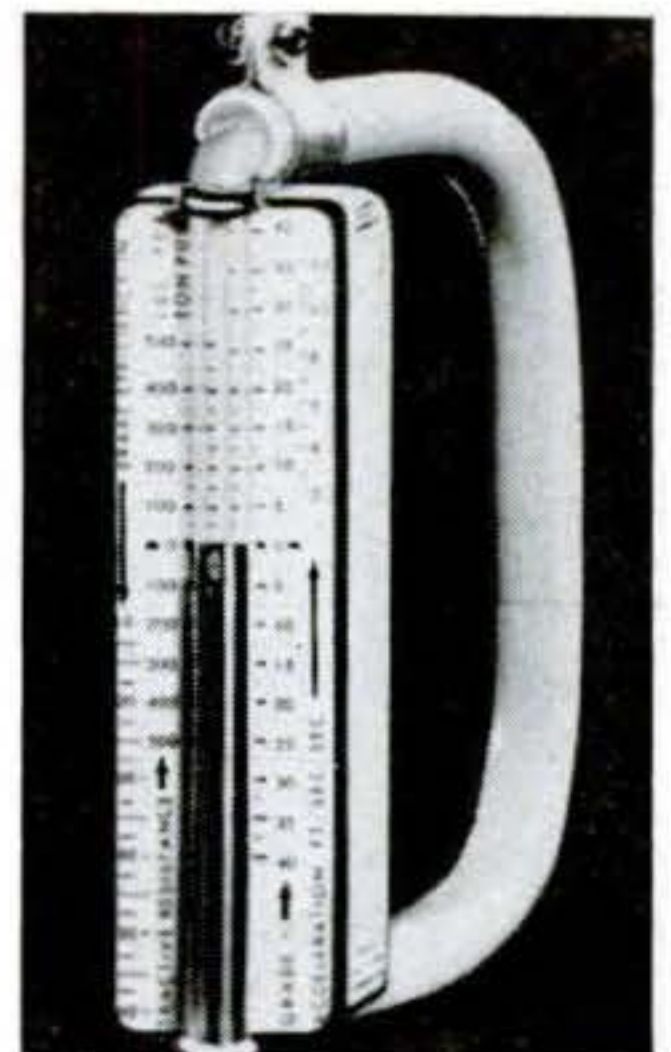

Further information on these new car products can be obtained from: 1. Nu-Way Kolorwall, Inc., 1797 W. Adams Blvd., Los Angeles 18; 2. Tech Products, Inc., 615 Pennsylvania Ave., Elizabeth, N.J.; 3. Jano Sales Co., 2946 Los Feliz Blvd., Los Angeles 39; 4. Wallace Brands Co., 20 Broadway, Toledo 4, Ohio; 5. Almquist Engineering & Mfg., 315 Broad, Milford, Pa.



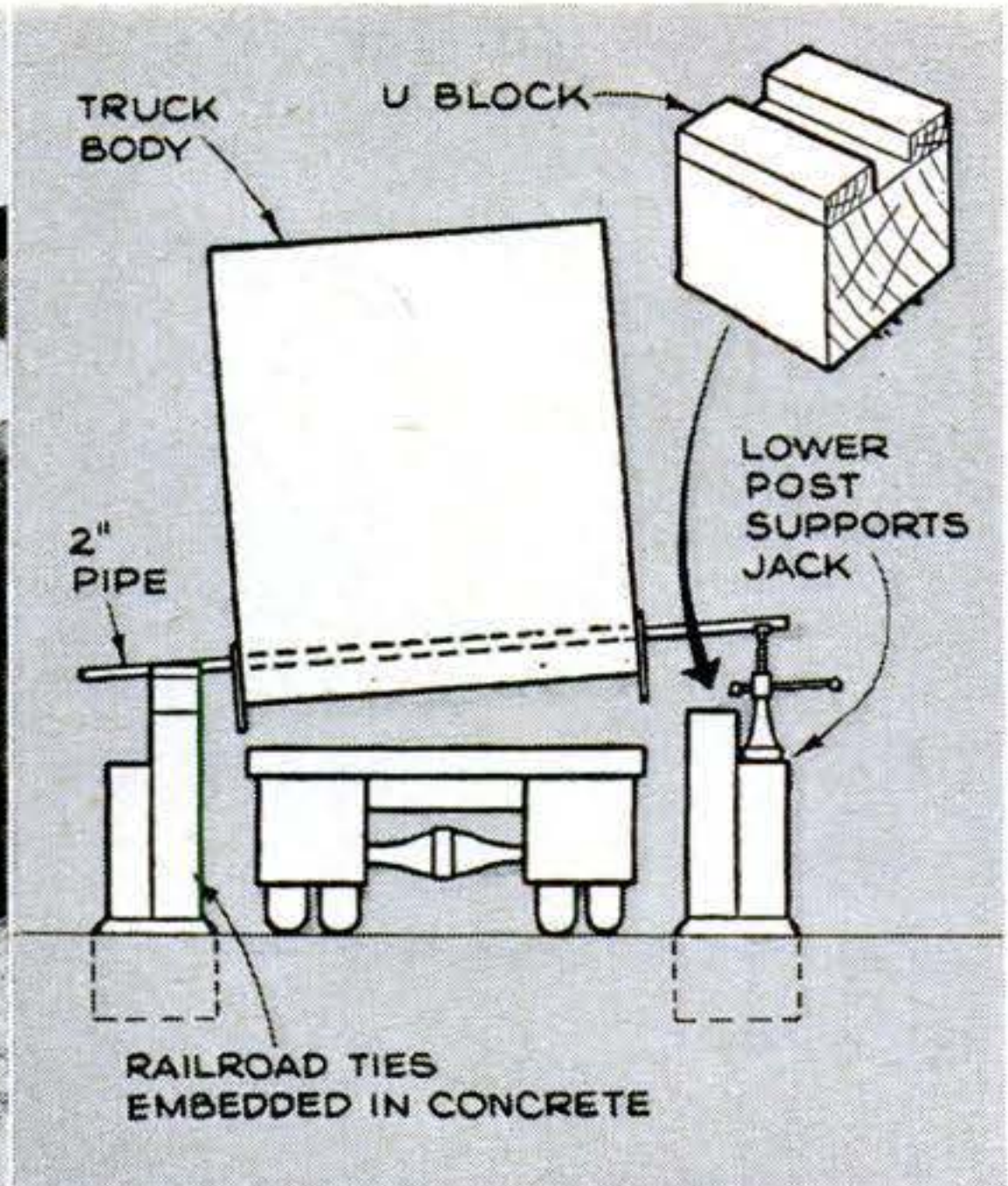
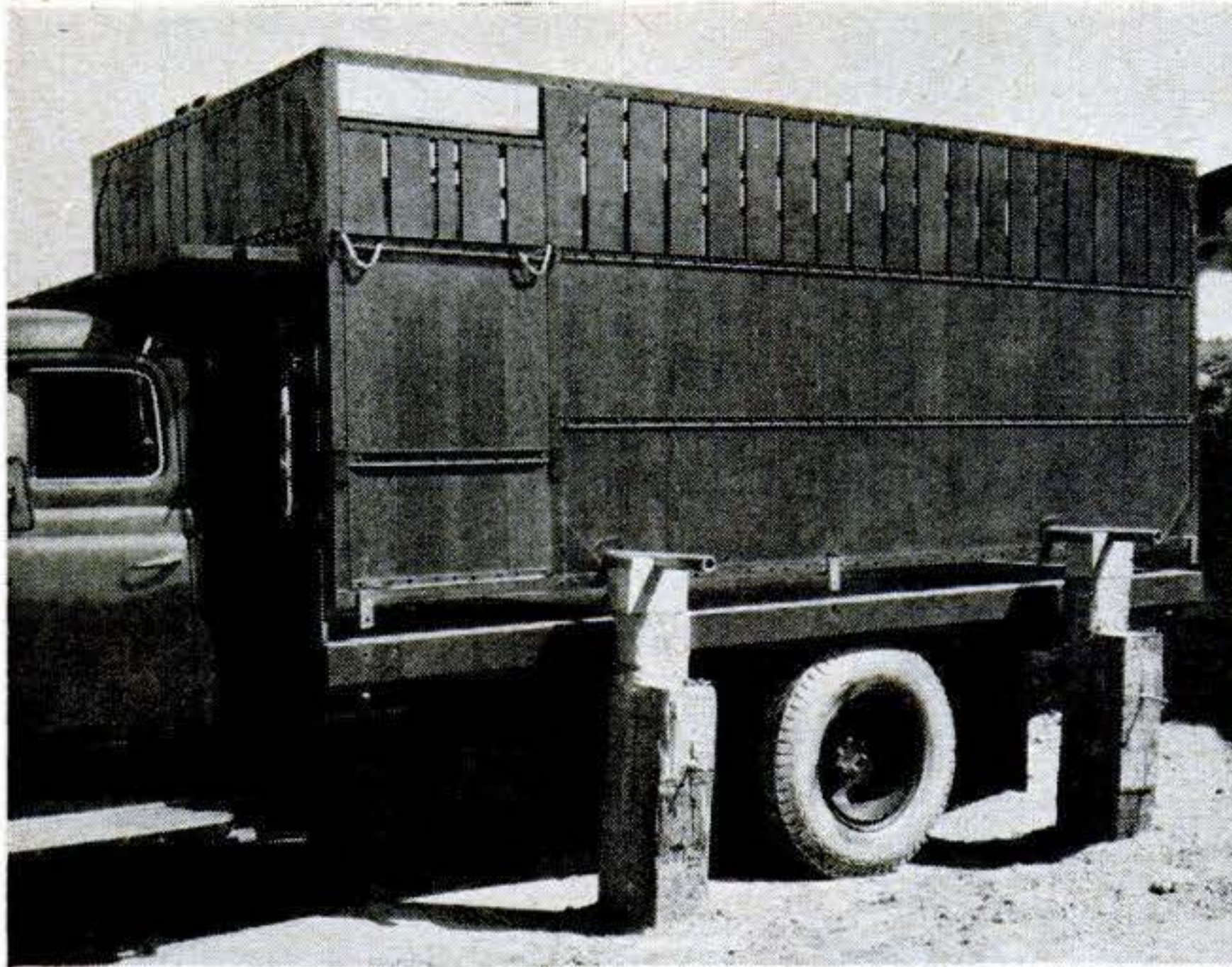

## One Man with a Jack Lifts the Heavy Body Off His Truck

JAMES PRATT of Nuevo, Calif., needs no help when he removes the heavy body from his truck. First, he backs up between four sturdy uprights made of old railroad ties embedded in concrete.

After removing six bolts that attach the body to the frame, Pratt slips two lengths of 2" pipe through metal-collared holes in the body aligned with the uprights. Placing a jack on the stepped-down outer section of

one of the uprights, he jacks the pipe end up until he can insert a U-shaped block between the pipe and the higher inner section of the upright.

Pratt repeats the operation until the truck body is supported entirely by the posts. Then he climbs in his truck, pulls into the clear, and the monster truck body remains behind, resting securely on the heavy railroad ties.—*Hi Sibley, Nuevo, Calif.*

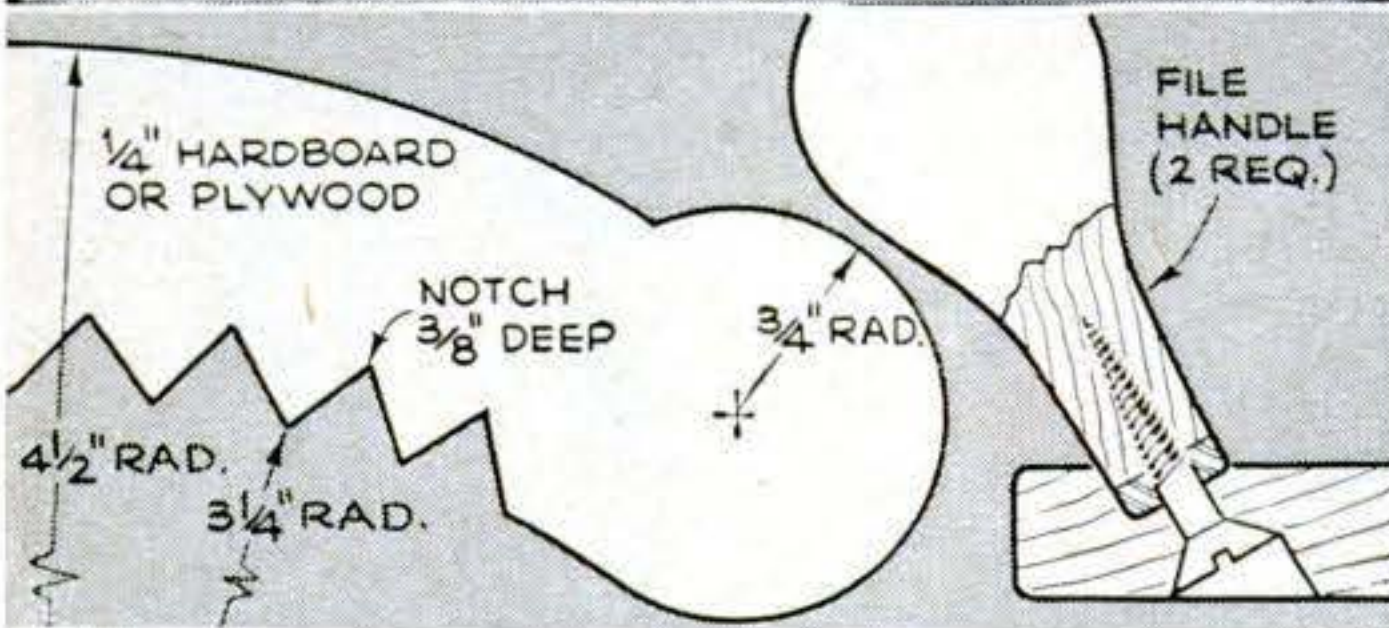
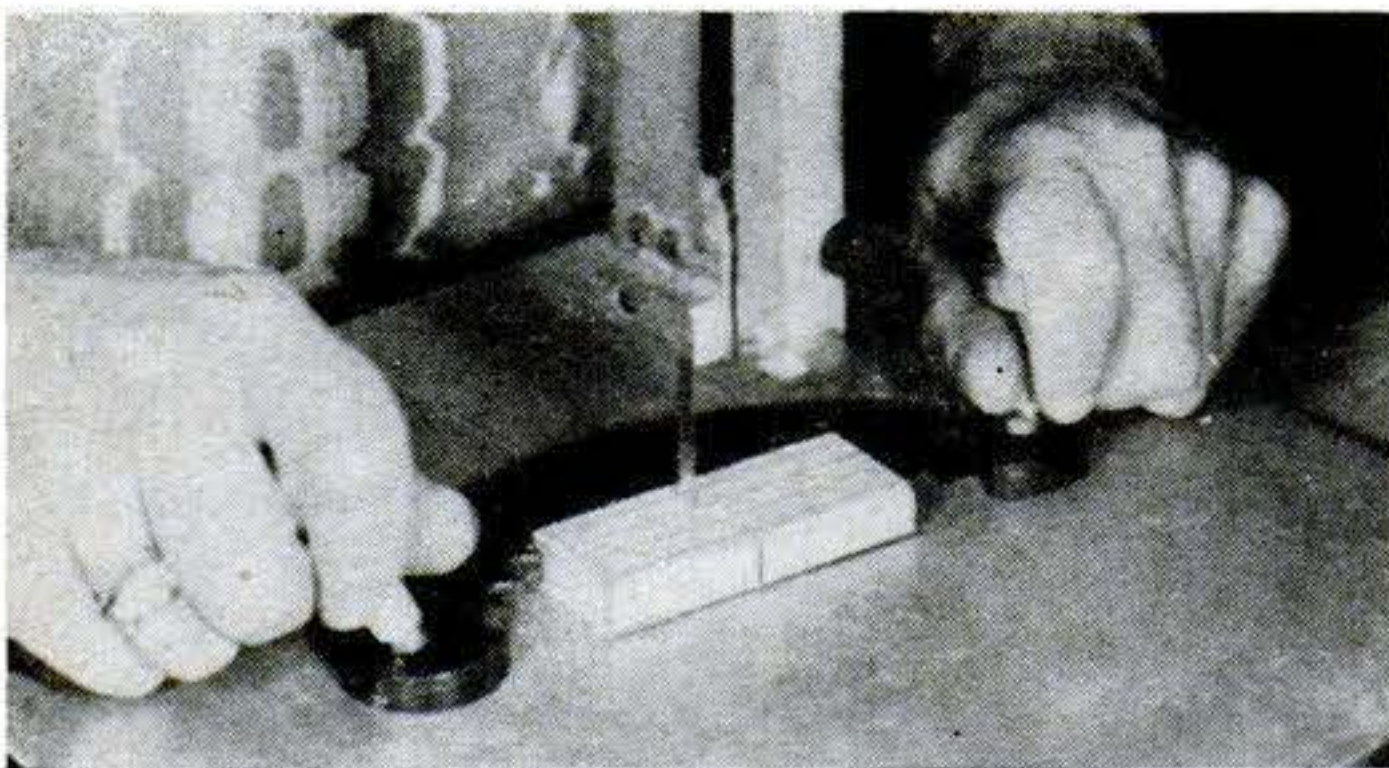

## Saw Pusher Protects Fingers

SMALL work of almost any shape can be safely guided into the blade of a bandsaw with this two-handled pusher. Notches in the curved inside edge grip the workpiece at its corners, permitting more accurate cutting of intricate pieces as well as straight cuts.—*Phil McCafferty, Stanwood, Iowa.*

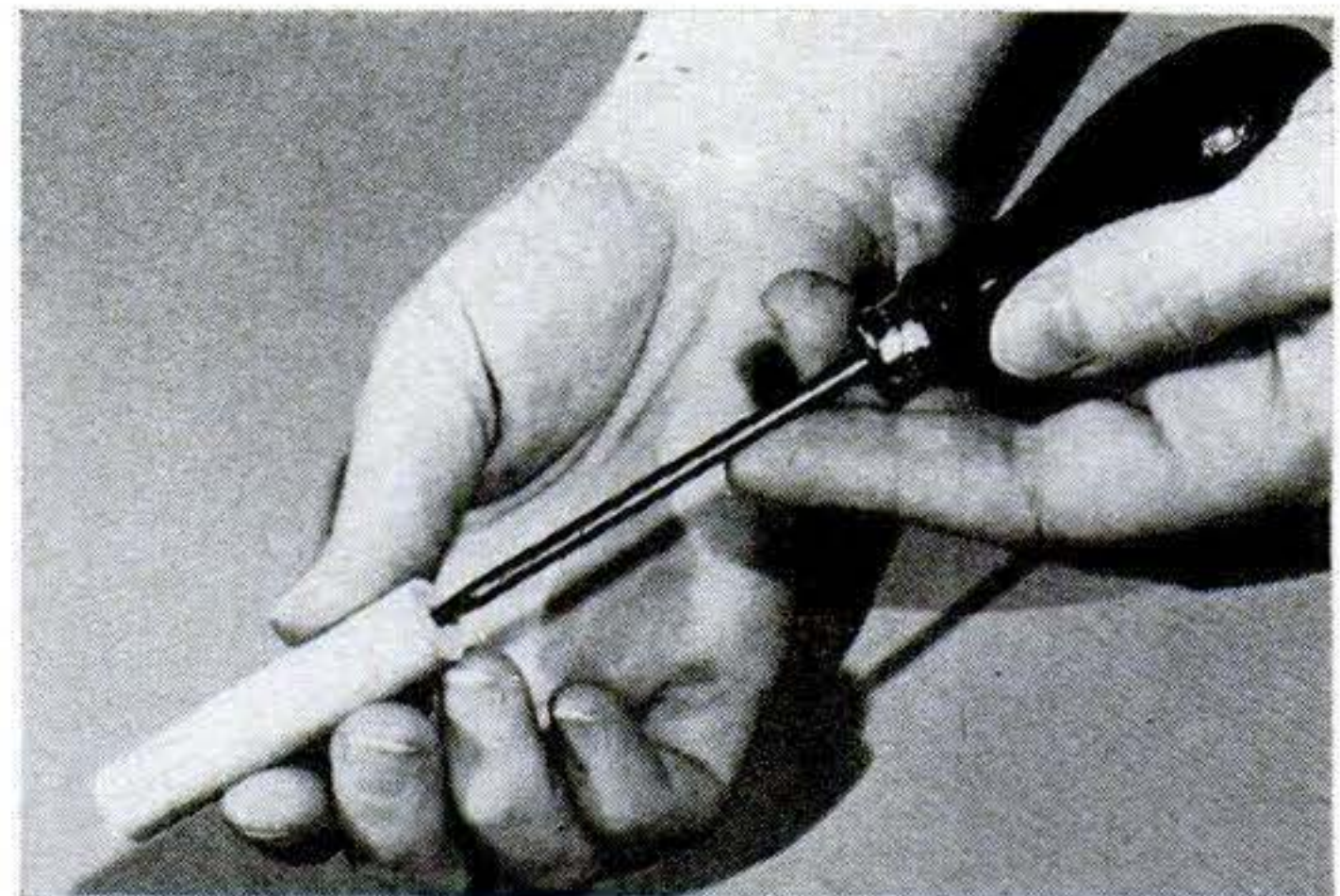

## Drilled Dowel Sheathes Awl

SHEATHE your awl or scribe when you put it away to protect yourself and the tool. The sheath? A bit of dowel drilled part way to provide a snug fit for the tool shaft.—*Frank Javor, North Bergen, N. J.*

## Pipe Straps Open Drawers

SPARE conduit straps neatly solve the problem of putting handles on workshop drawers if you have no conventional drawer pulls at hand. The straps are just the right shape and are easily screwed onto the drawers.



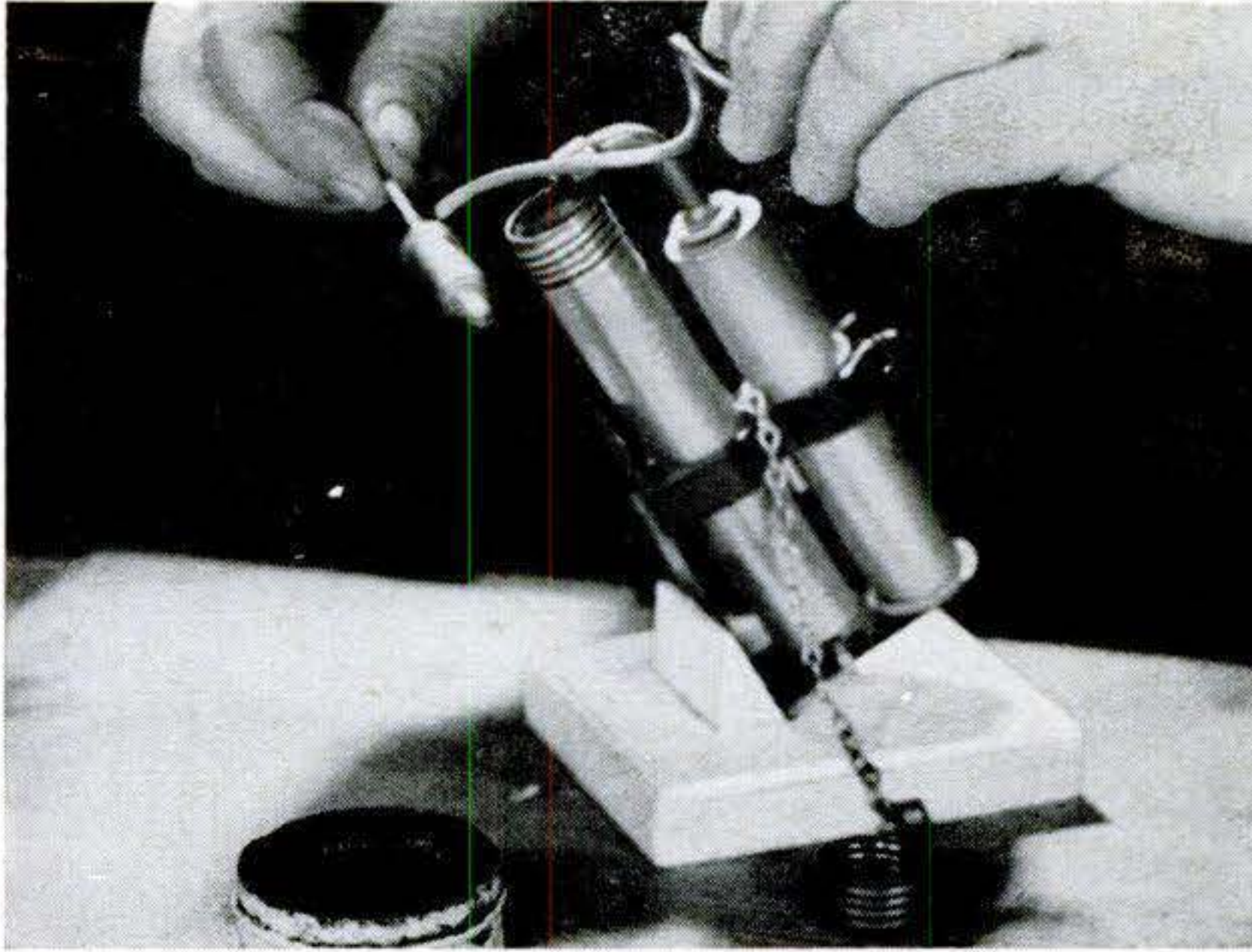

**Self-Standing Torch.** This mount for an alcohol torch keeps it from tipping over, while leaving both hands free. At a touch it tilts forward, where the torch delivers its hottest flame. The base and angle block are made of wood, the upright and clip from any thin sheet metal. A wide staple bent from coat-hanger wire is driven into the base over the leg of the upright as a hinge pin. The pin holds the mount to the base, yet permits tipping it and the torch forward.—*J. M. Finn, Pittstown, N. J.*

# NEW Shop Ideas

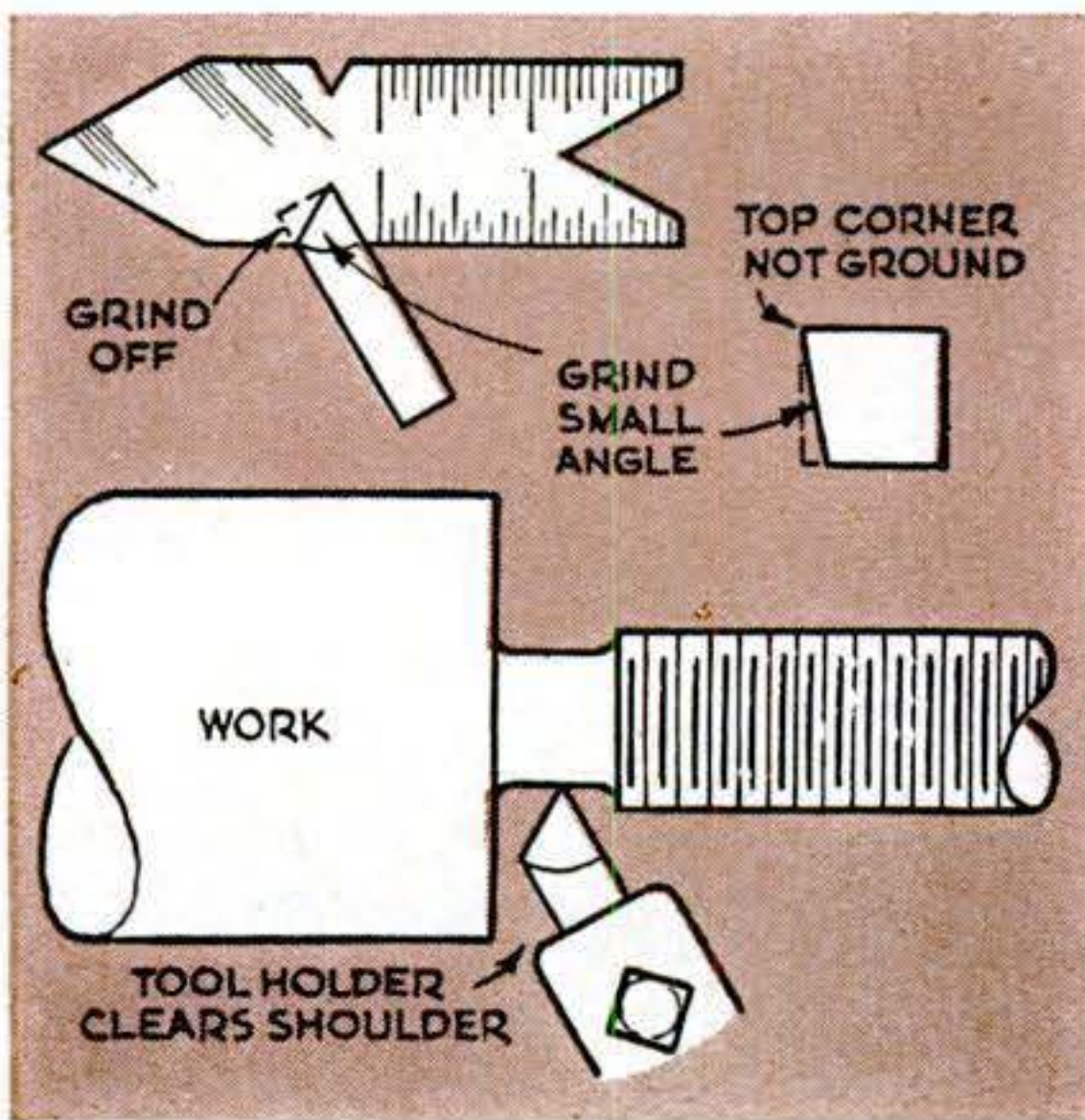
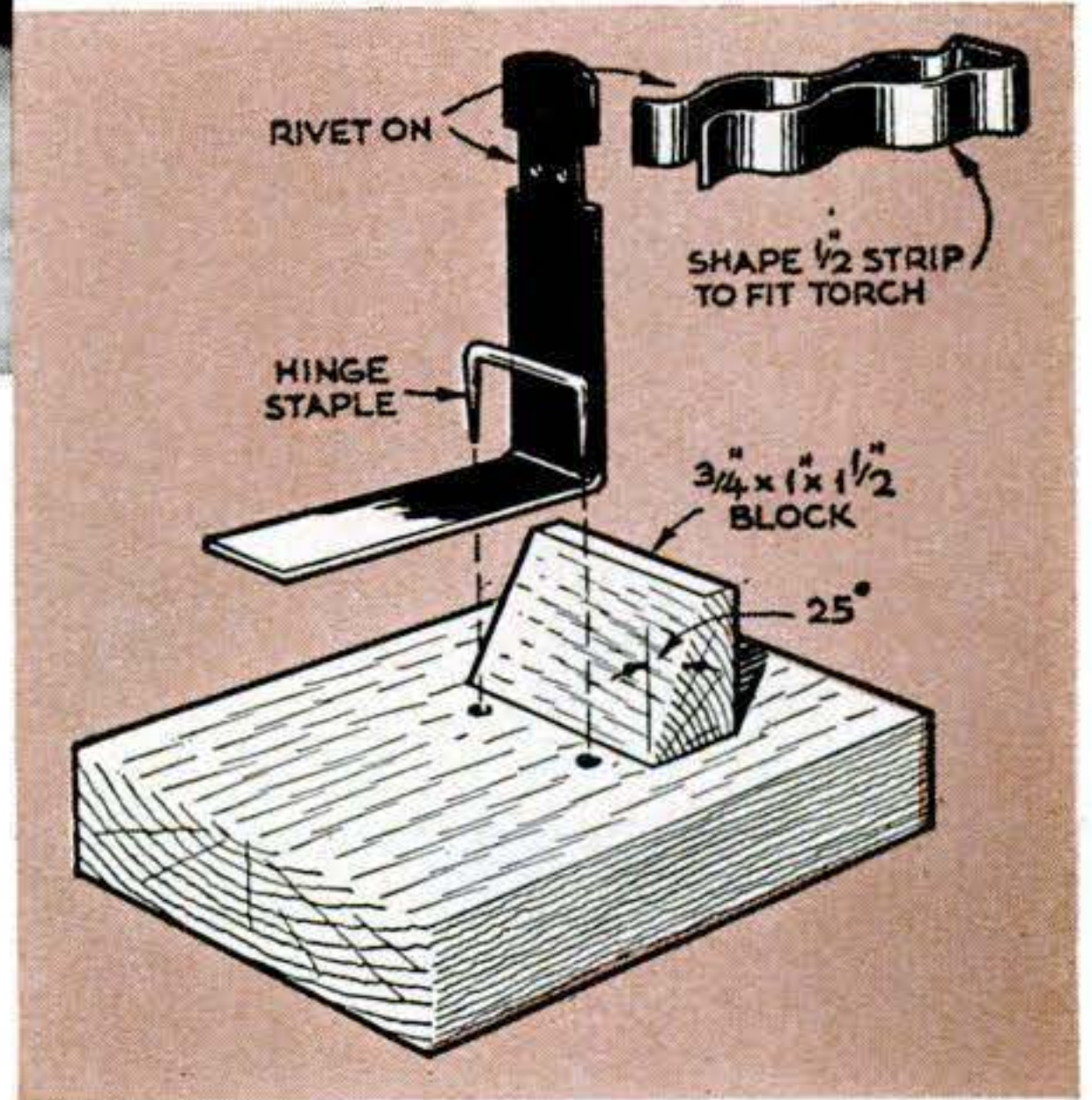

**Threading to a Shoulder.** The common V-thread tool runs into trouble when it must work close to a large shoulder. I grind mine as shown to get farther in without interference. It is even easier to shape than the usual V tool, for most of the grinding is done at the left-hand corner.

The right-hand edge is left untouched except for a small relief angle that is ground on the side below the cutting edge of the tool bit.—*H. J. Gerber, Stillwater, Okla.*

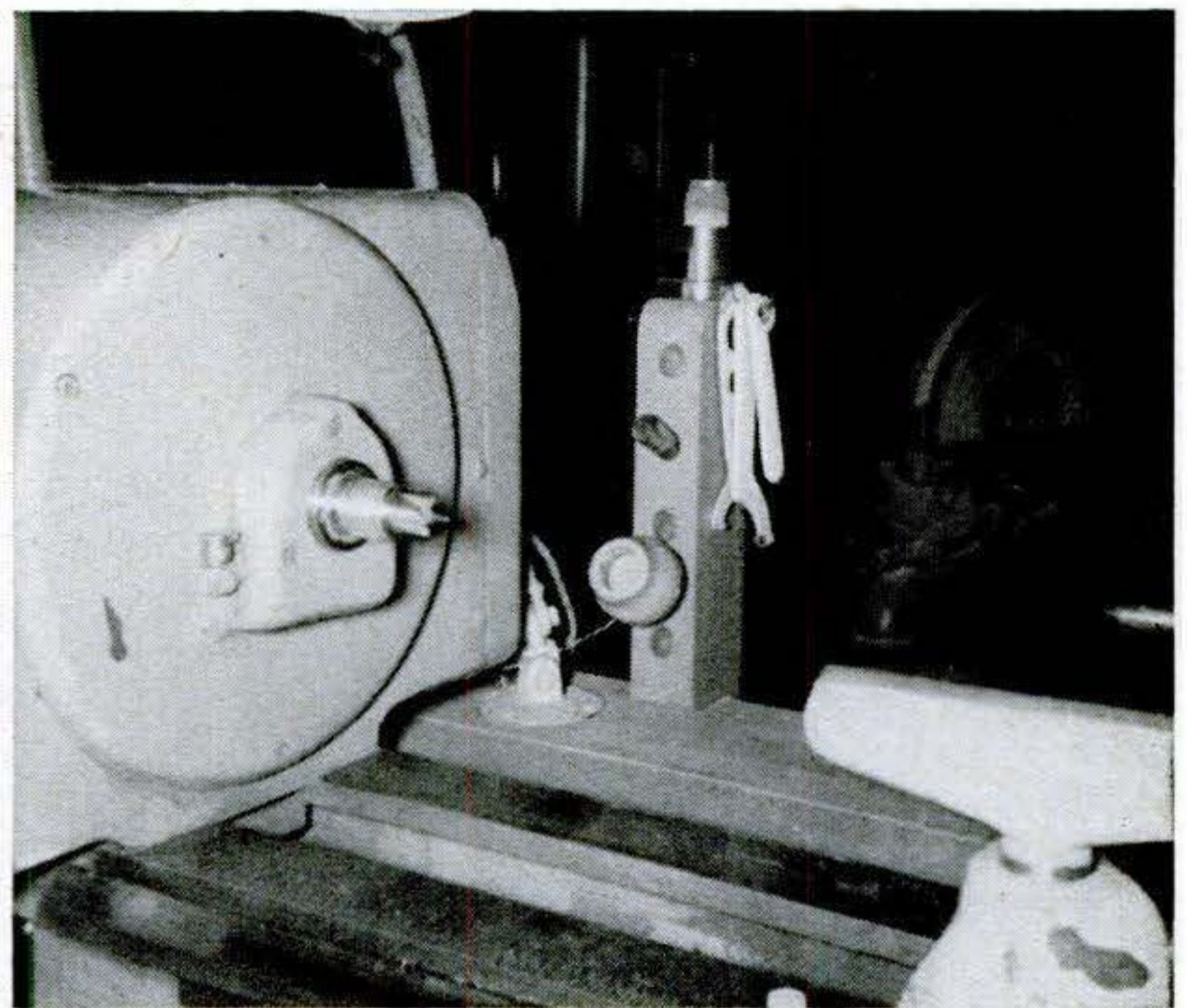

**Post Holds Lathe Tools.** Instead of leaving lathe centers, wrenches and other accessories under the lathe ways, where they always got buried under piles of chips, I now mount them on a wooden post behind the machine. Five 3/4" holes are bored into the wide face of a two-by-three at an angle as sockets for centers and the like.

Wrenches are hung on nails and cup hooks driven into the edge of the post, which is bolted to the lathe bench.—*Adam H. Sabatose, Brockway, Pa.*



## MORE SHOP TIPS

**Protect Shaft Ends.** Tightening up a screw-type wheel puller may burr over the end of a shaft, making removal of the wheel or pulley difficult. Placing a nut between the puller screw and the shaft is a simple way to prevent any possible damage occurring to the shaft.—George E. Leith, Longview, Tex.

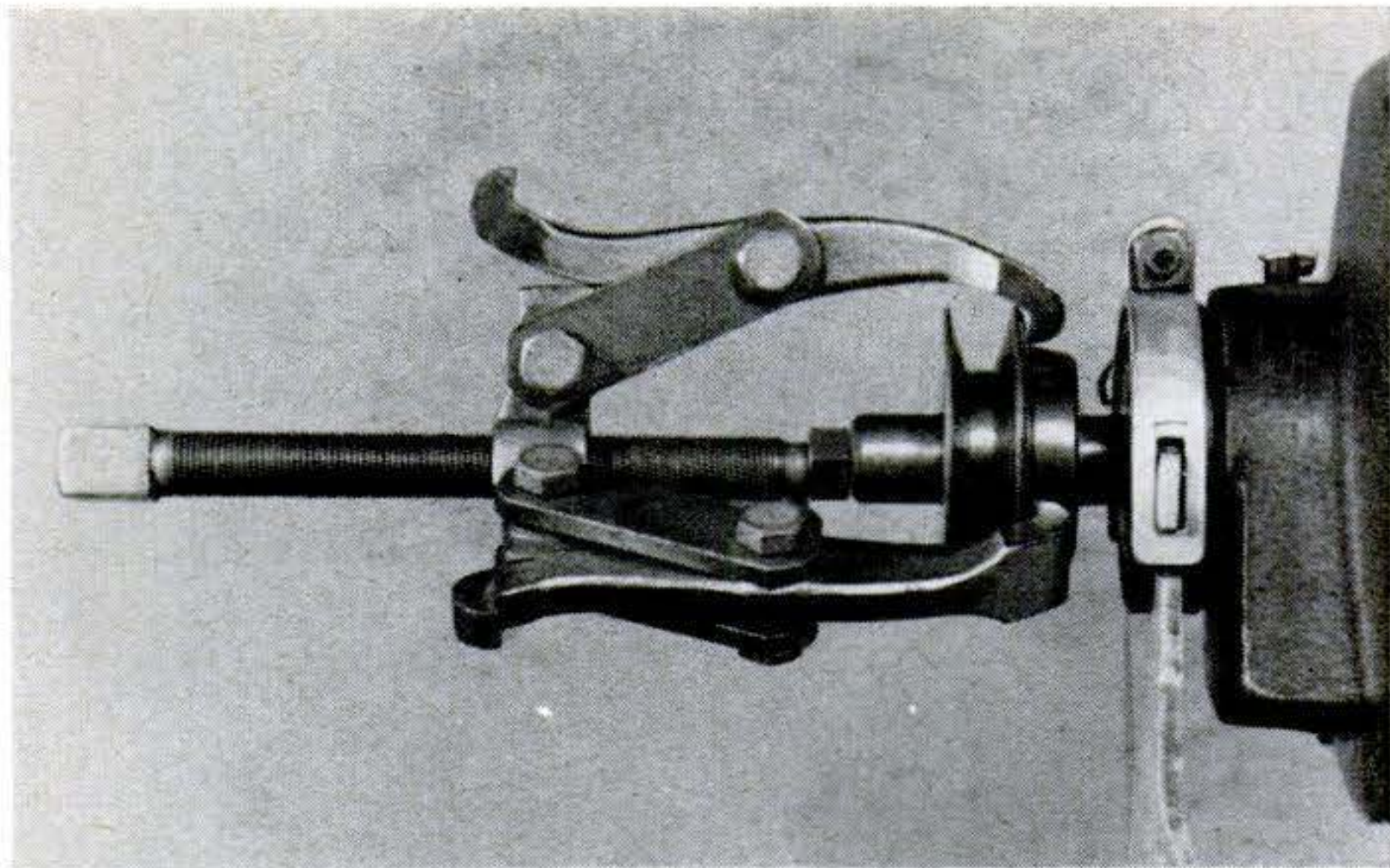

**Tape Clears File Teeth.** A quick way to clean a fine file is to stick a piece of surgical adhesive tape along it and rub it hard. When the tape is pulled off the file, clogging chips will come right along with it.—Lillian Koslover, Brooklyn, N. Y.

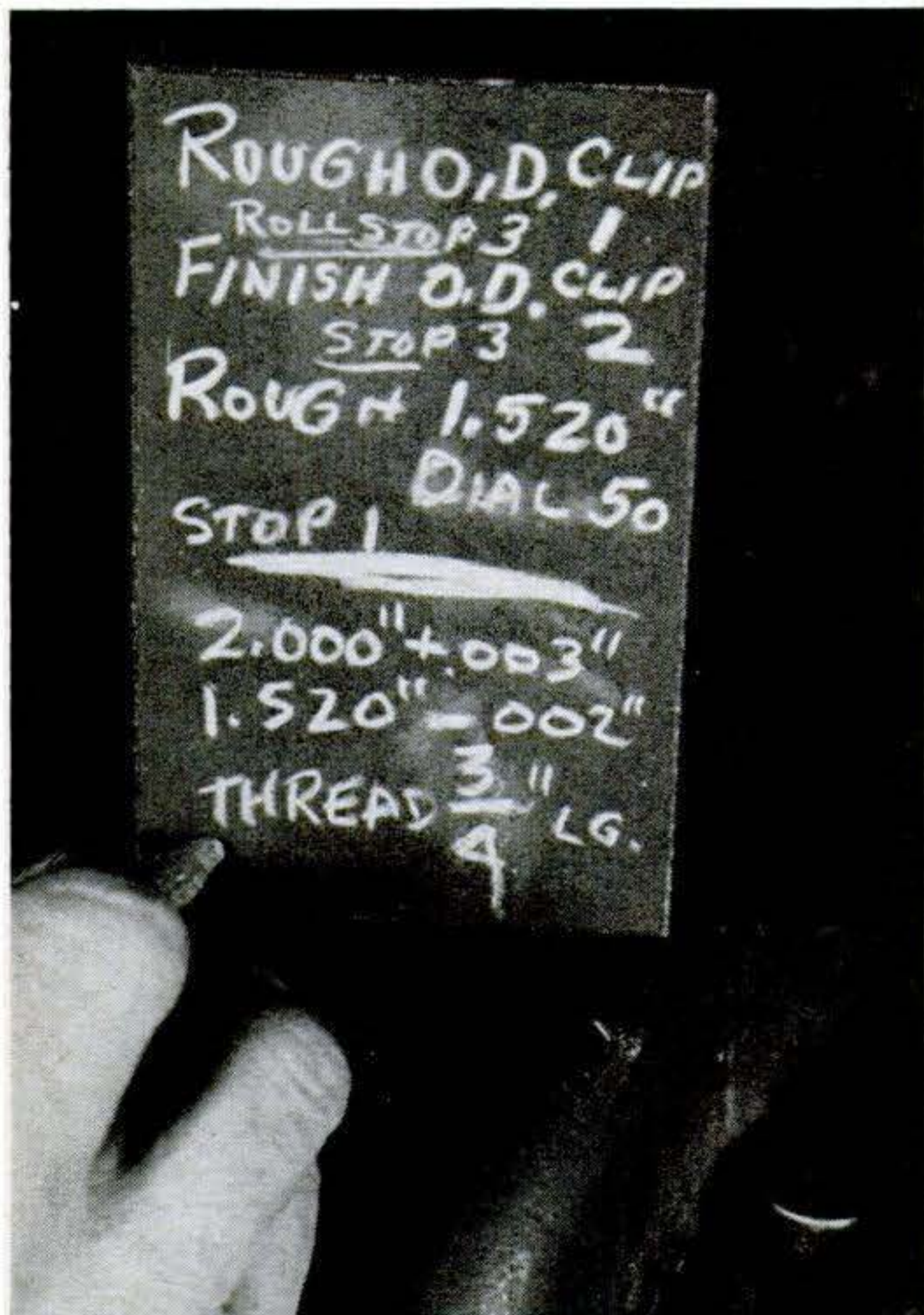

**Jot Down Work Memos.** There's no need to mumble to yourself to remember a dimension or tool setting. Mount a child's slate near the lathe or other tool and keep a bit of chalk handy. Use the slate to write down reminders on such details as successive carriage stops, tool-depth feeds and diameters.—Phil McCafferty, Stanwood, Iowa.

**Heat Rejuvenates Springs.** Although overstretched springs can be pulled back to normal size, they will become distorted the first time they are again flexed. To prevent this, heat them in a kitchen oven at 450° for 20 minutes after reshaping and allow to cool in air. This modest temperature relieves stresses in the steel, restoring the springs' normal elasticity.

To lengthen a coil spring, stretch it as desired and heat-treat it this same way. To shorten compression springs, tie them to the size wanted and heat. Homemade springs wound from spring-steel wire will be improved by the same treatment. If an oven is not available, polish the steel bright and heat the spring in an open torch flame until the steel just turns purple-blue.

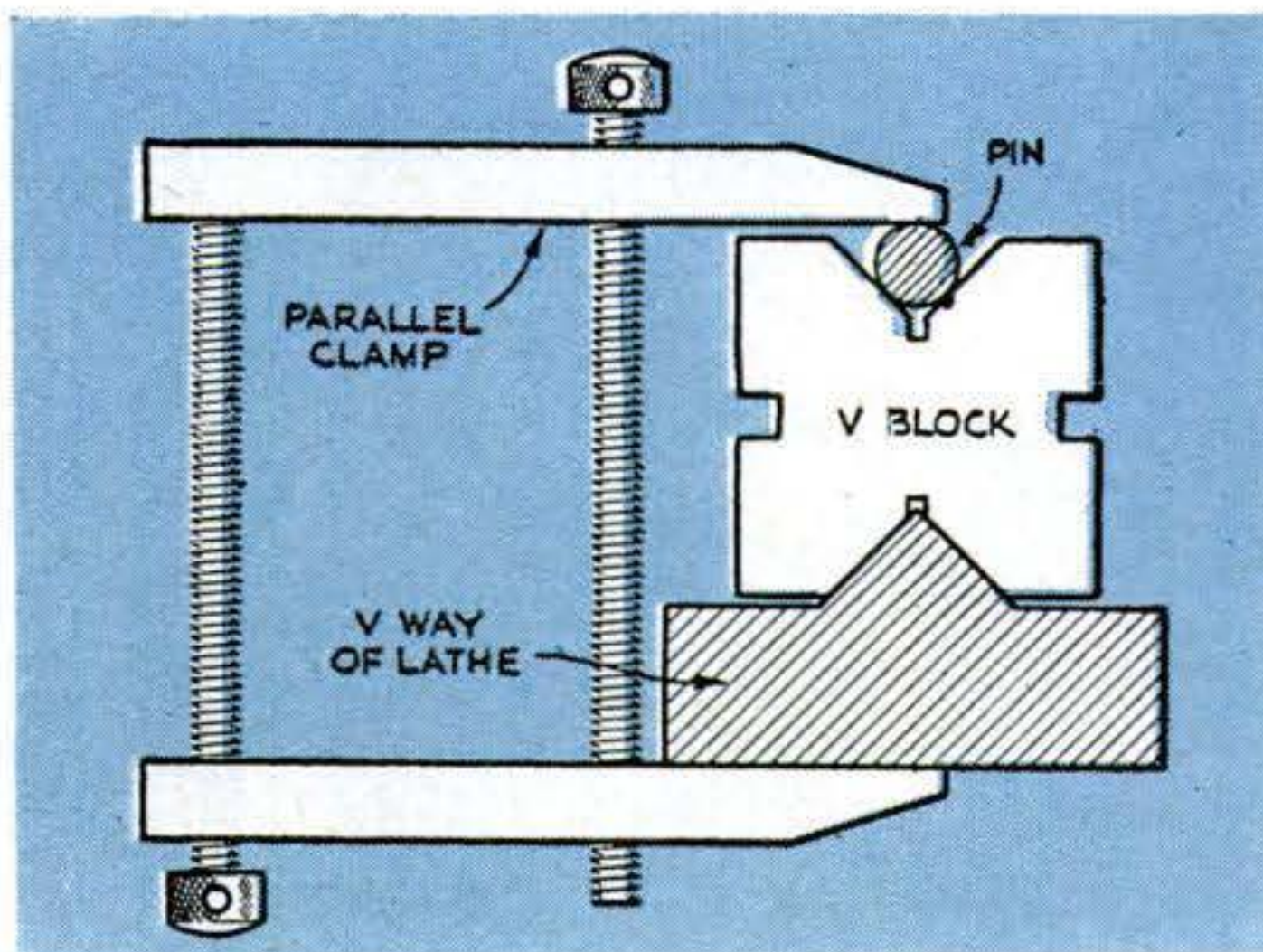

**Emergency Carriage Stop.** For a lathe with V ways, a carriage stop can be made from a V block. Place it on the front way, lay a pin or rod in the upper groove, and lock with a parallel clamp. Even if you have a carriage stop, this dodge is useful when two of them are needed on certain projects.—Frank LaSaracina, New York City.



# 7 UNUSUAL USES FOR Corks



BASE FOR HOT POTS

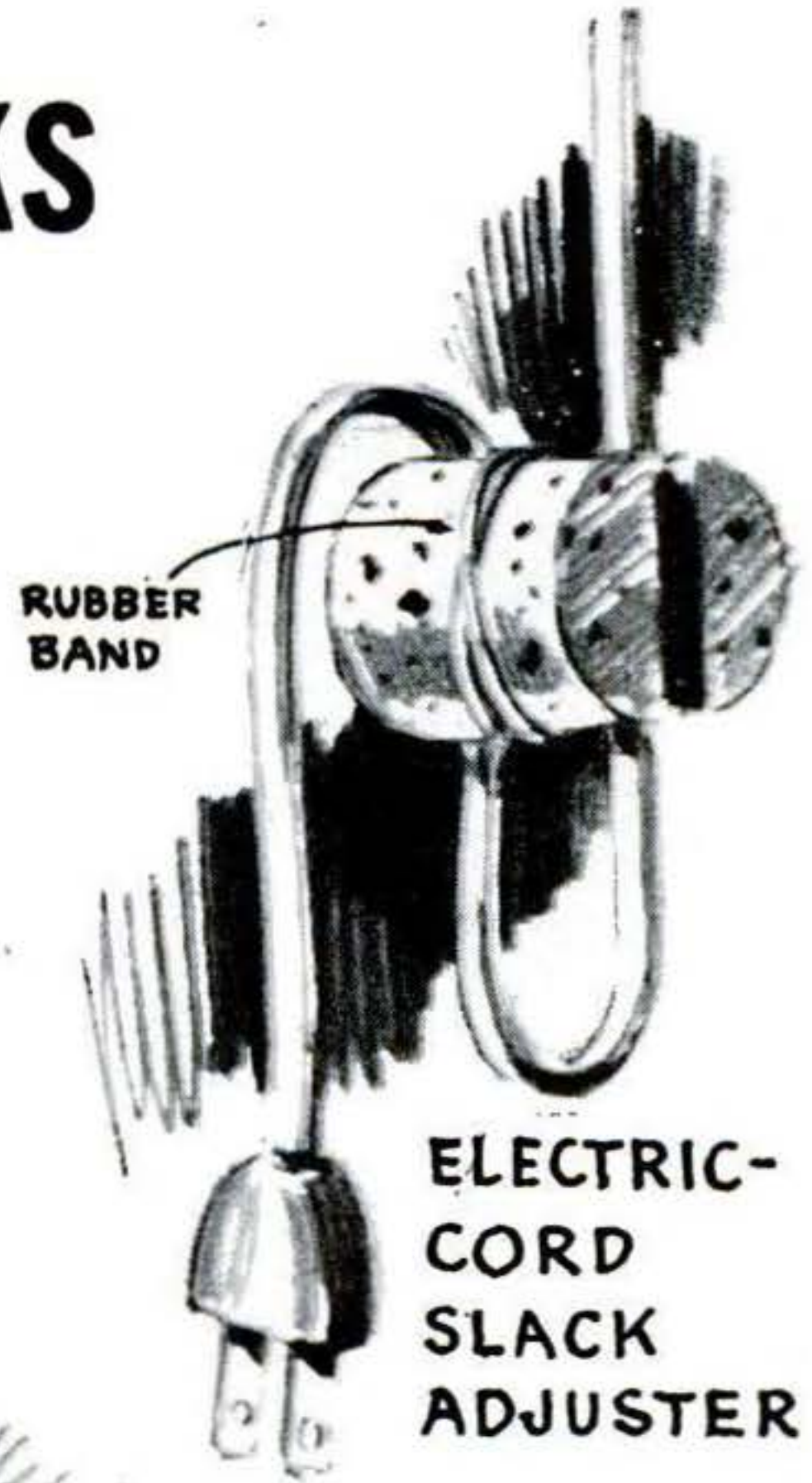

LIGHT PULL



DRAWING BOARD "PIN CUSHION"

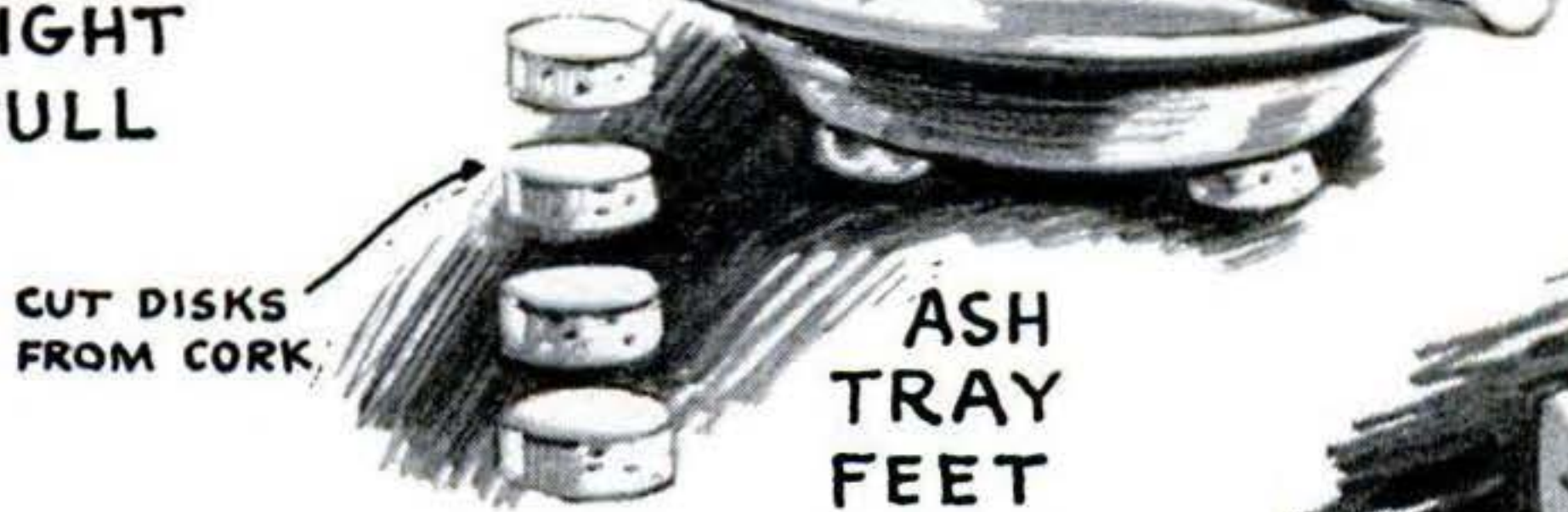

ASH TRAY FEET

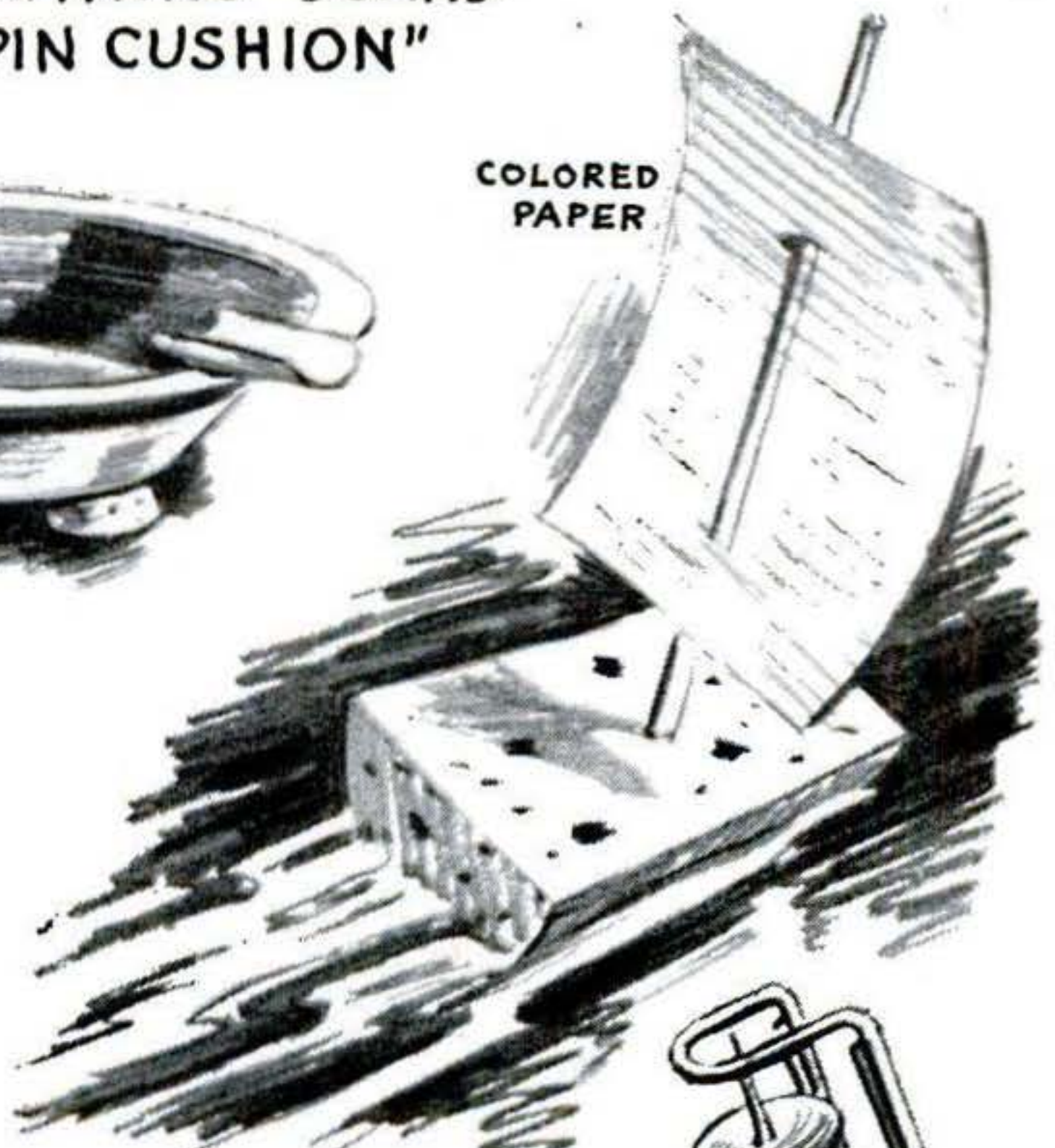

BATHTUB SAILBOAT



DART



# 7 Rules for Putting Up TV Antennas

**1 AIM THE ANTENNA** directly at the station. You may have to compromise on the best direction for the channels you watch most often. Have someone watch the set and let you know when the reception seems best.

**2 MOUNT THE ELEMENTS** at least six feet from any other antennas, power lines, tin roofs or other metal objects to avoid interference from them.

**3 USE A LEAD-IN** of high quality. A cheap cable may produce mismatch, resulting in the loss of signal strength. It's best to renew the lead-in if it is more than three years old.

**4 USE STAND-OFF INSULATORS** on both the mast and house to space the lead-in away from any metal and keep the insulation from wearing away.

**5 KEEP THE LEAD-IN SHORT**, following the most direct route from antenna to set. Surplus line cuts signal strength. Leave just enough behind the set so that you can pull the cabinet away from the wall.

**6 INSTALL A LIGHTNING AR-RESTER** on the lead-in where the latter enters the house. Also attach ground wire to the arrester and run to ground rod.

**7 GROUND THE MAST** with No. 6 wire clamped to the lower end and run to a six-foot length of  $\frac{1}{2}$ " pipe or a commercial grounding rod driven at least four feet into the ground. Sand the pipe and TV mast under the electrical contacts. You can also run ground wires to a water pipe. Never use a gas pipe.

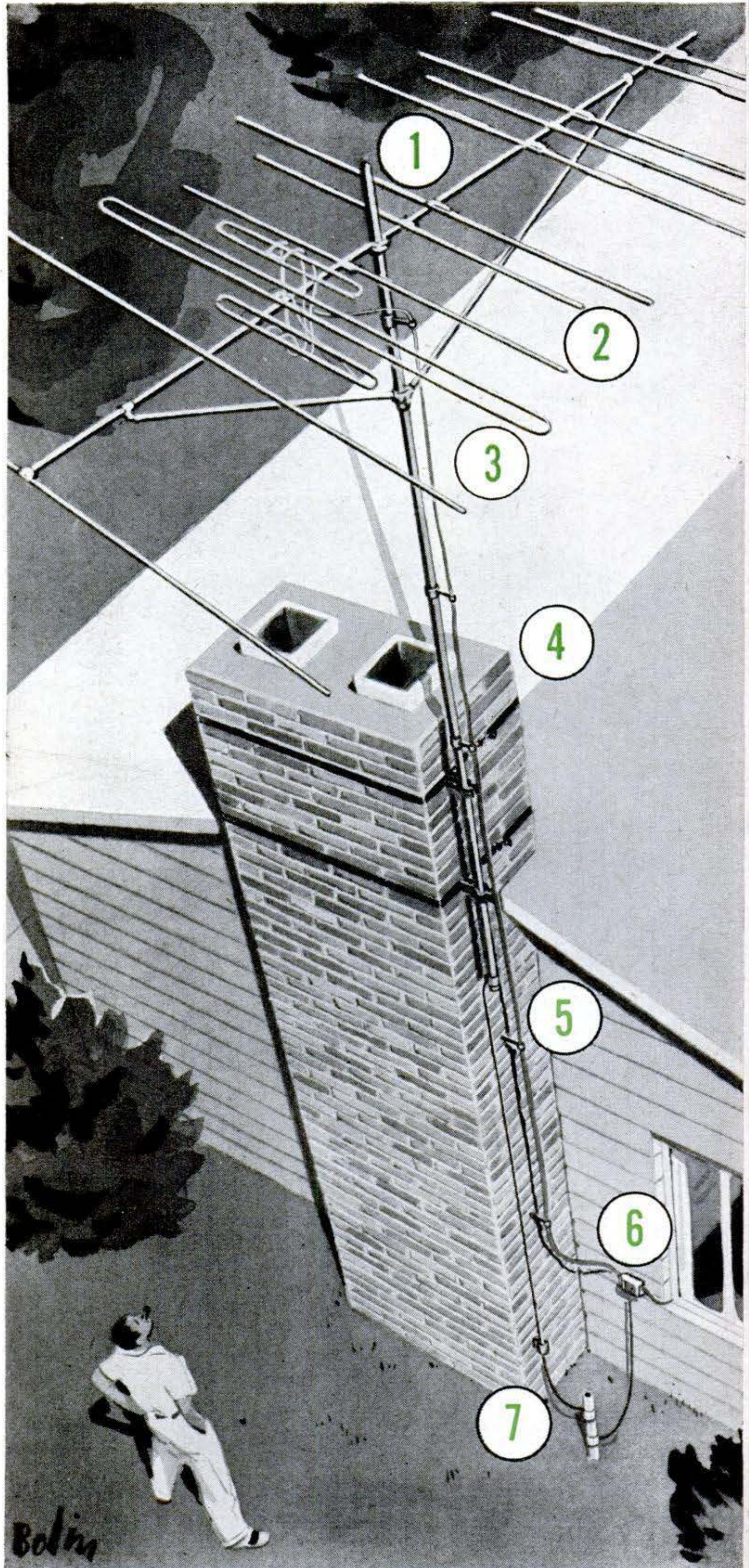





# Is Your TV Antenna Worn Out?

**A new one, or an overhaul of the old, may brighten the picture and rout those ghosts.**

**By Matthew Mandl**

**I**S YOUR television picture weak and unstable? Does your reception seem to be poorer today than a few years ago? Are ghosts and snow sneaking in where they have no right to be?

If so, the fault may be a worn-out antenna. You may think of this as a bunch of metal arms with wires attached that nothing much could happen to. Actually, your antenna is a delicate electronic system that must generate tiny, precisely matched amounts of current and deliver them to your set to give you a picture.

Like any device exposed to the elements, an antenna deteriorates to the point where one several years old may be a major cause of inferior reception. Usually the loss of quality is so gradual that you may not be aware of it.

Your existing antenna may also be an old-style type with insufficient gain—ability to increase signal strength—and thus incapable of rejecting signals which cause interference.

Overhauling your old antenna or adding a new one may thus do wonders to improve your picture—without your even touching the set.

**Renewing the old.** Since many faults will not show up except under close inspection, it's best to start by removing the antenna to the ground where you can work on it safely and leisurely.

After weathering for several years, electrical connections may have become loose and one or two of the elements may have fallen out of the assembly. Bolts often rust through and break. In other cases, high winds may have bent the elements from their correct position, affecting their performance.

Rain, chimney soot, salt air and smog all contribute to the

Mr. Mandl is the author of *Mandl's Television Servicing and Hearing Aids, Their Use, Care and Repair*, and is co-author of *Television & FM Antenna Guide*. He is currently lecturer in electronics at Temple University.



## New antennas are easier to put up, pull in more picture to see



**VHF ANTENNA**, covering channels from 2 to 13, comes assembled and snaps open in an instant. This conical type, made by JFD, can be used singly in strong-signal areas or in stacks up to three for distant reception.

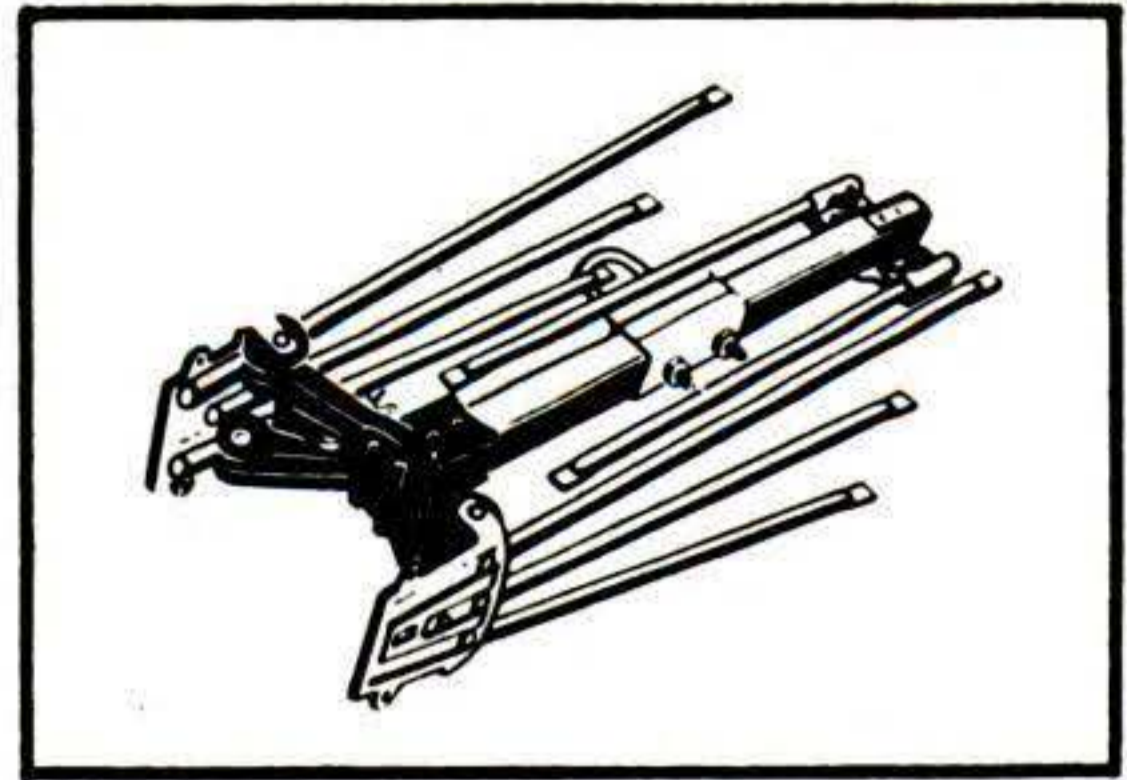

**IT COMES FOLDED IN CARTON**

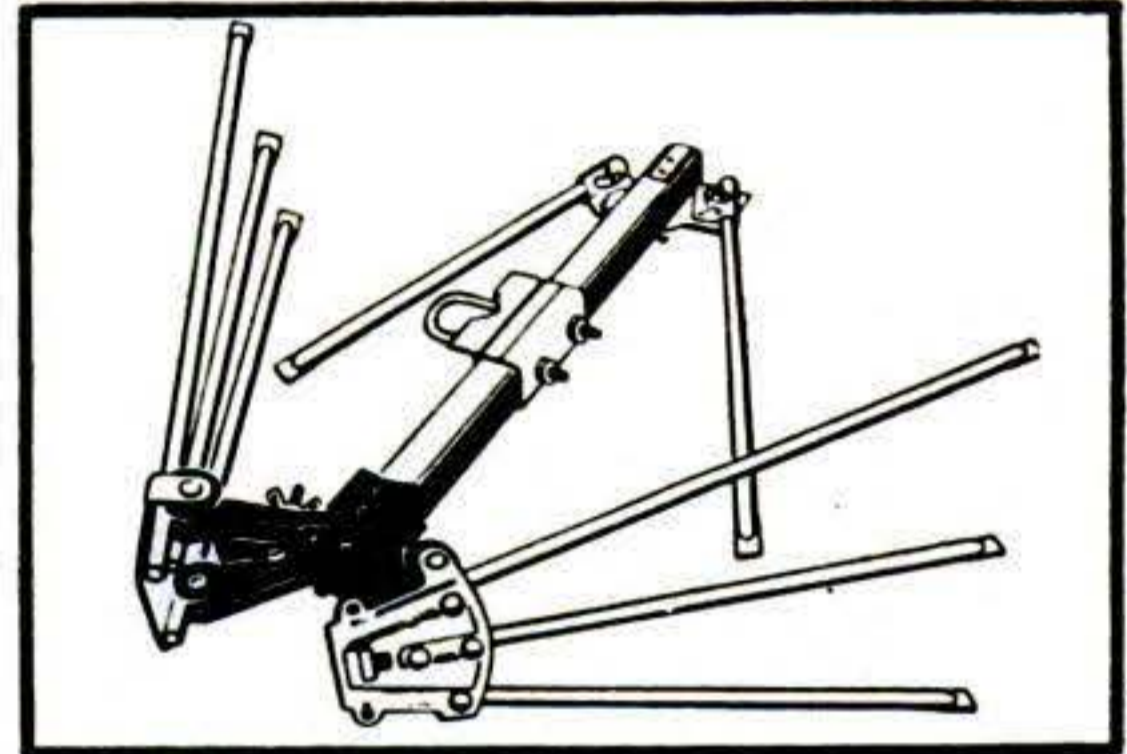

**ARMS SNAP OPEN BY SPRINGS**

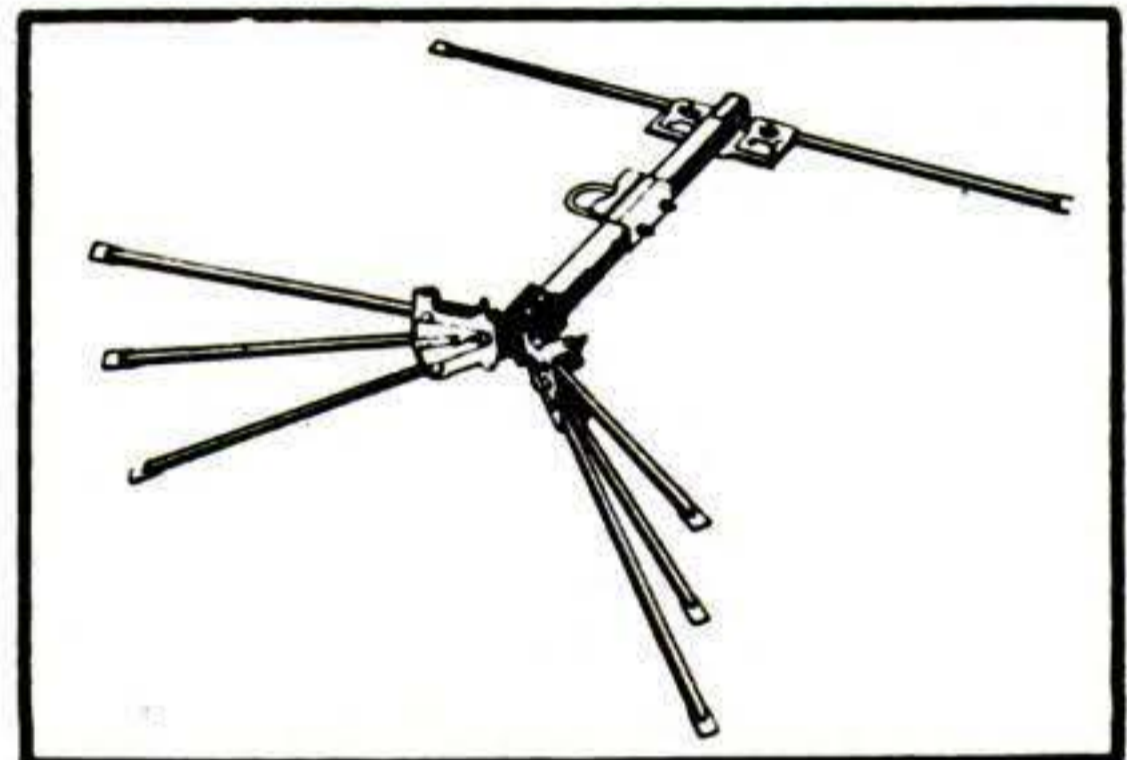

**ELEMENTS LOCK IN POSITION**

rusting and corrosion of the elements. Even aluminum rods corrode when exposed to some of these conditions. Insulators that have cracked, absorbing moisture, or have become coated with dust and soot, no longer retain their non-conductive properties, and the picture signal loses strength.

The lead-in itself may cause poor reception. If yours is over three years old, the chances are it isn't performing as it should. The plastic insulation becomes brittle and cracks, permitting leakages between the two wires that upset the delicate electronic balance.

**What you can do.** If the antenna insulator is intact, it should be cleaned with carbon tetrachloride to remove any dirt that has built up on it. Also remove

the clamp sections that hold the antenna rods. If either the clamps or the rods are corroded, sandpaper or wire-brush the parts to make a good electrical connection.

**Rusted bolts** should be replaced with galvanized or copper ones. You can try to straighten any elements that are out of position, but be careful not to crack the insulators. If they're bent too badly, your best bet is to discard them.

If the lead-in has been up a year or so and looks healthy, you can restore it by cleaning to remove caked-on dirt. Crop off the old ends so you'll have clean, unbroken new wire to attach to the terminals.

**Attaching the lead-in.** The insulation should split down the center just so far





**UHF CORNER REFLECTOR** has a bent-metal grid to increase receptivity in weak-signal areas. An Amphenol make, it receives all channels from 14 to 83. Similar JFD model (inset) has a "bow-tie" dipole backed by a radarlike parabolic reflector. Both types are highly directional in sensitivity and need accurate aiming.

that the ends can be fanned out and secured to the antenna posts. Strip only enough insulation to permit good electrical contact. The remaining insulation on the split portions will prevent shorts and make them more rigid.

**The lead-in** should then be carried down the mast through a series of stand-off insulators, with the first placed as close to the split end as you can to prevent flexing and breaking in a high wind. If your original lead-in was simply taped to the mast, a lot of trouble may have been there—you must keep the transmission line away from all metal parts to avoid interference.

To prolong the life of the antenna, you can coat it with a plastic film such as the kind that comes in spray cans.

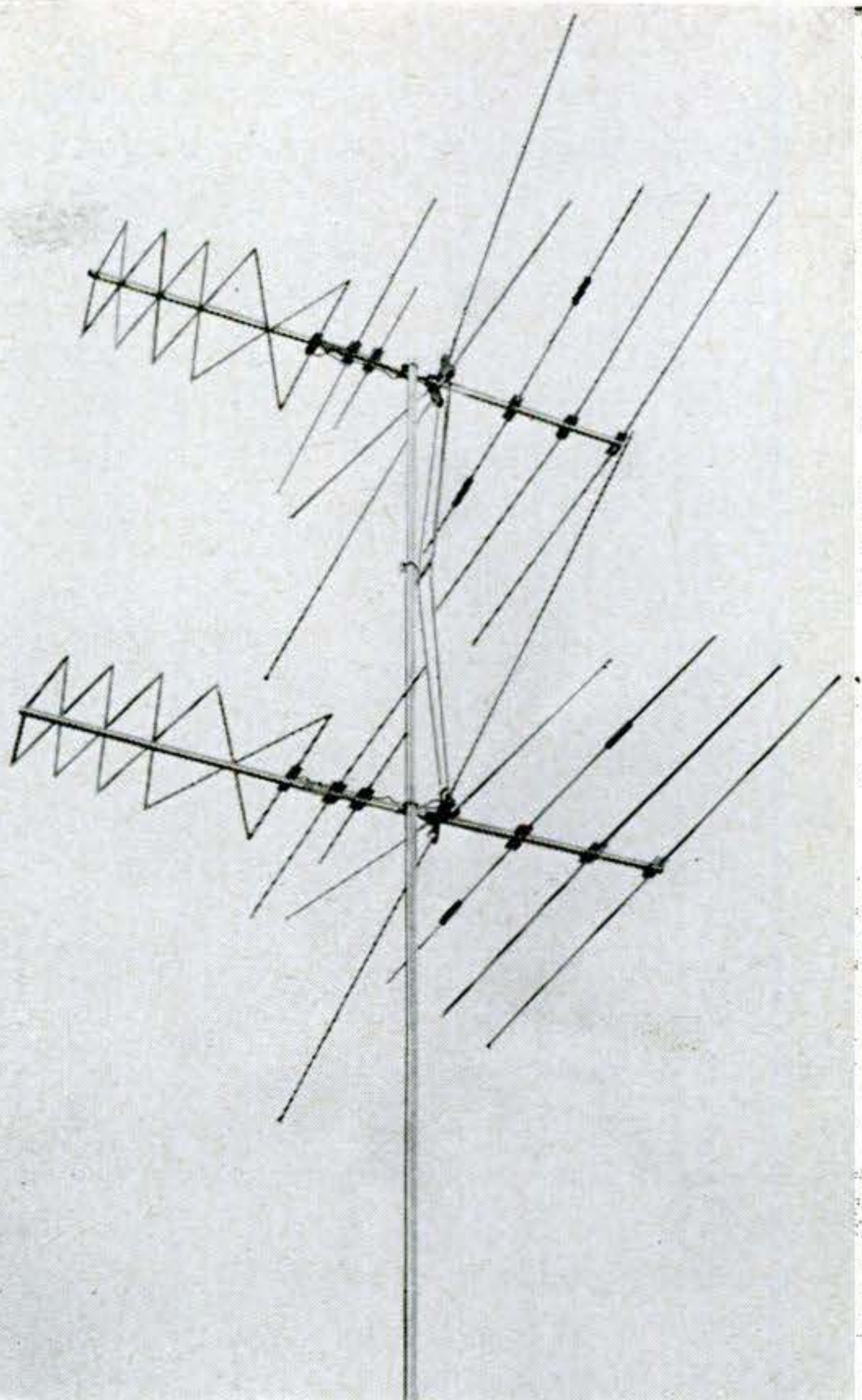

**COMBINATION VHF-UHF ANTENNA** brings in both very-high-frequency channels from 2 to 13 and ultrahigh-frequency channels from 14 to 83. The JFD model combines both flat-plane conical and flat-plane helical designs. It comes assembled, can be used singly or stacked in pairs for better reception in fringe areas.

Cover all the elements including the insulator. This protects against rust as well as preventing leakages caused by moisture or high humidity.

If you have a motor to rotate the antenna, the housing should be removed and the parts lubricated. The four-conductor motor cable usually has a clear-plastic insulation that is more readily affected by sun than the darker type of lead-in. Cracks and splits frequently occur after a few years, and the cable should be replaced.

**Installing a new antenna.** Many stations have increased their power during the past few years, modern receivers have much more gain, and higher-gain antennas are now available.

Many companies are now offering the



assembled antennas that "snap up" into proper element position when ready for installation. Some antenna kits include the complete antenna plus necessary hardware, stand-off insulators, mast sections, lead-in and other accessories.

With a kit like this, a new antenna can be installed quickly and easily by anyone who isn't afraid to climb a ladder.

The popular bi-conical antenna is a good broadband antenna for channels 2 to 13 and has fairly good signal pickup for metropolitan areas. When two such types are stacked, good reception for distances up to 50 or 60 miles is possible. The bi-conical type of antenna is extremely sensitive to direction and requires a motor to aim it if television stations are located in different directions.

Another popular antenna is the motorless type which has a multi-conductor line that selects the direction of signal pickup by a switch at the receiver. Its gain is comparable to that of the bi-conical type and it is suitable for use in metropolitan areas.

**Fringe reception.** Where signal strength is weak and stations are up to approximately 100 miles away, the newer-type Yagi antennas should be used. These are multielement antennas which provide exceptionally high gain.

Many other improved antenna types are also available and give much better reception without an increase in installation height over older antennas. In some instances, the newer types will outperform the older antennas even at a reduced height. Height, however, is still an important factor, and in an area that is known to have poor signal strength, the antenna should be installed as high as

possible within the limits of safety and resistance to wind.

**UHF reception.** UHF signals (all channels above 13) suffer more losses than VHF signals and thus cannot usually be received over as great distances. Best results are assured by using the Yagi (multielement) types and also the "bow-tie" corner-reflector types.

It is not good practice to attach a UHF antenna and a VHF antenna to a single common transmission line because each one "loads" down the other, and reception for both is poorer. If you need both a UHF and a VHF antenna, you can reduce losses by using a separate transmission line for each antenna, or by using a single line with a crossover network that minimizes the tendency of one antenna to affect the other.

It is even more important to mount UHF antennas high and clear of surrounding objects than VHF antennas. High-gain antennas are particularly sensitive to the direction of the pickup and must be carefully aimed at the station.

**Indoor antennas.** In many metropolitan areas VHF signal strength is sufficient for good reception with an indoor antenna. The indoor types, however, pick up more interference because they are lower. Thus, an outdoor installation may be necessary to minimize streaks in the picture caused by auto ignitions, vacuum cleaners and other electric devices.

You may also be able to improve your reception with some of the newer indoor antenna types that replace the old rabbit-ear units. These have phasing bar elements and selector switches to provide better impedance matching between the indoor antenna and the receiver. **END**



**WOOD SHIM** makes it easy to mount an antenna mast on a chimney with an overhanging cap. Strap a two-by-four to the chimney first, then fasten on the mast clamps with lag screws into the wood.



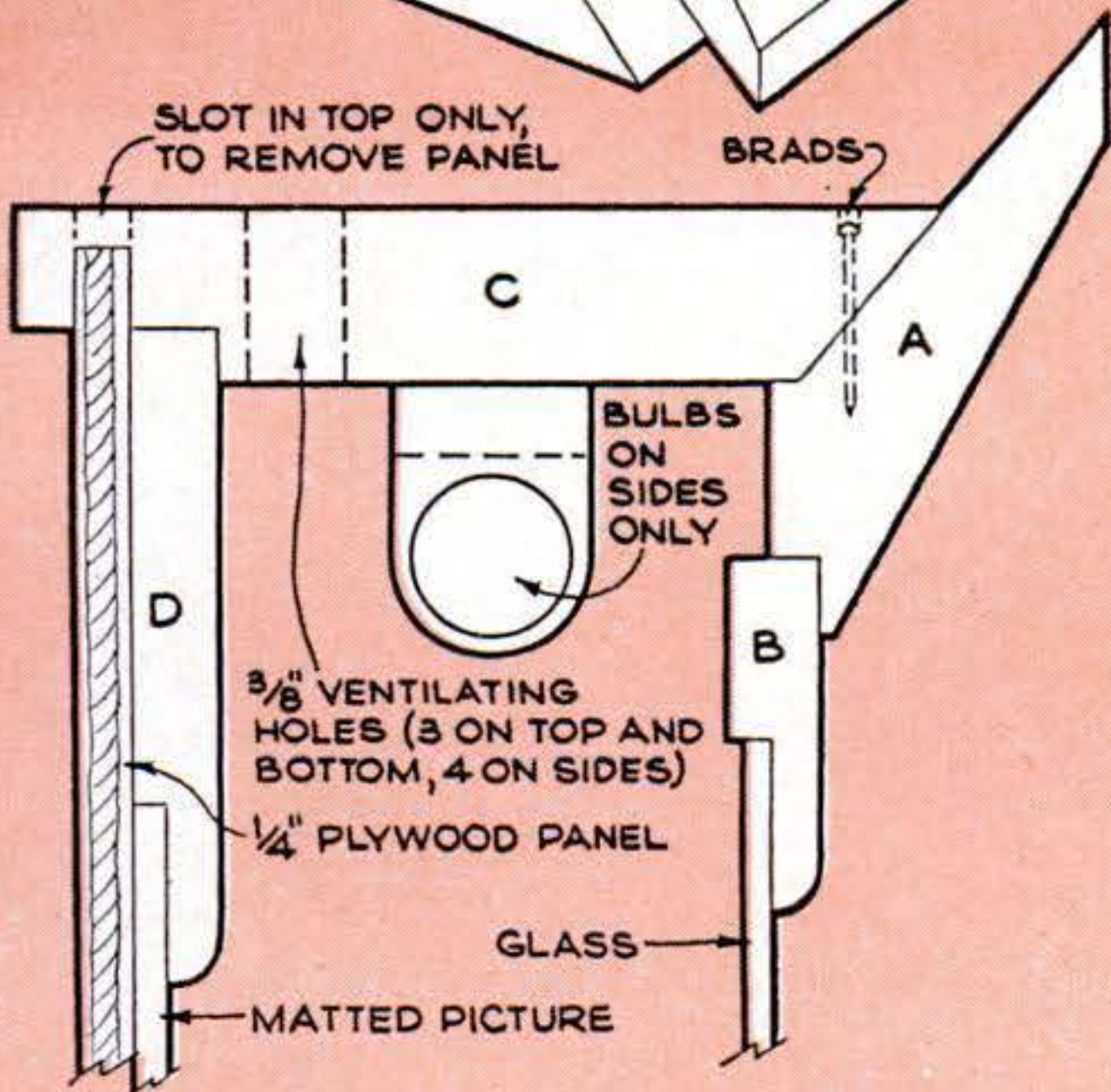
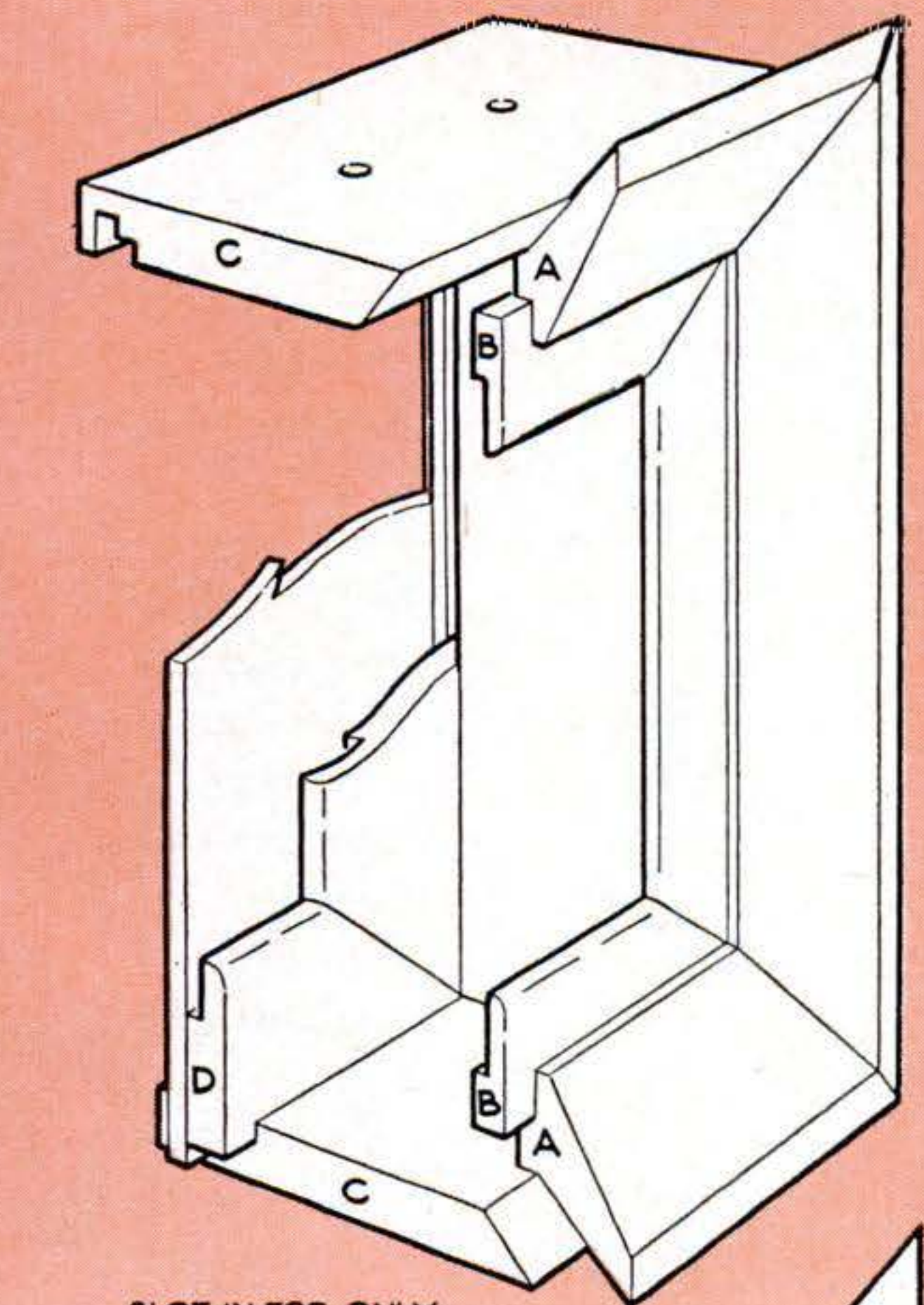

**SECTION AND SIDE-VIEW DRAWINGS** show how sub-frames are assembled to form the light box and mountings for glass, photo mat and panel.

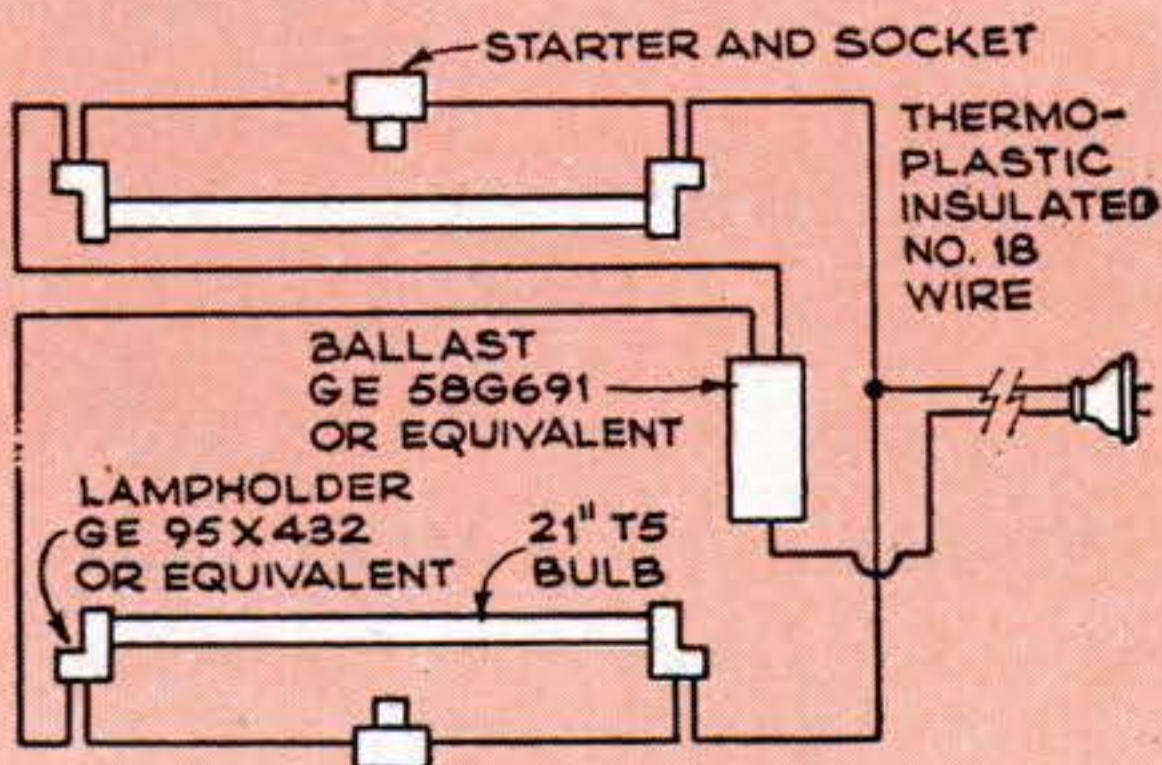

**WIRING DIAGRAM** for fluorescent lamps. Mounted on inner faces of sub-frame C, the tubes won't show.

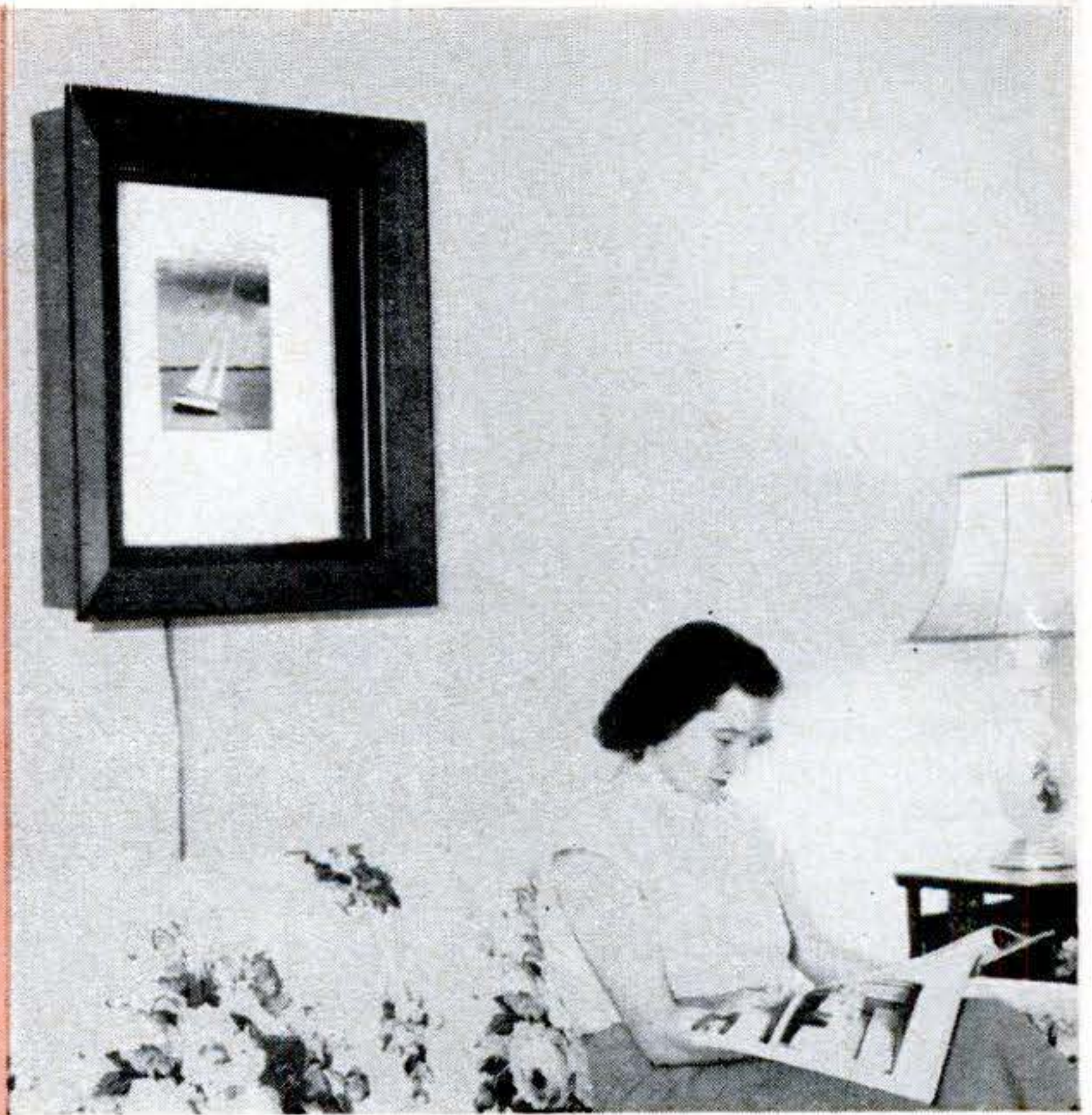

## Frame Spotlights Prize Photographs

*You can switch pictures in a jiffy with this fluorescent shadow box.*

**T**HIS deep picture frame displays your favorite camera studies in the even light of concealed fluorescent lamps. When you tire of one print—presto—a sliding panel at the back of the frame permits a quick change to a new picture.

As shown in the cross-section drawing, the picture frame is made up of four sub-frame assemblies: A, B, C and D. The outside dimensions of sub-frame A are 23 $\frac{1}{4}$ " by 27 $\frac{1}{4}$ "; sub-frame B, 18 $\frac{1}{2}$ " by 22 $\frac{1}{2}$ "; C, 21 $\frac{1}{2}$ " by 25 $\frac{1}{2}$ "; and D, 20 $\frac{3}{8}$ " by 24 $\frac{1}{2}$ ". Glue molding templates scaled up from the drawing to the ends of the stock to be cut. I used solid Honduras mahogany for all of the framing parts, but any attractive hardwood will do.

Run off the bevel cuts, grooves and rabbets on a circular saw. Quarter-round the inner edges of moldings B and D with sandpaper, after making preliminary bevel cuts. Miter the ends of all parts and assemble sub-frames A, B and D with glue and small brads.

Before assembling sub-frame C, continue the rabbet at the rear through the top mem-



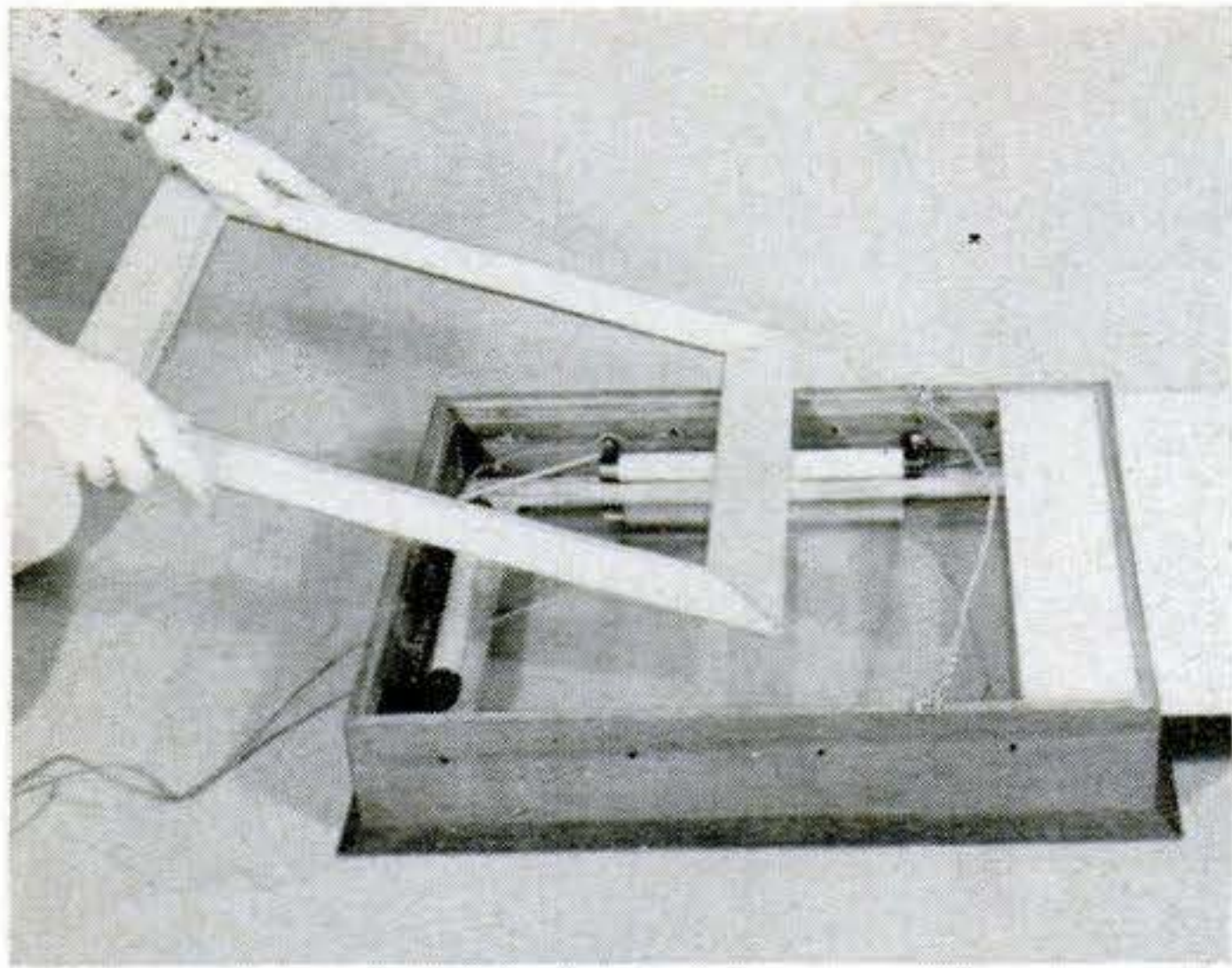

**YOU SLIDE THE BACKING PANEL UP** to change pictures and also to remove sub-frame D so you can insert a new tube or starter easily. It's also handy for cleaning the picture glass.

ber, to form a slot through which a  $\frac{1}{4}$ "-plywood backing panel can be removed for picture changing. Also, drill holes through all four sides of this sub-frame to act as ventilators for the fluorescent lamps.

Glue sub-frames A and B together. Then glue and brad sub-frame C to A.

Sub-frame D is not attached to C, but is held firmly in place in the rabbeted recess by the backing panel.

This removable feature of sub-frame D will make it easy for you to replace burned-out lamps, starters, or a broken picture glass.

I used four lamps in my illuminated picture frame, but two are adequate. Best for this use are the 21", T5 type, which have a tube diameter of  $\frac{5}{8}$ ". To recess them so they will not show, buy the fittings (four lamp holders, one 28-watt ballast, two starters and two starter sockets) separately, and mount them directly on the inner faces of sub-frame C. Thread the light cord out through the central ventilating hole in the bottom of the frame and cut in a feed-through switch at a convenient height.

Sand and finish the frame to harmonize with its surroundings. Finally, with sub-frame D removed, insert picture glass in B and secure it with glazier's points.—*Ben Ball, Jr., Groves, Texas.*

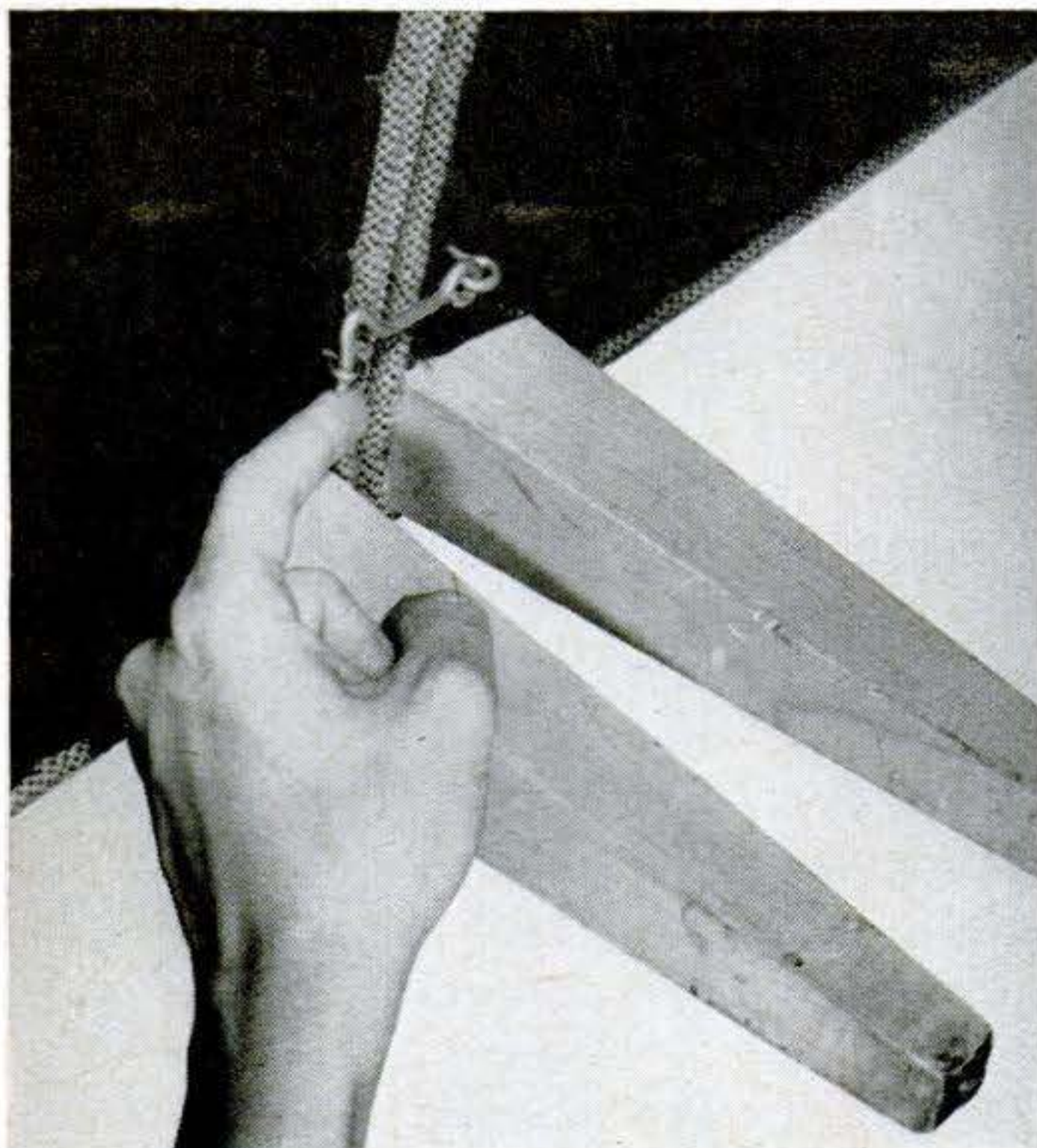

### Sofa Units Hooked Together

SECTIONAL sofa units won't drift apart if you tie the frames together with hooks and eyes. Be sure to allow for the thickness of the upholstery when setting the eyes.—*Thomas P. Ramirez, Fond du Lac, Wisc.*

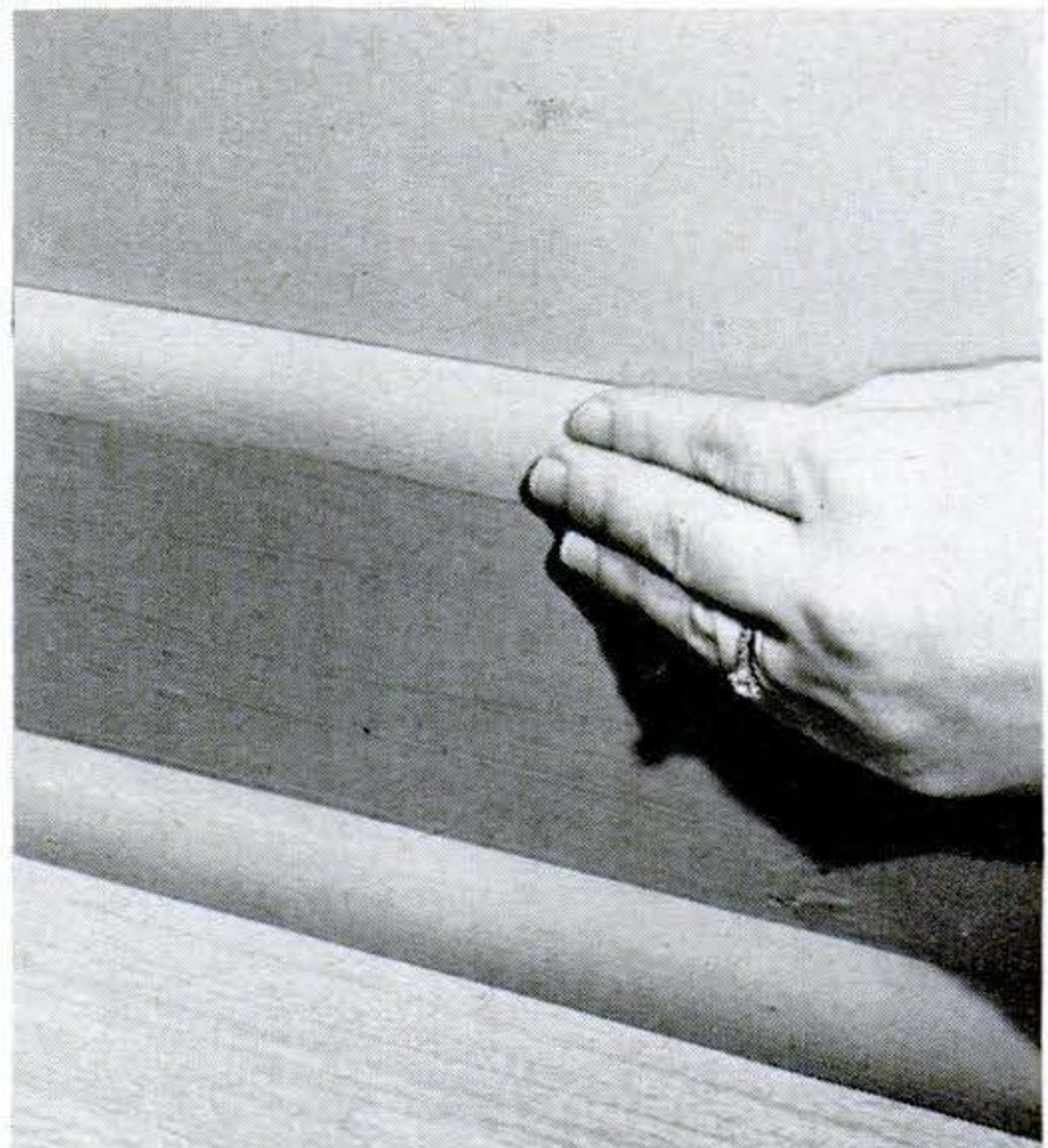

### Plank, Molding Trim Wall Base

A MODERN baseboard can be made from  $\frac{3}{4}$ " shelving and quarter round, assembled as shown. The curved top keeps dust from catching, makes the baseboard easy to clean.—*Frank A. Javor, North Bergen, N. J.*



# Five Darkroom Tips

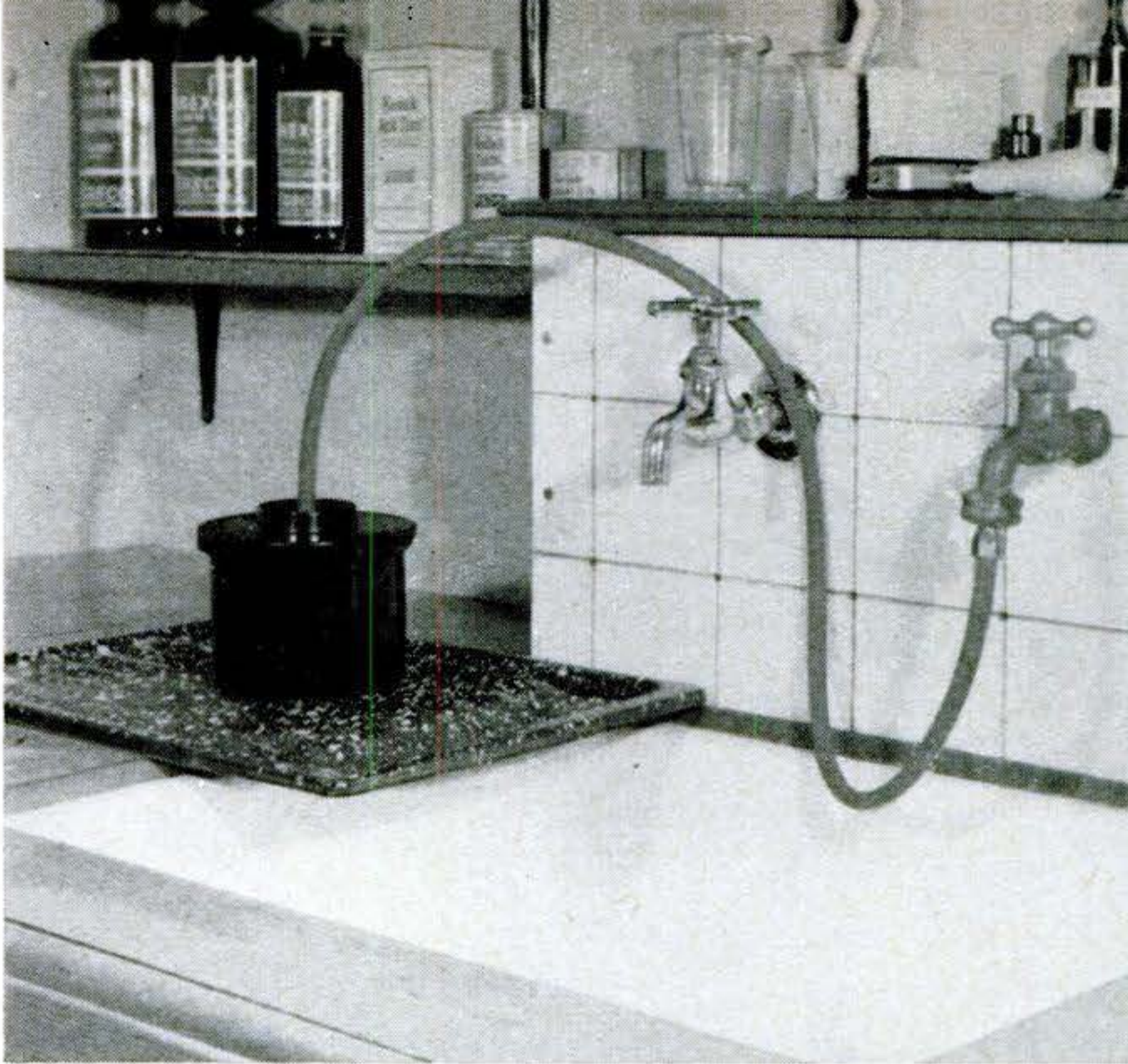

**1 TRAY BOOSTS SINK SPACE.** Does film washing slow you down by cluttering up your darkroom sink? An enameled stove tray, located like the one at the left, will give you extra working surface. Drill two or three holes near the deep end of the tray and place it so the water overflow will drain back into the sink.

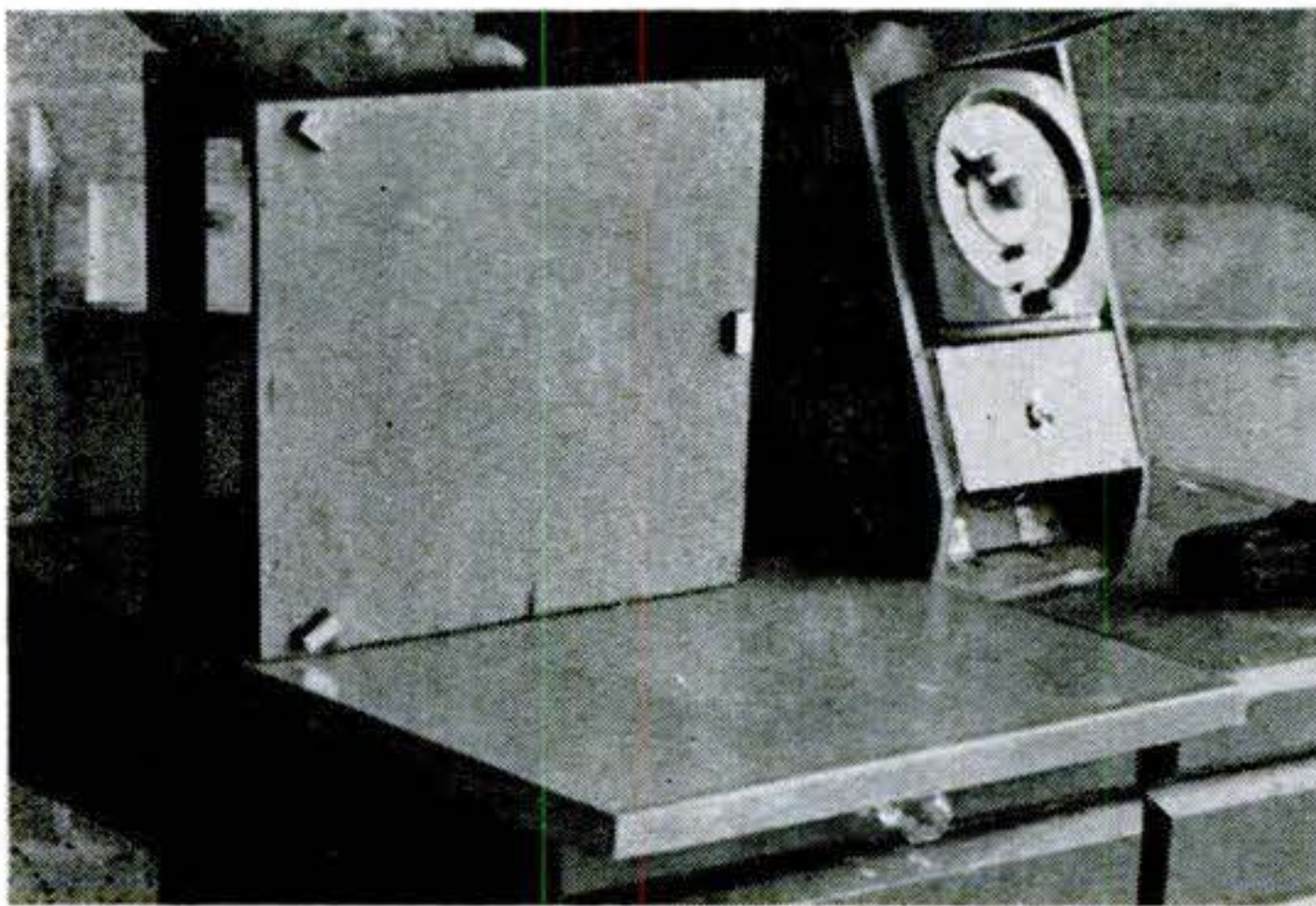

**2 MAGNETS STEADY EASEL.** Does your easel skitter after you get it set just right for duplicate printing? Stop it by covering the enlarger table with a steel sheet and cementing magnets to the easel bottom. Coat the metal with non-reflecting paint. The magnets steady the easel yet still allow you to shift it.



**3 EDGE LIGHT REVEALS DUST.** Even a careful brushing may leave some dust on a negative, resulting in spots on the prints. To see if you've missed any dust, check the negative in the dark by directing the beam of a flashlight across the surface. Edge-lighting will make remaining dust on the film stand out clearly.

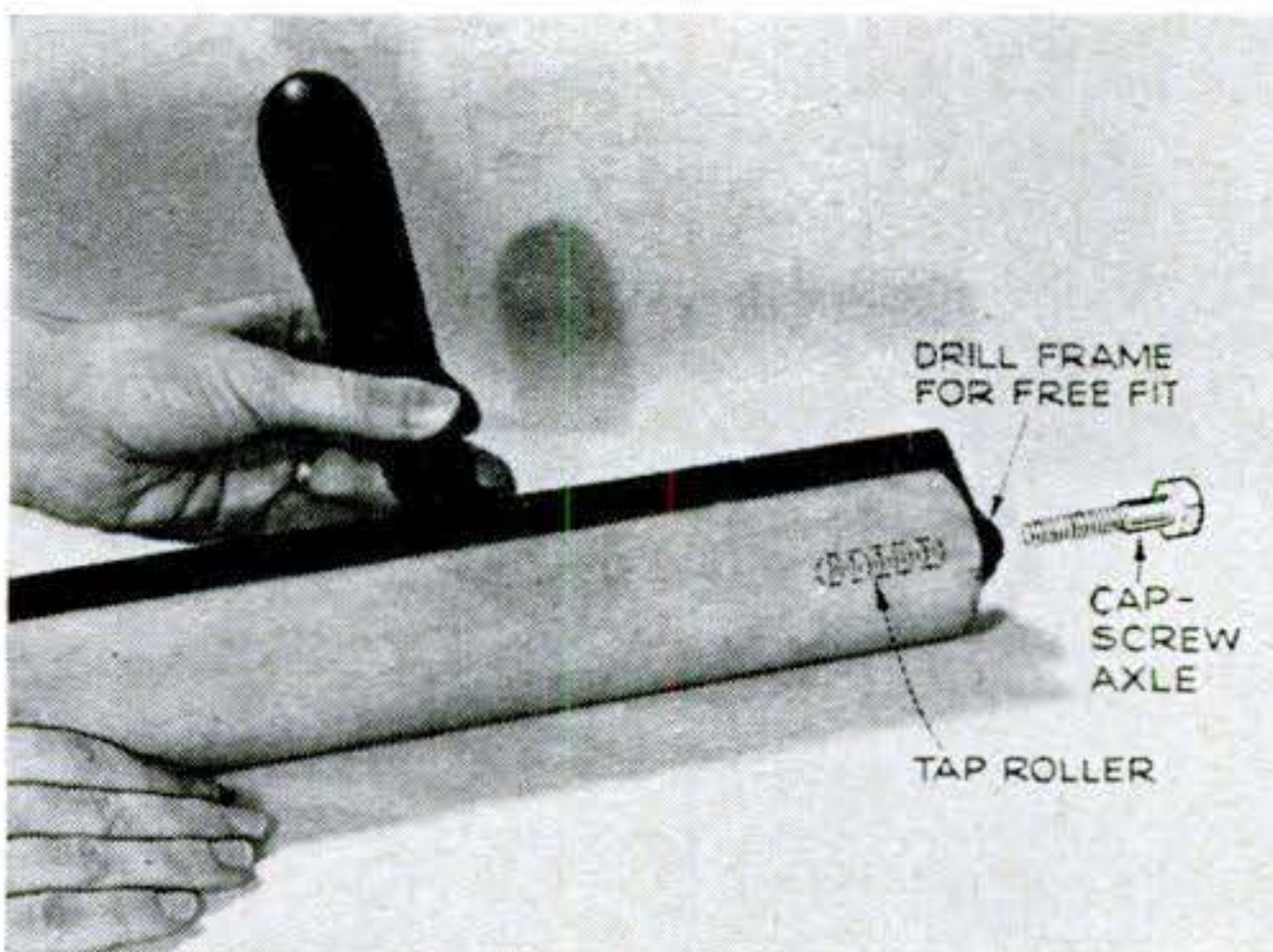

**4 WRINGER ROLLER SQUEEGEE.** You can make a king-size, heavy-duty darkroom roller from a discarded clothes wringer and a frame bent out of channel iron. Cut the roller to fit, tap its shaft ends for cap screws, and drill holes in frame legs to clear screws. Bolt on a tool handle and your roller's in business.

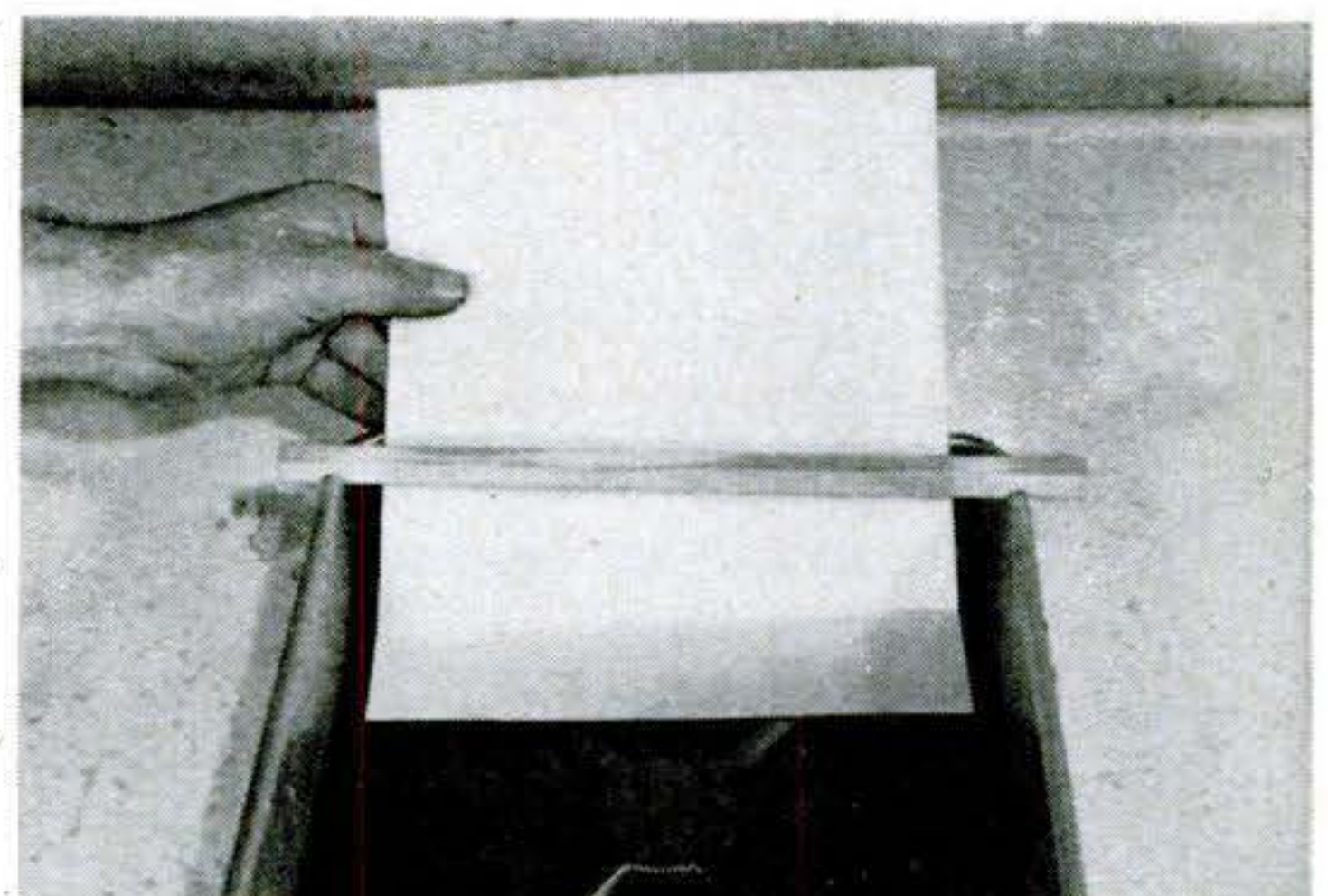

**5 STRIP DUNKS PRINTS EVENLY.** A hardwood strip hooked near one end of a developing tray will guide paper into the soup, eliminate spots and streaks caused by uneven dunking. Saw, file, or carve notches in stick for tight fit on tray flange, then sand stick glass-smooth. Slide in paper between the strip and tray rim.



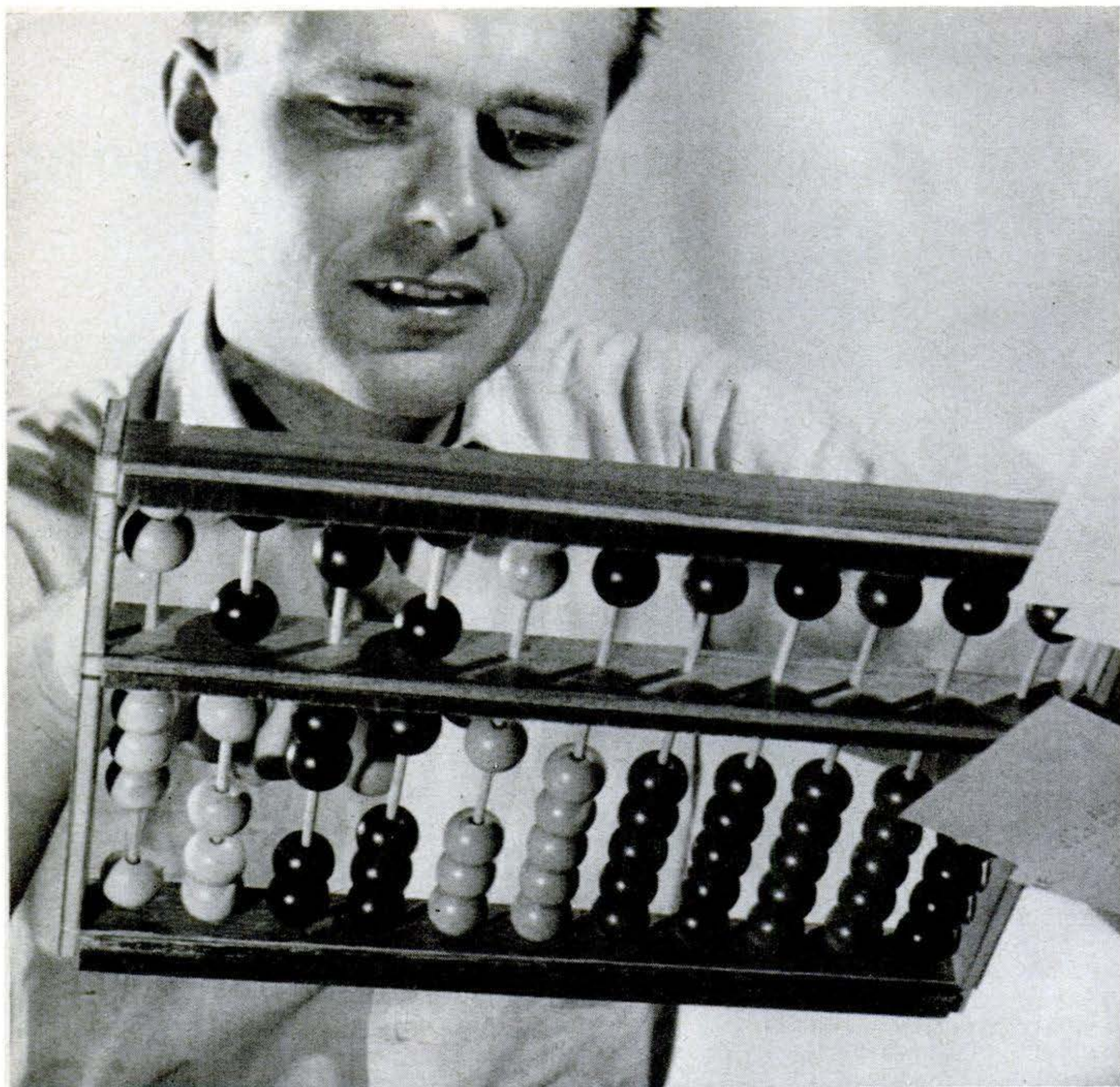

# How to Make and Use an Abacus

**By Darrell Huff**

**Y**OU can—right this evening in your own workshop—turn out a device that's capable of outfiguring a \$700 electric calculating machine.

It's the ancient Oriental abacus, a simple frame in which colorful wood beads slide on thin dowels. The type shown here is similar to one with which a skilled Japanese abacus operator took on an American using a high-speed calculator. The abacus won four to one in addition, subtraction and division, coming in sec-

ond only in calculating multiplication.

You may not want to outrace an electric computer, but you can use an abacus to do long, error-inducing jobs such as adding big columns of figures.

*It helps with the bills, too.* Want to total up those monthly bills or make a quick check on the bank statement? Without even writing down the numbers first, you can just enter the amounts on the abacus, and the final figure will be the total. The abacus makes a running total as you go along.

It's also a perfect gift for youngsters



learning arithmetic. Watching the numbers take shape under their fingers helps them *see* arithmetic.

Seven schools in the Milwaukee area have been teaching this way—and are turning out kids who *love* arithmetic.

It's also a lot of just plain fun. It could make your bridge and canasta scoring easy and accurate.

**How it works.** In principle, the abacus is just an adding machine without gears connecting the columns. The columns, from right to left, represent units, tens, hundreds, thousands, and so on, as in written arithmetic.

The horizontal crossbar is the axis along which calculations are made. Beads representing numbers are moved down from the top against the bar and up from the bottom. All other "neutral" beads

are left against the top and bottom rails.

The five  $\frac{3}{4}$ " beads below the crossbar on each of the 11 dowels have a value of 1 and the two on each dowel above the bar a value of 5. Operation is simply a system of setting up beads along the crossbar and then adding or subtracting more beads to get the answer.

The pictures on the next two pages show how to add and subtract. For more advanced work, you can get an instruction booklet called *Bead Arithmetic*\* for 60 cents postpaid.

\*Service Supply Co., 831 Grant Ave., San Francisco 8.

**How to make the frame for the abacus**

**FRAME RAILS** are thin strips glued and nailed to  $\frac{1}{4}$ "-plywood back. Pad the clamp jaws (right) to avoid marring the wood. (Back was removed in some photos here to show beads better.) The  $\frac{1}{8}$ " dowels pass through center, but end in blind holes in top and bottom rails. Arrange beads—you need 77—in different-colored columns, but don't mix colors in any one column.

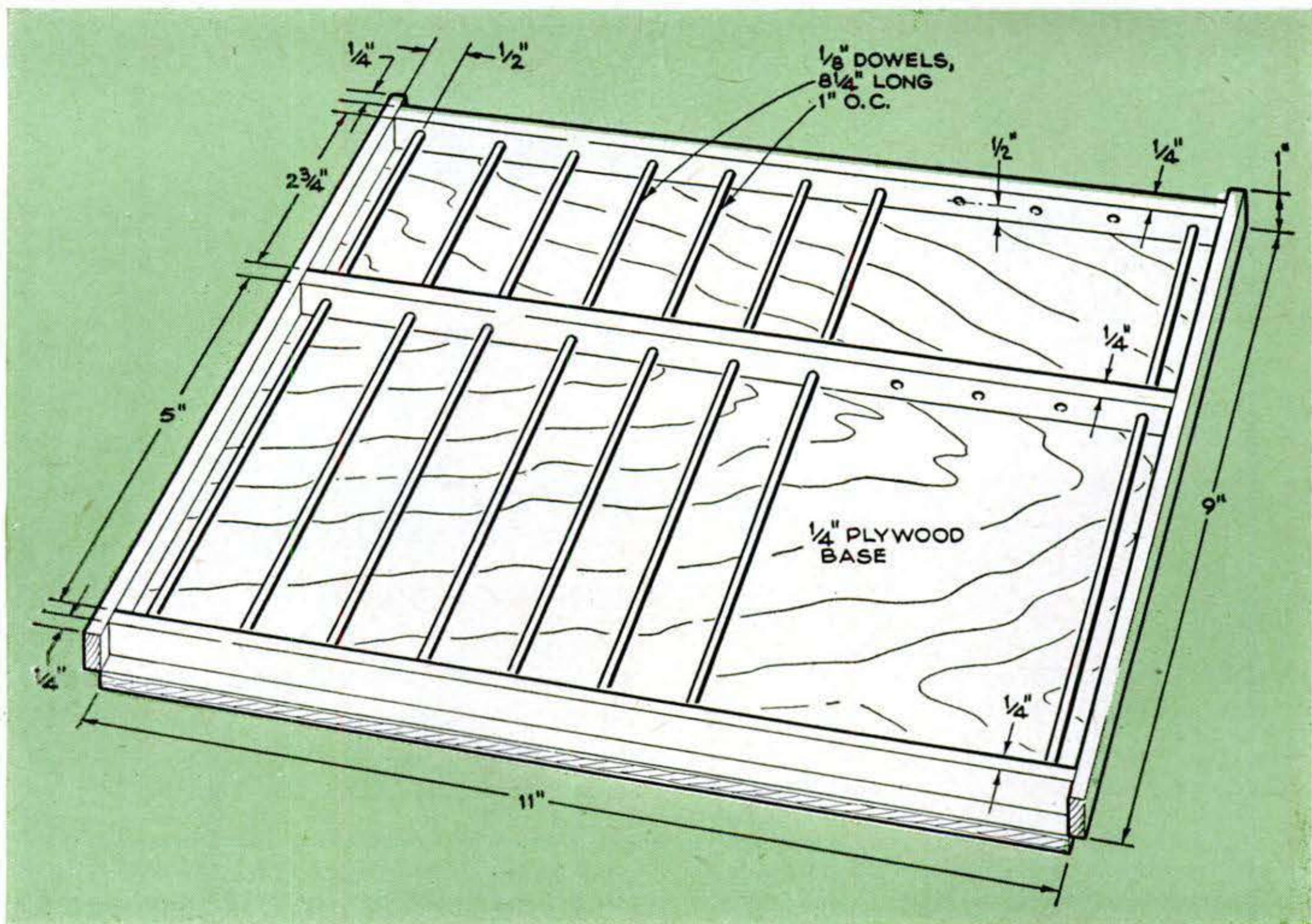
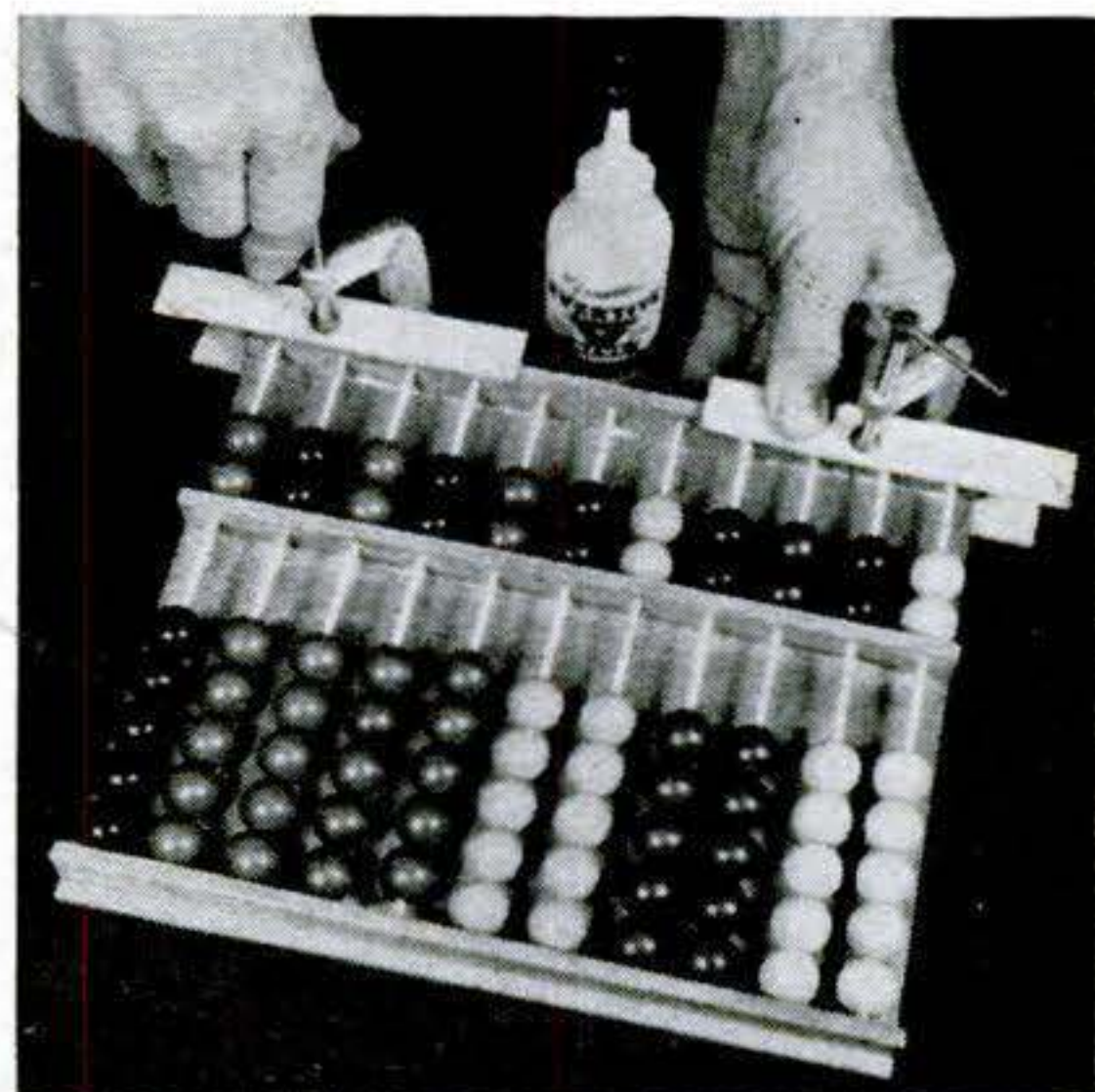



## How to add

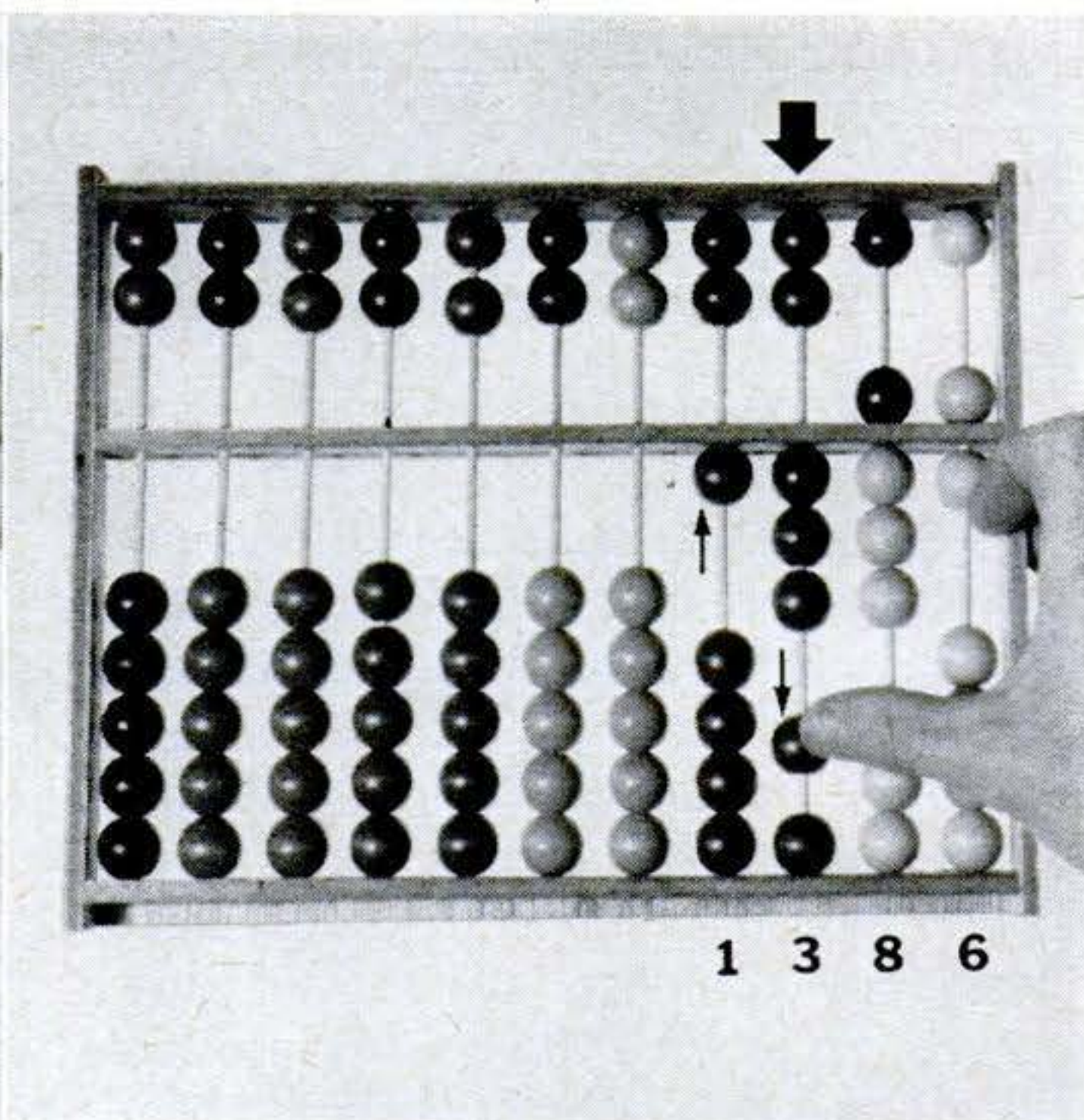
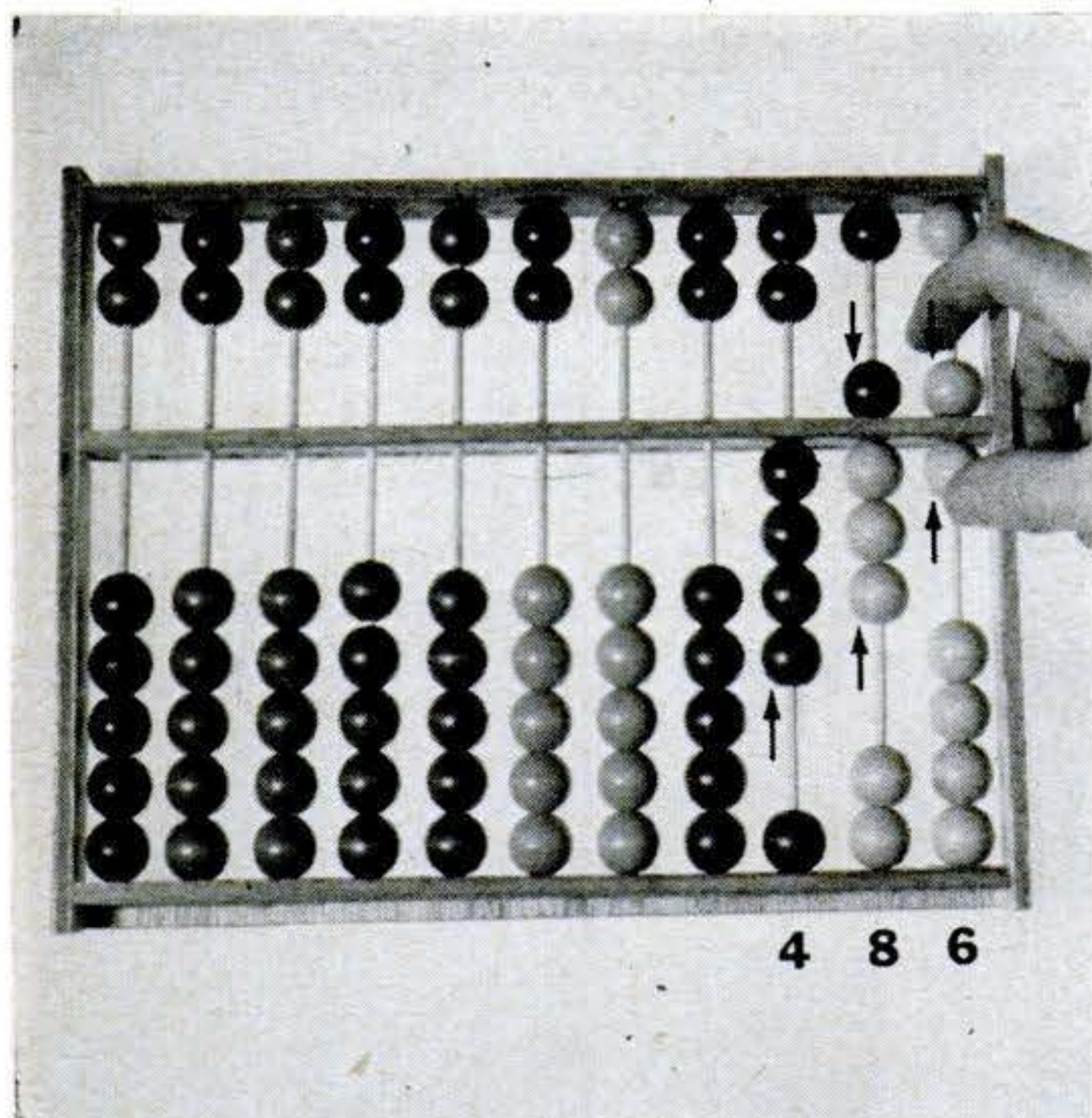

**1 THE PROBLEM:** Add 486 plus 901 plus 32. Begin by representing the first number, 486, along the crossbar, starting in the third column from the right. Use four lower beads for the 4, three lower beads and one upper one for the 8, and one lower and one upper bead for the 6. Remember that the upper beads are worth 5, the lower ones 1. The number on the abacus now reads 486, as the picture above shows.

**2 START ADDING** the 901 at the *left*, not the right. Adding 9 to the 4 already on the abacus gives you 13, so move one bead down in the third column from the right, changing the 4 to a 3, and move up one bead in the fourth column, making 13. Another way to add 9 is to think of it as adding 10 and subtracting 1. Move up one in fourth column (adding 10) and one down in third (subtracting 1).

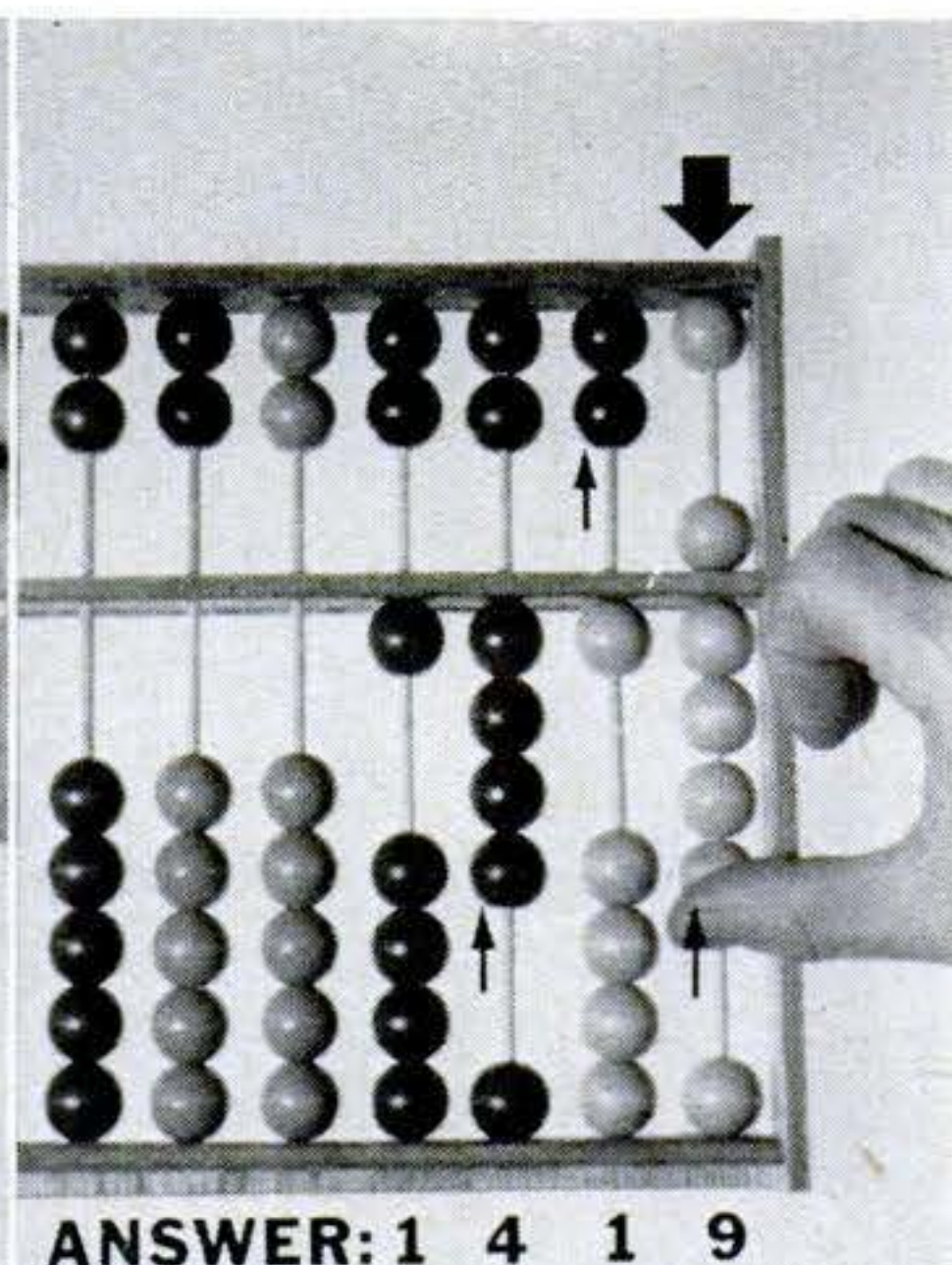
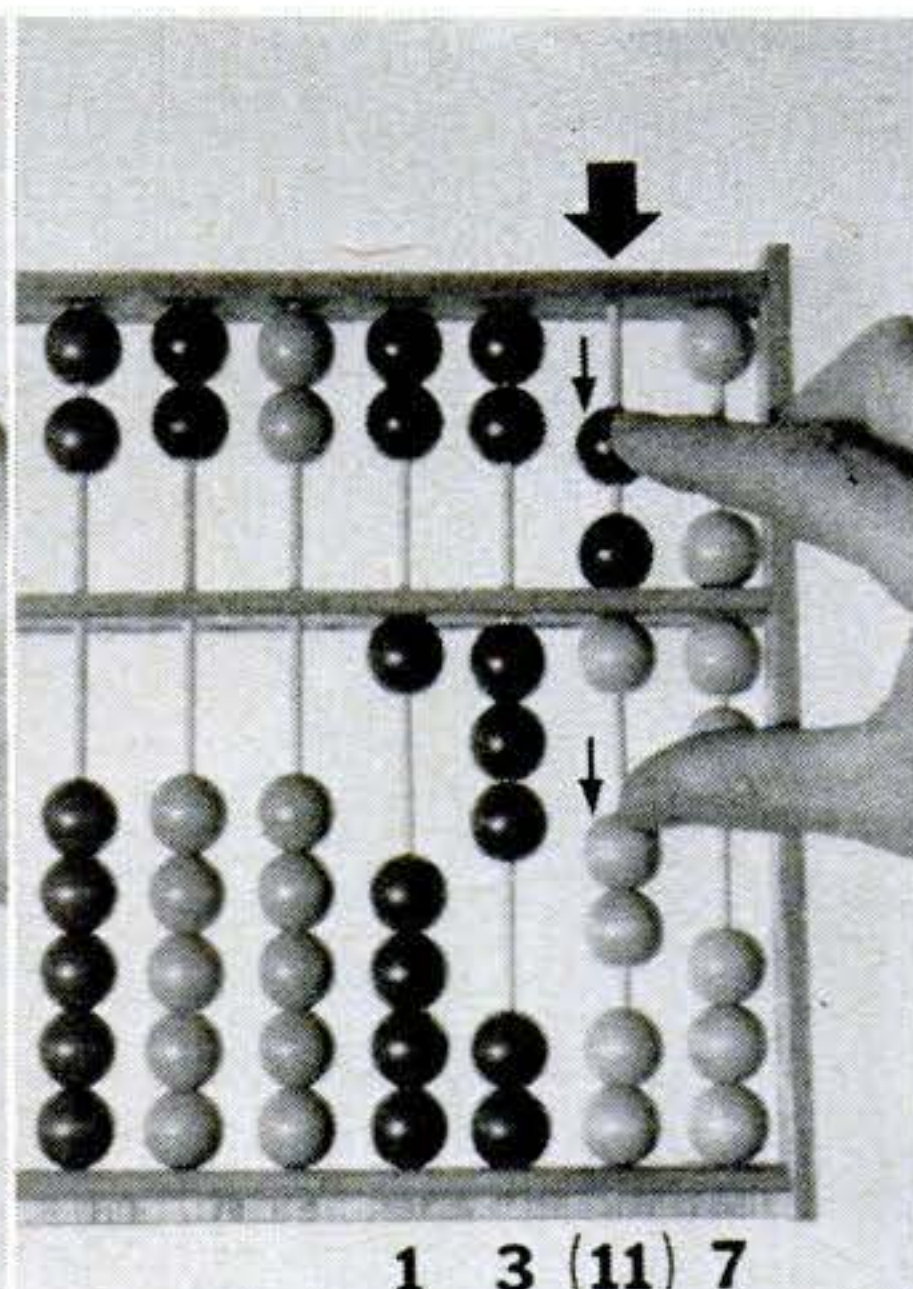
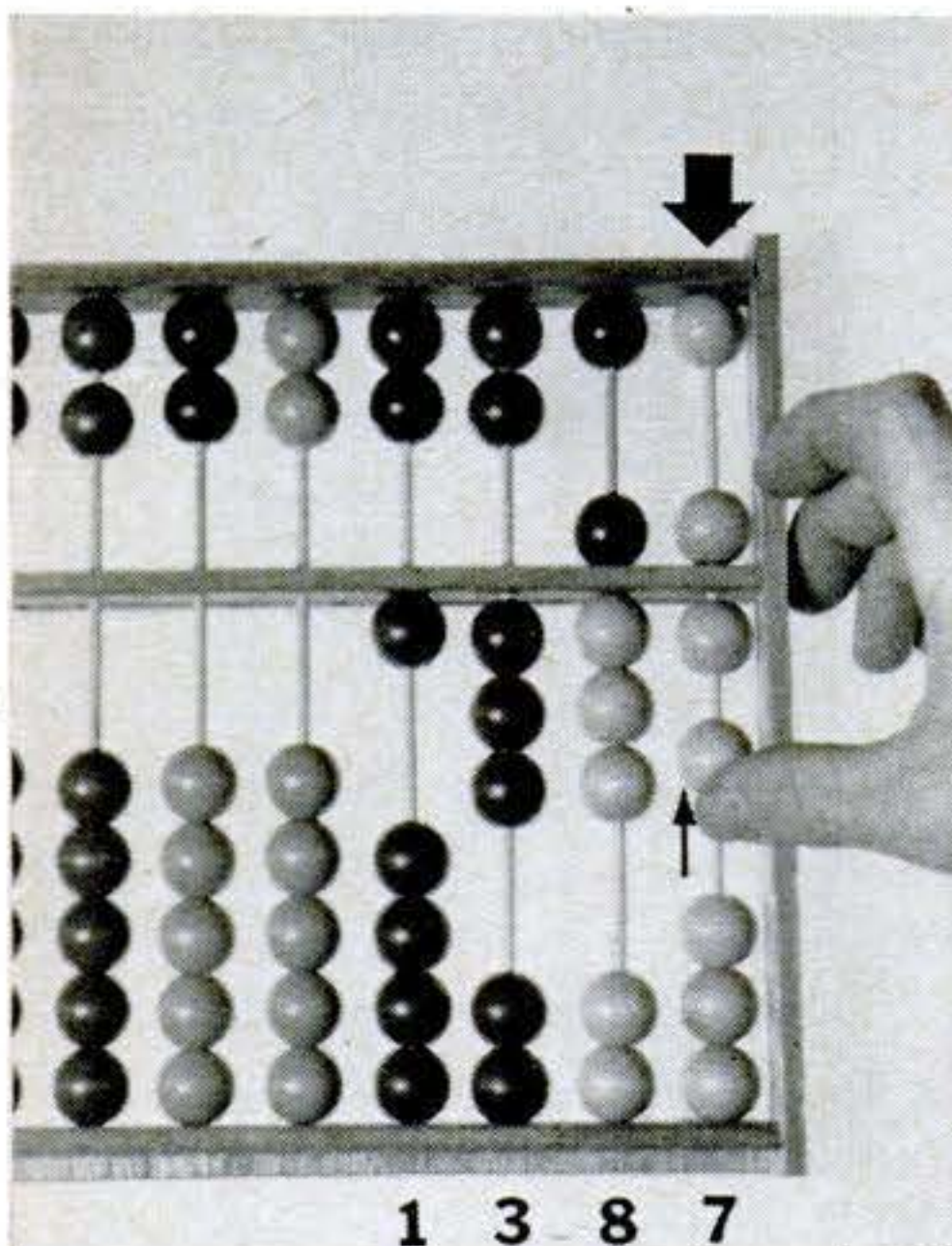

**3 SINCE THE NEXT DIGIT** in 901 is 0, you don't have to add anything in that column. Add 1 to 6 in the right-hand column by pushing up one lower bead. Arrow indicates the column being worked on. You can make your own pointer by bending a small U-shaped tab of metal to slide along the top rail.

**4 NOW ADD THE 32**, beginning with the 3 in the second column from the right. This should be done by moving down the second upper bead (worth 5) and subtracting two lower beads. The total in this column is now 11 (two upper beads plus one lower one).

**5 BUT THIS MAKES MORE THAN** 10, so you "carry over" the first digit (1), just as in written arithmetic, by taking away the two upper beads in the second column and adding one lower bead to the third. Then add the 2 in the right-hand column by moving up two more lower beads. This gives 1,419.



## How to subtract

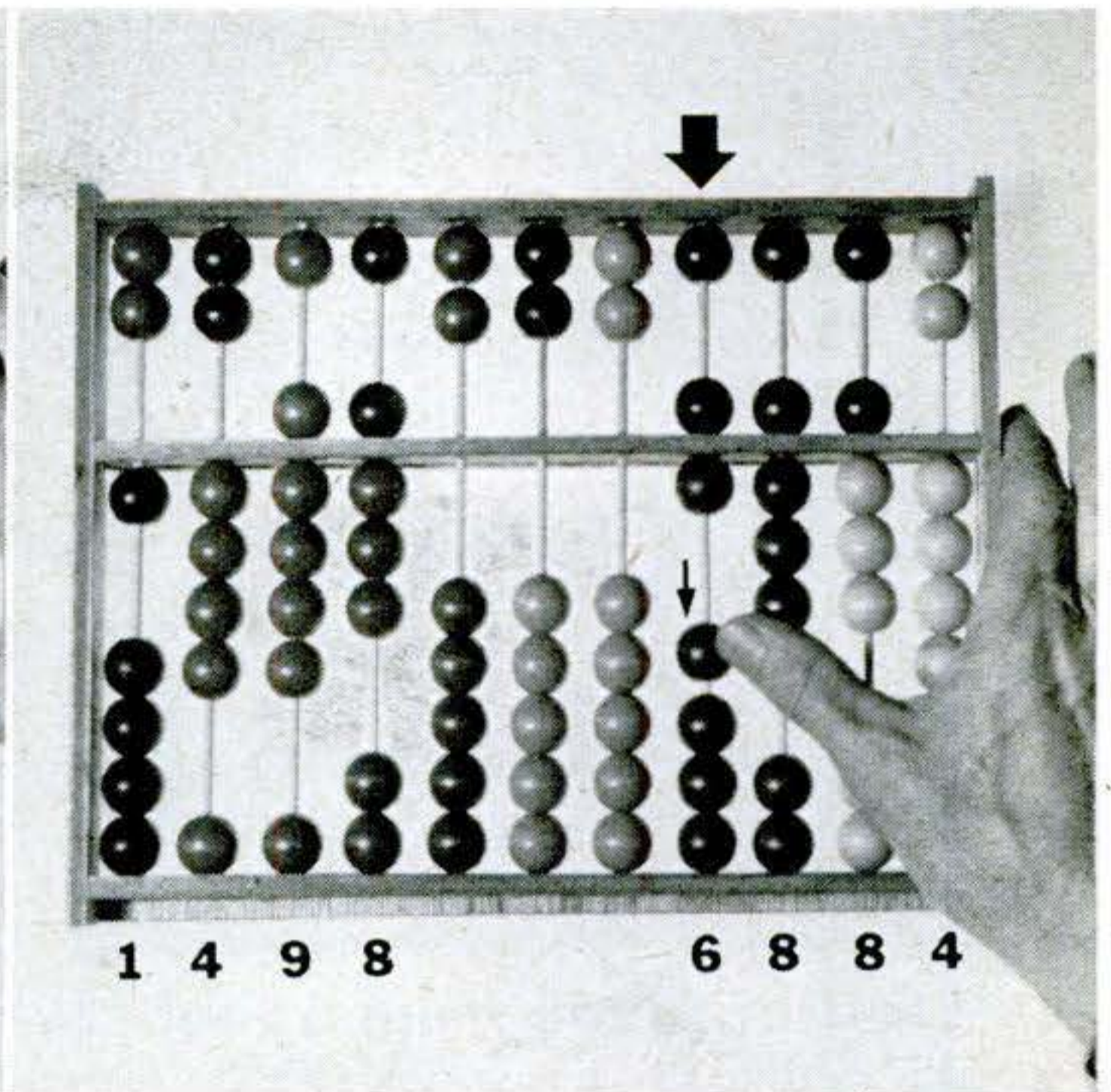
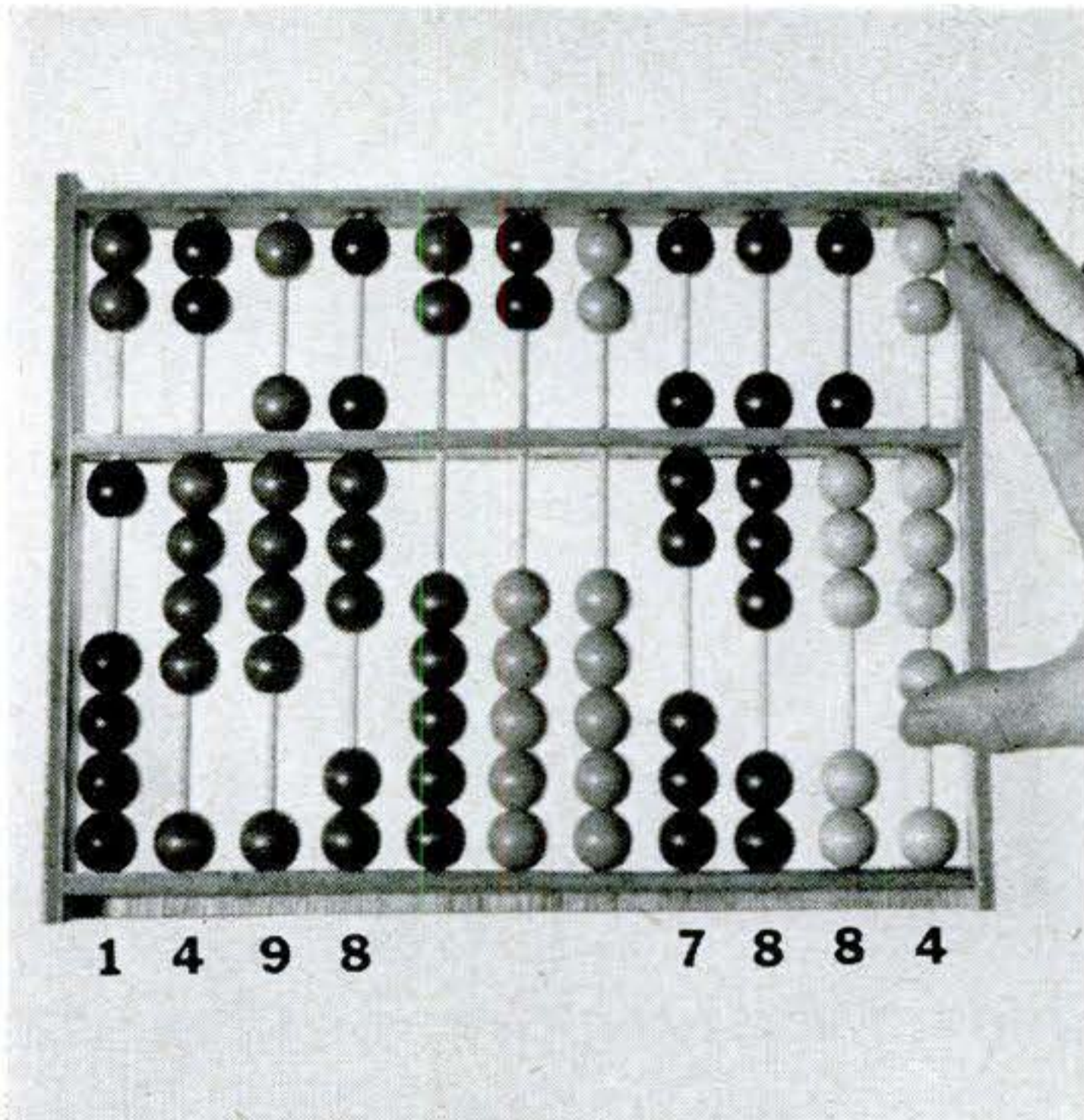

**1 THE PROBLEM:** Subtract 1,498 from 7,884. Represent the 7,884 along the crossbar at the right-hand side of the abacus. Place the 1,498 at the left-hand side, just to remember it. As in addition, each column is worth 10 times the column to its immediate right—units, tens, hundreds, thousands and so on. Good fingering practice is to move lower beads with your thumb, upper beads with index or middle finger.

**2 START SUBTRACTING** from the left, as in addition. Take 1, the first digit in the number 1,498, away from 7, the first digit in the number 7,884. Do this by moving down one lower bead in the fourth column from the right, leaving 6. As you subtract each digit, you can remove the corresponding one from the left-hand side of the abacus as a reminder to show you just how far you have progressed.

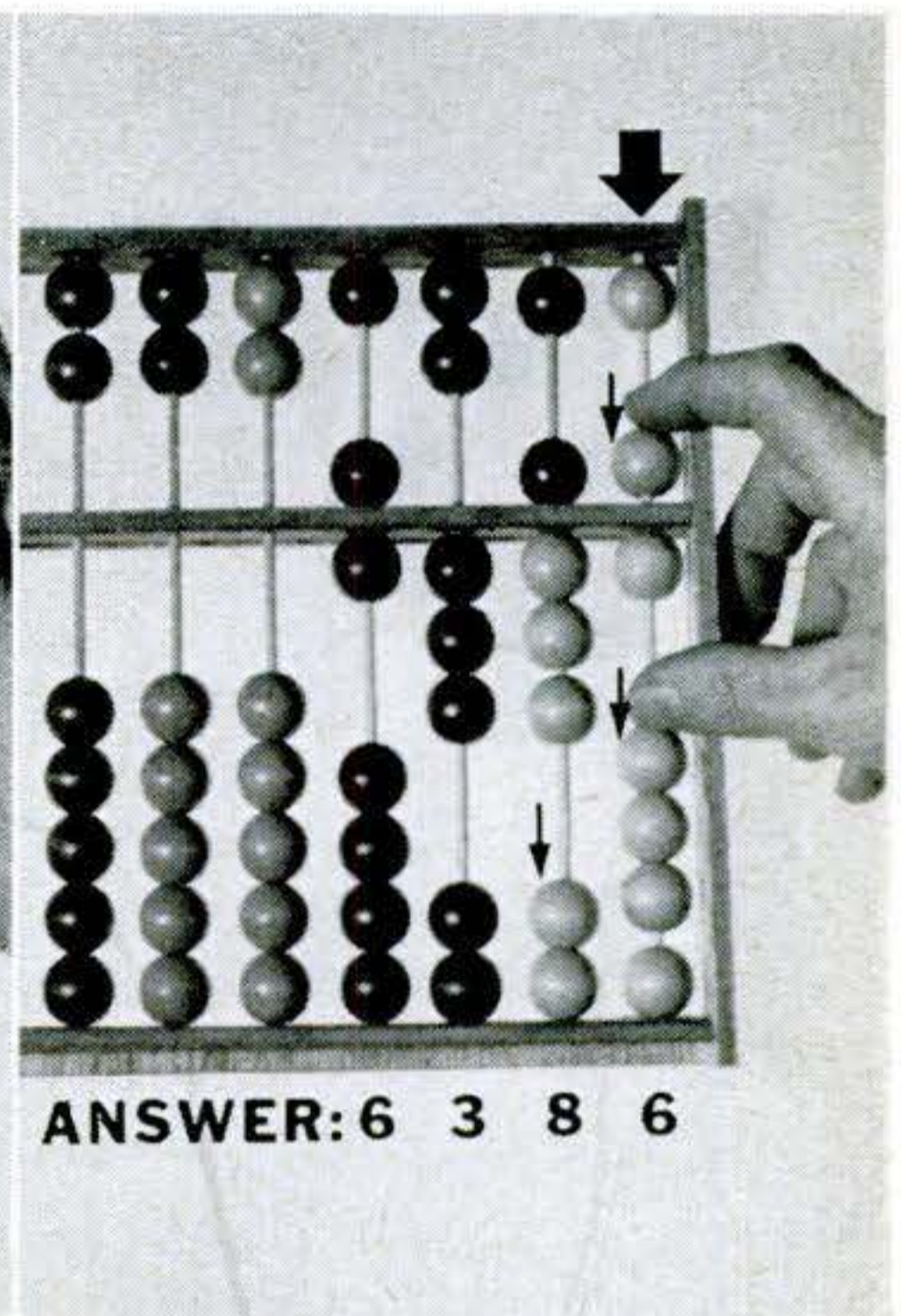
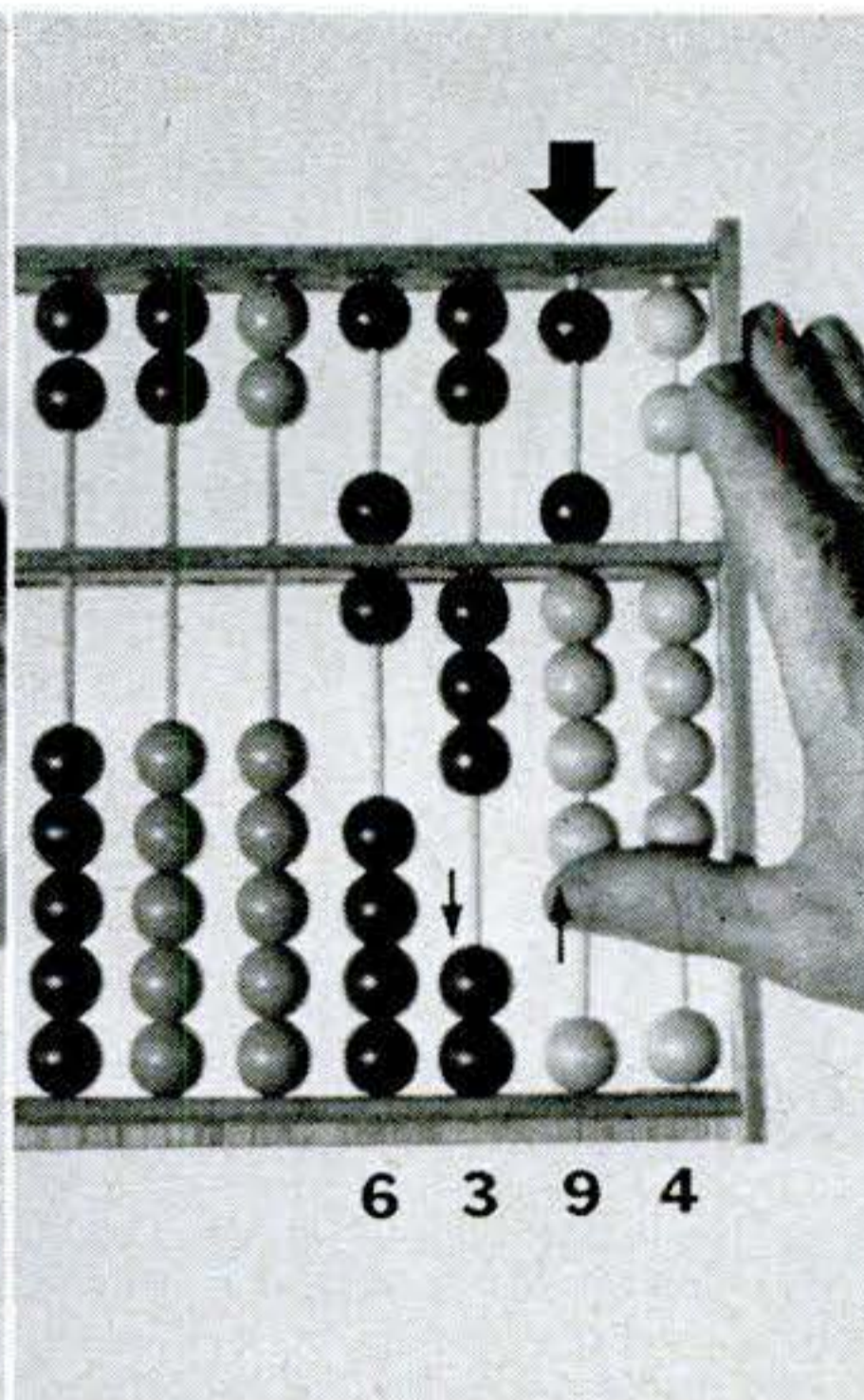
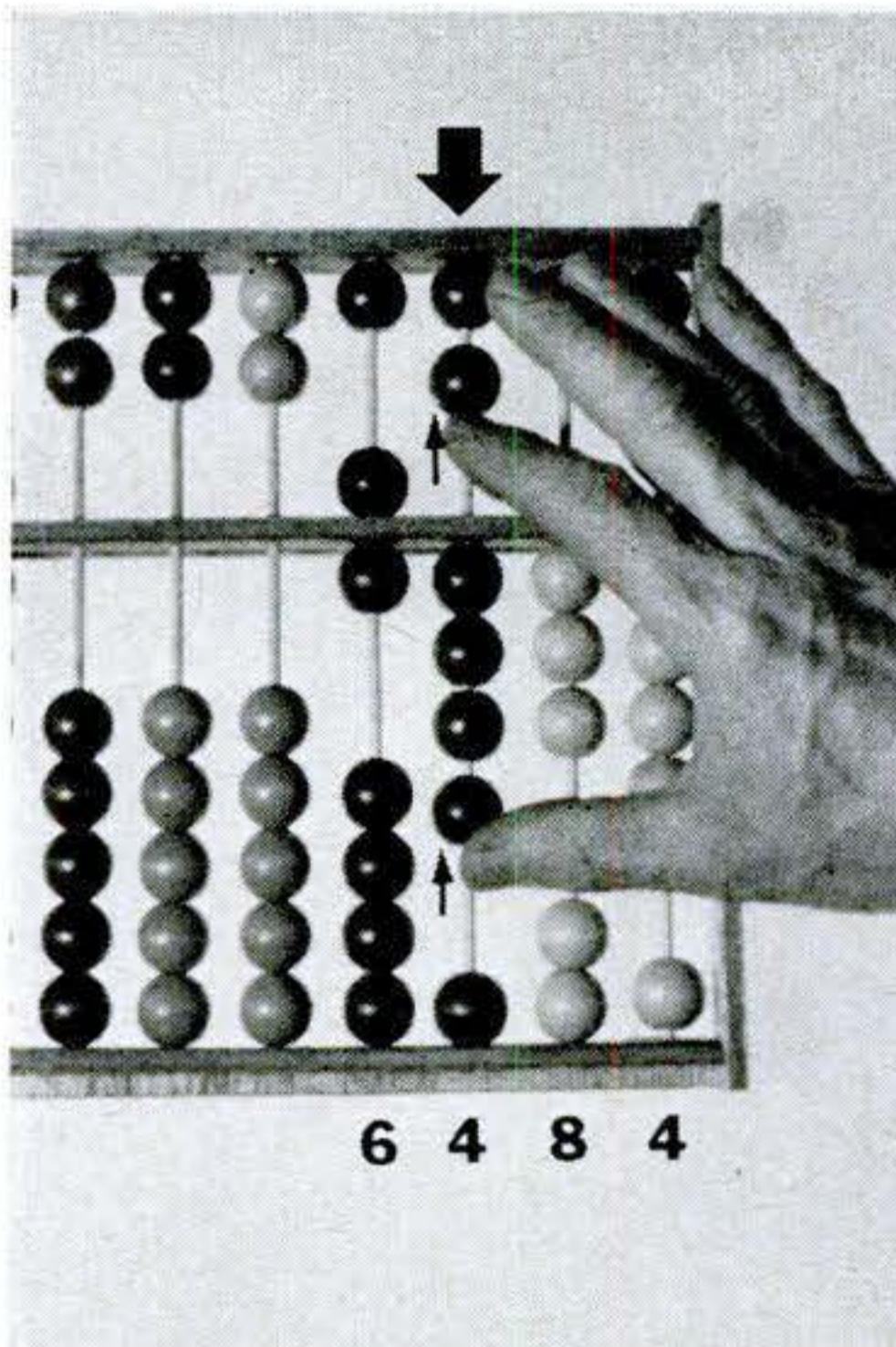

**3 IN THE NEXT COLUMN** to the right, take 4 away from 8 by canceling (moving up) the upper bead (which is worth 5), and then adding one lower bead (subtracting 4 is the same as subtracting 5 and adding 1). The upper bead is now removed from the crossbar, and the new number reads 6,484.

**4 THE NEXT STEP** is to subtract 9 from 8 in the second column from the right. Since you don't have enough beads to subtract from, "borrow" 10 from the third column by moving down one lower bead. Then add one lower bead to the second column to make the 9.

**5 NOW SUBTRACT** the final 8 from the 4 in the right-hand column. Again borrow 10 from the column to the left, subtracting one lower bead making it 8; then add to the right-hand column to make 6. To add the 2, add one upper bead and subtract three lower beads, giving the answer—6,386.





### Paint Roller Made from Spool

A SMALL thread spool with flanges removed and the finger of an old wool glove form this tiny roller for painting wood edges or other small areas. The axle is a  $\frac{1}{4}$ " dowel inserted into a  $\frac{1}{2}$ "-dowel handle. Taping the axle's end keeps the spool on. Cut the pan from the side of a gallon can.

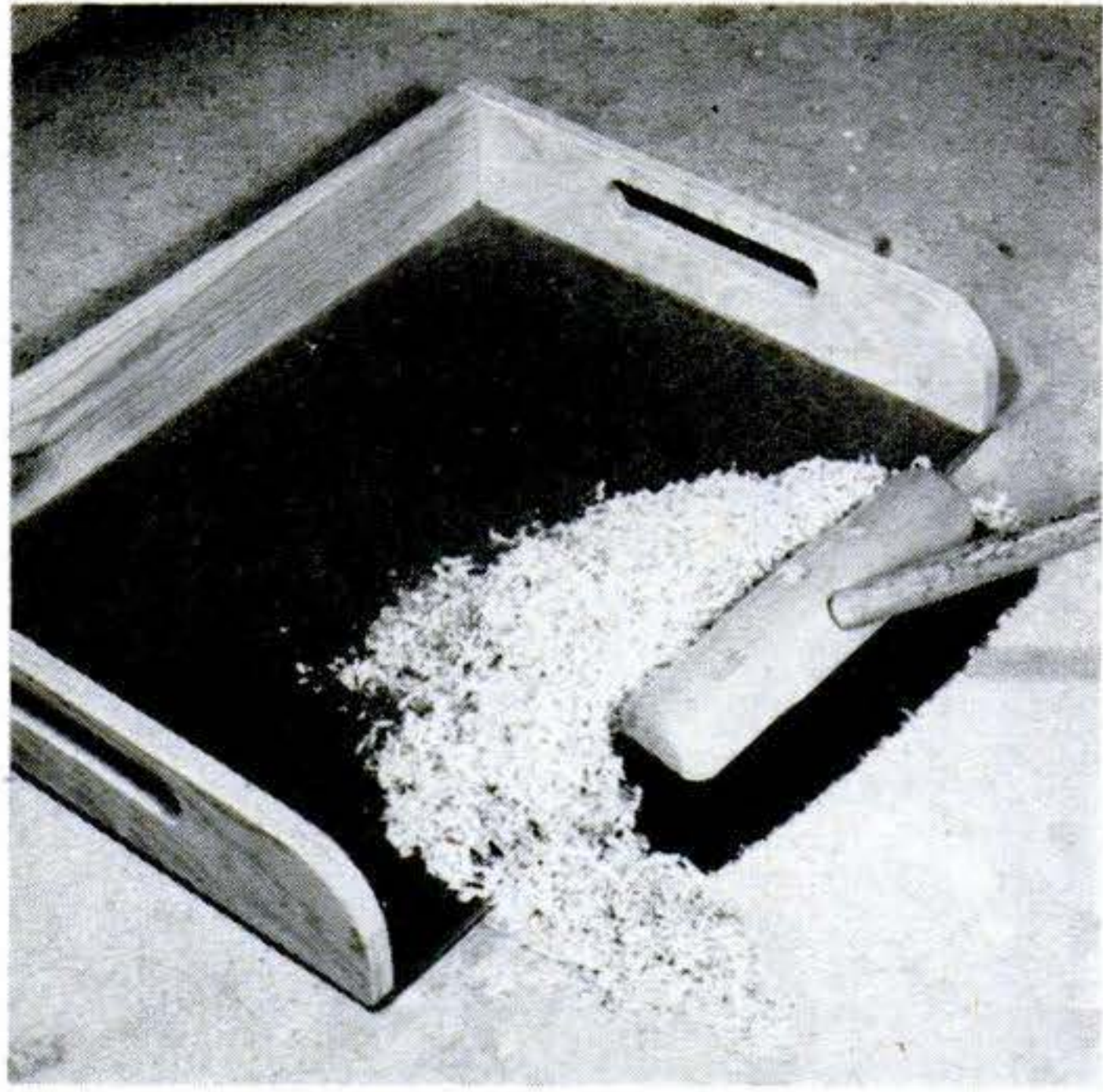

### Jumbo Dustpan Speeds Cleanup

A KING-SIZE dustpan made of scraps helps you clean up wood chips and sawdust in a hurry. Use one-by-fours for the sides and hardboard for the 18"-by-24" bottom. Bevel the front edge of the hardboard and put rubber bumpers on the bottom at the rear of the dustpan to make it tilt forward.

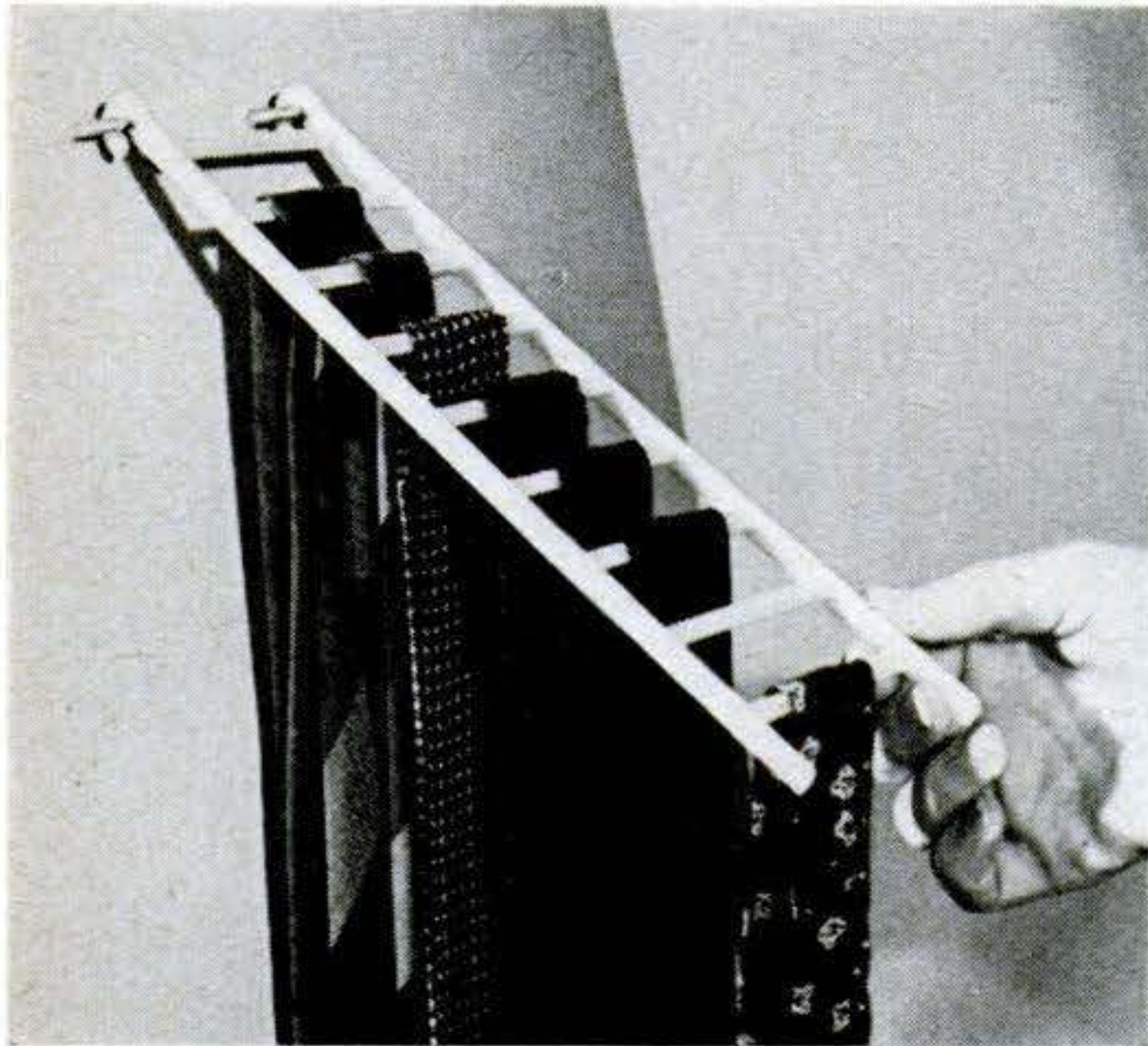

### Bird Ladder Becomes Tie Rack

THIS plastic ladder isn't for the birds—it holds your ties. You can get one at a dime store. Hook the ladder into two screw eyes.—*Frank A. Javor, North Bergen, N. J.*

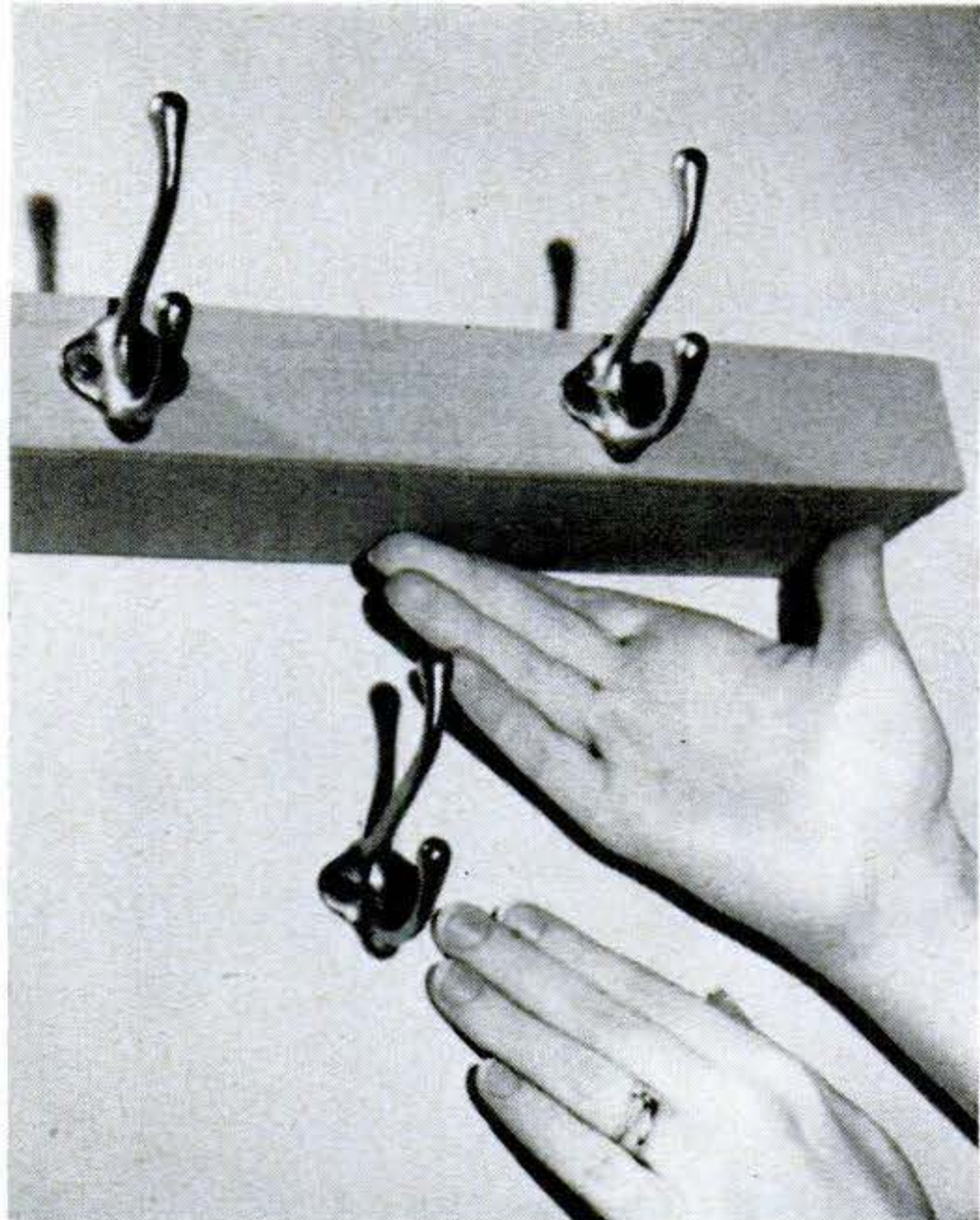

### Second Tier Gives Extra Hooks

You can double the number of coat hooks in a given wall space by screwing a second row of hooks, on a two-by-four, to the wall. Secure the two-by-four with angle brackets. The added four inches gives ample clearance.

### Old Foam Rubber Pads Chairs

A SUPPLY of foam rubber for padding furniture can be removed from the seats of junked autos. One car yields enough suitable material to pad about six chair seats.—*Bob Johnson, Lakewood, N. J.*



# THE CONTINENTAL MARK II



Continental Division • Ford Motor Company

America's Newest and Most Distinctive  
Motor Car—Equipped with the World's  
Newest and Most Advanced  
Spark Plugs!

*Turbo-Action*

## CHAMPIONS

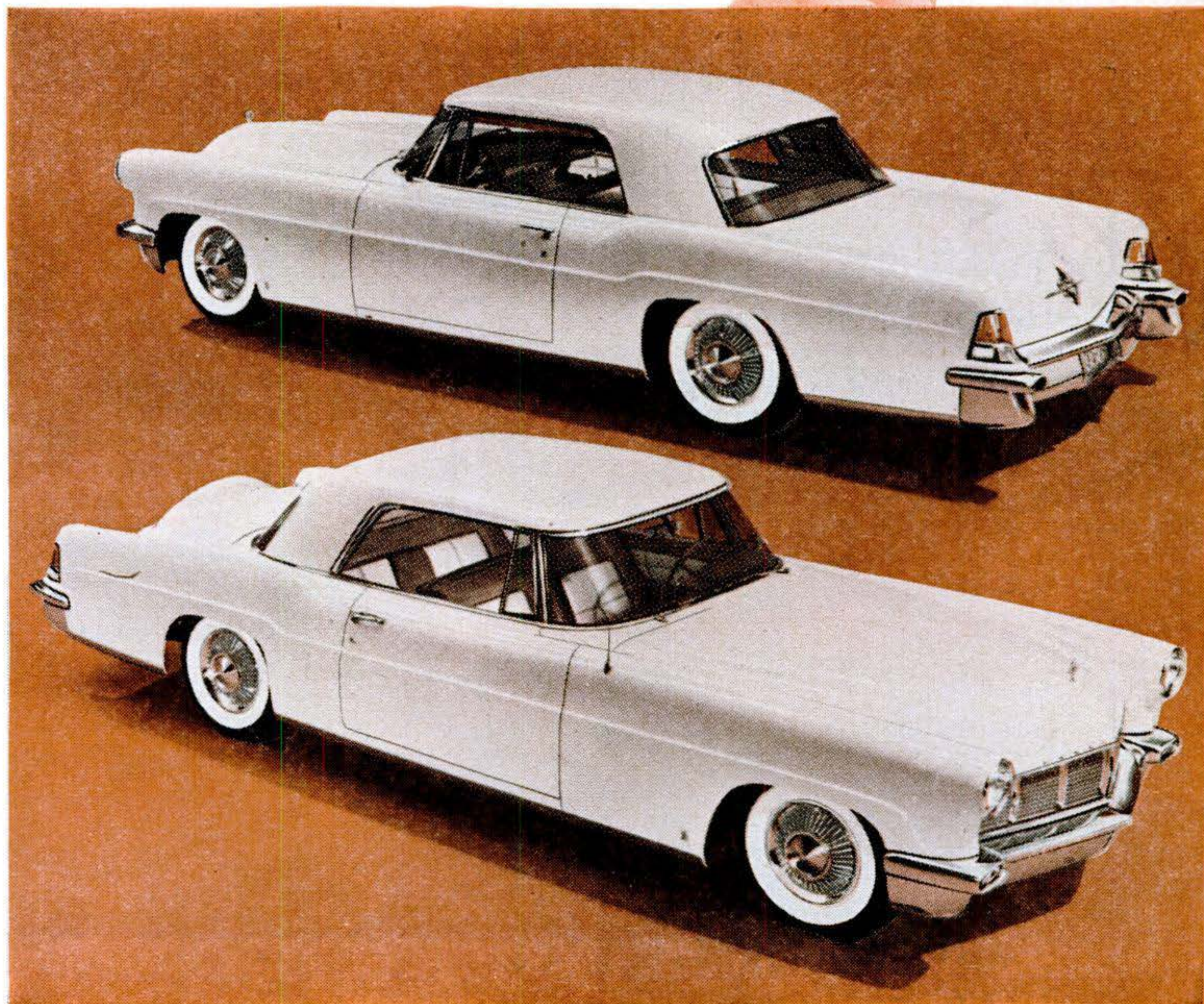



## NEW DO-IT-YOURSELF KITS

↙ **Develop your own negatives . . .**

↙ **Print your own snapshots . . .**



## **. . . and do it the easy way with a Kodak Photo-Hobby Outfit**

It's a thrill to watch a blank sheet of paper change into a familiar snapshot scene right before your eyes. And with a Kodak Photo-Hobby Outfit that thrill can be *yours*.

If you're a beginner—you'll like the simple, compact, "no-fuss" versatility of the new do-it-yourself Photo-Hobby Outfits. With Velite Printing Paper, for instance, you don't even turn off the room lights in order to print sparkling snapshots. Just subdue the brightest lights, add water to three chemicals, and start printing. To develop

negatives you darken a room long enough to place a roll of exposed film in the developing tank, then switch on the lights. The chemicals do the rest.

If you're an experienced amateur—a Photo-Hobby Outfit can be a handy time-saver for making your "proofs." As for the extra pictures other members of the family want, here's a thought: With a Photo-Hobby Outfit, they can print their own snapshots and photo-greeting cards. Best of all, they'll enjoy doing it!

Now—read the details below.

### **New Kodak De Luxe Photo-Hobby Outfit**

**\$16.95**

**Similar Outfit with Printing  
Frame instead of Photo-  
Hobby Printer**

**\$9.95**

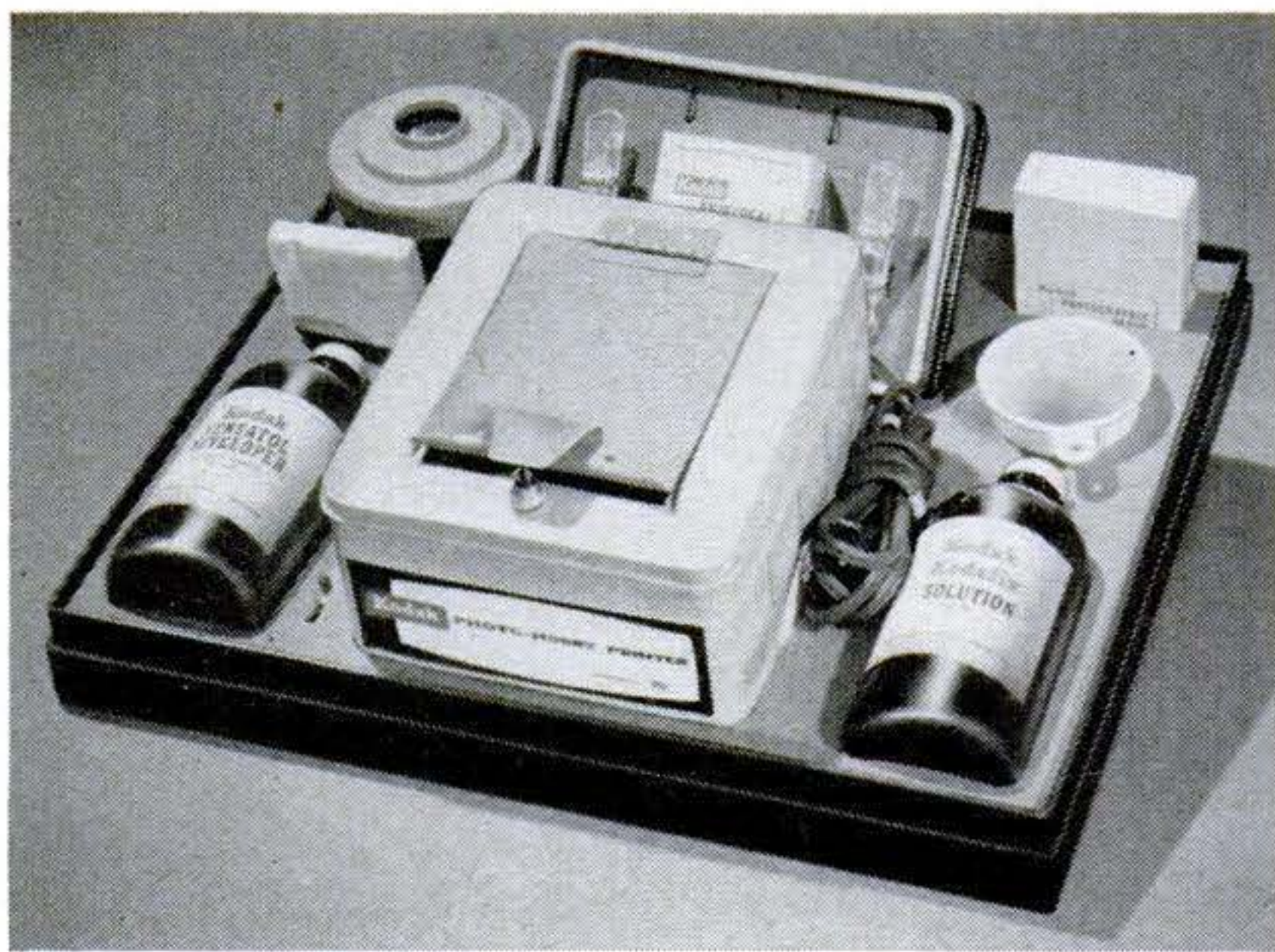

Here's what you get in this outfit—1. A Kodak Photo-Hobby Printer, Model A, with a built-in lamp socket (takes a 60-watt lamp for Velite Paper, or 15-watt lamps for other Kodak contact-printing papers); a hinged platen, red safety light, switch for controlling exposure time. 2. Kodacraft Printing Mask Set with openings to fit all popular-sized negatives. 3. Kodacraft Roll-Film Tank with two aprons for 127 and 620-120 film

sizes. 4. 16 ozs. liquid Kodak Versatol Developer. 5. 16 ozs. Kodafix Solution. 6. Six 8-oz. packets of Kodak Universal Stop Bath. 7. 100-sheet package of 2½" x 3½" Kodak Velite Paper. 8. 4-oz. plastic measuring cup. 9. Three 5" x 7" Tenite Rocker Trays. 10. Kodak Glass Stirring Rod. 11. Kodak Darkroom Thermometer. 12. 2 Plastic Film Clips. 13. Blotter Book for drying prints. 14. Viscose Sponge. Also, Simplified Instruction Card.



# New Photo-Hobby Outfits feature "Do-It-Yourself" Instruction Cards

Packed with each of the two outfits described on the previous page is a big 11 x 14-inch card. On one side are simple 1-2-3 instructions for *developing* negatives . . . the other side for *printing*. You can't miss. It's the easiest-to-follow guide you've ever seen.

**P.S. for Christmas**—Either one of the new Kodak Outfits makes a wonderful gift for snapshot fans of any age. Want one for yourself? Drop a hint in the right place—now! Want one for someone else? You'll be making someone very happy!



## When you need more Photo-Hobby Outfit materials . . .

Next time you visit your photo dealer, ask him to show you the Kodak chemicals that have been prepared for do-it-yourself hobbyists. Some of them come in ready-mixed liquid form. Others are in handy foil packets—you simply mix the powder with water and it's ready for use. Here are several chemicals particularly suitable for home use. (The first two are Photo-Hobby Outfit liquid chemicals you'll want to replace, along with Velite Printing Paper, before your original supply runs out.)

**Kodak Versatol Developer**—An economical "all-purpose" developer. Dilute 1:7 (1 part developer to 7 parts water) for developing negatives in a tank. For clear, sparkling prints, dilute 1:3. 8-oz. bottle, \$.35. Quart, \$1.



**Kodafix Solution**—A concentrated hardening-fixing bath which makes the images permanent on film and paper. Requires only the addition of water to prepare it for use. Quart bottle (to make 1 gallon), \$1.



**Kodak Microdol Liquid Developer**—For even finer-grain negatives (hence finer-grained prints) than an all-purpose developer can provide, use Microdol for developing your *negatives*, and Versatol (see above) for developing your snapshot *prints*. Microdol comes ready for use without dilution. 1 quart, \$1.



**Kodak Rapid Selenium Toner**—Usable at various dilutions to give your snapshot images permanent cold-brown tones. 8-oz. bottle, \$1.05.



**Kodak Brown Toner**—Dilutes 1:32 to give snapshot images warm-brown tones. 8-oz. bottle, \$.90.



**Kodak Photo-Flo Solution**—Highly concentrated wetting agent that lets water run off film and paper surfaces without leaving water marks and streaks. Note to 35mm users: As you may know, 35mm film differs from paper-backed roll film in that it has gelatin on one side and a plastic base on the reverse (instead of gelatin on both sides). Kodak Photo-Flo does a remarkable job in wetting *both* the plastic base and gelatin surface to let the water run off without leaving streaks or spots. No need to even sponge the film. 4-oz. bottle (to make 6 gallons), \$.45; 16-oz. bottle (to make 24 gallons), \$.90.



**Ask to see the handy foil packets of Kodak chemicals, too.**

*Prices are list, include Federal Tax where applicable, and are subject to change without notice.*

**Eastman Kodak Company**  
Rochester 4, N. Y.

**Kodak**  
TRADE-MARK



## Kids' Showcase Is a Hatbox

KIDS will get a big kick out of having a display case for the sea shells they salvage. Mom will be glad to supply one of her plastic hatboxes; it also prevents torn pockets and keeps the shells from being scattered about.—*H. Leeper, Canton, Ohio.*

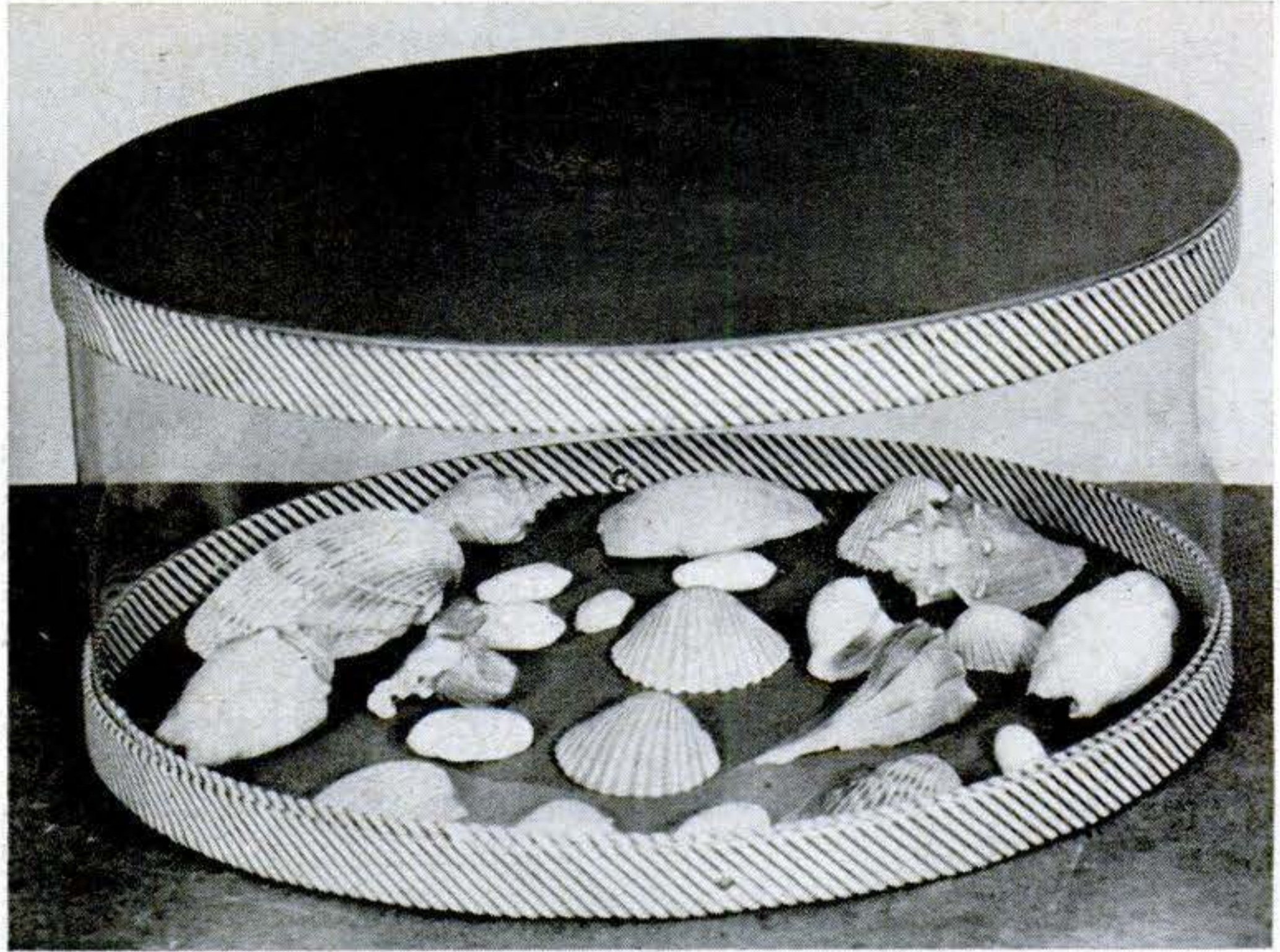

## Tire Puts Bounce in Horseshoes

PITCHING horseshoes can be made safer for kids by providing rubber ones hacksawed in 1" slices from an old tire.—*John Krill, North Lima, Ohio.*

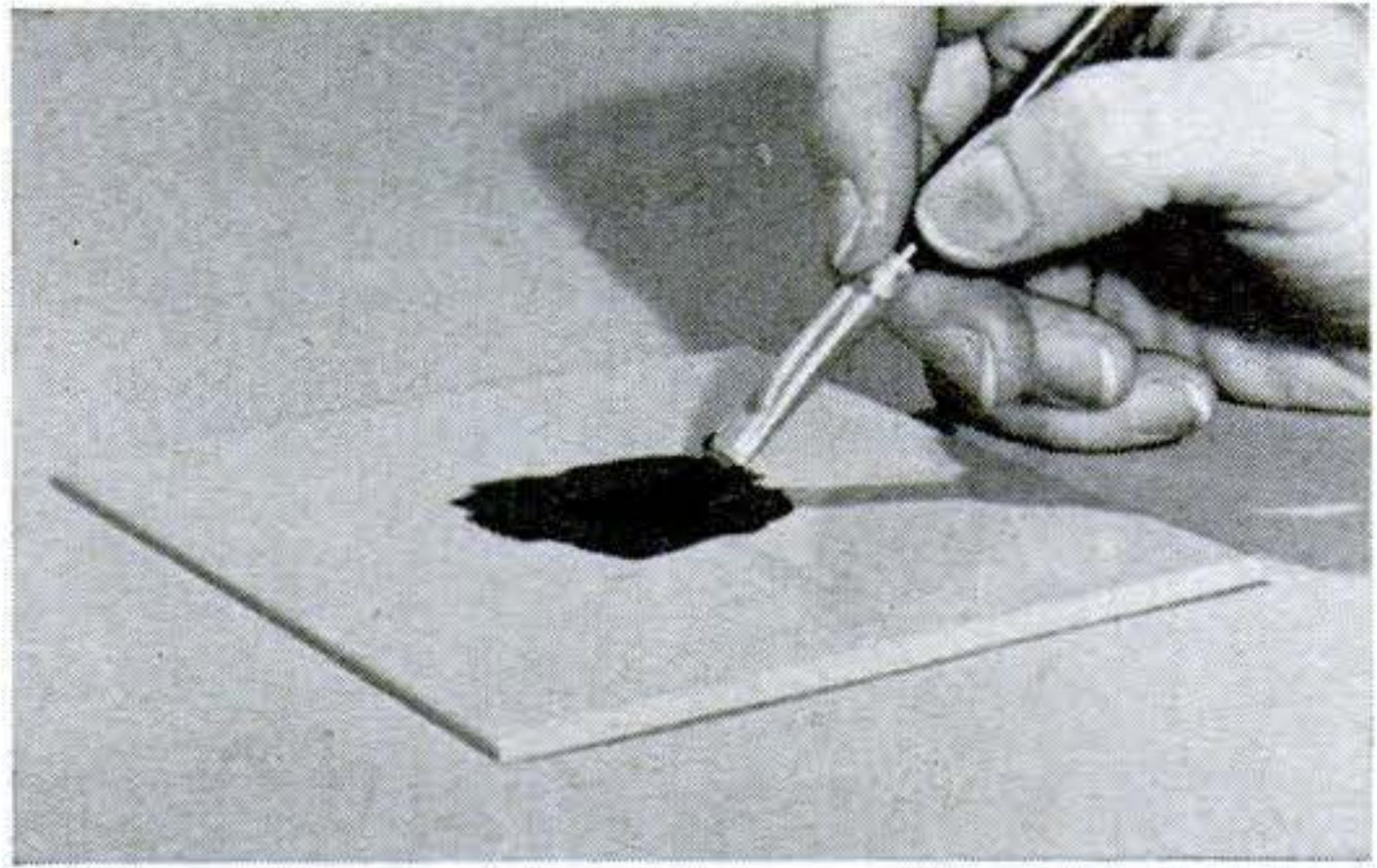

## Tile Serves as Palette

DON'T throw away those extra pieces of plastic tile. They make hard-to-beat palettes for the amateur artist. Use them to mix oil or water colors next time you play painter.

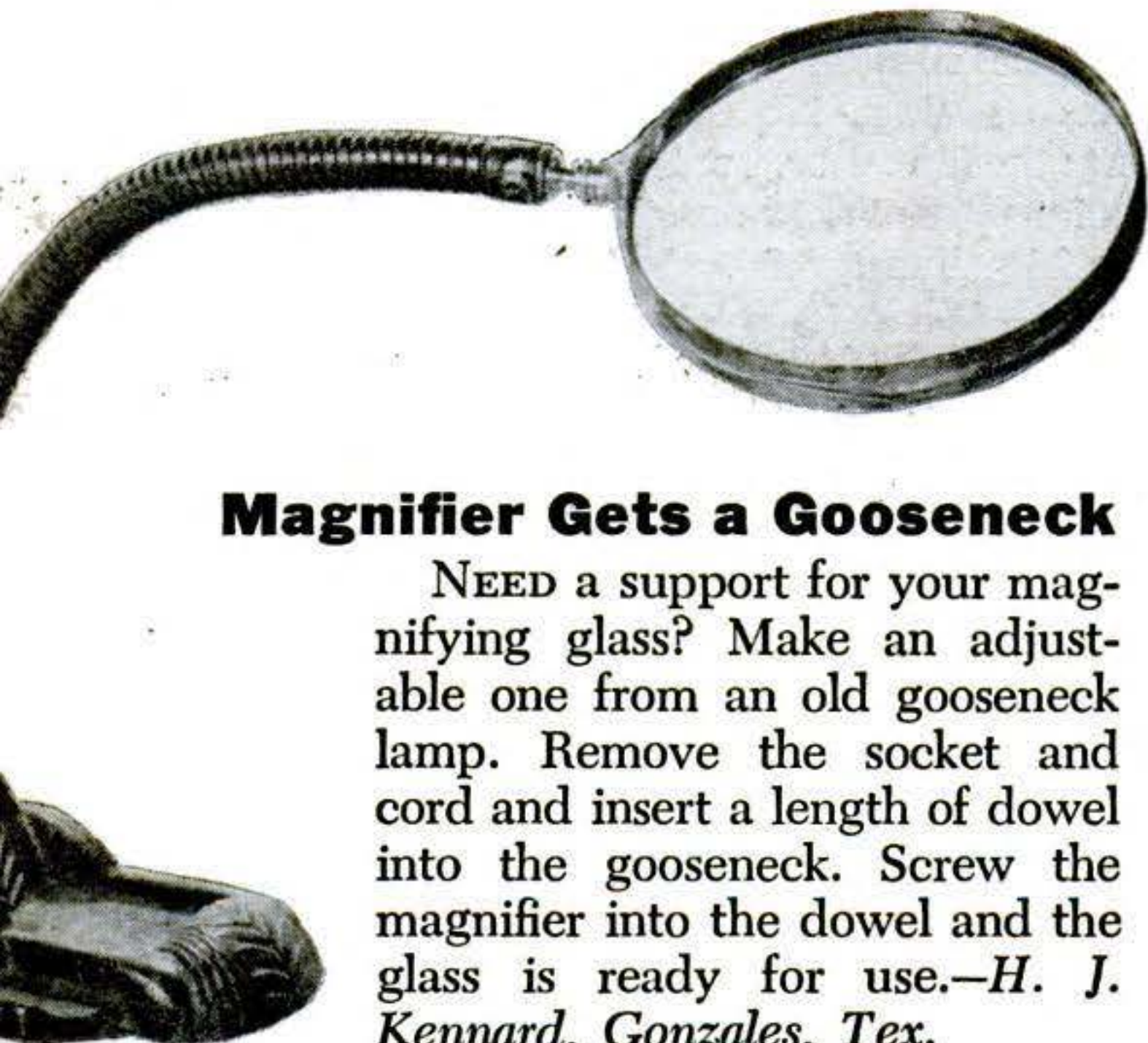

## Magnifier Gets a Gooseneck

NEED a support for your magnifying glass? Make an adjustable one from an old gooseneck lamp. Remove the socket and cord and insert a length of dowel into the gooseneck. Screw the magnifier into the dowel and the glass is ready for use.—*H. J. Kennard, Gonzales, Tex.*

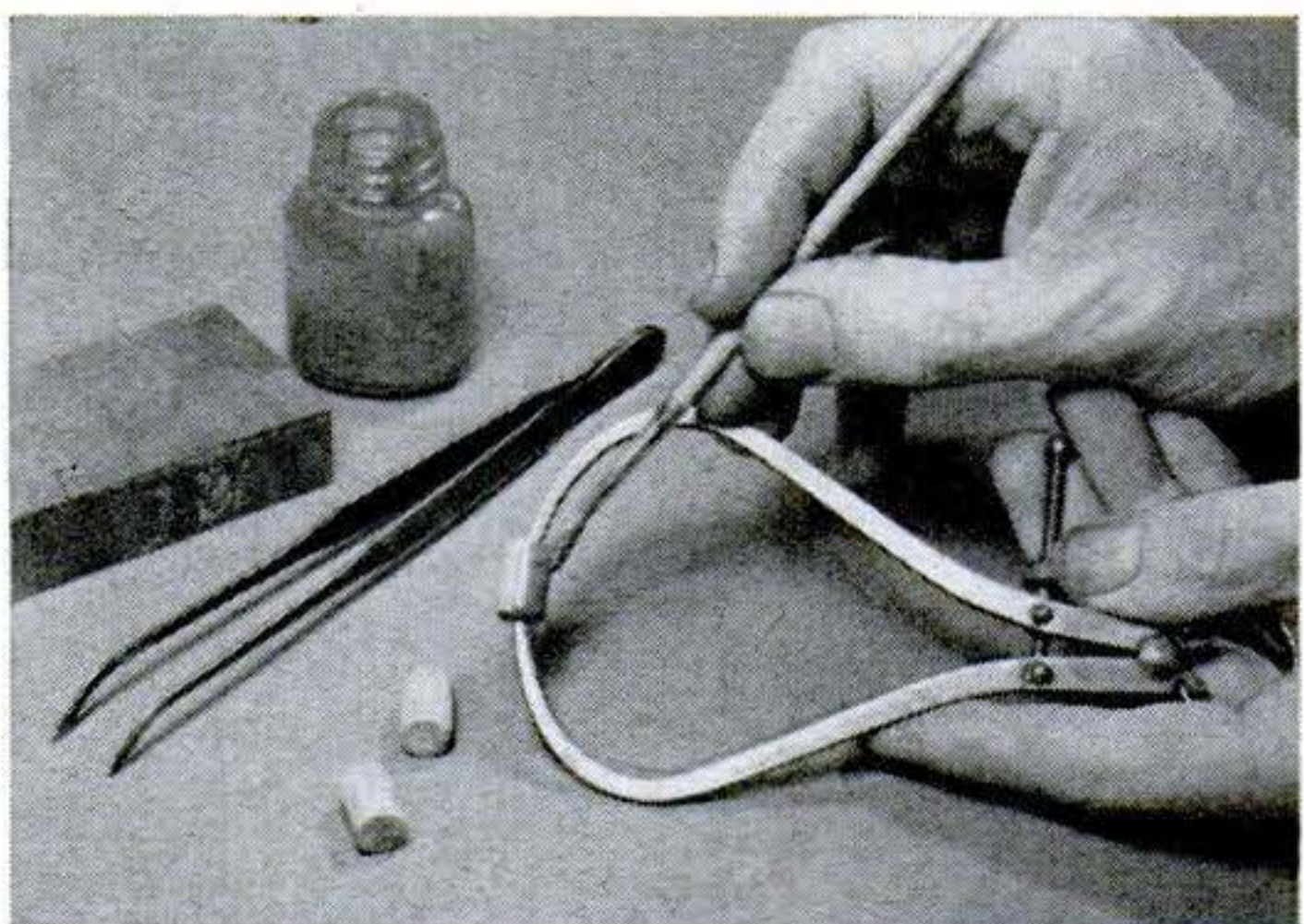

## Calipers Hold Model Parts

PAINING model parts is easy if you hold them with calipers. Then use tweezers to lean the drying pieces against a block.—*Walter E. Burton, Akron, Ohio.*



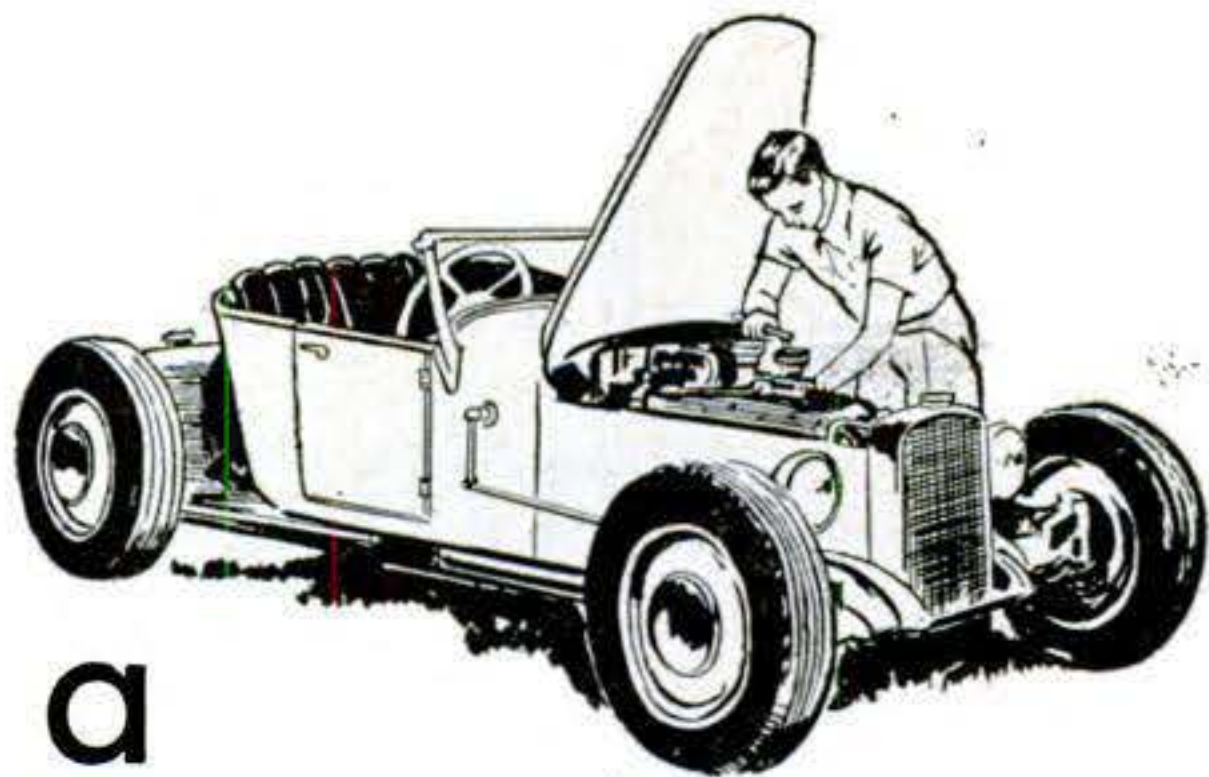

got a  
**MECHANICAL SKILL?**

**You'll go places  
 FASTER in the  
 U. S. AIR FORCE!**

**HERE'S WHY:** Men with mechanical skills find that they can get ahead in the U. S. Air Force. As an Airman, you'll have the chance to develop your technical ability and learn a skill that will pay well – and win you extra stripes. Such interesting

career fields as Aircraft and Engine Maintenance, Rocket Propulsion and Intricate Equipment Maintenance are open to you, if you qualify.

Don't delay—visit your local Air Force Recruiter, or mail the coupon.

**SEND FOR YOUR FREE BOOKLET**



M-28-PS

**AIRMAN INFORMATION BRANCH**  
 Box 2202, Wright-Patterson AFB, Ohio

Please send me more information on my opportunities as an Airman in the U. S. Air Force.

Name \_\_\_\_\_

Address \_\_\_\_\_

City \_\_\_\_\_ Zone \_\_\_\_\_ State \_\_\_\_\_

**U. S.  
 AIR FORCE**



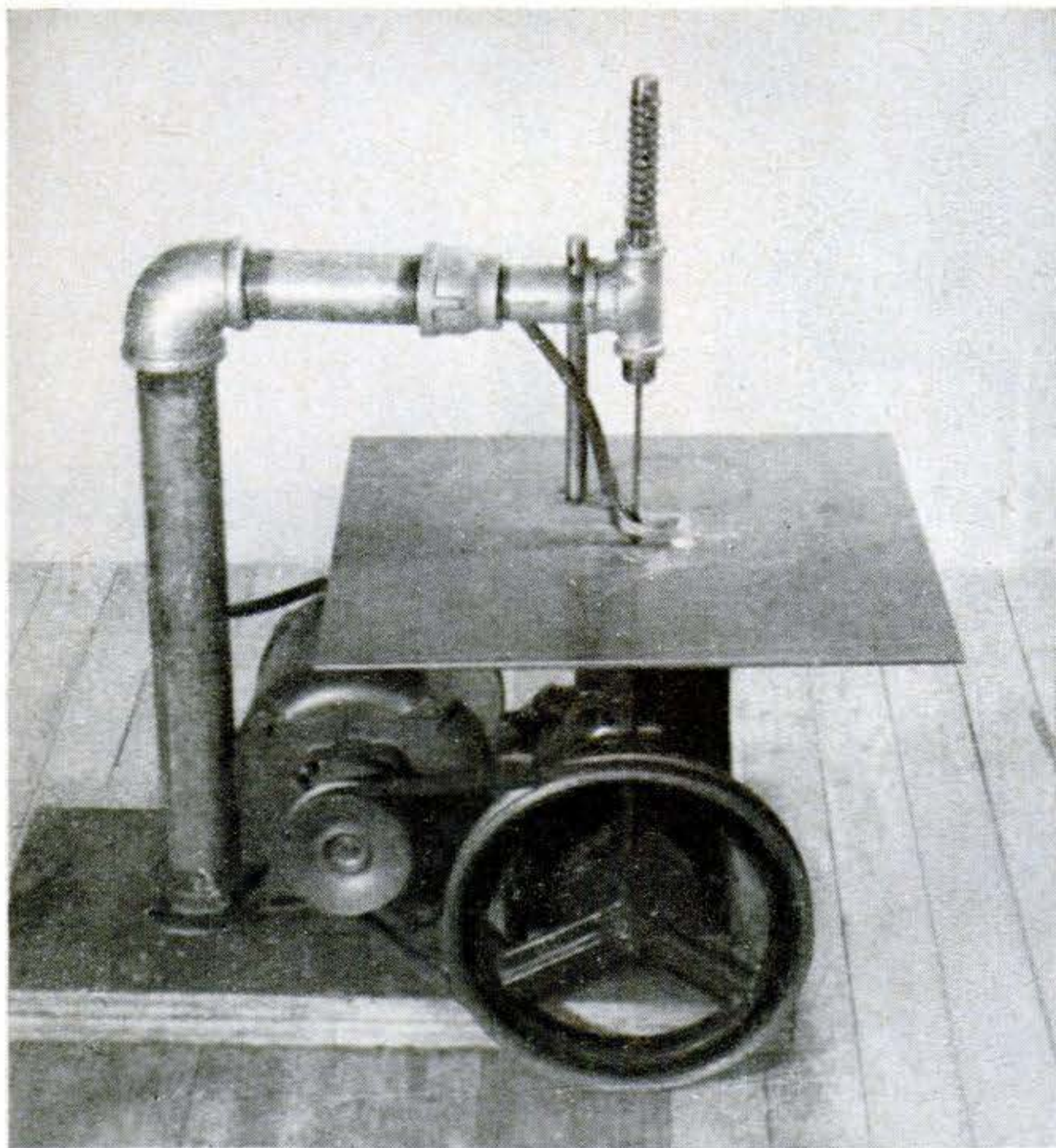

# How We Built A Jigsaw

By Julius Nauta  
and John Ferry

**B**Y BUILDING a jigsaw around a junked compressor, you save half the work. The up-and-down motion of the compressor's piston drives the saw blade, the cylinder casting supports the saw table, and air compressed on the piston's down stroke blows sawdust off the work.

You can buy an old compressor for a dollar or so. Clean it with solvent or degreaser and remove the cylinder head and valve plate. Drill and tap four 10-32 holes in the top of the piston for attaching the chuck. Make the chuck from a  $\frac{3}{4}$ " piece of  $1\frac{1}{4}$ " steel rod. Drill a  $\frac{1}{4}$ " hole in its center to hold blades or machine files and drill and tap four holes converging at the center hole for setscrews. Drill four clearance-holes for the mounting screws and fasten chuck to piston.

**For the table,** first drill a  $\frac{1}{2}$ " hole in the center of a 14"-square piece of  $\frac{1}{4}$ " aluminum. Then drill mounting holes to match the bolt holes in the top of the cylinder and fasten it in position with flathead machine screws to fit the threads. Use  $\frac{3}{8}$ " pipe nipples, 1" long, to raise the table clear of the chuck. Bolt the compressor to a 12"-by-20" base which is made of two thicknesses of  $\frac{3}{4}$ " plywood.

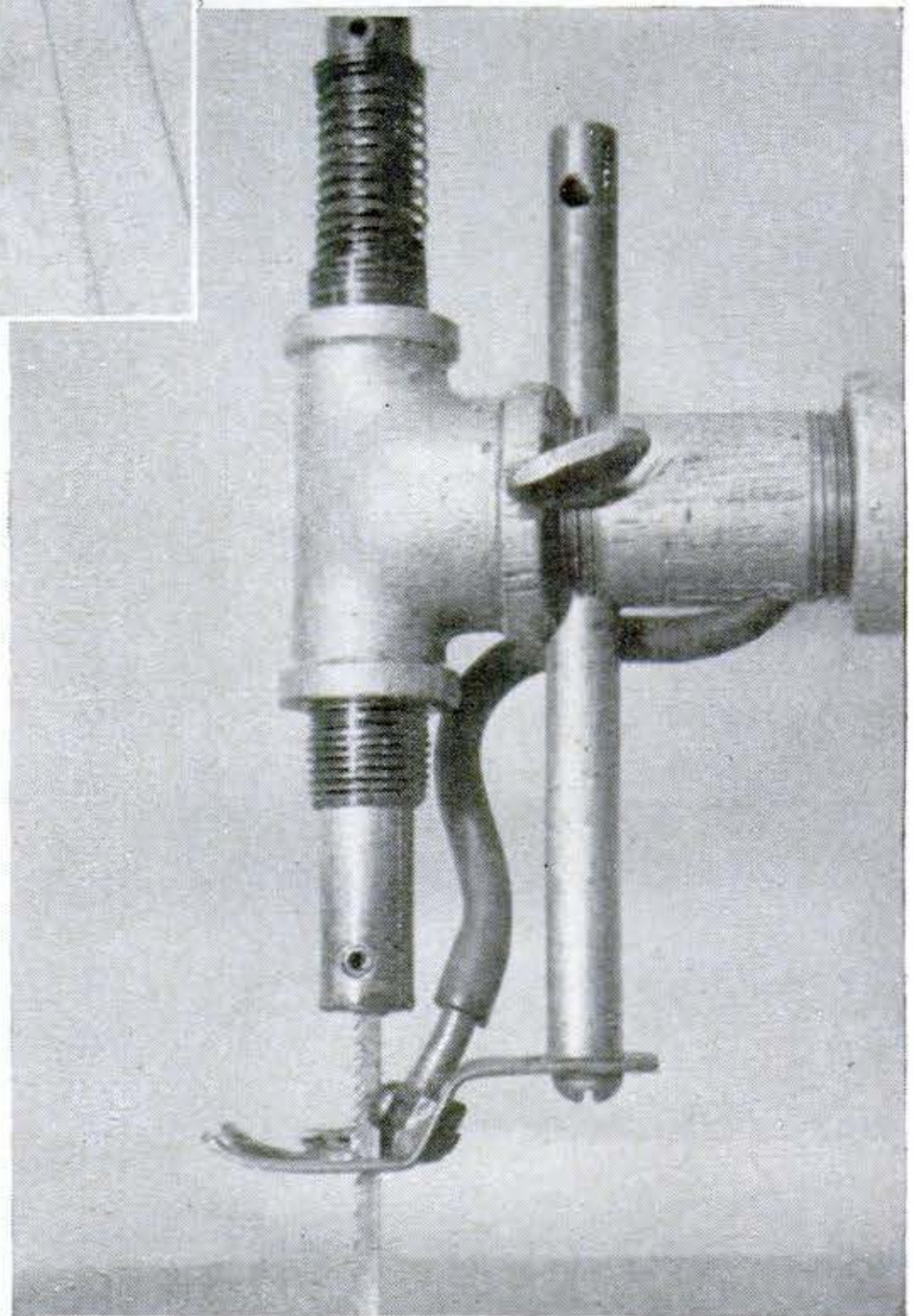

**OVERARM HEAD** is a pipe tee with a short nipple screwed to top and bottom threads. After assembling, these nipples are reamed  $\frac{5}{8}$ " to align their inside diameter. A round-head bolt is set in the crook of the hold-down foot so the slot can act as the blade guide.

The overarm is a plumber's nightmare, but it's sturdy. Assemble the components first, then position the pipe flange on the base so that the center of the T head is directly over the hole in the chuck. After

[Continued on page 244]



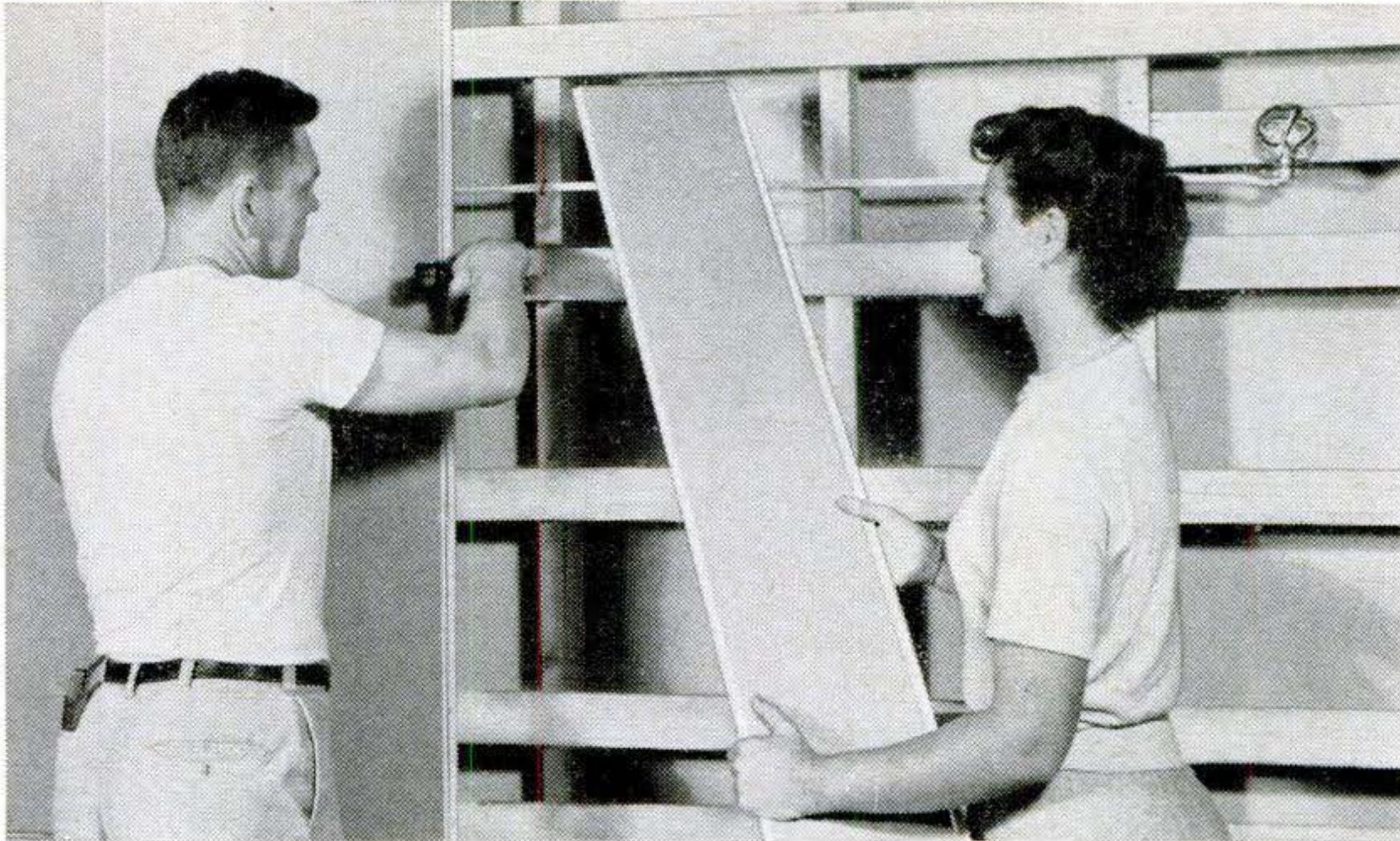

Lok-Bevel joint hides staples or nail heads, speeds installation, and provides neat, even joint lines.

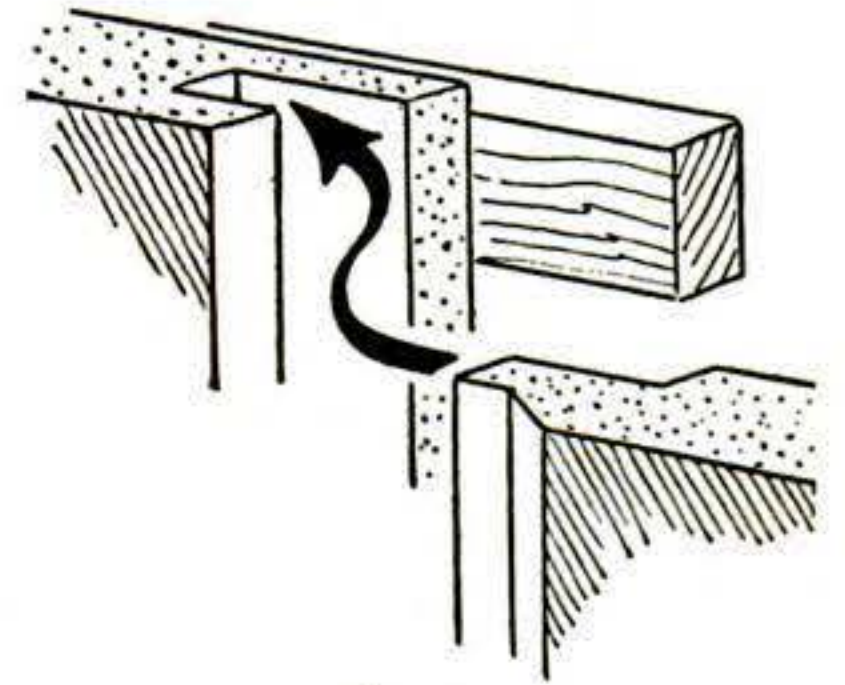

Easy-to-handle Temlok Plank goes up fast by stapling or nailing. Once pre-finished Temlok is installed the job is done—no painting or further finishing is necessary.

## How to Build a Basement Game Room with Temlok Tile and Plank

You can do the job yourself, easily and economically, by installing Armstrong Temlok® Tile on the ceiling and Armstrong Temlok Plank on the walls. These attractive interior finishes rapidly turn an unused basement into extra living space because they build, decorate, and insulate in one application.

Start by framing the foundation walls with 2" x 4" studs on 24" centers. Then apply 1" x 3" furring strips, one foot apart.

Next, nail or staple Temlok to the furring

strips. The exclusive Lok-Bevel® joint on both Temlok Tile and Plank has an extra wide nailing flange for quick, easy installation. For sturdy lower walls, use Armstrong Temwood® backed up with Temlok Wall-board.

Armstrong Temlok interior finishes are handsomely pre-finished. Temlok Tile is available in Snow White or Light Ivory; sizes, 12" x 12", 12" x 24", 16" x 16", 16" x 32". Temlok Plank comes in a random Suntan Blend; sizes, 8", 12", and 16" wide—8' long.

For complete details, see your local lumber dealer. He'll be glad to give you help with your remodeling plans.

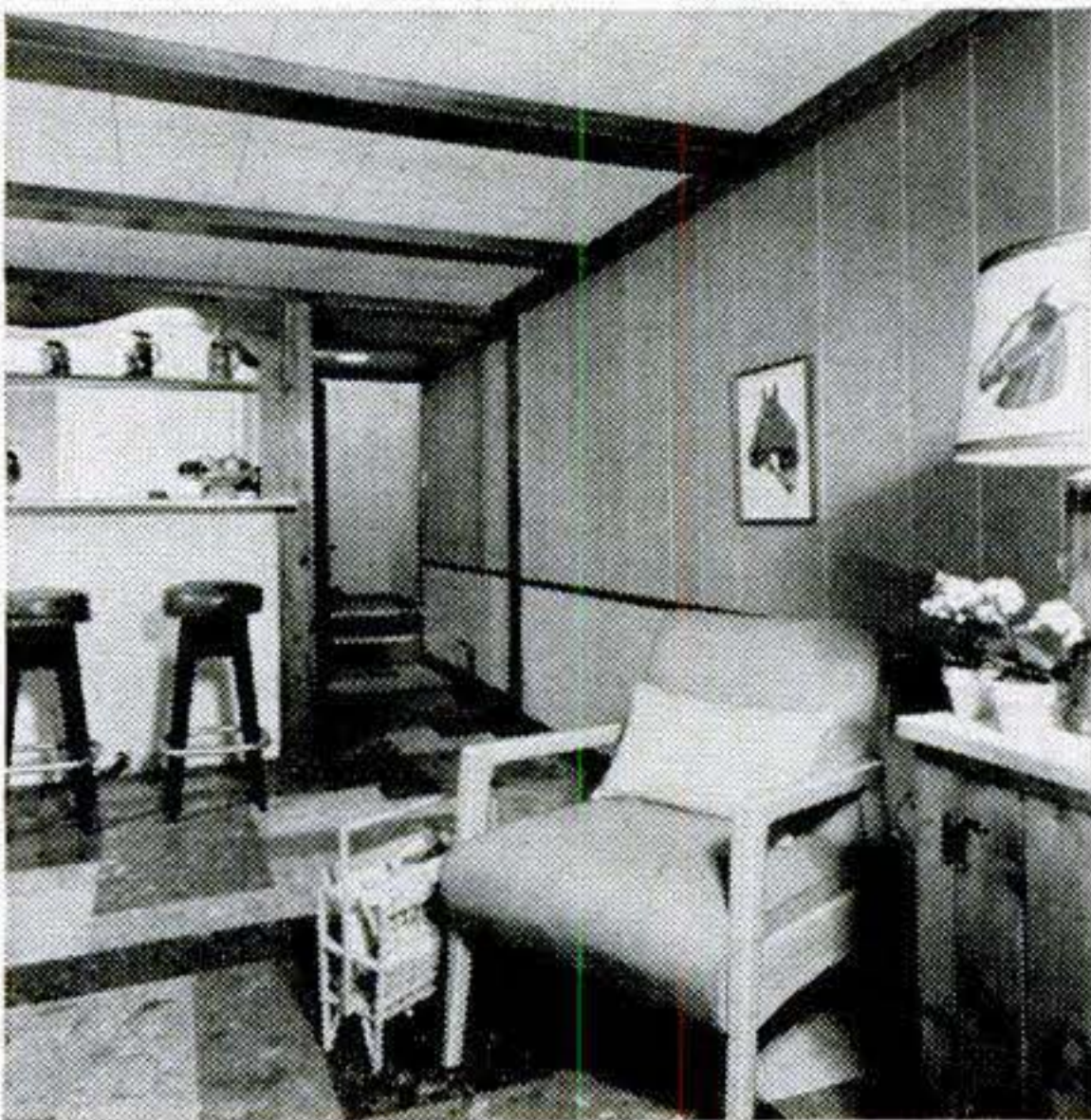

Basement game room is attractively finished with Temlok Tile and Plank. They offer a fast and economical way to turn wasted cellar space into comfortable living areas.

Send for free booklet, "New Ways to Remodel Your Home." Just write Armstrong Cork Company, 3511 Washington Avenue, Lancaster, Pennsylvania.

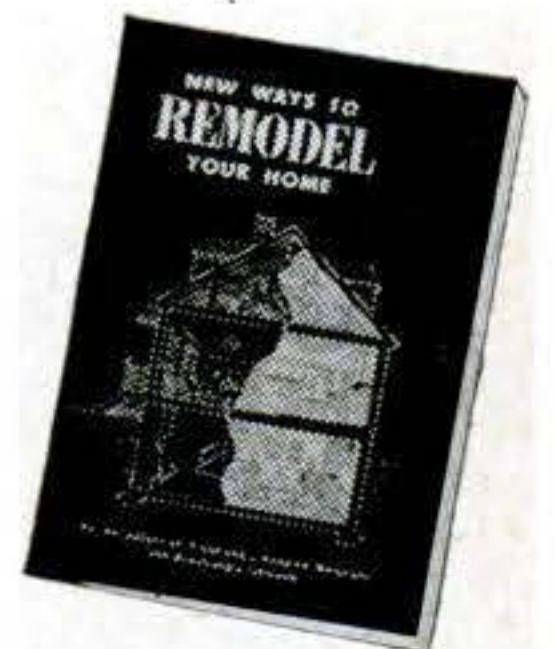

# Armstrong TEMLOK

Cushiontone® • M-67® Monowall® • Insulating Wool  
Hardboards • All-Purpose Cements

NOVEMBER 1955 243



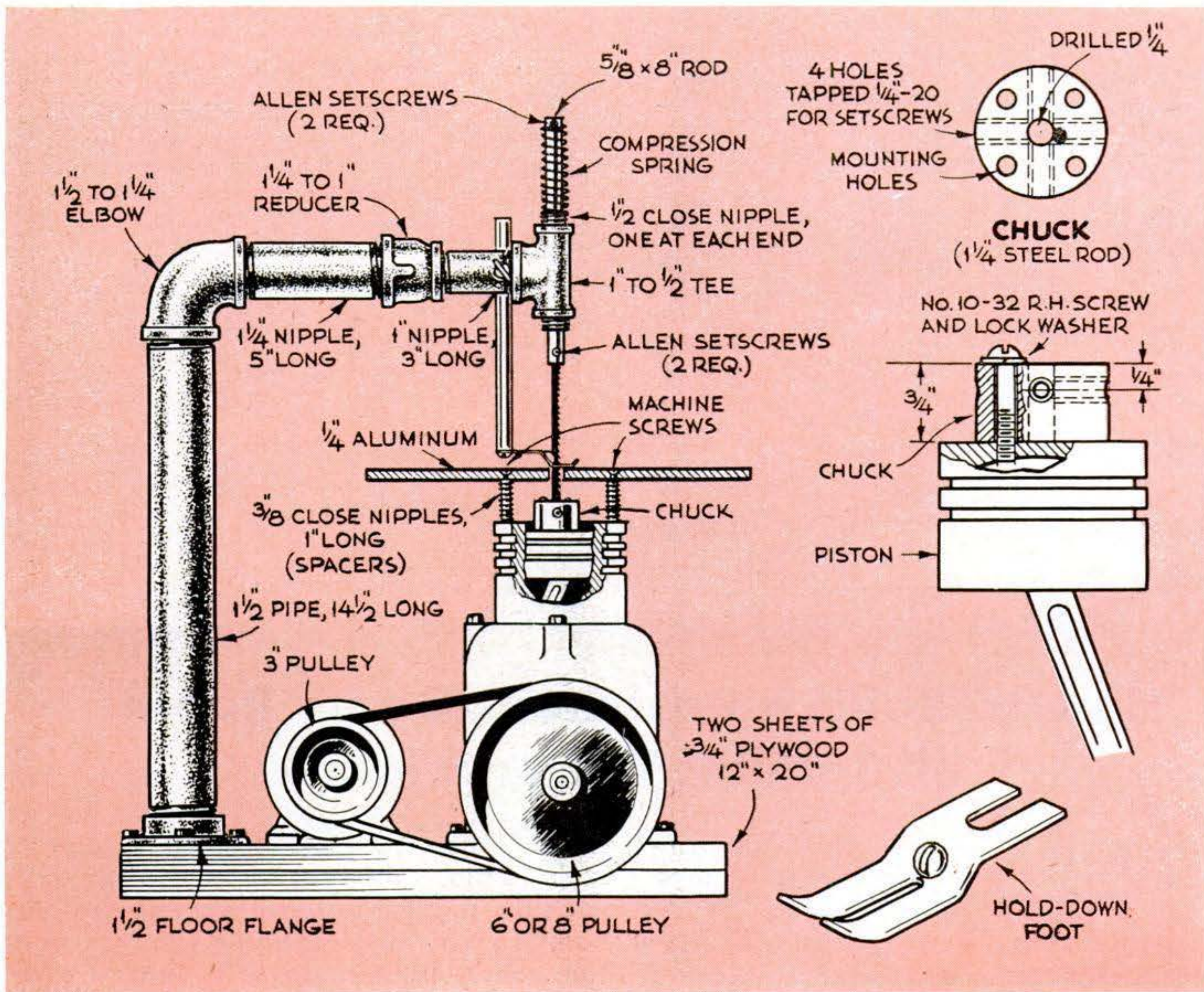

[Continued from page 242]

the flange is bolted down, the head can be aligned perfectly by screwing the pipe nipples on the overarm in or out.

Drill a  $\frac{1}{4}$ " hole in one end of an 8" length of  $\frac{5}{8}$ " steel rod to make the upper chuck. Drill and tap a transverse hole through the center hole for two setscrews to grip the top of the blade. Drill a similar hole at the top of the rod for two setscrews, about  $\frac{1}{2}$ " long. Turn them tight against each other so their ends project and rest on compression spring.

Drill a vertical  $\frac{1}{2}$ " hole through the front nipple, just behind the T, for the hold-down-foot rod. Drill a transverse hole for a thumbscrew. Make the hold-down-foot from  $\frac{1}{16}$ " flat steel and fasten a round-head bolt to it so that the slot in the bolt head serves as a blade guide.

**A blower to keep sawdust** off the cutting line is a nice refinement. Slip windshield-wiper hose over the compressor's intake shut-off valve or drill into the side

of the crankcase for an air fitting to take advantage of air forced into it on the piston's downstroke. Run the hose through holes drilled in the overarm and end it with a piece of partly flattened tubing aimed at the cutting area and soldered to the hold-down foot.

Bolt a 1/6- or 1/4-hp. 1,725-r.p.m. motor in place behind the compressor and mount a toggle switch on the base.

When cutting pieces within the capacity of the overarm, use the blade parallel with the arm and grip it with the setscrews on the sides of the chuck. Turn the blade to cut sideways, and grip it with the setscrews at the front and rear of the chuck when cutting long boards that would hit the overarm column.

Grip the shanks of machine files in the lower chuck. Raise the hold-down foot out of the way and lock it.

If the tool vibrates in use, cut one or two coils off the overarm spring or use a softer spring.





It's a Jig Saw!



It's a Router!



It's a Shaper!

# ROTO-JIG

## Amazing new 3-in-1 tool!

Now! See and try the revolutionary *quality* tool that puts dozens of new skills at your fingertips — Porter-Cable's sensational new Roto-Jig! *Three most-wanted tools in one!*

Use Roto-Jig as a portable router, for mortising, grooving, rabbeting. Use it as a rotary jig saw—cut intricate contours and freehand shapes. Use it as a shaper, for accurate moulding, beading, joining.

Roto-Jig gives you truly *professional* results every time—in fine cabinet work, furniture-making, home improvements, shop work of every kind. And you can own it *complete* at a big \$7.00 saving—if you act now!

**Special introductory offer!** Model 140 Roto-Jig, complete with Router Base, Jig Saw Base, and Shaper Table—\$61.95 value—now only **\$54.95!**

### Porter-Cable

*Quality Electric Tools*



SEE YOUR DEALER — OR MAIL COUPON TODAY!

PORTER-CABLE MACHINE CO.  
515A N. Salina St., Syracuse 8, N. Y.

Yes, send me a complete catalog sheet on the Model 140 Roto-Jig, and the name of my nearest dealer.

Name \_\_\_\_\_

Address \_\_\_\_\_

City \_\_\_\_\_ Zone \_\_\_\_\_ State \_\_\_\_\_



**Gus Obeys Orders**  
[Continued from page 168]

from the old Ford's transmission as it lay there. He got a scoop of sawdust to cover up the spot.

"Yeah," he said finally, "and neither did I. The trouble is, it wasn't a first-class job of repair. Barnstable's clutch was bad enough for any normal driver to want to have it rebuilt. But it wasn't bad enough for Barnstable to have wanted it rebuilt. I'm not so sure the clutch was causing his shift shudder and chatter after all."

"You don't tell me!" a beauteous expression of mirth came to Stan's face. "Is this good—the old coot paid for a job that, if he'd known it, he might have been happy to go without."

"Maybe," Gus said thoughtfully. "That's just where the shoe may pinch. What's going to happen if his car shudders and chatters when it shifts the same as it did before? Sounded like it would when he drove out."

"Crimminy!" Stan breathed. "Sure as shooting, the ring-tailed character will come back in here like a mad dog with a tin can on its tail."

Gus shrugged helplessly.

"I tried to tell him," he said grimly. "I wanted to check the car out—but he was so darned suspicious. Golly, here he comes now."

**B**ARNSTABLE drove into the Model Garage, brought the Ford to a shuddering halt, leaped out like a spindle-shanked rooster.

"You gypped me!" he yelled. "It's worse than it was."

"Not worse," Gus said placidly. "You got a new clutch—remember."

"I'll sue you," Barnstable threatened.

"What for?" Gus queried, leaning calmly against the bench and lighting his pipe. "You got what you insisted on having, didn't you?"

"That's right, Silas," Stan agreed.

Gus and Stan could see the awful truth now dawning on Barnstable's face—he had guessed wrong, forced Gus to follow his guess and, worse yet, put out money without curing his trouble.

"Do you mean to tell me," he began weakly, "that I . . . ?"

"No," Gus said, anticipating his words, "I don't. I shouldn't do it, but if you'll quit being so suspicious, and give me a free hand, I'll try to fix you up without any further charge. . . . Where did you get the grease that you have in your transmission?"

"What business is that of yours?" Barnstable sputtered.

**S**TAN HICKS cut in. "He got it," he said sharply, "from Robler, when he drained the summer grease from his trucks—Robler told me so himself."

"And," Barnstable said triumphantly, "Robler didn't charge me anything for it, either. You can still get a bargain at some of the garages in this town."

"Ah!" Gus grunted. "So that's it. That grease would be far too heavy for the transmission of your light car, Silas. It could be the thing that's causing your shift shudder and chatter."

"You knew it all the time," Barnstable accused.

"I didn't," Gus told him, "and I don't know it for sure now. I only suspected it after you drove out when I noticed some of your transmission grease on the floor."

"Ordinarily such heavy grease might not cause a car to chatter when being shifted, if the car was in good condition otherwise. But with a hundred thousand miles of wear on transmission gears, universal joint and drive bushings, it could be the cause of it."

"Let's see. Stan, drain and flush Silas's transmission and fill it with the proper grease."

When this job was done, a much-chastened Barnstable permitted Gus to road-test the Ford. The shift shudder and chatter were largely gone.

"Maybe," Stan Hicks told Gus later, "this will teach the old coot a lesson."

"I doubt it," Gus said. "Hang it all, if a man doesn't trust his mechanic, he'd best hunt up one he does trust." **END**

**NEXT MONTH: Gus plays a double role.**



# Power-Mount

## GIVES YOU 5 MORE REASONS FOR WANTING SHOPSMITH!

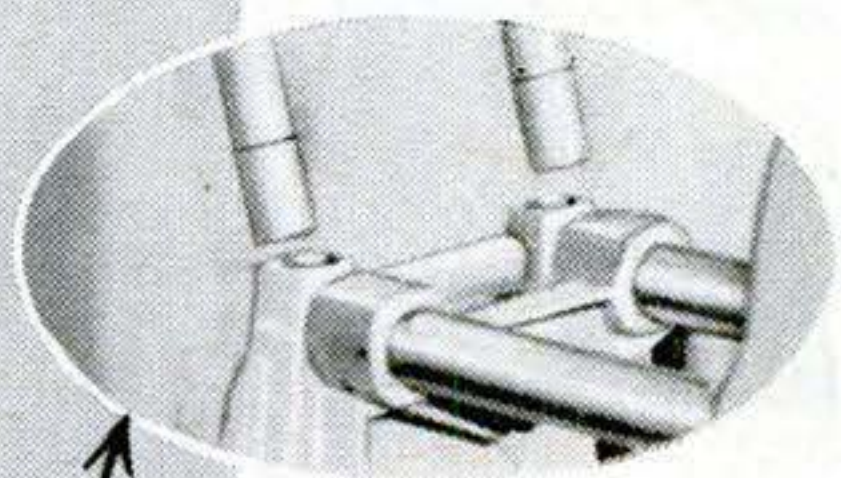

Power-Mount is the exclusive SHOPSMITH® feature that lets you take advantage of SHOPSMITH'S ¾-hp. motor and Speed-Dial to operate other tools.

Two auxiliary spindles drive jointer, jigsaw, sprayer. Each of the tools is mounted on your SHOPSMITH with twin-tubes.

**1** Power-Mount saves you money by eliminating need for extra stands, motors, pulleys, etc.

**2** Power-Mount saves you space—simply store tools "on-the-wall" when not in use on SHOPSMITH.

**3** Power-Mount lets you add the rugged 4" MAGNA Jointer for use with SHOPSMITH for simultaneous saw-jointing.

**4** Power-Mount lets you add the big 18" MAGNA Jigsaw for use alone... or with SHOPSMITH for jigsaw-disc (or drum) sanding operations.

**5** Power-Mount lets you add the versatile new MAGNA Paint Sprayer for painting or staining projects that you build on your SHOPSMITH.

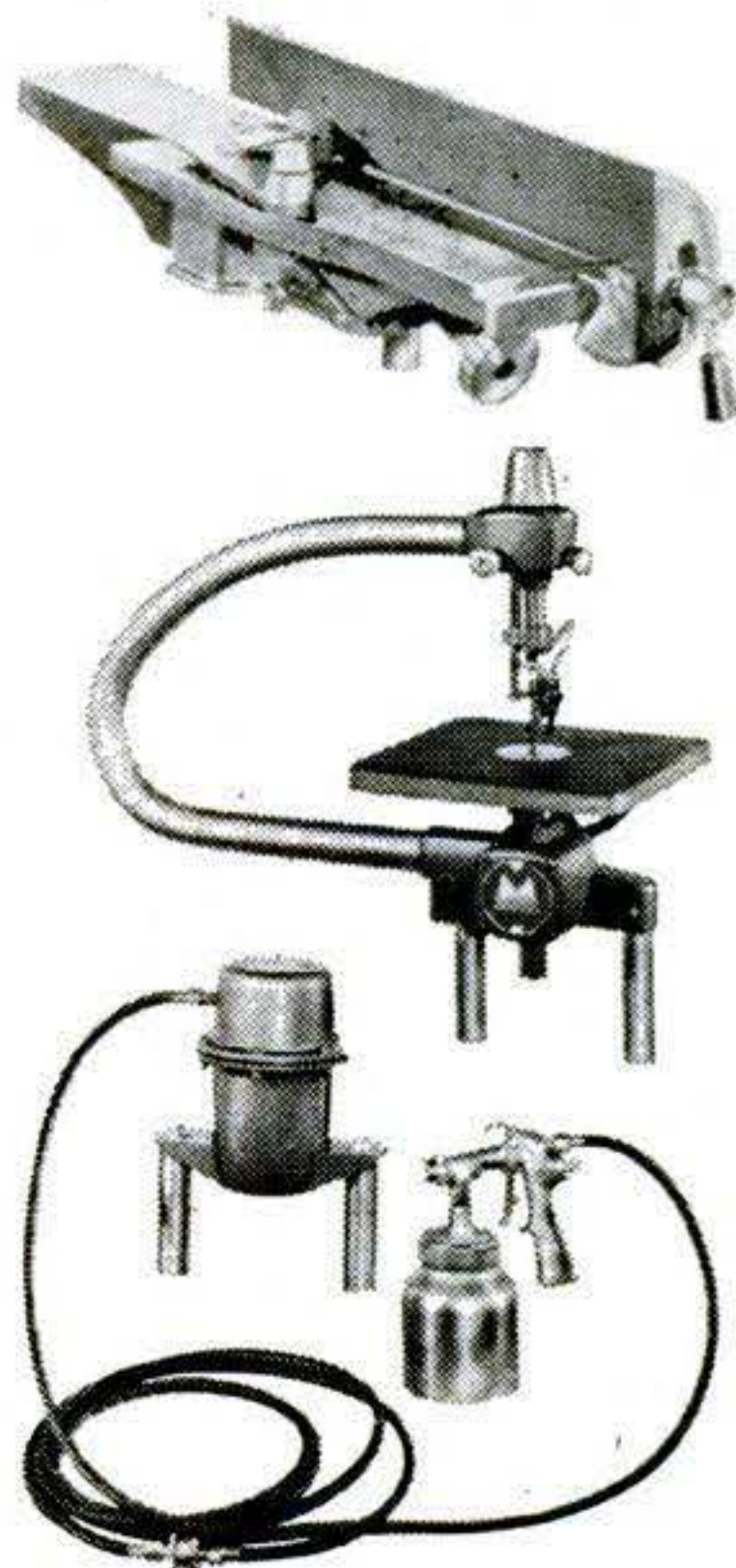

There are many more reasons why you'll want SHOPSMITH in your workshop. See and try this versatile power workshop at your leading hardware or department store or any Montgomery Ward store. It's yours for as little as \$3 a week.

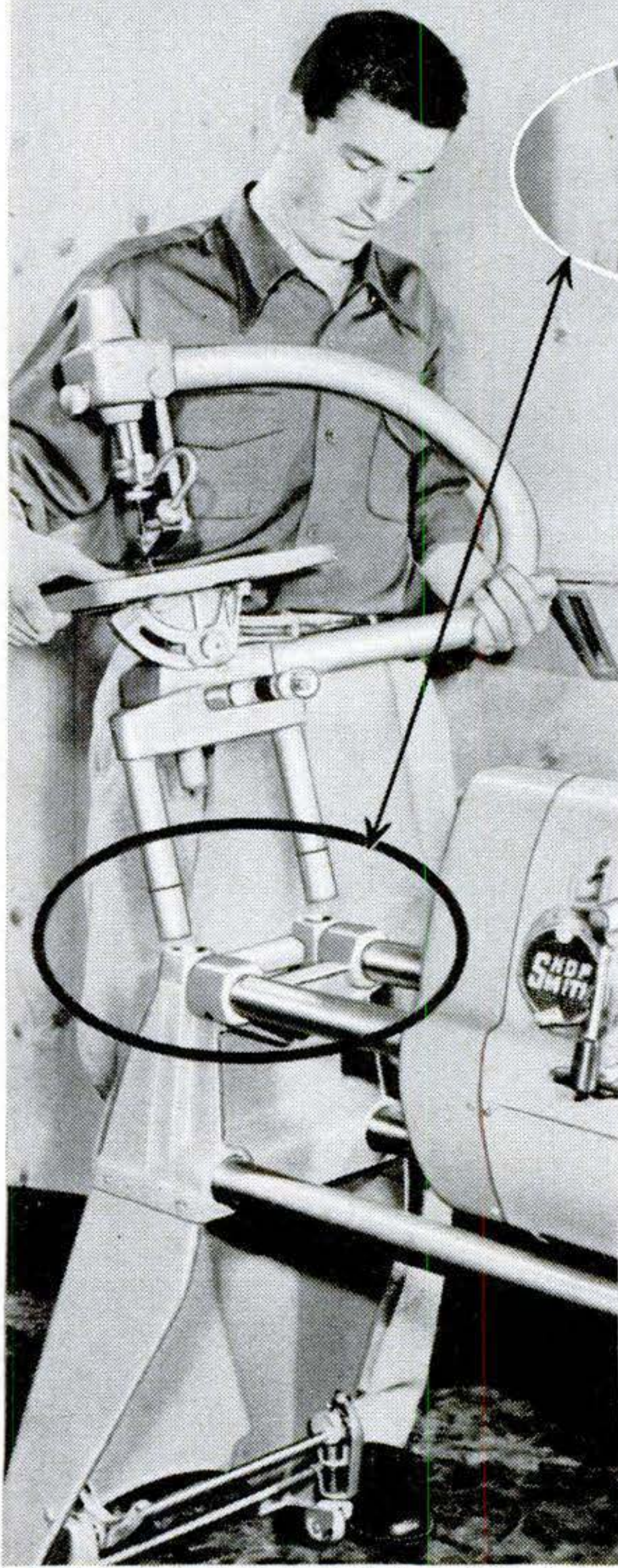

### MAIL COUPON FOR 3 FREE BOOKS

1. "Project Digest." 36 pages of modern woodworking projects.

2. The valuable home-shop guide: "What to Look for When You Buy Power Tools."

3. Illustrated 20-page SHOPSMITH catalog.



### MAGNA Engineering Corporation

Dept. 311-A, at factory nearest you:  
Waynedale, Fort Wayne, Indiana, OR Menlo Park, Calif.

Please send me 3 free books.

Name \_\_\_\_\_

Address \_\_\_\_\_

City \_\_\_\_\_ Zone \_\_\_\_\_ State \_\_\_\_\_

If you already own SHOPSMITH, check whether you have SHOPSMITH Mark 5 , or SHOPSMITH Model 10 ER .



Completely NEW and ORIGINAL

# Paramount WOOD



THE SECRET OF SIMPLICITY IS PARAMOUNT'S

**"MAGIC-BOOM"!**

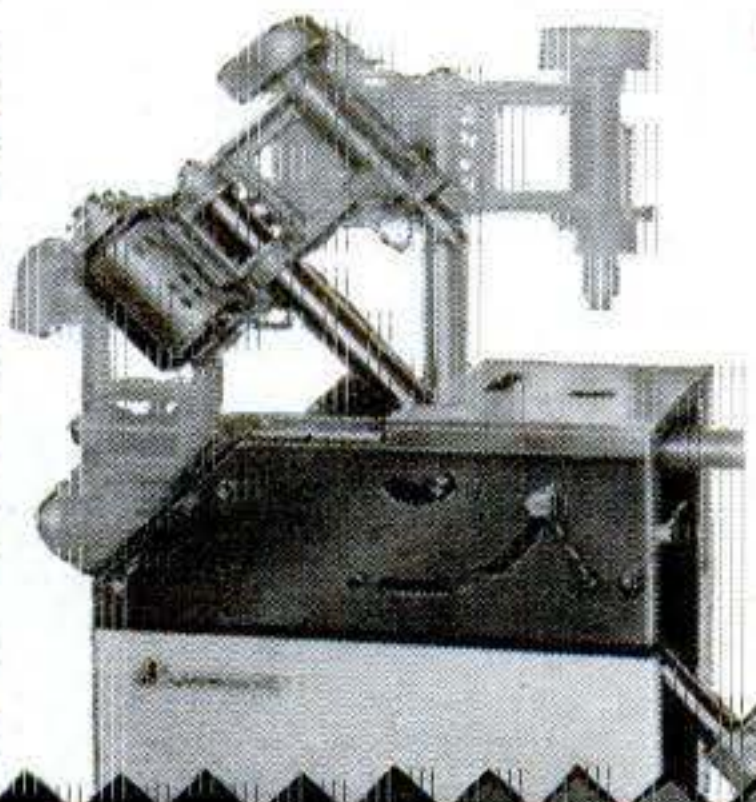

Exclusive! The basic principle of Paramount's patented "Magic-Boom" is a combination Pinch-Lock Pivot Block Bearing that permits sliding, rotating and tilting movements never before possible in a multi-tool. Provides unlimited work combinations and new adaptations . . . precise alignment from one tool position to another!



# MULTI-PURPOSE TOOL..

# worker

**Compact! Rugged! Simple to operate!**

**Does all complex woodworking jobs quickly and safely!**

**Simplicity of design eliminates mechanical troubles!**

If you ever thought multi-tools were complicated to handle, confusing to operate, or troublesome to maintain—*get ready to change your mind!* A new engineering idea has made possible the greatest advancement in home workshop history. Not until now has there been a multi-purpose power tool so simple and compact in design—so easy to operate—so rugged in construction—so trouble-free in performance.

**Compact**—Only 2 feet square! **Versatile**—Unlimited work combinations!

**Portable**—Take it from job to job! **Precision**—To industrial standards!

If you are interested in a home workshop, or are considering the purchase of a power tool, you owe it to yourself to see the new Paramount Woodworker. The purchase of a home workshop tool is an investment for a lifetime of power tool satisfaction and trouble-free service. Shop every multi-tool on the market. Compare them one against the other. There is no better way to prove to yourself the

value and advantages of owning a new Paramount Woodworker!

**Get the facts!** Mail the coupon below for immediate information and name of your nearest dealer. See and operate the new Paramount Woodworker—examine the features that make it the most revolutionary multi-tool on the market. Once you do, you'll never be satisfied with any other power tool!



Only

**\$27950**

COMPLETE

ASK DEALER FOR EASY TERMS

{ with motor and attachments, ready to plug in.

**Mail this coupon today!**

PARAMOUNT WOODWORKER, Dept. PS-11.

Ideal Metal Products, Inc., 1644 West LaFayette, Detroit 16, Michigan

Please send me complete information about the new Paramount Woodworker and the name of my nearest dealer.

NAME \_\_\_\_\_

ADDRESS \_\_\_\_\_

CITY \_\_\_\_\_ ZONE \_\_\_\_\_ STATE \_\_\_\_\_

## TWO SAWS!



Standard cut-off saw and self-retracting push-up saw. Correct speed automatically fixed.

## A LATHE!

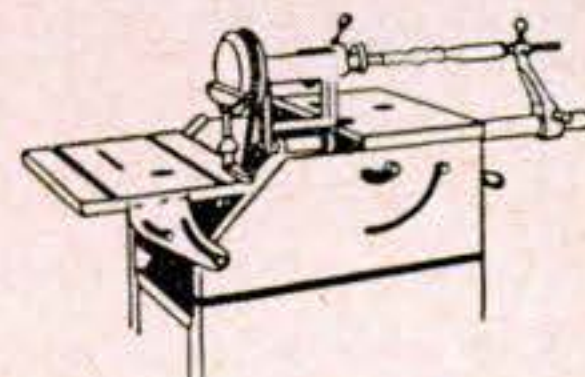

Tilting, sliding and rotating feature for set-up flexibility.

## A HORIZONTAL DRILL!

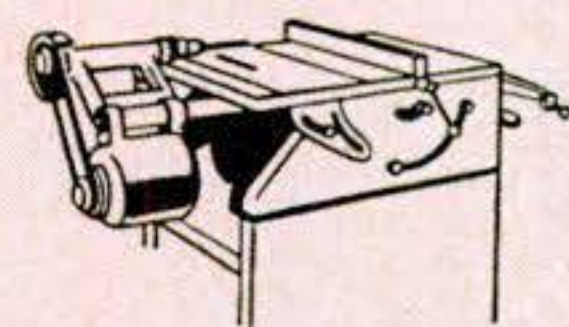

No limit to length of work. Finger-tip micro-adjustment for accurate set-ups.

## A DRILL PRESS!

A 360° radial drill press. Precision control raises and lowers head without strain.

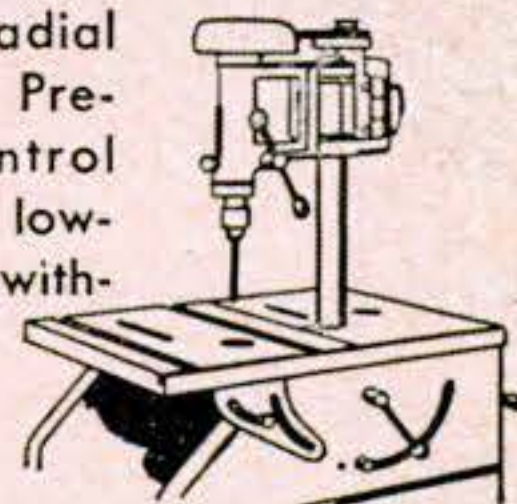

## A SANDER!

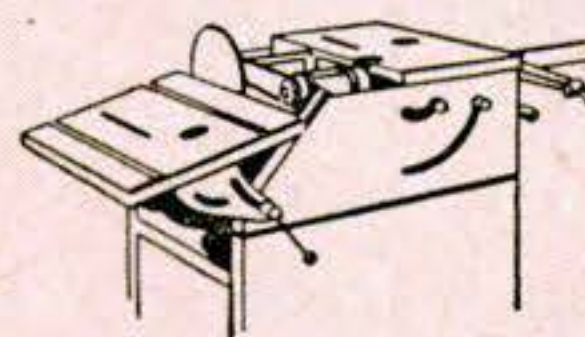

Largest sanding table in home workshop field. Engineered drive insures correct speed.



## Pipe Vise Mounted on Column Provides Extra Clearance

THIS homemade column clamp puts my pipe vise where I can get at it from either side. When I need extra space for long stock I can swing it around 90°.

I bolted the vise to a wood base, and U-bolted this to a steel column. The U bolts are iron rods threaded at the ends. Strips of angle iron at top and bottom serve as washers and keep the wood from splitting. — *Adolph Sprengel, Chicago.*

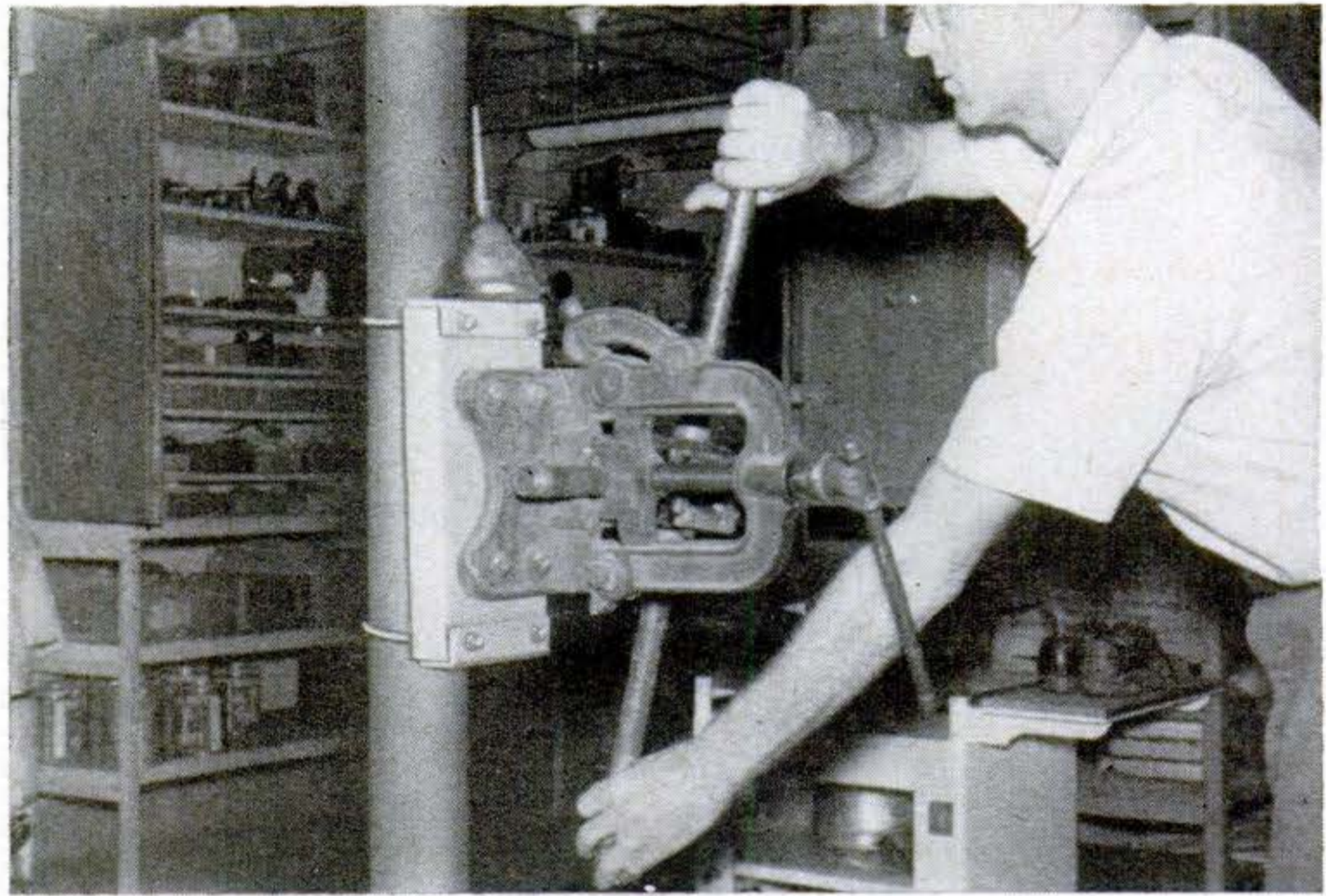

## Rubber Pads Silence Jigsaw

VIBRATOR-POWERED jigsaws may jig and vibrate too much for the neighbors' comfort or your own. If yours does, slip a sponge-rubber powder puff—or a section cut from a kneeling pad—under each foot of the saw. — *Frank A. Javor, North Bergen, N. J.*

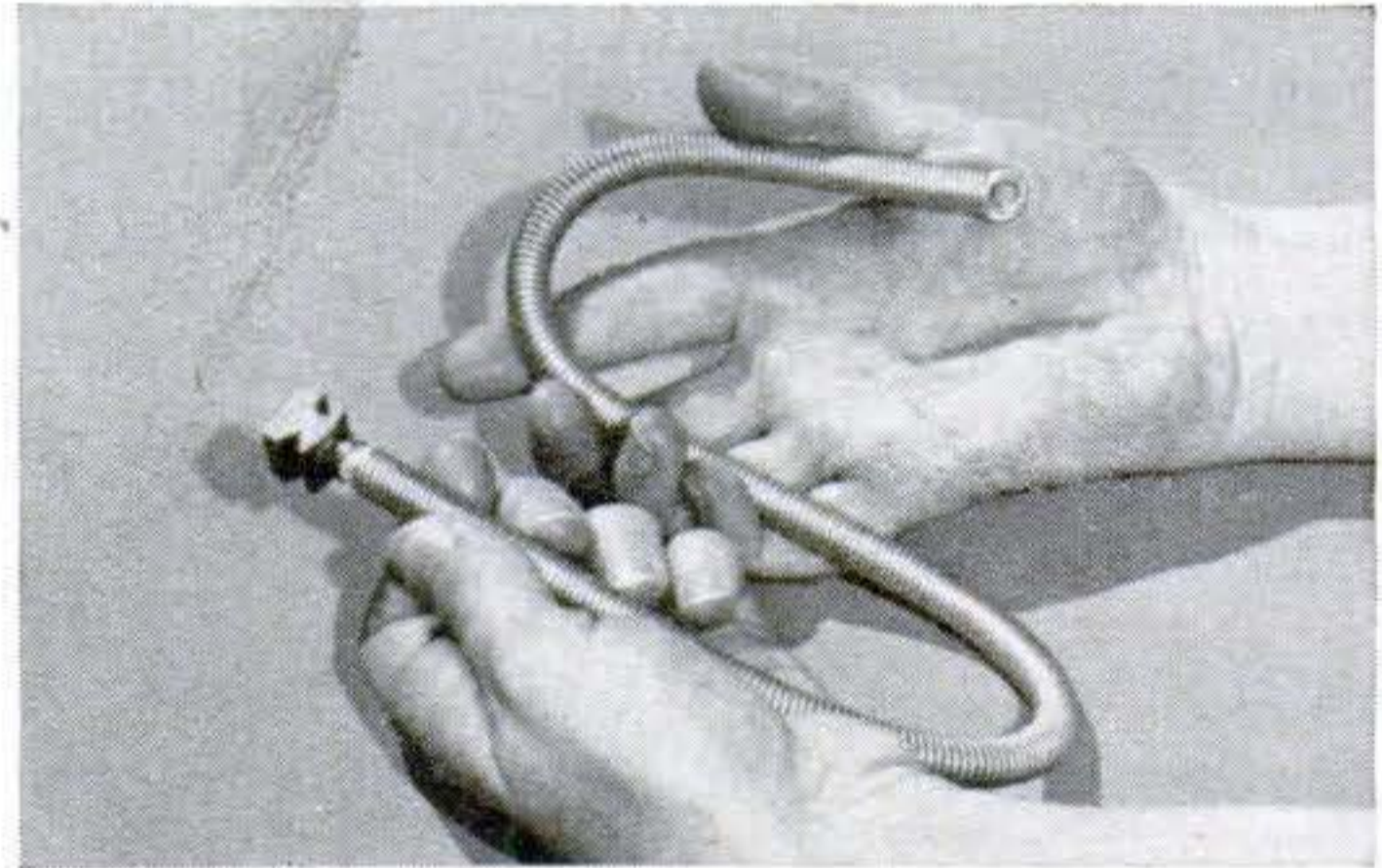

## Spring Makes Snakelike Magnet

YOU can fish metal objects out of odd crannies with this gooseneck retriever. To make it, whittle down the wood handle of a small bulletin-board magnet and force-fit it snugly into one end of a screen-door or a similar type of flexible spring.

## Thrust Bearing Under Pulley Takes End Load, Saves Motor

WHEN it is necessary to use a motor with sleeve bearings in a vertical position, as on a drill press, support the weight of the armature shaft by a thrust bearing between the motor housing and the pulley.

File the housing end flat, and slip the bearing and pulley on the motor shaft. Then tighten the pulley setscrews while pulling upward on the shaft to relieve pressure on the bottom end. If the motor is a brush type, be sure to see that the brushes are centered on the commutator before tightening the pulley against the thrust bearing. — *H. Landauer, Tampa, Fla.*

SHAFT PULLED UP WHILE PULLEY SETSCREWS ARE TIGHTENED.

OLD OIL CUP REPLACED BY ANGLE CUP

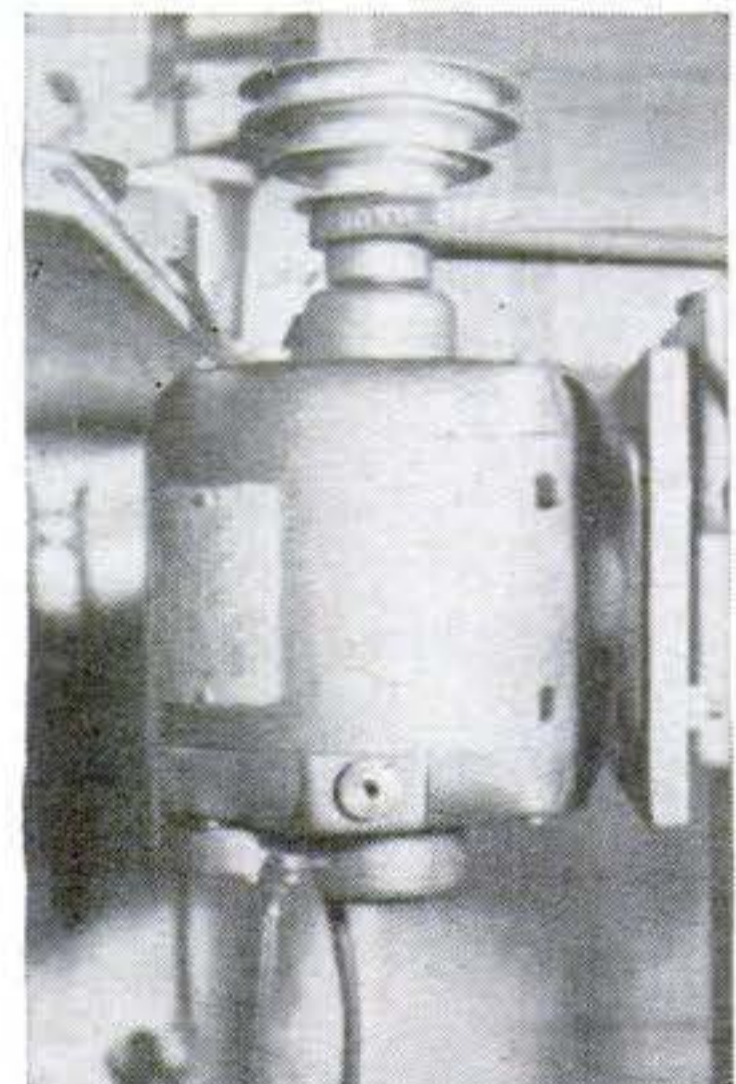
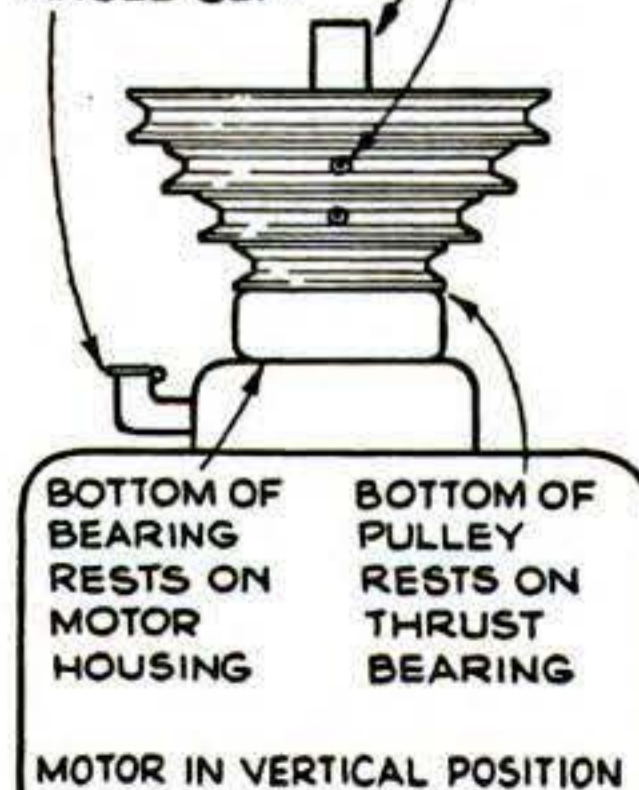





# The Right STANLEY Tool

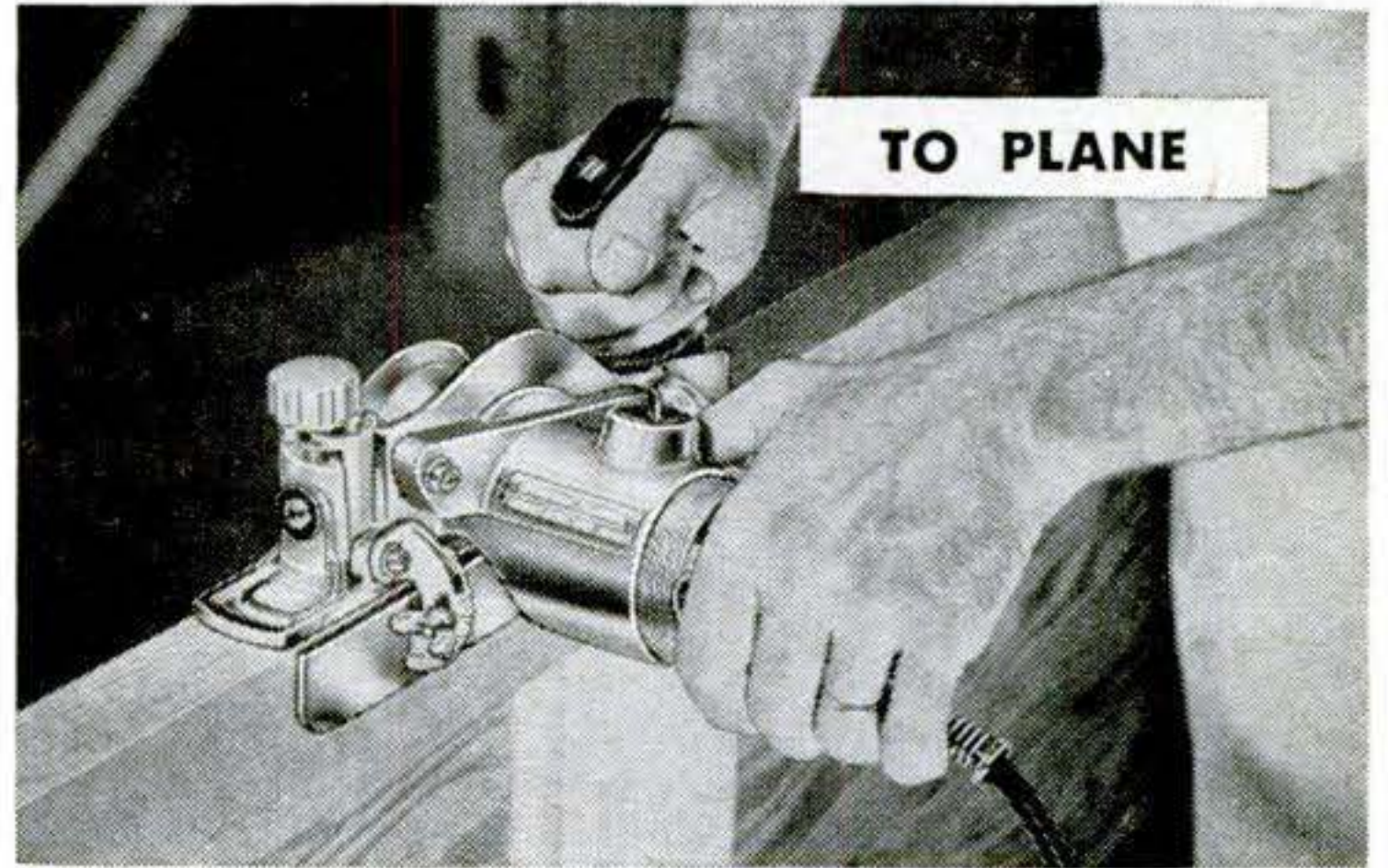
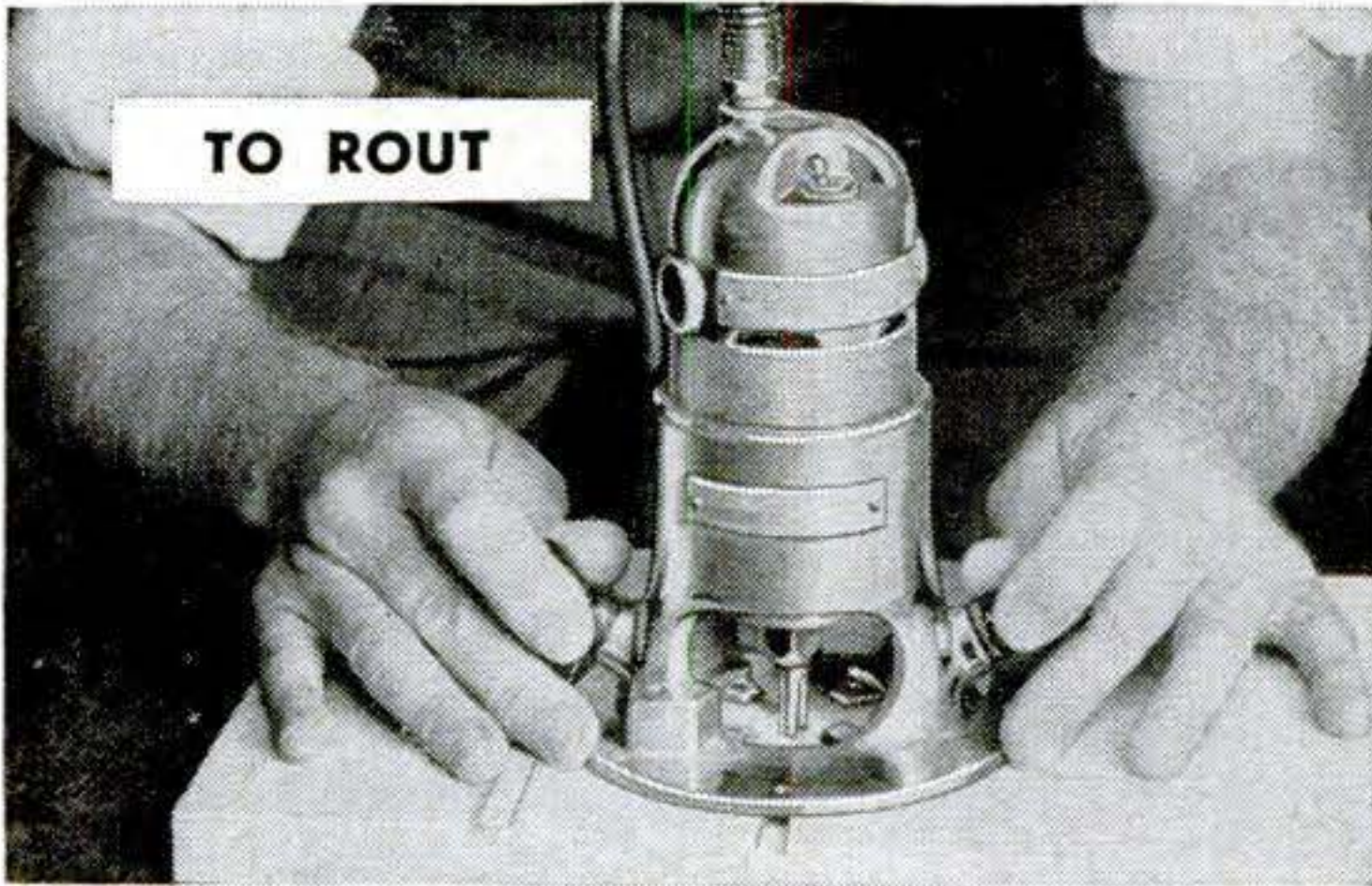

The rugged little work horse of the workshop in 90% of your woodworking jobs. Versatile, light weight and high speed, its motor is used to power the plane shown. *H15 Router* — \$39.95.

This tool is a wonder for smooth and easy planing. Just right for fitting storm and screen doors and windows, trimming wood, plastic or aluminum veneers on table and counter tops. When you have H15 Router, Kit is all you need to convert to power plane. *H106 Plane Adapter Kit* — \$30.50.

## New! Router-Plane Kit

Combines H15 and H106 with gauge and bit in handy fitted carrying case. *H100* — \$89.95.

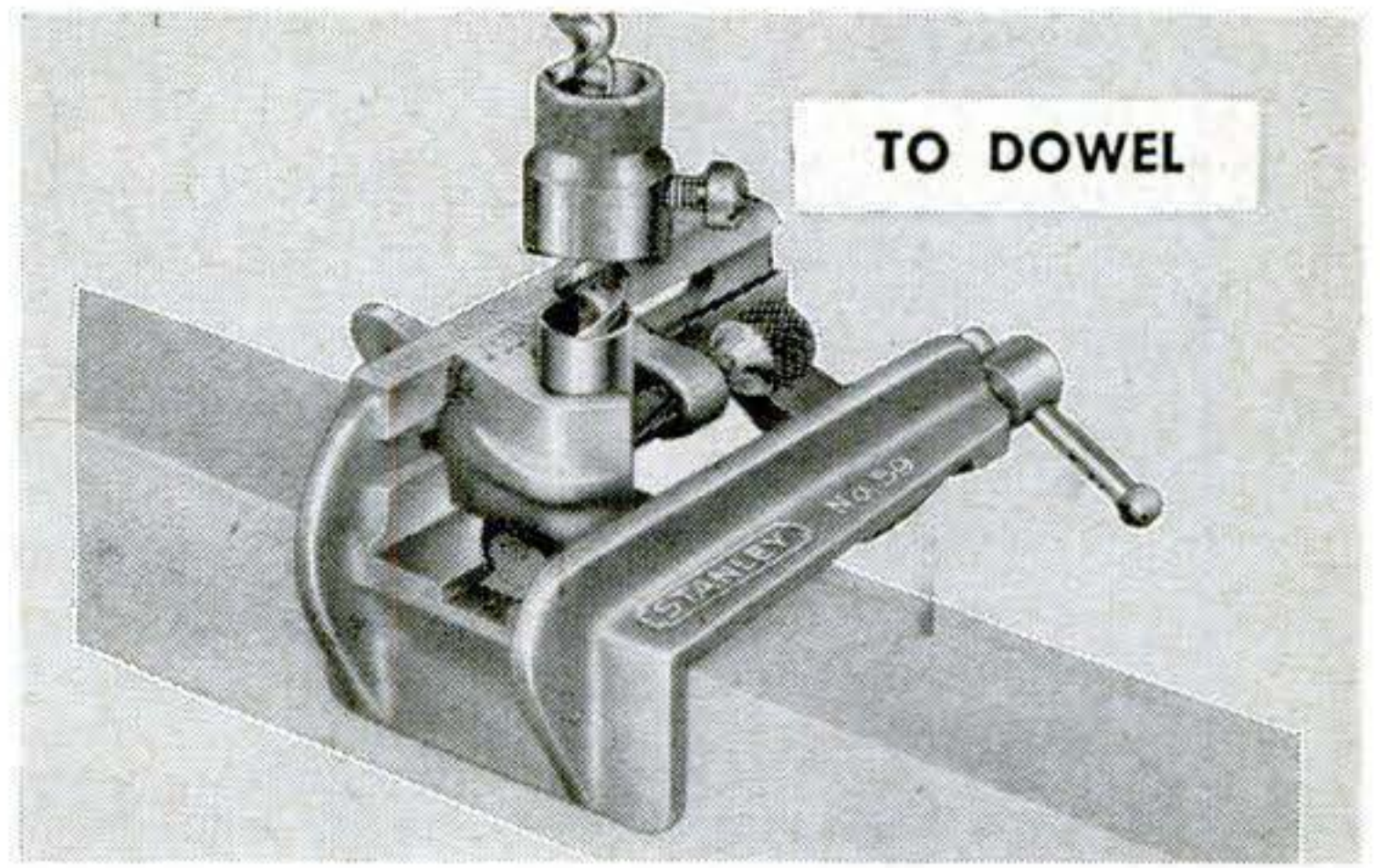
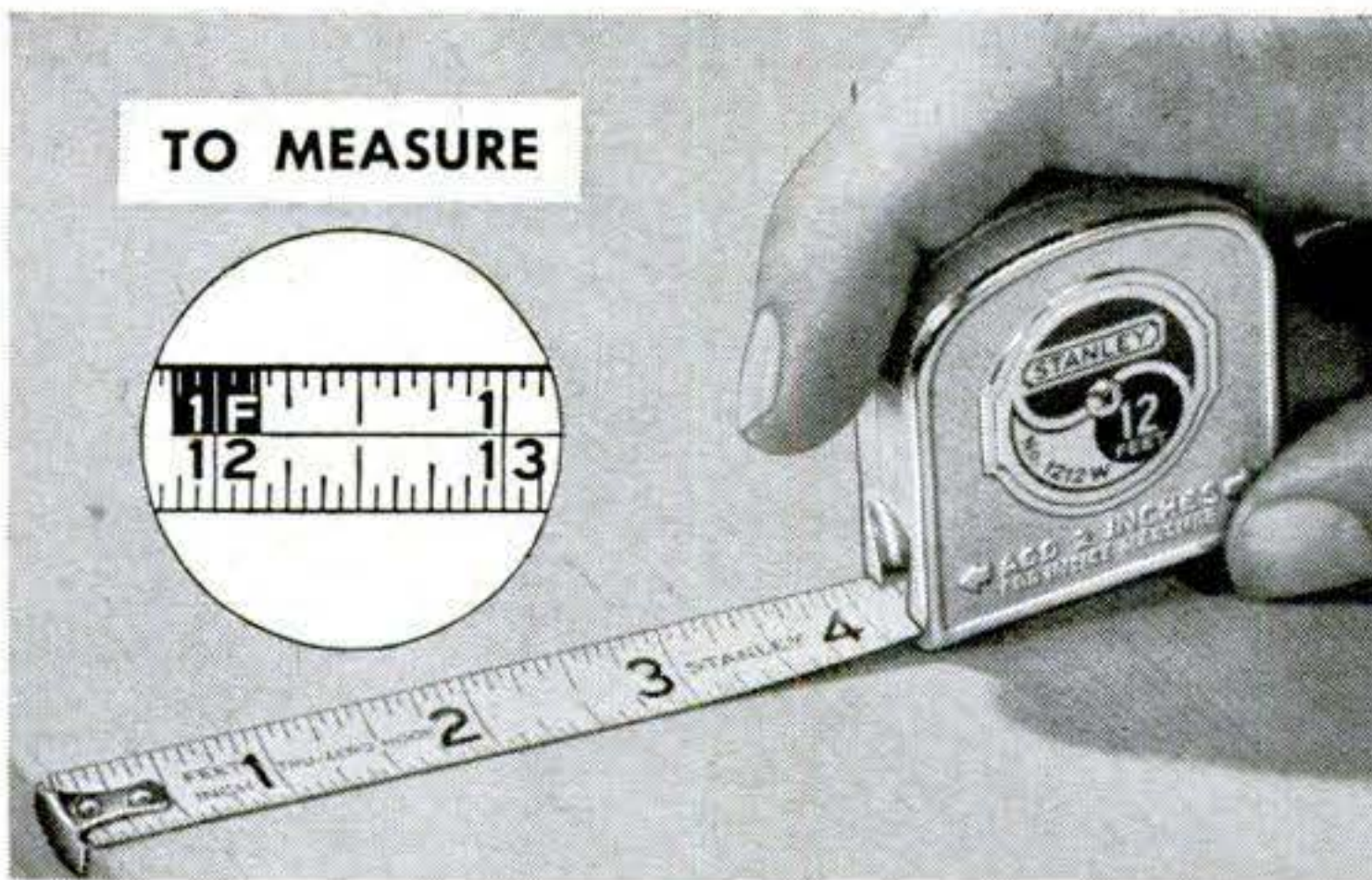

144 inches of easy reading, easy-to-use, measuring accuracy in a compact 2 inch case. A full 12 ft. blade with *convenient* scales in both inches and feet and continuous inches, as shown. Rule comes in smart, useful plastic box with magnifying lens. Be precise... say Stanley. It's a *good rule*. *No. 1212W* — \$1.89. Also available in 6, 8 and 10 ft. lengths — 98¢ to \$1.49.

Joining two pieces of wood together is one of the first jobs a woodworker masters... and it isn't really *mastered* until you do it with dowels. Here's a jig from the Toolbox of the World that makes good doweling easy. With it you can bore holes accurately in edge, end or surface of wood. 6 guides for  $\frac{3}{16}$  to  $\frac{1}{2}$  inch bits and depth gauge furnished. *No. 59 Doweling Jig* — \$6.50.

# STANLEY

The Stanley Works • New Britain, Conn.

TOOLS • ELECTRIC TOOLS  
HARDWARE • STEEL • STEEL STRAPPING

Department TE, The Stanley Works,  
63N Elm St., New Britain, Conn.

Gentlemen:

Please send me ( ) free Tool Catalog  
( ) free Electric Tool Catalog  
Check Catalog(s) you want.

Name \_\_\_\_\_

Address \_\_\_\_\_

City \_\_\_\_\_ Zone \_\_\_\_\_ State \_\_\_\_\_



# Care and Feeding of Engines

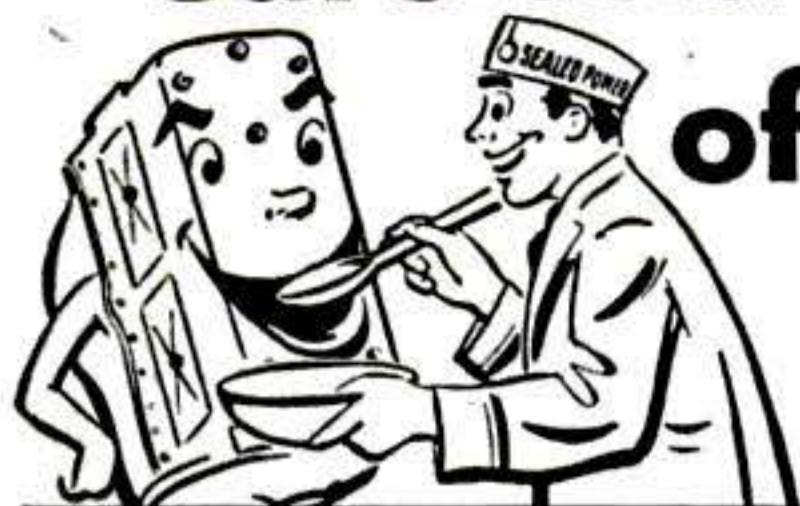

BY  
S. P. CORP

## VALVE ADJUSTMENT

Before you start to adjust valves, consult manufacturer's specifications and know the answers to these questions: 1. Should your valves be set hot or cold? 2. What are the intake valve tappet clearances? 3. What are the exhaust valve tappet clearances?

Tappet clearances *below* specifications will make camshaft open valves too early and close them late, which can cause exhaust valve burning. **NEVER REDUCE VALVE TAPPET CLEARANCE TO ELIMINATE NOISE.** Instead, look for worn tappets or misalignment of valves in the guides.

Tappet clearances *above* specifications cause camshaft to open intake valve late and close too early, reducing amount of fuel entering cylinder, and losing power. The same condition in exhaust valves imposes an extra load on connecting rod bearings. Always follow specifications!

**NOTE:** These facts do not apply to valves with hydraulic valve lifters.

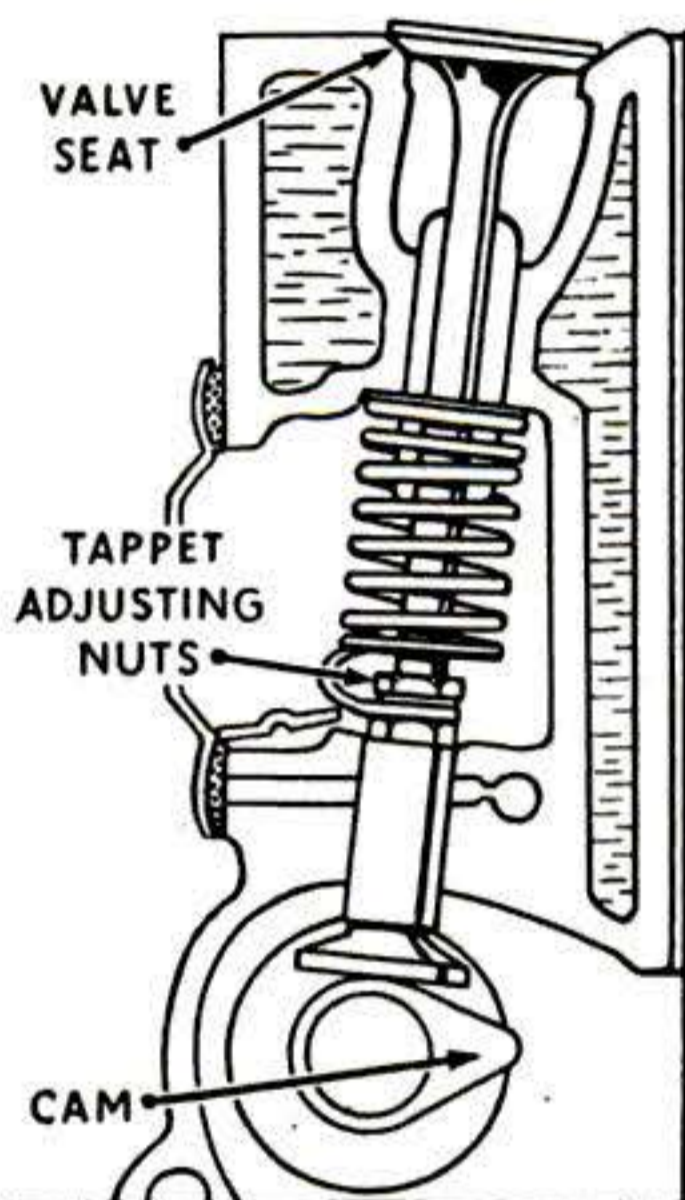

## LOCATING A MYSTERIOUS MISS

If a cylinder misses, look for corrosion in the distributor cap. Pull each wire out of the cap and clean sockets with a wire brush. If corrosion has eaten away the metal, or terminals are eroded, get a new cap. Also check to see that carbon brush is not chipped or broken. Inspect rotor for cracks or oxidation at the tip. If tip is burned, the resulting gap could cause that mysterious miss. In such a case, you need a new cap and a new rotor.

## GET THIS FREE MANUAL

Send a postal card request for your free copy of "Care and Feeding of Engines," the new illustrated manual of car care. It contains helpful hints on everything from Air Cleaners to Windshield Wipers. When you re-ring, use Sealed Power KromeX Ring Sets for fast break-in, immediate oil control, and double ring life. Solid chrome faces on top compression ring and oil ring side rails fight heat, friction, corrosion. Sealed Power, Dept. H-11, Muskegon, Michigan.



# Sealed Power

## PISTON RINGS

## Biggest Airlift

[Continued from page 152]

destination—Ashiya Air Force Base on Japan's island of Kyushu. One of the amazing things to me was that our big plane's wheels touched down on the runway at Ashiya within minutes of our scheduled time of arrival. I found out later that no plane out of the 43 that formed the actual air bridge was more than one hour late! Quite a record for a 9,000 mile flight, mostly over water.

As each Globemaster landed, the Red Devils of the 508th were transported by rail to the three camps—Kashii, Chickamauga and Wood—that will be their bases during their tour of duty.

*Within 60 hours* after the first Globemaster had landed at Ashiya it had been checked and serviced and was taking on a load of the 187th's Angels from Hell

.....  
*A brilliant man is one who is shrewd enough to recognize you're a genius.*

—THE SIDEWALK SUPERINTENDENT

.....  
at Itazuke Air Force Base for the island-hopping trip back to the States.

On the average, each of the Globemasters used in the actual transfer mission was away from its home field in the eastern U.S. no more than 166 hours.

The secret of the joint Army and Air Force part of Operation Gyroscope (code name for the Army's world-wide program of troop rotation) was, as always, detailed preparation. Two weeks before the first Globemaster took off with its load of men from Fort Campbell, Ky., maintenance crews, spare engines and parts, and spare Globemasters were flown to Travis, Hawaii, Wake and Japan. Close to 1,000 men of the 63rd Troop Carrier Wing of the 18th Air Force manned and serviced the planes along the route.

*To the Army and Air Force*, the airlift of the Devils and the Angels was just another peacetime tactical problem. According to Major General Chester E. McCarty, commander of the 18th Air Force, it would be just as routine, given the needed planes, to move any number of men to any point in the world. **END**



**NEW!** *the motor you asked for...*

KIEKHAEFER  
**MERCURY**

**MARK 30 turbo 4**

See it at your dealer's now!

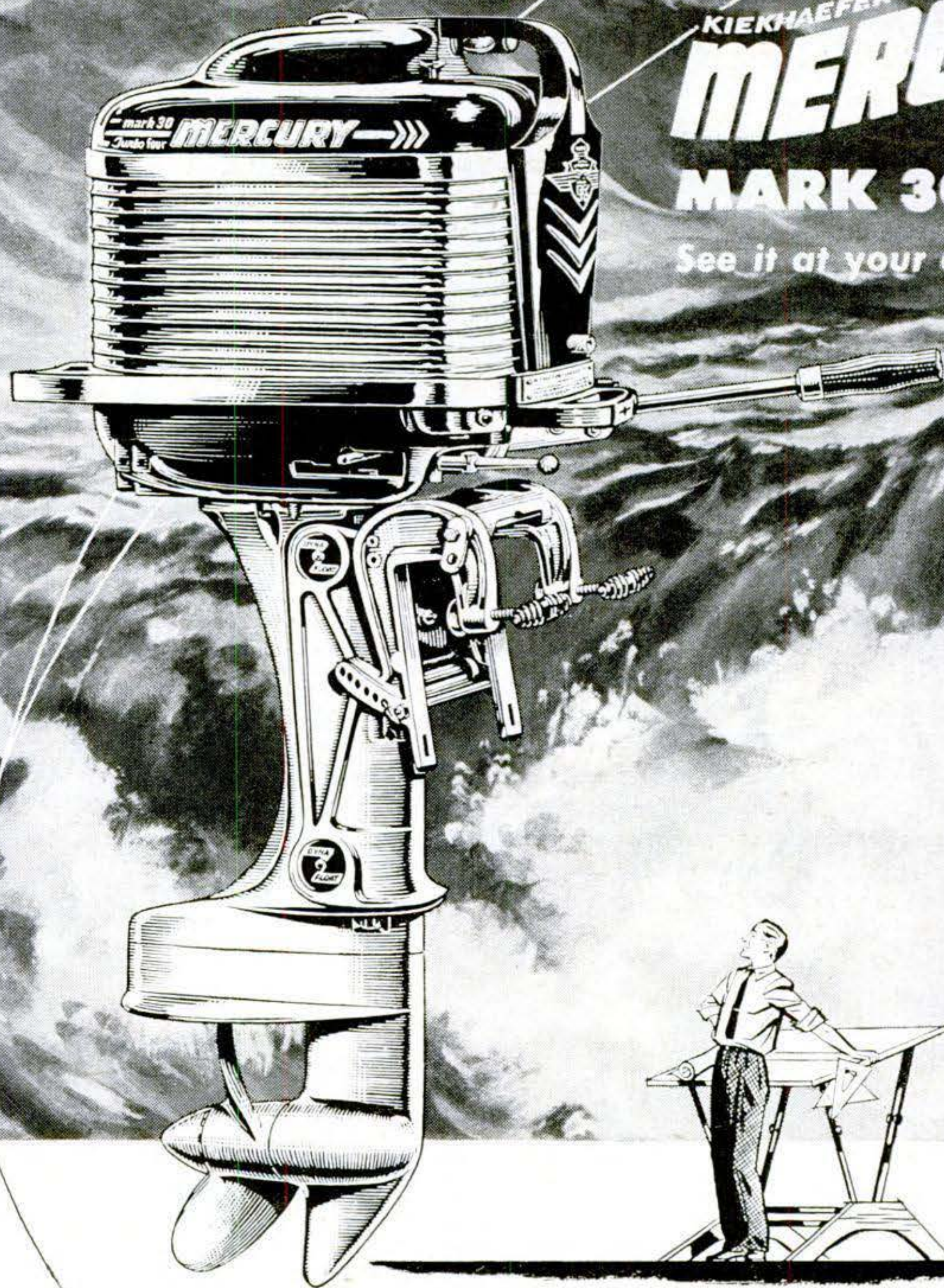

A 30 h.p. Alternate Four, weighing only 110 lbs... the exclusive Mercury carrying handles actually make it seem lighter... available with 12-volt electric starter and generator... all the quality Mercury features.

Proved by years of brutal field testing, backed by experience only Mercury has from building more than two million horsepower of famous 4 cylinder Thunderbolt engines! The finest, smoothest, most powerful engine in its class... fully qualified to wear the Mercury trade mark.

**MERCURY... THE MOST POWERFUL NAME IN OUTBOARDS**  
**REMEMBER... A FOUR IS BOUND TO BE BETTER**

6½ gal. remote fuel tank  
standard equipment



# HOW TO GET THE MOST OUT OF FILES

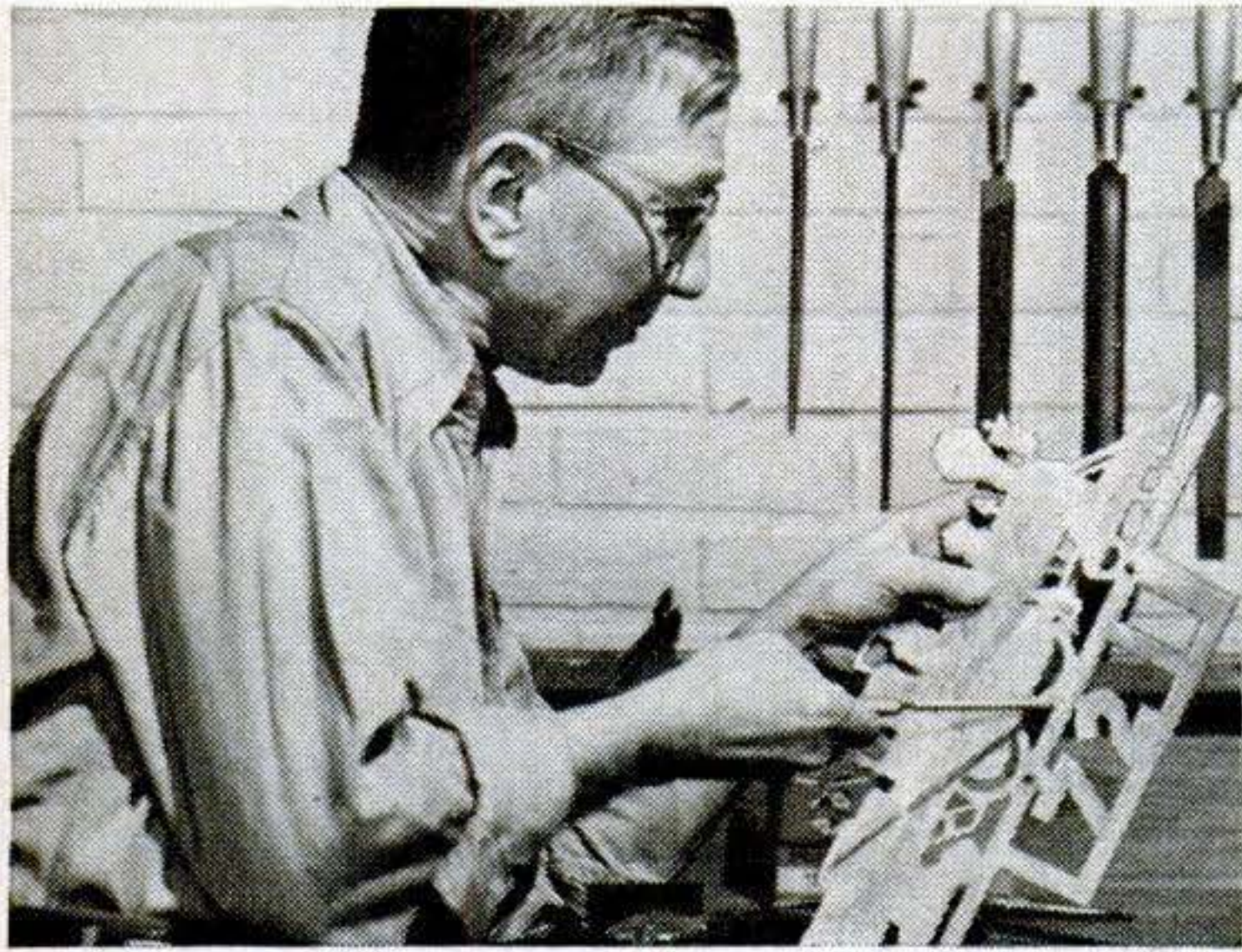

**You do better work and your files last longer when you follow these few simple rules**

- 1. CHOOSE THE RIGHT FILE FOR THE JOB.** Nicholson triangular Slim Taper, and Mill, Flat, Half Round, Round and Square Bastard files fill basic workshop needs. For coarser or finer filing, or work on special materials, there are Nicholson files especially for the job.
- 2. USE FILES CORRECTLY.** Each kind of filing—straight, draw or lathe—has its own file grip and motion. Holding the file at exactly the desired angle is important. Work height is important, too: elbow height normally, lower for heavy filing, near eye level for precise work.
- 3. TAKE CARE OF FILES.** Protect precisely-formed teeth by standing your Nicholson files in a rack or hanging them by their handles. *Never* throw them in with other tools or stack them. Clean often with a Nicholson File Card or Brush. A soft iron "scorer" helps remove stubborn pinnings. Chalk removes oils or grease.

**At good hardware stores everywhere**

**Experienced craftsmen choose Nicholson files for uniform high quality and long work life.**

Write for free 50-page file "textbook." "**File Philosophy**" tells you more about how to choose, use and care for files.

**NICHOLSON U.S.A.** **NICHOLSON FILE COMPANY** **BLACK DIAMOND U.S.A.**  
 19 Acorn St., Providence 1, R. I.  
 (In Canada: Nicholson File Company of Canada Ltd., Port Hope, Ontario)

**NICHOLSON FILES** FOR EVERY PURPOSE

## Mexican Road Lures Do-It-Yourselfers

[Continued from page 160]

selves; they couldn't break, didn't rattle.

*Work gloves* to save washing hands so often that the skin might crack in the dry climate.

*Bags*—plastic and paper, including waterproof, for wet things and to protect pans and packages from abrasion.

*The kids!* This was a trip they really enjoyed. It taught them a lot. Generally speaking, Mexicans seem to be fond of children. We were welcomed most heartily and felt we were given rather special treatment because we had them along.

*Not so handy.* We encumbered ourselves with a certain amount of junk we'd have been happier without—things like these:

*Good luggage.* It was hard to pack and got badly beaten up. Flexible zipper

.....

*If you are in doubt as to whether or not your house needs redecorating, the children will usually do all they can to help you decide.*

—THE SIDEWALK SUPERINTENDENT

.....

cases and surplus duffel bags were better.

*Jeep can* for extra water. It turned out to be a nuisance that delivered only rusty water. A water bag is better.

*Hats* for streetwear are not necessary. Women usually wear scarves in Mexico, men can always pick up cheap sombreros if they need protection from the sun.

*Extra clothing* of any kind took more room than it was worth. Stick to synthetics and wash them out each night if necessary. They'll be dry by morning.

But don't go too well prepared. If we'd taken perfectly good advice and set out with all new tires, we'd have missed the fun of shopping for a new one in a Sears, Roebuck just a few rods from the only catacombs this side of Rome.

That, incidentally, was where we got our front wheels aligned not once but twice within an hour: I couldn't find the Spanish to tell the mechanic that his buddy, now invisible, had already done the job the ticket called for. **END**



# NOW! A Genuine *SKIL* Saw for only \$29.95

Built to handle 95% of your  
"home and hobby" Jobs

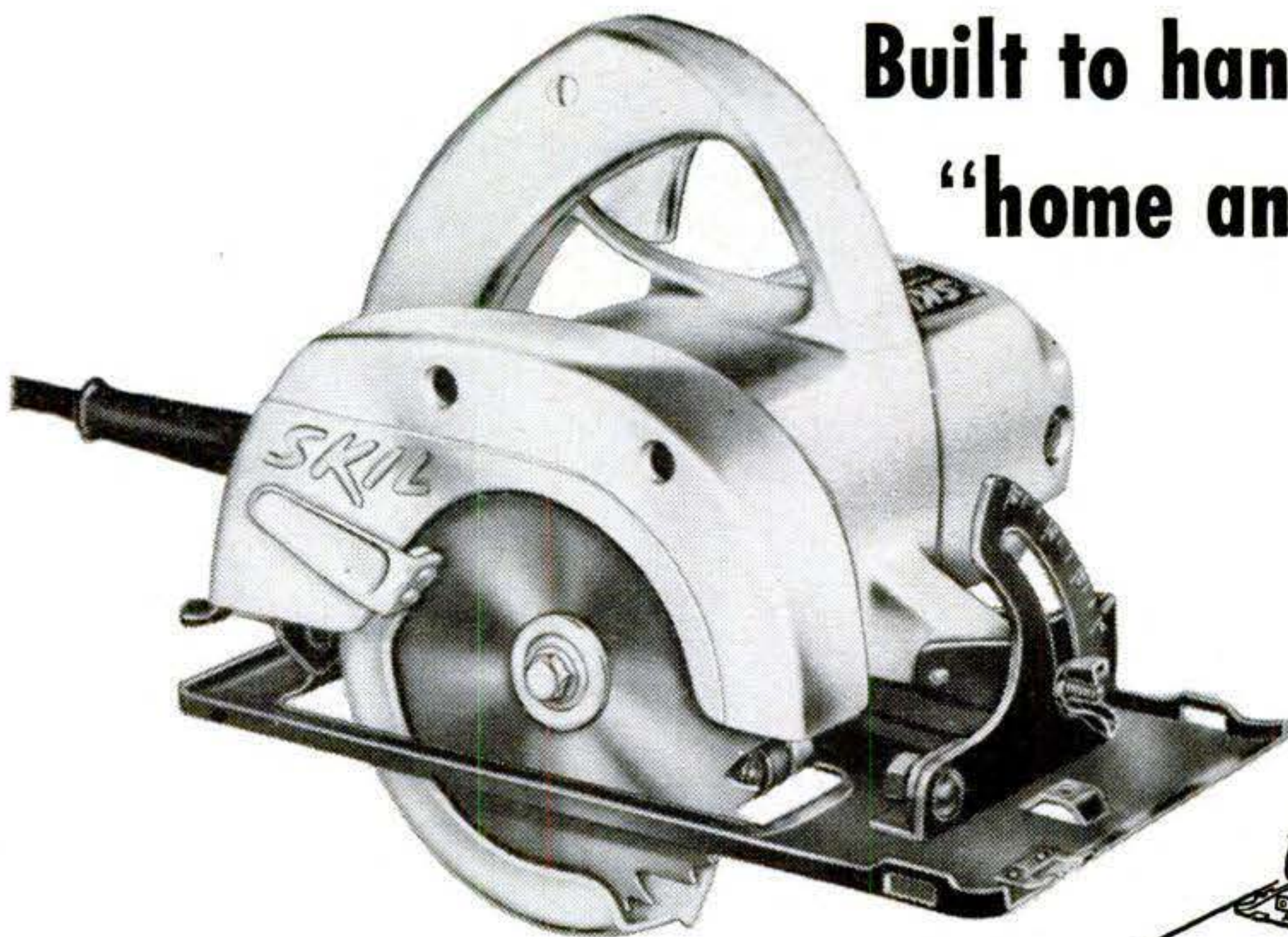

Here's all the power and performance you need for almost any home or workshop sawing job—at a fraction of the price you'd pay for a heavier saw! This quality SKIL saw has ample capacity to speed through paneling, plywood, tongue-and-groove board and shelving. Makes quick work of Celotex, wall board,

Formica and other materials. Cuts 2 by 4's simply by flipping the board. Lightweight comfort-grip handle for easy one-hand operation. Cuts to 1-5/32" vertical depth, makes 45° bevel cuts to 1" depth. This is a "must" for every home. Ask for a demonstration at your Hardware Dealer's today!

## No Other Saw Offers these Famous SKIL Features for Only \$29.95!

- Powerpacked motor • Guard lift-depth and bevel adjustments • Trigger-type switch • Built-in sawdust blower • Telescoping blade guard • Comfort-grip handle

## 4 1/4" SKIL SAW, Model 504

does these and many more sawing jobs! Build screens, storms, sashes! Build cabinets or built-ins! Build a spare room in attic or basement!

# SKIL

BUILDERS TOOLS

Made Only by SKIL Corporation, Formerly SKILSAW, Inc.  
5033 Elston Ave., Chicago 30, Illinois  
3601 Dundas Street West, Toronto 9, Ontario  
Factory Branches in ALL Leading Cities

## Win a Ford Victoria—or One of Many Other Valuable FREE Prizes!

It's easy to win—there's nothing to buy!  
Enter the big SKIL Grand Prize Contest!  
Entry blanks at your Hardware Dealer's!





# INSTALL IT YOURSELF!

*Needs No Extra Surface Finishes*

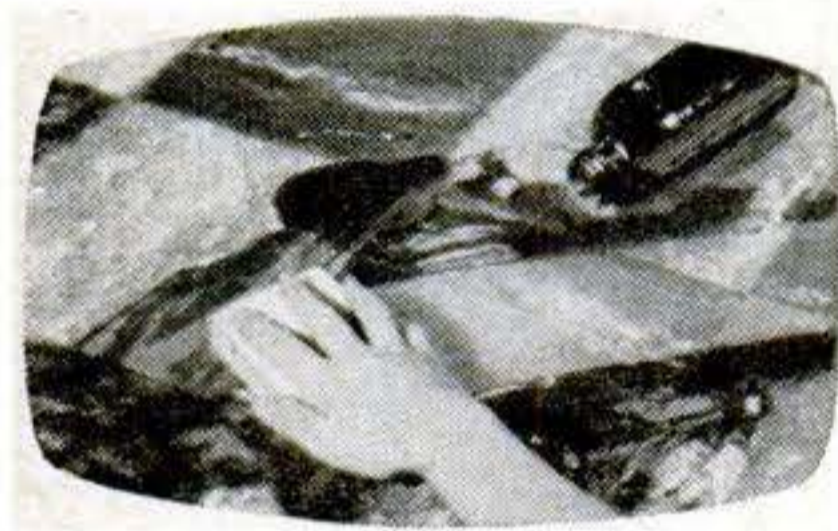

*Defies Destruction*

*Anti-Slip Surface*

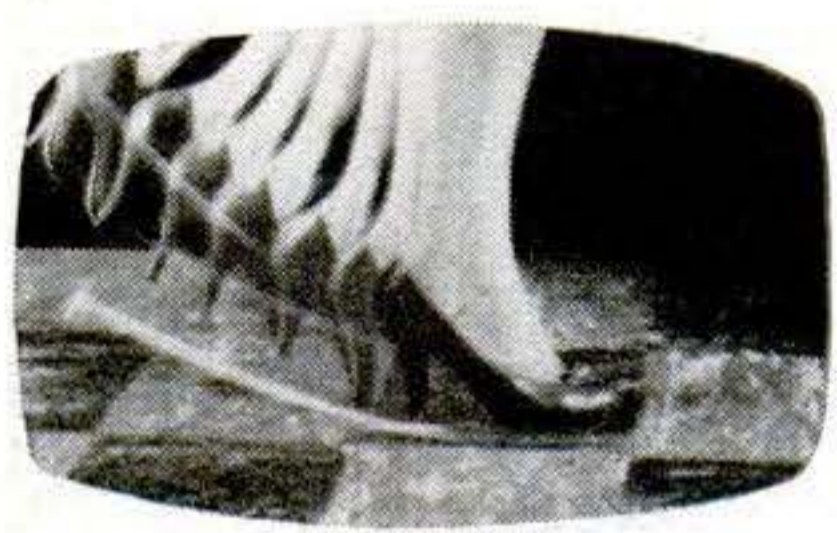

*Gives Maximum Wear*

It's ideal for any floor, no matter where!



B. F. GOODRICH CO.  
Dept. PS10, Flooring Division  
Watertown 72, Mass.

Please send FREE color chart on B. F. Goodrich Koroseal Floor Tile.

Name.....

Street.....

City..... State.....

## Giant Glider to Climb 13 Miles

[Continued from page 108]

feet—a world's record altitude—in the tremendous lee wave east of the Sierra Nevada mountains in California. The pilot who set this mark, Laurence E. Edgar, 38-year-old senior flight-test engineer for Goodyear Aircraft, later figured in another incident that demonstrates the treacherous dangers lurking in these powerful air currents.

He was descending from 40,000 feet when his glider fell to pieces around him. Here is how he describes it:

*"I flew into a blast of wind, at about 15,000 feet, that smacked me with the sound of a car hitting a truck at high speed. I was torn out of my safety har-*

.....  
*Anyone can become wealthy in America by inventing something useful that doesn't last long—like home permanents.*  
 —THE SIDEWALK SUPERINTENDENT  
 .....

ness and thrown through the canopy of the cockpit.

"I fumbled across my chest for the ripcord of my parachute and yanked. It opened immediately and soon I was turning and swinging quite violently. Every so often I would be yanked upward in the turbulent air.

"I came out of the turbulence just below the main roll cloud, a massive, dark, boiling thing. I didn't want to get carried up into it again. I pulled on the shrouds at one side to collapse the chute partially so I could get down to a safe level quickly. I could see parts of the sailplane being carried up past me and disappearing into the cloud."

*The wild turbulence* that disintegrated Larry Edgar's beefed-up glider—one of the most rugged flying machines ever built—gave vivid proof that the full extent of the wiles and strength of a lee wave are still not known.

Scientists are continuing to probe its secrets—to protect ordinary aircraft from its dangers and to tame its power for exploration of our space frontier. END



# TORO



**10-INCH DELUXE  
TILT-ARBOR SAW\***  
(8-inch models available)

## NOW! Professional quality in a new line of home power tools!

See the difference? From the rugged extra-heavy steel castings, to the precision-ground mirror-polished working surfaces, Toro power tools give you a new standard of quality in home workshop power equipment.

Look at that 10-inch tilt-arbor saw! The single, massive, out-in-front control either tilts, or raises and lowers the blade. And check these other "out-in-front" Toro features: the integral casting of rip-fence track and table... the smooth-sliding rip

fence that locks solidly in place, front and back, with quick lever-action.

No wonder the new Toro power tools are so accurate! They're backed by 40 years' experience in building precision power equipment—including the world's most complete line of power mowers.

See this professional quality line of Toro power tools at your dealer's soon—or mail coupon below for a deluxe full-color catalog.

*\*Table extensions and stand optional.*

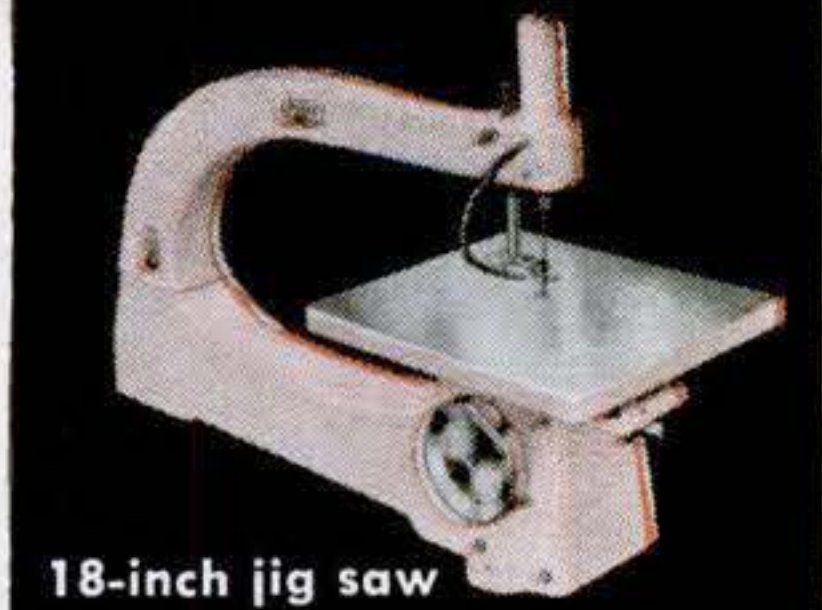

18-inch jig saw



4 & 6-inch  
jointer-planers



4-inch  
belt sander

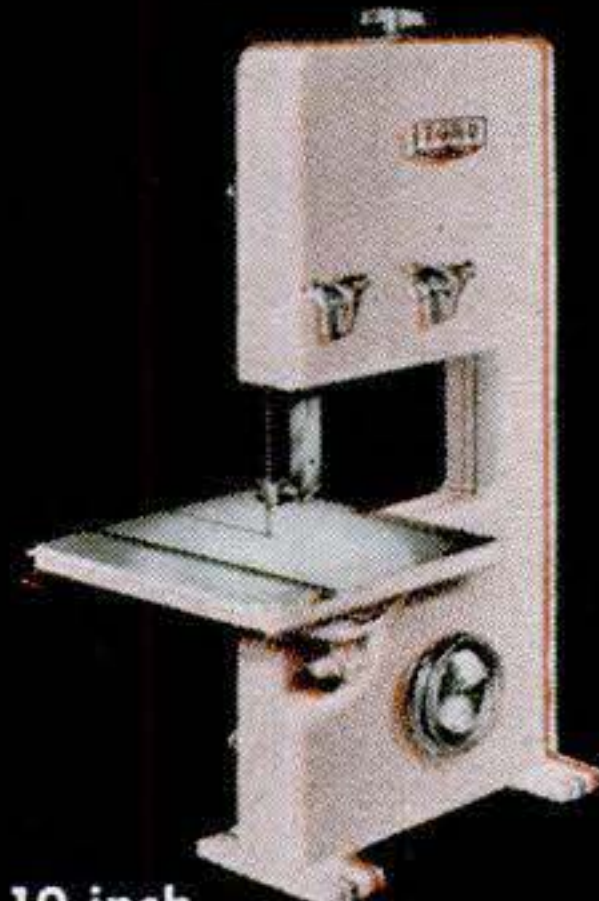

10-inch  
band saw

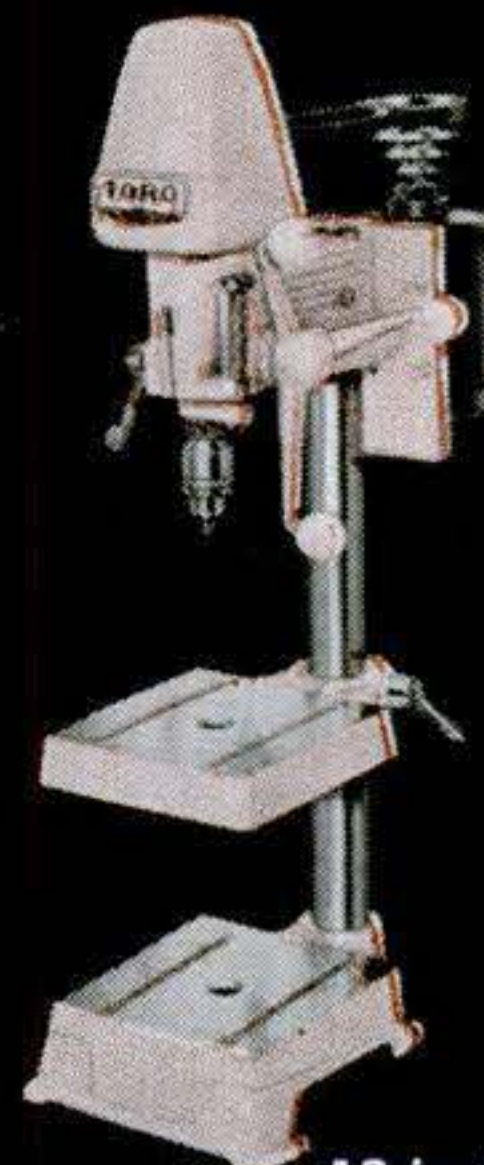

12-inch  
drill press

**TORO MANUFACTURING CORP.** Minneapolis 6, Minn., Dept. 115

YES! I'd like a free copy of the deluxe Toro power tools catalog!

NAME.....

ADDRESS.....

CITY.....ZONE...STATE.....





# Looking for Something?



## ELECTRICAL SUPPLIES



## FROM BATTERIES TO WIRES WHATEVER YOU NEED

Find It Fast  
In The  
'Yellow Pages'



### Dolly Saves GI's Aching Back

It's light, it's convenient, it's a duffel-bag hand truck; and its builder, Sgt. George M. Harmon of Levittown, N. Y., thinks that every GI should have one. He built the simple two-wheel cart after 13½ years' service and half a dozen trips overseas, and now he's the envy of every aching back in his outfit.

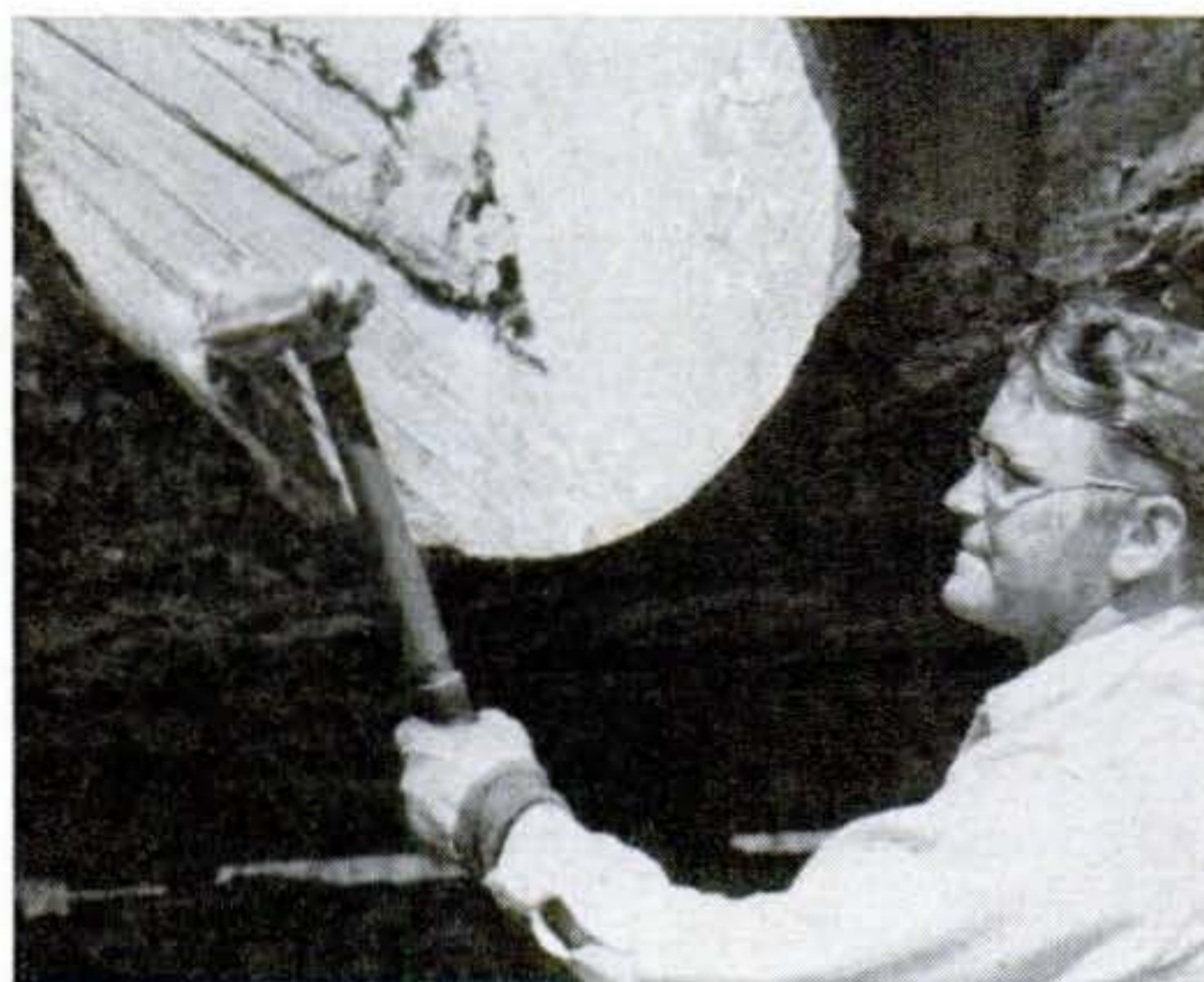

### Log Brander Colors Its Tracks

EVERY time inventor Jack Jamieson swings his strange hammer against the rim of that log butt, he leaves a colored cougar track with an indented symbol in its center. It makes logs easier to identify, and helps foil log rustlers. Paint squeezes from a handle reservoir and spits out through several tiny jets on impact.



**Don't  
forget  
your  
change!**

Mighty well-trained dog!

Trained to register *two* important things! Change oil in your car at factory-recommended intervals—and—change your AC Oil Filter every 5,000 miles! If you forget your change you'll be "out" money, important money should your engine be damaged. So, take the AC Sludgehound's friendly tip. Change filter. Be sure the filter change is to an AC—the filter that takes out every tiniest particle of grit, dirt, dust, metal—to really protect your engine. An AC Oil Filter won't remove the valuable detergents used in today's heavy-duty engine oils.

Ask for the best—AC.



...change oil and filter now!

10 times the filtering area ↓

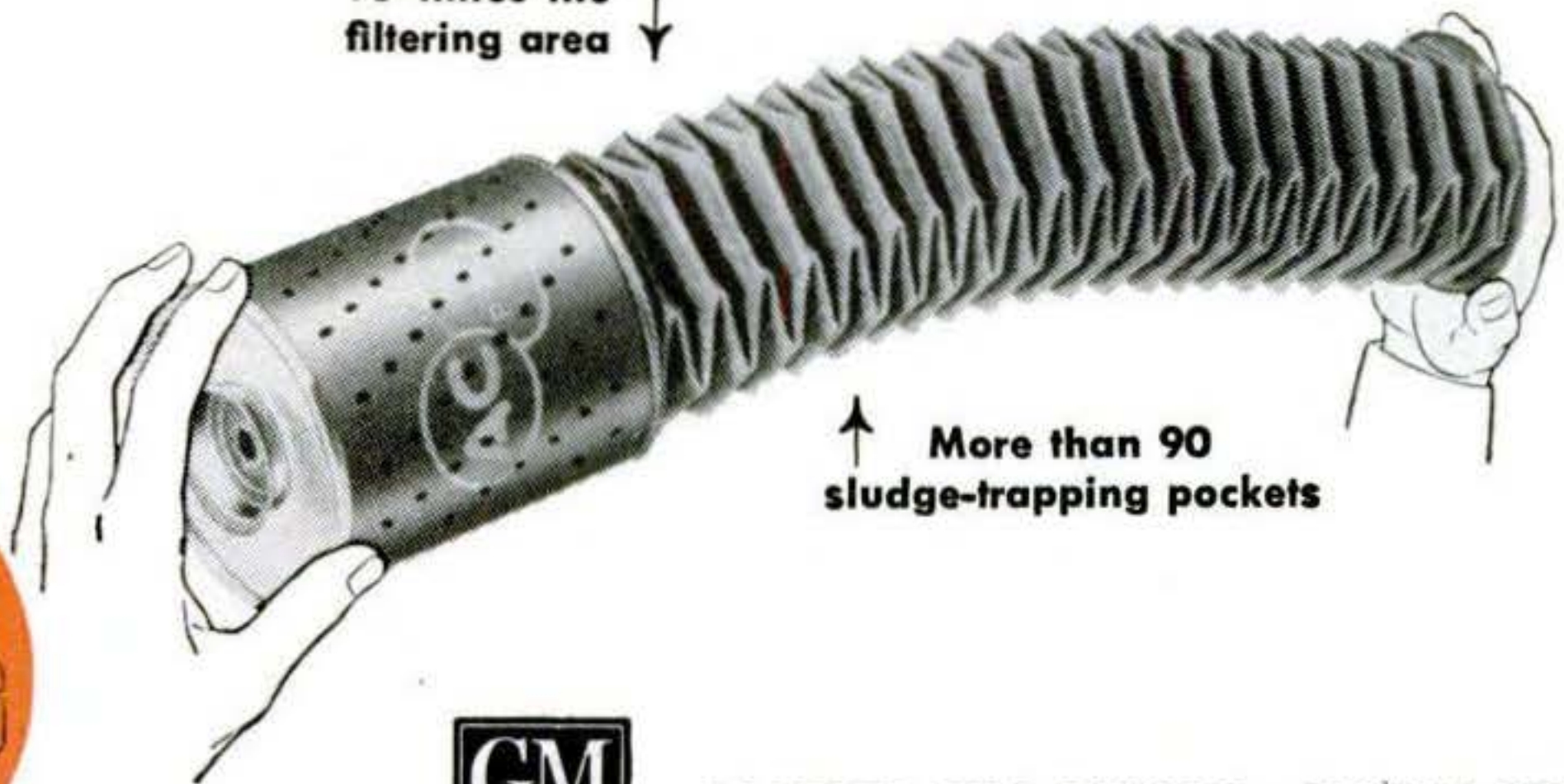

↑ More than 90 sludge-trapping pockets



Watch  
BIG TOWN  
NBC-TV



AC SPARK PLUG DIVISION • GENERAL MOTORS CORPORATION • FLINT, MICHIGAN

**THE ONLY FACTORY-APPROVED FILTER FOR CADILLAC • BUICK • OLDSMOBILE • PONTIAC • CHEVROLET • GMC**

NOVEMBER 1955 259



## Hydra-Matic Dampens That Thump

[Continued from page 121]

tle. To mend that, Pontiac and Cadillac in 1955 have provided a part-throttle downshift up to 28 m.p.h. Now you can get that part-throttle spurt up to 35 m.p.h.

The forthcoming Oldsmobile will, of course, have the new transmission too.

**Other changes** in the 1956 Cadillacs and Pontiacs are substantial. The regular Caddy is pegged at 285 hp., up 35, and the fancy pants Eldorado at 305, up 35. Compression is hiked to 9.75-to-1.

Cadillac boosted its horsepower by making numerous modifications in its engines. The bore is up to four inches, a boost of 1/5 inch, and the stroke to 3 13/16, up about 3/16. The displacement is boosted from 331 cubic inches to 365. High-lift cams have been installed, and a spring has been added under the little check valve on the automatic lash compensators to mend "float" above 4,500 r.p.m.—allowing a thousand more revs.

**Axle ratios continue to drop.** At 3.36:1 in 1955, Caddy's is at 3.07:1 for

'56. And, important to the feel of that wheel, the over-all power-steering ratio is changed from 21.3:1 to 19.2:1.

Caddy also introduced a high-priced hardtop coupe, the Seville—apparently

.....

*The reason the way of the transgressor is so hard is the traffic on it is so heavy.*

—THE SIDEWALK SUPERINTENDENT

.....

meant to compete with the Ford Motor Co.'s Bar Harbor Continental.

Pontiac, too, has something new in body shells, a four-door hardtop. Its engine displacement is now at 316.6 cubic inches, up from 287. Horsepowers, of course, are up here too. The top Star Chief series boasts 227, up a whole 47 horses. You can get a modest 205 horsepower in Pontiac's 870 and 860 series, and the bigger engine is optional.

But, for driving pleasure, it's that 1956 Hydra-Matic transmission that makes all the difference. END

*Good News for budget-minded HANDYMEN...*

**now buy this basic**

# POWER TOOL WORKSHOP

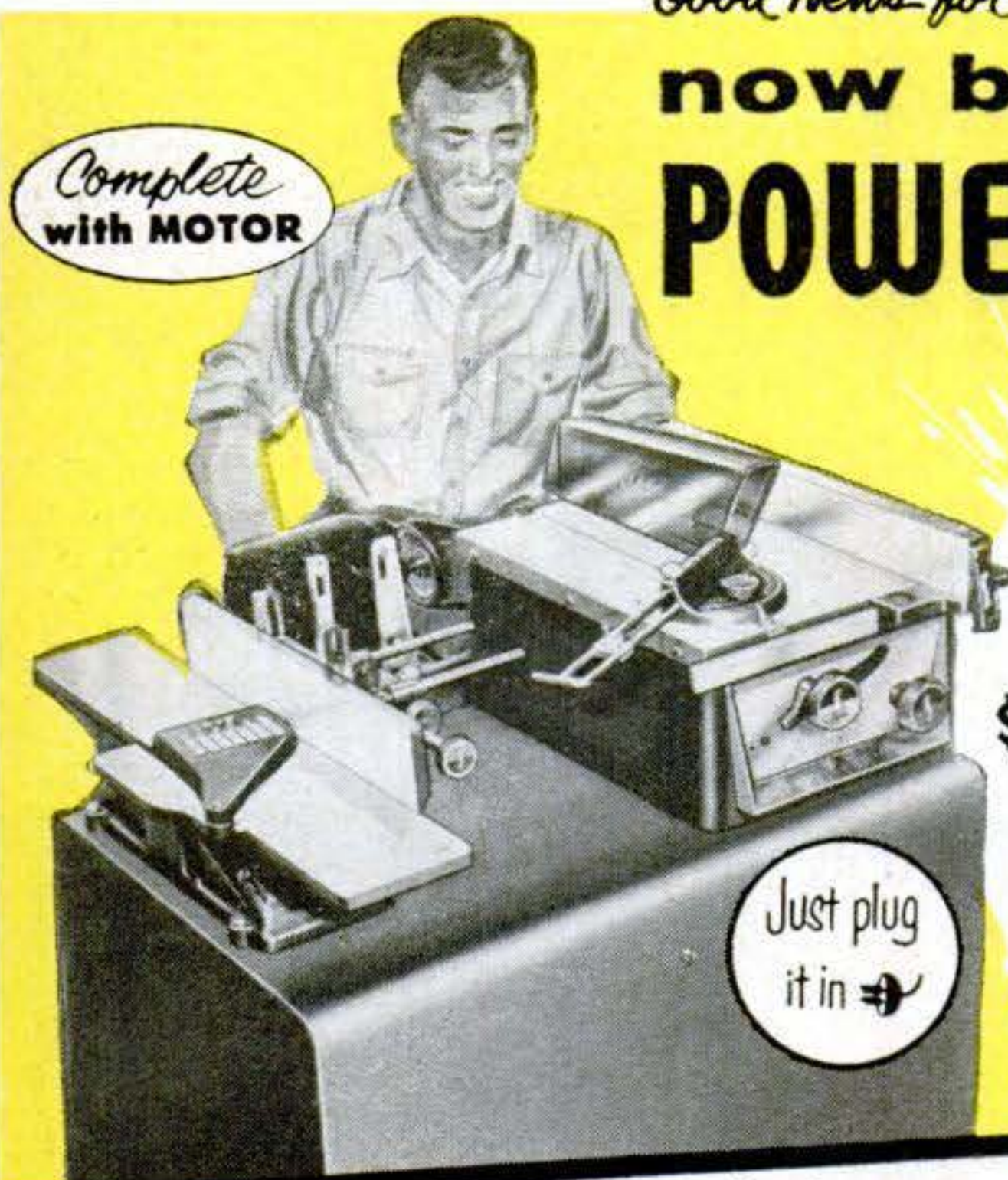

for only  
**\$1750**  
DOWN

and small  
monthly  
payments

### Look at these saw-jointer features

- Ready to plug in
- Handy switch in front
- Complete with 1/2 HP motor
- 8" saw with 2 1/2" depth, 13"x16" table size, mitre gauge and rip fence
- 4" jointer-planer with 3/8" cut, 4"x26" table and flexible guard
- All steel stand 26"x34" and 36" high
- Sealed-for-life ball bearings
- Complete only \$174.50



## IT'S THE NEW Shopmaster

### SAW-JOINTER COMBINATION

Now you can buy Shopmaster tools on the famous GECC Handyman payment plan. Pay only 10% down and balance in up to 18 months. Buy the Shopmaster Saw-Jointer combination or any Shopmaster tools totaling more than \$150 on this wonderful handyman payment plan. It's Shopmaster's way to give you tomorrow's power tools right now!



**It's America's Greatest Power Tool Value!!**

**WRITE FOR FREE CATALOG**

# Shopmaster

ROOM 11D, 1214 SO. THIRD ST., MINNEAPOLIS, MINN.



# New G-E *All-Weather* Headlamps protect you from 3 night driving hazards!

Replace your present headlamps now! A pair costs so little

## 1. THEY HELP YOU SEE THROUGH FOG, RAIN, SNOW

The top photo at right was taken with ordinary headlamps. A man changing a tire a short distance ahead is practically invisible in the fog. The bottom picture shows the identical scene, this time with General Electric *All-Weather* Headlamps. Now the man changing a tire is clearly seen *through* the fog—and in time to stop.

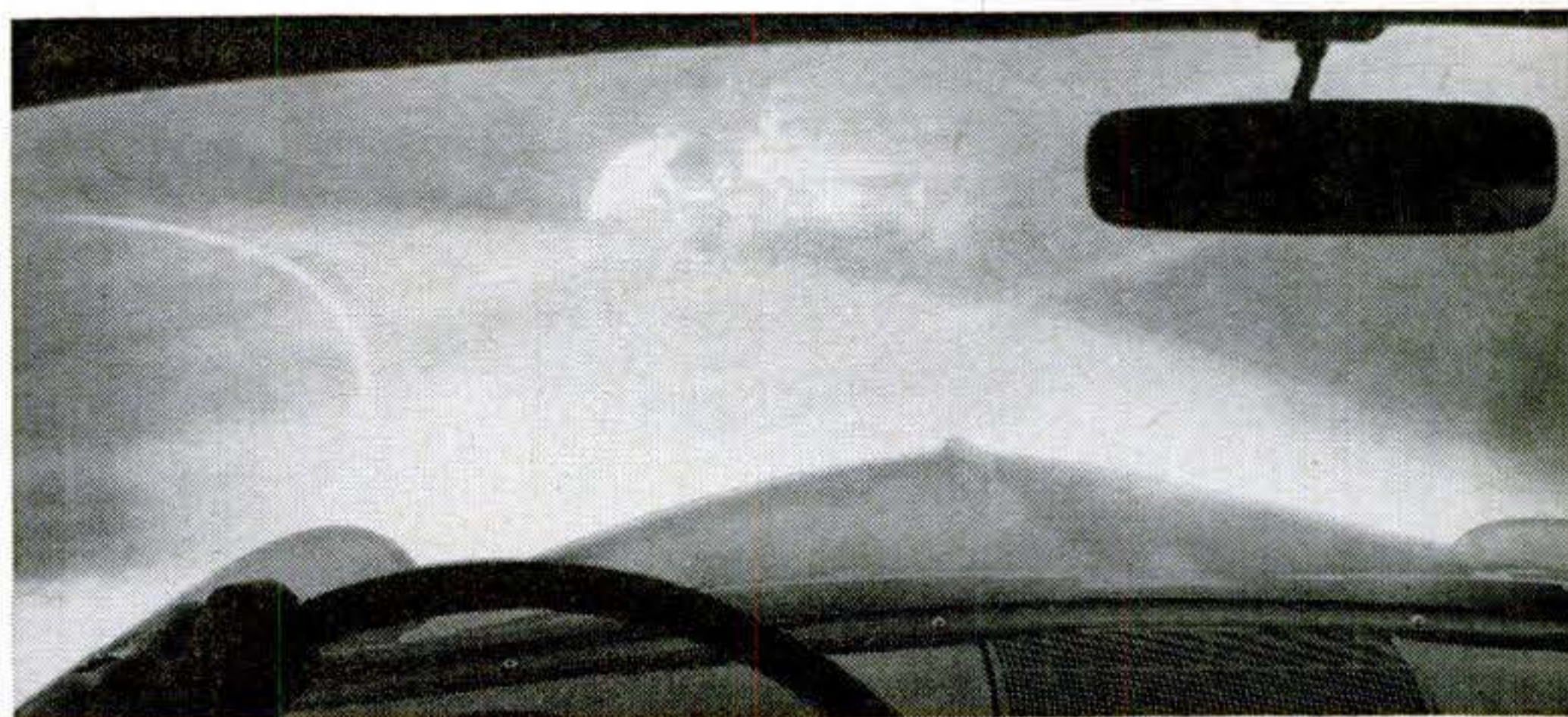

G-E *All-Weather* Headlamps help you see through fog, rain and snow far better than ordinary headlamps. The uncontrolled upward light from ordinary headlamps reflects off the fog and back into the driver's eyes, as blinding "kick-back" glare. But G-E *All-Weather* Headlamps have a specially designed shield over the lower beam filament. It blocks out the uncontrolled upward light making it easier to see in fog, rain and snow, with little or no interference from kick-back glare.

## 2. THEY MAKE IT EASIER TO SEE THE ROAD AGAINST ONCOMING HEADLAMPS

Photo at left below shows how you see against oncoming headlamps when your car has ordinary headlamps. 50 feet beyond the oncoming car, a pedestrian can barely be seen. In photo at right, your car now has G-E *All-Weather* Headlamps. The pedestrian is now clearly visible. Your seeing distance along the right-hand curb is increased by as much as 80 feet.



OLD HEADLAMP



NEW G-E *All-Weather* HEADLAMP

## 3. THEY PUT LIGHT FAR DOWN THE ROAD TO LET YOU SEE CURVES, DIPS AND OBSTACLES

General Electric *All-Weather* Headlamps are more powerful than ordinary headlamps. The 6-volt size, for instance, gives 25% more light! Since the fog shield does *not* cover the upper-beam filament, you get maximum light for distant seeing in clear weather. The extra light is spread over a wide area, including the shoulders of the road, to show curves and obstacles while they're still far away.

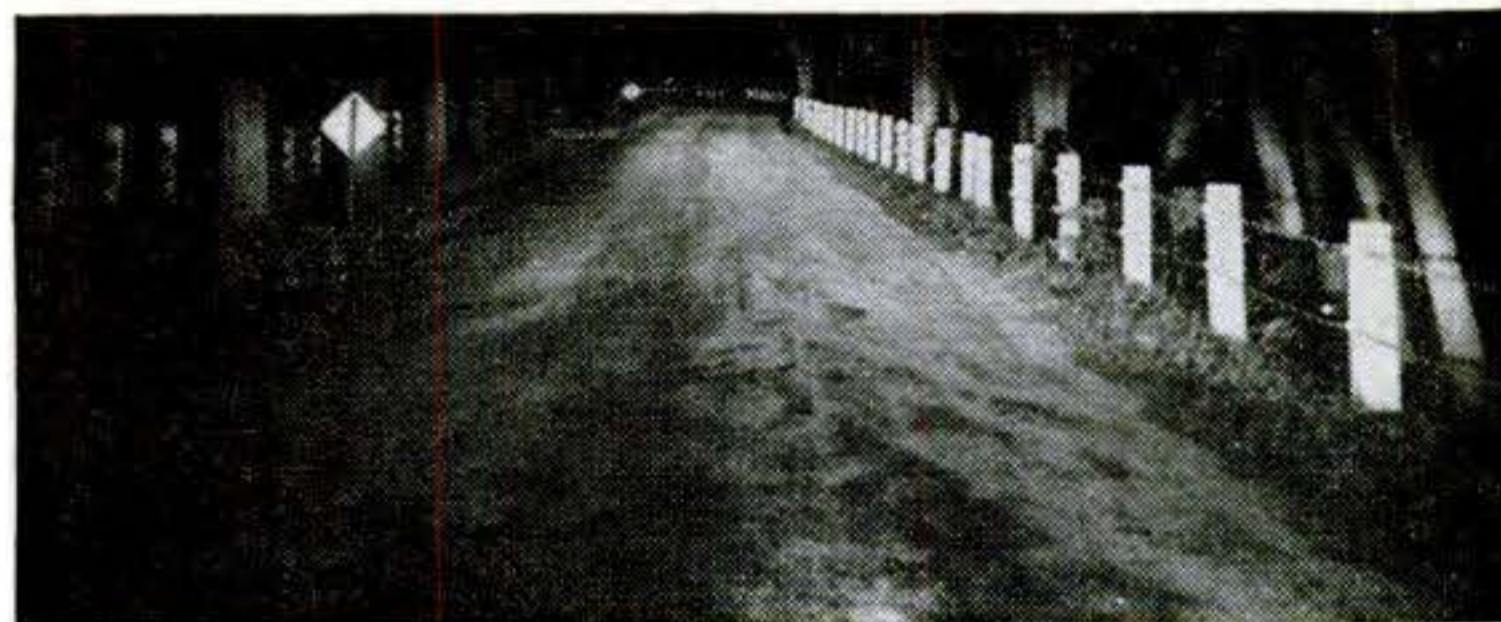

## REPLACE PRESENT HEADLAMPS NOW—G-E *All-Weather* HEADLAMPS FIT YOUR CAR

Don't wait until your present headlamps burn out. Put General Electric *All-Weather* Headlamps on your car today! Miniature Lamp Dept., General Electric, Nela Park, Cleveland 12, Ohio.



*Progress Is Our Most Important Product*

**GENERAL  ELECTRIC**

NOVEMBER 1955 261





**“This stuff can  
MURDER  
your car engine!”**

—says Fonty Flock  
ace stock car driver

**Destructive grit and sludge can run up big  
repair bills—if your oil filter is clogged**

Your oil filter traps so much road dust, hard carbon and metal filings in about 4000 miles that it becomes clogged. Naturally, a clogged filter can't protect your engine. You need a new Purolator® Oil Filter! Up to 10 times more effective than ordinary filters, Purolator keeps your engine running cleaner, smoother, longer. Ask your serviceman to install a new Purolator Micronic® Refill every 4000 miles. Takes only minutes. From \$1.60.

© 1955, Purolator Products, Inc., Rahway, N. J.; Toronto, Canada

**9 out of 10 NASCAR racing drivers use**

**PurOlator**  
*America's No.1 Oil Filter*

262 POPULAR SCIENCE



**Plastic Booth Cuts Shop Noise**

THE clatter and screech of heavy machinery won't compete with telephone conversations when extensions are tucked inside this Celanese-plastic sound shield. The sound-absorbing booth reduces noise level in a busy shop location to that of an average office, says its maker, Design Craft Limited, Toronto.



**Roll Doors Speed Truck Loading**

FLEXIBLE side panels that roll up and down like windows put all the cargo space in this truck within sight and reach. The Timmons Metal Products Co., Columbus, Ohio, uses glass-fiber sheets for the doors. The lightweight panels move in guide rails, need no lifting mechanism, and won't chip, dent, break or warp.



# Get the battery with the **GIANT PLATES**

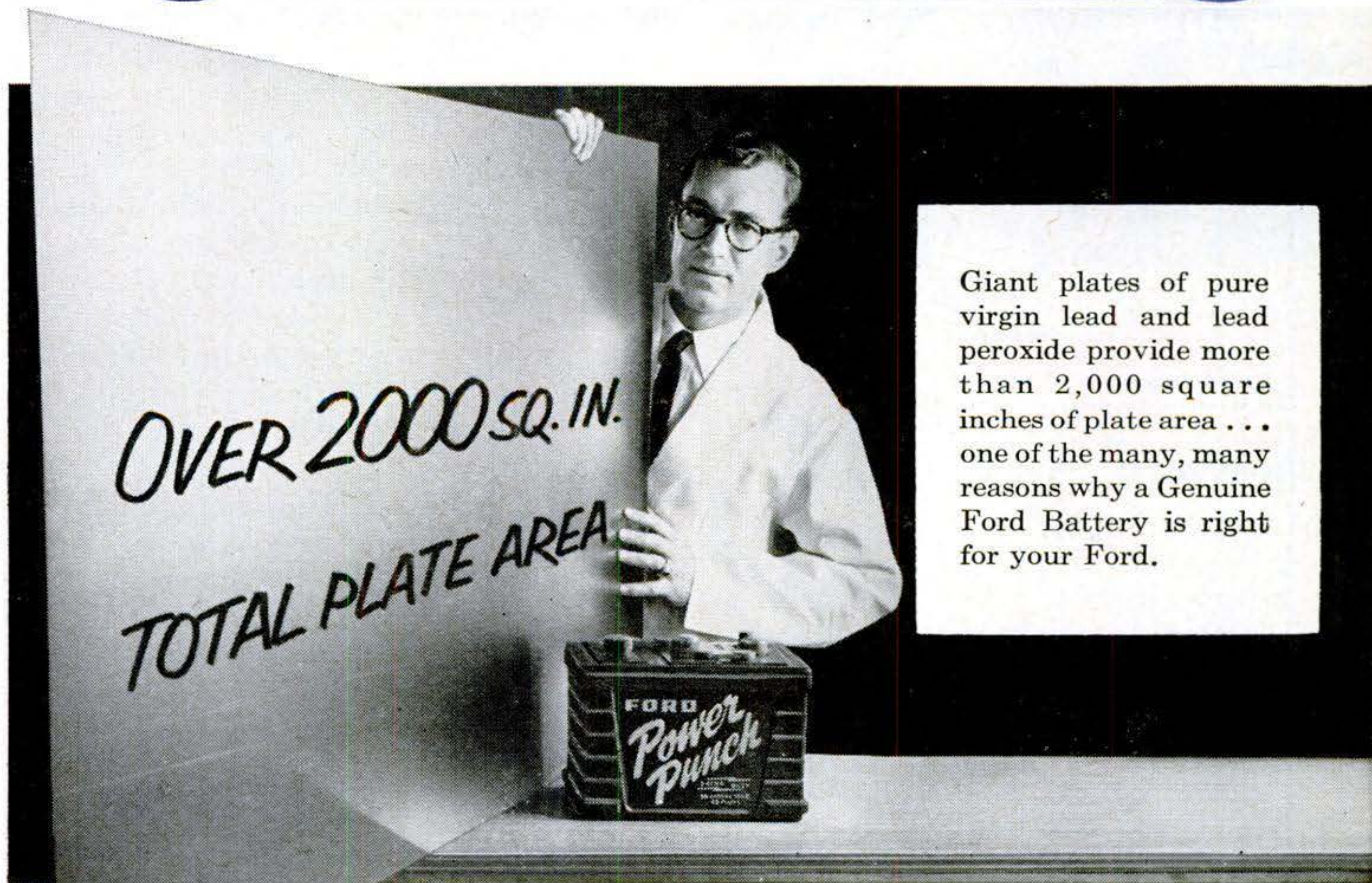

Giant plates of pure virgin lead and lead peroxide provide more than 2,000 square inches of plate area . . . one of the many, many reasons why a Genuine Ford Battery is right for your Ford.

*Genuine Ford "Power Punch" Batteries have extra big plates to give you greater power and longer life*

Now's the time to make sure for the cold months ahead, your Ford is ready to give you all the ready-to-go performance that was originally built into it.

A simple check by your dealer will tell if a new battery is advisable. If necessary, he can supply the Genuine Ford "Power Punch" battery with exactly the *right* capacity for your Ford's electrical system. Ford "Power Punch" batteries, like all Genuine Ford Parts, must pass exhaustive tests

by the men who originally built your Ford before being approved for manufacture.

Remember, whenever replacements will add to your Ford's "go," always insist on Genuine Ford Parts—they're made right, to fit right, to last longer.

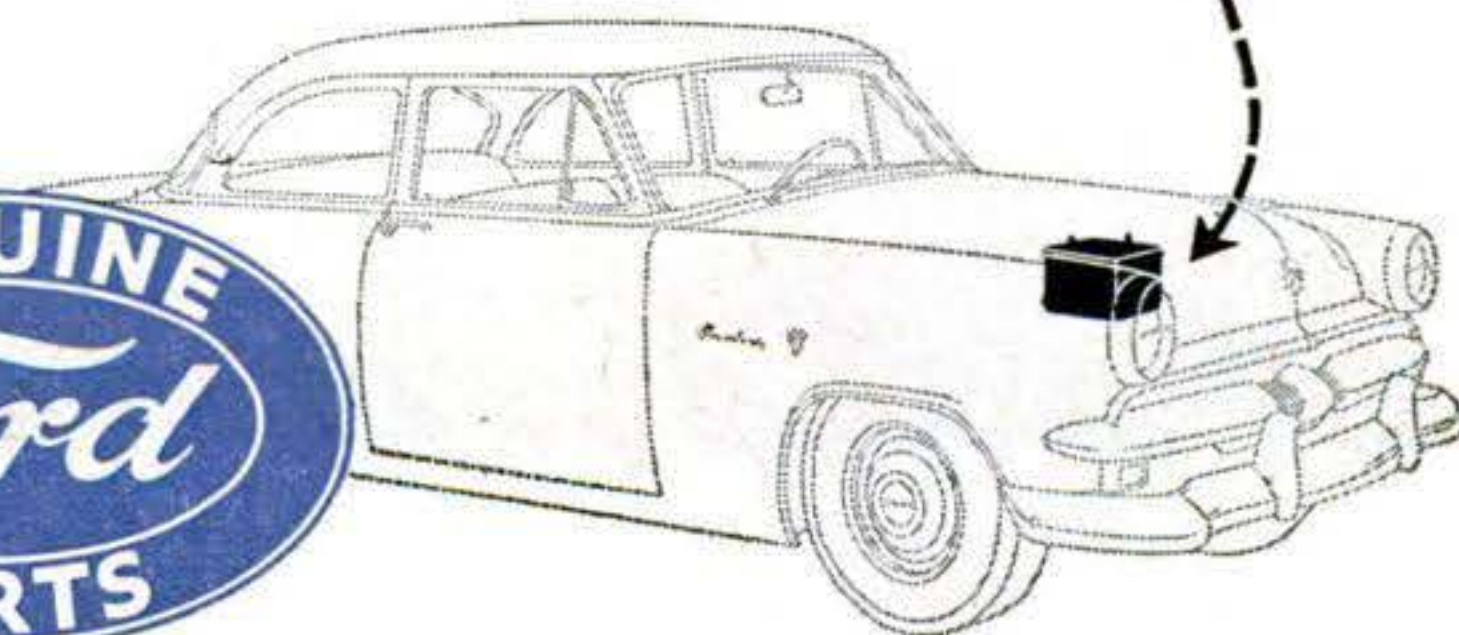

**Keep your Ford all Ford**



## Continental Unveils a Royal Coach

[Continued from page 125]

steering, transmission, seat, windows and those vent panes. A manual synchromesh box can be had as custom equipment for those who insist on being difficult. Instrumentation is all by wagging pointers, none by chinchy warning lights, and the gauges all have a splendid Swiss look to them. Hanging over the transmission hump, trimly crafted in dull gold, are a set of handles to adjust the climate within Mark II to suit your whim.

At this point it is necessary to pause, especially if you are a budgeted man. For tabbed to the carpeting on the hump, gleaming in gold, is a small metal plate engraved: "Built Expressly For . . ." You provide the name.

For a taste of Mark II in motion, light up the 285-plus-horsepower V-8. You can verify that it's running by glancing at the tach or oil-pressure gauge. Seat not just right? Finger the buttons and you not only ease  $4\frac{1}{2}$  inches to or fro and up or down, but also tilt forward or back an inch or two.

Comfy? Then toe down the torque converter to LO, skim away, and don't clock the acceleration. All you'd find out is that the car is fast, and that you are a boor. Driving or even riding in Mark II might well be described as a great, wide, wonderful whirl. Each passenger, nestled in a body-molded seat and with his feet down in a private floor well, is cradled in his own cockpit. The ride, though exceedingly soft, is not spongy or loose. This 5,000-pound car handles unexpectedly well, perhaps because of the low, low CG and the tight 22:1 steering.

**Underlying principle.** Up front the Lincoln-built OHV engine has enough jazz to urge Mark II very nearly as fast as the fastest. Nearly but not quite: Continental owners are not the sort to worry about maintaining their rank in the hot-mill community. The underlying principle around the Continental plant is to build it as well as possible, with all the performance good sense dictates, in a style good taste will appreciate for

[Continued on page 266]

help yourself  
to the  
handiest  
plier  
ever  
designed

CHAN NEL LOCK

No. 420

GRIPS LIKE  
A PIPE  
WRENCH

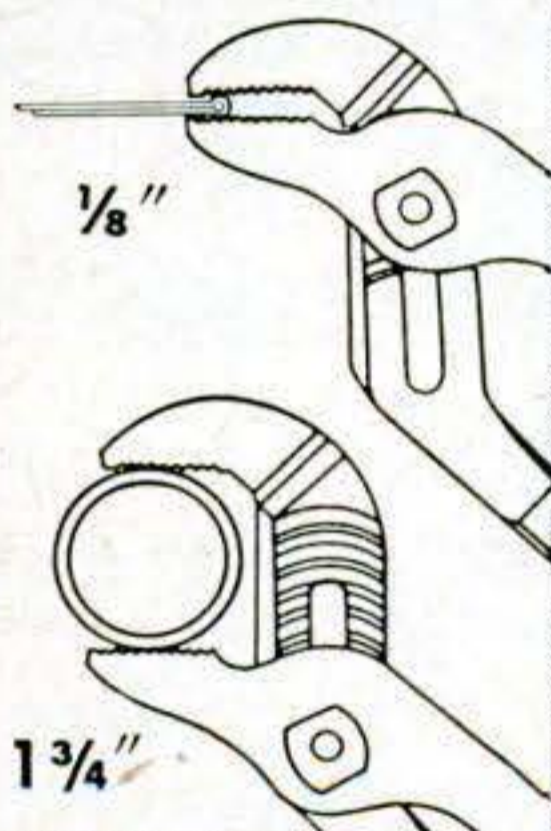

No other plier does so many jobs so well as a Channellock No. 420. Grips anything from a small cotter pin to a  $1\frac{3}{4}$ " hex nut. And what a grip! Just like a pipe wrench. What's more, Channellocks are streamlined . . . easy to use in hard-to-get-at places. Ask your hardware man for a Channellock plier. You'll soon agree with thousands of other craftsmen . . . Channellock is the handiest plier of them all.

BE SURE IT'S A GENUINE CHANNELLOCK

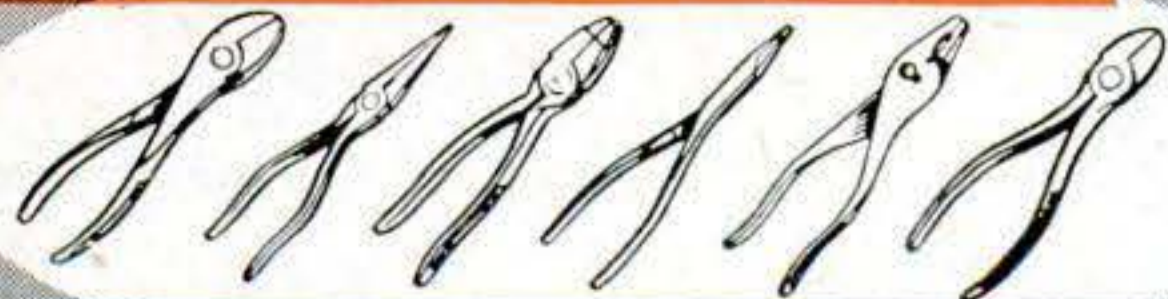

CHAMPION DEARMENT TOOL CO. MEADVILLE, PA.





with BIG 3/4 hp motor!

# New 1956 AMF DeWalt "Power Shop" makes all home woodworking easy!

Here, in one big-capacity machine, is a complete home workshop... that gives you...

- The *power* you need for any operation
- 3-D versatility to handle any home project
- The *professional accuracy* to do any job quickly, easily, *expertly*
- The built-in *safety* you *want* in your home

See a demonstration of the new 1956 AMF DeWalt Power Shop at your dealer's today. Now more than ever, it's the finest, safest, most complete home workshop you can buy.

\$239 delivered (saw blade and 3/4 hp. motor included). EASY BUDGET TERMS

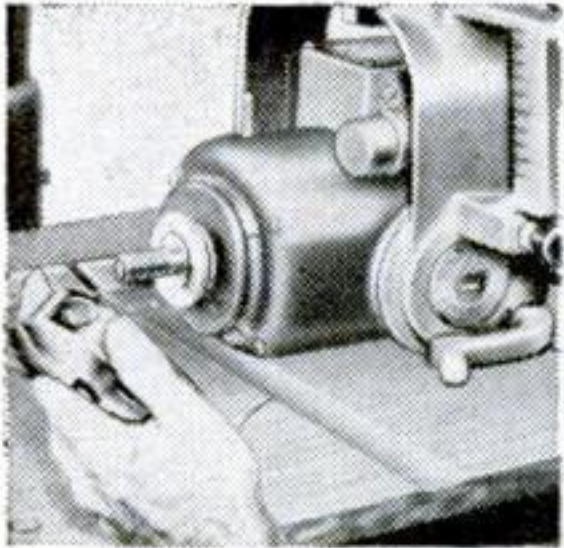

**New 3/4 hp. direct-drive, custom-built motor.** Rugged, reserve power for the toughest jobs — staying power for steady use.



**Easy, safe, top-side cutting.** Always see your mark and your cut — never work "blind." Saw moves above the work.

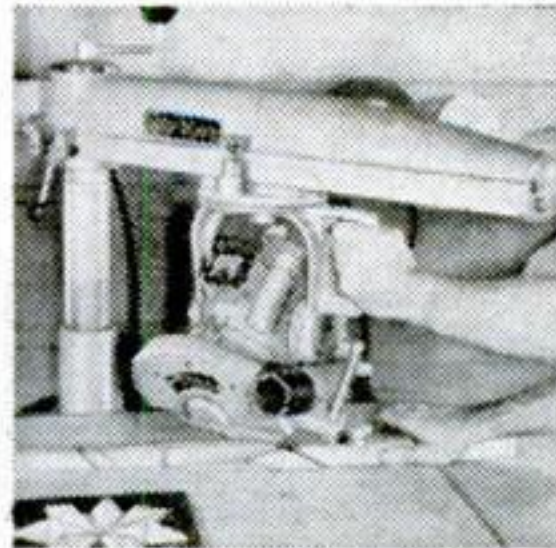

**Straight-line material handling.** Arm swings 360°. Motor rotates 360°—tilts past 90°. Material always moves straight on level table.

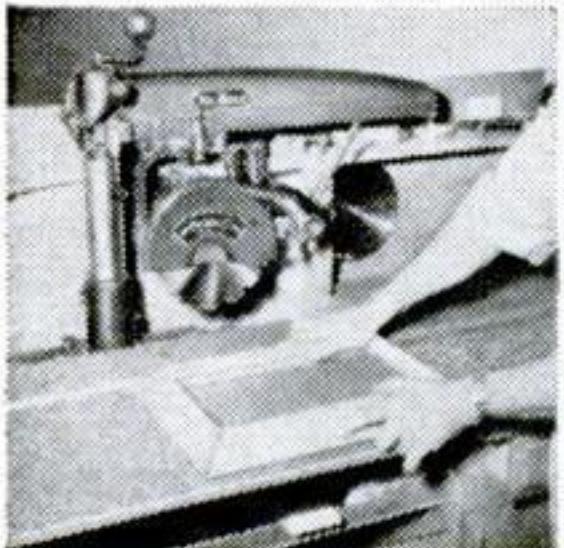

**No floor space needed.** Built into work bench, arm swings clear of work area... swings back when needed.



**Exclusive New Shaper-Jointer Fence.** Converts saw to a 2" jointer at 1/3rd the cost. Positions work for accuracy, safety.

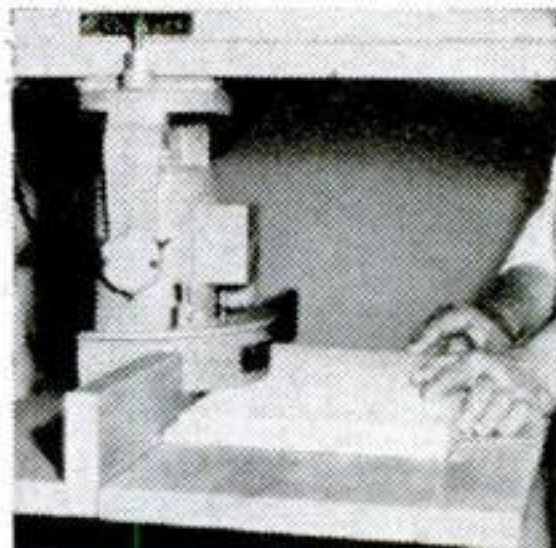

**Exclusive New Shaper Guard.** A DeWalt "First" safety accessory. Totally encloses knives and spindle—raises for adjusting work.

**Complete versatility.** Simply change tool on motor shaft. Your AMF DeWalt saws, dados, shapes, sands, bores, routs, surfaces, joints. It buffs, grinds, turns, cuts curves... does everything in woodworking.

**New safety.** New safety key switch — one of many DeWalt home safety features — turns power on or off. Take key with you and your family is completely protected.

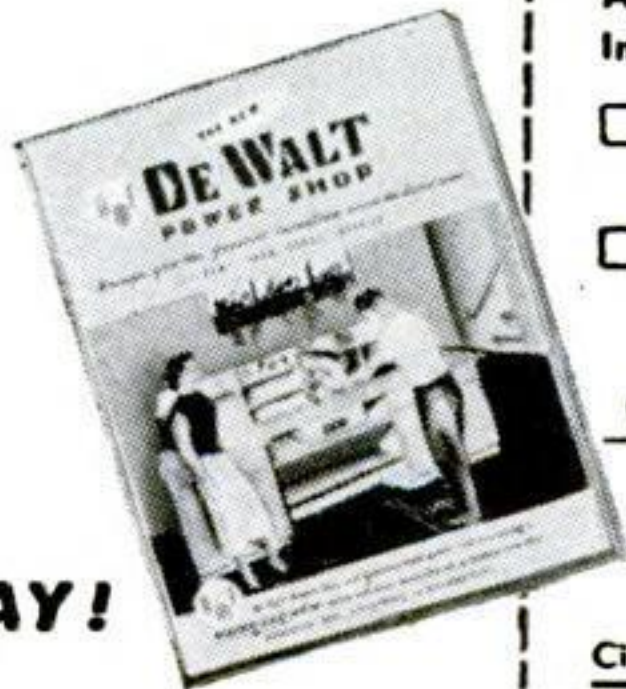

AMF DeWalt, Dept. PS-55-11, Lancaster, Pa.  
In Canada: DeWalt Canada, Ltd., Guelph, Ontario

- Please send me Free Colorful 20-page Booklet on how to do everything in woodworking... easily.
- Please send me Free plans on how to build a home workbench.

Name \_\_\_\_\_

Address \_\_\_\_\_

City \_\_\_\_\_ Zone \_\_\_\_\_ State \_\_\_\_\_

**SEND COUPON TODAY!**



## Continental Unveils a Royal Coach

[Continued from page 264]

years. Mark III is not due until we're all some years older.

At first the silence of the car may spook you; with the windows up, there is no clamor from the peasantry outside, and very little sound beyond a faint hum of V-8 basso. Enough body insulation to paper a radio studio helps achieve this. Vibration has been damped out both on the drawing boards and on the hand-fitted assembly.

**The pieces.** A pause to look at the parts of America's most expensive auto tells a lot. As Continental engineer Matt Wyatt points out, Mark II's sheet metal is the heaviest in the industry. It positively refuses to bong; if you knee a side panel it refuses to pop but just leans reluctantly. Rap on the hood or deck lid and they sound like grand-piano lids.

The frame under this gold-dusted chariot looks at first like a war-surplus gun platform. It weighs a ponderous 535 pounds by itself, and is a rugged, lad-

derlike layout of box rails and tubular cross members. There's a box-member spine running down the center carrying the three-piece drive shaft strapped to its back. Up front is a sturdy box-and-tube cross member that might be something left over from an M-48 tank.

Every car built is road-tested on Continental's private track, run long enough so that the break-in oil can be drained and replaced, and then tuned to a sharp edge. The moment an owner takes delivery, he can set out for Patagonia at full throttle if he wants to. And if he ever needs to check on the car's idiosyncrasies, there is an envelope on file at the factory that tells everything about it from engine to paint job.

Unless Mark II's owner is a mechanical type, he may not even know about some of its hidden gimmicks. Such as the special steel spring hangers that are designed to prevent rump slew and to keep

[Continued on page 268]

### IT SMELLS GRAND



WANT AROMA WITH "LIFT"? MAN, HERE'S HOW

### IT PACKS RIGHT



AND IT PACKS SO NEAT IT RATES A BOW

### IT SMOKES SWEET



IT'S THE PIPE-BLEND CHAMP YOU MUST ALLOW

### IT CAN'T BITE!

SIR WALTER RALEIGH'S BLEND OF CHOICE KENTUCKY BURLEYS IS EXTRA-AGED TO GUARD AGAINST TONGUE BITE.

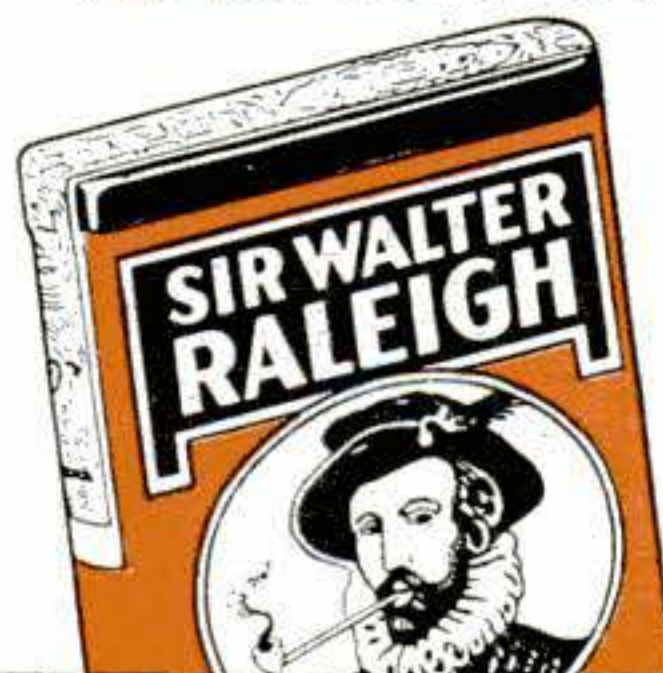

## FREE!

24-PAGE BOOKLET ON PIPE CARE. JUST WRITE TO: SIR WALTER RALEIGH DEPT. H5, LOUISVILLE, KY.



# UTICA® Adjustable Wrenches FOR THE BEST IN GOOD TURNS

Yes, many, many good turns because they offer you a very special UTICA feature. The jaws surfaces are extra hardened by UTICA's own process of electronic induction. Jaws resist nicks and burrs, stay smooth and new-like up to 10 times longer than ordinary adjustable wrenches.

An adjustable wrench is a mighty handy tool, but be sure to look for the name UTICA on the handle. Sizes from 4" up to 18"



LOOK FOR  
THE NAME  
**UTICA®**

No. 91



THE HALLMARK OF QUALITY  
UTICA DROP FORGE & TOOL CORP.  
UTICA 4, N. Y.

In Canada: Adlam Tool & Supply Co., Ltd., Montreal

## ADD YEARS TO THE LIFE OF YOUR ROOF!

Stop Leaks!  
Save Big Repair Bills  
with **GLASSTITE®** Liquid  
Glass Roof Coating

Easy Do-It-Yourself Job  
FULL 12 YEAR GUARANTEE



Paint your roof NOW with Glasstite—and save hundreds of dollars in repairs through years to come. It's an easy do-it-yourself job. This new scientifically developed liquid glass coating provides a tough leathery surface on any type of roof. *Guaranteed* to remain water tight at least 12 years.

Glasstite is positively one of the best "life insurances" you can buy for any roof, new or old. Protects indefinitely against deterioration. **INTRODUCTORY PRICE** only \$6.25 for a 5 gallon container of black Glasstite which effectively covers 200 square feet. Also available in aluminum at additional cost. We will ship, carrying charges collect, by most economical means. Order now. Send check or money order. Give your roof the penny's worth of prevention that saves many dollars in repair.

INQUIRIES FROM DEALERS INVITED

**MORT CO.** Dept. P 4th St. & Girard Ave.  
Philadelphia 23, Pa.

Established in 1900 and Producing Quality Products for 55 Years

## GIVE MEASURING TOOLS THIS CHRISTMAS....



### YOU'LL FIND **LUFKIN TOOLS**

Will Fill Your Christmas List . . .  
And Not Empty Your Pocketbook!

For The Home Handyman  
Or Lady-Of-The-House  
**WHITE CLAD  
MEZURALL TAPE RULE**  
6, 8, 10 and 12 ft. lengths.  
Snow white line, jet black figures,  
extra strong featherweight  
magnesium case.  
98c to \$1.89



For The Do-It-Yourself  
Or Home Craftsman  
**SUPER WHITE CLAD  
MEZURALL TAPE RULE**  
Wide 3/4-inch line. 16-inch centers  
indicated. 10 and 12 ft.  
lengths. Extra strong feather-  
weight case. Extra big self-  
adjusting end hook.  
\$2.39 and \$2.89

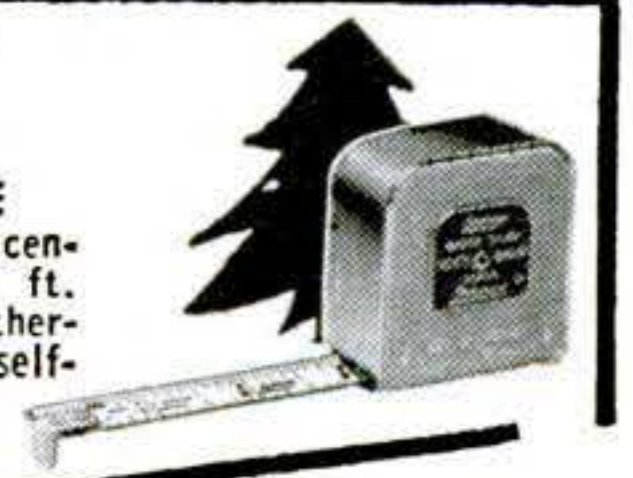

For The Lawn and Garden  
Enthusiast Or Outdoor  
Construction Worker  
**WHITE CLAD BANNER  
LONG STEEL TAPE**  
25, 50, 75 and 100 ft. lengths.  
Snow white line with jet black  
markings. Attractive maroon vinyl  
covered case.  
\$3.50 to \$6.50



ALL LUFKIN WHITE CLADS ARE PACKAGED IN  
ATTRACTIVE, REUSABLE PLASTIC CASES . . . MAKING  
IDEAL CHRISTMAS PACKAGES.

BUY **LUFKIN** TAPES • RULES •  
PRECISION TOOLS  
FROM YOUR HARDWARE, LUMBER OR TOOL DEALER  
**THE LUFKIN RULE CO. • SAGINAW, MICH.**



**Hastings Oil Filter  
Cartridges keep oil  
clean from  
filter change to filter  
change\* when  
replaced as normally  
recommended... The  
reason is  
DENSITE**

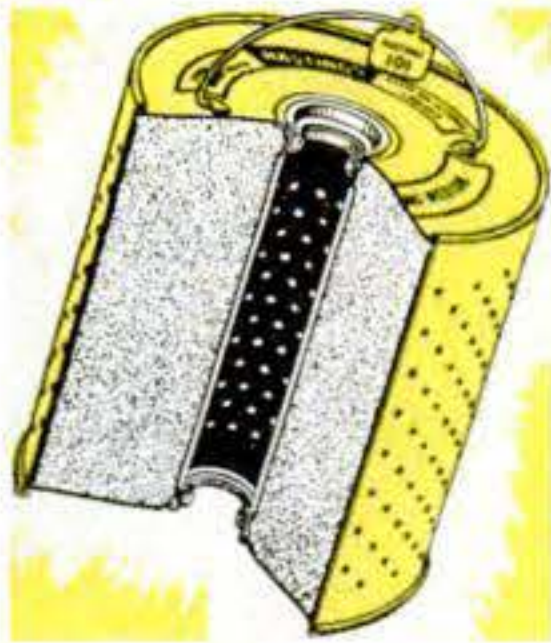

Densite—an amazing new type of filtering material—is made of millions of selected raw cotton fibres, pressure packed so oil must flow through countless tiny openings, pass many surfaces of fibres. The most microscopic abrasives cling to these fibres—and stay there!

Next time you change oil—change your filter cartridge. Ask for Hastings and have clean motor oil *all the time!*

\* As proven by tests conducted in accordance with U. S. Bureau of Standards procedure.

HASTINGS MANUFACTURING CO. • HASTINGS, MICH.

**HASTINGS**  
**OIL FILTER**  
**CARTRIDGES**  
**with DENSITE**

**Continental Unveils a Royal Coach**

[Continued from page 266]

out tar-strip thump-thumps. Or the new fancy-pants shock absorbers that have thermostats in them (to equalize ride during speed on a rough road when shocks run hot, and slowness on a smooth road when they run cool).

Another tony touch about Mark II is provided by the slatted wheel covers. These spray sunlight over the onlookers whenever the car moves. The first attempt had the hub, disk and spear spokes stamped out in one piece. The designers held their noses. So now each spoke is screwed on separately, and it takes almost as long to build a Continental wheel as to make a complete Ford.

This pinch-no-pennies philosophy doesn't mean that the Continental Divis-

.....

*Nothing arouses a woman's curiosity like a neatly tied package that her husband thinks he has hidden from her.*

—THE SIDEWALK SUPERINTENDENT

.....

ion is off its fiscal rocker. The car is being made for two reasons, prestige and profit, and it is well known which of that pair fills the hamper at the A & P. The break-even production for a year of Mark IIs is reputedly 2,500 cars.

**The chi-chi market.** The goal doesn't appear difficult. Months before the car was publicly unveiled, 1,200 definite orders, many with deposits, had arrived at the plant. This appears to confirm the theory that there are a substantial number of people around who have continuing difficulty in disposing of their money. Continental did not, however, content itself with theory. Preliminary decisions were taken only after a sharp scrutiny of such glittering straws in the wind as sales of yachts, fur coats, homes costing over \$75,000, and world cruises.

Out of these statistical meditations, Continental has distilled a heady production estimate of 2,500 to 4,000 Mark IIs a year. Certainly a lot more people than that will long to see their names in the golden writing on the floor. **END**



**STOP  
COSTLY HEATING**

# Leaks

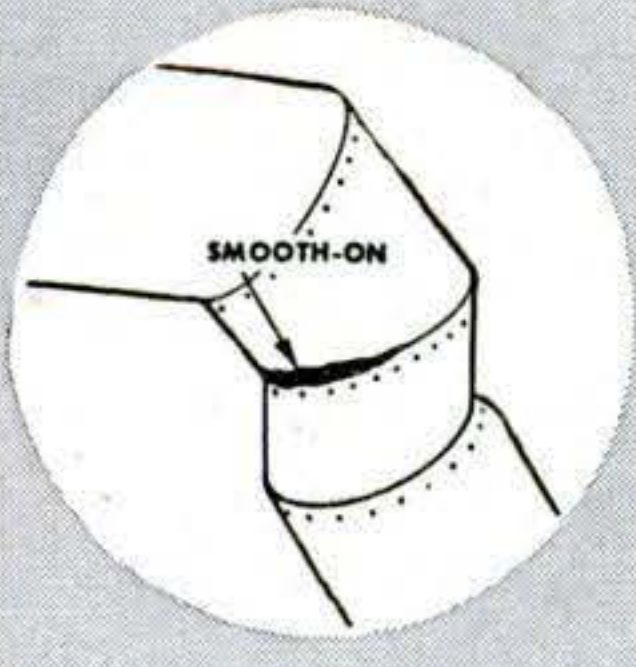
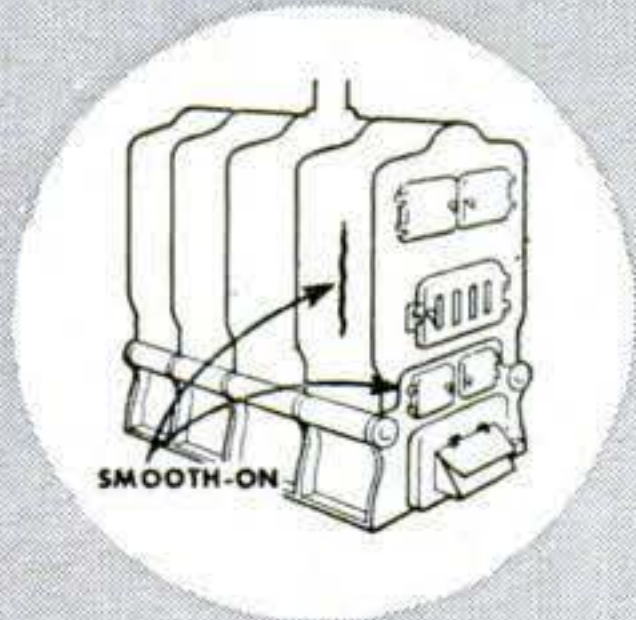

Use Smooth-On No. 1, the IRON repair cement. It hardens like metal, fills cracks and holes in any casting, pipe, radiator, or fitting. Does the job by expanding inside the repair, gets stronger with age. Withstands water, steam, gas, fire, and smoke, stops wasteful drafts in conversion jobs.

**FREE 48-Page Repair Handbook**

gives details for these and dozens of other repairs. Written so you can "do

it yourself." Get a copy at your own hardware store or drop us a card. Sent postpaid.

**SMOOTH-ON MANUFACTURING COMPANY**  
Dept. 58, 572 Communipaw Avenue, Jersey City 4, N. J.

# SMOOTH-ON

**The amazing wood filler that accepts a stain, can be planed, power sanded and dries quickly!**

For use in the home, on the farm, on the boat and in industry

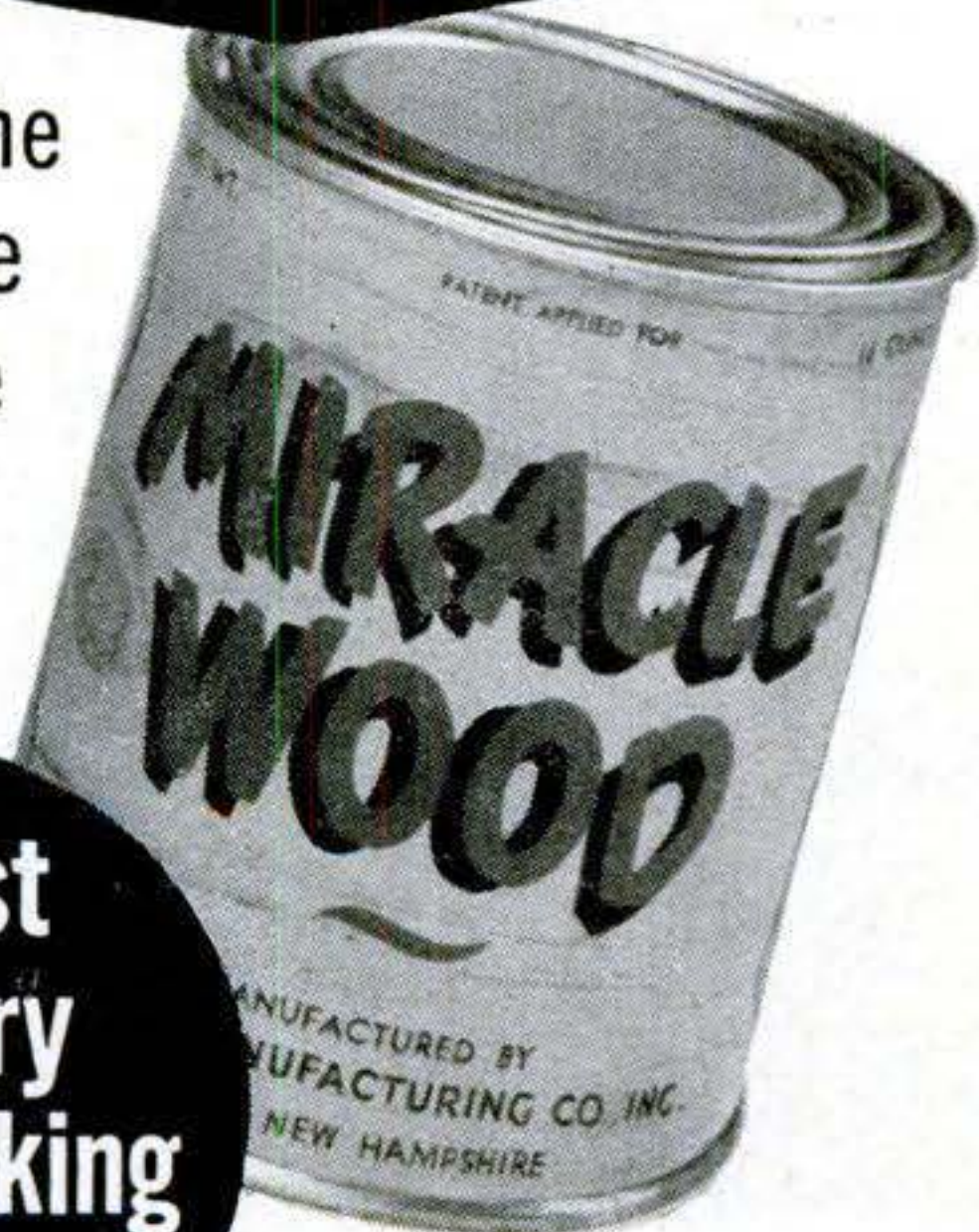

**A must in every woodworking shop!**

**NEWTON Mfg. Co., Inc.**  
45 Lowell St., Nashua, N.H.

# IRWIN

## SANTA CLAUS SPECIALS



for the handy man, hobbyist, teen-age and professional woodworkers



**No. DM (x) Borchest Set**

**only \$15.50**

13 Irwin original solid center auger bits, sizes 1/4" to 1". Beautiful hand rubbed oak chest in Christmas box with colorful gift card and transparent lid. Patented spring-steel clips hold bits in place. Sizes shown for easy selection. Each bit hardened full length for longer life.



**only \$4.39**

**Speedbor "88" for 1/4" electric drills**

Set of six in red plastic roll, sizes 3/8" to 1". Exclusive hollow ground point with spade-type cutters do more work with less power—in hard and soft woods, plaster, plastics, etc. Size markings on each bit. Hang-A-Bit Hole for easy storing on nail or pin.

**No. 22 (x) Micro-Dial Expansive Bit**



**only \$3.15**

It bores accurately from 7/8" up to 3". Change sizes with easy turn of a dial. Two cutters supplied with each bit. Drop forged from special bit steel, heat treated full length. A dependable all-purpose bit that does the work of complete set of individual sizes.

See Your Independent Hardware Dealer

**IRWIN** the original solid center auger bit  
Wilmington, Ohio screw drivers, screw driver bits



# IN INDUSTRY...

The grip, accuracy and durability of the Jacobs Plain Bearing Chuck have made it standard equipment all over the world. This model, especially designed for drill presses, features a Jacobs-engineered PLUS—the threaded locking collar for extra safety and more versatile use of the tool.

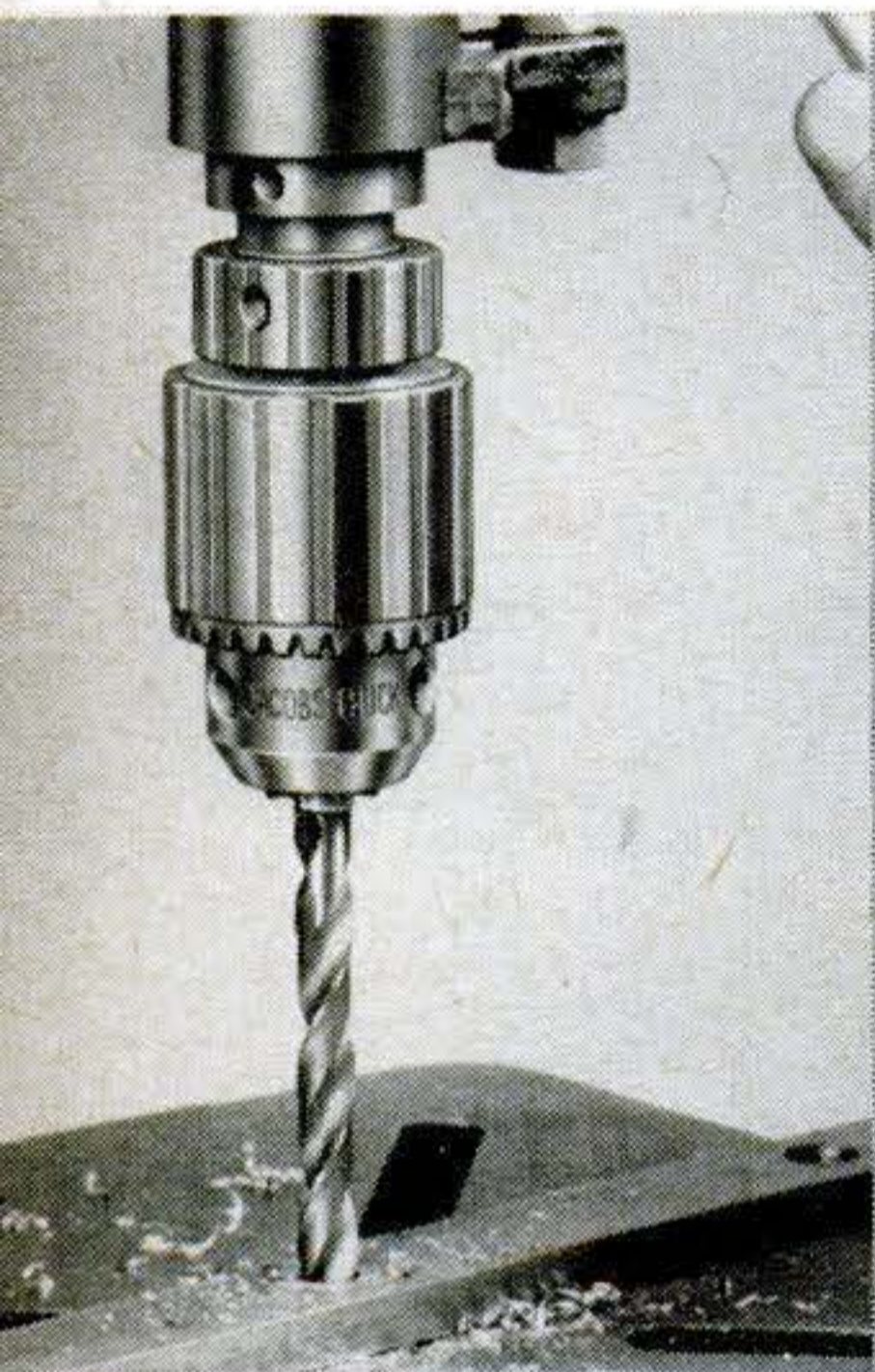

AND  
IN THE  
**HOME  
SHOP**

The Jacobs Plain Bearing Chuck equipped with threaded locking collar makes any drill press a safer, surer, more versatile tool.

**Safer** because the threaded collar keeps chuck locked on tapered spindle regardless of speeds or type of thrust.

**Surer** because it's a Jacobs, the most accurate, holdingest, longest lasting chuck of its kind — anywhere.

**More versatile** because it eliminates the necessity of using special collet chucks or similar adapters for holding routing, carving or dovetailing bits.

When you work with a drill press or portable electric tool you'll hold your drill or bit best when you use the Jacobs Chuck. There is none better for accuracy, grip and durability. The Jacobs Manufacturing Company, West Hartford 10, Connecticut.



**Jacobs**  
C H U C K S

## Car Hi-Fi Plays 16 $\frac{2}{3}$ -R.P.M. Records

[Continued from page 132]

against the fast pull of a bump. Its pivot—a simple shaft riding a bearing ball in a close-fitting hole—gets this uncanny ability from a silicone fluid. Silicones are those versatile chemicals that make bouncing putty, tough electrical insulation, waterproofing compounds and many other products. In this case, the silicone's odd habit of changing its viscosity is put to work. The silicone in the pivot hole is thin, permitting the pivot shaft to turn freely so long as the turning is slow. But try to turn the shaft quickly and the silicone becomes much more viscous, grabbing the shaft to retard its movement.

The cartridge—a special ceramic type—is not fastened directly to the tone arm, but rests on the end of a second arm that can swing up and down inside the horizontally swinging tone arm. This arm is counterweighted to balance on its pivot. With no weight on the needle, a spring forces it into gentle contact with the record: total pressure about 1/10 ounce.

**What's on.** Each player will come equipped with an assortment of six records—nine to 12 hours' listening. In this starting library is something for everybody: Tchaikovsky's *Pathetique* and Borodin's *Prince Igor*, *The Pajama Game* musical, *The Ballad of Davy Crockett*, romantic and jazz orchestral music, Cole Porter and Victor Herbert selections, and George Bernard Shaw's *Don Juan in Hell* recited by Charles Boyer, Cedric Hardwicke, Charles Laughton and Agnes Moorehead.

Columbia Records already has a catalogue listing 30 other selections on the 16 $\frac{2}{3}$ -r.p.m. discs. There are classical and popular orchestral music, musical comedy songs, dramatic readings and seven records for children.

Special car records are likely to come, though not in the works just yet. A keep-awake disc would be useful—it might ring a bell or whistle at you every so often, or maybe say sharply: "Wake up, mister! Time to pull over for coffee."

Records designed to amuse children

[Continued on page 272]



## 1/4" ELECTRIC DRILL

One of the first and best home power tool investments. Full powered, permanently lubricated, drill in metal, wood, concrete. Complete Drill Tool set includes horizontal stand and accessories for polishing, sanding, sharpening, cleaning, buffing.

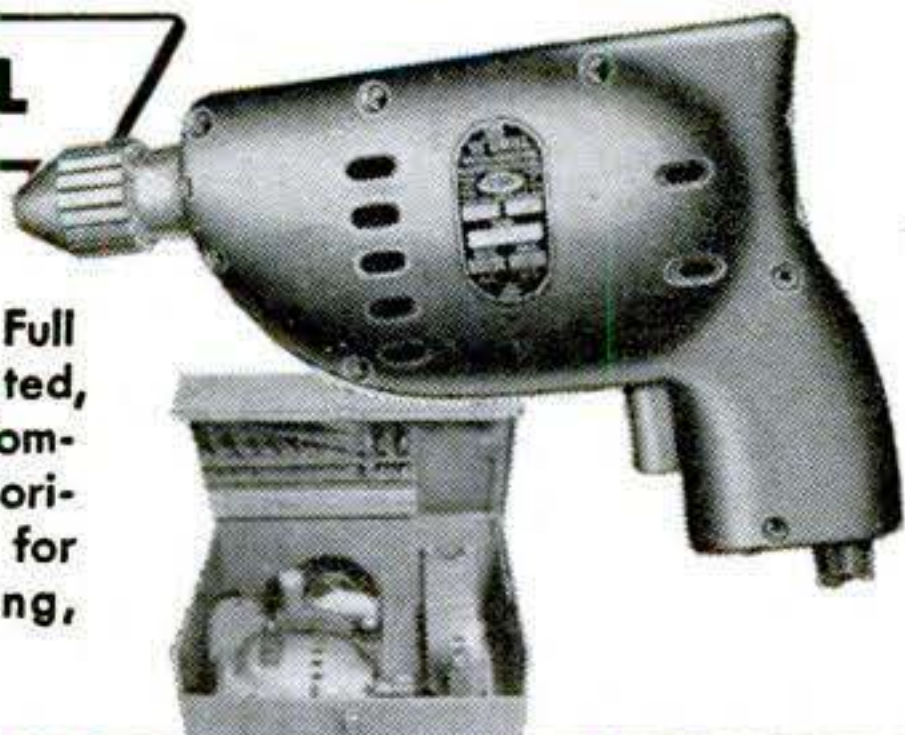

*You'll Always Be Glad  
You Bought a*



## FLAT SANDER

Fast, powerful, light, dependable—orbital action. At 4,000 cycles per second produces fine finish on all woods, metals, fibres, etc., wherever hand sanding is usually employed.

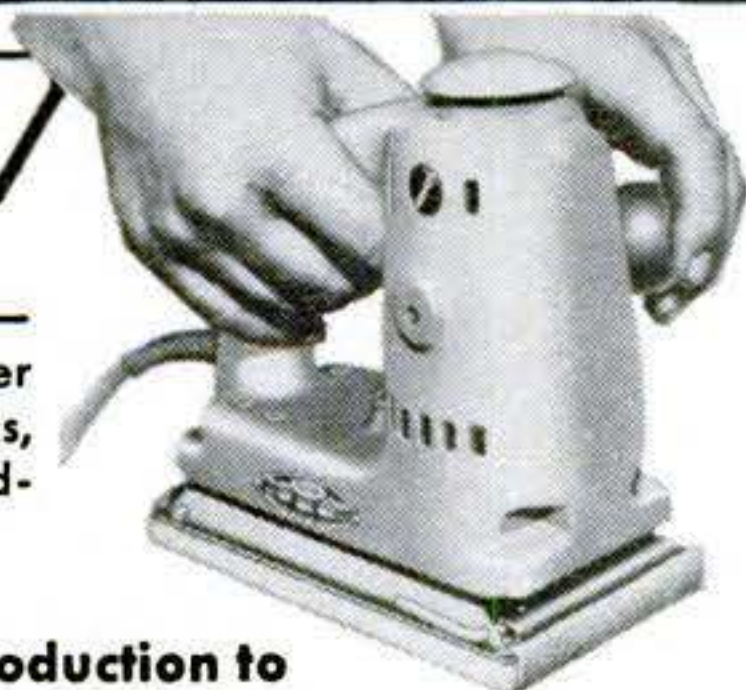

The SIOUX name needs no introduction to the skilled mechanic who makes his living working with power tools. In the aircraft and automotive fields and in industry they're the tools the professionals have used for over 40 years!

WRITE FOR  
FREE  
CATALOG!



## POWER SAW

This modern SIOUX hand saw is really rugged with a world of surplus power. Available in 8 1/4", 7 1/2" and a 6 1/2" Model that will saw through 2 x 4's at a 45° angle with plenty of blade to spare.

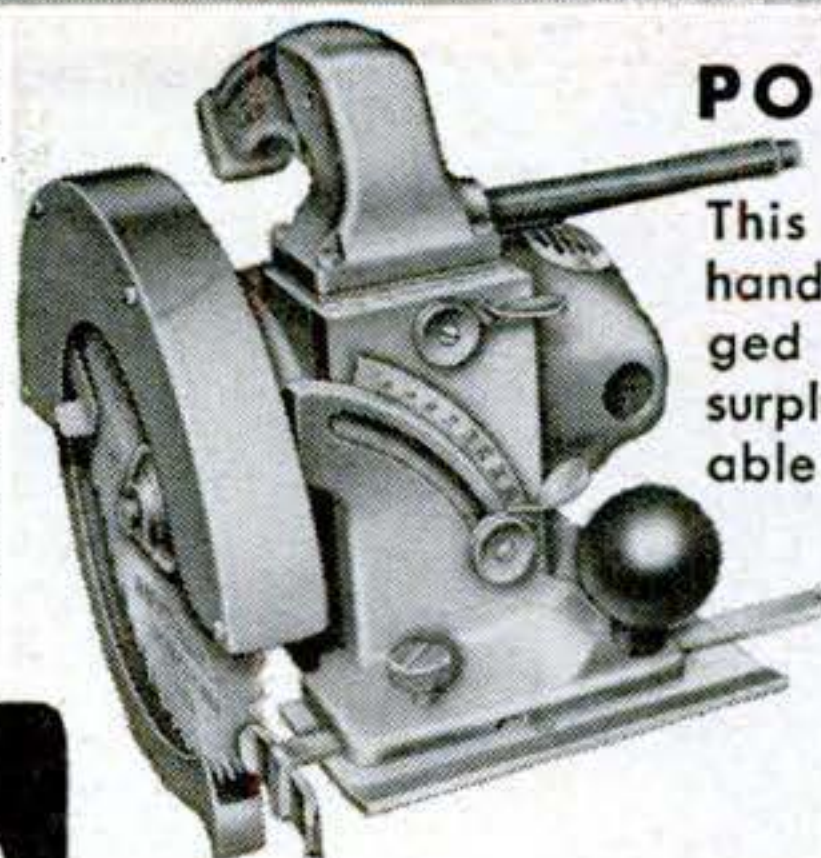

**Mitre Cuts**—Adjustable base for bevel cuts from 0 to 45°, to 1 1/8" depth. Spring lift with nut adjustment is quick, accurate.



**Cross Cutting**—Edge of base follows line. High speed makes it many times faster than hand sawing.



**Rip Sawing**—Adjustable rip scale guide is plainly graduated in fractions of an inch. Blower keeps line of cut free of saw dust.



ALBERTSON & CO., INC. • SIOUX CITY, IOWA

YOU DO A BETTER JOB WITH

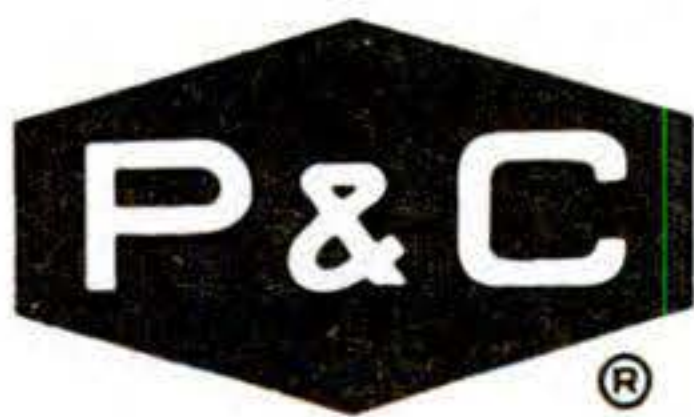

**PUNCHES  
and  
CHISELS**

There's a BIG difference in chisels and punches. You need P&C quality to go through the toughest steel with speed and ease.

- Quality P&C Alloy Steel
- Properly Heat Treated
- Comfortable Grip
- Polished Flats & Points
- Properly Balanced

Buy P&C today...  
the best tools  
money can  
buy. Shop  
from P&C  
Merchandisers,  
in over  
10,000 stores.



**P&C TOOL CO.**

DEPT. F-6 • BOX 5926  
PORTLAND 22, OREGON

*Bright Idea!*

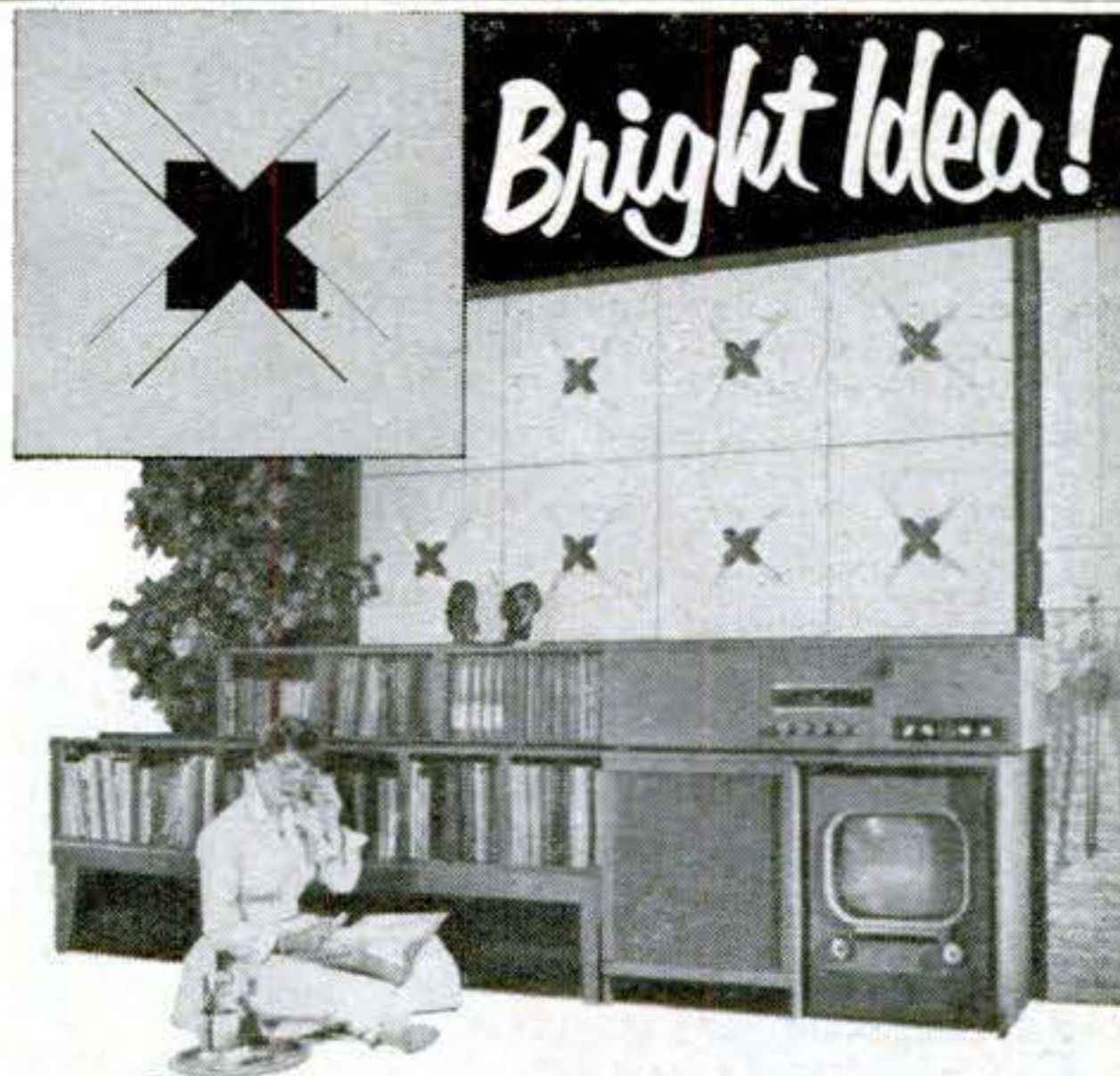

*Make* with  
(RHYMES WITH O.K.) **FIR PLYWOOD**

Exciting new way of decorating with fir plywood. Create bold, colorful designs by "weaving" slits in plywood with dowels or other inserts. Use for dramatic lighting effects, room dividers, fences, doors. Wonderful for remodeling, "do-it-yourself."

**FREE BOOKLET**—contains step-by-step instructions, ideas, design suggestions. See your lumber dealer or write (USA Only) Douglas Fir Plywood Association, Dept 1111 Tacoma 2, Wash.





on long trips are a possibility. There might also be travelogues; as you toured a region you could play a disc that spied local history and sights.

The tiny records should last indefinitely. Test discs have been played hundreds of times without noticeable wear.

**Why 16<sup>2</sup>/<sub>3</sub>?** The new record speed is not really new. It has been used for years for the Talking Book records furnished to blind people. It was adopted for the car phonograph, says Dr. Peter Goldmark, CBS research chief who headed the development, mainly because of the very long playing time it would give with a small record. And this speed is about as low as you can go and still get faithful music reproduction, Dr. Goldmark adds. The player covers a range up to notes of 10,000 cycles, providing unusual fidelity for an automobile outfit.

The phonograph is the fruit of years of dreaming about recorded music in a car. Dr. Goldmark and his staff first envisioned a tape player, but slide-rule work convinced them that discs were more practical. The tape player never got beyond the paper stage.

**What about home use?** CBS has no plans for a 16<sup>2</sup>/<sub>3</sub> attachment for home phonographs, Dr. Goldmark says, but he agrees that it might have advantages.

The small records make possible important savings on expensive raw materials, yet play so long that an automatic changer would not be essential. The player's ruggedness would also make it ideal for children's use; you can slide the tone arm across a record without damaging either record or pickup. **END**

**Modest Cost Makes Uranium Precious-Metal Bargain**

REFINED uranium metal for atomic-furnace fuel now costs only \$20 a pound, the Atomic Energy Commission reveals. This makes it currently worth about twice its weight or four times its bulk in silver, and much cheaper than gold. Potentially a pound of uranium is equivalent in heat energy to 1,500 tons of coal, costing about \$9,000.

You can do those **BIG PAY Jobs** with this **LOW COST HOBART**

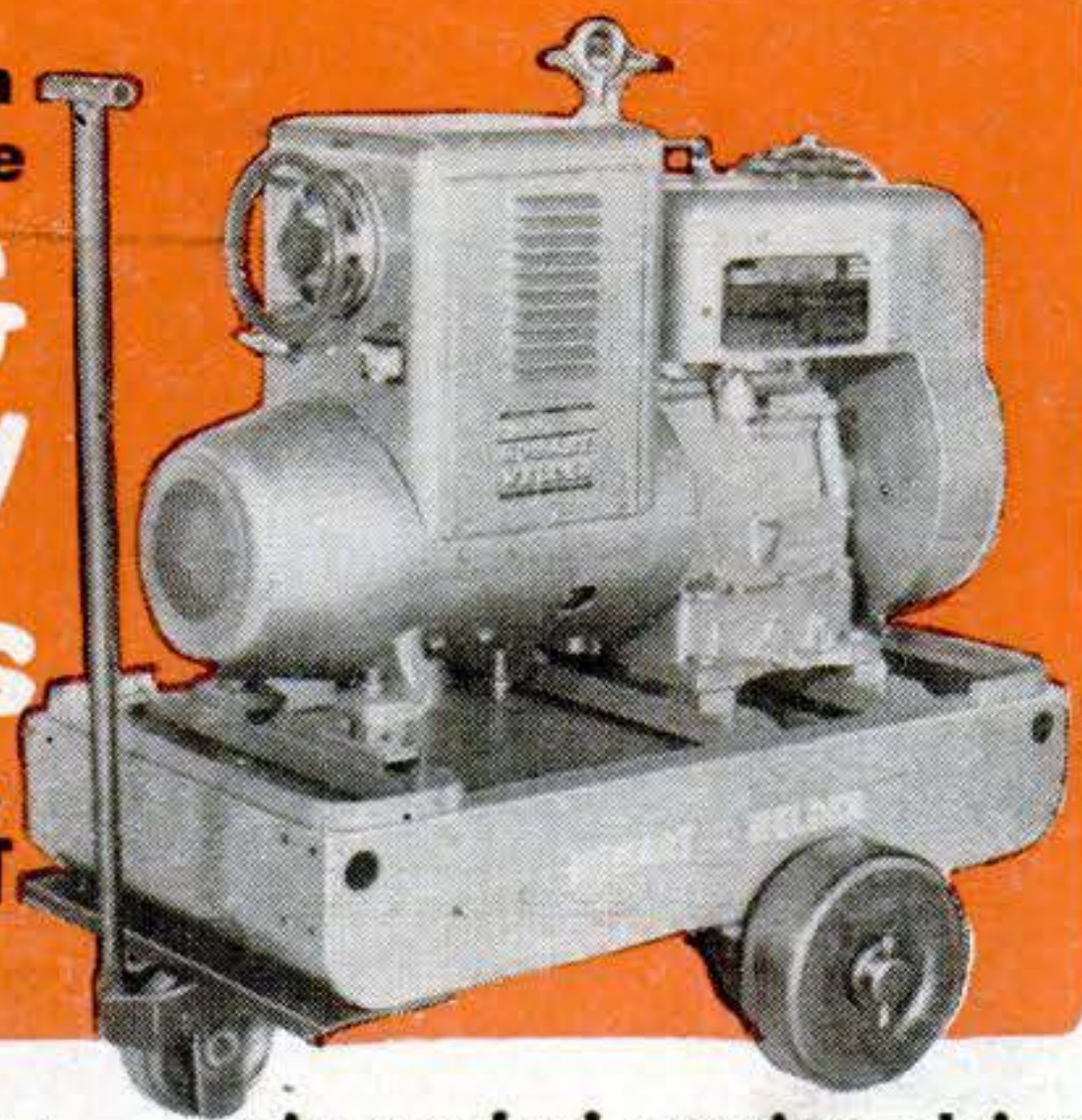

**"Husky Boy" air-cooled engine drive arc welder**

**Welds Anywhere!**

In or out of the shop, the "Husky Boy" can earn bigger profits for you. And you save more on the purchase cost. Lighter weight makes it ideal for using on small service truck for quick emergency calls. For use in the shop, wheels and handles are available at a slight additional cost.

**Full 200 amps. (not skimped)**

Specially built for smaller shops requiring lighter weight and lower investment, the "Bantam Champ" gives full 200 amp.

**You can "Build Your Own"**

You can save even more by "Building Your Own" with this Hobart generator. Just connect the "Build-Your-Own" to your own used auto engine . . . it's perfect for small operations which do not justify a complete, factory built outfit.

**AC Welder with AC Power for tools**

The AC-AC Welder and Power Unit lets you do numerous repair jobs where no power is available . . . also furnishes emergency power for electric lights and power tools. 200 or 300 amp. size plus 5KW AC power.



**Welding Lessons \$1.00**  
 Complete operator's training course. 200 pages fully illustrated.

**AC Transformer type**

For improved AC welding performance. Operates on single phase 220 power lines.

**HOBART WELDING SCHOOL**

Be your own boss! Learn profitable arc welding at the non-profit Hobart Trade School. Skilled instructors give you on-the-job training. Complete or partial courses with latest equipment. G. I. bill approved. Write for free booklet.

Check these **Low investment HOBART** welders too!



200 Ampere Bantam Champ



Generator for "Building Your Own"



Transformer Type AC Welder

**Vest Pocket Guide FREE!**

HOBART BROS. CO., BOX P-115, TROY, OHIO  
 "One of the world's largest builders of Arc Welders" Phone 21223

**Hobart Brothers Co., Box P-115, Troy, Ohio**  
 Please send additional data on items checked:

"Husky Boy"       "Bantam Champ"       Welders' Vest Pocket Guide

Transformer Type AC       "Build Your Own"

Hobart Welding School

Welding Lessons, \$1.00

NAME \_\_\_\_\_

ADDRESS \_\_\_\_\_

CITY \_\_\_\_\_ STATE \_\_\_\_\_



hall side

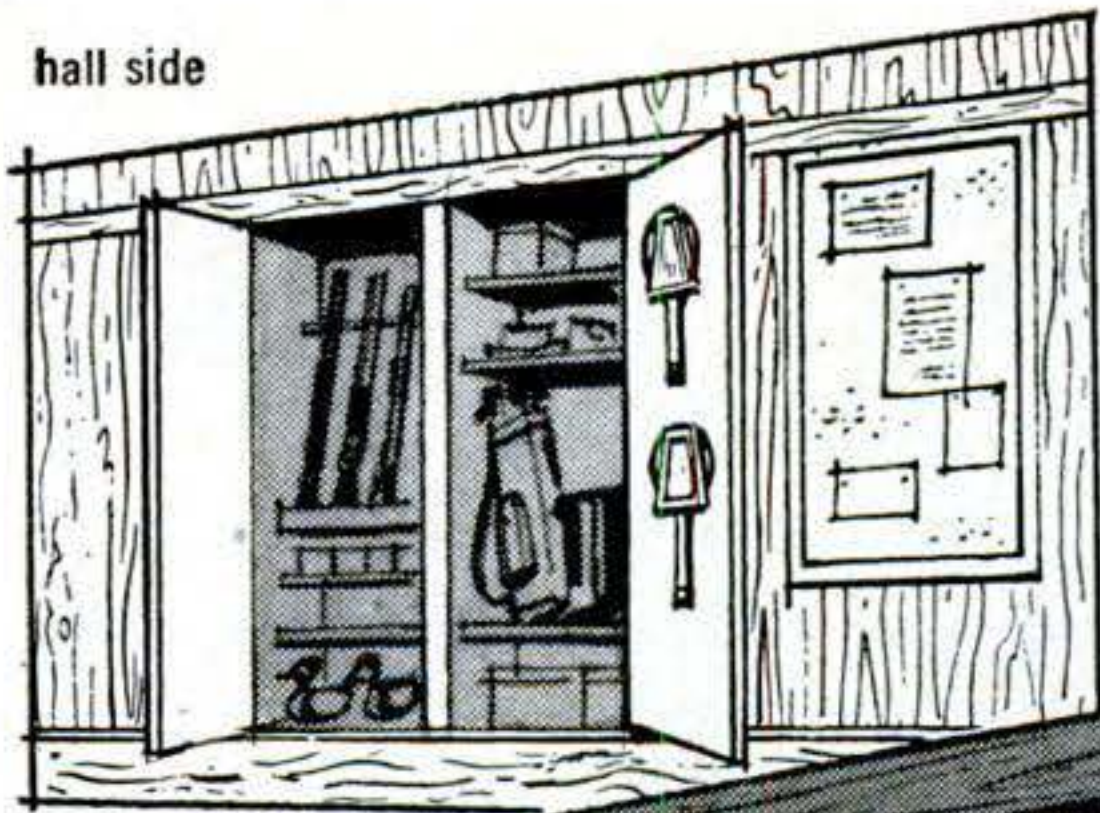

# This storage wall serves two rooms!

get complete detail drawings and easy-to-follow directions in

## FREE PATTERN KIT 322

—along with the picture-packed booklet, "Enchanting Homes of Western Pines." Write for it to Western Pine Association, Dept. 322-L, Yeon Bldg., Portland 4, Oregon

The clean-cutting woods of the Western Pines\* prove perfect for this well-organized storage wall. Built into an existing partition — or planned for a new home—it includes a wardrobe with shoe-rack, drop-leaf desk, shelves, cupboard and sports equipment cabinet.

The smooth surface and even grain of the Western Pines take all finishes well. You'll find these carefully selected, well-seasoned woods a joy to work—and economical, too. Your local lumber dealer will give you an estimate—see him soon!



bedroom side

# the Western Pines

- \* IDAHO WHITE PINE
- \* PONDEROSA PINE
- \* SUGAR PINE

## HOME REPAIR TIP No. 21

**WRAP ELECTRIC CORDS** tightly, safely with "SCOTCH" Brand 33 Plastic Tape. Thin, tough tape stretches to conform, makes neat, permanent wrap. Use this long-wearing, waterproof tape to mend frayed cords, torn rainwear, too. "SCOTCH" 33 Plastic Tape—39¢ or 79¢ at stores everywhere. ©1955, Minnesota Mining and Manufacturing Co., St. Paul 6, Minn.



6-ft. only  
**\$1.49**

Insist on  
*Evans*  
**TAPES "KING-SIZE"**

At your hardware store



**EXCLUSIVE!** Belt clip for handy carrying. Also available in 8, 10, 12-ft. lengths with free plastic utility case.

1699

## INSULATE Right With ZONOLITE®



Says **DANNY KAYE**, star of "THE COURT JESTER" Paramount comedy hit in VistaVision... color by Technicolor You don't even have to be "handy" to insulate your own home in 4 miraculously short hours with Zonolite vermiculite insulating fill. Pour it, level it, *leave it!* Start saving immediately on fuel bills—Zonolite often pays for itself in two or three seasons. Rotproof, rodent-proof, 100% fireproof. Guaranteed to outlast life of your home. Send coupon today.

**DO IT YOURSELF** in one afternoon... save up to 40% on fuel bills

as low as  
**\$67<sup>60</sup>**  
insulates an average attic

Mail This  
Coupon Today

ZONOLITE COMPANY,  
Dept. PSM-115,  
135 S. LaSalle St.  
Chicago 3, Illinois  
Please rush me how-to-do-it  
free booklet HI-47 "Safety,  
Comfort, Savings in Your  
Home."

Name \_\_\_\_\_

Address \_\_\_\_\_

City \_\_\_\_\_

Zone \_\_\_\_\_ State \_\_\_\_\_

NOW ON SALE WHEREVER LUMBER AND BUILDING MATERIALS ARE SOLD





**TOPS FOR YOUR CHRISTMAS LIST...**

to give or receive . . .  
here's a gift for year-'round use

# WELLER POWER SANDER

Try your hand with this premium power sander. It's the most useful addition you can make to practical tools that get your work done faster and with results you'll be proud of.

The comfortable, compact design fits snugly in your hand. It responds perfectly to precision work, and it is practically impossible to stall.

Straight-line action sands with the grain, gives satin smooth finishes and flawless feathering with no bucking or twisting. Using a polishing cloth, the fast 14,400 strokes per minute give an expensive, high-gloss finish to any waxed surface. The Weller Sander-Polisher never needs lubrication.

**LARGEST SANDING AREA** in its price class is 25 square inches—more than twice that of comparable sanders—gets you finished faster.

**SIMPLE, SECURE PAPER GRIP** requires no special tools, holds paper or polishing cloth tightly under tension, the easiest, surest grip you'll find anywhere.

*Screw Driver Slot*

**GOES ALL THE WAY INTO CORNERS** and up to risers—exclusive, low design is less than 3" high—goes under low places with ease.

*Sands with the grain*

**COMPLETE WITH ASSORTED SANDING PAPER AND POLISHING CLOTH . . \$14.95**

Ask your Hardware Dealer for a demonstration or write direct for literature.

*Weller*

**ELECTRIC CORP.**  
806 Packer Street  
Easton, Penna.



## All Wool and a Ewe Wide

THIS ewe is all dressed up to keep her wool clean on dusty, windy rangeland. And come early shearing in chilly spring, the blanket will keep her warm. A zippered pleat in front takes up the slack left by the shorn wool. New Mexico sheepmen report that the blankets also "spook" coyotes, making them keep their distance.



## New Scope Sees Deep into Night

ARMY experts have beefed up the World War II sniperscope to pinpoint targets in total darkness at far greater range. Run by a battery pack worn by the rifleman, it bathes objects in its path in infrared rays to make them visible in the 20,000-volt telescopic image tube.



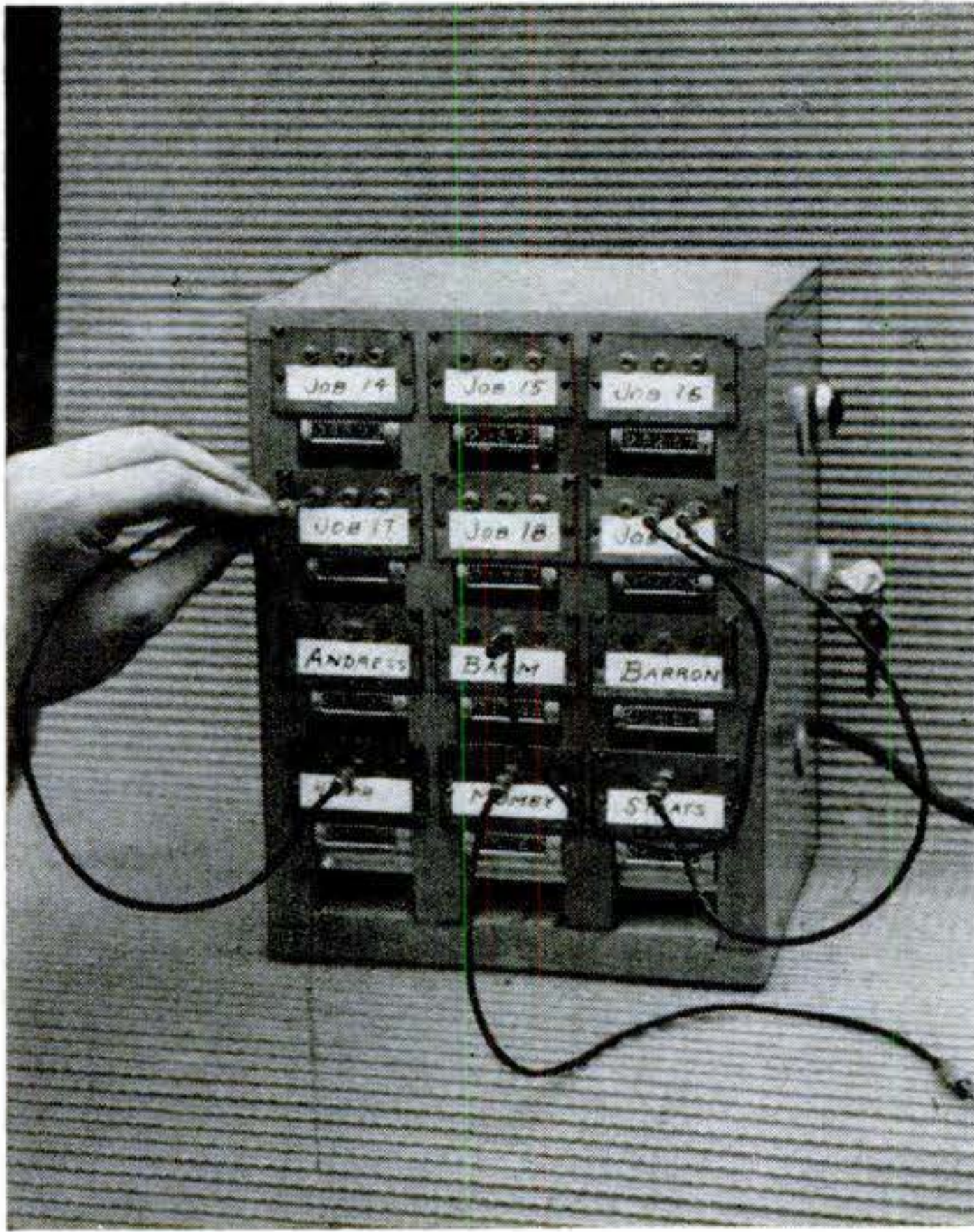

### Man-Clock Keeps Job Accounts

EARL ALLGAIER'S Arlington, Va., shop devised this work analyzer to simplify cost and payroll accounting. When one of the six employees starts work, he plugs a jumper into a counter marked with his name and another bearing the job number. A timer then records the man-hours spent on each task. Several men can plug into one job.



### Clock Ticks Off Time on Mars

HERE'S a clock made for tourists bound for Mars. The outer dial shows Martian time, the bottom dial earth time. Calendar dials tick off dates on the two planets. A year on Mars has 56-day months and each day lasts more than 24½ hours. Hamilton Watch built the clock for exhibitions.



**MOST USEFUL GIFT  
TO GIVE OR RECEIVE...**

# WELLER SOLDERING KIT

with an instant-heat Soldering Gun

For hundreds of "do-it-yourself" jobs here's a tool you'll never part with once you try it. Perfectly balanced, pistol grip design fits your hand for instant action. Pull the trigger, full soldering heat and spotlights come on immediately... release, and they're off. No waiting, never any need to unplug.

Streamlined design slides easily into tight places and prefocused spotlights let you see what you are doing. Full, constant heat is maintained at the tip which is chisel-shape for maximum heat transfer.

Long-life tips last and last, and are easily and quickly replaced—only 50c for a package of 2. Special cutting and smoothing tips are available for dozens of extra jobs.



**COMPLETE SOLDERING SET . . . only \$7.95**

Weller 100 Watt Soldering Gun is supplied with famous Kester Solder, Soldering Brush, Weller Soldering Aid for making tight connections. Ask your Hardware Dealer for a demonstration or write direct for literature.

*Weller*

**ELECTRIC CORP.  
806 Packer Street  
Easton, Penna.**



Christmas decorations you make with scissors

and

REYNOLDS Do-It-Yourself ALUMINUM



Ask for Plans Nos. 118 and 127. For Toys, Plan No. 119.

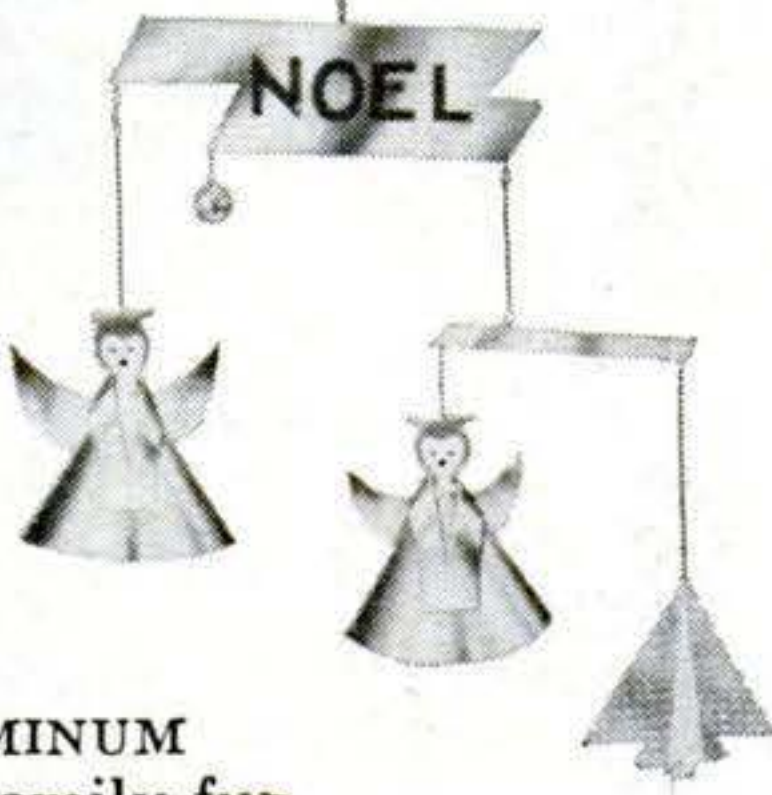

MAKING SHINING ALUMINUM DECORATIONS is great family fun. Amazingly easy to cut with ordinary household scissors. Use them outside or in — they can't rust or lose their luster. There's special fun for grown-ups in making strong, rustproof toys as wonderful Christmas morning surprises.

Your hardware or building supply dealer has Reynolds *Do-It-Yourself* Aluminum plus plans for these handsome Christmas projects.

Don't forget a good supply of Reynolds *Do-It-Yourself* Aluminum with power tool gifts

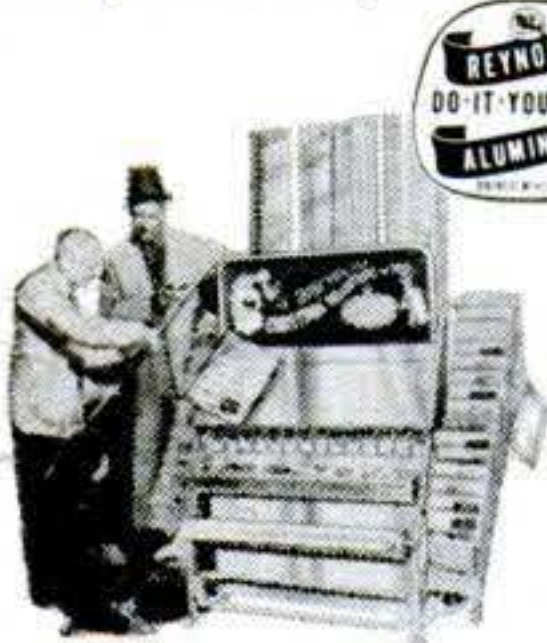

LOOK FOR THIS RACK AT YOUR DEALER'S



See "Frontier" Sundays on NBC-TV  
**REYNOLDS DO-IT-YOURSELF ALUMINUM**

Reynolds Metals Co., Louisville 1, Ky.

Also available in Canada



**Skyhook Lifts Rig Climbers**

A DERRICKMAN'S climbing weight is cut in half when he wears this counterbalanced safety belt. A cable fastened to his belt and to a counterweight (upper left) passes through a pulley at the top of the rig. Dykes, Inc., Houston, says tower workers ascend faster and easier with the Skyhook and feel fresher when they get to the top.



**Prefab Nests Are for the Birds**

TO LEARN more about the homing habits of swallows, Dr. Wilbur Mayhew of the University of California at Riverside will mass-produce bird homes. Next spring's nests will be cast from this master mold. They'll be just like the real thing except for remote-control doors to help Dr. Mayhew detain his guests for further study.





**CRAFTSMAN'S**

**CATALOG**

with \$5  
in discount  
coupons

**Get this 88 page catalog TODAY.**

88 illustrated pages, full of information and low prices on items for the home handyman. Everything from plywoods, lumber, veneers, mouldings and glues, to hardware and furniture trim; several pages of easy plans, lamp parts, metals and a section of bandings and inlays . . . not to mention the money saving \$5 in discount coupons.

Please enclose 25c for handling and postage. This will be credited to your first order.

**Minnesota Woodworkers Supply Co.**  
1713 Olson Hwy., Minneapolis 5, Minn.



**EARN  
UP TO  
\$100<sup>00</sup> PER WEEK  
IN YOUR SPARE TIME!**

**TEACH OTHERS TO DRIVE  
SAFELY . . .**

Earn extra money at the standard rate of \$5.00 per hour . . . working with Safety and Public officials with this new, specially designed PORTABLE DUAL CONTROL! Fits almost all late model cars . . . installed or removed in minutes. Millions learn to drive every year . . . you can teach them, safely, and earn up to \$175.00 per week full time with the PORTABLE DUAL CONTROL . . . order yours today, start earning money immediately!

For Cars with STANDARD TRANSMISSIONS \$30.00

For Cars with AUTOMATIC TRANSMISSIONS \$25.00

SPECIFY YEAR, MAKE AND MODEL



INCLUDED—FREE OF CHARGE—OUR FAMOUS COURSE  
"How To Be A Successful Driver-Training Instructor"

Send Check, Money Order, F.O.B. Detroit  
Portable Dual Controls, Inc., Box 62, Detroit 31, Michigan

THEY'RE **NEW!**

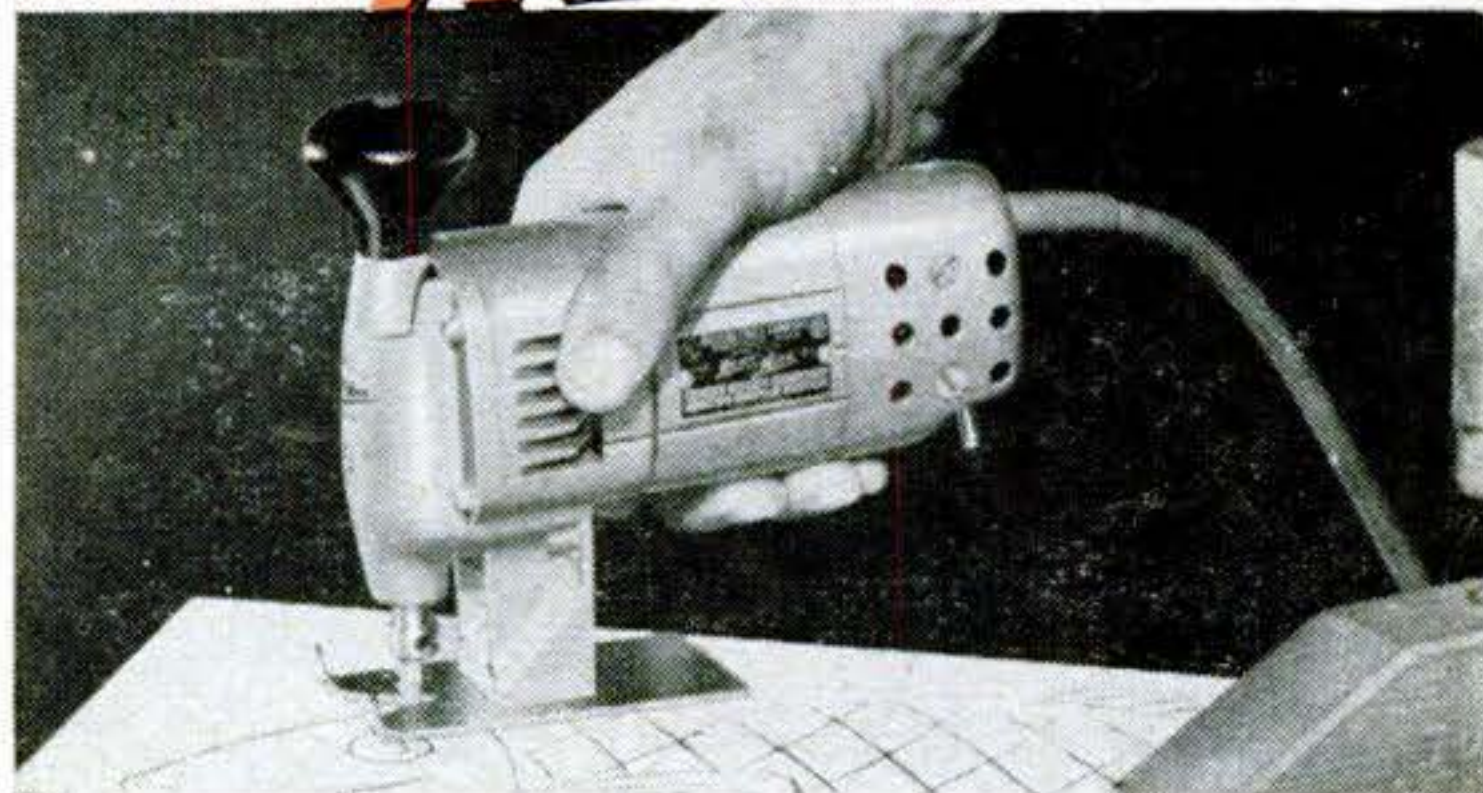

**FASTEST-CUTTING JIG SAW MADE!** This powerful new Millers Falls tool is a jig saw, hack saw, coping saw, rip saw, crosscut and keyhole saw all in one. Makes curved, straight or irregular cuts in wood, metal, all kinds of material—in places often inaccessible to other saws! Exclusive design features and special blades result in far greater cutting speed than any similar saw.

**No. 480 Dyno-Mite Electric Jig Saw**  
Regular \$44.95 — Special for Xmas \$39.95

THEY'RE  
**DYNO-MITE**



**FOR THAT PROFESSIONAL FINISH!** This new Millers Falls Orbital Sander finish-sands furniture, cabinets, interior trim . . . removes paint, varnish or surface imperfections . . . all without tracking, scoring or burning surface. High-speed orbital action permits sanding with or across the grain. Light weight makes it easy to use on overhead and vertical as well as horizontal surfaces.

**No. 580 Dyno-Mite Electric Orbital Sander**  
Regular \$44.95 — Special for Xmas \$39.95

THEY'RE

**Millers Falls**

**Finest Power  
Tools Made**



**FREE AT YOUR HARDWARE DEALER'S**  
Ask for these folders on the whole power-packed line of Millers Falls Dyno-Mite electric tools including the remarkable new Dyno-Mite Power Workshop, or write direct.

MILLERS FALLS CO. • Dept. PS-9 • Greenfield, Mass.

NOVEMBER 1955 277



# Build this BOY'S ROOM ...right in your own attic!

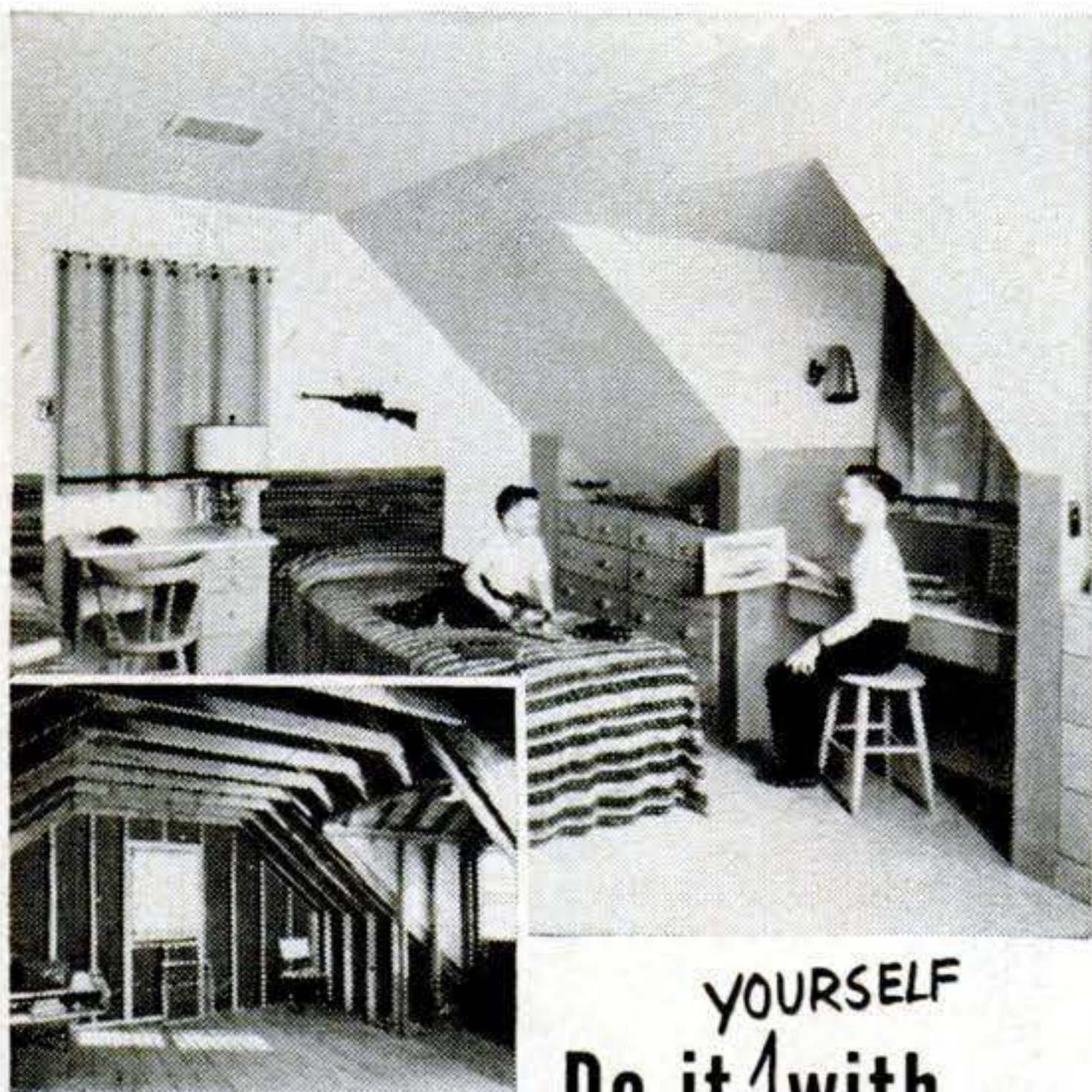

YOURSELF  
Do it <sup>1</sup> with

## Gold Bond Building Products



It's easy to turn wasted attic space into a handsome boy's room like the one shown above with Gold Bond Building Products. Start by stapling up new fireproof Twin-sulation...cuts winter heat bills and keeps your new room up to 15° cooler in summer. Next, nail up sturdy Gold Bond Gypsum Wallboard for smooth fireproof walls and ceilings. And, for a fast finish, decorate with your favorite shade of Gold Bond Velvet...dries in 20 minutes. It's scrubable, too!

NATIONAL GYPSUM CO., BUFFALO 2, N. Y.

Mail this coupon for more information about easy-to-use Gold Bond Add-A-Room products.



### MAIL COUPON TODAY

NATIONAL GYPSUM COMPANY  
Dept. PS-115, Buffalo 2, N. Y.

Please send me my Gold Bond Add-A-Room Packet. Enclosed is 10¢ to cover mailing.

Name.....

Address.....

City.....Zone.....County.....State.....

## Science Closes In on the Common Cold

[Continued from page 139]

They proceeded much as Dr. Salk had in making polio vaccine. First they grew the APC-3 virus in a culture made of kidney tissue from monkeys. Then they killed the virus with formaldehyde.

The result is known as a killed virus vaccine. Even though the virus in it is dead, the body marshals up antibodies to fight it.

From Hagerstown, the virus fighters moved to the federal reformatory at Chillicothe, Ohio, for a formal trial of the vaccine. First they took a blood sample from each volunteer and added it to a tissue culture in which the virus was growing.

In a third of the cases, growth stopped. This meant the men already had antibodies in their blood: they had encountered this virus before and become immune.

Then the investigators divided the susceptible men into two groups, of roughly 50 inmates each, and gave one group a shot of vaccine and the other a shot of salt water. Four weeks later, using a little cotton swab, they placed APC-3 virus on the lower eyelids of everybody in both groups.

A few days after the virus inoculations, a man-made epidemic began sweeping through the Chillicothe volunteers. It took 90 percent of the men who had not received the real vaccine, only 20 percent of those who had.

Huebner feels good about those results, but he emphasizes the problems that must be overcome before a vaccine is ready for general use.

**The most important** stems from the fact that *eleven* APC viruses have come to light since Huebner started to track the common cold, and there may be more.

In the laboratory, all the APC viruses act very much alike. They attack tissues in a characteristic fashion. They are quickly killed by even moderate heat (about 130 degrees F.) but resist cold very well. Sulfa drugs and the antibiotics have no effect on them. Finally, as in

[Continued on page 302]



# Now You Can Have The Right Screw

Southern's **FREE SIZE-CHART** ready for your shop

Get your chart of sizes and technical information and keep it handy. Know the exact screw your job calls for . . . Phillips or slotted.

"Extras" and "Specials" in regular stock at regular prices. All Southern Screws USA-made to USA specifications, or better!

Wood Screws, Stove Bolts, Machine Screws, A & B Tapping Screws and Roll Thread Carriage Bolts. Phillips and slotted screws in all popular head styles — steel, brass, silicon bronze, aluminum, stainless steel, and standard plated finishes.

When you buy screws, ask your dealer for Southern. If he doesn't have the style or size you need, ask him to special order, we'll be glad to take care of your needs. Write today for your free Technical Chart and Illustrated booklet, "How Wood Screws Are Made." Address Box 1360-P2, Southern Screw Company, Stateville, N. C.

Sold Through Leading Wholesale Distributors.

Warehouses: New York • Chicago • Dallas • Los Angeles



## Shark Brand Swedish Chisels



Make Your job easier. You'll do neater, more accurate woodworking with SHARK BRAND SWEDISH CHARCOAL STEEL paring chisels . . . hold their sharpness 3 times longer than ordinary chisels.

Write for new folder Dept. PS

**Sandvik** SAW & TOOL  
DIVISION OF SANDVIK STEEL, INC.  
1702 NEVINS RD., FAIR LAWN, N. J.



**For TOP Performance,**

**make RED SEAL POWER the Heart of Your Machine**

Building a scooter or midget racer? Need a new engine on your lawnmower? Best power for ANY job within their range is one of these newest Red Seals. Greater piston displacement, for power in excess of rating—plus more "lug" at low speeds, eliminating stalls. Exclusive Contex ignition system speeds and simplifies adjustment, doubles life of points and plug, and low oil level ignition cutoff ends hazards of running dry. 14 rugged models, horizontal and vertical shaft. Write TODAY for name of Red Seal dealer nearest you.



AU Series Horizontal Shaft



AV Series Vertical Shaft



**Continental Motors Corporation**  
INDUSTRIAL AIR-COOLED ENGINE DIVISION  
12800 KERCHEVAL AVE., DETROIT 15, MICH.



# HOW TO ELIMINATE STALLING

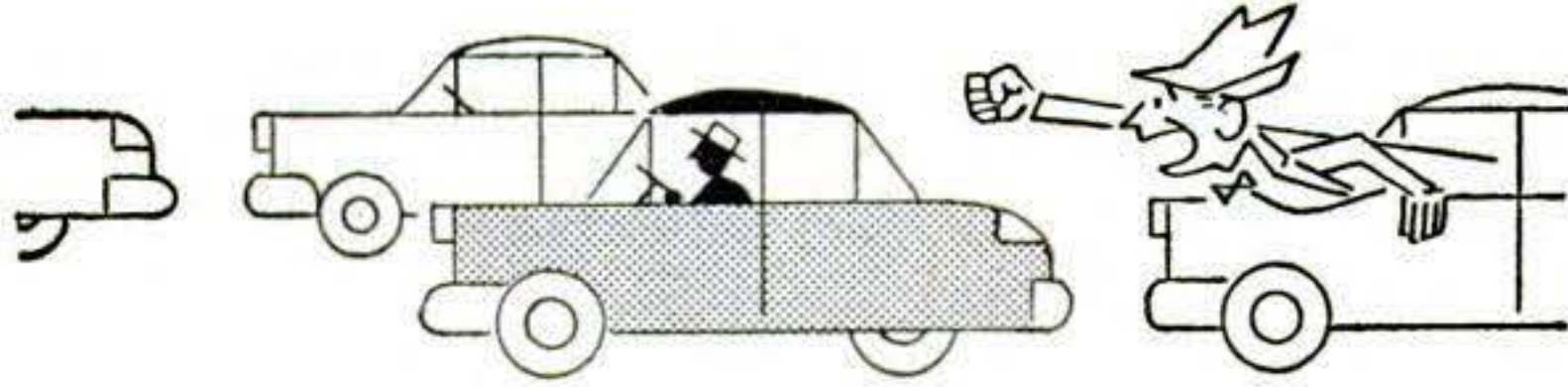

## LAZY PICK-UP

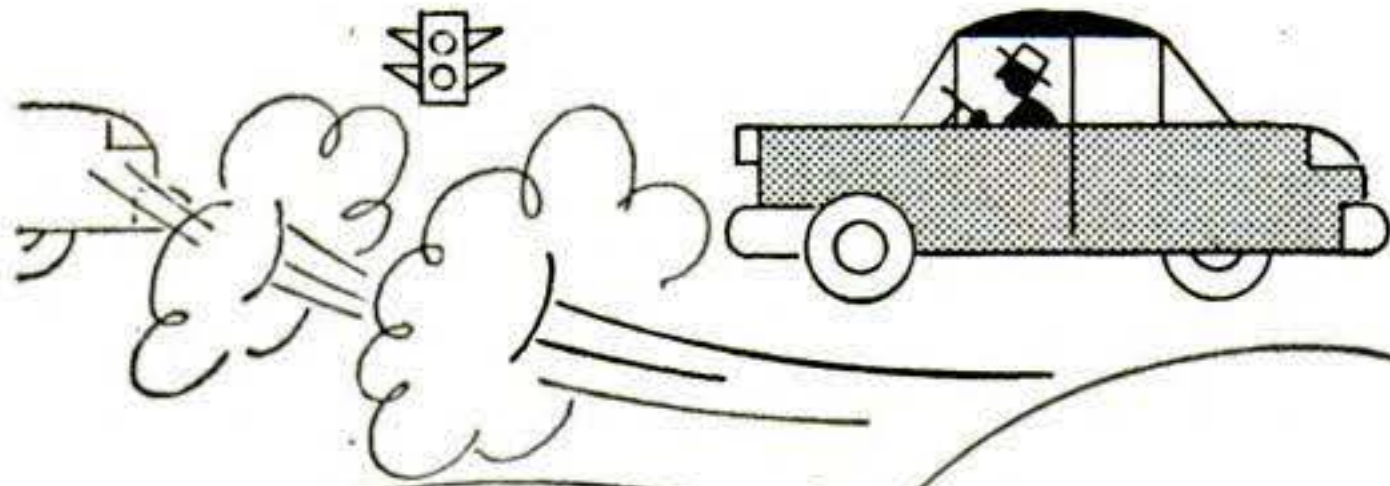

clean your carburetor with **GUMOUT**

If your car's running sick—stalling, with lazy pick-up—chances are it's suffering from a dirty carburetor. Gum and dirt are choking off the vital fuel and air supply.

But—there's no need to tear down the carburetor!

GUMOUT cleans out your carburetor while you drive. Just add GUMOUT to your gas tank every two or three months. You'll keep your carburetor sparkling clean the year 'round. There's nothing like it!

GUMOUT is sold by service stations and auto supply stores everywhere.

GUMOUT DIVISION, Pennsylvania Refining Co.  
2670 Lisbon Road, Cleveland 4, Ohio

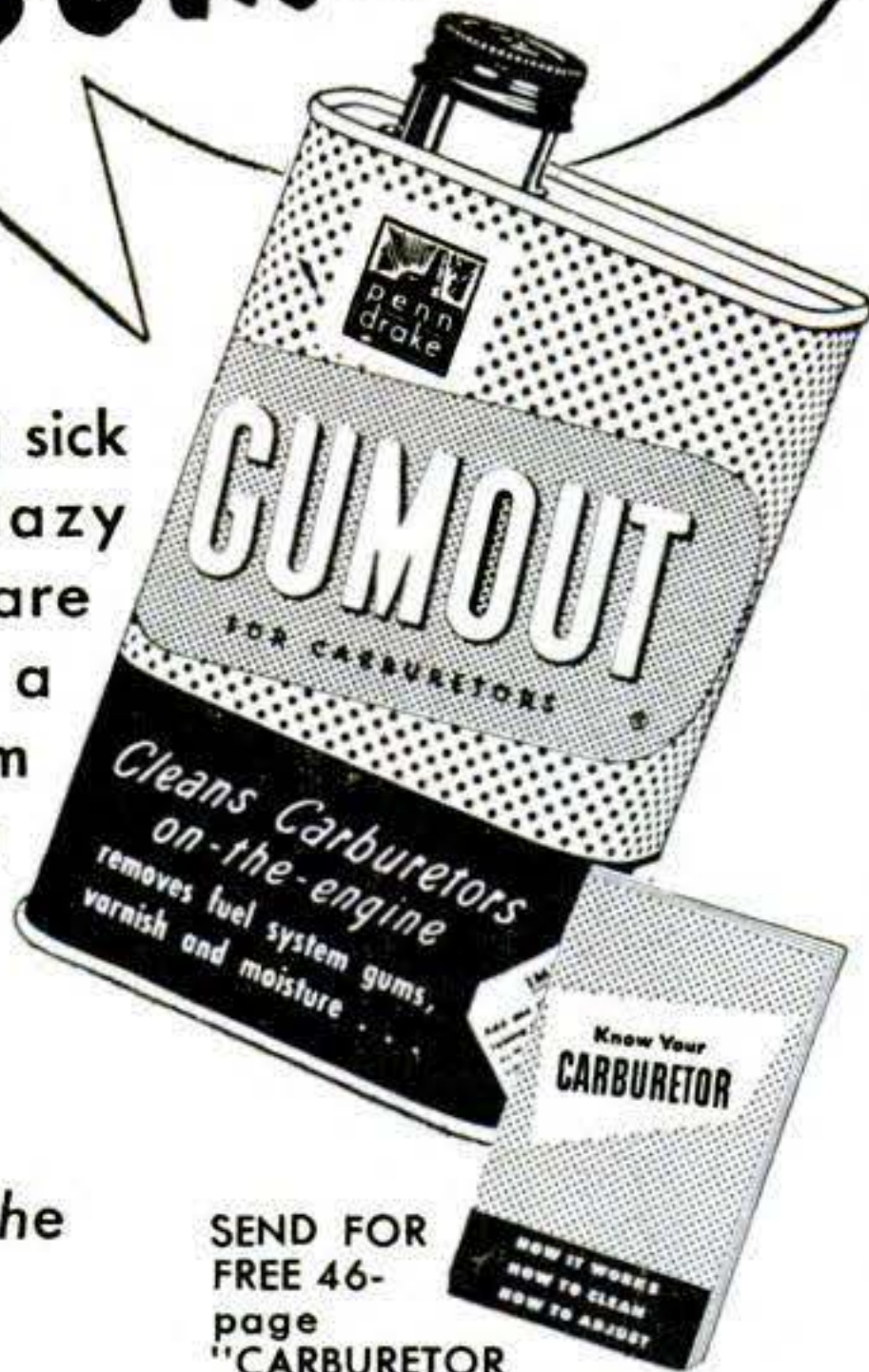

SEND FOR FREE 46-page "CARBURETOR HANDBOOK." Gives you all the answers. Good to have.

GUMOUT, due to its amazing solvent action, has many additional uses around the home and workshop. If you'd like to know about them, ask for Technical Bulletin 103-G when writing for your free Carburetor Handbook.



### Optional Self Starter

### 5-HP . . . SAVE YOUR HEART!

- Blows snow where you want it—handles any snow, deep or light, wet or dry.
- Or use Snowplow attachment . . . 48" wide. Both powered by powerful 5-HP Gravelly. Only 2 of 23 year 'round tools! . . . *Easy Pay Plan*—only 20% down!

Write today for FREE 24-page "Power vs Drudgery" Booklet.



**GRAVELLY TRACTORS, INC.**

BOX 1184, DUNBAR, W. VA.

**FIELD-TESTED FOR 34 YEARS**

## NOW—THE QUICK-WAY TO SHARPEN ALL CIRCULAR SAWS

**NEW**

Model PG-12 Complete No extras to buy. **\$16.50** Postage Paid



Model PG-12 sharpens joints, gums, and retools all cross cut, rip, combination, miter, and planer blades up to 12" in diameter. Two precision index plates give versatile, accurate sharpening. Guarantees precise spacing of teeth. New safety rest prevents tilting and gouging of blade. Save time and money. Special \$3.00 grinding wheel also included for use on your own power table. Fits regular or radial swing tables.

Order today. Send check, cash, or money order. We pay postage. **QUICK-WAY SAW CO.**  
100 Hornby Drive, Painted Post, N. Y.



### ELECTRIC WELDER

AC or DC  
110 Volt

The "Little Marvel" all-metal welder. 5-year written guarantee. Welds 1/8" metal or money back. Repairs tanks, tools, fenders, machine parts, etc. Complete with everything—rods, unit, eye shield, directions. \$6.95 plus 50c postage. Flame torch accessory for soldering, cutting, brazing \$3.95 complete with carbons, brass rods, flux. \$2.00 deposit on C.O.D. 1/4 inch Transformer Welder \$21.95 F.O.B.

**ESSAY MFG. CO.,** Dept. 47, Quincy 69, Mass.

**\$6.95** Complete

## A PRECISION LEVELING INSTRUMENT for only \$12.95

With the New LEVELALL one man can do the work of two men and a transit, quickly, easily, accurately. All alone you can speedily level points for footings, forms, piping, batter boards, sills, lintels, floors, ceilings, roads, driveways, lawns—any type of construction work. Send for Free booklet or, better yet, order a DeLuxe Levelall today.

Name \_\_\_\_\_

Street \_\_\_\_\_

City \_\_\_\_\_ Zone \_\_\_\_\_ State \_\_\_\_\_

Mail 75' DeLuxe Levelall @ \$12.95  Regular 50' model @ \$9.95  Ship postpaid full price enclosed

Ship C.O.D. Money-back satisfaction guaranteed.

**LEVELALL 81-K Webster Street, Rockland, Mass.**



just \$5.00 a week puts  
YOU on a  
**Cushman**  
**EAGLE**

Up to  
75 miles  
per  
gallon

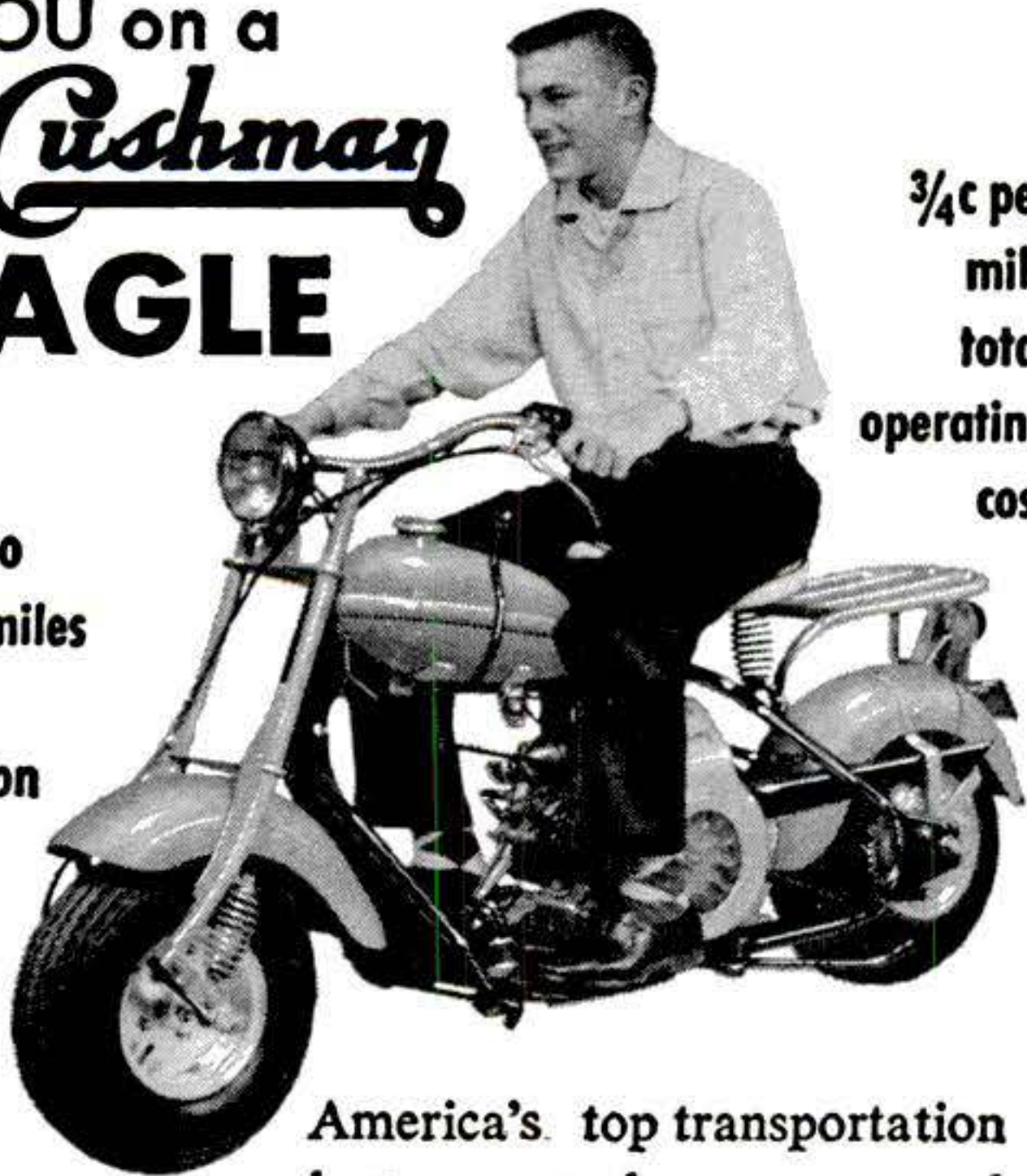

3/4c per  
mile  
total  
operating  
cost

America's top transportation  
buy . . . endurance proved.

See your nearest dealer for a FREE  
demonstration or write for illustrated  
literature.

**CUSHMAN MOTOR WORKS, inc.**  
957 No. 21 Lincoln, Nebraska

**NEW '56  
CATALOG**  
**NEW  
'56 MODELS**  
**BOAT  
KITS**

BUY DIRECT—SAVE UP TO 2/3 !  
FACTORY-TO-YOU! No Dealers



You SAVE the PROFIT  
Save on the finest quality  
boat kits. Lowest prices in  
history. Mahogany decks,  
brass screws, easy to build.  
23 models 8-19' All types!

SEND 10c FOR 1956 KIT CATALOG!  
Includes Fiberglass—Accessories—Trailers, etc.

**BOAT  
PLANS**

OVER 50 PLANS with FULL-SIZE PATTERNS

Send 10c for NEW PLAN CATALOG. Build your boat from  
modern, easy-to-follow plans with patterns. Saves time and  
money! All types included: Prams to Cruisers from 6' to 25'

CRAIG-CRAFT (DEPT. 30) TONAWANDA, N.Y.

**DRILL • SAW • REAM • CUT**  
**ALL WITH ONE BIT!**  
**BEAVER SPEED SAW DRILL BIT**



ONLY  
**\$2.45** each  
3 for \$7.00  
POSTPAID

Beaver's new improved high speed side  
cutting drill bit can be used on any elec-  
tric drill, drill press, lathe or milling  
machine. Made from the finest American high speed steel. 3 1/2"  
long. 2" side cutting section. 1/4" diameter. Designed to cut steel,  
wood, plastic, aluminum, etc. A versatile time-saving tool for  
EVERYONE. Money back guarantee! Three types available: All-  
Purpose, Wood and Heavy Metal—specify type desired. Buy them  
from your dealer today! Or send cash, check or money order NOW.  
SET OF 3 MAKES AN IDEAL GIFT.  
Dealer inquiries invited.

**BEAVER DRILL & TOOL COMPANY**

3008A McGee Trafficway

Kansas City 8, Missouri

*Kitty Kimsul says:*

*"Here's the easiest  
insulation of all to cut,  
measure and install!"*

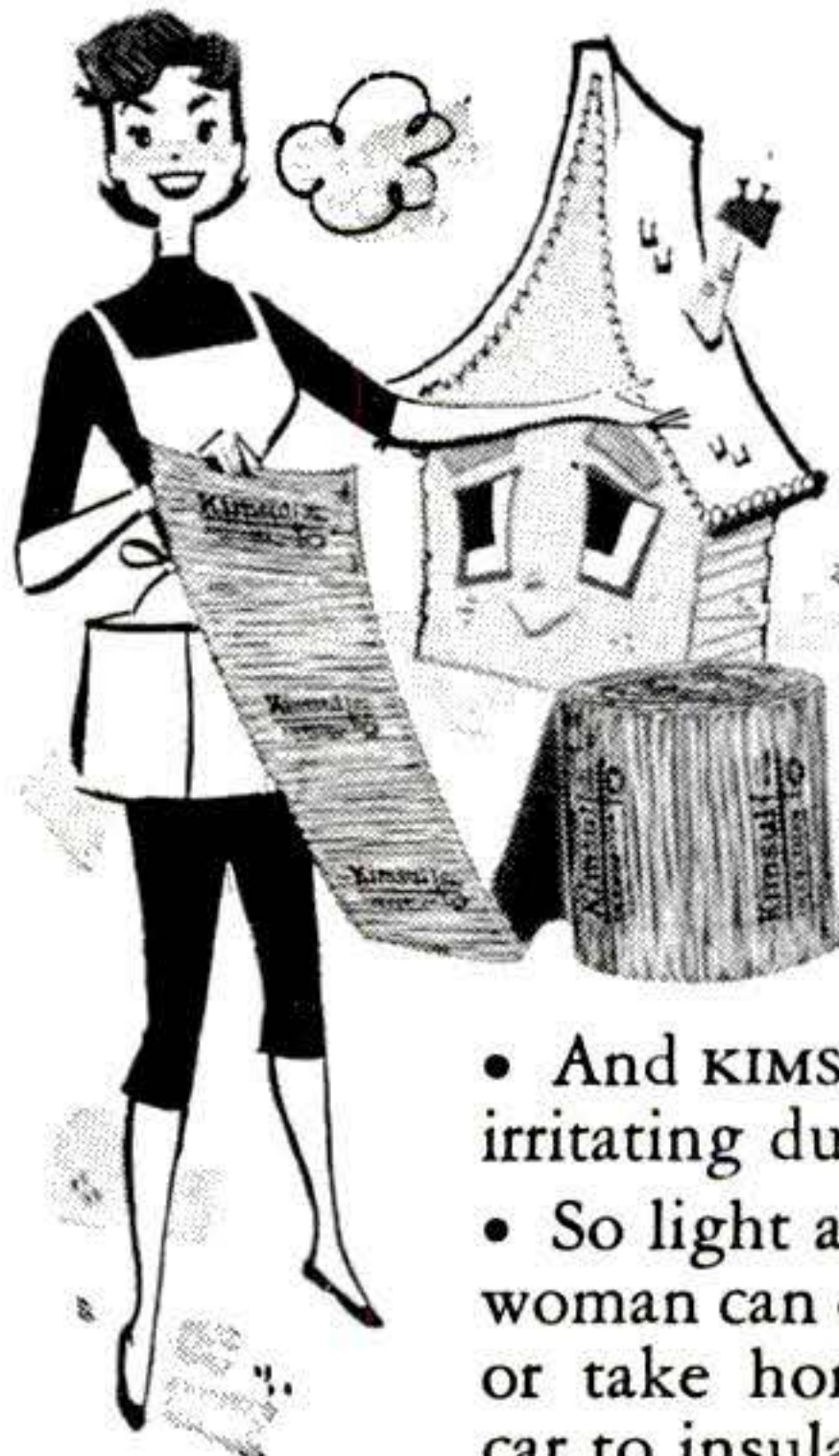

• KIMSUL Insu-  
lation is de-  
signed to cut  
winter fuel bills  
up to 33%—to  
keep your house  
up to 20° cooler  
in summer.

- And KIMSUL is clean—free of  
irritating dust and slivers.
- So light and compact even a  
woman can carry a 200 ft. roll—  
or take home enough in the  
car to insulate an entire attic.

*At your Kimsul  
lumber dealer's—this  
denim cobbler's apron.*

*Regular \$2.50 value—  
only 89¢*

Perfect for hobby work, gar-  
dening, barbecuing. Has three  
large pockets, adjustable waist  
and neck bands. Only at your  
KIMSUL lumber dealer's and  
only for a limited time.



**KIMSUL** A PRODUCT OF  
Kimberly-Clark

**INSULATION**

Kimberly-Clark Corporation • Neenah, Wisconsin

NOVEMBER 1955 281



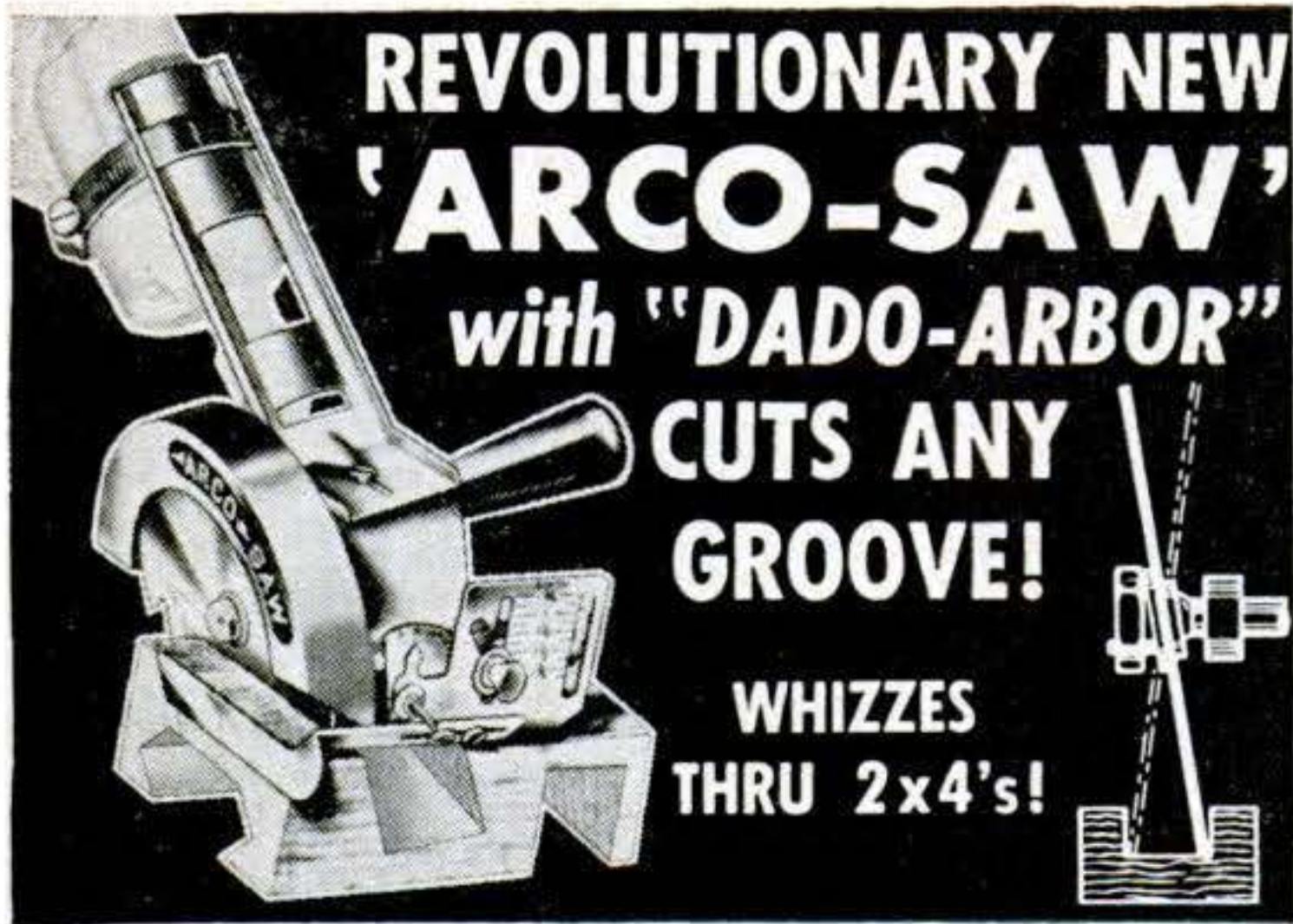

# REVOLUTIONARY NEW 'ARCO-SAW'

with "DADO-ARBOR"  
CUTS ANY  
GROOVE!

WHIZZES  
THRU 2x4's!

Not even a \$100 Portable Saw has a dado cutter! "Arco-Saw" (guaranteed to fit any 1/4" electric drill) with sensational new "Dado-Arbor" adjusts easily to cut any size groove up to 1 1/2" wide x 1" deep in ONE CUT! Graduated Depth-Bevel-Rip Gages adjust for depth of cut up to 1 3/4" angle cuts to 45°. Amazing swivel action of "Dado-Arbor" (see sketch above) cuts large grooves cleanly and accurately with little power. "Dado-Arbor" is easily removed to use the saw for straight ripping, crosscutting or angle cuts. Right angle steel gear drive and safety-yoke permit ONE HAND operation. Includes quick-cutting 5" Safecut Blade.

BLADES—5" Rip, X-cut or Combination \$1.75

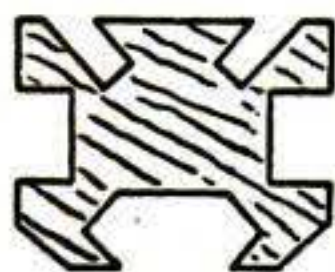

CUT GROOVES  
LIKE THESE

ONLY  
**\$12.95**

# "ARCO JIG-SAW"

WITH EXCLUSIVE NEW  
CIRCLE-  
CUTTER  
& RIP  
GAGE!



Another "ARCO" FIRST! "Arco Jig-Saw" (guaranteed to fit any 1/4" drill) with Adjustable Circle-Cutter & Rip Gage saves hours of work—assures professional-looking results everytime—whether cutting circles, curved patterns, or straight cutting. Cuts perfect circles any size up to 20" diameter; rips accurate widths any size up to 10" wide. Has same capacity and cutting speed as \$55 jig saws. Does work of Jig, Keyhole, Coping, Rip, Crosscut, Band & Hack-saw! Built-in "Air-Jet" blows away sawdust. Cuts intricate patterns—however large—in plywood, plastics, metals—even cuts 2x4's! Starts inside holes. Includes blade. Converts to Table Model with either



RIPPING WITH GAGE

**\$8.95** No. 500  
without  
gages.  
**\$9.95** No. 550  
with  
gages.

No. 401 "ARCO STAND" Sturdy Casting & Clamp... \$2.75  
or No. 410 "ARCO DRILL-SHOP" incl. "Arco Stand," 1/4" drill arbor, 4" buffing wheel, 3" wire brush, 3" grindstone & rouge. Special low price... \$4.50  
6 Extra Asst. Blades for wood, plastics, metals... \$1.95

SOLD AT BETTER HDWE. STORES EVERYWHERE. If not available, order direct and try these amazing tools on our UNCONDITIONAL 10-DAY MONEY BACK GUARANTEE. Send check or M.O. (ppd.) C.O.D.'s—plus post.

**ARROW METAL PRODUCTS CO.**

Dept. PS-11, 140 WEST BROADWAY, NEW YORK 13, N.Y.



*spray paint it  
yourself!*

Faster . . . better . . . easier!  
Anyone can quickly learn to do a professional job of spray painting. Takes less skill than brush painting. 4 to 5 times faster. Pressure Queen pictured. Only 4-cylinder portable air compressor. Continuous air flow without pulsation. Sprays paint undiluted—

Priced low. See dealer or write 151 Railroad Ave., Harrison, Ohio.

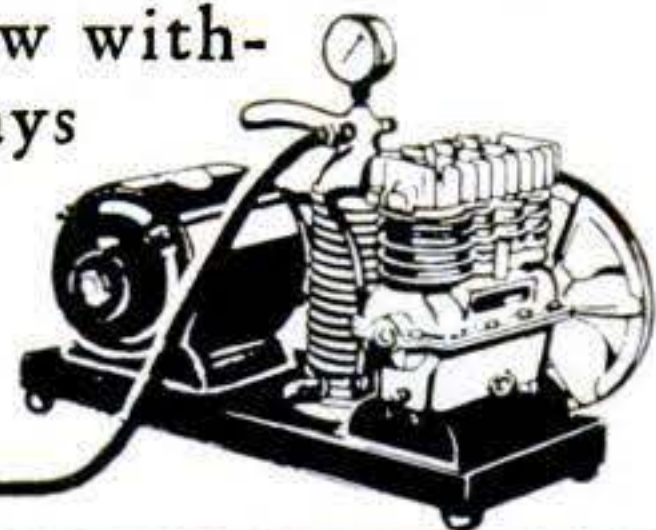

**CAMPBELL-HAUSFELD**

# on any object **ELECTROPLATE**

ANY OBJECT IN HOME, SHOP, GARAGE—



NOW with our NEW ELECTROCHEMICAL Outfit. You can easily do your own plating. Not a paint. But a hard durable metal plate, equal to commercial plating. Get your own plating kit with instructions on plating metal and non-metal objects as Tools, Auto Parts, Silverware, Jewelry, Baby Shoes and 1001 other articles with Chrome, Nickel, Copper, Gold, etc. SEND NO MONEY. Everything sent C.O.D. for the low price of ONLY \$5.95 or send \$5.95 now and receive it postpaid. Money back in 7 days if not satisfied. M.Z. SALES CO. Dept. H-1, 113 West 42nd St., New York 36, N.Y.

# IS THERE A FORTUNE IN YOUR BACK YARD?

Uranium can be found almost anywhere. Dig up a small sample of soil or stone (approx. 1/4 cup) and mail to The Martin Co., 23 E. Baltimore Ave., Lansdowne, Pa. with 75 cents plus 25 cents handling costs. We will test your sample for radioactivity and send you a written report on our findings.

Insist on  
*Evans*  
**TAPES**  
50 ft.-100 ft. long  
At your hardware store  
For building and gardening measuring.

**\$4.49**  
from

each with FREE plastic utility case and  
SPECIAL HOOK-RING ATTACHMENT FOR EASY ONE-MAN MEASURING

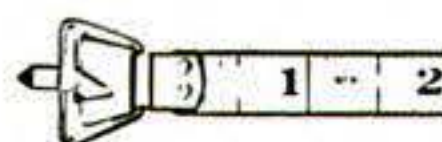

SPECIAL HOOK-RING ATTACHMENT FOR EASY ONE-MAN MEASURING



SHOP BY MAIL and  
**Save**  
at GROBAN'S

**SURPLUS & NEW MANUFACTURE EQUIPMENT**

- FOR HOME, FARM & FACTORY -  
All items unconditionally guaranteed!

**A. C. ELECTRIC GENERATOR**

 7 1/2 K.W. (7500 WATTS) single phase.  
**ITEM #G-75-D** 110/220 volt output. 3 wire system, 2 bearing construction. 5 groove 6" V belt pulley included. Self-excited. Foot mounted. Drive generator from tractor or stand by engine. Ample power for 6 room house. Dimensions: 34" x 11 1/2". Shipping Wt. 420 lbs. F.O.B. Chicago ..... **295.00**

Complete control box for these generators includes A.C. rheostat, automatic voltage regulator, field rheostat, and voltmeter, already wired and ready to connect to generator. List price \$167.00. Our Price. **56.45**

**GROBAN HYDRAULIC SPEED REDUCER**

with FINGERTIP CONTROL

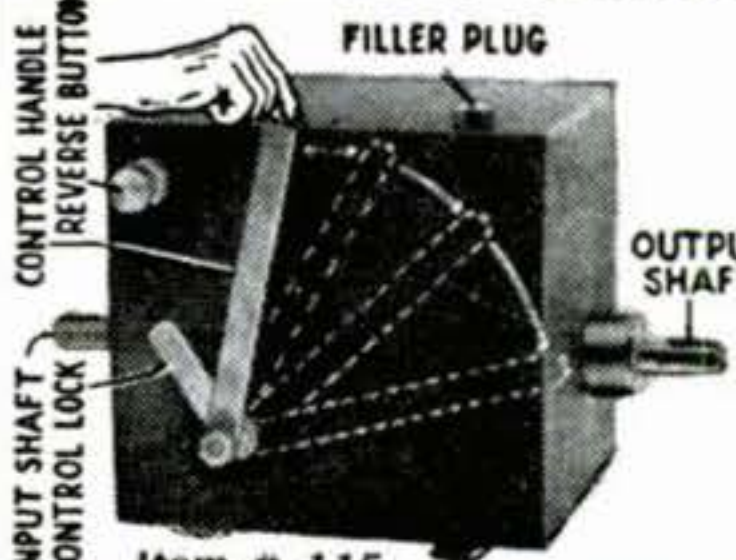

Item # 115  
**FOR:** Reamer Drives • Midget Cars • Feed Mills • Canning Machines • Conveyors • Lathes • Milling Machines • Motor Boats • Cream Separators • Garden Tractors • Pumps.  
Variable output speeds from 0 to input speed available by moving control handle. Locking handle maintains setting. Use input power of 1/4 to 1 1/2 H.P. Shafts 5/8" diam. Input rotation counter-clockwise facing shaft. Input speed 750 R.P.M. 7 1/2" x 7 1/2" x 11 1/2". Gov't acquisition cost \$428.00. Shpg. wt. 31 lbs. Complete with 2 qts. of oil and full instructions. F.O.B. Chicago ..... **54.50**

**MULTI PURPOSE HYDRAULIC PUMP OR MOTOR**

 **ITEM #55** Silent, high efficiency. Helical Gear Type Ball Bearing. Hydraulic Pump or Motor. Rated 8 Gal. Per Min. At 1500 R.P.M. — delivers 1000 P.S.I. Using 6 H.P. — Reversible Rotation — 3/4" Pipe Thread Inlet and Outlet Ports — 1/4" Drain Port — 3/4" shaft with keyway and flat for either direct or pulley drive. Dimensions — 5 3/8" high, 7 1/4" long, 5 1/8" wide. Shipping weight 18 lbs. F.O.B. Chicago ..... **45.50**

**FREE FALL & WINTER CATALOG**

1956 EDITION. 52 PAGES, chock-full of unsurpassed War Surplus Equipment Bargains for farm, home, factory, workshop. Write letter today.

**FACTORY-TO-YOU-VALUE PORTABLE ELECTRIC LIGHT PLANTS**

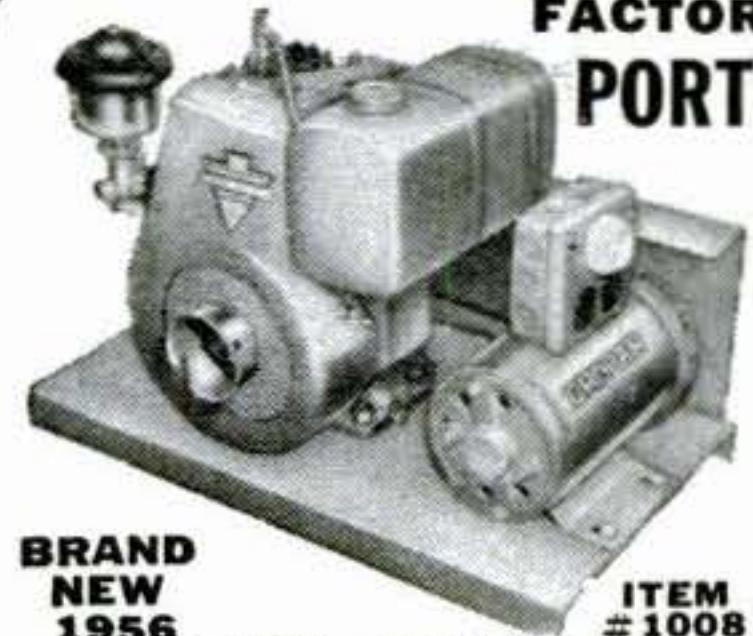

**POWER TO OPERATE:**  
• Electric Saw, Electric Drills, Pipe Bender.  
• Refrigerator, Deep Freezer, Incubator.  
• Water Pump, Radio, Lights, Air-conditioner.  
**BRAND NEW 1956** **ITEM #1008**  
**COMPACT—FITS IN THE TRUNK OF YOUR CAR**  
**1000 WATTS OUTPUT**, continuous duty. 115 Volts A.C. 60 cycles, 9 amps. Powered by husky, easy starting Clinton engine. Engine and generator operate at 3600 R.P.M. for maximum efficiency at minimum weight. Both units are mounted on steel base, with heavy sheet metal belt guard. Generator is self regulating, and is equipped with outlet box containing fuse and 2 A.C. convenience receptacles. Cost only 5c an hour to operate. Dimensions: Length 20 1/2", Width 12", Height 16". Shipping wt. 100 lbs. F.O.B. Chicago ..... **149.50**  
**700 WATT—GENERATOR SET**—same as above, slightly smaller—with Briggs-Stratton Engine—Model 708—F.O.B. Chicago ..... **129.50**

**Brand New! 5-TON BLACKHAWK HYDRAULIC LIFT KIT**

Now Only **38.95** Complete  
**THE COMPLETE KIT**  
For—• Dumping farm wagons • Adjusting depth of plows • Hydraulic press • Hydraulic jack • Snow plows.  
**KIT CONSISTS OF:**  
1—Brand new Blackhawk Model P-151—Hydraulic hand pump with built-in oil tank and release valve. Rated from 1200 P.S.I.—to 8400 P.S.I. 20" handle. Dim. 8"x6"x6". **Item #82** ..... **22.50**  
1—6 Ft. length double wire braid rubber covered hydraulic hose—tested to 20,000 lbs.! **Item #27B4** ..... **3.95**  
1—Hydraulic cylinder, 2" bore, 8" stroke, husky 1" solid steel shaft, will lift 10,000 lbs., using pump pressure. Standard clevis mounting. May be used for double action service. **Item #41C1C** ..... **12.50**  
2-Qts. non-foaming hydraulic fluid ..... **1.00**  
All necessary hydraulic fittings. Total ship. wt.—40 lbs.  
**COMPLETE KIT PRICE** ..... **38.95**  
ALL OF ABOVE INCLUDED F.O.B. Chicago

**Brand New—U. S. Navy Cost \$146.00 OBERDORFER Self-Priming BRONZE PUMPS**

 **ITEM No. 324**  
For:—• Insecticide Spraying • Sprinkling • Water Pumping • Sump Pump • Fuel Transfer—Rated Speed—500 to 2000 R.P.M.—Perfect for P.T.O., Direct or Belt Drive. Output —63 Gal. Per Min., 150 P.S.I.—use 1/2 to 6 H.P.—1 1/4" Pipe Thread Ports. 2 Grease Cups included. 1" Solid Bronze Shaft—Shipping Wt. 38 Lbs. Save **27.50** 118.50 F.O.B. Chicago.....

**ORDER DIRECT FROM AD SATISFACTION GUARANTEED**  
Send Payment or Purchase Order Today  
To place phone orders call WEBster 9-3793

**GROBAN SUPPLY CO.** Dept. PS-11  
1139 S. WABASH AVE., CHICAGO 5, ILL.

**RUGGED!! 20 TON MASSIVE!! CAPACITY**

**HYDRAULIC CYLINDER**  
• ALL STEEL CONSTRUCTION  
• 7 1/4" BORE—15" STROKE  
• DOUBLE ACTION  
 **ITEM #1715**  
• 41,300 LBS. PRESSURE WITH 1000 P.S.I. PUMP OUTPUT.  
• UP TO 70,000 LBS.—CAPACITY ON INTERMITTENT SERVICE.  
• SOLID STEEL 2 1/2" PISTON ROD  
• 1" PORTS  
• OVERALL DIAMETER—10 1/2"  
• DISTANCE BETWEEN CENTERS—28 1/4" CLOSED—43 1/4" OPEN.  
**IDEAL FOR:**  
★ HYDRAULIC PRESSES ★ DUMP TRUCK HOISTS ★ TD-18, TD-24 INTERNATIONAL HARVESTER DOZERS AND GRADERS ★ LEVELING RAMPS ★ INDUSTRIAL MACHINERY ★ ROAD MACHINERY ★ FARM MACHINERY ★ HYDRAULIC TAIL GATES  
Replacement cost—\$260.00  
Shipping Wt.—155 lbs.  
**SPECIAL PRICE** **80.00**  
F.O.B. Chicago.....

**BRAND NEW 1 H.P. 12 Volt Electric Motor**

• For electric wheel chairs (Pop. Mech. design—Mar. '53).  
• For electric golf carts.  
• For self-propelled scooters, childrens midget cars.  
 **ITEM NO. 308**  
Rated 1 H.P.,—100 amps., 5600 R.P.M., 12 volts, D.C. — This double shaft motor of ball-bearing construction may be run on 6 volts for lower horsepower requirements. —Standard 5/8" shafts, nut and bolt electrical terminals, flange mountings—Dimensions: 9" x 4 1/2" x 4 1/2" Ship. wt. 19 lbs. A real value at..... **12.50**  
F.O.B. Chicago

**GROBAN FOUR-WAY OPEN CENTER HYDRAULIC CONTROL VALVE**

 **ITEM #126** — Four-way open center control valve, with built-in adjustable relief valve factory set at 1000 P.S.I. Spring loaded neutral position. For use with one double acting cylinder. In neutral position cylinder is locked and pump unloaded. Can be used as single unit or mounted in series. Has 3/4" pipe thread inlet and outlet. 1/2" pipe thread cylinder ports. Finger grip handle. Ship. wt. 10 1/2 lbs.

**AN OUTSTANDING BUY!**  
F.O.B. Chicago **21.50**

**Double Your Income... Find a Fortune!**

It's easy! Just read these FREE booklets (60c value) ... "Treasure Hunting for Fun and Profit" and "How to Be A Successful Uranium Prospector". Others have found fortunes on vacations and in their own backyards. TIME PAYMENT PLAN! Delay may cost you money. Send for FREE booklets today!  
**FISHER RESEARCH LABORATORY, INC.**  
Dept. 5, 1961 University Ave. Palo Alto, Calif.







Please every member of your family!  
Give the gift everyone can use!

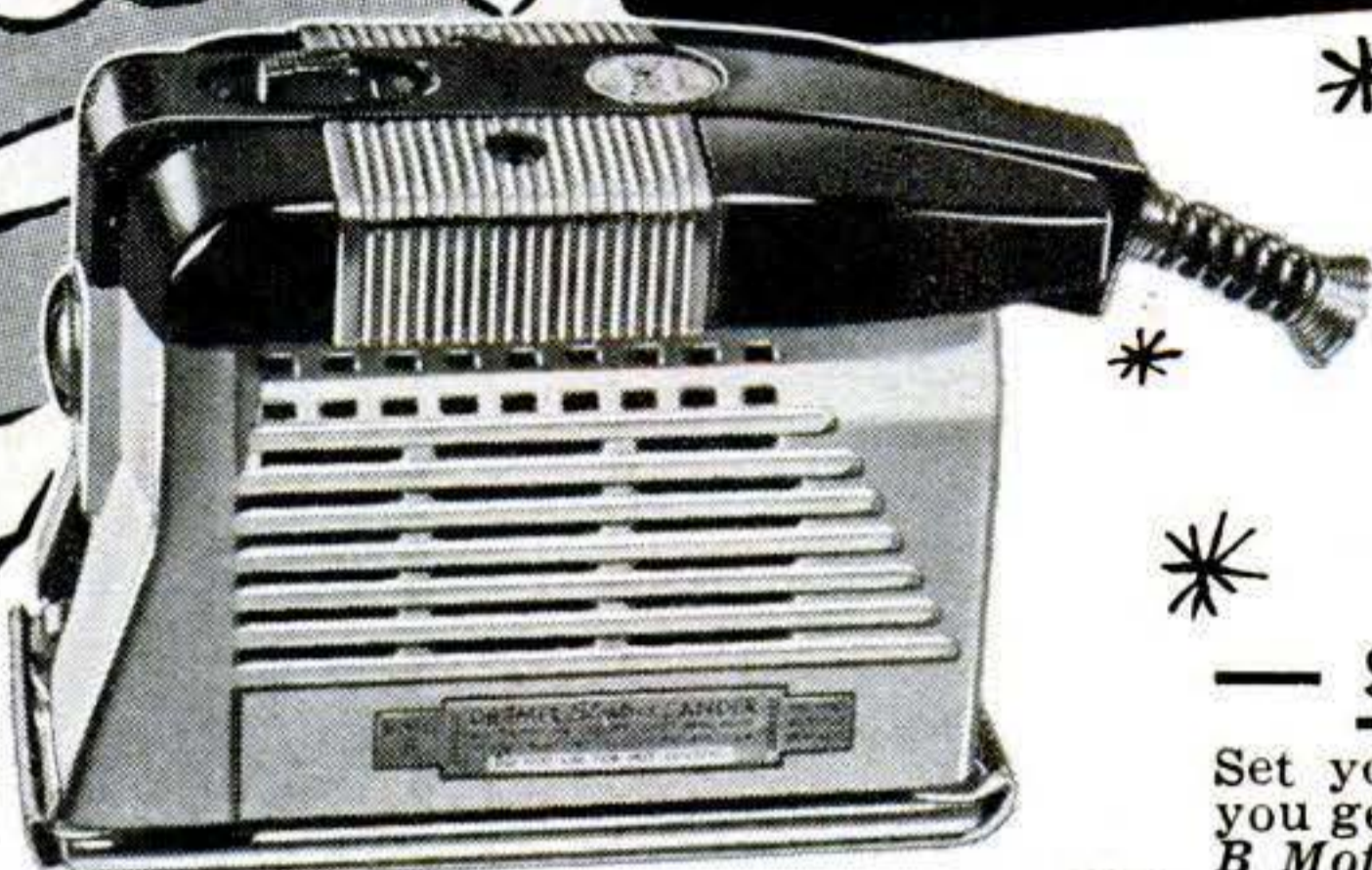

with 13 sq. in. sanding pad **\$14.85**



**Model 2000 Sander**, with steel case, 21 sq. in. sanding pad, **\$24.50**

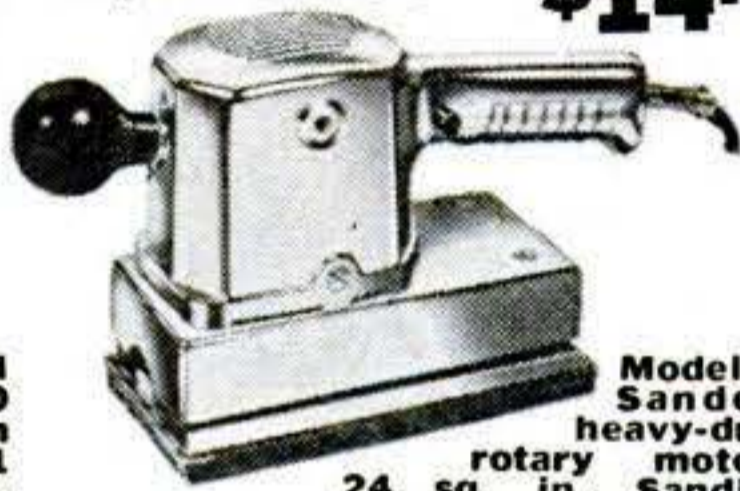

**Model 53 Sander**, heavy-duty rotary motor, 24 sq. in. sanding pad, **\$34.85**

## NEW DREMEL

### Model B Moto-Sander

IT SANDS—*Flawlessly!*  
IT POLISHES—*Perfectly!*  
IT MASSAGES—*Soothingly!*

and it features

#### — STRAIGHT-LINE-ACTION —

Set yourself for a new high in excitement when you get your first look at the new DREMEL Model B Moto-Sander. Here's versatile performance that will make the whole family itch to put it to work! The Model B is a combination sander-polisher-massager that delivers 14,400 straight-line strokes per minute, for perfect finishes guaranteed free of orbital scratches and swirls. It has power-to-spare for finish sanding, furniture polishing, a host of jobs in every home.

**SEE YOUR DEALER.** If he cannot supply, order direct on 5-day trial, money-back guarantee. Remit in full for post-paid shipment. Or send \$2 now, pay postman balance plus COD. fee.

**DREMEL MFG. CO., Dept. L-125, Racine, Wisconsin**  
**WRITE FOR POWER TOOL CATALOG**

## DEPEND ON DREMEL FOR NEW IDEAS IN POWER TOOLS!

### Get This NEW Catalog of WOOD AND WOODWORKING MATERIALS

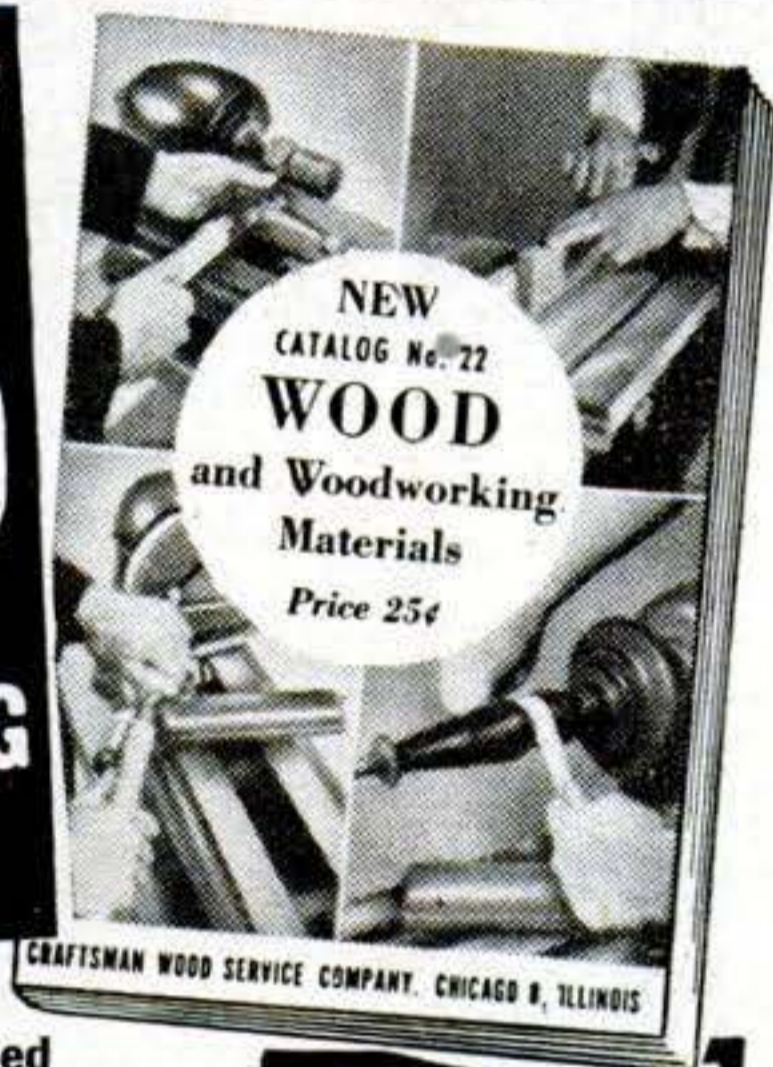

**128 PAGES**  
Many in full color

packed with rare, fancy & imported woods... veneers, plywoods, patterns, tools, ornaments, hardware... everything for the woodworker.

**MAIL COUPON NOW!**

World's Largest Selection of Finest Domestic and Imported Woods... Mouldings, Hardware, Tools, — ALL AT LOW MONEY SAVING PRICES!

Your complete wood buying guide and project book. Craftsman is your best, most complete source of finest kiln-dried domestic and rare imported woods, beautiful wood inlays, colorful bandings, matched plywoods, embossed mouldings, carved ornaments, newest woodworking tools, "hard to find" cabinet hardware and fittings... more than 1,500 items! Packed with newest scroll saw patterns, project ideas & money making plans. Enclose 25c (refunded with first order) to help pay mailing, handling cost. Write now!

**Craftsman Wood Service Co., Dept. B-11, 2729 S. Mary Street - Chicago 8, Ill.**

**CRAFTSMAN SERVICE CO., Dept. B-11, 2729 S. Mary St., Chicago 8, Ill.**

Enclosed find 25c. Rush me new *Woodworkers' Catalog Handbook.*

NAME.....

ADDRESS.....

CITY.....ZONE.....STATE.....

### Build her this doll house for Christmas



EASI-BILD Pattern #596, Pack-A-Way Doll House. Just trace, saw, assemble. Send 50¢ in cash or stamps to Elmer's Pattern Dept. PS-115, P.O. Box 215, Pleasantville, N. Y.

and build it best with

## ELMER'S® GLUE-ALL

Here's how you can be a wonderful Santa to your little girl — and save money, too!

Build this doll house quick and easy with a full-size pattern and ELMER'S® GLUE-ALL... the strong, durable plastic glue that speeds assembly. Elmer's sets fast, dries clear, won't stain. It's ideal for any gluing job with wood, paper, cloth, leather—any porous material. Convenient squeeze bottle eliminates mess and waste—comes in sizes from 29¢ to \$1.00. Get it at your hardware, lumber, or paint store.

The Borden Company, Chemical Division, 350 Madison Ave., New York 17, N. Y.





This year give more than a gift . . .

# GIVE A HOBBY!

This year, make your Christmas gift an investment in productive family fun! The new DREMEL Moto-Jig Saw is the most pleasurable power tool ever marketed—out-performs cumbersome jig saws costing many dollars more, yet is so easy to use even a novice becomes an expert in no time. Weighs only 12 lbs., sets up anywhere to make any corner a hobby shop! You'll make furniture, cabinets, toys, 1001 useful projects. You'll save by doing your own home repairs. Best of all, you'll unite the whole family around an exciting woodworking hobby. The DREMEL is super-safe—even women and children love it. For an eye-popping experience, try it in your own home.



## NEW DREMEL MOTO-JIG SAW The Whole Family Will Love It!

**Cuts 1 3/4" wood, metals, plastics!**

**Saws to center of 30" circle!**

**Super-Safe Blade Guard!**

**Blade faces 4 ways!**

**SEE YOUR DEALER.** If he cannot supply, order direct on 5-day trial, money-back guarantee. Remit in full for postpaid shipment. Or send \$2 now, pay postman balance plus C.O.D. fee. DREMEL MFG. CO., Dept. L-125, Racine, Wisconsin.

WRITE FOR POWER TOOL CATALOG

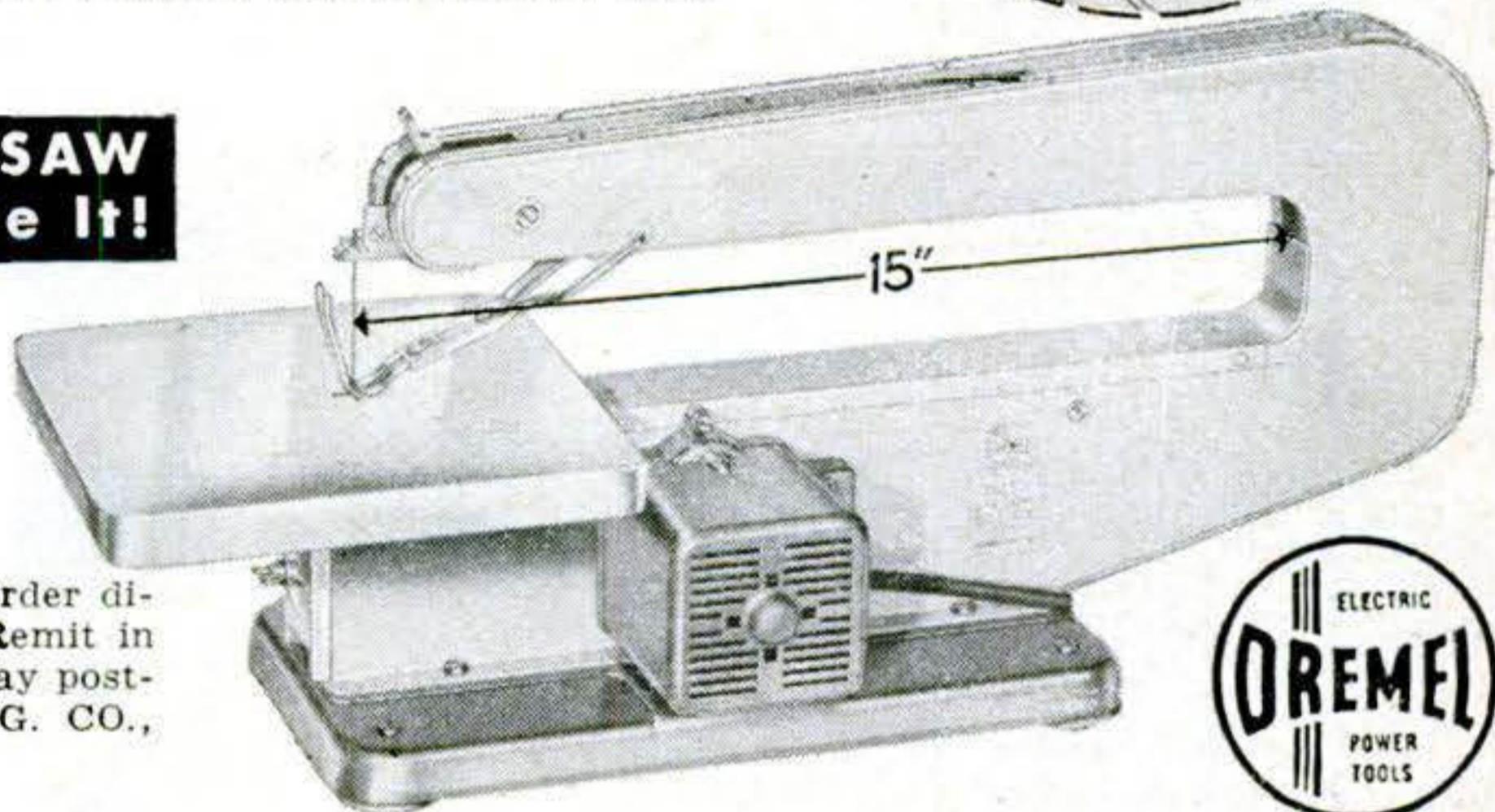

**Model 8 (8" throat) \$23.50**

**Model 15 (15" throat) \$29.50**

**DREMEL Mfg. Co., Dept. L-125, RACINE, WISCONSIN**

# POWERFUL

# MOTOR

**FREE! 2 FRESH BATTERIES TO POWER YOUR KIT**

**DRIVES MODEL PLANES, BOATS, CONSTRUCTION SETS, Etc. WITH AMAZING SPEED! RUNS ON FLASHLIGHT BATTERIES!**

**BOYS! MODEL-MAKERS!** Get this new MIGHTY MIDGET D. C. Electric Motor. It's a honey! Looks and runs just like a big one. Motor is powerful yet measures only 1 x 1 x 1 1/4 inches; weighs one ounce! Turns up to 6,800 r.p.m.'s. REVERSES instantly. Motor is in durable black plastic housing. Comes complete with clip holder, transparent plastic gearbox—PLUS five extra gears and pulleys for working out your own ratios. No shocks, sparks or shorts. And no transformer is needed.

Endless hours of fun. Educational, too! Money back guarantee!

Send no money. Order today. Pay postman only \$2.98 plus postage when delivered. Or send \$2.98 with order and we will pay postage. Supply is limited. Write NOW!

**CRAFT INDUSTRIES**

Dept. A-301, 520 Fifth Ave., New York, N. Y.



**ONLY \$2.98**



Runs on Ordinary Flashlight Batteries!



Multi-Ratio Gearbox Included!

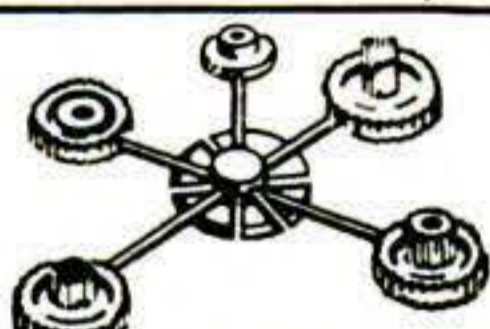

Plus 5 Extra Gears and Pulleys!

## Snap-on Tools FOR MAINTENANCE AND SERVICE

In the maintenance of all industrial machinery, the right tools save precious hours . . . help mechanics do more and better work. Throughout industry—aviation—construction—petroleum—automotive—agriculture . . . Snap-on tools and special tool sets are the outstanding choice for efficient maintenance and product assembly work. They cost less to use because they last many times longer than cheap tools. Write today for free catalog of more than 4,000 Snap-on tools.

**SNAP-ON TOOLS CORPORATION**  
8060-K 28th Ave. • Kenosha, Wis., U.S.A.

\*Snap-on is the trademark of Snap-on Tools Corp.

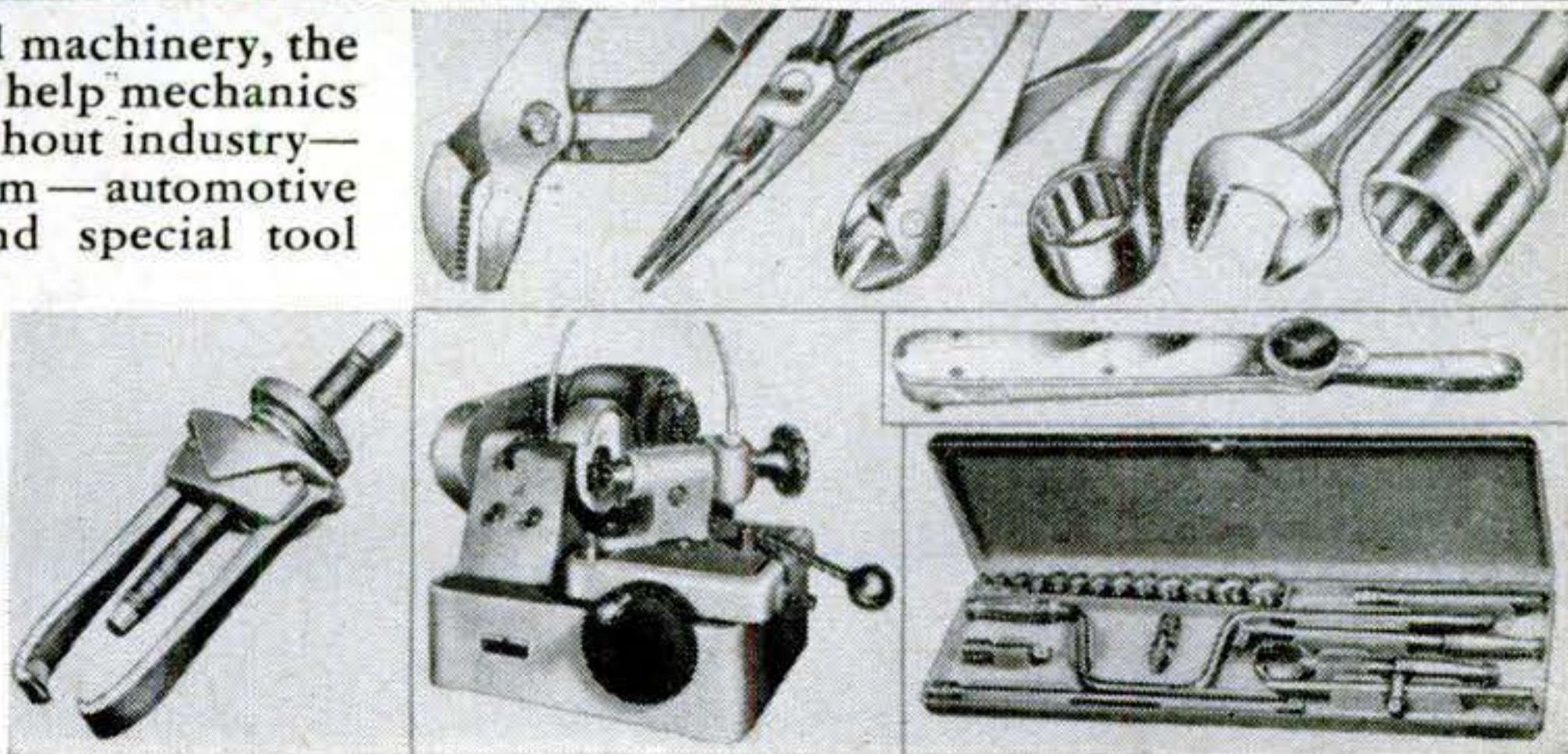



# TIME SAVING TIPS

## ALL YOU NEED IS A TUBE OF DU PONT DUCO CEMENT

REG. U.S. PAT. OFF.

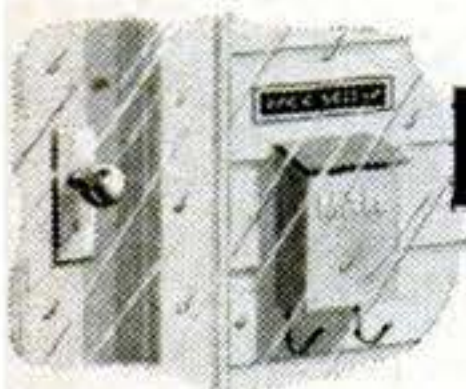

### WATERPROOF

Secure outdoor nameplates for any kind of weather with tough, waterproof "Duco" Cement.



Re-set loose bathroom tiles with "Duco" Cement—strong, waterproof bond prevents breakage!

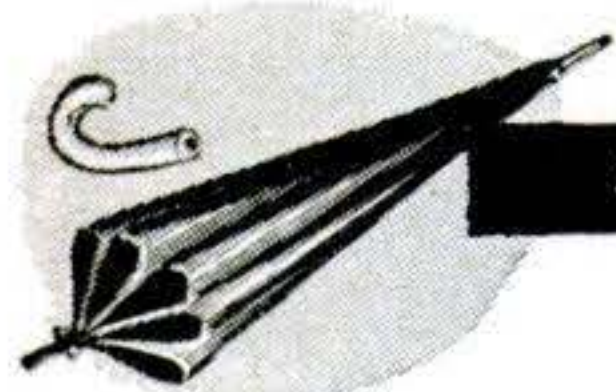

### STRONG

Put loose umbrella handles back on to stay with tight-gripping "Duco" Cement.

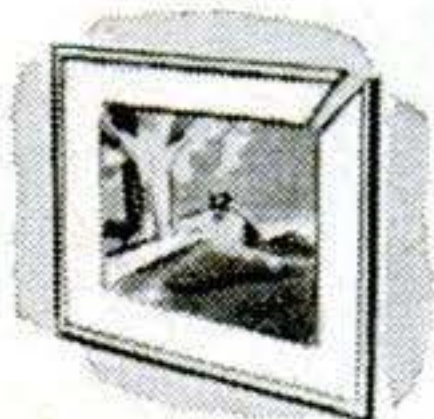

Stiffen wobbly picture frames fast—just put tough "Duco" Cement in mitered corners and on backing.



### CLEAR

Give broken fingernails first aid with clear "Duco" Cement—can't be seen, stops further damage!

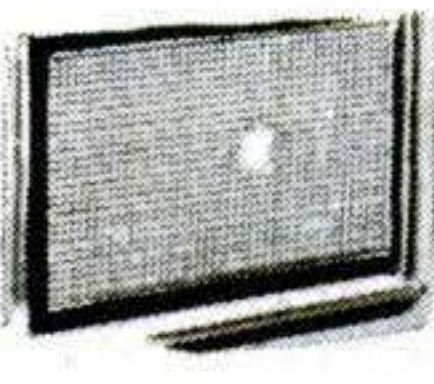

Patch torn wire screening. Transparent "Duco" Cement lets light in, keeps bugs out.

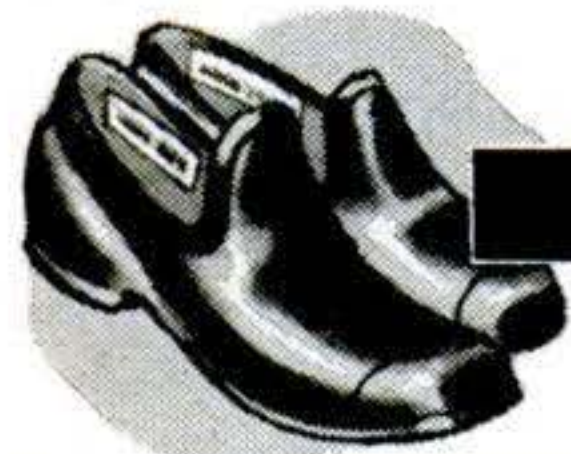

### FLEXIBLE

Put name tags in your over-shoes with "Duco" Cement—it's flexible, won't come loose when you walk.

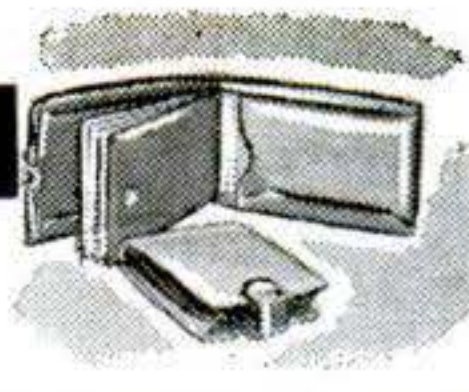

Repair leather wallets, compacts, coin purses like new with strong, flexible "Duco" Cement.



NEW CAP HAS HANDY APPLICATOR TIP



BETTER THINGS FOR BETTER LIVING  
... THROUGH CHEMISTRY

## MODERN

### LAWN MOWER SHARPENER

### COMPARE BEFORE YOU BUY

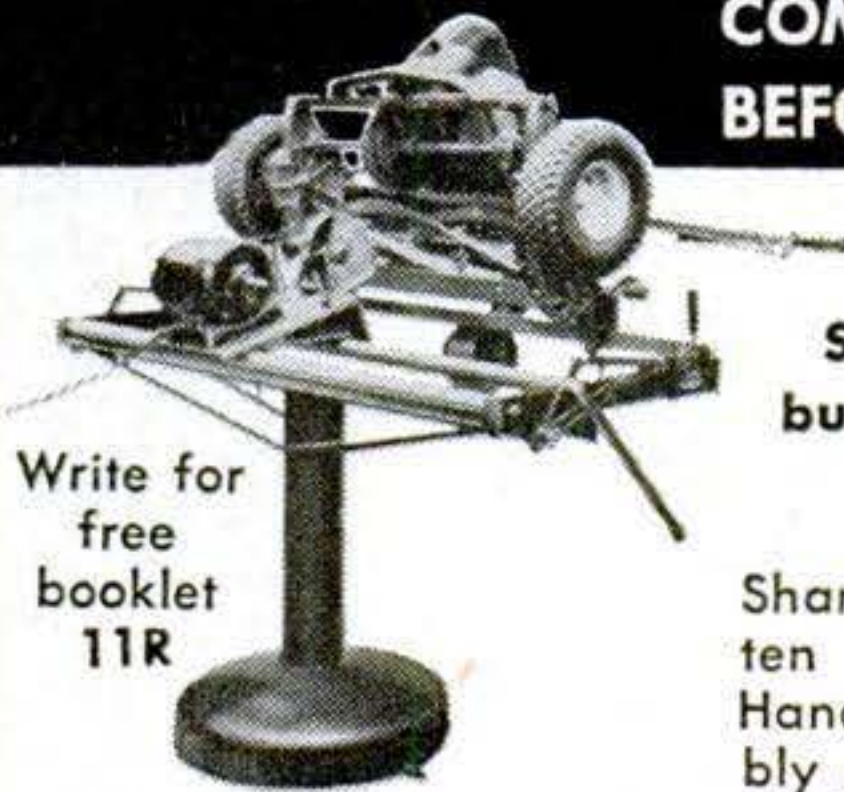

Write for free booklet  
11R

Start your own business—  
increase your income

Sharpens any mower in ten to twenty minutes. Handles complete assembly of all reel types including 36 in. power mowers. Handle, wheels, roller, and engine are not removed.

Oil remains in engine while sharpening. Bed knife sharpened in same centers—no attachments needed.

**\$26300**

**MODERN MFG. CO.**

F.O.B. PASADENA

160 N. FAIR OAKS, PASADENA, CALIF.



## MAGNETS

**225 lb. PULL**

GENUINE ALNICO—NEVER WEAKENS

AMAZING, PERMANENT MAGNETS—WILL NOT WEAKEN! NON-ELECTRIC Retrieve guns, tackle, tools and other steel items from lake, river, plating tanks, drains or other hard-to-reach spots. Recover drills, taps, etc. from sweepings. Clear alley of harmful tacks, nails. Many other uses. Pays for itself quickly. GUARANTEED. Try any magnet one week. Money refunded if you are not well pleased.

No. S-725 (Weights 54 oz.) Has pull of 225 lbs. on steel block \$15.00  
No. S-625 (Weights 70 oz.) Has pull of 125 lbs. on steel block \$ 8.50  
No. S-575 (Weights 18 oz.) Has pull of 75 lbs. on steel block \$ 6.00  
No. S-500 (Weights 13 oz.) Has pull of 50 lbs. on steel block \$ 4.00  
No. S-101 U-Shaped Magnet (Wt. 2 1/4 oz.) Pull of 6 1/2 lbs. 2 for \$ 1.50  
No. S-30 Hobbyist assortment of five small magnets. . . . . \$ 1.00  
No. S-48 Powerful Hot Pad Magnets. 8 for \$1.00. . . . . 30 for \$ 3.00  
Send Money Order or check. We pay postage. No C.O.D.'s.  
MIAMI MAGNET COMPANY, 3240 N.W. 27th Ave., Miami 42, Fla.

## SHEET METAL BRAKES

Forms angles, locks, pans, etc. New eccentric clamps. All steel construction. Size 15"-16 gauge steel, \$23.50; 36" - 22 ga., \$35.50; 48" - 24 ga. \$52.00. Floor Stand, \$8.00.

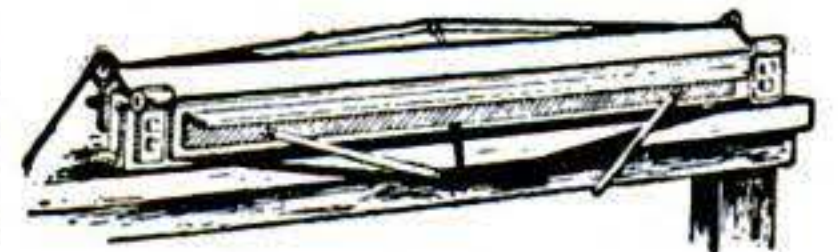
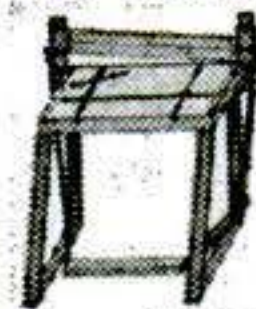

**SHEARS** Foot Squaring Shear, 30"-24 ga., \$115.00  
Hand Squaring Shear, 36"-24 ga., \$80.00  
Angle Shear, 3 Adj. Gauges 7"-16 ga. \$16.50

ORDER DIRECT OR SEND FOR CATALOG

VYKE MFG. CO., 2433 15th St., Denver 2, Colo.

### do it faster...better!

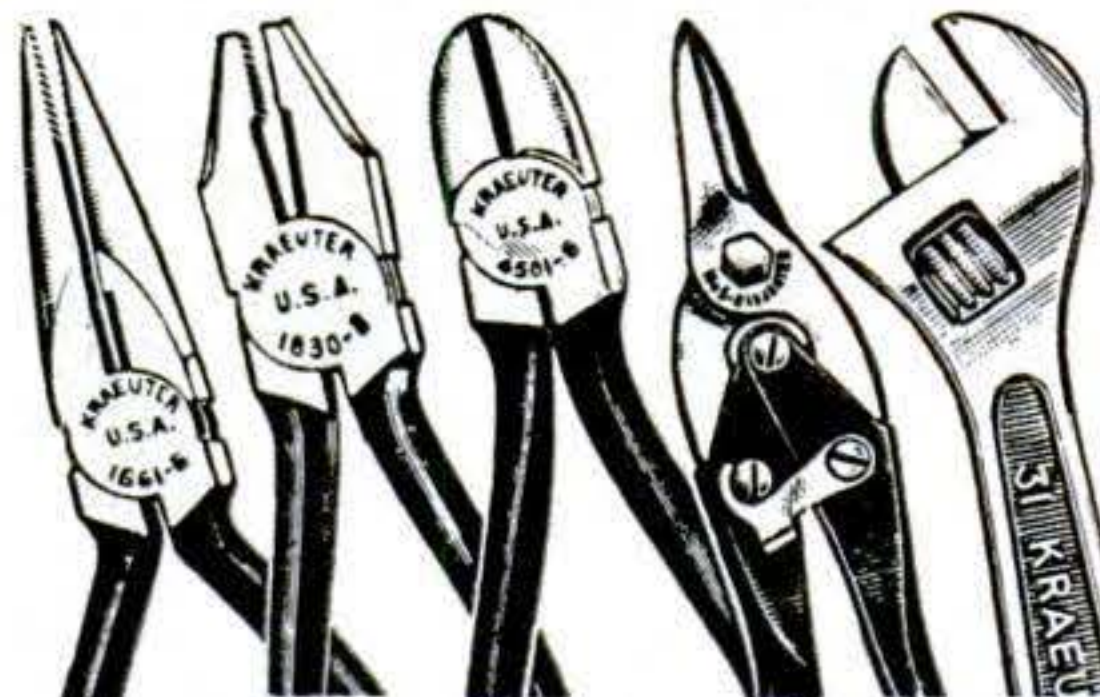

PLIERS,  
CHISELS,  
PUNCHES,  
SNIPS,  
ADJUSTABLE  
WRENCHES

Buy wherever fine tools are sold in U. S. and Canada.

# KRAEUTER



# Stop Needless Oil Changes!

## REFINOL

Today's Most Advanced  
OIL RE-REFINING FILTER  
Ends Needless Oil Waste!

Not just another filter! REFINOL not only cleans continuously, but actually REFINES oil as you drive, by utilizing motor heat! Keeps oil in high grade lubricating condition. Adds thousands of miles to motor life. REFINOL REMOVES solids. REMOVES water. PREVENTS excess dilution. PREVENTS acid-sludge formation. MAINTAINS stable viscosity, while ELIMINATING oil changes.

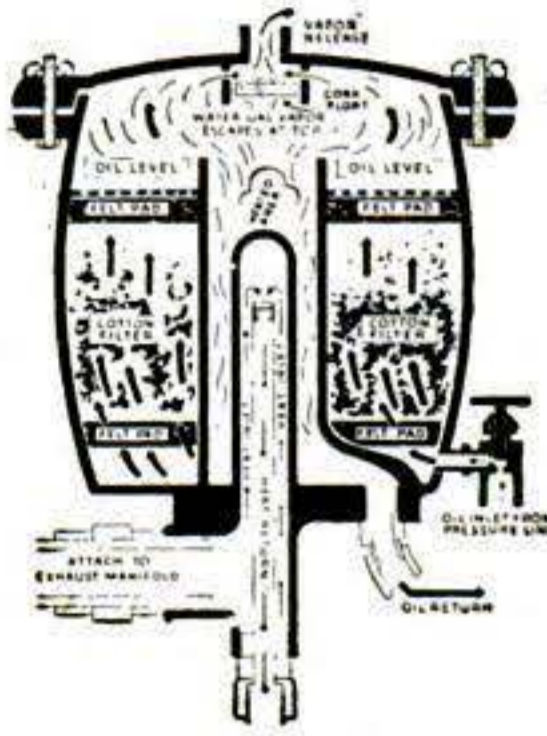

**NEVER CHANGE OIL! WITH REFINOL INSTALLED YOU CAN EVEN USE CRANKCASE DRAININGS!**

**AGENTS—DEALERS WANTED!**

**U. S. BUREAU OF STANDARDS, Bul. 86 states:**  
"Oil does not wear out mechanically."

Easily installed on any car, truck, tractor. Cleaning, RE-REFINING action effective immediately. Send Postcard for free details, pictures, vital oil facts, how airlines, buslines, other big oil users save untold sums of money yearly because they know Oil does not wear out mechanically. Write today, no obligation.

**INTERNATIONAL REFINOL CO.**  
9242 Broadway, Dept. PS-11  
Brookfield, Ill.

## Metal Turning Lathe for Model Makers

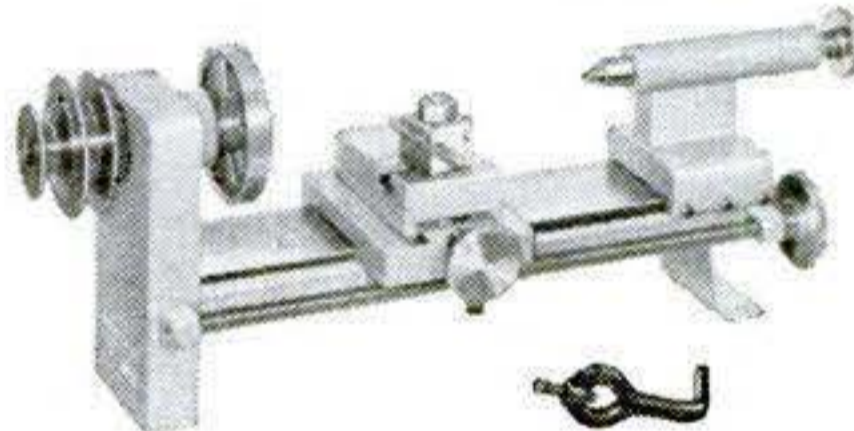

**With Ball Bearing Headstock Spindle**  
For Home Work Shops, Model Builders, Hobbyists. Use it to earn money; develop inventions; make repair parts; do machine work on models.

All steel, practical lathe. Length of Bed—12"; 4 1/2" Swing; Distance between centers—7"; Tailstock travel—1 1/2"; 0 Center in Tailstock; 0 Center in spindle; spindle has 1/2" x 20 thread—1/4" hole; Complete with face plate, driving dog and mounting bolts. Weight, 25 lbs. Guaranteed. Price, except motor—

**only \$2575**  
f.o.b. Lansing

Rosemoor Mfg. Co. 2609 Bernice Rd., Lansing, Illinois

## Automatic Saw Set...



**MAKE EXTRA PROFITS!**  
Set 400 teeth per minute on hand or band saws, 4 to 16 point, with the BeMaCo Automatic Saw Set. Fast, accurate, true hammer-anvil action sets teeth uniformly, eliminates tooth breakage. Used profitably by saw shops and manufacturers everywhere. Every machine positively guaranteed!  
Write for details—today!

Saw Machine Division 19-S

**BEAVER MFG. CO.**  
800 ISIS AVENUE • INGLEWOOD, CALIF.

## YOU NEED THIS QUALITY SAW!

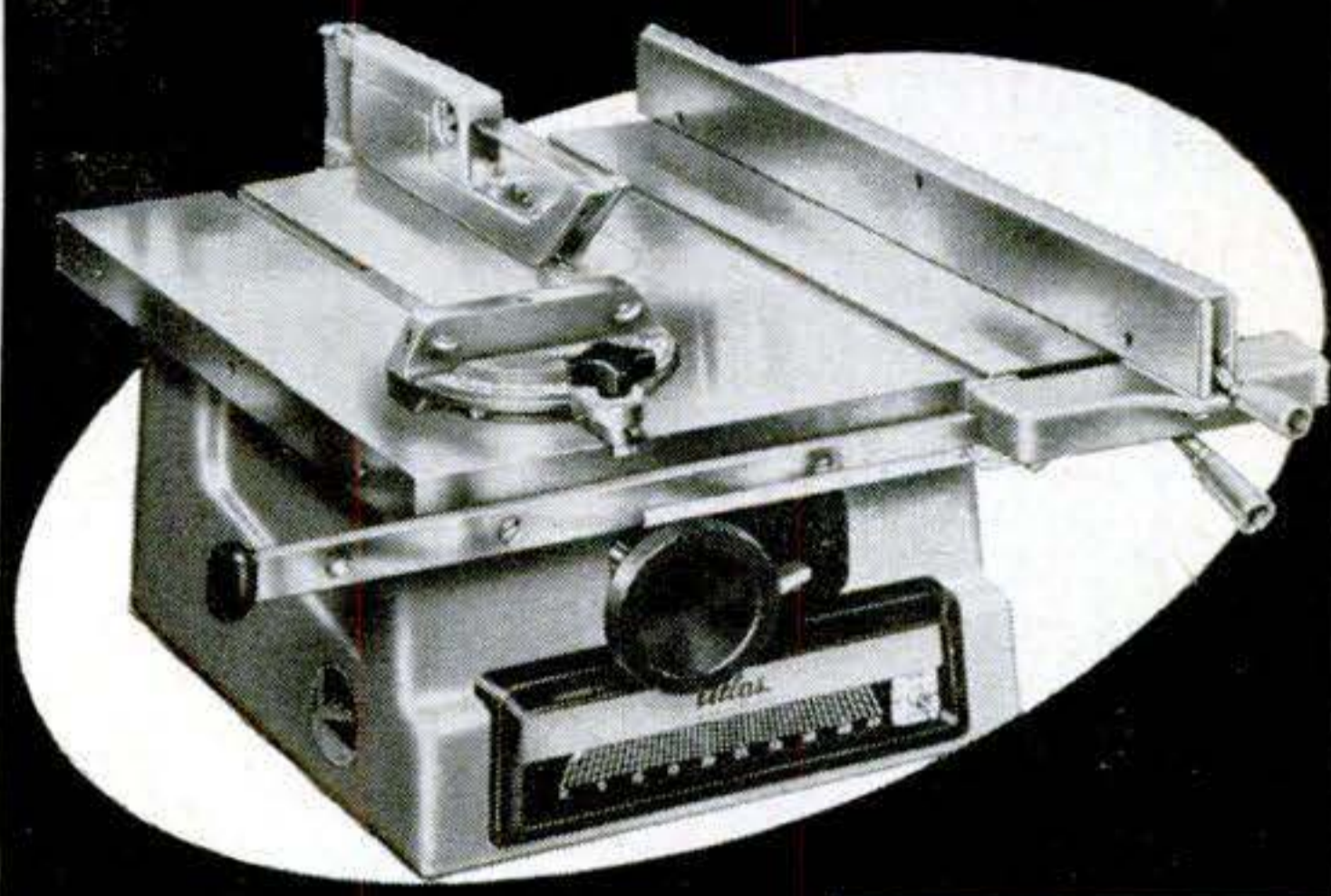

## -TO DO QUALITY WOODWORKING

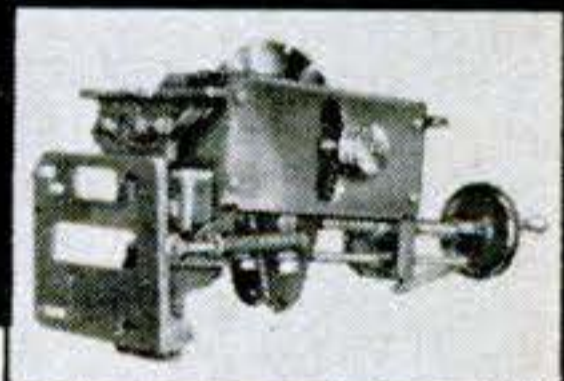

With this ATLAS 8" saw you can crosscut, rip, miter, dado and shape with greater accuracy and smoothness. This great saw, the crowning achievement of 45 years of precision machine tool building, is really solid... with massive grey iron table, bigger arbor, balanced tilt mechanism, triangular arbor support, sealed-for-life ball bearings, and many other exclusive features.

**ADVANCED BOX CONSTRUCTION and TRIANGULAR BOX ARM** combine to maintain absolute maximum rigidity. You always cut true regardless of angle of tilt or depth of cut.



**NEW BIGGER ARBOR and sealed-for-life ball bearings...** for smoother performance and longer life.

## Atlas BUILDS A COMPLETE LINE OF WOOD AND METALWORKING TOOLS

ATLAS enjoys a worldwide reputation for quality machine tools... wood and metalworking tools that excel in precision and performance. See your nearest franchised ATLAS Dealer.



**FAMOUS DOUBLE-LOCKING LIFT-OFF FENCE** — a single lever quickly locks or releases both ends... lifts off at any position.

## WRITE FOR FREE CATALOG

# Atlas 8"

## TILT / ARBOR BALL BEARING Circular SAW

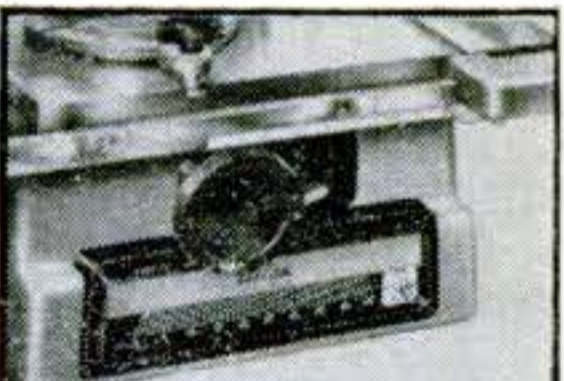

**NEW PUSH-PULL DUAL CONTROL** — one convenient handwheel sets blade height and angle.



**Atlas Press Company**  
Quality Machine Tools Since 1911

ATLAS WOODWORKING POWER TOOLS  
ATLAS METALWORKING MACHINE TOOLS  
CLAUSING HEAVY DUTY MACHINE TOOLS  
1125 N. PITCHER ST., KALAMAZOO, MICHIGAN



**WAR SURPLUS AND OTHER BARGAINS SAVE UP TO 90%**



**RADIANT MAGNIFIER**

A compact, illuminated hi-powered magnifier of chromium-plated brass. Ideal for inspection work, engineers, engravers, template work, stamp collectors, nautical charts, road maps, fingerprints, etc. Complete with batteries — \$6.95 ppd USA.

**PUROLATOR OIL FILTERS**

The perfect filter to keep motor oil or hyd. fluid clean at all times. Permanent type. Protect your pump, engine, midget racer or boat with this unit. Inlet & outlet port 1/2". Accommodates 16 GPM at 20 PSI. Mtg. brackets. A \$25 value. NEW. \$3.85 ppd USA.



**MICROSWITCH**

Normally open or closed...dual purpose. For automatic contacting, light, sound, model train systems, chimes, etc. Approx. Govt. cost \$15. NEW. 5 for \$2 ppd USA.



**SPECIAL ON \$4770 NAVY AUXILIARY POWER UNITS AIR COOLED**

Ideal for your shop, camp, cottage, farm, trailer, home, boat or mines. Makes a terrific welder for any size job. Also excellent for auxiliary power in pumping wells, operating saws, or wherever power is needed. 30D-1A Lawrence, 24V. 2 Cylinder opposed 4-cycle 10 1/2 H.P. comes complete with various generators which can be attached to standard stud mounting. Shpg. wt. cased 350 lbs. Like new. Type 2 CM70-B9-140 amps., 24V — \$125. Type P1, 200 amps., 24V — \$137.50. AC-DC NEA5 (DC side 24V, 200 amps., AC side 10.5 amps., 1200 watts). 800-cycle 2400 RPM — \$142.50.



**"HELIOS" ORIGINAL TOOLMAKERS VERNIER CALIPERS**

ULTRAPRECISION — Imported. Used by machinists at Lockheed, Douglas, Bendix, GM, RCA, GE. Model 51/2E. Genuine Helios. Hardened lapped precision surfaces. 1/1000" and 1/128" graduations. Handy slide roll and thumb lock. Quick, accurate depth. A \$35 value. Satine finish. ALL NEW, just \$6.95. Leather carrying case, \$1 extra.

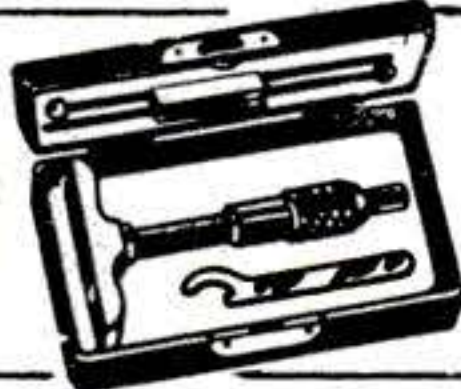

**MICROMETER DEPTH GAUGE**

With 3 rods to measure all depths from 0 to 3 inches by thousandths. Hardened tool steel lead screw has full 1 inch run. Base is 2 1/2" long, hardened ground and hand lapped. Accuracy guaranteed. Mfd. by Millers Falls Co. GOV'T COST approx. \$30. NEW — \$10.95 ppd. USA. In velvet case.

**MICROMETERS** Chrome plated, precision engineered, carefully tooled to give long life. All new 0-1" cap. \$2.25 ea., 1-2" cap. \$3.50.



**PRECISION GROUND SQUARES**

Production engineer's squares. Accuracy guaranteed. Mfd. by Wright & Moore, Sheffield, Eng. Square blades hardened & tempered. Individually packed in wood box. Brand NEW. Fraction of original cost. 2" — \$2.75; 3" — \$3; 4" — \$3.25; 5" — \$3.50; 6" — \$3.75; 9" — \$7; 12" — \$8.75.

**NEW PUMP AND MOTOR**

Pump has 1" connections, built-in relief valve, adjustable up to 1500 lbs. Max capacity 6 GPM. 1 1/2 H.P., 24-volt motor. 4000 RPM. Can be used on 12 or 36 volts. Govt. cost approx. \$350 — our price — NEW — \$9.95.



**SENSITIVE ALTIMETER**

in 10 Ft. Increments. Famous Pioneer! 0 to 35,000 ft. (inches of Mercury). Tested and inspected in our own instrument lab. Guaranteed perfect. Approx. Govt. Cost \$150. NOW ONLY \$13.95 PREPAID!



**NEW 1955 CATALOG**

Biggest ever... new low prices... Send 25c for your copy today. Prices otherwise stated. Check, money order or cash. 25% deposit for C.O.D.

**AIRBORNE SALES CO., INC. DEPT. PS1155**  
8501 Stellar Drive, Culver City, Calif.

**64" FLEXIBLE SHAFT WOVEN WIRE CORE**

USE AS ELECTRIC DRILL

\$5.95

REAL BARGAIN — cannot be duplicated for \$15.00. Coupling fits 1/2" or 3/4" motor shaft (state which); other end fits standard chuck. Durable, heavy.

72" \$6.95  
SIZE

Use it for grinding, polishing, buffing, drilling, etc. Heavier constr. Chuck for same only \$1.25. Send check or money order and we will ship P.P. prepaid or C.O.D. Plus Postage. Money refunded if not satisfied.



**L. C. DOWNEY CO. — Dept. S**  
8004 TRAYMORE AVE., PHILA. 18, PA.

**STOP FROZEN PIPES!**



**ELECTRIC HEATING TAPE**

Self Adhesive! Just Wrap It On and Plug It In — It Sticks!

Easily, quickly applied. Protects water pipes, oil lines, pumps. Use thermostat for automatic operation.

Low Cost . . . Do-It-Yourself Prevent Costly Repair Bills

Trouble free, lasts for years. Protect to 50° below zero with WRAP-ON fiberglass insulation. No tools needed.

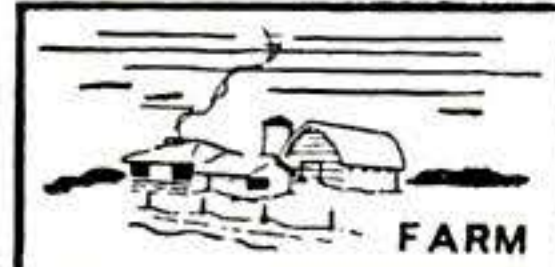

FARM

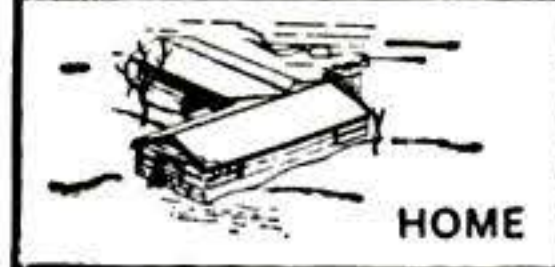

HOME



TRAILER

send today for your

**FREE**

WRAP-ON instructions

At hardware, electric, farm, poultry and trailer dealers.

**WRAP-ON** Co., 340 W. Huron St. Dept. 708, Chicago 10, Ill.

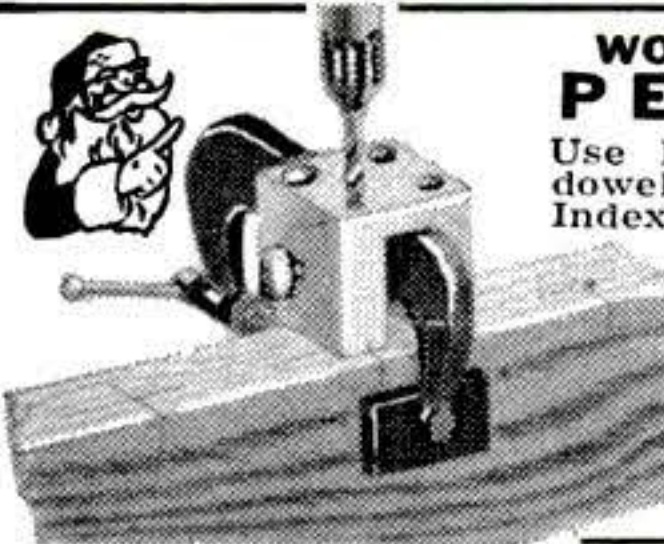

**WONDERFUL CHRISTMAS GIFT! PERFECT JOINTS**

Use LEE DRILL JIG to drill accurate dowel holes on any edge, surface or end. Indexes on two axes. Jig and Clamp as shown. \$4.99 postpaid. Matching bits insure perfect fit. \$2.85 set. Satisfaction or money back . . . FREE! Screw, Drill and rod gauge given free with order. Free illustrated catalog.

**M. D. LEE TOOL CO.**  
Box 22-S, Irondequoit Br. Rochester 17, N.Y.

**VARIABLE SPEED HYDRAULIC POWER TRANSMISSION**



It has Infinite Speeds 0 to 550 Reverse Automatic Overload Protection: Adjustable Torque up to 180 inch pounds, 5/8" Input and Output Shafts. It will handle 1/4 to 1 1/2 H.P. Motor. Case measures 7 1/2" long 7" high 6 1/2" wide. VALUE OVER \$300. Shipping Wt. 25#. On C.O.D. Orders we require only \$54.50 a 10% Deposit. Fob. Chicago

DIRZUIS MACHINE SHOP "T", 1423-25 52nd Ave., Cicero 50, Ill.

**CONCRETE MIXERS DIRECT FROM MANUFACTURER**

BEST SMALL MIXER MADE, OVER THREE THOUSAND SOLD LAST YEAR. QUICK DELIVERY. WRITE TODAY FOR CIRCULARS AND LOWEST PRICES.

**UNITED STATES FORGE AND FOUNDRY CO.**  
CONSTRUCTION EQUIPMENT DIV. PULASKI, NEW YORK



**MAKE UP TO \$5 AN HOUR WITH**

**EASISHARP**

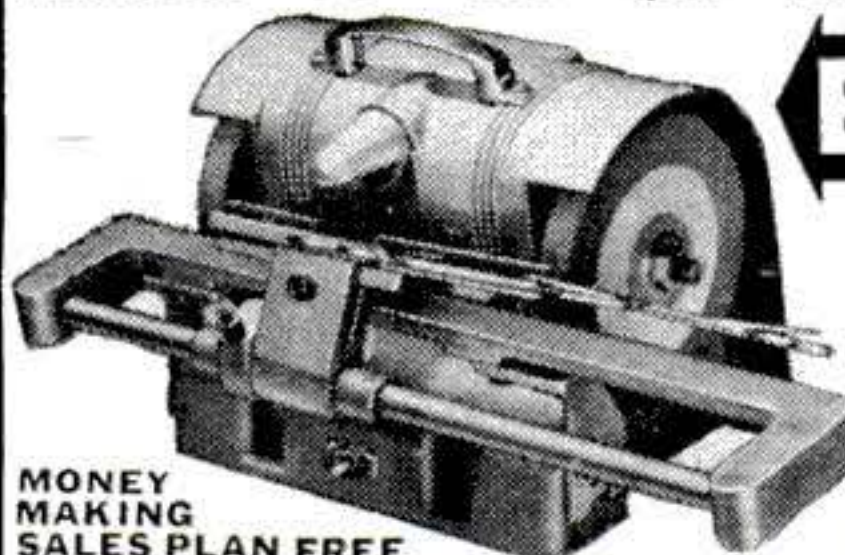

Big profits in your spare time sharpening scissors. We show you how to start making money immediately. This is your chance now to have your own business and a steady income. Sharpen a pair of scissors in less than two minutes! A child can operate it. Weighs only 10 lbs. Every home, barber, tailor, dressmaker — everybody uses scissors and all need sharpening two to four times a year. Don't let someone else beat you to this opportunity. Write immediately to

MONEY MAKING SALES PLAN FREE

**SERR-EDGE MACHINE CO., 9733 Lorain Ave., Cleveland, Ohio**



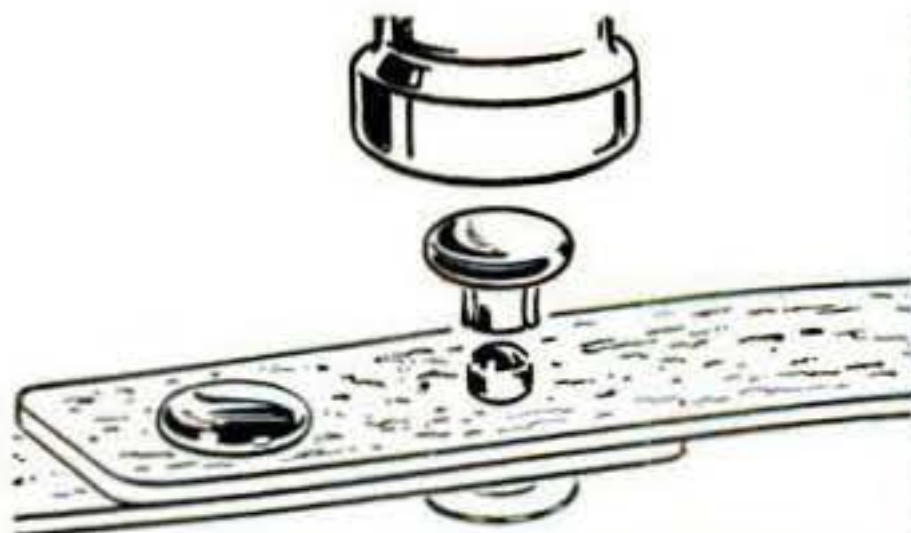

## SPEEDY RIVETS

simply swat  
with a hammer

Fasten leather, cloth, paper, plastics. Quick, secure, permanent repairs . . . ideal for craftwork, too. Simply make a hole in each part to be fastened, push rivet together through holes, place on firm surface and swat with a hammer. Gilt, nickel, black, brown finishes. Large (6 per card) or small (10 per card) sizes.

AT HARDWARE  
COUNTERS  
EVERYWHERE

15¢  
per card

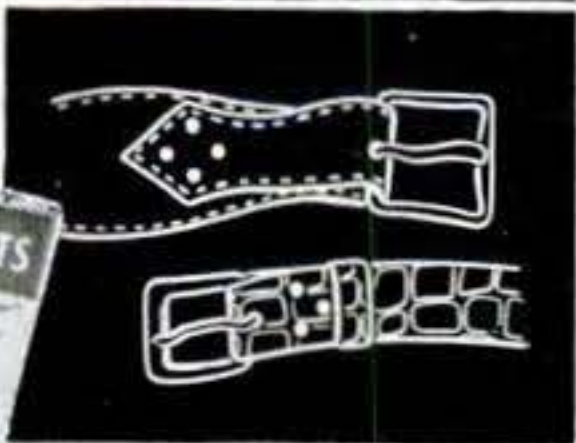
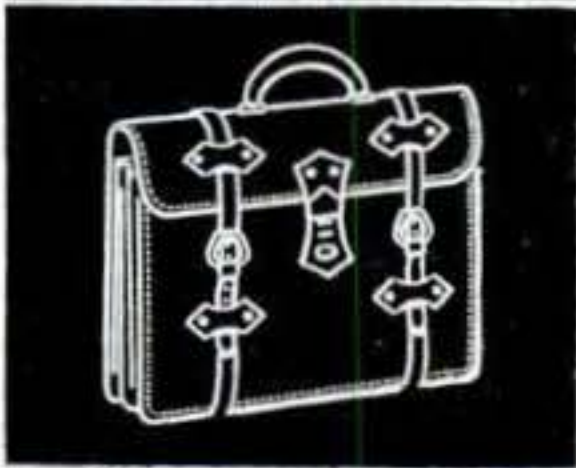

THE **DOT** LINE

3229 S. Ashland Ave., Chicago 8, Ill.

## ONE-MAN SAWMILL LOW \$50<sup>00</sup> AS... DOWN



Take BELSAW Portable Sawmill right to the trees—turn out valuable lumber for home and farm—sell to local yards—make up to \$50 a day custom sawing for neighbors. BELSAW lasts a lifetime. No crew needed. Power with tractor or auto engine. Beginners get excellent results. Send today for FREE BOOK.

FREE  
BOOK

**BELSAW MACHINERY CO**  
3476 Field Bldg. Kansas City 11, Missouri

Guaranteed original equipment  
Replacement Auto Parts . . . at  
**Western Auto**

## KING MIDGET—WORLD'S LOWEST PRICED CAR



Lower priced, improved performance. Drive it for 75c per week. Also KING MIDGET JUNIOR, finely engineered, less than one-third cost of any comparable car, one twelfth cost of large cars. Agents wanted. IT WILL PAY YOU TO GET THE FACTS. Send 25c for literature and agents proposition on both cars, or \$1 (refunded first order) for this plus actual assembly book and service manual.

**MIDGET MOTORS MFG. CO., ATHENS 2, OHIO**

# the NEW Estwing

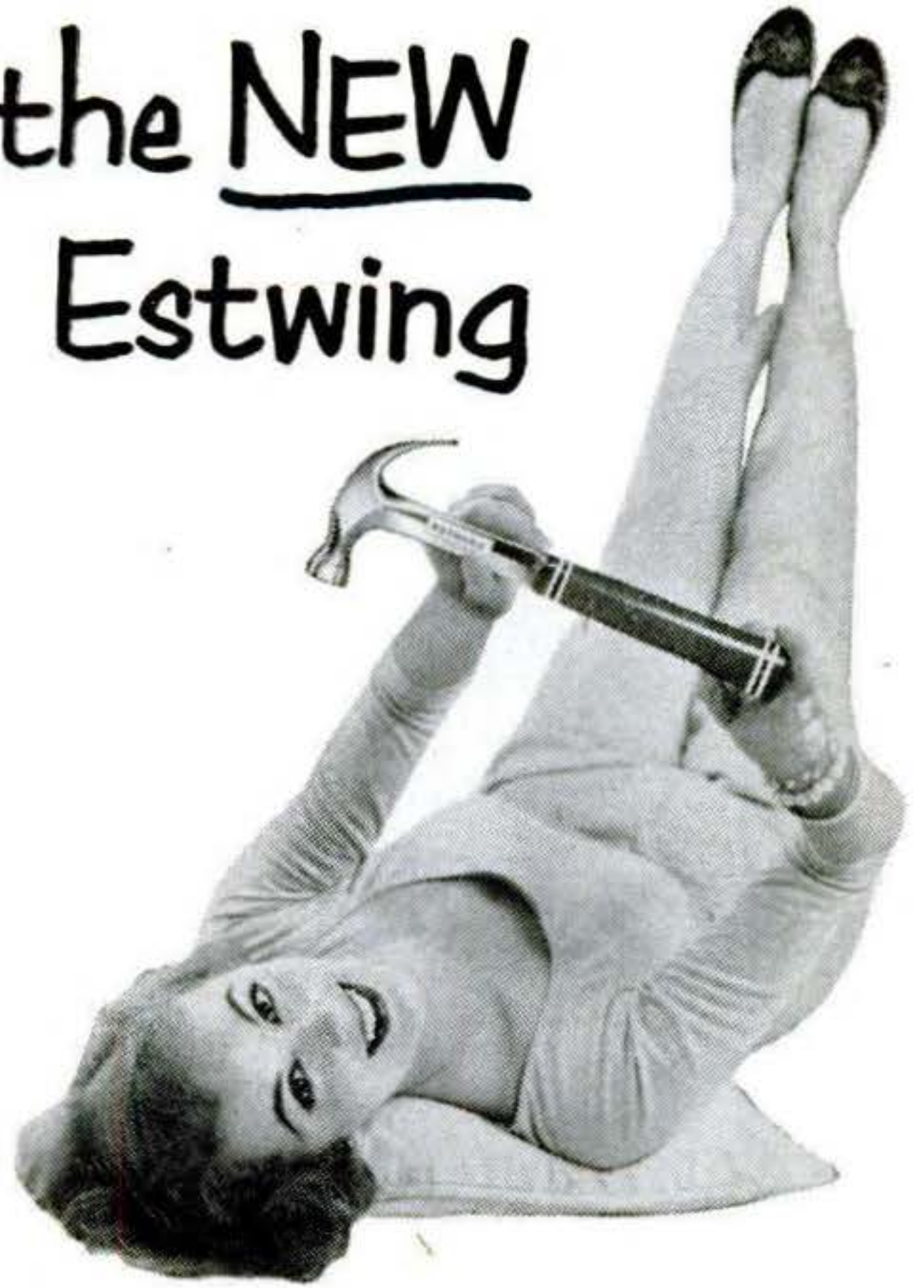

## A REAL MAN'S GIFT FOR HOME AND HOBBIES

Estwing makes the world's only ONE PIECE hammers, hatchets and axes. They're GUARANTEED UNBREAKABLE in all normal use. The shock absorbing grip is made of GENUINE LEATHER.



Beautifully gift boxed . . . Ask for ESTWING in either Brite-Chrome or high polish finish at all leading hardware stores.



Send 10¢ for  
handy nail guide  
and Estwing  
catalog.



Estwing Mfg. Co., Dept. 11-S Rockford, Ill.

NOVEMBER 1955 289





# FREE PLAN

tells how to start your own business  
**FILING SAWS**

Here is a steady repeat CASH business you can start in your own basement or garage in your spare time and make up to \$3 or \$5 an hour. You can file hand, band and cross-cut circular saws on the Foley Saw Filer. No eyestrain—no experience needed. "The first saw I sharpened with my Foley Filer came out 100%" —writes Clarence E. Parsons. Every saw you sharpen with the Foley Saw Filer brings you more customers. "I rented a two-car garage and have all the work I can do."—Charles H. Smith.

## FREE BOOK "Money Making Facts"

shows just how you can start at home in spare time with small investment, no overhead—and develop into a full-time repair shop. Send coupon today for this practical plan. No salesman will call.

### SEND COUPON FOR FREE BOOK

**FOLEY MFG. CO.** 1119-5 Foley Bldg.  
Minneapolis 18, Minnesota  
Send Free Book "Money Making Facts"



Name \_\_\_\_\_  
Address \_\_\_\_\_

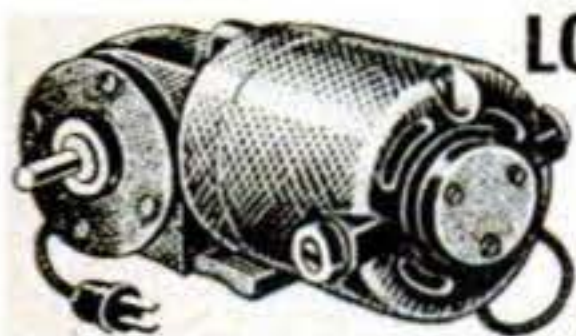

### LOW Speed, Gear Head MOTOR

Develops as much as 1/4 HP

10-RPM, Ball Bearing **\$14.50**  
FULLY GUARANTEED Reg. Price \$35.00 PRE-PAID

Such versatile motors are hard to find . . . applicable for countless Experimental and Laboratory uses. Ideal for building special equipment that save valuable man hours. Can be used as a variable speed unit with a low cost rheostat. BALL BEARING . . . mounts in any position! Extra heavy-duty series type motor (operates on AC or DC). 110 Volt, 25-60 cycle, 1/2" diam. shaft. Rugged cast iron construction! Operates conveyors, jeweler's lathes, timing devices . . . perfect for revolving window displays and sign rotation . . . 1,001 uses! Order from ad. We pay shipping.

FREE CATALOG of Compressors, Welders, Power Plants  
ROBERTS ELECTRIC CO., Dept. PS-328, 849 W. Grand, Chicago 22, Ill.

## The CHRISTMAS GIFT for Lifetime Enjoyment WELD IT YOURSELF IN A JIFFY!



Weld, Cut, Braze, Solder; Iron, Steel, Brass, Bronze, Aluminum and other metals safely and easily. Make your wrought iron furniture, porch railings, fences, knick-knacks and other metal specialties. With this fine equipment anyone can do professional-like work with little practice. The Dynamic is an industrial type transformer arc welder designed to operate from any properly wired 110 volt AC line.

NOW as a FALL SPECIAL you will receive an \$8.00 Twin Carbon Arc Torch FREE to complete your welding workshop. Order TODAY!

Literature on larger equipment available on request.

DYNAMIC WELDER COMPANY, 1808 S. Federal Street, Dept. D3-M, Chicago 16, Illinois

### EASY PAY PLAN

Low down-payment. Pay as you weld. Money back guarantee. Complete outfit including special FALL GIFT.

**Only \$38.50**  
F.O.B. Factory



# MENDS MOST ANYTHING

"HOLDS LIKE IRON"

Used by fine furniture makers. Ideal for home and office. In 3/4 oz. or 2 1/2 oz. sizes.

## DITCH-WITCH TRENCHER



Portable DITCH-WITCH digs 4 1/2" or 6" deep, even ditches to 36" depth in all types of soil. Four rugged models. Complete unit — self-propelled. **OUTDIGS 8 MEN**  
Write for Illustrated Literature

The CHARLES MACHINE WORKS  
637 B Street Perry, Oklahoma

**STOP LOOKING FOR YOUR BITS!**  
**BITZGO SAVES BITS-TIME-MONEY!**

Attaches to drill cord without removing plug. Holds 13 bits thru 1/4 inch. All rubber and light weight. Never is in the way. Bits can't fall out. . . . With 13 U. S. made high speed guaranteed bits. . . . \$6.98 ppd.

**\$1.98 ppd.** LESS BITS

Ideal Gift. Satisfaction Guaranteed. Send Check or M.O. Today!  
The DONART Co. 425 E. Plymouth Circle, Minneapolis 16, Minn.



Kelsey EXCELSIOR Presses.

## Print Your Own

Cards, Stationery, Advertising, labels, circulars, photo and movie titles, church work, tags, etc. Save money. Sold direct from factory only. Raised printing like engraving, too. **Print for Others, Good Profit.** Have a home print shop. Easy rules supplied. Pays for itself in a short time. Write for free catalog of outfits and all details.

KELSEY PRESSES, N-33, Meriden, Conn.

## TOOLS WHOLESALE

**MAKE EXTRA MONEY**

Start your own business. Sell tools to your friends, neighbors, for industrial & institutional use.

A MILLION DOLLAR INVENTORY AT YOUR FINGERTIPS. NO STOCK TO CARRY, ORDER AS YOU NEED IT.

Send \$1. deposit for dealer's card and get the giant new 1955 wholesale catalog at no extra charge. \$1. is credited to your first purchase or refunded if you are not 100% satisfied.

• Stanley, Millers Falls, Plumb, Disston, Wiss, and hundreds of other nationally advertised name brand tools, appliances, motors, elec. tools, power tools and others too numerous to mention.

**WHOLESALE DISCOUNTS**  
Up to 50% off

SILVO HARDWARE CO., Dept. PS-11 108 Market St., Phila. 6 Pa.





FOR CHRISTMAS, SHOW HER

# ... what you can do for a tired room with \$33\* worth of Weldwood Sea-Swirl®

Give yourself a gift of easy-to-use Weldwood Sea-Swirl—and you can give the whole family a surprise they'll enjoy for years! You'll be amazed at the new warmth and charm you can give a room with a wall of Weldwood Plywood Paneling.

It's easy to work with Weldwood. In just a few hours you can sit back and admire your handiwork—the subtle, textured beauty that only real wood offers. Ask your lumber dealer to help you plan this wonderful Christmas surprise. Or see the complete Weldwood line at one of our 87 showrooms in principal cities.

## ASK YOUR LUMBER DEALER FOR Weldwood® HARDWOOD PLYWOOD

A product of  
United States Plywood Corporation  
World's Largest Plywood Organization

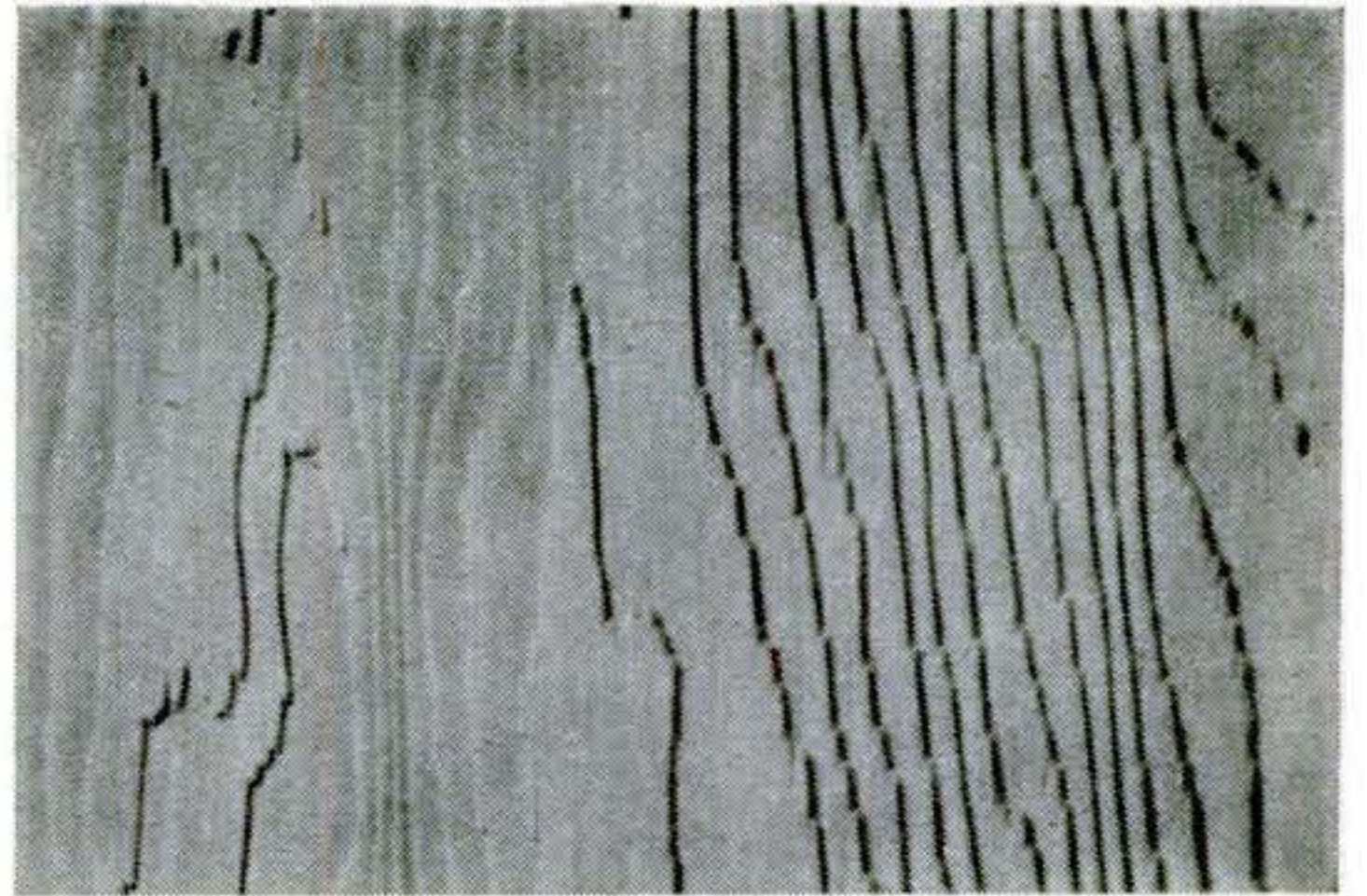

\*Weldwood Sea-Swirl captures the clear, weathered look of driftwood, and enough for a 12' x 8' wall costs just \$33. Or you may prefer Surfwood®—it costs only \$26 for the same wall.

### GET BIG, NEW DO-IT-YOURSELF BOOK!

This brand-new 40-page booklet shows how to panel a wall, how to glue and finish plywood... gives all kinds of tips for home craftsmen plus dozens of pictures of projects you can make with plywood. Send 25¢ for your copy today!

United States Plywood Corporation  
Box 61, New York 46, New York



Enclosed is 25¢ for the new Weldwood Do-It-Yourself book. Please rush my copy.

PS 11-5

NAME.....  
ADDRESS.....  
CITY.....STATE.....

**WONDER PASTE**  
*makes it easy*

**Paint comes off clean**

The painter's favorite remover. Softens up the toughest paint, varnish, enamel or shellac so it comes off in one easy scraping. Harmless to wood, metal, veneers and hands. Won't run on upright surfaces. Get Wonder-Paste at paint and hardware stores.

● Write for leaflet and advice on removing.

Wilson-Imperial Co., 121 Chestnut St., Newark 5, N.J.

CONVERT YOUR TABLE SAW TO A JIG SAW IN 3 MINUTES WITH

## CIRCLE JIG

This is not a toy. It uses standard saw blades. Cuts 2 3/4" thick stock—cuts to center of 16" to 24" board. Easy to install on any 1/2" or 5/8" table saw without machining, drilling or tapping—simply clamp on with ordinary wrench. Add a jig saw to your shop at this small cost.

**Retail Price \$11.95**  
SLIGHTLY HIGHER ON WEST COAST  
See your dealer or send \$11.95 to

**VERSA TOOL MFG. CO. INC.**  
401 Lake Ave. Dept. S Racine, Wis.

PLUMBING ELECTRICAL HOLDING WOODWORKING

**YOU NAME THE JOB-AND VISE-GRIP DOES IT QUICKER!**

WORKS!

HOME REPAIR PORTABLE VISE TURNING

**MAKES EVERY JOB EASY... HOME - FARM - FACTORY - SHOP**

You can tackle ANY job—with Vice-Grip! LOCKS onto work with Ton-Grip! Turns, twists, pulls, cuts, h-o-l-d-s. So MANY tools in one! 7" and 10", cutter optional. \$1.85 to \$2.60 at your dealer.  
PETERSEN MFG. CO., Dept. P-11, DeWitt, Nebr.



# GIGANTIC MAIL SALE

WAR SURPLUS  
EXCESS INVENTORY  
BANKRUPT STOCK

## ARMY POWER PLANTS

\* Marvelous buys in new condition Govt. surplus plants and generators. We pay freight!

- \*1000-w, 115-v, 60-c. \$149.50
- \*2000-w, 115-v, 60-c. \$289.50
- \*3000-w, 115-v, 60-c. \$349.50
- \*7500-w, 115-v, 60-c. \$590.00
- \*3000-w, DC generator \$58.75

Send for free bulletin

## AIR COMPRESSORS—TANKS, Etc.

Save to 70% on air fittings, tanks, compressors, etc. See our catalog.

- \*Piston Air Compressor 150 lb. \$18.91
- \*Air Corp 300-lb. Pressure Tank 6.79
- \*Auto Pressure Switch for Motor 4.95
- \*Professional Paint Spray Gun 9.95
- \*DeLuxe Air Kit complete 45.49

## NAVY CENTRIFUGAL PUMP

\* Leading make. All bronze ball bearing hi capacity. Complete with pulley, 1 1/2" inlet, 1 1/4" outlet. Will pump up to 140 GPM. Pressures to 65 ft. Suction lift to 18 ft. Gov't. Cost \$65.50. Prepaid \$24.61

## SPECIAL LISTINGS

We list below some super prepaid-to-you bargains available in limited quantities only.

- \*\$150 G.E. Experimental Amplifier... \$6.97
- \*\$40 Pressure 8" Gauge 100 Lbs. 9.17
- \*\$15 Gov't. Sleeping Bag with Cover 5.74
- \*\$3 Finest Wood 1"x16" Chisels 1.19
- \*\$150 5-Row Weed Spray Outfits 97.65
- \*\$30 Electronic Experimental Kit 4.99
- \*\$15 Army First Aid Chests 6.95
- \*Eastman Film and Paper—savings to 70%!

## HYDRAULIC HAND PUMP

\* Build your own arbor press, wagon unloader, shop tool tester, etc. Genuine brand new Blackhawk hi-pressure hydraulic hand pump system. Complete unit including reservoir, check valve, etc. Will develop pressure to 8,000 lbs! Wt. 35 lbs. Gov't Cost over \$100, Prepaid.....\$23.95

## SPECIAL OF THE MONTH!

### Contractor-Architect Level

\* Excellent highly accurate professional instrument made by leading manufacturer. Ideal for setting foundations, grading, farm contouring, surveying etc.

\* Powerful erecting optical telescope micrometer adjustment, polished graduated degree scale, sensitive spirit bubble, etc.

\* Furnished complete with 8 1/2-ft. 3-sec. rod, fine tripod and polished wood carrying case. Our 4-star buy!

Prepaid to you..... **\$39.15**

## SPECIALS FROM PREVIOUS ADS

- \*Step-by-step Telephone Switches... \$13.91
- \*110-V Selsyn Motors... Pr. 12.97
- \*Finest Heavy 10x12-ft. Tarps... 11.99
- \*Giant Light with Motor... 48.90
- \*AC-DC Power Rectifier... 15.61
- \*Finest 7x50 Binoculars... 36.95
- \*Gov't. Prismatic Periscopes... 2.99

We pay transportation to you except where stated "FOB Lincoln." Write for large FREE Catalog.

**BURDEN SALES COMPANY**  
833 "O" ST. LINCOLN, NEBR.

# DO MORE PLANING JOBS WITH LOW COST BELSAW

## Exclusive MONEY-MAKING features:

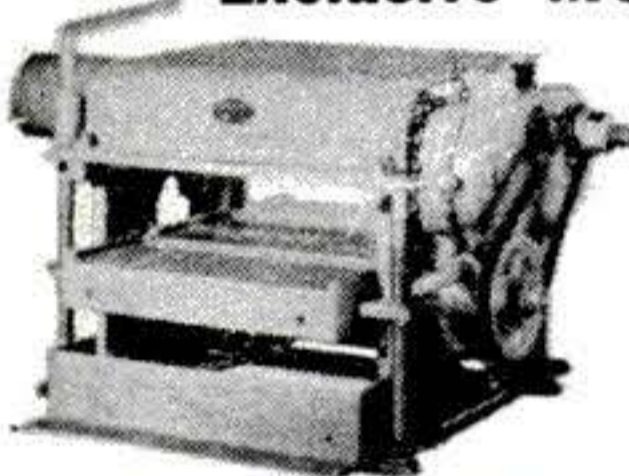

- Full 12 1/4 in. x 6 in. capacity
- Power feeds at 24 ft. a minute. (Easily adjusted for lower feed rate)
- Machined cast iron bed; adjustable rolls, total bed length 42 in.
- Provides for Grinding Knives in the Cutterhead.
- Attachments for Jointing, Rabbeting, Tongue, Groove, Matching.

Belsaw Multi-Duty Planer for cabinet shops, builders, lumber yards, woodworking plants and spare time work shops... Now you can convert low cost rough and random size lumber into high priced cabinet finished stock... Easy to make flooring and popular patterns. Belsaw quickly returns cost with savings on raw material... profits on finished stock.

Send Today for FREE literature on Belsaw, the LOW COST, high speed production planer.

## BELSAW MACHINERY CO

2066 Field Bldg. • Kansas City 11, Missouri

LOW DOWN  
PAYMENT  
EASY  
TERMS

**SHAW DU-ALL** PLOW, CULTIVATE, MOW, RAKE  
BULLDOZE, SNOWPLOW  
SAW WOOD

## TRACTORS

Just steer it with power turn. Several walking & riding models up to 14 H.P. Low price! Write for FREE literature.

**SHAW Manufacturing Co.**  
5711 Front St., Galesburg, Kansas  
668-PS N. 4th St., Columbus, Ohio

## P-1 GENERATORS

200-250 Amp, 24 Volt DC, 4500 RPM. Makes dandy Arc Welder. Cost \$396. Like NEW. SPECIAL \$11.88  
FOB Texas, \$12.88 FOB York, Diagram Free.  
GOVT. Overhauled \$19.80. GUARANTEED.

## 180° OFFSET DRIVE

(Reduction Gear Box)

86 to 1. For use where tremendous power at low take-off RPM is desired. 6 gears rotate on self lubricated Hi-Speed Ball Bearings. 3/8" x 1 1/4" shafts. 5" x 6" x 6" overall. \$12.87 Postpaid. NEW Cat. -1000's Big Bargains -10c

**KARL ORT, Dept. P.S. 11, York, Pa.**

## BUILD A JET ENGINE

COMPLETE PLANS, SPECIFICATIONS AND INSTRUCTIONS for experimental jet engine for HELICOPTER—BOAT—HOTROD—GLIDER

Full scale blue line plans include latest scientific developments for engines of 20, 40, 100 lb. thrust. Specify vehicle and power required. Send no money. Any one plan \$4.50 plus C.O.D. chg. and postage. Check or M.O. with order \$4.50 ppd. Order now.

**NATIONAL JET ENGINE COMPANY, Box 710, Mesa, Arizona**

## Buy and Hold U.S. Defense Bonds

## IT HOLDS—And How!

For BEST RESULTS you can always depend on Wilhold Glue. Clean to use! Damp-proof! Invisible when dry! In plastic applicators, tubes, jars.

At your hardware or building supply store

## WILHOLD WHITE GLUE

WILHOLD PRODUCTS CO., Los Angeles 31 • Chicago 44

**39¢**

# The Chief WORK BENCH

Built to Last a Lifetime!

With Bottom Shelf and 18" Sq. Drawer. 2"x6", Solid Plank, Grooved and Dovetailed Top and 1"x8" Back Rail, Shellacked to a Smooth, Satiny Finish.

MOHAWK LUMBER CO. Dept. 32  
14525 W. Chicago Blvd. Detroit 27, Mich.  
Enclosed  Check  Money Order for \$.....  
Ship.....CHIEF WORK BENCHES at  
Quantity  
\$19.95 each, F.O.B. Detroit, Mich.  
 Send C.O.D., \$5 Deposit Enclosed.

NAME.....  
ADDRESS.....  
CITY.....STATE.....

• 6 Ft. Long • 34" High • 26" Deep. Shipped Knock-down, with Bolts, Nuts and Screws and ABC Chart for Quick, Simple Assembly.

Prompt Delivery  
**MOHAWK LUMBER CO.**  
14525 W. Chicago Boulevard  
DETROIT 27, MICHIGAN



**\$19.95**  
F.O.B. DETROIT

Send Check or Money Order, or Will Ship C. O. D. (\$5 Deposit)



# FIRST AID TO SAW BLADES!

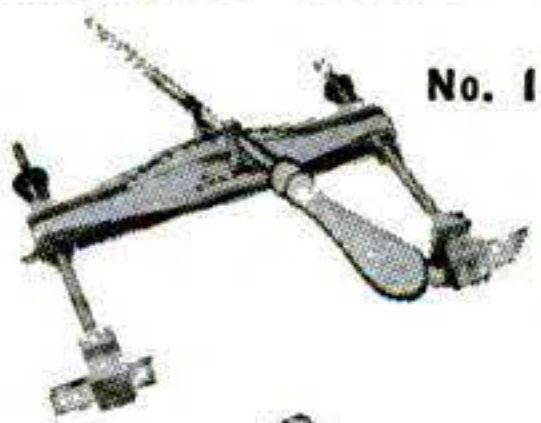

No. 1



No. 2

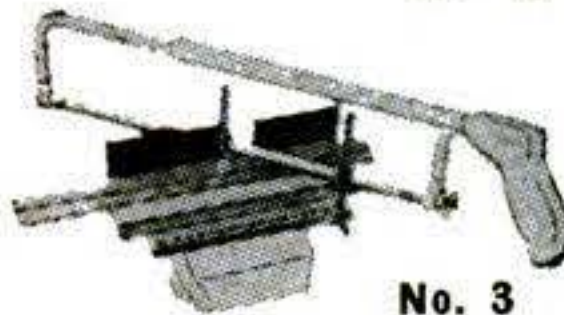

No. 3

- 1. CIRCLE SHARP.** Sharpens circular saw perfectly . . . and in a jiffy. Holds the blade securely and guides the file at correct angle for sharpening all saw blades from 6"-10" diam.,—including cross cut, rip, combination and planer blades . . . . . \$5.95
- 2. CIRCLE SET.** Resets teeth of your circular saw blades quickly and easily. Sets any saw blade up to 18" without removing it from its arbor. . . . . \$1.50
- 3. MITER-ALL.** Enables you to cut accurate miters in metal, as well as wood, with your hacksaw. Can be clamped in a vise or fastened to work bench. Cuts stock up to 1 1/2" h. x 2" w. from 90 degrees-45 degrees in 5 steps. . . . . \$4.35
- 4. GRIND-IT** assures correct angles for grinding cutting tools. This lightweight jig handles joiner blades, wood chisels, cold chisels, drills, etc. during straight or hollow grinding . . . . . \$5.95
- 5. BANDSHARP** sharpens bandsaw blades speedily by sharpening 3 teeth at a time. Suitable for wood-cutting blades 3/16"-1 1/4" w. . . . . \$3.95

Quality Steel and Tough Aluminum Used

All tools sent postpaid. 10-day money-back guarantee. For additional labor-saving tools not listed above, write for catalog.

## RIVERSIDE ENTERPRISES

14-P RIVERSIDE, CORNING, N. Y.

# 10 New DELTA HARD COVER BOOKS

"How To Get The Most Out Of" your Power Tools. Clearly written, illustrated. New projects, ideas. Write for FREE descriptive folder: Delta Power Tool Division, Rockwell Manufacturing Company, 504L North Lexington Avenue, Pittsburgh 8, Pa.

## BUILD D.C. WELDER

We show you how to build 75-350 amp. D.C. welder for your shop or farm from war surplus aircraft generator. No rewinding necessary. Guaranteed workable. Easy and cheap to build. **PLANS 35c.** Send today and we'll include **FREE** LeJay's "How to Weld" booklet (regularly 50c) and **Big War Surplus & Electrical Catalog.**



LEJAY Mfg. Co., 1223 LeJay Bldg. Minn. 8, Minn.

## NEW, IMPROVED CALCULATOR FOR WOODWORKERS only 25c



Instantly gives information on lumber, nails, concrete mixes, painting materials, etc. Convenient, simple to read. Just set dial for nail specifications, to convert linear to board feet, find bit sizes for screws, compare characteristics of woods. 6" diameter heavily varnished cardboard. Send 25c, no stamps, please to Greenlee Tool Co., 2131, Columbia Avenue, Rockford, Illinois.

## SURPLUS AIRCRAFT GENERATORS

Type	Voltage	Amps	Base	Cond.	Gr. Wt.	Price
L-2	24	25	Square	OH	34#	\$8.50
L-3	24	25	Square	OH	34#	\$6.50
P-1	24	200	Round	U	60#	\$15.00
R-1	24	300	Round	U	60#	\$27.50
307-8	12	25	Square	U	20#	\$10.00
E7-A	12	50	Round	N	40#	\$12.50

(All have spline 7/8" X 1 1/2" shaft; Express or Motor Freight fob)

- Voltage Regulator, carbon pile. 24V, to 200A, w/base \$3.50
- Relay, reverse current, 24V, to 200A \$3.50
- Compass, magnetic, NAF \$9.95
- Compass, Astro, Mark II, in case \$6.95
- Pump, hand wobble, liquid, 2. 3/4" ports, D-2 \$4.95
- Engine, Aircraft, 190 and 240HP, air cooled.
- Good for air boats & sleighs, orchard blowers, etc. \$112.50 up.
- (All items fob Houston; here priced from 2% to 10% of orig. cost)

AERO PARTS SUPPLY, 8102 Lockheed, Dept. 111, Houston 17, Texas

free

GET THE WORLD'S LEADING TV & RADIO PARTS AND EQUIPMENT CATALOG

# ALLIED'S 1956 ELECTRONIC SUPPLY GUIDE

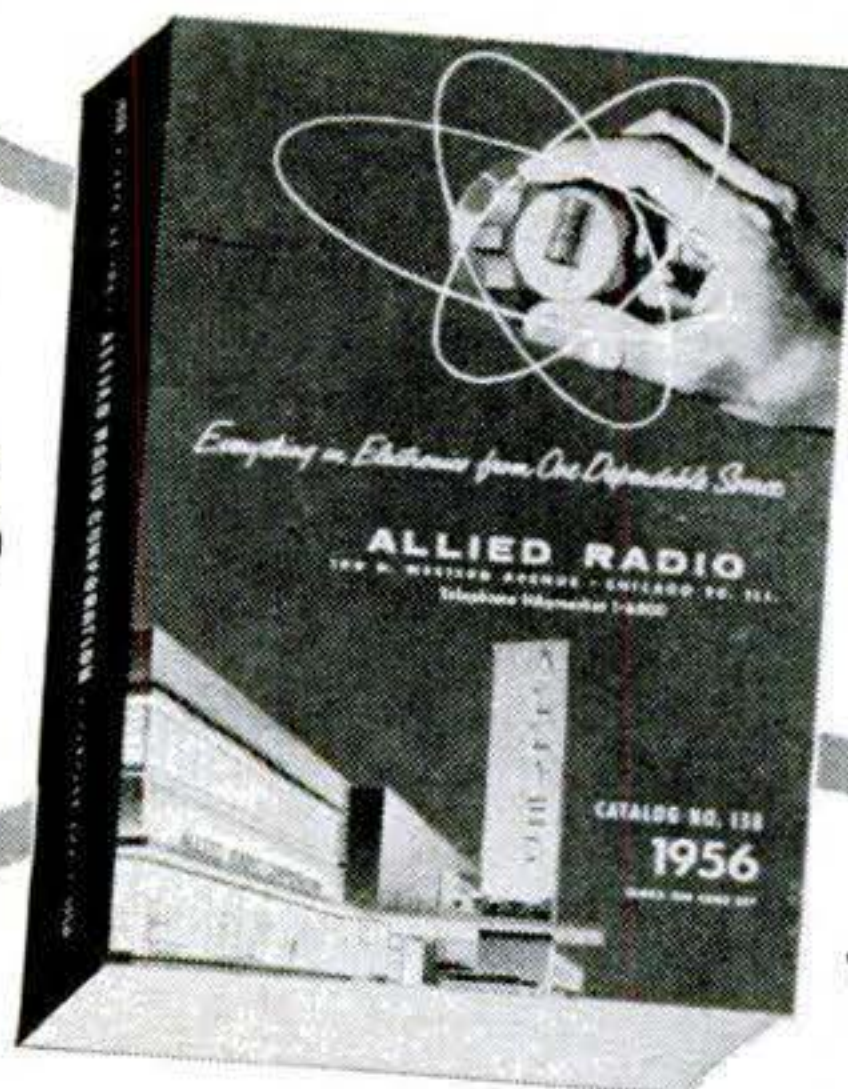

324 VALUE-PACKED PAGES

Save on Everything in Electronics

WORLD'S LARGEST STOCKS

Everything for Experimenters, Builders, Amateurs, Servicemen, Engineers and Hi-Fi Experts

Send for ALLIED'S big 324-page Catalog, offering the world's largest selection of latest top-quality electronic equipment at lowest, money-saving prices. Features High Fidelity systems and components; recorders and phono equipment; TV tubes, antennas and accessories; Amateur station equipment; P.A. systems; test instruments; latest build-your-own kits; industrial electronic supplies—plus thousands of parts, tubes, transistors, tools and books. Get everything, get more for your money—send today for your FREE 1956 ALLIED Catalog!



ALLIED RADIO

Send for FREE CATALOG

ALLIED RADIO CORP., Dept. 7-LL-5  
100 N. Western Ave., Chicago 80, Ill.

Rush FREE 1956 ALLIED 324-Page Catalog

Name \_\_\_\_\_

Address \_\_\_\_\_

City \_\_\_\_\_ Zone \_\_\_\_\_ State \_\_\_\_\_



**\$12<sup>50</sup>** *Edition of* **AUDUBON'S**  
*for joining this true adventure book club—*

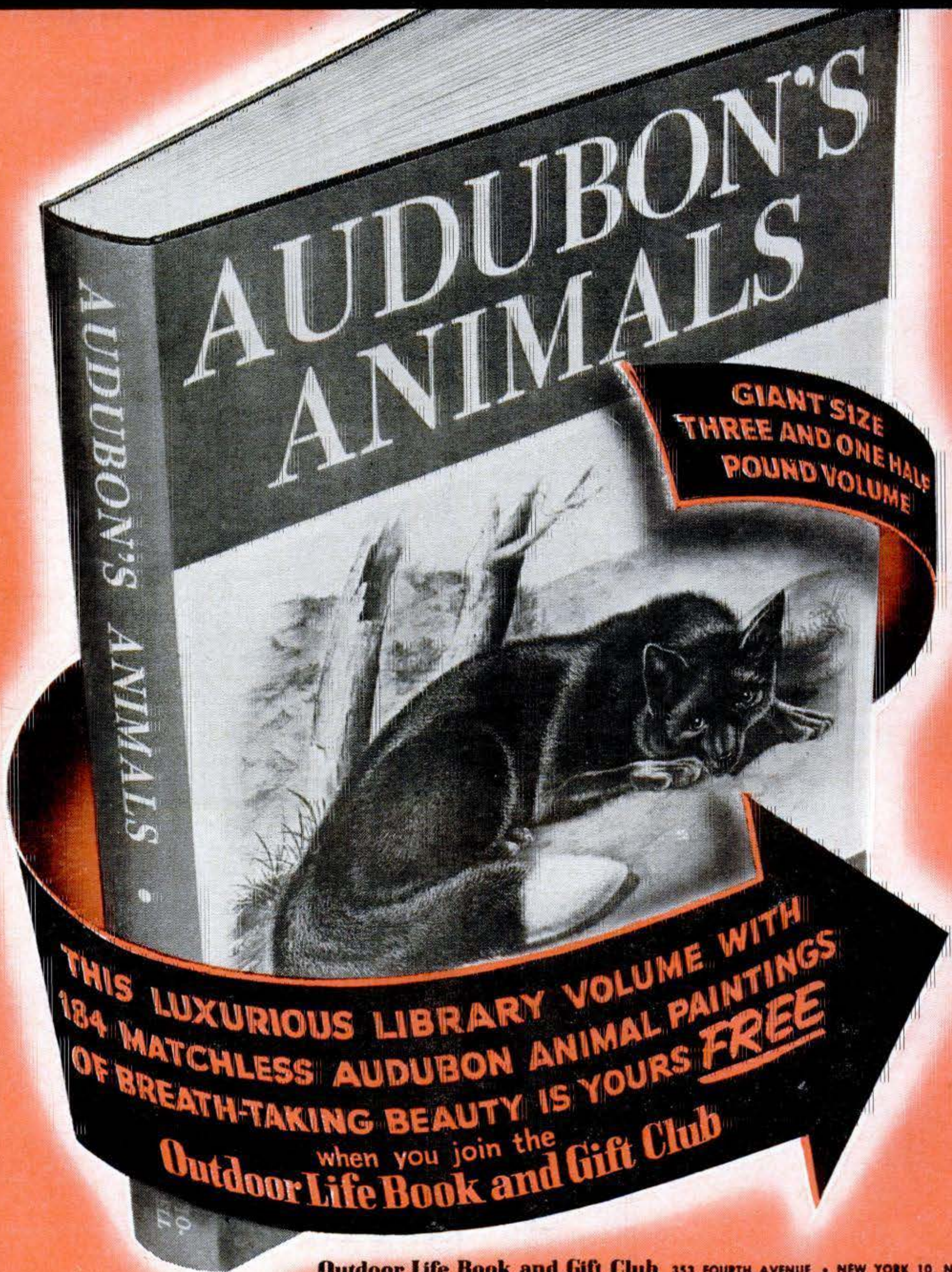

**GIANT SIZE  
THREE AND ONE HALF  
POUND VOLUME!**

**THIS LUXURIOUS LIBRARY VOLUME WITH  
184 MATCHLESS AUDUBON ANIMAL PAINTINGS  
OF BREATH-TAKING BEAUTY IS YOURS FREE  
when you join the  
**Outdoor Life Book and Gift Club****

**Outdoor Life Book and Gift Club 353 FOURTH AVENUE • NEW YORK 10, N. Y.**



# ANIMALS yours FREE

## Outdoor Life Book and Gift Club



From Plate 5.  
FEMALE JAGUAR



From Plate 45.  
VIRGINIA WHITE-TAILED DEER

For the first time in *one volume* you'll see *all* the world-famous animal paintings of John J. Audubon — 184 picture masterpieces, 16 in exquisite full color! Duplicating the priceless original editions, this special luxury volume sells everywhere for \$12.50. But you, as a joining member of the OUTDOOR LIFE BOOK AND GIFT CLUB, will receive this beautiful volume *absolutely free!*

You'll be thrilled with the gorgeous paintings of rare and familiar American animals — white-tailed deer, mountain lions, marsh rabbits, jaguars, otters, blue foxes, panthers, antelopes, bears and many, many more! Each one depicts in faultless detail the true grace and beauty of wild animals. Each one is printed on high-quality paper suitable for framing.

In addition to the 184 matchless paintings (some never before printed in *any* book), AUDUBON'S ANIMALS also gives you the complete story of Audubon's life and his own fascinating descriptions of each animal. How proud you'll be to own and display a treasure like this — and it's yours *absolutely free* for joining!

### HUGE DISCOUNTS on Today's Best Adventure Books!

The Outdoor Life Book and Gift Club is backed by the vast resources of Outdoor Life Magazine. That means we can make huge printings of today's best adventure books. And huge printings mean *huge savings* — passed on to you in unusually high members' discounts — up to 60% off bookstore prices! In addition, you get a *free surprise gift* with every selection you take.

Each month you'll receive a Club Bulletin with full details on the next selection. If you want it, *you do nothing*. It will automatically be shipped to you. If you don't want it, merely return the special form always provided. That's all there is to it! Remember, your free gift comes with every selection — and you need accept only four selections in the next year!

### 40% MEMBERS' DISCOUNT ON YOUR FIRST SELECTION—

## THE RIVERS RAN EAST

THE RIVERS RAN EAST is a breathtaking account of the search for the Seven Lost Cities of Gold, buried for centuries in the mysterious Amazon jungles.

With reckless bravery, famous explorer Leonard Clark conquered unbelievable obstacles: man-eating crocodiles, fierce head hunters, strange unknown drugs, deadly insects! This exciting book has been hailed as one of the greatest true adventure stories ever recorded!

THE RIVERS RAN EAST will be sent to you as your first selection along with your FREE copy of AUDUBON'S ANIMALS and your FREE surprise gift.

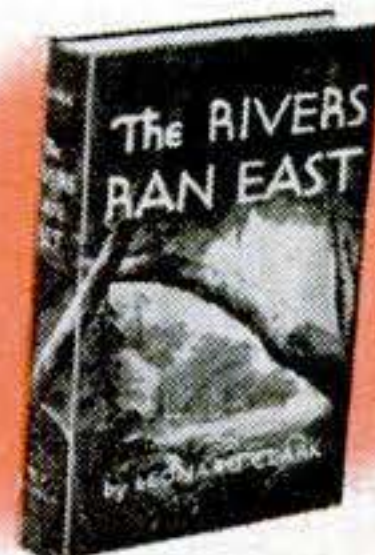

Regular price: \$5.00  
CLUB PRICE: \$2.95

### YOU GET A FREE SURPRISE GIFT WITH EVERY SELECTION!



Besides your magnificent \$12.50 copy of AUDUBON'S ANIMALS, you will receive your *free surprise gift-of-the-month* with your first selection! And, with each future selection you take at reduced members' prices, you will receive a new and different free gift!

You'll be delighted with these monthly gifts — such valuable items as a leather-cased precision magnifier... handsome sportsman's money clip... screwdriver set with four interchangeable steel blades... colorful Christmas cards with matching envelopes and more! And even better free gifts are scheduled for the months ahead!

Remember — beginning with "THE RIVERS RAN EAST", and with every OUTDOOR LIFE BOOK CLUB selection you choose thereafter, you'll receive an exciting gift-of-the-month, FREE!

### MAIL YOUR ENROLLMENT TODAY!

#### Charter Membership Enrollment Form

Outdoor Life Book & Gift Club  
353 Fourth Avenue, New York 10, N. Y.

Enroll me as a Charter Member of the New OUTDOOR LIFE BOOK & GIFT CLUB and send me AUDUBON'S ANIMALS *free* (bookstore price, \$12.50) as my bonus for joining. Also send my first monthly selection, THE RIVERS RAN EAST, *plus* my FREE surprise gift. Bill me later for my first selection at special Club Member's discount price of only \$2.95 (plus few cents postage) instead of regular price of \$5.00! *There are no other charges!*

Each month I will receive an advance description of the next selection which I can either refuse or examine FREE for 10 full days. If I decide to keep it, I am entitled to my FREE gift and member's discount up to as much as 60% off bookstore price. As a Charter Member, I need accept only four books a year.

PS-11-55

NAME \_\_\_\_\_

ADDRESS \_\_\_\_\_

CITY & ZONE \_\_\_\_\_ STATE \_\_\_\_\_



# STANLEY

## Screw-Mate®



**DOES 4 JOBS AT ONCE  
AND MAKES IT EASY!**



### No. 1525 Stanley Screw-Mate Countersink

This marvelous little tool does 4 jobs at once . . . quickly, easily and right.  $\frac{1}{4}$ " shank for hand drill, power drill or drill press. Makes (1) pilot hole, (2) shank clearance, (3) it countersinks, and (4) drills exactly correct screw depth *in one operation!* Holding power of screws is increased to the maximum. Here's professional woodworking made easy by Stanley Screw-Mate!

At your favorite hardware store. 22 sizes at 75¢ each; 2 extra large sizes \$1.25 each. If your dealer can't supply you, let us send you the 5 most popular sizes of Stanley Screw-Mates . . .  $\frac{3}{4}$ " x #7, 1" x #8,  $1\frac{1}{4}$ " x #8,  $1\frac{1}{4}$ " x #10 and  $1\frac{1}{2}$ " x #12 in handy holder. Ask for No. 1525B set. Send your check or money order for \$3.69, and dealer's name to Stanley Tools, 63N Elm Street, New Britain, Conn., and this Screw-Mate set will be sent post-paid by return mail.

1525B

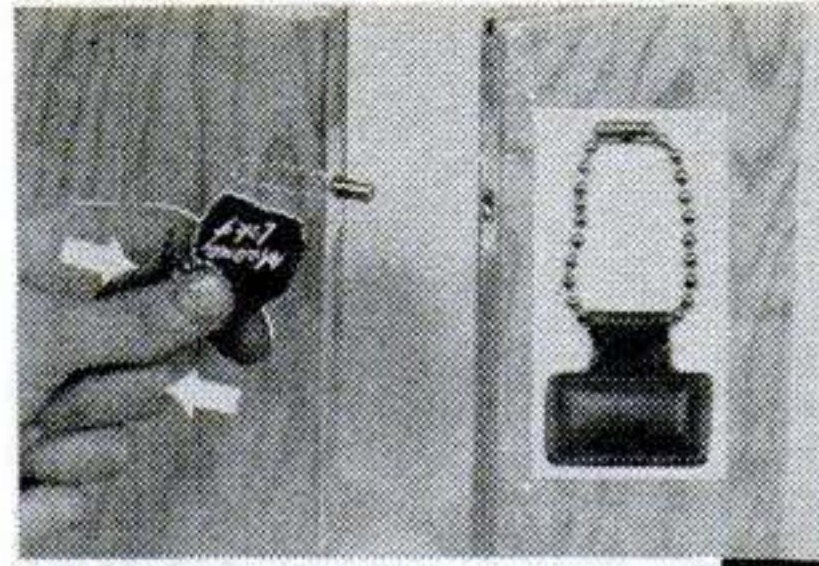
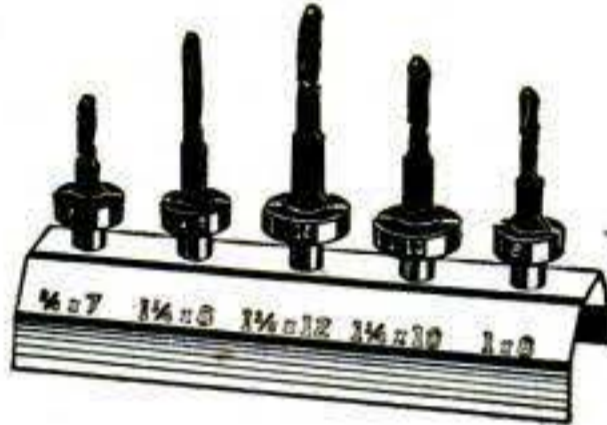

## FOOLPROOF magnetic LOCK!!

### PROTECT VALUABLES...CHILDREN

With this easy-to-install invisible lock you can now lock any wooden drawer, cabinet, or door without damaging the appearance with an unsightly keyhole. The Lock, installed beneath surface of wood is magnetic. Specially designed magnetic "key" slides lock open and closed from outside without even touching wood's surface. Magnetic "key" with one lock, 98c (see inset). Extra locks 59c. Powerful deluxe "key" with one lock, \$1.98. Write today, to

**MAGNA LOK**

P. O. BOX 43 · OAKLAND 1, CALIF.

**ORDER  
TODAY!!**

### NEW "WIZARD" TOOL DRILL GRINDING GUIDE

MAKE OLD DRILLS LIKE NEW...

For re-pointing dull and broken twist drills up to  $\frac{1}{2}$ " in diameter. One piece cast Aluminum. Simple. Anyone can use it. Order yours to-day. \$1.00 post-paid.

**BRASS CASTING CO.**  
P. O. Box 3056 Memphis 9, Tenn.



\$1.00  
POSTPAID

CAN'T  
WEAR OUT  
Grinding  
Wheel or  
Disc Sander

## MAGNETS

ASSORTED MAGNETS with big list of handy uses.....5 for \$1  
POWERFUL POCKET MAGNET ideal for testing metals..... \$1  
RETRIEVING MAGNET pulls tools, etc., from tank or lake..... \$4  
HOT PAD MAGNETS to insert in your own hot pads.....8 for \$1  
BULLETIN BOARD MAGNETS to "pin-up" memos, etc.....8 for \$1  
EXPLORE, LEARN—Electricity, Magnetism, Electro-Magnets, Complete Kit & instructions with 22 experiments and models.....\$3.98  
Free Catalog. 100% Satisfaction Guaranteed..... POSTPAID  
**PARK MAGNETS, 6511, 1557 Greenbay Rd., Highland Park, Ill.**

### \$6.95 DRAINS cellars, cisterns, wash tubs; IRRIGATES - CIRCULATES - SPRAYS

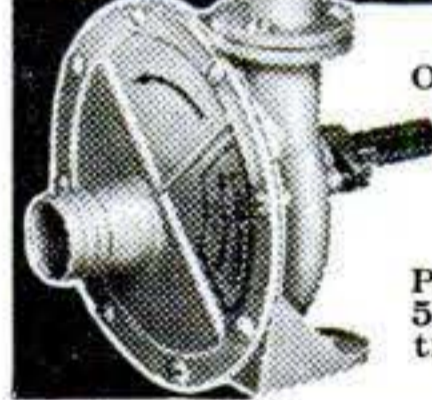

**1,001 USES—HOUSE, GARDEN, FARM**  
Original All-Purpose Pump has 3,000 GPH capacity, 450 GPH 80' high; or 1800 GPH from 25' well. Use any  $\frac{1}{8}$  to  $\frac{3}{4}$  HP motor. Stainless steel shaft. Oil-less bearing. 1" inlet;  $\frac{3}{4}$ " outlet. Motor coupling included.

**DOES NOT CLOG OR RUST**  
Postpaid if cash with order. (West of Miss. add 50c.) **MONEY BACK GUARANTEE.** Larger Centrifugal Pumps and Gear Pumps in all sizes.  
**LABAWCO PUMPS, Belle Mead 3A, N. J.**

## EASY! NOW FIX 1001 'ROUND-THE-HOUSE JOBS!

**Dot fasten-it-kit**—handy, re-usable plastic case contains 106 pieces special hardware fasteners with how and where to use folder! Angle Joiners—Wiggle, Flooring and Masonry Nails—Toggle Bolts—TeeNuts—Push, Lock and Wing Nuts—Speedy Rivets! Repair furniture, screens, fasten to cement, rivet, fix squeaky floors and hundreds more . . . easy, expert results . . . no special tools!

Send No Money . . .  
Send Your Name and Address to:  
**THE DOT LINE 3231 S. Ashland Ave., Chicago 8, Ill.**



order today!  
only \$2.00

## Whatever your hobby

Model building, whittling, Indiancrafts, leather, plastics or any other creative handicraft

### x-acto knives, tools & sets

designed by craftsmen and precision-made for fine craftsmanship

## will help you do a better job

and get more fun and satisfaction from your hobby.

Interested in Indiancrafts?

Send 25¢ for Beadcraft booklet; instructions, full color designs, patterns.

X-acto 28 page catalog—25¢

No. 62 X-ACTO DOUBLE KNIFE SET

—\$2.50

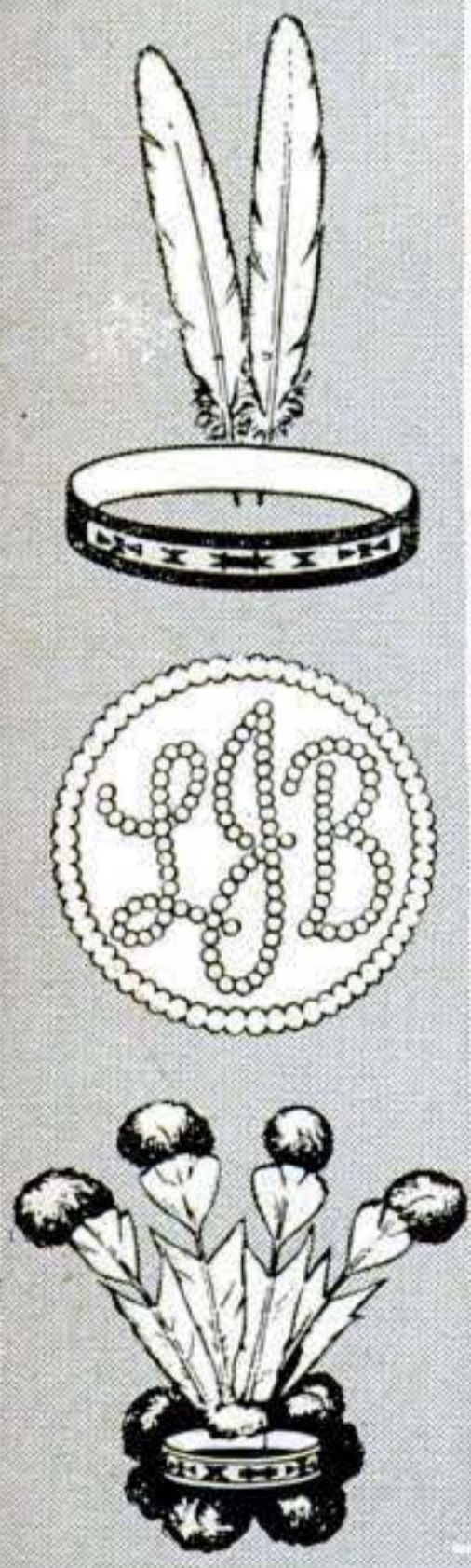

**x-acto**  
KNIVES • TOOLS  
HANDICRAFT KITS

X-ACTO, INC., 48-47 Van Dam St., Long Island City 1, N. Y.



# deft-finish it yourself

IT'S SO EASY



Dries in 30 Minutes

**DEFT WOOD FINISH FOR ALL INTERIOR WOOD SURFACES**

Clear, semi-gloss bar top finish. Deft seals, primes, finishes. Nothing else to use. Will not darken. No thinning, no brush marks. Get a professional finish every time. Use on paneling, floors, cabinets, furniture, etc. Insist on Deft, wherever paints are sold. Or write for free booklet.

DESMOND BROS., 1826 W. 54th St., Los Angeles 62, Calif.

**POWERFUL! LOW COST!**  
Light • Rugged • Maneuverable

America's best tractor value. More useable power -- pulling, pushing, driving. 770 lbs. Pulls 12" plow. Gear Drive 8.4 Hp. B&S engine. Roller Bearings. B&W 4 speed Trans. Clutch. Diff. Full line implements. 100% satisfaction guaranteed.

Write for FREE CATALOG  
**COUNTRY SQUIRE TRACTOR CO.**  
P. O. Box 107-A-11  
Muskego Wisconsin

**COUNTRY SQUIRE TRACTOR**



**CAMELS HAIR BRUSHES! 20 FOR \$1.00**

**SURPLUS**



Imagine! Never used Camels Hair Brushes that cost many, many times this low price. You actually buy these brushes at less than the cost to manufacture. For use in the home, office, shop or store. For touch-up, pasting, drawing, lens cleaner, typewriter cleaner, cleaning precision instruments, guns, tools, sporting equipment and hundreds of other uses. Assorted sizes. Money back if not satisfied. 20 brushes, \$1.00. 42 brushes \$2.00. Supply limited. Order NOW! Add 10c postage.

MATTHEW DAY CO., INC., 12 E. Madison St., Dept. 387, Dumont, N. J.

**AMAZING BARGAINS—SAVE TO 100%**

**75 MOUNTED WHEELS AND MINIATURE CUTTERS**



For cutting and grinding on wood, metal or plastic. Includes 26 mtd. wheels and points on 3/32" shanks; 24 miniature cutters on 3/32" shanks; 25 short shank min. cutters. Will fit all electric drills and hand grinders.

Regular \$11.00  
Value, Only

**\$4.50**  
Post Paid

**FLEXIBLE SHAFT \$9.50 Value \$4.95**



Fits all electric drills & hand power tools. 35 3/4" long. Oilite bearings. Core of specially wound, high carbon steel wire in flexible steel casing. Will accommodate tool shafts up to 1/8" dia. For lathes, electric drills, etc.

**\$4.95**  
Post paid



**18 ROTARY CUTTERS**

\$13.50 Value  
**\$5.85**  
Post-paid

assorted sizes cutter on 1/8" or 3/32" shank. Will fit all hand grinders. Ideal for cutting wood, metal, or plastic. Brand new.

**SCHUPACK SUPPLY CO.** 7331 Cottage Grove, Dept. S-63  
Chicago 19, Ill.

NEW ILLUSTRATED CATALOG, 10c

# Make \$500 an Hour CASH PROFIT THE DAY YOU START!

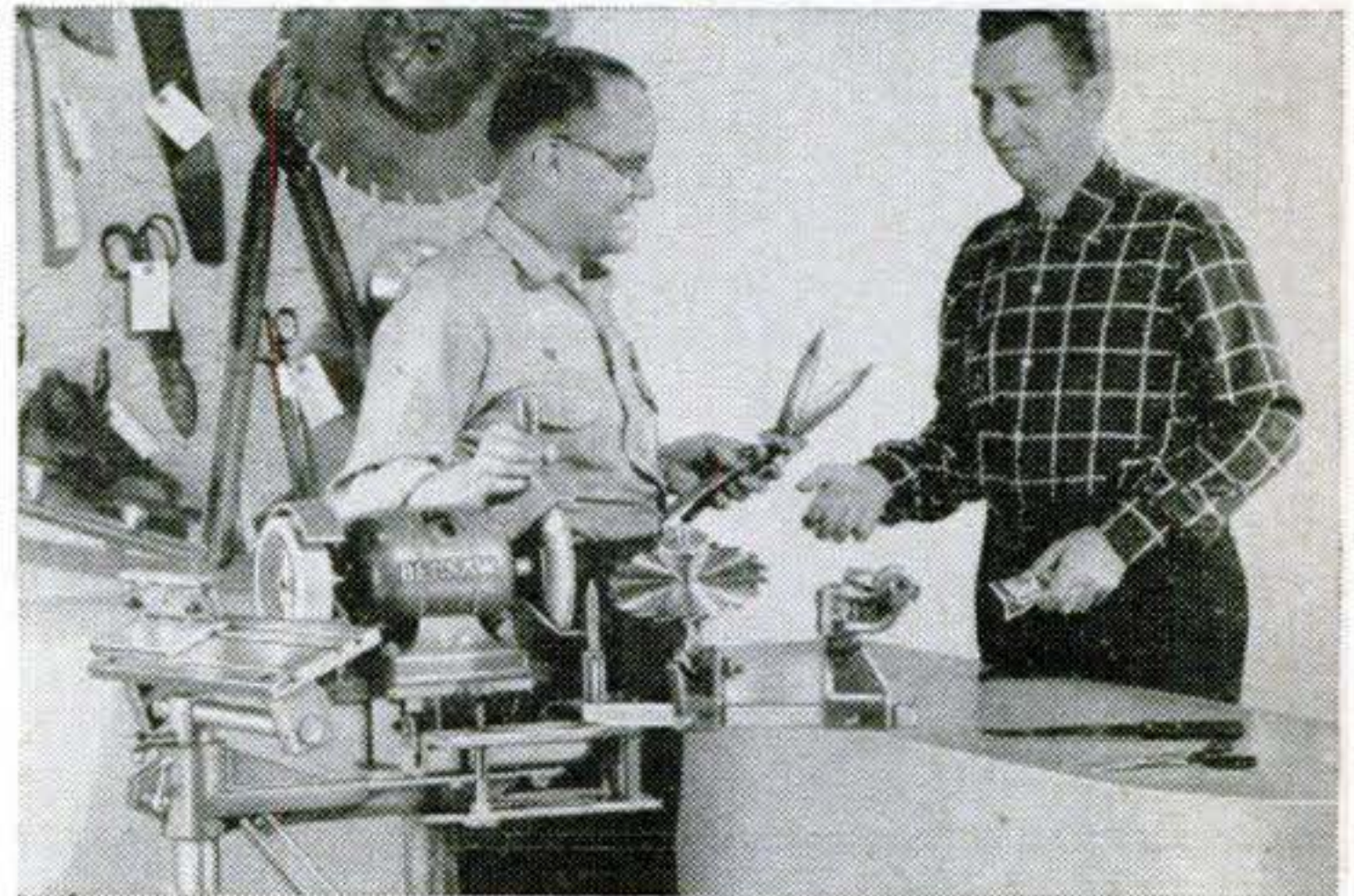

**START YOUR OWN BUSINESS AT HOME... SHARPEN HOUSEHOLD, GARDEN AND SHOP TOOLS IN SPARE TIME**

Now you can turn spare time into Big Cash Profits with new Belsaw Sharp-All. Sharpen knives, scissors, shears, snips, ice skates, mower blades, hedge trimmers, grass whips, axes, chisels, screw drivers, scrapers and saws... just about any household, garden and shop tool. Your own CASH business with no inventory. No calls to make. No experience needed.

Learn how easily you can start your own spare time business. Amazing low cost easy-payment plan. Send postcard for FREE BOOK.

**BELSAW SHARP-ALL CO**

706 Field Bldg.

Kansas City 11, Missouri



Super-honed wheel and special axle, perfect design and workmanship guaranteed. Long life and perfect, easy cuts. Factory-sealed packaging for your protection.

**Red Devil GLASS CUTTERS**



**FREE**

How To Cut Glass. Illustrated instructions on tools and methods of cutting glass.

**Red Devil Tools.** Dept. 130

130 Coit Street, Irvington, N. J.

Please send FREE copy of "HOW TO CUT GLASS."

NAME \_\_\_\_\_  
ADDRESS \_\_\_\_\_  
CITY \_\_\_\_\_ ZONE \_\_\_\_\_ STATE \_\_\_\_\_

1663



# NEW!



8 Ft. rolls  
1" wide,  
79¢ each.  
Oak,  
African  
Mahogany,  
Walnut,  
Birch or Fir.



Another  
Weldwood  
Wizard



EDGE PLYWOOD...  
DECORATE THINGS...  
with new Flexible  
**Weldwood®**  
**Wood-Trim®**

No more exposed edges when you make things of plywood—things like tables, desks, cabinets or other projects. Wood-Trim covers the edge with real wood veneer... gives a real "pro" finish. Apply it in minutes—without clamping, ironing, sawing, nailing, using Weldwood Contact Cement or Weldwood Presto-Set Glue.

And you'll invent countless decorative uses for Wood-Trim, too! For instance, you'll trim lamp shades and picture frames with Wood-Trim, decorate coffee tables, clocks, waste baskets, etc.

At hardware, paint and lumber dealers or write for free leaflet. Dept. 308

UNITED STATES PLYWOOD CORP., N.Y. 36, N.Y.

2 Passenger  
"Eshelman"  
SPORT CAR  
& Golf Cars  
1 the cost  
of any  
5 other auto  
70 Miles  
per Gal.  
Free  
Catalog

**ESHELMAN**  
FOR Better LAWNS  
And GARDENS

Women can operate it.  
1 to 8 H.P.  
Shipping Points:  
BALTO., CHICAGO, RENO  
Free Catalog Write:  
**ESHELMAN CO.,**  
Dept. R-411  
109 Light St., Balto. 2. Md.

Tillers  
Riding  
Mowers.  
Tractors  
Low as  
**\$69**

RAKES  
PLOWS  
CULTIVATES  
HARROWS  
HAULS  
SPRAYS  
SAWS  
DOZER  
MOWS  
CUTS  
ROLLS  
TILLS  
SNOW  
PLOW

Works in seconds!

DEODORIZED  
**Liquid WRENCH**  
It melts the rust away

3 oz. CAN  
**30c**

**Loosens Rusted Bolts**  
nuts... screws... parts

**LIQUID WRENCH**

AT HARDWARE STORES, GARAGES,  
FILLING STATIONS EVERYWHERE

For information write manufacturer  
**RADIATOR SPECIALTY CO.**  
Charlotte, N. C.

**STICK WITH**  
**LEPAGE'S**  
**GLUE**

REPLACEMENT OR REFUND OF MONEY  
Guaranteed by  
Good Housekeeping  
IF NOT AS ADVERTISED THEREIN

**GLOUCESTER, MASS.**

**DON'T DIG**  
'TIL YOU KNOW WHERE

The most amazing instrument you've ever seen! MAGNA-PROBE traces water, gas and sewer lines. Saves hours of expensive and unnecessary digging. Just as efficient over concrete as bare ground. Works indoors or outside. MAGNA-PROBE will amaze you by the way the probes (each of a different type metal) are attracted to each other in the presence of linear moisture sources in pipe lines. Simple, unique, practical. Thousands of satisfied users include Public Utilities and Government Agencies. Money back guarantee. Send Check or money order. (No C.O.D.'s)

ONLY  
**\$2.98**  
Post-paid

Complete with easy-to-use instruments.  
**THE MAGNA PROBE CO.**  
6024 Mayfield Road  
Cleveland 24, Ohio

**Wholesale!** **TOOLS! GUNS! CAMERAS!**

BUY TOOLS PHOTO EQUIPMENT, SPORTING GOODS, JEWELRY AND THOUSANDS OTHER NATIONALLY ADVERTISED PRODUCTS AT BIG DISCOUNTS SAVE ON OWN PURCHASES BIG PROFITS SELLING TO OTHERS. POSTCARD BRINGS FREE COPY "THE WHOLESALE PLAN"

Get up to  
**40% off**

**AMERICAN BUYERS SERVICE**

HERTEL STATION, DEPT. 8, BUFFALO 16, NEW YORK

**USE YOUR BENCH SAW** INCHES 1 2

FOR JOINTING & CUTTING MOULDINGS

With our six inch tool steel cutters you can make beautiful mouldings for picture frames, furniture, and house construction. Cutters as shown.

**DIRECT FROM FACTORY!**

One inch wide—\$1.98; 1 1/2 inch wide—\$2.49 ea. Postpaid. Guaranteed. List & Folder free. State hole size.

**JOHN A. SANDSTROM**  
Rt. 2 P. Clearwater, Fla.

Insist on **Evans TAPES**  
**POCKET SIZE**  
At Your Hardware Store

6, 8, 10, 12-ft. lengths

from **98c**

with FREE plastic utility case.

Self-adjusting sliding hook starts you at zero for accurate inside or outside measuring.



# NEW 1956 CATALOGS

# CUSTOM-CRAFT BOAT KITS



World's largest line! Over 200 boats: Kits, Formed-hulls, Semi & Custom-finished! All types: Prams to Cruisers! 8-21 ft. Tops in design-styling-performance! Easier to build! Tredronic bottom—Bulkhead construction—Flying stern, etc.!

SEND 25c FOR NEW 52 PAGE CATALOG

All New for '56! Shows all models plus hardware—accessories—paint & fiberglass! CATALOG plus "Selection-Operation-Maintenance" Handbook \$1.00

# CUSTOM-CRAFT PLANS & PATTERNS

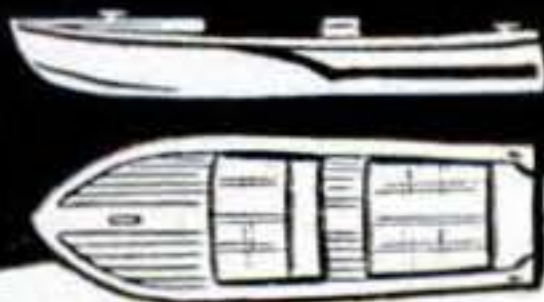

with NEW

# FRAME-PAC KITS

World's largest selection—over 200 plans, full-size patterns & Frame-Pac kits! Designed especially for home building! All types: prams—kayaks—racers—runabouts—catamarans—houseboats—cruisers—inboard or outboard! 6-40 ft.! Wood—plywood—steel!

SEND 35c FOR ALL-NEW DESIGN CATALOG

Over 60 pages! Design catalog PLUS Boat Building Handbook \$1.00

CUSTOM-CRAFT (DEPT. B) BUFFALO 7, N. Y.

# BARRON Drill Press TOOLS



## ROTARY PLANER

Planes • Rabbits  
Tenons • Panels  
Routs • Bevels

Only \$8.50 COMPLETE

## FOR WORKSHOP AND INDUSTRIAL USES...

Over 40 precision built woodworking tools and accessories... Hi-Speed Router Bits—Rotary Surface Sanders & Drum Sanders—Safety Shaper Cutters—Dovetail Cutters—Large Auxiliary Metal Tables—All Metal Shaper Fences—Spindle Adapters—Handy Bench Vises. Many other items indispensable for accurate, useful, versatile workshop use. Every tool sold on complete satisfaction or your money back. See your Barron Dealer. Ask for special folder — "24 Extra Uses for Your Drill Press."

FREE Workshop Guide & Catalog

BARRON TOOL CO. INC.

301 Architects Bldg., Detroit 1, Mich.

## 24-PAGE ILLUSTRATED DO-IT-YOURSELF PROJECTS BOOK

Describes attic finishing, built-in cabinets, add-a-room, recreation room, kitchen remodeling, summer cottage and farm projects. Contains helpful information on how to get started, planning, cost estimating, materials purchasing, and proper procedures, also nail charts, moulding designs, etc. Send only 25c and also receive FREE 52-PAGE POWER TOOL CATALOG.

BOICE—CRANE COMPANY

944 Central Avenue

Toledo 6, Ohio

## KEEP ALL SAWS SHARP

### SUPER SAW FILER NO. 6

IT'S NEW! with Automatic DEPTH CONTROL ROLLERS  
Automatically controls DEPTH—ANGLE—PITCH

Perfect bevel and angle maintained, and fool-proof depth control for all Rip, Cross-cut, and Handsaws. Precision made and calibrated for instant setting at desired angle. Can be used in any vise or clamp. Complete with file, only... \$6.50 ppd.

SAVE TIME AND \$\$\$



### JOINT & SHARPEN CIRCULAR SAWS

Sensational new Super Filer No. 11 joints and sharpens both hand and circular saws 6" to 10" with all teeth the correct height, depth, pitch and bevel. Easy to use—when file hits hardened steel roller, teeth are finished. Saw runs true and smooth with no side pull. Complete with special 8" file \$9.95 ppd. "TRU CIRCLE" saw set automatically sets teeth at 10° or more \$2.95.



SHARP SAWS CUT TRUER



SEND FOR FREE CATALOG

Guaranteed

A. D. McBURNEY, 5908 Hollywood Blvd., Hollywood 28, Cal., Dept. 5-115

# LOOK! All New - All Precision - All Deluxe SUPERSHOP MODEL X

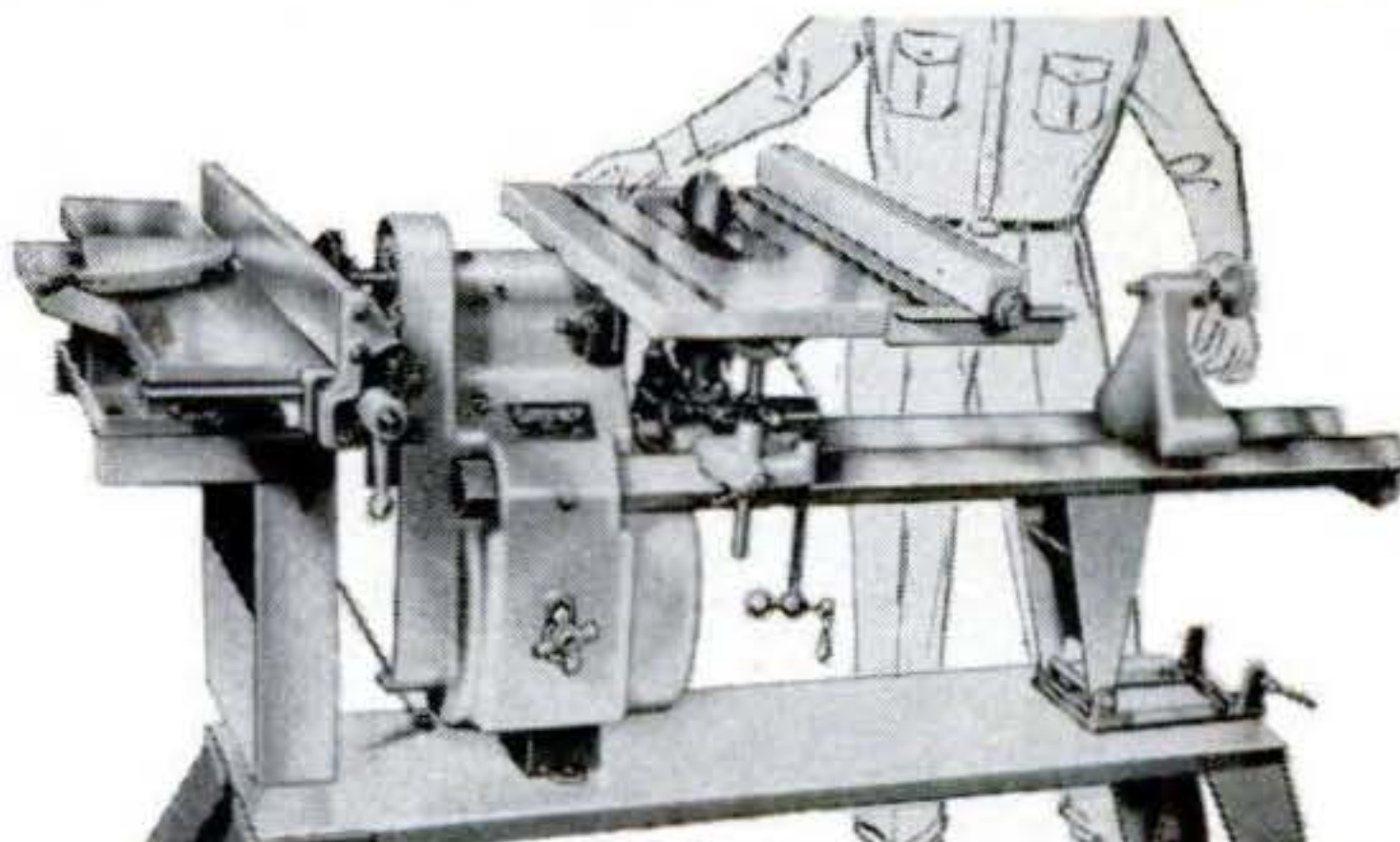

8" SAW

WE PAY ALL FREIGHT FOR YOUR FREE HOME TRIAL

ONLY \$139.50 EASY PAY PLAN



Vert. Drill Press

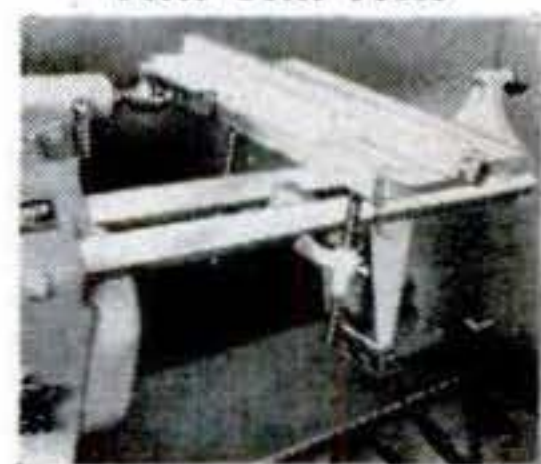

Hor. Drill Press

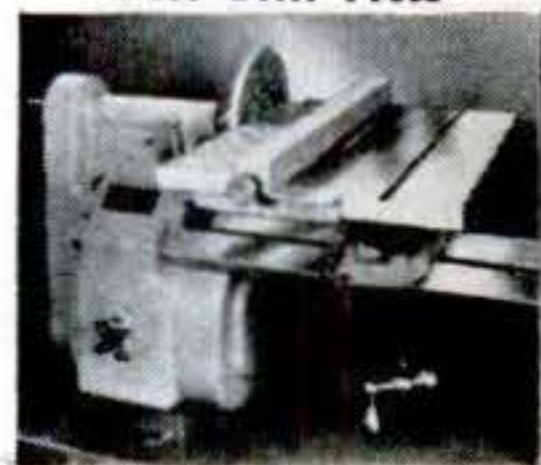

8" Sander

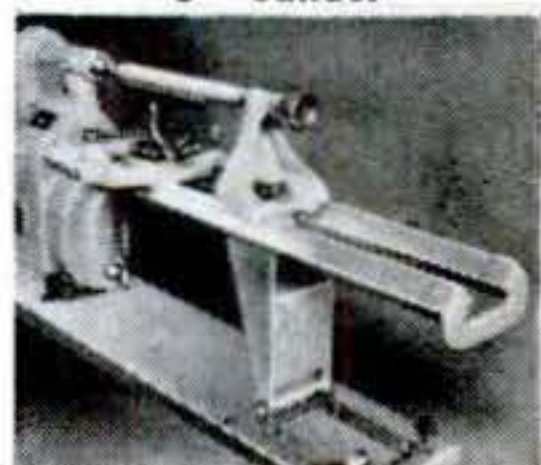

30" Lathe



5" Grinder

Never before have you seen so much deluxe, precision-built power tool workshop at any price! Designed for the man who wants the best. Massive cast and precision-machined headstock, self-centering inverted "V" bedways (like precision metal lathes), exclusive non-friction speed changer, extra-large cast and precision-ground saw table. 100% ball bearing, lifetime-lubricated. You save by ordering direct from factory. You are invited to test Supershop Model X in your home FREE. Mail coupon or postcard for FREE brochures, photos, details, specifications, accessory list — and amazing freight prepaid FREE HOME TRIAL PLAN. All free.

MAIL COUPON OR POSTCARD TODAY

POWER TOOLS, INC. 277 Yates Ave. Beloit, Wisconsin

NAME \_\_\_\_\_  
ADDRESS \_\_\_\_\_  
CITY \_\_\_\_\_ STATE \_\_\_\_\_



# BUILD YOUR OWN POWER TOOLS - WITH GIL-BILT PARTS KITS

**Exclusive GIL-BILT Build-It-Yourself Features**

- No machining—built easily with hand tools only
- No blueprint reading — step-by-step pictorial plans, full scale patterns, actual photographs.
- Sturdy wood, aluminum and steel construction
- Capacity and performance of commercial saws selling from \$60 to \$250.
- Proved performance. Nationally advertised and sold for 8 years. Satisfied customers around the world.

**PLANS only \$1.00 EACH POSTPAID**

## GIL-BILT 10-in. TILT/ARBOR SAW

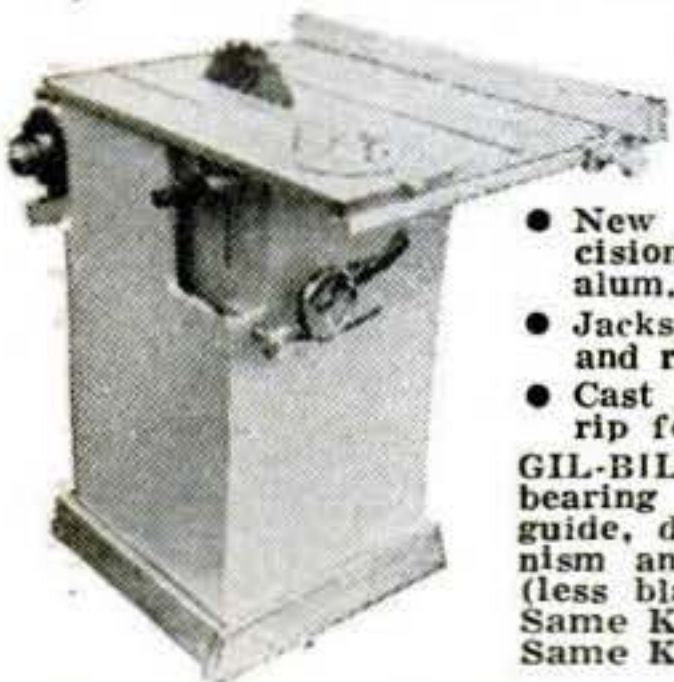

- 27x28 in. table, 13½ in. capacity in front of blade
- 10 in. blade cuts ¾ in. deep, tilts full 45 degrees
- Floor model 34" high, table always stays level

- New Departure ball bearing arbor, ¾" precision shaft turned down for ⅝" bore blades, alum. housing, shipped ready to run.
- Jackscrew and 4½ in dia. handwheel lowers and raises blade.
- Cast aluminum miter gauge and self-aligning rip fence guide

GIL-BILT Metal Parts Kit includes Plans, ball bearing arbor, miter gauge and bar, rip fence guide, dado insert, lock knobs, jackscrew mechanism and handwheel, and all other metal parts (less blade) .....\$22.95  
Same Kit with 10" Combination Blade \$25.90  
Same Kit with 8" Combination Blade \$24.90

## GIL-BILT 12-INCH BAND SAW

- Cuts to center of 24 inch circle
- Handles stock up to 6 inches thick
- 18x18 inch table tilts 45 degrees
- Lower wheel and drive pulley runs on sealed New Departure Ball Bearings; Upper wheel runs on two ⅝" bore Oilite Bronze bearings.
- Upper wheel tension and tilt mechanism of cast aluminum, completely assembled
- Upper and lower blade guides. Each has ball thrust bearing, self-lub bronze jaws
- Rigid cast aluminum wheels fully machined ready-to-install. Heavy rubber tires
- Uses standard 78 inch blades up to ¾ in. wide
- Fully enclosed mechanism for utmost safety



GIL-BILT Metal Parts Kit includes Plans, rubber tires, aluminum wheels, ¼ in. blade, ball bearing spindle, tilt mechanism, blade guides, table tilt segments, and all other metal parts.....\$23.95  
Return Kits in 10 days for refund if not satisfied.  
For shipments up to 600 miles, add 5%; over 600 add 10%. Amount in excess of actual postage will be refunded.  
Order Kit now, or order Plans at \$1.00 each and Kit later less cost of plans. Write for **FREE** Catalog.

**GILLIOM POWER TOOLS**

Dept. 70-L, Lambert Field  
St. Louis 21, Missouri

## THIS INEXPENSIVE EASY-TO-OPERATE MACHINE

Brought Mr. C. H. R. of Ohio  
**\$3,688.20**  
in one season

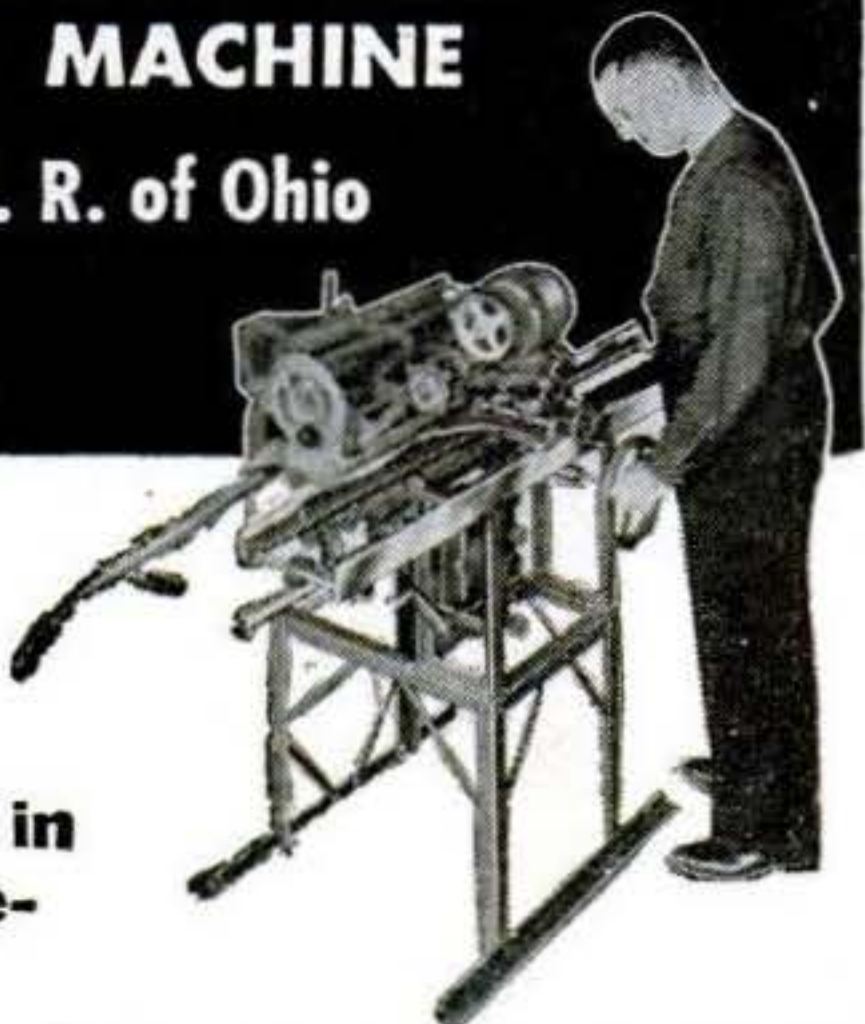

You, too, can be your own boss in this fine business. Spare or full time, earning big money in your garage or basement.

Yes, C. H. R. is only one of many who write about their success with the Universal Lawn Mower Grinder. Another says, "I am buying a home and my Universal is going to be a tremendous help paying for it." Whether you are buying or want to buy a home, want the security of a sound future or living comforts extra money brings, you owe it to yourself to send the coupon today. Investigate our success plan now—get everything you need to develop a good profitable business of your own.

**ROGERS MFG. CO., DEPT. P-115, LINDSEY, OHIO**

**Fill in and mail this coupon now**

Rogers Mfg. Company  
Dept. P-115, Lindsey, Ohio

Gentlemen: Please rush me details about the profit possibilities of the Universal Lawn Mower Grinder.

NAME.....

ADDRESS.....

CITY..... STATE.....

**ROGERS  
MANUFACTURING  
COMPANY  
LINDSEY,  
OHIO**

## INTERNATIONAL DRILL • SAW HI-SPEED COPE SAW DRILL BIT



**NEW LOW PRICE**  
Ideal as Christmas Gift

**REAM • CUT**  
**\$2.95**  
POST PAID  
**3 for \$8.50**

DRILL, SAW, REAM... metal, pipe, wood, plastic, Transite, etc. Use with electric drill, slow drill press, lathe, milling machine. Drills own starting hole, upper part of bit is used to cut, saw, ream circles, ovals, squares, scrolls. Easy to use. Ideal for carpenters, mechanics, electricians, plumbers, hobbyists, etc. Abrasive resistant, high speed steel. Flutes ground from solid. Withstands severe continuous use without breaking. Resharpens free. Takes place of up to \$50.00 in tools. 1" diameter, 2" cutting sections, total length 3½". Three types—All purpose, Wood, Heavy Metal. Specify type needed. Set of three \$8.50. Details on request. Shipped same day. Money-back guarantee. Dealer inquiries invited. **Order Now. Send Cash, Check or Money Order to**  
INTERNATIONAL TWIST DRILL CORP. 618 Wyandotte, Rm. 696  
Kansas City 6, Mo.

# WE NEED YOU!



**UNITED  
CEREBRAL  
PALSY**

## P U M P S



Centrifugal—rustproof. Oilite bearings—Automatic Seal. For Laundry trays, Displays, Cesspools. Non-clogging—will take some solids.

**\$5.95** ¾" to 1½"  
**\$8.95** 1" to 1"



Self-Priming Rubber Impeller. Watering lawns, Cesspools, every pump need up to 30 lbs. Self-priming, no foot valve needed. Only one wearing part.  
½"—\$11.95 ¾"—\$17.95 1"—\$25.00

**\$11.95** ½"



### SUMP CELLAR AUTOMATIC

Cutler-Hammer Floatswitch. Full size copper float. Rustproof pump body. 1" outlet with ½ HP Westinghouse Motor. If less motor Unit, is complete with all parts to take standard motor. Price complete less motor \$15.00

**\$15.00**  
Less Motor  
**\$29.50**  
With Motor

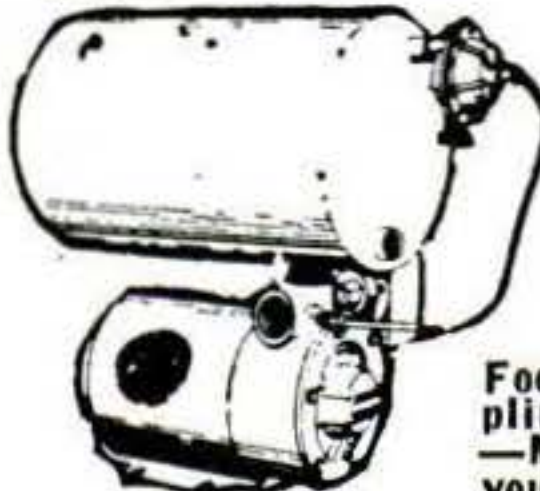

### COMPLETE WATER SYSTEM

Automatic with Air control. Automatic pressure switch galvanized tank. Self-priming G.E. Motor. Enough water for average family. Can be installed in basement or under sink.

**\$59.95**

Foot Valves—Check Valves—Plastic Pipe Couplings—Float Switches—Pump Blades—Shafts—Motors. Please give us complete details of your needs to save time.

**MEDFORD MFG. CO.**

**MEDFORD, N.J.**



# SAVE ON PALLEY DO-IT-YOURSELF BARGAINS

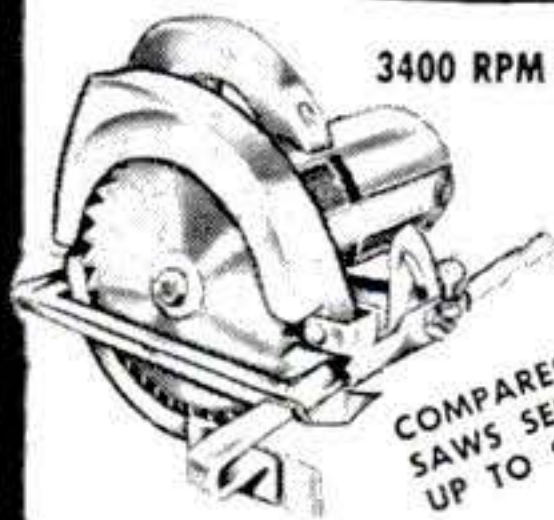

3400 RPM 1/2 HP POWER SAW

**RIPS - CROSSCUTS CUTS A FINISHED 2x4 LIKE A KNIFE THROUGH BUTTER**

COMPARES TO SAWS SELLING UP TO \$49.50

**Only 19.98** Complete with 5-1/2" Blade

A rugged, professional type, adjustable saw. Will cut any angle from 0 to 45°. Has an adjustable (0 to 6") rip fence. Safety-trigger switch on handle. Full 1/2 HP Universal AC-DC, 110-120 Volt, 60 cycle motor. Weighs only 6 1/2 lbs. Thousands already sold. Your satisfaction guaranteed.

EXTRA SAW BLADES — Available in Rip, Crosscut or Combination. Please Specify price per each **2.75 EA.**

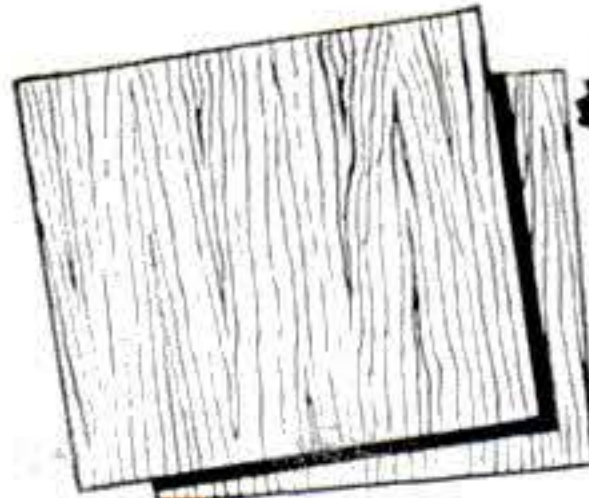

# SAVE 50% on Genuine Select PHILIPPINE MAHOGANY PLYWOOD

BUY DIRECT FROM IMPORTER

Ideal For Fine CABINET WORK, FURNITURE, Paneling DENS, OFFICES, HOTELS, etc.

Our prices are LESS THAN DOMESTIC PLYWOOD at WHOLESALE. This selected LUAN MAHOGANY meets the most rigid specifications. It is WEATHER and WATER RESISTANT. You'll be amazed at the beauty of this fine wood. Its rich golden elegance will thrill you. Rotary cut for beauty of grain. Both sides sanded and ready to use. Bonded with finest resin adhesive. Face side unjointed.

See for YOURSELF FREE SAMPLE on request!

Available in three thicknesses — 3mm (approx. 1/8"), 4mm and 1/4" ALL orders shipped by special Truck for lowest rates. No order accepted for less than 100 lbs. equal to (4) 1/4" sheets, (6) 4mm sheets or (8) 3mm.

3mm (1/8") x 3 ft. x 6 ft. — \$5.00 value. **1.79 PER SHEET** Minimum order 8 sheets

4mm x 4 ft. x 8 ft. — \$7.50 value. **3.89 PER SHEET** Min. order 6 sheets

1/4" x 4 ft. x 8 ft. — \$9.50 value. **4.99 PER SHEET** Min. order 4 sheets

## HARDWOOD LEGS WITH BRASS TIPS BUILD OR RESTYLE YOUR OWN FURNITURE

Beautifully turned, fully seasoned hardwood legs. Smoothly sanded and complete with brushed Brass tip and sturdy steel mounting plate. Available Finished or Unfinished — Finished units come in Blonde, Silver Fox, Mahogany or Charcoal Black. Please Specify type.

Price per set of 4 with Brass tip.

SIZE	FINISHED	UNFINISHED	SIZE	FINISHED	UNFINISHED
4"	\$2.65	\$2.15	14"	\$4.40	\$3.95
6"	3.00	2.65	16"	4.75	4.40
8"	3.55	3.00	18"	5.35	4.75
12"	3.95	3.55	28"	6.25	5.35

## NEW 4-SPEED HOBBY MOTOR



A rugged, precision built electric motor — operates on 110 volt, 60 cycle current. Originally built for the Navy — NOW converted for YOU! Has four take-off shafts turning at 5, 25, 150 and 4000 RPM. Cost Government approximately \$35.00 NOW.

**9.95**

## 12oz. PORTABLE STOVE FOR HUNTER-HIKER-ETC.

Smallest, most compact, yet entirely practical cooking stove you've ever seen. NO PUMPING — NO PRIMING necessary — entirely self-generating. Has collapsible grill for frying pan or coffee pot. Burns 2-1/2 hours on one filling of regular gas. ALL BRASS construction. Weighs 12ozs. Ideal for Prospector, Camper, Hiker, Picnic, etc. Guaranteed 1 year.



**3.98**

## ARMY PICMATTOCK

Small, easy to use. Has a 12" steel head with a Mattock on one side and a Pick on the other. Has a 16 1/2" hardwood handle. With canvas case.

**NEW 1.29**

## BOLD KNIFE & CASE

Made of top quality Vanadium steel. 15" long. Ideal for clearing brush. With sturdy belt sheath.



**1.98**



## ARMY MACHETTE

Has 22" Vanadium steel blade. A hardwood handle. Sturdy belt sheath, 27" overall.

**ONLY 1.98**

**Palley SUPPLY COMPANY**

2263 E. VERNON AVE., DEPT. PS-11 LOS ANGELES 58, CALIF.

Order From This Ad. Pay by M.O. or check. P.O.'s acptd. from D&B firms. 1/2 deposit with C.O.D.'s. All Prices FOB Los Angeles.



## TRANSLUCENT FIBERGLASS PANELS

Special purchase of 500,000 sq. ft. SAVE 40%. Finest Quality. In all lengths and widths. Full range of colors. As described in Oct., 54 issue of Popular Mechanics. Write for FREE Booklet and Sample. 85¢ sq. ft. value. **49¢**

Save on Manufacturer's Surplus and Closeouts! Top Quality. Ideal for Nooks, Chairs, Beds, Patio, etc. Add 75¢ cutting charge on ALL orders under \$5.00.

## FOAM RUBBER

**SLAB STOCK**  
Smooth both sides. A solid but spongy material. Ideal for all types of pads.

Thick	Per Sq. Ft.	Thick	Per Sq. Ft.
1/4"	25¢	3/4"	75¢
3/8"	38¢	1"	\$1.00
1/2"	50¢	1-1/4"	1.25

**CORED STOCK**  
Smooth on top and cored on the bottom for maximum resilience.

Thick	Per Sq. Ft.	Thick	Per Sq. Ft.
1-1/2"	\$1.00	3"	\$2.60
2"	1.50	4"	3.00
2-1/2"	1.90	4-1/2"	3.20

## PALLEY 100-200-300 POWER MICROSCOPE

An ideal Xmas Gift for the Student, Amateur Scientist, etc. Study insects, plant life, plant tissue, etc. Has fine ground and polished lenses. Precision ALL-METAL construction — this is NOT A TOY! The triple, revolving objective lens turret will allow you to select 100X — 200X or 300 power magnification. Has right or left hand rack & pinion adjustment for smooth, precise movement. Body inclines 90°. Adjustable plano sub-stage mirror. Complete in sturdy, dove-tailed hardwood case.

**ONLY 8.95**

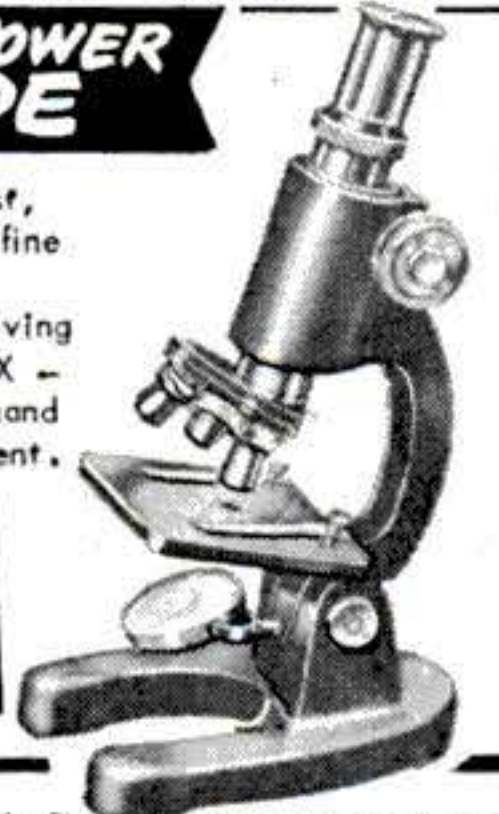

## A XMAS GIFT THRILL RADIO RECEIVER

Here's a COMPLETE RADIO RECEIVER that picks up STANDARD BROADCAST STATIONS without using batteries or electricity! Just plug in the headset, antenna and ground wires and tune in your favorite program. You'll be amazed at the STRONG, CLEAR SIGNAL. Has a 100KC tuning range. Comes complete with Receiver, Antenna and Ground wires plus a Headset with two 2000 Ohm ear phones. NOT A TOY — A Genuine Crystal Receiver!

WITH HEADSET **ONLY 3.95**

# MONEY in '314'

make **\$3 to \$5** an hour in SPARE TIME

**with New Foley Grinder** Start your own sharpening business in your basement or garage with this new low-cost Foley "314" Grinder. Make up to \$3 or \$5 an hour in spare time. "314" does fast, precision work sharpening circular saws up to 44 inches diameter; dado heads, rotary power lawn mower blades, ice skates, scissors, sharp edged tools. Also does sanding, buffing, polishing. Easy to operate—no experience needed. Send postcard today for free literature on big-value, low-cost "314". No salesman will call—we sell only by mail.

**FOLEY MFG. CO., 1176-5 Foley Bldg., Minneapolis 18, Minn.**

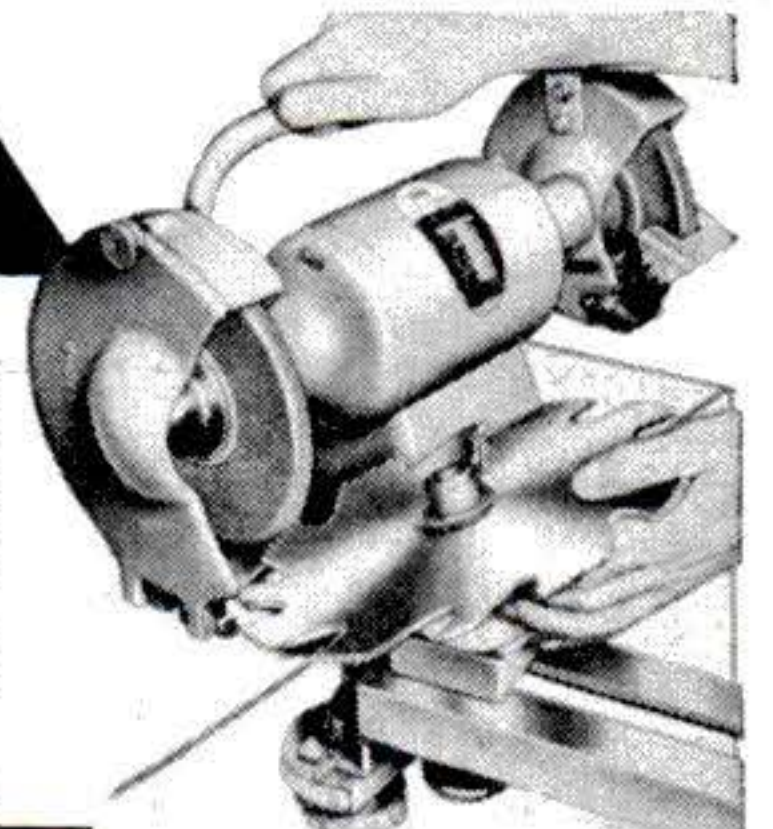



## Science Closes In on the Common Cold

[Continued from page 278]

the case of the common cold, they don't make laboratory animals sick.

Despite these similarities, the APC viruses are distinct types, and a vaccine for one does not affect the others.

What kind of sickness do they cause?

In the case of five of them, doctors don't know. They have been isolated only once or twice and are still among the "orphan viruses": those not yet certainly connected with any disease.

The other six cause fever and sore throat, plus, in many cases, red and watery eyes. Types 1, 2 and 5 seem to affect young children mostly. The great majority of reformatory volunteers tested by Huebner had developed immunity to these three and most other adults are probably immune, too. Several people in Huebner's lab, however, have picked them up, and he has had 3 and 4. The symptoms were much the same—sore eyes, sore throat, and slight fever.

On the basis of studies at the Army Medical School under Dr. Maurice Hilleman and by other research groups, including Huebner's, Type 4 is immediately important. This is because it has turned up in epidemics of what Army doctors call ARD—Acute Respiratory Disease—which are common among recruits.

Types 3 and 7 have also been found among recruits, so Huebner and his associates are now working on a multi-purpose vaccine intended to be effective against 4 and 7 as well as 3. The plan is to test it at certain Army camps this winter. At the best, a vaccine for general use, Huebner believes, is a year away.

Would such a vaccine end the menace of the common cold?

"What most people call a cold," Huebner points out, "may be any one of 25 or more different viruses, provided it isn't just an allergy. That explains why you can get a cold tomorrow, recover from it, and catch another next month.

"But some of the viruses associated with what is often called a cold have now been isolated, and tests have shown that we can produce a vaccine against at least one of them. We ought to be able to go on from there."

In sum, doctors don't know how to cure a "cold." The only proved treatment, as with other virus diseases, is rest. But they are whittling away at the block of viruses responsible, and they offer the hope that one day you will be able to take shots of several multi-purpose vaccines and win protection that may last for years. END

.....  
NEXT MONTH ...

## Further Adventures of TV's Gus Wilson



ART MARGOLIS' anecdotes about his experiences as a TV serviceman are rapidly making him as famous in his field as Gus Wilson is among auto mechanics.

You'll find some of his best stories yet in the December issue of POPULAR SCIENCE MONTHLY. He'll tell you then about his adventures in extending the lives of television tubes that had seemed about ready for the junk heap. Margolis articles that you'll remember from previous issues have included "Why TV Condensers Give Up the Ghost" and "8 Strange Tales of TV Antenna Troubles."



**PORTABLE LIGHT PLANTS**

**1300-1500 WATT PLANT**  
115v. 60 cyc. AC Push Button Start. Powered by a 3 1/2 HP. Clinton engine. Combines big output with easy portability. Provides emergency power for operating any oil burner, sump pump, freezer, television, lights, communications systems, etc. which require up to 1500 watts. (Item 22). Wt. 110 lbs. Reg. \$475 value, Factory price...



**\$239.50**

**1750 Watt Plant** Powered by 4.5 Briggs engine. Electric starting & battery charging built-in! Factory price...

**\$279.50**

**MASTER-LITE 2500 Watt Plant**  
110/120 v. 60 cyc. AC. A powerful plant, ruggedly constructed and yet designed for easy portability. Can be started by rope or built-in 12 v. electric push button starter. Built-in winding to charge battery. Powered by a big 5.10 HP Briggs engine, complete with all accessories. Includes control box, voltmeter, and handy plug-in power receptacle. An ideal plant for permanent or stand-by service. Wt. 225 lb. Reg. price \$645.00 (Item 21) Factory Price .....

(Item 21)

**\$329.50**

**3500 Watt Plant Push Button Start** (Item 23)  
115 v. 60 cyc. AC. Similar to above, but larger and 33% more capacity. Wt. 270 lbs. Reg. \$760. Factory Price.....

**\$379.50**

**DUAL VOLTAGE 110/220** for any of above plants—\$30 additional

**52 pc. SOCKET SET**

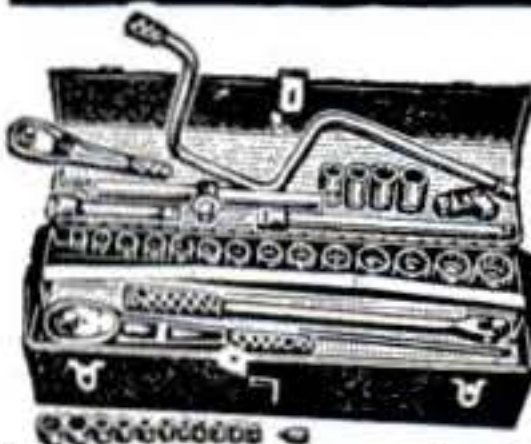

Highest quality, guaranteed non-breakable sockets made by Husky. Beautifully matched chrome thin wall alloy absolutely the best. Contains a complete set of 28 sockets in 1/2" drive, 3/8" drive and 1/4" drive, plus all necessary extensions, handles, speeders, reversible ratchets, etc.; all uncond. guaranteed against breakage. A beautiful set of tools that will handle any job; in a big doghouse steel box. Wt. 17 lbs. (Item 205) List price \$62.90. Factory Special.....

**\$27.95**

**44 Pc. SOCKET SET**

(Item 596) Same unconditionally guaranteed, non-breakable sockets as above. Complete range of 21 sockets from 1/4" thru 7/16" (1/4" drive) & 7/16" thru 1-1/16" (1/2" drive). Two extensions, reversible 1/2" ratchet, 3 drift punches, sliding "T" head, all angle coupling, 1/2" speeder, 1/4" breaker, 5 pc. high chrome alloy combination wrench set and 8 pc. offset wrench set in big doghouse tool box with ample room for other tools. Reg. \$49.50. Wt. 16 lb.....

**\$21.95**

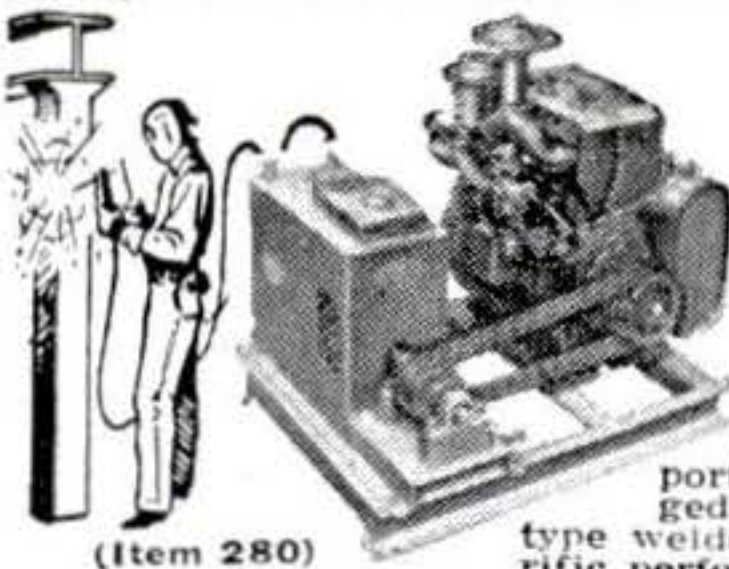

**MASTER DC ARC WELDERS**

Now! a portable, rugged, industrial type welder with terrific performance, yet

at a price hundreds of dollars less than you'd expect. Senior model made for years of trouble-free, continuous service. High capacity DC welding unit enables you to tackle any job with confidence—easily welds anything up to 2" plate using from 1/16" to 1/4" rods. Built-in stabilizer and cooling system makes arc easy to strike and hold. Dual control rheostat provides low heat soldering, brazing and welding from 30 to 300 amps. Complete with instructions, guarantee and triple V-belt or flat pulley. You can pay more, but you can't buy a better welder.

**WELDER ONLY—DUAL CONTROL MODEL.** Same as above, but drive with your tractor, jeep or gas engine of 14 HP or more. (Item 38a.) Wt. 110 lbs. \$450 value.....

**\$119.50**

**WELDER ONLY—STANDARD MODEL.** Same as above but with single rheostat for heavy metal welding only. (Item 38.) Wt. 110 lbs. \$400 value. Special..

**\$99.75**

**COMPLETE POWER MASTER** (Illustrated above) powered by a 14.6 hp., air cooled Wisconsin engine. Wt. 480 lbs. (Item 280) Compares with welder costing \$1200. Factory Special.....

**\$449.50**

**WELDING KIT** Two 10 ft. leads, welding helmet, electrode holder, ground clamp. Sold only with welder at...

**\$10.50**

**get MASTER MECHANIC'S BEDROCK FACTORY PRICES**

**600-700 WATT PLANT**

(Item 24)

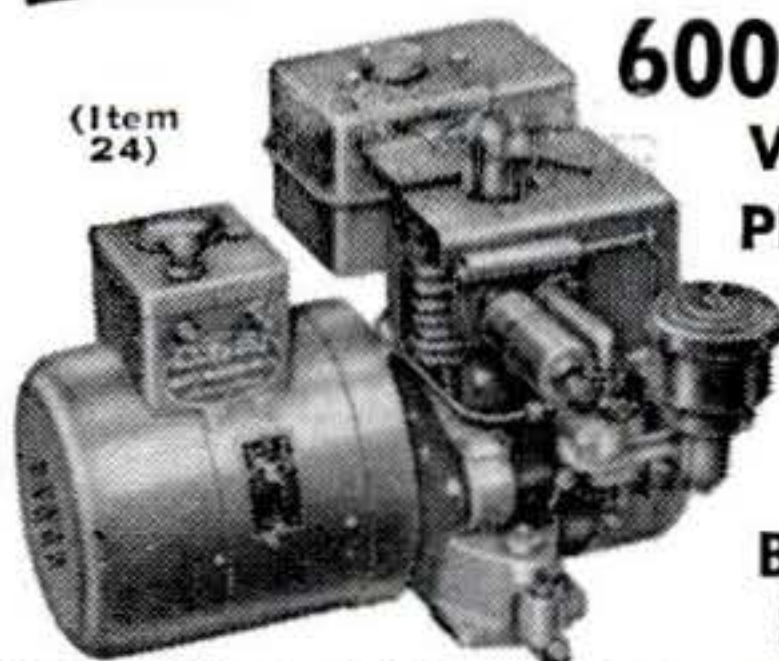

**PUSH BUTTON START**

115 v. 60 cyc. AC Powered by a rugged 2 HP. easy starting Briggs engine. No wiring necessary: just plug in and operate. Plenty of current for any oil burner, freezer, brooder, emergency lights, etc. which require up to 700 watts. Ideal for television and radios. Complete with voltmeter and built-in winding to charge 6 v. auto batteries. (Item 24) Wt. 75 lbs. Easily fits in car trunk. Be prepared if storm knocks out power lines. Regular \$275.00 value.....

**\$143.50**

**1000-1200 Watt Plant** (Item 45) same as Item 24 but larger generator and engine with 50% greater output.....

**\$199.50**

**MASTER MECHANIC'S LIVE STEAM**

**in 30 seconds from a cold start!**

**JET STEAM MASTER**

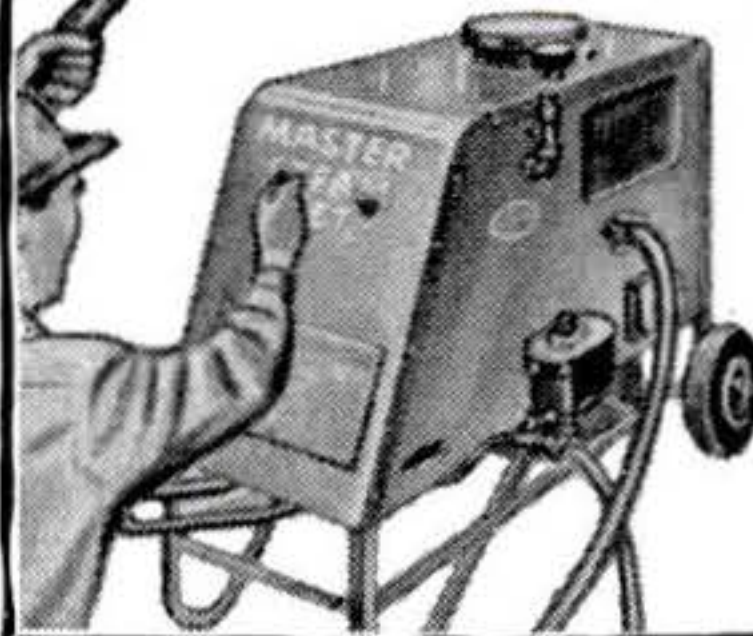

The first portable, completely automatic steam generator ever offered at a real down to earth price. Produces live steam at 100 lbs. pressure in 30 seconds from a cold start! Instantly cleans sticky grease, dirt, rust, old paint, etc. off implements and road machinery. Develops large volume of high pressure steam on 2 pints of fuel oil—costs only 5c to clean an entire auto or tractor engine. Pays for itself in a few weeks. Sterilizes soil. Sterilizes as it cleans—milk equipment, etc. Fully automatic—oil fired, forced draft, built-in lifetime bronze water circulating pump. Uses water from standard hose outlet. Simple and safe—anyone can use it; built-in safety valve. Complete with 12 ft. of hi-pressure steam hose and new triple efficiency steam gun that automatically mixes in soap solution if desired. Wt. 250 lbs. Item 462

**\$329.50**

**EXTENSION CORD**

Heavy duty and very flexible. Neoprene 14-2 cable. 20 year quality. Wt. 12 lbs. (Item 185) 100 ft. Complete with rubber plug and outlet. A terrific buy at only

**\$8.95**

**No. 10-2 POWER CABLE.** Heavy duty, very flexible, rubber covered, 50 ft. with male and female fittings. Wt. 9 lbs. (Item 592a) \$10.45 50 ft. without fittings (Item 592).....

**No. 12-2 POWER CABLE.** Very flexible rubber covered, special outside shield for grounding power tools, etc. 50 ft. (Item 199) wt. 8 lbs. \$6.95. 100 ft. (Item 200).....

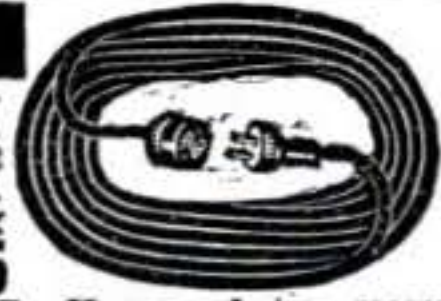

**HI-FLO Centrifugal PUMP**



Completely self-priming! No foot valve required. Tremendous capacity—100 gal. per min. Special impeller enables pump to handle muddy or sandy water. Simple to operate—simply start engine and watch the water go. Powered by a rugged, easy-starting 2 HP Briggs engine. Pre-lubricated sealed bearings for years of heavy low-cost service. Big 1 1/2" Model. Item 502. Wt. 70 lbs. Factory price.....

**\$134.50**

**9 TON HYDRAULIC PRESS**

A tremendously powerful hydraulic press, capable of exerting 18,000 lbs. pressure. Pays for itself many times over—straightening bent connecting rods, king pins, crankshafts, axles, link pins and bars—or pushing out frozen bearings and bushings. Developed pressure under precise control and visible at all times on accurate gauge. Complete with both large and small anvils and jigs to straighten any kind of curve or bend. (Item 464) Wt. 110 lb. Actual list price \$365. Our special close-out price.....

**\$69.50**



**LESS THAN WHOLESALE**

**GIANT 2000-2500 WATT PLANT**

110-120 v. 60 cyc. AC. absolutely the best made—exclusive dynamically balanced armature; heavy windings develop up to 5000 watt overload for motor starting. Skid mounted—portable. Powered by an easy starting Briggs or Wisconsin 6 HP engine—complete with all accessories; engine easily disconnected for other uses. Big outlet box, voltmeter, no wiring necessary. Ample current for all purposes. Factory warranty. (Item 31) Wt. 210 lb. Reg. price \$585. Special at.....

**\$299.50**

Same plant with electric self starter (Item 31a).....

**\$359.50**

Generator only and control box.....

**\$169.50**

**DUAL VOLTAGE 110-220** available on any of above models for \$28.00 additional.

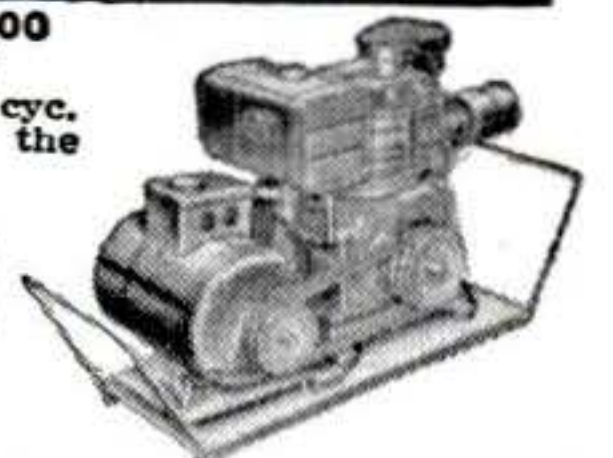

**DIESEL LIGHT PLANT**

(Item 1660) Diesel Master—11-12 kw. 110/220 v. AC single or 3 phase. 1800 rpm direct connected. Electric Self-starting. Engineered for permanent power where continuous low-cost, heavy duty service is important. Wt. 1350 lb.

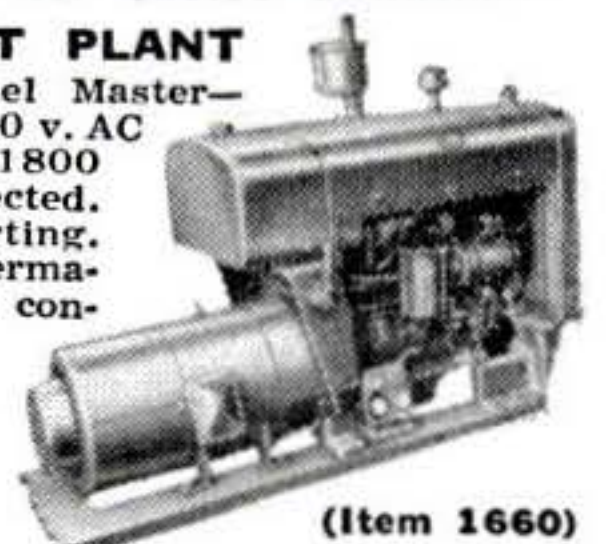

(Item 1660)

Reg. list \$3650.00 Factory Price.....

**\$1895.00**

**GAS DRIVEN PLANT.** 10-11 kw 115-230 v. 60 cyc. AC, single or 3 phase, powered by 4 cylinder Wisconsin air cooled engine. Belt driven. Simple, reliable, 5 V-belt drive mounted on rugged steel skid. (Item 217) (with crank start) Wt. 900 lb. Factory price.....

**\$1075.00**

Same plant with self-starter.....

**\$1145.00**

We make every type and size of light plants—Write, giving us your requirements!

**HEATING & VENTILATING FAN**

(Item 10) Easily installed in furnace pipes. Forces even heat to all rooms. Overrange removes kitchen smoke and odors. Powerful continuous duty motor.



110-120 v. AC. Mount in wall or ceiling to ventilate any area. Quiet, super-efficient fan moves huge volume of air. (400 to 600 CFM)

8" Pipe, wt. 5 lb..... \$6.85  
9" Pipe, wt. 6 lb..... \$7.85  
10" Pipe, wt. 7 lb..... \$8.85  
12" Pipe, wt. 8 lb..... \$9.85

**HEAVY DUTY FAN.** Semi-enclosed motor, suitable for spray booths, restaurant exhausts, poultry houses, etc. 10" Fan, wt. 8 lbs. (Item 10E)..... \$11.95  
12" Fan, wt. 10 lbs. (Item 10D)..... \$12.95

**CONDITIONAIRE VENTILATING FANS**

Save big money installing your own exhaust fan. Efficient propeller type blade moves huge volume of air quietly and effortlessly. Heavy welded frame—pre-drilled for easy installation. Just cut opening and bolt in place. Continuous duty motors. Ideal for attics, restaurants, garages, barns, chicken houses, etc. Control manually or with thermostat.



Blade Opening	CFM	Wt.	Item	Price
16"	18 1/4"	2925	19 lb. 365a	\$27.95
18"	19 1/4"	3600	27 lb. 365b	\$31.95
20"	21 1/4"	4100	30 lb. 365c	\$39.95

**JET FLOW BLOWER**

Tremendous air movement (1800 CFM) and quiet operation make this double inlet 10" turbine blower unbeatable for heating, cooling, drying and air conditioning. Ideal for attic or barn ventilation, converting gravity heating to forced air; spray booth exhausts, etc. Operates with any 1/4, 1/3 or 1/2 HP motor. Oversized, long life bearings. Includes variable speed motor pulley and belt. Dimensions 19" hi x 18" x 16 1/2". Outlet opening 13" x 11 3/8". Wt. 45 lbs. Item 245. Reg. \$54.50. Factory Special.....

**\$27.50**

**HEAVY DUTY 1/4 HP motor** for above \$16.95

**12" TURBINE BLOWER** Similar to above, but larger with 2400 CFM capacity. Wt. 65 lbs. (Item 245a) Reg. \$70.00. Factory Spec. \$34.50



Send check or M.O. Prices f.o.b. Factory. 10 day Money back guarantee. SEND 10c for... **1956** **MASTER MECHANIC MFG. CO.,** DEPT. 51-L **Burlington, Wis. Catalog**



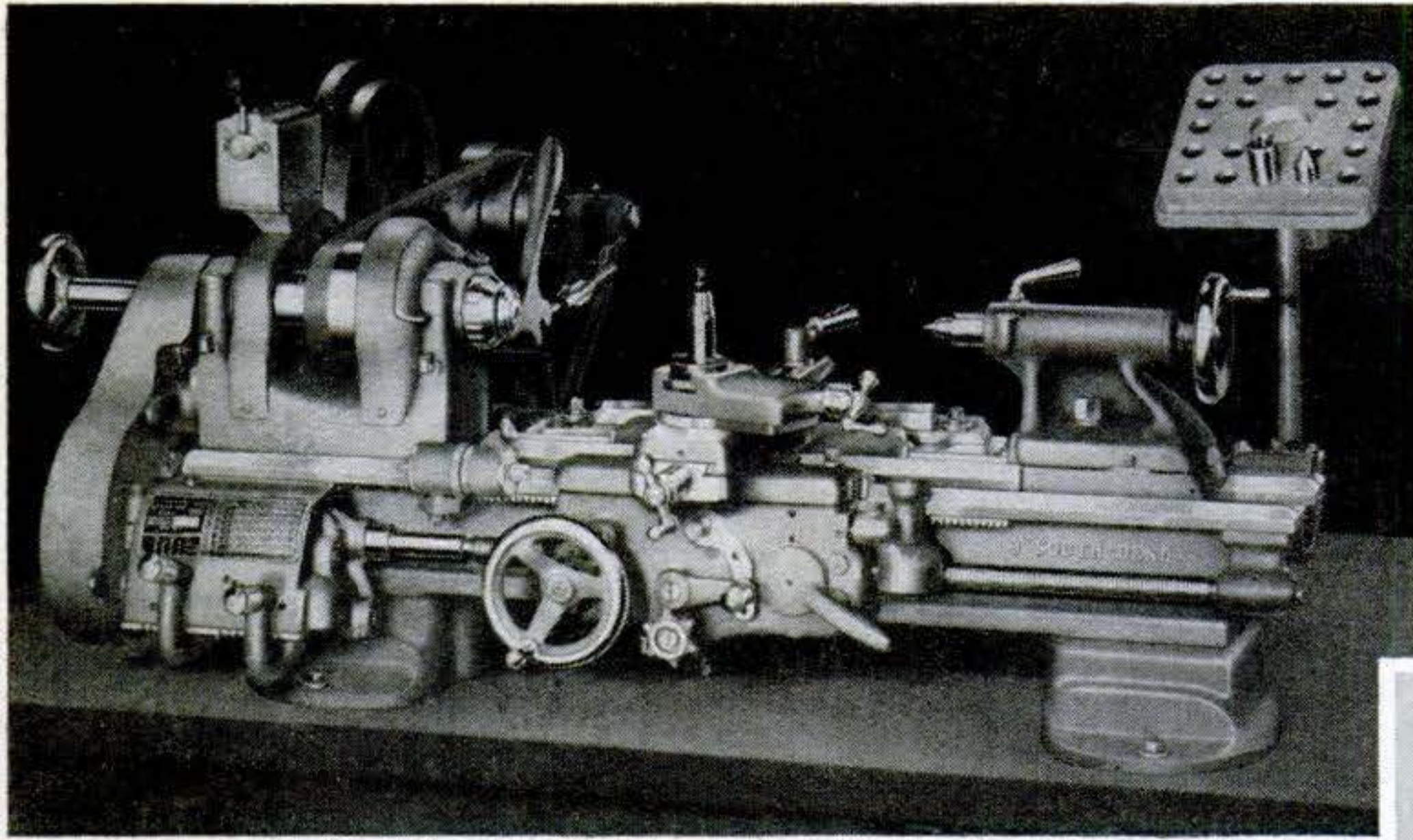

9" x 3' Toolroom Bench Lathe with toolroom attachments, less electrical equipment, f.o.b. factory, **\$608**

# South Bend

**Built Better**  
TO GIVE YOU A  
**Better Buy**

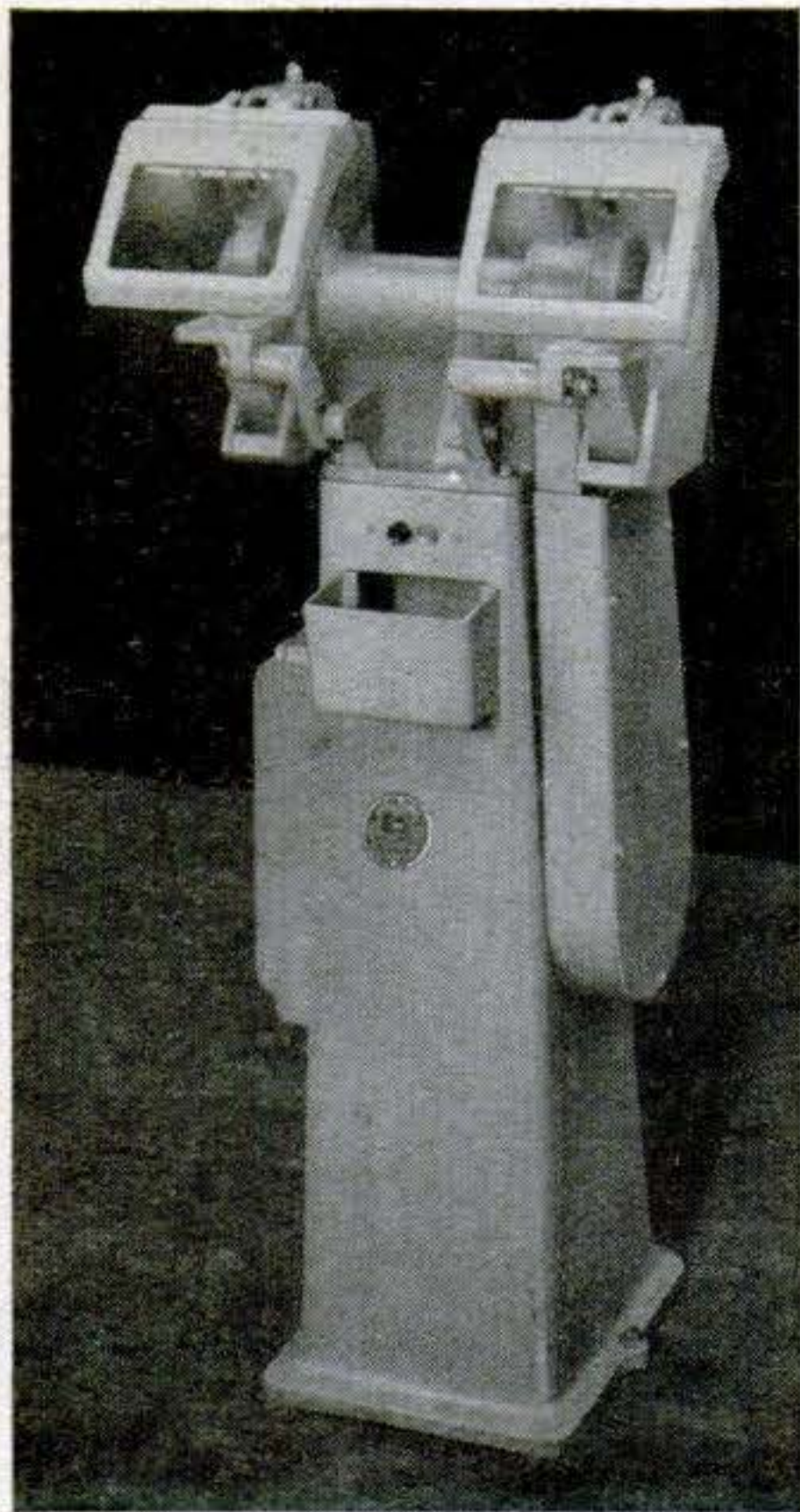

10" Pedestal Grinder with wheels and lights, but less motor. f.o.b. factory, **\$248**

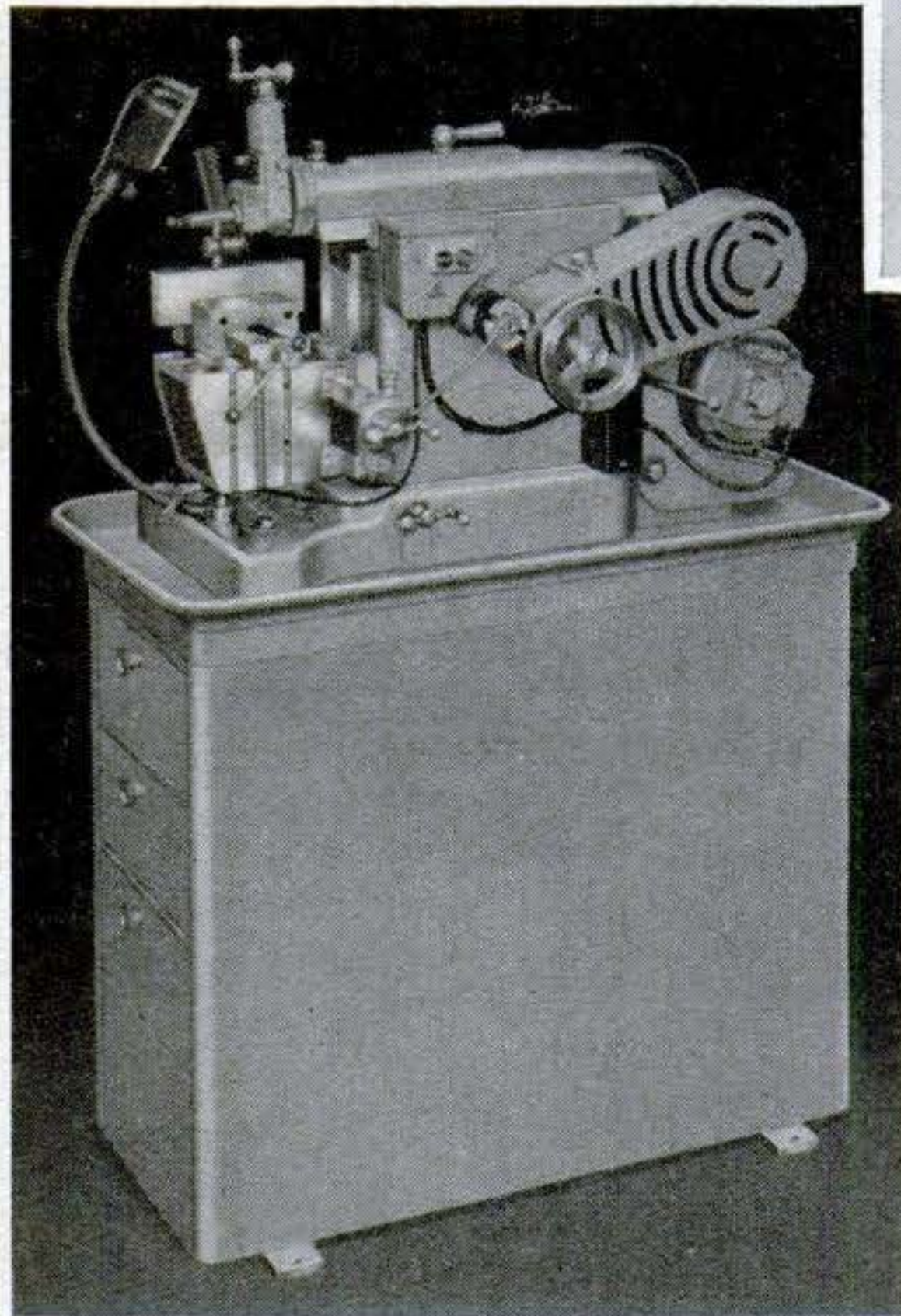

7" Bench Shaper with light, vise and pressure lubrication but less metal bench and motor, f.o.b. factory, **\$551**

South Bend Machine Tools contribute to the skill and ability of the most expert technician because they are a match for the most exacting tolerances required. Versatile and easy to operate they enable you to do more and better work. Quality built throughout, they represent maximum value at minimum cost. Regardless of the kind of machine work you do, it will be to your advantage to learn more about South Bend. Mail coupon for complete information without obligation.

### TIME PAYMENTS

only **3 1/4%**

annual interest on original unpaid balance. Low down payment and monthly installments.

Compared with our costs  
**OUR PRICES ARE LOWER**  
than they were back in 1941



Prices are closely tied to costs. Costs are still rising. Buy now before increased costs necessitate higher prices.

SEND INFORMATION CHECKED:



9" and 10" BENCH LATHES

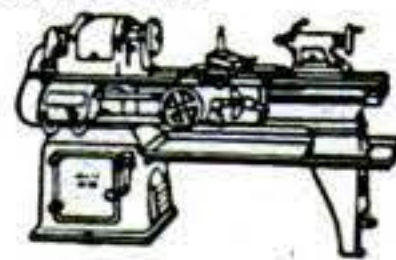

10" to 16-24" FLOOR LATHES



DRILL PRESSES

TOOL GRINDERS

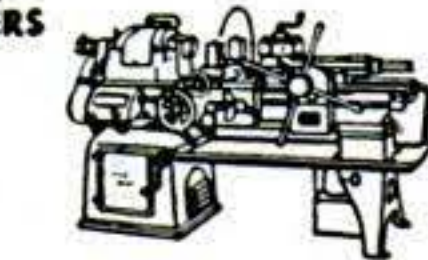

1/2" & 1" Collet TURRET LATHES

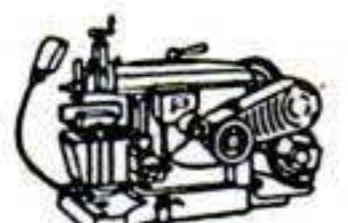

7" BENCH SHAPERS

Name \_\_\_\_\_ Street \_\_\_\_\_

City \_\_\_\_\_ State \_\_\_\_\_

Building Better Tools Since 1906 • SOUTH BEND LATHE • South Bend 22, Indiana





# 49½¢ STORM WINDOW

## protects your family all winter!

### New Trans-Kleer Storm Window Goes on In 5 Minutes Without Tools, Hooks, Screws or Nails

#### 10.8 Sq. Ft. Window Costs only 49½¢

NOW . . . Storm Windows need not cost you up to \$14.00 apiece. American industry has developed a lightweight flexible product that enables you to seal out wintry blasts for only 49½¢ a window! Imagine it! For pennies per window you can insulate EVERY ROOM in your home! This new material was developed by the Gary plant of a billion-dollar American manufacturing firm—for use by the U.S. Government during the last war. It looks like glass, yet can't peel off, never chips, shatters or rattles. Actually flexible like rubber. Has a tensile strength of over one ton per square inch. Crystal clear, not milky or yellowish like some plastic materials. Weighs less than 1/10th of the lightest glass windows ever developed. Even a large window comes to less than 8 oz. Not affected by snow, sleet, rain or dampness—because it's 100% waterproof. Won't crack even at 53 degrees BELOW FREEZING! Use and re-use it YEAR AFTER YEAR for winter comfort and protection.

#### Sensational Discovery Used By Army To Fight Cold

One of the big problems of the last war was how to defend our troops and protect equipment against the ravages of Arctic winters. One of the world's greatest manufacturing companies was ordered to build a special plant and soon millions of yards of this new material was moving out to Alaska, the Aleutians, Iceland and Greenland. Finally, it was released to the public and ever since the demand has been greater than the supply! The Gary plant of famous REYNOLDS METALS COMPANY is working round-the-clock trying to supply it!

#### Use Year After Year—No Upkeep Cost!

At winter's end just fold away your Trans-Kleer like cloth for use next year. You can air the room anytime, too—lift the Adheso border to let in fresh air, then press back and it's sealed tight again! Cleans easily with a damp rag. It's no wonder so many home owners, hospitals, churches and public buildings use this tried and tested REYNOLDS product! TRANS-KLEER comes in kits 36 inches by 432 inches and costs you only \$4.95 complete with Adheso border! That is enough for 10 windows—each measuring 10.8 sq. ft.—just 49½¢ each! In all you receive 108 SQUARE FEET for only \$4.95! Good GLASS storm windows cost from \$7.95 to \$16.00—for ten you'd have to pay \$79 to \$160.00. With this remarkable REYNOLDS product you not only save a terrific amount in the purchase price, you also cut down enormously on your fuel bills!

#### Install Trans-Kleer Windows in 5 Minutes

Trans-Kleer storm windows require no nails, hooks, screws or tools. No back-breaking toil or broken glass to contend with. Cut off required amount, trim to fit the inside of your window, large or small, square, round, rectangular—it makes no difference! Then press on the special Adheso border supplied and your storm window is firmly in place. Simple, easy—a child can install them.

#### Test In Your Home AT OUR RISK!

Here's your chance to get Trans-Kleer on a HOME TRIAL BASIS. You can't lose a single penny. Mail the coupon at right and a 36 by 432-inch kit—108 SQUARE FEET—will be shipped you immediately, complete with Adheso border. Deposit only \$4.95 plus postage with the mailman. Try TWO windows inside any room. Test them—see for yourself how they seal out drafts. Compare the temperature—any 25¢ thermometer will do—compare with any other room in your home. See the difference—feel the difference! Then if you're not convinced they're every bit as effective as any storm window—why, just keep the TWO windows and return the balance and get your \$4.95 back at once!

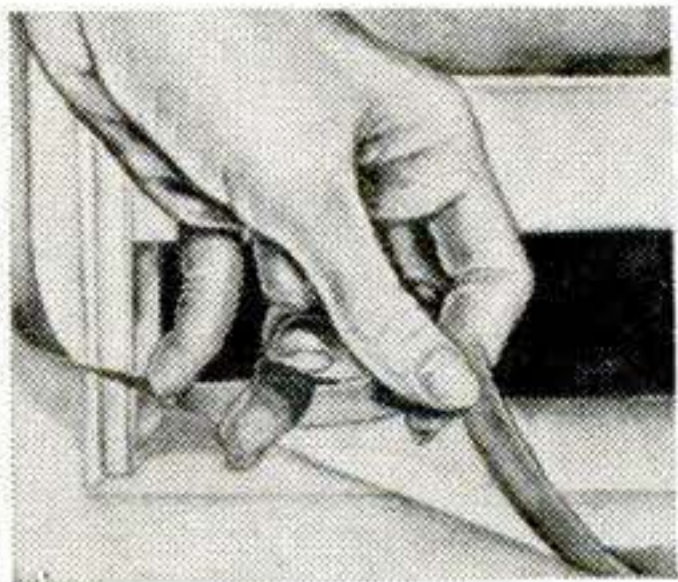

#### Just Lift Up For Airing

Trans-Kleer goes on quickly inside the window. To ventilate just lift the Adheso border. You may then open the storm window as much as you wish. Press back and you have perfect sealed-in insulation again. (See picture.) The special Adheso borders supplied with the Trans-Kleer windows will not lose their adhesiveness even if you air the rooms daily. They seal the Trans-Kleer to the frame snugly, tightly.

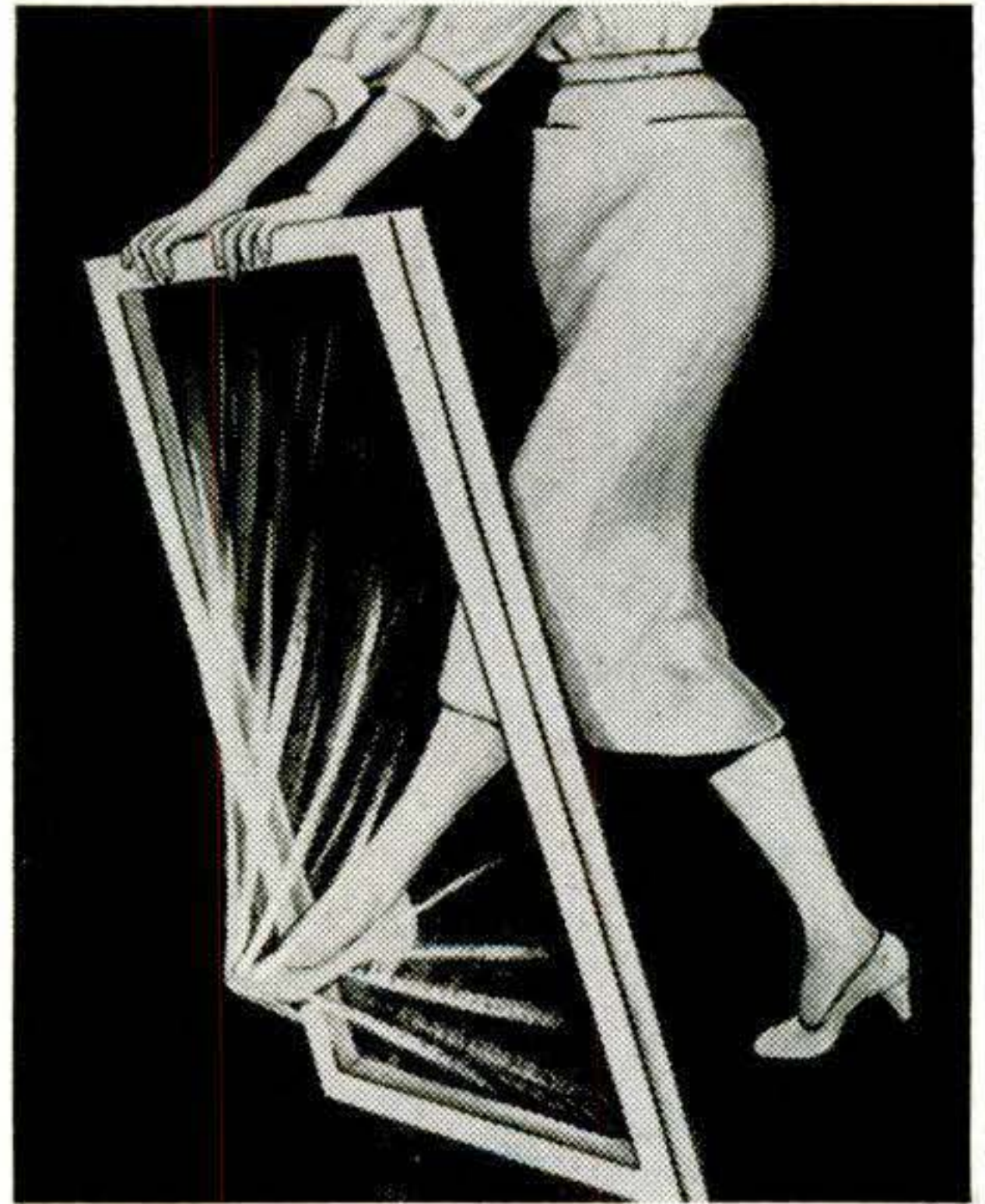

STRETCHES WITHOUT BREAKING!

#### Avoid Disappointment—Order Now!

Millions of folks in the U. S. and Canada are reading this same ad in hundreds of magazines and newspapers. Despite enormous production facilities, the REYNOLDS ALUMINUM people can turn out so much and no more! Don't wait until it's too late! Play safe! Rush the coupon NOW! If you wish to save postage cost, send check, cash or m. o. for \$4.95 and the windows will be shipped postage free.

#### THORESEN'S, Dept. 7-M-47

352 Fourth Ave. New York 10, N. Y.

CANADIANS: Same price! Same guarantee! Order from our Canadian Subsidiary: THORESEN LTD., 45 St. James St., West, Dept. US-47, Montreal 1, Que.

#### RUSH FOR FREE HOME TRIAL!

Thoresen's, Dept. 7-M-47  
352 Fourth Ave., New York 10, N. Y.

RUSH . . . kits of Trans-Kleer measuring 108 sq. ft. each, enough for 10 windows averaging 10.8 sq. ft. each. Include improved Adheso Sealing Border and easy picture instructions at no extra cost. I will try 2 windows and if I'm not satisfied for any reason, I'll return the remainder within one week for FULL REFUND of my money. I will keep the 2 windows free.

- Payment enclosed. Send Prepaid.
- Send C.O.D. plus postage.

#### CHECK AMOUNT DESIRED

- 1 KIT (108 sq. ft.) for 10 windows—4.95
- 2 KITS (216 sq. ft.) for 20 windows—8.95

Name.....

Address.....

City.....State.....



*"PRESTONE" BRAND anti-freeze protects  
your car from freeze-ups all winter long!*

## Guarantee

"National Carbon Company, A Division of Union Carbide and Carbon Corporation, specifically guarantees that 'Prestone' brand anti-freeze, if used according to printed directions\* in normal water cooling systems, will protect the cooling system of your car against freezing and clogging from rust formation for a full winter; also that it will not boil away, will not cause damage to car finish, or to the metal or rubber parts of the cooling system, and that it will not leak out of a cooling system tight enough to hold water."

\*Ask your dealer for copy.

You're SET, You're SAFE, You're SURE,  
when you find the **GREEN TAG** attached by your dealer



# PRESTONE

## ANTI-FREEZE

LIST PRICE **\$3<sup>25</sup>** A GALLON, 85¢ PER QUART

The terms "Prestone" and "Eveready" are registered trade-marks of Union Carbide and Carbon Corporation  
NATIONAL CARBON COMPANY • A Division of Union Carbide and Carbon Corporation • 30 E. 42nd St., N. Y. 17, N. Y.