

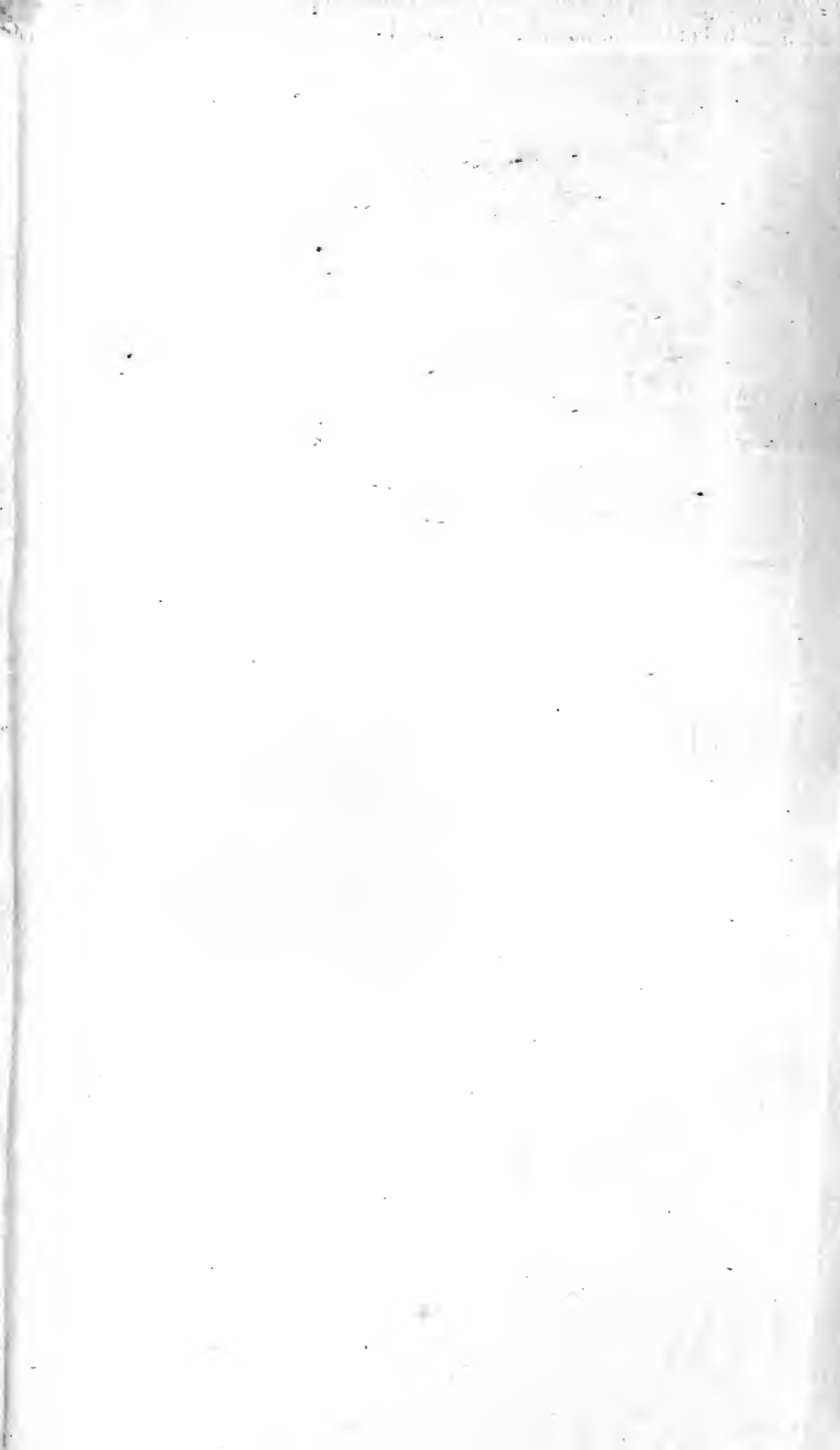

3 1761 06238096 9



Students Library Club
Medical Building
University of Toronto

Digitized by the Internet Archive
in 2007 with funding from
Microsoft Corporation

444

PRACTICAL ORGANIC AND
BIO-CHEMISTRY

BY THE SAME AUTHOR.

THE CHEMICAL CHANGES AND PRODUCTS
RESULTING FROM FERMENTATION.

8vo. 6s. 6d. net.

MONOGRAPHS ON BIO-CHEMISTRY.

EDITED BY

R. H. A. PLIMMER, D.Sc., AND F. G. HOPKINS, F.R.S., D.Sc.

Royal 8vo.

THE NATURE OF ENZYME ACTION. By W. M. BAYLISS,
M.A., D.Sc., F.R.S. 5s. 6d. net.

THE CHEMICAL CONSTITUTION OF THE PROTEINS.
By R. H. A. PLIMMER, D.Sc.

Part I., ANALYSIS. 6s. net.

Third Edition.

Part II., SYNTHESIS. 4s. net.

Second Edition.

THE GENERAL CHARACTERS OF THE PROTEINS.
By S. B. SCHRYVER, Ph.D., D.Sc.

THE VEGETABLE PROTEINS. By THOMAS B. OSBORNE,
Ph.D. 4s. net.

THE SIMPLE CARBOHYDRATES AND THE GLUCO-
SIDES. By E. FRANKLAND ARMSTRONG, D.Sc., Ph.D.
5s. 6d. net.

THE FATS. By J. B. LEATHES, F.R.S., M.A., M.B., F.R.C.S.

ALCOHOLIC FERMENTATION. By ARTHUR HARDEN,
Ph.D., D.Sc., F.R.S. 4s. 6d. net.

THE PHYSIOLOGY OF PROTEIN METABOLISM. By
E. P. CATHCART, M.D., Ch.B., D.Sc.

SOIL CONDITIONS AND PLANT GROWTH. By EDWARD
J. RUSSELL, D.Sc. (Lond.). With Diagrams. 6s. 6d. net.

OXIDATIONS AND REDUCTIONS IN THE ANIMAL
BODY. By H. D. DAKIN, D.Sc., F.I.C.

THE SIMPLER NATURAL BASES. By GEORGE BARGER,
M.A., D.Sc. 6s. 6d. net.

NUCLEIC ACIDS. Their Chemical Properties and Physio-
logical Conduct. By WALTER JONES, Ph.D. 4s. net.

LECITHIN AND ALLIED SUBSTANCES. THE LIPINS.
By HUGH MACLEAN, D.Sc., M.D.

THE RESPIRATORY EXCHANGE OF ANIMALS AND
MAN. By AUGUST KROGH, Ph.D. 6s. 6d. net.

Other Volumes are in preparation.

LONGMANS, GREEN AND CO.,
LONDON, NEW YORK, BOMBAY, CALCUTTA, AND MADRAS.

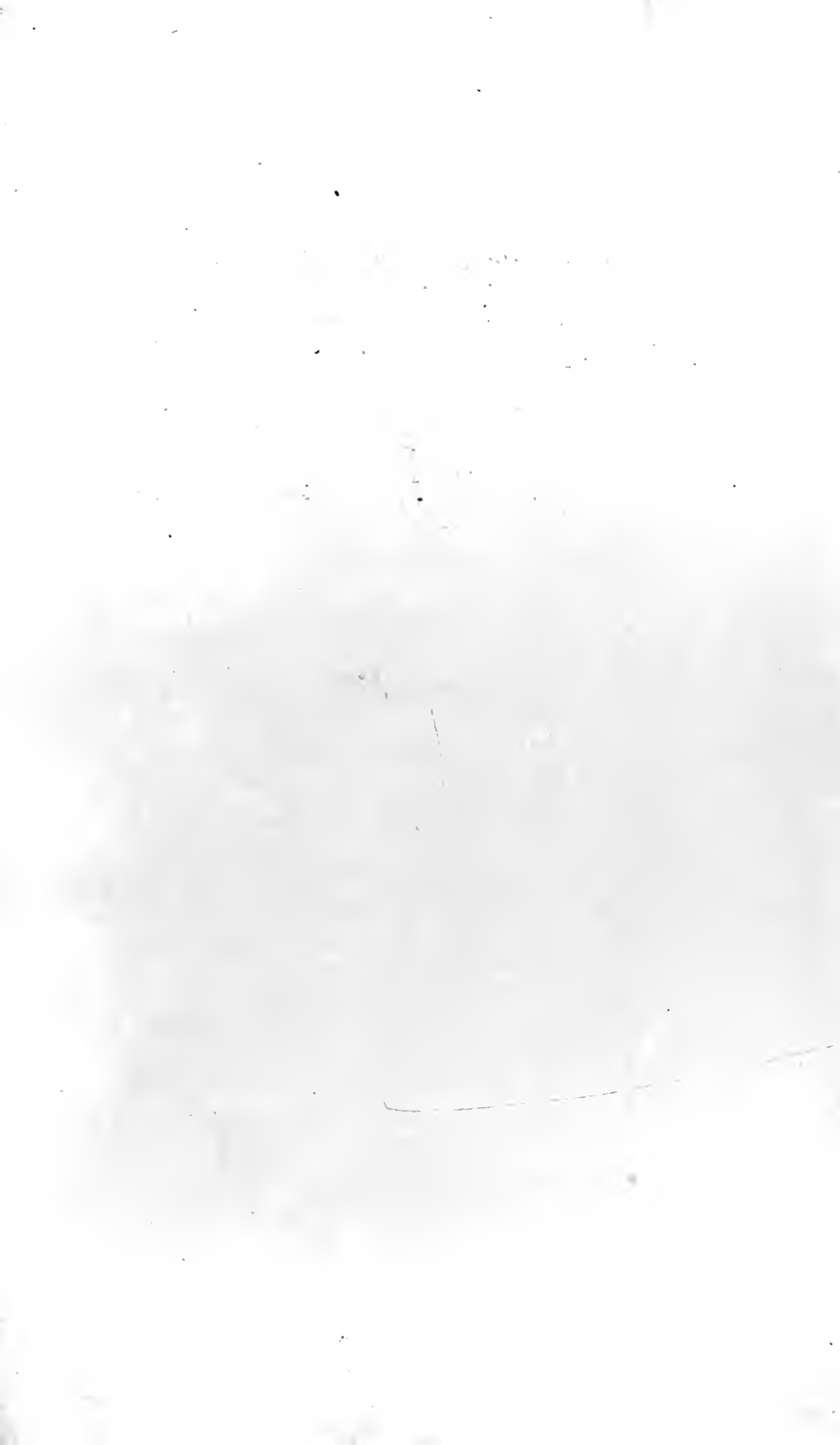

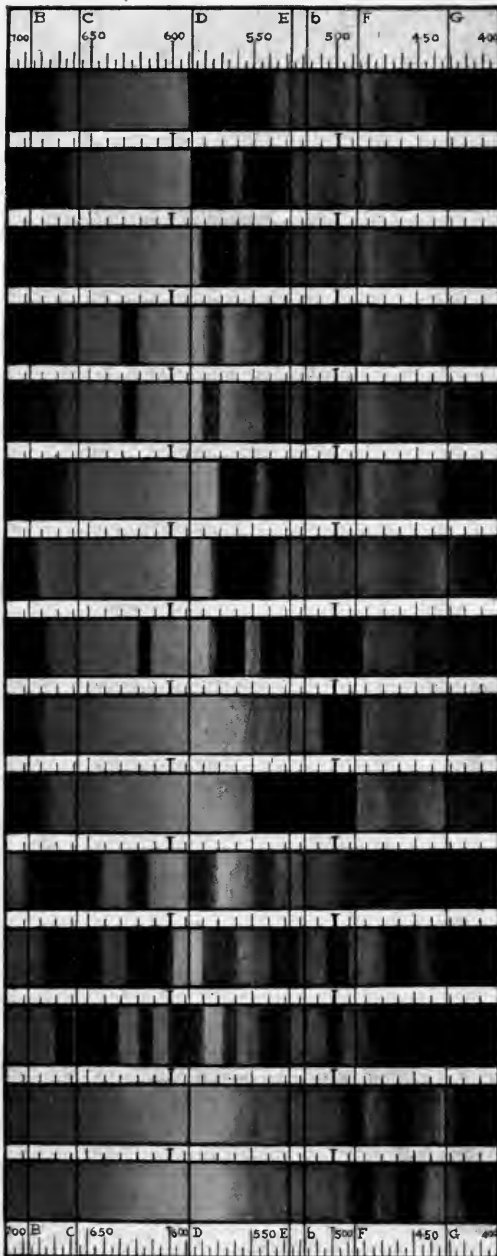

Haemoglobin 1:100.

Oxyhaemoglobin 1:100.

Carboxyhaemoglobin 1:100.

Methaemoglobin : neutral.

Haematin in acid alcohol.

Haemochromogen in alkaline solution, 1:100.

Haematoporphyrin in 1% H_2SO_4 .

Haematoporphyrin in 5% NH_3 .

Urobilin.

Uroerythrin.

Chlorophyll in living nettle leaf

a—Chlorophyll in ether.

b—Chlorophyll in ether.

Carotin in alcohol.

Xanthophyll in alcohol.

ABSORPTION SPECTRA.

MPhy
P

PRACTICAL ORGANIC AND BIO-CHEMISTRY

(171)

BY
Robert Henry Lewis
R. H. A. PLIMMER

READER IN PHYSIOLOGICAL CHEMISTRY, UNIVERSITY OF LONDON, UNIVERSITY COLLEGE

WITH COLOURED PLATE AND OTHER ILLUSTRATIONS IN THE TEXT

NEW AND REVISED EDITION

248058
27.10.30

LONGMANS, GREEN AND CO.
39 PATERNOSTER ROW, LONDON
FOURTH AVENUE & 30TH STREET, NEW YORK
BOMBAY, CALCUTTA, AND MADRAS

1918

STATE OF
NEW YORK
JAN 11 1881
OFFICE OF THE
COMMISSIONER OF
THE LAND OFFICE

PREFACE TO REVISED EDITION.

FOR this edition the text has been thoroughly revised. Several sections have been rewritten and some new methods of preparation and analysis have been incorporated.

R. H. A. P.

November, 1917.

PREFACE.

IN this edition the same method is adopted as was followed in the former edition, entitled "Practical Physiological Chemistry," but further experience in teaching has led me to believe that the book would be improved and made more useful if its scope were extended. New sections upon organic chemistry and organic substances found in plants, together with methods used in more advanced work, are therefore included.

As the basis of the book is Organic Chemistry this term is used in its title, and since the subject is also treated from the botanical side, the term Bio-Chemistry is substituted for Physiological Chemistry, a term too often restricted to the aspect of the animal side of the subject.

The book is still intended mainly for medical students, but it contains the essentials for all students of Biology. The medical student will gain rather than lose by having additional matter, though it may not be of immediate use to him. A survey of the sections upon plant compounds should give him a wider outlook and a deeper insight into the wonderful substances connected with the phenomena of Life, and withal, they may be useful for reference.

In order to help the student in using the book the essentials of the subject are printed in large type, while the botanical and more advanced portions are printed in small type. The more important practical experiments suitable for a preliminary course are indicated by asterisks and correspond to the small type of the former edition.

I am much indebted to Dr. C. Lovatt Evans for his assistance in the sections on "The Function of Hæmoglobin" and "The Analysis of Blood Gases". Mr. W. W. Reeve, B.Sc., has kindly assisted me with the proofs.

R. H. A. P.

PREFACE TO FORMER EDITION.

THIS book was originally compiled as a handbook for practical work in Physiological Chemistry at University College, London, since no single text or class book covered the complete course, or treated Physiological Chemistry as part of the subject of organic Chemistry, or even as an independent subject.

The present book must still be regarded mainly as a compilation. It represents an attempt to give to the worker a nearly complete statement of the whole subject. Each section has a short explanatory summary of the essential points, so as to connect the various sections together. The essential points are illustrated by the practical experiments, which are printed in different type.

The illustrations are also compiled from various sources. These are mentioned underneath each figure. The illustrations of apparatus not so mentioned have been drawn from my own sketches. For those of the osazone crystals, haemin, and tyrosine, I am indebted to Miss V. G. Sheffield, who has also kindly helped in reading the proof sheets.

In most physiological chemistry laboratories the strengths of the reagents employed are very various, e.g. dilute acetic acid may be 1 per cent., or 2 per cent., or 5 per cent., or even 10 per cent. In order that all workers may employ a reagent of standard concentration, a list of reagents has been carefully drawn up and is appended.

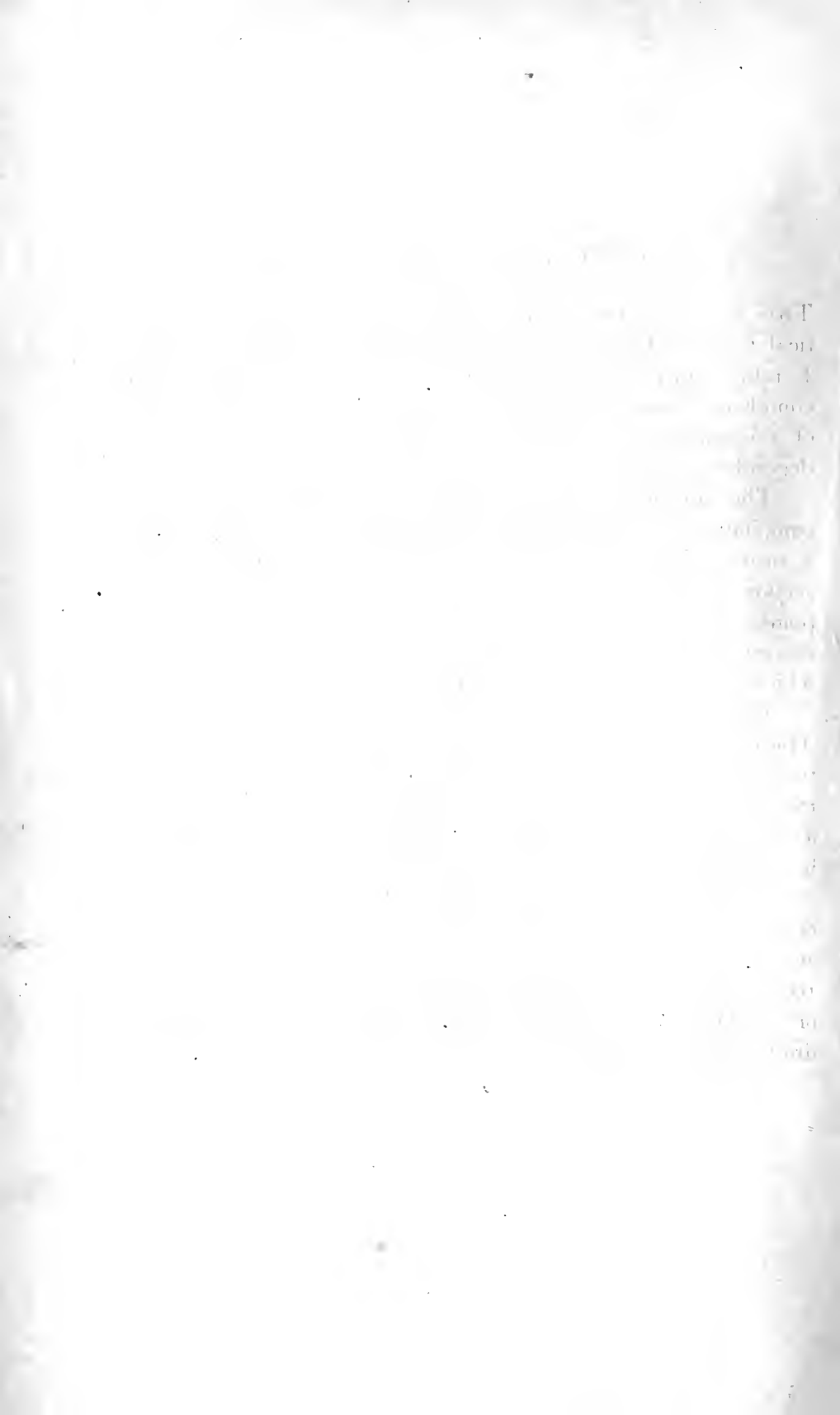

CONTENTS.

	PAGE
DEFINITION	1
RECOGNITION OF AN ORGANIC COMPOUND	2
ISOLATION AND PREPARATION OF PURE ORGANIC COMPOUNDS. CRITERIA OF THEIR PURITY	3
I. Purification of a Liquid by Distillation. Determination of the Boiling-point, 4; II. Separation of Liquids, 8; Evaporation of Liquids, 13; III. Separation of Solid and Liquid. Filtration, 15; IV. Purification of Solids by Crystallisation, 17; Determination of the Melting-point, 23; V. Separation of Solids, 25; Isolation of Solids from Solution, 26.	
COMPOSITION OF ORGANIC COMPOUNDS	28
A. Elementary Composition. Detection of the Elements, 28; B. Quantitative Composition. Estimation of the Elements, 31; C. Calculation of Results, 41; D. Determination of Molecular Weight, 42.	
IDENTIFICATION OF AN ORGANIC COMPOUND	46
HYDROCARBONS	49
A. Saturated, 49; B. Unsaturated (<i>a</i>) Olefines, 54, (<i>b</i>) Acetylenes, 56.	
HALOGEN DERIVATIVES OF THE HYDROCARBONS	57
Monohalogen Derivatives. Alkyl Halides, 57; Dihalogen Derivatives, 58; Trihalogen Derivatives. Chloroform, 59. Iodoform, 62.	
ALCOHOLS	63
Methyl Alcohol, 63; Ethyl Alcohol, 64; Propyl Alcohols, 68; Butyl Alcohols, 68; Amyl Alcohols, 69; Higher Alcohols, 70.	
ESTERS	71
Esters of Inorganic Acids, 71; Esters of Organic Acids, 72; Hydrolysis of Esters, 74.	
ETHERS. ETHYL ETHER	76
MERCAPTANS AND SULPHIDES	78
ALDEHYDES	80
Formaldehyde, 80; Acetaldehyde, 80; Estimation, 85; Chloral, 86; Chloral Hydrate, 86.	
KETONES. ACETONE	88
THE FATTY ACIDS	93
Formic Acid, 94; Acetic Acid, 96; the Higher Fatty Acids, 99.	
HALOGEN SUBSTITUTION DERIVATIVES OF THE FATTY ACIDS	100
ACID OR ACYL CHLORIDES	101
ACID ANHYDRIDES	102

	PAGE
UNSATURATED ALCOHOLS, ALDEHYDES AND FATTY ACIDS	103
HYDROXY-, KETO- AND DIBASIC ACIDS	106
AMINES	124
AMIDES	129
THE AMINO ACIDS	137
BETAINES	150
CYANOGEN COMPOUNDS	152
GUANIDINE AND ITS DERIVATIVES	164
DI-, TRI- AND POLYHYDRIC ALCOHOLS	173
FATS AND OILS. WAXES. LECITHINS	175
THE CARBOHYDRATES	183
THE MONOSACCHARIDES	184
PROPERTIES AND REACTIONS OF THE MONOSACCHARIDES	190
A. Glucose, 190 ; B. Fructose, 194 ; C. Galactose, 195 ; D. Mannose, 195 ; E. Pentoses, 195 ; F. Glycuronic Acid, 196.	
THE DISACCHARIDES : CANE SUGAR ; LACTOSE ; MALTOSÉ	197
TRISACCHARIDES AND TETRASACCHARIDES	202
CHITIN AND CHONDROITIN	203
THE POLYSACCHARIDES : STARCH ; DEXTRINS ; GLYCOGEN ; CELLULOSE	205
GLUCOSIDES	214
ESTIMATION OF CARBOHYDRATES	216
A. Estimation by Means of the Polarimeter, 216 ; B. Estimation by Reduction of Copper Salts, 221 ; C. Estimation by Fermentation, 233 ; Estimation of Pentoses, 234 ; Estimation of Disaccharides, 235 ; Estimation of Polysaccharides, 236.	
CARBOCYCLIC COMPOUNDS	237
AROMATIC COMPOUNDS	238
Benzene and its Monosubstitution Derivatives, 240 ; Disubstitution Deriva- tives of Benzene, 260 ; Trisubstitution Derivatives of Benzene, 270 ; Tetrasubstitution Derivatives of Benzene, 273.	
TANNINS	274
HETEROCYCLIC COMPOUNDS	276
UREIDES	277
A. Ureides of Monobasic Acids, 277 ; B. Ureides of Hydroxy and Alde- hyde Acids, 277 ; C. Ureides of Dibasic Acids, 279.	
PYRIMIDINES	282
GLYOXALINE OR IMINAZOLE DERIVATIVES	284
PURINES	286
NUCLEIC ACIDS	299
FURFURANE, OR FURANE, AND ITS DERIVATIVES	303
THIOPHENE AND ITS DERIVATIVES	304
PYRROLE AND ITS DERIVATIVES	304
PYRIDINE AND ITS DERIVATIVES	307

CONTENTS

xi

	PAGE
HYDROAROMATIC COMPOUNDS	310
The Inositols	310
The Terpenes	312
The Cholesterols	319
Bile Acids	322
COMPLEX AROMATIC COMPOUNDS	330
THE ANTHOXANTHINS	338
THE ANTHOCYANS	340
INDOLE AND ITS DERIVATIVES	342
QUINOLINE AND ISOQUINOLINE	350
THE ALKALOIDS	351
THE PROTEINS	361
The General Reactions of the Proteins, 365 ; A. Colour Reactions, 365 ; B. Coagulation Reactions, 368 ; C. Precipitation Reactions, 368.	
Derivatives of Proteins, 370 ; Metaproteins, 370 ; Proteoses and Peptones, 371 ; Separation of Proteoses and Peptones, 372 ; Peptone, 373.	
APPENDIX TO PROTEINS. COLLOIDS AND COLLOIDAL SOLUTIONS	374
ENZYMES. FERMENTATION	391
Localisation of the Enzymes and the Chemical Changes in the Organism, 396 ; Demonstration of the Action of Enzymes, 399 ; the Catalytic Action of Enzymes, 413 ; the Synthetical Action of Enzymes, 415 ; the Measurement of the Activity of Enzymes, 416.	
Appendix to Digestion—	
I. The Acids in the Gastric Contents, 427 ; II. The Constituents of Bile, 429 ; III. Gall Stones, 431.	
THE INDIVIDUAL GROUPS OF PROTEINS	432
Protamines	432
Histones	433
Coagulable Proteins. Albumins. Globulins	435
The Coagulable Proteins of Egg-White, 436 ; Blood, 438 ; Milk, 446 ; Muscle, 447 ; Other Animal Tissues, 449 ; Plants, 450.	
Gliadins and Glutelins	452
The Scleroproteins	454
Phosphoproteins	457
Milk, 457 ; Egg-Yolk, 463.	
Nucleoproteins	465
Glucoproteins	468
Chromoproteins	472
Blood, 472. The Reactions of Hæmoglobin in Defibrinated Blood. Spec- troscopic Examination of Hæmoglobin and its Derivatives, 478. Estimation of Hæmoglobin, 486. Crystals of Oxyhæmoglobin and Derivatives, 491. The Function of Hæmoglobin as Carrier of Oxygen, 497. The Blood as Carrier of Carbon Dioxide, 510.	
THE CHEMICAL CONSTITUTION OF HÆMIN AND HÆMATOPORPHYRIN	516
THE PIGMENTS OF LEAVES. THE CHLOROPHYLLS AND CAROTINOIDS	519
METABOLISM. INTEGRATION OF THE CHEMICAL PROCESSES	533
COMPOSITION OF THE COMMONER TISSUES USED AS FOOD-STUFFS FOR ANIMALS	537

	PAGE
ANALYSIS OF NORMAL URINE	539
Micro-Methods for the Analysis of the Nitrogenous Constituents of Urine	556
Appendix to Urine	564
1. The Pigments, 564 ; 2. Urinary Sediments, 565 ; 3. Urinary Calculi, 568 ; 4. Inborn Errors of Metabolism, 569 ; 5. Pathological Urines : (1) Diabetic, 570 ; (2) Protein, 571 ; (3) Blood, 572 ; (4) Bile, 572.	
ANALYSIS OF TISSUES	573
A. The Inorganic Constituents	573
B. Proteins	575
C. Nitrogenous Extractives	577
D. Carbohydrates	585
E. Lactic Acid	590
F. Aceto-acetic Acid	593
G. β -Hydroxybutyric Acid	597
H. Fat	601
I. Cholesterol	603
TABLES	605
LIST OF REAGENTS	610
INDEX	618

DEFINITION.

THE substances composing the organic material connected with the phenomena of life, and the great majority of the products of vital activity, are mixtures of compounds of the element Carbon.

From these substances the chemist has isolated numerous pure carbon compounds and prepared others ; he has also synthesised carbon compounds from their elements.

About 150,000 carbon compounds are now known. The possibility of their existence is due to the unique property which the element carbon possesses of being able to combine with itself ; compounds are known which contain in their molecules from one up to sixty atoms of carbon directly joined together.

Of these 150,000 carbon compounds only a small number are directly concerned in vital processes.

The chemistry of all the carbon compounds is termed organic chemistry.

The chemistry of those carbon compounds which are the constituents of living matter and are concerned in vital processes is physiological or biological chemistry ; the term physiological chemistry more frequently refers to the compounds and their functions in animals ; the term biological chemistry comprises the compounds and their functions in both plants and animals. The changes which they undergo and the functions which they fulfil in the living plant or animal form the subject of chemical physiology.

Though a distinction can be made between biological chemistry and chemical physiology, the two subjects are so closely interrelated that they are essentially only different aspects of the same subject. No biological change can be followed until a knowledge of the chemical properties of the substances involved has first been acquired. Chemical physiology is thus dependent on biological chemistry, or Bio-chemistry. Bio-chemistry is the branch of organic chemistry which deals with the natural organic compounds and with the functions of these compounds in nature.

RECOGNITION OF AN ORGANIC COMPOUND.

Organic compounds are distinguished from inorganic compounds by being combustible: on heating they generally char, sometimes take fire, and on prolonged heating completely burn away leaving no ash. Inorganic compounds when heated do not char and they leave a residue. A mixture of an organic compound and an inorganic compound will also char and leave a residue. There are a few exceptions to this general rule: oxalic acid and its salts amongst the organic compounds do not char on heating; amongst the inorganic compounds the ammonium salts volatilise leaving no ash. An oxalate leaves a residue of the oxide of the metal with which it is combined.

* The following experiments exemplify these statements:—

1. A small piece of paraffin wax heated upon platinum foil will melt, take fire, and will completely burn away leaving no residue.
2. A crystal of cane sugar heated in the same way will melt, char, and on further heating will disappear completely.
3. A few crystals of common salt heated on platinum foil will melt, and unless heated very strongly, e.g. with a blowpipe flame, will remain as a solid white mass when allowed to cool.
4. A small piece of soap heated as above will char, the vapours evolved may take fire, and when the charred particles have all vanished a white or nearly white residue will remain.

Note.—It is in this way that substances composed of organic and inorganic matter are recognised. The composition of the inorganic residue is found out by the usual methods of inorganic analysis after the organic matter has been destroyed by heating.

5. No appreciable change will be seen on heating a little oxalic acid or an oxalate, e.g. calcium oxalate.
6. Ammonium chloride volatilises on heating and leaves no residue.
7. To prove the presence of carbon in oxalic acid or in an oxalate the substance is heated in a small glass tube and the gases evolved are passed into lime or baryta water. A precipitate of calcium or barium carbonate indicates the presence of carbon.

8. On heating ammonium chloride as in 7, there is no formation of carbonate.

ISOLATION AND PREPARATION OF PURE ORGANIC COMPOUNDS.

CRITERIA OF THEIR PURITY.

The organic material which composes all animal and vegetable cells consists of a mixture of numerous compounds. In order to investigate their evolution and their degradation in nature it is necessary to separate these compounds from one another and to prepare each of them in a state of purity. The pure substance can then be analysed and its chemical and physical properties ascertained. Knowledge of the pure compounds shows their chemical relationship to one another and an idea of their rôle in nature is obtained. This idea is proved or disproved by an investigation of the changes which the organism, as a whole or individual portions of it, can effect in these substances.

In the study of the chemical properties of the compounds, other compounds are formed by their interaction. These compounds also require isolation and purification. The principal operations in organic and biological chemistry will thus consist in the isolation and preparation of pure compounds.

The methods of separating organic compounds are based upon differences in the properties of the substances under investigation. These differences are taken advantage of as much as possible ; sometimes they are so gross that the separation is simple, sometimes they are so small that the separation is of extreme difficulty, and in these cases a separation can only be effected when sufficient material is available.

Solid organic compounds are more numerous than liquid ; gases are comparatively rare.

Solids are most usually separated and purified by solution in water or organic solvents. The methods for the manipulation of liquids are therefore most frequently used and are described first.

I. PURIFICATION OF A LIQUID BY DISTILLATION— DETERMINATION OF THE BOILING-POINT.

A liquid is purified by distillation. The criterion of the purity of a liquid is its boiling-point. A pure liquid has a constant boiling-point.

* A. Drying and Cleaning of Apparatus.

Since organic liquids are very frequently not miscible with water all the apparatus which is used with them must be dry.

The apparatus may be dried in an oven for some time, but on removal to prevent deposition of aqueous vapour a current of air is blown through them whilst they are hot and during cooling. The current of air is most conveniently got from bellows, or by suction with a pump. The tubing, or if the glass vessel be narrow, a glass tube inserted in the tubing, is placed inside the vessel so that the farthest extremity is dried and cooled first.

More usually since the vessels are wet with water, they are rinsed with alcohol after draining as much water away as possible, then with ether after again draining. A current of air from the bellows or water-pump is drawn through to evaporate the ether. The vessel may be warmed in a luminous flame, when no more ether is present and the vessel is not quite dry, and air driven through as above. It is important that all the ether be evaporated, since it may become ignited or form an explosive mixture inside the vessel.

Apparatus which contains charred matter may be cleaned by oxidising it away with potassium bichromate and sulphuric acid, or by heating in it a mixture of concentrated sulphuric and nitric acids, washing with water and proceeding as above to dry it.

* B. Distillation of a Liquid and Determination of its Boiling-point.

The liquid is placed in a clean, dry fractionating or distilling flask—a round-bottom flask with a side tube in its neck¹—of suitable size so that only about half or at most two-thirds of the space is filled. Some small pieces of unglazed porcelain, or porous earthenware, or pieces of platinum, are added to ensure steady boiling without bumping. The neck of the flask is closed with a well-fitting cork² which

¹ With liquids of high boiling-point the flask should have the side tube low down so as to prevent decomposition by the high temperature.

² Rubber corks are dissolved by many organic liquids and consequently are not used, except in special cases.

is bored to carry a thermometer. The position of the thermometer is so adjusted that the bulb is just below or opposite the side tube and not touching the walls. The side tube is connected by a cork to a clean, dry condenser, which is supported by a clamp, and a slow stream of cold water is allowed to flow through the condenser. A receiver (flask) is placed at the other end of the condenser (Fig. 1).

A water condenser is not used for liquids boiling above 120° ; the vapours are condensed by being passed through a simple tube (the inner tube of the above condenser). The vapours of liquids boiling at very high temperatures are condensed in the side tube of the distilling flask. If the vapours condense to a solid on cooling, the solid is melted by a flame so that the liquid runs into the receiver and does not block up the side tube.

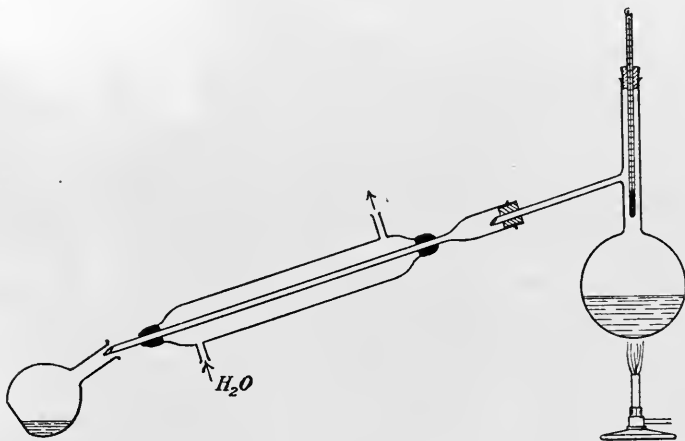

FIG. 1.

Liquids boiling below 100° are heated on a water-bath, liquids boiling above 100° are heated directly with a flame, which is moved round and round under the bottom of the flask until boiling begins. When boiling commences it must be kept on continuously and vigorously and not interrupted by the removal of the flame or by draughts.

When the vapour from the boiling liquid reaches the thermometer, the temperature is seen to rise rapidly, and then becomes stationary at a definite temperature. This is the boiling-point of the liquid. Drops of condensed liquid are usually seen to fall from the end of the thermometer into the flask. The heating is continued until all the liquid boiling at this temperature has distilled over into the receiver. The portion remaining in the distilling flask contains the impurities.

Towards the end of the distillation the thermometer may be seen to rise slowly and the last portion to distil 1° higher than the first portion. Most pure liquids boil over a range of $.5^{\circ}$ or 1° or sometimes more.

* Chloroform and aniline may be used as examples.

Correction for Boiling-point.

A correction should be applied when the mercury in the thermometer passes outside the neck of the flask as this portion is cooled below the temperature of the vapour of the liquid. The following amount is added to the observed temperature T —

$$n(T - t) \times .000154$$

where n is the number of scale divisions projecting, t the temperature of the air recorded by another thermometer held at a point about the centre of the projecting thread and screened from heat radiation from below by a sheet of cardboard.

A short thermometer registering only 50° and which can be completely inserted in the vapour is used for more accurate determinations. Sets of thermometers registering intervals of 50° between 0° and 360° can be purchased.

Determination of the Boiling-point of Small Quantities.

When insufficient liquid is available for distillation its boiling-point can be determined by placing it in a test tube and heating it through an opening in a sheet of asbestos. The thermometer is held in the vapour.

If only a few drops of liquid are available the boiling-point can be ascertained by introducing it into a small test tube, attaching the test tube to a thermometer by a rubber band and heating the two together in a beaker containing sulphuric acid. In the liquid is placed a piece of capillary tubing, a melting-point tube (p. 24) which is sealed *near* the end immersed in the liquid. As the temperature of the bath rises bubbles escape from the capillary and ascend through the liquid. At the boiling-point they form a continuous stream and the temperature of the bath is noted. Several determinations are made with fresh pieces of capillary and the mean will give the boiling-point of the liquid.

C. Distillation *in Vacuo*.

Liquids which boil at high temperatures and decompose on distillation under atmospheric pressure can frequently be distilled under reduced pressure.

The liquid is distilled from a fractionating flask, the side tube of which is inserted in another fractionating flask, or other stout vessel with a side tube, which acts as receiver. This is kept cold by allowing a stream of cold water to run over it; the water is collected in a funnel, which serves as a support to the receiver and it runs thence to the waste. The vacuum is produced by connecting the side tube of the receiver with a water pump or a mechanical pump. A gauge is in connection between the apparatus and the pump by a T piece so that the pressure can be ascertained.

To ensure continuous ebullition without bumping a slow stream of air, or carbon dioxide from a Kipp apparatus if the liquid tends to oxidise or decompose in the air, is passed through the liquid by inserting in the cork a tube with a long capillary which reaches almost to the bottom. The supply of air is regulated by means of a screw pinch on a piece of pressure-tubing placed on the end of the glass tube. The apparatus is shown in Fig. 2.

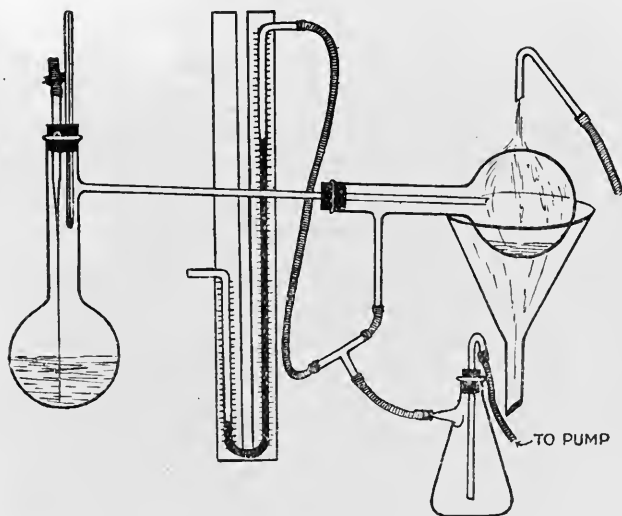

FIG. 2.

A distilling flask with a double neck as in Fig. 7 (p. 11) is more convenient than a simple distilling flask; the neck with the side tube carries the thermometer, the other neck the capillary.

The heating of the flask during distillation *in vacuo* is best effected by means of a bath; overheating is prevented, and the flask and its contents can be completely immersed which ensures a uniform temperature.

Rubber corks are used in vacuum distillation as they more easily prevent leakage in of air. If they are attacked by the vapours of the liquid they may be protected by placing a piece of cork between their ends and the vapours.

II. SEPARATION OF LIQUIDS.

A. Mechanically.

* (a) Two liquids, if they are not miscible, are easily separated from one another. They are placed in a tap funnel or separating funnel (Fig. 3), either cylindrical or pear-shaped according to the volume, the stopper is removed and the heavier liquid run out and collected. The lighter liquid is poured out through the top so as to avoid contamination by coming in contact with drops of the other liquid remaining in the stem.

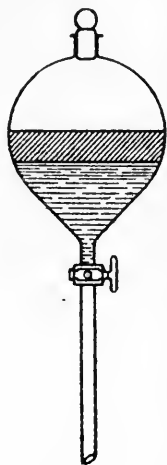

FIG. 3.

(b) Two liquids, if they are miscible, may not both be soluble in the same solvent; such a solvent must not be miscible with one of the constituents. On shaking the mixture with the solvent in a separating funnel, the mixture will separate into two layers. In shaking up two liquids in a separating funnel, the stopper of the funnel is held in the palm of one hand, and as usually an increase of pressure occurs, especially if ether and water be the liquids, the tap of the funnel is occasionally opened after allowing the liquids to settle at the other end. After thoroughly shaking, the liquids are allowed to separate, the stopper is removed and the heavier liquid is run out. The insoluble liquid is shaken up once or twice more with more solvent, and is purified by drying, if necessary, and distillation. The solvent, if water be one of the liquids, is dried by shaking it, or allowing it to stand for 12-24 hours with solid calcium chloride, or sodium sulphate, or potassium carbonate. It is separated from the soluble constituent by fractional distillation, or treated as the case necessitates.

* As an example, a mixture of equal parts of alcohol (50 c.c.) and chloroform may be made. On shaking up with two volumes of water in a separating funnel, the chloroform separates and sinks. It is removed and the other constituents are poured out. The chloroform is returned and shaken once more with water. It is run out and the moisture is removed by shaking or standing with some calcium chloride from which it is filtered and then distilled.

B. Fractional Distillation.

A mixture of two or more miscible liquids may be separated from one another by fractional distillation if their boiling-points differ by 20-30°.

The mixture is distilled as described previously (p. 4), preferably from a flask with its side tube high in the neck and the thermometer is carefully watched. The first portion which distils will consist mainly or entirely of the more volatile constituent which has a higher vapour pressure; the last portion will consist of the less volatile constituent having a lower vapour pressure or higher boiling-point. Between these portions there may be a small intermediate fraction consisting of a mixture of the liquids. The three portions or fractions are collected in separate receivers.

E.g.—

A mixture of equal volumes of chloroform and aniline will give on fractional distillation a fraction boiling at 61° (almost pure chloroform), an intermediate fraction, and a final fraction boiling at 183° (almost pure aniline). During the distillation of such a mixture when the boiling-point of a constituent exceeds 120° the water should be run out of the condenser.

Redistillation of the first and last fractions will give each of them in a state of purity.

If a mixture of liquids contains constituents which have boiling-points fairly close to one another, the fractionation must be repeated several times until each fraction is found to have a constant boiling-point.

The separation of such a mixture is greatly facilitated by the use of a fractionating column or still-head. This is simply a device to lengthen the neck of the distilling flask so that the higher boiling fractions are exposed to the air and condensed before they reach the condenser and run back into the flask. Numerous forms have been invented; two efficient forms are those of Hempel and of Young (pear still-head, Fig. 4).

The former consists of a glass tube filled with glass beads and a side tube. The latter consists of a piece of glass tubing upon which are blown 2, 3, 4 or more bulbs of a pear shape, and a side tube. The liquid is placed in a round-bottom flask, the fractional column inserted and this in turn connected by its side tube to the condenser. The mixture in the flask, to which several small pieces of



FIG. 4.

porous earthenware have been added, is heated over a gauze at such a rate that the condensed liquid comes over drop by drop. Fractions are collected at 5° or 10° ranges of temperature.

The redistillation of each fraction is carried out as follows: In the apparatus which has been washed out and dried fraction I is put which boiled, say, at 90-95°, and distilled till the thermometer shows 95°, when the distillation is stopped and fraction II, 95-100°, is added to the remainder in the flask. On distilling, fractions below 95° are collected in the first receiver and the second fraction is distilled till the temperature reaches 100°. Distillation is stopped and the next fraction added. The process is continued until all the fractions have been redistilled. Finally the main fractions boiling at the extremes will be obtained.

A mixture of benzene, toluene and xylene, such as occurs in coal tar, may be taken in illustration.

Constant Boiling Mixtures.

It frequently happens that two liquids form a mixture which has a constant boiling-point and behaves like a single liquid. Such a mixture cannot be separated by fractional distillation, although more or less separation may be possible by distilling at a different pressure.

Such a mixture may have a boiling-point which is lower than either of its constituents, or higher.

Excess of either constituent in the mixture beyond that forming the constant boiling mixture can be separated by fractional distillation and it will distil over either before or after the mixture according to the boiling-points. Such constant boiling mixtures are mixtures of ethyl alcohol and water, methyl alcohol and acetone, benzene and alcohol, pyridine and water, water and formic acid, chloroform and acetone. They can only be separated by chemical means.

Fractional Distillation *in Vacuo*.

The same apparatus as described above for distillation *in vacuo* can be used for fractional distillation *in vacuo*, but as each fraction distils the apparatus must be disconnected so as to insert a new receiver. To avoid releasing the vacuum and disconnecting the apparatus, and to allow fractional distillation to proceed continuously several contrivances have been suggested. Usually the vapours of liquids distilled *in vacuo* condense without being cooled by water or ice, and an apparatus as in Fig. 5 may be used. The receivers are turned into position when necessary. A very simple form is shown in

Fig. 6: the apparatus can be rotated on the cork connecting it with the distilling flask when a new fraction begins to distil over.

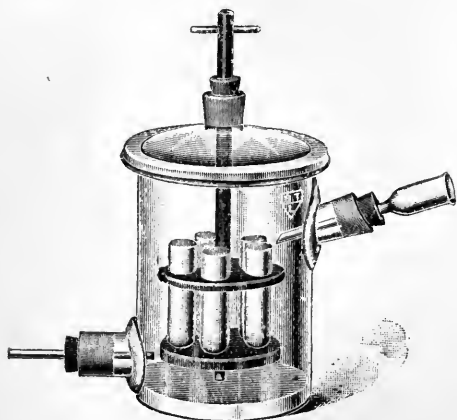

FIG. 5.

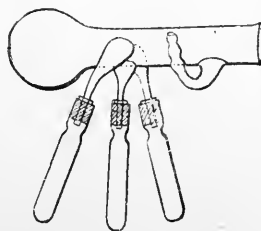

FIG. 6.

An apparatus of the type in Fig. 7 is the most convenient. By means of the several taps the receiver can be shut off and its vacuum released, whilst distillation continues and the fraction collects in the bulb. The fresh

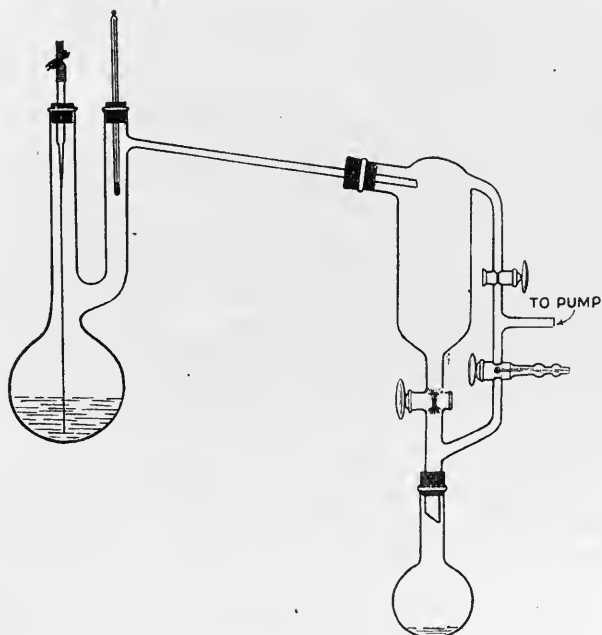

FIG. 7.

receiver is exhausted whilst the taps to the bulb and distilling flasks are closed; no great decrease of vacuum occurs as the small receivers are rapidly exhausted.

If necessary the bulb and receiver can be cooled by a stream of cold water, or by immersing the receiver in ice or a freezing mixture.

C. Steam Distillation.

Very frequently a separation of a liquid or a solid from a mixture can be effected by the process of steam distillation. The liquid, or solid, has usually a higher boiling-point than water, but the vapours of the liquid and of the water do not interfere with each other. The effect of the steam is to reinforce the vapour pressure of the liquid, so that the liquid distils with water under atmospheric pressure at a lower temperature.

Steam is generated in a large flask, or tin can, which is provided with a cork carrying a long safety tube about 80 cm. long, reaching almost to the bottom, and with a delivery tube. The flask is half-filled with water. The delivery tube when the steam is ready is connected to the flask containing the mixture. This flask is placed in a

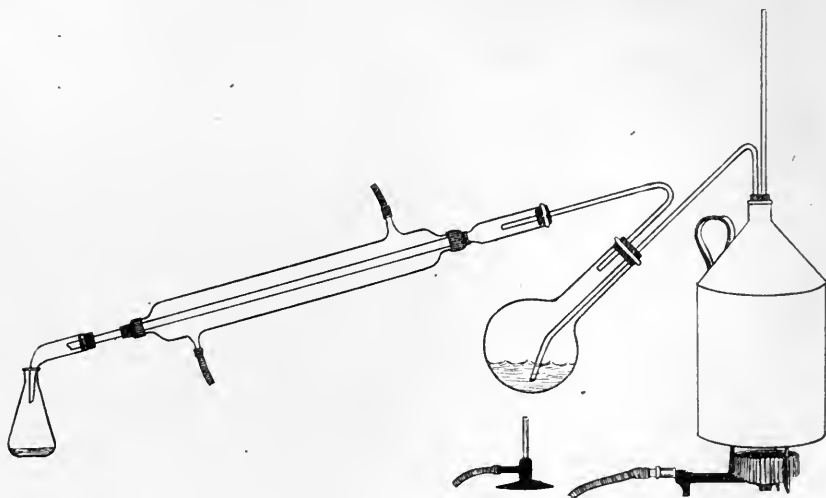

FIG. 8.

sloping position so as to prevent splashing of its contents and mechanical carrying over of substance into the condenser. The steam is passed into the bottom of the vessel by a tube which is bent so that its end lies in a vertical position, and to prevent condensation of the steam the flask is also heated. The steam and other vapour reach a long condenser by which water and substance are condensed and are collected in a receiver (Fig. 8).

The separation of substance and water is effected by filtration if solid, by simple separation if liquid, or by extraction with a solvent such as ether, chloroform, etc. The solvent is then dried, removed by distillation, and the substance or substances obtained by distillation or fractional distillation.

EVAPORATION OF LIQUIDS.

Only aqueous solutions can be evaporated over a flame, and the evaporation should be completed over a water-bath to prevent charring the substance as it becomes concentrated. Evaporation over a flame must be carefully watched to prevent charring and also to avoid spurting when the solution begins to concentrate.

Most organic liquids which are used as solvents are readily inflammable and must not be brought near a flame.

When a considerable amount of solvent is present it is removed by distillation and in cases where the solvent (ether, acetone, ligroin, etc.) is very readily inflammable the distillation must be carried out on a water-bath, heated by a flame specially protected by a gauze, or by steam, or electrically. If the bath be heated by a burner, the end of the condenser should be placed as far away as possible and a sheet of cardboard or asbestos interposed between the burner and receiver.

Not only is evaporation by distillation absolutely necessary with inflammable liquids, but also it is economical. The solvent is recovered and after purification can be used again.

When only small quantities of liquids up to 25 c.c. require evaporation they are set aside, away from flames, and allowed to evaporate spontaneously, or they may be put upon a warm water-bath, with the flame extinguished.

Another common procedure is to evaporate small quantities by placing them in a vacuum desiccator and exhausting. The evaporation is greatly accelerated if the liquid be previously warmed on a water-bath and whilst warm put into the desiccator.

Evaporation *in Vacuo*.

Evaporation *in vacuo* is the most rapid method of concentrating solutions, especially if the temperature can be kept at an elevated point.

Very frequently evaporation of solutions must be carried out at a low temperature (35-45°) to prevent decomposition. This is carried out in the same way as distillation *in vacuo*, the distilling flask being kept in water at 35-45°. With large flasks of 2-3 litres capacity and a good vacuum of about 15 mm., a litre of water can be distilled off in 2-2½ hours at 35-45°. Instead of a distilling flask an ordinary flask fitted with capillary and bent tube may be used and a similar one as receiver.

Frothing During Evaporation *in Vacuo*.

Aqueous solutions of extracts of plant or animal matter have a great tendency to froth during concentration *in vacuo*.

The froth can be broken by allowing drops of alcohol to fall upon it from a tap funnel inserted into the distilling flask. The alcohol vapour helps in the evaporation when the vacuum has been established.

The liquid to be evaporated can be allowed to flow into the exhausted vessel through a spiral tube at such a rate that no large volume is ever present in the flask.

A contrivance to catch the froth and return it to the flask has been devised by Davis and Daish. It has been very useful for evaporating plant extracts. It is shown in Fig. 9.

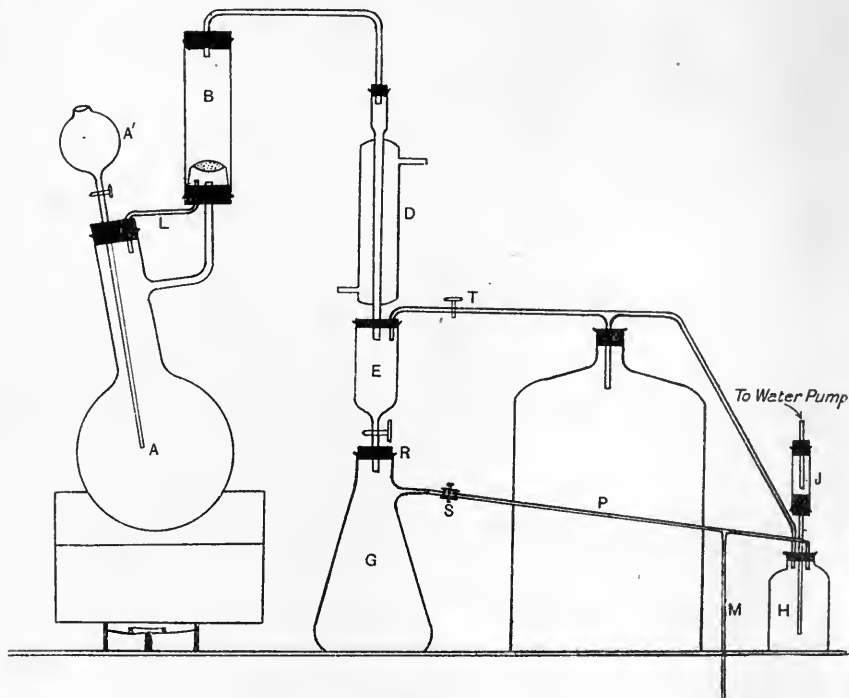

FIG. 9.—From the *Journal of Agricultural Science*, Vol. V, p. 435 (Cambridge University Press).

Any froth which is formed is broken by the piece of copper gauze in B and the liquid runs back into the flask A: The vapours are condensed by the condenser D and collected in G. The glass piece E is introduced so as to allow of the emptying of G: the tap is turned and the screw clamp on the pressure-tubing at S closed; liquid collects in E whilst G is removed, emptied, replaced and evacuated. The tube M leads to a manometer, the bottles P and H and the valve J serve to regulate inequalities of pressure.

III. SEPARATION OF SOLID AND LIQUID. FILTRATION.

The mixture of solid and liquid may consist of suspended particles consisting of residues of filter paper, etc., which do not require examination, or it may consist of matter requiring examination, obtained either naturally or by evaporation of the liquid, or it may consist of solid in a crystalline form purified by crystallisation.

Obviously the procedure to adopt is filtration. Filtration is effected in several ways depending on the material.

(a) Fluted or Pleated Filter Paper.

Suspended matter is removed by filtration through a filter paper folded in the ordinary way to fit a funnel, or better and more rapidly through a fluted or pleated filter paper which exposes as large a surface as possible to the liquid. A filter paper is folded into quarters in the ordinary way. Each quarter is then bisected by folding towards the hollow of the central fold, and each of these divisions is bisected again in such a way that the hollows and ridges alternate (Fig. 10). More pleats are obtained in the same way by bisecting the divisions and folding alternately. The paper is thoroughly pressed to make the pleats permanent.

Such a filter paper is used for rapidly filtering off a small number of particles and also for filtering off solid matter which is not crystalline, such as the residues remaining after extracting animal and plant tissues with solvents, residues which are not easily filtered by the other methods.

(b) Filter Plate. Buchner Funnel.

The filtration of crystalline compounds is best effected by means of a perforated porcelain plate placed in a funnel or a complete funnel of porcelain of this pattern (Buchner or Hirsch funnel). The perforations are covered over with a filter paper of the right size and to prevent breaking of the paper two thicknesses may be used, or better hardened filter paper. The paper is wetted with the liquid and sucked down by a vacuum produced by a filter pump (Fig. 11).

The substance is placed upon the paper and the liquid drained off as

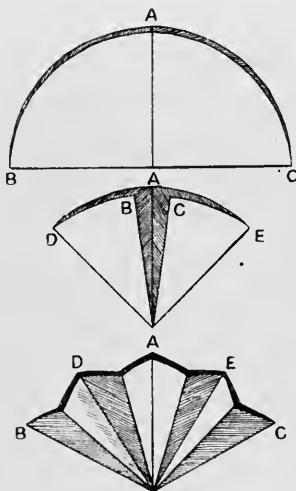

FIG. 10.

completely as possible, the solid being pressed down with a spatula or flat piece of glass. The solid is washed two or three times with solvent which is added in small portions. The whole of the solid must be wetted and the solvent drained off completely before more is added.

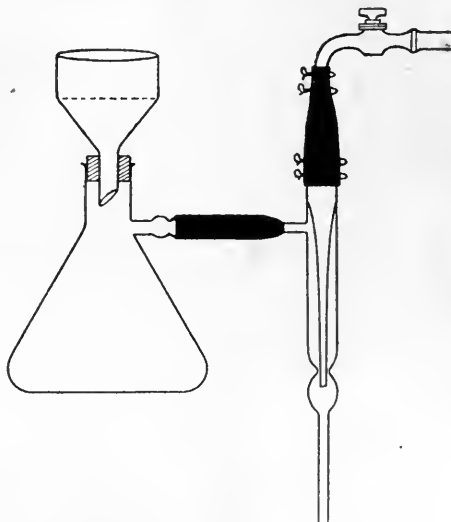

FIG. 11.

(c) By Filter Presses.

Large quantities of solid matter with small amounts of liquid are separated by means of a filter press. The material is pressed either between layers of cloth or in a sheet of cloth which can be folded to make a sort of bag. Squeezing by hand in the latter method will remove some of the liquid and the greater pressure from a press will remove nearly all. The dry residue can be taken out, stirred up with solvent and again pressed out.

The greatest pressure usually attainable is from a Buchner press or a hydraulic press. The solid matter must be in a fairly dry condition and, if moist, is mixed with some absorbent, generally siliceous earth or "Kieselguhr". Liquid is squeezed out of this mass by the high pressure.

Subsequent filtration through a fluted paper is usually necessary after filtration by a filter press as particles come through the pores in the cloth.

(d) Through a Layer of Neutral Material.

Solutions containing colloidal particles are generally most difficult to filter as the particles either come through fluted filter paper or soon clog the pores.

Osborne has used filter paper pulp as a medium for filtering solutions of proteins. A sufficient quantity of pulp is mixed with the liquid and this is poured upon the paper on a Buchner funnel, where it forms a layer exposing a large surface and prevents the underneath paper from breaking and becoming clogged.

A layer of siliceous earth upon a Buchner funnel has also been found very effective. A sufficient quantity of the siliceous earth is mixed in a small mortar with the liquid and poured upon the funnel so as to form a layer from 1-2 cm. thick, and the liquid is then filtered through this.

The first portions of filtrate may be cloudy, and must be returned to the filter and filtered again.

IV. PURIFICATION OF SOLIDS BY CRYSTALLISATION.

The majority of solid organic compounds are crystalline, but many of the complex solids, such as starch, glycogen, various proteins, which belong to the class of substances termed colloids, have not yet been prepared in a crystalline form and are only known in an amorphous state. Others, such as the fats, though obtainable in a crystalline form, are mixtures of closely related substances and it is extremely difficult, or almost impossible, to separate them into individual compounds.

The separation of a solid in a crystalline form is essential to its preparation in a pure condition. Its recrystallisation, when once obtained in a crystalline form, will lead to its preparation in a state of purity.

The criterion of the purity of a crystalline solid compound is its melting-point. A pure solid organic compound melts sharply at a definite temperature. An impure organic compound does not melt sharply and it melts at too low a temperature. The knowledge of the melting-point of a compound helps in its identification.

(a) Choice of Solvent for Crystallisation.

The purification of a solid by crystallisation depends very largely upon the choice of a suitable solvent. The best condition for purification is very slight solubility in the cold solvent and ready solubility in the boiling solvent. A hot saturated solution of the solid will deposit the greater part of the solid in a crystalline condition on cooling, and if the solution be allowed to cool slowly the crystals which are deposited will be more regular than if the solution be cooled rapidly.

In order to ascertain the solubility of a substance in a solvent the substance must be in a fine state of division. A small quantity of the substance is finely powdered in a watch glass with a glass rod, or better in a small agate mortar with a pestle.

A few milligrams of the substance are then placed in a small test tube, a few drops of solvent are added and the solid well stirred or shaken with it. If the solid is apparently not soluble in this amount of solvent more is gradually added, and so it can be determined whether the substance is easily soluble, moderately soluble, or insoluble in the cold liquid.

Substances which are readily soluble in cold solvent are not usually recrystallised from this medium since there will be no great difference in solubility in the hot and cold liquid, and a large quantity of solid will remain in solution even when crystals are obtained.

The solvent in those cases where the substance is slightly soluble or insoluble is now heated; if the solid dissolves easily more is added until the solution is saturated; if not, more solvent is added so as to bring, if possible, the solid into solution. The solution is cooled by holding under running water and it is noticed how much of the solid crystallises out. If a considerable quantity separates out, the solvent will probably be suitable for recrystallising larger quantities.

Sometimes crystallisation does not occur spontaneously on cooling, but it may be started by scratching the sides of the test tube or by adding a crystal of the solid.

The following solvents are most frequently used :—

- | | | |
|-------------|----------------|-------------------------|
| (1) water | (4) benzene | (7) glacial acetic acid |
| (2) alcohol | (5) chloroform | (8) methyl alcohol |
| (3) acetone | (6) ligroin | |

* The following substances—cane sugar, oxalic acid, benzoic acid, urea and succinic acid—may be taken as examples for observing the difference in solubility in water and alcohol, and for the choice of solvent for crystallisation.

(b) Recrystallisation.

If the suitable solvent has been found to be water, or glacial acetic acid or a liquid which is not inflammable and boils at a fairly high temperature, the recrystallisation may be carried out in a beaker heated over a gauze.

If the suitable solvent has been found to be alcohol, acetone, ligroin, benzene—liquids which are volatile and inflammable—the recrystallisation must be carried out in a flask to which is attached a reflux or inverted condenser, as in Fig. 12.

Solvents boiling below 90° are heated on the water-bath, above 100° over a flame through a wire gauze and with an air condenser (inner tube of condenser or a tube about 80 cm. long by 1.5-1 cm. in diameter) as reflux.

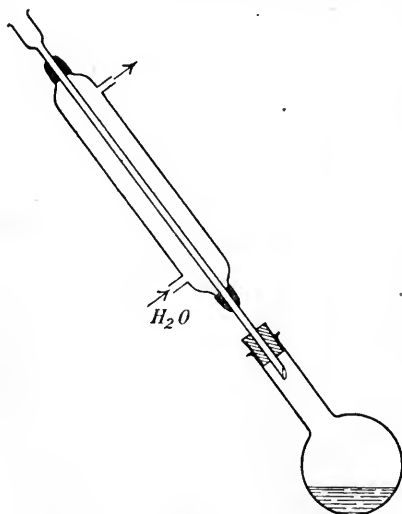

FIG. 12.

(i) Solution.

The substance to be recrystallised is powdered finely and placed in a flask or beaker with a small quantity of solvent. Excess of solvent must be avoided as the object is to prepare a hot saturated solution. The solvent is boiled. If, after boiling for some time, a considerable amount of solid remains, more solvent is cautiously added (through the condenser) and the boiling continued; solvent is added until the whole of the solid, except insoluble matter, is dissolved. It should be noted that the last portions of a solid often only dissolve with difficulty and fresh solvent should not be added too soon.

(ii) Filtration.

Particles of insoluble impurity are now filtered off by rapidly filtering the hot solution through a pleated filter paper. Very frequently the solution is very concentrated and begins to crystallise immediately filtration is commenced. To avoid this a funnel with a very short stem or without stem is used, and it is previously heated in an oven or by passing through a flame; the solution is filtered whilst it is still hot.

When the tendency to crystallise immediately is very pronounced the filtration must be carried out through a funnel heated by steam. The funnel may be surrounded by coils of metallic piping through which steam from a generator is passed, or it may be enclosed in a larger metal funnel with two walls between which there is water and from the outer of which there is a projection for heating the contents by a flame. Care must be taken that inflammable liquids do not become ignited if this form of hot-water funnel be used. The water can be raised to boiling and the flame removed.

If crystallisation of solid should commence during the filtration, the funnel and paper are placed over the flask, the paper pierced and the particles washed with a little solvent into the flask and the solution again boiled up.

The filtrate is collected in a beaker of such a size that it is not filled more than two-thirds.

Some liquids "creep," and if the vessel be filled too full or if shallow dishes be used the solution will creep over the edge and deposit crusts of impure crystals over the edges.

If crystals begin to separate before the filtration is completed, it is best to heat the filtrate until solution is again effected. To exclude dust and prevent evaporation, the beaker is covered with a clock glass with its convex side uppermost. Condensed drops of solvent will then run towards the side and not drop into the liquid and disturb the formation of the crystals. The solution is set aside in a cool place to crystallise.

Crystallisation may be complete as soon as the solution is cold, or it may take several hours, or days.

(iii) Collecting of Pure Crystals.

Any crusts of crystals which may have formed on the sides and edges of the vessel by evaporation must be removed before the remainder of the crystals are collected, as they are impure. They are carefully scraped off with a spatula and collected and returned to the mother liquor after filtration.

The pure crystals are collected on a filter plate or on a Buchner funnel (p. 16). The vessel is rinsed out with a little solvent which is used also for washing the crystals, and washing is done two or three times.

(iv) Drying of Pure Crystals.

The crystals are left to drain as completely as possible in the funnel and are then transferred to either

- (1) several thicknesses of filter paper and the liquid pressed out;
- (2) a piece of unglazed porous plate, carefully dusted before use;
- (3) a watch or clock glass and dried in the air.

To keep out dust they are covered over by a clock glass or funnel which is raised up about 2 cm. on supports so that an air space is left for the solvent to evaporate; this may take 24 hours; or they are dried by placing them in a vacuum desiccator over sulphuric acid, soda lime, etc.

Sometimes the crystals, if placed on a watch glass and when they are nearly free from solvent, are dried by putting the glass containing them on a boiling water-bath. The crystals in this case should not melt below 100° or contain sufficient solvent that they dissolve in it on warming. They are cooled by placing in a desiccator.

Some substances, e.g. carbohydrates, are very difficult to dry completely, but can be obtained anhydrous by keeping them *in vacuo* at 100° or 130° in presence of phosphorus pentoxide for a few hours. A convenient form of apparatus for drying such compounds is shown in Fig. 13. The substance is put into a tube or boat and placed in the central vacuum vessel. This is connected by a ground joint to a bulb containing P_2O_5 in the neck of which there should be some glass wool to prevent P_2O_5 from entering the vacuum tube. It is exhausted and heated by inserting in a jacket tube, which is kept hot by the vapour of a liquid boiled in a flask below and condensed above.

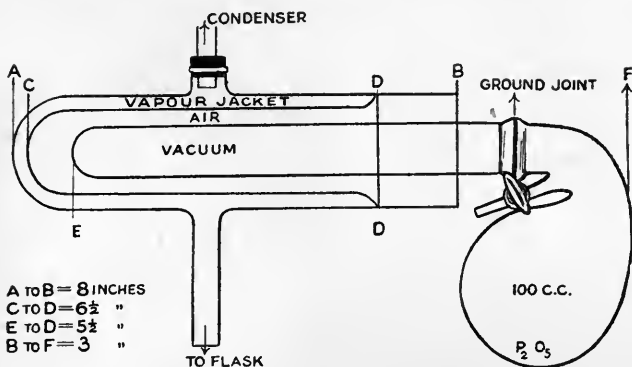

FIG. 13.

(v) Mother Liquor.

The mother liquor generally contains some dissolved solid, which should be recovered. The impure crusts, if any, are added to the liquid and the liquid is concentrated by distilling or evaporating (p. 13) until crystals begin to separate. The solution is poured or filtered into a beaker and allowed to cool; a second crop crystallises out and is treated as above. A third and more crops may be obtained on further concentration. These are not so pure as the original crop, but may be recrystallised and obtained pure.

(vi) Decolorising Solutions.

Substances containing tarry or resinous impurities or colouring matter cannot sometimes be freed from them by simple recrystallisation. During recrystallisation and while the solid is in solution (especially aqueous or alcoholic), the solution is boiled for 2-5 minutes or longer with a small quantity of blood charcoal which is removed by filtration. The first portions of filtrate generally require filtering again through the same paper as the finely divided charcoal passes through at first. To remove colouring matter from a solution which should be colourless, prolonged boiling with several quantities of charcoal is sometimes necessary.

* The purification by crystallisation of about 5 gm. benzoic acid, oxalic acid and succinic acid from water and of urea from alcohol serve as simple examples of the method of recrystallisation.

(c) Crystallisation from a Mixture of Solvents.

A solid may be too readily soluble in some solvents, but insoluble in other solvents, and consequently its recrystallisation from a single solvent may be difficult. Crystallisation may be then effected by using a mixture of solvents. A concentrated solution is made in the hot solvent and the other solvent is added whilst the first is still hot until the mixture becomes turbid, when it is allowed to cool. Sometimes it is better to add the second solvent to a strong solution until it is turbid, heating until the turbidity has gone, and adding, if necessary, more of the first solvent. On cooling crystals may appear.

Alcohol and water, acetone and water, benzene and ligroin, chloroform and ligroin, alcohol and ether are mixtures of solvents frequently used.

Trials should be made to ascertain the best mixture of solvents.

(d) Crystallisation by Evaporation.

Another possibility is that the substance is easily soluble in all solvents. Crystallisation is then effected by partial evaporation. The filtered solution is placed in a shallow dish, i.e. a crystallising dish; it is covered with a funnel or clock glass which is raised up so as to leave an air space and the dish is preferably placed on a clock glass in case the solution creeps, so that the crystals can be scraped up without contamination from the bench. Crystals gradually form and they are removed before complete evaporation has occurred. Crusts are removed and treated as described above; the crystals are filtered off, washed with very little solvent and dried. The mother liquor in this case will contain a large amount of solid.

The evaporation need not be conducted in the air; it may be hastened by placing the solution in a desiccator over sulphuric acid, etc., and under reduced pressure, or by evaporation by distilling the solution; if aqueous, evaporation over a flame or on a water-bath.

(e) Solids Soluble with Difficulty in all Solvents.

If a solid is almost insoluble in all solvents recrystallisation is effected, after preliminary testing, by boiling the solid for some time with the best solvent, filtering off the insoluble portion, and evaporating the filtrate to a small volume. The crystals which separate are treated in the way described above.

Operations with Small Quantities.

Filters of small sizes are obtainable to retain the solid. Small filter flasks to contain the mother liquor are obtainable in the shape of test tubes, or a test tube may be placed inside the filter flask so that the mother liquor collects in it.

When there is too little solid and mother liquor for filtration, the crystals and mother liquor are placed upon a piece of porous earthenware or between sheets of filter paper, so that the liquid is absorbed.

Recrystallisation of the solid may be effected in a small test tube, and the mother liquor may be dissolved out of the filter paper or earthenware, if required.

*** DETERMINATION OF THE MELTING-POINT.**

A small quantity of the finely powdered substance is introduced into a melting-point tube; this is attached to a thermometer and the two are heated together in a bath until the substance is seen to melt. The first determination of an unknown substance is usually only approximate: it is repeated, heating rapidly to within 10° and then more slowly.

A small beaker containing water is used as a bath if the melting-point is below 100° , and the thermometer in a cork is held in the centre of it by a clamp. The beaker is heated over a gauze by a small flame and the liquid is stirred with a circular glass stirrer.

A flask of about 50 c.c. capacity with a long neck (10-20 cm.) filled about two-thirds with strong sulphuric acid is more generally used. The thermometer is secured in a cork into which a notch is cut to

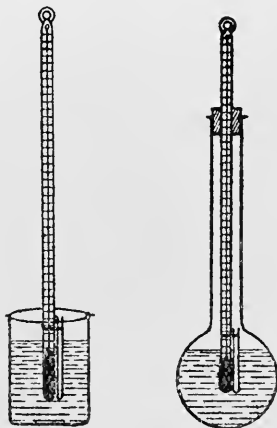

FIG. 14.

allow hot air to escape when the flask is heated and to see the graduations if the mercury reaches this level. The flask is held by a clamp and heated with a flame directly, the burner being inclined at an angle and held by the hand so that it is heated round and round and not directly in the centre (Fig. 14). After frequent use the acid becomes dark in colour, but it will become clear again if a tiny crystal of potassium nitrate be added.

Paraffin wax is most generally used when the melting-point of a substance is above the boiling-point of sulphuric acid (290°). The solid substance is introduced and melted until it fills two-thirds of the space. It becomes brown after being used several times and must be renewed

A melting-point tube consists of a capillary of thin glass about 1 mm. in diameter, 5-6 cm. long and closed at one end. It is made by heating near one end a dry piece of glass tubing of about 1 cm. bore in a blow-pipe flame until it is red-hot and soft, removing it from the flame and pulling it out carefully just when the glass begins to harden. A long capillary tube is thus made. Several more such lengths can be made from the glass tube if the capillary so made be broken off about 2-3 inches from the remainder of the glass tube. The long capillaries are cut into short lengths of about 5-6 cm. by scratching at these distances with a file and breaking by bending. Short lengths and lengths of too small bore must be rejected. One end of each capillary is sealed by holding it in a small flame. The tubes so made are preserved in a corked dry test tube.

The powdered substance is introduced by scooping up solid with the open end and making it fall to the other end by gently tapping the closed end on the bench. This process is repeated until sufficient of the substance to occupy a length of 2-5 mm. in the capillary has been introduced and shaken down, or pushed down with a fine wire, so as to form a compact and continuous layer.

The filled melting-point tube is attached to the thermometer so that the substance is on a level with the bulb. If a bath of water or paraffin wax be used the attachment is made with a strip of rubber cut from a length of rubber tubing. If a bath of sulphuric acid be used the attachment is made by adhesion. The thermometer is wetted with acid and if held horizontally the acid runs along it. The melting-point tube is wetted with acid by drawing it along the thermometer and it will adhere when the surfaces of contact are wet and will not fall off on putting it carefully into the bath.

* The pure specimens of benzoic acid, succinic acid and urea may be used for determination of the melting-point.

Corrected Melting-point Determinations.

Just as in the case of boiling-point determinations a correction should be made for the thread of mercury outside the bath. The small thermometers of 50° range may be used and attached by platinum wire to the ordinary thermometer. A corrected thermometer is generally used which has been calibrated against the small ones.

V. SEPARATION OF SOLIDS.

It is almost impossible to formulate a general scheme for the separation of a mixture of solids. The separation depends to a very large extent upon whether all the constituents, or whether only one constituent, or whether one or more groups of compounds in the mixture, is to be investigated; it depends also upon the nature of the constituents in the mixture and of those requiring separation.

A scheme of extraction with various solvents, such as the following, may be adopted for the separation of the constituents in a natural product.

Extraction with Solvents.

The solvents most commonly used in separating one or a group of constituents from plant or animal material are:—

- (1) Ether, chloroform, petroleum ether, acetone, methyl alcohol.
- (2) Dilute mineral acid (HCl).
- (3) Dilute alkali—sodium carbonate and sodium hydroxide.
- (4) Water or glycerol.

When solvents such as ether, petroleum ether, etc., which are not miscible with water are used as the first solvent, the material is generally dried preparatory to their use.

The extraction of the material can be carried out in several ways:—

(1) If ether, etc., be used, the extraction is effected in a Soxhlet apparatus (p. 178), or, more simply, by hanging up the material in a paper or linen bag in a wide tube so that condensed liquid falls upon the material and from the material back to the extracting solvent.

(2) In a percolator.

(3) Or simply in a glass or metal vessel. The mass is frequently stirred with the solvent and filtered off and the residue pressed out.

Drying of Material.

Plant and animal tissues are composed to a very large extent of water, which varies from 10-75 per cent. in amount, and in order to ensure proper contact of solvent, which is immiscible with water, with the material it is necessary to dry it before extraction.

Plant tissues are generally more easily dried than animal tissues; the material is brought into a fine state of division by chopping, or grinding, or some other process, by hand or by machinery, and it is exposed to temperatures ranging from 40-100°, depending on the constituent required.

Animal tissues which consist mainly of protein are more troublesome to obtain in a dry state. They are more difficult to bring into a fine state of

division and on simple drying by exposure the surface forms an impenetrable skin, preventing evaporation of water. Mincing, chopping, grinding with sand and other processes are used to prepare them for drying.

It is essential that drying be carried out rapidly to prevent metabolic changes going on during the process of drying.

(a) **Exposure to Air or Indifferent Gas.**

The finely ground material is spread over a large surface on glass plates, or if vegetable on a metal mesh. It can be left exposed to air at the ordinary temperature or in a room or box at 40° or higher, or better by blowing a current of clean air, heated to 40°, over the surface. To prevent oxidation of the constituents during drying, the material is placed in a vacuum desiccator or suitable chamber through which a current of carbon dioxide or nitrogen can be blown instead of air.

After exposure to air or indifferent gas, more water can generally be removed by placing the material in a vacuum desiccator over dehydrating agents.

(b) **Treatment with Alcohol, or Acetone.**

Since alcohol and acetone are miscible with water in all proportions, they not only help to remove water, but also they disturb the conditions in the tissue, which are necessary for metabolic changes, by precipitating proteins, etc., and by disturbing the peculiar solubility of fatty and protein material. The material is mixed with about an equal bulk of solvent or sufficient to cover it completely and the mass is allowed to stand for 12-24 hours. The material may be put into boiling solvent and heated for about an hour.

The solvent is filtered or strained off and the tissue treated again with the same solvent, or with ether, etc. Substances are soluble in the mixture of alcohol or acetone and water separated from the tissue and this extract requires examination.

(c) **Admixture with Neutral Dehydrating Agent.**

Animal tissues after grinding are sometimes mixed with anhydrous sodium sulphate, or calcium sulphate, by grinding together equal parts in a mortar. The mixture sets after some time to a cake which can be finely ground and extracted with ether, acetone, etc. By boiling with alcohol proteins are coagulated and the other constituents may be extracted with water.

ISOLATION OF SOLIDS FROM SOLUTION.

The extracts obtained above, either directly or after concentration by evaporation, evaporation *in vacuo*, distillation, etc. (if acid or alkaline after neutralisation), or solutions of solid compounds whether natural or obtained by chemical reactions between compounds, may be treated in several ways in order to separate the solid compound.

A. Precipitation.

(i) By adding another solvent.

(ii) By acidifying. Aqueous or alkaline aqueous extracts may contain acids. On acidifying with mineral acid, the acid or acids, if they are insoluble or soluble with difficulty in water, will be precipitated.

(iii) By making alkaline. Aqueous and acid extracts may contain bases ; when made alkaline with sodium carbonate or sodium hydroxide, the base or bases may be precipitated.

(iv) If no precipitate has been obtained in (ii.) or (iii.) the solution may be submitted to steam distillation. Volatile acids and bases distil over.

(v) Acids may be precipitated from the exactly neutral solution as insoluble salts of heavy and other metals by adding lead acetate, mercurous nitrate, calcium chloride, etc.

(vi) Bases may be precipitated by adding to the previously acidified solution phosphotungstic acid, or other reagents used for precipitating alkaloids from solutions.

(vii) Bases may be precipitated (especially from alcoholic solution) as double salts with mercuric chloride, gold chloride, platinum chloride.

B. Extraction.

The acid or alkaline extract may be extracted with an immiscible solvent by repeated shaking or by means of an extractor (p. 600).

C. Fractional Crystallisation.

The solution on evaporation may deposit crystals. On filtering and evaporating further, another crop of crystals may be obtained.

D. Salting Out.

Proteins, polysaccharides, soaps and other complex compounds separate out when their aqueous solutions are saturated with sodium chloride, magnesium, zinc and ammonium sulphates.

E. Dialysis.

Mixtures of colloids and crystalloids are separated by dialysis.

F. By Preparing Suitable Chemical Derivatives.

Some knowledge of the chemical nature of the compound is essential before a derivative can be prepared. The principal reactions of the various groups of compounds are given under the separate headings.

Two other procedures are occasionally employed in separating solids :—

(i) **Sublimation.** On carefully heating a mixture in a basin, one or more solids may be volatilised. The vapours are condensed on a cool clock glass or funnel and the substance is thus obtained.

(ii) **Sedimentation.** A mixture of solids of different specific gravity may be separated by shaking with a liquid of suitable density.

Separation may not be effected by applying any one of the above methods. Usually only an incomplete separation is made and further separation is carried out by using another method.

COMPOSITION OF ORGANIC COMPOUNDS.

A pure carbon compound which has been prepared is analysed, i.e. the elements besides carbon contained in it and their amounts are determined.

Carbon compounds may contain the elements hydrogen, oxygen, nitrogen, halogens, sulphur, phosphorus, etc., either singly or collectively. Usually all the possible elements are not present, but the proteins contain carbon, hydrogen, oxygen, nitrogen and sulphur; some contain also phosphorus and a few contain halogens. Proteins belong to the most complex of the organic compounds. The method of analysis of the compound is varied according to the elements which are present. The elementary composition, or detection of the elements, precedes the quantitative composition. Since all organic compounds contain carbon and most of them contain hydrogen it is not absolutely essential that the presence of these elements should be ascertained. Their quantitative analysis is carried out simultaneously under the same conditions.

A. ELEMENTARY COMPOSITION.

DETECTION OF THE ELEMENTS.

* 1. Carbon and Hydrogen.

(a) A small portion of the substance (e.g. cane sugar) is gently heated in a test tube or on platinum foil. It melts and chars. The charring denotes the presence of carbon. There is a condensation of water on the sides of the tube where it is cool; this denotes the presence of hydrogen.

(b) About 5 grms. of finely powdered cupric oxide are dried thoroughly by heating in a small crucible. Whilst still warm¹ it is mixed with a little of the substance (e.g. oxalic acid) and the mixture is introduced into a hard glass tube. The end is closed with a cork through which passes a glass tube, bent at right angles. This end is dipped into a little baryta water contained in a small beaker or test tube. On heating the mixture in the hard glass tube, water will condense on the cooler parts of the tube—presence of hydrogen; and the baryta water will become turbid owing to the formation of barium carbonate—presence of carbon.

¹ As cupric oxide takes up water on cooling it must be used warm, otherwise it must be allowed to cool in a desiccator over sulphuric acid.

* 2. **Nitrogen.**

(a) *As Ammonia.*—A portion of the substance (e.g. caseinogen) is ground up with soda-lime and heated in a dry test tube. Ammonia is given off as shown by the smell, by litmus paper and by the production of white fumes when a glass rod dipped in hydrochloric acid is held over the mouth of the tube (Will and Varrentrapp's method).

The peculiar smell of burning flesh, horn, etc., produced on heating such substances alone, also indicates the presence of nitrogen.

(b) *As Sodium Cyanide.*—A small piece of metallic sodium is heated in a small dry test tube of hard glass until the metal begins to boil; successive minute portions of the substance (dried egg albumin) are added. The heating is continued for a short time, the tube is cooled, and the lower end of it is broken in a mortar, containing a few drops of alcohol; water is added when effervescence has ceased. The solution is transferred to a test tube, warmed and filtered. To the filtrate some ferrous sulphate solution (this must be freshly prepared by dissolving a few small crystals in a little water) and caustic soda are added and it is boiled for a few minutes. It is cooled and a drop or two of ferric chloride and excess of dilute hydrochloric acid are added. A precipitate or coloration of Prussian blue indicates the presence of nitrogen (Lassaigne's method).

Note.—It is important that the substance be made to come into proper contact with the sodium.

Castellana's Modification of this Test.—A small quantity of the substance is intimately mixed with about ten times its quantity of equal parts of magnesium powder and dry sodium carbonate and gently heated until the magnesium burns; it is then heated to redness as with the sodium (b). The remainder of process is carried out as described above, i.e. breaking the tube in a mortar, etc.

* 3. **Halogens.**

(a) *Beilstein's Test.*—A piece of copper wire is heated in a Bunsen flame until the flame is no longer coloured green. A little of the substance, e.g. chloroform, is placed on it and it is again heated. Copper chloride is formed which colours the flame green.

(b) *Halogen* may also be detected by means of sodium employed just as in the nitrogen test. The filtered solution is acidified with nitric acid, boiled to remove any hydrocyanic acid which will be formed if the substance also contains nitrogen, and then treated with silver nitrate.

The nature of the halogen may be determined by treating a little of the acidified solution with chlorine water, and then testing with starch solution for iodine, or by extracting with carbon bisulphide or chloroform for bromine.

(c) *Heating with Lime*.—Halogens are best detected by heating with quicklime. The substance is finely powdered and mixed intimately with lime (if liquid, e.g. chloroform, the lime is moistened with the substance) and then heated strongly. When cool, water is added and the lime dissolved in nitric acid. On adding silver nitrate, a precipitate of silver halide is obtained if halogen be present.

* 4. Sulphur.

(a) As sodium sulphide. A small portion of the substance is heated with metallic sodium as described under 2 (b). The hot tube is broken in a little water, the contents are filtered and tested for sodium sulphide with (1) lead acetate, (2) sodium nitroprusside.

(b) As sulphate. A small portion of the substance (dried fibrin) is fused in a crucible with three times its quantity of fusion mixture $\{2\text{KNO}_3 + \text{Na}_2\text{CO}_3\}$. The mixture is heated cautiously at first round the edge and the heating is continued after the fusion until all charred particles have vanished. The mass, when cool, is extracted with hot water and the filtered solution is tested for sulphates with barium chloride in the presence of mineral acid (HCl or HNO_3).

* 5. Phosphorus.

(a) Some caseinogen is fused with fusion mixture as described for sulphur, the fused mass is extracted with hot water, and the solution is divided into two parts. To the one part is added excess of nitric acid and ammonium molybdate: a yellow precipitate on warming indicates phosphoric acid; to the other part excess of ammonia is added and phosphates are precipitated with magnesia mixture.

(b) A small quantity of caseinogen in a small flask is covered with 5-10 c.c. of concentrated sulphuric acid and an equal volume of concentrated nitric acid is added. The mixture is heated gently over a small flame (in the draught chamber) until the mixture becomes colourless. If it becomes brown, it is cooled, more nitric acid is added and it is heated again. When it is colourless, it is allowed to cool, water and a little ammonium nitrate solution are added and it is heated nearly to boiling; on adding ammonium molybdate solution, a yellow colour or precipitate indicates the presence of phosphoric acid (Neumann's method).

6. Other Elements.

Amongst natural compounds the most important other elements combined with carbon are iron, e.g. iron in hæmoglobin, ferrocyanides, and magnesium, e.g. magnesium in chlorophyll. Copper is found in certain other animal pigments. Silicon is present in certain vegetables, e.g. in grasses. Organic silicon, arsenic, antimony and magnesium compounds have been prepared in the laboratory. These elements are best detected after the organic matter has been completely removed by burning either alone or in the presence of an oxidising agent (fusion mixture). Thus:—

* **Detection of Iron in Hæmoglobin.**—A small portion of hæmoglobin is heated in a crucible with 3-4 times its quantity of fusion mixture until all the organic matter has been oxidised. The mass, when cold, is dissolved in dilute hydrochloric acid. The solution is filtered and the filtrate is tested for ferric salts with (a) ammonium thiocyanate and (b) potassium ferrocyanide.

B. QUANTITATIVE COMPOSITION.

ESTIMATION OF THE ELEMENTS.

1. Carbon and Hydrogen.

An organic compound on oxidation with copper oxide is converted into carbon dioxide and water. The amount of each element contained in the compound is determined by weighing the carbon dioxide and water produced from a known weight of the compound.

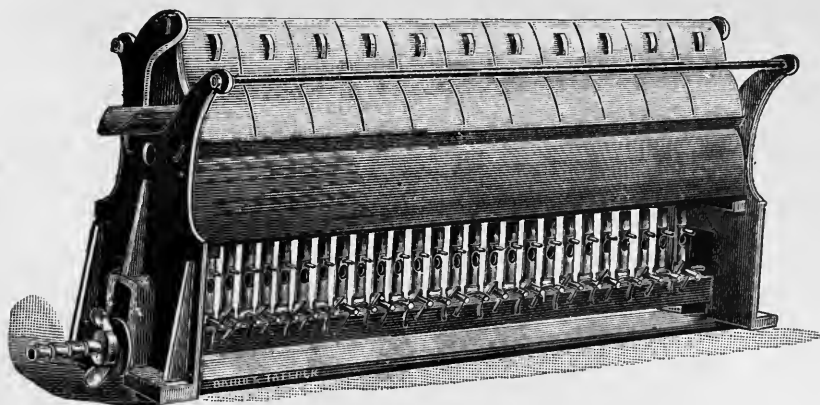

FIG. 15.—Combustion Furnace.

The analysis is carried out in a long tube of hard glass, a combustion tube, about 80 cm. long, which is heated in a furnace (Fig. 15).

Five-eighths of the length of the tube is filled with coarse copper oxide which is kept in position by narrow plugs of oxidised copper gauze. Next to the copper oxide there is a small boat (copper or porcelain) of suitable size, containing a known weight of the substance, and the remaining space is filled by a roll of oxidised copper gauze (Fig. 16). This end of the tube is connected with a gasometer

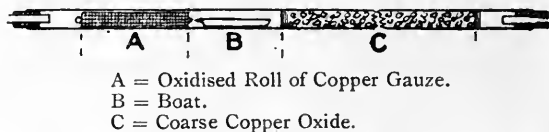
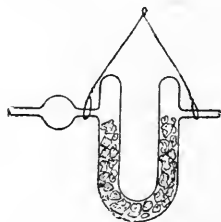
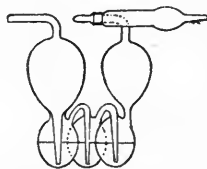

FIG. 16.—From Price and Twiss' "Practical Organic Chemistry".

containing air (or oxygen) and a current of air freed from carbon dioxide and water by passing through potash and sulphuric acid or calcium chloride, is passed through the combustion tube so as to drive out the products of the combustion and to help in the oxidation. To the other end of the combustion tube are attached absorption tubes (Fig. 17), of which there are various forms, to collect the carbon dioxide



Calcium Chloride Tube.



Potash Absorption Bulbs.

FIG. 17.—From Price and Twiss' "Practical Organic Chemistry".

and water. The first absorption tube, generally of U-shape, contains calcium chloride¹ or pumice wetted with concentrated sulphuric acid; the second, generally complex in shape so as to give several surfaces, contains caustic potash of 33 per cent. strength; a small tube containing calcium chloride is attached so as to retain water vapour, which may be carried away during the passage of the gases. These tubes are weighed before and after the combustion and their increase in weight gives the required data.

¹After filling the tube with calcium chloride dry carbon dioxide must be passed through it until its weight remains constant.

In practice, the combustion tube is filled, as described, with coarse copper oxide, which has been heated to redness in a copper basin and allowed to cool. The plugs and the roll are made of copper gauze which is rolled round a piece of copper wire and heated in a blowpipe flame to oxidise the metallic copper and burn away any organic matter. A space is left for the boat. The tube is heated in the furnace at a low red heat and a current of dry clean air or oxygen is passed through the tube from the gasometer. The carbon dioxide and water present in the tube and on the copper oxide are thus removed and the copper is completely oxidised to copper oxide. The heating of that portion of the combustion tube into which the boat is to be placed is discontinued so that this portion cools to room temperature whilst the rest of the tube is kept at a red heat. The absorption tubes are filled and weighed. About .2 gm. of substance is exactly weighed out into the boat which has been heated and cooled in a desiccator. When the end of the combustion tube is cool the absorption tubes are attached, that for water next to the tube. From the other end the roll is removed with a hooked copper wire, the boat quickly introduced and the roll replaced. The tube is closed and the pure air or oxygen current passed through at a rate of about 3 bubbles every two seconds. The roll is heated commencing at the end farthest from the boat and the heating is gradually extended from this point towards the boat and the coarse copper oxide until the substance has burnt away and the whole tube is heated from end to end. The air or oxygen current is continued for about half an hour after the combustion is finished so as to drive out the water and carbon dioxide. Any water which condenses on the end of the combustion tube is driven into the absorption tubes by means of a small flame, or hot brick, held under the end of the combustion tube. When the oxidation is completed, the absorption tubes are removed, allowed to cool for $\frac{1}{2}$ to 1 hour and weighed.

This method of analysis requires some modification if elements other than hydrogen or oxygen are present in the substance.

(a) *Halogens*.—On combustion, the halogen in an organic compound is evolved as hydrogen halide, or as halogen. To prevent its entry into the absorption tubes it is combined with silver as silver halide. This is effected by putting at the end of the combustion tube a roll of silver gauze.

(b) *Nitrogen*.—Oxides of nitrogen may be evolved when organic nitrogenous compounds are analysed. A roll of metallic copper gauze, prepared by heating a roll in a blowpipe flame and dropping it into a few c.c. of methyl alcohol contained in a test tube (held in a duster) and drying at 100° , is introduced at the end of the combustion tube. Any oxides of nitrogen are thus reduced to nitrogen and prevented from being absorbed by the potash.

(c) *Sulphur and Phosphorus*.—To prevent hydrogen sulphide or hydrogen phosphide being formed, the oxidation of the organic compound is effected with lead chromate instead of copper oxide and the substance is mixed with it instead of being placed in the boat. Lead chromate may replace the coarse copper oxide entirely or about half of it.

Organic phosphorus compounds are very difficult to oxidise completely and frequently give results for carbon which are too low by about .5 to 1 per cent.

2. Nitrogen.

(a) **Dumas' Method.**—On heating an organic compound containing nitrogen with copper oxide, its nitrogen is given off as nitrogen. The gas given off from a known weight of substance is collected and its volume measured, from which value its weight can be calculated.

The analysis in practice is carried out in a similar way to that described for carbon and hydrogen, but the substance is mixed with finely powdered copper oxide and introduced into the tube, and a roll of reduced copper gauze is placed at the end of the combustion tube so as to reduce any oxides of nitrogen, which may be formed, to nitrogen. Instead of a current of air, a current of carbon dioxide is passed through the tube. The gas is collected in a Schiff's nitrometer over caustic potash which absorbs the carbon dioxide leaving the nitrogen (Fig. 18).

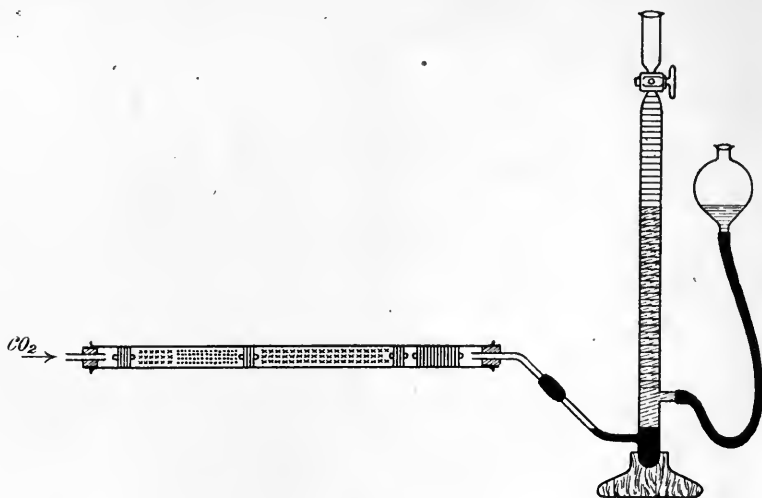

FIG. 18.

There are several ways of passing the carbon dioxide through the combustion tube; it may be evolved from a Kipp apparatus or it may be evolved by heating magnesite, either contained in a special tube or in the combustion tube, which in this case is sealed at the end. It is obvious that before carrying out the analysis all the air must be expelled from the apparatus.

* (b) **Kjeldahl's Method.**—The principle of this method consists in oxidising the substance with concentrated sulphuric acid; the nitrogen is converted into ammonia. The solution is made alkaline with caustic soda and distilled. The ammonia is evolved and is collected in excess of standard acid; on subsequent titration with standard alkali the amount evolved is given by difference.

This method is much simpler to carry out than the Dumas' method, but it cannot be employed for all nitrogen-containing compounds.

Dakin and Dudley¹ have found that pyrrole and its derivatives, piperidine and some of its derivatives give satisfactory results if the heating of the substance—about 15 gm.—with sulphuric acid be continued for at least four hours after the solution becomes clear. Pyridine, quinoline, pyrazole and their derivatives do not give satisfactory results.

Of other groups of compounds, nitro-, nitroso-, azo-, diazo-, hydrazo-, aminoazo- compounds, also compounds of nitric and nitrous acid, i.e. those compounds containing nitrogen joined to oxygen or another nitrogen atom, give satisfactory results if they are previously reduced with tin. Osazones do not give satisfactory results.

On account of its simplicity this method has found extensive use in biological chemistry. The large group of compounds—the proteins—all contain nitrogen; the amount of protein in a solution is estimated by determining the nitrogen content (see below); and the amount of nitrogen in urine is a factor of importance in studying metabolism.

In most laboratories there is an apparatus in which six determinations can be carried out at the same time as in Fig. 20, p. 37.

* **Example: Estimation of Nitrogen in Egg-white Solution.**

A known volume, say 5 c.c., of the egg-white solution is placed with a pipette into a clean round-bottom Jena glass flask of 700 c.c. capacity. 10 or 20 c.c. of pure concentrated sulphuric acid and a crystal of copper sulphate, about the size of a pea and weighing about 0.25 gm., which helps in the oxidation, are added. (1 gm. of potassium sulphate is also sometimes added for this purpose, as it raises the temperature.) The flask is heated in a fume-cupboard until the liquid, which at first becomes brown from charring, becomes quite or nearly colourless, a process which takes about an hour. The flask is allowed to cool and is half-filled with distilled water. By means of a special distillation tube it is connected to a condenser set up in a vertical position as in Fig. 19, No. 1.

¹J. Biol. Chem., 1914, 17, 275.

With a pipette a quantity of standard sulphuric acid (5 c.c. of N or 50 c.c. $\cdot 1N$ H_2SO_4) are measured out into a clean beaker or flask (preferably conical) of about 600 c.c. capacity, and this is placed below the condenser so that the end of the condenser just reaches the surface of the liquid. It is preferable to add a few drops of indicator, methyl orange or alizarin red,¹ before the distillation is commenced in case more acid is required than that originally taken; the change in colour of the indicator gives notice of this fact.

Sometimes the distillation is carried out without using a condenser (Fig. 19, No. 2); the end of the special distilling tube is then dipped into the standard acid. There is in this case usually greater danger of the liquid being sucked back into the flask which is being distilled, and further the glass is attacked by the ammonia with liberation of alkali, which causes inaccuracies in the determination.

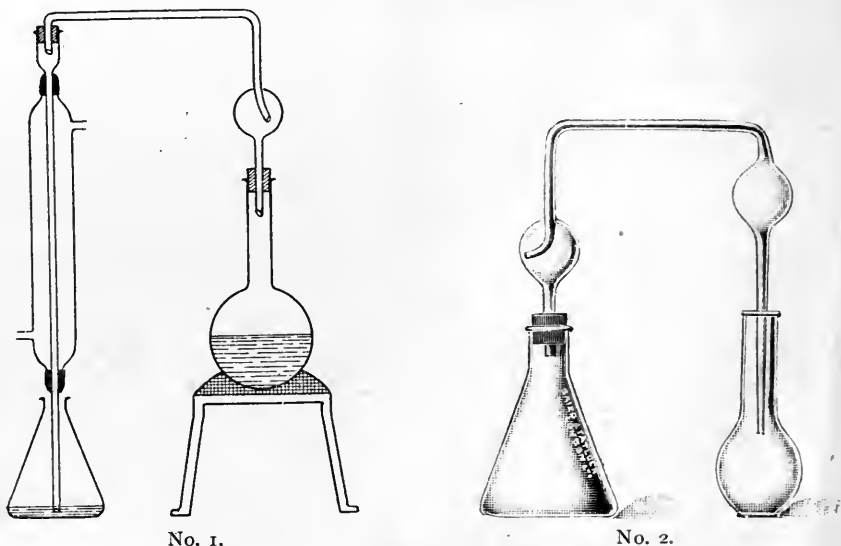
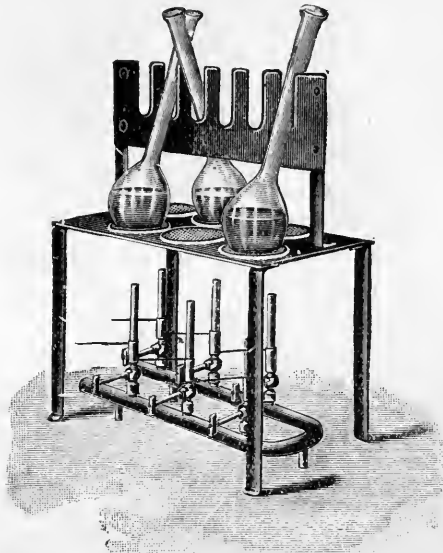

FIG. 19.

The round-bottomed flask is removed, a piece of porous earthenware is added and excess of caustic soda solution (50 c.c. of 40 per cent. for every 10 c.c. concentrated H_2SO_4 used) is run in under the dilute acid without mixing. The flask is connected again to the condenser seeing that all corks fit tightly. The soda and acid are mixed and the ammonia is distilled off into the acid. In about half an hour the ammonia will have completely passed over into the standard acid. To

¹ Cochineal, congo red and other indicators may also be used, or the titration may be effected using sodium iodate and potassium iodide and standard thiosulphate solution (p. 563).



No. 1.

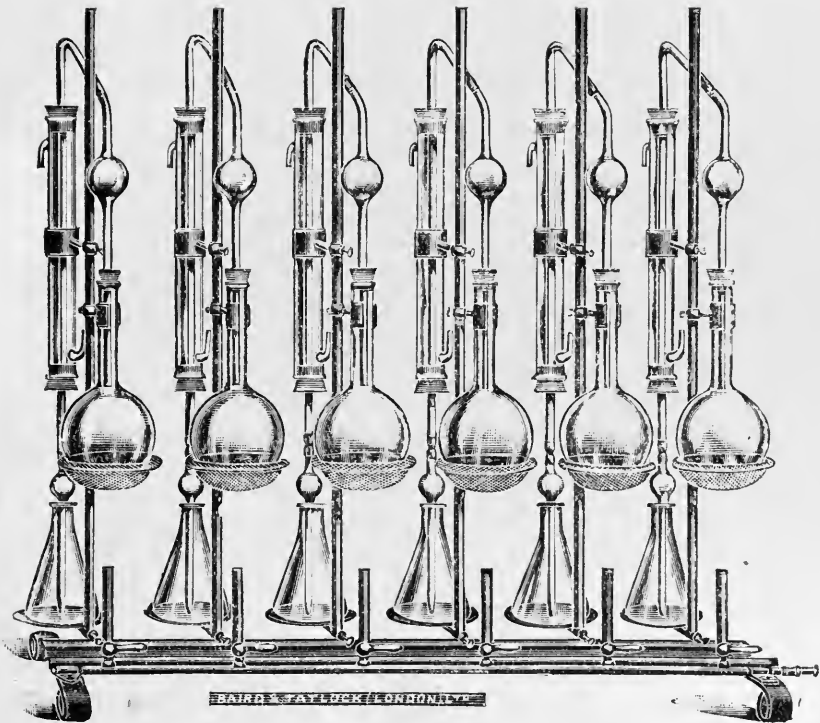

No. 2.

FIG. 20.—Apparatus for estimation of nitrogen by Kjeldahl's method.

3. Halogens.

After completely oxidising all the organic matter to carbon dioxide and water, the halogens are present as inorganic compounds and are estimated in the usual way.

The commonest method is to oxidise a known weight of the substance in a sealed tube with fuming nitric acid at 200° for several hours, a few crystals of silver nitrate being at the same time placed in the tube: silver halide is formed and this is washed out of the tube and weighed (Carius).

In practice, about $\cdot 2$ gm. of the substance is weighed out into a narrow test tube about 2 in. long. Some silver nitrate crystals are placed in a thick-walled combustion tube sealed at one end and covered with 10-20 c.c. of concentrated nitric acid, care being taken not to wet the sides of the tube with acid. This is done by introducing the acid through a tube with a long capillary. The test tube containing the substance is put in avoiding contact of the substance with the acid. The open end of the tube is now sealed in the following way: a glass rod for a handle is fastened by heating to the side of the tube at the open end. The tube is heated near this end in a blow-pipe flame in such a way that the walls collapse together; when it is nearly closed the end is drawn out so as to form a capillary tube with even and thick walls. The capillary is sealed by pulling off the end with the handle attached. The tube is wrapped in asbestos paper and carefully placed, capillary outwards, in an iron tube which can be closed with a screw cap. The iron jacket and tube are placed in a specially constructed furnace in such a position that the capillary point faces a wall. Should the tube burst, the contents are then not blown into the room. The tube is heated to about $200-220^{\circ}$ for 4 or 5 hours. The furnace and contents are allowed to cool. The cap of the iron tube is removed and the capillary point allowed to project a little. The point is heated in a flame. When the glass is soft the pressure inside the tube forces an opening. Owing to the high pressure inside the tube it is unsafe to open the tube in any other way. The capillary is cut off and the contents washed out into a beaker. The silver halide is filtered off and weighed by the usual method employed in inorganic chemistry.

Less frequently, halogens are estimated by heating the substance in a combustion tube with quicklime.

A thin layer of quicklime is placed at the closed end of a combustion tube. Next to this is put a mixture of the substance (about $\cdot 2$ gm.) with quicklime and then another layer of quicklime. The tube is heated in a furnace, as in the estimation of carbon and hydrogen, the layers of quicklime being heated to redness before the mixture of substance and lime.

The contents of the tube, after the oxidation, are dissolved in nitric acid and the halogen precipitated with silver nitrate. The silver halide is filtered off, washed, dried and weighed.

A convenient method of estimating chlorine is that described by Neumann. The substance is oxidised with a mixture of nitric acid and sulphuric acid. Hydrochloric acid is evolved, and this is collected in a solution of silver nitrate. After boiling the solution for about half an hour to remove hydrogen cyanide, which is also formed if nitrogen be present in the substance, the silver chloride is filtered off, washed, dried and weighed.¹

¹ See J. Physiol., vol. 31, p. 65.

4. Sulphur.

This element is most generally estimated by the same method as the halogens (Carius); sulphuric acid is formed and precipitated as barium sulphate.

It is more convenient to oxidise the substance in a nickel crucible with sodium or barium peroxide; the contents are acidified with hydrochloric acid and the barium sulphate formed is weighed. Still more convenient is the oxidation mixture used for estimating total sulphur in urine (see p. 542).

5. Phosphorus.

Phosphorus is usually estimated in the same way as sulphur by the Carius method, the phosphoric acid formed being precipitated as ammonium magnesium phosphate.

The most rapid and convenient method is that of Neumann. The substance is oxidised in an open flask with a mixture of nitric and sulphuric acids. The phosphoric acid formed is precipitated as ammonium phosphomolybdate and this is then estimated by solution in excess of $\cdot 5N$ caustic soda and subsequent titration with $\cdot 5N$ sulphuric acid. The difference between $\cdot 5N$ NaOH and $\cdot 5N$ H_2SO_4 multiplied by 1.268 gives the number of milligrams of P_2O_5 in the given weight of substance taken.¹ This method is described on p. 545.

Micro-Analyses.

Minute quantities of substance can be analysed by the methods devised by Pregl. These methods are difficult to perform and require much practice. The full details are given by Pregl in Abderhalden's "Handbüch der Biochemischen Arbeitsmethoden," vol. v., part 2, p. 1307.

Folin has also described a method for estimating nitrogen with special reference to its estimation in urine and blood. Its technique is comparatively simple and is given on p. 558.

¹ See J. Physiol., 1906, 33, 439.

C. CALCULATION OF RESULTS.

With the exception of oxygen all the elements present in an organic compound are thus estimated. The amount of oxygen is found by difference.

From the figures obtained the percentage composition is calculated, i.e. the amount given by 100 grams of substance, thus:—

0.2009 gm. substance gave 0.2987 gm. CO₂ and 0.1092 gm. H₂O.
0.1887 gm. „ „ 15.2 c.c. moist N at 16.5° and 767 mm.

Now, 0.2987 gm. CO₂ = 0.2987 × $\frac{12}{44}$ gm. C = 0.2987 × $\frac{3}{11}$ gm. C = 0.0815 gm. C.

0.1092 gm. H₂O = 0.1092 × $\frac{2}{18}$ gm. H = 0.1092 × $\frac{1}{9}$ gm. H = 0.01213 gm. H.

15.2 c.c. moist N at 767 mm. and 16.5° C. = $\frac{15.2 \times 753^* \times 273}{760 \times 289.5}$ c.c. at 0° and 760 mm.
= 14.2 c.c.

= 14.2 × $\frac{28}{22.400}$ gm.

= 0.01775 gm. N.

∴ percentage of C = $\frac{0.0815 \times 100}{0.2009}$ = 40.56.

H = $\frac{0.01213 \times 100}{0.2009}$ = 6.04.

N = $\frac{0.01775 \times 100}{0.1887}$ = 9.40.

O by difference = 44.00.
Total = 100.00

The formula of the compound is obtained by dividing the percentages by the atomic weights of the elements; the ratio of the number of atoms to each other is then obtained by dividing by the lowest value:—

$$\text{C } \frac{40.56}{12} = 3.38 \div 0.67 = 5.$$

$$\text{H } \frac{6.04}{1} = 6.04 \div 0.67 = 9.$$

$$\text{N } \frac{9.40}{14} = 0.67 \div 0.67 = 1.$$

$$\text{O } \frac{44.0}{16} = 2.75 \div 0.67 = 4.1.$$

The formula of the compound is therefore C₅H₉NO₄.

In any estimation only a difference of 0.2-0.3 per cent. is allowed between the values found and those calculated from the formula. The calculated values are

C = 40.81.	diff. = - 0.25.
H = 6.12.	= + 0.08.
N = 9.52.	= - 0.12.

The analysis was therefore sufficiently accurate.

* Vapour pressure of water at 16.5° C. = 14.0 mm. ∴ pressure on gas = 767 - 14 = 753 mm.

D. DETERMINATION OF THE MOLECULAR WEIGHT.

As will be seen later, several organic compounds can have the same empirical formula, thus, for instance, lactic acid $C_3H_6O_3$ and glucose $C_6H_{12}O_6$ have the same empirical formula, namely CH_2O .

In order to ascertain which of these formulæ is the correct one, a molecular weight determination is carried out, i.e. the weight of the molecule of the substance compared with that of an atom of hydrogen (Avogadro's law).

The methods employed to determine the molecular weight are of two kinds: (a) physical, (b) chemical.

(a) Physical Methods.

1. **Victor Meyer's Method.**—Of the physical methods, that by Victor Meyer is the most frequently used when the substance can be vaporised without decomposition. A known weight of the substance is converted into vapour at a temperature $40-50^\circ$ above its boiling-point in a special apparatus. The air previously contained in the apparatus is displaced by the vapour, collected in a graduated cylinder and its volume measured; this volume, after making corrections for temperature and pressure, corresponds to that occupied by the substance.

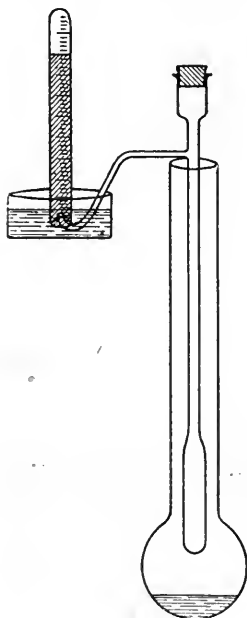

FIG. 21.

Thus, if v c.c. are given by w grammes substance,

$$\therefore 22,400 \text{ c.c. are given by } \frac{w \times 22,400}{v} \\ = \text{mol. wt.}$$

The apparatus employed is shown in the accompanying Fig. 21. A liquid, boiling $40-50^\circ$ above the temperature at which the substance is volatilised, is boiled in the round bulb of the outer vessel. As soon as the temperature is constant and no more air escapes from the inner vessel by the side tube, the inverted graduated cylinder, filled with water, is placed over the end of the side tube, the cork is removed and a known weight of substance, contained in a small glass vessel, is dropped through the opening into the inner vessel and the cork is quickly replaced. The substance is rapidly vaporised and the vapour displaces an equal volume of air, which is driven out and collected and measured in the graduated cylinder.

2. **Raoult-Beckmann Method.**—Substances dissolved in a liquid lower its freezing-point. It was shown by Raoult that the freezing-point was lowered the same number of degrees when weights of different substances proportional to their molecular weights were dissolved in the same volume of liquid. Each liquid was found to have a definite freezing-point. By employing this value as a constant, the molecular weight of an unknown substance can be found. It is given by the formula

$$M = \frac{100 \times C \times w}{dW},$$

where C is the constant, w the weight of the substance, W the weight of the solvent, and d the depression of the freezing-point.

The constants are :—water 19 benzene 49
acetic acid 39 phenol 76

Conversely by determining the lowering of the freezing-point, the amount of salt in a solution can be ascertained, e.g. in serum, urine.

The apparatus (Fig. 22) devised by Beckmann consists of the freezing-point tube C with side opening D . It is closed by a cork through which a Beckmann thermometer T and a stirrer S (through a glass tube) pass. The Beckmann thermometer is a large thermometer graduated usually in $\frac{1}{1000}$ parts of a degree and having a range of only 5-6 degrees.¹ The tube C is placed in a wider tube B which serves as a jacket and prevents too rapid cooling. This is fixed in position in a freezing mixture of salt and ice in the vessel A by a cork which fits the opening in the brass lid L . The brass lid has also openings for the passage of a stirrer E and a thermometer. In carrying out a determination a known weight of solvent is placed in C and its freezing-point is taken. The tube is then removed and the solid allowed to melt. A known weight of substance is then introduced through D , dissolved in the liquid and the freezing-point again determined.

Several determinations of the freezing-point of the solvent and the solvent containing the substance should be taken. Whilst the freezing-point is being taken the liquid becomes super-cooled. To prevent very great super-cooling it is vigorously stirred with the stirrer. At the freezing-point the temperature rises and the highest point reached is taken as the freezing-point.

Similarly, a rise in the boiling-point of a solvent, when substances are dissolved in it, will give the molecular weight of the substance.

Micro-Molecular Weight Determinations.

Micro-molecular weight determinations may be made by Barger's method.²

¹ It is so constructed that mercury can be removed from the thread or introduced into the thread from a small bulb at the top. It can thus be used for any liquid.

² Trans. Chem. Soc., 1904, 85, 286.

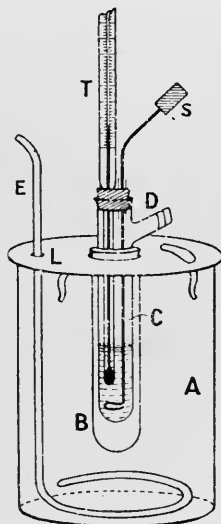

FIG. 22.—(From Findlay's "Practical Physical Chemistry".)

(b) Chemical Methods.

When the substance is an acid or a base the molecular weight can be determined by chemical methods.

(1) In the case of an acid :—

The molecular weight can be calculated from the amount of standard alkali required to neutralise, using phenolphthalein as indicator, a known weight of the acid, according to the equation

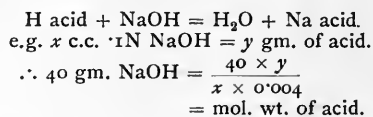

If the acid be dibasic or tribasic, two or three molecules of sodium hydroxide will be required. The presence of such an acid will be indicated by titrating the acid using methyl orange, or alizarin red, and phenolphthalein as indicators. The acid salt will be neutral to methyl orange or alizarin red, the neutral salt to phenolphthalein. The basicity of the acid is definitely ascertained by the analysis of the salt and the free acid.

It is most usual to employ the silver salt of an acid. A quantity of the salt is prepared by adding silver nitrate to the neutral solution of the acid, filtering off the silver salt, washing and drying it. A known weight is heated in a crucible and the metallic silver obtained is weighed.

a gm. of silver salt gave b gm. of silver.

If the acid be monobasic it will contain 1 atom of silver,

107.9 gm. of silver will be contained in $\frac{107.9 \times a}{b}$ gm. of silver salt.

Since the silver replaces 1 atom of hydrogen

$\therefore \frac{107.9 \times a}{b} - 107.9 + 1$ is the mol. wt. of the acid.

If the acid be dibasic it will contain 2 atoms of silver,

107.9 \times 2 gm. of silver will be contained in $\frac{107.9 \times 2 \times a}{b}$ gm. of silver salt.

Since the silver replaces 2 atoms of hydrogen

$\therefore \frac{107.9 \times 2 \times a}{b} - (107.9 \times 2) + 2$ is the mol. wt. of the acid.

The zinc salt or barium salt is also sometimes employed; a known weight of salt is heated with a drop of concentrated sulphuric acid in a crucible; zinc or barium sulphate is obtained from which the amount of barium or zinc is calculated.

(2) In the case of a base :—

Organic bases form double salts with metallic salts, such as platinum chloride, mercuric chloride. On heating the double salt in a crucible, a residue of the metal is left. The estimation of the amount of metal in a known weight of the compound gives the molecular weight.

Ammonia and platinum chloride give the compound ammonio-platinum chloride,



The organic bases form analogous compounds, the base replacing the ammonia. Their general formula is therefore

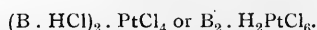

The molecular weight of 2 molecules of base is thus

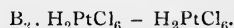

e.g. x gm. of salt gave y gm. of platinum.

\therefore 194.8 gm. platinum will be given by $\frac{194.8 \times x}{y}$ gm. salt $\text{B}_2 \cdot \text{H}_2\text{PtCl}_6$.

Now 194.8 gm. platinum are contained in 409.8 gm. H_2PtCl_6 .

$\therefore \frac{194.8 \times x}{y} - 409.8$ is the molecular weight of B_2 .

Hence molecular weight of 1 molecule of base is $\frac{194.8 \times x}{y} - 409.8$

The gold salts have the general formula,

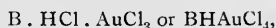

from which the molecular weight of the base is calculated in a similar way.

IDENTIFICATION OF AN ORGANIC COMPOUND.

Knowing the formula of a pure organic compound from its analysis and molecular weight, it has to be identified. The compound may be a known or an unknown one.

To find out if the compound is known reference is made to Richter's "Lexicon of Carbon Compounds"¹ in which the melting-points and other constants of the various compounds are given. Corresponding properties identify the substance.

If the compound be unknown, further analysis is necessary; it must be ascertained to what group of carbon compounds the unknown body belongs, whether it is an alcohol, an ester, an acid, a carbohydrate, an amide, an amine, a protein, etc. With the complex natural substances this is a matter of great difficulty, and it may take many years before a question is settled; e.g. tyrosine was discovered in 1846 and its constitution only definitely proved in 1882.

The identification of an unknown substance, or the rapid identification of a known substance, is greatly facilitated by a few preliminary tests. If in solution a portion of it should be evaporated to see if there is a residue and whether it is solid or liquid. The residue can be tested for the elements present, especially nitrogen. If there is no residue the solution must be distilled and the boiling-point observed.

1. **Colour.** Vegetable colouring matters: if blue, they are changed to red by acid and the blue colour is restored, or changed to a green, by ammonia; if yellow, they are changed to brown by alkali and the colour is restored by acid.

Ferric salts and copper salts are reddish-brown and blue or green respectively.

Many coloured compounds show absorption spectra, such as hæmoglobin and its derivatives.

2. **Taste.** Tasting must be done carefully on account of the extremely poisonous nature of some organic compounds. A drop of a weak solution in water or alcohol may be used. Acids have a sour and astringent taste. Alkaloids and glucosides are bitter. Sugars and glycerol are sweet.

¹ The most recent compounds are given in the yearly volumes of the Journals of the English and Foreign Chemical Societies.

3. **Odour.** The odour is sometimes characteristic.

4. **Appearance.** The appearance under the microscope gives evidence of homogeneity or impurity. The microscopical appearance is very useful in identifying the different kinds of starch. Many substances have a characteristic crystalline structure, e.g. cholesterol, cystine, osazones of carbohydrates, etc.

5. **Effect of Heat.** By heating the substance firstly on platinum, secondly in a small dry tube many valuable details can be ascertained. The odour may be peculiar, the substance may melt, char, decompose, sublime, or boil. The melting-point and boiling-point of solids and liquids can be observed directly after such a preliminary examination.

6. **Detection of the Elements.** By ascertaining whether the substance does or does not contain nitrogen, it may be placed in either of the following groups :—

Non-nitrogenous.

Hydrocarbons.
Alcohols, phenols.
Esters, ethers.
Aldehydes.
Ketones.
Acids and Salts.
Fats and cholesterol.
Carbohydrates.

Nitrogenous.

Cyanogen compounds.
Amides.
Amines.
Amino acids.
Guanidine compounds.
Purines.
Proteins.

7. Solubility.

(a) Alkali salts and salts of bases,

The lower alcohols, aldehydes, acids, ketones, amides, amines

The polyhydric alcohols and carbohydrates

Phenols and hydroxy acids

In general, compounds containing several OH groups

} are soluble
in cold water.

(b) Aromatic acids are insoluble or very slightly soluble, but dissolve in boiling water.

Starch is insoluble and gives an opalescent solution with hot water.

Tyrosine, cystine and uric acid are soluble with difficulty in water.

Fats, higher fatty acids and cholesterol are insoluble in water, but soluble in ether.

8. Behaviour towards Reagents.

(a) *Reaction of aqueous solution to litmus.*

A marked acid reaction indicates an acid or a phenol; if there is an odour, it may be a volatile fatty acid or a phenol.

A neutral reaction indicates a salt of an acid or a base; an alcohol, aldehyde, ketone (note smell), carbohydrate. An ester in alcoholic or ethereal solution has also a neutral reaction.

An alkaline reaction indicates a base, or an acid dissolved in excess of alkali.

(b) *Sodium carbonate*: acids insoluble in water, e.g. uric acid, also cystine, tyrosine dissolve; bases insoluble in water do not dissolve or if in solution are precipitated.

(c) *Sodium hydroxide*: ammonium salts are decomposed with evolution of ammonia and bases are liberated from their salts. On boiling, amides are decomposed, and esters are hydrolysed.

(d) *Hydrochloric acid*: acids insoluble in water do not dissolve or if in solution are precipitated; bases insoluble in water dissolve, e.g. tyrosine, cystine, aniline.

(e) *Sulphuric acid.*

(f) *Nitric acid.*

(g) *Bromine water.*

(h) *Permanganate.*

(i) *Effect of heating with soda lime.*

The exactly neutral solution may be tested with

(j) *Schiff's reagent*—for aldehydes.

(k) *Ammoniacal silver nitrate*—for aldehydes, reducing carbohydrates, etc.

(l) *Fehling's solution*—for aldehydes, reducing carbohydrates, etc.

(m) *Ferric chloride*—for phenols (violet or green colour),
for acetoacetic acid (claret colour),
for formates, acetates (reddish-brown colour,
precipitate on boiling),
for lactates, oxalates (yellow colour).

(n) *Calcium chloride*—for oxalates, urates, etc. (insoluble calcium salts are precipitated).

(o) *Sodium nitroprusside and sodium hydroxide* :—

Acetone gives a red colour, changing to purple with acetic acid.

Creatinine ,, a red ,, ,, ,, yellow ,, ,, ,,

Indole ,, a blue-violet ,, ,, ,, blue ,, ,, ,,

Confirmatory tests must be made after an indication of the nature of the substance has been obtained, according to the reactions given under the various groups of compounds.

HYDROCARBONS.

A. SATURATED.

The simplest organic compounds are the hydrocarbons, which consist of carbon united with hydrogen.

Carbon is a tetravalent element, but, unlike other elements, the carbon atom can combine with itself many times, thus 2, 3, 4, 5, 6, etc., carbon atoms can be combined together.

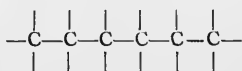

The hydrocarbons are the compounds in which the remaining valencies of the carbon atoms so joined together are satisfied by hydrogen, as for example in

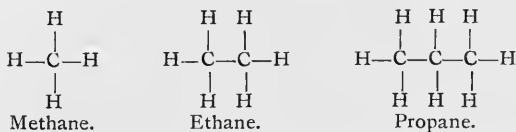

They form a homologous series of compounds in which the member containing 1 carbon atom more than the preceding one also contains 2 hydrogen atoms more, i.e. the members differ from one another by CH_2 . They possess the general formula $\text{C}_n\text{H}_{2n+2}$.

If we continue the process of adding CH_2 to propane, two ways are possible: it may be added to one of the end carbon atoms or to the middle carbon atom. The two compounds

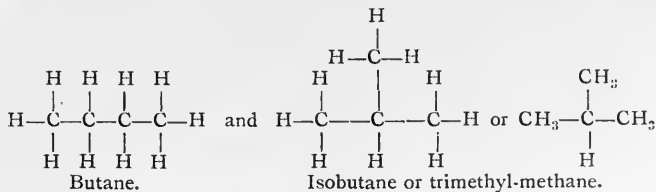

are thus obtainable. Continuing the process we obtain

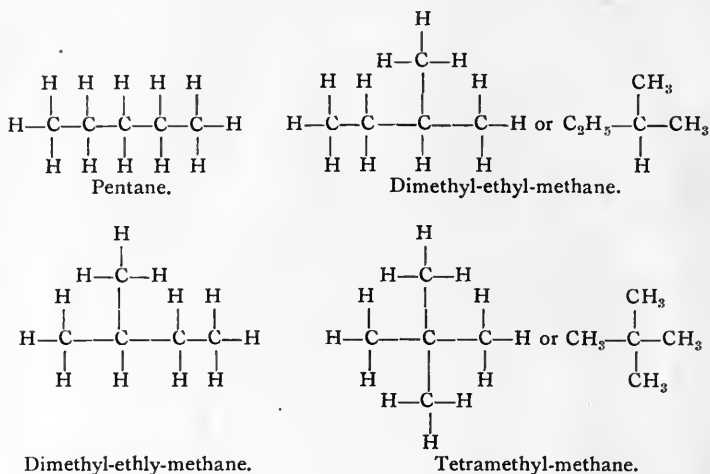

Two of these compounds are identical in structure, so that only three compounds can be derived from butane and isobutane.

Two or more compounds which have the same empirical composition (C_4H_{10} or C_5H_{12}), but a different structure as represented by the graphic formulæ, are therefore possible. Such compounds are known as *isomers*.

The compounds with a straight chain of carbon atoms are termed normal compounds. Those with a branched chain of carbon atoms are regarded as derivatives of methane, the radicles CH_3 , C_2H_5 , C_3H_7 , etc., being termed methyl, ethyl, propyl, etc., which shows their origin from the parent hydrocarbon.

In accordance with this theory an enormous number of hydrocarbons are possible; those containing from 1 up to 60 atoms of carbon in their molecule are actually known. The theory was advanced and developed to account for their large number.

The saturated hydrocarbons are the basis of the nomenclature and classification of all the carbon compounds. The carbon compounds are classified according as to whether they contain 1, 2, 3, or 4, etc., carbon atoms in their molecule, i.e. whether they are derived from methane, ethane, propane, butane, etc.

The saturated hydrocarbons are thus distinguished by the suffix *ane*; the prefix *meth* means 1 carbon atom; *eth* means 2 carbon atoms; *prop* means 3 carbon atoms, and so on.

The majority of the saturated hydrocarbons are natural substances. The lower members of the series of the hydrocarbons (up to 4 carbon atoms, which are gases) are formed by the dry distillation of diverse organic substances and are contained in coal gas. Methane occurs in

coal seams, but was originally called marsh gas, because it was found to escape from the water of ponds, where it is now known to be formed by the decomposition of cellulose. By a similar process of bacterial action it may be produced in the intestines of animals. The middle members, containing 5-16 atoms of carbon, are liquids, and are contained in petroleum, which consists of a mixture of saturated hydrocarbons. The higher members are solids.

Two theories have been advanced to account for their formation. According to the first, they are the products of the dry distillation of animal remains; according to the second, they are formed by the action of water upon the metallic carbides, of which the interior of the earth is supposed to consist. If the former supposition be the correct one, as the most recent work tends to show, they become of still greater interest in biological chemistry.

Several fractions are separated by the fractional distillation of the natural mineral oil. The following are the principal fractions from American petroleum:—

- | | |
|---|---|
| 1. Cymogene, B.P. 0° | } gases which are liquefied by pressure and used for producing cold by evaporation. |
| 2. Rhigolene, B.P. 18° | |
| 3. Petroleum ether or naphtha, B.P. 50°-60° | } contains chiefly pentane and hexane. |
| 4. Benzoline or Benzine, B.P. 70°-90° | |
| 5. Ligroin or "petrol," B.P. 90°-120° | } contain chiefly heptane and octane. |
| 6. Petroleum Benzine, B.P. 120°-150° | |
| 7. Paraffin oil or Kerosene, B.P. 150°-300° | } contains chiefly octane to hexadecane. |
| 8. Vaseline, B.P. above 300° | |

The fractions may be purified by shaking with concentrated sulphuric acid and caustic soda to remove unsaturated hydrocarbons.

The portions of higher boiling-point are decomposed by overheating or by distilling under pressure (cracking process) and yield fractions of lower boiling-point.

The other natural mineral oils, found in Russia, Roumania, etc., are also distilled fractionally. They contain generally less of the lower boiling fractions and a greater quantity of naphthene hydrocarbons (p. 237).

Liquid hydrocarbons are also prepared by the distillation of bituminous shale.

The higher members, which are solid, remain as distillation residues, and are also found in nature, e.g. ozokerit.

The distillation residues are converted into oil and paraffin wax by freezing and pressing; the liquid portion forms lubricating oil and the solid portion paraffin wax. The residues and fractions may be purified by treatment with sulphuric acid and caustic soda.

Examination of a Commercial Specimen of Hydrocarbons by Fractional Distillation.

- * On distilling 50-100 c.c. of ligroin or kerosene from a small distilling flask attached to a condenser and observing the temperature indicated by the thermometer, it will be seen that the temperature never remains constant for any length of time. The substance is a mixture. Several fractions which boil within 10° or 20° ranges of temperature can be collected in separate receivers. By redistilling these fractions and using a fractionating column (cf. p. 9) a pure product with a constant boiling-point can eventually be obtained.

Properties.

- * The saturated hydrocarbons have a peculiar odour. They are insoluble in water, but are soluble in alcohol, ether and other organic liquids.

Inflammability.

Marsh gas and the other gases burn with a non-luminous flame and form explosive mixtures when mixed with a certain proportion of oxygen or air.

- * The lower members amongst the liquids are also inflammable and burn with a more or less luminous flame. E.g. if about 3 c.c. of ligroin be placed in a watch glass and a lighted match applied it will burn.

- * The higher liquid members do not burn until they have been warmed. E.g. on applying a lighted match to about 3 c.c. of kerosene contained in a watch glass, the flame is extinguished, but if the kerosene be warmed on the water-bath to about 40° and a lighted match again applied, the vapours of the kerosene will be ignited.

In a lamp the kerosene rises to the surface of the wick by capillarity, and on applying a light the oil becomes hot and turns into inflammable vapour.

Inertness towards Chemical Reagents.

- * The saturated hydrocarbons are very inert substances ; they are not acted upon by concentrated acids or alkalies except under special conditions, and on account of their stability they are known as the paraffins from *parum affinis*, little affinity.

E.g. on shaking about 1 c.c. of ligroin or kerosene with

- (a) concentrated sulphuric acid,
- (b) concentrated nitric acid,
- (c) potassium permanganate solution,
- (d) bromine dissolved in chloroform,

there is no reaction, unless the commercial mixture of hydrocarbons contain hydrocarbons belonging to the unsaturated series.

They are acted upon by the halogens forming substitution products (p. 57).

Synthetical Preparation.

1. The lower members of the series can be prepared by the action of water on certain metallic carbides, e.g. :—

* Marsh gas is evolved if about 2 gm. of aluminium carbide in a test tube be covered with water. The gas may be collected in an inverted test tube and shown to be inflammable.

* 2. Saturated hydrocarbons can be prepared by the dry distillation of the dry sodium salt (1 part) of a fatty acid with soda lime (3 parts).

E.g. Methane is given off when fused sodium acetate and soda lime in the above proportions are heated together in a test tube. The evolved gas may be ignited at the mouth of the tube.



3. Saturated hydrocarbons are prepared from the corresponding halogen derivative by reduction with hydriodic acid, zinc-copper couple, zinc and hydrochloric acid, etc.

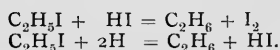

4. The higher members of the series are prepared from the lower members by treating the dry halogen derivative (alkyl halide) with zinc or with sodium :—

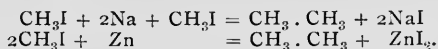

B. UNSATURATED.

In addition to the series of saturated hydrocarbons there are other series which contain less hydrogen in the molecule and are represented by the general formulæ C_nH_{2n} (olefines) and C_nH_{2n-2} (acetylenes). The two compounds ethylene or ethene, C_2H_4 , and acetylene or ethine, C_2H_2 , are the first and typical examples. They are represented by the constitutional formulæ:—

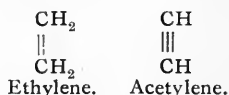

The four valencies of the carbon atoms are not completely satisfied by hydrogen atoms and they are therefore termed the unsaturated hydrocarbons. The unsaturated hydrocarbons are given the suffix *ene* and *ine* respectively. The higher members are derived from the corresponding saturated hydrocarbons by the loss of two or four hydrogen atoms and the insertion of a double or triple bond. Isomers exist amongst the higher members, and further, compounds are known which contain two or more double bonds in their molecule, e.g.

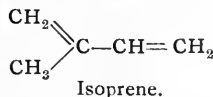

It should be noted that the double and the triple bonds do not indicate greater, but on the contrary lesser, stability.

(a) OLEFINES.

Preparation.

1. The olefines are most usually prepared by abstracting the elements of water from alcohols by means of dehydrating agents—zinc chloride, sulphuric acid, phosphoric acid:—

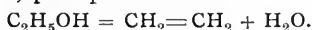

The preparation of ethylene by this method is described on p. 58.

2. Olefines are prepared by the action of alcoholic potash upon the alkyl halide (p. 57).

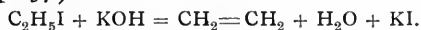

Ethylene may be prepared as follows:—

50 c.c. of a 20 per cent. solution of caustic potash in alcohol is placed in a 250 c.c. distilling flask in the neck of which a tap funnel is fastened with a cork. The distilling flask is fixed on a stand at an angle so that its neck may be attached to an inverted condenser (or its neck bent at an angle). A glass tube suitably bent leads from the condenser to a water trough. The potash solution is warmed and about 15 c.c. of ethyl iodide are slowly dropped in. Ethylene is evolved and potassium iodide is precipitated. When all the air has been displaced from the apparatus the gas may be collected in a gas cylinder over water.

Note.—Ether is formed in the reaction according to the equation:—

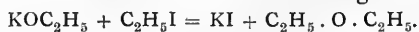

Properties.

The lower members with 2, 3 and 4 atoms of carbon are gases. The higher members are liquids and solids. They are lighter than water in which they are only slightly soluble. They are soluble in alcohol, ether and other organic liquids. They are inflammable and burn with a luminous, smoky flame.

Addition Reactions.

(1) **Hydrogen.** When mixed with hydrogen and passed through a hot tube over platinum black, or finely divided nickel, they are converted into saturated hydrocarbons :—



The catalyst can be suspended in an inert solvent and a mixture of ethylene and hydrogen bubbled through the liquid.

(2) **Halogens.** The olefines combine with the halogens, chlorine and bromine, but less readily with iodine, to form halogen compounds containing two atoms of halogen (see p. 57):—

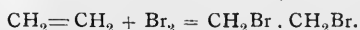

(3) **Halogen Acids.** The following reaction occurs :—



(4) **Sulphuric Acid.** The alkyl hydrogen sulphate (p. 71) is formed by addition :—

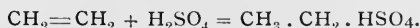

This reaction serves for the separation of saturated and unsaturated hydrocarbons.

(5) **Hypochlorous Acid.** Chlorhydrins are formed :—

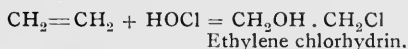

(6) **Potassium Permanganate.** The olefines are oxidised by dilute permanganate :—

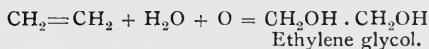

This reaction may be used for detecting unsaturated compounds in a mixture of hydrocarbons.

(b) ACETYLENES.

Preparation.

Acetylene is formed by the incomplete combustion of other hydrocarbons, but is most usually prepared by the action of water upon calcium carbide :—

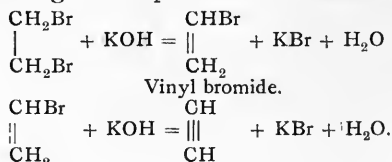

The hydrocarbons of this group are prepared by the action of alcoholic potash upon halogen compounds in the same way as ethylene :—

*Properties.*

The lower members are gases, the higher members are liquids. Acetylene is soluble in water (1 : 1) and other organic liquids. Acetone dissolves thirty-one times its own volume of the gas at N.T.P. Acetylene burns with a smoky, intensely hot flame which is very luminous; it is consequently employed for illuminating purposes, the burners, generally of clay, being designed so that complete combustion is effected.

Addition Reactions.

Acetylene and its homologues behave like the olefines, but react with two molecules :—

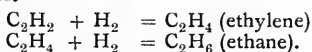
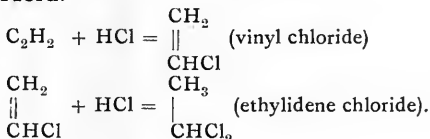
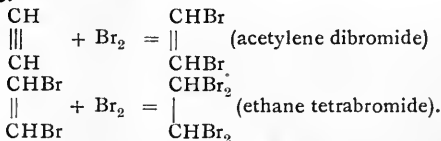
(1) **Hydrogen.**(2) **Halogen Acid.**(3) **Halogens.**

Acetylene and the other members of the series form characteristic compounds with copper, silver and other heavy metals.

Cuprous acetylide, C_2Cu_2 , and silver acetylide, C_2Ag_2 , are precipitated as amorphous compounds when acetylene is passed through ammoniacal solutions of cuprous chloride or silver nitrate. In the dry state these compounds are very explosive; they are decomposed on treatment with hydrochloric acid or potassium cyanide yielding acetylene. Acetylene may be separated from other hydrocarbons by this property.

HALOGEN DERIVATIVES OF THE HYDROCARBONS.

The only chemical property of the saturated hydrocarbons is that they are attacked by the halogens yielding halogen substitution derivatives, one atom of hydrogen being progressively replaced by an atom of halogen; thus, from methane by the action of chlorine, we can obtain

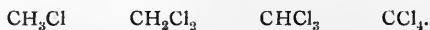

A mixture of the compounds results and the reaction is slow, so that, in practice, these compounds are not prepared from the hydrocarbon, but from other compounds.

The unsaturated hydrocarbons differ from the saturated hydrocarbons in their behaviour to the halogens. They react by addition, thus, e.g. ethylene combines with two atoms of bromine, forming the saturated compound, ethylene dibromide :—

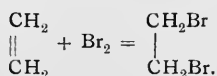

Dihalogen compounds of this type are generally prepared by this reaction.

MONOHALOGEN DERIVATIVES. ALKYL HALIDES.

Preparation.

The alkyl halides are prepared from the corresponding alcohol by the action of the halogen acid, or by the action of the phosphorus halide :—

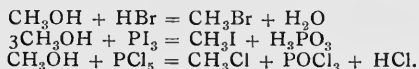

Preparation of Methyl Iodide.

18 gm. of methyl alcohol and 5 gm. of red phosphorus are placed in a small flask (250 c.c.) and a reflux condenser is attached to it. 50 gm. of iodine are slowly added by detaching the flask from the condenser and rapidly refluxing. Heat is evolved in the reaction and loss of alcohol and iodide is prevented by the condenser. The apparatus and mixture is allowed to stand for 12 to 24 hours so that the reaction completes itself. The contents of the flask are distilled from a water-bath. The distillate is shaken in a separating funnel with dilute caustic soda to remove iodine and hydriodic acid, and if sufficient has been used the lower layer of methyl iodide will be colourless. The lower layer of methyl iodide is separated, allowed to stand with a little calcium chloride till it is clear and distilled from a water-bath (b.p. 44°).

About 45 gm. or 75 per cent. of the theoretical yield should be obtained.

Preparation of Ethyl Bromide.

A distilling flask of about 1 litre capacity is closed by a cork and its neck attached to a condenser. To the end of the condenser is attached an adapter (a bent tube wide at one end and narrow at the other, p. 12) which dips under water contained in a conical flask of about 250 c.c. capacity cooled by standing in ice. 54 c.c. (100 gm.) of sulphuric acid are mixed in the flask with 75 c.c. (60 gm.) of absolute alcohol and cooled to the temperature of the air. 100 gm. of coarsely powdered potassium bromide are added to the contents of the flask and the mixture is heated on a sand bath or carefully on a gauze. The contents boil and froth up and heavy oily drops of ethyl bromide collect under the water in the receiver. If the frothing is too great the flask is removed from the source of heat for a minute. The heating is continued so long as oily drops distil over. The contents of the receiver are placed in a separating funnel and the lower layer collected. It is purified by returning to the separating funnel and shaking with a dilute solution of sodium carbonate. The ethyl bromide is then shaken with water to remove alkali and it is placed in a clean dry distilling flask and left in contact with calcium chloride till it is clear. The flask is furnished with a thermometer, attached to a condenser and the ethyl bromide (b.p. 35-40°) distilled over from a water-bath. About 75 to 80 gm. should be obtained.

DIHALOGEN DERIVATIVES.

Methylene chloride, CH_2Cl_2 , is generally prepared by reducing chloroform in alcoholic solution with zinc and hydrochloric acid.

Methylene iodide, CH_2I_2 , is prepared by reducing iodoform with hydriodic acid.

Methylene bromide, CH_2Br_2 , is prepared by treating methylene iodide with bromine:—

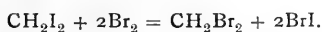

The numerous isomers of the halogen derivatives of the higher hydrocarbons are prepared by various methods, e.g. :—

- (a) by addition of halogen to unsaturated hydrocarbons;
- (b) by the action of phosphorus pentachloride upon the aldehydes and ketones.

Preparation of Ethylene Dibromide.

Ethylene is prepared by dropping a mixture of 30 c.c. of absolute alcohol and 80 c.c. sulphuric acid from a tap funnel upon a mixture of 124 c.c. of alcohol and 108 c.c. of concentrated sulphuric acid contained in a 2 litre flask and mixed with sand to prevent frothing, the mixture being gently heated until a steady stream of gas is evolved. The evolved gas is passed through two wash bottles¹ with safety tubes containing caustic soda solution to remove sulphur dioxide into two ordinary wash bottles containing 50 c.c. bromine and 1 c.c. of water and 15 c.c. of bromine and 1 c.c. of water respectively. These two bottles are placed in a basin of water to which ice may be added to prevent the contents becoming warm during the reaction. The outlet tube is connected to a tower containing soda lime so that bromine vapour does not escape into the room. The bromine in the bottles is gradually decolorised

¹ It may be necessary to change these bottles for fresh ones during the preparation.

and changes into ethylene bromide which may have a straw-yellow colour. The heavy liquid product is shaken in a separating funnel with dilute caustic soda solution and then with water. It is dried with calcium chloride and purified by distillation (b.p. 130-132°). About 60 gm. should be obtained.

Properties of the Monohalogen and Dihalogen Derivatives.

The monohalogen derivatives are liquids heavier than water in which they are insoluble or only slightly soluble. They have a peculiar smell and do not burn readily. Their properties are in general like those of chloroform (p. 60).

Chemically the monohalogen derivatives or alkylhalides are very reactive substances and readily exchange the atom of halogen with other atoms or groups. They are thus largely used for introducing *alkyl* radicles into other compounds, thus :—

1. $\text{CH}_3\text{I} + 2\text{H} = \text{CH}_4 + \text{HI}$ (p. 53). *Methane.*
2. $\text{CH}_3\text{I} + \text{Zn} + \text{CH}_3\text{I} = \text{C}_2\text{H}_6 + \text{ZnI}_2$ (p. 53). *Ethane.*
3. $\text{CH}_3\text{I} + 2\text{Zn} + \text{CH}_3\text{I} = \text{CH}_3 \cdot \text{Zn} \cdot \text{CH}_3 + \text{ZnI}_2$.
4. $\text{CH}_3\text{I} + \text{KOH} = \text{CH}_3\text{OH} + \text{KI}$ (p. 63).
aqueous
5. $\text{C}_2\text{H}_5\text{I} + \text{KOH} = \text{C}_2\text{H}_4 + \text{KI} + \text{H}_2\text{O}$ (p. 54).
alcoholic
6. $\text{C}_2\text{H}_5\text{I} + \text{NH}_3 = \text{C}_2\text{H}_5\text{NH}_2 + \text{HI}$ (p. 124).
7. $\text{C}_2\text{H}_5\text{I} + \text{KCN} = \text{C}_2\text{H}_5\text{CN} + \text{KI}$ (p. 158).
8. $\text{C}_2\text{H}_5\text{I} + \text{KNO}_2 = \text{C}_2\text{H}_5\text{NO}_2 + \text{KI}$.
9. $\text{C}_2\text{H}_5\text{I} + \text{KHS} = \text{C}_2\text{H}_5\text{HS} + \text{KI}$ (p. 78).

The dihalogen derivatives are very similar to the monohalogen derivatives in both their physical and chemical properties. Both the halogen atoms can be replaced by OH, NH_2 , etc.

TRIHALOGEN DERIVATIVES.

CHLOROFORM.

* Preparation.

100 gm. of fresh bleaching powder are rubbed up in a mortar with 200 c.c. of water so as to form a paste, the paste is rinsed into a large flask of about 1000 c.c. capacity with another 200 c.c. of water; 25 c.c. of acetone or alcohol are added and the mixture shaken up thoroughly. The flask is connected by means of a bent tube to a condenser and receiver and gently heated through a wire gauze. As soon as the reaction commences, which is shown by the frothing, the flame is removed. When the frothing has subsided and the reaction has moderated, the contents of the flask are boiled until no more chloroform distils over with the water. The chloroform consists of heavy oily drops which sink in water, and it forms the lower layer of the distillate.

The distillate is transferred to a separating funnel and shaken with a little dilute caustic soda solution; the lower layer of chloroform

form is drawn off into a clean, dry flask and dried by adding anhydrous calcium chloride, either by shaking for 5-10 minutes or allowing to stand from 12-24 hours, until it is clear. The chloroform is filtered into a clean, dry distilling flask and distilled.

The mechanism of the reaction by which the chloroform is formed is probably :—

1. The oxidation of the alcohol to aldehyde (p. 80),

$$\text{CH}_3 \cdot \text{CH}_2\text{OH} + \text{O} = \text{CH}_3 \cdot \text{CHO} + \text{H}_2\text{O}.$$
2. The chlorination of the aldehyde to chloral,

$$\text{CH}_3 \cdot \text{CHO} + 3\text{Cl}_2 = \text{CCl}_3 \cdot \text{CHO} + 3\text{HCl}.$$
3. The decomposition of the chloral to chloroform and calcium formate by the calcium hydroxide (p. 87),

$$2\text{CCl}_3 \cdot \text{CHO} + \text{Ca}(\text{OH})_2 = 2\text{CHCl}_3 + (\text{HCOO})_2\text{Ca}.$$

Purification of Commercial Chloroform.

Chloroform prepared from alcohol, methylated spirit (methylated chloroform) or acetone may contain chlorine, hypochlorous acid or hydrochloric acid, aldehyde, etc.

The specimen is shaken several times with water, the chloroform is separated, dried with (1) calcium chloride, (2) phosphorus pentoxide and distilled.

The last traces of alcohol may also be removed by adding slices of metallic sodium, allowing to stand for 12-24 hours and then distilling.

* *Properties.*

Chloroform is a volatile colourless liquid with a distinct and sharp odour and sweetish taste. It boils at 61° and has a sp. gr. of 1.483-1.487.

* Its vapour does not burn, but when mixed with alcohol the combined vapours burn with a smoky flame edged with green.

It is soluble in about 200 volumes of cold water (44 gm. in 100 c.c.) to which it gives a sweet taste.

It mixes in all proportions with absolute alcohol, ether, benzene, petroleum ether. It is slightly soluble in dilute alcohol and readily dissolves fats, resins, india-rubber, camphor, iodine, bromine.

Many specimens of commercial chloroform undergo change on keeping, especially in the light, and are liable to contain chlorine, hypochlorous acid or hydrochloric acid. This decomposition is hindered by the addition of 1 per cent. of alcohol. The bottle should be kept in the dark. 1 c.c. of chloroform on evaporation should leave no residue and if allowed to evaporate on clean filter paper should leave no disagreeable odour.

* Chloroform is decomposed by boiling with aqueous alkali, more rapidly in alcoholic solution, into alkali formate and chloride :—



A few drops of chloroform are heated with dilute caustic soda. The presence of chloride is tested for in a small portion of the solution, the remainder is neutralised exactly, if it be still alkaline, and heated with mercuric chloride solution. A deposit of mercurous chloride and mercury shows the presence of formate.

Tests for Impurities in Chloroform.

* A quantity of the specimen is shaken up with two volumes of water. The water is separated and silver nitrate is added. Pure chloroform gives no reaction, but a precipitate of silver chloride indicates the presence of chlorides. If, on heating, the precipitate blackens the presence of aldehyde or formic acid is indicated. The water should not react with blue litmus.

* Chloroform is not soluble in concentrated sulphuric acid. Any darkening which occurs on shaking them together is due to the presence of aldehyde, methyl alcohol, etc. The presence of alcohol in chloroform may be detected by shaking some of the specimen with five volumes of water, filtering through a wet paper, and testing for alcohol in the filtrate by the iodoform reaction (p. 67).

Tests for Chloroform.

* (1) A red or yellow precipitate of cuprous oxide is formed on adding some solution of chloroform in water to Fehling's solution (p. 84) and heating.

* (2) *Carbylamine Reaction*.—To the dilute solution of chloroform in water is added some alcoholic sodium hydroxide and a drop of aniline and the mixture heated. Phenyl isonitrile or carbylamine is formed, which has a disgusting smell:—

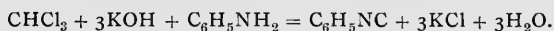

This reaction is extraordinarily sensitive and will detect one part of chloroform in 5000 parts of alcohol. It is also given by bromoform, iodoform, chloral, trichloroacetic acid and substances which yield chloroform when treated with alkali.

From liquids, such as blood, it is better to remove the chloroform as described under estimation and to test the liquid in the receiver.

Estimation of Chloroform.

Hydrochloric acid is formed when chloroform vapour mixed with hydrogen is passed through a red hot tube.

Hydrogen is slowly passed into a flask containing the solution of chloroform and the flask is gently heated. The mixed vapours are passed through a short, heated combustion tube containing platinum wire gauze or loose asbestos and into a receiver containing water. The contents of the receiver are titrated with standard alkali or precipitated with silver nitrate. As acetylene and hydrogen cyanide may also be present the contents of the receiver should be boiled before titrating or precipitating.

This procedure may be used for detecting and estimating chloroform in blood and other liquids which do not contain other chlorinated compounds.

IODOFORM.* *Preparation.*

4 gm. of crystallised sodium carbonate are dissolved in 20 c.c. of water. 2 c.c. of absolute alcohol and 2 gm. of iodine are added, and the solution warmed to about 70° on the water-bath until it is decolorised. Iodoform separates as a lemon-yellow powder. It is filtered off, washed with cold water and dried on an unglazed plate.

— The melting-point of the preparation serves to prove its identity.

Properties.

- * Iodoform is a light yellow, shining crystalline solid with a persistent unpleasant odour. It has a characteristic microscopic appearance—hexagonal plates, stars, or rosettes, and melts at 119°. On gently heating it sublimes without change, but on heating strongly it is decomposed: violet vapours of iodine are formed and a deposit of carbon is left.

Iodoform is nearly insoluble in water (1 part in 10,000) and in dilute acids and alkalis. It is slightly soluble in alcohol (1 part in 50) but more easily soluble in absolute alcohol (1 part in 23). It is easily soluble in ether, chloroform and carbon disulphide, but very slightly soluble in glycerol, benzene and petroleum ether. In its chemical properties iodoform closely resembles chloroform.

Tests for Impurities in Iodoform.

1. No residue should remain when it is heated in the air.
2. It should be completely soluble in boiling alcohol, but insoluble in brine.
3. On shaking up with water and filtering, the filtrate should give no reaction with barium chloride or silver nitrate.
4. If picric acid be present as adulterant, it may be detected (a) By testing the aqueous extract with potassium cyanide when a reddish-brown coloration is produced. (b) By treating with caustic soda solution and shaking this solution with chloroform. Picric acid remains in the aqueous solution. (c) By extracting the acid with dilute sodium carbonate solution, neutralising exactly with acetic acid and adding potassium nitrate; potassium picrate is precipitated.

ALCOHOLS.

Alcohols are hydrocarbons in which a hydrogen atom (or more in the case of the higher members, e.g. glycerol) has been substituted by a hydroxyl or OH group. This relationship is shown :—

1. By the action of water and aqueous alkalies upon the halogen mono-substituted hydrocarbons :—



2. By the action of phosphorus pentachloride upon the alcohol :—



All alcohols are designated by the suffix -ol, e.g. methyl alcohol or methanol, ethyl alcohol or ethanol.

Most of the alcohols are natural substances and serve as the starting point for the preparation of other compounds.

METHYL ALCOHOL. $\text{CH}_3 \cdot \text{OH}$.

Commercial Methyl Alcohol.

Preparation.

Methyl alcohol, together with acetone, acetic acid, methyl acetate and other substances is formed in the dry distillation of wood. The acid aqueous distillate is known as pyroligneous acid; on standing wood tar separates out. The acid liquid contains 1-2 per cent. of methyl alcohol, 1-5 per cent. of acetone and about 10 per cent. of acetic acid. It is distilled until the distillate has a specific gravity of 9-1. The crude wood spirit so obtained is a greenish-yellow liquid with disagreeable odour. It is mixed with about 2 per cent. of lime and again distilled. This retains the acetic acid as calcium acetate, the neutral substances—methyl alcohol, acetone, acetaldehyde, methyl acetate passing over. This distillate is wood spirit and contains about 93 per cent. of methyl alcohol. It is diluted with water to precipitate oily impurities and is again treated with lime and distilled. Basic impurities are removed by distilling it with 1-2 per cent. of sulphuric acid and the methyl alcohol boiling at 64-66° is collected.

Methyl alcohol is also prepared by dry distillation from vinasses—the mass remaining after fermentation of the residues from the preparation of beet sugar.

Pure Methyl Alcohol.

Commercial methyl alcohol contains acetone. By dissolving anhydrous oxalic acid (prepared by heating oxalic acid at 100°) in the boiling spirit, methyl oxalate is formed; it separates in crystals on cooling. The crystals are filtered off, washed free from acetone with water, and then decomposed into oxalic acid and methyl alcohol by boiling with water or ammonia. Methyl alcohol is obtained on distillation and is dehydrated by distilling over quicklime (see under ethyl alcohol).

Pure methyl alcohol may also be obtained by boiling commercial methyl alcohol with anhydrous calcium chloride. Calcium chloride crystallises out in combination with methyl alcohol as $\text{CaCl}_2 + 4\text{CH}_3\text{OH}$ from the saturated solution on cooling. The crystals are drained from the mother liquor and are decomposed by heating; methyl alcohol is evolved and is collected.

The acetone may also be removed by passing chlorine into it forming trichloroacetone. The methyl alcohol is separated by fractional distillation.

Properties.

Methyl alcohol is a colourless liquid which boils at 66° and has a sp. gr. of 0.797 at 15° . It closely resembles ethyl alcohol in its properties, but it does not give the iodoform reaction.

ETHYL ALCOHOL.*Preparation.*

Ethyl alcohol is obtained by the fermentation of sugar by yeast and occurs in all fermented liquids such as wine and beer. It is made chiefly from potatoes and cereals, the starch being first converted into the sugar, glucose, which is fermented by the yeast and changed into alcohol and carbon dioxide.

1. Rectified Spirit.

The alcohol produced by fermentation is separated from the fermented liquor by distillation. The distillate is then fractionally redistilled, or rectified, so as to separate as much water as possible and the greater part of the higher alcohols. The product is rectified spirit. It contains about 84 per cent. by weight of ethyl alcohol and has a sp. gr. of 0.838 at 15° .

2. Methylated Spirit.

The rectified spirit is denatured and rendered unfit for drinking purposes by the addition to it of one-ninth of its volume of wood spirit and three-eighths of 1 per cent. of mineral naphtha or paraffin oil.

Since 1905 methylated spirit has been obtainable in approved scientific institutions free of duty and free from mineral naphtha.

3. Absolute Alcohol.

Rectified spirit is filtered through charcoal and fractionally distilled, the first portions which contain aldehyde and the last portions which contain fusel oil being rejected. The middle fraction is distilled over quicklime and commercial absolute alcohol is obtained. This contains about .5 per cent. of water. Pure alcohol is prepared from this by adding the requisite quantity of metallic sodium or calcium and again distilling.

4. Absolute Alcohol from Methylated Spirit.

Methylated spirit (1 litre) is boiled upon a water-bath under a reflux or inverted condenser (p. 18) with about 30 gm. of caustic soda for one hour in a 2-litre flask. Acetone, aldehyde and other impurities are destroyed and the spirit turns brown. The contents of the flask are distilled and the distillate collected in another flask of the same capacity containing 400-500 gm. of quicklime. The flask is connected with a reflux condenser and either allowed to stand for twenty-four hours or heated for one hour on a water-bath. The liquid is distilled again without pouring off from the flask. The yield of absolute alcohol is about 80 per cent., and it contains 2-3 per cent. of water. By treating it again with half the previous quantity of quicklime the amount of water may be reduced to less than 1 per cent. The boiling-point (76-78°) may be determined by distilling 50 c.c. in a small apparatus.

Properties.

(1) Ethyl alcohol is a colourless, pleasant-smelling liquid with a hot taste. It boils at 78° and has a sp. gr. of .79384 at 15.5° or 60° F.

* (2) It mixes with water in all proportions. Absolute alcohol is very hygroscopic and readily absorbs water on exposure to the air.

On mixing alcohol with water there is an evolution of heat and a contraction in bulk.

The addition of water to methylated spirit produces a cloudiness due to the precipitation of the mineral naphtha.

* (3) Alcohol burns with a faint blue non-luminous flame even when mixed with considerable amounts of water.

On mixing 10 c.c. of alcohol with 10 c.c. of water in a measuring cylinder the evolution of heat will be noticed, and when the mixture is cold the diminution in volume can be measured. By placing the mixture in a small basin and applying a light it will be seen whether it is or is not inflammable.

Detection of Water in Absolute Alcohol.

- * (a) If the alcohol contains a considerable quantity of water its presence will be shown by adding some anhydrous copper sulphate which turns blue.¹
- * (b) 0.5 per cent. of water may be detected by adding a crystal of potassium permanganate; the liquid will assume a pink colour.
- (c) Traces of water in absolute alcohol according to Yvon may be detected by means of calcium carbide. If water be present, bubbles of acetylene are given off and the liquid becomes milky, due to the formation of calcium hydroxide.

Reactions.*1. Action of Sodium.*

- * On adding about 1 gm. of sodium to 20 c.c. of absolute alcohol in a small flask there is an evolution of hydrogen just as with water, but the reaction is by no means so violent. The gas which is evolved may be collected in an inverted test tube and shown to be hydrogen by burning.

When the sodium has dissolved the solution is evaporated to dryness on the water-bath. A white solid—sodium ethoxide—remains, which is very hygroscopic and is decomposed by water, yielding alcohol which can be recognised by its smell and by the iodoform test:—

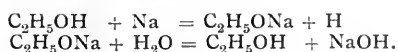

This reaction shows that one of the hydrogen atoms in alcohol is replaceable by sodium.

2. Action of Phosphorus Pentachloride.

- * On adding a little phosphorus pentachloride to a small quantity of alcohol, a vigorous action occurs and hydrochloric acid fumes are evolved. Ethyl chloride and phosphorus oxychloride are the other products. The smell of ethyl chloride will be noticed when the hydrochloric acid fumes cease to be given off. This reaction shows the presence of an hydroxyl or OH group:—



¹ Prepared by gently heating a crystal of copper sulphate in a crucible until it falls to powder.

Tests.

- * (1) *Smell*.—Even in dilute solutions alcohol may be detected by its smell.
- * (2) *Oxidation to Acetaldehyde*.—On warming a little dilute alcohol in a test tube with a few drops of potassium dichromate and some dilute sulphuric acid the pungent characteristic odour of aldehyde will be observed and the solution turns green:—
- $$\text{C}_2\text{H}_5\text{OH} + \text{O} = \text{CH}_3 \cdot \text{CHO} + \text{H}_2\text{O}.$$
- * (3) *Formation of Ethyl Acetate*.—The fruity odour of ethyl acetate is produced when some of the dilute solution is heated with concentrated sulphuric acid and a little solid sodium acetate.
- * (4) *Iodoform Reaction* (Lieben).—About an equal volume of iodine in potassium iodide is added to a very dilute solution of alcohol—1 or 2 drops in half a test tube full of water—and then, drop by drop, caustic soda till the mixture is decolorised. On gently warming the mixture, iodoform is formed and may be recognised by its characteristic smell. A yellow crystalline precipitate will separate if the solution of alcohol is not too weak.

Note.—This very sensitive reaction is not characteristic of alcohol as it may be given by aldehyde, acetone, acetic ester and other substances which contain the grouping $\text{CH}_3-\overset{\text{O}}{\underset{\text{O}}{\text{C}}}$ joined to oxygen.

Alcohol gives the reaction on warming, acetone gives the reaction in the cold.

Estimation of Alcohol in Beer, Wines, Spirits.

The amount of alcohol in these liquids is ascertained by distilling off the alcohol and determining the specific gravity of the distillate.

(a) 100 c.c. beer are distilled and 80 c.c. distillate are collected.

(b) 100 c.c. wine + 80 c.c. water and a little tannin are distilled and nearly 100 c.c. distillate are collected.

(c) 50 c.c. spirit + 100 c.c. water, or 25 c.c. spirit + 150 c.c. water, are distilled and nearly 100 c.c. distillate are collected.

The distillate is made up to 100 c.c. with water, the liquids are mixed, and the sp. gr. at 15.5° or 60° F. is determined by weighing in a sp. gr. bottle. The amount is given by referring to an alcohol specific gravity table for the percentage by weight. The amount in the sample is ascertained from the formula:—

$$\frac{\text{sp. gr. of distillate} \times \text{amount of distillate in c.c.} \times \text{per cent. of alcohol from table}}{\text{sp. gr. of sample} \times \text{amount of sample taken}} = \text{percentage of abs. alc. by weight in the sample.}$$

If the specific gravity of the sample be unknown, it may be calculated from

$$\frac{\text{wt. of distillate} \times \text{per cent. of alcohol from table}}{\text{wt. of sample taken}} = \text{percentage of abs. alc. by weight in the sample.}$$

PROPYL ALCOHOLS. C_3H_7OH .**Normal Propyl Alcohol.** $CH_3 \cdot CH_2 \cdot CH_2OH$.

Normal propyl alcohol is formed in the process of alcoholic fermentation and is contained in fusel oil, from which it is obtained by fractional distillation. It is present to the extent of about 3 per cent. in the fusel oil obtained from potato spirit.

It is a liquid resembling ethyl alcohol but with a less pleasant smell, and burns with a luminous flame. It boils at 97° and has a sp. gr. of $\cdot 807$ at 15° .

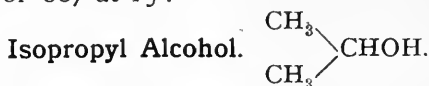

Isopropyl alcohol is prepared either by the reduction of acetone with sodium amalgam or from isopropyl iodide by boiling it with lead hydroxide and water. Isopropyl iodide is prepared by the action of phosphorus and iodine upon dilute glycerol.

It is a liquid resembling normal propyl alcohol, but it boils at 82° and has a sp. gr. of $\cdot 792$ at 15° .

BUTYL ALCOHOLS. C_4H_9OH .

Four isomers are possible in the case of the butyl alcohols:—

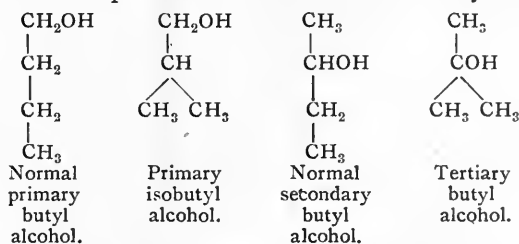

The chief of these is primary isobutyl alcohol which is formed in alcoholic fermentation and is separated by fractional distillation from the fusel oil.

Normal primary butyl alcohol has once been found in fusel oil. It is formed by the action of the *Schizomyces* upon glycerol. *Bacillus butylicus* (contained in the excrement of cows) produces 6-8 per cent. from glycerol and 10 per cent. from mannitol. Normal secondary butyl alcohol and tertiary butyl alcohol are prepared by synthetical methods. The butyl alcohols are liquids with the following boiling-points and specific gravities at 20° :—

	B.P.	Sp. Gr.		B.P.	Sp. Gr.
Normal primary	117°	$\cdot 810$	Primary isobutyl	107°	$\cdot 806$
Normal secondary	100°	$\cdot 808$	Tertiary	83°	$\cdot 786$

They are not miscible with water in all proportions; normal primary butyl alcohol requires 12 parts of water to dissolve it.

AMYL ALCOHOLS. $C_5H_{11}OH$.

Eight isomers are possible, all of which are known :—

	B.P.	Sp. Gr. at 20°.
1. Normal primary, $CH_3 \cdot CH_2 \cdot CH_2 \cdot CH_2 \cdot CH_2OH$	138°	·817
2. Isobutyl carbinol, $\begin{array}{l} CH_3 \\ \diagdown \\ CH \cdot CH_2 \cdot CH_2OH \\ \diagup \\ CH_3 \end{array}$	130°	·810
3. Secondary butyl carbinol, $\begin{array}{l} CH_3 \\ \diagdown \\ CH_3CH_2 \cdot CH \cdot CH_2OH \\ \diagup \end{array}$	128°	·816
4. Tertiary butyl carbinol, (primary) $\begin{array}{l} CH_3 \\ \diagdown \\ CH_3 - C \cdot CH_2OH \\ \diagup \\ CH_3 \end{array}$	113°	—
5. Methyl propyl carbinol, (secondary) $\begin{array}{l} CH_3 \\ \diagdown \\ CH_3 \cdot CH_2 \cdot CH_2 \cdot CHO \\ \diagup \end{array}$	119°	—
6. Methyl isopropyl carbinol, (secondary) $\begin{array}{l} CH_3 \\ \diagdown \\ CH_3 \cdot CH_2 \cdot CH \cdot CHO \\ \diagup \\ CH_3 \end{array}$	112°	·819
7. Diethyl carbinol, (secondary) $\begin{array}{l} CH_3 \cdot CH_2 \\ \diagdown \\ CH_3 \cdot CH_2 \cdot CHO \\ \diagup \end{array}$	117°	—
8. Dimethyl ethyl carbinol, (tertiary) $\begin{array}{l} CH_3 \\ \diagdown \\ CH_3 - C \cdot OH \\ \diagup \\ CH_3 \cdot CH_2 \end{array}$	102°	—

Secondary butyl carbinol contains an asymmetric carbon atom (see under lactic acid) and consequently exists in a dextro- and a laevo-form. Together with primary isobutyl alcohol and propyl alcohol the two amyl alcohols, isobutyl carbinol and laevo-secondary butyl carbinol, are the principal constituents of fusel oil—and they together constitute fermentation amyl alcohol.

The fusel oil from potatoes or cereals contains chiefly isobutyl carbinol, secondary butyl carbinol being present only to 13·22 per cent. The fusel oil from beet molasses contains 48·58 per cent. of secondary butyl carbinol.

Fermentation amyl alcohol is a strongly refractive liquid which boils at 130-131° and is very slightly soluble in water—3·3 volumes in 100 volumes of water at 22°. Its vapours, on being inhaled, produce a peculiar sensation in the head, causing headache, etc. The two alcohols cannot be separated by fractional distillation, but only by chemical means. The mixture generally referred to as amyl alcohol is frequently used as a solvent.

HIGHER ALCOHOLS.

A hexyl alcohol has been isolated from the fusel oil obtained from grape skins. Two primary hexyl alcohols occur as esters: n-primary hexyl alcohol in the oil from the seeds of the parsnip, *Heracleum giganteum*, and 3-methylpentanol in Roman camomile oil.

Normal primary heptyl alcohol is prepared by the reduction of oenanthylic aldehyde which is obtained by distilling castor oil.

Normal primary octyl alcohol occurs in the oil from the fruits of the parsnips, *Heracleum sphondylium*, *Heracleum giganteum* and *Pastinaca sativa*.

Normal nonyl alcohol is prepared by reducing with sodium and alcohol methyl heptyl ketone which is contained up to 5 per cent. in oil of rue.

Normal secondary undecylic alcohol is prepared by reducing methyl nonyl ketone, which occurs in camomile in large quantities.

n-dodecyl alcohol occurs as ester in oil of *Cascara sagrada*.

Normal hexadecyl alcohol, or cetyl alcohol, $C_{16}H_{38}OH$, the most important of the higher alcohols, is easily prepared from spermaceti, in which it is present as ester, by hydrolising the ester with alcoholic soda, diluting with water, filtering off and recrystallising the cetyl alcohol from alcohol. Cetyl alcohol has also been described as being present in the fat from an ovarian dermoid cyst. Cetyl alcohol is a white solid which melts at 50° .

Ceryl alcohol, $C_{27}H_{55}OH$, or more probably $C_{26}H_{53}OH$, is prepared from Chinese wax, and melts at $76-79^{\circ}$.

Myricyl alcohol, $C_{30}H_{61}OH$, is best prepared from carnauba wax. Beeswax contains this alcohol or the alcohol $C_{31}H_{63}OH$.

Psylla-stearyl alcohol, $C_{33}H_{68}O$, has been obtained from the fat of the leaf louse (*Psylla alni*).

ESTERS.

Alcohols are like the bases NaOH, KOH in containing an OH group. The bases combine with acids to form salts. Alcohols combine with acids to form esters.

An enormous number of esters is possible since any alcohol can be combined with any acid, inorganic or organic. The organic acids may be grouped into three classes: (*a*) those insoluble or very insoluble in water; (*b*) those soluble in water, but volatile with steam; (*c*) those soluble in water, but not volatile with steam.

Preparation.

There are several methods of preparing esters:—

(1) By the action of the acid upon the alcohol in the presence of a dehydrating agent, or catalyst.

(2) By the action of concentrated sulphuric acid upon the sodium salt of the acid and the alcohol.

(3) By the action of the acid chloride, or anhydride, upon the alcohol.

(4) By the action of the alkyl halide upon the silver salt.

ESTERS OF INORGANIC ACIDS.

Halogen Acids.

These compounds are the same as the monosubstituted halogen derivatives of the hydrocarbons (p. 57):—

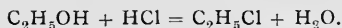

Amyl Nitrite.

The calculated quantity of concentrated sulphuric acid is allowed to drop slowly upon the calculated quantity of sodium nitrite mixed with the calculated quantity of amyl alcohol contained in a flask cooled by a freezing mixture. Amyl nitrite floats to the surface as an oil. It is separated, washed with water, dried with calcium chloride and distilled.

* **Ethyl Sulphuric Acid. Barium and Potassium Ethyl Sulphate.**

10 c.c. of concentrated sulphuric acid are poured carefully into and mixed with 20 c.c. of ethyl alcohol; the mixture becomes hot. It is heated on a water-bath under a reflux condenser for $\frac{1}{2}$ -1 hour. On cooling it is poured into about 200 c.c. of cold water. The acid solution is neutralised to litmus by stirring it up with calcium or

barium carbonate. Carbon dioxide is evolved and the excess of sulphuric acid is precipitated as insoluble sulphate; this is filtered off after heating on a water-bath for $\frac{1}{2}$ -1 hour. The solution contains calcium or barium ethyl sulphate (as shown below under hydrolysis).

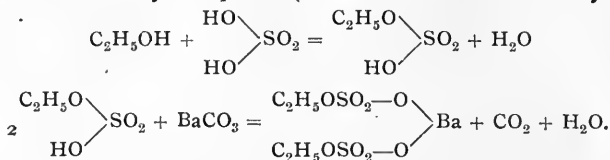

The clear filtrate is heated on the water-bath and treated with a strong solution of potassium carbonate (10 gm.) or potassium oxalate until no further precipitate is formed:—

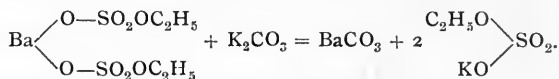

The barium carbonate is filtered off and the filtrate evaporated to a small volume (a drop withdrawn on a glass rod should crystallise on cooling). The crystals which form after standing for several hours are filtered off, washed with dilute alcohol and dried between sheets of filter paper. The mother liquor yields more crystals on further evaporation. The salt is dissolved in boiling alcohol under a reflux condenser, filtered, using a hot-water funnel, and allowed to crystallise out.

ESTERS OF ORGANIC ACID.

* Ethyl Acetate.

Molecular proportions of glacial acetic acid (50 c.c.) and absolute alcohol (50 c.c.) are mixed in a distilling flask, and 1 per cent. by volume of concentrated sulphuric acid (1 c.c.) is added. The distilling flask is connected to a condenser and receiver and the mixture is distilled. A yield of 86.5 per cent. of ester is obtained (Senderens' method). Ethyl sulphuric acid appears to be the catalyst: \rightarrow

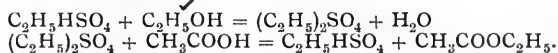

The distillate which contains water, alcohol and acetic acid is purified by shaking it in a separating funnel with strong sodium carbonate solution which is added in small quantities until the aqueous portion shows an alkaline reaction. The aqueous portion is withdrawn and the ester shaken with saturated salt or strong calcium chloride solution to remove alcohol; the ester layer is separated and dried by contact with solid calcium chloride. It is then distilled from a dry flask, the portion passing over when the thermometer reads 74-78° being collected.

Ethyl Benzoate.

20 gm. of benzoic acid are dissolved in 75 c.c. of absolute alcohol and 1 c.c. of concentrated sulphuric acid is added. The flask containing the mixture is connected to a reflux condenser and gently heated for 1-2 hours over a gauze, a piece of porcelain being added to prevent bumping. The esterification is complete when, on testing by pouring a few drops into water, only oil drops and no crystalline benzoic acid is seen. The whole is then poured into about 400 c.c. of water and the oil is allowed to settle. The water is decanted off and the remainder is shaken up with ether in a separating funnel. The aqueous layer is withdrawn, the ethereal layer shaken with sodium carbonate solution and then with water. It is dried with calcium chloride and the ether distilled off over a water-bath. The ester is distilled over a flame and the fraction boiling from $210-215^{\circ}$ is collected. Ethyl benzoate boils at 213° .

Properties.

Esters are usually liquids having a sweet and fragrant odour; a few are solid.

Neutral esters of monobasic, dibasic, etc., acids are insoluble in water, or only slightly soluble, e.g. ethyl formate and acetate.

Acid esters of dibasic, etc., acids are soluble in water, e.g. ethyl sulphuric acid, ethyl oxalic acid, etc.

○ Neutral esters are soluble in alcohol and ether, acid esters may be soluble in alcohol, but are insoluble in ether.

Esters are comparatively inert substances and are unaffected by cold dilute sodium carbonate, sodium hydroxide, hydrochloric acid, sulphuric acid, but there are exceptions, e.g. methyl oxalate, which is decomposed by cold dilute caustic soda. They are acted upon by sodium more or less readily (cf. ethers). All esters are hydrolysed by boiling with water, acids, or alkalis. The last method of hydrolysis is known as saponification. They are thus converted into their constituents, namely acid and alcohol. The recognition of these identifies the ester. Esters which are of frequent occurrence in animals and plants are identified in this way. The hydrolysis is effected by boiling under a reflux condenser with aqueous sodium hydroxide, or 80 per cent. sulphuric acid. If only the acid is to be identified hydrolysis is effected by boiling with alcoholic sodium hydroxide. The alcohol is isolated by distilling the alkaline liquid if the alcohol be volatile, by extracting the alkaline solution with ether if not volatile, and it is identified by the reactions for alcohols. If the alcoholic portion of the ester be a phenol or an aromatic alcohol it does not distil and is not extracted

from an alkaline solution. The solution must be firstly acidified to liberate the phenol (see under phenols). The acid, which is formed by hydrolysis with alkali, is liberated by acidifying the cold solution with mineral acid—sulphuric acid. If insoluble it is filtered off; if soluble and volatile with steam, distilled; if soluble and not volatile, it is extracted with ether or precipitated as insoluble calcium or other salt.

HYDROLYSIS OF ESTERS.

* Ethyl Sulphuric Acid.

Ethyl sulphuric acid is not readily hydrolysed by alkali, but it is decomposed by boiling with acid.

The solution of calcium or barium ethyl sulphate obtained above contains one or other of these bases as shown by adding dilute sulphuric acid, the insoluble sulphate being precipitated.

If a portion of the solution be heated with dilute hydrochloric acid for 3-5 minutes, the insoluble sulphate is again precipitated :—

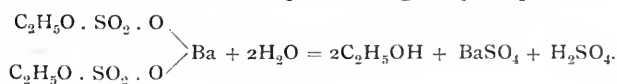

* Ethyl Acetate.

About 10 c.c. of ethyl acetate are placed in a flask with about 80 c.c. of sodium hydroxide, and the mixture is boiled over a gauze under a reflux condenser for 20-30 minutes until no more oily drops are visible and until the smell of ethyl acetate has disappeared. A piece of unglazed porcelain is added with advantage to prevent bumping of the liquid during the heating :—



The flask is connected with a condenser and about a quarter of the liquid is distilled over.

This liquid contains the alcohol. It may be identified by the tests for ethyl alcohol.

The alcohol is separated and identified by saturating the solution with solid potassium carbonate, collecting the alcohol in a pipette, determining its boiling-point and performing other reactions for the alcohol.

The liquid remaining in the flask is acidified with dilute sulphuric acid and again distilled as long as the distillate reacts acid to litmus.

The distillate is neutralised and evaporated down and the acetic acid prepared and identified (p. 97).

Ethyl Benzoate.

The hydrolysis is effected as described above for ethyl acetate.

The insoluble acid is more readily prepared by hydrolysing with alcoholic soda and then identified:—

5-10 gm. of the ester are placed in a flask and boiled under a reflux condenser with excess of caustic soda (1-2 gm.), dissolved in 10 c.c. water and 100 c.c. of alcohol, for 10-15 minutes. The saponification is continued until a few drops poured into water show no oily drops of unchanged ester.

If any insoluble sodium benzoate separates out, it is dissolved by adding a little water through the condenser.

The solution is poured into an evaporating basin, water added and the alcohol evaporated off on the water-bath. On cooling and after adding about 25-50 c.c. of water the solution is acidified with dilute mineral acid. Benzoic acid is precipitated. It is washed with water, recrystallised from hot water, and identified (p. 256).

Ethyl Oxalate.

10-20 gm. of ethyl oxalate are hydrolysed with caustic soda solution containing sufficient alkali (6-12 gm.) as described under ethyl acetate and the alcohol is distilled off.

The acid contained in the solution on acidifying with mineral acid is not precipitated nor is it volatile with steam. The acid solution may be extracted several times with ether, the ethereal solution distilled to remove the ether, and the acid which is left identified.

Oxalic acid is more easily separated as its calcium salt. The acid liquid is carefully neutralised with soda and calcium oxalate is precipitated by adding calcium chloride. The acid is obtained as described under oxalic acid (p. 108).

ETHERS.

Preparation.

Ethers are prepared either by distilling alcohols with concentrated sulphuric acid or by the action of sodium ethoxide upon an alkyl halide:—

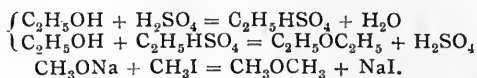

If in the first preparation a different alcohol be used in the second reaction, and if in the second preparation the alkoxide and halide contain different radicles, mixed ethers are formed, e.g.

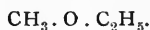
**ETHYL ETHER.***Preparation.*

Ethyl ether is generally prepared by distilling ethyl alcohol with sulphuric acid—hence its name of sulphuric ether. According to the equation the sulphuric acid is combined and again liberated so that it should be possible to convert an unlimited quantity of alcohol into ether, but bye-products are formed which interfere with the reaction. The process is known as the continuous process.

A distilling flask of about 500 c.c. capacity is fitted with a tap funnel and a thermometer, the bulb of which reaches nearly to the bottom of the flask. The neck of the flask is connected to a long condenser and the receiver is cooled by standing in ice water. A mixture of 110 c.c. of absolute alcohol and 80 c.c. of concentrated sulphuric acid is placed in the flask and heated to 140-145°. At this temperature ether is formed and absolute alcohol is dropped in from the tap funnel at the same rate as the liquid distils. The preparation is continued until about twice the volume of alcohol originally mixed with the sulphuric acid has been added. The distillate consists of ether, alcohol, water and sulphurous acid. It is put into a separating funnel and shaken with dilute caustic soda. The alkaline layer is withdrawn and the upper layer of ether shaken with saturated salt solution, which is also withdrawn. The ether is put into a distilling flask, which is loosely corked, and dried by being allowed to stand in contact with calcium chloride for 12-24 hours. The flask is connected with a condenser and the ether distilled off from a water-bath (b.p. 35°).

Purification of Ethyl Ether.

The ether obtained above contains traces of alcohol and water. These can only be removed by treatment with metallic sodium. The ether is placed in a flask, provided with a calcium chloride tube to prevent access of moisture and to allow the escape of hydrogen, and several slices of sodium are added. When no further effervescence is observed the ether is decanted into a distilling flask and distilled from a water-bath. Pure ether of constant boiling-point 35° is collected.

Purification of Commercial Methylated Ether.

This ether is made by the continuous process from methylated spirit and contains water, alcohol and other impurities. The ether may be washed with water to remove most of the alcohol. By distilling it over solid caustic potash, aldehydic impurities are destroyed. It is dried by standing over calcium chloride and then treated with metallic sodium.

Sometimes, after treatment with sodium, ether is left in contact with phosphorus pentoxide and then distilled from the solid dehydrating agent.

* Distillation of Ether. Precautions.

As ether is very inflammable and exceedingly volatile no flame should be in the neighbourhood. Ether should never be distilled over a free flame and the most convenient way, if steam or electric heaters are not available, is to heat a water-bath, extinguish the flame, and immerse the distilling flask containing the ether in the hot water.

Large quantities of ether should not be distilled from a large flask, but a small flask provided with a tap funnel should be employed. As the ether distils a fresh quantity can be added without interrupting the distillation. The ether should be collected in small receivers and transferred to a larger reservoir.

Properties.

The first member of the series, dimethyl ether, is a gas.

Ethyl ether, or simply ether, the chief representative of the group, is a very volatile, colourless liquid with a pleasant characteristic smell. It boils at 35° and has a sp. gr. of $\cdot 7195$ at 15° . It is sparingly soluble in water, less soluble in glycerol. It mixes in all proportions with alcohol, chloroform, benzene, ligroin, and is largely used as a solvent for fats, resins, etc. The lower members of ethers of the aliphatic series are also volatile liquids, like ethyl ether, which boil at a lower temperature than the alcohol from which they are derived. The highest members are odourless solids.

The ethers are inert compounds and are not acted upon by phosphorus pentachloride and sodium (distinction from alcohols), or by aqueous or alcoholic potash (distinction from halogen compounds and esters).

The lower members—especially those containing methyl and ethyl radicles—are decomposed by heating with hydriodic acid forming alkyl iodides (distinction from hydrocarbons). This reaction is used in estimating methoxy— CH_3O —and ethoxy $\text{C}_2\text{H}_5\text{O}$ groups in organic compounds (Zeisel's method).

MERCAPTANS AND SULPHIDES.

The sulphur compounds corresponding to the alcohols, i.e. thio-alcohols, are known as mercaptans; the sulphur compounds corresponding to the ethers, i.e. thio-ethers, are known as sulphides, or alkyl sulphides. Disulphides are also known.

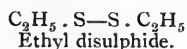
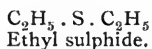
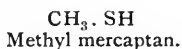
**Mercaptans.**

Methyl mercaptan is a product of the putrefaction of proteins. It occurs in the urine after a diet of asparagus and gives it the peculiar unpleasant odour.

Preparation.

Mercaptans are prepared:—

(1) By heating the alcohol with phosphorus pentasulphide:—



(2) By heating the alkyl halide or alkyl potassium sulphate with potassium hydrosulphide:—

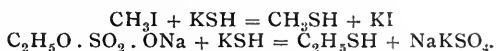

* About 2-5 c.c. of a saturated solution of sodium ethyl sulphate are made alkaline with sodium hydroxide and an equal volume of sodium hydrosulphide (33 per cent.) is added. On warming ethyl mercaptan is formed which is recognised by its garlic-like unpleasant odour.

Properties.

Methyl mercaptan is a gas, ethyl mercaptan is a colourless liquid boiling at 36°. The other mercaptans are also liquids which are insoluble in water and have a disgusting smell.

Like the alcohols they react with sodium with evolution of hydrogen:—

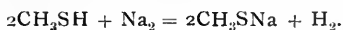

The mercaptans react with mercuric oxide forming crystalline compounds:—

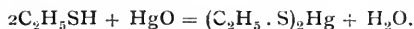

These compounds are termed mercaptides, the name of the group being derived from the mercury compounds. On oxidation with nitric acid the mercaptans yield sulphonic acids:—

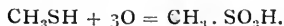

The sulphonic acids are isomeric with alkyl hydrogen sulphites. The latter compounds are esters and are hydrolysed by alkali; the sulphonic acids are stable. In the sulphonic acids the sulphur atom is joined to carbon, in the sulphites it is joined to oxygen:—

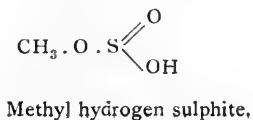
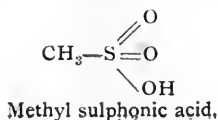

Alkyl Sulphides.

Ethyl sulphide, $C_2H_5 \cdot S \cdot C_2H_5$, is another product of the putrefaction of proteins, being derived from cystine (p. 143).

Preparation.

Sulphides are obtained :—

(1) By the action of phosphorus pentasulphide upon ethers :—

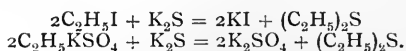

(2) By the action of potassium sulphide on an alkyl halide or alkyl potassium sulphate :—

*Properties.*

The sulphides are colourless, neutral liquids with very unpleasant smell ; ethyl sulphide boils at 91° .

They resemble the ethers in being comparatively stable compounds. On oxidation with nitric acid, they are converted into sulphones which are stable crystalline compounds :—

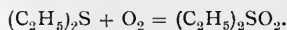
**Alkyl Disulphides.**

Disulphides are formed when mercaptans are exposed to the air :—

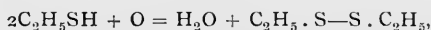

or by the action of iodine upon sodium mercaptides :—



ALDEHYDES.

Aldehydes are the first products of oxidation of primary alcohols, e.g. :—

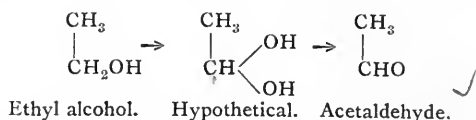

The hypothetical intermediate compound does not exist; it at once loses a molecule of water and is converted into aldehyde. Two OH groups cannot exist attached to one carbon atom; aldehyde is formed by loss of water. There are a few exceptions, such as chloral hydrate,

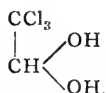

Formaldehyde is formed from methyl alcohol, propyl aldehyde from primary propyl alcohol, etc.

The group $-\text{CHO}$ or $-\text{C} \begin{array}{l} \text{H} \\ // \\ \text{O} \end{array}$ is characteristic of aldehydes.

Preparation.

When the alcohol is available the aldehyde is usually prepared by oxidation; otherwise it may be prepared by the dry distillation of molecular proportions of calcium formate and the calcium salt of the corresponding acid (compare ketones).

FORMALDEHYDE.

Preparation.

Formaldehyde is prepared by passing the vapour of methyl alcohol mixed with air over heated platinum or copper, or other substances. The formaldehyde formed by oxidation is passed into water.

Formol, or formalin, is a commercial aqueous solution containing 40 per cent. of formaldehyde.

ACETALDEHYDE.

Preparation.

25 gm. of coarsely powdered potassium bichromate and 100 c.c. of water are placed in a distilling flask of 250 c.c. capacity. The flask is connected with a condenser and a strong current of cold water is made to flow through it. Through a tap funnel, secured in the neck of the

flask by a well-fitting cork, a mixture of 25 gm. (30 c.c. of absolute alcohol and 35 gm. (20 c.c.) of concentrated sulphuric acid is slowly added to the contents of the flask which have been gently warmed and the flame removed. During the addition the contents of the flask, which darken in colour, are occasionally shaken. A mixture of aldehyde, alcohol and water distils over. When the mixture has been added the flask is heated until all the aldehyde (recognised by smell) has distilled over.

The tests for acetaldehyde can be carried out with this distillate (p. 84).

Purification.

The solution is redistilled through an inverted condenser filled with water at 30-35°. Water and alcohol are condensed, but the aldehyde passes on. The aldehyde vapour is passed through a 100 c.c. pipette into about 30 c.c. of pure dry ether contained in a bottle standing in ice.

Pure ammonia, prepared by gently heating concentrated ammonia solution with a small flame and dried by passage through a tower containing quicklime, is passed into the ether until it is saturated. Aldehyde ammonia crystallises out. After standing for one hour the ether is decanted off, the crystals are drained on a Buchner filter and washed with ether.

The crystals of aldehyde ammonia are dissolved in an equal weight of water, and the solution is distilled with a mixture of 1.5 parts of sulphuric acid and 2 parts of water from a water-bath, which is gradually raised to boiling. The receiver is cooled in ice. The distillate is dried with calcium chloride from which the aldehyde is distilled in a bath at 20° and collected in a receiver in ice. The aldehyde must be preserved in a well-stoppered bottle.

Properties of Aldehydes.

Formaldehyde is a gas at the ordinary temperature easily soluble in water and alcohol and with a peculiar pungent smell.

Acetaldehyde is a colourless liquid having a fruity pungent smell and boils at 21°. It is easily soluble in water, alcohol and ether.

The next members of the series of aldehydes are also liquids and resemble acetaldehyde very closely in their properties.

Polymerisation.

Paraformaldehyde or Paraform.

* On evaporating formalin (about 1 c.c.) in a watch-glass on a water-bath a solid mass of paraformaldehyde is left.

If a portion of the solid be heated in a test tube dissociation occurs at about 100°, the mass melts between 153 and 172°, a white sublimate is formed and formaldehyde is evolved.

Paracetaldehyde or Paraldehyde.

* On adding a drop of concentrated sulphuric acid to about 1 c.c. of acetaldehyde, a violent reaction occurs and the liquid becomes hot. Paraldehyde $(\text{CH}_3 \cdot \text{CHO})_3$ separates out as an oil on diluting with water. Acetaldehyde is re-formed if the acid aqueous liquid be heated.

Paraldehyde is a colourless liquid which boils at 124° .

Metaldehyde.

The polymer, metaldehyde, is formed from acetaldehyde when it is treated with hydrochloric acid gas or dilute sulphuric acid at a low temperature.

Aldol Condensation.

Solutions of formaldehyde and acetaldehyde when kept with dilute solutions of lime or potassium carbonate undergo aldol condensation.

Formaldehyde gives a sweet syrup which contains monosaccharides, especially dl-fructose:—

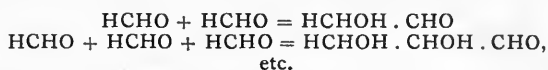

Acetaldehyde gives aldol:—

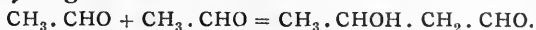

These reactions of aldehyde probably take place in nature. In plants, under the action of light and chlorophyll, carbon dioxide is reduced to formaldehyde which undergoes aldol condensation into sugars. The higher fatty acids are probably formed from acetaldehyde in this way in both animals and plants.

Action of Ammonia.**Hexamethylene Tetramine.**

Formaldehyde behaves differently to the other aldehydes.

* On adding ammonia gradually to formalin (1 c.c. in 5 c.c. water) it is absorbed. On now adding excess of ammonia and evaporating on the water-bath hexamethylene tetramine, or urotropin, remains as a white solid:—

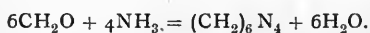

Hexamethylene tetramine consists of colourless crystals soluble in about 1.5 parts of hot or cold water and 10 parts of alcohol. It is volatilised on heating and it is converted into ammonium sulphate and formaldehyde on treatment with strong sulphuric acid.

Aldehyde Ammonia.

On passing dry ammonia gas into a dry ethereal solution of acetaldehyde, acetaldehyde ammonia is formed:—

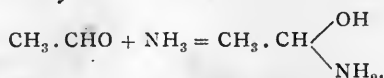

Acetaldehyde ammonia is a white crystalline compound easily

soluble in water and alcohol, and easily decomposed by acids and alkalis.

On dissolving a little aldehyde ammonia and heating with dilute sulphuric acid, aldehyde is given off. Ammonia is also evolved on heating with dilute caustic soda.

Aldehyde Sodium Bisulphite.

* On adding 1-2 c.c. of a cold saturated solution of sodium bisulphite to 5-10 drops of aldehyde and shaking vigorously, aldehyde sodium bisulphite crystallises out :—

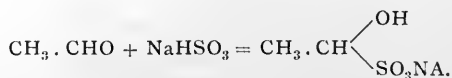

Aldehyde Cyanhydrin.

Hydrogen cyanide combines with aldehydes forming cyanohydrins :—

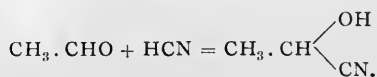

In this way another carbon atom can be added to organic compounds. Compounds containing the CN group are hydrolysed by acids or alkalis and converted into the corresponding acid (see cyanogen compounds) :—

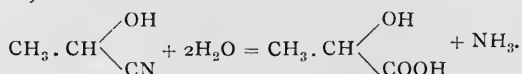

Aldehyde Hydrazone.

Aldehydes combine with hydrazine and substituted hydrazines, especially phenylhydrazine, forming hydrazones.

* The calculated quantities of aldehyde (·5 c.c.), phenylhydrazine hydrochloride (·2 gm.) and cryst. sodium acetate (·5 gm.) are dissolved in about 10 c.c. of water and warmed ; an oil (acetaldehyde phenylhydrazone) is formed :—

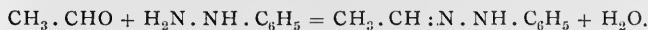

Aldoxime.

Aldehydes combine with hydroxylamine forming oximes :—

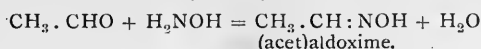

The calculated quantity of hydroxylamine hydrochloride is dissolved in water, the equivalent quantity of caustic soda required to liberate the hydroxylamine is added and then the calculated quantity of the aldehyde. The mixture is shaken and allowed to stand until it no longer reduces Fehling's solution. The oxime is extracted with ether, most of the ether distilled off, and the concentrated solution poured into a basin. The crystals which separate are drained on a porous plate and recrystallised from ligroin.

Tests.

Aldehydes are easily further oxidised into the corresponding fatty acids containing the same number of carbon atoms and they consequently behave as reducing agents.

Reduction of Metallic Oxides in Alkaline Solution.*(a) Silver.*

- * An ammoniacal solution of silver hydroxide is prepared by adding dilute ammonia¹ to silver nitrate until the precipitate first formed just re-dissolves. Some dilute aldehyde solution is added and the mixture is placed in a cold water-bath and heated to the boiling-point. A mirror of metallic silver forms on the glass.

A very sensitive reagent may be prepared by mixing equal volumes of 10 per cent. silver nitrate and sodium hydroxide and then adding ammonia drop by drop till the silver hydroxide dissolves.

A mirror is formed immediately if the solution contains 1 per cent. of acetaldehyde, in 30 seconds if 1 per thousand; a yellow-brown mirror forms in 5 minutes if 1 per 10,000 be present.

(b) Copper.

- * Dilute aldehyde solution reduces Fehling's solution¹ on warming with the formation of cuprous oxide.

Action of Sodium Hydroxide.

- * Except with formaldehyde, benzaldehyde and a few other aldehydes, caustic soda solution decomposes dilute aldehyde solutions on warming. Yellow to brownish-red resins which rise to the surface—*aldehyde resin*—are formed. The liquid has usually a peculiar smell. Aldehyde resin is insoluble in water, but soluble in alcohol and ether.

Formaldehyde is converted into methyl alcohol and formic acid.

Oxidation.

Aldehydes are converted into the corresponding acid on warming their solutions with potassium bichromate and dilute sulphuric acid, the solution becoming green.

The aldehyde may be identified by preparing the acid by oxidation.

Schiff's Test.

- * A solution of magenta, or fuchsin, is decolorised by bubbling sulphur dioxide through it. On adding the dilute aldehyde solution the purple-red colour returns.

Numerous other sensitive tests have been described for aldehydes, especially formaldehyde. The following one has been used more particularly in testing for formaldehyde in distillates from plant leaves, etc.

¹ Fehling's solution consists of copper sulphate, caustic soda and Rochelle salt (sodium potassium tartrate). On adding caustic soda to copper sulphate a blue precipitate of cupric hydrate $\text{Cu}(\text{OH})_2$ is formed, which turns black on boiling. The presence of the Rochelle salt keeps the $\text{Cu}(\text{OH})_2$ in solution forming a deep blue solution. This solution does not keep, so that it must be freshly made for each experiment. For this purpose two solutions are therefore kept. The one contains the copper sulphate, the other the Rochelle salt and caustic soda. When required for use, equal parts of each are mixed together, and this forms the reagent.

Rimini's Test.

A small quantity (2 drops) of phenylhydrazine is added to the solution, then a drop of dilute freshly prepared sodium nitroprusside solution and a few drops of sodium hydroxide solution. A deep blue colour forms if formaldehyde be present; the colour changes through green and brown to red.

Schryver has modified this test and made it more sensitive: 2 c.c. of a freshly prepared and filtered 1 per cent. solution of phenylhydrazine hydrochloride are added to 10 c.c. of the solution of formaldehyde, then 1 c.c. of a 5 per cent. solution of sodium ferricyanide and 5 c.c. of hydrochloric acid; a magenta colour is formed. This test will show the presence of 1 part of formaldehyde in 100,000 to 1,000,000 parts of solution. No colour is given by acetaldehyde.

ESTIMATION.**Formaldehyde.***(a) By Converting into Hexamethylenetetramine.*

25 c.c. of normal ammonium hydroxide solution are placed in a 100 c.c. strong bottle provided with a rubber stopper. A measured volume of the solution (not containing above .5 gm. of formaldehyde) is added. The cork is securely fastened by tying and the bottle is submerged in a cold water-bath which is then heated to boiling for 1 hour, the bottle being kept under water the whole time. The bottle is cooled, opened and the contents titrated with standard acid until the methyl orange which is used as indicator first becomes red.

A series of bottles should be taken containing different amounts, or none, of the aldehyde solution. Allowing for the blank each c.c. of normal ammonium hydroxide used corresponds to .0601 gm. of formaldehyde.

The estimation should be carried out in water. The formaldehyde is therefore distilled from its original solution, e.g. milk, plant extracts, and the distillate is used.

(b) By Titrating with Iodine and Sodium Thiosulphate.

A known volume of the solution (10 c.c.) is mixed with 25 c.c. of .1N iodine solution, and sodium hydroxide is added drop by drop till the liquid becomes clear yellow. The flask is closed for 10 minutes, dilute hydrochloric acid is added, and the free iodine is titrated with .1N thiosulphate.

2 atoms of iodine = 1 molecule of formaldehyde.

Good results are not given by this method for aldehydes other than formaldehyde.

Acetaldehyde.*By Combination with Sulphite.*

The solution of sulphite is prepared by dissolving 12.6 gm. of sodium sulphite in 400 c.c. of water, adding 100 c.c. of .1N sulphuric acid and diluting to 1000 c.c. with the purest ethyl alcohol of 95 per cent.

The volume of aldehyde solution, not containing more than 2 per cent. of aldehyde, is placed in a 100 c.c. measuring flask. A known volume of the sulphite solution is added and the mixture diluted to 100 c.c. with the purest 50 per cent. alcohol. A blank with the reagents is carried out simultaneously.

The flasks are kept at 50° for 4 hours, cooled and titrated with standard iodine solution, using starch as indicator.

Each c.c. of .1N iodine solution corresponds to .0032 gm. of SO₂ or .0022 gm. of acetaldehyde.



Preparation.

Chloral is prepared by the prolonged action (about 10 days) of dry chlorine upon absolute alcohol. The gas is passed into the cold alcohol until it is saturated and acquires a sp. gr. of 1.400 and the temperature is gradually raised to 100°. Chloral alcoholate is formed. An equal weight of concentrated sulphuric acid is added and the mixture is distilled. The fraction passing over between 94 and 100° is collected, neutralised with calcium carbonate and again distilled.

Properties.

Chloral is a colourless oily liquid with a peculiar penetrating smell, having a sp. gr. of 1.502 at 18°. It boils at 97° and is soluble in ether and chloroform.

Metachloral.

On keeping, or on leaving in contact with moderately concentrated sulphuric acid, chloral polymerises to metachloral, a solid which is sparingly soluble in boiling water, but insoluble in cold water, alcohol and ether. The polymerisation does not occur with pure chloral and may be hindered by adding chloroform. On heating to 180° metachloral is decomposed and chloral distils over.

Chloral Alcoholate.

If chloral be mixed with an equivalent quantity of absolute alcohol, chloral alcoholate is formed.

It consists of white crystals which melt at 46° and boil at 113.5° and are readily soluble in chloroform (distinction from chloral hydrate).



Preparation.

* Equivalent parts of chloral (6. c.c.) and water (1 c.c.) are mixed together. The mixture becomes hot and solidifies to a mass of crystals of chloral hydrate.

Properties.

Chloral hydrate is a white crystalline solid, which melts at 50-51°. It is soluble in 1.5 times its weight of water, also in alcohol, ether, petroleum ether and carbon disulphide. It is soluble with difficulty in cold chloroform.

Pure chloral hydrate is completely volatile on heating and commences to boil rapidly at 97-98°.

Reconversion into Chloral.

* About 2 gm. of chloral hydrate are placed in a dry test tube and covered with concentrated sulphuric acid and the mixture is warmed gently. Chloral is formed and floats to the surface.

An aqueous solution heated with zinc to 50° and gradually treated with dilute acid yields aldehyde and paraldehyde which may be distilled off.

Tests for Chloral and Chloral Hydrate.

* Aqueous solutions in the cold give no reaction with silver nitrate. On adding a few drops of ammonia and boiling, metallic silver is deposited.

Aqueous solutions reduce Fehling's solution on heating. Traces of chloral may be detected by the carbylamine reaction for chloroform (p. 61).

Decomposition of Chloral by Alkali.

* Chloral or chloral hydrate is rapidly decomposed by caustic alkali with the formation of chloroform and alkali formate:—

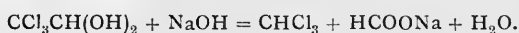

The odour of chloroform is noticed at once on gently warming an aqueous solution of chloral with caustic soda.

Estimation.

1. By measuring the volume of chloroform.

25 gm. of chloral hydrate or chloral are placed in a graduated cylinder and excess of sodium hydroxide solution (80-100 c.c.) are carefully added. The tube is kept well cooled at first on account of the violence of the reaction. Afterwards the cylinder is closed and shaken. On standing the liquid becomes clear and separates into two layers. When cold (at 17°) the volume of the lower layer of chloroform is measured. The volume in c.c. multiplied by 1.84 gives the number of grams of chloral, or by 2.064 of chloral hydrate, in the sample.

2. By titrating the acid.

1-2 gm. are dissolved in water and shaken with barium carbonate to remove any acid. The carbonate is filtered off and washed. Excess of normal caustic soda (100-150 c.c.) is added and the solution titrated with normal acid, using litmus as indicator.

Each c.c. of alkali neutralised = .1475 gm. chloral or .1655 gm. chloral hydrate.

Butyric Chloral Hydrate.

This compound is formed when chlorine is passed into paraldehyde or acetaldehyde. It is a white crystalline substance with peculiar fruity flavour and melts at 78°.

KETONES.

Ketones are the first products of the oxidation of secondary alcohols, e.g. :—

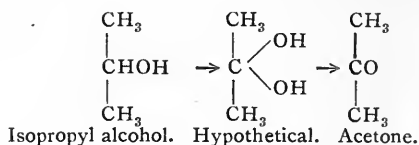

The same statements apply here as in the case of the formation of aldehydes.

The group $>\text{CO}$ is characteristic of ketones.

Acetone is the first member of the homologous series of ketones and the chief representative.

ACETONE.

Preparation.

Acetone is formed in the dry distillation of wood and is separated from methyl alcohol by fractional distillation (p. 63).

Acetone is also prepared by the dry distillation of calcium or barium acetate :—

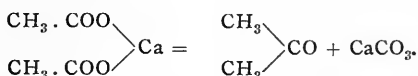

- * 50-100 gm. of dry calcium acetate are placed in a retort or distilling flask and at first heated gently, afterwards more strongly, and the vapours are passed through a condenser. A brownish liquid collects in the receiver. It contains acetone, aldehyde and higher ketones. The acetone is separated by fractional distillation.

Purification.

The proper quantity of crude acetone (100 gm. or 125 c.c.) is added to the calculated quantity of sodium bisulphite (70 gm.) in saturated solution (this should smell of sulphur dioxide, if not, SO_2 is passed into it until it smells strongly of the gas), and the mixture is shaken vigorously in a closed vessel. Heat is evolved and a mass of crystals, $\text{C}_3\text{H}_6\text{O} \cdot \text{NaHSO}_3$, separates out. After standing, the crystals are filtered off on a Buchner funnel and well drained. They are placed in a distilling flask and decomposed by adding a solution of sodium carbonate (40 gm.). The solution is distilled, preferably using a fractionating column, until the thermometer reaches 60° .

The distillate is dried with calcium chloride and the acetone distilled off.

Properties.

Ketones closely resemble aldehydes in most of their properties, but there are several differences.

Acetone is a colourless, pleasant smelling liquid which boils at 56° and has a sp. gr. of $\cdot 797$ at 15° . It is very volatile and inflammable. It mixes with water, alcohol and ether in all proportions. Like alcohol it can be separated from water by saturating the solution with potassium carbonate.

Polymerisation and Condensation.

Acetone does not polymerise like aldehyde, but when distilled with moderately concentrated sulphuric acid it is converted into mesitylene (sym. trimethylbenzene).

Action of Ammonia.

Acetone does not form simple condensation products with ammonia like aldehyde does, but it reacts forming diacetonamine, $\text{C}_6\text{H}_{13}\text{ON}$, and triacetonamine, $\text{C}_9\text{H}_{17}\text{ON}$.

Acetone Sodium Bisulphite.

* On shaking together about 1 c.c. of acetone and 5 c.c. of a cold saturated solution of sodium bisulphite, acetone sodium bisulphite crystallises out:—

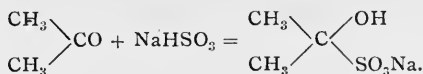
**Acetone Cyanhydrin.**

Acetone combines with hydrogen cyanide forming the addition compound, acetone cyanhydrin:—

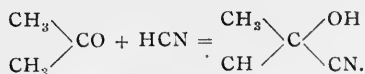

Acetone Phenylhydrazone.

Acetone combines with hydrazine and substituted hydrazines forming hydrazones:—

- * Acetone phenylhydrazone is formed as an oil when acetone is mixed with phenylhydrazine hydrochloride and sodium acetate:—

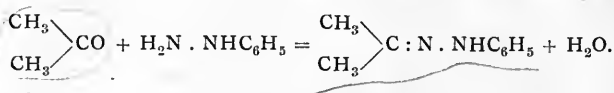
**Acetoxime.**

Combination occurs between acetone and hydroxylamine when the calculated quantities are allowed to react together as described under aldehyde (p. 83):—

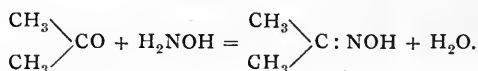
**Tests for Acetone.**

Acetone is more stable than aldehyde and does not behave as a reducing agent.

* Acetone reduces ammoniacal silver nitrate solution on prolonged boiling.

* Acetone does not reduce Fehling's solution.

* Acetone does not give a resin when heated with sodium hydroxide.

* Acetone does not give Schiff's test.

These four reactions are characteristic only for aldehydes.

Oxidation.

* Acetone is oxidised on heating with potassium bichromate and sulphuric acid and yields acetic and formic acids:—

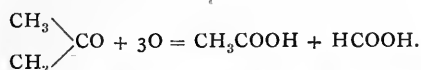

The constitution of a ketone is determined by identifying the acids it yields on oxidation.

From 2-5 gm. of the ketone are mixed in a flask attached to a reflux condenser with 30-50 c.c. water and the calculated quantity of sulphuric acid is added. The calculated quantity of finely powdered potassium bichromate is added in portions of 5-1 gm. If the oxidation is very energetic, the contents should be cooled and kept at 50-60°. The flask is finally heated on the water-bath for 15 minutes. The acids are then distilled and collected in the receiver (see under acids).

* *Iodoform Reaction (Lieben).*

Acetone gives iodoform in the cold; 3-5 drops of sodium hydroxide are added to about 2 c.c. of the solution and then, drop by drop iodine solution until the liquid is faintly yellow. Iodoform separates at once.

If ammonia be used in place of sodium hydroxide and iodine solution be added drop by drop, a small black precipitate of nitrogen iodide is formed. On standing, or on warming, this disappears and iodoform is produced; this reaction may serve to distinguish acetone and alcohol.

* *Sodium Nitroprusside Test (Legal).*

On adding about 5 drops of freshly prepared sodium nitroprusside solution to about 5 c.c. of the dilute acetone and about 1 c.c. of sodium hydroxide, a ruby-red colour is produced. This fades to yellow on standing.

If the reaction be repeated and the solution acidified at once with acetic acid, a purple-red colour is produced.

* Rothera suggests that the reaction be carried out by adding 3 drops of 5 per cent. sodium nitroprusside and 1-2 c.c. of ammonia to the dilute acetone and a small quantity of solid ammonium sulphate. A permanganate colour slowly develops, reaches a maximum in about 30 minutes and then fades away.

Creatinine does not react under these conditions; a brownish-red colour is given by aldehydes.

Salicylic Aldehyde Test.

1 gm. of solid potassium hydroxide is added to 10 c.c. of the acetone solution, and before it dissolves 10 drops of salicylic aldehyde are added. On warming to 70° a purple-red contact ring appears. If the potash has dissolved before adding the salicylic aldehyde the liquid becomes yellow, red, and finally purple-red.

Note.—The iodoform, nitroprusside and salicylic aldehyde reactions are carried out preferably in colourless solutions. The acetone should be separated by distillation and the distillate tested.

Estimation of Acetone.

1. Acetone is most usually estimated by converting it into iodoform with excess of iodine and caustic soda and titrating the excess of iodine with thio-sulphate (Messinger's method).

In the case of wood spirit 5 c.c. are added to 25 c.c. of N sodium hydroxide contained in a stoppered bottle of 200 c.c. capacity; the mixture is well shaken and allowed to stand 5-10 minutes. 0.2N iodine solution is slowly run in from a burette drop by drop, shaking thoroughly till the upper portion of the solution on standing for a minute becomes quite clear. A few more c.c. of the iodine solution are run in so as to have an excess of about 25 per cent. and the solution is allowed to stand 10-15 minutes. 25 c.c. of N sulphuric acid are added and the iodine which is liberated is titrated with 0.1N sodium thiosulphate solution, using starch as indicator.

1 c.c. 0.1N iodine solution = 0.00967 gm. acetone.

A blank experiment should be made as sodium hydroxide may contain nitrite.

Aldehydes and other compounds which react with iodine are included in this estimation, if present.

2. Jolles has suggested the estimation of acetone by conversion into acetone sodium bisulphite with excess of sodium hydrogen sulphite and titration of the excess of sulphite with standard iodine solution.

3-4 times the excess of the bisulphite solution of known strength is added to the acetone solution; after standing for 30 hours the excess is titrated with 0.1N iodine solution.

1 mol. of $\text{NaHSO}_3 = 2$ atoms of I = 1 mol. of acetone.

3. Denigès makes use of an insoluble compound of acetone with mercuric sulphate for the estimation of acetone. The reagent is prepared by dissolving 5 gm. of mercuric oxide in 100 c.c. of water to which 20 c.c. of sulphuric acid have been added.

The acetone content of the solution must be not greater than 2 per cent. so that strong solutions must be diluted. 25 c.c. of the reagent are added to 25 c.c. of the solution and the mixture heated on the water-bath for 10 minutes. The precipitate is filtered off on a weighed filter, washed with not more than 100 c.c. of cold water, dried at 100° and weighed. The amount of acetone in the precipitate, $3\text{Hg}_5\text{S}_2\text{O}_{11} \cdot 4\text{C}_3\text{H}_6\text{O}$, is obtained by multiplying by the factor 0.0609.

This reaction can be carried out volumetrically by estimating the excess of mercury. The mercuric sulphate solution must therefore be of known strength. The filtrate and washings from the precipitate are collected and made up to 100 c.c. To 20 c.c. of this solution 15 c.c. of ammonia, 50 c.c. of water and 10 c.c. potassium cyanide solution (13 gm. per litre) are added. The excess of cyanide is estimated by titration with 0.1N silver nitrate solution, using potassium iodide as indicator, until there is a slight permanent precipitate.

Since acetone is a decomposition product of aceto-acetic acid and the two compounds are usually associated in tissues and extracts of organs, the estimation of acetone in urine, etc., is combined with the estimation of aceto-acetic acid (p. 593).

THE FATTY ACIDS.

The fatty acids are the second products of oxidation of the primary alcohols, the aldehydes being the intermediate products. Secondary alcohols and ketones also give rise to fatty acids on oxidation, but the number of carbon atoms in the molecules of the fatty acids so formed is less than in the original secondary alcohol. Conversely, on reduction fatty acids give aldehydes and primary alcohols, thus :—



The fatty acids are characterised by the presence of the carboxyl or —COOH group.

They occur widely distributed in nature, both in the free state and in combination with glycerol as the fats.

Only those acids containing an even number of carbon atoms occur in combination as fats, and as far as is known they all have a straight chain of carbon atoms. Acids with an uneven number of carbon atoms and with branched chains of carbon atoms are also found in nature.

The lower members of the series of the fatty acids up to capric acid with 10 carbon atoms are volatile with steam and hence are termed the volatile fatty acids. They are separated in this way from the higher members which are not volatile with steam. They thus form two groups.

In the following list are given the names of the homologous series of hydrocarbons, primary alcohols, aldehydes and fatty acids :—

Number of Carbon Atoms.	Saturated Hydrocarbon.	Primary Alcohol —CH ₂ OH.	Aldehyde —CHO.	Fatty Acid —COOH.
1	Methane	Methyl	Formaldehyde	Formic
2	Ethane	Ethyl	Acetaldehyde	Acetic
3	Propane	Propyl	Propionic aldehyde	Propionic
4	Butane	Butyl	Butyric "	Butyric
5	Pentane	Amyl	Valeric "	Valerianic
6	Hexane	Hexyl	Caproic "	Caproic
7	Heptane	Heptyl	Oenanthic "	Oenanthic
8	Octane	Octyl	Caprylic "	Caprylic
9	Nonane	Nonyl	Pelargonic "	Pelargonic
10	Decane	Decyl	Capric "	Capric
11	Undecane	Undecyl	Undecylic "	Undecylic
12	Dodecane	Dodecyl	Lauric "	Lauric
13	Tridecane	—	Tridecylic "	Tridecylic
14	Tetradecane	Tetradecyl	Myristic "	Myristic
15	Pentadecane	—	—	Pentadecylic
16	Hexadecane	Cetyl	Palmitic "	Palmitic
17	Heptadecane	—	Margaric "	Margaric
18	Octadecane	Octadecyl	Stearic "	Stearic
19	Nonadecane	—	—	—
20	Eicosane	—	—	Arachic
21	Heneicosane	—	—	—
22	Docosane	—	—	Behenic
23	Tricosane	—	—	—
24	Tetracosane	—	—	Lignoceric
25	—	—	—	—
26	—	Ceryl	—	Cerotic
27	Heptacosane	—	—	—
28	—	—	—	—
29	—	—	—	—
30	—	Myricyl	—	Melissic

FORMIC ACID. H . COOH.*Preparation.*

Formic acid was first prepared by distilling crushed ants with water—hence its name. The stings of some insects and plants also probably contain it. It occurs together with acetic and other lower fatty acids in urine. It can be obtained by oxidising methyl alcohol with potassium permanganate. It is formed in the decomposition of chloroform by alkali (p. 60), by the action of water upon hydrogen cyanide (p. 154), and its alkaline salts are obtained by the reaction of carbon monoxide with alkalis:—

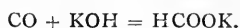

It is manufactured by heating glycerol with oxalic acid. It has been shown by Chattaway that in this reaction glyceryl acid oxalate is formed; on raising the temperature carbon dioxide is evolved and glyceryl monoformin is produced. On hydrolysing this ester with a further quantity of oxalic acid, formic acid is produced and the acid oxalate again formed. There is thus a continuous reaction:—

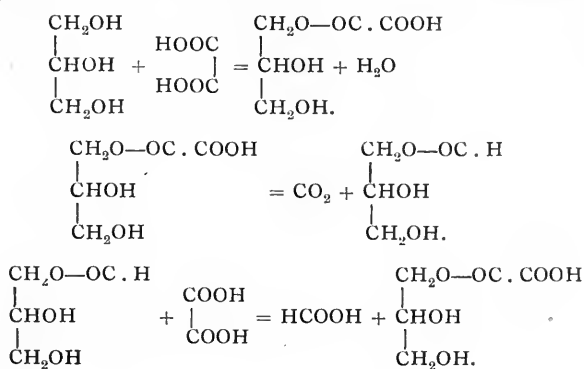
*Properties.*

Formic acid is a colourless volatile liquid with pungent odour. It has a sp. gr. of 1.221 at 20°, freezes at 8.3°, and boils at 100°. It is a very strong acid, about 12 times as strong as acetic acid, and produces blisters on the skin and intense irritation.

It dissolves in water, alcohol and ether, and in general properties resembles acetic acid.

The formates crystallise well and are prepared in the same way as acetates (p. 97). The lead and magnesium salts are insoluble in alcohol; the corresponding acetates are soluble. The acids may therefore be separated by treating a concentrated solution of these salts with alcohol; the formate is then precipitated. Potassium formate is almost insoluble in alcohol and may thus also be separated from the acetate, which is soluble.

Reactions and Detection.

A solution of formic acid must be exactly neutralised with soda or ammonia before the tests can be carried out. Solid formates are obtained by evaporating their solutions to dryness.

* (1) On boiling a solution of a formate with dilute sulphuric acid, formic acid is evolved. Its pungent odour is only perceptible with strong solutions.

* (2) On heating a solid formate with concentrated sulphuric acid, carbon monoxide is evolved and it may be ignited at the mouth of the test tube.

* (3) Ethyl formate is formed when solid formates are heated with alcohol and concentrated sulphuric acid.

* (4) A red solution containing ferric formate is obtained when ferric chloride or ferric nitrate is added to a solution of a formate. On heating a reddish-brown precipitate of basic ferric formate is produced.

Formic acid differs from acetic acid in its reducing properties which are due to the presence of the aldehyde group CHO in its molecule.

* (5) In concentrated solution it forms with silver nitrate a white crystalline precipitate of silver formate. This precipitate darkens on standing owing to reduction to metallic silver. A precipitate is not formed in dilute solution, but the solution is reduced on heating with separation of metallic silver. The reduction is retarded in the presence of ammonia.

* (6) On adding mercuric chloride solution and heating a precipitate of mercurous chloride is produced, which, on further heating, may be reduced to metallic mercury.

ACETIC ACID. $\text{CH}_3\cdot\text{COOH}$.*Preparation.*

Acetic acid is one of the few products made commercially by biological methods, i.e. by the oxidation of dilute alcohol by means of the micro-organism *Mycoderma aceti*, or "mother of vinegar". Mechanical contrivances are used in order to expose a large surface of the alcoholic liquid to the air so that the acetification is as rapid as possible.

Wine, red and white, cider, beer and malt, and sugar prepared from starch are the materials from which the vinegar is made. Besides acetic acid vinegar contains other organic acids, sugar, dextrin and colouring matters which were present in the original material. The amount of acetic acid in the solution varies from about 3-12 per cent., the average quantity being about 5 per cent.

A large quantity of acetic acid is produced by the dry distillation of wood, the crude material obtained in this way being termed pyro-ligneous acid (p. 63). Tarry matter separates out on adding hydrochloric acid to the solution which has been neutralised with lime and distilled to remove methyl alcohol and acetone. The clear liquid is neutralised and evaporated to dryness and the dry residue heated to decompose the empyreumatic products. Comparatively pure acetic acid is obtained on distilling the residue with hydrochloric acid. Pure acetic acid is prepared by distilling with potassium bichromate, or neutralising with soda and distilling the sodium salt, which has been heated to destroy tarry matter, with sulphuric or hydrochloric acid.

* **Preparation by the Oxidation of Alcohol with Permanganate.**

14 gm. of potassium permanganate are dissolved in about 200 c.c. of water in a litre flask and 8 c.c. of concentrated sulphuric acid are added. The flask is fitted with a reflux condenser and through the condenser a mixture of 5 c.c. of alcohol and 50 c.c. of water is slowly added. The reaction must be kept moderate and, after all the alcohol has been added, the mixture is boiled for about 15 minutes. The acetic acid is separated by distilling over about three-fourths of the liquid. The distillate will contain the acetic acid which may be tested for as described on p. 97.

Properties.

Acetic acid is a colourless liquid with a characteristic pungent smell. The pure acid boils at 119° and distils without decomposition; on cooling it crystallises in plates which melt at 17° and hence is termed glacial acetic acid; its sp. gr. at 16.5° is 1.052.

It is miscible in all proportions with water, alcohol and ether. Heat is evolved on adding water to acetic acid and there is a contraction in volume.

The liquid is not inflammable, but its vapour burns with a blue flame.

Acetic acid is a very corrosive liquid and dissolves oils, resins, camphor, gelatin and many metallic salts which are insoluble in water. It is a very stable compound and is attacked only with difficulty by the most powerful oxidising agents. It is not affected by nitric acid or chromic acid. A solution of chromic acid in acetic acid is employed for oxidising hydrocarbons. Chlorine converts it into chloroacetic acids (p. 100).

As an acid, acetic acid forms salts. Most of the salts are soluble in water; the silver and mercurous salts are sparingly soluble; the sodium and potassium salts are soluble in alcohol. Some of the basic salts are insoluble.

* The salts are prepared by boiling the acid with the oxide or carbonate of the metal until the solution is neutral, filtering and evaporating the solution until crystallisation begins. The metallic acetates on being subjected to dry distillation yield acetone.

* Reactions and Detection.

Free acetic acid may be recognised by its odour. The acid solution is *exactly neutralised* with sodium hydroxide and then tested. Neutral solutions of acetates may be tested directly. Insoluble (basic) acetates are converted into sodium acetate by boiling with sodium carbonate, filtering off the insoluble carbonate, neutralising and testing the filtrate:—

* (1) On warming the solution with dilute sulphuric acid the pungent odour of acetic acid is evolved.

* (2) On adding ferric nitrate or ferric chloride, the neutral solution gives a deep red liquid, which contains ferric acetate. An excess must be avoided. On boiling, the liquid becomes colourless and a brownish-red precipitate of basic ferric acetate is produced.

The cold red liquid is decolourised by adding dilute hydrochloric or sulphuric acid, but not by mercuric chloride solution.

* (3) Concentrated solutions and dry acetates give the smell of ethyl acetate on heating with alcohol and concentrated sulphuric acid.

(4) On mixing a solid acetate with arsenious oxide and heating, cacodyl oxide, which has a garlic-like smell, is evolved. Only minute quantities should be used as the product is *very poisonous*.

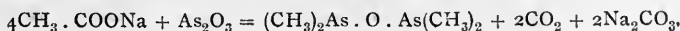

Propionic Acid. $\text{CH}_3 \cdot \text{CH}_2 \cdot \text{COOH}$.

Propionic acid is present with acetic acid in pyroligneous acid; it is found in sweat and is a product of putrefactive fermentation. It is most easily prepared by the oxidation of propyl alcohol with potassium bichromate and sulphuric acid.

Propionic acid closely resembles acetic acid in its properties: it is a liquid which boils at 140° and has a sp. gr. of .996 at 19° . It mixes with water in all proportions, and may be separated from solution by adding calcium chloride, which causes it to float as an oily layer.

Butyric Acid. $\text{CH}_3 \cdot \text{CH}_2 \cdot \text{CH}_2 \cdot \text{COOH}$.

Butyric acid occurs in the free state in various animal and vegetable secretions in the form of its glyceride—butyrim; it is always stated to exist in butter to the extent of about 6 per cent., but this compound could not be separated by Hurlley by the distillation of pure butter *in vacuo*. Since butyric acid results from the putrefaction of proteins and amino acids, it seems most probable that its occurrence in butter is due to the presence of butter milk which has not been removed and which has undergone decomposition. Its smell is always obvious in rancid butter.

Butyric acid is prepared by the butyric fermentation of glucose and other carbohydrates in the same way as lactic acid (p. 110). The filtered solution is evaporated, acidified and distilled.

Butyric acid is a colourless liquid with a pungent and disagreeable smell. Like propionic acid it can be separated from aqueous solution by the addition of calcium chloride.

Isobutyric Acid. $\begin{array}{l} \text{CH}_3 \\ \text{CH}_3 \end{array} \text{CH} \cdot \text{COOH}$.

Isobutyric acid is found as the free acid, or as ester, in certain plants. It is a product of putrefaction of proteins and would arise from the amino acid, valine. It is very like normal butyric acid, but not so offensive in smell.

Valerianic or Valeric Acids. $\text{C}_4\text{H}_{10} \cdot \text{COOH}$.

Four isomers are possible. The common valerianic acid is isovaleric acid $\begin{array}{l} \text{CH}_3 \\ \text{CH}_3 \end{array} \text{CH} \cdot \text{CH}_2 \cdot \text{COOH}$ which occurs in valerian root and various other animal and vegetable secretions. It is probably formed by the decomposition of leucine.

Methyl ethyl acetic acid $\begin{array}{l} \text{CH}_3 \\ \text{C}_2\text{H}_5 \end{array} \text{CH} \cdot \text{COOH}$ is also found in nature.

This compound is optically active and would be derived from isoleucine by putrefaction.

Normal valerianic acid, which has been found as a fermentation product, presumably of carbohydrate, most likely arises from amino acids in the same way as the other acids.

These acids are liquids with an unpleasant smell and behave in most respects like butyric acid.

Caproic to Myristic Acids.

The fatty acids with 6, 8 and 10 carbon atoms are found in combination in various fats. They are liquids slightly soluble in water.

The fatty acids with 12 and 14 atoms of carbon are solids of low melting-point,

THE HIGHER FATTY ACIDS.

The principal higher fatty acids are palmitic and stearic acids with 16 and 18 atoms of carbon in their molecules respectively. These acids, together with oleic acid (p. 105), are obtained by the hydrolysis of fats. The liquid oleic acid is removed by pressure, and the solid mixture of palmitic and stearic acids, "stearine," is used for making candles.

Properties.

The higher fatty acids are white odourless solids. On heating, they melt at a low temperature, and on further heating they boil giving off white vapours which condense on the cool parts of the test tube.

They are insoluble in water, slightly soluble in alcohol and readily soluble in ether. The solubility in alcohol may be seen by adding some of the alcoholic solution to some alcohol containing a drop of dilute caustic soda and a drop of phenolphthalein. The red colour of the latter is discharged.

They dissolve in dilute caustic alkali, aqueous or alcoholic, forming solutions of soap.

Soaps.

Soaps are the sodium and potassium salts of the higher fatty acids; the former constitute hard soaps, the latter soft soaps.

- * (1) Solutions of soap in water have an alkaline reaction to litmus owing to partial hydrolysis of the salt.
- * (2) On adding excess of mineral acid (H_2SO_4) to a solution of soap in water the fatty acids are liberated and form a precipitate which floats to the surface.
- * (3) On adding calcium chloride or magnesium sulphate to a solution of soap in water a curdy precipitate of the calcium or magnesium salt is formed just as is obtained with hard water.
- * (4) On adding finely powdered sodium chloride to a soap solution the soap is salted out as a curdy mass which clings to the side of the vessel.

HALOGEN SUBSTITUTION DERIVATIVES OF THE FATTY ACIDS.

The fatty acids behave like a saturated hydrocarbon towards the halogens, especially chlorine and bromine, substitution of hydrogen atoms in the chain of carbon atoms (not the COOH group) taking place. The most typical compounds are mono-, di- and tri-chloroacetic acids.

In the case of the higher fatty acids containing three and more carbon atoms several isomers can be formed :—



These acids are distinguished by using the Greek letters, that carbon atom next to the carboxyl group being called the α -carbon atom, the next β , the next γ , and so on.

Preparation.

The chloro-substituted fatty acids are prepared (*a*) by the action of chlorine upon the fatty acid in direct sunlight, or in the presence of iodine, or (*b*) by the action of halogen upon the acid chloride (p. 101), or (*c*) by indirect methods from malonic ester.

Monochloroacetic Acid.

Chlorine is passed into boiling acetic acid, to which a little sulphur or iodine has been added :—

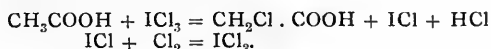

Monochloroacetic acid is a colourless solid melting at 62° and boiling at $185\text{--}187^\circ$. It closely resembles acetic acid in its reactions.

Dichloroacetic Acid.

Dichloroacetic acid is usually prepared by heating chloral hydrate with potassium cyanide or ferrocyanide :—



It is a liquid which boils at $190\text{--}191^\circ$.

Trichloroacetic Acid.

Trichloroacetic acid is prepared by oxidising chloral with concentrated nitric acid :—

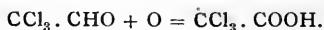

It is a colourless solid melting at 55° and boiling at 195° . On boiling with alkalis it is converted into chloroform and carbonate :—

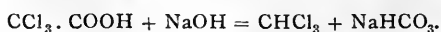

It forms salts with bases and yields an acid chloride (p. 101) like acetic acid.

The acidity of these acids increases with the number of chlorine atoms; trichloroacetic acid is a strong acid almost equal to mineral acids.

ACID OR ACYL CHLORIDES.

The fatty acids, like the alcohols, contain a hydroxyl group. Phosphorus pentachloride and phosphorus trichloride act upon the acids forming the acid or acyl chloride :—



Preparation of Acetyl Chloride.

A distilling flask is fitted with a tap funnel and connected with a condenser and receiver. If the preparation be not carried out in a fume cupboard, the receiver should be connected with a tower containing soda lime to absorb hydrochloric acid.

25 gm. of glacial acetic acid are placed in the distilling flask and 20 gm. of phosphorus trichloride are slowly dropped upon it through the tap funnel. The flask is warmed upon a water-bath at 40-50° until the hydrochloric acid evolution has ceased; the contents of the flask are then distilled from a water-bath. Acetyl chloride, which boils at 55°, passes over.

Properties of Acyl Chlorides.

Formyl chloride is not known. Acetyl chloride is a liquid, other acyl chlorides are liquids or solids. They fume in moist air and undergo decomposition into hydrochloric acid and the acid from which they are derived.

Reactions of Acyl Chlorides.

Acyl chlorides are decomposed by water giving the acid and hydrochloric acid :—

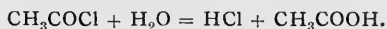

They react with alcohols giving esters (p. 71).

They react with ammonia giving amides (p. 129).

The acyl chlorides, though decomposed by water, are sometimes only decomposed slowly and can be used in aqueous or alkaline solution for preparing esters or for preparing acyl derivatives of amines. The process is known as acetylation, or acylation, or arylation if aromatic acid chlorides be used. An alkaline solution of the alcohol or of an amine is shaken with the acyl chloride. The ester or acyl derivative is generally insoluble and can be filtered off and purified by crystallisation.

ACID ANHYDRIDES.

If acid chlorides be allowed to act upon the sodium salt of a fatty acid an acid anhydride is formed:—

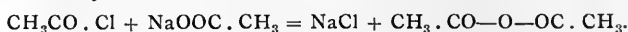

The constitution of these compounds is analogous to the ethers; two radicles are united by an oxygen atom. Mixed anhydrides can be prepared by using different acyl chlorides and different sodium salts of fatty acids:—

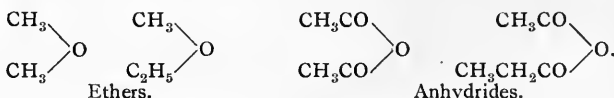
**Preparation of Acetic Anhydride.**

40 gm. of fused sodium acetate are placed in a retort which is connected to a condenser and receiver and fitted with a dropping funnel. 30 gm. of acetyl chloride are run in slowly and the contents of the flask are kept cold by immersion in cold water. The contents of the retort are well stirred and distilled. Acetic anhydride, which boils at 139° , passes over between 130° and 140° .

Properties.

The anhydrides are liquids possessing a pungent smell, but do not fume in the air.

Reactions.

The reactions of the anhydrides are the same as the acyl chlorides.

They are decomposed by water giving the constituent acid.

They yield esters with alcohols.

They yield amides with ammonia.

Like the acyl chlorides they are also used for acylating alcohols and compounds containing amino (NH_2) groups. The compound is boiled under an air condenser with the anhydride for some hours and poured into water. The acyl derivative is generally insoluble and is recrystallised from a suitable solvent.

UNSATURATED ALCOHOLS, ALDEHYDES AND FATTY ACIDS.

Allyl alcohol, acrolein and acrylic acid are unsaturated compounds and the first members of the series :—

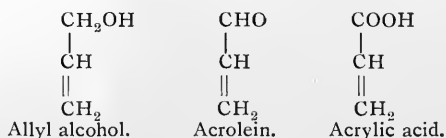

Amongst the unsaturated acids there are several which occur in nature.

Allyl Alcohol.

Preparation.

Allyl alcohol is prepared by distilling glycerol at a temperature of about 260° with oxalic acid. As stated on p. 94 the acid oxalic ester of glycerol is formed; on heating it to a high temperature the neutral ester is produced and decomposed, yielding allyl alcohol and carbon dioxide :—

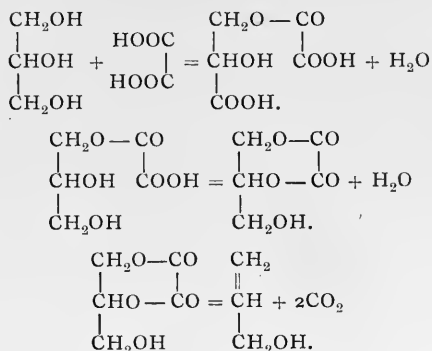

The liquid which distils over between 220 and 260° is collected and redistilled, the thermometer being placed in the liquid. Allyl alcohol is present in the fraction boiling below 105° . It is dehydrated with potassium carbonate and again distilled.

Properties.

Allyl alcohol is a colourless neutral liquid with an irritating smell and boils at 96-97°. It mixes with water, alcohol and ether in all proportions.

It has the properties of a primary alcohol and of an unsaturated compound, e.g. it reacts with sodium, forms esters and yields acrolein and acrylic acid on oxidation; it combines with 2 atoms of chlorine or bromine.

Esters of Allyl Alcohol.

Allyl iodide.—This ester may be prepared from allyl alcohol, but is more conveniently prepared from glycerol by the action of phosphorus and iodine. The glycerol is probably converted into tri-iodide, which decomposes into iodine and allyl iodide.

It is a colourless liquid boiling at 101° with the odour of garlic.

Allyl sulphide.—Allyl sulphide occurs in garlic and other plants, and is obtained by distilling the plant after it has been macerated with water.

It may be prepared from allyl iodide by heating with potassium sulphide in alcoholic solution (cf. p. 79).

It is a colourless, oily liquid boiling at 140° with the smell of garlic and hence is termed oil of garlic.

Allyl isothiocyanate is a constituent of black mustard seeds and is termed oil of mustard.

Acrolein.*Preparation.*

Acrolein is prepared by distilling glycerol (1 part) with potassium hydrogen sulphate (2 parts):—

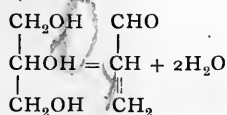

- * The smell of acrolein is noticed on heating a few drops of glycerol in a dry test tube with anhydrous phosphoric acid or acid potassium sulphate.

Properties.

Acrolein is a colourless liquid boiling at 52°, with a most irritating and peculiar odour; it affects the eyes, producing tears, and it forms sores upon the skin.

It has the reactions of an aldehyde, but does not combine with sodium bisulphite, and also the reactions of unsaturated compounds.

Unsaturated Fatty Acids.

These acids contain in their molecule one or more pairs of their carbon atoms linked together by a double bond. Unsaturated acids containing a triple bond are also known.

Acrylic acid is the simplest and first member of the homologous series of unsaturated acids containing one double bond. It was first obtained by the oxidation of acrolein with silver oxide, but is more readily prepared by the reactions described for obtaining unsaturated hydrocarbons (p. 54) from β -bromopropionic acid.

Acrylic acid is a liquid with a pungent smell and boils at 140° .

The next member is *crotonic acid*, $\text{CH}_3 \cdot \text{CH}=\text{CH} \cdot \text{COOH}$.

Crotonic acid is a solid which melts at 72° .

Oleic acid, which contains 18 carbon atoms and the double bond in the middle of the chain, is present in combination with glycerol in animal and vegetable fats from which it is prepared (p. 99).

Oleic acid at the ordinary temperature is a colourless, oily liquid of sp. gr. 900 at 11.8° with neither smell nor taste. It oxidises very readily in the air, becoming brown, acid in reaction and rancid in smell. It can be frozen to a white crystalline solid which melts at 14° . It cannot be distilled at the ordinary temperature, but at 10 mm. pressure it distils at 223° and it is volatile with superheated steam.

Linoleic acid also contains 18 carbon atoms, but two double bonds. It is contained in linseed and other oils.

Linoleic acid resembles oleic acid, but is more readily oxidised by the oxygen of the air. It is owing to its presence and that of other more unsaturated acids in linseed, cotton seed and rape seed oils that these oils possess the property of forming the so-called "drying oils". Oxygen is absorbed and transparent resinous substances are formed.

The salts of the unsaturated fatty acids are more soluble than those of the saturated fatty acids. The lead and mercury salts of oleic acid are soluble in ether and are used for separating the mixture of acids obtained from fats.

Owing to the presence of the double bonds the unsaturated acids combine by addition with the halogens, halogen acids, etc., and reduce permanganate solution becoming oxidised; thus—

* If a solution of oleic acid in chloroform be treated with bromine dissolved in chloroform, or iodine dissolved in chloroform containing also mercuric chloride, the colour of the halogen is discharged until the acid is completely saturated by absorption of the halogen.

* If a solution of sodium oleate be poured into a solution of potassium permanganate, the colour of the permanganate disappears and manganese dioxide separates out.

HYDROXY-, KETO- AND DIBASIC ACIDS.

In the previous sections compounds having only a single function of either alcohol, aldehyde, or acid have been considered. In compounds of carbon containing two or more atoms of carbon in their molecule the replacement of hydrogen atoms by other atoms or groups can occur in several of the atoms, and compounds will result which have multiple functions. They may be alcohol and acid, ketone and acid, etc., at the same time. The properties of such compounds are the sum of the properties possessed by the particular groups contained in the molecule. Numerous natural compounds are included amongst the large number of compounds which are theoretically possible: most, if not all, of these have been prepared in the laboratory.

COMPOUNDS CONTAINING TWO CARBON ATOMS.

The variety of the compounds is most easily seen in the series of compounds which are derived from ethane:—

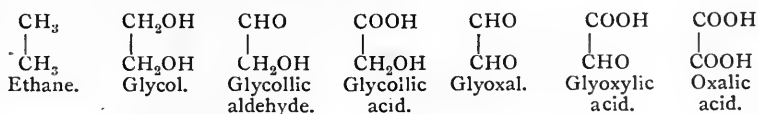

Glycollic Aldehyde.

Glycollic aldehyde is prepared by oxidising glycol with hydrogen peroxide in the presence of ferrous sulphate, or by hydrolysing bromoacetaldehyde with baryta.

It is a sweet crystalline substance having the properties of an aldehyde. It is the first representative of the group of carbohydrates.

Glycollic Acid.

Glycollic acid is prepared by boiling potassium chloracetate under a reflux condenser with water:—

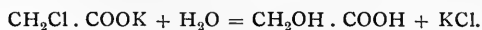

The solution is evaporated *in vacuo* to dryness and the glycollic acid extracted from the residue with acetone.

It is present in unripe fruit and was first obtained from glycine. Glycollic acid is a deliquescent crystalline solid which melts about 80°. It is a monobasic acid and at the same time a primary alcohol, and consequently has the properties of both of these types of compounds.

Glyoxal.

Glyoxal can be prepared by oxidising acetaldehyde with nitric acid at the ordinary temperature and is isolated as its bisulphite compound.

It is an amorphous solid, or when not quite free from water, a syrup. It has all the properties of an aldehyde.

Glyoxylic Acid.*Preparation.*

Glyoxylic acid is prepared most conveniently by the reduction of oxalic acid; sodium amalgam was most frequently employed until Benedict suggested the use of magnesium.

About 1 gm. of powdered magnesium is placed in a small flask and just covered with distilled water; 25 c.c. of saturated oxalic acid solution are slowly added. The reaction proceeds rapidly with liberation of heat and the flask should be cooled with water. The insoluble magnesium oxalate, which is formed, is filtered off and the glyoxylic acid is obtained by evaporation *in vacuo*.

Properties.

Glyoxylic acid is a syrup, very soluble in water. It gives the reactions of an acid and of an aldehyde.

The solution, prepared above, may be tested for aldehyde by Schiff's reaction, ammoniacal silver nitrate and other reactions. It is used in testing for proteins, the above solution being acidified with acetic acid and made up to 100 c.c. with distilled water.

Oxalic Acid.

Oxalic acid occurs naturally in many plants—e.g. sorrel, rhubarb—deposited in the cells as calcium oxalate. Small quantities of oxalic acid are present in normal urine, from 0.2-1.2 gm. in 24 hours. It arises most probably from the carbohydrate of the diet. An increased output follows the consumption of rhubarb and other vegetables which contain oxalic acid, and occasionally an increased output occurs in certain diseases, e.g. in diabetes. Calculi of calcium oxalate are sometimes found in the bladder and kidneys.

Preparation.

Oxalic acid is formed by the oxidation of numerous organic compounds, acetic acid and sugar. It is made commercially by the oxidation of the cellulose of sawdust with air and caustic alkali. A mixture of caustic potash and caustic soda is made into a paste with sawdust and heated in open vessels to about 240°. The mass is extracted with cold water; the potash dissolves leaving sodium oxalate which is only slightly soluble. By boiling the sodium oxalate with milk of lime, insoluble calcium oxalate is formed. This is washed and decomposed with sulphuric acid, and the oxalic acid isolated from the solution by crystallisation.

The alkali salts of oxalic acid are made commercially by heating alkali formates. The reaction proceeds most easily in the presence of small amounts of alkali at 280° under diminished pressure, or at 400° in absence of air:—

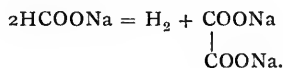
*Properties.*

- * Oxalic acid crystallises from water in colourless prisms containing 2 molecules of water of crystallisation (m.p. 101.5°). On heating to 100°, it loses the water, becomes opaque and forms a white powder which melts at 189°

It is easily soluble in alcohol, but only slightly soluble in ether. It is insoluble in chloroform, benzene and petroleum ether.

Reactions.

- * (1) On heating on platinum, nickel, or a crucible lid, oxalic acid is volatilised without charring.
- * (2) No charring occurs on heating oxalic acid with concentrated sulphuric acid, but it is decomposed yielding carbon monoxide and carbon dioxide:—

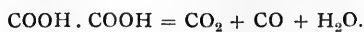

The gases may be passed into lime or baryta water; barium carbonate is precipitated and the carbon monoxide may be ignited.

* (3) On warming a solution of oxalic acid with dilute sulphuric acid and potassium permanganate, it is oxidised with liberation of carbon dioxide and the permanganate is decolorised:—

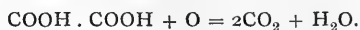

* (4) Calcium oxalate is precipitated when calcium chloride is added to a solution of a neutral oxalate. It is insoluble in acetic acid, but soluble in mineral acids.

(5) Mercurous nitrate gives a precipitate of mercurous oxalate even in very dilute solutions of neutral oxalates.

Detection.

* Oxalic acid is precipitated from a neutral solution, or a solution acidified with acetic acid as calcium oxalate. The crystalline form of the precipitate (p. 565) is very characteristic. The calcium oxalate is filtered off and can be identified by heating it or by the action of permanganate in sulphuric acid solution.

Estimation.

The solution, e.g. urine, is treated with calcium chloride and ammonia and evaporated to a small bulk. The precipitate which consists of calcium phosphate, sulphate and oxalate is separated by filtration and washed with water. It is dissolved in a small quantity of dilute hydrochloric acid (30 c.c.) and extracted from aqueous solution by extracting in an extractor (see p. 600) with ether. The ether is evaporated off, the residue dissolved in water, neutralised with ammonia, acidified with acetic acid, and precipitated with calcium chloride. The calcium oxalate is filtered off, ignited, and weighed as CaO, or dissolved in dilute sulphuric acid and titrated with standard permanganate.

COMPOUNDS CONTAINING THREE CARBON ATOMS.

The number of compounds which can be derived from propane are more numerous than those from ethane, since the extra carbon atom introduces further possible combinations and permutations. The principal compounds are :—

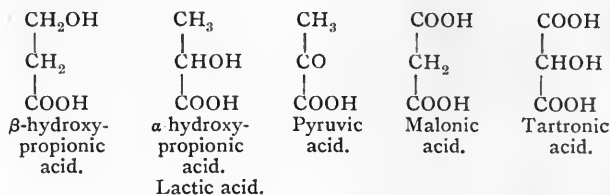

The first two compounds are isomers; in their nomenclature the position of the hydroxyl group is indicated by the Greek letters α and β , the lettering or numbering being commenced at the carbon atom next to the COOH group, which stands at the end of the chain (cf. p. 100).

Lactic Acid.

Lactic is formed by the fermentation of sugar by lactic acid bacteria; hence its presence in milk when it turns sour. Lactic acid is contained in muscle, especially after activity, and other organs of the animal body.

Preparation.

Lactic acid has been prepared synthetically by several methods, but its usual method of preparation is by fermentation, i.e. by biological means.

- * To a solution of 50 gm. of cane sugar in 500 c.c. of water 20 gm. of chalk or zinc carbonate and 20-30 c.c. of sour milk (which contains lactic acid bacteria) are added and the mixture is kept in a warm place, or better in an incubator at 37° , for 6-8 days and occasionally shaken. The chalk or zinc carbonate is added to neutralise the lactic acid which hinders the growth of the bacteria. Calcium or zinc lactate is formed.

The solution is boiled to kill bacteria, filtered, and evaporated on the water-bath till crystallisation commences and allowed to cool. The lactate is filtered off, pressed between sheets of filter paper and recrystallised from hot water. The acid is obtained from the salt by decomposition with sulphuric acid, extraction of the liquid with ether, and removal of the ether by distillation.

Properties.

* Lactic acid is a syrupy liquid having a sp. gr. of 1.248 at 15°. It is decomposed on distillation at ordinary atmospheric pressure, but at a pressure of 5-1 mm. it distils at about 85° and then sets to a hygroscopic crystalline solid melting at 18°. It is soluble in water, alcohol or ether, and is only very slightly volatile with steam.

Lactic acid is the simplest compound which exhibits the phenomenon of circular polarisation. Most natural compounds exhibit this phenomenon. Circular polarisation is the property of rotating a ray of polarised light to either the right or the left.

According to its source lactic acid may be either dextrorotatory, or laevorotatory, or inactive. Thus lactic acid from muscle—sarcoplactic acid—is dextrorotatory. Certain bacteria produce laevorotatory lactic acid. Fermentation lactic acid is inactive.

The examination of natural substances which exhibit circular polarisation has shown that they all contain one or more asymmetric carbon atoms, i.e. carbon atoms combined with four different groups. By representing the carbon atom as a regular tetrahedron and placing the different groups at the four apices, Van't Hoff and Le Bel have given us an explanation of the phenomenon. Adopting any arrangement of the groups round the tetrahedron, a reverse arrangement is represented by its image in a mirror. If therefore one variety is represented by the first arrangement, the mirror image of the figure represents the opposite variety. Projected on to a plane surface the following formulæ are then obtained :—

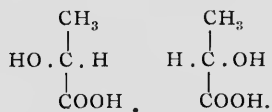

One figure will represent laevo or *l*-lactic acid, the other figure dextro or *d*-lactic acid. A mixture of the two in equal quantities represents inactive or *d*-lactic acid. This can be proved by the separation of inactive lactic acid into its constituent *d*- and *l*-forms by the fractional crystallisation of its strychnine salt.

These optical isomers are known as stereoisomers and the phenomenon as stereoisomerism.

Lactic acid has the chemical properties of a secondary alcohol and of an acid. The most characteristic salt of lactic acid is the zinc salt. This is prepared by boiling a solution of lactic acid for some time with excess of zinc carbonate and filtering whilst hot. On cooling, zinc lactate crystallises out, if the solution be sufficiently concentrated.

Detection.

- * (1) Lactic acid in concentrated solution is decomposed by heating with concentrated sulphuric acid with the formation of carbon monoxide; the gas may be ignited at the mouth of the test tube:—

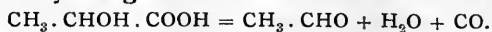

Weak solutions of lactic acid are neutralised with sodium carbonate and evaporated to a small volume before heating with sulphuric acid.

- (2) The formation of acetaldehyde may be detected by *Denigès'* method. The dilute solution of lactic acid is heated for 2 minutes in a boiling water-bath with 10 times its volume of concentrated sulphuric acid. The liquid is cooled, and 2 or 3 drops of a 5 per cent. solution of guaiacol in alcohol are added. On mixing, a rose-red colour—formed from the aldehyde and guaiacol—is produced which increases in intensity on standing.
- * (3) Lactic acid forms a soluble deep yellow ferric salt. If a dilute solution of ferric chloride (scarcely coloured) be treated with a few drops of a dilute solution of lactic acid, the colour becomes yellow.
- Other hydroxy acids and oxalic acid also give a similar colour.
- * (4) *Uffelmann's Test.*—Uffelmann's reagent—a 1 or 2 per cent. solution of phenol treated with ferric chloride solution till of a distinctly violet colour—is changed to yellow on the addition of lactic acid.

Note.—Mineral acids decolorise the reagent; other organic acids also give a yellow or brownish colour.

- * (5) Lactic acid gives the iodoform reaction (p. 67).
- (6) *Thiophene Test.*—A few drops of a 1 per cent. solution of lactic acid in alcohol are added to 5 c.c. of concentrated sulphuric acid containing 3 drops of saturated copper sulphate solution and heated in a boiling water-bath for 5 minutes. Two drops of a 2 per cent. alcoholic solution of thiophene are added to the cooled solution, and on again warming a cherry-red colour is formed (*Hopkins*).

These tests for lactic acid are not easily observed in extracts of organs, etc., which contain lactic acid. The lactic acid should be extracted with ether, the ethereal solution evaporated and the residue then tested for lactic acid.

Estimation.

Lactic acid is sometimes estimated by converting it into its zinc salt by boiling the solution with excess of zinc carbonate, filtering, evaporating and weighing the zinc lactate which crystallises out. It is more usually estimated by oxidising it with permanganate in acid solution; acetaldehyde is formed:—



The acetaldehyde is distilled off during the oxidation, collected and determined by treatment with excess of standard potassium bisulphite solution, the excess of which is estimated by titration with standard iodine solution (see p. 85).

The estimation of lactic acid in tissues is described on p. 590.

Pyruvic Acid.

The work of recent years shows that pyruvic acid and other ketonic acids are very probably intermediate products in the catabolism of fatty acids and proteins. Pyruvic acid may be a stage in the transformation of sugar into alcohol and carbon dioxide and into lactic acid:—

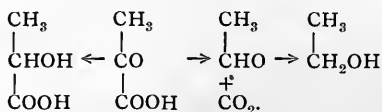

Preparation.

Pyruvic acid is usually prepared from tartaric acid. A mixture of 500 gm. of tartaric acid and 780 gm. of potassium bisulphate is distilled from a 2 li. copper retort provided with a condenser; the receiver is cooled with ice. The distillate is redistilled *in vacuo* using a fractionating column. A yield of about 60 per cent. is obtained.

Properties.

Pyruvic acid is a liquid which freezes at 9° and boils at 168° under atmospheric pressure, or at 59-60° at 12 mm. pressure. It smells very like acetic acid. It has the properties of an acid and of a ketone and forms a characteristic hydrazone.

Test.

Hurtley has described the following delicate test for pyruvic acid. The test depends upon the formation of a red colour on oxidising the phenylhydrazone of pyruvic acid. The reaction is positive at a dilution of 1 in 10,000 and can be obtained at a dilution of 1 in 100,000.

10 c.c. of pyruvic acid (1 per cent.) are treated with 10 c.c. of phenylhydrazine hydrochloride solution (6.41 gm. in 500 c.c. acid = 5 gm. pyruvic acid); about 2 c.c. of persulphuric acid (25 gm. $\text{K}_2\text{S}_2\text{O}_8$ are ground up with 50 gm. H_2SO_4 and left for 1 hour, then poured upon ice and diluted to 500 c.c.) are added avoiding an excess and then 5 c.c. concentrated hydrochloric acid. A red colour develops.

Malonic Acid.

This acid is found in beetroot as its calcium salt. It was originally prepared by the oxidation of malic acid with potassium bichromate and sulphuric acid, but is usually made by the cyanide synthesis from chloroacetic acid.

Potassium chloracetate is boiled with potassium cyanide; the product is hydrolysed with hydrochloric acid and the solution evaporated to dryness. The residue is extracted with ether, and the malonic acid obtained by distillation of the ether.

Malonic acid is a colourless, crystalline solid which melts at 132°, and is readily soluble in water, alcohol and ether. On heating to 140-150° it loses carbon dioxide and is converted into acetic acid:—

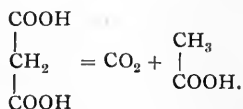

The diethyl ester of malonic acid is a compound much used for the synthesis of other organic compounds.

COMPOUNDS CONTAINING FOUR CARBON ATOMS.

The vegetable acids, malic and tartaric, and the two acids, β -hydroxybutyric and acetylacetic, which are found in urine in cases of diabetes are the chief biological representatives of this group of compounds. Succinic acid is the dibasic acid of this series; malic acid is monohydroxy-succinic acid; tartaric acid is dihydroxy-succinic acid:—

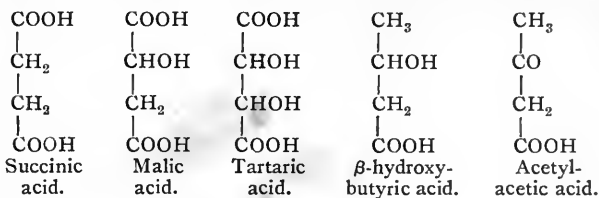

Succinic Acid.

Succinic acid occurs in certain lignites and fossils, in lettuce, unripe grapes and other fruits. It has also been found in animal tissues and meat extracts.

Succinic acid is obtained by the dry distillation of amber. The aqueous distillate is filtered whilst hot to separate oil, and on cooling crystals of succinic acid are deposited. They may be purified by boiling with nitric acid and recrystallisation.

Succinic acid is usually prepared by the fermentation by yeast of calcium malate or ammonium tartrate. It is formed by the reduction of these compounds.

Succinic acid crystallises in colourless prisms or plates which melt at 182° . On heating, it emits suffocating fumes; at higher temperatures it boils and gives a sublimate of succinic anhydride.

It is not readily soluble in cold water, but dissolves readily in alcohol and sparingly in ether. It is insoluble in chloroform and benzene.

Malic Acid.

Malic acid is contained in apples, pears and other fruits. It is usually prepared from rhubarb stalks or unripe mountain ash berries. The juice is boiled with milk of lime; the neutral calcium salt is precipitated. The salt is recrystallised from dilute nitric acid and the acid salt is so obtained. It is decomposed with the calculated quantity of sulphuric acid, the liquid is filtered from calcium sulphate and evaporated. Malic acid crystallises out.

Malic acid crystallises in groups of colourless 4 or 6-sided prisms. It is deliquescent and readily soluble in water, alcohol and ether.

On heating to about 180° , it melts and loses water yielding fumaric and maleic acids.

Malic acid is optically active and contains one asymmetric carbon atom. The natural form is *L*-malic acid.

The salts of malic acid resemble those of citric, oxalic and tartaric acids. Calcium malate is not precipitated in the cold. On boiling in neutral and concentrated solution calcium malate is precipitated; alcohol precipitates calcium malate from dilute aqueous solution. A mixture of oxalic, tartaric, citric and malic acids may thus be separated. The oxalate and tartrate are precipitated from dilute solution in the cold; on boiling the filtrate calcium citrate is precipitated, and on adding 2 volumes of alcohol to the filtrate calcium malate is thrown down.

Tartaric Acid.

Tartaric acid occurs in certain plant juices; its only important source is grape juice. During fermentation a deposit forms on the bottom—lees—and a crystalline crust on the sides—tartar or argol—of the cask. The argol consists mainly of potassium hydrogen tartrate and calcium tartrate. Their precipitation is due to their insolubility in the alcohol as it is produced. If the crude argol be boiled with water and filtered and the solution crystallised, cream of tartar separates out, the term cream of tartar having arisen from the fact that the salt collects in crusts on the surface during the evaporation.

Preparation.

Tartaric acid is prepared from tartar by dissolving it in water and neutralising with lime. Insoluble calcium tartrate is thrown down and from the solution, which still contains tartaric acid, insoluble calcium tartrate is precipitated by adding calcium sulphate or calcium chloride. The insoluble calcium salt is decomposed with sulphuric acid and tartaric acid isolated from the solution by crystallisation.

Properties.

Tartaric acid crystallises in large hemihedral monoclinic prisms which are colourless and transparent. It melts at 167-170° and is easily soluble in water and alcohol, but insoluble in ether.

Tartaric acid is optically active; the ordinary tartaric acid is dextro-rotatory having $[\alpha]_D = 13.1^\circ$ for a 15 per cent. solution and $= 14.7^\circ$ for a 2 per cent. solution. A laevo-tartaric acid and two inactive forms of tartaric acid also exist. Tartaric acid contains two asymmetric carbon atoms in its molecule and to these carbon atoms the same groups are attached. If the arrangement of these groups round each carbon atom is the same, an optically active form will result; but if different an inactive form will result; in the former case both asymmetric carbon atoms are rotating to the right or to the left; in the latter case the one carbon atom rotates in one direction as much as the other carbon atom rotates in the other direction and they neutralise one another. Internal compensation occurs.

This inactive acid is known as meso-tartaric acid and is produced by prolonged heating of dextrorotatory tartaric acid to 165° with a small quantity of water.

The other inactive form is a mixture of the dextro and laevo forms in equal proportions. As a mixture it can be separated into its two constituents. It occurs with *d*-tartaric in crude tartars.

Reactions.

- * (1) On heating, tartaric acid melts and chars giving off an odour resembling that of burnt sugar.
- * (2) Tartaric acid chars almost immediately when it is heated with concentrated sulphuric acid.
- * (3) A white precipitate of silver tartrate is formed on adding silver nitrate to a neutral solution of a tartrate. The precipitate dissolves in ammonia and when this solution is slowly warmed a silver mirror is formed on the sides of the vessel.
- * (4) On adding calcium chloride to a *cold* solution of a neutral tartrate (sodium potassium tartrate) a white precipitate of calcium tartrate is formed. This precipitate, after filtering and washing, is soluble in acetic acid and caustic soda (free from carbonate); on boiling the solution in the latter, it is reprecipitated (distinction from calcium oxalate).
- * (5) A precipitate of potassium hydrogen tartrate is formed on adding potassium chloride and acetic acid to a not too dilute solution of a tartrate.

This reaction is used in estimating tartaric acid.

* (6) The presence of tartaric acid or tartrates in a solution prevents the precipitation of metallic hydroxides by caustic soda.

(a) No precipitate is formed if caustic soda be added to ferric chloride solution containing some tartrate solution, but a yellow-brown solution results.

(b) A dark-blue solution results if caustic soda be added to copper sulphate solution containing a tartrate.

This property is used in the preparation of Fehling's solution.

Citric Acid.

Citric acid is another hydroxy acid, which occurs in the free state in the juices of many plants. Small quantities are present in milk.

Preparation.

About 5.5 per cent. of citric acid is obtainable from good lemons; about 1 per cent. from unripe gooseberries. It is usually extracted from lemons, limes and bergamot. The hot liquid is neutralised with calcium carbonate, and the calcium citrate so obtained is decomposed by sulphuric acid in equivalent amount. The solution on evaporation gives citric acid.

Citric acid contains 6 atoms of carbon in its molecule, 5 being in a normal straight chain. Its formula is

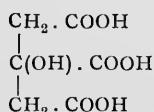

which shows that it is a tribasic acid. It closely resembles tartaric acid, but there are many points of difference.

Properties.

Citric acid is obtainable either as a crystalline powder, or in transparent colourless prisms having the formula $\text{C}_6\text{H}_8\text{O}_7 \cdot \text{H}_2\text{O}$. It has a strong acid taste, is very easily soluble in water, and is also soluble in dilute and absolute alcohol; it is almost insoluble in ether, chloroform, petroleum ether and benzene.

Reactions.

* (1) On heating, citric acid loses water becoming anhydrous, melts and decomposes, giving off acid fumes of aconitic acid.

* (2) When heated with concentrated sulphuric acid, citric acid chars slowly.

* (3) Silver citrate is precipitated on adding silver nitrate to a neutral solution of citric acid or a citrate. The precipitate dissolves in ammonia, but the solution on warming is not reduced and does not form a silver mirror.

- * (4) Calcium citrate is not precipitated when calcium chloride is added to a cold neutral solution of a citrate. This salt is less soluble in hot water and hence on boiling the solution calcium citrate is precipitated; it dissolves again as the solution cools.
- * (5) Citric acid does not form an insoluble acid potassium salt when its solutions are treated with potassium chloride and acetic acid.

Aceto-Acetic Acid or Acetylacetic Acid.

Ethyl aceto-acetate was prepared in 1863 by Geuther by acting upon ethyl acetate with sodium and acidifying the product with acetic acid. An oil resulted; it was separated and purified by distillation.

Ethyl aceto-acetate is a liquid with a fruity smell which boils at 182°. It is largely used in synthesis in organic chemistry, like malonic ester.

Aceto-acetic acid can be prepared from the ester by hydrolysis. It is a very unstable, strongly acid, hygroscopic syrup which decomposes on warming into acetone and carbon dioxide. Solutions of aceto-acetic acid are readily decomposed on distilling with dilute acid or alkali.

Traces of aceto-acetic acid occur in normal urine—2.4 mg. in 24 hours. The amount is increased in starvation, on a diet of protein, and on a diet of fat—i.e. whenever there is a shortage of carbohydrate. The excretion of aceto-acetic acid is lessened if carbohydrate be added to the food.

The origin of the aceto-acetic acid in the urine appears to be partly from the protein of the food, but mainly from the fat. The work of Knoop and of Dakin has shown that the oxidation of the fatty acids takes place at the β -carbon atom; the long chains are broken down with the loss of 2 carbon atoms at a time. This accounts in part for the occurrence of those fatty acids in nature containing an even number of carbon atoms. Butyric acid, if present as such or formed by the oxidation of higher fatty acids by β -oxidation, is oxidised and converted into aceto-acetic acid or β -hydroxybutyric acid:—

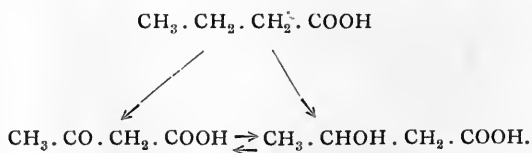

Aceto-acetic acid is converted by reduction into β -hydroxybutyric acid, and *vice versa*, β -hydroxybutyric acid is converted by oxidation into aceto-acetic acid. It seems most likely that aceto-acetic acid, the keto acid, is the chief product of the oxidation of butyric acid.

The formation of aceto-acetic acid in the organism from fat when carbohydrate is withheld from the food explains its formation in diabetes. Here the organism has lost its power of utilising the carbohydrate in the food, or its power of utilising carbohydrate is greatly diminished.

Aceto-acetic acid is very unstable and is readily converted into acetone and carbon dioxide. This decomposition occurs spontaneously in normal urine.

The three closely related substances, β -hydroxybutyric acid, aceto-acetic acid and acetone are generally referred to in medical literature as the acetone bodies. There is no basis for the older statement that mild cases of diabetes excrete only acetone, that severer cases excrete acetone and aceto-acetic acid, and that still severer cases excrete β -hydroxybutyric acid in addition. It seems to have been due to a misinterpretation of the tests and to the inadequacy of our methods of estimating these substances.

The occurrence of acetone in the breath of diabetics can be accounted for by the difference in the blood circulation. This is slow through the systemic system and lung capillaries through which the blood passes before it goes to the kidney. Venous blood is more acid than arterial blood, so that the conditions for the decomposition of aceto-acetic acid are most favourable. Acetone is very volatile and if decomposition occurs during the passage of the blood through the lungs it would pass into the expired air.¹

Tests.

The various tests for aceto-acetic acid were reviewed and summarised by W. H. Hurlley in 1913 in the "Lancet" for 26th April, and the following preparation of a dilute solution of sodium aceto-acetate was described:—

13 gm. of pure ethyl aceto-acetate are treated with 100 c.c. of normal caustic soda and diluted to 500 c.c. The ester is almost completely hydrolysed by allowing this solution to stand for 44½ hours. A solution containing 1 gm. of aceto-acetic acid is obtained by diluting it to 5000 c.c., or better, by diluting 49·2 c.c. of this solution to 1 litre. This solution is conveniently used for the tests.

¹ See the excellent account by Kennaway in the "Guy's Hospital Reports," Vol. LXVII,

- * (1) *Gerhardt's Ferric Chloride Test*.—Dilute ferric chloride solution, added drop by drop, to about 10 c.c. of the solution gives a claret-red colour.

The delicacy of this reaction is very nearly 1 in 100,000.

In applying this test to urine a precipitate of ferric phosphate is formed. Ferric chloride is added so long as a precipitate is produced and the ferric phosphate filtered off. On adding ferric chloride to the filtrate the claret colour appears if aceto-acetic acid be present.

The delicacy of the reaction with urine is less than given above on account of the presence of other substances which give a red colour with the iron salt.

There is also the disadvantage in testing urine that aromatic compounds—salicylates, antipyrine—which are excreted after their administration, also give a violet colour with ferric chloride.

To avoid confusion the urine is shaken with benzene or chloroform which removes salicylic acid. The urine is then acidified with sulphuric acid and shaken with ether which extracts the aceto-acetic acid. The ethereal solution on shaking with dilute ferric chloride solution will give the claret colour. The colour disappears on standing for 12-24 hours. Thiocyanic acid is also extracted by ether, but the colour of ferric thiocyanate is permanent.

The statement that the colour if produced by aceto-acetic acid disappears on boiling is, according to Kennaway, not exactly true. The colour in either case becomes paler and redder, and in the case of aceto-acetic acid a reddish flocculent precipitate appears on boiling.

- * (2) *Legal's Sodium Nitroprusside Test*.—On adding 3 drops of a freshly prepared 5 per cent. solution of sodium nitroprusside to about 10 c.c. of the solution and rendering alkaline with a few drops of caustic soda, a deep red colour is formed. The colour changes to magenta on acidifying with acetic acid.

When applied to urine it should be remembered that creatinine gives a similar colour reaction (p. 171).

- * (3) *Rothera's Sodium Nitroprusside Test*.—10 c.c. of the solution are saturated with ammonium sulphate by adding 5 gm. of the crystals; 3 drops of 5 per cent. sodium nitroprusside and 2 c.c. of strong ammonia are then added. A fine permanganate colour is produced.

1 part of aceto-acetic acid in 100,000 gives the reaction in 2 minutes, 1 part in 400,000 in 5 minutes.

This reaction was described as characteristic for acetone but was shown by Hurtley to be far more delicate for aceto-acetic acid.

(4) *Arnold's Test*.—This test depends upon the formation of a colouring matter from aceto-acetic acid and diazotised para-amino-acetophenone:—

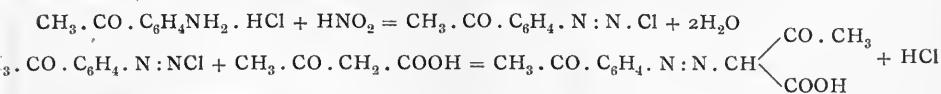

Two solutions are required:—

(a) 1 gm. of para-amino-acetophenone dissolved in a little water with the aid of 2 c.c. of concentrated hydrochloric acid and made up to 100 c.c.

(b) 1 gm. of sodium nitrite dissolved in water and made up to 100 c.c.

2 volumes of (a) and 1 volume of (b) are mixed, an equal volume of the solution is added to the mixture and 1 or 2 drops of strong ammonia. A large excess of concentrated hydrochloric acid (15 c.c.) is added to a portion of the above (2 c.c.). A fine purple colour is produced.

In testing urine, Arnold recommends filtering it through animal charcoal before applying the test. The delicacy is increased and more urine can be added to the mixture of (a) and (b) than if unfiltered urine be used.

The sensitiveness of the test is increased according to Lipliawsky if, after adding the excess of hydrochloric acid, 3 c.c. of chloroform and 2-4 drops of ferric chloride be added and the mixture carefully shaken so as to avoid an emulsion. The purple colour is taken up by the chloroform forming a very stable solution.

The delicacy of the test is 1 in 40,000. The reaction is also given by ethyl aceto-acetate, but not by other substances, and can therefore be directly applied to the urine of patients who have taken salicylic acid preparations, antipyrine, etc.

(5) *Riegler's Absorption of Iodine Test*.—This test depends upon the formation of iodo-aceto-acetic acid, a colourless substance:—

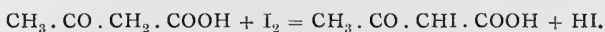

The conditions necessary for this test are that the solution must be acid and that iodine must be present.

10 c.c. of the solution, or of urine, are acidified with 5 drops of 30 per cent. acetic acid and 5 drops of iodine solution are added. This mixture is shaken with 2 or 3 c.c. of chloroform. No colour appears if aceto-acetic acid be present.

The amount of aceto-acetic acid present in the solution can be gauged from the amount of iodine solution which is required to be added so as to form an excess over that required to combine with the aceto-acetic acid and so as to colour the chloroform violet.

Ondrejovich has modified the test as follows:—

5 c.c. of the solution, or urine, are acidified with 5 drops of 50 per cent. acetic acid and 1 drop of 1 in 2000 solution of methylene blue added. The liquid should be distinctly blue. The liquid turns red on adding cautiously 2 to 4 drops of tincture of iodine or iodine solution, and the red colour turns blue or green at a speed depending on the amount of aceto-acetic acid present. The green colour is restored if the solution has been made too acid.

Indican also absorbs iodine, but its amount in urine is so small that it may be neglected. No other substance seems to show this reaction.

(6) *Hurtley's Test*.—The reaction involved in this test is the conversion of aceto-acetic acid into isonitroso-acetone by nitrous acid. This compound forms salts; the ferrous salt has a purple colour:—

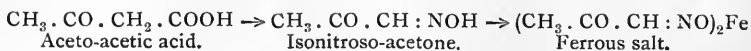

2·5 c.c. of concentrated hydrochloric acid and 1 c.c. of a 1 per cent. solution of sodium nitrite are added to 10 c.c. of the solution, or of urine, and allowed to stand for 2 minutes. 15 c.c. of strong ammonia and 5 c.c. of a 10 per cent. solution of ferrous sulphate or of ferrous chloride (2 gm. iron in 100 c.c.) are added; the mixture is shaken and poured into a 50 c.c. Nessler glass where it is allowed to stand undisturbed. It is inadvisable to filter. A violet or purple colour is slowly produced at a speed depending on the amount of aceto-acetic acid present. The colour deepens for several hours after its first appearance.

The reaction appears at a dilution of 1 in 50,000. Ethyl aceto-acetate gives a blue colour when more nitrite than prescribed above is used; acetone does not react.

The reaction is very useful for gauging the amount of aceto-acetic acid in a solution or in urine.

By diluting a 1 per cent. solution of sodium aceto-acetate prepared as described on p. 119 so that it contains ·025, ·02, ·15 and ·01 gm. of aceto-acetic acid in 100 c.c. and applying the test to these four solutions at the same time as it is applied to the unknown, and allowing them to stand 4 or 5 hours the initially turbid liquids become clear and the unknown can be placed in position amongst the standards. Solutions, or samples of urine, containing more than the standard amounts must be diluted 10 or 20 times, and the test repeated.

Estimation.

The estimation of aceto-acetic acid is based upon its decomposition into acetone and carbon dioxide by heating with dilute acid. The acetone is separated by distillation and determined by converting it into iodoform with excess of ·1N iodine solution and caustic soda, the excess of iodine being found by titration with ·1N sodium thiosulphate solution:—

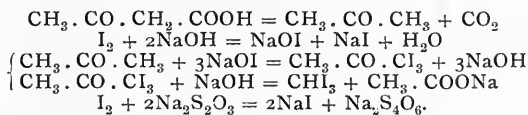

The estimation of aceto-acetic acid in urine and tissues is described on p. 593.

β -Hydroxybutyric Acid.

β -Hydroxybutyric acid is readily prepared by the reduction of aceto-acetic acid. In this way it probably arises in the animal body. β -hydroxybutyric acid contains an asymmetric carbon atom and can therefore occur in three forms—dextro, laevo and inactive. The laevo form is present in urine in diabetes and under the conditions detailed under aceto-acetic acid. The dextro form is produced by the reduction of aceto-acetic acid by yeast. The inactive form is produced by chemical reducing agents.

β -hydroxybutyric acid is usually obtained as a colourless syrup, but has been prepared in colourless crystalline plates by Magnus Levy; these sinter at $47\text{--}48\cdot5^\circ$ and melt at $49\text{--}50^\circ$. It is very hygroscopic.

It is easily soluble in water, alcohol, ether, ethyl acetate and acetone but not in benzene and petroleum ether.

The rotation of *l*- β -hydroxybutyric acid is $[\alpha]_D^{20} = -24\cdot12^\circ$ at temperatures between 17 and 22° and in concentration less than 12 per cent.

Several salts have been prepared in a crystalline condition, e.g. silver, calcium, zinc.

Detection.

β -hydroxybutyric acid has no reactions like aceto-acetic acid. Its detection is therefore indirect.

(1) It is converted into *a*-crotonic acid by loss of water either by heating alone or more readily by heating with dilute sulphuric acid:—



Urine is mixed with an equal volume of concentrated sulphuric acid and distilled; during the process the volume is kept constant by adding water to the contents of the distilling flask through a tap funnel. Crotonic acid sometimes separates out from the first portions of the distillate, but usually the distillate is extracted with ether. The ether is allowed to evaporate spontaneously; the crystals of crotonic acid which separate are pressed out on a porous plate and their melting-point determined. Crotonic acid melts at $71\text{--}72^\circ$. The melting-point must be ascertained since benzoic acid also passes into the distillate. They may be purified by solution in ether and precipitation by petrol ether.

(2) By oxidation with potassium bichromate and sulphuric acid or with hydrogen peroxide and ferrous sulphate it is converted into aceto-acetic acid and then into acetone by decomposition of the aceto-acetic acid (see under estimation).

The detection of hydroxybutyric acid is carried out most certainly by isolation of the substance by extracting it with ether in the same way as it is estimated (p. 597).

AMINES.

The amines are compounds which are derived from ammonia by the replacement of one, two, or three of its hydrogen atoms by alkyl groups, e.g.—

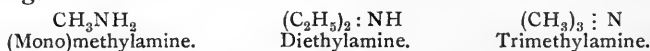

Their relationship to the hydrocarbons is shown by their method of preparation from the alkyl halides. Primary amines may be regarded as derived from hydrocarbons in which a hydrogen atom has been replaced by the amino (NH_2) group, or as derived from alcohols in which the hydroxyl group has been replaced by the amino group. Numerous amines occur in nature; they are products of decomposition of the amino acids, which lose carbon dioxide during putrefaction.

Preparation.

When an alkyl halide is treated with alcoholic ammonia, the halogen atom is replaced by the NH_2 group. This new compound again reacts with the alkyl halide, and the reaction continues until all the hydrogen atoms of ammonia are substituted by alkyl groups:—

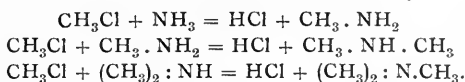

A mixture of the three compounds is obtained.

The three compounds are termed respectively a primary, a secondary, and a tertiary amine according as 1, 2, and 3 of the hydrogen atoms in ammonia are replaced by alkyl groups. If the alkyl groups are the same, they are known as simple amines, if different, as in methylethylamine, they are known as mixed amines.

Primary amines are characterised by the presence of the amino (:NH_2) group; secondary amines are characterised by the presence of the imino (:NH) group; tertiary amines by :N completely substituted by alkyl groups.

Primary amines can also be prepared:—

(1) By the hydrolysis of isocyanates:—

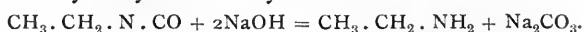

Primary amines were first prepared by this reaction by Wurtz in 1849;

(2) By the reduction of nitriles (p. 158):—



This reaction serves for passing from a lower to a higher series.

(3) by the reduction of oximes :—



(4) by the action of bromine on an amide :—

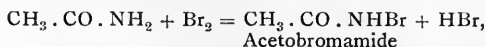

and the decomposition of the bromamide by heating with excess of sodium hydroxide. Hydrobromic acid is removed and an isocyanate is formed :—

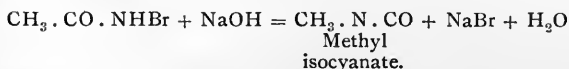

the isocyanate on hydrolysis gives the primary amine :—

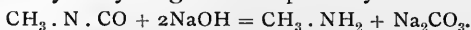

This reaction serves for passing from a higher series of compounds to a lower one containing one atom of carbon less in the molecule.

Diamines.

Dihalogen derivatives yield diamines in a similar manner :—

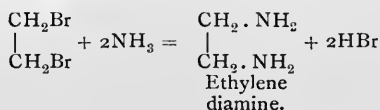

The two compounds, putrescine and cadaverine, are products of the putrefaction of the corresponding diamino acids, ornithine and lysine :—

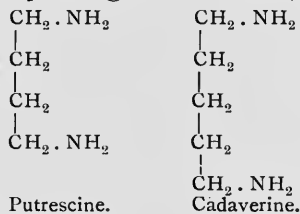

The isolation of amines from natural sources involves a complicated process of extraction, precipitation, etc., depending on the formation of double salts with mercuric chloride, gold chloride, platinum chloride, etc. Full details can be found in Barger's Monograph "The Simple Natural Bases".

Properties.

The lower members, whether primary, secondary, or tertiary, are gases, the next members are liquids, the highest members are solids. They have a characteristic and peculiar smell, which is pungent like ammonia and "fishy" in the lower members. The lower members are easily soluble in water and closely resemble ammonia.

Like ammonia they are strong bases which turn red litmus blue and unite with acids to form salts. These salts are frequently deliquescent, and generally soluble in water, sometimes in alcohol, chloroform and

other organic solvents. The bases are liberated on adding sodium hydroxide to their solution. The salts yield double salts with gold, platinum chloride, etc.; these are of use for determining the molecular weight of the base (p. 45).

Reactions of a Primary Amine (Methylamine).

- * (1) On treating a solution of methylamine hydrochloride, or about 2 gm. of the solid, with sodium hydroxide, the base is liberated:—

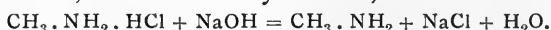

Methylamine resembles ammonia in odour, but is "fishy," turns red litmus blue, and fumes with vapours of hydrochloric acid. It differs from ammonia in being combustible.

(2) A double salt is formed on adding an alcoholic solution of gold or platinum chloride to an alcoholic solution of methylamine hydrochloride.

- * (3) *Action of Nitrous Acid.*—On adding dilute hydrochloric acid and a few drops of sodium nitrite solution to a solution of methylamine hydrochloride, there is an evolution of nitrogen (the gas extinguishes a glowing splinter) and methyl alcohol is formed:—

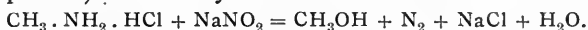

This reaction is characteristic of primary amines; they are converted into the corresponding alcohol.

- * (4) *Carbylamine Reaction.*—On warming a solution of methylamine hydrochloride with *one drop* of chloroform and alcoholic sodium hydroxide, methylcarbylamine, or isocyanide, is formed:—

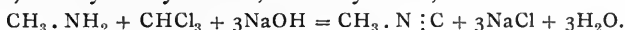

(5) *Reaction with Acetyl Chloride.*—Primary amines react with acetyl chloride, benzoyl chloride, etc., to form substituted amides:—

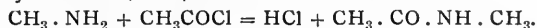

These compounds are crystalline and serve for identifying the amine.

Reactions of a Secondary Amine (Dimethylamine).

- * (1) Dimethylamine is liberated from a solution of dimethylamine hydrochloride on treatment with sodium hydroxide:—

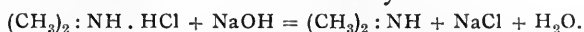

It is a gas with an ammoniacal and fishy odour and resembles methylamine.

(2) A double salt is formed with alcoholic solutions of the heavy metals.

- * (3) *Action of Nitrous Acid.*—On adding dilute hydrochloric acid and some nitrite to a solution of dimethylamine hydrochloride, there is no evolution of nitrogen, but dimethylnitrosamine is formed:—

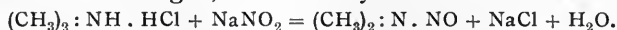

Dimethylnitrosamine is a yellowish oil which is volatile with steam and can thus be separated.

It is reconverted into the secondary amine by the action of concentrated hydrochloric acid.

(4) *Carbylamine Reaction*.—Dimethylamine and secondary amines do not yield isocyanides with chloroform and alcoholic potash.

(5) *Reaction with Acetyl Chloride*.—Secondary amines form with acetyl chloride, etc., crystalline substituted amides which are useful for purposes of identification :—

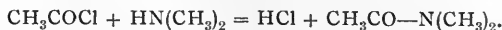

Reactions of a Tertiary Amine (Trimethylamine).

(1) Trimethylamine is evolved on adding excess of alkali to a solution of its hydrochloride :—



It is a gas like the primary and secondary amines with a fishy ammoniacal odour and is combustible.

(2) Double salts are formed on adding alcoholic solutions of gold chloride, etc., to an alcoholic solution of trimethylamine hydrochloride.

(3) *Action of Nitrous Acid*.—Trimethylamine does not react with nitrous acid.

(4) *Carbylamine Reaction*.—This reaction is not given by trimethylamine and tertiary amines.

(5) *Reaction with Acetyl Chloride*.—Tertiary amines do not react.

(6) *Quaternary Ammonium Salts*.—Tertiary amines combine with alkyl iodides to form a quaternary ammonium salt :—

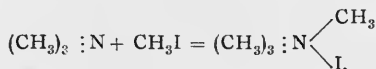

In this compound the halogen atom can be replaced by the hydroxyl group :—

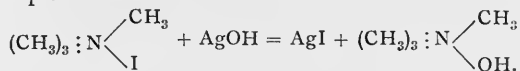

Choline.

Choline, or hydroxy-ethyl-trimethyl-ammonium hydroxide is a trimethylamine derivative of ethyl alcohol,

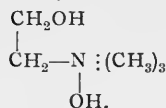

It occurs in the free state in most animal tissues and is widely distributed in plants. It is a constituent of lecithin, which is present in egg yolk, nervous tissue, and in seeds of plants from which it arises by hydrolysis.

Preparation.

Choline is usually prepared from egg yolk. The lecithin is extracted with ether or alcohol. The residue left on evaporation of the solvent is hydrolysed by boiling with baryta. The barium soaps (p. 99), which are formed, are filtered off and the solution evaporated to dryness. The choline is extracted

from the dry residue with alcohol and precipitated as double salt with mercuric or platinum chloride, from which its hydrochloride is obtained by decomposition with hydrogen sulphide.

Synthetically choline has been prepared by the action of trimethylamine upon ethylene oxide (glycol anhydride, p. 173):—

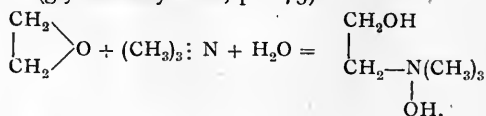

Properties.

Choline is a hygroscopic crystalline mass which has an alkaline reaction. It forms salts with acids such as choline hydrochloride,

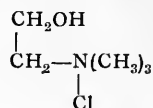

and these salts form double salts with the salts of heavy metals.

Choline has no peculiar reactions and must be isolated and analysed in the form of its salts for its identification. It is decomposed by boiling with alkalis yielding trimethylamine and glycol.

Esters of Choline.

As an alcohol choline forms esters with acids:—

(1) Acetyl choline, $\text{CH}_2\text{O—OC} \cdot \text{CH}_3$

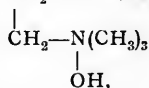

has been found in ergot.

(2) Palmityl choline, $\text{CH}_2\text{O—OC} \cdot \text{C}_{15}\text{H}_{31}$

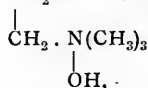

has also been prepared. It is easily soluble in water and readily hydrolysed by alkali. It has a powerful hæmolytic action (Fourneau and Page).

(3) Choline nitrite, $\text{CH}_2\text{O—NO}$ and choline nitrate, $\text{CH}_2\text{O—NO}_2$



resemble the toxic constituents of the toad-stool (*Amanita agarica*). The nitrite is formed by the action of nitric acid on choline and was formerly supposed to be the aldehyde (pseudomuscarine);

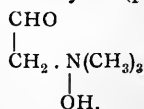

The ethyl ether of choline resembles the action of natural muscarine still more closely (Ewins).

Esters of choline have marked pharmacological actions. They have only recently been isolated and prepared and will probably account for many characteristic physiological actions.

AMIDES.

The amides are derivatives of fatty acids, dibasic acids, etc., in which the hydroxyl of the carboxyl group or groups has been replaced by an amino (NH_2) group. They may also be regarded as derived from ammonia by the replacement of one of the hydrogen atoms by an acid radicle, e.g. :—

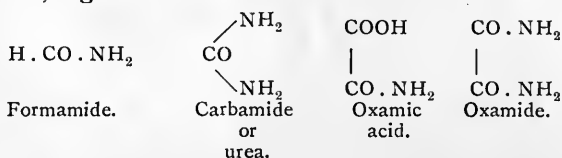

Amides are found in nature both in animals and plants: in plants asparagine, the monamide of aspartic acid (p. 138), is perhaps the most common, in animals urea. Urea is formed by the liver (and other organs) from ammonia and carbon dioxide. It circulates in the blood and is excreted by the kidney. Urine contains about 2 per cent. or 30 gm. per day.

The amides resemble the primary amines in containing an amino (NH_2) group, but differ from them in other respects.

Preparation.

Amides are prepared by several methods :—

(1) by the distillation of the ammonium salt of an acid :—



(2) by the action of ammonia upon an acid chloride :—

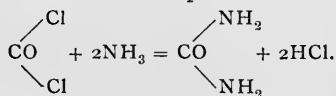

(3) by the action of ammonia upon an acid anhydride :—

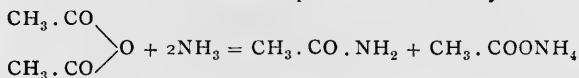

(4) by the action of ammonia upon an ester :—

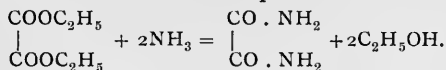

Properties.

The amides, except formamide which is liquid, are white crystalline solids generally easily soluble in water and alcohol. The substitution of a hydrogen atom in ammonia by acid radicles decreases its basic character; the amides are consequently neutral in reaction, but they are weak bases and form salts only with strong acids. They are unstable compounds and are readily decomposed into their constituent acid and ammonia by boiling with acid or alkali,

Acetamide.*Preparation.*

Acetamide is usually prepared by distilling ammonium acetate. About 50 gm. are melted in a basin and poured into a distilling flask attached to a wide air condenser. Water, acetic acid and ammonia first pass over on heating, but at about 180° acetamide commences to distil. It solidifies in the receiver. A better yield is obtained if, previous to the distillation, the ammonium acetate be heated in a sealed tube to 200° for 5 hours.

- * Acetamide is more easily prepared by mixing together 5 c.c. of ethyl acetate and 5 c.c. of strong ammonia (sp. gr. .880) in a small flask, closing the flask and allowing it to stand in a warm place for some time. The two layers gradually form a single homogeneous solution. The liquid is fractionally distilled: ammonia, alcohol and water pass over first and subsequently acetamide, which solidifies.

Properties and Reactions.

Acetamide is a white crystalline solid which melts at 82° and boils at 222°. It is easily soluble in water, alcohol and ether. It forms a salt with hydrochloric acid when the gas is passed into its solution in ether; the salt is decomposed by water.

- * (1) On boiling a solution of acetamide (about 50 c.c.) with an excess of caustic soda, ammonia is evolved, recognisable by its smell and action on red litmus paper. The boiling is continued until ammonia is no longer produced, and the solution is tested for acetic acid by carefully neutralising and adding ferric chloride (p. 97).
- * (2) Acetamide is also hydrolysed by heating with acid in the same way; the ammonia may be detected by adding excess of magnesium oxide and boiling; the acid by neutralising and testing with ferric chloride:—

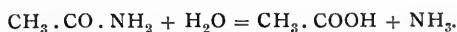

- * (3) On adding dilute hydrochloric acid and a few drops of sodium nitrite solution to a solution of acetamide, an effervescence of nitrogen occurs:—

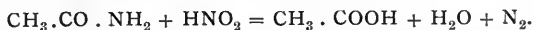

Acetic acid is formed and may be detected in the usual manner.

This reaction is typical of all organic compounds containing the NH_2 group (compare primary amines and amino acids).

Oxamide.*Preparation.*

- * Oxamide is precipitated on adding excess of ammonia to ethyl oxalate (1 c.c.). The precipitate is filtered off, washed with water and dried.

Properties and Reactions.

Oxamide is a white solid almost insoluble in water.

- * On boiling it for some time with caustic soda, it gradually dissolves forming sodium oxalate and at the same time ammonia is evolved.

Carbamide or Urea.

Preparation.

* (a) By synthesis from ammonium cyanate.

A solution of approximately equal parts of ammonium sulphate and potassium cyanate (p. 160) are boiled together and evaporated to dryness on the water-bath. The dry residue is extracted with alcohol, which dissolves the urea leaving potassium sulphate. Urea is left as a residue on evaporating the alcoholic solution on a water-bath. It is crystallised from alcohol:—

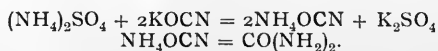

(b) By other synthetical methods.

Urea is formed by the methods described for the preparation of amides.

(c) From urine.

* (i) About 25 or 50 c.c. of urine are evaporated to dryness on the water-bath. The dry residue is treated with about 10 c.c. of acetone allowing the solvent to boil on a hot water-bath. The acetone is poured off into a clean vessel and allowed to evaporate (not in the neighbourhood of a flame). Urea crystallises out in long silky needles and is recrystallised from alcohol. A yield of about 1 gm. per 50 c.c. of urine should be obtained.

* (ii) 100 c.c. of urine are evaporated to a syrupy consistency (to about $\frac{1}{6}$) and thoroughly cooled by immersion in cold water. Excess of concentrated nitric acid is added to the cold solution, the solution being kept cold during the addition and stirred vigorously. Urea nitrate is precipitated in crystalline form. The crystals are filtered off through glass wool, or asbestos, and freed as much as possible from mother liquor by pressing between sheets of paper, or the crystals are placed on a porous plate and drained from mother liquor. About 4 gm. should be obtained corresponding to about 2 gm. of urea (163 gm. nitrate contain 60 gm. urea). Urea is prepared from the nitrate by mixing it with excess of barium carbonate and adding a little alcohol to form a paste; carbon dioxide is evolved, barium nitrate and urea are formed. The paste is extracted with hot alcohol, the alcohol filtered from barium carbonate and evaporated. Urea separates in needles and is recrystallised from alcohol.

(iii) Urea may also be prepared from urine by precipitating it as urea oxalate by adding 1 gm. of oxalic acid to every 10 c.c. urine; the yield is about 1 per cent. (Roaf).

Properties and Reactions.

Urea is a white solid which crystallises from water in long prisms (Fig. 23). It melts at 132° and is easily soluble in water, alcohol, acetone, but not in ether or chloroform.

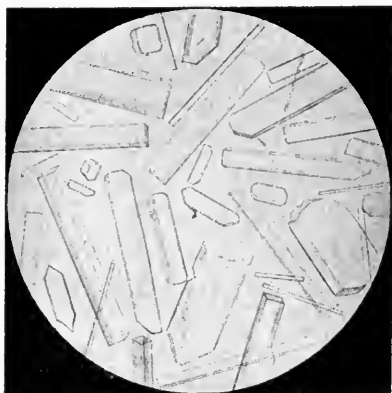
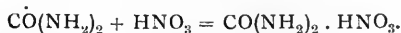

FIG. 23.—Urea. (After Funke.)

(1) As an amide it is a weak base and forms salts with strong acids.

(a) *Urea nitrate*.—If a few crystals of urea be dissolved in water on a watch glass and one or two drops of concentrated nitric acid be added, crystals of urea nitrate are formed. These are seen to consist of rhombic six-sided platelets, often imbricated (like tiles) when examined under the microscope

(Fig. 24).



* (b) *Urea oxalate*.—If a saturated solution of oxalic acid be used instead of nitric acid, crystals of urea oxalate are formed. Under the microscope they are seen to consist of short rhombic prisms (Fig. 25),

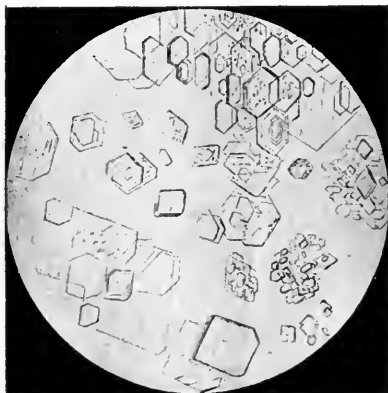
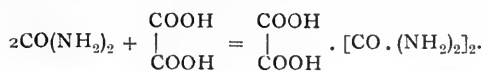

FIG. 24.—Urea nitrate.

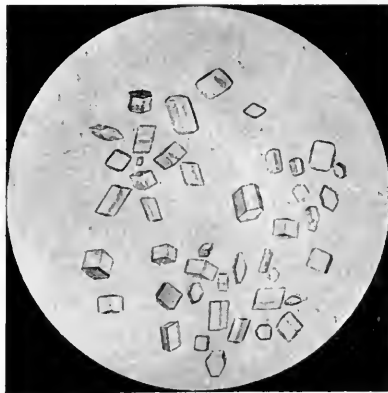
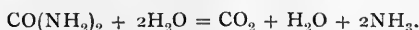

FIG. 25.—Urea oxalate.

(After Funke.)

* (2) *Action of Sodium Hydroxide.*—Urea is decomposed with evolution of ammonia by boiling its solution with excess of caustic soda :—



* (3) *Action of Nitrous Acid.*—On adding dilute hydrochloric acid and a few drops of sodium nitrite solution to some urea solution, an effervescence of nitrogen and carbon dioxide takes place :—

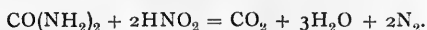

* (4) *Action of Hypobromite.*—Urea is decomposed into carbon dioxide and nitrogen on adding sodium hypobromite to its solution :—

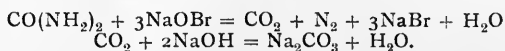

Note.—An effervescence also occurs when sodium hypobromite is added to ammonium chloride.

* (5) *Biuret.*—On heating some urea in a test tube it melts; on continuation of the heating the mass becomes solid, white and opaque: ammonia is evolved and a ring of sublimed cyanuric acid may be formed on the cooler parts of the test tube. The white residue consists mainly of biuret, but contains also cyanuric acid; on treating the mass with water the biuret dissolves. On pouring off the water and testing it with caustic soda and 1 or 2 drops of dilute copper sulphate (1 per cent.) a pink colour is formed (biuret reaction).

The residue dissolves in dilute ammonia; if barium chloride be added to a portion of this solution a white precipitate of barium cyanurate is formed; on adding copper sulphate to another portion an amethyst-coloured precipitate of copper cyanurate is formed :—

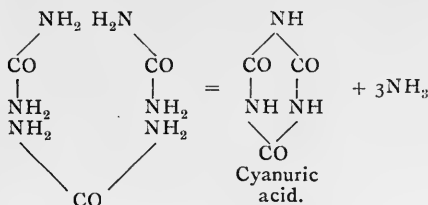
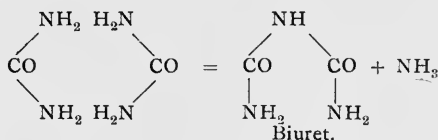

(6) By adding dilute mercuric nitrate solution (1 per cent.), urea is precipitated from the solution as a white compound having the composition $\text{CO}(\text{NH}_2)_2 \cdot \text{Hg}(\text{NO}_3)_2 \cdot \text{HgO}$.

Estimation.

Urea is hydrolysed by water, acids, or alkalis into carbonic acid and ammonia ; it is decomposed by nitrous acid or alkaline hypobromite into carbon dioxide and nitrogen. These reactions are made use of in order to determine the amount of urea in a given solution.

* (1) **Hypobromite Method.**

The most simple and rapid method is the decomposition by alkaline hypobromite ; the carbon dioxide is absorbed by the alkali and the evolved nitrogen is collected and measured. This method is the one suggested by Hüfner and most frequently employed in medical practice. The estimation is generally carried out in the apparatus designed by Dupré and known as Dupré's ureometer (Fig. 26).

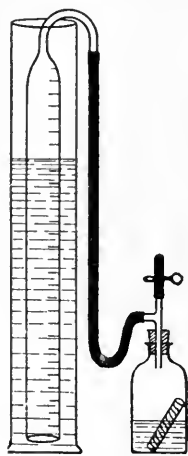

FIG. 26.

The estimation is carried out as follows :—

25 c.c. of freshly-prepared hypobromite solution¹ are placed in the bottle of about 120 c.c. capacity. 5 c.c. of urea solution are measured out with a pipette into a small tube which is placed in the bottle, taking great care not to upset the solution into the hypobromite. The bottle is closed with an india-rubber stopper and placed in cold water to cool. Through the india-rubber stopper a glass T-piece passes. One end of this is connected by rubber tubing to a graduated burette which is placed in a jar of water. The rubber tubing is of such a length that the burette can be lifted out of the water without stretching. The other end of the T-piece is closed by a piece of rubber tubing and a small clip. The burette is filled with water by opening the screw clip ; and it is raised or lowered until the water stands at the uppermost graduation and at the same level outside and inside. The clip is closed and leakage in the system is tested for by raising and lowering the burette in the water for at least a minute and then seeing whether the level of the water returns to the top graduation when the water inside and outside the tube are again made to stand at the same level. When the system has been tested to see that it is air-tight the analysis can be commenced. The reading of the top graduation is noted. The bottle is tilted so as to upset the urea solution in the little tube into the hypobromite solution and it is thoroughly washed out with the latter. Nitrogen is rapidly evolved and displaces the water in the burette.

¹ 100 gm. caustic soda are dissolved in 250 c.c. water and to the cold liquid 25 c.c. bromine are added.

The bottle must now be brought to its original temperature by placing it for a few minutes in a fresh supply of cold water. As soon as it is cool, the burette is raised till the level of the water is the same inside and outside and the level is read. The difference in the readings gives the volume of nitrogen evolved. By making the levels inside and outside the burette the same, this volume is measured at the atmospheric pressure. The temperature of the water and the barometric pressure and the tension of aqueous vapour at that temperature are ascertained and the volume of nitrogen is corrected to the volume at 0° and 760 mm. by the formula:—

$$\frac{V \times 273 \times (B - T)}{(273 + t) \times 760}$$

where V = volume of gas evolved, B = barometric pressure, T = tension of aqueous vapour (p. 608).

The amount of urea corresponding to this volume is given by the equation:—

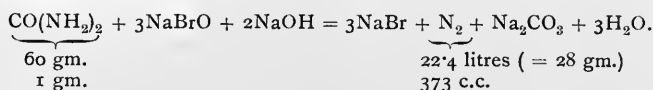

from which the amount of urea in 5 c.c. of the solution is calculated; hence the amount in 100 or 1000 c.c.

Actually, however, only 354 c.c. nitrogen are evolved by 1 gm. of urea so that the method is not quite accurate; this should be allowed for.

(2) By Hydrolytic Methods.

The most accurate methods of estimating urea are by hydrolysis. Urea is rapidly hydrolysed by alkali, but more slowly by hydrochloric acid.

(i) *By Acid.*

The hydrolysis by acid proceeds rapidly and is complete in about 1 hour if the hydrolysis be effected at a temperature of about 150 - 160° as was shown by Folin. This method has been particularly useful in the analysis of urine and is described on p. 553.

* (ii) *By Urease.*

Since the discovery of the enzyme, urease, in the soy bean which converts urea into ammonia and carbon dioxide, this hydrolytic agent has displaced hydrochloric acid on account of simplicity. An apparatus consisting of a wash bottle, a gas cylinder or other tall vessel, and a receiving bottle is required (Fig. 27). The gas cylinder is fitted with a cork carrying a long tube reaching to the bottom and a short tube;

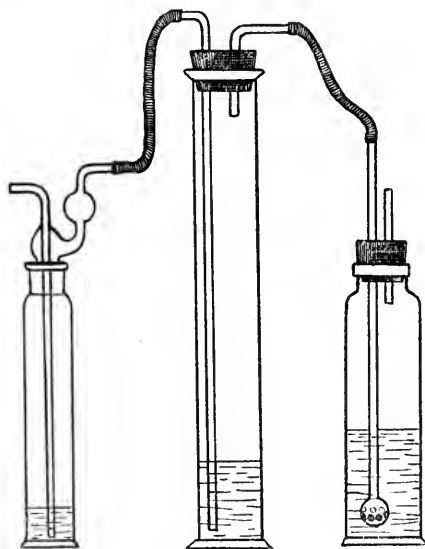
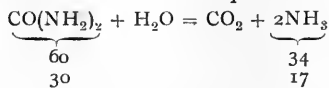

FIG. 27.

tube; the receiving bottle is fitted with a cork carrying a tube with a bulb blown at its end and pierced with several small holes. The long tube in the gas cylinder is connected by rubber tubing to the wash bottle and the short tube to the bulb tube of the receiving bottle. Air is drawn as rapidly as possible through the apparatus by suction with a pump attached to the short tube of the receiving bottle.

The wash bottle contains sulphuric acid to remove ammonia from the air drawn through the vessels. The receiving bottle contains a known

volume (25 or 50 c.c.) of $\cdot 1N$ sulphuric acid coloured with a few drops of alizarin red or methyl orange solution. 5 c.c. of the solution of urea (1-2 per cent.), 25 c.c. of water, and about 2 c.c. of kerosene or liquid paraffin and 0.5 to 1 gm. of powdered soy bean are placed in the gas cylinder, and air is drawn through the apparatus for $\frac{1}{2}$ to 1 hour depending on the amount of urea present. The gas cylinder should be placed in warm water at 40° or in a bath kept at 40° to hasten the decomposition of the urea. At the end of this time the parts of the apparatus are disjoined, 1 gm. of anhydrous sodium carbonate put into the gas cylinder so as to liberate ammonia which may be retained as ammonium salt, the connections are again made and the ammonia drawn into the receiving bottle by air suction for another half-hour. The excess of $\cdot 1N$ acid in the bottle is titrated with $\cdot 1N$ alkali. The amount of urea is calculated from the equation:—



1 c.c. of $\cdot 1N$ alkali = 0.003 gm. urea.

THE AMINO ACIDS.

The amino acids are derivatives of the fatty acids, or of the dibasic acids, in which one or more of the hydrogen atoms in the chain have been replaced by the NH_2 group. They are both amines and acids in their chemical nature.

These compounds can at the same time contain hydroxyl (OH) groups or thio (SH) groups in their molecule and further aromatic and other radicles can be substituted for hydrogen atoms in the chain. The main characteristic is the presence of an amino group and a carboxyl group.

They form an excessively important group of compounds, since they are constituents of the proteins, in which they are combined together in various proportions (see p. 361). Amino acids have also been isolated from extracts of animal and vegetable tissues. The following have been definitely identified as constituents of proteins from which they are obtained by hydrolysis:—

A. Monoaminomonocarboxylic Acids.

Glycine, or glycoll, or amino-acetic acid:—

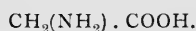

Alanine, or α -aminopropionic acid:—



Serine, or β -hydroxy- α -aminopropionic acid:—

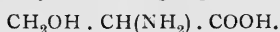

Cysteine, or β -thio- α -aminopropionic acid, formed by the decomposition of cystine:—

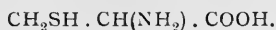

Cystine, or dicycysteine, or di-(β -thio- α -aminopropionic acid):—

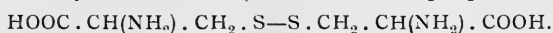

Phenylalanine, or β -phenyl- α -aminopropionic acid:—

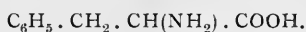

Tyrosine, or β -parahydroxyphenyl- α -aminopropionic acid:—



Histidine, or β -iminazole- α -aminopropionic acid:—

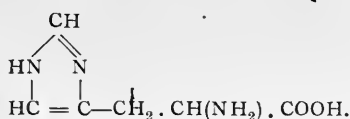

Tryptophan, or β -indole- α -aminopropionic acid :—



Valine, or α -aminoisovalerianic acid :—

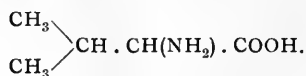

Leucine, or α -aminoisocaproic acid :—

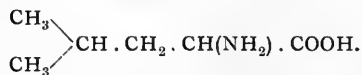

Isoleucine, or β -methyl- β -ethyl- α -aminopropionic acid :—

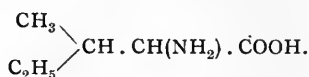

B. Monoaminodicarboxylic Acids.

Aspartic acid, or aminosuccinic acid :—



Glutamic acid, or α -aminoglutaric acid :—

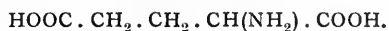

C. Diaminomonocarboxylic Acids.

Ornithine, or α -, δ -diaminovalerianic acid, formed by the decomposition of arginine (p. 165) :—

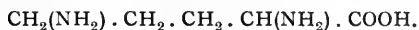

Lysine, or α -, ϵ -diaminocaproic acid :—

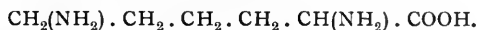

It should be noted that all these amino acids are α -amino derivatives of acids, i.e. derivatives in which a hydrogen atom in the α -carbon atom next to the COOH group has been substituted.

In addition to these compounds the substances, proline and hydroxyproline are found as constituents of the protein molecule (pp. 304, 306).

Preparation.

The amino acids are prepared by two general methods :—

(I) By the action of ammonia upon the corresponding halogen derivative :—

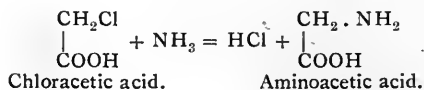

(2) By the addition of hydrogen cyanide and ammonia to aldehydes and the subsequent hydrolysis of the aminocyanohydrin:—

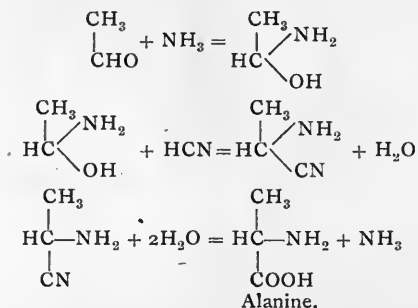

These reactions cannot always be used in the synthesis of amino acids since the halogen derivative or aldehyde is sometimes difficult to obtain. These amino acids have therefore been prepared by indirect methods. A full account of the syntheses is given in the author's "Chemical Constitution of the Proteins," Part II., 3rd edition. The amino acid is not always prepared most easily by synthesis, but by the hydrolysis of proteins, e.g. tyrosine, cystine, etc.

Properties.

The amino acids in a pure state are white crystalline substances having characteristic forms. Glycine and leucine crystals are shown in Figs. 28 and 29.

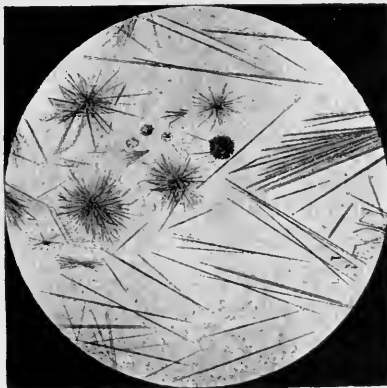
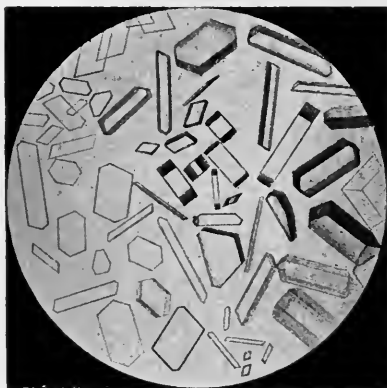

FIG. 28.—Glycine.

FIG. 29.—Leucine.

(From Funke's "Atlas of Physiological Chemistry".)

They are usually easily soluble in water (cystine and tyrosine are exceptions) but insoluble in alcohol (proline and hydroxyproline are exceptions) and ether. They have generally high melting-points and decompose when they melt, losing carbon dioxide.

If only one of each of the amino or acid groups be present in the molecule the substance is neutral, the basic group neutralising the acid group, but when either two amino groups or two acid groups with only one of the other groups are present, the substance is basic or acidic in character.

The monoaminomonocarboxylic acids, which have a neutral reaction, possess a sweet taste, which is different for the different substances, and serves (with experienced workers) as a useful guide for defining the particular amino acid present in a solution.

Except glycine, the amino acids are optically active; some are dextrorotatory, others laevorotatory. An inactive mixture is formed by synthesis. In all cases it has been separated into its stereoisomers.

Reactions.

The reactions of glycine are typical of the reactions of all the amino acids, but glycine does not give certain reactions which are characteristic of cystine (p. 143), tyrosine (p. 267), tryptophan (p. 348), the amino acids which contain thio or aromatic groups in their molecules.

Reactions of Glycine.

A. *As Acid.*

(1) Glycine forms salt with bases :—

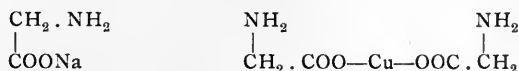

The copper salt is the most characteristic salt of amino acids; it has a somewhat deep blue colour and generally crystallises well, so that it serves for the isolation of amino acids and for their identification by a determination of the copper content.

- * On boiling a solution of glycine with excess of copper hydrate or copper carbonate, filtering off the excess and evaporating the solution until it crystallises and then allowing to cool, the blue copper salt of glycine crystallises out.
- * The depth of colour of the copper salt of glycine can be seen by adding a few drops of copper sulphate solution to a solution of glycine. The shade of colour is different to that of copper sulphate and in comparison deeper.

(2) Glycine forms esters with alcohols :—



These esters are prepared by passing dry hydrogen chloride into a suspension of the amino acid in absolute alcohol. The amino acid is converted into its hydrochloride, dissolves and is esterified :—

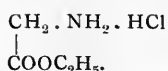

The ester is obtained by evaporating off the alcohol, making alkaline with soda and extracting the ester with ether. The esters of amino acids are generally oily liquids having an alkaline reaction. They can be distilled *in vacuo*. The complex mixture of amino acids which results on the hydrolysis of proteins is separated by fractional distillation of the esters *in vacuo*.

B. As Amine.

(1) Glycine forms salts with acids, e.g. :—

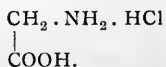

These salts are generally crystalline and very easily soluble in water and are acid in reaction.

Glutamic acid hydrochloride is soluble with difficulty in concentrated hydrochloric acid and is separated from a mixture of amino acids in this way.

The amino acid is obtained from the salt by neutralising with soda, or other alkali, e.g. silver hydroxide, and crystallisation.

(2) Ammonia is not evolved on boiling an amino acid with sodium hydroxide (compare acid amides).

On boiling a solution of glycine with caustic soda, no evolution of ammonia can be detected by smell, litmus paper, etc.

(3) Like amines, amino acids are decomposed by nitrous acid. On adding dilute hydrochloric acid and a few drops of sodium nitrite solution to a solution of glycine, there is an evolution of nitrogen :—

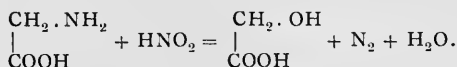

The corresponding hydroxy acid is formed.

(4) On treating with acid chlorides, the amino acids yield substituted amides :—

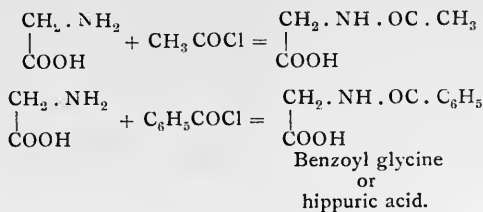

The benzoyl derivatives are readily formed by shaking the amino acid in solution in sodium bicarbonate with benzoyl chloride.

Hippuric Acid. $C_6H_5CO-NH \cdot CH_2 \cdot COOH$.

Hippuric acid, or benzoyl glycine, is formed synthetically by the kidney when benzoic acid is injected into the blood-stream of animals. It is a compound which is normally present in the urine of animals, especially herbivora. Benzoic acid is formed from the aromatic substances of the food and is converted into hippuric acid during its excretion.

Preparation from Urine.

- * Hippuric acid is readily obtained from herbivorous urine by adding 1 c.c. of concentrated hydrochloric acid and 12 gm. of ammonium sulphate to every 25 c.c. The compound commences to crystallise out in about 5 minutes and the crystallisation is complete in 10-

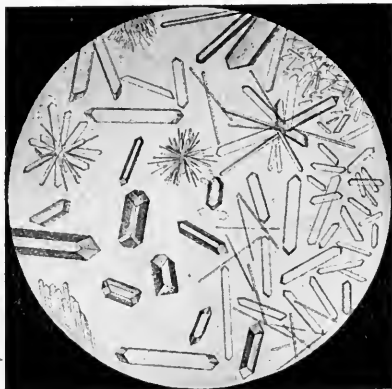

FIG. 30.—Hippuric acid. (After Funke.)

15 minutes. The crystals are filtered off and dried. They are generally more or less pigmented and are purified by recrystallisation from boiling water with the addition of a small quantity of animal charcoal. On filtering and cooling the filtrate, hippuric acid crystallises out in the form of needles (Fig. 30).

Properties and Reactions.

Hippuric acid is a white crystalline substance which melts at 187.5° . It is soluble with difficulty in cold water, but readily in hot water, in alcohol and ethyl acetate. It is only slightly soluble in ether and chloroform and insoluble in petroleum ether (this distinguishes it from benzoic acid).

- * (1) On heating, hippuric acid melts; the mass on further heating turns reddish-brown, due to the decomposition of the glycine, and a smell of bitter almonds is produced. A sublimate of benzoic acid is also formed. If this be dissolved in dilute sodium carbonate solution and the solution be acidified with dilute hydrochloric acid, benzoic acid is precipitated. The crystals have a different appearance under the microscope to hippuric acid and give the reactions for benzoic acid (p. 256).
- * (2) Ammonia is given off on heating hippuric acid with soda lime.
- * (3) Hippuric acid is hydrolysed into benzoic acid and glycine by boiling with concentrated hydrochloric acid:—

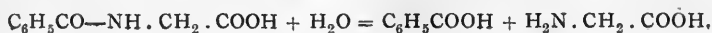

The benzoic acid crystallises out on cooling the solution and is separated by filtration.

The presence of glycine in the solution may be shown by adding a slight excess of ammonia, boiling the solution till neutral, and adding a few drops of copper sulphate solution; the deep blue colour characteristic of the copper salt of glycine is formed.

(4) On adding ferric chloride to a neutral solution of hippuric acid, a reddish-brown precipitate is formed; this is soluble in hydrochloric acid and the solution will deposit crystals of hippuric acid.

Cystine.

The amino acid, cystine, is present in greatest amount in some of those proteins belonging to the group of sclero-proteins, namely, the keratins. It has been found in the liver and other organs and occasionally forms concretions in the bladder and deposits in the urine (cystinuria). The amount excreted in these conditions is small, but from 0.5-1 gm. have been recorded *per diem*.

Preparation.

Cystine is prepared by the hydrolysis of keratins. Folin has shown that cystine can be readily obtained by the hydrolysis of wool.

Wool is hydrolysed into its constituent amino acids by boiling it under a reflux condenser with concentrated hydrochloric acid for about five hours in the proportion of 50 gm. wool to 100 c.c. acid.

Solid sodium acetate is slowly added to the hot solution until the reaction of the solution is no longer acid to congo red. A dark precipitate containing the cystine comes down on cooling. The precipitate is filtered off when the solution is cold and washed with cold water. It is dissolved in 5 per cent. hydrochloric acid, filtered from tarry matter and the solution is boiled with animal charcoal till it is colourless. The solution is filtered whilst hot and hot sodium acetate solution added until it is neutral to congo red. Cystine crystallises out in the typical hexagonal plates on cooling.

Properties.

Cystine crystallises in colourless hexagonal plates or prisms (Fig. 31). It is almost insoluble in water, alcohol and ether. It dissolves in dilute acids and in ammonia and

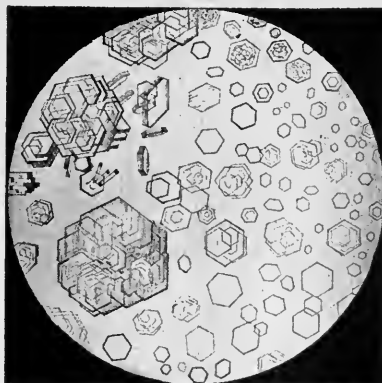

FIG. 31.—Cystine. (After Funke.)

in solutions of caustic alkali and alkali carbonates. It crystallises from its solution in ammonia in the typical hexagonal plates when the solution is allowed to evaporate. This is the most convenient way to obtain crystals for microscopic examination and identification by crystalline form.

If cystine be heated on platinum foil it burns with a bluish-green flame without melting.

The presence of sulphur in the molecule of cystine affords a means of readily distinguishing it from other amino acids. The sulphur is held in loose combination and is partially evolved as hydrogen sulphide on boiling with alkali :—

- * On dissolving some cystine in caustic alkali, or on adding caustic alkali to a solution of cystine, to which a drop of lead acetate solution has been added and boiling, a brownish or black precipitate of lead sulphide is formed.

Taurine.

Taurine, or aminoethyl sulphonic acid, is an amino acid containing sulphuric acid instead of carboxyl as the acid group. It has not been found as a constituent of proteins, but is probably derived from cystine or cysteine, which is converted by oxidation in the animal body into taurine :—

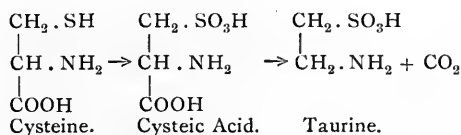

Taurine has been isolated from the lungs and kidneys of oxen and from the muscles of invertebrates. In combination with cholalic acid as taurocholic acid it is present in bile.

Preparation.

Taurine is most easily prepared from ox bile by boiling it for some hours with dilute hydrochloric acid. The filtrate from the insoluble anhydrides of the bile acids is concentrated on the water-bath to a small volume and filtered whilst hot from sodium chloride, etc. The solution is evaporated to dryness and the residue dissolved in 5 per cent. hydrochloric acid. It is precipitated from solution by adding 10 volumes of 95 per cent. alcohol. The crystals are purified by solution in acid, precipitation by alcohol and recrystallisation from water.

Properties.

Taurine crystallises in colourless four or six-sided prisms (Fig. 32). It is soluble in 15-16 parts of cold water, more easily in hot water. It is insoluble in absolute alcohol and ether, but is slightly soluble in cold dilute alcohol, more easily in hot.

It is decomposed on boiling with caustic alkali yielding acetic and sulphurous acids.

It is identified by its crystalline form, sulphur content, and the formation of a white insoluble compound when its solution is boiled with freshly precipitated mercuric oxide. It is not precipitated by metallic salts.

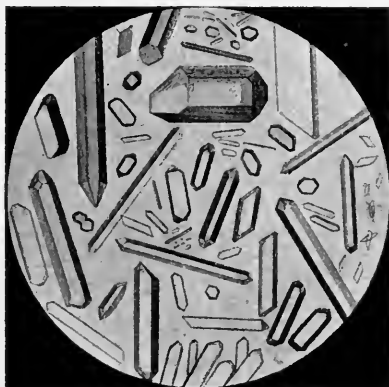
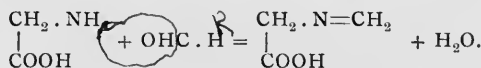

FIG. 32.—Taurine. (After Funke.)

Estimation of Amino Acids.*(1) By Titration.*

As the amino acids are neutral in reaction, they cannot be titrated by means of standard alkali like ordinary acids. They combine, however, with formaldehyde and yield an acid which can be titrated in this way:—



The process of estimation is carried out as follows:—

* 10 c.c. of commercial formalin are diluted with two volumes of water and neutralised with $\cdot 1\text{N}$ alkali, using 6 to 8 drops of phenolphthalein in the solution as indicator. This neutralised formalin is added to 20 or 25 c.c. of the amino acid solution measured out with a pipette into a small flask or beaker. The pink colour disappears. $\cdot 1\text{N}$ sodium hydroxide solution is run in from a burette until a distinct pink colour again appears. The number of c.c. of alkali used is noted.

If the amino acid be known its amount in the solution can be calculated:—

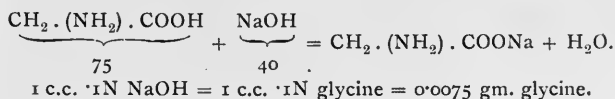

If the amino acid be unknown, or if a mixture of amino acids be present, the amount is best expressed in terms of $\cdot 1\text{N}$ acid, or in terms of nitrogen.

(2) *By estimation of the amino nitrogen.*

Van Slyke has shown that amino acids can be readily estimated by the measurement of the volume of nitrogen evolved by the action of nitrous acid according to the equation:—

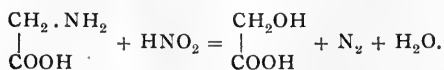

Half of the volume of nitrogen evolved corresponds to the amount of nitrogen in the amino acid.

The apparatus required is shown in Figs. 33 and 34.

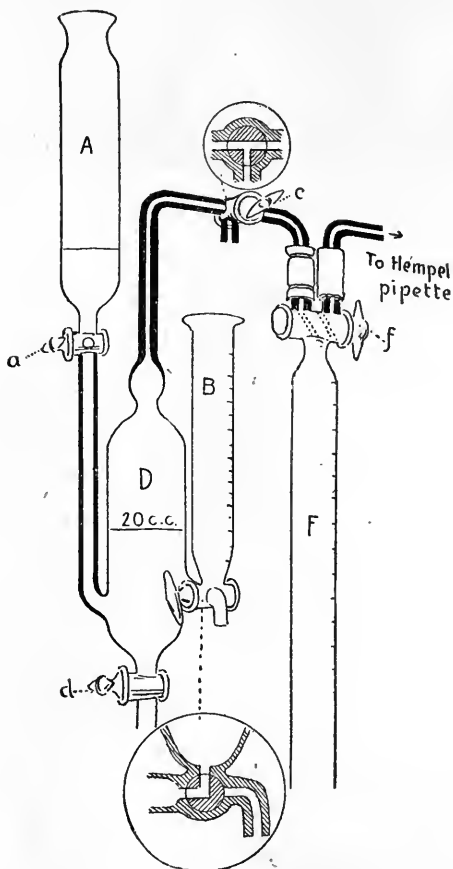

FIG. 33.

From the *J. Biological Chemistry*, 1912, **12**, 278.

It consists of the deaminising bulb D, of 40-45 c.c. capacity, to which are fused (1) a tap *d* for purposes of emptying it; (2) a cylindrical vessel A, of about 35 c.c. capacity with a mark at 7 c.c. and tap *a*; (3) a 10 c.c. burette, B. The glass tubing is strong walled and of 3 mm. diameter, and the bores of the taps should also be 3 mm. The connection between D and B should be at least 8 mm. inner diameter so as to allow free circulation. The bulb

is connected through a 3-way tap *c* with a large gas burette, F, of 150 c.c. capacity, the upper portion holding 40 c.c. and graduated in tenths. The gas burette is connected to a Hempel pipette of special shape (Fig. 34). The

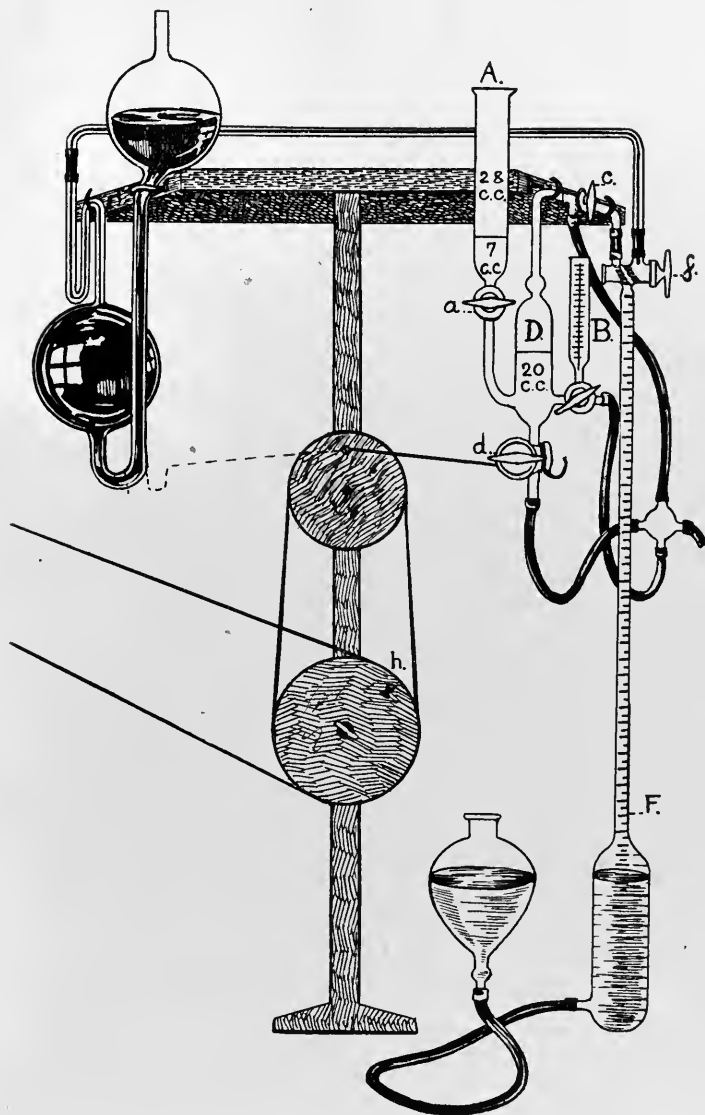

FIG. 34.

whole apparatus is arranged as in Fig. 34, so that the bulb D and Hempel pipette can be fastened by a specially bent hook to a wheel driven by a water or electric motor. The wheel should make 300-500 revolutions per minute.

In the original arrangement the parts of the apparatus are suspended by wires from clamps on a metal stand. The whole apparatus is thus moveable instead of being permanently fixed as in Fig. 34.

By this means the bulb and pipette can be shaken mechanically so as to hasten the reaction and facilitate the absorption of the nitric oxide evolved by the action of acid upon the nitrite. For convenience, rubber tubing is fastened to the tap of the bulb D, the burette B and the tap *c*, and arranged so that the liquids can be passed straight into the sink. It is also convenient to have a small handle *h* on the driving wheel so as to shake the vessels for short periods by hand.

The manipulation is carried out in three stages:—

(1) Displacement of the air in the apparatus.

The gas burette F is filled with water, the air being allowed to escape through *c*.

One bulb of the Hempel pipette is filled with a solution of alkaline permanganate.¹ By lowering the levelling bulb of the burette the air in the Hempel pipette is drawn into the gas burette until permanganate just reaches the tap. This air is driven out through *c* and water fills the gas burette and connection as far as *c*. The tap *c* is turned so as to shut off this part of the apparatus and to be in connection with D and the exit tube. 7 c.c. of glacial acetic acid are put into A and run into D. About 30 c.c. of sodium nitrite solution (30 per cent.) are put into A and run into D. Sufficient nitrite solution should be used so that excess stands in A above the tap. The tap *c* is closed by a quarter turn, and the bulb is shaken for a few seconds. The nitric oxide which is evolved drives the liquid into A. By opening the tap *c* to the exit, the liquid from A again fills the bulb D and the gas passes out at *c*. The tap *c* is again closed and the shaking repeated. The gas is let out and the shaking again repeated. In this way the air is driven out of the bulb D. Finally, a space of about 20 c.c. should be left in the bulb by shaking and driving the liquid into A; the tap *a* is closed.

Tap *c* is opened to connect D and F.

(2) Decomposition of the amino substance.

10 c.c. or less of the solution to be analysed is placed in the graduated burette B; any excess can be run off. The desired volume is run into D. The burette B need not be graduated; the desired amount can be introduced with a pipette into B, run into D, and B washed with a little water, which is also run into D.

D is shaken for 3-5 minutes. Only in a few cases is longer shaking necessary. If frothing occurs, as in the case of hydrolysed proteins, B can be washed out and a little capryl alcohol introduced through B.² If the reaction takes some time to complete, it is allowed to stand for the required time and finally shaken for 2 minutes.

The gas given off passes into the burette F. The residual gas in the bulb is driven into the burette F by opening the tap *a* and filling D with solution from A as far as the tap *c*.

(3) Absorption of nitric oxide and measurement of the nitrogen.

The tap of the burette F is turned so as to connect it with the Hempel pipette. The gas is driven into the pipette by raising the levelling tube. The Hempel pipette is shaken gently for 1-2 minutes, and the gas returned to the burette and measured. It is driven over into the permanganate again and returned to the burette. If no change in volume has occurred the volume is

¹ 50 gm. KMnO_4 + 25 gm. KOH per 1000 c.c.

² In later forms of apparatus another tube is sealed to D for introducing the capryl alcohol.

recorded at the temperature and barometric pressure. The weight of nitrogen corresponding to the amount of nitrogen in the amino substance is calculated or may be taken from the table compiled by Van Slyke and reproduced on p. 605.

In this table the allowance has been made for the evolution of only half of the volume. The weights are therefore those for the amino nitrogen.

During the measurement of the gas the bulb D can be emptied and washed. A fresh solution of permanganate is not required for every analysis; sufficient is present in the Hempel pipette for 10-12 estimations.

This pattern of apparatus has many advantages over the older pattern. Some 6-8 estimations can be made in an hour.

Micro Apparatus.

Van Slyke¹ has also described a smaller form of apparatus for use when only small quantities of material are available, such as in the analysis of the amino acids in blood, tissues, etc. Its dimensions are:—

(1) the gas burette: 10 c.c., the upper part, of 2 mm. diameter, measuring 2 c.c., and graduated in $\frac{1}{50}$ c.c., the lower part wider and graduated in $\frac{1}{20}$ c.c.; a gas burette holding a total volume of 20 or 30 c.c. is more advantageous as frequently more than 10 c.c. of nitric oxide is evolved;

(2) the deaminising bulb: 11-12 c.c.;

(3) the burette: 2 c.c.

The quantities of reagents required are 10 c.c. of sodium nitrite solution and 2.5 c.c. of acetic acid for which the correction for impurities amounts to .06-.12 c.c.

It is not necessary to have a smaller Hempel pipette for permanganate. With the micro apparatus the reagent in it lasts for a considerable time.

The solution to be analysed may be introduced into the burette with a pipette and the burette is washed with 6 or 7 drops of water.

The error in the estimation need not exceed .005 mg. when 2 c.c. or less gas is measured; with more gas .01 mg.

With the micro apparatus one-fifth of the amount required for the macro apparatus can be analysed. Not only is there an advantage economically with reagents, but also the apparatus is less fragile.

0.5 mg. of amino acid can be analysed with an accuracy of 1 per cent. It is slightly more rapid: at 15-20° 4 minutes' shaking suffice, at 20-25° 3 minutes, above 25° 2-2.5 minutes.

It is essential that the burettes be accurate and the stopcocks be tight. The burettes are tested by weighing the water they deliver; the stopcocks by submitting them to a pressure of a column of water 1 metre high.

The apparatus may be cleaned with a mixture of potassium bichromate and sulphuric acid.

A still smaller form of apparatus may be used.² See 3rd edition "The Chemical Constitution of the Proteins," Part I.

¹ J. Biol. Chem., 1913, 16, 121.

² *Ibid.*, 1915, 23, 408.

BETAINES.

Betaine, the first member of the series of trimethylamine derivatives of fatty acids, or trimethylamine acetic acid, has been known since 1863 and was given its name by Scheibler in 1866, who isolated it from the sap of the sugar beet (*Beta vulgaris*) and from molasses.

Betaine also occurs in a large number of plants and has been isolated from shrimp extract and extracts of other invertebrates; 05 per cent. has been separated from ox kidney.

Betaine, and the other members of the group, when dried at 100° lose a molecule of water. Their constitution is most probably that of the anhydride:—

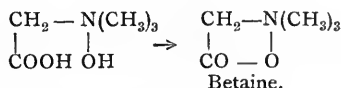

Other members of the group are:—

γ-n-butyro-betaine.

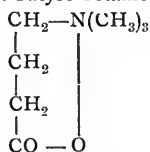

Carnitine or Novaine, or
α-hydroxy-*γ*-butyro-betaine.

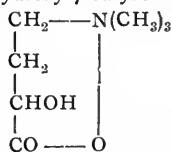

Trimethylhistidine.

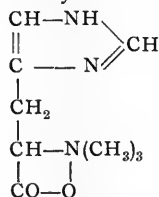

Ergothioneine, or
Thiohistidine-betaine.

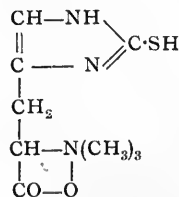

Stachydrine or
Proline-betaine.

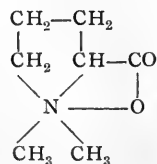

Betonicine and Turicine or
hydroxyproline-betaine.

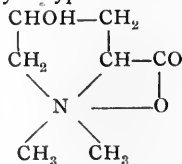

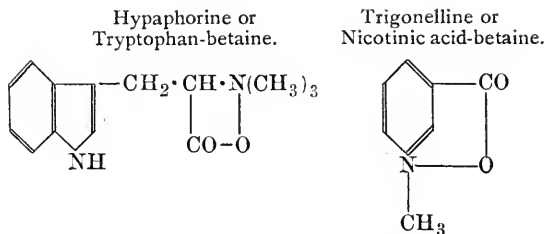

The betaines can be prepared by the methylation of the amino acids with methyl iodide and alkali but are usually obtained by separation from the natural sources.

They are colourless crystalline solids and have a feebly basic character forming salts with mineral acids, e.g. betaine hydrochloride, and double salts with salts of the heavy metals.

A full account of these compounds is given in Barger's "The Simpler Natural Bases".

CYANOGEN COMPOUNDS.

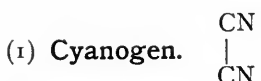

Cyanogen, as it contains only the two elements carbon and nitrogen, is the simplest carbon compound containing nitrogen. It is present in the gases of the blast furnace and is formed on passing electric sparks between carbon poles in an atmosphere of nitrogen, and on treating ammonium oxalate or oxamide (p. 130) with dehydrating agents, e.g. phosphorus pentoxide :—

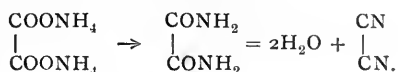

Preparation.

Cyanogen is most readily prepared by heating mercuric cyanide :—

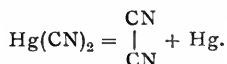

* On heating a small quantity of mercuric cyanide in a dry test tube, white fumes are given off which condense on the cooler parts of the tube. On igniting the gas at the open end it will be observed to burn with its characteristic pink flame.

Cyanogen is also prepared by heating a concentrated solution of 1 part of potassium cyanide with 2 parts of copper sulphate dissolved in 4 parts of water. A yellow precipitate of cupric cyanide, $\text{Cu}(\text{CN})_2$, is first formed and this decomposes into cyanogen and cuprous cyanide, CuCN :—

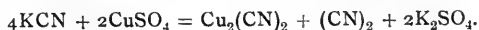

Properties.

Cyanogen is a colourless gas with a peculiar pungent smell and has been condensed to a liquid. It burns with a pink flame forming carbon dioxide and nitrogen. It is easily soluble in water and alcohol and is intensely poisonous.

Reactions.

Cyanogen and the other compounds of this group resemble the halogens very closely in their properties, thus on passing cyanogen into alkali it is converted into alkali cyanide and cyanate:—



Cyanogen is converted by hydrolysis, on boiling with acids, into oxalic acid and ammonia:—

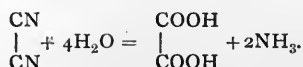

The compounds of this group which contain the CN radicle are termed nitriles, because on hydrolysis with acids they are converted into the corresponding acid: cyanogen is the nitrile of oxalic acid or oxalonitrile.

(2) **Hydrogen Cyanide, or Prussic Acid.** HCN.

Hydrogen cyanide is present in numerous plants, e.g. in laurel leaves, bitter almonds, cherry and peach kernels, usually in combination with glucose and benzaldehyde as the glucoside amygdalin (p. 215), which is hydrolysed by acids, or by enzymes in the plant, into its constituents. It is formed by the oxidation of glycine and other amino acids; it may thus be produced in animals and plants: the latter probably then combine it with glucose to form a glucoside, the former apparently combine it with sulphur to form sulphocyanide or thiocyanate, which is present in saliva and other secretions.

Preparation.

* A dilute solution of hydrogen cyanide is obtained by distilling potassium ferrocyanide, or a cyanide, with dilute sulphuric acid:—

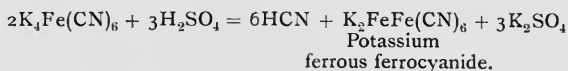

A small flask is connected with a condenser by means of a bent tube; the open end of the condenser is dipped into water in a test tube containing a drop of strong caustic soda. 10 c.c. of a cold saturated solution of potassium ferrocyanide and 20 c.c. of 20 per cent. sulphuric acid are put in the flask. On heating, hydrogen cyanide distils over and is converted into sodium cyanide. Its presence is tested for by converting it into Prussian blue by heating in alkaline solution with a ferrous salt, acidifying and adding a drop of ferric chloride. The distillation should be carried out in the fume cupboard.

Note.—Carbon monoxide is obtained when anhydrous potassium ferrocyanide is heated with concentrated sulphuric acid.

Hydrogen cyanide is also obtained by dehydrating ammonium formate, or formamide, with phosphorus pentoxide.

Pure anhydrous hydrogen cyanide is prepared by distilling potassium cyanide with moderately concentrated sulphuric acid, passing the gas over anhydrous calcium chloride and collecting the distillate in a receiver cooled by ice.

Properties.

Pure hydrogen cyanide is a colourless, mobile liquid having a specific gravity of 0.697 at 18°. It becomes a crystalline solid at -15° and it boils at 26.5° . It has a peculiar smell, resembling that of oil of bitter almonds and is intensely poisonous. It burns with a violet flame and is easily soluble in water and alcohol.

It is a very weak acid and turns blue litmus only a faint red.

Reactions.

Aqueous solutions of hydrogen cyanide are unstable and slowly undergo decomposition into ammonium formate:—

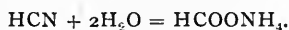

The pure acid is also rapidly decomposed by concentrated hydrochloric acid. Formamide is first formed and this passes into formic acid and ammonium chloride:—

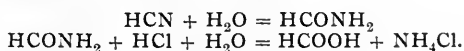

Hydrogen cyanide is thus the nitrile of formic acid.

The salts of hydrocyanic acid are decomposed in the same way on boiling their aqueous solutions:—

- * If about 20 c.c. of a 1 per cent. potassium cyanide solution be boiled for some time it is converted into ammonia and potassium formate. The ammonia is readily detected by its action on red litmus paper and the formate may be detected by testing the solution, after the ammonia has been given off, with (1) ferric chloride and with (2) mercuric chloride, as on p. 95.

Hydrogen cyanide in alcoholic solution is reduced by sodium to methylamine:—

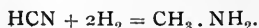

Metallic Cyanides.

Hydrogen cyanide resembles hydrochloric acid in behaviour, forming salts with alkalis and metallic hydroxides. The alkaline salts crystallise like sodium and potassium chloride; the silver salt is white and insoluble in water and acids, but soluble in ammonia. Silver cyanide, unlike silver chloride, is decomposed by boiling with mineral acids forming hydrogen cyanide.

The chief salt is potassium cyanide which is used extensively for extracting gold and in electroplating.

Preparation of Potassium Cyanide.

Potassium cyanide is prepared by fusing potassium ferrocyanide:—



On heating about 1 gm. of potassium ferrocyanide in a crucible to redness, allowing to cool, extracting the mass with water and filtering, the solution will be found to contain potassium cyanide as shown by the test on p. 156.

In this reaction the whole of the nitrogen of the ferrocyanide is not obtained as cyanide; if potassium ferrocyanide be fused with potassium carbonate a mixture of cyanate and cyanide is formed:—



If potassium ferrocyanide be fused with sodium, a mixture of potassium and sodium cyanides results:—



The cyanides dissolve in water leaving the iron and are obtained by evaporation.

Large quantities of cyanide are now prepared by two other methods:—

(1) by heating sodium with charcoal in a current of ammonia at 400°. Sodamide is formed and converted into sodium cyanamide (p. 159):—

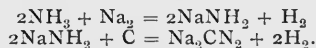

On raising the temperature to 800° the sodium cyanamide and charcoal react, forming sodium cyanide:—



Sodium cyanide is formed directly at 800°:—



(2) by heating beet-sugar molasses to 1000°. At this temperature the trimethylamine is decomposed into hydrogen cyanide and methane:—



Sodium cyanide is prepared by passing the gases into sodium hydrate and evaporating the solution.

Metallic gold dissolves in potassium cyanide solution in the presence of air or other oxidising agent:—



forming a double cyanide from which the gold is obtained by electrolysis.

Double Cyanides.

The alkali cyanides dissolve the insoluble cyanides of silver, gold and other heavy metals forming the double cyanides :—

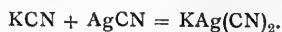

- * On adding a few drops of a 1 per cent. solution of potassium cyanide to a few drops of silver nitrate solution, a white precipitate of silver cyanide is formed :—



On adding more potassium cyanide solution, the precipitate dissolves forming the double salt. The double salt is decomposed with the formation of silver cyanide by adding dilute nitric acid :—



The double cyanides are extensively used in electroplating ; on electrolysis the compound is decomposed with the formation of potassium and $\text{Ag}(\text{CN})_2$ ions at the cathode and anode respectively. The double cyanide is reduced at the cathode, the silver being deposited. Silver is used as the anode and is dissolved by the $\text{Ag}(\text{CN})_2$ ions forming 2AgCN , which is soluble in potassium cyanide giving the double cyanide. The reactions are thus :—

**Tests for Cyanides.**

- * (1) The smell of hydrogen cyanide, either before or after acidifying the solution with dilute nitric acid and warming, is an indication of the presence of a cyanide.
- * (2) The formation of silver cyanide, by adding silver nitrate to a solution acidified with nitric acid, or better by holding a drop of silver nitrate on a glass rod in the vapour of the solution in (1), also indicates the presence of a cyanide.
- * (3) The formation of Prussian blue by boiling the solution with a ferrous salt and alkali, acidifying and then adding a drop of ferric chloride is characteristic.
- * (4) The formation of ferric thiocyanate by adding to the solution a drop of ammonium sulphide, evaporating to dryness, acidifying with hydrochloric acid and adding a drop of ferric chloride is the most delicate way of detecting a cyanide.

If a cyanide be present with other organic substances, e.g. in stomach contents, etc., in cases of poisoning, the material is acidified with a non-volatile organic acid, such as tartaric acid, and distilled. The distillate is tested for hydrogen cyanide as above.

Complex Cyanides.

The cyanides of sodium and potassium are converted into ferrocyanides on boiling their solutions with ferrous salts in alkaline solution. This reaction is made use of in testing for nitrogen in organic compounds.

Potassium Ferrocyanide. $K_4Fe(CN)_6$.*Preparation.*

Potassium ferrocyanide is prepared by fusing together protein residues, such as blood, or horn, or leather with scrap iron and potassium carbonate. The fused mass is extracted with water and the yellow solution which results is evaporated down until it crystallises.

Potassium ferrocyanide is also prepared from the hydrogen cyanide, which is a bye-product in the manufacture of coal gas. The hydrogen cyanide is absorbed by iron oxide in the "purifiers". By boiling this material with lime, calcium ferrocyanide is formed; potassium ferrocyanide is obtained by treating it with potassium carbonate. Sometimes the hydrogen cyanide is converted into sodium ferrocyanide by passing it into an alkaline solution of ferrous salts.

Properties and Reactions.

Potassium ferrocyanide forms large yellow crystals (yellow prussiate of potash) which are easily soluble in water.

(1) On adding concentrated hydrochloric acid to a saturated solution of potassium ferrocyanide, hydroferrocyanic acid is thrown down as a white precipitate. It turns blue on filtering owing to decomposition and oxidation.

(2) On adding a drop of ferric chloride solution to a solution of potassium ferrocyanide, a blue precipitate (Prussian blue) is formed:—

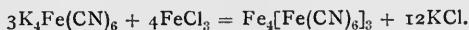

(3) Other metals also form insoluble ferrocyanides if their solutions be added to a solution of potassium ferrocyanide.

Zinc ferrocyanide is white, copper ferrocyanide is reddish-brown, uranium ferrocyanide is brown.

Sodium Nitroprusside. $Na_2Fe(CN)_5 \cdot NO$.

Potassium ferrocyanide is converted into nitroprusside by the action of moderately concentrated nitric acid; potassium nitrate crystallises out and is removed. The solution on neutralisation with sodium carbonate yields sodium nitroprusside on evaporation.

Sodium nitroprusside, $Na_2Fe(CN)_5 \cdot NO + 2H_2O$, forms beautiful red rhombic prisms which are easily soluble in water; the solution is a sensitive reagent for sulphides, acetone, etc.

Potassium Ferricyanide. $K_3Fe(CN)_6$.*Preparation.*

Potassium ferricyanide is formed by the oxidation of potassium ferrocyanide by means of chlorine or bromine :—

- * On adding a slight excess of bromine water to some potassium ferrocyanide solution and boiling off the excess of bromine the colour changes from yellow to brown-red, and on evaporation of the solution red crystals of potassium ferricyanide are obtained.

Properties and Reactions.

Potassium ferricyanide, or red prussiate of potash, is a red crystalline substance soluble in water, giving a reddish-yellow solution.

- * (1) On adding ferric chloride to its solution it turns dark brown.
 * (2) On adding a solution of a ferrous salt to its solution, a deep-blue precipitate (Turnbull's blue) is formed :—

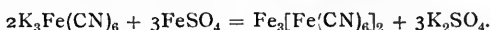

- * (3) In alkaline solution it is decomposed into potassium ferrocyanide and oxygen ; it acts therefore as an oxidising agent :—

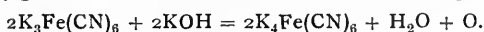

Thus, if some litharge be added to a solution of potassium ferricyanide rendered alkaline with sodium hydroxide and warmed, it becomes brown owing to the formation of lead peroxide, PbO_2 . The solution may be tested for ferrocyanide by filtering, acidifying and adding ferric chloride which gives a precipitate of Prussian blue.

Alkyl Cyanides—Nitriles.*Preparation.*

When potassium cyanide is treated with an alkyl iodide (methyl, ethyl, etc., iodide) the alkyl cyanide is obtained :—

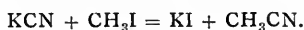

These compounds are also formed by treating the amides of the corresponding acid with phosphorus pentoxide :—

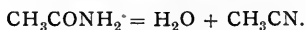
*Properties and Reactions.*

The lower members of the series are liquids with peculiar smell, and are more or less soluble in water ; the higher members are solids.

Like hydrogen cyanide they are hydrolysed by acids into the corresponding acid :—

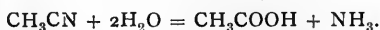

On reduction they are converted into amines :—

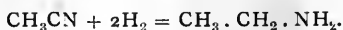

Alkyl Isocyanides.

If silver cyanide be treated with alkyl iodides, isocyanides, compounds isomeric with the above, are formed :—



It would thus appear that silver cyanide has a different structure to potassium cyanide or that in the reaction a rearrangement occurs :—



These compounds are also formed by heating primary amines (p. 61) with chloroform and potash :—

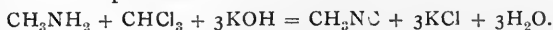

They are liquids with an abominable smell : on hydrolysis they give the corresponding amine and formic acid :—

**Cyanogen Chloride.** ClCN .

If mercuric cyanide, potassium cyanide, or hydrogen cyanide be treated with chlorine, cyanogen chloride is obtained :—

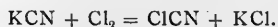

This compound, which is a liquid, polymerises on standing into solid cyanuric chloride, $\text{Cl}_3\text{C}_3\text{N}_3$. Potash converts liquid cyanogen chloride into potassium cyanate, and solid cyanuric chloride into potassium cyanurate :—

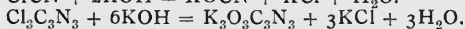
**Cyanamide.** $\text{NH}_2 \cdot \text{CN}$.

Cyanamide is formed on passing cyanogen chloride into an ethereal or aqueous solution of ammonia :—



It is more readily obtained by the action of mercuric oxide on thiourea :—

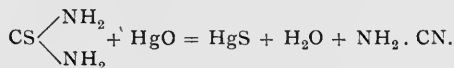

Calcium cyanamide is manufactured by passing nitrogen over calcium carbide at 1000° .

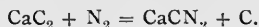

Cyanamide is prepared from this salt by decomposition with aluminium sulphate, filtration, evaporation *in vacuo* and crystallisation from ether.

Sodium cyanamide is prepared as described on p. 155.

Cyanamide forms colourless hygroscopic crystals, easily soluble in water, alcohol and ether, and melting at 40° . It forms salts with strong acids and also with bases. The salts with acids are decomposed by water. The calcium salt is frequently employed as an artificial manure.

Cyanamide is readily hydrolysed by the action of acids forming urea :

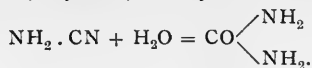

By the action of hydrogen sulphide it is converted into thiourea, and by ammonia it is converted into guanidine.

Cyanamide is used in the synthesis of creatine and arginine (p. 165). These compounds behave like cyanamide in giving urea on hydrolysis.

Cyanic Acid. HOCN.

Cyanic acid is formed by distilling cyanuric acid.

A small quantity of cyanuric acid is placed in a small bulb blown upon the end of a glass tube and the glass tubing is bent at an angle. The end of the glass tube leads into a test tube surrounded by a freezing mixture. On heating, the cyanuric acid is decomposed and cyanic acid collects in the test tube as a liquid.

Cyanic acid is only stable below 0° and is a mobile, volatile liquid with a strong acid reaction and with a smell resembling that of glacial acetic acid. It produces blisters upon the skin.

Pure cyanic acid, on exposure to the air, polymerises to cyanuric acid, with explosiveness; a small quantity, such as prepared above, polymerises with a cracking noise.

It is an extremely unstable substance; its aqueous solution above 0° decomposes giving carbon dioxide and ammonia:—

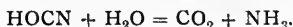

It dissolves in alcohol forming the ethyl ester of allophanic acid:—



Its salts are more stable than the free acid.

Potassium Cyanate, KOCN.

Potassium cyanate is formed by the oxidation of potassium cyanide by a variety of oxidising agents, air, lead oxide, potassium permanganate, or sodium hypochlorite.

It may be prepared from potassium cyanide as follows:—

- * About 1 gm. of potassium cyanide is heated in a crucible in a fume cupboard until it melts. Lead oxide is added in small quantities to the fused mass so long as visible reduction occurs. The mass, when cold, is extracted with water; potassium cyanate crystallises out on evaporation.

It may also be conveniently prepared from potassium ferrocyanide: a mixture of 4 parts of potassium ferrocyanide and 3 parts of potassium bichromate are carefully heated in an iron dish, avoiding the formation of ammonia. The potassium cyanate is extracted with water.

Potassium cyanate forms shining leaflets or quadratic plates. It dissolves readily in cold water, with difficulty in hot alcohol.

In aqueous solution it is unstable and decomposes forming ammonia and potassium carbonate.

- * This decomposition can be seen with the solution prepared above; carbon dioxide is evolved on adding sulphuric acid, and the presence of ammonia may be shown by making alkaline, warming and testing with red litmus.

Ammonium Cyanate.

Ammonium cyanate is prepared by bringing cyanic acid into contact with dry ammonia.

It is a white crystalline powder soluble in water; the aqueous solution on evaporation yields urea (p. 131).

The salts of cyanic acid with the heavy metals are insoluble and are formed from potassium cyanate by double decomposition.

Cyanuric Acid. $\text{H}_3\text{O}_3\text{C}_3\text{N}_3$.

Cyanuric acid has probably the constitution,

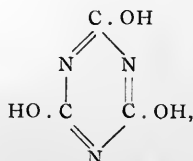

and is prepared from urea :—

(1) by heating it (p. 133);

(2) by passing chlorine over it at $130\text{--}140^\circ$;

(3) by heating it with a solution of carbonyl chloride in toluene at $190\text{--}230^\circ$.



Cyanuric acid crystallises from water with 2 molecules of water of crystallisation in large rhombic prisms. It is soluble in 40 parts of cold water, more easily in hot water and alcohol. It is decomposed by boiling with acids into carbon dioxide and ammonia.

It is a tribasic acid forming soluble salts with the alkali metals and insoluble salts with the heavy metals; the copper salt is violet in colour.

Alkyl Isocyanates and Alkyl Cyanates.

Alkyl isocyanates are formed on heating silver cyanate with an alkyl iodide :—



These compounds are also obtained when potassium cyanate is distilled with alkyl potassium sulphate :—

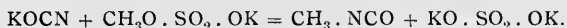

A rearrangement of the atoms of the molecule has occurred on heating.

The alkyl isocyanates are volatile liquids with a strong, disagreeable, suffocating odour. They boil without decomposition and are soluble in ether. They polymerise on standing forming isocyanuric esters.

Their structure is shown by their conversion into amines by the action of potash :—

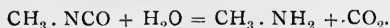

The alkyl cyanates are obtained by the action of cyanogen chloride on sodium alkoxide :—

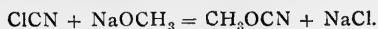

They are colourless ethereal liquids, which at once polymerise to cyanurates.

Alkyl cyanurates are obtained from sodium alkoxide and cyanuric chloride.

Thiocyanic Acid. HSCN.

Thiocyanic acid, or sulphocyanic acid, has long been known to be present in the form of its salts in saliva and it has also been found in other secretions of the animal body. The amount is always very small.

Thiocyanic acid is obtained by distilling its potassium salt with dilute sulphuric acid, or by the action of dry hydrogen sulphide upon mercuric thiocyanate.

Thiocyanic acid is a gas and, like cyanic acid, is easily condensed in a freezing mixture to a liquid which has a penetrating and acrid odour and is soluble in water and alcohol. It is an unstable substance; on removal from the freezing mixture it polymerises to a yellow amorphous body. It forms soluble salts with the alkali metals and insoluble salts with the heavy metals.

Potassium Thiocyanate.

Potassium thiocyanate is readily prepared from potassium cyanide by evaporating its solution with flowers of sulphur or ammonium sulphide: thus:—

- * 10 c.c. of a 1 per cent. solution of potassium cyanide are boiled for some minutes with flowers of sulphur and filtered. The presence of potassium thiocyanate is shown by the red colour which is formed on the addition of a drop of ferric chloride solution.

Potassium thiocyanate crystallises from alcohol in long colourless prisms, which deliquesce in the air.

Sodium thiocyanate is also deliquescent.

Ammonium thiocyanate is prepared in a similar manner to the potassium salt. It is a product obtained in the manufacture of coal gas from ammonium salts, hydrogen cyanide and sulphur.

It is usually prepared by the action of carbon bisulphide upon alcoholic ammonia, or ammonia under pressure. Ammonium thiocarbamate is formed, and this is decomposed by steam into ammonium cyanate and hydrogen sulphide:—

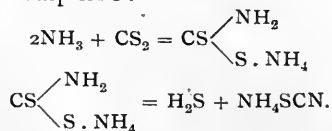

Ammonium thiocyanate crystallises in prisms which are easily soluble in water and alcohol.

Metallic Thiocyanates.

- * (1) Ferric thiocyanate is formed on adding ferric chloride solution to a soluble thiocyanate; ferric thiocyanate is soluble and has an intense red colour and is used in detecting thiocyanates.
- * (2) Silver thiocyanate is thrown down as a white curdy precipitate on adding silver nitrate to a solution of a thiocyanate.

Alkyl Thiocyanates and Alkyl Isothiocyanates.

Allyl isothiocyanate occurs in combination in the glucoside, sinigrin, of mustard seed. The allyl thiocyanate is formed on contact with water, the glucoside being decomposed by the enzyme, myrosin. To the allyl thiocyanate is due the pungent smell and taste of mustard.

Alkyl thiocyanates are prepared by the action of alkyl halides upon potassium thiocyanate:—



Alkyl isothiocyanates, or mustard oils, are obtained by heating alkyl thiocyanates, isomeric change occurring:—



They are also prepared by the action of primary amines on carbon bisulphide in alcoholic or ethereal solution, and then heating the aqueous solution of the thiocarbamate so formed with mercury chloride or ferric chloride:—

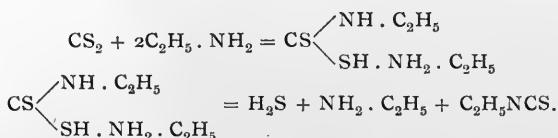

The alkyl isothiocyanate distils over with steam.

The alkyl thiocyanates are oily liquids, insoluble in water, possessing a garlic-like smell.

The alkyl isothiocyanates are pungent smelling liquids, the odour of which provokes tears. They are generally called mustard oils on account of the occurrence of allyl isothiocyanate in mustard. They boil at a lower temperature than the isomeric alkyl thiocyanates and are almost insoluble in water.

Constitution of Alkyl Thiocyanates and Isothiocyanates.

In the thiocyanates the alkyl group is joined to the sulphur atom; in the isothiocyanates it is attached to the nitrogen atom as is shown by the following reactions:—

(1) Thiocyanates on reduction give the primary amine and a mercaptan:—

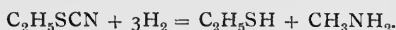

(2) Thiocyanates on oxidation give a sulphonic acid:—

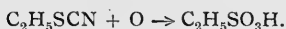

(3) Thiocyanates on treatment with alcoholic potash give alcohol and potassium thiocyanate:—

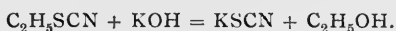

These reactions point to the attachment of the alkyl group to the sulphur atom.

(1) Isothiocyanates on heating with hydrochloric acid yield amines:—



(2) Isothiocyanates on reduction yield a primary amine and thioformaldehyde:—

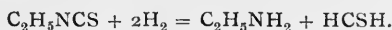

(3) Isothiocyanates are converted into isocyanates by boiling their solution in alcohol with mercuric oxide or chloride:—



The alkyl group is thus attached to the nitrogen atom.

GUANIDINE AND ITS DERIVATIVES.

Guanidine was first obtained by the oxidation of guanine (p. 294), and is also a product of the oxidation of arginine (p. 165) with permanganate. Its formation by the oxidation of arginine explains its formation in the oxidation of proteins, which contain arginine. Guanidine has been found in self-digested solutions of pancreas and in extracts of vetch seedlings and in the sap of the beet.

Guanidine is formed by the action of ammonia upon ortho-carbonic ester in a manner similar to the preparation of urea from ethyl carbonate or carbonic ester (p. 129):—

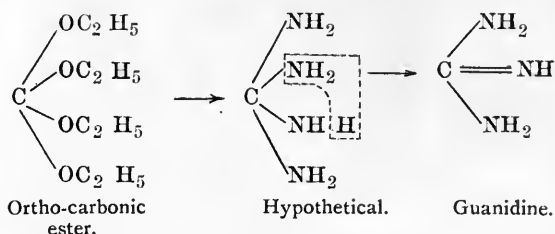

It is generally prepared by the action of ammonia upon cyanamide:—

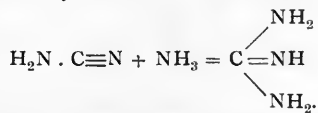

In practice, this reaction is most conveniently accomplished by heating ammonium thiocyanate to 180-190°. Thiourea and cyanamide are formed. The cyanamide reacts with ammonium thiocyanate to yield guanidine thiocyanate:—

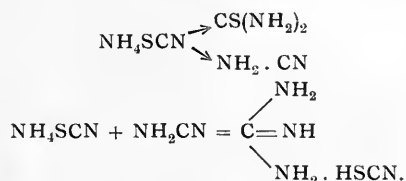

Guanidine is thus urea in which the O atom has been replaced by the =NH (imino) group.

Guanidine is a deliquescent crystalline substance, easily soluble in water and alcohol. It is a strong base; its solutions have an alkaline reaction and absorb carbon dioxide from the air forming guanidine carbonate, $(\text{CH}_5\text{N}_3)_2 \cdot \text{H}_2\text{CO}_3$, which is soluble in water, but not in alcohol. Guanidine also forms salts with other acids; the nitrate, $\text{CH}_5\text{N}_3 \cdot \text{HNO}_3$, is not easily soluble and consists of large plates which melt at 214°. The chief salt is the picrate which melts at 315° and is very insoluble in cold water. This salt is used for the isolation of guanidine from solution and for its estimation. Double salts are formed with gold chloride and cadmium chloride.

Guanidine is hydrolysed by alkalis into urea and ammonia:—

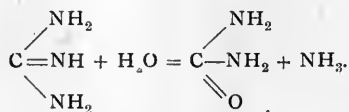

Methyl Guanidine and Dimethyl Guanidine.



Methyl guanidine has been isolated from meat and meat extracts, in which about 1 per cent. is present. It has also been isolated from urine.

Dimethyl guanidine has been isolated from urine.

Methyl guanidine is probably derived from creatine.



Arginine, or δ -guanidine- α -aminovalerianic acid is a constituent of the protein molecule; in some proteins—the protamines—it forms over 80 per cent. of the molecule (p. 432). It was discovered in extracts of seedlings.

Preparation.

Arginine is most easily prepared by the hydrolysis of edestin, the protein of hemp seed,¹ or from seedlings of the yellow lupin.² Its constitution was proved by its synthesis from cyanamide and ornithine:—

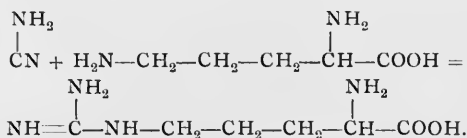

Properties and Reactions.

Arginine is a white crystalline substance, easily soluble in water, but insoluble in alcohol. It melts with decomposition at 207.5°. It is a strong base and absorbs carbon dioxide from the air forming arginine carbonate. It also forms salts with other acids, of which the nitrate is the principal one.

Natural arginine is optically active, the synthetical product is optically inactive but has been separated into its stereoisomers.

Like guanidine it is hydrolysed by alkalis into urea and ornithine:—

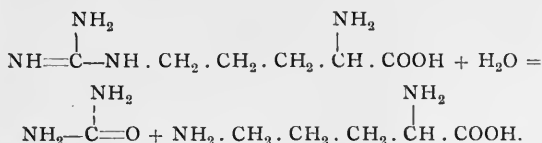

This hydrolysis of arginine occurs in the liver by the action of the enzyme arginase. A portion of the urea in the urine is probably derived in this way.

¹ See Ber., 1905, 38, 4187.

² See Zeit. Physiol. Chem., 1902, 35, 314.

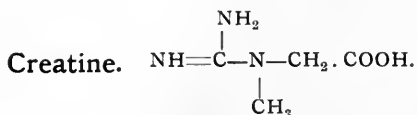

Creatine, or methyl guanidine acetic acid, is a constituent of all vertebrate muscle and is most abundant in voluntary muscle. The creatine content of the muscle of any particular species is remarkably constant; thus .5 per cent. in rabbit's, .45 per cent. in cat's, .39 per cent. in man's, .37 per cent. in dog's muscle. It is not present normally in human urine, but appears under certain conditions, e.g. when carbohydrates are absent from the food, in diabetes and other diseases. It is present in the urine of infants and children and in that of women after menstruation, and during and after pregnancy. Creatine is normally present in bird's urine.

Preparation.

Creatine is more readily prepared from meat or from urine than by synthesis.

(1) From meat.

Finely minced meat is extracted several times with hot water. The aqueous solution is boiled to remove coagulable proteins and filtered. The filtrate is treated with lead acetate so long as a precipitate is formed and again filtered. Excess of lead is removed from the solution by means of hydrogen sulphide and the filtrate from lead sulphide is evaporated down to a small volume. Creatine crystallises out as the solution stands. It is filtered off and washed with 88 per cent. alcohol.

(2) From urine.

A solution containing chiefly creatinine is obtained from urine as described on p. 169. Folin¹ has given the following method of preparing creatine from it:—

The solution is evaporated to dryness on the water-bath and the residue dissolved in 15-20 parts of boiling water. Twice as much 95 per cent. alcohol is added to this boiling solution. Nearly the whole of the creatine separates out in a few hours; it is filtered off after standing in a cool place for about 12-16 hours and washed with dilute alcohol (1 part water, 2 parts alcohol).

The filtrate and washings are placed in a large flask and kept in a water-bath at 80-90° for a week. The creatinine is converted into creatine; the conversion of the creatinine can be controlled by removing samples and estimating it (p. 171), but the weight of the flask and its contents must be known.

The solution is evaporated to dryness; the residue is dissolved in boiling water so as to make a 10 per cent. solution of the creatinine still present and 2 volumes of alcohol added as above. This procedure can be continued until nearly the whole of the creatinine is converted into creatine. About 30 per cent. of material is lost, but a yield of creatine equal in weight to that of the creatinine is obtained.

¹ J. Biol. Chem., 1914, 17, 463.

S. R. Benedict¹ gives a simpler method for preparing creatine from creatinine zinc chloride :—

100 gm. of creatinine zinc chloride are heated to boiling in a large basin with 700 c.c. of water; 150 gm. of pure powdered calcium hydrate are added and the mixture is stirred and boiled for twenty minutes. The hot mixture is filtered and the residue washed with hot water. The filtrate is treated for a few minutes with hydrogen sulphide to remove zinc and filtered through a folded paper. It is acidified with about 5 c.c. of glacial acetic acid and rapidly boiled down to about 200 c.c. The solution is allowed to cool and kept at 0°. The crystals of creatine are filtered off, washed with cold water and alcohol, and dried. The filtrate is kept to recover unchanged creatinine. The creatine is recrystallised by solution in seven times its weight of boiling water, which is allowed to cool slowly and stand for some hours at 0°. It is filtered off, washed with alcohol and ether, and dried in the air for thirty minutes. The creatine contains water of crystallisation which is lost by exposure to the air. It may be dehydrated by heating for some hours at 95°. The yield is about 18 gm.

About 50 per cent. of the creatinine is not converted in this process, but it is not advisable to boil longer with the lime as loss of creatinine occurs.

The creatinine is recovered by diluting the solution with alcohol and treating with about 50 c.c. of a 30 per cent. alcoholic solution of zinc chloride.

Creatine has been synthesised from cyanamide and sarcosine, or methyl-glycine :—

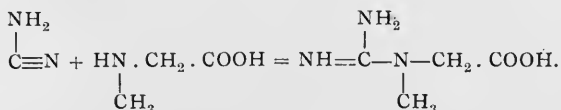

Properties and Reactions.

Creatine separates from water in colourless, transparent, hard rhombic prisms (Fig 35), containing one molecule of water of crystallisation, which is given off at 100°, the specimen becoming opaque. It has a peculiar bitter taste, is easily soluble in hot water, less so in cold (1 in 74), almost insoluble in alcohol and insoluble in ether. Its solution has a neutral reaction. It forms salts with acids which are very unstable.

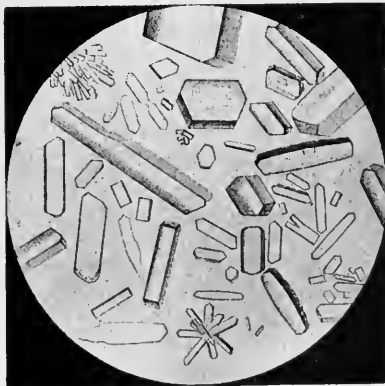
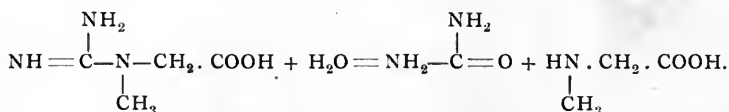

FIG. 35.—Creatine. (After Funke.)

It is hydrolysed by alkalis into urea and sarcosine and may, therefore, like arginine, contribute to the quantity of urea in urine :—

¹J. Biol. Chem., 1914, 18, 186.



It is converted by boiling with acids into creatinine.

Conversion of Creatine into Creatinine. Estimation of Creatine.

It has long been known that creatine on heating with acids is converted into its anhydride creatinine:—

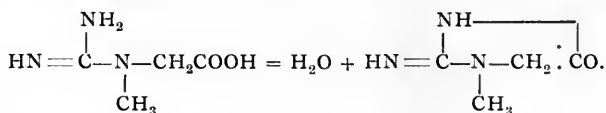

The reverse action takes place when creatinine solutions are heated to boiling, or on boiling with alkalis.

The solution containing creatine of a concentration of about 0.1 per cent. is heated on a water-bath in a flask covered with a watch glass with an equal volume of normal hydrochloric acid for 3-4 hours, or the aqueous solution is heated in a flask covered with tin-foil in an autoclave at 130-140° for half an hour exclusive of the time taken in heating up and cooling the autoclave.

Benedict finds it most convenient to boil down to dryness the solution of creatine to which has been added an equal volume of N hydrochloric acid, the final evaporation being done on a water-bath.

Solid creatine on heating at 130-140° for 3 hours in an autoclave is also converted into creatinine. The mixture of creatine and creatinine obtained in the above preparation from urine may be converted into creatinine by adding one to two drops of water for every gram of substance and heating in an autoclave for 3 hours at 130-140°.

The estimation is effected as is described for creatinine (p. 171) by neutralising, adding picric acid and soda and comparing the colour against a standard.

Creatinine.

Creatinine is present in all mammalian urines. The amount of creatinine in human urine varies from about 0.75-1.5 gm. per diem. It is not present in muscle or it is present only in traces. It has been found in wheat, rye and other crops and has been isolated from cultivated soil.

Creatinine is present in meat extracts. Its presence is probably due to the action of the acids of muscle extracts upon creatine during evaporation.

Preparation.

Creatinine is obtained from creatine by boiling with acids. It is most conveniently prepared from human urine by Folin's method and it is advantageous to use as large quantities of *fresh*, not ammoniacal, urine as possible.

60-80 gm. of picric acid (i.e. 6-8 gms. per litre of urine) are dissolved in 400 c.c. of hot alcohol and are added with stirring to 8 litres of urine. The double picrate of creatinine and potassium is precipitated. After the mixture has stood for 12-24 hours the liquid is decanted or syphoned off and the precipitate drained and washed with cold water on a Buchner funnel.

100 gm. of dry potassium carbonate and 750 c.c. of water are added to 500 gm. of dry picrate, the mixture is thoroughly stirred for 10 minutes and allowed to stand for 1-2 hours. The precipitate is filtered off on a Buchner funnel and the sediment washed two or three times with small quantities of water. The filtrate containing the creatinine is transferred to a large jar and 100 c.c. of 99 per cent. acetic acid (1 c.c. per gm. of carbonate) are added in such a way that it drops upon the foam which is formed and breaks it up. The acid solution which is wine-red in colour is treated with one-fourth of its volume of a concentrated alcoholic zinc chloride solution.¹ A large precipitate of creatinine zinc chloride is formed at once, if sufficient zinc chloride has been added, and is filtered off.

This double salt is decomposed by lead hydroxide which must be freshly precipitated and is prepared from lead nitrate. 4-5 gm. of lead nitrate per gm. of creatinine zinc salt are dissolved in 7-8 parts of cold water and precipitated by adding 2 c.c. of strong ammonia per gm. of nitrate. The lead hydroxide settles rapidly, the liquid is syphoned off, and the hydroxide washed three times with large quantities of water.

The creatinine zinc chloride is placed in 30 parts of water previously heated to boiling and contained in a flask filled not more than two-thirds, and again heated to boiling so as to dissolve as large a portion as possible. The lead hydroxide in suspension in water is added in portions of about one-fifth of the requisite quantity and the mixture is boiled after each addition. The solution is boiled for half to one hour after all the hydroxide has been added so that the precipitate becomes granular, cooled and filtered. The filtrate should be clear, but if not clear may be treated with hydrogen sulphide and again filtered. The filtrate is freed from lead by hydrogen sulphide and evaporated to dryness. The dry residue consists of creatinine and creatine. It

¹ One part of zinc chloride dissolves in about one part of alcohol; a sediment of zinc hydroxide may be brought into solution by adding a few drops of hydrochloric acid.

is converted into creatinine by heating with 1-2 drops of water per gm. of solid in an autoclave at 130-140° for 3 hours. A little boiling water is poured over the residue and alcohol added. Pure creatinine (98-100 per cent.) is obtained.

S. R. Benedict¹ finds the following procedure for preparing creatinine from urine more convenient than that described by Folin. At least 10 litres of urine should be used.

18 gm. of picric acid per litre of urine are dissolved in about 50 c.c. of hot alcohol and added with stirring to the urine, which must be fresh. The potassium creatinine picrate which is precipitated is filtered off after about 12 hours upon a Buchner funnel and washed once or twice with saturated picric acid solution. The dry, or nearly dry, picrate is decomposed by stirring it in a mortar with concentrated hydrochloric acid (60 c.c. per 100 gm. picrate) for 3-5 minutes. The picric acid is filtered off by suction through a hardened filter paper and washed once or twice with a small quantity of water. The filtrate is transferred to a flask and neutralised with excess of magnesium oxide (commercial, heavy) which is added in small quantities at a time whilst the liquid is kept cold with water. The liquid turns bright yellow when it is neutral and litmus may be used to test the reaction. The mixture is filtered by suction and the residue is washed once or twice with a little water. The filtrate is acidified with a few c.c. of glacial acetic acid (paying no attention to a precipitate which may form), diluted with 4 volumes of alcohol and filtered after about 15 minutes from a small precipitate (chiefly calcium sulphate). The filtrate is treated with a 30 per cent. alcoholic solution of zinc chloride, using 3-4 c.c. per litre of urine employed, stirred well and allowed to stand for 12 hours. The precipitate of creatinine zinc chloride is filtered off and washed once, with water, 50 per cent. alcohol and 95 per cent. alcohol. A nearly white product is obtained in a yield of 1.5-1.8 gm. per litre of urine.

Though a 10 per cent. loss is incurred, the creatinine zinc chloride must be recrystallised: 10 gm. of the compound are treated with 100 c.c. of water, about 60 c.c. of N sulphuric acid are added and the mixture is heated till a clear solution is obtained; 4 gm. of animal charcoal are added and the boiling is continued for 1 minute. The solution is filtered and the residue is washed with water. The filtrate is transferred to a beaker and treated with 3 c.c. of zinc chloride solution and 7 gm. of potassium acetate dissolved in a little water. After 10 minutes the solution is diluted with an equal volume of alcohol and allowed to stand in a cool place. The crystals which separate contain some potassium sulphate; this is removed by stirring them up twice with their weight of water, washing with water and alcohol. 8.5-9 gm. of recrystallised salt are obtained.

Creatinine is prepared from the recrystallised zinc chloride compound by placing the powdered substance in a dry flask and treating it with seven times its weight of concentrated aqueous ammonia and warming slightly until a clear solution is obtained, avoiding loss of ammonia as far as possible. The flask is stoppered and kept at 0°. Pure creatinine crystallises out in a yield of 60-80 per cent. If it be slightly brown, it may be recrystallised from boiling alcohol, or by dissolving it in five times its weight of ammonia as described above.

¹ J. Biol. Chem., 1914, 8, 1813.

Properties.

Creatinine separates from hot saturated solutions in colourless, shining prisms (Fig. 36), from cold saturated solutions in plates or prisms containing $2\text{H}_2\text{O}$. It has a caustic taste and its solutions react slightly alkaline. It is soluble in 11.5 parts of cold water, more easily in hot water, in 625 parts of cold absolute alcohol and more easily in hot alcohol.

It behaves as a strong alkali displacing ammonia from its salts. It forms salts with acids and double salts with salts of the heavy metals, of which the zinc chloride double salt is the most characteristic.

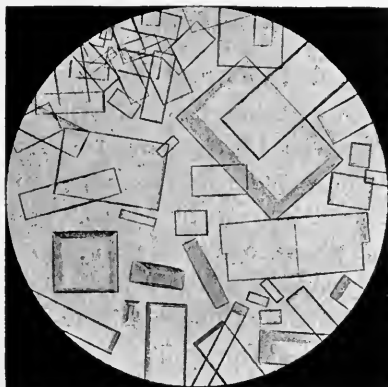

FIG. 36.—Creatinine. (After Funke.)

Reactions.

Creatinine has two reactions by which its presence in a solution can be detected, e.g. in urine:—

(1) *Sodium Nitroprusside Reaction (Weyl).*

* A few drops of a dilute freshly prepared solution of sodium nitroprusside are added to a small quantity of the solution (urine) and dilute sodium hydroxide is added drop by drop. The solution becomes red in colour and in a short time changes to yellow. If the yellow solution be acidified with glacial acetic acid and heated, the solution becomes green and a deposit of Prussian blue forms on standing.

Note.—Acetone gives a similar colour reaction, but the colour changes to purple on acidifying. It is advisable to remove acetone, if present, by boiling the solution before testing for creatinine.

(2) *Picric Acid Reaction (Jaffé).*

* To the solution containing creatinine (urine) some saturated picric acid solution is added and the mixture made alkaline with sodium hydrate. The solution becomes deep orange in colour which remains permanent for some hours.

One part of creatinine in 5000 can be detected by this reaction.

Note.—Aldehyde, acetone and other compounds also reduce picric acid in the cold; glucose, fructose, urea, etc., reduce it on warming (Chapman).¹ The picric acid is converted into picramic acid, aminodinitrophenol and diamino-nitrophenol.

¹ Analyst, 1909.

Estimation of Creatinine.

Folin has shown that creatinine can be accurately estimated by means of Jaffé's reaction. The orange-red colour produced is matched in a colorimeter against the colour of .5N solution of potassium bichromate, or better against a solution of creatinine or creatinine zinc chloride which is treated with the same amount of picric acid and caustic soda (see pp. 555, 562).

The Biological Relationship of Creatine and Creatinine.

From the chemical point of view the presence of creatinine in urine would be explained by its formation from the creatine in muscle by an enzyme in the animal body. An enzyme which can convert creatine into creatinine has been described as being present in the liver. The physiological experiments do not bear out this relationship. The daily amount of creatinine in urine is constant in amount and is derived mainly from the tissues, but very small amounts come also from the food. The addition of creatine to the food does not increase the amount of creatinine in urine. If the amount of creatine eaten be 1 gm. it is not excreted as such or as creatinine; if more than 1 gm. be eaten, the excess over 1 gm. is excreted as creatine. The amount of creatinine eliminated is also related to the muscular condition; less is eliminated at rest, more at work.

Folin has suggested the following explanation:—

Creatine is a normal constituent of the living muscle. At death the muscle substance breaks down giving creatine. Normally the muscle substance during its life processes gives rise to creatinine. During fasting, in fevers, etc., the normal breakdown is accompanied by the breakdown into creatine. Creatine, taken as food, is absorbed into the muscle and the excess is eliminated. The presence of traces of creatine in urine, or of creatinine in muscle, arise chemically by the action of acids or alkalies.

DI-, TRI- AND POLYHYDRIC ALCOHOLS.

In compounds containing two or more carbon atoms in their molecule not only can one of the hydrogen atoms be replaced by OH groups, but also 2, 3, 4, etc., so long as two OH groups are not attached to 1 carbon atom (see aldehydes). Thus:—

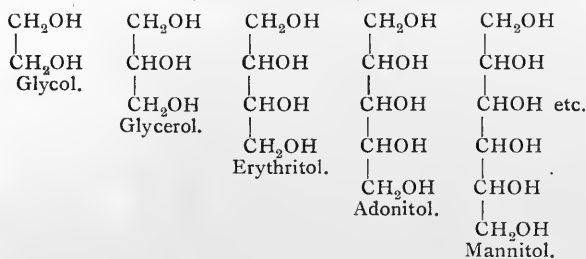

These compounds have the properties of primary and secondary alcohols.

Glycol.

Glycol is the first member of the series of polyhydric alcohols, and is prepared from ethylene dibromide:—

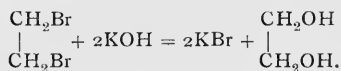

Glycol is a colourless syrupy liquid with a sweet taste; it boils at 198° and has a sp. gr. of 1.1297 at 0°. It is miscible with water and alcohol in all proportions, but is very slightly soluble in ether. It is very hygroscopic and takes up water from the atmosphere forming a hydrate $\text{C}_2\text{H}_6\text{O}_2 \cdot 2\text{H}_2\text{O}$.

Glycerol.

Glycerol, a trihydric alcohol, is the chief member of the series. It occurs in nature in the free state, but mainly in combination with fatty acids in the form of esters—the fats or glycerides—from which it is prepared by hydrolysis (p. 177).

Glycerol is a thick, colourless, very hygroscopic liquid without smell but with a sweet taste. It boils and distils under atmospheric pressure at 290° but undergoes slight decomposition; *in vacuo* it can be distilled without decomposition. If kept at 0° for some time it crystallises and the crystals melt at 17°. It has a sp. gr. of 1.265 at 15°.

It mixes in all proportions with water and alcohol but is insoluble in ether and chloroform.

Glycerol dissolves alkalis and many inorganic salts ; its presence in a solution prevents the precipitation of cupric hydrate by alkalis. This behaviour is common to other compounds which contain several OH groups in their molecule, such as tartaric acid and the sugars.

Tests.

- * (1) On account of its oily appearance it may be mistaken for fat. On moistening a piece of paper with a drop of glycerol, the paper becomes marked as with a grease spot, but on washing the paper with water and drying the spot is removed.
- * (2) On heating a few drops of glycerol in a dry test tube with potassium bisulphate or anhydrous phosphoric acid the pungent odour of acrolein (p. 104) is noticed :—

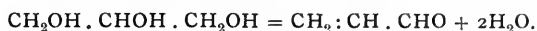

- * (3) On adding an aqueous solution of glycerol (about 20 per cent.) to a 5 per cent. solution of borax, to which sufficient phenolphthalein solution has been added to produce a distinct red colour, the red colour is discharged, but on boiling it returns if excess of glycerol has not been used. This is known as Dunstan's test.

Any polyhydric alcohol may give this reaction. Ammonium salts also decolorise the solution, but the colour does not return on heating.

Several polyhydric alcohols, containing 4 carbon atoms, erythritols, exist. They differ from one another in their stereochemistry (see tartaric acid). The inactive, internally compensated, compound occurs naturally.

Adonitol is the natural pentahydric alcohol: the other stereoisomeric forms are obtained by the reduction of the pentoses.

Mannitol.

The hexahydric alcohols can exist in ten stereoisomeric forms, eight of which are known. They are closely related to the monosaccharides from which they are obtained on reduction and to which they give rise on oxidation. Mannitol and sorbitol are found in nature, the others have been prepared from the hexoses.

Mannitol is obtained from manna, the juice of the manna ash, by extracting it with hot water or hot dilute alcohol and crystallising the solution. It crystallises from water in prisms, from alcohol in silky needles and melts at 165-166°. It requires 6 parts of water for solution ; it is very slightly soluble in cold alcohol and almost insoluble in ether.

FATS AND OILS. WAXES. LECITHINS OR LIPINS.

Fats and oils are present as reserve food material in most animal and vegetable tissues. They are the esters of the higher fatty acids, especially palmitic, stearic and oleic acids, with glycerol. All these glyceryl esters have similar names in which the name of the fatty acid describes the nature of the fat, e.g. butyrin, caproin, palmitin, olein.

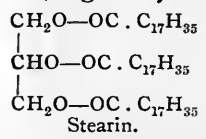

There is no chemical distinction between oils and fats ; the solid esters are fats, the liquid esters are oils. The consistency of a fat or oil depends upon the nature of its constituents. Beef and mutton tallow which are hard solids contain chiefly palmitin and stearin. Lard and human fat which are soft solids contain more olein. Palm oil consists principally of palmitin. The vegetable oils, such as olive, cotton seed and linseed oils contain chiefly olein or other esters of unsaturated acids.

Fats are economically of great value as food, as illuminating agents, as lubricating agents, for soap making and for other purposes.

Waxes, which in appearance somewhat resemble fats, are chemically very different. They are esters of the higher alcohols, cetyl alcohol, $\text{C}_{16}\text{H}_{33}\text{OH}$, myristic alcohol, $\text{C}_{30}\text{H}_{61}\text{OH}$, and cholesterol, $\text{C}_{27}\text{H}_{45}\text{OH}$, with the higher fatty acids, e.g. carnauba wax contains ceryl and myrcyl alcohols and cerotic and carnaubic acids ; wool wax or lanolin contains cholesterol ; spermaceti is the palmitic acid ester of cetyl alcohol.

Lecithins are present in all animal and vegetable cells and accompany the fat, but are intimately associated with the life processes, existing in loose combination with protein. Lecithin has the composition and properties of a fat, but contains in addition phosphoric acid and choline (p. 127),

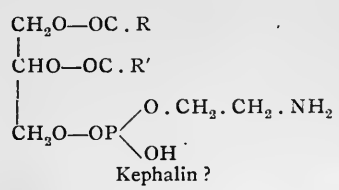
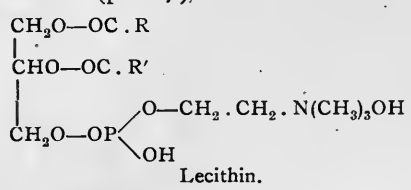

Kephalin has a similar composition but contains amino-ethyl alcohol in the place of choline. These two lipins are generally found together in most tissues and are difficult to separate. They both contain a saturated acid and an unsaturated acid. About 10 per cent. of lecithin is present in egg yolk ; liver and blood contain about 2 per cent., vegetable tissues from .25 to 1.5 per cent.

The substance, sphingomyelin, is also found in tissues, but in larger quantities in brain substance. It contains phosphorus like lecithin and kephalin, but not glycerol. Its constituents are two fatty acids, choline, sphingosine and phosphoric acid. These three substances form the group of phosphatides. Sphingosine is an unsaturated compound and contains two hydroxyl groups :—

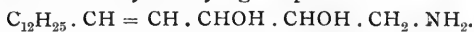

Brain tissue contains sphingomyelin and the two cerebrosides, phrenosin and kersin. This mixture constitutes protagon. The cerebrosides do not contain phosphorus. They are composed of the base sphingosine, galactose and a fatty acid, the sphingosine in combination with the galactose in the form of a glucoside and in combination with the fatty acid in the form of an acid amide :—

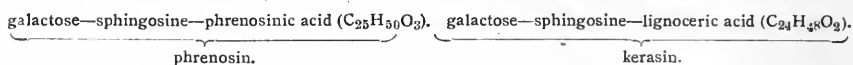

These compounds have also been isolated from other organs. A full account of these substances is given in Maclean's monograph.

Properties.

Fats and oils, waxes and lecithin have solubilities like the fatty acids. They are not soluble in water and are not soluble in dilute cold sodium hydroxide.

On warming, the fats melt and become oils. They have fairly definite melting-points. Fats and oils are not easily soluble in alcohol, but dissolve readily in ether, ligroin, carbon disulphide, etc.

Lecithin is easily soluble in cold absolute alcohol, in ether and other solvents. It is nearly insoluble in acetone, and may be precipitated from a concentrated ethereal solution by the addition of acetone. Kephalin is not soluble in alcohol. The cerebrosides dissolve in hot alcohol, acetone, benzene, but not in the cold solvent. They are insoluble in ether.

Extraction of Fats, etc.

The fats are contained in animal and vegetable tissues mixed with protein and carbohydrate. Three methods are in use for their separation. The oldest and simplest method consists in melting out the fat from the tissue by simply placing it in a suitable receptacle of muslin or cloth in a warm room; the fat melts and runs out leaving the remainder of the tissue behind. The most modern method consists in pressing out the fat in a hydraulic press; this is the method most frequently employed for obtaining the oils from vegetable seeds. The third method consists in extracting the fat by means of suitable solvents, such as benzine, carbon disulphide. Alcohol and ether are not usually employed for this purpose, but they are generally used if an estimation of fat in a tissue be required. For food the fat or oil is pressed out; for soap making and other purposes the residue is extracted.

Composition. Hydrolysis.

Fats are hydrolysed into their constituent fatty acids and glycerol by boiling with water, treatment with steam, and by boiling with acids and alkalis. This latter process of decomposing fats and esters is known as saponification and is a special form of hydrolysis; it was first used in the manufacture of soap, hence the term.

Fats undergo the process of hydrolysis during digestion. They are decomposed by the enzyme lipase in the pancreatic juice and hydrolysed into their constituents, fatty acids and glycerol. Emulsification occurs in the intestine, where the reaction is alkaline, during the process of the hydrolysis.

(a) Butter.

* A small quantity (2 gm.) of butter is heated with excess of alcoholic sodium hydroxide until a clear yellow solution is obtained. No oil drops should be seen on pouring the solution into water. The aqueous solution is heated to expel alcohol, acidified with dilute sulphuric acid and again heated. The smell of butyric and other volatile fatty acids is noticed. They are obtained by distilling the acid solution. The higher fatty acids are also present, but do not distil and remain as an oily layer on the surface of the hot liquid.

(b) Olive Oil.

* If a little olive oil be dissolved in twice its quantity of ether and 5 times the volume of 2 per cent. alcoholic sodium hydroxide be added, and the mixture be allowed to stand in a corked vessel, it gradually solidifies and forms a jelly. Complete saponification has occurred and soap has been formed. The jelly dissolves in water and the soap solution will give (a) a precipitate of fatty acids on acidifying with sulphuric acid and (b) a precipitate of the calcium soap on adding calcium chloride solution.

(c) Lard.

* About 5 gm. of lard are boiled with 25 c.c. of 10 per cent. alcoholic sodium hydroxide under a reflux condenser for 5-10 minutes to saponify the fat. 25-50 c.c. of water are added; if the saponification is complete no oil drops should be seen; if it be incomplete, the saponification is continued by adding alcoholic soda and again boiling. The liquid is poured into an evaporating basin and the alcohol evaporated on a water-bath. The solution is acidified with sulphuric acid; the fatty acids are precipitated and are filtered off through a wet paper and washed free from acid with water. The filtrate contains the glycerol which is detected as described below.

The presence of fatty acid in the precipitate is shown :—

- * (1) By dissolving a small portion in ether and adding the solution to alcohol containing a drop of phenolphthalein and a few drops of dilute sodium hydroxide. The red colour disappears.
- * (2) By dissolving another portion in dilute sodium hydroxide. A soap lather is formed on shaking it up with warm water.

The soap is salted out by adding sodium chloride and rises to the surface.

A precipitate of calcium soap is formed on adding calcium chloride.

- * (3) On heating with acid potassium sulphate there is no smell of acrolein, if the precipitate has been washed free from glycerol.

- * The presence of glycerol in the filtrate is shown by neutralising it and evaporating it to a syrup on the water-bath. The syrup is mixed with alcohol which precipitates the sodium sulphate. The alcoholic solution is poured off and evaporated, and the residue tested for glycerol by heating it with acid potassium sulphate, when acrolein is formed.

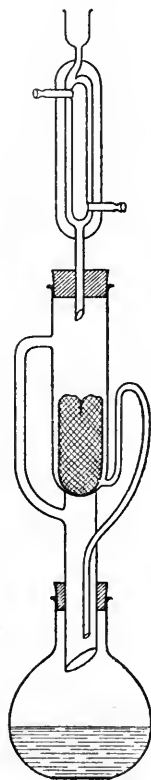

FIG. 37.

Estimation of Fats, etc.

In the estimation of fat, the tissue must first be dried: this is effected by mixing a known weight of the material with clean dry sand or other suitable absorbing medium and then heating for 1-2 hours in a steam oven. In the case of milk, it is most convenient to absorb a known weight (or volume) in clean fat-free filter paper, which is made into a small roll, and to dry this. The dried material is then placed in a paper thimble of suitable size and this is extracted with ether for 2-3 hours in a Soxhlet apparatus, which allows of a continual extraction for that time without constant attention. The Soxhlet apparatus (Fig. 37) consists of (1) a small dry flask, the weight of which has been accurately determined, (2) a special extracting tube into which the thimble and material is placed, (3) a short condenser. The extracting tube is composed of a wide piece of glass tubing like a test tube fused at its closed end to a narrower piece of glass tubing which is cut off at an angle at its other extremity. Just below the join of these pieces of tubing a glass side tube is fused into the narrower piece; its other end is fused into the wider piece at the upper end. At the base of the wide tube, on the other side of the apparatus, one end of a narrow

syphon tube is attached; its other end is fused to the narrow piece through which it passes and opens just above the angular extremity. The narrow end of this tube is fastened into the flask; the condenser is attached to the wider end. Ether is placed in the flask which is gently heated. The volatilised ether passes through the side tube and reaches the condenser. The condensed drops fall upon the thimble and cover it. When completely covered the ether is syphoned off and returns to the flask and the process is repeated. It remains to distil off the ether from the flask, dry at 100° and weigh. The difference in weight gives the amount of fat in the known weight of tissue.

This method gives comparatively good results; other substances besides fats are extracted from the tissue and some of the fat, present inside the cells, is not extracted. It is now more usual to estimate the fat as fatty acid, see page 601.

Analysis.

The natural fats consist of a mixture of the glyceryl esters of the saturated fatty acids, butyric, caproic, palmitic and stearic, of the unsaturated fatty acids, oleic, linoleic and others and also of hydroxy fatty acids. Free fatty acids are present in small quantities and increase in amount as the fat is kept. The various fats and oils have a fairly constant composition so that by determining the amounts of the various constituents it can be identified. The following six analyses are usually made:—

- (1) the acid value, i.e. the amount of potassium hydroxide in mgm. required to neutralise the free fatty acid in 1 gm. of fat;
- (2) the saponification value, i.e. the amount of potassium hydroxide in mgm. required to saponify 1 gm. of the fat;
- (3) the iodine value, i.e. the amount of iodine in gm. absorbed by 100 gm. of the fat;
- (4) the Reichert-Meissl or Reichert-Wollny value, i.e. the amount of potassium hydroxide in c.c. of $\cdot 1N$ required to neutralise the volatile fatty acids in 5 gm. of the fat;
- (5) the Hehner value, i.e. the amount of non-volatile and insoluble fatty acids (and unsaponifiable matter) present in 5 gm. of the fat;
- (6) the acetyl value, i.e. the amount of potassium hydroxide required to combine with the acetic acid in 1 gm. of fat, which has been acetylated.

The values of some of the commoner fats are given in the accompanying table:—

Fat.	Saponification value.	Iodine value.	Reichert-Wollny value.	Acetyl value.
Butter . . .	220-233	26.50	26.33	2.8.6
Lard . . .	195.5	46.70	.68	2.6
Tallow . . .	192-200	35.46	0.5	2.7-8.6
Olive oil . . .	185-196	79.88	0.6	10.6
Linseed oil . . .	192-195	173.201	0	4.0
Cotton seed oil	193-195	108-110	—	—
Coco-nut fat . . .	246-260	8-10	6.6-7.0	1-12
Palm-nut fat . . .	242-250	13-17	5.6.8	2.8.5

Determination of the Acid Value.

A weighed amount of fat, from 3 or 5 to 10 gm., is dissolved in neutral alcohol¹ or a mixture of alcohol and ether, a few drops of phenolphthalein are added and the solution is titrated with $\cdot 1N$ or $\cdot 5N$ potassium hydroxide until it is pink in colour. The pink colour should be permanent for about 2 minutes: after this time it usually disappears.

The acid value depends on the purity and age of the fat, i.e. on the amount of hydrolysis and oxidation that has taken place.

Determination of the Saponification Value.

The fat is saponified with an approximately $\cdot 5N$ solution of alcoholic potassium hydroxide, standardised against $\cdot 5N$ hydrochloric acid.

The alcoholic potassium hydroxide is prepared by dissolving 28 gm. of pure potassium hydroxide in a little water and diluting to 1000 c.c. with alcohol or purified methylated spirit; after 24 hours the solution is filtered into a litre bottle, which is closed by a rubber stopper carrying a 25 c.c. pipette. The pipette is closed by a piece of rubber tubing and a glass rod.

In measuring out the volume it is convenient to allow the liquid to run out of the pipette without touching the sides of the vessel and then to let three drops fall from the end.

A weighed amount of fat (1.5 to 2 gm.) is heated in a 200 c.c. flask on a water-bath under a reflux condenser with 25 c.c. of the alcoholic potash solution for 30 minutes. At the same time a blank experiment (i.e. the same experiment without the fat) is carried out. The contents of the flasks are heated so that they boil gently and are shaken from time to time.

When the saponification is complete and the fat has dissolved giving a clear solution, 1 c.c. of phenolphthalein solution is added and the mixture is titrated with $\cdot 5N$ hydrochloric acid.

The difference between the values found in the blank experiment and the one with fat is the volume of $\cdot 5N$ alkali required to saponify the fat. Hence the amount in mgm. required to saponify 1 gm. of fat can be calculated.

Determination of the Iodine Value.

There are two methods of determining the iodine value, (a) Hübl's, (b) Wijs. The process is the same in the two methods, the difference being in the iodine solution. Hübl used a mixture of iodine and mercuric chloride, Wijs iodine trichloride.

The following reagents are required:—

(1) Iodine solution.

(a) Hübl's. Equal volumes, e.g. 30 c.c. of a solution of 25 gm. of iodine in 500 c.c. of pure 95 per cent. alcohol and of a solution (filtered if necessary) of 30 gm. of mercuric chloride in 500 c.c. of pure 95 per cent. alcohol are mixed 12-24 hours before use. The mixture should not be used if it has been prepared longer than 24 hours.

(b) Wijs. 9.4 gm. of iodine trichloride are dissolved in 200 c.c. of glacial acetic acid contained in a 300 c.c. flask heated on the water-bath and closed with a cork carrying a calcium chloride tube; at the same time 7.2 gm. of finely powdered iodine are dissolved in glacial acetic acid in a similar way. The two solutions are poured into a 1000 c.c. flask and any undissolved iodine dissolved in a fresh portion of acetic acid. The mixed solutions are cooled and made up to 1000 c.c.

This solution may also be made by dissolving 13 gm. of iodine in 1000 c.c. of glacial acetic acid and passing washed and dry chlorine through the solution. A colour change occurs at the point when iodine trichloride is formed. In preparing the solution, the iodine content of the solution is determined before the passage of the chlorine; the chlorine is passed into the solution until the iodine content is doubled (Lewkowitch).

¹ Methylated spirit which has been kept in contact with sodium hydroxide and distilled may be used. If it should contain acid it may be neutralised with $\cdot 1N$ potassium hydroxide until it shows a faint pink colour to phenolphthalein, a few drops of which are added as indicator.

(2) .1N thiosulphate solution. This is prepared by dissolving 24.823 gm. of the pure salt in 1000 c.c. of water or by dissolving 25 gm. of the salt in 1000 c.c. and standardising after 24 hours against potassium bichromate as follows:—

20 c.c. of a bichromate solution containing 3.8657 gm. in 1000 c.c. are placed in a bottle containing 10 c.c. of the potassium iodide solution. 5 c.c. of concentrated hydrochloric acid are added. The brown solution is titrated with the thiosulphate solution, using starch solution as indicator.

Since 20 c.c. of the bichromate solution yields 0.2 gm. iodine, 1 c.c. of thiosulphate = $\frac{2}{x}$ gm. of iodine, if x c.c. are required in the titration.

(3) 10 per cent. potassium iodide solution. The quantity of iodate present must be taken into consideration.

(4) 1 per cent. starch solution.

(5) Pure chloroform or carbon tetrachloride. Their purity is tested by adding 10 c.c. of iodine solution and titrating after 2-3 hours. The value should be same as for 10 c.c. iodine solution.

Pure glacial acetic acid (purified by recrystallisation). It should not give a green colour on heating with bichromate and sulphuric acid after prolonged standing.

Procedure:—

.15 to .18 gm. of marine animal oil, .2 to .3 gm. of semi-drying oil, .3 to .4 gm. of non-drying oil, or .8 to 1.0 gm. of solid fat is placed in a 500-800 c.c. bottle with well-fitting stopper and dissolved in 10 c.c. of chloroform or carbon tetrachloride.¹ 25 or 50 c.c. of iodine solution are added, the pipette being allowed to drain for 2 or 3 drops after it has emptied. Iodine solution and solvent must give a clear solution on shaking, otherwise more solvent is added. The mixture is kept in a dark place for 6-8 hours in the case of fat and non-drying oils, for 8-10 hours in the case of semi-drying oils or for 12-18 hours in the case of marine animal oils. The mixture must contain 3 times the amount of iodine necessary and should be deep brown after 2 hours. More iodine solution is added, if the colour be paler. 15-20 c.c. of potassium iodide solution and 400 c.c. of water are added and the iodine titrated with .1N thiosulphate. If a red precipitate should form, more potassium iodide must be added. 25 c.c. of the iodine solution are titrated previously or subsequently. The difference gives the amount of iodine absorbed. The result is calculated:—

e.g. 25 c.c. iodine solution = 35.5 c.c. .1N Thio	}	∴ iodine used = 16.9 c.c. .1N	
0.983 gm. fat + 25 c.c. iodine solution = 18.6 c.c. .1N Thio			" " = 16.9 × .0127
∴ 100 gm. fat = 21.8 gm. iodine.			gm. iodine

Determination of the Reichert-Wollny Value.

The standard apparatus for this estimation is shown in Fig. 38.

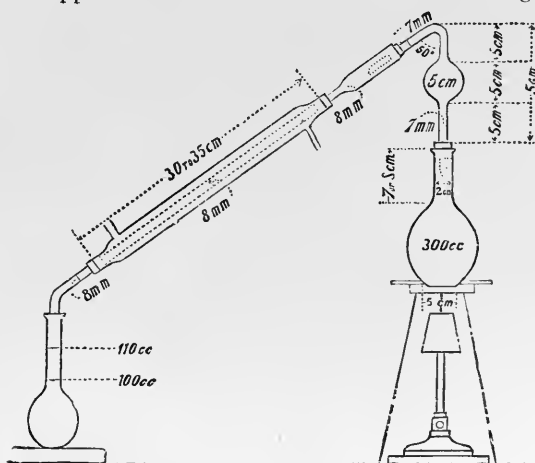

FIG. 38.

¹ Glacial acetic acid in the case of oxidised oils not completely soluble in carbon tetrachloride.

5 gm. of the fat are weighed out into a flask with a flat bottom of about 250 c.c. capacity and with a neck 2 cm. wide and 7-8 cm. long. 2 c.c. of a solution of 98 per cent. caustic soda in an equal weight of water, which is protected from carbonic acid, and 10 c.c. of 92 per cent. alcohol are added. The contents are heated on a water-bath under a reflux condenser for 15 minutes; the alcohol is removed by warming the flask for about 30 minutes without a condenser; 100 c.c. of boiling water, freed from carbon dioxide by boiling for at least 10 minutes, are added and the soap dissolved. The flask is connected to a condenser by a bent tube 7 mm. in diameter and 15 cm. in length from the cork of the flask. The condenser is 8 mm. in diameter and 35 cm. long. The contents of the flask are acidified with 40 c.c. of N sulphuric acid, a piece of porcelain added, and distilled from an asbestos board 12 cm. in diameter containing an opening 5 cm. in diameter. The heating is begun cautiously so as to melt the fatty acids and then at such a rate that 110 c.c. distil over in about 30 minutes. The distillate is collected in a measuring flask of 110 c.c. capacity. The distillate is mixed and 100 c.c. are titrated with $\cdot 1N$ alkali using 0.5 c.c. of 1 per cent. phenolphthalein solution as indicator.

Determination of the Hehner Value.

3-4 gm. of the fat are weighed out in a porcelain basin 13 cm. in diameter; 50 c.c. of alcohol and 1.2 gm. of potassium hydroxide are added. The mixture is heated on a water-bath with constant stirring till saponification is complete and until a clear solution is obtained. If a drop of water be added and no turbidity be produced, the saponification is complete. The solution is evaporated till it becomes pasty and 100 to 150 c.c. of water are added. It is acidified with sulphuric acid and warmed till the fatty acids form an oily layer on the surface. The fatty acids are filtered off on to a weighed filtered paper 10 cm. in diameter. This should have a texture so that it prevents fatty acid from passing through it and it is half filled with hot water and kept at this level with hot water during the filtration. The fatty acids are washed till the washings no longer react acid. The filter and its contents are dried at 100° for two hours, cooled and weighed.

Determination of the Acetyl Value.

10 gm. of the fat are boiled with twice the weight of acetic anhydride in a round flask under a reflux air condenser for two hours. The solution is poured into about 500 c.c. of hot water contained in a beaker and boiled for half an hour, whilst a slow current of carbon dioxide is passed through it to prevent bumping. On standing it separates into two layers; the aqueous layer is syphoned off and the remaining oil washed three times with water, so as to remove acetic acid, which may be tested for by its acid reaction. The acetylated fat is collected on a filter paper and dried at 100° .

2.5 gm. of the acetylated product are saponified with $\cdot 1N$ alcoholic potash as described under determination of the saponification value. The solution is evaporated to expel the alcohol and the residue dissolved in water. The same volume of $\cdot 1N$ acid as of alkali used in the saponification is added and the solution warmed. The aqueous solution is syphoned off through a wet filter and the fatty acids washed with hot water till all the acid is removed. The filtrate and washings are titrated with $\cdot 1N$ alkali using phenolphthalein as indicator. Soluble fatty acids, if present in the fat, must be separately determined in the same way and their amount deducted from the value obtained.

THE CARBOHYDRATES.

The very large group of compounds termed the carbohydrates, or sugars, are compounds of the nature of alcohols, primary and secondary, and at the same time aldehyde or ketone. Their empirical formula shows that they consist essentially of carbon and water, $C_n(H_2O)_n$ —hence their name—though substances other than carbohydrates, e.g. formaldehyde, CH_2O , acetic acid, $C_2H_4O_2$, and lactic acid, $C_3H_6O_3$, also possess the same empirical formula, and some carbohydrates have empirical formulæ in which the ratio of the elements H : O is not 2 : 1, e.g. the methyl pentose, rhamnose $C_6H_{12}O_5$.

This group of compounds contains simple and complex members. The simple members contain 2, 3, 4, 5, 6, 7, 8, 9 carbon atoms in their molecule, the chief physiological representatives being the members with 6 carbon atoms and in a lesser degree those with 5 atoms of carbon. It was formerly supposed that only those members containing 6 atoms of carbon belonged to the class of sugars, and it is convenient to term the six carbon atom representatives the sugars, whilst the whole group is termed the carbohydrates.

The complex members consist of combinations together in an anhydride form of 2, 3, 4 and more of the simple units, generally of those containing 6 carbon atoms and also of those with 5 carbon atoms. Accordingly as they contain 2, 3, etc., simple units in combination they are termed disaccharides, trisaccharides, or polysaccharides, the simple unit being termed a monosaccharide. All the complex members are converted into their constituent single units by hydrolysis with acids. The members of the carbohydrate group are distinguished by the suffix -ose, but this suffix is not applied to some of the complex compounds.

The carbohydrates are especially abundant in plants; the amount present in animals is by comparison very small. The complex carbohydrates form the structural basis of plants and are deposited in various parts as reserve material and as food-stuffs for the young plant. Both the complex reserve material and the simple carbohydrates are the chief food-stuff of animals.

The physical properties, appearance, solubility, taste, etc., of the various carbohydrates is very different and no proper classification can be based upon their properties, but they are classified according to their complexity :—

Monosaccharides.

Diose.	Glycollic aldehyde.
Trioses.	Glyceric aldehyde, dihydroxyacetone.
Tetroses.	Erythrose, threose.
Pentoses.	Arabinose, xylose, ribose, etc.
Hexoses.	<u>Glucose, mannose, galactose</u> , etc.
	In this group it is convenient to include <i>d</i> -glucosamine or aminoglucose.
	<u>Fructose, sorbose</u> , etc.
Heptoses, etc.	

Disaccharides.

Sucrose, maltose, lactose.

Trisaccharides.

Raffinose.

Tetrasaccharides.

Stachyose.

Polysaccharides.

Starch, cellulose, dextrin, glycogen, inulin.
Gums, pectins, pentosans, mannosans, etc.

THE MONOSACCHARIDES.**Diose.**

Glycollic aldehyde, $\begin{array}{c} \text{CH}_2\text{OH}, \\ | \\ \text{CHO} \end{array}$ which contains a primary alcohol

group and an aldehyde group, is the first member of the series. It is derived, like all the members of the carbohydrate group, by oxidation of the corresponding dihydric alcohol, glycol.

Trioses.

Glyceric aldehyde and dihydroxyacetone are obtained from gly-



cerol by oxidation with sodium hypobromite or hydrogen peroxide in the presence of ferrous sulphate. They contain respectively an aldehyde and ketone group and they are the first examples of an isomeric aldose and a ketose. Glyceric aldehyde contains an asymmetric carbon atom, but the two stereoisomers, *d*- and *l*-glycerose, have not yet been separated.

Tetroses.

The tetroses contain 4 atoms of carbon. An aldose or a ketose are theoretically possible and several stereoisomers, e.g. the aldotetroses, *d*- and *l*-erythrose, threose.

Pentoses.

Five carbon atoms are present in the molecule of a pentose, and isomers, an aldose and 2 ketoses, are possible. Three asymmetric carbon atoms are present: 2^3 or 8 stereoisomeric aldoses can exist. All but one are known, but all do not occur in nature.

d-ribose is contained in the nucleic acid of plants from which it is obtained by hydrolysis.

l-arabinose is contained in the polysaccharides cherry gum, gum arabic, peach gum. It is obtained by the hydrolysis of these substances with dilute sulphuric acid. Arabinose crystallises in prisms, has a sweet taste, is dextrorotatory, though termed *l*-arabinose on account of its stereochemical relation to glucose; it melts at 160° .

Xylose is obtained by the hydrolysis of wood gum or xylane, straw, and various forms of cellulose. It is optically inactive and melts at $144-145^\circ$.

A pentose, as yet not definitely identified, but probably, arabinose or ribose, is excreted in the urine in certain diseases.

Methyl Pentoses.

Rhamnose, $C_6H_{12}O_5$, is obtained by the hydrolysis of the glucosides, quercitrin, xanthorhamnin, and some saponins. Rhamnose crystallises with a molecule of water, $C_6H_{14}O_6$, and was formerly regarded as a hexahydric alcohol—*isodulcitol*. It melts at 93° .

Fucose in seaweed, chinovose in chinovin, and other methyl pentoses have also been prepared.

Hexoses.

The hexoses contain 6 atoms of carbon; two isomeric ketoses and one aldose are possible. Four asymmetric carbon atoms are present in the molecule of an aldohexose; 2^4 or 16 stereoisomers are possible but only three are found in nature. Most of the other stereoisomers have been prepared in the laboratory by Emil Fischer. Two stereoisomeric ketoses are also found in nature. The formulæ of the natural hexoses are:—

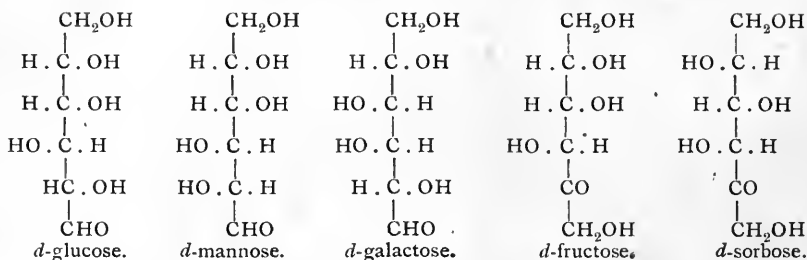

Constitution of the Aldoses (Glucose).

Analysis and molecular weight determinations show that glucose has the empirical formula $\text{C}_6\text{H}_{12}\text{O}_6$. The 6 atoms of carbon are joined together in a straight chain as is shown by its reduction with hydriodic acid into normal hexyl iodide. The stability of the compound and the formation of esters with 5 molecules of acid show the presence of five OH groups attached to different carbon atoms. The remaining group is an aldehyde group as shown by the aldehyde reactions and the formation of an acid, gluconic acid, by oxidation. Further oxidation of glucose gives a dibasic acid by the oxidation of the primary alcohol group.

Glycuronic acid, another oxidation product of glucose, is formed in the animal body; in the formation of this compound the primary alcohol group of glucose is oxidised whilst the aldehyde group is unchanged. Glycuronic acid is formed under certain conditions, e.g. after the administration of chloral hydrate. Chloral, and also other compounds, apparently combine with the aldehyde group of glucose; the alcohol group is then oxidised in the body and the combination product (paired glycuronic acid) is excreted in the urine. The best source of glycuronic acid is euxanthic acid, the calcium and magnesium salt of which constitutes the yellow pigment, Indian yellow. This is obtained from the urine of cows that have been fed on mango leaves. Glycuronic acid is prepared by hydrolysis of the Indian yellow, or other combination product. We have therefore

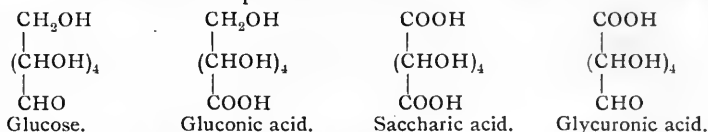

Constitution of the Ketoses (Fructose).

The 6 carbon atoms in fructose are present in a straight chain. It can be reduced to normal hexyl iodide. Five hydroxyl groups are present. On oxidation fructose breaks down giving trihydroxybutyric acid and glycollic acid, which shows the presence of a ketone group and in the position shown in the formula. Further proof of the position of the ketone group is given by the formation of a cyanohydrin which yields an acid. This acid on reduction gives methylbutylacetic acid.

Glucose and the other hexoses are represented above as hydroxy aldehydes, but this constitution does not entirely explain all their chemical and physical properties.

(1) A freshly prepared solution of glucose shows a higher rotatory power than a solution which has been kept for some hours (Mutarotation). Tanret has isolated from glucose solutions, under certain

conditions, two compounds, one of which, α -glucose, has a high initial rotatory power of 110° , the other, β -glucose, a low one of 19° . On being kept in solution both compounds give a solution of the same rotatory power of 52.5° .

(2) Two isomeric methyl etc. derivatives (glucosides) are also obtainable from glucose.

(3) Glucose in its chemical behaviour is also less active than is expected.

These properties are most satisfactorily explained by assuming that glucose has a γ -lactone formula, i.e. a formula in which four carbon atoms and an oxygen atom are included in a ring. It is derived from the hypothetical aldehydrol :—

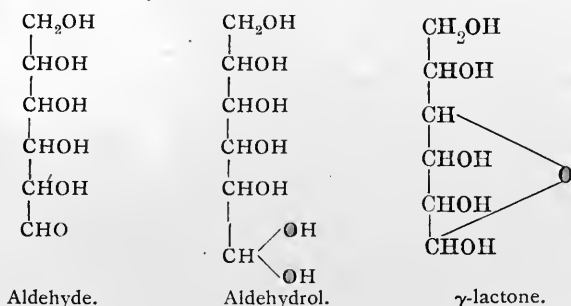

Under these conditions the carbon atom to which the aldehyde group was attached becomes asymmetric. Two stereoisomeric forms are therefore possible. These represent α - and β -glucose :—

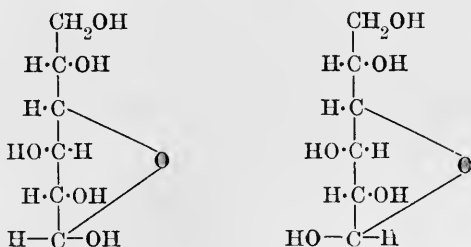

Each form in solution will change into the aldehydrol form and then into the other form. A solution of constant rotatory power will contain an equilibrium mixture of α - and β -glucose depending on the concentration. The solution will give the reactions of an aldehyde as it will contain a small quantity of aldehydrol (aldehyde). The two derivatives are obtained from the α - and β -forms.

Glucose, Grape Sugar, or Dextrose.

Glucose occurs in the seeds, leaves and other parts of plants and together with fructose in sweet fruits and honey. It is present to the extent of about .1 per cent. in the blood of animals and in other organs of the animal body. It is formed by the hydrolysis of cane sugar and other polysaccharides which contain it.

Small quantities of glucose are most conveniently prepared from cane sugar as follows: 40 gm. of powdered cane sugar are added to a mixture of 5 c.c. of concentrated hydrochloric acid and 120 c.c. of 90 per cent. alcohol heated to 45-50°. The mixture is kept at this temperature for 2 hours with occasional stirring and allowed to cool. Glucose crystallises out on cooling, more rapidly after adding a crystal of anhydrous glucose which helps the crystallisation. The crystals are filtered off, washed with alcohol and recrystallised from a mixture of 2 parts of alcohol and 1 of water.

Commercially, glucose is prepared from the starch of potato, maize, etc. The starch is hydrolysed by heating in copper vessels with dilute sulphuric acid under 3 atmospheres pressure. The solution is neutralised with chalk, the calcium sulphate filtered off and the filtrate heated with animal charcoal to decolorise it. It is evaporated *in vacuo* to a syrup and allowed to stand. The glucose crystallises in a cake of small crystals, which are purified by crystallisation from dilute alcohol.

Glucose crystallises from alcohol, or concentrated aqueous solutions at 30°, in needles which are anhydrous. It crystallises from cold water in the form of plates of the composition $C_6H_{12}O_6 \cdot H_2O$. It is easily soluble in water, very slightly soluble in absolute alcohol, but more soluble in methyl alcohol. It is insoluble in ether. Glucose and other carbohydrates are difficult to prepare free from moisture. This can only be effected by heating them *in vacuo* at 70-110° in a vessel connected to phosphorus pentoxide (see p. 21).

Fructose, Fruit Sugar, or Laevulose.

Fructose occurs with glucose in fruits, honey, etc. It is most easily prepared from the polysaccharide inulin by boiling it with 5 parts of .5 per cent. sulphuric acid, or dilute oxalic acid, for 1 hour. The acid is removed with barium carbonate and the solution is treated with charcoal and evaporated to a syrup. The syrup is dissolved in alcohol from which fructose slowly crystallises out.

On a large scale fructose is made from cane sugar. The solution of cane sugar which has been hydrolysed by dilute acid is neutralised and treated with milk of lime. An insoluble calcium compound of fructose is formed; this is filtered off, decomposed with carbon dioxide and the fructose obtained as above.

Fructose crystallises from alcohol in the form of rhombic crystals; it crystallises from water in needles of the composition $2C_6H_{12}O_6 \cdot H_2O$. It is soluble in hot absolute alcohol and can thus be separated from other sugars.

Mannose.

Mannose does not occur as such in nature, but is widely distributed as the polysaccharide mannan. It can be obtained by the oxidation of mannitol, but is usually prepared by the hydrolysis of the mannan contained in ivory-nut, which is used in making buttons. The material is hydrolysed by heating it on a water-bath for 6 hours with twice its weight of 6 per cent. hydrochloric acid. The insoluble matter is removed by filtration and the solution is decolorised by heating with animal charcoal, neutralised and treated with phenylhydrazine acetate. Mannose phenylhydrazone is formed from which the sugar is obtained by decomposing it with cold concentrated hydrochloric acid. Mannose is a hard colourless solid, which deliquesces, is easily soluble in water, slightly soluble in alcohol and insoluble in ether.

Galactose.

Galactose occurs in combination with glucose in milk-sugar, or lactose, in some gums and seaweeds as the polysaccharide galactan and in some glucosides, e.g. xanthorhamnin and saponin of plants, the cerebrosides of the brain and nervous tissue of animals.

It is prepared from lactose by boiling it with 4 times its weight of 2 per cent. sulphuric acid for 6 hours. The solution is concentrated and allowed to crystallise. The crude galactose is recrystallised by dissolving it in four-fifths of its weight of water and adding 2 volumes of 93 per cent. alcohol. Galactose consists of very small hexagonal crystals which melt at 168°.

d-Glucosamine.

The hydrochloride of glucosamine or aminoglucose was obtained in 1878 from chitin, the organic constituent of the shells of the lobster. It has since been obtained from the organic material of the shells of other arthropods. It is a constituent of fungus cellulose and has been prepared from various glucoproteins (p. 468). These conjugated proteins contain glucosamine or a polysaccharide composed of glucosamine as their carbohydrate moiety.

d-Glucosamine was synthesised by Fischer and Leuchs from d-arabinose and was shown to have the formula,

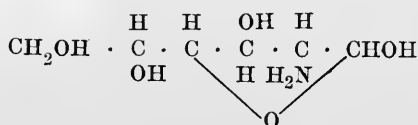
*Preparation.*

Chitin (p. 203), or lobster or crab shells, which have been treated with dilute hydrochloric acid to decompose the calcium carbonate and washed with water, are gently boiled with concentrated hydrochloric acid for 3-4 hours. The solution is evaporated until it crystallises and allowed to cool. The dark brown crystals of glucosamine hydrochloride are filtered off, dissolved in water and the solution evaporated until it crystallises. Glucosamine may be obtained from the hydrochloride by the action of diethylamine or sodium methylate.

Properties.

Glucosamine is a very unstable base and is known chiefly in the form of its hydrochloride.

Glucosamine hydrochloride forms large colourless glistening crystals which are soluble in water.

It cannot be converted directly into glucose; by the action of nitrous acid it is converted into chitose which Fischer and Andreae have shown to be a furfurane derivative of the formula,

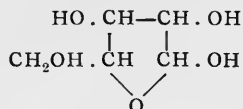

Glucosamine is hence frequently termed chitosamine.

It resembles glucose closely in its properties: it forms a pentacetyl derivative, an oxime and a phenyl-hydrazone and yields an osazone identical with glucosazone.

Its solutions behave like those of glucose as a reducing agent to Fehling's solution, etc.

PROPERTIES AND REACTIONS OF THE MONO-SACCHARIDES.

The properties and reactions of the monosaccharides are very similar, the differences between the individual members being only in certain peculiarities. The reactions of glucose may be taken as typical of the reactions of all monosaccharides.

A. GLUCOSE.

(1) Formation of Esters.

Glucose is converted by acids, acid anhydrides and acid chlorides into esters.

* Pentabenzoyl glucose is precipitated when a solution of glucose is shaken with benzoyl chloride and excess of sodium hydroxide:—

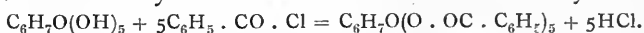

(2) Formation of Compounds with Metallic Hydroxides.

Glucose forms compounds with metallic hydroxides which are analagous to the alkoxides.

(a) If copper sulphate and sodium hydroxide be added to a solution of glucose in the proportions of

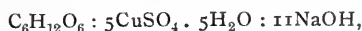

the glucose is precipitated almost completely from solutions as a voluminous blue compound.

(b) On adding basic lead acetate and caustic soda, or ammonia, to a solution of glucose in the proportions of

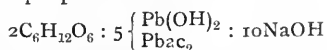

the glucose is precipitated completely as an insoluble white compound.

The precipitation is not complete unless these quantities are nearly proportional. Glucose is most conveniently removed from solution by this means.

(3) Reduction.

When glucose is reduced with sodium amalgam it is converted into the hexahydric alcohol, sorbitol.

(4) Oxidation.

When oxidised by bromine water glucose is converted into gluconic acid; when oxidised by nitric acid it is converted into saccharic acid.

(5) **Action of Alkali.**—Glucose is acted upon by sodium hydroxide at 37°. The rotation of the solution diminishes and its acidity increases. It passes over into fructose and mannose. Carbonates have a slighter action and ammonia of the same concentration is almost without action.

* *Moore's Test.*—On boiling a solution of glucose with sodium hydroxide it turns yellow, then dark brown, and smells of caramel. The smell becomes more distinct on acidifying the solution with dilute sulphuric acid and its colour becomes lighter. Lactic acid and other acids are formed.

* (6) **Action of Concentrated Hydrochloric Acid.**—If a solution of glucose be boiled for some time with an equal volume of concentrated hydrochloric acid, the solution becomes brown and “humus” substances, which are black, separate out. The chief product of the action of hydrochloric acid on glucose is laevulinic acid or acetylpropionic acid, $\text{CH}_3 \cdot \text{CO} \cdot \text{CH}_2 \cdot \text{CH}_2 \cdot \text{COOH}$.

(7) **Reduction of Metallic Oxides in Alkaline Solution.**

* (a) *Silver.*—On adding a solution of glucose to some ammoniacal silver nitrate solution (prepared by adding dilute ammonia to silver nitrate until the precipitate first formed is just redissolved) and warming in the water-bath, a mirror of metallic silver gradually forms.

(b) *Copper.*

* (i) *Trommer's Test.*—On making a solution of glucose alkaline with sodium hydroxide and adding copper sulphate, drop by drop, shaking after each addition, the solution becomes deep blue. The addition of excess of copper sulphate causes the precipitation of cupric hydrate, i.e. it is no longer dissolved by the glucose solution. The addition of a few small crystals of Rochelle salt will redissolve the precipitate (see Fehling's test). On heating the clear blue solution nearly to boiling a yellowish-red precipitate of cuprous oxide is formed.

* (ii) *Fehling's Test.*—On adding some glucose solution to equal quantities of Fehling's solution (a) CuSO_4 , (b) $\text{NaOH} + \text{NaK Tart}$. and heating to boiling, cuprous oxide is precipitated.

It should be noted that ammonium salts modify the reaction; the cuprous oxide is not precipitated, but the blue colour of the solution becomes less intense and may disappear.

* (iii) *Benedict's Test.*—As glucose is destroyed by the action of sodium hydroxide the reaction is more sensitive if sodium carbonate be employed in its place. If sodium citrate be substituted for Rochelle salt a permanent solution (Benedict's qualitative reagent, p. 613) is obtained.

On adding 5 to 10 drops of glucose solution to about 5 c.c. of the reagent and boiling vigorously for 2 or 3 minutes, it becomes turbid with a red, yellow, or green precipitate which fills up the solution depending on the amount of glucose. If the amount of glucose be very small a precipitate is only observed on allowing the solution to cool.

The test is sensitive to .08 per cent. of glucose.

* (iv) *Barfoed's Test.*—Glucose also reduces cupric hydrate in acetic acid solution. If some glucose solution be added, drop by drop, to some Barfoed's reagent which is kept boiling during the addition, red cuprous oxide is precipitated.

This test is given by glucose and other monosaccharides, but not by lactose and maltose. It may be used for distinguishing between glucose and the disaccharides, but the reagent must be freshly prepared, otherwise maltose and lactose will also reduce it.

(c) *Bismuth.*

Boettger's Test.—On boiling some glucose solution with a few crystals of bismuth subnitrate and twice the quantity of sodium carbonate, the bismuth hydrate first formed becomes reduced to metallic bismuth; the precipitate becomes grey or black in colour.

Nylander's Test.—If 5 parts of glucose solution be boiled with 1 part of Nylander's reagent (p. 613) for 2-5 minutes, reduction occurs and a black precipitate settles out on cooling.

These reactions are particularly useful for detecting small quantities of glucose in urine. The uric acid and creatinine in urine also reduce Fehling's solution, but not Nylander's solution.

(8) **Reduction of Dye-stuffs.**

(i) On adding picric acid and caustic soda to a solution of glucose and warming, a blood-red colour is formed due to the formation of picramic acid.

(ii) On warming a dilute solution of sodium sulphindigotate, made alkaline with sodium carbonate, with some glucose solution, the blue colour changes to green, purple-red and finally yellow. The blue colour returns on cooling and shaking the solution with air.

(iii) If some glucose solution be added to about 5 c.c. of a solution of safranin and the mixture boiled, the opaque red colour changes to light yellow.

(9) **Formation of Osazones.**—The reaction of glucose and other reducing sugars with phenylhydrazine is very characteristic, as it serves for the identification of the different carbohydrates. Glucose reacts with phenylhydrazine in acetic acid solution in two stages; the phenylhydrazone is first formed:—

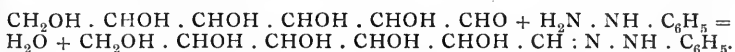

This is a colourless compound soluble in water.

The secondary alcohol group next to the aldehyde group is oxidised by excess of the reagent to the ketone group, which reacts with phenylhydrazine and an osazone is formed:—

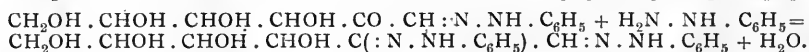
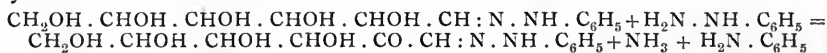

On adding equal quantities of phenylhydrazine and glacial acetic acid (5 to 10 drops of each), or ~~1 part of phenylhydrazine hydrochloride and 2 parts of sodium acetate~~ to about 20 c.c. of glucose solution and warming in a boiling water-bath for half to one hour, a yellow crystalline mass of phenylglucosazone is formed. The solution is allowed to cool, the crystals are filtered off and examined under a microscope. They consist of long needles arranged in sheaves as in Fig. 39.

* (10) **Fermentation.**—Glucose is fermented by yeast into alcohol and carbon dioxide. If a little fresh yeast be rubbed up with some glucose solution and a test tube be filled with the mixture and inverted in warm water in a crucible at 25°, it will be seen that after a short time bubbles rise to the top and displace the liquid. In about 24 hours most of the glucose will have disappeared and alcohol can be detected in the liquid.

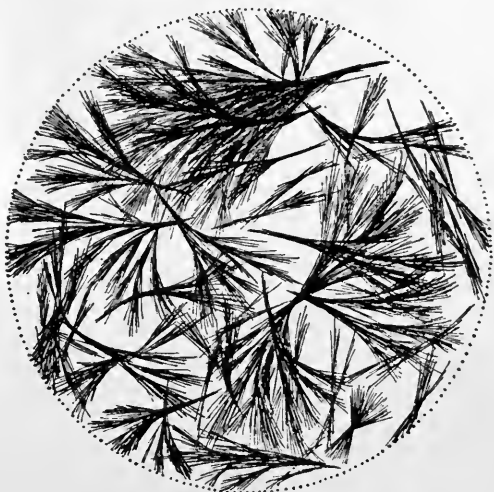
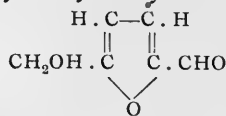

FIG. 39.—Glucosazone.

* (11) **Molisch's Test.**—On adding a drop of *a*-naphthol solution to about 5 c.c. of glucose solution and running about 5 c.c. of concentrated sulphuric acid below it, a purple ring appears at the surfaces of contact, either at once or after a short time. The two liquids may be mixed but the mixture must be kept cold by holding under running water. The whole liquid becomes reddish-violet. An examination of the coloured solution with a spectroscope will show an absorption band between D and E, whilst the violet end is totally absorbed (cf. p. 478). *ω*-Hydroxymethyl furfural, which gives the pigment with *a*-naphthol,



is formed.

This reaction is the most general one for all carbohydrates.

* (12) **Rotation.**—Glucose in solution is dextrorotatory when examined with a polarimeter, and shows mutarotation—the initial high rotatory power decreases and becomes constant in about 24 hours, or on boiling, or on adding a drop of ammonia.

(13) **Hydrogen Cyanide.**—Glucose combines with hydrogen cyanide forming a cyanohydrin, which yields an acid containing seven carbon atoms on hydrolysis. This acid (or its γ -lactone or anhydride) on reduction yields an heptose. Octoses and nonoses have been prepared by continuing the addition of hydrogen cyanide to the heptose and octose.

(14) **Hydroxylamine.**—Glucose reacts with hydroxylamine to form an oxime. The oxime loses water on heating with concentrated sodium hydroxide giving the nitrile of gluconic acid. On further heating hydrogen cyanide is split off and a pentose is formed.

A pentose is more easily obtained by oxidising gluconic acid with hydrogen peroxide in the presence of ferrous salts.

B. FRUCTOSE.

Fructose gives all the reactions given by glucose, but the following differences should be noted:—

(3) **Reduction.**—Fructose on reduction with sodium amalgam gives a mixture of sorbitol and mannitol.

(4) **Oxidation.**—Fructose on oxidation gives trihydroxybutyric acid and glycollic acid.

* (6) **Action of Concentrated Hydrochloric Acid.**—On boiling a solution of fructose with concentrated hydrochloric acid, the solution generally becomes red or red-brown before it ultimately turns dark brown.

* (7) **Reduction of Metallic Oxides in Alkaline Solution.**—Although fructose is a ketose, it nevertheless reduces metallic oxides in alkaline solution. This is due to the terminal—CO . CH₂OH group which is easily oxidisable. Though acetone does not reduce metallic oxides, monohydroxyacetone CH₃ . CO . CH₂OH does, as it contains the above grouping.

* (9) **Formation of Osazones.**—Fructose gives a phenylosazone identical with phenylglucosazone, as can be seen when the crystals are examined under the microscope, melting-point, analysis, etc.

(10) **Fermentation.**—Fructose ferments more rapidly than glucose with yeast.

* (12) **Rotation.**—Fructose solutions are laevorotatory. Laevorotatory fructose is known as *d*-fructose on account of its stereochemical relationship to glucose; the asymmetry of glucose is the basis of the stereochemical configuration of all carbohydrates.

* **Special Test. Selivanoff's Test.**—On adding a few crystals of resorcinol to a mixture of equal parts of concentrated hydrochloric acid and water and a very small quantity of fructose solution and heating, the solution becomes red in colour and deposits a brownish-red precipitate, which dissolves in alcohol giving a red solution.

ω -Hydroxymethylfurfural is formed by the action of the acid upon fructose and combines with the resorcinol giving the red pigment,

C. GALACTOSE.

Galactose gives the same reactions as glucose. It differs from glucose in the following particulars:—

(3) **Reduction.**—Galactose on reduction with sodium amalgam gives the hexahydric alcohol, dulcitol.

(4) **Oxidation.**—Galactose on oxidation gives galactonic acid. On further oxidation with nitric acid it yields mucic acid.

(9) **Formation of Osazones.**—Galactose gives a different phenylosazone.

(10) **Fermentation.**—Galactose is fermented by yeast, but much less rapidly than glucose.

(12) **Rotation.**—Galactose has a higher dextrorotatory power than glucose.

D. MANNOSE.

Mannose differs in the following particulars from glucose:—

(3) **Reduction.**—Mannitol is formed by reduction with sodium amalgam.

(4) **Oxidation.**—It yields mannonic acid and saccharic acid on oxidation.

(9) **Formation of Hydrazone and Osazone.**—Mannose forms a phenylhydrazone which is soluble with difficulty in water. It forms the same phenylosazone as glucose.

(12) **Rotation.**—Mannose is dextrorotatory, but has a different rotatory power.

E. PENTOSE.

The pentoses give most of the reactions given by glucose but with the following differences:—

(3) **Reduction.**—They give pentahydric alcohols.

(4) **Oxidation.**—They give acids containing five carbon atoms.

(6) **Action of Concentrated Hydrochloric Acid.**—The pentoses on boiling with hydrochloric acid yield furfural, which is volatile with steam and may be detected with aniline acetate.

* If a solution containing pentose,¹ or pentosan, e.g. gum arabic solution, be boiled with about half its volume of hydrochloric acid and if a piece of filter paper moistened with aniline acetate solution (prepared from equal parts of aniline, glacial acetic acid and water) be held in the vapour escaping from the vessel after most of the hydrochloric acid has been evolved, a bright crimson colour will be formed.

* (7) **Reduction of Metallic Oxides in Alkaline Solution.**—Pentoses reduce Fehling's solution on warming for some time.

(9) **Formation of Osazones.**—The pentoses form phenylosazones with phenylhydrazine in acetic acid solution. They differ from phenylglucosazone in melting-point, analysis, etc.

(10) **Fermentation.**—Pentoses are not fermented by yeast.

(12) **Rotation.**—Pentoses are dextrorotatory, or inactive.

¹A solution containing arabinose may be readily prepared by boiling 5 gm. of gum arabic in 100 c.c. water with 10 c.c. of concentrated hydrochloric acid for 5 minutes and then neutralising with alkali.

Special Tests.

- * (1) *Phloroglucinol Reaction*.—On adding an equal volume of concentrated hydrochloric acid and a small quantity of phloroglucinol to a solution of a pentose and heating the mixture in a boiling water-bath, it gradually becomes cherry red in colour and turbid and a precipitate is formed. The precipitate is dissolved by amyl alcohol, if the cold solution be shaken up with this solvent; the amyl alcohol solution will show on examination with a spectroscope an absorption band between D and E.

The formation of a precipitate is not itself sufficient evidence for the presence of a pentose, since a precipitate may be formed on heating other substances with acid and phloroglucinol.

- * (2) *Orcinol Reaction (Tollens)*.—If a mixture of equal parts of concentrated hydrochloric acid and pentose, or pentosan solution, be heated with a little orcinol, the solution becomes red, then violet, finally blue or blue-green with the separation of a precipitate. The appearance of the green colour may be hastened by adding a drop of ferric chloride to a *portion* of the solution. The *remainder* of the solution on being shaken with amyl alcohol imparts a bluish-red colour to the amyl alcohol, which gradually becomes green. The solution on examination with a spectroscope shows an absorption band between C and D but near D.

Bial's Modification.—On adding Bial's reagent (p. 614) drop by drop to about 5 c.c. of a boiling solution of a pentose, a bright green colour is produced. This is soluble in amyl alcohol, as above.

F. GLYCURONIC ACID.

Glycuronic acid resembles the pentoses in its reactions.

A solution of glycuronic acid may be prepared by boiling a small quantity of Indian yellow with dilute hydrochloric acid, cooling, filtering off the euxanthone and neutralising the solution.

- (1) It reduces Fehling's solution.
- (2) It gives the phloroglucinol and orcinol reactions.
- (3) It does not ferment.
- (4) The free acid is dextrorotatory, but when combined with euxanthone or other compounds it is laevorotatory.

THE DISACCHARIDES.

The disaccharides consist of two units of monosaccharide combined together with loss of water. Theoretically any two monosaccharides can be thus combined, but actually only a few disaccharides are known. Most of these are natural compounds, but some have been obtained by synthesis. Their composition is shown by hydrolysis—by acids or enzymes—when they are converted into their constituents, e.g. in the case of a bihexose :—

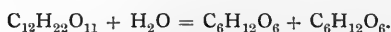

The natural disaccharides are of two kinds, those which reduce Fehling's solution and those which do not, and they are usually classified accordingly :—

<i>Non-Reducing.</i>		<i>Reducing.</i>					
Sucrose	{ Glucose or Saccharose, or Cane Sugar { Fructose	Lactose	{ Glucose or Milk Sugar { Galactose Melibiose { Glucose Galactose	Isolactose { Glucose - Galactose			
Trehalose		{ Glucose { Glucose			Maltose	{ Glucose { Glucose	Isomaltose { Glucose Glucose
					Gentiobiose		
		Vicianose	{ Glucose { Arabinose Gluco-xylose { Glucose Xylose	Galacto-arabinose { Galactose Arabinose			

It is not yet definitely known how the two units are combined together. In the non-reducing members the two functional aldehyde or ketone groupings will be combined; in the reducing members the aldehyde or ketone grouping of the one unit will be united to one of the hydroxyl groups of the other unit. The following are the probable formula for

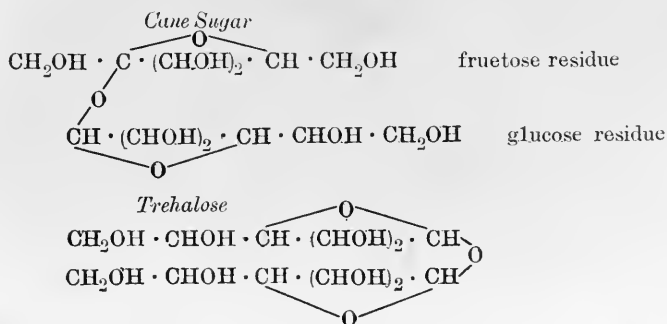

Reactions.

Cane sugar differs considerably from glucose in many of its reactions.

(1) *Formation of Esters.*—Cane sugar forms esters with eight hydroxyl groups.

(2) *Formation of Compounds with Metallic Hydroxides.*—Cane sugar forms insoluble compounds with lime, strontia, lead hydroxide, etc., more easily than glucose; this property as mentioned above is made use of in its commercial preparation.

* (5) *Action of Alkali.*—Cane sugar, since it contains no aldehyde or ketone group, is not acted upon by alkali and does not give Moore's test.

* (6) *Action of Hydrochloric Acid.*—Cane sugar is easily hydrolysed by boiling with dilute hydrochloric acid into glucose and fructose. Concentrated hydrochloric acid has the same action upon it as upon fructose (and glucose).

* (7) *Reduction of Metallic Oxides in Alkaline Solution.*—Cane sugar does not reduce Fehling's solution, etc. Cane sugar, after hydrolysis by boiling with dilute acid and neutralisation of the acid with sodium hydroxide, reduces Fehling's solution, etc.

* (9) *Formation of Osazones.*—Cane sugar does not form a phenyl-osazone. After hydrolysis by acids into glucose and fructose, phenyl-glucosazone is formed.

* (10) *Fermentation.*—Cane sugar is fermented by yeast, but before fermentation into carbon dioxide and alcohol it is converted by hydrolysis by the enzyme, invertase, in the yeast into glucose and fructose.

* (11) *Molisch's Test.*—Cane sugar gives Molisch's reaction.

* (12) *Rotation.*—Cane sugar is dextrorotatory. After hydrolysis by acids the mixture of glucose and fructose in equal parts shows laevo-rotation due to the laevo-rotation of fructose being greater than the dextro-rotation of glucose. Owing to the change of rotation, or inversion, the mixture of glucose and fructose obtained from cane sugar is generally spoken of as invert sugar.

Cane sugar gives Selivanoff's reaction since it contains fructose.

LACTOSE.

Lactose, or milk sugar, occurs in the milk of all animals, but has not been found in plants; about 4 per cent. is present in cow's milk, from 6-8 per cent. in human milk.

Lactose is prepared and manufactured from whey. The whey is evaporated and the lactose crystallises out; it is purified by recrystallisation from water.

Lactose forms a white crystalline powder, soluble in water, but insoluble in alcohol. In taste it is less sweet than glucose or cane sugar.

Reactions.

Lactose resembles glucose in its reactions.

(1) *Formation of Esters.*—Lactose forms esters with eight hydroxyl groups.

(4) *Oxidation.*—On oxidation of lactose with nitric acid, a mixture of mucic and saccharic acids is formed.

* (5) *Action of Alkali.*—Lactose gives Moore's test.

* (6) *Action of Hydrochloric Acid.*—Lactose is hydrolysed by boiling with dilute acid into a mixture of glucose and galactose. Strong acid has the same effect as upon glucose.

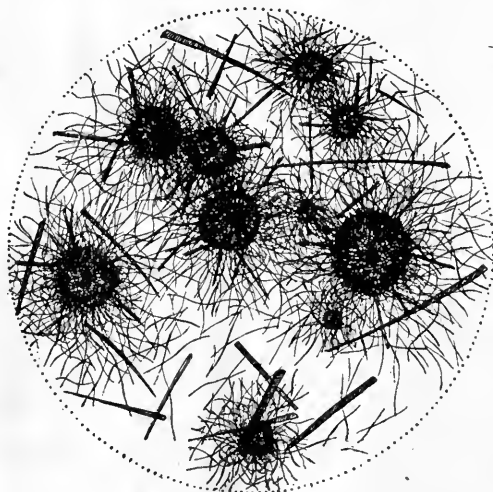

FIG. 40.—Lactosazone.

* (7) *Reduction of Metallic Hydroxides in Alkaline Solution.*—The reducing power of lactose is less than that of glucose. (See under estimation.) After hydrolysis by acids the mixture of glucose and galactose has a greater reducing power than lactose.

Lactose does not reduce Barfoed's reagent.

* (9) *Formation of Osazone.*—Lactose forms an osazone with phenylhydrazine in acetic acid solution in the same way as glucose. Lactosazone is soluble in boiling water; the compound separates as the solution cools. Its crystalline form (Fig. 40) is different from that of glucose and it is thus most easily distinguished from glucosazone and also maltosazone.

* (10) *Fermentation.*—Lactose is not fermented by yeast.

* (11) *Molisch's Test.*—Lactose gives Molisch's reaction.

* (12) *Rotation.*—Lactose is dextrorotatory. After hydrolysis by acids into a mixture of glucose and galactose the rotatory power of the solution is greater than before.

MALTOSE.

Maltose is found in plants and is formed in considerable quantities from starch during the germination of barley and other cereals. The polysaccharide is hydrolysed by the enzyme, diastase, in the grain into a mixture of maltose and dextrin :—

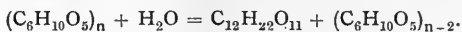

Maltose is also formed by the careful hydrolysis of starch by acids, and also from glycogen by the action of diastase.

Diastase prepared from barley (30 gm.), (see p. 399), is added to 30 gm. of starch or soluble starch in 3000 c.c. of water. The mixture is kept at 50° for 3 hours and then for 12 hours at room temperature. 60 per cent. of maltose is formed. The solution is filtered, evaporated to a thin syrup and poured into 95 per cent. alcohol. The precipitate of dextrin is removed and the alcohol distilled from the solution. Maltose separates out on standing. It is purified by dissolving in a little water, pouring into boiling alcohol, filtering, removing the alcohol and allowing to crystallise (Baker and Day, Brit. Assoc. Report, 1908, Sect. B., 671).

Maltose is readily soluble in water from which it crystallises in white needles of the composition $C_{12}H_{22}O_{11} \cdot H_2O$.

Reactions.

Maltose resembles glucose in its reactions more closely than lactose.

(1) *Formation of Esters.*—It forms esters with eight hydroxyl groups.

(5) *Action of Alkali.*—Maltose gives Moore's test.

(6) *Action of Hydrochloric Acid.*—Maltose is hydrolysed by boiling with dilute hydrochloric acid into two molecules of glucose.

Concentrated hydrochloric acid has the same action upon it as upon glucose.

(7) *Reduction of Metallic Hydroxides in Alkaline Solution.*—Maltose reduces Fehling's solution etc., but its reducing power is less than that of glucose. After hydrolysis by acids the reducing power of the solution is greater than before hydrolysis.

Maltose does not reduce Barfoed's reagent.

(9) *Formation of Osazone.*—Maltose behaves like lactose in forming an osazone with phenylhydrazine in acetic acid solution; it is soluble in boiling



FIG. 41.—Maltosazone.

water and crystallises out as the hot solution cools. In its appearance maltosazone is different to glucosazone and lactosazone (Fig. 41); also in its melting-point, etc.

(10) *Fermentation*.—Maltose is fermented by yeast, being converted by the enzyme maltase in the yeast into glucose, which yields alcohol and carbon dioxide.

(11) *Molisch's Test*.—Maltose gives Molisch's reaction.

(12) *Rotation*.—Maltose has a high rotation. The rotatory power of a solution of maltose diminishes when the maltose is hydrolysed by acid.

Other Disaccharides.

Trehalose occurs in certain fungi.

Isomaltose was obtained by Fischer by the action of strong acids on glucose. Its formation from starch, together with maltose, by the action of diastase has not been definitely proved.

Gentiobiose is obtained from the trisaccharide gentianose by hydrolysis with acids or by the enzyme invertase.

Cellobiose has been prepared from cellulose.

Melibiose is a product of the hydrolysis of the trisaccharide raffinose.

Turanose is prepared from melicitose.

Vicianose is present in the glucoside vicianin, obtained from the seeds of the vetch (*Vicia angustifolia*).

TRISACCHARIDES AND TETRASACCHARIDES.

The number of known compounds in this group is small. They are

Mannotriose.

glucose—galactose—galactose.

Rhamninoise.

galactose—rhamnose—rhamnose.

Raffinose.

fructose—glucose—galactose.

Gentianose.

fructose—glucose—glucose.

Melicitose.

glucose—fructose—glucose ?

Stachyose.

fructose—glucose—galactose—galactose.

Further details of these carbohydrates are given in Armstrong's monograph, "The Simple Carbohydrates and Glucosides".

CHITIN AND CHONDROITIN.

These polysaccharides which contain glucosamine as monosaccharide unit appear to be tetrasaccharides.

Chitin.

Chitin is composed of four glucosamine units or of three glucosamine units and one glucose unit, the amino groups of the glucosamine being acetylated. It has been represented as having the formula

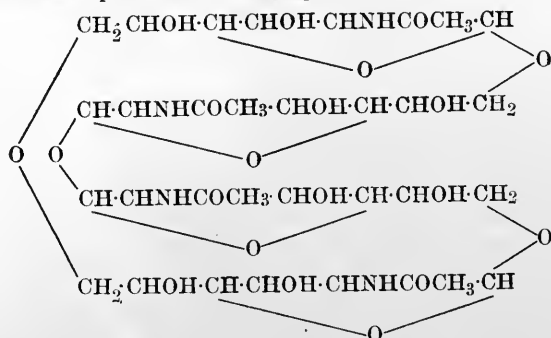

but this formula requires confirmation.

Chitin is prepared from the shells of lobsters or crabs ; they are freed from meat, etc., mechanically, or by treatment with dilute sodium hydroxide and washing with water, dried and powdered. The powder is treated with dilute hydrochloric acid, water, boiling alcohol, water, boiling alcohol and ether.

The powder as obtained above is colourless ; if the whole of small animals such as cockchafer be used the chitin consists of the skeletal structure of the animal. It is insoluble in water and other solvents, but is decomposed by concentrated hydrochloric acid yielding glucosamine hydrochloride (p. 189) and acetic acid. Three or four molecules of acetic acid are given by chitin.

Chondroitin.

Chondroitin or chondroitin sulphuric acid, is contained in cartilage either as such or in combination with protein, as a glucoprotein, i.e. as a chondroprotein. The work of Levene and La Forge¹ shows that it is a tetrasaccharide consisting of two chondrosamine units and two glycuronic acid units, the amino groups of the chondrosamine units being acetylated and its primary alcohol groups esterified with sulphuric acid. They gave it the formula :—

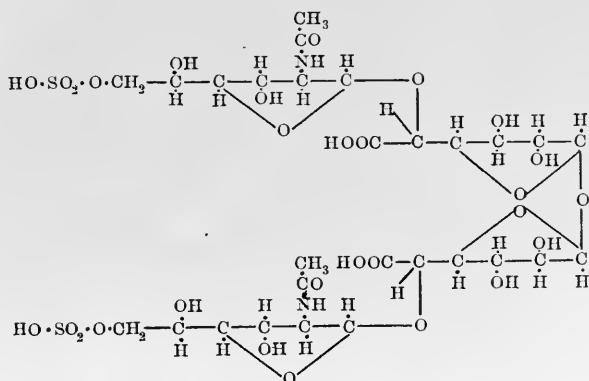

¹ J. Biol. Chem., 1913, 15, 69, 155.

Chondroitin on hydrolysis with hydrochloric acid yields chondrosin. The sulphuric acid and acetic acid are split off and the molecule ruptured between the glycuronic acid molecules. Chondrosin is a glucosidic combination of chondrosamine and glycuronic acid.

Preparation of the Barium Salt of Chondroitin and Chondroitin Sulphuric Acid.

The nasal septa of cattle, freed from bone and other extraneous material, are ground up in a meat chopper. 5 kilo. portions are allowed to stand for 2 days with 10 litres of a 2 per cent. solution of potassium hydroxide. The solution is strained off through a cloth, the insoluble matter treated with 5 litres of potash solution and washed with water. The solutions are united, acidified with acetic acid and concentrated on a water-bath with excess of barium carbonate to about half the volume. The clear liquid is poured off and the residue filtered on a folded filter. The liquid and filtrate are acidified with acetic acid and evaporated to about 2 litres with barium carbonate. The solid matter, consisting of protein and barium carbonate, is separated from the clear yellow liquid by centrifugalisation and dropped into 8 volumes of glacial acetic acid and stirred with a mechanical stirrer. The acid potassium salt is precipitated, filtered off, washed with glacial acetic acid, alcohol and ether. 200 gm. of this product, which may give a slight biuret reaction, are dissolved in 10 litres of water, the solution is mechanically stirred and basic lead acetate added so long as a precipitate is formed. The lead salt is filtered off, washed with water by grinding in a mortar, suspended in 5 litres of water, to which 100 gm. of barium acetate and 50 c.c. of acetic acid have been added, and decomposed with hydrogen sulphide. The lead sulphide is filtered off and the slightly turbid solution is precipitated by adding one-third of its volume of alcohol. The barium salt thus obtained is filtered off and washed with 50 per cent. alcohol, 95 per cent. alcohol, absolute alcohol and ether. It forms a white powder and is a mixture of the barium salt of chondroitin and chondroitin sulphuric acid.

Preparation of Chondrosin.

50 gm. of the barium salt of chondroitin sulphuric acid are dissolved in 150 c.c. of equal parts of concentrated hydrochloric acid and water and heated for an hour on the water-bath. Barium sulphate begins to separate out at once, the solution after 1 hour showing the maximum reduction of Fehling's solution. The filtered solution is evaporated *in vacuo* to a thick syrup, the syrup is dissolved in 40 c.c. of hot water and poured into 500 c.c. of absolute alcohol; partial precipitation of chondrosin hydrochloride takes place. 2 volumes of absolute ether are added after 12-16 hours and the precipitate is filtered off and washed with absolute ether. About 27 gm., dried over calcium chloride for 2 days, are obtained. It may be purified by solution in water and reprecipitated with alcohol and ether. It is a colourless powder, which is not hygroscopic if properly washed.

THE POLYSACCHARIDES.

The polysaccharides are substances of high molecular weight. The size of their molecule is unknown, but it is composed of a large number of monosaccharide units. Their empirical formula is usually represented by $(C_6H_{10}O_5)_n$, but many polysaccharides contain pentose units as well as hexose units and may consist entirely of pentose units $(C_5H_8O_4)_n$. They may be classified into the following groups:—

Hexosans.—Glucosans:—Starch, dextrin, glycogen, cellulose.

Fructosans:—Inulin.

Mannans.

Galactans.

Pentosans.—Gums, pectins.

Hexosan-Pentosans.—Lignocellulose, hemicellulose.

STARCH.

Starch is present in various parts of plants and has been found in green leaves, fruits, seeds, tubers, etc. The amount of starch present in the seeds of cereals varies from 50-70 per cent. of the dry weight; potatoes contain from 15-30 per cent. It occurs in definite granules—starch grains—which are made up of concentric layers around a hilum. When examined under a microscope these granules are seen to be of different forms. The source of starch grains can thus be ascertained from their microscopic structure.

Preparation.

Starch is prepared from wheat, rice, maize, potatoes, etc., by mechanical processes. The material is disintegrated by crushing, washed with water and passed through sieves. The starch in suspension passes through and is allowed to settle. The water is drained off and the starch grains are dried.

Starch may be purified by making a 1 per cent. suspension in water, freezing and allowing to melt. The starch is left as a residue whilst the liquid contains the impurities. The operation is repeated four or five times.

** Properties.*

Starch grains form a white powder which is insoluble in cold water. If boiled with water the granules swell and burst forming an opalescent solution, termed starch paste. Such a solution is most conveniently made by rubbing starch grains into a cream with water and pouring the cream into boiling water and boiling for some minutes. The paste so formed varies in consistency with the amount of starch. Dilute solutions from 1-4 per cent. are limp, but stronger solutions set into opaque white jellies.

Soluble Starch.

Starch grains consist of at least two substances. The French workers Maquenne and Roux term them amylocellulose or amylose, the chief constituent, and amylopectin. Amylose (granulose of previous workers) is partially soluble in boiling water, but completely soluble in boiling water under pressure. On cooling, the insoluble portion is again obtained by "reversion". The one seems to be a polymer of the other. Amylopectin is a gum-like substance which swells up without dissolving in water. The gelatinisation of starch paste is said to be due to the amylopectin.

Fernbach states that soluble starch can be obtained from potato starch by pouring a 1-2 per cent. suspension into a large excess of acetone and shaking vigorously. A flocculent precipitate is formed, which, if filtered off, ground up with acetone in a mortar and dried *in vacuo*, dissolves in cold water.

Starch grains treated with dilute hydrochloric acid of about 10 per cent. for 24 hours do not lose their external appearance, but they become soluble in hot water without forming a paste. Alcohol precipitates from the solution a white powder, soluble in water, termed soluble starch (Brown and Morris).

Soluble starch is most readily prepared by allowing 500 gm. of starch to stand in contact with 1000 c.c. of dilute hydrochloric acid of sp. gr. 1.037 for 7 days, stirring the mixture daily, pouring off the acid, washing the residue free from acid with water by decantation, the last portions containing a trace of ammonia, and drying it by exposure to the air. The dry product, ground up in a mortar and rubbed through a fine hair sieve, is soluble in warm water giving a clear solution (Lintner).

Another method of preparing soluble starch is to treat 400 gm. of potato starch with 2300 c.c. of water and 80 c.c. of N HCl in a flask in boiling water for 1.5 hours. The solution is cooled to 50°, made ammoniacal and 800 c.c. of alcohol added. The solution is strained through muslin, and whilst warm, poured into 4000 c.c. of alcohol. After 48 hours the precipitate is filtered off, washed with alcohol and spread out to dry.

Reactions.

The following reactions are given by starch paste or a solution of soluble starch.

* (1) *Action of Alcohol.*

Starch is precipitated completely by adding an equal volume of alcohol.

* (2) *Action of Iodine.*

If a few drops of iodine solution be added to a starch solution, a dark blue colour appears. On heating the solution, the colour disappears, but appears again on cooling.

The blue colour is discharged on adding 1-2 drops of caustic soda. The colour reappears on neutralising with dilute hydrochloric acid.

* (3) *Basic Lead Acetate.*

On adding basic lead acetate to starch solutions, the starch is precipitated.

* (4) *Ammonium Sulphate.*

Starch is precipitated from solution by adding an equal volume of saturated ammonium sulphate solution, i.e. by half saturation with this salt.

* (5) *Fehling's Solution.*

Starch solutions do not reduce Fehling's solution.

* (6) *Hydrolysis.*

Starch is easily hydrolysed into glucose by boiling its solution with dilute sulphuric acid for a few minutes. The presence of glucose can be shown by neutralising with soda and testing with Fehling's solution.

(7) *Rotation.*

Solutions of soluble starch have a high dextrorotatory power.

DEXTRINS.

Dextrins are glucosans which are intermediate in complexity between starch and maltose. They have been found in plants, but are usually obtained by the hydrolysis of starch by the diastase in malt extract.

The existence of a large number of dextrins has been supposed, but only two can be easily distinguished—erythrodextrin, which gives a reddish-brown colour with iodine, and achroodextrin, which gives no colour with iodine. Erythro-dextrin is probably a mixture of achroo-dextrin with a small amount of starch (Ost).

Baker¹ has described a dextrin, termed α -amylodextrin, which results from the action of the diastase of ungerminated barley upon starch paste, or soluble starch. It gives a blue colour with iodine.

Preparation.

The dextrins are prepared by the action of malt extract at 55° or by the diastase of ungerminated barley at 45-50° upon starch paste or soluble starch. The starch is converted by the malt diastase in 2-3 hours into a mixture of 80 per cent. maltose and 20 per cent. dextrin, by the barley diastase into a mixture of 60-65 per cent. of maltose and 35-40 per cent. of dextrin. In the former case the reaction can be followed by testing portions of the solution at intervals with iodine; the blue coloration disappears passing through a stage at which a reddish-brown colour is observed.

The prolonged action of malt extract slowly converts the dextrin into maltose. Maquenne and Roux consider that the maltose is derived from amylose and the dextrin from amylopectin.

The solution containing the products of hydrolysis is concentrated and the dextrin is precipitated by pouring it into alcohol. The precipitate is dissolved in water and reprecipitated with alcohol.

Commercial dextrin is prepared by heating starch at 180-200°, until it has a pale brown colour. If the starch be previously treated with acid, it is heated at a lower temperature.

¹ J. Chem. Soc., 1902, 81, 1177.

* *Properties.*

Commercial dextrin obtained by heating starch is a yellow-brown powder.

The dextrin obtained by the hydrolysis of starch by malt extract is a white powder resembling starch. It is composed chiefly of achroo-dextrin and is soluble in water giving a sticky solution. The solution has a faint sweet taste and a peculiar smell.

The dextrin obtained by the action of barley diastase is similar in appearance.

*Reactions.** (1) *Action of Alcohol.*

Dextrin is insoluble in alcohol and is precipitated from its solution in water by excess of alcohol.

* (2) *Action of Iodine.*

Commercial dextrin generally gives a reddish-brown coloration on treating with 1-2 drops of iodine solution; this is due to the presence of erythro-dextrin. The coloration disappears on heating and reappears on cooling.

The dextrin produced by malt diastase gives no colour with iodine. That produced by barley diastase gives a blue colour.

* (3) *Basic Lead Acetate.*

Dextrin is not precipitated from solution by basic lead acetate.

(4) *Ammonium Sulphate.*

Dextrin is not precipitated by half saturation with ammonium sulphate.

* (5) *Fehling's Solution.*

The dextrins reduce Fehling's solution slightly.

* (6) *Reduction of Dye-stuffs.*

Solutions of dextrin produce a red colour on warming with picric acid and sodium hydroxide.

* (7) *Hydrolysis.*

Dextrin is easily hydrolysed into glucose by boiling its solution with dilute sulphuric acid for a few minutes. The presence of glucose is shown by neutralising the solution with soda and testing with Fehling's solution.

* (8) *Action of Alkali.*

On warming a solution of dextrin with alkali it becomes yellow or yellow-brown in colour.

(9) *Fermentation.*

Dextrin is not fermented by yeast.

(10) *Rotation.*

Dextrin has a high dextrorotatory power.

GLYCOGEN.

Glycogen is present as reserve food material in the organs of animals, but is also found in plants. In plants it is present in largest amount in yeast, as much as 30 per cent. of the dry weight having been recorded. In animals glycogen exists in greatest amount in the liver, usually from 1-4 per cent., but 12-16 per cent. have been obtained and 20 per cent. from frog's liver. Glycogen is found in other organs of animals, especially muscle. Heart muscle always seems to contain a quantity of glycogen. Oysters and other molluscs contain considerable quantities of glycogen.

*Preparation.**From Liver.*

In order to obtain as large an amount of glycogen as possible the animal should be fed on a diet containing carbohydrate. The livers of rabbits contain a considerable quantity if they have been fed on carrots 5 or 6 hours previously. The animal is killed by bleeding, the liver removed and washed out with saline solution. It is broken up into small pieces and thrown into boiling water acidified with acetic acid. The proteins of the liver are thus coagulated and the enzyme which converts glycogen into glucose is destroyed. The pieces of liver are ground up finely in a mortar and extracted with boiling water. The extracts are combined (the remainder of the proteins precipitated by adding an equal volume of 10 per cent. trichloroacetic acid), and the opalescent solution precipitated by adding an equal volume of alcohol. The precipitate is redissolved in water and reprecipitated with alcohol. The precipitate is dried by treating with alcohol several times, then with ether and placing in a desiccator over sulphuric acid.

Pfluger's method of preparing glycogen yields a purer preparation:—

The finely broken up liver is stirred up with water and 60 per cent. potassium hydroxide so that it contains 15 per cent. KOH and heated for 2 hours on the water-bath. The solution is filtered and mixed with an equal volume of alcohol. The glycogen is precipitated and washed with a mixture of 1 part of 15 per cent. KOH and 2 parts of alcohol. It may be redissolved and reprecipitated by alcohol. It is then washed with alcohol and ether and dried.

From Yeast.

Yeast is ground up with sand to rupture the cells, extracted with boiling water, and the filtered solution precipitated by adding an equal volume of alcohol. The precipitate is collected, washed with 50 per cent. alcohol and heated for 2 hours on a boiling water-bath with a solution of 60 per cent. potassium hydroxide to dissolve proteins. The liquid is cooled, poured into an equal volume of water, filtered and precipitated by adding two volumes of alcohol. The precipitate of glycogen is washed with alcohol containing KOH and then with alcohol. It is purified by solution in water, neutralisation of the alkali with acetic acid, and precipitation with an equal volume of alcohol. This procedure is carried out several times. The product contains yeast gum. This is removed by dissolving in water and saturating the solution with ammonium sulphate. The glycogen is precipitated and washed with ammonium

sulphate, again dissolved and again precipitated. Finally it is dissolved in water, the ammonium sulphate removed by dialysis, and the glycogen precipitated by alcohol. It is washed with alcohol and ether and dried.

Properties.

- * Pure glycogen is a white amorphous powder, soluble in cold water forming an opalescent solution, which is very characteristic.

Reactions.

- * (1) *Action of Alcohol.*

Glycogen is precipitated from solution by adding an equal volume of alcohol. The precipitation does not occur if the solution does not contain some salts; a small quantity, 0.5 gm. of sodium chloride, is required to precipitate a 1 per cent. solution of glycogen with two volumes of absolute alcohol.

- * (2) *Action of Iodine.*

Solutions of glycogen give a reddish-brown colour on treatment with 1 to 2 drops of iodine solution. The coloration disappears on heating and reappears on cooling.

- * (3) *Basic Lead Acetate.*

Solutions of glycogen are precipitated by basic lead acetate.

- * (4) *Ammonium Sulphate.*

Solutions of glycogen are not precipitated by half saturation with ammonium sulphate, but the glycogen is precipitated by complete saturation of the solution with ammonium sulphate crystals.

- * (5) *Fehling's Solution.*

Glycogen does not reduce Fehling's solution.

- * (6) *Hydrolysis.*

Glycogen is converted into glucose by hydrolysis. Solutions of glycogen, boiled with dilute acid and neutralised, reduce Fehling's solution.

- * (7) *Action of Alkali.*

Glycogen is not acted upon by alkali.

- (8) *Fermentation.*

Glycogen is not fermented by yeast.

- (9) *Rotation.*

Glycogen has a high dextrorotatory power.

CELLULOSE.

The cell walls of plants, which are elaborated by the protoplasm, are supposed to consist primarily of the substance termed cellulose, but during growth the plant forms other substances which are encrusted in the cellulose, so that the material of the cell wall consists of a mixture (or compound) of cellulose and other substances. The materials which are encrusted in the cellulose are lignin¹ or lignone forming lignocellulose in wood, straw, etc., pectins and gummy substances forming pectocellulose, fatty substances forming adipocellulose. The material which contains most cellulose is the fibre of the cotton plant, hemp and flax. Pure cellulose is generally made from these products. Wood contains 50-60 per cent. of cellulose; straw contains a similar amount, but silica is also present.

Cellulose is also found in the animal kingdom; the tunicin in the cell walls of tunicates is said to be identical with cellulose.

Preparation of Cellulose from Cotton.

Since cellulose is very resistant to most chemicals pure cellulose is prepared from cotton fibre by the following treatment:—

The fibre is boiled with 1-2 per cent. caustic potash and washed with water. Pectins are thus removed. The fibre is treated with bromine or chlorine at the ordinary temperature. The lignin or lignone is destroyed and dissolves. The fibre is then treated with sodium sulphate, carbonate or hydrate. The residue is washed with water and dried.

Preparation of Paper Cellulose.

Linon rags or cotton waste are cleaned, cut up and boiled under pressure, firstly with dilute sodium carbonate and secondly dilute caustic soda so as to disintegrate them. The material is bleached with chlorine, washed free from the halogen, treated with resin, soap and alum, and spread out in thin layers to dry. The fibres thus become felted together. Wood is disintegrated and the lignin dissolved out by treatment with calcium bisulphite. The residue is treated as above with soap, etc.

Paper of an inferior quality is made from wood which has not been treated; it gives the reactions for pentose if a solution of aniline acetate be poured upon it or if it be treated with a 1-2 per cent. solution of phloroglucinol in alcohol and dilute hydrochloric acid. On exposure to light such paper becomes yellow.

Properties.

Pure cellulose is a white substance which is hygroscopic and absorbs about 10 per cent. of water. The water is removed by heating it to 100°.

Solubility.

It is insoluble in water and all ordinary solvents, but it is decomposed by heating with water under pressure.

It becomes gelatinous in a solution of zinc chloride and finally dissolves. On stirring 1 part of cellulose with 6 parts of zinc chloride in 10 parts of water at 60°, it gelatinises after some time; on raising the temperature by placing it in a boiling water-bath the cellulose gradually dissolves.

Cellulose dissolves rapidly in a cold solution of zinc chloride in twice its weight of hydrochloric acid.

Cellulose dissolves in a solution of ammoniacal cupric oxide (Schweitzer's reagent). On adding acid, it is precipitated.

¹ Lignin appears to contain aromatic substances and pentosans.

One variety of artificial silk is prepared by dissolving mercerised cotton in Schweitzer's reagent (see p. 616), and running it in a thin stream into dilute sulphuric acid. A thread of cellulose is thus precipitated.

Reactions.

(1) *Action of Alkali.*

Dilute solutions (1-2 per cent.) of caustic soda even at 100° have no action upon cellulose. More concentrated solutions (10 per cent.) cause the fibres to swell and become cylindrical and destroy the central canal. The appearance becomes glossy. This property was used by Mercer for treating cotton to make it appear like silk.

Cellulose treated with 15 per cent. alkali reacts with carbon disulphide, forming a thiocarbonate. This substance decomposes in the air giving carbon disulphide and cellulose. The solution, if forced through fine openings and allowed to come into the air, forms continuous threads of artificial silk.

(2) *Action of Acids.*

Dilute sulphuric acid converts cellulose into hydrocellulose.

Dilute nitric acid (sp. gr. 1.25) at 80° converts cellulose into oxycellulose which reduces Fehling's solution.

Concentrated sulphuric acid dissolves cellulose. On diluting the solution, a gelatinous compound is precipitated. This substance is called amyloid, as it gives a blue colour with iodine, like starch. Parchment paper is made by treating paper with 2 parts of sulphuric acid and 1 part of water and then washing the acid away with water.

(3) *Formation of Esters.*

(a) *Nitric acid.*

Concentrated nitric acid, or a mixture of this acid with sulphuric acid, converts cellulose into nitric acid esters. Collodion is a mixture of the tri- and tetra-nitrates dissolved in a mixture of equal parts of alcohol and ether. Celluloid is a mixture of the tri- and tetra-nitrates with camphor.

Gun cotton, or pyroxylin, is cellulose hexanitrate and is prepared by treating cotton waste (freed from fats by treating with alkali) with a mixture of 1 part nitric acid and 3 parts sulphuric acid. The product, which has still the original appearance, is washed with water, moulded and dried. It is converted into smokeless powder by dissolving in acetone or ethyl acetate and evaporating the solution. When mixed with nitroglycerine and other substances it forms blasting gelatin, cordite, etc.

Artificial india-rubber is a product prepared by mixing together tri- and tetra-nitrocellulose with castor-oil. The inflammability of this material is eliminated by treating it with alkali.

(b) *Acetic acid.*

Cellulose acetates are obtained on treating cellulose with glacial acetic acid and acetic anhydride in the presence of concentrated sulphuric acid. These compounds are insoluble in water, but soluble in organic solvents. A solution of tetra-acetyl cellulose in acetone on evaporation yields artificial gutta-percha.

A white precipitate is formed when a solution of cellulose acetate in glacial acetic acid is poured into alcohol. This solid does not melt, but burns without leaving an ash. It forms "solid spirit".

It is also used to make artificial silk.

(4) *Hydrolysis.*

Cellulose is dissolved by concentrated sulphuric acid, which hydrolyses it to glucose.

Inulin.

Inulin occurs in the sap of a number of plants and is most abundant in the tubers of the dahlia (10-12 per cent.) and artichoke.

Inulin is prepared from dahlia tubers by crushing and pressing out the juice; the residue yields more inulin if boiled up with water and chalk. The two solutions are combined, boiled with chalk to neutralise acids, filtered and treated with lead acetate as long as a precipitate is formed. The filtered solution is treated with hydrogen sulphide, filtered from lead sulphide and evaporated to half its volume. An equal volume of alcohol is added and the precipitate of inulin filtered off after 1-2 days. It may be purified by dissolving in water, warming the solution with animal charcoal, filtering and reprecipitating with alcohol. The precipitate is washed with alcohol and ether and dried in a desiccator over sulphuric acid.

Inulin forms a white powder with a sphaerocrystalline appearance. It has no taste. It swells up and dissolves in hot water giving a clear solution.

Reactions.

(1) *Action of Alcohol.*—Inulin is insoluble in alcohol and is precipitated from solution by adding an equal volume of alcohol.

(2) *Action of Iodine.*—Solutions of inulin give a brownish coloration with iodine. The iodine solution used must be very weak and it is advisable to carry out a control test, i.e. adding the same amount of iodine to an equal volume of water.

(3) *Basic Lead Acetate.*—Inulin solutions are precipitated by basic lead acetate.

(4) *Fehling's Solution.*—Inulin does not reduce Fehling's solution.

(5) *Hydrolysis.*—Inulin is very easily hydrolysed by mineral acids and converted into fructose. The hydrolysed solution, after neutralisation, gives the reactions for fructose.

(6) *Rotation.*—Inulin has laevorotation.

Mannans. Galactans. Hemicellulose, etc.

Polysaccharides different from those previously described occur in the seeds of numerous plants. They have resemblances to cellulose, but differ from cellulose in dissolving in dilute alkali, in being hydrolysed by dilute mineral acids and in yielding other monosaccharides as well as glucose. They are soluble in Schweitzer's reagent after treatment for a short time with dilute hydrochloric acid. They form a very indefinite group of substances and require further investigation.

Gums. Pectins. Mucilages.

The gums, pectins and mucilages are complex polysaccharides containing both hexose and pentose units. The gums appear to be carbohydrates combined with acids; some are completely soluble, others are partially soluble in water and others only swell up with water.

Mucilages are very widely distributed in plants and form a slimy liquid with water.

Pectins are contained in fruits, turnips, etc. The gelatinisation of boiled fruit extracts is probably due to the presence of pectin.

Schryver and Haynes¹ showed that these plant materials contained the acid substance, pectinogen, which is soluble in water. Pectinogen is readily changed into another acid substance, pectin, by dilute alkali. Mineral acids precipitate pectin as a gel from the alkaline solution; calcium chloride gives a gelatinous precipitate of the calcium salt. Pectin has the composition $C_{17}H_{24}O_{16}$ and contains a pentose group. Pectinogen is extracted from the pressed residue of the plants by warm 0.5 per cent. ammonium oxalate solution,

¹ *Biochem. J.*, 1916, 10, 539.

GLUCOSIDES.

In addition to the carbohydrates there also occur in nature a large number of compounds which contain glucose, more rarely other sugars, e.g. galactose, rhamnose and disaccharides, combined with other organic compounds, especially those belonging to the aromatic series. These are the glucosides. Glucosides have also been prepared in the laboratory from glucose, mannose, maltose, etc. Two isomers are generally thus obtained, termed the α - and β -glucosides. The chief of the synthetic glucosides are the α - and β -methyl glucosides which are prepared by the action of hydrochloric acid upon a solution of glucose in methyl alcohol. They are derived from α - and β -glucose by the replacement of the hydrogen atom in the hydroxyl group attached to the carbon atom which possesses aldehydic properties:—

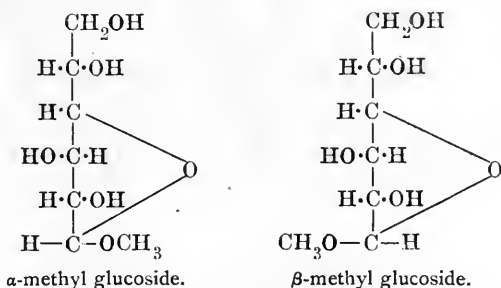

These two glucosides, besides having different physical properties, behave differently towards the enzymes, maltase and emulsin. Maltase hydrolyses the α -glucoside, but not the β -glucoside, emulsin hydrolyses the β -glucoside, but not the α -glucoside. The natural glucosides are, in general, hydrolysed only by emulsin and would be derivatives of β -glucose, i.e. β -glucosides.

The three best-known glucosides are probably

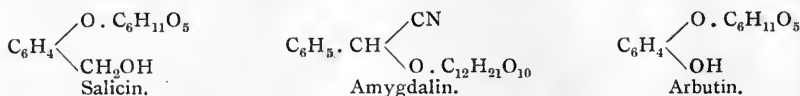

Salicin is a combination of glucose with saligenin or salicylic alcohol.

Amygdalin is a combination of 2 molecules of glucose, hydrogen cyanide and benzaldehyde.

Arbutin is a combination of glucose with hydroquinone (p. 261).

The composition of glucosides is ascertained by identification of their products of hydrolysis.

Preparation.

The quantity of glucoside present in plants is usually small. Since enzymes are present which hydrolyse the glucoside, it is advantageous to destroy the enzyme by heating with water or alcohol before extracting the glucoside. The glucoside is usually isolated by extracting the material with water, alcohol, ethyl acetate or other organic solvent, concentrating the extract and crystallising out the glucoside. In some cases the extract requires purification so that no general scheme can be given for isolating glucosides.

Properties.

- * The glucosides are usually white crystalline substances, soluble in water and having a bitter taste. They are soluble in some organic solvents, but generally insoluble in ether.

Reactions of Salicin.

- * (1) Salicin does not reduce Fehling's solution.
- * (2) Salicin solutions are hydrolysed by boiling with dilute sulphuric acid into glucose and salicylic alcohol. The solution, after neutralisation with soda, reduces Fehling's solution.

Reactions of Amygdalin.

- * (1) Solutions of amygdalin do not reduce Fehling's solution.
- * (2) Solutions of amygdalin are hydrolysed by boiling with dilute nitric acid into benzaldehyde, hydrogen cyanide and glucose. The solution smells of benzaldehyde and hydrogen cyanide. The presence of hydrogen cyanide may be shown by testing with silver nitrate; the presence of glucose by neutralising with soda and testing with Fehling's solution.

Other glucosides are known which also contain hydrogen cyanide. They are generally referred to as cyanogenetic glucosides. Their presence in leaves may be detected by chewing a small piece of the material, or better by introducing the bruised material and a drop of chloroform into a small test tube, hanging a piece of picric acid test paper¹ in it and closing it with a cork. Hydrogen cyanide is slowly evolved and it colours the test paper orange red.

¹ This is prepared by dipping strips of filter paper into a 1 per cent. solution of picric acid, drying them, wetting them with a 10 per cent. solution of sodium carbonate and again drying.

ESTIMATION OF CARBOHYDRATES.

The methods of estimating carbohydrates depend ultimately on the methods of estimating glucose. Though at first sight the estimation of glucose may appear as a comparatively easy task, yet on examination of the literature few subjects seem to have been more worked at than this simple problem. Over thirty methods have been devised by the most distinguished chemists and new ones are continually being described and advocated.

Three of the properties of glucose (and other carbohydrates) are most usually made use of for its estimation :—

A. Its optical activity, by means of the polarimeter.

B. Its aldehyde character, by the reduction of metallic salts, especially copper.

C. Its fermentation, by yeast.

Each of these methods has its own particular advantages, which depend mainly upon its convenience, ease of manipulation, rapidity of completion, and desired accuracy.

A. ESTIMATION BY MEANS OF THE POLARIMETER.

1. The Construction of a Polarimeter.

In an ordinary ray of light the vibrations of the waves take place in all planes perpendicular to the direction of its propagation. If such a ray of light be passed through a crystal of Iceland- or calc-spar and an object be observed through the crystal, two images will be seen. The ray of light has been split into two rays, one of which has been more refracted than the other. The more refracted, or ordinary, ray travels through the crystal just as it would travel through glass and obeys the laws of refraction. The less refracted, or extraordinary, ray does not obey the ordinary laws of refraction, and it shows a movable image when the crystal is rotated. Both of these rays in their passage through the crystal have been polarised in two directions at right

angles to each other : i.e. the vibrations of each ray which are transmitted are now only in one plane.

By employing a rhombohedron of Iceland-spar, cutting it across through its obtuse angles, polishing the cut surfaces, cementing together these cut surfaces with Canada balsam, and blackening the longer sides, a prism is obtained. On passing light through this prism, the ordinary ray is totally reflected by the cut surfaces and absorbed by the blackened side, whilst the extraordinary ray passes through and emerges in a direction parallel to the source of the light. Such a prism is termed, after its discoverer, a Nicol prism.

In a polarimeter two Nicol prisms, mounted in line with one another, are employed. The first is fixed, the second is capable of being rotated. Light is passed through the first prism (the polariser) and reaches the second prism (the analyser). If this second prism be exactly parallel to the first, the beam of light will also pass through it; if it be not exactly parallel but inclined at an angle, less light will pass through it; if the second prism be at right angles to the first, or crossed, the light is entirely cut off.

By interposing between the prisms, set parallel to one another, a solution of an optically active substance, the amount of the light is diminished, but it can be brought to its original intensity by rotating the analysing prism. The amount of rotation necessary to effect this corresponds with the power of rotation of the solution. As the analysing prism is mounted on a graduated circle, the number of degrees rotated can be measured. This is the rotatory power of the solution.

The determination of equal illumination of light in such an instrument before and after its passage through an optically active solution is very difficult and the readings are erroneous. Several devices have been adopted to overcome this difficulty, the simplest being that of Laurent. Laurent placed behind the polariser a quartz plate of special thickness and of such a size that it covered half the field. This quartz plate divides the ray of light passing through it into two rays, one of which is retarded by half a wave length and therefore reversed in direction, whilst the other is unaffected. The resultant ray formed on emergence by their fusion will be vibrating in a plane at an angle to the original plane, i.e. the polarised light passing through the quartz plate is rotated through a certain angle. Thus, if AO be the original plane before passage through the quartz plate, it is resolved into AC and AD. Supposing AD is retarded and reversed, then the components AC and

AD^1 will form the resultant plane AR. The angle $CAO = \text{angle } CAR$.

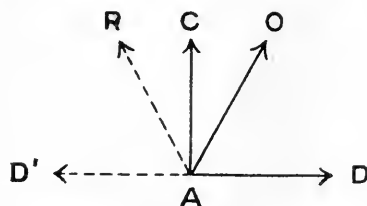

Two beams of polarised light at an angle to one another will therefore reach the analyser. If the analyser be set parallel to the beam AO arriving from the uncovered portion, this half of the field will appear light and the other half will appear dark. If it be set parallel to the beam AR coming from the covered portion, this half of the field will appear light and the other half dark. By adjusting the analyser a position will be found where the two halves will appear equally illuminated. This position is the zero point.

The two halves of the field are illuminated by component portions of the two beams. At the zero point the two prisms are almost in a crossed position. The instrument is most sensitive under these conditions, but the amount of light is at a minimum.

In other polarimeters, such as Lippich's, a prism which has the same effect as a quartz plate is placed in the centre of the field. The centre and sides of the field appear dark or light.

In determinations with such polarimeters monochromatic light must be used; for convenience, sodium light is generally used, and in this case a cell containing potassium bichromate is introduced in front of the polariser to cut off blue rays; green light from a mercury lamp is sometimes used.

A polarimeter (Figs. 42, 43) will thus consist of a bichromate cell, a polarising prism, a quartz plate over half the field, a trough to take the solution to be examined, an analysing prism mounted in a movable

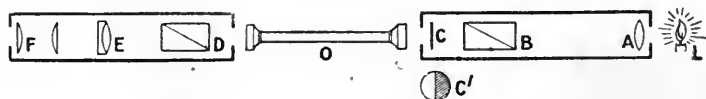
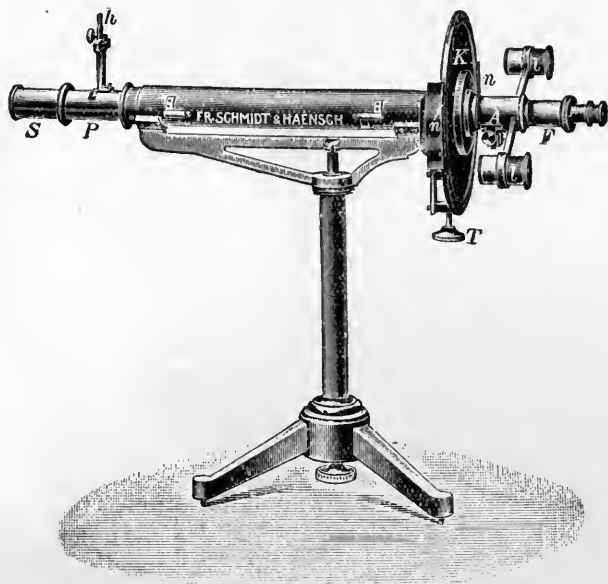

FIG. 42.

L = source of light. A = lens to render rays of light parallel. B = polarising prism. C, C' = quartz plate. O = observation tube. D = analysing prism. E, F = telescope. (From Findlay's "Practical Physical Chemistry".)

circle graduated in degrees. There is, in addition, a telescope to focus the edge of the quartz plate and a double vernier on each side of the circle in which the analyser is mounted. This vernier is fixed and graduated in fractions of a degree, or in minutes.



F G. 43.

At S, lens and bichromate cell. At P, polarising prism. At *h*, lever to rotate polarising prism. At A, analysing prism which can be rotated by a screw. At F, telescope with eye-piece. K = graduated scale. *n, n'* = fixed verniers. T = screw for rotating graduated scale. *l* = magnifying lens to read scale and verniers.

2. The Observation Tube.

The solution of the substance is placed in a special observation tube (Fig. 44). These tubes are generally 0.5, 1, 2, 2.2 decimetres long; they are made of glass of the exact length; the ends are closed by cover glasses held in place by a screw cap and rubber washer. Very small tubes for use with small amounts of solution are also made.

These tubes are thoroughly dried by pushing a plug of filter paper through them, or thoroughly washed by rinsing several times with the

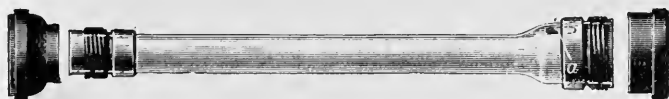

FIG. 44.

solution under examination. The cover glasses must be dry and without serious scratches. One end of the tube is closed by a cover glass, brass cap and washer, and the solution is filtered into it at the other end until a meniscus just projects above the opening. A short time is given to allow air-bubbles to rise. The other cover glass is slid horizontally over the end of the tube so that it pushes off the excess of liquid and exactly covers the end leaving no air-bubbles

underneath it and no liquid on its upper surface. The brass cap and washer is then screwed down over it. The brass caps must not press too tightly on the glass covers.

3. Reading the Polarimeter.

At the point of equal illumination of the two halves of the field the zero of the circular scale coincides, or very nearly coincides, with the zero of the vernier. The exact position must be determined. When an optically active substance is placed between the prisms and equal illumination of the two fields restored, the circular scale will have moved in a clockwise direction (= dextrorotation), or in a counter clockwise direction (= laevorotation), from the vernier. The distance apart of the two zeros measured on the circular scale gives the amount of rotation in degrees; the fraction, or minutes, more is given by the vernier scale.

Several observations of the zero point of the instrument and then several of the solution must always be made. The mean of each is taken and the difference gives the rotation.

4. Estimation.

As the rotatory powers of all the common optically active compounds have now been determined, use can be made of these values to determine the strength of an unknown solution. These values are expressed as specific rotatory power, i.e. the rotation of 1 gm. of substance in 1 c.c. of liquid examined in a layer 1 decimetre (10 cm.) long, i.e. it is the rotatory power of a 100 per cent. solution. This has not actually been carried out, but it has been calculated from the rotations of exactly known strengths of solution. The symbol $[\alpha]_D$ is used to express this value, the D standing for sodium light. The rotation varies with the temperature of the solution and is also recorded; this reading is included in the symbol, thus $[\alpha]_D^{20}$. Rotations are generally measured at 20°, but may be taken at other temperatures.

The following are the values for the principal sugars in solutions containing about 10 per cent:—

Mannose = + 14.2°	Lactose = + 52.5°	Glycogen = + 196.6°
Glucose = + 52.7°	Maltose = + 138°	Dextrin = + 195°
Fructose = - 93°	Sucrose = + 66.5°	Starch = + 199°
Galactose = + 83°	Raffinose = + 104°	

The strength of the solution is then given by the formula:—

$$[\alpha]_D = \pm \frac{\alpha \times 100}{c \times l}$$

in which $[\alpha]_D$ = specific rotation.

α = observed rotation.

c = concentration.

l = length of tube in decimetres.

B. ESTIMATION BY REDUCTION OF COPPER SALTS.

This method of estimating glucose is the one most frequently used and is the one which is the most varied in manipulation. The variations may be divided into the following groups:—

I. Complete reduction of cupric to cuprous salt.

Methods of Fehling-Soxhlet ; Pavy ; Gerrard ; Benedict.

II. Incomplete reduction of cupric to cuprous salt.

(a) Gravimetric by the estimation of the precipitated cuprous oxide.

Methods of Maercher ; Allihn ; Kjeldahl ; Brown, Morris and Millar ; Pflüger.

(b) Volumetric.

(i) Direct—by the estimation of the precipitated cuprous oxide.

Methods of Mohr-Bertrand ; Caven and Hill ; Sidersky ; Bang's second method.

(ii) Indirect—by the estimation of the residual cupric salt.

Methods of Lehmann-Maquenne ; Bang's first method.

* (i) **Fehling-Soxhlet Method.**

Barreswil in 1844 was the first to use this property as a means of estimating glucose, his reagent consisting of an alkaline solution of neutral potassium tartrate and copper sulphate. Fehling, in 1849 and 1858, established this reduction process of estimating glucose by showing that the ratio of glucose to cupric oxide was 1 : 5. He used Rochelle salt, as suggested by Bödeker, in place of neutral potassium tartrate. It was found later that the ratio of 1 : 5 was not exact and that it varied with the concentration, alkalinity and time of boiling. These difficulties were overcome in 1880 by Soxhlet, who showed that accurate results could be obtained if (1) the copper solution had always the same concentration and (2) the sugar solution under examination had a concentration of about 1 per cent. Soxhlet, following suggestions by Krause and Staedeler and by Graeger, employed two solutions, which were mixed in equal volumes immediately before use. Such solutions were found to keep well, whereas, if mixed, the titer changed and the solution reduced itself on boiling.

The method as described by Fehling with Soxhlet's modifications is the simplest and the one most commonly used at the present time for a rapid and very fairly accurate estimation of glucose.

It is as follows:—

(a) Preliminary Rough Estimation.

10 c.c. of Fehling's solution (i.e. 5 c.c. of each) are measured out with a pipette into a porcelain basin or small flask, diluted with about 40 c.c. of water and raised to the boiling-point.

The sugar solution is run in from a burette, 1 c.c. at a time, whilst the Fehling's solution is kept gently boiling the whole time.

The reduction must be allowed to complete itself before adding a fresh quantity of the sugar solution.

It is noted when the blue colour of the solution has entirely disappeared. The solution may become slightly yellow, due to the action of the alkali of the Fehling's solution upon excess of the sugar solution.

An idea of how much sugar is present in the solution is thus obtained.

(b) Dilution or Concentration of the Sugar Solution.

Since the method is only accurate if the concentration of the sugar is between 0.5 and 1 per cent., the sugar solution must be diluted or concentrated.

It is best to have as nearly as possible 10 c.c. of the diluted or concentrated sugar solution = 10 c.c. of Fehling's solution. If less than 10 c.c. of the glucose solution have been used, a known volume of the solution is diluted; if more, a known volume is concentrated to a smaller volume, e.g. 100 c.c. to 30 c.c.

Suppose 3 c.c. of the sugar solution were sufficient; then 3 c.c. should be diluted to 10 c.c.

It is more convenient to dilute a larger quantity: 30 c.c. are measured out with a pipette into a 100 c.c. measuring flask, the flask is filled to the mark with water and the contents are mixed: or 30 c.c. are measured into a dry flask and 70 c.c. of water are added with a clean pipette.

The burette is carefully rinsed out with the diluted sugar solution and the final titration carried out.

(c) **Final Titration.**

10 c.c. of Fehling's solution are diluted as before and the diluted glucose solution carefully added to the boiling liquid. It is advisable to run in at once a little less than the amount required to decolorise the solution entirely (say 8 c.c.), and then to add cautiously 0.1 to 0.2 c.c. at a time until there is complete decolorisation, always allowing time for the reduction to occur. This final titration should be repeated running in practically all the glucose solution necessary at one time, and then completing with 0.1 c.c. at a time. Suppose 10.1 c.c. were insufficient, but 10.3 c.c. too much, as seen by a faint yellow coloration of the solution, then 10.2 c.c. is the proper value.

Soxhlet carried out altogether 5 or 6 titrations, adding more or less than the exact amount of glucose solution at once, and thus determined the limits of too much and too little until they approached one another and differed by only 0.1 c.c.

(d) **The Determination of the End Point.**

The great difficulty of the estimation is the determination of the end point, i.e. when the blue colour is completely discharged. The eye by itself is not very sensitive, but the first trace of yellow in the solution can generally be seen. When the sugar solution is added 0.1 c.c. at a time, this amount, or 0.2 c.c., can be deducted, depending on the observer's judgment.

Lavalle has suggested that the dilution of the Fehling's solution be done with caustic soda solution instead of with water. The cuprous oxide either settles better or stays in solution, depending on the amount used; but the result is not so accurate in the presence of excess of caustic soda.

(e) **Use of Indicators.**

(1) *Potassium Ferrocyanide.*

Both Fehling and Soxhlet used indicators to determine the end point. A small quantity of the solution is removed and filtered if necessary, or a drop may be taken and tested by adding some acetic acid to acidify it and potassium ferrocyanide. A brown coloration or precipitate of copper ferrocyanide shows that copper is still present in the solution. No colour is formed when the reduction is complete.

In the case of the estimation of glucose in urine the indicator cannot be used, since the ammonia which is formed dissolves some of the cuprous oxide and a colour is given with the ferrocyanide.

(2) *Starch and Potassium Iodide.*

This indicator was suggested in 1903 by Harrison (see p. 614). Its use depends upon the liberation of iodine by cupric salts and it will show the presence of copper sulphate in a dilution of 1 in 20,000.

A drop of the titration solution is added to 1 c.c. of the indicator acidified with 10 drops of acetic acid. A red or blue colour is shown if cupric salt be present; no colour is given when reduction is complete.

(3) *Ferrous Thiocyanate.*

A more suitable and convenient indicator and one easy to prepare is that described by Ling and Rendle in 1905 (see p. 614). It consists of an acid solution of ammonium thiocyanate and ferrous ammonium sulphate. On treatment with a cupric salt, the ferrous salt is oxidised to ferric which reacts with the thiocyanate giving the bright-red ferric thiocyanate.

This indicator is recommended in making the sugar estimations in malting processes.

In practice, the titration is carried out in a small flask in preference to a basin, and on nearing the end point at which the blue colour is discharged drops are taken out and placed against one of a series of drops of indicator upon a glass plate on a white surface. The reduction of the Fehling's solution is complete when a red coloration is no longer produced.

(4) *Reduced Phenolphthalein.*

Carletti suggested this indicator in 1913 (see p. 614).

If cupric salt be still present in the titration solution when a drop is added to a drop of the reagent + 2-3 drops of 10 per cent. potassium cyanide solution, a red colour is produced.

(f) **Calculation of the Result.**

Knowing the dilution, the amount of sugar in the original solution can be calculated.

$$10 \text{ c.c. Fehling's solution} = 0.05 \text{ gm. glucose,}$$

$$\therefore 10.2 \text{ c.c. diluted sugar solution} = 0.05 \text{ gm. glucose.}$$

$$\text{Now } 100 \text{ c.c. diluted sugar solution contain } 30 \text{ c.c. original sugar solution,}$$

$$\therefore 10.2 \text{ c.c. diluted sugar solution contain } \frac{30 \times 10.2}{100} \text{ c.c. original sugar solution,}$$

$$\therefore \frac{30 \times 10.2}{100} \text{ c.c. original solution} = 0.05 \text{ gm. glucose,}$$

$$\therefore 100 \text{ c.c. original sugar solution} = \frac{100 \times 100 \times .05}{30 \times 10.2}$$

$$= 1.6 \text{ per cent.}$$

The values of Fehling's solution for other monosaccharides are almost the same as glucose, thus 10 c.c. = .05 gm. glucose = .0511 gm. galactose = .05144 gm. fructose = .0431 gm. mannose.

* (ii) **Pavy's Method.**

Owing to the difficulty experienced in determining the end point in Fehling's method, especially in the case of the estimation of glucose in liquids, such as urine, owing to the formation of ammonia, which prevents the precipitation of cuprous oxide (cf. p. 191), the use of ammonium salts was introduced by Monier. A practical method for estimating glucose was worked out by Pavy.

Procedure.

50 c.c. of Pavy's solution (see p. 615) are measured with a burette into a 200 c.c. conical flask. The flask is closed by a cork with two holes; through one of these the end of the burette containing the sugar solution is passed and through the other an escape tube to carry off steam and ammonia. To prevent the ammonia fumes coming into the air, Pavy fitted to the escape tube a U-tube containing pumice and sulphuric acid, but it is most convenient to fit a valve as described by Allen. This consists of a short length of rubber tubing closed at its end by a piece of glass rod and cut near the end with a V-shaped slit. This arrangement is preferable to the valve described in 1904 by Kumagawa and Suto. The end of the valve is placed in a dilute solution of sulphuric acid, which is renewed when the acid is neutralised.

The solution is boiled to drive out the air, which readily oxidises ammoniacal cuprous solutions, and the sugar solution (0.5 to 1 c.c. at a time) is gradually run in until the blue colour is discharged, the solution being kept boiling throughout to exclude air. Sufficient time must be allowed for the reduction to take place, as it is slower than with Fehling's solution. The valve prevents any liquid being sucked back, if the sugar solution be run in so quickly that boiling is stopped.

Just as in Fehling's method, the sugar solution must be of such a strength that 10 c.c. = 50 c.c. of Pavy's solution. The titration must be carried out rapidly and must be completed *within three minutes*, otherwise the ammonia is all evolved before the titration is completed and cuprous oxide is deposited. The boiling must not be interrupted and the sugar solution must be run in at such a rate that the solution is kept boiling the whole time. The final estimation should be made by running in rather less (.5 c.c.) than the amount required and finishing off more slowly. The minimal amount which is found to reduce the Pavy's solution completely, when added at one time, is the exact volume of the solution required.

The amount of sugar in the solution is calculated from

$$10 \text{ c.c. Pavy's solution} = 0.005 \text{ gm. glucose.}$$

The method has been compared against other methods by Kinoshita who finds it very accurate.

(iii) **Gerrard's Method.**

In 1892 Gerrard found that potassium cyanide was an effective agent for dissolving cuprous oxide and prevented its precipitation from Fehling's solution when reduced by glucose. This observation led to a simple method for estimating glucose. It was improved by Allen and described by him as the best method. The method has an advantage over Pavy's method in the absence of the ammonia vapour and in that the reoxidation of the cuprous oxide is slower.

On adding potassium cyanide to Fehling's solution it is decolorised, the colourless double salt of copper and potassium cyanide being formed :—

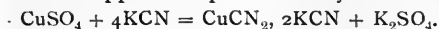

If excess of Fehling's solution above that capable of being decolorised be added the blue colour remains, and when boiled with glucose this amount is reduced without the precipitation of cuprous oxide.

Allen described the following procedure :—

10 c.c. of Fehling's solution are diluted with 40 c.c. of water and heated to boiling in a porcelain basin. An approximately 5 per cent. solution of potassium cyanide is run into the boiling liquid from a burette until it is just decolorised, excess being carefully avoided. Another 10 c.c. of Fehling's solution are added and the sugar solution of about 0.5 per cent. strength run in slowly until the blue colour vanishes. Only the last portion of the Fehling solution is reduced by the glucose so that as in Fehling's method 10 c.c. = 0.05 gm. glucose.

* (iv) **S. G. Benedict's Method.**

In 1907 S. G. Benedict introduced yet another method for the direct volumetric estimation of glucose on account of the difficulties and inconveniences of the other methods. In 1910 he published improvements in his method and it seems as if this will be the one most generally used.

If potassium thiocyanate be added to Fehling's solution, the cuprous oxide is not precipitated on reduction, but if carbonate be used instead of caustic alkali, a white precipitate of cuprous thiocyanate is formed. The method depends upon the precipitation of the reduced copper as cuprous thiocyanate and decolorisation of the solution.

Procedure.

25 c.c. of the reagent (see p. 613) are measured with a pipette into a porcelain basin, 25-30 cm. in diameter; 10-20 gm. of cryst. sodium carbonate (or 5-10 gm. anhydrous sodium carbonate) and a small quantity of pumice, or a piece of porous earthenware, are added. The solution is boiled vigorously over a free flame and the sugar solution is run in rapidly till a heavy white precipitate is produced and the blue colour begins perceptibly to diminish. The sugar solution is then run in more slowly with constant vigorous boiling of the reagent until the blue colour has entirely disappeared. An interval of 30 seconds between the additions of sugar solution (drop by drop) towards the end should be given, and water may be added to replace that lost by evaporation. The sugar solution should be of 0.5-1 per cent. as in Fehling's method.

The calculation of the result is from

$$25 \text{ c.c. reagent} = 0.05 \text{ gm. glucose or } 0.53 \text{ gm. fructose.}$$

II. (a) The Gravimetric Estimation.

No attempt seems to have been made to estimate sugars by determining the weight of cuprous oxide precipitated until 1878 when experiments were made by Maercker, who found that accurate results were obtained if the reduction were carried out under definite conditions. His procedure was to boil for 20 minutes an excess of Fehling's solution with a sugar solution of about 0.1 per cent., the total volume of the solution being kept constant; the cuprous oxide was filtered off rapidly through filter paper, washed free from alkali with boiling water and reduced in a current of hydrogen to metallic copper which was weighed. The possible errors were unreduced cuprous oxide in the filter paper and absorption of hydrogen by the reduced copper.

Allihn repeated these experiments in 1880; instead of filter paper he used an asbestos pad in a glass tube, which was designed by Soxhlet, and boiled the Fehling solution for 2 minutes. The accuracy of Maercker's results was confirmed and the method has since been known as Allihn's method. Salomon in 1881 again stated that the method was accurate if the solution contained about 0.1 per cent. of sugar. Kjeldahl in 1895 studied the method and stated that the main error was introduced by reoxidation on the surface of the liquid during the boiling rather than by reoxidation during filtration. He recommended passing a current of hydrogen or coal gas through the liquid during the period in which it was heated.

H. T. Brown, Morris and Millar published in 1897 the results of a very extended study of the methods of estimating sugars in which they pointed out that the chief considerations to be attended to were: (1) the use of Fehling's solution of constant composition, (2) the maintenance of the same degree of dilution in all experiments, (3) the precipitation of an amount of copper which shall fall between certain limits, and (4) an invariable method of determination, both as regards mode and time of heating.

Their process is carried out as follows:—

50 c.c. of freshly mixed Fehling's solution are placed in a beaker of about 250 c.c. capacity and having a diameter of 7.5 cm. This is placed in a boiling water-bath; when the solution has attained the temperature of the boiling water, an accurately weighed or measured volume of the sugar solution is added and the volume made up to 100 c.c. with boiling distilled water. The beaker is covered with a clock glass and the heating continued for exactly 12 minutes. The precipitated cuprous oxide is rapidly filtered through a Soxhlet tube with asbestos pad, washed first by decantation with hot water, then with water, alcohol and ether, and finally dried. The dry cuprous oxide is reduced to metallic copper by gentle heating in a stream of hydrogen and weighed; or it is oxidised by heating to cupric oxide and weighed.

A correction must be made for the reduction which takes place when the Fehling's solution is heated alone. The amount of sugar corresponding to the copper is given in the table on p. 605.

These figures were confirmed by Davis and Daish in 1913 who also drew attention to other particulars. (a) The asbestos used in filtering. This should be treated for 30 minutes with boiling 20 per cent. sodium hydroxide and washed thoroughly with water. (b) The filtering through a Gooch crucible instead of a Soxhlet tube. (c) The oxidation of the cuprous oxide to cupric oxide by heating the crucible in a protecting crucible for 30 minutes with a $\frac{1}{2}$ inch Teclu burner until the weight is constant. The conversion into cupric oxide seems particularly favourable, if sugar estimations in plant extracts be required.

Pflüger has also examined the gravimetric estimation of glucose and has found that the principal error in Allihn's procedure is the time of boiling;

2 minutes were insufficient, whereas 30 minutes sufficed if the heating were carried out in a boiling water-bath and not over a flame. He has also shown that the estimation was equally accurate when the precipitate was weighed as cuprous oxide, cupric oxide or metallic copper. He considered that the estimation as cuprous oxide was the most accurate for the estimation of small quantities of glucose.

Pflüger has published a table of the corresponding quantities of cuprous oxide and glucose.¹

The corresponding quantity of glucose can be obtained from the table on p. 603, if the amount of Cu_2O be multiplied by $\cdot 8883$ or $1\cdot 1117$ respectively to give the corresponding amount of Cu or CuO .

Davis and Daish's preference for the estimation as cupric oxide in the case of plant extracts is probably to be accounted for by incomplete removal of other compounds carried down with the cuprous oxide and removed by heating.

II. (b) Volumetric Estimation of the Precipitated Cuprous Oxide.

(i) *Mohr-Bertrand Method.*

The volumetric estimation of the cuprous oxide formed by the reduction of alkaline cupric sulphate solution seems to have been first carried out in 1873 by Mohr, who based his process upon one of Schwarz's methods (1852), namely that of dissolving the cuprous oxide in an acid solution of ferric chloride and estimating the amount of ferrous chloride so formed. Mohr dissolved the cuprous oxide in an acid solution of ferric sulphate and titrated the ferrous salt with permanganate.

This process has been recommended by several workers, amongst whom may be mentioned Sonntag, Wood and Berry, and Bertrand. The last author has made very thorough experiments with this method and has published tables giving the amounts of glucose, lactose and maltose corresponding to the amount of reduced copper. The method is now generally referred to as Bertrand's method. The solutions required are given on p. 613.

Procedure.

20 c.c. of the sugar solution, which should contain about $\cdot 1$ per cent. and preferably a little less, are placed in a conical flask of 125-150 c.c. capacity; 20 c.c. of the copper solution A and 20 c.c. of the alkaline solution B are added, and the mixture heated to boiling over a flame and kept gently boiling for exactly 3 minutes. If a smaller volume of sugar solution be used, water is added so that the total volume is 60 c.c. The flask is removed from

¹ Pflüger's Archiv, 1903, 96, 105.

the flame and allowed to stand for about $\frac{1}{2}$ minute so that the cuprous oxide settles.

The liquid is filtered by suction through an asbestos filter of a special pattern. It is a glass tube about 14 cm. long constricted near the centre; the upper portion is about 6 cm. long and 17 mm. wide; the lower portion about 8 cm. long with a conical bulb just below the upper portion. The upper part contains the asbestos—coarse fibres being put near the constriction, less coarse particles above, and at the top very fine particles. The whole thickness of asbestos is about 1 cm., the upper portion being from 1-2 mm. thick. A filter flask of about 150 c.c. capacity is usually taken to receive the liquid.

In filtering, as little as possible of the cuprous oxide is allowed to come upon the filter so as to prevent the formation of a compact mass, which subsequently dissolves with difficulty. The cuprous oxide is washed with a little hot water, allowed to settle, and the water poured off through the filter. It is not necessary to wash the precipitate absolutely free from alkali and Rochelle salt, but this is advisable. The cuprous oxide in the flask is treated with 5, 10, or 20 c.c. of the ferric sulphate solution; it dissolves giving a green solution. This is poured upon the filter; the particles of cuprous oxide dissolve more quickly if the top layer be stirred up with a glass rod. The liquid is received in the filter flask which has been rinsed out, or more conveniently in another clean filter flask. A few more drops of the ferric solution may be used if necessary. The conical flask is washed out with water and the washings passed through the filter.

The solution is titrated with the permanganate solution, the colour change from green to rose with 1 drop excess of permanganate being noted; another drop usually shows an intense rose colour. The duration of the operation is 15-20 minutes.

After repeated use the upper layer of asbestos becomes dark in colour; it is removed, dried and calcined, and returned to its position.

Calculation of the Results.

The result is calculated from the equations:—

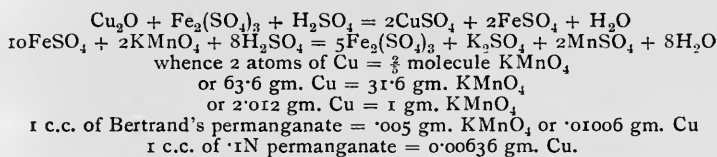

The standardisation of the permanganate against ammonium oxalate $\text{C}_2\text{H}_2\text{O}_4$, $2\text{NH}_3 + \text{H}_2\text{O}$ is carried out by Bertrand by dissolving .250 gm. in about 50-100 c.c. water, adding 1-2 c.c. of sulphuric acid, heating to 60-80° and titrating with the permanganate, of which about 22 c.c. will be required.

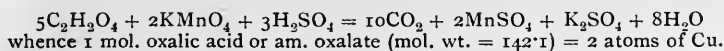

The weight of oxalate multiplied by $\frac{63.6 \times 2}{142.1}$ or 0.895 gives the amount of copper corresponding to the number of c.c. of permanganate used, from which the value for 1 c.c. permanganate can be calculated.

The values for glucose are given in a table compiled by Bertrand (see p. 606).

Bang's Second Method.

Bang¹ has found that if the reduction of cupric sulphate be carried out in the presence of thiocyanate or chloride in carbonate solution, cuprous thiocyanate or cuprous chloride is formed and is not precipitated, i.e. that in the presence of excess of potassium thiocyanate or chloride the reversible reaction

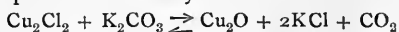

proceeds only in the right-hand direction. A cupric solution reduced by glucose will contain cuprous chloride. Bang estimates the reduced copper salt by titration in alkaline carbonate solution with standard iodine solution:—

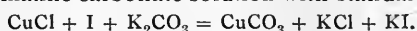

The solution which becomes colourless in the reduction again becomes blue on oxidation, but if small amounts are used the colour is pale blue, and when the iodine titration is carried out using starch as indicator, the deep blue colour formed indicating excess of iodine is easily seen.

The preparation of the reagents is given on p. 613.

Procedure.

Owing to the ready oxidation special precautions have to be taken during the reduction by the glucose and the titration with the iodine solution: 0.1 or 0.2 c.c. (or more) of the glucose solution are put into a 100 c.c. Jena glass flask with a straight neck and no rim, and 55 c.c. of the alkaline copper solution are added.

The flask is fitted with a rubber tube 4.5 cm. long and 3 mm. thick, leaving about 2 cm. projecting, and boiled for 3 minutes. Just before the expiration of this time a spring clip² is put over the rubber and closed at the end of the time of boiling. The flask is rapidly cooled under running water. The clip is removed and the titration effected with .1N, or .01N, or .04N iodine,³ after adding 0.5-1 c.c. of the starch solution.⁴ During the titration the flask is only shaken gently to prevent access of air, but it is advisable and preferable to pass into it a current of carbon dioxide by means of a bent tube which can be fastened by a band to the flask. The amount of iodine solution is proportional to the amount of glucose present.

The number of c.c. used divided by 2.70 gives the amount of glucose in gm.⁵

0.4 c.c. should be deducted; this amount is generally absorbed by the alkaline copper solution.

The factor for .1N iodine solution is .285, for .04N iodine solution 0.7 (.28 × 2.5).

¹ Biochem. Zs., 1913, 49, 1.

² A special clip is made by Mekaniker Hill, Lund, Denmark.

³ The latter are prepared by diluting a .1N solution with boiled out water and can be kept for three months in the dark without undergoing alteration.

The .01N solution is conveniently prepared from iodide and iodate:—

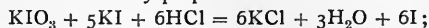

an equivalent quantity of iodine to hydrogen chloride is formed. It is made by pouring 1 c.c. of 2 per cent. potassium iodate solution into a 100 c.c. measuring flask, adding 2 to 2.5 gm. of potassium iodide and 10 c.c. of .1N hydrochloric acid and filling up to the mark with boiled out water.

⁴ 1 per cent. solution of soluble starch in saturated potassium chloride solution. It keeps indefinitely.

⁵ 26.5 c.c. .01N iodine solution = 10 mg. glucose;
or 2.67 c.c. " " " = 1 mg. " "

Caven and Hill's Method.

Caven and Hill in 1897 and 1898 suggested that the cuprous oxide should be dissolved in an acid solution of permanganate (1 part H_2SO_4 , 3 parts H_2O and .2N $KMnO_4$ standardised against oxalic acid) and the titration of the permanganate used in the oxidation with oxalic acid. In the actual process it was preferred to add excess of oxalic acid and to titrate back with permanganate.

The amount of cuprous oxide was obtained by multiplying the oxygen value of the permanganate by 8.91 $\left(\frac{Cu_2O}{O}\right)$ and the glucose by using the factor .5045.

Sidersky's Method.

This method has been used by sugar experts chiefly in France. The cuprous oxide is dissolved in excess of standard sulphuric acid and the excess determined by titrating with .5N ammonia. It is carried out as follows:—

The cuprous oxide is filtered off and washed free from alkali. It is dissolved in 25 c.c. N sulphuric acid, a few crystals of potassium chlorate being added and the reagent heated till solution is effected. An equivalent quantity of standard ammonia is added; a blue colour is obtained and N sulphuric acid is run in till the colour is of a permanent greenish tint. The copper sulphate is thus the indicator.

The amount of glucose is calculated as follows:—

$$1 \text{ c.c. N } H_2SO_4 = .0318 \text{ gm. copper.}$$

The amount of invert sugar is given by multiplying by .3546.

II. (b) (ii) Estimation of Residual Cupric Salt.

Numerous suggestions have been put forward for estimating the excess of copper sulphate which is not converted into cuprous oxide by reduction by glucose: thus

- (1) Weill and also Pellet suggested its titration with zinc chloride.
- (2) Maumené suggested its titration with sodium sulphide.
- (3) Lehmann in 1897, Riegler in 1898, Maquenne in 1899, and Schoorl in 1899 suggested its titration with potassium iodide and thiosulphate.
- (4) Volhard suggested its reduction with sulphur dioxide and precipitation as cuprous thiocyanate with excess of ammonium thiocyanate, and the estimation of the thiocyanate with silver solution.
- (5) Bang suggested its titration with hydroxylamine.

Of these methods that of Lehmann or Maquenne and of Bang are the simplest and are frequently used.

The Lehmann-Maquetenne Method.

The principle of this method depends upon the liberation of iodine on adding potassium iodide to copper sulphate, and the estimation of the iodine by means of sodium thiosulphate :—

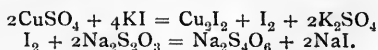

Lehmann's procedure was to make up the Fehling solution to a definite volume after its reduction by glucose, and to take out an aliquot part for the titration after the cuprous oxide had settled. Riegler filtered off the cuprous oxide and titrated the filtrate and washings. Maquetenne and Schoorl titrate the cupric salt without removing the cuprous oxide.

The conditions for the reduction of Fehling's solution by glucose and by lactose have been standardised by Peters (1912) and by Cole,¹ who described also a simple asbestos filter made out of a calcium chloride tube and a simple way of boiling the Fehling solution for exactly 2 minutes.

The procedure of Maquetenne is the following :—

10 c.c. of each of the two Fehling's solutions are measured into a 250 c.c. conical flask and 10-40 c.c. of the sugar solution² are added; the total volume of the solution for the reduction must be 60 c.c. and water is added if necessary. The solution is boiled for exactly 2 minutes, and cooled under running water. 20 c.c. of 20 per cent. potassium iodide and 20 c.c. of 25 per cent. sulphuric acid are added and the solution is titrated with 1N thiosulphate solution (24·83 gm. per litre), using 1 c.c. of 1 per cent. starch solution as indicator.

A blank determination of Fehling's solution gives the amount of thiosulphate solution (27·8 c.c.) required for 20 c.c. of Fehling's solution and from this figure is deducted the number of c.c. required in the titration.

The following table gives the corresponding amounts of glucose :—

Thiosulphate. c.c.	Glucose. mg.	Thiosulphate. c.c.	Glucose. mg.	Thiosulphate. c.c.	Glucose. mg.
1	3·1	11	35·7	21	70·7
2	6·2	12	39·1	22	74·5
3	9·3	13	42·5	23	78·5
4	12·5	14	45·9	24	82·5
5	15·7	15	49·3	25	86·5
6	19·0	16	52·8	26	90·6
7	22·3	17	56·3	27	94·8
8	25·6	18	59·8	28	97·9
9	28·9	19	63·3	29	100·0
10	32·3	20	66·9	30	

Bang's First Method.

In this method the reduction of the copper solution is effected in potassium carbonate solution to which potassium thiocyanate is added. Cuprous thiocyanate is formed and remains in solution. Excess of cupric salt is estimated by hydroxylamine solution. Bang has published a card giving the reagents, the procedure, and a table of corresponding values of glucose and hydroxylamine. This method has been superseded by his other method (p. 230).

¹ Tables for converting the copper figures into glucose and lactose are given in this paper, *Biochemical Journal*, 1914, 8, 134.

² The sugar solution added must contain less than 1 gm. glucose.

C. ESTIMATION BY FERMENTATION.

Sugar is sometimes estimated by fermentation with yeast in an Einhorn fermentation tube. This is a U-shaped tube, one limb of which is closed and the other expanded into a bulb (Fig. 45).

The closed limb of these tubes is filled with the sugar solution to which some yeast has been added. Mercury is placed at the bend. The carbon dioxide evolved collects in the closed limb and drives down the solution into the other and wider limb. The narrow limb is graduated in percentages of glucose, so that the amount of sugar can be directly read off.

This fermentation method is not very accurate and is consequently not often used for estimating sugar.

Another method of estimation is by taking the specific gravity of the solution before and after fermentation.

The most accurate results by fermentation are obtained with Lohnstein's apparatus (Fig. 46).

A U-shaped tube is employed. The straight limb is left open, but the bulb is closed, after filling, with a stopper. The straight limb is narrower at the base than at the upper end, and upon the end rests a wooden scale graduated in percentages of glucose; the graduations on one side are for working at room temperature, on the other side at 37° .

A definite weight of mercury is placed in the bend; it almost fills the bulb and reaches up the narrow part of the limb to about the zero mark on the scale. Upon the surface of the mercury in the bulb is placed 0.5 c.c. of glucose solution and 1-2 drops of a suspension of yeast in water. The stopper (carefully greased) is inserted. It is perforated with a small hole which coincides with a similar hole at the neck of the bulb. With the two openings together so that air can enter or be displaced the apparatus is tilted so as to put the mercury in the limb at the zero point of the scale. The stopper is then turned to close the apparatus and it is set aside for the fermentation to proceed for 12-24 hours at room temperature or for 3-4 hours at 37° . To prevent the stopper being forced out by the pressure of the gas it is covered with a weight.

The percentage of glucose is read off on the scale when the fermentation has ended and the apparatus has returned to room temperature, if the fermentation took place at 37° . Lohnstein shows that a more accurate result is obtained if the readings are taken at 37° and 20° and if the percentage is calculated from an equation.

The apparatus should be cleansed immediately after use; the opening on the stopper is slowly made to coincide with the opening of the bulb. The mercury level takes the original position. The liquid is removed with a small pad of cotton wool, and the surface of the mercury washed with a little water, which is drained away by fresh cotton wool.



FIG. 45.



FIG. 46.

ESTIMATION OF PENTOSE.

Like the hexoses, the pentoses reduce Fehling's solution and can be estimated in the same way, if they are present in the solution alone; generally a mixture of pentose and other carbohydrates is present; under these conditions the pentose can be estimated by converting it into furfural (p. 303) by distillation with hydrochloric acid, and combining the furfural with phloroglucinol and weighing the compound.

The estimation is usually carried out in the following way:—

A quantity of material is taken which will yield an amount of phloroglucide varying from 0.3 but not exceeding 3 gm. It is distilled from a flask, which is provided with a tap funnel and connecting tube with a trap leading to a condenser, with 100 c.c. of 12 per cent. hydrochloric acid at such a rate that 30 c.c. pass over in 10 minutes. The distillate is filtered through a small filter paper as it is collected. When 30 c.c. have distilled over, 30 c.c. of dilute acid are passed through the tap funnel into the flask, and the distillation continued for another 10 minutes. This addition is continued 12 times or until about 360 c.c. of distillate have been collected.¹ To the whole distillate about double the amount of pure phloroglucinol² required dissolved in 12 per cent. hydrochloric acid is added and the mixture well stirred. The solution turns yellow, then green, and a precipitate at first green in colour, but ultimately black, separates out. The volume is made up to 400 c.c. and after standing for 12 hours the precipitate is collected on a weighed filter, washed with 150 c.c. of water, dried for 4 hours at 100°, cooled and weighed.

The amount of furfural is $(a + 0.052) \times 0.5185$

„ „ pentose is $(a + 0.052) \times 1.0075$

„ „ pentosan is $(a + 0.052) \times 0.8866$

where a is the amount of phloroglucide and 0.052 is the quantity of phloroglucide not precipitated but remaining in solution under the above conditions.

Methyl pentoses behave in the same way. The phloroglucide they produce is soluble in alcohol. The alcohol soluble portion of the precipitate is returned as methyl pentose.

Note.—Cunningham and Doré³ have shown that ω -hydroxy-methyl furfuraldehyde is formed by the action of acids upon hexoses, starch and celluloses in amounts varying from 1-2 per cent. It is slowly formed and does not interfere in the estimation of pentosans, if aniline acetate be used as indicator. It causes inaccuracies in the estimation of methyl pentosans.

Flohil⁴ showed that the furfural in the distillate could be estimated by means of Fehling's solution, either gravimetrically or by the iodometric method. Eynon and Lane⁵ thoroughly tested this method and a further improvement was introduced by Baker and Hulton.⁶ The furfural-containing distillate is not collected after it ceases to react with aniline acetate containing sufficient sodium acetate, a period of 5 minutes being given to decide upon the negative reaction. Usually all the furfural has passed over in 200-300 c.c. of distillate. 10 c.c. of distillate are titrated with 0.5N alkali. 50-75 c.c. in a 250 c.c. conical flask are neutralised with saturated sodium hydroxide, the solution being kept cold, 20 c.c. of Fehling's solution are added, the mixture diluted to 100 c.c. and heated under a reflux in a boiling water-bath for 40 minutes. The cuprous oxide is estimated gravimetrically. A blank experiment with an equivalent quantity of salt is also carried out; the amount of cuprous oxide from 2.4 mgm. is deducted.

3 mgm. Cu = 1 mgm. furfural.

¹ The completion of the distillation may be tested by means of aniline acetate; a drop of reagent and a drop of distillate are placed side by side on a piece of filter paper; if no red colour appears the distillation is complete.

² The purity of the phloroglucinol may be tested for by dissolving a small quantity in a few drops of acetic anhydride, heating almost to boiling and adding a few drops of concentrated sulphuric acid. A violet colour shows the presence of diresorcinol.

³ Biochem. J., 1914, 8, 438.

⁴ Chem. Weekblad, 1910, 7, 1057.

⁵ Analyst, 1912, 37, 41.

⁶ *Ibid.*, 1916, 41, 294.

ESTIMATION OF DISACCHARIDES.

* A. Cane Sugar.

Cane sugar is estimated by taking the reducing power of the solution after hydrolysis by acid; fructose and glucose have very nearly the same reducing power.

A known volume of the cane sugar solution (say 40 c.c.) is hydrolysed by warming on the water-bath for 5-10 minutes with 5 c.c. of dilute hydrochloric acid. The solution is cooled, neutralised with 5 c.c. of caustic soda, and made up to a definite volume in a measuring flask (say 100 c.c.), rinsing out the flask with the water necessary to make up the 100 c.c. The amount of reducing sugar is then estimated by Fehling's, Pavy's or any of the other methods previously described. The sugar solution should be of a strength so that 10 c.c. = 10 c.c. Fehling's or 50 c.c. Pavy's solution, i.e. contain about the equivalent of 5 per cent. of glucose.

The percentage of cane sugar is calculated from the equation :—

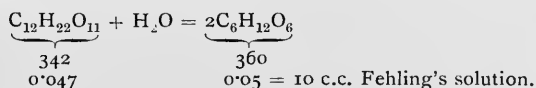

B. Lactose and Maltose.

Lactose and maltose are estimated in the same way as glucose by Fehling's or other methods, but their reducing power is less than that of glucose. Consequently, since Fehling's solution is a standard for glucose, a factor has to be employed in order to obtain the equivalent value for these disaccharides. The factor is obtained by determining the reducing power before and after hydrolysing them into monosaccharides by acid, thus :—

A definite volume of the lactose solution is taken and diluted, as previously done for glucose, with water so that 10 c.c. reduce 10 c.c. Fehling's solution (or 50 c.c. Pavy solution). The value is determined exactly.

Exactly the same quantity of the lactose solution is hydrolysed by boiling for 3-4 hours in a flask with one-tenth of its volume of dilute sulphuric acid; water must be added to replace that lost on boiling, or the hydrolysis is carried out by heating under a reflux

condenser. The solution is cooled, neutralised with soda, and made up to the same volume as the non-hydrolysed lactose solution with water as above.

It is best to make up the solutions in a measuring flask, e.g. 25 c.c. lactose solution are diluted to 100 c.c.; 25 c.c. lactose solution are hydrolysed by acid, neutralised, and washed into the 100 c.c. measuring flask.

The reducing value of the hydrolysed lactose solution is taken exactly.

The factor is $\frac{\text{reducing power of lactose in c.c.}}{\text{reducing power of hydrolysed lactose in c.c.}} = \frac{10}{7}$.

The ratio of the reducing powers of glucose : lactose : maltose are as 1 : 0.74 : 0.62.

The percentage of lactose may be calculated as follows:—

x c.c. = 10 c.c. Fehling's solution.

$\therefore x \times \frac{7.4}{10}$ c.c. = 0.05 gm. lactose.

or x c.c. = $0.05 \times \frac{10}{7.4}$ gm. lactose.

Hence 100 c.c. = $0.05 \times \frac{10}{7.4} \times \frac{100}{x}$ gm. lactose.

The weights of the disaccharides which will reduce completely 10 c.c. of Fehling's solution are:—

cane sugar 0.0475 gm.

maltose 0.0807 „

lactose 0.0678 „

ESTIMATION OF POLYSACCHARIDES.

All polysaccharides are estimated in the same way as cane sugar, i.e. by taking the reducing value of a known weight or volume of the solution after hydrolysis by acid, i.e. in terms of glucose:—

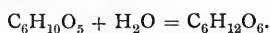

CARBOCYCLIC COMPOUNDS.

In addition to the series of aliphatic compounds, series of carbon compounds are known in which the atoms of carbon—three to nine—are linked together in a ring. Amongst them we find saturated and unsaturated compounds. They do not form such a large group as the aliphatic compounds except those which contain six atoms of carbon. These form a special group by themselves known as the aromatic and hydroaromatic compounds.

Only a few, excluding the aromatic compounds, are found in nature, the majority being synthetical products. They are termed polymethylenes or cyclo-paraffins, cyclo-olefines and cyclo-diolefines. Thus in the case of the hydrocarbons, we have :—

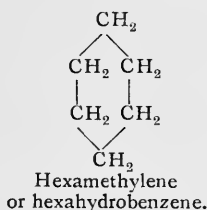
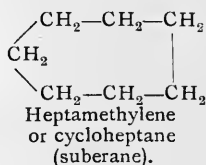
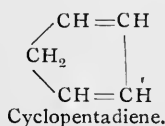
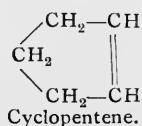
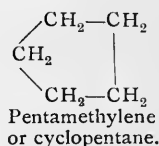
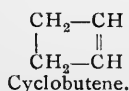
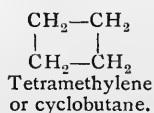
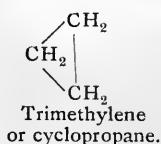

Some of these hydrocarbons, chiefly alkyl derivatives of pentamethylene and hexamethylene, are present in Galician and Russian petroleum, and are known as naphthenes. They resemble the paraffins in their properties.

If hydrogen atoms be substituted by hydroxyl groups, ketonic groups, carboxylic groups, such as in :—

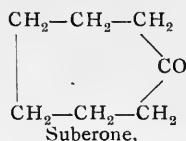

a series of compounds is formed which have the properties of aliphatic compounds into which they can be easily transformed.

AROMATIC COMPOUNDS.

Aromatic compounds are mostly contained in the fragrant and peculiar smelling oils, resins, etc., which are present in the flowers, leaves and other parts of plants and which often ooze out when the bark is broken. Though only a few aromatic compounds are actually found in animals, yet they are essential to their life. Turpentine, india-rubber, tannin, oil of lemon, oil of cloves, cinnamon and numerous plant pigments are aromatic compounds. They derive their name from their origin in these sweet-smelling natural substances.

Another great source of aromatic compounds is coal tar, which is a complex mixture, but contains benzene, the parent substance from which all the other compounds can be derived.

In some respects the aromatic resemble the fatty or aliphatic compounds, but in other respects they are totally different. They differ by having a greater carbon content and in being more resistant to oxidation, reduction, etc. The more complex substances can be oxidised and converted into simpler substances, but these simpler substances are resistant and are found to possess a stable nucleus composed of six atoms of carbon. This nucleus is not easily oxidised to compounds containing fewer carbon atoms, but on oxidation it is converted into carbon dioxide and water. The presence of a nucleus of six carbon atoms is thus a characteristic of aromatic compounds.

Another characteristic is the formation of nitro compounds and sulphonic acid derivatives by the direct action of nitric and sulphuric acids.

The Structure of Aromatic Compounds.

Our representation of the structure of the aromatic compounds is based upon the theory of Kekulé, which was published in 1865.

Benzene, C_6H_6 , is the simplest aromatic compound containing six carbon atoms. Its properties do not correspond to the properties of an unsaturated hydrocarbon, such as :—

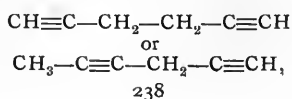

but point to the presence of six CH groups and a symmetrical arrangement of the six carbon and six hydrogen atoms in the molecule. A structure in which the six carbon atoms are united in a *closed* chain or ring and joined by alternate single and double bonds, a hydrogen atom being united to each carbon atom, satisfies the tetravalency of the carbon atom and it gives a symmetrical structure, thus :—

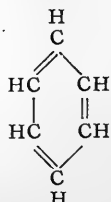

The symmetry of the molecule can be represented by a regular hexagon at each angle of which there is a CH group ; thus :—

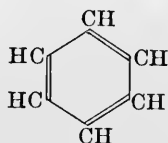

This structure represents benzene as an unsaturated compound. In some respects benzene behaves like an olefine, but not in all respects, e.g. it forms addition compounds with the halogens and with hydrogen, but not with the halogen acids and sulphuric acid, nor does it decolorise permanganate in the cold.

It explains the formation of derivatives by the substitution of hydrogen atoms by other elements or groups, and on account of its symmetry explains the formation of one monosubstitution derivative, three disubstitution derivatives, and so on.

The alternate linking of the carbon atoms by double and single bonds would point to the existence of two isomeric monosubstitution derivatives. To overcome this difficulty Kekulé assumed that there was a continual alternation between the double and single bonds, and that the double bonds are not like the double bonds in unsaturated aliphatic compounds.

The closed chain or ring structure has been accepted by all chemists, but some chemists have suggested a different figure such as a prism. This does not explain the substitution derivatives as well as the centric formula proposed by Armstrong, in which the extra bonds to make the carbon atoms tetravalent simply point to the centre of the figure, and come into play only under certain conditions, e.g. amongst the hydroaromatic compounds.

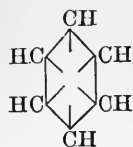

For simplification, the benzene nucleus is generally represented as a regular hexagon, at each angle of which the existence of a carbon atom and a hydrogen atom is recognised.



The substitution products are then indicated by introducing only the particular radicle or radicles. Further, the carbon atoms are generally numbered in order. The compound is 1-chloro-3-nitrobenzene.

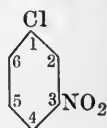

BENZENE AND ITS MONOSUBSTITUTION DERIVATIVES.

Benzene.

Benzene was discovered by Faraday in 1825 in illuminating gas prepared from oil, before the introduction of coal gas. The gases were condensed to a liquid from which benzene was isolated by distillation. Mitscherlich prepared benzene in 1834 by distilling benzoic acid with lime and in 1845 it was found in coal tar by Hofmann. Berthelot obtained benzene by passing acetylene through a red-hot tube.

Preparation.

Benzene is obtained from coal tar. Coal tar consists of a complex mixture of aromatic compounds which are acid, basic and neutral in character. It also contains unsaturated paraffins. The gases obtained by the destructive distillation of coal are passed through vertical condensers connected to a trough. The condensed liquids collect in the trough and are drawn off. A ton of coal yields from 10-20 gallons of tar.

Distillation of Coal Tar.

Coal tar is distilled in wrought-iron stills and the distillate is collected in the following fractions:—

(1) Light oil, or crude naphtha, which distils up to 150° and contains benzene, toluene, xylene. It forms 3-5 per cent.

(2) Middle oil, or carbolic oil, which distils from 150-210° and contains naphthalene and carbolic acid. It forms 8-10 per cent.

(3) Heavy oil, or creosote oil, which distils from 210-270° and forms 8-10 per cent.

(4) Anthracene oil, which distils from 270-400° and contains anthracene. It is coloured green and forms 16-20 per cent.

Pitch remains in the still.

The terms light oil, middle oil, heavy oil denote the specific gravity of the distillate with regard to water. A sample is run into water during the distillation; if it floats it is light oil, if it sinks it is heavy oil. The middle oil passes over as soon as light oil no longer distils over.

Benzene and its homologues are prepared from the light oil. The fraction is shaken with strong sulphuric acid which removes basic substances, such as aniline, pyridine, and also unsaturated hydrocarbons. It is next shaken with sodium hydroxide which removes acid substances, carbolic acid and the sulphuric acid. It is washed by shaking with water and fractionally distilled. Pure benzene is isolated from the first fraction by careful fractional distillation.

Properties.

Benzene is an oily colourless liquid with peculiar smell and boils at 80°. It solidifies on cooling and the crystals melt at 5.4°. Its specific gravity is .874 at 20°. It is inflammable and burns with a smoky and luminous flame. It is insoluble in water, but mixes with alcohol and ether. Benzene is a good solvent for resins, fats, etc., and is frequently used for extraction. It dissolves iodine, phosphorus, sulphur, etc.

Benzene is called benzole commercially, the terminal *e* being added to show that it does not possess a hydroxyl (OH) group; the suffix *ol*, as previously mentioned, is used to designate alcohols.

Chlorobenzene, C_6H_5Cl . **Bromobenzene**, C_6H_5Br . **Iodobenzene**, C_6H_5I .

Like the aliphatic hydrocarbons benzene is acted upon by the halogens, chlorine and bromine, and converted into substitution derivatives. This reaction proceeds most easily in the presence of a halogen carrier, such as iodine (iodine chloride is formed which chlorinates more vigorously):—

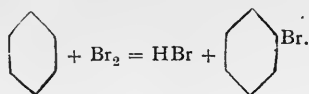

- * This reaction can be observed by adding a few drops of bromine to a few c.c. of benzene in a test tube. The evolution of hydrobromic acid is slow. If a piece of aluminium mercury couple or some iron filings be added to a few c.c. of benzene in another test tube and then a few drops of bromine, the reaction is more rapid.

Benzene is not acted upon by iodine, but iodobenzene has been prepared by heating benzene with iodine and iodic acid :—

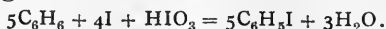

Iodobenzene is obtained through the diazo reaction (p. 249).

Properties.

These halogen derivatives are colourless liquids with a faint but not disagreeable smell. They boil without decomposition, are insoluble in water but soluble in organic solvents.

Reactions.

These compounds are more stable than the corresponding aliphatic halogen compounds. The halogen atom is *not* replaceable by OH groups or other groups.

Nitrobenzene. $\text{C}_6\text{H}_5\text{NO}_2$.

Benzene is not acted upon by dilute nitric acid, but it is converted into nitrobenzene by the action of concentrated nitric acid (nitration) :—

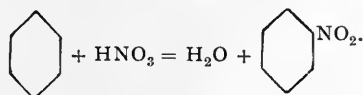

This reaction is one of the principal reactions which benzene and its derivatives undergo and in which aromatic compounds differ from aliphatic compounds.

Preparation.

- * 3 or 4 drops of benzene are added to a mixture of 2 c.c. of concentrated sulphuric acid and 1 c.c. of concentrated nitric acid and warmed. Nitrobenzene is formed and is recognised by its smell of bitter almonds, which remains after removing the excess of acid by alkali.

On a larger scale nitrobenzene may be prepared as follows :—

100 gm. of concentrated nitric acid are added with shaking to 150 gm. of concentrated sulphuric acid in a 500 c.c. flask and cooled by placing under running water. 50 gm. of benzene are added in portions of 2 c.c. to the cold mixture of acids; after each addition the mixture is thoroughly shaken. There is an energetic reaction and the contents of the flask must be kept below 50° by immersing it in cold water. The addition of benzene should take at least half an hour. The reaction is completed by heating the contents of the flask under an air condenser in a water-bath at 60° . The nitrobenzene floats as an oil on the surface. It is separated from the acid by means of a tap funnel and shaken with water. The heavier layer of nitrobenzene is separated, washed with excess of sodium carbonate solution to remove acid and again

with water. It is dried by being shaken with calcium chloride, filtered through glass wool and distilled, using an air condenser, the fraction boiling from 204-208° being collected. A small residue of dinitrobenzene may remain in the flask.

Properties.

Nitrobenzene is a pale yellow liquid which possesses an odour of bitter almonds. It boils at 205° and can be frozen to a solid which melts at 3°. It is frequently used for scenting soap but chiefly in the preparation of aniline and benzidine: it is sometimes used as a solvent.

Benzene Sulphonic Acid. $C_6H_5 \cdot SO_3H$.

Benzene slowly dissolves in warm concentrated sulphuric acid and is converted into benzene sulphonic acid (sulphonation):—

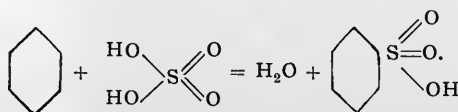

Preparation.

* 2 c.c. of benzene are mixed with 7 c.c. of concentrated sulphuric acid and carefully heated with constant shaking. The benzene which at first floats on the surface gradually dissolves. A clear solution is obtained on pouring a portion of the cooled mixture into water. Sodium benzene sulphonate separates if some be poured into a saturated solution of sodium chloride.

On a larger scale the benzene and sulphuric acid are carefully heated under a reflux condenser with constant stirring. The reaction product is poured into water (or salt solution if the sodium salt be required) and the solution neutralised with calcium carbonate. The calcium sulphate is filtered off and the filtrate is evaporated until the calcium salt crystallises. The other salts or the free acid are prepared from the calcium salt by double decomposition with potassium carbonate, etc., or sulphuric acid.

Properties.

Benzene sulphonic acid is a hygroscopic solid which is readily soluble in water and melts at 50°. The solution is strongly acid.

It forms salts with the metallic carbonates, or oxides. These salts generally crystallise well.

On heating, the sulphonic acid is decomposed. The sulphonic acid group may be removed by heating it in a sealed tube with concentrated hydrochloric acid or with strong sulphuric acid in a current of steam; the hydrocarbon is regenerated:—

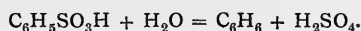

Benzene Sulphonyl Chloride.

Benzene sulphonic acid or its salts are converted by the action of phosphorus pentachloride into benzene sulphonyl chloride :—

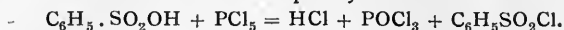

The two substances are heated on a water-bath till hydrochloric acid is no longer evolved. The product is poured into water and the sulphonyl chloride extracted with ether. It is purified by distillation *in vacuo*.

Benzene sulphonyl chloride is a white solid which melts at 14° and boils at 116° . It has a pungent odour and is not rapidly decomposed by water.

By the action of ammonium carbonate upon benzene sulphonyl chloride *benzene sulphonamide* is formed :—

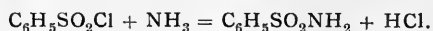

Benzene sulphonyl chloride also reacts with aniline and primary amines, secondary amines, but not with tertiary amines :—

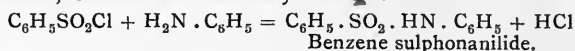

With alcohols it forms esters :—

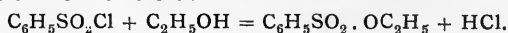
**Phenol.** C_6H_5OH .

Phenol is obtained by fusing benzene sulphonic acid with caustic potash.

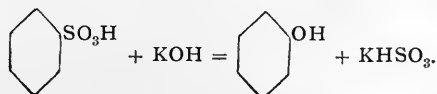

It is also obtained by the decomposition of diazobenzene (p. 249).

Preparation.

Phenol is contained in coal tar and is present in the middle oil fraction. This fraction on cooling deposits crystals of naphthalene, which are filtered off and pressed out. The oil is shaken with caustic soda which dissolves the phenol; the alkaline layer is separated and treated with sulphuric acid. Phenol separates out as an oil: it is washed with water and distilled. The distillate is separated into pure crystalline phenol and impure liquid phenol.

Properties.

Phenol crystallises in colourless prisms which are deliquescent and turn pink on contact with air and light. It melts at 42° and boils at 182° . It has a characteristic smell, is very poisonous and has a marked caustic action upon the skin. It is not easily soluble in water (1 part in 15 parts of water), but it dissolves in alcohol and other organic solvents. It is volatile with steam.

Phenol in its constitution is a tertiary alcohol; on oxidation it is broken down and gives a variety of products. It differs from aliphatic compounds containing hydroxyl groups in having acid properties. It reacts with caustic alkalies but not with carbonates and forms salts which are obtained by evaporating the solution, e.g. potassium phenate.

These salts are stable to water, but are decomposed by carbon dioxide. It has acid properties and hence is usually termed carboic acid.

As an alcohol it will form esters, but owing to its acid character the esters are not easily formed by the direct action of the acid. They are prepared by the action of the acid chloride, or anhydride, upon the phenol or its potassium salt :—

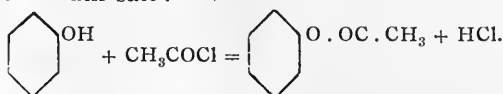

Phenyl sulphuric acid is present in mammalian urine.

Phenol also forms ethers; these are prepared by the action of an alkyl iodide upon potassium phenate :—

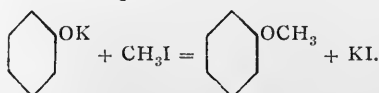

These ethers resemble the aliphatic ethers, but also show the typical aromatic reactions with nitric acid, etc.

Reactions and Tests.

- * (1) A violet coloration is formed on adding a few drops of ferric chloride solution to a solution of phenol in water.
- * (2) Phenol is readily brominated. On adding bromine water gradually to some phenol solution, there is first a cloudiness due to mono- and dibromophenol which are characterised by a very penetrating smell. The further addition of bromine water produces a precipitate of tribromophenol in yellowish-white needles or flakes. Tribromophenol is formed directly with very dilute solutions of phenol.
- * (3) Phenol is also readily nitrated. On adding concentrated nitric acid to a solution of phenol and warming, a yellow colour is produced. On cooling and making alkaline with ammonia, the colour becomes orange. Picric acid is formed :—



- * (4) A deep red coloration is produced on adding Millon's reagent to a solution of phenol and warming.

Detection of Phenol in Urine (Roaf).

- * 1 c.c. of concentrated hydrochloric acid is added to 10 c.c. of horse's urine and the mixture is boiled for two minutes. The phenyl-sulphuric acid is hydrolysed. The solution is cooled and extracted with ether. The ethereal layer is separated and the ether evaporated. The residue dissolved in water will give the reaction with Millon's reagent.

It is better to distil the urine with dilute sulphuric acid—sufficient concentrated acid being added to make the mixture contain 5 per cent.—and collect about a quarter of the volume. The phenol can be tested for in the distillate.

Aminobenzene or Aniline. $C_6H_5.NH_2$.

Nitrobenzene is converted into aniline by the action of reducing agents in acid solution :—

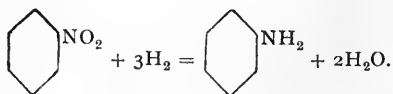
*Preparation.*

- * To 3 or 4 drops of nitrobenzene about 4 gm. of granulated tin and 3-4 c.c. of concentrated hydrochloric acid are added. The mixture is warmed to start the reaction and it is kept warm until the reaction ceases and until the smell of nitrobenzene is no longer perceptible. An excess of caustic soda is added and the alkaline solution is extracted with ether. The ether is allowed to evaporate in a basin and the residue is tested for aniline by treating it with bleaching powder solution; a purple colour appears which becomes dirty red.

On a larger scale 20 gm. of nitrobenzene and 40 gm. of granulated tin are placed in a litre flask and warmed on a water-bath for a few minutes. The flask is removed from the bath and fitted with an air condenser. 80 c.c. of concentrated hydrochloric acid are added in portions of 5 c.c. during the course of half an hour. If the mixture react violently, it is cooled in water. The reaction is completed by heating the flask on a boiling water-bath for about one hour. If the smell of nitrobenzene be still observed more hydrochloric acid may be added and the heating continued until it vanishes.

The double salt $(C_6H_5.NH_2.HCl)_2.SnCl_4$ separates out if the product be allowed to cool; it is diluted with a 100 c.c. of water and immediately decomposed by carefully adding 65 gm. of caustic soda dissolved in a 100 c.c. of water. Heat is developed on neutralising and stannic hydrate is precipitated; this dissolves in excess of caustic soda and there results a dirty liquid containing aniline floating on the surface. The aniline is separated by distillation in steam (p. 12). The distillate is collected so long as drops of aniline pass over. The aniline is extracted by shaking it with ether and the ethereal solution is dried with solid caustic soda. The ether is distilled off from a water-bath and the residue is distilled over a flame. Aniline passes over at $182-184^\circ$ as a pale yellow liquid.

Properties.

Aniline is a pale yellow oily liquid which boils at 182° and has a peculiar odour. It gradually turns brown on exposure to light and air.

Aniline is soluble with difficulty in water, but easily in alcohol and ether.

- * The solubility of aniline in water can be readily seen by placing 3 or 4 drops in a test tube full of water and shaking vigorously. The oily drops will be no longer visible.

Aniline is a weak base and forms salts with acids from which it is liberated by alkalis, thus :—

- * • About 1 c.c. of aniline is placed in about 10 c.c. of dilute hydrochloric acid. On shaking the aniline dissolves. On making alkaline with about 10 c.c. of caustic soda the aniline separates in oily drops.

The salt of the aniline is obtained by evaporating its solution in the corresponding amount of acid until it crystallises.

Reactions.

- * (1) Aniline is readily brominated:—

A solution of aniline in water is prepared as above and bromine water is added; a pinkish precipitate, which becomes grey-green, of tribromaniline is formed:—

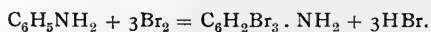

- * (2) In aqueous solution (above) it is readily oxidised by bleaching powder, giving a violet coloration.
- * (3) It turns black when it is oxidised with potassium bichromate and dilute sulphuric acid.
- * (4) A blue colour is formed if a drop of aniline be mixed with 2 or 3 drops of strong sulphuric acid and the paste so formed stirred with a few drops of potassium bichromate solution.
- (5) It gives the carbylamine reaction with chloroform and alcoholic potash (p. 61).

Acetanilide. $\text{C}_6\text{H}_5 \cdot \text{NH} \cdot \text{OC} \cdot \text{CH}_3$.

Aniline is acylated by treatment with acetyl chloride, glacial acetic acid or acetic anhydride:—

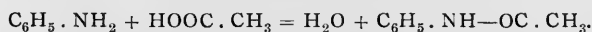

Preparation.

- * 2 c.c. of aniline are boiled under a reflux air condenser with 4 c.c. of glacial acetic acid for an hour. The mixture is poured into water. Acetanilide is precipitated and is recrystallised from boiling water.

Properties.

Acetanilide is a white crystalline solid which melts at 114° and is used in medicine under the name of antifebrin. It is readily decomposed by boiling with acids or alkalis:—

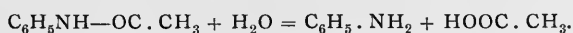

- * Thus, on boiling about 2 gm. of acetanilide with about 5 c.c. of concentrated hydrochloric acid for a few minutes and pouring the solution into water, a clear solution is obtained. On adding excess of caustic soda, the aniline is precipitated and may be extracted with ether and tested for as above.

Alkyl Anilines.

Aniline as a primary amine will react with one or two molecules of an alkyl halide to form alkyl anilines:—

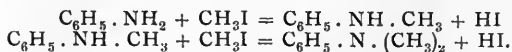

These compounds are readily obtained by heating aniline with the alcohol and hydrochloric acid at 200 to 250°:—

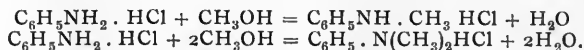

The methyl anilines are stronger bases than aniline, as they are more like the aliphatic amines. They may be regarded as phenylmethylaniline and phenyldimethylaniline.

Methyl aniline is a colourless oily liquid which boils at 192°. As a secondary amine it gives a nitrosamine with nitrous acid.

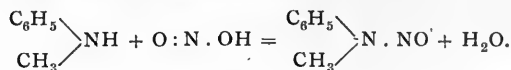

Phenyl-methyl-nitrosamine is a yellow oil which gives Liebermann's nitroso reaction.

Dimethylaniline is a colourless oil which boils at 192°; it is largely used in the dye industry.

Dialkylanilines, such as dimethylaniline, react with nitrous acid giving nitroso compounds: in these compounds the reaction takes place with the hydrogen atom in the para position (p. 260) in the benzene nucleus:—

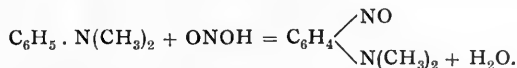

Diphenylamine cannot be prepared by heating aniline with bromobenzene, but is obtained by heating aniline hydrochloride with aniline in a closed vessel at 240°.

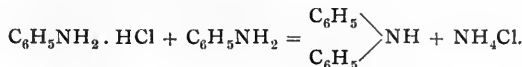

Diphenylamine is a crystalline solid melting at 54° and boiling at 310°. It is a very weak base, its salts being decomposed by water; it is almost insoluble in dilute acids. It dissolves in concentrated sulphuric acid. This solution on the addition of a trace of nitric acid gives a deep blue coloration and serves for detecting nitrates. Diphenylamine owing to the acid character of the phenyl groups reacts with potassium giving potassium diphenylamine,

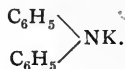
**Triphenylamine.** $(\text{C}_6\text{H}_5)_3\text{N}$.

This compound is prepared by heating potassium diphenylamine with bromobenzene at 300°. It is a colourless crystalline solid melting at 127°. It does not form salts with acids.

Diazobenzene. $C_6H_5 \cdot N : N \cdot OH$ or $C_6H_5 \cdot N(:N) \cdot OH$.

Aniline is a primary amine. Primary amines of the aliphatic series are converted by the action of nitrous acid into the corresponding alcohol, but diazobenzene is formed by the action of nitrous acid upon aniline :—

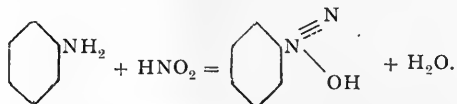

The reaction is carried out at about 0° .

Properties.

Diazobenzene behaves like a strong base (NH_4OH) and is known *only* in the form of its salts. When liberated from a solution of its salts it is precipitated as a yellow oil which is very unstable and decomposes with explosion. It forms crystalline salts with mineral acids, which are also explosive. The nitrate explodes violently if gently struck ; the other salts explode on heating. These salts are easily soluble in water, less soluble in alcohol and insoluble in ether. They are generally called diazonium salts.

Reactions.

(1) An aqueous solution of a diazonium salt is decomposed on boiling. Nitrogen is evolved and phenol is formed :—

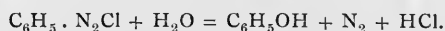

Thus :—

A few drops of sodium nitrite solution are added to a dilute solution of aniline in hydrochloric acid. Diazobenzene chloride is formed. On warming the solution, it is decomposed with evolution of nitrogen and the smell of phenol (carbolic acid) becomes noticeable.

(2) On boiling a diazobenzene salt with absolute alcohol, nitrogen is evolved and benzene is formed, reduction occurring :—

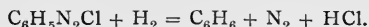

(3) A precipitate of diazobenzene perbromide is formed on adding bromine dissolved in potassium bromide to a solution of diazobenzene chloride ; on boiling with alcohol, nitrogen is evolved and bromobenzene is formed :—

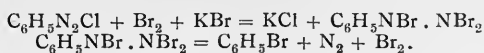

(4) Iodobenzene is formed if potassium iodide be added to a solution of diazobenzene chloride and the solution warmed :—

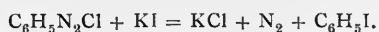

(5) *Sandmeyer's Reactions.*

On adding a solution of cuprous chloride in hydrochloric acid, or " " " " " cuprous bromide in hydrobromic acid, or " " " " " cuprous cyanide in potassium cyanide, to a solution of diazobenzene chloride and warming, nitrogen is evolved and chlorobenzene, bromobenzene or cyanobenzene (phenylcyanide) is formed :—

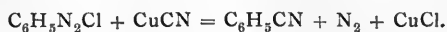

In practice these reactions are carried out by mixing aniline with a slight excess of hydrochloric acid, cooling in ice and adding the calculated quantity of sodium nitrite solution, as shown by testing with potassium iodide-starch paper. The aqueous solution is warmed, or potassium iodide is added, or it is poured into the solution of the cuprous salt and warmed. The product can generally be isolated by steam distillation.

Phenylhydrazine. $\text{C}_6\text{H}_5 \cdot \text{NH} \cdot \text{NH}_2$.

Phenylhydrazine is obtained by reducing diazonium chloride with stannous chloride :—

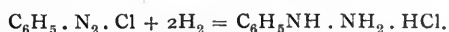

Its constitution is proved by its conversion into aniline and ammonia by reduction with zinc and hydrochloric acid :—

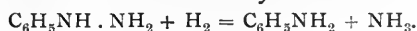
*Preparation.*

A molecular proportion of aniline (9.3 gm.) is dissolved in about 10 times the calculated quantity of concentrated hydrochloric acid (200 c.c.), thoroughly cooled in ice and diazotised by adding the calculated quantity of sodium nitrite (6.9 gm.). As soon as excess of nitrite is present, as indicated by starch-iodide paper, rather more than the calculated quantity of stannous chloride (45 gm.) dissolved in the proper amount of concentrated hydrochloric acid (100 c.c.) is slowly added. Phenylhydrazine hydrochloride separates out. It is filtered off by suction and washed with concentrated hydrochloric acid. It is dissolved in water and decomposed with excess of caustic soda; the oil is extracted with ether, the ethereal solution dried with solid potash, the ether distilled off and the base distilled *in vacuo*.

Properties.

Phenylhydrazine consists of colourless prisms which melt at 23° and boil at 241° with slight decomposition. It dissolves slightly in cold water and easily in alcohol and ether. As a strong base it forms salts with acids; the hydrochloride crystallises in needles and is easily soluble in warm water.

Reactions.

(1) Phenylhydrazine and its salts reduce Fehling's solution.

(2) It is converted into benzene on heating its solutions with copper sulphate or ferric chloride.

(3) It combines with aldehydes, ketones and carbohydrates to form hydrazones and osazones. The hydrazone is decomposed by concentrated hydrochloric acid, and on reduction gives an amine and aniline.

Toluene. $C_6H_5 \cdot CH_3$.

Toluene, or methylbenzene, or phenylmethane, is present in coal tar and is contained with benzene in the first fraction on fractionally distilling the tar. It is separated from benzene by fractional distillation.

Toluene is also obtained from balsam of tolu, or from toluic acid by distillation with soda lime—a reaction analogous to the preparation of methane from sodium acetate :—

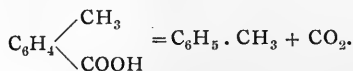

Toluene can be prepared from benzene by either of the following two reactions :—

(1) *Fittig's Reaction.*—A mixture of bromobenzene and methyl bromide is heated with sodium :—

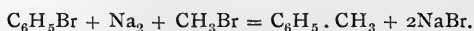

(2) *Friedel and Craft's Reaction.*—Benzene is heated with methyl iodide in the presence of aluminium chloride :—

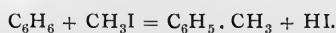

In this reaction a compound of benzene and aluminium chloride is probably first formed and this compound reacts with the alkyl halide :—

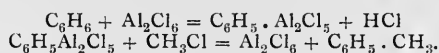

Dry benzene is treated under a reflux condenser with a third of its weight of aluminium chloride and the alkyl chloride is slowly added. The benzene may be mixed with a neutral solvent such as ether or petroleum ether. The mixture is heated on a water-bath until halogen acid is no longer evolved. The mixture is allowed to cool and water added to dissolve the aluminium chloride; the layer of benzene and ether is separated, dried with calcium chloride, the ether distilled off and the residue distilled.

Properties.

Toluene, an oily colourless liquid with characteristic smell, boils at 110° and has a sp. gr. of $\cdot 882$ at 0° . It burns with a smoky luminous flame, is insoluble in water, but soluble in organic solvents. It is known commercially as toluole. Toluene closely resembles benzene in its properties in forming nitro- and other derivatives, but it differs from benzene in being also an aliphatic compound. Toluene is the first instance of an aromatic compound containing a side chain. It is this side chain which gives toluene the properties of an aliphatic compound. (See benzyl chloride, alcohol, benzaldehyde, etc.)

On oxidation with dilute nitric acid and other oxidising agents, the nucleus remains intact but the side chain is oxidised to a carboxyl group :—



Ethylbenzene, $C_6H_5 \cdot C_2H_5$, and other Homologues of Benzene.

Ethylbenzene is also contained in coal tar and can be prepared from benzene by the reactions given under toluene. It is a liquid like toluene, but boils at 134° and is isomeric with the xylenes (p. 260).

The other homologues, propyl, butyl, etc., benzene can be prepared in the same way.

These homologues of benzene contain both a benzene nucleus and an aliphatic radicle or side chain. They behave as aromatic compounds by forming nitro and sulphonic acid derivatives. They behave as aliphatic compounds in forming halogen derivatives in which the halogen atom can be replaced by OH and other groups. On oxidation the side chain undergoes shortening until ultimately benzoic acid is formed :—

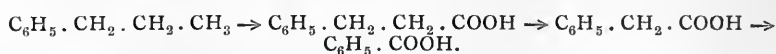

Styrene or Phenylethylene, $C_6H_5 \cdot CH = CH_2$, is an aromatic hydrocarbon containing an unsaturated group in the side chain. It is obtained by heating cinnamic acid.

Benzyl Chloride, $C_6H_5 \cdot CH_2Cl$.

Benzyl chloride is the chief representative of an aromatic compound in which a halogen atom is present in the side chain. Like aliphatic compounds it can be obtained by the action of phosphorus pentachloride upon the corresponding alcohol—benzyl alcohol $C_6H_5 \cdot CH_2OH$. The radicle $C_6H_5 \cdot CH_2$ is termed benzyl in order to distinguish it from the radicle C_6H_5 which is termed phenyl.

Preparation.

Benzyl chloride is prepared by passing a stream of dry chlorine into toluene, heated under a reflux condenser, until the increase in weight corresponding to the equation has been reached. The product is then separated and purified by distillation. The reaction takes place most readily if the flask be exposed to sunlight. The following reaction takes place :—

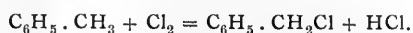

The procedure is quite different to that used in the preparation of bromobenzene and chlorotoluene (p. 241).

Properties.

Benzyl chloride is a colourless liquid which boils at 176° . It has an unpleasant smell, is insoluble in water, but soluble in alcohol, ether and benzene.

It is nitrated, sulphonated, etc., by nitric or sulphuric acid, but in its other reactions it resembles ethyl chloride. It is mainly used for the preparation of benzaldehyde.

Benzal Chloride, $C_6H_5 \cdot CHCl_2$.

This compound is prepared by the further action of chlorine upon boiling toluene, until chlorine corresponding to the equation,

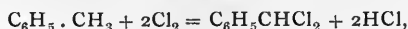

has been absorbed.

It can be obtained by the action of phosphorus pentachloride upon benzaldehyde :—

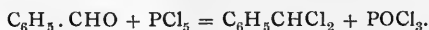

Benzal chloride is a colourless liquid of boiling-point 206° ; it is also used for making benzaldehyde.

Benzotrichloride, $C_6H_5 \cdot CCl_3$, or **Phenylchloroform**.

By the further action of chlorine upon toluene, benzotrichloride is formed :—

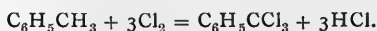

It is a liquid which boils at 213° and is converted into benzoic acid by boiling with water.

Benzyl Alcohol, $C_6H_5 \cdot CH_2OH$.

Benzyl alcohol occurs as such and also as ester with benzoic and cinnamic acids in the resin storax, in balsam of Tolu and balsam of Peru.

It is the chief type of an aromatic alcohol in which the hydroxyl group is present in the side chain (compare phenol).

Preparation.

As an alcohol it may be obtained by reducing the corresponding aldehyde, benzaldehyde :—

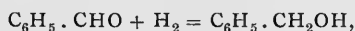

or by the action of water and aqueous alkalis upon benzyl chloride :—

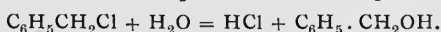

Benzyl alcohol is usually obtained by the action of aqueous potassium hydroxide upon benzaldehyde :—



Benzaldehyde is shaken up with four times the amount of potash dissolved in about an equal weight of water. The emulsion which is formed is allowed to stand for twenty-four hours. On the addition of water, the potassium benzoate dissolves; the solution is extracted with ether, the ether dried and the benzyl alcohol obtained by distillation.

Properties.

Benzyl alcohol is a colourless liquid of boiling-point 206° ; it is not easily soluble in water, but dissolves in alcohol and ether. It behaves like ethyl alcohol with sodium and phosphorus pentachloride. It forms esters with acids or acid anhydrides, etc., e.g. benzyl bromide, benzyl acetate.

Benzaldehyde. $C_6H_5 \cdot CHO$.

Benzaldehyde was originally isolated from bitter almonds and called oil of bitter almonds. The almonds contain the glucoside, amygdalin, which is hydrolysed by the enzyme, emulsin, into glucose benzaldehyde and prussic acid. It is the aldehyde of benzyl alcohol from which it may be obtained by oxidation with nitric acid.

It may be obtained by distilling calcium benzoate with calcium formate in the same way as aliphatic aldehydes.

Preparation.

(1) Benzaldehyde is prepared from benzal chloride by boiling it with dilute sulphuric acid or lime water under pressure :—



(2) Or it is prepared by boiling benzyl chloride with lead nitrate or copper nitrate. Benzyl alcohol is probably first formed and is oxidised to the aldehyde :—

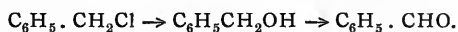

Molecular proportions of benzyl chloride (12.6 gm.) and copper nitrate (20 gm.), dissolved in about the same weight of water (25 c.c.), are boiled for 6-8 hours under a reflux condenser, whilst a current of carbon dioxide is passed through the mixture to expel oxides of nitrogen and to avoid further oxidation. When the oil contains no chlorine or only traces as shown by testing it, after washing with water, with silver nitrate and nitric acid, the oil is extracted with ether and the ethereal extract is shaken with saturated sodium bisulphite solution. The crystalline bisulphite compound is filtered off and washed with ether. The benzaldehyde is obtained by decomposing it with dilute sulphuric acid, extracting with ether, drying and distilling.

(3) It is prepared by Friedel and Craft's reaction from benzene, a mixture of carbon monoxide and chlorine being passed into the benzene. Formylchloride is apparently formed which reacts as follows :—

*Properties.*

Benzaldehyde is a colourless liquid with a strong smell of bitter almonds. It boils at 179° and has a sp. gr. of 1.05 at 15° . It is very slightly soluble in water, but dissolves in alcohol and ether. It is used extensively for flavouring purposes.

Reactions.

In most reactions benzaldehyde resembles the aliphatic aldehydes :—

* (1) It is easily oxidised; by exposure to air crystals of benzoic acid gradually separate :—

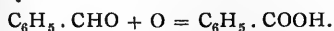

(2) On reduction it yields benzyl alcohol (p. 253).

(3) It yields benzal chloride with phosphorus pentachloride.

(4) It gives an oxime with hydroxylamine.

- * (5) It gives a hydrazone with phenylhydrazine.
- * (6) It combines with sodium bisulphite.
- (7) It combines with hydrogen cyanide.

In the following reactions benzaldehyde and other aromatic aldehydes, which have the aldehyde group attached to the benzene nucleus, differ from aliphatic aldehydes :—

- * (1) It does not reduce Fehling's solution or ammoniacal silver solutions.
- (2) It does not polymerise.
- (3) It gives a mixture of alcohol and acid on treating with potash.
- (4) It is converted into benzoin on shaking with an alcoholic solution of potassium cyanide :—

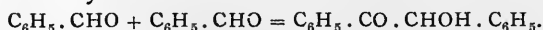

Benzoin is a complex ketonic alcohol formed by the condensation of two molecules of benzaldehyde.

- (5) It condenses with acetone and aniline on shaking up the two substances with a few drops of caustic soda :—

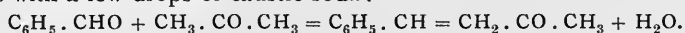

As an aromatic compound benzaldehyde forms nitro, sulphonic acid derivatives, etc.

If nitrobenzaldehyde in acetone solution be mixed with a few drops of dilute caustic soda, a precipitate of indigo-blue (p. 343) slowly forms :—

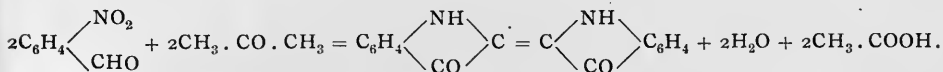

Benzoic Acid, $\text{C}_6\text{H}_5 \cdot \text{COOH}$.

Benzoic acid occurs in gum benzoin and other resins such as balsam of Peru. In gum benzoin it is present chiefly as the ester, benzyl benzoate.

Preparation.

(1) Benzoic acid is readily obtained by subliming gum benzoin. Gum benzoin is heated on an iron tray or porcelain basin, the tray being covered with a cone of filter paper or a funnel. The resin melts and the benzoic acid which volatilises condenses on the cone. It is recrystallised from water.

(2) Benzoic acid is made commercially by oxidising benzyl chloride with 60 per cent. nitric acid.

(3) It is also prepared by heating the calcium salt of phthalic acid.

(4) It can be prepared by the hydrolysis of the nitrile, phenyl cyanide.

(5) As previously mentioned, it results from the oxidation of aromatic compounds possessing a side chain.

Properties.

Benzoic acid forms glistening crystals which melt at 121.5° and boil at 249°

- * On heating, it melts and gives off white vapours with characteristic smell and suffocating effect upon the throat ; the vapours condense as a crystalline sublimate.

It dissolves easily in hot water and crystallises out on cooling ; it is only slightly soluble in cold water (1 part in 400).

It dissolves in alcohol and ether and other organic solvents.

- * It forms salts with alkalis, dissolving in caustic alkalis and alkali carbonates, in lime water, etc. ; on acidifying these solutions, it is precipitated.

- * A neutral solution gives a precipitate of a pale brown colour with ferric chloride.

It is easily nitrated : nitrobenzoic acid is formed on evaporating a little benzoic acid in a porcelain basin with nitric acid.

It is converted into benzene by heating with soda lime.

It forms esters, e.g. ethylbenzoate (p. 73) is formed if benzoic acid be heated with a little alcohol and a few drops of concentrated sulphuric acid. The ester has a peculiar aromatic odour and boils at 213° .

Benzoyl Chloride, $C_6H_5 \cdot CO \cdot Cl$.

This compound is formed by the action of phosphorus pentachloride upon benzoic acid :—

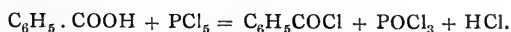

Benzoic acid and a slight excess of phosphorus pentachloride are placed in a distilling flask ; the reaction proceeds at the ordinary temperature and the vapours of hydrogen chloride are passed into soda. As soon as the reaction is complete the contents are distilled in a fume cupboard ; phosphorus oxychloride passes over at 107° , benzoyl chloride at about 198° . It is purified by redistillation.

Benzoyl chloride is a colourless oily liquid with a peculiar pungent smell. It is slowly decomposed by water into benzoic acid and more readily by alcohol into ethyl benzoate.

Benzoic Anhydride, $(C_6H_5 \cdot CO)_2O$.

The anhydride of benzoic acid is prepared like other anhydrides by the action of benzoyl chloride upon sodium benzoate :—



It is a colourless crystalline substance melting at 42° and resembles acetic anhydride.

Benzamide, $C_6H_5 \cdot CO \cdot NH_2$.

Benzamide is prepared by either of the reactions :—

(1) Benzoyl chloride and ammonia :—



Benzoyl chloride is mixed with a slight excess of dry ammonium carbonate in a mortar until the smell of benzoyl chloride vanishes. Cold water is added to dissolve the ammonium salts ; the insoluble benzamide is crystallised from hot water.

(2) Ammonia and ethyl benzoate.

Benzamide is a colourless crystalline solid melting at 130° , easily soluble in hot water, but soluble with difficulty in cold. It is decomposed by boiling with acids, or alkalis, into benzoic acid and ammonia.

Benzonitrile, or Phenyl Cyanide, $C_6H_5 \cdot CN$.

Benzonitrile is prepared :—

(1) by fusing potassium benzene sulphonate with potassium cyanide or ferrocyanide :—

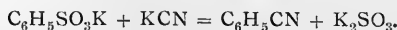

(2) by Sandmeyer's reaction from aniline ; the aniline is diazotised and the solution heated with cuprous cyanide (p. 250).

Benzonitrile is a colourless oil with a smell resembling that of nitrobenzene. It boils at 191° and resembles the aliphatic nitriles in its reactions :—

(1) hydrolysis :—

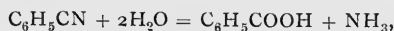

(2) reduction :—

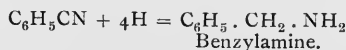
**Benzylamine**, $C_6H_5 \cdot CH_2 \cdot NH_2$.

Benzylamine is an aromatic amine in which the amino group is present in the side chain (compare aniline). It is prepared like the aliphatic primary amines (p. 124) :—

(1) ammonia upon benzyl chloride ;

(2) bromine and potash upon the amide of phenylacetic acid ;

(3) reduction of the nitrile or oxime.

It is a colourless oily liquid boiling at 187° with pungent smell. It is a strong base like the aliphatic primary amines and with similar properties.

Dibenzylamine, $(C_6H_5 \cdot CH_2)_2NH$. **Tribenzylamine**, $(C_6H_5 \cdot CH_2)_3N$.

Again, these compounds resemble the secondary and tertiary aliphatic amines. They are obtained by heating benzylamine with benzylchloride.

The three amines are formed when benzylchloride is heated with ammonia.

They have the typical aromatic reactions, as well as the aliphatic ones.

Acetophenone, $C_6H_5 \cdot CO \cdot CH_3$.

Acetophenone is an example of an aromatic ketone. It is formed by distilling calcium benzoate with calcium acetate.

Acetophenone is most readily prepared by slowly dropping 1 molecular proportion of acetyl chloride upon 1 molecule of benzene containing in suspension 1 molecule of aluminium chloride and cooled with ice. When the evolution of hydrochloric acid is over, ice-cold water is very carefully added. The solution is extracted with ether, the ethereal extract dried and distilled. Acetophenone passes over between 194 and 200°:—

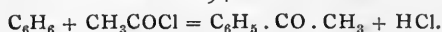

This reaction is a general one for preparing aromatic ketones.

Acetophenone is a crystalline solid melting at 20.5° and boiling at 202°. It is soluble in water and alcohol. It is sometimes used as a hypnotic under the term hypnone. It closely resembles acetone and the aliphatic ketones in giving a secondary alcohol on reduction, benzoic acid and acetic acid on oxidation and in forming an oxime and a phenylhydrazone. It resembles benzene in forming nitro- and other derivatives.

Benzophenone, $C_6H_5 \cdot CO \cdot C_6H_5$.

Benzophenone is obtained by heating calcium benzoate and is prepared by the action of benzoyl chloride upon benzene in the presence of aluminium chloride.

It is a crystalline solid melting at 48-49° and resembles acetophenone. It yields diphenylmethane on reduction with zinc dust.

Phenylacetic Acid, $C_6H_5 \cdot CH_2 \cdot COOH$.

This acid containing a carboxyl group in the side chain is formed in the putrefaction of proteins, arising from phenylalanine.

Synthetically it is obtained from benzyl chloride:—

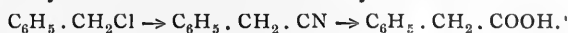

Molecular proportions of benzyl chloride and potassium cyanide are boiled in dilute alcoholic solution for 3-4 hours. The benzyl cyanide is isolated by fractional distillation (220-335° fraction) and hydrolysed by boiling with dilute sulphuric acid. The phenylacetic acid is purified by crystallisation.

Phenylacetic acid crystallises in colourless shining plates which melt at 76.5° and boil at 262°. It has a characteristic smell.

Phenaceturic Acid, $C_6H_5 \cdot CH_2 \cdot CO-NH \cdot CH_2 \cdot COOH$.

Phenylacetic acid, which is formed in the large intestine in small amounts, on absorption into the body, or when it is injected into the blood, is excreted as phenaceturic acid, i.e. in combination with glycine. It thus resembles benzoic acid, which is excreted as hippuric acid (p. 142).

It is a colourless crystalline substance melting at 143°, is soluble with difficulty in water, but easily in alcohol. It is hydrolysed by boiling with acids into phenylacetic acid and glycine.

Phenylpropionic Acid, $C_6H_5 \cdot CH_2 \cdot CH_2 \cdot COOH$.

Phenylpropionic acid accompanies phenylacetic acid amongst the putrefaction products of proteins.

It is most conveniently prepared by reducing cinnamic acid:—

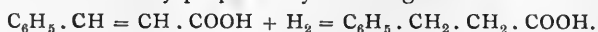

It is a colourless crystalline substance melting at 47° and boiling at 280°.

Cinnamic Acid, $C_6H_5 \cdot CH=CH \cdot COOH$.

Cinnamic acid is the chief representative of an aromatic compound containing an unsaturated acid as the side chain. It occurs in greatest amount in storax, the resin of *Styrax officinalis*.

It is prepared from storax by warming it with dilute sodium hydroxide; the filtered alkaline solution is acidified with hydrochloric acid. Cinnamic acid is precipitated and purified by crystallisation from water.

Cinnamic acid is usually prepared by synthesis by Perkin's reaction:—



Molecular proportions of benzaldehyde and sodium acetate are heated in an oil-bath under a reflux condenser with 3-4 parts of acetic anhydride for 8-10 hours. The mixture is poured into water and unchanged benzaldehyde is removed by steam distillation; the residue is treated with caustic soda, filtered from oily impurities and acidified with concentrated hydrochloric acid. Cinnamic acid is precipitated and purified by crystallisation from water.

Cinnamic acid crystallises in needles and melts at 133° . It is soluble with difficulty in cold water, more easily in hot water. It dissolves in alcohol, ether and other organic solvents. As an aromatic compound it forms nitro derivatives. As an unsaturated aliphatic compound cinnamic acid forms addition compounds with bromine and halogen acids. It is converted by reduction into phenylpropionic acid or hydrocinnamic acid. It is readily oxidised in the cold by permanganate, a solution of cinnamic acid in alkali decolorising permanganate immediately.

Cinnamic Aldehyde, $C_6H_5 \cdot CH=CH \cdot CHO$.

Cinnamic aldehyde is the chief constituent of oil of cinnamon from which it may be obtained by treatment with sodium bisulphite.

It is a liquid which boils at 247° and has the peculiar and characteristic odour of cinnamon. It resembles the aliphatic aldehydes in properties.

Phenylalanine, $C_6H_5 \cdot CH_2 \cdot CH \cdot (NH_2)COOH$.

Phenylalanine was first isolated from an extract of growing seedlings and subsequently recognised as a constituent of proteins; it is the constituent which gives rise to phenylpropionic and phenylacetic acids during putrefaction. It also gives rise to phenylethylamine, and most probably cinnamic acid is also derived from it. In the decomposition either carbon dioxide or ammonia is lost and then the side chain is oxidised:—

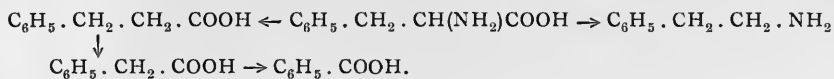

Phenylalanine is isolated with some difficulty from the complicated mixture of amino acids resulting from proteins; full details are given in "The Chemical Constitution of Proteins," Part I.

It has also been prepared by synthesis (see "The Chemical Constitution of Proteins," 2nd ed. Part I., or 3rd ed. Part II.).

Phenylalanine crystallises in glistening platelets which melt at $275-280^\circ$. The natural substance is laevorotatory. It has aromatic properties and the properties of an amino acid.

Mandelic Acid, $C_6H_5 \cdot CHOH \cdot COOH$.

Mandelic acid is formed when amygdalin is hydrolysed by boiling with acids; it is present in amygdalin as the nitrile of mandelic acid :—

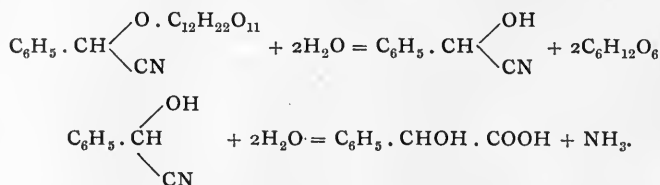

It is prepared synthetically from benzaldehyde; the benzaldehyde is converted into the cyanohydrin and this is hydrolysed.

Mandelic acid is a colourless crystalline solid which melts at 133° . It is soluble in water, ether and other organic solvents. The natural acid is optically active and laevorotatory; the synthetical acid has been separated into its stereoisomers by the usual methods.

Mandelic acid closely resembles lactic acid in its properties, as it contains the OH group in the side chain. It differs from salicylic acid and other aromatic acids which contain the OH group attached to the benzene nucleus.

DISUBSTITUTION PRODUCTS OF BENZENE.

The disubstitution products of benzene exist in three forms :—

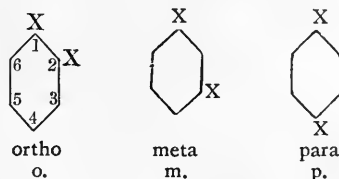

The number of derivatives is very large. They can be divided into those in which the substituting groups are the same and those in which they are different.

Dimethylbenzenes or Xylenes, $C_6H_4 \begin{cases} CH_3 \\ CH_3 \end{cases}$.

These three compounds are present in coal tar and are contained in the benzene fraction from which they are prepared by fractional distillation; m-xylene exists in largest amount. The fraction in which they are present boils at $136-141^\circ$. Their boiling-points are so close that they cannot be separated by fractional distillation; their separation depends on the formation of nitro- and sulphonic acid derivatives.

They closely resemble benzene and toluene and are obtained from these compounds by the same methods as toluene is prepared from benzene. A different isomer is formed under different conditions.

They yield nitro- and other derivatives, and on oxidation are converted into methyl benzoic acids and into phthalic acids.

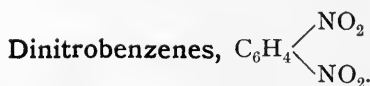

m-Dinitrobenzene is obtained by nitrating benzene with sulphuric acid and nitric acid and heating. It is a yellow crystalline solid melting at 90° .

o- and p-Dinitrobenzenes are formed in small quantities at the same time. They are colourless solids melting at 118° and 173° respectively.



Like aniline they are obtained by reducing the dinitrobenzenes. They also resemble aniline. m-Phenylenediamine melts at 63° . It gives a deep yellow colour with nitrites and is used for detecting nitrites in small quantities.



The m-compound is formed by heating benzene with two molecular proportions of sulphuric acid.

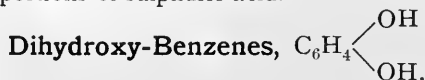

The three isomeric dihydroxy benzenes are natural compounds and are termed:—

Catechol,
or
pyrocatechin

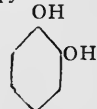

Ortho.

Resorcinol



Meta.

Hydroquinone,
or
quinol



OH
Para.

Catechol occurs in catechu, a resin obtained from *Acacia catechu*, and was first obtained from this source. It is prepared by fusing o-phenolsulphonic acid with potash, or by reducing guaiacol with hydriodic acid:—

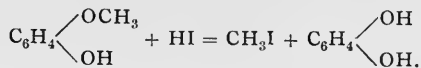

It is a colourless crystalline solid melting at 104° .

Resorcinol is obtained by fusing benzene-m-disulphonic acid and the other disulphonic acids with potash at higher temperatures.

It forms colourless crystals which melt at 110° and are easily soluble in water, alcohol, ether. It is used largely for making eosin and other dyes.

Quinol is formed by the hydrolysis of the glucoside, arbutin, by boiling with water. It is usually prepared by reducing quinone with sulphurous acid. It is a colourless crystalline solid melting at 169° and very easily soluble in water.

Quinone.

Quinol is easily oxidised by ferric chloride to quinone, but quinone is usually prepared by oxidising aniline with potassium bichromate and sulphuric acid.

It is a yellow crystalline solid with a peculiar smell and melts at 116° . It is not very soluble in water, but dissolves in alcohol and ether. It is volatile in steam.

Quinone in some respects behaves as a diketone, but in other respects as an aromatic compound: it is generally represented by the

formula  in which there are two pairs of double bonds. On reduction the centric formula is formed, but on oxidation it breaks down at the double linkings; it combines with 2 or 4 atoms of bromine.

Reactions of Catechol, Resorcinol, Quinol.

* Aqueous solutions behave as follows:—

(1) With FeCl_3 :—Catechol gives a green coloration; this colour changes to violet, then to red on adding sodium carbonate or ammonia. Resorcinol gives a deep violet coloration. Quinol on boiling with ferric chloride yields quinone with its peculiar irritating smell.

* (2) With bromine water:—Resorcinol gives a crystalline precipitate of tribromoresorcinol.

* (3) Catechol and quinol reduce ammoniacal silver nitrate.

* (4) Catechol and quinol reduce Fehling's solution.

* (5) Solutions of catechol and quinol, made alkaline with caustic soda, turn brown, firstly at the surface but on shaking throughout the whole solution. This is due to absorption of oxygen and oxidation.

* (6) With Millon's reagent:—Quinol gives a yellow colour and then a yellow precipitate which becomes red on heating.

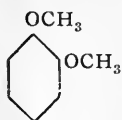
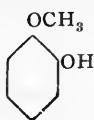
Guaiacol and Veratrol.

These compounds are methyl derivatives of catechol and are contained in natural substances. Guaiacol, like o-hydroxy-phenols, gives a coloration with ferric chloride; veratrol gives no coloration.

Phthalic Acids.

The three phthalic acids, or benzene dicarboxylic acids,

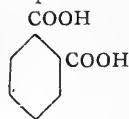

Ortho, or
phthalic acid,

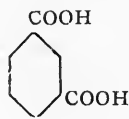

Meta, or
isophthalic acid,

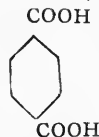

Para, or
terephthalic acid,

are obtained by oxidising the xylenes with nitric acid, or the toluic (methyl benzoic) acids with permanganate. Phthalic acid results from the oxidation of naphthalene.

They are crystalline solids resembling benzoic acid. Phthalic acid on heating is converted into phthalic anhydride,

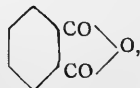

a substance used in making fluorescein, eosin and other dyes.

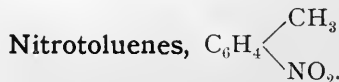

The o- and p-compounds are obtained by nitrating toluene; the m-compound is obtained by indirect methods. They are all solids.



o- and p-Toluidine are obtained by reducing o- and p-nitrotoluene; o-toluidine is an oil, p-toluidine is a crystalline solid. The m-compound is obtained in a similar way and is an oil.

They yield diazonium salts with nitrous acid and behave generally like aniline.



m-Nitraniline is obtained by the partial reduction of m-dinitrobenzene with alcoholic ammonium sulphide. The o- and p-nitraniline cannot be obtained by nitrating aniline, but are obtained by nitrating acetanilide and saponifying the nitro-acetanilides.

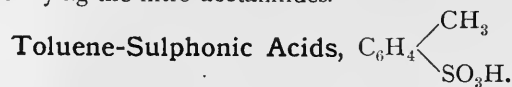

The o- and p-compounds result by sulphonating toluene, the o-compound being the chief product. They yield the cresols on fusion with potash.



The p-compound is obtained by heating aniline sulphate at 200° for some hours.

It is a colourless crystalline solid easily soluble in hot water, very little in cold. It does not behave as a base, but the amino group can be diazotised. It is used largely in making dyes.

Saligenin, or Salicylic Alcohol, $C_6H_4 \begin{matrix} \diagup OH \\ \diagdown CH_2OH \end{matrix}$.

Saligenin occurs as the glucoside, salicin, in the bark of the willow tree. The glucoside, on hydrolysis, gives glucose and saligenin.

It is generally prepared by reducing salicylic aldehyde with sodium amalgam and dilute alcohol.

Saligenin is a crystalline solid which melts at 82° and is easily soluble in water. It is o-hydroxy-benzyl alcohol.

As it contains a phenolic group in the α -position it gives a blue-violet colour with ferric chloride. It forms alkali salts with alkaline hydroxides and behaves like a phenol. It also behaves like a primary aliphatic alcohol and is converted on oxidation into salicylic aldehyde and salicylic acid.

Salicylic Aldehyde, $C_6H_4 \begin{matrix} \diagup OH \\ \diagdown CHO \end{matrix}$.

o-Salicylic aldehyde is found in certain volatile oils from plants.

It can be prepared by oxidising saligenin with potassium bichromate and sulphuric acid.

It is generally prepared by Reimer's reaction: a mixture of phenol, chloroform and caustic potash is heated under a reflux condenser:—

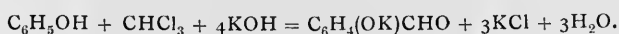

The solution is acidified after distilling off the chloroform and distilled with steam; phenol and o-salicylic aldehyde pass over. The distillate is extracted with ether and the aldehyde converted into the bisulphite compound; this is decomposed with sodium carbonate, the salicylaldehyde extracted with ether and distilled.

p-Hydroxybenzaldehyde is also formed in the reaction, but is not volatile with steam.

Salicylic aldehyde is an oily liquid boiling at 196° with characteristic aromatic smell: it gives a violet colour with ferric chloride.

Salicylic Acids, $C_6H_4 \begin{matrix} \diagup OH \\ \diagdown COOH \end{matrix}$.

The chief of the hydroxy-benzoic acids is the o-compound or salicylic acid, which occurs in the flowers of *Spiraea ulmaria* and in the form of its methyl ester in oil of winter green.

Salicylic acid was formerly prepared (1) by the hydrolysis of oil of winter green; (2) by oxidising salicylic alcohol; (3) by the action of nitrous acid on anthranilic acid.

It is now prepared almost entirely from phenol :—Sodium phenate is heated in carbon dioxide ; sodium phenyl carbonate is formed :—

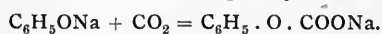

On heating, this is changed into sodium salicylate :—

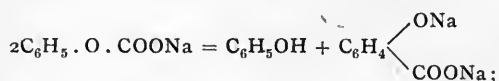

half the phenol used is recovered.

If the sodium phenyl carbonate be heated under pressure at 120–140°, it yields the acid salt of salicylic acid :—

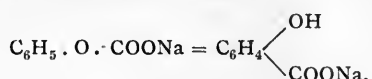

Salicylic acid forms colourless needles which melt at 155°. It is not easily soluble in cold water, but dissolves readily in hot water, alcohol, ether and other organic solvents. It is an antiseptic, like phenol, and is used for preserving food-stuffs and also largely in medicine, more frequently in the form of its derivatives, aspirin and salol.

Salicylic acid behaves as an acid and as a phenol ; it dissolves in caustic alkali forming a salt with the carboxyl and phenolic groups ; in alkali carbonates forming a salt only with the carboxyl group.

Reactions.

- * (1) On heating it melts and sublimes, but on further heating it loses carbon dioxide and yields phenol.

The formation of phenol takes place more readily on heating with soda lime.

- * (2) As it is a phenol it gives the reactions :—

- * (a) With ferric chloride—a violet colour. This is discharged by mineral acids, but not by acetic acid. It may thus be distinguished from phenol.

Note.—Only the hydroxy acid containing the OH group in the ortho position gives a violet colour with ferric chloride.

The m- and p-compounds do not give colours with ferric chloride.

- * (b) With bromine water—a yellowish-white precipitate of dibromo- and tribromosalicylic acids.
- * (c) With nitric acid—a yellow colour intensified on making the solution alkaline with ammonia.
- * (d) With Millon's reagent—a red colour on heating.

Aspirin is acetyl-salicylic acid. It is prepared by heating salicylic acid with acetyl chloride or acetic anhydride :—

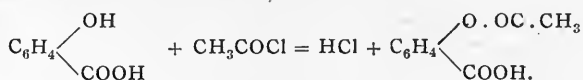

On hydrolysis by acids or alkalis, it yields acetic and salicylic acids.

Salol is phenyl salicylate. It is prepared by heating a mixture of sodium phenate and sodium salicylate with phosphorus oxychloride :—

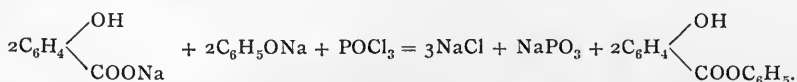

On hydrolysis, it yields phenol and salicylic acid.

If the hydrolysis of aspirin and salol be effected with caustic soda the sodium salts are obtained ; on acidifying with sulphuric acid, salicylic acid is precipitated and the acetic acid or phenol can be isolated by steam distillation.

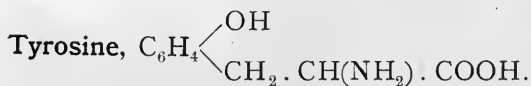

Tyrosine or p-hydroxyphenylalanine is a constituent of proteins from which it was first obtained by Liebig in 1846 who fused cheese (*τυρος*) with caustic potash. It has since been isolated from the products of hydrolysis of most proteins. It is found in the liver and other organs in certain diseases in considerable quantities ; in minute amounts it is present in all tissues.

Preparation.

The best yield of tyrosine is obtained from silk ; silk is hydrolysed by boiling with concentrated hydrochloric acid for 5 or 6 hours, the solution is evaporated to remove hydrochloric acid, the greater part of the remainder is removed as cuprous chloride by adding cuprous oxide, and on neutralising the solution tyrosine separates out. It may also be obtained by hydrolysing silk and other proteins with six times their amount of 30 per cent. sulphuric acid, removing the sulphuric acid with baryta and concentrating the solution. Tyrosine separates out and is recrystallised.

It is most easy to prepare tyrosine by the tryptic digestion of caseinogen. 100-500 gm. of caseinogen are dissolved in 2-10 litres of 4 per cent. sodium carbonate, 1-2 gm. of dried pancreas (trypsin) are added and 1-2 per cent. of toluene or chloroform are shaken up with the solution to prevent putrefaction. The solution is kept at 35° for 7-10 days. It becomes cloudy with the separation of tyrosine which gradually settles out. The filtrate gives the reactions for tyrosine and on evaporation and on cooling deposits a further quantity. Almost pure tyrosine may be obtained from the first deposit by dissolving it in 1N hydrochloric acid, boiling with charcoal to decolorise it and exactly neutralising the clear solution with ammonia. Pure tyrosine may be obtained from the second deposit by the same treatment repeated two or three times.

Properties.

Tyrosine is a colourless crystalline solid, which is soluble with difficulty in cold water, more easily in hot. It dissolves readily in dilute acids or alkalis from which it separates on neutralising the solution.

- * If a small quantity of tyrosine be dissolved in a drop of ammonia on a glass slide and the ammonia be allowed to evaporate, the tyrosine crystallises out in characteristic bunches of fine needles (Fig. 47). It is insoluble in alcohol and ether.



FIG. 47.

Reactions and Tests.

- * (1) Its crystalline form is very characteristic.
- * (2) It gives a yellow colour on heating with nitric acid; this becomes orange on making alkaline with ammonia.
- * (3) It gives a red colour, even in extreme dilution, on heating with Millon's reagent.
- (4) *Piria's test.*—3 drops of concentrated sulphuric acid are put on a little tyrosine in a dry test tube and it is placed in the boiling water-bath for half an hour. The red liquid is diluted with 10 c.c. of water and neutralised with barium carbonate. The filtrate (from BaSO_4) on evaporation to a small volume gives a violet colour with 2-3 drops of ferric chloride, showing the presence of phenol.
- (5) When boiled with copper carbonate it gives a blue copper salt like aliphatic amino acids.
- (6) *Mörner's test.*—A solution of tyrosine gives a green colour on boiling with a solution of formalin in sulphuric acid (1 vol. formalin, 45 vols. water, 55 vols. conc. H_2SO_4).
- (7) A wine-red colour is formed if tyrosine be added to 3 or 4 drops of formalin in 5 c.c. of concentrated sulphuric acid. The liquid becomes green on adding double the volume of glacial acetic acid and boiling (*Denigès*).

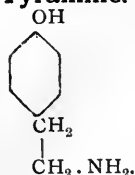
Tyramine.

Tyramine or p-hydroxyphenylethylamine is a base formed from tyrosine by putrefaction. It occurs in ergot of which it is one of the active principles.

The decomposition of tyrosine by putrefaction is exactly similar to that of phenylalanine and takes place in the following stages:—

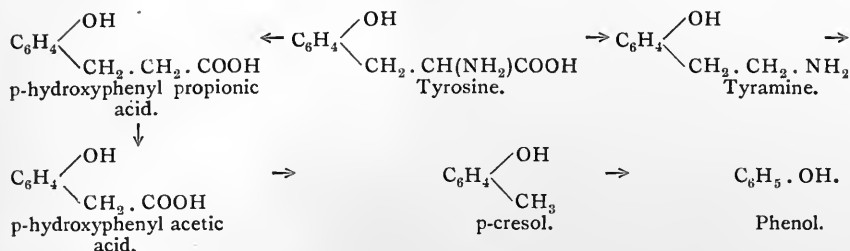

The two following other disubstitution products of benzene occur in nature:—

- (1) **Cymene**, or methylisopropyl benzene, which occurs in numerous essential oils (p. 312) and can be obtained by heating camphor with phosphorus pentoxide, by heating turpentine with concentrated sulphuric acid and by reducing carvacrol and thymol with phosphorus pentasulphide.

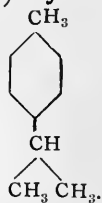

It is a colourless liquid which boils at 175-176° and has a sp. gr. of .8722 at 0°. It yields p-toluic acid and terephthalic acid on oxidation.

- (2) **Anethole**, or p-methoxyphenylpropylene, is the principal constituent of oil of aniseed. It yields p-methoxybenzoic acid, or anisic acid, on oxidation with chromic acid, but anisic aldehyde or p-methoxybenzaldehyde on oxidation with bichromate and sulphuric acid. Anisic aldehyde on reduction with sodium amalgam and alcohol is converted into anisic alcohol.

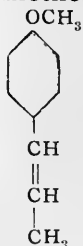

TRISUBSTITUTION DERIVATIVES OF BENZENE.

Trisubstitution derivatives of benzene exist in the three forms :—

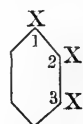

Vicinal.

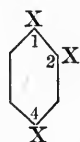

Asymmetric.

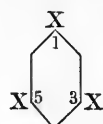

Symmetric.

and the number of isomers is very large. Mention can only be made of those which occur naturally, or are prepared from natural sources.

The trihydric phenols,

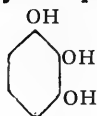

Pyrogallol.

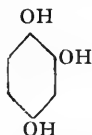

Hydroxyquinol.

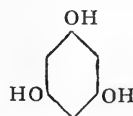

Phloroglucinol.

Pyrogallol, or pyrogallic acid, is obtained by heating gallic acid at 210° until carbon dioxide is no longer evolved :—



It is a colourless crystalline solid, which melts at 115° . It is easily soluble in water, but less in alcohol and ether. It will be noticed that the solubility of phenols in water increases with the number of hydroxyl groups.

Hydroxyquinol is obtained by fusing quinol with potash. It dissolves easily in water and melts at 140° .

Phloroglucinol results from the fusion of numerous resins with caustic potash. It is prepared by fusing resorcinol with caustic potash.

Phloroglucinol is a crystalline solid containing two molecules of water and melting at 218° . It is very soluble in water and is also soluble in alcohol and ether. In most respects it behaves as a trihydroxyphenol, but it forms an oxime and probably has also a ketonic structure.

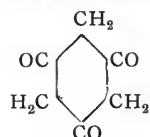
*Reactions.*

- * (1) With ferric chloride, pyrogallol gives a deep-blue coloration; hydroxyquinol gives a greenish-brown colour which changes to blue on adding sodium carbonate and then to red; phloroglucinol gives a blue violet coloration.
- * (2) In alkaline solution in contact with air, they absorb oxygen and the solution becomes brown. Pyrogallol is consequently used for absorbing oxygen.
- * (3) They all reduce Fehling's solution and ammoniacal silver nitrate.

Orcinol is dihydroxy-toluene. **Thymol** and **carvacrol** are derivatives of cymene:—

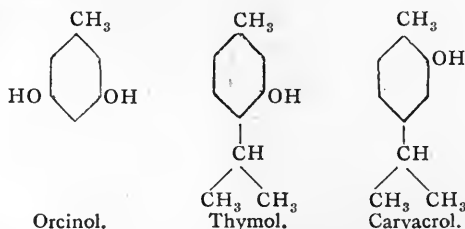

Protocatechuic acid, or catechol-carboxylic acid, results from the fusion of numerous resins, e.g. gum benzoin, catechin resin, with caustic potash. It is prepared by heating catechol with water and ammonium carbonate to 140° .

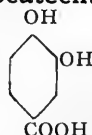

It is a colourless crystalline solid melting at 199° and dissolves readily in water.

With ferric chloride its solution gives a green colour which changes to blue and then to red on the addition of very dilute sodium carbonate. With ferrous sulphate a violet colour is given. It is precipitated from solution by lead acetate.

Veratric acid, the dimethyl ether of protocatechuic acid, occurs in the seeds of *Veratrum sabadilla*, together with veratrine.

Vanillin is obtained from **coniferyl alcohol** by oxidation with chromic acid. Vanillin is the sweet-smelling constituent of the vanilla bean.

Coniferyl alcohol occurs in the glucoside, coniferin, and is obtained from it by hydrolysis.

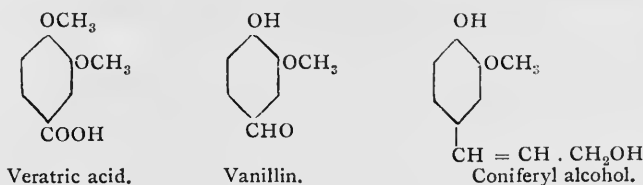

Homogentisic acid, or quinol-acetic acid, is found in the urine in the rare disorder known as alkaptonuria.

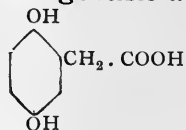

Its presence is first shown by the urine turning brown and black on standing, or by its reducing power.

It is a white crystalline solid melting at $146-147^{\circ}$.

As a derivative of hydroquinone it reacts with

- (1) ferric chloride ;
- (2) Fehling's solution or ammoniacal silver nitrate ;
- (3) turns black in the air in alkaline solution.

Adrenaline is a derivative of catechol and is the active principle of the adrenal gland from which it is prepared as well as by synthesis.

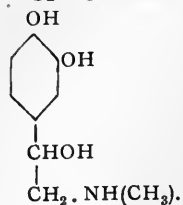

The natural substance is laevorotatory: the synthetic is inactive; the dextrorotatory form has only a very slight pharmacological action in comparison with the laevorotatory or natural form.

Preparation.

Abel's method is probably the most convenient one for preparing adrenaline. To minced suprarenal glands in a series of flasks is added with thorough shaking an equal weight of 3.5 per cent. trichloroacetic acid in alcohol. After 12 hours the mass is filtered. The filtrate is concentrated to about one-fiftieth and again filtered. Concentrated ammonia is added to the filtrate until the liquid just smells perceptibly of ammonia. Adrenaline is precipitated, filtered off, washed with water, alcohol and ether. A yield of about .2 per cent. is obtained. A further .1 per cent. can be obtained by extracting the mass again with trichloroacetic acid. It is recrystallised by solution in alcohol containing oxalic acid and precipitation by ammonia.

Properties.

Adrenaline is a colourless crystalline solid melting at 211-212°. It is not easily soluble in cold water, but more readily in hot water and is not soluble in most organic solvents.

It is a strong base and dissolves in mineral acids; as a phenol it dissolves in caustic alkalis, but not in carbonates or ammonia. Its aqueous solutions are not stable, but turn pink in the air.

Reactions.

(1) Ferric chloride in neutral or faintly acid solution gives a green coloration which on the careful addition of very dilute alkali changes to violet, red-violet and red.

(2) Oxidising agents and air produce a pink colour; potassium persulphate added up to .1 per cent. to the solution of adrenaline gives a colour at a dilution of 1 in 5,000,000 (Ewins).

(3) Adrenaline gives an intense blue colour with Folin's phosphotungstic acid reagent for uric acid (see p. 557). One part in 3,000,000 parts of water gives a reaction with this reagent.

A full account of adrenaline is given in Barger's "Simpler Natural Bases".

Estimation.

The estimation of adrenaline in the suprarenal gland is most easily effected by means of the colour reaction with phosphotungstic acid as shown by Folin, Cannon and Denis in 1913.

The weighed gland is ground up in a mortar with sand and .1N hydrochloric acid and rinsed into a conical flask. 15 c.c. of .1N acid and 45 c.c. of water are used for every 2 gm. of gland. The solution is raised to boiling; there is no coagulation, but on adding 5 c.c. of 10 per cent. sodium acetate solution for every 15 c.c. hydrochloric acid and again heating to boiling, coagulation of the protein occurs. The mixture except the sand is transferred to a 100 c.c. measuring flask and diluted to the mark. The solution is filtered or centrifuged. 5 c.c. of the filtrate are pipetted into a 100 c.c.

measuring flask and at the same time 1 c.c. of the standard uric acid solution (below) into another 100 c.c. flask. To each are added 2 c.c. of the uric acid reagent and 20 c.c. of saturated sodium carbonate solution. They are allowed to stand for 2 to 3 minutes, diluted to the mark, mixed, and the colours compared in a Duboscq colorimeter, the uric acid tint being placed at 20 mm.

Adrenaline gives exactly 3 times the colour that uric acid does: the readings in the colorimeter are proportional.

The uric acid standard contains 1 mgm. uric acid dissolved in 1 c.c. of 4 per cent. lithium carbonate solution and is prepared by dissolving 250 mgm. in 25-50 c.c. of water + 25 c.c. Li_2CO_3 solution by shaking for an hour and diluting to 250 c.c. in a measuring flask. The other standard solution which is permanent may also be used (see p. 557).

TETRASUBSTITUTION PRODUCTS OF BENZENE.

Picric acid, which is so easily formed from phenol, is trinitrophenol.

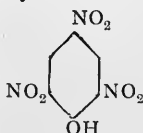

It is a tetrasubstitution product of benzene.

Theoretically a large number of tetrasubstitution products of benzene are capable of existence, but the number of natural compounds which are included here is very small.

Gallic Acid.

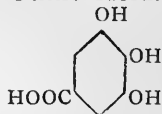

Gallic acid is present in gall nuts, tea and other plants.

It is prepared by the hydrolysis of tannin.

It crystallises in silky needles which melt at 220° . It is not very soluble in cold water, but readily in hot water. It dissolves in alkalis and the solution turns brown in the air. It resembles pyrogallol in its reactions with ferric chloride, Fehling's solution, etc.

It does not precipitate gelatin and is not precipitated by lead acetate.

Tannic Acid or Digallic Acid.

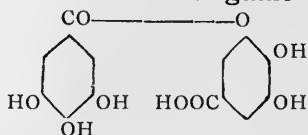

This acid, the anhydride of gallic acid, occurs in gall nuts, sumach and other kinds of bark.

It may be prepared by heating gallic acid with phosphorus oxychloride. Its constitution is not definitely known and it is sometimes referred to as tannin, but the synthetical product obtained from gallic acid has not the same properties as natural tannin which contains digallic acid in its constitution.

The natural product is here referred to as tannin, the synthetical as digallic acid.

Two other digallic acids are known.

TANNINS.

The various kinds of tannin which can be extracted from gall nuts, sumach, pomegranate, oak bark, kino, etc., seem to belong to two main groups according to the reactions which they give with ferric chloride, bromine water, etc. They appear to contain a pyrogallol nucleus, or a catechol nucleus, thus:—

	Pyrogallol variety	Catechol variety
Ferric salts . . .	Dark blue	Greenish-black.
Bromine water . . .	No precipitate	Yellow or brown precipitate.
Leather . . .	Produce a "bloom"	No bloom.
Conc. H ₂ SO ₄ . . .	—	Dark red ring at junction of liquids.

Some of the tannins of the catechol variety, gambier and cutch, appear to contain a phloroglucinol nucleus, since a pine shaving moistened with an extract and treated with concentrated hydrochloric acid gives a red or purple stain which is characteristic of phloroglucinol.

Constitution.

As yet the constitution of the various tannins has not been definitely determined, but it appears from the work of Emil Fischer and his pupils that the tannins are esters of glucose with gallic acid, digallic acid and other complex phenolic acids.

Fischer and his pupils have definitely shown that the tannin from Aleppo, Chinese and other galls contains 7-8 per cent. of glucose. The tannin was carefully purified; the purified product was hydrolysed by dilute sulphuric acid and the glucose identified and estimated. If the former supposition that tannins were glucosides were correct, a larger amount of glucose would result. The yield of glucose corresponds very closely to that which would be obtained if tannin were the pentadigalloyl ester of glucose. This constitution, though not absolutely proved, has been made extremely probable by synthesis. Fischer has prepared esters of glucose with a series of these phenolic acids and they possess the main properties of the tannins.

Tannins would therefore be constituted thus:—

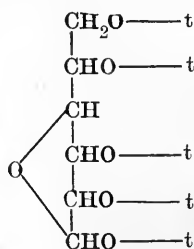

where t represents a complex acid like tannic acid or digallic acid.

These compounds correspond to the fats in which glycerol is the basis and various fatty acids are combined with it.

This constitution not only allows for a large number of varieties of tannins where t is the same throughout the molecule, but also where t is different.¹

In addition to the interest attached to the syntheses of a tannin there is another interest. Some of the synthetical tannins possess very high molecular weights; one of them has a higher molecular weight, 2051, than any other known synthetical compound, and has largely exceeded the figure of 1213, which is the molecular weight of the synthetical octadecapeptide (p. 363).

Oak-gall Tannin.

Tannin is prepared from finely powdered gall nuts by extraction with a mixture of 12 parts of ether and 3 parts of alcohol; 12 parts of water are added and the mixture thoroughly shaken. The lower aqueous layer is separated and evaporated. The tannin may be purified by boiling with charcoal. Or the powdered gall nut is heated under a reflux condenser with a mixture of 30 parts of ether, 5 parts of water and 2 parts of alcohol. The lowest layer contains about 30 per cent. of tannin which is obtained as above.

Tannin is an amorphous powder; the pseudo-crystalline appearance of some kinds of tannin results from the method of its preparation, a syrupy solution being drawn up into threads, which are dried and broken. It is almost colourless when pure. It dissolves easily in water and its solution is acid in reaction to litmus and has an astringent taste. It is soluble in alcohol and glycerol, but very little soluble in ether, chloroform, ligroin. It is precipitated from solution by hydrochloric acid and sulphuric acid; it is soluble in alkalis and the alkaline solution turns brown on exposure to the air.

It is decomposed on heating at 160-215° into pyrogallol, gallic acid and other products.

Reactions.

- (1) With ferrous sulphate—containing no ferric salt—there is no change, but on exposing to the air the solution darkens.
- (2) With ferric chloride—a blue-black colour or precipitate is formed (ink).
- (3) It is precipitated from solution by gelatin, hide powder (leather and other proteins).
- (4) It precipitates alkaloids from solution.
- (5) Dilute iodine solution gives a pink colour.
- (6) Potassium cyanide gives a reddish-brown colour, which changes to brown; on shaking with air the red tint appears again.
- (7) Lime water gives a grey precipitate.
- (8) It is precipitated by lead acetate or by lead nitrate.

¹ A summary of the researches on tannins is given in the "Ber. deutsch. Chem. Ges.," 1913, 46, 3253.

HETEROCYCLIC COMPOUNDS.

Numerous compounds exist containing rings or nuclei composed of carbon atoms and atoms of other elements, especially oxygen, sulphur and nitrogen. These ring compounds are grouped together as the heterocyclic compounds.

Some of the heterocyclic compounds are closely connected with the aliphatic series of compounds, e.g. the anhydrides of dibasic acids, such as succinic anhydride; the γ -lactones and other lactones; the imides from ammonium salts of dibasic acids, such as succinimide; the polymers of the aldehydes, such as trioxymethylene, paraldehyde; and of cyanic acid, namely, cyanuric acid. Creatinine may also be placed in this group. In these compounds the ring is formed easily and it is easily ruptured. They are therefore usually considered as aliphatic compounds. Other heterocyclic compounds possess a more stable ring and they resemble the aromatic substances very closely in their properties. They include pyridine, quinoline and their derivatives, the alkaloids.

Intermediately between these two classes there are other heterocyclic ring compounds which do not possess the chief properties of aromatic compounds in forming nitro- and sulphonic acid derivatives, but they possess a ring which is comparatively stable and is not easily broken down. In this group are included the cyclic ureides, pyrimidine and purine and their derivatives, pyrrole, thiophene, furfuran.

As in the carbocyclic compounds the rings containing 5 atoms and 6 atoms are the most stable.

UREIDES.

In the same way as ammonia forms amides with acids so also does urea form ureides. Ureides are therefore derivatives of urea with acid radicles.

A. UREIDES OF MONOBASIC ACIDS, e.g. acetyl urea.

These are obtained by the action of acid chlorides, or acid anhydrides, upon urea :—

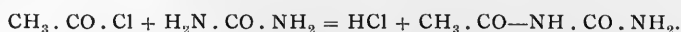

They are solid compounds. Acetyl urea forms long silky needles which melt at 214° and which are not easily soluble in cold water or alcohol. They are neutral in reaction and do not form salts with acids.

Like amides they are easily decomposed by hydrolysis, especially by alkalis and are converted into their constituents :—

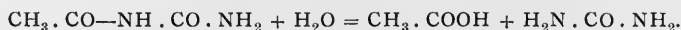

The urea may be decomposed into ammonia and carbon dioxide.

Diacetyl urea, $\text{CH}_3 \cdot \text{CO} \text{—} \text{NH} \cdot \text{CO} \cdot \text{NH} \text{—} \text{CO} \cdot \text{CH}_3$, is formed by the action of carbonyl chloride upon acetamide.

B. UREIDES OF HYDROXY AND ALDEHYDE ACIDS.

Two classes of ureides are formed with these acids, an open chain compound such as hydantoic acid, and a closed chain compound (a cyclic ureide) such as hydantoin. Both these compounds are ureides of glycollic acid :—

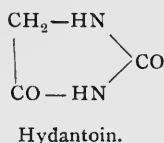
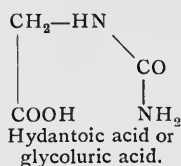

Hydantoic Acid.

Hydantoic acid is obtained from hydantoin by boiling it with baryta water. It may be synthesised from glycine sulphate and potassium cyanate, a reaction analogous to the synthesis of urea :—

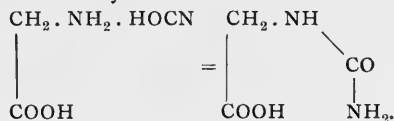

Hydantoic acid is a white solid easily soluble in water and alcohol. It is converted into glycine, carbon dioxide and ammonia on heating with hydriodic acid.

Hydantoin.

Hydantoin is obtained by heating allantoine and alloxanic acid, two oxidation products of uric acid, with hydriodic acid. It is prepared synthetically by heating bromacetyl urea with alcoholic ammonia:—

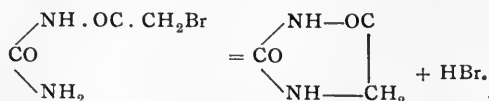

It is a white crystalline solid which melts at 216° .

Allantoine.

Allantoine is a combination of 2 molecules of urea with glyoxylic acid, and is derived from the hypothetical dihydroxy-acetic acid:—

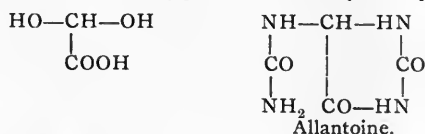

Allantoine was first found in the allantoic fluid of calves; it has since been found in the urine of various animals, ox, dog, monkey, rabbit, sheep, and also in various organs of animals. It has been found in plants. Allantoine is an oxidation product of uric acid, and arises in those animals in which allantoine is present in the urine by the oxidation of uric acid.

*Preparation.**(1) By the Oxidation of Uric Acid.*

100 gm. of uric acid are suspended in 1500-2000 c.c. of water and dissolved by the careful addition of caustic soda in small quantities at a time. The alkaline liquid is treated with a concentrated solution of 62 gm. of potassium permanganate and well stirred. Manganese dioxide is formed and the permanganate decolorised. This takes place rapidly and is complete in about an hour; it must be tested for by filtering a sample if necessary. As soon as the solution is decolorised, it is filtered from manganese dioxide, acidified with acetic acid and evaporated (best *in vacuo*) until it crystallises. The crystals are recrystallised from hot water.

(2) From the Urine of Dogs, etc.

The urine is treated with a concentrated solution of phosphotungstic acid to remove pigments, etc. The excess of phosphotungstic acid is removed with lead carbonate and excess of lead with hydrogen sulphide and then the hydrogen sulphide is removed. Chlorides are removed with silver acetate, excess of silver with hydrogen sulphide and the hydrogen sulphide by a current of air. The allantoine is precipitated by adding a .5 per cent. solution of mercuric acetate in sodium acetate. The precipitate is filtered off, washed and decomposed with hydrogen sulphide. Allantoine crystallises out on evaporation of the solution.

Properties.

Allantoine forms shining colourless prisms which have no taste or smell and are neutral in reaction to litmus. It is not easily soluble in cold water (1 in 160 parts) or cold alcohol but easily soluble in hot water and hot alcohol; on heating it turns brown at 220° and melts with decomposition at 231°.

Allantoine forms compounds with metals: it is precipitated by ammoniacal silver solutions: the precipitate is soluble in ammonia; it is also precipitated by salts of lead, copper and mercury (see above). It reduces Fehling's solution on prolonged boiling.

Allantoine is decomposed by hydrolysis with acids or alkalies, giving urea (or ammonia and carbon dioxide) and acetic acid and oxalic acid. It is also decomposed by hypobromite solution with evolution of nitrogen.

Tests and Identification.

In order to identify allantoine it must be isolated from solution, either as such or as its silver compound, and analysed; the silver compound contains 40.73 per cent. of silver. The presence of glyoxylic acid may be shown (1) by boiling with alkali and testing the solution by adding some dilute indole solution and pouring sulphuric acid under the mixture; a red ring is formed at the junction of the liquids. (2) By boiling with about 15 per cent. soda for 1-2 minutes, cooling, acidifying with acetic acid and testing for oxalic acid with calcium chloride.

C. UREIDES OF DIBASIC ACIDS.

Some of these ureides were first obtained by the oxidation of uric acid and were the fundamental substances from which its constitution was determined. Others were prepared synthetically in the study of these ureides and in the attempts to prepare uric acid synthetically.

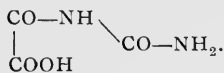
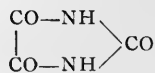
Parabanic Acid and Oxaluric Acid.

Parabanic acid, or Oxalylurea, is formed on oxidising uric acid with nitric acid: It is prepared synthetically by the action of phosphorus oxychloride upon a mixture of urea and oxalic acid.

Parabanic acid is a white crystalline substance, which is soluble in water and alcohol.

Oxaluric acid is obtained by the action of bromine upon parabanic acid and by the action of water upon salts of parabanic acid.

Oxaluric acid is a crystalline powder soluble in water with difficulty and is present in small quantities in urine.

Both parabanic acid and oxaluric acid are decomposed by hydrolysis by boiling with water, acids, or alkalies into urea and oxalic acid.

A series of ureides is derived from acids containing three carbon atoms in their molecule:—

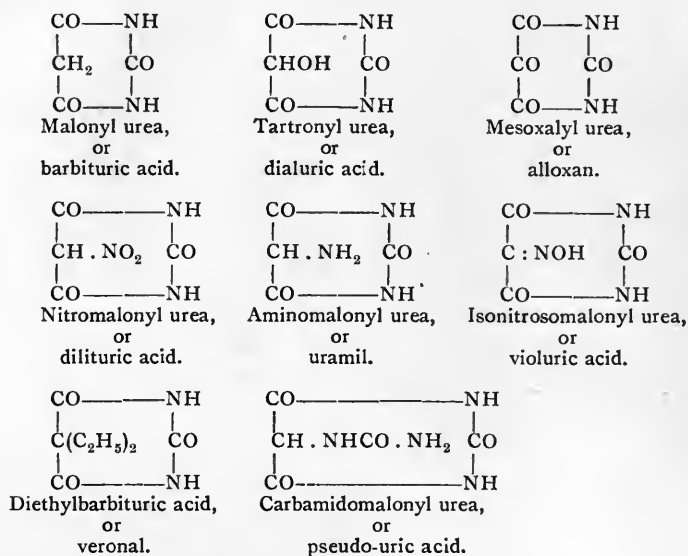

Uric acid, the principal ureide biologically, is derived from a hypothetical acid, $\text{C}(\text{OH})_2 = \text{C}(\text{OH})\text{---COOH}$, containing 3 carbon atoms and 2 molecules of urea; it has the formula:—

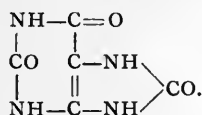

Alloxan.

Alloxan is the most interesting of this series of compounds as it can be transformed into the others; it forms the central point in our knowledge of the constitution of uric acid and other purines (p. 286).

Preparation.

Alloxan is produced by the careful oxidation of uric acid with nitric acid, bromine or chlorine; also by the oxidation of xanthine.

It is easy to prepare alloxantin from uric acid and to prepare alloxan from alloxantin.

Alloxantin may be prepared as follows: 10 gm. of uric acid are covered with 20 c.c. of water and 20 gm. of concentrated hydrochloric acid and heated to 35°; 2.5 gm. of powdered potassium chlorate are gradually added with continuous stirring. The uric acid dissolves and a pale yellow liquid results. This is diluted with about 75 c.c. of water, allowed to stand and filtered. The filtrate, which contains alloxan, is saturated with hydrogen sulphide and allowed to stand for 12-16 hours. Alloxantin mixed with sulphur separates out; it is filtered off and washed with water. It is separated from sulphur by solution in a small quantity of boiling water from which it separates on cooling in colourless crystals. These crystals are sometimes tinged with pink.

Alloxantin is readily reduced or oxidised.

Alloxan is prepared : 3 gm. of finely powdered alloxantin are mixed with 3 gm. of concentrated nitric acid and 7 gm. fuming nitric acid (sp. gr. 1.5). Slow oxidation occurs on standing and large crystals of alloxan are formed. The oxidation is complete in about 2 days and is shown by the complete solubility of the crystals in water. The crystals are placed on a porous plate to drain off the nitric acid and dried in the air. They are recrystallised from water.

Properties.

Alloxan is a white crystalline substance which separates from water in long shining rhombic prisms containing 4 molecules of water of crystallisation ; on exposure to air, the crystals effloresce and lose 3 molecules of water ; the last molecule of water is driven off by heating to 150°.

It is easily soluble in water ; the solution has an acid reaction and disagreeable taste and it slowly turns the skin a purple red. A deep indigo blue colour is formed when ferrous sulphate is added to its solution.

If a few drops of its solution in water be evaporated to dryness and the reddish residue be treated with ammonia, it turns purple.

Reactions.

(1) Alloxantin is formed by the action of reducing agents upon alloxan in the cold :—

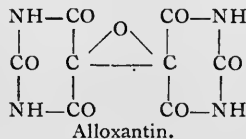

(2) Dialuric acid is formed by the action of reducing agents on alloxan on warming.

(3) Parabanic acid and carbon dioxide are formed by the oxidation of alloxan with boiling dilute nitric acid.

(4) Barbituric acid is obtained from alloxantin by the action of concentrated sulphuric acid.

(5) Dilituric acid is formed by the action of fuming nitric acid upon alloxantin, or by the oxidation of violuric acid.

(6) Violuric acid is formed by the action of potassium nitrite upon alloxantin, or by the action of hydroxylamine upon alloxan.

(7) Uramil is formed by the reduction of dilituric acid and violuric acid.

These ureides are white crystalline substances which are easily soluble in water ; uramil is only slightly soluble and becomes red on exposure to the air.

PYRIMIDINES.

The cyclic ureides derived from urea and acids containing three carbon atoms (p. 280) are heterocyclic compounds. Those cyclic ureides which are derived from urea and the unsaturated acids, acrylic acid, methylacrylic acid, crotonic acid, form the group of compounds termed the pyrimidines. They have the structure :—

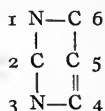

To this group belong the three compounds, thymine, uracil and cytosine which are constituents of nucleic acid :—

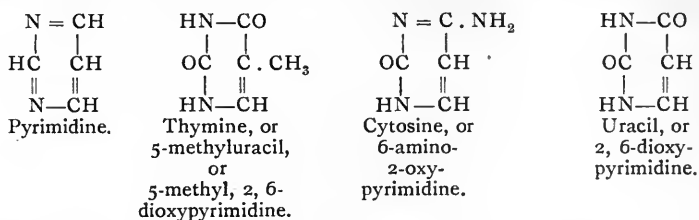

The ring contained in these compounds is a portion of the ring structure of the purines and it was first supposed that cytosine and uracil were decomposition products of adenine and guanine, but it has been definitely proved that these compounds are not secondary products and that they are part of the molecule of nucleic acid (p. 299).

Preparation.

These three compounds have been prepared by synthesis and their constitution established (see W. Jones' monograph on Nucleic Acid). They are more readily prepared from nucleic acid. Plant nucleic acid yields uracil and cytosine; animal nucleic acid yields thymine and cytosine. The following method is given by W. Jones :—

50 gm. of nucleic acid are hydrolysed by heating in an autoclave with 250 c.c. of 25 per cent. sulphuric acid for 5 hours at 150-160°. The solution is diluted with water to 1000 c.c. and hot saturated baryta is added in excess to remove phosphoric and sulphuric acids. The excess of baryta is removed with carbon dioxide. The yellow solution is evaporated to about 400 c.c. and faintly acidified with nitric acid. The purines, which are precipitated, are filtered off. Silver nitrate is added to precipitate the remainder of the purines. To the clear yellow filtrate silver nitrate is added in small portions until a test portion gives a yellow coloration with a drop of baryta on a watch glass. The solution is made faintly alkaline with baryta and the precipitate of pyrimidine silver compounds is filtered off. The subsequent treatment depends on whether thymine and cytosine are being prepared from animal nucleic acid or uracil and cytosine from plant nucleic acid.

(a) Thymine and Cytosine.

The precipitate is suspended in hot water and decomposed with hydrochloric acid. Traces of silver chloride which remain in solution are removed by hydrogen sulphide and the filtrate from silver sulphide is evaporated *in vacuo* at 60° to a small volume. Thymine separates out during evaporation and on cooling. It is filtered off and recrystallised from hot water containing animal charcoal.

The filtrate containing cytosine is carefully evaporated to dryness to remove hydrochloric acid and dissolved in a small amount of water. Some thymine may remain undissolved. The solution contains cytosine hydrochloride from which the picrate or platinichloride may be made. Cytosine is obtained by treating the concentrated solution with ammonia; it crystallises out and is purified by recrystallisation from water.

(b) Uracil and Cytosine.

The precipitate of pyrimidine silver compounds is suspended in hot water and decomposed with hydrogen sulphide. If barium be present, it is quantitatively removed with sulphuric acid and the solution is concentrated. The cytosine is precipitated by slowly adding a hot saturated solution of picric acid. The cytosine picrate is recrystallised from water, dissolved in 5 per cent. hydrochloric acid and separated from picric acid by extracting the solution with ether. The solution of cytosine hydrochloride yields cytosine as above.

The uracil is obtained from the filtrate by acidifying with sulphuric acid, extracting the picric acid with ether, removing the sulphuric acid with baryta, evaporating to a small volume and allowing it to crystallise out. The impure crusts of crystals are recrystallised firstly from hot water containing charcoal and then from 5 per cent. sulphuric acid.

Properties.

Thymine generally crystallises from water in rosettes of small platelets, sometimes in the form of needles.

It is soluble with difficulty in cold water—4 parts in 100 parts of water at 25°—but easily in hot water. It is slightly soluble in alcohol. It sublimes if carefully heated and melts when heated in a capillary at 321° with decomposition.

It does not form salts with acids, but a potassium salt has been prepared.

It combines with silver nitrate forming a compound which is precipitated by ammonia or baryta; the compound is soluble in excess of ammonia, but not of baryta.

It is precipitated by mercuric nitrate, but not by phosphotungstic acid.

It is identified by its melting-point, sublimation and analysis.

Cytosine crystallises in colourless glistening plates containing 1H₂O which is given off at 100°. It decomposes at 320-325°. It is soluble with difficulty in water—1 part in 129 parts of water at 25°. Cytosine forms salts with acids; the chief salt is the picrate which turns brown on heating at 255° and melts at 270°.

It forms also double salts with platinum chloride, etc.

It behaves like thymine towards silver nitrate and ammonia or baryta.

It is slowly precipitated by mercuric sulphate and also by phosphotungstic acid.

It is converted into uracil by the action of nitrous acid.

Uracil forms a white crystalline powder consisting of needles arranged in clusters. It partially sublimes on heating and gives off red vapours.

It is soluble with difficulty in cold water, more easily in hot and is almost insoluble in alcohol and ether.

It behaves like thymine towards silver nitrate and ammonia or baryta. It is precipitated by mercuric nitrate, but not by phosphotungstic acid.

GLYOXALINE OR IMINAZOLE DERIVATIVES.

Histidine, histamine and urocanic acid are compounds which contain the heterocyclic glyoxaline or iminazole ring made up of 2 nitrogen atoms and 3 carbon atoms :—

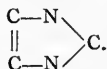

This ring structure is also present in the purine ring which is a combination of the pyrimidine and iminazole rings.

Histidine is β -iminazole- α -aminopropionic acid.

Histamine is β -iminazole-ethylamine.

Urocanic acid is β -iminazole-acrylic acid.

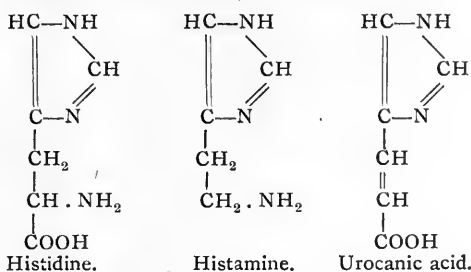

Histidine is a constituent of proteins and is contained in greatest amount in the protein hæmoglobin.

Histamine is a product of the putrefaction of histidine (or proteins). It is a constituent of ergot and is present in putrified meat, etc. It has a marked physiological action upon the sympathetic nervous system.

Urocanic acid has been isolated twice from the urine of dogs and also from a trypsin digest of protein.

Histidine.

Preparation.

Histidine can be readily prepared from blood as follows :—

2 parts of ox blood are added in portions to 1 part of concentrated hydrochloric acid contained in a large round-bottom flask and heated to boiling for 10 hours. The solution is evaporated to remove most of the hydrochloric acid, nearly neutralised and filtered. The yellow filtrate is made alkaline with sodium carbonate and boiled until ammonia is no longer evolved, again filtered and precipitated with mercuric chloride solution, the reaction

being kept slightly alkaline with sodium carbonate. The precipitate is filtered off, washed and dissolved in a minimum of dilute hydrochloric acid. The filtered solution is considerably diluted, some mercuric chloride added and precipitated with sodium carbonate. The precipitate is filtered off, washed, suspended in water and decomposed with hydrogen sulphide. The filtrate from mercuric sulphide on evaporation yields histidine monochloride. 10 litres of blood give from 70-90 gm. (Knoop, 1907).

Properties.

Histidine forms small platelets which melt at 253° with decomposition. It is easily soluble in water, very slightly soluble in alcohol and insoluble in ether.

Its solution is alkaline in reaction; it forms salts with acids and also double salts with gold chloride, etc.

It is precipitated by silver nitrate and ammonia or baryta water, by mercuric sulphate in sulphuric acid solution and by phosphotungstic acid.

Reactions.

(1) A solution of histidine treated with sodium hydroxide and a trace of copper sulphate and heated gives a violet colour, which changes to red (compare biuret reaction).

(2) A solution of histidine made alkaline with sodium carbonate and treated with 3-5 c.c. of a fresh alkaline (Na_2CO_3) solution of about 0.5 gm. of diazobenzene sulphonic acid¹ gives on standing a deep cherry-red colour, which changes to orange on acidifying (Pauly).

The delicacy of this reaction is 1 in 20,000; with 1 in 100,000 a pale red colour is produced.

Tyrosine gives a similar colour with the reagent and must consequently be absent from the solution.

A modification of the reaction by which histidine can be distinguished from tyrosine was devised by Totani.²

(3) An acid aqueous solution of histidine is treated with bromine water until it has a permanent yellow colour. On heating, the yellow colour disappears, but the solution becomes gradually red until it assumes a deep wine-red colour and a black amorphous precipitate settles out. This reaction is positive in a dilution of 1 in 1000.

Pilocarpine.

This basic substance or alkaloid (p. 351) contains an iminazole ring. Its formula is probably the following:—

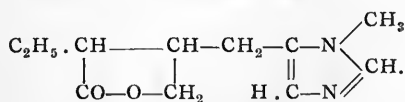

¹ This is prepared by stirring 2 gm. of finely powdered sulphanilic acid into a paste with 3 c.c. of water and 2 c.c. of conc. hydrochloric acid. The paste is treated, within a period of 1 minute, with a fresh solution of 1 gm. of potassium nitrite in 1 to 2 c.c. of water, the mixture being cooled after each addition with cold water. Most of the sulphanilic acid rapidly dissolves and a thick white crystalline precipitate of diazobenzene sulphonic acid forms. It is filtered off after a few minutes and washed with a little water.

² Biochem. J., 1915, 9, 385.

PURINES.

Uric acid, xanthine, hypoxanthine, guanine, adenine, caffeine, theobromine and others are classed together in the special group of compounds known as the purines. Not only are these compounds found associated in nature in both animals and plants, but also they are chemically very closely related. They yield alloxan, or dimethylalloxan, on oxidation, and have many other similar reactions.

All these compounds have been synthesised by Emil Fischer and their exact chemical relationship to one another established. The result of these investigations has shown that they are all derived from the compound purine, which stands in the same kind of relationship to them as a hydrocarbon does to an alcohol, an amine, etc. Thus :—

Purine	$C_5H_4N_4$
Hypoxanthine = monoxypurine	$C_5H_4N_4O$
Xanthine = dioxypurine	$C_5H_4N_4O_2$
Uric acid = trioxypurine	$C_5H_4N_4O_3$
Adenine = aminopurine	$C_5H_5N_4 \cdot NH_2$
Guanine = amino-oxypurine	$C_5H_5N_4 \cdot O \cdot NH_2$
Theobromine = dimethyl dioxypurine	$C_5H_6N_4O_2(CH_3)_2$
Theophyllin = dimethyl dioxypurine	$C_5H_6N_4O_2(CH_3)_2$
Caffeine = trimethyl dioxypurine	$C_5H_5N_4O_2(CH_3)_3$

The compounds have the heterocyclic ring structure in which the atoms are numbered in the following order :—

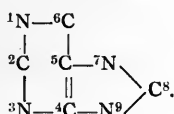

The formulæ for the various compounds are :—

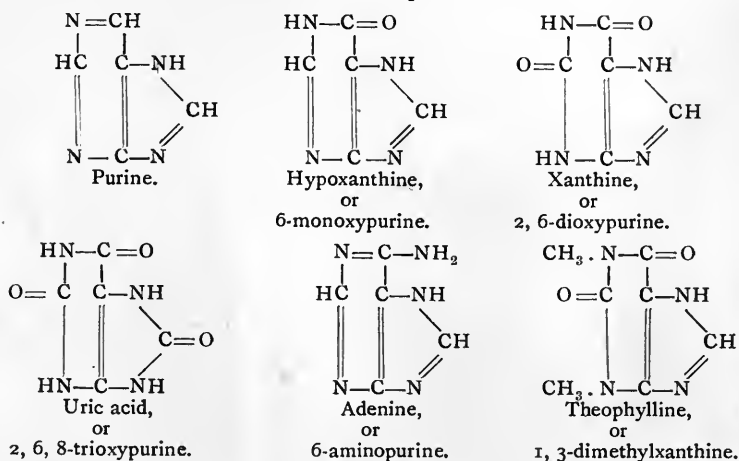

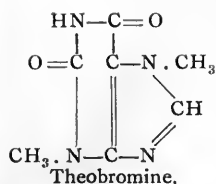

or
3, 7-dimethylxanthine.

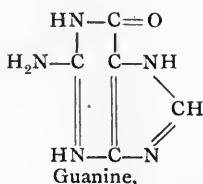

or
2-amino, 6-oxy-purine.

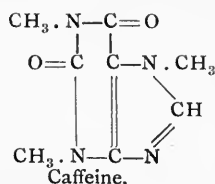

or
1, 3, 7-trimethylxanthine.

It will be noticed that the complex or ring of atoms is the same in all these compounds, but that according as the compounds contain oxygen atoms attached to a carbon atom the double bond is changed in position so as to keep the nitrogen and carbon atoms trivalent and tetravalent respectively. The double bond between the carbon atoms 4 and 5 is the same throughout.

URIC ACID.

Scheele discovered uric acid in urinary calculi in 1776 and also isolated it from urine. He made a careful investigation of its properties and reactions, most of which are still used at the present time for its identification. It was called lithic acid or ouric acid by Fourcroy in 1793, who showed that it contained urea. It was discovered in guano in 1805 and in bird's excrement in 1815, and later it was shown to be the chief constituent of snakes' excrement. Prout about this time showed that uric acid on oxidation with nitric acid gave alloxan. It was first analysed in 1834 by Liebig and Wöhler and found to possess the empirical formula $\text{C}_5\text{H}_4\text{N}_4\text{O}_3$. These workers by oxidising uric acid with lead peroxide obtained allantoin, which had been previously found in the allantoinic fluid of calves. Other ureides were obtained by Strecker and by Baeyer who established their constitution.

The formation of alloxan and urea, and of allantoin, by the oxidation of uric acid, showed that uric acid contained 2 molecules of urea and that it contained the structures of alloxan and allantoin in its molecule;—

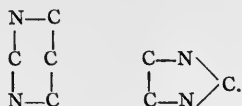

Two formulæ were put forward to represent the constitution of uric acid:—

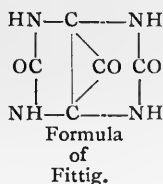
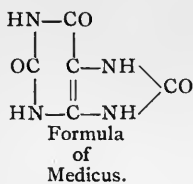

The formula proposed by Medicus was ultimately proved to be the correct one by the synthesis of uric acid by Fischer.

The previous syntheses of uric acid by Horbaczewski (1) by fusing together glycooll and urea, (2) by combining trichlorlactamide with urea :—

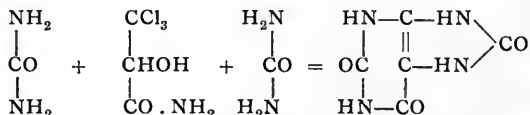

did not definitely prove its constitution. The synthesis by Behrend and Roosen from aceto-acetic acid and the following synthesis commenced by Baeyer and completed by Fischer proves the constitution of uric acid :—

(1) Malonyl urea or barbituric acid is obtained by heating urea and malonic acid with phosphorus oxychloride.

(2) Nitrous acid converts malonyl urea into oximidomesoxalyl urea or violuric acid.

(3) Aminomalonyl urea or uramil is obtained by reducing violuric acid.

(4) Potassium cyanate converts uramil by rearrangement, as in the formation of urea, into pseudo-uric acid.

(5) Pseudo-uric acid loses water on heating with fused oxalic acid, or boiling with hydrochloric acid, and is changed into uric acid.

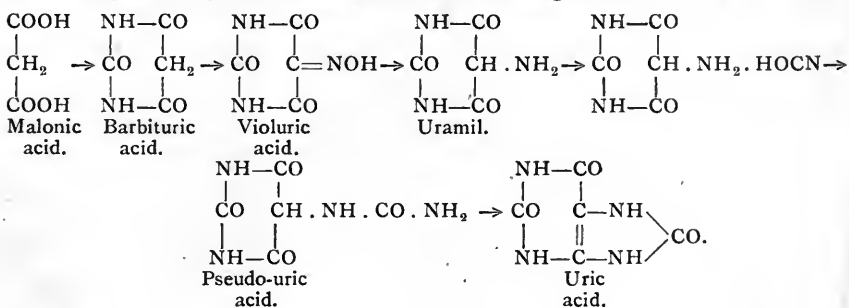

Preparation.

* (1) From Snakes' Excrement, or Guano.

5 to 1 gm. of snakes' excrement (or guano) is powdered, suspended in 100 c.c. of water, heated nearly to boiling and dissolved by adding dilute sodium hydroxide. The solution is heated until ammonia from ammonium salts and urea is no longer evolved and filtered from insoluble material (sand, etc.). Excess of dilute hydrochloric acid is added to the filtrate. Uric acid is precipitated; it is filtered off when the solution has cooled and washed free from acid with water. The product is generally almost pure, but may be purified by dissolving

in sodium hydroxide and reprecipitating with acid. It is dried in the air or at 100° .

(2) *From Human Urine.*

* A twenty-four hours' quantity of human urine contains from 0.5 to 1.5 gm. of uric acid, sometimes as much as 2.0 or 2.5 gm.

(a) 500 c.c. of urine are treated with 50 c.c. of concentrated hydrochloric acid and allowed to stand in a cool place for twenty-four hours. Pigmented crystals of uric acid slowly separate out and adhere to the sides of the vessel.

Microscopic examination of the crystals shows that they consist of irregular, much pigmented crystals, generally arranged in sheaves (Figs. 48, 80, p. 565).

* (b) 100 c.c. of urine are saturated with crystals of ammonium chloride (27 gm. necessary) and 1 or 2 drops of strong ammonia are added. A gelatinous precipitate of ammonium hydrogen urate is formed. This is filtered off after about fifteen minutes. It can be shown to contain uric acid by testing a small portion by the murexide test. The uric acid is obtained from the precipitate by dissolving it in the smallest quantity of hot water containing a drop of sodium hydroxide, filtering, if necessary, and acidifying with a drop of concentrated hydrochloric acid. Uric acid crystallises out on cooling if too much water has not been used in dissolving the ammonium urate.

Properties.

Pure uric acid is a colourless crystalline powder, but as obtained from solutions containing urinary pigments it is generally more or less pigmented; the pigment is difficult to remove by treatment with animal charcoal. The crystals usually consist of rhombic plates or prisms, but various shapes are observed depending on the rate of its crystallisation from solution. These are shown in Fig. 48.

Uric acid has no taste or smell. It is only slightly soluble in water—1 part in 39,500 parts of water at 18° , 1 part in about 1900 parts of hot water. It is insoluble in alcohol and ether, but soluble in glycerol. It is soluble in solutions of the borates, phosphates, carbonates and acetates of the alkali metals, with the formation of acid salts of these acids and of uric acid. It dissolves in concentrated sulphuric acid from which it is precipitated by the addition of water.



FIG. 48.—Uric acid. (After Funke.)

Uric acid is a weak acid and forms two series of salts, neutral and acid salts. The formation of salts can be explained either by the tautomeric formula in which hydroxyl groups attached to the carbon

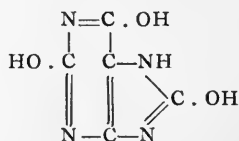

atoms are present, evidence of which is shown by the action of phosphorus trichloride upon uric acid, which gives trichloropurine, or by assuming that the acid character of the CO groups influences the properties of the hydrogen atoms attached to the N atoms so that they are acidic in character and replaceable by metals.

The neutral salts, such as $\text{C}_5\text{H}_2\text{Na}_2\text{N}_4\text{O}_3$, are comparatively easily soluble in water and are obtained on dissolving uric acid in alkali hydroxides or in hot solutions of the carbonates. Lithium urate is the most soluble salt of uric acid.

Uric acid is insoluble in cold solutions of the carbonates and may thus be separated from other acids such as benzoic acid.

The acid salts, such as $\text{C}_5\text{H}_3\text{NaN}_4\text{O}_3$, are soluble with difficulty in water. They are obtained on passing carbon dioxide into a solution of the neutral salt.

One part of acid sodium urate is soluble in 1100-1200 parts of cold water and 125 parts of hot water; 1 part of acid potassium urate is

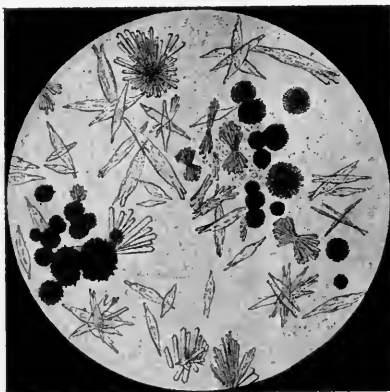

FIG. 49.—Sodium urate.
(After Funke.)

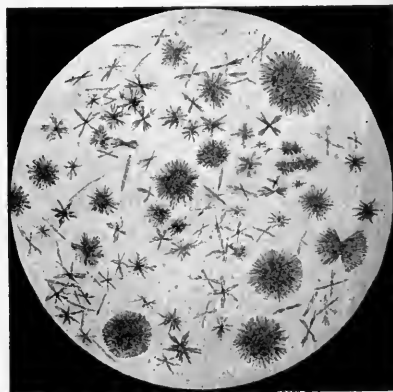

FIG. 50.—Ammonium urate.
(After Funke.)

soluble in 800 parts of cold water and in 70 parts of hot water; 1 part of acid ammonium urate is soluble in 1600 parts of cold water, more easily in hot water and is insoluble in ammonium chloride solution.

A double compound of uric acid and acid sodium urate, $C_5H_4N_4O_3$ + $C_5H_3NaN_4O_5$, is said to be deposited in gouty joints and cartilages.

All the salts are decomposed by acetic acid or hydrochloric acid with the gradual separation of uric acid.

Reactions.

* (1) On heating, uric acid is decomposed with the formation of urea, ammonium carbonate, cyanuric acid and hydrogen cyanide and a charred mass remains.

* (2) Uric acid is decomposed on heating with solid potassium hydroxide with the formation of ammonia and potassium cyanide; the presence of potassium cyanide may be shown by extracting the residue with water and testing for cyanides (p. 156).

* (3) Uric acid chars on heating with concentrated sulphuric acid.

* (4) *Murexide Test.*—On evaporating a small quantity of uric acid or an urate to dryness with dilute nitric acid, a yellow or yellowish-red residue is left. On adding to it a drop of ammonia with a glass rod, the colour changes to purple; ammonium purpurate or murexide is formed. A drop of caustic soda gives a blue-violet colour.

* (5) *Schiff's Test.*—A solution of uric acid in sodium carbonate solution reduces silver nitrate. This is best observed by pouring some of the urate solution upon a filter paper moistened with silver nitrate. A black stain of metallic silver results.

* (6) *Fehling's Solution.*—A white precipitate of copper urate is formed when a solution of uric acid is added to Fehling's solution and warmed. On boiling for some time, the solution is reduced with the formation of cuprous oxide.

Note.—On this account urine on prolonged boiling reduces Fehling's solution and the reduction may be wrongly attributed to small amounts of glucose (see under pathological urines).

(7) If a small quantity of uric acid be carefully heated with dilute nitric acid just to effervescence and the excess of acid be carefully evaporated so as to avoid coloration, a blue colour results on the addition of 2-3 drops of concentrated sulphuric acid and a few drops of commercial benzene (containing thiophene). The colour changes to brown on evaporation of the benzene, but returns on again adding benzene (*Denigès*).

(8) Dilute solutions of uric acid are completely precipitated by the addition of ammoniacal silver nitrate and magnesia mixture. Silver magnesium urate is formed.

(9) Dilute solutions of uric acid are precipitated by adding copper sulphate and sodium bisulphite. On boiling, cuprous urate is formed.

These two reactions (8) and (9) are used in the precipitation of uric acid and the other purines from urine and extracts of tissues.

(10) Very dilute solutions of uric acid containing 5 mg. give an intense blue colour with a specially prepared phosphotungstic acid reagent (p. 557), (*Folin*).

Estimation of Uric Acid.

- * A. Uric acid is readily oxidised by potassium permanganate and converted into allantoin and other products of its oxidation. Use is made of this reaction for its estimation. From solutions, such as urine, in which other organic substances are present, the uric acid must be precipitated before it can be estimated (p. 554).

0.5N potassium permanganate (1.581 gm. per litre) is commonly used in the process.

The permanganate solution is placed in a burette with a glass tap (rubber cannot be used as it is attacked by permanganate). The level of the liquid in the burette is most conveniently read by holding a lighted match behind it.

100 c.c. of a solution of uric acid, or the same volume of a solution containing a weighed quantity of uric acid, or solid urate (0.5-1 gm. dissolved in water containing soda and diluted to 1 litre), are placed in a flask or beaker, 20 c.c. of concentrated sulphuric acid are added, the solutions are well mixed and the permanganate is run in whilst the solution is hot.

At first every drop of permanganate is decolorised before it diffuses through the liquid. The end point is reached as soon as a drop produces a pink flush throughout the liquid. This pink colour disappears on standing; another drop of permanganate will again produce a pink flush. This can be continued for some time so that the first pink flush must be carefully looked for.

Calculation :—

1 c.c. of 0.5N KMnO_4 corresponds to 0.00375 gm. uric acid.

$\therefore x$ c.c. correspond to $x \times 0.00375$ gm. in 100 c.c. solution.

B. By means of the colour reaction with phosphotungstic acid Folin has shown that quantities of uric acid amounting to 1 mg. in 1 c.c. can be accurately estimated. This method is particularly useful for estimating uric acid in blood and can be used for estimating uric acid in small quantities of urine (pp. 565, 580).

Xanthine.

Xanthine was discovered in an urinary calculus by Marcet in 1817 and in 1859 Scherer found it in meat and pancreas. It has since been shown to be present in other animal organs and to be widely distributed in plants.

Its constitution was indicated by its products of oxidation, alloxan and urea; Fischer proved it by synthesis.

Preparation.

Xanthine is most easily prepared by the action of nitrous acid upon guanine.

Its preparation from extracts of tissues involves a complicated process of separation from other purines (p. 584).

Properties.

Xanthine is a colourless powder which assumes a waxy appearance on rubbing. It separates slowly from its solution in alkali on the addition of acetic acid in the form of colourless nodules consisting of microscopic rhombic shining platelets containing 1 molecule of water of crystallisation.

It is very slightly soluble in water—1 part in 14,151 parts at 16°, 1 part in 1300-1500 parts at 100°. It is insoluble in alcohol and ether. It is easily soluble in caustic alkalies and in 2 per cent. ammonia. On evaporation of the ammoniacal solution, xanthine separates in groups of platelets. It is soluble with difficulty in cold dilute nitric and hydrochloric acids, but more easily on warming. It dissolves with difficulty in 5 per cent. sulphuric acid even on boiling. Xanthine hydrochloride and other salts are decomposed by water.

Ammoniacal silver nitrate precipitates it from solution as $C_5H_4N_4O_2 \cdot Ag_2O$; the precipitate is soluble in nitric acid and from this solution xanthine silver nitrate, $C_5H_4N_4O_2 \cdot AgNO_3$, slowly separates in aggregates of tiny needles. This compound is soluble with difficulty in nitric acid.

Reactions.

(1) On evaporation with nitric acid, xanthine leaves a yellow residue, which is coloured red by caustic soda and becomes purple on heating.

(2) On boiling a small quantity of xanthine with chlorine water, or with dilute hydrochloric acid and a small crystal of potassium chlorate, and evaporating the solution to dryness, a white or pale yellow residue is left. On bringing this into contact with ammonia vapour under a glass cover, it changes to a rose red colour (murexide).

(3) On adding a specimen of xanthine to a little bleaching powder in caustic soda in a watch glass, the surface of the specimen becomes dark green, then brown; the colour ultimately disappears.

(4) A solution of xanthine in dilute sodium hydroxide gives a red colour on the addition of diazobenzene sulphonic acid (see p. 285).

(5) Xanthine is precipitated, like uric acid, by silver nitrate and ammonia and by copper sulphate and sodium bisulphite.

Hypoxanthine.

Hypoxanthine, like xanthine, occurs widely distributed in the tissues of animals and plants.

Its constitution has been proved by synthesis by Emil Fischer.

Preparation.

It is prepared most easily by the action of nitrous acid upon adenine. Its isolation from tissues necessitates a complicated process of separation from other purine bases (p. 584).

Properties.

Hypoxanthine forms colourless microscopic crystals, soluble with difficulty in water; 1 part is soluble in 1400 parts of water at 19° and in 70 parts of boiling water. It is practically insoluble in alcohol.

It is soluble in dilute acids and alkalies and in ammonia and forms salts with acids, bases and other salts, which crystallise readily.

The hydrochloride $C_5H_4N_4O \cdot HCl + H_2O$ and other salts with acids decompose on recrystallisation from water.

The nitrate $C_5H_4N_4O \cdot HNO_3 + H_2O$ is insoluble in nitric acid. Platinochlorides, picrates and other salts are known.

Reactions.

Hypoxanthine differs from xanthine in not giving reactions with nitric acid and chlorine water, but the reaction with diazobenzene sulphonic acid is positive if an excess of alkali be avoided.

It is precipitated from solution by ammoniacal silver nitrate and by copper sulphate and sodium bisulphite.

Guanine.

Guanine is also found widely distributed in the tissues of animals and plants and is a constituent of nucleic acid. It is the chief constituent of the excrement of spiders and is found in Peru guano in small quantities. It is deposited in the muscles and joints of pigs in certain cases of illness and it occurs in fish scales and other epidermal structures of fishes.

Fischer has proved its constitution by synthesis.

*Preparation.**From Guano.*

The material is extracted with boiling dilute lime water and then with sodium carbonate solution as long as the extracts are coloured. On acidifying the extracts with acetic acid, uric acid and guanine separate out. This mixture is boiled with dilute hydrochloric acid and made alkaline with ammonia; the guanine is precipitated.

From Nucleic Acid. (Jones.)

50 gm. of nucleic acid are hydrolysed by heating in a boiling water-bath under a reflux condenser for 2 hours with 200 c.c. of 10 per cent. sulphuric acid. The hot solution is treated with concentrated ammonia until it is neutral, the ammonia being added slowly as soon as the precipitation of guanine begins. An excess of ammonia is added until 2 per cent. is present.

The guanine which is precipitated in a granular form is filtered off and washed with ammonia. It is suspended in boiling water and dissolved by adding a minimum of 20 per cent. sulphuric acid. The solution is decolorised by boiling with charcoal (the decolorisation does not occur readily if excess of sulphuric acid has been used) and the guanine precipitated by adding ammonia as above; it is filtered off, dried at 40° and dissolved in 20-25 times its weight of boiling 5 per cent. hydrochloric acid. Pure guanine hydrochloride crystallises out on cooling. It is filtered off, washed with dilute hydrochloric acid and dried in the air.

Pure guanine is prepared from the hydrochloride by dissolving it in boiling 1 per cent. hydrochloric acid and adding ammonia.

Adenine is prepared from the ammoniacal filtrate and washings after filtering off guanine which may deposit on standing (see under Adenine).

From Tissue Extracts.

It is precipitated by ammoniacal silver nitrate or copper sulphate and sodium bisulphite and separated from other purine bases as described on p. 584.

Properties.

Guanine forms a colourless, generally amorphous, powder. It is insoluble in water, alcohol, ether and soluble with difficulty in ammonia. It is easily soluble in all mineral acids and alkalies.

The sulphate $(C_5H_5N_5O)_2 \cdot H_2SO_4 \cdot 2H_2O$ and other salts are generally decomposed by water.

The metaphosphate $C_5H_5N_5O \cdot HPO_3 \cdot xH_2O$ is precipitated on adding metaphosphoric acid to its solution; it is stable to water and is soluble with difficulty in water and dilute acids.

Guanine forms a very insoluble picrate, $C_5H_5N_5O \cdot C_6H_3N_3O_7 + H_2O$. The picrates of xanthine and hypoxanthine are more soluble.

Its compound with silver nitrate $C_5H_5N_5O \cdot AgNO_3$ is almost insoluble in cold nitric acid, but more soluble in hot, from which it crystallises on cooling.

Potassium ferricyanide gives prismatic yellow-brown crystals with dilute solutions of guanine.

Reactions.

Guanine on evaporation with dilute nitric acid leaves a brownish-red residue, which becomes bluish-violet on heating. The combinations with picric acid and potassium ferricyanide distinguish it from xanthine and hypoxanthine; its behaviour towards metaphosphoric acid from hypoxanthine and adenine.

Adenine.

Adenine was first obtained by Kossel from the pancreas, but has since been obtained from other organs and from plants. Its constitution was proved by synthesis (Emil Fischer).

Preparation.

Adenine may be prepared from extracts of tea, or from nucleic acid, or from tissue extracts (p. 584).

From Nucleic Acid.

The ammoniacal filtrate free from guanine is acidified with 20 per cent. sulphuric acid, heated to boiling and treated with 10 per cent. copper sulphate solution as long as a white precipitate is formed and until yellow cuprous oxide begins to be formed. (Usually sodium bisulphite solution is added with the copper sulphate solution, but this is not necessary when the solution contains pentose.) The mixture is boiled for several minutes and filtered. The precipitate is washed with boiling water, suspended in hot water and decomposed with hydrogen sulphide. The filtrate from the copper sulphide is evaporated to dryness and the residue of adenine is crystallised from hot 5 per cent. sulphuric acid and decolorised with charcoal, if necessary. Pure adenine sulphate is obtained.

Properties.

Adenine forms long colourless needles with 3 molecules of water of crystallisation, or whetstone-like crystals; the former become opaque on exposure to air and if heated in insufficient water become opaque at 53°. It sublimes at 220° and at 250° partially decomposes. It melts if heated rapidly in a capillary tube at 360-365°, becoming brown before reaching the melting-point, at which temperature it decomposes.

It is soluble with difficulty in cold water, 1 part in 1086 parts, but it is more easily soluble in hot water. The solution has a neutral reaction. It dissolves in alkalis, mineral acids and acetic acid and is precipitated on neutralising the solutions. It is more easily soluble in ammonia than guanine, but less so than hypoxanthine.

It forms salts with acids and other salts; the double salt with gold chloride helps to distinguish it from the other nuclein bases. The picrate is very insoluble and serves for isolating it from solution and separating it from hypoxanthine.

Reactions.

Adenine gives no reaction on evaporation with nitric acid or with chlorine water. The reaction with diazobenzenesulphonic acid is positive if excess of alkali be avoided.

Adenine behaves in a characteristic manner on heating with zinc and hydrochloric acid on the water-bath. The solution turns purple-red; if filtered, made strongly alkaline with caustic soda and allowed to stand or shaken with air, it turns ruby-red and then brownish-red. Guanine does not give this reaction, but hypoxanthine gives the colours, though fainter.

Caffeine. Theophylline. Theobromine.

These three compounds are not found in animals but are fairly widely distributed in plants. Caffeine and theobromine are the active constituents of tea, coffee and cocoa: they produce a stimulating effect on the central nervous system and act as powerful diuretics.

Caffeine.

Caffeine is present to the extent of .8-1.7 per cent. in coffee beans, 1-1.8 per cent. in cocoa beans, 1-2 per cent. in kola nuts, 2-5 per cent. in tea leaves; 2.5-5 per cent. is present in guarana, the roasted fruit of *Paullinia* which is eaten in South America.

Preparation.

Caffeine is readily prepared from tea leaves by boiling about 250 gm. with 500 c.c. of water for 15 minutes; the solution is filtered through cloth into a basin and the leaves boiled again with 250 c.c. water and again filtered off. The odour is due to a small quantity of essential oil and the solution contains protein and tannin, which gives it the brown colour. The proteins and tannin are removed by adding basic lead acetate as long as a precipitate is formed. The precipitate is filtered off and washed with water and the solution is treated with sulphuric acid or hydrogen sulphide to remove lead. The lead sulphate or sulphide is filtered off and the solution evaporated with some charcoal until its volume is 250-300 c.c. It is filtered from charcoal and when cold extracted two or three times with chloroform. The chloroform is distilled off and the caffeine, which remains, is recrystallised from boiling water containing animal charcoal. From 1-2 gm. are obtained.

Properties.

Caffeine forms long silky needles containing one molecule of water of crystallisation which it loses at 100°. It melts at 233° and has a bitter taste. It forms salts with mineral salts which are decomposed by water.

Caffeine, on evaporation with chlorine water, leaves a reddish-brown residue which becomes purple when treated with ammonia.

Theobromine.

Theobromine is present to the extent of 1.5-2.4 per cent. in cocoa beans; smaller amounts are present in kola nuts and tea leaves; it is not present in coffee beans.

Theobromine forms a crystalline powder which has a bitter taste, is soluble with difficulty in hot water and alcohol but is easily soluble in ammonia. It forms salts with mineral acids, which are decomposed by water, and with silver nitrate and other metallic salts.

Theophylline.

Theophylline was discovered by Kossel in 1888 in extracts of tea and has been synthesised by Emil Fischer.

It forms a white powder which melts at 264°.

Paraxanthine or 1, 7-dimethylxanthine	} have been isolated from human urine. They are products formed from caffeine in the organism.
Heteroxanthine or 7-methylxanthine	
1-methylxanthine	
Epiguanine or 7-methylguanidine	

The Biological Relationship of the Purines.

Adenine and guanine are constituents of the nucleic acid of animals and plants. Whilst still in combination in the molecule of nucleic acid they may be acted upon by enzymes in the tissues and converted respectively into hypoxanthine and xanthine. Nucleic acid on decomposition in the tissues will yield adenine and guanine, or hypoxanthine and xanthine. Adenine and guanine are acted upon by the enzymes, adenase and guanase, in the tissues and converted into hypoxanthine and xanthine. These enzymes are present in most organs, but not in all organs; sometimes an organ contains both enzymes, sometimes only one enzyme, sometimes neither enzyme. Hypoxanthine is oxidised by the tissues to xanthine and xanthine is oxidised to uric acid (xanthine oxidase). In some animals, but not in man, uric acid is oxidised to allantoin (uricase). The changes may be briefly represented as follows :—

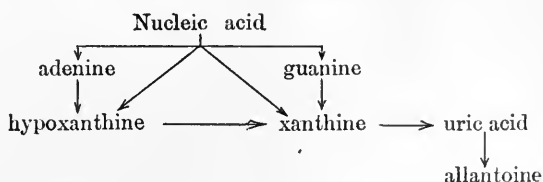

The mechanism of these transformations has been difficult to elucidate and much confusion as to the origin of uric acid has existed. A full account of the work is given in W. Jones' monograph on "Nucleic Acids".

NUCLEIC ACIDS.

The first chemical examination of cell nuclei was made in 1868 by F. Miescher. Pus cells were digested with artificial gastric juice; the protoplasm dissolved and a residue consisting of the more resistant nuclei was left as an insoluble grey powder. This dissolved in dilute sodium carbonate and was precipitated by dilute acetic acid. It was found to contain phosphoric acid and to give the colour tests for proteins. It was named nuclein.

Eight years later Miescher examined the spermatozoa of Rhine salmon. He found that they consisted almost entirely of a salt composed of the base protamine (a protein) and an organic acid which he termed nucleic acid; this contained phosphorus.

Nucleins were prepared from other tissues, yeast, red blood corpuscles, etc., by other workers. They were analysed most carefully by Kossel and his pupils to whom our knowledge of the constitution of nucleic acid is almost entirely due. Kossel found that nucleins and also nucleic acid, for which a method of preparation from thymus and other organs was devised by Kossel and Neumann, on hydrolysis by acids gave rise to the purine bases, guanine, xanthine, hypoxanthine and adenine. The two bases, guanine and adenine, have since been shown to be the only ones present in nucleic acid. In addition to the two purine bases three other bases, the three pyrimidine bases, thymine, uracil and cytosine, have been shown to be present in nucleic acid, and besides these compounds there is also present a carbohydrate, a hexose or a pentose. These compounds are obtained from animal or plant nucleic acids. Nucleic acids consist of a carbohydrate, phosphoric acid, two purine bases and two pyrimidine bases, as expressed in the following scheme:—

<i>Animal Nucleic Acid.</i>	<i>Plant Nucleic Acid.</i>
Phosphoric acid.	Phosphoric acid.
Hexose (lævulinic acid).	Pentose = <i>d</i> -ribose.
Guanine.	Guanine.
Adenine.	Adenine.
Cytosine.	Cytosine.
Thymine.	Uracil.

Plant nucleic acid differs from animal nucleic acid in the nature of the carbohydrate constituent and in the nature of one of the pyrimidine constituents.

It appears that all animal nucleic acids are the same and that all plant nucleic acids are the same.

The constitution of the nucleic acids has not yet been definitely

ascertained, but the following formulæ have been provisionally assigned:—

Animal Nucleic Acid.

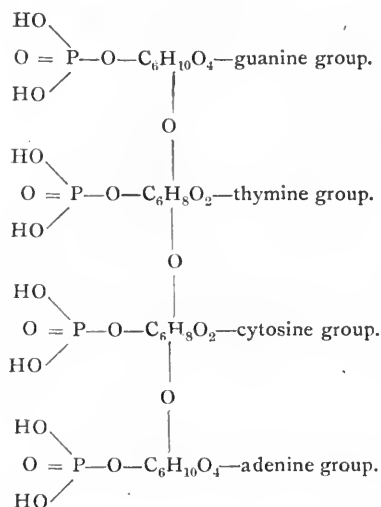

*Plant Nucleic Acid.*¹

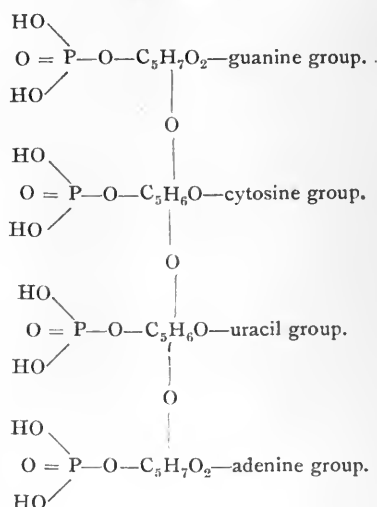

The combination of phosphoric acid with carbohydrate in each case has been proved by the isolation of a carbohydrate ester of phosphoric acid, and the combination of purine base with carbohydrate by the isolation of such a compound. This compound is a glucoside and glucosides of carbohydrate and purine have been synthesised by Emil Fischer. There is as yet no evidence as to how the groups are combined together.

Each of the groupings—phosphoric acid + carbohydrate + purine or pyrimidine base—is termed a mononucleotide. Nucleic acid is thus a tetranucleotide. The carbohydrate and purine base or pyrimidine combination is known as a nucleoside.

***a*-Nucleoproteins.**

If aqueous extracts of various organs be made and these extracts be acidified with acetic acid, a precipitate consisting of protein and nucleic acid is formed. It has been termed nucleoprotein.

These *a*-nucleoproteins must be regarded as salts or of combinations of nucleic acid and protein; as salts on account of the occurrence of protamine nucleate in spermatozoa, their easy separation, and on account of the property of nucleic acid of precipitating protein from solution when a solution of sodium nucleate in a solution of protein is acidified.

***β*-Nucleoproteins. Mononucleotides.**

If organs, especially the pancreas, be suspended in water, the suspension raised to the boiling-point and filtered from the coagulum of protein which is formed, a clear yellow liquid is obtained. If this

¹ Jones and Read, *J. Biol. Chem.*, 1917, **31**, 40.

liquid be acidified with acetic acid a precipitate is formed. This precipitate on purification does not contain protein. It is a mononucleotide, termed guanylic acid, and consists of guanine, pentose and phosphoric acid. Another mononucleotide, inosinic acid, has been prepared from meat extract. It consists of xanthine, pentose and phosphoric acid, and is identical with vernine, a mononucleotide prepared from plants.

These β -nucleoproteins of animals have thus the constitution of plant nucleic acids. They are not constituents of the nuclei of animal cells, but have been ingested by the tissue from vegetable food.

The work of the various investigators upon nucleic acid is given by Walter Jones in his monograph on Nucleic Acid.

Preparation of Nucleic Acid from Thymus, etc.

There are various methods for preparing nucleic acid, but the following given by W. Jones is most convenient:—

1 kilo. of thymus, freed from fat, connective tissue, etc., and finely minced, is added in small portions to 2 litres of boiling water containing 33 gm. of sodium hydroxide and 100 gm. of sodium acetate. The material dissolves giving a pale brown solution: lumps are removed and brought into solution separately by heating over a flame. The solution is heated in a boiling water-bath for 2 hours with occasional stirring. It is diluted with one-third of its volume of water and acidified to litmus with 50 per cent. acetic acid; about 100 c.c. are required. The proper acidity must be obtained so as to ensure rapid filtration; it can be attained by adding acetic acid or sodium hydroxide as may be required. The solution is heated to boiling and filtered through a hot-water funnel. It will gelatinise on cooling. The solution and washings are evaporated to 750 c.c. and poured slowly into 1 litre of 95 per cent. alcohol. Sodium nucleate mixed with phosphates is precipitated. After 12-16 hours the liquid is decanted away and the precipitate pressed out, washed with 80 per cent. alcohol and 90 per cent. alcohol, the final parts of the washings being pressed out. The precipitate is placed in a flask with 300 c.c. of water and heated on a water-bath. The phosphates collect leaving a clear liquid. To facilitate filtration through a hot-water funnel 10 c.c. of 20 per cent. sodium hydroxide are added. The filtrate is acidified with acetic acid and poured into 75 c.c. of 95 per cent. alcohol. The liquid is decanted and the precipitate washed as before. It is ground up in a mortar with one or two changes of absolute alcohol—a greater amount of washing causes emulsification—and it crumbles to a fine powder, which is filtered off and washed with alcohol and dried in a desiccator. About 33 gm. of sodium nucleate are obtained from 1 kilo. of thymus.

Nucleic acid can be obtained by pouring the solution into about 3 volumes of alcohol containing 2 c.c. of concentrated hydrochloric acid per 100 c.c.

Properties.

Nucleic acid is a white powder, insoluble in alcohol and ether, but soluble in alkalis and ammonia; it is insoluble in water forming a slimy mass. It is not precipitated from dilute alkaline aqueous solution by acetic acid, but it is precipitated by mineral acids. Acetic acid will precipitate nucleic acid from concentrated solutions in the presence of small amounts of alkaline acetates.

The sodium salt dissolves in water; a 4 per cent. solution gelatinises. The solutions are optically active. The phosphorus and nitrogen content serve to characterise nucleic acid, but proper characterisation is only possible by an analysis of its decomposition products.

Preparation of Plant Nucleic Acids.

These nucleic acids are most simply prepared by the method of Clarke and Schryver.¹ The material is boiled with alcohol to render the proteins insoluble and extracted with 10 per cent. sodium chloride solution; on acidifying the extract, the nucleic acid is precipitated. In the case of wheat embryos it is advantageous to digest away the starch previous to the extraction.

(i) Preparation of Yeast Nucleic Acid.

30 lbs. of freshly pressed yeast are mixed with excess of 95 per cent. alcohol and allowed to stand for 24 hours. The alcohol is filtered off on a Buchner funnel and the solid dried in the air.

The air-dried solid, in portions of 1 kilo., is boiled for 2 hours with 95 per cent. alcohol, filtered off, pressed, dried in an air current at 37° and ground to a fine powder. 1 kilo. of this material is extracted for 4-5 days with 10 litres of 10 per cent. sodium chloride solution at 60-80°, the mass being raised to this temperature daily and allowed to cool slowly. The extract is strained through muslin and the residue pressed out. The extract is filtered clear through paper and acidified with dilute hydrochloric acid (1 : 1) which is added with vigorous stirring. Nucleic acid separates and settles out as a hard cake. After 2 hours the liquid is syphoned off; the crude nucleic acid is washed with 50 per cent. alcohol till free from chlorine, left under 95 per cent. alcohol for 24 hours, washed with absolute alcohol and ether. A fine light brown powder in a yield of 1.5 per cent. is obtained. The crude nucleic acid (20 gm.) is purified by dissolving in 10 per cent. sodium acetate solution (500 c.c.), filtering from insoluble matter, adding 100 c.c. of alcohol and acidifying with hydrochloric acid. A white mass separates; it is washed with 50 per cent. alcohol, 95 per cent. alcohol, ether and dried *in vacuo*. This preparation contains 9.3 per cent. of phosphorus and 16.4 per cent. of nitrogen. Further purification is effected by dissolving 5 gm. in 200 c.c. of water and 100 c.c. of 0.1 per cent. caustic potash and precipitating the clear solution with 20 c.c. of .5N hydrochloric acid. An equal volume of alcohol is added, the precipitate of nucleic acid is filtered off, washed with alcohol and ether and dried *in vacuo*. It contains 9.6 per cent. of phosphorus and 16.4 per cent. of nitrogen.

(ii) Preparation of Wheat Nucleic Acid (Tritico-nucleic acid).

1 kilo. of fresh wheat embryos is boiled for 2 hours with 3 litres of 95 per cent. alcohol, filtered and pressed free from the liquid and dried in the air. The air-dried material is put in small portions at a time in 10 litres of water and heated for 2 hours in a boiling water-bath to gelatinise the starch. The thick paste so formed is transferred to two flasks and cooled to 40° and to each are added 2.5 gm. of takadiastose. The liquids are covered with a layer of toluene and fermentation allowed to continue till starch can no longer be detected. The liquid is boiled, cooled, sodium chloride added so as to make a 10 per cent. solution of salt, and heated daily for 4-5 days to 60-80°. The solution is filtered through paper pulp and pressed out from the residue. 100 c.c. of hydrochloric acid (1 : 1) are added to the clear filtrate. The precipitate of crude nucleic acid is washed free from chlorine with 50 per cent. alcohol, left under 95 per cent. alcohol, washed with absolute alcohol and ether and dried *in vacuo*. Yield = 7 gm.

Purification of the nucleic acid is carried out by solution in 400 c.c. of 0.1 per cent. caustic potash, precipitation with hydrochloric acid, washing with alcohol and ether and drying in the air. This product contains 8.9 per cent. of phosphorus and 16.3 per cent. of nitrogen.

¹ Biochem. J., 1917, 11.

FURFURANE, OR FURANE, AND ITS DERIVATIVES.

Furfurane and its derivatives contain a five-membered ring made up of 4 carbon atoms and 1 oxygen atom.

The origin, main interest and importance of these compounds is in the fact that they are formed from carbohydrates by dry distillation, or by distillation with acids. The following compounds are so obtained:—

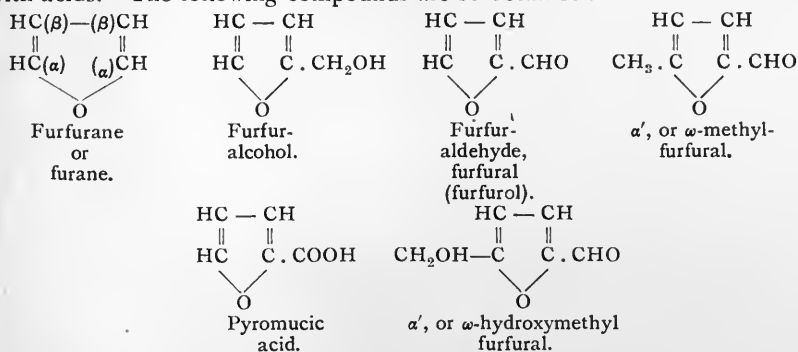

Furfurane, $\text{C}_4\text{H}_4\text{O}$, is obtained by the distillation of the barium salt of pyromucic acid and is contained in the tar from pinewood. Furfurane is a liquid with a peculiar smell. It boils at 32° and is insoluble in water. It is reduced to tetrahydrofurfurane when passed over zinc dust, or nickel dust, heated to 170° . It reacts violently with concentrated hydrochloric acid forming a brown amorphous substance, and gives a purplish colour reaction with sulphuric acid and isatin or phenanthraquinone.

Furfuralcohol, $\text{C}_4\text{H}_3\text{O} \cdot \text{CH}_2\text{OH}$, is formed from furfuraldehyde by reduction, or by the action of caustic soda. It is present in the oil from roasted coffee. It is a colourless liquid which boils at 171° and is easily soluble in water. In solution it rapidly resinifies. It gives a blue-green colour to a pinewood shaving moistened with hydrochloric acid.

Furfuraldehyde, $\text{C}_4\text{H}_3\text{O} \cdot \text{CHO}$.

Furfuraldehyde or furfural is the chief compound of the group and is formed from bran and other carbohydrates by distillation with dilute sulphuric acid. It is formed quantitatively by the distillation of pentoses with dilute acid and therefore serves in their estimation (p. 234):—

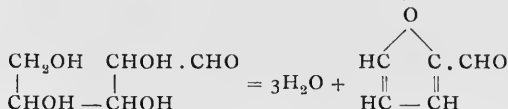

It is a colourless liquid, which boils at 162° and has a peculiar aromatic smell. It turns brown in the air, is easily soluble in alcohol, but only slightly soluble in water.

It has all the properties of an aromatic aldehyde forming an oxime, a hydrazone, etc. By alkali it is converted into a mixture of alcohol and aldehyde. It condenses with numerous other compounds. It gives colour reactions with α -naphthol and other phenols which serve in testing for carbohydrates (p. 193).

α -Methyl-furfuraldehyde, $\text{C}_4\text{H}_2\text{O} \cdot \text{CH}_3 \cdot \text{CHO}$, is formed by the distillation of methyl pentoses with hydrochloric acid and resembles furfural.

Hydroxymethyl-furfuraldehyde, $\text{C}_4\text{H}_2\text{O} \cdot \text{CH}_2\text{OH} \cdot \text{CHO}$, is formed in small quantities from hexoses, especially ketoses, by the action of concentrated acids. It resembles furfural. Molisch's reaction for carbohydrates (p. 193) is due to this substance.

Pyromucic Acid, $\text{C}_4\text{H}_3\text{O} \cdot \text{COOH}$, is obtained by the dry distillation of mucic acid or by the oxidation of furfural. It is a liquid which boils at 134° .

THIOPHENE AND ITS DERIVATIVES.

Thiophene, C_4H_4S , was discovered in the benzene from coal tar from which it was obtained by extraction with concentrated sulphuric acid. Its constitution has been shown to be

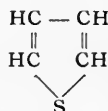

a heterocyclic compound containing 4 carbon atoms and a sulphur atom.

Thiophene resembles benzene in its reactions more closely than furfurane and pyrrole, but as yet neither thiophene nor its derivatives have been obtained from natural substances.

PYRROLE AND ITS DERIVATIVES.

Pyrrole and its derivatives are closely connected with the proteins and with the two respiratory pigments, chlorophyll and hæmoglobin. A pyrrole derivative is also present in the molecule of nicotine, and cocaine contains a pyrrole nucleus. The heterocyclic ring in pyrrole consists of 4 carbon atoms and 1 nitrogen atom. We have to consider the following compounds in order to understand the constitution of the proteins and the complex chlorophyll and hæmoglobin molecules :—

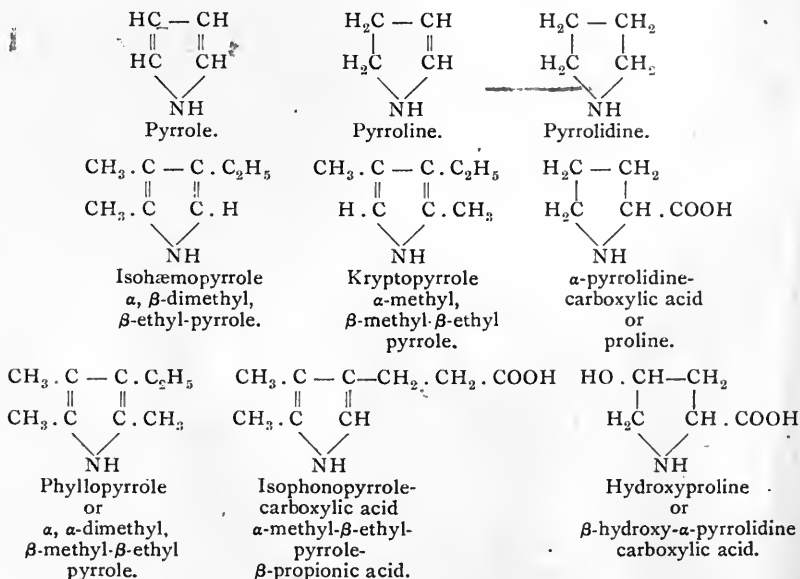

Pyrrrole. C_4H_5N .

Pyrrrole was found in coal tar in 1834 and in bone oil in 1858 and is usually obtained from bone oil.

Preparation.

The oil which is obtained by the dry distillation of bones contains pyridine and basic substances, aromatic hydrocarbons, pyrrole and its homologues, but consists mainly of the nitriles of fatty acids. The basic substances are removed by agitation with dilute acid, the nitriles are hydrolysed by boiling with alkali and the oil which remains is fractionally distilled. The fraction passing over between 115 and 130° contains the pyrrole. By boiling with solid caustic potash it is converted into solid potassium pyrrole, C_4H_4NK , which is filtered off and decomposed by water. The pyrrole is then isolated by distillation.

Fat-free bone gelatin is said to give a distillate consisting mainly of pyrrole and its homologues.

It is probably formed from the proline and hydroxyproline contained in the protein, but may also arise by the dry distillation of glutamic acid.

It has been synthesised by passing acetylene and ammonia through red-hot tubes, by the dry distillation of the ammonium salt of mucic acid and by the reduction of succinimide by distillation over zinc dust:—

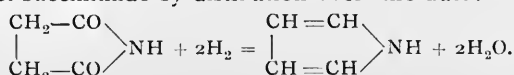
*Properties.*

Pyrrrole is a colourless liquid smelling like chloroform but turning brown in the air. It boils at 131° , is very slightly soluble in water, but is easily soluble in alcohol and ether.

Pyrrrole is a secondary amine and has a slight basic character; it dissolves slowly in dilute acids and is converted into a resin by strong acids. Its solution in dilute acids on warming deposits a red precipitate termed pyrrole red.

It gives a fiery red colour with a pine shaving moistened with hydrochloric acid. Hence its name from $\pi\rho\rho\rho\varsigma$.

As a secondary amine pyrrole forms a nitroso compound with sodium ethoxide and amyl nitrite.

Potassium dissolves in pyrrole with evolution of hydrogen. The combination of pyrrole with potassium to form solid potassium pyrrole is probably due to the acid influence of the CH groups.

The pyrrole ring is easily ruptured. Succinyl dialdoxime is formed by the action of hydroxylamine upon pyrrole. α -substituted pyrroles yield ketoximes, β -substituted pyrroles yield aldoximes from which dibasic acids can be obtained. This reaction serves for determining the position of substituting groups.

Pyrrrole reacts violently with halogens; but derivatives are obtained by using dilute solutions. Tetraiodopyrrole, which is prepared by the action of iodine on pyrrole in the presence of alkali, forms yellow-brown prisms which melt at 140° . Under the name of iodol it is used as an antiseptic and has an advantage over iodoform in possessing no smell.

Pyrroline and Pyrrolidine.

Pyrrole is easily reduced by zinc and acetic acid, or by electrolysis, to pyrroline; it is converted into pyrrolidine by hydriodic acid, or by passing pyrrole and hydrogen over nickel dust heated to 190°.

Pyrrole is a liquid boiling at 91° and has an ammoniacal smell. It is a strong base and forms stable salts with acids.

Pyrrolidine is a liquid which has a smell resembling pepper. It boils at 87° and like pyrroline is a strong base.

Proline and Hydroxyproline.

These compounds are constituents of proteins. They result from the hydrolysis of proteins by acids or alkalis. A complex process of separation is required to isolate them from proteins (see "Chemical Constitution of the Proteins"). They differ from other units of the protein molecule by being easily soluble in alcohol (cf. glycine, p. 139).

Alkyl Derivatives of Pyrrole.

Derivatives of pyrrole are easily prepared from potassium pyrrole. Potassium pyrrole reacts with alkyl halides, acid chlorides, etc., to form derivatives in which the substituting group is attached to the nitrogen atom:—

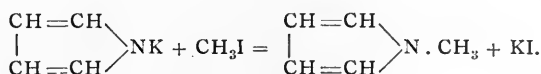

On heating, these compounds undergo rearrangement; the substituting group changes its position and attaches itself to a carbon atom.

Isohæmopyrrole, kryptopyrrole, phyllopyrrole and other alkyl pyrroles are formed by the reduction of hæmin, chlorophyll and bile pigments. A mixture is obtained from which the individual compounds are separated.

PYRIDINE AND ITS DERIVATIVES.

The six-membered heterocyclic ring compounds, containing 5 atoms of carbon and 1 atom of nitrogen, of which pyridine is the simplest member and from which all the other compounds of the group can be derived, resemble the benzene compounds very closely. The simpler members are present in coal tar and bone oil and are formed by the oxidation of the complex alkaloids which occur in plants.

The Structure of Pyridine.

The empirical formula of pyridine, C_5H_5N , points to its not being an open chain compound. For reasons similar to those which led to the adoption of a closed ring structure for the constitution of benzene and from the great similarity which pyridine has to benzene in its reactions the following ring structure has been assigned to pyridine:—

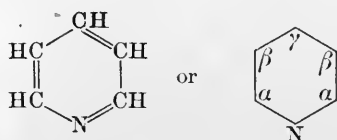

This structure shows that pyridine is a tertiary base, that three isomeric monosubstitution and six disubstitution derivatives can be derived from it; in general it expresses all the facts known about pyridine and its derivatives.

Pyridine.

Pyridine was first obtained from bone oil, but is contained in coal tar from which it is usually prepared.

Preparation.

The acid solution, or liquor, which results in the purification of benzene and its homologues from coal tar is treated with sodium hydroxide; the basic substances separate out as oils. This oil consists of a mixture of pyridine, its homologues, quinoline and other substances. These constituents can be separated by repeated fractional distillation, but the pure compounds are finally isolated by the fractional crystallisation of their salts. The bases are liberated from the salt by alkali and purified by distillation.

Bone oil is extracted with sulphuric acid; the bases are separated by sodium hydroxide, distilled and purified as described above.

Properties.

Pyridine is a colourless liquid which boils at 115° and has a specific gravity of 1.003 at 0° . It has a pungent characteristic and disagreeable odour and mixes with water in all proportions.

It is a strong base, which can turn red litmus blue, and forms salts with acids.

Pyridine is a tertiary amine as shown by its negative behaviour to nitrous acid and the fact that it combines with alkyl halides to form pyridine alkyl halides, such as pyridine methiodide $C_5H_5N \cdot CH_3I$.

On heating, the methyl group attached to the N atom changes its position and α -alkyl pyridines are formed,

This reaction may be used as a test for pyridine :—

If a few drops of pyridine be heated with a few drops of methyl iodide, a violent reaction takes place and pyridine methiodide is formed. On adding a small quantity of solid potash and again heating, the compound is decomposed and the disagreeable smell of methyl pyridine hydroxide will be noticed.

Pyridine is not oxidised by nitric acid, or chromic acid, and it is only slowly attacked by the halogens and sulphuric acid forming substitution products.

Piperidine. $C_5H_{10}NH$.

Piperidine is a constituent of the alkaloid piperine from which it is obtained by hydrolysis with alkali.

It is formed by the reduction of pyridine with sodium and alcohol, and it is converted into pyridine by heating with concentrated sulphuric acid at 300° :—

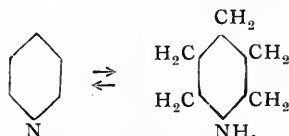

Piperidine is also formed by the distillation of pentamethylene diamine :—

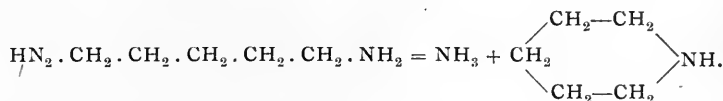

Preparation.

Powdered pepper is extracted with alcohol; the extract is evaporated to dryness and the residue is distilled with soda. The alkaline distillate is neutralised with hydrochloric acid and evaporated to dryness. The residue which consists of ammonium chloride and piperidine hydrochloride is treated with hot alcohol. The solution containing the piperidine hydrochloride is evaporated and distilled with soda and the oil which passes over is purified by distillation.

Properties.

Piperidine is a colourless liquid which boils at 106° . It has the pungent smell of pepper and mixes with water. It is a strong base and a secondary amine, forming nitrosopiperidine with nitrous acid.

Homologues of Pyridine.

The following homologues of pyridine, mixed with pyridine, are contained in the basic fraction of coal tar and bone oil and are separated by fractional distillation as stated under pyridine.

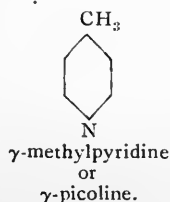
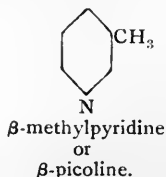
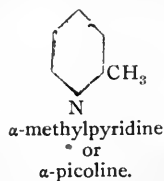
I. The monomethyl pyridines or picolines:—**II. The Dimethyl pyridines or lutidines.****III. The trimethyl pyridines or collidines.**

They closely resemble pyridine in properties.

Pyridine Carboxylic Acids.

The side chain of the methyl pyridines on oxidation is converted into carboxyl and the pyridine carboxylic acids are obtained:—

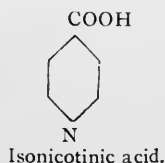
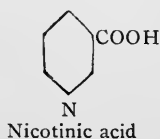
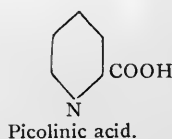

These compounds are white crystalline solids soluble in water. They possess basic properties and acidic properties forming salts with acids and bases.

Nicotinic Acid is formed by the oxidation of nicotine (p. 353). This substance therefore contains a substituting group in the β -position of the ring.

Picolinic Acid gives a red coloration with ferrous sulphate. This reaction is given by all acids derived from pyridine containing a carboxyl group in the α -position.

Quinolinic Acid is formed by the oxidation of quinoline with permanganate. Quinolinic acid is a dibasic acid having the constitution:—

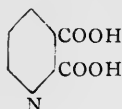

It is a crystalline solid, soluble with difficulty in water. It gives an orange coloration with ferrous sulphate which shows that one carboxyl group is in the α -position. It is converted into nicotinic acid when it is heated to 190° . These reactions show the position of the carboxyl groups.

HYDRO-AROMATIC COMPOUNDS.

Benzene, its homologues and derivatives, though they form a special group of compounds with special properties, behave nevertheless in some respects like unsaturated compounds. They can be reduced under certain conditions and they will combine by addition with the halogens on exposure to sunlight. The reduced compounds are known as the hydro-aromatic compounds, and the halogen addition compounds are regarded as derived by substitution from reduced benzene. The aromatic compounds are most easily reduced by the method of Sabatier, which consists in passing their vapour mixed with hydrogen over nickel dust heated to about 170° .

Benzene gives three reduction products :—

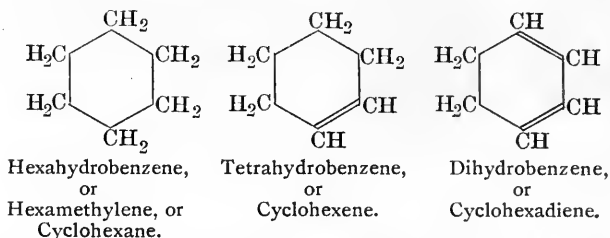

These compounds correspond to the carbocyclic compounds containing 3, 4, 5, etc., atoms of carbon (p. 237), and have properties like the aliphatic compounds.

The number of compounds in this group is not very large, but the natural compounds, the terpenes, inositols, cholesterol, cholalic acid are hydro-aromatic compounds.

THE INOSITOLS.

The small number of natural compounds included under this heading are hydroxy-derivatives of hexahydrobenzene.

Quercitol, or cyclohexanepentol, is found in acorns and in the leaves of *Chamaerops humilis*, a variety of palm. It is a colourless solid which melts at 235° and is dextro-rotatory, $[\alpha]_D = +24.16^{\circ}$. A laevorotatory quercitol has been found in the leaves of *Gymnema sylvestre*. It melts at 174° and has $[\alpha]_D = -73.9^{\circ}$.

Inositol. Several varieties of inositol have been found in nature :— an inactive form, 2 active forms and a racemic form. Seven inactive forms are theoretically capable of existence. *i*-Inositol is found in heart-muscle and other animal organs, but is present in larger amounts in unripe beans and peas. It is present in the free state and also in combination with phosphoric acid as ester in the husks of various cereals. The calcium and magnesium

salt of this acid is termed *Phytin*. *d*-Inositol is obtained by the reduction of pinitol with hydriodic acid. *l*-Inositol is obtained from quebrachitol by reduction.

Scyllitol, an inactive inositol, is present in the organs of various elasmobranch fish—the dog fish, skate and shark.

Cocositol has been isolated from the leaves of cocos and closely resembles *i*-inositol.

Pinitol is monomethyl *d*-inositol.

Quebrachitol is monomethyl *l*-inositol.

i-Inositol.

Preparation.

(1) From phytin. Phytin is extracted from unripe peas or husks of cereals with dilute hydrochloric acid. The acid extract is either neutralised or made alkaline with ammonia, or calcium chloride is added and it is made alkaline with ammonia. The calcium-magnesium or calcium salt of phytic acid, or phytin, is precipitated. It is redissolved in acid and reprecipitated, filtered off and dried.

Phytin is hydrolysed by heating in a sealed tube with dilute sulphuric acid to about 150° for several hours. On removing the acids with baryta and evaporating to a small volume and adding alcohol, the inositol is precipitated.

It is recrystallised from a mixture of water and alcohol.

(2) From muscle. Muscle is extracted with water; the aqueous extract is boiled to coagulate proteins and the filtrate treated with lead acetate to remove the remaining proteins. The clear solution is precipitated with basic lead acetate. The precipitate is suspended in water and decomposed with hydrogen sulphide and the solution, filtered from lead sulphide, is concentrated. On adding from 2-4 volumes of alcohol and filtering rapidly from any amorphous precipitate and allowing to stand, inositol crystallises out, or ether may be added until a turbidity appears and the mixture again allowed to stand. The crystals are recrystallised from water to which from 2-4 parts of alcohol are added.

Properties.

i-inositol separates in large colourless crystals (Fig. 51) or, if impure, in bunches of small crystals, and contains two molecules of water of crystallisation which are given off at 110° . The anhydrous substance melts at 225° . It is soluble in water (1 part in 7.5 parts at 20°) and the solution has a sweet taste. On account of this property and its empirical composition it was formerly called muscle sugar. It does not reduce Fehling's solution, nor has it any of the properties of a carbohydrate.

Reactions.

(1) *Sherer's Test.*—A rose-red colour is formed on evaporating a small quantity with nitric acid in a porcelaine basin nearly to dryness, adding ammonia and a few drops of calcium chloride and again evaporating to dryness.

(2) *Seidel's Test.*—If in the above reaction strontium acetate be used instead of calcium chloride, a green colour and a violet precipitate are formed.

(3) *Gallois' Test.*—On evaporating a solution of inositol nearly to dryness, adding a drop of mercuric nitrate and again evaporating to dryness, a yellowish residue is left. This turns a dark rose-red on warming; the colour disappears on cooling.

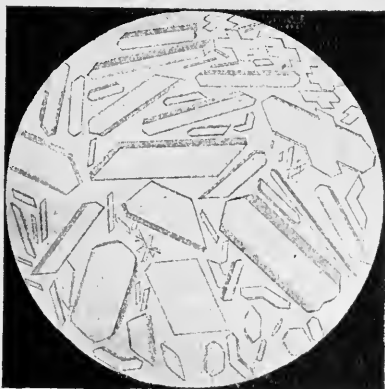

FIG. 51.—Inositol. (After Funke.)

THE TERPENE GROUP.

Nearly all parts of plants contain volatile substances with a highly characteristic and pleasant smell. These substances are the essential oils, e.g., oil of turpentine, oil of lemons, etc. The various kinds of camphor, which are crystalline solids, the resins and india-rubber are closely related substances.

They are prepared from plants by steam distillation, by pressing, or by extraction with organic solvents. Besides their use in perfumery, in making essences, they are used in the preparation of oil paints, varnishes, etc. Several are used in medicine.

The essential oils are generally complex mixtures, the main constituent imparting the characteristic properties; several essential oils may contain the same constituent and yet differ in smell on account of the presence of different highly odoriferous substances. Oil of turpentine exists in the greatest quantity. It flows from the stems of pine trees when incisions are made in the surface and consists of solids dissolved in the liquid. Crude oil of turpentine is separated by steam distillation, the solids remaining behind and constituting colophony or resin.

The chief constituent of oil of turpentine is pinene. Limonene is present in oil of lemon. They are colourless, very refractive liquids boiling between 150 and 180°. Camphene is solid. They are insoluble in water, but soluble in most organic liquids. They are good solvents, dissolving resin, caoutchouc, iodine, phosphorus and sulphur. The majority are optically active; sometimes both the dextro and laevo forms are found in nature, and the inactive mixture of some of them has been prepared.

Reactions.

- (1) They easily polymerise to form resinous substances.
- (2) On exposure to air or oxygen, they are oxidised and yield resins.
- (3) On oxidation with permanganate, etc., they are converted into benzene derivatives.
- (4) On treatment with ozone, they form ozonides.
- (5) On reduction, they are converted into hydroterpenes.
- (6) They combine with bromine and halogen acids to form addition compounds, which are frequently crystalline solids.
- (7) They react with nitrosyl chloride, NOCl.

Constitution of the Members of the Terpene Group.

Most of the members of the terpene group are unsaturated hydrocarbons of the formula $C_{10}H_{16}$; others, such as camphor, are alcoholic or ketonic derivatives and possess the empirical formulæ $C_{10}H_{16}O$, $C_{10}H_{18}O$, $C_{10}H_{20}O$.

Though most of the hydrocarbons have the empirical formula $C_{10}H_{16}$ several have the formulæ $C_{15}H_{24}$, $C_{20}H_{32}$ and $(C_5H_8)_n$. The unsaturated hydrocarbon isoprene, C_5H_8 , has the same percentage composition and is obtained by the distillation of caoutchouc; it polymerises to a hydrocarbon $C_{10}H_{16}$ and can be made to polymerise to caoutchouc, the constituent of rubber. The group may therefore be divided into

and from these a larger number of isomers, menthadienes, containing two double bonds, e.g.

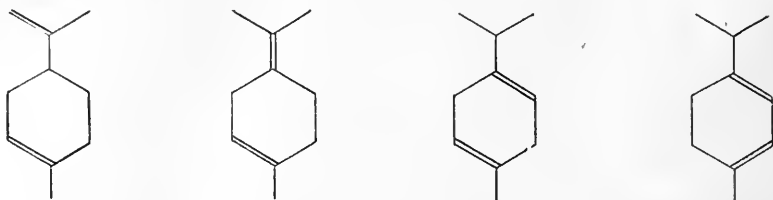

Further, instead of forming the second double bond between two adjacent carbon atoms union may be formed between the carbon atoms 8 and 3, 8 and 2, 8 and 1, thus

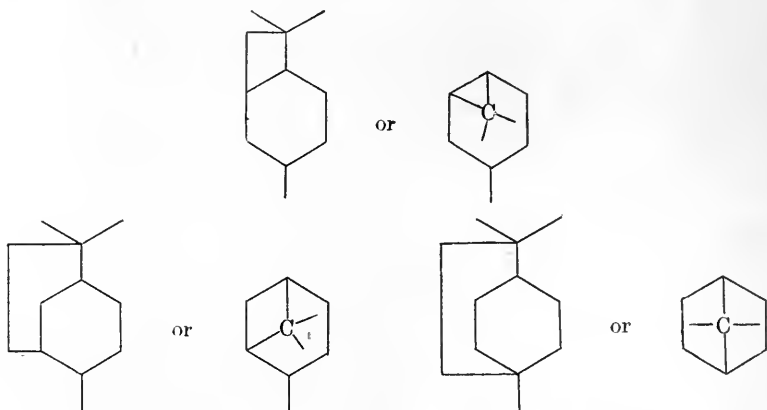

The chief terpenes and their oxygen derivatives are classified in several groups and have been found to possess the following structural formulæ:—

Menthane Group.

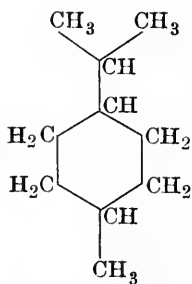

Menthane.

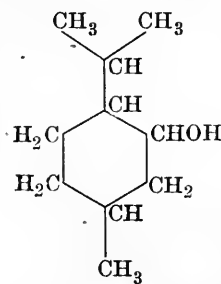

Menthol.

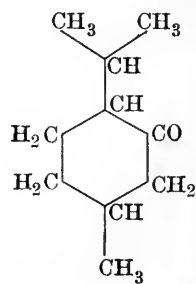

Menthone.

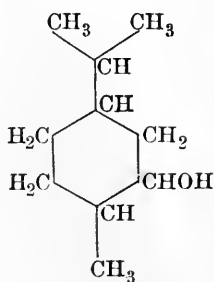

Carvomenthol.

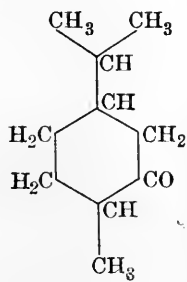

Carvomenthone.

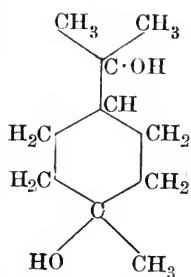

trans-Terpin.

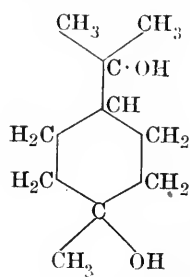

cis-Terpin.

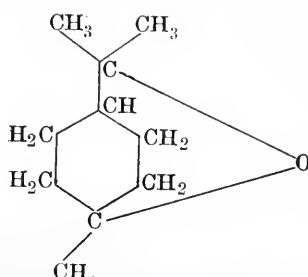

Cineol, eucalyptol.

Menthane is not a natural product.

Menthol is the chief constituent of peppermint oil and can be made by reducing menthone.

Menthone is present in Japanese, American and Russian peppermint oil, It exists in two optically active forms.

Terpin is formed by the action of dilute acids upon the terpenes in turpentine and upon other terpenes.

Cineol is found in eucalyptus oil and is the anhydride of cis-terpin.

Terpin easily forms a crystalline hydrate which melts at 117°.

Menthene Group, C₁₀H₁₈

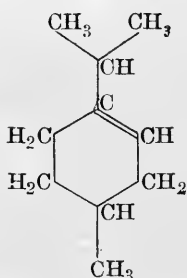

Menthene.

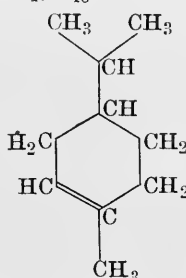

Carvomenthene.

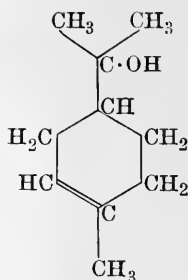

α -Terpinol.

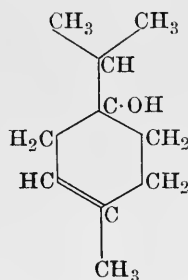

Terpinenol.

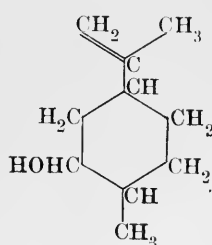

Dihydrocarveol.

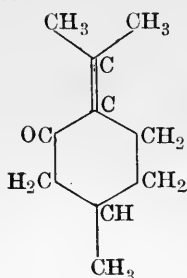

Pulegone.

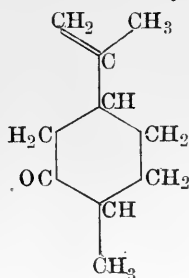

Dihydrocarvone.

“Liquid” terpineol is made from terpin hydrate by treatment with dilute sulphuric acid and is used largely in perfumery. Terpinolene is found in cardamom and majoram oil. Dihydrocarveol has been detected in oil of kummel. Pulegone is contained in the essential oils of *Mentha pulegium* and *Hedeoma pulegioides* and dihydrocarvone has been found in kummel oil.

Menthadiene Group.

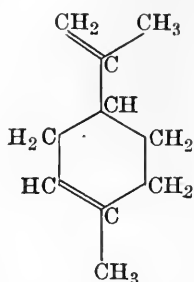

d and *l*-limonene,
d, *l*-limonene
or
dipentene.

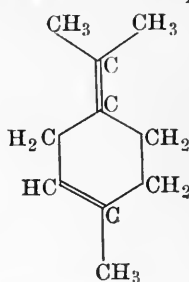

Terpinolene,
not natural.

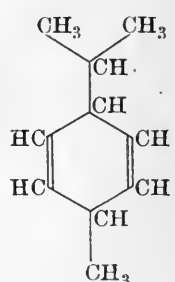

2, 4- Δ -Menthadiene,
not natural.

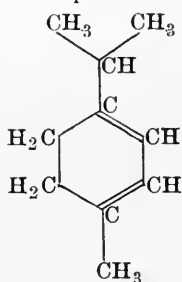

α -Terpinene

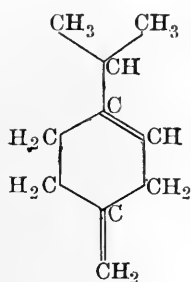

β -Terpinene,
not natural.

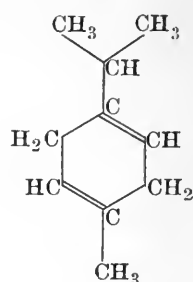

γ -Terpinene.

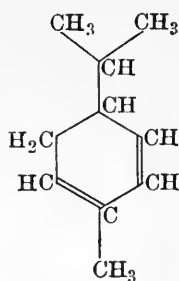

α -Phellandrene.

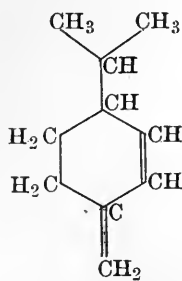

β -Phellandrene.

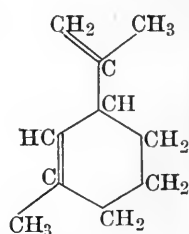

Sylvestrene.

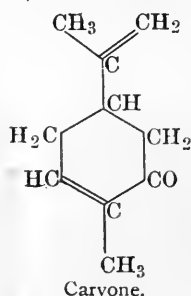

Carvone.

d-Limonene is found in numerous essential oils, in that of lemon, bergamot, kummel, dill, celery.

l-Limonene is present in pine-needle oil and Russian peppermint oil.

Dipentene, or *d, l*-limonene, is present in Russian and Swedish turpentine which has been heated to a high temperature. It is also formed by heating other terpenes. It is contained in the distillate from rubber, having been formed by the polymerisation of isoprene.

α and γ -Terpinenes are found in cardamom oil and other oils. They have a smell of lemons.

Phellandrene is present in fennel oil. Carvone is present in oil of kummel and oil of dill.

Sylvestrene is contained in Swedish and Russian turpentine and pine-needle oil. It is dextrorotatory and also has a smell of lemons.

Pinane Group.

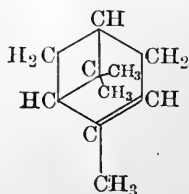

d and *l*-Pinene.

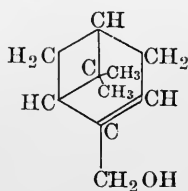

Myrtenol

Camphane Group.

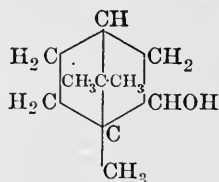

Borneol or
Borneo camphor.

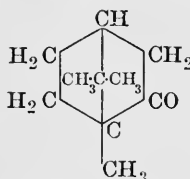

Camphor or
Japan camphor.

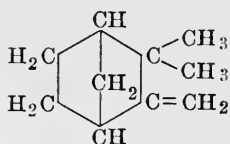

Camphene.

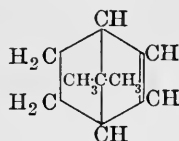

Bornylene.

d-Pinene is the chief constituent of American, Algerian and Greek turpentine, *l*-pinene of French and Spanish turpentine; both are prepared by fractional distillation.

Camphene is a solid terpene and is known in its optically active forms. It is present in numerous essential oils—ginger, Siberian pine-needle, camphor. Bornylene is not a natural terpene, but borneol occurs as *d*-borneol in *Dryobalanops Camphora*, which is grown in Borneo and Sumatra, as *l*-borneol in the oil of *Blumea balsamifera*. As ester with fatty acids it occurs in pine-needle oil. It is very like Japan camphor, but has also a peppermint smell.

d-Camphor, or Japan camphor, occurs in the camphor tree, *Cinnamomum camphora*, and is obtained by distillation and sublimation. It is made artificially from the pinene in turpentine. Pinene is converted into

borneol or isoborneol and oxidised with permanganate, ozone, or nitric acid. It is a colourless, transparent, tough mass, which crystallises from alcohol and is very volatile, and is used in making celluloid and smokeless gunpowder.

Sabinane Group.

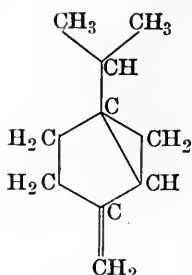

Sabinene.

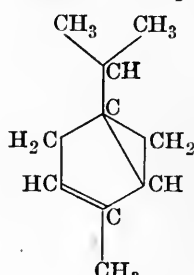

α -Thujene.

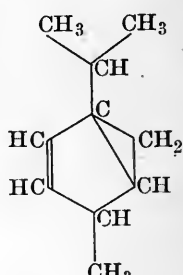

β -Thujene.

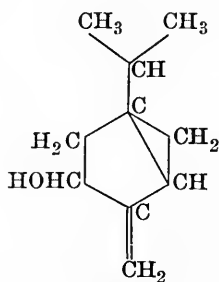

Sabinol.

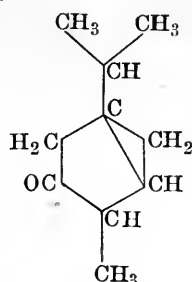

Thujone.

These terpenes are present in various essential oils in small quantities.

It seems most likely that all the terpenes are made by the condensation of isoprene by the action of acids in the plant juices, and it is most remarkable that so many different isomers can be formed from the unsaturated isoprene. The method of formation of isoprene in plants is unknown, but it may arise by removal of carbon dioxide and ammonia from leucine and isoleucine.

Caryophyllene, santalene, santalol belong to the sesquiterpene group. They are present in the various essential oils, are yellowish, viscous liquids boiling between 250 - 280° with slight but not pleasant smell, and they easily change into resins.

The diterpenes and polyterpenes are also yellow viscous liquids boiling above 300° and not easily volatile with steam. They are found in balsams and resins.

The resins occur in the plant oils and are also formed from the terpenes by oxidation in the air. Their solutions in the terpenes are generally called balsams; the solid resins are amorphous shining substances. They consist of a mixture of resin acids and dissolve in alkalis from which they are precipitated by acids. They yield various aromatic compounds by fusion with potash and on reduction yield benzene, naphthalene, etc.

Caoutchouc, the constituent of rubber, is particularly important industrially. The substance which forms caoutchouc can be extracted by ether from the plant juice, and on exposure to light or by action of acids it polymerises to rubber. Pure caoutchouc is soluble in benzene, carbon disulphide, chloroform, etc. It is acted upon by ozone giving a diozonide.

It can take up sulphur by kneading with sulphur or by treating with sulphur dissolved in sulphur chloride and this combination constitutes rubber, ebonite.

The colour of rubber depends on whether lead oxide, antimony oxide, etc., has been used in the vulcanising process.

THE CHOLESTEROLS.

Cholesterol.

Cholesterol was discovered in bile and has been found in the bile of all animals with one exception. It has since been shown to be present in small quantities in blood and the tissues of man and animals; in somewhat large quantities it is present in bone marrow and nervous tissue. It is very seldom found in urine and, when found, only in the smallest quantities. Crystalline deposits of cholesterol are found in pathological effusions, in pus and in diseased arteries. Gallstones usually consist almost entirely of cholesterol. Not only is cholesterol present as such, but also in the form of its esters with the higher fatty acids. Lanolin, or wool fat, is composed mainly of esters of cholesterol.

Constitution.

Cholesterol has been shown to contain an OH group and to be a secondary alcohol by oxidation to a ketone. It contains one unsaturated bond and an isoamyl group. It belongs to the group of terpenes and its formula according to Windaus is the following:—

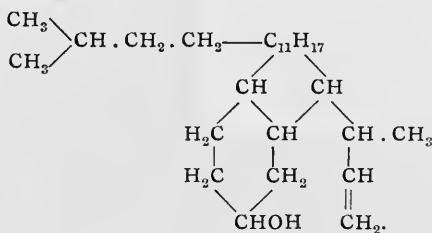

The structure of $\text{C}_{11}\text{H}_{17}$ has still to be determined.

Preparation.

(1) *From Gallstones.*

Cholesterol is most easily prepared from gallstones. The powdered stone is extracted with a mixture of ether and alcohol. The filtered solution on evaporation leaves a residue of cholesterol. It is purified by boiling with alcoholic potash, the solution is evaporated to dryness and the residue extracted with ether. The crystals obtained after evaporation of the ether are recrystallised from alcohol.

(2) *From Brain.*

Sheep's brain is thoroughly ground up with some sand and about 3 parts of plaster of Paris. This mass when it has become hard is powdered and covered with acetone. Dried sheep's brain is extracted with acetone. The acetone is filtered off and the mass again treated with acetone. On distilling off the acetone, crystals of cholesterol remain. They may be purified as above.

(3) *From Tissues.*

The tissue is dried by spreading out in thin layers on plates, by mixing with alcohol and evaporating, or by mixing with an absorbent material, such as sand or siliceous earth. The dry mass is extracted with ether in a Soxhlet extractor. The ethereal extract is mixed with excess of alcoholic potassium hydroxide to saponify the fats and esters, any soap which is formed is filtered off and the ethereal solution distilled to remove ether. The residue is dissolved in water and extracted with ether. The ethereal solution containing the cholesterol is evaporated and the cholesterol recrystallised.

Properties.

* Cholesterol forms a white crystalline solid melting at 147° . It crystallises in needles from ether, benzene, etc.; in characteristic four-sided plates with a notched angle and containing 1 molecule of water of crystallisation (Fig. 52) from aqueous alcohol. It is insoluble in water and soluble with difficulty in cold alcohol. In hot alcohol, ether, acetone, chloroform and other organic solvents it is readily soluble.

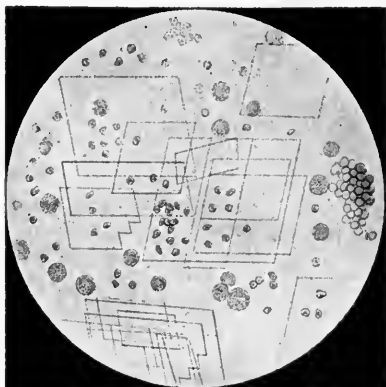

FIG. 52.—Cholesterol. (After Funke.)

The unsaturated character of cholesterol is shown by the formation of addition compounds with the halogens and halogen acids.

As an alcohol, cholesterol forms esters. The acetate and benzoate are very characteristic and serve to distinguish cholesterol from phytosterols (p. 322).

Cholesteryl Acetate.—A small quantity of dry cholesterol is boiled with 2 or 3 c.c. of acetic anhydride for 1 or 2 minutes. The acetic anhydride is evaporated, or the solution is poured into water. The residue, or precipitate, is crystallised from dilute alcohol. It melts at 114° .

Cholesteryl Benzoate.—Cholesterol is boiled with benzoyl chloride for a few minutes and the solution poured into alcohol. The precipitate of cholesteryl benzoate is recrystallised from hot alcohol. This compound melts at 145° to a turbid liquid, which becomes clear at $178-180^{\circ}$; on cooling it exhibits a play of colours, of which blue is the most marked.

Esters of cholesterol with palmitic, oleic and other acids have also been prepared.

Tests.

- * (1) Crystalline form of crystals separated from alcohol.
- * (2) On running a drop of sulphuric acid (5 vols. of conc. acid to 1 vol. of water) upon some crystals on a glass slide, covered with a cover slip, the crystals become red. A drop of iodine solution placed against the cover slip and brought into contact with the crystals by drawing it through with filter paper, changes the colour of the crystals at the points of contact to violet, blue and black.
- * (3) *Salkowski's Reaction.*—A small quantity of dry cholesterol is dissolved in a little chloroform in a dry test tube. An equal volume of concentrated sulphuric acid is added and the liquids mixed. The chloroform rises to the surface coloured at first red, then purple, and the sulphuric acid is yellow and shows a green fluorescence. If the chloroform be poured into a basin it becomes blue, green and yellow. It is decolorised if water be added, but the colour returns on adding strong sulphuric acid. The colour is only stable in the presence of acid. If the sulphuric acid be diluted with glacial acetic acid it becomes red, but still shows a green fluorescence.
- * (4) *Liebermann's Reaction.*—A little cholesterol is dissolved in about 2 c.c. of chloroform in a dry test tube, 2 or 3 drops of acetic anhydride are added and drop by drop concentrated sulphuric acid. A red colour, which becomes blue and finally bluish-green, is formed.
- (5) *Tschugaieff's Reaction.*—A little cholesterol is dissolved in glacial acetic acid, excess of acetyl chloride and a piece of fused zinc chloride are added and the mixture warmed for 5 minutes. The solution becomes red, with a green fluorescence.
- (6) *Neuberg's Reaction.*—If to some cholesterol dissolved in 2 or 3 c.c. of absolute alcohol a trace of rhamnose (or a solution of methyl furfural) be added and sulphuric acid be run under the solution, a red ring is formed at the junction; on mixing and keeping the mixture cold, the red colour diffuses throughout the fluid.

Isocholesterol. $C_{27}H_{46}O$.

Isocholesterol has been found together with cholesterol in lanolin.

Coprosterol. $C_{27}H_{48}O$.

Coprosterol has been found in human fæces; it is probably formed by the reduction of cholesterol in the large intestine.

Hippocoprosterol.

Two compounds, $C_{27}H_{54}O$ and $C_{27}H_{52}O$, have been isolated from horses' manure and are probably reduction products of phytosterol.

Spongosterol. $C_{19}H_{32}O$?

This compound has been isolated from sponges and is very like cholesterol in appearance but melts at 119-120°.

Phytosterols. $C_{27}H_{46}O$.

Compounds very similar to cholesterol have been prepared from plants and have been termed phytosterols. They are probably mixtures of isomeric compounds, that from the Calabar bean having been shown to be a mixture of sitosterol, $C_{27}H_{45}OH$, and stigmasterol, $C_{30}H_{47}OH$. They are mostly contained in the fat of plant seeds.

They are prepared from the vegetable fat of the seeds by saponification with alcoholic potash; the alcohol is evaporated and the residue dissolved in water. The aqueous solution is extracted with ether, and this extract on evaporation yields the phytosterol, which is recrystallised from alcohol.

The phytosterols crystallise like cholesterol, but the crystals are usually six-sided. The melting-point of the phytosterols varies from $135-144^{\circ}$, but is usually $135-137^{\circ}$. In solubility they resemble cholesterol and form acetates and benzoates. The acetates melt at $125-137^{\circ}$. They can only be distinguished from cholesterol by their crystalline form and the melting-point of the acetates.

BILE ACIDS.

The bile of animals contains the sodium salts of glycocholic and taurocholic acids, glycocholeic and taurocholeic acids. These acids are decomposed by boiling the bile with sodium hydroxide and yield glycine or taurine and cholalic, choleic and deoxycholic acids. Choleic acid, according to Wieland and Sorge,¹ is a combination of 8 mols. of deoxycholeic acid with 1 mol. of fatty acid (palmitic or stearic). They have prepared similar combinations of deoxycholeic acid with acetic and other fatty acids.

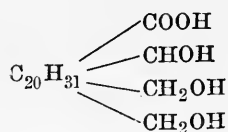
Cholalic Acid or Cholic Acid. $C_{24}H_{40}O_5$.

Though the constitution of cholalic acid is unknown, its properties and reactions seem to show that it should be included amongst the hydro-aromatic compounds. Its products of oxidation and their properties show that it is a trihydroxy monobasic acid.

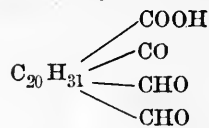
Dehydrocholalic Acid. $C_{24}H_{34}O_5$.

This acid is obtained by the oxidation of cholalic acid with chromic acid in glacial acetic acid. It crystallises from alcohol in needles melting at $231-232^{\circ}$; it is soluble with difficulty in cold water and cold alcohol, is dextrorotatory and has a bitter taste. It forms esters, yields a trioxime with hydroxylamine and contains 1 keto and 2 aldehyde groups.

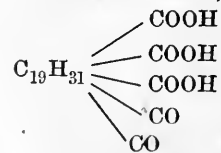
Bilianic Acid, $C_{24}H_{34}O_8$, and Isobilianic Acid.

These acids are formed by the oxidation of cholalic acid or dehydrocholalic acid with potassium permanganate in alkaline solution.

Bilianic acid is soluble with difficulty in cold water, and crystallises from alcohol in sparkling crystals. It is a tribasic acid containing two ketonic groups.

Cilianic Acid. $C_{20}H_{28}O_8$.

This is another tribasic acid obtained by the oxidation of cholalic acid.

¹ Zeitschr. physiol. Chem., 1916, 97, 1.

Preparation of Cholic Acid, Choleic Acid and Deoxycholic Acid.

The most recent methods of preparing these acids from bile are described by Pregl and Buchtala,¹ by Schryver² and by Mair.³

Schryver's Method.

2.5 litres of bile are heated in an iron vessel under a reflux condenser for 30 hours with 170 gm. of sodium hydroxide dissolved in 300 c.c. of water. Two volumes of water are added and the hot solution acidified with excess of hydrochloric acid, the mixture being vigorously stirred after each small addition of acid. The crude acids separate out as a thick oil, which forms a pasty mass on cooling; a small quantity separates in a granular form. After standing for 12 hours, the acids are filtered off, washed free from mineral acid by kneading with water, dried on a water-bath and powdered. They are dissolved in dilute ammonia, the solution is diluted so as not to contain more than 5 per cent. of the salts and boiled for 10 minutes with animal charcoal to remove some of the pigment. The acids are reprecipitated with hydrochloric acid, washed, dried *in vacuo* over calcium chloride and soda lime, the mass being removed from time to time to powder the surface lumps and to expose the under layers. The mass is readily powdered as more water is removed and is finally obtained in a granular form. It is added to boiling acetone till the solvent is saturated, the solution is filtered and allowed to cool. The crystals so formed are filtered off and washed with cold acetone. The filtrate and washings on concentration yield further crops of crystals. A syrupy mother liquor finally results from which only a few crystals separate on prolonged standing. Over 80 per cent. of the acids having a light greenish tinge are thus obtained.

The separation of the three acids depends on the different behaviour of their magnesium salts. The crude product is suspended in alcohol, the alcohol warmed and caustic soda added from a burette till the solution is just alkaline to phenolphthalein which is added to the liquid. The alcohol is evaporated and the sodium salts dissolved in water so that they form a 1 per cent. solution. The alkaline solution is filtered, dilute acetic acid added till the red colour disappears and treated with $\frac{1}{10}$ of its volume of 20 per cent. magnesium chloride solution. On heating the clear solution on a water-bath, a bulky crystalline precipitate gradually separates; sometimes it becomes almost a paste. It is heated for 1 hour and *allowed to cool*.

The precipitate of magnesium choleate and deoxycholate (with not more than $\frac{1}{5}$ of its total of cholic acid) is filtered off by suction and the mother liquor removed as far as possible (below). The acids are regenerated from the magnesium salts by rubbing in mortar with excess of dilute hydrochloric acid; they become granular on standing, are easily filtered off, washed free from acid and dried *in vacuo*. They are dissolved in alcohol with the addition of caustic soda as before, the solution is neutralised, diluted so as to contain about 2 per cent. of salts and treated with about $\frac{1}{5}$ of its volume of 20 per cent. barium chloride solution. The precipitated barium salts become granular and crystalline on standing for 16 hours. The liquid is syphoned off on a Buchner filter and the solid added. It is washed by grinding in a mortar several times with water. This insoluble barium salt consists of barium choleate from which almost pure choleic acid is obtained by stirring up in mortar with dilute hydrochloric acid.

The filtrate and washings are acidified, the precipitate of deoxycholic and

¹ Zeitschr. physiol. Chem., 1911, 74, 198.

² J. Physiol., 1912, 44, 265.

³ Biochem J., 1917, 11, 11.

cholic acids filtered off, washed, converted as before into their sodium salts and the hot solution treated with 20 per cent. magnesium chloride. The precipitate consists mainly of magnesium deoxycholate; a further quantity is obtained on concentrating the solution and allowing to cool.

The mother liquor (above) containing magnesium cholate is concentrated to about one-fifth, crystals of magnesium deoxycholeate are filtered off, and the cholic acid precipitated by adding acid. It is at first resinous, but becomes crystalline on standing.

The crude yellowish crystalline mass of cholic acid is washed, dried *in vacuo* and recrystallised from hot alcohol. Further crops of crystals are yielded by concentration of the mother liquor. The remainder is separated by warming the solution with caustic soda, to hydrolyse ethyl cholate, evaporating off the alcohol, dissolving the residue in water and acidifying. The precipitated acid is dried, converted into its sodium salt as in the preparation and treated with barium chloride to remove choleate and deoxycholate. The acid is reprecipitated and crystallised from alcohol. The cholic acid in the last mother liquors is isolated by converting into the sodium salt, evaporating off the alcohol and acidifying in the presence of ether. 90 per cent. of the crude acid is obtained in a crystalline form melting at 197°. It is generally slightly yellow.

Choleic acid is obtained from the barium salt by grinding with dilute hydrochloric acid. It is almost pure and melts (after drying at 110°) at 184°. Small quantities are recrystallised from acetone, or large quantities from alcohol; in the latter case, the mother liquors are boiled with caustic soda, the alcohol evaporated, the residue dissolved in water and hydrochloric acid added. The precipitated acid is washed, dried and recrystallised from acetone.

Deoxycholic acid is precipitated on grinding the magnesium salt with acid. It is filtered off, washed and recrystallised from acetone. Pure deoxycholic acid is prepared by crystallisation from glacial acetic acid. 225 gm. of cholic acid, 75 gm. of choleic acid and 40 gm. of deoxycholic acid are obtained from 10 litres of bile.

Mair's Method.

This method is designed to prepare deoxycholic acid.

240 gm. of sodium hydroxide are dissolved by stirring and heating in 4 litres of ox bile. The alkaline solution is boiled gently for 20 hours in an iron digester and its volume reduced by evaporation to 2-3 litres. The hot solution is neutralised to phenolphthalein by adding about 350 c.c. of conc. hydrochloric acid. A flocculent precipitate of silica, amounting to 1-2 gm. per 1000 c.c. of bile is thrown down and filtered off after cooling. The filtrate is acidified to litmus by adding about 50 c.c. of glacial acetic acid. The bile acids separate as a fluid crystalline mass, which is at first white, but rapidly absorbs pigment; by gentle rotation of the flask, the acids can be made to adhere in a single mass from which the liquid is decanted. The pasty mass retains acetic acid tenaciously and is squeezed to remove the liquid. It is put into a 1 litre flask and dissolved by heating in about 600 c.c. of glacial acetic acid. The solution is poured into a beaker and allowed to stand for 2-3 days. The crystals which separate and consist of deoxycholic acid, cholalic acid and some fatty acid are filtered off and washed free from pigment with 60 per cent. acetic acid. They are dissolved in about 300 c.c. of hot glacial acetic acid, filtered from silica (?) and the solution allowed to stand. The crystals, mainly deoxycholic acid, are separated, dried between porous tiles and dissolved in about 750 c.c. of 60 per cent. acetic acid. The hot solution is

poured into a beaker and the small quantity of oily substance separated after cooling. The crystals are filtered off, washed with 60 per cent. acetic acid and water and dried at 100° . The product melts at $170-175^{\circ}$. A yield of 32 gm. melting at $172-173^{\circ}$ and 42 gm. melting at 170° was obtained from 4 litres of bile.

Deoxycholic acid can be prepared in a similar way from commercial sodium taurocholate by boiling 500 gm. with 3 litres of water and 200 gm. of caustic soda. A yield of 25 gm. melting at $173-174^{\circ}$ results.

Cholic acid is prepared from the mother liquors by distilling off the acetic acid *in vacuo*, treating the residue with hot alcohol and making alkaline to phenolphthalein with caustic soda; the alcohol is evaporated, the sodium salts dissolved in water and the cholic acid precipitated with hydrochloric acid. The fluid crystalline mass is squeezed to remove mother liquor and digested with hot water to remove acetic acid. A hard cake smelling of acetic acid results on cooling; it is broken up, powdered, dried *in vacuo* over caustic soda and subsequently at 100° . It is recrystallised from 2 volumes of absolute alcohol. 50 gm. of cholic acid and 7 gm. of fatty acid were obtained from 4 litres of bile. Schryver's method gives a bigger yield of cholic acid.

Properties of Cholalic Acid.

Cholalic acid is soluble in water, 1 part in 4000 cold, 1 part in 750 hot; it is more soluble in alcohol, 1 part in 20. It dissolves in alkalis and in alkaline carbonates with evolution of carbon dioxide. It crystallises from dilute aqueous solutions or from dilute acetic acid in tetrahedra containing 1 molecule of water and from alcohol containing 1 molecule of alcohol, which is given off at 130° . It has a sweet-bitter taste and the anhydrous substance melts at 195° .

Cholalic acid is dextrorotatory.

It gives off aromatic vapours when heated and is stable to alkali. The alkaline salts are easily soluble in water, less so in alcohol; they crystallise on evaporating the alcoholic solution or on precipitating it with ether. The lead and barium salts are precipitated on adding lead acetate or barium chloride to a not too dilute solution. The barium salt crystallises in glistening needles arranged in rosettes and is easily soluble in alcohol and hot water.

On heating to high temperatures or with dehydrating agents, e.g. glacial acetic acid it is converted into anhydrides—dyslysin, choloidic acid—which are not crystalline and are reconverted into cholalic acid by boiling with alcoholic potash. On oxidation cholalic acid is converted into dehydrocholalic acid, bilianic acid, isobilianic acid. Another acid, cholcamphoric acid, $C_{10}H_{16}O_4$, has also been obtained. It is not easily reduced, but an acid, cholylic acid, $C_{24}H_{40}O_2$, has been obtained.

Reactions and Tests of Cholalic Acid.

(1) The crystalline form, dextrorotation and the formation of aromatic substances on heating are an indication of the presence of cholalic acid.

(2) *Mylius' Reaction.*—If 0.2 gm. of cholalic acid be dissolved in 0.5 gm. of alcohol and 1 c.c. of 1N iodine solution be added and the solution gradually diluted with water, the brown liquid sets to a mass of microscopic needles with a metallic lustre and blue appearance.

(3) Cholalic acid dissolves in concentrated sulphuric acid, giving a reddish-yellow solution with a green fluorescence.

(4) *Pettenkofer's Reaction.*—On adding concentrated sulphuric acid drop by drop to an aqueous solution of cholalic acid in which a tiny crystal of cane sugar has been dissolved and keeping the temperature below 70° , the cholalic

acid is precipitated but redissolves giving a cherry-red, then a purple solution, which becomes bluer in shade on keeping. The purple solution shows an absorption band between D and E.

Reactions (3) and (4) are given by other compounds and are not distinctive for cholalic acid.

Properties of Choleic Acid. $C_{24}H_{40}O_4$?

Choleic acid crystallises from alcohol in bundles of flat needles which melt at $185-190^\circ$. It is soluble with difficulty in water, more easily in ether and readily in absolute alcohol, but less so than cholalic acid. It is dextrorotatory. On oxidation it yields dehydrocholeic acid, cholanic acid.

Properties of Deoxycholic Acid. $C_{24}H_{40}O_4$.

It melts at $172-173^\circ$ and has $[\alpha]_D^{20} + 57.02$.

Glycocholic Acid. $C_{26}H_{43}O_6N$.

$C_{23}H_{39}O_5 \cdot CO$
 $\quad \quad \quad |$
 $\quad \quad \quad NH - CH_2 \cdot COOH$. Glycocholic acid is present in ox and human bile (7-9 per cent.), but not in that of carnivora. It is converted by hydrolysis with acids into cholalic acid and glycine, and has been synthesised.

Preparation.

(1) *Hüfner's Method.*

Fresh ox bile is covered with a layer of ether in a measuring cylinder and treated with concentrated hydrochloric acid (2 c.c. to 40 c.c. bile). The turbidity at first formed becomes crystalline. The ether is poured off, the mass stirred with water, well shaken, filtered and washed with cold water till the washings are colourless. The precipitate is purified as given in Hammarsten's method.

(2) *Plattner's Method.*

Bile is evaporated to a syrup and extracted with alcohol. The solution is decolorised by boiling with charcoal, some of the alcohol is distilled off and the concentrated alcoholic solution is precipitated with ether. The precipitate becomes crystalline on standing from a few hours to some days and consists of sodium glycocholate, glycocholate and taurocholate (Plattner's crystallised bile). The crystals are dissolved in water, some ether and then dilute sulphuric acid are added until there is a permanent cloudiness. A mass of fine shining needles fills the solution. They are filtered off and washed free from acid with water. The mixture of acids is separated by Hammarsten's method.

(3) *Hammarsten's Method.*

Ox bile is evaporated to a syrup, the syrup extracted with alcohol and the alcoholic extract evaporated. The residue is dissolved in water and precipitated with lead acetate. The precipitate is decomposed by boiling with sodium carbonate, the solution evaporated to dryness and extracted with alcohol. The alcoholic solution is evaporated, the residue is dissolved in water and boiled with charcoal to decolorise. The solution is mixed with ether and precipitated with hydrochloric acid according to Hüfner's method. The crystals are washed free from hydrochloric acid.

The mixture of acids contained in this precipitate is separated as follows:—

Glycocholic acid is separated by boiling out the precipitate with water; it separates out on cooling and is recrystallised from water.

The residue is dissolved in very dilute alkali and the neutral solution treated with barium chloride. The sticky mass of barium salts is dissolved in boiling water and treated with sodium carbonate. The filtrate is evaporated and extracted with alcohol. The alcoholic extract is evaporated, the residue dissolved in water, the solution decolorised by boiling with charcoal and precipitated in dilute solution with hydrochloric acid and ether as above. The glycocholic acid is precipitated and is purified by repeating the process

Properties.

Glycocholic acid crystallises in needles (Fig. 53) which are soluble with difficulty in cold water (1 part in 300), more easily in hot water (1 part in 120), very easily soluble in alcohol and in alkalis, almost insoluble in ether. The alcoholic solution on the addition of water becomes turbid and deposits crystals. The alkaline solution is precipitated by acids. On heating in a capillary tube, glycocholic acid softens at 133° and melts at 152° . It has a sweet-bitter taste and is dextrorotatory. The alkaline salts are obtained by evaporation of the alcoholic solution; they dissolve fats and cholesterol and give precipitates with lead acetate, ferric chloride, silver nitrate. The lead salt is soluble in hot alcohol and separates as a powder on cooling. The barium salt is easily soluble in water.

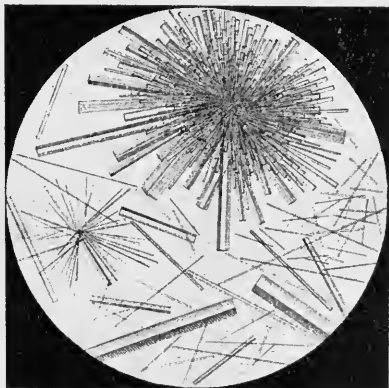

FIG. 53.—Glycocholic acid. (After Funke.)

On boiling with water, glycocholic acid changes into paraglycocholic acid which crystallises in platelets melting at 183 - 188° . It is reconverted into glycocholic acid by crystallisation from alcohol.

It dissolves in concentrated sulphuric acid and on warming cholonic acid, $C_{26}H_{45}O_5N$, separates out. This substance is also formed by boiling glycocholic acid with concentrated hydrochloric acid. Its barium salt is insoluble in water.

Glycocholic acid is distinguished by its solubility, taste and rotation. It gives the fluorescent reaction and Pettenkofer's reaction, but not Mylius' reaction described under cholalic acid.

Glycocholeic Acid. $C_{26}N_{43}O_5N$ or $C_{27}H_{45}O_5N$.

This acid accompanies glycocholic acid in bile.

It is prepared as described under glycocholic acid.

Glycocholeic acid crystallises in prisms or bunches of fine needles which melt at $175-176^\circ$. It has a bitter taste, is almost insoluble in cold and boiling water, but is easily soluble in alcohol.

Its alkaline salts are soluble in water, but not so easily as those of glycocholic acid. They are precipitated by calcium, barium and magnesium salts. The barium salt is precipitated as a sticky mass, but crystallises from water in bunches of needles.

It yields glycine and choleic acid on hydrolysis by acids or by alkalis.

Glycocholeic acid is distinguished from glycocholic acid by melting-point, rotation and insolubility, also by the insolubility of its barium salt, otherwise it resembles glycocholic acid.

Glychoyochoic Acids.

Two acids, α -glychoyochoic acid and β -glychoyochoic acid, have been prepared from pig's bile. They differ slightly in properties from glycocholic acid and have been seldom investigated.

Fellinic Acid. $C_{23}H_{40}O_3$.

Fellinic acid, together with cholalic acid, has been obtained from human bile.

Chenocholeic acid, $C_{27}H_{44}O_4$, Ursocholeic acid, $C_{18}H_{28}O_4$? and Lithofellinic acid, $C_{20}H_{36}O_4$, are other acids obtained from different biles.

Taurocholic Acid. $C_{26}H_{45}O_7NS$.

Taurocholic acid accompanies glycocholic acid in ox bile. It is present in fish bile and snake's bile. Dog's bile and the bile of carnivora do not contain glycocholic acid. In all cases it is present as the sodium salt.

Preparation.

Hammarsten gives the following preparation of taurocholic acid from cod's bile and dog's bile.

(a) From Cod's Bile.

The bile is precipitated with ferric chloride, the filtrate is treated with sodium carbonate to remove iron, the solution from the ferric carbonate is nearly neutralised and saturated with sodium chloride. The precipitate of taurocholate is washed with saturated salt solution, dissolved in water and again precipitated with salt. The taurocholate is dissolved in water and separated from sodium chloride by repeated evaporation and solution in alcohol. Taurocholic acid is obtained from the sodium salt by rubbing with alcohol containing about 2 per cent. of sulphuric acid, shaking up, filtering from sodium sulphate and adding ether. The flocculent precipitate is separated, dissolved in absolute alcohol and again thrown down with ether. The clear solution of the precipitate in alcohol is treated with a few drops of water and then with ether till it is turbid. An amorphous precipitate, if formed, is rapidly filtered off and more ether is added. The acid commences to crystallise out after some time and when the amount ceases to increase ether may be again added. This is continued until no further crystals are obtained.

(b) From Dog's Bile.

Dog's bile is treated with alcohol to remove mucin and the alcoholic filtrate is evaporated to dryness. The residue is dissolved in absolute alcohol and carefully treated with ether. The precipitate is pressed out and dissolved in water. The solution is fractionally precipitated with ferric chloride, the reaction being kept neutral by adding sodium carbonate, and diluted with water. This is continued so long as the precipitates on decomposing with sodium carbonate give a solution having a bitter taste. Taurocholic acid is obtained from the precipitate. The filtrate is neutralised, and evaporated; the residue is then extracted with alcohol: evaporation and extraction are repeated several times. The free acid is obtained from the salt as described under cod's bile.

Properties.

Taurocholic acid is easily soluble in water, the amorphous form more easily than the crystalline. It dissolves easily in alcohol, but is insoluble in ether, benzene, chloroform. It has a sweet, very slightly bitter, taste and is dextrorotatory. It yields taurine and cholalic acid on hydrolysis.

The amorphous form separates on adding ether to the alcoholic solution; the crystalline form on adding ether to the alcoholic solution containing a drop of water. The crystals contain 1 molecule of water. Taurocholic acid on heating turns yellow or brown at 100°, sinters at 140°, begins to decompose at 160° and melts at 180° to a brown liquid.

The sodium salt is soluble in water, less so in cold alcohol; from hot alcohol it separates in large flakes if the solution does not set as a jelly. It can be obtained as crystals by adding ether to the alcoholic solution.

The sodium salt is not precipitated by lead acetate or ferric chloride.

It resembles the other bile acids in giving the fluorescent and Pettenkofer's reaction, but is distinguished by its taste, solubility and sulphur content.

Taurocholic Acid.

Taurocholic acid accompanies taurocholic acid in dog's bile.

The precipitates obtained in the preparation of taurocholic acid with ferric chloride and sodium carbonate are decomposed with sodium carbonate; the filtrate is evaporated and the residue extracted with hot alcohol. The alcoholic solution is evaporated and extracted with cold alcohol. Extraction and evaporation are repeated until a clear solution results. The acid is obtained by treating this solution with alcohol containing hydrochloric acid, the sodium chloride is filtered off and the solution precipitated with ether.

Taurocholic acid is readily soluble in alcohol, but insoluble in ether, chloroform and benzene. It is amorphous and deliquescent and has a bitter taste.

COMPLEX AROMATIC COMPOUNDS.

In addition to benzene and its substitution products, compounds in which only one benzene ring is present, numerous compounds are known which contain two or more benzene nuclei. These nuclei may be joined by means of one or more carbon atoms, or they may be joined together directly.

Diphenylmethane.

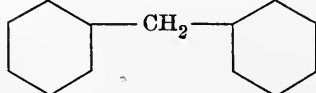

Diphenylmethane is the first and chief example of a complex aromatic compound in which two benzene rings are united by a carbon atom.

It is obtained by heating benzene with benzyl chloride in the presence of aluminium chloride :—



Diphenylmethane is a crystalline solid, which melts at 26.5° . It closely resembles benzene in forming nitro and other derivatives. On oxidation with chromic acid it yields benzophenone, $\text{C}_6\text{H}_5 \cdot \text{CO} \cdot \text{C}_6\text{H}_5$.

Triphenylmethane.

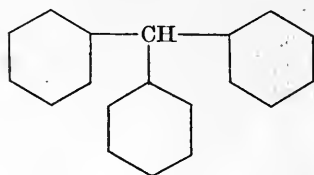

Triphenylmethane contains three benzene nuclei joined to one carbon atom, and is obtained by heating benzal chloride with benzene in the presence of aluminium chloride :—

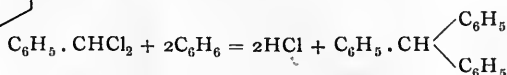

or by heating benzene with chloroform in the presence of aluminium chloride :—

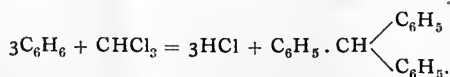

Triphenylmethane is a colourless solid, which melts at 92° and boils at 358° . It is not easily soluble in cold alcohol, but dissolves easily in ether and benzene.

It yields nitro compounds, amino compounds and other derivatives. These derivatives form the group of rosaniline dyes (p. 335).

When oxidised with chromic acid it is converted into triphenylcarbinol (C_6H_5)₃.C.OH.

Diphenyl.

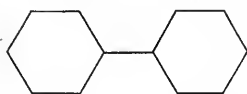

Diphenyl is the first instance of aromatic compounds in which the benzene rings are directly joined together by a single bond. It is prepared by treating an ethereal solution of bromobenzene with sodium :—

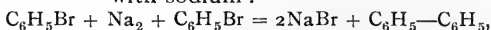

or it is formed when benzene vapour is passed through a red-hot tube.

It is a colourless solid melting at 71° and boiling at 254°; it closely resembles benzene in its reactions. On oxidation it yields benzoic acid.

Azoxybenzene.

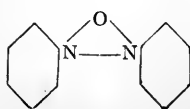

When nitrobenzene is reduced with alkaline reducing agents, such as sodium and alcohol, it yields azoxybenzene. Azoxybenzene is a yellow crystalline solid melting at 36°. It is insoluble in water, but soluble in alcohol, ether and organic solvents.

Azobenzene.

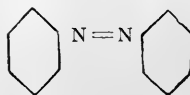

Azobenzene is formed when azoxybenzene is carefully distilled with three parts of iron filings.

It is a brilliant red crystalline solid which melts at 68° and distils at 293°. It is not soluble in water, but dissolves in organic solvents.

Hydrazobenzene.

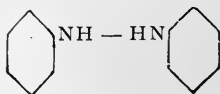

When azobenzene is reduced with alkaline reagents, ammonium sulphide, or zinc and caustic soda, it is converted into hydrazobenzene.

Hydrazobenzene forms colourless crystals which melt at 131°. It is reduced by zinc dust and acetic acid to aniline.

Benzidine.

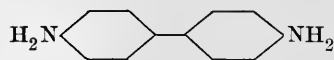

Benzidine, or diamino-diphenyl, is formed when hydrazobenzene is treated with concentrated hydrochloric acid; intramolecular rearrangement takes place.

It may be obtained by treating azobenzene with tin and concentrated hydrochloric acid.

Benzidine forms colourless crystals which melt at 128°.

It is a base like aniline, forming salts with acids. The sulphate is very insoluble and is used for estimating sulphates.

It is diazotised by nitrous acid and, like aniline, is used largely in the preparation of dyes.

Naphthalene.

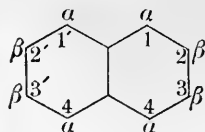

Naphthalene, the hydrocarbon which is present in coal tar in the largest quantity, is present in the second fraction, boiling from 170-230°, when the tar is fractionally distilled.

The second fraction on cooling deposits crystals of naphthalene. These are separated from phenols, etc., by pressure. The impure mass is shaken with caustic soda to remove the remainder of the phenols, washed and warmed with sulphuric acid, which sulphonates the impurities, dissolving them. The naphthalene is obtained by distillation or sublimation.

Naphthalene is a colourless solid crystallising in shining plates which melt at 79° and boil at 218° . It has a characteristic smell and is extremely volatile. All the naphthalene formed by the distillation of coal is not condensed and a portion reaches the gas mains and gas pipes; in cold weather the naphthalene crystallises out and may cause blocking of the pipes. It does not dissolve in water, but it dissolves easily in hot alcohol, ether and other organic solvents. It combines with picric acid, like other complex hydrocarbons, to form a yellow crystalline solid which melts at 149° .

When naphthalene is oxidised by dilute nitric acid or chromic acid, it yields *o*-phthalic acid. On nitration it yields α -nitronaphthalene; α -aminonaphthalene is formed by the reduction of the nitro compound. Nitronaphthalene on oxidation gives nitrophthalic acid: aminonaphthalene gives phthalic acid. The formation of phthalic acid shows the presence of one benzene ring with substituting groups in the *o*-position. The same is shown by the oxidation of nitronaphthalene, but the oxidation of aminonaphthalene shows that a different benzene ring is oxidised to that which is oxidised in the case of nitronaphthalene. Naphthalene would thus contain two benzene rings joined together in the ortho-position as represented by the formula. This constitution is proved by synthesis and emphasised by the similarity in behaviour of naphthalene to benzene.

Derivatives of Naphthalene.

Naphthalene resembles benzene in forming nitro, sulphonic acid, amino-derivatives. Two monosubstitution derivatives can be formed, the α and the β forms. In some cases both are formed, in other cases only one is formed. The accompanying formulæ show how these derivatives are prepared from naphthalene:—

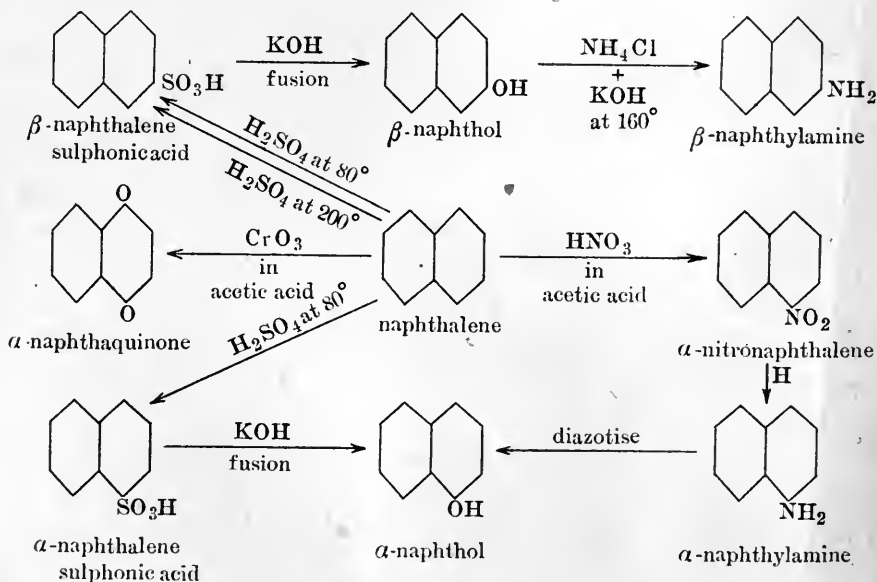

The naphthalene sulphonic acids are crystalline hygroscopic solids.

α -naphthol is crystalline, melts at 95° and boils at 280° ; it resembles phenol in smell, is only slightly soluble in water, but dissolves easily in alcohol and ether. It gives a violet flocculent precipitate with ferric chloride.

β -naphthol is a crystalline solid, melting at 138° . It forms nitro derivatives like phenol, many of which are used as dyes.

α -naphthylamine is a colourless, crystalline solid melting at 50° and boiling at 300° . It has an unpleasant smell and turns red on exposure to air; on oxidation it is converted into α -naphthaquinone. It gives a blue precipitate with ferric chloride.

β -naphthylamine is a colourless crystalline solid, melting at 112° and boiling at 294° . It has no smell and gives no precipitate with ferric chloride.

It gives phthalic acid on oxidation.

α -nitronaphthalene is yellow, melts at 61° and boils at 304° .

β -nitronaphthalene, prepared by indirect methods, melts at 79° .

The chief derivatives of naphthalene are the naphthol sulphonic acids and naphthylamine sulphonic acids of which 14 isomers of each are possible.

Naphthalene and its substitution products are extensively used in the preparation of dyes. Apparently no natural compound contains a naphthalene ring.

Anthracene.

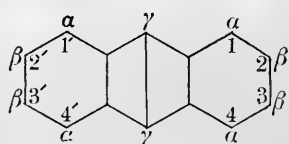

The chief interest attaching to anthracene is that it is the parent hydrocarbon from which the red dye of madder root is derived.

Anthracene is a constituent of coal tar and is isolated like naphthalene from the fraction boiling above 270° .

Its constitution has been arrived at by its resemblance in properties to benzene and naphthalene and by its synthesis by treating tetrabromo-ethane with benzene in presence of aluminium chloride:—

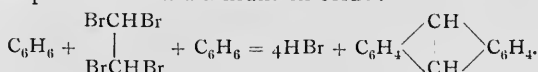

It is a colourless crystalline solid with a blue fluorescence, melting at 213° and boiling at 351° . It is insoluble in water, very slightly soluble in alcohol and ether, but easily soluble in benzene.

Anthracene resembles benzene and naphthalene fairly closely, but it is oxidised by nitric acid and converted into anthraquinone.

Anthraquinone.

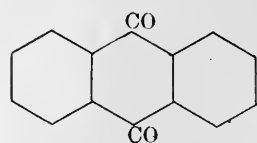

Anthraquinone is prepared by oxidising anthracene with sodium bichromate and sulphuric acid and is the chief derivative of anthracene.

It consists of pale yellow needles which melt at 285° . It resembles the aromatic ketones, e.g. benzophenone, rather than quinone and is a very stable compound. It is used in making alizarin and other dyes.

Alizarin.

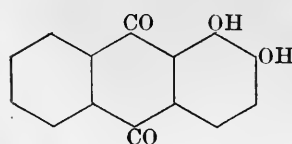

Alizarin occurs in madder root as the glucoside termed ruberythric acid. This glucoside on hydrolysis by enzymes, or by acids, gives two molecules of glucose and alizarin, the "Turkey red" dye. Since its synthesis by Graebe and Liebermann who determined its constitution, alizarin is made entirely from anthraquinone.

Anthraquinone is converted by sulphonation with sulphuric acid at 250° , or by heating with fuming sulphuric acid at 160° , into anthraquinone- β -monosulphonic acid. The solution is diluted with water, unchanged anthraquinone is filtered off and the solution neutralised with soda. Sodium anthraquinone- β -monosulphonate crystallises out and is purified by crystallisation. It is heated with caustic soda and a small quantity of potassium chlorate; the sodium salt of alizarin is obtained from which alizarin is precipitated on acidifying:—

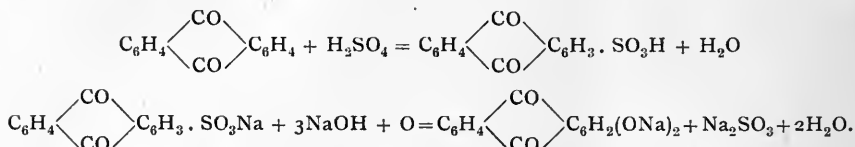

Alizarin forms dark red prisms melting at 290° . It is almost insoluble in water, slightly soluble in alcohol.

As a phenol it forms salts with alkalis; the solution in caustic soda has a violet colour; the salts with the divalent and trivalent metals are insoluble and of various colours; these salts are the dyes which colour the fabrics.

Purpurin.

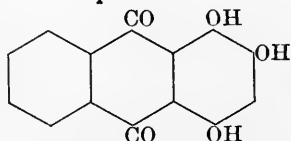

Purpurin or 1, 2, 4-trihydroxy-anthraquinone is present in madder root with alizarin and is made by oxidising alizarin with manganese dioxide and sulphuric acid.

It forms dark red needles which melt at 253° ; in dyeing it gives yellower shades than alizarin.

Anthropurpurin

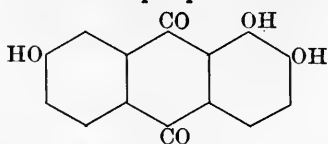

and

Flavopurpurin

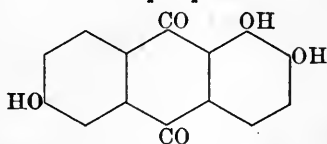

are two other anthraquinone derivatives used as dyes. It may be noted that only those derivatives containing two hydroxy groups in the 1, 2 position form dyes.

Mention may finally be made of the following complex aromatic compounds:—

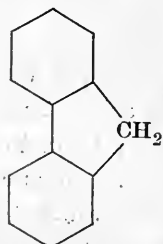

Fluorene.

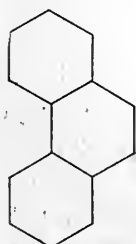

Phenanthrene.

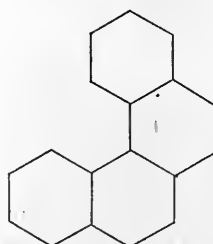

Chrysene.

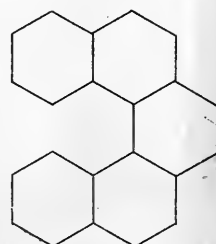

Picene.

DYES.

Most of the dyes in common use are derivatives of the complex aromatic compounds. They may be divided into the following groups:—

- | | |
|----------------------------------|----------------------|
| (1) Nitro compounds. | (3) Azo compounds. |
| (2) Triphenylmethane compounds : | (4) Phenols. |
| (a) basic. | (5) Indigo (p. 345). |
| (b) acidic. | |

Nitro Compounds.

The nitro compounds are yellow dyes, mainly used for dyeing silk and wool, and on this account, since cotton is the chief material which requires dyeing, are few in number.

Picric acid dyes silk and wool, but not cotton, as can be easily verified by dipping silk or wool and cotton into picric acid solution, removing and washing. The silk or wool is dyed, the cotton is not dyed.

Martius yellow, dinitro- α -naphthol, is the chief nitro compound used for dyeing silk and wool. The commercial substance is the sodium salt.

Naphthol yellow is the sulphonic acid of Martius yellow. The potassium salt is the commercial dye.

Triphenyl Methane Compounds.

Malachite green is prepared by heating a mixture of benzaldehyde and dimethylaniline with zinc chloride:—

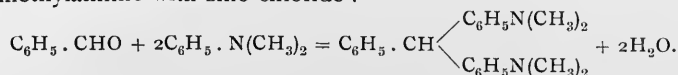

It dyes silk and wool a bluish-green; but cotton only after mordanting (p. 337).

Brilliant green is prepared in the same way using diethylaniline:—

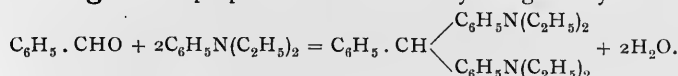

Acid green is prepared from benzaldehyde and ethylbenzylaniline:—

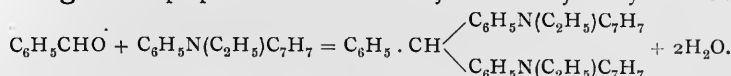

It dyes silk and wool in an acid solution, but is not used for dyeing cotton.

Pararosaniline is prepared by oxidising a mixture of *p*-toluidine and aniline with arsenic acid or nitrobenzene. Probably the *p*-toluidine is first oxidised to the aldehyde:—

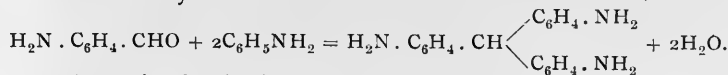

On further oxidation it gives the carbinol:—

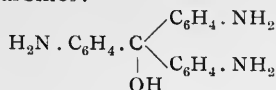

Rosaniline, Fuchsine or Magenta.

This compound is prepared by oxidising a mixture of *p*-toluidine, *o*-toluidine and aniline as above:—

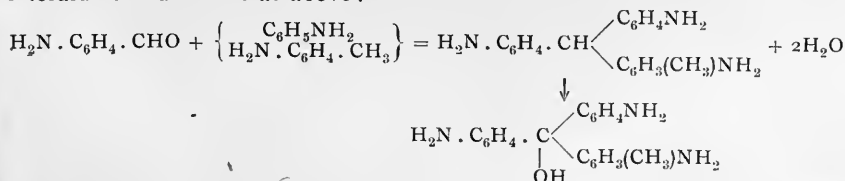

Pararosaniline and rosaniline are reddish-blue dyes.

These compounds on heating with methyl iodide become methylated. The colour becomes bluer. It is still more blue when ethyl iodide is used, and pure blue when phenyl groups are introduced, e.g. **aniline blue**.

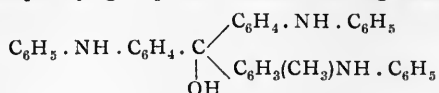

Phenolphthalein is prepared by condensing together phenol and phthalic anhydride:—

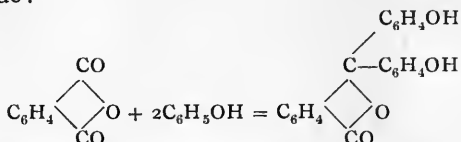

Fluorescein is obtained by condensing resorcinol with phthalic anhydride.

Eosin is obtained by condensing dibromo-resorcinol with phthalic anhydride. It is a tetrabromofluorescein.

Erythrosin is obtained by condensing di-iodoresorcinol with phthalic anhydride. It is tetra-iodo-fluorescein.

These dyes have a magnificent greenish fluorescence and are mostly used for dyeing silk. Eosin is used as red ink, phenolphthalein is the well-known indicator. The phenol acid is colourless, the alkaline salt is coloured.

Constitution of Triphenylmethane Dyes. The Theory of Colour.

An examination of the coloured aromatic compounds has shown that they contain particular groupings, e.g. the nitro-group, the azo-group. Quinones are also coloured compounds. The triphenylmethane derivatives are neither nitro-compounds nor azo-compounds; they are believed to have a quinonoid structure:—

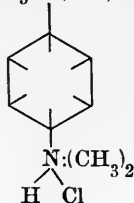
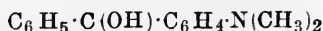

Colourless leuco base.

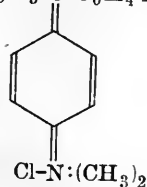
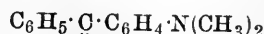

Coloured base.

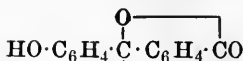

Colourless anhydride
of
phenolphthalein.

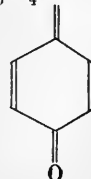
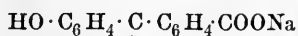

Coloured sodium salt.

Malachite green, as prepared above, is a colourless crystalline solid and is known as the leuco base; on oxidation it is converted into the green compound

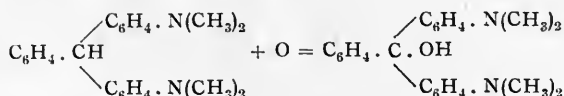

which is known as the colour base.

The colour bases of the rosanilines are formed directly; on reduction they give the leuco base.

These colour bases form salts with acids, e.g.

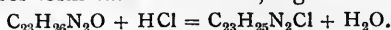

Azodyes.

Diazonium salts are prepared by treating aniline and other aromatic amines with nitrous acid. Besides yielding phenol on boiling and giving various derivatives by the Sandmeyer reaction these diazonium salts have the property of combining with amines and phenols:—

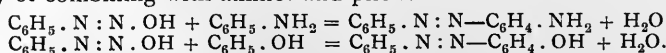

By means of this reaction an enormous number of dyes can be prepared which are either basic (aniline component) or acidic (phenol component). The following are examples:—

Helianthin from diazotised sulphanilic acid and dimethylaniline.

Chrysoidin from diazotised aniline and *m*-phenylenediamine.

Bismarck brown from diazotised *m*-phenylenediamine and *m*-phenylenediamine.

Resorcin yellow from diazotised sulphanilic acid and resorcinol.

Congo red from diazotised benzidine and naphthionic acid (naphthylamine sulphonic acid).

The free acid is blue in colour, the salts are red.

The Process of Dyeing.

There are many coloured substances amongst the aromatic compounds which are not dyes, e.g. dinitrobenzene is yellow, azobenzene is red, but the chief essential that a coloured substance should be a dye is that it should form an insoluble compound, which cannot be washed out by water, upon the fabric or material to be dyed. It will be noticed that the dyes above mentioned are either basic or acidic substances and are thus capable of forming salts with alkalies or with acids.

Silk and wool are proteins and are compounds of the nature of amino acids, i.e. they are both basic and acidic in their properties. Most dyes combine with them and give insoluble salts. Cotton is a carbohydrate and forms no compounds with acids and bases. Cotton can, however, be dyed by mordanting, i.e. impregnating the fabric with an acid such as tannic acid, or a base such as alumina, ferric oxide, etc. Basic dyes form insoluble tannates, acidic dyes form insoluble salts or lakes. In calico printing the pattern is marked out with the mordant in a thick solution, such as gum, to prevent it from spreading.

The formation of insoluble salts upon the fabric is the chief method of producing insoluble deposits upon the fibre, but most probably the following method occurs at the same time. The dyes are all compounds of high molecular weight and form colloidal solutions (suspensions of the finest particles). The fabric, whether it consists of silk, wool or cotton, is a colloid. The process of precipitation of colloids from solution by means of electrolytes, especially those with trivalent ions, and the process of mutual precipitation of two colloids will also be concerned in the fixing of the dye upon the fabric.

THE ANTHOXANTHINS.

The yellow plant pigments usually called flavones and xanthenes are most conveniently termed the anthoxanthins, the term used in 1835 by Marquart and again suggested by Willstätter in 1913 on account of their similarity to the anthocyanins.

The anthoxanthins are derived from the complex benzene- γ -pyrone nucleus. The γ -pyrone nucleus is the heterocyclic six-membered ring containing an oxygen atom and a keto group in the para- or γ -position to the oxygen atom. The keto group in this ring does not behave in all respects like a ketone group; it forms no derivative with hydroxylamine. The oxygen atom is also peculiar in its properties; it is basic and combines with mineral acids to form salts, the oxygen atom becoming quadrivalent.

Flavone and xanthone are phenyl derivatives of benzo- γ -pyrone. The yellow pigments are hydroxy derivatives of:—

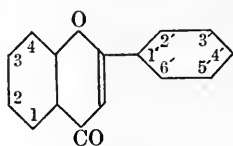
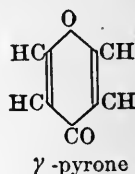

Flavone.

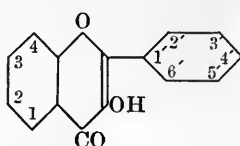

Flavonol
or
hydroxyflavone.

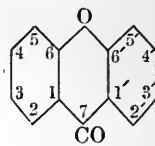

Xanthone.

The constitution of the anthoxanthins has been shown to be the following:—

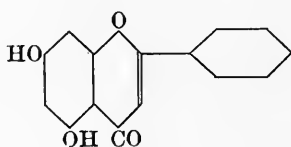

Chrysin
or
1, 3-dihydroxyflavone.

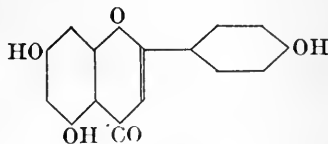

Apigenin
or
1, 3, 4'-trihydroxy-
flavone.

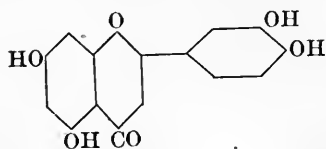

Luteolin
or
1, 3, 3', 4'-
tetrahydroxy-
flavone.

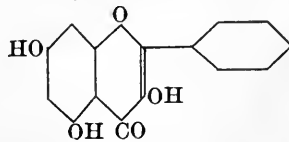

Galangin
or
1, 3-dihydroxyflavonol.

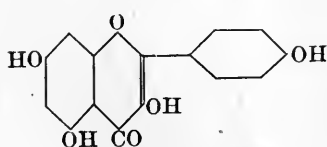

Caempferol
or
1, 3, 4'-trihydroxy-
flavonol.

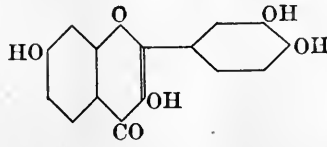

Fisetin
or
3, 3', 4'-trihydroxy-
flavonol.

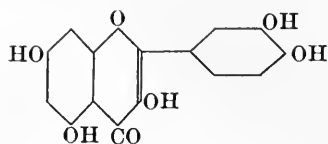

Quercetin
or
1, 3, 3', 4'-tetrahydroxy-
flavonol.

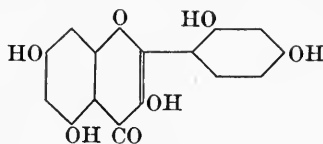

Morin
or
1, 3, 2', 4'-
tetrahydroxy-
flavonol.

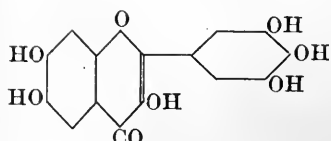

Myricetin
or
1, 3, 3', 4', 5'-
pentahydroxy-flavonol.

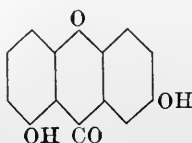

Euxanthone
or
2, 3'-dihydroxy-
xanthone.

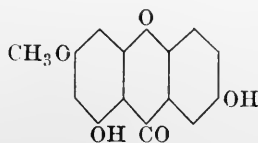

Gentisin
or
4-methoxy-
2, 3'-dihydroxy-
xanthone.

These pigments thus contain the simple aromatic compounds, benzene, phenol, catechol, resorcinol or pyrogallol combined with benzo- γ -pyrone. On decomposition they yield polyhydroxybenzoic acids (protocatechuic, hydroxybenzoic, or resorcylic) and the above phenols. Their formulæ have been arrived at by the study of these decomposition products and have been proved by synthesis. The details of the products of decomposition and the synthesis are given in the larger text-books of organic chemistry.

Chrysin occurs in various species of poplar and mallows.

Apigenin occurs in parsley and celery in the form of the glucoside, apiin.

Luteolin is the yellow colouring matter of weld or dyer's broom.

Galangin is found in the root of *Galanga*.

Caempferol is contained in *Galanga* root and combined with rhamnose as the glucoside, caempferitrin, in Java indigo.

Fisetin is present in Fiset wood (*Rhus cotinus*) and Quebracho wood (*Quebracho colorado*).

Quercetin is found with fisetin and also as glucoside, with rhamnose, in oak bark (*Quercus tinctoria*). It is present in the flowers of the horse-chestnut and in the skin of onions.

Morin is a constituent of yellow wood (*Morus tinctoria*).

Myricetin is the yellow pigment in the bark of *Myrica nagi*.

Euxanthone is formed when cattle are fed with mango leaves and is excreted in combination with glycuronic acid as euxanthic acid (Indian yellow).

Gentisin is the yellow pigment present in *Gentiana lutea*.

These pigments are yellow crystalline solids, very slightly soluble in water. They dissolve in acids giving yellow or yellowish-red solutions; they also dissolve in alkalis giving solutions which are yellow or reddish. Some of them give a dull green or red-brown coloration with ferric chloride.

THE ANTHOCYANS.

The red, violet and blue pigments which are present in the blossoms, in many fruits and in some leaves of plants, and which can be extracted with water or aqueous alcohol, are grouped together as the Anthocyanins. According to Molisch they occur not only dissolved in the juices of the cell, but also in amorphous and crystalline forms. Molisch obtained crystals by allowing aqueous or acetic acid extracts to evaporate slowly under the cover slip of a microscope slide. The colour of the aqueous solution of these pigments fades on standing from which it would appear that the pigments are very unstable.

The chemical investigation of these pigments has shown that they are glucosides and that the pigment is related to that of the group of anthoxanthin pigments. The study of these pigments was taken up by Willstätter and his pupils in 1913 and is still in progress. They have shown that these pigments are glucosides and that they are derivatives of the complex benzo-pyrylium nucleus. This nucleus differs from the benzo- γ -pyrone nucleus in having a CH group in the place of the CO group.

The properties of this group differ markedly from those of the benzo-pyrone group. The oxygen atom in the pyrone ring can become quadrivalent and form salts with acids; it is feebly basic; the salts are unstable and are decomposed by water. The oxygen atom in the benzopyrylium ring can also be quadrivalent and form salts with acids. It is strongly basic; the salts are stable and not easily decomposed by water.

The benzene ring contains hydroxyl groups; their phenolic character allows of the formation of salts with alkali. These properties explain the existence of the red, violet and blue colours; the red is the acid salt, the blue is the potassium or metallic salt and the violet is the anhydride of the pigment; thus the colour is due to the quinonoid structure of the molecule. The

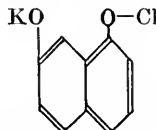
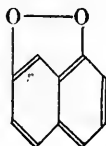
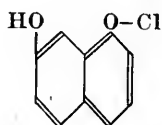
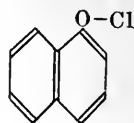
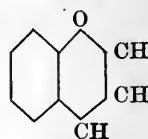

apparent instability of the compounds from the disappearance of the colour of the solutions is not confirmed. The colour returns on acidifying or on evaporating the solution. The pigment apparently undergoes an isomerisation.

More convenient methods of preparation than the older one (involving precipitation by lead acetate) have been discovered by Willstätter and his pupils; they depend on the formation of oxonium salts which are soluble with difficulty.

The skins of blue grapes, whortle berries and *Althaea rosa* are extracted with cold glacial acetic acid. The extract is precipitated with ether. The syrupy precipitate is washed with ether and dissolved in a warm aqueous solution of picric acid. The picrate crystallises out on cooling. A solution of the hydrochloride is obtained by treating the picrate with methyl alcohol containing hydrochloric acid and is precipitated with a mixture of ether and petroleum ether. The chloride is crystallised from aqueous alcohol containing hydrochloric acid.

The isolation of the anthocyanins from other plants depends on the insolubility of the chlorides. These salts are generally soluble in water or dilute acid, but soluble with difficulty in 7-15 per cent. hydrochloric acid.

The anthocyan are glucosides and are converted by hydrolysis with acids into glucose and anthocyanidins. The anthocyanidins are pigments like the anthocyan, but they are soluble in amyl alcohol. The glucosidic character of the anthocyan can be easily demonstrated :—

1-2 gm. of blossom are rubbed with 5-10 parts of sand and a few c.c. of dilute sulphuric acid and a small quantity of alcohol; some talc is added to help filtration. The mass is shaken with amyl alcohol. The emulsion which is formed may be broken by pouring upon a wet filter and then pouring the material upon a dry filter. On washing the amyl alcohol with water or sodium acetate solution it will not be coloured or only faintly. Another portion of the blossom may be heated for half an hour with the acid and treated in the same way. The amyl alcohol will be pigmented.

The same can be observed with 0.5-1 gm. of anthocyan, but the filtration is not necessary.

The following anthocyan have been investigated :—

- (1) Cornflower and rose—
cyanin \rightarrow 2 \times glucose + cyanidin.
- (2) Cranberry—
idain \rightarrow galactose + cyanidin.
- (3) Blue grapes—
oenin \rightarrow glucose + oenidin.
- (4) Whortle berry and *Althaea rosea*—
myrtillin. \rightarrow glucose + myrtillidin.
- (5) Larkspur—
delphinin \rightarrow 2 mol. glucose + 2 mol. *p*-oxybenzoic acid + delphinidin
- (6) Pelargonium—
pelargonin \rightarrow 2 \times glucose + pelargonidin.

The anthocyanidins are closely related to the anthoxanthins :—

Cyanidin is isomeric with luteolin, caempferol and fisetin.

Pelargonidin is isomeric with apigenin and galangin.

Delphinidin is isomeric with quercetin and morin.

Cyanidin on heating with alkali gives phloroglucinol and protocatechuic acid.

Pelargonidin on heating with alkali gives phloroglucinol and *p*-hydroxybenzoic acid.

Delphinidin on heating with alkali gives phloroglucinol and gallic acid.

The constitution of these anthocyanidins is probably :—

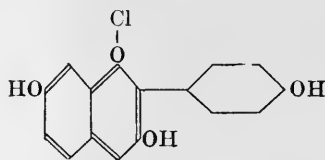

Pelargonidin.

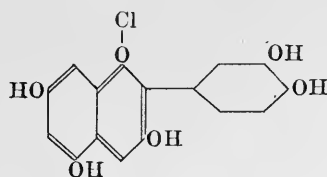

Cyanidin.

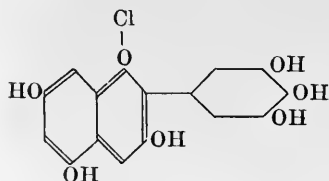

Delphinidin.

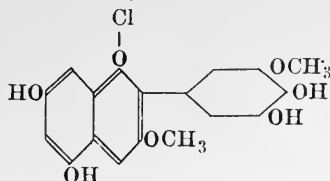

Oenidin.

Though these compounds are so closely related to the anthoxanthins, the transformation of the one group into the other is not easily effected, but quercetin on reduction has been converted into cyanidin. It is very likely that the two groups of compounds are converted into one another by oxidative and reducing enzymes.

INDOLE AND ITS DERIVATIVES.

Indigo, tryptophan, scatole, indole are natural substances which contain the heterocyclic indole ring—the complex nucleus made up of a benzene ring and a pyrrole ring :—

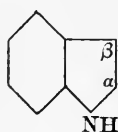

The compounds containing this ring have the properties of benzene and of pyrrole.

Indole.

Indole was first obtained by the reduction of indigo by distillation with zinc dust and also in the same way from other products obtained from indigo. It was identified as one of the products of the putrefaction of protein, together with scatole, and it is present in animal excrement. It is a constituent of coal tar and is isolated from the fraction of basic character which distils between 240 and 260°. Its constitution has been shown to be :—

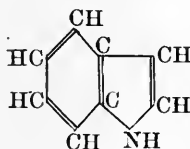

Preparation.

Indole is most easily prepared by the putrefaction of meat or other proteins. 1 kilo. of meat is minced and mixed with about 4000 c.c. water; 2 gm. of potassium phosphate, 5 gm. of magnesium sulphate and about 30 gm. of crystallised sodium carbonate and a piece of putrid meat are added. The vessel is closed and connected with another flask containing lead acetate and the two vessels are placed in a warm place at about 35°. Bubbles of gas are evolved containing hydrogen sulphide, mercaptan, etc.; these are absorbed by the lead acetate.

The mixture is kept for about 5 or 6 days, acidified with acetic acid and distilled. The distillate, which contains indole and scatole and phenols, is made alkaline with soda and again distilled. Such a solution gives the reactions of indole. The distillate is acidified with hydrochloric acid and treated with picric acid. The precipitate is distilled with ammonia and this distillate is extracted with ether. The ethereal solution on evaporation gives a mixture of indole and scatole. The mixture is dissolved in absolute alcohol and treated with 8-10 volumes of water. The scatole is precipitated. The two compounds thus separated are purified by crystallisation from aqueous alcohol or ligroin.

Properties.

Indole crystallises in glistening platelets which melt at 52°. It is volatile in steam and these vapours have a peculiar and unpleasant smell. It is fairly soluble in alcohol, ether, chloroform, benzene, ligroin.

It is a weak base, a secondary amine, and combines with strong acids to form salts.

Reactions.

- * (1) A pine shaving moistened with hydrochloric acid and introduced into an alcoholic solution of indole becomes red.
- * (2) On the addition of a few drops of nitric acid and, drop by drop, a few drops of very dilute potassium nitrite solution (·1 per cent.) to a solution of indole, the solution becomes red and in strong solutions a precipitate of nitrosoindole is formed. (Baeyer.)
- * (3) On adding half the volume of a 2 per cent. alcoholic solution of p-dimethylaminobenzaldehyde to a solution of indole and, drop by drop, 25 per cent. hydrochloric acid until a red colour appears, the further addition of a few drops of 0·5 per cent. sodium nitrite solution gives a dark red colour. (Ehrlich.)
- * (4) On adding sodium nitroprusside solution to indole solution until it is of a yellow colour and then a few drops of caustic soda a deep violet-blue colour is obtained; the addition of acetic acid changes it to pure blue. (Legal.)
- * (5) If under a solution of indole treated with glyoxylic acid a layer of concentrated sulphuric acid be run, a red colour is produced at the point of contact. (Hopkins.) This reaction is sensitive to 1 in 500,000.
- * (6) If formaldehyde be used instead of glyoxylic acid a similar colour is produced. This reaction is sensitive to 1 in 700,000 (Kondo.)

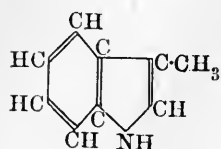
Scatole or β -Methyl Indole.

Scatole was first isolated from fæces and recognised as a constituent of the intestinal contents of man and animals. Later it was obtained by the fusion of proteins with alkali and isolated from the products of putrefaction. It is also a product of the reduction of indigo with zinc dust.

The preparation of scatole is given under indole.

Scatole crystallises in colourless platelets melting at 95° and boiling at $265\text{--}266^\circ$. It has a pungent fæcal smell. It dissolves in water, but less readily than indole, but is more easily volatile in steam than indole. It dissolves in alcohol, ether, benzene, chloroform.

It is a weak base and combines with acids to form salts; the hydrochloride is easily soluble in alcohol, but insoluble in water and ether.

Reactions.

(1) It dissolves in concentrated hydrochloric acid giving a violet coloured solution. A purple-red is formed on warming its solution in sulphuric acid.

* (2) With nitric acid and sodium nitrite it gives a white turbidity (compare indole).

* (3) With p-dimethylaminobenzaldehyde solution it gives a blue-violet colour which turns blue with sodium nitrite (compare indole).

* (4) With sodium nitroprusside and soda it gives a yellow colour, which turns violet on heating for a few minutes with half its volume of glacial acetic acid.

* (5) The glyoxylic acid reaction is rose-red in colour.

* (6) The formaldehyde reaction is yellow or brown, but red if a trace of a ferric salt be present.

(7) The pine shaving reaction is negative, but if a pine shaving dipped in an alcoholic solution of scatole be placed in cold concentrated hydrochloric acid it becomes cherry-red, changing after a little while to a dark violet.

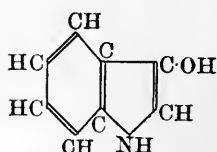
Indoxyl and Indican.

Indoxyl occurs in various species of the indigofera and in woad, *Isatis tinctoria*, probably in combination with glucose as the glucoside, indican. The glucoside is hydrolysed by enzymes in the plant leaves and converted into indoxyl, which undergoes oxidation to indigo blue. Indoxyl occurs in human and mammalian urine in combination with sulphuric acid and glycuronic acid as ester. It is hydrolysed by acid and oxidised to indigo blue.

Indoxyl consists of yellow crystals which dissolve in water with a green fluorescence, also in alcohol, ether, acetone. It melts at 85°. Dilute acids convert it into a red substance and an unpleasant smell is produced. In alkaline solution it oxidises in the air to indigo.

Detection in Urine.

Indoxyl is detected by conversion into indigo blue :—

(1) An equal volume of concentrated hydrochloric acid is added to 10 c.c. of urine and 2 or 3 c.c. of chloroform. A very dilute solution of bleaching powder is added, *drop by drop*, and the solution is inverted after the addition of each drop. The chloroform becomes bluish-violet owing to the formation of indigo blue. Excess of bleaching powder must be avoided as the indigo blue undergoes further oxidation to colourless compounds.

(2) The further oxidation is to a large extent avoided by using a fresh solution of ferric chloride in concentrated hydrochloric acid as the oxidising agent (Obermayer's reagent). An equal volume of this reagent and a few c.c. of chloroform are added to the urine. On mixing thoroughly for 1-2 minutes by inverting the liquids, the chloroform becomes blue.

(3) Salkowski recommends the use of copper sulphate as the oxidising agent to prevent further oxidation. An equal volume of hydrochloric acid, 1 c.c. of copper sulphate solution and a few c.c. of chloroform are added to 10 c.c. of urine and the mixture shaken carefully as above.

(4) The following other oxidising agents may be employed :—

One drop of a 10 per cent. solution of potassium persulphate to 5 or 6 c.c. of urine.

One drop of a 3 per cent. solution of potassium chlorate to 10 c.c. of urine.

Indigo Blue or Indigotin.

Indigo blue is formed by the oxidation of indoxyl in alkaline solution on exposure to the air. Two molecules of indoxyl combine in this reaction :—

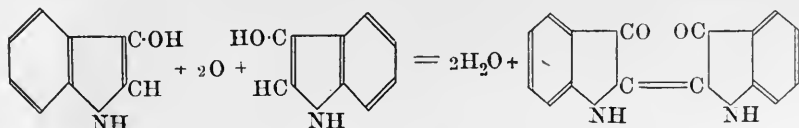

Indigo blue is a dark blue powder and shows a metallic coppery lustre on rubbing. It sublimes giving copper-red glistening prisms. It is insoluble in water, alcohol, ether, dilute acids and alkalis, and has neither smell nor taste. It dissolves in aniline and molten paraffin with a purple-red colour, also in turpentine from which it crystallises.

Owing to its insolubility it is converted into indigo white or into indigotin sulphonc acid so as to be used as a dye.

Indigo blue has been synthesised by various methods. The synthetic product is cheaper than the natural and is gradually displacing the natural product as a dye.

Indigo White.

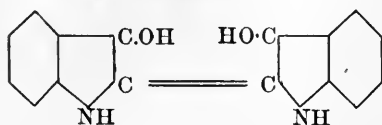

The insolubility of indigo blue renders it useless as such for dyeing purposes. On reduction by zinc dust and alkali, hydrosulphite, or by electrolysis it is converted into indigo white. In air this solution reoxidises and forms indigo blue.

In dyeing the indigo blue is reduced, the cloth soaked in the solution and exposed to the air. Insoluble indigo blue is deposited on the fibres.

Indigo white can be precipitated from solution in absence of air as white crystals which dissolve in alcohol, ether and alkalies with a yellow colour.

Indirubin or Indigo Red and Isoindigotin.

Natural indigo blue is generally associated with small quantities of indigo red. This is formed by a combination of 1 molecule of indoxyl with 1 molecule of the isomeric oxindole:—

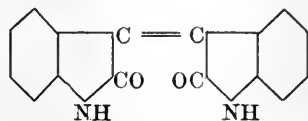
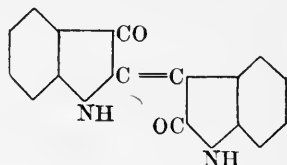

Combination occurs between the α and β carbon atoms. If combination occurs between the two β carbon atoms, isoindigotin is formed.

Indole- β -Acetic Acid.

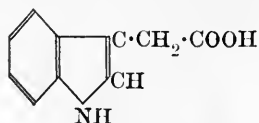

This compound was first found amongst the putrefactive decomposition products of proteins. It is often present in urine and is found particularly in cases of intestinal disorder.

It crystallises in platelets melting at 164° and is soluble with difficulty in water, but easily in alcohol and ether. On heating it decomposes into carbon dioxide and scatole.

Reactions.

(1) On adding a few drops of pure nitric acid and drop by drop a 2 per cent. solution of potassium nitrite to a solution of indole-acetic acid, a cherry-red colour is formed, followed by a turbidity and separation of a red pigment.

(2) A purple-red colour and precipitate is formed when an equal volume of concentrated hydrochloric acid and a few drops of a 1-2 per cent. solution of bleaching powder are added to its solution.

(3) A violet colour is formed (before and after boiling) if an equal volume of concentrated hydrochloric acid and a few drops of ferric chloride solution be added to a solution of indole-acetic acid.

(4) A red colour is formed with p-dimethylaminobenzaldehyde (see under indole).

The Urorosein Reaction of Urine.

* This reaction consists in the formation of a red pigment when concentrated hydrochloric acid and a drop or two of sodium nitrite solution is added to urine. Stale urines give this reaction on the addition of hydrochloric acid only, as nitrites are formed by bacterial decomposition of other constituents in the urine. The colour disappears on adding alkali but reappears on acidifying.

Urorosein is insoluble in ether and chloroform, but dissolves in alcohol and amyl alcohol with a red colour. The amyl alcoholic solution shows an absorption band in the green, between D and E, but nearer D. Urorosein is most probably nitrosoindole-acetic acid.

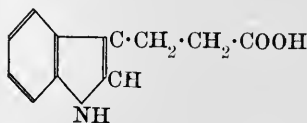
Indole- β -Propionic Acid.

Indole propionic acid has also been shown to be a putrefactive decomposition product of proteins.

It crystallises in prisms or irregular plates, is slightly soluble in water, but easily soluble in alcohol and ether.

Reactions.

(1) Indole- β -propionic acid forms a nitroso compound with potassium nitrite. In concentrated solution on the addition of concentrated potassium nitrite and acetic acid, a yellow crystalline mass may be obtained.

(2) An aqueous solution gives a white turbidity with ferric chloride which becomes red on heating.

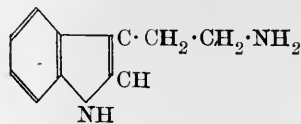
Indole-ethylamine.

Indole-ethylamine is another substance which is formed in the putrefaction of proteins and of tryptophan. It is one of the amines which have a marked physiological action, but is not so marked in its action as p-hydroxy-phenyl-ethylamine or iminazolyl-ethylamine.

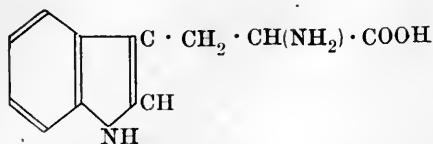
Tryptophan.

Tryptophan was shown to be a constituent of proteins by Hopkins and Cole in 1902, who isolated it from the mixture of amino acids which results from the digestion of proteins with the enzyme, trypsin. Its discovery gave the clue to the well-known Adamkiewicz reaction of proteins and the proteinochrome reaction of tryptic digests.

Preparation.

1 kilo. of caseinogen is dissolved in about 8 litres of .8 per cent. crystallised sodium carbonate solution and digested with 2.4 gm. of a trypsin preparation for 5-6 days at 37° in the presence of toluene or chloroform as an antiseptic. The digestion is allowed to proceed until a sample of 5-10 c.c. withdrawn at intervals gives a maximum colour reaction with bromine water after acidifying with acetic acid. The digestion is stopped by heating the solution to 80°. The insoluble portion, consisting of undigested proteins, calcium phosphate and tyrosine, is filtered off and the clear filtrate, better after concentration *in vacuo* to a volume of about 1 litre and filtration from tyrosine, is acidified with sulphuric acid until it contains 5 per cent. The acid solution is precipitated with a 10 per cent. solution of mercuric sulphate in 5 per cent. sulphuric acid. After 12 hours the precipitate, which contains tryptophan, tyrosine and cystine, is filtered off and washed with 5 per cent. sulphuric acid to remove tyrosine until the washings show only a faint reaction with Millons' reagent for tyrosine.

The precipitate is suspended in water, warmed and decomposed with hydrogen sulphide. The filtrate from mercuric sulphide is freed from hydrogen sulphide by a current of air, acidified to 5 per cent. with sulphuric acid and again precipitated with the acid mercuric sulphate solution. The cystine comes down first and is removed; the tryptophan is thrown out on the addition of more mercuric sulphate. The precipitate is washed with 5 per cent. sulphuric acid, decomposed with hydrogen sulphide and the solution, freed from sulphuric acid by baryta, is evaporated *in vacuo* to a small volume. Tryptophan separates out and is recrystallised from a mixture of water and alcohol containing animal charcoal. The yield of tryptophan is from 5-10 gm.

Properties.

Tryptophan crystallises in colourless glistening platelets which are not easily soluble in cold water, but readily in hot. It is insoluble in absolute alcohol and ether. It dissolves easily in hot pyridine, less easily in cold. On heating in a capillary tube it changes colour at 220°, becomes brown at 240° and melts at 252°. If heated quickly it turns yellow at 260° and melts at 289°. Tryptophan is a weak base and forms salts with acids. As an amino acid it forms salts and forms acyl derivatives with acid chlorides, some of which serve for its isolation and characterisation.

Reactions.

Tryptophan, even when mixed with other amino acids, is readily recognised in solution by the following reactions :—

- * (1) *Bromine water reaction.* About 5 c.c. of the solution are acidified with acetic acid and bromine water is added drop by drop ; a reddish-violet colour appears. This gradually deepens, but disappears if too much bromine water be added, giving a yellow solution. When the maximum reddish-violet colour is obtained, the solution is shaken with 2 or 3 c.c. of amyl alcohol ; the amyl alcohol dissolves the pigment and separates coloured reddish-violet.
- * (2) *Glyoxylic acid reaction.* A small quantity of glyoxylic acid solution is added to about 5 c.c. of the solution and concentrated sulphuric acid is run under its surface ; at the point of junction a reddish-violet ring appears and on gently mixing the two liquids the colour spreads throughout the mixture.
- (3) On mixing a tryptophan solution with an alcoholic solution of benzaldehyde and running underneath it concentrated sulphuric acid containing ferric sulphate, a blue colour is formed at the junction.
- (4) Using formaldehyde instead of benzaldehyde, the colour at the junction of the liquids is blue-violet.
- (5) With p-dimethylaminobenzaldehyde and concentrated hydrochloric acid a red colour is formed (see under indole).
- (6) A pine shaving wetted with hydrochloric acid, washed with water, dipped into a concentrated solution of tryptophan and dried, becomes purple in colour.

The Biological Relationship of the Indole Derivatives.

Indole and scatole have long been known to be putrefactive products of protein, the other compounds were found later. The discovery of tryptophan and the determination of its constitution has shown that all these compounds are derived from it ; in many cases the direct conversion of tryptophan in putrefaction has been carried out. The stages in the decomposition of tryptophan are similar to those which tyrosine undergoes, namely :—

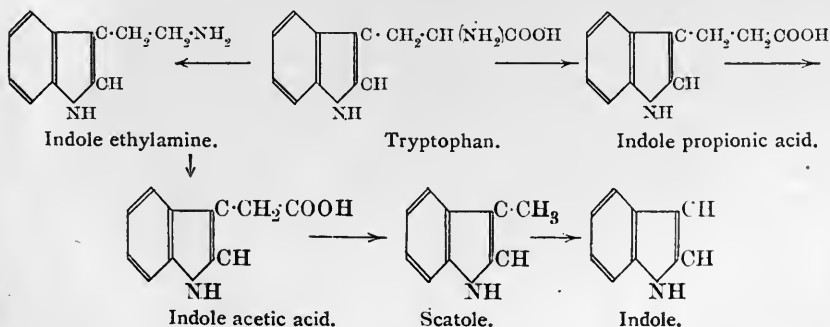

Indole is oxidised and converted into indoxyl which is combined with sulphuric acid (or glucose) to form indican. Indican on hydrolysis yields indoxyl, which is oxidised in the air or by oxidising agents to indigo blue.

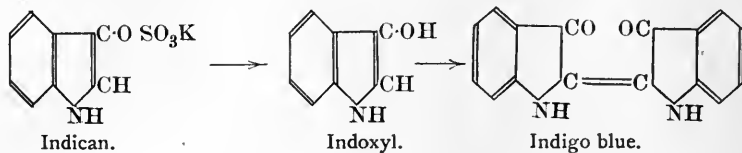

QUINOLINE AND ISOQUINOLINE.

These compounds have the empirical formula C_9H_7N and are present in coal tar and bone oil. Their constitution is expressed by the formulæ :—

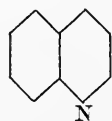

Quinoline.

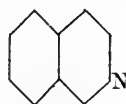

Isoquinoline.

The presence of the pyridine ring in these compounds is shown by their oxidation. Quinoline gives quinolinic acid : isoquinoline gives β , γ -pyridine dicarboxylic acid or cinchomeric acid and phthalic acid. The formulæ of both compounds have been proved by synthesis.

Preparation.

Quinoline is usually prepared by synthesis. Isoquinoline is prepared from the fraction of coal tar or bone oil which distils between 236 and 243° . The bases are converted into sulphates and fractionally crystallised from alcohol. The sulphate is decomposed by potash and the base distilled.

Properties.

Quinoline is a colourless oily liquid which boils at 239° and has a specific gravity of 1.095 at 20° . It has a peculiar and pleasant smell and is only slightly soluble in water. Isoquinoline is a colourless solid which melts at 23° , boils at 241° and closely resembles quinoline.

Both compounds are tertiary amines and form salts with acids. They are stable ring compounds resembling naphthalene and pyridine.

THE ALKALOIDS.

The term vegetable alkaloids was originally applied to the group of basic substances (hence the name alkaloid), which were found in plants, to distinguish them from basic substances (amines, formerly ptomaines or toxines) found in animals, formed mainly by putrefaction. The term alkaloid is now applied only to the basic substances occurring in plants which contain in their constitution either a pyridine, quinoline, isoquinoline, or pyrrole or pyrrolidine ring, or several rings. They are classified according to the ring into the following groups :—

I. Pyridine group :—

Piperine, coniine, trigonelline (p. 151), nicotine.

II. Pyrrolidine group :—

Hygrine, stachydrine (p. 150).

III. Tropane group :—

Atropine, hyoscyamine, hyoscine, cocaine.

IV. Quinoline group :—

Quinine, cinchonine, strychnine, brucine.

V. Isoquinoline group :—

Narcotine, narceine, morphine, codeine, papaverine, berberine.

The constitution of most of the alkaloids is known, but some are still under investigation. The details of the work upon the elucidation of their constitution are very complex. Only the formulæ of the chief compounds can therefore be given so as to show their relationship to pyridine and the other nuclei.

The alkaloids generally occur in plants in the form of salts with organic acids, such as citric, tartaric, malic, oxalic, succinic. They are liberated from the salts by means of alkali and can frequently be extracted from the alkaline solution by means of chloroform, ether and other organic solvents. Most of the alkaloids are solid compounds; coniine, nicotine and a few others are liquid. They generally contain oxygen in their composition, but again there are exceptions.

Most alkaloids give precipitates with the following reagents :—

- (1) tannic acid ;
- (2) picric acid ;
- (3) iodine in potassium iodide ;
- (4) mercuric iodide in potassium iodide ;
- (5) phosphotungstic acid and phosphomolybdic acid.

These reagents, termed alkaloidal reagents, also give precipitates with amines and other bases and with proteins. They cannot in consequence be considered as specific for the alkaloids, but they are sometimes useful for isolating and detecting alkaloids.

Piperine.

Piperine is found in the fruit of the various varieties of pepper ; about 8 or 9 per cent. is present in black pepper.

Powdered pepper is warmed with lime water for 15-20 minutes and the mixture is evaporated to dryness. The dry residue is extracted with ether. The ethereal solution on distillation leaves piperine, which is purified by crystallisation from alcohol.

Piperine is a white solid which melts at 128°. It is almost insoluble in water. It behaves as a weak base and dissolves in concentrated sulphuric acid giving a deep red solution.

Constitution.

On distillation with alcoholic potash, piperine is converted into piperidine and piperic acid. Piperine is the amide of piperidine and piperic acid. It has been synthesised by the action of piperic acid chloride on piperidine:

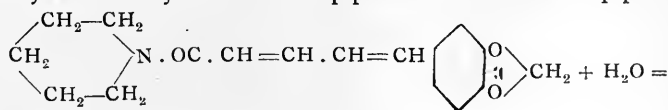

Piperine.

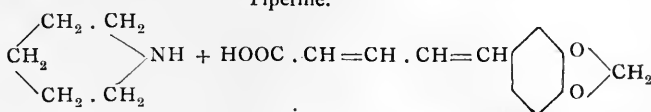

Piperidine.

Piperic acid or
3, 4 methylene dihydroxycinnamenyl-
acrylic acid.

Coniine. $\text{C}_8\text{H}_{17}\text{N}$.

Coniine is the alkaloid which is present in the seeds of hemlock. It is prepared therefrom by distillation with sodium hydroxide.

Coniine is a colourless liquid which boils at 167°. It has a peculiar and penetrating odour and turns brown in the air. It is soluble in water and is a strong base forming salts with acids.

The natural substance is optically active and dextrorotatory.

Constitution.

Coniine has been shown to be α -propylpiperidine and has been synthesised as follows :—

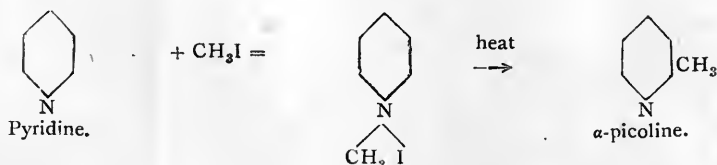

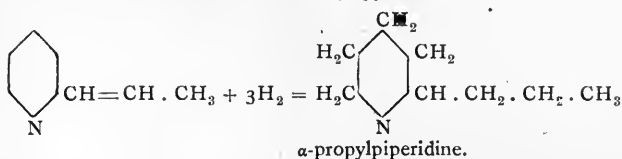
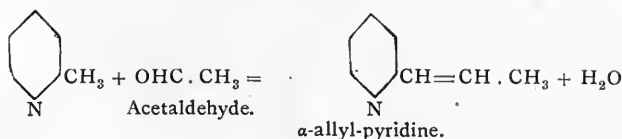

The inactive coniine was separated into *d*- and *l*-coniine by the fractional crystallisation of its tartrate.

Nicotine. $\text{C}_{10}\text{H}_{14}\text{N}_2$.

Nicotine occurs to the extent of 6-8 per cent. in tobacco leaves in combination with organic acids (malic or citric).

Preparation.

Tobacco leaves are boiled out with water. The aqueous solution is concentrated, made alkaline with lime and distilled. The distillate is acidified with oxalic acid and evaporated. The concentrated solution is rendered alkaline with soda and extracted with ether. The ethereal extract on distillation leaves the nicotine, which is purified by distillation in a current of hydrogen.

Properties.

Nicotine is a colourless oily liquid which boils at 241° . It possesses an unpleasant smell and a burning taste. It is intensely poisonous. In air it undergoes oxidation, turning brown.

It is a ditertiary base and forms salts with acids, which are dextro-rotatory, and combines with two molecules of methyl iodide.

Constitution.

On oxidation with chromic acid it yields nicotinic acid showing that it possesses a substituting group in the β -position of the pyridine ring. This substituting group has been found to be *N*-methyl-pyrrolidine, the methyl group being attached to the nitrogen atom. It is *N*-methyl-pyrrolidine-pyridine.

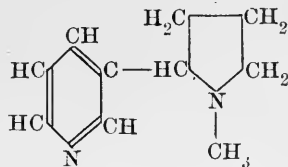

Hygrine.

Hygrine has been shown to be β -acetyl-*N*-methyl pyrrolidine.

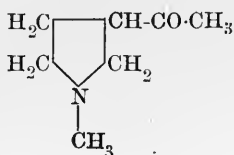

Atropine or dl-Hyoscyamine. $C_{17}H_{23}O_3N$.

Atropine (or daturine) is found in the deadly nightshade, *Atropa belladonna*, in henbane, *Hyoscyamus niger*, and together with *l*-hyoscyamine in *Datura stramonium*.

The juice (1 litre) obtained by pressing the plant is made alkaline with potash (4 gm.) and extracted with chloroform (25 c.c.). The chloroform extract is evaporated and the residue is treated with dilute sulphuric acid which dissolves the base. On adding potassium carbonate to the acid solution the atropine is precipitated and is crystallised from alcohol.

Atropine is a white crystalline solid separating in prisms from dilute alcohol. It melts at 115° , is almost insoluble in water but is easily soluble in alcohol, ether and chloroform. It is extremely poisonous, from 0.5-2 gm. being a lethal dose. It is a strong base and forms salts with acids which are easily soluble in water. The sulphate is most commonly used in medicine for dilating the pupils and other purposes.

Atropine may be tested for as follows: on evaporating a small quantity with a drop of fuming nitric acid a yellow residue is left. This turns violet, changing to red, on adding a drop of alcoholic potash.

Constitution.

On hydrolysis by boiling with baryta, atropine is converted into tropine and tropic acid.

Tropic acid is α -phenyl- β -hydroxypropionic acid.

Tropine has been shown to be the N-methyl derivative of a γ -hydroxy-piperidine nucleus containing two extra methylene groups, or as a hydroxy derivative of a combined piperidine and pyrrolidine nucleus to which a methyl group is attached at the nitrogen atom.

Atropine is the tropic acid ester of tropine:—

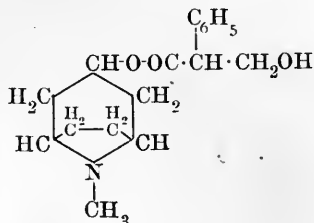

and it has been synthesised from its constituents.

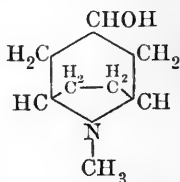

Cinchonine. $C_{19}H_{22}ON_2$.

Cinchonine is present together with quinine in the varieties of cinchona bark, the grey bark containing as much as 2.5 per cent.

It is prepared from the solutions remaining from the preparation of quinine; they are made alkaline with caustic soda and the precipitate so formed is dissolved in a small quantity of boiling alcohol; on cooling, cinchonine is deposited. It is purified by converting it into its sulphate and crystallising from water.

Cinchonine separates in colourless prisms which melt at 255° , is soluble with difficulty in water, but more easily soluble in alcohol, ether, etc. It is a weak base and it forms salts with acids. It is a tertiary base, combining with two molecules of methyl iodide.

Constitution.

Cinchonine is an unsaturated compound and combines with two atoms of bromine, or with one molecule of hydrochloric acid.

On oxidation it yields cinchonic acid or quinoline- γ -carboxylic acid and another product which has been shown to be a piperidine derivative.

Cinchonine is thus a derivative of quinoline and contains a piperidine ring. Its constitution is the following:—

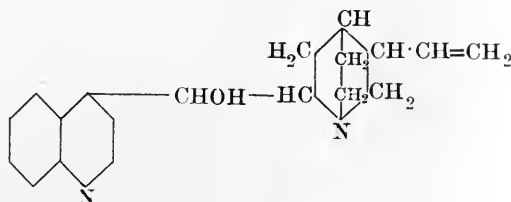
**Quinine.** $C_{20}H_{24}N_2O_2$.

Quinine, together with cinchonine, is contained in cinchona bark up to about 3 per cent.; the yellow bark of Calisaya contains up to 12 per cent.

Preparation.

The bark is powdered and treated with dilute sulphuric acid; from the acid solution the bases are precipitated by adding soda. The mixture of bases is dissolved in alcohol and the solution is neutralised with sulphuric acid. The sulphates, which are so obtained, are recrystallised from water. Quinine sulphate is the most insoluble and separates out first. It is converted into quinine by precipitation with ammonia.

Properties.

Quinine crystallises from water with three molecules of water of crystallisation. The anhydrous substance melts at 173° . It is very slightly soluble in water, but is soluble in alcohol and ether. It has a bitter taste and is a feeble base. It forms salts with acids. The sulphate and hydrochloride are used in medicine. Like cinchonine it is a ditertiary base and combines with two molecules of methyl iodide.

Quinine may be tested for by the following reaction:—

A solution of a quinine salt on the addition of chlorine water or bromine water followed by ammonia gives a green precipitate. This dissolves in excess of ammonia giving an emerald-green solution.

Quinine is very similar in constitution to cinchonine and is methoxy-cinchonine :—

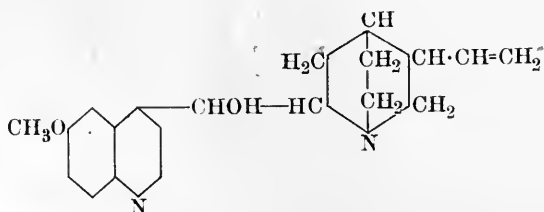

Strychnine. $C_{21}H_{22}O_2N_2$.

Strychnine is the poisonous alkaloid of the seeds of *Strychnos nux vomica*, in which it is present together with brucine.

The powdered seed is extracted with hot dilute alcohol. The alcoholic solution is evaporated and the aqueous remainder is treated with lead acetate which precipitates tannin, proteins, etc. The excess of lead is removed by treatment with hydrogen sulphide and the filtrate from the lead sulphide is freed from hydrogen sulphide. Magnesia is added to precipitate the alkaloids which are filtered off after standing. The mixture of brucine and strychnine is separated by alcohol which dissolves the brucine. The strychnine is purified by crystallisation from alcohol.

Strychnine crystallises in colourless prisms which melt at 284° . It is very slightly soluble in water and its solutions have a very bitter taste. It is a weak base and forms salts with acids.

Though it contains 2 nitrogen atoms it is only a monacid base and combines with only 1 molecule of methyl iodide.

Strychnine gives the following reaction by which it may be detected :—

On treating a small quantity of strychnine or a strychnine salt with concentrated sulphuric acid in a porcelain basin and on adding a small amount of powdered potassium bichromate, a violet solution is produced which becomes red and then yellow.

The constitution of strychnine has not yet been definitely determined, but it is a derivative of quinoline.

Brucine. $C_{21}H_{20}(OCH_3)_2O_2N_2$.

Brucine is present with strychnine in the seeds of *nux vomica*.

Preparation.

The alcoholic solution, in which the brucine has dissolved in the separation from strychnine, is evaporated to dryness. The residue is dissolved in dilute acetic acid and this solution is evaporated so as to remove the strychnine which is also contained in it. The strychnine separates out on evaporation and is filtered off, the strychnine acetate being an unstable salt. The brucine acetate is dissolved in water and the brucine is precipitated by adding caustic soda. It is crystallised from alcohol.

Properties.

Brucine crystallises from water in colourless prisms with 4 molecules of water of crystallisation. The anhydrous substance melts at 178° . It is slightly soluble in water and alcohol and is very similar to strychnine, but is not so poisonous.

It gives the following reaction :—

A deep brown-red colour is formed on adding nitric acid to a brucine salt; the colour changes to yellow on warming. The colour becomes violet on adding stannous chloride.

Constitution.

Brucine seems to be a dimethoxy derivative of strychnine and is a derivative of quinoline.

Morphine. $C_{17}H_{19}NO_3$.

Morphine is the chief alkaloid contained in the heads of poppies, *Papaver somniferum*. The alkaloids are present as sulphates and meconates.

Preparation.

Incisions are made in poppy heads and the juice which exudes is collected and dried. This dry mass is termed opium.

The opium is treated with boiling water and the solution containing the salts of the bases is made alkaline with milk of lime. Calcium meconate and the alkaloids are precipitated. The alkaline solution containing the morphine is concentrated and warmed with ammonium chloride, so as to form calcium chloride, as long as ammonia is evolved. On standing morphine separates out and is crystallised from alcohol.

Properties.

Morphine crystallises from alcohol in small colourless prisms with one molecule of water. It is slightly soluble in water and its solution has a bitter taste. It is soluble in alcohol. An alcoholic solution of opium is termed laudanum.

It is a base which forms salts with acids, the hydrochloride being used in medicine; it combines with 1 molecule of methyl iodide.

Morphine may be detected by the following reactions :—

(1) A deep blue coloration is formed on adding ferric chloride to a solution of a morphine salt.

(2) On adding a little morphine solution to iodic acid solution, iodine is liberated and forms a brownish-red precipitate which reacts with starch.

(3) On dissolving morphine in concentrated sulphuric acid and adding concentrated nitric acid, after about 15 hours a deep blue-violet colour, which changes to red, is produced.

It is converted into apomorphine by loss of 1 molecule of water on heating with concentrated hydrochloric acid.

Constitution.

Morphine contains one hydroxyl group and one alcoholic group and on distillation yields pyridine and quinoline. Its constitution has not yet been definitely determined, but is probably

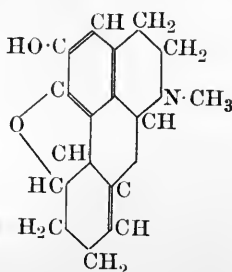

It thus contains an isoquinoline nucleus and a phenanthrene nucleus.

Codeine. $C_{17}H_{17}NO(OCH_3)OH$.

Codeine is also contained in opium. It can be obtained by methylating opium and is thus a methyl derivative of morphine. Its constitution is still not definitely known.

Papaverine, Laudanosine, Narcotine, Narceine.

These alkaloids are present in small quantities in opium with morphine. They are isoquinoline derivatives :—

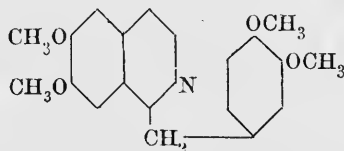

Papaverine
or
tetramethoxybenzylisoquinoline.

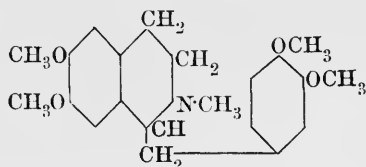

Laudanosine
or
N-methyl-tetrahydropapaverine.

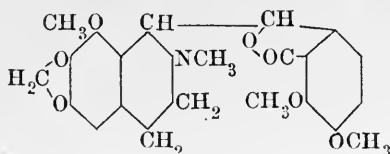

Narcotine.

Narcotine yields cotarnine and meconin on hydrolysis :—

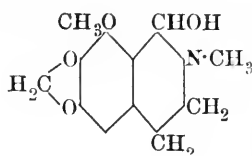

Cotarnine.

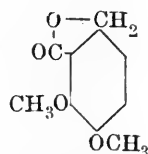

Meconin.

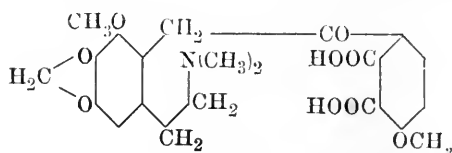

Narceine.

Berberine. $C_{20}H_{19}O_5N$.

Berberine is an alkaloid found in *Berberis vulgaris* and in other plants. It has a still more complicated structure :—

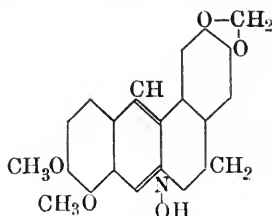

The details of the determination of the structure of the alkaloids can be found in the special books dealing with alkaloids.

THE PROTEINS.

Proteins make up the greater part of the solid matter of all animal cells and tissues and are present in various parts of plants. Meat and eggs consist mainly of protein; milk, seeds and some fruits contain a large proportion of it. Protein is thus an essential ingredient of our food.

Composition of Proteins.

Proteins are composed of amino acids, which may be regarded as the units of the protein molecule just in the same way as a polysaccharide is composed of monosaccharide units and a fat of glycerol and various fatty acid units. The amino acids are obtained by the hydrolysis of proteins with acids, alkalies or enzymes. Up to the present time 18 amino acids have been found to occur in the protein molecule—hence its complexity—but, though 18 units may be present in some proteins, others contain fewer, and in some cases a protein has been found to be composed of only 2 or 3 units. The percentage amounts of the various amino acids, which have been obtained by the hydrolysis of some of the proteins, are given in the following table:—

	Salmine.	Globin of Hæmoglobin (Horse).	Serum-albumin.	Serum-globulin.	Excelsin from Brazil Nut.	Caseinogen.	Gelatin.	Silk-fibroin.				
Glycine - -			0	3·5	0·6		16·5	36·0				
Alanine - -		4·2	2·7	2·2	2·3	0·9	0·8	21·0				
Valine - -	4·3	} 29·0	} 20·0	} 18·7	} 8·7	} 10·5	1·0					
Leucine - -											2·1	1·5
Isoleucine -												
Phenylalanine		4·2	3·1	3·8	3·5	3·2	0·4	1·5				
Tyrosine - -		1·3	2·1	2·5	3·1	4·5	0	10·5				
Serine - -	7·8	0·6	0·6			0·2	0·4	1·6				
Cystine - -		0·3	2·5	0·7		0·1						
Proline - -	11·0	2·3	1·0	2·8	3·6	3·1	5·2	+				
Oxyproline -		1·0				0·3	3·0					
Aspartic acid		4·4	3·1	2·5	3·8	1·2	0·6	+				
Glutamic acid		1·7	7·7	8·5	12·9	11·0	0·9	0				
Arginine - -	87·4	5·4			16·1	4·8	7·6	1·0				
Lysine - -	0	4·3			1·6	5·8	2·8	+				
Histidine - -	0	11·0			1·5	2·6	0·4	+				
Tryptophan -		+	+	+	+	1·5	0					

We may notice in particular that salmine contains 87 per cent. of arginine, that hæmoglobin contains 11 per cent. of histidine, that silk-fibroin is composed chiefly of glycine, alanine and tyrosine. Some vegetable proteins, those of the cereals, contain about 40 per cent. of glutamic acid. Numerous other differences can be noted, e.g. that glycine is present in serum globulin, but absent in serum albumin. But no stress must be laid upon other small differences since the method of analysis is not a quantitative one. The amounts actually

present are in most cases greater than is given. The total sum of the isolated amino acids is generally about 50 per cent. ; it is 70 per cent. in the case of hæmoglobin and nearly 90 per cent. has been obtained from a vegetable protein.

The analytical data of all the proteins which have been analysed will be found in the "Chemical Constitution of the Proteins," Part I. In this book is also given a full account of the methods of analysis of the proteins. Here it is not possible to give more than a very brief outline of the method of separating the amino acids.

Hydrolysis of Proteins and Separation of the Amino Acids.

The hydrolysis of proteins is generally effected according to the particular amino acid or group of amino acids required. The preparation of cystine, tyrosine and tryptophan is given on pp. 143, 267, 348.

The other amino acids are divided into two groups—monoamino acids and diamino acids. The latter is separated from the former by precipitation with phosphotungstic acid.

If the diamino acids are required, the protein is hydrolysed by boiling for 12-24 hours with 6 times its weight of 33 per cent. sulphuric acid.

If the monoamino acids are required, the protein is hydrolysed by boiling for 6-12 hours with 3 times its weight of concentrated hydrochloric acid.

If both groups are required, the protein is hydrolysed with sulphuric acid, the diamino acids are removed with phosphotungstic acid, the filtrate is freed from sulphuric acid and treated according to the procedure for monoamino acids.

If all amino acids are required, tryptophan is first separated; the solution after removing mercury is hydrolysed with sulphuric acid, the diamino acids are precipitated with phosphotungstic acid and the filtrate treated for monoamino acids as mentioned below.

The separation of the diamino acids depends upon the following reactions :—

The phosphotungstate precipitate is decomposed with baryta; the solution is treated with silver sulphate and saturated with baryta. Arginine and histidine are precipitated. The lysine in the filtrate is finally precipitated by picric acid. Arginine and histidine are separated by a second precipitation with silver nitrate in neutral solution; the histidine is thrown down; the arginine is thrown down by saturating the filtrate with baryta. The diamino acids are then recovered from the precipitates.

The separation of the monoamino acids is effected thus :—

The hydrolysed solution is evaporated and saturated with dry hydrogen chloride; glutamic acid hydrochloride is precipitated.

The filtrate is esterified by mixing with 3 volumes of absolute alcohol and saturating it with dry hydrogen chloride; glycine ester hydrochloride is precipitated.

The esters of the other amino acids are separated by extracting with ether after liberating them from their hydrochlorides with caustic soda and saturating the solution with potassium carbonate. The esters, after distilling off the ether which has been dried with sodium sulphate, are separated by fractional distillation *in vacuo*.

The fractions of esters are hydrolysed by water, or by baryta, and the mixture of two or three amino acids separated by fractional crystallisation, or by the fractional crystallisation of their copper and other salts. Proline is contained in the lower boiling fractions. It is soluble in alcohol and is thus separated from the amino acids which are insoluble.

Constitution of the Proteins.

The work of Emil Fischer and his pupils has shown that the amino acid units are combined together in the form of acid amides, i.e. the carboxyl group of one amino acid is combined with the amino group of another amino acid, e.g. :—

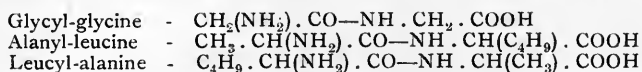

in which the units may either be the same or different, and combined in any possible order.

These combinations of amino acids have been termed by Emil Fischer the polypeptides. The above compounds are dipeptides. In the same way we may have :—

Tripeptides, e.g.

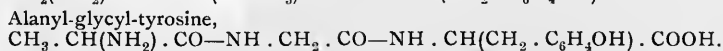
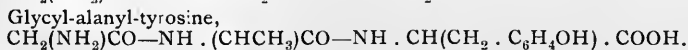
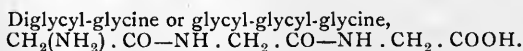

Tetrapeptides, e.g.

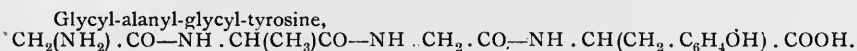

Pentapeptides, hexapeptides, etc.

The most complex polypeptide known is an octadecapeptide, which is composed of eighteen units made up of three leucine and fifteen glycine units. This compound, if it had been found in nature, would undoubtedly have been regarded as a true protein.

The synthesis of these polypeptides has been effected in three ways. The simplest of the methods of combining two or more amino acids together is by the action of the acid chloride derivative of one unit upon the other unit, e.g. alanyl-leucine is formed by the action of alanyl-chloride upon leucine :—

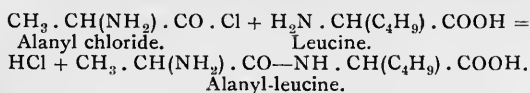

By the action of another amino acid chloride upon this compound a tripeptide will be formed and the continuation of the process will lead eventually to the most complex polypeptides. The new compound (di- or tripeptide) is again an amino acid and can be converted into its acid chloride. This acid chloride will react with another amino acid, a dipeptide, tripeptide, etc., yielding a tetra-, a penta-, a hexapeptide.

The amino acids can be combined together in any order, e.g. a-b-c-d, b-c-a-d, etc. Consequently an enormous number of isomers is possible.

The chief evidence which we possess in support of this polypeptide constitution of the proteins is (1) the hydrolysis of these polypeptides by trypsin and other proteoclastic enzymes into their constituent units in the same way as the natural proteins are hydrolysed, (2) the isolation of polypeptides from the natural proteins, e.g. glycyl-tyrosine.

Classification.

The known proteins are classified according to their origin, solubility, coagulability on heating and other physical properties without reference to their chemical composition. This classification is, however, borne out by their actual chemical composition as far as it is known.

The following is the classification adopted by the Chemical and Physiological Societies in 1907 :—

1. Protamines.
2. Histones.
3. Albumins
4. Globulins
5. Glutelins.
6. Gliadins.¹
7. Scleroproteins.
8. Phosphoproteins.
9. Conjugated Proteins.
 - (a) Nucleoproteins.
 - (b) Glucoproteins.
 - (c) Chromoproteins.
10. Derivatives of Proteins.
 - (a) Metaproteins.
 - (b) Proteoses.
 - (c) Peptones.
 - (d) Polypeptides.

¹ Prolamins is the American terminology of this group.

THE GENERAL REACTIONS OF PROTEINS.

Though proteins are classified into so many groups, they give a series of reactions which are very characteristic and which serve for their identification.

The exact group to which a protein belongs is more difficult to determine, but it can be ascertained by reference to the physical properties of the members of the different groups.

The general reactions depend upon :—

- (1) The constituent units (the colour reactions).
- (2) The basic character of the units, especially the diamino acid units (the precipitation by alkaloidal reagents).
- (3) Their colloidal nature and high molecular weight (coagulation reactions).

All proteins do not give all the reactions ; if a particular unit is missing the colour reaction for that unit will be absent ; some of the coagulation reactions are negative with some of the groups. Consequently it is necessary to perform several of the reactions before the presence of protein is verified.

* The general reactions of a protein are given by a solution of egg-white, which is very conveniently prepared as follows :—

Egg-white is beaten to break up the membranes, filtered through calico and diluted with nineteen times its volume of water. A precipitate of ovomucin (formerly regarded as globulin) separates out, but it passes into solution on adding a little salt solution (NaCl, Am_2SO_4).

Undiluted egg-white has a faintly alkaline reaction and contains about 10 or 12 per cent. of protein. The solution may show very faint alkalinity to litmus and contains 0.5 to 1 per cent. of protein.

A. COLOUR REACTIONS.

(1) Biuret.

* To some of the protein solution is added caustic soda and then, drop by drop, dilute copper sulphate solution (1 per cent.), mixing after each addition : a violet colour appears. Excess of copper sulphate must be avoided as its blue colour masks the reaction.

This reaction is due to the presence of at least two CO—NH groups. (See under urea.)

(2) **Xanthoproteic.**

- * On heating a portion of the protein solution with concentrated nitric acid, a yellow colour is formed; the colour changes to orange on adding ammonia or soda in excess to the cooled solution.

This reaction is most probably due to the formation of nitro compounds with the aromatic units contained in the protein, namely, tyrosine, phenylalanine.

(3) **Millon's.**

- * On adding Millon's reagent to some of the protein solution, a white precipitate is formed; it becomes red on heating.

This reaction is due to the presence of tyrosine in the protein. (Compare hydroxy derivatives of benzene.)

(4) **Sulphur.**

- * A drop of lead acetate solution is added to some of the protein solution and sufficient caustic soda to redissolve the precipitate which is first formed. A brown coloration, sometimes black, occurs on boiling.

This reaction is due to the separation of hydrogen sulphide from the cystine unit, which gives lead sulphide with the lead acetate.

(5) **Adamkiewicz' or Glyoxylic Acid.**

- * If excess of glacial acetic acid be added to the solution and concentrated sulphuric acid be run underneath it, on standing, or on gently shaking, a reddish-violet colour appears at the junction of the fluids which gradually spreads throughout the solution.

It has been shown by Hopkins and Cole that this reaction is due to the presence of glyoxylic acid in the glacial acetic acid; it is therefore better to use a solution of glyoxylic acid instead of glacial acetic which (if kept in the dark) may not contain this substance.

- * A little glyoxylic acid solution is added to some of the protein solution and concentrated sulphuric acid is run in as before to the bottom of the test tube. The reddish-violet ring as above described slowly forms.

This reaction is due to the presence of tryptophan in the protein molecule. Some substance is formed from the glyoxylic acid which reacts with the tryptophan.

A similar colour is produced on adding commercial sulphuric acid to a protein solution containing a minimal quantity of formaldehyde. This reaction is brought about by the presence of oxidising agents in the sulphuric acid which act upon the formaldehyde (Rosenheim). It is not due to the formation of glyoxylic acid by aldol condensation of formaldehyde and oxidation (Dakin).

It should be noted that this reaction has been used for many years for detecting formaldehyde added to milk as a preservative.

Proteins, precipitated by alcohol and washed with ether, give a blue colour when heated with concentrated hydrochloric acid. (Liebermann's reaction.) A reddish-violet colour, which ultimately becomes brown, is produced on heating proteins with concentrated hydrochloric acid.

These reactions, according to Cole, are due to the presence of tryptophan: in the first, glyoxylic acid is derived from the alcohol and ether: in the second, furfural is formed from carbohydrate in the protein and reacts with the tryptophan.

The green to blue colour produced when proteins are heated with benzaldehyde, a drop of ferric chloride and concentrated hydrochloric acid—(Reichl's reaction)—is also due to the presence of tryptophan.

(6) **Molisch's.**

* A few drops of α -naphthol solution are added to the protein solution and mixed thoroughly. Concentrated sulphuric acid is run under the solution. At the junction of the two liquids a purple-red ring is formed.

This reaction is due to the formation of furfural from the carbohydrate radicle in the protein and to its combination with α -naphthol.

B. COAGULATION REACTIONS.**(1) Heat.**

- * On heating some of the solution an opalescence occurs, with perhaps a slight precipitate on the surface of the glass. But on faintly acidifying it, or another portion, with 1-2 drops of dilute acetic acid and again heating, a cloudiness and then a flocculent precipitate of coagulated protein is formed. This precipitate is not soluble in dilute acids and alkalies in the cold, but it gradually dissolves on heating with caustic soda.

Coagulation did not occur at first as the reaction was alkaline ; it only occurs when the solution is faintly acid.

(2) Alcohol.

- * A precipitate is formed if excess of alcohol be added to some of the solution. This precipitate is at first capable of re-solution in water, but on prolonged contact with alcohol it is rendered insoluble, the protein being coagulated.

(2a) Ether. On adding about half a volume of ether to some of the solution and mixing thoroughly by inverting the liquids, a gelatinous solution results, which contains coagulated protein.

(3) Strong Mineral Acids.

- * *Heller's Test.*—Concentrated nitric acid is added to some of the solution by means of a pipette, or by gently pouring down the sides of the tube, so that the acid forms a distinct layer below the solution. At the junction of the two liquids a white ring of coagulated protein is formed. The precipitate does not dissolve in excess of the acid, if the liquids be mixed by shaking.

C. PRECIPITATION REACTIONS.**(1) Solutions of Heavy Metals.**

- * *Mercuric Chloride.*—If 2 or 3 drops of mercuric chloride solution be added to some of the protein solution, a heavy white precipitate of the mercury compound is formed. This dissolves on adding some saturated sodium chloride solution. The mercury compound is reprecipitated from its solution in sodium chloride on adding a few drops of dilute hydrochloric acid.
- * *Copper sulphate*, added drop by drop, forms a bluish-violet precipitate which dissolves in caustic soda, giving a violet solution (biuret reaction).
- * *Ferric chloride* gives a precipitate soluble in excess.
- * *Lead acetate* and *basic lead acetate* give white precipitates.

(2) Alkaloidal Reagents in Acid Solution.

- * (a) *Hydroferrocyanic acid*. A few drops of glacial acetic acid are added to a little of the protein solution and then, drop by drop, potassium ferrocyanide solution. A voluminous precipitate is formed. This precipitation is less complete in the presence of neutral salts and does not occur in neutral solutions.
- * (b) *Picric acid*. A yellowish precipitate is formed on adding picric acid to egg-white solution.
- (c) *Potassio-mercuric iodide (Brücke's reagent)*. A whitish precipitate is formed when the protein solution is acidified with dilute hydrochloric acid and a few drops of potassio-mercuric iodide are added.
- (d) *Trichloroacetic acid*. A white precipitate is formed on adding an equal volume of 10 per cent. trichloroacetic acid.
- * (e) *Tannic acid*. A brownish precipitate is formed.
- * (f) *Bromine water* gives a white precipitate.
- (g) *Phosphotungstic acid*. A white precipitate is produced when phosphotungstic acid is added to the protein solution previously acidified with hydrochloric or sulphuric acid.

These reagents are the most commonly employed for removing proteins from solution, e.g. in the analysis of blood.

The tannic acid compound is of commercial importance. Leather is made by tanning skins.

The hydroferrocyanic acid reaction is often used clinically for detecting protein ("albumin") in the urine.

ESTIMATION OF PROTEIN.

Picric acid is used in the estimation of protein by Esbach's method.

- * Some of the solution is poured into the Esbach tube (Fig. 54) up to the mark U and then Esbach's reagent up to the mark R. The tube is corked, the contents are mixed by inverting 2 or 3 times without shaking and allowed to stand for 24 hours. The tube is graduated in amounts of protein in grams per litre; the height of the deposit gives the amount. This method is often employed in estimating "albumin" in urine.



FIG. 54.

Alkaloidal reagents
& alkaline
Base
Hydroferrocyanic Acid

DERIVATIVES OF PROTEINS.

Proteins are hydrolysed into their constituent amino acids by boiling with concentrated mineral acids or alkalis for 6-10 hours. This hydrolysis of the complex protein takes place in several stages, products intermediate between the large protein molecule and the amino acid molecule being formed. These are metaprotein, proteoses, peptones and polypeptides. In the formation of metaprotein only a comparatively small change in the protein molecule occurs. Proteoses and peptones are formed by the breaking up of the large molecule into several large complexes, each of which is gradually hydrolysed into smaller complexes, from which the amino acids are finally formed.

The metaproteins, the proteoses and the peptones still possess some of the properties of a typical protein, but the amino acids do not. The polypeptides are intermediate between the peptones and amino acids; some resemble the peptones, others the amino acids. In all probability peptone is a mixture of polypeptides.

METAPROTEINS.

The most typical metaproteins are formed from the mixture of albumin and globulin of egg-white or of blood serum, but they are also formed from the other proteins.

Preparation.

Metaprotein is most easily prepared by the action of acid or alkali upon proteins. It is formed fairly rapidly at 60° and higher temperatures, more slowly at 37°.

(a) By Acid.

- * (i) Egg-white or serum is mixed with 10 times its volume of 0.4 per cent. hydrochloric acid and kept in an incubator at 37° for at least 24 hours.
- * (ii) Egg-white or serum is mixed with one-third of its volume of glacial acetic acid and allowed to stand. The mixture sets to an opaque jelly. The opacity is due to the coagulation of the protein by the strong acid. On diluting with water the jelly dissolves leaving coagulated protein.

(b) By Alkali.

- * (i) Egg-white or serum is mixed with 10 times its volume of 0.1 per cent. sodium hydroxide and kept at 37° for about 18 hours.
- * (ii) Egg-white or serum is mixed with about one-third of its volume of 2N sodium hydroxide. On standing it sets to a transparent jelly (Lieberkühn's jelly). The jelly dissolves on diluting with water.
- * Small quantities may be rapidly prepared by adding about one quarter of the volume of dilute acid or alkali to 10 or 20 c.c. of an egg-white solution and keeping in water at 40-50° for 10-15 minutes.

Properties.

The solutions prepared above are known as acid metaprotein or acid albumin and alkali metaprotein or alkali albumin.

- * (1) No coagulation occurs on boiling a portion of the solution.
- (2) Metaprotein is insoluble in water.

* On carefully neutralising the solutions with 2N acid or alkali respectively, the metaprotein is precipitated when the solution is just acid to litmus; it redissolves in an excess of either acid or alkali. The precipitate is allowed to settle, the bulk of the water decanted and the remainder filtered. The precipitate is washed with water and examined as follows:—

- (3) Metaprotein is soluble in dilute acid or alkali.
- * A portion of the precipitate will dissolve in dilute acid or alkali, and will be precipitated on neutralising.
- * (4) Metaprotein is coagulated by heating in neutral solution. A portion of the precipitate is suspended in water and heated. Coagulation occurs. This is verified by adding a drop of dilute acid to the cold solution when the precipitate is no longer found to be soluble.
- * (5) Behaviour towards salt solutions.

Acid metaprotein solutions are precipitated completely on saturating the solution with (a) sodium chloride, (b) magnesium sulphate, or (c) by half saturation with ammonium sulphate. Alkali metaprotein solutions are not precipitated by saturation with sodium chloride, but are precipitated by saturation with magnesium sulphate or half-saturation with ammonium sulphate.

(6) Both solutions give the colour reactions and some of the other general protein reactions.

PROTEOSES AND PEPTONES.

A mixture of these substances is formed by the hydrolysis of proteins. They are termed albumose, globulose, caseose, etc., fibrin-peptone, gelatin-peptone, histo-peptone, etc., according to the name of the protein from which they arise.

Preparation.

The mixture of proteoses and peptones is most easily prepared by digesting a protein (egg-white, meat, etc.) with 20 parts of 4 per cent. hydrochloric acid and with about 0.1 gm. of pepsin at 37° for several days.

Witte's peptone is a commercial peptone prepared in this way from fibrin. Similar commercial peptone preparations are made from other proteins.

Properties.

The commercial mixtures consist of amorphous powders, white or pale yellow in colour, easily and generally completely soluble in water, but sometimes a small residue remains undissolved. A solution of the mixture (5 per cent.) shows the following reactions:—

A. Colour Reactions.

- * The colour reactions for proteins are generally positive.

B. Coagulation Reactions.

- * (1) No coagulum is formed on boiling the solution after acidifying with a drop of acetic acid.
- * (2) A white precipitate is formed on adding nitric acid, drop by drop, especially in presence of salts. This precipitate dissolves on heating, but reappears on cooling.
- * (3) Alcohol precipitates the proteoses more or less entirely; the precipitate is not coagulated by standing in contact with alcohol and redissolves on adding water.

C. Precipitation Reactions.**(a) Heavy Metals.**

- * The solution is precipitated by solutions of the heavy metals: copper sulphate, lead acetate, mercuric chloride.

(b) Alkaloidal Reagents.

- * (1) A white precipitate is formed on adding a drop of glacial acetic acid and 2 or 3 drops of potassium ferrocyanide. This precipitate dissolves on heating but reappears on cooling.
- * (2) Tannic acid gives a white precipitate.
- * (3) Other alkaloidal reagents also produce precipitates.

SEPARATION OF PROTEOSES AND PEPTONE.

The mixture of derivatives obtained by the hydrolysis of a protein is separated by salting out from the solution. Saturation with sodium chloride or magnesium sulphate produces the same effect as half saturation with ammonium sulphate or zinc sulphate. Ammonium sulphate is used almost exclusively.

(1) Primary Proteoses.

- * A white precipitate of primary proteoses is formed when an exactly equal volume of saturated ammonium sulphate solution is added to a solution of Witte's peptone (20 or 25 c.c. should be used in testing). If the mixture be well stirred with a glass rod covered at the end with a piece of rubber tubing, the precipitate may gather upon the end of the rod and can be almost completely removed in this way, otherwise it is separated by filtering.

The mass thus collected may be dissolved in warm water. The cold solution will give the previous reactions for the mixture of proteoses and peptone.

This precipitate according to Haslam contains three substances :—

α -protoproteose.
 β -protoproteose.
 Heteroproteose.

The α and β protoproteoses are very similar to one another and are easily soluble in water. Heteroproteose is very little soluble in water and can be separated from the others by dialysis; it is precipitated from solution.

Heteroproteose and the protoproteoses are more easily separated by means of alcohol. Heteroproteose is precipitated by 32 per cent. of alcohol; protoproteose is soluble in alcohol up to 80 per cent.

If an equal volume of alcohol be added to the above solution of primary proteoses, the heteroproteose will be precipitated.

(2) Secondary or Deuteroproteoses.

- * These proteoses are precipitated by complete saturation of the solution of proteoses and peptone with ammonium sulphate. The filtrate remaining after the precipitation of the primary proteoses is acidified with a drop of dilute sulphuric acid and saturated with finely powdered ammonium sulphate.¹ A flocculent precipitate comes down and is filtered off.

If it be dissolved in water, it will be found not to give all the above reactions for proteoses, e.g. :—

- * The reactions with acetic acid and potassium ferrocyanide, concentrated nitric acid, copper sulphate are negative.

This precipitate also consists of a mixture of at least two deuteroproteoses, α and β , and a third has been described. They differ in their behaviour towards ammonium sulphate.

Both the primary and secondary proteoses are very indefinite substances and methods have still to be devised for a perfect separation.

PEPTONE.

Peptone is not precipitated by saturation with ammonium sulphate. It therefore remains in solution after the proteoses have been removed.

Its chief characteristic is the biuret reaction :—

- * A portion of the filtrate is treated with excess of strong caustic soda solution (40 per cent. or solid substance) and a drop or two of 1 per cent. copper sulphate solution. A pink colour appears, which is characteristic of peptone. It is necessary to add a large excess of caustic soda if ammonium sulphate be present in the solution, in order to decompose it and in order that the alkalinity should be due to sodium hydroxide; the alkalinity of ammonia does not produce the colour.

Of the other colour reactions they are sometimes positive, sometimes negative, depending on the peptone.

Peptone is precipitated by some of the precipitating reagents, e.g. tannic acid, phosphotungstic acid, lead acetate, but not by others.

Peptone again is a mixture which has not been perfectly separated; at least two peptones are present.

¹ 4 gm. to every 10 c.c. of half saturated solution.

APPENDIX TO PROTEINS.

COLLOIDS AND COLLOIDAL SOLUTIONS.¹

The proteins, also the fats and soaps and the polysaccharides, the principal substances with which physiological chemistry has to deal, are colloids. Their properties depend so much upon this fact that it is necessary to examine the nature of colloids and colloidal solutions.

Crystalloids and Colloids.

Thomas Graham between 1861 and 1864, whilst studying the diffusion of dissolved substances through organic membranes, such as parchment paper, found that some substances dialysed, or passed freely through the membrane, but that other substances did not pass through or passed through very slowly. The substances belonging to the first class were salt, sugar, urea, etc., which crystallised well: the substances belonging to the second class like gelatin, albumin, gum, starch, did not crystallise. He distinguished the two classes as crystalloids and colloids.

Natural and Artificial Colloids.

The substances belonging to the group of colloids show amongst themselves many differences:—

Hot solutions of gelatin or agar on cooling form jellies which redissolve on warming. Solutions of albumin on heating coagulate, i.e. form an insoluble precipitate. Solutions of gum neither set to a jelly nor coagulate, but always form more or less viscous solutions.

Graham found that substances like silicic acid, ferric hydroxide, etc., substances which are usually insoluble, could be made to form true solutions in their appearance to the eye, and that the solid matter in apparent solution did not diffuse through parchment membranes.

These artificial solutions had one peculiar property: they underwent a marked and irreversible change on the addition of a small quantity of an electrolyte. The solid matter was either precipitated or the solution set to a jelly; neither the precipitate nor the jelly could be redissolved to form a solution.

¹ An excellent description is given by Hatschek, "An Introduction to the Physics and Chemistry of Colloids," from which book most of these notes have been compiled.

Variety of Solvent.

It is now known that other solvents besides water can dissolve substances forming colloidal solutions.

Cellulose dissolved in Schweitzer's reagent or in zinc chloride forms a colloidal solution from which the substance is precipitated as a gelatinous mass. Nitrocellulose dissolved in acetic acid, acetone, or alcohol-ether, forms a colloidal solution. Sodium chloride can be made to form a colloidal solution in petroleum ether and the alkali metals in organic solvents.

Sols and Gels.

Graham called the apparent solutions of colloids colloidal solutions, or sols, and the precipitated or gelatinous substance, gels. We can further distinguish the solvent by prefixing its name, e.g. hydrosol, alcoholgel, etc.

PREPARATION OF ARTIFICIAL COLLOIDAL SOLUTIONS.¹**A. Colloidal Solutions of Metallic Sulphides.**

(a) *Cadmium Sulphide*.—A fine suspension of cadmium sulphate, previously washed with distilled water, is treated with hydrogen sulphide. The solution gradually becomes milky and finally has a yellow colour with a reddish surface. The excess of hydrogen sulphide is removed by a current of nitrogen or by boiling.

- * (b) *Arsenious Sulphide*.—About 1 gm. of arsenious acid is boiled for a few minutes with about 75 c.c. of distilled water; the solution is filtered and allowed to cool. On passing hydrogen sulphide through the cold solution, it turns a yellow-orange colour with a greenish surface.

B. Colloidal Solution of Ferric Hydroxide.

- * 1 c.c. of a filtered 33 per cent. solution of ferric chloride is added to 100 c.c. of boiling distilled water. A reddish-brown solution is obtained.

A colloidal solution of ferric hydroxide may also be obtained by dialysing a solution of ferric chloride.

C. Colloidal Solutions of Gold and Silver by Reduction.

1 c.c. of 1 per cent. gold chloride solution is diluted with 25 c.c. of distilled water. 2 gm. of tannic acid are dissolved in 100 c.c. of water.

On mixing 1 volume of the gold chloride solution with 3 volumes of the tannic acid, a blue solution is formed. On mixing 1 volume of the gold chloride solution with 1 volume of the tannic acid, a red solution is formed.

Similar solutions may be made by treating gold chloride solution with a solution of 1 gm. of hydroquinone or pyrogallol dissolved in 500 c.c. of water.

- * Ammonia is added drop by drop to 10 c.c. of silver nitrate solution until the precipitate first formed just redissolves. The solution is diluted with 200 c.c. of water. On mixing equal volumes of this solution with the 2 per cent. tannic acid, a brown solution having a greenish colour in reflected light is formed.

¹ In preparing artificial colloidal solutions the glass vessels must be absolutely clean, preferably new, and washed with nitric or chromic acid. Freshly distilled water should also be used.

D. Colloidal Solutions of Platinum and Silver by Disintegration.

On forming an arc between two pieces of platinum or silver wire under distilled water, i.e. by separating the two poles when a suitable current is passed, a colloidal solution of the metal is formed. The larger particles which are formed settle and can be separated by decantation or filtration.

The metal, e.g. bismuth or chromium, is ground finely in a ball mill and treated for several days alternately with concentrated alkali and acid. On treating with water a colloidal solution results.

Colloidal copper and silver solutions are obtained if distilled water be boiled in copper and silver vessels.

Colloidal lead solutions are formed when water, free from oxygen and from which oxygen is excluded, is kept in contact with lead.

* A suspension of fine particles of kaolin is obtained by shaking some kaolin vigorously with water and pouring off from the larger particles which settle rapidly.

E. Colloidal Solution of Lead Chromate Using Viscous Media.

Sols of lead chromate and barium sulphate can be prepared if the reactions leading to their formation be carried out in a solution containing a colloid such as a solution of caseinogen.

Colloidal solutions of some inorganic salts may be prepared by dissolving them in glycerol and pouring the solution into water (Craw).

* E.g. if some potassium chromate and lead nitrate be dissolved separately in glycerol, the solutions mixed and poured into water, a colloidal solution of lead chromate is formed.

Detection of Colloidal Solutions.**I. Dialysis.**

The simplest and most convenient way of showing the presence of a colloid in solution is that of dialysis as used by Graham.

As dialyser Graham employed a piece of parchment paper fastened between two hoops forming a sort of tray which could be immersed in water or other liquids. As the object is to obtain as large a surface as possible the parchment paper is conveniently made in the form of a sausage skin. The colloidal solution is introduced into the sausage skin, the ends may be tied tightly and the skin is immersed in water or other liquid, or it may be bent into U shape and suspended in a large tall vessel.

Thimbles made of parchment paper are useful for small quantities of solution, and "soufflet" cases may also be used, especially for testing solutions. Fish-bladder is another material frequently employed.

Collodion thimbles or tubes prepared by coating surfaces of test tubes, etc., with a solution of collodion in acetic acid, followed by immersion in water and removal of the tough membrane from the glass, form excellent dialysers.

In all cases a current of water is slowly circulated through the beaker or other vessel, or the dialyser may be put into several changes of distilled water, e.g. :—

- * (a) Some litmus solution is placed with a drop or two of dilute hydrochloric acid in a parchment paper dish which is allowed to float in a beaker of distilled water. The litmus does not diffuse out, but the hydrochloric acid passes into the surrounding water. It may be tested for by silver nitrate in the presence of nitric acid. If the process of dialysis be continued sufficiently long (repeated changes of water), the red colour will disappear and the litmus will become blue.
- * (b) The same experiment is repeated with a mixture of starch solution and glucose; the former being a colloid does not diffuse out, but the latter, a crystalloid, diffuses out and can be tested for in the surrounding water by Trommer's or Fehling's test.
- * (c) Egg-white solution treated in the same way does not diffuse out through a parchment paper membrane. The surrounding water, if tested for protein by the xanthoproteic, Millon's and the biuret reactions, will show that protein is absent.

The globulin may be precipitated in the paper dish if the egg-white solution be dialysed long enough, as it is insoluble in distilled water; it dissolves on adding a little salt.

II. Tyndall Phenomenon.

If a bright beam of light be passed through a colloidal solution contained in a vessel with parallel sides and the solution be viewed from the side, it will appear turbid, sometimes with a coloured sheen.

- * III. Colloidal solutions are often opalescent, e.g. starch, glycogen. Some are coloured and show a pseudo-fluorescence: their colour in transmitted light is different to their colour in reflected light.
 - * IV. Colloidal solutions, especially those of natural substances, have a great tendency to froth if shaken.
 - V. Colloidal solutions cannot generally be filtered through filter paper and behave like suspensions.
 - * E.g. a suspension of kaolin, prepared by shaking up kaolin with water, on filtration passes through, leaving only the large particles.
- Similarly, arsenious sulphide sol passes through filter paper.

NATURE OF COLLOIDAL SOLUTIONS.

Faraday, in 1857, who prepared a colloidal gold solution having a red colour by treating gold chloride with an ethereal solution of phosphorus, expressed the opinion that the gold was suspended in the liquid in an extremely fine state of division.

Colloidal solutions have been shown by various methods to consist of suspensions of extremely fine particles. The colloidal condition is a state, not a form of matter.

Suspensions and Emulsions. Suspensoids and Emulsoids.

According as the suspension of fine particles may consist either of solid particles or of liquid particles, two classes are distinguished:—

(a) Suspensoid, in which the particles are solid, rigid and not deformable.

(b) Emulsoid, in which the particles are liquid and deformable.

Most of the natural colloidal solutions are emulsoids; most of the artificial colloidal solutions are suspensoids. They are sometimes referred to as reversible and irreversible respectively, this terminology referring to their behaviour with electrolytes.

Continuous and Disperse Phases.

It is usual to refer to the particles in suspension as the disperse phase and the medium in which they are suspended as the continuous phase. The continuous phase may be more concentrated in the form of a jelly or even a solid; the disperse phase will then consist of drops of liquid or dilute solution in suspension.

Filtration of the Particles Ultra-filtration.

Though the minute particles in a sol cannot be filtered off through filter paper yet they are retained if they be filtered through paper impregnated with either gelatin hardened with formalin, or collodion (Bechhold), or if they be filtered through a clay filter impregnated with gelatin (Martin). The solution is forced through these filters by pressure and a clear solution free from particles results.

Size of the Particles.

(a) Knowing the strength of the gelatin or collodion filter, from which, the size of the pores can be determined, the size of colloidal particles can be estimated. The pores in a 2.5 and 5 per cent. collodion filter are from 21 $\mu\mu$ to 930 $\mu\mu$.¹ Particles which are retained are probably larger than the size of the pores.

(b) In the Tyndall phenomenon the particles in the solution which reflect the light must be smaller than the wave length of light, i.e. from 450 to 760 $\mu\mu$ for the visible spectrum.

¹ μ = '001 mm. $\mu\mu$ = '001 μ = '000001 mm.

The particles may possibly be molecules with a high molecular weight, e.g. albumin, complex dye-stuffs. In the case of metallic and other inorganic sols the particles probably consist of aggregates of molecules.

The particles have been shown to behave like gases, filling the space in which they are contained and obeying definite laws.

Visibility of the Particles. The Ultramicroscope.

The particles in a colloidal solution are too small to be seen with an ordinary microscope, but in most cases the particles can be seen with the so-called ultramicroscope. With this instrument a strong beam of light is sent horizontally through the solution, which is viewed with a microscope. The particles reflect the light into the microscope and appear as bright specks. Instead of the ultramicroscope arrangement, many colloidal solutions will show particles by reflected light if a cardioid condenser be used with an ordinary microscope.

Brownian Movement of Particles.

The small particles visible in the ultramicroscope, like many larger particles under a microscope, show Brownian movement.

Non-Settling of Particles due to Electric Charge.

The mere smallness of the particles is not sufficient to account for the long time taken for a suspensoid to settle, nor is the fact that the particles are in Brownian movement.

The non-settling of the particles is due mainly to the fact that they are electrically charged and are thus repelled from one another, preventing coalescence to form larger particles or aggregates.

Almost any substance in contact with water assumes an electric charge; most substances become negatively charged. The charge can be reduced to zero or even reversed in direction by the addition of a suitable electrolyte. The particles in a coarse suspension are also electrically charged.

Determination of the Electric Charge of the Particles.

The electric charge on the suspensoid particles may be determined by placing the sol in a U tube; above the sol on each side is put a layer of distilled water. An electric current is passed through the contents of the U tube, the poles being in the water. The particles will travel to the positive or negative pole.

This may also be done on a microscope slide furnished at each side with a platinum wire connected with an electric current. A drop of the sol is put on the slide and the particles, when the current is passed, will travel to one side or the other.

PROPERTIES OF COLLOIDAL SOLUTIONS.

A. Suspensions and Suspensoids.

(1) *Concentration*.—These colloidal solutions are generally very dilute and contain only a fraction of 1 per cent. of solid matter in suspension.

(2) *Osmotic Pressure*.—They have a low osmotic pressure. The freezing-point of the continuous phase is lowered very slightly and the boiling-point is raised very slightly.

(3) *Viscosity*.—The viscosity of a suspensoid sol is only slightly higher than that of water and is proportional to the amount of solid matter present.

* (4) *Behaviour to Electrolytes*.—

(a) The suspended particles are precipitated immediately or in a short time by the addition of a small quantity of an electrolyte, e.g. :—

If a few drops of saturated sodium sulphate be added to colloidal ferric hydroxide solution, or of metallic silver, the solid matter is precipitated.

(b) Salts containing divalent ions are more effective than salts with monovalent ions; salts with trivalent more than those with divalent.

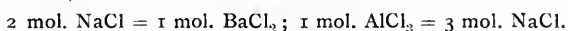

The particles are probably discharged by the oppositely charged ion so that they no longer repel one another, but coalesce to form larger aggregates.

(5) *Behaviour to other Suspensoids*.

Positively charged suspensoids will precipitate negatively charged suspensoids. Both suspensoids are precipitated together. If the two colloidal solutions contain an equal number of particles with a suitable number of electric charges both are completely precipitated, e.g. :—

* Varying quantities (1, 2, 3 c.c.) of ferric hydroxide sol may be added to varying quantities of arsenious sulphide sol (3, 2, 1 c.c.). Precipitation will occur. The excess of either sol remains and the precipitate contains both substances, as can be seen from the colour of the precipitate and of the solution.

(6) *Influence of Emulsoids*.

* Emulsoids protect suspensoids from precipitation by electrolytes. It seems that a layer of emulsoid particles is formed round the suspensoid and so alters its properties; e.g. if ferric hydroxide sol or arsenious sulphide be diluted with (a) an equal volume of water, (b) an equal volume of albumin solution, and sodium chloride solution be carefully added to each, the amount required to precipitate in (b) will be considerably greater than in (a).

B. Emulsions.

Emulsions are systems of two liquids insoluble in each other; they consist of comparatively coarse liquid particles of one liquid in another with which it does not mix.

Emulsions are of two kinds: (*a*) a small quantity of a liquid in suspension in a large amount of another liquid; (*b*) a large amount of one liquid suspended in another liquid; in this class the continuous phase must consist of a solution of a colloid such as soap, protein, or saponin.

Formation of Emulsions.

(*a*) An emulsion of oil in water is obtained if a fine stream of oil be injected into water.

* An emulsion is formed if an alcoholic solution of oil be poured into water.

* (*b*) Permanent emulsions are formed when colloids are present in a solution and the solution is shaken up with another liquid. The most typical permanent emulsions are observed with fats and oils.

The fats are neutral substances, but generally they contain a little fatty acid, which gives them an acid reaction and causes the formation of an emulsion when they are shaken up with alkali:—

In five test tubes are placed:—

(1)	(2)	(3)	(4)	(5)
10 c.c. H ₂ O	10 c.c. H ₂ O	10 c.c. H ₂ O	10 c.c. H ₂ O	10 c.c. H ₂ O
2 c.c. neutral ¹ olive oil.	1 drop 8% NaOH 2 c.c. neutral olive oil.	2 drops oleic acid 2 c.c. neutral olive oil.	1 drop 8% NaOH 2 drops oleic acid 2 c.c. neutral olive oil.	1 drop 8% NaOH 2 c.c. ordinary olive oil.

Each is shaken thoroughly. Only in (4) and (5) is a permanent emulsion formed, separation occurring in (1), (2) and (3) after a short time. (5) shows that ordinary fat contains free fatty acid.

The same result can also be seen by dropping a little neutral olive oil and a little ordinary olive oil on to the surface of some dilute sodium carbonate solution in watch glasses. The neutral oil drop remains clear, whilst the ordinary oil drop spreads out and gives a milky emulsion.

The formation of emulsions is due to the fact that a layer of soap, formed by the combination of the free acid with the alkali, is made round the fat particle.

¹ Neutral olive oil is prepared by dissolving it in ether, shaking up with dilute sodium carbonate solution, washing free from alkali and finally distilling off the ether.

- * In the same way an emulsion is obtained when oil or petroleum is shaken up with egg-albumin. In both cases a layer of coagulated egg-albumin is formed round each particle.

To prove this:—A little egg-albumin solution is shaken up in a test tube; a fine layer of mechanically coagulated egg-albumin will be seen to be formed and it rises to the surface on standing.

- * Protein solutions have free-surface coatings; by mechanically shaking, these are heaped up to form solid masses of protein. The following simple experiment demonstrates the surface coating of a protein solution:—

Two beakers are taken; in the first is placed clean water, in the second egg-white solution. On to the surface of each is floated a magnetised needle and a magnet is brought near. In the first beaker, the needle spins round; in the second, only a slight attraction or repulsion is seen. If the beaker be suspended by a wire, in the latter case the whole beaker would swing round, whereas in the former only the needle would rotate (Ramsden).

Milk and rubber latex are examples of naturally occurring permanent emulsions. Milk contains fat globules in a solution of the protein caseinogen; rubber latex contains drops in a solution of vegetable protein.

An extreme case is an emulsion of 99 per cent. of oil and 1 per cent. of soap solution which is of such a consistency that it can be cut into cubes.

Properties of Emulsions.

(a) The properties of the first kind of emulsions in which a small quantity of liquid is present in another liquid—1 part in 10,000—are almost the same as those of suspensoids. The globules show Brownian movement, they are precipitated or coagulated by electrolytes and can be retained by ultra-filters. The particles are comparatively rigid and are separated from one another by thick films or layers of the continuous phase.

(b) The properties of the second kind of emulsions in which the quantity of disperse phase is large are very different.

(1) *Viscosity.*—They are very viscous, an extreme case being the soap and oil emulsion mentioned above, which is almost a solid.

(2) *Closeeness together of the Particles.*—If particles of a solid or rigid sphere be put together so that they touch, they will occupy 74 per cent. of the volume. Such a condition gives a thick paste, which is a solid. If particles of a liquid or a deformable sphere be put together so that they touch, the particles will become flattened and their face will have the shape of a dodecahedron. The whole system remains a viscous liquid. There is no limit to the ratio of the disperse phase to the total volume.

(3) *Surface Tension of the Continuous Phase.*—In these emulsions the continuous phase must be a solution of an emulsoid colloid. Such solutions froth when they are shaken. Frothing is due to a lowering of the surface tension of the solvent by the substance in solution. This lowering of the surface tension takes place at the points of contact between the two phases, i.e. the interfacial tension is lowered, which prevents tearing of the films of continuous phase between the particles.

(4) *Structure of an Emulsion.*—The globules are flattened and form polyhedra, and they are separated by thin films of continuous phase. The whole system will be represented by a honeycomb structure filled with globules. On shearing, the whole surface of an emulsion becomes enlarged, the polyhedra moving over one another. Surface energy in spite of the lowered surface tension will be developed and it appears as viscosity.

C. Emulsoids.

Silicic acid sol is one of the few examples of an inorganic emulsoid. The organic emulsoids are very various. The types are represented by gelatin and agar, albumin, gum-arabic, cellulose and nitrocellulose solutions.

Preparation of Emulsoid Sols.

(a) *Silicic Acid*.—A solution of sodium silicate is treated with excess of hydrochloric acid and dialysed. A clear solution remains in the dialyser.

(b) *Gelatin and Agar*.—These substances dissolve in hot water.

(c) *Albumin* dissolves in cold water.

(d) *Cellulose* dissolves in Schweitzer's reagent or zinc chloride solution.

(e) *Nitrocellulose*¹ dissolves in alcohol-ether, acetone, acetic acid, etc.

General Properties of Emulsoid Sols.

(1) *Concentration*.—These colloidal solutions can be prepared of various strengths and are not necessarily dilute as suspensoid sols.

(2) *Osmotic Pressure*.—They have a low osmotic pressure.

(3) *Viscosity*. They have a high viscosity.

(4) *Behaviour to Electrolytes*.—Silicic acid resembles suspensoid sols by being precipitated as a gel with a small quantity of electrolyte.

The organic sols require larger amounts of electrolytes to precipitate them from solution, thus :—

* (a) Sodium chloride is added to soap solution in small quantities at a time and occasionally shaken. The soap is precipitated after a large amount has been added.

* (b) On adding ammonium sulphate to starch solution precipitation of the starch occurs after a considerable quantity has been added if the solution be occasionally shaken so as to dissolve the salt.

* (c) If some egg-white solution be saturated with (1) sodium chloride, (2) magnesium sulphate, by grinding it in a mortar with the salt, a small quantity of globulin is precipitated.

The same result is obtained by half-saturating the egg-white solution with ammonium sulphate, i.e. by adding an equal volume of saturated ammonium sulphate solution. On saturating the filtrate with finely powdered ammonium sulphate crystals, the egg albumin is precipitated. This method is employed for separating globulins, which are less soluble, from albumins, which are more soluble and are only precipitated from solution by completely saturating with ammonium sulphate (see under proteins).

¹ Cellulose nitrates.

(5) *Behaviour towards Suspensoids.*—Suspensoids and emulsoids, if they have opposite electrical charges, mutually precipitate one another. This property is made use of in precipitating proteins from solution (many, if not all, of the alkaloidal reagents act in this way):—

* If to some egg-albumin solution or dilute serum an equal volume or more of colloidal ferric hydroxide be added, and then about .5 to 1 gm. of sodium sulphate and the mixture be well shaken, a brownish mass containing the protein and excess of ferric hydroxide is precipitated. The filtered solution will not contain protein as shown by the biuret reaction, Millon's reaction, etc.

(6) *Electrical Charge.*—The electrical charges on the particles of an emulsoid sol are chiefly due to the reaction of the medium, e.g. albumin in neutral solution is not charged and does not travel in an electric field. Albumin in faintly acid solution has a positive charge and travels to the negative pole. Albumin in faintly alkaline solution has a negative charge and travels to the positive pole.

(7) *Adsorption.*—If an emulsoid sol be precipitated by electrolytes or by suspensoids, dissolved substances are taken out of solution in the same way as with suspensoids.

Special Properties of Emulsoids.

The properties of emulsoids show many differences among themselves and many differences from the properties of suspensoids and emulsions.

(1) *Silicic Acid.*

Silicic acid sol on treatment with an electrolyte behaves like a suspensoid; a small quantity of electrolyte causes gel formation. The gel takes the form of a jelly which gradually becomes more viscous and sets to a hard mass with no separation of water. The change of state is continuous, proceeding until the mass sets.

Thus, if excess of sodium silicate solution of sp. gr. 1.16 be added to 2N hydrochloric acid, an opaque gel containing the salt is formed which gradually becomes more viscous and sets. The rigid gel cannot be redissolved. The colloidal solution thus resembles a suspensoid sol in that the transformation is irreversible.

(2) *Gelatin and Agar.*

Both gelatin and agar dissolve in hot water. The solution on cooling sets to a jelly. A quite stiff gel is formed by 2 per cent. agar solution. These non-rigid or elastic gels can be dissolved again on warming. The transformation is reversible; they show the phenomenon of hysteresis. The setting-point is influenced by the presence of salts: citrates raise the setting-point, thiocyanates lower it or may prevent setting.

Albumin.

Solutions of albumin coagulate on heating at temperatures varying from 50 to 70°. The exact temperature depends upon the amount and kind of salt present; in the presence of thiocyanates heat coagulation does not occur even at the boiling-point. The transformation is irreversible.

Solutions of albumin are precipitated by high concentrations of electrolytes (Na_2SO_4 , $(\text{NH}_4)_2\text{SO}_4$, MgSO_4). These precipitates redissolve in water; the transformation is reversible.

The precipitates formed by CaCl_2 , SrCl_2 , BaCl_2 become insoluble on standing, whilst the precipitates formed by solutions of heavy metals are insoluble.

Caseinogen, Gum-Arabic.

These sols do not coagulate on heating and do not form gels. The solutions are simply more or less viscous at different temperatures.

Cellulose, Nitrocellulose.

These sols form coherent gels when the solvent is removed by evaporation or by washing out with water.

Transition of Emulsoids to true Solutions.

Some substances form emulsoid sols in one solvent, but true solutions in another solvent.

E.g. soap in water is an emulsoid sol, in alcohol a true solution; tannin in glacial acetic acid is a true solution, in water an emulsoid sol.

There are many differences amongst the dye-stuffs; eosin resembles a true solution; fuchsin forms an emulsoid sol.

Nature of Emulsoids.

Emulsoids possess many of the properties of emulsions, especially high viscosity, and they show many differences from the suspensoids. Their behaviour can only be explained on the assumption that they are systems of two liquid phases, i.e. as systems consisting of dilute solutions of a colloid containing droplets or globules of more concentrated solution.

They differ from emulsions in the ease in which the solvent may pass from one phase into the other. Gelatin sol is a continuous liquid phase containing droplets of higher concentration: gelatin jelly is a continuous solid phase containing droplets of dilute liquid. In dissolving gelatin, sol formation takes place by imbibition of water and swelling; there is disintegration of the original system.

The effect of salts upon the coagulation of albumin and upon jelly formation is to affect the distribution of the solvent between the two phases. They act by altering the compressibility of water. Solution of an emulsoid generally occurs with contraction.

Properties of Gels.

The gels formed by silicic acid, gelatin, agar, etc., which may contain as much as 90 per cent. of water, possess some of the properties of solids. They may be put into two groups—the rigid or nearly non-elastic gel like silicic acid and the elastic gel like gelatin, collodion, etc.

(1) Behaviour to Water.

(a) The rigid gel of silicic acid is translucent; on exposure to the air it loses water, becoming opaque, and with loss of more water it again becomes clear. The amount of water present in the solid material corresponds with the tension of aqueous vapour, the ratio of the constituents, silicic acid and water, changing continuously. No definite hydrate is formed such as occurs with crystals containing water of crystallisation. The formation of many siliceous minerals may be accounted for in this way. The elastic gel, like gelatin, which is reversible, also behaves in a similar manner to water; the amount of water present in it depends on the tension of aqueous vapour.

(b) Gelatin behaves differently when immersed in water; it swells and much more water is taken up; it is given off again on exposure to the air. This absorption of water is of great physiological importance.

(c) Though an absorption of water and swelling take place when an elastic gel is put into water, the actual volume of the gel and water is less than the total volume of the two substances. There is compression of the water.

The decrease in volume is demonstrated by Hatschek by placing a known weight of gelatin in a pycnometer, filling it with water, and immersing the vessel in water. When the gelatin has swollen, the vessel is taken out of the water, dried and weighed. There is an increase in weight which shows that water has entered the vessel. To compress water to an extent corresponding to 2 per cent. of the original volume requires 400 atmospheres.

(d) Heat is liberated during the swelling of the gels. It has been measured and found to vary from 5 to 10 gm. calories per gm. of gel.

(e) The total volume decreases, but the gel in water swells. This increase in volume has been measured and it has been found that against a pressure of 42 atmospheres a gel will swell by 16 per cent. of its volume; against a pressure of 1 atmosphere the increase in volume is 330 per cent.

From this it can be calculated that 1 gm. of gel on swelling will lift 1 kilo. to a height of 3.3 cm.

(2) The elasticity, the optical constants and thermal expansion of gels differentiate them from both liquids and solids.

When not strained they resemble liquids. If stretched, (1) they contract on warming and rapid cooling produces expansion, (2) they become doubly refracting.

They are deformed without change of volume (cross-section \times length); on stretching a cylinder of gelatin its cross-section diminishes as the length increases.

(3) *Nature of Gels.*—In composition gels resemble the organic material of plants; in these there is a cell structure. Liquid is enclosed in cells formed by a solid phase. Gels consist of a solid¹ continuous phase enclosing a liquid phase.

The reversibility is accompanied by a distribution of water between the phases and is affected by the presence of salts.

(4) *Diffusion of Substances and Reactions in Gels.*—In dilute gels diffusion takes place as in water. The rate is slower with strong gels. The rate of diffusion is affected by various substances: urea, iodides, chlorides accelerate diffusion; sodium sulphate, glucose, alcohol, glycerol retard diffusion.

These substances affect the distribution of water between the two phases and probably also the relative volumes of the gel wall and the free liquid. Diffusion takes place chiefly in the liquid. The reaction does not proceed continuously, but the product if insoluble is deposited in strata. Many substances can thus be obtained in the form of large crystals and often spherulites are formed.

Some organic compounds on separation from hot solvents on cooling first form transient gels which gradually crystallise. Crystalline minerals may be formed from gels in a similar way.

(5) *Structure of Gels.*—Gels resemble the organic matter of plants and animals in composition—that is solid matter containing 80-90 per cent. of water. Cell structure in animals and plants is visible with a microscope. Though apparent structure can be seen in gels with a microscope it is not real, but the presence of a structure in gels is indicated by the diffusion and reaction of substances in gels.

The Phenomenon of Adsorption by Colloids.

The phenomenon of adsorption by colloids is due partly to the large boundary surface between the particles and partly to the electrical charge upon the particles. In some cases the first cause may predominate, in other cases the second cause.

¹ In this connection a solid is a substance less deformable than a liquid, but not non-deformable.

(1) *The Large Boundary Surface.*

The surface of a liquid against its vapour or another liquid is in tension, known as surface tension or interfacial tension. Such a tension also exists between a gas and a solid, and a liquid and a solid.

Work is required to produce or to enlarge a surface. A surface is a seat of energy and on this account a surface tends to become a minimum. The surface energy is measured by the product of the surface and surface tension per unit length.

The surface tension tends to reduce the surface and establish equilibrium with other forces acting in the body of a liquid.

Gases in contact with a surface produce a lowering of the surface tension, the amount of lowering being characteristic for each gas. With rising gas pressure or concentration there is a lowered surface tension. It is accompanied by condensation of the gas on the surface. The same occurs at the boundary of a solid and a gas.

In a froth which has a large surface there is a higher concentration than in the liquid, and with froth formation there is lowered surface tension. There is thus an increase in concentration in the surface or adsorption with a lowered surface tension. If a dissolved substance in increasing concentration increases surface tension, it is less concentrated in the surface than in the liquid. If a dissolved substance in increasing concentration lowers surface tension, it accumulates on the surface. A small amount of a substance in solution can increase the surface tension only slightly, but a small amount can lower the surface tension greatly.

The amount of adsorption is proportional to the active surface. It proceeds to a definite end point or equilibrium.

This is expressed mathematically by

$$\frac{y}{m} = ac^n$$

where m = amount of adsorbent, y = quantity adsorbed and c is the end or equilibrium concentration in the liquid after adsorption. a and n are constants depending on the solution and adsorbent. This equation shows the peculiarities of adsorption.

(2) *The Electric Charge.*

In precipitating colloids by electrolytes the charge of opposite sign is the effective ion: equi-valent amounts of the ions produce the same effect. In the mutual precipitation of colloids the precipitation occurs with colloids of opposite charge. In the first case the ion is carried down with the colloid; in the second case both colloids are precipitated. The large surface of the colloid further influences the electric charge and in the case of emulsoids the viscosity also.

Peculiarities of Adsorption.*(1) Amount of Adsorption.*

The amount adsorbed from a solution does not increase in direct proportion to the increase in concentration. It thus differs from chemical reactions, e.g. 10 times the concentration produces only 4 times the adsorption. Relatively more substance is adsorbed from dilute solution than from a concentrated one.

(2) Different Adsorption from Different Solvents.

Usually the adsorption of substances from water is greater than from organic solvents. This peculiarity may be of practical use. Dyes can be removed from aqueous solution completely by charcoal, the particles being concentrated on the surface. On putting the charcoal into alcohol, the dye passes into the alcohol. This is due to the surface concentration of the dye on the charcoal being in excess of that necessary to produce equilibrium between the phases.

(3) Selective Adsorption.

Substances are not adsorbed to the same extent; benzoic acid or salicylic acid are more adsorbed than acetic acid by charcoal. This selective adsorption has been put to practical use in capillary analysis, e.g. :—

Strips of filter paper are partly suspended in different solutions; the liquid rises into the paper; above a certain height there is only water; the height to which the dissolved substance rises is different; the more adsorbed substance does not rise so high as the less adsorbed.

Lead salts on filtering through paper are retained by the surface of the paper and account for loss in the concentration of the solutions.

(4) Adsorption by Different Adsorbents.

Though the adsorbents may differ in active surface they adsorb the same relative amount of substance: thus if A adsorbs more X than Y, B also adsorbs more X than Y.

(5) Reactions accompanying Adsorption.

Chemical reactions may occur at the same time as adsorption, e.g. :—

Alumina adsorbs the acid of congo red at the ordinary temperature without chemical reaction as seen by the colour, which is blue; on warming, chemical reaction takes place; the alumina becomes red in colour, the colour of the salts of congo red.

(6) Effect of Adsorption on Extraction by Solvents.

If there is adsorption of one substance by another, repeated extractions must be made to separate them.

(7) Filtration of Particles through Sand, etc.

The sand particles having a negative charge will retain a definite quantity of positively charged colloids, such as colloidal ferric hydroxide and some dye-stuffs. This is apparently due only to the discharge of the electric charges on the particles.

ENZYMES. FERMENTATION.

In the previous sections an outline has been given of the organic compounds which are found in nature, both in plants and in animals. Their variety is very great, and they include not only simple compounds such as alcohol, glycerol, fatty acids, lactic acid, urea, amino acids, and many others, but also the more complex, such as chlorophyll, hæmoglobin, and the three large groups, carbohydrates, fats and proteins. These three groups make up the main portion of the solid matter of plants and animals, and are concerned intimately with the functional activity of the organism.

We have to investigate how (the change from the complex compound to the simple, such as starch and glucose to alcohol and carbon dioxide, protein to amino acids, and *vice versa* from the simple to the complex, is effected in nature.

The (hydrolysis and decomposition of the complex compounds is effected by the reagents grouped together under the term enzymes.) (The formation of the complex compound from the simple ones is effected by the same reagents.) The decomposition is most easily ascertained and followed, but the formation is only followed with difficulty and it has been actually observed only in a few instances. Nevertheless it is believed that the synthesis of all the complex compounds is effected by enzymes.

Historical.

(The formation of alcohol and carbon dioxide from sugar was known to the ancients,) and (on account of the effervescence, or apparent ebullition of the liquid, during the decomposition of the sugar, the process was called fermentation, from *fervere*, to boil.) In the middle ages the decomposition of proteins was recognised as an analogous process to that of fermentation and the terms putrefaction and fermentation were frequently used to denote any process of decomposition. (Not until the beginning of the nineteenth century, mainly between 1830 and 1840, was it recognised that fermentation was due to the presence of living cells) (Schwann, La Tour, Kützing, Pasteur). At about the same time it was discovered that extracts of plants—barley and almonds, and a little later that extracts of animal organs—of the stomach and pancreas, were able to effect the decomposition of the complex compounds, starch, amygdalin and proteins into simpler ones.) The effective substance in barley extract was called diastase, that in almonds, emulsin, that in the stomach, pepsin, that in the pancreas, trypsin. (There were thus two varieties of active agents—the one living (yeast)—the other not living (diastase, etc.), and they were called respectively organised ferments and soluble or unorganised ferments.)

Pasteur, who posited the necessity of life for fermentation, was opposed by Liebig who, without clearly stating his ideas, was of the opinion that there was something in the yeast cell which actually produced the fermentation. Traube, in 1858, clearly stated the position that the yeast cell contained a soluble ferment to which the decomposition was due. On account of the confusion of the terms it was suggested by Kühne in 1878 that the soluble ferment should be termed enzyme (from *εν ζυμη*, in yeast), which signifies that something in yeast which causes the fermentation of sugar.

(Not until 1897 was it definitely shown by Buchner that yeast did contain an enzyme which fermented sugar in the absence of the living cells, and later it was shown that other cells and bacteria also contained soluble ferments. The term enzyme is now used for the active agent in all cases, and the term fermentation for the process of decomposition.) In France the term 'diastases' is used as a general word for enzymes.

Occurrence and Preparation.

✓ Enzymes are present in all living cells. They are either excreted in the juices by definite cells or glands of the organism, e.g. by the salivary glands, the pancreas, etc. : that is, they act normally outside the cells which produce them (ectoenzymes), or they are not excreted : that is, they act inside the cell envelope (endoenzymes).

For purposes of investigation in the former case the juices of the glands, such as saliva and pancreatic juice, are collected. In the latter case the enzymes are extracted from the cells in which they are present ; the cells require to be ruptured so as to obtain their contents. (The glands producing the secretion may also be extracted to obtain the enzyme.)

The cells are ruptured by the following methods :—

(1) By drying the cells at a low temperature at 20 to 30° and sometimes subsequently warming the dried mass to 50 or 60°.

(2) By drying the cells by stirring up the tissue with alcohol or acetone and pouring off the liquid after a short time of contact.

The dried material is treated with water ; the aqueous solution is filtered and precipitated with alcohol.

(3) By autolysis in the presence of toluene or other antiseptics ; the cells are either mixed with antiseptic, or the tissue is minced and suspended in water containing toluene, etc. The enzymes in the cell dissolve the cell membrane and pass into solution.

(4) By mechanical disintegration ; the cells are ground in a mortar with sand. The ground-up mass may be diluted with water, or the liquid contents may be separated from the cell walls by hydraulic pressure.

This method was used by Buchner to show the presence of the enzyme in yeast which ferments sugar. The ground-up yeast cells which formed a liquid mass, were mixed with siliceous earth to form a thick paste. The thick paste was pressed in a powerful hydraulic press.

The liquid, which oozed out, was filtered (1) through paper and (2) through a clay candle to remove unbroken cells.

The dried material is treated with water or with glycerin. The solution is filtered and precipitated with alcohol.

The autolytic extracts, or the liquids produced by mechanical disintegration, may be mixed with water or glycerol and precipitated with alcohol.

The alcohol precipitate is dissolved in water, reprecipitated with alcohol, filtered off, washed with alcohol and ether and dried *in vacuo* over sulphuric acid.

Too frequent solution and precipitation by alcohol is avoided as much enzyme is lost in the process.

Aqueous or glycerin extracts of the dried material or the fresh gland also contain the enzymes and may be used directly, as is usually the case when enzymes are to be detected in tissues.

Chemical Nature.

The chemical constitution of enzymes is still quite unknown; they have been supposed to be proteins, nucleoproteins and carbohydrates from the fact that the enzyme solution gave the reactions of these classes of compounds. The purest preparations of invertase and amylase that have been prepared have contained carbohydrate; the purest preparation of pepsin has not contained nucleoprotein.

(Though the chemical nature of enzymes is unknown they belong to the group of colloidal substances; thus, they do not diffuse through parchment paper and other membranes.)

Properties of Enzymes.

(1) Enzymes can only be recognised by their activity.

(2) Enzymes are specific in their action. An enzyme acts only upon one compound, or a group of compounds, such as the fats and proteins. The most striking instance of their specificity is observed in the α - and β -glucosides. The enzyme maltase acts only upon α -glucosides: the enzyme emulsin only upon β -glucosides.

(3) Enzymes act by combination, or by adsorption, with the compound upon which they act. From the combination of an enzyme with the substance upon which it acts and its specific property, arose the image of Emil Fischer, that the enzyme was to the substance as a key is to a lock. Only the proper key will open the lock. In illustration of these properties Armstrong likened the specificity and combination to the fitting of a glove upon the hand. Only the right-hand glove will fit the right hand. There may be combination, but unless it is with every digit there is no enzyme action.

(4) Enzymes act as catalysts, i.e. they increase the rate of a reaction which is normally proceeding at so slow a rate that it cannot be detected.

(5) Enzymes, like catalysts, act more rapidly at high temperatures, but there is a limit to the increase in the rate produced by enzymes.

They are unstable catalysts; they are usually destroyed at a temperature of 56 to 60 or 65°. At 0° their action is nil, or considerably less than at room temperature; at body temperature and up to 45° their catalytic action is at the optimum; at higher temperatures it is more rapid, but the enzyme rapidly undergoes destruction so that the result of the action is generally less than at 37° to 45°.

(6) Enzymes are very sensitive to the presence of salts, acids and alkalis. Many enzymes will not act unless salt is present. Some, like pepsin, act only in the presence of very dilute acid (·1N); others, like trypsin, act best in the presence of dilute alkali (·1N). Most enzymes act best in a very faintly alkaline medium. The action of all enzymes is stopped by acid or alkali exceeding ·1N.

(7) Some enzymes require the presence of particular salts or other substances for their action, i.e. require a co-enzyme. E.g. phosphates are essential in the fermentation of sugar to alcohol and carbon dioxide, the fat-hydrolysing enzymes require the presence of bile salts, oxidising enzymes require the presence of iron or manganese salts.

(8) Some enzymes in their action are inhibited by other enzymes or anti-enzymes.

(9) Many enzymes require liberation from a precursor before they act—proenzymes, e.g. trypsin and its precursor—trypsinogen.

(A full account of the action of enzymes is given by Prof. Bayliss in the "Nature of Enzyme Action". Only the general principles of the action of enzymes can be mentioned here.)

Nomenclature.

Enzymes are designated by the suffix -ase, the first part of the word being that of the name of the substance upon which the enzyme acts. The substance upon which the enzyme acts is known as the substrate or hydrolyte. Most enzymes act by hydrolysis and are hydrolytic. Those which act upon the carbohydrates are sometimes termed sucroclastic (sugar-splitting), upon fats, lipolytic or lipoclastic, upon proteins, proteolytic or proteoclastic. Other enzymes act by oxidation of the substrate and are termed oxidases. Another group of enzymes acts upon amino groupings forming hydroxy or keto groups and enzymes can also remove carbon dioxide from carboxylic acid groups. They may therefore be classified as follows:—

A. *Hydrolytic.*

I. *Sucroclastic.*

ENZYME.	SUBSTRATE.	PRODUCT.
Diastase } or Amylase. }	Starch or Amylum.	Dextrin + Maltose.
Inulase.	Glycogen.	" "
Invertase } or Sucrase. }	Inulin.	Fructose.
Lactase.	Cane Sugar.	Glucose + Fructose.
Maltase } or α -Glucase. }	Raffinose.	Fructose + Melibiose { Glucose. Galactose.
Emulsin } or β -Glucase. }	Lactose.	Glucose + Galactose.
Zymase.	Maltose.	Glucose + Glucose.
	α -Glucosides.	α -Glucose.
	β -Glucosides.	β -Glucose.
	Amygdalin.	Benzaldehyde, HCN, 2 mols. Glucose.
	Glucose.	
	Fructose.	CO ₂ + Alcohol.
	Mannose.	
	Galactose.	

II. *Lipoclastic.*

Lipase.	Fats.	Glycerol + Fatty Acid.
---------	-------	------------------------

III. *Proteoclastic.*

Pepsin.	Proteins.	Proteoses + Peptone.
Trypsin.	"	Amino acids.
Erepsin.	Proteoses.	" "
Papain.	Proteins.	" "

B. *Oxidases.*

Catalase.	Hydrogen Peroxide.	Oxygen.
Peroxidase.	Peroxides:—	
	Hydrogen peroxide } or Organic peroxides. }	" Active " Oxygen.

C. *Deaminases.*

Guanase.	Guanine.	Xanthine.
Adenase.	Adenine.	Hypoxanthine.
{ Amino acid- Deaminase.	Amino acids.	{ Hydroxy- or Keto- acids.

D. *Carboxylases.*

Carboxylase.	Keto acids.	CO ₂ + aldehyde.
---	Amino acids.	CO ₂ + amines.

This list does not include all the known enzymes; there are many more amongst the carbohydrate splitting enzymes. The lipoclastic enzymes can be subdivided into butyrylase, lecithinase. Xanthine is oxidised to uric acid by uricase and a whole series of enzymes are concerned in the hydrolysis of nucleic acid each acting upon a particular substrate. They are grouped together as nucleases and would include guanase and adenase as well as nucleotidases, etc.

LOCALISATION OF THE ENZYMES AND THE CHEMICAL CHANGES IN THE ORGANISM.

In the unicellular plants and animals the various chemical changes in the organic compounds must occur in the single cell. The colloidal substances are ingested and broken down by enzymes into crystalline and diffusible substances. These diffuse into the cell and are built up into colloids, which again are broken down and converted into other crystalline substances capable of diffusing out of the cell. In the process of evolution of the higher plants and animals a differentiation of groups of cells into special tissues or organs has occurred. Like the single cell, the cells of each organ must originally have been able to effect all the chemical changes, but during evolution the power of effecting some of them has become lost, whilst the power of effecting others has become increased. Individual organs can effect most changes, but not all; some are effected by only one organ. Thus, for example, in animals, the organs of the alimentary canal are chiefly concerned in the hydrolysis of the proteins, carbohydrates and fats; the liver is concerned mainly in the metabolism of fats and carbohydrates, the conversion of ammonia into urea and the destruction and removal of blood pigment; the kidney is a filter which removes waste products; the ductless glands produce special substances to maintain the general equilibrium of the organism. The sequence of chemical processes taking place in the alimentary canal of animals is termed digestion.

In plants, the differentiation is much less than in animals: the growing points and the cambium layer in the stems are the active tissues, also the cells in the flower, or tuber, which produce the seed and embryo. Specialised cells are found in the insectivorous plants—in *Nepenthes* in the lining membrane of the pitchers, in *Drosera* in special tentacles. Certain cells in the surface of the scutellum of *Zea Mais* have a glandular appearance, but these glands have no lumen.

Very frequently in plants the enzyme may be present in one cell and its substrate in an adjoining cell. They come into contact when the cell walls are broken, artificially by crushing the tissue or by the action of anæsthetics.

Sucroclastic enzymes are present in greater variety and more abundantly in plants; proteoclastic enzymes in animals. This accords with the general composition of the organic matter of plants and animals.

Digestion in Animals.

The three classes of organic compounds, the fats, the carbohydrates and the proteins, are taken in as food and are hydrolysed into their constituents before they can pass through the wall of the alimentary canal and can be assimilated.

I. *Saliva.*

The first digestion of food occurs in the mouth by the action of the saliva, the secretion of the salivary glands. The saliva contains the enzyme diastase, or amylase, which hydrolyses starch (and glycogen) converting it into dextrin and maltose. In the mouth, however, very little enzyme action takes place, the food being only moistened by the saliva and swallowed. The action occurs in the stomach, where the food is in the form of a mass in the fundus; here only the exterior of the mass is in contact with the hydrochloric acid of the gastric juice, which inhibits the action of the diastase; the starch in the interior of the mass is slowly digested.

II. *Gastric Juice.*

The first hydrolysis of proteins occurs in the stomach by the enzyme pepsin. Pepsin is secreted by certain cells of the gastric mucous membrane. It acts only in the presence of hydrochloric acid, which is secreted by other cells. In disease, lactic acid is sometimes found in the contents of the stomach. Besides pepsin, the enzyme, rennin, is present in the cells of the mucous membrane, but it is very probable that pepsin and rennin are identical. Rennin acts upon caseinogen, the protein of milk, converting it into casein (see under milk, p. 461).

III. *Pancreatic Juice.*

From the stomach the food passes into the intestine. The acid contents of the stomach, when they pass into the duodenum and come in contact with its mucous membrane, induce the secretion of secretin. The secretin passes into the blood and is carried to the pancreas, where it excites a flow of pancreatic juice. This juice has very little action upon proteins, but it contains lipase and diastase which hydrolyse fats and starch respectively. As soon as the pancreatic juice, which contains trypsinogen, comes into the intestine, it becomes activated by the enzyme enterokinase and converted into the powerful proteoclastic enzyme, trypsin. Enterokinase is secreted by the glands of the duodenum. Trypsin acts upon unchanged proteins, proteoses, etc., from the stomach and converts them almost entirely into amino acids. A complex polypeptide is also formed which is not acted upon by trypsin.

IV. *Intestinal Juice.*

The cells of the small intestine also produce a secretion—the succus entericus—which contains erepsin, a peculiar proteoclastic enzyme discovered by Cohnheim; it acts only upon proteoses and peptones, converting them into amino acids. This juice also contains invertase and lactase. These enzymes act not only in the secreted juice but also inside the cells of the mucous membrane. Any unhydrolysed protein or polysaccharide is hydrolysed into its constituents.

V. *Autolysis.*

Proteoclastic and other enzymes are present in all tissues; they are concerned in the breaking down of the constituents of the tissue and in their synthesis.

They are the cause of the auto- or self-digestion of the tissues after death; in starvation, food is supplied by the breaking down of some organs at the expense of other organs by the autolytic enzymes.

VI. *Putrefaction.*

In the large intestine food remains are acted upon by bacteria. Amino acids are formed from proteins and they are further broken down into amines, carbon dioxide, indole, scatole, hydrogen sulphide, fatty acids. Unabsorbed carbohydrates and fats are also hydrolysed and decomposed.

VII. *The Liver.*

The liver is concerned most intimately with the products formed during digestion in the intestine, especially the monosaccharides and the fats, and with the regulation of their amount in the blood. Monosaccharides, chiefly glucose, are converted into glycogen and retained as reserve food-stuff to be broken down again when the amount of glucose in the blood sinks below its normal limit. 1 to 2 per cent. of glycogen is present in the livers of well-nourished animals, but generally it varies from .1 to .5 per cent. According to Külz the greatest amount is present in the liver 14 to 16 hours after a meal. The fats undergo changes in the liver cells—the saturated become unsaturated and they are oxidised to simpler fatty acids and hydroxy acids which circulate in the blood. The amino acids undergo deamination in the liver as well as in the other tissues. Liver cells contain arginase, which hydrolyses arginine to urea and ornithine. The liver is additionally concerned in the formation of urea from ammonia and carbon dioxide; in birds with that of uric acid as well. It also breaks down the hæmoglobin of the blood and excretes the products, bilirubin and biliverdin, into the intestine through the bile duct.

DEMONSTRATION OF THE ACTION OF ENZYMES.

Since enzymes can only be recognised by their action, their demonstration necessitates the knowledge of the chemical and physical properties of the compounds upon which they act; e.g. starch and its products maltose and dextrin, fats and their products glycerol and fatty acids, proteins and their products the proteoses, peptones and amino acids. Either the disappearance of substrate, or the appearance of the products, or both, may be demonstrated.

Frequently the amount of enzyme in a solution or in a preparation is very small and a considerable time must be allowed before its action can be demonstrated, e.g. from 1 day to 3 or 4 days. Under these conditions an antiseptic, preferably 1 per cent. of toluene or chloroform, is added to prevent the action of bacteria. The antiseptics destroy the bacteria or inhibit their growth; they have no action on the enzyme.

* I. Diastase or Amylase.

(1) *Malt Diastase.*

The chief source of diastase is malt. Malt is prepared by steeping barley or other seeds of cereals in water and allowing them to germinate in a warm place until the plumules have reached a length of about $\frac{1}{2}$ inch. The sprouted grain is dried and cured in a kiln. The composition of the grain alters under these conditions: the amount of starch decreases, the amount of reducing carbohydrates increases. Its colour is light to dark yellow. The seeds should break easily, should have a white interior and a sweet flavour. Malt should be free from broken and damaged seeds and the dried rootlets.

Malt extract is prepared from the dried material by treatment with water; the aqueous solution may be evaporated to dryness. Its chief use is in brewing, but it is used in medicine as a food for its high content in maltose and for its diastatic action; some varieties of malt extract contain no diastase as they have been boiled.

A 1 to 2 per cent. filtered extract serves for the demonstration of diastase.

An active diastase is prepared by treating malt, or ground barley, with 2 to 4 parts of 20 per cent. alcohol, for 24 hours. The extract is precipitated by adding not more than $2\frac{1}{2}$ volumes of alcohol. The precipitate is rapidly treated with absolute alcohol and ether and dried *in vacuo*. (Lintner.)

(2) *Pancreatic Diastase.*

A solution containing diastase can be prepared from the pancreas of animals by allowing a fresh pancreas (free from fat), which has been finely minced, to stand with twice its weight of glycerin, for 12 to 24 hours and straining through muslin. Before use the solution may be diluted with 1 to 2 volumes of water or preferably 1 to 2 drops of the concentrated extract may be used. Diastase is present in pancreatic juice and may be detected in 1 to 1 c.c. as described below.

* (3) *Salivary Diastase.*

A solution of this diastase is prepared by rinsing out the mouth two or three times with 20 c.c. of distilled water, warmed to 40°, for 1 to 2 minutes. The water is collected in a beaker and filtered.

A 1 to 2 per cent. solution of soluble starch or starch paste solution is prepared as substrate. The presence of diastase is shown by the disappearance of starch and the appearance of erythro-dextrin, achroo-dextrin and maltose; thus:—

A series of drops of iodine solution are placed upon a porcelain plate, or upon a glass plate on white paper. 5 c.c. of starch solution are placed in each of two test tubes, 5 c.c. of diastase solution is placed in the one and 5 c.c. of boiled diastase solution in the other.

The second tube acts as a control. The hydrolysis proceeds more rapidly at 40° so that the test tubes are placed in a bath at this temperature.

A drop is removed from each solution immediately after the mixtures have been made and placed against an iodine drop.

The mixture in the first tube soon becomes less opaque, if starch paste solution has been used.

At intervals of half a minute, or a minute, drops are removed from each test tube and placed against another iodine drop. The blue colour given by the control tube is given each time the test is made, but the colour becomes reddish-brown in the case of the other tube and finally no colour at all is given. Achroodextrin and maltose have been formed. Each test tube, after about 5 minutes, is tested with Fehling's solution. The control tube shows no reduction, but the presence of maltose in the other tube is shown by a marked reduction.

* *Effect of Temperature, 0° , 45° , 100° , upon Diastase.*

The same experiment is performed with two test tubes containing 5 c.c. of starch solution and 5 c.c. of diastase solution, but one of them is placed in cold water, or better, ice, and the second in a water-bath at 45° . The time when the various colours are given and when no colour is given with the iodine drops is noted.

The hydrolysis takes place more slowly in the tube kept at the lower temperature. A third test tube is prepared containing 5 c.c. of starch solution, but to it is added 5 c.c. of boiled and cooled diastase solution. It is placed in the bath at 45° . A drop taken from this tube will give a blue colour with iodine. The enzyme has been destroyed by boiling.

In experiments with enzymes a control experiment is carried out with boiled enzyme solution instead of water. The enzyme solution usually contains other substances besides the enzyme and the same amount of these is added to the substrate in each experiment. It is extremely important to carry out such a control experiment, especially in cases where a rough measurement has to be made to demonstrate enzyme action, e.g. in the cases of lactase and maltase.

* *Effect of Acid, Alkali and Salt upon Diastase.*

5 c.c. of starch solution, 1 c.c. of water and 5 c.c. of saliva solution are placed in one test tube.

5 c.c. of starch solution, 1 c.c. of dilute hydrochloric acid (1N or 0.4 per cent.) and 5 c.c. of saliva solution are placed in a second test tube.

5 c.c. of starch solution, 1 c.c. of dilute acetic acid (0.5 per cent.) and 5 c.c. of saliva solution are placed in a third test tube.

5 c.c. of starch solution, 1 c.c. of dilute alkali (0.1N or 0.4 per cent.) and 5 c.c. of saliva solution are placed in a fourth test tube.

5 c.c. of starch solution, 1 c.c. of sodium chloride solution (1 per cent.) and 5 c.c. of saliva solution are placed in a fifth test tube.

The five tubes are placed in the water-bath at 40° and at intervals drops from each are tested with iodine solution.

Hydrochloric acid completely stops the action of diastase; acetic acid hinders the action, i.e. the conversion of starch into achroodextrin and maltose takes longer; alkali may hasten, but if strong will stop the action. A small concentration of sodium chloride hastens the action; sodium chloride of a concentration of 5 per cent. will hinder the action.

* II. Invertase.

The best source of invertase is yeast from which it may be prepared by several methods. *Method of Autolysis.*—It is most conveniently prepared by grinding 500 gm. yeast with 30 gm. of calcium carbonate into a thick paste and placing the paste in a wide-mouthed bottle. 25 c.c. of chloroform are added and it is kept for 3-4 days in a warm room. The solution is filtered from the insoluble matter and treated with an equal volume of alcohol. The precipitate is washed with alcohol and ether and dried *in vacuo* over sulphuric acid.

A 1-1 per cent. solution of the preparation is used to demonstrate the action of invertase. The autolysed yeast, if diluted about 100 times with water, also serves for showing the presence of invertase.

* A cane-sugar solution of 1 per cent. is prepared as substrate; 5 c.c. of the invertase solution are added to 5 or 10 c.c. of the cane sugar solution; at the same time 5 c.c. of boiled invertase solution are added to another 5 c.c. of cane sugar solution to act as a control.

The solutions may be kept for about 5 minutes at room temperature or at 40°. They are tested with Fehling's solution. Reduction only occurs in the first tube due to the formation of glucose and fructose.

Demonstration of Invertase in the Succus Entericus or Intestinal Mucous Membrane.

* The succus entericus, or an extract of the cells of the mucous membrane of the small intestine, prepared by grinding the material with sand, allowing it to stand with water for 12 hours in the presence of toluene and straining through muslin, is divided into two equal portions. One portion is boiled and cooled. To each portion is added an equal volume of 1 per cent. cane sugar solution. 1 per cent. of toluene is added to each and the two mixtures are kept at 37° for 12-24 hours. Each solution is tested with Fehling's solution. Reduction only occurs where the unboiled extract is present showing the presence of invertase.

* **III. Emulsin.**

Emulsin is prepared most easily from almonds. The almonds are ground and the oil is pressed out. The residual cake is treated with water at room temperature. The filtered solution is acidified with acetic acid (2 drops per 100 c.c.) to precipitate proteins. The filtrate is treated with an equal volume of alcohol. The enzyme preparation is thrown down, washed with alcohol and ether and dried. The precipitate can be immediately redissolved in water and used in experiments with emulsin.

* A substrate of 2 per cent. salicin is conveniently used. 5 c.c. of salicin solution are placed in each of two test tubes. To the one are added 5 c.c. of emulsin solution; to the other are added 5 c.c. of boiled emulsin solution. The two tubes are placed in a water-bath at 40° for 15-30 minutes or longer; in the latter case 1 per cent. of toluene should also be added. The solutions are tested with Fehling's solution. Reduction occurs in the first tube in which the salicin has been hydrolysed to saligenin and glucose.

Amygdalin may also be used as substrate and the formation of hydrogen cyanide tested for with picric acid paper.¹ This method has been used by Armstrong for detecting emulsin in plants. The plant leaf, etc., is put into a small test tube containing a drop of chloroform, and a few drops of amygdalin solution; the test tube is closed with a cork, to which is attached a piece of picric acid paper. If emulsin be present, the paper becomes brick-red in colour from the action of hydrogen cyanide. In a similar way the presence of amygdalin, of emulsin together with amygdalin, may be tested for.

* **IV. Lactase and Maltase.**

Since both lactose and maltose reduce Fehling's solution their hydrolysis by enzymes is difficult to demonstrate. It can only be satisfactorily demonstrated by the measurement of the reducing power. Lactose and maltose do not reduce Barfoed's reagent which is reduced by glucose and monosaccharides. Hence this reagent will serve to show the presence of these enzymes thus:—

* *Demonstration of Lactase in Intestinal Mucous Membrane.*

The mucous membrane is scraped off, ground up with sand to break the cells and kept in water with 1 per cent. of toluene for 12-24 hours. The solution is strained through muslin and divided into two nearly equal parts, say of 105 and 110 c.c. The larger part is boiled and cooled.

100 c.c. of unboiled solution are added to 100 c.c. of 5 per cent. lactose solution in a small flask (1). 100 c.c. of boiled solution are added to 100 c.c. of 5 per cent. lactose solution in a small flask (2). 1 c.c. of toluene is added to each; the two flasks are corked and kept at 37° for 1-4 days.

Flask (1) will show a reduction when tested with Barfoed's reagent.

Flask (2) will not show a reduction; if there is a slight reduction, this will be due to the presence of glucose in the extract.

¹ Filter paper moistened with a solution of 1 gm. picric acid + 10 gm. of Na₂CO₃ in 100 c.c. of water.

* **V. Zymase (Yeast).**

(Yeast contains a mixture of several enzymes. Its principal enzyme is zymase,) which acts upon the four natural hexoses. It contains also maltase and invertase, but it does not contain lactase. Lactase is only present in special yeasts, such as kefir. It is owing to the presence of maltase and invertase that yeast is able to ferment maltose and cane sugar and convert them into alcohol and carbon dioxide. Lactose is not fermented as it is not hydrolysed into its constituent monosaccharides. Before alcoholic fermentation can occur hydrolysis into monosaccharides must take place.

* The action of yeast upon the sugars is most conveniently demonstrated with a series of Einhorn fermentation tubes (p. 233). They are filled with 1 per cent. solutions of glucose, fructose, galactose, maltose, cane sugar and lactose, and a small piece of yeast is added to each. Fermentation proceeds slowly, but in 12 hours it will be observed that all the sugars except lactose have been fermented and that galactose is fermented more slowly, as shown by the smaller volume of carbon dioxide evolved.

The presence of zymase in the yeast can be shown either by preparing yeast juice by Buchner's method (p. 392) or by preparing maceration extract by Lebedeff's method. Fresh yeast is carefully dried. 100 gm. of the dried material are treated with 300 c.c. of water for 2 hours at 37°. The mixture is filtered rapidly on a large folded filter paper and the filtrate is collected in a vessel in ice.

Portions of 5 c.c. or 10 c.c. are added to 1 per cent. solutions of glucose, fructose and the other sugars in Einhorn fermentation tubes. After some hours the formation of carbon dioxide will become visible.

* **Specificity of the Action of Enzymes.**

* 5 c.c. of diastase solution are added to 5 c.c. of cane sugar solution and kept at 40° for some time. There is no conversion of cane sugar by diastase into glucose and fructose as shown by testing for reducing sugar with Fehling's solution.

* The same experiment is performed with 5 c.c. of salicin solution instead of cane sugar. Again there is no reduction of Fehling's solution.

* In the same way the action of 5 c.c. of the invertase solution is tested upon 5 c.c. of starch solution at 40°. There is no hydrolysis of starch by invertase. If any action occurs it is due to impurity in the invertase solution, i.e. to its containing a little diastase. It is very difficult to obtain enzyme solutions which contain only one enzyme. Most cell contents contain a mixture of enzymes.

* 5 c.c. of emulsin solution will not hydrolyse 5 c.c. of starch solution or 5 c.c. of cane sugar solution.

In the experiments with yeast neither invertase, nor maltase, nor zymase acted upon lactose.

* VI. **Lipase.**

Preparations of lipase are most conveniently obtained from castor-oil seeds and from pigs' pancreas:—

(a) Lipase from castor-oil seeds.

The seeds are shelled, freed from oil by pressure or by treatment with ether or petroleum ether and finely ground up with $\cdot 1N$ acetic acid.

The lipase is liberated by the treatment with acid. The insoluble matter is filtered off and washed free from acid. A suspension of it is made in water.

(b) Lipase from pancreas.

The pancreas is freed from fat, weighed, finely minced and ground up with sand. It is then extracted for 24 hours with a mixture consisting of 90 parts of pure glycerol and 10 parts of 1 per cent. sodium carbonate solution, 10 c.c. of this mixture being used for every gram of pancreas. The fluid is strained through muslin and is kept at 0° . The lipase is destroyed as soon as the fluid becomes acid; this happens generally in about three days.

An active extract may also be prepared by treating the fresh and finely minced pancreas with twice its weight of $\cdot 5$ per cent. sodium carbonate solution for 12 hours and straining through muslin.

As substrate for the action of lipase neutral olive oil (see p. 381), an emulsion of egg-yolk in water, milk and esters, such as ethyl butyrate, may be used. Hydrolysis occurs with the formation of fatty acids which are recognised by the acidity of the solution.

* The activity of the enzyme is shown as follows:—

(1) 5 c.c. of oil, or ester, are mixed with 5 c.c. of suspension, or extract.

(2) 5 c.c. of oil, or ester, are mixed with 5 c.c. of boiled suspension, or extract.

The two mixtures are placed in a water-bath at 40° for at least half an hour, preferably 2 or 3 hours, and the contents are occasionally mixed by shaking. At the end of this time a few drops of phenolphthalein are added to each and they are titrated with $\cdot 1N$ alkali. More acid will be required to neutralise the contents of (1).

* The presence of lipase in castor-oil seeds may be demonstrated as follows: 1 gm. of seed, freed from shell, is ground up with 25 c.c. of water saturated with chloroform; two equal parts of the suspension (10 c.c.) are placed in two test tubes and to each is added 1 c.c. of dilute acetic acid to liberate the enzyme. One portion is immediately boiled. The substrate is the oil of the seed. Both test tubes are kept at 40° for half to one hour. A few drops of phenolphthalein are added and they are titrated with $\cdot 1N$ alkali. More alkali will be required to neutralise the acid in the tube containing unboiled enzyme showing that fatty acids have been formed.

Demonstration of the Presence of Lipase in Pancreatic Juice.

- * The lipase in pancreatic juice may be demonstrated by adding a few drops, or 1 c.c., to neutral olive oil (about 5 c.c.) containing a drop of phenolphthalein. The mixture is coloured red by running in $\cdot 1N$ alkali from a burette. On keeping warm at 40° and occasionally shaking, decolorisation takes place. More alkali is run in, drop by drop, until the red colour again appears. It will disappear again. This can be repeated several times.

Effect of Bile Salts on Pancreatic Lipase.

- * Bile salts increase the rate of hydrolysis of fats by lipase and act as a co-enzyme. This can be demonstrated by the following three experiments :—

- (1) 5 c.c. neutral oil + 5 c.c. pancreas extract + 1 c.c. of water.
- (2) 5 c.c. ,, ,, + 5 c.c. ,, ,, + 1 c.c. of 1 per cent. bile salt solution.
- (3) 5 c.c. ,, ,, + 5 c.c. boiled ,, ,, + 1 c.c. of 1 per cent. bile salt solution.

These three mixtures are kept at 40° for half an hour and titrated with $\cdot 1N$ alkali using phenolphthalein as indicator. No. 3 requires least alkali, No. 2 requires most. More hydrolysis therefore occurs in the presence of bile salts.

* VII. Pepsin.

A solution of pepsin is readily prepared by treating the mucous membrane of the stomach with glycerin for 12-24 hours and straining the solution through muslin. Before use the glycerin extract is diluted with 2 or 3 volumes of water.

Dry preparations of pepsin in the form of powder or scales are obtained by precipitating aqueous extracts with alcohol, or evaporating them to dryness at a temperature below 40° . They generally dissolve slowly in water or $\cdot 1N$ hydrochloric acid. A 1 per cent. solution is convenient for the demonstration of pepsin.

As substrate for detecting the presence of pepsin, threads of fibrin or pieces of coagulated white of egg, are generally used.

- * The action of pepsin is demonstrated with five test tubes containing the following mixtures :—

- (1) 5 c.c. of water + 1 c.c. of pepsin solution + a piece of fibrin.
- (2) 5 c.c. of $\cdot 1N$ HCl + 1 c.c. of water + a piece of fibrin.
- (3) 5 c.c. of $\cdot 1N$ HCl + 1 c.c. of pepsin solution + a piece of fibrin.
- (4) 5 c.c. of $\cdot 1N$ HCl + 1 c.c. of boiled pepsin solution + a piece of fibrin.
- (5) 5 c.c. of $\cdot 1N$ Na_2CO_3 + 1 c.c. of pepsin solution + a piece of fibrin.

The test tubes are placed in a bath at 40°.

Pepsin will only act in the presence of acid; consequently digestion or solution of the fibrin will only take place in the third test tube, where, in about half an hour, the fibrin will have disappeared. In order to show that it is not the acid which has this effect, the second tube, containing no pepsin but only acid, was used as a control. In this tube the fibrin will have become swollen, but not dissolved. The first, fourth and fifth tubes will be seen to be unaltered. They both contained pepsin and they show that pepsin will not act in a neutral or alkaline medium. Hence pepsin only acts in the presence of acid.

* **Action of Alkali on Pepsin.**

Pepsin is destroyed by the action of dilute alkaline solutions, such as are found in the intestine, where the action of pepsin ceases for this reason; thus 2 c.c. of dilute sodium carbonate solution are added to 5 c.c. of pepsin solution and it is put in a water-bath at 40° for at least half an hour. It is neutralised with 0·4 per cent. hydrochloric acid, an equal volume of 0·4 per cent. hydrochloric acid and a piece of fibrin are added and it is again kept at 40°. Digestion will not occur.

* *The Products of the Action of Pepsin.*

Proteins are hydrolysed by pepsin and converted into metaproteins, proteoses and peptones. In a very prolonged digestion amino acids may be formed in small quantities: they are most probably formed by the action of other proteoclastic enzymes—the autolytic enzymes—which have been extracted from the cells of the mucous membrane together with pepsin.

* Several grams (2·5) of fibrin or egg-white are placed in 1N hydrochloric acid solution and 5-10 c.c. of pepsin solution are added. The fibrin dissolves in the course of half to one hour.

The presence of

- (1) Metaprotein is shown by neutralising and filtering.
- (2) Proteoses by boiling and acidifying the filtrate and testing a portion with concentrated nitric acid. The precipitate which is formed dissolves on heating and reappears on cooling. They are removed by saturating the solution with ammonium sulphate.
- (3) Peptone by testing the filtrate from the ammonium sulphate precipitate by the biuret reaction in the presence of excess of caustic soda (p. 373).

* VIII. Trypsin.

Trypsin is the activated proteoclastic enzyme of the pancreas. It may be prepared by extracting the minced gland with glycerin for 12-24 hours and straining through muslin. The solution is diluted with 2-3 volumes of water before use.

An active solution of trypsin may also be prepared by treating the minced pancreas with 3 times its weight of distilled water and an equal weight of alcohol for 3 days at room temperature with occasional shaking. The solution is strained through muslin and filtered. To the filtrate 1 c.c. of concentrated hydrochloric acid per 1000 c.c. is added. A precipitate which forms is allowed to settle and is filtered off.

In preparing trypsin from the pancreas it is advisable to add a small amount of the mucous membrane of the intestine so as to activate the enzyme in case this is not done by contact with the intestine on removing the pancreas.

Dry preparations of trypsin can be obtained by mincing the pancreas and drying, or by precipitating with alcohol or evaporating the extracts.

Numerous preparations of trypsin can be obtained commercially, e.g. Benger's liquor pancreaticus, holadin of Messrs. Fairchild Bros. & Foster. This latter preparation also contains lipase and diastase.

* Solution of fibrin or coagulated egg-white by the enzyme, as in the case of pepsin, is the simplest means of investigating the presence and action of trypsin.

Four test tubes are filled with the following mixtures:—

✓ (1) 5 c.c. of trypsin + 5 c.c. of .5 per cent. Na_2CO_3 + a piece of fibrin.

✓ (2) 5 c.c. of trypsin + 5 c.c. of water + a piece of fibrin.

✓ (3) 5 c.c. of trypsin + 5 c.c. of .1N HCl + a piece of fibrin.

✓ (4) 5 c.c. of boiled trypsin + 5 c.c. of .5 per cent. Na_2CO_3 + a piece of fibrin.

The four tubes are placed in a water-bath at 40°. Only in the first tube will any change be seen. In the tube containing hydrochloric acid the fibrin swells without dissolving. In the aqueous solution there is no visible change, nor in the tube containing boiled enzyme. Trypsin thus acts only in faintly alkaline solution of 0.2-0.5 per cent. concentration.

As substrate polypeptides, such as glycyl-tyrosine, glycyl-tryptophan and a peptone from silk have been used to detect trypsin. The tyrosine separates out and the bromine water reaction for tryptophan becomes positive.

* *The Products of the Action of Trypsin.*

Proteins are hydrolysed by trypsin and converted into amino acids (and a polypeptide).

The demonstration of the amino acids can be shown in a digest of protein, prepared by treating about 100 gm. of caseinogen, or other protein, dissolved in 2000 c.c. of 1N ammonia or sodium carbonate at 37° for several days with about 1 gm. of dried pancreas preparation in the presence of toluene or chloroform.

(1) The solution will most probably contain a white precipitate, which consists mainly of tyrosine. This is proved by filtering it off, washing and dissolving it in dilute acetic acid and testing with Millon's reagent (p. 268).

(2) The filtrate from the tyrosine can be shown to contain tryptophan by acidifying a portion of about 5 c.c. with acetic acid and adding bromine water, drop by drop, as described on p. 349.

(3) On evaporating the filtered solution on a water-bath to a small volume and allowing to stand for about 24 hours, a crystalline crust forms. This consists mainly of tyrosine as can be shown by microscopic examination, especially after solution in a drop of ammonia. The crystals will also give Millon's reaction.

(4) On further evaporation of the filtrate leucine and glutamic acid separate out on standing. Microscopic examination will show that the crystals consist mainly of rounded cones with a radiating striation (leucine). If free from tyrosine they will not give Millon's reaction. They dissolve in hot water and form copper salts, as can be shown by adding a very little caustic soda and a few drops of copper sulphate. The precipitate of cupric hydroxide dissolves on warming, giving a blue solution.

* IX. *Trypsinogen.*

Trypsinogen is present in the pancreas and is contained in pancreatic juice; it may be prepared from the pancreas by the method described by Mellanby and Woolley :—

The pancreas is removed without contact with the intestines. It is finely minced and treated with twice its weight of 5 per cent. hydrochloric acid at room temperature for 12 hours. The solution is strained through muslin and neutralised with sodium carbonate. The precipitate is filtered off and the solution is kept under toluene.

Preparation of Pancreatic Juice.

The mucous membrane of the small intestine is ground up with sand and boiled with dilute hydrochloric acid. The boiling solution is neutralised with dilute alkali. Coagulable proteins are thus precipitated and filtered off. The solution contains *secretin*. Secretin is not an enzyme as it can be boiled, but belongs to the class of substances termed *hormones* by Professor Starling.

A cannula is placed in the pancreatic duct and the solution of secretin is slowly injected into the jugular vein. Pancreatic juice flows from the cannula after each injection and is collected in a clean vessel. It is mixed with an equal volume of 2 per cent. sodium fluoride to preserve it.

* *Activation by Enterokinase. Conversion of Trypsinogen into Trypsin.*

A solution of enterokinase is prepared by making an aqueous extract of the mucous membrane of the upper part of the small intestine.

(a) As substrate a capillary tube (Mett's tube, cf. p. 421) of 1-2 mm. bore about 2 cm. long and filled with coloured gelatin is generally used. These are prepared by drawing up hot 10 to 20 per cent. gelatin solution stained with methylene blue or gentian violet into the tube, placing the tube horizontally and allowing the gelatin to set. The tube is cut into pieces 1-2 cm. long. They can only be used for experiments at room temperature; at 40° the gelatin melts and flows out of the tube.

Two of these tubes are placed in each of three small conical flasks together with 5 c.c. of 5 per cent. sodium carbonate solution.

In the first is placed 1-2 c.c. of pancreatic juice or trypsinogen solution.

In the second is placed 1-2 c.c. of pancreatic juice or trypsinogen solution + a few drops of enterokinase solution.

In the third is placed 1-2 c.c. of boiled pancreatic juice or trypsinogen solution and a few drops of enterokinase solution.

The flasks are kept at room temperature for 8 to 10 hours.

No solution or digestion of the gelatin occurs in No. 1 or No. 3 which contained the trypsinogen or the boiled trypsinogen, but in No. 2 the gelatin will have been dissolved at both ends of the capillary tube.

* (b) H. Bierry and V. Henri have shown that milk is a very sensitive substrate for observing the activation of pancreatic juice by enterokinase. The milk is centrifugalised and filtered from fatty particles through wet paper and is sterilised by heating.

In four clean test tubes are placed:—

(1) 5 c.c. of milk + 5 drops of pancreatic juice.

(2) 5 c.c. of milk + 5 drops of pancreatic juice + 2 drops of intestinal extract.

(3) 5 c.c. of milk + 5 drops of boiled pancreatic juice + 2 drops of intestinal extract.

(4) 5 c.c. of milk + 2 drops of intestinal extract.

They are put in a water-bath at 40° for 10 to 15 minutes. No change will be found to have occurred in tubes No. 1, No. 3 and No. 4, whereas in No. 2 there is an immediate clarification of the milk, which becomes transparent after the lapse of the above time.

* **X. Erepsin.**

Erepsin is contained in the cells of the mucous membrane of the small intestine and a solution is prepared by grinding the membrane with sand and treating with water, to which 1 per cent. of toluene has been added, for 12 to 24 hours. The solution is strained from sand and connective tissue through muslin. Erepsin acts upon proteoses and peptones forming amino acids; a 2 per cent. solution of Witte's peptone is therefore used as substrate.

Two portions of Witte's peptone solution (500 c.c.) are placed in bottles; to one portion 100 c.c. of erepsin solution are added; to the other portion 100 c.c. of boiled erepsin solution. To both are added 6 c.c. of toluene and they are kept at 37° for 1 to 3 days.

A portion of each is examined for proteoses and peptones by the biuret reaction by adding exactly the same amount of caustic soda solution (5 c.c.) and exactly the same amount of 1 per cent. copper sulphate solution.

The solution which contained boiled enzyme will show the biuret reaction (the substrate is unchanged).

The solution which contained enzyme will either not show the biuret reaction or it will be fainter than in the other solution (the substrate has been hydrolysed completely or not quite completely).

XI. Papain and Vegetable Proteoclastic Enzymes.

Papain is prepared from the juice of the papaw tree by evaporation or by precipitation with alcohol.

Bromelin is present in the juice of the pine-apple; the juice is neutralised before testing its action.

These enzymes can be demonstrated in a similar way to pepsin and trypsin by using fibrin or coagulated egg-white as substrate:—

In six test tubes are placed:—

- (1) 5 c.c. of water + 5 c.c. of papain solution + a piece of fibrin;
- (2) 5 c.c. of water + 5 c.c. of boiled papain solution + a piece of fibrin;
- (3) 5 c.c. of 1N HCl + 5 c.c. of papain solution + a piece of fibrin;
- (4) 5 c.c. of 1N HCl + 5 c.c. of boiled papain solution + a piece of fibrin;
- (5) 5 c.c. of 1N Na_2CO_3 + 5 c.c. of papain solution + a piece of fibrin;
- (6) 5 c.c. of 1N Na_2CO_3 + 5 c.c. of boiled papain solution + a piece of fibrin; and they are put in a water-bath at 40°.

The fibrin dissolves in (3) and (5) fairly rapidly; very slowly or not visibly in (1). There is no solution in (2), (4), (6).

Papain thus acts in the presence of either acid or alkali.

The Products of the Action of Vegetable Proteoclastic Enzymes.

In most respects the vegetable proteoclastic enzymes resemble trypsin. They form amino acids from proteins. Their action is very slow and complete conversion of protein to amino acids takes several weeks. The experiment is performed as described under trypsin with 100 gm. of caseinogen.

The Presence of two Vegetable Proteoclastic Enzymes.

By extracting seeds of *Cannabis sativa* with 10 per cent. salt solution and acidifying the solution with acetic acid, Vines has separated the proteoclastic enzymes of the plants into two groups. The precipitate contains a pepsin, the filtrate an erepsin. Since other extracts can also be separated in a similar manner, Vines considers that plants contain two kinds of proteoclastic enzymes: (1) Peptic, producing proteoses, etc.; (2) Ereptic, producing amino acids from proteins and proteoses, etc.

XII. Oxidases.

A. *Catalase*.

A catalase is present in most animal and vegetable tissues. Solutions may be prepared by extracting the tissues with water; the extracts are usually not very active and a piece of tissue is used directly.

Since catalase acts upon hydrogen peroxide with the formation of oxygen only hydrogen peroxide can be used as substrate.

* E.g. a piece of liver is placed in a test tube and covered with a dilute solution of hydrogen peroxide. An evolution of oxygen occurs.

B. *Peroxidase*.

Peroxidases are very abundant in plant tissues. Active solutions are best prepared from horse-radish, potato, or fungi, by grinding up the material, treating with water and filtering from insoluble matter.

A substrate is usually present in the plant tissue together with the enzyme. On bruising the tissue it becomes brown like the cut surfaces of apples and pears, or it may become blue or red as in some species of fungi. The substrate is a dihydric or trihydric phenol—such as hydroquinone or pyrogallol. In the tissue an organic peroxide, or oxygenase, is also frequently present. On bruising the tissue, oxygen is taken up from the air and the peroxide is formed. The peroxidase acts upon the peroxide giving “active” or nascent oxygen, which oxidises the substrate. These oxidases are sometimes called direct oxidases.

Sometimes the colour is only given after hydrogen peroxide or other peroxides (especially organic peroxides), such as are present in oil of turpentine which has been exposed to the air, are added. Such oxidases are called indirect oxidases.

For purposes of demonstration a variety of phenolic substances are used as substrate.

(1) Guaiacum. A freshly prepared 1 per cent. solution in alcohol (tincture of guaiacum). It changes to blue on oxidation.

(2) Guaiaconic acid, the constituent of guaiacum. A .5 to 1 per cent. solution in alcohol.

(3) *α*-naphthol. A 1 per cent. solution in equal parts of water and alcohol. When oxidised it becomes lavender in colour. This substrate has been largely used in botanical work.

(4) Guaiacol. A 2 per cent. solution in alcohol. It is oxidised to tetraguaiacoquinone, which is red.

(5) Benzidine. A 1 per cent. solution in 50 per cent. alcohol. It becomes blue on oxidation and a brown precipitate is formed.

(6) *p*-phenylenediamine hydrochloride. A 1 per cent. solution in water. It becomes greenish in colour.

(7) Indophenol. A 1 per cent. *α*-naphthol solution in 50 per cent. alcohol and a 1 per cent. aqueous solution of *p*-phenylenediamine hydrochloride are required. 2 or 3 drops of each of these are added to the enzyme solution which is made faintly alkaline with sodium carbonate. A purple solution results.

* A few drops of any of these reagents are added to about 5 c.c. of the oxidase solution to which a few c.c. of hydrogen peroxide have been added. The colour slowly forms.

Peroxidases are present in milk and blood (pp. 458, 476).

* The direct oxidase may be observed in potato: a drop of guaiacum solution is placed upon the cut surface; in a short time it becomes blue.

* The presence of an oxidase in minced tissues is readily detected by the indophenol reaction as shown by Vernon.¹ The reaction takes place according to the equation:—

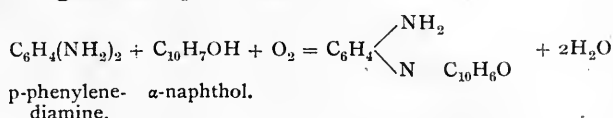

The substrate consists of 144 per cent. solution of *α*-naphthol (0.01 M) and 11 per cent. paraphenylenediamine (0.01 M) in 50 per cent. alcohol. 5 c.c. of the solution together with about 5 c.c. of 1 per cent. sodium carbonate solution are poured upon 5 to 1 gm. of minced tissue in a flat dish (a Petri dish 8.8 cm.) and well stirred with the tissue. The indophenol begins to form almost at once.

¹ J. Physiol., 42, 402.

THE CATALYTIC ACTION OF ENZYMES.

The resemblance of the action of enzymes to that of inorganic catalysts was pointed out by Berzelius. The agent producing the chemical change apparently takes no part in the reaction and can at the end be recovered unchanged. Minute quantities are capable of effecting a large amount of change; as an example may be quoted O'Sullivan and Tompson's statement that invertase can hydrolyse 200,000 times its weight of cane sugar.

The resemblance is most marked if the velocity of the action of enzymes be compared with that of inorganic catalysts, as is shown in the curves in Fig. 55.

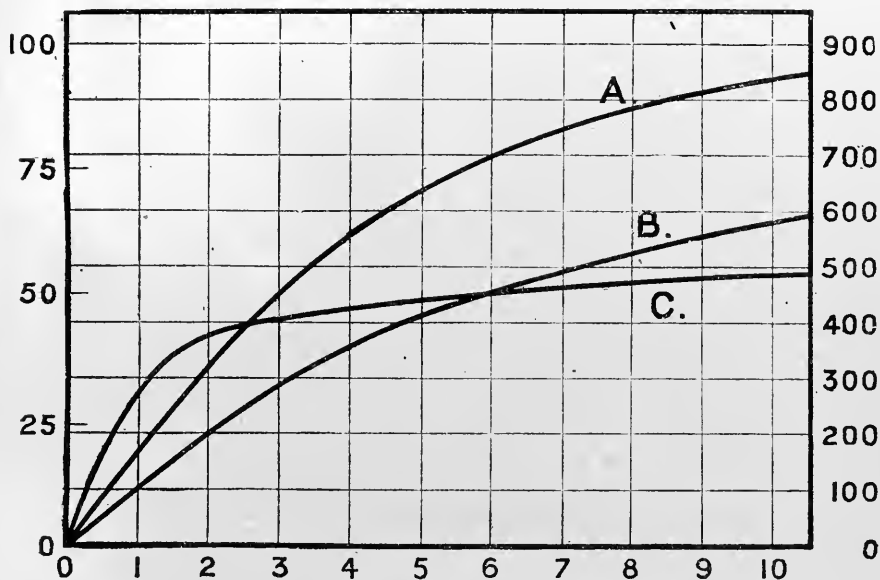

FIG. 55.—From Bayliss's "Nature of Enzyme Action".

Curve B is the velocity of the action of hydrochloric acid upon cane sugar. Curve A is that of invertase upon cane sugar. Curve C is that of trypsin upon caseinogen. This latter curve is the most typical of enzyme action, that of invertase being more exceptional.

The curve B is a logarithmic curve. The enzyme curves deviate from this in two important particulars. They are linear at the commencement and at the end. The cause of the deviation of the enzymic curve from that of a proper catalytic curve has been found to be due to three causes:—

(1) Disappearance of the enzyme during the course of the action. Enzyme solutions, as previously stated, are never pure; they contain other substances which act upon and remove or destroy the enzyme.

(2) Effect of the products of the action; they hinder the reaction.

(3) Combination of the enzyme with the substrate which also takes an appreciable time.

The linear part of the curve is the result when either substrate is in excess at the beginning, or enzyme in excess at the end.

Demonstration of the Catalytic Action of Enzymes.

The catalytic action of enzymes is readily followed by analysing the amount of decrease of the substrate or the amount of the products formed at intervals during the progress of the reaction.

Physical methods of analysis are preferable to chemical methods as they are easier of manipulation, e.g. :—

(1) Optical activity. The rotation of the solution of enzyme and substrate is taken immediately the mixture is made and at intervals of 1 minute, 1 hour, 1 day afterwards. Throughout the experiment a constant temperature must be maintained.

(2) Electrical conductivity. This method can be employed when electrolytes are produced as end products, e.g. fatty acids from ethyl butyrate and amino acids by the action of trypsin upon proteins.

(3) Viscosity. Protein solutions are viscous and the decrease in viscosity can be measured. The results by this method are not so accurate.

When chemical methods are employed samples of the solution must be removed at the beginning and at intervals from a larger bulk of solution. The action of the enzyme must be stopped immediately after removing the solution. This cannot be effectively accomplished by boiling as it is impossible to raise the temperature of the samples to boiling at the same rate; it can only be done by pouring the enzyme solution into boiling water. In this case dilution occurs and the manipulation of the solution is troublesome.

The action of the enzyme is most effectively stopped by adding an excess of alkali or acid. In the case of carbohydrates the mutarotation¹ of the solution takes place immediately on adding the alkali. Since enzymes are associated with proteins or complex carbohydrates, precipitation with heavy metals or tannic acid is very convenient. A definite volume of the solution is added to a definite volume of the reagent. A known volume of the filtrate is analysed after removing the heavy metal or other reagent. Each sample is analysed in exactly the same way.

¹The sugar is split off in either the α or β forms; the equilibrium mixture is thus obtained immediately; by noticing the change in rotation on adding alkali it can be ascertained whether the α or β form of the sugar is contained in the substrate.

THE SYNTHETICAL ACTION OF ENZYMES.

The majority of the chemical changes effected by enzymes are hydrolytic changes. The substrate consists of a compound which can be hydrolysed into two or more constituents and in most instances the organic compound has been synthesised from its constituents. The reactions are reversible. The typical example of a reversible reaction is the formation and hydrolysis of methyl acetate:—

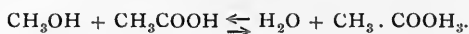

These reactions have been measured and it has been found that an equilibrium is reached from whichever side the reaction is started when the composition of the mixture of the four substances is

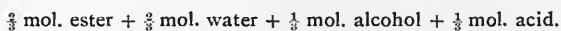

Other similar reactions have also been measured and their equilibrium positions have been determined. Reversible reactions proceed according to the Law of Mass Action. The effect of a catalyst upon reversible reactions, as it effects the reaction to the same degree from both sides, is not to alter the position of equilibrium of the reaction. The final position in the case of enzymes is usually reached when the products of hydrolysis make up over 90 and sometimes nearly 100 per cent. of the mixture. This is on account of the large proportion of water present. Enzymes as catalysts should therefore accelerate the reaction in both directions, i.e. be capable of synthesising the compounds which they hydrolyse. The synthetic power of enzymes has been demonstrated in only a few cases, e.g. that of maltase by Croft Hill, of lipase, of emulsin and of trypsin. The demonstration of the synthetical action of enzymes is difficult as the equilibrium point is generally so near the point of complete hydrolysis. It can be shown most easily in the cases of lipase and of emulsin. The following experiment devised by Bayliss shows the synthetical action of emulsin:—

18 parts of pure anhydrous glucose are dissolved in 12 parts of water and cooled. 40 parts of dry glycerol and 3 parts of emulsin are added. The rotation of the mixture ($+2.83^\circ$) is taken immediately the mixture is made. The mixture is kept at 47° for seven days and the rotation again observed ($+1.80^\circ$); in fifteen days the rotation is -1.6° , which corresponds to 75 per cent. of synthesis. A control experiment is made with emulsin alone omitting the glucose. In order to show that glucose has not disappeared by other reactions, the mixture is diluted with 2 to 3 volumes of water and a fresh quantity (5 gm.) of emulsin is added. The rotation of the solution is taken immediately and again after 2 or 3 days when hydrolysis is complete. It will be found to be the same as the original rotation of the mixture, allowing for the dilution.

Croft Hill and Bayliss point out that though the synthetical reaction is so small it suffices for synthesis in nature; the synthetical product is usually a colloid and insoluble; it is removed from the reaction and synthesis will continue. Bayliss considers that we have no cause for believing that there are enzymes which act specially as synthetical catalysts of the natural compounds.

THE MEASUREMENT OF THE ACTIVITY OF ENZYMES.

In order to determine the activity of an enzyme solution four factors must be taken into account. This was first clearly established by Kjeldahl in 1879 in the case of the diastatic enzyme of malt, namely :—

- (1) The temperature at which the action takes place.
- (2) The time during which the enzyme acts.
- (3) The amount of enzyme solution.
- (4) The concentration of the substrate solution.

The amount of enzyme solution must be small in comparison with the amount of substrate and the change must not exceed 30-40 per cent. of the total change. These statements correspond to the curve of the catalytic action of enzymes. The curve is linear at the commencement and again at the end. The measurement is proportional only during the linear part of the curve where the amount of enzyme is small and the substrate large in comparison. The linear portion of the curve corresponds to 30-40 per cent. of hydrolysis.

The temperature and the concentration of the substrate are fixed, and by fixing either the time or the amount of enzyme solution the fourth factor can be determined. As the basis of comparison it is best to determine the time taken to effect an equal change. This is most important where the reaction takes place in stages; comparable values can be obtained only in this way. More frequently the amount of enzyme required to produce an equal change, or the amount of change produced by equal amounts of enzyme solution in a given time, is determined.

The measurements are made either by chemical methods or by physical methods, depending upon the properties of the substrate and the products.

I. Diastase.

The measurement of the diastatic activity of malt is of practical importance in brewing and certain standard methods of making the extract and of determining the hydrolysis have been adopted.

Preparation of the Extract.

25 gm. of malt are treated with 500 c.c. of water for 3 hours at 21°. The solution is filtered and the first 100 c.c. are rejected. The activity of the perfectly clear extract is determined by method (a) or (b).

(a) Lintner's Method.

In each of a series of ten clean test tubes is placed the same quantity of soluble starch solution (10 c.c. of 2 per cent.) and then a progressively increasing quantity of enzyme solution, thus 0.1 c.c. in No. 1, 0.2 c.c. in No. 2, 0.3 c.c. in No. 3, and so on. The contents are mixed and placed in a water-bath at 21° for exactly 1 hour. 5 c.c. of Fehling's solution are now placed in each tube, the tubes are heated in a boiling water-bath for 20 minutes and then examined. Some of the tubes in the series will show no blue colour, or are faintly yellow, whilst others are still blue. The amount of enzyme in the first colourless tube is that amount which will just convert the fixed amount of starch into maltose in the given time.

The diastatic power is based upon 0.1 c.c. enzyme solution and called 100. ∴ if the result was between the sixth and seventh tubes the diastatic power, D, is

$$\frac{100}{0.65} \times 0.1 = 15.55.$$

Generally 1.5 is deducted as due to reducing sugars in the extract. The extract is diluted with an equal volume of water, if D is very high.

It is generally necessary to repeat the experiment once or twice.

(b) Ling's Method.

3 c.c. of the diastase extract are added to 100 c.c. of 2 per cent. soluble starch solution in a 200 c.c. measuring flask heated to 21°. It is allowed to act for 1 hour at this temperature. 10 c.c. of .1N caustic alkali are added to stop the action; the solution is cooled to 15.5°, made up to 200 c.c. and well mixed. The amount of reducing sugar is estimated against 5 c.c. Fehling's solution heated to boiling over a naked flame, the solution being added slowly, 5 c.c. at a time, and kept boiling until the reduction is complete as ascertained by Ling's indicator. The result is calculated from

$$D = \frac{1000}{xy}$$

where D is the diastatic activity, x = c.c. of malt extract in 100 c.c. of diluted solution, y = c.c. of liquid required to reduce the Fehling's solution.

It is not accurate for values of D above 50 so that less malt extract (2 c.c. or 1 c.c.) must be taken and the measurement repeated.

(c) Roberts' Method.

Though not so accurate, this method is the most rapid to carry out. Here the time taken to effect the change of 1 per cent. starch solution into achroodextrin is measured. The stage at which no colour is given by iodine solution, i.e. when the last traces of erythro-dextrin have been converted into achroodextrin, is known as the achromic point. The time taken to reach this point is termed the "chromic period". The time taken to reach the achromic point must be between 2 and 10 minutes. The diastatic power D is the number of c.c. of starch solution which can be converted by 1 c.c. of enzyme solution in 5 minutes, or

$$D = \frac{n}{v} \times \frac{5}{t}$$

where n = number of c.c. starch solution taken, v = volume of enzyme solution (dilution must be known), t = time, 5 = 5 minutes.

5 c.c. of 1 per cent. starch solution are warmed to 40° and 1.5 c.c. of diastase solution are added. The time is noted at which the mixture is made. At intervals of $\frac{1}{2}$ to 1 minute a drop is removed and tested against a drop of iodine solution. The time is taken at which no colour is given, i.e. when the achromic point is reached.

Vernon¹ states that this method is very exact if corrected by means of a table which he gives.

(d) *Wohlgenuth's Method.*

This method is carried out in a similar way to Lintner's method with varying quantities of enzyme solution, but the disappearance of starch as shown by the iodine reaction is taken account of.

5 c.c. of 1 per cent. starch solution are placed in each of a series of 10 tubes and cooled to 0°, whilst an increasing quantity of enzyme solution is added to each tube in the series. They are transferred to a bath at 40° for 30 or 60 minutes and after this time again cooled to 0° to stop the action. Each tube is filled with water and one drop of .1N iodine solution is added to each. The colours are blue, blue-violet, reddish and yellow. The limit is taken as that tube which still shows a violet colour. The activity of the solution is then calculated on the basis of the power of 1 c.c. enzyme solution. Thus if the tube in the series contain 0.3 c.c. enzyme solution, then the diastatic power at 40° in 30 minutes or D_{30}^{40} is $\frac{5}{0.3} = 16.6$.

It has been shown by Evans² that this method only gives certain values for D, that the values are only approximate and that it is not accurate when the volumes of saliva added are in geometrical progression. He finds that the achromic point method is more delicate.

(e) *Other Methods.*

The reducing sugar may be estimated gravimetrically or by any other method for estimating carbohydrates. Proteins, etc., should be removed before the estimation (see under lactase).

Pancreatic Diastase.

The diastase of the pancreas does not hydrolyse properly except in the presence of salts; 3 gm. of sodium chloride and 7 c.c. of .2N disodium phosphate should be added per 100 c.c. of reaction mixture.³

¹ J. Physiol., 27, 182.

² *Ibid.*, 44, 220.

³ Sherman, Kendall and Clark, J. Amer. Chem. Soc., 1910, 32, 1073.

II. Invertase, Emulsin.

In measuring the activity of these enzymes either the reduction is estimated, preferably after removing proteins as under lactase, or the change in optical activity is observed.

A known weight of preparation is dissolved or extracted with water and made up to a definite volume.

1 to 5 c.c. or other suitable volume of the solution or extract, is added to 100 c.c. of 2.5 per cent. substrate solution. The solution is observed in the polarimeter at once and at definite intervals and the readings noted; or after a fixed interval of time at room temperature, or at 37°, the action is stopped with 10 c.c. of .1N alkali, the volume made up to 200 or 250 c.c., and the reduction measured (a) against 5 or 10 c.c. of Fehling's solution, or (b) gravimetrically.

III. Lactase, Maltase.

The measurement of the activity of lactase and maltase on account of the small differences in reduction, and rotation also in the case of lactase, is somewhat tedious. A control experiment must be performed. Lactase solutions generally contain a large amount of protein if prepared from the intestine and this must be removed before an estimation can be carried out.

Two portions of 100 c.c. of 5 per cent. lactose solution are placed in two 250 c.c. flasks. To each 50 or 100 c.c. of lactase solution or intestinal extract are added. To one of them (C), the control, 5 or 10 c.c. of neutral mercuric nitrate solution are added.¹ To both are added 5 c.c. of toluene. They are kept in corked flasks at 37° for 3-4 days. (Instead of adding mercuric nitrate to (C), 50 c.c. of boiled and cooled enzyme solution might have been added and mercuric nitrate added to both after 3-4 days.) The same volume of mercuric nitrate solution is added to the other flask containing enzyme (E) and mixed. The two flasks are now in the same stage of operations and their contents are treated as follows:—

(1) Filtered through dry papers into dry flasks.

(2) Equal volumes of filtrate (as much as possible) are taken and neutralised to litmus with sodium hydroxide from a burette (about 4-8 c.c.). The same quantity is added to both.

(3) The precipitate is filtered off through a dry paper and the filtrate collected in a dry flask.

(4) Equal volumes of filtrate (as much as possible) are taken and treated with hydrogen sulphide. The gas is passed on to the surface of the solution. Only a small quantity is required to remove the last traces of mercury.

(5) Excess of hydrogen sulphide is removed by adding copper sulphate solution until the smell disappears and it has a faint blue colour.

(6) The solution is filtered from the sulphides and the volume is made up to 250 or 500 c.c.

The reducing sugar is estimated gravimetrically or by Bertrand's method.

The percentage of hydrolysis is calculated as follows:—

The reducing power of the control multiplied by $\frac{1.0}{T}$ is the reducing power of lactose if completely hydrolysed. The difference between this figure and the original is that of total hydrolysis T.

The difference between the control figure and that of the enzyme solution is the actual hydrolysis A.

Hence percentage is $A : T = x : 100$.

¹ 220 gm. of mercuric oxide are suspended in about 200 c.c. of water and dissolved by adding concentrated nitric acid. The solution is treated with caustic soda until a permanent precipitate of mercuric oxide is formed. The solution is filtered and made up to 1000 c.c.

Zymase.

The activity of zymase is measured by estimating the amount of carbon dioxide which is evolved. This is effected most simply by determining the loss in weight: 20 c.c. or a known volume of zymase solution are placed in an Erlenmeyer flask with a known amount of sugar solution and 1 per cent. of toluene is added. The flask is closed with a Meissl tube and the loss in weight determined.

It may also be determined by mixing known amounts of the zymase solution with sugar solution and some toluene in a flask connected to another flask containing excess of N sodium hydroxide. The first flask is fitted with a valve and the second, containing the sodium hydroxide, is connected with a soda lime tube. Air is sucked through the flask at the end of the experiment through the sodium hydroxide, the enzyme solution being boiled to expel the last trace of carbon dioxide. The sodium hydroxide solution is titrated firstly against phenolphthalein and secondly against methyl orange. The difference in the values gives the amount of carbon dioxide.

Harden, Thompson and Young¹ have described a very accurate method in which the estimation is effected volumetrically.

Lipase.

Lipase acts upon fats producing fatty acids. Its activity is measured by titrating the mixture of enzyme, fat and fatty acids. A known volume of enzyme solution is added to a known amount of ester (ethyl butyrate), of fat (neutral olive oil), or egg-yolk, suspended in water; the mixture is kept at 37° and titrated after 2-24 hours. A control is made with boiled enzyme or a similar mixture titrated immediately after the addition of the enzyme solution.

¹ Biochem. J., 1910, 5, 230; see also Harden's monograph on "Alcoholic Fermentation".

Proteoclastic Enzymes.

The numerous methods which have been employed for comparing the strengths of two proteoclastic enzymes may be divided into two main groups.

I. Those in which the action of the enzyme is determined by observing the rate of solution of an insoluble substrate.

II. Those in which the rate of formation of the products of the action of the enzyme is observed.

Of these the former is generally used for pepsin, the latter for trypsin.

A. Pepsin.

(a) *Brücke's Method.*

In this method the time taken to dissolve equal-sized threads of fibrin is noted. The more active enzyme produces solution in the shorter time.

(b) *Mett's Method.*

Numerous results, especially those in Pavloff's laboratory, upon digestion by enzymes have been obtained by this method. It consists in directly measuring the amount of protein digested in a given time, the protein being contained in narrow tubes open at both ends and known as Mett's tubes.

Mett's tubes consist of a small length of coagulated egg-white or serum in a narrow glass tube of 2 mm. bore, and are made by drawing up egg-white into the glass tubing (no air bubbles must be present in the egg-white) and placing it in nearly boiling water for 2-3 minutes. This tubing is then cut up into lengths of about 1 cm. The coagulated egg-albumin must form a continuous layer free from air spaces. Two small pieces of tube are placed in the enzyme solution and after a definite lapse of time the pieces are laid upon a mm. scale and the amount dissolved from each end measured. The mean of these readings is taken.

5 c.c. of 0.4 per cent. hydrochloric acid, 5 c.c. of pepsin solution and 1 or 2 Mett's tubes are placed in a small conical flask. The flask is stoppered and kept at 37° for 8-10 hours. It is then removed and the amount of protein digested from each end of the Mett's tubes is measured. The mean is taken. In this experiment where the action is for a long period of time, according to the Schütz law the squares of the lengths digested represent the activity of the enzyme more accurately than the direct ratio.

* (c) *Grützner's Method.*

This method is the one which has been most frequently employed on account of the rapidity with which the results are obtained. Fibrin, stained with carmine, is the substrate used; a definite quantity is added to the enzyme solution and according to the rate of digestion of the fibrin more or less of the dye-stuff passes into solution. Comparison is made by observing the depth of the colour.

Roaf has suggested the use of fibrin stained with congo red instead of carmine. This possesses the advantage that the stained fibrin can be used in both acid and alkaline media; carmine-stained fibrin can only be used in acid media as carmine is dissolved out of the fibrin by alkalies.

The fibrin is prepared in the following way :—

Fresh fibrin is minced, washed till free from blood and placed for 24 hours in a 0.5 per cent. solution of congo red in the proportions of 50 gm. of fibrin to 100 c.c. of congo-red solution. The mass is poured into a large volume of water heated to 80° to fix the dye and kept at this temperature for about 5 minutes. The fibrin is then placed in a cloth and washed in running water; the excess of water is squeezed out and the fibrin is preserved in a mixture of equal parts of glycerol and water, a little toluene being added as a preservative.

Another modification consists in the use of stained cubes of coagulated egg-white.

* A known quantity of 0.5 gm. of congo-red fibrin, 5 c.c. of 0.4 per cent. hydrochloric acid and 5 c.c. of the pepsin solution are placed in a test tube and put in a water-bath at 40° for half an hour. After this time sufficient solid anhydrous sodium carbonate is added to change the blue colour of the congo red to red. This also stops the action of the enzyme. A measured volume is removed; in order to compare two pepsin digests water is added from a burette to the deeper one till the tints of the two solutions are the same. The amount of water added is noted. The strengths of the enzymes are to one another as the amount of dilution: thus if an equal volume of water be added the strengths are as 2 : 1.

(d) *Fuld's Method.*

By making use of edestin as substrate and its precipitability by salts from its solution in hydrochloric acid, Fuld has devised a very simple method for measuring the activity of pepsin solutions. Varying amounts of the enzyme are added to definite volumes of the edestin solution in a series of tubes and after a prescribed lapse of time sodium chloride is added; the first tube in each series in which a precipitate of edestin is no longer formed is noted, i.e. the tube containing least enzyme. Thus :—

5 c.c. of the 0.5 per cent. edestin solution in 0.4 per cent. hydrochloric acid are measured out with a pipette into each of a series of five test tubes. To these tubes is added in order, 0.2 c.c., 0.4 c.c., 0.6 c.c., 0.8 c.c., 1.0 c.c. of the pepsin solution A from a burette (generally 2 drops = 0.1 c.c.). The same operations are performed with pepsin solution B.

The tubes are kept at the ordinary temperature for half an hour, or longer, but the same time for each series; then to each tube is added 1 c.c. of saturated sodium chloride solution. The first tube in which a precipitate of edestin is no longer produced is noted.

* (e) *Hata's Method.*

It was shown by Hata in 1909 that a suspension of coagulated egg-white was a very delicate substrate for estimating the activity of pepsin solutions. Under the influence of the enzyme the cloudy solution becomes quite clear. This method also possesses the advantage that egg-white is obtainable everywhere and the suspension is readily prepared. The comparison is carried out by adding varying quantities of enzyme solution to the substrate and observing in which tube clarification is produced by the least amount of enzyme after a given time.

The substrate is prepared by rubbing up egg-white in a basin until it is of a uniform consistency. It is then slowly mixed and rubbed up with water until it has been diluted five times. The solution is strained through muslin and heated in a water-bath at 60° for 20 minutes, after which it is once more strained through muslin. A homogeneous suspension is thus obtained. Before use it is diluted with 9 volumes of water.

5 c.c. of the above substrate are measured out into each of a series of five test tubes. To each is added 5 c.c. of 0.4 per cent. hydrochloric acid solution and then in order, 0.2, 0.4, 0.6, 0.8, and 1 c.c. of pepsin solution. The tubes are placed in a water-bath at 40° for 15 or 30 minutes. It is noted in which tube in the series the smallest amount of enzyme first produces complete clarification.

(f) *Gross' Method.*

Gross has suggested a solution of caseinogen instead of edestin for estimating peptic activity. It is prepared by dissolving 1 gm. of pure caseinogen in 16 c.c. of 25 per cent. hydrochloric acid of sp. gr. 1.124 in a 1000 c.c. flask on a water-bath and diluting to 1000 c.c. It is precipitated by a 20 per cent. solution of sodium acetate.

A series of tubes are filled with varying quantities of the pepsin solution from .1 to 1 c.c. To each 10 c.c. of the caseinogen solution warmed to 40° are added. The series is placed in a bath at 38-40° for 15 minutes. A few drops of the sodium acetate solution are added to each tube; undigested caseinogen is precipitated. The smallest quantity required to digest the 10 c.c. is the value noted.

If 1 c.c. of pepsin solution be the basis of the calculation and .025 c.c. were sufficient, the pepsin solution corresponds to $\frac{1}{40}$ or 40 units.

Other methods for estimating pepsin are those of Hammerschlag, who uses Esbach's reagent to precipitate unchanged protein; of Volhard, who digests caseinogen and titrates the amount of hydrochloric acid used up in combination with caseoses; of Jacoby, who digests the protein ricin in suspension in dilute hydrochloric acid in a similar way to Hata.

B. Trypsin.*(a) Mett's Method.*

The activity of a trypsin solution can be measured by Mett's method in the same way as described for pepsin. The tubes may contain either egg-white or gelatin (p. 409). 5 c.c. of 4 per cent. sodium carbonate solution and 5 c.c. of the trypsin are placed in a small conical flask together with 1 or 2 Mett's tubes. 1 c.c. of toluene, or chloroform, is also put in the flask as antiseptic. After periods of 2, 4, 8-24 hours the lengths digested from each end are measured.

The squares of the lengths digested more nearly represent the activity than the actual lengths which are measured.

(b) Roberts' Method.

The action of trypsin upon milk serves as a very convenient and simple property for determining the activity of the enzyme. Roberts in 1881 discovered that trypsin acting upon milk produced a striking change in its properties at an early stage of its digestion, namely, coagulation on heating due to the formation of casein (metacasein as it was termed). This property disappears at the end of the digestion.

30 c.c. of milk are diluted with 30 c.c. of water in a small flask and warmed to 40°; 1.5 c.c. of the trypsin solution are added. The time is noticed and at the end of every minute a portion of 5 c.c. is withdrawn and heated to boiling. It is noticed at what time a distinct curdling or precipitation occurs. A sample on heating shows incipient curdling before the actual appearance of the curdling; this indicates that the next sample will probably coagulate properly.

The activities of trypsin solutions are proportional to the time taken to produce curdling.

Vernon¹ considers this method very exact if the values are corrected by reference to a table.

(c) Fuld-Gross Method.

Another convenient method of measuring the activity of trypsin solutions is that of Fuld-Gross. A caseinogen solution is digested with trypsin; acidulated alcohol is added to precipitate unchanged caseinogen after a certain time.

The substrate is prepared by dissolving 1 gm. of pure caseinogen in 5 c.c. of 1N sodium hydroxide + 25 c.c. of water and heating to boiling. The solution is cooled; about 4.5 c.c. of 1N HCl are added to neutralise the excess of alkali and the volume is made up to 100 c.c. It keeps for 48 hours; it is not advisable to add toluene which tends to precipitate the caseinogen.

The acid solution is prepared by mixing together 1 part of glacial acetic acid, 49 parts of water and 50 parts of 96 per cent. alcohol.

Ten test tubes are filled in series with increasing amounts of trypsin solution—0.1 to 1 c.c. Water is added to make the volumes, where necessary, equal to 1 c.c. 2 c.c. of the caseinogen solution are added to each tube and they are placed for 1 hour in a bath at 37°. They are removed and 6 drops of the acid alcohol added to each. In those tubes containing undigested caseinogen there is a flocculent precipitate. The first tube containing no precipitate in which there is the smallest amount of enzyme is noticed. The result is calculated according to the number of c.c. of caseinogen solution which can be digested by 1 c.c. of enzyme solution: thus supposing it were 2.

$$.02 : 2 = 1 : x \quad x = 100$$

The trypsin solution is spoken of as containing 10 units.

¹ J. Physiol., 27, 182.

* (d) *Sørensen's Method.*

The most accurate and simple method is that of Sørensen. In this method the rate of formation of the products of the action of the enzyme, namely, the amino acids, is measured. The amino acids contain both a carboxyl group and an amino group and consequently their reaction is neutral. By combining the amino group with formaldehyde, its basic character is destroyed and the carboxyl group is free to exert its acid character. The reaction which takes place is:—

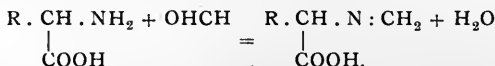

Samples of a trypsin digest of caseinogen, gelatin, etc., are treated at intervals with neutral formaldehyde. They show a gradual increase in acidity as the action of the enzyme proceeds; the rate of the increase depends on the strength of the enzyme.

60 c.c. of formalin are diluted with two volumes of water and neutralised by running in $\cdot 1\text{N}$ alkali from a burette until the colour is just red to phenolphthalein, which is added as indicator.

100 c.c. of a 4 per cent. caseinogen solution in 0.4 per cent. sodium carbonate solution are measured out into a small flask, warmed to 40° and then 5 c.c. or more of the trypsin solution are added; the mixture is kept at 40° . Immediately after the addition a sample of 25 c.c. is removed with a pipette and 30 c.c. of the previously neutralised formaldehyde solution are added. At intervals of half an hour, one hour, one hour and a half, two hours, further samples of 25 c.c. are removed and to them are added 30 c.c. of the formaldehyde solution and a few drops of phenolphthalein. Each sample as it is obtained is titrated with the $\cdot 1\text{N}$ alkali in the burette until the solution has a distinctly red colour. The amount of alkali used for each sample is noted.

(e) *Method by Estimating the Nitrogen of the Amino Acids.*

Proteins are precipitated by the various alkaloidal reagents. These reagents are of use in measuring the action of trypsin. Most frequently tannic acid is used, but trichloroacetic acid and phosphotungstic acid are also employed.

100 c.c. of a solution of protein, as in Sørensen's method, are mixed with a known amount of trypsin solution and digested for 2.48 hours in the presence of toluene. Immediately after mixing and at intervals of 15, 30, or 60 minutes a sample of 10 c.c. is removed and put into 10 c.c. of tannic acid or trichloroacetic acid solution. When the precipitate has settled the solution is filtered through a dry paper into a dry vessel. A nitrogen estimation by Kjeldahl's method is made with 5 c.c. or any aliquot portion of the filtrate.

(f) *Physical Methods.*

Several physical methods can be used to estimate trypsin, but they are adapted mainly for the study of the catalytic action. The change in electrical conductivity, in viscosity, in rotation has been frequently observed in experiments with trypsin.

Oxidases.**A. Catalase.**

The measurement of catalase is effected by estimating volumetrically the amount of oxygen produced.

B. Peroxidases.

The estimation of the activity of a peroxidase is most easily effected colorimetrically; the colour produced may be estimated with a spectrophotometer.

If an insoluble precipitate is produced it can be filtered off and weighed, or it can be centrifuged and its bulk measured in the centrifuge tube.

The methods are so various and depend so much upon the particular reaction suitable to the peroxidase that they must be referred to in the larger text-books.

The indophenol reaction is very convenient as shown by Vernon.¹

The indophenol which is insoluble and is deposited on the tissue is dissolved by adding a known volume of alcohol (10 c.c.); after 25 minutes the alcohol solution is filtered and compared colorimetrically with a standard prepared by adding 1 part of the substrate to 200 parts of 50 per cent. alcohol and sufficient bleaching powder (1 part of .5 per cent. solution) to give a maximum tint on standing (1-2 days). The colour of the standard keeps for some weeks and then fades. The standard is kept in a sealed tube, a known volume of the indophenol is put into a similar test tube and diluted till the colours match. The colour varies from purplish pink to violet, depending on the amount of alcohol present, and can be made to match by adding water or alcohol. The colour is white with alcohol and pink with water.

¹ J. Physiol., 42, 402. See p. 412.

APPENDIX TO DIGESTION.

I. THE ACIDS IN THE GASTRIC CONTENTS.

Normally hydrochloric acid to the extent of about .4 per cent. is secreted by the gastric mucous membrane, but in disease it may be absent and lactic acid may be found.

Detection of the Acids.

The presence of an acid in a solution is shown by the colour change it produces in an organic dye-stuff or indicator. In pure aqueous solutions mineral acids give a distinct colour change, organic acids give a less distinct colour change. The colour change is masked in the presence of proteoses and peptones which are present in the gastric contents, owing to the combination of the acid with the protein in the form of a salt, so that it is difficult to decide whether hydrochloric acid, free or combined, is present or absent. A decision may be arrived at by making use of a series of indicators :—

- (a) methyl violet ;
- (b) methyl orange, or dimethylaminoazobenzene (Töpfer's reagent) ;
- (c) Congo red ;
- (d) Uffelmann's reagent—2 per cent. phenol treated with dilute ferric chloride till of an amethyst-violet colour (it is used especially for lactic acid, p. 112) ;
- (e) Gunzberg's reagent—2 gm. phloroglucinol, 1 gm. vanillin, 30 gm. absolute alcohol (it is used especially for hydrochloric acid).

The test with Gunzberg's reagent is carried out thus :—

About 10 drops of the solution are placed in a small basin, 2-3 drops of freshly prepared Gunzberg's reagent are added, and they are evaporated very carefully over a small flame, oscillating the basin and blowing upon the mixture. Charring must be prevented.

* The differences in the colours of the indicators under the various conditions may be seen by carrying out the following six experiments with 1-2 drops of each of the indicators :—

- (1) 2 c.c. of 0.4 per cent. hydrochloric acid (the strength occurring in gastric juice).
- (2) 2 c.c. of dilute lactic acid (8 c.c. in 1000 c.c. water).
- (3) 2 c.c. of 0.4 per cent. hydrochloric acid and 2 c.c. of dilute lactic acid.
- (4) 2 c.c. of 0.4 per cent. hydrochloric acid and 2 c.c. of 2 per cent. Witte's peptone solution in 5 per cent. sodium chloride solution. (This is to simulate the products of gastric digestion.)
- (5) 2 c.c. of dilute lactic acid and 2 c.c. of 2 per cent. Witte's peptone solution in 5 per cent. sodium chloride solution.

(6) 2 c.c. of 0.4 per cent. hydrochloric acid, 2 c.c. of dilute lactic acid and 2 c.c. of Witte's peptone solution.

A survey of the results will be given if the colour be written in the table:—

	Methyl-violet.	Methyl-orange.	Congo red.	Uffelmann's reagent.	Gunzberg's reagent.
HCl - - - - -					
Lactic acid - - - -					
HCl + lactic acid - -					
HCl + peptone - - -					
Lactic acid + peptone - -					
HCl + lactic acid + peptone					

In performing experiments with gastric contents it may be advisable to reproduce some of these experiments and compare the colour with these.

Estimation of the Acids.

There is no very satisfactory way of estimating the amount of free hydrochloric acid, combined hydrochloric acid and organic acid in gastric contents. Töpfer's method of titrating a known volume with (1) phenolphthalein, (2) dimethylaminoazobenzene to an orange yellow, not yellow tint, (3) alizarin red, gives the following information:—

(1) total acids, i.e. free mineral acid + combined mineral acid + organic acid.

(2) free mineral acid.

(3) free mineral acid + organic acid.

(1) minus (3) combined mineral acid.

(3) minus (2) organic acid.

The data are not absolutely correct, but they serve well for comparative determinations. If the above six mixtures of acids + peptone be titrated figures such as the following are obtained:—

	HCl 2 c.c.	Lactic acid 2 c.c.	HCl 2 c.c. + Lactic acid 2 c.c.	Peptone 5 c.c.	Peptone 5 c.c. + 2 c.c. HCl.	Peptone 5 c.c. + 2 c.c. Lactic acid.	Peptone 5 c.c. + 2 c.c. HCl + 2 c.c. Lactic acid.
Phth	1.7	1.7	3.4	0.3	2.0	2.0	3.8
Töpfer	1.6	1.5	3.1	0	0.8	0	2.2
Alizarin red	1.7	1.7	3.4	0	1.3	1.3	2.8

II. THE CONSTITUENTS OF BILE.

The constituents of the bile are :—

(1) The colouring matters, bilirubin and biliverdin, the latter formed by the oxidation of the former.

(2) The bile salts, the sodium salts of glycocholic and taurocholic acids.

(3) A small quantity of mucin or nucleoprotein (the more recent work insists on the presence of the latter, but both are probably present).

(4) Cholesterol, which gives rise to gall-stones in certain conditions.

Examination of Ox or Sheep Bile.

* (1) It has a faintly alkaline reaction to litmus ; the bitter taste and peculiar odour should be noticed.

* (2) It does not coagulate on heating.

* (3) On acidifying a small quantity with acetic acid a precipitate is formed which is insoluble in excess of acetic acid. As above stated, this precipitate was considered to be mucin owing to its insolubility in excess of acid, nucleoprotein being soluble ; in the presence of bile salts the precipitate of nucleoprotein is insoluble.

* (3a) No pigment is extracted on shaking up a little bile with ether. If a few drops of dilute hydrochloric acid be added, both nucleoprotein and pigment are liberated as free acids from their sodium compounds. The nucleoprotein is precipitated, but the pigment passes into solution on shaking with the ether.

* (4) **Gmelin's Test for Bile Pigments.**—A little bile is carefully placed on the surface of some fuming nitric acid in a test tube, either by pouring it carefully down the side of the tube or by means of a pipette. On shaking the tube very gently a play of colours will be seen as the bile becomes oxidised. Generally the colours are yellow, red, violet, blue, green ;

or,

A drop of fuming nitric acid is placed on a thin film of bile in a porcelain basin. Rings of the various colours will be seen ;

or,

A little bile is filtered several times through an ordinary filter paper and a drop of fuming nitric acid is placed on the paper. The colours will be seen.

* (5) **Huppert's Test for Bile Pigments.**—This test is especially useful for detecting bile pigments in urine.

5 c.c. of bile are diluted with 25-50 c.c. of water and 4 c.c. of sodium phosphate solution and 6 c.c. of calcium chloride solution are added. The precipitate is filtered off. It carries down the pigment mechanically or may contain an insoluble calcium compound of bilirubin ; it is heated with 5 c.c. of alcohol and a few drops of concentrated hydrochloric acid. A fine green colour is formed. The formation of the green colour may require the addition of an oxidising agent such as a few drops of ferric chloride or potassium chlorate solution (Cole).

- * (6) **Pettenkofer's Test for Bile Salts.**—A fragment of cane sugar is dissolved in a little bile which has been diluted 10 times with water; when it has dissolved, about 5 c.c. of concentrated sulphuric acid are run into the bottom of the test tube and shaken gently. A purple colour develops slowly. Furfural is formed by the action of the concentrated sulphuric acid on the sugar; this reacts with the bile acids, giving the purple colour. Excess of sugar must be avoided as it may be charred by the strong acid and spoil the colour. The colour disappears on diluting with water and is only stable in the presence of strong sulphuric acid. If a portion of the purple liquid be diluted with 50 per cent. sulphuric acid and examined in the spectroscope, two absorption bands, the one between C and D, nearer D, and the other in the green, can be observed.

This test is sometimes performed by shaking up the bile with a little sugar solution so as to obtain a froth; on pouring in the concentrated sulphuric acid the colour appears where it has come in contact with the froth.

- * (7) **Hay's Test for Bile Salts (Surface Tension Test).**—A little bile in a test tube is diluted with water and some flowers of sulphur are sprinkled on the surface. They sink. If the experiment be repeated with pure water, the particles of sulphur will float.

On performing the same test with strong mineral acids, ammonia, brine, ammonium sulphate solution, etc., the sulphur floats. It sinks in alcohol, ether, chloroform, olive oil, etc., in fact in all liquids with a surface tension less than 60 dynes per sq. cm.

This test depends upon the power of the bile salts to lower the surface tension of water. It is particularly valuable for detecting bile salts in urine where other coloured substances may interfere with Pettenkofer's test. Alcohol, which has a low surface tension, must, if present, be previously removed by evaporation.

Grunbaum has described a method of estimating bile salts in urine which depends on this property of bile salts. The rate of escape of urine from standard capillary tubes is measured; the higher the concentration the greater is the rate.

Draughtsmen employ this property of bile salts in making tracings on oiled paper on which the ink collects in drops and does not spread. On treating the paper with ox bile and allowing it to dry the difficulty is overcome owing to the reduction in surface tension. This experiment with oiled paper treated with bile may be tried with advantage.

In the same way oil will pass through a filter paper moistened with dilute bile solution, whereas it will not pass through a paper moistened with water. This statement may easily be verified.

(8) **Solvent Action of Bile Salts on Fatty Acids containing Oleic Acid.**—If some fatty acids from mutton or beef fat be stirred with water, they do not dissolve; on adding a little bile and stirring up again, fatty acids can be detected in the filtrate by evaporating to dryness, heating and noting the characteristic odour. This process no doubt occurs in the digestion and absorption of fats.

(9) **Oliver's Test for Bile Salts.**—This depends upon the power of the bile acids to precipitate peptone in acid solution and is useful for showing the presence of bile salts in the urine, e.g.—

About 20 c.c. of bile are evaporated to complete dryness on the water-bath. The residue is heated with 20 c.c. of alcohol on the water-bath stirring the mixture thoroughly with a glass rod. A little more alcohol is added and it is filtered. The filtrate is evaporated to dryness on the water-bath and the residue extracted with about 30 c.c. of hot water. A solution of the pigments and the salts of bile, free from proteins, is obtained on filtering.

If a portion of this solution be acidified with glacial acetic acid, the bile acids are not thrown down, but on adding an equal quantity of 1 per cent. Witte's peptone solution a turbidity or a precipitate is obtained, insoluble in excess of acid.

As applied to urine, it is only necessary to acidify with acetic acid, filter till quite clear and treat with an equal volume of 1 per cent. Witte's peptone solution.

* (10) **Cholesterol** may be detected as follows (Roaf):—

10 c.c. of bile are evaporated to dryness on the water-bath. The residue is extracted several times with small quantities of ether, pouring each ether extract into another evaporating basin. The ether is allowed to evaporate and the residue is dissolved in about 2 c.c. of chloroform. It gives Salkowski's and Liebermann's reactions.

III. GALL STONES.

Calculi of various sizes and shapes and of variable number occur in the gall bladder. Three kinds have been distinguished:—

(1) **Pigmented Chalk Stones.**

In man these stones are small; in the ox and pig stones as large as a walnut have been found. They are heavier than water. They consist almost entirely of the calcium salt of bilirubin and contain very little or no biliverdin. Sometimes black or greenish-black metallic-looking stones, which consist of bilifuscin and biliverdin, occur. Iron and copper are generally present.

(2) **Cholesterol Stones.**

The shape and size of the cholesterol stones are very variable; they are generally lighter than water and are composed of concentric layers. Their surface if fractured appears crystalline; if cut, waxy. If the fractured surface be rubbed with the nail it also looks waxy. By rubbing against one another in the gall bladder they are generally faceted. They are almost white and usually show pigmented edges (pigmented chalk).

(3) **Calcium Carbonate and Phosphate.**

These stones are very rare in man.

THE INDIVIDUAL GROUPS OF PROTEINS.

PROTAMINES.

The protamines occur in ripe fish sperm in which they are present as salts of nucleic acid. Salmine, the first known member of the group, was discovered by Miescher in salmon sperm. The other members have been isolated by Kossel and his pupils from the sperm of other fishes. They are named according to the fish from which they are obtained, e.g. sturine from sturgeon, clupeine from herring, scombrine from mackerel, cyprinine from carp. Our knowledge of these proteins is almost entirely due to Kossel and his pupils, who have shown that they are composed principally of diamino acids, especially arginine, which in some cases makes up over 80 per cent. of the molecule. It seems that they are the diamino acid constituents of muscle protein since the testicles grow at the expense of the muscles in the spawning season, the fish taking no food and living upon the mono-amino acid portion.

Preparation.

The ripe or nearly ripe testicles are smashed up, shaken continuously with water and the liquid strained through a cloth. The milky fluid, which contains the spermatozoa, is acidified with a few drops of acetic acid which causes them to clot together. The clotted mass is filtered off, boiled several times with alcohol and then with ether to remove fats and dried in the air. The dry matter (about 100 gm. portions) is shaken for 15 minutes with 5 times its volume of 1 per cent. sulphuric acid, filtered off and the extraction with acid repeated several times. The combined extracts are treated with 3 volumes of alcohol. Protamine sulphate is precipitated, filtered off after 12-24 hours, redissolved in water and precipitated with alcohol. It is dissolved in about 1500 c.c. of hot water; on cooling, protamine sulphate separates as a yellowish or brownish oil. The solution is concentrated and allowed to stand in a separating funnel. A further quantity of oil, but contaminated with nucleic acid, collects. It is dissolved in warm water and treated with sodium picrate. The precipitate of protamine picrate is filtered off, washed and reconverted into sulphate by extraction with ether in presence of an excess of sulphuric acid. The aqueous acid solution is precipitated with alcohol; solution in water and precipitation with alcohol is repeated. Solution and precipitation must be repeated until the protamine sulphate forms a loose, white precipitate and is not sticky.

Properties.

The protamines in the free state have not been much investigated; they are strong bases, blueing litmus, and absorb carbon dioxide from the air. They are easily soluble in water, but insoluble in alcohol and ether. They are not coagulated by heating, do not diffuse, give the biuret reaction, sometimes other colour reactions and are laevorotatory.

They form salts with acids of which the sulphate is the principal. The chlorides are more easily soluble, as also the carbonates and nitrates. They form insoluble double salts with platinum chloride and mercuric chloride.

They dissolve copper hydroxide giving solutions of a violet colour.

They are precipitated by alkaloidal reagents in neutral or faintly alkaline solution and are precipitated from solution by salts. They give precipitates with other proteins, excepting the secondary proteoses, peptones and polypeptides.

They are precipitated from solution by a solution of sodium nucleate as protamine nucleate.

They contain 25-30 per cent. of nitrogen in their molecule, no sulphur and no phosphorus.

HISTONES.

The group of proteins termed histones was established by Kossel, who isolated a histone from the red blood corpuscles of the goose. Other members of the group have since been isolated from the unripe testicles of fish and from the thymus. During maturing of the sperm the histone in some cases remains unchanged, but in other cases changes into protamine.

Preparation.(1) *From Unripe Fish Sperm.*

The material is first treated as in the preparation of protamines, but it is extracted with dilute hydrochloric acid. The extract is saturated with sodium chloride, the precipitate is freed from salt by dialysis and the solution precipitated by ammonia.

(2) *From Red Blood Corpuscles.*

The paste of corpuscles is treated with water and ether; the insoluble residue after washing with water is extracted with dilute hydrochloric acid. The solution is saturated with sodium chloride and the precipitate is freed from salt by dialysis. The histone is then precipitated by adding ammonia.

(3) *From Thymus Nucleohistone* (p. 466).

The nucleohistone is treated with 0.8 per cent. hydrochloric acid and the solution is precipitated with ammonia.

Thymus histone is also formed when solutions of nucleohistone are saturated with salt. The histone is precipitated on adding ammonia.

Properties.

The various histones vary considerably in properties. They contain about 18-19 per cent. of nitrogen; some contain sulphur, others do not.

They are basic and are intermediate between albumins and globulins and the protamines, yielding on hydrolysis a larger proportion of arginine than albumins and globulins, but less than protamines.

Their properties resemble in part the coagulable proteins, in part the protamines and in part the proteoses.

A neutral solution, free from salt, is precipitated by ammonia, but according to Bang the histone from red blood corpuscles is soluble in excess, but comes down on saturating the solution with ammonium sulphate. Histones are also precipitated by caustic alkalies and alkaline earths. Towards nitric acid they behave like the proteoses. They are precipitated by the alkaloidal reagents also in neutral solution. Like the protamines they are precipitated by albumin and primary proteoses. They are not coagulated by heat, but coagulation occurs in the presence of salt. The coagulum dissolves in dilute hydrochloric acid.

Globin.

Globin, the protein moiety of the conjugated protein, hæmoglobin (p. 472), has been considered to be a histone, though in its properties it has many points of difference.

Preparation.

A solution of hæmoglobin is dialysed to remove salts and treated with very dilute hydrochloric acid—20 c.c. of 0.1N HCl to 200 c.c. of hæmoglobin solution containing 1.84 gm. (Gamgee and Hill)—until a flocculent brown precipitate which forms is just redissolved. One fifth of the volume of 80 per cent. alcohol is added and the solution shaken several times with half its volume of ether. The clear aqueous solution on neutralisation gives a flocculent precipitate. It is rapidly filtered off, washed with water, dissolved in dilute acetic acid and dialysed. The globin is precipitated on adding alcohol.

Properties.

Globin dissolves in water and it differs from histones in that the neutral solution, in the absence of salts, gives a precipitate which is readily soluble in excess of ammonia, and that ammonium chloride only precipitates it when a large excess of ammonia is not present.

Globin gives most of the colour reactions of proteins; it is not precipitated by most of the heavy metals.

It contains about 17 per cent. of nitrogen of which 29 per cent. is in the form of diamino acids. In this respect it resembles the histones, but the chief diamino acid is histidine, not arginine.

COAGULABLE PROTEINS. ALBUMINS. GLOBULINS.

These proteins generally occur together in most tissues and fluids of animals, e.g. in egg-white, blood and muscular tissue. They are also present in various parts of plants, especially in the fruits and seeds.

The coagulable proteins are the most typical proteins and are often called native proteins. They have the common property of being changed into insoluble modifications when their solutions are heated to boiling in the presence of a little acetic acid. The insoluble form is also present in the various animal tissues—such as muscle.

The chief distinction between albumins and globulins is their behaviour towards water and solutions of salts. They can be separated from solution in an unchanged condition in this way. A large number of salts have been used for this purpose, the principal ones being sodium chloride, magnesium sulphate and ammonium sulphate.

Albumins are soluble in water and in dilute salt solutions. Albumins are not precipitated by saturating their aqueous solutions with sodium chloride or magnesium sulphate nor by half-saturation with ammonium sulphate (i.e. adding an equal volume of saturated ammonium sulphate), but they are precipitated by saturation of the solution with ammonium sulphate.

Globulins are insoluble in water, but soluble in dilute salt solutions. Globulins are precipitated from dilute salt solutions by saturation with sodium chloride or magnesium sulphate, or by half-saturation with ammonium sulphate.¹

There are, however, several globulins which behave slightly differently by being soluble in water, or by being precipitated with less salt than is required for complete saturation. These are atypical globulins.

¹ The amount of salt required to saturate an aqueous solution is

3·6 gm. of sodium chloride for every 10 c.c.

10·2 gm. of cryst. magnesium sulphate for every 10 c.c.

4·0 gm. of ammonium sulphate for every 10 c.c. of half-saturated solution.

It is better to weigh out the requisite amount of salt than to add it until no more dissolves, as an excess in this way avoided and does not interfere with further operations.

THE COAGULABLE PROTEINS OF EGG-WHITE.

White of egg is made up of a pale yellow fluid contained in a network of a fibrinous material, which is broken up by beating the egg and the egg-white obtained by straining it through calico.

Egg-white has a faintly alkaline reaction to litmus and a specific gravity of 1.045. It contains 13.3 per cent. of solid matter, 85-88 per cent. being water. Of the solid matter 12.2 per cent. is protein; the remainder is glucose .5 per cent., ash .66 per cent. and traces of soaps, fat and cholesterol. Of the protein 6.7 per cent. is globulin, 10 per cent. is ovomucoid or ovomucin, a glycoprotein (p. 471).

Globulin (Ovoglobulin).*Preparation.*

The globulin is precipitated from egg-white or a solution of egg-white by saturation with sodium chloride or magnesium sulphate, or by half-saturation with ammonium sulphate.

- * An equal volume of saturated ammonium sulphate solution is added slowly to egg-white, or a solution of egg-white in water, with constant stirring. After standing the precipitate is filtered off, dissolved in water¹ and precipitated again with ammonium sulphate.

This process is repeated several times. The final solution is dialysed to remove salt and the protein can be obtained by evaporation of the solution at a low temperature.

- * In a coagulated state it may be separated by acidifying and boiling (p. 368), washing the coagulum with water, alcohol and ether, and drying in the air, or by precipitating with alcohol, drying with alcohol, washing with ether and exposing to the air.

Properties.

In the uncoagulated state, globulin is an amorphous yellow mass, insoluble in water but soluble in dilute salt solutions; it is precipitated from solution by saturation with sodium chloride, magnesium sulphate, or by half-saturation with ammonium sulphate.

The solution in salt solutions shows all the general reactions for proteins.

In the coagulated state, globulin forms an amorphous white powder which is insoluble in water and dilute salt solutions. It dissolves slowly on warming in dilute acids and alkalies, undergoing hydrolysis into derivatives (metaprotein).

A suspension in water will show most of the colour reactions for proteins.

This substance has been termed ovomucin by Osborne and Campbell. It is not certain if it is a single protein.

¹ Sufficient salt is still present to make the solution a dilute salt solution.

Albumin (Ovalbumin).

Preparation.

- * Ovalbumin remains in solution after the globulin has been precipitated by half-saturation with ammonium sulphate.

The filtrate is saturated with finely powdered crystals of ammonium sulphate. The precipitate is dissolved in water and again precipitated with ammonium sulphate and the process is repeated several times. The last precipitate is dissolved in water and the solution is dialysed to remove the salt. The albumin is obtained on evaporation *in vacuo* at 40°.

- * Coagulated albumin is obtained by acidifying the solution and boiling, washing the coagulum with water, alcohol and ether, and drying, or by pouring it into several volumes of alcohol. The coagulum is washed by decantation with alcohol and ether and dried.

Preparation of Crystalline Ovalbumin (Hopkins).

Fresh egg-white is beaten into a froth with an exactly equal volume of saturated ammonium sulphate solution and the mixture is filtered after standing for some hours. 10 per cent. acetic acid is added to the filtrate from a burette with constant stirring until it becomes distinctly turbid. 1 c.c. of acetic acid is then added for every 100 c.c. of filtrate. An amorphous precipitate is first formed, but on standing it becomes crystalline and with frequent shaking the whole of the ovalbumin crystallises in 5-6 hours. After 24 hours it is filtered off, washed with ammonium sulphate containing 1 per cent. of acetic acid and dissolved in water (1 part in 10). Saturated ammonium sulphate solution is carefully added with gentle shaking until a permanent precipitate results, and then for every litre 2 c.c. more of ammonium sulphate. The ovalbumin crystallises out and is washed as before. The crystalline mass contains ammonium sulphate. A solution free from ammonium sulphate is obtained by dialysis, or as above either in the uncoagulated or coagulated condition. The yield is 50 gm. from 1000 c.c. of egg-white.

Preparation of Conalbumin.

The whole of the ovalbumin can never be obtained in a crystalline condition. According to Osborne and Campbell only 50 per cent. of the albumin can be crystallised. The remainder is termed conalbumin. It is prepared from the filtrate by saturation with ammonium sulphate as described under albumin.

Properties.

Ovalbumin in an uncoagulated state is an amorphous mass of a yellowish colour, soluble in water and dilute salt solutions. It is not precipitated from solution by saturation with sodium chloride, magnesium sulphate or half-saturation with ammonium sulphate, but is precipitated by complete saturation with ammonium sulphate.

A 2.5 per cent. solution in water coagulates at 60-64°; in 10 per cent. salt solution at 68-70°.

Conalbumin is very similar to ovalbumin, but it coagulates at a lower temperature and has a higher rotation.

The solutions of ovalbumin, crystalline ovalbumin and conalbumin give all the general reactions for proteins.

The coagulated albumins are insoluble in water and salt solutions, but dissolve slowly in acid and alkali yielding solutions of derivatives (metaprotein).

THE COAGULABLE PROTEINS OF BLOOD.

Blood is a fluid which contains proteins, salts, glucose, amino acids and other simple compounds in solution, and red and white blood corpuscles in suspension. The presence of blood platelets in living blood, i.e. in the blood vessels, is denied by some observers, but they are undoubtedly present when the blood is shed, their formation being instantaneous.

I. Clotting of Blood.

Blood drawn from a blood vessel clots spontaneously into a solid mass or clot. On standing the clot slowly contracts, expressing the almost colourless blood-serum. The clot consists of the insoluble protein, fibrin, which has entangled the blood corpuscles. The fibrin, almost free from corpuscles, can be obtained by whipping the blood whilst it clots and washing the fibrin threads with water to remove the entangled corpuscles; defibrinated blood remains, which contains the corpuscles. Thus

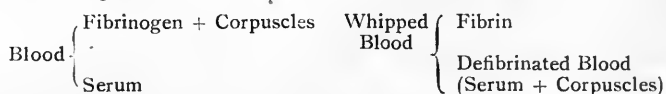

* This may be readily observed as follows:—

A little freshly drawn blood is collected in two watch glasses. The one is allowed to clot; after a time the clot contracts, expressing the serum. The other is defibrinated by stirring it with a pin or needle. The fibrin adheres to the needle and defibrinated blood remains. The fibrin can be washed free from corpuscles by water and an almost colourless mass remains.

II. Factors concerned in Clotting of Blood.

In the process of clotting the insoluble protein fibrin is formed.

It arises from fibrinogen, a soluble protein contained in the blood plasma, by the action of fibrin ferment or thrombin.

Thrombin again does not exist normally in the blood, but is formed from precursors after the blood is shed in the presence of calcium salts. According to Morawitz the precursors are thrombogen, which exists as such in the plasma, and thrombokinase, which is produced by the corpuscles or platelets, or may come from other tissues. The evidence for the presence of thrombokinase was obtained from experiments with birds' blood; if it be carefully collected and the corpuscles separated without damage, it does not clot, but it clots on adding damaged corpuscles or a scraping of muscular tissue. These substances were previously described by Wooldridge under the names B fibrinogen (= thrombogen), A fibrinogen (= thrombokinase), and C fibrinogen (= fibrinogen). The older observers, Alex. Schmidt, Hammarsten, Arthus, only recognised the stage prothrombin which was converted into thrombin by calcium salts.

Thrombin has been considered to be a ferment or enzyme, but the observations of Howell and Rettger show that a solution of thrombin, if obtained almost free from protein, is stable to heat. Enzymes are generally recognised to be more or less easily destroyed by heating.

The following scheme represents the processes which occur in the formation of fibrin :—

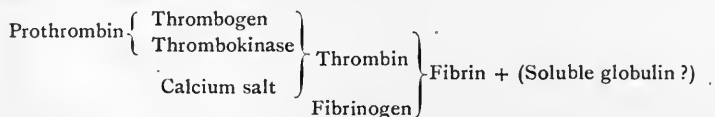

For the elucidation of the above factors in the scheme of blood clotting it was necessary to prevent the blood from clotting, to prepare fibrinogen in a pure state from non-coagulated blood, to prepare a solution of fibrin ferment or thrombin and to determine the factors leading to the formation of thrombin.

III. Prevention of Clotting of Blood.

Blood may be prevented from clotting by collecting it in various salt solutions when it is drawn, e.g. sodium sulphate, magnesium sulphate, potassium oxalate, sodium fluoride, sodium citrate. Salt plasmas are thus obtained.

Clotting may also be hindered or prevented by keeping the drawn blood at a low temperature (0°), or by adding leech extract to it immediately after it is drawn.

If peptone be injected into the circulation, or if leech extract or the active principle of leech extract, termed hirudin, be injected, the blood when drawn does not coagulate.

Preparation of Salt Plasmas.

(a) *Sodium sulphate.*—1 part of blood is collected in 1 part of saturated sodium sulphate solution (500 c.c. to 500 c.c.).

(b) *Magnesium sulphate.*—3 parts of blood are collected in 1 part of saturated magnesium sulphate solution (750 c.c. to 250 c.c.).

(c) *Oxalate.*—9 parts of blood are collected in 1 part of potassium oxalate solution (1 per cent.) (900 c.c. to 100 c.c.).

(d) *Fluoride.*—9 parts of blood are collected in 1 part of sodium fluoride solution (3 per cent.) (900 c.c. to 100 c.c.).

During the mixing each is well shaken. The plasma is then separated from the corpuscles by centrifugalising. All these plasmas should be quite free from blood corpuscles, as the stromata of these may serve as the mother substance of the ferment. It is difficult, however, to obtain them quite free from hæmoglobin, which gives them a reddish colour.

Fibrinogen.

Fibrinogen can be prepared from the salt plasmas by precipitation with sodium chloride or ammonium sulphate.

(a) From sodium sulphate plasma.

A precipitate, the plasmine of Denis, is formed when sodium sulphate plasma is saturated with sodium chloride. This precipitate consists of fibrinogen and serum globulin.

Fibrinogen is precipitated by adding an equal volume of saturated sodium chloride solution. The precipitate is filtered off, washed with half-saturated sodium chloride solution, dissolved in water and reprecipitated.

(b) From magnesium sulphate plasma.

Fibrinogen is precipitated by adding an equal volume of saturated sodium chloride solution to magnesium sulphate plasma. The precipitate is filtered off and washed with half-saturated sodium chloride solution. It is purified by dissolving in water and reprecipitating with sodium sulphate.

(c) From oxalate plasma.

(i) The fibrinogen is precipitated by adding an equal volume of saturated sodium chloride solution (Ca-free). It is filtered off and washed with half-saturated sodium chloride solution, redissolved and reprecipitated.

- * (ii) The fibrinogen is precipitated by quarter-saturation with ammonium sulphate. Every 12 c.c. of oxalate plasma are diluted with 30 c.c. of water and 20 c.c. of saturated ammonium sulphate are added. The precipitate is filtered off, washed with quarter-saturated ammonium sulphate, dissolved in water and reprecipitated.

Fibrinogen gives the colour reactions, coagulation reactions and precipitation reactions of proteins.

It is a globulin, being soluble in dilute salt solutions but insoluble in water. It is precipitated from solution by salts, but less than complete saturation (half-saturation) with sodium chloride and less than half-saturation (quarter-saturation) with ammonium sulphate throws it out of solution. It is, therefore, an atypical globulin.

Its temperature of heat coagulation in a dilute salt solution is 56° .

It is converted into insoluble fibrin by thrombin :—

(a) *Fibrinogen from Sodium Sulphate Plasma.*

The fibrinogen on solution in water,¹ if it has been well washed, will not clot if kept at 40° for 10-15 minutes, but it is converted into fibrin if a little serum or fibrin ferment solution be added.

(b) *Fibrinogen from Magnesium Sulphate Plasma.*

A solution of the well-washed fibrinogen in water¹ does not clot on warming to 40° , but it gives fibrin if a drop of serum or thrombin solution be added.

(c) *Fibrinogen from Oxalate Plasma.*

- * A solution of fibrinogen in water¹ may clot at 40° on adding calcium chloride as it will be contaminated with thrombokinase and thrombogen.

It is converted into fibrin if a drop of serum or thrombin solution be added.

Fibrin.

Fibrin is not usually prepared from fibrinogen, but directly from blood. The blood, when drawn, is immediately whipped with a bundle of twigs. Threads of fibrin collect on the twigs; they are removed, placed in a muslin bag and washed with running water.

¹ It dissolves in water as sufficient salt is still present with it.

The freshly prepared threads of fibrin are nearly colourless; on drying by exposure to the air they form a brownish mass. The fresh threads are best preserved in glycerin, which is easily removed by washing.

Fibrin is insoluble in water, salt solutions, cold dilute solutions of acids and alkalis. It dissolves on warming in dilute acid or alkali, but undergoes hydrolysis into its derivatives.

A suspension of fibrin in water will give the colour reactions for proteins. The solution in acid or alkali will behave like metaprotein, or proteoses and peptone, depending on the length of time the solution has been heated. It will be precipitated by heavy metals and alkaloidal reagents.

Thrombin.

Thrombin is not present in blood plasma, but is formed in the process of clotting: it will therefore be present in the serum and upon the fibrin.

(1) *Preparation from Serum or Defibrinated Blood.*

1 volume of serum or defibrinated blood is mixed with 15-20 volumes of alcohol and the mixture is allowed to stand for some weeks. The precipitate, which is formed, is filtered off, washed with alcohol and dried in a desiccator. It contains thrombin, which is extracted by water (Schmidt).

(2) *Preparation from Fibrin.*

It is best to use fibrin which has been obtained from blood diluted with 10 volumes of water and which has been washed with water. This fibrin is preserved in weak alcohol. A solution of thrombin is obtained by extracting the fibrin with 8 per cent. sodium chloride solution (Gamgee).

IV. The Formation of Fibrin by Interaction of Calcium Salts, Thrombogen and Thrombokinase.

The formation of fibrin is easily observed by the following experiments with the salt plasmas:—

* (a) *Sodium Sulphate Plasma.*

Clotting occurs on diluting a small quantity with 5 volumes of water and keeping the solution warm at 40°. The clotting is more rapid if a drop of serum or thrombin solution be added.

This plasma contains fibrinogen and also thrombin. They have been prevented from interacting by the presence of neutral salts, hence on dilution the plasma clots.

* (b) *Magnesium Sulphate Plasma.*

This plasma on dilution with 9 volumes of water and warming to 40° does not clot.

It clots on diluting as above and adding a drop of serum or thrombin solution.

This plasma contains fibrinogen, but no thrombin. The formation of thrombin has been prevented by the presence of magnesium sulphate.

* (c) *Oxalate Plasma.*

On diluting with 5 volumes of water, no clotting occurs at 40°. Clotting occurs on diluting and adding a few drops of calcium chloride and warming to 40°.

On diluting and adding a drop of serum, freed from calcium salts by precipitation with oxalate, and warming to 40°, clotting occurs.

This plasma contains fibrinogen, but the formation of thrombin has been prevented by the absence of calcium salts. On their addition thrombin is formed and clotting takes place.

Serum contains thrombin, and hence, when added free from calcium salts to plasma free from calcium salts, clotting occurs. Calcium salts are therefore necessary for the formation of thrombin.

* (d) *Fluoride Plasma.*

On diluting with 2 volumes of water, it does not clot on warming to 40°.

No clotting occurs on diluting and adding a few drops of calcium chloride and warming to 40°.

Clotting occurs on diluting and adding a drop of serum or thrombin solution.

Clotting occurs on diluting and adding a scraping of muscle or other tissue.

These results are only obtained if the plasma has been thoroughly centrifugalised; if improperly centrifugalised, corpuscles will be present which yield thrombokinase.

The plasma contains fibrinogen and thrombogen, but no thrombokinase. Thrombin cannot be formed in the absence of thrombokinase when calcium salts are added.

Composition of Blood.

Blood plasma consists mainly of water; the solid matter amounts to less than 10 per cent. The proportions of the constituents have been frequently determined and some of the analyses for 1000 c.c. are given in the following tables:—

	Horse.		Man and other Animals.	Chicken.	Frog.
	Hoppe Seyler.	Hammarsten.			
Water	908.4	917.6	70 to 97	54	—
Solids	91.6	82.4			
	<u>1000.0</u>	<u>1000.0</u>			
Fibrin	10.1	6.5			
Globulin	—	38.4			
Albumin	—	24.6			
Total Proteins	<u>77.6</u>	<u>69.5</u>	55 to 84	39.5	25.4
Fat	1.2	} 12.9			
Extractives	4.0				
Soluble Salts	6.4				
Insoluble Salts	1.7				
	} 13.3				

	Total Protein.	Fibrinogen.	Globulin.	Albumin.	} by Lewinsky.
Man	72·6	4·2	28·3	40·1	
Dog	60·3	6·0	22·6	31·7	
Sheep	72·9	4·6	30·0	38·3	
Horse	80·4	4·5	47·9	28·0	
Pig	80·5	6·5	29·8	44·2	

The ratio globulin to albumin in man is usually 1 : 1·15 but 1 : 1·39 to 2·13 has been found. In starvation the globulin increases.

	Man (by Schmidt).	Other Animals (by Bunge and Abderhalden).
K ₂ O	0·387 to 0·40	0·225 to 0·270
Na ₂ O	4·290	4·251 to 4·442
CaO	0·155	0·119 to 0·131
MgO	0·101	0·040 to 0·046
Cl	3·565 to 3·659	3·627 to 4·170
P ₂ O ₅	—	0·052 to 0·085

Serum.

Blood plasma contains four coagulable proteins, fibrinogen, serum globulin, pseudoglobulin and serum albumin; also a nucleoprotein in small quantities. With the exception of fibrinogen the same proteins are contained in serum. Serum also contains the other constituents of blood.

Defibrinated blood contains the red and white corpuscles in addition. These are removed by centrifuging and serum probably more or less pigmented by hæmoglobin results.

Serum, free from hæmoglobin, is a faintly yellow fluid of sp. gr. 1030 and alkaline to litmus.

A dilute solution of serum (1-10 of water) acidified with a drop of acetic acid coagulates on heating at 70-80°, chiefly between 73-75°

It gives all the general reactions for proteins.

The Coagulable Proteins.

According to Haslam¹ the three coagulable proteins of serum have the following properties by means of which they can be separated:—

Globulin, or euglobulin—insoluble in water	} precipitated by half-saturation with ammonium sulphate.
Pseudoglobulin—soluble in water	

Albumin—soluble in water, precipitated by complete saturation with ammonium sulphate.

Globulin or Euglobulin.

Preparation.

(a) Globulin is prepared by dialysing serum; the precipitate is redissolved in dilute salt solution and again dialysed. This process is repeated several times.

(b) Globulin is precipitated from serum by acidifying it with acetic acid and passing carbon dioxide through it. The precipitate is dissolved in dilute salt solution and again thrown out, preferably by dialysis or by sodium chloride.

¹ Biochem. J., 1913, vol. vii.

- * (c) Serum is half-saturated with ammonium sulphate. The precipitate is treated with saturated sodium chloride solution. The globulin is insoluble. It can be purified by dissolving in dilute salt solution and precipitating with sodium chloride.

The globulin is obtained in a coagulated state by treating the precipitate with alcohol and ether, or it may be obtained by dissolving in dilute salt solution, acidifying and boiling. The coagulum is washed with boiling water and dried with alcohol and ether.

Properties.

The uncoagulated protein is a white amorphous substance, insoluble in water, but soluble in dilute salt solutions. It is precipitated by saturating its solution with sodium chloride or magnesium sulphate or by half-saturation with ammonium sulphate.

It gives the general reactions of the proteins and is a typical globulin. The coagulated protein is insoluble, but dissolves on warming in dilute acids and alkalis, undergoing conversion into derivatives.

Pseudoglobulin.

Preparation.

Serum is half-saturated with ammonium sulphate solution. The precipitate is treated with saturated sodium chloride solution. The pseudoglobulin dissolves and is thrown out again by half-saturation with ammonium sulphate. It is dissolved in sodium chloride solution and the solution dialysed.

In a coagulated state it is obtained by precipitating with alcohol and drying with alcohol and ether, or by acidifying the solution and boiling, drying the coagulum after washing with alcohol and ether.

Properties.

The uncoagulated protein, if its solution in water be evaporated *in vacuo*, will form an amorphous glassy mass of a yellow to brown colour. The coagulated protein is an amorphous white or nearly white powder.

Pseudoglobulin is not a typical globulin as it is soluble in water and in saturated sodium chloride solution.

Its solution gives the general reactions for proteins.

Serum Albumin.

Preparation.

- * Serum albumin remains in solution after the globulins have been precipitated by half-saturation with ammonium sulphate. It is precipitated by complete saturation of the filtrate with ammonium sulphate.

It is purified by dissolving in water, half-saturating with ammonium sulphate, filtering and completely saturating with ammonium sulphate and repeating the process several times. The final solution is dialysed to remove ammonium sulphate and the coagulated protein obtained either by acidifying and boiling, or by precipitation with alcohol, or it may be evaporated *in vacuo*.

Preparation of Crystalline Serum Albumin.

The globulins are removed by slowly adding an equal volume of saturated ammonium sulphate to serum and stirring thoroughly; after 4 or 5 hours they are filtered off. The filtrate is treated with $\cdot 2N$ sulphuric acid until there is a permanent turbidity (10-14 c.c. per 100 c.c.). Crystals separate out as the solution stands. They are filtered off, dissolved in water and recrystallised by adding acid and ammonium sulphate. This is repeated several times.

Coagulated protein is obtained from it by pouring its solution in water into alcohol, washing the coagulum with water and drying with alcohol and ether.

Properties.

Uncoagulated serum albumin, obtained by evaporation of the dialysed solution, forms an amorphous yellowish mass. It is soluble in water and its solution is coagulated by heating when acidified with acetic acid. It shows all the general reactions of the proteins.

Coagulated serum albumin forms a white amorphous powder which is insoluble in water and salt solutions. It is dissolved by dilute acids and alkalis on warming and is hydrolysed into derivatives. It is more resistant to acids than egg-albumin.

Protein Content of Serum.

The total amount of protein in blood serum varies considerably. Hartley¹ found that bovine serum contained from 6.9 per cent. and that the relative amounts of the three proteins varied, but that the composition in protein of the serum of a healthy animal remained constant for periods of 11-21 days. In disease, the total amount was found to diminish, the amount of albumin varied little, but the amount of euglobulin diminished considerably. Albumin formed 37.50 per cent., euglobulin 21.31 per cent. of the total proteins in healthy animals; in diseased animals the euglobulin diminished to 10 per cent. and less.

Hartley refers to observations by other workers and gives the following method of estimation.

Estimation of Coagulable Proteins in Blood or Serum.

The blood is defibrinated and centrifugalised.

Total protein is estimated by adding 10 c.c. of blood to 190 c.c. of distilled water, acidifying the solution and coagulating by heat. The precipitate is filtered off, washed with water and alcohol, dried at 100° and weighed.

Albumin is estimated by adding 10 c.c. of blood to 90 c.c. of distilled water and half-saturating the solution with 100 c.c. of saturated ammonium sulphate. An aliquot portion of the filtrate is acidified and boiled. The coagulum is filtered off, washed with water, alcohol and ether, dried at 100° and weighed.

Pseudoglobulin is estimated by adding 10 c.c. of serum to 20 c.c. of distilled water; 10.5 gm. of sodium chloride are slowly added and the volume is made up to 100 c.c. with saturated sodium chloride solution. The precipitate is filtered off after 4 hours. An aliquot part of the filtrate is acidified and boiled. The coagulum is filtered off, washed with alcohol and ether, dried at 100° and weighed.

The globulin is estimated by calculating the difference.

¹ "Memoirs of the Department of Agriculture in India," 1914, Vol. I, No. iv.

THE COAGULABLE PROTEINS OF MILK.

In addition to the protein caseinogen (p. 460), milk contains small quantities of coagulable proteins, lactoglobulin and lactalbumin, which closely resemble those of blood.

Lactoglobulin.

Milk is saturated with finely powdered sodium chloride to remove the caseinogen. The filtrate is saturated with magnesium sulphate. The precipitate is dissolved in water and again precipitated and the process is repeated. The precipitate is dissolved in water and dialysed to remove salts, or coagulated by heat in acid solution.

Lactoglobulin closely resembles serum globulin. Crowther and Raistrick's analysis of lactoglobulin points to its identity with serum globulin.

Lactalbumin.

Milk is saturated at 30° with magnesium sulphate which precipitates the caseinogen and lactoglobulin. The filtrate is acidified with acetic acid so that the content of acid is about 1 per cent. The precipitate is filtered off, pressed out and dissolved in water; the solution is neutralised and dialysed; the lactalbumin is obtained on evaporation *in vacuo*, or as coagulated protein by heat coagulation or by precipitation with alcohol.

Lactalbumin is very similar to serum albumin but differs in rotation and percentage composition. It has been obtained in a crystalline state in the same way as serum albumin. It behaves like serum albumin in other respects.

THE COAGULABLE PROTEINS OF MUSCLE.

The solid matter of muscle consists essentially of proteins, the principal other constituents being fat, extractives (creatine and other nitrogenous substances) and lactic acid. Lean meat has the following average composition :—

Water	75	
Solid	25	{
		Protein 20
		Extractives 3
		Fat 1
		Salts 1

Living muscle consists of a semi-fluid muscle plasma which is faintly alkaline in reaction to litmus. As the result of death the soluble proteins undergo clotting—*rigor mortis*—and become insoluble; the reaction becomes acid due to the formation of lactic acid. The coagulation is accelerated by acids and by a rise of temperature and does not occur in weak alkaline solutions or in the absence of salts.

During life, the coagulation change seems to be brought about by lactic acid and the disappearance of the insoluble protein is owing to its re-solution by the lactic acid which also disappears and is again built up into the soluble protein.

The disappearance of rigor mortis after death is probably due to solution of the insoluble protein by a proteoclastic enzyme which converts it into metaprotein and other derivatives.

Two soluble proteins—only one according to Mellanby¹—are present in living muscle :—(1) Paramyosinogen, (2) myosinogen in the proportions of one-fifth and four-fifths respectively. These are converted by clotting into myosin, the former directly, the latter through the stage of soluble myosin, thus

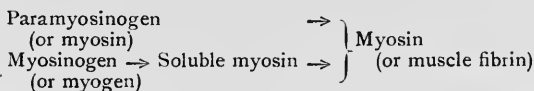

Paramyosinogen and Myosinogen.

Preparation.

Fresh muscle, veal, or the muscles of a rabbit freed from blood by perfusing the vessels through the aorta with '9 per cent. sodium chloride solution, are chopped up finely and treated with '9 per cent. sodium chloride solution.

The extract is slightly acid due to the presence of lactic acid which can be tested for by Uffelmann's test or Hopkins' test (p. 112). The extract is treated with three-fourths of its volume of saturated ammonium sulphate. The paramyosinogen is precipitated. It is dissolved and reprecipitated several times, or separated out by dialysis. The protein can then be prepared as described under ovoglobulin and serum globulins.

The filtrate from the paramyosinogen is saturated with ammonium sulphate. The precipitate of myosinogen so formed is purified by solution and reprecipitation.

¹ J. Physiol., 1908, Proc.

Properties.

One of the chief differences between these proteins is their temperature of heat coagulation. Paramyosinogen coagulates at 47° ; myosinogen at 56° .

The extract obtained from fresh muscle on heating will coagulate at about 47° and after filtering off the flakes of protein it will coagulate again at about 56° . (Coagulation may take place at about 40° . This is the coagulation temperature of soluble myosin formed from myosinogen.)

Paramyosinogen is a typical globulin; it is insoluble in water and is precipitated by half-saturation with ammonium sulphate. Myosinogen is an atypical globulin; it is soluble in water and is only partially precipitated by half-saturation with ammonium sulphate. It resembles an albumin very closely.

They give the general reactions for proteins.

Paramyosinogen from Dead Muscle.* *Preparation.*

The residue after the above extraction of paramyosinogen and myosinogen is ground up with sand and treated with five volumes of 10 or 15 per cent. ammonium chloride solution. The liquid is strained from sand and insoluble protein.

On dialysis it yields a precipitate of paramyosinogen, which is purified by re-resolution in salt solution and dialysis.

Properties.

* The properties of paramyosinogen can be well seen with the above extract:—

(1) Insolubility in water. On pouring some of the solution into a large volume of water it is precipitated: the liquid is decanted off. The remaining suspension is:—

(2) Soluble in dilute sodium chloride and precipitated on saturating with sodium chloride.

(3) Soluble in dilute ammonium sulphate and precipitated by half-saturation with ammonium sulphate.

(4) Coagulated at about 47° when dissolved in dilute ammonium sulphate.

Myosin.

Myosin is insoluble in water and dilute salt solutions and remains as a residue with the connective tissue. It has the properties of a coagulated protein and dissolves on warming in dilute acids and alkalis, giving solutions of the metaprotein, syntonin.

THE COAGULABLE PROTEINS OF OTHER ANIMAL TISSUES.

Most tissues on treatment with salt solution yield an extract which contains proteins similar to those of muscle; further, a protein like paramyosinogen can be extracted with 10-15 per cent. ammonium sulphate solution. The bulk of the protein, as in the case of muscle, consists of coagulated protein, like myosin.

These proteins have been very little investigated except those in the thyroid and crystalline lens.

Thyreoglobulin.

Thyreoglobulin is a globulin of the thyroid gland which contains iodine in organic combination and to which the physiological action of the gland is said to be due.

The finely minced gland is extracted with water; the extract is mixed with an equal volume of saturated ammonium sulphate solution and the precipitate is filtered off and washed with half-saturated ammonium sulphate. It is dissolved in water and again precipitated. The precipitate is dissolved in water and thrown down, either by acidifying and washing the precipitate with acidulated water till free from salt, or by dialysis, or by alcohol precipitation.

Thyreoglobulin forms a colourless powder, insoluble in water but soluble in salt solutions; it coagulates at 65-67° in 10 per cent. salt solution. The preparation contains various amounts of iodine, sometimes as much as 5 per cent., sometimes none. The iodine is split off by boiling with concentrated hydrochloric acid; on boiling with dilute acids iodothyryn is formed, which contains up to 14 per cent. of iodine.

Crystallin.

The crystalline lens of animals contains apparently two globulins which have been termed α - and β -crystallin.

α -crystallin.—The lens is treated with water and the filtered solution is carefully acidified with acetic acid. The precipitate so formed is dissolved in dilute ammonia and re-precipitated by acid.

β -crystallin.—The inner quarter of the lens is treated with water and the filtered solution precipitated with acetic acid. The filtrate is neutralised and saturated with magnesium sulphate. The precipitate is purified by solution and re-precipitation and the final solution is dialysed or precipitated by alcohol.

α -crystallin is precipitated by acetic acid or by carbon dioxide from neutral solution. It coagulates in aqueous solution at 72°. α -crystallin is not a typical globulin, but resembles pseudo-globulin and also the nucleoproteins.

β -crystallin in salt solution coagulates at 63°. β -crystallin is a typical globulin.

THE COAGULABLE PROTEINS OF PLANTS.

Coagulable proteins are present in various parts of plants, but are particularly abundant in oil and leguminous seeds, in which they form the reserve protein of the endosperm. The amount of protein in the seeds is determined by a nitrogen estimation by Kjeldahl's method, but since the vegetable proteins contain more nitrogen than animal proteins the factor 5.68 is employed instead of 6.25. The protein content of various seeds is as follows:—

Dried haricot beans	14 to 25	per cent.
„ lentils . . .	19 to 24	„ „
„ peas . . .	19 to 23	„ „
Nuts . . .	15 to 28	„ „

Vegetables and fruits contain from 1-1.5 per cent. of protein, the edible portion of beans about 7 per cent.

Globulin forms the greater part of the protein of the seeds, but small amounts of albumin are also present.

It seems that the pea, horse bean, lentil and vetch contain the same principal protein, the globulin termed legumin. In the three first mentioned there is also another globulin termed vicilin. These globulins are separated from one another by fractional precipitation with ammonium sulphate. These seeds contain small quantities of the albumin, legumelin.

The oil seeds also contain globulins as their principal protein. Many of them have been obtained in a crystalline form. The amount of albumin in them is very small.

The albumin, termed leucosin, is present in wheat in small quantities and similar albumins are present in other cereals.

They make up from .2-2 per cent. of the total protein.

Globulins from Leguminous Seeds (Pea).

Preparation.

Pea flour (10 gm. or more) is stirred up with twice its weight of 10 per cent. sodium chloride solution and allowed to stand for about an hour. The liquid is filtered from the insoluble residue which consists mainly of starch (as shown by iodine test) and saturated with ammonium sulphate crystals (80 gm. per 100 c.c.). The legumin and vicilin are precipitated and filtered off. They are dissolved in dilute ammonium sulphate solution ($\frac{1}{10}$ saturated) and saturated ammonium sulphate solution is added in the proportion of 150 c.c. to 100 c.c. of solution ($\frac{6}{10}$ saturation). The legumin is precipitated; it is purified by repeating the process of precipitation with $\frac{6}{10}$ saturated ammonium sulphate and separated by dialysis. The filtrate from the legumin is saturated with ammonium sulphate. The vicilin is precipitated and purified by solution, $\frac{6}{10}$ saturation and complete saturation as above and finally separated by dialysis.

These proteins can be extracted with sodium benzoate solution (see under edestin).

Properties.

These globulins have the same properties as other globulins; they are insoluble in water and are precipitated by pouring their solutions in salt into a large volume of water or by dialysis.

Legumin dissolved in 10 per cent. sodium chloride does not coagulate on boiling. Vicilin is coagulated under the same conditions.

Legumelin.

Legumelin has the properties of an albumin and is not precipitated by the dialysis of the vicilin. It therefore remains in solution and is obtained by evaporation *in vacuo* at 40° or by heat coagulation.

Globulins from Oil Seeds (Nuts).

The ground-up nut is treated with petroleum ether to remove the oil or fat. The fat-free residue (10 gm. or more) is treated with twice its weight of 10 per cent. sodium chloride solution. The solution is filtered off and poured into a large volume of water, or dialysed. A precipitate of globulin is produced which gradually settles and is purified by solution in salt solution and precipitation with water. It is filtered off and washed with water.

The globulins of the oil seeds prepared as above are usually amorphous powders, insoluble in water but soluble in salt solutions. They have the general properties of a globulin and show the general reactions of proteins.

Crystalline Globulins from Oil Seeds.*(a) Excelsin from Brazil Nuts.*

The nut is ground up and freed from oil as described under edestin. The residue is extracted with 10 per cent. sodium chloride solution and the extract is dialysed. It is thus precipitated slowly from solution and is obtained in crystalline hexagonal plates.

(b) Edestin from Hempseed.

The seed (1 kilo) is crushed and pressed in a hydraulic press to remove the oil. The residue is treated with petroleum ether and again pressed. The fat-free residue is extracted with 1000 c.c. of 5 per cent. sodium chloride solution at 60° and the solution filtered through calico. On cooling a precipitate settles out; it is filtered off, washed with water and dissolved in 500 c.c. of 5 per cent. sodium chloride solution at 60°. On cooling edestin separates in a crystalline form. It is filtered off, washed with salt solution, alcohol and ether and dried in the air. About 100 gm. are obtained from 1000 gm. of hempseed.

A further quantity of edestin separates if the filtrate be dialysed, but as spheroidal masses and not in the same crystalline state.

Reeves¹ has shown that these crystalline globulins are more easily extracted from the seeds by .5N (about 7 per cent.) sodium benzoate solution:—

The ground hempseed or minced Brazil nut is treated with petroleum ether, poured upon a Buchner funnel and washed with this solvent till free from oil. The husks of the hempseed are removed by sifting through coarse muslin. 500 gm. of the material are mixed with 500 c.c. of the benzoate solution; after 30 minutes torn blotting paper is put into the mass so as to make it appear quite dry; the dry mass is wrapped in filter paper and pressed out in a hydraulic press. 300-400 c.c. of liquid are squeezed out. The solid matter is again extracted with 500 c.c. of solvent and treated in a similar way. A third extraction is necessary in the case of Brazil nuts. The extracts are poured into 10 litres of cold water. Edestin or excelsin settles out on standing in a cool place for 12 hours. The clear liquid is decanted and the paste centrifugalised. A compact powder results; it is washed once or twice with water, once with 95 per cent. alcohol, once with absolute alcohol, and twice with dry ether and transferred to a vacuum desiccator. A product almost completely soluble in 10 per cent. sodium chloride solution is obtained. It can be crystallised from warm sodium chloride solution. Yield: edestin 29 per cent., excelsin 20 per cent.

¹ Biochem. J., 1915, 9, 508.

Globulin and Albumin from Cereals.

These proteins are present only in small quantities in the flour, but the germ contains up to 10 per cent. of coagulable proteins.

The germ is extracted with water; sufficient salt is present to dissolve some of the globulin, or the germ is extracted with 10 per cent. salt solution. The proteins are precipitated by saturating the extract with ammonium sulphate. The precipitate is dissolved in water or salt solution and dialysed. The globulin is precipitated and purified by again dissolving and dialysing. The albumin (leucosin of wheat) in the solution is obtained by heat coagulation. The two proteins have the general properties of globulins and albumins.

GLIADINS AND GLUTELINS.

The chief constituents of the seeds of cereals are starch and protein. Small quantities of fat and salts are also present.

The chief protein constituents form a distinct group which is not represented in other plants nor in animals. They are therefore known as gliadins and glutelins. The percentage composition of the protein matter of the flour of cereals is the following :—

	Wheat.	Barley.	Maize.	Oats.	Rice.	Rye.
Total protein . . .	10	11	8.6		7.0	8.5
Gliadin . . .	4.25	4.0	5.0	1.25	0	4.0
Glutelin . . .	4.0	4.5	3.1			2.5
Globulin6					
Albumin3	2.3	.45	1.5		2.0

The mixture of glutelin and gliadin in roughly equal proportions is known as gluten.

Gluten.

* About 20 gm. of flour is made into a dough with 8-10 c.c. of water and the dough is allowed to stand for 15-60 minutes. It is washed by kneading in a piece of muslin under running water. The washing is continued until no more starch can be removed. The remainder has a sticky elastic consistency and is of a grey to pale yellow colour. When it is dried the gluten forms a brittle mass like glue and is yellow-brown in colour. It is contaminated with the fat of the grain and some starch.

The formation of gluten is due to the gliadin, which makes a sticky mass with water and binds together the particles of glutelin. The elastic properties of gluten depend mainly upon the proportion of salts present in the flour, especially phosphates. Rye does not form gluten but contains a large proportion of a gummy polysaccharide.

Gliadin.

Gliadin is not easily prepared from gluten, but is prepared from flour by extracting it with hot alcohol (74 per cent. by volume). The alcohol extract is concentrated *in vacuo* and poured into absolute alcohol. The precipitate may be dissolved in dilute alcohol and poured into absolute alcohol.

Gliadin prepared as above forms an amorphous powder, but if prepared by evaporation of the dilute alcohol it forms a yellow-brown sticky mass which dries like glue.

Gliadin is insoluble in water and in absolute alcohol, but dissolves in dilute alcohol of 50-70 per cent. It is also insoluble in dilute salt solutions. It dissolves slowly in warm acids and alkalies and is converted into derivatives.

It gives most of the general reactions for proteins.

Besides its peculiar solubilities gliadin also differs considerably in composition from other proteins: it contains a large amount of proline and also amide groups—hence gliadins have been termed prolamins. They also contain a large amount of glutamic acid.

Wheat Glutelin or Glutenin.

Glutenin is most easily prepared from gluten. The gluten is boiled several times with alcohol and the residue dissolved in 0.2 per cent. potassium hydroxide. On neutralisation of the solution with acetic acid, the glutenin is precipitated and may be purified by repeating the solution in alkali and precipitation with acetic acid. The precipitate is washed and dried with alcohol and ether.

Glutenin forms an amorphous powder which is insoluble in water and in salt solutions, but soluble in .2 per cent. acid or alkali. It is converted into derivatives by stronger acids and alkalies. It gives most of the general reactions for proteins.

THE SCLEROPROTEINS.

The scleroproteins constitute the greater part of the skeletal structures of animal organisms. Just as their origin is very various, so also are their properties, but usually they are proteins insoluble in most reagents. They may be divided into several groups.

Keratins.

The keratins form the hard structure of hair, nails, feathers, horn, tortoise-shell, whalebone, etc.

The finely chopped material is boiled with alcohol, ether and water. Fats, salts and other soluble constituents are thus removed; other proteins which may be present are removed by digestion with pepsin and trypsin. The insoluble residue is washed with water, alcohol and ether and dried.

The keratins, when they have been dried, are hygroscopic substances and swell up slightly in water. They are insoluble in all reagents, but when boiled with acids and alkalis they dissolve and are converted into derivatives. Hydrogen sulphide and mercaptan are given off when they are boiled with acids. They are characterised chiefly by their high sulphur content, from 2 per cent. in pig's hoof to 15 per cent. in human hair.

They give most of the colour reactions for proteins (p. 365).

Egg-membranes.

The materials surrounding the eggs of birds, turtles and fish are grouped together as a special group of scleroproteins, but they are closely related to the keratins. The hard material, koilin, in birds' crops may be included here.

The membrane is treated for several days with dilute caustic soda (0.1 per cent.), washed with water and soaked in dilute hydrochloric acid for several days to remove any inorganic matter or gelatinous matter which is separated mechanically. The material is washed with cold water, boiling water, hot dilute acetic acid and boiled with alcohol and ether.

They are insoluble substances resembling the keratins; they give most of the colour reactions of proteins, but generally contain less sulphur than the keratins.

Elastin.

Elastin is the constituent of elastic tissue and is especially abundant in the ligamentum nuchæ. The skeletal structure of the eggs of several fish and reptiles is said to consist of elastin.

Ligamentum nuchæ is washed with water, treated for several days with fresh portions of half-saturated lime water to remove mucoids, boiled with 10 per cent. acetic acid, treated with cold 5 per cent. hydrochloric acid, again boiled with acetic acid and treated with hydrochloric acid, washed with water and boiled with alcohol and ether.

Elastin as thus prepared has a yellowish colour. It can be ground into a powder. The finely powdered substance dissolves slowly in cold 2 per cent. hydrochloric acid or 1 per cent. potash on warming. By stronger acids it is decomposed and forms derivatives.

It gives most of the colour reactions for proteins, but not the sulphur test.

Collagen.

Collagen forms the greater part of the ground substance surrounding the connective tissue cells in connective tissue, of the corpuscles in bone and of tendon; it also forms part of the substance of cartilage, cornea and fish scales.

Bones are treated (1) with dilute hydrochloric acid to remove inorganic calcium salts, (2) with dilute alkali to remove organic matter.

Tendons are digested for several days with trypsin to remove proteins and washed with water.

Collagen is a colourless material which swells up in cold water, in dilute acids and dilute alkalis. It is insoluble in organic solvents; it dissolves with swelling in strong caustic alkalis but not in carbonates. It dissolves in pepsin solutions but not in trypsin solutions unless the collagen has been previously heated with water to 70° or treated with acid. It is changed into derivatives when it is dissolved. It is converted by tannic acid into a form of leather, undergoing shrinkage. It slowly dissolves on boiling with water with evolution of ammonia and conversion into gelatin.

Gelatin.*Preparation.*

Gelatin is formed by boiling collagen with water. The collagen of fish is the most easily converted into gelatin; that from older animals with greater difficulty than from young. The gelatin is obtained from the solution by evaporation and is generally procurable in the form of sheets.

Purification.

Commercial gelatin may be purified by soaking it for several days in (1) water containing ether, (2) several weeks in changes of dilute sodium hydroxide, (3) very dilute acetic acid, (4) water. It is hardened with alcohol, dissolved in hot water and precipitated with alcohol. The precipitate is dried with alcohol and ether and placed in a desiccator over sulphuric acid.

Properties.

- * Gelatin swells up in cold water, but does not dissolve. It dissolves in hot water and solutions above about 1 per cent. set to a jelly on cooling and redissolve on heating. The heating cannot be repeated very often as the gelatin is hydrolysed and the solution no longer sets to a jelly on cooling. It dissolves very slightly in dilute alkali and is insoluble in alcohol.
- * Of the general reactions for proteins the xanthoproteic, Millon, sulphur and Adamkiewicz' reactions are very faint. Gelatin, therefore, does not contain those amino acids which are the cause of the reaction. It is not precipitated by concentrated mineral acids.
- * Mercuric chloride does not precipitate gelatin in neutral solution, but it precipitates it in presence of hydrochloric acid.

Hydroferrocyanic acid precipitates it only under certain conditions. Tannic acid gives a copious and voluminous precipitate.

Gelatin is not precipitated by saturation with sodium chloride, but comes down on acidifying.

Gelatin is precipitated from solution by saturation with magnesium sulphate or by half-saturation with ammonium sulphate.

Other Scleroproteins in Vertebrate Animals.

Several other scleroproteins have been described, but have been little investigated; they are:—

Reticulin of the reticular connective tissue in lymph glands, liver and kidneys.

Albumoid of the lens.

Albumoid of cartilage.

Albumoid of bone or *osseoalbumoid*.

Membranin of the capsule of the lens.

Scleroproteins of Invertebrate Animals.

Silk consists of two proteins, silk-fibroin and silk-gelatin, or sericin. Silk is heated two or three times for 3 hours at 117-120° with 25 times its weight of water. Silk-gelatin goes into solution, leaving the fibroin.

Fibroin has the appearance of silk, but is not glossy and is insoluble. Of the colour reactions for proteins it gives the Millon and biuret reactions.

Silk-gelatin resembles ordinary gelatin.

Spider's silk closely resembles fibroin and contains no silk-gelatin.

Conchiolin is the insoluble protein in the shell of molluscs.

Gorgonin is the insoluble protein in corals.

Spongin is the insoluble protein of sponges and contains iodine.

PHOSPHOPROTEINS.

The phosphoproteins constitute the greater part of the protein present in the food-stuffs of young mammals and of embryo birds. They are present in milk, in the eggs of birds and the eggs of frogs and fish. Their characteristic is that they contain phosphorus to the extent of nearly 1 per cent. In this respect they resemble the nucleoproteins and were formerly termed nuclealbumins, but they differ from nucleoproteins in that the phosphorus is probably in combination with one of the amino acids; in the nucleoproteins the phosphorus is present in the nucleic acid with which the protein is combined.

MILK.

Milk contains three proteins, caseinogen (or casein), lactoglobulin, lactalbumin, the carbohydrate lactose, butter fat, together with small amounts of lecithin and a yellow pigment, salts, chiefly calcium phosphate, and also in small quantities citric acid, creatine, allantoin. The milk of different animals has not the same percentage composition:—

	Human.	Cow.	Goat.	Mare.	Ass.	Whale.	Elephant.
Fat	3·5	3·5	4·3	1·1	1·6	19·4	19·6
Protein	1·5	3·5	4·6	1·9	2·2	9·5	3·1
Lactose	6·8	4·8	4·0	6·6	6·1	0·	8·8
Ash	0·2	0·7	0·6	0·3	0·5	1·0	0·5

Cow's milk and goat's milk are very similar. Human milk contains less protein and more lactose. Mare's and ass' milk most nearly approach human milk in composition. The other milks contain nearly 5 times as much fat and differ considerably.

Cow's Milk.

Appearance.

Milk is a white or pale yellow fluid which is opaque except in thin layers. The peculiar non-transparent appearance is due partly to an emulsion of finely divided fat particles and partly to the opalescence of the calcium salt of caseinogen.

* The *fat particles* of varying size are visible under the microscope and some of them exhibit Brownian movement.

* The *specific gravity* of milk varies from 1028-1035. It is usually taken with a lactometer, a specially graduated and delicate hydrometer. It rises gradually for some time after it has been drawn and the specific gravity should not be taken till after 5 hours. In mixing milks the formation of air bubbles must be carefully avoided as they are held rather tenaciously and cause errors in the determination of the specific gravity owing to the removal of the fat, the lightest constituent, which floats to the surface. Skimmed milk has a higher specific gravity, from 1033-1037.

* The reaction of milk to litmus is amphoteric, but it is generally alkaline to red litmus paper.

* *The Effect of Heat.*—No coagulation of proteins occurs on boiling milk, but a scum forms on hot milk on standing. This is due to evaporation on the surface, a layer of the dried constituents forming there and separating out. It forms each time milk is boiled and allowed to cool. The coagulated proteins will be present in the first scum.

Differentiation between Fresh and Boiled Milk.

* Fresh milk gives the *Guaïac reaction*. Some tincture of guaiacum is added to a little fresh milk and a little hydrogen peroxide. On mixing and allowing to stand, it gradually becomes blue owing to the oxidation of the guaiacol in the tincture by an oxidising enzyme, or oxidase in the milk. Instead of hydrogen peroxide, old oil of turpentine, which contains a peroxide, may be used. The reaction generally succeeds better with this than with the hydrogen peroxide.

Boiled milk does not give this reaction, as the oxidase is destroyed by heating.

Separation of the Fat.

* The fat of milk gradually rises to the surface on standing, forming cream, but it is generally separated by centrifugalisation. The fat may also be extracted by shaking some milk with twice its volume of ether. The ether deposits the fat on evaporation. After removal of the fat by ether the opacity of milk is hardly altered and is due to the opalescence of the calcium salt of caseinogen.

* If milk be treated with a little caustic soda and shaken with ether, the aqueous solution is translucent as the sodium salt of caseinogen is formed, which does not give an opalescent solution.

Butter.

Butter is obtained from cream by churning. It consists of the triglycerides of palmitic, stearic and oleic acids like other fats, but contains in addition the triglycerides of butyric and caproic acids (tributyryn, tricaproïn). Recent work by Caldwell and Hurtleÿ points to the absence of tributyrin in butter. When it becomes rancid by the action of bacteria—which contain the enzyme lipase—the smell of butyric acid and caproic acid is noticeable. The presence of these lower volatile fatty acids constitutes the chief difference between butter and ordinary fat. The butyric acid probably arises from the glutamic acid of the caseinogen which is converted by bacteria into butyric acid. Butter usually contains some milk and therefore also caseinogen; hence the origin of the butyric acid.

Margarine is prepared from animal fat, or from vegetable fats. These are generally oils, so that they are thickened. This is effected by hydrogenisation, i.e. reducing unsaturated fatty acid to the saturated. Butter is frequently added to margarine.

Separation of Caseinogen and other Proteins.

* 10-20 c.c. of milk diluted with 3 volumes of water are gradually acidified with dilute acetic acid avoiding excess ; a flocculent precipitate of caseinogen and fat is formed. The filtrate on nearly neutralising with soda and boiling coagulates (cf. p. 446). It contains the lactose and phosphates (below).

Presence of Lactose and Phosphates.

* Milk turns yellow, then brown, on heating with dilute caustic soda, due to the action of alkali on lactose.

* The filtrate from the separation of caseinogen and the coagulable proteins will show the presence of a reducing carbohydrate ; its nature can be determined by preparing the osazone with phenylhydrazine and acetic acid.

* The same filtrate will give the reactions for phosphate with nitric acid and ammonium molybdate, or magnesia mixture and ammonia.

Effect of Salts.

* Saturation of milk with sodium chloride precipitates the calcium salt of caseinogen together with the fat. Saturation of milk with magnesium sulphate, or half-saturation of milk with ammonium sulphate, precipitates the calcium salt of caseinogen and the globulin, together with the fat. The solution of the precipitate in water, filtered through a wet paper to remove the fat, is opalescent.

* Saturation of milk with ammonium sulphate precipitates the calcium salt of caseinogen, the globulin and albumin, together with the fat.

Human Milk.

In appearance human milk resembles cow's milk, but it has a different composition as shown in the table on p. 457. The amount of phosphates in human milk is also less than in cow's milk.

Not only is there a difference in composition, but also the caseinogen of human milk appears to be different. It is more difficult to precipitate this caseinogen with acid.

The preparation of caseinogen from human milk is best effected by freezing the milk for 2-3 hours after diluting with 5 volumes of water and adding 60-80 c.c. of 1N acetic acid and subsequently shaking and warming to 40° for a few minutes.

Human milk does not always clot with rennet (p. 461). This depends on the smaller quantity of calcium salts in human milk. The clot is also usually not so firm as the clot of cow's milk and the calcium caseate separates in flakes.

Humanised Milk.

Cow's milk can be altered in composition so as to approach or be the same as that of human milk. Dilution of cow's milk reduces the amount of protein ; lactose and fat are then added to bring up the content of these constituents. Humanised milk is most easily and best prepared by adding an equal volume of whey to cow's milk and then lactose and fat. If in preparing the whey the milk be continually stirred, the caseinogen is separated and the fat remains in suspension in the liquid.

Caseinogen.

Not only is caseinogen the chief protein present in milk, forming as it does about 80 per cent., but also it is of great value as a food-stuff: in milk, in the form of cheese, in numerous commercial preparations, such as plasmon, sanatogen, nutrose and many others. It is used commercially for many purposes, e.g. in making painting materials, in making adhesives, in making artificial ivory, celluloid, bone, buttons; in waterproofing paper materials; in making fireproof materials when mixed with asbestos; in glazing, in solidifying oils, in making soaps.

The food-stuffs are generally fine powders soluble in water; they are frequently mixed with carbohydrates and medicinal substances, such as sodium glycerophosphate in sanatogen. The caseinogen is usually in the form of a sodium, potassium, or ammonium salt prepared by treatment with sodium bicarbonate, sodium citrate, sodium phosphate. The amount of protein in these substances is from 20 to 95 per cent.

Preparation.

Commercial caseinogen is prepared by treating skimmed milk with dilute sulphuric or hydrochloric acid. The precipitate of caseinogen is filtered off and dried; the dry preparation contains about 10 per cent. of water.

Pure caseinogen is prepared by acidifying skimmed milk which has been diluted with water, washing the precipitate with water, dissolving it in dilute alkali, reprecipitating and repeating this procedure several times. The precipitate is finally treated with alcohol and ether, to remove fat, and dried.

A very pure caseinogen is prepared as follows:—

1000 c.c. of skim milk are diluted with 6000 c.c. of water and the caseinogen is precipitated by adding, with constant stirring, about 1000 c.c. of dilute acetic acid (10-15 c.c. glacial acetic acid in 1000 c.c.), avoiding a marked excess of acid.

The precipitate is allowed to settle and the solution decanted; it is washed with large amounts of distilled water until the washings are no longer acid. The precipitate is dissolved in dilute ammonia (5 c.c. of .880 ammonia in 1000 c.c. of water) to form a solution neutral to litmus. The solution is diluted with 6000 c.c. of water and precipitated with dilute acetic acid. Less acid is now required than before. The precipitate is washed as before, redissolved in ammonia and again thrown down by acid. The process is repeated five or six times. The precipitate is finally filtered off on a Buchner funnel and washed free from acid. The washed precipitate is suspended in 1000 c.c. of .1N hydrochloric acid and shaken for 2 hours to remove inorganic salts. This is repeated twice. It is washed free from acid, treated with 1000 c.c. each of strong alcohol and ether and dried at room temperature. It is finely ground and dried at 45-50°. The ash content of this preparation is from .25 to .3 per cent.

For conductivity experiments the caseinogen is shaken several times with conductivity water before it is dried with pure alcohol and ether.

Properties.

* Caseinogen forms a white granular powder, which is insoluble in water; it is insoluble in dilute acids in the cold, but on warming it dissolves slowly, undergoing decomposition into derivatives. It dissolves in dilute alkalis forming salts; these are best made by rubbing the caseinogen in a mortar with small quantities of the alkali, or alkali carbonate in the presence of a drop of phenolphthalein, more alkali being added only when the pink colour disappears. 1 gm. of caseinogen dissolves in 8 c.c. of 1N alkali. On rubbing with carbonates carbon dioxide is evolved.

Caseinogen forms two series of salts; those with calcium oxide contain respectively 1.5 and 2.5 per cent. of calcium oxide. The neutral salt containing 1.5 per cent. of CaO is neutral to litmus; the basic salt containing 2.5 per cent. of CaO is neutral to phenolphthalein. A solution of caseinogen in lime-water when made neutral to phenolphthalein is milky in appearance, but when neutralised to litmus the milky appearance is much more distinct.

* A neutral solution of caseinogen in caustic alkali gives most of the general reactions for proteins.

The presence of phosphorus in caseinogen is shown by incinerating or oxidising it and testing for phosphates (p. 30).

* The phosphorus in caseinogen and phosphoproteins is separated by the action of dilute alkali. On warming caseinogen with caustic alkali of about 1 per cent. strength for five minutes in a boiling water-bath, acidifying and filtering, the filtrate will show the presence of inorganic phosphates when tested with nitric acid and ammonium molybdate.

The Action of Rennin upon Caseinogen.

* The most characteristic property of caseinogen is its conversion into casein, or paracasein, by the action of the enzyme, rennin or chymosin. Rennin is prepared by extracting the fourth stomach (rennet) of the calf with salt solution, or glycerin, and can be obtained commercially either in solution or in the form of powder or tablets. The conversion is most noticeable with the soluble calcium salt of caseinogen in milk which is converted into the insoluble calcium salt of casein; in the presence of calcium salts the milk clots.

The conversion takes place more rapidly in the presence of a trace of acid or acid salts, but is prevented by alkali. The presence of calcium salts is essential to the formation of a clot. Boiled milk does not clot with rennin since soluble calcium salts (bicarbonates, acid phosphates) are made insoluble (carbonates, phosphates), but it clots if soluble calcium salts or a few drops of acid be added. The change seems to take place in three stages: (1) the conversion of calcium caseinogenate into calcium caseate; (2) the formation of soluble calcium salts from insoluble salts; (3) the change in viscosity and clotting of the calcium caseate.

The factors concerned in the clotting of milk are illustrated by the following experiments. The various mixtures of milk and rennet are placed in a water-bath at 40° and the time taken to produce coagulation is noted :—

	Time of Coagulation.
(1) 5 c.c. of milk + 2 c.c. of rennet extract	+
(2) 5 c.c. of milk + 2 c.c. of boiled rennet extract	+
(3) 5 c.c. of milk + 1 or 2 drops dilute acetic acid + 2 c.c. of rennet extract (More acetic acid precipitates caseinogen)	0
(4) 5 c.c. of milk + 2 c.c. dil. Na ₂ CO ₃ solution + 2 c.c. rennet extract	0
(5) 5 c.c. of milk + 1 c.c. of potassium oxalate solution + 2 c.c. of rennet extract	0
(6) 5 c.c. of milk + 1 c.c. of potassium oxalate solution + 2 c.c. of rennet extract for 10 minutes. The rennet is now destroyed by boiling, the solution cooled and 1 c.c. of CaCl ₂ solution added; clotting or precipitation occurs	+
(7) 5 c.c. of cold boiled milk + 2 c.c. of rennet extract	0
(8) 5 c.c. of cold boiled milk + 1 c.c. of calcium chloride solution + 2 c.c. of rennet extract	+
(9) 5 c.c. of cold boiled milk + 2 or 3 drops of dilute acetic acid + 2 c.c. of rennet extract	+
(The acid produces soluble calcium salts and accelerates the clotting)	

The coagulation of milk takes place normally in digestion in the stomach and is usually attributed to the presence of the enzyme rennin, but Pavloff and other workers consider that the clotting of milk is produced by the action of pepsin in neutral, or very faintly acid, solution. The identity of the two enzymes, pepsin and rennin, is emphasised by the fact that the proteoclastic enzymes of plants, such as occur in pineapple juice, clot milk if their solutions be nearly neutralised. Trypsin in very small amounts will also clot milk.

If the change of calcium caseinogenate into calcium caseate is a stage of pepsin digestion, casein may represent the stage of metaprotein; the calcium salt of it is insoluble and is therefore precipitated.

Cheese.

The action of rennin upon milk is used in the preparation of junket and cheese. Extract of rennet is added to milk, or skimmed milk, and the mixture kept in a warm place. It clots and forms junket. On standing the clot contracts and a clear liquid, termed whey, exudes. By cutting the clot into cubes the whey oozes out more rapidly, and as it oozes out the cubes are stirred, cut smaller and gradually piled one upon another, so that they press out the remainder of the whey. The cubes gradually form a mass which is again cut up and the process continued till the mass is sufficiently dry. Salt is added and the mass is pressed out so that it forms a solid lump. It is allowed to stand and ripen, a process which is due to enzyme action. These are hard cheeses. By the action of moulds and bacteria they become green.

Soft cheeses are prepared in the same way, but the whey is not removed by cutting the curd; the clot is allowed to contract and most of the whey may be pressed out, but the soft cheese always contains some whey. It ripens more rapidly than hard cheese and the ripening is due to the action of bacteria.

The whey which has oozed out contains the lactose, phosphates and soluble proteins and is used for preparing milk sugar.

EGG-YOLK.

Egg-yolk contains fat, lecithin, lutein (the yellow colouring matter), cholesterol, the phosphoprotein vitellin and small quantities of a coagulable protein livetin. The vitellin and lecithin appear to be in a kind of loose combination and this combination was formerly termed vitellin. It is preferable to term the protein vitellin and the combination lecitho-vitellin.

Lecitho-vitellin.

Preparation.

(a) Egg-yolks are broken in a bottle and shaken several times with ether, until the ether has only a faint yellow colour. The residue is dissolved in 10 per cent. sodium chloride and poured into a large volume of water or dialysed. Lecitho-vitellin is precipitated. This compound cannot be dried with alcohol and ether as it separates into lecithin and vitellin, but it can be filtered off, washed with water, dried by pressure between sheets of paper and *in vacuo* over sulphuric acid.

(b) Egg-yolk is mixed with 10 per cent. sodium chloride solution and the mixture is extracted several times with ether. The salt solution is dialysed or poured into 20 volumes of water. It is purified by solution in sodium chloride and precipitation with water.

Livetin is contained in the water into which the egg-yolk solution in sodium chloride is poured. It coagulates when the solution is acidified and boiled. It differs in this way from vitellin as well as in its phosphorus content.

Properties.

* A solution of lecitho-vitellin in 10 per cent. sodium chloride prepared from egg-yolk as above coagulates on heating at 70-75°. The compound in solution behaves like a globulin in being insoluble in water and in being precipitated by saturation with magnesium sulphate, or half-saturation with ammonium sulphate. It gradually breaks up into lecithin and vitellin by repetition of precipitations or on long contact with water. It gives the colour reactions and most of the precipitation reactions for proteins. It is converted by alcohol into lecithin and vitellin.

Vitellin.*Preparation.*

The precipitates of lecitho-vitellin obtained by either of the above methods are treated with warm alcohol and ether. The lecithin is dissolved and the vitellin remains.

Since the protein of egg-yolk consists mainly of vitellin it can be prepared directly from dried yolk (commercial or from yolks spread out on a plate and allowed to dry in the air) by extracting them with cold alcohol, hot alcohol and ether. The residue is vitellin, containing livetin and other constituents of yolk in small quantities.

Properties.

Vitellin forms a granular powder, which is pale yellow to reddish-yellow in colour. It is insoluble in water and salt solutions; also in dilute acids; it dissolves slowly in stronger acids undergoing hydrolysis. It also dissolves slowly in dilute alkali and probably undergoes hydrolysis. It contains about 1 per cent. of phosphorus as shown by incineration or other methods of oxidation (p. 30). The phosphorus is split off by warming with dilute alkali in the same way as from caseinogen (p. 461).

Ichthulin.

Phosphoproteins have been prepared from the eggs of various fish, e.g. cod, carp and salmon. Like the vitellin from egg-yolk they seem to be in combination with lecithin and are termed ichthulin. They have not been frequently investigated. The phosphoprotein in sturgeon's egg is hydrolysed by dilute alkali with the separation of inorganic phosphate.

NUCLEOPROTEINS.

The nucleoproteins are the constituents of cell nuclei and are consequently widely distributed. A nucleoprotein has been prepared from almost every organ, but only a few have been at all well investigated. They are made up of varying amounts of protein and nucleic acid and are best considered as salts of protein with nucleic acid in different proportions, in the same way as the tribasic phosphoric acid can form three series of salts with bases. The combination of the nucleic acid and the protein is very unstable, thus favouring the idea that they are salts. The two components are easily separated by the action of alkali and the protein can be precipitated by alkaloidal reagents, leaving the nucleic acid in solution. The substance in combination with protein is termed a prosthetic group. The prosthetic group is nucleic acid.

Two varieties of nucleoprotein can be distinguished :—

α-Nucleoproteins.

These are obtained when a tissue is treated with cold water, or cold 0.95 per cent. salt solution, and the milky solution after filtration acidified with acetic acid.

β-Nucleoproteins.

β-Nucleoproteins are obtained by boiling a tissue with water so as to coagulate most of the proteins and adding acetic acid to the clear filtrate. They contain less protein than the *α*-nucleoproteins and the prosthetic group is different. The guanylic acid of the pancreas is the best-known example of a *β*-nucleoprotein. The prosthetic group is a mononucleotide and contains a pentose in its molecule ; it is consequently a constituent of a plant nucleic acid (p. 300).

Jones considers that the *β*-nucleoproteins are not constituents of the cell nuclei, but that they are present in the contents of the cell having entered the tissue with the food.

Nucleins.

Nucleoproteins on digestion with pepsin are not completely hydrolysed, i.e. the protein portion is not completely separated. A residue remains which is insoluble in the pepsin solution and consists of protein combined with nucleic acid. This residue is termed nuclein. Nucleins are the insoluble residues (excluding remainders of scleroproteins) which remain after tissues have been digested with pepsin. These residues frequently contain iron. The nuclein remaining when egg-yolk is digested with pepsin has been called hæmatogen on account of its iron content. It arises from the cell nuclei of the germinal layer.

Nucleoproteins and nucleins are insoluble in water and very dilute acids, but they dissolve in dilute alkali and stronger acids. One of their features is the presence of phosphorus and frequently the

presence of phosphorus in a protein precipitate whether organic or inorganic has sufficed to place it in the class of nucleoproteins. The only characteristic of a nucleoprotein is the presence of nucleic acid and the formation of purine and pyrimidine bases on hydrolysis. Nucleoproteins may be distinguished from phosphoproteins by the action of alkali; the former are stable and do not yield phosphoric acid on hydrolysis by alkali.

Nucleoproteins of the Thymus.

The thymus contains two nucleoproteins—a nucleo-histone and a nucleoprotein.

Thymus β -Nucleohistone.

Preparation (Bang).

The minced thymus is treated for 1 or 2 days with water containing toluene. The fluid is separated by straining and centrifugalisation. Calcium chloride is added to it until it contains .2 per cent. The precipitate is separated by centrifugalisation. The filtrate contains nucleoprotein (below). It is stirred up with (1) alcohol which is decanted and (2) water. After several hours the precipitate is filtered off and stirred up with 2 per cent. sodium chloride solution. After 24 hours the liquid is filtered off. It is clear, has a bluish fluorescence and is diluted so that it contains 1 per cent. of sodium chloride. The precipitate of nucleohistone is filtered off, dissolved in water and thrown down by adding calcium chloride until .2 per cent. is present. Solution in water and precipitation with .2 per cent. calcium chloride is repeated several times.

Properties.

Thymus nucleohistone is insoluble in water, but its ammonium and alkali salts are easily soluble in alkali and ammonia. Sodium chloride precipitates sodium histone nucleate, which is soluble in 2 per cent. sodium chloride solution. Histone is precipitated if more salt be added.

It behaves in a similar way towards magnesium and ammonium sulphate; a precipitate is formed, soluble in excess; it is not precipitated by saturation with magnesium sulphate, but it comes down with 70 per cent. of ammonium sulphate.

It is decomposed by alkalies and ammonia; by the action of ammonia histone is formed; it is also decomposed by .3 per cent. of hydrochloric acid, but by weaker acids nucleohistone is precipitated from solution.

Thymus α -Nucleoprotein.

Preparation.

A precipitate of thymus nucleoproteins is formed on adding dilute acetic acid to the filtrate from the calcium chloride precipitate (above). It is easily soluble in excess of acid, particularly hydrochloric acid.

Thymus nucleoprotein is obtained by extracting thymus glands with 0.9 per cent. sodium chloride solution. The nucleohistone does not dissolve. The extract is acidified with acetic acid.

Properties.

The α -nucleoprotein of the thymus is not precipitated by salt and very incompletely by calcium chloride. It is precipitated by saturating its solution with sodium chloride or magnesium sulphate and by 25-30 per cent. saturation with ammonium sulphate. It is thus more easily precipitated than the nucleohistone.

It is decomposed by dilute hydrochloric acid into protein and nucleic acid; the protein is of the nature of acid metaprotein.

Nucleohistones of Lymphatic Organs.

In a similar way to the preparation of thymus nucleohistone, nucleohistones have been prepared from lymphatic glands, spleen and a lymphosarcoma.

They differ from thymus nucleohistone in that their alkali salts and the calcium chloride precipitate is soluble in 1 per cent. sodium chloride, but otherwise closely resemble it.

α -Nucleoprotein of the Pancreas.

The minced glands are treated with 9 per cent. salt solution; the filtered solution is precipitated with acetic acid; the precipitate is washed with dilute acetic acid, dissolved in water containing a little sodium carbonate and precipitated with acetic acid. Solution and precipitation are repeated several times. The precipitate is finally treated with alcohol and ether. These operations must be conducted at a low temperature.

Pancreas α -nucleoprotein is an amorphous powder insoluble in water, but soluble in dilute alkali; it is insoluble in very dilute acetic acid, but slightly soluble in more concentrated acid. It is decomposed by boiling with water; the filtered solution is precipitated by acetic acid and a precipitate is obtained containing less protein and more nucleic acid.

β -Nucleoprotein of the Pancreas.

The minced glands are boiled with water and filtered. The solution is acidified with acetic or hydrochloric acid. The precipitate of β -nucleoprotein is dissolved in dilute alkali and again thrown down with acid several times. It is washed with alcohol and ether.

The β -nucleoprotein of the pancreas is an amorphous powder insoluble in water and dilute acids, but soluble in dilute alkali. It is decomposed by boiling with alkali, yielding guanilic acid (p. 301) and alkali metaprotein.

α -Nucleoprotein of Blood Serum.

Carbon dioxide is passed into horse's serum (p. 443) diluted with 20 volumes of water. The precipitate of nucleoprotein and globulin is allowed to settle and separated by centrifuging. It is treated with 1 per cent. salt solution for 6 hours and the solution which contains the globulin is poured off. The sediment is dissolved in 1 per cent. salt solution containing a trace of sodium carbonate and dilute acetic acid is added. The precipitate is filtered off and washed with alcohol, ether and chloroform.

It forms an amorphous powder insoluble in water and dilute acids, but is soluble in excess of acetic acid; it dissolves in dilute alkali. It loses its solubility by contact with alcohol. It is precipitated by saturating its solution with magnesium sulphate or by half-saturation with ammonium sulphate. It is precipitated by calcium chloride, but is soluble in excess.

Other α -Nucleoproteins.

α -Nucleoproteins have been prepared from suprarenal glands, submaxillary glands, placenta and muscle by slight modifications of the above process. The gland is extracted with dilute alkali and precipitated with acetic acid and the precipitate is purified by re-solution and re-precipitation.

Other β -Nucleoproteins.

β -Nucleoproteins have been prepared from the liver, mammary gland and other organs in a similar way to the β -nucleoprotein of the pancreas.

GLUCOPROTEINS.

Various tissues of the animal body contain proteins which on examination appear to belong to yet another class of proteins. They are characterised by the formation of a reducing carbohydrate on hydrolysis and are consequently classed together as the glucoproteins. Like other conjugated proteins the prosthetic or carbohydrate group is easily split off by hydrolysis. The carbohydrate radicle in most cases is glucosamine, or a polysaccharide composed of glucosamine units, such as chitin or chondroitin.

Three classes of glucoproteins can be distinguished:—

(1) *The Mucins*.—These are soluble in water and dilute alkali but insoluble in excess of acetic acid and very dilute hydrochloric acid; they give their solutions a slimy or gummy appearance and are precipitated in sticky strands of material.

(2) *The Pseudomucins*.—These are soluble in water and dilute alkali, but unlike mucins are soluble in acetic acid. Their solutions are slimy and they are precipitated by alcohol in the form of strands.

(3) *The Mucoïds*.—These are soluble in water, dilute acids and alkalis; their solutions are not slimy; on evaporation they leave brownish membranes and they are precipitated by alcohol as white powders. Most of the proteins belonging to this group have not been extensively studied and they deserve further investigation.

Mucin of the Submaxillary Gland.*Preparation.*

The minced gland is treated with water. The liquid is poured off and concentrated hydrochloric acid is added until 15 per cent. is present. The mucin, which is precipitated, dissolves on stirring but is thrown down by adding 2-3 volumes of water. The liquid is poured or strained off; the precipitate is dissolved in 15 per cent. hydrochloric acid and thrown down by adding water. This procedure is repeated. The precipitate is washed with water, alcohol and ether and dried.

Properties.

Submaxillary mucin forms an almost colourless powder which has an acid reaction. It is not soluble in water but dissolves on adding a trace of alkali, giving a slimy solution. The solution is not coagulated by boiling, but is precipitated by acetic acid. The precipitate is insoluble in excess of acetic acid and has the appearance of gelatinous strings which collect upon a glass rod when the precipitate is stirred. The solution gives most of the colour reactions for proteins; it is precipitated by alcohol in the presence of neutral salts and also by heavy metals. A solution containing salts is not precipitated by small quantities of acetic acid nor by hydroferrocyanic acid, but it is precipitated by tannic acid. Mucin is digested by pepsin and trypsin; it is decomposed by dilute alkali giving gummy solutions and it is converted into a proteose by boiling with water at 110-150° with separation of a reducing carbohydrate.

20 per cent. of reducing carbohydrate calculated as glucose, together with acetic acid, is formed by hydrolysis on boiling for 3 hours with 3 per cent. hydrochloric acid.

Saliva.*Presence of Mucin.*

- * About 10-15 c.c. of saliva are collected in a beaker. Its reaction is faintly alkaline, but may be neutral or slightly acid at first from bacterial decomposition in the mouth.
- * On adding acetic acid, the mucin is precipitated and is insoluble in excess of acetic acid; on stirring the liquid, the mucin collects together on the rod and may thus be removed. The remaining liquid contains only traces of protein as shown by e.g. Millon's reagent.
- * The precipitate on solution in dilute alkali carbonate will be found to give most of the general reactions for proteins. It is also soluble in 1 per cent. hydrochloric acid.
- * On boiling the solution with dilute hydrochloric acid for about 5 minutes, neutralising and testing with Fehling's solution, a small quantity of cuprous oxide will settle out on standing.

Presence of Thiocyanic Acid.

- * Saliva generally contains small quantities of thiocyanic acid. This is shown by treating it with a drop of ferric chloride solution. A red colour is produced. The red colour is discharged by a drop of mercuric chloride solution. (Smoker's saliva generally contains more thiocyanic acid than that of non-smokers.)

Presence of Diastase.

This has been shown on p. 399.

Mucin of the Mucous Membrane of the Respiratory Passages.

This mucin is prepared from sputum. The sputum, free from cells and food particles, of a clear gelatinous appearance, is put into alcohol and shaken. It becomes fibrous and is separated from particles of protein, etc., by straining through cloth. It is shaken with (1) 0.5 per cent. HCl; (2) 0.1 per cent. Na_2CO_3 ; (3) 0.5 per cent. HCl to remove protein and nucleoprotein. It is dissolved in dilute caustic soda solution; the solution is filtered and centrifuged, acidified with acetic acid and precipitated with alcohol.

The mucin is a fibrous solid. It gives an opalescent solution with water which becomes clear on adding alkali. It is slightly soluble in 1 per cent. hydrochloric acid. Its solution is precipitated by saturation with ammonium sulphate. 30-35 per cent. of reducing carbohydrate is formed by boiling it for 3 hours with 3 per cent. hydrochloric acid.

Mucin of Serosa.

This mucin is present in synovial fluid and sometimes in ascitic fluid to which it gives the slimy consistency. The liquid, diluted if necessary with water, is precipitated by adding acetic acid so that the content of acid is 1 per cent. The precipitate is dissolved in water containing alkali and reprecipitated with acetic acid. The process is repeated and the precipitate washed with alcohol and ether.

The mucin is soluble in water containing alkali; the solution does not coagulate on heating and has a slimy appearance. The substance is not soluble in excess of acetic acid, but is soluble in very dilute hydrochloric acid. It is precipitated by half-saturation with ammonium sulphate. A reducing carbohydrate is formed on hydrolysis.

Mucin of Slugs.

The sticky mass, obtained by irritation of the mantle, is milky in appearance owing to the presence of calcium carbonate; it is put into 0.1 per cent. caustic potash solution. The mucin is precipitated by acetic acid. Solution and precipitation are repeated several times.

This mucin resembles the mucin of the submaxillary gland. It is not soluble in 1-2 per cent. HCl.

Another mucin has been obtained from the foot of the slug.

Mucin of Fish Eggs.

The eggs are treated with water and the aqueous solution is diluted and hydrochloric acid added until 3 per cent. is present. (The ichthulin is not precipitated.) The precipitate is washed, dissolved in dilute alkali and thrown down with acid several times.

This mucin is similar to submaxillary mucin in being insoluble in 1 per cent. hydrochloric acid.

Pseudomucin.

Pseudomucin is present in ovarian cysts and is whitish and slimy in appearance. The cysts are treated with alcohol and the stringy precipitate which is formed collects on a glass rod on stirring. It is ground up under alcohol, washed with ether and dissolved in water. The solution is precipitated with alcohol.

Pseudomucin forms a nearly colourless powder giving an opalescent solution with water. Acetic acid forms a turbidity but no precipitate. The solution is precipitated by tannic acid, hydroferrocyanic acid and basic lead acetate. About 30 per cent. of reducing carbohydrate is formed on hydrolysis.

Paramucin.

The solid, pale yellow, glistening substance found in many ovarian cysts has been termed paramucin. The mass is treated with alcohol containing hydrochloric acid, alcohol and ether. The mass contracts and can be obtained in this way as a powder.

It is insoluble in water, swells up in alkali becoming gelatinous and slowly dissolves. The solution behaves like solutions of mucin. Acetic acid produces a precipitate which is soluble in excess.

It yields about 10 per cent. of reducing carbohydrate on hydrolysis. By pepsin digestion Leathes has isolated a protein-free substance termed paramucosin.

Mucin of the Cornea (Corneomuroid).

The cornea is freed from epithelium and treated with water or very dilute alkali. The solution is acidified with acetic acid.

Corneomuroid is insoluble in water, but dissolves in alkali. Its solutions behave like mucin solutions, but are not slimy.

Mucin of the Lens (Hyalomuroid).

The liquid of the lens is filtered, diluted with 2-3 volumes of water and acetic acid added until 1 per cent. is present. The precipitate closely resembles corneomuroid.

Chondromuroid.

Finely divided cartilage is extracted at 40° with water: hydrochloric acid is added to the solution until it contains 2-4 per cent. and it is warmed on the water-bath. A white flocculent precipitate gradually separates out. It is dissolved in water containing a trace of alkali and is purified by precipitation with hydrochloric acid.

It is a colourless powder having an acid reaction and is insoluble in water. It is precipitated from its solution in alkali by acetic and dilute mineral acids. It is not precipitated by mercuric chloride or tannic acid, but copper sulphate and lead acetate precipitate it. Chondroitin sulphuric acid is formed by peptic digestion.

Tendomucoid.

The tendon (Achilles tendon) is treated with 9 per cent. sodium chloride solution and washed with water. It is then extracted with dilute lime water and this solution is precipitated with acetic or hydrochloric acid. The precipitate is dissolved in lime water and again thrown out with acid. It is washed with water, alcohol and ether.

Tendomucoid forms a nearly white solid, which is insoluble in 1-2 per cent. hydrochloric acid; it is insoluble in water, but soluble in dilute alkali. When digested with pepsin it yields chondroitin sulphuric acid.

Osseomucoid.

Bones are decalcified by treatment with 2-4 per cent. hydrochloric acid. The decalcified material is treated with half-saturated lime water and the alkaline solution is acidified with hydrochloric acid (to 2 per cent.). The precipitate of osseomucoid is washed with acidulated water and pure water, redissolved and reprecipitated.

Osseomucoid forms a colourless or faintly yellow coloured powder of acid reaction. It dissolves in dilute alkali and alkali carbonate and in 5 per cent. salt solution. From its solution in alkali it is precipitated by acid.

It yields an acid similar to chondroitin sulphuric acid by digestion with pepsin.

Amyloid.

Amyloid occurs under pathological conditions in brain and nervous tissue, in the liver, spleen, kidneys as fine concentric granules, or as glassy deposits. Such tissues give with iodine a red-brown to violet colour, a violet or blue colour with iodine and sulphuric acid, a reddish colour on treatment with methyl violet followed by acetic acid. It has been isolated by mechanical means and it forms homogeneous, circular or elliptical, granules which on drying yield a yellow or brown powder.

It is insoluble in water, weak acids and weak alkalies; it gives the general protein reactions. It is changed by contact with alkalies or by peptic digestion into such a form that the iodine and sulphuric acid reaction is no longer positive. It seems to contain chondroitin sulphuric acid.

Ovomucoid.

White of egg is diluted with water and poured into boiling water faintly acidified with acetic acid to coagulate the albumin. The filtrate is evaporated down to a small volume and poured into alcohol. The ovomucoid is precipitated. Ovomucoid may also be obtained by saturating the solution with ammonium sulphate. The precipitate is dissolved in warm water and precipitated with alcohol. It is washed with alcohol and ether and dried. Ovomucoid forms a colourless amorphous powder soluble in cold water. The aqueous solution on evaporation leaves a horny, transparent residue, insoluble in cold water, but soluble in hot water. The aqueous solution is not precipitated by acetic acid.

Solutions of ovomucoid are not precipitated by mercuric chloride, but they are precipitated by tannic acid and phosphotungstic acid in acid solution.

On boiling with acid, glucosamine is formed, as can be shown by heating 10 c.c. of a solution with an equal volume of concentrated hydrochloric acid for 5 minutes, cooling, neutralising and testing with Fehling's solution; the cuprous oxide is generally seen after the solution has stood so as to allow it to settle.

Serum Mucoid.

A glucoprotein very similar to ovomucoid is present in serum and it is prepared in the same way by pouring 200 c.c. of serum or defibrinated blood into 1000 c.c. of boiling water containing 20 c.c. of 2 per cent. acetic acid. The filtrate from the coagulated proteins is evaporated and poured into alcohol. It may also be prepared from the solution when the proteins are coagulated by alcohol.

Urinary Mucoid.

This glucoprotein is contained in the nubescolæ of the urine. It is soluble in dilute ammonia and is precipitated by acetic acid; the precipitate is soluble in excess of acetic and other acids. It closely resembles ovomucoid in many of its properties.

CHROMOPROTEINS.

The only well-defined member of this group of conjugated proteins is hæmoglobin, which is composed of the coloured substance hæmatin or hæmochromogen (p. 482) and the protein globin. The substance hæmocyanin, which is found in the blood of molluscs and crustacea, has been regarded as a similar conjugated protein, but more recent work does not confirm the older idea. Hæmocyanin contains copper in the place of iron in the coloured moiety of its molecule.

Hæmoglobin.

Hæmoglobin is present in the blood of all vertebrate animals and of some invertebrates. It is found either in solution in the liquid or more usually is contained in the red blood corpuscles, from which it can easily be separated. It is present in muscular and nervous tissue and under pathological conditions appears in the urine and fæces.

The hæmatin portion of hæmoglobin seems to be the same in all animals, but the protein portion may be different.

The hæmoglobin in the red blood corpuscles of the higher animals has been chiefly investigated. The red blood corpuscles can be separated from blood which has been prevented from clotting, e.g. by oxalates, or from defibrinated blood by centrifugalisation. Most of the properties and reactions of hæmoglobin can be easily studied directly with blood or defibrinated blood so that its isolation is not essential.

BLOOD.

* (1) Reaction.

Blood is alkaline in reaction to litmus and methyl orange; it is acid to phenolphthalein. The alkalinity is due chiefly to disodium phosphate and corresponds to $\cdot 4$ per cent. or $\cdot 1N$ sodium hydroxide.

The alkalinity to litmus is easily seen by placing a drop of blood upon a piece of neutral glazed litmus paper and in 10-30 seconds washing off the blood with distilled water; a blue mark remains.

* (2) Specific Gravity.

The specific gravity of human blood is usually from 1054-1060, but values of 1040 and 1065 have been observed. The specific gravity of defibrinated blood usually varies from 1050-1055.

Determination.

The specific gravity can be determined by weighing against an equal volume of water.

It is most readily determined with fair accuracy by Hammerschlag's method. A mixture of chloroform and benzene or ligroin of specific gravity about 1055 is prepared. A drop of blood is blown out from a capillary tube below the surface of the mixture; it assumes a spherical shape and will float or sink. Benzene or chloroform is added until the mixture is such that the drop neither sinks nor rises. The specific gravity of the mixture is ascertained by means of a hydrometer or by means of specific gravity beads. It is the same as that of the blood.

* The specific gravity may also be determined by Roy and Lloyd-Jones' method. A series of solutions of sodium sulphate of specific gravity from 1035-1070 are prepared. Portions of these solutions are placed in glass thimbles or small test tubes. The blood from the finger (or defibrinated blood) is drawn up into a capillary pipette which is made from a glass tube and bent at right angles; the pipette is conveniently furnished with an india-rubber cap. A drop of blood is ejected from the pipette in the centre of one of these solutions. It rises or sinks; drops are ejected into neighbouring solutions. In one of them it will remain stationary. The specific gravity of this solution will be the same as that of the blood.

(3) The Red Blood Corpuscles.

The number of red blood corpuscles in the blood of animals varies in health considerably, thus it is roughly:—

In man	5,000,000	} in 1 cubic millimetre.
dog	6,500,000	
cat	9,000,000	
pig	6,000,000-8,000,000	
horse	7,700,000	
ox	6,000,000-8,000,000	
sheep	10,000,000	
goat	13,000,000-18,000,000	

Variations in the number of corpuscles occur in man when he lives at different altitudes, more corpuscles being present at high altitudes. Variations in the number also occur pathologically. A variation of 100,000 in 5,000,000 is of no physiological importance.

Dogs' red corpuscles have the following composition (Abderhalden):—

Water	64.4 per cent.	Hæmoglobin	32.75 per cent.
Solids	35.6 ,,	Proteins	9.92 ,,

Enumeration of the Red Blood Corpuscles.

The number of red blood corpuscles in blood are counted with a hæmocytometer. A drop of blood is diluted and put into a special cell, the bottom of which is ruled with a number of minute squares. By microscopic observation the number of corpuscles on several squares are counted. Two patterns of hæmocytometer are commonly used, that of Gowers and that of Thoma-Zeiss.

(a) With Gowers' Hæmocytometer.

The apparatus required (Fig. 56) for enumerating the red blood corpuscles consists of two pipettes A and B: A has a capacity of 995 cmm. and B of 5 cmm.; a mixing vessel D; a glass stirrer E; a lancet F; and a brass plate C for a

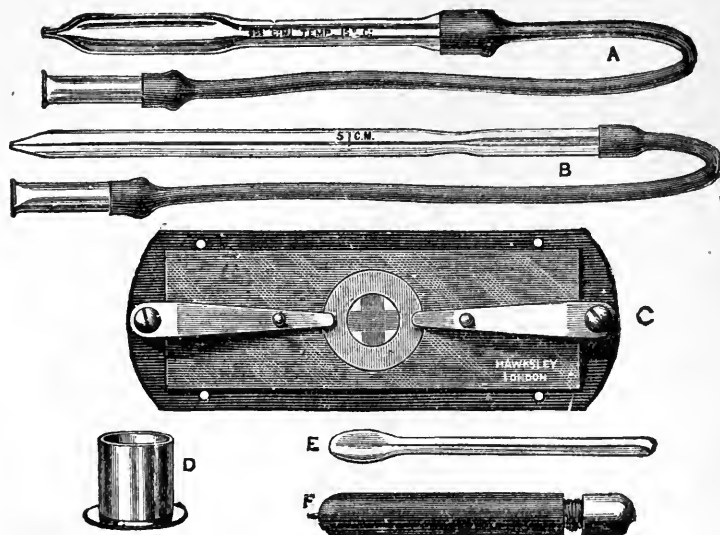

FIG. 56.—Gowers' Hæmocytometer.

microscope stage upon which is fixed a cell 0.2 mm. deep. The bottom of the cell is ruled with squares 1 mm. in diameter and the cell can be covered with a slip which is held in place by two brass springs.

Sodium sulphate solution of sp. gr. 1.025 is sucked up into the pipette A and 995 cmm. are blown into the vessel D.

The finger is washed with acetone and pricked with the lancet; the first drop of blood is not used but is washed away. The second drop of blood is sucked up in the capillary tube B and an amount corresponding to 5 cmm. is blown into the sulphate solution in D.

The blood and sulphate are mixed with the stirrer E by rotating it between the finger and thumb. A small quantity of this mixture is placed in the cell, the cell is covered and the cover slip secured in position by lifting the springs upon it. The corpuscles sink to the bottom of the cell upon the squares.

The number of corpuscles on 10 squares are counted under a microscope. About 50 corpuscles are the average per square.

Their number multiplied by 10,000 gives the number in 1 cmm. of the blood.

(b) With the Thoma-Zeiss Hæmocytometer.

The apparatus (Fig. 57) consists of (1) a glass slide upon which is fastened a square glass cell : a circular disc ruled in squares of $\frac{1}{400}$ sq. mm. area is cemented to the floor of the cell. The cell is covered with a cover slip. The height of the cover slip from the bottom of the cell is .1 mm. A volume of liquid

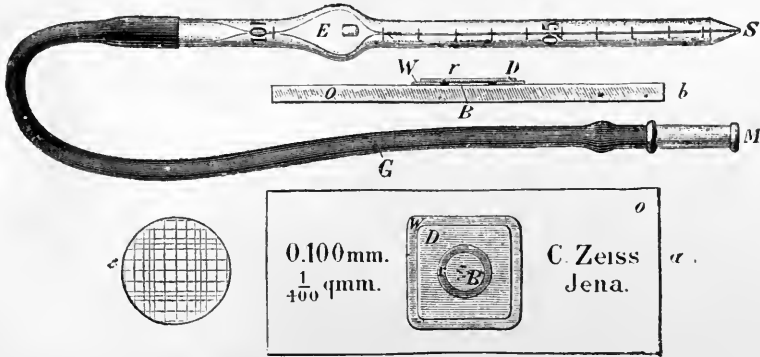

FIG. 57.

occupying $.1 \times \frac{1}{400}$ or $\frac{1}{4000}$ cmm. is above each square ; (2) a graduated pipette with a bulb containing a glass bead. These divisions bear an exact ratio to the volume of the blood.

The second drop of fresh blood from the finger or ear, cleaned with acetone, and obtained by pricking with a lancet, is sucked up in the pipette to the mark .3, .5 or 1. The pipette is wiped and diluting fluid (Hayem's fluid = 5 gm. HgCl₂ + 5 gm. Na₂SO₄ + 1 gm. NaCl + 200 c.c. H₂O, coloured with methyl violet) is sucked up to the mark 101 whilst the pipette is continuously rotated between the finger and thumb so as to ensure mixing. The pipette is closed with the fingers without removing the rubber tube and the contents are shaken for 1 minute. Three or four drops are blown out of the pipette and then a minute drop is placed on the centre of the ruled disc. The cell is covered with the cover slip, avoiding any escape of the liquid into the portion around the disc. The number of corpuscles in 40 squares is counted. Corpuscles on the top and right side do not belong to the square. The counting should be in the order five left to right, five right to left in next row, five left to right in next row and so on. It is advisable to note the totals for each 5 or 10 squares.

The dilution of the blood is as the volume of blood taken to the total volume of the mixture, e.g. :—

$$\begin{array}{ccc} .3/100 & .5/100 & 1/100 \\ \text{i.e. it is } \frac{100}{.3}, \frac{100}{.5}, \frac{100}{1} \end{array}$$

The volume of the liquid above the squares is $\frac{1}{4000}$.

Hence the number of corpuscles per cubic millimetre of blood is

$$\frac{4000 \times \text{dilution} \times \text{total corpuscles counted}}{\text{No. of squares counted}}$$

The error is 5 per cent. when 16 squares are counted, 2 per cent. for 100 and 1 per cent. for 400.

* (4) **Laking of Blood. Hæmolysis.**

Blood, or defibrinated blood, is opaque even in very thin layers but becomes transparent when the hæmoglobin, which is normally contained in the red blood corpuscles, is discharged from them. The blood is said to be laked or hæmolyzed.

Blood may be laked in several ways:—

- * (a) By osmosis, i.e. by diluting it with 2 or 3 volumes of water, or by adding blood to excess of water. A solution is obtained which is transparent and has a bright red colour. In the process of osmosis water passes into the corpuscles, bursts them and liberates the hæmoglobin. This does not occur when blood is mixed with 0.9 per cent. sodium chloride solution, since the contents of the corpuscles and the saline solution have the same osmotic pressure or are isotonic.

More concentrated solutions of salt produce crenation of the corpuscles since water is withdrawn from them. Such solutions are hypertonic; more dilute solutions are hypotonic.

- * (b) By the action of weak alkali. Blood is mixed with .9 per cent. sodium chloride solution and a few drops of alkali are added. The blood becomes transparent.

- * (c) By the action of chloroform or ether. Blood diluted with .9 per cent. salt solution becomes transparent if a few drops of ether or chloroform are added and mixed with it.

(d) By alternate freezing and thawing. The blood on subsequent dilution, with .9 per cent sodium chloride will be transparent.

- * (e) By the action of urea. Blood mixed with an isotonic solution of urea becomes transparent.

(f) By glucosides such as saponin.

(g) By bacterial toxins, snake venoms and by the blood serum of another animal.

* (5) **The Catalytic Action.**

Blood contains a very active catalytic enzyme, or catalase, which is sometimes termed hæmase. An evolution of oxygen occurs on adding a little hydrogen peroxide to defibrinated blood.

* (6) **The Peroxidase Action.**

Blood, owing to the presence of hæmoglobin, gives very marked peroxidase reactions (p. 411).

(a) *With Guaiacum.*

- * One drop of blood is diluted considerably with water (about 10 c.c.), one-half of its volume of hydrogen peroxide (20 vols. per cent.) is mixed with the solution and upon the surface is floated some fresh tincture of guaiacum or better a 1 per cent. alcoholic solution of guaiaconic acid. A blue colour gradually develops above the resinous ring

at the point of contact and diffuses into the clear zone above it. The blue colour ultimately disappears. The blood should not be left in contact with the peroxide for even as long as 5 minutes before adding the guaiaconic acid solution.

More usually a few c.c. of 1 per cent. guaiaconic acid in equal parts of alcohol and water are mixed with half the volume of 3 per cent. hydrogen peroxide and the blood solution added. The blue colour develops and disappears.

This reaction succeeds when blood is diluted 1 in 10,000. It is not due to any enzyme as it is given by boiled solutions of blood. It depends upon the presence of iron as it is not given by hæmatoporphyrin but is given by all the derivatives of hæmoglobin which contain iron. It may be termed a pseudo-peroxidase reaction (Buckmaster).

* (b) *With Benzidine.*

3 or 4 milligrams of benzidine are dissolved in 2 c.c. of glacial acetic acid; 10 drops are put into a clean test tube and mixed with 30 c.c. of 3 per cent. hydrogen peroxide. No colour should appear. A blue-green colour is formed on adding a dilute solution of blood. This reaction has a delicacy of at least 1 in 100,000 depending on the method of carrying out the reaction.

(c) *With Aloin.*

25 gm. of aloin are dissolved in 25 c.c. of water + 25 c.c. of alcohol; 10-20 drops of this clear yellow solution are mixed with twice the volume of 3 per cent. hydrogen peroxide and the blood solution is added. The colour becomes a purple red.

This reaction is less sensitive than the guaiacum reaction.

(d) *With Malachite Green.*

25 gm. of the leucobase of malachite green are dissolved in 12 c.c. of glacial acetic acid + 163 c.c. of water.

10 drops of this solution are mixed with 3 volumes of 3 per cent. hydrogen peroxide solution and the solution of blood, previously boiled, is added. The colour becomes green. This reaction shows 1 part of blood in 100,000.

(e) *With p-Phenylenediamine Hydrochloride.*

A 5 per cent. solution of this substance in water is prepared.

1-2 drops are mixed with 15-20 drops of 3 per cent. hydrogen peroxide solution and the blood solution is added. An olive-green colour is slowly formed. If a few drops of dilute acetic acid be added to the mixture, the green colour changes to brown-red.

(f) *With Phenolphthalin.*

0.32 gm. of phenolphthalin are dissolved in 21 c.c. of 1N pure sodium hydroxide and diluted to 100 c.c. with water. 1 c.c. of N hydrogen peroxide is added. On the addition of blood solution, the phenolphthalin is oxidised to phenolphthalein with the formation of a red colour.

This reaction is sensitive to 1 part of blood in 1,000,000.

THE REACTIONS OF HÆMOGLOBIN IN DEFIBRINATED BLOOD.

SPECTROSCOPIC EXAMINATION OF HÆMOGLOBIN AND ITS DERIVATIVES.

Hæmoglobin and its derivatives show typical absorption bands when their solutions are examined with a spectroscope. The formation of the derivatives is thus readily observed and they are thus easily identified.

Construction of a Spectroscope.

A spectroscope consists essentially of 3 parts, a collimator or tube furnished with a slit at one end and a convex lens at the other so as to produce a beam of parallel rays, a prism and a telescope to focus the light for observation. There is usually also a scale of wave lengths attached to the telescope so as to be able to note the position of any absorption bands. The beam of white light of parallel rays which reaches the prism from the collimator is resolved by the unequal refraction of its constituents at each bent surface into a band of light of several colours. This band of light is termed a spectrum, the colours being red, orange, yellow, green, blue, violet and indigo.

A spectrum obtained from a beam of sunlight shows a series of vertical dark lines—the Fraunhofer's lines. Thus in the red region three lines are seen; they are known as the A, B, C lines; in the yellow region one line, the D line; in the green three, the E, *b*, F lines; in the violet two, the G and H lines. These dark lines are due to the absorption of light in these regions of the spectrum by the passage of the light through certain volatile substances in the sun's atmosphere. The D line is due to sodium vapour as can be shown by passing ordinary light through sodium vapour; a line or rather two lines very close together, are seen in the D position. The other lines are due to the vapours of other elements. The colour of light after passing through a coloured liquid is the colour which is not absorbed by the liquid.

When light is passed through a solution of hæmoglobin it is absorbed in certain regions. These regions become visible when the light is passed through a prism. They are the absorption bands.

In an ordinary spectroscope the field of vision is at an angle to the original source of light, but for convenience a direct vision spectroscope is used. Such a spectroscope consists of a series of prisms of crown and flint glass. The light which enters is refracted at each prism and finally emerges in the same direction as the original beam of light.

An absorption band has a certain width and a point of maximum absorption which does not alter with different concentrations of the solution; this point of maximum absorption is determined in very accurate work and noted on the line of wave lengths. The width of the band alters with different concentrations and is therefore not registered. For ordinary work the absorption bands visible to the eye only are noted, but for detailed work the absorption bands in the ultra-violet region, which are not visible to the eye, are also determined by photographing on special plates.

The Absorption Spectra of Hæmoglobin and its Derivatives.

A solution of 1 volume of defibrinated blood, or blood, is gradually diluted with 30 volumes of water and examined with a spectroscope. The concentrated solution appears dark red to the naked eye, but light will be found to pass through the red region of the spectrum between the Fraunhofer's lines C and D. On diluting, light will pass through the green region and between the red and green regions a dark absorption band will be seen. On diluting further,

this band becomes resolved into two, the one lying nearer D being narrower than the other. It is immediately to the right of the sodium or D line, as can be seen by introducing a little sodium chloride into the flame when examined by gaslight. At the same time light will pass through the violet region.

It should be noted at what dilution of the blood these two bands are first clearly visible, so that this dilution can be used for the examination of the derivatives.

* (a) **Oxyhæmoglobin.** HbO_2 .

The two bands as seen above are characteristic of oxyhæmoglobin.

Very dilute solutions of oxyhæmoglobin, yellowish-red in colour to the naked eye, still show the two characteristic bands.

* (b) **(Reduced) Hæmoglobin.** Hb.

The most remarkable property of hæmoglobin is its power of absorbing a molecule of oxygen and its power of giving it up again. Oxyhæmoglobin and hæmoglobin exist side by side in circulating blood; oxyhæmoglobin preponderates in amount in arterial blood, hæmoglobin usually in venous blood; the difference in the red shade of two kinds of blood shows which preponderates; the bright red colour is that of oxyhæmoglobin, the dull red colour is that of hæmoglobin. Blood kept in the absence of oxygen becomes dull red and will contain hæmoglobin. Hæmoglobin is characterised by a single absorption band.

Solutions of hæmoglobin can be artificially prepared by the action of reducing agents upon blood, such as alkaline solutions of ferrous salts (Stokes' reagent), ammonium sulphide, sodium thio-sulphate, hydrazine; thus

* (i) A few drops of ammonium sulphide are added to a solution of oxyhæmoglobin and the solution is gently warmed to about 50° . The colour becomes darker and on examination with a spectroscope a single broad absorption band will be seen between D and E.

* (ii) Two or three drops of Stokes' reagent¹ are added to a solution of oxyhæmoglobin. It acts more rapidly than ammonium sulphide and need not be warmed. The single absorption band of hæmoglobin is seen with a spectroscope.

* *Conversion of Hæmoglobin into Oxyhæmoglobin.*

On shaking up the solution of hæmoglobin with air, it is converted into oxyhæmoglobin and two bands become visible. If excess of reducing agent has been added the two bands will disappear and the solution will show the single band of hæmoglobin.

¹ Stokes' reagent consists of ferrous sulphate, tartaric acid and ammonia. It is prepared by dissolving 3 gm. ferrous sulphate in cold water, adding a cold solution of 2 gm. tartaric acid and then making the mixture up to 100 c.c. Strong ammonia is then added till the precipitate first formed is redissolved. The solution rapidly absorbs oxygen and must therefore be freshly prepared. The solution of ferrous sulphate and tartaric acid can be kept for some time; the ammonia is therefore added when the reagent is required for use.

* (c) **Carboxyhæmoglobin.** COHb.

Hæmoglobin combines with carbon monoxide forming carboxyhæmoglobin. Carboxyhæmoglobin differs from oxyhæmoglobin in being more stable; it can only be dissociated by prolonged treatment with oxygen. It is formed in cases of coal-gas poisoning by the action of the carbon monoxide in the gas. Owing to its stability cases of coal-gas poisoning are generally fatal.

A stream of coal gas is passed through a solution of defibrinated blood. It assumes a cherry red colour as compared with the yellowish-red of oxyhæmoglobin, due to the smaller absorption of light in the blue and violet regions.

Spectroscopic examination will show two bands like those of oxyhæmoglobin, but they are situated slightly nearer the violet end of the spectrum. The difference in position can only be determined by the use of a spectroscope with a scale of wave lengths.

* *Differentiation between Carboxyhæmoglobin and Oxyhæmoglobin.*

Oxyhæmoglobin is reduced to hæmoglobin by reducing agents, but carboxyhæmoglobin is not reduced. If therefore some ammonium sulphide be added to a solution of carboxyhæmoglobin and the solution be gently warmed, no change is noticed in the absorption bands.

The blood in cases of suspected coal-gas poisoning must always be tested by the reduction.

Solutions of carboxyhæmoglobin (saturated with carbon monoxide) become light red in colour on treatment with an equal volume of 40 per cent. caustic soda; a red precipitate is deposited. Solutions of oxyhæmoglobin give a brown coloration and brownish-black precipitate.

Tannic acid gives a red precipitate with carboxyhæmoglobin solutions; a greenish-brown precipitate with oxyhæmoglobin.

On boiling a pure solution of carboxyhæmoglobin, a red precipitate is obtained; oxyhæmoglobin solutions give a brown precipitate.

Nitric Oxide Hæmoglobin. NOHb.

Hæmoglobin combines with nitric oxide in the same way as with carbon monoxide; this compound is more stable than carboxyhæmoglobin. It is prepared from carboxyhæmoglobin by passing nitric oxide into the solution. The solution is placed in a vessel so that the air is first expelled by passing a current of neutral gas (nitrogen or hydrogen); the nitric oxide is passed in and the excess expelled in the same way. If prepared from oxyhæmoglobin the solution must contain alkali to absorb nitric acid produced by combination of oxygen and nitric oxide.

Solutions of nitric oxide hæmoglobin possess a bright red colour and show two absorption bands like those of carboxyhæmoglobin. On boiling they give a red precipitate.

Nitric oxide hæmoglobin is formed together with methæmoglobin when nitrates are taken by the mouth; the red colour of meat pickled with potassium nitrate is due to nitric oxide hæmoglobin (Haldane).

Cyanhæmoglobin. HbCN.

Solutions of oxyhæmoglobin are converted into cyanhæmoglobin when they are mixed with potassium cyanide or hydrogen cyanide and allowed to stand or warmed to 40°. The colour becomes orange-yellow (Preyer).

Solutions of methæmoglobin are changed immediately into cyanhæmoglobin when they are treated with 5 per cent. hydrogen cyanide solution (Kobert).

Alkaline solutions of methæmoglobin also yield cyanhæmoglobin on treatment with potassium cyanide.

Cyanhæmoglobin is also a stable compound and contains 158 per cent. of CN. It shows a broad absorption band in the green.

It is converted into hæmatin by the action of sodium hydroxide; hæmatin gives cyanhæmatin with hydrogen cyanide; cyanhæmatin, on reduction with ammonium sulphide, gives cyanhæmochromogen and hæmochromogen.

Sulphhæmoglobin.

Sulphhæmoglobin is produced on passing hydrogen sulphide through a solution of blood. It is formed in putrefaction by the action of this gas which is produced by bacterial action on protein. It was believed to be the cause of the greenish colour of the skin of corpses (Hoppe-Seyler).

Gamgee did not consider it as a definite compound, but Clarke and Hurlty¹ believe it to be a distinct substance. The solution is green in thin layers, red in thick layers and shows an absorption band in the green towards the violet end.

* **Methæmoglobin.** HbO?

Solutions of oxyhæmoglobin on exposure to the air become brown in colour and on spectroscopic examination show an absorption band in the red as well as the two bands of oxyhæmoglobin. The substance giving the extra band was called methæmoglobin by Hoppe-Seyler in 1864.

Methæmoglobin is produced by the action of numerous substances upon hæmoglobin—such as nitrates, chlorates, permanganates, hydrogen peroxide, nitrobenzene, pyrogallol, etc. It is most conveniently prepared by the action of potassium or sodium ferricyanide, thus:—

* A dilute solution of blood is treated with a few drops of a strong solution of potassium ferricyanide. The solution becomes reddish-brown in colour. On examination with a spectroscope, the solution shows an absorption band to the red side of D and the blue end is markedly absorbed. There is also a faint band in the green-blue region. On dilution the two bands of unchanged oxyhæmoglobin may appear.

The absorption band in the red is most characteristic for methæmoglobin.

If the solution of methæmoglobin be made faintly alkaline with a few drops of ammonia, alkaline methæmoglobin is formed. The solution is more red in colour and shows two bands between D and E like those of oxyhæmoglobin and a third fainter band to the red side of D.

* *Conversion of Methæmoglobin into Hæmoglobin and Oxyhæmoglobin.*

¶ Methæmoglobin is converted by reducing agents, e.g. ammonium sulphide, into hæmoglobin and on shaking with air oxyhæmoglobin is formed.

Solutions of methæmoglobin may thus be distinguished from solutions of hæmatin.

¹ J. Physiol., Vol. 36.

The Change of Oxyhæmoglobin into Methæmoglobin.

When oxyhæmoglobin is converted into methæmoglobin a volume of oxygen equal to that originally combined with the oxyhæmoglobin is evolved. Methæmoglobin is usually said to contain the same amount of oxygen as oxyhæmoglobin; it is probably in a different state of combination, as it cannot be removed by submitting the methæmoglobin to a vacuum as in the case of oxyhæmoglobin. This change is represented as follows:—

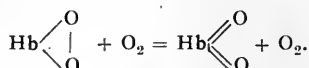

* The evolution of oxygen in the conversion of oxyhæmoglobin into methæmoglobin can be readily observed:—

An equal volume of water is added to a little defibrinated blood in a test tube and warmed to 50°. An equal volume of potassium ferricyanide solution is mixed with this solution. If the tube be inclined for a short time, the evolution of bubbles of oxygen will be seen.

The later work of Letsche and of Buckmaster upon the action of hydrazine on oxyhæmoglobin and methæmoglobin shows that methæmoglobin contains half as much oxygen as is present in oxyhæmoglobin. Methæmoglobin has more probably the formula $\text{Hb}=\text{O}$ and the conversion of oxyhæmoglobin into methæmoglobin may be

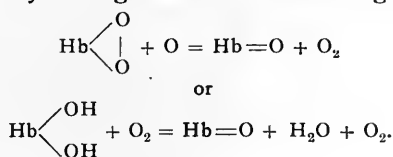

* **Hæmatin.**

Hæmoglobin is decomposed by the action of dilute alkalies or of dilute acids into hæmatin and globin; also by digestion with pepsin and hydrochloric acid. Hæmatin is insoluble in water, but soluble in acids or alkalies, giving solutions which are known as acid hæmatin and alkaline hæmatin. In alkaline solution hæmatin can be reduced by Stokes' reagent or ammonium sulphide to hæmochromogen, or reduced alkaline hæmatin. These changes can also be seen with a solution of defibrinated blood.

* *Acid Hæmatin.*

A quarter of a volume of 33 per cent. acetic acid is mixed with some diluted blood (1 : 5) and warmed in a water-bath to 40 or 50° for 5-10 minutes. The solution becomes brown. On diluting a portion with water and examining with a spectroscope an absorption band in the red between C and D will be seen. This is characteristic of acid hæmatin; it resembles the absorption spectrum of methæmoglobin. Its position depends on the amount of acid present in the solution; it is nearer C with more acid.

* *Conversion into Hæmochromogen.*

The solution is made faintly alkaline with dilute caustic soda and filtered. Stokes' reagent or ammonium sulphide is added to the filtrate. The two characteristic bands of hæmochromogen are seen with a spectroscope in the green region.

Acid Hæmatin in Alcohol.

Acid hæmatin is soluble in alcohol. A solution is most readily obtained by adding sufficient alcohol to blood to precipitate the proteins. The precipitate is warmed with alcohol containing 1 per cent. of sulphuric acid. A dark-brown solution of acid hæmatin showing the absorption bands is obtained.

Acid Hæmatin in Ether.

Acid hæmatin dissolves in ether. An ethereal solution is prepared by adding half the volume of glacial acetic acid to defibrinated blood and an equal volume of ether and mixing thoroughly. The ethereal solution of acid hæmatin rises to the surface. On pouring it off into a clean vessel and examining it with a spectroscope it will show the characteristic band in the red region and a broader band between D and F. This band is resolved into two bands if the solution be diluted with acid ether (1 part of glacial acetic acid to 2 parts of ether). There is a narrow band in the light green to the red side of E and a broader, darker one in the green. A fourth very faint band may be seen on the violet side of D.

* *Alkaline Hæmatin.*

Dilute defibrinated blood (1 : 5) is mixed with half its volume of alcoholic caustic soda solution and heated gradually nearly to the boiling-point. The colour becomes brown. On cooling and shaking with air (reducing substances are formed by the action of alkali and may reduce the hæmatin to hæmochromogen) and examining the solution with a spectroscope, a broad but very faint band will be seen to the red side of D, extending a short distance towards the violet side. The blue end of the spectrum is considerably absorbed.

Alkaline Hæmatin in Alcohol.

Alkaline hæmatin is soluble in alcohol and is prepared by mixing a little defibrinated blood with solid potassium carbonate so as to form a paste and evaporating to dryness on the water-bath. The dry residue is boiled in a flask on a water-bath with alcohol. The filtered solution shows the absorption band of alkaline hæmatin. It is more distinct than with the aqueous solution.

* *Conversion into Hæmochromogen.*

A few drops of ammonium sulphide are added to the alkaline solution and warmed. The solution becomes red in colour and on spectroscopic examination shows two bands in the green, the one nearer D being very prominent and sharply defined, the other being much fainter.

In very dilute solutions only the one band is seen but the absorption of light here is very great. A solution of oxyhæmoglobin, where the absorption bands can scarcely be seen, on conversion into hæmochromogen, will show this single band.

The conversion of hæmoglobin into hæmochromogen is a very delicate test for blood stains; the stain is heated with 1 per cent. caustic soda, the solution is cooled and filtered and then reduced. Examination with the spectroscope shows one or both absorption bands.

* **Hæmin.**

Hæmatin forms a hydrochloride which is insoluble in acetic acid and is termed hæmin. It crystallises in blue-black prisms and is very easily prepared as a microscopical preparation:—

A drop of blood is placed on a glass slide and allowed to dry, or it is dried by gently heating over a flame. The dry residue is scraped into a little heap and a drop of glacial acetic acid added to it from the

end of a glass rod. It is rubbed up into a paste and a little is put on a clean slide. A drop of glacial acetic acid is added, it is covered with a cover slip and heated over a small flame till the acid just begins to boil. The slide is allowed to cool and examined with a microscope. Small black or brownish-black crystals of hæmin are seen as shown in Fig. 58. If no crystals are visible, the glass slide is again heated and the heating may be repeated two or three times.



FIG. 58.—Hæmin crystals.

* **Hæmatoporphyrin.**

Hæmoglobin and hæmatin are decomposed by the action of strong acids and converted into hæmatoporphyrin.

Hæmatoporphyrin is free from iron, whereas hæmatin still contains this element. The removal of the iron from hæmatin in the absence of reducing agents is accomplished only with difficulty and is only effected by strong reagents, such as concentrated sulphuric acid, glacial acetic acid saturated with hydrobromic acid, or hydrochloric acid, and heated to 130° in a sealed tube. The hæmatoporphyrin obtained by the action of sulphuric acid is hæmatoporphyrin anhydride.

Hæmatoporphyrin is more readily formed from reduced hæmoglobin by the action of moderately concentrated hydrochloric acid.

The iron is also readily removed from hæmochromogen by dilute acids and reducing agents of an acid nature easily set free hæmatoporphyrin from hæmatin. Hence the stability of iron in hæmatin is dependent on the presence of oxygen.

It is very probable that the cells of the body deal with the blood pigment in the reduced condition, which, as seen above, is easily changed into hæmatoporphyrin. Its occurrence in the urine in cases of hæmatoporphyrinuria can be thus accounted for. Alkaline hæmatoporphyrin occurs in urine.

Hæmatoporphyrin is soluble in dilute acids and alkalies giving solutions of acid and alkaline hæmatoporphyrin.

* *Acid Hæmatoporphyrin.*

(a) A few drops of blood are mixed with 5 c.c. of concentrated sulphuric acid. A purple solution is obtained, which, when examined with the spectroscope, will show two well-marked absorption bands. One of the absorption bands lies in the orange between C and D; the other, which is broader and darker, lies in the yellow-green between D and E. The solution may be diluted with glacial acetic acid, if necessary.

(b) Blood which has stood for 2-3 days in the cold, i.e. has become reduced by standing, is treated with one-third of its volume of concentrated hydrochloric acid and filtered. The mass of hæmatoporphyrin and precipitated proteins is extracted with alcohol; the alcoholic filtrate shows the spectrum of acid hæmatoporphyrin (Laidlaw).

* *Alkaline Hæmatoporphyrin.*

(a) The sulphuric acid solution of hæmatoporphyrin is poured into excess of distilled water. The solution is cooled and neutralised with caustic soda. A pigmented precipitate containing most of the hæmatoporphyrin separates out. Sodium acetate makes the precipitation more complete. The precipitate is filtered off and dissolved in dilute caustic soda. The solution of alkaline hæmatoporphyrin so obtained shows, when examined with the spectroscope, four absorption bands, a narrow one in the red, a broader and darker one in the green, a third in the green extending to the violet side of E and a fourth at the junction of the blue and green.

(b) On rendering the hydrochloric acid solution just alkaline with ammonia, the spectrum of alkaline hæmatoporphyrin may be observed. It is, however, best seen if the alcoholic solution be evaporated to dryness on the water-bath and the pigment dissolved in dilute ammonia.

* **Estimation of Hæmoglobin.**

Most of the methods which have been devised for the estimation of hæmoglobin depend upon the comparison of the colour of blood with that of carefully prepared standard colours. These standard colours are either various shades of red painted on paper, or coloured glass, or they are a standard colour in solution made from a suitably diluted normal blood. The standard solution may be blood, treated with carbon monoxide to give carboxyhæmoglobin, diluted to a fixed amount.

The amount of hæmoglobin may also be determined by ascertaining the oxygen capacity of the blood and indirectly by an enumeration of the red blood corpuscles if each corpuscle contains the normal amount.

A. Colorimetrically.

* (1) *Tallquist's Method.*

In this method the colour of a drop of blood is matched against a series of red spots on paper. These spots have colours varying from light to dark red and represent percentages from 10 to 100. They are arranged in a series and by their side is a circular opening in the paper. A drop of blood from the finger is touched with a piece of white blotting-paper, or filter paper, and allowed to diffuse through the paper so as to give an even stain. As soon as the blood is dry, the stain is viewed through the openings in the paper against the standards and the colours are matched. The percentage of hæmoglobin in the blood corresponds with that of the standard. As the standards do not show every unit a very close approximation cannot be made, e.g. the blood stain may be deeper in colour than the 95 per cent. standard, but paler than the 100 per cent. one. The method gives good average results, but is not very accurate.

(2) *Von Fleischl's Method.*

In this method an apparatus (Fig. 59) consisting of a mirror (*R*), a coloured

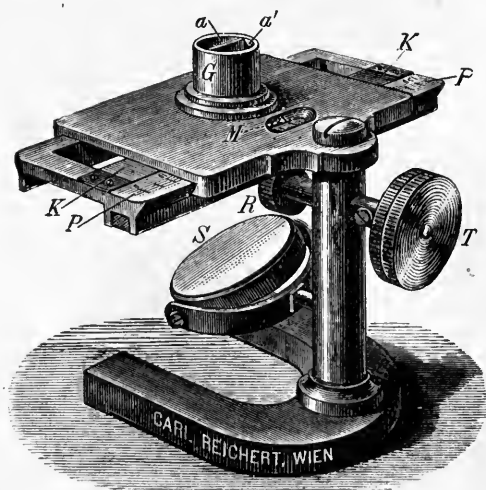

FIG. 59.

glass wedge (*K*) and a circular cell (*G*) with two partitions (*a*, *a'*) is used. The mirror has a white reflecting surface (*S*) and is adjusted to send light through the coloured wedge and through the two compartments of the cell. One of the compartments of the cell is filled with water; in the other compartment is placed a small amount of water; 20 cmm. of blood are collected from the finger in a specially graduated capillary pipette and ejected into the water in this compartment, which is then completely filled with water. The volume of the compartment is such that the blood is diluted 100 times.

The colours are observed and the wedge is moved by means of a screw (*T*) until the colours match. The graduated scale (*P*) on the instrument gives the percentage of hæmoglobin.

(3) *Oliver's Method.*

A series of standard test colours (*a*) circular in shape and graduated from 10-100 per cent. of hæmoglobin and prepared against a Lovibond's tintometer are arranged in a series on a frame. A capillary pipette (*c*) attached to a small handle is filled with blood from the finger. By means of a pipette (*d*) the blood is washed from the capillary into a small circular cell (*e*). The cell is nearly filled with water and the blood and water are mixed with the handle of the capillary pipette. The cell is covered with a cover glass; a bubble should form to show that the cell is not filled too full. The cell is matched against the series of standards, the exact matching being ascertained with a camera

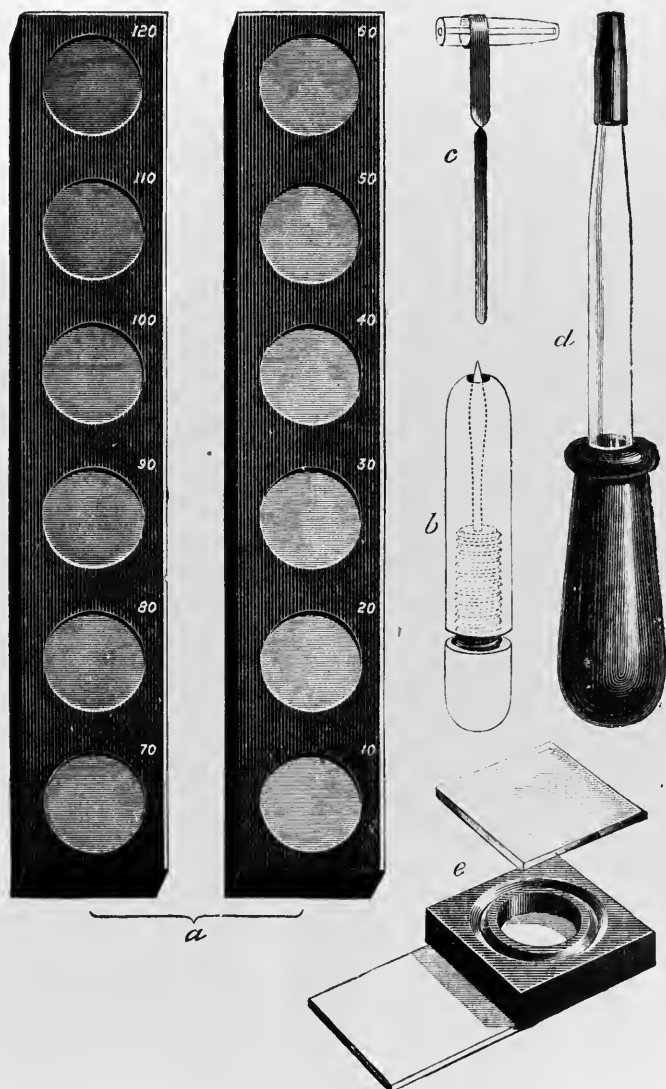

FIG. 60.

tube. Artificial light should be used. If the colour does not match any standard exactly, the nearest lower standard is adjusted by adding to it thin discs until the match is perfect. These discs are also graduated.

(4) *Hoppe-Seyler's Method.*

1 c.c. of blood is diluted with a known small amount of water and compared against a standard solution of oxyhæmoglobin prepared from the pure crystalline compound. The unknown is diluted until the colours match. The amount of dilution is noted. The dilution of the standard is known; the two colours are proportional to their dilutions and the hæmoglobin value can thus be calculated.

* (5) *Gowers' Method.*

Gowers, instead of using a hæmoglobin standard as in Hoppe-Seyler's method, used a standard of glycerin jelly stained with picrocarmine of such a colour that it corresponded to normal blood diluted 100 times with water. It is contained in a small sealed tube. The comparison is made in a similar tube with 20 cmm. of blood which is diluted with water until it has the same tint. This tube is graduated in percentages so that the value is directly observed. The method of estimation is carried out in the same way as is described under Haldane's method.

* (6) *Haldane's Method.*

Haldane has modified Gowers' method by using a standard solution of ox blood or sheep's blood saturated with carbon monoxide in the place of the carmine-tinted glycerin jelly. The standard is a 1 per cent. solution of defibrinated ox blood saturated with coal gas. It has an oxygen capacity, determined by Haldane's ferricyanide method, of 18.5 per cent.; the carbon monoxide capacity is the same. Since 1 gm. of hæmoglobin combines with 1.34 c.c. of oxygen at N.T.P., it corresponds to 13.8 per cent. of hæmoglobin. This is the same as that of adult males. Women's blood averages 11 per cent., children's blood 13 per cent. In determining the percentage of hæmoglobin in these cases $\frac{1}{3}$ should be added for women's blood and $\frac{1}{7}$ for children's. The standard, kept in the dark, will remain unaltered for years.

The apparatus necessary for the estimation is the standard tube

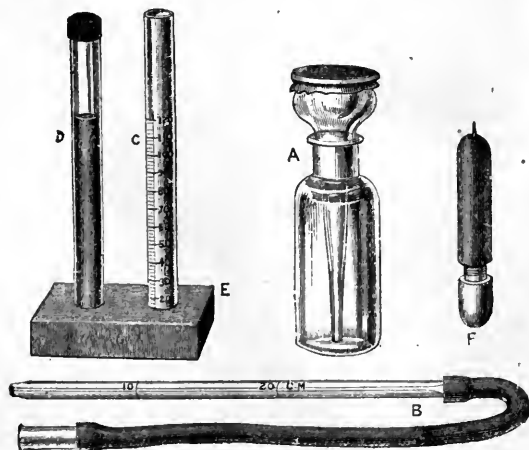

FIG. 61.

(D), a companion tube graduated in percentages (C), a lancet for pricking the finger (F), a pipette to measure 20 cmm. of blood (B), a tube to pass carbon monoxide or coal gas into the vessel and a bottle of distilled water saturated with coal gas with a drop pipette for gradually diluting the blood (A). The items are shown in Fig. 61.

The process of estimation is carried out as follows:—

The water is saturated with coal gas by attaching the cap of the special tube for the purpose to a gas burner and passing in the gas. The water is shaken several times with the gas so that it becomes saturated.

In the small tube, which is graduated in percentages from 0 to 100 or 120, is placed less water than will be ultimately needed to dilute the blood to the required tint. It contains 2 c.c. when filled up to the mark 100.

The finger is pricked with the lancet and blood is sucked up into the capillary pipette a little beyond the mark 20 (= 20 cmm. or 0.02 c.c.). The point of the capillary is wiped clean and the pipette is dabbed on the back of the hand until the blood stands at the mark. The blood is blown to the bottom of the tube below the water; the pipette is rinsed out with the water above it. The solution is carefully diluted and mixed with water saturated with coal gas and its tint is compared with that of the standard. Two readings should be taken: (1) when the colours are the same, (2) when the colour is appreciably lighter. The mean of these is taken. The scale gives percentages of hæmoglobin.

* (7) *Sahl's Method.*

In principle and practice this method is the same as Gowers' or Haldane's method, but the standard is a small tube of acid hæmatin. 20 cmm. of blood are put into .1N hydrochloric acid in the companion tube. Conversion to acid hæmatin takes place and the solution is diluted until it matches the standard.

In many respects this method is preferable to the previous ones.

B. By Determination of the Oxygen Capacity.

The determination of the oxygen capacity of blood is described on p. 498. The amount of hæmoglobin can be calculated from the following data:—

1 c.c. of normal blood combines with .185 c.c. of O_2 at 0° and 760 mm.

1 gm. of hæmoglobin combines with 1.34 c.c. of O_2 at 0° and 760 mm.

from which it is found that

1 c.c. normal blood contains .138 gm. of hæmoglobin.

Normal blood thus combines with 18.5 per cent. of oxygen at 0° and 760 mm. and contains 13.8 per cent. of hæmoglobin. If the hæmoglobin is expressed as 100, the oxygen capacity value must be multiplied by $\frac{100}{18.5}$ or 5.4.

Tests for Blood in Stains, etc.* (1) *Peroxidase Reactions.*

The stain is dissolved and tested with guaiacum, benzidine and other reagents. The solution should be boiled so as to exclude the presence of peroxidase and it should be remembered that other compounds such as halogens give the reaction.

This test serves chiefly as a guide.

* (2) *Spectroscopic Examination.*

The absorption spectra of hæmoglobin and its derivatives afford the best means of detecting blood in the form of spots, stains, etc.

The spot is scraped off the material—after its position has been carefully noted. The material, or if on cloth a piece of the cloth, is soaked in a small quantity of water or 9 per cent. sodium chloride. If the solution is coloured it is examined with a spectroscope, small amounts with a micro-spectroscope, i.e. a spectroscope attached to a microscope.

If the solution is not coloured or coloured too little to show absorption bands, the material is warmed with a little caustic soda solution. Hæmatin is formed and shown to be present by conversion by reduction with ammonium sulphide to hæmochromogen. Both absorption bands may be seen, but generally only one; this band is visible even in very dilute solution.

* (3) *Teichmann's Test. Formation of Hæmin.*

This test depends upon the formation of hæmin crystals and is carried out in the same way as with a small drop of blood. The blood stain is scraped up and treated with acetic acid as on p. 484.

Stains on iron work are said not to give the crystals.

A stain on cloth which cannot be scraped off is dissolved in glacial acetic acid. If the stain be old, it is necessary to add a crystal of sodium chloride, as the chlorides may have been dissolved out.

Dilute solutions of blood are precipitated by acidifying with acetic acid and adding tannic acid (freshly prepared). The dried precipitate is heated on a slide with a trace of sodium chloride and glacial acetic acid.

Various modifications have been suggested for this method.¹

¹ See Biochem. J., Vols. VII. and VIII.

CRYSTALS OF OXYHÆMOGLOBIN AND DERIVATIVES.

The ease with which crystals of oxyhæmoglobin can be prepared from the blood of animals differs very considerably and numerous methods have been tried. Generally, only sufficient crystals for microscopic examination can be prepared; the preparation is difficult and frequently unsuccessful. Larger quantities of crystals can be prepared from the blood of the horse and of the ox.

Oxyhæmoglobin.*Preparation for Microscopic Examination.*

(a) From rat's or horse's blood. An equal volume of distilled water and 1 or 2 drops of ether are added to the blood and mixed thoroughly. A drop of the solution is placed on a microscope slide and covered with a cover slip when the edges begin to dry. Crystals gradually separate out.

(b) From dog's, rat's, guinea-pig's, or horse's blood. The defibrinated blood is laked by adding ether, or better ethyl acetate, drop by drop. Ammonium oxalate solution is added until 1.5 per cent. is present. Crystals of oxyhæmoglobin separate out, especially if the solution be cooled to 0°.

(c) From dog's, rat's, squirrel's, man's, rabbit's, or pig's blood. The defibrinated blood is laked by freezing and thawing several times in a platinum basin. After the last thawing it is poured into a dish in layers less than 1.5 cm. thick. Crystals separate out if the dish is set aside in a cool place.

(d) From dog's, ox, rabbit's and other bloods. One-sixteenth of its volume of ether is added to the defibrinated blood and the blood is laked by shaking for some minutes in a stoppered bottle, the stopper being removed to allow air to escape as the ether evaporates and being allowed to become coated with dry blood so as to prevent the entry of air. The bottle is kept at an even temperature for two or more days. On removing a drop, placing it on a microscope slide, covering it when the edges commence to dry, crystals gradually form. The crystals are crystals of hæmoglobin.

If human blood be mixed with putrid sheep's serum it will give crystals by this method (Copeman).

Preparation in Large Quantities.

Ox blood or horse's blood is defibrinated and strained through muslin and centrifuged at 2000-2400 revolutions per minute. The serum is decanted, the sediment of corpuscles stirred up with 0.85 per cent. sodium chloride in amount equal to that of the serum and again centrifuged. The solution is decanted and the sediment dissolved in the smallest quantity of water at 37°. To the solution cooled to 0° is added half its volume of ice-cold ether; the mixture is placed in a separating funnel, shaken several times and allowed to stand for 24 hours at 0°. Of the three layers which form, the lowest clear one is carefully collected (the middle one contains residues of corpuscles and is gelatinous, the top one is ether), filtered into a flask kept at 0° and freed from ether by a current of air purified by passage through permanganate and sulphuric acid. Ice-cold alcohol is added to the ice-cold solution—one-third of the volume in the case of ox blood, one-quarter in the case of horse's blood. This mixture is kept in a freezing mixture. In 12 hours crystals are obtained from horse's blood, in 24 hours from ox blood. The crystals are separated by a centrifuge, if possible at 0°, washed with ice-cold 20 per cent. alcohol and then water, dissolved in distilled water at 30°, cooled to -3° and left to crystallise. This is repeated 2 or 3 times. The crystals are finally placed on filter paper and dried *in vacuo* for 6 hours over sulphuric acid. They are powdered and dried in hydrogen at 100°.

Crystals of oxyhæmoglobin may be more rapidly prepared from horse's blood by Abderhalden's modification of the Zinoffsky method:—

The red blood corpuscles, after separating the serum and washing with 10 per cent. sodium chloride solution, are mixed with twice their volume of water and warmed to 37°. Ammonia is added to dissolve the stroma of the corpuscles and the solution is exactly neutralised with dilute hydrochloric acid. A quarter of its volume of alcohol is added and the mixture is kept at 0°. Crystals separate out on standing. They are separated, washed with alcohol and water in the above proportions and recrystallised by solution in two volumes of water, adding a quarter volume of alcohol and cooling to 0°.

Properties.

The crystals of oxyhæmoglobin obtained from the blood of different animals are generally microscopic, seldom exceeding 5 mm. in length and of a yellow-red colour. They vary in shape. Figs. 62-65 show some of the

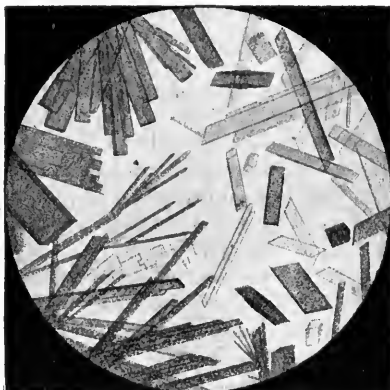

FIG. 62.—Human.

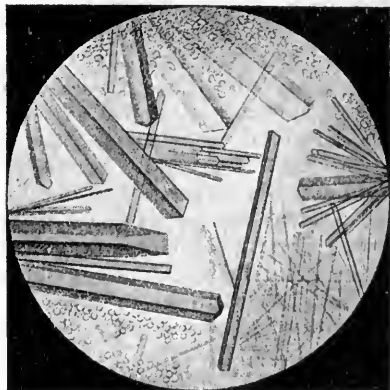

FIG. 63.—Cat.

(After Funke.)

forms of crystalline oxyhæmoglobin. Those from guinea-pig's and rat's blood are generally tetrahedra or octahedra, those from squirrel's blood are six-sided plates, those from goose's blood are rhombic plates, those from dog's and horse's blood are usually four-sided prisms.

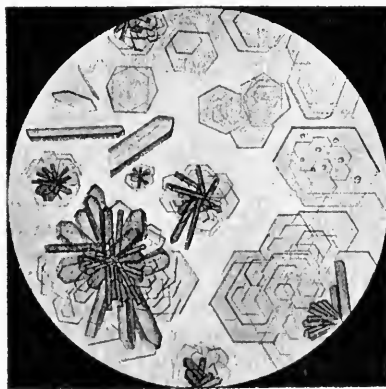

FIG. 64.—Squirrel.

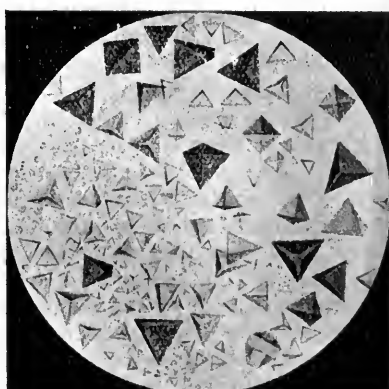

FIG. 65.—Guinea-pig.

(After Funke.)

They generally contain water of crystallisation—an amount of 14.35 per cent. has been evolved on heating crystals dried *in vacuo* to 116°. The crystals if carefully dried at low temperatures can be heated to 100° without decomposition, but decomposition occurs if they are moist, as shown by the change in colour.

Oxyhæmoglobin crystals dissolve more or less readily in water according to the blood from which they have been prepared; they also dissolve in dilute alcohol, but are insoluble in ether, chloroform, benzene and most other organic solvents.

Dilute aqueous solutions are more stable than concentrated ones and solutions containing a few drops of alkali carbonate are more stable than neutral solutions.

Solutions of oxyhæmoglobin show the colour reactions for proteins but the reactions are more or less masked by the pigment. They coagulate on heating and are precipitated by alcohol and strong acids. Decomposition into hæmatin and globin occurs. They are not precipitated by lead acetate, but they are precipitated by solutions of the alkaloidal reagents in acid solution.

Solutions of oxyhæmoglobin are dextrorotatory ($+10^\circ$ for a 1·2 per cent. solution).

Hæmoglobin.

Crystals of hæmoglobin are obtained in the same way as those of oxyhæmoglobin after the blood has been reduced by exposure to a vacuum, with Stokes' reagent or other reagents.

Hæmoglobin crystals separate if blood be kept in a sealed vessel.

Crystals of hæmoglobin are dark red in colour, usually isomorphous with those of oxyhæmoglobin. They are more easily soluble in water and on exposure to the air absorb oxygen changing into oxyhæmoglobin. Hæmoglobin is decomposed by acids and alkalies in the absence of oxygen into hæmochromogen and globin.

Carboxyhæmoglobin.

Carbon monoxide is passed through a concentrated solution of oxyhæmoglobin and the solution is treated as described under oxyhæmoglobin.

Crystals of carboxyhæmoglobin resemble those of oxyhæmoglobin and dissolve in water with a carmine-red colour. 1 gm. of carboxyhæmoglobin contains 1·34 c.c. of CO at 0° and 760 mm. (Hüfner). It is more stable than oxyhæmoglobin, but the carbon monoxide can be removed by exposure to a vacuum or passing oxygen through its solution. It also loses carbon monoxide slowly on standing in the air and is converted into oxy- and methæmoglobin. It is converted into methæmoglobin by the action of potassium ferricyanide (Haldane).

It shows a spectrum very similar to that of oxyhæmoglobin. Its solutions on heating give a pale red coagulum, due to decomposition into carboxyhæmochromogen and protein. It becomes darker in the air due to the formation of hæmatin.

Nitric Oxide Hæmoglobin.

Nitric oxide is passed into a solution of carboxyhæmoglobin crystals or a solution of methæmoglobin is shaken with nitric oxide. The solution by treatment as described under oxyhæmoglobin yields crystals of nitric oxide hæmoglobin.

The crystals of nitric oxide hæmoglobin are similar to those of oxyhæmoglobin and their spectrum is almost identical with that of oxyhæmoglobin.

Methæmoglobin.

A concentrated solution of oxyhæmoglobin of pig's, horse's, or dog's blood is treated with 10 per cent. potassium ferricyanide solution until it is of a dark brown colour, cooled to 0° and ice-cold alcohol added as in the preparation of oxyhæmoglobin. Crystals separate out on standing at 0° .

The crystals of methæmoglobin which have been obtained are slender needles of a reddish-brown colour, easily soluble in water. The solution in water and acids is red-brown in colour, in alkali red. The solution is precipitated by lead acetate or basic lead acetate.

The spectrum of the solution shows one band in the red.

Cyanhæmoglobin.

A solution of methæmoglobin prepared from horse's blood is treated with 5 per cent. hydrogen cyanide solution till the colour changes to red. One quarter of its volume of alcohol is added. On cooling to 0°, crystals of cyanhæmoglobin separate out.

Cyanhæmoglobin forms long prisms which are hygroscopic and contain 5.7 per cent. of water. They dissolve in water giving a red solution which has a shade of yellow. They contain 15.8 per cent. of cyanogen. Its spectrum in neutral or faintly alkaline solution shows a broad absorption band in the green towards the violet end. It is converted by hydrogen sulphide into hæmoglobin.

Hæmatin.

Hæmatin is most easily prepared from hæmin, its hydrochloride. Hoppe-Seyler obtained it from blood by the action of strong acetic acid in the presence of ether. The filtered ethereal solution deposits hæmatin in an amorphous form.

It is prepared from hæmin by dissolving it in cold 10 per cent. sodium hydroxide solution and carefully adding dilute hydrochloric acid to the solution. The precipitate is filtered off and washed.

Hæmatin forms an amorphous blue-black solid which is insoluble in water, alcohol, chloroform, or aqueous solutions of acids. It dissolves in acetic acid, alcoholic solutions of acids and alkalis and pyridine. The acid solutions are brown-red in colour, the alkaline solutions are dull green and dichroic. Calcium and barium salts are obtained by adding the chlorides of these metals to an ammoniacal solution.

Solutions of hæmatin show the typical absorption spectra.

Hæmin.

Several methods have been described for the preparation of hæmin; of these, that of Schälfejeff gives the best yield and is the most convenient.¹

200 c.c. of defibrinated blood are slowly added with stirring to 1 litre of glacial acetic acid saturated with sodium chloride and heated to 90-95°. The temperature falls and is again raised to 90°. The hot filtered solution deposits crystals on cooling. They are filtered off, washed with water and 65 per cent. alcohol and dried *in vacuo*. They are recrystallised by dissolving in 50 c.c. of a mixture consisting of 15 parts of 95 per cent. alcohol, 4 parts of water and 1 part of ammonia of sp. gr. 0.91, a process which takes about 30 minutes at room temperature.

This solution is added to 4-6 times its volume of glacial acetic acid saturated with sodium chloride at a temperature of 110°. The crystals which separate out on cooling are washed with 2 per cent. hydrochloric acid and dried *in vacuo*. 3-4 gm. are obtained from a litre of blood.

Willstätter has improved the Schälfejeff method:—

(1) Defibrinated blood or filtered blood is allowed to drop in a stream from a dropping funnel into 3 litres of glacial acetic acid containing some solid sodium chloride, or 1 c.c. of saturated sodium chloride solution per litre, contained in a 4 litre round-bottom flask and heated so that its temperature is 95°. The end of the funnel is so high that the vapours do not come into contact with the blood so as to cause coagulation and the acetic acid is stirred continuously, avoiding contact of the blood with the sides of the vessel. The liquid is heated for 15 minutes. Hæmin crystallises and after 2-3 days is filtered off on cloth, washed with acetic acid, water, alcohol and ether. 4.5-5.5 gm. of pure hæmin are obtained from 1 litre of blood.

¹ Other methods are given in the Zeit. Physiol. Chem., 30, 126 and 384; 29, 187; 49,

(2) Blood is centrifuged at 3000-5000 revolutions per minute in a Jouan centrifuge made by Leune in Paris (model C), or in a centrifuge made by Heine in Viersen; 635-660 c.c. of serum are separated in 10 minutes. The blood corpuscles can be washed with 9 per cent. sodium chloride solution, but this is not necessary. With the French centrifuge serum and corpuscles can be separated whilst the instrument is running, but under these conditions the corpuscles are broken by contact with the walls. 2 litres of blood give 7 litres of oxyhæmoglobin solution. The corpuscles in suspension, or the solution of hæmoglobin, is poured slowly into 2 litres of gently boiling glacial acetic acid containing 10 gm. of sodium chloride which is stirred with a mechanical stirrer. Contact of the blood with the stirrer and sides of the vessel is avoided. The mixture is kept boiling for 10 minutes and in the course of 15 minutes 1000 c.c. of water are added. Hæmin crystallises out and after 24 hours is filtered off on a double layer of cloth, washed with acetic acid, alcohol and ether. 4.6-5.2 gm. are obtained from 1 litre of blood. Recrystallisation is not necessary.

The products which are obtained by the various methods have been supposed to be different, but Küster¹ has shown that the differences are due to impurities.

Hæmin is purified by dissolving it in chloroform containing quinine or pyridine in the proportions of 1 gm. of hæmin to 1 gm. of quinine and 50 c.c. of chloroform, or to 2 c.c. of pyridine and 20 c.c. of chloroform, filtering and adding alcohol containing hydrochloric acid or acetic acid to neutralise the base. Hæmin crystallises out.

Hæmin consists of minute bluish-black crystals with a metallic lustre. It is insoluble in water, alcohol and ether. It dissolves slightly in dilute mineral acids and alcohol containing hydrochloric or acetic acid. It is soluble in solutions of caustic alkali and alkali carbonates.

Hæmochromogen.

A specimen of hæmochromogen for microscopic examination can be obtained by mixing a drop of blood with a drop of pyridine on a glass slide, adding a drop of ammonium sulphide, covering with a cover slip and allowing it to stand. A better method is to mix a drop of blood with a drop of pyridine and a drop of 50 per cent. hydrazine hydrate, cover with a cover slip, heat to nearly boiling and allow to cool.

The crystals are delicate slender needles of a ruby-red colour, often arranged in rosettes.

Hæmatoporphyrin.

Hæmatoporphyrin can be prepared by treating blood with concentrated sulphuric acid, or reduced blood with dilute acid. Hæmatoporphyrin is obtained by pouring the concentrated acid solution into water. It is most conveniently prepared from its hydrochloride and is precipitated by adding sodium acetate to the solution as an amorphous flocculent precipitate of a brown colour. It dissolves in solutions of alkali hydroxide and of alkali carbonate, in dilute mineral acids and alcohol; it is not easily soluble in ether, chloroform or amyl alcohol and it is insoluble in water and acetic acid. It is precipitated from solutions by lead acetate and salts.

Its solution in acid alcohol has the characteristic purple colour. Alkaline solutions are red with a red fluorescence.

¹Zeit. Physiol. Chem., 40, 391.

Hæmatoporphyrin Hydrochloride.

5 gm. of hæmin are added in small portions with continual shaking to 75 c.c. of glacial acetic acid saturated with hydrobromic acid at 10°. The liquid is allowed to stand at room temperature for 3 or 4 days with occasional shaking. The hæmin slowly dissolves and a purple-red solution of hæmatoporphyrin is obtained. The acid solution is poured into water and filtered; hæmatoporphyrin, which is insoluble in acetic acid, together with iron oxide, is precipitated on neutralisation of the hydrobromic acid with sodium hydroxide.

The precipitate is washed by decantation with water until the washings no longer react with silver nitrate. The moist precipitate is treated with dilute sodium hydroxide on a water-bath. The hæmatoporphyrin dissolves and is filtered from ferric oxide. By neutralising the filtrate with acetic acid the hæmatoporphyrin is thrown down, filtered off and washed. It is made into a paste with water and carefully treated with dilute hydrochloric acid so as to dissolve the pigment. The solution is filtered from resinous matter and treated with more hydrochloric acid; if resin be again precipitated, it is removed by filtration and the solution is evaporated *in vacuo* over sulphuric acid. Hæmatoporphyrin hydrochloride crystallises out. The crystals are filtered off and washed with 10 per cent. hydrochloric acid. They are recrystallised in the same way.

Hæmatoporphyrin hydrochloride forms needles arranged in rosettes of the formula $C_{33}H_{38}O_6N_4 \cdot 2HCl$ and of a purple-red colour. It dissolves easily in dilute hydrochloric acid, not so easily in more concentrated acid.

Crystalline Hæmatoporphyrin (Willstätter).

Willstätter has found that hæmin dissolves readily in glacial acetic acid saturated with hydrobromic acid only if its specific gravity is 1.41 at 0°. He puts 36 gm. of hæmin in 700-900 c.c. of the reagent and shakes for 15 minutes; in about 7 hours it is completely in solution. The solution is poured into 5 litres of water and filtered from coarse particles through talc. On standing for 3 hours the addition product is hydrolysed. The hæmatoporphyrin and ferric oxide, precipitated by adding sodium acetate, are filtered off, washed with water and dried at the ordinary temperature; the yield is 34 gm. The precipitate is dissolved in sodium hydroxide, the solution filtered from ferric hydroxide and the filtrate acidified with acetic acid. The hæmatoporphyrin is filtered off and washed.

The moist material from 10 gm. of hæmin is dissolved in 1 litre of alcohol and poured into 25 litres of ether in 7 separating funnels. The alcohol is washed away by running tap water through the ether for 20 minutes. Some flocculent calcium salt which separates is collected and converted into hæmatoporphyrin. The ethereal solution is dried with sodium sulphate and concentrated to a volume of 1 litre. Hæmatoporphyrin separates out and crystallises on standing. It is filtered off, washed with ether and dried in a desiccator; 4.5 gm. are obtained.

The crystals have a violet colour, red-brown in transmitted light. They are soluble with difficulty in ether, methyl alcohol and 96 per cent. ethyl alcohol, more easily in absolute alcohol and easily soluble in acetone and glacial acetic acid. They are slightly soluble in .03 per cent. HCl, completely in .4 per cent. HCl. *In vacuo* at 105° they lose 1 mol. of water. It is a stable compound of the formula $C_{33}H_{38}O_6N_4$.

THE FUNCTION OF HÆMOGLOBIN AS CARRIER OF OXYGEN.

The solubility of oxygen at N.T.P. in water is about .4 c.c. in 100 c.c. ; in blood it is about .7 c.c. in 100 c.c., excluding the amount in combination with hæmoglobin. This quantity of oxygen in the blood does not suffice to supply the needs of the body for oxygen. Hæmoglobin has the function of being a special solvent for oxygen and of acting as the carrier of oxygen to the tissues. 1 gm. of hæmoglobin combines with 1.34 c.c. of oxygen at N.T.P. This quantity of oxygen is so definite that it is generally believed that the oxygen is in actual chemical combination, but it is thought also that it is simply in solution in the hæmoglobin (by adsorption).

Hæmoglobin readily combines with oxygen and readily gives it up again, especially under the conditions in blood where the temperature is relatively high (37°), salts and acids, especially carbonic acid, are present. Under these conditions the dissociation of oxygen from the hæmoglobin is as rapid as the association of oxygen by the hæmoglobin ; they occur at about the same rate, in less than one second, i.e. in about the same time as the flow of blood through the capillaries. Pure hæmoglobin solutions behave differently, the association is rapid, the dissociation is slow in comparison.

The association and dissociation of the hæmoglobin follow the same laws that hold for the partial pressure of gases, whether they are in a gaseous state or dissolved in a liquid in contact with gas. Transference takes place from the region where the partial pressure (or tension if dissolved) or relative amount of the gas is high to the region where the partial pressure or the relative amount of gas is low. Association occurs in the lungs where the partial pressure of oxygen in the alveolar air is high ; dissociation occurs in the tissues where the partial pressure or tension of the oxygen in the hæmoglobin is higher than it is in the tissues.

Determinations have been made to ascertain the relative amounts of hæmoglobin and oxyhæmoglobin which are formed when a hæmoglobin (or oxyhæmoglobin) solution is exposed in a closed vessel to different partial pressures of oxygen. These varying partial pressures of oxygen are prepared by mixing oxygen or air with nitrogen in the required proportions in the vessels. Small volumes of blood are introduced and exposed to the large volumes of the known gaseous mixtures at a definite temperature until equilibrium is reached. The amount of oxygen in the sample of blood is then determined by the ferricyanide method (p. 498) and expressed as a percentage of the total oxygen capacity of the blood. The following table is typical of the results obtained ; the percentage of hæmoglobin is found by deducting the percentage of oxyhæmoglobin from 100.

Partial pressure of oxygen in mm.	0	5	10	20	50	100
Percentage of oxyhæmoglobin	0	37	55	72	87	94
Percentage of hæmoglobin	100	63	45	28	13	6

The results can be expressed in the form of a curve, the dissociation curve.

The hæmoglobin is almost completely associated with oxygen at 100 mm.; at atmospheric oxygen pressure, $\frac{760}{760}$ or 150 mm. the association would be complete. The partial pressure of the oxygen in the lung is about 100 mm., or about 13·2 per cent. of the atmospheric pressure, so that in the lungs the hæmoglobin becomes nearly saturated with oxygen; at 10 mm. partial pressure about equal parts of hæmoglobin and oxyhæmoglobin are present. Over 30 per cent. of oxyhæmoglobin is still present at 5 mm. partial pressure.

The hæmoglobin in the body is never completely saturated with oxygen, except when it is in contact with the air of the lungs. A sample of blood whether taken from a vein or artery always contains a mixture of oxyhæmoglobin and hæmoglobin.

The Estimation of Oxygen in Blood and the Oxygen Capacity of Blood.

Haldane has shown that when oxyhæmoglobin is treated with potassium ferricyanide the whole of the oxygen of the oxyhæmoglobin is evolved and methæmoglobin is formed (p. 482). The amount of oxygen in blood can thus be readily determined. The circulating blood contains a mixture of oxyhæmoglobin and hæmoglobin. The total amount of oxygen which is obtainable from the blood when it has been exposed to the air so that it contains only oxyhæmoglobin is the oxygen capacity of the blood. The oxygen capacity depends on the total amount of hæmoglobin in the blood and thus indirectly it will give the hæmoglobin content (p. 489).

* (1) *Haldane's Method.*

Haldane¹ originally estimated the oxygen and oxygen capacity in an apparatus which was almost identical with the Dupré apparatus for estimating urea and the estimation can be performed in such an apparatus. The graduations of the burette should be to 0.05 c.c.

20 c.c. of (defibrinated) blood are measured out with a pipette and introduced into the bottle of about 120 c.c. capacity. The last drops of blood must not be blown out, but are expelled by closing the top of the pipette with the finger and warming the bulb with the hand. 30 c.c. of dilute ammonia solution (1 part ammonia of sp. gr. 0.880 in 500 parts distilled water) are added and mixed with the blood. The ammonia prevents the evolution of carbonic acid whilst the water lyses the corpuscles. The solution should be quite transparent. If the laking be not complete, more ammonia must be added. 4 c.c. of saturated potassium ferricyanide solution are put in the small tube, which should be slightly longer than the width of the bottle, and it is placed upright in the large bottle without spilling. The bottle is closed with a rubber stopper through which a glass T-tube passes; this is connected at one end with a burette in a cylinder of water by india-rubber tubing and closed at the other end with a clip. The bottle is put in a vessel of water of the same temperature as that of the room. By opening the clip, the level of the water in the burette is brought nearly to the top and to the same height as the water in the cylinder. The clip is closed and the height in the burette is read off. The bottle is tilted so as to upset the ferricyanide solution and shaken gently as long as gas is evolved, the little tube being repeatedly emptied so that all the oxygen is given off. When the oxygen ceases to be evolved, the bottle is replaced in the water and cold or hot water is added to it until it attains the same temperature as at the commencement. (This is shown by means of a pressure gauge for very accurate work, as in Haldane's apparatus, Fig. 66.) The burette is adjusted so that the water has the same level inside and outside and the volume of the gas is read off. The difference in readings gives the amount of oxygen evolved from 20 c.c. of blood.

This volume should be reduced to 0° and 760 mm. and a correction should be made for the pipette which delivers only about 19.6 c.c. of blood instead of 20 c.c. of blood. Further, in very accurate work account must be taken of the air in the bottle, which has become richer in oxygen; oxygen is twice as soluble as nitrogen.

¹ J. Physiol., Vol. 25.

- * The oxygen capacity is determined in the same way, but 25-30 c.c. of the blood are first saturated with oxygen by spreading over the surface of a large flask without producing a froth.

3.7 c.c. are given off by 20 c.c. of normal blood containing 13.8 per cent. of hæmoglobin.

A better and more sensitive form of apparatus was devised later and is shown in Fig. 66.

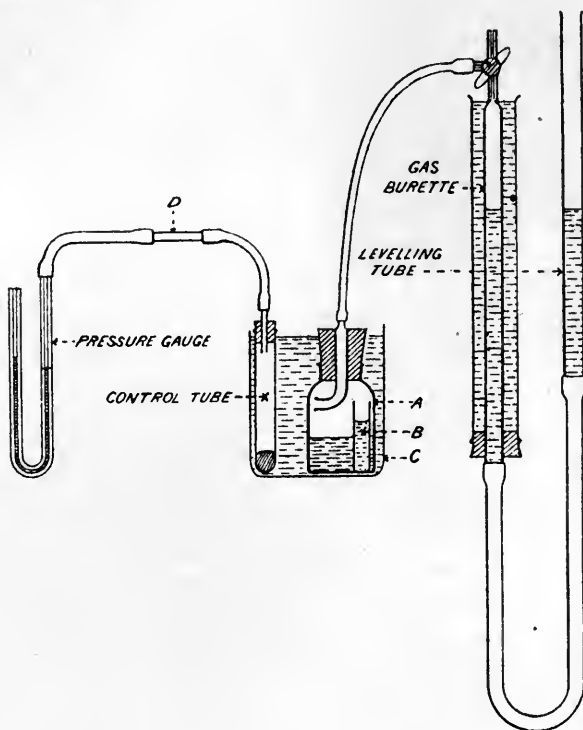

FIG. 66.—(From *J. Physiol.*, Vol. XXV., Cambridge University Press.)

A gauge is introduced so that the temperature before and after the action of the ferricyanide is more easily kept constant. The volume is measured in a gas burette filled with water.

(2) *Barcroft and Haldane's Method.*

Barcroft and Haldane in 1902 described a method for estimating the oxygen in small quantities of blood (1 c.c.). The apparatus required is shown in Fig. 67.

It consists of two bottles of about 25 c.c. capacity with glass stoppers prolonged into the interior in the form of a cup. They are connected by india-rubber tubing to pressure gauges upon each of which there is a 3-way tap connecting the bottle and manometer to the air. The bottles and gauges are fixed upon a stand so that the two bottles can be immersed together in the same bath of water and thus have the same temperature. One of the

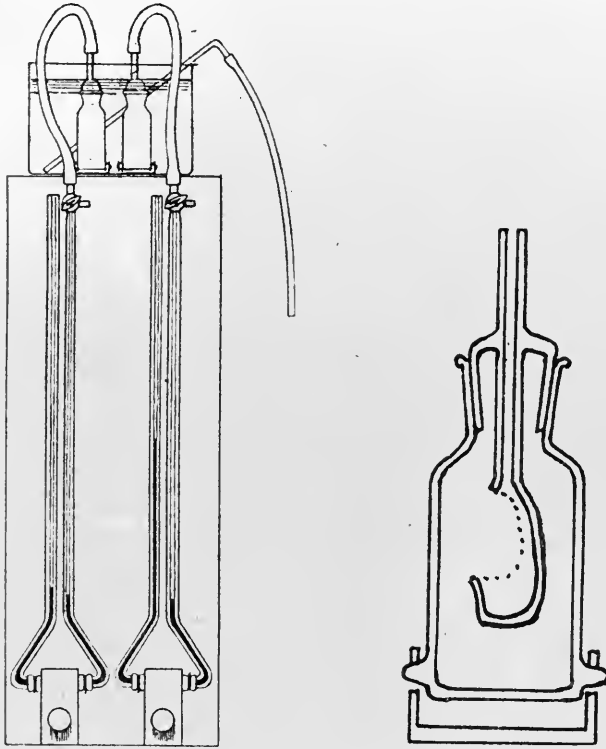

FIG. 67.—(From *J. Physiol.*, 28, 233, Cambridge University Press.)

bottles is not used and simply serves as a control for recording temperature changes, etc. The blood is placed in ammonia solution in one of the bottles and ferricyanide in the cup. On upsetting the ferricyanide into the blood the volume of gas evolved causes a change of level in the pressure gauge which is observed. The volume of gas is measured by the change of pressure. This is effected by the use of rubber tubing at the base of the gauges, which can be compressed by a screw. Before the experiment the levels of the two gauges are set at the zero point with the taps open to the air and therefore at atmospheric pressure. The tap of the bottle in which the experiment is performed is shut to the air, the ferricyanide is upset, and when the temperature is the same throughout, the levels of both gauges are brought to the original levels in the limbs attached to the bottles by altering the pressure of the screws

on the rubber tubes. The liquid in the gauge in the other limbs rises. The difference in level between the two limbs gives the increase of pressure due to the evolution of oxygen.

The pressure gauges are filled with water; at 15° the normal barometric pressure equals 10,340 mm. of water.

The volume of oxygen evolved at 760 mm.

$$= \frac{\text{volume of air in the apparatus} \times \text{corrected reading of gauge}}{10340}$$

If the bottle had a capacity of 23.35 c.c. and the fluids used had a volume of 2.75 c.c., then the volume of air is 20.6 c.c.

Supposing the gauge to read 100 mm. the oxygen evolved is

$$20.6 \times \frac{100}{10340} = 2.01 \text{ c.c.}$$

This volume is corrected to 0°.

The capacity of the bottle is ascertained by weighing it empty and full of water; the capacity of the connections by adjusting the gauge to zero and raising the pressure to a definite amount (1) with the vessel attached, (2) with a stopper in place of the bottle.

$$\frac{\text{Capacity of bottle : capacity of connecting tubes} = \text{Change of volume in (1) : change of volume in (2).}$$

This method has been improved and modified by Brodie and by Barcroft and his co-workers. In its original form it is seldom used, but the principle of using pressure change to determine the volume is maintained.

(3) *Barcroft's Method.*

The apparatus in its most convenient form for estimating oxygen in 1 c.c.

of blood was illustrated in 1910 and again in 1911¹ (Fig. 68). It consists of two glass egg-shaped bottles fused to a pressure gauge, which at the top is provided with 3-ways taps and at its base is connected by a wider piece of tubing by means of a cork, A, to a 1 c.c. pipette, X, graduated in $\frac{1}{100}$ ths. To the pipette is attached a piece of rubber tubing, C, upon which a screw can be tightened or relaxed. A piece of glass tubing, B, is put into the rubber tubing; it is sealed when the level of the liquid in the limbs of the gauge has been adjusted. The bottles are furnished with hollow stoppers inside which there are small tubes. These are to contain the ferricyanide solution. They are open at the side of the stopper, but the contents do not flow out until the opening is in contact with a small ampulla on the neck of the flask. The bottles have a capacity of about 30 c.c.

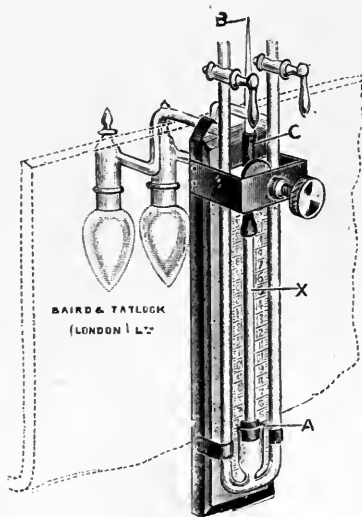

FIG. 68.

and the bore of the gauge is 1 mm.

The gauge is filled with clove oil (10,000 mm. = 760 mm. of mercury) which is introduced at the wide part of the gauge, A, nearly filling it. The cork carrying the pipette, X, is inserted avoiding air bubbles and the oil ascends in the limbs

¹ J. Physiol., 42, 513.

and pipette. It should reach to a height of about one-quarter of the length of the limbs and nearly to the top of the pipette. The glass tube, B, above the screw is sealed off.

In order to determine the oxygen, it is necessary to know the volume of the bottles, including the stoppers and about half of one limb of the gauge to the nearest 0.1 c.c. and the pressure change indicated by the gauge in terms of volume.

The pressure change indicated by the gauge is determined by adjusting the screw (with the taps open) so that a known volume, e.g. .2 c.c., is driven from the pipette into the two limbs into which it passes equally. The oil rises in these limbs and the rise is measured on the scale. .1 c.c. will pass into each limb; it will produce a rise of r_1 mm., i.e. a change of level of r_1 mm. of oil is given by .1 c.c. This should be determined for different parts of the limbs. The volume of the bottles is ascertained by introducing into the bottle a known volume of water, say 10 c.c., in order to reduce the air space, lowering the level of the oil in the limbs with the taps open to the air by altering the position of the screw, closing the tap on the side to be measured and forcing a volume of air corresponding to .1 c.c. into the bottle, i.e. by adjusting the screw so that the oil travels r_1 mm. on the closed side. The level of the oil on the other side is raised considerably; the difference of the levels (r_2) is noted. This is the pressure necessary to drive .1 c.c. into the closed bottle. The volume is calculated from Boyle's law:—

In order to introduce into the bottle another volume V where V is the volume of the bottle, atmospheric pressure would have to be exerted (10,000 mm. of clove oil); actually, a change of .1 c.c. was produced by r_2 mm.:—

$$10,000 : V = r_2 : .1$$

$$\text{Hence } V = \frac{10,000 \times .1}{r_2}.$$

To this must be added the 10 c.c. of water introduced.

The oxygen content of blood is determined by putting into one of the bottles 2 c.c. of dilute ammonia (4 c.c. of .880 sp. gr. to 1000 c.c. of water) and running 1 c.c. of blood carefully beneath it. The stoppers are greased and fitted and .3 c.c. of saturated ferricyanide solution is put into the little tube. The bottles are put into a bath with gauge vertical until the temperature is constant. This is shown by closing the taps to the air and observing if there is a change of level in the manometer. The level is conveniently adjusted about half-way up the limb. If there be a change, the taps are opened again for a minute, closed and the gauge observed. As soon as the temperature is constant, the tap to the air of the bottle not being used is opened, the blood is laked by shaking with a rotatory motion for a minute, the ferricyanide is emptied into the blood by turning the bottle and the oxygen is liberated by shaking. The volume of the gas in the bottle and limb of the apparatus is restored to its original level by adjusting the screw. The oil rises in the other limb. The rise is measured = r_3 mm. Since the volumes of the liquids (3.3 c.c.) introduced are known, the actual air space has a volume V minus this amount = v_1 .

$$\frac{r_3 \times v_1}{10,000} \text{ cmm. is the oxygen present in 1 c.c. of blood.}$$

This volume must be corrected for temperature and pressure and tension of aqueous vapour and for the actual volume of blood delivered by the pipette (generally .96 instead of 1 c.c.).

(4) *Barcroft's Differential Method.*

The oxygen content and the oxygen capacity of two samples of blood, arterial and venous, of a volume of 1 c.c. or 1 c.c. can be determined by the differential method which has been elaborated by Barcroft. In this method either the form of apparatus used in the previous method or the later pattern (Figs. 69 and 70) can be used.

The later pattern of apparatus consists of two egg-shaped bottles fitted with hollow stoppers. In that for 1 c.c. of blood the stoppers are prolonged into the interior of the flask and terminate in small cups to hold the ferricyanide solution. In that for 1 c.c. of blood there is a small receptacle in the bottle to hold the ferricyanide. The stoppers outside the flasks are continued into capillary tubes to each of which there is fused a 3-way tap. One end of each tap is fused to a small pressure gauge. The interior of each vessel can be thus connected to the air or with one limb of the manometer (or with both).

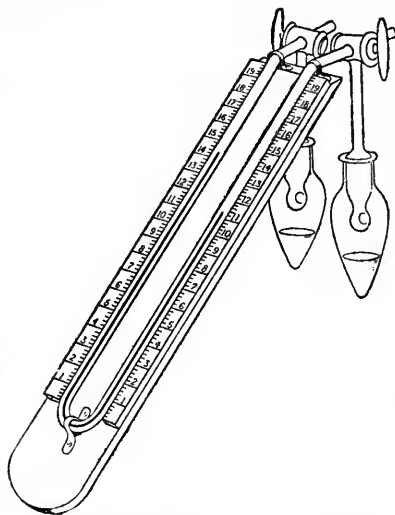

FIG. 69.—(From Barcroft's "Respiratory Function of the Blood," Cambridge University Press.)

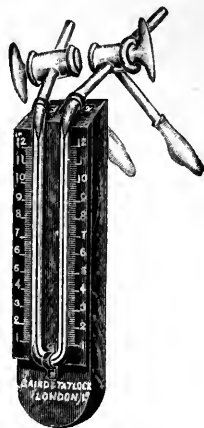

FIG. 70.

The apparatus is mounted on a stand upon the front of which there is a scale for reading the manometer and upon the back a hook so that the two flasks, which are at the same level, can be immersed in a large bath at constant temperature, whilst the manometer hangs vertically outside the bath and the taps are easily accessible.

The manometer is filled to about half-way up each limb with clove oil; in order that it registers properly it must be absolutely clean and dry. The filling of the manometer with oil is done by removing one of the stoppers and turning the other stopper so that the manometer is shut off from the other bottle and the air. The oil is sucked up into a pipette, the end of the pipette is put through the gap where the stopper has been taken out and pushed as far as the top of the manometer. Sufficient oil is introduced to fill up the one limb of the manometer and as far as the zero point of the other limb, the tap on the other side being carefully opened to the air so that the oil can come up to the zero point on this side of the manometer. The tap is closed and if excess of oil has been put in, it is removed with a sponge on a piece of wire introduced in the same way as the pipette. On opening the tap the oil will occupy the proper position. The other tap is replaced.

When the taps on both sides are closed to the air and open to the bottles any difference in pressure in the two bottles is recorded by the manometer, the clove oil moving down on the side of greater pressure and up on the other side. The pressure is given by the difference between the two sides.

The Calibration of the Apparatus.

Since the principle of the method depends upon knowing the volume of the air space in each bottle and the pressure difference in the manometer when a volume of oxygen is evolved in each of the bottles, the apparatus must be calibrated. The second bottle acts simply as an automatic correction for changes of vapour tension, temperature and surface tension brought about during the manipulations. Instead of knowing the volume of the bottles it suffices for most purposes, *provided that the same volumes of blood and reagents are always used*, to determine a constant, K, which represents the number of cmm. of gas (*v*) set free in the flask for each mm. difference of level in the manometer (*p*);

$$K = \frac{v}{p} \text{ or } v = Kp$$

i.e. the number of mm. pressure produced multiplied by the constant of the apparatus gives the volume in cmm. of gas evolved in the apparatus.

The constant may be determined by liberating a known volume of gas in one of the vessels and observing the pressure difference for this volume as described by Barcroft and Burn.¹

A definite volume of gas is most easily liberated in the apparatus by preparing oxygen from hydrogen peroxide and $\cdot 1N$ permanganate according to the equations:—

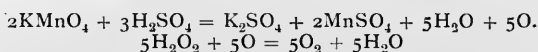

from which it is calculated that

$$316 \text{ gm. } KMnO_4 = 5 \times 22.2 \text{ litres of oxygen}$$

or

$$\cdot 00316 \text{ gm. } KMnO_4 = 1.11 \text{ c.c. of oxygen at } 0^\circ \text{ and } 760 \text{ mm.}$$

20 volume per cent. hydrogen peroxide is used, 40 c.c. being diluted to 1000 c.c. 1 c.c. of this solution should give off about $\cdot 2$ c.c. of oxygen.

Before use the diluted hydrogen peroxide solution must be titrated as follows:—

50 c.c. of the diluted solution are acidified with sulphuric acid and titrated with the $\cdot 1N$ permanganate until a pink colour results. 8-10 c.c. of permanganate should be required; if less than this volume be used, the peroxide solution is too weak and a fresh one must be prepared.

If 8.5 c.c. of permanganate be used, then the volume of oxygen liberated from 1 c.c. of dilute peroxide will be $\frac{1.11 \times 8.5}{50}$, or $\cdot 1887$ c.c. at 0° and 760 mm. This is the volume at N.T.P. which will be liberated when these quantities are put into the apparatus.

The two taps are opened to the air. It is important to pay careful attention to this operation so as to avoid breaking the apparatus. The two flasks are removed; the stoppers are carefully greased. Into one of the flasks (right) is put 1 c.c. of peroxide + 2 c.c. of $\cdot 01N$ sulphuric acid; into its cup in the stopper is put 0.2 c.c. of $\cdot 1N$ permanganate and the opening is covered with a piece of filter paper. Into the other flask (left) is put 1 c.c. of peroxide + 2 c.c. of $\cdot 01N$ sulphuric acid; into its cup in the stopper is put 0.2 c.c. of water and the opening covered with filter paper.

The bottles are carefully replaced.

The apparatus is hung up with the flasks in a water-bath of constant temperature for 5 minutes, with the taps open to the air.

The taps are closed to the air, both flasks being placed in contact with the manometer.

¹ J. Physiol., Vol. 45.

The levels of the manometer on each side are read. The levels are again read after 1 minute; they should be the same as before and almost identical, e.g. at 9.5 on each side. A difference of .05 between them may be neglected. If they are not identical, both taps are opened to the air and closed again, and this is continued until they are identical, i.e. till the temperature is constant.

The apparatus is removed from the bath (taps shut to the air, open to manometer) and the permanganate and water upset into the flask by shaking.

The flasks are shaken for 1 minute. The apparatus is replaced in the bath for 5 minutes.

The levels of the manometer are read and they are read again after successive minutes till they remain constant.

The liquid in the permanganate bottle should be pink.

The difference of level of each side is calculated by subtraction, e.g. 9.5 has decreased to 7.55 and 9.55 has increased to 11.50, i.e. 1.95 and 1.95. The total difference is thus 3.9 cm. or 39 mm.

As the temperature has been constant, the pressure (p) varies as the volume (v)

$$\text{i.e. } v = Kp \text{ or } K = \frac{v}{p}$$

p is 39 and v is .1887 c.c. at 0° and 760 mm.

$$\text{or } .1887 \times \frac{273 + t}{273} \times \frac{760}{B}$$

where t and B are the temperature and barometric pressure at the time of the experiment. K is then calculated. This is the constant where the bottle contains 3.2 c.c.; hence the constant for the empty bottle is ($K - .32$).

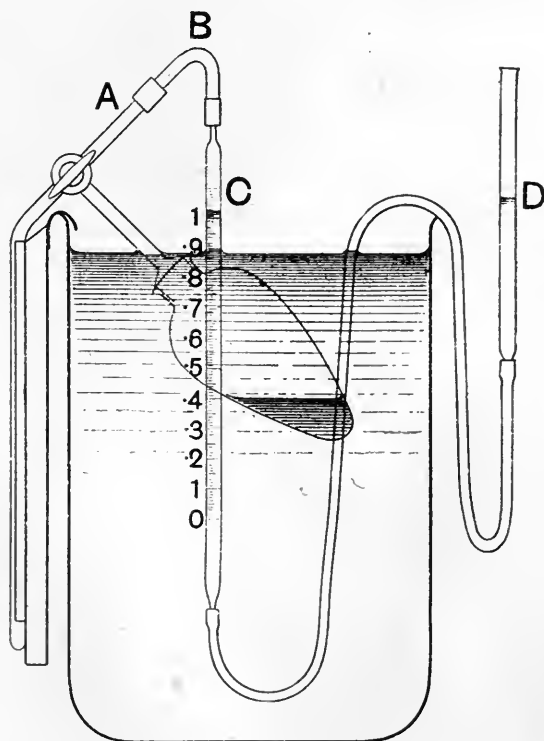

FIG. 71.—(From J. Physiol., 47, 273, Cambridge University Press.)

The constant is more easily determined by Hoffmann's procedure. Fig. 71 shows the apparatus required:—

The 3-way tap of one of the bulbs (A) is connected by a piece of bent capillary tubing (B) and thick rubber joints with a 1 c.c. pipette (C) graduated in $\frac{1}{100}$ ths. The lower end of the pipette is connected by thin rubber tubing to a second graduated pipette (D). The pipette C is placed in the water-bath with the flask which is being calibrated. Water is poured into pipette D which is levelled so that the water reaches the zero mark of pipette C, the tap of the manometer being opened to the air by removing the stopper. When the temperature is constant (in about 5 minutes) the tap is replaced and arranged so as to connect A with the manometer and the flask. The tap of the other flask is turned so as to close it from the air. The level of the manometer is read, say 9.2 cm. on each side. By raising D a volume of air (.25 to .4 c.c.) is slowly introduced into the apparatus and the manometer is read again. Supposing .28 c.c. or 280 cmm. were introduced and the manometer levels were 5.8 and 12.6 cm., the pressure difference (p) is

$$\left. \begin{array}{l} 9.2 - 5.8 = 3.4 \\ 12.6 - 9.2 = 3.4 \end{array} \right\} \text{ or } 6.8 \text{ cm. or } 68 \text{ mm.}$$

$$K = \frac{v}{p} = \frac{280}{68} = 4.12.$$

A correction must be made for the dead space (S) between the level of the water in C and the 3-way tap. This is determined by raising D and filling the apparatus as far as the tap with water, noting the volume which runs out of D. Supposing it to be .75 c.c. (= 750 cmm.), the correct constant is

$$\begin{aligned} k' &= K - \frac{S}{10,000} \\ &= 4.12 - .075 = 4.045. \end{aligned}$$

This constant 4.045 is the constant for the empty bottle. When any volume (v) of liquid is in the bottle the constant is different. Thus for 3.2 c.c. of liquid (the amount generally used) the value is

$$k'' = k' - \frac{v}{10,000} = 4.045 - .32 = 3.73 \text{ (nearly).}$$

3.73 is the working constant of the apparatus in those cases where the total volume of blood plus reagents is 3.2 c.c. The constant must be determined in this way for each bottle.

Note.—It is important that the bottles and stoppers on which they fit are designated by some mark, as the constant so determined only applies for the same bottle connected with the same side of the same manometer. Any confusion in making determinations is disastrous.

The difference in volume of the two bottles is compensated by adding more ammonia solution to the larger bottle. The difference in volumes ($V - V'$) in cmm. of the two bottles may be found from their constants (K and K'), thus $V - V' = 10,000 (K - K')$.

Determination of the Oxygen Capacity of Blood.

The bottles and stoppers of the apparatus are cleaned with hot alcoholic potash, rinsed with water and dried.

A saturated solution of potassium ferricyanide is meanwhile prepared by grinding the solid with distilled water in a mortar and decanting the supernatant solution.

The necks of the bottles are greased with lard or vaselin; 2 c.c. of ammonia solution (4 parts of .880 ammonia in 1000 c.c. of distilled water) are put into each bottle.

1 c.c. of defibrinated (or hirudinised or oxalated) blood is added to the contents of each bottle and well shaken so as to lake the blood and saturate it with oxygen.

Both taps are opened to the air and into the cup on one side (right) 0.2 c.c. of ferricyanide is put with a fine pipette. A strip of filter paper (2 cm. long and 1 mm. broad) is put upon the cup so that it projects from the cup but does not touch the ferricyanide. It facilitates the subsequent emptying of the cup.

Both bottles are fixed on their respective sides of the apparatus and placed in the water-bath for 5 minutes. The pressure levels are noted, the taps closed to the air and the levels noted again after 1 minute. If there be alteration, the taps are opened for 5 minutes and closed again for 1 minute. When there is no alteration after 1 minute, the ferricyanide is upset into the bottle. The apparatus held in a vertical position is gently shaken in a horizontal direction for 1 minute and replaced in the bath for 1 minute. The pressure levels are read; shaking and replacement in the bath for 1 minute are repeated till a constant maximal pressure is obtained.

Supposing the difference be 49 mm. and the constant of the apparatus is 3.73.

$$v = p \times k = 49 \times 3.73 = 183 \text{ cmm. or } 183 \text{ c.c.}$$

This volume is corrected for temperature and pressure and allowance must be made for the 1 c.c. pipette delivering .96 c.c. of blood. The oxygen capacity of the blood is

$$183 \times \frac{273}{289} \times \frac{753}{760} \times \frac{1}{.96} = 179 \text{ c.c. per 1 c.c. of blood}$$

or 17.9 per cent.

if 16° be the temperature and 753 mm. the barometric pressure. A duplicate determination is carried out in the other bottle of the apparatus, if desired.

Determination of the Oxygen Content of Blood.

The bottles of the differential apparatus are cleaned and set up as in the determination of the oxygen capacity.

2 c.c. of ammonia are put into each bottle.

1 c.c. of the blood is carefully run under the ammonia solution in one bottle.

1 c.c. of the blood, saturated with oxygen, is carefully placed under the ammonia in the other bottle.

If the unsaturated blood is placed in the right-hand bottle and the saturated blood in the left-hand bottle, .2 c.c. of potassium ferricyanide is put in the right-hand cup with a strip of filter paper.

The bottles are put upon the stoppers and the bottles placed in the water-bath, care being taken not to disturb the layer of blood beneath the ammonia.

The taps are closed to the air when the temperature is constant and there is equilibrium.

The blood is now mixed with the ammonia by gently shaking the apparatus for at least 2 or 3 minutes so as to ensure complete laking.

The ferricyanide in the right-hand bottle is upset and the oxygen driven off by shaking.

The maximum pressure change is noted.

Supposing it to be 17 mm., then the amount of oxygen is

$$17 \times 3.73 = 0.0634 \text{ c.c. per c.c. of blood}$$

or 6.34 per cent.

This amount is corrected for temperature and pressure and for the volume delivered by the pipette.

A further correction of 0.01 c.c. or 1 per cent. is added to allow for the solubility of oxygen and nitrogen in the plasma of the unsaturated blood.

Determination of the Difference in the Oxygen Content between Arterial and Venous Blood.

This determination is one of the most useful for studying the gaseous metabolism of organs and is very simple, provided that the arterial blood is saturated or nearly saturated with oxygen, as is usually the case.

Samples of blood from the artery and the vein are drawn into 1 c.c. pipettes containing a little hirudin solution to prevent coagulation.

Ferricyanide is not required as the determination depends upon the measurement of the difference between the amounts of oxygen absorbed by the two bloods when they are shaken to saturation with air.

The two bottles should have as nearly as possible the same constant, i.e. be of equal volume. Since the bottles are rarely quite equal, equality is obtained by placing 2 c.c. of ammonia in the smaller bottle and adding to the other bottle as much ammonia as is necessary to leave an air space of the same volume as in the smaller bottle.¹

Beneath the ammonia in each bottle is put 1 c.c. of arterial blood in the left-hand and 1 c.c. of venous blood in the right-hand. The bottles are fitted on the stoppers without disturbing the blood, the temperature is equalised and the taps are closed to the air. The blood is laked and both bottles are equally saturated by shaking until a maximum difference of pressure is observed. (The oil ascends on the side of the venous blood.) The difference (d) multiplied by the constant (k) of the smaller bottle gives the difference in oxygen per c.c. of blood in cmm. There is no correction for temperature and pressure.

Determination of the Percentage Saturation of Blood with Oxygen.

This determination is often required for the construction of dissociation curves for blood. It may be carried out in two ways:—

(1) The oxygen content is determined and the oxygen capacity is determined by adding ferricyanide to the saturated blood.

If p_1 and p_2 are respectively the two readings, the percentage saturation is given by

$$\frac{p_1 \times 100}{p_2}$$

(2) The difference in oxygen content between the blood and saturated blood is determined and then the total capacity is determined by adding ferricyanide to one side.

If the difference in pressure after complete saturation be p , and if it be p' after the action of ferricyanide, $p'-p$ is the pressure produced by the oxygen originally present in the unsaturated blood if it alone were liberated. The percentage saturation is

$$\frac{p' - p}{p'} \times 100.$$

The apparatus for 1 c.c. of blood is used in an exactly similar way as the larger apparatus but with 2 c.c. of ammonia solution, 1 c.c. of blood in the lower part and a drop of ferricyanide in the upper bulb.

With the older form of apparatus (see p. 502) there are some slight differences in technique. The pressure screw must not be altered from its initial position and it is better to substitute a short piece of glass rod for the pipette and screw. Thus modified it is used in the same way as the later form of apparatus.

The volumes of the bottles may be determined from the formula:—

V (cmm.) = 10,000 (K - area of manometer tubing in sq. mm.) where K is the differential constant. The area of the manometer tubing is given by

$$\frac{\text{volume}}{\text{pressure}} = \frac{i}{r_1}$$

¹ The difference in the volumes ($V_1 - V_2$) of the two bottles may be found from their constants K_1 and K_2 , thus

$$V_1 - V_2 = 10,000 (K_1 - K_2) \text{ cmm.}$$

THE BLOOD AS CARRIER OF CARBON DIOXIDE.

The solubility of carbon dioxide in water at N.T.P. is about 100 c.c. in 100 c.c. The solubility in blood is about the same figure, but an additional amount dissolves in the alkali of the medium as carbonate and bicarbonate and the proteins of the blood also form an unstable combination with carbon dioxide. Buckmaster¹ found that the amount of carbon dioxide absorbed by blood rises and falls with the amount of hæmoglobin, and concluded that hæmoglobin was capable of absorbing considerable quantities of carbon dioxide at pressures between 70 and 760 mm. Consequently, hæmoglobin has also the function of carrier of carbon dioxide.

The amount of carbon dioxide in solution in the blood does not approach saturation of the liquid with the gas. 100 volumes of venous blood contain about 46 volumes of carbon dioxide. Most of the carbon dioxide is in combination as carbonates, only about 5 per cent. being actually in solution. This has been determined by a similar method to that used in ascertaining the saturation of hæmoglobin—by exposing blood to different amounts of carbon dioxide and analysing the gas before and after the experiment. Blood absorbs carbon dioxide at a partial pressure of carbon dioxide higher than 5 mm. and gives it up at a partial pressure lower than 5 mm.

The carbon dioxide exchange in the animal body is in the converse order to that of the oxygen.

The Blood as a Solvent for Nitrogen.

Water dissolves 2 c.c. of nitrogen at N.T.P. per 100 c.c. A little more than this amount is dissolved by blood, but the amount of nitrogen in water or in blood exposed to the atmosphere which contains $\frac{4}{5}$ of its volume as nitrogen is $\frac{4}{5} \times 2$ or 1.6 c.c. This amount of nitrogen is always present in blood, whether it be arterial or venous.

Estimation of Carbon Dioxide in Blood.

A rough estimation of the carbon dioxide in blood can be made in a similar apparatus to that used in estimating oxygen by Haldane's method. The oxygen is first liberated or estimated. The carbon dioxide is liberated by disconnecting the apparatus, putting tartaric acid in the small tube, again connecting the various parts and upsetting the tartaric acid into the liquid; the gas must be collected at a constant pressure by attaching the collecting burette at its lower end to a collapsible reservoir to which is connected another burette for reading the pressure. Corrections must be made for the solubility of the carbon dioxide in water. The estimation may also be carried out in the differential apparatus of Barcroft (p. 504).

The data for carbon dioxide are not so accurate as those for oxygen.

¹ J. Physiol., 1917, 51, 164.

The Gases of the Blood.

The average content of arterial and venous blood is:—

	Arterial Blood.	Venous Blood.	
Oxygen	20	8-12	} c.c. per 100 c.c.
Carbon Dioxide	40	46-50	
Nitrogen	1-2	1-2	

The nitrogen is the same in both; arterial blood contains 8-12 c.c. more oxygen than venous and 6-10 c.c. less carbon dioxide.

Estimation of the Gases of the Blood.

Gases can be expelled from liquids by boiling or by exposing them to a vacuum. A combination of the two processes is used in estimating the gases of the blood. The gases are collected and analysed.

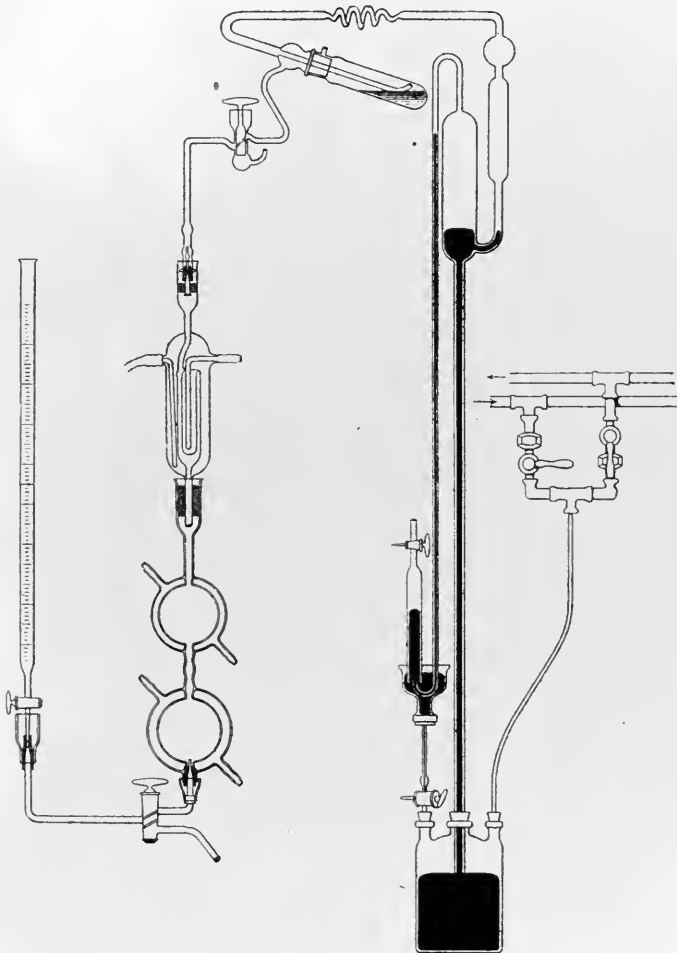

FIG. 72.—(From J. Physiol., 39, 433, Cambridge University Press.)

Extraction of the Gases.

The expulsion of gases from blood is carried out in the apparatus devised by Barcroft and shown in Fig. 72.

A similar apparatus with no taps has been constructed by Gardner and Buckmaster: it possesses the advantage that no leakage of air into the apparatus through the taps can occur when the apparatus is evacuated.

It consists of a vessel in the form of two bulbs surrounded by water jackets, a condenser cooled by ice water, a drying chamber (test tube) containing sulphuric acid, a glass pump with a valve, a trough containing mercury, a tube filled with mercury to collect the gases and a burette to introduce the blood. The part between the burette and the bulbs also contains mercury.

The whole apparatus is exhausted by first evacuating with a water pump at the point where the burette is put and then raising the mercury so that it fills the expanded portion and just runs out into the trough; it is prevented from reaching the rest of the apparatus by the valve. The mercury is lowered; gas is thus removed from the rest of the apparatus. It is raised again; the gas is driven out into the trough in front of the mercury. When the mercury reaches the trough it is again lowered. This process is continued until no more gas can be removed as is shown by the absence of gas bubbles in the trough when the mercury is raised. The mercury has to be raised and lowered some 10 or 20 times; this is conveniently effected by water pressure, as shown in the figure, p. 511.

The blood is collected in the burette containing hirudin or oxalate by inserting it in the artery or vein of an animal with the tap open. As soon as it has filled and contains a proper sample of blood, the tap is closed. It is connected to the bulb vessel and the mercury is displaced by blood. On turning the tap to the bulb, blood rushes in; the tap is closed again. The volume of blood introduced is measured on the burette. The bulbs are heated by a hot water current and the evolved gases are pumped out in the same way as in evacuating, but instead of being driven into the air they are driven into the gas tube which is placed over the end of the pump. The condenser and sulphuric acid remove the water vapour from the gases as they are collected. The gas in the gas tube is transferred into a measuring tube, measured and analysed.

Analysis of the Gases.

The analysis of the gases is carried out according to the general methods of gas analysis; the gas is measured in a graduated tube connected with a levelling tube and enclosed in a vessel which is kept at a constant temperature by running water. By raising the levelling tube the gas is driven into caustic potash solution to absorb the carbon dioxide. It is returned to the graduated tube and measured. The difference in volume is the amount of carbon dioxide. By again raising the levelling tube it is driven into alkaline pyrogallol solution to absorb the oxygen; it is returned to the graduated tube. The difference in volume is oxygen. The residual gas is nitrogen.

The apparatus generally used for blood gas analysis is that of Haldane, Fig. 73.

A gas burette (G) and a control tube (C) are contained in a vessel of water to give a constant temperature. The gas burette is connected at its base with the levelling tube; at the top it has a 2-way tap (T): (a) to the air and for filling; (b) to the absorption pipettes. The absorption pipettes (S and P) are separated from one another and from the gas burette by a 3-way tap. The absorption pipette (S) contains 20 per cent. caustic potash. It is connected with a reservoir (R) and has a mark (F) on it and also by a side tube (Y) to the control tube (C) through the tap (M). The absorption pipette (P) contains pyrogallol solution (10 gm. pyrogallol in 100 c.c. saturated caustic potash) and has a mark (H).

The apparatus is designed to effect an analysis in presence of aqueous vapour and in the presence of nitrogen contained in the capillary tubes between the gas burette and the absorption bulbs. The nitrogen prevents the potash and pyrogallol from entering the gas burette, the potash and

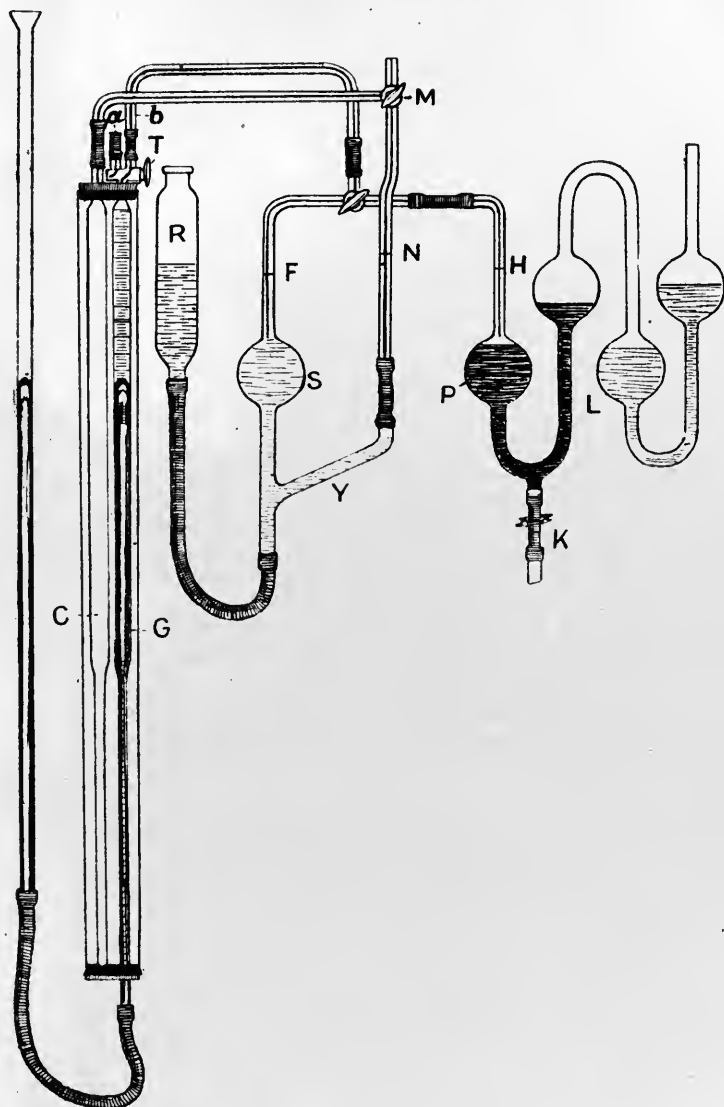

FIG. 73.

pyrogallol bulbs having marks upon their limbs so that the volume of gas can always be made the same by making the liquids stand at the marks. The control tube (C) and its connection with the potash bulb and reservoir (R) allows of the volume of air in it and the connections being kept constant to the mark (N) by adjusting the height of the liquid in R.

Manipulation.

If the apparatus has been recently pieced together it is necessary to fill the connections with nitrogen. This is done in the same way as in an analysis of gas:—

Both the control tube (C) and the potash bulb are connected to the atmosphere through M and to one another. The level of the potash is then put at the mark (N) by adjusting the height of R. The tap (M) is closed and is not turned again until the analysis is finished.

The tap (T) is opened to the air and air is drawn into the gas burette by lowering the levelling tube. The tap is closed to the air. The volume is read by turning the tap to connect S and G and adjusting the levelling tube so that the potash stands at F. The tap being open to the potash absorption bulb, the gas is driven out of the burette until mercury just reaches the tap (T) which is closed. After some minutes, to allow absorption to occur, the tap (T) is opened and the levelling tube lowered until the gas returns to the burette and the potash stands at F and also at N. The latter position is adjusted by moving R. The volume is noted. The gas is now driven into the bulb (P) by raising the levelling tube and turning the 3-way tap to the bulb (P). After some minutes it is returned to the gas burette by lowering the levelling tube and allowing the pyrogallol to reach the mark (H). The gas is driven over several times into the pyrogallol until on measuring the volume it remains the same.

A small quantity of oxygen remains between the 3-way tap and F. This is absorbed by driving the gas again into the potash bulb, returning it to the burette and then driving it into the pyrogallol. The gas is returned to the burette leaving the pyrogallol standing at H and the 3-way tap turned. Before finally reading the volume, the gas is driven again into the potash bulb, the level at N adjusted by R, and returned to the burette leaving the potash at F. The volume is read off. The capillary tubes are thus filled with nitrogen and the compensation for changes of temperature have been made.

An analysis of gas is made in the same way after driving out the nitrogen in G through T to the air and drawing in the sample to be analysed.

The Analysis of Atmospheric Air, Expired Air and Alveolar Air with Haldane's Gas Analysis Apparatus.

(I) *Atmospheric Air.*

The air from the room is introduced into the gas burette by lowering the mercury levelling tube.

The direct estimation of the amount of carbon dioxide may be neglected as this gas is present in such small amounts. The analyses should be repeated until the correct figures (20.96 per cent.) are obtained for atmospheric oxygen.

(2) *Expired Air.*

A balloon of thick gold beater's skin from 50-100 litres in capacity is emptied by rolling it up to a scroll. It is then rinsed out with expired air by blowing into it and again rolling it up. It is half-filled with expired air by making a number of steady normal expirations into it, the inspired air being taken in through the nose, or the inspired and expired air may be separated by valves attached to an anæsthetic mask fitting over the mouth and nose. A sample of the well-mixed expired air is drawn off from the centre of the bag by a long glass tube which has been filled with expired air just previously. The gas in the sample tube is drawn into the gas burette of the apparatus, measured and analysed for carbon dioxide and oxygen.

If the volume of expired air and the time taken to collect it have been measured, the gaseous exchange per minute can be calculated.

(3) *Alveolar Air.*

Alveolar air is collected most easily by the method of Haldane and Priestley:—

A piece of canvas-lined hosepipe 4 feet long and 1 inch in diameter is fitted with a glass tube as mouthpiece, .75 to 1 inch in diameter, to which is attached a side tube of narrow bore (1-2 mm.). The gas burette of the analysis apparatus is fastened to the side tube by a piece of stout india-rubber tubing. The levelling tube of the burette is placed at such a level that the burette can be half-filled with the alveolar air when the tap is opened.

The subject breathes quietly and at the end of a normal inspiration applies his mouth to the mouthpiece and makes a very rapid and complete forced expiration. At the end he closes the mouthpiece with his tongue and at the same time opens the tap of the gas burette so that alveolar air (i.e. supplemental air) is drawn into it and fills this space. The tap is closed and the levelling tube placed so that the mercury in the gas burette will fall to the lowest graduation when the tap is open. The subject again breathes quietly and steadily for some time; at the end of a normal expiration he makes a second complete and forced expiration through the tube, closes the mouthpiece with his tongue and opens the tap of the gas burette. The alveolar air is drawn in and fills the burette. The mixture of the two samples of alveolar air will have a composition intermediate between that at inspiration and expiration. The gas is analysed. The single analysis carried out in this way obviates the necessity of performing two analyses and taking the mean.

In the same way the composition of alveolar air (*a*) after taking 20 deep rapid breaths, (*b*) after holding the breath for 30 seconds and (*c*) immediately after severe exercise can be determined.

THE CHEMICAL CONSTITUTION OF HÆMIN AND HÆMATOPORPHYRIN.

Hæmin and hæmatoporphyrin contain pyrrole nuclei in their molecule, as has been shown by (1) dry distillation; pyrrole is formed; (2) oxidation; the imide of hæmatinic acid,

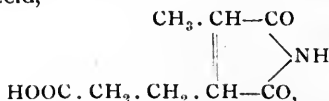

is formed (Küster); (3) reduction; hæmopyrrole is formed (Nencki and Zaleski). Mesoporphyrin, which resembles phylloporphyrin from chlorophyll, is obtained by milder reducing action. Hæmopyrrole has been proved to be a mixture of phyllopyrrole, isohæmopyrrole and kryptopyrrole (p. 304). At least three pyrrole nuclei are thus present in these compounds; from the yield of hæmatinic acid it seemed most probable that four pyrrole nuclei were contained in these compounds. Both Nencki and Küster suggested formulæ for these compounds containing four pyrrole nuclei.

Willstätter and his pupils have carried out experiments upon hæmin as well as upon chlorophyll and they have proved that the compound ætioporphyrin is the parent substance from which both chlorophyll and hæmin are derived.

The empirical formulæ of hæmin, hæmatoporphyrin and mesoporphyrin according to Willstätter are

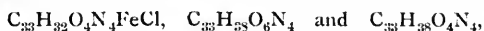

instead of those previously adopted containing 34 atoms of carbon.

Hæmin contains iron in organic combination, hæmatoporphyrin does not contain iron. The conversion of hæmin into hæmatoporphyrin is a complex reaction and has been supposed to take place by the addition of hydrobromic acid followed by its removal. This has been proved by Willstätter who has isolated the following addition products,

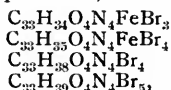

which give hæmatoporphyrin on hydrolysis. Hæmatoporphyrin was known only as an amorphous compound, but Willstätter has prepared it in a crystalline state (p. 496).

Two other compounds very similar to hæmatoporphyrin are obtained by the hydrolysis of the hydrochloric acid addition compounds of hæmin, namely, hæmino- and hæmidoporphyrin.

By heating hæmatoporphyrin with pyridine and methyl alcoholic potash in an autoclave it loses carbon dioxide and is converted into hæmoporphyrin $\text{C}_{333}\text{H}_{36}\text{O}_4\text{N}_4$. If hæmin be heated in a similar way it yields mesohæmin, from which on removal of the iron, mesoporphyrin is formed, identical with the mesoporphyrin obtained by Nencki and Zaleski from hæmin by reduction with hydriodic acid. Hæmoporphyrin is converted into ætioporphyrin by heating with soda lime.

Willstätter and M. Fischer point out that hæmin is a dicarboxylic acid as was first shown by Nencki and Zaleski and confirmed by Küster; in its iron-free form it has the formula

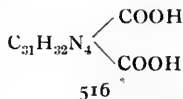

It combines with 2 molecules of hydrobromic acid; in this reaction the firm combination of the iron is loosened and the molecule undergoes an alteration probably consisting in a change in the mode of combination of two of the nitrogen atoms. The addition compound is hydrolysed and converted into hæmatoporphyrin, two bromine atoms being replaced by two OH groups. Hæmatoporphyrin is a dihydroxy-dibasic acid :—

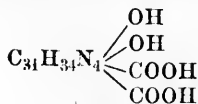

In the conversion of hæmatoporphyrin into hæmoporphyrin by heating with methyl alcoholic potash in pyridine solution reduction takes place as well as loss of water :—

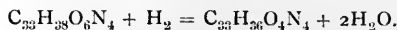

Hæmoporphyrin is also a dibasic acid :—

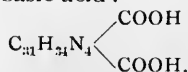

By heating it with soda lime, it loses 2 molecules of carbon dioxide and is converted into ætioporphyrin :—



Hæmin is reduced by methyl alcoholic potash in pyridine solution to mesohæmin. Mesohæmin is converted by hydrobromic acid through addition products to mesoporphyrin which is a dibasic acid isomeric with hæmoporphyrin.

Ætioporphyrin (p. 523) has probably the formula :—

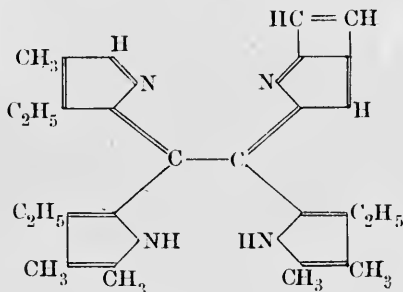

Ætioporphyrin, $\text{C}_{31}\text{H}_{36}\text{N}_4$.

The probable formula of hæmoporphyrin is derived from this by introducing two COOH groups into two of the ethyl groups :—

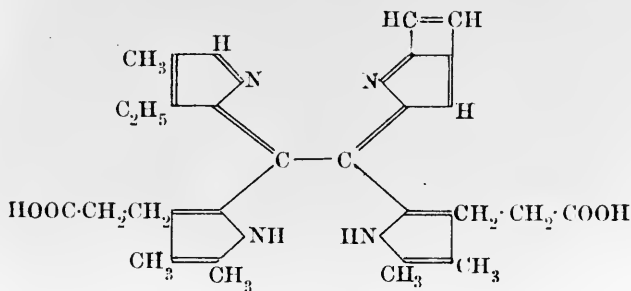

Hæmoporphyrin, $\text{C}_{33}\text{H}_{38}\text{O}_4\text{N}_4$.

Hæmatoporphyrin contains two hydroxyl groups; one of these is attached to the third ethyl group, the other to the vinyl grouping, which no longer forms a cyclobutene ring :—

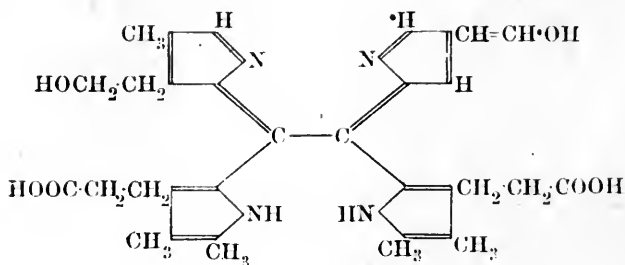
Haematoporphyrin, $C_{33}H_{28}O_6N_4$.

In the formation of haematoporphyrin from haemin a rearrangement of the bonds of the two central carbon atoms occurs and also another rearrangement of the groups so that haemin probably contains a pair of condensed pyrrole nuclei:—

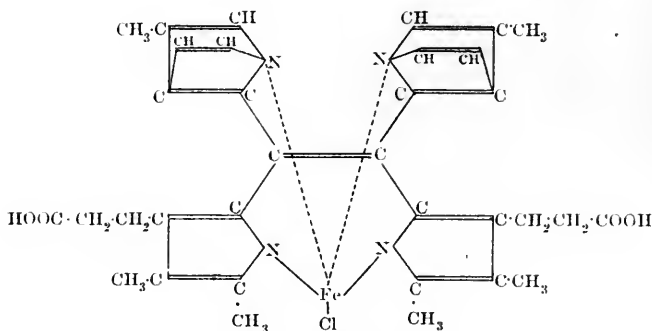
Haemin, $C_{33}H_{32}O_4N_4FeCl$.

A very similar formula has been put forward by H. Fischer:—

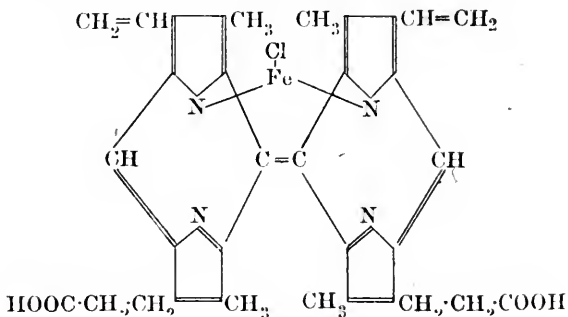
Haemin, $C_{27}H_{30}N_4O_4FeCl$.

The bile pigments are closely related to haemin; bilirubin or haemoidin is found in old blood clots; it gives the same oxidation products and reduction products as haemin. H. Fischer has proposed for bilirubin the formula:—

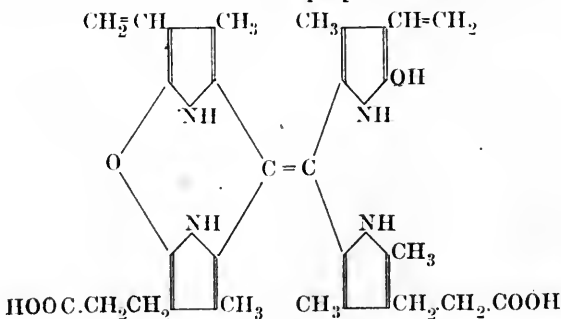

Bilirubin.

THE PIGMENTS OF LEAVES.

THE CHLOROPHYLLS AND CAROTINOIDS.

The work of Willstätter and his pupils dating from 1906 upon the composition and constitution of the pigments in plant leaves has greatly increased our knowledge of this most complex and difficult subject. Willstätter, in conjunction with Stoll, has summarised his results in book form ¹ and presented us with his conception of the chemistry of these pigments. The close analogy which was believed to exist between chlorophyll and hæmoglobin, though it differs in detail, is confirmed. Chlorophyll, like hæmoglobin, consists of substituted pyrrole nuclei.

Four pigments are contained in the chloroplasts of the leaf :—

Chlorophyll <i>a</i>	$C_{55}H_{72}O_5N_4Mg$
Chlorophyll <i>b</i>	$C_{53}H_{70}O_6N_4Mg$
Carotin	$C_{40}H_{56}$
Xanthophyll	$C_{40}H_{56}O_2$

Chlorophyll and fucoxanthin, $C_{40}H_{54}O_6$, are the pigments of the brown algæ.

Fresh leaves contain about .2 per cent. of chlorophyll *a*, .75 per cent. of chlorophyll *b*, .33 per cent. of xanthophyll and .155 per cent. of carotin.

Chlorophyll *a* and *b*.

The two chlorophylls have a very similar composition and differ only by the replacement of two hydrogen atoms in *a* by an oxygen atom in *b*. Both contain magnesium in organic combination and both are acid esters of a tri-basic acid, termed chlorophyllin, with (1) phytol, $C_{20}H_{39}OH$, an unsaturated primary alcohol with a branched chain of carbon atoms, whose constitution is unknown but is represented by

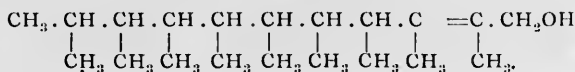

(2) methyl alcohol.

They are esters of chlorophyllin, i.e. methyl phytyl chlorophyllides.

¹ "Untersuchungen über Chlorophyll," Berlin, 1913.

Chlorophyll *a* differs from chlorophyll *b* in containing a lactam group, which is suggested as existing between the third COOH group and an NH₂ group, termed the γ group. Chlorophyll *b* does not apparently contain a lactam group. They are represented by the formulæ:—

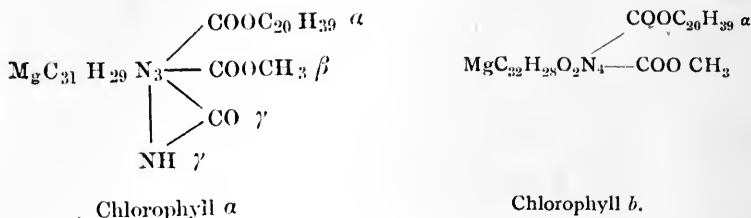

Both chlorophyll *a* and chlorophyll *b* are very unstable compounds, being decomposed by acid, alkali and the enzyme chlorophyllase, which is present in the plant together with the chlorophylls.

Action of Chlorophyllase. Crystalline Chlorophyll.

Chlorophyllase acts upon chlorophyll *a* and chlorophyll *b* in methyl or ethyl alcoholic solution. The action takes place during a slow extraction of the chlorophyll from the leaf with dilute alcohol. The effect of the enzyme is to hydrolyse the ester partially; it removes the phytol and at the same time the COOH group is esterified with the methyl or ethyl alcohol. In the case of methyl alcohol the change is

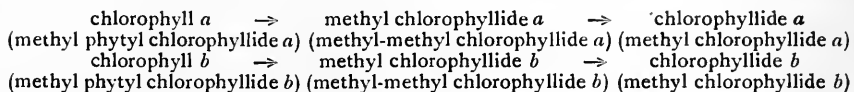

These compounds crystallise very readily on evaporation of the solution. Crystallised chlorophyll is a mixture of ethylchlorophyllide *a* and ethylchlorophyllide *b*.

Action of Alkali. Decomposition of the Chlorophylls.

By the action of alkali upon chlorophyll the ester groupings are hydrolysed. At the same time a rearrangement occurs in the molecule of both chlorophyll *a* and chlorophyll *b*. Two products are obtained from each, namely, the tribasic acids, chlorophyllin *a* and isochlorophyllin *a*, chlorophyllin *b* and isochlorophyllin *b*.

In the case of chlorophyll *a* the action of alkali is also to open the lactam ring and the formation of another lactam ring with either the α COOH group and the γ NH₂ group or the γ COOH group and the δ NH₂ group.

The chlorophyllins on heating with alkali lose carbon dioxide yielding dibasic acids. On heating these dibasic acids to a higher temperature carbon dioxide is again split off and monobasic acids are formed. If these monocarboxylic acids be heated with soda lime, they lose carbon dioxide and yield the corresponding hydrocarbon, aetiophyllin. These changes are represented as follows:—

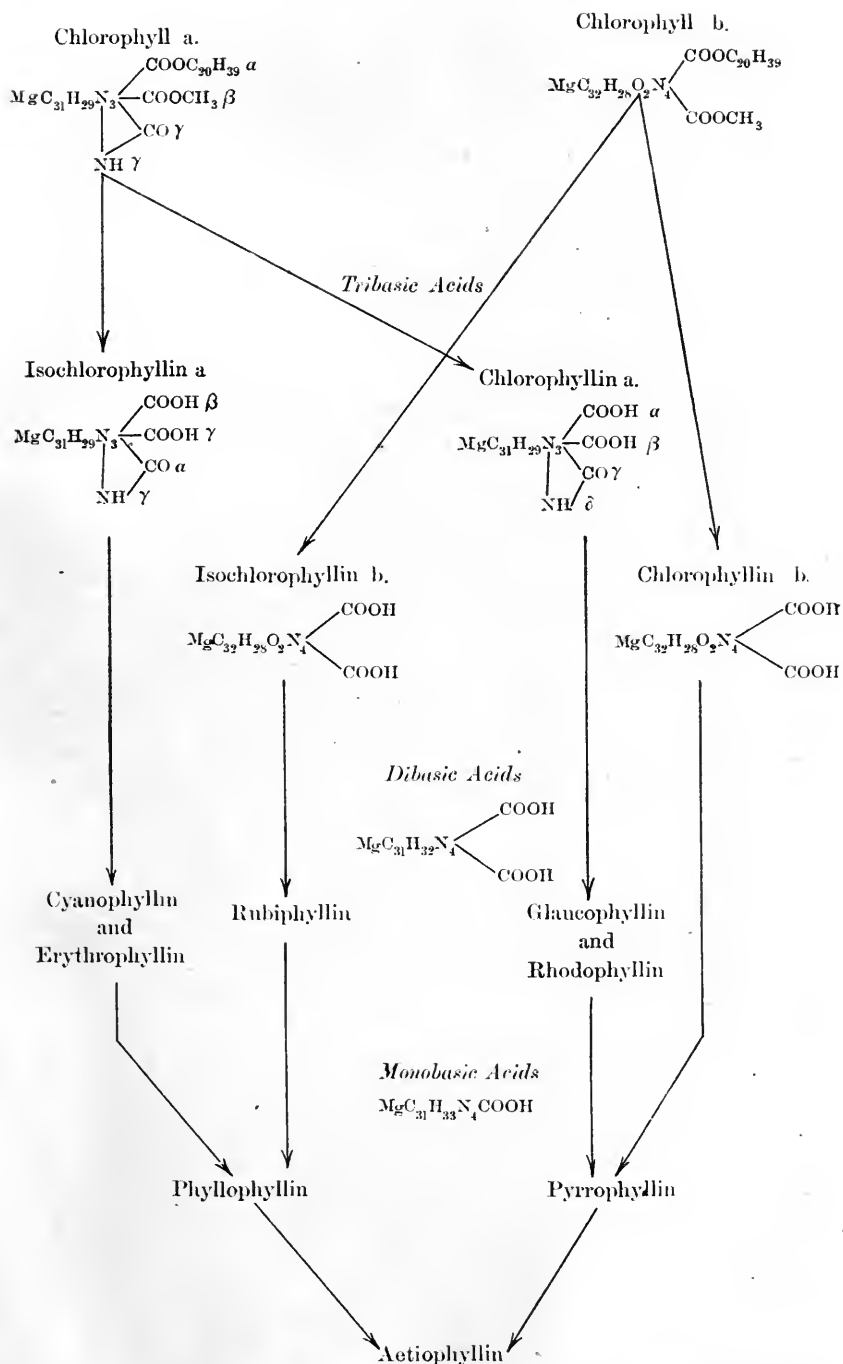

In all these compounds the magnesium is still present in organic combination. These magnesium-containing compounds are all designated as phyllins.

The Action of Acids. Removal of the Magnesium.

The action of very dilute acid, oxalic acid or even hydrochloric acid, upon chlorophyll *a* and chlorophyll *b* is to remove the magnesium without changing the molecule, except that hydrogen takes the place of the magnesium. Dilute acid also removes the magnesium from the products formed by the action of alkali. A series of compounds is thus obtained:—

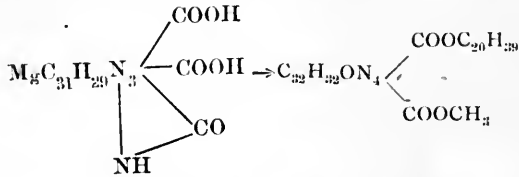

Chlorophyllin *a*.

Phæophytin *a*.

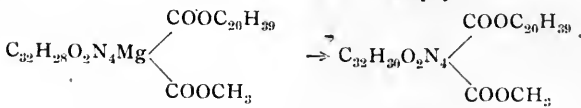

Chlorophyll *b*.

Phæophytin *b*.

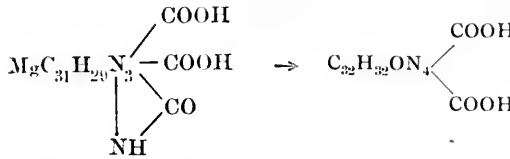

Isochlorophyllin *a*.

Phytochlorin *e*.

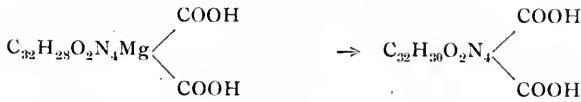

Isochlorophyllin *b*.

Phytorhodin *g*.

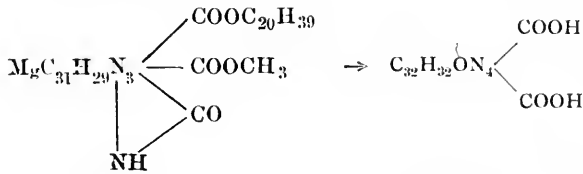

Chlorophyll *a*.

Phytochlorin *f* and *g*.

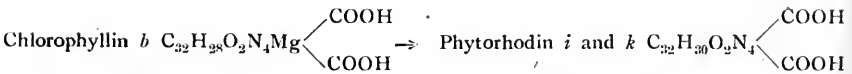

Chlorophyllin *b*

Phytorhodin *i* and *k*

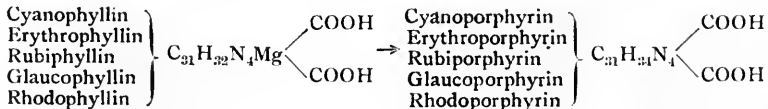

Cyanophyllin }
Erythrophyllin }
Rubiphyllin }
Glaucophyllin }
Rhodophyllin }

Cyanoporphyrin }
Erythroporphyrin }
Rubiporphyrin }
Glaucoporphyrin }
Rhodoporphyrin }

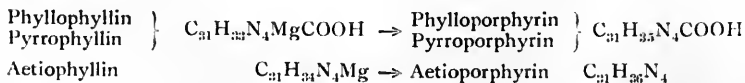

Phyllophyllin }
Pyrrophyllin }

Phylloporphyrin }
Pyrroporphyrin }



Phæophytin *a* and phæophytin *b* have the same composition as chlorophyll *a* and chlorophyll *b*, except for the presence of magnesium. They are

esters. By the action of methyl alcoholic hydrochloric acid they are changed into methyl esters (methyl phæophorbides) which are saponified by concentrated hydrochloric acid to the acids (phæophorbides). The phæophorbides on heating with alkali are saponified, giving phytochlorin *e* and phytorhodin *g*.

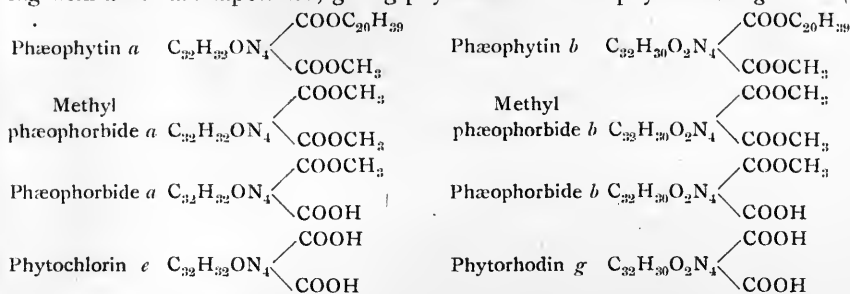

Phytochlorin *e* and phytorhodin *g* are the two chief products of the decomposition of the chlorophylls. Their formation led to the discovery of the presence of the two chlorophylls in leaves. The constitution of the molecule of chlorophyll depends upon the constitution of the molecule of ætiophyllin or ætioporphyrin.

The Constitution of Aetiophyllin and Aetioporphyrin.

The oxidation products of the derivatives of chlorophyll *a* and chlorophyll *b* with various oxidising agents are methyl-ethyl-maleinimide and hæmatinic acid,

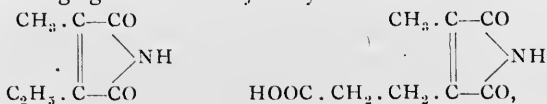

the same products which are formed from hæmin and its derivatives.

The derivatives obtained by reducing chlorophyll consist of the three substituted pyrroles (p. 304) :—

- Phyllopyrrole
- Isohæmopyrrole
- Kryptopyrrole.

Four pyrrole rings are present in ætioporphyrin united together by two carbon atoms and to one of the pyrrole rings two carbon atoms are attached forming a cyclobutene ring. Willstätter represents the constitution of ætioporphyrin and ætiophyllin by the formulæ :—

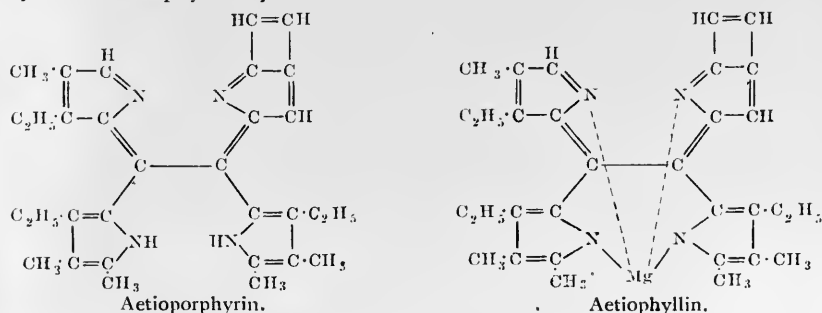

The COOH groups in the phytochlorin *e* and phytorhodin *g* and in the various phyllins are in the positions represented by the ethyl groups as propionic acid radicles.

The exact constitution has still to be ascertained; the above are suggested formulæ, which may prove to be the correct ones.

Formulæ have not yet been ascribed to xanthophyll, carotin and fucoxanthin.

Chlorophyll.

Preparation.

Chlorophyll and the other pigments may be extracted from fresh or dried leaves. It is advantageous to use dried leaves; their bulk is smaller with a consequent saving of solvent and they are more easily ground to a powder. Leaves contain 70-80 per cent. of water and may be dried in a steam oven.

Many leaves are spoilt by keeping, e.g. grass, others are spoilt by drying, but several varieties can be dried without any change taking place in the chlorophyll. Dried stinging nettle leaves are the most convenient source.

Fresh leaves must be used for the analysis of the amount of chlorophyll. Of the several methods used by Willstätter, that of rapid extraction on a Buchner funnel is the most convenient.

The dried material ($\frac{1}{2}$ kilo.¹) is placed upon a large Buchner funnel or similar contrivance in a layer 4-5 cm. thick. It is slowly treated with 1.5-2 litres of 90 per cent. alcohol, or better 80 per cent. acetone, suction being started after the powder has become moistened and the solvent being gradually added. The material loses its green colour when it is extracted so that solvent need no longer be added when the layer on sampling shows the absence of green colour. About 900 c.c. of extract is obtained from 500 gm. of material.

Fresh material (2.5 kilos.) is ground up. It gives a sticky olive-brown paste, It is partially dried and cleaned by shaking in a bottle with 500 c.c. of acetone. The filtered liquid has a yellow-brown colour, but contains no chlorophyll. The residue is freed from acetone by pressure at 200 atmospheres in a Buchner press; it weighs about .8 kilo. and is ground up to a powder. The powder is shaken in a bottle with 1500 c.c. of acetone for 5 minutes, which gives a concentration of 80 per cent. acetone, and 1 litre of 80 per cent. acetone is added. The liquid is filtered off on a Buchner funnel and the solid washed three times with 500 c.c. of 80 per cent. acetone. The time occupied in the process is $1\frac{1}{2}$ hours and 4.7 gm. of chlorophyll are extracted.

This method was useful in preparing the pigments from brown algæ.

The extract, if it be concentrated and if it deposits an oily layer, is diluted with .25-.5 times its volume of 80 per cent. acetone. It is shaken with finely powdered talc which takes up some of the pigment. The pigment is completely thrown out by adding 300 c.c. of water. The precipitate is filtered off on a layer of talc; the liquid is yellow-green in colour and is discarded. The pigment on the talc is washed with 500-600 c.c. of 65 per cent. acetone, which removes yellow pigment, and with water until the final washings do not smell of acetone. The talc is sucked dry and shaken in a bottle with ether and sodium sulphate. The ethereal solution is filtered through sodium sulphate and evaporated to a syrup. The syrup is gradually mixed with 400-500 c.c. of petroleum ether. The precipitated chlorophyll is filtered off. The yield is about 3 gm. and contains 90-95 per cent. of chlorophyll. Some chlorophyll, which is contained in the petrol ether filtrate, is obtained by washing it with 80 per cent. methyl alcohol and precipitating by adding water.

Purification.

The pigment contained in an 80 per cent. acetone extract is transferred into petrol ether by pouring it into about an equal volume of this solvent contained in a separating funnel. About one-eighth of its volume of water is added and the mixture carefully shaken. The lower layer of a yellowish-green colour is removed and the upper layer is shaken twice with about 250 c.c. of 80 per cent. acetone. The acetone is removed by shaking four times with 125 c.c. of water. To remove xanthophyll the petrol ether is shaken with 500 c.c. of 80 per cent. methyl alcohol four or more times until it shows only a faint-yellow colour. This extract contains about .2 gm. of xanthophyll (p. 530).

The petrol ether is freed from acetone and methyl alcohol by shaking four times with 500 c.c. of water. It loses its fluorescence, becomes cloudy

¹ One kilo. costs 65-80 shillings.

and the chlorophyll is precipitated. The suspension in the petrol ether is shaken with sodium sulphate and about 35 gm. of talc and filtered through a layer of 15 gm. of talc, which is stirred up to facilitate the filtration. The filtrate contains carotin which may be isolated from it (p. 530).

The chlorophyll on the talc is washed with petrol ether and finally with petroleum ether of boiling-point 30-50°. It is dissolved in 250 c.c. of ether, the ethereal solution is filtered through sodium sulphate, evaporated to 25 c.c., again filtered and evaporated to 5 c.c. The chlorophyll is precipitated by adding 200 c.c. of petroleum ether. It is filtered off on talc, dissolved in ether and the solution evaporated in a desiccator. The yield is about 3 gm. from 500 gm. and represents three-fourths of the total pigment.

Properties.

Chlorophyll (*a + b*) forms a blue-black solid with metallic lustre having a crystalline appearance under the microscope. On powdering it becomes a dull-green or a blue-black powder. It shows no sharp melting-point; depending on the rate of heating; it forms oily drops at 93-96° and 103-105°.

It is easily soluble in absolute alcohol; ether, benzene, chloroform, carbon disulphide, most easily soluble in pyridine. The alcoholic solution has a blue-green colour. The ethereal solution is a beautiful blue-green with a strong fluorescence and a bluer tone than the alcoholic. In carbon disulphide its solution is green in colour. It is not so easily soluble in 95 per cent. ethyl or methyl alcohol and it is soluble with difficulty in 90 per cent. alcohol. It is soluble with difficulty in cold petrol ether, more easily in the hot solvent. It dissolves easily in petroleum ether containing methyl or ethyl alcohol.

In anhydrous alcoholic solution chlorophyll undergoes a remarkable change termed allomerisation which makes its isolation very difficult. This change is hindered by adding a trace of acid, 0.1 gm. of oxalic acid in 1000 c.c. of alcohol. Its spectrum shows a marked absorption band in the red region and a fainter one towards the orange. The violet end is completely absorbed.

Tests for the Purity of Chlorophyll.

(1) It must leave an ash consisting of pure magnesium oxide corresponding to 4.5 per cent. of its weight. If phæophytin be present, the spectrum shows absorption bands near E and between E and F.

(2) *Phase Test.*—On saponification with methyl alcoholic potash in ethereal solution, the colour becomes brown changing in a few minutes back to the original green.

This does not occur with the allomerised material.

(3) It must contain no yellow pigments. The ethereal solution in the above phase test must be colourless. On slowly adding water to the alkaline solution, the ether should become yellow.

(4) *Hydrolysis Test.*—A few mgm. of the substance are boiled with 3-4 c.c. of methyl alcoholic potash for several minutes avoiding too great a concentration. The solution is acidified and extracted with 30 c.c. of ether. The ethereal solution is extracted with (*a*) 4 per cent. hydrochloric acid, (*b*) 9 per cent. hydrochloric acid to remove phytochlorin *e* and phytorhodin *g*. It is subsequently shaken with 12 per cent. hydrochloric acid when the ether becomes quite colourless. On neutralising and shaking with ether, it shows the red colour of phytorhodin. The colour is not red if allomerised chlorophyll be present.

(5) Phytol should form one-third of the molecule. This is most conveniently tested by extracting the saponified ethereal solution with 22 per cent. hydrochloric acid which dissolves the chlorophyllides.

Separation of Chlorophyll into its Components *a* and *b*.

The separation of the mixture of the *a* and *b* chlorophylls depends upon the partition of the constituents between the solvents, petroleum ether which dissolves chlorophyll *a* and methyl alcohol which dissolves chlorophyll *b*.

The chlorophyll mixture (8 gm.) is dissolved in 150-200 c.c. of ether, filtered and poured into 4000 c.c. of petrol ether. By adding 50-100 c.c. of methyl alcohol any precipitate is dissolved. The solution is freed from ether by shaking twice with 2 litres of 80 per cent. methyl alcohol. This serves also to remove the yellow pigments if raw chlorophyll be used.

The petrol ether is shaken 14-16 times with 2 litres of 85 per cent. methyl alcohol which has been saturated with petrol ether (5.5-10 per cent. are taken up) and containing .01 gm. of oxalic acid per litre.

The petroleum ether layer containing the chlorophyll *a* is washed with water which throws down the pigment. It is collected upon 30-100 gm. of talc, filtered off on talc and washed with petrol ether. The pigment is dissolved by shaking the talc in a bottle with ether, the blue solution is filtered repeatedly and concentrated; finally the ether is removed in a desiccator until a dry mass is obtained.

The first methyl alcohol extract containing the chlorophyll *b* is diluted with 1 litre of methyl alcohol, washed with 1 litre of petrol ether, poured into 2 litres of ether and partition of the solvents effected by adding water.

The second methyl alcohol extract is diluted and treated with the wash petrol ether from the first extract + $\frac{1}{2}$ litre petrol ether more. It is transferred to the ether from the first extract + 1 litre of ether more.

In each case the petrol ether is freed from methyl alcohol with water. The third and fourth extracts are treated in the same way. The other extracts are mixed with gradually decreasing quantities of methyl alcohol, 900, 800, 700 c.c., etc. They are washed with the same petrol ether increased in volume by adding $\frac{1}{2}$ litre more.

The pigment is in each case transferred from the methyl alcohol to ether by adding water. The solvent consists of ether + petrol ether. It is freed from methyl alcohol by washing with water, dried with sodium sulphate and evaporated to 500 c.c. Further evaporation to 30 or 40 c.c. is carried out *in vacuo*; the pigment is precipitated by adding 300 c.c. of petrol ether and filtered on talc; the filtrate contains chlorophyll *a*. It is purified by dissolving in ether and precipitating with petrol ether several times; it is washed with petrol ether, dissolved in ether, precipitated with petrol ether, filtered and dried in a desiccator.

Properties of Chlorophyll a.

Chlorophyll *a* consists of microcrystalline bunches of lancet-shaped leaflets of a blue-black colour; on powdering they have a green tint. It melts at 117-120°.

It dissolves readily in absolute alcohol, ether, benzene, acetone, chloroform and carbon disulphide. The alcoholic solution is blue-green with a deep-red fluorescence; the ethereal solution is blue, greenish when dilute. The solution in carbon disulphide has a yellow tint.

It is very slightly soluble in cold methyl alcohol, still less in 80 per cent. alcohol and 90 per cent. methyl alcohol. It is soluble with difficulty in petrol ether, but dissolves if alcohol be present.

A colloidal solution, which has a blue-green fluorescence, is obtained on pouring an acetone or alcoholic solution into water.

The ethereal solution is decomposed rapidly by shaking with 20 per cent. hydrochloric acid; with excess of acid the colour is blue. In performing the phase test the colour changes to yellow.

Properties of Chlorophyll b.

Chlorophyll *b* is a microcrystalline solid and forms a powder of a dark-green to green-black colour. It sinters at 86-92° and melts at 120-130°.

It dissolves readily in absolute alcohol, ether and benzene, like the *a* component, but not quite so easily. The alcoholic and ethereal solutions are green, yellowish compared with those of chlorophyll *a*. The carbon disulphide solution is yellow-green. The benzene solution in sunlight becomes red before it is bleached.

It dissolves with difficulty in cold methyl alcohol, 90 per cent. ethyl alcohol and methyl alcohol.

It is not so easily decomposed by hydrochloric acid as chlorophyll *a* and the colour is green. In performing the phase test the colour changes to red.

The Chlorophyllides.

Preparation.

Chlorophyll is partially hydrolysed by chlorophyllase with separation of phytol; the carboxyl group is esterified with methyl or ethyl alcohol with the formation of methyl or ethyl chlorophyllide. Chlorophyllide may also be obtained.

Leaves rich in chlorophyllase are used, e.g. those of *Galleopsis tetrahit*.

(1) *Ethyl Chlorophyllide. Crystalline Chlorophyll.*

1 kilo. of powdered fresh leaves is mixed with 2 litres of 90 per cent. alcohol and allowed to stand 12-24 hours. The solid is filtered off on a Buchner funnel and washed with 2.5 litres of acetone in portions of 500 c.c. The combined alcohol and acetone solutions are mixed with 150 gm. of coarse talc and diluted by stirring with 4.5 litres of water in the course of 1 hour. The chlorophyllide separates and is filtered off on talc. The talc is rapidly washed with (1) 250 c.c. of 55 per cent. acetone and (2) 250 c.c. of 55 per cent. alcohol, which are removed by suction, (3) 1500 c.c. of petrol ether, (4) 500 c.c. of ether. These solutions contain all the xanthophyll and carotin (p. 530). Though the ether has a green colour it contains very little chlorophyllide. The talc is treated with 250 c.c. of absolute alcohol containing .005 gm. of oxalic acid to prevent allomerisation and the deep green filtrate is mixed with 3-4 litres of ether. The ether is shaken with 2 litres of water to remove alcohol, dried with sodium sulphate and evaporated to 1500 c.c. It is filtered and evaporated to 20 c.c. Ethyl chlorophyllide crystallises out during the evaporation and on standing. The yield is 4.5-5 gm. or .1 per cent. of fresh leaves.

(2) *Methyl Chlorophyllide.*

2 kilos. of dried leaves are treated with a mixture of 3.2 litres of acetone and 0.8 litre of 80 per cent. methyl alcohol for about 40 hours. The mass is filtered through muslin on a Buchner funnel and washed with 4.5 litres of acetone in portions, allowing each portion to soak into the material before sucking it off. The filtrate occupying a volume of 6.7 litres is mixed with 300 gm. of coarse talc, stirred well and diluted slowly (in $1\frac{1}{2}$ hours) with 7 litres of water. Methyl chlorophyllide crystallises out, is filtered off on a layer of talc and washed with (1) 500 c.c. of 50 per cent. acetone, (2) 500 c.c. of 50 per cent. alcohol. The talc is sucked dry, shaken with 2 litres of petrol ether, filtered off and washed with (1) petrol ether, (2) ether. The talc is treated with 800 c.c. of absolute alcohol containing .02 gm. of oxalic acid and the methyl chlorophyllide obtained in the same way as ethyl chlorophyllide. A yield of .5 gm. per kilo. is obtained.

(3) *Chlorophyllide.*

24 kilos. of fresh leaves are placed in 29 litres of pure acetone in 3 large vessels. After 3-4 hours the chlorophyllide is present in the solution, which is separated by centrifugalising, mixed with 500-600 gm. of talc and diluted slowly with twice the volume of water. The liquid is decanted and the talc with the crystals of chlorophyllide filtered off on a Buchner funnel. It is divided into 4 portions. It is washed on the funnel with (1) ether until the solvent becomes pale green, (2) 300 c.c. of acetone. The chlorophyllide dissolves in the acetone. It is transferred to ethereal solution (2 litres for each portion) by adding water. The ether is freed from acetone by washing with water and dried with sodium sulphate. The ethereal solution is rapidly evaporated nearly to dryness. The chlorophyllide crystallises out in a yield of 12 gm. or 0.05 per cent. of the fresh leaves.

Separation of the a and b Chlorophyllides.

The separation of these constituents is effected in a similar way to that of the *a* and *b* chlorophylls by partition between solvents.

The *b* components of methyl chlorophyllide dissolve in 50-60 per cent. methyl alcohol, of chlorophyllide in 40-50 per cent. methyl alcohol, the *a* components in an ether-petrol ether mixture.

Properties.(1) *Ethyl Chlorophyllide. Crystalline Chlorophyll.*

The mixture contains on an average 2.5 parts of *a* to 1 part of *b* and consists of six- or three-sided platelets of blue-black colour with metallic lustre. It is dark-green when powdered. It is decomposed on heating with evolution of pyrrole vapours. It is easily soluble in absolute alcohol, methyl alcohol, acetone, hot chloroform and benzene. It dissolves with difficulty in ether and is insoluble in petrol ether. It may be recrystallised from 90 per cent. alcohol containing a trace of oxalic acid. The solution in ether is blue-green, in alcohol it is yellowish.

It yields *a* and *b* ethyl phæophorbides with hydrochloric acid; these have a different solubility; the *b* component first crystallises out of ether in black rhombic platelets, the *a* component crystallises in blue-green needles.

(2) *Methyl Chlorophyllide a.*

Methyl chlorophyllide *a* crystallises in rhombic platelets of a green or blue-green colour and forms a blue-black powder. It is easily soluble in alcohol and acetone, soluble with difficulty in ether, benzene, carbon disulphide, exceedingly easily soluble in pyridine.

Methyl Chlorophyllide b.

Methyl chlorophyllide *b* crystallises in rhombic platelets of green-black colour which are yellow or olive-green or brown in transmitted light.

It easily dissolves in alcohol, with difficulty in ether and benzene. The ethereal solution is green, the alcoholic is yellow-green with a red fluorescence. In the phase test the ether becomes red.

(3) *Chlorophyllide a.*

Chlorophyllide *a* crystallises in six-sided platelets of a blue-black colour, green or blue-green in transmitted light.

It is very easily soluble in absolute alcohol and acetone, with difficulty in ether and 96 per cent. alcohol, insoluble in cold benzene and petrol ether.

Chlorophyllide b.

Chlorophyllide *b* crystallises with difficulty and decomposes on concentration of its solution. It separates from acetone in six-sided platelets of a yellow, yellow-green or olive-green colour. It is easily soluble in alcohol giving a solution of a green colour and brownish-red fluorescence.

Phæophytin.

Phæophytin, the chief product which is used for preparing the other decomposition products of chlorophyll, is readily prepared on a large scale:—

4 kilos. of dried leaves are moistened on a large filter with 2 litres of 90 per cent. alcohol and extracted by adding 4 litres of the alcohol in portions, each portion being sucked off after it has soaked into the material. The liquid measures 4 litres. Two quantities of 4 litres are worked up together. 160 c.c. of 10 per cent. alcoholic hydrochloric acid are added. The colour changes at once to brown and phæophytin separates. The liquid is decanted, the mass filtered off and washed with 96 per cent. alcohol. The moist mass is broken up with a silver spatula and dried *in vacuo*. The yield is 3.6-5 gm. per kilo.; 180-250 gm. of phæophytin can be prepared in a day from 40-48 kilos. of dried leaves with suitable apparatus.

Phæophytin forms a waxy crystalline solid of a blue-black colour. Its solution is olive-brown in colour, red in thick layers.

It is very easily soluble in benzene and chloroform, almost insoluble in petrol ether; it is not easily soluble in ether and with difficulty in hot alcohol.

Separation of Phæophytin into Phæophorbides a and b.

Phæophytin and other products differ from chlorophyll by having acid and basic properties. It has been found by Willstätter that these compounds are soluble in certain concentrations of acid. By shaking the solutions in ether with the particular strength of acid the one constituent dissolves leaving the other in ethereal solution.

Phæophytin can be separated into its two components by shaking it in ethereal solution with 30 per cent. hydrochloric acid, which dissolves phæophorbide *a*, leaving phæophorbide *b* in ethereal solution.

Hydrolysis of Phæophytin. Preparation of Phytol, Phytochlorin *e* and Phytorhodin *g*.

Phæophytin is hydrolysed with either cold or hot methyl alcoholic potash. (a) 1 gm. is shaken for 2-3 days with quartz pebbles or glass beads and 10 c.c. of alcoholic potash (600 gm. in 1000 c.c. methyl alcohol); (b) 6 gm. of phæophytin are dissolved in 20 c.c. of pyridine at 80° and poured into a gently boiling solution of methyl alcoholic potash (250 c.c. + 160 gm. KOH) contained in a silver beaker and stirred with a silver rod and boiled gently for half a minute. The beaker is cooled immediately with water.

The cold solution is covered with ether and water is added to cause the ether to separate. The alkaline solution is shaken several times with ether to remove the phytol. The ethereal solution which has a brown colour is washed several times with (1) dilute alkali, (2) concentrated hydrochloric acid, (3) water. The acid washings have a blue-green colour. It is concentrated to 1500 c.c. if 20 gm. phæophytin are used, decolorised by shaking with charcoal and the ether is evaporated off; the last traces of ether are removed by heating the oily residue at 90° for $\frac{3}{4}$ hour. The oil is purified by distillation *in vacuo*.

The alkaline solution (from 20 gm. phæophytin) is diluted and acidified and the pigments transferred into 12 litres of ether. The phytochlorin is isolated by shaking the ether three times with 4 litres of 4 per cent. hydrochloric acid. The acid solutions are washed with 1.15 litres of ether. The aqueous solution is nearly neutralised and extracted with ether. The ether is evaporated to about 500 c.c.; the phytochlorin crystallises out in a yield of 5.2 gm.

The ethereal solution containing phytorhodin is washed twice with 6 per cent. hydrochloric acid to remove the last traces of phytochlorin and concentrated. It crystallises out in a yield of 2.8 gm.

Phytol.

Phytol is a colourless oil which boils at 203-204° at 9-10 mm. pressure and at 145° at 0.03-0.04 mm. and mixes with most organic solvents.

As an unsaturated compound it combines with halogens and ozone and is easily auto-oxidisable. On reduction it yields the hydrocarbon $C_{20}H_{42}$ and on oxidation gives a ketone $C_{17}H_{34}O$.

Phytochlorin *e*.

Phytochlorin *e*, which is formed from chlorophyll *a*, consists of greenish-brown crystals; it gives a brownish-black powder. It exists in two forms which have slightly different solubilities in alcohol, acetic acid, acetone, chloroform.

Phytorhodin *g*.

Phytorhodin *g*, from chlorophyll *b*, crystallises from ether in six-sided prisms of a dark-red to black colour with metallic lustre. Its solution in ether, alcohol and acetic acid is deep red in colour with a blue tinge and slight dark-red fluorescence. It is easily soluble in pyridine, also in alcohol and acetic acid. The crystals do not dissolve in ether and chloroform.

Xanthophyll and Carotin.

These compounds are obtained as bye-products in the preparation of pure chlorophyll and in the preparation of the chlorophyllides.

Xanthophyll.

Xanthophyll is contained in the methyl alcoholic washings of the petroleum ether (p. 524). They are mixed with 4-5 litres of ether and diluted with water. The ethereal solution is shaken with 30-50 c.c. of concentrated methyl alcoholic potash to saponify chlorophyll *b* which is also present; the chlorophyllin is removed by shaking the solution with water. The ethereal solution containing the xanthophyll is dried with sodium sulphate, evaporated to 30 c.c. and mixed with 200-300 c.c. of methyl alcohol. By further evaporation the ether is removed and the hot filtered methyl alcoholic solution deposits crystals of xanthophyll on cooling; if a small quantity of water be added the separation is complete. The yield is 0.8 gm. from 2 kilos. of dried leaf.

Carotin.

Carotin is contained in the petrol ether filtrate from chlorophyll (p. 525). It is concentrated *in vacuo* at 40° to a small volume and the oily residue is mixed with 300 c.c. of 95 per cent. alcohol. Carotin immediately begins to separate in crystals, the separation becoming complete on standing. A colourless impurity which also separates is dissolved by adding 200-300 c.c. of petrol ether and immediately filtering off the carotin, which is washed with a mixture of 2 volumes of petrol ether and 1 volume of ether. The yield is 0.25 gm. from 2 kilos. of leaves.

Xanthophyll and Carotin.

These pigments are contained together in the ether and petrol ether washings of the chlorophyllides. The washings are shaken with 30 c.c. of concentrated methyl alcoholic potash to saponify the chlorophyll. This may be repeated. The solution is diluted with water so as to obtain a yellow ethereal solution and a green alkaline solution of the chlorophyllin salt. The alkaline solution is extracted twice with ether.

The xanthophyll and carotin are separated by partition between petrol ether and methyl alcohol. The solution is shaken twice with 1 litre of 85 per cent. methyl alcohol, four times with 90 per cent. methyl alcohol. The pigment is transferred to ether which occupies a volume of 2.5 litres.

The xanthophyll in ether and the carotin in petrol ether are washed and the solutions evaporated, finally *in vacuo* at 40°. The xanthophyll is precipitated by adding 1 litre of petrol ether and filtered off on talc at 0°. It is dissolved in 1 litre of ether, the solution is concentrated and diluted with methyl alcohol and the ether evaporated. If xanthophyll separates, it is re-dissolved by warming with the addition of more methyl alcohol. On cooling the xanthophyll crystallises out. The yield is about 1 gm. and 0.3 gm. can be obtained by adding water to the filtrate.

The carotin crystallises from the petrol ether solution concentrated to 150 c.c. on adding 600 c.c. of 95 per cent. alcohol. Its yield is 0.3 gm.

Carotin.

Carotin is more easily prepared from carrots. The dried powdered carrot is extracted in a percolator with petrol ether. The extract is concentrated *in vacuo* at 40°. Impure carotin crystallises out and is purified by solution in carbon disulphide and fractional precipitation with alcohol; the first precipitates are the impurities.

125 gm. of pure carotin are obtained from 5000 kilos. of fresh carrots or 472 kilos. of dried material.

Properties of Carotin.

Carotin crystallises in rhombohedra and in rhombic platelets of bright copper-blue colour, red in transmitted light. It melts at about 174° .

Carotin is easily soluble in benzene, chloroform and carbon disulphide. The solutions in the two former solvents are yellow, in carbon disulphide red in colour. It is soluble with difficulty in boiling ethyl and methyl alcohols and acetone, almost insoluble in the cold. 900 c.c. of boiling ether, or 1.5 litres of boiling petrol ether, dissolve 1 gm.

It dissolves in concentrated sulphuric acid giving an indigo-blue solution. It is an unsaturated compound and undergoes auto-oxidation. The crystals on exposure to the air lose their colour and about 35-40 per cent. of their weight. With iodine it forms a deep violet addition compound of the formula $C_{40}H_{56}I_2$.

Its spectrum in alcoholic solution shows two bands in the blue region with absorption of the violet end; in carbon disulphide solution there is a band in the green and a band in the blue.

Properties of Xanthophyll.

Xanthophyll forms long platelets of a yellow to red colour in transmitted light with a steel blue lustre. It melts at $173-174^{\circ}$. Xanthophyll is easily soluble in chloroform, with difficulty in carbon disulphide, insoluble in petrol-ether. 1 gm. dissolves in 300 c.c. of boiling ether, in 700 c.c. of boiling ethyl alcohol, in 5000 c.c. of cold alcohol. Its solutions have a yellow colour. It behaves like carotin towards air, concentrated sulphuric acid and halogens.

Its spectrum in alcoholic solution is very similar to that of carotin; in carbon disulphide there is a third band in the blue region.

Fucoxanthin.

The brown algae are extracted as described on p. 524 in the same way as chlorophyll from fresh material and the chlorophyll is precipitated. The filtrates from 15-20 kilos. material occupying a volume of 40 litres are mixed in portions of 4 litres with 1 litre of a mixture of 3 volumes of petrol ether and 1 volume of ether and treated with 1500 c.c. of water. The aqueous acetone layer of a yellow-green colour is removed, the ether-petrol ether solution is freed from acetone by washing and concentrated to 500 c.c. This solution is mixed with 500 c.c. of ether to dissolve the fucoxanthin which separates. The xanthophyll and fucoxanthin present in the solution are separated by shaking 4 times with 1 litre and twice with 500 c.c. of 70 per cent. methyl alcohol saturated with petrol ether. The xanthophyll in the methyl alcoholic solution is removed by shaking it with an equal volume of a mixture of 5 volumes of petrol ether and 1 volume of ether. The fucoxanthin which also dissolves is recovered by evaporating it *in vacuo*, diluting with ether and shaking twice with 70 per cent. methyl alcohol; these solutions are also washed with the ether-petrol ether mixture. The fucoxanthin in the methyl alcohol is transferred into ethereal solution by adding water, the ether is evaporated off and the fucoxanthin is precipitated by adding 1 litre of petrol ether per 200 c.c. About 2 gm. are obtained.

Fucoxanthin is easily soluble in all organic solvents except petrol ether and methyl alcohol. It crystallises from methyl alcohol in monoclinic brown-red prisms with a blue lustre. It melts at $159-160^{\circ}$. The ethereal solution is orange-yellow in colour, the alcoholic is brownish, the carbon disulphide one is reddish.

It forms a crystalline addition product with iodine and has a slight basic character.

Lycopin.

Lycopin, the pigment of the tomato, is isomeric with carotin. Willstätter and Escher isolated 11 gm. of the pigment from 74 kilos. of tomato preserves, whose dry weight was 5.6 kg. The material was shaken in portions of 8 kilos. with 4 litres of 96 per cent. alcohol. The coagulated mass was strained off, pressed out and again shaken with 2.3 litres of alcohol. The solid was finally pressed out in a hydraulic press and dried in a steam oven. The dry mass was extracted with carbon disulphide in a percolator and the solvent evaporated off *in vacuo* at 40°. The deep red-brown residue was diluted with 3 volumes of absolute alcohol, filtered off on a porcelain funnel and washed with petrol ether. The product was purified by crystallisation from gasolin of boiling-point 50-80° of which 4.5 litres are required to dissolve 1 gm. of lycopin, or by solution in carbon disulphide and precipitation with absolute alcohol.

Carotin is also present in the tomato.

THE LIPOCHROMES.

The yellow or orange-red pigments occurring in animals are generally grouped together under the term lipochromes. Thudichum and Schunck showed that they were related to the yellow vegetable pigments. They have also been investigated by Willstätter and Escher who have isolated 0.45 gm. of carotin from 10,000 ovaries.

Lutein, the yellow pigment of egg-yolk, is isomeric with xanthophyll; 4 gm. of impure and 2.6 gm. of pure lutein have been isolated from 6000 yolks.

The yellow pigment of butter fat has been shown by Palmer and Eckles¹ to consist mainly of carotin; xanthophyll is also present. These pigments are taken up from the food of the cow, the colour of the milk or butter depending greatly upon the amount of the pigments in the food given. These workers have further shown that the pigment of the body fat and blood serum of cows is also carotin and xanthophyll. The carotin is apparently present in the blood serum in combination with albumin. This combination and the greater stability of carotin to the digestive juices accounts for its presence in greater amount in the animal tissues, as well as the greater solubility of xanthophyll in bile which leads to its excretion in the fæces.

It might be noted that carotin has been isolated from gall-stones by H. Fischer and Röse.

¹ J. Biol. Chem., 1914, 17.

METABOLISM.

INTEGRATION OF THE CHEMICAL PROCESSES.

CONSTITUENTS OF A CELL.

A living cell consists of a mixture of organic and inorganic substances dissolved or suspended in water ; water makes up about three-quarters of the total mass of the cell, the other constituents about one-quarter.

The twelve elements : carbon, hydrogen, nitrogen, oxygen, sulphur, phosphorus, chlorine (iodine), sodium, potassium, calcium, iron and magnesium enter into the composition of the various compounds which compose the material of all living organisms ; of these, only oxygen and nitrogen exist in the free state dissolved in the liquid.

The inorganic compounds are water and salts, chiefly the chlorides, sulphates and phosphates of sodium, potassium, calcium, magnesium.

The organic compounds are very numerous in their variety. Proteins, carbohydrates, fats and nucleins are the essential substances, also the most complex. Alcohol, lactic acid, amino acids, urea and purines represent stages in the processes of their building up and breaking down, i.e. in their synthesis and decomposition, or anabolism and catabolism.

LIFE-CYCLE OF THE ELEMENTS.

During the life processes of animals and plants an interchange of inorganic into organic and of organic into inorganic compounds occurs. The change of inorganic into organic is effected by the plant from the carbon dioxide in the atmosphere and the ammonia and salts in the soil. The change of organic into inorganic is effected by the animal. The organic compounds synthesised by the plant enter the animal as food and are converted into carbon dioxide which leaves the body by the lungs, salts, urea and other simple organic compounds which leave the body in the urine. The faeces contains matter which has not been utilised by the animal. The urea and the other organic compounds in the excreta are finally broken down into carbon dioxide, ammonia, etc., by bacteria. There is thus a complete life-cycle of the elements and a balance-sheet can be made.

LIFE-CYCLE OF THE COMPOUNDS.

Our knowledge of the complete course of the changes which the various organic compounds undergo in their synthesis and degradation in both plants and animals is so insufficient that it is not possible to draw up a full and proper balance-sheet, such as the following:—

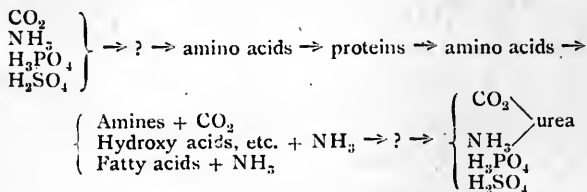

But a balance-sheet representing the beginning and the middle and the end can be more or less satisfactorily drawn up. The elements in the soil and the amount of protein, fat and carbohydrate in the plant can be determined. The amount of these constituents in the food of animals and the amount of carbon dioxide, ammonia, urea, etc., in their excreta can be determined. Thus, a known weight of carbohydrate or fat eaten by an animal is represented by the corresponding weight of carbon dioxide evolved through the lungs, unless some is retained in the body, in which case the body weight of the animal will increase. Similarly a known weight of protein or nitrogenous food will be represented by the corresponding weight of nitrogen in the urine. The actual amount of each constituent ingested by an animal is the amount consumed less the amount contained in the faeces, which consists of undigested food, i.e. food which has not entered the circulation. When the intake and the output of the constituents is the same, then the animal is said to be in nitrogen, phosphorus, etc., equilibrium; when less is put out than is taken in, then there is retention or assimilation and increase of body weight; when the output is greater, then there is loss of weight.

In addition to these factors, the energy factor can also be ascertained. Each compound has a certain caloric value and can evolve on complete combustion a definite amount of heat. This serves to maintain the body temperature. The total heat evolved by the body corresponds to the heat value of the food. The physiological heat value of

1 gm. of protein is	4.1 large calories ¹ ; 1 oz. = 116 cal.
1 gm. of fat is	9.3 " " ; 1 " = 263 " "
1 gm. of carbohydrate is	4.1 " " ; 1 " = 116 " "

¹ A large calorie is the heat required to raise 1000 gm. of water from 0°.1° (= 1000 small calories).

All these data are obtained by a series of analyses :—

I. The Energy Metabolism.

As synthetic agent the plant in forming the complex compounds from inorganic materials absorbs energy from the sun's rays. It is represented by the analysis of its tissues in terms of carbohydrate, fat, protein. In animals the energy metabolism is determined by the analysis of its food in terms of fat, protein, carbohydrate and the amount of heat given off by the animal. The animal is placed in a special form of calorimeter through which air of a constant temperature can be passed, measured and analysed. The experiments are complicated and difficult to perform.

II. The Carbon Metabolism of the Carbohydrates, Fats and Proteins.

In plants this is determined by the analysis of the tissues, the carbon being derived from the atmosphere.

The carbon metabolism in animals is determined by the analysis of the inspired and expired air. The animal is placed in a suitable chamber, fed upon a given food, the volume of gas which enters and leaves is measured and samples of each are analysed. The carbon in the urine and excreta should also be estimated.

As in the above experiments special apparatus is required and the analyses are difficult to perform. Reference must be made to the special books upon these subjects.

III. The Total Nitrogen Metabolism.

The total nitrogen metabolism in plants and animals is ascertained by the analysis of the nitrogen in the soil, or in special culture solutions, of the nitrogen in the plant tissue, of the nitrogen in the food and in the excreta of animals. These analyses are usually effected by Kjeldahl's method.

IV. The Nitrogen Metabolism of Individual Compounds.

The total nitrogen value is the sum of the amounts of nitrogen in the various compounds. It can be subdivided into numerous groups :—

Nitrates Nitrites Ammonia Other nitrogenous compounds	}	in the soil	Nitrates Nitrites Ammonia Amides Amino acids Proteins Purines etc. Ammonia	}	in the plant.
Amides Amino acids Proteins Purines Creatine etc.	}	in the food of animals	Urea Uric acid Purines etc.	}	in the excreta of animals

Each of these groups is estimated in the various tissues,

V. The Metabolism of Inorganic Compounds.

The metabolism of the inorganic compounds is determined by the analysis of sulphates, phosphates, sodium, potassium, etc., in the soil, the plant, the food, the excreta of the animals.

The total nitrogen metabolism, the metabolism of the individual nitrogenous compounds and of the inorganic compounds, in contradistinction to the energy and carbon metabolism, is very easy to determine and requires no special apparatus. A great deal of our present knowledge of dietetics is based upon these analyses in urine and valuable conclusions can be drawn from them.

COMPOSITION OF THE COMMONER TISSUES USED AS FOOD-STUFFS FOR ANIMALS.

The principal constituents of all animal and vegetable tissues consist of water, proteins, carbohydrates, fats and salts. In addition, various other substances are present, which are grouped together, under the term "extractives". Amongst the extractives are found the decomposition products of the above three classes of compounds, viz. amino acids, glucose, purines, urea, creatine, creatinine, etc.

Animal tissues consist mainly of protein with fat and only traces of carbohydrates. In vegetable tissues the amount of carbohydrate preponderates and the amount of protein is small. Protein is present in greatest amount in the legumes; cereals also contain fairly large quantities. Fruits and green leaves consist mainly of water, nuts almost entirely of protein and fat (oil). The following table shows the proportion of the various constituents in the commoner tissues or food-stuffs:—

	Water.	Protein.	Fat.	Carbohydrate.		Mineral Matter.
				Digestible.	Cellulose.	
Lean meat . . .	77	21	1.5	0.3	—	1.3
Eggs . . .	74	13	12	—	—	1.1
Cheese . . .	36-60	25-33	7.3	3-7	—	3.4
Cow's milk . . .	88	3.4	3.2	4.8	—	0.7
Human milk . . .	90	2.0	3.1	5.0	—	0.2
Wheat flour . . .	13	10	1	75	0.3	0.5
Peas, beans, etc. . .	15	25	2	50	5	3
Potatoes . . .	75	2	0.2	21	1	1
Fruit . . .	84	0.5	—	10	4	0.5
Nuts (average) . . .	5	20	60	10	—	1

Mention must also be made of the substances, termed vitamins by Funk, of unknown constitution, the absence of which in food-stuffs, e.g. polished rice, produces the deficiency diseases scurvy, beri-beri, pellagra, etc.

Food-stuffs, especially milk and some animal fats, contain an unknown compound which is necessary for the growth of animals. It is removed from food-stuffs by treatment with alcohol and ether and seems to be destroyed by prolonged heating. It is contained in the fatty constituents and is free from nitrogen (Osborne and Mendel). The constituents of eggs and of milk can maintain the early life of animals, but no single food-stuff contains the proportion of these substances which are necessary to maintain life in an adult; consequently a mixed diet is almost universally taken.

A man of the average weight of 70 kilos. performing light muscular work under starvation conditions loses 2240 large calories a day. To counterbalance this loss and making allowances for the non-utilisation in the body of some of the food, a diet yielding from 2500-2700 calories is required. The standards usually adopted are those of Atwater, namely:—

3000 calories for light	muscular work
3500 " " medium	" "
4500 " " heavy	" "

The main part of the caloric value of the food is supplied by the carbohydrate and fat of the diet. The quantities of these food-stuffs are increased or diminished so as to produce the necessary caloric value, whilst the daily supply of protein is varied very slightly: 110 gm., 125 gm., 150 gm. for light, medium, and heavy work respectively. Although smaller quantities of protein, from 60-70 gm. as shown by Chittenden and by Hindhede, can be taken without loss of body weight and with perfect maintenance of health, yet the figure of 90-100 gm. of protein is regarded as a daily minimum.

In considering protein as a diet, reference should be made to the relative amounts of the constituent amino acids. A protein diet should contain all the amino acids; if an amino acid be absent in a protein it should be eaten as such or given in another protein.

A diet consisting of—

500 gm. carbohydrate	will give a caloric value of	2050
60 " fat	" " " " " "	558
100 " protein	" " " " " "	410
		Total 3018

These figures represent dry weight. The actual content of protein, carbohydrate and fat in various food-stuffs is given on p. 537.

If we make a 10 per cent. allowance for non-utilisation, the caloric value becomes 2700.

The average daily output in the urine of the various nitrogenous constituents on a fixed carbohydrate and fat diet, but variable protein diet (egg-white, meat, etc.), the total quantity ingested corresponding to 100 gm. standard is given in the following table:—

Diet.	Acidity ·1N.	P ₂ O ₅ . gm.	Ammonia. gm.	Urea. gm.	Creatinine. gm.	Uric Acid. gm.	Total N. gm.
Mixed	652	2·76	0·52	30·35	1·29	0·86	16·01
Meat	453	2·42	0·43	31·58	1·38	0·79	17·09
Egg-white	308	1·13	0·34	31·69	1·12	0·51	16·23
Egg-white + Na ₂ HPO ₄	402	1·39	0·40	30·65	1·24	0·46	15·91
+ CaCl ₂	331	0·73	0·65	28·83	0·97	0·50	15·10
+ lecithin	446	2·05	0·62	28·22	1·08	0·44	14·80
+ lemco	384	2·25	0·47	31·79	1·69	0·76	16·56
+ herring roe	778	4·44	0·86	29·19	1·27	1·16	16·53

Diet.	CORRESPONDING NITROGEN VALUES OF THE ABOVE.			AMOUNT OF NITROGEN IN PER CENT. OF THE TOTAL NITROGEN.				
	Urea N. gm.	Creati- nine N. gm.	Uric Acid N. gm.	Am- monia.	Urea.	Creati- nine.	Uric Acid.	Undeter- mined.
Mixed	13.91	0.52	0.29	3.3	86.2	3.3	1.8	4.2
Meat	15.01	0.50	0.26	2.5	86.8	3.0	1.5	4.8
Egg-white	14.75	0.42	0.17	2.0	91.0	2.6	1.1	2.7
Egg-white + Na ₂ HPO ₄	14.30	0.46	0.16	2.5	89.1	2.9	1.0	3.9
+ CaCl ₂	13.46	0.37	0.17	3.5	89.1	2.4	1.1	3.5
+ lecithin	13.15	0.41	0.15	3.6	88.9	2.8	1.0	3.5
+ lemco	14.50	0.63	0.26	2.5	90.3	3.5	1.5	1.9
+ herring roe	13.62	0.48	0.41	3.7	84.0	2.8	2.2	5.8

The undetermined nitrogen is nitrogen which is not represented as urea, ammonia, etc. Its amount varies from about 3.6 per cent. of the total nitrogen and it consists of nitrogen present in the pigments of the urine and in unknown compounds.

ANALYSIS OF NORMAL URINE.

* **Colour.**—The colour is of a transparent yellow which varies from light yellow to orange or red-brown; the froth which forms on shaking soon disappears. It contains no sediment, but on standing a cloudiness of mucoid appears containing epithelial cells.

Urine has a characteristic and peculiar odour.

* **Reaction.**—The reaction is acid to litmus paper. This acidity is due to acid phosphates and not to free acid. At the full height of digestion it may be slightly alkaline and may show a cloudiness due to the presence of phosphates. It becomes alkaline on standing owing to the setting in of "ammoniacal fermentation" by the *micrococcus ureae*, which converts urea into ammonium carbonate. This change is in reality due to the action of the enzyme—urease—liberated from the micro-organism.

* **Specific Gravity.**—The specific gravity varies from 1010-1040. The average is 1015-1025. The specific gravity is ascertained with a hydrometer (urinometer).

* **Volume.**—Its volume varies. The average volume is 1000-1500 c.c. per day under normal conditions.

It is very advantageous to make the volume up to 2000 c.c. after taking the specific gravity and before carrying out quantitative analysis.

* Chlorides.

Chlorides are generally estimated by Volhard's method. The principle of this method consists in precipitating the chlorides by excess of a standard solution of silver nitrate in the presence of nitric acid. The excess of silver is then estimated in an aliquot part of the filtrate with a solution of potassium or ammonium thiocyanate, which has been previously standardised against the silver solution, a ferric salt being used as indicator.

The following solutions are required :—

- (1) $\cdot 1N$ silver nitrate solution, or a solution of such a strength that 1 c.c. corresponds to $0\cdot 01$ gm. $NaCl$.
- (2) $\cdot 1N$ potassium or ammonium thiocyanate solution standardised against the silver nitrate solution.
- (3) Pure nitric acid free from chlorides.
- (4) A saturated solution of iron alum.

Procedure.

(1) *Standardisation of the Thiocyanate Solution.*—10 c.c. of the silver nitrate solution are placed with a pipette in a beaker; 5 c.c. of pure nitric acid, 5 c.c. of iron alum solution and 80 c.c. of water are added. The thiocyanate solution is run in from a burette until a permanent red tinge is obtained. The amount required for the 10 c.c. silver nitrate solution is noted.

(2) *Analysis.*—10 c.c. of urine are placed with a pipette in a 100 c.c. measuring flask. About 4 c.c. of pure nitric acid and 20 c.c. with a pipette of the standard silver nitrate solution are added. The flask is filled up to the mark with distilled water, the contents are mixed and filtered into a dry vessel through a dry paper.

50 c.c. of the filtrate are taken with a pipette, some iron alum is added as indicator and they are titrated with the thiocyanate solution until a permanent red colour is obtained.

The calculation of the result is :—

$$\begin{aligned} 50 \text{ c.c. filtrate} &= S \text{ c.c. KCNS} \\ \therefore 100 \text{ c.c. } &= 2S \text{ c.c. KCNS.} \\ \text{Now } x \text{ c.c. KCNS} &= 10 \text{ c.c. AgNO}_3 \\ \therefore 2S \text{ c.c. } &= \frac{10 \times 2S}{x} \end{aligned}$$

This is the excess not utilised to precipitate the chlorides:

$$\therefore \left(20 - \frac{10 \times 2S}{x} \right) = \text{amount of AgNO}_3 \text{ solution used.}$$

As $\cdot 1N$ $AgNO_3 = \cdot 1N$ $NaCl$, 1 c.c. solution = $0\cdot 00585$ gm. $NaCl$.

Hence $NaCl$ in gm. in the volume passed in 24 hours is calculated.

Sulphates.

Sulphur is present in urine in three forms :—

- (1) Inorganic sulphates.
- (2) Ethereal sulphates.
- (3) Neutral sulphur.

The sulphates are derived mainly from the sulphur in the protein ; the amount of sulphate in the food is small. The average amount of sulphate in urine is 2.5 to 3.0 gm. per day. It varies directly with that of the nitrogen. The value of $\frac{\text{total N}}{\text{H}_2\text{SO}_4}$ is about 5. The ethereal sulphates increase in amount when putrefactive changes occur in the intestine or if poisonous substances, such as phenol, be taken. It is often of great importance to know the relative amounts of inorganic and ethereal sulphates.

The neutral sulphur consists of cystine, thiocyanates, sulphides and other substances. The estimation of the various forms of sulphur is effected by determining (1) the amount of inorganic sulphate, (2) the amount of ethereal sulphate, after removal of the inorganic sulphate, by hydrolysis to inorganic sulphate, or by hydrolysis of the ethereal sulphate and determination of the inorganic and ethereal sulphate together and taking the difference, (3) the estimation of the total sulphates after oxidising the neutral sulphur to sulphate. The difference between this amount and that of inorganic + ethereal is the amount of neutral sulphur.

Gravimetric Estimation.

The usual and most accurate method of determining the various forms of sulphur in urine is gravimetric. The following procedure of Folin is the one usually adopted :—

(1) *Ethereal + Inorganic Sulphates.*

5 c.c. of 4 per cent. potassium chlorate solution and 5 c.c. of concentrated hydrochloric acid are added to 50 c.c. of urine in a 200 c.c. conical flask. The mixture is boiled for 5-10 minutes so as to hydrolyse the ethereal sulphates and to oxidise the pigments of the urine. The solution becomes colourless. 25 c.c. of 10 per cent. barium chloride solution are slowly dropped in through a funnel with a capillary point. The solution is kept just below the boiling-point for $\frac{1}{2}$ -1 hour. The barium sulphate is filtered off on filter paper, washed for half an hour with hot water, at intervals of a few minutes hot 5 per cent. ammonium chloride being substituted for the water, so that in all five or six additions of ammonium chloride take place in the course of the first twenty minutes' washings. The filter and precipitate are dried by folding and pressing gently between dry filter papers and are transferred to a weighed crucible; 3 or 4 c.c. of alcohol are poured into the crucible and ignited. This dries and partially burns the filter paper. The residue is heated to whiteness, cooled and weighed.

The barium sulphate may also be collected on a Gooch crucible.

(2) *Ethereal Sulphates.*

200 c.c. of urine are placed in a beaker and 100 c.c. of 10 per cent. barium chloride solution are added. The mixture is stirred and set aside for 24 hours. The clear supernatant liquid is decanted into a dry beaker and filtered. 150 c.c. of the filtrate (= 100 c.c. of urine) are measured into a 400 c.c. conical flask, 10-15 c.c. of concentrated hydrochloric acid and 10-15 c.c. of 4 per cent. potassium chlorate solution are added. The mixture is heated to boiling. The remainder of the operation is the same as above (1).

(3) *Total Sulphates.*

(Denis' modification of Benedict's process.)

25 c.c. of urine are placed in a porcelain basin, 4.5 cm. in diameter, and evaporated to dryness with 5 c.c. of a copper nitrate oxidising solution.¹ The residue is first gently heated with a small flame and finally to redness for 10-15 minutes. The black residue is dissolved in 10-15 c.c. of 10 per cent. hydrochloric acid, which is gently warmed. The solution is transferred to a 200 c.c. conical flask, diluted to 100 or 150 c.c. and precipitated with 25 c.c. of 10 per cent. barium chloride solution as above.

A blank must be made with the oxidising solution.

* *Volumetric Estimation.*

The inorganic and ethereal sulphates may be estimated by the volumetric method proposed by Rosenheim and Drummond in 1913. It depends upon the insolubility of benzidine sulphate in very dilute hydrochloric acid. Excess of acid hinders the precipitation.

* (1) *Inorganic Sulphates.*

25 c.c. of urine are pipetted into a clean 250 c.c. flask or beaker and acidified to congo red with 1-2 c.c. of dilute hydrochloric acid; 100 c.c. of benzidine chloride solution² are now added. After 10-15 minutes the benzidine sulphate is filtered off through a small filter and washed free from acid with water saturated with benzidine sulphate. The precipitate, together with the paper, is returned to the flask or beaker, about 50 c.c. of water are added and the contents of the flask are heated to about 80°. A few drops of phenolphthalein are put in and the solution is titrated with .1N sodium hydrate until it is red in colour.

The result is in c.c. of .1N H_2SO_4 (1 c.c. = 0.0049 gm. H_2SO_4).

¹ 25 gm. copper nitrate + 25 gm. sodium chloride + 10 gm. ammonium nitrate per 100 c.c.

² This is prepared by rubbing 4 gm. of benzidine into a fine paste with about 10 c.c. of water and transferring it with about 500 c.c. of water into a 2-litre flask. 5 c.c. of concentrated hydrochloric acid are added and the volume made up to 2000 c.c. with water. (100 c.c. of this solution will precipitate .1 gm. H_2SO_4 .)

* (2) *Inorganic + Ethereal Sulphates.*

25 c.c. of urine as above are boiled gently for 15-20 minutes with 20 c.c. of dilute hydrochloric acid to hydrolyse the ethereal sulphates. The solution is cooled, neutralised and again acidified to congo red; 100 c.c. of benzidine chloride solution are added. The remainder of the process is as described under inorganic sulphates.

* (3) *Ethereal Sulphates.*

The amount of ethereal sulphates is the difference between the amounts found in (2) and (1).

(4) *Total Sulphates.*

10 c.c. of urine are evaporated to dryness in a small basin, 5-7 cm. in diameter, on a water-bath with 5 c.c. of Denis-Benedict's oxidising reagent (p. 542). The basin is covered with a clock glass and the dry residue is carefully heated over a flame until the copper nitrate is completely decomposed and converted into copper oxide. The basin is allowed to cool and the contents are dissolved in 10 c.c. of dilute hydrochloric acid and 10 c.c. of water. The solution is neutralised, made very faintly alkaline with caustic soda and warmed. The precipitate of copper oxide is filtered off and thoroughly washed. To the filtrate, now of a volume of about 25 c.c., are added 1-2 c.c. of dilute hydrochloric acid and 100 c.c. of benzidine chloride solution. The benzidine sulphate is filtered off and treated as under (1).

(5) *Neutral Sulphur.*

The difference between the amounts found in (4) and (2) is the amount of neutral sulphur.

* **Phosphates.**

The amount of phosphates in urine bears a direct relation to the amount of food ingested. Phosphorus compounds—phosphates, nucleic acid, lecithin, phosphoprotein—are present in all foods. The animal converts the organic compounds into inorganic phosphate. Only a small quantity of phosphorus is excreted in the urine in organic combination. The average daily excretion of P_2O_5 is about 2.5 gm.

* *Volumetric Estimation of Inorganic Phosphates.*

The usual method of estimating phosphates in urine depends upon their precipitation as uranium phosphate $(UO_2)HPO_4$ by a standard solution of uranium acetate, or uranium nitrate in the presence of sodium acetate and acetic acid:—



The determination of the end point, at which excess of soluble uranium salt is first in solution, is shown by means of potassium ferrocyanide, or by cochineal tincture, which becomes green at this point.

The following reagents are required:—

- (1) Acid sodium acetate solution. (2) Cochineal tincture.
- (3) .1N uranium solution of which 1 c.c. = 0.00355 gm. P_2O_5 , or a solution of such a strength that 1 c.c. = 0.005 gm. or 5 mgm. P_2O_5 .

The uranium solution cannot be prepared directly but requires to be standardised against a standard phosphate solution. Generally sodium phosphate is employed; 12 gm. are weighed out and dissolved in 1000 c.c. of water; 50 c.c. of this solution are evaporated to dryness, incinerated and weighed as pyrophosphate. From this weight the amount of P_2O_5 in 50 c.c. can be calculated and the remainder of the solution can be diluted, so that 50 c.c. contain 0.1 gm. P_2O_5 . It is simpler to use acid potassium phosphate, KH_2PO_4 , which can be weighed out directly and dissolved in water, so that 50 c.c. contain 0.1 gm. P_2O_5 . 50 c.c. of this solution are titrated with the uranium solution (36 gm. in 1 litre) in the manner described below; the uranium solution is then diluted so that 1 c.c. = 5 mgm. or 3.55 mgm. of P_2O_5 .

Procedure.

50 c.c. of urine are placed with a pipette in a 100 c.c. beaker, 5 c.c. of acid sodium acetate solution and a few drops of cochineal tincture are added. The urine is heated to boiling and the standard uranium acetate solution is run in slowly from a burette as long as a precipitate is formed. The solution is kept boiling and uranium solution is added, drop by drop, until the red colour is changed to green. The end point is best tested by taking out a drop of the solution and placing it in contact with a drop of potassium ferrocyanide solution, or a little heap of finely powdered ferrocyanide, on a white piece of porcelain. A brown colour or precipitate is formed when excess of soluble uranium salt is present in the solution. (A few more drops are generally required to reach this point than to turn the cochineal green.) The calculation of the result is:—

50 c.c. of urine = n c.c. of uranium solution = $n \times 0.005$ gm. or $n \times 0.00355$ gm. P_2O_5 . Hence the quantity of P_2O_5 in the 24 hours' quantity of urine is calculated.

Estimation of Total Phosphates.

The above method gives the amount of inorganic phosphates. In order to estimate the total phosphates, i.e. inorganic phosphate + phosphoric acid in organic combination, the latter must be oxidised and converted into inorganic phosphate. This is rapidly effected and estimated by Neumann's method with certain improvements:—

10 c.c. of urine are placed in a 500 c.c. round-bottom Jena glass flask; 10 c.c. of concentrated sulphuric acid and about 5 c.c. of concentrated nitric acid are added. The mixture is carefully heated in a fume cupboard until oxides of nitrogen are no longer evolved. The residue should be white or nearly white; if not, the flask is allowed to cool, 3 or 4 c.c. of nitric acid are added and it is again heated. When the oxidation is complete, as shown by the white appearance of the acid, the flask is allowed to cool; 150 c.c. of water and 20 c.c. of 80 per cent. ammonium nitrate are added and the solution heated to about 85°; about 20 c.c. of 10 per cent. ammonium molybdate are added. The solution, which becomes yellow, is shaken; ammonium phosphomolybdate separates out. After 10-15 minutes, or when the solution is cold, the precipitate is filtered off by suction through a straight glass funnel in which a perforated platinum plate is fused, as in Fig. 74, and upon which there is an accurately fitting filter paper. The flask and precipitate are washed free from acid with water; the precipitate and filter paper are returned to the flask by a stream of water. A known excess of .5N sodium hydrate is added to dissolve the precipitate and about 300 c.c. of water. The solution is boiled to remove ammonia, cooled and the excess of alkali is titrated with .5N sulphuric acid, using 6-8 drops of phenolphthalein as indicator.

Each c.c. of .5N alkali used to dissolve the precipitate corresponds to 1.268 mgm. of P_2O_5 or .5536 mgm. of P.

Gravimetric Estimation of Inorganic Phosphates.

10 c.c. of urine are diluted with 20-30 c.c. of water; an excess of magnesium citrate mixture¹ (5-10 c.c.) is added and the solution is made distinctly alkaline with ammonia. It is stirred well, covered with paper and allowed to stand at least 12 hours. The precipitate of ammonium magnesium phosphate is collected on a small filter paper, washed thoroughly with dilute ammonia and dried at 100°. The precipitate and filter paper are incinerated in a weighed crucible and heated to bright redness for 15-30 minutes so as to convert the ammonium magnesium phosphate into magnesium pyrophosphate. The crucible is cooled in a desiccator and weighed. The increase in weight gives the amount of magnesium pyrophosphate. This amount multiplied by .638 gives the amount of P_2O_5 .

Estimation of Organic Phosphorus.

The difference between the amounts of total phosphates and inorganic phosphates by the gravimetric method is the amount of organic phosphate in terms of P_2O_5 .

¹ This mixture should be used instead of magnesia mixture as it prevents the precipitation of calcium salts and organic matter.

It is prepared by dissolving 400 gm. of citric acid in 500 c.c. of water. To the hot solution 20 gm. of magnesium oxide are added. The solution is cooled and treated with 400 c.c. of .880 ammonia. The volume is made up to 1500 c.c. and after standing for 24 hours the solution is filtered.



FIG. 74.

Calcium and Magnesium.

Only small amounts of calcium and magnesium are present in urine so that large quantities of urine must be used in their analysis. Two methods are used for their estimation:—

(a) 200 c.c. of urine are made alkaline with ammonia; the precipitate, consisting of calcium and magnesium phosphates, is filtered off, washed and dissolved in the smallest quantity of dilute hydrochloric acid. Sodium acetate is added to the solution and the calcium is precipitated as oxalate by adding ammonium oxalate. The precipitate is filtered off, washed and dried at 100° ; the precipitate and filter paper are heated in a weighed crucible until of constant weight. The increase in weight gives the amount of calcium oxide.

The filtrate and washings from the calcium oxalate, to which a few drops of sodium phosphate solution may be added, are made alkaline with ammonia. Ammonium magnesium phosphate¹ is precipitated and converted into pyrophosphate as in the gravimetric estimation of inorganic phosphates (p. 545).

(b) 200 c.c. of urine are evaporated in portions of 25 or 50 c.c. with 10 c.c. of sulphuric acid contained in a 200 c.c. conical Jena glass flask and oxidised by adding nitric acid as described under estimation of total phosphates (p. 545). When the oxidation is complete about 10 c.c. of water are added and the mixture again evaporated so as to remove nitric acid as completely as possible. To the remainder about 40 c.c. of water are added and 1-2 volumes of alcohol. The mixture is warmed on a water-bath and allowed to stand until it is cold. Calcium sulphate is precipitated; it is filtered off on a weighed Gooch crucible, washed and dried at 100° or at a red heat.

The filtrate and washings from the calcium sulphate are evaporated to remove alcohol and treated with concentrated nitric acid to remove organic matter as above. The acid remainder is diluted with water and made alkaline with ammonia. Ammonium magnesium phosphate is precipitated and treated as above.

(c) Cahen and Hurlley² found that the incinerated residue of urine or tissues was most suitably dissolved in phosphoric acid. The calcium is precipitated from this solution as oxalate and estimated volumetrically or gravimetrically.

100 c.c. of urine are evaporated on a water-bath, dried at 120° and incinerated. 100 gm. of heart, muscle, etc., less of an aorta rich in calcium, are dried and incinerated.

10 c.c. of phosphoric acid of sp. gr. 1.2 (1 vol. syrupy phosphoric acid to 3 vols. water), or 20 c.c. if much calcium be present, are added to the residue. The calcium dissolves completely on warming. The solution is filtered, diluted with 50 or 100 c.c. of water and treated with 5 times the necessary quantity of oxalic acid solution (37.8 gm. per litre), e.g. if .2 gm. of calcium be present as calcium carbonate, 100 c.c. would be necessary. Calcium oxalate is rapidly precipitated in a crystalline state, but completion of the precipitation only occurs on adding an equivalent volume of ammonia (10.2 gm. NH_3 per litre); it must be added slowly from a burette with shaking, if magnesium be present. Calcium oxalate is not precipitated in a suitable condition if ammonium oxalate be used. The calcium oxalate is filtered off on a small conical Buchner funnel, washed 7 times with cold water, returned together with filter paper to the vessel in which it was precipitated and titrated with permanganate solution after adding 10 c.c. of dilute sulphuric acid (1:1) and heating to nearly boiling. The sulphuric acid usually requires a separate titration and this figure is deducted from the previous figure.

The gravimetric estimation is effected as under (a). The magnesium in the filtrate is precipitated on adding concentrated ammonia to the filtrate and estimated as pyrophosphate.

¹ Minute quantities of ferric phosphate are present in this precipitate, but may be neglected.

² Biochem. J., 1916, 10, 308.

Iron.

The amount of iron in urine (and tissues) is generally so small that at least 500 c.c. of urine must be used.

The organic matter is first removed by oxidation:—

(1) By evaporating and igniting the residue. It is best to ignite, then to dissolve the residue in some concentrated hydrochloric acid, filter from unburnt carbon, ignite the filter paper and carbon residues and dissolve the ash in hydrochloric acid. Any reduced iron may be oxidised by boiling the solution for 10 minutes with a drop of hydrogen peroxide.

(2) By oxidation with nitric acid and sulphuric acid (p. 545). The oxidation of large quantities of urine with nitric acid and sulphuric acid is best effected by mixing the urine with one-tenth of its volume of nitric acid and gradually adding this mixture to the sulphuric acid.

The volumes of acid used must be noted and the reagents must be analysed for their content in iron:—

A large quantity (500 c.c.) is evaporated in a platinum basin or round-bottom flask to 5 or 10 c.c. In the case of nitric acid it must be removed by evaporation several times with a measured quantity of sulphuric acid (10-20 c.c.) of known iron content until sulphur dioxide is evolved. In the case of hydrochloric acid the several final evaporations are not necessary. The pure acids were found by Jahn to contain:—

·1045 mg. Fe in 1000 c.c.	H ₂ SO ₄
·1080 " "	HCl
·1704 " "	HNO ₃

Of the various methods for estimating small quantities of iron the best seems to be the titanium chloride method which depends upon the reaction:—

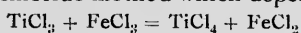

Jahn¹ has worked out the details for its use with physiological liquids and tissues:—

(1) The Preparation of a Standard Iron Solution.

Instead of using ferrous ammonium sulphate it is more convenient to use pure ferric oxide (Kahlbaum). The oxide is heated at 150° for 5 hours to remove the last traces of water. 0·14297 gm. (= ·1 gm. Fe) are placed in a round bottom flask and dissolved by heating in 20 c.c. of concentrated sulphuric acid and 200 c.c. of water. The flask is shaken on account of bumping, allowed to cool several times, water lost by evaporation being replaced. The clear solution is diluted to 1000 c.c. (1 c.c. = 0·0001 gm. of Fe).

(2) Preparation and Standardisation of the Titanium Chloride Solution.

10 c.c. of commercial 15 per cent. titanium chloride solution are gently boiled in a very small beaker with 10 c.c. of pure concentrated hydrochloric acid. The vapours are tested for hydrogen sulphide with lead acetate paper; if it be present the solution is boiled till it has been removed. The solution is rapidly cooled and diluted in a flask to 2000 c.c. with boiled out water. Owing to its being so easily oxidised it must be kept in an atmosphere of hydrogen prepared in a Kipp apparatus and freed from hydrogen sulphide by passage through permanganate. The flask is therefore fitted with a rubber stopper with two holes; the tubes through the stopper pass to the bottom. Hydrogen is passed through one tube and the other tube is connected to a burette. The burette is also connected with the hydrogen apparatus.

The titration must be carried out in an atmosphere free from oxygen and is effected most conveniently in a 250 c.c. filter flask, through which by the side tube a current of carbon dioxide is passed; the end of the burette should reach below the level of the side tube.

¹ Z. physiol. Chem., 1911, 75, 308.

10 c.c. of the iron solution are placed in the flask and diluted with 100 c.c. of air-free water. 10 c.c. of pure concentrated sulphuric acid are added; when the solution is cold 5 c.c. of 40 per cent. potassium thiocyanate are added as indicator. When the air has been displaced by carbon dioxide, the titanium solution is run in till it is colourless, i.e. in excess. The excess is determined by titrating with the iron solution until a red colour appears. This red colour must be permanent for 5 minutes, e.g. :—

10 c.c. iron solution + 7.75 c.c. titanium solution + 4.3 c.c. iron solution.
 7.75 c.c. titanium solution = 1.43 c.c. iron solution = 1.43 mgm. iron.
 \therefore 1 c.c. titanium solution = 0.1845 mgm. Fe.

Owing to the instability of the titanium chloride solution it should be standardised before and after a series of iron estimations.

(3) Estimation of Iron.

5 c.c. of concentrated sulphuric acid are added to a measured volume of the solution: when it is cold 5 c.c. of 40 per cent. potassium thiocyanate are added, the air is displaced and excess of titanium solution is run in. The excess is determined by titrating with the iron solution, e.g.

20 c.c. titanium solution were used and excess titrated with 3.2 c.c. iron solution.
 20 c.c. titanium solution = 3.690 mgm. Fe - 3.2 mgm. Fe = 3.370 mgm. Fe.

Sodium and Potassium.

20-100 c.c. of urine are oxidised (1) by evaporation and ashing, or (2) with nitric and sulphuric acids. The residue from (1) is dissolved in water or dilute hydrochloric acid and filtered from insoluble salts. The residue from (2) is heated in a platinum basin till nearly all the sulphuric acid has been volatilised. It is diluted with water.

The solution obtained by either method is treated with barium chloride as long as a precipitate is formed and baryta water is added till the solution has a distinct alkaline reaction. The precipitate of phosphates and sulphates is filtered off and well washed. The filtrate and washings are treated with ammonia and ammonium carbonate to remove barium salts; these are filtered off and washed. The filtrate and washings are evaporated to dryness. The residue is heated to redness to remove ammonium salts, dissolved and treated again with ammonia and ammonium carbonate and filtered. The filtrate is acidified with hydrochloric acid, evaporated and heated to redness. The weight of this residue is the amount of sodium and potassium chlorides. It is dissolved in water, the potassium is estimated in it by precipitation with platinum chloride, or better, perchloric acid, and the amount of sodium calculated by difference.

Potassium.

As Perchlorate.

The perchlorate method of estimating potassium has been tested by W. A. Davis¹ who recommends its use for the analysis of potassium in soil, ash of plants, etc. The advantage of this method is that small quantities of sulphates, phosphates, barium, magnesium and calcium do not interfere. Large quantities of sulphate, etc., must be removed as above. Iron salts must be absent.

The extract of soil, the aqueous extract of the ash of plant tissues, or the extract of the ash of animal tissues and urine previously treated as above, is evaporated to dryness in a porcelain basin and heated to dull redness for about 15 minutes. The heating is continued for so long that, on dissolving, a colourless solution free from iron results.

If sulphates be present in large amount they are removed by adding 5-10 c.c. of saturated baryta solution, evaporating and igniting as above.

¹ J. Agric. Sci., 1912, 5, 52.

The residue is extracted with boiling water, the particles of iron oxide being broken up with a glass rod as completely as possible. The extracts are filtered into a glass evaporating dish of $3\frac{1}{4}$ inches diameter. The soluble sodium and potassium salts are generally dissolved out when water sufficient to fill the dish has been used, but another 50 c.c. may be employed.

The aqueous extract is evaporated *nearly* to dryness after adding 2.5 c.c. of 20 per cent. perchloric acid solution¹ (sp. gr. 1.125); the evaporation is carried so far that there is a vigorous evolution of heavy white fumes of perchloric acid and is conveniently effected on a sand-bath; should the evaporation proceed to dryness and no spirting occur, the residue may be dissolved in a few drops of perchloric acid solution.

The evaporated solution is stirred with 20 c.c. of 95 per cent. alcohol; after settling, the liquid is poured through a 9 cm. filter paper, which has been dried to constant weight at 100° in a stoppered weighing bottle ($2 \times 1\frac{1}{2}$ inches), or on a Gooch with a layer of asbestos $\frac{1}{8}$ inch thick; the residue is treated with 10 c.c. of 95 per cent. alcohol containing .2 per cent. of perchloric acid; ² the insoluble potassium perchlorate is transferred to the filter, the last portions being washed upon it by means of 20-30 c.c. of the alcohol containing perchloric acid. The perchloric acid is washed away by a minimal quantity of alcohol as shown by testing the washings with sensitive litmus paper. It is important to wash the top edges of the filter paper thoroughly as it will blacken on the subsequent drying at 100°; 120-150 c.c. of alcohol may be used.

The paper is dried in the funnel at 100° for 20 minutes and then in the weighing bottle until the weight is constant (1 mgm. $\text{KClO}_4 = 0.3401$ mgm. K_2O).

As Cobaltinitrite.

H. H. Green³ has adapted the cobaltinitrite method for estimating potassium in urine:—

25 c.c. of urine are evaporated to dryness in a platinum dish and gently ignited at a dull-red heat. The ash is moistened with nitric acid and reignited until it is free from organic matter and ammonium salts. The ash is dissolved in water containing a few drops of dilute hydrochloric acid and washed into a 200 c.c. porcelain basin. The solution is neutralised or made slightly alkaline with a few drops of caustic soda, acidified with acetic acid and evaporated to between 5 and 10 c.c. 1 c.c. of glacial acetic acid and 10 c.c. of cobaltinitrite reagent⁴ are added and the evaporation continued until the syrup will set to a stiff mass on cooling. The cold mass consisting of the yellow precipitate, $\text{K}_2\text{NaCo}(\text{NO}_2)_6 \cdot \text{H}_2\text{O}$, embedded in a dark-purple matrix, is stirred up and allowed to soak with 50 c.c. of 10 per cent. acetic acid until the precipitate is disentangled and the solution has a tawny colour. The yellow precipitate is washed by decantation with dilute acetic acid, the washings being poured through an asbestos filter. The precipitate is completely transferred to the filter, washed with cold water and sucked dry. Six washings by decantation with altogether 300 c.c. are generally sufficient. Complete retention of the precipitate may be attained by using a second disc of asbestos on the first.

¹ This suffices for .2 gm. of a mixture of $\text{KCl} + \text{NaCl}$, but 5 c.c. more of perchloric acid must be added if the quantity be greater.

² Prepared by adding 5 c.c. of 20 per cent. perchloric acid to 500 c.c. of alcohol.

³ *Biochem. J.*, 6.

⁴ This is prepared by dissolving 113 gm. of cobalt acetate in 400 c.c. of water and adding 100 c.c. glacial acetic acid; 220 gm. of sodium nitrite are separately dissolved in 400 c.c. of water and the two solutions are mixed with stirring. The last portions of NO_2 are removed by evacuation or by blowing air through the solution. After 24 hours any sediment is filtered off and the volume diluted to 1 litre. The solution has a dark-plum colour, is kept in the dark and is decanted before use.

During the washing 300 c.c. of water are heated to boiling and excess (30-50 c.c.) of $\cdot 2N$ permanganate is added from a burette. The asbestos and the precipitate are dropped into this solution and the remainder washed in. Sufficient sulphuric acid (20 c.c. of 25 per cent.) is added, the mixture well stirred and gently boiled for about 5 minutes until the yellow precipitate is completely decomposed. Manganese hydroxide separates out. Standard oxalic acid is run in from a burette until it has dissolved and the liquid is clear and of a very faint pink colour. The excess of oxalic acid is titrated with $\cdot 2N$ permanganate. The difference between the amounts of oxalic acid and permanganate gives the amount of permanganate used.

$$1 \text{ c.c. } \cdot 2N \text{ KMnO}_4 = 0\cdot001714 \text{ gm. K}_2\text{O.}$$

It is advisable to standardise the permanganate against potassium chloride; a concentration of permanganate, so that 1 c.c. = $0\cdot002 \text{ gm. K}_2\text{O}$ is more convenient than exactly $\cdot 2N$. 31.6 c.c. of this strength of permanganate = 10 c.c. of 1 per cent. KCl.

* **Acidity.**

In order to estimate the acidity a sufficient amount of alkali of known strength is added from a burette until neutralisation is produced, as indicated by the colour reaction of phenolphthalein, which has been previously added. It must be remembered that different indicators give different results. Congo red and methyl orange are only affected by strong acids, whereas litmus and phenolphthalein are affected by weak acids, such as carbonic acid. The two former do not react with urine.

* *Procedure.*

(a) 25 c.c. of urine are measured out with a pipette into a flask or beaker and diluted with 50-100 c.c. of water. About 6 drops of phenolphthalein solution are added and $\cdot 1N$ sodium hydroxide is run in from a burette until the solution has a permanent and distinct pink colour. - Owing to the presence of calcium salts in the urine the end point is difficult to see.

(b) To overcome the difficulty Folin recommends that the titration be carried out in the presence of neutral potassium oxalate:—

* 25 c.c. of urine are diluted with an equal volume of water, 15 gm. of finely powdered potassium oxalate and 4-5 drops of phenolphthalein are added. The solution is shaken for 1-2 minutes to dissolve most of the oxalate and whilst the solution is still cold from the effect of the oxalate, it is titrated with $\cdot 1N$ alkali until a permanent pink tint remains.

This neutral solution is used in the estimation of "ammonia" (p. 551).

As urine contains a mixture of acids, the result is not expressed in terms of any particular acid, but in terms of $\cdot 1N$ acid either per 100 c.c. of urine or per 24 hours' quantity (diluted to 2000 c.c.), thus:—

Suppose 25 c.c. urine required 4.5 c.c. of $\cdot 1N$ alkali, the acidity is 18 c.c. per 100 c.c. or 360 c.c. $\cdot 1N$ per 24 hours' quantity.

* **Ammonia.**

The estimation of ammonia in urine until 1902 was a matter of considerable trouble on account of the length of time required to perform an analysis, but in that year Folin introduced his æration method for removing the ammonia from urine made alkaline with sodium carbonate.

Folin's Method.

The apparatus required for this estimation is the same as that used in estimating urea by means of urease (p. 136).

25 c.c. of urine are placed in the tall gas cylinder together with 1 gm. of anhydrous sodium carbonate and a few c.c. of toluene or paraffin. The cylinder is connected to the receiver containing 10 or 20 c.c. of .1N acid coloured with a few drops of alizarin red as indicator.

The cylinder is placed in a bath at 40° and a good air current is passed for 1 hour (longer if the suction is not rapid). The liquid in the receiver is titrated with .1N alkali.

The results are expressed in gm. of NH₃, or better in terms of nitrogen as ammonia per 24 hours' quantity of urine (2000 c.c.) Thus suppose 6.0 c.c. alkali were required.

$$\begin{aligned} 10 - 6.0 &= 4.0 \text{ c.c. } .1N \text{ NH}_3 \\ &= 4 \times .0017 \text{ gm. NH}_3 \text{ or } 4 \times .0014 \text{ gm. N as ammonia} \\ &= 4 \times .0017 \times \frac{2000}{25} \text{ gm. NH}_3, \text{ or } 4 \times .0014 \times \frac{2000}{25} \text{ gm. N as ammonia per 24 hours.} \end{aligned}$$

Various modifications of this method have been put forward, e.g. using baryta instead of sodium carbonate. In this case the amount of amino acids can be estimated in the remainder (below).

* **Estimation of "Ammonia". Ammonia + Amino Acids.**

In 1908 Malfatti showed that the ammonia in urine could be rapidly estimated by titrating neutralised urine after the addition of formaldehyde. The method depends upon the fact that when a neutral solution of an ammonium salt is treated with formaldehyde, combination occurs with the formation of hexamethylenetetramine (urotropin) with the liberation of a corresponding amount of acid which can be titrated with .1N NaOH. The reaction is

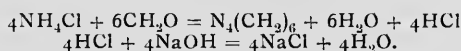

The amount so obtained is higher than the value obtained by the Folin method and is due to the presence in the urine of small amounts of amino acids which also react with formaldehyde (p. 145). The result is therefore the amount of ammonia and amino acids.

Since the amino acids are present only in very small amounts, the value can be used as an expression of the ammonia content. The method is particularly useful for clinical work.

Procedure.

To the neutralised urine remaining after the acidity estimation are added 10 c.c. of formalin which has been diluted with 2 volumes of water and neutralised with .1N alkali to phenolphthalein.

The pink colour of the urine disappears; .1N alkali is run in from a burette until a permanent pink colour is again obtained. The number of c.c. required is noted.

The result is expressed in gm. of NH₃ or gm. of ammonia N.

Amino Acids.

The exact estimation of the amino acids in urine is troublesome to effect. A very close approximation is given by the difference between the ammonia and "ammonia" values. It is more accurately obtained by performing the ammonia estimation by Folin's method using 50 c.c. of urine and 50 c.c. of baryta water. The remainder in the cylinder is washed into a 250 c.c. measuring flask, diluted to the mark, mixed and filtered; 100 c.c. portions of the filtrate are neutralised to phenolphthalein with $\cdot 2N$ hydrochloric acid; 10 c.c. of neutralised formalin are added and the solution is titrated with $\cdot 1N$ alkali.

The value multiplied by $\frac{2.5}{0}$ is the amount in 25 c.c. of urine. Hence the amount in the 24 hours' quantity. It is best expressed in terms of nitrogen.

* **Total Nitrogen.**

This estimation is carried out by Kjeldahl's method as described on pp. 35-38.

5 c.c. of urine are heated with 10 c.c. of pure sulphuric acid and a small crystal of copper sulphate till oxidation is complete.

The ammonia formed is distilled off and collected in 50 c.c. $\cdot 1N$ H_2SO_4 .

Titration with $\cdot 1N$ NaOH gives the amount of $\cdot 1N$ NH_3 in 5 c.c. of urine.

Hence the amount of nitrogen in the 24 hours' quantity (2000 c.c.), e.g.

$$\begin{aligned} &\text{Suppose } 100 \text{ c.c. } \cdot 1N \text{ } H_2SO_4 \text{ were taken and } 66 \text{ c.c. } \cdot 1N \text{ NaOH used.} \\ \text{Difference} &= 34 \text{ c.c. } \cdot 1N \text{ } H_2SO_4 = 34 \text{ c.c. } \cdot 1N \text{ } NH_3 = 34 \text{ c.c. } \cdot 1N \text{ nitrogen.} \\ &= 34 \times 0.0014 \text{ gm. N in } 5 \text{ c.c. of urine.} \\ &= 19.04 \text{ gm. in } 2000 \text{ c.c.} \end{aligned}$$

* **Urea.**

(1) The most rapid method of estimating urea is the hypobromite method as described on p. 134.

5 c.c. of urine are treated with 25 c.c. of hypobromite solution and the volume of nitrogen evolved is measured.

As 354 c.c. of nitrogen at 0° and 760 mm. pressure are evolved by 1 gm. of urea or $\cdot 47$ gm. of nitrogen as urea, the amount of urea or urea nitrogen in 5 c.c. urine can be calculated. Hence the amount in the 24 hours' volume.

Other substances such as ammonia, creatine, uric acid, evolve nitrogen under these conditions, but it is very small in comparison.

The method gives good comparative values for clinical work.

* (2) The most accurate method of estimating urea is by the hydrolysis of the urea by urease.

It is carried out exactly as described on p. 136 using 5 c.c. urine and collecting the ammonia in 50 c.c. of $\cdot 1N$ acid containing a few drops of alizarin red.

Since the ammonia of the urine is included in this estimation its amount must be deducted.

(3) Equally good results are given by Folin's method:—

5 c.c. of urine are heated with 20 gm. of crystallised magnesium chloride, 5 c.c. of concentrated hydrochloric acid, a few c.c. of thick paraffin and a few drops of alizarin red, under a reflux condenser of a U-shaped pattern, shown in Fig. 75, in a 200 c.c. conical or round bottom flask. The mixture is heated so as to drive off water into the condenser. As soon as the drops falling from the condenser produce a distinct bump the heating is lessened so that condensed drops fall about every 20 seconds. The heating is continued in this way for 1 hour. If the solution becomes alkaline during the hydrolysis of the urea, a few c.c. of the acid water in the condenser are tipped into the flask.

When the hydrolysis is complete, the contents of the flask are washed into a 700 or 1000 c.c. round bottom flask; the ammonia is distilled off as in Kjeldahl's method, and collected in 50 c.c. of .1N acid, but not more than 10 c.c. of caustic soda (40 per cent.) should be added to make the contents of the flask alkaline, as magnesium hydroxide is precipitated and causes bumping. The distillation requires about 1 hour.

The amount of .1N acid neutralised, less the amount of .1N acid found for the ammonia which is included in this estimation, per 5 c.c. gives the amount of urea:—

$$1 \text{ c.c. } .1N \text{ alkali} = .0014 \text{ gm urea nitrogen} = .003 \text{ gm. urea.}$$

Allantoine.

Allantoine is present in human urine in only minute quantities, but in dogs and many other animals it takes the place of uric acid. Allantoine is hydrolysed by hydrochloric acid in the same way as urea; it is readily estimated by difference between the hydrolysis value with hydrochloric acid as above and the urea value by means of urease, both with 5 c.c. of urine.¹

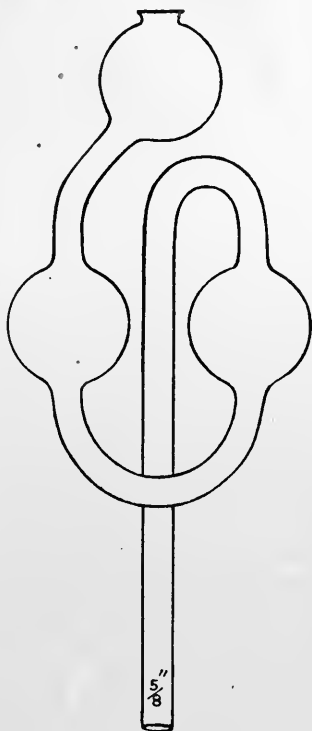

FIG. 75.

¹ Biochem. J., 1914, 8, 70.

* **Uric Acid.**

In 1892 it was shown by Hopkins that uric acid could be completely precipitated from urine as ammonium urate by saturating the urine with ammonium chloride. Its amount was estimated by converting this into uric acid by the action of hydrochloric acid, dissolving the latter in sodium carbonate and titrating with standard permanganate solution. Very accurate results are obtained by Folin and Schaffer's method, which is in reality a shortened Hopkins' method. It is the one most commonly employed.

For this method the following reagents are required :—

- (1) Uranium acetate mixture (see p. 614).
- (2) 10 per cent. ammonium sulphate solution.
- (3) 0.05N potassium permanganate solution made by dissolving 1.581 gm. pure potassium permanganate in 1 litre of water (1 c.c. = 0.00375 gm. uric acid).

* *Procedure.*

200 c.c. of urine are measured out with a pipette into a 500 c.c. flask and 50 c.c. of the uranium acetate mixture are added. The solutions are mixed and allowed to stand for about half an hour so as to allow the precipitate to settle. This precipitate contains a mucoid substance which, if not thus removed, renders the subsequent filtration and washing of the ammonium urate precipitate very slow. The supernatant liquid is filtered off through a dry filter into a dry vessel; 125 c.c. (= 100 c.c. urine) of this are measured out with pipettes into a beaker; 5 c.c. of concentrated ammonia are added and mixed and it is allowed to stand covered with paper for 12-24 hours.

The supernatant liquid is carefully decanted upon a filter, the precipitate of ammonium urate is washed on to the filter with 10 per cent. ammonium sulphate solution and washed once or twice with the same reagent to remove the chlorides as completely as possible.

The filter is removed from the funnel, opened and with a fine stream of water the ammonium urate precipitate is washed into a beaker or flask. To the ammonium urate precipitate, suspended in about 100 c.c. of water, 15 c.c. of concentrated sulphuric acid are added and it is titrated at once without cooling with 0.05N potassium permanganate until a pink colour is first seen throughout the solution (cf. p. 292).

The result is calculated as follows :—

$$\begin{aligned} 1 \text{ c.c. } 0.05N \text{ KMnO}_4 &= 0.00375 \text{ gm. uric acid,} \\ \therefore x \text{ c.c. } &= x \times 0.00375 \text{ gm. uric acid,} \end{aligned}$$

but since ammonium urate is slightly soluble a correction of 3 mgm. for every 100 c.c. of urine used must be added. The result is :—

100 c.c. urine contain $x \times 0.00375 + 0.003$ gm. uric acid, from which the amount in the 24 hours' quantity is calculated.

* Creatinine.

Creatinine is estimated by Folin's adaptation of the Jaffé colour reaction of creatinine with picric acid and caustic soda (p. 171). Folin found that a layer 8 mm. deep of .5N potassium bichromate solution had the same colour as a layer 8.1 mm. deep of a solution prepared from 10 mgm. of pure creatinine, picric acid and caustic soda. By comparing the colour of an unknown solution with that of bichromate in a Duboscq colorimeter, the amount of creatinine can be determined as the colours are directly proportional.

Procedure.

10 c.c. of urine are measured with a pipette into a 500 c.c. measuring flask, 15 c.c. of saturated picric acid solution and exactly 5 c.c. of 10 per cent. sodium hydroxide are added. The mixture is allowed to stand for 5-7 minutes and diluted to 500 c.c. with water. The colour of this solution is compared with that of .5N bichromate in a colorimeter.

The bichromate solution is placed in one of the cups of the colorimeter and the depth through which the colour is viewed is adjusted to 8 mm. by means of the screw and the vernier on the scale. The unknown is placed in the other cup. The comparison is made by altering the depth by means of the screw on this side of the instrument until the colours match. Readings should be taken by matching from too light and from too dark and the mean of 6-10 readings should be taken.

The result is calculated as follows:—

Suppose 9.5 mm. of the unknown match 8 mm. of the bichromate, then since 8.1 mm. of the bichromate corresponds to 10 mgm. of creatinine and since the readings are proportional,

$$10 \times \frac{8.1}{9.5}, \text{ or } 8.4 \text{ mgm., creatinine are present in 10 c.c. urine.}$$

Hence the amount in the 24 hours' quantity is calculated.

Creatine + Creatinine.

Though creatine is not normally present in urine, it appears in certain pathological conditions.

It is estimated by conversion into creatinine as described on p. 168.

The difference between the estimations of creatinine and creatine + creatinine gives the amount of creatine.

Benedict¹ gives the following procedure:—

A volume of urine containing between 7 and 12 mgm. of total creatinine is put into a small flask or beaker together with 10-20 c.c. of N hydrochloric acid and a pinch or two of powdered or granulated lead. The effect of the lead is to prevent pigment formation. The mixture is boiled nearly to dryness over a flame and then evaporated to dryness on a water-bath or by holding the vessel in the hand and heating carefully. The residue is dissolved in 10 c.c. of hot water and the solution rinsed through a plug of cotton or glass wool into a 500 c.c. measuring flask; 20-25 c.c. of picric acid solution are added and 7-8 c.c. of 10 per cent. sodium hydrate containing 5 per cent. of Rochelle salt, which prevents turbidity due to the presence of lead hydroxide. After 5-7 minutes the volume is made up to 500 c.c. and the colour compared with the standard.

¹J. Biol. Chem., 1914, 18, 192.

MICRO-METHODS FOR THE ANALYSIS OF THE NITROGENEOUS CONSTITUENTS OF URINE.

Folin and his co-workers, who have adapted and devised methods for analysing the soluble non-protein nitrogenous constituents of blood, have shown that these methods can be used for the analysis of the same constituents in urine if smaller quantities of urine be taken, or if the urine in some of the analyses be considerably diluted. It has since been shown that the urea can be estimated by means of urease using smaller quantities of urine. By thus reducing the amount of urine the time taken to effect the analyses is considerably shortened. These methods are particularly useful for the analysis of the urine of fish and small animals where only small quantities of urine are obtainable.

The analyses are made colorimetrically: ammonia by comparison with a standard ammonium sulphate with Nessler's reagent, uric acid with the phosphotungstic acid reaction, creatinine with picric acid and caustic soda. The ammonia analyses can, however, be made by titration with $0.02N$ alkali. In all cases the ammonia is liberated by the aeration method, as used in the estimation of ammonia and urea by the urease method (p. 136). Jena glass test tubes 20 cm. long and 2.3 cm. wide are employed. The ammonia is either removed by suction with a good water-pump and water supply or by blowing with an air blast. The arrangement of the apparatus is shown in Figs. 76 and 77.

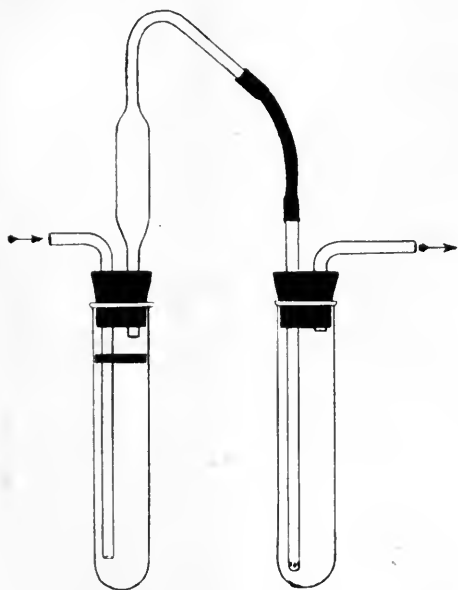

FIG. 76. (After Folin.)

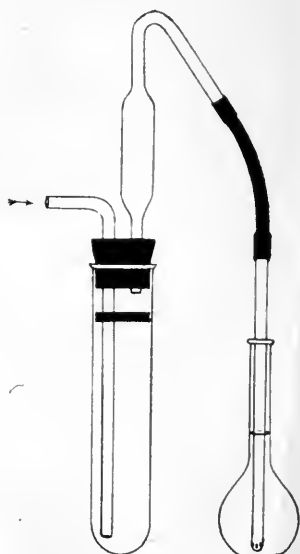

FIG. 77. (After Folin.)

Old pipettes of 20-30 c.c. capacity serve well as the traps; to prevent splashing over a piece of rubber is cut to shape, put through a hole upon the entry tube and fitted below the exit tube.

The other apparatus required is:—

A Duboscq colorimeter.

A micro-burner.

Accurate 1 c.c. pipettes of the Ostwald pattern. Their contents are delivered by allowing the pipette to drain against the sides of the vessel for 10 seconds and then blowing out clean.

Glass tubes sealed at the end and perforated with about 6 small holes.

50 c.c. and 100 c.c. measuring flasks.

The reagents required are:—

(1) Standard Ammonium Sulphate Solution.

Pure commercial ammonium sulphate (13.2 gm.) is purified by decomposing it with caustic soda (8.0 gm.); the ammonia, which is liberated, is aspirated into sulphuric acid (9.8 gm.), diluted with 2-3 volumes of water. The ammonium sulphate is precipitated with alcohol, filtered off, dissolved in water and again precipitated with alcohol. It is dried over sulphuric acid. 1 c.c. of a solution containing 4.7206 gm. ammonium sulphate in 1000 c.c. corresponds to 1 mgm. nitrogen.

(2) Nessler's Reagent (see p. 615).**(3) Standard Uric Acid Solution.**

(a) 0.25 gm. of uric acid are rinsed with 25-50 c.c. of water into a 250 c.c. measuring flask. 25 c.c. of .4 per cent. lithium carbonate solution are added and solution of the uric acid effected by shaking occasionally for 1 hour. It is diluted to 250 c.c. This solution will keep for about a week.

(b) 1 gm. of uric acid is placed in a 1000 c.c. measuring flask and dissolved in 200 c.c. of .4 per cent. lithium carbonate solution; 40 c.c. of 40 per cent. formaldehyde solution (formalin) are added, the mixture is shaken and allowed to stand for a few minutes. It is acidified with 20 c.c. of N acetic acid and diluted to 1000 c.c. The solution should remain clear for 24 hours and is standardised against the fresh solution (a). 5 c.c. of this solution give about the same colour as the solution containing 1 mgm. of uric acid in 1 c.c.

(4) Phosphotungstic Acid Reagent.

100 gm. of sodium tungstate and 80 c.c. of 85 per cent. phosphoric acid solution are added to 750 gm. of water. The mixture is boiled gently for 2 hours under a reflux condenser, cooled and diluted to 1000 c.c. 2 c.c. give the maximum colour with 1 mgm. of uric acid.

(5) Standard Creatinine Solution.

Creatinine zinc chloride is prepared from urine as described on p. 169.

It is purified by recrystallising it three times by dissolving it in 10 parts of boiling 25 per cent. acetic acid, adding one-tenth of its volume of concentrated alcoholic zinc chloride solution and 1.5 volumes of alcohol. The precipitate is filtered off after standing for 12-16 hours and washed with alcohol. It is dried *in vacuo* over sulphuric acid. Creatinine zinc chloride is readily soluble in .1N hydrochloric acid.

1.6106 gm. are dissolved in 1000 c.c. of acid. 1 c.c. contains 1 mgm. of creatinine.

A litre of such a solution will suffice for several thousand creatinine estimations.

Estimation of Total Nitrogen. (Micro-Kjeldahl.)*(a) By Titration.*

1 c.c. of urine + 1 c.c. of water + 1 c.c. conc. H_2SO_4 + 1 gm. K_2SO_4 + a



FIG. 78.
(After Folin.)

pebble to prevent bumping are placed in a test tube and boiled over a micro-burner for about 6 minutes, but not less than 2 minutes after the mixture has become clear. The oxidation is greatly facilitated by placing over the test tube a broken 25 c.c. pipette bent as shown in Fig. 78 and with its shorter end pushed into the bulb. The bent end is connected with a suction pump. The water is in this way prevented from condensing on the sides of the test tube from which it can run back upon the sulphuric acid. To prevent air currents affecting the micro-burner small beakers without bottoms serve as convenient shields.

The contents are allowed to cool for about 3 minutes until they become viscous, but they are not allowed to solidify. 6 c.c. of water are added, at first drop by drop, and then more rapidly.

5 or 10 c.c. of $\cdot 1N$ acid and a drop of alizarin red are placed in the receiving test tube.

3 c.c. of saturated caustic soda, or 4 c.c. of 40 per cent. soda, are added to the sulphuric acid by sucking it up in the tube which reaches to the bottom of the test tube and through which air is passed. The ammonia is aspirated into the standard

acid for 2 minutes with a slow current of air and 8 minutes with a rapid current, or longer if the air current be not powerful. (The time must be determined with the apparatus to be used.)

The contents of the flask after washing out the tube with a small quantity of water are titrated with $\cdot 02 N$ alkali.

(b) Colorimetrically.

Normal human urine contains 5-20 mgm. of nitrogen per 1 c.c. This amount is too great for estimation by the colorimetric method; the urine must therefore be diluted so that 1 c.c. contains $\cdot 75$ to $1\cdot 5$ mgm. of nitrogen:—

If the sp. gr. is over 1018, 5 c.c. are diluted to 50 c.c.

If the sp. gr. is under 1018, 5 c.c. are diluted to 25 c.c.

1 c.c. of the diluted urine is oxidised and its ammonia collected in 2 c.c. of $\cdot 1N$ acid and 20 c.c. of water in a 100 c.c. measuring flask if the blowing method is adopted; in 2 c.c. of $\cdot 1N$ acid + 8 c.c. water if the suction method is used and transferred to a 100 c.c. measuring flask.

The solutions are diluted to about 60 c.c.

A quantity of pure ammonium sulphate solution corresponding to 1 mgm. of N is measured out and diluted to about 60 c.c. in another 100 c.c. measuring flask. 5 c.c. Nessler reagent, diluted with 25 c.c. of water, are added to each flask. The maximum colour develops in half an hour. The flasks are filled to the mark, the contents are mixed and the colorimetric comparison is made in a Duboscq colorimeter. The standard is set at 20. The result is given by

$$\frac{\text{standard reading}}{\text{unknown reading}} = \frac{20}{x} = \text{mgm. of N in volume of urine taken.}$$

Gulick¹ has simplified this procedure by oxidising the material with smaller quantities of sulphuric acid and potassium sulphate:—

The urine is diluted 4-10 times with an acid mixture consisting of 125 c.c. water, 40 c.c. sulphuric acid, 5 c.c. of saturated mercuric chloride solution, 20 gm. of potassium sulphate and diluted to 200 c.c. with water, so that 5 c.c. of the diluted urine contains from .4 to .7 mgm. of nitrogen.

5 c.c. of this diluted urine are measured into a small oxidising flask, which consists of a pear-shaped bulb of 15 c.c. capacity blown upon the end of a glass tube and bent so that the bulb is at an angle to the tube when the tube is placed in a vertical position. A bead or a spiral of platinum wire 4-5 mm. long is added and the solution is heated for at least 1 minute after it has become clear; the total time of oxidation is from 6-10 minutes. When cool the contents of the flask are dissolved in water, washed into a 50 c.c. measuring flask and Nesslerised.

The oxidation may also be effected with larger quantities of urine (1-2 c.c.). They are heated in a flask of 25-50 c.c. capacity exclusive of the neck with 1 c.c. of sulphuric acid, 1 gm. of potassium sulphate and 3 drops of saturated mercuric chloride solution for 15-20 minutes, avoiding frothing. The resulting mixture is dissolved in water and diluted to 100 c.c. in a measuring flask. An aliquot part, 5 c.c. containing .35-.7 mgm., is removed and Nesslerised in a 50 c.c. measuring flask.

The Nesslerising may be effected with a solution containing 15 gm. of mercuric iodide, 10 gm. of potassium iodide, 40 gm. of sodium hydroxide and water to 500 c.c. The sodium hydroxide is dissolved in water and set aside to cool; the iodides are dissolved in about 15 c.c. of water, transferred to the 500 c.c. flask with the aid of the alkali and the volume diluted to 500 c.c. The solution is transferred to a stoppered conical flask and the precipitate allowed to settle or it may be filtered. This solution can be used directly for quantities of nitrogen from 0 to 1 mgm. per 50 c.c. The standard ammonium sulphate solution and the unknown are put into 50 c.c. volumetric flasks with about 40 c.c. of water, 5 c.c. of the reagent are added and the solutions diluted to the 50 c.c. mark. The colour comparison should be made within an hour.

Bock and Benedict² have pointed out certain sources of error in the Folin-Farmer method, but find that the results by the colorimetric method are within 2 or 3 per cent. of those obtained by the ordinary Kjeldahl method. They prefer to distil off the ammonia rather than aspirate and they connect the test tube, to which water has been added, by rubber tubing to a condenser. Distillation is also preferred by Pregl and by Wolf (see below).

¹ J. Biol. Chem., 1914, 18, 541.

² *Ibid.*, 1915, 20, 47.

Estimation of Ammonia.

The ammonia is aspirated off by suction in the two test tubes for 10 minutes or longer according to the pump, or by blowing, and estimated:—

(a) By Titration with .02N Alkali.

5 c.c. undiluted urine + a few drops of a solution containing 10 gm. potassium carbonate and 15 gm. of potassium oxalate per 100 c.c. are put into one test tube and the ammonia collected in 5 c.c. .1 N HCl.

(b) Colorimetrically.

1-5 c.c. of diluted urine or 1 c.c. of undiluted urine + K_2CO_3 and $K_2Ox.$ solution as above are put into one tube and 2 c.c. of .1N HCl in the other. The remainder of the process is as described under total nitrogen.

Estimation of Urea.

(1) The urea is decomposed by heating with potassium acetate at $150-160^\circ$ for $\frac{1}{2}-1\frac{1}{2}$ hours. The exact temperature is ascertained by introducing a tiny bulb containing mercury chloriodide. This is prepared by heating together molecular proportions of mercuric iodide and mercuric chloride at $150-160^\circ$ for 6-8 hours. The fused mass is powdered and kept dry. Small quantities are sealed up in bulbs 1 mm. in diameter.

1 c.c. of undiluted urine is put into a Jena glass test tube containing 7 gm. of dry potassium acetate. This is dried by keeping it at 115° for 24 hours; 1 c.c. of 50 per cent. acetic acid, a temperature indicator bulb and a little powdered zinc are added. The test tube is closed with a rubber cork carrying an empty calcium chloride tube (25×1.5 cm.) to act as a condenser, and held by a clamp over a micro-burner. In about 2 minutes the mixture begins to boil and the mercury chloriodide in the bulb melts showing a temperature of $153-160^\circ$. The boiling is continued for 10 minutes. The flame is removed and the contents of the test tube are diluted with 5 c.c. of water which is added with a pipette through the calcium chloride tube so as to rinse down the sides.

(a) By Titration with .02N Acid.

The ammonia is aspirated into 10 c.c. of .1N acid after adding 2 c.c. of saturated caustic soda in the same way as described under the total N estimation.

(b) Colorimetrically.

1 c.c. of diluted urine is decomposed as described above and the ammonia is collected in 2 c.c. of .1 N acid.

The rest of the procedure is as under total nitrogen.

(2) It is easier to decompose the urea by means of urease and to carry out the method as described on p. 136 in test tubes.

(a) By Titration with .02N Alkali.

1 c.c. of urine + .25 gm. powdered soy bean are aspirated for $\frac{1}{4}-\frac{1}{2}$ hour. .25 gm. of sodium carbonate are added and aspirated for $\frac{1}{4}-\frac{1}{2}$ hour. The ammonia is collected in 5 c.c. of .1N acid.

(b) Colorimetrically.

1 c.c. of diluted urine are treated as above.

The ammonia is collected in 2 c.c. of .1N acid and estimated in the same way as under total nitrogen.

Estimation of Uric Acid.

The estimation of uric acid is effected by colorimetric comparison with a standard solution treated in the same way. The uric acid is isolated from urine by either of the methods (a) or (b):—

(a) *After Evaporation.*

2-5 c.c. of urine are measured into a 100 c.c. beaker, a drop of saturated oxalic acid solution is added and they are carefully evaporated to dryness on a water-bath or over a free flame. The evaporation is continued until the upper parts of the beaker are dry.

10-15 c.c. of a mixture of 2 parts of pure ether and 1 part of methyl alcohol are added to the dry residue. After 5 minutes they are carefully poured off and another 10 c.c. of the mixture added; they are poured off when the insoluble matter has settled. This mixture dissolves the phenols, but leaves the uric acid. There are two slight errors which balance themselves: the uric acid is not absolutely insoluble and the phenolic substances are not entirely removed if there are large residues from the urine.

For ordinary routine work 90 per cent. alcohol may be used.

5-10 c.c. of water and a drop of saturated sodium carbonate solution are added to the washed residue which is stirred till it passes into solution.

2 c.c. of the reagent + 20 c.c. of saturated sodium carbonate solution are added. The blue solution after 15 minutes is transferred to a 100 c.c. measuring flask and diluted to the mark.

At the same time the number of c.c. of the uric acid standard, containing 1 mgm. of uric acid, is treated with 2 c.c. of reagent and 20 c.c. of carbonate solution and transferred to a 100 c.c. flask after 15 minutes.

This standard will serve for several estimations which are carried out at the same time.

(b) *By Precipitation.*

1 or 2 c.c. of urine are measured into a centrifuge tube with an Ostwald pipette and water is added to make the volume = 5 c.c.: 6 drops of 3 per cent. silver lactate solution, 2 drops of magnesia mixture and 10-20 drops of .880 ammonia (to dissolve silver chloride) are added. The tubes are centrifuged for 1-2 minutes at 2000 revolutions. The supernatant liquid is poured off and to the precipitate are added 6 drops of fresh saturated hydrogen sulphide solution and a drop of concentrated hydrochloric acid. The tube is placed in a boiling water-bath until the hydrogen sulphide has disappeared. This may be tested for by adding a drop of lead acetate solution after 5 minutes. The heating is continued if hydrogen sulphide be present. The tube is allowed to cool and 2 c.c. of reagent and 20 c.c. of saturated sodium carbonate solution are added. After 15 minutes the solution is transferred to a 50 c.c. flask and diluted to the mark.

A standard with 1 mgm. of uric acid is prepared at the same time.

If the urine contain albumin, there is a brown colour after adding the hydrogen sulphide. After removing the gas, 2 or 10 drops of 10 per cent. acetic acid are added to the hot solution to remove it.

Estimation of Creatinine.

This method is the same as described on p. 555, but smaller quantities are used; a creatinine standard is used instead of bichromate.

1 c.c. of urine + 20 c.c. of picric acid solution + 1.5 c.c. of 10 per cent. caustic soda from a burette are placed in a 100 c.c. measuring flask. At the same time 1 c.c. of standard creatinine solution is treated in the same way.

After 10 minutes the flasks are filled to the mark with water, the contents are mixed and the colour comparison is made. The standard is set at 10, 15, or 20.

$$\frac{\text{standard}}{\text{unknown}} = \text{mgm. creatinine in 1 c.c. urine.}$$

The determination must be repeated with more or less urine if the reading is less than $\frac{2}{3}$ or more than $1\frac{1}{2}$ times that of the standard.

The creatinine standard should not be diluted so that 5 c.c. of it can be measured out instead of 1 c.c., and 5 c.c. of the urine should not be diluted to 500 c.c., but 5 c.c. of urine diluted 4 times (1:4) may be used, or 5 or 10 c.c. of standard may be used. In the latter case 5 c.c. of alkali must be added. If the urine is so dilute that 5 c.c. are necessary, the standard should also be diluted to 5 c.c. with water before adding the picric acid and soda.

Standards of 0.5 and 0.2 mgm. of creatinine may be used. Other creatinine solutions may be similarly estimated.

Estimation of Creatine.

The conversion of creatine into creatinine in small quantities is effected by heating with picric acid.

Enough urine to give 0.7-1.5 mgm. creatinine is measured into a 200 c.c. weighed conical Jena glass flask, 20 c.c. of picric acid and 130 c.c. of water are added. The solution is gently boiled over a micro-burner for about one hour, a few small pebbles being introduced to promote even boiling; the heat is increased so that it evaporates to rather less than 20 c.c. The flask is placed on the balance and water is added so that the contents weigh 20-25 gm. The solution is cooled and 1.5 c.c. of 10 per cent. sodium hydroxide are added. At the same time a standard 1 mgm. of creatinine is prepared.

The conversion can be effected in an autoclave by heating with the picric acid for half an hour at 120°, cooling and adding the soda as above.

Micro methods other than those of Folin for determining total nitrogen have also been devised. Pregl oxidises the material in a wide test tube upon which a small bulb is blown. The solution is made alkaline, the ammonia is distilled over with steam through a special trap and collected in $N/70$ acid and titrated with $N/70$ alkali using methyl red as indicator.

Bang also distils over the ammonia and titrates with thiosulphate after adding iodate and iodide to the acid.

The method described by Wolf¹ is very simple and convenient :—

1 c.c. of the diluted urine (or blood, see p. 579) is put into a 70 c.c. Jena glass flask and oxidised by heating it, with a micro-burner, for $\frac{1}{2}$ -1 hour with 1 c.c. of fuming sulphuric acid containing 7 per cent. of SO_3 , 1 gm. of potassium sulphate and a drop of 5 per cent. copper sulphate solution. 2 c.c. of water are added and, when cold, 4 c.c. of 40 per cent. caustic soda are run under the acid. The flask is fitted with a head piece containing a perforated silver disc fused into it; this is attached by a rubber joint to block tin tubing of $\frac{3}{16}$ inch diameter which is bent over and fitted with a condenser, as shown in Fig. 79. A glass tube drawn out at one end is fitted to the end of the tin tubing by means of rubber. This is immersed in 5 c.c. of $N/140$ sulphuric acid.

After the connections have been made the acid and alkali in the flask are mixed and distilled. The distillation takes about 5 minutes. After washing the condenser with a few c.c. of water, the excess of acid is titrated as follows: 2 c.c. of 2 per cent. sodium iodate and 2 c.c. of 2 per cent. potassium iodide are added; a narrow delivery tube through which pure air purified by passage through cylinders containing dilute sulphuric acid and 25 per cent. caustic potash and fitted with calcium chloride tubes is put into the solution; the contents of the flask are titrated with $N/280$ sodium thiosulphate delivered from a 10 c.c. burette with fine point and graduated in $\frac{1}{20}$ c.c., 5 drops of 1 per cent. soluble starch solution being added as soon as the colour of the iodine becomes faint.

A control using all the reagents is made at the same time and the amount of thiosulphate used in the experiment is subtracted from the total amount used in the control.

1 c.c. = 0.0001 gm. nitrogen.

Wolf distils over and estimates the ammonia obtained by the hydrolysis of urea by Folin's method with potassium acetate in the same way, using 10 drops of 40 per cent. caustic soda to render the solution alkaline.

¹ J. Physiol., 1914, 49, 89.

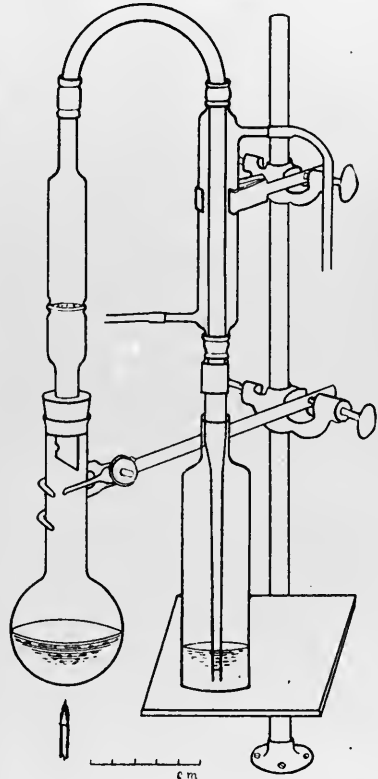

Fig. 79.—(From J. Physiol., 49, 90, Cambridge University Press.)

APPENDIX TO URINE.

I. THE PIGMENTS.

(1) The chief pigment of the urine is urochrome, which gives urine its yellow colour.

(2) Urobilin is present only in small quantities, generally in the form of its chromogen, urobilinogen. Under certain pathological conditions its amount may be greatly increased. Urobilin is derived from hæmatin and is very like hydrobilirubin, which is obtained by reduction of bilirubin. It is identical with stercobilin, the yellow pigment of the fæces.

(3) Uroerythrin gives the pink colour to urate sediments. Normally it is present only in small amounts, but is greatly increased in certain diseases.

(4) Hæmatoporphyrin is also only present in small amounts.

I. Urochrome and Urobilin in Normal Urine.

Normal urine shows no absorption bands with the spectroscope but only a general absorption of the violet. Neither urochrome nor urobilinogen show absorption bands.

Urine is saturated with ammonium sulphate crystals¹ and allowed to stand a short time. The precipitate, which consists of ammonium urate associated with the chromogen of urobilin, is filtered off and extracted with hot alcohol. The alcoholic solution shows no absorption band or only a very faint one; on acidifying it, the chromogen is broken up and the absorption band of urobilin can be seen at the junction of the green and blue.

To the filtrate containing the ammonium sulphate is added 2-3 times its volume of alcohol. The ammonium sulphate is precipitated and a clear yellow layer of alcohol containing the urochrome forms above the salt solution. It shows no absorption bands on examination with the spectroscope.

II. Pathological Urine Containing Excess of Urobilin (or Normal Urine).

The urates are precipitated by saturating the urine with ammonium chloride² and filtered off. The filtrate is saturated with ammonium sulphate, acidified with a drop of sulphuric acid and shaken up with a mixture of 2 parts of ether and 1 part of chloroform. The urobilin is taken up by this solvent and shows the absorption band well. If the ether-chloroform layer be pipetted into another test tube and shaken well with water made slightly alkaline with caustic soda, the pigment passes entirely into the alkaline solution. A solution of urobilin in alcohol shows a green fluorescence and an absorption band in the green between *b* and *F*.

III. Pathological Urine Containing a Pink Urate Sediment, Uroerythrin.

The urate sediment is filtered off. If to a portion of this precipitate caustic soda be added, the pink colour becomes green. If the remainder of the precipitate be dissolved in hot water and the solution extracted with acetic ester or amyl alcohol, a pink solution is obtained which shows two absorption bands in the green; if weak, only one.

IV. Hæmatoporphyrin in Normal Urine.

For the detection of hæmatoporphyrin in normal urine, in which it is present as alkaline hæmatoporphyrin, at least 200-400 c.c. are necessary, but in pathological urine, where its quantity is increased, a smaller quantity can be used. The best method is that of Garrod. To every 100 c.c. of urine are added 20 c.c. of dilute caustic soda. This precipitates the earthy phosphates which carry down the pigment. The urine must give a precipitate like that of normal urine, otherwise calcium phosphate in acetic acid solution must be added before precipitating. This is obtained by precipitating a little calcium chloride with sodium phosphate in a test tube. Too large a precipitate should be avoided. The earthy phosphates are allowed to settle and the supernatant liquid is poured off; they are transferred to a filter paper and washed with water (till the washings are colourless if hæmatoporphyrin free from other pigments be required; too much washing must be avoided if only a little hæmatoporphyrin be present). The precipitate is extracted with alcohol, acidified with hydrochloric acid and the solution is examined for the spectrum of acid hæmatoporphyrin.

¹ 80 gm. per 100 c.c.

² 27 gm. per 100 c.c.

2. URINARY SEDIMENTS.

The sediment is separated by means of the centrifuge and examined under the microscope.

A. IN ACID URINE.

Amorphous Deposits.**(1) Urates.**

This deposit is known as "brick dust" from its pink colour (uroerythrin). It may contain crystalline forms and may dissolve completely on warming the urine.

A little of the sediment is boiled with water. It is soluble; the hot solution is acidified with hydrochloric acid and cooled. Uric acid crystallises out; the crystals are examined with the microscope and tested with the murexide reaction.

Urates may deposit from concentrated urine on cooling, as is commonly found in fevers.

The chief constituent is acid sodium urate.

(2) Calcium Oxalate.

Calcium oxalate has the appearance of dumb-bell or spheroidal bodies (envelope crystals) under the microscope. It is insoluble in strong acetic acid and ammonia, but soluble in hydrochloric acid.

(3) Bilirubin or Hæmatoidin.

Yellow granular amorphous masses, which give Gmelin's reaction, generally consist of bilirubin.

Crystalline Deposits.**(4) Uric Acid.**

This is known as cayenne pepper deposit as it is of sandy red colour. It has a distinctive crystalline form under the microscope and gives the murexide reaction (Fig. 80).

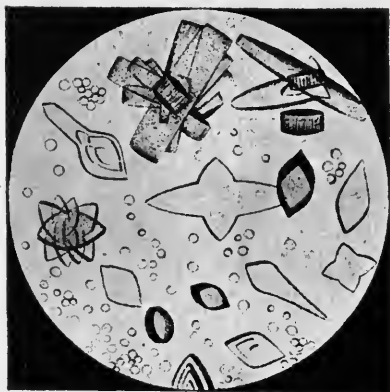

FIG. 80.—Deposit of uric acid.
(After Funke.)

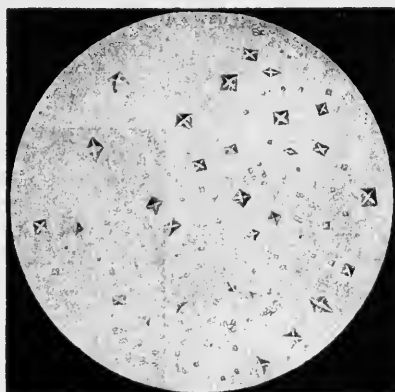

FIG. 81.—Deposit of calcium oxalate.
(After Funke.)

(5) Calcium Oxalate.

This sediment consists of colourless, transparent, highly refractive octahedral crystals (envelope shaped). It is insoluble in acetic acid, but soluble in hydrochloric acid (Fig. 81).

(6) Ammonium Magnesium Phosphate.

Ammonium magnesium phosphate crystals separate in the form of knife-rests from faintly acid urine (Fig. 82). They are soluble in acetic acid. The

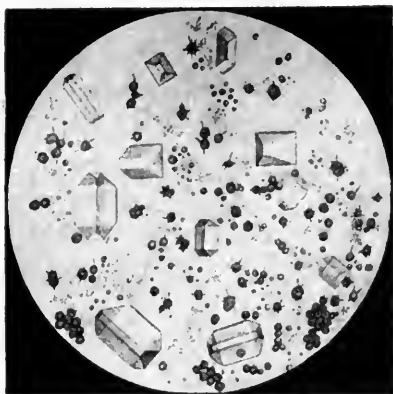

FIG. 82.—Deposit of triple phosphate (am. mag. phosphate) and ammonium urate. (After Funke.)

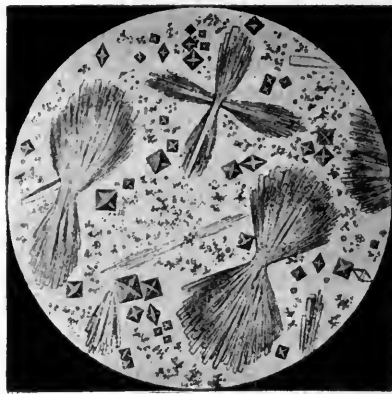

FIG. 83.—Deposit of uric acid, sodium urate and calcium oxalate. (After Funke.)

smaller crystals may resemble calcium oxalate in appearance, but are distinguished by their solubility in acetic acid.

(7) Calcium Hydrogen Phosphate. $\text{CaHPO}_4 \cdot 2\text{H}_2\text{O}$.

Large prismatic crystals, often arranged in rosettes, consist of calcium hydrogen phosphate. On adding a solution of ammonium carbonate, the crystals are eaten into and break down into an amorphous deposit. They are easily soluble in dilute acetic acid.

(8) Bilirubin or Hæmatoidin.

These occur as small yellow rhombic plates which give Gmelin's reaction (Fig. 84).

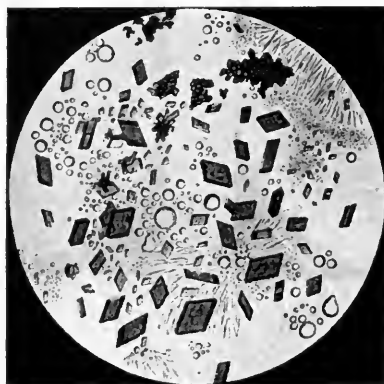

FIG. 84.—Hæmatoidin.

(9) Tyrosine.

Tyrosine may be present as fine needles in star-shaped bundles (p. 268). They are insoluble in acetic acid, but soluble in ammonia and hydrochloric acid and give Millon's reaction.

(10) Cystine.

Cystine deposits are very rare and consist of colourless regular hexagonal plates (p. 143) which are soluble in ammonia, but insoluble in acetic acid.

B. IN ALKALINE URINE.**Amorphous.****(1) Earthy Phosphates.**

Earthy phosphates appear as fine granules and are easily soluble in dilute acetic acid.

(2) Calcium Carbonate.

Deposits of calcium carbonate consist of fine granules or dumb-bell-shaped spheroidal masses sometimes having a concentric striation. They are easily soluble in acetic acid with evolution of carbon dioxide and effervescence.

(3) Acid Ammonium Urate.

Spherules with small crystals adhering, "hedgehog spines," are composed of acid ammonium urate (Fig. 82). They are generally pigmented and dissolve in hydrochloric acid from which uric acid separates.

Crystalline.**(4) Ammonium Magnesium Phosphate.**

Ammonium magnesium phosphate crystals are easily obtained from urine undergoing ammoniacal fermentation. They consist of large colourless prisms of knife-rest or coffin-lid shape.

(5) Crystalline Calcium Phosphate. CaHPO_4 .

This deposit occurs rarely and appears as rosettes of prisms or spherules.

3. URINARY CALCULI.

The various constituents of urine which form sediments may take part in the formation of urinary calculi, which are of frequent occurrence and vary in size from that of a pea to that of a goose egg. They are generally coloured, commonly yellow-grey, yellow-brown or reddish-brown. Their surface may be smooth and polished, or rough and uneven. When fractured, they appear to consist of regular concentric layers which can often be scaled off.

(1) **Urate Stones.**

They consist generally of ammonium urate and are of a brown colour and very hard; they are pale yellow when powdered. They give the murexide reaction and ammonia is evolved on boiling with caustic soda.

(2) **Calcium Oxalate Stones.**

After the urate stones these are the most frequent in occurrence. They are either smooth and small, "hempseed stones," or as large as a hen's egg with a rough and uneven surface, "mulberry stones". They cause hæmorrhage and have therefore a superficial dark brown colour. They are soluble in hydrochloric acid without effervescence, but not in acetic acid. On heating they are converted into calcium carbonate, which dissolves in acetic acid with effervescence.

(3) **Phosphate Stones.**

These stones can reach a large size. They consist of calcium phosphate and triple phosphate and generally contain ammonium urate and calcium oxalate. Their colour varies: it may be white, grey, pale yellow, or even lilac (from indigo red). Their surface is uneven. They do not burn on heating; when crushed the powder is soluble in acids without effervescence and the solution gives the reactions for phosphoric acid and calcium. Ammonia is evolved from stones containing triple phosphate on heating with caustic soda.

(4) **Calcium Carbonate Stones.**

These stones occur chiefly in herbivora and very rarely in man. They have a chalky appearance, are white in colour and dissolve in acids with evolution of carbon dioxide:

(5) **Cystine Stones.**

These stones are rare and of various sizes. They may be as large as a hen's egg. Their surface is smooth or uneven, white or dull yellow, and they show a crystalline fracture; they are not very hard. On heating they burn away almost entirely with a blue flame. They give the reaction for cystine (p. 144).

(6) **Xanthine Stones.**

These stones are still rarer and vary in size from a pea to a hen's egg. In colour they are dull white, yellow-brown or red-brown. They are not very hard and they show an amorphous fracture, becoming waxy on rubbing. They are completely combustible and give a yellow murexide reaction.

(7) **Urostealiths.**

These stones have only been observed a few times. They are soft and elastic when wet, brittle, amorphous and waxy when dry. They burn with a luminous flame when heated and consist of fat and cholesterol.

4. INBORN ERRORS OF METABOLISM.

Under this title A. E. Garrod has grouped together four anomalies in metabolism, namely, albinism, alkaptonuria, cystinuria, pentosuria. These anomalies are of life-long persistence and in most cases are inborn. They may occur as temporary phenomena in disease.

(1) Albinism.

The essential phenomenon of albinism is the absence of pigments of the melanin group which play the chief part in the coloration of man and the lower animals. All varieties of melanins are absent in albinos—white hair, pink eyes, unpigmented skin.

The lipochrome pigments which colour fats, serum, etc., yellow are not absent.

(2) Alkaptonuria.

This is the best-known example of an inborn error. It is rendered evident by the freshly passed urine of an alkaptonuric beginning to darken on exposure to the air, due to absorption of oxygen. The darkening commences at the surface and gradually spreads through the liquid until it assumes a black colour. Alkali greatly hastens the darkening.

The urine, heated with Fehling's solution, gives a deep brown colour and there is a copious reduction. The colour of the liquid differentiates it from the reduction produced by other substances. Ammoniacal silver nitrate solution is rapidly reduced in the cold. Nylander's reagent is darkened, but there is no reduction to bismuth. A yellow precipitate is formed when such urine is treated with Millon's reagent. The most striking reaction is given with ferric chloride. If the reagent be allowed to fall drop by drop into the urine, a momentary deep blue colour appears; this can be continued until oxidation is complete.

The first case of alkaptonuria was described by Marcet in 1823; in 1858 Bodeker showed that the reducing substance was not glucose. Wolkow and Baumann in 1891 clearly established that the peculiar body in the urine was homogentisic acid (hydroquinone acetic acid, p. 271).

It is derived from the aromatic compounds—tyrosine and phenylalanine—in the protein food and probably represents a stage in their catabolism in the body.

(3) Cystinuria.

Cases of cystinuria are characterised by the deposits of cystine crystals in the form of hexagonal plates in the urine. The odour of hydrogen sulphide may become apparent when the urine decomposes.

The first case was that described by Wollaston in 1810, who obtained a cystine calculus from the bladder of a child. The phenomenon is believed to be the most common of the inborn errors, but is difficult of recognition.

It is also apparently due to incomplete oxidation of protein, especially the cystine unit. Frequently the diamines, putrescine and cadaverine, more rarely leucine and tyrosine, are found with cystine in the urine.

(4) Pentosuria.

The first case of the excretion of a pentose in the urine was described by Salkowski and Jastrowitz in 1892. Several cases have since been recorded. Though the urine reduced Fehling's solution, it did not ferment with yeast and was optically inactive. An osazone melting at 159° was isolated; glucosazone melts at 205° . The presence of pentose can be confirmed by the phloroglucinol and orcinol tests (see p. 196).

5. PATHOLOGICAL URINES.

(1) **DIABETIC.**

Diabetic urine contains glucose; β -hydroxybutyric acid, aceto-acetic acid and acetone are often present in diabetes mellitus.

Glucose.

The tests for glucose are given under carbohydrates.

Nylander's Test.

This reagent has the advantage over Fehling's by not being reduced by creatinine or uric acid. It is reduced by glycuronic acid. 1 c.c. reagent is added to 10 c.c. urine; on heating, the solution becomes yellow, brown, dark-brown; metallic bismuth finally separates out. If the quantity of sugar be small, the urine darkens, and after standing for some time, a black deposit of metallic bismuth settles out. The test will indicate 0.05 per cent. of glucose.

The Fermentation Test.

This succeeds well if the quantity of sugar be large, but if the quantity be small as indicated by Nylander's test it may not succeed. The urine is then allowed to ferment for 24-28 hours and is tested again with Nylander's reagent. If Nylander's test is now negative, glucose was originally present; if positive, the reduction is probably due to other reducing substances, e.g. glycuronic acid, lactose.

The Phenylhydrazine Test.

This test is carried out preferably as follows: to 5 c.c. of urine are added 2 c.c. of 50 per cent. acetic acid saturated with sodium acetate and 2 drops of phenylhydrazine. The solution is evaporated down to 3 c.c., cooled rapidly, again warmed and then allowed to cool slowly. Crystals separate out even if there be a very small percentage of glucose (Neumann).

The Polarisation Test.

The polarimeter distinguishes between glucose, fructose and conjugated glycuronic acid, which is lævo-rotatory. If the urine be highly coloured, it is first precipitated with lead acetate (10 c.c. of a 25 per cent. solution for every 50 c.c. of urine) and the filtrate examined. The volumes must be known if the glucose is to be estimated by the polarimeter.

The estimation of glucose is most usually carried out by Pavy's method or by Benedict's method; the fermentation method (Lohnstein) is convenient.

Aceto-Acetic Acid.

Aceto-acetic acid is tested for as follows:—

(1) To some of the urine is added dilute ferric chloride as long as a precipitate of ferric phosphate continues to form. This is filtered off and to the filtrate a few more drops of ferric chloride are added. If aceto-acetic acid be present, the colour becomes like claret.

(2) Some urine is acidified with sulphuric acid and shaken up with ether. The ether is poured off into another test tube and shaken with ferric chloride solution. A red colour is produced if aceto-acetic acid be present.

(3) On heating with dilute alkali or acid, the aceto-acetic acid is decomposed yielding acetone; this may be detected by its odour, but is more certainly detected by distilling and examining for acetone the first 20 c.c. of the distillate from 250 c.c. urine by the following tests:—

(a) Iodoform test: $\text{NaOH} + \text{I}$ in KI . The precipitate should be examined with a microscope.

(b) Alcoholic solution of $\text{I} + \text{NH}_3$. Iodoform and a black precipitate of nitrogen iodide, which disappears gradually leaving the iodoform, are formed.

(c) Legal's test. A few drops of freshly prepared sodium nitro-prusside solution are added and it is rendered alkaline with caustic soda. A deep-red colour is formed. If acidified with acetic acid, the colour becomes reddish-purple.

The estimation of aceto-acetic acid is given on p. 593.

β -Hydroxybutyric Acid.

It is difficult to prove the presence of β -hydroxybutyric acid in urine. If a large amount be present, the urine will show lævo-rotation after fermentation of the glucose. Its presence can only be shown with certainty by extraction in the same way as it is estimated (p. 597).

(2) PROTEIN.**A. Coagulable Protein. ("Albumin.")**

Most commonly coagulable protein is found and tested for by:—

(1) Heat Coagulation.

This is best performed by heating after adding to a little of the filtered urine one-sixth of its volume of saturated sodium chloride. The precipitate which is formed may consist of coagulated protein or earthy phosphates, or both. The precipitate of earthy phosphates dissolves, whilst the coagulated protein separates out in flakes if 2 drops of 33 per cent. acetic acid be added for every 10 c.c. urine.

(2) Heller's Test.

Some urine is poured on to the surface of a little concentrated nitric acid in a test tube, taking care that the two solutions do not mix. To prevent this the nitric acid may be saturated with ammonium nitrate. If protein be present, a whitish ring will form at the junction. There may be also a reddish ring due to indigo red and indigo blue. If the urine be concentrated urea nitrate may separate out, but here the precipitate is obviously crystalline. Uric acid may also separate if a large quantity of urates be present. This can be prevented by diluting before testing with the nitric acid.

(3) Hydroferrocyanic Acid.

This test is given under reactions of proteins (p. 369).

(4) *The Colour Reactions* cannot be applied directly to urine, but to the heat coagulum suspended in water. Millon's reagent and the biuret reaction should be tried; the coagulum in the latter case is dissolved in hot caustic soda.

Characterisation and Separation of a Mixture of Proteins.

(a) *Albumin and Globulin.*—The globulin is precipitated by half-saturating the urine with ammonium sulphate and filtered off. It is dissolved in 2 per cent. sodium chloride solution. The solution is acidified and heated.

The albumin in the filtrate is coagulated on acidifying with acetic acid and heating. The protein nature of the precipitates should be confirmed by the colour tests.

(b) *Proteose and Coagulable Protein.*—The solution is saturated with ammonium sulphate (8 parts to 10 parts urine) and heated for a few seconds, so that the coagulable protein is coagulated. The precipitate is filtered off and extracted with alcohol to remove urobilin, which also gives the biuret reaction. It is extracted with boiling water which dissolves the proteose. This solution is tested with the biuret, xanthoproteic and Millon's reactions.

(5) Estimation.

The protein is estimated by Esbach's method (see under proteins, p. 369). The urine must be acidified with acetic acid if it is not acid and diluted till its specific gravity is 1.006-1.008.

B. The Bence-Jones Protein.

In rare cases of disease of the bone-marrow, a peculiar protein, the Bence-Jones protein, appears in the urine.

This protein is precipitated on heating the urine to 50-60° and redissolves, more or less completely, according to the reaction and the amount of salt in the urine, when the heating is continued to the boiling-point. The protein is not dialysable and can be precipitated by adding double the volume of saturated ammonium sulphate solution or alcohol. The exact nature of the body is unknown but it has resemblances to globulin and proteose and yields the same amino acids on hydrolysis.

(3) BLOOD.

The appearance of the urine may be reddish. The urine is centrifuged to separate corpuscles and these are examined with the microscope.

The guaiac reaction (p. 476) may be tried and the solution is examined with the spectroscope.

Hæmochromogen is prepared by boiling with caustic soda, cooling and reducing with ammonium sulphide; this pigment shows the absorption bands when the other blood pigments do not (see under hæmoglobin).

The pigment can be precipitated with the earthy phosphates by caustic soda.

(4) BILE.

Bile pigments are tested for as follows:—

The urine is filtered through paper and Gmelin's reaction is performed.	} See under bile.
Huppert's reaction is convenient for small quantities.	

If some tincture of iodine be poured carefully upon some urine in a test tube, a green ring appears at the junction of the liquids.

Bile acids are tested for by

(1) Pettenkofer's test (after concentration if necessary).	} See under bile.
(2) Hay's test.	
(3) Oliver's test.	

ANALYSIS OF TISSUES.

A. THE INORGANIC CONSTITUENTS.

The analysis of the inorganic constituents in tissues can only be determined after the organic matter has been removed by oxidation. The sulphur, phosphorus, etc., which are present in organic combination, are oxidised to sulphates, phosphates, etc., and are determined together with the sulphates and phosphates which are present as such. The analyses of tissues which have been performed have usually been effected after oxidation of the organic matter; consequently the data will include the amounts of these elements present in organic combination. There is no satisfactory method of estimating these elements in organic and inorganic combination separately, but comparative data of very fair accuracy may be obtained by placing the tissue in alcohol and boiling it for some hours on a water-bath to coagulate the proteins. The alcohol is poured off and evaporated to dryness. The residue of protein and also the alcoholic residue are extracted repeatedly with (1) ether, (2) water or dilute acid (HNO_3); the aqueous extracts are combined and in these extracts the elements are estimated as described under urine. The extracts may contain small quantities of organic matter, but these do not seriously interfere. The ethereal extracts contain fats, lecithin, etc., in which sulphur, nitrogen and phosphorus may be estimated (pp. 542, 555, 545).

It is most usual to oxidise the organic matter by burning and to analyse the ash which is so obtained. Special precautions have to be taken in preparing the ash and the incineration is usually performed as follows:—

The material is dried in a platinum basin on a steam bath and weighed.

The dry substance (about 1 gm.) is carefully heated with a small flame as long as volatile and combustible substances are given off and the mass no longer changes on further heating. The heating should not be above a dull-red heat. The mass is allowed to cool and it is treated several times with boiling water, each portion of water being poured off through a filter. The aqueous solution is evaporated on a water-bath. The charred mass, together with the filter paper, is dried and again heated in the basin to dull-redness. The mass is boiled out with water, the aqueous solution added to the previous one and evaporated. This process is again repeated and thus the soluble salts are extracted. Heating at too high a temperature may result in a loss of sodium and potassium chlorides.

The extracted mass is heated to a higher temperature until all or nearly all the organic matter has been oxidised. The residue is treated with boiling water and the solution evaporated and combined with the previous ones. The insoluble matter is dissolved in dilute hydrochloric acid.

An aqueous and an acid extract are obtained. In these extracts the elements are estimated according to the methods of inorganic chemistry, in the same way as is described for the analysis of sodium, potassium, magnesium, calcium, iron, phosphates, sulphates in urine (pp. 548, 546, 545, 542).

The aqueous extract contains those salts which are soluble in water and is generally alkaline owing to the presence of alkali carbonates and phosphates.

Separate portions are tested and analysed for carbonic acid, sulphuric acid, phosphoric acid, hydrochloric acid, sodium and potassium. Calcium sulphate is occasionally found in the aqueous extract. The acid extract is tested and analysed for calcium, magnesium, iron, phosphates, and sulphates.

The most convenient method of analysing a tissue for the elementary and inorganic constituents is to oxidise the material with sulphuric acid and nitric acid and to analyse the solution as is described under urine.

Sulphur cannot be estimated by this method, but the tissue is dissolved and partially oxidised by nitric acid, the final oxidation being effected with copper nitrate in the same way as the analysis of total sulphur in urine.

Estimation of Iodine.

On account of the minute quantities of iodine present in tissues special methods have to be adopted for its detection and estimation. Cameron¹ has reviewed these methods and finds that the method given by Hunter is very accurate. A very similar method is adopted by Kendall.²

The material (.5 gm. of thyroid gland) is placed in a 5.9 cm. nickel crucible and moistened with 5-6 c.c. of 30 per cent. sodium hydroxide; 10-15 gm. of stick sodium hydroxide, broken into small pieces, are added and the crucible heated on a hot plate till the excess of water has evaporated and the contents are syrupy. Spattering, which may take place if only small quantities of organic matter are present, is prevented by adding a small amount of gallic acid. The crucible is placed in a larger nickel crucible, 7.8 cm., containing a layer .5 cm. deep of sand. The crucibles are heated over a 15.6 cm. Méker burner in a special apparatus so that the bottom of the larger crucible attains a dull-red heat. Overheating produces creeping of the fused alkali, underheating prevents complete oxidation of the organic matter. The melted mass at first foams, but this ceases in 5-10 minutes and the melt settles to the bottom with evolution of only a few gas bubbles. The small crucible is now removed and partially cooled by agitating the contents with a rotary motion; 5-10 mgm. of potassium nitrate are added. This oxidises the remaining organic matter with evolution of bubbles. One or more additions of nitrate must be made until no more bubbles of gas are given off. The oxidation should be complete in 10-15 minutes. The fused mass is poured into the cover of the small crucible and allowed to cool.

The cold material in the crucible and cover are put into a tall beaker of 600-800 c.c. capacity with some talcum powder and 125-150 c.c. of water and dissolved by heating on a hot plate. The solution is transferred to a 500 c.c. conical flask and should be a clear colourless solution of about 200 c.c. in volume. 1 c.c. of 10 per cent. sodium bisulphite and a few drops of methyl orange are added. The bisulphite has a reducing action preventing loss of iodine, retaining it as hydriodic acid. The solution is cooled and neutralised by running in 85 per cent. phosphoric acid, the flask being shaken with a rotary motion to expel carbon dioxide. Only a few drops more acid should be added after the indicator has changed colour. A few drops of bromine are added with shaking until the solution becomes distinctly yellow. The volume is diluted to between 250 and 300 c.c. and boiled for 8-10 minutes upon a hot plate until the solution becomes colourless; 5-10 drops of 5 per cent. sodium salicylate solution (prepared by dissolving 5 gm. of salicylic acid in dilute sodium hydroxide and diluting to 100 c.c.: the solution should be only slightly alkaline) are added and the flask cooled in water. The volume must not be less than 175-200 c.c. When cold 5 c.c. of 10 per cent. potassium iodide solution are added and the liberated iodine titrated with .005N thiosulphate solution using a few drops of .5 per cent. soluble starch solution as indicator. If there be not an immediate liberation of iodine, 3-4 c.c. of the phosphoric acid are added.

¹ J. Biol. Chem., 1914, 18, 335.

² *Ibid.*, 19, 251.

B. PROTEINS.

Although several proteins are generally present together in animal and vegetable tissues it is not usual to determine the amount of each protein in them; only the total amount of protein is ascertained.

The total amount of protein is estimated by Kjeldahl's method (p. 35); 1.2 gm. of moist material, or 2.4 gm. of dry material, are taken for the analysis.

Since most proteins contain about 15 per cent. of nitrogen the result in gm. of nitrogen is multiplied by $\frac{100}{15}$ or 6.6. The figure 6.25 is generally used; in the case of vegetable proteins the figure 5.68 should be used (p. 450).

This value will include the nitrogen contained in the nitrogenous extractives. Their amount is so small in most tissues that it is neglected.

In order to estimate the amount of the individual proteins the properties of these proteins must be taken into account so that they may be separated from one another. Separation of proteins cannot in most cases be effected by ammonium sulphate but zinc sulphate may be used. Proteins behave in exactly the same way to zinc sulphate as they do to ammonium sulphate. Either the precipitate may be filtered off and its total nitrogen determined or the loss of nitrogen in the filtrate may be determined.

The analysis of the proteins in milk may be taken as a typical example.

Analysis of the Proteins in Milk.

Total Protein.

(1) The nitrogen in 5 c.c. is determined by Kjeldahl's method and the figure multiplied by 6.38.

The non-protein nitrogen in cow's milk varies from 0.022 to 0.034 per cent., in human milk from 0.014 to 0.026 per cent. Taking these figures into account, the protein nitrogen in cow's milk would therefore be 94 per cent. of the total, in human milk 91 per cent.

(2) The amount of total protein in milk may be rapidly determined by titration after the addition of formaldehyde. Strontium hydroxide should be used as alkali.

10 c.c. of milk are titrated with .1N alkali using 0.5 c.c. of 1 per cent. phenolphthalein solution as indicator until a faintly pink colour is obtained. 2 c.c. or more of formalin neutralised with the same alkali to phenolphthalein are added and the mixture is titrated with .1N alkali until the same pink colour is again obtained.

The number of c.c. used multiplied by .17 gives the amount of total proteins.

Caseinogen.

(1) 40 c.c. of saturated magnesium sulphate solution are added to 20 c.c. of milk; the powdered salt is then added until the solution is saturated. The precipitate is allowed to settle, filtered and washed several times with saturated magnesium sulphate solution. The filter paper and precipitate are put into a Kjeldahl flask and the nitrogen estimated. The figure multiplied by 6.38 gives the amount of caseinogen.

The amount of globulin is so small that it is neglected.

The filtrate is used for the estimation of the albumin (below).

(2) 10 gm. of milk are diluted with 90 c.c. of water at 40-42°, 1.5 c.c. of 10 per cent. acetic acid are added slowly, a few drops at a time, with stirring until the liquid above the precipitate is clear or nearly clear. After standing for 5 minutes the precipitate is washed 3 times by decantation, the washings being poured through a filter; the precipitate is transferred completely to the paper. The nitrogen in the washed precipitate is estimated by Kjeldahl's method. The figure multiplied by 6.38 gives the amount of caseinogen. The filtrate is used for the estimation of albumin.

Albumin.

(1) The filtrate and washings from caseinogen above (1) are treated with Almen's reagent.¹ The precipitate is filtered off and washed. The amount of nitrogen in this precipitate determined by Kjeldahl's method and multiplied by 6.38 gives the amount of albumin.

(2) The filtrate and washings from the caseinogen above (2) are neutralised with sodium hydroxide: 0.3 c.c. of 10 per cent. acetic acid is added and the solution boiled for 15 minutes. The coagulated albumin is collected on a filter and washed; the nitrogen in it is determined by Kjeldahl's method.

¹ 4 gm. tannin in 190 c.c. of 50 per cent. alcohol and 8 c.c. of 25 per cent. acetic acid.

C. NITROGENOUS EXTRACTIVES.

The nitrogenous extractives existing in the tissues consist of amino acids, urea, ammonia, creatine, creatinine, uric acid, etc. The amount of amino acids can be determined by Van Slyke's method of estimating amino nitrogen, the amount of the other constituents by Folin's micro methods (p. 556).

I. Amino Acids (Amino Nitrogen).

(a) Blood.

30-50 c.c. of freshly drawn blood are mixed with 9-10 volumes of 95 per cent. alcohol in a graduated cylinder to precipitate the proteins, or known volumes are mixed. The total volume must be known. The blood and alcohol are thoroughly mixed and allowed to stand for 24 hours. The solution is filtered through a dry pleated filter paper and collected in a measuring cylinder. The volume of filtrate is noted and it is concentrated, preferably *in vacuo*, to a volume of 3-5 c.c. The nitrogen in this volume is determined by the action of nitrous acid as on p. 149. This volume may be diluted to 10 c.c. and 9.5-9.8 c.c. used, or it may be put directly into the burette together with the washings. To prevent frothing a few drops of caprylic alcohol may be added.

The amount of nitrogen evolved from the ammonia present in the blood is negligible, but a correction is required for that evolved from the urea; it amounts to about 3 per cent. This correction is determined by shaking for a period of 4 minutes at below 20°, for 3.5 minutes at 20-25°, or for 2-3 minutes above 25°, measuring the gas and again shaking for a similar period and measuring the gas. The amino acids react rapidly, urea reacts slowly. Urea only is decomposed in the second period of shaking; as it reacts at a uniform rate the amount of gas evolved in the second period is a measure of that evolved in the first period. By deducting this amount the gas evolved from amino acids only is ascertained. The correction may also be determined by noting the amount of gas evolved per minute, if the first measurement is not finished in 2-4 minutes, and calculating for the time of the reaction for the amino acids.

About 4 mgm. of amino nitrogen are found for 100 c.c. of blood.

(b) Tissues.

5-30 gm. of tissue (weighed to .01 gm.) are cut into small pieces and covered with boiling water containing 1 c.c. of 50 per cent. acetic acid per 1000 c.c. and heated on a boiling water-bath until the proteins are coagulated (20-30 minutes). The pieces are lifted out with forceps and minced finely, returned to the same water and heated for another 10 minutes. The supernatant liquid is decanted through glass wool and the residue heated with fresh boiling acidified water for 5-10 minutes, using 5-10 c.c. per gm. of tissue. The solution is decanted through the same filter. This is repeated 4-5 times so as to extract the amino acids completely. The extracts are concentrated *in vacuo* to about 20 c.c. The concentrated solution is transferred with a minimum amount of wash water to a conical flask and mixed with 9-10 volumes of 95 per cent. alcohol, or 5 volumes of absolute or methyl alcohol. The small amount of protein not coagulated by heat is thus precipitated. After standing for 24 hours the solution is filtered, the residue washed with 80 per cent. alcohol and concentrated *in vacuo* to 10-20 c.c., a few drops of phenolphthalein and 25 per cent. sodium hydrate being added to render the solution alkaline. Ammonia is thus driven off during the concentration. If the distillate be collected in .02N acid, the amount of ammonia is also determined (about 10 mgm. per 100 gm.). When the solution has been concentrated to about 10 or 20 c.c., the distillation *in vacuo* is interrupted and the solution acidified with 50 per cent. acetic acid. About 50 c.c. of water are added and the concentration continued to a volume of a few c.c. If the amount of tissue used be less than 10 gm., it is advisable to concentrate finally in a smaller flask of 300-500 c.c. capacity. The concentrated solution is transferred to a 10 c.c. or a 25 c.c. measuring flask and the amino nitrogen determined by the action of nitrous acid: 10 c.c. portions are taken if the larger apparatus, 2 c.c. portions if the micro apparatus, be used. The time of reaction is 4-5 minutes at 15-20°, 3 minutes at 20-25°, and 2-2.5 minutes above 25°. A correction for urea, etc., is determined in the same way as described under blood and is deducted.

The correction for urea, etc., may be omitted, also the removal of ammonia.

The chief error is in the sampling of the tissue; two portions of the same organ seldom give the same results; it is almost impossible to obtain absolutely homogeneous samples of tissue.

From 50-73 mgm. of amino nitrogen are given by 100 gm. of tissue.

II. Total Non-Protein Nitrogen, Ammonia, Urea, Creatinine, Creatine, Uric Acid.

(a) Blood.

(1) *Drawing of Blood.*

The blood is drawn through hypodermic needles into 2 or 5 c.c. pipettes, 1 mm. in diameter and about 25 mm. long. The needles are immersed in a dilute solution of vaselin in ether and allowed to drain on clean paper for a few minutes. They are sterilised before drawing human blood.

The needle is attached to the pipette by rubber tubing. A pinch of finely powdered potassium oxalate (to prevent clotting) is put into the upper end of the pipette and allowed to drop into the tip. The upper end of the pipette is fastened by rubber tubing to a mouthpiece and a pinch cock is put upon the rubber near the pipette. One person inserts the needle into the artery or vein; another person regulates the blood flow by means of the pinch cock and by suction so that the exact quantity is obtained.

(2) *Removal of Proteins.*

The blood is transferred into 25 c.c. (for 2 c.c. blood) or 50 c.c. (for 5 c.c. blood) measuring flasks half-filled with pure methyl alcohol, free from acetone; the flasks are filled to the mark and thoroughly shaken.

After 2 or more hours the contents of the flasks are filtered through dry papers into dry flasks and 2 or 3 drops of a saturated solution of zinc chloride in alcohol are added. After a few minutes they are again filtered through dry papers. The zinc chloride precipitates the remainder of the proteins and colouring matter.

The same volume of the filtrate is taken for each analysis.

In the case of cat's blood 2 c.c. are diluted to 25 c.c.: 5 c.c. filtrate are used = 4 c.c. blood.

In the case of human blood 5 c.c. are diluted to 50 c.c.: 10 c.c. filtrate are used = 1 c.c. blood.

(3) *Estimation of Total Nitrogen* (p. 558).

5 or 10 c.c. are placed in a Jena glass test tube, 1 drop of sulphuric acid, 1 drop of paraffin and a pebble are added and the methyl alcohol is removed by placing the test tube in a boiling water-bath for 5-10 minutes.

The oxidation is effected with 1 c.c. of sulphuric acid, 1 gm. of K_2SO_4 , 1 drop of $CuSO_4$.

The ammonia is collected in 1 c.c. of .1N acid + 2-3 c.c. of water and estimated by the colorimetric method with 7-8 c.c. of diluted Nessler, or more if much ammonia be present.

The standard containing 1 mgm. N is set at 20.

The results are expressed in mgm. N per 100 c.c. (or 100 gm.) blood and are obtained from the following formulæ:—

$$\frac{50}{R} \times D \text{ is the figure with 2 c.c. blood and 5 c.c. filtrate,}$$

$$\frac{20}{R} \times D \text{ ,, ,, ,, ,, 5 c.c. ,, ,, 10 c.c. ,,}$$

where R is the reading of the colorimeter and D is the volume to which the ammonia has been diluted.

(4) *Estimation of Ammonia* (p. 560).

This estimation is the most difficult, as blood decomposes rapidly and gives too high values. The analysis has to be made with hundredths of a milligram instead of tenths. It cannot be estimated in the colorimeter in the ordinary way and the colour of the Nessler reagent is yellow or yellow-green.

The Duboscq colorimeter is modified by attaching to one side an iris diaphragm, putting the unknown into a 10 cm. polarimeter tube and removing the glass prism. Excess of Nessler reagent must be avoided (the green tint is due to excess) and dilutions to the final volume must be made with water absolutely free from ammonia prepared by adding bromine water and a few drops of concentrated caustic soda solution.

10 c.c. of the filtrate from systemic blood
or 5 c.c. " " portal or mesenteric blood

are placed in a test tube with 2-3 c.c. of oxalate-carbonate solution and 5 c.c. of toluene.

The air current is continued for 20-30 minutes and the ammonia is collected in 5-6 drops of 1N acid and 1 c.c. of water. Splashing may be hindered by introducing into the test tube a small funnel with broken stem.

The solution is Nesslerised with 1 c.c. of dilute reagent diluted to 10 c.c. in a measuring flask and put in the polarimeter tube. Two standard solutions containing .5 and 1 mgm. of nitrogen diluted to 100 c.c. are used.

The unknown remains stationary so that the standard is adjusted.

The microscope diaphragm is used and it is fastened to the instrument by two screw clamps on to the top of the colorimeter platform on which the cup stands. A new zero-point must be established.

(5) *Estimation of Urea* (p. 560).

5 c.c. filtrate (cat's blood), or 10 c.c. filtrate (human blood), are placed in a test tube with a drop of dilute acetic acid and 2 or 3 drops of paraffin, and the alcohol is removed by evaporation *in vacuo*. The test tube is closed with a 2-holed rubber stopper; a tube with a capillary several inches long and reaching to the bottom is placed in one hole and a bent tube to attach to the pump in the other. It is placed in warm water and the vacuum is started; in 10-30 minutes the alcohol is removed. The capillary is broken off and left in the test tube.

The hydrolysis is effected by heating for 8-10 minutes with 2 c.c. of 25 per cent. acetic acid and 7 gm. of potassium acetate.

The ammonia is collected, Nesslerised with 3 c.c. reagent and diluted to 10 c.c.

The hydrolysis may also be effected with urease (p. 561).

Estimation of Uric Acid (p. 561).

10-50 c.c. of blood are drawn and placed in a weighed bottle containing .1 gm. of finely powdered potassium oxalate and shaken immediately to prevent clotting. The bottle is weighed to determine the amount of blood.

This oxalate blood is poured into 5 times its weight of boiling .01N acetic acid (10 c.c. N acid diluted to 1000 c.c.) and the mixture raised to boiling. The proteins are coagulated. The precipitate is filtered off whilst the solution is hot, returned with a spatula to the flask, covered with 200 c.c. of boiling water for 5 minutes and filtered off through the same filter as before. The filtrate is clear if no clotting has taken place.

If clotting has occurred, the solution cannot be heated to boiling but is filtered sooner. The clot is broken up with a glass rod, put into a mortar, ground up with hot water and put on to the filter. It is washed with 200 c.c. of water. The filtrate is reddish, but on boiling and filtering a clear solution will result.

The combined filtrate and washings are acidified with 5 c.c. of 50 per cent. acetic acid and evaporated in a porcelain basin to about 3 c.c. This liquid is poured into a centrifuge tube and the basin washed out with two portions of 2 c.c. of .1 per cent. lithium carbonate, solid matter being loosened with a rubber-tipped stirring rod.

The liquid in the centrifuge tube is treated with 5 drops of silver lactate solution, etc., and treated as described on p. 561, but after the hydrogen sulphide has been boiled off, the contents are poured into a beaker and the inside of the tube carefully washed without disturbing the precipitate with about 4 c.c. of water; 2 c.c. of the uric acid reagent, and 10, 15 or 20 c.c. of saturated sodium carbonate solution, depending on whether dilution is made to 25, 50 or 100 c.c., are added. This can be judged by inspecting the standard made previously with 1 mgm. of uric acid and 2 c.c. reagent diluted to 100 c.c. The solution can be filtered if necessary before comparing the colours.

The result is given in mgm. uric acid per 100 c.c., or 100 gm., of blood by the formula $\frac{20 V}{RW}$,

where 20 is depth in mm. of the standard,

where R is depth in mm. of the unknown,

where V is volume of dilution (25, 50 or 100),

where W is weight of blood taken.

Estimation of Creatinine (p. 562).

In collecting the blood for this determination excess of oxalate must be avoided as potassium picrate may be precipitated. It should be measured out from a 20 per cent. solution of which 10 drops are enough for 30 c.c. of blood.

10 or 20 c.c. of blood are placed in a 50 or 100 c.c. measuring flask, or better into a 50 or 100 c.c. stoppered measuring cylinder; the vessel is filled to the mark with saturated picric acid solution¹ and the contents shaken a few times. About 1 gm. of picric acid is added and the contents are shaken for 5 minutes. This gives a saturated solution of picric acid. The mixture is put into centrifuge tubes and solution and precipitate are separated.

If more blood be available, double the quantities can be taken and the precipitate filtered off.

The filtrate is compared with a solution of .2 mgm. of creatinine in 100 c.c., prepared by taking 1 mgm. of creatinine from the standard and diluting it to 500 c.c. in a measuring flask with saturated picric acid solution. This solution can be kept for several determinations.

10, 15 or 20 c.c. of the filtrate are compared with the same volume of this dilute standard by adding 1 c.c. of 10 per cent. sodium hydrate to each and allowing the colour to develop for 10 minutes. No further dilution is necessary. The most accurate way of measuring out the alkali is by drops, which should be determined for 5 c.c. and a fifth of this number taken.

The standard may be set at 10, 15 or 20 mm.

$$\frac{\text{standard reading}}{\text{reading of unknown}} = \text{mgm. of creatinine per 100 c.c. of blood.}$$

¹ Freshly prepared solutions of pure picric acid must be used (Folin and Doisy, J. Biol. Chem., 1917, 28, 349).

Estimation of Creatine and Creatinine.

The same procedure is carried out as above to obtain the picric acid filtrate; 10 c.c. of it are placed in a flask which is covered with tin foil and heated in an autoclave at 120° for 20 minutes; the autoclave is opened after it has cooled.

The solution is rinsed into a 25 c.c. measuring flask with saturated picric acid solution, filled to the mark and 1.25 c.c. of sodium hydrate are added to give the colour.

2 or 3 standard creatinine solutions are required for the comparison on account of the variations in the creatine content.

1 c.c. of 10 per cent. caustic soda is added to 20 c.c. of each of these.

The comparison is made with the appropriate standard at 10 mm.

The result is given by:—

$$\frac{\text{reading of stand.} \times 125 \times \text{creatinine content in mgm.}}{\text{reading of unknown}} = \text{mgm. of creatine + creatinine in 100 c.c.}$$

The amounts of the soluble nitrogenous extractives as determined by Folin by his micro-methods in mgm. per 100 gm. of blood are as follows:—

	Total N.	Urea N.	Uric Acid N.	Creatinine N.	Creatine N.
Rabbit	31	13	.05	—	—
Sheep	28	13	.05	—	—
Pig	32	14	.05	—	—
Horse (antitoxin animal)	54	28	.05	—	—
Monkey	60	38	.05	—	—
Ox	24	14	.2	—	—
Cat { on liver diet	60	34	.2	1-2 ¹	8-10 ¹
{ on milk and egg	67	37	.2		
{ on rice and cream	31	20	.2	—	—
Chicken	32	8	4.9	—	—
Duck	34	7	4.8	—	—
Goose	26	8	4.8	—	—
Man	22-26	11-13	{ .7 1-2 2.2-3.7	—	—

In man higher values than the above for total nitrogen were found in cases of syphilis and insanity.

Man has more uric acid in his blood than any other mammal; normal blood contains 1.2 or 2.5 mgm.; in cases of gout the amount is not greater than 6 mgm. The output of uric acid in the urine according to Folin is a question of kidney efficiency, since there is no greater output in the urine in cases of gout, etc. The kidney action is selective and in cases of gout, etc., the kidney is damaged with reference to uric acid and is unable to bring the blood content down to the normal value.

¹ After 24 hours' fasting.

(b) Muscle and Tissues.

5 gm. are cut into strips immediately after removal and put into 50 c.c. of alcohol in a conical flask. They are ground up and treated with fresh alcohol for 12-16 hours. The alcoholic solutions are combined and put into a 100 c.c. measuring flask, a few drops of alcoholic zinc chloride solution are added, the volume made up to the mark and the solution filtered.

Total Nitrogen, Ammonia and Urea.

10 c.c. of the filtrate are used for the analysis of total nitrogen, ammonia and urea which are carried out in the same way as described under blood.

Creatinine.

10 gm. of fresh muscle are put into a mortar 10-15 cm. in diameter, cut up into small pieces with scissors and ground up with 20 gm. of sand into a fairly uniform thick paste. 43 c.c. of saturated picric acid solution are gradually added, whilst the rubbing is continued and finally about 1 gm. of solid picric acid. The rubbing and stirring are continued for 5-10 minutes after the last addition of picric acid. The proteins are thus converted into insoluble picrates. The object of adding 43 c.c. of picric acid is to allow for 75 per cent. of water in the muscle and so as to have as nearly as possible 50 c.c. of solution.

In the case of other tissues, liver and brain especially, it is advisable to add 2 c.c. of formalin to the 10 gm. of tissue and to allow to stand for 10 minutes before treating as above with picric acid solution. The mixture is poured upon a filter; 20 c.c. of the filtrate are put into a dry measuring cylinder, 1 c.c. of 10 per cent. sodium hydrate is added and the mixture allowed to stand to develop the colour.

20 c.c. of a standard solution of .5 mgm. creatinine in 100 c.c. picric acid are treated with 1 c.c. of 10 per cent sodium hydrate.

The colours are compared setting the standard at 20 mm.

$$\frac{20 \times 2.5}{\text{reading}} = \text{mgm. creatinine in 100 gm. of muscle.}$$

Creatine.

5 gm. of muscle or tissue are cut up finely with scissors or a meat grinder and placed in a 200 c.c. conical flask; 100 c.c. of .5N sulphuric acid are added. The flask is covered with tin foil and put in a autoclave at 130-135° for 30-40 minutes. The autoclave is opened when it has cooled below 100° and the contents of the flask transferred to a 200 c.c. measuring flask. The flocculent masses of tissue are broken by shaking and the volume made up to the mark. The solution is filtered.

10 c.c. of the solution are titrated with 10 per cent. sodium hydrate with phenolphthalein as indicator.

Another 10 c.c. are placed in a 100 c.c. measuring flask and 1.5 c.c. + the amount of 10 per cent. sodium hydrate used to neutralise the solution are added, the colour developed and the solution is diluted to the mark.

As standard for muscle 1 mgm. of creatine per c.c. (= 1.389 gm. of creatinine zinc chloride per 1000 c.c.) and as standard for other tissues .5 mgm. of creatine per c.c. is used.

In the former case the standard is put at 10, in the latter at 20 mm.

Under these conditions

$$\frac{4000}{\text{reading}} = \text{mgm. creatine per 100 gm. of muscle.}$$

(c) Milk.

The creatinine and creatine estimations are carried out in the same way as is described for blood.

III. The Separation and Isolation of Purine Bases from Tissues or Extracts of Tissues. (Jones.)

The tissue is allowed to digest or dissolve itself by placing the minced material in water and allowing the mixture to stand at 40° for some days in the presence of chloroform to prevent putrefaction. Except connective tissue the whole tissue gradually dissolves. This solution, or an aqueous extract, is heated to boiling and made faintly alkaline with soda to dissolve any purines which are insoluble or soluble with difficulty and then acidified with acetic acid. Proteins which are present are coagulated, filtered off and washed.

The filtrate is treated at its boiling-point with 10 per cent. copper sulphate solution and saturated sodium bisulphite solution which are added alternately so long as a white precipitate is formed and until yellow cuprous oxide begins to come down.

The precipitate of purine copper compounds is filtered off, washed, suspended in boiling water and decomposed with sodium sulphide. It is difficult to determine the end point of the reaction as an emulsion is formed, but a test drop placed against a drop of lead acetate on a filter paper will form lead sulphide when sufficient sulphide has been added. Acetic acid is added to the boiling solution until the copper sulphide aggregates, or if guanine be present, sulphuric acid is used. The solution contains the mixture of purine bases.

The separation of the purine bases is greatly facilitated if it be known whether one, two or all are present.

(a) If uric acid be present in greatest amount it is separated by adding 25 c.c. of concentrated hydrochloric acid and evaporating the solution to 25 c.c. Nearly the whole of the uric acid separates out.

(b) If uric acid be mixed with xanthine, these may be separated by dissolving in concentrated sulphuric acid (·1 gm. in 2 c.c.) and diluting with four volumes of water. The uric acid separates out on stirring. The xanthine is obtained by again precipitating as copper compound and treating as under (d).

(c) Guanine and adenine are separated before xanthine and hypoxanthine. The solution is made alkaline with ammonia and precipitated with a slight excess of ammoniacal silver nitrate. The well-washed silver precipitate is suspended in hot water and decomposed with hydrochloric acid. An emulsion may be formed if guanine be absent and xanthine be present, but it can be made to sediment by an excess of hydrochloric acid.

The filtrate from the silver chloride is heated to boiling and treated with ammonia. Guanine is precipitated and purified by preparing the chloride (p. 295). Ammonia is removed from the filtrate by boiling, the solution is acidified to methyl orange with hydrochloric acid and the adenine is precipitated as picrate by adding sodium picrate (p. 296).

The picric acid is removed by extracting the solution acidified with sulphuric acid with ether, the solution is neutralised with soda, the purine bases thrown out as before with copper sulphate and bisulphite and recovered.

(d) The solution containing xanthine and hypoxanthine is acidified with hydrochloric acid and carefully evaporated to dryness with constant stirring, the residue moistened with water and again evaporated. The xanthine hydrochloride is thus decomposed; on extracting the residue with water it is present as free base and is insoluble, whilst hypoxanthine hydrochloride dissolves.

The xanthine is dissolved in 15 parts of warm 3·3 per cent. caustic soda and the solution is poured into two-thirds of its volume of 32 per cent. nitric acid from which nitrous acid has been removed by boiling. Xanthine nitrate crystallises out on cooling. It is dissolved in dilute ammonia and the solution evaporated. Pure xanthine crystallises out.

The solution of hypoxanthine hydrochloride is diluted, precipitated with copper sulphate and bisulphite and the precipitate decomposed with hydrogen sulphide. The solution is evaporated to dryness and the residue crystallised from 30 parts of pure 6 per cent. nitric acid. Hypoxanthine nitrate crystallises out.

D. CARBOHYDRATES.

The carbohydrates which are present in the tissues used as foodstuffs consist mainly of starch. Small quantities of glucose may also be present. Biscuits, cakes, etc., will contain cane sugar in addition.

Fresh animal tissues contain glycogen.

Estimation of Starch.

The simplest method of estimating starch is a modified form of the Pflüger method for estimating glycogen in animal tissues; as adopted by Armstrong it is as follows:—

10 gm. of the substance are boiled for half an hour with 80 c.c. of 5 per cent. potassium hydrate under a reflux condenser. The mixture must be well shaken at first as frothing occurs; the frothing can be lessened by adding a few drops of amyl alcohol. The liquid, generally brown in colour, is cooled and poured into 200 c.c. of 80 per cent. alcohol. The starch is precipitated; it is stirred to cause it to agglomerate and allowed to settle; it is filtered off, washed with dilute alcohol and put into a 300 c.c. flask, in which it is hydrolysed by boiling with 200 c.c. of 7.5 per cent. (by volume) hydrochloric acid for 2.5-3 hours. The solution is neutralised, made up to 250 c.c. and the glucose estimated by any of the methods for estimating glucose (p. 216).

Estimation of Cane Sugar and Glucose.

10 gm. of the powdered material are covered and stirred up with .4 per cent. hydrochloric acid. The acid is decanted through a filter paper into a measuring flask of 250 or 500 c.c. capacity. The material is again covered with acid and the acid decanted. The extraction is continued in this way some six or seven times until a test portion shows the absence of glucose and cane sugar. The solution is diluted to the mark.

In one or more aliquot portions the glucose is estimated and in one or more portions the cane sugar is estimated according to the methods given on p. 235.

Estimation of Glycogen (Pflüger's method).

The amount of glycogen in animal tissues varies considerably so that small or large quantities of material must be taken accordingly.

The shorter method of Pflüger¹ gives good results:—

100 gm. of the minced tissue are put into 100 c.c. of boiling 60 per cent. potassium hydroxide and heated for about two hours until the tissue has completely dissolved (excepting connective tissue). On cooling, 200 c.c. of water are added and thoroughly mixed with the solution. The glycogen is precipitated by adding 400 c.c. of 96 per cent. alcohol. The precipitate is allowed to settle and the liquid is decanted through a 15 cm. filter paper. The precipitate is washed once with a mixture of 1 volume of 15 per cent. potassium hydroxide and 2 volumes of 96 per cent. alcohol, finally with 66 per cent. alcohol. It is dissolved in boiling water; the filter paper and insoluble residue are also boiled out with water. If there be a large separation of protein with the glycogen, it is boiled out twice. The aqueous solutions are neutralised. Concentrated hydrochloric acid is added to make 2.2 per cent. and the glycogen is hydrolysed by boiling for 3 hours. The solution is neutralised and filtered and the glucose is estimated by polarimeter or by reduction.

Glycogen = glucose \times .927.

¹ Pflüger's Arch., 103, 169.

Estimation of a Mixture of Carbohydrates.

The analysis of a mixture of carbohydrates, mono-, di- and polysaccharides, such as occur in natural materials, especially in extracts of plants, is based upon the determination of the rotation and reducing value of the solutions before and after hydrolysis. All di- and polysaccharides are not hydrolysed equally readily, e.g. cane sugar is readily hydrolysed by organic acids, such as citric acid, whereas maltose is stable. Mineral acids hydrolyse all di- and polysaccharides but not equally readily. The analysis of mixtures is based upon these differences. The subject of the analysis of mixtures of carbohydrates, especially those present in plant extracts, has been carefully studied by Davis and Daish,¹ who emphasise the following particulars:—

(1) Glucose and fructose are destroyed by prolonged heating with 2.5-5 per cent. hydrochloric acid at 70°.

(2) Maltose is not hydrolysed by boiling with 10 per cent. citric acid.

(3) Cane sugar is completely hydrolysed by boiling with 2 per cent. citric acid for 10 minutes, but in presence of acetates, etc., at least 4 per cent. citric acid is required.

They recommend the following procedure for the analysis of the carbohydrates in a plant extract:—

(1) The material is dropped into a large volume of boiling 95 per cent. alcohol to which 1 per cent. of its volume of ammonia of sp. gr. .880 is added, so as to destroy the enzymes and prevent changes in the proportions of the carbohydrates present in the material.

(2) The liquid is separated and the residue is extracted in a large Soxhlet extractor with boiling alcohol: the soluble carbohydrates are generally removed as soon as the extract becomes colourless. The liquid is then pressed out from the residue by a hydraulic press. The cake of solid so obtained is dried in a steam oven for 18 hours, ground up and used for the analysis of starch (below).

(3) The alcoholic liquids are concentrated *in vacuo* and made up to a definite volume, say 500 c.c.

(4) Total solid is determined in 2 portions of 20 c.c. each by evaporating and drying *in vacuo* at 100° for 18 hours.

(5) 440 c.c. are treated with basic lead acetate; the precipitate is filtered off on a Buchner funnel and washed. The volume is made up to, say, 2 litres = solution A.

(6) 300 c.c. of A are treated with solid sodium carbonate to remove lead and made up to 500 c.c. = solution B.

(7) 25 c.c. of B are taken for reduction and polarisation in a 2 decimeter tube.

The result gives the amount of glucose, fructose, maltose and pentose together.

(8) 50 c.c. of solution B are hydrolysed.

(a) By invertase. The quantity is acidified to *methyl orange* with a few drops of concentrated sulphuric acid, 1-2 c.c. of autolysed yeast (invertase) are added together with 2 or 3 drops of toluene as preservative and the mixture kept at 38-40° for 24 hours. 5-10 c.c. of alumina cream are added and the solution filtered. The filtrate and washings are made up to 100 c.c. The reduction and rotation of 50 c.c. are taken.

(b) By 10 per cent. citric acid. The quantity is acidified as above and solid crystalline citric acid added to make 10 per cent. The solution is boiled for 10 minutes, cooled, neutralised to phenolphthalein with sodium hydroxide, made up to 100 c.c. and its rotation and reduction are taken.

The results from (a) and (b) should agree closely.

The amount of cane sugar is calculated from the increase in reduction or change of rotation.

(9) The lead is removed from 300 c.c. of solution A by hydrogen sulphide. The precipitate is washed and the filtrate and washings made up to about 450 c.c. Excess of hydrogen sulphide is removed by drawing air through the solution for about 1.5 hours, a trace of ferric hydroxide being added to remove the last traces, and the solution is made up to 500 c.c.

Three portions of 50 c.c. each are fermented with (a) *Saccharomyces marxianus*, (b) *S. anomalus*, (c) *S. exiguus* and two portions of 50 c.c. (d) and (e) are fermented with baker's yeast. For the fermentation the acidity of the solution is reduced by adding 2.5 c.c. of N sodium carbonate. 5 c.c. of sterilised yeast water is also added, the mixture sterilised and inoculated with the yeast, stoppered with cotton wool, and kept at 25° for 21.28 days. When the fermentation is complete, 5 c.c. of alumina cream are added, the solution made up to 100 c.c. at 15°, filtered and the reduction value of 50 c.c. determined. The amount of maltose is obtained from the difference between the average of (a), (b), (c) and of (d), (e).

(10) 50 c.c. of solution A are distilled with hydrochloric acid for the determination of the amount of pentoses (p. 234). The presence of hexoses does not seriously interfere with the result, but they may be removed by fermentation.

(11) The amount of glucose and fructose is ascertained by subtracting the values for pentose and maltose. The relative amounts of glucose and fructose are obtained from

$$\begin{aligned} 2.205 g + 2.205 f &= \text{CuO in gm. reduced per 100 c.c.}^1 \\ 1.48 g - 2.76 f &= \text{rotation in 1 dm. tube in scale divisions.} \end{aligned}$$

(12) A portion of the dried solid from (2) is taken after thorough sampling on a sheet of paper and dried to constant weight at 100° or 110° *in vacuo* over phosphorus pentoxide. Heating for 24 hours, sometimes longer, is necessary.

(13) The dry material—if necessary, previously extracted with 20 c.c. of water for 24 hours, filtered and washed to remove gums, etc.—is gelatinised with 200 c.c. of water in a beaker which is heated in a water-bath at 100° for half an hour.

The solution is cooled to 38°, 0.1 gm. of taka-diastrase and 2 c.c. of toluene are added and the mixture kept at 38° for 24 hours. The hydrolysis of the starch into glucose and maltose is then complete. The mixture is heated to boiling and the clear solution above the solid material filtered into a 500 c.c. measuring flask, the solid being washed several times with water and the washings collected in the flask until the volume is about 475 c.c. Tannins, etc., are precipitated from the solution by adding basic lead acetate, the amount required being from 5.25 c.c. Excess should be avoided, tests being made to ascertain when sufficient has been added. The solution is made up to 500 c.c. and filtered. 100 c.c. of the filtrate are placed in a 110 c.c. measuring flask and the excess of lead precipitated by adding solid sodium carbonate. The volume is adjusted to 110 c.c. and the solution filtered. The rotation of the solution and the reducing value of 50 c.c. are determined. Supposing the reducing value is equal to .4492 gm. CuO and the rotation value is 1.995°, the amount is calculated, using Brown, Morris and Millar's data for 1 gm. of glucose or maltose and the corresponding amount of CuO, from the equations

$$\begin{aligned} 2.369 g + 1.362 m &= .4492 \\ 4.216 g + 11.008 m &= 1.995^\circ \end{aligned}$$

$$\left. \begin{aligned} \text{whence } g &= .1095 \text{ gm.} \\ m &= .1394 \text{ gm.} \end{aligned} \right\} \text{in 50 c.c.} \quad \left. \begin{aligned} \text{or } .1095 \times \frac{110}{50} \times \frac{500}{100} &= 1.2045 \text{ gm.} \\ \text{or } .1394 \times \frac{110}{50} \times \frac{500}{100} &= 1.5344 \text{ gm.} \end{aligned} \right\} \text{in 500 c.c.}$$

$$\begin{aligned} \text{Starch corresponding to glucose} &= 0.90 \times 1.2045 = 1.0840 \\ \text{,, ,, ,, maltose} &= 1.5334 \div 1.055 = 1.4535 \end{aligned}$$

$$\therefore \text{Total starch} = 2.5375 \text{ gm. in dried material taken.}$$

$$\begin{aligned} 1.2045 \text{ g of CuO are reduced by } & 1 \text{ gm. glucose or 1 gm. fructose.} \\ 1.48 = \text{rotation in scale divisions of } & 1 \text{ gm. glucose in 100 c.c. solution.} \\ 2.76 = \text{,, ,, ,, ,, } & \text{,, 1 gm. fructose in 100 c.c. solution.} \\ \text{(Brown and Morris, 1893.)} & \end{aligned}$$

Estimation of Glucose in Blood.

The exact determination of glucose in small quantities of blood (1-2 c.c. and less) is a problem of some difficulty; numerous adaptations of the methods of estimating glucose after removal of the protein have been tried. The various processes have been tested by A. D. Gardner and H. Maclean¹ who recommend the removal of protein by precipitation with colloidal iron solution and the estimation of the glucose by a modified Bertrand procedure.

Maclean² has improved the method of removing protein from blood by means of colloidal iron and has adopted a simpler and more convenient method of estimating the glucose. This method depends on the formation of cuprous iodide on acidifying an alkaline solution containing copper sulphate, iodide and iodate after being boiled with glucose. This solution is titrated before and after reduction with $\cdot 004N$ thiosulphate. The first result gives the total iodine content, the second the amount of iodine not in combination as cuprous iodide: the difference gives the amount of iodine in combination with reduced copper from which the amount of glucose is determined. Maclean has published a table giving the amounts of glucose corresponding to the amount of thiosulphate which is required for the cuprous iodide.

The reagents and apparatus required are:—

- (1) Dialysed iron, free from acid, of sp. gr. not under 1.045.
- (2) .5 per cent. phosphoric acid solution.
- (3) Saturated aqueous solution of sodium sulphate.
- (4) Alkaline copper iodine solution:

Potassium bicarbonate	20 gm.
Potassium carbonate	10 gm.
Copper sulphate (<i>exactly</i> 5 per cent. aqueous solution)	15 c.c.
Potassium iodide	1 gm.
Potassium iodate	exactly 0.1 gm.
Distilled water to 100 c.c.	

This is prepared by dissolving the 20 gm. of bicarbonate by gentle heating in 50-60 c.c. of water; the 10 gm. of carbonate are then added. Before the whole of this has dissolved, the 15 c.c. of copper sulphate are gradually added with gentle shaking. After the resulting effervescence has ceased, the volume is nearly made up and any undissolved potassium salt brought into solution by gentle heating, if necessary. The iodide and iodate are added and the volume made up to 100 c.c.

- (5) $\cdot 004N$ sodium thiosulphate solution:

This must be prepared fresh daily from $\cdot 1N$ solution, which can be kept in the dark for a comparatively long time. The $\cdot 1N$ solution is prepared by dissolving 2.4823 gm. of pure sodium thiosulphate $Na_2S_2O_3 \cdot 5H_2O$ in 100 c.c. of water. The thiosulphate crystals are purified by grinding up the pure salt with alcohol, filtering, treating with ether and drying in the air.

- (6) Starch solution:

1 gm. of soluble starch is dissolved in 100 c.c. boiling water and cooled.

- (7) Pure hydrochloric acid of sp. gr. 1.16.

Conical flasks of 100 c.c.

Condenser from which the lower part of projecting inner tube has been cut off, or test tube fitted with glass tubing for the circulation of cold water.

- (8) Filter papers about 15 cm. in diameter.

- (9) Pieces of washed and dried calico 6-8 inches square.

- (10) Funnels.

¹ Biochem. J., 1914, 8, 391.

² J. Physiol., 1916, 50, 163.

The procedure, which takes 15 minutes, is the following:—

1 c.c. of blood is collected in an accurately graduated 1 c.c. pipette, or in a special Hawksley pipette graduated to contain 1 c.c. of blood under standard conditions, and run into 20 c.c. of distilled water contained in a mortar. The blood sinks and the pipette is rinsed out several times with the supernatant water so as to remove the last traces of blood from the pipette. The mixture is stirred with a pestle and 2 c.c. of the phosphoric acid solution are added. After stirring, 15 c.c. of dialysed iron are run in from a burette and well mixed and then 2 c.c. of sodium sulphate solution. The total volume is now 40 c.c. On stirring this mixture it forms a thick paste, which gradually becomes more fluid. The liquid and solid are separated by pouring upon a filter paper contained in a square of calico in a funnel, collecting the ends of the calico together and gradually squeezing. Most of the liquid can thus be separated in a clear condition, if the squeezing be carefully done, but it is better to press the liquid through quickly and to filter the turbid solution through a small filter. 30 c.c. can be obtained. 20 c.c., or 15 c.c. if the blood contain large amounts of sugar + 5 c.c. of water, are used for the estimation. 3 c.c. of the alkaline copper iodine solution are added to 20 c.c. of the clear solution in a 100 c.c. conical flask and the mixture boiled under a reflux condenser. The reflux should not be attached by a cork, but its lower end is rested on the neck of the flask, or the test tube with circulating water is put in the open end.

The boiling is continued for *exactly* 10 minutes from the time at which the flask is placed over the flame. The time taken to reach the boiling-point should be from 1 minute 30 seconds to 1 minute 50 seconds. A small manometer to regulate the gas pressure, such as described by Cole,¹ is useful if many determinations have to be made. The flask is removed and *thoroughly* cooled in running water for 1.5 minutes. 5 c.c. of hydrochloric acid are added to the *cold* solution and after effervescence has subsided it is shaken for .5 minute. The whole of this operation should not exceed 1 minute in duration. A few drops of starch solution are added and the solution titrated with .004N thio-sulphate solution. The difference between this figure and that obtained in a determination with 3 c.c. of copper iodine solution in 20 c.c. of water gives the amount of thio-sulphate required for the iodine in the cuprous iodide. The corresponding amount of glucose is given in the table on p. 606. The result must be multiplied by 2, since 20 c.c. of the total 40 c.c. were used. It is the amount in 1 c.c. of blood.

The results are about .01 per cent. too high. This is due to the presence in blood of an iodine absorbing substance. Its amount can be determined by carrying out an experiment with 20 c.c. of blood filtrate and 3 c.c. of an alkaline iodine solution containing no copper. This amount is deducted. In still more accurate determinations, allowance must be made for the small amount of substance produced by boiling glucose with alkali, which also absorbs iodine and accounts for $\frac{1}{11}$ of the total absorption. This small amount is determined by an experiment in which 20 c.c. of the filtrate are boiled with the alkaline iodine solution containing no copper.

By this method Maclean was able to show that diabetic blood showed no decrease in glycolytic power and inferred that diabetic tissues, like normal tissues, possessed the power of destroying glucose.

Bang's Micro-Method.

Bang² has adapted his second method (p. 230) for estimating glucose in 2-3 drops of blood. This method has been found to be satisfactory by Gardner and Maclean who have made one or two important modifications. It is carried out as follows:—

¹ Biochem. J., 1914, 8, 137.

² Biochem. Zs., 1913, 49, 1; 1914, 57, 300.

The drops of blood are soaked up in weighed pieces of filter paper¹ 12 × 25 mm. in size and 1 mm. thick weighing about 100 mgm. and weighed.

The weighing is most conveniently effected with a torsion balance.² The paper containing the blood is placed for 3-5 minutes in an oven at 90-100° to coagulate the proteins. The glucose contained in the blood is extracted by immersing the paper in 7 c.c. of a solution containing 150 c.c. of saturated potassium chloride solution, 70 c.c. of water and 2-3 drops of 40 per cent. acetic acid for 45 minutes to 1 hour, during which time it is raised twice to the boiling-point. The solution is poured into a 50 c.c. Jena glass flask with a straight neck and no rim. The paper is again boiled out with 4 c.c. of the above solution in the same way and this is put into the flask. 3 c.c. of the alkaline copper solution (see p. 613) are added. The flask is closed with a piece of rubber tubing 3 mm. thick and 4-5 cm. long leaving 2 cm. over, which can be clamped with a spring clip or a special clip.³ Dissolved gases are removed by shaking and exhausting the flask with a suction pump. The contents of the flask are heated to boiling for 3 minutes⁴; just before the expiration of this time the tubing is closed with the cap. The flask is rapidly cooled under running water. The rubber cap is removed, and to prevent oxidation a current of carbon dioxide is immediately passed through the flask by a small tube which is bent for convenience and attached to the flask by a band. The reduced cuprous salt is titrated with '01N iodine solution or '005N iodine solution which is prepared from '1N iodine solution contained in a 2 c.c. burette with a fine point and graduated in fiftieths of a c.c. using 2-3 drops of starch solution as indicator. In all cases '01 per cent. should be subtracted from the final result since blood contains a substance which reduces iodine.

Gardner and Maclean state that at least four parallel determinations should be carried out and the mean of 3 or 4 satisfactory estimations taken as the correct figure.

E. LACTIC ACID.

In order to estimate lactic acid in blood and tissues it must first be separated by extraction. The analysis of the lactic acid is then made either by conversion into its zinc salt, which is weighed, or by oxidation to aldehyde, which is titrated. Wolf⁵ has tested the various methods and finds that the determination as zinc salt is the most accurate; the determination as aldehyde gives about 95 per cent. of the total. In extracting the lactic acid Wolf finds that the best method is to absorb the concentrated solution containing the lactic acid into filter paper, rather than with a special liquid extractor. His procedure closely follows that of Embden and his co-workers:—

The blood or tissue is placed in 10 volumes of cold 2 per cent. hydrochloric acid and, after standing, an equal volume of 5 per cent. mercuric chloride is added. (Embden used 200 c.c. defibrinated blood, or blood collected in sodium fluoride solution, 200 c.c. water, 400 c.c. HCl and 400 c.c. HgCl₂.) The proteins are precipitated and after standing at least 12 hours, are removed by filtration on a Buchner funnel, the precipitate being washed several times with a solution of equal parts of the acid and mercuric chloride solution. The colourless filtrate is treated with hydrogen sulphide, the sulphide precipitate is washed and the sulphuretted hydrogen removed from the filtrate by a current of air. The acid solution is evaporated *in vacuo* to about 10 c.c. and the

¹ No. 264a. Made by Finbruken, Stockholm. It must be boiled out several times with water containing a few drops of acetic acid until a test experiment shows that it contains no reducing substances.

² By Hartmann and Braun or Warmbrunn and Quilitz.

³ Made by Mekaniker Hill, Lund, Denmark.

⁴ 1 minute 10 seconds to 1 minute 25 seconds generally elapse to raise to boiling-point, after which the boiling is continued for 2 minutes.

⁵ J. Physiol., 1914, 48, 341.

solution poured over a strip of filter paper. The flask is washed out with small quantities of water and the washings poured upon another strip of paper. The strips are rolled whilst wet, placed in a Soxhlet extractor and extracted with washed ether for 3-4 hours; 100 c.c. of water are added and the ether removed by distillation.

(Embden performs two estimations each with 500-600 c.c. of solution; the solution is neutralised with strong caustic soda, then slightly acidified with hydrochloric acid and concentrated *in vacuo* to 100 c.c. at a temperature below 50° C. The liquid must be clear and nearly colourless and of neutral or slightly acid reaction. If it has become alkaline, the extraction cannot be continued as the alkali may have produced lactic acid from glucose. The solution is transferred to an extractor, acidified with 15 c.c. of 60 per cent. phosphoric acid and saturated with ammonium sulphate. The ether extraction is continued for 30 hours and subsequently for another 10 hours to ascertain if the whole has been extracted during the first period.

The contents of the flask are transferred to a conical flask and the remains washed into it with ether; 20 c.c. of water are added, the ether evaporated off and then 200-300 c.c. more water.)

The solution is filtered and heated on a boiling water-bath for 1 hour with excess of lead carbonate. The contents are allowed to stand at 0° for 12-16 hours and filtered from the precipitate which consists mainly of lead phosphate and which is thoroughly washed with water. The lead is removed with hydrogen sulphide, the precipitate washed and the hydrogen sulphide removed by a current of air. The solution is boiled with an excess of zinc carbonate, again filtered, concentrated to 20 c.c. and any precipitate filtered off. The filtrate is evaporated to dryness in a weighed basin, the white crystals dried at 110° and weighed.

The purity of the salt should be ascertained by a determination of the water of crystallisation and the zinc content.

The estimation of lactic acid as aldehyde in the zinc salt is effected by the method of von Fürth and Charnass as follows:—

The zinc lactate is dissolved in hot water and washed into a round bottom flask of 800 c.c. capacity. The volume of water should not exceed 50 c.c. and the amount of lactic acid .2 gm. 300 c.c. of .5 per cent. sulphuric acid and about .5 per cent. of talc are added. The flask is fitted with a dropping funnel and safety tube leading to a condenser, placed most conveniently in a vertical position and the end of which dips under 150 c.c. of water and a measured quantity of .2N bisulphite solution contained in a litre flask. The solution is distilled and when boiling has commenced .01N permanganate is dropped in at the rate of 90-120 drops per minute. The oxidation is continued until the solution appears brown and then for 10 minutes longer, during which time the permanganate is run in more slowly.

The contents of the receiver are titrated with .1N iodine solution using starch as indicator:—

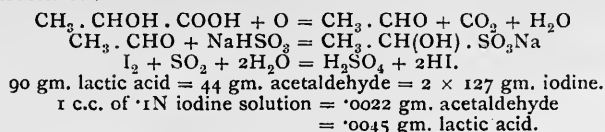

The bisulphite solution is titrated with iodine just before use, since its strength alters on keeping, but it does not alter during the time taken in the oxidation process.

The isolation of zinc lactate is necessary since the solution may also contain other hydroxy acids, but in those cases in which no other hydroxy acids are known to be present the estimation can be carried out with the ether extract after removal of the ether.

Note.—The precipitation of proteins from muscle juice is effected by adding 1 volume of hydrochloric acid and 1 volume of mercuric chloride.

The extraction and estimation of lactic acid in urine is effected in a similar way.

(1) The urine (500 c.c.) is evaporated *in vacuo* at 50° to about 100 c.c. and extracted with ether¹ in the extractor after adding 50 per cent. phosphoric acid with or without the addition of ammonium sulphate. Ammonia is added to the ether extract which is evaporated on the water-bath (50 c.c.-20 c.c.); this removes the ether and excess of ammonia. The solution is distilled in the apparatus described above with 300 c.c. dilute sulphuric acid (the reaction must be strongly acid) until 200 c.c. have passed over. A second distillation using 0.1N permanganate is then carried out: the titration of this distillate as above gives the quantity of lactic acid (Dapper's procedure).

(2) The urine (250 c.c.) is treated with phosphotungstic acid, excess of which is removed with baryta and excess of baryta with carbon dioxide. The solution is evaporated, acidified with phosphoric acid and the operations described above carried out (Ishihara's procedure).

(3) A similar procedure by Ryffel² depends upon the decomposition of lactic acid into acetaldehyde with 50 per cent. sulphuric acid and the estimation of the acetaldehyde colorimetrically.

The method gives results which are about 80 per cent. of the theoretical, if the estimation be effected by titration with bisulphite and iodine. The direct distillation and estimation with bisulphite and iodine is the most convenient and rapid for routine work.

45 c.c. of concentrated sulphuric acid are added to 40 c.c. urine in a 500 c.c. round bottom flask, the mixture being kept cold during the addition. The flask is connected to a steam generator on the one side and a condenser on the other. A rapid current of steam is passed in; the temperature of the flask as indicated by a thermometer as soon as distillation commences is about 140°, but should be raised by heating to 155° and kept within 2° of this temperature by moderating the current of steam. The decomposition is complete in 30 minutes after about 100 c.c. have been collected. This distillate may be titrated as above or again distilled after making just alkaline and estimated colorimetrically.

¹ The ether is purified by shaking with 50 per cent. caustic potash and then with water until the washings are free from alkali.

² J. Physiol., 1909, 39, Proc. v.

F. ACETO-ACETIC ACID.

Since acetone is usually present in urine and tissues together with aceto-acetic acid, the estimation gives the amount of these two compounds together. Acetone may be estimated separately by the method of Folin¹ or of Embden and Engel.² The separation and estimation of acetone is usually not required as it arises by the decomposition of aceto-acetic acid.

In Urine.

The procedure usually adopted in the estimation is that of Messinger as applied by Huppert (Messinger-Huppert). Since urine on distillation with acid may yield phenol, ammonia, nitrous acid and formic acid, substances which also react with iodine, the distillation is carried out with acetic acid to prevent the hydrolysis of phenol sulphuric acid; the distillate is redistilled after shaking it with calcium carbonate to remove nitrous and formic acids and with sulphuric acid to retain the ammonia.

20 c.c. of diabetic urine (human)	} are the quantities usually required.
50-100 c.c. of febrile " "	
" " of urine passed during starvation	
500 c.c. of normal urine	

The urine is placed in a flask of about 600 or 700 c.c. capacity. 2 c.c. of 50 per cent. acetic acid for every 100 c.c. of urine are added and distilled water, if necessary. The flask is connected with a condenser which is most conveniently arranged in a vertical position so that the end may be made to dip beneath the surface of some water contained in another flask of 600 c.c. used as receiver. The contents of the flask are distilled until they become almost dry and $\frac{1}{5}$ have passed over. The distillate is shaken with 10 gm. of calcium carbonate; 2 c.c. of dilute sulphuric acid (2N) are added and it is again distilled. To prevent frothing about 20 c.c. of liquid paraffin may be added.

The distillate is collected below the surface of some water made faintly alkaline with sodium hydroxide and contained in a 1000 c.c. bottle which can be closed with a ground glass stopper; $\frac{1}{5}$ are again distilled over.

The acetone in the distillate is converted into iodoform by adding 30 c.c. of 15 per cent. sodium hydroxide and excess of .1N iodine solution, shaking for $\frac{1}{4}$ of a minute and allowing to stand for 15 minutes in the closed bottle. The presence of excess of iodine may be ascertained by adding a drop of hydrochloric acid; a brown coloration due to separation of iodine will appear. If insufficient has been added, a further quantity must be run in and allowed to react for 5 minutes.

The excess of iodine is determined by acidifying the solution with hydrochloric acid and titrating with .1N sodium thiosulphate solution until the solution is only slightly yellow. Starch solution is added and the titration continued until the blue colour disappears and a clear or milky white solution results on standing for 1 minute.

$$\begin{array}{l}
 \left. \begin{array}{l} 102 \text{ gm. aceto-acetic acid} \\ 58 \text{ gm. acetone} \end{array} \right\} = 762 \text{ gm. I.} \\
 1 \text{ c.c. } \cdot 1\text{N iodine solution} = \cdot 0127 \text{ gm. iodine.} \\
 \phantom{1 \text{ c.c. } \cdot 1\text{N iodine solution}} = \cdot 0017 \text{ gm. aceto-acetic acid.} \\
 \phantom{1 \text{ c.c. } \cdot 1\text{N iodine solution}} = \cdot 000967 \text{ gm. acetone.}
 \end{array}$$

A blank experiment should be made with the reagents on account of the presence of sodium nitrite in some samples of caustic soda.

A rather more complicated manipulation is used by Shaffer and Marriott who subsequently estimate hydroxybutyric acid (see p. 597).

Embden has found that the same result is obtained by a single short distillation from acid solution. By thus avoiding the high concentration of the urine, glucose, if present, is not decomposed with the formation of products which absorb iodine. The procedure is the following:—

¹ J. Biol. Chem., 1907, 3, 177.

² Beitr. chem. Physiol. Path., 1908, 11, 324.

The urine, 20 c.c., or more if it contain little acetone, is mixed with 150 c.c. water and 2 c.c. of 50 per cent. acetic acid and distilled for 25 minutes; during this time about 60 c.c. of liquid should pass over; the vapours are cooled in an efficient condenser, through which a rapid stream of water must be passed, and collected in a 150 c.c. water. The end of the condenser should reach below the surface of the water as described above.

The titration is carried out with this distillate. 30 c.c. of 33 per cent. sodium hydroxide solution and excess of .1N iodine solution from a burette are added and the liquids mixed by gentle shaking. The presence of excess of iodine can be ascertained by the appearance of a brown coloration at the point of contact on adding a drop of hydrochloric acid. Iodoform separates out. After 5 minutes the contents are acidified with 25 per cent. hydrochloric acid and titrated with .1N sodium thiosulphate solution using starch as indicator.

Alcohol, if present in the urine, would pass over with the acetone, but it is converted into iodoform very slowly in the cold. Its presence scarcely affects the estimation.

Acetaldehyde, which may arise by decomposition of substances in the urine, seriously affects the estimation. It is removed by redistilling the distillate with sodium hydroxide solution and 20 c.c. of hydrogen peroxide solution. It is not present in the distillate except under special circumstances.

In Tissues.

The estimation of acetone and aceto-acetic acid in tissues is carried out in a similar way: 150 c.c. of blood or 150 gm. of minced tissue are mixed with 4-5 volumes of water, acidified and distilled.

To avoid bumping during the distillation it is advisable to remove the protein. The blood or tissue is mixed with an equal volume of water and twice the volume of 2 per cent. hydrochloric acid and 5 per cent. mercuric chloride solution and well stirred. The solution is filtered when the precipitate has settled, or after about 12 hours, and the estimation carried out with 500 c.c. of the filtrate.

Marriott also gives a method in conjunction with his method for estimating hydroxybutyric acid in tissues (see p. 598).

Small Amounts.

Small amounts of acetone are best estimated by the method of Scott-Wilson.¹ The acetone is distilled from the solution and precipitated as a keto-mercury cyanide compound²:—

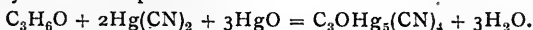

The mercury contained in this compound is estimated by titration with thiocyanate after oxidation of the organic matter.

The liquid (100 c.c. normal urine) is placed in a flask of about 500 c.c. capacity together with 1 c.c. of concentrated sulphuric acid and 25 gm. of anhydrous sodium sulphate. The flask is provided with a 2-holed rubber cork; through one opening a bent tube reaching to the bottom of the flask is inserted; at its outer end it is fitted with a piece of rubber tube closed by a piece of glass rod; through the other opening passes a bent tube connecting this flask to another of similar capacity and reaching to the bottom of the latter. This flask contains 10 c.c. of 40 per cent. sodium hydroxide solution and is connected by tubing to a condenser. By means of an adapter the distillate from the condenser is conducted below the surface of the reagent³ contained in a conical flask. The liquids in the flask are heated to boiling, that containing the alkali being made to reach this temperature sooner than the other so as to prevent condensation of vapours in it.

¹ J. Physiol., 1911, 42, 444; cf. Marriott, J. Biol. Chem., 1913, 16, 281.

² The precipitation is effected by the following reagent which is prepared by dissolving 10 gm. of mercuric cyanide in 600 c.c. of water and adding 180 gm. of sodium hydroxide in 600 c.c. of water. To the cold solution are added slowly with constant stirring 400 c.c. of a .7268 per cent. solution of silver nitrate (2.9 gm. in 400 c.c. of water). The solution is set aside for about 3 days and the supernatant liquid poured off from the small sediment.

³ 30 c.c. are required for each mgm. of acetone.

The acetone distils from the first flask, is freed from phenol and volatile organic acids by passing through the caustic alkali and is precipitated in the receiver as keto-mercury compound. The distillation is continued for 5 minutes after the first appearance of a turbidity in the receiver. When the heating is discontinued the glass rod is removed from the rubber piece of tubing so as to prevent back suction of the liquids. The adapter is disconnected, rinsed out and the precipitation is allowed to complete itself by standing for 10 minutes.

The precipitate is filtered off through a thick filter paper or asbestos mat in a Gooch crucible, the pores of which have been closed by first filtering an aqueous suspension of talcum. The first runnings, if turbid, must be passed through the filter again until a clear filtrate is obtained. The flask and precipitate are washed with distilled water until the washings are free from silver. The precipitate together with the filter paper or asbestos mat are transferred from the crucible by means of a pointed glass hook to a clean flask or beaker and any particles adhering to the crucible or hook are washed in with a jet of acid mixture.¹ More acid mixture is added so that the volume used altogether is about 10 c.c. 1 c.c. of .2N potassium permanganate solution is added and the contents of the flask boiled for 1-2 minutes till they are colourless. It is better to add a few drops of permanganate during the boiling so that a persistent brown colour is present and to decolorise by adding a few drops of strong yellow nitric acid. The contents of the flask are cooled and titrated with .1N thiocyanate solution² (about .1 per cent. KSCN; 1 c.c. = 1 mg. Hg), using 2 c.c. of saturated ferric alum solution as indicator until a brownish tinge appears. A control beaker containing 1 drop excess of thiocyanate should be at hand for comparison.

1 c.c. .1N KSCN = .001 gm. Hg = .0058 gm. acetone (Scott-Wilson).
 " " " = .00644 " (Marriott).

... *Micro Analysis.*

The above methods are not suitable for the estimation of the acetone and aceto-acetic acid in small amounts of blood, but the Scott-Wilson method can be adapted to the estimation of 0.2-0.5 mgm. acetone as shown by Marriott.³ With such small quantities of acetone the reagent gives a turbidity which can be compared in a nephelometer with the turbidity given by a standard acetone solution containing .5 mgm. Folin and Denis⁴ find that the turbidity comparisons can be made with a Duboscq colorimeter thus avoiding the use of the nephelometer. The colorimeter must be carefully adjusted to the light so that the two fields are perfectly alike when a standard suspension is read against itself. It is preferable to have the light coming through a hole in a dark (green) window shade so as to exclude the interference of more or less bright objects.

In mixing the solutions in which the suspensions are formed they must not be shaken, but only gently rotated or inverted.

The procedure of Folin and Denis with small quantities of urine can be adapted to the estimation in blood, following Marriott's preliminary treatment to remove the proteins:—

The air current method using test tubes (p. 556) is used. The pre-formed acetone is obtained by aeration of the cold solution; if the solution be warmed both the pre-formed acetone and that from aceto-acetic acid is obtained; finally acetone is obtained from hydroxybutyric acid by oxidation with bichromate (p. 598). The comparison is made with the precipitate formed by a standard acetone solution containing .5 mgm.

¹ 40 parts HNO₃, 5 parts H₂SO₄, 55 parts H₂O.

² This may be standardised against mercuric nitrate.

³ J. Biol. Chem., 1913, 16, 289, 293; 1914, 18, 507.

⁴ *Ibid.*, 1914, 18, 263.
38*

(1) *Standard Acetone Solution.*

Folin and Denis have found, like Marriott, that freshly distilled solutions give more turbidity than undistilled. In order to avoid continual distillations for the preparation of the standard solution, they dilute a stronger solution with .25N sulphuric acid and thus obtain a standard which keeps for several weeks. It is prepared by diluting 2 c.c. of pure acetone, prepared from its bisulphite compound, with 500 c.c. of water, distilling and collecting the distillate in 100 c.c. of .25N sulphuric acid. The volume is diluted with acid to about 1000 c.c. and its acetone content determined by titration with iodine and thiosulphate (p. 593). The calculated quantity of this solution is diluted with .25N acid so that 10 c.c. contain .5 mgm. Further standards are prepared by taking this quantity, distilling and diluting with acid so that 10 c.c. of the distilled diluted solution contain .5 mgm.

(2) *Acetone Estimation.*

0.5-5 c.c. of urine (sufficient to give .5 mgm. acetone) are put in the test tube with 1 c.c. of 10 per cent. sulphuric acid and the acetone aspirated into 10 c.c. of 2 per cent. sodium bisulphite solution.¹ The aeration for .2 mgm. is complete in 10 minutes with a good water supply.

(3) *Acetone + Aceto-Acetic Acid Estimation.*

Fresh urine generally contains 2-10 times more aceto-acetic acid than acetone, so that the sample must be diluted so as to contain .3-.7 mgm. of total acetone.

The suitable quantity of urine is put into the test tube with 1 c.c. of 10 per cent. sulphuric acid and is heated in a boiling water-bath, the acetone being collected as above. An extremely slow air current is used for the first 10 minutes and is then increased, but need not be rapid, for another 5 minutes.

(4) *Comparison with the Standard Solution.*

The solutions are transferred to a 100 c.c. measuring flask, diluted to 50 or 60 c.c., 15 c.c. of Scott-Wilson reagent are added, made up to 100 c.c. and mixed. At the same time 10 c.c. of standard acetone solution (.5 mgm.) are added to 10 c.c. of the same bisulphite solution² in a 100 c.c. flask and diluted to 50 or 60 c.c.; 15 c.c. of reagent are added, made up to 100 c.c. and mixed. The turbidities are compared in a Duboscq colorimeter and are directly proportional (1 mgm. acetone = 1.8 mgm. aceto-acetic acid).

Estimation in Blood (Marriott).

The blood is drawn by puncture; 1-2 c.c. in cases of acidosis, 5 c.c. in cases with little or no acidosis. It is run into a weighed 50 c.c. conical flask containing 20 c.c. of 1 per cent. potassium oxalate. The flask is weighed and the increase gives the amount of blood. Sufficient colloidal iron solution is added to bring the volume to 50 c.c. and the solutions are mixed; .5 gm. of sodium sulphate is added, the flask is stoppered and well shaken to dissolve the sulphate and break up the mass of precipitate. The thick liquid is put into a centrifuge tube and centrifuged for about 2 minutes. The clear liquid is poured off through a filter paper and used for the estimation.

This procedure is similar to that used by Gardner and Maclean for glucose estimations in blood (p. 588) and the same quantities and manipulation could be equally well taken.

The acetone determination is made in 15 or 30 c.c. of the filtrate by distillation with 30 c.c. of sulphuric acid of sp. gr. 1.59, redistilled with peroxide and sodium hydroxide as in the general method (p. 593). This gives pre-formed acetone + acetone from aceto-acetic acid. By aeration the pre-formed acetone only is obtained.

The clear liquid free from proteins could be used for the acetone estimations by the Folin and Denis procedure.

¹ This dilute solution does not keep for more than a week, but is easily prepared when required. Dilute bisulphite retains the acetone perfectly; if water be used, the air current must be much slower.

² This must be used to obtain strictly comparable turbidities.

G. β -HYDROXYBUTYRIC ACID.

Three methods have been proposed for the estimation of β -hydroxybutyric acid :—

(1) Conversion into crotonic acid by distillation with sulphuric acid. This method originally described by Darmstaedter has not been found entirely satisfactory ; Ryffel described another procedure in 1905.¹

(2) Conversion into aceto-acetic acid by oxidation and estimation of the acetone by decomposition of the aceto-acetic acid.

This method has been worked out by Shaffer. The results are too low by about 10 per cent. as was shown later by Shaffer and Marriott² and also by Kennaway.³ The error appears to be constant so that the method can be employed if 10 per cent. be added to the values obtained.

In Urine.

Shaffer and Marriott's procedure is as follows :—

25 to 100 c.c. of urine (50 c.c. average) are placed in a 500 c.c. measuring flask containing 200-300 c.c. of water. A volume of basic lead acetate solution (U.S.P.) equal to the volume of urine is added and the liquids well mixed. A volume of strong ammonia water equal to half of the basic lead acetate solution is poured in and the volume made up to 500 c.c. with water. The contents are mixed and filtered after standing for a few minutes through a fluted filter paper. This treatment removes glucose and pigments. 200 c.c. of the filtrate are measured out into an 800 or 1000 c.c. round bottom flask, diluted to about 600 c.c. and 15 c.c. of concentrated sulphuric acid are added together with some talc or a piece of porcelain. The solution is distilled and 200 c.c. distillate collected in another 800 c.c. flask, the end of the condenser being placed under some water in this receiver. In order that the volume in the flask does not become less than 400-500 c.c., water is occasionally added through a tap funnel fitted in the neck of the flask.

This distillate contains acetone from aceto-acetic acid. It is redistilled after adding 10 c.c. of 10 per cent. sodium hydroxide solution and the distillate collected and titrated as described under aceto-acetic acid.

The residue of urine is again distilled and at the same time oxidised with potassium bichromate, of which 5.10 gm. is generally sufficient ; if the liquid turns green more will be required. The volume must be kept between 400-500 c.c. It is most convenient to keep a 10 per cent. solution of bichromate and to dilute 10 c.c. to 100 c.c. for each determination. 20 c.c. of the diluted solution are added through the tap funnel and alternately water, and 10 c.c. portions of bichromate are added every 15-20 minutes. If the liquid turns green, the bichromate must be added at shorter intervals. The oxidation and distillation is continued at a moderate rate for 2-3 hours.

The distillate is collected in a 1000 c.c. round bottom flask as before and redistilled after adding 10 c.c. of 10 per cent. sodium hydroxide and 25 c.c. of 3 per cent. hydrogen peroxide, the heating being cautious until the hydrogen peroxide is decomposed. Acetaldehyde obtained by the oxidation of lactic acid is removed by this second distillation. This distillate is titrated with iodine and thiosulphate.

1 c.c. .1N iodine solution = 0.001793 gm. hydroxybutyric acid.

¹ J. Physiol., 32, Proc. LVI.

² J. Biol. Chem., 1913, 16, 265.

³ Biochem. J., 1914, 8, 230.

In Tissues.

Marriott¹ has adapted the method for the estimation of hydroxybutyric acid in tissues:—

100 c.c. blood (or 50 to 100 gm. of minced tissue) are diluted with 400 c.c. of water and put through a dropping funnel into a 2-3 litre flask which is connected with a condenser and receiving flask containing 500 c.c. of water, the end of the condenser dipping into the water. The large flask containing 500 c.c. of water, 3.5 c.c. of glacial acetic acid and some powdered talc is heated to boiling. The blood is added at such a rate that boiling does not cease. The contents are distilled until 300 c.c. distillate have passed over; a small amount of foam which may pass over is of no consequence as the distillate is redistilled. The distillate contains acetone (pre-formed and from aceto-acetic acid). It is redistilled after adding a little dilute sulphuric acid which retains ammonia. It is again distilled after adding 20 c.c. of 3 per cent. hydrogen peroxide and a slight excess of alkali. This serves to destroy and hold back aldehydes, hydrogen sulphide and volatile acids. The distillate is titrated with iodine and thiosulphate (see p. 593).

The contents of the large flask whilst still hot are treated with about 15 c.c. of 20 per cent. sodium carbonate solution. As soon as sufficient has been added; the dark colour changes to brown and a precipitate settles, leaving a clear straw-coloured liquid of amphoteric reaction. The contents of the flask are boiled for 1-2 minutes, allowed to cool, transferred to a 1000 c.c. measuring cylinder and diluted to 1000 c.c. The contents are mixed and filtered on a Buchner funnel. 700 c.c. of the filtrate are put into a 1000 c.c. graduated flask, 30 c.c. basic lead acetate solution (U.S.P.) and 15 c.c. of strong ammonia are added and the volume made up to 1000 c.c. The contents are mixed, allowed to stand for a time and filtered through a dry folded paper. 900 c.c. of the filtrate are taken, boiled to remove the greater part of the ammonia and concentrated to 500 c.c. After cooling, excess of dilute sulphuric acid is added to remove the lead and then 30 c.c. of 50 per cent. sulphuric acid. The solution is put in a 1000 c.c. flask furnished with a dropping funnel and connected to a condenser. The contents are distilled, running in bichromate so that the liquid always retains a yellow colour and a volume of about 400-500 c.c.; 5 gm. bichromate is usually sufficient. Slow distillation is continued for 2 hours and 600-800 c.c. of distillate are collected, the end of the condenser being kept under water. The distillate is redistilled with 20 c.c. of peroxide and 5 c.c. of 10 per cent. sodium hydroxide. The distillate is titrated with iodine and thiosulphate (p. 597).

Micro-Analysis.

The oxidation method of Shaffer has been found by Folin and Denis to give correct results if the amount of hydroxybutyric acid to be oxidised is about 2-5 mgm.

Folin and Denis estimate hydroxybutyric acid in a similar way to acetone and aceto-acetic acid (see p. 593):—

The urine is diluted 10-50 times so that the volume to be taken contains about 2 mgm. The volume of diluted urine is put into a 500 c.c. round bottom flask with 200 c.c. of water and 5 c.c. of 10 per cent. sulphuric acid and boiled for 10 minutes to remove acetone and aceto-acetic acid. 25 c.c. of a solution containing 2 per cent. of potassium bichromate and 35 per cent. of sulphuric acid are added. The solution is distilled for 40-60 minutes, using an efficient condenser, the end of which is under 75-100 c.c. of

¹ J. Biol. Chem., 1913, 16, 293.

water in a Kjeldahl flask. The distillation and oxidation is best effected by rapidly raising to the boiling-point, heating gently for 30 minutes with little or no distillate passing over and then more rapidly for 15 minutes. 80 to 125 c.c. of distillate should be obtained in this time. 2 gm. of sodium peroxide are added to the distillate and the distillation repeated until 80 c.c. have passed over in about 10-15 minutes. The second distillate is collected under 10 c.c. of water in a 100 c.c. measuring flask. It is diluted to 100 c.c. and mixed; 25 or 50 c.c. are removed into another flask containing 25 c.c. water, 15 c.c. of Scott-Wilson reagent are added and the mixture diluted to 100 c.c.

At the same time 15 mgm. acetone are treated in the same way (see under acetone, p. 596).

1 mgm. acetone = 1.78 mgm. hydroxybutyric acid.

Notes.—The use of sodium peroxide obviates the use of lead acetate to remove glucose, glycuronic acid, etc.

Urines containing no sugar need not be distilled twice. The distillate is collected in 10 c.c. of water in a 100 c.c. measuring flask and diluted to 100 c.c.; 1-2 gm. of sodium peroxide are added to it and mixed with it a few times. This treatment removes the disturbing substances obtained by the distillation of the urine; 25 or 50 c.c. are taken for the estimation.

The estimation of hydroxybutyric acid in 1-5 c.c. of blood is effected by Marriott in a similar way to the general method, but using a nephelometer to estimate the acetone formed (see under acetone, p. 595).

The solution after removal of the proteins could be treated equally well by the method of Folin and Denis and it is a little simpler to carry out.

(3) Extraction with ether and estimation by rotation.

β -hydroxybutyric acid is most frequently estimated by this method; the results are affected by the presence of other substances in the extract which are also optically active, but their amounts are usually so small that they are neglected.

The urine (100-300 c.c.) may be evaporated and mixed with sand or plaster to form a dry mass, which is extracted in a Soxhlet apparatus with ether, according to the description of Bergell¹ or Black.²

It is preferable to extract the urine which has been acidified with sulphuric acid with ether in a special extraction apparatus.

(a) The urine (300-600 c.c.) is saturated with ammonium sulphate (80-90 gm. per 100 c.c.), strongly acidified with sulphuric acid and extracted for 24, 48, or 72 hours in the extractor with ether according to the rate of the current of ether. The ethereal solution is filtered into a basin and the ether allowed to evaporate spontaneously or rapidly distilled off. The residue is cooled, dissolved in 5-8 c.c. of water and filtered from hippuric acid and oily products into a small measuring flask of 10 or 20 c.c. capacity. The volume is made up and the rotation determined after clearing the solution with a small quantity of "kieselguhr" or charcoal.

(b) Hurlley³ treats 100 c.c. urine with 40 per cent. ferric chloride solution which is run in from a burette until ferric phosphate is no longer precipitated, but an amount insufficient for the aceto-acetic acid reaction to appear; 1000 c.c. are then treated with the proportional amount. 500 c.c. of the filtrate and the amount corresponding to half the number of c.c. of ferric chloride added are acidified with 13 c.c. of sulphuric acid (1 vol. acid + 1

¹ Z. Physiol. Chem., 1901, 33, 310.

² J. Biol. Chem., 1908-9, 5, 208.

³ I am much indebted to Dr. Hurlley for telling me his procedure and for much other information respecting "acetone" bodies.

vol. water) and extracted in his special form of extractor¹ (Fig. 85) for 24 hours at 65° or longer at lower temperatures, several pieces of broken porcelain being added to the ether in the boiling flask. The ether is distilled off below 80°, water is added, the solution boiled for 1 minute and made up to 50 or

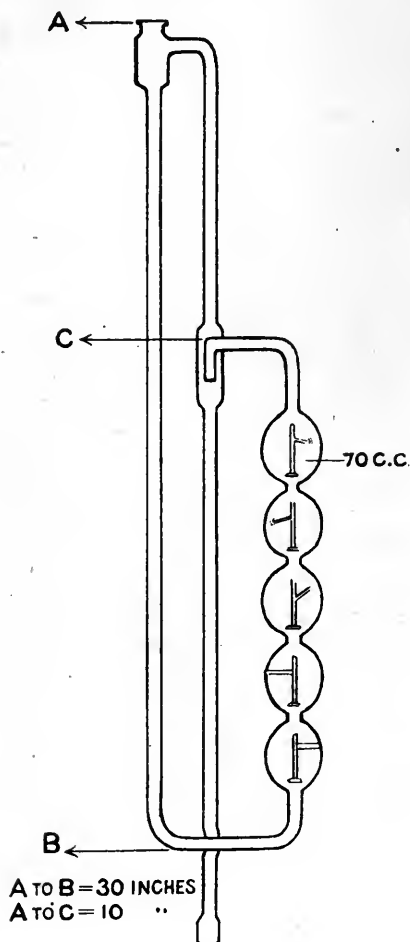

FIG. 85.

100 c.c. in a measuring flask. If there be much pigment, it is preferable to allow the solution to stand for 24 hours. The solution is filtered and its acid value determined by titration as well as its rotation by the polarimeter. The two values generally agree closely although slight traces of sulphuric acid are usually present.

¹ In filling the extractor the aqueous solution is poured in until it reaches the middle of the last and top bulb but one.

H. FAT.

It has been shown by Kumagawa and Suto¹ that the methods of Rosenfeld and of Pflüger for the estimation of fat in tissues are inaccurate and that accurate estimations of fat in tissues can only be obtained by converting the fat into fatty acids, i.e. estimating the fat as fatty acid. This method has been adopted by most workers and they have introduced some slight improvements (Hartley, Mottram). Tamura² does not consider that these improvements are necessary.

A convenient way of effecting the estimation is described by Mottram³:—

The organ is minced and thoroughly mixed after removal of the visible fat and connective tissue. Portions of 10-15 gm. are introduced through a funnel into weighed pressure bottles of about 150 c.c. capacity. The bottles are weighed and the same volume of 60 per cent. potassium hydroxide as there are grams of tissue are added. The bottles are closed with rubber stoppers, exhausted with a water pump and heated for 1.5 hours in a boiling water-bath, during which time they are frequently shaken, especially at first. The alkaline solution is transferred to a 250 c.c. separating funnel, the stoppers of which have been moistened with glycerin, and the bottle is rinsed out with warm water. The combined solution and washings are cooled with water and acidified with 20 c.c. of concentrated hydrochloric acid which is added slowly. A copious precipitate is formed. The acid solution is cooled and shaken for 30 seconds with 50 c.c. of purified ether. Separation takes place rapidly and the acid solution is run into a beaker until the precipitate begins to leave the funnel. The ethereal solution is siphoned into a CO₂ flask and the funnel rinsed twice with 10 c.c. of ether, the rinsings being siphoned into the same flask.

The precipitate which remains is dissolved in a few drops of strong potash and the solution is shaken for 30 seconds with 50 c.c. of ether. Before the emulsion has time to settle the acid solution in the beaker is added and the mixture shaken for 30 seconds. If separation does not take place at once, the funnel may be put in an incubator at 37° for a few minutes. The acid solution, but not the precipitate is run off and the ether siphoned into the CO₂ flask, the funnel being rinsed as before.

The solution of the precipitate is repeated, but 25 c.c. of ether are used in the extraction which is carried out as before.

¹ Biochem. Zs., 1908, 8, 212.

² *Ibid.*, 1913, 51, 463.

³ J. Physiol., 1910, 40, 131.

The united ethereal extracts are evaporated nearly to dryness in a current of carbon dioxide; absolute dryness is avoided as it causes pigmentation of the fatty acids. The residual solution is left to stand in an atmosphere of CO_2 for about 12 hours. A brown crystalline mass remains. This is dissolved in about 50 c.c. of petrol ether boiling at $40-60^\circ$ and the solution is filtered through asbestos¹ contained in a small glass cup upon a platinum cone attached to a long tube as in Fig. 86.



The filtrate is collected in a 250 c.c. separating funnel: the flask is rinsed out with petrol ether and the washings collected in the same separating funnel. The filter is also washed, especially the lower end.

To the solution are added 50 c.c. of a mixture of equal parts of strong absolute alcoholic potash and water and a few drops of phenolphthalein. The contents are shaken for 30 seconds. The lower layer is run off, when it has separated, into a 250 c.c. graduated cylinder. The petrol ether is washed with 50 c.c. and 25 c.c. of alcoholic potash as above. The united alkaline alcoholic solutions are acidified with 5 c.c. of concentrated hydrochloric acid. The fatty acids, so precipitated, are extracted by shaking twice with 50 c.c. and once with 25 c.c. of petrol ether, which is siphoned into a CO_2 flask. The funnel is rinsed between each extraction with 10 c.c. of petrol ether which is added to the main bulk. The united solutions and washings are evaporated in a current of carbon dioxide till the volume is 20 c.c. This solution is filtered as above through asbestos into a clean weighed glass flask (20-35 gm. in weight) fitted with a ground-in stopper with short entrance and exit tubes. The flask and filter are washed and the washings collected. The petrol is distilled off in a current of carbon dioxide and the fatty acids dried to constant weight *in vacuo* at 100° (six hours) and weighed.

They are dissolved in carbon tetrachloride for determination of the iodine values (p. 180).

¹The asbestos is treated with caustic alkali and *aqua regia* and washed with water. It is shaken with water for several hours to tease it. It is poured upon the filter, the water washed away with alcohol and ether, and dried. A layer 1 cm. deep is advantageous and it should be renewed for each estimation.

FIG. 86. —
(From J. Physiol., 38, 297, Cambridge University Press.)

I. CHOLESTEROL.

The most accurate method of estimating cholesterol in tissues is that adopted by Gardner and his co-workers, the method in the case of blood having been described by Gardner and Fraser.¹ This procedure is for the estimation of cholesterol and cholesterol esters. The blood is weighed and mixed with plaster of Paris; the dry mass is finely powdered and extracted for several days (or weeks) in a Soxhlet extractor with ether.

Gravimetrically.

(a) *Cholesterol.*

The ethereal extract is evaporated to dryness, the residue is weighed and taken up with 95 per cent. alcohol. Excess of digitonin dissolved in 95 per cent. alcohol is added and the mixture, after standing some time, is evaporated to dryness in a vacuum desiccator. The precipitate of the insoluble digitonin cholesteride

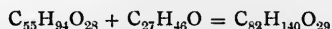

is washed by decantation with ether until the washings give no residue on evaporation. The washings are filtered through a Gooch crucible, or better a tared filter paper, which has been similarly treated. The excess of digitonin is dissolved with distilled water, the washing being continued until the water leaves no residue on evaporation. The precipitate is dried at 110°, cooled and weighed.

(b) *Cholesterol Ester.*

The ethereal washings are saponified with excess of sodium ethoxide, the ethereal solution is filtered from soap and the soap washed with ether. The ethereal solution and washings are freed from soap, alkali and alcohol by washing with water, dried with calcium chloride and evaporated to dryness. The dry residue is dissolved in 95 per cent. alcohol and treated as under (a).

(c) *Total Cholesterol. Cholesterol and Cholesterol Ester.*

It is preferable to estimate the total cholesterol in the tissues and to deduct the amount of cholesterol so as to obtain the amount of cholesterol as ester. A second portion of material is required. It is dried and extracted with ether as described (a), the ethereal solution is saponified with sodium ethoxide and filtered from soap, which is washed with ether, the ethereal solution and washings are freed from alkali, etc., with water, dried, evaporated and the residue dissolved in alcohol and precipitated with digitonin as under (a).

In these experiments the whole of the blood is used and it is divided into two portions as nearly equal in weight as possible.

Total cholesterol is about .08 per cent.

Cholesterol ester is about .04 " "

Colorimetrically.

Grigaut has described a method for estimating cholesterol in small quantities of blood or serum and tissues; the cholesterol is extracted with alcohol and ether, Liebermann's reaction is performed and the colour compared with the colour produced in the same way with a known amount of cholesterol.

It is carried out as follows:—

2 c.c. of serum are placed in a specially made separating funnel of a total volume of about 50 c.c. and with a narrow portion to contain about 15 c.c., points showing the level of 15 c.c. and 30 c.c. being marked; 60 per cent. alcohol containing .5 per cent. of sodium hydroxide is added as far as the

¹ Proc. Royal Soc., 1910, B, 82, 560.

mark 15 c.c. and ether to the mark 30 c.c. The vessel is stoppered and the contents mixed by inverting twice. After standing the lower layer is separated and replaced by 20 c.c. of water which is allowed to run down the sides. After 5 minutes the water is withdrawn and a second washing with water carried out in the same way. The ether is put into a basin of 30 c.c. capacity, the funnel washed with ether and the ether and the washings evaporated.

The residue is dissolved in 2 c.c. of chloroform, the solution placed in a graduated test tube of 10 c.c. capacity and the basin washed out with about 3 c.c. of chloroform which is also transferred to the test tube.

2 c.c. of acetic anhydride and 3 drops of sulphuric acid (66 per cent.) are added.

At the same time 5 c.c. of a solution of .06 per cent. cholesterol in chloroform together with 3 drops of acetic anhydride and 3 drops of sulphuric acid are placed in another graduated test tube.

The green colorations of the solutions are compared in half an hour when the maximal coloration is reached. 5 c.c. of each of the solutions are poured into the cups of a dilution colorimeter and the deeper one is diluted with a mixture of chloroform, acetic anhydride and sulphuric acid in the above proportions.

If n is the number of c.c. of the diluted solution and P is the cholesterol content of 1000 c.c. of serum,

$$P = 0.30 \times n \text{ gm. if the unknown is diluted.}$$

$$P = \frac{7.50}{n} \text{ gm. if the control is diluted.}$$

In the case of tissues 0.2-1 gm. is placed in a 90 c.c. flask, 30 c.c. of 70 per cent. alcohol containing 1 per cent. of sodium hydroxide are added, and the mixture heated in a boiling water-bath till the tissue dissolves and the volume is about 15 c.c. These 15 c.c. are put in the special separating funnel (above) and the flask is washed out with 15 c.c. of ether. The rest of the process is the same as with serum.

If P is the amount of cholesterol in 1000 gm. of tissue,

$$P = \frac{0.6n}{p} \text{ gm. if the unknown is diluted,}$$

$$P = \frac{15}{n \times p} \text{ gm. if the control is diluted,}$$

where p is the weight of the tissue taken.

For larger quantities of serum or tissue Grigaut describes a gravimetric method:—

20 c.c. of serum are placed in a 250 c.c. flask, 20 c.c. of 40 per cent. sodium hydroxide are added and the mixture is heated in an autoclave at 110° for 1 hour.

5-10 gm. of tissue are mixed with 40 c.c. of 40 per cent. sodium hydroxide diluted with an equal volume of water and heated in an autoclave at 110° for 1 hour.

The solution is put into a separating funnel and shaken whilst still warm (at 40-45°) with 60 c.c. of ether. The lower layer is withdrawn, warmed to 40-45° and again shaken with 60 c.c. of ether. This extraction is carried out 10 times.

The ethereal solutions are evaporated, the residue is dissolved in 50 c.c. of 95 per cent. alcohol containing 1 c.c. of 1 per cent. alcoholic sodium hydroxide and the solution is evaporated on a water-bath. The residue is heated in a steam oven for half an hour and the dry residue is dissolved in petroleum ether whilst the vessel is still warm. The impurities are insoluble and are filtered off through asbestos and washed with petroleum ether. The petrol solutions are evaporated in a weighed basin. Pure cholesterol separates; it is dried at 100°, cooled and weighed.

TABLE¹ OF REDUCING VALUES OF VARYING QUANTITIES OF DEXTROSE, LEVULOSE AND INVERT-SUGAR UNDER THE STANDARD CONDITIONS GIVEN ON PAGE 227.

(Adopted by Brown, Morris and Millar, "Journal of the Chemical Society," 1897, vol. lxxi., p. 281.)

Dextrose.				Levulose.				Invert-Sugar.		
Dextrose. Grms.	Cu. Grms.	CuO. Grms.	Cu. Corresponding to 1 Grm. Dextrose.	Levulose. Grms.	Cu. Grms.	CuO. Grms.	Cu. Corresponding to 1 Grm. Levulose.	Invert-Sugar. Grms.	Cu. Grms.	CuO. Grms.
'050	'1030	'1289	2'060	'050	'0923	'1155	1'846	'050	'0975	'1221
'055	'1134	'1422	2'061	'055	'1027	'1287	1'858	'055	'1076	'1349
'060	'1238	'1552	2'063	'060	'1122	'1407	1'870	'060	'1176	'1474
'065	'1342	'1682	2'062	'065	'1216	'1524	1'871	'065	'1275	'1598
'070	'1443	'1809	2'061	'070	'1312	'1645	1'874	'070	'1373	'1721
'075	'1543	'1935	2'058	'075	'1405	'1761	1'873	'075	'1468	'1840
'080	'1644	'2061	2'055	'080	'1500	'1881	1'875	'080	'1566	'1963
'085	'1740	'2187	2'046	'085	'1590	'1993	1'871	'085	'1662	'2084
'090	'1834	'2299	2'038	'090	'1686	'2114	1'873	'090	'1755	'2200
'095	'1930	'2420	2'033	'095	'1774	'2224	1'868	'095	'1848	'2317
'100	'2027	'2538	2'027	'100	'1862	'2331	1'862	'100	'1941	'2430
'105	'2123	'2662	2'024	'105	'1952	'2447	1'859	'105	'2034	'2550
'110	'2218	'2781	2'020	'110	'2040	'2558	1'855	'110	'2128	'2668
'115	'2313	'2900	2'012	'115	'2129	'2669	1'851	'115	'2220	'2783
'120	'2404	'3014	2'003	'120	'2215	'2777	1'846	'120	'2311	'2898
'125	'2496	'3130	1'997	'125	'2303	'2887	1'843	'125	'2400	'3009
'130	'2585	'3241	1'990	'130	'2390	'2997	1'840	'130	'2489	'3121
'135	'2675	'3354	1'981	'135	'2477	'3106	1'834	'135	'2578	'3232
'140	'2762	'3463	1'973	'140	'2559	'3209	1'828	'140	'2663	'3339
'145	'2850	'3573	1'964	'145	'2641	'3311	1'822	'145	'2750	'3448
'150	'2934	'3673	1'956	'150	'2723	'3409	1'815	'150	'2832	'3546
'155	'3020	'3787	1'948	'155	'2805	'3517	1'811	'155	'2915	'3655
'160	'3103	'3891	1'940	'160	'2889	'3622	1'806	'160	'3002	'3764
'165	'3187	'3996	1'931	'165	'2972	'3726	1'803	'165	'3086	'3869
'170	'3268	'4098	1'922	'170	'3053	'3828	1'799	'170	'3167	'3971
'175	'3350	'4200	1'914	'175	'3134	'3930	1'793	'175	'3251	'4076
'180	'3431	'4302	1'906	'180	'3216	'4032	1'787	'180	'3331	'4177
'185	'3508	'4399	1'896	'185	'3297	'4134	1'782	'185	'3410	'4276
'190	'3590	'4501	1'890	'190	'3377	'4234	1'777	'190	'3490	'4376
'195	'3668	'4599	1'881	'195	'3457	'4335	1'773	'195	'3570	'4476
'200	'3745	'4689	1'872	'200	'3539	'4431	1'769	'200	'3650	'4570
'205	'3822	'4792	1'863	'205	'3616	'4534	1'765	'205	'3726	'4672

The sugar values for weights of Cu or CuO lying between any of the weights given in the above table must be arrived at by calculation.

Example.—The amount of dextrose corresponding with '2385 grm. Cu is required. On referring to the table '2313 grm. Cu corresponds with '115 grm. dextrose; and '2404 grm. Cu with '120 grm. dextrose. Hence '2404 - '2313 = '0991 grm. Cu; and '120 - '115 = '005 grm. dextrose. Therefore '0991 grm. Cu = '005 grms. dextrose in the portion of the table used. Now the difference between the amount of Cu found, '2385, and the nearest lower amount in the table, '2313 grm. is '0072 grm. Hence: '0991 : '005 :: '0072 : '004. Therefore '115 + '004 = '119 grm. dextrose corresponding to '2385 grm. Cu.

¹ Reproduced from Adrian J. Brown's "Laboratory Studies for Brewing Students" (Longmans & Co.).

Table of Corresponding Values of Glucose and Copper for Bertrand's Method of Estimating Glucose (p. 228).

Reprinted from G. Bertrand et P. Thomas' "Guide pour les Manipulations de Chemie Biologie" (H. Dunod et E. Pinat, Éditeurs à Paris).

Glucose mgm.	Copper mgm.	Glucose mgm.	Copper mgm.	Glucose mgm.	Copper mgm.	Glucose mgm.	Copper mgm.	Glucose mgm.	Copper mgm.
10.	20·4	29	57·2	47	90·0	65	121·3	83	150·9
11	22·4	30	59·1	48	91·8	66	123·0	84	152·5
12	24·3	31	60·9	49	93·6	67	124·7	85	154·0
13	26·3	32	62·8	50	95·4	68	126·4	86	155·6
14	28·3	33	64·6	51	97·1	69	128·1	87	157·2
15	30·2	34	66·5	52	98·9	70	129·8	88	158·8
16	32·2	35	68·3	53	100·6	71	131·4	89	160·4
17	34·2	36	70·1	54	102·3	72	133·1	90	162·0
18	36·2	37	72·0	55	104·1	73	134·7	91	163·6
19	38·1	38	73·8	56	105·8	74	136·3	92	165·2
20	40·1	39	75·7	57	107·6	75	137·9	93	166·7
21	42·0	40	77·5	58	109·3	76	139·6	94	168·3
22	43·9	41	79·3	59	111·1	77	141·2	95	169·9
23	45·8	42	81·1	60	112·8	78	142·8	96	171·5
24	47·7	43	82·9	61	114·5	79	144·5	97	173·1
25	49·6	44	84·7	62	116·2	80	146·1	98	174·6
26	51·5	45	86·4	63	117·9	81	147·7	99	176·2
27	53·4	46	88·2	64	119·6	82	149·3	100	177·8
28	55·3								

Table of Corresponding Values of $\frac{N}{250}$ Thiosulphate and Glucose for Maclean's Method of Estimating Glucose in Blood¹ (p. 588).

'004N Thio- sulphate c.c.	Glucose mgm.	'004N Thio- sulphate c.c.	Glucose mgm.	'004N Thio- sulphate c.c.	Glucose mgm.	'004N Thio- sulphate c.c.	Glucose mgm.	'004N Thio- sulphate c.c.	Glucose mgm.
0·40	0·05	3·94	0·47	7·57	0·86	11·25	1·25	14·67	1·63
0·60	0·07	4·03	0·48	7·66	0·87	11·34	1·26	14·76	1·64
0·78	0·10	4·11	0·49	7·75	0·88	11·43	1·27	14·85	1·65
0·86	0·11	4·20	0·50	7·84	0·89	11·52	1·28	14·94	1·66
0·93	0·12	4·28	0·51	7·93	0·90	11·61	1·29	15·03	1·67
1·01	0·13	4·36	0·52	8·00	0·91	11·70	1·30	15·12	1·68
1·10	0·14	4·45	0·53	8·09	0·92	11·79	1·31	15·21	1·69
1·17	0·15	4·55	0·54	8·18	0·93	11·88	1·32	15·30	1·70
1·25	0·16	4·65	0·55	8·27	0·94	11·97	1·33	15·39	1·71
1·32	0·17	4·74	0·56	8·37	0·95	12·06	1·34	15·48	1·72
1·40	0·18	4·84	0·57	8·47	0·96	12·15	1·35	15·57	1·73
1·48	0·19	4·95	0·58	8·58	0·97	12·24	1·36	15·63	1·74
1·55	0·20	5·05	0·59	8·67	0·98	12·33	1·37	15·72	1·75
1·63	0·21	5·15	0·60	8·76	0·99	12·42	1·38	15·81	1·76
1·71	0·22	5·24	0·61	8·87	1·00	12·51	1·39	15·90	1·77
1·79	0·23	5·33	0·62	8·98	1·01	12·60	1·40	16·00	1·78
1·89	0·24	5·41	0·63	9·09	1·02	12·69	1·41	16·10	1·79
1·98	0·25	5·50	0·64	9·21	1·03	12·78	1·42	16·20	1·80
2·08	0·26	5·59	0·65	9·32	1·04	12·87	1·43	16·29	1·81
2·18	0·27	5·67	0·66	9·43	1·05	12·96	1·44	16·39	1·82
2·28	0·28	5·82	0·67	9·54	1·06	13·05	1·45	16·49	1·83
2·37	0·29	5·91	0·68	9·63	1·07	13·14	1·46	16·59	1·84
2·46	0·30	6·00	0·69	9·72	1·08	13·23	1·47	16·69	1·85
2·54	0·31	6·10	0·70	9·81	1·09	13·32	1·48	16·80	1·86
2·62	0·32	6·19	0·71	9·90	1·10	13·41	1·49	16·90	1·87
2·71	0·33	6·27	0·72	9·99	1·11	13·50	1·50	17·00	1·88
2·80	0·34	6·36	0·73	10·08	1·12	13·59	1·51	17·10	1·89
2·89	0·35	6·45	0·74	10·17	1·13	13·68	1·52	17·20	1·90
2·98	0·36	6·53	0·75	10·26	1·14	13·77	1·53	17·30	1·91
3·08	0·37	6·64	0·76	10·35	1·15	13·86	1·54	17·40	1·92
3·18	0·38	6·75	0·77	10·44	1·16	13·95	1·55	17·50	1·93
3·27	0·39	6·86	0·78	10·53	1·17	14·04	1·56	17·60	1·94
3·36	0·40	6·95	0·79	10·62	1·18	14·13	1·57	17·70	1·95
3·44	0·41	7·04	0·80	10·71	1·19	14·22	1·58	17·80	1·96
3·52	0·42	7·12	0·81	10·80	1·20	14·31	1·59	17·90	1·97
3·61	0·43	7·21	0·82	10·89	1·21	14·40	1·60	18·00	1·98
3·69	0·44	7·30	0·83	10·98	1·22	14·49	1·61	18·10	1·99
3·78	0·45	7·39	0·84	11·07	1·23	14·58	1·62	18·20	2·00
3·86	0·46	7·48	0·85	11·16	1·24				

¹ J. Physiol., 1916, 50, 177.

Table of Milligrams of Amino Nitrogen corresponding to 1 c.c. of Nitrogen Gas at 11°-30° C.;
728-772 mm. pressure.

t	728	730	732	734	736	738	740	742	744	746	748	750
11°	0.5680	0.5695	0.5510	0.5725	0.5745	0.5760	0.5775	0.5790	0.5805	0.5820	0.5840	0.5855
12°	0.5655	0.5670	0.5685	0.5700	0.5720	0.5735	0.5750	0.5765	0.5780	0.5795	0.5815	0.5830
13°	0.5630	0.5645	0.5660	0.5675	0.5695	0.5710	0.5725	0.5740	0.5755	0.5770	0.5785	0.5805
14°	0.5605	0.5620	0.5635	0.5650	0.5665	0.5680	0.5700	0.5715	0.5730	0.5745	0.5760	0.5775
15°	0.5580	0.5595	0.5610	0.5625	0.5640	0.5655	0.5670	0.5685	0.5705	0.5720	0.5735	0.5750
16°	0.5555	0.5570	0.5585	0.5600	0.5615	0.5630	0.5645	0.5660	0.5675	0.5690	0.5710	0.5725
17°	0.5525	0.5540	0.5555	0.5575	0.5590	0.5605	0.5620	0.5635	0.5650	0.5665	0.5680	0.5695
18°	0.5500	0.5515	0.5530	0.5545	0.5560	0.5580	0.5595	0.5610	0.5625	0.5640	0.5655	0.5670
19°	0.5475	0.5490	0.5505	0.5520	0.5535	0.5550	0.5565	0.5580	0.5595	0.5610	0.5630	0.5645
20°	0.5445	0.5460	0.5475	0.5495	0.5510	0.5525	0.5540	0.5555	0.5570	0.5585	0.5600	0.5615
21°	0.5420	0.5435	0.5450	0.5465	0.5480	0.5495	0.5510	0.5525	0.5540	0.5555	0.5575	0.5590
22°	0.5395	0.5410	0.5425	0.5440	0.5455	0.5470	0.5485	0.5500	0.5515	0.5530	0.5545	0.5560
23°	0.5365	0.5380	0.5395	0.5410	0.5425	0.5440	0.5455	0.5470	0.5485	0.5500	0.5515	0.5530
24°	0.5335	0.5350	0.5365	0.5380	0.5400	0.5415	0.5430	0.5445	0.5460	0.5475	0.5490	0.5505
25°	0.5310	0.5325	0.5340	0.5355	0.5370	0.5385	0.5400	0.5415	0.5430	0.5445	0.5460	0.5475
26°	0.5260	0.5295	0.5310	0.5325	0.5340	0.5355	0.5370	0.5365	0.5400	0.5415	0.5430	0.5445
27°	0.5250	0.5265	0.5280	0.5295	0.5310	0.5325	0.5340	0.5355	0.5370	0.5385	0.5400	0.5415
28°	0.5220	0.5235	0.5250	0.5265	0.5280	0.5295	0.5310	0.5325	0.5340	0.5355	0.5370	0.5385
29°	0.5195	0.5210	0.5220	0.5235	0.5250	0.5265	0.5280	0.5295	0.5310	0.5325	0.5340	0.5355
30°	0.5160	0.5175	0.5190	0.5205	0.5220	0.5235	0.5250	0.5265	0.5280	0.5295	0.5310	0.5325
t	752	754	756	758	760	762	764	766	768	770	772	
11°	0.5870	0.5885	0.5900	0.5915	0.5935	0.5950	0.5965	0.5980	0.5995	0.6010	0.6030	
12°	0.5845	0.5860	0.5875	0.5890	0.5905	0.5925	0.5940	0.5955	0.5970	0.5985	0.6000	
13°	0.5820	0.5835	0.5850	0.5865	0.5880	0.5895	0.5910	0.5930	0.5945	0.5960	0.5975	
14°	0.5790	0.5805	0.5825	0.5840	0.5855	0.5870	0.5885	0.5900	0.5915	0.5935	0.5950	
15°	0.5765	0.5765	0.5795	0.5810	0.5830	0.5845	0.5860	0.5875	0.5890	0.5905	0.5920	
16°	0.5740	0.5755	0.5770	0.5785	0.5800	0.5815	0.5830	0.5850	0.5865	0.5880	0.5895	
17°	0.5710	0.5730	0.5745	0.5760	0.5775	0.5790	0.5805	0.5820	0.5825	0.5850	0.5865	
18°	0.5685	0.5700	0.5715	0.5730	0.5745	0.5765	0.5780	0.5795	0.5810	0.5825	0.5840	
19°	0.5660	0.5675	0.5690	0.5705	0.5720	0.5735	0.5750	0.5765	0.5780	0.5795	0.5810	
20°	0.5630	0.5645	0.5660	0.5675	0.5690	0.5705	0.5725	0.5740	0.5755	0.5770	0.5785	
21°	0.5605	0.5620	0.5635	0.5650	0.5665	0.5680	0.5695	0.5710	0.5725	0.5740	0.5755	
22°	0.5575	0.5590	0.5605	0.5620	0.5635	0.5650	0.5665	0.5680	0.5695	0.5715	0.5730	
23°	0.5545	0.5560	0.5575	0.5595	0.5610	0.5625	0.5640	0.5655	0.5670	0.5685	0.5700	
24°	0.5520	0.5535	0.5550	0.5565	0.5580	0.5595	0.5610	0.5625	0.5640	0.5655	0.5670	
25°	0.5490	0.5505	0.5520	0.5535	0.5550	0.5565	0.5580	0.5595	0.5610	0.5625	0.5640	
26°	0.5460	0.5475	0.5490	0.5505	0.5520	0.5535	0.5550	0.5565	0.5580	0.5595	0.5610	
27°	0.5430	0.5445	0.5460	0.5475	0.5490	0.5505	0.5520	0.5535	0.5550	0.5565	0.5580	
28°	0.5400	0.5415	0.5430	0.5445	0.5460	0.5475	0.5490	0.5505	0.5520	0.5535	0.5550	
29°	0.5370	0.5385	0.5400	0.5415	0.5430	0.5445	0.5460	0.5475	0.5490	0.5505	0.5520	
30°	0.5340	0.5355	0.5370	0.5385	0.5400	0.5415	0.5430	0.5445	0.5460	0.5475	0.5490	

TABLE OF PRESSURE OF AQUEOUS VAPOUR (REGNAULT).

Temperature C.	Pressure in mm. of Mercury.	Temperature C.	Pressure in mm. of Mercury.
0.0	4.6	15.0	12.7
0.5	4.8	15.5	13.1
1.0	4.9	16.0	13.5
1.5	5.1	16.5	14.0
2.0	5.3	17.0	14.4
2.5	5.5	17.5	14.9
3.0	5.7	18.0	15.4
3.5	5.9	18.5	15.8
4.0	6.1	19.0	16.3
4.5	6.3	19.5	16.9
5.0	6.5	20.0	17.4
5.5	6.8	20.5	17.9
6.0	7.0	21.0	18.5
6.5	7.2	21.5	19.1
7.0	7.5	22.0	19.7
7.5	7.8	22.5	20.3
8.0	8.0	23.0	20.9
8.5	8.3	23.5	21.5
9.0	8.6	24.0	22.2
9.5	8.9	24.5	22.9
10.0	9.2	25.0	23.5
10.5	9.5	25.5	24.3
11.0	9.8	26.0	25.0
11.5	10.1	26.5	25.7
12.0	10.5	27.0	26.5
12.5	10.8	27.5	27.3
13.0	11.2	28.0	28.1
13.5	11.5	28.5	28.9
14.0	11.9	29.0	29.8
14.5	12.3	29.5	30.7

TABLE OF METRIC AND ENGLISH WEIGHTS AND MEASURES.

1 cm.	= '375 inch.	1 inch	= 2.55 cm.
1 metre	= 1.0904 yards. = 39.37 inches.	1 foot	= '305 metre.
		1 yard	= '9144 metre.
1 gm.	= 15.4 grains. = '0353 oz. = '032 oz. (Troy). = 15 grains (Troy).	1 grain	= 64.8 milligm. = '065 gm.
		1 oz.	= 28.35 gm.
1 kilo.	= 2.2046 lbs.	1 oz. (Troy)	= 31.1 gm.
		1 lb.	= 453.6 gm.
1 c.c.	= 16.89 minims. = '28 drachm. = '035 oz.	(1 grain)	= 1 minim = '059 c.c.
		20 minims	= 1 scruple = 1.18 c.c.
		3 scruples	= 1 drachm = 3.55 c.c.
1 litre	= 1.76 pints. = 35.2 oz. = '22 gallon.	8 drachms	= 1 oz. = 28.42 c.c.
		20 oz.	= 1 pint = '57 litre.
		160 oz.	= 1 gallon = 4.546 litres.
1 gallon	= 277.27 cubic inches (water). = 10 lbs. = 70.000 grains.		
1 cubic foot (water)	= 62.42 lbs.		
1 fluid oz.	= 1 oz. Avoirdupois.		
1 fluid drachm	= 2 drams Avoirdupois.		
1 lb.	= 7000 grains.		

TABLE OF INTERNATIONAL ATOMIC WEIGHTS.

O = 16			O = 16		
Aluminium	Al	27.1	Manganese	Mn	54.93
Antimony	Sb	120.2	Mercury	Hg	200.6
Arsenic	As	74.96	Molybdenum	Mo	96.0
Barium	Ba	137.37	Nickel	Ni	58.68
Bismuth	Bi	208.0	Nitrogen	N	14.01
Boron	B	11.0	Osmium	Os	190.9
Bromine	Br	79.92	Oxygen	O	16.00
Cadmium	Cd	112.40	Palladium	Pd	106.7
Calcium	Ca	40.07	Phosphorus	P	31.04
Carbon	C	12.00	Platinum	Pt	195.2
Chlorine	Cl	35.46	Potassium	K	39.10
Chromium	Cr	52.0	Selenium	Se	79.2
Cobalt	Co	58.97	Silicon	Si	28.3
Copper	Cu	63.57	Silver	Ag	107.88
Fluorine	F	19.0	Sodium	Na	23.00
Glucinum	Gl	9.1	Strontium	Sr	87.63
Gold	Au	197.2	Sulphur	S	32.07
Hydrogen	H	1.008	Tantalum	Ta	181.5
Iodine	I	126.92	Tellurium	Te	127.5
Iridium	Ir	193.1	Tin	Sn	119.0
Iron	Fe	55.84	Titanium	Ti	48.1
Lanthanum	La	139.0	Tungsten	W	184.0
Lead	Pb	207.10	Uranium	U	238.5
Lithium	Li	6.94	Zinc	Zn	65.37
Magnesium	Mg	24.32			

LIST OF REAGENTS.

ACIDS.

	100 c.c. contain
Acetic acid, glacial, sp. gr. 1.06	111.1 gm. CH ₃ COOH
Acetic acid, dilute, $\frac{1}{2}$ normal (27 c.c. glacial acetic acid made up to 1 litre)	3.0 gm. CH ₃ COOH
Hydrochloric acid, concentrated, sp. gr. 1.16	36.6 gm. HCl
Hydrochloric acid, dilute, $\frac{2}{1}$ normal (200 c.c. conc. acid made up to 1 litre)	7.3 gm. HCl
Hydrochloric acid, dilute, $\frac{1}{10}$ normal (10 c.c. conc. acid made up to 1 litre)	0.36 gm. HCl
Nitric acid, fuming, sp. gr. 1.50 (about 65 per cent.)	
Nitric acid, concentrated, sp. gr. 1.42	99.1 gm. HNO ₃
Nitric acid, dilute, $\frac{2}{1}$ normal (125 c.c. conc. acid made up to 1 litre)	12.6 gm. HNO ₃
Sulphuric acid, concentrated, sp. gr. 1.84	175.9 gm. H ₂ SO ₄
Sulphuric acid, dilute, $\frac{2}{1}$ normal (56 c.c. conc. sulphuric acid made up to 1 litre)	9.8 gm. H ₂ SO ₄
Sulphuric acid, dilute, $\frac{1}{10}$ normal (2.8 c.c. conc. sulphuric acid made up to 1 litre)	0.5 gm. H ₂ SO ₄

ALKALIES.

Ammonia, concentrated, sp. gr. .880	31.0 gm. NH ₃
Ammonia, dilute, $\frac{2}{1}$ normal (105 c.c. conc. ammonia made up to 1 litre)	3.4 gm. NH ₃
Barium hydroxide, $\frac{1}{4}$ normal (40 gm. Ba(OH) ₂ · 8H ₂ O dissolved in water and made up to 1 litre)	4.2 gm. Ba(OH) ₂
Sodium hydroxide, sp. gr. 1.34	40 gm. NaOH
(410 gm. 98 per cent. caustic soda dissolved in water and made up to 1 litre)	
(426 gm. 94 per cent. caustic soda dissolved in water and made up to 1 litre)	
Sodium hydroxide, dilute, $\frac{2}{1}$ normal	8.0 gm. NaOH
(82 gm. 98 per cent. caustic soda dissolved in water and made up to 1 litre)	
(85 gm. 94 per cent. caustic soda dissolved in water and made up to 1 litre)	
Sodium hydroxide, dilute, $\frac{1}{10}$ normal	0.4 gm. NaOH
(4.1 gm. 98 per cent. caustic soda dissolved in water and made up to 1 litre)	
(4.2 gm. 94 per cent. caustic soda dissolved in water and made up to 1 litre)	

SALT SOLUTIONS.

	100 c.c. contain
Ammonium chloride, $\frac{2}{1}$ normal	10.7 gm.
(107 gm. NH_4Cl dissolved in water and made up to 1 litre)	
Ammonium carbonate, $\frac{1}{1}$ normal	4.8 gm.
(48 gm. $(\text{NH}_4)_2\text{CO}_3$ dissolved in water and made up to 1 litre)	
Ammonium molybdate	11.5 gm.
(124 gm. $(\text{NH}_4)_6\text{Mo}_7\text{O}_{24} \cdot 4\text{H}_2\text{O}$ dissolved in cold water and made up to 1 litre)	
Ammonium nitrate, $\frac{1}{1}$ normal	80 gm.
(800 gm. NH_4NO_3 dissolved in water and made up to 1 litre)	
Ammonium sulphide, $\frac{2}{1}$ normal	6.8 gm.
Barium chloride, $\frac{1}{1}$ normal	10.4 gm.
(122 gm. $\text{BaCl}_2 \cdot 2\text{H}_2\text{O}$ dissolved in water and made up to 1 litre)	
Calcium chloride, $\frac{1}{2}$ normal	2.7 gm.
(55 gm. $\text{CaCl}_2 \cdot 6\text{H}_2\text{O}$ dissolved in water and made up to 1 litre)	
Copper sulphate (Fehling's solution A), about $\frac{1}{2}$ normal	4.0 gm.
(69.3 gm. $\text{CuSO}_4 \cdot 5\text{H}_2\text{O}$ dissolved in water and made up to 1 litre)	
Ferric chloride, $\frac{1}{2}$ normal	2.7 gm.
(27 gm. dissolved in water and made up to 1 litre)	
Iodine solution, $\frac{1}{10}$ normal	1.3 gm.
(13 gm. iodine dissolved in 30 gm. KI in 250 c.c. water and made up to 1 litre)	
Lead acetate, $\frac{1}{2}$ normal	8.1 gm.
(95 gm. $\text{Pb}(\text{C}_2\text{H}_3\text{O}_2)_2 \cdot 3\text{H}_2\text{O}$ dissolved in water and made up to 1 litre)	
Lead acetate, basic $\frac{1}{2}$ normal	13.6 gm.
(56 gm. litharge dissolved in 95 gm. lead acetate in about 800 c.c. water and then made up to 1 litre)	
Mercuric chloride, $\frac{1}{2}$ normal	6.8 gm.
(68 gm. HgCl_2 dissolved in water and made up to 1 litre)	
Potassium bichromate, $\frac{1}{2}$ normal	2.4 gm.
(24.55 gm. $\text{K}_2\text{Cr}_2\text{O}_7$ dissolved in water and made up to 1 litre)	
Potassium chloride, $\frac{1}{1}$ normal	7.4 gm.
(4.5 gm. KCl dissolved in water and made up to 1 litre)	
Potassium ferrocyanide, $\frac{1}{2}$ normal	4.0 gm.
(53 gm. $\text{K}_4\text{Fe}(\text{CN})_6 \cdot 3\text{H}_2\text{O}$ dissolved in water and made up to 1 litre)	
Potassium ferricyanide, $\frac{2}{1}$ normal	4.4 gm.
(44 gm. $\text{K}_3\text{Fe}(\text{CN})_6$ dissolved in water and made up to 1 litre)	
Potassium oxalate, $\frac{1}{10}$ normal	0.8 gm.
(8.3 gm. $\text{K}_2\text{C}_2\text{O}_4$ dissolved in water and made up to 1 litre)	
Potassium permanganate, $\frac{1}{20}$ normal	1.6 gm.
(1.581 gm. KMnO_4 dissolved in water and made up to 1 litre)	
Potassium thiocyanate, $\frac{1}{10}$ normal	1.0 gm.
(9.73 gm. KSCN dissolved in water and made up to 1 litre)	
Sodium carbonate, $\frac{1}{2}$ normal	2.6 gm.
(71.5 gm. $\text{Na}_2\text{CO}_3 \cdot 10\text{H}_2\text{O}$ dissolved in water and made up to 1 litre)	

	100 c.c. contain
Sodium chloride, $\frac{2}{1}$ normal (117 gm. NaCl dissolved in water and made up to 1 litre)	117 gm.
Silver nitrate, $\frac{1}{10}$ normal (17 gm. AgNO ₃ dissolved in water and made up to 1 litre)	17 gm.
Sodium nitrite, $\frac{1}{10}$ normal (6.9 gm. NaNO ₂ dissolved in water and made up to 1 litre)	0.7 gm.
Sodium phosphate, $\frac{1}{1}$ normal (119.5 gm. Na ₂ HPO ₄ · 12H ₂ O dissolved in water and made up to 1 litre)	4.7 gm.
Uranium acetate, $\frac{1}{10}$ normal (21.3 gm. UrO ₂ (C ₂ H ₃ O ₂) ₂ · 2H ₂ O dissolved in water and made up to 1 litre) (1 c.c. = 0.00355 gm. P ₂ O ₅)	2.1 gm.
Uranium nitrate, $\frac{1}{10}$ normal (25.18 gm. UrO ₂ (NO ₃) ₂ · 6H ₂ O dissolved in water and made up to 1 litre) (1 c.c. = 0.00355 gm. P ₂ O ₅)	2.5 gm.

• SOLIDS.

Ammonium carbonate.	Phosphorous pentachloride.
Ammonium chloride.	Phosphorous pentoxide.
Ammonium sulphate.	Potassium bichromate.
Barium carbonate.	Potassium carbonate.
Bismuth subnitrate.	Potassium oxalate.
Borax.	Potassium sulphate.
Bleaching powder.	Potassium sulphate (acid).
Calcium carbonate.	Potassium permanganate.
Calcium chloride (dry)	Soda, caustic.
Calcium sulphate (plaster of Paris)	Soda, lime.
Copper carbonate.	Sodium acetate, crystal.
Copper oxide.	Sodium acetate, fused.
Copper turnings.	Sodium carbonate (dry).
Ferrous sulphate.	Sodium chloride.
Fusion mixture (3 parts KNO ₃ , 1 part Na ₂ CO ₃).	Sodium (metallic).
Lime.	Sodium nitrite.
Litharge.	Sodium nitroprusside.
Magnesium oxide.	Sodium sulphate.
Magnesium powder.	Stannous chloride.
Magnesium sulphate.	Sulphur, flowers of.
	Zinc carbonate.

SPECIAL REAGENTS.

- Acid sodium acetate.* 100 gm. sodium acetate } are dissolved in water and
30 c.c. glacial acetic acid } made up to 1 litre.
- Alcoholic caustic soda.* 20 gm. sodium, or } are dissolved in alcohol and made
20 gm. caustic soda } up to 1 litre.
- Ammonium sulphate solution (sat.).* 780 gm. ammonium sulphate are dissolved in water and made up to 1 litre.
- Bang's reagent for glucose estimation.* $\left\{ \begin{array}{l} 100 \text{ gm. potassium carbonate} \\ 66 \text{ gm. potassium chloride} \\ 160 \text{ gm. potassium bicarbonate} \end{array} \right\}$ are dissolved in the order given in about 700 c.c. water at 30°.
- 100 c.c. of 4.4 per cent. copper sulphate (or 4.4 gm.) are added and the whole diluted to 1000 c.c. after the carbon dioxide is evolved. The solution is only gently shaken so as to prevent entry of air. After 24 hours 300 c.c. are diluted to 1000 c.c. with sat. potassium chloride solution, shaken gently and used after 24 hours. 50 c.c. = 10 mg. glucose.
- Barfoed's reagent.* 66 gm. cupric acetate } are dissolved in water and
10 c.c. glacial acetic acid } made up to 1 litre.
- Benedict's qualitative reagent for glucose, etc.* 173 gm. sodium citrate } are dissolved in about 600 c.c.
100 gm. anhydrous } water, filtered into a 1 litre
sodium carbonate } measuring cylinder and diluted to about 850 c.c.
- 17.3 gm. $\text{CuSO}_4 \cdot 5\text{H}_2\text{O}$ are dissolved in 100 c.c. water and diluted to 150 c.c. This solution is added with constant stirring to the citrate-carbonate solution contained in a beaker. The mixture is immediately ready for use.
- Benedict's quantitative reagent for glucose, etc.* $\left\{ \begin{array}{l} 200 \text{ gm. Na}_2\text{CO}_3 \cdot 10\text{H}_2\text{O} \\ \text{or} \\ 100 \text{ gm. Na}_2\text{CO}_3 \\ 200 \text{ gm. sodium citrate} \\ 125 \text{ gm. KSCN} \end{array} \right\}$ are dissolved with the aid of heat in enough water to make about 800 c.c. volume, and filtered.
- Exactly 18 gm. of pure $\text{CuSO}_4 \cdot 5\text{H}_2\text{O}$ are dissolved in 100 c.c. water and poured into the above solution with constant stirring. 5 c.c. of 5 per cent. potassium ferrocyanide solution are added and the whole diluted to exactly 1 litre.
- The addition of the trace of ferrocyanide prevents precipitation of red cuprous oxide. The solution apparently keeps indefinitely.
- Bertrand's reagents for glucose estimation.* $\left\{ \begin{array}{l} \text{A. Copper sulphate} \quad 40 \text{ gm. ;} \\ \text{B. Rochelle salt} \quad 200 \text{ gm. ;} \\ \quad \text{NaOH} \quad 150 \text{ ,, } \\ \text{C. Ferric sulphate} \quad 50 \text{ gm. ;} \\ \quad \text{H}_2\text{SO}_4 \quad 200 \text{ ,, } \\ \text{D. KMnO}_4 \quad 5 \text{ gm. ;} \end{array} \right\}$ water to 1000 c.c.

- Bial's reagent for pentoses.* 1 gm. orcinol is dissolved in 500 c.c. of 30 per cent. HCl to which 30 drops of 10 per cent. ferric chloride have been added.
- Bromine water.* 25 c.c. bromine in 1000 c.c. water.
- Brücke's reagent.* 50 gm. potassium iodide in 500 c.c. water are saturated with mercuric iodide (120 gm.) and made up to 1 litre.
- Carlett's indicator (reduced phenolphthalein).* 1 gm. of phenolphthalein is boiled with 10 gm. of KOH and 5 gm. of zinc dust and sufficient water till it is colourless. The solution is made up to 100 c.c. and kept in a yellow bottle.
- Esbach's reagent.* 10 gm. picric acid } are dissolved in water and made up
20 gm. citric acid } to 1 litre.
- Fehling's solution.* Equal volumes of A and B.
A. 69.28 gm. copper sulphate are dissolved in water and made up to 1 litre.
B. 346 gm. Rochelle salt (NaK tartrate) } are dissolved in water
130 gm. caustic soda } and made up to 1 litre.
- Folin's uranium acetate mixture (uric acid).* 500 gm. ammonium sulphate } are dissolved in 650 c.c.
5 gm. uranium acetate } water. The volume is
6 c.c. glacial acetic acid } about 1 litre.
- Formalin.* Commercial 40 per cent. solution of formaldehyde.
- Glyoxylic acid solution.* 10 gm. magnesium powder are covered with water; 250 c.c. sat. oxalic acid solution are added slowly, and the solution kept cool. The magnesium oxalate is filtered off and the solution is acidified with acetic acid and made up to 1 litre.
- Guaiacum tincture.* 1 gm. of guaiacum is dissolved in 100 c.c. alcohol.
- Gunzberg's reagent.* 4 gm. phloroglucin } are dissolved in 100 c.c. absolute
2 gm. vanillin } alcohol.
- Harrison's indicator.* A pinch of starch is boiled with a few c.c. of water and to it is added 100 c.c. of freshly prepared 10 per cent. KI solution. This solution does not keep for more than 2 or 3 hours.
- Hydrogen peroxide.* 10 vols. commercial.
- Iron alum solution (sat.).* 300 gm. iron alum in 1 litre water.
- Ling and Rendle's indicator.* 15 gm. ammonium thiocyanate } are dissolved in 10 c.c.
10 gm. ferrous ammonium sul- } water at 45° and im-
phate } mediately cooled.
5 c.c. conc. hydrochloric acid are then added.
The solution has usually a brownish colour and is decolorised by adding a small quantity of zinc dust. This must be repeated after some time. The indicator loses its sensitiveness if decolorised too often.
- Magnesia mixture.* 55 gm. magnesium chloride } are dissolved in water
70 gm. ammonium chloride } and made up to 1 litre.
125 c.c. ammonia (sp. gr. .880) }
- Magnesium sulphate solution (sat.).* 600 gm. cryst. magnesium sulphate are dissolved in water and made up to 1 litre.

- Mercuric nitrate.* 10 gm. mercuric nitrate are dissolved in water and made up to 1 litre.
- Millon's reagent.* 400 gm. mercury (= 30 c.c.) are dissolved in 570 c.c. conc. nitric acid. The solution is then diluted with two volumes of water.
- α -Naphthol solution.* 144 gm. α -naphthol are dissolved in alcohol and made up to 1 litre with alcohol.
- Nessler's reagent.* 62.5 gm. of potassium iodide are dissolved in 250 c.c. of distilled water. A few c.c. of this solution are set aside. To the remainder is added a cold saturated solution of mercuric chloride (about 500 c.c.) until the precipitate of mercuric iodide no longer dissolves on stirring. As soon as a permanent precipitate results the few c.c. which were removed are added so as to dissolve the precipitate. Mercuric chloride is again added very gradually until a slight permanent precipitate is formed. A cold solution of 150 gm. of potassium hydrate dissolved in 150 c.c. of water is slowly added and the volume is made up to 1000 c.c. A brown precipitate settles and a pale greenish-yellow solution is obtained. It is decanted into a smaller vessel before use.
- This reagent is diluted with 5 volumes of water before adding it to the ammonia solution so as to avoid a turbidity. One-third of the quantity should be added at a time.
- 5 c.c. of the reagent diluted with 25 c.c. of water are required for 1 mgm. of nitrogen in the ammonia solutions.
- Nylander's solution.* 40 gm. Rochelle salt } are dissolved in 1000 c.c.
20 gm. bismuth subnitrate } caustic soda (8 per cent.).
- Obermayer's reagent.* 4 gm. ferric chloride are dissolved in 1 litre conc. hydrochloric acid.
- Oil of turpentine.* Commercial.
- Oxalic acid solution (sat.).* 100 gm. oxalic acid are dissolved in 1 litre of water.
- Pavy's solution.* 120 c.c. Fehling's solution } are made up to 1 litre
300 c.c. ammonia (sp. gr. .880) } with water.
- Phenol solution.* 20 gm. carbolic acid are dissolved in 1 litre of water.
- Phosphotungstic acid solution.* 50 gm. phosphotungstic acid } are dissolved in water and
30 c.c. conc. sulphuric acid } made up to 1 litre.
- Picric acid solution (sat.).* 12 gm. picric acid are dissolved in water and made up to 1 litre.

<i>Sodium bisulphite solution (sat.).</i>	600 gm. sodium bisulphite are dissolved in water and made up to 1 litre.
<i>Sodium chloride solution (sat.).</i>	370 gm. sodium chloride are dissolved in water and made up to 1 litre.
<i>Sodium fluoride solution.</i>	20 gm. sodium fluoride are dissolved in water and made up to 1 litre.
<i>Sodium hypobromite solution.</i>	25 c.c. bromine are added to 100 gm. caustic soda dissolved in 250 c.c. water.
<i>Sodium sulphate solution : sp. gr. 1030.</i>	40 gm. sodium sulphate are dissolved in 520 c.c. water.
<i>sp. gr. 1035.</i>	45 gm. " " " 510 c.c. "
<i>sp. gr. 1040.</i>	50 gm. " " " 500 c.c. "
<i>sp. gr. 1045.</i>	55 gm. " " " 500 c.c. "
<i>sp. gr. 1050.</i>	70 gm. " " " 500 c.c. "
<i>sp. gr. 1055.</i>	85 gm. " " " 500 c.c. "
<i>sp. gr. 1060.</i>	90 gm. " " " 500 c.c. "
<i>sp. gr. 1065.</i>	95 gm. " " " 500 c.c. "
<i>sp. gr. 1070.</i>	100 gm. " " " 500 c.c. "
<i>Stoke's reagent.</i>	30 gm. ferrous sulphate } are dissolved in water and 20 gm. tartaric acid } made up to 1 litre. When required for use, strong ammonia is added until the precipitate first formed is redissolved.
<i>Schweitzer's reagent.</i>	Ammonium chloride and caustic soda are added to a solution of copper sulphate. The blue precipitate is filtered off, washed, pressed and dissolved in ammonia of sp. gr. 92.
<i>Tannic acid solution.</i>	100 gm. tannic acid 25 gm. sodium acetate } are dissolved in water and 25 gm. sodium chloride } made up to 1 litre. 50 c.c. glacial acetic acid }
<i>Tartaric acid solution (sat.).</i>	750 gm. tartaric acid are dissolved in water and made up to 1 litre.
<i>Trichloroacetic acid solution.</i>	100 gm. trichloroacetic acid are dissolved in water and made up to 1 litre.
<i>Uffelmann's reagent.</i>	Ferric chloride solution is added to 2 per cent. phenol solution till it is of a violet colour.

ORGANIC REAGENTS.

Acetic anhydride.
Acetone.
Alcohol.
Amyl alcohol.
Benzoyl chloride.
Chloroform.
Ether.
Glycero!

Orcinol.
Petroleum.
Phenylhydrazine.
Phenylhydrazine hydrochloride.
Phloroglucinol.
Resorcinol.
Toluene.

INDICATORS.

- Alizarin red.* 10 gm. sodium alizarin sulphonate are dissolved in water and made up to 1 litre = 1 per cent.
- Cochineal tincture.* 5 gm. cochineal are extracted with 150 c.c. alcohol + 100 cc. water for several days; the solution is then filtered.
- Congo red.* 1 gm. congo red is dissolved in water and made up to 1 litre = 0.1 per cent.
- Litmus.* 10 gm. litmus are finely powdered and extracted with 50 cc. hot water. The blue liquid is decanted and made up to 1 litre = 1 per cent.
- Methyl orange.* 1 gm. methyl orange is dissolved in 500 c.c. alcohol and made up to 1 litre with water = 0.1 per cent.
- Methyl violet.* 1 gm. methyl violet is dissolved in water and made up to 1 litre = 0.1 per cent.
- Phenolphthalein.* 10 gm. phenolphthalein are dissolved in alcohol and made up to 1 litre with alcohol = 1 per cent.

INDEX.

- ABSOLUTE** alcohol, 65, 66.
Absorption bands in spectrum, 478.
 — — of acid hæmatin, 482, 483.
 — — — alkaline hæmatin, 483.
 — — — carboxyhæmoglobin, 480.
 — — — carotin, 531.
 — — — chlorophyll, 525.
 — — — cyanhæmoglobin, 481.
 — — — hæmatoporphyrin, 485.
 — — — hæmochromogen, 483.
 — — — hæmoglobin, 479.
 — — — methæmoglobin, 481.
 — — — Molisch's reaction (carbohy-
 drates), 193.
 — — — nitric oxide hæmoglobin, 480.
 — — — orcinol reaction (pentoses), 196.
 — — — oxyhæmoglobin, 478-479.
 — — — phloroglucinol reaction (pentoses),
 196.
 — — — Pettenkofer's reaction (bile acids),
 325, 430.
 — — — sulphæmoglobin, 481.
 — — — urobilin, 564.
 — — — uroerythrin, 564.
 — — — xanthophyll, 531.
 — — — tubes (combustion), 32.
Acetaldehyde, 67 **80-84**, 107, 112, 353.
 — estimation, 85.
Acetaldoxime, 83.
Acetamide, 130, 277.
Acetate, ethyl, 67, 72, 74, 97.
Acetates, 88, 97.
Acetic acid, 18, 22, 62, **96-97**, 108, 130, 183,
 203, 267, 279, 468.
 — anhydride, 102, 259, 267.
 — ester, *see* Ethyl acetate.
Aceto-acetic acid, or acetyl acetic acid, 114,
118-122, 288, 570.
 — estimation, 593-596.
Acetone, 10, 13, 18, 25, 59, 63, 65, 68, **88-92**,
 194.
 — bodies, 119.
 — estimation in tissues, 593.
 — from acetyl acetic acid, 119.
 — in urine, 570.
Acetophenone, 258.
Acetylation, 101, 102.
Acetylene, 54, **56**, 240, 305.
Acetylenes, 54, **56**.
Acetyl chloride, 101, 126, 127, 258, 267.
 — choline, 128.
 — propionic acid, 191.
 — salicylic acid, 267.
 — urea, 277.
 — value (fats), 179, 182.
Achromic point, 417.
Achroodextrin, 207, 399, 400, 417.
Acid albumin, 371.
 — amides, **129**, 363.
 — anhydrides, **102**, 277.
 — chlorides, 71, **101**, 129, 190, 277.
 — green, 335.
 — hæmatin, 482-483.
 — value (fats), 179, 180.
Acidity estimation (urine), 550.
 — — gastric juice, 428.
Acids, amino, 137-149.
 — classes of, 71.
 — dibasic, 106-117.
 — fatty, 93-99.
 — in gastric contents, 427-428.
Aconitic acid, 117.
Acrolein, 103, **104**, 174, 178.
Acrylic acid, 103, **105**.
 — — ureides, 282.
Activation of trypsinogen, 409.
Adamkiewicz' reaction (proteins), 348, 366.
Addition (additive) compounds, 56, 58.
Adenase, 298, 395.
Adenine, 282, **286**, 294, 295, **296**, 298, 299,
 300, 395, **584**.
Adipocellulose, 211.
Adonitol, 173, 174.
Adrenaline, **271-273**.
Adsorption, 385, **388-390**.
Aetiophyllin, 520, 521, 522, **523**.
Aetioporphyrin, 516, **517**, 522, **523**.
Air, analysis, 514-515.
 — condenser, 5, 18.
Alanine, **137**, **139**, 361.
Alanyl-glycyl-tyrosine, 363.
Alanyl-leucine, 363.
Albinism, 569.
Albumins, 364, 374, 384, 385, 386, **435**.
 — blood serum, 443, **444**, 445.
 — cereals, 450, 452.
 — egg-white, 437.
 — legumes, 450.
 — milk, 446.
 — urine, 369, 571.
 — wheat, 450, 451.
Albumoid, 456.
Albumose, 371.
Alcohol, *see* Ethyl alcohol.
 — aromatic, 253.
Alcoholic fermentation, **391-392**, **403**.
Alcohols, **63-70**, 71, **173**, **183**.
Aldehyde, *see* Acetaldehyde.
Aldehydes, 58, **80-87**, 139, 183, 186, 216, 395.
 — aromatic, 255.
Aldehydrol, 187.
Aldol, 82.
 — condensation, 82.
Aldose, 184, 185, 186.

- Aldotetroses, 185.
 Alimentary canal (chemical changes), 397-398.
 Aliphatic series, 276.
 Alizarin, 333-334.
 Alkali albumin, 371.
 — hæmatin, 482, 483.
 Alkaloidal reagent, 352.
 Alkaloids, 276, 351-360.
 Alkaptonuria, 271, 569.
 Alkyl anilines, 248.
 — cyanates, 161.
 — cyanides, 158.
 — halides, 57-59, 71, 76, 78, 124.
 — hydrogen sulphate, 55.
 — — sulphites, 78.
 — isocyanates, 124, 161.
 — isocyanides, 159.
 — isothiocyanates, 163.
 — pyrroles, 306.
 — sulphides, 78, 79.
 — thiocyanates, 163.
 Allantoine, 278-279, 287, 292, 298, 457.
 — estimation, urine, 553.
 Allihn's method (glucose estimation), 227.
 Alloxan, 280-281, 286, 287, 293.
 Alloxanic acid, 278.
 Alloxantin, 280, 281.
 Allyl alcohol, 103, 104.
 — esters, 104.
 — iodide, 104.
 — isothiocyanate, 104, 163.
 — pyridine, 353.
 — sulphide, 104.
 Almonds, 391, 402.
 Aluminium carbide, 53.
 Amides, 101, 102, 125, 129-136, 158, 277, 363.
 Amines, 124-128, 129, 141, 158, 159, 161, 163, 248, 395.
 Amino acids, 137-149, 361-364, 395, 397, 398, 406, 408, 410, 425.
 — — amounts in proteins, 361.
 — — estimation, 145-149.
 — — in blood and tissues, 577, 578.
 — — in urine, 551-552.
 — — separation of, 362.
 Amino-acetic acid, 137, 138.
 — benzene, 246.
 — cyanohydrin, 139.
 — ethyl alcohol, 175.
 — — sulphonic acid, 144.
 — glucose, 184, 189.
 — glutaric acid, 138.
 — isocaproic acid, 138.
 — isovalerianic acid, 138.
 — malonyl urea, 280, 288.
 — naphthalene, 332.
 — nitrogen, 146.
 — oxypurine, 286, 287.
 — propionic acid, 137.
 — purine, 286.
 — toluenes, 263.
 Ammonia estimation (urine), 551, 552, 560.
 — (blood and tissues), 580, 583.
 Ammonium acetate, 130.
 — cyanate, 131, 161, 162.
 — formate, 154.
 — magnesium phosphate (urine deposit), 566.
 Ammonium purpurate, 291.
 — thiocarbamate, 162.
 — thiocyanate, 162, 164.
 — urate, 289, 290, 567.
 Amygdalin, 153, 214, 215, 254, 260, 391, 395, 402.
 Amyl alcohols, 69.
 — nitrite, 71.
 Amylase, 393, 395, 397, 399-401.
 Amylocellulose, 206.
 Amyloid, 212, 471.
 Amylopectin, 206, 207.
 Amylose, 206, 207.
 Amylum, 395.
 Analysis of blood gases, 510-515.
 — — fats, 179-182.
 — — tissues, 573-604.
 Anethole, 269.
 Anhydrides of dibasic acids, 276.
 Aniline, 241, 243, 246-247, 248, 249, 250, 257, 262, 264, 331, 335.
 — blue, 336.
 Anisic acid, 269.
 — alcohol, 269.
 — aldehyde, 269.
 Anthocyanidins, 341.
 Anthocyanins, 340, 341.
 Anthoxanthins, 338-339, 341.
 Anthracene, 241, 333.
 — oil, 241.
 Anthranilic acids, 264, 266.
 Anthraquinone, 333, 334.
 Anthropurpurin, 334.
 Anti-enzymes, 394.
 Antifebrin, 247.
 Apigenin, 338, 341.
 Apparatus (drying and cleaning), 4.
 Arabinose, 184, 185, 189, 195, 197.
 Arbutin, 214, 215.
 Arginase, 165, 398.
 Arginine, 138, 160, 164, 165, 361, 362, 398, 432.
 Argol, 115.
 Arnold's test (aceto-acetic acid), 121.
 Aromatic compounds, 237, 238-273.
 — ketones, 258.
 Arylation, 101.
 Asparagine, 129.
 Aspartic acid, 138, 361.
 Aspirin, 266, 267.
 Association, oxygen and hæmoglobin, 497, 498.
 Asymmetric carbon atom, 111, 116.
 Atropine, 351, 354.
 Autodigestion, 398.
 Autolysis, 392, 398, 401.
 Autolytic enzymes, 406.
 Avogadro's law, 42.
 Azobenzene, 331.
 Azo-dyes, 337.
 Azoxybenzene, 331.
 BANG'S methods, glucose estimation, 230, 232, 589.
 Barbituric acid, 280, 281, 288.
 Barcroft and Haldane's method, oxygen capacity and content of blood, 501-502.
 Barcroft's apparatus, blood gases, 511.

- Barcroft's differential method, oxygen capacity and content of blood, 504-509.
 — method, oxygen capacity and content of blood, 502-503.
- Barfoed's test, 191-192, 200, 201.
- Barley proteins, 452.
- Beans, protein content, 450.
- Beeswax, 70.
- Beilstein's test, halogens, 29.
- Bence-Jones protein, 572.
- Benedict's method, glucose estimation, 226.
 — — sulphur estimation, 542.
 — test, glucose, 191.
- Benzal chloride, 253, 254, 330.
- Benzaldehyde, 153, 215, 252, 253, 254-255, 259, 260, 335, 395.
- Benzamide, 257.
- Benzene, 10, 18, 22, 238, 240-241, 249, 250, 251, 258, 304, 310, 330, 331, 333.
 — disulphonic acids, 261.
 — nucleus, 238-240.
 — γ -pyrone nucleus, 338, 340.
 — sulphonamide, 244.
 — sulphonanilide, 244.
 — sulphonic acid, 243, 244.
 — sulphonyl chloride, 244.
- Benzidine, 243, 331, 412, 477.
 — method, sulphate estimation, 542.
- Benzoate, ethyl, 73, 75, 256, 257.
- Benzoic acid, 75, 142, 143, 240, 252, 253, 254, 255-256, 258, 331, 355.
 — anhydride, 256.
- Benzoin, 255.
- Benzole, 241.
- Benzonitrile, 257.
- Benzophenone, 258, 330.
- Benzopyrylium nucleus, 340.
- Benzotrichloride, 253.
- Benzoyl chloride, 256, 257, 258.
 — glycine, 141, 142.
- Benzyl alcohol, 252, 253, 254.
 — chloride, 252, 253, 254, 255, 257, 258, 330.
 — radicle, 252.
- Benzylamine, 257.
- Berberine, 351, 360.
- Bertrand's method, glucose estimation, 228, 229.
- Betaine, 150.
- Betaines, 150-151.
- Betonicine, 150.
- Bial's test (pentoses), 196.
- Bihexose, 196.
- Bile, 144, 319, 322, 429-431.
 — acids, 322-329.
 — in lipase action, 405.
 — — urine, 572.
 — pigments, 308, 518.
 — salts, 429.
- Bilanic acid, 322.
- Bilirubin, 398, 429, 518, 564.
 — urinary deposit, 565, 566.
- Biliverdin, 398, 429.
- Bismarck brown, 337.
- Biuret, 133.
 — reaction, 133.
 — — (proteins), 365, 373, 410.
- Blood, 438-445, 472-477.
 Blood, carbon dioxide estimation, 510-515.
 — catalytic action, 476.
 — clotting, 438-442.
 — coagulation, 438-442.
 — composition, 442-443.
 — estimation, hæmoglobin, 486-489.
 — fibrin ferment, 438, 439.
 — gases, 510-515.
 — glucose estimation, 588-589.
 — hæmolysis, 476.
 — in urine, 572.
 — laking, 476.
 — nitrogenous extractives, 577-578, 579-582.
 — oxygen capacity and content, 498-509.
 — peroxidase action, 476-477, 490.
 — platelets, 438.
 — proteins, 438-445.
 — reaction, 472.
 — serum, 370, 438.
 — solvent for nitrogen, 510.
 — specific gravity, 472-473.
 — stains, 483, 490.
 — thrombin, 438, 439.
- Boettger's test (glucose), 192.
- Boiling-point determination of liquids, 4-6.
 — — — correction, 6.
- Bone oil, 305, 307.
- Borneol, 317, 318.
- Bornylene, 317.
- Boundary surface, colloids, 388, 389.
- Brain, 176.
- Brick dust deposit, urine, 565.
- Brilliant green, 335.
- Bromamide, 125.
- Bromelin, 410.
- Bromobenzene, 241-242, 249, 250, 251, 252, 331.
- Brucine, 351, 357-358.
- Brucke's method, pepsin, 421.
 — reagent (protein precipitant), 369.
- Buchner funnel, 15.
- Buchner's method (zymase), 392-393.
- Butane, 49.
- Butter, 177, 457, 458.
- Butyl alcohols, 68.
- Butyric acid, 98, 118, 177, 458.
 — chloral hydrate, 87.
 — fermentation, 98.
- Butyryn, 98, 175.
- Butyrynase, 395.
- Butyrobetaine, 150.
- CACODYL oxide, 97.
- Cadaverine, 125, 569.
- Caempferol, 338, 341.
- Caffeine, 286, 287, 297.
- Calcium, carbide, 56, 155.
 — carbonate, urine deposit, 567.
 — — calculi, 568.
 — caseate, 461.
 — caseinogenate, 461.
 — chloride tube, 32.
 — estimation, 546.
 — fructosate, 188.
 — hydrogen phosphate (urine deposit), 566, 567.
 — oxalate, 108.
 — — calculi, 568.

- Calcium, oxalate, urine deposit, 565.
 — soap, 99, 177, 178.
 — tartrate, 115, 116.
- Calculation of analytical results, 41.
- Calculi, biliary, 431.
 — urinary, 287, 293, 568.
- Camphane group, 317.
- Camphene, 312, 317.
- Camphor, 269, 312, 317.
- Cane sugar, 188, 197, 198-199, 403.
 — — action of invertase, 395, 401.
 — — estimation, 235, 585, 586.
- Caoutchouc, 312, 318.
- Capillary analysis, 390.
- Capric acid, 93, 98.
- Caproic acid, 93, 98, 458.
- Caproin, 175.
- Caprylic acid, 93, 98.
- Caramel, 198.
- Carbamide, 129, 131-136.
- Carbamidomalonyl urea, 280.
- Carbides, 51, 53, 56.
- Carbocyclic compounds, 237.
- Carbohydrates, 20, 106, 183-236, 303, 397, 398.
 — action of enzymes, 394, 395.
 — digestion of, 397, 398.
 — estimation, 216-236.
 — in foodstuffs, 537.
 — — nucleic acids, 299, 300.
 — — proteins, 367, 468.
 — — tissues, 585-590.
 — — urine, 569, 570.
- Carbolic acid, 241.
 — oil, 241.
- Carbon atom, asymmetric, III, 115, 116.
 — detection, 28.
 — estimation, 31-33.
 — monoxide, 94, 108, 112, 154.
- Carboxyhæmoglobin, 480, 493.
- Carboxylase, 395.
- Carboxyl group, 93.
- Carbylamine reaction, 61, 126, 247.
- Carnaubic acid, 175.
- Carnitine, 150.
- Carotin, 519, 523, 525, 527, 530-531, 532.
- Carotinoids, 519-532.
- Carvacrol, 269, 271.
- Carvomenthene, 315.
- Carvomenthol, 314.
- Carvomenthone, 314.
- Carvone, 316, 317.
- Caryophyllene, 318.
- Casein, 397, 457, 461, 462.
- Caseinogen, 267, 348, 361, 386, 397, 408, 423, 446, 457, 459, 460-462.
 — composition, 361.
 — presence of phosphorus, 461.
 — rennet, action of, 461.
 — separation from milk, 459, 460.
 — substrate for enzyme action, 408, 425.
- Caseose, 371.
- Castellana's test (nitrogen), 29.
- Castor-oil seeds (lipase), 404.
- Catalase, 395, 411, 426.
 — blood, 476.
- Catalytic action, enzymes, 393, 394, 413-414.
- Catechol, 261-262, 271, 274.
- Catechol-carboxylic acid, 271.
- Cayenne pepper deposit, urine, 565.
- Cellobiose, 197, 202.
- Cells, constituents of, 533.
- Celluloid, 212.
- Cellulose, 108, 184, 185, 189, 202, 205, 211-212, 375, 384, 386.
- Centric formula, benzene, 239.
- Cereals, proteins, 451-453.
- Cerebrosides, 176, 189.
- Cerotic acid, 175.
- Ceryl alcohol, 70, 175.
- Cetyl alcohol, 70, 175.
- Chalk stones, pigmented, 431.
- Cheese, 462.
- Chemical changes in organism, 396-398.
 — methods, molecular weight, 44-45.
- Chenochoic acid, 326.
- Chinese wax, 70.
- Chinovose, 185.
- Chitin, 189, 203, 468.
- Chitose, 189.
- Chloracetic acids, 97, 100, 113, 138.
- Chloral, 60, 86, 100, 186.
 — alcoholate, 86.
 — hydrate, 80, 86-87, 100, 186.
- Chlorhydrins, 55.
- Chlorides, estimation in urine, 540.
- Chlorine, detection, 29.
 — estimation, 39.
- Chlorobenzene, 241-242, 250.
- Chloroform, 10, 18, 22, 25, 59-61, 87, 94, 265, 330.
- Chlorophyllase, 520, 527.
- Chlorophyllides, 519, 520, 525, 527-528.
- Chlorophyllins, 519, 520, 521, 522.
- Chlorophylls, 304, 306, 516, 519-532.
- Chloropropionic acid, 100.
- Cholalic acid, 310, 322-323, 325.
- Choleic acid, 322, 323, 324, 326.
- Cholesterol, 310, 319-321, 429, 431.
 — estimation, 603, 604.
- Cholesterols, 319-322.
- Cholesteryl esters, 320, 603.
- Cholic acid, *see* Cholalic acid, 322.
- Cholicamphoric acid, 325.
- Choline, 127-128, 175, 176.
- Choloidic acid, 323.
- Cholonic acid, 325.
- Cholylic acid, 325.
- Chondroitin, 203-204, 468, 471.
- Chondromucoid, 470.
- Chondrosamine, 203.
- Chondrosin, 204.
- Chromic period, 417.
- Chromoproteins, 364, 472.
- Chrysene, 334.
- Chrysin, 338.
- Chrysoidin, 337.
- Chymosin, 461.
- Cilianic acid, 322.
- Cineol, 315.
- Cinchoheronic acid, 350.
- Cinchonine, 351, 356.
- Cinnamic acid, 252, 253, 258, 259.
 — aldehyde, 259.
- Circular polarisation, III.
- Citral geraniol, 313.

- Citric acid, 115, 117, 457.
 Citronellol, 313.
 Classification of proteins, 364.
 Cleaning of apparatus, 4.
 Clotting of blood, 438-442.
 — milk, 461, 462.
 Clupeine, 432.
 Coagulable proteins, 364, 435-451.
 — blood, 438-445.
 — egg white, 436-437.
 — milk, 446.
 — muscle, 447-448.
 — plants, 450-451.
 — tissues, 449.
 Coagulation of blood, 438, 442.
 — milk, 461-462.
 — reactions of proteins, 365, 368.
 Coal gas poisoning, 480.
 Coal tar, 238, 240, 244, 252, 330, 331, 342, 350.
 Cocaine, 304, 351, 355.
 Cocositol, 310.
 Codeine, 351, 359.
 Co-enzyme, 394.
 Collagen, 455.
 Collidines, 309.
 Colloidal particles (filtration), 16.
 Colloids, 17, 374-390, 396.
 Colophony, 312.
 Colour reactions of proteins, 365-367.
 Combustions, 31-34.
 Comparison of enzymes, 416-426.
 Complex aromatic compounds, 330-341.
 Composition, blood, 442-443.
 — elementary, 28-31.
 — empirical, 50.
 — foodstuffs, 537.
 — quantitative, 31-40.
 — of proteins, 361.
 Conalbumin, 437.
 Concentration, colloidal solutions, 380, 384.
 Conchiolin, 456.
 Condenser, 5.
 — inverted, 18.
 — reflux, 18.
 Congo-red, 337, 390.
 Coniferin, 271.
 Coniferyl alcohol, 271.
 Coniine, 351, 352.
 Conjugated proteins, 364.
 Constant boiling mixtures, 10.
 Constituents of cells, 533-534.
 Constitution of proteins, 363.
 Continuous phase, 378, 381, 383.
 Coprosterol, 321.
 Corneomucoid, 470.
 Correction for boiling-point, 6.
 — melting-point, 24.
 Cotarnine, 360.
 Cracking process, 51.
 Creatine, 160, 166-168, 169, 172, 447, 457.
 — estimation, 168, 555, 562, 582, 583.
 Creatinine, 166, 167, 168, 169-172, 192, 276.
 — estimation, 172, 555, 557, 562, 581, 582, 583.
 Creosote oil, 241.
 Cresols, 263, 264, 269.
 Crotonic acid, 105, 123.
 Crotonic acid ureides, 282.
 Crystallins, 449.
 Crystalline vegetable globulins, 450, 451.
 Crystallisation, 17-22.
 — of ovalbumin, 437.
 — oxyhaemoglobin and derivatives, 491-496.
 — serum albumin, 445.
 Crystalloids, 374.
 Cyanamide, 159-160, 164, 165, 167.
 Cyanates, 131, 153, 155, 159, 160-161, 277.
 Cyanhaemoglobin, 481, 492.
 Cyanic acid, 160, 161.
 Cyanide synthesis, 113.
 Cyanides, 153, 154, 155, 156, 160, 162, 257, 258, 291.
 — alkyl, 158.
 — complex, 157.
 — double, 156.
 Cyanidin, 341.
 Cyanin, 341.
 Cyanobenzene, 250.
 Cyanogen, 152-153.
 — chloride, 159, 161.
 — compounds, 152-163.
 Cyanogenetic glucosides, 215.
 Cyanohydrins, 83, 186, 193, 260.
 Cyanophyllin, 521, 522.
 Cyanoporphyrin, 522.
 Cyanurates, 133, 159, 161.
 Cyanuric acid, 133, 160, 161, 276, 291.
 — chloride, 159, 161.
 Cyclohexadiene, 310.
 Cyclohexane, 310.
 Cyclohexene, 310.
 Cycloparaffins, 237.
 Cymene, 269, 271, 313.
 Cymogene, 51.
 Cyprinine, 432.
 Cysteic acid, 144.
 Cysteine, 137, 144.
 Cystine, 137, 139, 140, 143-144, 361, 366, 541.
 — calculi, 143, 568, 569.
 — urine deposit, 143, 567, 569.
 Cystinuria, 143, 569.
 Cytosine, 282-283, 299, 300.

 DATURINE, 354.
 Deamination, 395.
 Deaminisation, amino acids, 395, 398.
 Decane, 93.
 Decolorising solutions, 21.
 Defibrinated blood, 438, 443, 472, 476.
 Definitions, 1.
 Dehydrocholic acid, 322.
 Delphinidin, 341.
 Delphinin, 341.
 Denigès' test (tyrosine), 268.
 — (uric acid), 291.
 Deoxycholic acid, 322, 323, 324, 326.
 Deposits, urine, 565-567.
 Derivatives, addition, 55, 58.
 — of proteins, 364, 370-373.
 — substitution, 53-57.
 Desaturation of fats, 398.
 Detection of acids in gastric contents, 427.
 — colloidal solutions, 376.
 — elements, 28-31.

- Determination of boiling-point, 5.
 — — melting-point, 23.
 — — molecular weight, 42-45.
 Deuteroproteoses, 373.
 Dextrins, 184, 201, 205, 207-208, 395, 397.
 Dextrose, 188, *see* Glucose.
 Diabetes, 119, 570-571.
 Diacetonamine, 89.
 Diacetyl urea, 277.
 Dialuric acid, 280, 281.
 Dialysis, 27, 374, 376.
 Diamines, 125.
 Diamino acids, 138, 362, 432.
 Diaminobenzenes, 261.
 Diaminocaproic acid, 138.
 Diaminodiphenyl, 331.
 Diaminovalerianic, 138.
 Diastase, 391, 395, 397, 399-401, 403, 416-418.
 "Diastases," 392.
 Diastatic power, 417, 418.
 Diazobenzene, 244, 249.
 Diazonium salts, 249.
 Diazo reactions, 242, 249-250.
 Dibasic acids, 106-117.
 — — ureides, 279-281.
 Dibenzylamine, 257.
 Dibromophenol, 245.
 Dichloroacetic acid, 100.
 Dicysteine, 137.
 Diet, standard, 538.
 Diethylaniline, 335.
 Diethylamine, 124.
 Diethylbarbituric acid, 280.
 Diffusion in gels, 386.
 Digallic acid, 273, 274.
 Digestion, 396, 397-398.
 Diglycyl-glycine, 363.
 Dihalogen derivatives of hydrocarbons, 58-59.
 Dihydric alcohol, 173.
 Dihydrobenzene, 310.
 Dihydrocarveol, 315, 316.
 Dihydrocarvone, 315, 316.
 Dihydroxyacetic acid, 278.
 Dihydroxyacetone, 184.
 Dihydroxybenzenes, 261, 262.
 Dihydroxysuccinic acid, 114.
 Dihydroxytoluene, 271.
 Diluric acid, 280, 281.
 Dimethylalloxan, 286.
 Dimethylamine, 126.
 Dimethylaniline, 248, 335.
 Dimethylbenzenes, 260.
 Dimethyldioxypurines, 286.
 Dimethylethylmethane, 50.
 Dimethylguanidine, 165.
 Dimethylxanthines, 286, 287.
 Dinitrobenzenes, 261.
 Dinitronaphthol, 335.
 Diose, 184.
 Dioxypurine, 286.
 Dipentene, 316, 317.
 Dipeptides, 363.
 Diphenyl, 331.
 Diphenylamine, 248.
 Diphenylmethane, 258, 330.
 Disaccharides, 183, 184, 192, 196-202, 214.
 — — estimation, 235-236.
 Disaccharides, hydrolysis by enzymes, 395, 401, 402, 419.
 Disperse phase, 378, 383.
 Dissociation, oxygen and hæmoglobin, 497-498.
 Distillation of liquids, 4-6.
 — — — fractional, 9.
 — — — steam, 12.
 — — — *in vacuo*, 7.
 — — — — fractional, 10-11.
 — "dry" wood, 63, 96.
 Distilling flask, 4.
 Disubstitution derivatives, benzene, 260-269.
 Disulphides, 78, 79.
 Diterpenes, 313, 318.
 Dodecyl alcohol, 70.
 Double cyanides, 156.
 "Dry" distillation of wood, 63 96.
 "Drying" oils, 105.
 Drying apparatus, *vacuum*, 20.
 — of apparatus, 4.
 — — crystals, 20.
 — — liquids, 8.
 — — material for extraction, 25.
 Dulcitol, 195.
 Dumas' method, nitrogen, 34.
 Dunstan's test, glycerol, 174.
 Dupré's ureometer, 134.
 Dyes, 331, 332, 334, 335-337, 390.
 Dyslysine, 325.
 EGGONINE, 355.
 Ectoenzymes, 392.
 Edestin, 422, 451.
 Egg-albumin, 384, 385.
 — — for enzyme action, 405, 407, 410, 422, 423.
 — globulin, 377, 384, 436.
 — membranes, 454.
 — white, 365, 370, 377, 382, 384, 436.
 — — constituents, 436.
 — — nitrogen estimation, 35.
 — — protein estimation, 35.
 — — reactions, 365-369.
 — yolk, 463.
 Einhorn fermentation tube, 233, 403.
 Elastic gel, 387.
 Elastin, 454.
 Electric charge on colloidal particles, 379, 380, 385, 388, 389.
 Electrolytes, action on colloidal solutions, 380, 383, 384, 386.
 Elementary composition, 28-31.
 Empirical composition, 50.
 Emulsification, 177.
 Emulsion, 214, 254, 391, 395, 402, 403, 415, 419.
 Emulsions, 378, 381-383, 386.
 Emulsoids, 378, 380, 384-386.
 Endoenzymes, 392.
 Enterokinase, 397, 409.
 Enumeration of red blood corpuscles, 474-476, 486.
 Envelope crystals, 565.
 Enzymes, 391-426.
 — comparison of, 416-426.
 — Schütz law, 421, 424.
 Eosin, 261, 263, 336.

- Epiguanine, 297.
 Equilibrium metabolic, 534.
 Erepsin, 395, 398, **409-410**.
 Ergot, 128, 269, 284.
 Ergothioneine, 150.
 Erythrose, 184, 185.
 Erythritol, 173, 174.
 Erythroextrin, 207, 399.
 Erythrophyllin, 521, 522.
 Erythroporphyrin, 522.
 Erythrosin, 336.
 Esbach's method, protein, 369.
 Essential oils, 312-318.
 Esters, **71-75**, 101, 102, 104, 129, 140, 175, 190, 198, 200, 201, 300, 310, 404.
 — hydrolysis, 74-75.
 — identification, 73.
 Estimation of acetaldehyde, 85.
 — — aceto-acetic acid, 122, 593-596.
 — — acetone, 91.
 — — acidity (gastric contents), 428.
 — — — (urine), 550.
 — — — adrenaline, 272.
 — — — albumin (milk), 576.
 — — — alcohol (wine, etc.), 67.
 — — — allantoine (urine), 553.
 — — — amino acids, 145-149.
 — — — — (tissues), 577-578.
 — — — — (urine), 552.
 — — — ammonia (blood and tissues), 580, 583.
 — — — — (urine), 551, 560.
 — — — bile salts, 430.
 — — — blood gases, 510-515.
 — — — calcium, 546.
 — — — cane sugar, 235, 585, 586.
 — — — carbohydrates, 216-236, 585-590.
 — — — carbon, 31-33.
 — — — caseinogen, milk, 576.
 — — — catalases, 426.
 — — — chloral, 87.
 — — — chlorides (urine), 540.
 — — — chloroform, 61.
 — — — cholesterol, 603-604.
 — — — creatine, 168, 559, 562.
 — — — — (blood and tissues), 581, 582, 583.
 — — — creatinine, 172, 555, 562.
 — — — — (blood and tissues), 581, 582, 583.
 — — — diastase, 416-418.
 — — — disaccharides, 235-236.
 — — — emulsin, 419.
 — — — enzyme action, 416-426.
 — — — fat, 178, **601-602**.
 — — — formaldehyde, 85.
 — — — fructose, 220, 224, 586.
 — — — galactose, 220, 224.
 — — — glucose, 220, **221-224**, 225, 326, 227, 228, 230, 231, 232, **585, 586**.
 — — — — blood, 588-589.
 — — — glycogen, **585**.
 — — — hæmoglobin, 486-489.
 — — — hydrogen, 31-33.
 — — — hydroxybutyric acid, 597-600.
 — — — inorganic constituents, tissues, 573-574.
 — — — invertase, 419.
 — — — iodine, tissues, 574.
 — — — iron, 547-548.
 Estimation of lactase, 419.
 — — — lactic acid, 112, 590-592.
 — — — lactose, 236.
 — — — lipase, 420.
 — — — magnesium, 546.
 — — — maltase, 419.
 — — — maltose, 236, 586.
 — — — mannose, 220, 224.
 — — — monosaccharides, 220, 221-234.
 — — — nitrogen, 34-38.
 — — — nitrogenous extractives (blood and tissues), 577-584.
 — — — — constituents (urine), 552, 558.
 — — — oxalic acid, 109.
 — — — oxidases, 426.
 — — — oxygen capacity and content, blood, 498-509.
 — — — pepsin, 421-423.
 — — — peroxidases, 426.
 — — — phosphates (urine), 544-545.
 — — — phosphorus, 40, 545.
 — — — — tissues, 573.
 — — — polysaccharides, 236.
 — — — potassium, 548-550.
 — — — proteins, 38, 369, 575-576.
 — — — proteoclastic enzymes, 421-425.
 — — — purine bases (tissues), 584.
 — — — sodium, 548.
 — — — starch, 585, 587.
 — — — sulphates (urine), 541-543.
 — — — — (tissues), 573.
 — — — trypsin, 424-425.
 — — — urea, 134-136.
 — — — — (blood and tissues), 580, 583.
 — — — — (urine), 552-553, 560.
 — — — uric acid, 292.
 — — — — (blood and tissues), 580, 584.
 — — — — (urine), 554, 561.
 — — — zymase, 419.
 Ethane, **49**, 56.
 — — — tetrabromide, 56.
 Ethanol, 63.
 Ethene, 54.
 Ether, *see* Ethyl ether.
 Ethers, **76-77**, 102.
 Ethine, 54.
 Ethoxide, sodium, 66.
 Ethyl acetate, 67, **72**, 74, 97, 130.
 — — — alcohol, 10, 18, 22, **64-67**, 96, 163, 193, 391, 395.
 — — — benzene, 252.
 — — — benzoate, **73**, 75, 257.
 — — — bromide, 58.
 — — — carbonate, 164.
 — — — chloride, 66.
 — — — disulphide, 78.
 — — — ether, 13, 22, 25, **76-77**.
 — — — formate, 73, 95.
 — — — mercaptan, 78.
 — — — oxalate, 75, 130.
 — — — oxalic acid, 73.
 — — — sulphates, 71, 74.
 — — — sulphide, 78, 79.
 — — — sulphuric acid, 71, 73, 74.
 Ethylene, **54**, 56, 58.
 — — — diamine, 125.
 — — — dibromide, 55, 57, 58, 173.
 — — — glycol, 55.

- Ethylene, oxide, 128.
 Ethoxide, sodium, 66, 76.
 Ethoxy group, 77.
 Ethylidene chloride, 56.
 Eucalyptol, 315.
 Euglobulin, 443.
 Euxanthic acid, 186, 339.
 Euxanthone, 339.
 Evaporation of liquids, 13-14.
 — — — *in vacuo*, 13-14.
 Excelsin, 361, 451.
 Extraction of fats, 176.
 — with solvents, 25, 27.
 Extractives, 537.
 FÆCES, 342, 344, 533.
 Fats, 17, 93, 99, 105, 173, 175-182, 374, 381.
 — action of enzymes, 394, 395, 397, 398, 404, 420.
 — analysis, 179-182.
 — composition, 177.
 — digestion, 397-398.
 — emulsification, 177, 381.
 — estimation, 178-179, 601 602.
 — extraction, 176.
 — hydrolysis, 177.
 — identification, 179.
 — in blood, 442.
 — — foodstuffs, 447, 450, 457, 463, 537.
 — — metabolism, 398.
 Fatty acids, 93-99, 175, 176, 177, 178.
 Fehling-Soxhlet method, carbohydrate estimation, 221 224.
 Fehling's reaction, 191.
 — solution, 84.
 Fellinic acid, 328.
 Fermentation, 193, 194, 195, 196, 199, 200, 202, 208, 210, 216, 391-426.
 — carbohydrate estimation by, 233, 570.
 Ferricyanides, 158.
 Ferrocyanides, 153, 154, 155, 157, 158, 160.
 Fibrin, 438, 439, 440-441.
 — ferment, 438, 439.
 — for enzyme action, 405, 407, 410, 421, 422.
 Fibrinogen, 438, 439-440, 441, 442, 443.
 Fibrin-peptone, 371.
 Filter paper, fluted, 15.
 — — hardened, 15.
 — — plate, 15.
 — — press, 16.
 — — pump, 16.
 Filtration of colloids, 378.
 Fisetin, 338, 341.
 Fish-sperm, 432, 433.
 Pittig's reaction, 251.
 Flavones, 338-339.
 Flavonol, 338.
 Flavopurpurin, 334.
 Fluorene, 334.
 Fluorescein, 263, 336.
 Fluted filter paper, 15.
 Foodstuffs, composition, 537.
 Formaldehyde, 80, 81, 183.
 — estimation, 85.
 — in milk, 366.
 Formalin, 80, 145.
 Formamide, 129, 154.
 Formates, 94, 95.
 Formic acid, 10, 94-95, 154, 159, 198.
 — — nitrile, 154.
 Formol, 80.
 Formula, empirical, 50.
 — general, hydrocarbons, 49, 54.
 — graphic, 50.
 Fractional crystallisation, 27.
 — distillation, 9, 52.
 — — *in vacuo*, 10-11.
 Fractionating column, 9.
 — flask, 4.
 Friedel and Craft's reaction, 251, 254.
 Froth, 377, 383, 389.
 Frothing, evaporation *in vacuo*, 14.
 Fructosans, 205.
 Fructose, 184, 186, 187, 188, 190, 194, 197, 198, 199, 202, 213, 395, 403, 586.
 Fruit sugar, 188, *see* Fructose.
 Fruits, protein content, 450.
 Fuchsine, 335.
 Fucose, 185.
 Fucoxanthin, 519, 523, 531.
 Fuld-Gross method (trypsin), 424.
 Fuld's method (pepsin), 422.
 Fumaric acid, 115.
 Funnel, Buchner, 15.
 — hot water, 19.
 — separating, 8.
 Furane, 303.
 Furfural, 303, 367, 430.
 Furfuralcohol, 303.
 Furfuraldehyde, 303.
 Furfurane, 276, 303.
 Furfurool, 303.
 Fusel oil, 65, 68, 69, 70.
 Fusion mixture, 30.
 GALACTANS, 189, 205, 213.
 Galacto-arabinose, 197.
 Galactonic acid, 195.
 Galactose, 176, 184, 186, 189, 195, 197, 200, 202, 214, 395, 403.
 Galangin, 338, 341.
 Gallic acid, 270, 273, 274, 275, 341.
 Gallois' test (inositol), 311.
 Gall stones, 319, 431.
 Gases in blood, 497, 510.
 — — estimation, 510-515.
 Gastric juice, 397, 427-428.
 Gelatin, 273, 275, 305, 361, 374, 384, 385, 386, 387, 409, 455.
 Gels, 375, 384, 385, 386, 387-388.
 General formula, hydrocarbons, 49, 54.
 — reactions of proteins, 365-369.
 Gentianose, 202.
 Gentriobiose, 197, 202.
 Gentisin, 339.
 Geraniol, 313.
 Gerhardt's reaction, acetoacetic acid, 120.
 Gerrard's method, glucose estimation, 226.
 Glaucophyllin, 521, 522.
 Glauco porphyrin, 522.
 Gliadins, 364, 452-453.
 Globin, 361, 434, 482.
 Globulins, 364, 377, 384, 435.
 — blood, 443-444.
 — cereals, 450, 452.

- Globulins, crystalline vegetable, 450, 451.
 — egg, 365, 436.
 — fruits, 450.
 — meat, 447-448.
 — milk, 446.
 — nuts, 450-451.
 — serum, 443-444.
- Globulose, 371.
- Glucose, 395.
- Gluconic acid, 186, 190, 194.
 — — nitrile, 194.
- Glucoproteins, 189, 203, 364, 468-471.
- Glucosamine, 184, 189, 203, 468.
- Glucosans, 205, 207.
- Glucosazone, 193.
- Glucose, 64, 98, 153, 184, 185, 186, 187, 188, 189, 190-194, 197, 198, 199, 200, 201, 202, 203, 207, 208, 209, 210, 212, 214, 215, 216, 254, 265, 274, 395, 398, 403, 415.
 — estimation, 220, 221-224, 225, 226, 227, 228, 230, 231, 232, 585, 586, 587.
 — — in blood, 588-589.
 — — — urine, 570.
- Glucosides, 153, 163, 214-215, 274, 300, 333, 341, 344, 393, 395.
- Glucosyllose, 197.
- Glutamic acid, 138, 305, 361, 408, 458.
 — — hydrochloride, 141, 362.
- Glutelins, 364, 452-453.
- Gluten, 452.
- Glyceric aldehyde, 184.
- Glycerides, 173.
- Glycerol, 68, 94, 103, 104, 105, 173-174, 175, 176, 177, 178, 184, 395.
- Glycerophosphoric acid, 175.
- Glycerose, 184.
- Glyceryl acid oxalate, 94, 103.
 — esters, 175.
 — monoformin, 94.
- Glycine, 107, 137, 139, 140, 142, 143, 153, 258, 277, 322, 328, 361.
 — ester hydrochloride, 362.
- Glycocholeic acid, 328.
- Glycocholic acid, 322, 326-327.
- Glycocholl, 137, 288, *see* Glycine.
- Glycogen, 17, 184, 201, 205, 208-210, 377, 395, 398.
 — estimation, 585.
- Glycohyocholic acids, 328.
- Glycol, 106, 173, 184.
 — anhydride, 128.
- Glycollic acid, 106, 107, 186, 194.
 — — ureides, 277.
 — aldehyde, 106, 184.
- Glycoluric acid, 277.
- Glycuronic acid, 186, 196, 203.
- Glycyl-alanyl-glycyl-tyrosine, 363.
- Glycyl-alanyl-tyrosine, 363.
- Glycyl-glycyl-glycine, 363.
- Glycyl-glycine, 363.
- Glycyl-tryptophan, 407.
- Glycyl-tyrosine, 364, 407.
- Glyoxal, 106, 107.
- Glyoxaline derivatives, 284-285.
- Glyoxylic acid, 106, 107, 278, 279.
 — — reaction (proteins), 366.
- Gmelin's test, bile pigments, 429.
- Gorgonin, 456.
- Gowers' hæmocytometer, 474.
 — method (hæmoglobin estimation), 488.
- Granulose, 206.
- Grape sugar, 188, *see* Glucose.
- Gravimetric estimation, glucose, 227.
- Gross' method (pepsin), 423.
- Grutznern's method, pepsin, 421-422.
- Guaiacol, 261, 262, 412.
- Guaiaconic acid, 411.
- Guaiacum reaction, blood, 476-477.
 — — milk, 458.
 — — oxidase, 411.
 — — peroxidase, 411.
- Guanase, 298, 395.
- Guanidine, 159, 164.
 — derivatives, 165-171.
- Guanine, 282, 286, 287, 293, 294-295, 296, 298, 299, 300, 301, 395, 584.
- Guanylic acid, 301, 465.
- Gums, 184, 205, 209, 213, 374, 386.
- Gun cotton, 212.
- Gunzberg's reaction (HCl in gastric juice), 427.
- HÆMASE, 476.
- Hæmatin, 472, 481, 482-483, 484, 490, 494, 564.
- Hæmatinic acid imide, 516, 523.
- Hæmatogen, 465.
- Hæmatoidin, 518, 565, 566.
- Hæmatoporphyrin, 484-485, 495-496, 564.
 — constitution, 516-518.
- Hæmidoporphyrin, 516.
- Hæmin, 306, 484, 490, 494-495.
 — constitution, 516-518.
- Hæminoporphyrin, 516.
- Hæmochromogen, 472, 482, 483, 484, 490, 495.
- Hæmocyanin, 472.
- Hæmocytometer (Gowers'), 474.
 — (Thoma-Zeiss), 475.
- Hæmoglobin, 284, 304, 361, 362, 398, 472, 473, 478-485.
 — crystals, 493.
 — detection of iron, 31.
 — estimation, 486-489.
 — as oxygen carrier, 497-509.
- Hæmolysis, 476.
- Hæmoporphyrin, 516, 517.
- Hæmopyrrole, 516.
- Haldane's apparatus, gas analysis, 513.
 — method, hæmoglobin, 488-489.
 — — oxygen capacity and content of blood, 499-500.
- Halogen derivatives, fatty acids, 100, 138, 139.
 — — hydrocarbons, 53, 55, 56, 57-62.
- Halogens, detection, 39.
 — estimation, 29.
- Hammerschlag's method (blood sp. gravity), 473.
 — — (pepsin), 423.
- Hata's method, pepsin, 423.
- Hay's test (bile salts), 430.
- Heat coagulation (proteins), 368, 371, 386, 435 ff.
- Heavy metals as protein precipitants, 368, 372.
 — oil, 241.

- "Hedgehog spines," 567.
 Hehner value (fats), 179, 182.
 Helianthin, 337.
 Heller's test (proteins), 368, 571.
 Hemicellulose, 205, 213.
 Hemiterpenes, 313.
 Heneicosane, 51.
 Heptadecane, 51.
 Heptamethylene, 237.
 Heptanes, 51.
 Heptyl alcohol, 70.
 Heterocyclic compounds, 276-309.
 Heteroproteose, 372-373.
 Heteroxanthine, 297.
 Hexadecyl alcohol, 70.
 Hexahydric alcohol, 190, 195.
 Hexahydrobenzene, 237, 310.
 Hexahydrocymene, 313.
 Hexamethylene, 237, 310.
 Hexamethylenetetramine, 82, 551.
 Hexane, 51.
 Hexapeptides, 363.
 Hexosan-pentosans, 205.
 Hexosans, 205.
 Hexose in nucleic acids, 299, 300.
 Hexoses, 184, 185-189, 213, 303.
 Hexyl alcohol, 70.
 — iodide, 186.
 Higher alcohols, 70.
 — fatty acids, 99.
 Hippocoprosterol, 321.
 Hippuric acid, 141, 142, 258.
 Hirsch funnel, 15.
 Hirudin, 439.
 Histamine, 284.
 Histidine, 137, 284-285, 361, 362, 434.
 Histones, 364, 433-434.
 Histopeptone, 371.
 Homogentisic acid, 271, 569.
 Homologous series, 49.
 Homologues of benzene, 251, 252.
 Hopkins' test (lactic acid), 112.
 Hoppe-Seyler's method (hæmoglobin), 488.
 Hormones, 408.
 Hüfner's method (urea), 134.
 "Humus," 191.
 Huppert's test (bile pigments), 429.
 Hurlley's test (aceto acetic acid), 122.
 — extractor, 600.
 Hyalomucoid, 470.
 Hydantoic acid, 277.
 Hydantoin, 277, 278.
 Hydrazobenzene, 331.
 Hydrazones, 83, 90, 192, 250, 255.
 Hydroaromatic compounds, 310-329.
 Hydrobilirubin, 564.
 Hydrocarbons, 49-56.
 — halogen derivatives, 57-62, 63.
 — nomenclature, 50.
 — saturated, 50-53.
 — unsaturated, 54-56, 312.
 Hydrocellulose, 212.
 Hydrochloric acid (gastric contents), 427, 428.
 Hydrocinnamic acid, 259.
 Hydrocyanic acid, *see* Hydrogen cyanide.
 Hydroferrocyanic acid, 157.
 — — as protein precipitant, 369.
 Hydrogen cyanide, 29, 83, 89, 139, 153-154, 156, 157, 193, 194, 215, 291, 395, 402.
 — detection, 28.
 — estimation, 31-33.
 Hydrolyte, 394.
 Hydroquinone, 215, 261-262.
 Hydroterpenes, 312.
 Hydroxy acids, 106-123, 141, 395.
 — — ureides of, 277-279.
 — aldehydes, 186.
 Hydroxy-aminopropionic acid, 137.
 Hydroxybenzoic acid, 341.
 Hydroxybenzyl alcohol, 265.
 Hydroxybutyric acid, 123, 570.
 — — estimation, 597-600.
 Hydroxybutyrobetaine, 150.
 Hydroxyethyltrimethylammonium hydroxide, 127.
 Hydroxyflavone, 338.
 Hydroxyl group, 63.
 Hydroxymethylfurfural, 193, 194, 303.
 Hydroxyphenyl acetic acid, 269.
 — alanine, 267.
 — aminopropionic acid, 137, 267.
 — ethylamine, 269.
 — propionic acid, 269.
 Hydroxyproline, 138, 139, 304, 305, 306, 361.
 — betaine, 150.
 Hydroxypropionic acid, 110.
 Hydroxyquinol, 270.
 Hygrine, 351, 353.
 Hyocholalic acids, 328.
 Hyoscine, 351.
 Hyoscyamine, 351, 354.
 Hypaphorine, 151.
 Hypnone, 258.
 Hypobromite method (urea estimation), 134.
 Hypoxanthine, 286, 294, 295, 206, 298, 299, 584.
 Hysteresis, colloids, 385.
 ICHTHULIN, 464.
 Idain, 341.
 Identification of organic compounds, 46-48.
 Imides, 276.
 Iminazole aminopropionic acid, 137, 284.
 — acrylic acid, 284.
 — derivatives, 284, 285.
 — ethylamine, 284.
 Imino group, 124, 164.
 Inactive tartaric acid, 116.
 Inborn errors of metabolism, 569.
 India-rubber, 238, 312, 318, 382.
 Indian yellow, 186, 196.
 Indican, 121, 344-345, 350.
 Indigo-blue, 342, 344, 345-346, 350.
 Indigo-red, 346.
 Indigotin, 345-346.
 Indigo-white, 346.
 Indirubin, 346.
 Indole, 342-343, 349, 350.
 — and derivatives, 342-350.
 — acetic acid, 346-347, 349.
 — aminopropionic acid, 138, *see* Tryptophan.
 — ethylamine, 347, 349.
 — propionic acid, 347, 349.
 Indophenol (oxidases), 412, 426.

- Indoxyl, 344-345, 350.
 Inflammable liquids, 13, 18, 19.
 Ink, 275.
 Inorganic constituents, analysis, tissues, 573, 574.
 Inosinic acid, 301.
 Inositol, 310, 311.
 Inositols, 310, 311.
 Interfacial tension, 389.
 Internal compensation, 116.
 Intestinal juice, 398, 401, 402, 409.
 Inulase, 395.
 Inulin, 184, 188, 205, 213, 395.
 Inversion, 199.
 Invertase, 199, 202, 393, 395, 401, 403, 413, 419.
 Invert sugar, 199.
 Inverted condenser, 18.
 Iodine, estimation in tissues, 574.
 — value (fats), 179, 180.
 Iodobenzene, 241-242, 249.
 Iodoform, 62, 67, 91, 305.
 — reaction, 67, 91, 112.
 Iodol, 305.
 Iodothylin, 449.
 Iron, detection in hæmoglobin, 31.
 — estimation, 547-548.
 Irreversible colloids, 378, 385, 386.
 Isobilanic acid, 322.
 Isoborneol, 317.
 Isobutane, 49.
 Isobutyl alcohol, 68.
 Isobutyric acid, 98.
 Isochlorophyllins, 520, 522.
 Isocholesterol, 321.
 Isocyanates, alkyl, 124, 125, 161, 163.
 Isocyanides, alkyl, 61, 126, 159.
 Isocyanuric esters, 161.
 Isohæmopyrrole, 304, 306, 516, 523.
 Iso-indigotin, 34.
 Isolactose, 197.
 Isolation of organic compounds, 3-27.
 Isoleucine, 98, 138, 318, 361.
 Isomaltose, 197, 202.
 Isomers, 50, 54.
 Isonicotinic acid, 309.
 Isonitrile, phenyl, 61.
 — reaction, 61, 126, 247.
 Isonitrosomalonyl urea, 280.
 Isophonopyrrole carboxylic acid, 304.
 Isophthalic acid, 263.
 Isoprene, 54, 312, 317, 318.
 Isopropyl alcohol, 68, 88.
 — iodide, 68.
 Isoquinoline, 350.
 Isothiocyanates, alkyl, 163.
 Isovaleric acid, 98.

 JACOBY'S method (pepsin), 423.
 Jaffe's reaction (creatinine), 171.
 Junket, 462.

 KEPHALIN, 175, 176.
 Kera-in, 176.
 Keratins, 454.
 Kerosene, 51, 52.
 Keto acids, 106, 113, 119, 395.
 Ketone group, 88.

 Ketones, 58, 88-92, 183, 258.
 Ketose, 184, 185, 186, 303.
 Kjeldahl's method (nitrogen), 35-38.
 Koilin, 454.
 Kryptopyrrole, 304, 306, 516, 523.

 LACTALBUMIN, 446, 447, 459.
 Lactase, 395, 402, 403, 419.
 Lactates, 111, 112.
 Lactic acid, 110-112, 183, 190.
 — — estimation, 590-592.
 — — in gastric contents, 395, 427.
 — — — muscle, 447.
 Lactoglobulin, 446, 457, 459.
 γ -lactone formula, 187.
 Lactones, 276.
 Lactosazone, 200.
 Lactose, 184, 189, 192, 197, 198, 200, 395, 407, 457, 459, 462.
 — estimation, 235.
 — hydrolysis, 395.
 Laevulinic acid, 191, 299.
 Laevulose, 188, *see* Fructose.
 Laking of blood, 476.
 Lanolin, 175, 319, 321.
 Lard, 175, 177.
 Lassaigne's test (nitrogen), 29.
 Laudanosine, 359.
 Lauric acid, 93, 98.
 Leather, 369.
 Leaves, pigments, 519-532.
 Lebedeff's method (zymase), 403.
 Lecithins, 127, 175, 176, 457, 463, 544.
 Lecitho-vitellin, 463.
 Legal's test (acetone), 91.
 — — (aceto-acetic acid), 120.
 Legumelin, 450, 451.
 Legumes, protein content, 450.
 Legumin, 450.
 Lehmann-Maquenne method (glucose estimation), 232.
 Lentils, protein content, 450.
 Leucine, 138, 139, 318, 361, 408.
 Leucosin, 450, 451.
 Leucyl-alanine, 363.
 Lieben's reaction (iodoform), 67, 91.
 Lieberkühn's jelly, 370.
 Liebermann's reaction (cholesterol), 321.
 — — (proteins), 367.
 Light oil, 240.
 Lignin, 211.
 Lignocellulose, 205, 211.
 Ligroin, 10, 13, 22, 51, 52.
 Limonene, 312, 316, 317.
 Linalool, 313.
 Ling-Rendle's indicator, 224.
 Ling's method (diastase), 417.
 Linoleic acid, 105.
 Lintner's method (diastase), 417.
 Lipase, 177, 395, 397, 404-405, 415, 420.
 Lipins, 175.
 Lipochromes, 532.
 Lipoclastic } enzymes, 394, 395.
 Lipolytic }
 Liquids, determination boiling-point, 4-6.
 — distillation, 4-6.
 — evaporation, 13 14.
 — fractional distillation, 9.

- Liquids, fractional, *in vacuo*, 10-11.
 — purification, 4.
 — separation from solids, 15-16.
 — steam distillation, 12.
- Lithic acid, 287.
- Lithofellic acid, 328.
- Liver, 396, 398.
- Livetin, 463.
- Localisation of enzymes, 396-398.
- Lohnstein's method (glucose estimation), 233.
- Lutein, 463, 532.
- Luteolin, 338, 349.
- Lutidines, 309.
- Lycopin, 532.
- Lysine, 138, 361, 362.
- MAGENTA**, 335.
- Magnesium, estimation, 546.
 — in chlorophyll, 31, 519, 521, 522.
- Maize proteins, 452.
- Malachite green, 335, 337, 477.
- Maleic acid, 115.
- Malic acid, 113, 114, 115.
- Malonic acid, 110, 113, 288.
- Malonyl urea, 280, 288.
- Malt, 399, 416.
- Maltase, 214, 395, 402, 403, 415, 419.
- Maltosazone, 201.
- Maltose, 184, 192, 197, 198, 201-202, 207, 214, 395, 397, 399, 400, 402, 403, 585-586.
- Mandelic acid, 260.
 — — nitrile, 260.
- Mannans, 188, 205, 213.
- Mannitol, 68, 173, 174, 188, 194, 195.
- Mannonic acid, 195.
- Mannosans, 184.
- Mannose, 184, 186, 188, 190, 195, 214, 395.
- Mannotriose, 202.
- Margarine, 458.
- Marsh gas, 51, 52, 53.
- Martius yellow, 335.
- Measurement, enzyme activity, 416-426.
- Meat, 166, 447.
- Meconin, 360.
- Melibiose, 197, 202, 395.
- Melicitose, 202.
- Melting-point, 17.
 — determination, 23.
- Membranin, 456.
- Menthadienes, 314, 316.
- Menthenes, 313, 315.
- Menthol, 314, 315.
- Menthone, 313, 314, 315.
- Mercaptans, 78, 163, 342, 454.
- Mercaptides, 78.
- Mesohæmin, 516, 517.
- Mesoporphyrin, 516, 517.
- Mesotartaric acid, 116.
- Mesoxalyl urea, 280.
- Metabolism, 533-538.
 — inborn errors, 569.
- Metacasein, 424.
- Metachloral, 86.
- Meta derivatives (benzene), 260.
- Metaldehyde, 82.
- Metaproteins, 364, 370-371, 406.
- Methæmoglobin, 481-482, 493, 498.
- Methane, 51, 52, 53.
- Methanol, 63.
- Methoxybenzaldehyde, 269.
- Methoxybenzoic acid, 267.
- Methoxy group, 77.
- Methoxypropylene, 269.
- Methyl acrylic acid ureide, 282.
 — alcohol, 10, 18, 25, 63-64, 94, 355, 519.
 — amine, 126.
 — anilines, 248.
 — benzene, 251.
 — benzoic acids, 260, 263.
 — bromide, 251.
 — butyl acetic acid, 186.
 — ethyl acetic acid, 98.
 — — aminopropionic acid, 138.
 — furfural, 303.
 — glucosides, 187, 214.
 — glycine, 167.
 — guanidine, 165.
 — — acetic acid, 166.
 — guanine, 297.
 — iodide, 57, 251.
 — indole, 344-345.
 — isopropyl benzene, 269.
 — mercaptan, 78.
 — oxalate, 64, 73.
 — pentose, 183, 185, 303.
 — pyridines, 309.
 — xanthine, 297.
- Methylated spirit, 64, 65.
- Methylene bromide, 58.
 — chloride, 58.
 — iodide, 58.
- Mett's method (pepsin, trypsin), 421, 424.
 — tubes, 409, 421.
- Micro-analyses, elements, 40.
 — analysis, acetone, 595-596.
 — — amino acids, 149.
 — — blood constituents, 577-583.
 — — urine constituents, 556-563.
 — molecular weight determination, 43.
- Middle oil, 241, 244.
- Milk, 178, 366, 382, 457-459.
 — clotting, 461-462.
 — coagulable proteins, 446.
 — creatine and creatinine estimation, 583.
 — for enzyme actions, 404, 409, 424.
 — proteins, estimation, 575-576.
 — rennin action, 461-462.
 — sugar, 197, *see* Lactose.
- Millon's reaction, 245, 262, 264, 266, 268.
 — — proteins, 366.
- Mohr-Bertrand's method (glucose estimation), 228-229.
- Molasses, 198.
- Molecular weight determination, 42-45.
- Molisch's reaction (proteins), 366.
 — test (carbohydrates), 193, 199, 200, 202.
- Mono-amino acids, 138, 362.
- Monobromophenol, 245.
- Monochloroacetic acid, 100.
- Monohalogen derivatives, hydrocarbons, 57-59.
- Monohydroxyacetone, 194.
- Monohydroxysuccinic acid, 114.
- Monomethylamine, 124.
- Mononucleotides, 300, 301, 465.
- Monosaccharides, 82, 174, 183, 184-189, 398.
 — estimation, 220-234.

- Monosaccharides, reactions, 190-196.
 Monosubstitution derivatives, benzene, 240-260.
 Monoxypurine, 286.
 Moore's test (carbohydrates), 190, 199, 200, 201.
 Mörner's test (tyrosine), 268.
 Morin, 339, 341.
 Morphine, 351, 358-359.
 Mother liquor, 21.
 — of vinegar, 96.
 Mucic acid, 195, 303, 305.
 Mucilages, 213.
 Mucins, 429, 468.
 Mucoids, 468.
 Murexide reaction (uric acid), 291.
 Muscarine, 128.
 Muscle, 166.
 — analysis, extractives, 583.
 — coagulable proteins, 447-448.
 — fibrin, 447.
 Mustard oils, 163.
 Mutarotation, 186, 193.
Mycoderma aceti, 96.
 Mylius' reaction (cholalic acid), 325.
 Myogen, 447.
 Myosin, 447, 448.
 Myosinogen, 447, 448.
 Myrcene, 312.
 Myricetin, 339.
 Myricyl alcohol, 70, 175.
 Myristic acid, 93, 98.
 — alcohol, 175.
 Myrosin, 163.
 Myrtenol, 317.
 Myrtillidin, 341.
 Myrtillin, 341.

 NAPHTHA, petroleum, 51.
 Naphthalene, 241, 244, 263, 331-333.
 — sulphonic acid, 332, 333.
 Naphthaquinone, 332.
 Naphthenes, 51, 237.
 α -Naphthol, 193, 332-333, 412.
 β -Naphthol, 332, 333.
 Naphthol sulphonic acids, 333.
 — yellow, 335.
 Naphthylamines, 332, 333.
 Naphthylamine sulphonic acids, 333.
 Narceine, 351, 357.
 Narcotine, 351, 359.
 Native proteins, 435.
 Neuberg's reaction (cholesterol), 321.
 Neumann's method (phosphorus), 30, 40.
 — (chlorine), 39.
 Neutral sulphur, urine, 541.
 Nicol prism, 217.
 Nicotine, 304, 309, 351, 353.
 Nicotinic acid, 309, 353.
 — — betaine, 151.
 Nitranilines, 263.
 Nitration, 242.
 Nitric oxide hæmoglobin, 480, 493.
 Nitrite, mandelic acid, 260.
 Nitriles, 124, 153, 158, 194, 305.
 Nitrobenzene, 242-243, 246, 331.
 Nitrobenzoic acid, 256.
 Nitrocellulose, 212, 375, 384, 386.
 Nitro-compounds, 238, 335.
 Nitrogen, detection, 29.
 — estimation, 34-38.
 — total, blood extractives, 579.
 — — urine, 552, 558, 563.
 Nitrogenous compounds, 47.
 Nitromalonyl urea, 280.
 Nitrometer, Schiff's, 34.
 Nitronaphthalenes, 332, 333.
 Nitrophthalic acid, 332.
 Nitroso derivative, amine, 126, 248.
 Nitroso-indole, 343.
 Nitrotoluenes, 263.
 Nomenclature basis, hydrocarbons, 50.
 Non-nitrogenous compounds, 47.
 Nonose, 193.
 Nonyl alcohol, 70.
 Normal compounds, 50.
 Novaine, 150.
 Nuclease, 395.
 Nucleic acids, 185, 282, 294, 295, 298, 299, 302, 432, 457, 465, 544.
 Nucleins, 185, 299, 465.
 Nucleoalbumins, 457.
 Nucleohistones, 466-467.
 Nucleoproteins, 300-301, 364, 429, 443, 457, 465-467.
 Nucleoside, 300.
 Nucleotidases, 395.
 Nucleus, benzene, 238-240.
 Nuts, protein content, 450.
 Nylander's test (glucose), 192, 570.

 OATS, proteins, 452.
 Obermayer's test, indican, 345.
 Observation tubes, polarimeter, 219.
 Ocimene, 313.
 Octadecapeptide, 275, 363.
 Octane, 51.
 Octose, 193.
 Octyl alcohol, 70.
 Oenidin, 341.
 Oenin, 341.
 Oil, olive, 177, 381, 404, 405.
 — of winter green, 265.
 Oils, 175-182, 238, 381.
 "Oils," drying, 105.
 Olefines, 54.
 Oleic acid, 99, 105, 175.
 Olein, 175.
 Oliver's method (hæmoglobin), 487.
 — test (bile salts), 431.
 Optical activity, 111, 115, 116, 216.
 Orcinol, 271.
 — reaction (pentoses), 196.
 Organic compounds, elementary composition, 28-31.
 — — identification, 46-48.
 — — quantitative composition, 31-40.
 — — recognition, 2.
 Organised ferments, 391.
 Ornithine, 138, 165, 398.
 Orthocarbonic ester, 164.
 Ortho-derivatives (benzene), 260.
 Osazones, 192, 194, 195, 200, 201, 250.
 Osmotic pressure, colloidal solutions, 380, 384.
 Osseomucoid, 471.

- Ouric acid, 287.
 Output of urinary constituents, 538.
 Ovalbumin, 437.
 Ovoglobulin, 436.
 Ovomucin, 365, 436.
 Ovomuroid, 471.
 Oxalate, calcium, 108, 109.
 — — calculi, 568.
 — — deposit (urine), 565.
 Oxalic acid, 2, 94, 103, 106, 107, **108-109**, 115, 153, 279.
 Oxalonitrile, 153.
 Oxaluric acid, 279.
 Oxalyl urea, 279.
 Oxamic acid, 129.
 Oxamide, 129, 130, 152.
 Oxidases, **394, 395, 411-412, 426, 458**.
 Oxidation of organic compounds, 31-40, 238, 251, 259, 263.
 Oximes, 84, 92, 125, 194, 254.
 Oximidomesoxalyl urea, 288.
 Oxindole, 346.
 Oxy acids, *see* Hydroxy acids.
 Oxycellulose, 212.
 Oxygen capacity and content of blood, 486, 488, 489, **498-509**.
 — estimation in blood, 498-509.
 — hæmoglobin as carrier, 497-509.
 — solubility in blood, 497.
 Oxygenase, 411.
 Oxyhæmoglobin, **479, 480, 481, 482, 483**.
 — crystals, **491-493**.
 Oxyurines, 286.
 Ozokerit, 51.
- PALMITIC acid, 99, 175.**
 Palmitin, 175.
 Palmitylcholine, 128.
 Pancreas, 267, 397, 399, 404, 407, 408.
 — nucleoproteins, 467.
 Pancreatic juice, 177, 397, 399, 405, **408-409**.
 Papain, 395, 410.
 Papaverine, 351, 359.
 Parabanic acid, **279, 281**.
 Paracasein, 461.
 Paracetaldehyde, 82.
 Para derivatives (benzene), 260.
 Paraffin oil, 51.
 Paraffins, 52.
 Paraffin wax, 2, 23, 51.
 Paraform, 81.
 Paraformaldehyde, 81.
 Paraglycocholic acid, 327.
 Paraldehyde, **82, 276**.
 Paramucin, 470.
 Paramyosinogen, **447, 448**.
 Pararosaniline, 335.
 Paraxanthine, 297.
 Parchment paper, 212.
 Pathological urines, 570-572.
 Pavy's method (carbohydrate estimation), 225.
 Peas, protein content, 450.
 Pectins, 184, 205, 211, **213**.
 Pectocellulose, 211.
 Pelargonidin, 341.
 Pelargonin, 341.
 Pentabenzoylglucose, 199.
 Pentahydric alcohols, 195.
 Pentamethylene, 237.
 Pentamethylenediamine, 125, 308.
 Pentapeptides, 363.
 Pentosans, 184, 195, 205.
 — estimation, 234.
 Pentose in nucleic acid, 299, 300, 301.
 Pentoses, 184, **185, 194, 195-196, 211, 213, 465**.
 — estimation, **234, 586**.
 Pentosuria, 185, 569.
 Pepsin, 391, 393, 394, 395, 397, **405-406**.
 Peptones, 364, 370, **371-372, 373, 395, 398, 406, 407, 409, 410**.
 Peroxidase, 395, **411-412, 426, 476**.
 Petrol, 51.
 Petroleum, 51.
 — benzene, 51.
 — ether, 25, 51.
 — naphtha, 51.
 Pettenkofer's test (bile acids), 325, 430.
 Pflüger's method (glycogen estimation), 585.
 Phæophorbides, **523, 528**.
 Phæophytins, 522, **528, 529**.
 Phellandrene, 316, 317.
 Phenacetic acid, 258.
 Phenanthrene, 334.
 Phenates, 244.
 Phenol, **244, 249, 264, 265, 266, 267, 269, 273, 336, 541**.
 Phenolphthalein, 336.
 Phenylacetic acid, 258, 259.
 Phenylalanine, 137, 258, **259, 361, 366**.
 Phenylaminopropionic acid, 137.
 Phenylchloroform, 253.
 Phenylcyanide, 250, 255, **257**.
 Phenylenediamines, 261, 412, 477.
 Phenylethylamine, 259.
 Phenylethylene, 252.
 Phenylglucosazone, 192, 194, 195.
 Phenylhydrazine, 83, 85, 90, 192, **250**.
 Phenylisonitrile, 61.
 Phenylmethane, 251.
 Phenylpropionic acid, 258, 259.
 Phenyl radicle, 252.
 Phenyl salicylate, 267.
 Phenyl sulphuric acid, 245.
 Phlorogluc nol, **270, 274, 341**.
 — test (pentoses), 196.
 Phosphates, estimation of, urine, 544-545.
 — calculi, 568.
 — in milk, 457, 459.
 — urinary deposits of, 566, 567.
 Phosphatides, 176.
 Phosphoproteins, 364, **457-464, 544**.
 Phosphorus, detection, 30.
 — estimation, 40, 545.
 — in caseinogen, 457, 461.
 — — nucleic acids, 299, 300, 301.
 — — nucleoproteins, 299, 300.
 — — urine, 544-545.
 — — vitellin, 464.
 Phosphotungstic reaction, uric acid, 291, **561**.
 Phrenosin, 176.
 Phthalic acids, 255, 260, **263, 332**.
 — anhydride, 263, 336.
 Phyllophyllin, 521, 522.
 Phylloporphyrin, 516, 522.
 Phyllopyrrole, **304, 306, 516, 523**.

- Phytin, 310, 311.
 Phytochlorins, 522, 523, 525, 529.
 Phytol, 519, 520, 525, 528, 529.
 Phytorhodins, 522, 523, 525, 529.
 Phytosterols, 320, 321, 322.
 Picene, 334.
 Picolines, 309.
 Picolinic acid, 309.
 Picric acid, 245, 273, 335.
 — — in iodoform, 62.
 — — protein precipitant, 369.
 — — test, creatinine, 171.
 — — — glucose, 192.
 Pigmented chalk stones, 431.
 Pigments of leaves, 519-532.
 — — urine, 564.
 Pilocarpine, 285.
 Pinanes, 317.
 Pinene, 312, 317.
 Pinitol, 310.
 Piperic acid, 352.
 Piperidine, 308, 352.
 Piperine, 308, 351, 352.
 Piria's test (tyrosine), 268.
 Pitch, 241.
 Plant nucleic acids, preparation, 302.
 Plants, coagulable proteins, 450-451.
 Plasmin of Denis, 439.
 Plasmon, 460.
 Plattner's crystallised bile, 326.
 Pleated filter paper, 15.
 Polarimeter, 216-220.
 Polarisation, circular, III.
 Polyhydric alcohols, 173.
 Polymerisation, acetone, 89.
 — aldehydes, 81-82.
 Polymers, aldehydes, 276.
 Polymethylenes, 237.
 Polypeptides, 363, 364, 370, 407, 408.
 Polysaccharides, 183, 184, 188, 189, 205-213, 374.
 — estimation, 236.
 Polyterpenes, 313, 318.
 Potassium, estimation, 548-550.
 Potatoes, 205.
 Precipitation colloids, 380, 384, 386, 389.
 — reactions of proteins, 365, 368-369.
 — solids from solution, 26-27.
 Preparation of enzymes, 392-393.
 — — pure compounds, 3-27.
 Prevention of blood coagulation, 439.
 Primary alcohols, 68, 69.
 — amines, 124, 126, 129, 248, 249.
 — proteoses, 372, 373.
 Pro-enzymes, 394.
 Prolamins, 364.
 Proline, 138, 139, 304, 305, 306, 361, 362.
 — betaine, 150.
 Propaldehyde, 80.
 Propane, 49.
 Propionic acid, 98.
 Propyl alcohol, 68, 80, 98.
 — aldehyde, 80.
 — piperidine, 352, 353.
 Prosthetic group, 465, 468.
 Protagon, 176.
 Protamine nucleate, 300, 433.
 Protamines, 165, 299, 364, 432-433.
 Proteinochrome reaction, 348.
 Proteins, 17, 78, 137, 164, 165, 259, 264, 267, 284, 299, 300, 301, 304, 305, 306, 361-373, 374, 382, 391, 397-398, 432-515.
 — action of enzymes, 391, 393, 395, 405-410, 421-425.
 — biuret reaction, 365-373.
 — classification, 364.
 — composition of, 361.
 — constitution of, 363.
 — derivatives of, 364.
 — digestion of, 397-398.
 — estimation of, 38, 369, 445, 575-576.
 — general reactions of, 365-369.
 — hydrolysis of, 362, 370.
 — in bile, 429.
 — — blood, 438-445.
 — — — serum, 443-445.
 — — cereals, 452-453.
 — — egg-white, 436-437.
 — — — yolk, 464.
 — — fruits, 450.
 — — gastric contents, 427.
 — — meat, 447-448.
 — — milk, 446, 457, 460, 575.
 — — muscle, 447-448.
 — — plant seeds, 450-453.
 — — saliva, 468-469.
 — — tissues, 449.
 — — urine, 571-572.
 — — vegetables, 450.
 — putrefaction of, 342, 344, 346, 347, 391.
 Proteoclastic } enzymes, 363, 394, 395, 396,
 Proteolytic } 406, 447.
 Proteoses, 364, 370, 371-372, 395, 398, 406, 409, 410.
 — deuterio, 373.
 — primary, 372-373.
 — secondary, 373.
 — separation, 372-373.
 Prothrombin, 438, 439.
 Protocatechuic acid, 271, 341.
 Protoproteoses, 372-373.
 Prussian blue, 29, 153, 156, 157, 158,
 Prussiates of potash, 157, 158.
 Prussic acid, 153, see Hydrogen cyanide.
 Pseudoglobulin, 443, 444.
 Pseudomucins, 468, 470.
 Pseudomuscarine, 128.
 Pseudo-uric acid, 280, 288.
 Psylla-stearylalcohol, 70.
 Ptomaines, 351.
 Pulegone, 315, 316.
 Purification of organic compounds, 4, 17.
 Purine, 276, 286.
 — metabolism, 298.
 — ring, 284.
 Purines, 282, 286-298.
 Purpurin, 334.
 Putrefaction, proteins, 284, 342, 344, 346, 347, 391, 398.
 Putrescine, 125, 569.
 Pyridine, 10, 241, 276, 305, 307-308.
 — derivatives, 308-309.
 Pyrimidine, 276, 282, 284.
 Pyrimidines, 282-283, 299.
 Pyrocatechin, 261-262.
 Pyrogallic acid, 270.

- Pyrogallol, 270, 273, 274, 275.
 Pyroligneous acid, 63, 96, 98.
 Pyromucic acid, 303.
 Pyroxylin, 212.
 Pyrrole, 276, 304, 305, 306, 516.
 — derivatives, 304-306.
 — red, 305.
 Pyrrolidine, 304, 306.
 — carboxylic acid, 304.
 Pyrroline, 304, 306.
 Pyrrophyllin, 521, 522.
 Pyrroporphyrin, 522.
 Pyruvic acid, 110, 113.
- QUANTITATIVE composition organic com-
 pounds, 31-40.
 Quaternary ammonium salt, 127.
 Quebrachitol, 310.
 Quercetin, 339, 341.
 Quercitol, 310.
 Quercitrin, 185.
 Quinine, 351, 356-357.
 Quinol, 261-262, 270.
 — acetic acid, 271.
 Quinoline, 276, 307, 309, 350.
 Quinolinic acid, 309, 350.
 Quinone, 261, 262.
 Quinonoid structure, 336, 340.
- RACEMIC acid, 116.
 Raffinose, 184, 202, 395.
 Raoult-Beckmann method, 43.
 Reaction of blood, 472.
 — — urine, 539.
 Reactions of carbohydrates, 190-215.
 — — proteins, 365-369.
 Reagents, 610-617.
 Recrystallisation, 18.
 Rectified spirit, 64.
 Red blood corpuscles, 438, 473-475, 486.
 — — — histone, 433.
 Refined petroleum, 51.
 Reflux condenser, 18.
 Reichert-Meissl or Reichert-Wollny value
 (fat), 179, 181.
 Reichl's reaction, proteins, 367.
 Reimer's reaction, salicylic aldehyde, 265.
 Rennet ferment } 397, 461-462.
 Rennin }
 Resins, 312, 318.
 Resorcinol, 194, 261-262, 270, 336.
 Resorcin yellow, 337.
 Results, calculation of, 41.
 Reticulin, 456.
 Reversible colloids, 378, 386.
 — reaction, 415.
 Rhamninose, 202.
 Rhamnose, 183, 185, 202.
 Rhigolene, 51.
 Rhodophyllin, 521, 522.
 Rhodoporphyrin, 522.
 Ribose, 184, 185, 299.
 Rice, proteins, 452.
 Riegler's test (aceto-acetic acid), 121.
 Rigid gel, 387.
Rigor mortis, 447.
 Ring structures, 239, 276.
 Roaf's method (pepsin), 421-422.
- Robert's method (diastase), 417-418.
 — (trypsin), 424.
 Rothera's test (acetone), 91.
 — — (aceto-acetic acid), 120.
 Rotations, carbohydrates, 220.
 Roy and Lloyd-Jones' method (specific gravity
 blood), 473.
 Rye proteins, 452.
 Rosaniline, 335-336.
 — dyes, 331, 335, 337.
 Ruberythric acid, 333.
 Rubiphyllin, 521, 522.
 Rubiporphyrin, 522.
- SABINANE group, 318.
 Sabinene, 318.
 Sabinol, 318.
 Saccharic acid, 186, 190, 195.
 Saccharin, 264.
 Saccharose, 197, *see* Cane sugar.
 Sahli's method (hæmoglobin), 489.
 Salicin, 214, 215, 265, 402.
 Salicylic acid, 260, 265-266, 267.
 — alcohol, 214, 215, 265.
 — aldehyde, 265.
 — — test (acetone), 91.
 Saligenin, 214, 265, 402.
 Saliva, 397, 469.
 Salivary glands (mucin), 468.
 Salkowski's reaction (cholesterol), 321.
 Salmine, 361, 432.
 Salol, 266, 267.
 Salt blood plasmas, 439-442.
 Salting out, 27.
 Sanatogen, 460.
 Sandmeyer's reactions, 250.
 Santalene, 318.
 Santalol, 318.
 Saponification, 73, 177.
 — value (fat), 179, 180.
 Saponins, 185, 189.
 Sarcosine, 167.
 Saturated hydrocarbons, 49-53, 55.
 Scatole, 342, 344, 349.
 Schiff's nitrometer, 34.
 — test (aldehydes), 84.
 — — (uric acid), 291.
 Schütz law (enzyme action), 421.
 Scleroproteins, 143, 364, 454-456.
 Scombrine, 432.
 Scyllitol, 310.
 Secondary alcohols, 68, 69, 88, 319.
 — amines, 124, 126, 305, 308.
 — proteoses, 373.
 Secretin, 397, 408.
 Sedimentation, 27.
 Sediments, urinary, 565-567.
 Seeds, proteins of, 450.
 Seidel's test (inositol), 311.
 Selivanoff's test (fructose), 194, 199.
 Separating funnel, 8.
 Separation of amino acids, 362.
 — — coagulable proteins, 435.
 — — liquids, 8-12.
 — — metaproteins, 371.
 — — milk constituents, 459.
 — — proteoses and peptones, 372-373.

- Separation of serum proteins, 443.
 — — solids, 25.
 — — — and liquids, 15-16.
 Sericin, 456.
 Series, homologous, 49, 93.
 Serine, 137, 361.
 Serosa, mucin, 469.
 Serum, 370, 438, 441.
 — albumin, 361, 443, 444, 445.
 — globulins, 361, 443-444, 445.
 — mucoid, 471.
 Sesquiterpenes, 313, 318.
 Sherer's test (inositol), 311.
 Side chain, 251, 252.
 Sidersky's method (glucose estimation), 231.
 Silk, 267, 456.
 Silk-fibroin, 361, 456.
 — gelatin, 456.
 — peptone, 407.
 Sinigrin, 163.
 Sitosterol, 322.
 Size of colloidal particles, 378.
 Soaps, 99, 177, 178, 320, 374, 384, 386.
 Sodamide, 155.
 Sodium estimation, 548.
 — nitroprusside, 157.
 — test (aceto-acetic acid), 120.
 — — — (acetone), 48, 91.
 — — — (creatinine), 48, 171.
 — — — (indole), 48, 343.
 Solids, isolation from solution, 26-27.
 — purification, 17.
 — separation from liquids, 15-16.
 — — of, 25-26.
 Sols, 375, 380, 384, 385, 386.
 Soluble ferments, 391.
 — myosin, 447.
 — starch, 206.
 Solution, 19.
 Solvent action of bile, 431.
 Solvents, extraction with, 25.
 — for crystallisation, 17-18.
 Sorbitol, 174, 190, 194.
 Sorbose, 184, 186.
 Sørensen's method (trypsin), 425.
 Soxhlet apparatus, 178.
 Specific action of enzymes, 393, 403.
 — gravity of blood, 472-473.
 — — — milk, 457.
 — — — urine, 539.
 — rotatory power, 220.
 Spectroscope, 478.
 Spectroscopic examination (hæmoglobin and derivatives), 478-485.
 Spectrum, 478.
 Spermaceti, 70, 175.
 Sphingomelin, 176.
 Sphingosine, 176.
 Spongion, 456.
 Spongosterol, 321.
 Stachydrine, 150, 351.
 Stachyose, 184, 202.
 Starch, 17, 64, 184, 188, 201, 205-207, 374, 377, 384, 391, 395, 397, 452.
 — action of diastase, 399-401, 417-418.
 — estimation, 585, 587.
 — paste, 205.
 Stearic acid, 99, 175.
 Stearin, 175.
 " Stearine," 99.
 Stercobilin, 564.
 Stereoisomerism, 111, 185.
 Stigmasterol, 322.
 Stomach contents, 427.
 — digestion in, 397.
 Storax, 259.
 Strychnine, 351, 357.
 Sturine, 432.
 Styrene, 252.
 Suberane, 237.
 Suberone, 237.
 Sublimation, 27.
 Submaxillary gland (mucin), 468.
 Substituted amides, 126-127, 141.
 Substitution derivatives, benzene, 240-273.
 — — halogen, 57-62.
 Substrate (enzyme action), 394, 399, 413.
 Succinic acid, 114.
 — anhydride, 276.
 Succinimide, 276, 305.
 Succinyl dialdoxime, 305.
 Succus entericus, 398, 401, 402.
 Sucrase, 395.
 Sucroclastic enzymes, 394, 395, 396.
 Sucrose, 184, 197, *see* Cane sugar.
 Suffix -ane, 50.
 — -ase, 394.
 — -ene, 54.
 — -ine, 54.
 — -ol, 63, 241.
 — -ose, 183.
 Sugars, 183-236, 374, 391.
 Sulphanilic acid, 263.
 Sulphates, estimation in urine, 541-543.
 Sulphæmoglobin, 481.
 Sulphides, 78, 79, 541.
 Sulphobenzonic acids, 264.
 Sulphocyanic acid, 162, *see* Thiocyanic acid.
 Sulphocyanides, 153, *see* Thiocyanates.
 Sulphonation, 243.
 Sulphonic acids, 78, 163.
 Sulphur, detection, 30.
 — estimation, 40.
 — in urine, 541.
 — in cystine, 144.
 — reaction (proteins), 366.
 Sulphuric acid, ethyl, 71, 73, 74.
 — ether, 76.
 Surface coating, egg-white solution, 382.
 — tension, 383, 389.
 — — bile, 430.
 Suspensions, 377, 378, 380.
 Suspensoids, 378, 380, 385, 386.
 Sylvestrene, 316, 317.
 Synthesis by enzymes, 391, 415.
 Syntonin, 448.
 TALLQUIST'S method (hæmoglobin), 486.
 Tannic acid, 273.
 Tannin, 238, 273, 274, 275, 386.
 Tannins, 274, 275.
 Tartar, 115.
 Tartaric acid, 113, 114, 115-117.
 Tartronic acid, 110.
 Tartronyl urea, 280.
 Taurine, 144-145, 322, 329.

- Taurocholic acid, 322, 329.
 Taurocholic acid, 144, 322, 328-329.
 Teichmann's test (blood stains), 490.
 Tendomucoid, 471.
 Terephthalic acid, 263, 269.
 Terpene group, 312-318.
 Terpin, 313, 315, 316.
 Terpinene, 316, 317.
 Terpineol, 315, 316.
 Terpinenol, 315, 316.
 Terpinolene, 316.
 Tertiary butyl alcohol, 68.
 — alcohol (phenol), 244.
 — amine, 124, 127, 307.
 Tetrabromethane, 333.
 Tetrahydrobenzene, 310.
 Tetrahydrofuran, 303.
 Tetra-iodopyrrole, 305.
 Tetramethylene, 237.
 Tetramethylmethane, 50.
 Tetranucleotide, 300.
 Tetrapeptides, 363.
 Tetrasaccharides, 184, 202.
 Tetrasubstitution derivatives, benzene, 273.
 Tetroses, 184, 185.
 Theobromine, 286, 287, 297.
 Theophylline, 286, 297.
 Thio-alcohols, 78.
 — aminopropionic acid, 137.
 Thiocarbamate, 162, 163.
 Thiocyanates, 153, 156, 162, 163, 164, 541.
 — alkyl, 163.
 Thiocyanic acid, 162, 469.
 Thioethers, 78.
 Thiolhistidine betaine, 150.
 Thiophene, 276, 304.
 — test (lactic acid), 112.
 Thiourea, 159, 164.
 Thoma-Zeiss hæmocyto-meter, 475.
 Threose, 184, 185.
 Thrombin, 438, 439, 441, 442.
 Thrombogen, 438, 439, 441, 442.
 Thrombokinase, 438, 439, 441, 442.
 Thujene, 318.
 Thujone, 318.
 Thymine, 282-283, 299, 300.
 Thymol, 269, 271.
 Thymushistone, 433.
 Thymus nucleic acid, preparation, 301.
 Thymusnucleohistone, 466.
 Thyreoglobulin, 449.
 Thyroid, iodine in, 449.
 Tissues, analysis, 573-604.
 Tollen's test (pentoses), 196.
 Toluene, 240, 251, 252, 253.
 — sulphonic acids, 263.
 Toluic acids, 251, 269.
 Toluidines, 263, 264, 335.
 Toluole, 251.
 Töpfer's method (acids gastric contents), 428.
 Total nitrogen estimation (urine), 552, 558, 563.
 — — — (blood and tissue extractives), 579, 583.
 Toxines, 351.
 Trehalose, 197, 202.
 Triacetonamine, 89.
 Tribenzylamine, 257.
 Tribromaniline, 247.
 Tribromophenol, 245.
 Tribromoresorcinol, 262.
 Tributyrin, 458.
 Tricaprin, 458.
 Trichloroacetic acid, 100.
 Trichloroacetone, 64.
 Trichlorolactamide, 288.
 Trichloropurine, 290.
 Triglycerides, 458.
 Trigonelline, 151, 351.
 Trihalogen derivatives, hydrocarbons, 59-62.
 Trihydric alcohol, 173.
 — phenols, 270.
 Trihydroxybutyric acid, 186, 194.
 Trimethylamine, 127.
 Trimethylamine acetic acid, 150.
 Trimethyldioxypurine, 286.
 Trimethylene, 237.
 Trimethylhistidine, 150.
 Trimethylmethane, 49.
 Trimethylxanthine, 287.
 Trinitrophenol, 273.
 Trioses, 184.
 Trioxyethylene, 276.
 Trioxypurine, 286.
 Tripeptides, 363.
 Triphenylcarbinol, 331.
 Triphenylmethane, 330-331.
 — derivatives, 335-336.
 Triple phosphate, urine deposit, 566.
 Trisaccharides, 183, 184, 202.
 Trisubstitution derivatives, benzene, 270-272.
 Tritico-nucleic acid, preparation, 302.
 Trommer's test (glucose), 191.
 Tropic acid, 354.
 Tropine, 354.
 Trypsin, 363, 391, 394, 395, 397, 407-408, 409, 413, 424-425.
 Trypsinogen, 394, 397, 408-409.
 Tryptophan, 138, 140, 342, 347, 348-349, 361, 362, 366, 367, 407, 408.
 Tryptophan-betaine, 151.
 Tschugaieff's reaction (cholesterol), 321.
 Tubes, absorption (combustions), 32.
 Turanose, 197, 202.
 Turicine, 150.
 Turnbull's blue, 158.
 Turpentine, 238, 269, 312.
 Tyndall phenomenon, 377, 378.
 Tyramine, 269.
 Tyrosine, 139, 140, 264, 267-268, 269, 361, 366, 407, 408, 567.
 UFFELMANN'S reaction (lactic acid), 112, 427.
 Ultra-filtration, 378.
 Ultra-microscope, 379.
 Undetermined nitrogen (urine), 538.
 Unorganised ferments, 391.
 Unsaturated acids, 103, 105, 282.
 — alcohols, 103, 104.
 — aldehydes, 103, 104.
 — compounds, 259.
 — hydrocarbons, 54-56, 58, 312.
 Uracil, 282-283, 299, 300.
 Uramil, 280, 281, 288.
 Urates, 290-291.
 — calculi, 568.

- Urates, sediments in urine, 565, 567.
 Urea, 129, **131-136**, 159, 160, 161, 165, 167,
 277, 278, 279, 282, 287, 288, 291, 293,
 398, 539.
 — estimation, 134-136.
 — — in blood and tissues, 580, 583.
 — — — urine, 552-553, 560.
 — nitrate, 131, **132**.
 — oxalate, 131, 132.
 — preparation from urine, 131.
 Urease, 136, 539, **552**, 556, 560.
 Ureides, 277-281.
 — cyclic, 276, 277, 282.
 Ureometer, Dupré's, 134.
 Uric acid, 278, 279, **280**, 286, **287-292**, 294,
 298, 395, 398, **582**.
 — — estimation, **292**.
 — — — (blood and tissues), 580, 584.
 — — — urine, **554**, 557, 561.
 — — preparation from urine, 289.
 — — urinary deposits, 565, 567.
 Uricase, 298, 395.
 Urine, **539-572**.
 — acidity, 550.
 — allantoine, 278-279, 553.
 — amino acids, 551-552.
 — ammonia, 551, 560.
 — calcium, 546.
 — calculi, 287, 293, **568**.
 — chlorides, 540.
 — colour, 539.
 — creatine, 166, 555, 562.
 — creatinine, 169-170, 555, 562.
 — cystine deposits, 567.
 — deposits, 565-567.
 — ethereal sulphates, 542-543.
 — hæmatoporphyrin, 484, 564.
 — hippuric acid, 142.
 — indican, 345.
 — iron, 547-548.
 — magnesium, 546.
 — mucoid, 471.
 — nitrogen, total, 552, 558, 563.
 — pathological, 570-572.
 — pigments, 564.
 — phenol, 245.
 — phosphates, 544-545.
 — phosphorus, total, 545.
 — potassium, 548-550.
 — reaction, 539.
 — sediments, 565-567.
 — sodium, 548.
 — specific gravity, 539.
 — sulphates, 541-543.
 — tyrosine deposit, 567.
 — undetermined nitrogen, 538.
 — urea, 129, 131, 552-553, 560.
 — uric acid, 287, 289, 554, 561, 565.
 — urorosin reaction, 347.
 — volume, 539.
 Urobilin, 564.
 Urobilinogen, 564.
 Urocanic acid, 284.
 Urochrome, 564.
 Uroerythrin, 564, 565.
 Urorosin reaction, urine, 347.
 Urostealiths, 568.
 Urotropin, 82, 551.
 Ursocholeic acid, 328.
 VALERIANIC acid, 98.
 Valeric acid, 98.
 Valine, 98, 137, 361.
 Vanillin, 271.
 Van Slyke's method (amino nitrogen), 146-
 149.
 Vaseline, 51.
 Vegetable globulins, 450-451.
 — proteins, 361, 362, 450-451.
 — proteoclastic enzymes, 410.
 Vegetables, protein content, 450.
 Veratric acid, 271.
 Veratrol, 262.
 Vernine, 301.
 Veronal, 280.
 Vicianin, 202.
 Vicianose, 197, 202.
 Vicilin, 450.
 Victor Meyer's method (molecular weight),
 42.
 Vinasses, 63.
 Vinegar, 96.
 Vinyl chloride, 56.
 Violuric acid, 280, 281, 288.
 Viscosity, colloidal solutions, **380**, 383, 384.
 Visibility of colloidal particles, 379.
 Vitamines, 537.
 Vitellin, 463, **464**.
 Volatile fatty acids, 93.
 — oils, 312-318.
 Volhard's method (pepsin), 423.
 Von Fleischl's method (hæmoglobin), 486.
 WAXES, 175.
 Weyl's test (creatinine), 171.
 Wheat nucleic acid, preparation, 302.
 Wheat, proteins, 452-453.
 Whey, 459, **462**.
 Will and Varrentrapp's method (nitrogen),
 29.
 Witte's peptone, **371**, 372, 373, 409, 427.
 Wohlgemuth's method (diastase), 418.
 Wood spirit, 63.
 — tar, 63.
 XANTHINE, 280, **286**, **293**, 295, 298, 299, 301,
584.
 — calculi, 293, 568.
 — oxidase, 298.
 Xanthoncs, 338.
 Xanthophyll, 519, 523, 524, 527, **530-531**, 532.
 Xanthoproteic reaction (proteins), 366.
 Xanthorhamnin, 185, 189.
 Xylenes, 240, 252, **260**, 263, 264.
 Xylose, 184, **185**, 197.
 YEAST, 391, 401.
 Yeast nucleic acid, preparation, 302.
 ZYMASE, 395, **403**, 419.





248058



MPhy

P

Author Plimmer, Robert Henry Aders

Title Practical organic and bio-chemistry. New ed.

University of Toronto
Library

**DO NOT
REMOVE
THE
CARD
FROM
THIS
POCKET**

Acme Library Card Pocket
Under Pat. "Ref. Index File"
Made by LIBRARY BUREAU

