

AS472
.A8P7
*

g

FOR THE PEOPLE
FOR EDVCATION
FOR SCIENCE

LIBRARY
OF
THE AMERICAN MUSEUM
OF
NATURAL HISTORY

ell. c



LIBRARY
OF THE
MUSEUM
OF NATURAL HISTORY

PROCEEDINGS

OF THE

ASIATIC SOCIETY OF BENGAL,

5.06(54.1) B

EDITED BY

THE HONORARY SECRETARIES.



JANUARY TO DECEMBER,

1871.



CALCUTTA.

PRINTED BY C. B. LEWIS, BAPTIST MISSION PRESS.

1871.

YAZERU
ROYAL
MUSEUM KATHMANDU
NEOTERIC JOURNAL 30

23-92479 - July 25

CONTENTS.



	<i>Page</i>
List of Members of the Asiatic Society of Bengal on the 31st December, 1870, Appendix in February Proceedings,	I
Abstract Statement of Receipts and Disbursements of the Asiatic Society of Bengal for the year 1870, Appendix in February Proceedings,	XIX
Proceedings for January, 1871,	1-20
Do. for February, 1871, including Annual Report and President's Address,	21-54
Do. for March, 1871,	55-80
Do. for April, „	81-94
Do. for May, „	95-118
Do. for June, „	119-136
Do. for July, „	137-158
Do. for August, „	159-176
Do. for September, „	177-224
Do. for October, „	225-229
Do. for November, „	231-250
Do. for December, „	251-298
Meteorological observations for January to December, 1871,	I to XCVIII
Appendix A,	300
Do. B,	306
Index,	307

<i>Plate (I)</i>	<i>List of plates</i>	<i>Page</i>
✓ - (I)	- - - - -	18
✓ - (II)	- - - - -	144
✓ - III	- - - - -	149
✓ - IV	- - - - -	220

ERRATA.

<i>Page</i>	<i>Line</i>	<i>For</i>	<i>Read</i>
2,	9,	H. W. Seevens,	H. W. Stevens.
36,	16,	Hootoone,	Hootoom.
56,	14,	M. S. Howell,	A. P. Howell.
„	16,	Filgatte,	Filgate.
„	22,	Bourn,	Bourne.
82,	3rd from below,	Insert,	A. P. Howell, Esq.
84,	2,	possess,	possesses.
„	7,	This,	It.
106,	23,	‘tail 0''·6.’	‘tail, 1''·2.’
107,	2,	<i>Cynonycterus</i> ,	<i>Cynonycteris</i> .
„	„	$\frac{1}{4}$,	$\frac{3}{4}$.
131,	17,	‘sun a moon’s limb.’	‘sun and moon’s limb.
„	29,	‘3'-2''·7''’,	‘— 3'-2''·7''’.
„	30,	‘4'-11''’,	‘— 4'-11''’.
134,	„	after In. $\frac{2-2}{6}$,	insert C. $\frac{1-1}{1-1}$.
225,	10,	Prákria,	Prákrita.
„	11,	Vyakuranam,	Vyákaranam.
247,	3,	Hálim,	Hátim.

APPENDIX.

LIST OF MEMBERS
OF THE
ASIATIC SOCIETY OF BENGAL,
ON THE 31ST DECEMBER, 1871.

LIST OF ORDINARY MEMBERS.

The * distinguishes Non-Subscribing, the † Non-Resident Members,
and the ‡ Life-Members.

N. B.—Gentlemen who may have changed their residence, since this list was drawn up, are requested to give intimation of such a change to the *Secretaries*, in order that the necessary alterations may be made in the subsequent edition. Errors or omissions in the following list should also be communicated to the Secretaries.

Gentlemen who are proceeding to Europe, with the intention of not returning to India, are particularly requested to notify to the *Secretaries*, whether it be their desire to continue as members of the Society.

Date of Election.		
1847 June 2.	*Abbot, Major-Gen. J., R. Artillery.	Europe
1871 March 1.	†Abbey Walter, Esq., Civil Surgeon.	Mergui
1860 Dec. 5.	Abdullatif Khán Bahádur, Maulavi.	Calcutta
1868 Sept. 2.	†Adam, R. M., Esq.	Sambhar Lake, viâ Jeypur
1869 Jan. 20.	†Adley, C. C., Esq., C. E., Nerbudda Coal & Iron Co.	Gunwarra, Central India
1860 July 4.	†Ahmad Khan, Sayyid, Bahádur.	Benares
1860 April 4.	†Aitchison, J. E. T., Esq., M. D.	Rawal Pindi.
1859 Feb. 2.	*Alabaster, C., Esq.	China
1871 Oct. 4.	Aldis, J. A., Esq., M. A.	Calcutta
1866 Jan. 17.	Allan, Lieut.-Col. A. S.	Calcutta
1852 July 7.	*Allan, C., Esq., B. C. S.	Europe
1869 Oct. 6.	*Allardyce, A., Esq.	Europe
1871 June 7.	†Alexander, J. W., Esq.	Patna
1860 Oct. 3.	Amir Alí Khán, Bahádur, Munshí.	Calcutta
1870 June 1.	†Amir Hasan Khán Bahádur, Rájá.	Mahmudabad, Oudh
1865 Jan. 11.	Anderson, Dr. J., F. L. S.	Calcutta
1843 Sept. 4.	*Anderson, Lieut.-Col. W., B. Artillery.	Europe
1864 Dec. 7.	*Anderson, W., Esq.	Europe
1861 Sept. 4.	*Asghar Alí Khán Bahádur, Nawáb.	Europe
1869 Feb. 3.	*Ashton, Rev. J. P.,	Europe
1861 July 3.	*Asphar, J. J. T. H., Esq.	Europe
1871 Sept. 6.	†Atkinson, E. T., Esq., C. S.	Allahabad
1855 July 4.	Atkinson, W. S., Esq., M. A., F. L. S.	Calcutta
1869 Feb. 3.	†Attar Singh Bahádur, Sirdár.	Loodiana
1871 April 5.	Ayrton, W. E., Esq.	Calcutta
1835 Oct. 7.	*Baker, Col. W. E., Bengal Engineers.	Europe
1859 Aug. 3.	Baláichánda Sínha, Bábu.	Calcutta
1865 Nov. 1.	†Ball, V., Esq., Geol. Survey.	Geol. S. Office
1860 Nov. 7.	Banerjea, Rev. K. M.	Calcutta

Date of Election.			
1869 Dec.	1.	†Barker, R. A., Esq., M. D.	Beerbhoom
1864 May	4.	*Barry, Dr. J. B.	Europe
1856 Sept.	3.	Bashiruddín, Sultán, Muhammad.	Chinsurah
1860 July	4.	†Batten, G. H. M., Esq., B. C. S.	Agra
1838 Jan.	3.	*Batten, J. H., Esq., B. C. S.	Europe
1869 Feb.	3.	†Baxter, J. B., Esq., M. R. C. S.	Sandheads
1859 May	4.	Bayley, E. C., Esq., B. C. S., C. S. I.	Calcutta
1861 Feb.	6.	Bayley, S. C., Esq., B. C. S.	Calcutta
1868 May	6.	*Baynes, J., Esq.	Europe
1849 June	6.	*Beadon, The Hon'ble Sir Cecil, B. C. S.	Europe
1864 Sept.	7.	†Beames, J., Esq., B. C. S.	Balasure
1841 April	7.	Beaufort, F. L., Esq., B. C. S.	Calcutta
1847 Aug.	4.	*Beekwith, J., Esq.	Europe
1867 July	3.	†Belletty, N. A., Esq.	Mymensing
1869 Jan.	20.	*Bellew, Dr. P. F.	Europe
1871 March	1.	Benedict, E., Esq., C. E.	Calcutta
1830 Sept.	1.	*Benson, Lieut.-Col. R.	Europe
1862 Oct.	8.	Bernard, C. E., Esq., B. C. S.	Calcutta
1862 June	4.	†Bhau Daji, Dr.	Bombay
1864 Nov.	2.	Bhudeva Mukerjea, Bábu.	Chinsurah
1840 July	15.	*Birch, Major-General Sir R. J. H., K. C. B.	Europe
1846 March	4.	*Blaggrave, Major T. C., 26th Regt., B. N. I.	Europe
1859 Sept.	7.	*Blane Col. Sir S. J.	Europe
1857 Mar.	4.	Blanford, H. F., Esq., A. R. S. M., F. G. S.	Calcutta
1859 Aug.	3.	†Blanford, W. T., Esq., A. R. S. M., F. G. S., Geol. Survey.	Geol. S. Office
1871 May	3.	†Bligh, C. F., Esq.	Toungoo, Burma.
1864 April	6.	Blochmann, H., Esq., M. A.	Calcutta
1857 Aug.	2.	*Bogle, Lieut.-Col. Sir. A., Kt.	Europe
1871 April	5.	†Bourn, T. W., Esq.	Yeotmahal, East Berar.
1871 April	5.	†Bourne, Walter, Esq., C. E.	Madapoor
1868 Jan.	15.	*Boxwell, J., Esq., C. S.	Europe
1854 Nov.	1.	*Boycott, Dr. T., B. M. S.	Europe
1860 March	2.	*Brandis, Dr. D.	Europe
1860 Oct.	3.	*Brandreth, The Hon'ble J. E. L.	Europe
1871 Oct.	4.	Briggs, J. A., Esq.	Calcutta
1870 Aug.	3.	†Broadley, A. M., Esq., C. S.	Behar
1866 April	4.	*Broderick, H. C., Esq., M. D.	Europe
1847 June	2.	*Brodie, Capt. T., 5th Regiment, B. N. I.	Europe
1871 Jan.	4.	Brough, R. S., Esq.	Calcutta
1866 Jan.	17.	†Brown, Col. D.	Rangoon
1866 Nov.	7.	†Browne, Lieut.-Col. Horace A.	Thayetmo, Burma
1866 June	6.	†Brownfield, C., Esq.	Kamrup
1868 June	3.	†Buck, E. C., Esq., C. S.	Cawnpur
1871 July	5.	†Buckland, C. T., Esq., C. S.	Burdwan
1866 June,	6.	†Buckle, Dr. H. B., C. B.	Dacca
1871 Sept.	6.	†Buckle, H., Esq.	Akyab

Date of Election.		
1869 Jan. 20.	†Cadell, A., Esq., B. A., C. S.	Mozaffernagar
1859 Sept. 7.	*Campbell, Dr. A.	Europe
1863 June 3.	Campbell, The Hon'ble G.	Calcutta
1860 Jan. 3.	†Carnac, J. H. Rivett, Esq., B. C. S.	Nagpur
1868 Aug. 5.	†Chandramohana Gosvámi, Pandita.	Gowhati
1863 Aug. 5.	†Chandranátha Ráya, Rája.	Nator
1871 Sept. 6.	†Chisholm, R. F., Esq.	Madras
1868 Feb. 5.	*Clark, Major E. G., Bengal Staff Corps.	Europe
1871 March 1.	†Clarke, C. B. Esq.	Dacca
1863 April 1.	*Cleghorn, Dr. H.	Europe
1868 Nov. 4.	†Cole, Lieut. H. H., R. E.	India
1862 April 2.	*Colles, J. A. P., Esq., M. D.	Europe
1851 March 5.	*Colvin, J. H. B., Esq., B. C. S.	Europe
1871 Oct. 4.	†Cooke, H. G., Esq., C. S.	Chittagong
1868 Dec. 2.	†Cooke, J. E., Esq.	Haidarabad
1860 Dec. 5.	*Cooper, F. H., Esq., B. C. S.	Europe
1870 June 1.	Couch, The Hon'ble Sir R.	Calcutta
1857 March 4.	*Cowell, E. B., Esq., M. A.	Europe
1866 May 2.	*Cox, W. H., Esq.	Europe
1861 July 3.	*Crockett, Oliver R., Esq.	China
1871 April 5.	Curtoys, W. J., Esq.	Calcutta
1868 Sept. 2.	Cutsem, E. Ch. Van, Esq.	Calcutta
1862 April 2.	*Dalrymple, F. A. E., Esq., C. S.	Europe
1847 June 2.	†Dalton, Col. E. T., C. S. I., Staff Corps.	Chota Nagpur
1870 May 4.	†Damant, G. H., Esq., C. S.	Dinajepore
1871 Jan. 4.	†Daukes, F. C., Esq., C. S.	Allahabad
1861 March 6.	Davey, N. T., Esq., Revenue Survey.	Howrah
1861 Nov. 6.	†Davies, The Hon'ble R. H., C. S. I., B. C. S.	Panjab
1869 April 7.	†Day, Dr. F., F. L. S., F. Z. S.	India
1856 June 4.	†DeBourbel, Major R., Bengal Engrs.	Oudh
1870 Feb. 2.	†DeFabeck, F. W. A., Esq., Bengal Medical Service.	Jeypore
1869 Oct. 6.	†Delmerick, J. G., Esq.	Rawal Pindi
1861 June 5.	*Denison, His Excellency Sir W., K. C. B.	Europe
1864 July 6.	Devendra Mallika, Babu.	Calcutta
1861 March 6.	*Devereux, The Hon'ble H. B., B. C. S.	Europe
1862 May 7.	†Dhanapati Singha Dughar, Ráya Bahádur.	Azimganj
1853 Sept. 7.	Dickens, Lieut.-Col. C. H.	Calcutta
1871 March 1.	Dijendranatha Thakura, Babu.	Calcutta
1870 May 4.	Dobson, G. E., Esq., M. B.	Calcutta
1859 Sept. 7.	†Douglas, Col. C.	Meerut
1869 Feb. 3.	†Drew, F., Esq.	Jummoo, viâ Sealkote
1870 March 8.	†Duke of Edinburgh, His Royal Highness.	Europe
1864 Dec. 7.	*Dunlop, H. G., Esq.	Europe
1867 June 5.	*Duthoit, W., Esq., C. S.	Europe
1861 May 1.	*Earle, Capt. E. L., Bengal Artillery.	Europe
1857 May 6.	*Eatwell, Dr. W. C. B.	Europe

Date of Election.			
1868 Oct.	7.	†Eddowes, W., Esq., M. D.	Erinpur
1863 May	6.	†Edgar, J. W. Esq., B. C. S.	Cachar
1840 Oct.	7.	*Edgeworth, M. P., Esq., B. C. S.	Europe
1865 Feb.	1.	*Egerton, Ph., Esq., B. C. S.	Europe
1846 Jan.	7.	*Elliot, Sir Walter, late M. C. S.	Europe
1859 Nov.	2.	†Elliot, C. A., Esq., B. C. S.	Allahabad
1856 March	5.	*Ellis, Lieut.-Col. R. R. W., 23rd Regt., B. N. I.	Europe
1854 Nov.	1.	*Elphinstone, Capt. M. W., 30th Regt., B. N. I.	Europe
1861 Jan.	9.	*Erskine, The Hon'ble C. J., Bombay C. S.	Europe
1856 Aug.	6.	*Erskine, Major W. C. B.	Europe
1871 Oct.	4.	†Evezard Col. G. E.	Poona
1863 Oct.	7.	Ewart, J., Esq., M. D.	Calcutta
1862 Aug.	6.	*Eyre, Col. Vincent, C. B.	Europe
1871 Feb.	1.	Farr, G. C. Esq.	Calcutta
1851 May	7.	Fayrer, Dr. J., C. S. I.	Calcutta
1863 Jan.	15.	†Fedden, Francis, Esq., Geol. Survey.	Geol. S. Office
1869 April	7.	†Ferrar, M. L., Esq., B. A., C. S.	Sitapur, Oudh
1868 May	6.	†Field, C. D., Esq., M. A., C. S.	Chittagong
1869 Sept.	1.	†Fisher, J. H., Esq., C. S.	Allahabad
1860 Mar.	7.	*Fitzwilliam, The Hon'ble W. S.	Europe
1867 April	3.	†Ford, Lieut.-Col. B.	Madras
1861 Feb.	6.	†Forest, R., Esq., Civil Engineer.	Dehra
1869 Oct.	12.	†Forlong, Lieut.-Col. J. G. R., Madras Staff Corps.	Abú, Rajputana
1863 June	3.	†Forsyth, T. D., Esq., C. B.	Umballa
1871 Nov.	1.	†Foster, J. M., Esq., M. R. C. P.	Nazeerah, Assam.
1868 April	1.	*Frederic of Schleswig-Holstein, H. R. H. Prince.	Europe
1860 March	7.	*Frere, Sir H. Bartle, K. C. B., B. C. S.	Europe [goon
1869 Sept.	1.	†Fryer, Capt. G. E., Dy. Commissioner.	B. Burma, Ran-
1859 Dec.	7.	Futteh Ali, Maulavi.	Calcutta
1867 Sept.	4.	*Pyfe, The Rev. W. C.	Europe
1849 Sept.	5.	*Fytche, Major Genl. A., C. S. I., Chief Commissioner of Burma.	Europe
1871 June	7.	Gangaprasad Sinha, Babu.	Calcutta
1871 Aug.	2.	†Gangaprasad, Munshi.	Moradabad
1859 Aug.	3.	*Gastrell, Col. J. E., Supdt., Rev. Survey.	Europe
1862 Feb.	5.	†Gauradása Basáka, Bábu.	Burdwan
1867 Sept.	4.	†Gauvain, Capt. V.	India
1867 Dec.	4.	Gay, E., Esq., M. A.	Calcutta
1868 Nov.	4.	*Geddes, J. C., Esq., C. S.	Europe
1859 Sept.	7.	Geogheghan, J., Esq., B. C. S.	Calcutta
1869 Feb.	3.	†Giriprasáda Singha, Thákur.	Allighur
1842 Sept.	2.	*Gladstone, W., Esq.	Europe

Date of Election.			
1861	Feb. 6.	*Godwin-Austen, Major H. H., Topographical Survey.	Europe
1869	Oct. 6.	†Gomes, A. D. B., Esq.	Sunderbuns
1859	Sept. 7.	*Goodeve, E., Esq., M. D.	Europe
1862	July, 2.	†Gordon, J. D., Esq., C. S. I., C. S.	Mysore
1869	July, 7.	†Gordon, Robert, Esq. C. E.	Henzaday, Burma.
1871	March 1.	†Gough, A. E., Esq.	Benares
1871	March 1.	†Govindacoomar Chaudhuri.	Mymensing
1863	Nov. 4.	†Gowan, Lieut.-Col. J. G.	Allahabad
1871	April 5.	†Graham, Major J. M.	Dhurrung
1859	Dec. 7.	*Grant, Sir J. P., K. C. B.	Europe
1860	Jan. 4.	*Grant, T. R., Esq.	Europe
1869	Oct. 6.	*Gray, R., Esq., M. B.	Europe
1867	June 5.	*Gregory, Capt. J., Depy. Commr.	Europe
1866	June 6.	†Gribble, T. W., Esq., B. C. S.	Sarun
1861	Sept. 4.	†Griffin, L. H., Esq., B. C. S.	Lahore
1860	Nov. 7.	†Griffith, R. T. H., Esq., M. A.	Benares
1861	Feb. 6.	†Growse, F. S., Esq., M. A., B. C. S.	Muttra
1871	Jan. 4.	Gunendranatha Thakura, Babu.	Calcutta
1864	Dec. 5.	†Gurucharana Dása, Bábu,	Jamu Kandi
1862	Feb. 5.	*Guthrie, Col. C. S., Bengal Engrs.	Europe
1871	June 7.	Habíburrahmán, Maulaví.	Calcutta
1867	July 3.	†Hacket, C. A., Esq., Geol Survey.	Geol. S. Office.
1869	April 7.	†Hæberlin, The Rev. C.	Ranchee, Chota Nagpur
1847	June 2.	*Hall, F. E., Esq., M. A., D. C. L.	Europe
1866	Jan. 17.	*Hamilton, Major T. C.	Europe
1863	June 3.	*Hamilton, Col. G. W.	Europe
1855	March 7.	†Hamilton, R., Esq.	Wurdah
1871	July 5.	Hamilton, Col. O.	Calcutta
1847	May 5.	*Hannynghton, Col. J. C., 63rd Regt., N. I.	Europe
1861	March 1.	†Harachandra Chaudhari, Babu.	Mymensing
1859	Oct. 12.	*Hardie, Dr. G. K.	Europe
1866	Nov. 1.	Harendra Krishna Bahádur, Kumár.	Calcutta
1862	Oct. 8.	*Harington, The Hon'ble H. B.	Europe
1871	Feb. 1.	*Harkness, T. F., Esq., C. S.	Europe
1861	Feb. 6.	†Harrison, A. S., Esq., B. A.	Bareilly
1859	Oct. 12.	†Haughton, Lieut.-Col. J. C., C. S. I.	Kooch Behar
1862	Aug. 6.	Heeley, W. L. Esq., B. A., C. S.	Calcutta
1866	April 4.	*Henry, N. A., Esq.	Europe
1853	July 6.	†Herschel, W. J., Sir, Bart., B. C. S.	Krishnagur
1854	March 1.	*Hichens, Lieut. W., Bengal Engrs.	Europe
1868	Aug. 5.	†Hobart, R. T., Esq., C. S.	Etab
1868	Nov. 4.	*Holroyd, Capt. W. R., M.	Europe
1863	July 1.	*Horne, C., Esq., C. S.	Europe
1863	Jan. 15.	*Howell, M. S., Esq., C. S.	Europe
1871	April, 5.	Howell, A. P., Esq., C. S.	Calcutta

Date of Election.			
1866 Feb.	7.	Hoyle, G. W., Esq.	Calcutta
1867 Aug.	7.	*Hughes, T. H., Esq., A. R. S. M., F. G. S., Geol. Survey.	Europe
1866 Jan.	17.	†Hughes, Captain W. G.	Akyab
1870 Jan.	5.	Hume, Allan O., Esq., C. B., C. S.	Calcutta
1870 June	1.	*Hunter, W. W., Esq., LL. D., C. S.	Europe
1867 May,	1.	*Hyatt, Dr. B. N., Civil Surgeon.	Europe
1868 April,	1.	*Hyde, Lieut.-Col. H., R. E.	Europe
1869 Sept.	1.	*Hyde, E., Esq.	Europe
1860 Jan.	4.	Innes, Lieut.-Col. J. J. McLeod, R. E.	Calcutta
1870 April	6.	*Innes, F. W. Esq., M. D., C. B.	Europe
1866 March	7.	†Irvine, W., Esq., C. S.	Goruckpur
1862 Oct.	8.	*Irwin, Valentine, Esq., C. S.	Europe
1871 March	1.	Isaac, T. S., Esq., C. E.	Calcutta
1853 Dec.	7.	†Isvariprasáda Singha Bahádur, Rájá.	Benares
1864 Sept.	7.	Jackson, The Hon'ble E.	Calcutta
1841 March	5.	*Jackson, W. B., Esq., B. C. S.	Europe
1861 Dec.	4.	*James, Major H. R., C. B.	Europe
1865 June	7.	†Jayakissen Dása Bahádur, Rájá, C. S. I.	Allighur
1845 Dec.	3.	*Jerdon, Dr. T. C.	Europe
1866 Feb.	7.	†Johnson, W. H., Esq.	Sialkote
1847 June	2.	*Johnstone, J., Esq.	Europe
1862 March	5.	†Johnstone, Capt. J. W. H., Assistant Commissioner.	Bunnoo, Panjab
1867 Dec.	4.	*Johnstone, Capt. J.	Europe
1859 Sept.	7.	*Jones, R., Esq.	Europe
1869 April	7.	Kabíruddín Ahmad, Maulaví.	Calcutta
1871 May	3.	Kaliprasanna Ghosha Babu.	Calcutta
1863 July	1.	*Kane, H. S., Esq., M. D.	Europe
1850 April	3.	*Kay, Rev. W., D. D.	Europe
1861 Dec.	4.	†Kempson, M., Esq., M. A.	Bareilly [Garden
1867 Dec.	4.	King, G. Esq., M. B.	Calcutta, Botanic
1867 March	6.	†King, Capt. H. W.	P. & O.Co.'s Office
1862 Jan.	15.	†King, W., Jr., Esq., Geol. Survey.	Madras
1867 March	6.	†Knox, G. E., Esq., C. S.	Allahabad
1869 May	5.	Kurz, S., Esq.	Calcutta Botanic Garden
1839 March	6.	*Laidlay, J. W., Esq.	Europe
1861 March	6.	*Laing, The Hon'ble S.	Europe
1869 Sept.	1.	*Latham, G., Esq., C. E.	Europe
1852 April	7.	*Lees, Lieut.-Col. W. N., LL. D.	Europe
1868 Feb.	5.	*Lees, L. H., Esq., M. D.	Europe
1868 July	1.	†Leitner, Dr. G. W.,	Lahore
1859 Dec.	7.	Leonard, H. Esq., M. A.	Calcutta
1870 July	6.	Lethbridge, E., Esq., M. A.	Hooghly
1869 June	2.	†Leupolt, J. C., Esq., C. S.	Etah
1865 June	7.	*Lewin, Capt. T. H.	Europe

Date of Election.			
1856 Feb.	6.	*Liebig, Dr. G., von.	Europe
1860 Jan.	4.	*Lindsay, E. J., Esq.	Europe
1862 Dec.	3.	†Lobb, S., Esq., M. A.	Krishnagur
1864 Nov.	2.	Locke, H. H., Esq.	Calcutta
1869 April	7.	*Lockwood, E. D., Esq., C. S.	Europe
1866 May	2.	*Lovett, Lieutenant B.	Ispahan
1866 Jan.	17.	†Low J. Esq., G. T. S.	Almora
1854 Nov.	1.	*Lushington, F. A., Esq., B. C. S.	Europe
1869 July	7.	†Lyll, C. J., Esq., B. A., C. S.	Allahabad
1870 April	6.	†Lyman, B. Smith, Esq.	America
1868 Dec.	2.	†Macauliff, M., Esq., B. A., C. S.	Hoshiarpore
1866 June	6.	Macdonald, Major J., Staff Corps.	Calcutta
1848 April	5.	*Maclagan, Col. R., R. E., F.R.S.E., F. R. G. S.	Europe
1867 July	3.	Macnamara, Dr. C.	Calcutta
1871 April	5.	Macnamara, Dr. F. N.	Calcutta
1870 May	4.	†Macnaghten, C., Esq.	Rajkote College, Kattywar
1853 April	6.	*Macrae, Dr. A. C.	Europe
1867 April	3.	Mahendralála Saracára, Dr.	Calcutta
1863 Jan.	15.	*Maine, Sir H. S.	Europe
1867 April	3.	†Mainwaring, Lieut.- Col. G. B.	Darjeeling
1860 Jan.	4.	*Mair, D. K., Esq., M. A.	Europe
1862 Sept.	3.	†Mallet, F. R., Esq., Geol. Survey.	Geol. S. Office
1852 Nov.	3.	Manickjee Rustamjee, Esq.	Calcutta
1867 March	6.	Markby, The Hon'ble W.	Calcutta
1869 July	7.	†Markham, A. M., Esq., C. S.	Bijnour
1850 Jan.	2.	*Marshman, J. C., Esq.	Europe
1863 Nov.	4.	*McClelland, Dr. J.	Europe
1837 Oct.	4.	*McLeod, Sir D. F., C. B., K. C. S. I., B. C. S.	Europe
1860 March	7.	†Medlicott, H. B., Esq., F. G. S., Geol. Survey.	Geol. S. Office
1855 Nov.	7.	*Middleton, J., Esq.	Europe
1861 Feb.	6.	*Melville, Capt. A. B., Staff Corps.	Europe
1871 Sept.	6.	†Miles, Capt. S. B.	Bombay
1850 April	3.	*Miles, A. J. M., Esq., B. C. S.	Europe
1870 July	6.	Miller, A. B., Esq.	Calcutta
1867 June	5.	Milman, R., D. D., The Right Rev. Lord Bishop of Calcutta.	Calcutta
1847 April	7.	*Money, D. J., Esq., B. C. S.	Europe
1856 Feb.	6.	†Money, W. J., Esq., C. S. I., B. C. S.	Nuddea
1867 March	6.	†Montgomerie, Major T. G., R. E.	Dera Doon
1854 Dec.	6.	*Morris, G. G., Esq., B. C. S.	Europe
1871 July	5.	†Muhammad Hasan Khalifah, Sayyid.	Patialah
1837 July	5.	*Muir, J., Esq.	Europe
1854 Oct.	11.	†Muir, Sir W., K. C. S. I., B. C. S.	Allahabad
1862 July	2.	†Napier of Magdala, Lord R., General, G. C. S. I., G. C. B.	India.

Date of Election.			
1871 Oct.	4.	†Neil, Dr. A.	Lahore
1869 May	5.	Nevill, G., Esq., C. M. Z. S.	Calcutta
1865 Feb.	1.	†Newal Kishwar Munshí.	Lucknow
1869 May	5.	†Newall, Lieut.-Col. D. J. F., R. A.	Gwalior
1870 Feb.	5.	†Newman, J. H., Esq., M. D.	Jodhpur, Rajputana
1871 Jan.	4.	†Newton, Isaac, Esq.	Umballa
1852 Sept.	1.	*Nicholls, Capt. W. T., 24th Regiment, M. N. I.	Europe
1869 July	7.	†Nursing Rao, A. V., Esq.	Vizagapatam
1871 July	5.	†Oates, E. W., Esq., C. E.	Prome, B. Burma
1871 Oct.	4.	*O'Kinealy, J., Esq., C. S.	Europe
1851 June	4.	Oldham, T., Esq., LL. D., F. R. S., Superintendent, Geol. Survey.	Calcutta
1869 April	5.	†Oldham, W., Esq., LL. D., C. S.	Ghazipur
1867 Aug.	7.	†Oldham, R. A., Esq., C. E.	Dehree.
1837 June	7.	*O'Shaughnessy, Sir W. R.	Europe
1847 Feb.	10.	*Ousely, Major W. R.	Europe
1864 Mar.	2.	*Palmer, Dr. W. J.	Europe
1862 May	7.	*Partridge, S. B., Esq., M. D.	Europe
1867 Feb.	6.	*Paul, J. Esq.	Europe
1871 Dec.	6.	†Peal, S. E., Esq.	Sibsagar, Assam
1867 Mar.	6.	Pearimohana Mukarji, M. A., Bábú.	Uttarparah
1860 Feb.	1.	†Pearse, Major G. G.	Bangalore
1868 Nov.	4.	†Pearson, C. E.	Rawul Pindi
1869 July	7.	Pell, S., Esq.	Calcutta
1864 Mar.	2.	Pellew, F. H., Esq., C. S.	Hooghly
1865 Sept.	6.	†Peppé, J. H., Esq.	Gya
1868 May	6.	Peterson, F. W., Esq.	Calcutta
1867 Nov.	6.	*Petit, Mons. Eugène.	Europe
1835 July	1.	*Phayre, Major G., Sir A. P., K. C. S. I., C. B.	Europe
1864 Nov.	2.	Phear, The Hon'ble J. B.	Calcutta
1869 Feb.	3.	†Pickford, J., Esq., M. A.	Madras
1867 Sept.	4.	*Place, Mons. V., Consul-Gen., France.	Europe
1870 Feb.	2.	†Powell Baden, H., Esq., C. S.	Lahore
1868 April	1.	†Pramathanátha Ráya, Kumár.	Digapati
1869 Feb.	3.	Pratápachandra Ghosha, B. A.	Calcutta
1871 June	7.	†Pratt, Capt. C. S., Staff-Corps.	Morar, Gwalior
1825 Mar.	9.	*Prinsep, C. R., Esq.	Europe
1862 Oct.	8.	†Pulínavihári Sen, Bábú.	Berhampur
1856 Mar.	5.	Rájendralála Mitra, Bábú.	Calcutta
1868 Jan.	15.	†Rákhaldass Haldar, Bábú.	Chota Nagpur
1871 June	7.	Rámakrishna Dása, Bábú.	Calcutta
1837 Feb.	1.	Ramánátha Thákura, Bábú.	Calcutta
1866 Jan.	17.	*Rattray, A., Esq. Asst. Commr.	Europe
1860 Mar.	7.	†Reid, H. S., Esq., C. S.	Allahabad

Date of Election.			
1871 July	5.	†Reid, J. R., Esq., C. S.	Azimghur
1857 June	7.	*Riddell, The Hon'ble H. B., B. C. S.	Europe
1868 April	1.	Robb, G., Esq.	Calcutta
1868 July	1.	*Roberts, Rev. J.	Europe
1863 April	1.	†Robertson, C., Esq., C. S.	Mirzapur
1865 Feb.	1.	Robinson, S. H., Esq.	Calcutta
1847 Dec.	1.	*Rogers, Capt. T. E.	Europe
1870 Dec.	7.	Rogers, A., Esq.	Calcutta
1871 May	3.	†Rogers, Capt. B.	Port Blair
1869 July	7.	*Ross, Lieut. J. C., R. E.	Europe
1870 Jan.	5.	†Ross, Alexander G., Capt. Staff Corps.	Simla
1871 April	5.	Rundall, Col. F. H.	Calcutta
			[Line
1871 Dec.	6.	†Samuells, Capt. W. L.	Pachumba, Chord
1871 May	3.	Sanderson, C., Esq.	Calcutta
1870 May	4.	Satyánand Ghoshála, Rája.	Calcutta
1861 Dec.	4.	†Saunders, C. B., Esq., C. B., B. C. S.	Haidarabad
1864 June	1.	*Saunders, J. O'B., Esq.	Europe
1854 Dec.	6.	†Saxton, Col. G. H., F. G. S., Madras Staff Corps.	Ootacamund
1854 May	2.	*Schiller, F., Esq.	Europe
1870 May	4.	†Schlich, Dr. W.	Kurachee
1869 Feb.	3.	Schwender, L., Esq.	Calcutta
1860 Feb.	1.	*Scott, Col. E. W. S.	Europe
1869 Aug.	4.	*Selbach, W., Esq.	Europe
1860 July	4.	†Shelverton, G., Esq.	Waltair, near Vizagapatam
1845 Jan.	14.	*Sherwill, Lieut.-Col. W. S., 66th Regiment, B. N. I., F. G. S., F. R. G. S.	Europe
1868 Oct.	7.	Shircore, Dr. S. M.	Calcutta
1863 April	1.	†Showers, Lieut.-Col. C. L.	Umballa
1866 June	6.	†Sime, J., Esq., B. A.	Delhi
1864 Sept.	7.	†Sladen, Major E. B.	Rangoon.
1866 June	6.	†Smart, R. B., Esq., Rev. Survey.	Raepur, Central Province
1865 July,	5.	Smith, D. Boyes, Esq., M. D.	Howrah
1868 April	1.	†Smith, McLaren W., Esq.	Berhampur
1856 Feb.	6.	*Smith, Col. J. F.	Europe
1871 July	5.	†Smith, J., Esq., C. S.	Ghazipur
1854 Sept.	6.	*Spankie, The Hon'ble R., B. C. S.	Allahabad.
1864 Mar.	2.	†Spearman, Capt. H. R.	Bhamo
1867 May	1.	†Steel, Lieut. E. H., R. A.	DeraGhazi Khan.
1867 Dec.	4.	*Stephen, Major J. G., 8th N. I.	Europe
1863 Sept.	2.	†Stewart, R. D., Esq.	Serajgunje
1864 April	6.	*Stewart, J. L., Esq., M. D.	Europe
1870 April	6.	Stewart, R., Esq.	Calcutta
1870 Sept.	7.	†St. John, R. T., Esq.	Akyab
1861 Sept.	4.	*Stokes, Whitley, Esq.	Europe
1863 Nov.	4.	Stoliczka, F., Esq., Ph. D., F. G. S., Geol. Survey.	Calcutta

Date of Election.			
1843 May	3.	*Strachey, Major General, R. F. R. S., F. L. S., F. G. S., C. S. I., C. B.	Europe
1869 Feb.	3.	Strachey, The Hon'ble J.	Calcutta
1859 Mar.	2.	†Stubbs, Major F. W., Bengal Artillery.	Lucknow
1858 July	7.	†Sutherland, H. C., Esq., B. C. S.	Sylhet
1864 Aug.	11.	Swinhoe, W., Esq.	Calcutta
1863 Sept.	3.	Syámácharana Saracára, Bábu.	Calcutta
1865 Sept.	6.	Tawney, C. H., Esq., M. A.	Calcutta
1865 April	5.	†Taylor, R., Esq.	Lahore
1860 May	2.	Temple, The Hon'ble Sir R., K. C. S. I., B. C. S.	Calcutta
1871 Feb.	1.	Tennant, Lieut.-Col. J. F., R. E., F. R. S.	Calcutta
1859 Mar.	2.	†Theobald, W., Esq., Geological Survey.	B. Burma
1869 Oct.	6.	†Thomson, A., Esq.	Faizabad
1860 June	6.	*Thompson, J. G., Esq.	Europe
1863 Mar.	4.	*Thompson, Major G. H., Bengal Staff Corps.	Europe
1863 June	4.	*Thornton, T. H., Esq., D. C. L., C. S.	Europe
1847 June	2.	Thuillier, Col. H. L., Royal Artillery, F. R. S., C. S. I.	Calcutta
1862 July	2.	*ThurLOW, The Hon'ble T. J. H.	Europe
1865 July	5.	†Tolbort, T. W. H., Esq., C. S.	Montgomery, Panjab
1865 July	5.	Tonnerre, Dr. C. F.	Calcutta
1862 Feb.	5.	*Torrens, Col. H. D.	Europe
1871 April	5.	Trefftz, Oscar, Esq.	Calcutta
1861 June	5.	*Tremlett, J. D., Esq., M. A., C. S.	Europe
1863 Mar.	4.	*Trevelyan, The Right Hon'ble Sir C., K. C. B.	Europe
1841 Feb.	3.	*Trevor, The Hon'ble C. B., B. C. S.	Europe
1861 Sept.	4.	Tween, A., Esq., Geological Survey.	Calcutta
1863 May	6.	†Tyler, Dr. J.	Mynpuri
1869 June	2.	†Udayachánda Datta, Bábu.	Nowakhali
1860 May	2.	†Vanrenen, Major A. D., Bengal Staff Corps.	Moradabad
1864 Feb.	3.	Verehère, A. M., Esq., M. D.	Barrackpore
1864 April	6.	†Vijayaráma Gajapati Ráj Munníá Sultán Bahádur, Máharájah Mirza.	Vizianagram
1870 June	1.	†Vrindávanachandra Maṇḍala, Bábu.	Balasure
1871 Feb.	1.	†Waagen, Dr. W.	Geol. Survey
1869 Augt.	4.	Wáhid Alí, Prince Jahán Qadr Muhammad, Bahádur.	Garden Reach
1865 Nov.	1.	Waldie, D., Esq., F. C. S.	Calcutta
1861 May	1.	*Walker, Col., J. T., Royal Engrs., Bombay.	Europe
1863 May	6.	*Wall, P. W. Esq., Esq., C. S.	Europe
1863 Oct.	7.	Waller, W. K., Esq., M. B.	Calcutta
1862 Jan.	15.	†Ward, G. E., Esq., B. C. S.	Furruckabad
1852 July	7.	*Ward, J. J., Esq., B. C. S.	Europe
1859 July	6.	*Warrand, R. H. M., Esq., B. C. S.	Europe
1865 May	3.	Waterhouse, Capt. J., R. A.	Calcutta

Date of Election.			
1854 July	5.	*Watson, J., Esq., B. C. S.	Europe
1847 Nov.	3.	*Waugh, Major-General Sir A. S., C. B., F. R. S., F. R. G. S.	Europe
1869 Sept.	1.	Westland, J., Esq., C. S.	Calcutta
1867 Feb.	6.	†Westmacott, E. V., Esq., B. A., C. S.	Dinajpur
1862 Oct.	8.	†Wheeler, J. T., Esq.	British Burma
1867 Aug.	7.	†Wilcox, F., Esq., Bengal Police.	Purulia
1867 Jan.	16.	*Williamson, Lieut. W. J.	Europe
1867 Mar.	6.	†Willson, W. G., Esq., B. A.	Krishnagur
1871 Mar.	1.	Willson, James, Esq.	Geol. Survey
1870 Aug.	3.	Wilson, R. H., Esq., C. S.	Calcutta
1859 Aug.	3.	*Wilmot, C. W., Esq.	Europe
1866 Mar.	7.	†Wise, Dr. J. F. N.	Dacca
1867 July	3.	†Wood, Dr. J. J.,	Ranchi
1870 Jan.	5.	Wood-Mason, J., Esq., F. G. S.	Calcutta
1851 May	7.	Woodrow, H., Esq., M. A.	Calcutta
1859 Mar.	2.	*Wortley, Major A. H. P.	Europe
1862 Aug.	6.	*Wylie, J. W., Esq., Bombay C. S.	Europe
1869 Sept.	1.	Yadulála Mallika, Bábu.	Calcutta
1868 June	3.	Yatíndramohana Thákura, Rajah Báhádur.	Calcutta
1867 Mar.	6.	Yogendranátha Mallika, Bábu.	Andul
1858 April	4.	*Young, Lieut.-Col. C. B.	Europe
1856 July	2.	*Yule, Col. H., R. E.	Europe
1871 Mar.	1.	†Ziáuddín Ahmad Khán Bahádur, Nawáb.	Delhi

LIST OF HONORARY MEMBERS.

Date of Election.			
1825 Mar.	9.	M. Garcin de Tassy, Membre de l'Inst.	Paris
1826 "	1.	Sir John Phillippart.	London
1829 July	1.	Count de Noe.	Paris
1831 "	7.	Prof. C. Lassen.	Bonn
1834 Nov.	5.	Col. W. H. Sykes, F. R. S.	London
1835 May	6.	Prof. Lea.	Philadelphia
1842 Feb.	4.	Dr. Ewald.	Göttingen
1842 "	4.	Right Hon'ble Sir Edward Ryan, Kt.	London
1843 Mar.	30.	Prof. Jules Mohl, Memb. de l'Institute.	Paris
1847 May	5.	His Highness Hekekyan Bey.	Egypt
1847 Sept.	1.	Col. W. Munro.	London
1847 Nov.	3.	His Highness the Nawab Nazim of Bengal.	Murshidabad
1848 Feb.	2.	Dr. J. D. Hooker, R. N., F. R. S.	Kew
1848 Mar.	8.	Prof. Henry.	Princeton, U. S.
1853 April	6.	Major-Gen. Sir H. C. Rawlinson, K. C. B., F. R. S., D. C. L.	London

Date of Election.				
1858	July	6.	B. H. Hodgson, Esq.	Europe
1859	Mar.	2.	The Hon'ble Sir J. W. Colville, Kt.	Europe
1860	Mar.	7.	Prof. Max Müller.	Oxford
1860	Nov.	7.	Mons. Stanislas Julien.	Paris
1860	"	7.	Dr. Robert Wight.	London
1860	"	7.	Edward Thomas, Esq.	London
1860	"	7.	Dr. Aloys Sprenger.	Bern
1860	"	7.	Dr. Albrecht Weber.	Berlin
1865	Sept.	6.	Edward Blyth, Esq.	Europe
1868	Feb.	5.	Genl. A. Cunningham, C. S. I.	India
1868	"	5.	Prof. Bápu Déva Sátri.	Benares
1868	"	5.	Dr. T. Thomson, F. R. S., F. L. S., F. G. S.	London
1868	Sept.	2.	A. Grote, Esq., C. S.	London
1871	June	7.	C. Darwin, Esq.	London

LIST OF CORRESPONDING MEMBERS.

Date of Election.				
1844	Oct.	2.	Macgowan, Dr. J.	Europe
1856	June	4.	Kremer, Herr A. von.	Alexandria
1856	"	4.	Porter, Rev. J.	Damascus
1856	"	4.	Schlagintweit, Herr H. von	Munich
1856	"	4.	Smith, Dr. E.	Beyrout
1856	"	4.	Taylor, J., Esq.	Bussorah
1856	"	4.	Wilson, Dr.	Bombay
1857	Mar.	4.	Neitner, J., Esq.	Ceylon
1858	Mar.	3.	Schlagintweit, Herr R. von	Giesen
1859	Nov.	2.	Frederick, Dr. H.	Batavia
1859	May	4.	Bleeker, Dr. H.	Batavia
1860	Feb.	1.	Baker, The Rev. H.	E. Malabar
1860	"	1.	Swinhoe, R., Esq., H. M.'s Consul.	Amoy
1860	April	4.	Haug, Dr. M.	Punah
1861	July	3.	Gosche, Dr. R.	Berlin
1862	Mar.	5.	Murray, A. Esq.	London
1863	Jan.	5.	Goldstücker, Dr. T.	London
1863	July	4.	Barnes, R. H., Esq.	Ceylon
1866	May	7.	Schlagintweit, Prof. E. von	Munich
1866	"	7.	Sherring, Rev. M. A.	Benares
1868	Feb.	5.	Foucaux, M. F. H.	Paris
1868	"	5.	Holmboe, Prof.	Christiania

LIST OF ASSOCIATE MEMBERS.

1835	Oct.	7.	Stephenson, J., Esq.	Europe
1838	Feb.	7.	Karámat Alí, Sayyid.	Hooghly
1843	Dec.	6.	Long, Rev. J.	Caleutta
1865	May	3.	Dall, Rev. C. H.	Caleutta

LOSS OF MEMBERS DURING 1871.

BY RETIREMENT.

C. F. Amery.	Lahore
Capt. J. P. Basevi, R. E.	Dera
T. Thomas, Esq.,	Lucknow
W. H. Stevens, Esq.	Darbanga
The Hon'ble Sir W. Grey, K. C. S. I.	Calcutta
L. B. Bowring, Esq.	Europe
W. C. Bonnerjee, Esq.	Calcutta
J. Schroeder, Esq.	Calcutta
Lieut.-Col. C. Macgregor.	Simla
Dr. S. C. Mackenzie.	Calcutta
R. J. Leeds, Esq.	Banda
Capt. R. D. Osborn.	Calcutta
Lieut. W. A. J. Wallace.	Calcutta
Col. A. D. Dickens,	Calcutta
Dr. H. Warth,	Panjab
J. F. Cockburn, Esq.	Kanoo Junction, E. I. R.
Dr. J. M. Fleming.	Kundua Nemar, Central Provinces

BY THE ELECTION BEING CANCELLED ON ACCOUNT OF NON-COMPLIANCE
WITH THE RULES OF THE SOCIETY.

Nawab Sir Sheriful Omra Bahadur.	Madras
----------------------------------	--------

STRUCK OFF.

A. G. Walker, Esq.	Onao, Oudh
C. J. Wilkinson, Esq.	Calcutta
Dr. C. Williams.	Rangoon
C. B. Garrett, Esq., C. S.	Sarun
F. J. Chambers, Esq.	Lucknow

BY DEATH.

The Hon'ble J. P. Norman.	Calcutta
The Ven'ble Archdeacon J. H. Pratt, M. A.	Calcutta

[APPENDIX.]

ABSTRACT STATEMENT
OF
RECEIPTS AND DISBURSEMENTS
OF THE
ASIATIC SOCIETY OF BENGAL
FOR
THE YEAR 1871.

STATEMENT

Abstract of the Cash Account

		RECEIPTS.		1871.	1870.
ADMISSION FEES.					
Received from Members,	...	Rs. 1,472	0 0	1,472 0 0	864 0 0
SUBSCRIPTIONS.					
Received from Members,	...	7,044	7 0	7,044 7 0	8,812 10 0
PUBLICATIONS.					
Sale proceeds of Journal and Proceedings,	...	706	9 3		
Subscriptions to ditto,	...	952	8 0		
Refund of Postage Stamps,	...	26	15 0		
Ditto of Freight,	...	3	8 0		
Ditto of Printing charges,	...	40	0 0		
				1,729 8 3	1,903 1 3
LIBRARY.					
Sale proceeds of Books,	...	359	11 3		
Refund of Freight,	...	8	0 0		
Ditto of Postage Stamps,	...	3	8 0		
				371 3 3	752 14 0
SECRETARY'S OFFICE.					
Received Commission on purchase of Postage Stamps, &c.,	14	1 1		
Ditto, Fine,	7	10 0		
Refund of the amount from Narpat Sinha Jemadar,	10	12 9		
				32 7 10	287 6 0
CONSERVATION OF SANSKRIT MSS.					
Received from the Accountant General of Bengal in part of the amount sanctioned towards the Conservation of Sanscrit MSS., being the 2nd half of 1870-71,	...	1,550	0 0		
Ditto, ditto, the 1st half of 1871-72,	...	1,550	0 0		
Sale proceeds of 7 Copies of Notices of Sanscrit MSS.,	7	0 0		
Refund of amount paid for copying Mi-dhātithi on the 27th April, 1871,	...	23	4 0		
Ditto, ditto, for copying Madana Párijat,	...	13	13 0		
				3,144 1 0	3,703 2 9
VESTED FUND.					
Received Interest on the Government Securities from the Bank of Bengal,	...	110	0 0		
Less income Tax on ditto,	...	1	2 0		
				108 14 0	
O. P. FUND.					
Received on account of Loan,	...	656	3 6		
				656 3 6	
MISCELLANEOUS.					
Col. E. T. Dalton, Ethnology of Bengal,	...	10,000	0 0		
Messrs. Williams and Norgate,	...	5	0 0		
Dr. F. Stoliczka,	...	50	6 3		
Walí-collah Sayyid,	...	548	14 8		
B. Quaritch, Esq.,	...	6	6 0		
E. T. Atkinson, Esq.,	...	31	4 0		
				10,641 14 11	
				Carried over, Rs. 14,558 12 10	

No. 1.

of the Asiatic Society for 1871.

DISBURSEMENTS.

PUBLICATIONS.	1871.	1870.
Paid Freight for sending Journal and Proceedings to Messrs. Williams and Norgate,	105 7 0	
Ditto Lithographing and Engraving charges,	1,437 7 0	
Ditto Printing charges, ...	3,253 2 6	
Ditto Commission on Sale of Books, &c., ...	73 5 4	
Ditto Binding charges, ..	6 0 0	
Ditto Paper for plates, &c., ...	129 11 9	
Ditto Purchase of Postage Stamps, ...	260 9 0	
Ditto Petty Charges, ..	8 4 3	
	<hr style="width: 100%; border: 0.5px solid black;"/>	
	5,273 14 10	5,239 13 5
LIBRARY.		
Paid Messrs. Williams and Norgate for purchase of Library Books as per their draft dated, 18th July, 1871, ...	1,255 9 4	
Ditto Salary of the Librarian, ...	810 0 0	
Ditto Establishment, ...	120 0 0	
Ditto Commission on Sale of Books, ...	33 9 2	
Ditto Purchase of Books, ...	106 0 0	
Ditto Landing Charges, ...	15 6 0	
Ditto Book Binding, ...	105 12 0	
Ditto Subscription to the Medical Gazette, ...	15 0 0	
Ditto Salary of Pankhaman, ..	40 0 0	
Ditto Postage Stamps, ...	4 3 0	
Ditto Bearing Postage, ...	1 9 3	
Ditto Petty Charges, ...	3 14 0	
	<hr style="width: 100%; border: 0.5px solid black;"/>	
	2,540 14 9	2,472 3 3
SECRETARY'S OFFICE.		
Paid General Establishment, ...	370 12 9	
Ditto Secretary's Office Establishment, ...	1,592 0 0	
Ditto Purchase of Postage Stamps, ...	134 10 2	
Ditto ditto of Stationery, ...	90 0 0	
Ditto Insufficient Postage, ...	1 6 4	
Ditto Bearing Postage, ...	2 13 2	
Ditto Meeting Charges, ...	159 13 0	
Ditto Commission on Collecting Subscriptions, ...	41 4 3	
Ditto Salary of Mali, ...	57 0 0	
Ditto Subscription to the Army List, ...	15 0 0	
Ditto Ditto, Directory, ...	12 0 0	
Ditto for preparing a Teak wood Board, ...	28 0 0	
Ditto Engraving and Printing charges, ...	78 0 0	
Ditto Donation to the Piddington Fund, ...	100 0 0	
Ditto Advertising charges, ...	7 12 0	
Ditto Editing charges for the Annual account-current of 1870, ..	75 0 0	
Ditto repairing a Clock, ...	8 0 0	
Ditto for a Marble Pedestal for Dr. Falconer's bust, ...	86 0 0	
Ditto fee to the Bank of Bengal for stamping blank cheques, ...	1 9 0	
Ditto Petty Charges,..	57 9 6	
	<hr style="width: 100%; border: 0.5px solid black;"/>	
	2,918 10 2	2,187 13 0
Carried over, Rs. 10,733 7 9		

RECEIPTS.

1871.

1870.

	Brought over, Rs.	10,641	14	11	14,558	12	10	
W. Duthoit, Esq.,	1	12	6			
A. E. Gaugh, Esq.,	0	1	10			
R. J. Leeds, Esq.,	2	9	6			
G. E. Ward, Esq.,	2	0	0			
W. Stokes, Esq.,	0	5	0			
Harigopal Padye, Esq.,	0	2	0			
The Rev. F. Foulkes,	0	4	0			
The Government North-Western Provinces,	21	12	0			
Babu Rakhal Dass Halder,	0	8	0			
Col. J. C. Haughton,	10	1	0			
Jugul Kissore,	11	12	0			
F. S. Growse, Esq.,	4	2	0			
Dr. G. W. Leitner,	1	12	0			
L. Schwendler, Esq.,	8	10	9			
Babu Rasavihari Vasu,	0	14	0			
Major M. W. Carr,	0	11	0			
W. L. Heeley, Esq.,	0	6	0			
			<hr/>				10,709	10 6

DISBURSEMENTS.

1871.

1870.

Brought over, Rs. 10,733 7 9

CONSERVATION OF SANSKRIT MSS.

Paid Salary for preparing Catalogue of Sanscrit MSS.,	300	0	0
Ditto ditto for Collecting Materials for Catalogue of MSS.,	379	8	5
Ditto ditto for translating the Sanscrit Catalogue,	112	10	8
Ditto Babu Rajendra Mitra, as advance for purchase of Sanscrit MSS.,	400	0	0
Ditto Printing Charges of Notices of Sanscrit MSS.,	641	8	0
Ditto for Stationery,	14	5	0
Ditto for Packing Charges,	24	14	0
Ditto Postage for sending Notices of Sanscrit MSS.,	7	2	0
Ditto Freight for ditto ditto,	43	6	0
Ditto Banghy expenses for ditto ditto,	7	8	0
Ditto Advertising Charges,	10	5	6
Ditto Copying MSS.,	13	13	0
Ditto Khurrua cloth, and Pasteboard &c., for Patahs for binding Sanscrit MSS.,	53	2	0
Petty Charges,	3	15	3

 2,012 1 10 1,527 6 6

VESTED FUND.

Paid Commission to the Bank of Bengal for drawing interest on the Government Securities,	0	4	4
---	---	---	---

 0 4 4

BUILDING.

Paid House rate,	432	0	0
Ditto Police and Lighting rate,	210	0	0
Ditto Water rate,	235	3	2

 877 3 2 910 10 3

O. P. FUND.

Paid on Loan,	274	9	9
----------------------	-----	---	---

 274 9 9

MISCELLANEOUS.

Col. E. T. Dalton, Ethnology of Bengal,	7,500	0	0
Sayyid Walli-oollah,	491	6	6
F. S. Growse, Esq.,	5	14	0
The Government, North-Western Provinces,	13	8	0
S. Lobb, Esq.,	6	6	0
Col. C. M. Macgregor,	0	9	9
G. E. Fryer, Esq.,	0	10	0
E. T. Atkinson, Esq.,	28	12	0
W. Oldham, Esq.,	0	13	0
Dr. C. Valentyne,	0	4	0
Col. J. C. Haughton,	8	0	0
J. G. Delmerick, Esq.,	1	2	0
Dr. G. W. Leitner,	1	12	0
L. Schwendler, Esq.,	8	10	9
G. Nevil, Esq.,	2	5	0
Jugul Kissore,	11	12	0
Guru Churn Doss,	0	2	0
J. Wood-Mason, Esq.,	3	3	6
Dr. F. Stoliczka,	6	8	0

 8,091 10 6

 Carried over, Rs. 13,897 10 10

RECEIPTS.

1871.

1870.

Brought over, Rs. 25,268 7 4

BALANCE OF 1870.

In the Bank of Bengal, viz. account-current

Dr. J. Muir, ...	898 10 0
Ditto Conservation of Sanscrit MSS., ...	1,717 1 9
Ditto Asiatic Society, ...	2,661 6 0

 5,277 1 9

Cash in hand, ...	125 15 3
-------------------	----------

 Rs. 30,671 8 4

DISBURSEMENTS.

1871.

1870.

		Brought over, Rs.	8,091 10	6 13,897 10	10
Babu Udaya Chanda Datta,	0 9 0		
Messrs. Trübner and Co.,	9 4 9		
Messrs. Asher and Co.,	12 4 0		
W. Irvine, Esq.,	5 15 6		
J. Beames, Esq.,	2 1 0		
Dr. J. B. Baxter,	0 6 0		
			<hr/>	8,122 2 9	
BALANCE.					
In the Bank of Bengal, <i>viz.</i> account-current					
Dr. Muir,	898 10 0		
Ditto Conservation of Sanscrit MSS.,	2,849 0 11		
Ditto Col. Dalton, Ethnology of Bengal,	2,450 12 0		
Ditto Asiatic Society,	2,236 5 7		
			<hr/>	8,434 12 6	
Cash in hand,		216 14 3	
				<hr/>	
			Rs.	30,671 8 4	
				<hr/>	

Errors and Omissions excepted,
 (Sd.) BUDDINATH BYSACK,
Cashier,
Asiatic Society, Bengal.

Audited and found correct,
 (Sd.) F. W. PETERSON,
 D. WALDIE.

STATEMENT
Abstract of the Cash Account,

RECEIPTS.

		1871.		1870.
ORIENTAL PUBLICATIONS.				
Received by Sale of Bibliotheca Indica, ...	2,405	3	0	
Ditto by Subscription to do. ...	9½	0	0	
Ditto Refund of Postage and Packing charges, ...	81	14	0	
	2,581	1	0	1,911 5 6
GOVERNMENT ALLOWANCE.				
Received from the General Treasury at 500 Rs. per month, ...	6,000	0	0	
Ditto ditto additional grant for the publication of Sanskrit works, at 250 Rs. per month, ...	3,000	0	0	
	9,000	0	0	9,000 0 0
VESTED FUND.				
Received Interest on the Government Security by the Bank of Bengal, ...	87	8	0	
Ditto by Sale of a new 5 per cent. Government Security, ...	3,500	0	0	
Ditto ditto Premium on do. ...	203	12	0	
Ditto ditto Interest on do. ...	23	9	9	
	3,727	5	9	
Less Commission and Brokerage on Selling Government Security, ...	3	14	6	
Ditto Income Tax on the Interest, ...	0	3	7	
	4	2	1	
	3,723	3	8	
	3,810	11	8	175 0 0
ASIATIC SOCIETY OF BENGAL.				
Received on Loan, ...	274	9	9	
	274	9	9	
MISCELLANEOUS.				
Babu Luchmun Singh, ...	4	0	0	
Chib Ghanano Sarawali, ...	2	14	6	
J. Bisch, Esq., ...	0	4	0	
N. Muller Row, Esq., ...	7	8	0	
Babu Tarini Churn Chuckerbutty, ...	1	8	0	
Babu Sadasakh Lall, ...	4	8	0	
Pandita Damaru Vallabha, ...	43	0	0	
Babu Nobin Chunder Roy, ...	2	7	0	
Pandita Chunder Kanta Tarkalanker, ...	1	11	0	
Babu Ram Chunder Bose, ...	35	8	0	
C. W. Macm, Esq., ...	40	0	0	
A. Roynoo Gopall, Esq., ...	0	5	0	
The Principal of the Dacca College, ...	1	2	0	
G. Jyanna, Esq., ...	2	12	0	
Babu Pearilall, ...	0	4	0	
Munshree Gungapershad, ...	2	8	0	
Ram Kissen G. Bhauder Kur, ...	0	2	0	
	150	5	6	
Carried over, Rs.	15,666	6	5	

No. 2.

Oriental Publication Fund, 1871.

DISBUSEMENTS.				1871.	1870.
ORIENTAL PUBLICATIONS.					
Paid Commission on Sale of Books,	...	250	6 0		
Packing Charges,	47	0 0		
Postage Stamps,	149	8 6		
Advertising Charges,	...	409	0 0		
Freight,	328	2 0		
Bearing Postage,	0	5 0		
Printing Charges,	12	10 0		
Petty Charges,	2	14 9		
				1,190	14 3 1,364 8 0
VESTED FUND.					
Paid Commission to the Bank of Bengal for drawing Interest on the Government Securities,	0	3 6		
Renewing a Government Security,	...	1	0 0		
Commission on Sale of the Government Security,	6	10 7		
Brokerage on ditto ditto,	3	2 0		
				11	0 1 0 7 0
LIBRARY.					
Paid Purchase of Books,	185	14 6		
Book Binding,	5	0 0		
				190	14 6 520 6 0
CUSTODY OF ORIENTAL WORKS.					
Paid Salary of the Librarian,	360	0 0		
Establishment,	574	0 0		
Stationery,	18	6 0		
Fee for Stamping Cheques,	4	11 0		
Ditto for auditing the Annual Account for 1870,	75	0 0		
Petty Charges,	51	2 6		
				1,083	3 6 1,225 1 0
ASIATIC SOCIETY OF BENGAL.					
Paid on account of Loan,	656	3 6		
				656	3 6
CATALOGUE OF SANSKRIT MSS.					
Paid Salary for Cataloguing Sanskrit MSS.,...	...	360	0 0		
				360	0 0 278 0 0
COPYING MSS.					
Paid Copying Charges,	198	5 0		
				198	5 0 71 3 6
AIN I AKBARI.					
Paid Munshi allowance,	390	0 0		
Ditto Printing Charges,	730	8 0		
				1,120	8 0 1,617 13 0
TAN'DYA MAHÁ BRÁHMANA.					
Paid Editing and Printing Charges,	1,312	12 0		
				1,312	12 0 3,593 12 0
MÍMÁNSÁ DARSANA.					
Paid Editing and Printing Charges,	539	10 0		
				539	10 0 427 2 0
Carried over, Rs.				6,663	6 10

		RECEIPTS.		1871.	1870.
	Brought over, Rs	150	5	615,666	6 5
M. Sasha Giri Sastri,	...	11	8	0	
Ram Lall Misser,	0	15	0	
Vadlamannati Damsdarayya,	...	1	2	0	
		<hr/>		163	14 6

Carried over, Rs. 15,830 4 11

DISBURSEMENTS.		1871.	1870.
Brought over, Rs.		6,663	6 10
NRISINHA TAPINI.			
Paid Editing and Printing Charges,	... 960 13 0		
Ditto Postage and Registering fee for return- ing MSS.,	... 0 6 0	961 3 0	
MAASIR ALAMGIRI.			
Paid Editing and Printing Charges,	.. 550 0 0	550 0 0	614 0 0
BIOGRAPHICAL DICTIONARY.			
Paid Editing and Printing Charges,	... 1,126 9 0	1,126 9 0	
BRAHMA SUTRA.			
Paid Printing Charges,	... 278 0 0	278 0 0	
SAMA VEDA.			
Paid Editing and Printing Charges,	... 984 9 0	984 9 0	108 8 6
GOPATHA BRAHMANA.			
Paid Printing Charges,	... 232 3 0	232 3 0	96 0 0
LATYAYANA SRAUTA SUTRA.			
Paid Printing Charges,	... 232 3 0	232 3 0	2,393 5 0
MATRI UPANISHAD.			
Paid Printing Charges,	... 109 6 0	109 6 0	18 2 3
TAITTIRIYA BRAHMANA.			
Paid Printing Charges,	... 310 10 0	310 10 0	348 0 0
TAITTIRIYA SANHITA.			
Paid Editing and Printing Charges,	... 339 12 0	339 12 0	96 0 0
POEMS CHAND.			
Paid Freight and Packing Charges for send- ing MSS.,	... 8 15 0	8 15 0	7 9 0
FARHANG RASHIDI.			
Paid Editing and Printing Charges,	... 703 0 0	703 0 0	468 12 0
TAITTIRIYA ARANYAKA.			
Paid Editing and Printing Charges,	... 396 8 0	396 8 0	380 12 0
CHATURVARGA CHINTAMANI.			
Paid Editing and Printing Charges,	... 656 6 0	656 6 0	
CHHANDA SUTRA.			
Paid Editing and Printing Charges,	... 328 3 0	328 3 0	
GOBIL SUTRA.			
Paid Editing and Printing Charges,	... 402 6 0		
Ditto Banghy Expenses &c., for sending Sanskrit Books &c., to Pandita Chandra Kanta Tarkaankar,	... 3 12 0	406 2 0	
TAITTIRIYA PRATISAKHYA.			
Paid Editing and Printing Charges,	... 328 3 0	328 3 0	
Carried over, Rs.		14,615	2 10

	RECEIPTS.	1871.	1870.
		Brought over, Rs. 15,830 4 11	
BALANCE OF 1870. In the Bank of Bengal,	836 4 7	

Rs. 16,666 9 6

		DISBURSEMENTS.	1871.	1870.
		Brought over, Rs.	14,615	2 10
K. Roghunath Row,	137 12 6		
Babu Heetalal Misser,	1 1 0		
Babu Luchmun Singh,	3 2 0		
Babu Tarini Churn Chuckerbutty,	1 8 0		
Damaru Jetta,	17 10 6		
The Principal of the Dacca College,	1 2 0		
Babu Brojo Bhusan Dass,	1 7 0		
J. Bisch, Esq.,	1 3 0		
Sadaskh Lall, Esq.,	3 12 0		
N. Mullor Row, Esq.,	7 8 0		
Damaru Vallabha,	43 0 0		
Babu Ram Chunder Bose,	14 8 0		
Major C. W. Carr,	0 10 0		
Ramkrishna G. Bhanderkur,	3 3 0		
Munshoo Gunga Persad,	5 11 6		
		<hr/>	243	2 6
BALANCE.				
In the Bank of Bengal,	1,786 5 7		
Cash in hand,	21 14 7		
		<hr/>	1,808	4 2
			<hr/>	<hr/>
		Rs.	16,666	9 6

Errors and Omissions excepted,
 (Sd.) BUDDINATH BYSACK,
Cashier,
Asiatic Society, Bengal.

Audited and found correct,
 (Sd.) F. W. PETERSON,
 D WALDIE.

STATEMENT No. 3.

Shewing the Assets and Liabilities of the Asiatic Society of Bengal on the 1st July. 1872.

ASSETS.		1871.	1870.	LIABILITIES.		1871.	1870.
CASH.							
In the Bank of Bengal,	...	8,434 12 6	5,277 1 9	Salary and Establishment for December, 1871,	...	300 0 0	241 14 8
Cash in hand,	216 14 3	125 15 3	Printing Charges of Journal and Proceedings for 1871, (actual and estimate),	2,350 0 0	1,494 15 0
Government Securities,	...	2,000 0 0	2,000 0 0	Plates &c., for Journal,	300 0 0	275 12 0
		<u>10,651 10 9</u>	<u>7,403 1 0</u>	Messrs. Williams and Norgate,	200 0 0	600 0 0
				House rate &c.,	225 0 0	156 0 0
				Conservation of Sanscrit MSS.,	...	2,849 0 11	1,717 1 9
				Dr. J. Muir,	898 10 0	898 10 0
				Ethnology of Bengal,	2,450 12 0	0 0 0
OUTSTANDING.							
Admission fees,	384 0 0	96 0 0				
Subscription,	5,086 11 8	4,432 6 8				
Sale of Journal,	383 13 11	275 6 11				
Subscription of do.	...	996 3 9	744 4 0				
Sale of Library Books,	...	351 7 0	382 6 0				
Due from O. P. Fund,	...	136 5 2	517 14 11				
		<u>Rs. 7,338 9 6</u>	<u>6,448 6 6</u>			<u>Rs. 9,573 6 11</u>	<u>5,384 5 5</u>

Errors and Omissions excepted,
 Sd. BUDDINATH BYSACK,
Cashier,
Asiatic Society, Bengal.

Audited and found correct,
 F. W. PETERSON,
 D. WALDIE,

STATEMENT No. 5.

Conservation of Sanscrit MSS. in Account Current with the Asiatic Society of Bengal.

	Cr.	Dr.
Balance, of 1870, ...	1,717 1 9	Rs. 1,998 4 10
Received from the Government of Bengal, being the half sum sanctioned, annually by Rs. 3,100, towards the Conservation and Publication of Sanscrit MSS., for the 2nd half of 1870-71, ...	1,550 0 0	... 2,849 0 11
Ditto ditto for the 1st half of 1871-72, ...	1,550 0 0	
Sale proceeds of 6 Copies of Notices of Sanscrit MSS., ...	7 0 0	
Refund of the amount paid to Poresnath Chatterjee, for Copying Medhalithi on the 27th April, 1870, ...	23 4 0	
	<u>4,847 5 9</u>	
	Rs. 4,847 5 9	<u>4,847 5 9</u>

XXX

Errors and Omissions excepted,
 (Sd.) BUDDINATH BYSACK,
Cashier,
Asiatic Society, Bengal.
 Audited and found correct,
 (Sd.) F. W. PETERSON,
 D. WADDIE.

PROCEEDINGS
OF THE
ASIATIC SOCIETY OF BENGAL

FOR JANUARY, 1871.



The monthly meeting of the Society was held on Wednesday the 4th instant at 9 o'clock P. M.

The Hon'ble Mr. Justice Phear, President, in the chair.

The minutes of the last meeting were read and confirmed.

Presentations were announced.

1. From the Government of India, Home Department, 5 photographs of the temples and inscriptions at Barsee Taklee and Pinjar.

2. From the Author—Rückblick auf die Jahre 1845 bis 1870, Schreiben von W. R. von Haidinger an Herrn E. Döll.

3. From Dr. Newman—five silver coins.

4. From H. v. Schlagintweit-Sakünlinsky—a revolving scale for measuring curved lines on maps, &c.

The following gentlemen duly proposed and seconded at the last meeting were balloted for and elected ordinary members.

Isaac Newton, Esq.

R. S. Brough, Esq.

F. C. Daukes, Esq.

Bábu Ganendranátha Thákura.

The following gentlemen are candidates for ballot at the next meeting.

T. F. Harkness, Esq., C. S., proposed by A. M. Markham, Esq. seconded by Col. A. D. Vanrenen.

Col. J. F. Tennant, proposed by Col. H. Hyde, seconded by Dr. F. Stoliczka.

Dr. W. Waagen, proposed by Dr. F. Stoliczka, seconded by Mr. H. Blochmann.

G. C. Farr, Esq., proposed by Mr. E. Hyde, seconded by Col. H. Hyde.

The following gentlemen have intimated their desire to withdraw from the Society, C. F. Amery, Esq., Capt. J. P. Basevi, R. E., T. Thomas, Esq., H. W. Seevens, Esq.

The Council reported on the progress which has been made in the collecting and preservation of Sanskrit MSS., and communicated the subjoined correspondence on the subject.

In laying this correspondence on the table the President observed, that inasmuch as the measures proposed and subsequently undertaken for the conservation of Sanskrit MSS., and the preparation of Catalogues, were communicated to the Society, in May 1869, the Council thought it right to inform the Society of the progress which had since been made in the matter. He referred to the original instructions of the Government, and the few alterations which have been suggested by the Society. The task was entrusted to Bābu Rājendralāla Mitra, whom the Government had recommended for it. One instalment of the "Notices &c." had been published and was on the table before them. It would be seen that this was not in the tabular form which the Government at first contemplated, but the deviation from it had been sanctioned by the Government of Bengal in their letter, dated 22nd May, 1869, and whether or not every one would consider it judicious, there were certainly very substantial reasons to be urged in support of it. When these "Notices" were submitted to Government, no objection was taken to the form of the publication, but it appears that the advisers of the Government considered that it was defective in certain important points. The President quoted a passage to this effect from an official letter of the Government of India. He could not better explain the error into which the Government had here fallen, than by reading the answer which the Secretary of the Society had written in behalf of the Council. In conclusion

he said it was almost incomprehensible, how the blunder came to be committed, not only in the Secretariat to the Government of India, but also by a scholar like Mr. Chalmers, to whose very positive but mistaken observations the President referred. These gentlemen must have penned their strictures without having read the Sanskrit, and yet it was in Sanskrit, that the Government letter directed the principal matter of the lists, inclusive of the very matter in question, to be published.

No. 395.

Asiatic Society's Rooms, Calcutta, 27th June, 1870.

From F. STOLICZKA, Esq. PH. D.,

Honorary Secretary, Asiatic Society of Bengal,

To the HON'BLE ASHLEY EDEN,

Secretary to the Government of Bengal.

SIR,—Referring to the correspondence, noted at margin, regarding the conservation of No. 5557 dated 23rd Nov., 1868 Govt. of Bengal. ing the records and purchases of „ 309 „ 1st May, 1869 As. Soc „ „ „ 1949 „ 22nd „ „ „ Govt. „ „ Sanskrit Manuscripts in native libraries, I am desired by the Council of the Asiatic Society to forward a copy of Bábu Rájendralála Mitra's report on the subject, explaining the operations which have been instituted by the Society for that purpose, in accordance with the orders of the Government of Bengal.

A specimen copy of No. 1 of the "Notices of Sanskrit MSS." is herewith enclosed, as well as copies of the lists noted in para. 8th of Bábu Rájendralála Mitra's letter.

The slight alteration in the arrangement of printing has also been explained by Bábu Rájendralála Mitra, and the Council of the Society hopes that this change will be advantageous.

The expenses incurred by the Society for the above object of collecting MSS. during the latter half of the official year, 1869 and 1870, are detailed in the accompanying bill, and in submitting the same for the consideration of the Government of Bengal, I am desired by the Council of the Asiatic Society of Bengal to request that the Society may be sanctioned to draw a quarterly or half yearly advance, equal to one fourth or one half of the annual grant sanctioned for the purpose. A detailed statement of the half

yearly expenses will be prepared and submitted to the Government of Bengal, if desired.

Bábu Rájendralála Mitra expects to publish annually 3 or 4 numbers of the Notices of Sanskrit MSS. ; of No. 1 of these Notices 150 copies have been printed, and they are now at the disposal of the Government of Bengal.

With regard to the distribution of the Notices, I am desired by the Council of the Asiatic Society to submit a list* of names to whom copies could be sent, for the favourable consideration of the Government of Bengal. The spare copies of these "Notices," the Council would suggest, may be sold to the public at one Rupee per number.

From BA'BU RA'JENDRALA'LA MITRA,

To the Secretary, Asiatic Society of Bengal.

Dated, Chitpur, 24th May, 1870.

SIR,—I have the honor to submit the following report on the operations carried on during the last official year for collecting information regarding Sanskrit MSS. extant in native libraries.

2. The final orders of Government on the subject were received in May 1869. I happened to be unwell at the time, and nothing was done until my arrival at Benares in the middle of June following, when I commenced to collect lists of such rare MSS., as were available in that city. Although some ultra orthodox pandits were averse to allow their collection to be examined and analysed for the information of Europeans, I had no difficulty in inducing several persons to allow me access to their Libraries for the purpose of taking notes and copies of such MSS. as I liked, and obtained much valuable information from some of the professors of the local Sanskrit College. Two native gentlemen of the city, Bábu Harischandra and Sitalprasád, very obligingly placed the whole of their collections, each containing upwards of two thousand works, at my disposal, and Pandit Vináyaka S'ástrí brought me a few rare MSS. of the Kalpa sutras and of the Sikshás. The Rájguru of Benares and several other pandits also offered me assistance, and I soon had a total of upwards of five thousand MSS. at my disposal. Owing, however, to the delicate state of my health at the time, and my

* This list is omitted in the present communication.

stay at Benares having been limited to seven weeks only, I could not examine more than about half of them. These were mostly works of which the Asiatic Society possesses copies. The few that appeared to me to be new have been included in the accompanying volume of "Notices."

3. The principle on which the notices have been drawn up has already been explained in my minute of April 1869.* I have taken the Catalogue of the Society's Library for my guide, and described only such works as were not included in it, except when better MSS. were met with than are to be found in Calcutta.

4. The plan of quoting the initial and the concluding sentences, as also the epigraphs, which was first suggested by me and approved by Government, rendered a departure from the tabular form originally proposed unavoidably necessary; but none of the heads of information recommended by Mr. Stokes has been omitted, and on the whole the form adopted will, I believe, be found to be in every respect convenient. It has greatly economised space, and obviated the necessity of printing, in narrow columns, long extracts, mostly in verse, and other matter not fit to be tabulated.

5. Among the works noticed I would draw the attention of the Committee to the Upanishads, most of which are rare, and have hitherto been known only through Duperron's translation of the Persian version of Dárá Sekoh. From three to five copies of each of them have now been obtained, and placed at the disposal of Professor Rámamaya Tarkaratna for publication in the Bibliotheca Indica. The little treatises on Vedic Phonetics (Nos. 132 to 136) are also rare, and of considerable interest. Professor Max Müller, in his history of Sanskrit literature notices only one of them—that of Nárada—and the others, therefore, I imagine, will be new to many scholars in Europe. The commentary of Súres'vara on the Brihádáryanaka Upanishad and that of Sankaránanda on the Atharva Upanishads are also worthy of note. Most of the dramatic works noticed are not included in the list annexed to Professor Wilson's Hindu Theatre; some of the medical works are also valuable, and the Mahábháshya is remarkable for age and accuracy. Altogether 204 works have been noticed, of which 69 are portions of

* Proceedings, Asiatic Society, Bengal, for May, 1869, p. 127 *et seq.*

the Vedas or commentaries thereon, 26 are treatises on Vedic ceremonials, and 8 parts of the Vedangas; 11 are on the Vedānta, 8 on the Nyāya, and 2 on astronomy, one of them being an exposition of Arabic terms borrowed by the Brahmans. Of grammatical treatises 2 only are included in the list, and of medical compilations 5; but law, rituals, poetry and the drama, are represented in it by 6, 12, 28, and 14 codices respectively.

6. On my return to Calcutta, a pandit was employed on a salary of Rs. 30 a month, and travelling allowances, to proceed to the mofussil. He commenced operations at Krishnagar and in five months collected the names and short descriptive accounts of about four hundred MSS. new to the Society. Among these are included a number of Tantras belonging to the Rájá of Krishnanagar; but few of them are of any great antiquity. Notices of these have been drawn up in the prescribed form, and will be sent to press in the course of next month.

7. In March last, advantage was taken of the Rev. J. Long's trip to Dacca to send the pandit to that district, and he has since been employed there. The field, however, does not seem to be promising, and no work of any value has yet been met with. I have, therefore, asked the pandit to return to Krishnagar, where and in the neighbouring town of Nuddea, the most renowned seat of the Nyāya school in Bengal, there remains yet much to be done.

8. In July 1869, two MS. lists were obtained from the Home Office, one containing the names of 2744 works said to be owned by Pandit Rádhákrishna of Lahore, and the other of works supposed by the Nepalese pandits to be rare in the Nepalese Libraries at Khatmandu. Both these have been printed, and copies are herewith submitted for inspection. The first contains the names of a great number of scarce works, but it has been much swelled out by inserting the same treatises under different names in different places. The Nepalese list contains nothing of any value.

9. Nominal lists have likewise been obtained from the renowned Pandit Rangáchári Svamí of Brindaban, and from different parts of Bengal, extracts from which will ere long be published.

10. Much has not been done in the way of purchasing MSS. At

Benares I could obtain only 9 codices, and three have since been purchased in Calcutta, making in all 12 as per margin.*

Purchases.

*Tattvánuśandhāna.
Tattvaparakāsikā.
Baudhāyana Sutravirtī.
Baiyāsikādhikaranamālā.
Srautaprāyāschittachandrikā.
Darshapurnamāsprayachittakārikā.
Prayogasūtra, by Keshada.
Baudhāyanās' somayāga, incomplete.
Dig-drīśya vivaranum ākhyā.
Ātmapurāna.
Ahitāgnero Anteshṭiprayoga.
Chayanapaddhati.
Ekāmra Purāna.
Ekāmra chandrika.
Pingala chhanda sutra with the commentary of Halāyudha.
Sānkhyāyana Grihya Sutra.
Kapila Śānhitā.
Hiranya kesi sutra.
Kāma sutra.
4 Sikshās.

Eleven MSS. have likewise been copied. An opportunity lately offered for securing a copy of Sāyana's commentary on the Ārchikas of the Sāma Veda, but as the Society has resolved to print that work in the Bibliotheca Indica, I did not deem it necessary to avail myself of it.

The following is an abstract of the expenditure incurred by the Society on account of Government for collecting lists of MSS. and preparing copies for press, as also for revising the proofs

of the Sanskrit portion of the Notices.

Salary of Travelling Pandit from 14th August 1869 to February 1870 @ 30 Rs.,	196	0	0
Travelling allowance for ditto for the period ending March 1870,	145	5	9
Stationery, postage and stamps for letters, Banghy expenses and Contingencies,	85	1	6
Printing charges of forms for collecting materials for Catalogue,	70	0	0
Copying MSS. with paper, &c.,	121	11	6
Salary of Pandit for preparing, copying and correcting catalogues for the press,	147	0	0
Purchase of Sanskrit MSS.,	64	0	0

Rs. .. 829 2 9

No bill has yet been presented for printing the Notices.

The cost will probably amount to Rs. 250 making a total of Rs. 1,079-2-9 against the Government grant of Rs. 3,200. The saving is due to the circumstance of no measures having been taken to commence operations until after the rains of last year. The ex-

penses during the current year will, it is believed, take up the whole of the amount sanctioned.

No. 2017.

From H. S. BEADON, Esq.,

*Offg. Under-Secretary to the Govt. of Bengal
To the Hony. Secy. to the Asiatic Society of Bengal.*

Fort William, the 11th July 1870.

SIR,—I am directed to acknowledge the receipt of your letter No. 395 dated the 27th ultimo, with its enclosures, reporting the operations carried out by the Society in view to giving effect to the wishes of Government for the discovery and preservation of records of ancient Sanskrit literature, and in reply I am to request that you will convey to the Society an expression of the Lieutenant-Governor's thanks for the trouble they have taken in the matter. His Honor also desires me to acknowledge the services rendered by Bábú Rájendralála Mitra in this undertaking. A copy of your letter and Bábú Rájendralála Mitra's report will be transmitted to the Government of India, and will also be published in the supplement to the *Calcutta Gazette*. A copy of the "catalogue of Sanskrit MSS." and of "notices of Sanskrit MSS." will also be furnished to the Government of India.

2. With reference to paragraph 4 of your letter the Lieutenant-Governor is pleased to sanction the payment of the bill submitted, amounting to Rs. 1,079-2-9, for expenses incurred by the Society in collecting MSS. during the second-half of the financial year 1869-70. The Accountant-General will be instructed accordingly, and will also be addressed in regard to advancing the Society funds to carry on future expenses, subject to adjustment half-yearly, as suggested by you.

3. The Lieutenant-Governor approves of the list proposed by you of persons and institutions to be supplied with copies of the "Notices of Sanskrit MSS.," but desires that the Cambridge University and the Coondoo* family of Bhagyokul, in Dacca, may be added to the distribution list. The number of copies thus

* *Vide* your letter No. 281 dated the 10th May 1870.

to be distributed is seventy-five, and I am to request that of the balance, fifty-five copies may be forwarded to this Government for

use and transmission to the Government of India, the remaining twenty copies being sold to the public at 1 Re. per copy.

No. 2734.

From H. S. BEADON, Esq.,

Offg. Under-Secy. to the Govt. of Bengal,

To the Honorary Secy. to the Asiatic Society of Bengal.

Fort William, the 19th September 1870.

SIR,—With reference to my letter No. 2017, dated the 11th July 1870, the subject of the discovery and preservation of records of ancient Sanskrit literature, I am directed to forward for the information

of your Society the accompanying copy of a letter* from the Government of India in the Home Department, containing the views of His Excellency the Governor-General in Council on the operations of the Society in this undertaking.

2. It will be seen that the catalogues [“Notices of Sanskrit manuscripts”] are considered incomplete in some points, which tend materially to lessen their value and usefulness, especially to European scholars, and the Government of India accordingly desire the insertion in the “Notices” of the names and addresses of the persons to whom the manuscripts belong, the places in which they are deposited, the number of pages in each manuscript, the number of lines in each page, and the peculiarities of the manuscripts, in order to afford a ready means of identifying them hereafter. The directions can be easily followed in all “Notices” that may be published hereafter, but this is of course not possible in the volume already printed. I am, however, to suggest that effect might be given to the wishes of the Government of India by adding a supplementary list of the manuscripts drawn up numerically with the additional information.

3. The Government of India, it will be noticed, desire to add sixteen names to the list of persons and Societies to whom copies of the “Notices” are to be circulated, and point out several typographical errors in the names in the list of the Society.

4. In conclusion I am to invite attention to the suggestion made by the Government of India in paragraph 5 of their letter regarding the use of better paper and type in printing the “Notices.”

* No. 3963 dated the 29th ultimo, and enclosed.

† The Cambridge University has already been included, *vide* paragraph 3 of my letter above quoted.

From E. C. Bayley, Esq., C. S. I., Secretary to the Government of India, Home Department, to the Officiating Secretary to the Government of Bengal, General Department,—(No. 3963, dated Simla, the 29th August, 1870.)

SIR,—I am directed to acknowledge the receipt of your letter No. 2018, dated the 11th ultimo, and the enclosed correspondence, showing the operations carried on by the Asiatic Society of Bengal in regard to the discovery and preservation of records of ancient Sanskrit literature.

2. In reply I am directed to state that the efforts that have been made by the Asiatic Society to give effect to the wishes of the Government for the discovery and conservation of these Sanskrit manuscripts are satisfactory. I am, however, to point out that the catalogues received with your letter are incomplete in some points, which tend materially to lessen their value and usefulness, especially to European scholars.

3. It is very desirable that the names of the persons to whom the manuscripts belong should be inserted in the notices, as should also the places in which they are deposited. This might still be done by adding a supplementary list of the manuscripts drawn up numerically, with the names of the owners and their addresses opposite. The number of pages in each manuscript, the number of lines in each page, and the peculiarities of the manuscripts, should also be given in the catalogues, as a means of identifying them hereafter.

4. The list of persons and Societies to whom it is proposed to distribute the notices may be also considerably enlarged, and there are some inaccuracies in that list. A corrected copy of the latter is enclosed, (here follows a list of institutions, &c., &c.).

From DR. F. STOLICZKA,

Hon. Secretary to the Asiatic Society of Bengal,

To H. S. BEADON, ESQ.,

Offg. Under-Secretary to the Government of Bengal.

SIR,—I have the honor, by direction of the Council of the Asiatic Society of Bengal, to acknowledge the receipt of your letter No.

2734, dated the 19th September last, forwarding copy of a letter from the Secretary to the Government of India, Home Department, No. 3963, dated Simla, the 29th August, 1870, and stating that the Notices of "Sanskrit Manuscripts" lately submitted by the Society "are considered incomplete in some points, which tend materially to lessen their value and usefulness, especially to European scholars," and that the Government of India accordingly desire the compilation of a "supplementary list of the manuscripts drawn up numerically" with the additional information.

2. In reply, I am directed to state that in the blank form, annexed to the Government of India letter No. 4353, dated 3rd November, 1868, which was forwarded to the Society for its guidance, there are nine columns: 1st for number; 2nd for name, in Devanagari; 3rd for ditto, in Roman character; 4th for subject matter and name of author; 5th for number of pages; 6th for number of lines in each page; 7th for substance on which is written and character; 8th for names of place where and of person with whom found, and 9th for remarks regarding accuracy and peculiarities. Of these, information under the heads 5, 6, 8, 9, it is now said, is wanting in the 'Notices.' On reference, however, to the Sanskrit text it will be seen that the required details regarding the 5th, 6th and 9th heads are given in the second para., and that regarding the 8th in the third para. under each name. The editor has likewise added (10th) the extent of the work calculated according to the Indian method in stanzas of 32 syllables each; 11th, the date of writing* whenever available; 12th, the initial words or stanza; 13th, the concluding words; 14th, the colophon which in Sanskrit works serves the purpose of the title page, and 15th, a full description of the work, its contents, history, and literary notices. The Council of the Asiatic Society fail, therefore, to perceive how it has been made out that information under some of the heads had not been supplied, and are driven to suppose that the Sanskrit portion of the "Notices" has been entirely overlooked by the Government of India. From a reference to those Notices, it is clear that more information of an useful character has been supplied than was asked for.

3. It might be said that if all the information had been given in English, it would have proved more convenient. But the word-

ing of the original order of Government left no option to the Society in the matter. It is there distinctly laid down that "all procurable unprinted lists of Sanskrit MSS. in native Libraries should be printed uniformly in octavo, in the Nagari character," and the editor could not depart from that positive injunction without laying himself open to censure. The scheme contemplated no quotations or extracts, and the Nagari character could not, therefore, be limited to any one particular part. It may be added that those who will hereafter wish to identify the MSS. noticed, will be men conversant with the Sanskrit literature, and to them the Sanskrit part of the Notices will prove more useful than the English part, while to Indian scholars, at the suggestion of one of whom the work has been undertaken by Government, the Sanskrit will be the only part of use, and for years to come the English will be of no avail. It is scarcely likely that those who know nothing of Sanskrit will interest themselves much in tracing old MSS. in that language.

4. Better paper will be used for the printing of the future Nos. of the "Notices."

The following copy of a minute relating to the cataloguing of Sanskrit MSS. has been received from the Secretary to the Government N. W. Provinces.

"NOTICES OF SANSKRIT MSS. by *Rājendralāla Mitra*.

(1.) "These Notices are most unsatisfactory. The editor states that he has taken "the catalogue of the Asiatic Society's Library for his guide, and has noticed only such works as are not to be found in it."

(2.) "He carefully avoids all mention of where the MSS. he comments on are to be found. He does not state who they belong to, what their value is, or whether Government should endeavour to purchase them.

(3.) "Whenever he gives a sensible notice it seems to be taken from Max Müller's Sanskrit Literature.

(4.) "A catalogue of this kind to be practically useful should contain a report of the places searched for MSS. and the place where each MS. is to be found.

(5.) "It should also mention whether the book is available or not to European scholars. The catalogues of the Bodleian, India Office and Berlin Libraries would shew this.

Sd. J. CHALMERS."

Minute of Bábu Rijendralála Mitra on the above [in a letter addressed to the Secretary].

Mr. Chalmers' criticisms are founded on the same imaginary shortcomings on which the Government of India commented on my unfortunate "Notices;" I have therefore only to refer to the reply lately forwarded to the Government of Bengal on the subject.

The 1st para. of the critique contains a general observation, the value of which depends on what follows. I need not therefore notice it.

The 2nd para. accuses me of having (1) carefully avoided all mention of where the MSS. commented upon are to be found; (2) whom they belong to; (3) what is their value; (4) and whether Government should endeavour to purchase them or not. The first three charges are, as you are aware, entirely unfounded—due either to the critic's not knowing the Sanskrit language, or to his having failed to qualify himself for the task he has assumed, by reading the Sanskrit portion of the Notices which would have at once shown him that the required information has been duly furnished. The last charge cannot be fairly brought against me. I am required by Government to print lists, and nothing but lists, in order that Sanskrit scholars in Europe and India may point out what MSS. should be purchased. The words of the Government letter are: "To print uniformly all procurable unprinted lists of Sanskrit manuscripts in Indian Libraries, and to send them to the various learned Societies of Europe, and to individual scholars in Europe and India, with an intimation that the Government will carefully attend to their suggestions as to which of the manuscripts therein mentioned should be examined, or transcribed." I have quoted this part of the letter in my Preface, and as Mr. Chalmers has read it, he should have suggested what MSS. are worth having, and not found fault with me for not doing what he as a

scholar and others are required to do. Sanskrit scholars in Bengal are exceedingly averse to sell MSS., but when opportunities do offer I never fail to take advantage of them, and purchase for Government whatever, in my humble opinion, appears valuable.

The 3rd para., without directly charging me with having cribbed from Max Müller's ancient Sanskrit Literature, insinuates that I have done so. I cannot but take this as unfair. I have given the name of Max Müller whenever I have quoted from him, and shall be glad to be shewn an instance to the contrary.

The 4th para. repeats the first charge of the 2nd, and therefore calls for no further remark.

The 5th contains a suggestion, but the published portion of the "Notices" should have shewn to Mr. Chalmers that it was uncalled for. I have quoted from Aufrecht's *Catalogi codicum manuscriptorum Bibliothecae Bodleianae*, and from Weber's *Verzeichniss der Sanskrit-Handschriften*, the only Berlin catalogue accessible to me. Mr. Chalmers seems not to be aware that no catalogue of the India House Library has yet been published, and therefore it is impossible to quote from it. I have lately got a MS. list of the contents of that Library through the kindness of Dr. Rost, and intend to notice it when necessary.

The real cause of the misunderstanding lies in the expectation that the Notices should serve the purpose of a catalogue raisonné which they do not profess to do, nor were they originally required to do. The Society undertook to supply only lists in the Nagari character of MSS. still extant in the country, with brief notes of their contents, in order that future scholars in Europe may be enabled to compile a complete catalogue of Sanskrit literature, and not to supply that desideratum now. The Government is of opinion that the time has not yet come for a comprehensive scheme of this kind, and if this be borne in mind, the "Notices" will not be found to be so defective as they are said to be.

The President placed on the table diagrams exhibiting the diurnal oscillations of the barometer observed by him at Dalhousie during a portion of last October. He did so, not on account of the merits of these curves, for they were only rough approxima-

tions to the truth, but in order to press on the attention of members of the Society the importance of observations of this kind in India. He mentioned the part which, according to a very generally received theory, the presence of vapour had in effecting the double maximum, and pointed out that this country seemed to afford extraordinary opportunity for the complete investigation of this subject.

Col. the Hon'ble R. Strachey begged to differ altogether from the views put forward by the President, and characterized the doctrine which attributes the daily oscillations of the barometric pressure solely to the influence of vapour in the atmosphere as a dogma. The actual tension of vapour at any place does not represent the portion of the total atmospheric pressure, due to the pressure of the vapour, and the difference between the total pressure and the vapour tension is not the pressure of the dry air. The very numerous barometric and hygrometric observations which he (Col. Strachey) had made in the plains of India and in the Himalayas, up to elevations of between 18 and 19000 feet, speak entirely against this view—which he thought had first been put forward by General Sabine,—inasmuch as the same fluctuations in the total pressure, which are to be observed in the plains, are equally marked at high elevations in Tibet, where there is extremely little moisture in the atmosphere. Col. Strachey referred to a paper which he had published on the subject some years ago in the Proceedings of the Royal Society on the distribution of vapour in the atmosphere, in which the data for the above conclusions of his were given at length. He said that the day maximum and minimum are unquestionably connected with the heating of the air by sun, and can be explained by the dispersion of the air over that part of the earth's surface where the temperature is highest, and its accumulation to the east and west of the most heated area. That this is the true cause of the phenomenon is also indicated by the fact, proved by observation, that the time of day maximum and minimum change according to the hour at which the sun rises and sets in different localities. The explanation of the nocturnal maxima and minima is more difficult, but they are probably secondary results of the diurnal changes of temperature.

Colonel Strachey noticed certain modifications of the usual daily maxima and minima in the atmospheric pressures, to be observed in the hills. These must be considered as purely local, and are to be explained as caused by certain disturbances of the planes of equal pressure in the air, due to the unequal expansion of the variable depth of air over the plains and mountain slopes, which again are followed by currents of air between the plains and the hills. During the day, the air is heated over the plain and forms a superior current toward the mountain, at night the converse takes place and gives rise to an inferior current towards the plain. These changes are quite analogous to the daily sea and land-breeze.

Dr. Stoliezka observed that he was struck with the great regularity with which the maxima and minima in the atmospheric pressure return at high elevation. He had made observations for two successive years on the elevated plains of Tibet, between 15 and 20,000 feet, and found that as a rule the maxima fell about the hour of 10 A. M. and 11 P. M., the minima between 3 and 5 P. M. and about 3 A. M. Certainly the regular oscillations of the atmosphere in these regions could not be attributed to the existence of vapour, for there is almost none whatever present. The annual rain fall scarcely amounts to half an inch.

In reply to remarks which fell from Col. Strachey, the President said that nothing could be further from his mind than any intention to set up or maintain the "dogma" which Col. Strachey attributed to him. In truth he had brought the matter forward solely for the purpose of urging that observation and research were still needed, and that the peculiar facilities of India in this respect were neglected. We had it in our power to make observations, with variations of condition as to elevation, humidity and temperature, such as could hardly be secured elsewhere. We could almost be said to be able to experiment in this subject, so great were our opportunities of making simultaneous observations at different heights in pretty nearly the same vertical line, and at variously situated stations, distributed over a largely extended surface of the earth. The advantages offered by the character, and position of the country for analysis of the elements of the problem and comparison of results seemed to be in a great measure unheeded. They could only

be effectively made use of by combined action, and of this at present it could hardly be said that there was any.

The following papers were brought before the meeting.

1. Notes on the district of Dera Ismail Khan, by T. W. H. Tolbort, Esq., C. S.

This paper contains notes on the history, archæology, and natural productions of the district; it will shortly appear in the *Journal of the Society*.

2. On the antiquity of Indian Architecture, by Bábu Rájendra-lála Mitra. (*Abstract.*)

The oldest remains that have come to light are the pillars of As'oka, and they are not of a greater age than the middle of the third century before Christ. Hence an opinion is gaining ground that the ancient Aryans were not proficient in the art of building substantial edifices with stones and bricks, and that the primitive Hindus were dwellers in thatched huts and mud houses. Mr. Fergusson, who has adopted this opinion, adds that the Hindus learnt the art of building from the Grecians who came to India with Alexander, and that the oldest specimens of architecture in the country appear to be in the first stage of transition from wood to stone. The author combats these opinions by a number of quotations from the *Rig Veda*—a work generally believed to be of the same age with the *Mosaic chronicles*—in which allusions are made to fortified towns, large palaces, three-storied dwellings, bricks, pillars and other objects which could not have existed without masonry works of some kind or other. Quotations are also given from Pánini, the *Rámáyana* and the *Mahábháratha* to prove the existence of masonry houses at a very early period of Indian history. It is denied that the Buddhist religion—a mere reformation of the old Hindu faith—could have any influence in originating architecture, and the invasion of Alexander, is compared to the recent British expedition to Abyssinia, in which very little impression was produced on the domestic arts of the Abyssinians. It is difficult to believe that Alexander brought any large number of quarriers, masons, and architects to leave some behind for the education of the people of

the country in architecture, and it would be absurd to suppose that a king, like As'oka, who is presumed to have originally lived in thatched huts, would of his own accord send for architects and quarriers from Greece to build him a palace. In reply to the argument founded on the ornaments of old Indian architecture being copied from wooden originals, it is contended that they do not suffice to indicate the exact age when the transition first took place, inasmuch as there is a spirit of conservatism, a mannerism or a survival of custom in architectural ornamentation, so strong that it preserves intact forms long after the lapse of the exigencies which first lead to their production, and such evidence, therefore, cannot be accepted as conclusive.

Rev. K. M. Benerjea made some observations in support of the views expressed by Bābu Rājendralāla Mitra.

Mr. Wood-Mason exhibited an interesting case of polydactylism (see pl. I), in a horse from Bagdad, and remarked that the splint-like rudiments of the metacarpals of the fourth toe on each fore-foot (iv. in figs. 1 et 2 of pl. I) had given rise to a supernumerary digit provided with the regular number of phalanges and encased in an asymmetrical hoof; the asymmetry of which was such, that the presence of another of the same shape internally to it would have formed a symmetrical pair, like the cleft hoof of a ruminant. The metatarsals of the fourth toe on each hind foot were by the law of correlation similarly affected, but the supernumerary hoofs of these were stouter and more irregular in shape. He next mentioned the fact that M. Arloing in a recent contribution* to our knowledge of the organization of the foot of the horse had described a polydactyle horse with the extra digits developed from the rudiments of the second toe (ii. in figs. 1 et 2); the hoofs of these only differed from those of the principal digits in their smaller size. He next distinguished between those monstrosities† that had resulted from injuries received by the embryo *in utero* or in the egg, between those which might be said to be due to the "anomalous retention of embryonic

* Ann. des sc. nat. (zool.), 5c Sér., vol. viii, pp. 55 et seqq., pl. 1.

† For full information on the subject of monstrosities *vide* Darwin's "Animals and Plants under domestication."

Fig. 1.

Fig. 2.

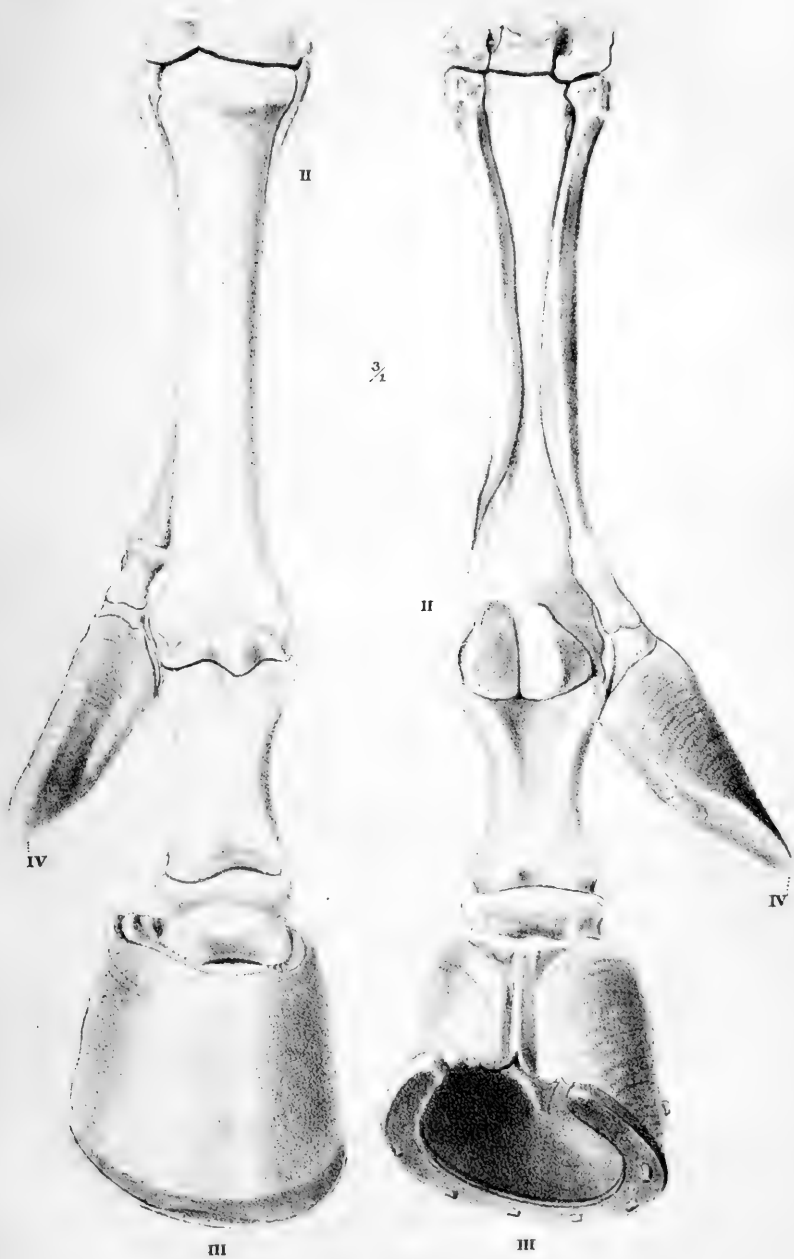

For reference see p. 18.



characters," and those that took the form of the re-development of visible rudiments of digits, or other structures, normally present in some remote ancestors of the group to which the individual affected belonged. This explanation applied to the polydactyle foot figured on the accompanying plate (I.). The resemblance to the extinct *Hipparion** would have been perfect if the two outer toes on each foot had been developed. In illustration of these remarks, he traced the Horses back in time to their three-toed progenitors, *Hipparion* and *Anchitherium*, whose remains abounded in the miocene deposits of Europe, India (in the Sewalik-hills), and America: in *Hipparion* the two outer toes of each foot possessed the same number of phalanges as the principal toe, but were reduced to mere dowlaws and did not touch the ground; in *Anchitherium*, on the the other hand, they were nearly equal in size to it. The figures sufficiently showed the great length and breadth of the "splints" (ii. et iv. in figs. 1 et 2), and the obtuseness of their distal extremities as compared with the slender, finely pointed character of these same structures in an ordinary horse.

Explanation of Plate I.

Fig. 1. Front view of right carpus (*minus* the proximal series of carpal bones) of a polydactyle horse; $\frac{1}{3}$ nat. size.

Fig 2. Posterior view of same.

The Roman numerals ii, iii, iv refer to the 2nd, 3rd and 4th digits respectively in both figures.

The following papers were received.

On terrestrial Mollusca from the neighbourhood of Moulmein, Tenasserim Provinces, by Dr. F. Stoliczka.

Monograph of the Indian *Cyprinidae*, Pt. I, by Dr. F. Day.

LIBRARY.

The following additions have been made to the Library since the meeting held in December last.

Presentations.

* * * Names of Donors in Capitals.

Proceedings of the Royal Institution of Great Britain, Vol. V. Part VII.—THE INSTITUTION.

Journal of the Chemical Society, Sept., 1870.—THE SOCIETY.

* *Vide* the magnificent memoirs of M. Gaudry and Dr. Leidy, and in connexion therewith Prof. Huxley's Presidential address to the Geological Society of London, February, 1870.

Journal of the Royal Asiatic Society of Bombay, Vol. IX. No. 26.—THE ROYAL ASIATIC SOCIETY OF BOMBAY.

Monatsbericht der K. Akademie der Wissenschaften zu Berlin, Juli, 1870.—AKAD. DER WISSENSCHAFTEN ZU BERLIN.

Zeitschrift der deutschen Morgenländischen Gesellschaft, Band XXIV, Heft 3.—THE EDITOR.

Rahasya Sandarbha, No. 62.—THE EDITOR.

The Pali Text of Kachchayano's Grammar, by F. Mason.—THE EDITOR.

Professional Papers of Indian Engineering, No. 29.—THE EDITOR.

Memoir of Dwarkanath Tagore, by Kissory Chand Mitra.—THE AUTHOR.

Memoirs of the Geological Survey of India, Palæontologia Indica, Vol. III. Nos. 1—4.—Icones Plantarum India Orientales, by Major H. Beddome, parts 4-6.—Flora Sylvetica, by Major H. Beddome, parts 3—5.—Selections from the Records of Government, Home Department, No. 80, Foreign Department, No. 81.—THE GOVERNMENT OF INDIA.

Records of the Geological Survey, Vol. III, Nos. 3-4.—THE GOVERNMENT OF BENGAL.

Purchase.

The Kamil, part 7.—Zenker's Turc-Arabe-Persian Dictionary part 16.—Lond. E. and D. Philosophical Magazine, No. 268.—Annals and Magazine of Natural History, No. 35.—Comptes Rendus, No. 9.—Museum Heineanum by Cabanis, Theil I—IV.

Exchange.

The Nature, Nos. 53—57.

PROCEEDINGS
OF THE
ASIATIC SOCIETY OF BENGAL

FOR FEBRUARY, 1871.



The annual meeting of the Society was held on Wednesday, at 9 P. M., 1st February, 1871.

The Hon'ble Mr. Justice Phear, President, in the chair.

The President called upon the Secretary to read the annual report of the Council.

ANNUAL REPORT FOR 1870.

The Council of the Asiatic Society of Bengal, in presenting their annual report for the year 1870, have again to congratulate the members on the healthy condition of activity which the Society has maintained.

During the year under review, there were 28 ordinary members elected, while in the same period, the Society sustained a loss of 57 members. Of this latter number 45 are due to death or resignation, and 12 have been removed from the list for non-compliance with the rules of the Society. The somewhat large number of resignations appears to be partially due to the introduction of the revised rules of the Society, by which members, leaving for Europe, are particularly requested to state, whether they wish that their membership should continue or not. Formerly information on this point was rarely given, and it was greatly on this account that the member list had grown to unnatural dimensions.

At the close of the year, the number of ordinary members was 414; of these 266 were paying members, and 148 absent. A marked decrease in these numbers is to be observed, when the

present year is compared with the past, and even with several of the preceding years, as will be seen from the subjoined table :—

	<i>Paying.</i>	<i>Absent.</i>	<i>Total.</i>
1861	225	55	280
1862	229	82	311
1863	276	79	355
1864	228	92	380
1865	267	109	376
1866	293	94	387
1867	307	109	416
1868	294	133	427
1869	304	138	442
1870	266	148	414

The Council regret to announce the death of the following ordinary members :—J. Kavenagh, Esq., R. Jardine, Esq., Lieut. R. C. Beavan, Bábu Rádhánátha Sikadára, M. H. Ormsby, Esq., LL. D., Bábu Káliprasanna Sípha, J. Avdall, Esq., Major J. J. Hovenden, Rájá Sir Deonáráyana Sípha, Bahádur, K. C. S. I., Dr. T. Anderson, F. L. S.

Although it might at first sight appear that the decrease in the accession of new members, and the somewhat numerous resignations are due to a diminishing appreciation of the scientific efforts of the Society on the part of the public, the Council take pleasure in remarking that such is far from being the case. On the contrary, the Council feel themselves justified in asserting that the interest of the scientific public in the working of the Society has in the last twelve months sensibly increased in India as well as abroad. This is particularly shewn by the largely increased demand for the publications of the Society, the sale of the Journal and Proceedings having been greater than in any previous year, and the Society having also received several offers of various foreign scientific institutions for an exchange of their publications. In no less a degree have the members themselves evinced their interest in the Society by the regularity of their contributions, both in the way of subscriptions and of scientific communications. The actual income of the Society has exceeded the estimate by an appreciable amount.

The numerous communications, forwarded to the Society,—chiefly by its members,—equally shew that the scientific interest in the Society are largely increasing. More than 50 valuable contributions in various branches of science and literature have been received, and this does not include many of the shorter papers printed in our Proceedings.

MUSEUM.

During the past year, the Council of the Society, in accordance with the provisions of Act XVII of 1865, and their previous practice, have continued to transfer all the donations received in the Natural History and Archaeological Departments, to the Trustees of the Indian Museum. A detailed statement of these donations has been published in the December Proceedings for last year.

The Council of the Asiatic Society feel it their painful duty to express, at this opportunity, their great regret, that the Government of India will not be able to provide in the new Museum building at the appointed time—23rd March, 1871,—the necessary accommodation, which the members of the Society had a right to expect for their valuable collections. The Council, however, entertain the hope, that the delay in carrying out the provisions of the Museum Act will be only temporary, and that the Government will spare no efforts to give to the public and the Society at the earliest possible moment, the benefits which it is the purpose of that Act to bring about.

COIN CABINET.

The Society's collection of Coins received an increase of 14 Copper coins, presented by Captain A. Bloomfield, M. L. Ferrar, Esq., and H. J. Rainey, Esq. A set of 17 silver coins has been purchased.

LIBRARY.

Within the past year, the Library received an addition of 776 volumes, or parts of volumes. Many of these were obtained in exchange for the publications of the Society, others were purchased, and for a considerable number the Society is indebted to private individuals and to the Government of India. Detailed lists of the monthly accessions to the Library have been regularly published in each number of the Proceedings. In the collection of manu-

cripts, valuable additions have also been made ; there were 94 Sanscrit manuscripts purchased or copied, and 6 Persian works were purchased.

The Council regret that it has been beyond their power to make the Library as useful as the members have a right to expect it to be, and as the Council would earnestly desire to make it. The difficulty lies principally in the inadequate space now available for the books. It was chiefly on that account that the new contemplated edition of the Library catalogue has not been completed. The Council will, however, endeavour to remedy this growing evil at the earliest possible opportunity, but they cannot take any effective steps until the Natural History collections are removed from the Society's house.

The collection of MSS. has also been examined during last year. Maulavi Abdul Hakim, under the Secretary's superintendence, checked the Arabic, Persian, and Hindústáni MSS., and Pundit Premchandra Choudhari examines at present the Sanscrit MSS. The Catalogue of the Pundit is to be a catalogue *raisonné* ; he has analyzed about 500 works on grammar, lexicography, prosody, prose and poetry, rhetoric, mathematics, astronomy, and medicine.

All MSS. received since the preparation of the old catalogues have been entered into the MS. catalogues of the Society.

A list of the Societies and other scientific institutions, with which exchanges of publications have been made, is appended further on.

PUBLICATIONS.

The Council have anxiously bestowed continued attention upon the publications, as these constitute the truest indicia of active life in the Society, and they have now the satisfaction to announce that the 49th volume of the Journal will very shortly be completed, and one volume of Proceedings was issued ; both will extend over more than 1200 pages, accompanied by 36 plates. It has been the aim of the officers of the Society not only to insure the regularity of issue of the various numbers of the Journal and Proceedings, but also to introduce an improvement in the illustrations accompanying the papers. The value of the improvements effected is clearly indicated by the increasing applications for the various numbers of the Journal and

Proceedings. The sale of these has been during the past year larger than in any previous year, amounting to Rs. 1903.

There have been issued for the year 1870, eleven numbers of Proceedings, equal to 347 pages, (exclusive of appendices), and 5 plates. Of the Journal, part I, (Philology, Archaeology, &c., &c., 3 numbers were issued and the 4th is ready for issue; the part will extend over 304 pages and 13 plates. Part II, Natural History, &c., was issued in 4 quarterly numbers, and includes 432 pages and 18 plates, and in addition 98 pages of Meteorological Observations. Each of these parts can form a separate volume, for each is separately paged, and provided with a special index, &c. &c.

BIBLIOTHECA INDICA.

During 1870, forty-seven fasciculi have been issued of Oriental works, *viz.*, 2 Arabic, 12 Persian, 30 Sanscrit, and 3 fasciculi of English Translations, *viz.*, 1 from the Persian, and 2 from the Sanscrit.

Arabic Works.

Maulavi 'Abdul Hai has issued 2 fasciculi of the *Içábah*, or Biographical Dictionary of Persons who knew Muhammad. The work was commenced by Dr. A. Sprenger, and continued by Maulavi 'Abdul Haq, whose death temporarily interfered with the progress of the book.

Persian Works.

Of Kháfí Khán's History, Maulavís Kabírúddín and Ghulám Qádir, of the Calcutta Madrasah, have issued six fasciculi. Another fasciculus will complete this important history of the Mughul Emperors of Delhi. Maulaví Aghá Ahmad 'Alí has issued 3 fasciculi of the *Maásir i 'Alamgirí*, a history of the reign of Aurangzib. Of the Quarto Text edition of the '*Aín i Akbarí*, Mr. Blochmann has issued two fasciculi; and one fasciculus of the English Translation.

Maulaví Zulfaqár 'Alí, of the Calcutta Madrasah, has brought out one fasciculus of the Critical Persian Dictionary, entitled '*Farhang i Rashídí*,' by Maulavi 'Abdurrashíd of Tattah.

Aghá Ahmad 'Alí's introduction to the *Sikandarnámah i Bahrí* is nearly completed and will shortly be issued.

Sanscrit Works.

In consequence of the additional grant of Rs. 3000 *per annum*, made by the Government of India for the publication of Sanscrit works, announced at the last Annual Meeting, the Sanscrit series has made considerable progress. No less than 30 fasciculi have been issued during the past year, against 9 in 1869 and 5 in 1868.

Bábu Rájendralála Mitra has issued 2 fasciculi of the Taittiriya Bráhmāna of the Black Yajur Veda, and one of the Aranyaka. Both works are now almost completed, and an index is in the course of preparation. Pandita Anandachandra Vedántavágisa has published 10 fasciculi of the Tándya Mahábráhmāna, and eight fasciculi of the Srāuta Sūtra of Látýáyana. The Council have entrusted the publication of the Sáma Veda Sanhitá to Pandita Satyavrata Sámasramí who has already issued the first fasciculus of the same with the Commentaries of Sáyana. Pandita Harachandra Vidyábhushana has published three fasciculi of the Agni Purána, and one of the Gopatha Bráhmāna of the Atharva Veda. He has also issued the Gopala Tapani of the same Veda, with the commentary of Visvesvara. Pandita Rámamaya Tarkaratna of the Sanscrit College, Calcutta, has published one fasciculus of the Nrisinha Tápaní with Sankara's Commentary; another fasciculus will complete the work. Pandita Mahesachandra Nyáyaratna has issued one fasciculus each of the Mimánsa Darsana and the Sanhitá of the Black Yajur Veda. Pandita Chandrakánta Tarkálankára is now editing the Gobhila Sūtra, and a fasciculus of the same is soon to be issued.

During 1870, Bábu Rájendralála Mitra issued the first number of Notices of "Sanskrit Manuscripts," and a second number has just been published. Bábu Rájendralála's annual report on the work done by the travelling pandit will appear at the end of the official year.

Professor E. B. Cowell issued his translation of the Maitri Upanishad, and Rev. K. M. Banerjea the first fasciculus of his translation of the Brahma Sutra.

The following is a detailed list of works published during 1870.

Old Series, Arabic.—A Biographical Dictionary of Persons who knew Muhammad, by Ibn Hajár, edited in Arabic by Maulavi Abdul Háí, Nos. 225, 226, Fasc. VIII and IX of Vol. IV.

New Series, Persian.—The *Muntakhab al Lubab* of Khafi Khan, edited by Maulavis Kabir al Din Ahmad and Ghulam Qadir, Nos. 178, 180, 186, 192, 204, 205, Fasc. XIII to XVIII.

The *Ain i Akbari* by Abul Fazl i Mubarak i Allámi, edited by H. Blochmann, M. A., Nos. 193, 211, Fasc. XI, XII.

The *Maasir i 'Alamgiri* of Muhammad Sáqi Must'aidd Khán, edited by Maulavi Aghá Ahmad Ali, No. 195, 210, Fasc. I, II.

The *Farhang i Rashidi* by Mullá Abdur Rashid of Tattah, edited and annotated by Maulavi Zulfaqár Ali, No. 200, Fasc. I.

Old Series, Sanscrit.—The *Taittiriya Bráhma*na of the Black Yajur Veda, with the commentary of Sáyanácharya, edited by Bábu Rájendralála Mitra, Nos. 222, 223, Fasc. XXIII, XXIV.

The *Sanhitá* of the Black Yajur Veda with the commentary of Mádhava Achárya, edited by Mahesachandra Náyaratna, Vol. III; No. 224, Fasc. XXIII.

New Series, Sanscrit.—*Tándya Mahábráhma*na with the commentary of Sáyana Achárya, edited by Anandachandra Vedantavagisa, Nos. 179, 182, 188, 190, 191, 199, 206, 207, 212, 217, Fasc. IV to XIII.

The *Srauta Sutra* of Látyáyana, with the commentary of Agniswami, edited by Anandachandra Vedantavagisa, Nos. 181, 184, 185, 187, 196, 198, 202, 213, Fasc. I to VIII.

Gopála Tápani of the Atharva Veda, with the commentary of Visvesvara, edited by Harachandra Vidyábhushana and Visvanátha Sastri, No. 183.

The *Agni Purána*, a system of Hindu Mythology and Tradition in the original Sanscrit, edited by Harachandra Vidyábhushana, No. 189, 197, 201, Fasc. I to III.

The *Taittiriya Áranjaka* of the Black Yajur Veda, with the commentary of Sáyanácharya, edited by Rájendralála Mitra, No. 203, Fasc. IX.

The *Mimánsá Darsana*, with the commentary of Savara Swamin, edited by Pandita Mahesachandra Nyáyaratna, Nos. 208, 209, Fasc. IX and X.

*Gopatha Bráhma*na of the Atharva Veda in the Original Sanscrit, edited by Harachandra Vidyábhushana, No. 215, Fasc. I.

The *Nrisinha Tápani* with the commentary of Sankara Achárya, edited by Rámamaya Tarkaratna, No. 216, Fasc. I.

English Translations.—The Ain i Akbari of Abul Fazl i Allami. Translated from the Persian by H. Blochmann, M. A., No. 194, Vol. I, Fasc. IV.

Old Series, Sanscrit.—The Maitri Upanishad with the commentary of Rámátirtha, edited with an English Translation by E. B. Cowell, M. A.

New Series, Sanscrit.—The Brahma Sutras, with the commentary of Sankaráchárya translated into English by Rev. K. M. Banerjea, No. 214, Fasc. I.

FINANCE.

The Council has already had occasion to remark that the financial condition of the Society is satisfactory. The expenditure has been as much as possible kept within the estimated limits of the various items, regulated by the income. The actual income has exceeded the estimated income by Rs. 745, while at the same time a saving of Rs. 582 was effected in the estimated expenditure, thus making a total surplus of Rs. 1,327, which, added to the balance of Rs. 1,540,* left to the credit of the Society at the close of 1869, makes a grand total of Rs. 2,867. The reserved funds of the Society in Government Securities, amounting to Bs. 2000, remained the same as in the previous year.

The Council were anxious to secure this surplus for the benefit of the Society, because they expect that in a short time a considerable outlay will be required for the repairs of the building, and they are equally alive to the necessity of increasing the amount, to be devoted for the proper accommodation and arrangement of the library, as soon as sufficient room for it can be obtained.

An abstract of the accounts for the year 1870 is shewn in the subjoined table:—

				INCOME.		Actual 1870.	
Admission fees,	Rs.	864	0	0
Subscriptions,	8,812	10	0
Publications,	1,903	1	3
Library,	752	14	0
Coin Fund,	0	0	0

* Excluding Rupees 898-10-0, held in trust for Dr. J. Muir.

Secretary's Office,	287	6	0
Vested Fund,	110	0	0
Miscellaneous,	914	4	10

13,644 4 1

Col. E. T. Dalton's Ethnology of Bengal, ..	5,000	0	0
Conservation of Sanscrit MSS., ..	3,703	2	9

22,347 6 10

Balance of 1869, in the Bank of Bengal :

Dr. J. Muir, 898 10 0

Asiatic Society, .. 1,411 4 7

Cash in hand, .. 128 1 9

1,539 6 4

2,438 0 4

Rs. 24,785 7 2

EXPENDITURE.

Publications,	Rs. 5,239	13	5
Library,	2,472	3	3
Secretary's Office,	2,585	2	3
Building,	910	10	3
Coin Fund,	13	6	4
Vested Fund,	0	4	4
Miscellaneous,	1,633	7	10

12,854 15 8

Ethnology of Bengal,

5,000 0 0

Conservation of Sanscrit MSS.,

1,527 6 6

19,382 6 2

Balance of 1870, in the Bank of Bengal.

Dr. J. Muir,

898 10 0

Conservation of Sanscrit MSS.,

1,653 1 9

2,551 11 9

Asiatic Society,	2,725	6	0		
Cash in hand,	125	15	3		
	<hr/>			2,851	5 3
				<hr/>	
				5,403	1 0
				<hr/>	
				Rs. 21,785	7 2
				<hr/>	

Your Council desire to place on record, that they have had under their consideration the very important question of reduction of the subscriptions now contributed by members, whether resident or non-resident. They have calculated the immediate loss of annual receipts which this would produce, and carefully estimated how far and how soon they could justly anticipate that the income of the Society would recover itself. They are confident, that such a reduction of the subscriptions would lead to a future increase of income, by bringing to the Society a considerable increase in the number of members, and would at the same time render that income less fluctuating by placing it on a wider and more secure basis. They felt strongly also that these benefits should be granted to the members of the Society at the earliest possible date: and seeing that the time is now near at hand (23rd March, 1871), when the Society under their contract with the Government of India will become entitled to such permanent addition to their income, as may be realized for the use of the building which they now occupy, (and which is valued and assessed at 400 Rs. per month), they were disposed to recommend to the Society the immediate reduction of the subscription of resident members by one-third, and of non-resident members by one-sixth of their present contributions. Any immediate reduction of income, resulting from this action, would have been more than recouped by the rent of their premises. After a full consideration, however, they have for various reasons resolved to leave this very important question until the time shall have actually arrived, when the Society will become entitled to realize this addition to their permanent income. They confine themselves, therefore, to expressing the hope, based on their conviction of the importance of the matter, that their successors in office may be enabled to satisfy the wishes and just expectations

of the members of the Society by carrying out at an early date this important change.

Rejecting, therefore for the present, the consideration of this question as affecting the income of the Society, the Council beg to submit the following estimate of the probable receipts and expenditure.

	INCOME.	EXPENDITURE.
Admission fees,.....Rs.	900 0 0	0 0 0
Subscriptions,.....	8,500 0 0	0 0 0
Publications,	1,500 0 0	5,000 0 0
Library,	600 0 0	2,600 0 0
Coin. Fund,.....	0 0 0	100 0 0
Secretary's Office,	0 0 0	2,800 0 0
Miscellaneous,	1,000 0 0	1,000 0 0
Building,.....	0 0 0	1,000 0 0
	Rs. 12,500 0 0	12,500 0 0

OFFICERS.

The general duties of the Secretary, including the publication of the monthly Proceedings, have been, as likewise in the previous year, carried on by the Honorary Secretaries, Mr. H. Blochmann and Dr. F. Stoliczka. The Philological Part (I.) of the Journal has been edited by Mr. Blochmann, and the Natural History Part (II.) by Dr. Stoliczka.

Colonel H. Hyde carried on the duties of Financial Secretary and Treasurer.

The Council desire to record their satisfaction with the good services which Bábu Pratápachandra Ghosha has rendered to the Society as Assistant Secretary and Librarian; they also favourably report on the services of Bábu Manilala Bysack, and Maulavi Sayyid Waliulla, assistants in the office and library.

—

List of Societies and other Institutions with which exchanges of publications have been made during 1870.

Batavia :—Société des Sciences des Indes Néerlandaises.

Berlin :—Royal Academy.

- Bombay :—Royal Asiatic Society.
 Boston :—Natural History Society.
 Bordeaux :—Bordeaux Academy.
 Buenos Aires :—Public Museum.
 Bruxelles :—Academie Royale des Sciences &c. de Belgique.
 Cherbourg :—Société Imperiale des Sciences Naturelles.
 Calcutta :—Agricultural and Horticultural Society of India.
 ——— :—Tattvavodhini Sabhá.
 ——— :—Geological Survey of India.
 Christiania :—University.
 Dacca :—Dacca News and Planters' Journal.
 Dera :—Great Trigonometrical Survey.
 Dublin :—Royal Irish Academy.
 ——— :—Natural History Society.
 Edinburgh :—Royal Society.
 Germany :—Oriental Society.
 Lahore :—Agricultural Society of Punjab.
 London :—Royal Society.
 ——— :—Royal Asiatic Society of Great Britain and Ireland.
 ——— :—Royal Institution.
 ——— :—Royal Geographical Society.
 ——— :—Museum of Practical Geology.
 ——— :—Zoological Society.
 ——— :—Statistical Society.
 ——— :—Geological Society.
 ——— :—Linnean Society.
 ——— :—Athenæum.
 ——— :—Anthropological Society.
 ——— :—Nature.
 Lyon :—Agricultural Society.
 Moscow :—Société des Naturalistes.
 Munich :—Royal Academy.
 Madras :—Government Central Museum.
 Manchester :—Literary and Philosophical Society.
 New York :—Commissioners of the Department of Agriculture.
 Netherlands :—Royal Society.
 Paris :—Ethnographical Society.

Paris :—Geographical Society.

——— :—Asiatic Society.

St. Petersburg :—Imperial Academy of Science.

Vienna :—Imperial Academy of Science.

——— :—Anthropological Society.

——— :—Zoological and Botanical Society.

——— :—Imperial Royal Geological Institute.

Washington :—Smithsonian Institution.

It was proposed by D. Waldie, Esq., and seconded by H. H. Locke, Esq., that the report be adopted.—Carried.

The President requested Mr. H. H. Locke, and Mr. J. Wood-Mason to act as Scrutineers.

During the time that the balloting lists for the election of officers and members of Council of the Society were examined, the President addressed the meeting.

PRESIDENT'S ADDRESS.

GENTLEMEN,—It will be seen from the report of the Council that the administration of our finances during the past year has been effected with care, and has been such as to exhibit very satisfactory results. For this, in great measure, we have to thank our excellent Financial Secretary, Colonel Hyde. The diminution of income, however, which appears to be imminent as a consequence of an apparently growing loss of members, will seriously cripple the Society, unless the current can be turned and our numbers be speedily augmented by new accessions. Unfortunately, the position in which the Society has for some time been, and still is, kept by reason of the non-completion of the New Museum building, is one of grievous embarrassment and disadvantage. The greater part of our house space is taken up by the Museum Trustees under statutable powers for the purpose of displaying the collections to the public. Our valuable library is rendered practically useless, for want of standing ground whereon to range the cases. And we have no room in which we can properly set out the current literary

and scientific periodicals for inspection and daily reference on the part of our members. Thus it has on this account alone become matter of public concern, that the existing state of things should not be prolonged. Moreover, by the Museum Act of 1866, the Council of the Society was in a manner charged with the duty of seeing that the building to be erected by the Government under the terms of that Act for the reception of the Collections should be fit and proper for its object. And the period prescribed by the Legislature for the completion of this building extended only to 23rd March, 1871. When, then, in the early part of the past year it was seen that the Museum building works remained at a stand still, and no sign was given by the Government of any immediate intention to resume them, it became incumbent upon the Council, as well on account of the interests of the Society as by reason of their statutable obligations, to press the exigency of the case upon the attention of Government. Actuated by this double motive, honourable alike, I venture to think on either part, the Council wrote to the Government of India, and received in reply a letter, which appearing as it does to ignore or set aside the original agreement made with the Society, has been to your Council matter of grave concern and regret. I will not, however, dwell upon this unpleasant incident, for after all, it may have been less due to design than to gaucherie and maladroitness in the State Secretariat.

I am sorry to say that the correspondence between your Council and the Government has led to nothing definite. The Council, in their reply to the communication of which I have spoken, while they remonstrated against the attitude which the Government assumed towards them, expressed their readiness to do all in their power to assist the Government out of its difficulties. To this no answer has been returned to us. And the matter therefore stands thus: The Government is under a statutable contract with the Society to complete the Museum building by the 23rd of next month, so far as to render it fitted to receive the extensive natural history and archæological collections which should then be transferred to the Museum Trustees. By the same contract, on the completion of the building, the Society is to have a portion thereof

for its own accommodation, and for the reception of its Library and other property. Our present house would thus, on the Government fulfilling its undertaking, become an additional source of revenue to us. These advantages to the Society were the consideration for the transfer to the Government on behalf of the public of our exceedingly valuable, and in many respects, unique collections. And so far as the public are concerned, this transfer took effect from the time of passing the Act, for it was one of the terms of the Act, that the collections of the Society and the additions thereto (subsequently to be made) should, until the building was so far completed, as to be in a condition to receive them, remain in the Society's house under the care of the Museum Trustees, and should be open to all persons desirous to view the same under rules to be established by the Trustees. This term in the contract has been fully complied with. And the result has been, that for some time past, the Society has been in the situation of need, and embarrassment which I have already described. I do not wish to exaggerate the difficulty which the Council now experiences in merely maintaining the existence so to speak of the Society. It is enough to say that it is very great, and increases every day. By our contract with the Government no doubt we were bound to bear this burden for a time, and we have no right to complain that it has proved to be more heavy than we anticipated. But we are entitled to expect that the Government will perform its side of the bargain, at any rate to the extent of enabling us to get free of the most heavy of our obligations at the appointed date. I wish to assume that it will do so. Although it is plainly impossible that the Museum building should be completed on the 23rd March, we have reason to believe, indeed I may say we know, that the works will be resumed almost immediately, and will be carried on to some sort of completion at, perhaps, no very distant date. It will, however, be a very serious matter to us, if we should be compelled to remain in our present situation until the building be made fitted in any degree to receive the collections. And there is no reason, why we should be called upon to suffer in this way. There is certainly a choice of modes for the Government in which it can afford us relief, and I do not even now doubt that it will adopt one or the

other of them. It is nevertheless much to be deplored that the Government has not yet, at the eleventh hour I may say, made us acquainted with the course which it proposes to pursue.

The Society has, I regret to state, sustained the loss of several valuable members by death during the past year. The names are all given in the Report of the Council, and I will only repeat one or two of them here.

Of these, Mr. Avdall was our oldest member. He was elected so long ago as the year 1826, and always maintained a strong interest in the welfare of the Society. He contributed several papers to the Journal.

Babú Kaliprosona Singh, although at the time of his death still a young man, had distinguished himself by his Bengali translation of the Mahabharat in 18 volumes. He had also translated some Sanscrit Dramas, and was known as the author of Sketches by Hootoone.

Mr. Ormsby, was for a short time one of the Honorary Secretaries of the Society.

And Lt. Beavn was a naturalist of considerable promise.

I have already spoken of the success which has attended the administration of our funds during the year, just terminated and have acknowledged how much we owe to Colonel Hyde for his exertions in this department. We are not the less indebted to our other Honorary Secretaries, Mr. Blochmann and Dr. Stoliczka, who by their unwearied labours, and the application of their great literary and scientific acquirements have brought our Journal, in the Philological and Natural History parts respectively, to a high pitch of excellence. Also both Bábu Rájendralála Mitra and Mr. Blochmann have done great public service by most ably editing, and superintending the publication of the Sanscrit and Persian works which we have been able to issue under the Government grant for that purpose; and the other learned pundits, engaged in the undertaking, have done their work in a manner deserving our best commendation.

The salaried staff of the Society, with Bábu Protapachandra Ghosha at their head, have performed their several duties to the entire satisfaction of the Council.

If I strictly conformed to the custom which generally regulates the character of the presidential addresses in Societies such as this, I should, at this point, endeavour to set out in some detail the more remarkable steps of advance which have been taken in science during the past year. I refrain, however, from following the usual course for two reasons. Firstly, because our table is now so amply supplied with the Journals and Proceedings of the principal scientific bodies of the West, that any of our members can, by a glance at a few title pages, acquire a fuller knowledge of that which has lately been, and is now being done by the Savants of Europe and America, than I could convey to him with the labour of many hours, at the risk after all of passing over his particular subject of interest. Secondly, and indeed I may say chiefly, because I wish to avail myself of this opportunity for the purpose of pressing upon your notice with earnestness, though at no great length, a topic which I conceive to be of considerable moment to the interests of meteorological science throughout the world.

Let me first, however, offer a few words of preface, for I do not assume that all, whom I desire to address, are conversant with the meteorological facts relevant to my object.

We most of us know in a more or less general way that nearly all the more important atmospheric currents, *i. e.* the persistent winds, gales and storms, owe their origin to the vertical displacement of air which, by reason of the sun's action, is continually taking place over a certain equatorial belt of the earth's surface. I need not now describe the process (though it is well to remember that it is not perfectly simple) by which the air over this belt becomes rarified and is caused to ascend. It is enough for my present object to remind you that the immediate consequence of this upward movement is a calm or rather comparative absence of horizontal motion in the air over the belt in question, an *inflow* of air along the earth's surface from the direction of each pole towards and up to this belt and a corresponding *outflow* above, of the risen air from the belt towards the poles.

The rotation of the earth introduces an apparent modification of these simple phenomena. If the surface of the earth were perfectly smooth, the relative course upon it of a free heavy particle, sup-

posed to be approaching the equator and to be moving under the influence of an initial velocity, would in consequence of the rotation, be such as to cut the successive parallels of latitude at continually diminishing angles on the eastern side; and the case would be reversed for a particle receding from the equator. Or to state the same proposition somewhat differently, a particle starting with a given velocity, in passing from the smaller circles of latitude to the larger would, as it went on, seem to observers at each successive point in its course to be coming from a more and more easterly direction, while conversely in passing from the larger circles to the smaller its apparent direction would grow to be more and more westerly. It is true that the earth's surface cannot be considered smooth even as regards its action upon such a mobile fluid as the atmosphere. The horizontal motion of masses of air over the earth is much checked by friction along the surface of contact or more correctly by the obstruction which is afforded by the earth's inequalities of surface. Still the effect of this disturbing cause is upon the whole of a subordinate character; and speaking generally without regard to special localities or occasions, I may say that the law which expresses the motion of a free particle relative to the earth, also gives with some degree of approximation the course of moving portions of the atmosphere. The flow of polar air towards the equatorial belt, of which I have spoken, thus becomes an easterly wind in both hemispheres, while the upper outflow or anti-trade current is westerly and in both cases with a certain exception the longer the course by which the current has reached a given point, the greater is its deviation from a polar direction. This explanation of the trade winds and of the intervening belt of calms was developed, more than a century ago, by Halley and all observations since made have served most fully to demonstrate its truth.

It is comparatively lately, however, that Dove and others have shown that the atmospheric phenomena of the trade and inter-trade regions are but simple cases of the air-movements which take place outside those limits. For instance, the well known veering of winds in the temperate zone is now held to be referable to precisely the same cause as is the peculiar constant direction of the trade-

currents. There is not much difficulty in perceiving one great reason why the problems furnished by the extra-tropical parts of the globe are of especial complexity. The volume of vapour-bearing air which, rising from the equatorial belt and escaping away northwards and southwards, constitutes the anti-trades, must, so to speak, shrink in volume as it proceeds towards the poles. It advances or flows away from the place of ascent in consequence of the superiority of the horizontal pressure which is represented by the sum of its own tension and that of its contained vapour at the height, where the lateral escape occurs over that of the adjacent portion of atmosphere. And it is enabled to pass into and fit itself to the gradually lessening spherical space which, as the result of gravitation, corresponds to the higher latitude of the terrestrial globe, because it gradually cools by radiation on its journey and as it cools contracts. The necessary result of this process is, that the onward flowing mixture of air and vapour comes to be at some point specifically heavier than the comparatively dry air which feeds the trades below it, and which is itself undergoing a converse process. Consequently the upper stream falls, or rather (for it is of course at any considerable distance from the equator generally moving with a high relative velocity) drives through the lower stratum, and makes its appearance on the earth's surface as a steady southwest wind in the northern hemisphere and as a northwest wind in the southern hemisphere. The downcoming in this way of the anti-trades determines the outside edge of the belt, over which the trades prevail, so that on the polar side of this edge the atmospheric phenomena are the resultants of a totally new order of things, namely, a conflict of currents of equatorial westerly winds on the one side with currents of polar easterly winds on the other, the currents constantly shifting beds *inter se* and always varying greatly in hygrometrical condition. We, therefore, see ample reason here for the complexity and variableness of the atmospheric phenomena in the extra-tropical zones.

I have so far entered upon these details, notwithstanding that every one present is probably more or less familiar with them, simply by way of leading the members of this Society and indeed through them, persons outside our body to consider the singular ad-

vantages which India offers for meteorological observation and research. The great peninsula covering as it does scarcely less than twenty-eight degrees of latitude is in various respects so special in its character, that the periodic shiftings of the equatorial wind belts of which I have spoken, have a greater range above its surface or in its neighbourhood than any where else probably in the whole circuit of the globe. Not only does the southern trade belt come up to and over it in the period of the southwest Monsoon, but in the other half of the year the polar edge of the northern trades lies far to the south of the Himalayas, thus bringing some of the principal phenomena of the extra-tropical region well within the observation of the Indian Meteorologist. So low as Calcutta we not unfrequently get warm equatorial breezes and showers of rain about Christmas time. Also neither of the trade winds preserves its normal character in our region. The belt of highest temperature does not, where it transverses this part of Asia in the summer months, mark the locus of minimum atmospheric pressure: observation appears to have shown that this minimum prevails at that time over an extensive area in Central Asia, while there are comparatively small spots of relative minimum within the peninsula itself. On the other hand in the winter months there seems commonly to exist in the northern part of the peninsula a locus of relative maximum pressure. The consequence of these conditions is, that instead of a trade-wind in the ordinary sense of the term, *i. e.* an atmospheric movement effected in approximately parallel currents towards an annulus which is coincident with the diurnal locus of maximum surface temperature, we have as long as the sun is on the north of the equator a *monsoon* converging towards a local focus of low pressure which lies outside that annulus; and at the opposite period of the year we perceive that the wind constantly inclines away, and often apparently blows directly, from a centre in the upper part of India. These recurring phenomena appear to present such a particular case of a general law as is especially valuable for the purposes of scientific inquiry.

Again a consideration of the possible causes which give rise to a separation between the simultaneous positions of places of minimum pressure and of maximum heat respectively, leads us to see another reason for rating highly the importance of

India as an area of meteorological observation. The height at which the mercury of the barometer stands, indicates to us something more than the mere amount of atmospheric pressure on the surface of the mercury in the bowl of the instrument. It gives us the weight of the whole superincumbent column of air and this necessarily varies with the composition of that column. Now with us in India during a great part at least, if not the whole of the year, the vertical atmospheric column is made up of two radically distinct portions, a lower and an upper, the one polar, comparatively cool, dry and dense, the other equatorial warm, vapour-bearing and specifically light. The barometer is immediately affected by any alteration of the relations between these portions. Also the heating of the surface soil has the effect, in an interval of time more or less short, of *diminishing* the air-material in the column which is vertically above it, and of contemporaneously increasing the vapour therein as long as a source of vapour remains at the base. These two changes are, it is manifest, diametrically opposite in character, and it would be impossible to say, *a priori* which would at any given hour prevail over the other. As a matter of fact, almost universally over all zones of the earth's surface, the barometric column exhibits regular diurnal oscillations in its height. In the temperate zones these oscillations are comparatively speaking, small. But in the tropical and subtropical regions the case is different. There, the barometer discloses considerable and, well marked periodic changes of atmospheric pressure during the twenty four-hours, constituting in the whole two distinct oscillations. At different times, various theories have been put forward to account for this phenomenon. I need not now endeavour to specify them in detail. I will, however, very shortly refer to two, in order to indicate the veil of uncertainty which still obscures the subject, and which we cannot hope to pierce except by the force of exhaustive observation. One explanation, which has been very extensively accepted, is based on the particular solar agency of which I have just spoken. The pressure at a given point in the atmosphere (in accordance with a well known law of pressure in elastic fluids) is taken to be the sum of two separate pressures, namely, the tension of the vapour at that point under the conditions

of density and temperature, which there obtain, and the pressure of the dry air alone at the same point exclusive of its contained vapour. The first may be calculated from data furnished by observation at the supposed point. And in this way conclusions have undoubtedly been reached, to the effect that, in general, of the two great components of the resultant atmospheric pressure, each exhibits a single continuous progression in the twenty-four hours, having its points of maximum and minimum non-coincident with those of the other, the two progressions being so related as not at any point to compensate each other. And thus it has been thought that the phenomenon is sufficiently traced to its causes.

On the other hand, many accurate observers, and notably our own distinguished meteorologist, Colonel Strachey, maintain that the facts do not bear out this explanation inasmuch as, among other things, the barometric oscillations are just as distinctly marked at elevations, where scarcely any vapour can be perceived to exist as elsewhere. And from curves, exhibiting the diurnal variations of the calculated vapour tension at Calcutta for every month of the year, which Mr. Blanford has been so kind as to show me; it is apparent to the eye that the explanation in question, to say the least of it, is exceedingly incomplete.

Colonel Strachey's own opinion is, I believe, that the single rarifying action of the sun is sufficient cause to produce the *whole* of the phenomenon. I have already, somewhat earlier in this address, had occasion to draw your attention to the fact, that that portion of the earth's surface, which at a given instant is the more nearly so to say under the sun becomes for a time, relatively speaking, heated more than the rest, and the consequence is (I do not now enter into the process) that the air above it is put into vertical motion, and after rising to some elevation makes its escape sideways. The proposition that motion of this sort takes place is beyond question. It is as I have before said the foundation of our theory of all winds, and of the trade-winds in particular. The pressure which gives rise to the lateral escape must urge in all directions alike, but the principal persistent outflow occurs *towards* the poles. Similarly the principal inflow is from the poles. As long as this condition of things obtains, the air-material is less than the aver-

age in the column of ascending air, and probably greater than the average in all azimuthal directions at some point where the two currents overlap each other. In the general case, then, it would seem that we should thus be presented at any instant with a locus of maximum pressure, forming a closed curve round the place of the sun, and surrounding an area of pressure less than the average. In fact this is very nearly the converse of the tidal action of the sun, and accordingly accounts very well for the periodic minimum pressure, which occurs in the day. But it would also seem to follow from this exposition that in general each of the diurnal maxima would take place at an hour which would vary from point to point along a given meridian; the antemeridional and postmeridional times approaching each other as you went polarwards until a point was reached at which they coalesced; after which point no diurnal period would be apparent. I need hardly say that the actual facts are very different from this. It may be, however, that a close enquiry into the conditions of the problem would shew that the maxima do not under this explanation lie along a closed curve, as I have assumed to be the general case, but that on the contrary the accumulation of material must be east and west of the sun in meridional lines. I am ashamed to say that I am not acquainted with Col. Strachey's papers on this topic, and I do not know precisely how he works out the explanation. But I think I may nevertheless venture to affirm that whatever may be his confidence in its completeness, he would be exceedingly glad to get extensively collected data, wherewith to test and to fortify it.

And even if we assume, as we rightly may, that in this matter a false importance has been attached to the element of vapour tension calculated at the point of observation, because it appears now to be certain that that element is not a simple function, and does not afford a measure, of the total vapour material which may exist in the superincumbent atmospheric column; still for that very reason the question remains open, how far does the local atmospheric pressure depend upon the existence of local sources of vapour.

If I have succeeded thus far in bringing you to my own point of view, I am sure you will see at once what immense value a complete, and connected system of barometric observations made

throughout India would have for science generally, and as means for the solution of this question in particular, under careful analysis and comparison? Every condition affecting the supply of vapour through the action of heat at the earth's surface, is a cause which influences the local atmospheric pressure in a direction contrary to that in which the heat alone operates, and we find such conditions existing in notable opposition of extreme throughout the countries which are immediately subject to Her Majesty's Indian Government. Need I contrast the maritime and the continental tracts, the deltas and the inland plateaux, the plains and the mountain peaks which I may say are paired against each other from the Himalayas to Point de Galle (more than the breadth of the northern tropic) and from the west coast of Malabar to the Salween. In truth we possess in India almost unrivalled opportunities for examining and analysing the atmospheric column in all its parts.

Doubtless the daily periodic changes of pressure, by their very nature, are ineffective to cause anything more than very limited oscillatory local movement of air masses. These movements, however, are not always insignificant in themselves, as for instance the land and sea breezes of our coast districts, the winds on the outer flanks of mountain ranges and in mountain valleys and the diurnal modifications of the Monsoon which we experience in Calcutta. But the daily phenomena of this class are especially important, because they are both the type and the material of those annual variations which are serious enough to be the governing forces in regard to the winds of this portion of the globe. We may in this matter liken the year to one long day with the solstices for midnight and noon. The gradual increase of temperature which takes place over the greater part of the earth's surface from a minimum in the winter months to a maximum in the summer months is (as in the case of a day of 24 hours and probably for a common reason) generally speaking accompanied by a double oscillation of the atmospheric pressure. In places of western Europe near the sea, where I may remark the source of vapour is unlimited, both sets of maxima and minima are I believe invariably strongly marked, the summer maximum which is attributed to the vapour, being commonly

the absolute maximum. But with advance into the interior of the continent, the phenomena change. For instance at St. Petersburg, the summer maximum divides itself into two subordinate maxima. Further on, as at Moscow, these two relative maxima are still found, but their absolute magnitudes are diminished and the sinking between them increased; and finally on this side of the Ural the summer maximum disappears altogether. The explanation which is commonly given, is that which I first referred to in accounting for the diurnal oscillations of the barometer. It is argued with much force that the rise towards a maximum goes on as long as the additions of vapour which are lifted up by the action of the heated surface continue to be more than sufficient to compensate for the increase of rarification brought about by the same agency. But as soon as the supply for any reason which may locally obtain falls below this amount, the process of rarification prevails to diminish the material in the atmospheric column and consequently to lower the pressure. Thus it would happen that all places which are in this way affected by, so to speak, a deficiency in the supply of vapour are surrounded by places where the atmospheric pressure at the same time stands relatively at a maximum. There is an element, which I have not yet mentioned, and which is more than any other influential as a cause affecting the efficiency of the earth's surface as a heating agent, and therefore affecting the density of the superincumbent atmospheric column. I refer to the activity of terrestrial radiation. This not only depends upon the material condition of the surface itself, but also upon the circumstances of the local situation. We all know the striking difference in this respect between the plains and a hill station. Professor Tyndall is of opinion that the presence of invisible vapour in the air operates to check the radiation from the earth's surface, and so is a principal ingredient in the varying circumstances upon which surface temperature depends.

That loci of maximum and minimum pressure do periodically manifest themselves as a consequence of the recurrence of the same local conditions is certain, as also that periodic winds or modifications of winds are the result. I will repeat that we seem to have especial advantages in this country for working out the problem

of the causes of this class of phenomena. One locus of such places of minimum pressure for the northern hemisphere in the hotter months appears to be a large tract of central Asia, extending down into, or rather having what I may call outliers in, our own Indian peninsula. I have already referred to this in mentioning the cause of our Monsoons. The part which this region of low barometer plays in governing the course of the periodic winds is only vaguely ascertained; and its possible influence as an element in the generation of our circular storms has not yet, I believe, been made the subject of serious inquiry. It would appear probable that the barrier to horizontal motion which is presented by the Himalayas must to a large extent exclude the barometrical condition of the atmosphere over Central Asia from being any significant element in the motion of the lower strata of the atmosphere over the peninsula of India, at any rate over those tracts which are comparatively close to the hills. The Himalayan range, if assumed to be of the effective height of 10,000 feet only, (probably the effective height is almost double this), would in truth be a dam to at least one-fourth of the whole material of the atmosphere, and to much more than that proportion of the therein contained vapour. For strata above this height, no doubt, any difference which might exist between the northern and southern pressures would become active; but it may, perhaps, be questioned whether there is much difference at a high level in any degree proportional to that which is found to obtain near the earth-surface; for assuming the relative smallness of weight in the trans-Himalayan atmospheric column to be in any considerable degree due to the absence of vapour, it is probable that this element affects the density of the lower part of the column especially. If, however, in consequence of the existence of the Himalayan mountain range, there is at one period of the year, so far as regards the Gangetic trough and the higher part of the Bay of Bengal, a motive force operative upon the upper strata of the atmosphere which has no effect or comparatively little effect upon the lower, there must thus arise by a sort of torsion such a divergence of currents in the body of the atmosphere as would be favorable to the formation of local centres of minimum pressure and consequent vorticalary

movement. This last consideration leads me to notice the remarkable mechanical effect which is produced upon the course of the lower streams of air in our regions by the physical configuration of the land. The peninsula of India acts as a wedge to divide the advancing stream of the southern trades into two branches, one of which slides up the Malabar coast, the other passes along the eastern side of the peninsula; a portion of the latter crossing the Bay of Bengal is headed by the highlands of Burma and by them diverted northward and westward along the flanks of the Himalayas. The angular space marked out by this last deflection lies on the left side of the stream, and therefore by an experimental law which the illustration of the free moving particle above given perhaps goes some way towards explaining, but which has also been otherwise ingeniously explained by Dove, the atmospheric pressure within the bend will be commonly less than that on the outside, and thus we here again meet with a cause tending to produce periodically in the neighbourhood of our shores a locus of relatively low barometrical pressure, and so to originate a rotatory motion of the air. And finally we have the periodic occurrence of warm currents in the eastern portion of the Bay of Bengal, to which Mr. Blanford in his valuable paper published in the Proceedings of the Royal Society attributes the generation of these low pressure centers.

It is I think apparent from the facts stated in the hasty sketch which I have just made, that India proper, the Bay of Bengal and Burma together, constitute a region which, for the purposes of one branch at least of meteorological science, demands to be taken and treated as a whole. It is a most happily situated field of view, singularly complete in itself, of distributed phenomena which are mutually inter-dependent and which cannot be separated without destruction of their value. It is rich in the data of the highest problems of the science. Within it are to be found in the simplest form those materials for inquiry and investigation which almost certainly contain the clue to further great advances in knowledge. If this valuable mine of scientific information is to be worked at public cost for the public advantage, is it not evident that the organization for the purpose should, if possible, be uniform for the whole area and subordinate in all its parts to one centre of manage-

ment? I am happy to say that the hypothesis of this question does not need to be argued out by me. The Government of this country has already satisfied itself that the regular observation of meteorological phenomena is work proper to be done at public expense. It is, therefore, I assume, desirous that the best available results should be arrived at. Now I do not hesitate to say, having regard to the peculiar circumstances of situation which I have mentioned, that a carefully prepared system of observations carried on throughout this tract, under the direction of one competent head, ought to yield results of the highest scientific importance to the whole world. Need I point out that in any system which is to be effective, the disposition of the stations must be matter of considered arrangement, with a view to combined work. The observations should be made in conformity with well devised directions adapted to secure results as complete as possible. The instruments upon the accuracy and uniformity of which everything depends should be issued from one central station after comparison and adjustment with standards there kept and maintained in efficiency. They should also from time to time be readjusted by reference to these same standards. Every station should be furnished with the means of keeping correct local time at least. And above all, the results of the local observations should be reduced and tabulated for publication and reference, under the instruction and superintendence of one directing head. Unless this be done, they are useless for comparison with the results of observations made with different instruments and under different circumstances, *i. e.* useless for the whole body of scientific men. As it is what have we?

British India for administrative and other purposes is divided into eight principal districts or provinces, *viz.*, Bengal, Madras, Bombay, N. W. Provinces, Oude, Panjab, Central Provinces and Burma; and in each of these, excepting Burma, is a separate local system of meteorological observation with its own independent head. It is remarkable, too, that the gentlemen who are at the head of these different systems, possess as little community of character and situation as can well be conceived. They are, in Bengal and the N. W. Provinces officers of the Educational Department, in the Panjab a member of the Medical Service, in Madras the

Government Astronomer, all specially salaried for this extra work ; in Bombay, the Superintendent of the Observatory, in Oude the "Scientific officer," and in the Central Provinces the Sanitary Commissioner, under an obligation to do this work *ex-officio*. There are no official relations between these provincial officers, and as a matter of fact, I believe, if one of them requires the registers, or results of a neighbouring province for comparison with his own, or for the purposes of scientific inquiry, he experiences great difficulty and delay in obtaining them.

Then again, in regard to organization, the systems seem to vary considerably in the different provinces. In the Panjab, I am informed, the officers who keep the registers are all volunteers ; and they seem to be somewhat irregular in the matter of observing, for according to the published reports out of 19 stations, from 2 only have continuous registers extending over $2\frac{1}{2}$ years been furnished ; from most of the other stations registers covering a few months only, or for interrupted periods, are forthcoming. In Bengal and Madras there is a paid observer at each station and also a superintending officer (generally the Civil Surgeon) who receives an allowance for supervising the work.

As to the instruments, the kinds in use are very diverse. The head of the system in each province, (except Madras, and from a recent period Bengal) gets them whence and how he can. For instance, barometers of several sorts, standards or aneroids, are employed indiscriminately, and consequently the registers of observations effected by them are of little value whenever small differences are important, as for example in the comparison of range in the daily oscillations of atmospheric pressure, inasmuch as no data exist by which due allowance can be made for the instrumental irregularities, and these are of the same order as the differences in question. In Bengal and Madras, the barometers are compared with a provincial standard at the Presidency towns. And those of two stations in the N. W. P. have been compared with the Calcutta standard. Whether or not in the other provinces any comparison is effected with a local standard I cannot say positively, though I have heard that it is not ; but certainly no attempt has yet been made to compare the local standards if there are any, with one as-

certained governing standard. Moreover, the elevation of the barometer-cisterns above the sea-level has been determined for exceedingly few stations out of Bengal. I need hardly remark, that registers of observations, which are subject to such drawbacks as these are unfortunately restricted in value.

The laborious, yet indispensable work of reducing the observations is but partially performed. Only in Bengal, and perhaps in Bombay, is the reporter furnished with a staff competent to relieve him of this purely mechanical duty. The result is, that most of the registers give the observations in their crude unreduced state; and therefore not generally available as data in extended investigations.

In Burma there is no established system of observation at all. Observers at Akyab and Port Blair send registers to the reporter for Bengal; but the most important of these registers is kept up solely by the voluntary exertions, and activity of the Civil Surgeon, who might at any moment leave his post and so extinguish the station as a place of meteorological record.

In Bengal again, curiously enough, the central Meteorological Observatory is quite independent of the Local Reporter, who is thus not only powerless in regard to the principal station of his own province, but is also reduced to the alternative of either testing his instruments himself personally, or of entrusting them for this object to officers, over whom he has no control. He is, moreover, in this way deprived of the means of carrying out any special experimental inquiry, however important it may be for the regulation of his own work.

I may add that, at Calcutta, even to this day, as our Council knows too well, for one reason or another we have nothing that we can offer to the scientific Societies of the West in exchange for their publications in meteorology. The so-called Observatory in Park Street, *lucus a non lucendo*, is so placed that no effective observation of the sky can be had from it. I need hardly say that oftentimes the forms and behaviour of the clouds give most important information relative to movements and even to the constitution of air masses at high altitudes. One or two especial instances of this have occurred lately, but our official observers have literally been unable to notice them.

Experiments of such a character as those which would be necessary to test Tyndall's theory in regard to the cause of the azure colour of the sky, or to measure the retardative operation of invisible vapour on terrestrial radiation, are, I believe, scarcely thought of as falling within the work of any meteorological station in India. And I do not know that a single spectroscope has yet been introduced into our official collections of instruments.

It seems to me that the state of things which I have just described is most discreditable. I should scarcely go too far if I said that it represents a good deal of money thrown away : certainly it is very remote from that which ought to be. Surely the time has come when in the place of this infirm and unsatisfactory system (or more properly want of system) a well planned simple organization inspired and directed by a man of real scientific power and acquirements should be put into action.

If anything that I have said to-night should help to hasten such a reform as this, my object will have been attained.

The scrutineers announced the following elections :

President.

The Hon'ble Mr. Justice Phear.

Vice-Presidents.

Th. Oldham, LL. D.

Bábu Rájendralála Mitra.

Lord Napier of Magdala, G. C. S. I., G. C. B.

Secretaries.

Col. H. Hyde, R. E. (Financial Dept.)

H. Blochmann, M. A. (Philological Dept.)

F. Stoliczka, Ph. D. (Natural History Dept.).

Members of Council.

The Hon'ble Mr. Justice Phear.

T. Oldham, Esq., LL. D., F. R. and G. S.

Bábu Rájendralála Mitra.

Lord Napier of Magdala, General, G. C. S. I., G. C. B.

Col. H. Hyde, R. E.

Bábu Devendra Mallika.

J. Ewart, Esq., M. D.

F. Stoliczka, Esq., Ph. D., F. G. S.
 H. Blochmann, Esq., M. A.
 Col. H. Thuillier, R. A., F. R. S., C. S. I.
 H. F. Blanford, Esq., F. G. S.
 W. S. Atkinson, Esq., M. A.
 F. W. Innis, Esq., M. D., C. B.
 E. Gay, Esq., M. A.
 W. W. Hunter, Esq., LL. D.

It was proposed by D. Waldie, Esq., seconded by Maulavi Abdullattif Khán, Bahádur, and carried unanimously—

That the marked thanks of the Society be given to the Secretaries for their earnest attention to the duties of their office during the past year, from which the regularity in the issue and the value of the Journal, as well as the very satisfactory financial condition of the Society, have largely resulted.

Messrs. L. Schwendler and J. Wood-Mason were appointed auditors of accounts for the past year.

The meeting then resolved itself into an Ordinary Monthly meeting.

The Hon'ble Mr. Justice Phear, President, in the chair.

The minutes of the last meeting were read and confirmed.

The receipt of the following presentations was announced—

1. From the Govt. of India—A copy of Antiquities of Kashmir, by Lieut. H. H. Cole, R. E.

2. From the Government of India, Home Dept.—nine photographs of the ancient temples in West Berars, and twenty-one photographs of ancient architectural structures in Mysore.

The following gentlemen duly proposed and seconded at the last meeting were balloted for and elected ordinary members.

Col. J. F. Tennant.

Dr. W. Waagen.

G. C. Farr, Esq.

T. F. Harkness, Esq., C. S.

The following gentlemen have been announced as candidates for ballot at the next meeting :

C. B. Clarke, Esq., M. A., Botanic Gardens, Calcutta, proposed by the Hon'ble J. B. Phear, seconded by W. S. Atkinson, Esq.

James Wilson, Esq., Cathedral Mission College, Calcutta, proposed by H. F. Blanford, Esq., seconded by H. Blochmann, Esq.

Bábu Dvijendranátha Thákura, proposed by H. Blochmann, Esq., seconded by Bábu Rájendralála Mitra.

Bábu Harachandra Chaudhuri, Zemindar, Sherepúr, Mymensing, proposed by H. Blochmann, Esq., seconded by Bábu Rájendralála Mitra.

Bábu Govindachandra Chaudhuri, Zemindar, Sherepúr, Mymensing, proposed by H. Blochmann, Esq., seconded by Dr. F. Stoliczka.

A. Gough, Esq., Queen's College, Benares, proposed by W. Oldham, Esq., seconded by H. Blochmann, Esq.

Nawáb Ziauddin Ahmad Khán, Bahádur, Chief of Luharú, Delhi, proposed by Maulavi Kabir uddin, seconded by H. Blochmann, Esq.

Walter Abbey, Esq., Civil Surgeon, Mergui, proposed by S. Kurz, Esq., seconded by Dr. F. Stoliczka.

E. Benedict, Esq., C. E., Calcutta, proposed by L. Schwendler, Esq., seconded by Col. H. Hyde.

T. S. Isaac, Esq., Supt. Engineer, Presidency Circle, proposed by T. Oldham, Esq., seconded by H. H. Locke, Esq.

The Hon. Sir W. Grey, and L. B. Bowring, Esq., have intimated their desire to resign the membership of the Society.

The receipt of the following communications was announced—

1. Arrangements for the discharge of long overland telegraph lines, by L. Schwendler, Esq.

2. Associations connected with various places situated in the sub-division Banka, Bhagulpúr, by Bábu Ráshbihari Vasu.

3. Mondari Vocabulary, by Bábu Rakhaldas Haldar.

LIBRARY.

The following additions have been made to the Library since the last meeting held in January last.

Presentations.

*** Names of Donors in Capitals.

The Report of the British Association for the advancement of Science, for 1869.—THE BRITISH ASSOCIATION.

Proceedings of the Royal Society of London, Vol. XIX, No. 123.—THE ROYAL SOCIETY.

Bullettins della Società Geografica Italiana, fasc. 5^o.—THE GEOGRAPHICAL SOCIETY OF ITALY.

Bulletin de la Société Impériale des Naturalistes de Moscow, 1870, No. I.—THE IMPERIAL SOCIETY OF NATURALISTS OF MOSCOW.

The Quarterly Journal of the Geological Society, No. 104.—THE GEOLOGICAL SOCIETY OF LONDON.

Journal of the Statistical Society, September, 1870.—THE STATISTICAL SOCIETY OF LONDON.

The Numismatic Chronicle, No. 39.—THE NUMISMATIC SOCIETY OF LONDON.

The Smithsonian Report for 1868; Smithsonian Miscellaneous Collection, Vols. 8 and 9; Smithsonian Contributions to knowledge, Vol. 16.—THE SMITHSONIAN INSTITUTION.

Cowell's Lectures on Hindu Law.—THE UNIVERSITY OF CALCUTTA.

Ramayana, Vol. 2, No. 5, edited by Hemachandra Bhuttacharya.—THE EDITOR.

Illustrations of Ancient Buildings in Kashmir, by Lieut. H. H. Cole; Deaths of Madras, during 1868.—THE GOVERNMENT OF INDIA.

Griffin's Panjab Chiefs.—THE GOVERNMENT OF THE PANJAB.

General Report of Public Instruction in Bengal during 1869-70; Annual Report of the Administration of the Bengal Presidency for 1869-70.—THE GOVERNMENT OF BENGAL.

Purchase.

Helpfenstein's Comparative Grammar of the Teutonic Languages :—Etude sur le rituel du respect social dans l'état Brahmanique, par C. Schœbel.—Vuller's Grammatica Linguæ Persicæ :—Das Jatapatala, von Dr. G. Thibaut :—Ueber die Entstehung und Verwendung der im Sanskrit mit R. anlautenden Personalendungen, von Th. Benfey :—Dr. A. Bastian's Sprach-vergleichende Studien :—V. von Strauss' Laò-tse's Taò tề King :—B. Gachet's Œuvres de Koutsa et de Hirayastoupa.—Dr. Stichel's Handbuch zur Morgenländischen Münzkunde, 1 Heft :—Deutsches Wörterbuch, 14 Band :—Dr. C. Semper's Reisen im Archipel der Philippinen, 1-2 Heft.—Philosophical Magazine, No. 269.—Calcutta Review, January, 171 :—Reeve's Con. Iconica, parts 284, 285 :—

Exchange.

The Nature, Nos. 58-61. The Athenæum, November, 1870.

PROCEEDINGS
OF THE
ASIATIC SOCIETY OF BENGAL
FOR MARCH, 1871.



The monthly meeting of the Society was held on Wednesday, the 1st instant, at 9 o'clock, P. M.

The Hon'ble Mr. Justice Phear, President, in the chair.

The minutes of the last meeting were read and confirmed.

Presentations were announced—

1. From the author—A copy of a pamphlet entitled : A revision of the *Terebratulidæ* and *Lingulidæ*, with remarks and description of some recent forms, by W. H. Dall, Esq., Smithsonian Institution.

2. From the author—a copy of *Tatvávali*, a treatise on Vaishasika Philosophy in Sanserit verse, with notes by the author, Pandit Chandrakánta Tarkálankára ;—also *Praváda Sataka* by the same.

3. From the author—General report on the Punjab Oil Lands, by Benj. Smith Lyman.

4. From Rev. C. H. Dall—Three Nepal coins bearing on the obverse in a square compartment the legend in Nágari characters श्रीश्रीनेपालसर्कार and on the reverse श्रीश्रीसुरेन्द्रविक्रमार्कदेव, and at the lower margin on the reverse the date १७८९ 1789.

Legend I. Sri Sri Sri Nepála Sarkára, the Government of Nepal.

„ II. Sri Sri Sri Surendra vikramárka Deva (the name of the prince).

The following gentlemen duly proposed and seconded at the last meeting were balloted for and elected ordinary members.

C. B. Clarke, Esq., M. A.

J. Wilson, Esq.

Bábu Dvijendranátha Thákura.

„ Harachandra Chaudhuri.

„ Govindacumára Chaudhuri.

A. Gough, Esq.

Nawab Ziauddin Ahmad Khán, Bahádur.

W. Abbey, Esq.

E. Benedict, Esq., C. E.

J. S. Isaac, Esq., C. E.

Benjamin Smith Lyman, Esq., has expressed his wish to become a life member of the Society, in conformity with rule 14 of the Bye-laws of the Society.

The following gentlemen are candidates for ballot at the next meeting :

Dr. F. N. Macnamara (for re-election), proposed by the Hon'ble J. B. Phear, seconded by D. Waldie, Esq.

Oscar Trefftz, Esq., Calcutta, proposed by H. Blochmann, Esq., seconded by Dr. W. Waagen.

M. S. Howell, Esq., proposed by Col. Hyde, seconded by Dr. Stoliczka.

Captain A. J. Filgatte, R. E., proposed by Col. Hyde, seconded by Dr. Stoliczka.

Major J. M. Graham, proposed by Col. Hyde, seconded by Col. Tennant.

Col. F. H. Rundall, R. E., proposed by Col. Hyde, seconded by Dr. T. Oldham.

T. M. Bourn, Esq., Mining Engineer, proposed by F. Fedden, Esq., seconded by Dr. T. Oldham.

W. J. Curtoys, Esq., proposed by the Hon'ble J. B. Phear, seconded by H. H. Locke, Esq.

W. E. Ayrton, Esq., proposed by the Hon'ble J. B. Phear, seconded by Col. Hyde.

Walter Bourne, Esq., C. E., proposed by Dr. T. Oldham, seconded by Dr. Stoliczka.

Mr. W. C. Bonnerjea has intimated his desire to withdraw from the Society.

J. Schroeder, Esq., and Lt.-Col. C. Macgregor have resigned their membership on their leaving India.

The following letters were read :—

1. From the Secy., Trustees Indian Museum, forwarding a correspondence on the earthquake felt in Sind on 28th October, 1870.

This correspondence is a copy of one forwarded by the Bombay Govt. to the Secy. of State for India.—The Collector of Shikarpore reports that a severe shock of an earthquake was felt about a quarter to 3 p. m. on the 28th October, 1870 ; it lasted for about a minute. The earthquake was especially felt at Naushera, Larkhana, Lubdurza, Mehur and Kukur, and the shock is stated to have been more severe in the hills than in the plains. A second but slighter shock was again felt at Nusseerabad, Teje, Mehur and Kukur on the 1st November, 1870.

Another report from the Commissioner in Sind says that a slight shock was experienced at Jacobabad and Thoole at about 2-30 p. m. on the 28th October, 1870.

A third report records a severe shock of an earthquake at Dadoo, lasting for about 5 minutes, at 2 p. m. on the 28th October, 1870 ; and a second slighter shock, lasting for about one minute, was felt about 3 p. m. on the same day. The earthquake appears to have been experienced throughout the Talooka Dadoo, as various reports state that shocks have also been felt at different times of the day and night on the 27th, 28th and 29th October, 1870. No serious damage appears to have been done.

2. From Mr. J. H. Samuells — addressed to, and communicated by, Col. Dalton.

Mr. Samuells reports that the temples near Harehoka in Chang Bhokar are very extensive, but unfortunately some of them are almost entirely in ruins and the destruction by the annual floods in the rainy season goes on so rapidly, that in another 100 years many will have probably altogether disappeared. The inscriptions are very much worn off, but what remained preserved, Mr. Samuells had taken rubbings of, and also executed plans of the different temples. The inscriptions appear to be in very old Nagari character.

The Council notified (in conformity with rule 13 B. of bye-laws) that the names of the following gentlemen have to be struck off the list of members for non-compliance with rule 13 of bye-laws.

A. G. Walker, Esq.

C. J. Wilkinson, Esq.

Dr. C. Williams.
 C. B. Garrett, Esq.
 F. J. Chambers, Esq.
 Bábu Nundolala Bose.
 J. C. Whishaw, Esq.
 H. Duhan, Esq.
 R. L. Martin, Esq.
 J. W. Sherer, Esq.

And that the election of Sir Sherif úl Omara, Bahádur, be cancelled for non-payment of admission fee —

Also that Rs. 1203 due from the above gentlemen, together with Rs. 204, due to the Society from Kaliprasanna Sinha, dead, and Rs. 57 from Ramanarayana Tarkalankara, dead, and Rs. 5-10, due to the Oriental Publication Fund from the last named, be written off.

The Council reported that they have elected the following gentlemen to serve in the several Committees* during the ensuing year.

Finance.

T. Oldham, Esq., LL. D.
 E. Gay, Esq., M. A.
 Col. A. Allan.

Library.

T. Oldham, Esq., LL. D.
 Col. A. Allan.
 Bábu Rájendralála Mitra.
 Dr. J. Anderson.
 J. Wood-Mason, Esq.
 Dr. Mohindralal Sircar.
 G. Nevill, Esq.
 Col. J. F. Tennant.
 E. Gay, Esq., M. A.

Philological.

E. C. Bayley, Esq., C. S. I.
 Bábu Rájendralála Mitra.
 C. Tawney, Esq.

* The President and Secretaries of the Society are *ex-officio* members of all Committees.

W. W. Hunter, Esq., LL. D.
 Rev. J. Long.
 Rev. K. M. Banerjea.
 Dr. Mohindralal Sircar.
 Maulavi Kabiruddin Ahmad.
 Maulavi Abdul Latif Khán.

Natural History.

T. Oldham, Esq., LL. D.
 Dr. J. Fayrer, C. S. I.
 Dr. J. Ewart.
 H. F. Blanford, Esq.
 W. T. Blanford, Esq.
 W. S. Atkinson, Esq.
 V. Ball, Esq.
 H. B. Medlicott, Esq.
 Dr. J. Anderson.
 D. Waldie, Esq.
 J. Wood-Mason, Esq.
 G. Nevill, Esq.
 Dr. Mohindralal Sircar.

Physical Science.

Lord Napier of Magdala, G. C. B., G. C. S. I.
 Col. H. L. Thuillier, C. S. I.
 T. Oldham, Esq., LL. D.
 Col. J. F. Tennant.
 H. F. Blanford, Esq.
 D. Waldie, Esq.
 L. Schwendler, Esq.

Coins.

E. C. Bayley, Esq., C. S. I.
 Bábu Rájendralála Mitra.
 Major F. W. Stubbs.
 Rev. M. A. Sherring.
 J. G. Delmerick, Esq.

Col. the Hon'ble R. Strachey made a communication to the effect, that the Government of India have lately resolved to place 4 lacs of rupees in deposit, which sum should be available for completing the new Museum building. He regretted the delay which has been caused in the construction of the building and stated that it was greatly due to the financial difficulty in which the Government of India found themselves a short time ago. Col. Strachey mentioned that the original approximate estimate amounted to about $3\frac{1}{2}$ lacs of rupees. This sum had been sanctioned by Government, and the work for the new building was commenced. Subsequently the regular estimate came up and it amounted to about 7 lacs. After about 4 lacs had already been spent, a revised estimate was called for, and this rose up to about 10 lacs. It was, therefore, not surprising that the Government stepped in and enquired into the whole matter carefully, and this caused such delay that it became impossible to complete the Museum within the appointed time, 23rd March, 1871. However he (Col. Strachey) hoped that the present action taken by Government in the matter would bring the building to its desired completion at as early a date as possible.

Col. Strachey's communication was most favorably received by the meeting.

Mr. H. F. Blanford exhibited several barometric and other meteorological curves and made the following observations :

The diagrams that I have to lay before the meeting this evening, will, I think, be interesting to the Society, as they exhibit in a graphic and readily appreciable form certain important features of our local Meteorology. Beyond this, there is no especial connexion between them ; each illustrates certain special points, some of which have recently been discussed in the Society, and they must be regarded as materials which have been generalized up a certain point ; representing facts which may be of important service in any future scientific treatment of our Meteorology.

The first sheet shews the mean diurnal variation of some of the principal Meteorological elements at Calcutta for each month of the year, as deduced from the hourly observations recorded for 16 years at the Surveyor General's Office. These elements are (1) the

total atmospheric pressure, (2) the temperature, (3) the vapour pressure, (4) the curve of saturated vapour pressure corresponding to that of temperature, and (5) the curve of humidity. The first shows the variation of the diurnal barometric tides for each month of the year, and I will draw attention to the great regularity of the wave curve which is one of double curvature, having an absolute maximum about 10 A. M. and an absolute minimum about 4 P. M. with a secondary maximum and minimum at 10 P. M. and 4 A. M. The hours of absolute maximum and minimum vary a little during the year, the former being about an hour earlier and the latter about an hour later in the hot months than in the cold. The difference of the morning and evening maximum is greatest in the driest months and least in the rains. In the latter this difference is comparatively small, the two crests having nearly the same height; but the afternoon minimum is always considerably lower than that of 4 A. M. The explanation of the double tide is a subject on which great diversity of opinion exists. The explanation found in most of our treatises is that originally suggested, I believe by Dove, and adopted by General Sabine and Sir John Herschell, *viz.* that the curve is compounded of two distinct elements, one of the dry air pressure which taken by itself has a maximum at about 4 A. M. and a minimum at 4 P. M., the other a curve of vapour pressure which has two maxima and two minima at or about the periods of the maxima and minima of the total pressure curve. Col. Strachey* who, as you are aware has given much attention to this subject, has long since pointed out the insufficiency of this explanation in the case of the barometric curves in India, or rather the failure of verification when the curve of observed vapour pressure is superimposed on a supposed dry air curve of a single periodic variation. And you will see that no composition of the vapour pressure curve of Calcutta with any such supposed curve will give a curve approaching in form or regularity to that of our tidal curve of total pressure.

The curves of vapour pressure exhibit great variations in the different months of the year. In the months of the rains, the pressure is almost unvarying, or there is but a slight increase during

* Similar objections have been raised by Mr. Broun, Professor Lamont of Munich and others.

the daytime and decrease towards early morning, forming a curve of single variation. From September to May the curve is more complicated. It presents a rise for an hour or two after sunrise; then in most months a rapid and deep depression to a minimum about 3 or 4 p. m., after which the rise is very rapid to 7 or 8 p. m. and thereafter (in the hot months) gradual to midnight. From this hour it falls again to sunrise. In December and January, the absolute minimum is at sunrise, in the other months in the afternoon, and it is deepest in March, (the driest month). The absolute maximum is in the evening or at midnight from October to March, and in the morning in April, May and June. The curve generally for all these months may be described as one conforming to that of temperature, but with a deep notch cut out of it during the warmer hours of the day, thus producing two crests, of which the earlier is the higher in the hottest months the later in the remainder. This form of curve is well known as characterizing a continental climate, and something similar, but much less in the relative and absolute magnitude of the afternoon depression, obtains at certain stations in the interior of Europe during the summer months. The curves of saturated vapour pressure are given for comparison, and the ratios of the two are shewn by the humidity curves which are almost an exact inversion of those of temperature. The temperature curves are of the same general form throughout; differing chiefly in the absolute magnitudes of their ordinates which are greatest in March, the driest, least in July and August the dampest months.

The next set of curves that I have to exhibit are the diurnal barometric curves for Simla, deduced from Major Boileau's hourly observations for 3 years. They are as regular and shew nearly as great a range of tidal pressure as those of Calcutta, but with this marked difference, that in all months except July and August the morning (4 A. M.) is the absolute minimum of the day. This peculiarity of the barometric curve has been noticed by Plantamour in the case of the Great Saint Bernard, and is stated to be characteristic of mountain stations situated on ridges, as distinguished from stations on plateaux and plains. The explanation given, I believe, by him is that the lower strata of the atmosphere being heated, lift a larger proportion of the upper atmosphere above

stations in the positions of Simla and the St. Bernard, and so diminish relatively the loss of pressure due to overflow in the highest regions of the atmosphere. Plantamour's law of the difference between stations on ridges and those on table-lands is borne out by our local experience, in so far that while Darjeeling, a ridge-station, in several months of the year has, like Simla, an absolute minimum at or about 4 A. M., both Shillong (4,800) feet and Huzaribaugh (2000 feet) which are on table-lands, have, like Calcutta, an absolute minimum in the afternoon.

The next sheet to which I have to direct attention is one showing the mean curves of pressure and temperature for the year, as given by the mean daily values of these elements at Calcutta for 15 years. The temperature curve exhibits great irregularities, as if there were a tendency to rapid changes at certain periods. Father Secchi has noticed a similar result on discussing the Roman registers for a much longer period, and Mr. Buchan has pointed out that the registers of Scotland show a tendency to the recurrence of warm and cold days at certain periods of the year. It would, however, be premature to draw any such conclusion from the registers of only 15 years.

I have here two sheets that show the variation of the mean daily pressure at a considerable number of stations, for the years 1869 and 1870. The northernmost station is Roorkee, the southernmost Port Blair. The chief noticeable feature that these curves present is the almost exact coincidence of all their irregularities, these being greatest at Roorkee and least at Port Blair. This correspondence of the barometric waves and the decrease in the amount of their variations in proceeding from north to south, was first pointed out in the case of European stations, many years ago, I believe, by Professor Daniell; and the explanation of the phenomenon given by Professor Dove is, that the alternations of the crests and troughs forming these irregular waves, depends on the prevalence of Polar and equatorial currents, the trade and antitrade currents which cross and alternate with each other in the Temperate Zone. These curves shew that the same phenomenon is presented here in the Monsoon region at all periods of the year, the variations being absolutely less, however, than in Europe, and decreasing in like manner as the stations are in lower latitudes

Finally I have to bring to the notice of the Society a set of curves shewing the mean diurnal variation of the wind for each month of the year at Calcutta. These have been drawn up from a discussion of 10 years' observations at the Surveyor General's Office. The observations are recorded only to eight points, *viz.*, N. NE. E. SE., &c., and I may remark how this very rough method of observation suffices (when so long a period as 10 years is considered), to shew a regular variation, even when in some months it amounts to little more than one point of the compass. The diurnal variation of the wind appears at first sight somewhat anomalous, since Calcutta is at no very great distance from the sea, and it might be expected that as at coast stations, there would be a tendency to a southerly or sea breeze during the latter part of the day and a land breeze at night. The case is, however, precisely the reverse. The land wind at Calcutta, *i. e.*, a WNW. wind prevails strongly during the day, in the cold and hot weather months, and even in the rains, when the variation is very small, the westerly tendency is still manifest; while the southerly or sea breeze prevails or tends to prevail during the night. When the mean of the whole year is considered, it appears that the WNW. wind tends to set in about 10 A. M., and to increase in force and steadiness up to about 4 P. M., after which the wind veers round rapidly to south, and a little east of south, in which quarter it continues till midnight or 1 A. M. It then diminishes in force and there is a tendency to calm until about sunrise. The coincidence of the prevalence of the westerly wind with the period during which the barometric gradient is from west to east, owing to the advance of the afternoon minimum from the eastward, suggests the cause of this phenomenon. It is true that this gradient is absolutely small, and the *loci* of maximum and minimum are separated by a quadrant of the earth's circumference; but the effect to be accounted for as the diurnal oscillation, when deduction is made of the mean monthly or annual component, is also small, being a predominance of 12 or 13 per cent. only, and is probably not greater than may be accounted for by the cause suggested, which must have *some* effect.

Colonel the Hon'ble R. Strachey said that he thought the Society, and indeed all persons interested in the progress of science, were much

indebted to Mr. Blanford for the manner in which he was taking up the study of the Meteorology of India, and of Calcutta in particular. It was an indisputable fact that there was no country in the world that had such great advantages as India, to offer to a student of Meteorological Science, if such a term could be used in the present state of our knowledge or rather ignorance. Here the great motive force of all atmospheric phenomena, the Sun, acted with an intensity and regularity that led to a corresponding intense and regular development of those phenomena, would render their study in a corresponding degree easy. The great plains of India presented vast areas of land over which the action of the atmosphere was remarkably little disturbed by local causes, and which thus offered special facilities for watching the principal phenomena attending that action. The mountains on the north of India, in like manner, gave advantages for enquiries into the condition of the atmosphere at great heights above the earth's surface, not equalled in any other part of the globe. The great ocean that surrounded the Peninsula, again, offered similar opportunities for observing the special phenomena due to the peculiarities of a marine surface, and to the juxtaposition of land and sea. On the whole he had no hesitation in saying that India was the country of all others in which meteorology could best be studied, and to which we should look for the investigations which could rescue meteorology from its present somewhat discreditable position, and advance it to that of a real Science.

Col. Strachey said he would offer a few comments on the chief topics of Mr. Blanford's instructions and observations.

First as to Vapour. He had on a former evening stated generally his objections to the suggested dependence of the double diurnal tide of pressure on the variations of the vapour pressure. It was impossible for any one who had looked at the facts to have a moment's doubt on this point, and it was obvious that, after having made the suggested allowance for the variations of vapour pressure, the double tide remains in the Bombay, Madras and Calcutta observations just as plainly marked as before, though somewhat altered in form.

As he had before said, to subtract the vapour pressure, as indicated

by a hygrometer, from the total pressure, indicated by the barometer, was to commit an act of folly. It meant nothing. It represented no physical fact. The vapour tension at the earth's surface was not the result of the pressure of the particles of vapour in the upper strata of the atmosphere, but of something quite different. It was the measure of the resistance offered to the passage of the vapour particles in an upward direction by the air particles, and the superincumbent vapour particles together; and the condition of the vapour in the upper strata proved that this resistance of the air particles was very great, so that, roughly speaking, the vapour tension was commonly about four times as great at any place as the pressure from above of the vapour particles. Of course there were great local variations from any such rough general average, but the average might be mentioned to show how senseless was the subtraction of the observed vapour tension from the observed total pressure.

Referring next to the local variations of vapour pressure at Calcutta, Col. Strachey remarked, that the only satisfactory way of considering such phenomena was in connexion with their physical causes, and that most of the apparent peculiarities, such as those noticed by Mr. Blanford, might readily be explained when viewed in this manner. He (Col. S.) had not had the means of critically examining the variations of vapour tension at Calcutta, but he remembered enough of the results of such an examination made by him of the phenomena at Madras, to be able to indicate to the Society the kind of analysis of these facts that he had suggested. Thus it was observed at Madras that at a certain hour of the day a very sudden increase occurred in the quantity of vapour. This was at once explained by the fact that at this hour the sea breeze became established. As the heat of the day increased, the wind blowing from over the sea brought in more vapour, and a maximum occurred in the afternoon. As the temperature fell, and the wind veered landward, the vapour became less, and when the land wind was thoroughly established, the vapour became much less, and a minimum was arrived at somewhere near the minimum of temperature. But certain subsidiary complications of this general rule were also observable. After the sun rose, the heat, radiated to the earth,

caused the rapid evaporation of any water, either a deposit of dew or pools of water &c., exposed to the rays of the sun. Thus a rapid development of vapour began. But soon the air became heated, and its capacity for vapour increased more rapidly than the process of evaporation could supply vapour. This caused the air to become relatively drier. Like operations in the converse sense took place in the evening. Such results were more or less visible in the observations made at various places that had come under his notice, but necessarily each locality would have its own peculiar conditions, and would show a special set of changes. It was, he thought, in some such manner as this that all Meteorological phenomena should be looked into, with the intention of ascertaining as far as possible the precise physical causes of their component elements. A mere record of facts such as was commonly put forward as a discussion of the Meteorological phenomena of any locality, could only be of use in a scientific point of view so far as it was thus treated, and he hoped that all observers would bear this in mind.

The variations of the pressure of the atmosphere were next referred to. Col. Strachey said that he had little doubt that the double tide was simply the result of the heating power of the sun on the atmosphere, though we did not distinctly know how the result was brought about. He remarked that the explanation of the phenomenon involved the solution of a very difficult problem in hydrodynamics, and that he believed that it was only by the aid of mathematical science that any precise explanation could be given. He regretted his own want of mathematical knowledge and hoped that some of the mathematicians of India or Europe might be led to investigate the problem. It was, to ascertain the effect produced, (on an elastic vapour atmosphere covering a sphere), by a source of heat gradually moving round the sphere. The necessary result of such a process could be generally stated with great ease, but its precise mathematical expression was quite a different thing. The Sun, the source of heat, certainly caused the expansion of the portion of the atmosphere between the meridians say of 8 o'clock A. M. and 5 P. M., and a general overflow of the upper parts of the atmospheric columns so expanded must take place to the east and the

west, causing a dispersion of air and consequent reduction of pressure, near the centre of the heated space, and a heaping up of air and increase of pressure at its two margins. This he believed to be the most likely explanation of the two maxima and the intervening minimum of pressure. At the same time he must guard himself by saying that the above was a very coarse and imperfect explanation of the phenomenon, not intended to be put forward as scientifically precise. As a fact the movement of the air particles which caused the diurnal tide of pressure was a *wave* movement, and not a real permanent movement of translation. This was proved by the circumstance that the tide of air pressure moved round the earth with the Sun and quite independent of the actual motion of the mass of the atmosphere at the place of observation. Col. S. referred to various peculiarities in the form of the curve of diurnal pressure at various places, and offered comments on some of them. He particularly suggested the propriety of making careful observations at some small island, in an extensive sea area within the tropics, as a means of ascertaining the normal diurnal curve in its simplest form. He noticed the well known mechanical law of the possible co-existence of any number of waves in a fluid body, and said that, no doubt, many of the local peculiarities of the barometrical curves, daily or other, were due to such superimposed waves, and that what the scientific observer had to do was to separate these and indicate their several causes.

Col. Strachey pointed out how the diurnal variation of pressure was most marked when the diurnal variation of temperature was greatest. Also how the daily tide was best marked near the equator, and gradually faded away towards the poles. He suggested as a sufficient explanation of this, that at the equator the force, exerted by the sun in creating the wave action in the atmosphere, continued constantly parallel to the actual motion of the air particles, forming the atmospheric wave as they revolved with the earth on its axis, and that consequently the impulse was accumulated in an intense degree, and a true accelerating force developed. As we leave the equator this parallelism is departed from, the actual direction of the air particles of the atmospheric wave being forced into a small circle of latitude, so that the impulse caused by the

heat is not accumulated, and at length at the pole no force at all can be exerted.

The gradual disappearance of the *regular* daily variations of pressure, as we recede from the equator, was pointed out to be a phenomenon analogous to the corresponding disappearance near the equator of the *irregular* variations of pressure, so strongly marked near the pole. The steadiness of the pressure in India which is most marked, and the change that takes place from the cold season of greatest pressure to the hot season of least pressure, were referred to as phenomena readily explained in the manner suggested in the case of the daily variations. The constancy of the pressure over large areas, and the propagation of what may be called the irregular variations, from day to day, over the whole of India, were phenomena which had been noticed by the late Mr. James Prinsep, and some very instructive diagrams exhibiting this had been published in the Society's Journal, Col. Strachey thought, in 1836. The subject had long ago attracted Col. S.'s notice, and he invited attention to it as well worthy of special examination, in connexion with what he had said regarding the superimposing of waves in a fluid mass. These great fluctuations, extending over half the continent of Asia, were manifestly in the nature of great waves, and the smaller fluctuations affecting smaller areas, were smaller waves, or so to speak ripples, breaking into the general fluid surface. This part of the subject was one of much interest, in which very little had yet been done, and he hoped that Mr. Blanford might be able to throw more light upon it.

The curves of temperature to which Mr. Blanford had directed attention were noticed by him as indicating certain *irregularities* of importance. Col. Strachey wished to say that in his opinion the first thing to do was to attend to the *regularities*. If we were ever to make a Science of Meteorology we must do it by supplying physical explanations of the observed phenomena. The *regular* phenomena were without any doubt those at the present time best deserving attention. When we had thoroughly mastered them, and were able to give a satisfactory explanation of their peculiarities, we should be in a reasonable position to advance to the *irregularities*. It certainly cannot be said that any such command has yet been ob-

tained over the laws of the ordinary diurnal change of temperature, and to the study of these, he would express a hope, that Indian observers would apply themselves. The primary causes of these changes were simple enough. On the one side, the Sun during the day added to the heat of the air and the earth, and on the other the air and the earth during the night threw off their heat into celestial space. Very little was yet known of how these operations took place, or why it was that special laws of increase and decrease of temperature governed each season or each locality. One of the causes of such variations he might refer to, (as before, rather in illustration of the general scope of his advice, than as an attempt to deal exhaustively with the subject), was the quantity of vapour in the air, by reason of which its power of transmitting radiant heat varied. As the air was dry, it transmitted more; as it was filled with vapour, it transmitted less heat. Thus the diurnal variations both by day and night would increase in extent as the air was drier, and vice versâ. Col. Strachey had examined the Madras observations with a view of ascertaining how the matter was, after the suggestion had been made by the researches of Professor Tyndall, and the result, as above stated, quite corroborated the laboratory experiments.

The diurnal winds of Upper India were very well known to all persons acquainted with that part of the country. That they were due to the daily variation of the pressure he had little doubt. They were not confined to India at all, and in truth extended all over Southern Asia up to the Caspian. The correctness of this theoretical explanation of these diurnal westerly winds, was, he thought, quite confirmed by the circumstance that during the months of dry westerly wind a faint easterly wind was common early in the morning, showing that the high pressure to the east of the place of observation had a similar effect to that produced to the west of it. Of course as the actual course of the crest of the wave of pressure was east to west, and the great fall of pressure was to the east of the crest, the westerly wind must be the best marked.

It is important, Col. S. said, always to bear in mind that wind is nothing more than a *consequence of inequality of pressure*, and, therefore, commonly, if not always, more or less directly of *changes*

of temperature. It is a vulgar error to drop out of view the essential change of pressure as the direct cause of wind, which should be studiously avoided in Col. Strachey's opinion by every scientific Meteorologist. The study of the winds, with the view of obtaining the precise explanation of their mechanical causes, is much to be recommended, but here, as in all other like enquiries, the observer must seek for true physical forces, and not permit himself to be blinded by the vague generalities which afflict this section of meteorology as they do all others.

Closely connected with the winds is the subject of rain, but on this he (Col. S.) would not venture to say anything excepting that, of all the phenomena with which meteorology affected to deal, this was least understood, and most involved in all sorts of misconceptions of the grossest description of the physical forces that were operative in its production.

In conclusion Col. Strachey said, he would earnestly exhort every one who desired to assist the progress of meteorology, to treat it in some such spirit as he had explained, to abandon the misleading dogmatism that had hitherto obstructed all real progress, and to seek for the precise, true, physical and mechanical forces which produce the phenomena that he studies.

The President briefly alluded to a few of the most important meteorological questions noticed by Col. Strachey, and expressed a hope that the time may soon arrive when it will be possible to carry out the many valuable suggestions which Col. Strachey has brought forward.

The following papers were read :—

ON A PRACTICAL METHOD FOR DETECTING BAD INSULATORS ON
TELEGRAPH LINES,—*by* LOUIS SCHWENDLER, ESQ.

One of the many practical measures, and certainly not one of the least important, introduced during the last few years with a view of increasing the efficiency of the Telegraph Department,

is the establishment of a scientific system of testing all materials and instruments employed on the line. Many practical results have already been obtained therefrom, but it is not the object of the present communication to enter into the details of this most interesting subject; I will, only point out one important fact that has been established.

A great many lines in India contain electrically defective insulators; some to such an extent as to lower the insulation to a degree which is fatal to the direct and regular working of long lines.

Why such insulators could creep in, notwithstanding the care taken in England to secure efficient Telegraph Stores for India, is a question with which I cannot deal at present, but which may perhaps form the subject of a *future* paper, when more data have been collected.*

The very fact that electrically defective insulators, showing nothing externally, do exist and are distributed over lines of such vast extent, has created the necessity of having a reliable method by which such insulators can be detected, and other perfect ones substituted with the least possible expense.

It is clear that such a method, if practicable, must be very simple, and the instruments used portable and handy.†

After some searching in this direction, the following method was found to answer the purpose most satisfactorily.

The principle of the method is to produce magneto-electric currents through the resistance of the insulator under test, and to measure these currents by the effect they have on the body of the tester.

* The cause for the low insulation of insulators seems to be the porous state of some porcelain, through which a minute quantity of water diffuses itself in time. When heating an imperfect insulator, it becomes always perfect, but immersing it a sufficiently long time in water, it becomes again imperfect.

The leakage seems to be invariably in this part of a porcelain which is cemented in the iron hood.

† To use a deflection method is out of the question, because the still comparatively high resistance of insulators, which have to be detected, would necessitate a high electromotive force, and a very delicate Galvanometer, which arrangements could not be made easily portable, as it is required when the tester proceeds along a line.

The subjoined diagram shows the connections readily :—

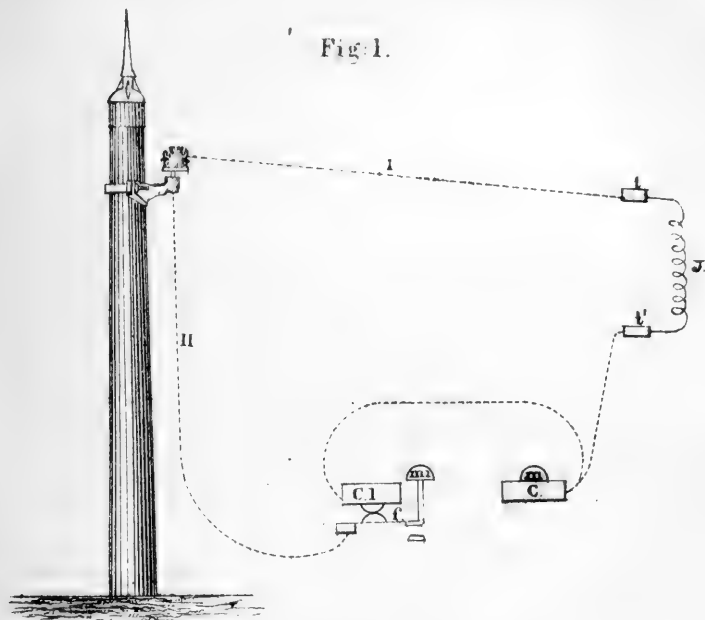

J is a magneto-electric machine, the two terminals *t* and *t'* of which are insulated from each other and from the ground.

t is in permanent contact with a perfectly insulated leading wire *I*, long enough to reach the insulator, to the iron hood of which it is to be hooked. .

t' is in permanent connection with the clamp *c* to which is fixed a small platinum knob, *m*, and both the clamps, *c* and *c'*, are permanently connected with each other. A good insulated leading wire, *II*, which is to be hooked on to the bracket of the insulator under test, is in contact with the moveable platinum knob *m'* which, however, is insulated from *c'*, when pressed down, but which in its position of rest, (or when not pressed down short), closes the circuit between *c* and *c'* at *f*.

The whole arrangement is constructed light but strong, protected from rain and can be carried along the line by one man only.

The tester proceeds as follows :—

After having cleaned the insulator carefully, he removes temporarily the line from the insulator and hooks the leading wire No. I to the iron hood and leading wire No. II to the bracket of the insulator. He then turns the handle of the magneto-electric machine with one hand, while one finger of the other is resting on the knob *m* of clamp *c*.

As soon as he touches with the other finger the knob *m'* of clamp *c'*, at the same time pressing it down, the metallic circuit between *c* and *m'* is opened, and the positive and negative magneto-electric currents have to pass from one finger to the other, and consequently, if strong enough, will give the tester sensible shocks, by which he is at once informed that the insulator under test is defective, and much under the fixed standard of insulation.

If the tester does not feel any current through his fingers, (a comparatively rough galvanoscop), he has only to repeat the experiment by placing his tongue on the knob *m*, while his hand still presses the knob *m'* down. If no current is felt by the tester through this most delicate galvanoscop, the tongue, he can rest assured that the insulator is perfect for all practical purposes.

By opening and closing the circuit alternately at the knob *m'*, the tester has it in his power to allow at short interval *currents* to pass through his tongue, and consequently will be able to detect the slightest induction currents.

The following experiments were made with insulators of known resistance to ascertain the highest limit by which the tongue is still able to detect induction currents.

The currents in these experiments were produced by one of Siemen's well known dial instruments, the revolving bobbin of which had a resistance = 1577 S. U.

The absolute resistance of each insulator was first carefully measured in the ordinary manner, without water in the porcelain cups, and the insulator afterwards tested by the method above described.

No. of Insulator.	Resistance in <i>mills.</i> S. U.	Strength of magneto-electric currents as indicated by the human body, through the resistance of the insulator under test.
1.	0.11	Strong shocks felt by fingers.
2.	0.13	Ditto ditto.
3.	0.145	Ditto ditto.
4.	0.19	Ditto ditto.
5.	0.75	Slight shocks felt by fingers.
6.	2.30	No shocks felt by fingers, but good shocks through tongue.
7.	5.70	No shocks felt by tongue, but a strong acid taste.
8.	7.1	Distinct, but slight acid taste.
9.	8.2	Ditto ditto.
10.	82.0	Nothing felt by tongue.
11.	189.0	Ditto ditto.
12.	615.0	Ditto ditto.
13.	2520.0	Ditto ditto.
14.	8	Ditto ditto.

From these experiments it follows that all insulators offering a resistance up to about 1 mill. S. U. can be detected by the fingers, and those above 1 mill. and under 8 mills. can be unmistakably detected by the tongue. It appeared also that tongues of different persons were equally sensitive, since several persons, Europeans and natives, acknowledged the known acid taste, even through the insulator No. 9, having 8.2 mill. S. U. resistance.

The highest limit of the method could of course be increased by filling the revolving bobbin of the magneto-electric machine with much finer wire and increasing the number of permanent magnets; however, this will be scarcely necessary, because it seems to be a fact that if an insulator has more than about 8 mills., the resistance is generally so high as to be practically infinite and, therefore, a

greater sensitiveness of the instrument would only complicate the method.

As it is intended that the tester himself should turn the handle of the magneto-electric machine, he has it entirely in his power to regulate the strength of the induction currents by turning faster or slower, and as, besides this, he always begins the testing by at first sending the currents through his fingers, no severe shocks can occur to him in the subsequent operation.

The method has also a safeguard in itself against carelessly rejecting good insulators, because the tester will certainly be careful in having the insulator properly cleaned before testing it, in order to avoid severe shocks.

There can also be scarcely any doubt that the tongue is the best detector in this particular case, because it is sufficiently sensitive, never comes out of order and indicates almost momentary currents; it is besides the cheapest instrument that could be used.

[*Note*]. This method may also with advantage be used for detecting bad joints in a telegraph line. It is then only necessary to connect the two ends of the joint to the two terminals of the magnetoelectric machine, in such a way that the body of the tester acts as a shunt to the joint.

A joint which offers a resistance of not less than 5 S. U. allows a current to pass sufficiently strong to be detected by the tongue; but if the joint has a resistance of more than 200 S. U. the current passing is strong enough to be felt already by the fingers of the tester.

Mr. W. E. Ayrton observed, that there is one point of excellency in Mr. Schwendler's arrangement for detecting bad insulators which, as Mr. Schwendler has not mentioned it, he should like to say a few words about. Testing insulators by passing a current through them is not new, but the current used for this purpose has up to the present time been that obtained from a galvanic battery, and to observe such a current a most delicate galvanometer is required. Now both a galvanic battery and a delicate galvanometer are in themselves most unportable, the battery because it must be

very large, and also because by being shaken its effect is greatly diminished, and a delicate galvanometer requires most careful adjustment each time before it is used after being moved. To obviate the use of a galvanic battery, Mr. Schwendler has suggested a magneto-electric machine which is much more portable and also has the same power as a very large battery. An ordinary magneto-electric machine, however, sends (rapid) reverse currents which would produce no effect on the needle of a galvanometer, even although the galvanometer were very delicate, because the rapid reverse currents produce a quick succession of opposite effects on the needle, or practically no effect at all. This, it is true, may be obviated by attaching to the magneto-electric machine a particular kind of reversing arrangement, but this is liable to get out of order. Consequently what is required is a delicate portable galvanometer affected by reverse currents, and such a galvanometer Mr. Schwendler has found in the human tongue, which is most delicate and certainly is most portable and is affected by reverse currents, therefore is most suitable to be used with the magneto-electric machine.

Mr. Schwendler exhibited the apparatus for testing the resistance of insulators and explained in detail the advantages of the practical method. The experiment, as described in the above paper, was tried by several members.

The President noticed that Mr. Lethbridge has brought an interesting communication relating to the old Dutch records in Chinsurah. It will be brought to the notice of the Society at the next meeting. There were also two other papers on the list.

ON A NEW GENUS OF BATS, WITH DESCRIPTION OF A NEW SPECIES OF *KERIVOULA*, by G. E. DOBSON, B. A., M. B., *Asst. Surgeon II. M. British Forces.* (Abstract.)

The new genus, described in this paper, is characterised by the presence of a *single phalanx in the 4th finger*, two in the 3rd and three in the 2nd. The single, terminal phalanx of the 4th finger, and second or terminal phalanx of the 3rd are rudimentary, so minute as to be scarcely discernible, and, therefore, do not add appreciably to the length of these fingers.

The typical number of phalanges in the 2nd, 3rd and 4th fingers of a bat is two in each digit; this number is often exceeded in many genera of Insectivorous bats by the addition of another short phalanx, but in no genus, hitherto described, is the number less than two. As the greatest breadth of a bat's wing is usually found by measuring along the 4th finger, it follows that, in this typical species where we find the terminal phalanx of the 4th finger rudimentary, and the homologue of the 1st phalanx only in other bats, (the 2nd and 3rd phalanges being suppressed), the wing must be comparatively extremely narrow. On account of this remarkable narrowness of the wing, the author suggests to call the new genus "*Stenopterus*." The type species is from Darjeeling.

The new *Kerivoula* differs from other allied species by certain peculiarities in the shape of the head, of the ears &c. The specific name *aurata* is proposed for it.

On Indian and Malayan Telphusidæ, by J. Wood-Mason, Esq.

The receipt of the following communication was also announced.

Notes on birds observed in the neighbourhood of Nagpur, Kampti, Central Provinces, Chikalda and Akola in Berar, by Lt.-Col. A. C. McMaster, Madras Staff Corps.

LIBRARY.

The following additions have been made to the Library since the meeting, held in February last.

Presentations.

*** Names of Donors in Capitals.

Philosophical Transactions of the Royal Society of London for 1870, vol. 160, part I.—Royal Society Catalogue of Scientific papers, vol. IV.—THE ROYAL SOCIETY OF LONDON.

Proceedings of the Royal Geographical Society, vol. XVI, No. 5.—THE R. GEOGRAPHICAL SOCIETY OF LONDON.

Journal of the Linnean Society, Zoology, Nos. 47 and 48, Botany 53 and 54.—Transactions of the same, vol. XXVI, part 4, XXVII, parts 1 and 2.—THE LINNEAN SOCIETY OF LONDON.

Geschichtliche Ergebnisse der Aegyptologie.—Die Entfaltung der Idee des Menschen durch die Weltgeschichte.—Sitzungsberichte 1869, II. Heft iii-iv; 1870, I. Hefte i-iv.—Abhandlungen der Phi-

losophisch-Philologischen Classe, Band XII; Abth. II; der Mathematisch-Physikalischen Classe, Band X, Abth. III.—BAYERISCHE AKADEMIE DER WISSENSCHAFTEN ZU MÜNCHEN.

Fossile Mollusken des Tertiär-Beckens von Wien, von Dr. M. Hörnes.—K. K. GEOLOGISCHE REICHSANSTALT, WIEN.

Mémoires de la Société Impériale des Sciences Naturelles de Cherbourg, Tom. XIII and XIV.—SOCIÉTÉ IMPÉRIALE DES SCIENCES NATURELLES DE CHERBOURG.

Monatsbericht, Novr. 1870.—Abhandlungen, 1869.—AKADEMIE DER WISSENSCHAFTEN ZU BERLIN.

Bulletin, Tom XV, Nos. 1, 2.—Mémoires, Tom XV, Nos. 5-8.—ACADEMIE IMPÉRIALE DES SCIENCES DE ST. PETERSBOURG.

Tatvávali.—Pravoda Sátaka, by Chandrakánta Tarkálankára.—THE AUTHOR.

A revision of the *Terebratulidæ* and *Lingulidæ*, with remarks on and description of some recent forms, by W. H. Dall.—THE AUTHOR.

La Langue et la Litterature Hindoustanies en 1870, par M. Garcin de Tassy.—THE AUTHOR.

General Report on the Panjab Oil-lands, by B. Smith Lyman, with 11 plates.—THE AUTHOR.

Ueber das Rámáyana, von A. Weber.—THE AUTHOR.

Journal of a Voyage up the Irrawaddy to Mandalay and Bhamo, by J. T. Wheeler.—THE AUTHOR.

Rahasya Sandarbha, No. 63.—BABU RAJENDRALALA MITRA.

Annual Report on the Convict Settlement of Port Blair for 1869-70.—THE GOVERNMENT OF INDIA.

Annual Report on the Administration of the Bengal Presidency for 1869-70.—Report of the Administration of the N. W. Provinces for 1869-70.—Report of the Administration of the Registration Department in Bengal for 1869-70.—The Cooch Behar Select Records, No. III.—THE GOVERNMENT OF BENGAL.

Report on the Meteorology of the Panjab, for 1869.—THE GOVERNMENT OF THE PANJAB.

Exchange.

The Athenæum, for December, 1870.

The Nature, Nos. 62-65.

Purchase.

Reisen in China von Peking zur Mongolischen Grenze, von Dr. A. Bastian :—F. Bopp's Vergleichende Grammatik :—The L. E. D. Philosophical Magazine, No. 270 :—Annals and Magazine of Natural History, No. 37 :—Zenker's Dictionnaire Turc-Arabe-Persan, Heft XVII :—Böhlingk und Roth' Sanskrit-Wörterbuch, Bogen 51-60.



PROCEEDINGS
OF THE
ASIATIC SOCIETY OF BENGAL

FOR APRIL, 1871.



The monthly meeting of the Society was held on Wednesday the 5th instant at 9 o'clock P. M.

The Hon'ble Mr. Justice Phear, President, in the chair.

The minutes of the last meeting were read and confirmed

Presentations were announced :—

1. From Col. T. C. Hamilton — a large round Gold coin, very thin, somewhat more than an inch in diameter.

Col. Hamilton writes that he received the coin from Mr. W. H. Pattisson, District Superintendent in Ramree, who obtained the same on the island Cheduba. In an account which Mr. Pattisson published in the Arracan News of 1871 (p. 27) regarding his trip on Cheduba island, the same officer states to have been informed that the inscription on the coin is in Cingalese, and that the coin was struck during the reign of Maha Paramat, king of Ceylon in the year of religion 446. This would nearly correspond with the year 1086, A. D. Since the publication of the account, just alluded to, Mr. Pattisson, however, believes to have ascertained that the inscription is in old Siamese character.

2. From G. Latham, Esquire — two charts of the Harbour of Bombay.

3. From Major J. M. Graham — a group of rudely moulded brass figures, representing "Lushais" and their social habits.

The following memorandum accompanied the donation :

"The group was presented by one of the 'Lushai' chiefs of the tribe of 'Nuttun Pooea' to Major Graham, then Deputy Commis-

sioner of the Hill parts of Chittagong. It consists of a great number of small brass figures and two trees, arranged on a wooden block, nearly ten inches square and about $1\frac{1}{2}$ inch thick."

"Amongst the figures will be found men engaged in acting, which consists in representations of fights, attacks on, or by, wild beasts, the proceedings of war parties, &c. Their singing is a low monotonous, buzzing chant, often accompanied by the music of drums, small gongs, and of a wind instrument which in appearance, and sound, strongly resembles the bagpipe. Liquor making, dancing, fishing, shooting, smoking &c. are also shown."

"On the trees are figures of birds, and animals, such as the Toucan, and the long-armed black ape or 'Hooluck.'"

"The method of fastening the bison, (*Bos Gaurus*), which animal is domesticated by the Lushais, will also be observed."

"The Bison is kept for the sake of his flesh and, as he represents a description of Lushai currency, he is much used in barter. It is also worthy of remark that, while the Lushais will eat almost anything under the sun, they will not touch milk, which they consider to be excrement."

4. From Lieut. W. Miller, M. N. I.—an egg of *Megapodius Nicobariensis* from Kamorta island and the carapace of a remarkably shaped Pagurid Crab from one of the small Nicobar islands.

From Capt. J. V. Falle,—a skin of the great Albatross, *Diomedea exulans*, Linn., shot off the Cape.

The following gentlemen duly proposed and seconded at the last meeting were balloted for and elected ordinary members :

Dr. F. N. Macnamara, (re-election).

Oscar Trefftz, Esq.

Capt. A. J. Filgatte, R. E.

Major J. M. Graham.

Col. F. H. Rundall.

T. M. Bourn, Esq.

W. J. Curtoys, Esq.

W. E. Ayrton, Esq.

W. Bourne, Esq., C. E.

The following gentlemen are candidates for ballot at the next meeting :

Bábu Káliprasanna Ghosha, proposed by Bábu Rájendralála Mitra, seconded by Mr. H. Blochmann.

Capt. B. Rogers, B. St. C., proposed by Mr. J. Wood-Mason, seconded by Col. H. Hyde.

C. F. Bligh, Esq., proposed by G. Nevill, Esq., seconded by J. Wood-Mason, Esq.

Ch. Sanderson, Esq., proposed by the Hon'ble J. B. Phear, seconded by H. H. Locke, Esq.

The following members have intimated their desire to withdraw from the Society.

Dr. S. C. Mackenzie.

R. J. Leeds, Esq.

Letters were read—

1. From Mr. St. John — On some North Arracan Celts.

Mr. St. John gives outlines of several celts in his collection. One large form is from Upper Burma and, in having a short abrupt shoulder, resembles the Burmese celts described and figured by Mr. Theobald in the Proceedings of the Society for 1869, p. 181 &c., pls. iii and iv. Two other celts are from the hills in North Arracan and are in form and size very similar to those figured in the Proceedings for 1870, pls. iii and iv. One of them has the lower edge sharpened from both sides, the other only from one. A fourth outline represents a long iron hatchet, of the shape of a broad chisel; it is still in use by the Arakanese in being simply put through a hole at the end of a stick of a male bamboo.

2. A letter was also read from Mr. E. C. Bayley, C. S. I., regarding a Goldmuhur, struck by Firúz Sháh Zufar in A. H. 791. The coin appears to be unique. A drawing of it will appear in the philological part of the Journal together with Mr. Bayley's notes.

The following papers were read—

1. ON INDIAN AND MALAYAN TELPHUSIDÆ, by J. Wood-Mason, Esq. (Abstract.)

The author gave a general sketch of the organisation of *Telphusa indica* and noticed its relation to the two other known species of the genus, *T. Leschenaultii* and *Guerini*. He also referred to the descriptions of 15 new species of which two belong to Milne-Edwards'

subgenus *Paratelphusa*, occurring in Eastern Bengal, which province possess a decided Malayan character in its fauna. Some remarks on the distribution of the various species were also made.

Dr. Stoliczka observed that the results at which Mr. Wood-Mason arrived regarding the geographical distribution of the Indian land-crabs are particularly interesting, because they were obtained independently of the examination of other groups of animals. This was chiefly due to Mr. W. T. Blanford in having pointed the distinctions existing between the Indian and Malayan fauna within the geographical area which we usually designate India. Many of the details on the subject are given in Mr. Blanford's paper on the Central Indian Reptiles, published in last year's Journal. It is, Dr. Stoliczka stated, natural enough that Burma, Eastern Bengal, stretching along the slopes of the Himalayas up to Nepal, should possess a fauna very closely allied to that of the Malayan peninsula and the neighbouring islands, but it is difficult to explain how the same Malayan forms have come into existence on nearly all the higher ranges of hills in South India, along the Malabar coast, and even on some perfectly isolated hills, while the intervening part of the lower country possesses an Indian fauna with a prevalence of African types. Reliable data regarding the distribution of the animals, particularly in India, are as yet very scanty, and carefully drawn up lists of those observed in various districts are much needed, that we may be able to explain the peculiar phenomenon of the isolation of the Malayan fauna in some parts of Southern India. It does not appear improbable that the fauna of India was at some remote period chiefly, or altogether, Malayan, and that it had been more or less destroyed in those parts which were affected by the enormous volcanic eruptions, characterized as the trappean formation of Central and N. W. India. It must have been somewhere about that time when a communication was established between India and Africa, and when African forms were enabled to travel eastwards and attain a firm hold in India. The immigration from the West must have been considerable, for it seems to have greatly checked the further development of the Malayan fauna, which remained preserved only on the more elevated hills, chiefly those consisting of gneissous and other metamorphic rocks. It is also

highly probable that the overflow of the traps produced a great change in the climate of India, particularly in the less elevated country, and that this climate was more favorable to the development of African than of Malayan forms.

2. ON SOME OLD DUTCH RECORDS OF THE SETTLEMENT OF CHINSURA ;
by E. Lethbridge, Esq., M. A.

A short time ago I accidentally discovered that some of the old records of the Danish settlement of Serampore, or Frederiksnagar, and some of those of the Dutch settlement of Chinsura, were preserved amongst the archives of the Judge's Court at Hooghly. By the permission of the Judge of Hooghly, I was allowed to examine these records; and I expected to open up a rich mine of antiquarian wealth, for Dutch records, at all events the European ones, are generally considered to be more full and detailed than any others, except Venetian records. The documents still preserved at Hooghly are contained in a large almira, and are covered with the dust of years. As I believe is the case with all the record repositories in India, there are absolutely no modern scientific appliances for the preservation of these papers; and consequently most of them are worm-eaten and decaying, and many are in a state of inseparable cohesion. I was somewhat disappointed to find that most of the Dutch papers which I examined were of only local importance; a large number were merely *protocoles* or *registers of the wills* of the old Dutch residents, and hardly any of them of any general scientific value at all. Fortunately, however, the records of the Court supplied me with a very good explanation of this fact; I found that in 1853 all the Dutch records of any historical and scientific value had been handed over bodily, and without even any proposal to retain copies of them in this country, by the Government of India, to the Government of the Netherlands' India; and by the latter had been doubtless at once transferred to the Royal Archives at the Hague. I have been fortunate enough to discover the list of these documents, made by the order of Mr. Torrens (the then Judge of Hooghly) at the time of the transfer; and a copy of this list I beg to be allowed to submit to the notice of the Society, (vide Appendix, p. 89).

To this list should be added (as is evident from certain remarks of Mr. Torrens) a complete series of the minutes of the Governors of Chinsura. Mr. Torrens says—"The latter must undoubtedly, I think, have been of very considerable historical importance;" and I venture to believe that the Society will agree with me that some of the series described in the accompanying list may probably be found to be of very high scientific value. The Government of His Majesty the King of the Netherlands is well known for its liberal encouragement of science; and it is very probable that, if the Society should think the matter of sufficient importance to warrant its being mooted, copies of the more important documents transferred from Chinsura, might be obtained without much difficulty from the Record Department at the Hague.

It may be worth while here to add a brief account of the circumstances of this transfer—an account which I have gleaned from the Records of the Judge's Court at Hooghly. It may be remembered that, at the time when Chinsura and other Dutch possessions on the Continent of India were exchanged for the British settlements in Sumatra, in 1824, a Dutch Officer (named the Fiscal) at Chinsura was, under the terms of the Treaty, taken into British employ, apparently to protect the interests of former Dutch subjects. Many of the old Dutch Records were retained in his custody; possibly *all* were so retained, but on this point I have not been able to obtain certain information. On the death of this officer in 1852, the Government of Netherlands' India expressed a wish "to be furnished by an early opportunity with the Dutch Records appertaining to the late office of the Fiscal of Chinsura." After some correspondence, the Governor-General ordered, on the 31st Dec. 1853, that all records possessing any general historical interest should be sent to Calcutta to be handed over to the Dutch authorities; all records having only local importance, and generally all those in Bengali, being retained in the Judge's office.

With regard to the contents of the more important records enumerated in the appended list:—

No. 57 is a book containing a Note of Warren Hastings on the capture of the Fort and Town of Chinsura in 1781. This may very possibly prove to be merely a copy of, or an extract from, a

Record of the Calcutta Foreign Office, which was established in 1783.

No. 42, contains 21 volumes of Journals and Minutes of the administration from 1773 to 1805; this would in all probability furnish materials for a fairly complete history of Netherlands' India for that period.

No. 12 is a packet containing copies of 5 firmans permitting the Dutch to trade in the provinces of Oudh, Allahabad, and Agra. The dates are not given.

No. 8 is a packet containing documents respecting transfer of some premises at Dacca from the French authorities to the Dutch in 1674. This is, I fancy, the earliest mention that we have of the French being settled in Bengal. The India House Records (calendared by Mr. Bruce) mention the arrival of a French fleet under Admiral de la Haye, in the Bay of Bengal in 1673; and Stewart says that the French settled here about 1676.

No. 6 contains two Perwanas under the seal of Vizier Sadoolah Khan respecting a house at Patna.

No. 4 contains documents respecting the acquisition of land at Baranagore by the Dutch in 1680.

No. 3 contains copies of grants respecting lands at Piplely and Balasore, in 1676.

In conclusion, I may perhaps be pardoned, if I venture to call the attention of the Society to a fact which must have frequently attracted the notice of many of its members:—I mean, the immense historical value of many of our Mofussil Records (especially those preserved at places of historical note like Hooghly, Burdwan and Dacca,) which are yearly crumbling away and becoming lost to science for ever, through lack of the most ordinary precautions for securing their preservation. I believe that in no other country in the world, possessing a civilised Government, is so little care bestowed on the preservation of the materials for its history; and in no country is there a greater need for such precautions as can be devised by the skill of the archivist. With regard to accessibility, our Mofussil Records are practically, for all purposes requiring extensive research, absolutely closed to the student; for whilst they are scattered in scores of remote and insecure hiding-places, with-

out indexes or calendars worthy of the name, and in the custody of record-keepers of no scientific skill and comparatively little intelligence, the search for a single fact would not unfrequently involve the waste of years, and years of hard labour. Moreover, the annual destruction of valuable documents that must go on in a climate, like that of Bengal, must be enormous. A memorandum, written by the late Mr. Piddington, is noted by Mr. Torrens, (then Secretary of the Asiatic Society), as a paper of very great value, and is printed in the Journal of the Society for July 1846. It indicates some of the peculiar dangers to which documents are exposed in India, owing to the deleterious nature of some of the ingredients of the ink generally used, and to other causes. The dangers resulting from the dampness of the climate; from the ravages of white-ants, rats, book-worms, and other vermin; from decay; from mutilation, inflicted either intentionally, or through ignorance or carelessness; from fire &c.—all these are sufficiently obvious. It will be within the recollection of the Society that a valuable collection of Oriental manuscripts, the property of Government, was recently damaged by rain; when a circular was issued by the Home Department, ordering that in all annual reports made by officers in charge of public libraries, museums, or collections, it should be specially stated whether or not the whole of the property is safe and in good condition. The present methods adopted in the preservation of all Mofussil Records are of such a nature that it is impossible that any documents can long remain in good condition. I believe that it was found, a short time ago, that the Collectorate Records at Jessore had been so extensively tampered with by interested parties, that the evidence of any of these documents was held to be almost worthless; and I have heard many district officers of experience state their belief that a similar state of things exists in many, if not in most of the Mofussil Record-Offices. It was stated last week in *the Pioneer* that the Records of the cutcherry at Ermakulam are at present inaccessible, owing to the number of the venomous serpents that have taken up their abode amongst them.

The Records are generally placed in common wooden almiras fastened by ordinary padlocks, and placed in rooms of more or less

general resort. The insecurity of such custody may perhaps best be-illustrated by a very brief description of the method of custody which is found necessary even in England, where the climate is much less injurious, and the fear of mutilation smaller. As soon as any sets of Records have been taken into the custody of the Master of the Rolls (who is ex-officio head of the English Record Department), they are cleaned, sorted, bound or mended as far as may be necessary and practicable, and placed in boxes for subsequent arrangement. Then a catalogue or general descriptive list is drawn up; and afterwards the more important documents are indexed, and the *most* important are ultimately calendared. When the work of arrangement is complete, they are placed in iron presses in the room assigned to their class. Every room in the building is separately fire-proof, being cased with iron and furnished with an iron-door which is thief-proof. Water can be turned on at a moment's notice in any room for the extinction of fire. Hot-air pipes are placed around every room, so that an equal temperature is preserved throughout the year; and by this means damp is excluded and rot arrested. Every part of the building being thus protected by every means that science can devise, the whole is constantly watched night and day, both by the Department (an Officer and an office-keeper being resident in an adjacent house) and by the Police; a police patrol is on duty throughout the night in the building. The perfect accessibility of all records is also well provided for.

Appendix.

List of Dutch Records likely to be of any historical value.

No. 1. 1 packet of papers or documents of Dutch Government, during the administration of C. Van Citter, Governor of Chinsura, dated the 29th April, 1795.

2. 1 packet of papers, dated the 5th July, 1771, in Dutch and Persian respecting the right of the Dutch Authorities at Pepley in some parcels of ground at Balasore.

3. 1 packet of original documents in Persian, and copies of grants relating to the Pepley Factory at Balasore, dated in 1084, Hidgree.

4. 1 packet containing documents in Persian respecting transfer of some land in Buranagore, by one Ramepur Mozoomdar to the Dutch authorities in 1088, Hidgree.
5. 1 packet containing documents in Persian respecting the purchase of a parcel of ground, Cassimbazar, dated 19th January, 1750.
6. 1 packet containing documents in Persian respecting the purchase of two houses at Patna, and copies of two Purwanahs with seal of Vizeer Sadoollah Khan, awarding possession of the houses to a Dutch General, (no name mentioned).
7. 1 packet containing document in Persian, respecting the proprietary title of a house at Dacca, which formerly belonged to one Mehdee Alli Khan (date and year not mentioned).
8. 1 packet containing documents, dated the 25th September, 1674, in Dutch and Persian, relative to the making over garden land with premises at Dacca, by the French Authorities.
9. 1 packet containing documents in Persian, and Bengalee, respecting purchase of some land in Beestoopore, zillah Moorshehabad, dated the 23rd December, 1772.
10. 1 packet containing documents in Dutch, Bengalee and Persian, respecting transfer of a water-course at Kalkapore to the Dutch Government.
11. 1 packet containing a deed of sale and a pottah in Persian and Bengalee, of a certain quantity of land at Cassimbazar, granted to Mr. T. M. Ross on the 21st instant, 1181, B. S.
12. 1 packet containing copies of 5 Firmans permitting the Dutch to trade in the provinces of Oude, Allahabad, and Agra, dated 1st February.
13. 1 packet containing documents respecting a house at Bala-sore.
14. 4 Prothocols in Dutch, marked A, B, D and E respective to Patna and Cassimbazar from 1763 to 1785.
15. 1 Prothocol in Dutch, during the incumbency of W. F. Van Citters from 1817 to 1818.
16. 2 ditto in Dutch of the Resident for 1823 and 1824.
17. 1 Diary in Dutch from 1818 to 1823.
18. 1 Order book in Dutch from 1820 to 1822.
19. 1 Account-current book in Dutch, 1793-4.

20. 1 Journal book in Dutch, 1793-4.
21. 1 packet containing in Dutch rules for prosecuting actions in Europe Courts.
22. 1 Book of certificates in English regarding sale of Japan Copper, &c., commencing from 28th August 1818 to 7th Feb. 1820.
23. 1 Register of certificates in Dutch and English respecting purchase of a ship and other property by a Dutch gentleman named L. Christianson on the 7th January, 1822.
24. 1 Batavia, account-current book in Dutch for 1794-5.
25. 1 Ditto ditto ditto ditto.
26. 1 Ditto ditto ditto ditto.
27. 1 Ditto ditto ditto ditto.
28. 1 Amsterdam ditto ditto ditto.
29. 1 Ditto ditto ditto ditto.
30. 1 Register of Pensioners in Dutch.
31. 1 Regulations respecting Batavia in Dutch for 1819.
32. Register of Minutes respecting Batavia in Dutch from 1820 to 1825.
33. 1 Book containing orders for the Police in Dutch for 1817.
34. 1 Widow Fund Regulation Book in Dutch for 1817.
35. 1 Military Widow Fund Book in Dutch for 1817.
36. 1 Ditto ditto ditto for 1822.
37. 1 Civil Widow Fund Book in Dutch for 1820.
38. 1 Ditto ditto ditto for 1822.
39. 1 Book containing receipts in English of Despatches addressed to the Governor-General of Balavi.
40. 1 Instruction Book in Dutch (date and year not mentioned).
41. 21 Principal Ledgers in Dutch from 1773 to 1806.
42. 21 Journals and Minutes in Dutch from 1773 to 1805.
43. 8 Orphan Account Books in Dutch from 1818 to 1825.
44. 12 Books containing letters received and copies of letters sent in Dutch from 1775 to 1821.
45. 7 Books containing orders respecting Batavia in Dutch, 1718-19 to 1825.
46. 4 Sequestratic or Account Books in Dutch from 1789 to 1814.
47. 8 Gastors or expense books in Dutch from 1799 to 1814.

48. 3 Regulation Books in Dutch from 1750 to 1766.
49. 2 Books containing statute for Batavia in Dutch from 1664 to 1669.
50. 1 Chinsura Police Regulation Book in Dutch for 1761.
51. 1 Memorial of the Residents of Chinsura, in Dutch, from 1819 to 1822.
52. 1 Book containing Proceedings in English and Dutch of the Dutch Court at Chinsura from 1815 to 1817.
53. 1 Memoir Book in Dutch.
54. 3 Books containing copies of letters in Dutch on various subjects.
55. 2 General Muster Rolls in Dutch shewing the names of officers appointed by the Dutch Government of Chinsura.
56. Correspondence on various subjects in Dutch and English between the Dutch authorities and English Commissioners.
57. One Book containing extract from the Proceedings of the Hon'ble Warren Hastings, Governor-General, relative to the capture of the Fort and Town of Chinsura, 1781.
58. 1 Book containing letters and receipts in Dutch from 1797 to 1798.
59. 2 Books containing letters of Colonel Van Citters in Dutch.
60. 2 Books containing copies of correspondence between the Dutch Governors of Chinsura and Batavia from 1792 to 1795.
61. 2 Registers of letters in Dutch and English of the 2nd Resident on various subjects, 1817.
62. 6 Various account Books in Dutch.
63. 20 Registers of letters in Dutch on various subjects.
64. 1 Batavia account-current book in Dutch.
65. 3 Account Books in Dutch from 1817 to 1821.
66. 1 Register of letters and accounts in Dutch and English relative to the old Church at Chinsura.

3. ON A QUANTITATIVE METHOD OF TESTING A "TELEGRAPH EARTH," by W. E. Ayrton, Esq. (Abstract.)

The method used up to the present time for testing a telegraph earth has been *qualitative* only. As, however, the electrical condition of every "earth" is of great practical importance, it is

necessary that some accurate *quantitative* method should be devised, in order that every telegraph office may ascertain whether the resistance of their earth is higher or lower than the maximum resistance allowed. The principal difficulty met with is that, if the resistance between two earths be measured successively with positive and negative currents, the same result is not obtained. Consequently the ordinary law for a Wheatstone's Bridge, or Differential Galvanometer, would not hold true. This difficulty, however, has been overcome in this paper, and formulæ are developed suitable for a Wheatstone's Bridge, a Differential Galvanometer, or simply for a Galvanometer of which the law of the deflections is known.

The details of some experiments are also given, and a particular instance is mentioned in which a much better "earth" was obtained by burying the plate in the upper stratum of soil than by burying it much deeper, on account of a bed of sandstone that existed at about fifteen feet below the surface.

Mr. Ayrton's paper will be printed in full in the natural history part of the *Journal*.

The following paper was received :

Notes on the Country of Braj, by F. S. Growse, Esq., M. A.,
B. C. S.

This paper will be published in the first number of the philological part of the *Journal* which will appear shortly.

LIBRARY.

The following additions have been made to the library since the meeting held in March last.

Presentations.

. Names of Donors in Capitals.

Monatsbericht der Königlich Preussischen Akademie der Wissenschaften zu Berlin, December 1870 :—AKADEMIE DER WISSENSCHAFTEN ZU BERLIN.

Selections from the Records of the Government of India, Home Department, No. LXXVII; Papers relating to the Nicobar Islands :—Govt. of India, Home Dept.

Rahasya Sandarbha, Vol. 6, No. 64 :—BABU RAJENDRALALA MITRA.

Rámáyana, Vol. II, No. 6, edited by Hemachandra Bhattá-chárya :—THE EDITOR.

Records of the Geological Survey of India, Vol. IV, part I :—THE GEOLOGICAL SURVEY OF INDIA.

Report on the Revenue Survey operations of the Lower Provinces, for 1869-70 :—General Report of the Revenue Survey operations of the Bengal Presidency upper circle, 1869-70 :—THE SURVEYOR GENERAL OF INDIA.

General Report on the operations of the Great Trigonometrical Survey of India, 1869-70 :—SUPERINTENDENT OF THE G. T. SURVEY OF INDIA.

Report on the Revenue Survey operations in British Burma, 1869-70 :—Selections from the Records of the Government of India, Home Department, No. LXXII :—Selections from the Records of the Bengal Government, P. W. D. No. I :—Report on the Administration of the Salt Department 1869-70 :—Palæontologia Indica, Vol. III, Nos. 1-8 :—THE GOVERNMENT OF BENGAL.

Flora Sylvatica, by Major R. H. Beddome, part VI :—Sanitary and Medical report on the settlement of Port Blair, Andamans, for 1869 :—THE GOVERNMENT OF INDIA.

Purchases.

Grimm's Deutsches Wörterbuch, Band XV. Lieferung 10 :—The Calcutta Review, April 1871 :—Hewitson's Exotic Butterflies, part 77 ;—The Annals and Magazine of Natural History, No. 38 :—The American Journal of Science, January 1871 :—The L. E. and D. Philosophical Magazine, No. 271 :—The Ibis, January, 1871 :—Conchologia Indica, part 2.

Errata in the March and April numbers of the Proceedings.

On p. 56	line 14	from above	read	A. P. Howell, Esq.	for	M. S. Howell, Esq.
” ” ” ”	16	” ”	”	Capt. A. J. Filgate,	”	Capt. A. J. Filgate.
” ” ” ”	22	” ”	”	T. M. Bourne, Esq.	”	T. M. Bourn, Esq.
” ” 82	” 32	” ”	”	ditto	”	ditto
” ” 84	” 2	” ”	”	possesses	”	possess
” ” ” ”	7	” ”	”	It was	”	This was

Rahasya Sandarbha, Vol. 6, No. 64 :—BABU RAJENDRALALA MITRA.

Rámáyana, Vol. II, No. 6, edited by Hemachandra Bhattá-chárya :—THE EDITOR.

Records of the Geological Survey of India, Vol. IV, part I :—THE GEOLOGICAL SURVEY OF INDIA.

Report on the Revenue Survey operations of the Lower Provinces, for 1869-70 :—General Report of the Revenue Survey operations of the Bengal Presidency upper circle, 1869-70 :—THE SURVEYOR GENERAL OF INDIA.

General Report on the operations of the Great Trigonometrical Survey of India, 1869-70 :—SUPERINTENDENT OF THE G. T. SUR-

and D. Philosophical Magazine, No. 271 :—The Ibis, January, 1871 :—Conchologia Indica, part 2.

PROCEEDINGS
OF THE
ASIATIC SOCIETY OF BENGAL
FOR MAY, 1871.

The monthly meeting of the Society was held on Wednesday, the 3rd instant at 9 p. m.

The Hon. Mr. Justice Phear, President, in the chair.

The minutes of the last meeting were read and confirmed.

The receipt of the following presentations was announced :—

1. From T. R. Lewis, Esq., M. B.—a copy of a Report on the Microscopic Objects found in Cholera Evacuations, &c.
2. From E. Blyth, Esq.,—several copies of a Note on the controversy between Mr. W. Theobald and Dr. Gray.

Mr. Blyth records his belief that the skull of *Testudo Phayrei*, which was transferred from Dr. Falconer's collection to the British Museum, belongs to a specimen of the same tortoise in the Society's collection; it was originally sent to the Calcutta Museum by Sir A. J. Phayre from Arracan. The fact was first noticed by Mr. W. Theobald, but its correctness was disputed by Dr. J. E. Gray in one of the late numbers of the Athenæum.

3. From S. E. Peal, Esq.,—a few notes on the cultivation and manufacture of Tea.

4. From Akshayacumára Datta,—a copy of The Religious Sects of the Hindus.

5. From His Highness Thákura Giriprasáda Sinha, Rájá of Besma, Allyghur, — a copy of Vedárthapradípa, Commentary of White Yajur Veda, Fasc. I, in Braj Bháshá.

6. From W. H. Dall, Esq., through Rev. H. Dall,—A Preliminary Sketch of a natural arrangement of the Order *Docoglossa*,

(Extract from the Proceedings of the Boston Society of Natural History); and Note on transversely striated muscular fibre among the *Gastropoda*, (from the American Journal of Science and Arts, Vol. I, February 1871).

7. From Rev. H. Gundert,—a copy of prospectus of a Malayalam and English Dictionary.

8. From Bábu Rájendralála Mitra—a dried specimen of a new species of *Scincus*. (For a description of the species see p. 115).

This specimen was obtained by Bábu R. Mitra from a Kashmir merchant, who stated that he brought the same from Arabia. The lizard is largely used medicinally in various diseases, and is particularly highly valued as an aphrodisiac by the Muhammadans. It is commonly known under the names of *regmáhi*, or the sandfish, *regzádah*, or the descendant of sand, and *sugunqúr*, which word is said to be of Greek origin. Scincs, and also the common green European lizards, had been formerly largely used by mediæval European physicians, who attributed to them most wonderful medicinal virtues in all kind of diseases.

In India the scinc is taken in the form of a paste mixed with saffron, cardamum and other spices, or in the form of a powder with beetle leaf, but it is never prescribed by Hindu physicians.

The following gentlemen were elected ordinary members :—

A. P. Howell, Esq.

Babu Káliprasanna Ghosha.

Capt. B. Rogers, B. S. C.

C. F. Bligh, Esq.

Ch. Sanderson, Esq.

The following gentlemen are candidates for ballot at the next meeting :—

Capt. C. Stewart Pratt, Adj. 34, N. I., Morar, proposed by Mr. Wood-Mason, seconded by Col. H. Hyde.

Moulavi Habiburrahmán, proposed by Mr. Blochmann, seconded by Bábu Rájendralála Mitra.

J. W. Alexander, Esq., proposed by Dr. T. Oldham, seconded by Dr. F. Stoliczka.

Bábu Gangáprasád Síñha, proposed by Mr. H. Blochmann, seconded by Maulavi Kabíruddín.

Bábu Rámakrishna Dása, proposed by Mr. H. Blochmann, seconded by Moulavi Kabíruddín.

The President reported that the Council had elected Dr. F. Stoliczka as a Trustee of the Indian Museum, on behalf of the Society, in place of Dr. S. B. Partridge who has resigned his trusteeship on leaving India.

The President also communicated a proposition of the Council that Ch. Darwin, Esq., be elected an honorary member of the Society.

The President said that according to the provisions of Rule 6 of the Bye-laws of the Society, the Council should, in the case of a proposition for the election of an honorary member, state the grounds on which the recommendation is based.

In the present case, the President thought it would scarcely be necessary to say anything more in support of the proposition of the Council, than to recall the very great influence which the works of the author of the 'Origin of species,' 'Animals and plants under domestication' and the 'Descent of Man' had upon the study of natural history in every one of its branches. Few can claim such a thoroughly philosophical treatment of natural history, as Ch. Darwin, who is justly styled the naturalist of the day.

The ballot will take place at the next meeting of the Society.

The following letters were read :—

1. From Major Stubbs—on a Muhammadan coin.

Mr. Blochmann said :—The coin of which Major Stubbs has sent a rubbing, is a most curious one. It was struck in A. H. 1202, (A. D., 1788) by Muhammad Bedár Bakht, whom the notorious Ghulám Qádir, on the 22nd Shawwál, 1202 (26th July, 1788) placed upon the throne of Dihlí. The reign of this puppet king, who was a son of Ahmad Sháh, was of short duration. When he was first brought forward, Sháh 'Álam (II.) was still upon the throne. Ghulám Qádir, sword in hand, made him descend, and sent him to his apartments, and three days later made the new emperor inflict corporal punishment upon his venerable predecessor. He used to lounge on the throne, side by side with Bedár Bakht, whom he covered with abuse and ridicule,

as he smoked the *huggah* into his face ; and on the 12th day after the accession, he destroyed the same throne for the plating which still adhered to it. On the 7th September, 1788, Ghulám Qádir left Dilhí, sending Bedár Bakht before him, and threw himself into the fort of Mírat. On the 21st December, he was attacked by the Mahrattas under Ráná Khán and De Boigne, and distrustful of his Patháns, he escaped the next day, when he was caught and sent a prisoner to Sindiah. Bedár Bakht was carried to Dihlí, where he was confined and ultimately slain.*

A drawing of the coin will be published in the Journal.

2. From Bábu Rashbihári Bose,—dated Banka, 8th April, 1871,—

“I have at last seen the Hindu work on Kharakpúr, which I have repeatedly mentioned to you, but instead of being a History of Kharakpúr, as I had expected it to be, it is unfortunately filled with descriptions of the beauty of six hundred Ránís of one of the Rájahs of Kharakpúr. The only thing interesting in it is the line of succession it gives of the Rájahs, which is as follows :—

1. Sangrám Sháh.
- |
2. Toral Mall.
- |
3. Bihrúz Singh.
- |
4. Tahawwur Singh.
- |
5. Kaiqobád.
- |
6. Afzún.
- |
7. Muzaffar 'Alí.

It is this last Rájah who owned 600 Ránís. The author of the work is one Brahma Dutt Chobay, a native of Ch'hetar (in my Sub-Division), who wrote in Falgoon, 1807, Sambat, when the Rájah was living. From the work it would appear that the Kharakpúr Rájahs trace their descent from the Solar race of the Kendowar caste.

It is plain from the above table that Toral Mall is identical with the Rájah whom the Muhammadan Historians call Roz-afzún, so named after his conversion to Islám. According to popular le-

* *Vide* Keene's Mogul Empire, pp. 172 to 183.

gends, as mentioned in my account of Kharakpúr, it was this prince who carried on a hopeless war with the Muhammadans, and being subsequently conveyed as a prisoner to Dihlí, and converted to Islám, had to marry a daughter or a relative of the emperor, who thereupon granted him several large pergunnahs as *jágír* by way of dowry. All the incidents related by me of this prince, such as his dreams, his flight, his refuge in Músakhól, his subsequent captivity, conversion and marriage, the suicide of his wife over a burning pile, and of his five daughters in the cataract of Pánch-kumár, seem to agree with what is related of him in Muhammadan Histories. But it would appear that nearly all this happened during his father's lifetime, and that he took a prominent part in his father's wars,—unless we suppose that, after his father's death, he contrived to make his escape from Dihlí, and carry on a war with his father's enemies from 1606 to 1615, when he was made a prisoner and converted to Islám.

It is worthy of notice that Toral Mall's father was called Sangrám Sháh (from Sangrám meaning *battle*), and not Singram, as the Muhammadan Historians seem to call him. Khorgo Singh from whom some would like to derive the name of Kharakpúr, was brother to Sangrám Singh.

I am now in a position to reply to the queries contained in your letter of the 10th December last.

1. Mahdá is a place about 6 miles north from Kharakpúr. It is called Mahdá, or Mahdá Chak. I have not been able to ascertain whether there are remains of a fort at that place.

2. There are two places named after Rájah Bihrúz. One of these is inpargannah Shikarábádá, about 4 miles north-east of Kharakpúr. Another is 6 miles south from Kharakpúr,—near a place called Dadrí, famous in the legend of Dobay Bhyrum, a deified Brahman Astrologer who figures conspicuously in the history of the Khetaurí Rájahs,—a legend which, together with several ballads relating to some other deified personages, I intend to send to the Asiatic Society.

There are several other places in Kharakpúr named after the successive Rájahs of the place. For instance, there is Muzaffarganj from Muzaffar 'Alí, Faiz 'Alíganj from Faiz 'Alí, Qádir-

ganj from Qádir 'Alí, Afzúnganj from Afzún, and Iqbálganj from Iqbál 'Alí.

3. There are at present no Rájahs of Kharakpúr in the district, all their estates including the jágírs granted by the emperor having been sold a few years ago by Mr. Latour by public auction, which led to long and harassing litigation. There are some illegitimate children of the last Rájah still surviving. I may as well mention here the remaining Rájahs of Kharakpúr subsequent to the table given above. Faiz 'Alí succeeded Muzaffar 'Alí, and was succeeded by Qádir 'Alí, who was succeeded in his turn by Iqbál 'Alí, who again was succeeded by Rahmat 'Alí, with whom the line became extinct."

The following papers were read :—

I.—STYLE OF DRESS IN ANCIENT INDIA, by Bábu Rájendralála Mitra,—(Abstract.)

Buchanan Hamilton, in his "Eastern India," first started the opinion that the ancient Hindus knew not the art of preparing needle-made dresses ; and it has since been adopted by Dr. Forbes Watson, Mrs. Manning, Dr. John Muir and others. The premises, however, on which this opinion is founded, appear to be untenable. Mention is made of the needle and sewing in the Rig Veda, which dates from twelve centuries before the Christian era according to the lowest computation, and the existence of those words in the language cannot be accounted for, except on the supposition that the people who used them knew and had what they meant. It is also argued that it is very unlikely, that the heroes of the Vedic age, who were able to forge, and were in the habit of using, armour and mail coats, never came to the idea of fashioning their clothes into made dresses. References are likewise made to the Rámáyana, the Mahábhárata and other ancient Sanskrit works to show that they allude to dresses which could not have been other than needle-made and shaped. The most overwhelming proofs on the subject are, however, met with in sculptures. Though the bulk of the human figures at Sánchi, Amarávati and Orissa are nudes or semi-nudes, still there are some which bear unmistakeable evidence of the antiquity of Indian made dresses. Among the Sánchi bas-reliefs there are several figures dressed in tunics which could never

have been fashioned without the aid of needles ; those of the two archers, one of them the Buddhist King, Piliyuk of Benares, figured in Mr. Fergusson's 'Tree and Serpent Worship,' (plate xxxvi) are particularly remarkable, inasmuch as the chapkans there shown are peculiarly Hindu, and the like of them has nowhere else been seen. On a Buddhist rail-post from Buddha Gayá which probably dates from a time earlier than the Sánchi rail, and which is now preserved in the Indian Museum, there are two figures fully dressed from the neck to the middle of the leg in a garment which appears strongly like the *jámá* of the present day. At Amarávati, there are also several figures dressed in tunics which owe their shape to the tailor's art. (Vide Fergusson's plates lxvi, lxxxiv). The Orissan sculptures offer even more positive proofs. In the Queen's palace (Rani Nour), among the rock-cut caves of Khandagiri there is a statue 4'—6" in height, cut out of the solid rock, which is dressed in a close fitting chapkan, with the skirts hanging down four inches below the knee, and having sleeves down to the wrist. Over the chapkan there is a haubert or coat of chain mail, the sleeves of which reach the elbow. A light scarf is wrapped round the waist, and its ends hang on the sides, holding on the left side a short sword. The head is partially mutilated, but there are traces on it of a twisted turban. The legs and the feet are enclosed in thick high boots or buskins. The age of the figure is supposed to be the third century before Christ, and the existence of chapkan, chain mail and boots at the time, it is believed, must be accepted as the most conclusive evidence on the subject. The dress differs so entirely from the chiton, the chlamys, the himation, and such other vestments as the soldiers of Alexander brought to India, that they cannot be accepted as Indian modifications of the Grecian dress, even if it were possible, which it is not, to suppose that such a foreign dress would at once be imitated in stone many hundreds of miles away from the place where it was exhibited in India. The dress reappears on some of the Amarávati bas-reliefs. Among the sculptures on the temples of Bhuvaneshvara there are representations of coats, kilts, bodices, *ghágrá*, *páyajámá*, and other articles of needle-made dress, some of them on gods and goddesses, and they cannot but be accepted as

indigenous. Among the Ajanta frescoes there are also traces of flowing dresses with sleeves, and they all tend to show that the Hindus knew, and did use, made dresses long before the advent of the Muhammadans in India.

In reply to the remark of Capt. Meadows Taylor, in which he says that the Hindus had no tailors among them, and that there is no word in their language for tailors, it is shown that in the Vocabulary of Amara Siñha, which dates from before the Christian era, there are two words for tailors, one, *tunnāvāya*, applying to darning, and the other, *sauchika*, to general tailoring : the derivation of the last word is given in Panini's rules. The profession of the latter was of sufficient importance to necessitate the establishment of a separate tribe, and a mixed class, the lawful issue of Vaisyas by Sudra women, was, according to the ancient law-book of Usanas, destined to live by it, and bear the distinctive title of needle-men, *suchika*.

Sanskrit words are next quoted to show the names which various kinds of made dresses bore in ancient times ; the most remarkable of these being *kanchuka*, *kañchulika*, *kurpāsa*, *angika*, *cholaka*, *chola*, *nivi*, &c. The first indicated the modern *jámá*, and warders, guards, and the personal attendants of kings generally dressed themselves in it. Kings, princes, chiefs and warriors, when they did not put on chain mail, wore a tunic, something closely like a chapkan. While ordinary people contented themselves with the simple *dhuti* and *chadar*, not unoften supplemented by a turban. Among women, the boddice was in general use, the body clothes consisting of either a *sári* or a *ghágrá* ; the former predominating. When respectable women went out of their houses, they generally wrapped themselves in a chudder thrown over their ordinary dress.

Sculptures, however, do not, in all cases, support the above deductions, and nudity is the prevailing character of the bas-reliefs of Sánchi, Amarāvati, and Orissa. The question is, therefore, raised as to how far those sculptures may be taken as evidences on the subject. On the one hand, it is difficult to reject the testimony of authentic graven stones ; on the other, the ancient records of the Hindus and the Buddhists, equally authentic, are in direct conflict with them. The former represent queens, princesses and ladies of rank in perfect

deshabille ; while the latter insist upon decency, modesty and covering of the person as of the utmost importance. Looking, however, to the facts that in many instances clothing is represented on females, but not to cover their modesty ; men and even children are clothed, but wives and mothers are left without any covering ; horses are covered with housings, but female beholders of the highest rank, standing in the verandas of two-storied houses and decked with a profusion of rich jewels, are made to content themselves with the raiment of the atmosphere ; it is concluded that the prevailing character of the bas-reliefs and statues of Sanchi and Amaravati is due, not so much to ethnic or social causes as, to the exigencies of art. No doubt the scantily clad Tamulian aboriginal races formed the great bulk of Buddhist congregations, and were more freely and plentifully represented on the monuments of their co-religionists than the Aryans, but their presence alone does not suffice to account for all the peculiarities noticed. It is supposed, therefore, that a conventional rule of art, such as has made the sculptors of Europe prefer the nude to the draped figure ; or a prevailing desire to display the female contour in all its attractiveness ; or the unskilfulness of early art ; or the difficulty of chiseling drapery on such coarse materials as were ordinarily accessible in this country ; or a combination of some, or all, those causes exercised a more potent influence on the action of the Indian artist than ethnic or social peculiarities in developing the human form in stone. There was likewise, it is to be presumed, a longing for variety, and a pruriency of imagination and design, which made the males appear in dresses of diverse kinds and the females in a state of nature. At Bhuvaneshvara a religious sentiment, that of veneration for the creative energy or phallic worship, was evidently also brought to bear upon art, and to produce an effect highly offensive to good taste. But whether so or not, it would, the author of the paper is of opinion, be as effectual to draw our conclusions regarding the costumes of the ancient Indians solely and exclusively from the sculptures they have left behind them, as it would be for the New-Zealander of Macaulay to do the same with reference to the Europeans of the 19th century from the collection of modern statuary in the Crystal Palace at Kensington or the Louvre.

II.—A HISTORY OF THE GAKK'HARS, by J. G. Delmerick, Esq.,
Rawul Pindee.

(Abstract.)

Mr. Blochmann read extracts from the paper, which is to be published in the forthcoming number of Part I, of the Journal, for 1871. He said—The historical notes collected by Mr. Delmerick are most interesting, and comprise nearly every notice of the tribe found in the Muhammadan Historians of India. Mr. Delmerick mentions above forty chiefs who ruled over the tribe from the time of Mahmúd Ghazní till our age. The present chief, Karam Dád Khán, receives from the Government a small pension as a sort of compensation for the losses suffered by his family during the Síkh Rule. For the early history of the tribe, the author has used traditional information obtained by him on the spot, and there is no doubt that the principal facts are reliable. The *Akbarnámah* places the final settlement of the Gakk'hars in the Ráwul Pinđí District somewhat later than local traditions.

Mr. Blochmann also mentioned that among the historical MSS. of the Society, there was a short history of Gakk'hars, presented some time ago by Major Pearse, who, on various occasions had contributed to the collections of the Society. There was a note on the fly-leaf of the MS. by the donor, according to which the work is "an extract from a larger work found at Rohtás." Mr. Delmerick, to whom the book had been sent, says regarding it—

"I consider it an original production from the brain of Donee Chand, the grandfather of Ráizádeh Ratan Chand of Goliana, zillah Ráwul Pinđí, the head of the ancient Qánúngo family. I had already seen a copy of it. I believe the few historical facts contained in it have been scraped together from various histories, and chiefly from the legends or tales related by the *bháts* of the country, particularly from the family *bhát* of the Gakk'hars, at Kúrí, zillah Ráwul Pinđí. The work was compiled by order of Major James Abbott, Deputy Commissioner of Hazára, and as Major Pearse was an Assistant Commissioner there for some time, he must have procured a copy of it from the Deputy Commissioner. It is perfectly worthless."

Mr. Lethbridge observed that, with regard to the occupation of Tibet by the Gakk'hars, it may be interesting to note the similarity between certain forms of the names of the chief towns of the Gakk'hars (which are properly Dangáli and Pharwála), and of those of Tibet, which are Lassa and Putala. De Laët, writing in 1631, speaks of "Kakares, whose chief towns are *Dankaler* and *Purhola*, a very broad and mountainous region, divided from Tartary by the ridges of the Caucasus." Mandelsloe calls the district "Kakires, with the chief towns *Dankalen* and *Binsola*." Rennell tells us, that the Tibetan capitals are sometimes called *Baronthala* and *Putala*, and sometimes *Tonker* and *Putala*.

III.—ON SOME NEW SPECIES OF MALAYAN BATS FROM THE COLLECTION OF DR. STOLICZKA,—by G. E. DOBSON, B. A., M. B., *Assistant Surgeon H. M.'s British Forces*.

Mr. Dobson said—I have the pleasure of bringing to the notice of the members of the Society four new species of Malayan bats from the collection of Dr. Stoliczka who, knowing what an interest I take in this order of Mammals, kindly placed at my disposal, for examination and description, the specimens collected by him at Penang, Moulmein, the Nicobar and Andaman Islands. Of these new species two belong to the frugivorous and two to the insectivorous divisions of bats, and represent four genera namely *Cynopterus*, *Macroglossus*, *Phyllorhina*, and *Asellia*. For these species I propose the following names:—

1. *Cynopterus brachysoma*.
2. *Macroglossus spelæus*.
3. *Phyllorhina Nicobarensis*.
4. *Asellia Stoliczkana*.

As full descriptions of these bats will be published with illustrations, in the natural history part of the Journal, the following short diagnoses of the species will suffice for the present:—

1. *Cy. brachysoma*, Dobson.

Head, broad, triangular; body very short; tail short and slender; fur bicoloured, slaty-blue with a greyish or silvery tinge; tips of the hairs sooty-brown.

Length : head and body 2".9 ; head 1".25 ; forearm 2".2 ; 2nd finger 4".0.

2. *M. spelæus*, Dobson.

Head long ; muzzle narrow, pointed ; tongue very long ; index finger *without* a claw ; a prominent, subcutaneous gland on each side of the anal opening ; fur short, dark-brown.

Length : head and body 4".2 ; tail 0".45 ; head 1".55 ; forearm 2".75 ; 2nd finger 4".6.

3. *Phyllorhina Nicobarensis*, Dobson.

Head long ; muzzle obtuse ; nose-leaf with three small points on its anterior margin, the transverse portion erect, forming an arc of a circle, rolled back on itself and overhanging the concave base which is divided into *two cells* by a single longitudinal fold. Wing membranes attached to base of metacarpal bone of outer toe.

Length : head and body 3".0 ; tail 1".7 ; forearm 2".5 ; tibia 1".0.

4. *Asellia Stoliczkana*, Dobson.

Ears acutely pointed, outer edge doubly emarginate immediately below the tip ; nose-leaf large, transverse portion erect, upper part of crest tri-acuminate, in form like an isosceles triangle with an obtuse vertical angle, having its apex divided into three points by two narrow incisions, perpendicular to the base. Fur pure white, with purplish-brown tips, beneath dirty-white.

Length : head and body, 1".6 ; tail 0".6 ; forearm 1".52 ; 2nd finger 2".6.

The discovery of the new species of *Macroglossus* leads to the necessity of an important change in the classification of the Pteropine bats, as proposed by Dr. Peters of Berlin.

Dr. Peters has devoted, perhaps, more attention to the examination of this interesting order than any other living naturalist, and his generalisations have, accordingly, been, I believe, very extensively accepted. In the Vol. of the monthly Proceedings of the Berlin Academy for the year 1867, page 865, he arranges the genera of the Pteropine bats (with the exception of *Pteropus*, of which he enumerates the species in a former paper in the same volume)—thus :—

A. *Index finger with a claw.*

2. *Cynonycteris*, D. $\frac{3.2}{3.3}$, $\frac{1}{1}$, $\frac{4}{4}$, $\frac{1}{1}$, $\frac{2.3}{3.3}$.
3. *Cynopterus*, D. $\frac{2.2}{2.3}$, $\frac{1}{1}$, $\frac{4}{4}$, $\frac{1}{1}$, $\frac{2.2}{3.2}$.
- 3a. *Ptenochirus*, D. $\frac{2.2}{2.3}$, $\frac{1}{1}$, $\frac{4}{2}$, $\frac{1}{1}$, $\frac{2.2}{3.2}$ cauda distincta.
4. *Megaerops*, D. $\frac{2.2}{2.3}$, $\frac{1}{1}$, $\frac{4}{2}$, $\frac{1}{1}$, $\frac{2.2}{3.2}$ cauda nulla.
5. *Harpyia*, D. $\frac{2.2}{2.3}$, $\frac{1}{1}$, $\frac{2}{0}$, $\frac{1}{1}$, $\frac{2.2}{3.2}$.
6. *Epomophorus*, D. $\frac{1.2}{2.3}$, $\frac{1}{1}$, $\frac{4}{4}$, $\frac{1}{1}$, $\frac{2.1}{3.2}$.
- 6a. *Hypsignathus*, D.
7. *Macroglossus*, D. $\frac{3.2}{3.3}$, $\frac{1}{1}$, $\frac{4}{4}$, $\frac{1}{1}$, $\frac{2.3}{3.3}$.

B. *Index finger without a claw.*

8. *Cephalotes*, D. $\frac{3.1}{3.3}$, $\frac{1}{1}$, $\frac{2}{2}$, $\frac{1}{1}$, $\frac{1.3}{3.3}$.
9. *Notopteris*, D. $\frac{2.2}{2.3}$, $\frac{1}{1}$, $\frac{1-1}{1-1}$, $\frac{1}{1}$, $\frac{2.2}{3.2}$.

It will be thus seen that the genus *Macroglossus*, according to Prof. Peters, comes under the head of the first division, or those bats provided with a claw on the index finger, and this generalisation was perfect so long as *M. minimus*, remained the type of the genus, but the above noticed new species, of which two spirit specimens are before you, has not the slightest trace of a claw on the index finger. That this is a true *Macroglossus* is sufficiently evident, if the form of the head, and the number, character, and arrangement of the teeth be compared with the same parts in *M. minimus*, the points of difference consisting in the possession or absence of a claw on the index finger, the place of attachment of the wing membrane to the foot, and the comparative length of the tail. These differences would, perhaps, warrant the formation of a new sub-genus for the reception of this species, which, however, I hesitate to do till the discovery of other species requires it.

The differences referred to would, no doubt, be of great importance in separating the species and placing them in different genera, were there associated with them correspondingly important differences in the form of the head, and the character, number and

arrangement of the teeth. But when we come to examine and compare these parts in the specimens of the two species, we are at once struck by the almost complete similarity of the specimens in these respects, the relative importance of which it is unnecessary to dwell upon.

Therefore that part of Prof. Peters's classification which depends on the presence or absence of a claw on the index finger must be abandoned, and some other generalisation, based on a more constant and important character, substituted, but I have not yet examined a sufficient number of species to enable me to indicate this character.

Among the bats obtained by Dr. Stoliczka at the Nicobars three specimens of *Miniopterus Australis*, Tomes, occur. Mr. Tomes in describing this species* says "the name under which I have described this species was given under the impression that it was exclusively a native of Australia. It was not until after I had arranged and named the specimens in the British Museum and in some other collections, that I found it to be an inhabitant of Timor (and probably of other islands of the Indian Archipelago), as well as of Australia, and that the name of *Australis* was not strictly appropriate. But to avoid the confusion which might possibly arise from a change of name, I have thought it desirable that it should remain unaltered." I believe this is the first time *M. Australis* has been recorded from the Nicobars, and in so recording it, I not only add a species to the fauna, but also a fresh locality to the species placed nearly as far north of the equator as its first locality was south of it, so that Mr. Tomes's surmise has proved correct, though I believe in a far wider sense than he expected, and taking the name *Australis* literally, he might with almost equal justice have called the species *septentrionalis*.

IV.—NOTES ON THE ANATOMY OF CREMNOCONCHUS SYHADRENSIS, by Dr. F. STOLICZKA.

A peculiar amphibious shell, living on the moist precipitous rocks of the Western Ghats near Bombay, was described by Mr.

* Annals and Mag. Nat. Hist. 1858, Vol. II. p. 161.

W. T. Blanford as *Cremnobates Syhadrensis*, in Ann. and Mag. N. II. for September, 1868, vol. I. In this paper Mr. Blanford noted the species as representing, in some respects, a connecting link between the LITTORINIDÆ and CYCLOSTOMIDÆ, but he inclined to its classification in the former family, although he was not able to discover the presence of gills.

In Ann. and Mag. N. II. for May 1869, vol. III, p. 343, Mr. Blanford proposed to substitute the generic name *Cremnoconchus* for *Cremnobates*, the latter having been preoccupied by Dr. Günther in Ichthyology. In Journ. Asiat. Soc. Bengal, Vol. XXXIX, p. 10, &c., Mr. Blanford added a new species to the genus, *C. conicus*, with the variety *canaliculatus*, and classed Layard's *Anculotus carinatus*, in the same genus. All three forms occur at Mahableshwar in similar localities, as the first named species; they appear to me to be only varieties of Layard's *carinatus*.

Prof. Troschel obtained a specimen of *Cremnoconchus Syhadrensis* with the animal dried in, but all he could examine were detached portions of the radula; these, however, agreed so well with those of *Littorina*, that no doubt remained as to the Littorinoid character of the species in question (vide Archiv für Naturgesch., 1867, pt. I, vol. XXXIII, p. 90).

In my review* of the genera of the family LITTORINIDÆ I have classed *Cremnoconchus* in the sub-family LACUNINÆ, but it appears that the species now known to constitute the genus shew rather more affinities to *Littorina* than to *Lacuna*. I shall return to this subject of classification again.

Considering the very great importance which attaches itself to the discovery of every form, representing a link between two others, now widely separated, I was glad to receive several specimens of *Cremnoconchus Syhadrensis* through Mr. Fairbank from the Mahableshwar cliffs. The following notes will give an outline of the principal anatomical characters of the species, in addition to those already noticed by Mr. Blanford and Prof. Troschel.

* Monograph of cretaceous Gastropoda, Palaeont. Indica, II, 1867-68, p. 262.

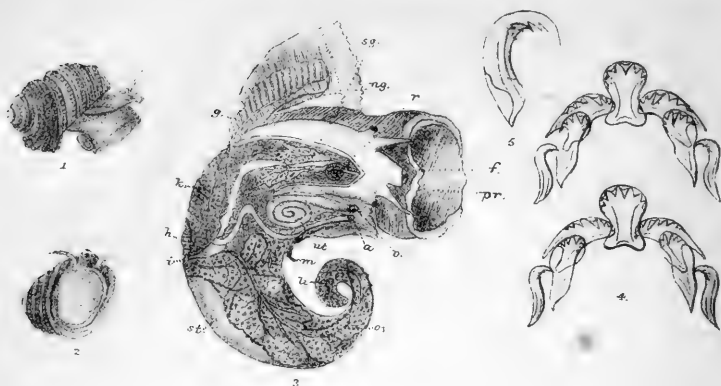

Cremmoconchus Syhadrensis, W. Blf.

1. Side view of a male specimen, partially protruding out of the shell.
2. View from below of another specimen, shewing the sole of the foot.
3. Anatomy of a female specimen :

<i>r</i> —radula,	<i>k</i> —kidney,	<i>li</i> —liver,	<i>o</i> —vagina.
<i>g</i> —gill,	<i>h</i> —heart,	<i>m</i> —shell retractor,	<i>f</i> —foot.
<i>ng</i> —obsolete plume,	<i>i</i> —intestines,	<i>ut</i> —uterus,	<i>pr</i> —muzzle.
<i>sg</i> —salivary glands,	<i>st</i> —stomach	<i>ov</i> —ovary,	<i>a</i> —anus.
4. 2 series of teeth of the radula. 5. side view of the centre tooth.

The animal (figs. 1-2) of *C. Syhadrensis* has a short rather stout body, with a thick subcylindrical foot, posteriorly with the operculum attached by a slight lobe, just above the base; mantle-edge very slightly crenated and somewhat thickened; muzzle short, thick, with the oral opening at the end, which is not lobed; tentacles subulate, of considerable length, rather far apart, pointed at the end, with large, black eyes on their outer swollen bases; sole of foot roundish or oval, with an indistinct median groove. Sexes distinct: male with a large, flatly depressed penis, perforated at the end, without any appendage.

General colour pale whitish grey, slightly darker on the back, and with a few irregular darker spots at the sides of the foot, tentacles usually blackish; the muzzle appears reddish on account of the red colour of the buccal parts.

The sexes appear slightly to differ in size; at least none of the males were as large as the females. The shell of the largest speci-

men of the latter measured : larger diam. 8, smaller diam. 7.5, total height 8 m.m.

The internal anatomy (fig. 3) does not essentially differ from that of other Prosobranchiate Gastropoda. The buccal parts in the mouth are soft, fleshy, with the usual cartilaginous valves internally. I have not observed a trace of a separate jaw. The oesophagus passes through the nervous ring, beyond which the salivary glands are situated. Stomach large, black ; it had vegetable matter inside, the animal having apparently been living on minute algae. Intestines very long. The uterus in the female is disc-like, large, flattened, of a greyish colour ; the ovarium very large, occupying the greater portion of the middle and also mostly of the posterior surface, and of the inner or columellar side of the body. In a full grown female, (examined in March) the eggs were somewhat more than one half millim. in diameter, yellow, with a large transparent, excentric, nucleus, enclosing a minute nucleolus.

In the male, the testis is situated, similarly to the ovary in the female ; it is generally of a pale yellowish colour and the spermatozoa are rather short, extremely thin, gradually thickened towards one end. In some specimens the testis occupied the whole of the surface of the terminal $1\frac{1}{2}$ whorls. The vas deferens lies along the ventral (or columellar) side and is of very great length ; it was filled with well developed spermatozoa.

The kidney is large, elongately ovate, grey, situated behind the gills. The liver is greenish, consisting of two anterior smaller lobes while a larger, much subdivided, lobe occupies the terminal portion of the body.

The gills consist of a single rather narrow plume, composed of thin fillets which are grown to the upper side of the gill-cavity. The fillets are on the right side very finely prolonged and partially become branched, resembling in this respect the breathing organ of pulmoniferous Mollusca ; the same form is already indicated in several of the more terrestrial than aquatic *Littorinæ*. To the right of the gill is a narrow thickening, which is generally stated to be a rudiment of a second plume ; it is barely indicated in this species.

The radula is narrow, very long, from 10-14 m.m. ; the greater

portion of it lies rolled in on the right side behind the mouth. It is composed of between 260-280 transverse rows of tænioglossate teeth, the formula being 3 . 1 . 3. (see fig. 4). The centre tooth is somewhat longer than broad, rounded above, strongly emarginate at the sides, and less so at the base. The upper edge is very strongly inflected, with 7 denticles of which the median one is the largest, (see fig. 5). Along the concave sides runs a very thin, raised lamella, and the projecting corners of the base are also bent upwards. The lateral teeth follow below each other under a rather steep angle; all have the upper edges strongly inflected, each having the median denticle the strongest and obliquely projecting, the outer 3 denticles on each side decreasing in size; on the outermost tooth the latter are sometimes hardly traceable. The general shape of the first lateral tooth is obliquely quadrangular, posteriorly deeply emarginate and with the posterior half of the upper edge thinner and a little longer. The bases of the two outer lateral teeth are obliquely, and more or less obtusely, pointed.

The teeth of *C. carinatus*, and its varieties, are perfectly similar to those of *Syhadrensis*, except that the median denticles of the teeth are a little stronger and more pointed, as compared with the adjoining lateral denticles.

When we compare the general anatomy of *Cremnoconchus* with that of *Littorina*,* we find that both are almost perfectly identical. Prof. Troschel, in the above noted communication (p. 94), characterized *Cremnoconchus* as possessing an umbilicated shell and the median teeth of the radula without laterally raised lamellæ, while *Littorina* has, according to the same author, a non-umbilicated shell and the median teeth with lateral lamellæ. The statement relating to *Cremnoconchus*, is, however, evidently an oversight on the part of Prof. Troschel. The median teeth of *Cremnoconchus* have, as already noticed, laterally raised lamellæ, and the shell is either umbilicated or not; as is clearly shewn by *Cremnoconchus carinatus*, and its varieties. In the two points alluded to, the genus, therefore, perfectly agrees with *Littorina*, and it is indeed not easy to find out sufficiently distinctive characters between the two.

* I have examined in connection with this subject *Littorina melanostoma*, and two other species very closely allied or identical with *undulata* and *intermedia*.

The form of the shell of both is so variable that no importance can be attached to it, the only difference being, that the one of *Cremnoconchus* has a peculiarly thin texture, and that it is covered with a very distinct olivaceous epidermis. As to animals, *Cremnoconchus* differs from *Littorina* by the subcylindrical foot, the sole of which is only indistinctly grooved, and by the males having the penis destitute of an appendage. There is no peculiar difference in the form of the teeth, except that each has 7 denticles, while in *Littorina* there are usually only 5 present. The operculum is also in both very similar, paucispiral and horny, only in most specimens of *C. Syhadrensis* it becomes in time quite testaceous.

For these reasons I believe, therefore, that *Cremnoconchus* can be regarded only as a subgenus of *Littorina*, and should be classed next to *Risella* (= *Bembicium*), the relative position of the lateral and central teeth being very similar in both. Of *Risella* two species occur on the Arracan coast, at the Andamans, and Nicobars, Penang, &c.

In my Monograph of the South Indian Gastropoda, (Pakcont. Indica, II, p. 259, et seq.), I have divided the LITTORINIDÆ into three sub-families, FOSSARINÆ, LACUNINÆ and LITTORININÆ. Subsequent researches make a thorough change in the classification of the family necessary.

In the first named sub-family only *Risella* can be regarded as a true Littorinid, and must be placed near *Littorina*. *Fossar* and its allies must be excluded from the present family. In the LACUNINÆ have provisionally to remain: *Lacuna*, *Modulus*, *Stenotis*, and *Lacunaria*, while *Lithojlyphus* is to all appearance a Risoid form, and must be classed near *Bythinia* and *Amnicola*. The LITTORININÆ include *Cycionema*, *Spironema*, *Amberleya*, *Echinella*, *Hamus*, *Risella*, *Cremnoconchus*, *Neritoides*, and *Littorina*. Researches in fossil conchology may increase this list considerably.

With regard to the relation of *Cremnoconchus* to *Cyclostomus*, *Cyclophorus*, and some of their allies, it is worth while drawing attention to the many points of similarity which exist between the *Littorinæ* in general and these operculated landshells. The animals, and their dentition, are in both often extremely similar, with the exception that the former have the end of the muzzle truncate, while the CYCLOPHORIDÆ have it lobed. The operculum in *Cyclo-*

stomus is similar, paucispiral, but testaceous, while it is horny in *Littorina*. *Cremnoconchus*, however, having occasionally a testaceous operculum, indicates a link between the two genera and it also inclines to the latter by the males not possessing an appendage to the penis. The gills of some *Littorinæ*, and particularly those of *Cremnoconchus*, equally indicate a passage to the form of the lungs of true PULMONATA. Further, the foot is grooved along the middle of the sole in *Littorinæ*, it is equally so in the *Cyclostomi*, only the two parts of the sole are in the latter genus still more developed on account of the arboreal habitat of the species, though very probably this will not be found to be so much the case in the purely terrestrial ones, and in *Cyclophorus* and others the groove has entirely disappeared. The *Littorinæ* have no jaw, at least none distinctly developed, neither have the *Cyclostomi*, but the *Cyclophori*, which may be said to be more terrestrial, than the former, possess a well-developed jaw, like the HELICIDÆ and other PULMONATA.

Considering these numerous points of structure which I have just noticed, it can be scarcely doubted that there exists an intimate relation between *Littorinæ* and *Cyclostomi* and their associates; and that the origin of the latter may be looked for in the explanation of certain slight changes in the organisation of the former. *Cremnoconchus*, as already stated, shews in several points a still greater inclination to *Cyclostomus*, than do the common *Littorinæ*. Mr. Blanford's general remarks on this subject were, therefore, perfectly justified, though he was not in possession of all the details upon which he might have been able to base more definite conclusions.

In point of general classification, the comparison of the anatomy of *Littorinæ* and *Cyclostomi* indicates, that among the different organs, the structure of the breathing organ seems to be subjected to a greater variation, or change, than are for instance the generative or digestive parts, or the radula, &c. Therefore, it is not advisable to use the breathing organ as an important character in the principal classification of the Mollusca, in the way in which it has been introduced for such a purpose in the systems of Cuvier and others.

I could quote other examples in support of this view, as for instance that of *Cerithidea obtusa*, where the gills have entirely disappeared, and become replaced by true lungs, while no one

will at the same time deny the close relation existing between the marine *Cerithia*, the brackish *Potamides* and the species of *Cerithidea* above referred to.

V. DESCRIPTION OF A NEW SPECIES OF SCINCUS,—by DR. J. ANDERSON.

Scincus Mitranus, n. sp.*

Head rather small and much pointed; tail short and thick at the base. Snout contracted behind the nostrils and dilated in front of them, sharp, spatulate and fossorial. Nasal crescentic, occupying the place of a first superior labial, but with the lateral portion of the rostral below it, in contact with the rostral, first labial, anterior loreal, large supranasal and small internasal. The supranasals large, not contiguous, pentagonal, four of their sides large and one very small, in contact with the internasal. Internasal small, rounded, lying between the rostral, nasal and supranasal. Rostral with a broad, rounded, sharp anterior margin; its sides much convergent; its posterior end forming only a narrow suture with the frontal; its under surface broad and slightly shelving upwards; its posterior margin a crescentic, cutting ridge, defined from the surface anterior to it, by a deep groove. The frontal large, conical from behind forwards, and pointedly unguiform, forming sutures with the rostral, supranasal, anterior loreal, and contiguous by its hinder margins with the post frontals. Post frontals large, pentagonal, broad in front, pointed behind, forming a broad suture together. Vertical of moderate size, rather narrow, its anterior margins forming an obtuse angle; lateral margins concave and slightly convergent; abruptly truncated posteriorly. Two pre-occipitals rather small, oblongly pentagonal, placed obliquely, and contiguous. Occipital considerably smaller than the vertical and wedge-shaped from before backwards: two rather large scales placed transversely along its external margin. Two small postoccipitals. Five large superciliaries with an internal line of four small plates, the first of which equals the length of the three succeeding ones. Four rather large scales form the lower margin of the eye, the anterior scale as long as the two behind it. Loreal region concave. Two elongated loreals one before the other, the anterior shield in contact with the supranasal, nasal and three lower labials. Eight upper labials, the two below the

* I have named this lizard in honour of my learned friend Bábu Rájendralála Mitra who obtained it under the circumstances mentioned on page 96.

eye the largest. Eight lower labials: a large shield behind the mental succeeded by three pairs of large shields, separated from each other by a median, longitudinal, row of three smaller shields. External ear completely hidden. Twenty-nine to thirty rows of smooth, imbricate scales round the middle of the body. Two large preanal scales.

Colour of dried specimen yellowish buff above, each scale with a white spot in the centre of its free margin with a brown spot on either side of it. Ten vertically elongated, or more or less rounded, deep red-brown spots along the side from the middle of the neck to above the thigh, the last spot reduced to little more than a speck. Sides and under surface yellowish. Snout to vent 4" 12"; vent to tip of tail 2" 5"; snout to posterior margin of occipital 8"; anterior limb 1" 1"; posterior limb, 1" 2".

The nails of this scinc are flat and broad, and rather concave on the under surface: the toes are laterally extended by the outward elongation of the dorsal scales, an arrangement which gives the foot great breadth, and suggests the idea that it is specially modified to a fossorial habit of life.

The specimen from which this description is drawn, was obtained by Bábu Rájendralála Mitra from a Kashmir merchant, who stated that it came from Arabia and that it was the El-adda of the Arabs. It is extremely likely that this term is a generic one applied to a number of nearly allied scincs, inhabiting Arabia, Syria, Egypt and Abyssinia, (see *antea*, p. 96).

The present species is distinguished from *S. officinalis*,—if the descriptions and drawings of that lizard are correct,—by its more markedly fossorial snout and by the number, form and disposition of its cranial plates, and by its peculiar coloration. Another species from Arabia is the *Sc. meccensis*, Hemp. and Ehr.

The reading of the next paper was postponed.

Notes on several Arabic and Persian inscriptions, by H. Blochmann, Esq., M. A.

The following communications have been received:—

1. *Legends and Ballads connected with persons deified, or held in great veneration, in Bhagulpúr and the neighbouring districts*, by Bábu Rashbihári Bose.

2. *List of birds, collected, or observed in the Wardha Valley and its vicinity near Chanda*, by W. T. Blanford, Esq.

LIBRARY.

The following additions have been made to the Library since the meeting held in April last :—

Presentations.

*** Names of Donors in Capitals.

Quarterly Journal of the Geological Society of London, Vol. XXVII, Part I:—THE GEOLOGICAL SOCIETY OF LONDON.

Transactions of the Royal Society of Edinburgh, Vol. XXVI, Part I;—Proceedings, Session 1869-70 :—THE ROYAL SOCIETY OF EDINBURGH.

Journal of the Chemical Society of London, Vol. VIII, November and December; Vol. IX, January :—THE CHEMICAL SOCIETY OF LONDON.

Journal Asiatique, No. 58 :—THE SOCIÉTÉ ASIATIQUE, PARIS.

Monatsbericht der K. Preussischen Akademie der Wissenschaften, January 1871 :—K. PREUSSISCHE AKADEMIE DER WISSENSCHAFTEN ZU BERLIN.

Atti della Reale Accademia delle Scienze di Torino, Vol. V, Disp. 1-7;—Vol. IV, Appendice;—Notizia Storica dei lavori fatti dalla classe di Scienze Fisiche e Matematiche, 1864-1865;—Observation de L'Essaim des E'toiles Filantes du 12-14. Novembre, 1869;—Bollettino Meteorologico ed Astronomico del Regio Osservatorio dell' Università di Torino, 1869 :—REALE ACCADEMIA DELLE SCIENZE DI TORINO.

Kongliga Svenska Vetenskaps-Akademiens Handlingar, Ny-Följd, 1864-67;—Meteorologiska Iakttagelser i Sverige utgifna af Kongliga Svenska Vetenskaps.—Akademien, anställda och bearbetade under inseedé af Er Edlund, 1864-66.—Lefnadsteckningar öfver K. Svenska Vetenskaps Akademiens, efter Ar 1854 aflinda, Ledamöter, Band I, Hälfte I;—Öfversigt, 1865—68.—Die Thierarten des Aristoteles von den Klassen der Säugethiere, Vögel, Reptilien und Insekten von Carl. J. Sundevall;—Conspectum Avium picinarium, edidit, Carl. J. Sundevall;—Hemiptera Africana descripsit Carolus Stål, Tom 1-4 :—KONGL. VETENSKAPS-AKADEMIE, STOCKHOLM.

Mémoires de la Société Royale des Sciences de Liège, 2^{me} Série, Tom 1-2 :—SOCIÉTÉ ROYALE DES SCIENCES DE LIÈGE.

Journal of the Agricultural and Horticultural Society of India, Vol. II, Pt. II:—THE AGRICULTURAL AND HORTICULTURAL SOCIETY OF INDIA.

Archivo per L'Antropologia e la Etnologia, pubblicato per Dr. P. Mantegazza, Dr. F. Finzi;—THE AUTHORS.

Brahma und die Brahmanen, von Dr. M. Haug:—THE AUTHOR.

Derivative Hypothesis of Life and Species, by Prof. Owen:—THE AUTHOR.

Preliminary Sketch of a Natural Arrangement of the Order *Docoglossa*, by W. H. Dall.—Note on the transversely striated muscular fibre among the Gasteropoda, by W. H. Dall:—THE AUTHOR.

The Religious Sects of the Hindus, by Akshayacumāra Datta:—THE AUTHOR.

A Report on the Microscopic Objects found in Cholera evacuations, by T. R. Lewis:—THE AUTHOR.

Rāmāyana, Vol. II, No. 7, Edited by Hemachandra:—THE EDITOR.

Rahasya Sandarbha, November, 1865:—THE EDITOR.

Flora Sylvatica, Part VII;—Icones Plantarum Indiæ Orientalis, Part VII;—General Report on the Topographical Surveys of India, 1869-70;—General Report on the operations of the Great Trigonometrical Survey of India, during 1869-70;—General Report on the Revenue Operations of the Bengal Presidency, 1869-70:—THE GOVERNMENT OF INDIA.

Vedārthapradīpa No. 1:—H. H. THA'KUR GIRIPRASAD SINHA.

Exchange.

The Athenæum for February, 1870.

Nature, Nos. 65-75.

Purchase.

Revue des deux Mondes, 15th October, 1870:—Journal des Savants, September, October, November, December 1870:—Comptes Rendus, Nos. 11-19:—American Journal of Science, February 1871:—Annals and Magazine of Natural History, March 1871:—L. E. and Dublin Philosophical Magazine, No. 272:—Thorell's Remarks on Synonyms of European Spiders, No. 1:—Thorell on European Spiders:—Gould's Birds of Asia, Part XXIII:—Ferguson's History of Architecture, Vols. I and II:—Cunningham's Geography of Ancient India, Vol. I.:—Tyndall's Diamagnetism:—Galton's Hereditary Genius:—Beale's Disease Germs:—Jacolliot The Bible in India:—Bhagavatgīta in Persian verse, (MS.) by Feizi.

PROCEEDINGS
OF THE
ASIATIC SOCIETY OF BENGAL

FOR JUNE, 1871.



The monthly meeting of the Society was held on Wednesday the 7th instant, at 9 o'clock P. M.

The Hon'ble Mr. Justice Phear, President, in the chair.

The Proceedings of the last meeting were read and confirmed.

Presentations were announced,—

1. From Bábu Rámadása Sena, a Bengali MS., entitled *Pas'úpás'amokshanam*, by the late Rádhámohana Sena.

2. From the author.—A copy of 'Remarks on the anatomy of the genus *Siphonaria*,' by W. H. Dall, Esq., and a copy of 'Materials towards a monograph of the *Gadiniide*,' by W. H. Dall, Esq.

3. From the author.—English Legislation for India, by A. M. Broadley, Esq., C. S.

4. From Rev. M. E. Lafont.—2 copies of 'Meteorological Observations made in the St. Xavier's College Observatory from July to December, 1870.'

5. From M. L. Ferrar, Esq., C. S., 2 silver and 6 copper coins, dug up at Qanouj.

The copper coins present no particular points of interest. They are a copper coin of Fírúz Sháh III. of Dihli, two copper coins of Ibráhim Sháh of Jaunpúr, one copper coin of Husain Sháh of Jaunpúr of A. H. 887, two defaced Bactrian copper coins, and fragments of two silver coins.

6. From the author.—A copy of Memoir of the Ghazeepeer District, by Wilton Oldham, LL. D., B. C. S.

7. From the author.—The Topography of the Mogul Empire, as known to the Dutch in 1631, &c., by E. Lethbridge, Esq., M. A.

8. From the Society.—Six copies of Abstract of Proceedings of the Muhammadan Literary Society of Calcutta.

Ch. Darwin, Esq., proposed by the Council at the last meeting of the Society was balloted for and elected an Honorary Member.

The following gentlemen duly proposed and seconded at the last meeting were balloted for and elected ordinary members :—

Capt. C. Stewart Pratt.

Maulaví Habíburrahmán.

J. W. Alexander, Esq.

Bábu Gangáprasád Sinha.

Bábu Rámakrishna Dása.

The following gentlemen are candidates for election at the July meeting :—

J. R. Reid, Esq., C. S., Azimghur, proposed by W. Oldham, Esq., LL.D., C. S., seconded by H. Blochmann, Esq.

J. Smith, Esq., C. S., Ghazípur, proposed by W. Oldham, Esq., LL.D., C. S., seconded by H. Blochmann, Esq.

E. W. Oates, Esq., C. E., proposed by S. Kurz, Esq., seconded by Dr. F. Stoliczka.

Col. Octavius Hamilton, proposed by the Hon'ble J. B. Phear, seconded by Col. H. Hyde.

C. T. Buckland, Esq., C. S., proposed by Col. H. Hyde, seconded by Dr. F. Stoliczka.

Khalífah Sayyid Muhammad Hasan, Prime Minister to His Highness the Mahárájah of Patíalah, proposed by Maulaví Abdool Luteef Khán Bahádúr, seconded by the Hon'ble J. B. Phear.

Capt. R. D. Osborn has intimated his desire to withdraw from the Society.

The President said that, acting on the request of Dr. Neil, Meteorological Reporter of the Punjab, he must ask the attention of the meeting for a few moments to a short correspondence which had passed between Dr. Neil and himself. It had happened un-

fortunately that a passage in the Presidential Address, delivered before the Society in March last, was so couched as to lead Dr. Neil to consider that it conveyed an incorrect representation of the state of Meteorological Observations in the Punjab, and accordingly that gentleman wrote to the President in the following terms:—

Lahore, May 11th, 1871.

‘DEAR SIR,—I was somewhat surprised to find you stating, in your Presidential Address at a recent meeting of the Asiatic Society, that “according to the published reports out of 19 stations,* from 2 only have continuous registers extending over two and a half years, been furnished,” &c. I must ask you to contradict this statement, as it disagrees entirely with facts, and in doing so, I trust you will give the same publicity both to your contradiction and to this letter, as has already been given to your address.’

‘From Multan alone I have records of continuous registrations from 1862 to the present time. From Lahore, Syalkote, Dera Ismael Khan, Rawalpindi, continuous registrations have been kept up since May 1866. Since January 1869, observations have been registered at Ludianah, and for three and a half years continuous registrations are on record at Shahpoor.’

‘At present registrations of—Barometric pressure, Hygrometry, Solar Temperature, Max. and Min. ditto., Direction of Wind, Rain-fall,—are being recorded in Lahore, Multan, Dera Ismael Khan, Rawalpindi, Ludianah, Dhurmsala and Murree, at all of which places the observers are *paid*. The observations are recorded on the plan recommended by Glaischer; the instruments are all good, the barometers being, in the cases of those at Lahore, Ludianah, Dera Ismael Khan, Dhurmsala and Murree, mercurial which have been compared with a standard. In other stations, registrations which do not include records of atmospheric pressure are kept as in Umritsur, Gurdaspore and Dalhousie. In some of the stations I have had anemographs erected for the continuous registration of the direction of the wind. A hiatus will occasionally occur in a register from such accidents as breakage or disorder of instruments. Out of three barometers (Adie’s Mercurial) which I ordered recently

* In the Panjab.

only one reached me which is destined for Ladakh. That embassy has already cost Government three barometers and myself one.'

The remaining portion of Dr. Neil's letter did not bear upon the particular matter of complaint, and therefore for the moment he, (the President), would abstain from reading it. He at once replied to Dr. Neil as follows :—

19th May, 1871.

'DEAR SIR,—Your letter, dated the 11th May, reached me late in the evening of the 17th. I regret much to learn from it that you consider you have occasion to complain of a statement lately made by me in the course of an Address to the Asiatic Society. You quote from the Address the following words, "According to the published reports, out of 19 stations in the Punjab, from 2 only have continuous registers, extending over two and a half years been furnished," and you say that this statement disagrees entirely with facts.'

'You will observe that in this passage, I do not refer to your records of registration, as to which I have indeed no information. I merely speak here of the published reports. And at the time when I delivered my address there were, I believe, but three of these, namely, the reports for 1866, 1867 and 1868. The report for 1869 was (if I am not mistaken) not then published. At any rate, I was certainly not aware of its existence.'

'The monthly abstracts in these three Reports for 1866, 1867 and 1868, appear to me to cover a period of almost exactly two and a half years. I have just now in consequence of your letter, carefully looked through these again, and I must confess I am quite unable to discover on this review that my original statement in reference to this period is in any degree erroneous. In regard to all excepting 2 out of the 19 stations, there seem to be breaks of greater or less extent in the continuity of every abstract. I take for instance your own-principal station of Lahore, I find there are no observations, or results of observations given, for the months of May, June, July, August and September 1868. I need hardly say, however, that I am nevertheless most ready (if you still wish me to do so) to comply with the request, which you make to the effect, that I should give the same publicity to your letter as was given to my address; and,

accordingly, unless I hear from you to the contrary I will take care that your letter is read at our next meeting, which will take place on Wednesday, 7th June, and is also published in our Proceedings.'

'I thank you very much for your kind words of courtesy towards myself.'

I am yours very faithfully

J. B. PHEAR,

Pres. of As. Soc. Bengal.

To A. NEIL, Esq., M. R. C. S. L.

Lahore.

To this letter he received the following answer :—

Lahore, 23rd May, 1871.

'DEAR SIR,—Your reply to my letter is, as I of course expected it to be, quite satisfactory. My Report for 1869 was out about the end of last year, but was not distributed till some time after. I should like my letter to be published, however, in the next issue of the Journal, not so much in reference to your remarks about my Reports, as because it contains my views, in great part at least, regarding the method of conducting Meteorology in this country, and what ought to be done in order to have a combined plan of registration. I believe Col. Strachey has for some time had the matter under consideration, and I wrote to him about the same time as I addressed you, but I have not as yet heard from him in reply.'

'The hiatus, which you note in the Lahore Register for part of 1868, was owing to my having had to leave the station for another, and some time elapsed before I could get a proper system of registration re-established. The breakage and damages that so often occur to inspections are a source of continual anxiety to me. Barometers are an especial source of grief and annoyance. Thanking you very much for your letter,'

'I am, dear Sir, Yours very faithfully,

A. NEIL.'

'As an explanatory footnote to my letter, I should like to say,—

'I have since learnt from the President of the Society that he had not seen my last Report (for 1869) before he delivered his ad-

dress. This of course explains the mistake which would necessarily find its way into most people's minds, that up to the time of his delivering his address, two and a half years of complete registration had been made in only 2 stations. The Registration of Meteorological Phenomena was only commenced in the middle of 1866.'

A. N.

Had it not been for the especial request made in this second letter of Dr. Neil, he, (the President), should have considered himself justified in laying before the meeting only that portion of Dr. Neil's first letter which he had already read, as being seemingly sufficient to satisfy Dr. Neil's purpose. He felt himself, however, under the circumstances constrained to read the remainder, although before doing so he must premise that one passage, at least, in it appeared to him to have a much greater tendency to discredit the Punjab observations, than any words employed by him in his address could possibly have. The remainder of the letter was as follows:—

'I gather from your address that you are of opinion that the whole Meteorological Registration of India should be under one directing head. I am quite of opinion that it should be as much as possible conducted upon one system, but that the entire management, with any regard to useful result, is within the mental capacity of one human being, is a question which hardly merits being argued. One definite system is requisite and necessary, and the simpler the system the better and more accurate will be the results. This most desirable starting-point would, I conceive, be best obtained by a conference of the present staff of Meteorologists. Each should have his own province to manage upon the defined system, and each should interpret the data with which he is supplied according as his better knowledge of his own province will guide him. My field of observation is, you will admit, a tolerably large one. It embraces about 10 parallels of Latitude by about an equal number of degrees of Longitude. Within this area there is much for the Meteorologist to consider. He has to do his best to interpret the laws which regulate the climatic phases of a country, part of which has an elevation of only a few hundred feet above sea level, while immense tracts have an altitude as high as any

known inhabited tract on the globe. To expect, therefore, that one directing head could so expand his powers of observation, however profound his knowledge of the general laws of Meteorology might be, as to grasp and interpret the masses of Meteorological facts which would pour in upon him from all the Provinces and Presidencies of India, is to expect a manifest impossibility. Our first and greatest necessity, I conceive to be the correct registration of barometric and wind phenomena. The form of barometer which pleases me most is Gay Lussac's syphon, read by two Verniers. Some object to the bother of reading two Verniers, but to this I always say—there is not so much trouble in reading two Verniers as there is in making all the troublesome corrections for capillarity, temperature, reduction to sea level &c. &c.* The anemograph which I have in use gives a pencil tracing of the direction of the wind for 24 hours. I enclose one for your inspection. It only gives the direction you will perceive. The force can be obtained as required by a separate instrument—such as Robinson's anemometer. I can generally form an idea whether the wind has been blowing high or gently, or even whether it has not been an absolute calm (we do not often have an absolute calm in the Punjab) by the *straightness* or otherwise of the tracing.'

'I have noted with great pleasure the evident interest which you take in the progress of Meteorological Science. We can no more foretell what the patient pursuit of this Science may disclose, than could the past generation have anticipated the wonderful and glorious revelations of geology, microscopy and electricity.'

I am, yours faithfully,

A. NEIL.

Prof. of Anatomy and Surgery, Lahore Medical School,

Meteorological Reporter for the Punjab.

THE HON'BLE MR. PHEAR,

President of the Asiatic Society of Bengal.

If the Meteorological Reporter of the Punjab really entertains the persuasion, as he seems here to intimate that he does, that by taking the two readings of a syphon barometer, he gets observations, which

* As in Fortin's barometers.

are such as to free him from the obligation to reduce them by such corrections as correction for temperature and for the height of the place of observation above the sea-level before publishing, then it is hardly too much to say that his letter discloses that which makes his own tables altogether untrustworthy.

The following papers were read :—

I.—NOTES ON SEVERAL ARABIC AND PERSIAN INSCRIPTIONS RECEIVED FROM MEMBERS OF THE SOCIETY,—by H. BLOCHMANN, ESQ., M. A., CALCUTTA MADRASAH. (Abstract.)

Mr. Blochmann said,—

The inscriptions which I lay before the meeting were received by the Society in the course of last year. Some of them were forwarded in the shape of rubbings, others were decyphered, by various members as Dr. W. Oldham, C. S., Gházípur; Mr. J. G. Delmerick, Ráwal Pindí; Mr. A. Cadell, C. S., Muzaffarnagar; Mr. A. S. Harrison, Bareilly College, and Mr. A. Carlyle, Agrah, to whom the Society owes several most costly contributions. One inscription I obtained from Burdwan.

I trust the members of our Society will continue to favour us with inscriptions and rubbings. These inscriptions, if not always of historical importance, are yet interesting, and help historians to correct dates and verify events, or settle boundaries, or fill up gaps—and this is especially the case with old Bengal inscriptions—in the lists of kings.

1. *An inscription received from Dr. W. Oldham.* It refers to the building of a mosque in A. D. 1527 by a Bengal Amír, who lived under Nuçrah Sháh, the same king of Bengal whose name occurs in the inscriptions at Sátganw. It is on black basalt, and was found at Sikandarpúr, zil'ah 'Azíngarh. The locality is here of importance.

2. *Two inscriptions from Mr. Delmerick.* One refers to the building of Fort Añak by Akbar in 1583 (991, A. H.); the other to the construction of the Margalah Pass by Aurangzib, when the emperor was at Hasan Abdál. Its date is A. D. 1672 (A. H. 1083).

3. *From Mr. A. S. Harrison.* An inscription from the Mausoleum of the famous Rohíláh Chief Háfiz Rahmat, and from two mosques. Also an inscription from a mosque in the Mírzái Mahallah, Bareílí, built by Hakím 'Alí of Gílán, a personal friend of Akbar, in 1579 (or A. H. 987), when the Hakím was Faujdár of Sambhal.

4. *From Mr. A. Cadell.* Two interesting inscriptions from the Mausoleums of two Bárha Sayyids of the Kundlíwál branch, S. Mahmúd and S. Chhahjú, who served under Akbar. The latter died in 1559-60 (A. H. 967), the former in 1574 (A. H. 982).

A peculiar interest attaches to the Bárha Sayyids, who up to the present time form an important element in the population of the Muzaffarnagar District. They trace their origin from one Sayyid Abul Farah who in the beginning of the Muhammadan rule immigrated from Wásit into India. The clan has received much attention from historians. Sir H. Elliot in his Glossary, and Mr. C. Elliott in his 'Chronicles of Onáo,' speak of them. Mr. R. J. Leeds has a lengthy note in his Report on the Castes and Races of the Muzaffarnagar District, and Mr. Cadell has forwarded together with the inscriptions several valuable genealogical trees.

The Bárha Sayyids first served under Akbar, and though praised in the histories for their valour and firmness in battle, they were sneered at for their boorish manners. But under Jahángír they became more refined, and in the following reigns their influence was very great, as may be seen from the fact that they made Farrukh Siyar, Rafi'uddarajat, Rafi'uddaulah, and Muhammad Sháh emperors; they dethroned and killed Jahándár Sháh and Farrukh Siyar, whom they had blinded; and they blinded and imprisoned Princes A'azzuddín, 'Alí Tabár, and Humáyún Bakht.

5. *From Mr. A. Carlyle.* Several inscriptions from tombs in the old cemetery at Ágrah. They do not refer to persons historically known, but are distinguished by their elegant verses. Also an inscription from the Ajmírí gate in Ágrah. It refers to the building of a mosque by one Hájí Sulaimán, in 1031 A. H., or A. D. 1622.

I draw the attention of the meeting to the beauty of the letters; Mr. Carlyle is a master in taking rubbings.

6. The last inscription I have received from Bardwán. It stands over the tomb of a Persian poet, Bahrám Darvish Saqqá. Our library has a copy of his works. He was a faqír, and wandered about the streets of Agra as a bhíshítí dispensing water among the poor. Hence also his nom-de-plume, *Saqqá*, a bhíshítí. He is mentioned in works in Persian literature, and it is stated that he died on his way to Ceylon. His tomb was discovered at Bardwán by the Persian writer Khushgo. From the inscription it appears that Saqqá died at Bardwán in A. D. 1574, or A. H. 982. People often pray at his tomb.

Within his shrine is also the tomb of Sher Afkan, Jágirdár of Bardwán in A. D. 1606, whom Jahángír had killed, in order to marry his beautiful wife, Mihrunnisá, to whom he gave the title of Núr Mahall, and later that of Núr Jahán.

The tombs of Bahrám Saqqá and Sher Afkan are the historical sights of Bardwán.

MEMORANDUM ON THE TOTAL ECLIPSE OF DECR. 11, 12, 1871,—
by LIEUT.-COL. J. F. TENNANT, R. E., F. R. S.

In December of this year we have a Total Eclipse visible in Southern India. The duration is short, but in some respects the circumstances are very favourable, as the Line of central Eclipse passes over the Nilgherry Hills, where I understand fine weather may be confidently expected. In order to be prepared, I have computed carefully the Central Line across India, and have added the extent to which errors of the Tabular place of the moon may be expected to shift it. In the following Table $\Delta\alpha$ represents the excess of the Moon's time above the Tabular Right Ascension in time, and $\Delta\delta$ the excess of the Tabular above the true S declination.

I hope to have before the Eclipse a knowledge what errors may be anticipated in the Tables and thus be in a position to choose a central spot, if it is worth making a change. The figures, however, show that this is not probable, the principal result of an error in Right Ascension being to shift the Centre of the Shadow along its path the deviation from which would be corrected by a small error in the declination which could hardly be foreseen.

Greenwich Mean Time.		Places of Centre of Shadow.																			
		North Latitude.			East Longitude.																
m. m.		13°	20′	9″	—	1225″	5	Δα	71″	75	Δδ	73°	19′	38″	2939″	8	Δα	—	12″	13	Δδ
14	25.0	12	50	52	—	1124.	7		69.	35		74	15	43	2719.	8		—	8.	57	
	25.5	12	23	37	—	1043.	6		68.	13		75	5	19	2588	9		—	6.	34	
	26.5	11	58	3	—	1001.	8		67.	34		75	52	23	2408.	6		—	4.	63	
	27.0	11	33	50	—	920.	5		66.	64		76	36	10	2275.	5		—	3.	24	
	27.5	11	10	49	—	871.	8		65.	95		77	17	27	2171.	5		—	1.	85	
	28.0	10	48	50	—	829.	7		65.	39		77	56	21	2081.	3		—	0.	76	
	28.5	10	28	10	—	792.	8		64.	91		78	32	48	2004.	0		—	0.	17	
	29.0	10	7	28	—	757.	7		64.	45		79	8	58	1925.	5		—	1.	05	
	29.5	9	47	52	—	728.	8		64.	06		79	42	56	1869.	2		—	1.	79	
	30.0	9	28	56	—	701.	7		63.	72		80	15	32	1812.	0		—	2.	38	

The duration of the Eclipse will be small. At the Nilgherries it will be about 2 minutes, but this cannot, so far as I know, be as yet accurately predicted from uncertainty as to the real diameters of the sun and moon, when free from the enlargement by irradiation. If the value of the moon's diameter deduced by Oudemans from Eclipses, be used with that of the Sun obtained in the Greenwich Transit Circle, then I find the duration in the Nilgherries just 2 minutes. The data of the Nautical Almanac give 2 minutes 7 seconds, and if I may judge from the result I got in 1868 the real duration will fall between these.

Short as this time is, it is enough with an adequate preparation to produce some results of value. It is long enough to allow Photographs to be taken of the Corona, as to whose structure there is more to be discovered. There seems now no sort of doubt that the Corona is not only a Solar appendage, but is, as I stated in

my Report on the Eclipse of 1868, the comparatively cold atmosphere of the Sun. This should be farther spectroscopically examined. Observers have differed about the number and position of the faint bright lines they have seen, but it does not seem that any one has connected the variations with the position of the part examined. To do this appears urgently necessary, and there have been additions made to the spectroscope which will allow more than one portion of the Corona to be examined, and its lines recorded during the short time it is visible.

There is another subject too of spectroscopic examination. Kirchhoff in his theory of the solar constitution supposed it surrounded by an extensive atmosphere consisting of metallic and other vapours, as well as gases, by the absorption of which the dark Fraunhofer lines were produced. It has long been clear that there was no such extensive atmosphere and some physicists have been satisfied that there is none such. Mr. Lockyer and his collaborators, though they have detected a greater number of bright lines at the bases of the prominences, have never approached, so far as I know, the number of even the conspicuous dark lines, whose explanation has, therefore, not been satisfactorily made out. At the Eclipse of December 22, 1870, however, Professor Young at the moment of obscuration, and for one or two seconds later, saw as far as he could judge every atmospheric line reversed, and this was confirmed by Mr. Pye. I have but the scant information of this point given in the Royal Astronomical Society's Council Report, but it is sufficient to show me why this has not been seen before by observers looking out for it, and also to make me feel the importance of verifying the observation.

To understand why it has not been seen before, it must be considered that the image of a bright object in the focus of a Telescope when relieved against comparative darkness is enlarged by a phenomenon known as irradiation; the light encroaches on the darkness. The sun thus appears larger and the moon smaller than the real size. This continues till the real contact of the Limbs internally; at this moment the thread of light, which previously had considerable width, appears suddenly broken and vanishes in a Total Eclipse: while in the Transit of a Planet or Annular Eclipse

there appears the "black drop" of the observers of the Transit of Venus in 1769. At A in this figure I have endeavoured to give some idea of this phenomenon in an Annular Eclipse, and at page 16, Vol. XXIX, of the monthly notices of the Astronomical Society will be found some figures illustrating this in a Planetary Transit.

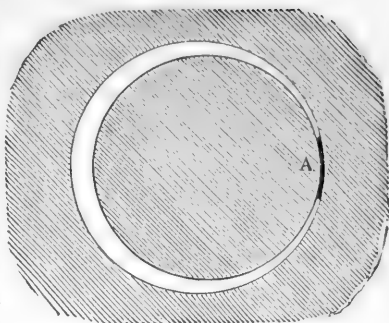

When we are dealing with so thin a stratum surrounding the true Photosphere, we cannot see it in sunshine, as it is lost in the irradiation, (it *may* be partly visible in very large Telescopes where the irradiation is very small), and we are very apt to lose it at the moment when the sun disappears, for it is found only between the places where a moment before the Sun a Moon's limb appeared, so that the observer following either of them might well miss it.

In the search for, and verification of this important observation, the duration of Total phase can matter little.

I have been in communication with the Home Secretary on the subject of observations of this Eclipse, and my views I may say have been most cordially received. I am not yet in a position to submit a proposition officially, but I have great hopes of being able to do so in a few days.*

P. S.—I may just mention that in plotting the Shadow Track on a map it is necessary to allow for the error of its zero of Longitude, a precaution often forgotten. The Longitudes of the G. T. Survey require a correction of $3^{\circ}2'7''$, and those of the Atlas of India one of $4^{\circ}11''$ to adjust them to the accepted Longitude of Madras.

The President was very glad to learn from Col. Tennant that the Government is likely to sanction a scientific expedition to the Nilgherries on the occasion of the Total Eclipse in December next. The objects to which Col. Tennant proposed to direct observation were, he need hardly say, of very great scientific interest and importance. The spectroscopic analysis of the Corona, so far

* This has since been done.

as it had yet been effected, had been productive of no very certain results. The matter could not, however, be in better hands than those of Col. Tennant. He only wished to suggest that those members of the Society, who might have the requisite leisure and opportunity, should, even with the unaided eye, endeavour to observe as carefully as possible the exact apparent shape and characteristics of the Corona. He believed that data of very considerable value might be thus obtained by persons, who knew how to observe.

Later in the evening Col. Tennant kindly consented to draw up some short directions which might serve as a guide to members of the Society who might visit localities of the Total Eclipse.

III.—NOTES ON THREE INSCRIPTIONS FOUND IN CHUTIA' NA'GPU'R, by BA'BU RAKHAL DAS HALDAR.

Mr. Blochmann read extracts from the paper, which will be published in the second number of the philological part of the Journal. The inscriptions are in Sanscrit and Hindí, of the years A. D. 1665, 1668, and 1737. In one of them (A. D. 1665), a Chutiá Nágpúr Rájah of the name of Raghunáth is mentioned.

Mr. Blochmann said—Bábú Rakhal Das Haldar remarks on the absence of authenticated historical information regarding Chutiá Nágpúr. Muhammadan historians certainly give very little to enable us to verify the details of the family history of the Rájahs. I have, however, collected the scattered notices which are found in the historical works of the Mughul period, not only regarding Chutiá Nágpúr, but also Pachet and Palámau, and trust they may throw some light on the history of these districts.

The notices are taken from the *Akbarnámah* (Lucknow edition, III., pp. 491, 641), the *Tuzuk i Jahángírí* (Sayyid Ahmad's edition, p. 155); the *Pádisháhnámah* (I., b., p. 317; II., pp. 248 to 250, and 356 to 361); and the *'Alamgírnámah* (pp. 649 to 660, and p. 972). A few additional notes may be gathered from Sarishtahdár Grant's essay on Bengal and Bihar Finances in the Vth Report.

The extracts will be published in the Journal. They refer to the first invasion of Chutiá Nágpúr (or Kokrah, as it is called,) under Shahbáz Khán Kambú, one of Akbar's generals, in A. D

1585, when Mádhú Singh was zamíndár of Kokrah, and to the second invasion, in 1616, under Ibráhím Khán Fath-jang, governor of Bihár, who defeated Rájah Durjun Sál. There are also some notes on the diamond washings as then carried on in the River Sank.

Regarding Pachet we have a short notice of Rájah Bir Naráin, who died in A. H. 1042-43, or A. D. 1632-33.

The extracts regarding Palámau refer to the invasions, in A. D. 1641 and 1643, by Sháistah Khán and Zabardast Khán, when Pratáb, son of Balbhadr, the Chero, and Tíj Rái, his usurping uncle, were Rájahs. Pratáb was afterwards reinstated, and was still alive in 1647. The *jama'* of Palámau was then R. 250,000, and the *peshkash* which the Rájahs had to pay to Sháhjahán's treasury, was fixed at a lac of rupees. The '*Alamgírnámah*' says that the Rájahs did not regularly pay the *peshkash*; and in 1661, the fourth year of Aurangzib's reign, Dáúd Khán, governor of Bihár, was ordered to invade the district. Of this expedition we have ample details. The result was that the forts Deokan, Koṭ'hi, and Kundah, were occupied, and Palámau itself was taken by storm on the 14th December, 1661, when the then Rájah, whose name is not given, had to submit to the appointment of an imperial Faujdár. The first Faujdár, Manklí Khán, remained at Palámau for a few years.

IV.—ON SOME NEW SPECIES OF PERSIAN BATS, by G. E. DOBSON,
B. A., M. B. *Assistant Surgeon H. M.'s British Forces.*

(Abstract.)

Mr. Dobson introduced to the notice of the Society two new species of Persian bats. One of the species is the type of a new genus of *Rhinolophine* bats, and its discovery leads to the necessity of forming for its reception a new group, as the characters given by Dr. Gray of the four groups into which he divides the *Rinolophida** do not admit of its being placed in any one of them.

The nasal appendages are very complicated, the anterior portion of the nose-leaf is horse-shoe shaped, consisting of two

* Proc. Zool. Soc. 1866.

laminæ; the upper, overlying lamina deeply emarginate in front, the opposite sides of the emargination turned upwards, and supporting the anterior portion of a broad, flat, longitudinal crest which ends in a triangular head above and between the nostrils. The hinder portion of the nose-leaf arises from a thick root immediately behind the nostrils; the base is hollow containing a single cell, the opening to which is guarded by a lanceolate process of membrane. The crest is trident shaped, consisting of a central, lanceolate process, similar to that below, but longer, and two lateral and somewhat broader projections, parallel to it, and nearly equal to it in length. On each side of this hinder nose-leaf are six cells of which one is situated behind and at its side, immediately above the eye, occupying the position of the minute pores observed in nearly all the animals of Gray's 2nd group.

The form of the ears, and the place of attachment of the outer margin are also remarkable, as well as the peculiar shape of the bones of the arm in the neighbourhood of the elbow joint.

For the new genus Mr. Dobson proposes the name *Trianops*, and for the species *persicus*.

Dentition.—In. $\frac{2}{4}$, c. $\frac{1-1}{1-1}$; pm. $\frac{2-2}{2-2}$, m. $\frac{3-3}{3-3}$.

Length of head and body 2".25; tail 1".2; forearm. 2".0.

The second new species belongs to the genus *Pipistrellus*, Gray. It approaches *P. serotinus*, but differs from it in the shape of the tragus, colour of the fur, &c.—Ears large, triangular, outer margin faintly hollowed out below the tip, and emarginate opposite the base of the tragus, terminating by forming a small lobe; tragus rather long with subacute, rounded tip, and almost straight inner margin; fur above dirty buff, beneath pale buff.

Dentition.—In. $\frac{2-2}{6}$; pm. $\frac{1-1}{2-2}$, m. $\frac{3-3}{3-3}$

The minute upper pre-molar, placed inside the line of the teeth, so commonly seen in the species of the genus to which this bat belongs, is not discernible in either of the two specimens brought from Persia.

Length of head and body 2".8; tail 2".0; forearm 2".2.

The specimens were obtained at an elevation of 4750 feet near Shiraz in Persia; Mr. Dobson accordingly proposes for the new species the name "*Shiraziensis*."

A full account of these new species, with notes on some others from the same region, will appear in Part II, of the Journal.

V.—NAMES OF BIRDS &C. IN FOUR OF THE ABORIGINAL LANGUAGES OF WESTERN BENGAL, by V. BALL, *Esq.*

This paper gives a list of names of a great number of birds and other animals in four of the languages which are spoken by the different aboriginal tribes in Western Bengal. A comparison of the names shews that, as a rule, there is a great difference in the designations of wild animals in the various languages noticed, while on the contrary the names of the domesticated animals are, as in most other languages, derived from the same root. This paper will be published in the Philological part of the Journal for the current year.

The receipt of the following communications was announced.

On the Death of Humáyún, by C. J. Rogers, Esq.

Legends and Ballads of the District of Bhágálpúr, by Bábu Rash Behari Bose.

Antiquities of Jájpúr, by Bábu Ch. Sikhur Bannerjí, Tumlook.

An account of the antiquities of Jesar-Ishwarípúr, by Bábu Rash Behari Bose, Banka.

LIBRARY.

The following additions have been made to the Library since the meeting held in May last:—

Presentations.

** Names of donors in Capitals.

Proceedings of the Royal Society, vol. XIX, No. 126.—THE ROYAL SOCIETY OF LONDON.

Proceedings, parts I-II, for 1870:—Transactions, vol. VIII, parts III-V.—THE ZOOLOGICAL SOCIETY OF LONDON.

Monatsbericht, Febr., März, 1871.—K. AKADEMIE DER WISSENSCHAFTEN ZU BERLIN.

Sitzungsberichte, 1870. Heft I-IV :—Denkschrift auf Christ. Erich Hermann von Meyer, von Carl. A. Zittel.—KÖNIGL. BAYER. AKADEMIE DER WISSENSCHAFTEN ZU MÜNCHEN.

Discorso del Commre Negri Cristoforo.—SOCIETA GEOGRAFICA ITALIANA.

Historical and Statistical Memoir of the Ghazeepeer District, by W. Oldham, B. C. S., LL. D, part I.—THE AUTHOR.

The Topography of the Moghul Empire as known to the Dutch in 1631, by E. Lethbridge.—THE AUTHOR.

English Legislation for India, by A. M. Broadley, C. S.—THE AUTHOR.

Gulzár-i-Kashmír, by Kripárám.—THE AUTHOR.

Materials towards the monograph of the *Gadiniidae*, by W. H. Dall :—Remarks on the Anatomy of the Genus *Siphonaria*, by W. H. Dall.—THE AUTHOR.

Pas'upás'amokshaṇam, by Rádhámohana Sena.—BA'BU RA'MA-DA'SA SENÁ.

Memoirs of the Geological Survey of India, vol. VII part 3 :—Palæontologia Indica, vol. III, Nos. 5-8.—THE SUPERINTENDENT OF THE GEOLOGICAL SURVEY OF INDIA.

Abstract of Proceedings of the Muhammadan Literary Society of Calcutta.—THE M. LITERARY SOCIETY.

Report on the Land Revenue Administration of the Lower Provinces, 1869-70.—THE GOVERNMENT OF BENGAL.

Records of the Geological Survey of India, vol. IV, parts I-II.—The Leepedeeppeeka.—General Report on the Administration of the Bombay Presidency, 1869-70.—THE GOVERNMENT OF INDIA.

Purchase.

The Westminster Review, April 1871.—The Annals and Magazine of Natural History, No XL.—The L. E. & D. Philosophical Magazine, No. 273.—Revue des Deux Mondes, Janr, Fevr., Mars, 1871.—Comptes Rendus, Nos. 1-12.—Hewitson's Exotic Butterflies, part 78.—Reeve's Conchologia Iconica, parts 286, 287.—Cheref-Námeh, vol. I, part II.—Ibn-El-Athíri vol. V.

Exchange.

The Athenæum for March, 1870.

The Nature, Nos. 76—79.

Errata in the two last numbers of 'Proceedings.'

- On page 106, line 23 from above read 'tail, 1".2' for 'tail 6".6.'
- " " 107, " 2 " " " *Cynonycteris* for *Cynonycterus*.
- " " " " " " " " $\frac{4}{4}$ for $\frac{1}{4}$.
- " " 131, " 17 " " " 'sun and moon's limbs' for
'sun a moon's limb.'
- " " " " 29 " " " '— 3'-2".7"' for '3'-2".7".'
- " " " " 30 " " " '— 4'-11"' for '4'-11".'
- " " 134, " 30 " " " after In. $\frac{2-2}{6}$ insert C. $\frac{1-1}{1-1}$.

1870

1871

1872

1873

1874

1875

1876

1877

1878

1879

1880

1881

1882

1883

1884

1885

1886

1887

1888

1889

1890

1891

1892

1893

1894

1895

1896

1897

1898

1899

1900

PROCEEDINGS
OF THE
ASIATIC SOCIETY OF BENGAL

FOR JULY, 1871.



The monthly meeting of the Society was held on Wednesday the 5th instant, at 9 P. M.

The Hon'ble Mr. Justice Phear, President, in the chair.

The minutes of the last meeting were read and confirmed. Presentations were announced—

1. From Rev. J. Long,—A copy of 'Historical Notice concerning Calcutta in the days of Job Charnock.'—A copy of the 'Holy Bible in short-hand.'—A copy of 'Outlines of Amharic,' by the Rev. C. H. Blumhardt.—A copy of a 'Manual of Geography in Maharatti,' vol. II, by Major T. Candy.—A copy of the Parsee Acts, by Sarabjee Shapoorjee Bengalee.—A copy of the Phonetic Journal for 1864.

2. From Rev. C. B. Lewis,—A copy of the Christian Spectator, Vol. I., No. I.

The Council reported that they have elected Col. J. F. Tennant as Member of Council and Financial Secretary, in place of Col. H. Hyde, proceeding on leave.

Also, that Mr. J. Beames, C. S., has resigned the task of editing Chand's poems.

The following gentlemen proposed and seconded at the last meeting were elected Ordinary Members—

J. R. Reid, Esq., C. S.

J. Smith, Esq., C. S.

E. W. Oates, Esq., C. E.

Col. O. Hamilton.

C. T. Buckland, Esq., C. S.

Khalifah Sayyid Muhammad Hasan, Prime-Minister to H. H. the Maharájah of Patialah.

The following is a candidate for ballot at the next meeting—

Bábú Ganga Prasád, Deputy Collector of Morádábád, proposed by Maulaví Abdullaṭif Khán, Bahádur, seconded by Bábu Rájendralála Mitra.

Lieut. W. A. J. Wallace has intimated his desire to withdraw from the Society.

The following communications were read :—

I.—OBSERVATIONS ON A PERSIAN MS. ON THE LIVES OF THE TWELVE APOSTLES, BY JEROME XAVIER,—by H. BLOCHMANN, ESQ., M. A., CALCUTTA MADRASAH.

At the meeting held in May last year, I laid before the Society a rare and curious Persian MS., entitled *Mirát-ul Quds*. It was a life of Christ, written by Jerome Xavier, nephew to the renowned Francis Xavier, and dedicated by him to the Emperor Akbar.

The sequel to this work has now turned up. The MS. before the meeting is a history of the lives of the twelve apostles by the same author. The copy belongs to the Serampore College Library, and seems to be unique. From a remark in the book, it appears that it was composed in 1608 A. D., the third year of Jahángír's reign. The first chapter, however, the life of St. Peter, was evidently written earlier, as the Latin translation of it by the celebrated Ludovicus de Dieu of Leyden speaks of it as a distinct work, and mentions A. D. 1600 as the year in which it was written.

In point of style, both works exhibit the same features. The sentences run smoothly and are occasionally elegant. We may, therefore, conclude that Mauláná 'Abdussattár of Láhor, who assisted J. Xavier in the *Mirát-ul Quds*, also superintended the translation of the sequel.

In the preface, J. Xavier dedicates the work to Jahángír. He says—

“As the history of the life of Christ was written during the reign of his late Majesty 'Arsh-áshyání Jakáluddín Akbarsháh, and was dedicated to him, receiving from him the title of *Mirát-ul Quds*, so, from motives of gratitude, has this history of the twelve apostles * * * * been written in honour of his Majesty the present

emperor, the successor in power and dignity, the true son and heir of the late emperor, the light of the dynasty that rules over the ideal and worldly kingdoms, the *Çáhib-qirán* (Lord of the auspicious conjunction), and will, I hope, meet with his approval, and receive a name from his Majesty, the shadow of God on earth."

Thus we see that the title of the former work, the *Mirát-ul Quds* was given by Akbar; but there is no record to show that Jahángír, whose indifference to everything, save superstition, is well known, conferred a title upon the lives of the twelve apostles.

The work itself calls for no further remark. The Rev. C. B. Lewis has lately written a review of it in the *Christian Spectator*, July, 1871. J. Xavier's life of St. Thomas contains nothing new. His mission to king Gondapherus of Hindústán and the establishment of the Nestorian Christians in the south of India are related in several works. The name of the king has been compared to that of king Gondophares who occurs on Bactrian coins. (Prinsep's *Antiquities* by Thomas, II, p. 214).

We know from Muhammadan historians (Badáoní) that Akbar's sons received lessons in the Christian religion; and the Dutch traveller De Laët (*De Imperio Magni Mogolis*, p. 271) tells us that Jahángír ordered the sons of his younger brother Prince Dányál to be baptized and instructed in Christianity, not because he cared for the religion, but because *he wished his nephews to appear despicable in the eyes of his Muhammadan courtiers*.*

Copies of both Persian works by Jerome Xavier have been made for the Library of the Society.

* Jam ante retulimus Regem quum majorem natu filium Gousro [Khusrau] minori suo filio Sultano Gorm [nunc Xa Ziahan, i. e. Sultán Khurram, now Sháhjahán] committeret, uná commississe fratris sui Dhan Cha [Dányál Sháh] qui Barampore discesserat filios, Xa-Ethimorem et Xa-Hossen [Sháh Tahmúras and Sháh Hoshang], quos in ipsa pueritia Jesuitis commiserat baptizandos et Christiana religione imbuendos, non quod Christianae religioni faveret, sed ut pueros Mahometanis invisos faceret; et eadem levitate a fide Christiana rursus abstraxerat.

I may mention that a notice of the first part of De Laët's work (the geographical portions) lately appeared in the *Calcutta Review* by Mr. Lethbridge of the Húglí College. The second part of De Laët's work, the historical portion, is also interesting and valuable, and deserves to be translated. His remarks on Jahángír's Mançabdárs and their Mançabs, on Khusrau's murder by Sháhjahán, the last fight with 'Usmán, on Abulfazl's death at the hand of Rájah Bir Singh Bundelah (wrongly called in nearly all printed histories *Nar Singh*) deserve the attention of historians.

II.—NOTES ON THE ALLAH UPANISHAD,—by BA'BU RA'JENDRALA'LA MITRA.

(Abstract.)

After adverting to the imitation of the Yajur Veda prepared by the Jesuit missionaries of Madras, during the last century, with a view to prove, by Vedic evidence, the authenticity of the Bible and the divinity of Jesus Christ, the author describes in detail a forgery which was committed about three centuries ago, to establish the divinity of Allah as described by the Emperor Akbar. A copy of this spurious document has lately been received from Bábu Harischandra of Benares. It bears the titled of "Allah Upanishad," and professes to be a chapter of the *Pippaláda Sákhá* of the Atharva Veda.

As the Sákhá in question is no longer extant, and has ceased to be so for several centuries, it has been appealed to by at least half a dozen apocryphal Upanishads, and notably by the *Gopála Tapáni*, to serve for their parentage, and the author of the work under notice, probably aware of the circumstance, has availed himself of it to escape detection. It opens in the usual Híndu style with a salutation to Gaṇeśa, and then describes Allah to be both Mitra and Varuna; that he is the bestower of all blessings, and the supporter of the Universe. He is the Lord of all the gods (illah), and manifest in his own light. He is addressed as the Allah of the prophet (*rasúl*) Muhammad Akbar, and gloried repeatedly by being called "the great God" in the Arabic phrase *Alláhu Akbar*. It terminates with a prayer for the preservation of men, cattle, lions and aquatic animals, in the course of which a female divinity, the destroyeress of demons (*asura sañháriní*) is invoked with the Tantric mystic formulæ *hrum*, *hriñ* and *phat*, which form the *vija mantra* of one of the manifestations of the goddess Durgá.

The language of the MS. is very obscure, apparently so made with a view to imitate the Vedic style, but the imitation is neither happy nor grammatically correct. A plural verb has been twice used for a singular nominative, and the adjectives do not always

From a cursory perusal of De Laët's work on Persia, I am inclined to think that it contains no original matter, but is a compilation from other works on Persia. Even in his work on India, there is much that is copied from others. His topographical notes on Bihar and Bengal are worthless, and often misleading.

correspond with their nouns. The collocation is also defective. The work nevertheless, when first published, met with great success, and many Hindus even now maintain its authenticity. The late Sir Rájá Rádhákánta was so far taken in by it that, on its authority, he introduced in his great lexicon the words Alla and Illa as Sanskrit vocables.

The use of Akbar's name suggests the idea that it was got up in the time of that emperor by one of his courtiers to give currency to his new faith among his Hindu subjects, but who it was, it is impossible now to determine. It is said in the *A'in i Akbari* that Badáoní, the author of the *Muntakhab uttavárikh*, was a great Sanskrit scholar, and was employed by Akbar in translating the Atharva Veda in Persian, but as he was a devout Muhammadan who looked with horror upon the new faith of his master, and freely stigmatized it in his history of Akbar's reign ; it is not at all likely that he would be guilty of calling Akbar a prophet, and Allah the God of Muhammad Akbar and not that of the Arabian prophet, unless we believe it was done with a view to ridicule the religion of Akbar, which is scarcely probable. A writer in the *Oudh Akhbar*, a Hindústání newspaper of Lucknow, says it is the work of the *Khánkhánán* of Akbar, but as there were several such officers during the long and prosperous reign of that monarch, it is not possible to ascertain which of them was the author of this gross religious imposition.

Mr. Blochmann said—

Bábu Rájendralála Mitra mentioned that the Allah Upanishad was ascribed to one of Akbar's Khán Khánáns. Akbar had three, Bairám, Mun'im Khán, and Mirzá 'Abdurrahím, son of Bairám. If any of the three had written the Allah Upanishad, it could only be the last. Bairám was a bigotted Shí'ah, and Mun'im a brave, pious soldier, anything else but a writer. Besides, the book could only have been written after A. H. 986, from which year Akbar had commenced to abjure Islám ; but Bairám died in 969, and Mun'im at Gaur in 983. Consequently, Mirzá 'Abdurrahím, the Khán Khánán *par excellence* of Akbar's reign, could be the only one to whom the imputation could refer. But he, too, was a most unlikely man to undertake the edition of a Hindú work. People

took him for a Shí'ah in Sunní garb, and nowhere does Badáoní, the censor of Akbar's age, make the slightest allusion to Hindú tendencies in the Khán Khánán.

The imputation therefore falls to the ground.

In connection with this subject, I may mention that the Society lately received from Allahabad a copy of a metrical Persian translation of the *Bhagavat Gítá*, the title page of which mentions Faizí as the author. A few weeks ago, I examined the book, and though some passages in it, especially the beginning, are well written, there are in it so many Hinduized Persian phrases and occasional slips in rhyme and metre, that I cannot bring myself to believe that Faizí is the author.

Maulaví 'Abdullaṭíf observed that Faizí was known to have been the first Muhammadan that studied Sanscrit, and as the Upanishad had been referred to Akbar's times, he might be the author of it.

Mr. Blochmann said that this was a mere supposition; the statement of Faizí being the first Muhammadan that learned Sanscrit was an exploded error [Elliot's Index, p. 259], and there was, besides, no evidence whatever that the great poet knew Sanscrit.

Maulaví 'Abdullaṭíf thought that under these circumstances Faizí resembled the many Europeans who got their Munshís to print works, putting their own names on the title page.

Mr. Blochmann said that Muhammadan historians invariably represent the translations which appeared during the reign of Akbar, as having been made from Hindí; and not directly by the Maulavís from the Sanscrit. Some of the translators, as Naqíb Khán, knew even so little of the vernacular, that they had to get help in reading the Hindí versions.

III.—MEMORANDUM ON THE THUNDER-STORM WHICH PASSED OVER CALCUTTA ON THE 8TH JUNE, 1871,—*by* J. O. N. JAMES, ESQ.

About 9 P. M. I first observed dark masses of cloud rolling up from the south, although the direction of the wind at the time was from the N. E. Gradually these clouds spread over from S. E. to West and N. W., and I then observed distant thunder with occasional flashes of lightning to S. W. and S. By 11 P. M. the entire

sky was overcast with heavy black clouds and about this time, I experienced a peculiar sensation of uneasiness which prevented me from sleeping. I got out of bed and walked into my verandah which faces the south, and had not been there above ten minutes, when I was startled by a regular crash of thunder on the west. Several crashes followed in quick succession on the north and N. W., and all, as far as I could possibly observe, came from clouds overhanging the northern portion of the city. This drew my attention to the north and I then walked out to an open terrace on the north of my house. It was now midnight, the wind had veered to south, and I distinctly observed black masses of cloud coming up from the south, while others seemed rushing towards them from the N. W. and north. The clouds from the south were apparently lower than those coming from the N. W. and N. On these clouds meeting or crossing each other, the first severe claps of thunder and vivid flashes of lightning were observed by me. At times the flashes of lightning followed with barely an interval of a second between each, while the roar of thunder was continuous for nearly 30 or 40 seconds at a time.

Rain coming on, I returned to the south verandah ; this was about 1 A. M. I now experienced a sensation very similar to that I had often felt when overtaken by storms in the higher Himalayas, *viz.*, an irritation about the surface of the skin caused by my hair turning, and felt sure that the storm was close in my neighbourhood. I now took up my position so as to watch the lightning conductors and observatory on the Surveyor General's Office, distant from my house about 150 yards :—

At 1-20 A. M. the large masses of black clouds seemed to me to be traversing over the southern portion of the city from W. to E., wind N. W. The lightning was extremely vivid and the thunder deafening, and I now first noticed, sparks (as it appeared to me) shooting in and out of the conductor over the anemometer at top of the S. G. O. observatory.

The appearance of the conductor is given in fig. 1, plate II. The portion of the conductor from A to A was alive with sparks, flashing to and from it. Suddenly there was a streak of lightning from a cloud overhead which almost blinded me, followed on the instant

by a detonation which made me shudder. The observatory appeared a mass of fire, there was a sound of metal striking metal, and I observed the large conductor on the east of the Surveyor Generals Office looking as if it was red hot. This was momentary, and as I was anxious to observe all I possibly could, I again watched the observatory. Again the conductor over the anemometer was alive with sparks along the same portion of it from A to A, but not a spark seemed to touch the point. This seemed extraordinary to me, so I watched more closely to see if any other portions of the conductor were similarly affected, and now noticed that the horizontal portion of it from the observatory to the back stair case was similarly affected, as roughly shewn in fig. 2, on pl. II; horizontal portions of the conductor from A to A and B to B receiving and emitting sparks.

About $\frac{1}{4}$ to 2 A. M. the lightning and thunder was incessant, at each flash and explosion the masses of cloud seemed to recede from each other, rise and then fall lower towards the earth than before. While watching this, there was a flash of lightning and I distinctly saw a stream of electricity, from a cloud overhead, discharged upon the Office, which shot back again into the cloud, and then flashed off towards the East end of Park Street; this discharge I believe struck No. 22, Park Street.

What I witnessed will be best understood from the drawing given in figure 3, of plate II.

The conductor above the anemometer (A) and the one on the east of the Office (B) again appeared red hot, and the horizontal portions emitted sparks for an instant only. After this there was a perfect lull for nearly 10 minutes and then followed a succession of flashes and detonations, all overhead, and from W. to S. over Chowringhee and Park Street and south towards the Martiniere, which I can only describe as a blaze of lightning and a terrific roar of thunder.

This first portion of the storm seemed to me to pass away to the South and East, and then turn round by east to north or N. East.

Throughout this storm, for nearly 4 hours, I closely watched the streams of electricity discharged towards this city and really fancied that nearly every house must have been struck. From Government

Plate II.

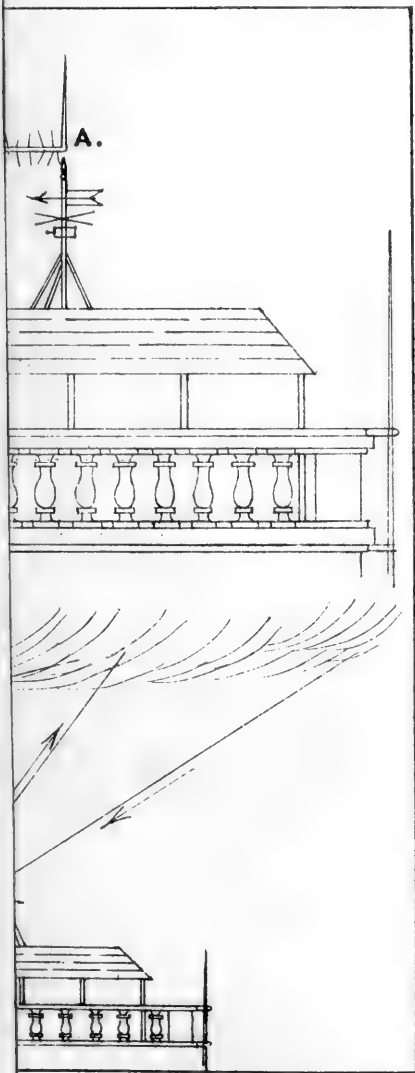

Engraved at the Surveyor General's Office Calcutta.

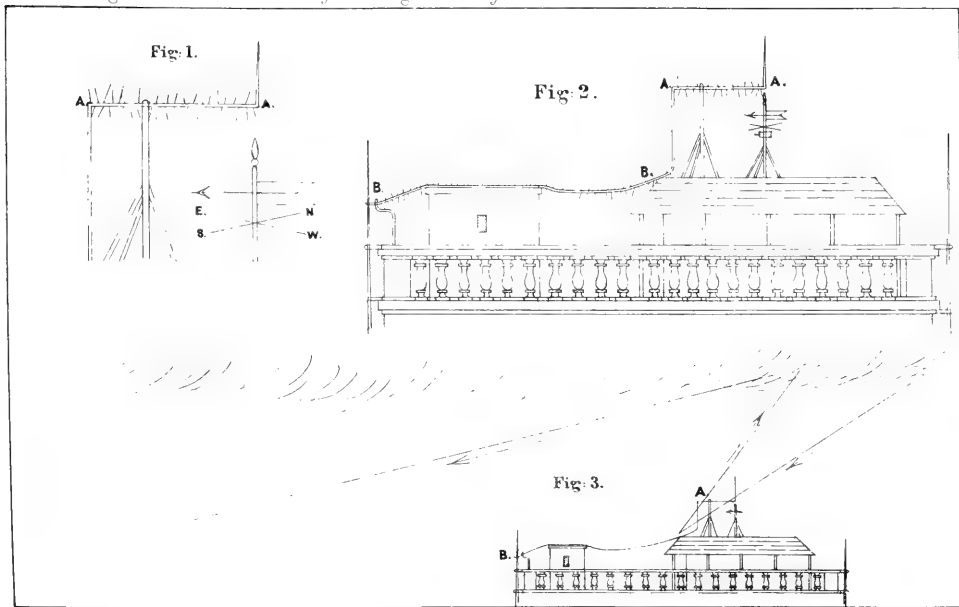

House northwards and westwards towards Howrah, there appeared to me an almost continuous discharge of the electric fluid, and as the storm advanced Southwards and Eastwards, I observed the same phenomena extending, as nearly as I could ascertain, in a circle from the Fort up Park Street to the Martiniere and over towards the General Hospital.

Mr. H. Blanford, in reading Mr. James' note, suggested that the appearance of sparks given off by the horizontal part of the conductor might perhaps be due to a discharge towards the falling rain drops. The zigzag flash returning from a struck object to the clouds and then back again to the earth may be ascribed to an optical deception.

Mr. Ayrton, said:—

Mr. James' paper is certainly a vivid description of an Indian thunderstorm. It is, however, I think, to less startling displays that we must look for our physical information about atmospheric electricity. Not only during visible storms, but at all times there occur in the air phenomena which instruments electrically more delicate than our senses are able to see and measure. The best kind of such instruments, electrometers as they are called, require, however, that the air inside them should be kept artificially dry; and unfortunately the season when observations of atmospheric electricity would be most interesting, viz. during the monsoon, is the very time when it is most difficult to maintain an artificially dried atmosphere. This difficulty, however, can be overcome when sufficient attention and time can be devoted to the management of the instrument;—observations too of this kind are only valuable when made regularly. Therefore, I think that observations of atmospheric electricity can only be carried on with any practical benefit, when they are in the hands of a man who can devote his time to meteorological registration. I would, therefore, strongly recommend to those who have the management of the Meteorological Department at Calcutta, that arrangements should be made similar to those already existing at Greenwich and Kew for the registration of the electric potential of the air.

The only steps that have, I believe, been taken to register atmospheric electricity in this country consisted in two portable elec-

trometers being sent out about two years ago to the Indian Telegraph Department, but from an error in packing they were both so damaged as to be unserviceable. These instruments too were more suited for making rough measurements at different places while travelling, than for making delicate measurements at an observatory. The instruments at present in use in Europe for this purpose are very perfect, and give on sensitive paper a photographic curve showing the electric state of the atmosphere.

As an example of the importance of observations of atmospheric and terrestrial currents I may mention that from tests made partly on the 10th, partly on the 11th, and partly on the 12th of February of this year, it appeared that very strong positive natural currents were flowing through the telegraph lines in the directions Deesa to Agra, Indore to Agra, Allahabad to Agra, Agra to Umballa, Calcutta to Raneegunge and Calcutta to Sahibgunge, in all cases in the same direction from southward to northward. In the cases where the line ran nearly due north and south the current was such as could have been produced by the insertion of about 8 galvanic cells in the line. In the other cases it varied from about 8 to 2 cells, depending partly on how nearly the line ran due north and south. On the 16th of February the earthquake occurred at Calcutta. Now I do not for a moment conclude from this solitary instance, that natural electric currents have necessarily any connection with Earthquakes, still as we know very little about either of these phenomena, it is just possible that they may be connected.

And if in the observatories in Europe and Australia it is thought worth while to carry on a regular system of observations of atmospheric electricity mainly for the purpose of endeavouring to connect the results of these observations with the weather, so that the electric state of the air may act as a barometer to foretell the weather, how much more important is it that such a system of observations should be established in a country like India, visited as it is by thunderstorms doing such a vast amount of damage.

Mr. Woodrow observed that he heard several persons stating that they saw the conductor of a house appearing red hot during the late storm.

Mr. H. F. Blanford mentioned that he had been informed by Mr. James of a very striking instance of this kind. At Bunnoo, which was frequently visited by severe thunderstorms, he was informed that an observatory erected for the G. T. Survey was protected by a lightning conductor, which was described as a thick iron rod. This rod was, as Mr. James assured him, subsequently found on the ground as a fused mass of iron, and having been removed was in another year found to have been fused like the former, and in a like condition. This effect was ascribed to lightning.

The President said they were indebted to Mr. James for a very graphic description of a thunderstorm. Some of the phenomena mentioned did not appear to be easy of explanation. The mode in which Mr. Blanford accounted for the manifestation of sparks or coruscations on the horizontal portion alone of the conductor was ingenious, but did not seem altogether satisfactory. Falling drops would, he supposed, pass in just as close proximity to the vertical portion of the rod as to the horizontal. Without any disparagement to Mr. James, it might perhaps be doubted whether he had been able to possess himself of the actual phenomena with complete accuracy. No class of phenomena was so difficult of precise observation, as that with which Mr. James had to deal, both on account of the extreme shortness of their duration, and the absence of a standard of comparison and measurement. In one particular, Mr. James had evidently been misled. The mutual recession and approach of two clouds upon the passage of a flash of lightning between them, of which he spoke, was illusory. The flash merely illumined and so revealed an interval between two cloud masses, which before were not separable from a back ground connecting them, and when the light disappeared again, the apparent connection was resumed. The mental impression produced by this rapid succession of events gave rise most naturally to the idea of relative motion of the two cloud masses. But actual motion to the same angular extent of oscillation as that which is, in this way, apparent in the instant of the flash would be something truly enormous!

The storm was evidently one of the ordinary type prevalent here at this time of the year. A lower vapour-bearing current

was passing over from the S. W. and S. This encounters, or is crossed by, the course of a condensing cause coming up from the N. W. The latter is no doubt a relatively colder and generally swifter moving current, somewhat above the first, often perhaps partially driving through it. The result is a curious movement *en echelon* : while the lower clouds appear to be coming from the S. W., the heavy storm masses as a whole gather first in the N. W. and seem to traverse the sky as if coming from that quarter. Also the two atmospheric currents in highly contrasted meteorological condition give rise to violent electrical disturbance. In the normal course of the monsoon rains, when the vapour-bearing current is not interfered with by a differently conditioned cross current, the precipitation of water, however heavy the downfall may be, is seldom found to be accompanied by any great manifestation of thunder and lightning. He, (the President,) was afraid that little confidence could be placed upon the correctness of the path attributed to the lightning flashes. Many causes of deception existed with regard to this. And he might make the same remark with regard to the behaviour of the clouds spoken of by Mr. James towards the east after the bulk of the storm had passed. It was always matter of much nicety to determine the true motion of a cloud mass. Indeed this could scarcely ever be done with much accuracy except for a limited region near the zenith. The apparent angular motion of a portion of a surging mass at a low altitude did not afford sufficient data for the purpose. It was then almost impossible with the eye alone to form even an approximate estimate of the geometrical dimensions. With regard to the alleged heating of the conductor to the extent of making it luminous, he would suggest by way of test for the future that a collar of wax or resin be kept continually surrounding the rods of all the principal buildings in the town.

Somewhat later in the evening Mr. Ayrton observed—

The explanation has just occurred to me of the phenomenon observed by Mr. James of sparks appearing to issue from the horizontal, but not from the vertical portions of the lightning discharges, so if it be not contrary to the rules of the Society, I will refer again to that subject.

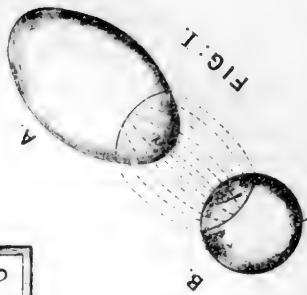
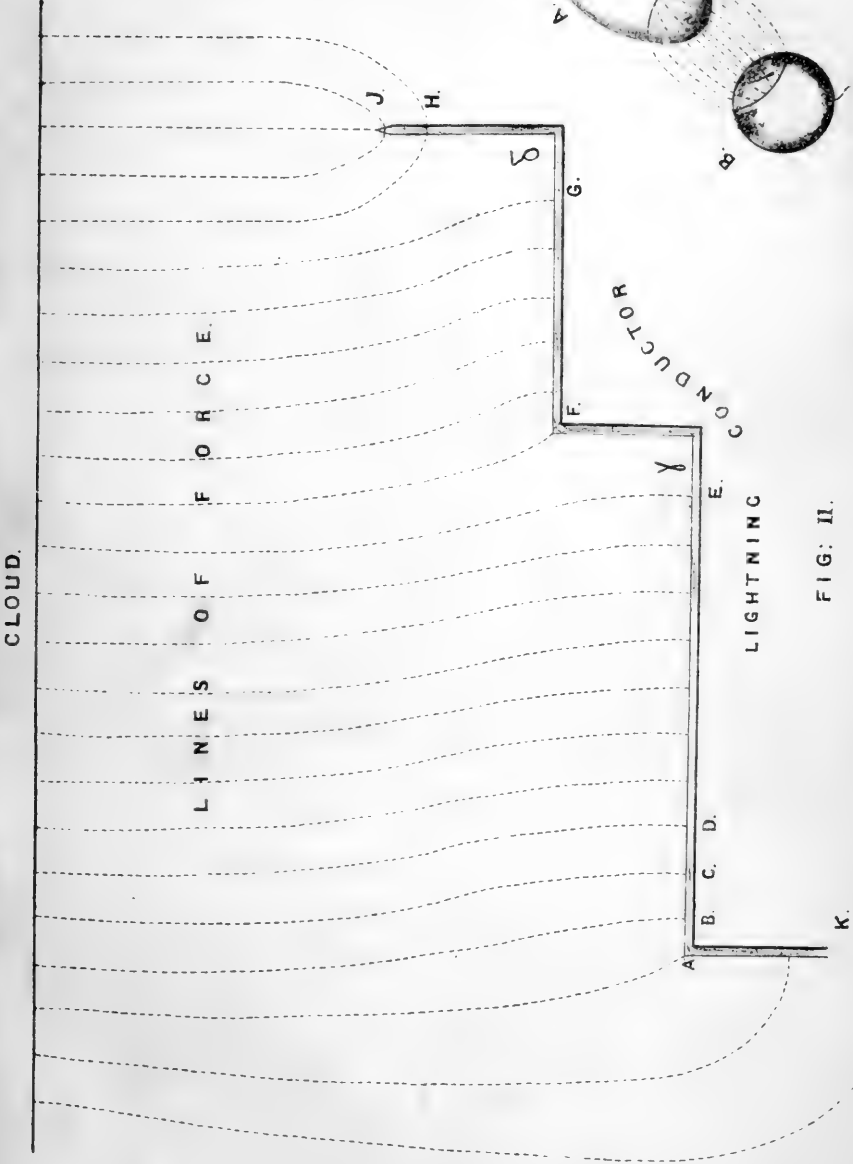

FIG: II.

Now by Faraday's law the portions of the conductor AB, BC, CD &c. each contain equal quantities of electricity, therefore those portions EF, GH which are longest contain least electricity, *per unit of length*. The electricity, therefore, will be most concentrated at the point J of the conductor and least concentrated at the angles γ , δ , and along the vertical portion KA. But the resultant pressure on the air, or tendency to produce discharge at any point near a charged body, is directly proportional to the electric density or the amount of electricity per unit of area at that point, therefore the discharge will be greatest at the point J, next greatest along the horizontal portions AE, FG, and least along the portions EF, GM and the vertical portion KA. The only difference being that at the point J the discharge although greatest will most probably be a silent one, whereas along the length of the conductor it will be disruptive or in the form of sparks. We may, therefore, expect to see *with the eye* no discharge along EF, GH, KL or at the point J, but sparks issuing from the horizontal portions AE and FG.

IV.—*Suggestions for Visitors to the Total Eclipse on 12th December, 1871, by Lieut.-Col. J. F. TENNANT, F. R. S.*

At the last meeting of the Society after the conclusion of my Memorandum the President suggested, that all who might have the opportunity should visit the Neilgherries, and should endeavour to contribute their share to the result, and that those having spectroscopes should use them. There is in fact no difficulty in seeing during the Total Phase of an Eclipse lines of light varying more or less in number and brightness with a spectroscope directed nearly to the sun; nor would it be impossible that any one so armed should see some lines of light or darkness which he believed to be unseen by others, but this would not be of any use. The light falling on the slit of a spectroscope at this time comes partly from the Corona and partly from the Protuberances, while there is of course such faint diffused light as is about. We know that this mixed light must vary with the point which happens to be in the prolongation of the line of vision of the spectroscope, but unless we can distinguish the objects which emit each ray we are really gaining little knowledge.

An amateur (in one sense we are all so) then, must before making up his mind to such a proceeding consider what he loses: I venture to say that he will entirely lose the great sight. In order to see with the spectroscope, he must deliberately shut himself out from this. He may then see what others have seen before, but he can, without special means, add no material fact to what is known, and it is far more likely that he will lose the real sight without seeing so much. If he is in any degree anxious or nervous, it is pretty certain that he will have no clear idea of what he sees in the instrument. The case of a man who having carefully made up his mind to objects and methods of examination, provides himself with adequate apparatus, and deliberately gives up the sight for the chance of being of use, is of course quite different. I could not recommend any one going down to the Eclipse-line without due preparation; to lose one of the most magnificent sights he can see, and to miss the opportunity of appreciating how much it has been given to man to penetrate into the mysteries of nature. I purpose, however, now, in pursuance of a promise to the President, to offer some suggestions to visitors who are not content with this.

Any person possessing a chronometer and the means of finding its error, will do a service if he will simply *note the four moments of contact of the Sun's and Moon's Limbs*. As I explained before, the first contact is especially difficult to note, but the other three are comparatively easy. He has then only to mark his place accurately on the Atlas of India, or some good map, and deduce his Latitude and Longitude and height above the Sea. These data will help towards the problem of determining the Solar and Lunar diameters and, if accurate, they cannot be too numerous.

As 'Totality comes on; if he does not mean to take the moment of the Sun's disappearance, I would advise him to lay aside his Telescope, and look for the strange fringes of colour or light and shade which mark the commencement of this Phase. I quote some accounts of this from Grant's History of Physical Astronomy.

In 1842, M. Fauvelle gives the following from Perpignan. "At the moment when the Eclipse was about to become Total, I perceived the ast rays of the sun to undulate with great intensity and

“*rapidity* on a white wall of one of the Military Establishments of the Rampart of St. Dominique. The effect might be compared with that which is observed when the light of the Sun falls upon a wall or ceiling after having been reflected from the surface of water in a state of agitation. The same phenomenon appeared at the emersion of the sun,” the undulations were at first very intense and gradually died away. “M. Arago states that during the few seconds devoted by his colleagues and himself to the observation of such phenomena the façades of the great tower of the citadel of Perpignan appeared illuminated by a *singularly fluctuating light*.” M. Lenthéric at Montpellier says “A little before the commencement of the total obscuration there were seen on the ground and on the walls *undulating shadows* composed of a succession of arcs, 3 or 4 decimetres in length, but of much less breadth, which seemed to *turn on themselves*. The effect was analogous to that produced by those moveable shadows which are seen at the bottom of a shallow basin filled with clear water when the surface, slightly agitated, is illuminated by the sun’s rays.”

At Seyne, Mr. Savournin says: “There were here and there seen shadows and luminous patches running after each other, the effect of which was similar to that produced by the passage of a succession of small clouds over the sun. These patches *were not all of the same colour, some were red; others yellow, blue or white*. The children amused themselves running after them, and trying to put their hands on them. This extraordinary phenomenon was remarked only a few instants before the complete disappearance of the sun.”

Professor Grant quotes some Swedish observations of 1733, but they do not seem to me to refer to the same phenomenon. The accompanying quoted by him from Delisle, however, clearly refers to this. “The second observation is one which a curious individual acquainted me with having made by mere accident. Having directed his attention to a large white wall, at the moment of the total immersion of an Eclipse of the Sun, he saw the Moon’s shadow pass upon the wall, *tinged with different colours*.”

This phenomenon was also seen and drawn by M. Poulain a

French officer at Goree in 1861, whose attention the Astronomer Royal called to it.

In 1868, I asked Col. Addison of H. M.'s 2nd (the Queen's) Regt. to examine this matter at Aden. I expressed considerable doubt as to the reality of the phenomenon which, save for M. Savournin's statement, that the children ran after these shadows, I think one might have considered (in the absence of evidence to the contrary) as caused while resting a weary eye. Col. Addison had a large sheet hung up and (I quote from memory)* more than one of his officers saw these shadows passing rapidly across the sheet; so rapidly that they could not measure the velocity; in the direction in which the Moon was advancing on the Sun.

Colonel Addison and M. Poulain are the sole persons I know, who have *looked for* this phenomenon, but it was seen again, unless I mistake, in 1869, and I believe that the following description by Mr. Charles Coale refers to it. "The grandest of all to us, who had no astronomical ambition, or astronomical knowledge, to gratify, was the effect upon the clouds during the total obscuration. Those who have had the privilege of being on White Top" (near Abingdon, Virginia and 5530 feet high) "and enjoying the westward scene, will remember the grand panoramic view of mountains beginning on the northern and southern horizon and stretching away to the west, till they seem to meet, and will appreciate the scene, which we now attempt to describe. Stretching along this semicircle of mountains in long horizontal lines, far below the Sun lay light and fleecy clouds, as if resting on their wings during the seeming struggle between the orbs above them. At the moment of the falling of the dark shadow, when naught was to be seen above but the stars and the circle of light around the moon, these clouds became arrayed in all the colours of the rainbow, presenting an indescribable richness with their back ground of sombre mountain. To our vision it was as if bands of broad ribbon of every conceivable hue had been stretched in parallel lines half round the universe." One sees here the pen work of the American Journalist: indeed Mr. Coale in another letter remarks that he was

* The papers were sent to the Royal Astronomical Society.

probably extravagant in giving the clouds all the colours of the rainbow (though he considers this allowable in country journalism) and he proceeds to name "pink, purple, yellow orange, and fiery red," and "a band of lilac," though not green or blue, as being colours he had seen. It is quite impossible notwithstanding exaggeration to compare this, which I take from Mr. Proctor's late work on the Sun; with the descriptions I have quoted from Professor Grant, without seeing that the phenomenon was the same that M. Savournin saw at Seyne. It is eminently fitted for examination by those unaccustomed to use instruments, and, while I believe worth investigation, will not deprive them of the great spectacle. The occasion will, I think, be very favourable.

To those one degree more professional who may possess telescopes on mountings and seek to do some further service, without too great a sacrifice of personal feelings, I would suggest the selection of certain parts of the Corona and their careful scrutiny, so as to enable drawings to be made and descriptions to be written immediately afterwards. The parts I would refer to are those which I have in my Report of 1868 called *flare*. I did not of course *see* them then, but it was quite impossible to examine carefully my original negatives without a strong conviction, that in those places at all events gas, luminous though much less so than the body of the protuberances, was streaming from them into the general light of the Corona. As photography will probably be entirely directed to the general Corona, these brighter parts will be to a great extent lost in detail. Indeed if they are to be done justice to by Photography, it must be by special arrangements allowing large pictures to be rapidly taken in some Eclipse of the future. At present I would call the attention of draughtsmen to these spots, from which, when found, they should not allow their attention to go. Moderate power would alone be necessary, though if the air be steady enough high power would concentrate the attention by limiting the space. It is alleged too that there are nodes and bands of light in the Corona of complicated structure and quite free of the Sun; these too might be noticed, probably the best plan will be to attack the first such object seen and adhere to it.

Lastly, I would urge on those who I trust may be induced to

go to the Eclipse track by curiosity or some hope of adding to knowledge, to remember, that well equipped parties (I hope the Madras Observatory may send one) are not able as a rule to choose better sites, from which views can be got, than many others about, and that there is nothing so injurious to good observation, as the motion, and even the presence, of strangers. Possibly volunteers may be wanted for some work; then, if you accept the position, do that work in perfect silence where it does not require speech; but, if you have no share in the *work*, keep at a distance from those who have, remembering that an involuntary motion or exclamation, may seriously disturb those who are endeavouring to close their minds to the surrounding circumstances, and to concentrate them on the duty they have undertaken. To suffer men who are content to lose all the great sight of the day for work, to do their work without interruption, is in itself a service to science, though one which does not force itself into notice.

V.—*The Antiquities of Jájpúr*,—by BABU CHUNDER SEKHAH BANURJI.
(Abstract).

Bábú Chander Sekhar Banurjí mentions early notices of Jájpúr, legends connected with the invasion of Orísá by the Afgháns under Kálá Pahár in 1558,* a description of the memorials of the Afghán conquest, the importance of Jájpúr as a place of pilgrimage, and a description of temples and several other works of Hindú sculpture.

The paper will be printed in the second number of Part I. of the Journal.

The receipt of the following communications was announced.

1. Monograph of Indian *Cyprinidæ*, Pt. II, by Surgeon F. Day.
2. Note on Lieut.-Col. MacMaster's list of birds from Nagpore, &c., by W. T. Blanford.

* This is the year mentioned by Stirling. But the Akbarnámah gives A. H. 975, or A. D. 1567. Such as take an interest in the history of Orísá, should read the beginning of the annals of the 37th year of Akbar's reign as given in the Akbarnámah, provided that good MSS. are obtainable. There are most extraordinary differences between Abulfazl's account and that of Stirling, which professes to be taken from the Púrí Vainsavali. The period of Orísá history in the Akbarnámah extends from about 1500 to the end of the 16th century.—THE EDITOR.

LIBRARY.

The following additions have been made to the Library since the meeting held in June last.

Presentations.

** Names of donors in Capitals-

Memoirs of the Royal Astronomical Society, Vols. XXXV—XXXVIII; Notices, Vols. XXVIII—XXX; Index to the First twenty-nine volumes of the Monthly Notices.—THE ROYAL ASTRONOMICAL SOCIETY OF LONDON.

Proceedings of the Royal Society, Vol. XIX, No. 127.—THE ROYAL SOCIETY OF LONDON.

Proceedings of the Royal Geographical Society, Vol. XV, No. I.—THE ROYAL GEOGRAPHICAL SOCIETY OF LONDON.

Journal of the Statistical Society of London, March 1871.—THE STATISTICAL SOCIETY OF LONDON.

Journal of the Chemical Society, February, March and April, 1871.—THE CHEMICAL SOCIETY OF LONDON.

Bollettino della Societa Geografica Italiana, volume sesto, 1st Maggio, 1871.—SOCIETA GEOGRAFICA ITALIANA.

Nyelvtudományi Közlemények, Kiadja A Magyar Tudományos Akadémia Nyelvtudományi Dízottsága, szerkeszti, Hunfalvy Pál. Hatodik Kötet, Füzet, első második, harmadik; Hetedik Kötet, Elso Füzet:—Ertekezések A. Természettudományi Osztály Köréleol. Kiadja a Magyar Tudományos Akadémia As Osztály Rendeletéből, szerkeszti, Gregurs Gyula, levelező tag; Tzam 1, IX, XI—XIII:—A Magyar Tudományos Akadémia Jegyzőköny, 1867, Fuzet 1-2, Almanach 1867, 1868, 1869, :—Nyelvtudományi Közlemények, Otödik Kötet, Füzet Első, Masodik, Harmadik:—Ertesítője Első Evfolyam, szám 1,— 17: Második Evfolyam, szám, 1—20.—A. MAGYAR TUDOMÁNYAS AKADEMIA, PEST.

Abstract of Proceedings of the Mahomedan Literary Society of Calcutta, 1871.—THE MAHOMEDAN LIT. SOCIETY OF CALCUTTA.

Historical and Statistical Memoir of the Ghazeepur District, by W. Oldham, B. C. S., LL. D., part I.—THE AUTHOR.

Report on the Hill of Mohendragiri and the native part of Barwah, by C. Palmer, Esq., M. D., Capt. W. G. Murray, and V. Ball, Esq., B. A.—DR. C. PALMER.

A Lecture on the Modern Buddhistic Researches by Bábu Ram Dass Sen.—THE AUTHOR.

Introduction to a Philosophical Grammar of Arabic, by G. W. Leitner.—THE AUTHOR.

The Topography of the Mogul Empire as known to the Dutch in 1631, by E. Lethbridge, M. A.—THE AUTHOR.

English Legislation for India by A. M. Broadley.—THE AUTHOR.

The Calcutta Journal of Medicine, Nos. 7—12.—THE EDITOR.

Über das Râmâyan von A. Weber.—H. BLOCHMANN, ESQ.

Christian Spectator, No. I.—REV. C. B. LEWIS.

Outlines of Amharic by Rev. C. H. Blumhardt;—Historical Notice concerning Calcutta;—A Manual of Geography by Major T. Candy;—The Holy Bible in Short Hand;—The Parsee Acts by Sarabjee Shapoorjee Bengalee;—Phonetic Journal, Vol. 23:—REV. J. LONG.

Report on the Financial Results of the Excise Administration in the Lower Provinces, 1869—70;—Report on the Cultivation and preparation of Tabacco in India, by Dr. Forbes Watson.—THE GOVERNMENT OF BENGAL.

Selections from the Records of the Bombay Government, Nos. 118, 119.—THE GOVERNMENT OF BOMBAY.

Purchase.

Reeve's Conchologia Iconica, 284—287.—Quarterly Review April 1871.—American Journal of Science, Nos. 3 and 4.—L. E. and Dublin Philosophical Magazine, No. 274.—Comptes Rendus Nos. 15—17.—Feer's Etudes Bouddhiques, pr. serie.—Vámbéry's Uigurische Sprachmonumente und das Kudatker Bilik.—Semper's Holothurien, Band I.—De Gœje Bibliotheca Geographica Arabicorum.—Reise in Hadramaut.—Spiegel's Erânische Alterthumskunde, Band I.—Lexicon Latino-Japonicum.—Darwin's Descent of Man, Vols. 1, 2.

PROCEEDINGS
OF THE
ASIATIC SOCIETY OF BENGAL
FOR AUGUST, 1871.



The monthly meeting of the Society was held on Wednesday the 2nd instant, at 9 o'clock, P. M.

The Hon'ble Mr. Justice Phear, President, in the chair.

The minutes of the last meeting were read and confirmed.

Presentations were announced—

1. From Father M. Lafont,—a copy of Results of Meteorological Observations, made at St. Xavier's College Observatory, during the first half of 1871.

2. From Bábu Frankissen Chatterjí,—a stone seal, found west of Bardwán.

The inscription of the seal has not yet been deciphered.

3. From C. R. Markham, Esq.,—a copy of 'Memoir on the Indian Surveys.'

4. From H. F. Blanford, Esq.,—a copy of Tamil Grammar by Rev. C. T. E. Rhenius,—and a copy of Tamil and English Dictionary by Rev. J. P. Rottler.

Bábu Gungaprasád, duly proposed and seconded at the last meeting, was elected an ordinary member.

The following gentlemen are candidates for ballot at the next meeting.

E. T. Atkinson, Esq., C. S. (for re-election), proposed by Dr. F. Stoliczka, seconded by Mr. H. Blochmann.

Robert Fellowes Chisholm, Esq., Consulting Architect to the Government of Madras, proposed by L. Schwendlor, Esq., seconded by Dr. F. Day.

Capt. S. B. Miles, Bombay S. C., Asst. Pol. Agent, Quáder, Makrán, proposed by L. Schwendler, Esq., seconded by Col. J. F. Tennant.

Henry Buckle, Esq., Asst. Commissioner, British Burma, proposed by Dr. T. Oldham, seconded by Dr. F. Stoliczka.

The following papers were read—

I. SOME REMARKS ON THE CONNECTION BETWEEN INERTIA
AND TIME, *by* W. E. AYRTON, Esq.,

The following was written not on account of its actual novelty, but because the ideas contained in it will probably be new to the majority of those present.

Of all the properties of matter inertia is, I think, the one least understood by the general reader. With weight, hardness, friction, elasticity, &c. he is perfectly familiar, but that matter possesses another property as important as any one of those I have mentioned never seems to present itself to him. If you ask an ordinary practical man why it is difficult to set a massive fly-wheel in motion, he will probably say on account of the weight and friction. The friction certainly does in a small degree prevent motion being given, but this can to a great extent be overcome by the bearings of the fly-wheel being well made.

And not only is it difficult to set a massive fly-wheel in motion, but it is difficult to stop such a wheel when in motion. This certainly is not caused by friction, since the friction would itself tend to stop the motion.

The weight too cannot in the least prevent motion being given to, or taken away from, a well balanced wheel, since the action of the earth on each side of the wheel is exactly the same.

There is, therefore, another property that matter possesses—its inability to change its own state of rest or motion. This property which is called inertia is best defined by Newton's law "Every body continues in its state of rest, or of uniform motion in a straight line, except in so far as it may be compelled by impressed forces to change that state." Now, by uniform motion we mean moving through equal spaces in equal times, or rather we should say, we call those times equal during which a body unacted upon by any

force describes equal spaces; for no person has an innate perception of equal times. Nobody can from his inner consciousness say one time is equal to another. Hours and minutes are as arbitrary in their conception, and require just as much explanation as degrees of temperature. By general consent the earth is the standard body that has been selected to determine equal times by its motion, so that according to Newton's law those times are called equal during which the earth describes equal spaces, or better during which any particular meridional plane describes equal angles. In fact when a person speaks of minutes or hours, he is tacitly assuming the fact of the earth's inertia. And for comparing time without the aid of the earth's rotation, clocks are used in which the condition of a body in motion, practically unacted upon by any force, is arrived at by compensating by the action of a compressed spring or otherwise for the inevitable forces of friction.

The earth and moon regarded as a mechanical system possess a certain amount of "energy," or power to do work. This energy is partly potential, that is, energy depending on the relative position of the earth and moon, and partly kinetic, that is, energy depending on the two bodies being in motion. Now the earth's daily rotation produces tides by the mutual attraction of the sea and moon, and as the motion of the sea on the surface of the earth is retarded by tidal friction a certain amount of the energy possessed by the system must be lost in overcoming the friction or in generating heat.

One effect of this loss of energy is to cause the periods of rotation of the earth round its axis and of the moon round the earth to become more and more equal, or in other words to make the period of the earth's diurnal rotation gradually longer and longer. The earth is, therefore, not a true time-keeper, and if a chronometer were set now to keep true sidereal time, we should expect, if the chronometer neither gained nor lost, to find at the end of a lapse of years, that it was apparently too fast, if compared with the then true sidereal time. Such a chronometer it has been calculated would at the end of a century be apparently 0.44 of a minute too fast.

To compare, therefore, time at one period of the earth's existence with time at another period we require, in addition to the sidereal and solar second, a mechanical second which would be defined as the period, or a definite portion of the period of vibration of a body practically quite unacted upon by any force. Such a time-keeper has been made at the University of Glasgow and consists of a spring pendulum truly balanced about its centre of inertia and hermetically sealed in an exhausted glass tube. The vibrations of such a pendulum are of course not in the least affected by the earth, and could only be influenced by the little air that has unavoidably been left in the tube producing some change in the metal of which the pendulum is composed. The number of vibrations of the pendulum per second are carefully counted now, and will be counted again at some future period, when the number will be apparently greater per second than it is now, since a sidereal second then will really be a longer time than a sidereal second now. In this way the actual loss of speed of the earth's diurnal rotation can be practically measured.

Col. Tennant said:—

He did not see how our idea of inertia involved an idea of time. Inertia was the passive power by which change of state was resisted, and when a body was at rest there was no question of time involved; but he had not come prepared to discuss this point in detail. The paper seemed to be mainly leading to the question which had lately been raised as to the effect of the tides in retarding the Earth's rotation on its axis, and he thought some account of this might be interesting.

He (Col. T.) would remark on Mr. Ayrton's statement that an increase in the duration of a revolution of 0.44 of a minute in a century has been found by calculation. The whole tidal problem is of extreme complication, and in its generality cannot be touched by analysis. The motion of the water has been deduced on certain hypotheses which are very far indeed from representing existent facts. Thus we have some knowledge of what the motion would be in a canal surrounding the earth equatorially and of uniform, or great, depth and section, or in similar canals passing through the poles;

also in canals of comparatively short length; and in various cases in canals where the wave is derived from a tide wave in the sea. The last case does not concern this problem greatly, and as regards the former cases the conditions imposed by the necessities of analysis make the results rather representations of the kind of phenomenon, than capable of giving accurate values by calculation. Of course when on any such hypothesis a theoretical result has been obtained, which shows that a retardation would take place in the earth's velocity of rotation, it is easy to assign values to the constants and to deduce a numerical result, but such results should be considered as arithmetical exercises, and not as real deductions proved. It was very much to be regretted, Col. Tennant thought, that mathematicians who calculate such things occasionally give the results without those words of caution which would prevent their being misunderstood.

This matter has of late received a great importance from the strong suspicion that there is a true retardation of sensible amount, and the evidence is quite unconnected with any investigations into the tides. It was found very soon after accurate observations of the Moon were taken, that the time of describing its orbit was less than formerly, it being quite impossible to represent old Eclipses by calculating from the known elements. For long it was found impossible to account for this phenomenon from gravity: at last Laplace deduced a result from this cause which so completely coincided with that necessary to explain the old Eclipses, that he thought himself justified in asserting that the sidereal day had not varied by $\frac{1}{1000}$ of a second between the time of Hipparchus and his day. His results were confirmed almost identically by Lagrange, and till very recently were accepted, with their consequence that any action of the tides was rejectaneous. Lately, however, Mr. J. C. Adams in the course of a re-examination of the Lunar Theory was led to a different result. He found that the true theoretical value of the Moon's acceleration only served to explain about half of the observed change in its motion of which the rest had to be explained. This conclusion was hotly disputed. French mathematicians, jealous of the honor of their countryman, upheld his results, but Mr. Adams' reasoning was unanswerable and has prevailed; it is acknowledged now that gravity alone does not produce the

acceleration of the Moon's motion. It has been suggested that the ether supposed to fill space, and whose existence had been considered probable from the peculiarities of the motion of Encke's comet produced a similar though less result on the moon, but De-launay suggested that the tides should produce a retardation of the Earth's velocity which might account for it.

Since then the theoretical discussion of the result of the tidal action has been in question. Col. Tennant had not been in the way of seeing all the solutions, but the problem is very intricate even on the limited hypotheses which render it analytically possible. The Astronomer Royal has shown that on the supposition of a canal equatorially surrounding the earth, the result of using the first order of small quantities only in the solution is that the friction produces no effect on the velocity of revolution, but that it retards the moon. This is precisely the opposite of the result sought, but he has also found in the terms of the second order one which would retard the earth.

This or any thing similar is very far from giving a trustworthy value of the retardation, however, and he (Col. T.) would caution all to hesitate before giving faith to figures on this subject.

Mr. Ayrton replied:—

With reference to Colonel Tennant's remark that "Inertia is the passive power by which change of state is resisted, and that when a body is at rest there is no question of time involved," it will be obvious that the first half of this sentence related to two things, a body at rest and a body in motion, whereas the second half of the sentence refers only to a body at rest. Now as regards a body in motion, inertia is the property it possesses to move uniformly. What, I ask, is meant by moving uniformly if no reference is to be made to time? Also what is meant by equal times, if no reference is to be made to the inertia of a body in motion? I therefore maintain, as before, that the two ideas inertia and equal times are so intimately connected, that neither can be explained without reference to the other.

What follows in Colonel Tennant's remarks rather tends to show the difficulty of applying direct calculation to the actual motion of

the sea, than to show that a retardation of the earth does not exist or that the rate of this retardation could not be calculated. The calculation to which I have alluded of 0.44 of a minute and to which Colonel Tennant objects so strongly was obtained in the following way by Prof. Thomson, Mr. Adams and Prof. Tait working together. They started with the assumption that the known difference between the acceleration of the moon relative to the earth, as calculated by Mr. Adams, and the actual relative acceleration, as observed by Mr. Dunthorne, was due to tidal friction, and then by allowing for the necessary consequent retardation of the moon's mean motion, and using a certain assumption with regard to the proportion of the retardations due to the moon and sun, they arrived at the result I have given. Now with reference to the general question, independently of any calculation, it appears to me that as long as the sea moves on the surface of the earth there must be tidal friction. Friction must produce heat. Heat produced in any system of bodies must to a certain extent be dissipated unless the heated bodies be surrounded by a perfectly non-conducting thermal envelope, a thing of course quite unknown. Wherever, therefore, heat is produced, there must be a certain loss of energy. And the loss of energy in the case in question must cause a retardation in the earth's diurnal rotation, unless there exists some other cause not yet ascertained which compensates for this loss of energy. The connection, therefore, between tidal friction and the undoubted fact of the earth's retardation possesses, I think, a high degree of probability.

The President understood Mr. Ayrton's remarks on Inertia to be intended to lead up to the principal topic of his short paper. Mr. Adams demonstrated, now many years ago, that Laplace's celebrated explanation of the Moon's acceleration was not nearly so complete as it had been thought to be. It left about one half of the inequality unaccounted for. But, to discover the true cause of this residuum was a task of the greatest difficulty. Any one who had practical experience in dealing with the formulæ of the Lunar Theory would know quite well how complicated the problem was. The best supposition—one he believed that was at this time

generally accepted,—seemed to be that the earth's angular velocity of rotation, an ingredient in the calculation, was not constant as it had always been assumed, but was slowly diminishing. The tide-action on the surface of the globe is considered by many eminent physicists sufficient to bring about such a result. On the other hand, if the earth is contracting in radius by a process of cooling denudation or degradation an acceleration of rotation to some extent would be the consequence. Hence it becomes a matter of interest, if possible, to contrive an accurate time-keeper who should be independent of the earth's rotation, and serve to make its deviation from constancy indisputable. He would be glad if Mr. Ayrton would kindly explain the particular mode in which this end was sought to be attained in the case of the Glasgow instrument.

Mr. Ayrton said:—

The pendulum at the Glasgow University to which I referred is made simply on the principle of the balance wheel of a watch, that is, a certain mass of metal is made to oscillate by the action of a spring, and independently of the action of gravity. The friction, however, of the pivot of the balance wheel is obviated by the wheel and spring being virtually in one. The arrangement can be best understood by imagining a straight flat piece of spring rigidly fixed at one end and having a mass of metal fixed at the other end which mass oscillates in a horizontal plane by the action of the spring. The actual arrangement of the pendulum is really more complicated than this, but the principal of action is as described.

As regards the President's remark that the earth by contracting may acquire sufficient acceleration to compensate for the retardation produced by tidal friction, I would mention that Laplace proved solely from Fourier's theory of the conduction of heat that the acceleration of the earth's diurnal rotation produced by shrinking from cooling could not have amounted to $\frac{1}{3000}$ th of a second in the last 2,000 years. Sir William Thomson has also shown that the acceleration from this cause must be extremely small compared with the probable retardation produced by tidal friction.

II.—ACCOUNT OF A VISIT TO THE EASTERN AND NORTHERN FRONTIERS OF INDEPENDENT SIKKIM, WITH NOTES ON THE ZOOLOGY OF THE ALPINE AND SUB-ALPINE REGIONS, *by* W. T. BLANFORD, F. G. S., C. M. Z. S. (*Abstract.*)

Mr. W. T. Blanford gave a brief account of a journey he had made in company with Captain Elwes to the Eastern and Northern frontiers of Sikkim in August, September, and October, 1870. Starting from Darjiling on the 13th August, they crossed the Tista to Kálingpúng in the Dáling Dúar of Bhútán, and thence marched, by Phýúdong, Rhinok, Chúsáchen and Lingtú, to the foot of the Jelep-lá, a pass leading into the Chúmbi valley of Tibet, considerably to the south of the Yáklá. Their object was, if unopposed, to cross this pass and march up the Chúmbi valley to the Tankrá-lá and to cross that to Láchúng, thus reaching the upper Tista drainage by a shorter and pleasanter road at this season than the hot and wet Tista valley. However, they found, their plans were known at Chúmbi where the Rája of Sikkim was staying, and the frontier was guarded. They spent a day near the Jelep-lá which is under 14000 ft. in height, and then marched northwards along the west slope of the Cholá range to Chumanáko near the Cholá. On their road they passed 3 lakes, each $1\frac{1}{2}$ to 2 miles in length, larger than any hitherto mapped in Sikkim and known as the Bidan-tso, Nemi-tso and Tanyek-tso. They also passed, besides the Yáklá, an unmapped pass called the Gnátui-lá.

At Chumanáko they found the Rája of Sikkim, who had come from Chúmbi to meet them, and begged them not to attempt to enter Tibetan territory. They, therefore, had to march round by Tamlung and the upper Tista valley to Láchúng. They remained for some days in the Láchúng valley at elevations of from 8000 to 16,000 feet and made a considerable collection of birds. The fauna is distinctly Palæ-arctic, a complete change taking place from the Malay fauna of Sikkim, when pine forests are entered at about 8,000 feet. Læmmergeyers, ravens, crows, choughs, tits, tree-creepers, redstarts, larks, pipits and finches, pheasants and snow partridges are the commonest birds. The mammals are burhel, goral, serow, bears and *Lagomys*.

On attempting to pass from the Láchung to the Láchen valley by the Donkia pass and the small portion of the upper Láchen valley which is in Tibet, the travellers found themselves again stopped by the Tibetans. After two or three days negotiation, a much higher official, the governor of Kambajong, arrived, and with much politeness said he was obliged to refuse to allow them to pass, as he had just received special orders on the subject from Jigatzi and Lhasa. They were, therefore, compelled again to descend to the hot Tísta valley, and make 10 long marches instead of 2 short ones to reach Kongra Lama pass or Djo-kong-tong, the Tibetan frontier in the Láchen valley. Here they again met the Súbá of Kambajong, who had procured some *Ovis ammon* and goa skins, and 4 live *Syrrhaptus Tibetanus* for them. They obtained from him a little information concerning Tibet, the most interesting of which was the absolute prohibition of all imports of tea from Sikkim.

Around Kongra Lama they obtained a few birds not elsewhere seen, amongst them a new *Montifringilla*. They left the pass on the 5th October and, marching back by the Tísta valley, reached Darjiling again on the 20th. In conclusion, Mr. Blanford briefly described some of the traces of former glaciers which he had seen. None were noticed on the Cholá range below 12000 feet elevation, but in the upper Tísta valley glacial markings descended to between 5000 and 6000 ft. He especially noticed the great moraines of the Láchung and Láchen valleys, described by Hooker, and expressed an opinion that the plains of Phálung, four miles long by two miles broad, were entirely composed of moraine accumulations, probably derived from the great glacier which passed down the Láchen valley.

Dr. Stoliczka said—he would not enter into the numerous details of observations made by Mr. Blanford on his interesting tour, but only allude to one or two points noticed by him. Referring to the difficulties which every traveller has at the present time to encounter in crossing the Tibetan frontier, it would appear, as if the Europeans had, so to say, come into discredit with the Tibetans within the last 20 years. Some 30 or 40 years ago, the difficulties

were by far not so great, as several Europeans had been able to enter Tibet through Bhútán, Kumaon and the Sutlej valley. It is remarkable for instance that the two Roman Catholic Missionaries Huc and Gabbet were allowed peacefully to cross the whole of Eastern Tibet and North China, even after they had been expelled from Lhasa. It is by no means likely that a European would be equally well treated at the present time. And still every one who approached any part of the frontier of that vast unknown country will understand the anxiety of a traveller to proceed into the interior of Tibet, where nearly everything is new to the observer. Indian officers had, sometimes under the greatest difficulties, devoted their time to explore the sources of rivers of other countries, while no one has as yet made an earnest attempt, or at any rate not succeeded, to discover the sources of the river from which India derives her name. If his (Dr. St.) memory serves him right, he thought, that the only reliable knowledge we have of the sources of the Indus is a statement by Moorcroft in his travels, that a range of hills separates the sources of the Indus from the Mansarovara lakes, but it is not even perfectly certain whether Moorcroft had seen these sources, or not. A subject of such general interest, as this, would by itself warrant the equipment of an expedition to these unknown regions. It is to be hoped that the endeavours of the Great Trigonometrical Survey to increase our knowledge of the geography of Tibet will sooner or later solve this problem.

With regard to the personal objections which Tibetans make to Europeans, attempting to cross the frontier from the Kumaon and Ladak side, Dr. Stoliczka thought, they appeared to him to be chiefly of a commercial nature. The Chinese as rulers of the country have a monopoly in supplying Tibet with tea, opium and all articles of luxury connected with the Bhudhist religion; and because they are afraid of losing this monopoly, they refuse Europeans access to the country. Naturally there are besides these other reasons, as for instance love for ruling or protection to a co-religionist, &c., but these seem to be of minor importance. The Tibetans themselves are not directly hostile to Europeans; they invariably say that they have orders not to allow Europeans to cross the frontier, and that if they would allow it, their homes

would be burned down and they themselves killed or expelled from the country. A European when he goes into Tibet from Kumaon, Spiti or Eastern Ladak is not opposed with force, but he is *starved out*. The success of an expedition into these regions rests, therefore, principally in provisioning a party for a couple of months, which it is certainly not difficult to do.

Another point to which Mr. Blanford alluded was the absence of any large moraines in the lower parts of Sikkim. The absence of any very extensive traces of glacial action in the N. W. Himalaya is equally remarkable, as compared for instance with the Alps. Large moraines and glacial deposits are in the N. W. Himalayas chiefly confined to the central range and to the north of it. In the valleys on the southern side of the N. W. Himalayas traces of old debris may be often seen 3000 and 4000 feet above the present level of the rivers, but these accumulations appear with very few exceptions to be common river deposits.

The following communications have been received :

III. A FIFTH LIST OF BENGAL ALGAE, DETERMINED BY DR. G. V. MARTENS, *communicated by* MR. S. KURZ.

No. 2758. *Oscillaria interrupta*, Martens. On muddy ground of dried-up tanks, Bot. gardens, Calcutta.

2759. *Anabæna mollis*, Kg.—Calcutta Botanic gardens, on mud along the edges of tanks, and in water.

2760. *Hydrocoleum violaceum*, Martens, n. sp.

Cæspite atrovioleaceo ; vaginis diametro 1/180 ad 1/150 lin., aretis, pellucidis ; filis inclusis ternis v. pluribus, flexuosis, 1/360 lin. crassis, pallide violaceis, obsolete articulatis ; articulis granulatis, diametro triplo brevioribus.—Calcutta, in stagnant waters of the Botanic gardens.

2762. *Lyngbya cincinnata*, Kg., invested by *Glaetila concatenata*, Kg., and colourless inarticulate filaments like *Leptothrix*, but indeterminate.—Seebpore, Howrah, in swamps and tanks, inhabiting the culms of grasses.

2763. *Nostoc gregarium*, Thuret.—Botanic garden, Calcutta, on inflorescences of a *Fimbristylis*, submerged in a tank.

(Unicum.) *Oscillaria Froelichii*, Kg., with the same *Leptothrix*

filaments, as mentioned sub No. 2762.—Calcutta, Botanic gardens, floating on stagnant waters.

2785. *Glæotila concatenata*, Kg.—Calcutta Botanic gardens, in tanks, floating; August, 1870.

2785 b. *Glæotila protogenita*, Kg.—Rajmahal, floating in tanks; October, 1870.

2792. *Microcystis olivacea*, Kg.—Muhudeepore, ruins of Gour in stagnant pools, with *Diatomaceæ*, *Closterium*, *Euglene*, etc.

2793. *Rhizoclonium Kochianum*, Kg., with single threads of *Lyngbya majuscula*, Harv., *Staurospermum cærulescens*, Kg., and other *Algæ*.—Rajmahal, floating in tanks near the station; October, 1870.

2798 and 2803. *Chatophora radians*, Kg.—On submerged bricks and dead branches in tanks at Rajmahal station; Oct. 1870.

2800. *Palmella bullosa*, Kg., occurs together with *Chatophora radians*, Kg.—Rajmahal station, in tanks, on submerged brick-stones; Oct. 1870.

2801. *Leptothrix muralis*, Kg.—Rajmahal (station), damp walls of the traveller's bungalow; Oct. 1870.

2802. *Hypheothrix subundulata*, Martens, n. sp.

Strato compacto, sordide olivaceo, filis 1/400 lin. crassis, pallide ærugineis, obsolete articulatis, granulatis; vaginis pellucidis, 1/350 lin. crassis, leviter undulatis.—Rajmahal, in tanks, on *Paludina* shells; Oct. 1870.

2804. *Spirogyra subæqua* β., fasciis spiralibus condensatis.—Rajmahal hills, Sahibgunj waterfalls, on rocks; Oct. 1870.

2811. *Spirogyra decimina*, Lk., with *Gomphonema dichotomum*, Kg.—Rajmahal hills, waterfall at the base of the hills near Sahibgunj, on trap rocks; Oct. 1870.

2812. *Protococcus vulgaris*, Kg.—On the ruins of one of the ancient gate-ways of Gour, Rajmahal; Oct. 1870.

2813. *Scytonema ærugineo-cinereum*, Kg.—On walls of buildings, very common in and around Calcutta.

2815. *Scytonema cinereum*, Men.—On a ruined bridge over the Ganges, S. of Rajmahal, on damp brickstones; Oct. 1870.

2817. *Cylindrospermum spirale*, Kg.—Calcutta, Botanic gardens, floating in tanks.

3037. *Polysiphonia angustissima*, Kg.—Calcutta, salt-lakes; Nov. 1870.

3038. *Polysiphonia polychroma*, Martens, n. sp.

Cæspitosa, pollicaris, pulchrè violacea, in rubrum, viridem, pallide fuscum et flavescentem colorem transiens; filis capillaribus, basi $1/20$ lin. crassis, radicanibus, superne complanatis; articulis pentasiphoneis, diametro plerumque æqualibus, margine corticatis, supremis brevissimis; ramis divaricatis oppositis alternisque; carpocloniis lateralibus curvatis.—Calcutta, salt-lakes; Nov. 1870.

3039 and 3050. *Hypoglossum pygmæum*, Martens, n. sp.

Fronde tenui purpurea, 3 ad 4 lin. longa, vix semi-lineam lata, repetite dichotoma; cellulis frondis quadrangularibus, costæ elongatis; segmentis linearibus, apicè incisus; soris in segmentis terminalibus et sporophyllis axillaribus ad costam aggregatis; cystocarpium stipitatis urceolatis. Calcutta, salt-lakes, on the culms of *Cyperus* and on submerged branchlets along Balliaghat canal; Nov. 1870.

3040. *Conferva Antillarum*, Kg.—Calcutta, salt-lakes, on submerged culms of *Panicum*. Nov. 1870.

3042 and 3043. *Lyngbya cinerascens*, Kg.—Calcutta, salt-lakes, on an old log of wood, in brackish water.

3044. *Scytonema granulatum*, Martens, n. sp.

Strato olivaceo fusco, tenui, pulverulento; filis simplicibus cum vagina $1/300$ ad $1/225$ lin. crassis, nunc virescentibus, nunc fuscis, laxè intricatis; vaginis arctis hyalinis; articulis distinctis diametro usque ad duplum brevioribus, duplici serie granulatis.—Calcutta, salt-lakes, on mud-banks. Nov. 1870.

3051. *Catenella Opuntia*, Grev., with *Chthonoblastus Lyngbyei*, Kg., and *Polysiphonia angustissima*, Kg.—Calcutta, salt-lakes; Nov. 1870.

3053. *Chatomorpha chlorotica*, Kg.—Calcutta, salt-lakes, common; Nov. 1870.

3054. *Hypheothrix tenax*, Martens, n. sp.

Strato compacto sordide virescente; filis pallide ærugineis v. lutescentibus, cum vagina $1/300$ ad $1/225$ lin. crassis, dense intricatis, obsolete articulatis; articulis diametro brevioribus, vaginis distinctis, hyalinis.—*Hyphe.* *investienti* proxima. Calcutta, salt-lakes, on roots, etc. Nov. 1870.

3055. *Oscillaria tenerrima*, Kg.—Calcutta, salt-lakes, on wet mud; Nov. 1870.

3057. *Leptothrix mamillosa*, Menegh.—Calcutta, salt-lakes, amongst *Algae*; on mud, submerged; Nov. 1870.

3058. *Leibleinia Juliana*, Kg.—Calcutta, salt-lakes, on *Najas*, *Potamogeton*, *Ceratophyllum*, etc.; Nov. 1870.

3059. *Oscillaria brevis*, Kg., with some filaments of the handsome *Spirulina oscillarioides*, Turpin.—Calcutta, salt-lakes, covering the mud with a layer of soft green. Nov. 1870.

3060. *Oscillaria versicolor*, Martens, n. sp.

Strato tenui fusco v. violaceo; filis 1/175 lin. crassis, violaceis v. fusciscentibus, interdum viridibus; articulis diametro triplo ad quadruplum brevioribus, ad genicula duplici serie granulatis; apicibus rectis.—Calcutta, salt-lakes, covering wet mud; Nov. 1870.

3061. *Hydrocoleum Lenormandi*, Martens, n. sp.

Vaginis pellucidis arctis, 1/100 lin. crassis; filis internis fasciculatim contortis, 1/600 lin. crassis, obsolete articulatis; articulis diametro æqualibus, subgranulatis.—At first observed in 1866, in the collections of the celebrated botanist, Mr. René Lenormand, at Vire, Dept. of the Calvados, from Java, and now found also by Mr. S. Kurz in the salt-lakes near Calcutta, on submerged grasses.

(Unicum.) *Phormidium Lyngbyaceum*, Kg.—Calcutta, salt-lakes, on an old submerged log of a tree; Nov. 1870.

IV. LIST OF ALGÆ COLLECTED BY MR. S. KURZ IN BURMA AND ADJACENT ISLANDS, BY DR. G. v. MARTENS, IN STUTTGARD.

This paper will appear in the Natural History Part of the Journal.

V. NOTE ON HEMIDACTYLUS MARMORATUS, H. KELAARTI, *Theob.*, AND ABLABES HUMBERTI, by WILLIAM T. BLANFORD.

In the Journal of the Asiatic Society for 1870, Vol. xxxix, Part ii, p. 363, I described a Gecko as new under the name of *Hemidactylus marmoratus*. I have since obtained many specimens of this species, which is not rare on trees, and is occasionally seen on houses, in the lower Godávári valley and neighbouring parts of

the Madras Presidency, and I find that, although the majority resemble the typical specimen in the absence of any enlarged tubercles on the back, a few are occasionally found with such tubercles, and that the form is only a small variety of *H. Leschenaultii*, with uniform or nearly uniform granulations.

The largest specimens I have as yet obtained of *Hemidactylus marmoratus* measure 5.2 inches of which the tail from the anus is exactly one half or 2.6. *H. Leschenaultii* grows to a larger size than this. I find in 4 specimens of the latter that the number of scales across the abdomen are respectively 36, 39, 39, 42, and the upper labials from 10 to 13, (usually 11 or 12,) lower labials 7 to 9, (8 being the prevailing number). In 4 specimens of the variety *marmoratus*, the scales across the abdomen vary from 34 to 42, (the numbers are 34, 38, 39, 42,) the upper labials vary from 10 to 12, the lower from 7 to 9. The femoral pores are quite as constant in number as either the scales across the abdomen or the labials, they are usually 12 in each thigh, but occasionally vary between 10 and 14.

From these differences, it is manifest that *Hemidactylus Kelaarti*, Theobald, must also be considered a variety of *H. Leschenaultii*. As I had, guided by Günther and other eminent herpetologists, attached a higher value to the presence or absence of enlarged tubercles on the back of this group of *Hemidactyli*, than the character deserves, it is probable that some of my other identifications on page 364 (loc. cit.) are incorrect.

I was in error in including *Ablabes Humberti* in the fauna characteristic of the Malabar province. I have found several specimens of a small snake near the lower Godávári which appears to belong to that species, and I find that the same form occurs near Calcutta. The only important difference between specimens from the different localities is in the number of ventral scales, which I find to be 155 in a Malabar specimen sent by Major Beddome to Dr. Stoliczka; about 210 in specimens from Ellore, and no less than 240 in one from Calcutta. This is a remarkable degree of variation certainly, and there is a corresponding difference in length, the snakes from Bengal and Ellore being more elongate. Dr. Günther, I should add, found the number of ventral scales to be 175.

LIBRARY,

The following additions have been made to the Library since the meeting held in July last.

Presentations.

*** Names of Donors in Capitals.

Proceedings Roy. Soc., London, vol. XIX, No. 128.—THE ROYAL SOCIETY OF LONDON.

Monatsbericht, April, 1871—Verzeichniss der Abhandlungen, von 1710-1870, in alphabetischer Folge der Verfasser.—K. AKADEMIE DER WISSENSCHAFTEN ZU BERLIN.

Proceedings Zool. Soc., 1870, part III.—THE ZOOLOGICAL SOCIETY OF LONDON.

Quarterly Journal Geol. Soc., vol. XXVII, part 2, No. 106.—THE GEOLOGICAL SOCIETY OF LONDON.

Bulletin, Année 1870, No. 2.—SOCIÉTÉ IMPÉRIALE DES NATURALISTES DE MOSCOU.

Bulletin, Juillet—Décembre 1870, Janvier—Février 1871.—SOCIÉTÉ DE GÉOGRAPHIE, PARIS.

E'vkönyvei, XI. 10, 11, 12 Darab; XIII. 1, 2, 4 Darab—Nyelv-tudományi Közlemények, VII Kotet 1. 2. 3 füzet, VIII Kotet, 1. 2. 3 füzet.—Ertekezések, II—X, szám—A Magyar Nyelv Szótára, V kotet, 1. 2. 3. 4 füzet—A Törvény Tudományi E'rtkezések, XII szám—Almanach 1869, 1870—E'rtesítője, II évfolyam 13-20, szám, III. évfolyam, 1-20 szám, IV. évfolyam 1-12 szám—A Magyar. Tud. Akad. Alapszabályai.—MAGYAR TUDOMÁNYOS AKADEMIA, PEST.

A Memoir on the Indian Surveys by C. R. Markham.—THE AUTHOR.

Ramayana, edited by Hemachandra, vol. II, No. 9.—THE EDITOR.

Professional Papers on Indian Engineering, Second Series, vol. I, No. I.—THE EDITOR.

Rottler's Tamil and English Dictionary.—Rhenius' Tamil Grammar.—H. F. BLANFORD, ESQ.

Memoirs of the Geological Survey of India, Palæontologia Indica, vol. III. Nos. 9-13.—THE SUPT. OF THE GEOLOGICAL SURVEY OF INDIA.

Selections from the Records of the Government of N. W. Provinces, vol. IV, Nos. iii—iv.—THE GOVERNMENT OF THE N. W. PROVINCES.

Purchase.

The L. E. D. Philosophical Magazine Nos. 275, 276.—The A. and M. of Natural History, No. 42.—Jacut's Wörterbuch, vol. VI part 1.—Dictionnaire Djaghatai-Turc.—The American Journal of Science, No. 50.—The Numismatic Chronicle, 1871, part I.—Revue Archéologie 1870, No. IX.—Revue des Deux Mondes, Jan., 1871.—Calcutta Review, July 1871.—Comptes Rendus, No. 18-22.—Reise der Fregatte Novara, Botanischer Theil, Band I.—Böhtlingk und Roth' Sanskrit-Wörterbuch, 45 Lief.

Exchange.

“Nature,” Nos. 80-88.

“Athenæum,” April and May, 1871.

PROCEEDINGS
OF THE
ASIATIC SOCIETY OF BENGAL

FOR SEPTEMBER, 1871.

The monthly meeting of the Society was held on Wednesday the 6th instant, at 9 o'clock P. M.

The Hon'ble Mr. Justice Phear, President, in the chair.

The minutes of the last meeting were read and confirmed.

The receipt of the following presentations was announced—

1. From Captain W. G. Maitland—Two Thibetan MSS., given to him by an inhabitant of the Naga Hills.

2. From the author—a copy of “Kulu, its Beauties, Antiquities, and Silver Mines, including a trip over the snowy range and glaciers,” by J. Calvert, Esq., F. G. S.

The following gentlemen were elected ordinary members—

E. T. Atkinson, Esq., (re-election).

R. F. Chisholm, Esq.

Captain S. B. Miles.

H. Buckle, Esq.

The following gentlemen are candidates for ballot at the next meeting.

J. A. Aldis, Esq., M. A., proposed by the Hon'ble J. B. Phear, seconded by Col. A. S. Allan.

Dr. A. Neil, Lahore, proposed by the Hon'ble J. B. Phear, seconded by H. F. Blanford, Esq.

J. O'Kinealy, Esq., C. S., proposed by Col. J. F. Tennant, seconded by Dr. F. Stoliczka.

J. A. Briggs, Esq., Asst. Supt. Telegraph Dept., proposed by Mr. L. Schwondler, seconded by Mr. W. E. Ayrton.

H. G. Cooke, Esq., C. S., Midnapur, proposed by Mr. J. Wood-Mason, seconded by Mr. H. Blochmann.

Col. G. E. Evezard, Magistrate of Poona, proposed by Mr. W. T. Blanford, seconded by Dr. F. Stoliczka.

Col. A. D. Dickens has tendered his resignation as a member of the Society.

The following letters were read—

From M. L. Ferrar, Esq., C. S., Seetapore, Audh, regarding the birthplace of Rájah Todar Mall.

“In Fasc. IV, of your translation of the *Aín Akbarí*, you record that Rájah Todar Mall was born at Láhor. Would you kindly inform me which of the native Historians gives his biography. I ask this, as the people of *Láharpúr*, a large town of 11000 inhabitants in the parganah of the same name, in this district (*Sítápúr*) and included in the *Aín Akbarí* in ‘*Sirkár Khairábád*’ all believe that he was a native of their town. I am inclined to think that they have good grounds for their belief, for in the first place the Rájah was not a mythical personage, like Rám Chandr or king Birát, whose birthplace is claimed by many places—and secondly, hard by Láharpúr is *Rájápúr*, called after the Rájah, and having a year-ly melá in his honour. At the present time, there is a large community of K’hatris (the Rájah’s caste) at Láharpúr. I think the point is worth clearing up.”

Mr. Blochmann said—

On the receipt of Mr. Ferrar’s letter, I looked up several MS. histories, and found that the *Maásir ul Umará* and the *Tafríh ul ’Imárat* call the Rájah a *Lahaurí*. The *Maásir* must have derived his information from the *Akbarnámah*, though I have not yet found a passage in that work, where the Rájah’s birthplace is given. I then asked Mr. Ferrar, to obtain more particulars regarding Todar Mall’s father, who is not mentioned in the histories, as I thought that the Láharpúrí Rájah might be the *Todar Mall Sháhjahání*, a distinguished Hindú courtier of Sháh-jahán’s time. But the Láharpúris evidently mean Akbar’s renowned minister of finances. Mr. Ferrar replied—

“I will make more enquiries from the Láharpúr people about Todar Mall, and shall let you know the result of them. Meanwhile, and since my last, I have been informed by a respectable

Bráhmaṇ of that place that Todar Mall's father was a 'Panjábi K'hatri,' and came and married the daughter of a Chápari K'hatri in Láharpúr, where the son was born. The latter seems to have lived there during his boyhood.

"Láharpúr contained 11000 inhabitants in 1869—and probably 15000 in the Nawábi. It takes its name from Láhari Mall, a Passi, who 500 years ago invaded the surrounding country. Up to then it had been known as 'Tughluqpúr,' having been founded by the Emperor Fírúz Tughluq (1357—1388, A. D.), who passed through there on his way to the Bahráich shrine of Sayyid Sálár. I hope that we may be able to settle the birthplace of such a notable personage as R. Todar Mall was."

Mr. W. T. Blanford exhibited a collection of chipped quartzite implements found about 40 miles west of Bhadráchalam on the Godávári. The 35 specimens exhibited were all found within a space of about 50 yards square, and at least as many more were rejected on account of being badly made. The place where they were found was in dense jungle, the rock soft sandstone, and the implements, as was usually the case in Southern India, had evidently been chipped from pebbles. Several were formed of white vein quartz, an unusual circumstance. The forms of these implements were those of the kind most frequently found in French and English gravels, and they varied from about 3 to 6 inches in length. That the spot where they were found was a place of manufacture was probable, not only from the occurrence of ill formed implements, but also from flakes, evidently chipped from the quartzite being abundant.

The following communications were read:—

1. LETTER FROM R. L. FORBES, ESQ., ASSISTANT COMMISSIONER, PALAMAU, REGARDING THE MUGHUL INVASIONS OF PALAMAU. COMMUNICATED *by* COL. E. T. DALTON, C. S. I.

(Abstract.)

Mr. Blochmann read the letter, which will be published in the forthcoming number of Part I of the Journal. The particulars of the conquest of Palámau by the Mughuls, and especially of the final

war under Dáúd Khán, Aurangzeb's general, are still remembered by the inhabitants of the district. Mr. Forbes's details prove in a most striking manner the reliability of our Muhammadan historians; the only discrepancies refer to the relationship of several Chero chiefs. His geographical remarks form a valuable commentary on several passages in the *Pádisháhnámah* and the '*Álangír-námah*, and correct, in one case, a bad reading of the Society's edition of the latter work.

2. NOTES ON AND TRANSLATION OF TWO COPPER-PLATE INSCRIPTIONS FROM CHAIBASSA, SINGBHU'M, *by* PRATAPACHANDRA GHOSHIA.

(Abstract.)

The copper tablets were discovered buried in the ground in the village of Bámangháti. They record grants of several villages Bámánvastí, &c., to two bráhmans by two princes of the Mayurbhanj family, a family still extant in the Katak Tributary Mahalls. The plates are each surmounted by a seal, bearing the name of the donor, and signs such as the bull, the trident, and the crescent moon. Rájábhanja, the son of Ranabhanja, is the donor mentioned in one tablet and Ranabhanja is the donor of the other. The tablet of Ranabhanja bears a date which is supposed to be 56 Samvat.

3. ON TWO SAURIAN GENERA EURYLEPIS AND PLOCEDERMA, BLYTH, WITH A DESCRIPTION OF A NEW SPECIES OF MABOUIA, FITZINGER,—*by* DR. ANDERSON, CURATOR, INDIAN MUSEUM.

In comparing some of the Reptiles in the Indian Museum with the catalogue of that Section prepared by Mr. Theobald for this Society, I have lately made two identifications which it is desirable should be put on record, as they refer to two of Mr. Blyth's genera which have hitherto escaped the notice of Herpetologists. I refer to the two genera *Eurylepis* and *Plocederma*. In Mr. Theobald's Catalogue, no mention is made of either of them, and I can only account for their having been overlooked by the circumstance that they were originally published as foot notes to two consecutive pages of the Journal of this Society for 1854.* The species illus-

* J. A. S. Beng. vol. xxiii, pp. 738-739.

trating the first mentioned so-called genus was referred by Theobald to *Plestiodon* of Dumeril and Bibron, and renamed by him *P. scutatus*, and the other species for which Blyth had suggested the generic term *Plocoderma* was placed by Theobald in the genus *Laudakia*, which he regarded as distinct from *Stellio*, and referred to Gray's species *Stellio tuberculatus*.

Before considering the affinities of these two forms I shall first point out the characters of the sub-genus *Eumeces* which Wiegmann, its author, regarded as only a subdivision of his Section *Euprepes*.

In the Catalogue of the Berlin Museum published in 1856* Lichtenstein identified *Plestiodon Aldrovandi*, D. and B., with *Scincus pavimentatus*. P. Geoffroy St. Hilaire†, but justly retained for *P. Aldrovandi*, D and B.‡ Schneider's name *auratum*§ which, even according to Dumeril and Bibron's showing, was entitled by priority to stand for the species to which they had affixed the name of *Aldrovandus*. Prof. Peters|| was the first after Wiegmann himself to direct attention to the fact that the *S. pavimentatus*, Is. Geoff. St. Hilaire was the type of Wiegmann's sub-genus *Eumeces* and Dr. Stoliczka¶ last year brought Peters' observation to the notice of this Society.

The history of the sub-genus *Eumeces* is as follows: In 1834, Wiegmann** in establishing the genus referred *S. rufescens*, Merr., and *S. punctatus*, Schneider, to it, but in the following year†† he pointed out that these two species did not belong to it. In 1837,‡‡ he indicated that *Eumeces* was intermediate between *Gongylus* and *Euprepes* and that *S. pavimentatus*, Is. Geoff. St. Hilaire, was the only species referable to it, and that it differed from *Euprepes* in the form of its tongue and dentition, but he did not regard these differences as of generic but only of sub-generic

* Nomen. Rept. et Amphib. Musei Zool., Berol., Lichtenstein, p. 19.

† Desc. d l'Egypt, p. 135, pl. 3, fig. 3, pl. 4, fig. 4, 4a.

‡ D. and B. Herpl. Genl. vol. v, p. 701, 704.

§ Schneider, Hist. Amph. Zoo. 11, p. 176. Günther places *S. auratus* in *Mabouia* and records it from Persia.

|| Monats. der Akad. zu Berlin, 1864, pp. 48, 49.

¶ Journ. As. Soc. Beng. 1870. vol xxxix p. 174.

** Herpet Mex. p. 36.

†† Arch. für Naturgesch. (Wieg.) vol. ii, p. 288.

‡‡ Wieg. l. c. vol. v, p. 132.

value. He states that the nostrils of *S. pavimentatus* are situated in the centre of a small nasal shield, but in his work on the Herpetology of Mexico he writes, "*naris in medio scutello sitæ (scutellis duobus in unum coalitis)*" which would lead me to conclude that he doubted whether the character of a single nasal shield were a reliable and constant feature. At that time he divided the genus into two small sub-divisions: one Section, *A.* containing *S. pavimentatus* and *S. rufescens*, Merr., the latter of which he afterwards referred to *Euprepes*, and another Section *B.* in which he placed *S. punctatus*, Schneider, and which he also afterwards located in *Euprepes*. The characters of the first sub-division were these, "*palpebra superior mediocris: inferior scutellato squamosa: dentes palatini numerosi.*" It is therefore to be understood that the scales of *Eumeces* (*E. pavimentatus*) were smooth the nostril in a single plate resulting from the coalescence of two nasals, the inferior eyelid scaly, and that it had palatine teeth.

In 1839, Dumeril and Bibron* do not appear to have been aware that Wiegmann had corrected his original mistake and had removed *S. rufescens* and *S. punctatus* from *Eumeces*, for they enter into an elaborate criticism of his arrangement of the genus in his Herpetology of Mexico. They regarded Wiegmann's *Eumeces* as not founded on a sufficient basis and they therefore retained his name simply to apply it to the group represented by the type *S. punctatus* of Schneider, which has a transparent eyelid, a double fronto-parietal and a small unilobular ear. They, however, in the same volume described the genus *Plestiodon* which has all the characters of Wiegmann's first section (*A.*) of *Eumeces* as represented by *Eumeces pavimentatus*, Geoff., which Professor Peters states is synonymous with *Scincus Schneideri*, Is. Geoff. St. Hilaire, *Plestiodon Aldrovandi*, D. and B., and *Plestiodon cyprius*, Cuv. Under these circumstances *Plestiodon* cannot stand, as *Eumeces* has the prior claim to acceptance.

Blyth's *Eurylepis* has the palatine teeth and palate of *Eumeces*, as described by Wiegmann, and also the scaly eyelid and smooth scales. The nostril, however, is not in a single plate but is placed between an anterior and posterior nasal shield, and not as described

* Herpet. Genl. vol. v.

by Blyth and Theobald in a small separate nasal shield. The head plates are arranged as in *E. pavimentatus* and the ear has from three to two lobes anteriorly. The only character of importance in which it differs from *Eumeces* as defined by Wiegmann, and illustrated by *E. pavimentatus*, is the occurrence of the nostril between two shields) but keeping in view Wiegmann's statement that the single nasal of *E. pavimentatus* results from the union of two, this singular difference can hardly be considered as generic. I therefore regard *Eurylepis* as another synonym of *Eumeces*, Wiegmann. *Eumeces* thus defined would appear to correspond with Fitzinger's* genus *Mabouia* which like *Eumeces* has a single nasal, a scaly eyelid and palatine teeth, and the palatine groove reaching forward to the eye, so that the only generic distinction that exists between them is the character of the nostril, but if I am correct in regarding that character as not of sufficient importance to separate *Eurylepis* from *Eumeces*, it cannot have more force when we compare *Mabouia* and *Eumeces* and I am therefore inclined to group together these smooth scaled skinks with palatine teeth and scaly eyelids under the first proposed term *Mabouia*, Fitzinger. *Scincus* which has palatine teeth is separated from *Mabouia* by its dilated toes and shovel-like muzzle.

There is this peculiarity in the scales of the this new form that led Blyth to term it *Eurylepis*, viz., that the scales on the middle of the back from on a line with the axilla as far back as on a line with the groin, while they have only the antero-posterior breadth of the scales of the sides of the back and sides, are so much transversely extended that each dorsal scale has the breadth of three of the lateral rows of scales. The middle of the back is thus covered, in the area defined, by a single row of narrow, hexagonal much transversely extended scales. The scales, between the occiput and the enlarged dorsal series, are of the same size as those in the sides. Each dorsal scale, large and small, is marked by shallow grooves† from the number of 3 to 10, or 11, the first number being restricted to the small scales and the latter occurring on the large scales or plates: the smaller scales have each a minute pore. If these grooves were brought together in pairs, they would produce

* Neue Class. der Rept. 1826, p. 23.

† D. and B. l. c. v. p. 702.

a keeled character in the scale, so that it would appear that they are perhaps modifications of the carinated form of scales. It should be borne in mind, however, that this form notwithstanding its grooved scales, is a truly smooth scaled scink. To revert, however, to the significance of the large dorsal plates in the form under consideration; it does not appear to me to merit generic status, because another and distinct species has recently come under my observation, in which there are two rows of enlarged dorsal shields, each about half the size of the large scales of the type of *Eurylepis*. *Mabouia* with the foregoing facts before us may be defined as follows:—

MABOUIA, Fitzinger.

Head conical, scales smooth and finely grooved; dorsal scales either of uniform size or enlarged. Tail long, round and smooth without spines; lower eyelid scaly. Nostril either in a single plate or between two plates, an anterior and posterior. Teeth numerous, conical, somewhat laterally compressed. Palatine teeth. Palatine notch broad on a level with the eye. Limbs moderately or well developed, rather far apart. Toes, 5, 5.

The species which has given rise to these remarks may be characterized as follows:

MABOUIA TENIOLATA, Blyth.

Eurylepis teniolatus, Blyth, Journ. As. Soc. xxii pp. 739, 740.

Plestiodon scutatus, Theobald, Cat. Rept. As. Soc. Mus. 1868, pp. 25, 26,

Eumeces scutatus, Theob., Jerdon, Proc. As. Soc. Bengal, 1870, p. 73.

Body rather elongated, limbs moderately developed and far apart, the distance between them equalling five times the interval between the shoulder and ear. Tail $1\frac{2}{3}$ of the length between the snout and the vent: cylindrical, regularly tapered. Supranasals transversely elongated forming a suture behind the rostral. Frontal transversely octagonal. Post-frontals pentagonal, broad externally but narrowing towards the common, broad, mesial suture. Vertical elongate, oblong; lateral and posterior margins concave. Two small pre-occipitals not forming a suture together, but separated by the point of the anterior extremity of an azygos, arrow-head-shaped occipital, with a moderately sized exoccipital shield, on either side

of it. Two temporals, one above the other between the exoccipital and the posterior margin of the last upper labial. A postocular between the two last labials, before the temporals, and with a small postocular above and two small shields in front of it. Six superciliaries, the third from before backwards being the largest. A rather large pentagonal præocular below the first superciliary. A vertically oblong loreal with its upper margin wedged in between the præfrontal and postfrontals. An hexagonal postnasal over the suture of the first and second labials. Two rows of very small shields between the upper labials and the scaly disk of the lower eyelid. Two transverse chin shields, one before the other, behind the mental, the hindermost being the largest and succeeded by three pairs of large shields, of which the anterior pair form a suture. Ear of moderate size with three or four strong denticulations on its anterior margin, the two uppermost being double the size of the others. A dorsal line of transversely broad, longitudinally narrow, hexagonal scales from over the shoulder to on a line with the groin. These scales are as broad as the three lines of scales external to them, and are obscurely marked by 10 or 11 fine grooves, while the small dorsal scales have three such fine sulci. Twenty-one rows of scales round the middle of the body. Scales on the under surface of the tail enlarged, those on the upper surface the same as on the side of the body. Two large anals separated by an oblique suture. Anterior limb when laid forwards reaches beyond the anterior angle of the eye; posterior limb reaches only a short way beyond one-third of the distance between the groin and the axilla. Centre of under surface of the feet covered with small tubercles; a line of larger tubercles on the hind foot embracing the smaller ones, and curving backwards from the outer to the inner toe. About 8 inter-maxillary, and 28 maxillary teeth in the upper jaw, as a whole; and five palatine teeth on either side.

The specimens are much faded, but the coloration appears to have been a pale olive grey above with a dark brown band running along the large, dorsal scales, and spotted with whitish. A dark brown band along the side from the eye and partially prolonged on to the tail. This band is ornamented at regular intervals with three longitudinal lines of whitish spots. Tail more or less darkly speckled, the markings tending to form transverse rings.

Length:—snout to vent 3," 8"" ; vent to tip of tail 5," 2"" ; head 6"" ; fore limb 10," hind limb 1", fourth toe 4.""

Hab. Punjáb, Salt Range.

Two specimens were collected by Mr. Theobald in the Salt Range of the Punjab, and presented by him to this Society and described by Mr. Blyth who created the above named genus for their reception. There cannot be a doubt as to their identity, but both, Blyth and Theobald, have fallen into some inaccuracies regarding certain of their characters. The former says that the nostril is pierced in a small, separate, nasal shield, an error repeated by Theobald. Mr. Blyth also states that the lower eyelid has a translucent disk, but Mr. Theobald more accurately describes it as scaly, with a transverse row of large plates. He, however, says the body is surrounded by 23 rows of scales while the two specimens exhibit only 21 in the middle of the body, and Blyth limited them to 19.

If I am wrong in my estimate of the value to be attached to the occurrence of the nostril between two plates, and the presence of the enlarged dorsal plates, then Blyth's *Eurylepis* will stand, but for the reasons stated, I do not regard these characters as generic.

MABOUIA BLYTHIANA, n. sp.

Rostral triangular, hexagonal, in contact with the supranasals. Anterior nasal triangular, rather small; posterior shield subquadrangular. Supranasals transversely oblong, forming a suture behind the rostral. Frontal transversely elongate, its anterior margins forming an obtuse angle. Posterior frontals large, hexagonal, forming a broad suture. Vertical elongate, lateral margins slightly convergent posteriorly, hinder margins forming an obtuse angle. Præoccipitals pentagonal, forming a broad suture behind the vertical. An azygos, wedge-shaped occipital. Exoccipitals of moderate size, pentagonal. Three rather large temporals between the exoccipitals and the two last upper labials, one anterior to the other two shields which lie one above the other, the former separated from the eye by a chain of small shields running from the anterior angle of the eye, along the upper eyelid and the lower margin of the eye to its anterior third. Six superciliaries, the first and last very small. A small point-

edly quadrangular, and a large, oblong shield along the anterior third of the lower margin of the eye, the former behind the latter, with a large pentagonal loreal in front of them, and a vertically elongated, hexagonal postnasal before the latter, in contact with the 2nd, upper labial, posterior nasal, supranasal, frontal, postfrontal and loreal. Eight upper labials, the seventh and eighth the largest, the anterior margin of the last on a line with the posterior angle of the eye. Seven lower labials, the last but one the largest. Mental like a labial, but more transversely elongated, with a large, azygos, pentagonal plate behind it, with the concavities of its two hinder margins directed backwards and in contact with two pairs of labials. A pair of transverse shields in contact with the second and third labials and forming a suture together behind the azygos plate; another large pair with a small azygos shield between the plates, succeeded by another pair with a still smaller pair behind the latter. Thirty rows of smooth scales round the middle of the body. Two longitudinal lines, in the middle of the back, of transversely elongated, hexagonal scales considerably larger than any of the other dorsal or lateral scales, and commencing from behind the occiput and diminishing in size on the root of the tail. Ventrals of moderate size with their posterior margins rounded. Two large præanals with a small external pair. Tail rounded, slightly, laterally compressed, long and tapering, one and two-thirds as long as the body. A single row of enlarged sub-caudals. Scales on the upper surface and sides of the tail of uniform size. Ear moderately large, erectly oval, with from three to four strong lobules on its anterior margin, the uppermost the strongest. Under surface of feet covered with tubercles, those of the hind foot embraced by an enlarged series extending from the base of the first to the base of the fifth toe. Limbs well developed, the fore limb reaching to the tip of the snout, and the hind limb when stretched forwards extending to the anterior third of the space between the axil and groin. Seven intermaxillary and 34 maxillary teeth in the whole of the upper jaw, and 36 in the mandible. Seven to eight palatine teeth on either side. Snout to vent, 3" 5"; vent to tip of tail 6"; head 7"; fore limb 1" 1"; hind limb 1" 6"; fourth toe 6."

Olive brown above; three dark-brown, longitudinal lines along

the back, from the nape to the base of the tail. A broader dark-brown band from the eye over the tympanum, along the side. A broad, pale-yellowish band below it from below the eye through one half of the tympanum along the sides to the groin. A palish dusky band from the angle of the mouth, over the shoulder, and along the side below the yellowish band. Upper surface and sides of tail pale, uniform brownish-olive. All the under parts yellowish.

Hab. Amritzur? Purchased from a Bokhara merchant who stated that he obtained it at Amritzur.

Blyth* in a notice of some Reptiles from the Panjáb writes of the next form which I purpose to consider, "a well marked second species of Dr. Gray's genus *Laudakia*, founded on *Agama tuberculata* of Hardwicke's Ill. Ind. Zool., if not rather a new genus affined to *Laudakia* (in which case this may bear the name *Plocederma*, nobis)." This specimen is still in the Museum and was referred by Theobald to *Laudakia tuberculata*, Gray, which he considered generically distinct from *Stellio*, and which it does not appear to be. The examples of the genus *Stellio* in the Indian Museum agree with Dr. Günther's figure of *S. indicus* which he afterwards referred to *S. tuberculatus*, Gray. There are, however, two well marked species of the genus in India as Dr. Stoliczka has shown me from the rich materials in his possession, and as he is to describe the result of his observations, I shall proceed to point out the characters of the type specimen of Blyth's supposed genus *Plocederma*, but, to enable me to do so, it is necessary for me to remark that the two species recognized by Dr. Stoliczka are distinguished by the size and distribution of the enlarged scales of the dorsal region. One species *S. tuberculatus* has the scales considerably and generally smaller than the other and more numerous, those on the back of the neck being scarcely enlarged, while in the other, larger-scaled form, the scales in that region partake to a certain extent of the nature of the dorsal scales and are prolonged more or less to the occiput. I am inclined to the conclusion that Blyth's *Plocederma* is a young individual of Dr. Stoliczka's large scaled form, but the following are the characters of Blyth's *S. melanurus*.

* Journ. As. Soc. Beng. xxiii, pp. 737,738.

STELLIO MELANURUS, Blyth.

Laudakia (Ploceoderma) melanura, Blyth, Journ. As. Soc. Beng. 1854, vol. xxiii, p. 737-739.

Laudakia tuberculata, Gray, Theobald, Cat. Rept. As. Soc. Beng., 1868, p. 38.

A short rudimentary crest of enlarged, keeled, tubercular scales. Scales of the back enlarged, imbricate, strongly keeled, with serrated free margins, and with a small apical spine. On the middle of the back, there are 8 rows of the enlarged scales much larger than those external to them which number 7 rows, gradually decreasing from within outwards, the outer row, however, abruptly separated by its greater size from the minute scales of the sides. In the large central rows of scales, the strong keels form longitudinal lines, while in those external to them, the keels form oblique lines, from within outwards. Half way between the middle of the back and the shoulder, the number of rows of enlarged dorsal scales decreases to 16, so that the scales are restricted to a much narrower area than on the back, but before the shoulder there is again a slight augmentation in their distribution, the rows increasing to about twenty, but the scales having diminished in size, the lateral extent covered by them is not much increased. On the back of the neck, there are no enlarged scales besides those of the central crest which begins where the enlarged scales stop, on a line with the shoulder. The scales on the sides of the body are granular, each with a minute apical spine and arranged in transverse lines, and there are no enlarged scales among them. (In this character it differs from *S. tuberculatus*). I count 149 rows of scales round the middle of the body, 53 of which are ventral, smooth and without any trace of keels. The scales on the upper surface of the limbs, with the exception of those on the tail, are the largest, their margins are serrated and each has an apical spine. The scales of the tail are large and arranged in verticils which are interrupted, however, in their curve on the upper surface of the base of the tail. All are keeled and have strong apical spines, with the exception of those in the middle of the under surface of the tail which have no keels, but generally have an apical spine, with a smaller one on each side of it. Nostril above the second and

third labials, but separated from them by two rows of scales. Seventeen upper and fifteen lower labials. A median line of slightly enlarged keeled scales behind the snout, and a similarly enlarged plate on the occiput. Two to three rows of enlarged conical, spined scales from below the eye to the tympanum. A group of tubercular, spinous scales at the anterior margin of the ear. A fold at the under margin of the tympanum prolonged to the neck, on the under surface and sides of which there are numerous folds, those in the latter locality being here and there covered with groups of spines. A pit before the shoulder from the upper anterior margin of which a fold is prolonged over the shoulder to the sides of the back with small spines occurring on it at intervals; a smaller and more indistinct fold between the latter fold and the shoulder with a few large spinous scales. The opening of the ear is very large and patulous. The tail is slightly dilated at its base and depressed, long and slender and more than twice as long as from the snout to the vent. The wrist reaches as far forwards as the snout, and the hind limb just touches the vent. The third finger is nearly the length of the fourth which is the proportion in the corresponding toes. A small callous patch of about 20 scales in the centre of the abdomen, with a præanal series of two rows of callous scales. A deep depression behind the vent. The dental formula of the upper jaw is premaxillary teeth $3 + 3 = 6$; maxillary teeth $13 + 13 = 26$; total 32. Snout to vent $3'' 2''$; vent to tip of tail $7'' 9''$; head $10''$; fore limb $1'' 8''$; hind limb $2'' 8''$; fourth toe $7''$.

Colour in spirit, I quote from Blyth, "Olive grey, probably olive green and changeable when alive; the head and body speckled over with dark scales, and also with some scales paler than the rest; the long slender portion of the tail dusky black and the lower parts pale and buffy white, apparently suffused with crimson when alive; the throat and below the shoulders beautifully marbled with greyish black, probably blue in the living animal."

Blyth states that the locality from whence the specimen was obtained was uncertain, but that he believed it to come from Kashmir. Mr. Theobald, however, who collected the specimen states in his Catalogue that it came from Simla.

4. NOTES ON SOME INDIAN AND BURMESE OPHIDIANS,
by DR. F. STOLICZKA.

(Abstract.)

In this paper notes are given of the following species : *Typhlops Horsfieldi*, *T. bothriorhynchus*, *T. braminus* and *T. pammeces*.

T. porrectus, n. sp.—18 longit. rows of scales ; 406-440 transverse rows on body, 11-12 on the tail ; head-shields regular ; eye very indistinct ; circumference $\frac{1}{2}\frac{1}{4}$ to $\frac{1}{2}\frac{1}{7}$ of length of body ; leaden or olivaceous brown above, paler below and on the head ; mouth and below tail pure white. Bengal and N. W. Provinces.

T. Andamanensis, n. sp.—18 longit. rows of scales, about 390 transverse rows on body and 17 on the tail ; head shields above regular ; one separate lower præ-ocular and one sub-ocular ; 4 labials, the third larger than the fourth ; circumference a little less than $\frac{1}{8}$ th of total length ; eye indistinct ; blackish brown above, vinaceous on side, grey, checkered with white, below. Andaman islands.

T. Theobaldanus, n. sp.—22 long. rows of scales ; 485 transverse rows on body, 26 on the tail ; circumference $\frac{1}{8}$ of the total length ; head-shields regular ; eyes perfectly indistinct ; uniform light brown ; India.

Simotes bicatenatus.—*Ablabes collaris*.—*Compsosoma Hodgsoni*.—*Zamenis fasciolatus*.—*Tropidonotus quincunctiatus*. Of this last species a variety is described and figured, with the posterior frontals united into one shield.

T. bellulus, n. sp.—19 rows of small, sharply carinate, scales, head-shields like in the last species, but the anterior frontals more obtuse in front, 9 upper labials of which the 4th, 5th and 6th enter the orbit, 1+2 temporals ; 140 ventrals, 63 subcaudals ; olive brown above with two series of little dark spots along the back, all ventrals black at the base ; Pegu (Mr. S. Kurz).

T. Himalayanus.—*T. junceus*.—*T. subminiatus*. A unicoloured large variety is figured and described of the last species.

T. macrops, Blyth, is the same as *T. macrophthalmus*, Günther, and most probably also identical with *T. Sikkimensis*, Anderson.

T. plumbicolor from Qualior.

Psammodphis condanurus. The N. W. Sub-Himalayan variety is possibly the same as *P. Leithii* of Günther, from Sind.

Dipsas Forsteni occurs at Pankabaree, base of Sikkim hills.

D. hexagonotus, Bl., is not identical with *D. multifasciata*, Bl., as suggested by Dr. Anderson.

D. bubalina is common in the low valleys of Sikkim.

D. trigonata from Qualior.

Leptorhytaon jara is not considered to be generically distinct from *Lycodon*.

Hypsirhina enhydris has sometimes 23 rows of scales.

Trimeresurus Andersoni of Theobald is quite distinct from *T. monticola* with which it was wrongly identified by Dr. Anderson. It is an Andaman species, and allied to *T. porphyraceus* of Blyth.

[This paper will be published with illustration in the Natural History Part of the Journal for the current year].

5. NOTES ON NEW OR LITTLE KNOWN INDIAN LIZARDS,
by DR. F. STOLICZKA.

(Abstract.)

After some preliminary remarks, the author gives notes on the following, known or new, species :—

LACERTIDÆ.

Tachydromus sexlineatus, and the allied species *T. meridionalis*, *T. Haughtonianus** and *T. septentrionalis*.—*Ophiops Jerdoni*, Blyth, = *Pseudophiops Jerdoni* = *Ps. Theobaldi* and ? = *Ps. Beddomei* of

* The naming of this species was the cause of a most unjustifiable attack by Dr. Anderson upon Dr. Jerdon, as recorded by the former in the Proc. of the Zool. Soc. of London for 1871, p. 156. I do not wish to repeat that presumptuous statement, which has justly elicited the indignation of naturalists at home; but a reference to p. 72 of the Society's Proceedings for February 1870 will shew, that it was I who originally gave that information to Dr. Jerdon, as recorded by him (l. cit.). The specimen, for which the new name was proposed, was received during my temporary tenure of the office as Curator of the Indian Museum, and as such I thought it right in communicating the information to Dr. Jerdon, whom I knew to be engaged in the preparation of a monograph of the Indian Reptiles. A few points of minor importance in the identification of the species have been afterwards compared by Dr. Jerdon, with the knowledge of one or the other of the officers of the Museum. The name *Haughtonianus* has been adopted by Jerdon on my suggestion.—Of all this Dr. Anderson should, or might, have been aware. But if he wishes to style himself a "Director" of the Museum, why should he be so anxious to apply Dr. Jerdon's statement "with the concurrence of the Curator" to himself? The monopoly of naming and describing specimens in a public Museum, which Dr. Anderson appears to claim as his exclusive right, has fortunately not yet been made law in the Indian Museum at Calcutta.

Jerdon.—*Ophiops* [*Gymnops*] *microlepis*, Blanf., from Kuhurbaloe.—*Acanthodactylus Cantoris*, from near Agra, Ambala, Ludiana &c.

GECKOTIDÆ.

In this family the more important species noticed are :
Of *Hemidactyli* 15 species are distinguished :

1. *H. triedrus*, from which Jerdon's *H. subtriedrus* is possibly distinct.
 2. *H. maculatus*, D. and B. (smaller form).
 3. *H. Pieresii*, Kelaart = *H. maculatus*, D. and B., large specimen, ? = *H. Sykesi*, Günther.
 - 4-5. *H. gracilis*, Blf., and *H. reticulatus*, Bedd.
 6. *H. frenatus*, (? = *H. punctatus*, Jerdon).
 7. *H. Leschenaultii* = *H. Kelaarti*, Theob., = *H. marmoratus*, Blanford.
 8. *H. Mortoni*, Theobald ; Burma.
 9. *H. Coctæi* = *H. Bengaliensis*, Anderson.
 10. *H. aurantiacus*, Bedd.
 11. *H. giganteus*, n. sp. Similar to *Coctæi*, but much larger, the general size being equal to that of *Gecko guttatus*. First labial not entering the nostril, 18—20 femoral pores on either side of thigh, separate in præ-anal region ; olive grey, marbled and spotted with darker.
- Hab.* Godávári valley near Badrachalam, on trees ; discovered by Mr. W. T. Blanford.
12. *H. [Doryura] Berdmorei*, Blyth. This species is re-described, and a figure of it given. Burma, Cachar, Sikkim Terai, Tísta valley and Kumaon.
 13. *H. [Doryura] Mandelianus*, n. sp. Body long, much depressed, as is also the tail, the latter with sharp lateral subtuberculate edges ; 12—14 upper, 10—12 lower labials ; first larger pair of enlarged chin-shields forms a suture, second smaller, separated from each other and from the labials by smaller scales ; 36 long. series of scales on middle of belly. No femoral pores observed. Grey, densely marbled and punctated or streaked with blackish and with intermixed larger pale spots. Pankabaree and Tísta valley in Lower Sikkim.

14-15. *H. [D.] Gaudama* and *H. [D.] Karenorum*, Theob.

Peripia Cantoris and *Peronii* have generally a distinct minute seta on the inner toe.

Nycteridium platyurus, Schneider, is = *Nyct. Schneiderianum*, Shaw, = *N. Himalayanum*, Anderson.

Gymnodactylus Lawderanus, n. sp. Body covered with small and larger tubercles; no enlarged scales behind the nostril, 9 upper, 8 lower labials; first pair of chin-shields forms a suture and is followed by smaller shields; 32 long. series of scales across belly; two pairs of femoral pores, close together on præ-anal region; pale greyish brown, densely spotted with dark brown; Kumaon; discovered by Mr. A. Lawder.

G. nebulosus, Beddome, is not = *G. nebulosus*, Blyth, (nomen nudum).

Gym. maculatus, Beddome, 1870, is not = *G. maculatus*, Steind., 1866.

Gym. marmoratus, Beddome, 1870, is not = *G. marmoratus*, D. and B., 1836.

Japalura variegata, may possibly be the same as *J. microlepis*, Jerdon, but is certainly distinct from Jerdon's *planidorsata*, the latter having been wrongly identified by Anderson with the first.

Sitana Ponticeriana extends eastward to the Ganges and northwards to Rûrkî and into the Panjáb.

Charasia Blanfordana, n. sp. = *Ch. dorsalis*, apud Blanford, J. A. S. B., vol. xxxix, 368; differs from the latter by its larger scales which are in 80—100 series round the body, &c.

Ch. [Oriotiaris] tricarinatus (Blyth) = *Oriot. Elliotti*, Günther.

Stellio Dayanus, n. sp., differs from *St. tuberculatus*, = *St. indicus* of Blyth, by the larger scales on the back, these being continuous on the neck; by having only 40 long. series of scales across belly, and by its longer tail and limbs, &c. Hurdwar; discovered by Dr. F. Day.

Euprepes [Tiliqua] macularius, Blyth, quite distinct from the next; varies very much in coloration.

E. [T.] carinatus has quite as often 5 as 3 keels on each scale.

Euprepes monticola, from Sahibgunj on the Ganges, has a transparent disc on lower eyelid.

Himulia indica, Gray, is distinct from *H. maculata*, Blyth and

also distinct from *H. Dussimieri*, D. and B. Characters of the three species accompanied by drawings are given.

Mocoo Sikkimensis is redescribed and is not the same as Günther's *Eum. Himalayanus*.

Mocoo sacra, n. sp. Like *Sikkimensis*, but more slender, with 22 longit. series of scales round the body and 40 transverse series between the limbs; ear denticulate in front; sub-caudals enlarged from near the anus; bronze brown above with a few dark spots, blackish at the anterior side; rest greenish white. Parisnáth; W. Bengal.

A new species of the very rare genus *Ristella*, Gray, has been discovered by Major Beddome in South India. A figure and description of it is given. It is named by Beddome *R. Malabarica*.

Riopa anguina, Theobald. Dr. Anderson has included two different species under this name (see Proc. Zool. Soc. Lon. 1871, p. 159). The measurements and dimensions are mostly those of true *anguina*, but the coloration is taken from a species which Theobald (Lin. Soc. Jour. Zool. p. 26) most probably noted under the name *R. Boringi*, but which is distinct from both these species. It differs from the former by its much longer limbs, but chiefly by its coloration; from the latter by the structure of scales, &c. The specific name *cyanella* is proposed for this new species.

Riopa albopunctata and *Hardwickii*. Notes on the structural affinities as well as on the geographical distribution of these two species are given.

[This paper will appear, with numerous illustrations, in the 1st number of the Nat. Hist. Part of the Journal for the ensuing year.]

6. ON HAMILTON BUCHANAN'S ORIGINAL DRAWINGS OF FISH IN THE LIBRARY OF THE ASIATIC SOCIETY OF BENGAL, by Surgeon F. DAY.

In the Library of the Asiatic Society of Bengal exist several volumes of manuscripts and drawings by Dr. Buchanan. In two of these are one hundred and forty-nine original, coloured delineations of fish, and 45 copies. On the former are "the specific names in Buchanan's handwriting, marked under the figures, so as to leave no doubt or difficulty in referring them to corresponding descriptions in the Gangetic fishes." (McClelland.)

In "Chambers' lives of Scotchmen," it is stated, that Buchanan Hamilton on his departure from India was deprived by the Marquis of Hastings of all his extensive drawings and papers relating to every branch of natural history. (McClelland.) Since this period it has been generally admitted that the Indian Government appropriated the private collections of drawings belonging to that officer.

Having been furnished with the original correspondence, I find that Buchanan, on having resigned the office of Superintendent of the Botanic Gardens, sailed for Europe in 1815 in the "Marchioness of Ely," taking with him "collections of natural history, coins and Hindu Manuscripts" which he presented to the Court of Directors of the East India Company.

In a communication from Dr. Hare, a successor to Dr. Buchanan, in the appointment of Superintendent of the Botanic Gardens, to the Chief Secretary to the Government, (dated July 27th, 1816), there occurs the following passage, "In a letter from the Right "Hon'ble the Governor-General of the 5th January, 1815, His "Excellency says: 'by a letter from Dr. Buchanan received here, "it appears that he proposes to carry to Europe all the drawings "of animals and plants collected by him during the tour which he "was employed to make in this country. Dr. Buchanan states "that it is his object to request the Court of Directors to accept "this collection as a present from him. Now, I apprehend that "those drawings are already the property of the Hon'ble Court, "the service for which Dr. Buchanan was employed and paid "having specifically been the furnishing Government with a know- "ledge of the animal and vegetable productions of this country, "delineations are essentially included in this service.' * * * The "drawings were transmitted to Government with the following "letter, dated 18th February. 'I have been honoured with your "letter of the 31st ultimo, withdrawing the permission of the "Hon'ble Vice-President in Council for sending to the Hon'ble "Court of Directors, such drawings of natural productions as "have been made at the Public expense, and desiring me to "deliver them to you which I have accordingly done by the bearer, " * * * my object in requesting, that I might be permitted to "present the drawings to the Court of Directors, did not originate

“ ‘in a view of claiming the merit of making a present to the Company of its own property, but arose from a conviction that their being deposited in the collection at the India House was the most probable means of rendering them useful to science.’ ” The drawings were kept in India to illustrate Dr. Buchanan’s statistical reports on several of the districts, and it was proposed to take copies of the originals, which were subsequently to be transmitted to England.

Some of these drawings have been transferred to the Illustrations of Indian Zoology, General Hardwicke having had them “copied from the drawings of Buchanan & Hamilton by that gentleman’s* consent.” (Richardson.) Others have been reproduced by McClelland in his Memoir on the *Cyprinidæ* of India, R. A. S. of B. 1839.

In the Zoological Record for 1869, p. 127, Dr. Günther observes of these drawings, that they “exist in triplicate, one copy being in the British Museum, where their free use is allowed.” He also remarks: “It may be questioned whether it is desirable to utilize drawings, the types of which are lost, in any other way, but as a help to supplement the insufficiently published descriptions.” But have the types been lost? In the “Catalogue of the Fishes of the British Museum,” Vol. III, p. iv, 1861, the receipt is acknowledged of “6. A collection of fishes from Bengal, believed to contain many typical specimens of Buchanan Hamilton’s work, presented by G. R. Waterhouse, Esq.”

The first consideration which suggests itself is, how was this collection obtained from Bengal? It does not appear to have existed in the Museum of the Asiatic Society or in the Botanical Gardens, whilst the collections conveyed to Europe by Buchanan were presented by him to the India House.

At page 471 in the same volume, Dr. Günther observes of the *Ophiocephalus aurantiacus*, H. B., “the typical specimen is not preserved in the collection presented by Mr. Waterhouse: and in fact the drawing is taken from the Hardwicke collection.” It would appear from this, that Dr. Günther had arrived at the conclusion, probably on good evidence, that Mr. Waterhouse had presented

* More probably with the consent of the Superintendent of the Botanic Gardens in whose charge they remained.

Hamilton Buchanan's *types* to the British Museum; he also observes in several places of specimens "probably types of the species." In short it seems that the original collection, or some part of it, still exists in the national one.

As to the second portion of the sentence, a slight inaccuracy has occurred, because Hamilton Buchanan could not have copied from the "Illustrations of Indian Zoology." He published the "Fishes of the Ganges" in 1822, and died in 1829. General Hardwicke returned to Europe in 1818, and his work was published in 1832 or 1833, several years after Hamilton Buchanan's death. Irrespective of this the original drawing, No. 60, was left in India in 1818, by Buchanan.

I cannot omit questioning whether the British Museum possesses copies of *all* these original drawings. My reasons for doubting are, that some omissions and wrong identifications, besides figures placed to the literary credit of General Hardwicke, instead of Hamilton Buchanan, have found a place in the B. M. Catalogues, which could scarcely have occurred, had Dr. Günther had access to such accurate delineations, as the Asiatic Society of Bengal possesses. I, therefore, propose enumerating the drawings which exist in the Library, the figures marked before each being identical with what I have placed in pencil on those of the collection, for the purpose of future identification.

In examining these drawings in volume marked iv, I have first placed the unpublished names as existing upon them within brackets, next the names as published in the fishes of the Ganges, with H. B. after each of them, and lastly the determinations in the Catalogue of the Fishes of the British Museum, as it is believed that that institution possesses copies of the original drawings, and it is also supposed the remains of the typical collection.*

- 1. (*Centropomus phulchanda*), $1\frac{7}{10}$ inches long. *Chanda phula*, H. B. = *Ambassis oblonga*, C. and V., B. M. Catal.

* By reproduced, it must be distinctly understood that I mean "with the leave of the author" or acknowledged as "obtained from H. B. collection," as M'Clelland observed of the use he made of them: "I have been more anxious to identify Buchanan's species than to describe new ones, and to reserve his names than to substitute others." By omitted I of course mean "accidentally" or "overlooked," and I believe due to the drawing in question not being amongst those in the British Museum.

2. (,, ? *bahrul*), $1\frac{2}{10}$ inches long. *C. baculis*, H. B. = A. — ? B. M. Catal.

3. (,, *bogoda*), $2\frac{3}{10}$ inches long. *C. bogoda*, H. B. = *Ambassis bogoda*, B. M. Catal.

4. (*Silurus chaca*), in Fishes of Ganges pl. 28, f. 43. *Platy-stacus chaca*, H. B. = *Chaca Buchanani*, Günther, B. M. Catal.

5. (,, *kanipabda*), 2 views, each 4 inches long. Probably the omitted first species of *Callichrous*. P. spine serrated. Maxillary barbels reach to the middle of the total length. Anal fin with about 63 rays.

6. (,, *pabda*), *Callichrous pabo*, H. B., pl. 22, f. 48. = *C. pabda*, B. M. Catal.

7. (*Malopterure kazali*), reproduced Ill. Ind. Zool. *Malapterurus coila*, H. B. = *Ailia Bengaliensis*, Gray, B. M. Catal.

8. (*Hypostomus ? sisor*), reproduced, Ill. Ind. Zool. *Sisor rabdophorus*, H. B. = *S. rabdophorus*, B. M. Catal.

9. (*Pimelodus mangoi*), 2 views, each 3 inches long. *Pimelodus mangois*, H. B. = *Amblyceps mangois*, B. M. Catal.

10. (,, ? *nibriundus*), 2 views, each $3\frac{1}{2}$ inches long. *P. telchitta*, H. B. = *Glyptosternum* — ? B. M. Catal. ; also probably *G. trilineatum*, Blyth, B. M. Catal.

11. (,, *batasi*), 2 views, each $3\frac{2}{10}$ inches long. Barbels all shorter than the head (quite different from pl. 23, f. 60, which is *P. carcio*, H. B., erroneously named *P. batasius*). *P. batasio*, H. B. = *Macrones batasio*, B. M. Catal.

12. (,, *hara*), 2 views, each $2\frac{4}{10}$ inches long. *P. hara*, H. B. = *Hara Buchanani*, Blyth, B. M. Catal.

13. (,, *changdramara*), 2 views, each 2 inches long, 2 short nasal, and 4 maxillary and mandibular barbels. *P. chandramara*, H. B. = *Macrones* — ? B. M. Catal.

14. (,, *muri vacha*), 2 views, each $3\frac{7}{10}$ inches long. *P. murius*, H. B. = *Eutropius ? murius* and *Pseudeutropius megalops*, Günther, B. M. Catal.

15. (,, *urua*), 2 views, each $2\frac{3}{10}$ inches long. *P. urua* H. B. = *Pseudeutropius atherinoides*, Bl., B. M. Catal.

16. (,, *auratus*), 2 views, each 9 inches long. *P. nenga*, H. B., reference omitted in B. M. Catal., = *Arius arioides*, C. and V., l. c.

17. (,, *khongta*), 2 views, each 3 inches long. *P. conta* H. B. = *Hara conta*, Blyth, B. M. Catal.

18. (,, *telgagra* and *menodu*), published as *P. corsula*, H. B., pl. 1, f. 72 = *Macrones* — ? B. M. Catal. = *Macrones trachacanthus*, C. and V., l. c.

19. (,, *tenggana*), *P. tengana*, H. B., pl. 39, f. 58 = *Macrones tengana*, B. M. Catal.

20. (,, *kenia*), *P. cenia*, H. B., pl. 31, f. 59, reference omitted in B. M. Catal. = *Macrones itchkeea*, Sykes l. cit., it is a *Hemipimelodus*.

21. (,, *cavasi*), *P. cavasius*, H. B. = *Macrones cavasius*, B. M. Catal.

22. (,, *kurki*), erroneously figured pl. 23, f. 60, as *P. batasius*; it is *P. batasius*, H. B. = *M. tengara*, H. B., in B. M. Catal., the latter name, however, referring to a different species with a long adipose dorsal fin, and therefore *P. batasius* and *P. carcio* must be distinct, and may both be good species, one with long, the other with short barbels.

23. ,, *viridescens*, H. B., pl. xi, f. 56, reference omitted in B. M. Catalogue; it is a *Hemipimelodus*.

24. (,, ? *nangra*), *P. nangra*, H. B., pl. xi, f. 63, reference omitted in B. M. Catalogue; it is a *Macrones*.

25. (,, *rama tengara*), *P. rama*, H. B., pl. 3, f. 55 = *Rita* — ? B. M. Catal.

26. *Ophisurus boro*, reproduced in Ill. Ind. Zool. *O. boro*, H. B. = *Ophichthys boro*, B. M. Catal.

The gills of this eel are contained in a large cavity on either side of the head, and do not communicate with each other. The fish distends this receptacle with air taken in by its mouth; it appears to be able to respire directly from the atmosphere, or by means of the air contained in the water. On holding its small gill opening firmly closed, it takes in air by its mouth; should its mouth be held closed, it struggles until its head is released, so as to be able to respire. If the gills are exposed by cutting away the gill membrane, and it is placed in water, it slowly moves its branchiæ, and appears to feel no inconvenience in being unable to obtain air direct through its mouth.

- 27. (, , *rostratus*), perhaps *O. hijala*, H. B., apparently omitted from B. M. Catalogue.
- 28. (, , *harangcha*), reproduced Ill. Ind. Zool. *O. harangcha*, H. B. = *O. boro*, B. M. Catal.
- 29. (*Muraenophis bazi*), nearly 12 inches long. *Muraena bagio*, H. B. = *Muraenesox cinereus*, Forsk., B. M. Catal.
- 30. (, , *tilebaim*), $8\frac{3}{4}$ inches long. *M. tile*, H. B. = *Muraena tile*, B. M. Catal.
- 31. (, , *sathete*), about 15 inches long. *M. sathete*, H. B. = *M. sathete*, B. M. Catal.
- 32. (*Muraena bamach*), reproduced Ill. Ind. Zool. as *M. Bengaliensis*; the same as *M. maculata*, H. B. = *Anguilla Bengaliensis*, B. M. Catal. H. B.'s name rejected as "(not Lacép.)," whilst no *A. maculata*, Lacépède, finds a place in the Catalogue.
- 33. (, , ? *rakta boruya*), reproduced in Ill. Ind. Zool. *M. raitaboura*, H. B. = *Moringua raitaboura*, B. M. Catal.
- 34. A shark is figured, *Squalus carcharias*? H. B., omitted in B. M. Catal., it is *Carcharias Gangeticus*, B. M. Catal.
- 35. (*Squallus characias*? *Kárntá*). This shark with a sharp nose was not described.
- 36. (*Trichopodus beje*), *T. colisa*, H. B., pl. 15, f. 40 = *Trichogaster fasciatus*, B. M. Catal.
- 37. (, , *ruber*), 2 inches long, *T. lalius*, H. B. = *T. fasciatus*, B. M. Catal.
- 38. (, , *vittatus*), $1\frac{9}{10}$ inches long, *T. chuna*, H. B. = *Trichogaster* — ? B. M. Catal.
- 39. (, , *fuscus*), $1\frac{7}{10}$ inches long. *T. sota*, H. B. = *T.* — ? B. M. Catal.
- 40. (, , *cærulescens*), $2\frac{2}{10}$ inches long. *T. cotra*, H. B. = *T. fasciatus*, B. M. Catal.
- 41. (*Acheiris jibha*), 11 inches long. *Cynoglossus lingua*, H. B. = *C. lingua*, B. M. Catal.
- 42. (, , *kukur jibha*), D. 100, A. 78, *A. cynoglossus*, H. B. = *Cynoglossus Hamiltonii*, Günther, B. M. Catal.
- 43. (*Pleuronectes arsi*), $2\frac{8}{10}$ inches long. *P. arsius*, H. B. = *Pseudorhombus arsius*, B. M. Catal., with the following remark, "a coloured drawing of this fish, 31 lines long, is in the collection of

drawings, presented by General Hardwicke to the British Museum."

44. (*Stolephorus balitora*), reproduced McClelland, *Cyprinus balitora*, H. B. = *Psilorhynchus balitora*, B. M. Catal.

45. („ *sukati*), reproduced McClelland, = *P. sucatio*, B. M. Catal. H. B. 7 247

46. (*Cobitis geto*), H. B., pl. xi, f. 96 = *Botia dario*, B. M. Catal.

47. („ *dari*), *C. dario*, H. B., pl. 29, f. 95 = *B. dario*, B. M. Catal.

48. („ *turi*), reproduced McClelland, *C. turio*, H. B. = *Nemachilus turio*, B. M. Catal.

49. („ *bilturi*), reproduced McClelland, *C. bilturio*, H. B. = *N. botia*, B. M. Catal.

50. („ *botya*), reproduced McClelland, *C. botia*, H. B. = *N. botia*, B. M. Catal.

51. („ *pangya*), reproduced McClelland, *C. pangia*, H. B. = *Acanthophtthalmus pangia*, B. M. Catal.

52. („ *khorika*), reproduced McClelland, *C. corica*, H. B. = *N. corica*, B. M. Catal.

53. Unnamed, reproduced McClelland as *C. soaturigina* = *N.* — ? B. M. Catal.

54. („ *savon khurika*), reproduced McClelland, *C. savona*, H. B. = *N. savona*, B. M. Catal.

55. („ *ghorgota*), reproduced McClelland, *C. gongota*, H. B. = *Cobitis gongota*, B. M. Catal.

56. „ *balgara*, H. B., reproduced McClelland = *Lepidocephalichthys balgara*, B. M. Catal.

57. („ *chota kukura*), reproduced McClelland, *C. cucura* H. B. = *Cobitis gongota*, H. B., B. M. Catal.

58. („ *gunte*), reproduced McClelland, *C. guntea*, H. B. = *Cobitis guntea*, B. M. Catal.

59, 60 and 61 are the originals of *Ophiocephalus barca*, pl. 35, f. 20. *O. aurantiacus*, pl. 23, f. 22, and *O. wrahle*, pl. 31, f. 17 = *O. barca*, *O. striatus*, and *O. gachua* ? in B. M. Catal. H. B.

62. *Ageniosus militaris*, outline only.

63. *Pseudeutropius*, unfinished.

64. (*Mugil bongon*). This fish does not appear to have been

described by Hamilton Buchanan, unless as *M. cephalus*? The Bangon in the Calcutta markets is *M. planiceps*, C. and V.

· 65. Unnamed. *Raia fluviatilis*, H. B. = *Trygon sephen*, B. M. Catal.

· 66. (*Katchanda*), $3\frac{8}{10}$ inches long, outline of head with intermaxillaries protruded. *Chanda? setifer*, H. B., omitted in B. M. Catalogue, appears to be = *Gerres altispinis*, Günther in B. M. Catalogue, the specimen of which belonged to the Buchanan collection; the species is abundant in Calcutta and Bombay.

67. (*Holocentrus? katkaya*), reproduced in Ill. of Ind. Zool. as *Pterapon trivittatus*, considered *Therapon servus*, Bl., in B. M. Catal., whereas *Coius trivittatus*, H. B., was the original description, and this = *T. trivittatus*, l. c.

· 68. (*Mugil kaskasiya*) 3 inches long. *M. cascasiæ*, H. B. = *M. —?*, B. M. Catal.

· 69. (*Mugil lævis*). *Mugil albula?* H. B., omitted from the B. M. Catalogue, the same species however, appears to be described as *M. nepalensis*, Günther, who records, one skin 8 inches long from the "fresh waters of Nepal" presented by Mr. Hodgson, and in Vol. i, p. 279, another marine fish *Therapon servus*, is thus referred to "Half-grown: stuffed. (Nepal?). Presented by B. H. Hodgson Esq." Both these fish ascend the Hooghly to within or a little above tidal influence, and perhaps the two skins were prepared in Calcutta. As not a single example of the Family *Mugilidæ* is found in Nepal, the designation *M. nepalensis* for this Calcutta fish is, I think, a little inappropriate, and I would suggest its being altered to *M. lævis*, H. B. (MS.). I may remark that I have lately obtained five specimens of it in the Hooghly at Calcutta.

70 and 71. Same as No. 64.

· 72. (*Cobitis chuno*), $1\frac{1}{10}$ inches. *Gobius chuno*, H. B., omitted in B. M. Catal.

· 73. („ *sadanundi*), $2\frac{1}{10}$ inches. *Gobius sadanundio*, H. B. = *G. sadanundio*, B. M. Catal.

74. *Gobius gutum*, H. B., $2\frac{3}{10}$ inches. = *G. —?* H. B., B. M. Catal., with the remark "a figure of it (No. 272) exists in the collection of drawings of fishes by Hardwicke (MSS. of the British Museum)."

- 75. („ *thutkuri*), $\frac{8}{10}$ inches. *G. minus*, H. B., omitted in B. M. Catalogue.
- 76. (*Gobioides squamulosa*), $5\frac{3}{10}$ inches. *G. ruber*, H. B. = *Trypauchen vagina*, B. M. Catal. It is a beautiful drawing of *Amblyopus Hermannianus*,* Lacép., showing most distinctly the crypts in which the scales are imbedded, which is not found in *T. vagina*. As a synonym of *Amblyopus Hermannianus*, *G. rubicundus*, H. B., is given, which latter is an entirely distinct species, delineated in H. B.'s work, and appears to be *Amblyopus tania*, Günther (B. M. Catal), a common species at Calcutta. I may here remark that in the Proc. Zool. Soc., 1869, p. 518, I considered *Amblyopus cirrhatus*, Blyth, as *Amblyopus cæculus*, Bl.; in the B. M. Catalogue it is *A. brachygaster*, Günther, which is similar to Blyth's species, whose name would have priority should the fish be looked upon as more than a variety. It is not uncommon in Calcutta.
- 77. (*Makalkar*) 8 inches. *Trichiurus lepturus*, H. B., apparently omitted from B. M. Catalogue.
78. (*Cheilodopterus butibere*) 4 inches, Ill. In. Zool., *C. butis*. H. B. = *Eleotris butis*, B. M. Catal.
- 79. (*Sygnathus kharke*), $4\frac{2}{10}$ inches long. *S. carce*, H. B. = *Ichthyocampus carce*, B. M. Catal.
- 80. („ *deokhuta*), $6\frac{7}{10}$ inches long. *S. deocata*, H. B. = *Doryichthys* — ? B. M. Catal.
- 81. (*Polynemus paradiseus*) 8 inches long. = *idem*, B. M. Catal. ○
- 82. („) 7 inches long. *P. teria*, H. B. = *P. tetradactylus*, B. M. Catal.
- 83. („ *raye*) 12 inches, *P. sele*, H. B. = *P. Indicus*, B. M. Catal.
84. Unfinished drawing of *Serranus*.
85. *Batrachoides gangene*, H. B., pl. 14, f. 8. = *Batrachus grunniens*, Bl., B. M. Catal.
- 86. (*Cottus* ? *chaka*), *Calliomorus chaca*, H. B., $4\frac{1}{10}$ inches long, = *Platycephalus insidiator*, Forsk., B. M. Catal.

* Dr. Cantor originally referred the descriptions to these species which probably he would not have done, had he seen the drawings. Should a doubt exist as to whether the *rubec* is a *Trypauchen* or an *Amblyopus*, I cannot imagine how there could be any respecting the latter species.

87. (*Clupanodon ? suborno khorika*), $1\frac{8}{10}$ inches long, reproduced in Ind. Zool. is *Corica soborna*, H. B., omitted from B. M. Catalogue, but under *Clupeoides pseudopterus* is quoted: "The fish which served for the figure of *Corica guborni*, Gray, Ind. Zool., was perhaps similar to *Cl. pseudopterus*,—it is also represented with separate anal finlets."

• 88. (*Clupanodon moti*), $5\frac{4}{10}$ inches long. *C. motius*, H. B. = *Pellona motius*, B. M. Catal.

• 89. (,, *chapra*), *C. chapra*, H. B., p. 248, omitted from the B. M. Catalogue. The drawing is reproduced in the Illustrations of Indian Zoology under the name of *C. Indica*, and = *Clupea Indica*, Gray, B. M. Catalogue. Another illustration in the Indian Zoology is considered as *C. chapra*, Gray, (l. c.), unfortunately this sheet is missing from the copy of the Indian Zoology in Calcutta, so I am unable to compare it with H. B.'s drawings.

90. (,, *champil*), $2\frac{8}{10}$ inches long, apparently not described. ◊

91. (*Atherina dhani*), $\frac{9}{10}$ of an inch long, reproduced McClelland. *A. danius*, H. B. = *Eleotris*—? B. M. Catal.

92. *Mystus ramcarati*, H. B., 8 inches long, reproduced Ill. ◊ Ind. Zool. = *Coilia ramcarati*, B. M. Catal.

• 93. (*Labrus darki*), $1\frac{2}{10}$ inches. *Labrus badis*, H. B. = *Badis Buchanani*, Bleeker, B. M. Catal.

• 94. (*Tetrodon kariya phoksa*), $2\frac{1}{2}$ inches long. *T. cutcutia*, H. B. = *T. cutcutia*, H. B., B., M. Catal.

95. (*Esox angulatus*), $4\frac{1}{2}$ inches long, not *E. ectuntio* H. B. ◊

96. (*Cyprinus korikon*), reproduced McClelland. *C. conchoniis*, H. B. = *Barbus conchoniis*, B. M. Catal.

97. (,, *teripungti*), reproduced McClelland. *C. terio*, H. B. = *B. terio*, B. M. Catal.

98. (,, *pungsi*), reproduced McClelland. *C. pausio*, H. B. = *Labeo*—? B. M. Catal.

99. (,, *jauyali*), reproduced McClelland. *C. joalius*, H. B. = *Labeo*—? B. M. Catal.

100. (,, *loya*), reproduced McClelland. *C. vagra*, H. B. = *Barilius*—? B. M. Catal.

• 101. (,, *gugani*), *C. guganio*, H. B. = *Barbus*—? B. M. Catal.

102. (,, *lati*), reproduced McClelland. *C. latius*, H. B. = *Crossochilus latius*, B. M. Catal.
103. *Cyprinus elanga*, H. B., $6\frac{3}{16}$ inches long = *Rasbora elanga*, B. M. Catal.
104. (,, *bukrangî*), 3 inches. *C. morar*, H. B.?
105. (,, *godiyari*), reproduced McClelland. *C. lanta*, H. B. = *Discognathus lanta*, B. M. Catal.
106. (,, *sada balitora*), reproduced McClelland. *C. sada*, H. B. = *Crossochilus sada*, B. M. Catal.
107. (,, *dyangra gohama*), reproduced McClelland. *C. gohama* H. B. = *Crossochilus gohama*, B. M. Catal.
108. (,, *dhenro*), *C. dero*, H. B., pl. 22, f. 78 = *Tylognathus*—? B. M. Catal.
109. (,, *mrigala*), H. B., pl. 6, f. 79 = *Cirrhina mrigala*, B. M. Catal.
110. (,, *moralâ*), H. B., pl. 18, f. 91 = *Labeo moralâ*, B. M. Catal.
111. (,, *chedra*), reproduced Ill. Ind. Zool. *C. chedra*, H. B. = *Barilius coesa*, H. B., B. M. Catal.
112. (,, *khoksa*). *C. coesa*, H. B., pl. 3, f. 77 = *B. coesa*, B. M. Catal.
113. (,, *morar*), H. B., pl. 31, f. 75 = *Aspidoparia morar*, B. M. Catal.
114. (,, *curabati bata*), *C. bata*, H. B. = *Cirrhina*—? B. M. Catalogue.
115. (,, *boga*), H. B., pl. 28, f. 80 = *Tylognathus boga*, B. M. Catal.
116. (,, *pangusiya*), reproduced McClelland, *C. pangusia*, H. B. = *Labeo pangusia*, B. M. Catal.
117. (,, *bangana*), reproduced McClelland, = *Tylognathus*—? B. M. Catal. ; it appears to be *Cirrhina reba*, H. B.
118. (,, *angra*), reproduced Ill. Ind. Zool. = *Labeo*—? B. M. Catal. 12 B. 438 1
119. (,, *kursi*), 10 inches long. L. l. 92, L. tr. 13/? , 14 rows of scales between l. l. and ventral fin. *C. cursis*, H. B. = *Labeo cursa*, B. M. Catal.

120. (,, *nandina*), *C. nandina*, H. B. pl. 8, f. 84 = *Labeo nandina*, B. M. Catal.
121. ,, *tor*, H. B., reproduced Ill. Ind. Zool. = *Barbus mosal*, B. M. Catal.; it is, however, a distinct species.
122. ,, *mosal*, H. B., reproduced Ill. Ind. Zool. = *B. mosal* B. M. Catal.
123. ,, *gonius*, H. B., pl. 4, f. 82. = *Labeo Dussumieri*? B. M. Catal.; however, it appears to be identical with *C. cursa* and *C. cursis*, H. B.
- 124. ,, *cursa*, H. B., 11½ inches long. L. l. 62. L. tr. 12/?; 13 or 14 rows of scales between l. l. and base of ventral fin. = *L. cursa*, B. M. Catal.
- 125. (,, *tilei*), *C. tileo*, H. B. = *Barilius tileo*, B. M. Catal.
126. (,, *goha*), H. B., reproduced Ill. Ind. Zool. = *Bola goha*, B. M. Catal.
127. (,, *kani punti*), reproduced McClelland, *C. canius*, H. B. = *Barbus gelius*, B. M. Catal.
- 128. (,, *bimaculatus*), *C. titius*, H. B. = *Barbus titius*, B. M. Catal.
129. ,, *phutunio*, H. B., reproduced McClelland, = *B. phutunio*, B. M. Catal.
130. (,, *phul chela*), reproduced McClelland, *C. phulo*, H. B. = *Chela phulo*, B. M. Catal.
131. (,, *bhola*), reproduced Ill. Ind. Zool. *C. bola*, H. B. = *Bola goha*, H. B., B. M. Catal.
132. (,, *koswati*), reproduced McClelland, *C. cosuatis*, H. B. = *Barbus cosuatis*, B. M. Catal.
133. (,, *geli punti*), reproduced McClelland, *C. gelius*, H. B. = *Barbus gelius*, B. M. Catal.
- 134. (,, *barila*), H. B. = *B. barila*, B. M. Catal. and? *B. morarensis*, Günther, l. c. The figure has been somewhat damaged by termites.
- 135. (,, *jaya*), H. B., 1 $\frac{8}{10}$ inches long = *Aspidoparia jaya*, B. M. Catal.
- 136. (,, *Dyangra anjana*), 3 $\frac{2}{10}$ inches long. *C. anjana*, H. B. = *Rasbora daniconius*, H. B., B. M. Catal.

137. (,, *phakra*), reproduced McClelland, *C. vagra*, H. B. = *Barilius* — ? B. M. Catal.
138. (,, *bulibola*), reproduced McClelland, *C. barna*, H. B. = *B. barna*, B. M. Catal.
139. *Cyprinus laubuca*, H., B. reproduced McClelland, = *Chela laubuca*, B. M. Catal.; it is a *Perilampus*, McClell. = *Cachius*, Günther; and *Eustira*, Günther.
140. (,, *dangila*), H. B., reproduced McClelland, = *Danio dangila*, B. M. Catal.
141. (,, *jongja*), reproduced McClelland. *C. jogia*, H. B. = *Nuria danrica*, H. B., B. M. Catal.
142. (,, *layukuli*). *C. atpar*, H. B., reproduced McClelland, = *Cachius atpar*, B. M. Catal. Much damaged by termites, one figure destroyed.
143. (,, *sutiha*), H. B., reproduced McClelland, = *Nuria danrica*, B. M. Catal.
144. (,, *kirki jongja*), reproduced McClelland. *C. rerio*, H. B. = *Barilius rerio*, B. M. Catal.
145. (,, *cachius*), H. B., reproduced McClelland, = *Cachius atpar*, B. M. Catal.
146. (,, *gora*) H. B. = *Chela gora*, B. M. Catal. The tail is injured by termites.

In Vol. I. of animals are 48 drawings of fish, some of which are duplicates of the foregoing, others copies of some missing figures; they are as follows.

No. 1 unfinished copy of No. 124; 2 = 146; 3 = 70; 4 = 70; 5 = 114; 6 = 86; 7 = 65; 8 = 32; 9 = 27; 10 = 8; 11 = 16; 12 = 140; 13 = 92; 14 = 6; 15 is a larger drawing of 123; 16 = 115; 17 = 28; 18 = 118; 19 = 61; 20 = 14; 21 = 29; 22 = 18; 23 = 78; 24 = 142; 25 = 117; 26 = 120; 27 *Mystus chitala*, H. B., reproduced Ill. Ind. Zool.; 28 = 109; 29 = 122; 30 = 82; 31 = 103; 32 = 126; 33 is a figure $7\frac{3}{10}$ inches long of *Sillago domina*. In fact all the rest are reproductions of the originals now in Vol. IV, except the following:—36, $9\frac{1}{2}$ inches long of *Catla Buchananii*, C. and V.; 39 is a figure $9\frac{1}{2}$ inches long of *Cyprinus chagunio* H. B., the original of which is missing. Dr. Günther

in the Zool. Record for 1869, demurring to my identification of *Barbus Beavani*, Günther, with *Cyprinus chagunio*, Ham. Buch., observes this fish has "large scales and minute barbels." In the figure there are about 41 scales along the lateral line and well developed rostral and maxillary barbels. The species may be readily recognised from the drawing. 48 is *Polynemus Indicus*, 11 $\frac{3}{4}$ inches long. This volume iv contains 50 coloured illustrations of fish. ?

[I would suggest that the numbers I have inserted on the drawings in pencil be recorded in ink, and that the original figures have the Society's stamp on each separate sheet].

7. MONOGRAPH OF INDIAN CYPRINIDÆ, Pt. III, by Surgeon F. DAY.

This is a continuation of Dr. Day's Monograph published in No. 3 of the Nat. Hist. Part of the Journal; it will appear in No. 4 of the same Part for the current year.

8. NOTES ON SOME LAND-SHELLS FROM THE VICINITY OF MOULMEIN, WITH DESCRIPTIONS OF NEW SPECIES,—by W. THEOBALD, ESQ.

Mr. Theobald gives notes regarding various species of *Cyclophorus* and *Streptaxis*, and a few other shells, found in the neighbourhood of Moulmein. If illustrations of the newly described species be supplied in time, the paper will appear in the 1st number of Part II of the Journal for the ensuing year, 1872.

9. NOTES ON THE ORNITHOLOGY OF CASHMIR,—
by W. E. BROOKS, ESQ., C. E., *Etawah*.

Mr. Brooks notices several imperfectly known or new species of birds from Cashmir. His observations on the breeding season, &c., of many of the species are particularly interesting.

The new species noticed in this paper are as follows:

Certhia Hodgsoni,—differs from *C. familiaris* by a much larger bill; less rufous tone on rump and upper tail coverts, and by having 4 plain primaries and the 5th marked with a buff patch on the outer web.

Sitta Cashmirensis.* Coloration very like that of *S. Himalayana*, but the wing is 3.3 inches; no white edgings to the under tail coverts.

* This is very close to *S. cæsia* of Europe, the two being exactly of the same size. EDIT.

Dumeticola major. Similar to *D. affinis*, Hodgs., but much larger; wing 2·28—2·3, tail 2·7, bill at front ·55, mid-toe and claw ·72 inches.

Horites pallidus. Above light olive grey or greyish olive with a slight tawny tinge on the wings; lower back and upper tail coverts lighter; a dull whitish grey supercilium; a pale brown streak through the eye; cheeks and ear coverts brownish; chin to abdomen greyish white, sides of breast and flanks and lower tail coverts pale brownish grey. Total length 5·15, wing 2·2, tail 2·2, bill 0·33, from gape 0·5, tarsus 0·9 inches.

Phylloscopus Tytleri. In plumage resembling *Ph. viridanus*, but of a richer and deeper olive; bill much longer, darker and of a more pointed and slender form than in the last species. Average length 4·75, wing 2·3, tail 1·7, bill at front 0·36, from nostril 0·31, tarsus 0·7 inches.

Motacilla Cashmirensis. Coloration as in *M. Luzonensis*, except that the chin and throat are black, the black extending for $2\frac{1}{4}$ inches from base of lower mandible; white portion of head as in *personata*, remainder of head and back deep black. Length 7·6, wing 3·55, tail 4, bill at front 0·5, tarsus ·97 inches.

Aldaia guttata. Larger than *gulgula* and not so rufous on the breast and with bolder markings; wing 3·7—3·9, tail 2·6—2·8 inches.

Sturnus nitens, Hume. Like *St. unicolor*, but smaller, with shorter wing and brighter colours.

[This paper will be published in full in the 1st number of the Nat. Hist. Part of the Journal for 1872].

10. NOTES ON NINE NEW SPECIES OF INDIAN AND INDO-CHINESE VESPERTILIONIDÆ, WITH REMARKS ON THE SYNONYMY AND CLASSIFICATION OF SOME OTHER SPECIES OF THE SAME FAMILY,—by G. E. DOBSON, B. A., M. B., *Assistant Surgeon H. M.'s British Forces*.

The following diagnoses of nine new species of bats are intended as prefatory to more detailed descriptions accompanied with illustrations to be published hereafter.

Sec.—SCOTOPHILINA, Gray.*

* Ann. and Mag. Nat. Hist., 1866.

Genus, *Nycticejus*, Rafinesque, Incisors, $\frac{1-1}{6}$.

Sub-genus, *Nycticejus*; promolars, $\frac{1-1}{2-2}$. wing-membrane attached to base of toes.

N. EMARGINATUS, Dobson.

Glands of the upper lip largely developed, forming rounded prominences between the nostrils and eyes; ears nearly as long as the head, with broadly rounded tips; outer side flatly emarginate beneath the tip causing it to project outwards; tragus moderately long, slightly curved inwards and obtusely pointed, maintaining almost the same breadth from the base to within a short distance of the tip. Fur, above, tricoloured, at the base dark ferruginous brown, then buff, the tips light yellowish brown; beneath, dark ferruginous brown at the base, the remaining portion buff.

Length, head and body 2".9; tail 2".2; ear (anteriorly) 0.85; forearm 2".2; thumb 0".45; tibia 0".85. *Loc.* ?

Genus, *Vesperugo*, Keys. Blas. Incisors, $\frac{2-2}{6}$.

Sub-genus, *Vesperus*, premolars, $\frac{1-1}{2-2}$. wing-membrane attached to base of toes.

V. PACHYOTIS, Dobson.

Head flat; muzzle very broad and short; glandular prominences of upper lip largely developed, immediately behind them a furrow extends from the anterior corner of one eye to the other in front of which the fur of the head does not pass: ears triangular above with rounded tips, outer side without emargination; lower portion of the ear from below the level of the tip of the tragus to the termination of the outer margin near the angle of the mouth very thick and fleshy; tragus short, curved inwards; teeth very minute, inner incisors bifid at their extremities, much larger and longer than the outer ones. Fur, above, dark brown throughout; beneath, a lighter shade of the same colour.

Length, head and body 2".2; tail, 1".6; ear (anteriorly) 0".55; forearm, 1".6; tibia, 0".65.

Loc. Kasia Hills, Bengal.

V. ANDERSONI,* Dobson.

* More detailed descriptions of this and of the next new species will appear in Dr. Anderson's forthcoming account of the Zoology of the Yunan Expedition.

Ears moderate with rounded tips, outer edge with a shallow but wide emargination beneath the tip, then convex and again emarginate opposite the base of the tragus; tragus obtusely pointed, inner margin straight, outer convex upwards; fur, above, dark brown with grayish tips; beneath, light grayish brown for two-thirds its length, the remaining portion ashy. Inner incisors long and bifid; outer incisors very short and acutely pointed, placed in front of the inner ones and lying on their outer sides.

Length, head and body, 2".6; tail, 1".9; ear (anteriorly) 0".75; forearm, 2".15; tibia, 0".85.

Loc. Momein, Yunan.

VESPERUS ATRATUS.

Nycticejus atratus, Blyth, Cat. Mamm. Mus. As. Soc. Beng. No. 96.

The following is Blyth's description of this species,—“Like (*Vesp.*) *fuliginosa*, Hodgson, J. A. S., IV, 700, (which Dr. Gray ranks as a *Scotophilus*), but with only one pair of upper incisors. Length of forearm $1\frac{3}{4}$ in.”

I have examined the type specimens thus described; their forearms correspond exactly with the measurement given, but Mr. Blyth has not been equally accurate in stating that they possess only one pair of upper incisors; there are certainly *two pairs* of upper incisors, but the outer ones are, as in many other species of the subgenus *Vesperus*, very small and might easily be overlooked; the inner incisors are remarkably long, but very unlike those which are so characteristic of the genus *Nycticejus*. The necessity, therefore, for changing the genus is apparent. The species is, however, still quite distinct from *Sc. fuliginosus*, Hodgs.

V. PACHYPUS.

Vespertilio pachypus, Temk. Mono. Mamm.

Vesperus pachypus, Wagner, Suppl. Schreber.

Scotophilus fulvidus, Blyth, J. A. S. Beng., Vol. XXVIII, 293.

I have compared the type specimens of *Sc. fulvidus*, Blyth, from Tenasserim with Temminck's description of *V. pachypus* from Sumatra and Java. The measurements agree in every respect with those of the latter species, and the colour of the fur, form of the feet, &c., equally correspond. I think it very probable Mr.

Blyth did not possess a copy of Temminck's Monograph when he described this species as, otherwise, he must, at least, have noticed in his description the close affinity of the species.

Subgenus, *Pipistrellus*, Gray; premolars, $\frac{2-3}{2-3}$; wing-membrane attached to the base of the toes.

P. AFFINIS, Dobson.

Head flat; glands of the upper lip so developed as to cause a deep depression between them on the face behind the nostrils; ears, measured from behind, as broad as long, outer edge without emargination; inner margin of tragus straight, outer convex upwards; tail long, of nine vertebræ, the last free; above, chocolate brown, lighter on the head and neck, tips of the hairs light brown; beneath, dark brown with light brown or ashy tips; on the pubes and along the thighs dirty white or very pale buff. Outer incisors acutely pointed, inner obtuse, flattened at their extremities; first upper premolar minute, placed inside the line of teeth and not distinguishable from without. Length, head and body, 1".9; tail 1".65; ear (anteriorly) 0".6; forearm 1".55; tibia 0".6.

Loc. Bhamaw, Yunan.

P. AUSTENIANUS, Dobson.

Ears triangular with broadly rounded tips, outer margin straight above for nearly half its length, then slightly convex to the base; tragus rather broad with a straight inner margin. Fur, sooty-brown throughout with grayish or ashy tips which give the fur on the ventral surface a grayish appearance; cutaneous system black, specimens in spirit appear altogether intensely black.

Incisors nearly equal in length, inner incisors bifid; first upper premolar minute, placed inside the line of teeth but may be distinguished from without.

Length, head and body 2".0; tail 1".4; forearm 1".4; ear (anteriorly) 0".65; tibia 0".6.

Loc. Cherra Punji, Bengal.

P. ANNECTANS, Dobson.

Head slightly elevated; face hairy; glandular prominences of upper lip small; ears pointed, outer margin deeply hollowed out beneath the tip causing it to project considerably; tragus long, acute, with a straight inner margin. The colour of the fur of a

specimen in spirit appears to be above, dark brown with lighter tips; beneath, brown with reddish tips. Upper incisors nearly equal in size; first upper premolar minute, placed slightly inside the line of teeth, second premolar nearly equal to canine in size. This species unites the external form of a *Vespertilio* to the dentition of *Pipistrellus*; the form of the ear and tragus is almost precisely similar to those of the next species which is a true *Vespertilio*.

Length, head and body 2".0; tail 1".6; ear (anteriorly) 0".6; forearm 1".8; tibia 0".75.

Loc. Naga Hills, Assam.

Sec.—VESPERTILIONINA, Gray.

Gen. *Vespertilio*, (as restricted, Gray).

Dentition,—in. $\frac{2-2}{6}$; c. $\frac{1-1}{1-1}$; p. m. $\frac{3-3}{3-3}$; m. $\frac{3-3}{3-3}$; wing-membrane attached to the base of the toes.

Subgenus, *Vespertilio*, Tomes.*

V. NIPALENSIS, Dobson.

Ears narrow and pointed; outer margin deeply hollowed out immediately beneath the tip causing it to project considerably; tragus long, narrow, and pointed; fur, above, black with brown tips; beneath, black for two-thirds its length, the remaining portion pure white; the whole ventral surface of specimens dried from spirit appears white and the dark portion of the hair is not perceived till the fur is raised. Canines very short; first and second premolars in both upper and lower jaws very small and conical.

Length, head and body 1".65; tail 1".35; ear (anteriorly) 0".48; forearm 1".35; tibia 0".6.

Loc. Katmandu, Nipal.

V. BLANFORDI, Dobson.

Outer side of ear with a deep emargination about the middle cutting off the lower portion which resembles very closely the large anti-tragus of the species of the genus *Rhinolophus*; muzzle pointed: face very hairy; fur, above, on the back, black for three-fourths its length, the remaining portion light yellowish-brown, on the top of the head, black with shining tips; beneath, black for three-

* Ann. and Mag. Nat. Hist. 1857.

fourths its length, remaining portion ashy. The first and second premolars in the lower jaw are very small, in the upper jaw they are still smaller and scarcely distinguishable without a lens.

Length, head and body 1".7; tail 1".5; ear (anteriorly) 0".5; forearm 1".28; tibia 0".5.

Loc. Sikkim; Simla; Dalhousie.

Subgenus, *Kerivoula*,* Gray.

K. fusca, Dobson.

Resembles *K. picta* very closely in its general form; on the outer side of the ear there is a wide emargination which forms the tip, and without which the ear would be regularly broadly oval as in *Murina suillus*; fur, above chocolate brown with paler tips; beneath of a somewhat darker shade of the same colour, the hairs tipped with yellowish-brown. This species differs from *K. Hardwickii*, Horsf. which it resembles in some respects, in the form of the ears, and colour and distribution of the fur.

Length, head and body 1".6; tail 1".6; ear (anteriorly) 0".45; forearm 1".3; tibia 0".6. *Loc.* ?

11. NOTES ON A COLLECTION OF BIRDS FROM SIKKIM,—

by W. T. BLANFORD, F. G. S., C. M. Z. S.

(Abstract.)

This is a description of a collection of skins made by Mr. L. Mandelli, together with a few notes on birds obtained at low elevations in Sikkim by the writer. Three species are described as new, and two others, *Zosterops simplex*, Swinh. and *Euspiza rutila*, Pall. are added to the fauna of the Eastern Himalayas. The new species are—

1. *Phylloscopus pallidipes*, sp. nov. Brownish olivaceous above, rump a little more rufescent, lores and a line through the eye to the upper part of the ear coverts dark brown, supercilia white, elongate, quills earthy brown with rufescent olive margins, central tail feathers the same colour as the back, outer ones earthy brown edged with olive. Lower parts silky white, sides of breast olivaceous. Under wing white. Bill dark above, pale below, legs very pale coloured. Wing 2.05 inches, tail 1.7, tarsus 0.76, bill

* As restricted by Tomes, Ann. and Mag. Nat. Hist. 1858.

from forehead 0·4, from gape 0·55. The 5th quill is the longest, exceeding the 1st by 0·87, second by 0·4, and 3rd by 0·15 in.

This species is distinguished from *P. tristis*, *P. neglectus*, and all allied forms by its pale coloured tarsi, and from most of them by its smaller size.

1. *Pellorneum Mandellii*, sp. nov. This is closely allied to *P. ruficeps*, Swains., but differs in its smaller size, approximating in this respect to *P. Tickelli*, Blyth. It is distinguished from both races by the much larger spots on the breast, and by having large spots on the sides and back of the neck, similar to those on the breast. Wing 2·65, tail 2·5, tarsus 0·95, bill from forehead 0·6, from gape 0·75.

3. *Propasser saturatus*, sp. nov. Male with lores, forehead, supercilia and cheeks pale silvery pink, the bases of the feathers brown; head above dark crimson with blackish centres to the feathers, ear coverts and sides of neck a little duller. Back with broad dashes of brown, edges of the feathers paler with a gloss of crimson, rump and upper tail coverts nearly the same colour as the back, wings and tail feathers earthy brown with red edges, and pale rosy spots on the tips of the outer webs of the wing coverts and of the last 3 quills. Chin greyish, throat full rose colour, darker than the cheeks, and with a silvery gloss; the breast deeper and darker red, abdomen pink, all the feathers of both with narrow central stripes; lower tail coverts brown, edged with pink. Length about 6 inches, wing 3·32, tail 2·6, tarsus 0·95, bill from front 0·49, from gape 0·52.

Female earthy brown, feathers of back paler edged, wing coverts and 3 last quills with albescent tips, rump tinged ochraceous. Under parts fulvous, all the feathers with dark centres, broader on the breast, narrower on the abdomen, which has a rufescent tinge.

This is the bird, a female of which was formerly assigned to *P. thura* by Mr. Blyth; the male is darker and richer in colour than its allies, and wants the pink rosy rump of the other Himalayan species.

The birds obtained by the author at higher elevations in Sikkim in 1870, are described in a separate paper.

12. NOTE ON THE ERROR OF THE CALCUTTA STANDARD BAROMETER, COMPARED WITH THOSE OF KEW AND GREENWICH,—*by* H. F. BLANFORD, ESQ.

This short paper will be published in the 4th number of the Journal for the current year.

13. ON A FORM OF GALVANOMETER SUITABLE FOR THE QUANTITATIVE MEASUREMENT OF THE ELECTROMOTIVE FORCE, AND INTERNAL RESISTANCE OF TELEGRAPH BATTERIES,—*by* W. E. AYRTON, ESQ.

(With plate IV.)

The efficiency of a galvanic battery depends on the magnitude of two properties it possesses, its electromotive force, or power to send a current, and its internal resistance, or power to impede a current. The greater the electromotive force the greater the current sent if the whole resistance in circuit remains the same, and the greater the internal resistance of the battery the less the current sent, other things remaining the same.

It is therefore of great practical importance in Telegraphy to be able easily to measure the electromotive force and internal resistance of a battery so as to see from day to day that the former does not diminish, and that the latter does not increase.

I will first examine the way in which this has been practically done up to the present time, and point out the objections there exist to this method.

A galvanometer was employed, on the bobbin of which were wound two coils, one of a comparatively high resistance, called the "intensity" coil, and the other of a comparatively low resistance, called the "quantity" coil. The electromotive force was measured by observing the deflection produced when the coil of high resistance was inserted between the battery poles; and the internal resistance could be found by comparing the deflections produced when the coils of high and low resistance were respectively used. In some instruments the low resistance galvanometer coil was dispensed with and instead the high resistance coil was shunted.

The reasoning being in both cases virtually the same, I will therefore only deal with the first case—the galvanometer wound with two coils.

Let d be the deflection produced on any particular galvanometer by a current C , then for small deflections

$$d = n \times C \times a;$$

where n is the number of convolutions, and a a constant depending on the form of the galvanometer and the size and power of the magnetic needle. Let this current C be produced by a battery having an electromotive force E , and an internal resistance R then

$$C = \frac{E}{R + G} \text{ by Ohm's law}$$

G being the resistance of the galvanometer

$$\therefore d = n \times \frac{E}{R + G} \times a \dots \dots \dots \text{I.}$$

or if we consider n and a constant

$$E \text{ varies as } (R + G) d \dots \dots \dots \text{II.}$$

Now if, G be very large compared with R then

$$E \text{ varies as } G \times d \dots \dots \dots \text{very nearly;}$$

that is to say the electromotive forces of batteries are directly proportional to the deflections they produce on a galvanometer having a very large resistance compared with the resistance of the batteries. This method will therefore answer with batteries of small internal resistance. But in the case of batteries consisting of a large number of cells joined in series (such batteries, in fact, as are necessarily in use in the Indian Telegraph on account of the great length of the lines) the internal battery resistance is itself large. Consequently, with such batteries it is impossible to use any cheap galvanometer, that is, a galvanometer not containing a large amount of wire, which will fulfil the condition that the galvanometer resistance shall be large compared with the battery resistance. The electromotive forces, therefore, of such batteries can only be very roughly compared by using the so-called "intensity" coil, unless the internal resistances of the batteries be in some way previously ascertained.

The internal resistance, if high, could be found in the following way :

let d be the deflection given by the battery when the "intensity" coil of resistance G is used, and let d' be the deflection given when the "quantity" coil of resistance G' is used, then from equation (I) we have, since both the coils are wound on one bobbin and the magnetic needle is the same in both cases,

$$\frac{d}{d'} = \frac{\frac{n E}{R + G}}{\frac{n' E}{R + G'}}$$

where n and n' are respectively the number of convolutions in the coils

$$\therefore R = \frac{n \times G' \times d' - n' \times G \times d}{n' \times d - n \times d'}$$

The resistance of different batteries, or of the same battery on different days, can be found in this way and then the ratio of their electromotive forces from equation II. This is a very round-about way of comparing electromotive forces, but is nevertheless the only way in which it can be done with the so-called "intensity" and "quantity" galvanometer coils if the battery resistance be large.

If now the question be to determine simply the resistance of a battery when the resistance is small, that of one cell for example, then it is impossible to get an accurate result with the "intensity" and "quantity" coils, for we see from equation (I) that if R be small compared with G , then a small percentage of change in R will produce no practical change in d , that is to say, when using the "intensity" coil the deflection will be practically the same whatever the resistance of the battery may be, as long as it is small compared with the resistance of the "intensity" coil.

Therefore with the "intensity" and "quantity" coils we cannot find accurately the resistance of a battery if small, and, secondly, we cannot compare the electromotive forces of two batteries without previously determining their internal resistances if the internal resistances be large. Such an instrument, therefore, for battery testing as Latimer Clark's Shunt Galvanometer which is arranged virtually on the principle I have been describing does not at all meet the requirements of the Indian Telegraph Department. And besides the instruments of this description that have been received are

exceedingly unsensitive for small differences, and also with the "intensity" coil 30, 40, or 50 cells all produce nearly the same deflection (90°) so that it is impossible practically with this galvanometer to compare the electromotive forces, or to find the internal resistances of large batteries.

What therefore is required is an instrument which will give independent accurate measurements in *absolute* units of the electromotive force and internal resistance of *any* battery. Such an instrument will be still more valuable if it be simple, portable, and tolerably cheap. All these requirements have been fulfilled in the little galvanometer arranged by Mr. Schwendler, and which therefore I have considered of sufficient interest to bring before the notice of this Society. This galvanometer that I have on the table is a tangent galvanometer the bobbin of which is wound with two coils one of thick wire and having a resistance of about one Siemens' Unit, and the other of thin wire and having a resistance of about 100 Siemens' units. Forming part of this instrument are two resistance coils of 200 and 2000 Siemens' units respectively. The 200 coil can be placed or not at pleasure in circuit with the thick galvanometer coil, and similarly the 2000 resistance coil with the thin galvanometer coil.

To (1) (*see* pl. iv,) is attached one end of each of the coils.

To (2) the other end of the thick coil.

To (3) the other end of the thin coil.

To measure the Resistance of a Battery.

Join the two poles of the battery to the two binding screws respectively of the galvanometer, and make the following observations, in each case the mean of the readings with + and — currents to be taken.

Plug up holes marked A and 200: then the battery, and the thick coil only are in circuit. Let the deflection of the needle be a° .

Remove plug from hole marked 200, but leave plug in hole marked A: then the battery, the thick coil, and a resistance of 200 S. U. are in circuit. Let the deflection be b° .

Let R be the internal resistance to be found of the battery, then

$$R = \frac{200 \times \tan b^\circ}{\tan a^\circ - \tan b^\circ} - 1 \text{ Siemens' Units.}$$

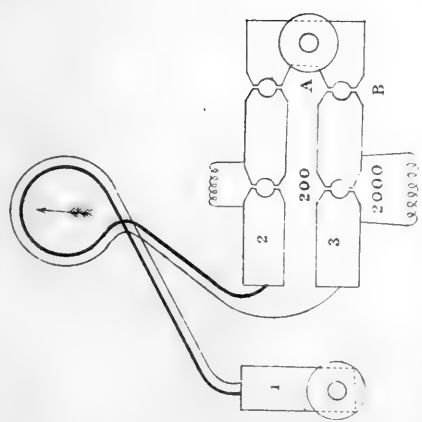

Symbolical figure showing the connections

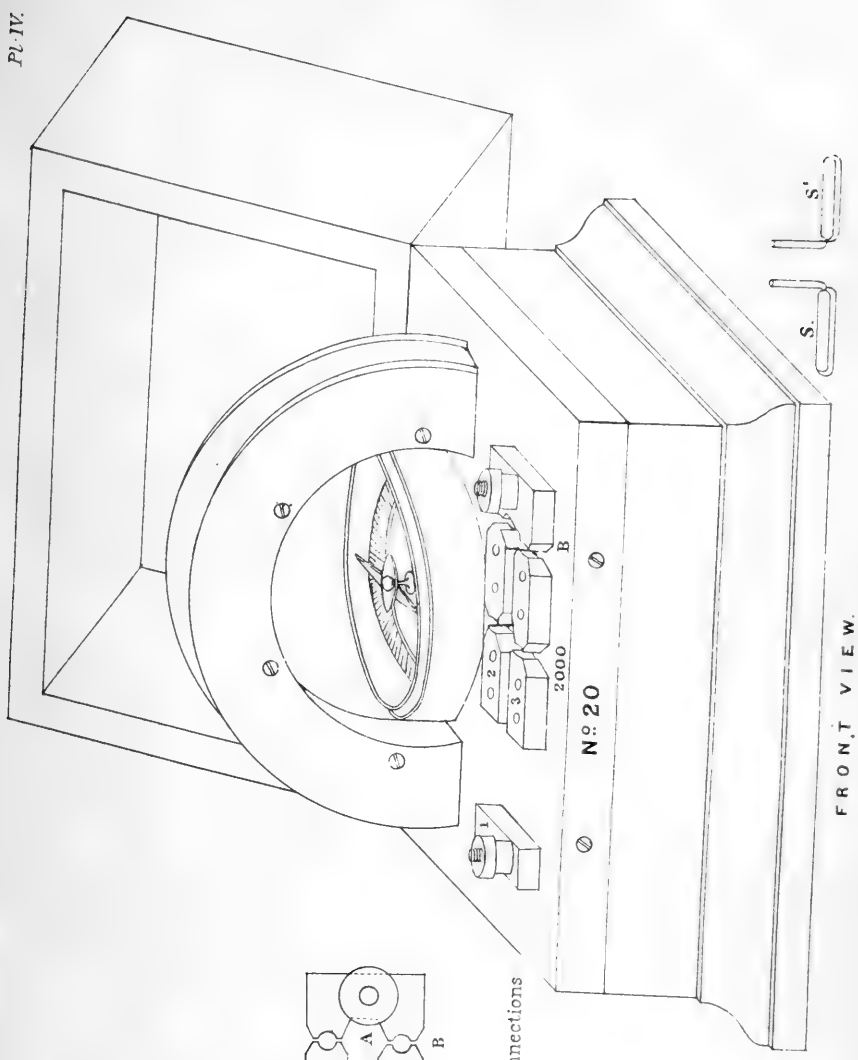

FRONT VIEW.



To measure the Resistance of a Non-Electromotor.

Insert this resistance in the battery branch, and repeat the preceding observations obtaining respectively deflections a_1° and b_1° then if r be the resistance to be found

$$R + r = \frac{200 \times \tan b_1^\circ}{\tan a_1^\circ - \tan b_1^\circ} - 1 \text{ Siemens' Units.}$$

Eliminating R from this and the preceding equation we have

$$r = 200 \left(\frac{\tan b_1^\circ}{\tan a_1^\circ - \tan b_1^\circ} - \frac{\tan b^\circ}{\tan a^\circ - \tan b^\circ} \right) \text{ S. U.}$$

The most constant electromotive force that can be practically made use of is that of a new Menotti's cell with clean zinc and copper, a standard cell as it is called. The electromotive force of such a cell is therefore taken as our unit of electromotive force.

To express the Electromotive Force of a Battery in terms of that of Standard cell.

Join the two poles of the battery to the two binding screws respectively of the galvanometer, and plug up holes marked B and 2000: then the battery and the thin coil only are in circuit. Let the deflection be l° .

Remove the plug from hole marked 2000, but leave plug in B: then the battery, the thin coil, and 2000 S. U. are in circuit. Let the deflection be m° .

Repeat these two tests with the standard cell substituted for the battery. Let the two deflections now obtained be p° and q° .

Then if E be the electromotive force of the battery, and e that of the standard cell,

$$E = \frac{\tan l^\circ \times \tan m^\circ}{\tan p^\circ \times \tan q^\circ} \times \frac{\tan p^\circ - \tan q^\circ}{\tan l^\circ - \tan m^\circ} \times e.$$

This galvanometer can also be used as a telegraphic receiving instrument but then the two copper stops, S, S', shown in the diagram, on pl. iv, should be placed one on each side of the aluminium needle. If well adjusted, signals can be read which are produced by ten Menotti's cells at the other end of a line about 400 miles long consisting of No. $5\frac{1}{2}$ wire and having an insulation of two millions per mile.

LIBRARY.

The following additions have been made to the Library since the meeting held in August last.

Presentations.

** Names of Donors in Capitals.

Catalogue of Syriac Manuscripts in the British Museum, acquired since 1838, by W. Wright.—THE TRUSTEES OF THE BRITISH MUSEUM.

The Journal of the Royal Asiatic Society of Great Britain and Ireland, vol. V, part I.—THE ROYAL ASIATIC SOCIETY.

Journal Asiatique, Nos. 59, 60.—THE ASIATIC SOCIETY OF PARIS.

Bulletin de la Société de Géographie, Mars, Avril, 1871.—THE GEOGRAPHICAL SOCIETY OF PARIS.

Monatsbericht der K. Akademie de Wissenschaften zu Berlin ; Mai 1871.—AKADEMIE DER WISSENSCHAFTEN ZU BERLIN.

Bijdragen tot de Taal-land-en Volkenkunde van Nederlandsch Indie, 3e Volgr. IV, V.—VOLKENKUNDE VAN NEDERLANDSCH INDIE.

Natuurkundig Tijdschrift voor Nederlandsch Indie, Dl. xxxi. Afl. 1-3.—NATUURKUNDIE VEREENIGING IN NEDERLANDSCH INDIE.

Bloemlezing uit Maleische Geschriften, 1te Stuk, door G. K. Niemann.—KONINKLIJK INSTITUUT VOOR DE TAAL-LAND-EN VOLKENKUNDE VAN NEDERLANDSCH INDIE.

Mémoires de la Société Royale des Antiquaires du Nord, 1869.—SOCIETE ROYALE DES ANTIQUAIRES DU NORD, COPENHAGUE.

Tillæg til Aarbuger for Nordisk Olduyndighedog Historie, 1869, Aarbuger 1869, III-IV, 1870, I.—NORDISKE OLDSKRIFT SELSKAB.

Sitzungsberichte Math.-Natur. classe, Bd. LX, 1.Abth, Heft III-V., 2.Abth, Heft-I, Bd. LXI, 1.Abth, Heft-I-V., 2.Abth-I-V; Bd. LXII, 2.Abth, Heft-I-III—Register zu den bänden 51 bis 60 der Sitzungsberichte—Archive für Oesterreichische Geschichte, Bd. LXII—LXV—Fontes Rerum Austriacarum Bd. XXX, Bd. XXXIII, Denkschriften, Math.-Natur. classe, Bd. XXX; Philos.-Hist. classe, Bd. XIX,—Almanach, Bd. XX—Phänologische Beobachtungen aus dem Pflanzen-und Thierreiche, von Karl Fritsch, Heft VIII.—KAISERLICHE AKADEMIE DER WISSENSCHAFTEN ZU WIEN.

Verhandlungen der K. K. Zoologisch-botanischen Gesellschaft, in Wien, Bd. XX.—KAISERLICH-KÖNIGLICHE ZOOLOGISCH-BOTANISCHE GESELLSCHAFT ZU WIEN.

Jahrbuch, Bd. XX, Nos. 1-4—Verhandlungen, Jahr 1870, Nos. 1-18.—KAISERLICH-KÖNIGLICHE GEOLOGISCHE REICHSANSTALT.

Tabulae codicum Manu Scriptorum in Bibliotheca Palatina Vindobonensis Asservatorum, volumen IV.—ACADEMIA CAESAREA VINDOBONENSIS.

Proceedings of the Academy of Natural Sciences of Philadelphia, 1870, Nos 1-3.—ACADEMY OF NATURAL SCIENCES OF PHILADELPHIA.

Proceedings of the Second Annual Session of the American Philological Association :—American Philological Association—Records of the Geological Survey of India, vol. IV, Part III.—SUPERINTENDENT OF THE GEOLOGICAL SURVEY OF INDIA.

Monographie der Gattung Certhiola, von Dr. O. Finsch.—THE AUTHOR.

Rahasya Sandarbha, edited by Babu Rajendralala Mitra, vol. VI, No. 66.—THE EDITOR.

The Calcutta Journal of Medicine, 1871, No. 7.—THE EDITOR.

The Christian Spectator, vol. I, No. 3.—THE EDITOR.

The Rámáyana, edited by Hemachandra, vol. II, No. 10.—THE EDITOR.

Sukla yajushi Vájasaneya Sanhita, edited by Gériprasada, Part II.—THE EDITOR.

Paramánuváda by Kálivara, Babu Ramadasa Sena.

The Flora Sylvatica, vol. XI, XII.—Geology and Zoology of Abyssinia, by W. T. Blanford.—THE GOVERNMENT OF INDIA.

Selections from the records of Government, vol. V, No. I.—THE GOVERNMENT OF THE N. W. PROVINCES.

Practical Hints to Emigrants to Tasmania, by H. M. Hull—Report on Native Papers for the week ending 19th and 26th August and 2nd September, 1871.—THE GOVERNMENT OF BENGAL.

Exchange.

The Athenæum, June 1871. Nature, Nos. 89-93.

Purchase.

The American Journal of Science, June, 1871—The Ibis, July 1871—The L. E. and Dublin Philosophical Magazine, July 1871—The Annals and Magazine of Natural History, July 1871—The Quarterly Review, July, 1871—The Westminster Review, July, 1871—The Edinburgh Review, July 1871—Revue des Deux Mondes, Juillet, 1871. Comptes Rendus, Nos 23, 24—Journal des Savants, Avril 1871—Hewitson's Exotic Butterflies, part 29.

PROCEEDINGS
OF THE
ASIATIC SOCIETY OF BENGAL
FOR OCTOBER, 1871.



The monthly meeting of the Society was held on Wednesday, the 4th October, at 9 p. m.

T. Oldham, Esq., LL. D., Vice-President, in the chair.

The minutes of the last meeting were read and confirmed.

The following presentations were laid on the table—

1. From Rájá Dhunapati Singh Bahádúr—A copy of *Prákria Manoramá Vyakuranam*.
2. From the author—a copy of *Satípariṇaya*, a Sanscrit poem, by Pandit Chandrakánta Tarkálankára.
3. From Rev. C. H. Dall, Report on the Brachiopoda, by W. H. Dall.

The following gentlemen were elected Ordinary Members—

J. A. Aldis, Esq., Dr. A. Neil, J. O'Kinealy, Esq., C. S., J. A. Briggs, Esq., H. G. Cooke, Esq., Col. J. E. Evezard.

J. M. Foster, Esq., M. D., Civil Surgeon, Nazeerah, Assam, proposed by Mr. J. Wood-Mason, seconded by Mr. H. F. Blanford, will be balloted for as a member of the Society at the next meeting.

The Council reported that they have elected Dr. G. King, a member of their body.

The Chairman, briefly referring to the sad loss which the Society had experienced by the cruel assassination of the late Offg. Chief-Justice, stated that the Council of the Society, of which Mr. Norman had for many years been an active and zealous member, had, at their last meeting, recorded their own expression of the pain with which

they had heard of the murder, which had deprived them of a long-esteemed colleague and friend. It appeared also to the Council that probably the Members themselves would prefer, at their general meeting, to put on the records of the Society a resolution expressive of their horror of the deed, which has so suddenly deprived them of one who was beloved by all that had the advantage of his acquaintance, and who had, from a few months after his arrival in the country, been a member of their Society, and a frequent and much-interested attendant at their meetings. If this were so, he would take the opportunity of proposing the following resolution—

‘The Society would desire to record the pain and sorrow with which they have heard of the cowardly murder of the late Chief-Justice Norman, in whom they have lost an earnest and truth-seeking supporter, an esteemed member of the Society, and a much respected friend.’

He believed it would, from the feeling of the meeting, be unnecessary that this should be formally seconded, as it would be carried without the slightest opposition.

Carried unanimously.

The Chairman also proposed that the Secretary should send copies of resolutions of the Society and the Council, together with a letter of condolence, to Mrs. Norman, and further, that out of respect to the memory of the late Chief-Justice, the meeting be adjourned.

Carried unanimously.

After announcing the receipt of the following paper, the Chairman adjourned the meeting.

ACCOUNT OF A VISIT TO THE EASTERN AND NORTHERN FRONTIERS OF INDEPENDENT SIKKIM WITH NOTES ON THE ZOOLOGY OF THE ALPINE AND SUBALPINE REGIONS.—PART II, ZOOLOGY.—*By* WILLIAM T. BLANFORD, F. G. S., C. M. Z. S. (Abstract.)

This is the second portion of the paper already noticed. It commences with a short note on the Sikkim fauna and remarks on the peculiarity of a belt of country, inhabited by animals with Malay affinities, intervening along the base and lower slopes of the Eastern Himalayas between the fauna of the Indian plains and the Palearctic region of the higher mountains. The peculiar

paucity, during summer, in Sikkim, of the migratory birds, which visit the plains of India during the winter, is pointed out, and the occasional replacement of those species which cross the Himalayas twice in the year, but do not breed there, by allied forms which never leave the mountains except as occasional stragglers.

The greater portion of the paper is devoted to notes on the range, habits, &c., of mammals and birds noticed by the writer in the Palearctic regions of Sikkim, with occasional descriptions of the rarer species, or of peculiar phases of coloration or plumage. Two birds are described as new. These are—

Montifringilla ruficollis, sp. nov. Pale umber above with darker streaks, the forehead whitish and the rump rufescent, a dark line from the lores, beneath the eye, and over the ear coverts; the latter and the sides of the neck ferruginous; the outer web of the first primary, a wing band formed by a large spot on the basal portion of the inner web of most of the secondaries, and the greater part of the smaller wing coverts white; all the basal portion of the tail feathers except the two middle ones cinereous, then a little white, and the tips for half an inch brown like the middle feathers. Lower parts white with two black diverging lines on the chin. In the female the ferruginous collar is brown behind and appears, to extend across the front of the neck. Length 6 inches, wing 3.75, tail 2.35, tarsus 0.82, bill from forehead 0.42.

The general coloration differs from that of the three other species belonging to restricted *Montifringilla*. That it is not the winter plumage of *M. Adamsi* is proved by that bird having more white on the tail and much narrower brown tips to the outer rectrices than the present species, and by its having the ends of some of the secondary quills white.

Otocoris Elwesi, sp. nov. This is near *O. penicillata*, but distinguished by the white of the sides of the neck intervening between the black of the cheeks and that of the breast. It is smaller than *O. longirostris*, and has a much shorter bill. The black on the head and breast is arranged as in *O. alpestris*, the back is pale fulvous brown with faint dusky streaks and passing into greyish lilac on the nape, back of neck, rump and wing coverts, the quills brown, the first primary with the outer web white, the middle rectrices the same

colour as the back, all the rest blackish, the two outer on each side edged and tipped with white; lower parts white, legs black.

Length 7.75 inches, wing 4.7, tail 3.2, tarsus 0.9, hind toe with its claw 0.75, the claw alone 0.38, bill from the forehead 0.4 from the gape 0.6.

Both these new species were found in the Láchén valley near the Tibetan frontier, in places where *Lepus Tibetanus*, *Leucosticte hamatopygia*, *Cinclus sordidus*, and other Tibetan animals were met with.

LIBRARY.

The following additions have been made to the Library since the meeting held in September last.

Presentations.

*** Names of Donors in Capitals.

Proceedings of the Royal Society of London, Vol. XIX, No. 129.—
THE ROYAL SOCIETY OF LONDON.

Proceedings of the Zoological Society of London, part I, 1871.—
Transactions of Do., Vol. VII., part VI.—THE ZOOLOG. SOCIETY,
LONDON.

Proceedings of the Royal Geographical Society, London, Vol.
XV, No. II.—THE ROYAL GEOGRAPHICAL SOCIETY OF LONDON.

Journal of the Royal Geographical Society, London, Vol. XL.—
THE ROYAL GEOGRAPHICAL SOCIETY OF LONDON.

Bulletin de la Société de Géographie, 1871, Mai-Juillet.—
SOCIÉTÉ DE LA GÉOGRAPHIE, PARIS.

Bulletins de l'Académie Royale de Belgique, 2me Tome, XXIX,
XXX.—Annuaire de l'Académie Royale de Belgique, 1871.—
Mémoires de l'Académie Royale de Belgique, Tome XXXVIII.—
Mémoires Couronnés et Mémoires des Savants Etrangers, Tomes
XXXV, XXXVI.—ACADEMIE ROYALE DES SCIENCES DES LET-
TRES ET DES BEAUX-ARTS DE BELGIQUE.

Mémoires de l'Académie Impériale des Sciences de St. Peters-
bourg, Tome XVI.—Bulletin de l'Académie, Tome XV.—
ACADEMIE IMPERIALE DES SCIENCES DE ST. PETERSBOURG.

Actes de l'Académie de Bordeaux; 1869, 3e et 4e trimestres.—
ACADEMIE DES SCIENCES, BELLES-LETTRES ET ARTS DE BORDEAUX.

Jahrbuch, Band XXI, No. I.—K.K. GEOL. REICHSANSTALT,
VIENNA.

Report on the Brachiopoda, by W. H. Dall.—THE AUTHOR.

The Ramáyana, Vol. II., edit. by Hemachandra.—THE EDITOR.

The Christian Spectator, 1871, Octr.—THE EDITOR.

The Calcutta Journal of Medicine, Aug. 1871.—THE EDITOR.

The Bongal Atlas, by Babu Rajendralala Mitra.—THE EDITOR.

Catalogus Codicum Orientalium Musei Britannici, part II, Codices Arabici, 1846-1871.—THE BRITISH MUSEUM.

Pehlavi Grammar, by P. D. B. Sungana.—THE TRUSTEES, SIR J. JEEJEEBHOY'S TRANSLATION FUND.

Prákrita Manoramá Vyákaranam.—RAJA GIRI PRASADA SINGH.

Tagore Lectures on Hindu Law, Vol. II, by H. Cowell.—THE REGISTRAR OF THE CALCUTTA UNIVERSITY.

Exchange.

The Nature, Nos. 89-92.—The Athenæum for July 1871.

Purchase.

Harold's Coleoperologische Forschungen, Heft I-VI.—Burmeister's Handbuch der Entomologie, 1-5.—Candéze, Monographie de E'latérides, 1-10.—Thomas's Pathan Kings of Delhi.—The Annals and Magazine of Natural History, 1871, Aug.—L. E. and D. Philosophical Magazine; 1871, Aug.—American Journal of Science, 1871, July.—The Calcutta Review, 1871, October.—Comptes Rendus, Juillet 1871.—Tenesser, Reisen in den Philippinen, Band II, Theil 2, Heft II.

PROCEEDINGS
OF THE
ASIATIC SOCIETY OF BENGAL
FOR NOVEMBER, 1871.

A meeting of the Society was held on Wednesday the 1st of November, 1871, at 9 P. M.

T. Oldham, Esq., LL. D., Vice-President, in the chair.

The minutes of the last meeting were read and confirmed.

The following presentations were laid on the table—

1.—From Capt. W. L. Samuells, Assist. Commissioner, Pachumba, Chord line,—Two copper axes.

The following letter accompanied the donation—

‘In my letter to you which accompanied the inscriptions, I mentioned to you that some singular looking pieces of copper had been accidentally found by a native of this district in digging for bamboo roots on the top of a hillock. I am sending you the only two specimens I have, and may as well tell you the circumstances under which I came by them.

‘On returning to Pachumba this year from the Rewah frontier, I set about making enquiries as to whether there were any known ruins or rock excavations in the neighbourhood, and one day in talking to an old resident of the place on this subject, he mentioned to me that last year a native had brought Mr. Heyne, the Manager of the Bengal Coal Company’s mines at Kurhurbaree, some three or four very curious looking pieces of copper, which he had dug out of a hillock on the borders of this subdivision. On enquiry I found that Mr. Heyne had given them all away, but I managed to recover one, which I can’t help thinking may have served as a head for a battle-axe. I have mounted it on a handle in true primitive fashion, and I leave you to judge whether a man with such a weapon in his hands could not lay about him with some meaning. Some who have seen it, think that it is made of bronze, others that it is pure copper; but that it has been formed by moulding in

sand, I think there is not a doubt of. At all events, the find was an interesting one, and I was consequently induced a few days ago to start off from here with the intention of visiting the locality, and having further excavations made under my own superintendence. I, therefore, went last Friday to the village where the finder of the articles lived, and on his appearing before me, he produced another piece of copper of the same weight as the supposed axe-head ($3\frac{1}{2}$ lbs), but elliptical in shape. What this can have been it is hard to conjecture. The native informed me that he had found five pieces altogether, three of which he gave to Mr. Heyne,* one to Mr. F. Peppé, the manager of the Gawan Estate (District Hazareebagh) and the fifth he that day put before me. He got them all within a cubit's depth of the surface of a hillock which covers an area of about 4 local cottahs (*i. e.*, about 10 or 12 cottahs of the Bengal standard measure), and there are, he says, several other hillocks near it, some larger and some smaller. But he refused to point out the locality, and gave a whole string of frivolous excuses for not doing so; but when I got him to myself he told me the true reason, and I cannot refrain from relating it as it is a curious instance of superstition.

‘It appears that this man, whose name is Anúp Telí, cultivated land about this very hillock, and he told me that the night after he found these things, he had a dream in which a *bhút* of terrible aspect appeared before him. He was no ordinary looking spirit, but of prodigious proportions, his skin being red and his clothes black, whilst a profusion of hair hung down his back from his head to his heels, each hair being as thick as a man's wrist. Having dismounted from a tiger which had carried him to Anúp's door, he entered the hut and pointing to the copper pieces, informed Anúp that they were his (the *bhút's*) property. Anúp at once expressed his willingness to give them up, but the *bhút* was for none of them. He wanted in exchange four hairs off Anúp's right knee, and in the bargain offered to relinquish all claim to the treasure which he said lay buried under the other hillocks in that locality. But the much-coveted hairs Anúp would not part with at any price. So the *bhút* mounted his tiger,

* Two of these were taken to Calcutta, by Dr. F. Stoliczka, Palæontologist, Geological Survey of India.

and trotted off in high dudgeon. When the day broke, Anúp proceeded to do a little ploughing before resuming his excavations at the hillock ; but as he passed that spot, one of his bullocks dropped down stone-dead, and within a few days the remaining two bullocks which he possessed died also. Upon this he deserted that place, and took up his residence in the village where he now lives. This, he says, happened three years ago, and till last year he concealed these copper pieces, which he believed to be gold ; but thinking he might then realise something by them, he carried them off in great secrecy to Mr. Heyne, to whom he imparted the information of where he had found them. But this little indiscretion brought fresh troubles on him ; for when he returned home, his little girl sickened and died. For this reason he said he never would tell another soul where the hillocks were and much less would he venture near the locality to point them out.

‘I believe the man from his demeanour to have been thoroughly sincere in his belief that evil would befall him, if he disclosed anything further that would lead others to the place ; for I used every kind of persuasion without avail, and even offered him Rs. 20 on the spot, but he begged me not to press him and assured me in a whisper that Mr. Heyne knew the exact place, as he had made a note of it in his pocket book. Finding now that such is the case, it is clear that the man had no motives of personal gain, as I at first thought, in withholding the information from me ; whilst the fact of his refusing the Rs. 20, being under ordinary circumstances a most unusual trait of native character, proves that his fears were at all events genuine.’

The Chairman, in soliciting any remarks which the members desired to offer on this very interesting find of Captain Samuells, said, that the specimens which he would send round, were, if intended for weapons or implements of any kind, of the rudest form. There could not be a doubt that they were, one entirely so, and the other to the extent of more than half its surface, simply the bloom, derived from the small copper furnaces which were known to have been in use with the old smelters or workers in copper in the country, and of which little smelting pots examples still remained. One, as he said, was entirely so. It bore all the marks of the fine earth or sand into which it was run, a rudely circular or slightly

oval thin plate of copper, just as the melted metal would naturally spread out, if poured out in the semi-viscous state in which such little pots would yield it. On this piece there was not a trace of hammering or of the application of any tool. The second on the other hand, though precisely similar to the first for one half its surface, had the other portion beaten and hammered up to a straight line, the two ends of this being hammered out into two shoulders or two semicircularly curved recesses, which would be admirably suited for the application of a handle formed of a split bamboo or stick, as Captain Samuells has applied it. But the curious part of it is, that is, if these were so intended for the application of a handle,—and with such a handle unquestionably the heavy mass of copper would form a rude, but very effective, axe or club, though not a cutting tool,—I say if this were the intention, it is doubly strange, that those who knew so well how to hammer this part so neatly into shape, should not also have hammered out the edge, so as to form a sharp cutting surface. This edge now remains with all the roughness and thickness of the old bloom just as it flowed from the melting pot.

“I believe the metal has not been examined as yet, so that I am unable to say whether it be pure copper or not, but it looks as if it were so.

“The discovery of any copper implements is of high interest, and while, thanking Captain Samuells for this contribution, it is hoped that the discovery may stimulate others to searching for such evidence of the state of metallurgical knowledge among the ancient dwellers in these lands.

“I may mention that within a few miles of where these copper blooms were found, there is a very large excavation, stretching for nearly half a mile on a local lode of copper ore. In this the ore is probably too diffused to pay for working now, but a very considerable quantity of copper must have been extracted from this place in olden times.”

2.—From J. M. Foster, Esq., M. D., through Mr. J. Wood Mason—three Asám small silver coins.

Babu Pratapa Chander Ghoshe, Assistant Secretary, said that the largest of the three coins contains the name of ‘Sri Brajanáth Singh, the king,’ and the two smaller that of ‘Sri Gaurináth.’ No years are mentioned.

The President mentioned that he had seen a complete collection of Asám coins with Mr. Leonard.

The following gentleman duly proposed and seconded at the last meeting was balloted for, and elected Ordinary Member—

J. M. Foster, Esq., M. D., Nazeerah, Assam.

The following gentlemen are candidates for ballot at the next meeting.

Capt. W. L. Samuells, Assistant Commissioner, Pachumba, Chord line, proposed by Col. E. T. Dalton, C. S. I., seconded by Mr. H. Blochmann.

S. E. Peal, Esq., Sibságar, Asám, proposed by Mr. J. Wood-Mason, seconded by Mr. H. Blochmann.

The Chairman said he had to report on the part of the Council that they had had under consideration the terms of Rule 29. By this rule, as now worded, it was compulsory on the Society to hold a meeting in each month in the year. Practically, however, it was found that during the months of September and October, it was extremely doubtful whether a sufficient number of members could be brought together to constitute a meeting, and rarely has it been that on one or other of the meeting evenings in these months, there had not been an adjournment, as there was not a quorum. Further than this which is the practical result—it has been felt, that with the seriously increased duties now devolving on the Secretaries, in editing the Journal and the Proceedings, it was not just or fair to those officers, who it must be remembered are purely honorary officers, to keep their time so pressingly occupied during the whole year, without any respite. It certainly is the rule elsewhere for Scientific Societies to have a certain recess during the year, and it is considered that it will be desirable to have such a recess here also. The Council, therefore, recommend that the words, '*excepting in September and October*' be inserted in Rule 29 after the words: "The Society shall meet on the first Wednesday in each month."

This being an alteration in the rules must be referred to the Society at large. Voting papers will be sent out, and as the time re-

quired for the rules will be given by this arrangement, the monthly meeting on the first Wednesday in February will be made the meeting for the discussion of the question.

The following letter was read—

From Capt. W. L. SAMUELLS, forwarding facsimiles of inscriptions, a plan, and a drawing of a rock cut temple at Harchoka, Chutiá Nágpúr.

‘I send you by *dák banghy* a parcel containing facsimiles of some inscriptions which I found cut on the pillars of a rock-cut temple at Harchoka in the Chutiá Nágpúr Tributary Mahál of Chang Bhokar, and which I came across this last season in settling the frontier line between Rewah and Chutiá Nágpúr.

‘One inscription (marked R) I got amongst some very interesting remains of rock-cut temples and monasteries near the village of Mára in Rewah. These temples were visited by a Capt. Blunt in 1795, and are mentioned by him in his “Narrative of a Route from Chunarghur to Yartnagoodum” published in 1801 in the 7th volume of the Asiatic Researches. On pages 73 and 74, he mentions having taken sketches of these temples with their measurements, which makes me anxious to know whether your Society is in possession of those sketches, and if so, whether I could be favoured with a view of them; for my visit to the Mára temples, from press of work, was, I regret to say, a very hurried one. I was therefore unable to make a plan of them as I should like to have done, if I had had the time. But if Capt. Blunt’s sketches are to the fore, I should be very much assisted in writing my report on these temples, if I had these sketches to refer to. Capt. Blunt states that he was unable to find any writing or inscription, and as far as the temples and monasteries go, I was similarly disappointed. But I doubt, if he noticed the remains of a stone aqueduct, as no mention is made of it in his narrative. It was in following up the remains and fragments of the aqueduct with a view to ascertaining from whence and for what distance the water had been conveyed by this artificial channel that I came to a spring which issued from a rock in the side of a hill, and found the rock excavated so as to form a grotto of the following dimensions—length 16’ 4”; depth 6’; height 4’. The roof is horizontal with

a plain frieze and cornice along its whole frontage, the former bearing in its centre sculptured figures in relief of Siva and Bhawani with a cobra's hooded head rising above them. The height of the frieze is 2'6". The shape of the grotto is rectangular, except that at one end the side wall forms an obtuse angle with the back wall from whence the spring of water issues. It was on this side wall that I found the inscription marked R.

'I was for some time puzzled to think what the singular device which is seen on the right was intended to represent, till it struck me that something similar to it might be got by twisting two blades of the long broad jungle grass in a particular way. I therefore cut two strips of paper to be used as a substitute for the grass and put a coloured line along the centre of each to represent the mid rib, and coloured the edges also to mark the lines which would indicate the breadth of the grass when cut in stone. In an envelope attached to the copy of this inscription you will find the paper figure I allude to, and on examining it, you will observe how exactly the directions of the coloured lines on the paper correspond with those shown in the copy of the inscribed device. This may be a mere coincidence, but still it is natural to suppose that the carver of the inscription had something in his mind's eye that suggested to him the device I am alluding to; and, that it was something of the nature suggested by me is, I think, more than probable.

'This *grotto*, as I have termed it, appears to me to bear some resemblance to the primitive wells of Thrace which are described as consisting of arched excavations in the sides of rocks where the water was directly obtainable from springs; with this difference only, that the *Mará* "well" or grotto, whichever is the more correct expression, has a flat roof instead of an arched one.'

Babu Pratapa Chandra Ghoshe said—

"The inscriptions are in old *Nágarí* characters, but are so rude, that the characters are identified with much difficulty. The inscriptions, so far as I have read them, are names of perhaps the donors of particular portions of the temple. They bear no date. I suppose they are Buddhistic, but I must not be certain before I read all the impressions sent by Capt. Samuells."

Mr. Blochmann said that Capt. Samuells had kindly promised to forward to the Society explanatory notes which would appear together with two plates in the Journal. The sketches taken by Capt. Blunt could not have been sent to the Society; at least there was no record shewing that they had been received.

The Chairman also exhibited several drawings of celts, received from Mr. J. J. Carey, Executive Engineer, Khangaon, regarding the following notice had appeared as a supplement to the Central Provinces' Gazette, dated 4th September, 1869.

'The stone circles lately found by me near the village of Khaiwarra, about 16 miles east of Arvi in the Wardah district, were opened by desire of Mr. Morris, Chief Commissioner, Central Provinces. The stone circles are on the east bank of a nullah running due north and south, the ground rising very rapidly, 12' 5" in 1,400 feet. I should think, there are quite 150 of these mounds dotted about in no regular form, along the edge of this nullah. In outward form they are precisely the same as those illustrated in Captain Meadows Taylor's book, with large stones rather evenly placed round. Numbers of these stones appeared to me to have passed through stone-dressers' hands, they having five sides rudely shaped, which makes me think they were originally intended to have been placed upright, not in the position found; however, nothing was found to indicate that any building was erected here, still it is strange that these five-sided stones should be there, and found lying flat on the ground. I am sure, they were never intended to be placed in that position. The mounds in every case were hollow at the top, making me think that a chamber would be found underneath, that the stones forming the ceiling had probably given way; but, on opening two, nothing was found to guarantee such an idea.

'I commenced digging operations on the principal mound in the place, 40 × 43 in diameter, there being more cut stone surrounding it, and three or four in the centre; very great care was taken in digging and removing stones. The top of one of these five-sided stones was hit upon close to the surface, and in the centre of the mound this was carefully left standing, while operations were going on up to one foot deep. Nothing but loose stones and earth was

removed, until about 15 inches from the surface broken red pottery began to show on the south side. At last some stiff leaden coloured clay was found, fast binding pieces of pottery, and on close examination large quantities of teeth were found, which evidently had been put into a *gurrak* and imbedded in this clay. These bones are, I believe, the back teeth of horses, in very good preservation. This clay then began to be found in patches, in which, as a rule, you always find pottery and other implements, and appeared in no other place than on the south side.

‘I was standing one evening looking on, when all of a sudden I saw a “find,” and immediately jumped down into the hole, and with the greatest care dug out of the clay, well cemented together, two copper bells, two round copper (in my opinion) ear-rings, and an iron axe; these I handled with the utmost care, vainly hoping that the whole would remain in this solid state; but after a few days, the heat of June soon dried up the clay, and the whole became detached. This and a few iron implements and a gold ring were the only things found. This excavation was carried down about 2·6 feet.

‘In the other we went down over three feet from the surface, and nothing but iron was found, very rust eaten. The only implement in good preservation was a kind of saucer for holding oil, which had a handle with a hook to hang by, and a spiral spring, which must I think have been wound round a stick.’

The following papers were read—

I.—*On a new Photo-callographic Printing Process.*—By CAPTAIN
J. WATERHOUSE, *Assistant Surveyor General.*

I have the pleasure to bring to your notice this evening a new process of photographic printing, I have lately worked out, which, though it can scarcely be called original, is in some respects new and, as I believe it has never before been worked in India, a description of it may not prove uninteresting to many of the members of this Society, more especially as the new process will be used for the reproduction of photographs and drawings of all kinds for the illustration of our Journal.

The few specimens I have with me, though very imperfect, are sufficient to shew the capabilities of the process. I have hitherto

chiefly practised on subjects in line in order to perfect myself in the manipulations, which were entirely new to me, but I know from the trials I have already made, that the process will also give excellent results in half tone as soon as I shall have been able to master the difficulties of the printing, and to obtain proper appliances. I am, therefore, unwilling to delay the publication of a process by which absolutely permanent photographic reproductions may be made from any class of subject with great perfection and economy by means of appliances which are within the reach of all.

In principle my process is similar to that introduced in 1866 by Tessier du Mothay, which was afterwards modified and improved by Albert of Munich and other Germans, and still further perfected by Ernest Edwards of London, who has brought it into extensive use under the name of Heliotype. Many of the members present may probably have read descriptions of it in some of the English serials, or have seen specimens in a publication entitled "Art, Pictorial and Industrial," which is illustrated entirely by its means.

The distinctive feature of all these processes is, that the printing surface is composed of gelatine, hardened in such a manner that it may stand the wear and tear of printing, and they all depend upon the well known property peculiar to a dried film of gelatine mixed with an alkaline bichromate of becoming insoluble after exposure to light, and repelling water in the parts exposed to light exactly in proportion to the amount of the action of the light upon them, and at the same time of acquiring a corresponding affinity for a greasy substance, such as printing ink. Although this property by itself has been most usefully applied in many photographic processes for the reproduction of subjects in line, it would be quite incapable of giving the required results in the processes now under notice, because the unexposed gelatine remains in a pulpy soft state incapable of withstanding the wear and tear of printing, and moreover it would be liable to dissolve entirely with any rise in temperature, the consequence of which would be the loss of all the lighter tones. It has been found, however, that the chromated gelatine film may be so hardened or oxidised by certain substances, such as the alums, especially chrome alum, tannin, chlorine, bichloride of mercury, permanganate of potash, and other suitable oxidising

agents, that it made quite insoluble in water, though still capable of retaining a certain amount of water, without interfering with its property of attracting greasy ink in the parts exposed to light and repelling it in the unexposed parts, so that if such a film be spread upon a surface of glass, metal, or other suitable material and after exposure to light under a photographic negative, be washed till all the chromic salt is removed, we obtain a printing surface possessing the properties of an ordinary lithographic stone, that is to say, it is absorbent of water in some parts, and absorbent of greasy ink in others, but, as I have mentioned, it also has another most valuable property which is not possessed by the lithographic stone, and which has been most aptly termed "a discriminating power of absorption," so that when it is inked in with a roller, the ink will be thickest on the parts representing the deepest shadows of the picture, and which have received the most exposure to light, the middle tints will take less, the lighter tints still less, while the high lights will take none at all, and be represented by white paper. It will readily be seen that in this way an exact transcript of the original photograph may be obtained, shewing the most delicate delineation of detail with as perfect gradation of tone as in a proof produced by the ordinary process of silver printing, but possessing the great advantages of a lithograph or engraving over a silver print in respect of undoubted permanence, cheapness and rapidity of production.

The above is the principle upon which these processes depend—the practice though presenting some difficulties of manipulation is very simple. A mixture of gelatine and bichromate of potash, with one of the hardening or oxidising substances I have mentioned, and also a little glycerine, sugar or other substance, capable of preventing the gelatine film from being too brittle is poured upon the surface of a perfectly level finely ground glass plate, and carefully dried in the dark in such a manner as to preserve a very even surface. When dry the plate is ready to be exposed under a reversed negative in the usual manner. After the surface has received sufficient exposure the plate is turned and its under surface is exposed to the full power of the light for a short time to render it thoroughly hard and insoluble and prevent it from swelling too much in the after washing. The plate is now

washed till all the bichromate is removed and is then rolled in with soft printing ink.

This is the simplest mode of printing but in the course of working out the Helio type process Mr. Edwards found that it was very difficult to obtain perfect contact between the negative and the gelatine film and thus it was impossible to obtain the sharpest results, so he thought of preparing a tissue which might be printed upon just like a sheet of sensitive photographic paper or carbon tissue and afterwards transferred on to a zinc plate or any other suitable surface which would stand the wear and tear of printing. This was a great and valuable improvement, but in the course of my experiments I found some difficulty in transferring the tissue, and as I find that with proper precautions fairly sharp results may be obtained by printing on the original plate, I have abandoned the use of tissue till I have more fully worked out the process.

I will now briefly describe the mode of working which, after many trials and failures I have found most successful.

Having well cleaned some pieces of finely ground plate glass such as is ordinarily used for looking-glasses, and having carefully levelled them. I prepare a mixture composed of—

Gelatine, 1 ounce.
Honey Soap, 30 to 60 grains.
Tannin, 10 grains.
Distilled water, 8 ounces.

I have found 10 grains of tannin to 1 ounce of gelatine sufficient to render it quite insoluble, and I think even less would do; but if more is added, it has the effect of rendering the film insensitive to light. The object of adding the soap is to render the film tough and prevent it from becoming brittle and breaking up when dried, its use for this purpose was first suggested by Mr. Johnson, in working the autotype process. Some precautions are necessary in mixing the solution so that it will give an even transparent film when dry. I have tried many kinds of soap, but I have found that the honey soap exported by Coward of London, such as is commonly sold by the boxwallas, is the best. The soap and tannin must be

separately dissolved in about 1 ounce of hot water, then mixed and added very gradually, and with constant stirring to the gelatine dissolved in the remaining 6 ounces of hot water. The mixture is then filtered through coarse cloth and poured on the plates. Should any air bubbles be formed they may be removed with the point of a pen-knife. The gelatine soon sets and as soon as I find the film is firm, I turn the plates face downwards and place them out to dry in the open air on suitable supports. They dry in from 12 to 24 hours or longer according to the state of the atmosphere. I think the plan I have here adopted of preparing the gelatine film without the addition of the sensitive bichromate is advantageous in many ways. It enables the plates to be dried in the open air, quickly and evenly and I find that when turned face downwards very little dust settles on them; another advantage is that a stock of plates may be prepared and kept till required to be sensitised for use. After sensitising the plates dry very quickly and heat may be used without any fear of the film becoming dissolved and flowing off the plate. I tried Mr. Edwards' process of mixing together the gelatine, chrome alum and bichromate of potash according to his published formula, but I found that the plates so prepared took a very long time to dry and required to be kept carefully level in the drying box, besides this there were other disadvantages which led me to abandon the use of chrome alum and substitute tannin with which I had made some experiments so long ago as 1866.

When the plates are thoroughly dry I immerse them in a solution of bichromate of potash about 1 oz. of the salt to 20 ounces of water and then place them in a drying box. As the gelatine is quite insoluble there is no necessity for keeping the plates level in this second drying and if necessary heat may be used. The plates dry in 2 or 3 hours and are then ready for use. I expose under a *reversed* negative for about 10 minutes in the sun for a clear line subject and about half an hour for a subject in half tone according to the density of the negative. When sufficiently exposed I remove the negative and expose the *back* of the sensitive plate to light for a few minutes in order to thoroughly harden the under surface of the gelatine film and prevent swelling and it from puckering up during the printing. The plate is then thoroughly

washed in several changes of water till all the bichromate is removed and is ready for printing.

The printing is the most difficult part of the whole process and success appears to depend entirely upon the composition of the ink. In printing line subjects some inks are too tough and cannot well be cleaned off the plate, others are too soft and are liable to be rubbed off when the plate is cleaned with a cloth. Then again in printing subjects in half tone a stiff ink will only take on the shadows, while a soft thin ink will take all over the plate and by giving a slight tone to the high lights destroy all brilliancy of effect. In printing subjects in line I roll in with a tolerably stiff ink made of ordinary lithographic chalk ink thinned with olive oil instead of varnish and before printing, clean the surface of the plate with a damp cloth. For half tone subjects, the plate must first be rolled in with stiff ink in order to obtain depth in the shadows and the detail of the half tones afterwards brought out by the use of a softer and lighter ink which should just be of such a consistency and tint that the half tones may all be well developed, but the high lights left clear. The inking in may be done with lithographic rollers, but rollers of india-rubber have been found better. The printing is best performed by vertical pressure in an ordinary type printing press which should be furnished with an india-rubber bed to prevent the glass plates being broken, and the plate should be covered with a padding of felt, so that the paper may be well pressed into the hollows forming the deepest shadows. Enamelled paper is the best for printing on, especially for subjects in half tone. The proofs I have with me have all been pulled in an ordinary copying press which I find answers the purpose fairly, though it is inconvenient in many respects.

If it is required to print on a tissue, a plan which certainly possesses many great advantages, a perfectly polished glass plate is used instead of ground glass, and the surface is rubbed with a solution of wax in ether, so that when it is dry, the film may be stripped off with ease. The composition I have described above makes an excellent tissue.

Such are the details of my process as far as I have gone, it is very imperfect in many points, but I am still working

at it, and hope soon to perfect and bring it into practical use in the Surveyor General's office for the reproduction of fine delicate drawings in line or brush shading, which are not susceptible of being reproduced by photography, and also to replace the costly and tedious process of silver printing for ordinary photographs.

The experience I have already gained has shewn me that the process is perfectly practical, and also exceedingly economical both in time and in material. It is true the preparation of the plates takes a long time, but once the plate is prepared, copies may be pulled from it at the rate of from 100 to 200 copies a day, and as the plates may be kept ready prepared, the time taken in their preparation is really of little consequence. As regards the cost of materials, I find that the preparation of a square foot of surface costs about 4 annas and 6 pie. This is a mere trifle, when the great advantages of the process are considered: 1st, in being able to copy drawings or other subjects in line with a sharpness and delicacy equal to the finest lithography or copper plate engraving, and 2ndly, in being able to print copies of shaded drawings or ordinary photographs, which shall be permanent and perfectly reproduce all the gradations of the original, and I need not point out how immensely valuable it will be for the reproduction and cheap circulation of photographs illustrating various branches of science.

I would only further add that I do not put this forward as an original process of my own, as I must acknowledge my obligations to former workers in the same direction. I can only claim to be the first to have worked out a practical process suitable for use in this country, and hope that the subject may be taken up by some of our Indian photographers.

II.—*Note on three Arabic Inscriptions by early Muhammadan Kings of Bengal, received from A. BROADLEY, Esq., C. S., BIHAR.—By H. BLOCHMANN Esq., M. A., Calcutta Madrasah.*

The three Arabic inscriptions which I have the pleasure to lay before the meeting, were sent to me, among others, by Mr. A. Broadley, C. S., Bihár. Mr. Broadley has taken rubbings of a large number of inscriptions, which he found on ruined buildings and shrines in the town of Bihár, a town, which in the early

period of Bengal history held a much higher rank than it does now-a-days. From the rubbings which I have examined, it is certain that Mr. Broadley's inscriptions will considerably add to our knowledge of the beginning of the Muhammadan period of Bengal History, and I hope that he will find leisure to publish his large collection, and add archeological notes on the old buildings of Bihár, and also collect the numerous legends, still current in the district, regarding the early Muhammadan invaders of Bengal.

My object in laying a few of Mr. Broadley's inscriptions before the meeting, is to direct attention to Bihár inscriptions in general, and to appeal to officers stationed in that province to send rubbings to our Society for publication. Every inscription with the name of a king and a date on it, is of value. At a former meeting, I explained what progress had been made, up to the present time, in the elucidation of Bihár and Bengal history. I mentioned that we do not even possess a correct and complete list of the Muhammadan kings of Bengal and Bihár, and that no historian had yet attempted to fix the limits to which the kingdom of Bengal, at various times, extended. There exist no MS. histories of Bengal; the first attempt at a connected history known to us, is the short chapter by Nizámuddín in the *Ṭabaqát i Akbarí*, which was composed so late as A. H. 1001, or A. D. 1592. For the beginning of the Muhammadan period, we have only occasional notices in the MS. histories of the Dihlí empire, and coins and inscriptions. The information which coins yield, will be found in Mr. E. Thomas's excellent Essay on the '*Initial Coinage of Bengal*' (Journal, A. S. Bengal, for 1867). He compiled a valuable list of the early Muhammadan Governors, and assigned to several kings, whose names were not to be found in the existing histories of Bengal, their proper places. As an example, I may mention the king Shamsuddín Fírúz, of whom Mr. Thomas found coins struck between 1315 and 1322, A. D. The inscriptions at Tribení near Húglí, which I laid last year before the Society, mention the same king as having reigned in 1313, A. D. Two of Mr. Broadley's inscriptions—and this will shew the value of his discoveries, prove—

1. that Fírúz already reigned in 1309 over (Western) Bengal, or Lak'hnautí.

2. That South Bihár under him belonged to Bengal, whilst other inscriptions shew that Bihár in 1352 again belonged to Dihlí.

3. That Shamsuddín had a son of the name of Hálím Khán, who in 1309 and 1315, and hence most likely during the intervening years, was governor of Bihár.

From a letter, I lately had from Mr. Broadley, it would also appear that portions of Hálím Khán's palace still exist, and that his descendants are still inhabitants of the town of Bihár.

Of the three inscriptions before the meeting two belong to Hálím Khán and contain the dates 1309 and 1315; the former inscription seems to have belonged to a sarái, the latter to a mosque.

The third inscription is of a still earlier date, and mentions an edifice built in A. H. 640, or A. D. 1242, by 'Izzuddín Abulfath Tughril Khán, who styles himself *Sultán*, and assumes other regal epithets, as *Kháqán ul Mu'azzam*, *khallada-ulláhu mulkahu*, &c., though his contemporary, the author of the *Tabaqát í Náqirí* merely calls him *Hákím*, or Governor, of Lak'hnauti, which was then looked upon as belonging to the Dihlí empire.

The characters of all three inscriptions are *Tughrá*.

III.—*A History of the Village of Aruṛa, Tahqíl Jagráon, Zil'ah Ludhiáná.*—By ATTAR SINGH, CHIEF OF BHADDAUR.

This paper is written in Hindí, and contains several interesting facts. The writer states that Aruṛa lies a little north of Bhaddaur, and eight *kos* south of Jagráon, and is inhabited by Muhammadans and Rájputés. The decline of the place dates from the time of Ahmad Sháh Durrání.

In old times, Aruṛa was inhabited by Rájputés of the Pramura clan. Many of the inhabitants were killed when the Muhammadans invaded the district, and many emigrated. Among the fugitives were also several families of Bráhmans, and hence it is that certain clans, as, for example, the Kálígotra Bráhmans of the hills of Chintapúrí, look upon Aruṛa as their original domicile.

The writer then mentions several legends of Rái Fírúz, under whom Aruṛa flourished. His tomb still exists, and in one of its inscriptions the year 1532 Samvat is legible. The old tank called Ráníyáná near Aruṛa is frequented by numerous pilgrims.

People say that the ancient name of the place is Ahichatta, and that its ruler, Rájá Buddhamáti composed a work in Prakrit, entitled Dharma Kathá, which is still used by the Púja tribe in the district. In the 15th chapter of this book, it is mentioned that a former prince of the city of Ahichatta, named Kanaka Ketu, reigned at the time of Mahávira Swámi, the twenty-fourth incarnation of Buddha. Under him the town was so large, that Bhaddaur and the adjoining villages were the suburbs of Aṛuṇa.

In conclusion, the writer mentions a few facts connected with Bhái Bahádur Singh of Bhaddaur, who died in A. D. 1866.

IV.—*Description of a New Species of Abrornis.*—By
W. E. BROOKS, ESQ., C. E., ETA'WAH.

ABRORNIS JERDONI.—The dark slatey-headed *Abrornis*. Dimensions—length of skin $3\frac{1}{2}$, but the bird in the flesh would probably measure $3\frac{3}{4}$; wing 1.82; tail 1.57; bill at front .35; from gape about .5; tarsus .72.

Colors similar to those of *A. Xanthoschistos*, but the slate colour of the head and shoulders is very dark and without the greenish tinge observed in the other species. There is no apparent light-coloured coronal streak, but a greyish white supercilium. Lower back bright yellow green, as are also upper tail coverts. Upper part of wing vivid green, all the coverts primaries secondaries and tertial as well as tail feathers edged vivid yellow green. Two outer tail feathers white on their *inner* webs; the white of the outer one being spotless, while that of the penultimate one is clouded with pale brown spots; but that of the lower surface of body from chin to under tail coverts bright yellow; bill and feet coloured as in the other species.

Dr. Jerdon was acquainted with this bird, and he procured the specimens which Mr. Hume and I have. I therefore name it after him; but he confounded it with *Abrornis Xanthoschistos*, Hodgson. I have examined Mr. Hodgson's original drawing with dimensions of the latter; and find it represents undoubtedly the North-Western bird, which extends to Cashmere. This drawing is very accurate, and perfectly accords with Cashmere, Dhurmsala and Kumaron birds; also with others procured on the Nepal border by Mr. Yeatman, in the cold season. Mr. Hodgson's dimensions of *Xan-*

thoschistos are—length $4\frac{3}{8}$; bill from gape $\frac{1}{2}$; tail $1\frac{3}{4}$; wing $2\frac{1}{8}$ to $2\frac{3}{16}$; tarsus $\frac{3}{4}$.

Dr. Jerdon's dimensions of *Albo-superciliaris* are—length $4\frac{1}{2}$; wing $2\frac{1}{4}$; tail $1\frac{7}{8}$; tarsus $\frac{3}{4}$. Inasmuch as these are the dimensions of Hodgson's bird, and as his drawing exactly represents the North-West species, I have no hesitation in putting *Albo-superciliaris* as a synonym of *Xanthoschistos*. *Abrornis Jerdoni* is the eastern representative of *A. Xanthoschistos*.

Mr. Ball exhibited several birds captured by him in the Red and Arabian Seas, and said—"I wish to make a few remarks upon some birds which I recently captured in the Red and Arabian Seas, when on board the Mail Steamer 'Mongolia.' I am more particularly anxious to exhibit them as they have been cured by a process somewhat novel. Having neither the facilities nor inclination for skinning them, and being unable to procure any pure carbolic acid, I tried the effect of injecting them with common disinfecting fluid. The result has been that the birds have kept admirably and are only now gradually drying up into mummies. The specimens include—

1st.—A male and female of the common *Tinnunculus alaudarius*.
Briss.

2nd.—A bird which I rather think may be a Hobby, *Hypotriorchis subbuteo*, L., but if so, it presents a very unusual phase of plumage. At some future time, I hope to describe it more fully.

3rd.—A species of Roller (*Coracias*) distinct from both the European and Indian birds. It comes nearest to the former, but differs from it in many details of plumage. Speaking generally, it has a more subdued coloration, and the violet blue of the lesser wing-coverts is not continued, as in *C. Garrula*, on to the shoulders. The head and neck too are a dirty green rather than a bluish green. I have not yet had time to ascertain whether it belongs to a known species.

4th.—A specimen of the somewhat rare Sanderling, *Calidris arenaria*, Tem. It came on board in the Arabian Sea in a very exhausted condition.

Besides the above, I observed many other land birds flying about or resting upon the ship. Notably a small party of six owls

which kept up with the ship for two days. •I in vain tried to capture a specimen, they were observed one by one to drop exhausted into the sea. I am unable to say with any degree of certainty to what species they may have belonged, but think it just possible that they may have been *Otus brachyotus*, Gmel. Their markings and size resembled those of that bird, they had most decided ear-tufts.—

The meeting then broke up.

LIBRARY.

The following additions have been made to the library since the meeting held in October last.

Presentations.

*** Names of Donors in Capitals.

Journal Asiatique, No. 62.—SOCIÉTÉ ASIATIQUE, PARIS.

The Quarterly Journal of the Geological Society, No. 107.—THE GEOLOGICAL SOCIETY OF LONDON.

Journal of the Chemical Society, May, June, and July, 1871.—THE CHEMICAL SOCIETY OF LONDON.

Monatsbericht der K. Pr. Akademie der Wissenschaften, July, 1871.—K. PR. AKADEMIE DER WISSENSCHAFTEN ZU BERLIN.

Memoires de la Société des Sciences Naturelles de Cherbourg, Tome xv.—SOCIÉTÉ DES SCIENCES NATURELLES DE CHERBOURG.

Zeitschrift der Deutschen Morgenländischen Gesellschaft, Band xxv, Heft. 1, 2.—THE EDITORS.

Indische Studien, von Dr. A. Weber, Band xii.—THE AUTHOR.

Wissenschaftlicher Jahresbericht über die Morgenländischen Studien, 1862 bis 1867, von Dr. R. Gösche.—THE AUTHOR.

Review of Christian Literature in India, during 1870, by J. Murdoch, LL.D.—THE AUTHOR.

Account of the Operations of the Great Trigon. Survey of India, vol. I., by Col. J. T. Walker, R. E.—THE SURV. GENERAL OF INDIA.

Selections from the Records of the Govern. of India, No. LXXXIII.—THE GOVERNMENT OF INDIA, HOME DEPARTMENT.

Purchase.

Numismatic Chronicle, Part II, 1871.—American Journal of Science, August, September, 1871.—Revue des Deux Mondes, Sept. 1871.—Comptes Rendus, 9, 10.—Journal des Savants, July August, 1871.

PROCEEDINGS
OF THE
ASIATIC SOCIETY OF BENGAL
FOR DECEMBER, 1871.



A meeting of the Society was held on Wednesday, the 6th instant at 9 o'clock P. M.

T. Oldham, Esq., LL. D., Vice-President, in the chair.

The minutes of the last meeting were read and confirmed.

The following presentations were announced—

1. From the Government of India in the Home Department, a set of photographs of temples, &c., in Bihár.

The following correspondence accompanied the donation.

From ARTHUR HOWELL, Esq., *Under-Secretary to the Government of India.*

I am directed to forward, for the use of the Asiatic Society, a

* 148 pictures.

From Government of Bengal No. 272, of 30th January, 1871, and Enclosures.

† From Ditto No. 2194, of 26th July, 1871, and Enclosure.

set* of photographs of the Antiquities of Behar, together with copies of the papers noted on the margin,† containing a short account of each subject by the photographer.

From T. F. PEPPE', Esq., *Sub-Deputy Opium Agent of Chota-Nagpore.*

I have the honor to forward herewith a concise notice of the photographs of the antiquities in the

With photographs, one complete set, viz., Nos. from 1 to 123, and one incomplete set, minus Nos. 3, 4, 6, 15, 16, 19, 22, 23, 26, 28, 38, 39, 42, 48, 49, 50, 53, 55, 56, 58, 67, 71, 72, 77, 79, 80, 81, 94, 98, 104, 106, 107, 108, 109, 111, 112, 114,

Behar division, of which I have negatives, as called for in your letter No. 66, dated 22nd July, and also one complete set of those

122, 123-39 which will be sent on their arrival from Calcutta.

Total sent—

Large 102

Small 105

Total ... 207

mentioned and numbered according to the descriptions. The Shahabad photographs are not included in the above, as I have unfortunately no copies of them.

As soon as they are received, the

copies and descriptions will be forwarded.

2. I also forward some duplicate copies, which will be completed as soon as the remaining copies are received from Calcutta. This therefore makes three copies of the photographs more or less complete. I regret to state the sets could not be supplied complete at once; but as this could not be done, care will be taken that the missing ones are hereafter sent.

3. In the meantime, I would beg to state that I have been put to considerable expense in having them printed in Calcutta, and that as so many more are still required to complete the seven copies of each, I would beg that an advance of Rs. 600 be given to enable me to have them printed.

4. My transfer to Chota-Nagpore has prevented me from taking negatives of some of the antiquities still remaining to be photographed, and would beg to mention them for your guidance:

The tower at Girriak.

The fort at Behar.

The rock sculptures at Pabuttee, east of Girriak.

5. I have also included some copies of negatives of Chumparun, which are probably not required. In that case they can be returned, and so much of the description as applies to them may be curtailed.

GYA.—There are a great many interesting structures and remains of antiquity in and about Gya, as it has been a place of considerable importance for many centuries. Unfortunately, during this time, there have been at least two changes of religion, and very few of the older structures are now intact; for as the buildings of the deserted faith were at hand and readily available, they were used in the construction of buildings belonging to the prevalent religion. On rare occasions only was a new temple built of fresh materials. With the exception of the temple of Vishnu Pad, all

the other temples are either converted Buddhist, or built with the materials obtained from Buddhist, buildings.

Photographs Nos. 1 and 2.—The temple of Vishnu Pad, the largest and most important in Gya, although comparatively modern, is a most imposing structure, but its confined situation prevents a good photograph being obtained of it. It fronts the east, and the *façade* is very striking, although greatly disfigured by ragged *purdahs*, &c.

No. 3.—To the south of the temple, and almost touching it, there is a handsome pillared hall, where the bare rock shows itself; in fact, the pillars are let into the solid rock for a foundation.

No. 4.—Alongside, to the north, is the temple of Gadadhur or mace-bearer, which must have been a fine stone temple, but has been modified and renewed at a comparatively late date, and a number of Buddhist figures are collected in and around it.

No. 5.—In front of the Vishnu Pad and Gadadhur temples is the holy place where the pilgrims bathe in the Fulgo, which forms a principal part in the ceremony of *Pind*, for which so many pilgrims annually visit Gya from all parts of Hindustan and Nipal.

Nos. 6 and 7.—The old town of Gya is picturesquely situated on a rocky ridge running along the bank of the Fulgo. Photographs Nos. 6 and 7 conjointly show the whole river front of the old town of Gya, with its background of hills, and the nearly dry bed of the river in the foreground.

Nos. 8 and 9.—Are views of the old town from the Ram Gya hill on the opposite bank of the Fulgo, and the village of Selemipur in the foreground.

Nos. 10 and 11.—The town extends from the banks of the Fulgo to the foot of the hills, occupying in fact the whole valley between; No. 10 is the view looking west from the high bank of the river, and No. 11 is the view looking north.

Nos. 12, 13, and 14.—The southern extremity of the town occupies a rocky eminence which commands the greater part of the town, and No. 12 is a view looking north from this point, and Nos. 13 and 14 are views looking south and west.

Nos. 15 and 16.—The peculiar priesthood of Gya, the Gyawáls, without whose assistance no ceremony is effective, have their houses

on the banks of the river, and in the most prominent sites within the city, but they, I believe, are restricted to certain portions of it. Photographs Nos. 15 and 16 are some of their houses along the banks of the Fulgo, many of them five and six stories high and very old.

Nos. 17 and 18.—To the south of the town the range of hills which surrounds the town ends in a conical hill called Brahmajoni, which is considered of great sanctity. There is a temple on the summit dedicated to the sakti or female energy of Brahma, hence the name. It is approached by a flight of stone steps leading up from below. The hill itself is 450 feet high, and is a prominent object in approaching Gya from every direction. It is one of the principal places which must be visited by the pilgrims who come to perform the ceremony of Pind.

Nos. 19 and 20.—Another of the principal places of pilgrimage is the Suruj Kund and temple. This is only a short distance from the Vishnu Pad. The temple is one of the oldest in Gya, and evidently belongs to Buddhist times. Inside there is a valuable inscription dated in the era of Buddha's death or Nirvan, which is of great value, as fixing the date of that event. The vestibule is formed of two double rows of pillars ten feet in height, and five pillars in each row. A great number of mutilated statues are let into the walls on either side.

No. 21.—Another place which must be visited by all pilgrims is the tank, or Kund Petta Mahaswar. The present buildings are quite modern, but a great number of Buddhist statues are collected in and around them.

Nos. 22 and 23.—The final ceremony of Pind is performed at the Achyber temple which is situated near the foot of the Brahmajoni hill and close to the Rukmini tank.

No. 24.—Gives the relative positions. The Achyber temple is very old, and must have been a monastery chapel, as the present buildings, although mostly rebuilt and altered, seem to have been originally a Buddhist monastery.

Nos. 25, 26, 27, and 28.—Higher up the same hill, which runs down to the Rukmini tank, there is an old temple much in the same style as the temple at Budh Gya called Mungla Deva, but of

later date, and on the same hill lower down, on the eastern side, is another of the same style facing the Sarasvatti tank.

Nos. 29 and 30.—The modern town of Gya, or more properly Sahibanj, contains few structures of any antiquity. The largest temple is a double-spired one, built by a wealthy Kaist, Fath Bahádur. Near this is a fine sculptured doorway.

No. 31.—Over one of the gateways of the town there is a fine arch. This was the limit of the city as originally enclosed. It has, however, extended very considerably to the north since then.

Buddh Gya—This place, so celebrated in the annals of the Buddhist world, is situated six miles to the south of Gya.

No. 32.—The great temple faces the east, and is 50 feet square at the base, and is 160 feet high. Colonel Cunningham gives the date of its erection by Amara Deva about 500, A. D. It is remarkable as being the finest brick structure still standing in India.

No. 33.—To the west of the temple itself is the famous Bodhi Drum, or tree of knowledge, famous throughout the Buddhist world as the tree under which Sakya Singha sat for six years, and is still visited by pilgrims from Burmah, Ceylon, &c. It is said to have been rooted out by a Brahmanist king, Sasanka, and renewed by his contemporary the Buddhist Purna Varmma. Only one large branch is now alive and from all appearances it will not last much longer. Excavations made some years ago under the auspices of the Asiatic Society showed that the whole temple was surrounded by a Buddhist railing similar to the one at Sanchi. This shows conclusively that the present temple occupies the exact site of the original one, as these railings bear inscriptions in the ancient Pali of the time of Asoka.

No. 34.—The front of the temple which faces the east is in very bad repair, and large masses come down every rainy season. In a few years the aspect of this side will be entirely changed. The porch in front has now nearly disappeared; only portions of the arch of its roof adhere to the said walls. The peculiarity of this portion is the Lehra or horizontal arch to the third story, and the radiating arches on the second story.

No. 35.—In front of the building there is a small arched doorway leading into the courtyard, in which is the Buddha Pad, or impres-

sion of Buddha's feet, to which offerings are made by all classes of pilgrims, as also to the Buddha tree, but none of the orthodox enter the temple itself.

No. 36.—The south side of the temple is in the best preservation, and many of the niches still contain plaster figures of Buddha, but in many they are wanting.

No. 37.—On the same side a deep excavation made to follow the railings disclosed the original plinth of the temple in tolerable preservation. This has since been filled up. It showed that the general level of the courtyard, and the surrounding part was considerably above the plinth which must have been approached by steps, instead of descending to it, as at present, through the arched passage in front.

The arches in the front supporting the entrance and roof of the first and second story have attracted considerable attention, and it has been doubted whether they were true radiating arches, and whether they were part of the original building. Both these doubts have been cleared away, but it is still a problem how they came to be built, and it has cast great doubts on the assigned age of the building itself. Fergusson has decided, principally on the fact of these arches, that the building cannot be of the age assigned to it by Colonel Cunningham, as it is quite anomalous to find arches in a purely Hindu structure of such an early date. The fact, however, remains, and there seems no other solution to it than that the Hindus did understand the principle of the arch, but only resorted to it in structures of brick, very few of which are now left.

No. 38.—Inside the little cenotaph, to the left of the entrance, there are some Buddhist figures, representing Buddha himself seated under the Buddha tree.

No. 39.—To the east of the great temple there is a smaller one of something of the same style, but much later, dedicated to Tara Deva.

BURRABUR.—The group of hills in which the caves have been excavated is about sixteen miles to the north of Gya, and some two miles from the bank of the Fulgo.

No. 40.—The most westerly hill is an isolated peak called

'Kawwa Dol,' or the crow's swing. There are a number of large boulders at the foot, which seem to have fallen from the top. Many of these are sculptured with rude lingams, &c., and on one to the north-west angle of the hill there is a short inscription, which, however, is nearly illegible.

No. 41.—On the east side of the hill there must have been a large temple, some few pillars of which are still standing, and a gigantic figure of the ascetic Budh, measuring eight feet high, with a breadth across the shoulders of six feet, still in its original position, with part of the original brick wall behind it.

No. 42.—The temple itself must have been a large one, but there are only a few pillars now standing somewhat apart from the shrine where the gigantic Budh is. Whether more than one structure existed here it is difficult to say, but a great many mounds are existing in the neighbourhood, and a large village must also have existed to the north-east.

To the east of the Kawwa Dol there is a group of hills, the highest being Burabee, and the whole group is called Burrabur. Near the centre of the group, and to the south, five caves have been excavated in the solid granite rock, and the labour expended in cutting, and subsequently polishing the compact granite must have been enormous. There are three of these caves in one group.

No. 43.—The Sudama and Lomas Rishi are cut in the western face of the rock; the Sudama to the north, and the Lomas Rishi to the south. The Sudama cave, which has a plain doorway, has an inscription in the ancient character of Asoka's pillars, cut in the side of the doorway. It records the excavation of the cave, in the twelfth year of the reign of Rajah Pyadasi, that is, of Asoka himself; the cave therefore dates as far back as 252 B. C. It consists of two rooms, a circular one of 19 feet, 11 inches in diameter, and an outer one 32 feet, 9 inches in length, by 196 inches in breadth, the walls are 6 feet, 9 inches in height from the vaulted roof, which has a rise of 5 feet, 6 inches, making the total height of the chamber 12 feet, 3 inches.

No. 44.—The Lomas Rishi is similar to the Sudama cave both in size and arrangements, but the roof is unfinished; while the walls

and roof of the Sudama cave are highly polished. The doorways of both caves are of the Egyptian style, but the porch of the Lomas Rishi has been enlarged and ornamented, and represents the gable end of a thatched house with a frieze of elephants surrounding the doorway, executed in a most artistic manner. Indeed the drawing of the elephants contrasts favourably with the popular modern representations of this animal. Colonel Cunningham is of opinion that this porch was executed at a later period than the cave itself. There is an inscription in the porch over the doorway, of the third or fourth century of our era. It is curious to remark that in the representations found on the bosses of the Buddhist railing at Budh Gya, there is a similar representation of the gable end of a thatched house forming the doorway of a cave also.

No. 45.—On the northern side of the same granite rock as the two preceding, there is the third cave of the group called the Karna Chopar. It is 33 feet, $6\frac{1}{2}$ inches long, by 14 feet wide. The sides of the cave are 6 feet, $1\frac{1}{2}$ inches high, and the vaulted roof has a rise of 4 feet, 8 inches, making the total height 10 feet, 9 inches. On the outside of the doorway, there is an inscription in the ancient Pali recording the excavation of the cave in the nineteenth year of the reign of Rajah Pyadasi, that is, of Asoka himself. The cave, therefore, dates as far back as 245 B. C. To the east of the doorway the rock has been cut away, and several rude sculptures have been executed on the scarped face representing a linga and two rude Brahminical figures.

No. 46.—The group of hills nearer the Fulgo river, and about half a mile to the east of the Burrabur group, is called Nagarjuni. There are several caves in this group. The largest is cut in the southern face of a rocky ridge, and is approached from below by a flight of rude stone steps. The height of the cave doorway, above the level of the plains, is about 50 feet. The cave itself measures 46 feet, 5 inches long, by 19 feet, 2 inches broad, both ends being semi-circular, and, in the inscription on the doorway in the ancient character of Asoka's edicts, the cave is called the 'Gopi's' cave, and was executed by Dasaratha on his accession to the throne. "The Gopi's cave, an abode lasting as the sun and moon, was caused to be excavated by Dasaratha, beloved of the Devas, on his accession,

as a hermitage for the most devoted Bhadantas (Buddhist ascetics)." Dasaratha, according to the Vishnu Purana, was the grandson of Asoka, and as the son of Asoka, Sayasus, only reigned eight years, the accession of Dasaratha must have taken place in 214, B. C.

Nos. 47 and 48.—The other caves in the Nagurjuni group are situated in the northern side, and on the southern face of a rocky ridge, running parallel with the Nagurjuni hill, there are two caves, one to the west being nearly hidden in a recess, and has its entrance facing the east. The cave itself is 16 feet, 4 inches, by 4 feet, 3 inches, and there is a rude brick wall running across it, dividing it into two rooms, which has been done by some late occupant, said to have been a Musalman fakir. There is an inscription in ancient Pali, in which the cave is called Vadithi-ka-Kubha, the rest being letter for letter the same as the inscription in the Gopi cave; the date is therefore the same.

No. 49.—The eastern cave has a small porch 6 feet long by 5½ feet broad, and the doorway is Egyptian, like all the doors of these caves. The cave itself is 11 feet, 3 inches, by 16 feet, 9 inches long; the roof is vaulted, 10 feet, 6 inches in total height. There is an inscription on the porch in the ancient character of Asoka's edicts, in which the cave is called Vapiya-ka-Kubha, or the well cave. The inscription is word for word the same as that on the Gopi cave, so that the date is the same, 214 B. C. In front of the cave there is a large well 9 feet in diameter. From various inscriptions on these caves it would seem that they have been at various times occupied by Buddhists and Brahmanists, but were originally excavated for Buddhist ascetics by the kings Asoka and Dasaratha, in the third century B. C. About the third or fourth century of our era, the kings Sardula Varma and Anunta Varma placed Brahminical images in three of them, and subsequently Mussulman fakirs took possession of them. They are now, and have been for many years, uninhabited.

Nos. 50 and 51.—Alongside the Vapiya cave there is a curious boulder poised on two others, and the cavity thus formed had been built up into a grotto no doubt for Buddhist ascetics. The Nagurjuni hills are some little distance from the Burrabur group,

and No. 51 is a view of the Burrabur group from the plains in front of the Nagurjuni cave.

No. 52.—Is the view of the Burrabur group from the rocky ridge in which the two northern caves are cut, with the Burrabur peak and temple in the centre.

DHARAWUT. Nos. 53 and 54.—Dharawut lies immediately to the north of the Burrabur hills, about $1\frac{1}{2}$ miles distant. There are large and extensive mounds in and around the present large village, and a large tank called Chandohur Tal, which is some 2,000 feet long by 800 feet in width, evidently as old as the Buddhist monasteries which existed here. On the banks of the tank there is a little temple, near which there is a fine standing figure of the famous Buddhisatva Avalokiteswara, the Pudma Pani of the Tibetans, and is always represented with a lotus in his hand.

Nos. 55 and 56.—From the little hill to the south of the tank, which is covered with brick and stone rubbish, some curious sculptures were obtained by the villagers searching for bricks, representing various objects of Buddhist worship.

NAIR. No. 57.—Nair is on the Patna and Gya road, west from Dharawut, and about twenty miles from Gya. There is a pillared temple close to the road very much in the same style as the temple at Poonawa. It consists of three rows of monolithic pillars, ten pillars in each row. Fronting the temple there is a further row of four pillars. The temple or shrine behind consists of brick and mud cement, but very little of it is now standing; the superstructure is entirely gone, and none of the temples of this form are sufficiently complete to allow of a conjecture as to their original form. The roof of the portico and the shrine is composed of large granite slabs, a linga now occupies the shrine, and there is a mutilated figure of Ganesh lying outside.

Judging by the size of the mound, and the part of the shrine remaining, the temple must have been a lofty one. The bricks are large and well made, although inferior in this respect to those used in the construction of the Buddha Gya temple. It is probable that the temple dates about 700 A. D.

No. 58.—Shows the temple from the east, with the remains of the shrine and mound of brick rubbish.

PALI. *No.* 59.—About seven miles nearer Gya, on the Patna road, there is a large mound with a small modern temple. Near this is a large slab with a representative of the same group of figures as at Koch Daphoo, &c.

KISPA. *Nos.* 60 and 61.—This place is nearly west from Nair, about six miles. There are large mounds there, and a very fine standing statue of Sakya Singha as a teacher with the Buddhist creed in an inscription round the head. Near the above there is a large four-armed figure sitting on the shoulders of another squatting figure. This figure is quite unique; this being the only specimen of the kind to be found in the district, it is not known to what it refers.

No. 62.—There is also a curious sculptured block, which it is difficult to make out to what it belonged. It could not have been the base of a linga, as that is invariably inserted into the yoni, whereas in this case there is no place for insertion.

GENJAN. *No.* 63.—About a mile and a half from Kiswa to the north-east, there is a village called Genjan on the top of a large mound. Here there is a very fine statue of Buddha the ascetic, with representations of the birth, teaching, and death or Nirvana of Sakya Singha in small figures surrounding it. This is one of the best-executed sculptures in the district, and although much mutilated and broken, it is of considerable interest.

RAJGEER. *No.* 64.—Rajagriha is one of the few places about which there can be no doubt of its identity, and was visited by the Chinese pilgrims, Fa-Hian in the fourth century, by Hwen Thsang in the sixth century. They both visited the 'Son Bundar' cave, famous in Buddhist annals as the spot where the first Buddhist synod was held in a temporary building in front of it, by Ajatasatru, Rajah of Magadha. There is an inscription cut on it not later than 200 A. D., but the cave itself is probably older. It measures 34 feet long by 17 feet wide, and is cut in the solid rock, but is neither smoothed nor polished.

No. 65.—The cite of the ancient city is now overgrown with brushwood, and is surrounded by hills in every direction. A small elevation in the centre marks the cite of a monastery chapel. View 65 is looking east from the door of the cave.

No. 66.—The modern temples round the hot springs are situated at the opening of the valley, leading to the site of the ancient city, and 66 is a view of the temples with a singular fort-looking structure on the hill behind and above them. It is composed of loose unsquared stones loosely put together.

No. 67.—Is a view from the same structure overlooking the hot springs and the flat country beyond them.

DEOKOOND. *No. 68.*—This place is situated to the west of Gya, about 25 miles, and some distance inland from the Sone. It must have been in early days a place of some importance, and a Buddhist monastery existed, only part of which now remains, and has been converted into a Brahminist temple, and a linga placed in the shrine, but great numbers of Buddhist votive stupas, &c., were scattered about some years ago, many of which, however, have lately been covered up. A fair is held here in the month of Falgoun, where great numbers of pilgrims assemble to bathe in the koond or tank. The original temple must have been a large one, judging by the mass of brick rubbish in which the shrine is sunk, and a road had to be excavated to allow of access to it. The shrine is now surmounted by a rude dome, but the lower part is still intact, and belongs to the early Buddhist type.

DAUDNAGAR. *No. 69.*—Daudnagar is a considerable town in the banks of the Sone, and forty miles west of Gya. The town which is comparatively modern, was founded by Dáúd Khán, a Pathán soldier, who signalized himself by his bravery, and who subsequently, as a reward for the conquest of Palámau, received jaggers in this neighbourhood. He erected a fortified serai for the protection of travellers, who were subject to robbery on the road along the banks of the Sone going to Patna. The photograph represents one of the gate-ways of the serai, which is now used as a dwelling-place by his descendants. Dáúd Khán died about 200 years ago.

SHAMSHERNAGAR. *No. 70.*—About eight miles lower down the Sone from Dáúdnagar there is a considerable village called Shamshernagar, founded and named after a nephew of Dáúd Khán, Shamsher Khán, and a very pleasing structure was built by him as his tomb. It is now rapidly falling to pieces, although still in possession of his descendants.

KONCH.—On the road between Dáúdnagar and Gya, about sixteen miles from the latter, is the village of Konch. It consists of two parts, the bazaar on the road side and the village proper, about 100 yards to the north. Between the two villages there are extensive mounds of brick rubbish, and a great many Buddhist figures and statues are scattered about. The principal one is life-sized, beautifully carved, but the head is wanting, and represents probably Surya.

Nos. 71, 72, and 73.—Higher up on the mound there are two purely Buddhist figures with the creed in inscriptions round the head, and two others, probably Surya, of a later type.

Nos. 74 and 75.—Passing through the village proper you come to the large temple mentioned by Buchanan, a drawing of which is given in the 1st volume of Martin's India. This building closely resembles in style that of the great temple at Budh Gya, and the construction is much the same; the materials are the same; beautifully moulded bricks and mud cement. The lower chamber is 10 feet square, and has an arched roof as in the Budh Gya temple. In the upper chamber the walls are gradually contracted, so that the four sides meet at the top.

No. 76.—The opening into the upper chamber is also on the Lehra principle. In the construction of this building the Hindus showed that they understood both kinds of arch, and used them as suited their requirements.

No. 77.—The west side of the temple has been much damaged by the heavy rains, and large masses keep falling year by year. Unless something is done, this fine temple will soon be a mass of rubbish.

No. 78.—A porch had been added to the original building, or more likely, the original porch had become ruinous, and had subsequently been repaired. It is 9 feet by 22 wide. In front of it a small courtyard has been added also 9 feet by 22 feet; a flight of steps led up from the level of the ground. In this courtyard and porch a great many figures have been inserted or ranged along the walls, many of which are figured in Martin's India.

No. 79.—To the north of the temple there are two cenotaphs over the remains of former mahants, but there is no monastic community settled here now, and the temple itself is not considered

orthodox. Notwithstanding that there is a linga now occupying the shrine, the building itself is by popular tradition the work of Kol Rajahs (a generic name for the aboriginal races). This bad odour with the orthodox would seem to prove its Buddhist origin.

No. 80.—Four miles east of Konch, on the same road, there is a village called Pali, where there must have been some large temples, only a few pillars of which are now standing. It must have been of the same style as those at Nair and Poonawa.

No. 81.—The sculptured doorway, part of which is lying under a tree close by, closely resembles the fine one at Poonawa.

SEHAREE. No. 82.—About eight miles west of Konch, near the village of Seharee, there is a small stone temple on the roadside; it is constructed entirely of Chunar stone, and was completed at Chunar and sent down fit for erection. It is now the pride of the little hamlet where it stands.

OOMGA.—This place is situated within a mile of the dâk bungalow of Madunpore on the grand trunk road, and fourteen miles west of Sherghâti.

No. 83.—The temple is built on a rocky spur of one of the highest hills overlooking the grand trunk road, and is built entirely of squared granite blocks without cement and is in excellent preservation. The height of the temple from the rock to the crest is about 60 feet, the extreme length from east to west is 63 feet, and the breadth 53 feet.

No. 84.—To the north and south there are balconies which give the temple a distinctive character, and marks a transition from the open pillared portico which had previously been the rule, as at Poonawa, Nair, and Pali.

No. 85.—The large porch in front was entirely enclosed, and was lighted by these side balconies, the interior has a very imposing appearance, and the monolithic pillars with bracket capital is a decided advance from plain column with cross brackets.

No. 86.—Inside there is a large slab of black chlorite with a long inscription recording the building of the temple by Bhairub Indra in Sambat 1496, *i. e.*, A. D. 1439, on Thursday, the light half of the moon Bysack, and was dedicated to Jagarnath, Balbhadru, and Subhadra. The shrine is, however, occupied by a linga.

No. 87.—To the south of the temple there is a fine large tank with a flight of stone steps on the east side nearest the fort, part of of which is still standing north and south of the tank. Several mounds indicate the position of the town.

No. 88.—Higher up the same hill on which the temple is built, and on the summit of a higher ridge, there is a curious little altar with a huge boulder alongside it. Under the boulder sacrifices of kids and other animals are still made. Every available ledge and spur on this hill seems to have been occupied by similar structures, and there are also a great number of figures and lingams both on this and the adjoining hills.

No. 89.—Still higher up, and also facing the east, are the ruins of another temple, nearly as large as the one lower down, and in the same style, but nearly the whole of the superstructure has fallen down. On the path between the two temples there are several inscriptions cut on the face of the rock, but from the texture of the granite they are nearly illegible.

On the hill opposite the dāk bungalow there is a small temple and tank which are of a much earlier date, and the bricks and style resemble those at Budh Gya. In this case also the chamber has an arched roof.

Deo. *No.* 90.—*Deo* is twelve miles to the west of Oomga, and there is a very fine temple here. It is in the same style as those at Oomga and like these built of squared blocks of stone. This temple, however, faces the west, and has been highly ornamented. There is no inscription on the temple, but it may be of a somewhat earlier date than those at Oomga.

No. 91.—This place is also the residence of the Maharajah Jai Pergash Singh, K. C. S. I. His palace, a large rambling building, is quite modern.

BRIDGE OVER THE POONPOON RIVER. *No.* 92.—The bridge over the Poonpoon river, where it crosses the grand trunk road between Muddunpore and Baroon, is given simply to show the character of the scenery on this part of the country. The Poonpoon, which is here only a few miles from its source, is a mean little stream, but as it collects the whole of the rainfall between the Sone and Morhur rivers, it becomes towards Patna a large river, which lays the country under water for many miles to the south-east of Patna.

CHEON.—Is situated north-east of Oomga, about eight miles. A large number of isolated little hills are dotted over the country for some distance north of the grand trunk road. Many of these large masses of granite are not shown in the revenue maps. Nearly every one of these hills had little structures of some kind on their summits.

Nos. 93 and 94.—To the east of the village of Cheon there are the ruins of a temple of considerable size built of squared granite black without cement. It is now in ruins, only part of the shrine and doorway remaining.

The interior of the shrine is occupied by a linga, and there are no inscriptions; but from its general resemblance to the temples at Oomga it may be considered as of the same date.

Nos. 95, 96, and 97.—To the south of this temple, and to the east of a little hill there is a fine, life-sized four-armed statue with many fragments of others, also several mounds and masses of brick rubbish on every side. About 300 yards to the west, on another little hill called Puchar, there is a cave about half way up the hill. It is a natural hollow which has been built up enclosing a chamber some 10 feet by 12, with a doorway supported on bracket pillars. Inside there is a figure of Budh surrounded by a seven-headed snake called 'lungabeer.' There is also a figure of Mahamaya, the mother of Budh.

No. 98.—A little platform has been constructed in front of the cave, and a flight of rude steps led up from below. The cave faces the south.

No. 99.—About a mile to the south there is another cluster of little hills within the boundary of the village of Deokillee where there are many little caves similar to the one at Cheon. Most of them are filled up. One curious altar-like structure crowns the summit of a ridge between two hills immediately above a natural hollow in a rock which was used as a tank.

No. 100.—And on the north of the hill a bund has been thrown across a hollow, thus forming a large tank, thus showing that the whole locality had been one of some importance. All these hills must have literally swarmed with Buddhist ascetics. Judging by the great number of little caves and structures, the remains of

which now exist, it is to be regretted that no inscriptions have come to light.

POONAWA. *No.* 101.—This village is situated fourteen miles west of Gya, and the principal antiquity is a pillared temple of Triloknath, which has no superstructure left, but which, according to Major Kittoe, was not the case when he visited it in 1847, at which time a considerable portion of the superstructure was still perfect.

No. 102.—One of the doorways is beautifully carved in black chlorite, and is the finest piece of sculpture of the kind in this part of the country.

SEETAMUREE.—This place, which seems to have escaped the notice of all the antiquaries who have visited this district, although only fourteen miles from Poonawa, shows how difficult it is to obtain information of the whereabouts of antiquities, even to enquirers who devote themselves to such pursuits.

The village is situated about a mile south-east of a village called Nadgurha on the Nawadah and Gya road, and fourteen miles east from Poonawa.

No. 103.—The cave is excavated in a large block of granite on an open plain; the doorway is of the Egyptian form, being 1 foot, 10 inches at the top and 2 feet, 2 inches at the bottom. The passage leads into the cave at an oblique angle, and is 3 feet, 5 inches long. The chamber itself is 15 feet, 8 inches along the floor, and 15 feet along the roof, and 6 feet, 4½ high in the centre, and 11 feet, 1½ in width. The roof is vaulted, and springs at once from the floor. The whole of the inside is highly polished, and the rock is as compact as those in which the caves are executed at Burrabur. Curiously enough there is no trace of an inscription, inside or outside. Inside, from the high polish every where, no inscription could escape notice; outside, without a recess being cut for its reception, no inscription could be cut, and there is no sign of any such recess. Its construction at any time must have been an achievement of no ordinary kind, and it is remarkable that an inscription should have been omitted. Its date cannot be less than those at Burrabur, which it so closely resembles. The form of the doorway and the polished interior are conclusive, I think, on this point.

KURKIAR. *No.* 104.—Is situated about three miles north-east

of Poonawa. There are large and extensive ruins at this place, and a great number of statues scattered over a large area.

The principal one is a figure of Sakya Singha sitting under the tree at Budh Gya, with representations of events of his life on either side, and a small inscription on the pedestal.

BURRAGAON.—There is no place in this district where the ruins are so extensive, or on such a large scale. Unfortunately, the greater part are hidden under immense mounds of brick rubbish, and although the place has been used as a quarry for bricks for many years, the foundations are not yet reached. The place is the site of the ancient Nalanda, according to Colonel Cunningham, where the greatest monastery in all India existed.

No. 105.—There are a series of lofty mounds some 60 feet high, covering a space 1,600 feet long, by 400 feet in width. The principal ruin is that of the great temple of Baladitya, which is said to have resembled that at Budh Gya, and must have been built between 450 and 500 A. D.

Nos. 106 and 107.—The statue enshrined in this temple was most likely the gigantic one now called Bhairav. It is in a sitting position, and is now collected with a number of smaller figures in a small courtyard at the foot of the large mound.

No. 108.—To the north there is a large statue of the ascetic Budh, with several inscriptions on it giving the names of the attendants.

No. 109.—There is also a Jain temple in the same style as the Budh Gya one, and is therefore of much the same age.

No. 110.—At the adjoining village of Jagdespore there is a very fine large figure of the ascetic Budh surrounded by demons and alluring females.

CHILLOR.—Major Kittoe notices this place as the site of one of the eighteen viharas of Behar. The ruins are very extensive, consisting of large mounds, with many figures and sculptures.

No. 111.—The principal one is of a beautifully carved one, nearly life-size, said by Major Kittoe to be a representative of Siva, but this is doubtful, as there is a small figure of Buddha in the head-dress, the outline of an antelope forms the upper edge of the dress, which may determine what the figure really is. The expression

and attitude of this figure has more life in it than is general amongst ancient sculptures.

DAPTHU.—Nos. 112 and 113.—Is situated about a mile inland to the east of the Fulgo, and about fourteen miles from Gya to the north. This seems to have been the site of a large Buddhist community, and the remains are extensive. There are two temples partly standing. The northern one was dedicated to Surya, and a large figure of the same is still standing inside.

No. 114.—Both temples seemed to have had a pillared portico in front, but which has since been built up with brick. The door of the shrine in the southern temple is very fine, and has been figured in the first volume of Martin's India. Outside there is the same curious group of a prince on horseback with the same attendants, &c., as at Konch, &c., only differently arranged.

Nos. 115 and 116.—The south of the district of Gya is bounded by a range of hills which form the boundary between Gya and Palamau near Maharajganj. Some of these hills are composed of huge masses of granite of very suggestive outlines. The most conspicuous of these is the 'kotila' or granary, the curious dome-like peak of which is nearly inaccessible. Nevertheless on certain occasions a light is observed on its summit which would show that some one has a knowledge of the way of getting up to the summit, although I believe the revenue surveyors failed to do so.

No. 117.—The continuation of the same hills, and where the Koel river runs round their base, and at the point where the rock slopes down into the river, three large boulders block the path. These stones are said to have been collected by the popular hero 'Bhimsen' for his 'chula' or cooking-place, which the arrangement of the three boulders favours, as they closely resemble the three stones used by travellers to rest their pots on while cooking.

On the sloping rock which dips into the river there are some curious worn hollows, which I have no doubt were caused by the women of the aboriginal tribes in husking their rice, as is the universal custom amongst the Kol tribes of Chota Nagpore, as the wooden instruments for this purpose, so commonly in use elsewhere, are not used by them. I could never obtain any clue as to the meaning of these depressions until I had seen the practice

of the Kol women, and it is known that the aboriginal tribe of Mhars were in possession of the country until dispossessed by the ancestors of the present Rajput family of Sonpura.

TIRHUT. *No.* 118.—Bukra. This place, which is one of the banks of the Gandack or Naraini, must have been a place of great importance, and has been identified as the ancient Vaisala. The principal antiquity is one of Asoka's pillars surmounted by a lion. It is only 18 feet above the present level of the ground, and 27 feet, 11 inches above the level of the surrounding fields. Colonel Cunningham made an excavation down to the water level, or 14 feet below the present surface, but found no inscription, and had not then reached the square base, so that the whole length above the water level is 32 feet, and, including the statue and capital, 44 feet 2 inches.

No. 119.—Immediately to the north, and outside the courtyard in which the pillars stand, there is a ruined brick stupa with a fine old pipul tree growing on the top. This place is famous in Buddhist annals as the place where the second Buddhist synod was held.

LOURYA NEAR ARE-RAJ. *No.* 120.—Between Bukra and Betteah, and twenty miles north-west of Kesariya, at a village called Lourya, there is another of Asoka's pillars, and of the same polished compact sandstone. It is $36\frac{1}{2}$ feet high and has no capital; it is 41·8 inches in diameter at the base, and $37\frac{1}{2}$ inches at the top. It has several of Asoka's edicts neatly engraved on both sides, and the letters are still as fresh and sharp as if only done a year ago.

SIMROUN.—On the borders of Nepal, north-east of Motihari, is the fort of Simroun, the ancient capital of Mithila. The ruins cover an area of sixteen square miles, but are so overgrown with dense jungle that it is almost impossible to make out anything. A brick wall of four feet thick by a further thickness of 10 feet of mud, surrounds the whole. The bricks used are large, $10' \times 7' \times 2'$, well burnt, and finely fitted together. Within the outer enclosure there is another, comprising about five acres; inside this was the palace and principal buildings. Between the two enclosures a great number of figures, carvings, statues, and large wells built with stone are scattered all over. The palace and many of the principal

buildings were built of squared blocks of sandstone 3 feet by $1\frac{1}{2}$. Some part of the walls are still standing, but from the irregularity of the upper courses they must have been rebuilt, so that little remains to show what the structures original were

Nos. 121 and 122.—Some large figures are collected near the little modern temple, which are beautifully carved, and seem representatives of Surya. Some slabs of sandstone are collected in the same place which no doubt formed part of a doorway, and executed in the very best manner. They consist of several figures enclosed in scrolls of lotus stem in a most beautiful and artistic manner.

No. 123.—An inscription let into the wall of the little temple is quite modern, but I am convinced this stone had an older inscription which must have been obliterated to receive the modern one.

No. 124.—This is a view of the rock in which the 'Karna Chowpar' cave, at Burrahur, has been excavated, and showing the general appearance from the east of the immense granite block in which the cave has been excavated, and also the scarped rock to the south.

No. 125.—Is a sculptured slab with a representation of the nine Avatars let into the wall of the porch of the temple at Konch.

No. 126.—Is a curious slab with some carved figures, and surmounted by some singular emblems with an inscription in Sanscrit underneath: unfortunately the inscription is too much worn to be decipherable. The figures represent a seated figure in the centre, something like a Budh, with male and female figures on either side. The emblems above are an open hand with a rosette in the palm; the emblems of the sun and moon on either side. There are three specimens of this emblematical stone in this district; the present one is from the banks of the large tank at Madinpore on the grand trunk road twenty-four miles west from Sherghátí, near the temple of Oonga; the other one is under a tree near that temple; and the third is on the temple of Gajadhur at Gya. All of these stones are nearly similar, and the stone is the same in each case, *viz.*, a soft soapstone, and in consequence the inscription is not readable in either of them. From the style of workmanship and the peculiar selection of this soft stone, it is probable that these stones are the work of a different race of people from the

carvers of the numerous statues and figures generally found in this district; the manner in which the hair is arranged in the figures differs also from the usual Buddhist and Hindi figures. It is believed that similar emblems are found on some Canarese inscriptions.

No. 127.—Is another view of the beautifully executed figure at Chillor, showing the standing figure of Budh, the teacher, alongside.

No. 128.—Is a view of the southern temple at Dapthoo; it is the larger of the two temples, and as it stands at present it consists of a pillared hall, which was originally open, but was subsequently enclosed. The shrine has now nearly fallen, and in the enclosed porch there are a great number of figures collected, most of them in very good preservation; but the want of light in the interior prevents their being photographed.

No. 129.—To the south of this temple there is a fine standing figure of Mahamaya, the mother of Budh, in good preservation and well executed; she is represented as four-armed, one hand holding a water vessel.

No. 130.—Is another view of the Vishnu Pud, at Gya, giving the whole of the upper portion of the temple, which, from its very confined situation, cannot be photographed as a whole.

No. 131.—Is a view of the old town of Gya looking west from the Vishnu Pud temple, with the Brahmajoni temple and hill in the distance.

No. 132.—Is another view of the fine old temple, at Deo, giving a better view of the south side of the temple, with part of the Maharajah's palace to the left.

SHAHABAD.

Sasseram, from having been selected by Sher Shah as his residence, was at one time a place of great importance, and there are very interesting buildings still in existence, although from inferior workmanship many of them are in a very dilapidated condition, and in a few more seasons some of them will have fallen.

Nos. 133 and 134.—The principal building is the tomb of the Emperor Sher Shah, which is situated to the west of the town in

the middle of a large tank. From the north side of the tank a bridge leads to the island, on which the tomb stands; it has partially fallen down, and is replaced by a mud embankment. The island is raised by steps from the level of the water. Above this is a wall 30 feet high, surmounted by battlements six feet high. The terrace is placed obliquely on the island, for what reason it is difficult to say. The four corners of the battlements are formed into octagonal buildings, forming inside airy apartments. There are two balconies projecting on either side supported by stone brackets covered by cupolas supported by four stone pillars. The tomb itself consists of a great hall surrounded by an arcade forming a gallery. In the centre of the great hall is the grave of the king opposite the niche for prayer: the other graves are said to be those of favourite officers.

No. 135.—Sher Shah also erected a large monument to the memory of his father Husain Khán Súr, in the middle of the town; it is enclosed in a large area by a high wall of cut stone; the tomb is not so large as that of his son, but like it consists of a large hall surrounded by an arcade and covered with a handsome dome.

Rohtasgarh.—This fortress is situated on the banks of the river Sone, at a distance of some thirty miles south of the grand trunk road, and occupies the whole of the crest of a nearly isolated spur of the great table-land. Buchanan Hamilton, in Martin's *India*, states that this important fortress derives its name from the young prince Rohitasiva, the son Harishchandra, a king of the family of the sun, in the most remote period of Hindu legend. His image, he further says, was worshipped at this place, until the time of Aurungzeb. From the time of Harishchandra until the 12th century of the Christian era, it is not known in whose possession the fortress remained, but at this time it belonged to Pratapa Devala, father of the last Hindu emperor, and it continued for some time subject to his descendants. The tradition is, that it came under the Mussulman rule in the time of Sher Shah, A. D. 1539, and that on its capture he immediately set to work on strengthening its defences, but that the works projected were never completed owing to his having discovered a more favourable situation at

Shergarh near Sasseram, where he erected a fortress named after himself. When Man Singh was selected as viceroy of Behar, he selected Rohtas as a place of safety for his treasure and family, and almost the whole of the present buildings were erected by him, and this is confirmed by the inscriptions on the principal entrance to the palace, and also on the gateway of the fortress leading to the main table-land called the Ketantya gate. From these it would appear that the works were finished in the year 1654 Sambat, or A. D. 1597.

The fortress occupies the whole of the plateau, measuring about four miles from east to west, and five miles north to south; but from the deep windings of the precipitous crest, the whole circumference is said to be twenty-eight miles round.

No. 136.—The palace called the Mahal Sarai extends its greatest length north and south and the principal front faces the west, where it overlooks a large enclosure, probably intended as a parade ground, as the principal state rooms have balconies projecting from the walls overlooking this enclosure.

No. 137.—At the southern end of the principal front is a large arched gateway with two elephants cut in the stone on either side, and consequently called the Hathiya Pul. Within this gate there are several vaults and recesses for the accommodation of the guard and the officers on duty.

No. 138.—Passing through this gateway the passage leads into a sort of courtyard, and immediately opposite the entrance is one of the finest buildings in the whole place. It was the public reception room, and was called the Barahdoware or twelve gates, and it is divided into two principal halls, one behind the other, with lofty arched roofs, and are the only respectably sized rooms in the whole palace.

No. 139.—The eastern face of Barahdoware is ornamented with a double row of arched doors giving light to the spacious halls behind, and also giving a light, graceful appearance to this side, which is wanting in the principal front.

No. 140.—The northern part of the palace seems to have been the quarter set aside for the ladies' apartments, and the chief building was surrounded on three sides by a flower garden. It

was the residence of the chief's wife, and was called the *Áinah Mahall*. Photograph No. 140 is the view looking west with the open verandah of the *Takht Pádisháhi* to the left.

No. 141.—Is a view of the same building from the opposite side looking south-east. This building is not overlooked by any part of the palace, except from the roof of the *Takht Pádisháhi* or principal state room, and evidently intended as the chief's audience room.

No. 142.—Is a view of the *Takht Pádisháhi* with the cupolas on the summit, and part of the country beyond the walls, which is very pretty and park-like.

No. 143.—The inscription over the principal entrance on the inner side is a fine specimen of the florid style of Persian writing. The inscription is given both in Hindi and Persian on the same tablet.

No. 144.—To the north-west of the palace, where Sher Shah had contemplated the erection of a citadel, there are the remains of several very large buildings. The principal one is the tomb of the superintendent of the works, who is said to have been an Abyssinian slave (*Habsli*). It is in the same style as the tomb at Sasseram, and is now picturesquely overgrown with jungle.

No. 145.—Between the palace and the edge of the precipice, there is a small ravine by which the water from the tanks above finds its way to the edge of the precipice over which it throws itself in a tiny rill, which is lost in spray before reaching the bottom. From the opposite bank of this ravine, a good view of the palace is obtained.

No. 146.—At the south-east corner of the table-land there are some curious old buildings constructed evidently with the stones from some still earlier buildings. At the foot of a long flight of steps, leading up to the Hindu temple and the mosque, is a small, but handsome, temple ascribed to Man Singh.

No. 147.—The *Lal-darwaza* or Red Gate seems to have been the principal entrance from the places below, and although the cliffs are nearly inaccessible themselves, they have been strengthened with works on a large scale. The cliffs are very grand and impressive. Photograph No. 147 is the view looking south over the ridge of the cliff.

No. 148.—The precipice all round the plateau is quite perpendicular, dipping down for a distance of 500 feet in some places, and nearly double that distance in others.

The following gentlemen duly proposed and seconded at the last meeting were balloted for and elected Ordinary Members—

Capt. W. L. Samuells, Assistant Commissioner, Pachumba,
Chord line,
S. E. Peal, Esq., Sibsagor, Asam.

The following gentleman is a candidate for ballot at the next meeting—

W. D. Butcher, Esq., M. R. C. S., proposed by Mr. G. Nevill, seconded by Mr. J. Wood-Mason.

The following gentlemen have intimated their desire to withdraw from the Society—

Dr. H. Warth; J. F. Cockburn, Esq.; Dr. J. M. Fleming.

The following letter from J. G. DELMERICK, Esq., Ráwalpindí, was read—

‘ I beg to inform you of the discovery of a hoard of seventy-four Indo-Bactrian hemidrachms in this District.

‘ Of these no less than fifty-eight were of Menander, *viz.* :—20, with bare head; 15, with helmeted head; 22, with bare head, hurling a javelin. 1. Owl on the reverse. Six were of Antimachus Nikephoros, and ten of Apollodotus, square, and of the common elephant and bull type.

‘ These coins were recently found by Sharaf, son of Najú, caste Mochí, age 16, of the village of Shakarparí, Tahçíl of Ráwalpindí. The site of their discovery is a ravine five miles due north of Ráwalpindí on the Saidpúr road. Sharaf was employed in digging out the root of a shrub when he accidentally came upon the coins in a hole. They might have been in a pot, which he thinks may have been broken by the spade with which he was digging, but he saw no pot. No buildings or ancient remains are anywhere near the spot, and Shakarparí is an insignificant village with no pucca buildings or ruins. The finder was rewarded from our local funds, and the whole of the coins, which were in perfect

preservation and as fresh looking as if just issued from a mint, were forwarded for deposit in the Central Museum at Láhör.'

Bábú Rájendralála Mitra read the following report, for 1870-71, on the progress he had made in cataloguing Sanskrit MSS. that are found in private libraries in Bengal.

"I have the honor to submit the following report on the operations carried on during the last official year (1870-71) for collecting information regarding Sanskrit manuscripts in native Libraries.

2. The task of searching for MSS. during the past year was confided to the travelling Pandit solely, circumstances not having permitted me to proceed to the mofussil. The Pandit had, however, the aid of the Rev. J. Long for a time at Dacca, and subsequently consulted me regularly about his work, furnishing me every week nominal lists of whatever MSS. he met with, and noticing in detail those only which I thought to be new or rare.

3. Nearly four months were spent by the Pandit at Dacca, Vikrampur, and other old towns and villages in Eastern Bengal, and most of the leading pandits and zemindars of those places were consulted. No one evinced any disposition to withhold information or aid. The Kundu family of Bhágyakula took great interest in the operations of the Pandit. They convened a meeting of the influential people of their neighbourhood at their house, and urged them to assist us with the loan of MSS. They also testified their sense of the importance of the undertaking by subscribing Rs. 1000, towards its furtherance. The amount was sent to the Government of Bengal, and has since been received by the Society. Dacca, however, though celebrated as a seat of commerce for over two thousand years, and the metropolis of Bengal for a time during the supremacy of the Muhammadans, never acquired any reputation for learning, and does not contain any Sanskrit work of great value. All the MSS. that were examined turned out to be such as are common everywhere, or of little importance. Between forty and fifty little treatises were found, which were new to the Society, and detailed notices of these have been secured.

4. On the return of the Pandit from Dacca he was sent to Bânsberiyá in Zilla Hugli, which was at one time noted as a seat

of Sanskrit learning ; but nothing of any interest was met with there.

5. The Pandit was therefore, after a fortnight's stay at that place, sent on to Burdwan where I had hoped to find large collections of MSS. in the Library of the Mahárájá and the pandits of the district. But I was equally disappointed there. The Mahárájá, at my request, very obligingly allowed the Pandit access to his Library, but there were not quite a hundred MSS. in Sanskrit, and they comprised the Mahábhárata and other well known works which have been already printed. The head pandit of the Mahárájá's palace, however, showed some works on the Vedánta new to the Society's Library, and notices of these have been duly secured. Burdwan, is a place of some antiquity, and was of considerable importance during the Muhammadan rule, but it seems, like Dacca, to be very poor in Sanskrit works, and there is not a single pandit of any note who has a decent collection of MSS.

6. The disappointment at Burdwan, however, was amply compensated at Mánkar, near the Boodbood station of the East Indian Railway. Bábu Hitalála Mis'ra, a zemindar and Honorary Magistrate of the sub-division, has an excellent library, in which the travelling Pandit found between five and six hundred works on the Vedánta. These I had hoped, would have occupied his time for at least four months, but before he had time to take notes of about forty or fifty works, the Dusserah vacation intervened, and the Bábu's pandit subsequently falling ill, there was nobody to keep the library open, and the travelling Pandit had to be removed to Halisahar, a small town situated opposite Hugli.

7. Halisahar had at one time a large number of *toles* or colleges of Sanskrit learning, and several are still extant. In the time of Rájá Krishnachandra Ráya of Nadia, about one hundred and fifty years ago, the place was celebrated for its Nyáya school, and some of the best pandits of Calcutta came from that place. But the pandits who now own the toles, proved the most bigotted of their kind, and offered so many obstacles, and raised so many difficulties, that after two months' stay, my travelling Pandit had to return without getting a single work of any importance.

8. During the last two months of the year, the travelling Pan-

dit was employed in examining the library of the late Sir Rájá Rádhákánta Bahádur, K. C. S. I. where he will have ample work for at least four months.

9. My assistant was, for a time during the period under report, employed in examining the library of Rájá Yatíndramohana Thakura of Calcutta, who has very kindly placed his collection of MSS. at my disposal. It is perhaps the richest private collection in Calcutta, and contains a larger number of Tantras than what I have any where else met with, not excepting the collections of the Asiatic Society of Bengal, and of the Sanskrit colleges of Calcutta and Benares. Very few works of this class have yet been examined by European orientalists, and owing to the circumstance of some of them being of an offensive character, they are generally looked upon with disfavour. They are wanting too in the halo of antiquity. The oldest among them, as far as I can guess, does not date before the 3rd century of Christ, and the bulk of them were composed probably between the 5th and the 12th centuries. They exercise, however, the most sovereign influence on the religious life of the Hindus, and control all their actions. A few display a curious phase of thought, in which a hypertrophy of the sentiment of veneration for the creative energy has led to the most mystic and obscene rites that mankind has ever indulged in. Some of the works of this class profess to be revelations by S'iva made at the request of his consort Párvatí, and a great many are acknowledged to be compilations, but they all have the same characteristics, the same style of composition, and very similar professions of faith. Their subjects are various. Ancient legends, topography, medicine, and grammar are frequently treated of, but those subjects are all intended to lead to the establishment of the preëminence of the female energy in the creation of the world, or the mysterious adoration of the phallic emblems as the means of salvation. Traces of this dogma may be noticed in the Egyptian, the Chaldee, the Hebrew, the Gnostic, the Greek and other ancient creeds, but nowhere has it been developed to so inordinate or revolting an extent, or carried to so extravagant a length as in the Tantras, and in that respect they are of interest to the antiquarian and the student of ancient religious history.

The mystic charms and mantras and gesticulations which the better class of these works inculcate have, further, almost entirely superseded the rituals of the Vedas, and in the present day scarcely a ceremonial is performed, or a prayer repeated by a Hindu, which does not borrow its primary elements from the Tantras. For a correct understanding of the modern Indian forms of religion it is necessary, therefore, that these works should be carefully examined, and their true character thoroughly brought to light. It may be added also that, however offensive some of these works may appear in the light of modern European civilization, they were held in peculiar esteem by the dreamy monastic followers of the Buddhist creed in the 7th, 8th and 9th centuries, who translated a great number of them, and compiled others, with a view to engraft their doctrines on Buddhism, and we find in Csoma de Korosi's essay on the Buddhist literature of Nipal and Tibet hundreds of Tantras noticed as forming parts of the sacred scriptures of those places. Mr. Hodgson describes them as containing the esoterics of the Buddhist religion of Nipal, and in connexion with the Buddhism of the north, these works, therefore, are also of importance.

10. According to the Níla Tantra, the original Tantric revelations of S'iva are reckoned at 64, but their number has of late multiplied manyfold, and in the collection of Rájá Yatíndramohana Thakura, there are upwards of three hundred different works. Most of them are, however, fragmentary, and others are avowed compilations. In the notices already published I have given brief accounts of upwards of a hundred of these works, and I hope ere long to add considerably to that number. In Europe there are not a score of these works to be met with in the India House, the Berlin, the Bodleian, and other collections.

11. Altogether notices of about six hundred manuscripts have been compiled, and are now ready for the press.

12. The publication of the notices has not been carried on so expeditiously as could be wished. The form originally suggested by me and approved by the Society, did not meet with the approbation of the Government of India, and the correspondence which thereupon ensued, prevented me from pushing on the work. I have, therefore, to report the publication of only two numbers of

about 250 pages, containing notices of 317 manuscripts. These, with the first number which has been reprinted (the first edition having been exhausted), constitute a volume of 360 pages, containing notices of 519 works, of which 40 are on rituals, phonetics and other Vedic subjects, 32 on the Nyáya, 17 on the Vedánta, 20 on astronomy and astrology, 14 grammars, 23 Kávyas, 14 Náṭakas and 38 Smṛiti treatises. The body of the Vedas are represented by only two works, the Rudrakáṇḍa of the Yajur Veda and the Chhándogya Bráhmaṇa of the Sáma Veda. This paucity is, however, not a subject of wonder, considering that the study of the Vedas had fallen into disuse in Bengal long before the reign of the Sena rájas, and the founder of their dynasty, nine hundred years ago had to obtain five Bráhmaṇs versed in Vedic rites from the King of Kanauj to officiate at a sacrifice. The descendants of those priests, who now constitute the bulk of the Bráhmaṇs of this province, have nowhere kept up the learning of their ancestors, and not a single native of Bengal is to be now met with who has systematically studied the Vedas. The Vedic Sútras are also ill-represented, and the few that have been noticed were obtained from Benares. The philosophical and theological portions of the Vedas, the Upanishads, have, however, been represented by no less than 75 treatises, most of which will be new to European scholars. The Puránas are met with in considerable numbers in Bengal, but as most of them are contained in the Library of the Asiatic Society, I have not deemed it expedient to notice them at length. On the completion of the Society's catalogue, which is now in a forward state, full information regarding them will be rendered accessible to scholars.

13. Annexed is a list of the MSS. which have been purchased for Government. Most of them, it is believed, will be new to the India House Library, though some of them are of little interest. They had to be bought as they formed parts of a collection which could not be broken up. Owing to the owner not having called for their price, most of them have not yet been paid for. Three of the works in the list, *viz.* the 2nd part of the Sāṅkháyana Súra, the Vivaraṇa Bháshya and the Chhándogapariśiṣṭa, were copied from codices in the possession of pandits at Benares.

Skanda Purániya Kshetramáhát- mya.	Goraksha-s'ataka.
S'aktisañgama Tantra.	Purnánanda-chakra.
Kámarúpa-yátrá paddhati.	Vas'ishthá-yogakánda.
Nigama-tattva-sára.	Is'vara-gítá.
Brahmajnána-mahá-tantra-sára.	Gañgáshṭaka.
Káli-sahasranáma stotra.	Annadákálpa.
S'rigurusahasranáma stotra.	Puras'charaṇa-rasollása.
Brahmajnána Tantra.	Gañgáshṭaka.
Náđijnána-dipiká.	Devíkavacha.
Dolárohaṇa-paddhati.	Dattátreya Sañhitá.
Kálistavarája.	Puras'charaṇa-viveka.
Syámá-stotra.	Gurú Tantra.
Yati-bhushaṇi.	Durgádádináma stotra.
Darsana-kaliká.	Takárádi-svarúpa.
S'ribhaktiratnávali.	Níla Tantra.
Harinámámṛita.	Vagalá Paṭala.
Isána Sañhitá.	Adbhuta-sára sañgraha.
Mátriká-kosha.	Rájavallabha.
Madana-párijáta.	Rogavinischaya.
S'ánti-s'ataka.	Sáñkhya Kaumudi.
Shaṭ-chakra Ṭippani.	Muṇḍamálá Tantra.
Vagalámukhí-kavacha.	Sandhyá paddhati.
————— Stotra.	Karpurastava Ṭíká.
Vástuhoma.	S'iva-sañhitá.
Grantha-sañgraha.	Gáyatrí-hridaya.
Chaurakávya saṭika.	Gauríkanchuliká.
Gáyatrí-hridaya.	Sundari-s'aktidána.
Gáyatrí-kalpa.	Do. Ṭíká.
Jnána Tantra.	Sahasranáma-stuti.
Gurugítá.	Vijakosha.
Piṭha-nírṇaya.	Gañgástava.
Sarasvatí Tantra.	Gáyatríbráhmaṇollása Tantra.
Guhyátiguhya Tantra.	Tripurá-samuchchaya Ṭíká.
Mugdhobodha-ṭíká.	Aparokshánubhuti.
Svatantra Tantra.	Svarodaya.
	Pavanavijaya.

Mátrikájaganmaṇḍala-kavacha.	Tarka Rahasya.
Grantha-saṅgraha.	Vyáptyanugama Rahasya.
Prasna-kaumudí.	Sámányalakṣhaṇá Rahasya.
Jyotihságara-sára.	Pakshatá Rahasya.
Chandronmílana.	Vrihannáradíya Purána.
Padártha-saṅgraha.	Tarka Ṭippaní.
Vyávastháṛṇava.	Vyáptyanugama Ṭippaní.
Dvitiyádivyutpattiváda.	Sámánya bháva Ṭippaní.
Anumiti Rahasya.	Siñha-vyághara Ṭippaní.
Vyápti-panchaka Rahasya.	Tárarahasya-vrittiká.
Siñha-vyághra Rahasya.	Kátantra-vrittiká.
Shatchakravivriṭi Ṭíká.	Kátantra-vritti-durga-ṭíká.
Suddhi-dípiká.	Kátantra paris'ishta.
Divya-chudámáni.	Durgávákya-prabodha.
Annapurná Upanishad.	Siddhánta-dípa.
Nirvána Upanishad.	Sabda-chintámányáloka.
Ekákshara Upanishad.	Smriti-chandríya sráddhakalá.
Yajnyavalkya Upanishad.	Válakrishṇáshta.
Akshamálika Upanishad.	Áchárasára Tantra.
Vyádhikarāṇa-dharmávachchti- na-bháva	Sráddhavidhi.
Sámányábháva Rahasya.	Chhandoga Paris'ishta.
Vis'eshavyápti Rahasya.	Vivarāna Bháshya.
Vyáptigrahopáya Rahasya.	Sáñkháyana Sútra, part II.

The following paper was read—

The Rock-cut Excavations at Harchoka, discovered by Captain W. L. Samuells when employed as Boundary Commissioner on the Rewah and Chutiá Nágpúr Frontier, Season 1870-71.—By CAPT. W. L. SAMUELLES, Assistant Commissioner, Pachumba, Chord line.

The Secretary read the paper, which will be printed in No. III of Part I of the Journal. A tracing of the excavations and a plan of the temples by Capt. Samuells will accompany the paper.

Colonel Thuillier moved that the thanks of the members are due to Capt. Samuells for his valuable and interesting contributions and donations to the Society.

The Chairman put the motion to the vote. Carried unanimously. A conversation ensued in which several members joined.

The receipt of the following papers was announced—

1. *List of Shells collected on the Arakan Coast.*—By W. Theobald Esq., Burma.
2. *On a New Species of Flamingo.*—By W. E. Brooks, Esq., C. E., Etáwah.

The meeting then broke up.

LIBRARY.

The following additions have been made to the library since the meeting held in November last.

Presentations.

*** Names of Donors in Capitals.

Journal Asiatique, No. 63.—SOCIÉTÉ ASIATIQUE, PARIS.

Journal of the Linnean Society, Zoology, Vol. XI, Nos. 49 to 52.—THE LINNEAN SOCIETY.

Ditto, Botany, Vol. XI, Nos. 54 to 56, Vol. XIII, No. 65.—THE LINNEAN SOCIETY.

Journal of the Statistical Society of London, Vol. XXXIV, Pt. III.—THE STATISTICAL SOCIETY OF LONDON.

Proceedings of the Royal Geographical Society, Vol. XV, Nos. 3, and 4.—THE ROYAL GEOGRAPHICAL SOCIETY.

Journal of the Anthropological Institute of Great Britain and Ireland, Vol. I, No. 2.—THE ANTHROPOLOGICAL INSTITUTE.

Annual Report of the Settlement of Port Blair for the year 1870-71.—THE GOVERNMENT OF INDIA, HOME DEPARTMENT.

Records of the Geological Survey of India, Vol. IV, Pt. IV.—THE GEOLOGICAL SURVEY OF INDIA.

Catalogue of the Syriac MSS. in the British Museum, Pt. II.—THE TRUSTEES OF THE BRITISH MUSEUM.

Memoirs of the Aksakof family, a sketch of Russian Rural Life seventy years ago.—REVD. J. LONG.

Catalogue, Punjab and Sindh Plants.—J. E. T. ARCHISON, Esq.,
M. D.

Seventh Annual Report of the Sanitary Commissioner to the
Government of India.—J. M. CUNNINGHAM, Esq., M. D.

The Calcutta Journal of Medicine, 1871, No. 9, Sept.—THE
EDITOR.

The Christian Spectator, 1871, Nov. and Dec.—THE EDITOR.

Purchase.

Tárikh-i-Jahángír (Mirzá Jahángír), MS. :—Journal des Savants,
September, 1871 :—Comptes Rendus, Nos. 11 to 14 :—Revue des
Deux Mondes, 1st October, 1871 :—The Annals and Magazine of
Natural History, 1871, September and October :—Westminster
Review October, 1871 :—L. E. and D. Philosophical Magazine, 1871,
September and October :—Hewitson Exotic Butterflies, Part 80 :—
Reeve's Conchologia Iconica, Parts 288, 289 :—Kitab al Fihrist, I
Band, Text :—Al Haríri's Durrat al Ghawwác :—Ma'súdí, Les
Prairies d'Or, texte et traduction, par C. Barbier de Meynard,
Tom VI.

APPENDIX.

CORRESPONDENCE RELATIVE TO DEEP SEA DREDGING.

Calcutta, 14th June, 1871.

*From F. STOLICZKA, PH. D., Hony. Secretary, As. Soc. of Bengal,
To E. C. BAYLEY, ESQ., C. S. I., Secretary to the Government of India, Home Department.*

SIR,—I am instructed by the President and Council of the Asiatic Society of Bengal, to solicit the favorable consideration of His Excellency the Viceroy and Governor-General in Council to a subject which appears to the Council of the Society one of the very highest importance, namely, the desirability of undertaking deep sea dredgings in Indian waters.

The Council believe they can best bring the matter before His Excellency in Council by submitting a copy of a Memorandum, drawn up at the suggestion of the Natural History Committee and, after full discussion by the Committee, accepted by the Council of the Society.

It cannot, the Council believe, be questioned that results are to be expected from deep sea dredgings of the highest importance for the progress of both biological and physical science. It is a well known fact, that in former periods of our planet there prevailed a much more uniform distribution of temperature, and of animal and vegetable life. In the kainozoic epoch the climate in Europe was somewhat similar to that of our present Indian and Australian waters, and many of the then inhabitants of the seas shew great affinities to those now found living in Indian seas. In order to trace the connection of these faunas, dredging in Indian waters would undoubtedly supply most valuable materials.

Again, as yet there have been no systematic observations made regarding the laws regulating the temperature of water in Indian seas, the various currents, the physical character of sea bottom, &c. Valuable results may, therefore, be justly expected for the progress of hydrography, and collaterally for the benefit of navigation; and

equally important will be the examination of the sea bottom for the study of geology and physical geography.

An undertaking of this range is beyond the means of any private individual, but its importance is so great that the Council believe it to be well worth the consideration of His Excellency the Viceroy and Governor-General in Council, and the enlightened Government of a powerful State like the Indian empire.

The Council of the Society are, therefore, confident that His Excellency in Council will approve generally of the proposal, put forward in the accompanying Memorandum, and trust that he will give the undertaking the same generous support which has been afforded to similar expeditions in England and other countries.

They would hope that steps might at once be taken in communication with the Admiral commanding the Indian stations, and that this project may be brought under the consideration of the Lord Commissioners of her Majesty's Admiralty at home, so that certain special preparations which will be required may be made without delay. Owing to the peculiar nature of the climate in these latitudes such researches can be favourably carried on only during one-half of the year, and the importance of completing preliminary arrangements at an early period becomes, therefore, more obvious.

Memorandum on Deep Sea Dredging Operations proposed to be undertaken in Indian Waters.

The Sub-Committee appointed to consider the desirability of undertaking Deep Sea Dredging in Indian waters, beg to submit the following Memorandum on this subject :—

The vast importance of Deep Sea Dredging for the study of Zoology, Geology, Physics and Hydrography has been placed beyond all doubt by the results of the explorations which have been lately carried on, and are still being prosecuted, under the auspices of the Governments of England, Sweden and Norway, and in America. In England, the importance of such researches was recommended to the consideration of the Royal Society of London chiefly for the following reasons :—

1. To test a rather generally accepted opinion that no animal life existed below the depth of a few hundred fathoms :
2. To determine the influence of light and of pressure upon animal life at great depths :
3. To further the study of the geographical distribution of animal and vegetable life.
4. To determine the temperature, the strength and direction of the currents, the relative Chemical composition and the amount of dissolved gases in Sea Water at various depths, &c.
5. To determine the nature of the Deep Sea bottom, the mode of its deposition, and the sources whence the materials composing it were derived.

The interest attaching to the study of these questions, and their important bearing upon the progress of Biological and Physical Science, having been duly considered by the Royal Society, it was resolved that application should be made to Government for assistance. The Lords Commissioners of the Admiralty in the most liberal manner acceded to the recommendation of the Royal Society by placing a suitable vessel at the disposal of the Dredging Committee by whom the Scientific exploration of the Deep Sea has been, and is being, most successfully prosecuted. The results of their explorations have been given from time to time in the reports printed in the Proceedings of the Royal Society (Vol. XVII, No. 107, Vol. XVIII, No. 121, &c.), and they fully justify the high expectation of success from the expedition which had been formed. The Sub-Committee would only draw attention to one or two of the most important acquisitions to science.

Dredging operations conducted down to the enormous depth of upwards of two thousand fathoms have proved the existence of animal and vegetable life in abundance, even at that vast depth.

Most valuable observations have been made on the rate of diminution of temperature with increase of depth. The existence of two distinct submarine climates in close proximity and on the same level, called respectively the Warm and the Cold areas, has been most conclusively proved, and each area has been shewn to possess its own peculiar fauna and sea-bed ; this in the warm area being almost entirely composed of *Globigerina*-mud and in the cold area

of fragments of rocks. It seems impossible to overrate the important bearing of these observations on the study of Geology. The Atlantic sea-bed was in places found to be covered with a jelly-like net work of protoplasm (*Bathybius* of Huxley), which offers a curious parallel to the Laurentian Eozoon, the oldest trace of animal life yet discovered.

Up to the present time naturalists in India never have had a possibility of carrying out such researches. There has been no vessel, fitted for such duties available, and no means of carrying them on. Since, however, it has been determined to form the Indian waters into a special naval station, and several steamers have been placed on the station, it is hoped that the possibilities of success have been entirely changed. The experienced officer who commands the station is fully alive to the great importance of enquiries such as we have alluded to, and has expressed his anxious willingness to aid them, in so far as his duty will permit. The readiness and friendly support which the Lords Commissioners of the British Admiralty have shewn in the promotion of any line of research calculated to advance knowledge, lead us also to hope that the same friendly aid will be extended to Indian naturalists, and we would, therefore, urge that an application be made to the Government of India for its support in these enquiries, with a request that it will also urge the question on the favourable consideration of the Lords Commissioners of Her Majesty's Admiralty, so that if consistent with naval duties, some one of the steamers, now in these waters, might for a time be placed at the service of the Committee.

It is beyond doubt that results of equal value and importance to those obtained by the Dredging Expeditions at home can, and will, be obtained by explorations of a similar kind undertaken in Indian waters, and, no regular dredging operations having ever been conducted in the seas of a tropical country, the Sub-Committee venture to think that the more favourable climate and the far richer fauna and flora of tropical and subtropical regions justify the expectation of even more numerous and more varied results, than those which have been obtained in colder regions. The variety and abundance of animal life must be enormous, because we have

to deal in the Indian seas with such vast differences of depth and, by a consequence, of temperature. It is known that these seas are the home of several species of Mollusca and other invertebrate animals only known to occur besides in the Middle and Upper Tertiaries of Europe. Of others occurring in the same, and even in more ancient, deposits, we know that the nearest living representatives are only to be found in Australian waters, and it would be a most valuable acquisition both for Geological and Zoological science, if we could in any way establish a connexion between these widely separated faunas.

Again, it is an acknowledged fact that complete and rapid destruction of organic life hardly ever extends over very large areas. We know the enormous richness of the Cephalopodous fauna that existed during the latter part of the Cretaceous Epoch in some districts of Southern India, and it seems to us almost incredible that such a vast variety of forms of animal life should have in one moment, so to speak, been entirely extinguished. Moreover, the fact that species of *Nautilus*, very similar to those found fossil in the deposits just mentioned, continue to live in the waters of the Bay of Bengal, almost justifies the expectation that some recent descendants of the *Ammonitidæ*, believed to be entirely extinct, also may have survived.

The Sub-Committee are confident that explorations of the deep sea in Indian waters will not only furnish data which will illustrate the modification of certain supposed laws regulating animal and vegetable life in countries Geographically and Climatologically different, but that they will undoubtedly supply much and most important material for the study and explanation of many yet obscure facts in Zoology, Geology, Physics, and the collateral branches of science.

The Sub-Committee, therefore, earnestly hope that Government may be led to regard the undertaking of Deep Sea Dredging in Indian waters as the most important source whence great progress to Natural History and Physical Science will result.

In the first instance your Committee would suggest the examination of the Bay of Bengal by a line of Dredging right across from new Juggurnath Black Temple to Cape Nigrails, to be fol-

lowed by another traverse from near Madras to the Andamans or the Nicobars, and again by a line from Ceylon to the coast of Sumatra. It would be necessary that, say three persons acquainted with the mode of enquiry should accompany each expedition, and it is hoped that sufficient accommodation could readily be found for them on board.

It is unnecessary to point out, that very vast acquisitions to our knowledge of the depths, currents, character of bottom, &c., of that part of the Indian Ocean and of the Bay of Bengal would result from these traverses, quite independently of the additions to our knowledge of the life, inhabiting these as yet entirely unsearched seas.

Your Sub-Committee, however, do not wish to insist on the adoption of this ground in the first instance. No course can be taken which will not yield a rich harvest of novelties and additions, and they would suggest that the convenience of the vessels on the station, should be one of the first considerations, as well as the climatal periods of Monsoon, &c., &c.

With regard to the appliances necessary for Deep Sea Dredging, the Sub-Committee beg to enumerate the following—

1. Three dredges of various sizes and an adequate supply of strong Manilla rope, which will probably be best obtained through the Admiralty. For heaving up the dredge, the vessel charged with the conduct of the expedition, should be provided with a donkey-engine, and might be otherwise so fitted as to render it adapted for the duty: the latest experiences in Deep Sea Dredging at home, have shewn that a double-cylinder donkey-engine proved to be the most efficient contrivance for hauling-in.

2. Sounding leads.

3. At least a dozen of Siemann's differential thermometers; or Prof. Miller's new Thermometer for Deep Sea Dredgings; these may be obtained from the Meteorological Department at home.

4. Water bottles.

5. In order to determine the nature and proportion of the dissolved gases, contained in sea water from various depths, an operation which must be performed at once on ship-board—3 glass hydrometers and 2 of Prof. Miller's apparatus for the Analysis of gases will be necessary.

6. The Sub-Committee believe that an annual grant of Rs. 2000, placed at the disposal of the Dredging Committee for the purchase of glass bottles, spirits of wine, scientific apparatus, &c., &c., necessary for the preservation and examination of the material obtained, would be sufficient.

7. They recommend that a Dredging Committee be appointed by the Government, including—

The President of the Asiatic Society of Bengal, for the time being.

Do., Natural History Committee, ditto.

Do., Physical Science, ditto ditto.

Thos. Oldham, Esq., LL. D., F. R. S., F. G. S.

Col. J. F. Tennant, R. E., F. R. S.

F. Stoliczka, Ph. D., F. G. S.

W. T. Blanford, Esq., F. G. S., C. M. Z. S.,

H. F. Blanford, Esq., F. G. S.

J. Anderson, Esq., M. D., F. L. S., F. Z. S.

J. Wood-Mason, Esq., F. G. S.

8. That this Committee be entrusted with the management of the explorations and with making suggestions as to the manner in which these can be best carried out.

9. That all specimens collected be in the hands of the Committee until they shall have been worked out; that the choicest specimens be eventually transferred to the Trustees of the Indian Museum where they should be preserved; and that the Committee have direction of the distribution of the duplicates to the Museums and men of science in Europe and America, who are engaged in similar researches.

10. That the report on each Dredging expedition be submitted to Government through the Committee by the officers who shall have had charge of the expedition.

THOMAS OLDHAM,

FERD. STOLICZKA,

JAMES WOOD-MASON.

From J. GEOGHEGAN, Esq., Under-Secretary to the Government of India, Department of Agriculture, Revenue and Commerce, To the Hony. Secretary to the Asiatic Society of Bengal.

Simla, the 28th August, 1871.

SIR,—I am directed to acknowledge the receipt of your letter No. 280, dated 14th June last, forwarding a Memo. on a proposed series of deep sea dredging operations in Indian waters, and requesting the Government of India to extend its support to the undertaking and to place a steamer at the disposal of the Committee appointed for the purpose.

In reply I am directed to state that the Governor-General in Council cordially approves of the proposal of the Society, and would be glad to make a steamer available for the undertaking. At present, however, no vessel can be spared either from the Royal Navy or the Indian Marine.

A Nautical Survey of the Indian seas is, however, contemplated, and when the result of inquiries that have been instituted in connection with that subject is arrived at, it will be considered whether a vessel can be made available for the joint purpose of carrying out the deep sea dredgings as well as the Marine Survey.

H. M. S. Forte, Seyshelles, August 26th.

From His Excellency the Commander-in-Chief Her Majesty's Naval Forces, East Indies.

To FERD. STOLICZKA, Hony. Secretary, Asiatic Society, Bengal.

SIR,—I have the pleasure to acknowledge the receipt of your letter, 23rd June, enclosing papers from the Asiatic Society regarding "Deep Sea Dredging."

I beg to assure your Society that I will assist in every way in my power so desirable an object. I would take the liberty to suggest to you to obtain as soon as possible all the apparatus necessary,—ready to embark in any vessel which may be made available.

I will represent to His Excellency the Viceroy that one of the two vessels of war stationed in the sea of Bengal might with ad-

vantage be employed on this service during N. E. Monsoon (supposing her services not otherwise urgently required) a temporary cabin being erected for the accommodation of the gentlemen who would conduct the scientific operations.

The small (or donkey) engine on board could be made to serve the purposes desired in the circular you have sent to me.

Asiatic Society's Rooms. Calcutta, 9th October, 1871.

From F. STOLICZKA, ESQ., PH. D., Hony. Secret. As. Soc. Bengal.

*To J. GEOGHEGAN, ESQ., Under-Secretary to the Government of India,
Department of Agriculture, Revenue and Commerce.*

SIR,—I have the honor to acknowledge your letter No. 181, dated Simla, 28th August, 1871 and to express the thanks of the Council of the Asiatic Society of Bengal for the great interest with which His Excellency the Governor-General in Council is prepared to meet the recommendation of the Society conveyed in my letter No. 280, dated 14th June, 1871.

The Council has been informed by His Excellency the Admiral of the India Naval station that there is a likelihood of a Steamer being available for the proposed Deep Sea Dredgings during the approaching North East Monsoons provided that "her services are not otherwise urgently required," and His Excellency suggests, that the necessary apparatus should be obtained as early as practicable.

The Society has also received most encouraging letters from the Secretary of the Royal Society of London, and other leading men of science at home.

Considering the great importance of the subject I have the honor, by direction of the Council of the Asiatic Society, to suggest that His Excellency the Viceroy and Governor-General of India may be pleased to appoint a Committee for Deep Sea Dredgings, and also to apply through the Right Hon'ble the Secretary of State to the Lords Commissioners of the Admiralty for the early supply of the necessary apparatus which I had the honor to specify in my letter, No. 280, dated 14th June, and enclosure.

The Council is confident that the Royal Society would be glad to afford their aid in selecting the necessary instruments, and also in testing their value. The application for those instruments just at this time would probably be opportune, as several expeditions for Deep Sea Dredging are being organized in England, in Norway, by the German Empire and by the United States.

From J. GEOGHEGAN, Esq., Under Secretary to the Government of India, Department of Agriculture Revenue and Commerce.

To the Honorary Secretary to the Asiatic Society of Bengal.

Simla, the 6th November, 1871.

SIR,—In reply to your letter, No. 500, dated 9th Ultimo, on the subject of a proposed series of Deep Sea Dredging operations in Indian waters, and the allotment of the Steamer for the purpose, I am directed to inform you that His Excellency the Governor-General in Council much regrets that it is not, at present, possible to promise the services of a vessel. The request will, however, be borne in mind and due intimation given of any arrangements which may hereafter become feasible. Copies of the Office Memorandum and enclosures accompany.

To His Excellency the Commander-in-Chief, Her Majesty's Naval Forces, East Indies.

SIR,—I am directed to acquaint you that a telegram to the following effect has this day been despatched to you :—

“PRECEDENCE.”

Your letter of 9th October, and telegram of 23rd, Your Excellency's proposals regarding “Dryad” approved.—She should go to Bombay for repair and fittings and be back at Sandheads by last week of December to take the King of Siam up to Calcutta.

Enclosure of letter No. 18 of 18th October will have informed Your Excellency that a man-of-war is now required at Sandheads only to meet the King of Siam.

I have &c.,

(Sd.) H. K. BURNE, *Colonel, Secy. to the Govt. of India.*

Simla, the 27th October, 1871.

Government of India, Marine Department, Simla, 1st November, 1871.

OFFICE MEMORANDUM.

With reference to the communication from the Department of No. 423, dated 28th Agriculture, Revenue and Commerce, noted October, 1871. in the margin, the undersigned has the honor to transmit copy of a letter from His Excellency the Commander-in-Chief of Her Majesty's Naval Forces, dated 9th October, and of the reply, No. 36, dated 27th October, regarding Her Majesty's Ship "Dryad."

2. The "Dryad" will proceed to Bombay for repairs and return to the Sandheads the last week in December, to meet and convey the King of Siam to Calcutta. She may perhaps afterwards be required to proceed to Burmah, so that it is much regretted that it is not at present possible to promise that her services shall be available for other duty, but the request will be borne in mind.

(Sd.) H. K. BURNE,

Secretary to the Government of India.

To the Department of Agriculture, Revenue and Commerce.

From His Excellency the Commander-in-Chief of Her Majesty's Naval Forces, East Indies.

To Major General H. W. NORMAN, C. B. Secretary to the Government of India, Marine Department.

H. M. S. "GLASGOW." *Trincomallie, 9th October, 1871.*

SIR,—I have the honor to acknowledge the receipt of your letter of the 21st ultimo.—(Marine Department No. 34) conveying the request of His Excellency the Viceroy for H. M. S. "Wolverene" to be sent to the Isthmus of Kra in January next to embark the King of Siam who is about to visit British India.

I have to inform you that the "Wolverene" has sailed for the East Coast of Africa, my Flag-ship (the "Glasgow") taking her place here.

Some time since I received a letter from Mr. Stoliczka, the Secretary to the Asiatic Society of Bengal, requesting my co-operation

in a scientific exploration of the sea of Bengal. I answered that I would take an early opportunity to consult with the Viceroy and to suggest that "the Second Vessel of War" stationed in this sea be so employed.

I wish now to propose that the "Dryad" (the Second Vessel of War) a ship of 1000 tons, be substituted for the "Wolverene;" and that on her arrival at Bombay next month, (for repairs) sufficient accommodation be temporarily added for the use of the scientific gentlemen, who would embark for the Marine explorations; this additional accommodation would render her a very suitable vessel to embark His Majesty of Siam.

I do not think the expense of this extra cabin-room would cost above £100.

I shall be glad to know His Excellency the Viceroy's opinion upon this proposition.

I have, &c.,
(Sd.) J. B. COCKBURN.

of the ... of the ...

of the ... of the ...

of the ... of the ...

of the ... of the ...

of the ... of the ...

of the ... of the ...

of the ... of the ...

of the ... of the ...

of the ... of the ...

APPENDICES.

APPENDIX A.

List of papers submitted to the Society during the year 1871, with dates when they were received, and how they were disposed of.*

[* Short communications and abstracts, chiefly printed in full in the Proceedings are not included in this list, but referred to in the General Index.

Authors.	Titles of Papers.	When received.	How disposed of.
Anderson, John, M. D.	A list of the Reptilian Accession to the Indian Museum, Calcutta, from 1865 to 1870, with a description of some new species,	28th Oct. 1870.	Printed in Journal, Pt. II, for 1871, p. 12.
Ayrton, W. E.	On a quantitative method of Testing a "Telegraph Earth,"	6th April 1871.	Printed in Journal, Pt. II, for 1871, p. 177.
Ball, V., B. A.	Names of Birds, &c., in four of the aboriginal languages of Western Bengal,	Printed in Journal, Pt. I, for 1871, p. 103.
Bayley, E. C., C. S., C. S. I.	Note on a gold coin bearing the name of Prince Firúz Sháh Zafar son of Firúz Sháh of Delhi,	Printed in Journal, Pt. I, for 1871, p. 160.
Bayley, E. C., C. S., C. S. I.	Translations from the Táríkh i Firúz-sháhí,	Will be printed in Journal, Pt. I, for 1872.

Blanford, H. F.	On some undescribed species of Campotoceras and other land shells,	2nd Dec. 1870.	Printed in Journal, Pt. II, for 1871, p. 39.
Blanford, H. F.	Note on the correction of the Calcutta Standard Barometer to the Kew and Greenwich Standards,	4th Sep. 1871.	Printed in Journal, Pt. II, for 1871, p. 446.
Blanford, W. T.	Note on Col. McMaster's list of Birds from Nagpur, &c.,	Printed in Journal, Pt. II, for 1871, p. 216.
Blanford, W. T.	List of Birds collected or observed in the Wardha Valley and its vicinity near Chanda,	14th April 1871.	Printed in Journal, Pt. II, for 1871, p. 268.
Blanford, W. T.	Account of a visit to the Eastern and Northern Frontiers of Independent Sikkim, with notes on the Zoology of the Alpine and Sub-alpine regions, Pt. I, ..	28th July 1871.	Printed in Journal, Pt. II, for 1871, p. 367.
Blochmann, H., M. A.	Notes from Muhammadan Historians on Chutiá Nágpúr, Pachet and Palámau,	Printed in Journal, Pt. I, for 1871, p. 111.
Chandrasekhara Banarji, ..	An account of the Antiquities of Jajpur in Orisa,	Printed in Journal, Pt. I, for 1871, p. 151.
Colvin, A., C. S.	Translations from the Tárikh i Fírúzsháhí,	Printed in Journal Pt., for 1871, p. 217.

Authors.	Titles of Papers.	When received.	How disposed of.
Day, F.	Monograph of Indian Cyprinidæ, (Pt. I.)	4th Jan. 1871.	Printed in Journal, Pt. II, for 1871, p. 95.
Day, F.	Monograph of Indian Cyprinidæ, (Pt. II.)	Printed in Journal, Pt. II, for 1871, p. 277.
Day, F.	Monograph of Indian Cyprinidæ, (Pt. III.)	Printed in Journal, Pt. II, for 1871, p. 337.
Delmerick, J. G.	A History of the Gakk'hars,	Printed in Journal, Pt. I, for 1871, p. 67.
Dobson, G. E., M. B.	On a New species of Vespertilio,	1st March 1871.	Printed in Journal for 1871, Pt. II, p. 186.
Dobson, G. E., M. B.	Description of four new species of Malayan Bats from the collection of Dr. Stoliczka,	3rd May 1871.	Printed in Journal, Pt. II, for 1871, p. 260.
Dobson, G. E., M. B. ...	On a new genus and species of Rhinolophidæ, with description of a new species of <i>Vesperus</i> , and Notes on some other species of insectivorous bats from Persia,	7th June 1871.	Printed in Journal, Pt. II, for 1871, p. 455.
Forbes, L. R.	Letter regarding the Mughul Invasions of Palámau,	1st June 1871.	Printed in Journal, Pt. I, for 1871, p. 129.
Godwin-Austen, H. H.	Descriptions of the species of <i>Alycaeinæ</i> known to inhabit the Khasi Hill Ranges,	2nd Dec. 1871.	Printed in Journal, Pt. II, for 178, p. 1 87.

Growse, F. S., M. A., C. S.	The Country of Braj,	Printed in Journal, Pt. I, for 1871, p. 34.
Kurz, S.	On some new or imperfectly known Indian Plants, (continuation from Journal, Vol. XXXIX, Pt. II, pp. 61-91,	2nd Dec. 1870.	Printed in Journal, Pt. II, for 1871, p. 45.
Kurz, S.	List of Algæ collected by Mr. S. Kurz, in Burmah and adjacent Islands, by Dr. G. v. Martens, in Stuttgart. Commu- nicated by Mr. S. Kurz,	15th July 1871.	Printed in Journal, Pt. II, for 1871, p. 461.
McMaster, A. C.	Notes on Birds observed in the neighbour- hood of Nagpore and Kamptee (Central Provinces) Chikalda and Akola in Berar,	24th Feb. 1871.	Printed in Journal, Pt. II, for 1871, p. 207.
Nevill, G. & H.	Description of new Mollusca from the Eastern Regions,	7th Sept. 1870.	Printed in Journal, Pt. II, for 1871, p. 1.
Pratâpach Ghosha,	Note on two Copperplate Inscriptions from Bámanghâú,	Printed in Journal, Pt. I, for 1871, p. 161.
Rájendralála Mitra,	The Alla Upanishad, a spurious chapter of the Atharva Veda,	5th July 1871.	Printed in Journal, Pt. I, for 1871, p. 170.
Rakhal Dass Haldar,	An Introduction to the Mundari Language,	Printed in Journal, Pt. I, for 1871, p. 46.
Rakhal Dass Haldar,	Notes on three inscriptions on stone found in Chutiá Nágpúr,	1st June 1871.	Printed in Journal, Pt. I, for 1871, p. 108.

Authors.	Titles of Papers.	When received.	How disposed of.
Rashbihari Bose,	Extracts from my Diary regarding a visit to K'harakpūr, in the district of Munger (Monghyr) and several places in the Banka Sub-Division, (Bhagulpore),	Printed in Journal, Pt. I, for 1871, p. 22.
Rashbihari Bose,	Legends and Ballads connected with persons deified or held in great veneration in Bhāgalpūr and the neighbouring districts (being extracts from Diaries),	Printed in Journal, Pt. I, for 1871, p. 138.
Rodgers, C. J.	Note on the Death of Humayun,	Printed in Journal, Pt. I, for 1871, p. 133.
Samuells, W. L.	The Rock-cut Excavations at Harchoka, discovered by Capt. W. L. Samuells, when employed as Boundary Commissioner on the Rewah and Chutia,	18th Nov. 1871.	Printed in Journal, Pt. I, for 1871, p. 177.
Schwendler, L.	Arrangement for the discharge of Long Overland Telegraph lines,	27th Jan. 1871.	Printed in Journal, Pt. II, for 1871, p. 78.
Stoliczka, F.	Notes on Terrestrial Mollusca from the neighbourhood of Moulmein (Tenasserim Province) with descriptions of new species,	5th Jan. 1871.	Printed in Journal, Pt. II, for 1871, pp. 143, 217.

Stoliczka, F.	Notes on some Indian and Burmese Ophidians,	22nd Aug. 1871.	Printed in Journal, Pt. II, for 1871, p. 421.
Tolbort, T. W. H., C. S.	Notes on the district of Dera Ismail Khan, Trans-Indus,	Printed in Journal, Pt. I, for 1871, p. 1.
Whalley, P., C. S.	The reign of Mu'izzuddín, translated from the Tárikh i Firúzsháhi	Printed in Journal, Pt. I, for 1871, p. 185.
Wood-Mason, J.	Contributions to Indian Carcinology. On Indian and Malayan Telphusidæ, Pt. I,	25th April 1871.	Printed in Journal for 1871, Pt. II, p. 189.
Wood-Mason, J.	On Indian and Malayan Telphusidæ, Pt. I,	25th April 1871.	Printed in Journal, Pt. II, for 1871, p. 201.
Wood-Mason, J.	On Indian and Malayan Telphusidæ, Pt. I,	25th April 1871.	Printed in Journal, Pt. II, for 1871, p. 449.

APPENDIX B.

List of Donations (not including Books, or other publications and MSS., these being acknowledged in the monthly library lists).

[Objects marked with an asterisk have been transferred to the Trustees of the Indian Museum].

Donors.	Donations.
Dall, The Rev. C. H.....	Three Nepal coins.
Falle, Capt. J. V.	*A skin of the great Albatross, <i>Diomedea exulans</i> , shot off the Cape.
Ferrar, M. L., Esq., C. S.....	Two silver and six copper coins dug up at Qanauj.
Foster, J. M., Esq., M. R. C. P.	Three Assam small silver coins.
Graham, Major, J. M.	*A group of rudely moulded brass figures, representing "Lushais" and their social habits.
Hamilton, Col. T. C.	*A large round gold coins very thin, somewhat more than an inch in diameter.
Miller, Lieut. W., M. N. I.	*An egg of <i>Megapodius Nicobariensis</i> from Kamorta island and the carapace of a remarkably shaped Pagurid crab from one of the small Nicobar islands.
Newman, Dr.	Five silver coins.
Prankissen Chatterji, Babu,....	A stone seal, found west of Bardwán.
Rájendralála Mitra, Bábu,	*A dried specimen of a new species of <i>Scincus</i> .
Samuells, Capt. W. L.	*Two copper axes.

INDEX.



	<i>Page</i>
A'azzuddín imprisoned,.....	127
Abbey (W.), Election of,	56
Abdul Latif on the Muhammadan who first studied Sanscrit,	142
Abdurrahim, Mirza, Akbar's Khan Khanan,	141
Ablabes collaris,	191
,, Humberti, Notes on,	173
Abornis albo-superciliaris,	249
,, xanthoschistos,	248
Abul Farah, Sayyid,.....	127
Acanthodaetylus Cantoris,	193
Acanthophthalmus pangia,	202
Accounts, Annual,	xx—xxxiv.
Áchárasára, Tantra,	283
Acheiris jibha,	201
,, kukurjibha,.....	201
Achyber temple,	254
Adbhuta Sára Sangraha,	282
Admiral de la Haye,.....	87
Aeiris cynoglossus,	201
Afzún,	98
Afzúnganj named after Rájah Afzún,	100
Ageniosus militaris,	202
Agra, Dutch trade in,	87
Ahichatta,	248
Ahitágnier Antesht̐hiprayoga,	7
Ahmad Khan (Nawab Ziauddin), Election of,	56
Ailia bengalensis,	199
Ainah Mahall,.....	275

	<i>Page</i>
Akshamálika Upanishad,	283
Alauda guttata,	210
Aldis (J. A.), Election of,	225
Alexander (J. W.), Election of,	120
Algæ, Fifth List of,	170
,, List of, from Birma,	173
Alí Tabár imprisoned,	127
Allahabad, Dutch trade in,	87
Allah Upanishad, Note on the,	140
Amara Deva,	255
Ambassis bogoda,	199
,, oblonga,	199
Amberleya,	113
Amblyopus brachigaster,	204
,, cirrhatus,	204
,, cœculus,	204
,, Hermannianus,	204
,, tenia,	204
Amnicola,	113
Amery (C. F.), Withdrawal of,	2
Anabœna mollis,	170
Ananta Varmá,	259
Anculotus carinatus,	109
Anderson (Dr. T.), Death of,	22
,, (Dr. J.), on a new Scincus,	115
,, ,, on a new Mabouia, and on two genera of Eurylepis and Plocoderma,	180
Angika,	102
Anguilla maculata,	201
,, bengalensis,	201
Annadá Kalpa,	282
Annapurná Upanishad,	283
Anumitirahasya,	283
Antimachus Nikephoros, Coin of,	276
Antiquities of Harchoka,	236
,, of Jájpúr,	135, 155

	<i>Page</i>
Antiquities of Jesar-Ishwarípúr,	135
Aparokshánubhuti,	282
Apollodotus, Coin of,	276
Arius arioides,	199
Arrakan, Celts from north,	83
Arakan shells,	284
Arura, History of,	247
Asellia Stoliczkana,	105
Ashtaka, Gangá,	282
Aspidoparia jaya,	207
,, morar,	206
As/oka, Pillars of,	17
Assam Coins,	234
Atharva Upanishads,	5
Atherina dhani,	205
,, danius,	205
Atkinson (E. T.), Re-election of,	177
Atma purána,	6
Atmospheric pressure, Day maxima and minima of,	17
Attar Sing (Sirdar) on the history of Arura,	242
Auditors, Election of,	52
Avdall (J.), Death of,	22
Ayrton (W. E.), Election of,	82
,, on bad insulators,	76
,, on the method of testing Telegraph Earth,	22
,, on Thunderstorms,	145
,, on Inertia and Time,	160
,, on a new Galvenometer,	47
Badis Buchanani,	205
Bahram Darwish Saqqa, Tomb of,	128
Bairam Khan, Akbar's Khan Khanan,	141
Baiyásikádhikarāna málá,	7
Balasure, Grants of lands at,	87
Balavi, Governor-General of,	91
Ball, V., on a new method of stuffing birds,	249

	<i>Page</i>
Ball (V.) Names of birds in four aboriginal languages of Western Bengal,	135
Bámanghāti,	180
Bámanbasti,	180
Bánsberiya,	277
Barahdowar e'	274
Barbus barna,	208
,, Beavani,	208
,, conchoniús,	205
,, cosuatis,	207
,, gelius,	207
,, morarensis,	207
,, mosala,	207
,, phutunio,	207
,, titius,	207
Burdwan, A stone seal from,	159
Barha Sayyid,	127
Barilius cocra,	206
,, rerio,	208
,, tileo,	207
Barometer, Diurnal oscillations of,	14
,, Errors of Standard,	217
Barometric curves,	60
Barsee Taklee, Antiquities of,	1
Basevi, (Capt J. P.), Withdrawal of,	2
Batavia, Account currents of,	91
Batrachoides gangene,	204
Batrachus grunniens,	204
Bats (Malayan) of Dr. Stoliczka,	105
,, New Persian,	133
Battery, Electromotive force of a,	221
,, Resistance of a,	220
Baudháyana Somayága,	7
,, Sûtra vritti,	7
Bayley (E. C), on gold Coin of Firuz Shah Zafar,	83
Beavan, (Lieut. R.), Death of,	22

	<i>Page</i>
Beestoopore, Purchase of land at,	90
Behar, Photographs from,	251
Benedict (E.), Election of,	56
Bengal, Arabic inscriptions of,	245
Belteah,	270
Bhagalpur, Legends and Ballads of,	116
Bibliotheca Indica, Report on,	25
Bihrey,	99
Bihruz Singh,	98
Birds from Kampti,	78
,, Names of, in four languages,	135
,, from Sikkim,	215
Blanford (H. F.) on Barometric curves,	60
,, on errors of Calcutta Standard Barometer,	217
,, on Thunder-storms,	148
(W. T.), on chipped implements,	179
,, Notes on Hemidactylus marmoratus and Ablabes Humberti,	173
,, Visit to Independent Sikkim,	167
,, on MacMaster's Nagpur Birds,	155
,, on Sikkim birds,	215
,, on the Zoology of Independent Sikkim,	226
,, on Wardah Birds,	116
Bligh (C. F.), Election of,	91
Blochmann (H.) on Allah Upanishad,	146
,, on Arabic Inscriptions,	245
,, on Arabic and Persian Inscriptions,	126
,, on several Arabic and Persian Inscriptions,	116
,, on Mr. Ferrar's letters,	178
,, on Gakk'hars,	104
,, on Harchoka inscription,	238
,, on Major Stubb's Coin,	97
,, on Xavier's Life of the twelve Apostles, ...	138
Bodhi Drum,	255

	<i>Page</i>
Bolagoha,	207
Botio dario,	202
Bourne, (W.), Election of,	82
,, (T. M.), Election of,	82
Bowring (L. B.), Withdrawal of,	53
Brahmajñāna-mahā-tantra-sāra,	282
,, Tantra,	282
Brahmajoni Hill,	254
Brahmo Dutt Chobay,	98
Braj, Notes on the Country of,	93
Brajanāth Sinha, Coin of,	234
Briggs (J. A.), Election of,	225
Broadley's (A.) Inscriptions,	245
Brooks (E.) on new Abrornis,	248
,, Cashmere Ornithology,	209
,, on a new Flamingo,	284
Brough, (R. S.), Election of,	1
Buckland (C. T.), Election of,	137
Buckle, (H.), Election of,	177
Buddamati, Raja,	248
Budh Gya,	254
Bukra, Antiquities of,	270
Burrabur,	256
Burragaon, Photographs of,	268
Burranagore,	90
Bythinia,	113
Cachius atpar,	208
Cadell's (A.), Arabic inscriptions,	126
Calidris arenaria,	249
Callichrons pabo,	199
Callineorus chaka,	204
Carcharias gangeticus,	201
Carlyle's (A.) inscriptions,	126
Cashmir Ornithology,	209
Cassimbazar, Purchase of land at,	90
Catenella opuntia,	172

	<i>Page</i>
Catla Buchanani,	208
Caves of Lomasha Rshi,	257
,, Sudama Rshi,.....	257
Celts from Arracan,	83
,, Khangaon,	238
Centropomus baeulis,	199
,, bagoda,	199
,, kanipabda,	199
,, pabda,	199
,, phulchanda,	198
Certhia familiaris,.....	209
,, Hodgsoni,.....	209
Cerithidea obtusa,.....	114
Chaca Buchanani,	199
Chadar,	102
Chaibása, Inscriptions from,	180
Chambers (F. J.) struck off	58
Chandra Sikhur Banerji on Jajpur,	135, 155
Chand, Poems of,	137
Chandronmilana,	28ç
Charasia Blanfordana,	194
,, tricarinatus,	194
Chaurakávyá Satika,.....	282
Chayanapaddhati,	7
Cheilodoptarus butibere,	204
Chela laubuca,	208
Cheon, Photograph of,.....	266
Chhajhu Sayyid,	127
Chhanda Sutra,.....	7
Chhandoga Paris 'ishṭa,	283
Chillor, Photographs of,	268
Chinsura, Dutch records from,.....	85
,, Police regulations,	92
Chipped implements from the Godaverí,	179
Chisholm (R. F.), Election of,.....	177
Chaetomorpha chlorotica,	172

	<i>Page</i>
Chætophora radians,.....	171
Chola,	102
Cholaka,	102
Chola range,	167
Christianson, (L.), a Dutch gentleman,	91
Chthonoblastus Lyngbyei,	172
Chumanáko,	167
Chumbi valley.	167
Chúsácken,	167
Cinclus sordidus,	228
Cirrhina mrigala,	206
Clarke, (C. B.); Election of,.....	55
Clupanodon champil,	205
,, chapra,	205
,, indica,	205
,, moti,	205
,, subærnopharika,	205
Clupea indica,	205
Clupeoides pseudopterus,....	205
Cobitis bolgara,	202
,, bilturio,	202
,, chuno,.....	203
,, corica,	202
,, cucurca,	202
,, geto,	202
,, gongota,	202
,, guntea,	202
,, khorika,.....	202
,, pangia,	202
,, Sadanandio,	203
,, savona,	202
,, turio,	202
Cockburn (J. F.), Withdrawal of,	276
Coilia ramcarati,	205
Coins from Asam,	234
,, Indo-Bactrian,	276

	<i>Page</i>
Coins of Brajanátha Sinha,	234
,, of Cheduba Island,	81
,, of Firúz Sháh Zafar,	83
,, of Firúz Sháh III of Dehli,	119
,, of Husain Sháh of Jaunpur,	119
,, of Ibráhím Sháh of Jaunpur,	119
,, of Muhammad Bedár Bakht,	97
,, from Nepal,	55
,, from Qanauj,	119
,, cabinet, Report on the,	28
Coius trivittatus,	203
Committees, Election of,	58
Compsosoma Hodgsoni,	191
Conferva Antillarum,	172
Conservation of Sanscrit MSS. Report on,	277
,, ,, Correspondence on,	3
Cooke (H. G.), Election of,	225
Copper axes from Pachumba,	231
Coraccias garrula,	249
Corica gubernia,	205
,, soborna,	205
Corona of the sun,	129
Cottus chaka,	204
Council, Election of the,	51
,, Election of a new members, 137,	225
Cremnobates Syhadrensis,	109
Cremnoconchus, Anatomy of,	108
,, carinatus,	112
,, Syhadrensis,	108
Crossochilus gohama,	206
,, latius,	206
,, sada,	206
Curtoys (W. J.), Election of,	82
Cyclonema,	113
Cyclophorus,	114
Cyclostomus,	113

	<i>Page</i>
Cylindrospermum spirale,	171
Cynoglossus lingua,	201
Cynopterus,	105
Cyprinidae, Indian,	19, 155, 209
Cyprinus angra,	206
„ anjana,	207
„ atpar,	208
„ balibala,	208
„ balitora,	202
„ bangana,	206
„ barna,	208
„ barila,	207
„ bata,	206
„ bimaculatus,	207
„ bhola,	207
„ boga,	206
„ bola,	207
„ bukrangi,	206
„ cachus,	208
„ canius,	207
„ chagunio,	208
„ chedra,	206
„ coesa,	206
„ conchonius,	205
„ cosuatis,	207
„ curabati-bata,	206
„ cursi,	206
„ cursis,	207
„ dangila,	208
„ dero,	206
„ dhrenro,	206
„ diangra-gohama,	206
„ Dyangra anjana,	207
„ elonga,	206
„ gelius,	207
„ geli punti,	207

	<i>Page</i>
Cyprinus godiyari,.....	206
„ goha,	207
„ gohama,	206
„ gonius,	207
„ gora,	208
„ guganio,	205
„ Jauyali,	205
„ jaya,	207
„ Joalius,	205
„ jogia,.....	082
„ kanipunti,.....	207
„ kirki jongja,.....	208
„ khoksa,	206
„ korikon,	205
„ koswati,.....	207
„ lamta,	206
„ lati,.....	206
„ latius,.....	206
„ laubucala,	208
„ layukuli,.....	208
„ loya,	205
„ morala,	206
„ morar,	206
„ mrigala,	206
„ mosala,	207
„ nandin,	207
„ phakra,	208
„ pangusiya,	206
„ pausio,	205
„ phulo,	207
„ phulchela,.....	207
„ phutunio,	207
„ pungsi,	205
„ rerio,	208
„ sada,	206
„ sada balitora,	206

	<i>Page</i>
Cyprinus sutiha,	208
,, terio,	205
,, teripungti,	205
,, tilei,	207
,, tileo,	207
,, titius,	207
,, tor,	207
,, vagra,	205, 208
Dacca, French property at,	87
Dalhousie, Variations of the Barometers at,	14
Danio dangila,	208
,, jongja,	208
Dapthu, Photographs of,	269
Dará Shikoh, translated by Duperroy,	5
Darsana Káliká,	282
Dars'apaurnamása práyaschitta káriká,	7
Darwin (C.), elected an honorary member,	120
,, proposed an honorary member,	97
Dattátreya Sanhitá,	282
Dáúd Khán,	262
,, Governor of Bihar,	133
Dáúdnagar, Photographs of,	262
Daukes, (F. C.), Election of,	1
Day (Dr. F.) on Indian Cyprinidæ,	19
,, ,, on Indian Cyprinidæ,	155
,, ,, on Hamilton Buchanan's original drawings,	195
,, ,, on Indian Cyprinidæ,	209
Delmerick (J. G.) on the Gakk'hars,	104
,, ,, Arabic inscriptions,	126
,, ,, on discovery of Indo-Bactrian coins,	276
Deokund, Photography,	262
Deonarayana Sing (Raja Sir), Death of,	22
Deo on the west of Oomga,	265
Dera Ismail Khan, Notes on,	17
Devikavacha,	282

	<i>Page</i>
Dharawat,	260
Dhuti,	102
Dickens (Col. A. D.), withdrawal of,	178
Digdrisyavivarana Akhya,	7
Diomedea exulans,	82
Dipsas bubalina,	192
,, Forsteni,	192
,, hexagonotus,	192
,, trigonota,	192
Discognathus lamta,	206
Divya Chudámani,	283
Djo-kong-tong,	168
Dobe Bhairam, the atrologer,	99
Dobson (G. E.) on new bats,	77
,, ,, on a new Kerivoula,	77
,, ,, on new Indo-Chinese Vespertilionidal, ...	210
,, ,, on Malayan Bats,	105
,, ,, on Persian Bats,	133
Docoglossa,	95
Dolárohana-paddhati,	282
Doneo Chand, author of a History of the Gakk'hars,	104
Dredging (Deep sea) Correspondence on,	286
Dress in ancient India, Style of,	100
Duhan (H.), Struck off,	58
Dunceticola affinis,	210
,, major,	260
Durgádádináma stotra,	282
Duperron's translation of Dárá Shikoh,	5
Duration of the totality of Eclipse of Dec. 11,	129
Durjun Sál, Raja,	133
Dutch records,	85
,, trade in Oudh,	87
Dvijendranátha Thákura Election of,	55
Dvitiyádvitiyatpatti váda,	285
Earthquake in Sind,	56
Echinella,	113

	<i>Page</i>
Eclipse, Memorandum on the total, of Decr. 11	128
Ekámra chandriká,	7
,, purána,	7
,, chandriká,	7
Ekákshara Upanishad,	283
Electromotive force of a Battery,.....	221
Electris butis,.....	204
Esox angulatus,	205
Eumeces scutatus,	184
,, parimentatus,	182
Euprepes macularius,.....	194
,, monticola,	194
Eurylepis, tæniolatus,	180, 184
Euspiza rutila,	215
Evezard (Col. J. E.), Election of,	225
Faiz Aliganj named after Rájah Faiz Áli,	99
Farr (G. C.), Election of,	52
Farrukh Siyar,	127
Fath Bahádur, House of,	255
Fergusson on the art of building among the Aryans,	17
Ferrar (M. L.), on Rájá Todar Mall's birthplace,.....	178
Filgate, (Capt. A. J.), Election of,	82
Finance, Report on,	28
Fírúz, Reign of,.....	246
,, Shah Zafar, Coin of,.....	119
Flamingo, New species of,	284
Fleming (Dr J. M.), withdrawal of,	278
Forbes, on the Mogul invasion of Palamau,	179
Foster's (J. M.), Assam silver coins,	234
,, Election of,	235
Fulgo, banks of the,	253
Gadádharma, Photograph of,.....	253
Gadinidæ,	119
Galvanometer, A new form of,	217
Gangáprasáda, Election of,	159
,, Sinha, Election of,	120

	<i>Page</i>
Gangástaka,	282
Gangástava,	282
Garrett (C. B.), struck off,	58
Gastors or Expense Books,	91
Gastropoda,	96
Gaurikanchuliká,	282
Gáyatribráhmañollása Tantra,	282
Gáyatri hridaya,	282
„ kalpa,	282
Gecko guattatus,	193
Genjan, Photographs of,	261
Gerres altispinis,	203
Ghulám Qádir dothronded Bedár Bakht,	97
Gitá, Guru,	282
Gitá, I's'vara,	282
Gnátui-la,	167
Glæotila concatenata,	171
„ protogenita,	107
Gobioides ruber,	214
„ rubicundus,	204
„ squamulosa,	204
Gobius chuno,	203
„ gutum,	203
„ nunus,	204
„ sadanandio,	203
„ thutkuri,	204
Godavari, chipped implements from,	79
Gopál Tápani,	140
Goraksha-s'ataka,	282
Gough, (A.), election of,	55
Govindacumara, Chaudhari, election of,	55
Graham (Major J. M.), election of,	82
Grantha-sangraha,	82
Grey (Sir W.), withdrawal of,	53
Grihya sutra,	
Growse (F. S.), on the country of Braj,	93

	<i>Page</i>
Gunendramohana Thákura, election of,.....	1
Gurúgítá,	282
Gurú Tantra,.....	282
Gulyátiguhya Tantra,	282
Gya, Old town of,	253
„ Photographs of,	282
Gyawals, Horses of the,	253
Gymnodactylus Lawderanus,	194
„ maculatus,	194
„ marmoratus,	194
„ nebulosus,	194
Habíburrahmán (Maulavi) election of,	120
Hafiz Rahmat, the Rohilah chief,	127
Hakím Ali, Faujdár of Sambal,	127
Hájí Sulaimán,	271
Halím Khán, son of Shamsuddín,	247
Halayudha's Pingala Chhandasútra,	7
Halisahar,	279
Hamilton (Col. O.), Election of,	137
Hamus,	112
Hara Buchanani,	199
„ conta, ..	200
Harchoka, Antiquities of,	57, 236, 283
Harischandra, king of Rohtasgarh,	273
Harkness (T. F.), Election of,	52
Harachandra Chaudhuri, election of,	55
Harinámá mrita,	282
Harrison's (A. S.), inscriptions,	126
Hasan Abdál, Aurungzeb at,	126
Hastings, Note of Warren,....	86
Hathiyaphul gateway,	274
Heliotype,	240
Hemidactylus aurantiacus,	193
„ Berdomorei,	193
„ bengalensis,	193
„ Coetæi,	193

	<i>Page</i>
Hemidactylus, frenatus,	193
„ giganteus,	193
„ Gaudama,	194
„ gracilis,	193
„ Karenorum,	194
„ Kelârti,	174, 193
„ Leschenaultii,	174, 198
„ maculatus,	193
„ Mandelianus,	193
„ marmoratus; Notes on,	173
„ Mortoni,	193
„ Pieresii,	193
„ subtriedrus,	193
„ Sykesi,	193
„ triedrus,	193
Hinulia Dussimieri,	195
„ indica,	194
„ maculata,	194
Hiranyakes'i sūtra,	7
Horites pallidus,	210
Horse, Polydactylism in,	28
Hovendon (Major J. J.), Death of,	22
Howell (A. P.), Election of,	96
Humáyún Bakht,	127
„ Death of,	135
Husain Shah, Coin of,	119
„ Khán Súr, father of Sher Shah,	273
Hydrocoleum Lenormandi,	173
„ violaceum,	170
Hygrometric observations on the plains of India,	15
Hypheothrix investienti,	172
„ subundulata,	171
„ tenax,	172
Hypotriorchis subbuteo,	249
Hypoglossum pygmœum,	172
Hypsirhina enhydri,	192

	<i>Page</i>
Ibráhim Sháh, Coin of,	119
,, Khán Fathjang,	133
Ichthyocampus carce,	204
Indian Architecture, Antiquity of,	17
,, Museum, Dr. Stoliczka a trustee of,	97
Inertia and time, Connection between,	160
Inscriptions, Arabic and Persian,	116
,, from Agrah,	127
,, of Bengal, Arabic,	245
,, from Bardwan,	128
,, from Bareli,	127
,, from Barsee Taklee,	1
,, from Chaibasa,	180
,, from Chutia Nagpur,	132
,, from Harchoka,	256
,, from Fort Atock,	126
,, from Sikandarpur,	126
Isaac (J. S.), Election of,	56
Isána Sanhitá,	282
Is'vara-gitá,	282
Iqbálganj named after Iqbál Áli,	100
Jyotihságara sára,	283
Jnána Tantra,	282
Jigatzi,	168
Jesar-Ishwaripur, Antiquities of,	138
Jelep-la,	167
Jardine, (R.) Decease of,	22
Japan copper, Sale of,	91
Japalura variegata,	194
,, microlepis,	194
James (J. O. N.), on a Thunderstorm which passed over Calcutta,	142
Jama,	101
Jajpur, Antiquities of,	135
Jahandar Shah killed,	127
Jagráon, History of,	247

	<i>Page</i>
Kaiqubád,	98
Kalkapore, Water course of,	90
Kalingpungin, the Daling Duar,.....	167
Káliprasanna Ghosha, Election of,	196
,, Sinha Death of,	22
Káli-sahasranáma stotra,	282
Káli sahasranáma,	282
Kálistava rája,	282
Kamba-jong	168
Kámarúpa yátra,	282
,, ,, paddhati,	282
Káma sutra,	7
Kampti, Birds from,.....	78
Kanchuka,	102
Kanchulika,	102
Kapila Sanhitá,	7
Karna Chapar, Photograph of,	258
Karam Dád Khan, chief of the Gakkars,	104
Karpurástava tiká,	282
Kavacha, Devi,	282
,, Mátriká jaganmandala,	223
,, Vagalámukhi,	282
Kavenagh (J.), Decease of,	22
Kowwa Dol rock,	257
Kendowar caste,	98
Kerivoula fusca,.....	215
,, Hardwickii,	215
,, pieta,	215
Keshada's Prayogasára,	7
Ketantya gate of Rohtagarh,	274
Kharakpur, Rajahs of,.....	98
Khórgo Singh,	99
Khushgo,	128
King (Dr. G.) elected a member of Council,	225
Kispa, Photographs of,.....	261
Indian Lizards,	192

	<i>Page</i>
Kœl river,	269
Konch, Photographs of,	263
Kongra Lama pass,	168
Kosha, Mátriká,	282
,, Vija,	282
Kshetra máhátmya,	282
Kund Petta Mahewára,	254
Kundus (The) of Bhágyakula,	277
Kurkihur, Photographs of,	267
Kurpása,	102
Kurz (S.) on Bengal Algæ,	170
Labeo cursa,	206
,, Dussumieri,	207
,, morala,	206
,, nandina,	207
,, pangusia,	206
Labrus badi,	205
,, darki,	205
Lachen,	168
Láchung,	167
Lacuna,	109
Lacunaria,	113
Láharpur,	178
Lhassa,	168
Laldarwaza of Rohtasgarh,	275
Landshells from Moulmein,	209
Landakia melanura,	189
,, tuberculata,	188, 189
Leeds (R. J.), Withdrawal of,	83
Lebra in Budh Gya,	255
Leibleinia Juliana,	173
Lepidocephalichthys balgara,	202
Leptorhytaon jara,	192
Leptothrix mamillosa,	173
,, muralis,	171
Lepus tebetanus,	228

	<i>Page</i>
Lethbridge on the Dutch records,	77, 85
„ on the Gakkhars in Tibet,	105
Leucosticta hæmatopygia,	228
Library, Additions to the, 19, 53, 78, 93, 117, 156, 135, 175, 222, 228, 250,	284
„ Annual Report on,	22
Lingtu,	167
List of Dutch records,	89
Lithoglyphus,	113
Littorina,	109
Lizards, Little known,	192
Lourya near Are-raj,	270
Lushais, Figures representing the,	81
Lyman (B. S.) a life member,	56
Lyngbya cincinnata,	170
„ cinerascens,	172
„ majuscula,	171
Mabouia, Blythiana,	186
„ tæniolata,	184
Mackenzie (Dr. S. C.), Withdrawal of,	83
Macnamara (Dr. F. N.) Re-election of,	182
Macroglossus, minimus,	107
„ spelæus,	105
Macrones cavasius,	200
„ itchkeea,	200
„ tengana,	200
„ tengara,	200
„ trachacanthus,	200
Madana párijáta,	282
Madhu Sing of Kokra,	133
Mahal Sarai palace,	274
Mahávira Svámi,	248
Mahda north of Kharakpur,	99
Málopterure kazali,	199
Malapterurus coila,	199
Mancar near Boodbood,	278

	<i>Page</i>
Mugdhabodha tiká,	282
Mahammad Bedár Bakht, son of Ahmad Shah,	97
,, Hasan, (Khalifa Sayyid), Election of,	137
,, Shah,	127
Mugil albula,	203
,, bongon,	202
,, cephalus,	203
,, kaskasiya,	203
,, lævis,	203
,, nepalensis,	233
,, planiceps,	203
Mundamálá Tantra,	282
Mungla Deva,	254
Munim Khan, Akbar's Khan Khanan,	141
Murina suillus,	215
Muræna bagio,	201
,, bamach,	201
,, raitaboura,	201
Murænesox cinereus,	201
Murænophis bazi,	201
Museum Building, Correspondence on,	60
,, Report on the,	23
Muzaffar Alí,	68
Muzaffarganj named after Muzaffar Alí,	99
Mystus chitala,	208
,, ramearati,	205
Nádijuána dipika,	282
Nagurjuni,	258
Naqib Khan,	142
Nagpur, Birds from,	78
,, (Chutea) Blochmann on,	132
Narada's Vedic phonetics,	5
Natdgurha on the Nawadah road,	267
Nowada Road,	267
Neil, Dr. A., contradiction of Mr. Phear's statement,	121
,, (Dr. A.), Election of,	225

	<i>Page</i>
Nemi-tso,	167
Neritoides,	113
Netherlands India, Administration of,	87
Newton (J.), Election of,	1
Nigama tatva,	282
Nila Tantra,	280, 282
Nirváṇa Upanishad,	283
Nivi, a kind of Hindu dress,	102
Nizámuddín,	246
Norman (The Hon. J. P.), Assassination of,	226
Nostoc gregarium,	170
Notices of Sanscrit MSS., Remarks on,	12
Nuṣrah Shah,	126
Nundolala Bose struck off,	58
Nuria danrica,	208
Nycticejus atratus,	212
,, emarginatus,	211
Oates (E. W.), Election of,	137
Officers, Election of the,	51
,, Report on,	31
O'Kinealy (J.), Election of,	225
Oldham's (Dr. W.), Arabic inscriptions,	126
,, (Dr. T.) on Pachumba axes,	233
Onáo, Chronicles of,	127
Oomga, Account of,	264
Ophichthys boro,	200
Ophidians, Indian and Burmese,	191
Ophiocephalus aurantiacus,	197, 202
,, barca,	203
,, striatus,	202
,, wrable,	202
Ophiops Jerdoni,	192
Ornithology of Cashmere,	209
Ophiops microlepis,	193
Ophisurus boro,	200
,, harangcha,	201

	<i>Page</i>
Ophisurus hijala,	201
„ rostratus,	201
„ tilebaim,	201
Oriotiaris Elliotti,	194
Ormsby, (M. H.) Death of,	22
Osborn (Capt. R. D.), Withārawal of,	120
Oscellaria brevis,	173
„ Froelichii,	170
„ interrupta,	170
„ tenerrima,	173
„ versicolor,	173
Otocoris alpestris,	227
„ Elwesi,	227
„ longirostris,	227
„ penicillata,	227
Otus brachyotus,	250
Oudh, Dutch trade in,	87
Ovis ammon,	168
Pachumba, Copper axes,	231
Paddhati, Dolārohana,	282
„ Kāmarupa yātra,	282
„ Sandhyā,	282
Padārtha-sangraha,	283
Pakshatā Rahasya,	283
Palamau, Mughul invasion of,	179
Pali, Photographs of,	261
Palmella bullosa,	171
Paratelphusa,	84
Pas'upas'a mokshanam,	119
Pavana vijaya,	282
Páyajámá,	101
Peal (S. E.), Election of,	276
Pellona chapra,	205
„ motius,	205
Pellorneum ruficeps,	216
„ Mandellii,	216

	<i>Page</i>
Pellorneum Tickelli,.....	216
Peply Factory,	89
Peripia Cantoris,	194
Petrapon trivittatus,	203
Phálung,.....	168
Phear, (J. B.), on atmospheric pressure,	16
Phonetics, Vedic,	5
Phormidium Lyngbyaceum,	173
Photocallographic Printing, New Process of,.....	239
Phyllorhina, nicobariensis,	105, 105
Phylloscopus neglectus,	216
,, pallidipes,	215
,, tristis,	216
,, Tytleri,	210
Phudong,	167
Piddington on deletrious ink,	88
Pingalachhanda Sútra,	7
Pimelodus batasius,	199, 200
,, carcio,	200
,, changdramara,.....	199
,, hara,.....	199
,, khongata,.....	200
,, kurki,	200
,, manggoi,	199
,, nangra,	200
,, rama,	200
,, veridescens,.....	200
Pipistrellus affinis,	213
,, annectans,.....	213
,, Austenianus,	213
,, serotinus,	134
Pipley, Grants of lands at,	87
Pippaláda S'ákhá,	140
Píṭha nirṇaya,	282
Platycephalus insidiator,.....	204
Platystacus chaca,.....	199

	<i>Page</i>
Plestiodon Aldrovandi,	181
„ seutatus,	184
Pleuronectes arsi,	201
„ arsius,	201
Polydactylism in a horse,	18
Polynemus indicus,	204, 209
„ paradiseus,	204
„ teria,	204
„ tetradactyla,	204
Polysiphonia angustissima,	172
„ polychroma,	172
Poonawa, Photographs of,	267
Poonpoon river, Bridge over the,	265
Praumra clan,	247
Pras'na-Kaumudi,	283
Pratab, son of Balbhadr,	133
Pratápachandra Ghosha, on Assam coins,	234
„ on Chaibassa inscriptions,	180
„ on Harchoka inscriptions,	237
Pratápa Devala, king of Rohtasgarh,	273
Pratt, (Capt. C. S.), Election of,	120
Prayogasára by Keshada,	7
Presentations received,	1
President's Address,	33
„ remarks on Inertia and Time,	165
„ „ on Thunder-storms,	147
Propasser saturatus,	216
„ thura,	216
Protococcus vulgaris,	171
Psammophis condanurus,	191
„ Leithei,	191
Psilorhynchus balitora,	20
„ sucatio,	20
Pseudophiops Beddomei,	19
„ Theobaldi,	192
„ Jerdoni,	192

	<i>Page</i>
Pseudorhombus arsius,	201
Pseudeutropius atherinoides,	199
„ megalops,	199
„ nenga,	199
„ urura,	199
Pterapon trivittatus,	203
Publications, Report on,	24
Purāṇa, Ātma,	7
„ Ekāmra,	7
„ Vrihannāradiya,	283
Purn 'a Varmma,	255
Púrṇánandachakra,	282
Puras 'charaṇa rasollāsa,	282
„ vineka,	282
Pyadasi, Raja,	257
Qadirganj, named after Qadir Ali,	100
Qanauj coins,	119
Rádhánátha Sikdara Death, of,	22
Rafí'uddarját,	127
Rafí'uddaulah,	127
Raia fluviatilis,	203
Rái Firuz,	247
Ráizadeh Ratan Chand, grandson of Donee Chand,	104
Rájaballabha,	282
Rájabhanja,	180
Rajápur,	178
Rájendralála Mitra, on the Allah Upanishad,	140
„ on Dress in Ancient India,	100
„ Notes on the Antiquity of Indian Architecture,	17
„ Reply to Mr. Chalmer's remarks, ..	13
„ on Sanserit MSS.,	277
Rajgeer, Photograph of,	261
Rakal Das Haldar, on Chutia Nagpur inscriptions,	132
Ramkrishna Dasa, Election of,	120
Rámesvar Mazumdar,	20

	<i>Page</i>
Ram Gya, Photograph of,	253
Ranabhanja,	180
Raná Khán,	98
Ranizana, Tank of,	247
Rashbihari Bose, on Bhagulpore Legends,	116
,, on a Hindoo work on Kharakpur, ..	98
,, on Jesar Ishwaripur,	134
Rasbora daniconius,	205
,, elonga,	206
Recess in September and October,	255
Reid (J. R.), Election of,	137
Riopa anguina,	195
,, Hardwickii,	195
,, alleopunctata,	195
,, Boringi,	195
Report, Annual,	21
Rhinok,	107
Rhizoclonium Kochianum,	171
Risella,	113
Rogers (Capt. B), Election of,	96
,, (C. J.), on the Death of Humayun,	135
Rogavinis'chaya,	282
Rohilah Chief, Mausoleum of the,	127
Rohtasgarh, Antiquities of,	273
Rohitasiva, founder of Rhotasgarh,	273
Ross (T. M.), grant of land to,	90
Roz-afzun,	98
Rukmini tank,	254
Rule 29, Change of the,	235
Rundall (Col. T. H.), Election of,	82
Sabine, (General) view of atmospheric pressure,	15
Sa'dulah Khan, Vizier,	87
Sahabad, Antiquities of,	272
Sahasranáma Stuti,	282
Saidpur road,	274
S'aktisangama Tantra,	282

	<i>Page</i>
Sámányabháva Rahasya,	283
Sambhal, Faujdar of,	127
Samuells (Capt. W. L.) Election of,	276
,, on Harchoka,	57
,, on Harchoka Antiquities,	236
,, on Pachumba axes,	231
,, Rock cut excavations at Harchoka,	283
Sanderson (C.), Election of,	96
Sandhyá paddhati,	282
Sangraha, Grantha,	282
Sangráam Sháh,	98
Sanhitá, Dattátreya,	282
,, Kapila,	7
,, Siva,	98
,, Isána,	282
S'ankaránanda's note on Atharva Upanishad,	5
S'ánkháyana Grihya Sutrá,	7, 283
S'ánkhya Kaumudí,	282
Sámányalakshana Rahasya,	283
Sanscrit MSS., Conservation of,	2, 277
S'ánti-s'ataka,	282
S'árdula Varmá,	259
Sarasvatí Tantra,	282
Sari,	102
Sasanaka,	285
Sasseram, Photographs of,	272
S'ataka, Goraksha,	282
,, S'ánti,	282
Sauchika,	102
Sayyid Mahmud, of Bárha,	127
Schwendler (L.), Tests of bad insulators,	72
Scincus officinalis,	116
,, Mitranus,	115
,, New species of,	96
,, rufescens,	181
,, pavimentatus,	181

	<i>Page</i>
Scineus punctatus,	181
Scotophilus fuliginosa,	212
,, fulvidus,	212
,, cinereum,	171
Seytonema gramelatum,	172
,, æruginio-cinereum,	171
Sectamoree near Nadgurha,	267
Seharee, Photographs of,	263
Sequestratic or Account Books,	91
Shahbaz Khan Kambu,	132
Shaistah Khan,	133
Shakarpari,	276
Shamshernagar, Photographs of,	262
Shamsuddin, Date of,	249
Shaṭ chakra tippani,	282
,, vivriti tika,	283
Sherif ul Omra (Sir) Election cancelled,	58
Sherer (J. W.), struck off,	58
Sher Afkan, Tomb of,	128
Sher Shah, Tomb of,	272
Shikarabad north of Kharakpur,	99
Shunt's Galvanometer of Latimer Clark,	219
Sikkim Birds,	215
,, (Independent), Account of,	167
,, ,, Visit to,	226
S'ikshás,	7
Sillago domina,	208
Sinha-vyágraha Rahasya,	283
Simroun, the ancient Capital of Mithila,	270
Simotes bicatenates,	191
Siphonaria, Anatomy of,	119
Sisor rabdophorus,	199
Sitana ponticeriana,	194
Sitta cashmerensis,	209
,, himalayanas,	209
S'iva-saṅhitá,	282

	<i>Page</i>
Skanda Purāṇa,	282
Smith (J.), Election of,	137
Smṛiti-chandriya srāddhakalā,	283
Spectroscopic analysis of the Corona,	13
Spirogyra decimina,	171
„ subæqua,	171
Spironema,	113
Spirulina oscillarioides,	173
Squallus characias,	201
Srāddhavidhi,	285
S'rigurusahasranāma stotra,	282
S'rautaprāyaschitta chandrikā,	7
S'ribhaktiratnāvali,	282
S'rigurú Sahasranāma,	282
Staurospermum cærulescens,	171
Stava, Gangá,	282
Stellio Dayanus,	194
„ indicus,	188
„ melanurus,	189
„ tuberculatus,	181, 188, 194
Stenotis,	113
Stevens (H. W.), Withdrawal of,	2
Stolephorus balitora,	202
„ suketi,	202
Stoliczka, F., on the Anatomy of Cremnoconchus,	108
„ on atmospheric pressure,	16
„ on Mr. Blanford's paper on Sikkim,	168
„ on the geographical distribution of Telphusidæ, ..	84
„ on Indian and Burmese Ophidians,	191
„ on Moulmein Terrestrial Mollusca,	19
„ appointed trustee of the Indian Museum,	97
Stotra, Durgádādimanāma,	282
„ Kālī sahasranāma,	282
„ S'riguru sahasranāma,	282
„ S'yamá,	282
„ Vagalámukhí,	282

	<i>Page</i>
Strachey (Col. R.), on Barometric Curves,	65
„ Remarks on Barometers,	15
St. John, on Arracan celts,	83
Stubbs (Major), on a Muhammadan coin,	97
<i>Sturnus unicolor</i> ,	210
„ <i>nitens</i> ,	210
Súchika,	102
Sudama Rshi cave,	257
Suddhi Dípika,	183
Sun, Spectroscopic examination of the,	138
Sundari saktidána tika,	181
„ saktidana,	282
Suresvaras, notes on Brihadáranyaka Upanishad,	5
Súrajkund, Temple of,	254
Svarodaya,	282
Svatantra Tantra,	282
S'yámá-stotra,	282
Sygnathus deocata,	204
„ <i>kharke</i> ,	204
Syrrhaptés tibétanus,	168
Tachydromus Haughtonianus,	192
„ <i>meridionælis</i> ,	192
„ <i>septentrionalis</i> ,	192
„ <i>sexlineatus</i> ,	192
Tahawwur Singh,	98
Takaradi Svarupa,	282
Talbort (T. W. H.) Notes on Dera Ismail Khan,	17
Tankra-la,	167
Tantra, Achárasahasra,	283
„ Brahmajnána,	282
„ Gáyatri bráhmanollása,	282
„ Guru,	282
„ Guhyáti guhya,	282
„ Jnana,	282
„ Mundamálá,	282
„ Níla,	282

	<i>Page</i>
Tantra sáktisangama,	282
„ sára, (Mahat) Brahmajnána,.....	282
„ Sarasvatí,.....	282
„ Svatantra,.....	282
„ Notes on.	279
Tanyek-tso,	167
Tarka Rahasya,.....	283
Tattvánu sandhána,	7
Tattva prakásíka,	7
„ sandhána,	7
Telphusa Guerini,	83
„ indíca,	83
„ Leschenaultii,	83
Telphusidæ, Malayan and Indian, ..	83, 78
Tennant (J. F.), Election of,	52
„ „ elected Member of Council,	137
„ on Inertia and time,	162
„ on the total eclipse of Decr 11th,	128
„ suggestions for visitors to the total eclipse,	150
Telegraph earth, Test of,.....	92
Testudo Phayrei, Notes on,	95
Tetrodon cutcutia,	205
„ kariya phoksa,	205
Theobald (W.), on Aracan shells,	284
„ on Moulmein shell,	209
Thomas (T.), Withdrawal of,	2
Therapon servus,	203
Thunder-storm,	142
Tibet, Observations on atmospheric pressure in,	16
Tíj Rái of Palámau,	133
Tinnunculus alandarius,	249
Tippani, Shatçakra,	282
Tirhut, Antiquities of,	270
Tista (The),	167
Todar Mall, Birthplace of,	178
Todar Mall of Bihár,.....	98

	<i>Page</i>
Treffts (O.), Election of,	82
Trichiurus lepturus,	204
Trichogaster fasciatus, chuna, cotra, lalius, sota,	201
Trichopodus beje, cœrulescens, colisa, fuscus, ruber, vittatus,	201
Trimeresurus Andersoni,	192
Tropidonotus bellules, himalayanus, junceus, macrops, ma-	
croplthalmus, plumbicolor, quincunctiatus, sikkimensis,	
subminiatus,	191
Tughril Khan,	247
Tunnavaya,	102
Turka Tippani,	283
Trygon sephen,	203
Trypanchen vagina,	204
Tylognathus boga,	206
Typhlops andamanensis, braminus, bothriorhynchus, Hors-	
fieldi, pammeceus, porrectus, Theobaldanus,	191
Upanishad, Akshamálika,	283
,, Anuapúrñá,	283
,, Commentary on Atharva,	5
,, Brihadáran'yaka,	5
,, Ekákshara,	283
,, Nirvana,	283
,, Yájnavalkya,	283
Vadithika kubba,	259
Vagalámukhi-kavacha,	282
Vagalá patala,	282
Vaisala identified with Bukra,	270
Valakrishn'áshtaka,	283
Vapiya well,	259
Vapour, Actual tension of,	15
Vasishtha yogakanda,	282
Vástu Homa,	282
Vespertilio Blanfordi, nepalensis, pachypus,	214
Vespertilionidæ, New Indo-Chinese,	210
Vesperus Andersoni, atratus, fuliginosa, prachiotis, pra-	
chypus,	211, 212

	<i>Page</i>
Vijákosha,	281
Viseshavya'pti bhava Rahasya,	283
Vishnu Pad in Gya,	253
Vivarana Bháshya,	283
Vrihannáradíya Purána,	283
Vyákarana bháva,	283
Vyaptanugama Rahasya,	283
Vyáptigrahopáya Rahasya,	283
Vyápti panchaka Rahasya,	283
Vyávastharnana,	283
Waagen (W.), Election of,	52
Walker (A. G.), struck off,	57
Wallace, (W. A. J.), Withdrawal of,	138
Warda birds,	116
Warth (H), Withdrawal of,	276
Waterhouse, J., on new Photo-callographic printing process,	239
West Berar Temples, Photographs of,	51
Whisham (J. B.), struck of,	58
Wilkinson, (J.) struck off,	57
Williams (C.) struck off,	58
Wilson (J.), Election of,	55
Wood-Mason (J.) on Telphusidæ,	78, 83
Xavier's (Jerome) Life of the Twelve Apostles,	138
Yakla,	167
Yati bhusani,	282
Zabardast Khan,	133
Zamenis fasciolotus,	191
Zosterops simplex,	115



Abstract of the Results of the Hourly Meteorological Observations taken at the Surveyor General's Office, Calcutta, in the month of January 1871.

Latitude 22° 33' 1" North. Longitude 88° 20' 34" East.

Height of the Cistern of the Standard Barometer above the sea level, 18.11 feet.

Daily Means, &c. of the Observations and of the Hygrometrical elements dependent thereon.

Date.	Mean Height of the Barometer at 32° Fahr.	Range of the Barometer during the day.			Mean Dry Bulb Thermometer.	Range of the Temperature during the day.		
		Max.	Min.	Diff.		Max.	Min.	Diff.
	Inches.	Inches.	Inches.	Inches.	o	o	o	o
1	29.907	29.998	29.843	0.155	71.5	81.6	63.5	18.1
2	.934	30.009	.883	.126	72.9	81.2	66.4	14.8
3	.986	.072	.928	.144	67.1	73.7	60.5	13.2
4	30.009	.107	.941	.166	62.3	70.0	56.0	14.0
5	29.969	.031	.897	.134	61.7	70.8	54.0	16.8
6	.954	.024	.889	.135	63.9	73.5	56.5	17.0
7	.985	.059	.931	.128	65.7	75.2	58.0	17.2
8	.981	.055	.930	.125	67.0	76.7	59.5	17.2
9	.985	.073	.936	.137	65.7	76.2	57.0	19.2
10	.970	.047	.912	.135	65.5	75.5	56.7	18.8
11	.948	.015	.910	.105	66.8	78.0	57.5	20.5
12	.962	.042	.924	.118	66.8	74.5	60.5	14.0
13	.977	.058	.923	.135	65.7	76.5	57.2	19.3
14	.996	.072	.943	.129	65.7	77.5	56.2	21.3
15	.986	.067	.931	.136	66.8	78.4	57.3	21.1
16	.971	.041	.901	.140	68.9	79.5	60.0	19.5
17	.945	.004	.900	.104	70.0	79.2	61.2	18.0
18	.982	.062	.930	.132	72.7	79.4	67.8	11.6
19	30.005	.106	.943	.163	72.3	79.8	65.4	14.4
20	29.976	.076	.897	.179	68.8	75.7	62.6	13.1
21	.943	.022	.881	.141	66.1	75.0	58.3	16.7
22	.959	.022	.913	.109	66.9	76.6	60.0	16.6
23	.989	.065	.932	.133	68.7	78.8	60.5	18.3
24	.984	.053	.947	.106	70.0	80.3	62.4	17.9
25	.977	.062	.923	.139	71.3	81.5	63.5	18.0
26	30.037	.119	.960	.159	69.3	76.9	62.2	14.7
27	.057	.148	.996	.152	65.6	75.0	57.5	17.5
28	.032	.115	.966	.149	64.5	74.7	55.5	19.2
29	.011	.099	.944	.155	66.8	77.3	58.4	18.9
30	.013	.099	.962	.137	69.4	79.5	61.0	18.5
31	.029	.104	.988	.116	70.9	81.0	61.6	19.4

The Mean Height of the Barometer, as likewise the Dry and Wet Bulb Thermometer Means are derived, from the hourly observations, made at the several hours during the day.

*Abstract of the Results of the Hourly Meteorological Observations
taken at the Surveyor General's Office, Calcutta,
in the month of January 1871.*

Daily Means, &c. of the Observations and of the Hygrometrical elements
dependent thereon.—(Continued.)

Date.	Mean Wet Bulb Ther- mometer.	Dry Bulb above Wet.	Computed Dew Point.	Dry Bulb above Dew Point.	Mean Elastic force of vapour.	Mean Weight of Vapour in a Cubic foot of air.	Additional Weight of Vapour required for complete saturation.	Mean degree of Humi- dity, complete satu- ration being unity.
	o	o	o	o	Inches.	T. gr.	T. gr.	
1	65.0	6.5	59.8	11.7	0.520	5.69	2.69	0.68
2	66.3	6.6	61.0	11.9	.541	.93	.80	.68
3	59.0	8.1	52.5	14.6	.407	4.50	.82	.62
4	55.9	6.4	50.1	12.2	.375	.19	.12	.66
5	56.0	5.7	50.9	10.8	.385	.31	1.88	.70
6	58.6	5.3	53.8	10.1	.425	.73	.90	.71
7	60.7	5.0	56.7	9.0	.469	5.19	.83	.74
8	60.9	6.1	56.0	11.0	.458	.07	2.23	.70
9	59.4	6.3	54.4	11.3	.434	4.81	.21	.69
10	59.0	6.5	53.8	11.7	.425	.71	.27	.68
11	60.5	6.3	55.5	11.3	.450	.99	.27	.69
12	60.0	6.8	54.6	12.2	.437	.84	.42	.67
13	58.0	7.7	51.8	13.9	.397	.40	.62	.63
14	58.0	7.7	51.8	13.9	.397	.40	.62	.63
15	58.5	8.3	51.9	14.9	.398	.41	.85	.61
16	60.9	8.0	54.5	14.4	.435	.80	.94	.62
17	63.0	7.0	57.4	12.6	.480	5.27	.73	.66
18	66.1	6.6	60.8	11.9	.537	.88	.80	.68
19	65.2	7.1	59.5	12.8	.515	.63	.95	.66
20	61.9	6.9	56.4	12.4	.464	.11	.60	.66
21	59.7	6.4	54.6	11.5	.437	4.84	.26	.68
22	60.4	6.5	55.2	11.7	.445	.93	.35	.68
23	61.8	6.9	56.3	12.4	.462	5.10	.59	.66
24	63.6	6.4	58.5	11.5	.498	.47	.53	.68
25	65.8	5.5	61.4	9.9	.548	6.02	.31	.72
26	61.9	7.4	56.0	13.3	.458	5.05	.78	.65
27	56.5	9.1	49.2	16.4	.363	4.04	.96	.58
28	56.8	7.7	50.6	13.9	.381	.24	.52	.63
29	59.6	7.2	53.8	13.0	.425	.70	.56	.65
30	63.0	6.4	57.9	11.5	.488	5.36	.50	.68
31	64.9	6.0	60.1	10.8	.525	.76	.47	.70

All the Hygrometrical elements are computed by the Greenwich Constants.

*Abstract of the Results of the Hourly Meteorological Observations
taken at the Surveyor General's Office, Calcutta,
in the month of January 1871.*

Hourly Means, &c. of the Observations and of the Hygrometrical elements dependent thereon.

Hour.	Mean Height of the Barometer at 32° Falt.	Range of the Barometer for each hour during the month.			Mean Dry Bulb Thermometer.	Range of the Temperature for each hour during the month.		
		Max.	Min.	Diff.		Max.	Min.	Diff.
	Inches.	Inches.	Inches.	Inches.	o	o	o	o
Mid-night.	29.981	30.064	29.896	0.168	63.9	71.5	58.3	13.2
1	.972	.049	.892	.157	63.2	70.0	57.2	12.8
2	.964	.038	.883	.155	62.5	69.4	56.0	13.4
3	.957	.031	.894	.137	61.9	68.5	55.7	12.8
4	.956	.026	.895	.131	61.3	68.0	55.5	12.5
5	.964	.051	.906	.145	60.8	67.8	55.0	12.8
6	.977	.072	.916	.156	60.4	68.0	54.2	13.8
7	30.001	.101	.941	.160	60.1	68.0	54.0	14.0
8	.031	.120	.970	.150	62.3	68.4	57.7	10.7
9	.057	.148	.991	.157	65.5	71.7	59.7	12.0
10	.061	.142	.998	.144	69.2	75.5	62.5	13.0
11	.043	.114	.976	.138	72.0	77.5	65.0	12.5
Noon.	.014	.082	.941	.141	74.0	79.0	67.0	12.0
1	29.979	.046	.899	.147	75.6	80.4	68.5	11.9
2	.954	.028	.873	.155	76.5	81.2	69.4	11.8
3	.939	.013	.851	.162	77.1	81.6	70.0	11.6
4	.931	.014	.843	.171	76.1	80.5	69.0	11.5
5	.934	.022	.846	.176	74.8	79.5	67.9	11.6
6	.943	.010	.855	.185	71.8	76.7	65.5	11.2
7	.959	.056	.870	.186	69.6	74.3	63.2	11.1
8	.978	.067	.880	.187	67.8	72.6	61.6	11.0
9	.992	.079	.893	.186	66.7	72.6	60.5	12.1
10	.998	.082	.899	.183	65.6	72.0	59.5	12.5
11	.993	.075	.894	.181	64.8	71.8	58.6	13.2

The Mean Height of the Barometer, as likewise the Dry and Wet Bulb Thermometer Means are derived from the observations made at the several hours during the month.

*Abstract of the Results of the Hourly Meteorological Observations
taken at the Surveyor General's Office, Calcutta,
in the month of January 1871.*

Hourly Means, &c. of the Observations and of the Hygrometrical elements
dependent thereon.—(Continued.)

Hour.	Mean Wet Bulb Ther- mometer.	Dry Bulb above Wet.	Computed Dew Point.	Dry Bulb above Dew Point.	Mean Elastic force of Vapour.	Mean Weight of Vapour in a Cubic foot of air.	Additional Weight of Vapour required for complete saturation.	Mean degree of Humi- dity, complete satura- tion being unity.
	o	o	o	o	Inches.	T. gr.	T. gr.	
Mid- night.	60.1	3.8	56.7	7.2	0.469	5.22	1.41	0.79
1	59.6	3.6	56.4	6.8	.464	.17	.32	.80
2	59.2	3.3	56.2	6.3	.461	.15	.20	.81
3	58.6	3.3	55.6	6.3	.452	.06	.17	.81
4	58.2	3.1	55.4	5.9	.449	.02	.10	.82
5	57.7	3.1	54.9	5.9	.441	4.94	.08	.82
6	57.4	3.0	54.7	5.7	.438	.91	.04	.83
7	57.1	3.0	54.4	5.7	.434	.86	.03	.83
8	58.1	4.2	54.3	8.0	.432	.83	.48	.77
9	59.8	5.7	55.2	10.3	.445	.95	2.03	.71
10	61.1	8.1	54.6	14.6	.437	.81	3.00	.62
11	62.0	10.0	54.0	18.0	.428	.69	.81	.55
Noon.	62.4	11.6	54.3	19.7	.432	.71	4.33	.52
1	63.0	12.6	54.2	21.4	.431	.68	.80	.49
2	63.0	13.5	53.5	23.0	.421	.57	5.18	.47
3	63.4	13.7	53.8	23.3	.425	.61	.31	.47
4	63.0	13.1	53.8	22.3	.425	.62	.01	.48
5	63.2	11.6	55.1	19.7	.444	.84	4.42	.52
6	63.9	7.9	57.6	14.2	.483	5.29	3.16	.63
7	63.4	6.2	58.4	11.2	.496	.46	2.44	.69
8	62.6	5.2	58.4	9.4	.496	.48	.00	.73
9	62.0	4.7	58.2	8.5	.493	.45	1.78	.75
10	61.4	4.2	58.0	7.6	.489	.42	.58	.77
11	60.7	4.1	57.4	7.4	.480	.33	.50	.78

All the Hygrometrical elements are computed by the Greenwich Constants.

Abstract of the Results of the Hourly Meteorological Observations
 taken at the Surveyor General's Office, Calcutta,
 in the month of January 1871.
 Solar Radiation, Weather, &c.

Date.	Max. Solar radiation.	Rain Gauge 1½ ft. above Ground.	WIND.			General aspect of the Sky.
			Prevailing direction.	Max. Pressure.	Daily Velocity.	
	o	Inches		lb	Miles	
1	135.2	...	W by N	...	100.6	B to 3 A.M., \i to 12 A.M., B afterwards. Slightly foggy at midnight, 1 A. M., & 8 P. M.
2	135.0	...	W S W & W N W	...	143.6	B. Slightly foggy from 7 to 10 P. M.
3	129.8	...	NW, N & N N W	...	185.0	B to 2 A. M., \i to 6 A. M., B afterwards. Foggy from 7 to 11 P. M.
4	129.5	...	N W & N N W.	0.3	136.0	B. Foggy at midnight & 1 A. M., & from 8 to 11 P. M.
5	126.5	...	NW, NNW & WN	...	159.4	B. Foggy at midnight & 1 A. M., & from 8 to 11 P. M.
6	128.0	...	W N W & N	...	143.6	B to 6 A. M., \i afterwards. Slightly foggy at midnight.
7	128.8	...	N by E & N W	...	126.9	B to 10 A. M., \i to 7 P. M. \i afterwards. Foggy from 9 to 11 P. M.
8	131.2	...	NW & W N W.	...	104.4	\i to 7 A. M., \i & \i to 6 P. M., B afterwards. Foggy from 8 to 11 P. M.
9	130.0	...	W N W & NNW	...	105.7	B to 11 A. M., \i to 6 P. M., B afterwards. Slightly foggy from midnight to 8 A. M., & 8 to 11 P. M.
10	132.5	...	N N W & W N W	...	108.0	\i & \i to 6 P. M., B afterwards. Slightly foggy from 7 to 11 P. M.
11	131.0	...	W N W & W by N	...	77.0	B. Slightly foggy from midnight to 6 A. M., & 8 to 11 P. M.
12	123.8	...	W N W.	...	107.4	B to 2 A. M., \i to 6 P. M., B afterwards.
13	130.0	...	W N W.	...	106.6	B. Slightly foggy from 9 to 11 P. M.
14	133.5	...	W by N & ENE.	...	73.0	B. Slightly foggy from midnight to 6 A. M.
15	133.0	...	E N E & N.	...	126.0	B to 7 A. M., \i to 10 A. M., B to 2 P. M., \i to 6 P. M., B afterwards. Slightly foggy from 7 to 11 P. M.
16	137.6	...	N N E & N.	...	150.6	B to 6 A. M., \i to 4 P. M., B afterwards.
17	137.8	...	NNE, NE & N by E	...	136.7	B to 5 A. M., \i afterwards.

\i Cirri, —i Strati, \i Cumuli, \i Ciro-strati, ~i Cumulo-strati, \i Nimbi, \i Cirro-cumuli, B clear, S stratoni, O overcast, T thunder, L lightning R rain, D drizzle.

*Abstract of the Results of the Hourly Meteorological Observations
taken at the Surveyor General's Office, Calcutta,
in the month of January 1871.
Solar Radiation, Weather, &c.*

Date.	Max. Solar radiation.	Rain Gauge 1½ ft. above Ground.	WIND.		General aspect of the Sky.	
			Prevailing direction.	Max. Pressure		
	°	Inches		lb	Miles	
18	124.3	...	NE, N by E & NNE	...	81.7	☽ i to 4 A. M., O to 9 A. M., S to 3 P. M., ☽ i to 7 P. M., S afterwards. Slightly foggy from 9 to 11 P. M., D at 5½ & 11 A. M.
19	134.5	...	N & N W	...	98.2	Chiefly B. Slightly foggy at midnight & 1 A. M.
20	135.0	...	N W & W	...	156.1	B. Slightly foggy at 10 & 11 P. M.
21	134.5	...	W & W by N	...	109.1	B. Slightly foggy at midnight.
22	134.0	...	W by N & WSW	...	105.6	B. Slightly foggy from 8 to 11 P. M.
23	134.5	...	W S W & W.	...	77.3	B.
24	138.0	...	W & WSW. [W	...	99.7	B.
25	136.2	...	W S W, SW & SS	...	129.3	B.
26	134.0	...	WNW & Variable,	...	146.0	O to 7 A. M., B afterwards. Foggy from 1 to 4 A. M.
27	133.5	...	W N W & W	0.8	126.2	B. Slightly foggy from 7 to 11 P. M.
28	133.0	...	W & W by S	...	96.5	B. Slightly foggy at midnight from 5 to 7 A. M. & 9 to 11 P. M.
29	131.5	...	W by S & W	...	109.0	B. to 1 P. M., ☽ i to 4 P. M., B. afterwards.
30	131.5	...	W by S & W	...	104.9	B. to 12 A. M., ☽ i, to 3 P. M., B afterwards
31	136.5	...	W by S & W	...	78.1	B. Slightly foggy from 7 to 9 P. M.

☽ i Cirri, — i Strati, ☽ i Cumuli, ☽ i Cirro-strati, ☽ i Cumulo-strati, ☽ i Nimbi, ☽ i Cirro-cumuli, B clear, S stratoni, O overcast, T thunder, L lightning, P rain, D drizzle.

*Abstract of the Results of the Hourly Meteorological Observations
taken at the Surveyor General's Office, Calcutta,
in the month of January 1871.*

MONTHLY RESULTS.

	Inches.
Mean height of the Barometer for the month... ..	29.983
Max. height of the Barometer occurred at 9 A. M. on the 27th. ...	30.148
Min. height of the Barometer occurred at 4 P. M. on the 1st. ...	29.843
<i>Extreme range</i> of the Barometer during the month	0.305
Mean of the daily Max. Pressures	30.062
Ditto ditto Min. ditto	29.926
<i>Mean daily range</i> of the Barometer during the month	0.136

	°
Mean Dry Bulb Thermometer for the month	67.6
Max. Temperature occurred at 3 P. M. on the 1st.	81.6
Min. Temperature occurred at 7 A. M. on the 5th.	54.0
<i>Extreme range</i> of the Temperature during the month	27.6
Mean of the daily Max. Temperature	77.1
Ditto ditto Min. ditto,	59.8
<i>Mean daily range</i> of the Temperature during the month... ..	17.3

Mean Wet Bulb Thermometer for the month	60.9
Mean Dry Bulb Thermometer above Mean Wet Bulb Thermometer	6.7
Computed Mean Dew-point for the month	55.5
Mean Dry Bulb Thermometer above computed mean Dew-point	12.1

	Inches.
Mean Elastic force of Vapour for the month	0.450

	Troy grain.
Mean Weight of Vapour for the month	4.98
Additional Weight of Vapour required for complete saturation	2.46
Mean degree of humidity for the month, complete saturation being unity 0.67	

	°
Mean Max. Solar radiation Thermometer for the month	132.4

	Inches.
Drizzled 1 day,—Max. fall of rain during 24 hours	Nil.
Total amount of rain during the month	Nil.
Total amount of rain indicated by the Gauge* attached to the anemometer during the month	Nil.
Prevailing direction of the Wind... ..	W N W, & W.

* Height 70 feet 10 inches above ground.

Abstract of the Results of the Hourly Meteorological Observations taken at the Surveyor General's Office, Calcutta, in the month of February 1871.

Latitude 22° 33' 1" North. Longitude 88° 20' 34" East.

Height of the Cistern of the Standard Barometer above the sea level, 18.11 feet.

Daily Means, &c. of the Observations and of the Hygrometrical elements dependent thereon.

Date.	Mean Height of the Barometer at 32° Fahr.	Range of the Barometer during the day.			Mean Dry Bulb Thermometer.	Range of the Temperature during the day.		
		Max.	Min.	Diff.		Max.	Min.	Diff.
	Inches.	Inches.	Inches.	Inches.	o	o	o	o
1	30.028	30.116	29.958	0.158	71.4	81.8	64.9	16.9
2	29.952	.037	.887	.150	71.2	83.2	60.5	22.7
3	.906	29.970	.840	.130	73.9	83.5	68.8	14.7
4	.909	.991	.834	.160	71.3	80.5	63.0	17.5
5	.868	.937	.803	.134	70.6	80.5	62.3	18.2
6	.894	.981	.841	.140	71.8	82.5	62.0	20.5
7	.903	.976	.847	.129	72.5	81.4	64.5	16.9
8	.895	.959	.838	.121	73.6	84.0	65.5	18.5
9	.899	.978	.850	.128	74.1	83.5	65.4	18.1
10	.899	.967	.840	.127	74.6	85.0	66.5	18.5
11	.912	.995	.865	.130	75.6	86.0	68.0	18.0
12	.893	.952	.840	.112	75.4	86.0	68.2	17.8
13	.882	.964	.809	.155	76.4	88.6	68.5	20.1
14	.887	.953	.839	.114	77.1	89.5	69.0	20.5
15	.885	.956	.837	.119	78.8	90.5	70.6	19.9
16	.872	.959	.816	.143	76.9	86.8	68.9	17.9
17	.916	30.019	.877	.142	69.9	74.0	66.7	7.3
18	.901	29.986	.836	.150	72.0	80.9	65.5	15.4
19	.926	.995	.865	.130	73.6	82.0	66.5	15.5
20	.926	.995	.866	.129	72.2	80.4	66.0	14.4
21	.955	30.031	.905	.126	71.3	80.4	62.0	18.4
22	.936	.025	.877	.148	74.5	85.0	65.2	19.8
23	.873	29.944	.809	.135	77.4	87.5	68.8	18.7
24	.890	.962	.830	.132	80.0	89.6	73.7	15.9
25	.915	.995	.847	.148	78.3	86.8	72.5	14.3
26	.905	.990	.833	.157	75.4	82.5	69.8	12.7
27	.878	.962	.836	.126	74.6	83.0	68.3	14.7
28	.896	.981	.841	.140	74.9	85.5	65.0	20.5

The Mean Height of the Barometer, as likewise the Dry and Wet Bulb Thermometer Means are derived, from the hourly observations, made at the several hours during the day.

*Abstract of the Results of the Hourly Meteorological Observations
taken at the Surveyor General's Office, Calcutta,
in the month of February 1871.*

Daily Means, &c. of the Observations and of the Hygrometrical elements
dependent thereon.—(Continued.)

Date.	Mean Wet Bulb Ther- mometer.	Dry Bulb above Wet.	Computed Dew Point.	Dry Bulb above Dew Point.	Mean Elastic force of vapour.	Mean Weight of Vapour in a Cubic foot of air.	Additional Weight of Vapour required for complete saturation.	Mean degree of Humi- dity, complete satu- ration being unity.
	o	o	o	o	Inches.	T. gr.	T. gr.	
1	64.8	6.6	59.5	11.9	0.515	5.64	2.71	0.68
2	63.5	7.7	57.3	13.9	.478	.24	3.06	.63
3	67.6	6.3	63.2	10.7	.582	6.35	2.66	.71
4	61.8	9.5	54.2	17.1	.431	4.72	3.61	.57
5	62.8	7.8	56.6	14.0	.467	5.13	.02	.63
6	64.1	7.7	57.9	13.9	.488	.34	.11	.63
7	65.9	6.6	60.6	11.9	.534	.84	2.79	.68
8	65.5	8.1	59.8	13.8	.520	.67	3.26	.64
9	66.4	7.7	61.0	13.1	.541	.90	.17	.65
10	68.6	6.0	64.4	10.2	.605	6.61	2.59	.72
11	68.9	6.7	64.2	11.4	.601	.54	.94	.69
12	69.5	5.9	65.4	10.0	.626	.81	.62	.72
13	69.4	7.0	64.5	11.9	.607	.60	3.12	.68
14	70.5	6.6	65.9	11.2	.636	.90	.02	.70
15	68.9	9.9	62.0	16.8	.559	.04	4.40	.58
16	69.2	7.7	63.8	13.1	.593	.44	3.42	.65
17	65.7	4.2	62.3	7.6	.565	.21	1.77	.78
18	66.9	5.1	62.8	9.2	.574	.29	2.21	.74
19	67.7	5.9	63.6	10.0	.590	.44	.49	.72
20	64.8	7.4	58.9	13.3	.504	5.52	3.03	.65
21	62.5	8.8	55.5	15.8	.450	4.94	.39	.59
22	67.8	6.7	63.1	11.4	.580	6.33	2.85	.69
23	72.3	5.1	68.7	8.7	.697	7.55	.46	.75
24	74.9	5.1	71.3	8.7	.758	8.18	.63	.76
25	71.8	6.5	67.2	11.1	.664	7.19	3.09	.70
26	66.1	9.3	59.6	15.8	.516	5.61	.82	.60
27	63.8	10.8	56.2	18.4	.461	.02	4.18	.55
28	66.9	8.0	61.3	13.6	.546	.95	3.33	.64

All the Hygrometrical elements are computed by the Greenwich Constants

*Abstract of the Results of the Hourly Meteorological Observations
taken at the Surveyor General's Office, Calcutta,
in the month of February 1871.*

Hourly Means, &c. of the Observations and of the Hygrometrical elements dependent thereon.

Hour:	Mean Height of the Barometer at 32° Fahr.	Range of the Barometer for each hour during the month.			Mean Dry Bulb Thermometer.	Range of the Temperature for each hour during the month.		
		Max.	Min.	Diff.		Max.	Min.	Diff.
	Inches.	Inches.	Inches.	Inches.	o	o	o	o
Mid-night.	29.914	30.042	29.872	0.170	70.3	76.0	65.5	10.5
1	.906	.035	.860	.175	69.7	75.5	64.5	11.0
2	.898	.032	.855	.177	69.1	75.3	63.7	11.6
3	.889	.024	.846	.178	68.5	75.0	63.0	12.0
4	.882	.027	.837	.190	68.0	74.7	62.0	12.7
5	.891	.041	.843	.198	67.6	74.5	61.5	13.0
6	.903	.057	.861	.196	67.1	74.5	61.0	13.5
7	.928	.066	.888	.178	67.0	73.7	60.5	13.2
8	.951	.090	.913	.177	69.2	76.5	63.8	12.7
9	.975	.113	.927	.186	72.1	78.7	66.5	12.2
10	.983	.116	.937	.179	75.2	81.5	70.0	11.5
11	.973	.102	.910	.192	78.2	84.5	72.0	12.5
Noon.	.946	.067	.890	.177	80.3	86.5	66.7	19.8
1	.910	.033	.841	.192	81.9	88.2	68.8	19.4
2	.879	.002	.819	.183	83.1	89.4	69.5	19.9
3	.861	29.979	.803	.176	83.7	90.5	70.0	20.5
4	.853	.963	.803	.160	83.4	90.3	69.5	20.8
5	.855	.958	.809	.149	82.2	88.4	68.0	20.4
6	.861	.964	.819	.145	79.2	84.5	68.4	16.1
7	.873	.978	.833	.145	76.3	81.5	68.0	13.5
8	.894	.992	.849	.143	74.4	79.0	67.8	11.2
9	.910	.999	.860	.139	72.7	77.0	67.7	9.3
10	.916	30.002	.874	.128	71.8	76.3	67.5	8.8
11	.916	29.991	.881	.110	71.2	76.3	66.5	9.8

The Mean Height of the Barometer, as likewise the Dry and Wet Bulb Thermometer Means are derived from the observations made at the several hours during the month.

*Abstract of the Results of the Hourly Meteorological Observations
taken at the Surveyor General's Office, Calcutta,
in the month of February 1871.*

Hourly Means, &c. of the Observations and of the Hygrometrical elements
dependent thereon.—(Continued.)

Hour.	Mean Wet Bulb Ther- mometer.	Dry Bulb above Wet.	Computed Dew Point.	Dry Bulb above Dew Point.	Mean Elastic force of Vapour.	Mean Weight of Vapour in a Cubic foot of air.	Additional Weight of Vapour required for complete saturation.	Mean degree of Humi- dity, complete satura- tion being unity.
	o	o	o	o	Inches.	T. gr.	T. gr.	
Mid- night.	66.5	3.8	63.5	6.8	0.588	6.46	1.62	0.80
1	66.2	3.5	63.4	6.3	.586	.45	.48	.81
2	65.9	3.2	63.3	5.8	.584	.43	.35	.83
3	65.7	2.8	63.5	5.0	.588	.48	.17	.85
4	65.4	2.6	63.3	4.7	.584	.44	.09	.86
5	65.1	2.5	63.1	4.5	.580	.41	.03	.86
6	64.8	2.3	63.0	4.1	.578	.40	0.92	.87
7	64.5	2.5	62.5	4.5	.568	.29	1.01	.86
8	65.7	3.5	62.9	6.3	.576	.35	.46	.81
9	66.9	5.2	62.7	9.4	.572	.27	2.26	.74
10	67.9	7.3	62.8	12.4	.574	.26	3.11	.67
11	68.4	9.8	61.5	16.7	.550	5.95	4.30	.58
Noon.	68.4	11.9	60.1	20.2	.525	.65	5.26	.52
1	68.6	13.3	59.3	22.6	.511	.48	.96	.48
2	68.6	14.5	58.4	24.7	.496	.31	6.55	.45
3	68.5	15.2	57.9	25.8	.488	.21	.86	.43
4	68.2	15.2	57.6	25.8	.483	.16	.80	.43
5	68.2	14.0	58.4	23.8	.496	.31	.23	.46
6	69.2	10.0	62.2	17.0	.563	6.08	4.48	.58
7	68.3	8.0	62.7	13.6	.572	.21	3.48	.64
8	67.4	6.6	63.2	11.2	.582	.35	2.80	.69
9	67.4	5.3	63.2	9.5	.582	.36	.32	.73
10	67.0	4.8	63.2	8.6	.582	.37	.08	.75
11	66.8	4.4	63.3	7.9	.584	.41	1.89	.77

All the Hygrometrical elements are computed by the Greenwich Constants.

Abstract of the Results of the Hourly Meteorological Observations
 taken at the Surveyor General's Office, Calcutta,
 in the month of February 1871.
 Solar Radiation, Weather, &c.

Date.	Max. Solar radiation.	Rain Gauge 1½ ft. above Ground.	WIND.			General aspect of the Sky.
			Prevailing direction.	Max. Pressure.	Daily Velocity.	
1	138.0	...	W & W N W	...	78.7	B. Foggy from 3 to 8 A. M., & 8 to 10 P. M.
2	138.0	...	W, W S W & S W	...	89.3	B to 6 P. M., \i afterwards. Slightly foggy at 6 & 7 A. M.
3	138.0	...	S S W & W	...	112.3	S to 7 A. M., \i to 6 P. M., B, afterwards. Slightly foggy from 1 to 5 A. M., & 8 to 11 P. M.
4	137.2	...	W S W & W by S	...	119.0	B. Foggy at 8 & 9 P. M.
5	135.5	...	S by W & W by S	...	89.7	B to 10 A. M., \i to 4 P. M. B, afterwards.
6	137.8	...	S S E & S by E	...	81.0	B.
7	134.7	...	S, S S E & S by E	...	76.6	B. to 11 A. M., \i to 2 P. M., \i to 5 P. M., B afterwards. Foggy from 6 to 8 A. M.
8	135.0	...	S & S S E	...	80.8	B.
9	134.0	...	S S W & W S W	...	80.0	B. Slightly foggy at 8 P. M.
10	136.0	...	S W & S S W	...	92.2	B. Foggy from 5 to 7 A. M.
11	138.5	...	S S W & S W	...	102.1	B.
12	137.0	...	S S W	...	142.1	B. Foggy from 2 to 5 A. M.
13	139.5	...	SSW, SW & S by W	...	187.3	B. Slightly foggy at 4 & 5 A. M.
14	135.5	...	S by W & S S W	...	107.1	B. Foggy from 3 to 8 A. M.
15	140.0	...	S S W & S W	...	126.0	B.
16	141.3	...	S W & Variable,	...	165.5	B to 6 A. M., \i to 5 P. M., B afterwards. Smart Shocks of Earthquake felt at 5¼ A. M.
17	...	0.25	Variable	...	132.0	\i to 10 A. M., O afterwards. R at 11 & 12 A. M., & 4 & 6 P. M.
18	136.2	...	W	...	131.3	Clouds of different kinds to 4 P. M., B afterwards.
19	141.3	0.10	W by N & S W	9.0	96.1	\i to 5 A. M., \i to 11 A. M., \i to 6 P. M., clouds of different kinds afterwards. L from 7 to 9 & at 11 P. M., T & R at 8 P. M.
20	135.5	...	S W & W by N	...	111.9	S to 4 A. M., \i to 10 A. M., B afterwards. Slightly foggy from 9 to 11 P. M.
21	140.0	...	WN W & W by S	...	100.0	B. Slightly foggy at midnight, & 1 A. M.
22	139.0	...	W S W & S W	...	109.9	B.
23	141.0	...	S by W, S & S S W	...	126.5	Chiefly B. Foggy at 6 A. M.
24	142.0	0.40	S by W & S S W	...	128.8	Clouds of various kinds. T at 6½ & 7 P. M., L from 6½ to 8 P. M., R at 6, 7 & 10½ P. M.

\i Cirri, —i Strati, ^i Cumuli, \i Ciro-strati, ~i Cumulo-strati, ~i Nimbi, \i Cirro-cumuli, B clear, S strati, O overcast, T thunder, L lightning
 P rain, D drizzle

*Abstract of the Results of the Hourly Meteorological Observations
taken at the Surveyor General's Office, Calcutta,
in the month of February 1871.*

Solar Radiation, Weather, &c.

Date.	Max. Solar radiation.	Rain Gauge 1½ ft. above Ground.	WIND.			General aspect of the Sky.
			Prevailing direction.	Max. Pressure	Daily Velocity.	
	o	Inches		lb	Miles	
25	139.0	...	S S W & W	...	195.6	B. Slightly foggy at 8 & 9 P M.
26	139.0	...	W by N & W by S	...	144.4	B.
27	140.0	...	W S W, W & W by S	...	101.1	B. Foggy from 4 to 7 A. M.
28	141.0	...	W S W, W by S, & S W.	...	101.2	B.

∩i Cirri,—i Strati, ∩i Cumuli, ∩i Cirro-strati, ∩i Cumulo-strati, ∩i Nimbi,
∩i Cirro-cumuli, B clear, S stratoni, O overcast, T thunder, L lightning,
R rain, D drizzle.

*Abstract of the Results of the Hourly Meteorological Observations
taken at the Surveyor General's Office, Calcutta,
in the month of February 1871.*

MONTHLY RESULTS.

	Inches.
Mean height of the Barometer for the month... ..	29.907
Max. height of the Barometer occurred at 10 A. M. on the 1st.	30.116
Min. height of the Barometer occurred at 3 & 4 P. M. on the 5th.	29.803
<i>Extreme range</i> of the Barometer during the month	0.313
Mean of the daily Max. Pressures	29.985
Ditto ditto Min. ditto	29.849
<i>Mean daily range</i> of the Barometer during the month	0.136

	°
Mean Dry Bulb Thermometer for the month	74.3
Max. Temperature occurred at 3 P. M. on the 15th.	90.5
Min. Temperature occurred at 7 A. M. on the 2nd.	60.5
<i>Extreme range</i> of the Temperature during the month	30.0
Mean of the daily Max. Temperature	84.0
Ditto ditto Min. ditto,	66.7
<i>Mean daily range</i> of the Temperature during the month... ..	17.3

Mean Wet Bulb Thermometer for the month	67.1
Mean Dry Bulb Thermometer above Mean Wet Bulb Thermometer	7.2
Computed Mean Dew-point for the month	62.1
Mean Dry Bulb Thermometer above computed mean Dew-point	12.2

Inches.

Mean Elastic force of Vapour for the month	0.561
---	-------

Troy grain.

Mean Weight of Vapour for the month	6.12
Additional Weight of Vapour required for complete saturation	3.00
Mean degree of humidity for the month, complete saturation being unity	0.67

°

Mean Max. Solar radiation Thermometer for the month	138.1
--	-------

Inches.

Rained 3 days,—Max. fall of rain during 24 hours	0.40
Total amount of rain during the month	0.75
Total amount of rain indicated by the Gauge* attached to the anemometer during the month	0.63
Prevailing direction of the Wind... ..	S S W, & S W.

* Height 70 feet 10 inches above ground.

Abstract of the Results of the Hourly Meteorological Observations taken at the Surveyor General's Office, Calcutta, in the month of Feb. 1871.

MONTHLY RESULTS.

Tables shewing the number of days on which at a given hour any particular wind blew, together with the number of days on which at the same hour, when any particular wind was blowing, it rained.

Hour.	N.	Rain on.	N. by E.	Rain on.	N. N. E.	Rain on.	E. N. E.	Rain on.	E. S. E.	Rain on.	S. E.	Rain on.	S. S. E.	Rain on.	S. S. W.	Rain on.	S. W.	Rain on.	W. S. W.	Rain on.	W. by N.	Rain on.	W. N. W.	Rain on.	N. W.	Rain on.	N. N. W.	Rain on.	N. by W.	Rain on.
Mid night.																														
1			1																				2		1					
2			1																				1							
3			1																				1							
4			2																				1							
5			1																				1							
6			1																				1							
7			1																				1							
8			1																				1							
9			1																				1							
10	1		1																				4							
11			1																				1							
Noon.	1		1																				2							
1			1																				3							
2			1																				1							
3			2																				3							
4			1																				2							
5			1																				3							
6			1																				1							
7			2																				2							
8			2																				3							
9			1																				5							
10			1																				3							
11			1																				3							

*Abstract of the Results of the Hourly Meteorological Observations
taken at the Surveyor General's Office, Calcutta,
in the month of March 1871.*

Latitude 22° 33' 1" North. Longitude 88° 20' 34" East.

Height of the Cistern of the Standard Barometer above the sea level, 18.11 feet.

Daily Means, &c. of the Observations and of the Hygrometrical elements
dependent thereon.

Date.	Mean Height of the Barometer at 32° Fahr.	Range of the Barometer during the day.			Mean Dry Bulb Thermometer.	Range of the Tempera- ture during the day.		
		Max.	Min.	Diff.		Max.	Min.	Diff.
	Inches.	Inches.	Inches.	Inches.	o	o	o	o
1	29.882	29.950	29.809	0.141	76.2	81.3	70.0	14.3
2	.923	30.012	.845	.167	69.2	70.5	67.0	3.5
3	.845	29.928	.789	.139	68.0	70.5	65.0	5.5
4	.847	.916	.788	.128	69.8	77.1	64.0	13.1
5	.953	30.034	.902	.132	71.8	79.5	66.0	13.5
6	.969	.650	.917	.133	73.2	82.0	65.4	16.6
7	.913	29.981	.846	.135	75.4	83.8	69.0	14.8
8	.944	30.028	.883	.145	74.0	82.5	67.0	15.5
9	.937	.009	.870	.139	76.2	86.7	67.5	19.2
10	.885	29.957	.812	.145	78.0	88.2	70.5	17.7
11	.880	.940	.816	.124	79.2	89.9	72.2	16.8
12	.891	.962	.831	.131	80.9	91.0	73.5	17.5
13	.859	.944	.782	.162	81.1	91.0	74.0	17.0
14	.784	.860	.711	.149	82.4	92.3	74.0	18.3
15	.698	.758	.638	.120	83.1	93.5	74.5	19.0
16	.762	.851	.669	.182	82.6	91.5	74.5	17.0
17	.849	.942	.793	.149	78.2	87.0	70.3	16.7
18	.836	.918	.788	.130	77.7	87.0	68.4	18.6
19	.837	.908	.783	.125	78.9	89.8	71.5	18.3
20	.884	.966	.831	.132	80.8	91.0	74.5	16.5
21	.868	.940	.793	.147	81.7	93.0	72.0	21.0
22	.837	.906	.778	.128	83.4	94.0	74.5	19.5
23	.854	.934	.791	.143	83.5	95.0	75.5	19.5
24	.818	.900	.746	.154	83.8	96.0	73.8	22.2
25	.776	.844	.717	.127	84.1	95.0	77.0	18.0
26	.797	.858	.730	.128	84.9	97.7	76.5	21.2
27	.849	.929	.779	.150	83.4	92.4	76.5	15.9
28	.832	.912	.768	.144	85.2	94.0	79.3	14.7
29	.818	.896	.754	.142	83.5	92.2	76.0	16.2
30	.761	.854	.642	.212	84.9	97.2	76.5	20.7
31	.750	.825	.666	.159	85.1	95.5	77.7	17.8

The Mean Height of the Barometer, as likewise the Dry and Wet Bulb Thermometer Means are derived, from the hourly observations, made at the several hours during the day.

*Abstract of the Results of the Hourly Meteorological Observations
taken at the Surveyor General's Office, Calcutta,
in the month of March 1871.*

Daily Means, &c. of the Observations and of the Hygrometrical elements
dependent thereon.—(Continued.)

Date.	Mean Wet Bulb Ther- mometer.	Dry Bulb above Wet.	Computed Dew Point.	Dry Bulb above Dew Point.	Mean Elastic force of vapour.	Mean Weight of Vapour in a Cubic foot of air.	Additional Weight of Vapour required for complete saturation.	Mean degree of Humi- dity, complete satu- ration being unity.
	o	o	o	o	Inches.	T. gr.	T. gr.	
1	72.8	3.4	70.4	5.8	0.736	8.00	1.66	0.83
2	68.0	1.2	67.0	2.2	.659	7.27	0.54	.93
3	66.8	1.2	65.8	2.2	.634	.01	.52	.93
4	66.1	3.7	63.1	6.7	.580	6.38	1.57	.80
5	65.9	5.9	61.2	10.6	.544	5.97	2.48	.71
6	67.2	6.0	62.4	10.8	.567	6.19	.63	.70
7	70.0	5.4	66.2	9.2	.642	.99	.44	.74
8	68.3	5.7	64.3	9.7	.603	.59	.45	.73
9	69.0	7.2	64.0	12.2	.597	.49	3.17	.67
10	73.1	4.9	69.7	8.3	.720	7.80	2.39	.77
11	73.7	5.5	69.8	9.4	.722	.81	.75	.74
12	73.6	7.3	68.5	12.4	.692	.47	3.63	.67
13	74.5	6.6	69.9	11.2	.725	.80	.37	.70
14	72.7	9.7	65.9	16.5	.636	6.82	4.79	.59
15	74.5	8.6	68.5	14.6	.692	7.42	.44	.63
16	72.3	10.3	65.1	17.5	.619	6.64	5.04	.57
17	64.4	13.8	54.7	23.5	.438	4.73	.52	.46
18	65.9	11.8	57.6	20.1	.483	5.22	4.88	.52
19	72.3	6.6	67.7	11.2	.674	7.30	3.17	.70
20	72.6	8.2	66.9	13.9	.657	.08	.99	.64
21	72.4	9.3	65.9	15.8	.636	6.83	4.54	.60
22	75.9	7.5	70.6	12.8	.741	7.94	.02	.66
23	73.1	10.4	65.8	17.7	.634	6.79	5.21	.57
24	74.2	9.6	67.5	16.3	.670	7.18	4.92	.59
25	77.7	6.4	73.2	10.9	.806	8.63	3.58	.71
26	74.6	10.3	67.4	17.5	.668	7.12	5.37	.57
27	77.5	5.9	73.4	10.0	.811	8.69	3.27	.73
28	77.8	7.4	72.6	12.6	.790	.43	4.18	.67
29	75.1	8.4	69.2	14.3	.708	7.59	.41	.63
30	77.8	7.1	72.8	12.1	.795	8.50	3.99	.68
31	79.3	5.8	75.2	9.9	.860	9.18	.39	.73

All the Hygrometrical elements are computed by the Greenwich Constants.

*Abstract of the Results of the Hourly Meteorological Observations
taken at the Surveyor General's Office, Calcutta,
in the month of March 1871.*

Hourly Means, &c. of the Observations and of the Hygrometrical elements
dependent thereon.

Hour.	Mean Height of the Barometer at 32° Fahr.	Range of the Barometer for each hour during the month.			Mean Dry Bulb Thermometer.	Range of the Tempera- ture for each hour during the month.		
		Max.	Min.	Diff.		Max.	Min.	Diff.
	Inches.	Inches.	Inches.	Inches.	o	o	o	o
Mid- night.	29.857	29.964	29.703	0.261	75.3	80.8	65.2	15.6
1	.844	.958	.690	.268	74.7	80.5	65.0	15.5
2	.830	.953	.673	.280	74.2	80.0	65.7	14.3
3	.821	.943	.669	.274	73.8	80.0	66.0	14.0
4	.818	.939	.668	.271	73.2	79.8	65.0	14.8
5	.829	.949	.674	.275	72.8	79.6	64.5	15.1
6	.848	.964	.688	.276	72.3	79.5	64.0	15.5
7	.871	.987	.710	.277	72.5	79.3	64.0	15.3
8	.899	30.014	.737	.277	74.8	81.5	65.0	16.5
9	.918	.046	.743	.303	77.4	84.0	66.5	17.5
10	.922	.050	.758	.292	80.2	87.0	68.0	19.0
11	.914	.040	.750	.290	83.1	90.2	68.7	21.5
Noon.	.892	.016	.732	.284	85.2	92.5	69.8	22.7
1	.864	29.992	.718	.274	86.7	94.3	69.5	24.8
2	.834	.958	.686	.272	87.8	96.0	69.7	26.3
3	.808	.933	.668	.265	88.5	97.2	69.5	27.7
4	.797	.920	.650	.270	88.4	97.7	70.4	27.3
5	.792	.924	.638	.286	87.3	96.0	70.0	26.0
6	.798	.927	.650	.277	84.4	92.0	69.3	22.7
7	.815	.935	.672	.263	81.3	87.6	69.2	18.4
8	.836	.957	.684	.273	79.3	85.0	69.0	16.0
9	.854	.968	.699	.269	78.0	83.8	68.0	15.8
10	.864	.971	.708	.263	76.9	81.8	67.0	14.8
11	.862	.971	.703	.268	76.2	81.2	67.0	14.2

The Mean Height of the Barometer, as likewise the Dry and Wet Bulb Thermometer Means are derived from the observations made at the several hours during the month.

*Abstract of the Results of the Hourly Meteorological Observations
taken at the Surveyor General's Office, Calcutta,
in the month of March 1871.*

Hourly Means, &c. of the Observations and of the Hygrometrical elements
dependent thereon.—(Continued.)

Hour.	Mean Wet Bulb Ther- mometer.	Dry Bulb above Wet,	Computed Dew Point.	Dry Bulb above Dew Point.	Mean Elastic force of Vapour.	Mean Weight of Vapour in a Cubic foot of air.	Additional Weight of Vapour required for complete saturation.	Mean degree of Humi- dity, complete satura- tion being unity.
	o	o	o	o	Inches.	T. gr.	F. gr.	
Mid- night.	72.5	2.8	70.5	4.8	0.739	8.05	1.35	0.86
1	72.1	2.6	70.3	4.4	.734	.02	.21	.87
2	71.8	2.4	70.1	4.1	.729	7.97	.12	.88
3	71.4	2.4	69.7	4.1	.720	.87	.11	.88
4	71.1	2.1	69.4	3.8	.713	.80	.02	.88
5	70.8	2.0	69.2	3.6	.708	.75	0.96	.89
6	70.4	1.9	68.9	3.4	.702	.69	.89	.90
7	70.6	1.9	69.1	3.4	.706	.73	.90	.90
8	71.7	3.1	69.5	5.3	.715	.80	1.46	.84
9	72.3	5.1	68.7	8.7	.697	.55	2.46	.75
10	72.3	7.4	67.6	12.6	.672	.25	3.63	.67
11	73.0	10.1	65.9	17.2	.636	6.82	5.04	.58
Noon.	73.0	12.2	64.5	20.7	.607	.48	6.13	.51
1	72.3	14.4	63.7	23.0	.591	.29	.89	.48
2	72.1	15.7	62.7	25.1	.572	.08	7.52	.45
3	72.4	16.1	62.7	25.8	.572	.06	.82	.44
4	72.6	15.8	63.1	25.3	.580	.15	.69	.44
5	73.1	14.2	61.6	22.7	.609	.47	6.94	.48
6	73.9	10.5	66.5	17.9	.648	.93	5.38	.56
7	73.3	8.0	67.7	13.6	.674	7.25	3.99	.65
8	72.7	6.6	68.1	11.2	.684	.38	.21	.70
9	72.5	5.5	68.6	9.4	.695	.53	2.66	.74
10	72.4	4.5	69.2	7.7	.708	.69	.17	.78
11	72.7	3.5	70.2	6.0	.732	.95	1.71	.82

All the Hygrometrical elements are computed by the Greenwich Constants.

Abstract of the Results of the Hourly Meteorological Observations
 taken at the Surveyor General's Office, Calcutta,
 in the month of March 1871.
 Solar Radiation, Weather, &c.

Date.	Max. Solar radiation.	Rain Gauge 1½ ft. above Ground.	WIND.			General aspect of the Sky.
			Prevailing direction.	Max. Pressure	Daily Velocity.	
1	136.5	0.65	S S W & S by W.	...	114.4	B to 3 A. M., S to 9 A. M., i to 4 P. M., O afterwards. T & L from 3¼ to 9 P. M. R at 1, 4 & from 6¼ to 11 P. M.
2	...	3.83	SSE & Variable.	...	178.1	O. T at 2½ A. M., 8 & 10 P. M. L at 2½ A. M. & 8 P. M. R nearly the whole day.
3	...	0.79	SE	...	224.2	Chiefly O. R from 1 to 4 & at 12 A. M., & from 2 to 5½ P. M.
4	132.0	0.14	W N W & N W	0.9	187.4	Chiefly B. Slightly foggy from 8 to 10 P. M. R at 3 A. M.
5	135.0	...	W & W S W	...	95.2	i to 5 A. M. B, to 10 A. M., i to 4 P. M. B, afterwards. Foggy from 7 to 11 A. M.
6	139.0	...	WSW, S by W & S	...	93.2	B to 11 A. M., i to 5 P. M., B afterwards.
7	137.0	...	S by W & S W	...	213.0	B to 9 A. M., i to 2 P. M., B to 8 P. M., i afterwards.
8	138.2	...	S S W & W by S	...	208.0	Chiefly B. Foggy from 4 to 10 A. M.
9	140.0	...	WSW, SSW & SW	...	113.4	B.
10	141.0	...	S & S S W	...	177.0	B.
11	142.5	...	S & S S W	...	59.1	B.
12	141.5	...	S by W & SW	...	101.0	B. Slightly foggy at 9 P. M.
13	141.5	...	S by W	...	163.8	B. Foggy from 4 to 9 A. M.
14	145.0	...	S by W & S W	...	91.5	Chiefly B. Slightly foggy at 6 A. M.
15	144.5	...	S S W & S W	...	127.4	B.
16	142.8	...	S & W	...	108.0	B. Slightly foggy from 5 to 7 A. M.
17	144.0	...	W N W & W	...	99.5	B.
18	140.0	...	W S W	...	99.3	B.
19	141.3	...	SSW & SW. [W.	...	138.3	B.
20	145.0	...	S by W, SSW & WS	...	136.1	Chiefly B. Slightly foggy at 6 & 7 A. M.
21	146.5	...	WSW, SW & SSW	...	109.6	B.
22	143.8	...	S by W & WSW	...	117.8	S to 2 A. M., B afterwards. Slightly foggy at 4 & 5 A. M.
23	148.8	...	S S W & W by S	...	120.6	B. Foggy from 4 to 8 A. M.
24	148.0	...	S W & S by W	...	169.7	B. to 5 A. M., i to 3 P. M., B afterwards.
25	143.0	...	SSW, S & SSE	...	230.5	B to 2 P. M., i to 8 P. M., B afterwards.
26	145.0	...	S by E, SW & W	...	180.4	B to 9 A. M., i to 1 P. M. B afterwards.

i Cirri, —i Strati, i Cumuli, i Ciro-strati, i Cumulo-strati, i Nimbi,
 i Cirro-cumuli, B clear, S strati, O overcast, T thunder, L lightning,
 P rain, D hail.

Abstract of the Results of the Hourly Meteorological Observations
taken at the Surveyor General's Office, Calcutta,
in the month of March 1871.
Solar Radiation, Weather, &c.

Date.	Max. Solar radiation.	Rain Gauge 1½ ft. above Ground.	WIND.			General aspect of the Sky.
			Prevailing direction.	Max. Pressure	Daily Velocity.	
27	141.0	Inches ...	SSW,SSE&S	lb ...	Miles 111.4	B to 3 A. M. S to 8 A. M. B to 2 P. M., \i to 7 P. M. S afterwards. Foggy at 6 A. M., L & D at 10½ P. M.
28	143.0	...	S by W	...	111.4	S. to 6 A. M., B afterwards.
29	140.0	...	S & S by W	...	105.4	\i to 8 A. M., B afterwards.
30	148.0	...	S by W & S	...	165.1	B to 5 P. M., \i afterwards.
31	146.8	...	SS E & S	...	229.0	B. to 2 P. M., \i to 8 P. M., B afterwards.

\i Cirri,—i Strati, \i Cunuli, \i Cirro-strati, \i Cumulo-strati, \i Nimbi,
\i Cirro-cumuli, B clear, S stratoni, O overcast, T thunder, L lightning,

*Abstract of the Results of the Hourly Meteorological Observations
taken at the Surveyor General's Office, Calcutta,
in the month of March 1871.*

MONTHLY RESULTS.

	Inches.
Mean height of the Barometer for the month... ..	29.850
Max. height of the Barometer occurred at 10 A. M. on the 6th.	30.050
Min. height of the Barometer occurred at 5 P. M. on the 15th.	29.638
<i>Extreme range</i> of the Barometer during the month	0.412
Mean of the daily Max. Pressures	29.926
Ditto ditto Min. ditto	29.783
<i>Mean daily range</i> of the Barometer during the month	0.143

	°
Mean Dry Bulb Thermometer for the month	79.4
Max. Temperature occurred at 4 P. M. on the 26th.	97.7
Min. Temperature occurred at 6 & 7 A. M. on the 4th.	64.0
<i>Extreme range</i> of the Temperature during the month	33.7
Mean of the daily Max. Temperature	88.7
Ditto ditto Min. ditto,	72.1
<i>Mean daily range</i> of the Temperature during the month... ..	16.6

Mean Wet Bulb Thermometer for the month	72.2
Mean Dry Bulb Thermometer above Mean Wet Bulb Thermometer	7.2
Computed Mean Dew-point for the month	67.2
Mean Dry Bulb Thermometer above computed mean Dew-point	12.2

	Inches.
Mean Elastic force of Vapour for the month	0.664

	Troy grain.
Mean Weight of Vapour for the month	7.17
Additional Weight of Vapour required for complete saturation	3.45
Mean degree of humidity for the month, complete saturation being unity	0.68

	°
Mean Max. Solar radiation Thermometer for the month	142.2

	Inches.
Rained 5 days.—Max. fall of rain during 24 hours	3.83
Total amount of rain during the month	5.41
Total amount of rain indicated by the Gauge* attached to the anemometer during the month	5.16
Prevailing direction of the Wind... .. S by W, & S S W.	

* Height 70 feet 10 inches above ground.

Abstract of the Results of the Hourly Meteorological Observations taken at the Surveyor General's Office, Calcutta, in the month of April 1871.

Latitude 22° 33' 1" North. Longitude 88° 20' 34" East.

Height of the Cistern of the Standard Barometer above the sea level, 18.11 feet.

Daily Means, &c. of the Observations and of the Hygrometrical elements dependent thereon.

Date.	Mean Height of the Barometer at 32° Fahrt.	Range of the Barometer during the day.			Mean Dry Bulb Thermometer.	Range of the Temperature during the day.		
		Max.	Min.	Diff.		Max.	Min.	Diff.
	Inches.	Inches.	Inches.	Inches.	o	o	o	o
1	29.770	29.852	29.715	0.137	84.6	94.4	78.0	16.4
2	.823	.894	.771	.123	83.6	90.0	78.8	11.2
3	.816	.872	.727	.145	82.1	89.5	73.6	15.9
4	.762	.836	.672	.164	80.2	88.0	72.3	15.7
5	.769	.847	.703	.144	82.8	91.3	76.5	14.8
6	.803	.876	.754	.122	82.7	89.2	79.0	10.2
7	.743	.813	.660	.153	83.8	91.0	78.5	12.5
8	.729	.795	.676	.119	84.3	93.0	78.6	14.4
9	.769	.826	.725	.101	83.7	88.2	80.5	7.7
10	.839	.909	.768	.141	85.5	93.3	80.8	12.5
11	.881	.948	.802	.146	84.9	92.7	78.7	14.0
12	.841	.915	.759	.156	85.3	94.5	79.5	15.0
13	.757	.826	.674	.152	85.4	94.2	80.5	13.7
14	.716	.766	.631	.135	85.0	93.6	79.4	14.2
15	.746	.854	.677	.177	81.0	93.0	72.3	20.7
16	.837	.895	.778	.117	75.8	83.0	72.0	11.0
17	.829	.911	.741	.170	79.3	88.6	71.0	17.6
18	.798	.866	.730	.136	81.6	90.0	74.0	16.0
19	.784	.860	.701	.159	83.7	92.5	77.5	15.0
20	.769	.826	.685	.141	81.9	93.0	74.3	18.7
21	.757	.820	.681	.139	80.2	90.2	73.5	16.7
22	.728	.831	.651	.180	76.2	80.8	72.2	8.6
23	.704	.775	.633	.142	79.7	87.6	72.4	15.2
24	.727	.800	.681	.119	81.2	86.3	75.2	11.1
25	.759	.816	.696	.120	81.9	89.0	77.7	11.3
26	.744	.818	.689	.129	81.9	89.2	74.5	14.7
27	.722	.788	.656	.132	85.0	92.6	79.5	13.1
28	.765	.855	.703	.152	85.5	93.0	80.0	13.0
29	.752	.830	.679	.151	86.0	93.8	81.0	12.8
30	.709	.784	.651	.133	86.1	94.5	80.0	14.5

The Mean Height of the Barometer, as likewise the Dry and Wet Bulb Thermometer Means are derived, from the hourly observations, made at the several hours during the day.

*Abstract of the Results of the Hourly Meteorological Observations
taken at the Surveyor General's Office, Calcutta,
in the month of April 1871.*

Daily Means, &c. of the Observations and of the Hygrometrical elements
dependent thereon.—(Continued.)

Date.	Mean Wet Bulb Ther- mometer.	Dry Bulb above Wet.	Computed Dew Point.	Dry Bulb above Dew Point.	Mean Elastic force of vapour.	Mean Weight of Vapour in a Cubic foot of air.	Additional Weight of Vapour required for complete saturation.	Mean degree of Humi- dity, complete satu- ration being unity.
	o	o	o	o	Inches.	T. gr.	T. gr.	
1	79.4	5.2	75.8	8.8	0.876	9.37	3.02	0.76
2	79.0	4.6	75.8	7.8	.876	.39	2.64	.78
3	76.9	5.2	73.3	8.8	.809	8.58	.83	.75
4	75.2	5.0	71.7	8.5	.768	.28	.60	.76
5	77.3	5.5	73.4	9.4	.811	.71	3.04	.74
6	79.3	3.4	76.9	5.3	.908	9.74	1.98	.83
7	79.8	4.0	77.0	6.8	.910	.75	2.35	.81
8	80.3	4.0	77.5	6.8	.925	.90	.38	.81
9	80.0	3.7	77.4	6.3	.922	.89	.18	.82
10	80.6	4.9	77.2	8.3	.916	.79	.93	.77
11	80.6	4.3	77.6	7.3	.928	.93	.56	.80
12	80.8	4.5	77.6	7.7	.928	.91	.73	.78
13	80.5	4.9	77.1	8.3	.913	.76	.92	.77
14	80.4	4.6	77.2	7.8	.916	.79	.74	.78
15	75.1	5.9	71.0	10.0	.751	8.09	3.05	.73
16	71.6	4.2	68.7	7.1	.697	7.58	1.96	.80
17	73.1	6.2	68.8	10.5	.699	.54	3.05	.71
18	75.3	6.3	70.9	10.7	.748	8.05	.29	.71
19	77.4	6.3	73.0	10.7	.801	.57	.50	.71
20	76.9	5.0	73.4	8.5	.811	.71	2.73	.76
21	74.4	5.8	70.3	9.9	.734	7.92	.96	.73
22	71.7	4.5	68.5	7.7	.692	.53	.13	.78
23	75.3	4.4	72.2	7.5	.781	8.41	.31	.79
24	76.5	4.7	73.2	8.0	.806	.68	.53	.77
25	78.0	3.9	75.3	6.6	.862	9.27	.17	.81
26	77.1	4.8	73.7	8.2	.819	8.82	.62	.77
27	81.0	4.0	78.2	6.8	.946	10.11	.42	.81
28	80.6	4.9	77.2	8.3	.916	9.79	.93	.77
29	81.7	4.3	78.7	7.3	.961	10.26	.65	.80
30	81.9	4.2	79.0	7.1	.970	.35	.60	.80

All the Hygrometrical elements are computed by the Greenwich Constants.

*Abstract of the Results of the Hourly Meteorological Observations
taken at the Surveyor General's Office, Calcutta,
in the month of April 1871.*

Hourly Means, &c. of the Observations and of the Hygrometrical elements
dependent thereon.

Hour.	Mean Height of the Barometer at 32° Fahr.	Range of the Barometer for each hour during the month.			Mean Dry Bulb Thermometer.	Range of the Tempera- ture for each hour during the month.		
		Max.	Min.	Diff.		Max.	Min.	Diff.
	Inches.	Inches.	Inches.	Inches.	o	o	o	o
Mid- night.	29.770	29.909	29.667	0.242	79.0	82.5	72.0	10.5
1	.761	.898	.663	.235	78.8	82.2	71.5	10.7
2	.751	.883	.658	.225	78.6	82.0	71.0	11.0
3	.742	.866	.651	.215	78.4	81.8	71.5	10.3
4	.745	.871	.674	.197	78.2	81.5	72.0	9.5
5	.762	.888	.692	.196	77.8	81.0	72.0	9.0
6	.778	.897	.709	.188	77.5	81.0	71.5	9.5
7	.797	.907	.735	.172	78.2	81.5	71.9	9.6
8	.817	.928	.755	.173	80.5	83.7	75.0	8.7
9	.832	.948	.763	.185	83.1	86.8	78.7	8.1
10	.840	.943	.765	.178	85.2	89.0	80.5	8.5
11	.829	.933	.760	.173	87.0	91.2	79.5	11.7
Noon.	.814	.915	.745	.170	88.2	92.5	73.5	19.0
1	.787	.895	.723	.172	89.3	93.5	72.2	21.3
2	.760	.861	.695	.166	89.6	94.5	73.2	21.3
3	.731	.837	.663	.174	89.7	94.5	74.2	20.3
4	.715	.817	.639	.178	89.0	94.0	76.5	17.5
5	.711	.809	.633	.176	87.7	92.5	78.0	14.5
6	.725	.819	.641	.178	85.5	90.0	75.7	14.3
7	.744	.854	.631	.223	82.7	86.6	72.3	14.3
8	.761	.853	.687	.166	81.1	85.5	72.3	13.2
9	.774	.883	.708	.175	80.5	83.6	73.0	10.6
10	.787	.891	.710	.181	79.9	83.2	72.5	10.7
11	.783	.898	.703	.195	79.4	82.6	72.5	10.1

The Mean Height of the Barometer, as likewise the Dry and Wet Bulb
Thermometer Means are derived from the observations made at the several
hours during the month.

*Abstract of the Results of the Hourly Meteorological Observations
taken at the Surveyor General's Office, Calcutta,
in the month of April 1871.*

Hourly Means, &c. of the Observations and of the Hygrometrical elements
dependent thereon.—(Continued.)

Hour.	Mean Wet Bulb Ther- mometer.	Dry Bulb above Wet.	Computed Dew Point.	Dry Bulb above Dew Point.	Mean Elastic force of Vapour.	Mean Weight of Vapour in a Cubic foot of air.	Additional Weight of Vapour required for complete saturation.	Mean degree of Humi- dity, complete satura- tion being unity.
	o	o	o	o	Inches.	T. gr.	T. gr.	
Mid- night.	76.1	2.9	74.1	4.9	0.830	8.98	1.52	0.86
1	76.0	2.8	74.0	4.8	.827	.95	.49	.86
2	75.9	2.7	74.0	4.6	.827	.95	.43	.86
3	75.9	2.5	74.1	4.3	.830	9.00	.31	.87
4	75.9	2.3	74.3	3.9	.835	.05	.20	.88
5	75.8	2.0	74.4	3.4	.838	.10	.03	.90
6	75.8	1.7	74.6	2.9	.843	.14	0.90	.91
7	76.3	1.9	75.0	3.2	.854	.25	1.00	.90
8	77.6	2.9	75.6	4.9	.871	.39	.59	.86
9	78.8	4.3	75.8	7.3	.876	.41	2.45	.79
10	79.7	5.5	75.8	9.4	.876	.37	3.24	.74
11	80.1	6.9	76.0	11.0	.882	.39	.90	.71
Noon.	80.4	7.8	75.7	12.5	.873	.26	4.50	.67
1	80.7	8.6	75.5	13.8	.868	.20	5.01	.65
2	80.4	9.2	74.9	14.7	.851	.00	.33	.63
3	80.5	9.2	75.0	14.7	.854	.03	.34	.63
4	80.4	8.6	75.2	13.8	.860	.11	4.97	.65
5	79.9	7.8	75.2	12.5	.860	.13	.43	.67
6	78.9	6.6	74.3	11.2	.835	8.92	3.80	.70
7	77.6	5.1	74.0	8.7	.827	.88	2.84	.76
8	76.9	4.2	74.0	7.1	.827	.91	.26	.80
9	76.8	3.7	74.2	6.3	.832	.98	.00	.82
10	76.9	3.0	74.8	5.1	.849	9.17	1.61	.85
11	76.6	2.8	74.6	4.8	.843	.11	.51	.86

All the Hygrometrical elements are computed by the Greenwich Constants.

Abstract of the Results of the Hourly Meteorological Observations
 taken at the Surveyor General's Office, Calcutta,
 in the month of April 1871.
 Solar Radiation, Weather, &c.

Date.	Max. Solar radiation.	Rain Gauge 1½ ft. above Ground.	WIND.			General aspect of the Sky.	
			Prevailing direction.	Max. Pressure	Daily Velocity.		
1	146.5	...	S.	...	lb	Miles	B. to 5 A. M., \i to 2 P. M., \i to 5 P. M., B to 8 P. M., \i afterwards. L on N at 9 P. M., D at 9½ A. M.
2	141.8	...	S.	211.3	Clouds of different kinds to 9 A. M., \i afterwards.
3	129.0	1.84	S & S S E	30.0	...	260.7	S to 5 P. M., O afterwards. Storm from 6¾ to 7 P. M. T & L from 6 to 11 P. M. R from 6¾ to 8 & at 11 P. M.
4	139.0	0.71	S S W & S	9.6	...	336.9	\i to 8 A. M., \i to 4 P. M., O afterwards. High wind from 6 to 6½ P. M. T L & R at midnight, & from 5 to 7 P. M.
5	142.0	...	S S W & S W	279.6	Chiefly \i L on S W at 7 P. M.
6	138.0	0.04	S S W & S	180.6	Clouds of various kinds. T at 4 6½ & 9 P. M. L. on N. at 6½ & 9 P. M. Light R at 5, 7 & 8¾ P. M.
7	143.7	...	S S W & S	224.2	Scuds to 10 A. M. B to 8 P. M. Scuds afterwards.
8	147.0	...	S by E & S	194.1	Scuds to 8 A. M. \i & \i to 7 P. M. Scuds afterwards.
9	136.0	...	S by W & S	198.3	Chiefly S.
10	149.0	...	S by W, S S W & S b. E	216.0	Scuds to 9 A. M. \i to 5 P. M. B afterwards.
11	140.8	...	S & S by W	211.0	Chiefly B.
12	145.0	...	S & S S W	215.7	B to 2 A. M. \i to 8 A. M. B to 2 P. M. \i afterwards.
13	144.8	...	S by W & S	217.5	S to 8 A. M. B to 11 A. M., \i to 7 P. M., B afterwards.
14	145.0	...	S S W & S	269.4	Chiefly \i L from 9 to 11 P. M.
15	140.0	0,07	Variable	0.9	...	244.4	S to 9 A. M., clouds of different kinds to 4 P. M. O to 9 P. M. B afterwards. L at midnight & 1 A. M. & from 6 to 8 P. M. T from 4½ to 8 P. M., Light R. at 9½ & 10¼ A. M., & from 4½ to 7 P. M.
16	128.3	...	E & Variable	2.0	...	212.7	S to 7 P. M., B afterwards. T from Noon to 2 P. M. D at 7 A. M. & 2 P. M.
17	145.5	...	E by N & Variable	108.2	Clouds of different kinds to 9 A. M., \i to 7 P. M. B afterwards L from 7¼ to 9 P. M.

\i Cirri, —i Strati, \i Cumuli, \i Ciro-strati, ~i Cumulo-strati, \i Nimbi, \i Cirro-cumuli, B clear, S stratoni, O overcast, T thunder, L lightning, R rain, D drizzle.

Abstract of the Results of the Hourly Meteorological Observations
taken at the Surveyor General's Office, Calcutta,
in the month of April 1871.

Solar Radiation, Weather, &c.

Date.	Max. Solar radiation.	Rain Gauge 1½ ft. above Ground.	WIND.			General aspect of the Sky.	
			Prevailing direction.	Max. Pressure.	Daily Velocity.		
18	148.0	...	SE & S	...	lb	92.4	B to A. M., \i to 9 A. M., \i to 4 P. M., \i to 7 P. M., B afterwards.
19	147.3	...	S by W & S S W	1.8	lb	91.2	B to 6 A. M., \i afterwards T & D at 3¼ P. M.
20	145.0	0.47	S by W & S S W	4.0	lb	164.7	B to 7 A. M. \i to 5 P. M. O afterwards. Brisk wind from 4½ to 5½ P. M. T from 5 to 8 P. M. L from 6 to 10 P. M. R. from 4¾ to 10 P. M.
21	142.0	0.12	EN E, S & S by W	4.4	lb	195.3	S to 4 A. M. \i to 1 P. M., S to 4 P. M., O afterwards. Brisk wind from 10 to 12 A. M. T & L from 5¾ to 8 P. M. Light R at 6, 8 & 11 P. M.
22	137.6	0.61	Variable	4.2	lb	261.0	O to 6 A. M. \i to 10 A. M., O to 2 P. M., \i to 7 P. M., O afterwards. Brisk wind at 11 A. M., 8¾ & 10½ P. M., T after intervals L at 3 A. M. & from 7 to 9 P. M., R from 9¾ A. M., to 2 & 8½ to 10 P. M.
23	142.0	...	S S W & S	...	lb	200.9	S to 5 A. M., \i to 10 A. M., \i afterwards. L on S W at 9¾ & 11 P. M.
24	142.5	...	S W & S by W	...	lb	65.0	S to 10 A. M., \i & \i afterwards. D at midnight.
25	145.0	1.46	S & S S E	...	lb	218.9	\i to 3 A. M., \i to 8 P. M., O afterwards. L from 9 to 11 P. M., T & R from 10 to 11 P. M.
26	140.8	0.40	S S W, S W & S	...	lb	165.3	O to 8 A. M., clouds of different kinds afterwards. T at midnight L at midnight & 8 P. M. R from midnight to 3 A. M.
27	147.0	...	S S W	...	lb	184.1	B to 7 A. M., \i to 8 P. M., \i afterwards. L on E at 7 P. M.
28	150.2	...	S by W, S S W & S	...	lb	131.1	\i to 11 A. M., \i to 6 P. M., B afterwards
29	145.5	...	S S W & S	...	lb	162.6	B to 3 A. M., \i to 3 P. M., B afterwards.
30	144.8	...	S & S by W	...	lb	267.8	B to 2 P. M., \i to 8 P. M., B afterwards.

\i Cirri, —i Strati, \i Cumuli, \i Cirro-strati, \i Cumulo-strati, \i Nimbi, \i Cirro-cumuli, B clear, S stratoni, O overcast, T thunder, L lightning, R rain, D drizzle.

*Abstract of the Results of the Hourly Meteorological Observations
taken at the Surveyor General's Office, Calcutta,
in the month of April 1871.*

MONTHLY RESULTS.

	Inches.
Mean height of the Barometer for the month... ..	29.772
Max. height of the Barometer occurred at 9 A. M. on the 11th. ...	29.948
Min. height of the Barometer occurred at 7 P. M. on the 14th. ...	29.631
<i>Extreme range</i> of the Barometer during the month ...	0.317
Mean of the daily Max. Pressures	29.843
Ditto ditto Min. ditto	29.762
<i>Mean daily range</i> of the Barometer during the month ...	0.141

	°
Mean Dry Bulb Thermometer for the month	82.7
Max. Temperature occurred at 2 & 3 P. M. on the 12th & 30th ...	94.5
Min. Temperature occurred at 2 A. M. on the 17th. ...	71.0
<i>Extreme range</i> of the Temperature during the month ...	23.5
Mean of the daily Max. Temperature	90.7
Ditto ditto Min. ditto,	76.7
<i>Mean daily range</i> of the Temperature during the month... ..	14.0

Mean Wet Bulb Thermometer for the month	77.9
Mean Dry Bulb Thermometer above Mean Wet Bulb Thermometer	4.8
Computed Mean Dew-point for the month	74.5
Mean Dry Bulb Thermometer above computed mean Dew-point ...	8.2

Inches.

Mean Elastic force of Vapour for the month	0.840
---	-------

	Troy grain.
Mean Weight of Vapour for the month	9.03
Additional Weight of Vapour required for complete saturation ...	2.60
Mean degree of humidity for the month, complete saturation being unity	0.77

°

Mean Max. Solar radiation Thermometer for the month ...	143.0
---	-------

Inches.

Rained 14 days,—Max. fall of rain during 24 hours	1.84
Total amount of rain during the month	5.72
Total amount of rain indicated by the Gauge* attached to the anemo- meter during the month	4.64
Prevailing direction of the Wind... .. S, S by W, & S S W.	

* Height 70 feet 10 inches above ground.

*Abstract of the Results of the Hourly Meteorological Observations
taken at the Surveyor General's Office, Calcutta,
in the month of May 1871.*

Latitude 22° 33' 1" North. Longitude 88° 20' 34" East.

Height of the Cistern of the Standard Barometer above the sea level, 18.11 feet.

Daily Means, &c. of the Observations and of the Hygrometrical elements
dependent thereon.

Date.	Mean Height of the Barometer at 32° Fahr.	Range of the Barometer during the day.			Mean Dry Bulb Thermometer.	Range of the Tempera- ture during the day.		
		Max.	Min.	Diff.		Max.	Min.	Diff.
	Inches.	Inches.	Inches.	Inches.	o	o	o	o
1	29.757	29.842	29.694	0.148	84.8	89.0	79.0	10.0
2	.787	.869	.721	.148	83.3	92.0	76.8	15.2
3	.766	.843	.709	.134	84.9	92.2	78.0	14.2
4	.750	.824	.639	.185	84.0	93.0	74.4	18.6
5	.729	.775	.656	.119	78.8	90.0	74.0	16.0
6	.705	.766	.599	.167	81.0	91.4	74.8	16.6
7	.683	.743	.589	.154	83.8	94.3	76.8	17.5
8	.697	.735	.627	.108	80.6	88.9	75.0	13.9
9	.704	.753	.649	.104	79.9	86.9	74.5	12.4
10	.714	.772	.644	.128	81.8	91.8	76.5	15.3
11	.723	.775	.637	.138	80.8	91.2	75.2	16.0
12	.718	.776	.640	.136	82.2	89.2	75.5	13.7
13	.713	.766	.616	.150	82.5	91.0	75.6	15.4
14	.687	.751	.604	.147	82.1	89.0	75.5	13.5
15	.661	.712	.587	.125	83.8	90.2	78.0	12.2
16	.651	.697	.574	.123	86.9	94.0	80.6	13.4
17	.662	.719	.595	.124	88.0	95.0	82.5	12.5
18	.641	.702	.555	.147	86.4	94.7	82.7	12.0
19	.590	.636	.523	.113	86.7	93.5	80.6	12.9
20	.577	.629	.506	.123	80.8	85.3	77.0	8.3
21	.551	.614	.459	.155	83.7	92.8	78.0	14.8
22	.538	.595	.475	.120	82.4	89.8	79.1	10.7
23	.537	.601	.428	.173	84.6	93.2	78.5	14.7
24	.571	.647	.533	.114	82.3	89.4	76.5	12.9
25	.645	.779	.586	.193	84.0	91.0	75.3	15.7
26	.695	.754	.653	.101	82.0	90.7	76.0	14.7
27	.747	.812	.687	.125	84.0	91.6	77.0	14.6
28	.735	.814	.641	.173	82.8	91.5	76.0	15.5
29	.730	.788	.659	.129	83.0	90.5	76.5	14.0
30	.690	.762	.612	.150	84.6	92.3	77.7	14.6
31	.669	.730	.604	.126	86.2	93.0	80.5	12.5

The Mean Height of the Barometer, as likewise the Dry and Wet Bulb Thermometer Means are derived, from the hourly observations, made at the several hours during the day.

*Abstract of the Results of the Hourly Meteorological Observations
taken at the Surveyor General's Office, Calcutta,
in the month of May 1871.*

Daily Means, &c. of the Observations and of the Hygrometrical elements
dependent thereon.—(Continued.)

Date.	Mean Wet Bulb Ther- mometer.	Dry Bulb above Wet.	Computed Dew Point.	Dry Bulb above Dew Point.	Mean Elastic force of vapour.	Mean Weight of Vapour in a Cubic foot of air.	Additional Weight of Vapour required for complete saturation.	Mean degree of Humi- dity, complete satu- ration being unity.
	o	o	o	o	Inches.	T. gr.	T. gr.	
1	80.5	4.3	77.5	7.3	0.925	9.90	2.56	0.80
2	75.9	7.4	70.7	12.6	.744	7.97	3.96	.67
3	78.1	6.8	73.3	11.6	.809	8.63	.86	.69
4	77.9	6.1	73.6	10.4	.817	.75	.42	.72
5	74.7	4.1	71.8	7.0	.771	.33	2.11	.80
6	75.9	5.1	72.3	8.7	.783	.43	.71	.76
7	78.0	5.8	73.9	9.9	.824	.83	3.27	.73
8	76.3	4.3	73.3	7.3	.809	.72	2.29	.79
9	76.1	3.8	73.4	6.5	.811	.75	.03	.81
10	77.8	4.0	75.0	6.8	.854	9.18	.22	.81
11	76.9	3.9	74.2	6.6	.832	8.96	.11	.81
12	78.0	4.2	75.1	7.1	.857	9.21	.33	.80
13	77.5	5.0	74.0	8.5	.827	8.88	.76	.76
14	78.2	3.9	75.5	6.6	.868	9.33	.18	.81
15	79.2	4.6	76.0	7.8	.882	.45	.65	.78
16	80.5	6.4	76.7	10.2	.902	.60	3.65	.73
17	81.2	6.8	77.1	10.9	.913	.70	.98	.71
18	81.5	4.9	78.1	8.3	.943	10.06	.00	.77
19	81.4	5.3	78.2	8.5	.946	.07	.11	.76
20	77.6	3.2	75.4	5.4	.865	9.34	1.73	.84
21	79.5	4.2	76.6	7.1	.899	.63	2.44	.80
22	79.5	2.9	77.5	4.9	.925	.94	1.67	.86
23	79.9	4.7	76.6	8.0	.899	.61	2.78	.78
24	79.7	2.6	77.9	4.4	.937	10.08	1.50	.87
25	80.5	3.5	78.0	6.0	.940	.07	2.10	.83
26	78.6	3.4	76.2	5.8	.887	9.54	1.93	.83
27	80.3	3.7	77.7	6.3	.931	.98	2.19	.82
28	78.5	4.3	75.5	7.3	.868	.33	.42	.79
29	78.7	4.3	75.7	7.3	.873	.38	.44	.79
30	78.7	5.9	74.6	10.0	.843	.02	3.37	.73
31	81.2	5.0	77.7	8.5	.931	.92	.07	.76

All the Hygrometrical elements are computed by the Greenwich Constants.

*Abstract of the Results of the Hourly Meteorological Observations
taken at the Surveyor General's Office, Calcutta,
in the month of May 1871.*

Hourly Means, &c. of the Observations and of the Hygrometrical elements
dependent thereon.

Hour.	Mean Height of the Barometer at 32° Fahr.	Range of the Barometer for each hour during the month.			Mean Dry Bulb Thermometer.	Range of the Tempera- ture for each hour during the month.		
		Max.	Min.	Diff.		Max.	Min.	Diff.
	Inches.	Inches.	Inches.	Inches.	o	o	o	o
Mid- night.	29.693	29.815	29.543	0.272	79.5	84.2	74.0	10.2
1	.683	.805	.526	.279	79.2	84.0	74.2	9.8
2	.672	.786	.513	.273	78.9	83.8	74.0	9.8
3	.665	.768	.500	.268	78.6	83.5	74.0	9.5
4	.665	.776	.504	.272	78.4	83.0	74.0	9.0
5	.675	.782	.522	.260	78.2	82.7	74.0	8.7
6	.691	.809	.540	.269	78.4	83.0	74.4	8.6
7	.710	.850	.572	.278	79.6	84.0	75.0	9.0
8	.724	.866	.583	.283	82.1	87.0	77.0	10.0
9	.732	.869	.591	.278	84.5	88.3	77.0	11.3
10	.730	.867	.582	.285	86.1	90.0	77.0	13.0
11	.717	.849	.571	.278	87.9	92.4	79.3	13.1
Noon.	.702	.829	.556	.273	88.4	93.5	76.5	17.0
1	.680	.798	.533	.265	89.3	94.7	77.5	17.2
2	.653	.768	.499	.269	89.5	95.0	79.3	15.7
3	.628	.735	.473	.262	89.6	95.0	79.2	15.8
4	.615	.721	.459	.262	89.8	95.0	80.6	14.4
5	.612	.735	.428	.307	88.0	94.8	76.0	18.8
6	.624	.727	.453	.274	86.2	94.0	75.4	17.6
7	.618	.736	.491	.245	83.5	90.0	76.0	14.0
8	.669	.763	.523	.240	81.9	87.5	75.0	12.5
9	.686	.810	.532	.278	81.3	86.7	75.0	11.7
10	.699	.832	.541	.291	80.6	85.4	75.0	10.4
11	.699	.842	.544	.298	80.0	84.6	74.4	10.2

The Mean Height of the Barometer, as likewise the Dry and Wet Bulb Thermometer Means are derived from the observations made at the several hours during the month.

*Abstract of the Results of the Hourly Meteorological Observations
taken at the Surveyor General's Office, Calcutta,
in the month of May 1871.*

Hourly Means, &c. of the Observations and of the Hygrometrical elements
dependent thereon.—(Continued.)

Hour.	Mean Wet Bulb Ther- mometer.	Dry Bulb above Wet.	Computed Dew Point.	Dry Bulb above Dew Point.	Mean Elastic force of Vapour.	Mean Weight of Vapour in a Cubic foot of air.	Additional Weight of Vapour required for complete saturation.	Mean degree of Humi- dity, complete satura- tion being unity.
	o	o	o	o	Inches.	T. gr.	T. gr.	
Mid- night.	76.7	2.8	74.7	4.8	0.846	9.14	1.52	0.86
1	76.6	2.6	74.8	4.4	.849	.19	.37	.87
2	76.6	2.3	75.0	3.9	.854	.24	.23	.88
3	76.4	2.2	74.9	3.7	.851	.21	.17	.89
4	76.4	2.0	75.0	3.4	.854	.25	.06	.90
5	76.4	1.8	75.1	3.1	.857	.28	0.97	.91
6	76.8	1.6	75.7	2.7	.873	.45	.86	.92
7	77.5	2.1	76.0	3.6	.882	.52	1.17	.89
8	78.8	3.3	76.5	5.6	.896	.63	.88	.84
9	79.8	4.7	76.5	8.0	.896	.59	2.76	.78
10	80.7	5.7	76.7	9.7	.902	.60	3.46	.74
11	81.2	6.7	77.2	10.7	.916	.73	.91	.71
Noon.	81.1	7.3	76.7	11.7	.902	.56	4.28	.69
1	81.4	7.9	76.7	12.6	.902	.55	.66	.67
2	81.2	8.3	76.2	13.3	.887	.41	.88	.66
3	80.9	8.7	75.7	13.9	.873	.24	5.09	.65
4	81.2	8.6	76.0	13.8	.882	.33	.09	.65
5	79.9	8.1	75.0	13.0	.854	.07	4.61	.66
6	79.5	6.7	74.8	11.4	.849	.06	3.93	.70
7	78.7	4.8	75.3	8.2	.862	.25	2.75	.77
8	77.8	4.1	74.9	7.0	.851	.15	.29	.80
9	77.8	3.5	75.3	6.0	.862	.29	1.95	.83
10	77.4	3.2	75.2	5.4	.860	.28	.73	.84
11	76.8	3.2	74.6	5.4	.843	.11	.70	.84

All the Hygrometrical elements are computed by the Greenwich Constants.

Abstract of the Results of the Hourly Meteorological Observations
 taken at the Surveyor General's Office, Calcutta,
 in the month of May 1871.
 Solar Radiation, Weather, &c.

Date.	Max. Solar radiation.	Rain Gauge 1½ ft. above Ground.	WIND.			General aspect of the Sky.
			Prevailing direction.	Max. Pressure	Daily Velocity.	
1	142.0	...	S & S by W	...	224.4	Chiefly \searrow i.
2	142.5	...	W & variable.	...	166.5	Chiefly \searrow i.
3	147.0	...	W & W by S	...	84.6	\searrow i to 12 A. M., \swarrow i to 6 P. M., B afterwards.
4	147.7	...	S S W & S by W	3.2	115.7	Chiefly \swarrow i. Brisk wind from 7¼ to 7½ P. M., T at 8 P. M. L on W at 7 & 8 P. M.
5	131.8	0.25	E S E & Variable	3.6	239.0	\searrow i to 3 A. M., B to 9 A. M., clouds of different kinds after- wards. Brisk wind from 11½ to 11¾ A. M. T at 11¼ & 12 A. M., & from 6 to 8 P. M., L from 6 to 8 P. M. R. at 11½ & 12 A. M., and from 6½ to 8 P. M.
6	148.5	...	WNW & variable.	...	202.7	Chiefly \swarrow i, D at 6½ P. M.
7	150.0	0.48	S E & S S W	19.5	83.3	Chiefly \swarrow i., strong wind at 6½ P. M. Hailstone at 6¼ P. M., T & L from 6 to 9 P. M. R from 6½ to 7½ P. M.
8	135.2	0.13	S E & Variable.	2.8	99.5	\searrow i, to 3 A. M., O to 6 A. M., clouds of different kinds to 6 P. M. O afterwards. Brisk wind at 1¼ P. M. T at 1 P. M. L on S at 9 P. M., Slight R at 1¼, 7 & 8 P. M.
9	145.0	...	S S E & S W	...	147.3	Chiefly \swarrow i.
10	141.0	0.24	S S W & S	1.7	98.0	Chiefly \swarrow i. Brisk wind between 4½ & 5 P. M. T at 4 & 5 P. M. R at 5 & 6 P. M.
11	147.4	0.27	S E & S by W	2.2	140.6	B to 10 A. M., \swarrow i, to 5 P. M. O afterwards. Brisk wind between 5 & 5½ P. M., T at 5½ & 7 P. M., L at 9 & 11 P. M., R from 5½ to 7 P. M.
12	146.5	0.16	SSW, SE & SSE	...	136.9	Clouds of different kinds to 7 A. M., \swarrow i to 7 P. M., O after- wards. T at 8½ P. M. L on S W at 8 P. M., R from 8¼ to 10 P. M.
13	150.0	1.40	S by E & S S W	7.8	114.0	\searrow i to 8 A. M., \swarrow i to 6 P. M., O afterwards. High wind at 7 P. M. T at 7 & 8 P. M. L from 7 to 9 P. M. R at 7 & 8 P. M.
14	145.0	...	S S E & E N E	...	113.3	O to 4 A. M., B to 9 A. M., \swarrow i to 6 P. M., S afterwards.

\searrow i Cirri, —i Strati, \swarrow i Cumuli, \swarrow i Cirro-strati, \sim i Cumulo-strati, \searrow i Nimbi,
 \searrow i Cirro-cumuli, B clear, S straton, O overcast, T thunder, L lightning,
 R rain, D drizzle

Abstract of the Results of the Hourly Meteorological Observations
taken at the Surveyor General's Office, Calcutta,
in the month of May 1871.
Solar Radiation, Weather, &c.

Date.	Max. Solar radiation.	Rain Gauge 1½ ft. above Ground.	WIND.			General aspect of the Sky.
			Prevailing direction.	Max. Pressure	Daily Velocity.	
15	150.2	0.89	S S W & Variable	1.7	108.8	B to 8 A. M., ☽ to 4 P. M. B afterwards. R between 1 & 2 P. M.
16	149.8	...	[S W SSW, S by W & W	...	46.3	B to 3 A. M., \i to 8 A. M., ☽ to 7 P. M. B afterwards. L at 9 & 10 P. M.
17	149.7	...	S S W & S by E	0.8	68.3	B to 9 A. M., ☽ to 5 P. M. B afterwards.
18	152.0	0.22	S by E & S W	1.8	72.7	B to 6 A. M., ☽ to 7 P. M. B afterwards. T at 2½ & 4½ P. M. R at 2, 3 & 5 P. M.
19	148.0	...	S S W	...	113.6	B to 4 A. M., \i to 4 P. M., S afterwards. L at midnight & from 7¼ to 9 P. M.
20	120.0	0.27	S by W & Variable	0.8	177.1	Chiefly O. L from 2 to 5 A. M., & at 10 P. M. T at 5 & from 8¼ to 10¼ A. M., R from 5½ to 10 A. M., & at 8 P. M.
21	149.0	0.19	S W & E S E	2.6	108.3	S to 10 A. M., ☽ to 7 P. M. O afterwards. Brisk wind between 5 & 5½ P. M. L on S at 8 P. M. R at 3½ & 5½ P. M.
22	145.8	0.21	E S E & W S W	2.4	85.4	Clouds of different kinds to 8 A. M., ☽ to 2 P. M. O to 6 P. M., \i to 9 P. M. B afterwards. Brisk wind, T & R at 2½ P. M.
23	144.3	...	W S W & S S E	1.9	46.8	B to 4 A. M., \i to 10 A. M., ☽ to 4 P. M., S afterwards. T at 4¼ & 5 P. M.
24	135.5	1.40	S S E & S by W	6.5	96.1	S to 6 A. M., \i to 10 A. M. O to 3 P. M., S afterwards. High wind at 11 A. M. T from 12 A. M., to 1 P. M., L at 11 & 12 A. M., & from 8 to 11 P. M., R at 11 & 12 A. M.
25	140.7	2.58	S S W	22.0	164.4	S to 10 A. M., ☽ to 7 P. M. O afterwards. Storm at 9¼ P. M., T & L at midnight & 1 A. M., & from 7 to 11 P. M., R from 7¾ to 10 P. M.
26	141.2	0.82	S W & S by E	11.4	239.8	O to 6 A. M., S to 3 P. M., O afterwards. High wind between 4¼ & 4½ P. M., T at 5 P. M., L at midnight & 1 A. M., & from 7 to 9 P. M., R from 4½ to 6 P. M.

\i Cirri,—i Strati, ☽ Cumuli, \i Cirro-strati, ☽ Cumulo-strati, \i Nimbi, \i Cirro-cumuli, B clear, S stratoni, O overcast, T thunder, L lightning,

*Abstract of the Result of the Hourly Meteorological Observations
taken at the Surveyor General's Office, Calcutta,
in the month of May 1871.
Solar Radiation, Weather, &c.*

Date.	Max. Solar radiation.	Rain Gauge 1 1/2 ft. above Ground.	WIND.			General aspect of the Sky.
			Prevailing direction.	Max. Pressure	Daily Velocity.	
27	145.8	...	S S W	...	147.8	O to 7 A. M., \curvearrowright i to 5 P. M., B afterwards. L on N W at 8 P. M.
28	145.0	1.57	SSW & Variable	3.8	126.9	S to 8 A. M., \curvearrowright i to 5 P. M., O afterwards. Brisk wind between 7 1/2 & 8 3/4 P. M. T & L from 7 to 11 P. M. R from 6 to 8 P. M. & at 11 P. M.
29	145.8	...	SW & E S E	...	155.2	S to 7 A. M., \curvearrowright i to 7 P. M., S afterwards. L on S at 8 P. M.
30	143.0	...	W	...	90.8	\ i & \ i to 7 A. M., B to 2 P. M. \curvearrowright i & \ i afterwards.
31	148.9	...	S W & S	...	99.7	Chiefly \curvearrowright i. L on N at 8 & 9 P. M.

\ i Cirri — i Strati, \curvearrowright i Cumuli, \ i Cirro-strati, ~ i Cumulo-strati ~ i Nimbi, \ i Cirro-Cumuli, B clear, S straton, O overcast, T thunder, L lightning,

*Abstract of the Results of the Hourly Meteorological Observations
taken at the Surveyor General's Office, Calcutta,
in the month of May 1871.*

MONTHLY RESULTS.

	Inches
Mean height of the Barometer for the month... ..	29.678
Max. height of the Barometer occurred at 9 A. M. on the 2nd. ...	29.869
Min. height of the Barometer occurred at 5 P. M. on the 23rd. ...	29.428
<i>Extreme range</i> of the Barometer during the month	0.441
Mean of the daily Max. Pressures	29.741
Ditto ditto Min. ditto	29.603
<i>Mean daily range</i> of the Barometer during the month	0.138

	°
Mean Dry Bulb Thermometer for the month	83.3
Max. Temperature occurred at 4P. M. on the 17th.	95.0
Min. Temperature occurred at 5 A. M. on the 5th.	74.0
<i>Extreme range</i> of the Temperature during the month	21.0
Mean of the daily Max. Temperature	91.2
Ditto ditto Min. ditto,	77.2
<i>Mean daily range</i> of the Temperature during the month... ..	14.0

Mean Wet Bulb Thermometer for the month	78.7
Mean Dry Bulb Thermometer above Mean Wet Bulb Thermometer	4.6
Computed Mean Dew-point for the month	75.5
Mean Dry Bulb Thermometer above computed mean Dew-point ...	7.8

Inches.

Mean Elastic force of Vapour for the month	0.868
---	-------

	Troy grain.
Mean Weight of Vapour for the month	9.31
Additional Weight of Vapour required for complete saturation ...	2.62
Mean degree of humidity for the month, complete saturation being unity 0.78	

°

Mean Max. Solar radiation Thermometer for the month ...	144.4
---	-------

	Inches.
Rained 17 days,—Max. fall of rain during 24 hours	2.58
Total amount of rain during the month	11.08
Total amount of rain indicated by the Gauge* attached to the anemometer during the month	9.33
Prevailing direction of the Wind... ..	S S W.

* Height 70 feet 10 inches above ground.

Handwritten text on a page with a header and footer. The text is mostly illegible due to fading and low resolution. The header appears to contain a date and possibly a page number. The main body of the text consists of several lines of cursive handwriting. The footer contains a few lines of text, possibly a signature or a reference number.

Abstract of the Results of the Hourly Meteorological Observations taken at the Surveyor General's Office, Calcutta, in the month of June 1871.

Latitude 22° 33' 1" North. Longitude 88° 20' 34" East.

Height of the Cistern of the Standard Barometer above the sea level, 18.11 feet.

Daily Means, &c. of the Observations and of the Hygrometrical elements dependent thereon.

Date.	Mean Height of the Barometer at 32° Fahr.	Range of the Barometer during the day.			Mean Dry Bulb Thermometer.	Range of the Temperature during the day.		
		Max.	Min.	Diff.		Max.	Min.	Diff.
	Inches.	Inches.	Inches.	Inches.	o	o	o	o
1	29.655	29.714	29.590	0.124	86.3	93.8	82.7	11.1
2	.625	.675	.550	.125	80.7	88.0	77.0	11.0
3	.579	.647	.497	.150	81.2	87.0	77.0	10.0
4	.526	.570	.471	.099	81.8	87.0	79.5	7.5
5	.551	.590	.508	.082	82.1	87.5	80.0	7.5
6	.549	.605	.488	.117	82.0	86.0	80.5	5.5
7	.520	.594	.454	.140	82.8	88.4	80.0	8.4
8	.508	.555	.454	.101	83.3	87.5	80.5	7.0
9	.520	.572	.459	.113	81.5	85.9	77.8	8.1
10	.565	.612	.512	.100	83.7	90.0	80.5	9.5
11	.578	.623	.537	.086	81.4	83.0	80.2	2.8
12	.541	.595	.469	.126	82.8	88.0	79.8	8.2
13	.515	.562	.455	.107	81.7	84.6	80.0	4.6
14	.488	.539	.407	.132	83.6	87.0	81.0	6.0
15	.472	.549	.405	.144	83.5	87.0	81.3	5.7
16	.437	.486	.374	.112	84.1	87.3	81.0	6.3
17	.460	.535	.403	.132	83.6	87.4	80.8	6.6
18	.528	.587	.482	.105	84.4	89.6	80.5	9.1
19	.543	.593	.484	.109	85.5	90.5	81.8	8.7
20	.465	.543	.370	.173	85.1	89.5	83.0	6.5
21	.428	.479	.371	.108	83.7	89.7	80.6	9.1
22	.405	.454	.342	.112	82.1	85.4	80.5	4.9
23	.425	.499	.370	.129	82.2	86.4	80.0	6.4
24	.490	.552	.441	.111	81.0	84.3	80.0	4.3
25	.531	.573	.466	.107	81.4	86.7	78.5	8.2
26	.536	.576	.474	.102	81.2	83.5	79.5	4.0
27	.501	.539	.444	.095	81.2	84.5	78.5	6.0
28	.519	.588	.463	.125	82.0	86.0	78.7	7.3
29	.598	.672	.531	.141	81.6	86.5	76.5	10.0
30	.635	.690	.580	.110	82.8	89.4	76.4	13.0

The Mean Height of the Barometer, as likewise the Dry and Wet Bulb Thermometer Means are derived, from the hourly observations, made at the several hours during the day.

*Abstract of the Results of the Hourly Meteorological Observations
taken at the Surveyor General's Office, Calcutta,
in the month of June 1871.*

Daily Means, &c. of the Observations and of the Hygrometrical elements
dependent thereon.—(Continued.)

Date.	Mean Wet Bulb Ther- mometer.	Dry Bulb above Wet.	Computed Dew Point.	Dry Bulb above Dew Point.	Mean Elastic force of vapour.	Mean Weight of Vapour in a Cubic foot of air.	Additional Weight of Vapour required for complete saturation.	Mean degree of Humi- dity, complete satu- ration being unity.
	°	°	°	°	Inches.	T. gr.	T. gr.	
1	82.1	4.2	79.2	7.1	0.976	10.41	2.61	0.80
2	78.7	2.0	77.3	3.4	.919	9.92	1.12	.90
3	78.9	2.3	77.3	3.9	.919	.90	.31	.88
4	79.7	2.1	78.2	3.6	.946	10.17	.23	.89
5	80.3	1.8	79.0	3.1	.970	.44	.07	.91
6	80.3	1.7	79.1	2.9	.973	.47	.00	.91
7	80.3	2.5	78.5	4.3	.955	.27	.48	.87
8	80.6	2.7	78.7	4.6	.961	.31	.62	.86
9	80.1	1.4	79.1	2.4	.973	.49	0.82	.93
10	80.4	3.3	78.1	5.6	.943	.10	1.97	.84
11	80.3	1.1	79.5	1.9	.986	.62	0.65	.94
12	81.0	1.8	79.7	3.1	.992	.66	1.09	.91
13	80.5	1.2	79.7	2.0	.992	.68	0.69	.94
14	81.5	2.1	80.0	3.6	1.001	.72	1.31	.89
15	81.3	2.2	79.8	3.7	0.995	.66	.34	.89
16	81.2	2.9	79.2	4.9	.976	.45	.76	.86
17	80.6	3.0	78.5	5.1	.955	.25	.78	.85
18	80.3	4.1	77.4	7.0	.922	9.87	2.44	.80
19	81.6	3.9	78.9	6.6	.967	10.32	.40	.81
20	82.6	2.5	80.8	4.3	1.027	.98	1.59	.87
21	80.9	2.8	78.9	4.8	0.967	.37	.70	.86
22	80.2	1.9	78.9	3.2	.967	.41	.10	.90
23	80.3	1.9	79.0	3.2	.970	.44	.10	.91
24	80.2	0.8	79.6	1.4	.989	.68	0.46	.96
25	79.9	1.5	78.8	2.6	.964	.38	.89	.92
26	79.3	1.9	78.0	3.2	.940	.13	1.08	.90
27	79.2	2.0	77.8	3.4	.934	.07	.14	.90
28	79.8	2.2	78.3	3.7	.949	.20	.27	.89
29	79.6	2.0	78.2	3.4	.946	.19	.15	.90
30	80.3	2.5	78.5	4.3	.955	.27	.48	.87

All the Hygrometrical elements are computed by the Greenwich Constants.

*Abstract of the Results of the Hourly Meteorological Observations
taken at the Surveyor General's Office, Calcutta,
in the month of June 1871.*

Hourly Means, &c. of the Observations and of the Hygrometrical elements dependent thereon.

Hour.	Mean Height of the Barometer at 32° Fahr.	Range of the Barometer for each hour during the month.			Mean Dry Bulb Thermometer.	Range of the Temperature for each hour during the month.		
		Max.	Min.	Diff.		Max.	Min.	Diff.
	Inches.	Inches.	Inches.	Inches.	°	°	°	°
Mid-night.	29.545	29.683	29.424	0.259	81.5	84.5	77.0	7.5
1	.533	.672	.412	.260	81.2	84.3	76.4	7.9
2	.521	.665	.407	.258	80.9	84.1	76.4	7.7
3	.507	.647	.399	.248	80.6	84.0	76.6	7.4
4	.502	.648	.398	.250	80.5	84.0	76.9	7.1
5	.511	.653	.403	.250	80.4	83.6	77.0	6.6
6	.525	.684	.414	.270	80.5	83.7	77.4	6.3
7	.539	.697	.426	.271	81.0	84.5	78.0	6.5
8	.556	.711	.438	.273	82.1	86.5	78.5	8.0
9	.563	.714	.442	.272	83.3	87.0	78.2	8.8
10	.563	.706	.454	.252	84.3	88.5	79.0	9.5
11	.557	.703	.440	.263	84.3	90.5	79.8	10.7
Noon.	.541	.679	.417	.262	85.0	91.7	81.0	10.7
1	.522	.642	.392	.250	85.1	93.0	77.5	15.5
2	.503	.627	.370	.257	85.3	93.8	77.0	16.8
3	.485	.604	.354	.250	85.0	91.0	78.2	12.8
4	.469	.590	.349	.241	84.8	90.0	78.4	11.6
5	.470	.600	.342	.258	84.2	88.9	79.0	9.9
6	.482	.602	.365	.237	83.6	87.6	79.0	8.6
7	.499	.621	.381	.240	82.9	86.0	79.5	6.5
8	.520	.635	.388	.247	82.3	85.3	77.9	7.4
9	.536	.661	.413	.248	82.1	85.0	78.0	7.0
10	.553	.670	.437	.233	81.8	85.0	76.5	8.5
11	.553	.672	.430	.242	81.6	84.0	76.8	7.2

The Mean Height of the Barometer, as likewise the Dry and Wet Bulb Thermometer Means are derived from the observations made at the several hours during the month.

*Abstract of the Results of the Hourly Meteorological Observations
taken at the Surveyor General's Office, Calcutta,
in the month of June 1871.*

Hourly Means, &c. of the Observations and of the Hygrometrical elements
dependent thereon.—(Continued.)

Hour.	Mean Wet Bulb Ther- mometer.	Dry Bulb above Wet.	Computed Dew Point.	Dry Bulb above Dew Point.	Mean Elastic force of Vapour.	Mean Weight of Vapour in a Cubic foot of air.	Additional Weight of Vapour required for complete saturation.	Mean degree of Humi- dity, complete satura- tion being unity.
	o	o	o	o	Inches.	T. gr.	T. gr.	
Mid- night.	80.1	1.4	79.1	2.4	0.973	10.49	0.82	0.93
1	79.8	1.4	78.8	2.4	.964	.40	.81	.93
2	79.6	1.3	78.7	2.2	.961	.37	.73	.93
3	79.5	1.1	78.7	1.9	.961	.37	.64	.94
4	79.3	1.2	78.5	2.0	.955	.31	.67	.94
5	79.3	1.1	78.5	1.9	.955	.31	.63	.94
6	79.4	1.1	78.6	1.9	.958	.34	.64	.94
7	79.7	1.3	78.8	2.2	.964	.40	.74	.93
8	80.3	1.8	79.0	3.1	.970	.44	1.07	.91
9	80.8	2.5	79.0	4.3	.970	.42	.51	.87
10	81.1	3.2	78.9	5.4	.967	.37	.91	.84
11	81.0	3.3	78.7	5.6	.961	.29	.99	.84
Noon.	81.5	3.5	79.0	6.0	.970	.37	2.16	.83
1	81.4	3.7	78.8	6.3	.964	.31	.26	.82
2	81.4	3.9	78.7	6.6	.961	.26	.38	.81
3	81.3	3.7	78.7	6.3	.961	.29	.24	.82
4	81.2	3.6	78.7	6.1	.961	.29	.17	.83
5	80.8	3.4	78.4	5.8	.952	.19	.05	.83
6	80.6	3.0	78.5	5.1	.955	.25	1.78	.85
7	80.6	2.3	79.0	3.9	.970	.42	.37	.88
8	80.3	2.0	78.9	3.4	.967	.41	.17	.90
9	80.2	1.9	78.9	3.2	.967	.41	.10	.90
10	80.2	1.6	79.1	2.7	.973	.47	0.93	.92
11	80.0	1.6	78.9	2.7	.967	.41	.93	.92

All the Hygrometrical elements are computed by the Greenwich Constants.

Abstract of the Results of the Hourly Meteorological Observations
 taken at the Surveyor General's Office, Calcutta,
 in the month of June 1871.
 Solar Radiation, Weather, &c.

Date.	Max. Solar radiation.	Rain Gauge 1½ ft. above Ground.	WIND.			General aspect of the Sky.
			Prevailing direction.	Max. Pressure.	Daily Velocity.	
1	151.0	0.51	S & Variable.	lb 1.7	Miles 133.5	Chiefly ζ . T at 5 p. m. Rat 9¼ p. m.
2	113.0	3.87	SSW & SW	1.3	152.4	S to 8 a. m. O afterwards. T from 10 a. m., to 6 p. m. L at 3 a. m., & from 12 a. m., to 2 p. m. R from 8¼ a. m., to 2 p. m.
3	139.4	0.68	SSE & S	2.0	101.4	O to 7 a. m. S to 1 p. m., ζ afterwards. T from 1 to 3, 7 to 9 a. m., & at 11 p. m. L from 1 to 3 a. m., at 7 & from 9 to 11 p. m. R from 1 to 3 a. m.
4	...	2.57	S & S by E	...	88.9	S to 6 a. m., ζ to 9 a. m., ζ & ζ to 2 p. m. O to 6 p. m. S afterwards. T at 6 & 7 a. m. & from 1 to 4 p. m. L at midnight. R at 2, 6, 10½ & 12 a. m. & from 1 to 3 p. m.
5	145.0	0.84	S by E, S & SSE	...	60.6	ζ to 12 a. m. O to 4 p. m. S afterwards. T at 1 p. m. R at 1 a. m., & 1 & 2 p. m.
6	140.0	0.11	SSE & ESE	...	59.9	ζ to 3 a. m. S to 7 a. m., ζ to 12 a. m. O to 6 p. m., ζ afterwards. T at 1 & 2 p. m. Slight R from 11½ a. m., to 3 p. m.
7	138.3	0.35	ESE & NNE	...	61.8	ζ to 3 a. m. S to 6 p. m. O afterwards. T at 10 a. m., and from 8 to 10 p. m. L from 8 to 10 p. m. Slight R at 11 a. m. & from 7 to 11 p. m.
8	132.0	0.12	WSW, NNW & NNE	...	120.3	O to 4 p. m., ζ & ζ afterwards. T at 2 a. m., & 11½ p. m. L at 2 a. m., & 11 p. m. R at 3 a. m.
9	127.6	4.04	W by S & SSW	2.0	101.9	O to 3 p. m. S afterwards. Brisk wind at 3¼ a. m. T from midnight to 7 a. m. & at 7 p. m. L from midnight to 6 a. m. & 7 to 11 p. m. R from midnight to 12½ a. m.
10	141.8	0.74	SW & SSW	0.8	152.2	S to 11 a. m., ζ & ζ to 4 p. m. O afterwards. T, L & R at 5 & 6 p. m.
11	...	0.34	SSE & S by E	...	102.7	Chiefly O. T from 1 to 4 & at 8 a. m. L from 1 to 4 a. m. Slight R from 2 to 6 & 10 to 12 a. m., & at 2 p. m.

ζ Cirri, ζ Strati, ζ Cumuli, ζ Cirro-strati, ζ Cumulo-strati, ζ Nimbi,

Abstract of the Results of the Hourly Meteorological Observations
 taken at the Surveyor General's Office, Calcutta,
 in the month of June 1871.
 Solar Radiation, Weather, &c.

Date.	Max. Solar radiation.	Rain Gauge 1½ ft. above Ground.	WIND.			General aspect of the Sky.
			Prevailing direction.	Max. Pressure	Daily Velocity.	
12	145.3	2.18	SE & SSE	...	199.3	S to 7 A. M., ☽ to 3 P. M. O to 7 P. M. B afterwards. L at 4 A. M., & 11 P. M. R from 12 A. M., to 3 P. M.
13	...	1.38	S by W & S	...	107.4	O to 7 P. M., ☽ afterwards. R at 1 & from 5 to 7 & 10½ A. M., to 1 P. M., & at 3 P. M.
14	152.3	0.06	S & SSW	...	77.4	Sto 4 A. M. O to 9 A. M., ☽ to 2 P. M. O to 9 P. M. B afterwards. Slight R at 8 A. M., 1, 4, 6 & 9 P. M.
15	137.5	0.13	WSW, S & S by E	...	75.9	Clouds of different kinds. Slight R at 2 A. M., & from 12 A. M. to 3 P. M.
16	...	0.25	S by E, S & S by W	...	171.5	☽ to 4 A. M. O to 7 A. M., ☽ & ☽ to 7 P. M. S afterwards. L on S at 11½ P. M. R at 7, 12 A. M., & 1 P. M.
17	149.2	0.01	S	...	206.5	S to 5 A. M., ☽ to 9 A. M., ☽ to 1 P. M. O afterwards. D at 6 A. M., 2½, 4 & 5 P. M.
18	146.5	...	S by W & SSW	...	165.8	O to 4 A. M. S to 8 A. M., ☽ to 11 A. M., ☽ to 6 P. M., ☽ afterwards.
19	148.5	...	SSW & S	...	114.8	☽ to 5 A. M., ☽ to 7 P. M. B afterwards.
20	127.0	...	S & ESE	...	115.8	O to 9 A. M., clouds of different kinds afterwards. L at 4 & 5 A. M., & 11 P. M. T at 8 A. M. D at 8 & 12 A. M., & 1 & 2½ P. M.
21	143.0	0.27	SE & E by S	...	153.2	☽ to 5 A. M. S to 10 A. M., ☽ to 8 P. M. O afterwards. R at 12 A. M., 4, 5 & 11 P. M.
22	...	0.84	SE & ESE	1.0	216.7	O to 3 A. M. S to 6 A. M., ☽ & ☽ to 9 A. M. O to 1 P. M., clouds of different kinds afterwards. R. at midnight, 10, 11 A. M., 1½, 2½, 4, 5 & 7 P. M.
23	138.8	0.45	ESE & SE	0.8	273.8	S to 6 A. M., ☽ to 1 P. M., O afterwards. T at 10½ P. M. Slight R at 1, 3, 11 A. M., 2, 6, 7 & from 9 to 11 P. M.
24	...	1.53	ESE & S	...	254.6	O. T at 2¼ & 6½ P. M. L at 2¼ P. M. R after intervals.

☽ Cirri, ☽ Strati, ☽ Cumuli, ☽ Cirro-strati, ☽ Cumulo-strati, ☽ Nimbi,
 ☽ Cirro-cumuli, ☽ clear, ☽ stratos, ☽ excess, ☽ thunder, ☽ lightning.

*Abstract of the Results of the Hourly Meteorological Observations
taken at the Surveyor General's Office, Calcutta,
in the month of June 1871.
Solar Radiation, Weather, &c..*

Date.	Max. Solar radiation.	Rain Gauge 1½ ft. above Ground.	WIND.			General aspect of the Sky.
			Prevailing direction.	Max. Pressure	Daily Velocity.	
	o	Inches		lb	Miles.	
25	120.0	0.44	S W & S S E	...	85.0	Chiefly O. R at 1½ & 3 A.M., & 4 P. M.
26	128.5	0.02	S S W	...	168.2	S to 6 A. M. O to 11 A. M. S afterwards. Light R from 7 to 11 A. M.
27	137.0	1.12	S S W & S W	0.8	179.1	Chiefly O. R from 1½ to 9 at 11 & 12 A. M., & 6 P. M.
28	114.0	0.21	S S W & S W	0.8	139.3	Chiefly O. Slight R at mid-night from 6 to 10 A.M., & between 7 & 8 P. M.
29	110.5	1.82	S S W & W S W	2.0	79.9	Chiefly O. R from 3 to 11 P. M.
30	134.0	0.47	WNW, SW & S S W	...	98.9	O to 9 A. M, S afterwards. T at 1 A. M. L at 1 A. M., & from 8 to 10 P. M. R from midnight to 4 A. M., at 1, 2½ & 11 P. M.

∩ i Cirri — i Strati, ∩ i Cumuli, ∩ i Cirro-strati, ∩ i Cumulo-strati ∩ i Nimbi,
∩ i Cirro-Cumuli, B clear, S strati, O overcast, T thunder, L lightning,

*Abstract of the Results of the Hourly Meteorological Observations
taken at the Surveyor General's Office, Calcutta,
in the month of June 1871.*

MONTHLY RESULTS.

	Inches.
Mean height of the Barometer for the month... ..	29.523
Max. height of the Barometer occurred at 9 A. M. on the 1st. ...	29.714
Min. height of the Barometer occurred at 5 P. M. on the 22nd. ...	29.342
<i>Extreme range</i> of the Barometer during the month	0.372
Mean of the daily Max. Pressures	29.579
Ditto ditto Min. ditto	29.462
<i>Mean daily range</i> of the Barometer during the month	0.117

	°
Mean Dry Bulb Thermometer for the month	82.7
Max. Temperature occurred at 2 P. M. on the 1st.	93.8
Min. Temperature occurred at 1 & 2 A. M. on the 30th.	76.4
<i>Extreme range</i> of the Temperature during the month	17.4
Mean of the daily Max. Temperature	87.2
Ditto ditto Min. ditto,	79.8
<i>Mean daily range</i> of the Temperature during the month... ..	7.4

Mean Wet Bulb Thermometer for the month	80.4
Mean Dry Bulb Thermometer above Mean Wet Bulb Thermometer ...	2.3
Computed Mean Dew-point for the month	78.8
Mean Dry Bulb Thermometer above computed mean Dew-point ...	3.9

Inches.

Mean Elastic force of Vapour for the month	0.964
---	-------

Troy grain.

Mean Weight of Vapour for the month	10.36
Additional Weight of Vapour required for complete saturation ...	1.36
Mean degree of humidity for the month, complete saturation being unity	0.88

°

Mean Max. Solar radiation Thermometer for the month ...	135.8
---	-------

Inches.

Rained 28 days,—Max. fall of rain during 24 hours	4.04
Total amount of rain during the month	25.35
Total amount of rain indicated by the Gauge* attached to the anemo- meter during the month	23.56
Prevailing direction of the Wind... ..	S & S S W.

* Height 70 feet 10 inches above ground.



*Abstract of the Results of the Hourly Meteorological Observations
taken at the Surveyor General's Office, Calcutta,
in the month of July 1871.*

Latitude 22° 33' 1" North. Longitude 88° 20' 34" East.

Height of the Cistern of the Standard Barometer above the sea level, 18.11 feet.

Daily Means, &c. of the Observations and of the Hygrometrical elements
dependent thereon.

Date.	Mean Height of the Barometer at 32° Fahr.	Range of the Barometer during the day.			Mean Dry Bulb Thermometer.	Range of the Tempera- ture during the day.		
		Max.	Min.	Diff.		Max.	Min.	Diff.
	Inches.	Inches.	Inches.	Inches.	o	o	o	o
1	29.608	29.666	29.528	0.138	80.3	87.5	76.4	11.1
2	.555	.594	.500	.094	78.1	80.5	75.5	5.0
3	.561	.633	.522	.111	82.4	88.0	79.0	9.0
4	.637	.683	.596	.087	82.9	87.4	79.4	8.0
5	.602	.666	.537	.129	83.7	88.5	80.2	8.3
6	.576	.616	.511	.105	84.4	89.8	80.5	9.3
7	.543	.594	.470	.124	85.1	90.0	81.5	8.5
8	.519	.563	.462	.101	83.8	90.2	81.2	9.0
9	.528	.588	.480	.108	83.1	85.7	81.0	4.7
10	.539	.581	.488	.093	83.2	86.7	80.7	6.0
11	.522	.579	.465	.114	83.3	89.0	79.4	9.6
12	.592	.660	.552	.108	81.9	86.5	78.0	8.5
13	.674	.724	.624	.100	80.0	81.8	77.6	4.2
14	.657	.721	.563	.158	83.5	88.4	80.5	7.9
15	.575	.641	.495	.149	84.4	87.5	81.4	6.1
16	.542	.596	.485	.111	83.3	86.0	81.0	5.0
17	.513	.555	.450	.105	82.6	86.4	78.5	7.9
18	.495	.537	.435	.102	83.9	89.9	80.5	9.4
19	.482	.520	.423	.097	83.2	89.0	80.2	8.8
20	.512	.561	.463	.101	82.4	86.5	80.0	6.5
21	.550	.598	.506	.092	80.9	84.2	78.0	6.2
22	.600	.639	.561	.078	79.0	81.5	78.2	3.3
23	.600	.637	.553	.084	81.6	84.6	79.0	5.6
24	.541	.607	.464	.143	82.9	86.8	80.5	6.3
25	.494	.540	.421	.119	79.6	83.9	77.2	6.7
26	.510	.583	.462	.121	82.9	89.0	78.0	11.0
27	.576	.618	.537	.081	82.5	87.6	78.8	8.8
28	.568	.611	.500	.111	84.0	89.0	79.5	9.5
29	.482	.561	.390	.171	84.8	90.5	81.1	9.4
30	.416	.494	.359	.135	82.4	86.0	80.0	6.0
31	.525	.613	.457	.156	80.9	82.8	79.4	3.4

The Mean Height of the Barometer, as likewise the Dry and Wet Bulb Thermometer Means are derived, from the hourly observations, made at the several hours during the day.

*Abstract of the Results of the Hourly Meteorological Observations
taken at the Surveyor General's Office, Calcutta,
in the month of July 1871.*

Daily Means, &c. of the Observations and of the Hygrometrical elements
dependent thereon.—(Continued.)

Date.	Mean Wet Bulb Thermometer.	Dry Bulb above Wet.	Computed Dew Point.	Dry Bulb above Dew Point.	Mean Elastic force of vapour.	Mean Weight of Vapour in a Cubic foot of air.	Additional Weight of Vapour required for complete saturation.	Mean degree of Humidity, complete saturation being unity.
	o	o	o	o	Inches.	T. gr.	T. gr.	
1	77.7	2.6	75.9	4.4	0.879	9.49	1.42	0.87
2	77.1	1.0	76.4	1.7	.893	.68	0.54	.95
3	79.7	2.7	77.8	4.6	.934	10.03	1.58	.86
4	79.5	3.4	77.1	5.8	.913	9.80	.99	.83
5	80.7	3.0	78.6	5.1	.958	10.28	.79	.85
6	81.2	3.2	79.0	5.4	.970	.40	.91	.85
7	81.7	3.4	79.3	5.8	.979	.46	2.11	.83
8	81.3	2.5	79.5	4.3	.986	.57	1.53	.87
9	81.1	2.0	79.7	3.4	.992	.66	.20	.90
10	81.4	1.8	80.1	3.1	1.005	.77	.12	.91
11	80.7	2.6	78.9	4.4	0.967	.39	.54	.87
12	79.4	2.5	77.6	4.3	.928	9.99	.45	.87
13	78.8	1.2	78.0	2.0	.940	10.15	0.66	.94
14	80.9	2.6	79.1	4.4	.973	.45	1.55	.87
15	81.6	2.8	79.6	4.8	.989	.58	.73	.86
16	81.0	2.3	79.4	3.9	.983	.54	.39	.88
17	80.1	2.5	78.3	4.3	.949	.20	.48	.87
18	80.8	3.1	78.6	5.3	.958	.28	.85	.85
19	80.4	2.8	78.4	4.8	.952	.21	.68	.86
20	80.2	2.2	78.7	3.7	.961	.33	.28	.89
21	78.9	2.0	77.5	3.4	.925	9.98	.12	.90
22	78.5	1.4	77.5	2.4	.925	10.00	0.78	.93
23	79.5	2.1	78.0	3.6	.940	.11	1.23	.89
24	79.8	3.1	77.6	5.3	.928	9.97	.82	.85
25	78.0	1.6	76.9	2.7	.908	.80	0.89	.92
26	79.4	3.5	76.9	6.0	.908	.74	2.05	.83
27	79.7	2.8	77.7	4.8	.931	10.00	1.64	.86
28	80.6	3.4	78.2	5.8	.946	.13	2.04	.83
29	81.2	3.6	78.7	6.1	.961	.29	.17	.83
30	80.1	2.3	78.5	3.9	.955	.27	1.34	.89
31	79.2	1.7	78.0	2.9	.940	.13	0.97	.91

All the Hygrometrical elements are computed by the Greenwich Constants.

*Abstract of the Results of the Hourly Meteorological Observations
taken at the Surveyor General's Office, Calcutta,
in the month of July 1871.*

Hourly Means, &c. of the Observations and of the Hygrometrical elements dependent thereon.

Hour.	Mean Height of the Barometer at 32° Fahr.	Range of the Barometer for each hour during the month.			Mean Dry Bulb Thermometer.	Range of the Temperature for each hour during the month.		
		Max.	Min.	Diff.		Max.	Min.	Diff.
	Inches.	Inches.	Inches.	Inches.	o	o	o	o
Mid-night.	29.574	29.710	29.457	0.253	81.1	83.0	77.0	6.0
1	.564	.701	.447	.254	80.7	82.6	76.3	6.3
2	.554	.693	.420	.273	80.4	82.2	76.0	6.2
3	.542	.682	.404	.278	80.1	82.3	75.7	6.6
4	.536	.662	.391	.271	79.8	82.3	75.6	6.7
5	.543	.671	.399	.272	79.7	82.5	75.6	6.9
6	.554	.674	.399	.275	79.7	82.5	75.5	7.0
7	.568	.691	.408	.283	80.5	83.0	77.0	6.0
8	.578	.714	.429	.285	81.6	84.5	77.3	7.2
9	.585	.721	.438	.283	82.9	85.8	78.0	7.8
10	.587	.715	.430	.285	83.8	87.5	78.2	9.3
11	.580	.724	.419	.305	84.7	88.5	79.0	9.5
Noon.	.567	.709	.401	.308	85.5	89.5	79.5	10.0
1	.550	.707	.391	.316	85.9	90.5	79.0	11.5
2	.531	.689	.384	.305	85.7	90.0	78.8	11.2
3	.513	.654	.366	.288	85.1	90.0	79.0	11.0
4	.500	.640	.359	.281	85.2	90.0	79.6	10.4
5	.495	.624	.371	.253	84.7	88.7	79.5	9.2
6	.508	.637	.384	.253	83.6	87.5	77.5	10.0
7	.528	.650	.411	.239	82.5	86.3	77.5	8.8
8	.548	.681	.431	.250	82.1	85.2	78.0	7.2
9	.567	.700	.458	.242	81.8	84.3	78.2	6.1
10	.581	.718	.472	.246	81.5	83.7	77.5	6.2
11	.582	.717	.464	.253	81.4	83.6	77.5	6.1

The Mean Height of the Barometer, as likewise the Dry and Wet Bulb Thermometer Means are derived from the observations made at the several hours during the month.

*Abstract of the Results of the Hourly Meteorological Observations
taken at the Surveyor General's Office, Calcutta,
in the month of July 1871.*

Hourly Means, &c. of the Observations and of the Hygrometrical elements
dependent thereon.—(Continued.)

Hour.	Mean Wet Bulb Ther- mometer.	Dry Bulb above Wet.	Computed Dew Point.	Dry Bulb above Dew Point.	Mean Elastic force of Vapour.	Mean Weight of Vapour in a Cubic foot of air.	Additional Weight of Vapour required for complete saturation.	Mean degree of Humi- dity, complete satura- tion being unity.
	o	o	o	o	Inches.	T. gr.	T. gr.	
Mid- night.	79.7	1.4	78.7	2.4	0.961	10.37	0.80	0.93
1	79.4	1.3	78.5	2.2	.955	.31	.73	.93
2	79.2	1.2	78.4	2.0	.952	.27	.67	.94
3	79.0	1.1	78.2	1.9	.946	.21	.63	.94
4	78.8	1.0	78.1	1.7	.943	.18	.57	.95
5	78.6	1.1	77.8	1.9	.934	.09	.63	.94
6	78.7	1.0	78.0	1.7	.940	.15	.57	.95
7	79.3	1.2	78.5	2.0	.955	.31	.67	.94
8	79.8	1.8	78.5	3.1	.955	.29	1.05	.91
9	80.1	2.8	78.1	4.8	.943	.12	.67	.86
10	80.5	3.3	78.2	5.6	.946	.13	.97	.84
11	80.9	3.8	78.2	6.5	.946	.11	2.31	.81
Noon.	81.2	4.3	78.2	7.3	.946	.11	.61	.80
1	81.3	4.6	78.1	7.8	.943	.06	.81	.78
2	81.1	4.6	77.9	7.8	.937	.00	.80	.78
3	81.2	3.9	78.5	6.6	.955	.21	.36	.81
4	81.1	4.1	78.2	7.0	.946	.11	.50	.80
5	80.8	3.9	78.1	6.6	.943	.08	.34	.81
6	80.5	3.1	78.3	5.3	.949	.18	1.85	.85
7	79.9	2.6	78.1	4.4	.943	.14	.50	.87
8	79.8	2.3	78.2	3.9	.946	.17	.34	.88
9	79.8	2.0	78.4	3.4	.952	.25	.15	.90
10	79.7	1.8	78.4	3.1	.952	.25	.06	.91
11	79.8	1.6	78.7	2.7	.961	.35	0.92	.92

All the Hygrometrical elements are computed by the Greenwich Constants.

Abstract of the Results of the Hourly Meteorological Observations
 taken at the Surveyor General's Office, Calcutta,
 in the month of July 1871.
 Solar Radiation, Weather, &c.

Date.	Max. Solar radiation.	Rain Gauge 1½ ft. above Ground.	WIND.			General aspect of the Sky.
			Prevailing direction.	Max. Pressure	Daily Velocity.	
1	143.5	2.24	S W, S S W & W [by S	lb 1.4	Miles 142.2	O to 12 A. M., \i to 5 P. M. O afterwards. R from midnight to 2 A. M., & 5½ to 11 P. M.
2	...	1.01	W S W & W by S.	...	159.9	O. R from midnight to 9 A. M., 1 to 2½ & at 6, 8 & 9 P. M.
3	150.0	0.02	W by S & S by W. [E.	...	111.1	O to 6 A. M., \i afterwards. Light R at 12 A. M., 1½ & 3½ P. M.
4	145.0	0.09	S by W, S S E & S by	0.5	208.4	B to 5 A. M., \i to 7 P. M. B afterwards. Slight R at 11 A. M., 1½ & 2½ P. M.
5	...	0.43	S S E & S by E.	...	219.9	S to 8 A. M., \i afterwards. L from 8 to 10 P. M. R from 12½ A. M., to 2½ P. M.
6	148.0	0.27	S by E & S.	...	109.3	\i to 6 A. M., \i to 7 P. M. B afterwards. R at 8 A. M. & 3 P. M.
7	145.0	...	S by E & S.	...	144.4	B to 4 A. M., \i & \i afterwards. T at 4 P. M.
8	144.0	0.84	S S E.	...	165.3	S to 7 A. M., \i to 1 P. M. O to 7 P. M. S afterwards. T at 1¼ & 5½ P. M. R at 4 A. M., 2, 3, 5 & 7 P. M.
9	120.0	0.49	S S E.	...	119.6	S to 3 A. M. O to 7 P. M. S afterwards. T at 9¾ A. M. 1, 2 & 3 P. M. L at 9 P. M. R at 9¼, 12 A. M., & 1 P. M.
10	126.0	0.36	S S E & S.	...	93.9	S to 8 A. M., \i, to 12 A. M. O to 4 P. M. S afterwards. T at 1½ P. M. Slight R at 12½ A. M. & from 2¼ to 4 & at 6½ P. M.
11	153.0	0.30	S by E & S S E	...	81.2	S to 4 A. M., \i to 8 A. M., \i to 2 P. M. O afterwards. R at 3 & between 7 & 8 P. M.
12	150.0	0.16	S by E & S W	...	112.5	O to 7 A. M., \i to 1 P. M. S to 4 P. M. O afterwards. Slight R from 1½ to 6 & at 10 A. M.
13	...	1.41	S by E & S	...	127.7	O to 4 P. M., \i to 8 P. M. S afterwards. R from 1½ A. M., to 3 P. M.
14	146.0	0.43	S & S S W,	...	174.6	O to 9 A. M., \i to 5 P. M. O afterwards. R at 5½ A. M., & from 6½ to 9 P. M.
15	125.8	0.11	S S W.	...	266.5	S to 4 P. M. O afterwards. T from 9 to 11 P. M. L from 8 to 10 P. M. Slight R at 8½ & 10 P. M.

\i Cirri,—i Strati, \i Cumuli, \i Cirro-strati, \i Cumulo-strati, \i Nimbi, \i Cirro-cumuli, B clear, S stratoni, O overcast, T thunder, L lightning,

*Abstract of the Results of the Hourly Meteorological Observations
taken at the Surveyor General's Office, Calcutta,
in the month of July 1871.
Solar Radiation, Weather, &c.*

Date.	Max. Solar radiation.	Rain Gauge 1½ ft. above Ground.	WIND.			General aspect of the Sky.
			Prevailing direction.	Max. Pressure	Daily Velocity.	
16	113.0	0.02	S & S W	ib ...	Miles 151.5	O to 10 A. M. S to 5 P. M. O afterwards. L on E at 9 P. M. Light R at 3 A. M.
17	148.8	0.83	W & S	...	85.6	O to 5 A. M., \i & \i to 10 A. M., \i to 2 P. M., \i after- wards. R at 3 & 4 A. M.
18	136.0	...	S, S E & E S E	...	30.4	\i to 4 A. M., \i & \i to 6 P. M. B afterwards. T at 8½ P. M. L on W at 11 P. M. D at 11 A. M., & 8½ P. M.
19	110.5	0.17	E S E & S E	...	266.2	Clouds of various kinds. T at 2 P. M. Slight R at 7 & 11½ A. M., 1½, 5½ & 7 P. M.
20	148.5	0.38	S E & S by E	0.8	257.4	O to 10 A. M. S afterwards. Slight R at 4, 10 & 12½ A. M., & 3, 6½ & 10 P. M.
21	129.4	1.12	S by E & S S W	...	120.6	O to 11 A. M. S afterwards. R at 2, 3½ & from 6 to 11 A. M.
22	...	0.42	S S W & S by W	...	133.9	Chiefly O. Slight R from 4 to 6 & 10 A. M., to 6 P. M.
23	120.0	0.05	S S W	...	120.1	O to 9 A. M. S to 7 P. M. O afterwards. Light R at 3½ A. M.
24	134.1	...	S S W & S W	...	121.9	O to 10 A. M., \i & \i to 8 P. M. O afterwards. L at 10 & 11 P. M. D at 8 A. M., & 10 P. M.
25	134.0	3.25	WSW, W&W by [S	...	101.7	Chiefly O. T & L at 1 & 2 A. M. R from 1 to 12 A. M., & 4 to 7 P. M.
26	145.0	0.11	W by S & S S E	...	87.7	S to 5 A. M., \i afterwards. Slight R at 4, 5 A. M., & 2 P. M.
27	129.6	0.13	S E. & S	...	190.7	B to 4 A. M. S to 9 A. M., \i to 4 P. M., \i afterwards. Slight R at 12 A. M., 2 & 4 P. M.
28	148.0	...	S & S by E	...	108.3	B to 2 A. M., \i to 8 P. M., \i afterwards. D at 4 & 6½ P. M.
29	147.2	0.05	S S E, E & E by N	0.5	144.2	S to 4 A. M., \i afterwards. Slight R from 7½ to 9 P. M.
30	128.0	0.51	E S E & S S E.	...	141.5	S to 6 A. M., \i to 4 P. M. O afterwards. R after intervals.
31	...	0.73	S & S by E	...	145.3	O. R after intervals.

\i Cirri,—i Strati, \i Cumuli, \i Cirro-strati, \i Cumulo-strati, \i Nimbi,
\i Cirro-cumuli, B clear, S strati, O overcast, T thunder, L lightning,
R rain, D drizzle

*Abstract of the Results of the Hourly Meteorological Observations
taken at the Surveyor General's Office, Calcutta,
in the month of July 1871.*

MONTHLY RESULTS.

	Inches.
Mean height of the Barometer for the month... ..	29.551
Max. height of the Barometer occurred at 11 A. M. on the 13th.	29.724
Min. height of the Barometer occurred at 4 P. M. on the 30th.	29.359
<i>Extreme range</i> of the Barometer during the month	0.365
Mean of the daily Max. Pressures	29.606
Ditto ditto Min. ditto	29.492
<i>Mean daily range</i> of the Barometer during the month	0.114

	°
Mean Dry Bulb Thermometer for the month	82.5
Max. Temperature occurred at 1 P. M. on the 29th.	90.5
Min. Temperature occurred at 6 A. M. on the 2nd.	75.5
<i>Extreme range</i> of the Temperature during the month	15.0
Mean of the daily Max. Temperature	86.8
Ditto ditto Min. ditto,	79.4
<i>Mean daily range</i> of the Temperature during the month... ..	7.4

Mean Wet Bulb Thermometer for the month	80.0
Mean Dry Bulb Thermometer above Mean Wet Bulb Thermometer	2.5
Computed Mean Dew-point for the month	78.2
Mean Dry Bulb Thermometer above computed mean Dew-point	4.3

	Inches.
Mean Elastic force of Vapour for the month	0.946

	Troy grain.
Mean Weight of Vapour for the month	10.17
Additional Weight of Vapour required for complete saturation	1.47
Mean degree of humidity for the month, complete saturation being unity 0.87	

	°
Mean Max. Solar radiation Thermometer for the month	137.2

	Inches.
Rained 30 days.—Max. fall of rain during 24 hours	3.25
Total amount of rain during the month	15.93
Total amount of rain indicated by the Gauge* attached to the anemo- meter during the month	14.77
Prevailing direction of the Wind... .. S by E, S & S W.	

* Height 70 feet 10 inches above ground.

*Abstract of the Results of the Hourly Meteorological Observations
taken at the Surveyor General's Office, Calcutta,
in the month of August 1871.*

Latitude 22° 33' 1" North. Longitude 88° 20' 34" East.

Height of the Cistern of the Standard Barometer above the sea level, 18.11 feet.

Daily Means, &c. of the Observations and of the Hygrometrical elements
dependent thereon.

Date.	Mean Height of the Barometer at 32° Fahr.	Range of the Barometer during the day.			Mean Dry Bulb Thermometer.	Range of the Tempera- ture during the day.		
		Max.	Min.	Diff.		Max.	Min.	Diff.
	Inches.	Inches.	Inches.	Inches.	o	o	o	o
1	29.624	29.672	29.584	0.088	78.9	79.8	77.5	2.3
2	.642	.692	.590	.102	80.9	84.3	78.8	5.5
3	.614	.667	.549	.118	82.9	88.9	79.3	9.6
4	.564	.603	.484	.119	81.4	88.5	80.5	8.0
5	.535	.580	.480	.100	81.9	88.2	82.7	5.5
6	.524	.564	.457	.107	84.7	89.2	82.0	7.2
7	.452	.528	.370	.158	83.8	88.7	80.6	8.1
8	.407	.456	.359	.097	82.1	86.0	80.5	5.5
9	.444	.500	.396	.104	82.6	88.0	80.5	7.5
10	.465	.508	.401	.107	83.8	89.6	80.5	9.1
11	.482	.524	.436	.088	83.4	91.3	80.5	10.8
12	.464	.508	.392	.116	83.2	87.0	81.0	6.0
13	.493	.586	.413	.173	82.8	86.2	80.7	5.5
14	.560	.604	.506	.098	83.8	88.2	81.0	7.2
15	.566	.601	.518	.083	82.4	86.5	79.8	6.7
16	.558	.624	.514	.110	80.0	81.3	78.7	2.6
17	.617	.690	.570	.120	82.1	86.9	78.2	8.7
18	.663	.721	.601	.120	84.1	88.2	79.9	8.3
19	.647	.689	.593	.096	83.6	86.0	81.0	5.0
20	.652	.692	.613	.079	83.5	86.5	81.5	5.0
21	.654	.697	.586	.111	81.6	87.0	78.0	9.0
22	.641	.703	.580	.123	81.4	86.0	78.7	7.3
23	.637	.688	.592	.096	81.8	86.8	78.5	8.3
24	.672	.716	.620	.096	83.4	87.4	80.0	7.4
25	.709	.760	.653	.107	84.0	88.6	79.5	9.1
26	.721	.774	.661	.113	83.9	88.0	81.2	6.8
27	.700	.747	.630	.117	82.9	87.0	79.5	7.5
28	.693	.734	.638	.096	82.5	87.2	79.8	7.4
29	.717	.763	.661	.102	83.6	88.5	79.6	8.9
30	.767	.831	.706	.125	84.9	91.0	80.0	11.0
31	.800	.859	.743	.116	83.6	89.0	80.8	8.2

The Mean Height of the Barometer, as likewise the Dry and Wet Bulb Thermometer Means are derived, from the hourly observations, made at the several hours during the day.

*Abstract of the Results of the Hourly Meteorological Observations
taken at the Surveyor General's Office, Calcutta,
in the month of August 1871.*

Daily Means, &c. of the Observations and of the Hygrometrical elements
dependent thereon.—(Continued.)

Date.	Mean Wet Bulb Ther- mometer.	Dry Bulb above Wet.	Computed Dew Point.	Dry Bulb above Dew Point.	Mean Elastic force of vapour.	Mean Weight of Vapour in a Cubic foot of air.	Additional Weight of Vapour required for complete saturation.	Mean degree of Humi- dity, complete satu- ration being unity.
	o	o	o	o	Inches.	T. gr.	T. gr.	
1	78.1	0.8	77.5	1.4	0.925	10.03	0.44	0.96
2	79.5	1.4	78.5	2.4	.955	.31	.79	.93
3	80.3	2.6	78.5	4.4	.955	.27	1.52	.87
4	81.2	3.2	79.0	5.4	.970	.40	.91	.95
5	82.1	2.8	80.1	4.8	1.005	.73	.76	.86
6	82.1	2.6	80.3	4.4	.011	.82	.60	.87
7	81.3	2.5	79.5	4.3	0.986	.57	.53	.87
8	80.7	1.4	79.7	2.4	.992	.68	0.83	.93
9	81.1	1.5	80.0	2.6	1.001	.75	.93	.92
10	81.1	2.7	79.2	4.6	0.976	.45	1.65	.86
11	81.1	2.3	79.5	3.9	.986	.57	.39	.88
12	81.2	2.0	79.8	3.4	.995	.69	.20	.90
13	80.6	2.2	79.1	3.7	.973	.45	.30	.89
14	81.5	2.3	79.9	3.9	.998	.69	.41	.88
15	80.8	1.6	79.7	2.7	.992	.66	0.95	.92
16	79.0	1.0	78.3	1.7	.949	.24	.57	.95
17	79.7	2.4	78.0	4.1	.940	.11	1.40	.88
18	80.3	3.8	77.6	6.5	.928	9.93	2.28	.81
19	81.4	2.2	79.9	3.7	.998	10.69	1.34	.89
20	80.4	3.1	78.2	5.3	.946	.15	.85	.85
21	79.6	2.0	78.2	3.4	.946	.19	.15	.90
22	79.0	2.4	77.3	4.1	.919	9.90	.37	.88
23	79.0	2.8	77.0	4.8	.910	.79	.61	.86
24	80.0	3.4	77.6	5.8	.928	.95	2.01	.83
25	80.3	3.7	77.7	6.3	.931	.98	.19	.82
26	81.3	2.6	79.5	4.4	.986	10.57	1.56	.87
27	80.4	2.5	78.6	4.3	.958	.30	.49	.87
28	80.2	2.3	78.6	3.9	.958	.30	.34	.89
29	80.3	3.3	78.0	5.6	.940	.07	.96	.84
30	81.0	3.9	78.3	6.6	.949	.14	2.35	.81
31	80.4	3.2	78.2	5.4	.946	.15	1.88	.84

All the Hygrometrical elements are computed by the Greenwich Constants.

*Abstract of the Results of the Hourly Meteorological Observations
taken at the Surveyor General's Office, Calcutta,
in the month of August 1871.*

Hourly Means, &c. of the Observations and of the Hygrometrical elements
dependent thereon.

Hour.	Mean Height of the Barometer at 32° Fahr.	Range of the Barometer for each hour during the month.			Mean Dry Bulb Thermometer.	Range of the Tempera- ture for each hour during the month.		
		Max.	Min.	Diff.		Max.	Min.	Diff.
	Inches.	Inches.	Inches.	Inches.	o	o	o	o
Mid- night.	29.620	29.820	29.423	0.397	81.4	84.0	78.5	5.5
1	.610	.813	.411	.402	81.2	83.8	78.6	5.2
2	.600	.806	.399	.407	81.0	83.4	78.8	4.6
3	.589	.794	.388	.406	80.8	83.2	78.5	4.7
4	.580	.781	.366	.415	80.6	83.0	78.5	4.5
5	.588	.787	.371	.416	80.5	82.9	77.5	5.4
6	.601	.794	.399	.395	80.5	82.7	77.5	5.2
7	.615	.800	.409	.391	81.0	83.8	78.0	5.8
8	.630	.820	.421	.399	82.0	85.0	78.3	6.7
9	.641	.838	.429	.409	83.2	86.8	78.8	8.0
10	.645	.859	.423	.436	84.2	87.8	79.1	8.7
11	.637	.841	.422	.419	85.4	89.0	79.0	10.0
Noon.	.622	.825	.410	.415	85.9	89.2	78.9	10.3
1	.602	.791	.401	.390	85.9	91.0	78.7	12.3
2	.581	.770	.387	.383	86.4	91.3	78.8	12.5
3	.565	.753	.382	.371	85.8	90.5	79.5	11.0
4	.500	.743	.359	.384	85.6	91.0	79.5	11.5
5	.500	.746	.369	.377	85.1	88.4	78.5	9.9
6	.561	.767	.385	.382	83.7	87.6	78.0	9.6
7	.579	.773	.394	.379	82.7	86.6	78.8	7.8
8	.600	.797	.403	.394	82.5	86.0	79.0	7.0
9	.622	.815	.422	.393	82.1	84.5	79.0	5.5
10	.637	.827	.427	.400	81.7	84.3	78.2	6.1
11	.637	.837	.439	.398	81.5	84.0	78.7	5.3

The Mean Height of the Barometer, as likewise the Dry and Wet Bulb Thermometer Means are derived from the observations made at the several hours during the month.

*Abstract of the Results of the Hourly Meteorological Observations
taken at the Surveyor General's Office, Calcutta,
in the month of August 1871.*

Hourly Means, &c. of the Observations and of the Hygrometrical elements
dependent thereon.—(Continued.)

Hour.	Mean Wet Bulb Ther- mometer.	Dry Bulb above Wet.	Computed Dew Point.	Dry Bulb above Dew Point.	Mean Elastic force of Vapour.	Mean Weight of Vapour in a Cubic foot of air.	Additional Weight of Vapour required for complete saturation.	Mean degree of Humi- dity, complete satura- tion being unity.
	o	o	o	o	Inches.	T. gr.	T. gr.	
Mid- night.	80.1	1.3	79.2	2.2	0.976	10.52	0.75	0.93
1	80.0	1.2	79.2	2.0	.976	.52	.69	.94
2	79.9	1.1	79.1	1.9	.973	.49	.65	.94
3	79.8	1.0	79.1	1.7	.973	.49	.58	.95
4	79.6	1.0	78.9	1.7	.967	.43	.58	.95
5	79.6	0.9	79.0	1.5	.970	.46	.52	.95
6	79.5	1.0	78.8	1.7	.964	.40	.58	.95
7	79.9	1.1	79.1	1.9	.973	.49	.65	.94
8	80.2	1.8	78.9	3.1	.967	.41	1.06	.91
9	80.6	2.6	78.8	4.4	.964	.36	.53	.87
10	80.8	3.4	78.4	5.8	.952	.19	2.05	.83
11	81.3	4.1	78.4	7.0	.952	.17	.51	.80
Noon.	81.5	4.4	78.4	7.5	.952	.15	.72	.79
1	81.5	4.4	78.4	7.5	.952	.15	.72	.79
2	81.7	4.7	78.4	8.0	.952	.15	.91	.78
3	81.3	4.5	78.1	7.7	.943	.06	.77	.78
4	81.6	4.0	78.8	6.8	.964	.29	.47	.81
5	81.2	3.9	78.5	6.6	.955	.21	.36	.81
6	80.7	3.0	78.6	5.1	.958	.28	1.79	.85
7	80.3	2.4	78.6	4.1	.958	.30	.42	.88
8	80.4	2.1	78.9	3.6	.967	.39	.25	.89
9	80.3	1.8	79.0	3.1	.970	.44	.07	.91
10	80.1	1.6	79.0	2.7	.970	.44	0.93	.92
11	80.0	1.5	78.9	2.6	.967	.41	.90	.92

All the Hygrometrical elements are computed by the Greenwich Constants.

Abstract of the Results of the Hourly Meteorological Observations
 taken at the Surveyor General's Office, Calcutta,
 in the month of August 1871.
 Solar Radiation, Weather, &c.

Date.	Max. Solar radiation.	Rain Gauge 1½ ft. above Ground.	WIND.		Daily Velocity.	General aspect of the Sky.
			Prevailing direction.	Max. Pressure		
	o	Inches		lb	Miles	
1	...	2.23	S & S by E	...	126.4	O to 6 P. M., ~i afterwards.
2	136.0	0.04	S by E & S by W.	...	83.6	R from 1½ A. M., to 6 P. M. S to 1 P. M., clouds of different kinds afterwards. Light R from 6 to 9 A. M.,
3	146.0	...	S by W, E & SW.	...	39.2	~i to 7 A. M., ~i afterwards. T at 6½ & 8 P. M. L on N W at 8 P. M. D at 5½ P. M.
4	147.5	...	S W, W & WSW.	...	94.2	~i to 3 A. M., ~i to 7 A. M., ~i afterwards. L on N at 11 P. M.
5	WS W, W by N & ^[N.]	...	111.3	~i to 8 A. M., clouds of different kinds afterwards. L at 8 & 10 P. M. D at 6½ P. M.
6	147.3	1.12	N & E N E.	...	97.6	~i & ~i to 5 P. M. O afterwards. T at 10¼ A. M. L at 9 P. M. R at 10¼ A. M., 1, 8 & 9 P. M.
7	128.0	0.04	N E & E N E	1.4	245.7	Clouds of various kinds. L at midnight. Light R a midnight 7½ A. M., 1½, 6½ & 9 P. M.
8	...	0.30	E & S E	1.6	272.3	O L on N. W. at 8 P. M. Slight R after intervals.
9	133.0	0.56	S E & S S E	...	240.3	O to 9 A. M., ~i to 8 P. M. S afterwards. T at 12½ A. M. & 3 P. M. L at 8 & 9 P. M. R at midnight, 1, 3, 8 A. M., 1 & 3 P. M.
10	149.2	0.03	S E & E S E.	...	181.1	O to 8 A. M., ~i to 7 P. M. S afterwards. T at 12½ A. M. L at 7, 9 & 11 P. M. Slight R at 2 A. M., & 3 P. M.
11	144.6	0.53	S S E, E & S	...	181.4	S to 8 A. M., ~i to 5 P. M. S afterwards. T at 4 & 5 P. M. L at midnight, 4 A. M., 8 & 9 P. M. R at 7, 8 A. M., & 2 P. M.
12	129.7	0.60	E by S, E N E & E ^[by N]	...	145.3	Chiefly ~i L at midnight, 1 A. M., 7 & 8 P. M. R at 6½, 9½, 11, 12½ A. M., 1½ & 5 P. M.
13	138.2	0.25	S by E, S S E & S	...	202.7	O to 11 A. M., clouds of different kinds afterwards. Slight R at 4, 5½, 10, 11 A. M., 1, 4 & 5 P. M.
14	152.0	...	S by E & S	...	235.2	S to 10 A. M., ~i afterwards. L on W at 5 A. M. D at 8 P. M.
15	145.2	0.56	S by W, S & SSW	...	102.9	~i to 6 A. M. O to 10 A. M., ~i to 3 P. M. O afterwards. T at 5½ P. M., Slight R from 8 to 12 A. M. & 3½ to 8 P. M.

~i Cirri, ~i Strati, ~i Cumuli, ~i Cirro-strati, ~i Cumulo-strati, ~i Nimbi, ~i Cirro-cumuli, B clear, S straton, O overcast, T thunder, L lightning,

Abstract of the Results of the Hourly Meteorological Observations taken at the Surveyor General's Office, Calcutta, in the month of August 1871.

Solar Radiation, Weather, &c.

Date.	Max. Solar radiation.	Rain Gauge 1½ ft. above Ground.	WIND.			General aspect of the Sky.
			Prevailing direction.	Max. Pressure	Daily Velocity.	
16	...	1.01	S S W	1.0	133.0	O to 6 P. M. S afterwards. Slight R from 3½ A. M., to 5 P. M.
17	141.5	0.92	S S W & S by W	...	178.0	O to 10 A. M., \curvearrowright i to 7 P. M. O afterwards. T & L between 7 & 8 P. M. R at 1, 3 A. M., & from 5½ to 11 P. M.
18	146.0	...	S, S W & S by W	...	157.9	\searrow i & \curvearrowright i to 9 A. M., \curvearrowright i to 4 P. M. S to 7 P. M. B afterwards. L at 11¼ P. M.
19	115.0	0.02	S S W & S by W	...	73.8	S. Light R at 6 A. M.
20	128.0	...	S by W & S W	...	87.8	S. L on N between midnight & 1 A. M.
21	141.3	2.69	S S W & S by W	1.5	96.5	Chiefly O. R from 1½ to 12 A. M., & 5 to 11 P. M.
22	126.5	0.16	W S W & S S W	...	194.7	O to 12 A. M., \curvearrowright i to 9 P. M. O afterwards. L on W at 8 & 9 P. M. Slight R at 2, 3, 6½, 9½, 12½ A. M., & 11 P. M.
23	150.5	0.02	W & S W	...	98.5	O to 8 A. M., \curvearrowright i & \searrow i to 3 P. M. S afterwards. Light R at midnight 1 & 7 A. M.
24	150.0	...	S W, W by S & W	...	84.4	O to 3 A. M. S to 8 A. M., \searrow i & \searrow i to 7 P. M. S afterwards. D at 5 & 8½ A. M.
25	149.6	...	S W & S S W	...	73.4	Chiefly S. L at 11¼ P. M. D at 6 & 8 A. M.
26	135.0	...	S W	...	53.9	Clouds of different kinds. L at midnight. D at 10 A. M.
27	144.0	0.19	S W, S & S S W	...	73.6	S to 9 A. M., \searrow i to 5 P. M. S afterwards. Slight R from 5½ to 7 P. M.
28	137.8	0.30	S S W & S by E	...	102.5	Clouds of different kinds to 3 P. M. S to 8 P. M., \searrow i afterwards. T at 3 P. M. Slight R at 4½, 12 A. M., 2 & 3 P. M.
29	144.5	0.25	S by E, S SE & S	...	85.0	B to 5 A. M., \curvearrowright i to 7 P. M. B afterwards. R at 11½ A. M., 1 & 4½ P. M.
30	153.2	0.07	S & S SE	...	50.9	\searrow i to 8 A. M., \curvearrowright i afterwards. T from 9 to 11 P. M. L from 6½ to 10 P. M. Slight R at 8¼ P. M.
31	137.0	0.22	S by E, SSE & S by ^[W]	0.4	80.6	\searrow i to 7 A. M., \curvearrowright i afterwards. T at 1 & 3 P. M. Slight R at 12½ A. M., 1½, 3, 6 & 7 P. M.

\searrow i Cirri,—i Strati, \curvearrowright i Cumuli, \searrow i Cirro-strati, \curvearrowright i Cumulo-strati, \searrow i Nimbi, \searrow i Cirro-cumuli, B clear, S stratoni, O overcast, T thunder, L lightning,

*Abstract of the Results of the Hourly Meteorological Observations
taken at the Surveyor General's Office, Calcutta,
in the month of August 1871.*

MONTHLY RESULTS.

	Inches.
Mean height of the Barometer for the month... ..	29.603
Max. height of the Barometer occurred at 10 A. M. on the 31st. ...	29.859
Min. height of the Barometer occurred at 4 P. M. on the 8th. ...	29.359
<i>Extreme range</i> of the Barometer during the month	0.500
Mean of the daily Max. Pressures	29.654
Ditto ditto Min. ditto	29.515
<i>Mean daily range</i> of the Barometer during the month	0.109

	°
Mean Dry Bulb Thermometer for the month	82.9
Max. Temperature occurred at 2 P. M. on the 11th.	91.3
Min. Temperature occurred at 5 & 6 A. M. on the 1st.	77.5
<i>Extreme range</i> of the Temperature during the month	13.8
Mean of the daily Max. Temperature	87.3
Ditto ditto Min. ditto,	80.0
<i>Mean daily range</i> of the Temperature during the month... ..	7.3

Mean Wet Bulb Thermometer for the month	80.5
Mean Dry Bulb Thermometer above Mean Wet Bulb Thermometer	2.4
Computed Mean Dew-point for the month	78.8
Mean Dry Bulb Thermometer above computed mean Dew-point ...	4.1

	Inches.
Mean Elastic force of Vapour for the month	0.964

	Troy grain.
Mean Weight of Vapour for the month	10.36
Additional Weight of Vapour required for complete saturation ...	1.43
Mean degree of humidity for the month, complete saturation being unity	0.88

	°
Mean Max. Solar radiation Thermometer for the month	140.6

	Inches.
Rained 28 days.—Max. fall of rain during 24 hours	2.69
Total amount of rain during the month	12.11
Total amount of rain indicated by the Gauge* attached to the anemo- meter during the month	10.68
Prevailing direction of the Wind... ..	S S W. & S. W.

* Height 70 feet 10 inches above ground.

Abstract of the Results of the Hourly Meteorological Observations taken at the Surveyor General's Office, Calcutta, in the month of September 1871.

Latitude 22° 33' 1" North. Longitude 88° 20' 34" East.

Height of the Cistern of the Standard Barometer above the sea level, 18.11 feet.

Daily Means, &c. of the Observations and of the Hygrometrical elements dependent thereon.

Date.	Mean Height of the Barometer at 3 rd Fahr.	Range of the Barometer during the day.			Mean Dry Bulb Thermometer.	Range of the Temperature during the day.		
		Max.	Min.	Diff.		Max.	Min.	Diff.
	Inches.	Inches.	Inches.	Inches.	o	o	o	o
1	29.755	29.837	29.668	0.169	83.3	86.5	80.8	5.7
2	.707	.765	.627	.138	83.6	88.5	80.6	7.9
3	.684	.732	.649	.083	83.9	87.2	81.5	5.7
4	.709	.755	.627	.128	83.3	91.0	79.0	12.0
5	.727	.778	.670	.108	81.2	87.7	78.0	9.7
6	.714	.765	.641	.124	81.7	86.5	79.0	7.5
7	.673	.736	.574	.162	82.0	87.4	78.5	8.9
8	.612	.678	.513	.165	84.3	90.8	78.8	12.0
9	.558	.611	.480	.131	83.6	88.5	81.4	7.1
10	.563	.616	.496	.120	82.4	87.1	79.0	8.1
11	.546	.609	.475	.134	82.4	88.4	80.0	8.4
12	.528	.583	.470	.113	79.8	81.5	78.6	2.9
13	.541	.606	.491	.112	79.9	84.0	77.8	6.2
14	.605	.673	.557	.116	80.8	83.7	78.5	5.2
15	.660	.709	.616	.093	82.2	86.2	78.2	8.0
16	.641	.695	.574	.121	83.1	87.6	79.5	8.1
17	.614	.656	.569	.087	82.1	85.0	79.5	5.5
18	.622	.662	.569	.093	81.5	88.4	79.3	9.1
19	.640	.699	.564	.135	82.6	88.7	78.6	10.1
20	.693	.746	.626	.120	83.7	88.8	80.2	8.6
21	.681	.747	.604	.143	84.3	89.9	80.8	9.1
22	.655	.698	.591	.107	82.1	88.0	79.5	8.5
23	.649	.699	.601	.098	80.5	82.6	79.5	3.1
24	.726	.833	.613	.199	80.4	83.3	79.1	4.2
25	.806	.873	.720	.153	82.8	87.9	78.5	9.4
26	.790	.836	.745	.091	82.5	87.8	78.5	9.3
27	.809	.857	.764	.093	83.4	88.7	78.7	10.0
28	.812	.884	.739	.145	84.2	89.5	79.5	10.0
29	.805	.870	.743	.127	83.3	87.4	79.6	7.8
30	.762	.819	.700	.119	84.3	89.8	80.0	9.8

The Mean Height of the Barometer, as likewise the Dry and Wet Bulb Thermometer Means are derived, from the hourly observations, made at the several hours during the day.

*Abstract of the Results of the Hourly Meteorological Observations
taken at the Surveyor General's Office, Calcutta,
in the month of September 1871.*

Daily Means, &c. of the Observations and of the Hygrometrical elements
dependent thereon.—(Continued.)

Date.	Mean Wet Bulb Ther- mometer.	Dry Bulb above Wet.	Computed Dew Point.	Dry Bulb above Dew Point.	Mean Elastic force of vapour.	Mean Weight of Vapour in a Cubic foot of air.	Additional Weight of Vapour required for complete saturation.	Mean degree of Humi- dity, complete satu- ration being unity.
	o	o	o	o	Inches.	T. gr.	T. gr.	
1	80.5	2.8	78.5	4.8	0.955	10.25	1.68	0.86
2	80.5	3.1	78.3	5.3	.949	.18	.85	.85
3	80.8	3.1	78.6	5.3	.958	.28	.85	.85
4	80.5	2.8	78.5	4.8	.955	.25	.68	.86
5	79.0	2.2	77.5	3.7	.925	9.96	.25	.89
6	79.3	2.4	77.6	4.1	.928	.99	.38	.88
7	79.5	2.5	77.7	4.3	.931	10.02	.45	.87
8	80.6	3.7	78.0	6.3	.940	.07	2.21	.82
9	80.6	3.0	78.5	5.1	.955	.25	1.78	.85
10	79.8	2.6	78.0	4.4	.940	.11	.50	.87
11	79.9	2.5	78.1	4.3	.943	.14	.47	.87
12	79.0	0.8	78.4	1.4	.952	.30	0.45	.96
13	79.0	0.9	78.4	1.5	.952	.27	.51	.95
14	79.7	1.1	78.9	1.9	.967	.43	.64	.94
15	80.0	2.2	78.5	3.7	.955	.27	1.27	.89
16	80.6	2.5	78.8	4.3	.964	.36	.50	.87
17	80.7	1.4	79.7	2.4	.992	.68	0.83	.93
18	80.0	1.5	78.9	2.6	.967	.41	.90	.92
19	80.2	2.4	78.5	4.1	.955	.27	1.41	.88
20	80.7	3.0	78.6	5.1	.958	.28	.79	.85
21	80.8	3.5	78.3	6.0	.949	.16	2.12	.83
22	80.0	2.1	78.5	3.6	.955	.27	1.24	.89
23	79.1	1.4	78.1	2.4	.943	.18	0.80	.93
24	79.2	1.2	78.4	2.0	.952	.27	.67	.94
25	79.9	2.9	77.9	4.9	.937	.06	1.69	.86
26	79.7	2.8	77.7	4.8	.931	.00	.64	.86
27	79.6	3.8	76.9	6.5	.908	9.72	2.24	.81
28	80.1	4.1	77.2	7.0	.916	.81	.43	.80
29	80.2	3.1	78.0	5.3	.940	10.09	1.84	.85
30	80.2	4.1	77.3	7.0	.919	9.84	2.44	.80

All the Hygrometrical elements are computed by the Greenwich Constants.

*Abstract of the Results of the Hourly Meteorological Observations
taken at the Surveyor General's Office, Calcutta,
in the month of September 1871.*

Hourly Means, &c. of the Observations and of the Hygrometrical elements dependent thereon.

Hour.	Mean Height of the Barometer at 32° Fahrt.	Range of the Barometer for each hour during the month.			Mean Dry Bulb Thermometer.	Range of the Temperature for each hour during the month.		
		Max.	Min.	Diff.		Max.	Min.	Diff.
	Inches.	Inches.	Inches.	Inches.	o	o	o	o
Mid-night.	29.694	29.837	29.542	0.295	80.9	83.6	79.2	4.4
1	.681	.826	.534	.292	80.6	83.2	79.0	4.2
2	.671	.811	.520	.291	80.4	83.0	78.8	4.2
3	.661	.807	.509	.298	80.2	82.5	78.5	4.0
4	.657	.805	.494	.311	79.9	82.0	78.5	3.5
5	.666	.819	.500	.319	79.7	81.5	78.2	3.3
6	.678	.842	.512	.330	79.7	81.5	78.5	3.0
7	.695	.845	.524	.321	80.3	82.4	78.0	4.4
8	.714	.866	.556	.310	81.8	84.2	78.0	6.2
9	.725	.883	.571	.312	83.4	86.2	77.8	8.4
10	.725	.884	.575	.309	84.2	87.4	78.1	9.3
11	.716	.867	.572	.295	85.3	88.0	80.0	8.0
Noon.	.697	.848	.563	.285	86.2	89.9	79.5	10.4
1	.669	.821	.514	.307	86.2	90.5	80.8	9.7
2	.643	.795	.497	.298	86.1	91.0	79.6	11.4
3	.624	.776	.470	.306	85.9	90.8	79.6	11.2
4	.620	.764	.480	.284	84.6	89.4	78.0	11.4
5	.621	.773	.472	.301	84.0	88.5	78.6	9.9
6	.632	.775	.482	.293	83.0	87.2	79.0	8.2
7	.654	.805	.490	.315	82.1	86.2	79.0	7.2
8	.679	.822	.515	.307	81.8	85.5	79.2	6.3
9	.698	.844	.524	.320	81.6	85.0	79.4	5.6
10	.705	.855	.534	.321	81.3	84.3	79.4	4.9
11	.702	.839	.551	.288	81.1	84.0	79.3	4.7

The Mean Height of the Barometer, as likewise the Dry and Wet Bulb Thermometer Means are derived from the observations made at the several hours during the month.

*Abstract of the Results of the Hourly Meteorological Observations
taken at the Surveyor General's Office, Calcutta,
in the month of September 1871.*

Hourly Means, &c. of the Observations and of the Hygrometrical elements
dependent thereon.—(Continued.)

Hour.	Mean Wet Bulb Ther- mometer.	Dry Bulb above Wet.	Computed Dew Point.	Dry Bulb above Dew Point.	Mean Elastic force of Vapour.	Mean Weight of Vapour in a Cubic foot of air.	Additional Weight of Vapour required for complete saturation.	Mean degree of Humi- dity, complete satura- tion being unity.
	o	o	o	o	Inches.	T. gr.	T. gr.	
Mid- night.	79.6	1.3	78.7	2.2	0.961	10.37	0.73	0.93
1	79.4	1.2	78.6	2.0	.958	.34	.67	.94
2	79.2	1.2	78.4	2.0	.952	.27	.67	.94
3	79.1	1.1	78.3	1.9	.949	.24	.64	.94
4	78.9	1.0	78.2	1.7	.946	.21	.57	.95
5	78.8	0.9	78.2	1.5	.946	.21	.51	.95
6	78.8	0.9	78.2	1.5	.946	.21	.51	.95
7	79.3	1.0	78.6	1.7	.958	.34	.57	.95
8	80.0	1.8	78.7	3.1	.961	.35	1.05	.91
9	80.4	3.0	78.3	5.1	.949	.18	.78	.85
10	80.4	3.8	77.7	6.5	.931	9.96	2.28	.81
11	81.0	4.3	78.0	7.3	.940	10.05	.59	.80
Noon.	81.2	5.0	77.7	8.5	.931	9.92	3.07	.76
1	81.1	5.1	77.5	8.7	.925	.86	.13	.76
2	81.2	4.9	77.8	8.3	.934	.97	2.98	.77
3	81.2	4.7	77.9	8.0	.937	10.00	.87	.78
4	80.6	4.0	77.8	6.8	.934	9.99	.40	.81
5	80.5	3.5	78.0	6.0	.940	10.07	.10	.83
6	80.2	2.8	78.2	4.8	.946	.15	1.67	.86
7	79.9	2.2	78.4	3.7	.952	.23	.28	.89
8	79.7	2.1	78.2	3.6	.946	.17	.23	.89
9	79.8	1.8	78.5	3.1	.955	.29	.05	.91
10	79.7	1.6	78.6	2.7	.958	.32	0.92	.92
11	79.7	1.4	78.7	2.4	.961	.37	.80	.93

All the Hygrometrical elements are computed by the Greenwich Constants.

Abstract of the Results of the Hourly Meteorological Observations
 taken at the Surveyor General's Office, Calcutta,
 in the month of September 1871.
 Solar Radiation, Weather, &c.

Date.	Max. Solar radiation.	Rain Gauge 1½ ft. above Ground.	WIND.		Daily Velocity.	General aspect of the Sky.
			Prevailing direction.	Max. Pressure		
	o	Inches		lb	Miles	
1	147.2	...	S by W & S SW.	...	22.8	S to 2 A. M., \nearrow to 8 A. M., \searrow to 4 P. M., \searrow afterwards. D at 1 P. M.
2	140.5	...	S by W & S S W	1.0	65.7	\searrow to 2 A. M. S to 4 P. M., \searrow & \searrow afterwards. D at 8 A. M.
3	137.6	...	S by W & S S W	...	101.1	\searrow to 2 A. M. S afterwards. L on S W at 7 & 8 P. M.
4	151.0	3.25	S by W & S W	2.4	146.0	S to 7 A. M., \searrow to 3 P. M. O afterwards. Brisk wind at 3¼ P. M. T at 4 & from 12½ A. M., to 6 P. M. L at 4 A. M., & from 4 to 8 P. M. Heavy R from 3¼ to 4½ P. M., & slight R from 4½ to 11 P. M.
5	147.0	1.28	S W & S by W	1.9	75.9	\searrow to 5 A. M., \searrow to 10 A. M. \searrow to 3 P. M. O afterwards. Brisk wind at 3½ P. M. T at 3½ & 5 P. M. L at 5 P. M. R from 1½ to 9 P. M.
6	150.6	0.35	S by W & S	...	41.0	O to 6 A. M., \searrow to 10 A. M., \searrow to 6 P. M. S afterwards. Slight R from 3 to 5 & at 9½ A. M.
7	144.5	0.20	S & S by E	0.6	125.1	S to 2 A. M., \searrow to 6 A. M., \searrow to 6 P. M. B afterwards. Rat 4 P. M.
8	148.8	...	S & S by E	...	44.9	B to 5 A. M., \searrow to 8 A. M., \searrow afterwards L from 7 to 11 P. M. D at 4½ P. M.
9	148.7	0.25	S by W, & E by S	...	30.2	O to 9 A. M., \searrow to 5 P. M. O to 8 P. M. S afterwards. L at midnight & 7 P. M. Slight R at 6, 7, 8 A. M. 3½ & 7 P. M.
10	141.0	0.09	E, S E & S E	0.2	70.0	O to 7 A. M., \searrow to 10 A. M., \searrow to 3 P. M. O to 7 P. M. B afterwards. Light R at 1½, 10½, 12¾ A. M., 2¾, 4, 5 & 6 P. M.
11	141.5	0.02	E. S. E. & E.	0.5	152.1	Clouds of different kinds. L at 7 & 10 P. M. Light R at 1¼, 2, 4 & 6 P. M.
12	...	1.26	E S E & S S. E.	...	142.7	O. L at midnight. Slight R at 3 & 4, from 6 A. M., to 1 P. M., & 3 to 6 P. M.
13	129.8	0.48	S S E & S by E	...	99.6	O to 10 A. M. S to 3 P. M. O afterward-. Slight R nearly the whole day.
14	114.8	0.68	S by E.	...	131.4	O to 7 A. M. S to 4 P. M. O to 7 P. M. B afterwards. Slight R from midnight to 7 A. M., & at 5 P. M.

\searrow Cirri, —i Strati, \searrow Cumuli, \searrow Cirro-strati, \searrow Cumulo-strati, \searrow Nimbi, \searrow Cirro-cumuli, B clear, S stratos, O overcast, T thunder, L lightning, R rain, D drizzle

Abstract of the Results of the Hourly Meteorological Observations
 taken at the Surveyor General's Office, Calcutta,
 in the month of September 1871.
 Solar Radiation, Weather, &c.

Date.	Max. Solar radiation.	Rain Gauge 1½ ft. above Ground.	WIND.			General aspect of the Sky.
			Prevailing direction.	Max. Pressure	Daily Velocity.	
15	120.0	0.07	S by E & S	...	147.0	O to 5 A. M. S to 7 P. M., \i afterwards. Slight R at 1, 2, 3, 4 A. M., 5½ & 10½ P. M.
16	134.0	0.15	S & S by E	...	216.4	B to 2 A. M. S to 6 A. M., \i to 9 A. M., \i to 7 P. M. B afterwards. Slight R at 4, 10 A. M. 1 & 3 P. M.
17	...	0.27	S & SSE	...	164.3	Clouds of different kinds to 10 A. M. O to 2 P. M. S afterwards. L on E from 8 to 10 P. M. Slight R at 2, 10, 12 A. M., & 1½ P. M.
18	147.8	0.18	S S E & S by E	1.4	93.2	B to 4 A. M. S to 8 A. M., \i to 12 A. M. O to 7 P. M. B afterwards. T at 1 P. M. Slight R at 10 A. M., 1, 2 & 3 P. M.
19	151.2	0.36	S by E, SE & SSE	...	101.5	B to 6 A. M., \i to 4 P. M. S to 8 P. M. B afterwards. T at 4 & 7 P. M. L from 7 to 11 P. M. R from 6½ to 7¾ P. M.
20	153.0	...	S S E & S E	...	103.9	B to 4 A. M., \i to 8 A. M., \i to 6 P. M. B afterwards. L at midnight & 7 P. M.
21	144.0	...	S S E & S E	...	78.8	B to 5 A. M., \i to 9 A. M., \i to 5 P. M. S afterwards.
22	144.0	0.25	S E	...	104.9	\i to 9 A. M., \i to 1 P. M. O to 7 P. M. S afterwards. T at 1¼, 2½ & 3 P. M. Slight R at 10 A. M., & from 1½ to 7 P. M.
23	114.0	0.20	E S E, S E & S S E	...	125.7	S to 7 A. M. O afterwards. L on N at midnight & 1 A. M. Slight R after intervals.
24	...	0.36	S S E & S E	...	223.8	Chiefly O Slight R from 1 to 3, at 8½, 9, 10½, A. M. & 1 P. M.
25	149.2	0.07	S S E & S	...	167.4	B to 5 A. M., \i to 9 A. M., \i to 4 P. M., \i afterwards. Slight R at 12¾ A. M.
26	147.0	0.16	S & S by W.	...	133.6	\i to 2 A. M. B to 6 A. M., \i & \i afterwards. R at 12½ A. M.
27	148.8	...	S by W & S S W	...	97.4	\i to 8 A. M., \i to 4 P. M., \i afterwards.
28	147.0	...	S S W, S by W & S	...	99.6	\i to 7 A. M., \i to 5 P. M. \i afterwards.
29	140.2	...	S & S by W	...	106.1	\i to 6 P. M. B afterwards.
30	147.0	...	S by W & S S W	...	134.3	\i & \i to 7 A. M., \i afterwards. L from 6½ to 8 P. M.

\i Cirri,—i Strati, \i Cumuli, \i Cirro-strati, \i Cumulo-strati, \i Nimbi, \i Cirro-cumuli, B clear, S strati, O overcast, T thunder, L lightning,

*Abstract of the Results of the Hourly Meteorological Observations
taken at the Surveyor General's Office, Calcutta,
in the month of September 1871.*

MONTHLY RESULTS.

	Inches.
Mean height of the Barometer for the month... ..	29.676
Max. height of the Barometer occurred at 10 A. M. on the 28th.	29.884
Min. height of the Barometer occurred at 3 P. M. on the 12th.	29.470
<i>Extreme range</i> of the Barometer during the month	0.414
Mean of the daily Max. Pressures	29.734
Ditto ditto Min. ditto	29.610
<i>Mean daily range</i> of the Barometer during the month	0.124

	°
Mean Dry Bulb Thermometer for the month	82.5
Max. Temperature occurred at 2 P. M. on the 4th.	91.0
Min. Temperature occurred at 9 A. M. on the 13th.	77.8
<i>Extreme range</i> of the Temperature during the month	13.2
Mean of the daily Max. Temperature	87.3
Ditto ditto Min. ditto,	79.4
<i>Mean daily range</i> of the Temperature during the month... ..	7.9

Mean Wet Bulb Thermometer for the month	80.0
Mean Dry Bulb Thermometer above Mean Wet Bulb Thermometer	2.5
Computed Mean Dew-point for the month	78.2
Mean Dry Bulb Thermometer above computed mean Dew-point	4.3

	Inches.
Mean Elastic force of Vapour for the month	0.946

	Troy grain.
Mean Weight of Vapour for the month	10.17
Additional Weight of Vapour required for complete saturation	1.47
Mean degree of humidity for the month, complete saturation being unity	0.87

	°
Mean Max. Solar radiation Thermometer for the month	141.9

	Inches.
Rained 23 days,—Max. fall of rain during 24 hours	3.25
Total amount of rain during the month	9.93
Total amount of rain indicated by the Gauge* attached to the anemo- meter during the month	9.25
Prevailing direction of the Wind S by W. S. S. E. & S.	

* Height 70 feet 10 inches above ground.

Abstract of the Results of the Hourly Meteorological Observations taken at the Surveyor General's Office, Calcutta, in the month of October 1871.

Latitude 22° 33' 1" North. Longitude 88° 20' 34" East.

Height of the Cistern of the Standard Barometer above the sea level, 18.11 feet.

Daily Means, &c. of the Observations and of the Hygrometrical elements dependent thereon.

Date.	Mean Height of the Barometer at 32° Fahrt.	Range of the Barometer during the day.			Mean Dry Bulb Thermometer.	Range of the Temperature during the day.		
		Max.	Min.	Diff.		Max.	Min.	Diff.
	Inches.	Inches.	Inches.	Inches.	o	o	o	o
1	29.756	29.804	29.704	0.100	81.8	90.4	81.5	8.9
2	.742	.794	.677	.117	85.4	90.3	81.0	9.3
3	.748	.798	.705	.093	86.2	91.7	82.0	9.7
4	.773	.827	.727	.100	86.0	92.0	81.5	10.5
5	.746	.803	.679	.124	86.2	91.6	81.0	10.6
6	.714	.768	.652	.116	86.2	91.8	82.0	9.8
7	.675	.724	.629	.095	85.1	90.6	80.5	10.1
8	.702	.760	.653	.107	84.9	90.7	79.5	11.2
9	.727	.796	.667	.129	85.1	91.5	79.0	12.5
10	.738	.798	.684	.114	86.0	91.7	81.3	10.4
11	.738	.814	.683	.131	82.8	85.3	79.5	5.8
12	.718	.800	.666	.134	79.5	82.0	77.5	4.5
13	.765	.834	.668	.166	80.5	84.0	78.0	6.0
14	.853	.903	.795	.108	80.8	84.3	78.5	5.8
15	.892	.947	.841	.106	81.9	88.0	77.5	10.5
16	.911	.977	.857	.120	83.6	89.8	79.4	10.4
17	.896	.968	.831	.137	82.9	89.0	79.0	10.0
18	.888	.951	.832	.119	81.8	88.0	77.0	11.0
19	.905	.967	.855	.112	81.2	88.5	75.8	12.7
20	.918	.976	.874	.102	79.9	87.4	73.5	13.9
21	.899	.962	.842	.120	80.7	87.4	74.3	13.1
22	.891	.957	.832	.125	81.7	88.3	76.4	11.9
23	.867	.931	.796	.138	81.2	87.5	77.5	10.0
24	.827	.888	.779	.109	74.6	78.0	72.7	5.3
25	.691	.771	.627	.144	72.7	74.5	71.5	3.0
26	.673	.759	.624	.135	74.1	78.0	71.0	7.0
27	.788	.856	.739	.117	77.3	85.2	71.0	14.2
28	.821	.882	.764	.118	78.9	86.0	73.0	13.0
29	.879	.939	.836	.103	79.1	86.0	73.7	12.3
30	.887	.955	.826	.129	78.7	85.0	73.5	11.5
31	.896	.960	.814	.116	78.3	85.8	71.8	14.0

The Mean Height of the Barometer, as likewise the Dry and Wet Bulb Thermometer Means are derived, from the hourly observations, made at the several hours during the day.

*Abstract of the Results of the Hourly Meteorological Observations
taken at the Surveyor General's Office, Calcutta,
in the month of October 1871.*

Daily Means, &c. of the Observations and of the Hygrometrical elements
dependent thereon.—(Continued.)

Date.	Mean Wet Bulb Ther- mometer.	Dry Bulb above Wet.	Computed Dew Point.	Dry Bulb above Dew Point.	Mean Elastic force of vapour.	Mean Weight of Vapour in a Cubic foot of air.	Additional Weight of Vapour required for complete saturation.	Mean degree of Humi- dity, complete satu- ration being unity.
	o	o	o	o	Inches.	T. gr.	T. gr.	
1	81.0	3.8	78.3	6.5	0.949	10.14	2.32	0.81
2	81.0	4.4	77.9	7.5	.937	.00	.68	.79
3	80.0	6.2	75.7	10.5	.873	9.30	3.69	.72
4	80.2	5.8	76.1	9.9	.885	.44	.47	.73
5	80.0	6.2	75.7	10.5	.873	.30	.69	.72
6	79.1	7.1	74.1	12.1	.830	8.85	4.14	.68
7	78.2	6.9	73.4	11.7	.811	.66	3.91	.69
8	78.3	6.6	73.7	11.2	.819	.76	.73	.70
9	78.9	6.2	74.6	10.5	.843	9.00	.57	.72
10	80.2	5.8	76.1	9.9	.885	.44	.47	.73
11	80.5	2.3	78.9	3.9	.967	10.39	1.36	.88
12	78.2	1.3	77.3	2.2	.919	9.94	0.72	.93
13	78.5	2.0	77.1	3.4	.913	.86	1.12	.90
14	78.6	2.2	77.1	3.7	.913	.84	.23	.89
15	78.6	3.3	76.3	5.6	.890	.57	.87	.84
16	78.3	5.3	74.6	9.0	.843	.03	3.00	.75
17	76.6	6.3	72.2	10.7	.781	8.36	.43	.71
18	75.4	6.4	70.9	10.9	.748	.05	.35	.71
19	73.6	7.6	68.3	12.9	.688	7.40	.81	.66
20	72.7	7.2	67.7	12.2	.674	.28	.50	.68
21	74.4	6.3	70.0	10.7	.727	.82	.22	.71
22	75.5	6.2	71.2	10.5	.756	8.12	.25	.71
23	76.4	4.8	73.0	8.2	.801	.62	2.59	.77
24	73.5	1.1	72.7	1.9	.792	.65	0.55	.94
25	71.8	0.9	71.1	1.6	.753	.25	.43	.95
26	71.7	2.4	70.0	4.1	.727	7.94	1.13	.88
27	73.0	4.3	70.0	7.3	.727	.89	2.09	.79
28	74.8	4.1	71.9	7.0	.773	8.36	.11	.80
29	74.7	4.4	71.6	7.5	.766	.27	.26	.79
30	73.3	5.4	69.5	9.2	.715	7.74	.67	.74
31	72.1	6.2	67.8	10.5	.677	.32	.96	.71

All the Hygrometrical elements are computed by the Greenwich Constants.

*Abstract of the Results of the Hourly Meteorological Observations
taken at the Surveyor General's Office, Calcutta,
in the month of October 1871.*

Hourly Means, &c. of the Observations and of the Hygrometrical elements
dependent thereon.

Hour.	Mean Height of the Barometer at 32° Falt.	Range of the Barometer for each hour during the month.			Mean Dry Bulb Thermometer.	Range of the Tempera- ture for each hour during the month.		
		Max.	Min.	Diff.		Max.	Min.	Diff.
	Inches.	Inches.	Inches.	Inches.	o	o	o	o
Mid- night.	29.807	29.918	29.672	0.246	79.0	81.2	71.7	12.5
1	.798	.911	.654	.257	78.6	84.0	71.5	12.5
2	.789	.908	.649	.259	78.3	83.8	71.5	12.3
3	.781	.902	.647	.255	78.0	83.6	71.5	12.1
4	.780	.901	.627	.274	77.8	83.5	71.5	12.0
5	.793	.915	.625	.290	77.6	83.4	71.0	12.4
6	.810	.943	.613	.300	77.5	83.2	71.0	12.2
7	.827	.945	.673	.272	78.3	83.7	71.7	12.0
8	.847	.965	.676	.289	80.6	85.5	72.0	13.5
9	.860	.977	.705	.272	82.2	87.5	72.5	15.0
10	.861	.974	.707	.267	83.9	89.5	73.0	16.5
11	.845	.960	.685	.275	84.8	90.5	73.0	17.5
Noon.	.824	.944	.668	.276	85.4	90.7	73.6	17.1
1	.798	.920	.646	.274	86.2	91.5	74.0	17.5
2	.774	.894	.632	.262	86.5	91.5	73.0	18.5
3	.759	.885	.624	.261	86.6	92.0	73.7	18.3
4	.755	.889	.631	.258	86.0	91.7	73.5	18.2
5	.760	.879	.634	.245	85.1	91.0	73.0	18.0
6	.769	.880	.642	.233	83.1	89.0	72.3	16.7
7	.787	.903	.656	.247	81.8	87.5	72.1	15.4
8	.808	.924	.672	.252	81.0	86.5	72.4	14.1
9	.819	.932	.671	.261	80.3	86.0	72.4	13.6
10	.824	.939	.689	.250	79.6	85.5	72.5	13.0
11	.821	.931	.682	.249	79.2	84.6	72.7	11.9

The Mean Height of the Barometer, as likewise the Dry and Wet Bulb
Thermometer Means are derived from the observations made at the several
hours during the month.

*Abstract of the Results of the Hourly Meteorological Observations
taken at the Surveyor General's Office, Calcutta,
in the month of October 1871.*

Hourly Means, &c. of the Observations and of the Hygrometrical elements
dependent thereon.—(Continued.)

Hour.	Mean Wet Bulb Ther- mometer.	Dry Bulb above Wet.	Computed Dew Point.	Dry Bulb above Dew Point.	Mean Elastic force of Vapour.	Mean Weight of Vapour in a Cubic foot of air.	Additional Weight of Vapour required for complete saturation.	Mean degree of Humi- dity, complete satura- tion being unity.
	o	o	o	o	Inches.	T. gr.	T. gr.	
Mid- night.	76.7	2.3	75.1	3.9	0.857	9.27	1.23	0.88
1	76.5	2.1	75.0	3.6	.854	.24	.14	.89
2	76.4	1.9	75.1	3.2	.857	.28	.00	.90
3	76.2	1.8	74.9	3.1	.851	.22	0.97	.91
4	76.2	1.6	75.1	2.7	.857	.28	.85	.92
5	76.0	1.6	74.9	2.7	.851	.22	.85	.92
6	75.9	1.6	74.8	2.7	.849	.20	.84	.92
7	76.5	1.8	75.2	3.1	.860	.31	.97	.91
8	77.2	3.4	74.8	5.8	.849	.15	1.86	.83
9	77.3	4.9	73.9	8.3	.824	8.87	2.67	.77
10	77.3	6.6	72.7	11.2	.792	.49	3.64	.70
11	77.0	7.8	71.5	13.3	.763	.16	4.30	.66
Noon.	77.1	8.3	71.3	14.1	.758	.10	.58	.64
1	77.0	9.2	70.6	15.6	.741	7.89	5.10	.61
2	76.8	9.7	71.0	15.5	.751	.99	.11	.61
3	76.5	10.1	70.4	16.2	.736	.84	.30	.60
4	76.4	9.6	69.7	16.3	.720	.68	.23	.60
5	76.9	8.2	71.2	13.9	.756	8.07	4.50	.64
6	77.1	6.0	72.9	10.2	.797	.56	3.30	.72
7	77.2	4.6	74.0	7.8	.827	.90	2.50	.78
8	77.1	3.9	74.4	6.6	.838	9.02	.12	.81
9	76.9	3.4	74.5	5.8	.840	.07	1.84	.83
10	76.8	2.8	74.8	4.8	.849	.17	.52	.86
11	76.7	2.5	74.9	4.3	.851	.21	.35	.87

All the Hygrometrical elements are computed by the Greenwich Constants.

Abstract of the Results of the Hourly Meteorological Observations taken at the Surveyor General's Office, Calcutta, in the month of October 1871.

Solar Radiation, Weather, &c.

Date.	Max. Solar radiation.	Rain Gauge 1½ ft. above Ground.	WIND.		Daily Velocity.	General aspect of the Sky.
			Prevailing direction.	Max. Pressure.		
1	153.2	...	S by W	...	129.0	∩i to 7 A. M., ∩i to 7 P. M. B afterwards. T at 12¼ A. M., 2½, 4 & 5 P. M. D at 5½ P. M.
2	152.0	...	S & S by W	...	108.6	B to 7 A. M., ∩i to 4 P. M. B afterwards.
3	146.3	...	S by W & W by N [& N W]	...	83.1	B to 12 A. M., ∩i to 5 P. M. B afterwards.
4	148.6	...	W by N, W N W	...	67.3	B to 8 A. M., ∩i to 6 P. M. B afterwards.
5	149.7	...	N W & W N W	...	69.8	B to 8 A. M., ∩i to 6 P. M. B afterwards.
6	152.0	...	W N W & W SW	...	73.2	B to 10 A. M., ∩i to 3 P. M. B afterwards.
7	153.3	...	W S W & W by S	...	79.3	B to 4 A. M., ∩i to 10 A. M. ∩i to 2 P. M., ∩i afterwards.
8	150.0	...	W by S & N W	0.5	76.5	B to 10 A. M., ∩i to 5 P. M. B afterwards.
9	149.0	...	N W & W N W	...	66.2	B to 10 A. M., ∩i to 3 P. M., ∩i to 6 P. M. B afterwards.
10	147.5	...	W N W	...	71.5	B to 5 A. M., ∩i to 10 A. M., ∩i to 6 P. M. B afterwards.
11	...	0.89	W N W & S E	...	80.1	S to 12 A. M. O to 7 P. M., ∩i afterwards. T at 9¼ A. M., 1 & 2½ P. M., R at 8, 11½ A. M., 1, 2½, 4½ & 6 P. M.
12	...	0.60	S. E, E S E & E.	...	122.5	Chiefly O. R at 4, 10, 11 A. M., & from 2 to 6 P. M.
13	127.0	...	S by W.	...	108.5	O to 10 A. M. S afterwards.
14	135.5	0.47	S by W & S S E	...	59.8	Clouds of different kinds to 6 P. M. B afterwards. L on N W at 6 P. M. R at 11 & 12 A. M.
15	153.0	...	S S E & S	...	75.7	B to 6 A. M., ∩i to 5 P. M. B afterwards. D at 12¼ A. M.
16	145.7	...	S, S by W & N by E	...	94.0	B to 9 A. M., ∩i to 4 P. M. B afterwards.
17	147.2	...	N by E & W	...	85.6	B to 9 A. M., ∩i to 4 P. M. B afterwards.
18	146.2	...	W & W S W	...	96.3	B.
19	147.0	...	W S W & W	...	81.0	B.
20	145.5	...	W & E N E	...	90.7	B to 10 A. M., ∩i to 5 P. M. B afterwards.
21	146.8	...	E N E & N by E [E N E.]	0.8	106.8	B to 10 A. M., ∩i to 6 P. M. B afterwards.
22	141.5	...	N by E, N N E &	...	155.6	B to 9 A. M., ∩i to 5 P. M. B afterwards.

∩i Cirri,—i Strati, ∩i Cumuli, ∩i Cirro-strati, ∩i Cumulo-strati, ∩i Nimbi, ∩i Cirro-cumuli, B clear, S straton, O overcast, T thunder, L lightning, R rain, D drizzle.

Abstract of the Results of the Hourly Meteorological Observations
taken at the Surveyor General's Office, Calcutta,
in the month of October 1871.

Solar Radiation, Weather, &c.

Date.	Max. Solar radiation.	Rain Gauge 1½ ft. above Ground.	WIND.			General aspect of the Sky.
			Prevailing direction.	Max. Pressure	Daily Velocity.	
23	145.0	0.03	ENE, NE & E by S	...	115.5	Clouds of different kinds to 6 A. M. B to 9 A. M. ☽ to 3 P. M., ☽ afterwards. Light R at 4½ P. M.
24	...	2.58	E by S & E S E	...	173.2	O. R from 4 A. M., to 11 P. M.
25	...	2.46	E, E by N & E N E	...	238.8	O. R from midnight to 2 P. M., & at 5 & 11 P. M.
26	130.0	...	N E & N W	...	378.4	O to 5 P. M. B afterwards. D at midnight.
27	144.7	...	N W & W N W	...	140.5	B to 12 A. M., ☽ to 4 P. M., ☽ afterwards.
28	143.0	...	W N W & S W	...	90.4	B.
29	144.0	...	S W	...	71.6	B to 1 P. M., ☽ to 6 P. M. B afterwards. Foggy from 3 to 8 A. M. & 8 to 11 P. M.
30	143.0	...	S W & W by S	...	42.5	B Slightly foggy from midnight to 2 & 5 to 7 A. M.
31	142.7	...	W by S & S S E	...	47.3	B. Slightly foggy at 10 P. M.

☽ i Cirri, — i Strati, ☽ i Cumuli, ☽ i Cirro-strati, ☽ i Cumulo-strati, ☽ i Nimbi, ☽ i Cirro-cumuli, B clear, S strati, O overcast, T thunder, L lightning, R rain, D drizzle.

*Abstract of the Results of the Hourly Meteorological Observations
taken at the Surveyor General's Office, Calcutta,
in the month of October 1871.*

MONTHLY RESULTS.

	Inches.
Mean height of the Barometer for the month... ..	29.804
Max. height of the Barometer occurred at 9 A. M. on the 16th.	29.977
Min. height of the Barometer occurred at 3 P. M. on the 26th.	29.624
<i>Extreme range</i> of the Barometer during the month	0.353
Mean of the daily Max. Pressures	29.867
Ditto ditto Min. ditto	29.748
<i>Mean daily range</i> of the Barometer during the month	0.119

	°
Mean Dry Bulb Thermometer for the month	81.6
Max. Temperature occurred at 3 P. M. on the 4th.	92.0
Min. Temperature occurred at 5 & 6 A. M. on the 26 th & 27th	71.0
<i>Extreme range</i> of the Temperature during the month	21.0
Mean of the daily Max. Temperature	87.1
Ditto ditto Min. ditto,	77.1
<i>Mean daily range</i> of the Temperature during the month... ..	10.0

Mean Wet Bulb Thermometer for the month	76.7
Mean Dry Bulb Thermometer above Mean Wet Bulb Thermometer	4.9
Computed Mean Dew-point for the month	73.3
Mean Dry Bulb Thermometer above computed mean Dew-point	8.3

	Inches.
Mean Elastic force of Vapour for the month	0.809

	Troy grain.
Mean Weight of Vapour for the month	8.70
Additional Weight of Vapour required for complete saturation	2.64
Mean degree of humidity for the month, complete saturation being unity	0.77

	°
Mean Max. Solar radiation Thermometer for the month	145.6

	Inches.
Rained 9 days,—Max. fall of rain during 24 hours	2.58
Total amount of rain during the month	7.03
Total amount of rain indicated by the Gauge* attached to the anemo- meter during the month	6.20
Prevailing direction of the Wind W. N. W, N. W. & S. by W.	

* Height 70 feet 10 inches above ground.

*Abstract of the Results of the Hourly Meteorological Observations
taken at the Surveyor General's Office, Calcutta,
in the month of November 1871.*

Latitude 22° 33' 1" North. Longitude 88° 20' 34" East.

Height of the Cistern of the Standard Barometer above the sea level, 18.11 feet.

Daily Means, &c. of the Observations and of the Hygrometrical elements
dependent thereon.

Date.	Mean Height of the Barometer at 32° Fahr.	Range of the Barometer during the day.			Mean Dry Bulb Thermometer.	Range of the Tempera- ture during the day.		
		Max.	Min.	Diff.		Max.	Min.	Diff.
	Inches.	Inches.	Inches.	Inches.	o	o	o	o
1	29.932	30.006	29.873	0.133	78.2	85.4	72.0	13.4
2	.934	.000	.878	.122	79.1	86.9	72.5	14.4
3	.947	.012	.900	.112	79.0	86.5	73.3	13.2
4	.950	.014	.894	.120	77.7	85.0	71.5	13.5
5	.970	.047	.919	.128	76.9	85.0	70.3	14.7
6	.986	.061	.927	.134	77.0	84.8	70.0	14.8
7	.957	.016	.905	.111	76.9	83.1	71.6	11.5
8	.942	.029	.873	.156	77.5	84.5	73.3	11.2
9	.936	.006	.874	.132	77.5	84.5	71.0	13.5
10	.930	.006	.869	.137	77.0	83.8	71.0	12.8
11	.916	29.993	.847	.146	76.4	83.6	72.0	11.6
12	.875	.939	.808	.131	75.9	83.6	69.5	14.1
13	.878	.926	.828	.098	76.9	84.0	71.2	12.8
14	.960	30.028	.891	.137	78.2	85.7	72.0	13.7
15	.942	.025	.869	.156	78.5	85.5	73.5	12.0
16	.931	.000	.888	.112	78.6	85.7	73.5	12.2
17	.984	.055	.932	.123	77.1	84.4	71.5	12.9
18	.993	.063	.925	.138	76.2	83.2	70.5	12.7
19	.968	.020	.922	.098	75.2	82.5	69.0	13.5
20	.993	.072	.929	.143	75.5	82.6	69.5	13.1
21	.992	.060	.932	.128	75.2	82.0	69.5	12.5
22	.988	.066	.941	.125	74.4	81.0	69.0	12.0
23	.970	.025	.908	.117	74.2	82.5	67.0	15.5
24	.998	.063	.952	.111	74.9	83.5	68.0	15.5
25	.992	.059	.939	.120	73.5	82.0	67.5	14.5
26	.962	.038	.897	.141	71.9	81.4	64.6	16.8
27	.929	29.989	.865	.124	70.7	79.7	63.2	16.5
28	.962	30.035	.914	.121	70.0	78.8	62.0	16.8
29	.947	.031	.878	.153	71.0	80.4	63.5	16.9
30	.908	29.969	.854	.115	73.0	82.4	65.0	17.4

The Mean Height of the Barometer, as likewise the Dry and Wet Bulb Thermometer Means are derived, from the hourly observations, made at the several hours during the day.

*Abstract of the Results of the Hourly Meteorological Observations
taken at the Surveyor General's Office, Calcutta,
in the month of November 1871*

Daily Means, &c. of the Observations and of the Hygrometrical elements
dependent thereon.—(Continued.)

Date.	Mean Wet Bulb Ther- mometer.	Dry Bulb above Wet.	Computed Dew Point.	Dry Bulb above Dew Point.	Mean Elastic force of vapour.	Mean Weight of Vapour in a Cubic foot of air.	Additional Weight of Vapour required for complete saturation.	Mean degree of Humi- dity, complete satu- ration being unity.
	o	o	o	o	Inches.	T. gr.	T. gr.	
1	72.7	5.5	68.8	9.4	0.699	7.57	2.68	0.74
2	74.3	4.8	70.9	8.2	.748	8.10	.43	.77
3	73.5	5.5	69.6	9.4	.717	7.76	.74	.74
4	71.3	6.4	66.8	10.9	.655	.10	3.00	.70
5	70.1	6.8	65.3	11.6	.623	6.76	.10	.69
6	70.8	6.2	66.5	10.5	.648	7.03	2.86	.71
7	72.1	4.8	68.7	8.2	.697	.57	.29	.77
8	72.8	4.7	69.5	8.0	.715	.75	.29	.77
9	72.0	5.5	68.1	9.4	.684	.41	.63	.74
10	71.4	5.6	67.5	9.5	.670	.27	.62	.74
11	70.4	6.0	66.2	10.2	.642	6.98	.74	.72
12	70.3	5.6	66.4	9.5	.646	7.03	.54	.74
13	71.2	5.7	67.2	9.7	.664	.20	.66	.73
14	73.5	4.7	70.2	8.0	.732	.92	.33	.77
15	73.2	5.3	69.5	9.0	.715	.74	.61	.75
16	72.4	6.2	68.1	10.5	.684	.38	3.00	.71
17	70.8	6.3	66.4	10.7	.646	.01	2.91	.71
18	70.8	5.4	67.0	9.2	.659	.17	.49	.74
19	68.2	7.0	63.3	11.9	.584	6.35	3.02	.68
20	69.7	5.8	65.6	9.9	.630	.86	2.60	.73
21	69.9	5.3	66.2	9.0	.642	.99	.38	.75
22	68.4	6.0	64.2	10.2	.601	.56	.59	.72
23	67.1	7.1	62.1	12.1	.561	.12	.97	.67
24	67.7	7.2	62.7	12.2	.572	.24	3.04	.67
25	64.8	8.7	58.7	14.8	.501	5.47	.43	.62
26	64.0	7.9	57.7	14.2	.485	.31	.17	.63
27	62.6	8.1	56.1	14.6	.459	.04	.14	.62
28	63.7	6.3	58.7	11.3	.501	.52	2.48	.69
29	65.0	6.0	60.2	10.8	.527	.78	.47	.70
30	65.9	7.1	60.2	12.8	.527	.76	3.00	.66

All the Hygrometrical elements are computed by the Greenwich Constants.

*Abstract of the Results of the Hourly Meteorological Observations
taken at the Surveyor General's Office, Calcutta,
in the month of November 1871.*

Hourly Means, &c. of the Observations and of the Hygrometrical elements
dependent thereon.

Hour.	Mean Height of the Barometer at 32° Fahr.	Range of the Barometer for each hour during the month.			Mean Dry Bulb Thermometer.	Range of the Tempera- ture for each hour during the month.		
		Max.	Min.	Diff.		Max.	Min.	Diff.
	Inches.	Inches.	Inches.	Inches.	o	o	o	o
Mid- night.	29.955	30.010	29.869	0.141	72.5	76.9	65.3	11.6
1	.947	.008	.863	.145	72.0	76.3	64.1	12.2
2	.940	.002	.851	.151	71.5	75.8	63.6	12.2
3	.933	29.996	.844	.152	70.9	75.0	63.0	12.0
4	.934	.993	.842	.151	70.4	74.7	62.5	12.2
5	.948	30.012	.859	.153	69.9	74.0	62.3	11.7
6	.965	.020	.877	.143	69.7	73.5	62.0	11.5
7	.983	.043	.906	.137	70.0	74.5	62.2	12.3
8	30.004	.057	.920	.137	73.2	77.5	66.8	10.7
9	.021	.072	.925	.147	76.0	80.5	70.2	10.3
10	.019	.066	.926	.140	78.4	82.0	73.0	9.0
11	29.998	.051	.907	.144	80.2	83.5	75.0	8.5
Noon.	.970	.052	.883	.142	81.6	85.2	77.0	8.2
1	.936	29.984	.853	.131	82.6	85.6	78.0	7.6
2	.914	.965	.835	.130	83.2	86.9	78.5	8.4
3	.901	.952	.814	.138	83.3	86.6	78.8	7.8
4	.896	.953	.808	.145	82.1	85.5	77.5	8.0
5	.904	.959	.814	.145	80.8	84.7	76.0	8.7
6	.914	.971	.829	.142	78.2	82.2	72.5	9.7
7	.932	.989	.848	.141	76.5	80.3	71.0	9.3
8	.951	30.003	.870	.133	75.3	79.2	69.5	9.7
9	.963	.018	.887	.131	74.3	77.8	68.5	9.3
10	.967	.023	.876	.147	73.6	77.0	67.0	10.0
11	.963	.016	.876	.140	73.0	77.0	66.5	10.5

The Mean Height of the Barometer, as likewise the Dry and Wet Bulb Thermometer Means are derived from the observations made at the several hours during the month.

*Abstract of the Results of the Hourly Meteorological Observations
taken at the Surveyor General's Office, Calcutta,
in the month of November 1871.*

Hourly Means, &c. of the Observations and of the Hygrometrical elements
dependent thereon.—(Continued.)

Hour.	Mean Wet Bulb Ther- mometer.	Dry Bulb above Wet.	Computed Dew Point.	Dry Bulb above Dew Point.	Mean Elastic force of Vapour.	Mean Weight of Vapour in a Cubic foot of air.	Additional Weight of Vapour required for complete saturation.	Mean degree of Humi- dity, complete satura- tion being unity.
	o	o	o	o	Inches.	T. gr.	T. gr.	
Mid- night.	69.5	3.0	67.1	5.4	0.661	7.25	1.38	0.84
1	69.2	2.8	67.0	5.0	.659	.23	.27	.85
2	68.8	2.7	66.6	4.9	.651	.14	.24	.85
3	68.4	2.5	66.4	4.5	.646	.10	.13	.86
4	68.0	2.4	66.1	4.3	.640	.04	.06	.87
5	67.8	2.1	66.1	3.8	.640	.04	0.94	.88
6	67.5	2.2	65.9	3.8	.636	.00	.93	.88
7	67.7	2.3	65.9	4.1	.636	.00	1.00	.88
8	69.2	4.0	66.0	7.2	.638	6.98	.84	.79
9	69.9	6.1	65.6	10.4	.630	.86	2.74	.72
10	70.3	8.1	64.6	13.8	.609	.59	3.72	.64
11	70.2	10.0	63.2	17.0	.582	.27	4.61	.58
Noon.	70.1	11.5	62.0	19.6	.559	.00	5.34	.53
1	70.1	12.5	61.3	21.3	.546	5.86	.82	.50
2	70.2	13.0	61.1	22.1	.543	.81	6.08	.49
3	70.0	13.3	60.7	22.6	.536	.72	.21	.48
4	69.8	12.3	61.2	20.9	.544	.84	5.67	.51
5	71.0	9.8	64.1	16.7	.599	6.44	.43	.58
6	71.7	6.5	67.1	11.1	.661	7.16	3.09	.70
7	71.5	5.0	68.0	8.5	.681	.39	2.36	.76
8	71.1	4.2	68.2	7.1	.686	.47	1.93	.80
9	70.7	3.6	68.2	6.1	.686	.49	.63	.82
10	70.2	3.4	67.8	5.8	.677	.39	.54	.83
11	69.8	3.2	67.2	5.8	.664	.26	.50	.83

All the Hygrometrical elements are computed by the Greenwich Constants.

*Abstract of the Results of the Hourly Meteorological Observations
taken at the Surveyor General's Office, Calcutta,
in the month of November 1871.
Solar Radiation, Weather, &c.*

Date.	Max. Solar radiation.	Rain Gauge 1½ ft. above Ground.	WIND.			General aspect of the Sky.
			Prevailing direction.	Max. Pressure.	Daily Velocity.	
	o	Inches		lb	Miles	
1	144.2	...	S S E & S	...	68.7	Chiefly B.
2	145.5	...	S & S W	...	95.0	B.
3	141.0	...	S S W & W	...	77.2	B. Slightly foggy at 9 & 10 P. M.
4	141.7	...	W, WSW & W by S	...	35.2	B.
5	141.0	...	W by S	...	51.7	B to 6 A. M., \i to 5 P. M. B afterwards.
6	141.8	...	W by S & N N E	...	79.2	B to 5 A. M., \i to 6 P. M. B afterwards. Slightly foggy from 9 to 11 P. M.
7	137.0	...	N N E & N W	...	47.5	B to 5 A. M., \i to 6 P. M. B afterwards. Slightly foggy at 1 A. M., & 10 P. M.
8	146.0	...	N W & N by W	...	35.3	B to 5 A. M., \i to 6 P. M. B afterwards.
9	143.2	...	N by W & N	...	30.3	B to 10 A. M., \i to 3 P. M. B afterwards. Slightly foggy from 4 to 6 A. M., & 9 to 11 P. M.
10	143.5	...	N & N by W	...	53.2	B to 10 A. M., \i to 4 P. M. B afterwards. Slightly foggy from midnight to 6 A. M.
11	142.5	...	N by W & N N W	...	73.2	B to 10 A. M., \i to 3 P. M. B afterwards. Slightly foggy from 9 to 11 P. M.
12	141.5	...	N N W & N E	...	66.4	B to 10 A. M., \i to 7 P. M. B afterwards.
13	139.0	...	E N E & S by W	...	56.4	B to 1 P. M., \i to 3 P. M. B afterwards.
14	140.0	...	S by W & S S W	...	59.0	B to 11 A. M., \i to 4 P. M. B afterwards.
15	140.0	...	S S W & W by S	...	67.8	Chiefly B.
16	139.0	...	W by S & W by N	...	90.7	Chiefly B.
17	148.0	...	W by N & W	...	57.7	B to 11 A. M., \i to 1 P. M. B afterwards. Slightly foggy at 11 P. M.
18	139.8	...	W & W by S	...	72.2	B to 11 A. M., \i to 2 P. M. B afterwards. Slightly foggy from 7 to 9 P. M.
19	137.8	...	W by S	...	52.4	B.
20	138.8	...	W by S & S S W	...	73.2	B. to 10 A. M., \i to 4 P. M. B afterwards. Foggy from 7 to 10 P. M.
21	137.5	...	S S W & S W	...	43.4	B to 11 A. M., \i to 3 P. M. B afterwards. Slightly foggy at 8 & 9 P. M.

\i Cirri,—i Strati, \i Cumuli, \i Cirro-strati, \i Cumulo-strati, \i Nimbi, \i Cirro-cumuli, B clear, S straton, O overcast, T thunder, L lightning, R rain, D drizzle.

Abstract of the Results of the Hourly Meteorological Observations
taken at the Surveyor General's Office, Calcutta,
in the month of November 1871.

Solar Radiation, Weather, &c.

Date.	Max. Solar radiation.	Rain Gauge 1½ ft. above Ground.	WIND.			General aspect of the Sky.
			Prevailing direction.	Max. Pressure	Daily Velocity.	
22	137.0	Inches	S W	lb	Miles	Chiefly B Slightly foggy at 9 P. M.
23	141.0	...	S W & W S W	...	108.0	B to 10 A. M., \i to 4 P. M. \i afterwards. Slightly foggy from 7 to 10 P. M.
24	140.0	...	W S W & W	...	76.1	\i to 2 A. M. B to 3 P. M., \i to 8 P. M. B afterwards. Slightly foggy at 7 P. M.
25	137.0	...	W & N N W	...	129.9	Chiefly B. Slightly foggy from 7 to 11 P. M.
26	137.0	...	N N W & W by N	...	124.8	Chiefly B. Slightly foggy at midnight & from 8 to 11 P. M.
27	137.0	...	[& N W W by N, W N W	...	118.8	B. Slightly foggy at midnight & 1 A. M., & from 7 to 11 P. M.
28	136.4	...	N W & N N W	...	100.9	B. Slightly foggy from midnight to 2 A. M., & 7 to 11 P. M.
29	136.8	...	N N W & N W	...	83.1	B to 2 P. M., \i to 7 P. M. B afterwards. Slightly foggy from midnight to 7 A. M., & at 9 P. M.
30	142.0	...	N W & W by N	...	76.3	B to 10 A. M., \i to 6 P. M. B afterwards.

\i Cirri,—i Strati, \i Cumuli, \i Cirro-strati, \i Cumulo-strati, \i Nimbi, \i Cirro-cumuli, B clear, S stratoni, O overcast, T thunder, L lightning, R rain, D drizzle.

*Abstract of the Results of the Hourly Meteorological Observations
taken at the Surveyor General's Office, Calcutta,
in the month of November 1871.*

MONTHLY RESULTS.

	Inches.
Mean height of the Barometer for the month... ..	29.952
Max. height of the Barometer occurred at 9 A. M. on the 20th.	30.072
Min. height of the Barometer occurred at 4 P. M. on the 12th.	29.808
<i>Extreme range</i> of the Barometer during the month	0.264
Mean of the daily Max. Pressures	30.022
Ditto ditto Min. ditto	29.894
<i>Mean daily range</i> of the Barometer during the month	0.128

	°
Mean Dry Bulb Thermometer for the month	75.8
Max. Temperature occurred at 2 P. M. on the 2nd	86.9
Min. Temperature occurred at 6 A. M. on the 28th.	62.0
<i>Extreme range</i> of the Temperature during the month	24.9
Mean of the daily Max. Temperature	83.5
Ditto ditto Min. ditto,	69.6
<i>Mean daily range</i> of the Temperature during the month... ..	13.9

Mean Wet Bulb Thermometer for the month	69.7
Mean Dry Bulb Thermometer above Mean Wet Bulb Thermometer	6.1
Computed Mean Dew-point for the month	65.4
Mean Dry Bulb Thermometer above computed mean Dew-point	10.4

	Inches.
Mean Elastic force of Vapour for the month	0.626

	Troy grain.
Mean Weight of Vapour for the month	6.81
Additional Weight of Vapour required for complete saturation	2.73
Mean degree of humidity for the month, complete saturation being unity	0.71

	°
Mean Max. Solar radiation Thermometer for the month	140.4

	Inches.
Rained no days.—Max. fall of rain during 24 hours	Nil
Total amount of rain during the month	Nil
Total amount of rain indicated by the Gauge* attached to the anemo- meter during the month	Nil
Prevailing direction of the Wind	W. by S, N. W. & W.

*Height 70 feet 10 inches above ground.

Abstract of the Results of the Hourly Meteorological Observations taken at the Surveyor General's Office, Calcutta, in the month of December 1871.

Latitude 22° 33' 1" North. Longitude 88° 20' 34" East.

Height of the Cistern of the Standard Barometer above the sea level, 18.11 feet.

Daily Means, &c. of the Observations and of the Hygrometrical elements dependent thereon.

Date.	Mean Height of the Barometer at 32° Fahr.	Range of the Barometer during the day.			Mean Dry Bulb Thermometer.	Range of the Temperature during the day.		
		Max.	Min.	Diff.		Max.	Min.	Diff.
	Inches.	Inches.	Inches.	Inches.	o	o	o	o
1	29.932	30.006	29.880	0.126	74.5	82.5	67.5	15.0
2	.991	.071	.929	.142	74.1	82.3	67.0	15.3
3	30.021	.102	.973	.129	70.7	79.2	64.0	15.2
4	.035	.116	.980	.136	67.9	76.4	60.5	15.9
5	.050	.138	30.004	.134	67.7	77.3	59.9	17.4
6	.023	.094	29.960	.134	69.6	79.2	61.1	18.1
7	.028	.115	.968	.147	70.8	79.7	63.5	16.2
8	.025	.104	.972	.132	69.4	78.0	62.7	15.3
9	.013	.088	.948	.140	69.2	78.5	61.9	16.6
10	29.984	.057	.923	.134	69.2	79.5	60.4	19.1
11	30.003	.076	.950	.126	70.5	80.5	63.2	17.3
12	.048	.123	.995	.128	69.8	79.5	62.2	17.3
13	.104	.174	30.054	.120	69.3	79.0	61.0	18.0
14	.128	.197	.062	.135	66.8	75.4	58.6	16.8
15	.114	.188	.065	.123	66.8	75.5	59.5	16.0
16	.080	.157	.011	.146	68.1	78.0	60.5	17.5
17	.102	.180	.048	.132	68.3	76.5	61.2	15.3
18	.114	.179	.051	.128	68.4	77.2	61.4	15.8
19	.114	.193	.058	.135	68.7	76.7	61.0	15.7
20	.059	.128	.006	.122	70.3	78.0	65.0	13.0
21	.019	.093	29.968	.125	69.5	77.7	63.0	14.7
22	29.998	.071	.949	.122	69.9	77.5	63.2	14.3
23	.984	.045	.926	.119	69.8	78.2	62.0	16.2
24	30.003	.077	.960	.117	70.3	77.7	63.0	14.7
25	.009	.068	.949	.119	70.9	77.2	66.0	11.2
26	.037	.118	.975	.143	68.5	75.6	63.0	12.6
27	.036	.110	.987	.123	67.4	75.0	60.0	15.0
28	.084	.171	30.017	.154	64.9	74.0	58.8	15.2
29	.100	.168	.042	.126	64.2	72.7	57.0	15.7
30	.056	.129	29.994	.135	65.7	75.4	57.8	17.6
31	.036	.114	.969	.145	68.6	78.5	60.2	18.3

The Mean Height of the Barometer, as likewise the Dry and Wet Bulb Thermometer Means are derived, from the hourly observations, made at the several hours during the day.

*Abstract of the Results of the Hourly Meteorological Observations
taken at the Surveyor General's Office, Calcutta,
in the month of December 1871.*

Daily Means, &c. of the Observations and of the Hygrometrical elements
dependent thereon.—(Continued.)

Date.	Mean Wet Bulb Ther- mometer.	Dry Bulb above Wet.	Computed Dew Point.	Dry Bulb above Dew Point.	Mean Elastic force of vapour.	Mean Weight of Vapour in a Cubic foot of air.	Additional Weight of Vapour required for complete saturation.	Mean degree of Humi- dity, complete satu- ration being unity.
	o	o	o	o	Inches.	T. gr.	T. gr.	
1	69.1	5.4	65.3	9.2	0.623	6.81	2.37	0.74
2	67.2	6.9	62.4	11.7	.567	.18	.89	.68
3	63.2	7.5	57.2	13.5	.476	5.22	.96	.64
4	60.7	7.2	54.9	13.0	.441	4.87	.64	.65
5	61.8	5.9	57.1	10.6	.475	5.24	.22	.70
6	63.6	6.0	58.8	10.8	.503	.53	.37	.70
7	65.3	5.5	60.9	9.9	.539	.92	.28	.72
8	63.4	6.0	58.6	10.8	.499	.50	.36	.70
9	62.8	6.4	57.7	11.5	.485	.33	.48	.68
10	62.6	6.6	57.3	11.9	.478	.26	.55	.67
11	63.7	6.8	58.3	12.2	.494	.43	.70	.67
12	63.6	6.2	58.6	11.2	.499	.50	.45	.69
13	62.1	7.2	56.3	13.0	.462	.09	.74	.65
14	59.9	6.9	54.4	12.4	.434	4.80	.46	.66
15	61.2	5.6	56.7	10.1	.469	5.18	.08	.71
16	63.0	5.1	58.9	9.2	.504	.57	1.98	.74
17	62.0	6.3	57.0	11.3	.473	.22	2.38	.69
18	62.3	6.1	57.4	11.0	.480	.29	.33	.69
19	63.2	5.5	58.8	9.9	.503	.54	.15	.72
20	65.1	5.2	60.9	9.4	.539	.93	.15	.73
21	64.5	5.0	60.5	9.0	.532	.86	.02	.74
22	64.5	5.4	60.2	9.7	.527	.79	.19	.73
23	64.4	5.4	60.1	9.7	.525	.77	.18	.73
24	65.5	4.8	61.7	8.6	.554	6.08	.00	.75
25	66.9	4.0	63.7	7.2	.591	.50	1.73	.79
26	63.1	5.4	58.8	9.7	.503	5.54	2.11	.72
27	61.8	5.6	57.3	10.1	.478	.28	.11	.71
28	59.5	5.4	55.2	9.7	.445	4.95	1.90	.72
29	58.6	5.6	53.6	10.6	.422	.69	2.00	.70
30	60.1	5.6	55.6	10.1	.452	5.02	.00	.72
31	62.8	5.8	58.2	10.4	.493	.44	.23	.71

All the Hygrometrical elements are computed by the Greenwich Constants.

*Abstract of the Results of the Hourly Meteorological Observations
taken at the Surveyor General's Office, Calcutta,
in the month of December 1871.*

Hourly Means, &c. of the Observations and of the Hygrometrical elements dependent thereon.

Hour.	Mean Height of the Barometer at the Barometer at 32° Fahr.	Range of the Barometer for each hour during the month.			Mean Dry Bulb Thermometer.	Range of the Temperature for each hour during the month.		
		Max.	Min.	Diff.		Max.	Min.	Diff.
	Inches.	Inches.	Inches.	Inches.	o	o	o	o
Mid-night.	30.015	30.150	29.914	0.236	65.4	71.0	61.0	10.0
1	.035	.141	.905	.236	64.7	70.5	60.5	10.0
2	.026	.125	.898	.227	61.1	70.0	59.3	10.7
3	.017	.118	.894	.224	63.6	69.4	59.1	10.3
4	.017	.129	.899	.230	63.1	69.0	58.8	10.2
5	.029	.137	.910	.227	62.6	68.0	58.0	10.0
6	.043	.145	.920	.225	62.1	67.5	57.5	10.0
7	.064	.165	.940	.225	61.9	67.5	57.0	10.5
8	.091	.178	.979	.199	64.8	71.4	59.7	11.7
9	.114	.196	30.006	.190	68.7	74.7	62.0	12.7
10	.117	.197	.003	.194	71.6	78.1	64.7	13.4
11	.099	.175	29.978	.197	73.9	81.0	66.8	14.2
Noon.	.068	.141	.945	.196	75.6	82.0	68.9	13.1
1	.032	.104	.911	.193	76.5	82.2	70.6	11.6
2	.008	.077	.898	.179	77.5	82.5	72.4	10.1
3	29.993	.071	.888	.183	77.5	82.2	72.7	9.5
4	.989	.065	.880	.185	76.3	81.2	71.8	9.4
5	.997	.072	.899	.173	74.9	79.6	71.0	8.6
6	30.007	.082	.912	.170	72.1	77.0	68.0	9.0
7	.023	.096	.930	.166	70.4	75.6	66.2	9.4
8	.041	.126	.949	.177	68.9	74.8	64.5	10.3
9	.055	.146	.959	.187	67.7	73.4	62.5	10.9
10	.061	.149	.971	.178	66.8	72.5	61.6	10.9
11	.057	.155	.970	.185	65.9	71.8	61.0	10.8

The Mean Height of the Barometer, as likewise the Dry and Wet Bulb Thermometer Means are derived from the observations made at the several hours during the month.

*Abstract of the Results of the Hourly Meteorological Observations
taken at the Surveyor General's Office, Calcutta,
in the month of December 1871.*

Hourly Means, &c. of the Observations and of the Hygrometrical elements
dependent thereon.—(Continued.)

Hour.	Mean Wet Bulb Ther- mometer.	Dry Bulb above Wet.	Computed Dew Point.	Dry Bulb above Dew Point.	Mean Elastic force of Vapour.	Mean Weight of Vapour in a Cubic foot of air.	Additional Weight of Vapour required for complete saturation.	Mean degree of Humi- dity, complete satura- tion being unity.
	o	o	o	o	Inches.	T. gr.	T. gr.	
Mid- night.	62.2	3.2	59.6	5.8	0.516	5.73	1.22	0.82
1	61.7	3.0	59.3	5.4	.511	.68	.12	.84
2	61.2	2.9	58.6	5.5	.499	.55	.12	.83
3	60.9	2.7	58.5	5.1	.498	.54	.03	.84
4	60.6	2.5	58.3	4.8	.494	.50	0.97	.85
5	60.1	2.5	57.8	4.8	.486	.43	.94	.85
6	59.8	2.3	57.7	4.4	.485	.42	.85	.86
7	59.7	2.2	57.7	4.2	.485	.42	.81	.87
8	61.4	3.4	58.7	6.1	.501	.57	1.26	.82
9	63.0	5.7	58.4	10.3	.496	.47	2.22	.71
10	64.0	7.6	57.9	13.7	.488	.34	3.06	.64
11	64.6	9.3	58.1	15.8	.491	.35	.66	.59
Noon.	65.1	10.5	57.7	17.9	.485	.26	4.22	.56
1	65.0	11.5	56.9	19.6	.472	.11	.64	.52
2	65.4	12.1	56.9	20.6	.472	.10	.94	.51
3	65.2	12.3	56.6	20.9	.467	.06	.98	.50
4	64.9	11.4	56.9	19.4	.472	.12	.57	.53
5	65.4	9.5	58.7	16.2	.501	.46	3.82	.59
6	65.8	6.3	60.8	11.3	.537	.89	2.64	.69
7	65.3	5.1	61.2	9.2	.544	.99	.11	.74
8	64.6	4.3	61.2	7.7	.544	6.00	1.74	.78
9	63.9	3.8	60.9	6.8	.539	5.96	.50	.80
10	63.2	3.6	60.3	6.5	.528	.85	.41	.81
11	62.6	3.3	60.0	5.9	.523	.80	.26	.82

All the Hygrometrical elements are computed by the Greenwich Constants.

Abstract of the Results of the Hourly Meteorological Observations taken at the Surveyor General's Office, Calcutta, in the month of December 1871.
Solar Radiation, Weather, &c.

Date.	Max. Solar radiation.	Rain Gauge 1½ ft. above Ground.	WIND.		General aspect of the Sky.	
			Prevailing direction.	Max. Pressure		
	o	Inches		lb	Miles	
1	136.0	...	W S W	...	93.4	∩i to 6 p. m. B afterwards. Slightly foggy at 8 p. m.
2	137.0	...	W N W & N N E	...	91.1	B to 2 A. M., ∩i to 7 A. M. B afterwards.
3	135.4	...	E N E & N N E	...	110.2	B Slightly foggy at 8 & 9 p. m.
4	135.5	...	N N E & N W	...	77.2	B. Slightly foggy from 7 to 11 p. m.
5	132.5	...	N W	...	66.5	Chiefly B.
6	135.0	...	N W & W S W	...	54.8	B. Slightly foggy from 5 to 7 A. M.
7	133.0	...	W S W & W by N	...	60.9	Chiefly B.
8	132.0	...	W & N	...	134.8	B. Slightly foggy from 9 to 11 p. m.
9	135.0	...	N & W N W	...	124.8	B. Slightly foggy at midnight & 1 A. M., & from 9 to 11 p. m.
10	134.0	...	W N W & W	...	57.0	B. Slightly foggy at 5 & 6 A. M.
11	136.0	...	W & W N W	...	89.3	B.
12	132.8	...	W by N & W	...	76.6	B. Slightly foggy from 8 to 10 p. m.
13	135.5	...	W & W N W	...	90.7	B.
14	132.8	...	W N W	...	84.7	Chiefly B. Slightly foggy at 9 & 10 p. m.
15	130.8	...	W N W	...	75.6	B to 1 p. m., ∩i to 5 p. m. B afterwards. Slightly foggy at midnight
16	127.5	...	W N W	...	71.2	B to 6 A. M., ∩i to 6 p. m. B afterwards. Slightly foggy from 6 to 8 A. M., & 7 to 9 p. m.
17	130.0	...	W N W & N N E	...	81.8	Chiefly B. Slightly foggy at 8 & 9 p. m.
18	135.2	...	N N E & S S W	...	109.9	B. to 5 A. M., ∩i to 5 p. m. B afterwards. Slightly foggy at 8 & 9 p. m.
19	132.0	...	S S W & S W	...	63.1	B to 9 A. M., ∩i afterwards. Slightly foggy from 8 to 10 p. m.,
20	132.5	...	S W	...	46.6	S to 2 A. M., ∩i to 4 A. M. S to 7 A. M., ∩i to 3 p. m. B afterwards. Slightly foggy from 7 to 10 p. m.
21	131.0	...	E by S & S E	...	63.4	B to 11 A. M., ∩i to 3 p. m. B afterwards. Slightly foggy at 5 & 6 A. M., & from 7 to 10 p. m.

∩i Cirri,—i Strati, ∩i Cumuli, ∩i Cirro-strati, ∩i Cumulo-strati, ∩i Nimbi, ∩i Cirro-cumuli, B clear, S strati, O overcast, T thunder, L lightning,

*Abstract of the Results of the Hourly Meteorological Observations
taken at the Surveyor General's Office, Calcutta,
in the month of December 1871.
Solar Radiation, Weather, &c.*

Date.	Max. Solar radiation.	Rain Gauge 1½ ft. above Ground.	WIND.			General aspect of the Sky.
			Prevailing direction.	Max. Pressure	Daily Velocity.	
22	134.0	...	S E & E S E	ib ...	Miles 57.4	B to 11 A. M., \curvearrowright i to 4 P. M. B afterwards. Slightly foggy at 6 & 7 A. M., & from 7 to 10 P. M.
23	138.5	...	E S E & S S E	...	61.2	B to 11 A. M., \curvearrowright i to 4 P. M., \curvearrowleft i afterwards.
24	135.0	...	S S E & S W	...	37.0	B to 10 A. M., \curvearrowleft i afterwards. Slightly foggy at 9 & 10 P. M.
25	138.4	...	S W & W N W	...	90.4	\curvearrowright i to 3 A. M. B to 11 A. M., \curvearrowright i to 6 P. M. B afterwards.
26	133.0	...	W N W & N W	...	132.1	B to 11 A. M., \curvearrowleft i to 3 P. M. B afterwards.
27	131.0	...	N W	...	95.2	B.
28	131.0	...	N N E & N N W	...	180.2	B. Slightly foggy at 7 & 8 P. M.
29	131.5	...	N by W & N W	...	101.0	B. Foggy from 9 to 11 P. M.
30	132.0	...	N W	...	72.7	B. Foggy at midnight & 1 A. M., & 10 & 11 P. M.
31	135.4	...	N W & W N W	...	68.3	B. Slightly foggy at mid- night & from 8 to 11 P. M.

\curvearrowleft i Cirri,—i Strati, \curvearrowright i Cumuli, \curvearrowleft i Cirro-strati, \curvearrowright i Cumulo-strati, \curvearrowleft i Nimbi,
 \curvearrowleft i Cirro-cumuli, B clear, S stratoni, O overcast, T thunder, L lightning,
B rain, D drizzle

*Abstract of the Results of the Hourly Meteorological Observations
taken at the Surveyor General's Office, Calcutta,
in the month of December 1871.*

MONTHLY RESULTS.

	Inches.
Mean height of the Barometer for the month... ..	30.043
Max. height of the Barometer occurred at 10 A. M. on the 14th. ...	30.197
Min. height of the Barometer occurred at 4 P. M. on the 1st. ...	29.880
<i>Extreme range</i> of the Barometer during the month	0.317
Mean of the daily Max. Pressures	30.118
Ditto ditto Min. ditto	29.986
<i>Mean daily range</i> of the Barometer during the month	0.132

	°
Mean Dry Bulb Thermometer for the month	69.0
Max. Temperature occurred at 2 P. M. on the 1st.	82.5
Min. Temperature occurred at 7 A. M. on the 29th.	57.0
<i>Extreme range</i> of the Temperature during the month	25.5
Mean of the daily Max. Temperature	77.7
Ditto ditto Min. ditto,	61.8
<i>Mean daily range</i> of the Temperature during the month... ..	15.9

Mean Wet Bulb Thermometer for the month	63.1
Mean Dry Bulb Thermometer above Mean Wet Bulb Thermometer	5.9
Computed Mean Dew-point for the month	58.4
Mean Dry Bulb Thermometer above computed mean Dew-point ...	10.6

	Inches.
Mean Elastic force of Vapour for the month	0.496

	Troy grain.
Mean Weight of Vapour for the month	5.46
Additional Weight of Vapour required for complete saturation ...	2.30
Mean degree of humidity for the month, complete saturation being unity	0.70

	°
Mean Max. Solar radiation Thermometer for the month	133.6

	Inches.
Rained no days,—Max. fall of rain during 24 hours	Nil
Total amount of rain during the month	Nil
Total amount of rain indicated by the Gauge* attached to the anemo- meter during the month	Nil
Prevailing direction of the Wind	W. N. W. & N W.

* Height 70 feet 10 inches above ground.



