

nm

PROCEEDINGS

OF THE

Cambridge Philosophical Society.

VOLUME X.

Cambridge:

PRINTED BY J. AND C. F. CLAY,
AT THE UNIVERSITY PRESS.

PROCEEDINGS

OF THE

CAMBRIDGE PHILOSOPHICAL SOCIETY.

VOLUME X.

OCTOBER 31, 1898—MAY 21, 1900.

Cambridge :

AT THE UNIVERSITY PRESS,

AND SOLD BY

DEIGHTON, BELL & CO. AND MACMILLAN & BOWES, CAMBRIDGE.

C. J. CLAY AND SONS, AVE MARIA LANE, LONDON.

1900





1911
W. H. R. (HOLLAR)
1911

CONTENTS.

VOL. X.

	PAGE
Annual General Meeting 1898, October 31	1
Mr A. BERRY, <i>On the evaluation of a certain determinant which occurs in the mathematical theory of statistics and in that of elliptic geometry of any number of dimensions</i>	2
Mr J. H. GRACE, (1) <i>Metrical Relations between Linear Complexes.</i> (2) <i>Apolar Systems of Quadrics</i>	10
Mr A. E. WESTERN, <i>Certain Systems of Quadratic Complex Numbers</i>	10
Mr H. F. BAKER, <i>On Mittag-Leffler's Theorem</i>	10
Professor J. J. THOMSON, <i>On the connection between the Chemical Composition of a Gas and the Ionization produced in it by Röntgen Rays</i>	10
Mr J. ZELENY, <i>On Convection Currents and on the Fall of Potential at the Electrodes, in Conduction produced by Röntgen Rays</i>	14
Mr H. A. WILSON, <i>On Velocity of Solidification</i>	25
Mr H. GADOW, <i>Orthogenetic Variation in the Shells of Chelonia</i>	35
Dr A. WILLEY, <i>Some points in the Morphology of the Enteropneusta</i>	37
Mr A. C. SEWARD and Mr A. W. HILL, <i>On Lepidodendron from the Calcififerous Sandstone of Scotland</i>	38
Professor LIVEING, <i>On the Flame-spectrum of Mercury, and its bearing on the distribution of energy in gases</i>	38
Professor LIVEING, <i>On the Variation of Intensity of the Absorption Bands of different Didymium Salts dissolved in water, and its bearing on the ionization theory of the colour of solutions of salts</i>	40
Professor DEWAR, <i>On the Comparative Colour of the Vapour of Iodine in Air at Atmospheric Pressure and in Vacuum</i>	44
Major MACMAHON, <i>On the Partitions of Numbers which possess symmetrical Graphs</i>	47

	PAGE
Professor J. J. THOMSON, <i>On the motion of a charged ion in a magnetic field</i>	49
Mr JOHN S. TOWNSEND, <i>The formation of clouds with ozone</i>	52
Mr H. C. POCKLINGTON, <i>On the Symbolic Integration of certain Differential Equations in Quaternions</i>	59
Mr H. C. POCKLINGTON, <i>On the conditions of sensitiveness in Detectors of Radiant Heat</i>	66
Mr J. STANLEY GARDINER, <i>On the Anatomy of a supposed New Species of Coenopsammia from Lifu</i>	72
Professor J. J. THOMSON, <i>On the Conductivity of Gases exposed to Entladungsstrahlen</i>	74
Mr W. BATESON and Miss D. F. M. PERTZ, <i>Notes on the inheritance of Variation in the Corolla of Veronica Buxbaumii (Plate I)</i>	78
Mr W. M ^c F. ORR, <i>On the product $J_m(x)J_n(x)$</i>	93
Rev. H. J. SHARPE, <i>On the Reflection of Sound at a Paraboloid</i>	101
Mr A. C. SEWARD, <i>Notes on the Binney Collection of Coal-Measure Plants. Plates III to VII</i>	137
Mr D. SHARP, <i>The Modification and Attitude of Idolum diabolicum, a Mantis of the kind called "floral simulators." Plate II</i>	175
Mr J. LARMOR, <i>On the Origin of Magneto-optic Rotation</i>	181
Proceedings at the Meetings held during the Session 1898—1899	183
Mr W. M ^c F. ORR, <i>On Semi-convergent Series</i>	189
Mr C. T. R. WILSON, <i>An Experiment on the Condensation of Clouds</i>	189
Mr J. J. LISTER, <i>The Skeleton of Astrosclera compared with that of the Pharetronid Sponges</i>	189
Dr S. F. HARMER, <i>Note on the name Balanoglossus</i>	190
Miss E. DALE, <i>On certain outgrowths (Intumescences) on the green parts of Hibiscus vitifolius Linn. Plates VIII, IX, X</i>	192
Mr H. W. RICHMOND, <i>On the condition that five straight lines situated in a space of four dimensions should lie on a quadric</i>	210
Professor LIVEING, <i>On the Influence of Temperature, and of Various Solvents, on the Absorption Spectra of Didymium and Erbium Salts</i>	213
Mr H. JACKSON, <i>Researches in the Sugar Group</i>	215
Mr A. HUTCHINSON, <i>On a New Mineral</i>	216
Mr JOHN S. TOWNSEND, <i>Secondary Röntgen Rays</i>	217
Mr J. GRAHAM KERR, <i>Note on hypotheses as to the origin of the Paired Limbs of Vertebrates</i>	227
Mr J. S. BUDGETT, <i>Observations on Polypterus and Protopteris</i>	236
Mr J. A. M ^c CLELLAND, <i>On the Conductivity of Gases from an Arc and from Incandescent Metals</i>	241
Miss D. F. M. PERTZ and Mr FRANCIS DARWIN, <i>Experiments on the Periodic Movement of Plants</i>	259
Mr A. C. SEWARD, <i>On the Wealden Plants from Bernissart</i>	259

	PAGE
Mr R. H. BIFFEN, <i>On the Biology of Bulgaria polymorpha</i>	260
Mr S. SKINNER, <i>On the Electro-chemical Equivalent of Carbon</i>	261
Mr ALFRED HARKER, <i>On the Magnetic Disturbances in the Isle of Skye</i> (with Plates XI, XII)	268
Mr A. C. DIXON, <i>On Differential Equations with two Independent</i> <i>Variables</i>	278
Mr G. E. H. BARRETT-HAMILTON, <i>A suggestion as to a possible mode of</i> <i>Origin of some of the Secondary Sexual Characters in Animals as</i> <i>afforded by Observations on certain Salmonids</i>	279
Mr W. L. H. DUCKWORTH and Mr B. H. PAIN, <i>An Account of some</i> <i>Eskimo from Labrador</i>	286
Mr W. L. H. DUCKWORTH and Mr D. H. FRASER, <i>A Description of some</i> <i>dental Rudiments in human crania</i>	292
Mr J. GRAHAM KERR, <i>On the Zoological Position of Palaeospondylus,</i> <i>Traquair</i>	298
Mr F. GOWLAND HOPKINS, <i>On the Separation of a pure Albumen from</i> <i>Egg-white</i>	300
Mr HERBERT RICHMOND, <i>On the simplest algebraic minimal curves, and</i> <i>the derived real minimal surfaces</i>	301
Mr G. B. MATHEWS, <i>Diophantine Inequalities</i>	302
Mr R. S. WILLOWS, <i>On the distance between the striae in the positive</i> <i>column and other phenomena connected with the discharge</i> (with Plate XIII)	302
Professor EWING, <i>The teaching of Mechanics by experiment</i>	316
Mr W. F. SHEPPARD, <i>On the calculation of the double integral expressing</i> <i>normal correlation</i>	317
Mr G. F. C. SEARLE, <i>Apparatus for Measuring the Extension of a Wire</i>	318
Professor MACALISTER, <i>Exhibition of Anomalous Bones from Predynastic</i> <i>Egyptian Skeletons</i>	325
Dr GASKELL, <i>Ammocoetes a Cephalaspid</i>	325
Mr H. H. BRINDLEY, <i>Note on some Abnormalities of the limbs and tail of</i> <i>Dipnoan Fishes</i> (with Plate XIV)	325
Mr WALTER MYERS, <i>The Standardisation of Antivenomous Serum</i>	328
Major MACMAHON, <i>On a certain Diophantine Inequality</i>	331
Mr RICHMOND, <i>On rational Space Curves of the fourth order</i>	331
Mr J. H. VINCENT, <i>Experiments on Impact</i>	332
Mr T. J. F. A. BROMWICH, <i>The Classification of Conics and Quadrics</i>	358
Dr LOUIS COBBETT, <i>On the Heat generated by certain Fibrous Substances</i> <i>when wetted</i>	372
Mr L. R. WILBERFORCE, <i>A Method of measuring the Retardation produced</i> <i>by a Crystal Plate</i>	376
Proceedings at the Meetings held during the Session 1899—1900	377
Hopkins Prize Awards	384
Index	385

LIST OF PLATES.

- Plate I. To illustrate the paper of Mr Bateson and Miss Pertz.
Plate II. To illustrate Mr Sharp's paper.
Plates III, IV, V, VI, VII. To illustrate Mr Seward's paper.
Plates VIII, IX, X. To illustrate Miss Dale's paper.
Plates XI, XII. To illustrate Mr Harker's paper.
Plate XIII. To illustrate Mr Willows' paper.
Plate XIV. To illustrate Mr Brindley's paper.

PROCEEDINGS

OF THE

Cambridge Philosophical Society.

ANNUAL GENERAL MEETING.

Monday, 31 October, 1898.

MR F. DARWIN, PRESIDENT, IN THE CHAIR.

The officers and new members of the Council for the ensuing year were elected:—

President :

Mr J. Larmor.

Vice-Presidents :

Mr F. Darwin, Dr Gaskell, Prof. Forsyth.

Treasurer :

Mr A. E. Shipley.

Secretaries :

Mr H. F. Newall, Mr W. Bateson, Mr H. F. Baker.

Ordinary Members of the Council.

Mr A. Scott.
 Mr J. E. Marr.
 Prof. H. Marshall Ward.
 Mr A. Harker.
 Mr A. Hutchinson.
 Prof. G. D. Liveing.
 Mr S. Skinner.
 Mr H. Gadow.
 Mr D. Sharp.
 Prof. J. J. Thomson.
 Mr L. R. Wilberforce.
 Mr A. Berry.

The following were elected Associates, having been nominated by the Council: Mr R. S. Whipple, Prof. J. C. McLennan, Mr R. S. Willows.

The names of the Benefactors were read.

The following Communications were made to the Society:—

(1) *On the evaluation of a certain determinant which occurs in the mathematical theory of statistics and in that of elliptic geometry of any number of dimensions.* By ARTHUR BERRY, M.A., King's College.

§ 1. *Introduction and Summary.*

Let R denote the symmetrical determinant of order n of which the constituent of the i th row and j th column is r_{ij} , where $r_{ij} = r_{ji}$ and $r_{ii} = 1$, so that there are $\frac{1}{2}n(n-1)$ distinct quantities r_{ij} , which are to be regarded as independent variables. Let R_{ij} denote the minor* of r_{ij} , and let R_i denote that of r_{ii} . Let

$$r_{ij} = R_{ij} / \sqrt{R_i R_j}.$$

Then it is required to evaluate the Jacobian

$$J \equiv \frac{\partial (r'_{12}, r'_{13}, \dots, r'_{n-1, n})}{\partial (r_{12}, r_{13}, \dots, r_{n-1, n})} \dots \dots \dots (1),$$

the suffixes being taken (for convenience) in the order:—

$$12; 13, 23; 14, 24, 34; \dots; 1n, 2n, \dots, (n-1)n.$$

* I use "minor" (in the sense which seems almost always the most convenient) to denote the result of erasing a row and column and affixing a sign according to the usual rule. This agrees with the notation used by Weber and Gordan and with the usage of Salmon, though according to his formal definition and the usage of several common English text-books no sign is to be affixed.

I was asked some time ago by Professor Karl Pearson to evaluate J for the case of $n = 4$, as this determinant had presented itself in his "Mathematical Contributions to the Theory of Evolution*."

In the case of $n = 3$, which I tried first, the Jacobian was evaluated without difficulty, by straightforward algebra. It was pointed out to me by Mr L. Crawford, Fellow of King's College, to whom I shewed the problem, that in the case of $n = 3$, R was the equivalent of a familiar determinant in spherical trigonometry, half the square root of which is (with the usual notation of Spherical Trigonometry) the expression

$$\sqrt{\sin s \sin (s - a) \sin (s - b) \sin (s - c)},$$

sometimes called the Staudtian; and Mr Crawford shewed that J could be easily evaluated in this case by means of the formulae of spherical trigonometry.

This naturally led me to try to interpret the general case in terms of the geometry of elliptic space of $n - 1$ dimensions, or—which is the same thing—in terms of that of the surface of a hypersphere in ordinary space of n dimensions. It appeared that if r_{ij} were taken to be the cosine of the "distance" between the vertices i and j of a polyhedron formed by n points 1, 2, ..., n , in elliptic space of $n - 1$ dimensions, then r'_{ij} was the cosine of one of the two "angles" between the two faces opposite the points i and j . From the known symmetry between distances and angles in elliptic space it at once followed that the relation between the quantities r_{ij} and the quantities r'_{ij} must be reciprocal, a result which it is easy to verify algebraically, and which is of great assistance in the work.

In § 2 I establish the connection with elliptic geometry and the reciprocal relation just referred to. In § 3 the result to be proved is stated, and the Jacobian is reduced to the quotient of two Jacobians J_1, J_2 of lower order. In § 4 the first of these is evaluated by a process depending on the assumed value of J for the case of $n - 1$. In the course of this work I get a rule (equation (7)) for the reduction of a symmetrical determinant of order n to one of order $n - 1$, a result which seems to me of some interest if it is not already well known. In § 5 the Jacobian J_2 is evaluated. In § 6 the results are collected.

* See *Pearson and Filon*: "On the Probable Errors of Frequency Constants and on the influence of Random Selection on Variation and Correlation." *Phil. Trans.* A. vol. 191 (1898), pp. 229—311.

§ 2. *Connection with Elliptic Geometry; and reciprocity between r and r' .*

With the methods and notation of Whitehead's *Universal Algebra* (Bk. VI., Chaps. I., II.), the reference elements $e_1 \dots e_n$ denoting the vertices of a polyhedron in elliptic space of $n - 1$ dimensions, and any point being denoted by $\Sigma \xi_i e_i$, let the equation of the absolute in point-coordinates be

$$\xi_1^2 + \dots + \xi_n^2 + 2r_{12} \xi_1 \xi_2 + \dots + 2r_{n-1, n} \xi_{n-1} \xi_n = 0.$$

The edge 12 meets this in the points

$$\xi_1^2 + \xi_2^2 + 2r_{12} \xi_1 \xi_2 = 0,$$

or

$$\xi_1 = -e^{\pm ia_{12}} \xi_2,$$

where

$$r_{12} = \cos a_{12};$$

\therefore one of the distances between e_1 and e_2 is one of the values of

$$\frac{\gamma}{2i} \log (e^{ia_{12}}/e^{-ia_{12}}) = \gamma a_{12}.$$

If therefore we take the space constant γ to be unity, r_{12} is the cosine of one of the distances between e_1 and e_2 .

If now we denote the faces opposite e_1, e_2, \dots by E_1, E_2, \dots , where E_1 is the supplement of e_1 , and represent any plane by $\Sigma \xi_i E_i$, then we know that the equation of the absolute in plane coordinates is

$$R_1 \xi_1^2 + \dots + R_n \xi_n^2 + 2R_{12} \xi_1 \xi_2 + \dots + 2R_{n-1, n} \xi_{n-1} \xi_n = 0,$$

the quantities R_i and R_{ij} being the minors as explained in § 1.

Hence the planes through the edge $E_1 E_2$ which touch the absolute are

$$R_1 \xi_1^2 + R_2 \xi_2^2 + 2R_{12} \xi_1 \xi_2 = 0,$$

or

$$\xi_1 = -\frac{R_{12} \pm \sqrt{R_{12}^2 - R_1 R_2}}{R_1} \xi_2$$

$$= -e^{\pm ia'_{12}} \xi_2,$$

where

$$\frac{R_{12}}{\sqrt{R_1 R_2}} = \cos a'_{12} = r'_{12}.$$

And hence as before one of the angles between the faces $E_1 E_2$, is

$$\frac{1}{2i} \log (e^{ia'_{12}}/e^{-ia'_{12}}) = a'_{12}.$$

Hence we have generally

$$r_{ij} = \cos a_{ij} \text{ and } r'_{ij} = \cos a'_{ij},$$

where a_{ij} is one of the two supplementary distances between the vertices i, j and a'_{ij} one of the two supplementary angles between the corresponding faces.

The choice made between the supplementary angles and distances is such that when two vertices i, j coincide, and

$$r_{ij} = \cos a_{ij} = 1,$$

then $r'_{ij} = \cos a'_{ij} = -1$, and conversely.

In the case of $n=3$ this is equivalent to taking a, b, c and the exterior angles $\pi - A, \pi - B, \pi - C$ as the sides and angles of the spherical triangle.

The Jacobian J can now be interpreted as the Jacobian of the angles between the faces of a polyhedron with respect to the lengths of the edges, multiplied by a simple function of the sines of these angles and lengths.

The relation between distances and angles in elliptic space being known to be reciprocal it follows that r_{ij} is formed from the quantities r' by the same process by which r'_{ij} is formed from the quantities r . We can use R', R'_i, R'_{ij} , &c. to denote the same functions of the quantities r'_{ij} as are R, R_i, R_{ij} of the quantities r_{ij} and in any formula we can now interchange dashed and undashed letters.

§ 3. *Statement of the result and reduction of J to a quotient of two simpler Jacobians.*

It is easy to verify that in the cases of $n=2, n=3$, the required Jacobian is

$$(-1)^{\frac{1}{2}n(n-1)} \left\{ R^{n-2} / \prod_1^n R_i \right\}^{\frac{1}{2}(n+1)} \dots \dots \dots (2).$$

This result will now be shewn to be true for n if it holds for $n-1$, so that its general truth will follow by induction.

Let the relations between the $\frac{1}{2}n(n-1)$ quantities r_{ij} and the $\frac{1}{2}n(n-1)$ quantities r'_{ij} be expressed by two groups of equations: viz. $\frac{1}{2}(n-1)(n-2)$ equations of the type

$$\Phi_{pq} \equiv -r'_{pq} + \phi(r_{12}, \dots) = 0, \quad p, q = 1, 2, \dots, n-1,$$

and $n-1$ equations of the type

$$F_{in} \equiv -r_{in} + f(r'_{i2}, \dots) = 0, \quad i = 1, 2, \dots, n-1.$$

Then by the ordinary rule for Jacobians we have

$$\frac{\partial (\Phi_{12}, \dots, \Phi_{n-1, n-1}, \dots, F_{1n}, \dots, F_{n-1, n})}{\partial (r_{12}, \dots, r_{n-1, n})} = (-1)^{\frac{1}{2}n(n-1)} \frac{\partial (\Phi_{12}, \dots, \Phi_{n-1, n-1}, \dots, F'_{1n}, \dots, F'_{n-1, n})}{\partial (r'_{12}, \dots, r'_{n-1, n})} \times \frac{\partial (r'_{12}, \dots, r'_{n-1, n})}{\partial (r_{12}, \dots, r_{n-1, n})} \dots\dots\dots(3).$$

By direct differentiation and substitution, followed by some obvious reductions, we find that the Jacobian on the left and the first Jacobian on the right are respectively equal to

$$(-1)^{n-1} J_1, \text{ and } (-1)^{\frac{1}{2}(n-1)(n-2)} J_2,$$

where

$$J_1 \equiv \frac{\partial (r'_{12}, r'_{13}, \dots, r'_{n-2, n-1})}{\partial (r_{12}, r_{13}, \dots, r_{n-2, n-1})} \dots\dots\dots(4),$$

and

$$J_2 = \frac{\partial (r_{1n}, r_{2n}, \dots, r_{n-1, n})}{\partial (r'_{1n}, r'_{2n}, \dots, r'_{n-1, n})} \dots\dots\dots(5).$$

It follows that the required Jacobian is given by

$$\frac{\partial (r'_{12}, r'_{13}, \dots, r'_{n-1, n})}{\partial (r_{12}, r_{13}, \dots, r_{n-1, n})} = (-1)^{\frac{1}{2}(n-1)(n-2) + n-1 + \frac{1}{2}(n-1)} J_1/J_2 = J_1/J_2 \dots(6).$$

§ 4. Evaluation of J_1 .

J_1 is a Jacobian of order $\frac{1}{2}(n-1)(n-2)$ but it is not a determinant of the type J for the case of $n-1$, since the quantities r' which occur in it are formed from the determinant of order n , not from that of order $n-1$, and they are consequently functions of the quantities r_{in} ($i = 1, 2, \dots, n-1$) as well as of those quantities r , which occur as independent variables in the differential coefficients.

To prevent confusion and to avoid undue multiplication of suffixes let us use the German letter \mathfrak{R} to denote the determinant of order $n-1$,

$$\begin{vmatrix} 1, & r_{12}, & \dots & r_{1, n-1} \\ \dots\dots\dots & & & \\ r_{1, n-1}, & \dots & \dots & 1 \end{vmatrix}$$

corresponding to the determinant R of order n ; and the corresponding German letters $\mathfrak{R}_i, \mathfrak{R}_{ij}, r_{ij}$ for the quantities corresponding in this case to R_i, R_{ij}, r_{ij} as already defined for the case of the determinant of order n . It will also be necessary in the course of

the work to replace those variables r which have suffixes not exceeding $n - 1$ by other variables ρ where

$$\rho_{ij} = (r_{ij} - r_{in} r_{jn}) / \sqrt{(1 - r_{in}^2)(1 - r_{jn}^2)}.$$

This substitution will be denoted by the notation $[\mathfrak{R}]_{r \rightarrow \rho}$ &c.

If in the determinant

$$R = \begin{vmatrix} 1, & r_{12}, & \dots, & r_{1n} \\ \dots & \dots & \dots & \dots \\ r_{1n}, & r_{2n}, & \dots, & 1 \end{vmatrix}$$

we multiply the last column by r_{in} and subtract it from the i th column ($i = 1, 2, \dots, n - 1$), we get

$$\begin{vmatrix} 1 - r_{1n}^2, & r_{12} - r_{1n}r_{2n}, & r_{13} - r_{1n}r_{3n}, & \dots & r_{1n} \\ r_{12} - r_{1n}r_{2n}, & 1 - r_{2n}^2, & \dots & \dots & r_{2n} \\ \dots & \dots & \dots & \dots & \dots \\ r_{1, n-1} - r_{1n}r_{n-1, n}, & \dots & \dots & 1 - r_{n-1, n}^2, & r_{n-1, n} \\ 0, & 0, & \dots & 0, & 1 \end{vmatrix}$$

$$= \begin{vmatrix} 1 - r_{1n}^2, & r_{12} - r_{1n}r_{2n}, & \dots & r_{1, n-1} - r_{1n}r_{n-1, n} \\ r_{12} - r_{1n}r_{2n}, & 1 - r_{2n}^2, & \dots & \dots \\ \dots & \dots & \dots & \dots \\ r_{1, n-1} - r_{1n}r_{n-1, n}, & \dots & \dots & 1 - r_{n-1, n}^2 \end{vmatrix}.$$

Dividing out the i th column and the i th row by

$$\sqrt{1 - r_{in}^2} \quad (i = 1, 2 \dots n - 1)$$

this becomes

$$\prod_{i=1}^{i=n-1} (1 - r_{in}^2) \cdot \begin{vmatrix} 1, & \rho_{12}, & \dots & \rho_{1, n-1} \\ \rho_{12}, & 1, & \dots & \rho_{2, n-1} \\ \dots & \dots & \dots & \dots \\ \rho_{1, n-1} & \dots & \dots & 1 \end{vmatrix}.$$

So that

$$R = \prod_{i=1}^{i=n-1} (1 - r_{in}^2) \cdot [\mathfrak{R}]_{r \rightarrow \rho} \dots \dots \dots (7),$$

with the notation just explained.

A slight modification of this work enables us to express any symmetrical determinant of order n as a symmetrical determinant of order $n - 1$, a result which is probably well known but which I do not remember to have seen before.

By exactly similar work we find that

$$R_j = (1 - r_{jn}^2)^{-1} \cdot \prod_{i=1}^{i=n-1} (1 - r_{in}^2) \cdot [\mathfrak{R}_j]_{r=\rho} \dots \dots \dots (8),$$

and

$$R_{jk} = (1 - r_{jn}^2)^{-1} (1 - r_{kn}^2)^{-1} \prod_{i=1}^{i=n-1} (1 - r_{in}^2) \cdot [\mathfrak{R}_{jk}]_{r=\rho} \dots \dots (9).$$

Whence

$$r'_{jk} = [r_{jk}]_{r=\rho} \dots \dots \dots (10).$$

Hence

$$\begin{aligned} J_1 &= \frac{\partial (r'_{12}, \dots, r'_{n-2, n-1})}{\partial (\rho_{12}, \dots, \rho_{n-2, n-1})} \cdot \frac{\partial (\rho_{12}, \dots, \rho_{n-2, n-1})}{\partial (r_{12}, \dots, r_{n-2, n-1})} \\ &= \left[\prod_{i=1}^{i=n-1} (1 - r_{in}^2) \right]^{-\frac{1}{2}(n-2)} \cdot \frac{\partial ([r'_{12}]_{r=\rho} \dots [r'_{n-2, n-1}]_{r=\rho})}{\partial (\rho_{12}, \dots, \rho_{n-2, n-1})} \dots (11). \end{aligned}$$

Since

$$\begin{aligned} \frac{\partial (\rho_{12}, \dots, \rho_{n-2, n-1})}{\partial (r_{12}, \dots, r_{n-2, n-1})} &= \prod_{i,j=1}^{i,j=n-1} \frac{1}{\sqrt{(1 - r_{in}^2)(1 - r_{jn}^2)}} \\ &= \left[\prod_{i=1}^{i=n-1} (1 - r_{in}^2) \right]^{-\frac{(n-2)}{2}}. \end{aligned}$$

But the Jacobian on the right-hand side of equation (11) is the Jacobian for the case $n-1$ of the same type as J , the quantities r being replaced by the corresponding quantities ρ ; so that by hypothesis (equation 2 of § 3) its value is

$$(-1)^{\frac{1}{2}(n-1)(n-2)} [\mathfrak{R}^{\frac{1}{2}n(n-3)} / (\prod_1^{n-1} \mathfrak{R}_j)^{\frac{1}{2}n}]_{r=\rho}.$$

Using equations (7), (8), (11) and reducing we obtain

$$(-1)^{\frac{1}{2}(n-1)(n-2)} J_1 = \prod_1^{n-1} (1 - r_{in}^2) \cdot R^{\frac{1}{2}n(n-3)} \cdot \left[\prod_1^{n-1} R_i \right]^{-\frac{1}{2}n} \dots (12).$$

§ 5. Evaluation of J_2 .

It is convenient first to evaluate instead of J_2 the corresponding quantity J'_2 , obtained by interchanging dashed and undashed letters.

We have first to evaluate

$$\frac{\partial r'_{in}}{\partial r_{jn}} \quad (i, j = 1, 2, \dots, n-1).$$

Now $1 - r'^2_{in} = (R_i R_n - R^2_{in}) / R_i R_n = R \cdot {}_i R_n / R_i R_n$

where ${}_i R_n$ denotes the second minor in R , obtained by erasing the i th and n th rows and columns.

Now R_n contains no quantity r with a suffix n , and ${}_iR_n$ contains no r with either of the suffixes i or n ; \therefore differentiating we obtain

$$\begin{aligned} r'_{in} \frac{\partial r'_{in}}{\partial r_{jn}} &= -\frac{1}{2} ({}_iR_n/R_n) \frac{\partial}{\partial r_{jn}} (R/R_i) = \frac{1}{2} {}_iR_n \left(R \frac{\partial R_i}{\partial r_{jn}} - R_i \frac{\partial R}{\partial r_{jn}} \right) / R_i^2 R_n \\ &= -{}_iR_n (R \cdot {}_iR_{jn} + R_i \cdot R_{jn}) / R_i^2 R_n, \end{aligned}$$

where ${}_iR_{jn}$ denotes the second minor in R , obtained by erasing the i th and j th rows and the i th and n th columns, and affixing a sign according to the ordinary rule; but

$$\begin{vmatrix} R_{in} & R_i \\ R_{jn} & R_{ij} \end{vmatrix} = R \cdot {}_iR_{jn},$$

$$\therefore R \cdot {}_iR_{jn} + R_i \cdot R_{jn} = R_{in} \cdot R_{ij}.$$

$$\therefore r'_{in} \frac{\partial r'_{in}}{\partial r_{jn}} = -R_{in} \cdot {}_iR_n \cdot R_{ij} / R_i^2 R_n.$$

And, in particular, if $i = j$,

$$r'_{in} \frac{\partial (r'_{in})}{\partial (r_{in})} = -R_{in} \cdot {}_iR_n / R_i R_n.$$

Hence the i th row in the Jacobian J_2' has the constituents

$$-R_{ij} R_{in} \cdot {}_iR_n / r'_{in} R_i^2 R_n. \quad (j = 1, 2, \dots, n-1)$$

Taking out the common factors and reducing we get

$$J_2' = (-1)^{n-1} \left[\prod_1^{n-1} ({}_iR_n / R_i^{3/2}) \right] R_n^{-\frac{1}{2}(n-1)} R^{n-2} \dots \dots (13),$$

and, interchanging dashed and undashed letters,

$$J_2 = (-1)^{n-1} \left[\prod_1^{n-1} ({}_iR'_n / R_i'^{3/2}) \right] R_n'^{-\frac{1}{2}(n-1)} R^{n-2} \dots (14).$$

But by some easy determinantal reductions we get

$${}_iR'_n = (1 - r_{in}^2) R_i R_n R^{n-3} / \prod_1^n R_j,$$

and
$$R'_i = R_i R^{n-2} / \prod_1^n R_j.$$

Substituting in (14) and reducing we obtain

$$J_2 = (-1)^{n-1} \left[\prod_1^{n-1} (1 - r_{in}^2) \right] \cdot R^{-(n-1)} R_n^{\frac{1}{2}n} \left[\prod_1^n R_i \right]^{\frac{1}{2}} \dots (15).$$

§ 6. Final result.

Substituting in equation (6) the values of J_1 and J_2 given by equations (12) and (15) we get

$$J = (-)^{\frac{1}{2}n(n-1)} \left\{ R^{n-2} / \prod_1^n R_i \right\}^{\frac{1}{2}(n+1)},$$

which is the required formula, the inductive proof of which is now complete.

(2) 1. *Metrical Relations between Linear Complexes.* 2. *Apolar Systems of Quadrics.* By J. H. GRACE, B.A., Peterhouse.

(3) *Certain Systems of Quadratic Complex Numbers.* By A. E. WESTERN, B.A., Trinity College.

[Printed in the *Transactions*, Vol. XVII. Part II.]

(4) *On Mittag-Leffler's Theorem.* By H. F. BAKER, M.A., St John's College.

(5) *On the connection between the Chemical Composition of a gas and the Ionization produced in it by Röntgen rays.* By J. J. THOMSON, M.A., F.R.S., Cavendish Professor of Physics.

This paper contains an account of experiments made to determine the ionization produced in a number of different gases when Röntgen rays pass through them. The method used to measure the ionization was as follows. It is well known that the current of electricity passing through Röntgenized gas does not increase proportionately to the electromotive force, the current approaches a finite limit beyond which it does not increase however large the electromotive force may be. This maximum current which we shall call the saturation current is determined by the condition that the number of ions used up by the current in one second is equal to the number of ions produced in that time by the rays. Thus the value of the saturation current is proportional to the number of ions produced by the rays in one second, so that to compare the ionization in two gases we have only to compare their saturation currents when exposed to rays of the same intensity. The measurement of the saturation current is comparatively easy, the chief difficulty is to ensure that the gases are exposed to radiation of the same intensity. The radiation from the bulbs used in these experiments was not constant enough to allow us to assume that it remained unaltered between successive experiments on different gases, it was therefore necessary to arrange the experiments in some way which would eliminate as

far as possible the effects of variations in the conditions of the bulb.

This was done by having two vessels *A* and *B* exposed to the rays simultaneously. *B* was used as a standard and was always filled with air while *A* was filled alternately with air and the gas under examination. Both *A* and *B* contained electrodes and the current of electricity between these electrodes was measured.

At first *A* and *B* were both filled with air and a series of readings of the leaks through *A* and *B* taken alternately until the constancy of the reading showed that the radiation from the bulb was approximately steady. These readings gave the ratio of the saturation currents through *A* and *B* when both were filled with air. *A* was now filled with the gas to be examined and the saturation currents through *A* and *B* again determined. These readings gave the ratio of the saturation current through *A* when filled with the gas to the saturation current through *B* when filled with air. From the first observation however we know the ratio of the saturation current through *A* when filled with air to that through *B* when filled with air. Combining these results we get the ratio of the saturation current through *A* when filled with the gas to the saturation current through *A* when filled with air. This ratio is the ratio of the ionization of the gas to the ionization of air.

The current in *A* and *B* passed between parallel plates furnished with a guard ring as in the figure. The plates were placed

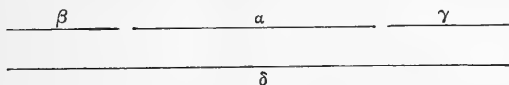

so that the Röntgen rays passed through the gas in a direction parallel to the plates. This arrangement was adopted to avoid the secondary effects which as Perrin has shown arise when the Röntgen rays strike against a metallic surface. The vessel *B* which was always filled with air was left open so that the rays went directly through the gas between the plates, the other vessel *A* which had to be filled with different gases was provided with an aluminium window through which the rays passed into the vessel. All the insulating supports used to support the plates in their position had to be screened from the Röntgen rays by metal screens; every solid against which the rays struck was made of metal, as the effects were found to be very irregular when this precaution was neglected. The coil and the exhausted tube used to produce the rays were in a large iron tank in which two aluminium windows were inserted, the vessels *A* and *B* were placed in front of these windows.

To measure the saturation current the plate α was connected to one pair of quadrants of an electrometer, the other pair of quadrants and the guard pieces β and γ were to earth, the two pairs of quadrants were at the beginning of the experiment connected together. The plate δ was connected to one terminal of a battery of small storage cells the other extremity of which was put to earth; for gases in which the ionization did not greatly exceed that of air, 200 cells giving a potential difference of 400 volts between the two plates which were 1 cm. apart were found sufficient to produce the saturation current, but for gases like Cl_2 , H_2S , SO_2 , HCl in which the ionization is very much larger than in air it was found necessary to use 600 cells to make sure that the maximum current was reached.

The connection between the two pairs of quadrants was then broken and when the rays were not passing through the gas and care had been taken with the insulation of the plates, the needle of the electrometer remained at rest; this was used as a test for the insulation. When however the rays passed through the gas the needle of the electrometer was deflected, as a charge of electricity passed across the gas from the plate δ to the plate α ; the quantity of electricity which passes in a given time, in these experiments 30 seconds, is proportional to the saturation current. Experiments were made with the positive terminal of the battery connected with δ and then the connections were reversed and the negative terminal was connected with δ , when the exhausted tube was working steadily, the deflections of the electrometer on opposite sides of the zero position were found to be the same in the two cases.

The tube used to generate the Röntgen rays gave out 'soft rays,' bulbs giving out very penetrating rays were found to be too variable for these experiments.

The results of the experiments are given in the following table, the numbers give the saturation current through the various gases, the saturation current through air being unity.

$\text{H}_2 = .33$	$\text{C}_2\text{N}_2 = 1.05$
$\text{N}_2 = .89$	$\text{C}_2\text{H}_2 = 1$
$\text{O}_2 = 1.1$	$\text{H}_2\text{S} = 6$
$\text{CO}_2 = 1.4$	$\text{SO}_2 = 6.4$
$\text{CO} = .86$	$\text{HCl} = 8.9$
$\text{NO} = 1.08$	$\text{Cl}_2 = 17.4$
$\text{N}_2\text{O} = 1.47$	$\text{NH}_3 = 1?$

The experiments with NH_3 could not be made with the same accuracy as with other gases as it was found impossible to dry the ammonia. The gas was passed through tubes several feet long

filled with lime, but in spite of this it retained sufficient moisture to produce a deposit of water on the insulating supports which in a few minutes destroyed the insulation.

The numbers given above show that with the exception of cyanogen the saturation current through the gases and therefore their ionization obeys the additive law, i.e. if $2[A]$, $2[B]$ represent the ionizations of the elementary substances A_2 , B_2 respectively the ionization of the compound gas represented by the formula A_pB_q will be equal to $p[A] + q[B]$.

If we assume the truth of this law and calculate from the saturation currents for H_2 , N_2 , O_2 , CO_2 , SO_2 and Cl_2 the ionization constants for H_2 , N_2 , O_2 , C_2 , S_2 , Cl_2 which we shall denote respectively by $2[H]$, $2[N]$, $2[O]$, $2[C]$, $2[S]$, $2[Cl]$, we find

$$[H] = \cdot 165$$

$$[N] = \cdot 445$$

$$[O] = \cdot 55$$

$$[C] = \cdot 3$$

$$[S] = 5\cdot 3$$

$$[Cl] = 8\cdot 7$$

and if we use these numbers to calculate the ionization in the other gases, we get the following table:

Gas	Ionization observed	Coefficient calculated
CO	$\cdot 86$	$\cdot 85$
NO	$1\cdot 08$	$\cdot 995$
N_2O	$1\cdot 47$	$1\cdot 44$
C_2N_2	$1\cdot 05$	$1\cdot 49$
C_2H_2	1	$\cdot 93$
H_2S	6	$5\cdot 63$
HCl	$8\cdot 9$	$8\cdot 865$
NH_3	1	$\cdot 94$

Thus the only case in which there is any serious discrepancy between the observed and calculated results is that of C_2N_2 ; there are other cases in which the additive law holds, such for example as Kopp's law of volumes where the atomic volume of cyanogen cannot be got from those of carbon and nitrogen.

The ionizations in H_2 , NH_3 , CO_2 , N_2O , SO_2 and HCl have been measured by Perrin (Thèses présentées à la Faculté des Sciences de Paris, 1897, p. 46); his results with the exception of the ionization in H_2 and NH_3 do not differ much from the preceding, in the case of H_2 and NH_3 however there is a very wide

divergence as the values given by Perrin for these gases are only about one-tenth of those found above.

The existence of the additive law for the ionization produced by the rays indicates that this ionization is probably not the separation of one atom from another in the molecule of a gas but a process occurring in the atom itself.

(6) *On Convection Currents and on the Fall of Potential at the Electrodes, in Conduction produced by Röntgen Rays.* By JOHN ZELENY, B.Sc., Assistant Professor of Physics, University of Minnesota.

I. CONVECTION CURRENTS PRODUCED BY RÖNTGEN RAYS.

The passage of electricity through a gas under the influence of Röntgen rays is accompanied by movements of the gas itself which are of considerable magnitude.

The presence of these convection currents can readily be made visible by means of particles suspended in the gas, and for this purpose it has been found convenient to use the ammonium chloride particles formed by the action of ammonia and hydrochloric acid.

One form of apparatus used for carrying on the experiments is represented in elevation in fig. 1.

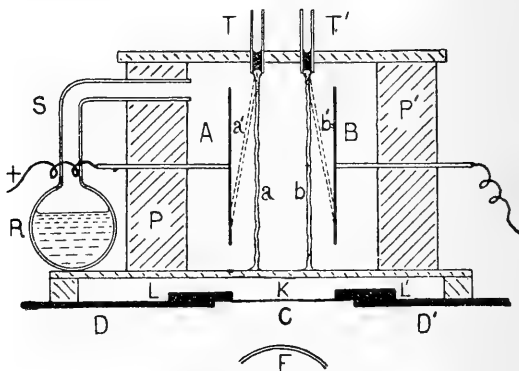

Fig. 1.

The two brass plates *A* and *B* are each 6.3 centimetres high and 2.8 centimetres wide, and act as electrodes in the gas, being connected to the opposite poles of a battery of storage cells.

The plates are enclosed in a box of which the sides *P* and *P'* are formed of paraffin blocks, while the other two sides are glass plates which leave the whole interior open to observation.

The bottom K of the box is made of wood to permit the entrance of the Röntgen rays, which pass from the source F through the aluminium window C in the cover DD' of a lead-covered box which contains the induction coil and tube.

The part of the space, in the box PP' , that is exposed to the rays can be regulated as desired by moving the lead strips L and L' , while observing the fluorescence on a screen placed above the apparatus.

The glass-bulb R contains aqua ammonia from which the tube S conducts the ammonia gas into the box PP' . Fastened to the cover of the latter are the two glass tubes T and T' , into which drops of hydrochloric acid are introduced. The particles of ammonium chloride formed at the lower ends of the tubes, where the acid is in contact with the ammonia in the air, descend in the box with a slow velocity producing well-defined whitish streams a and b near the plates A and B .

While the air in the box is at rest the particles move vertically downwards, and this motion is maintained when the plates are kept at the same potential and the air between them is exposed to Röntgen rays, or when the plates are at different potentials and the air is not exposed to the rays.

If however, while the plates are maintained at different potentials, the whole space between them is exposed to the rays the two streams are deflected or bodily carried each to its neighbouring plate.

When the rays are turned on, the streams of particles begin to move from their initial position with a velocity that is accelerated for an appreciable length of time, i.e. the particles do not assume a uniform motion at all quickly.

For a given intensity of the rays, the rate of the motion is dependent upon the potential gradient between the plates.

When the electric field is not too intense the streams assume a steady state in oblique positions as indicated by a' and b' in fig. 1. In this case the horizontal component of the motion is not large compared to the vertical one. But if the gradient is made much larger, the horizontal velocity may predominate greatly and the streams are carried bodily to the plates. The potential differences used in these experiments ranged from 40 to 320 volts for a distance of two centimetres.

It becomes necessary to show that the movements indicated by the streams are true indices of the actual motion of the gas, that the gas is set into motion and carries the particles with it, and that these are not themselves the primary cause of the motion.

If the ammonium chloride particles became charged in some way we might expect them to partake of movements somewhat similar to those observed.

But such charges are not acquired during formation, for in the absence of the rays the motion of the particles is not influenced by the electric field, and particles are equally affected when the rays are turned on, whether they were formed before or after the rays are allowed to act.

Any charges acquired from the ions produced in the gas do not give rise to the observed motions, for if both kinds of charges are present, the streams should separate into two parts, one going to each plate; and if on the other hand near each plate the particles get a charge opposite to that of the plate we could not thereby explain an experiment to be described later where both of the streams are drawn to the same plate.

While it thus seems clear that the motion of the stream is a fair representation of what is going on in the gas when the particles are not present, still in order to test this point further the following experiment was performed.

A carbonic acid gas generator was connected to a glass tube which ended in a small opening and projected upwards through the bottom *K* of the box *PP'* in fig. 1. A narrow jet of carbonic acid gas could thus be sent upwards in the neighbourhood of and parallel to one of the plates.

The jet was made visible due to its different refractive index, by projecting the whole apparatus with an arc-light as a shadow upon a screen.

With some care in choosing the proper orifice of efflux it was possible to obtain a portion of the jet, which maintained a distinct form even though its upward velocity was not large compared to the motions under investigation.

When the rays were turned on while the plates were at a different potential, the jet of carbonic acid gas was deflected towards its neighbouring plate, the same effect as was obtained by using the ammonium chloride particles. Since however a gas molecule cannot become electrified, the result here obtained cannot be ascribed to any secondary effect, and it is evident that during conduction the gas itself is set into motion.

It is well known that gas movements accompany the passage of electricity through gases in some other cases, and they are explained as due to the movement of electrified carriers through the gas.

In seeking to find the cause of the convection currents here under consideration we are at once led to ascribe them to the motion of the charged ions by means of which the conduction is carried on.

When an ion starts moving through a gas under the action of an electromotive force, its resulting velocity is assumed to become constant in a very short time.

All of the work now done by the field upon the moving ion is transferred to the body of the resisting gas, which therefore tends to move with the ion.

If an equal number of positive and negative ions are moving in opposite directions through a gas, the resulting velocity is nil; but if the ions of one sign are more numerous, that is, if a free charge exists in the gas, it then tends to move with accelerated motion in the direction taken by the predominant ions.

Now in the case of conduction under the influence of Röntgen rays it has been shown by J. J. Thomson and E. Rutherford* that a free charge exists in the gas, and the writer† has investigated the distribution of the charge between two plates and found that near each plate there is a charge in the gas opposite in sign to that of the plate, and that this decreases rapidly with the distance from the plates.

In the neighbourhood of each plate, therefore, there exists a force tending to move the gas towards the plate, while near the centre there is a neutral region.

If the two plates were unlimited in extent, then the motion of the gas would produce an inequality in the gas pressure which would counteract all further movements; but with limited plates the excess pressure at their surfaces is relieved sideways, and there results a set of convection currents whose velocity increases until the loss of energy due to friction is equal to that gained from the moving ions.

In accordance with this view, in the experiments described above it was seen that when the conduction begins the gas starts to move towards the electrodes, that this motion is accelerated for a noticeable length of time, that it is more vigorous with greater ionization and greater potential gradients, and that finally it assumes a steady state.

The configuration of the convection currents in the apparatus during the steady state has been traced in some cases, but is of no especial interest as it is so dependent upon the form and size of the apparatus used.

The view taken of the nature of the convection currents has been tested by a considerable number of experiments made with different forms of apparatus and under varying conditions; it may be useful to mention here a simple modification of the experiments already described.

If in the apparatus shown in fig. 1 the rays instead of falling upon all of the gas between the two plates are allowed to impinge only on a part next to one plate, as may be done by screening the other side by one of the movable strips of lead *L*, then as soon as

* J. J. Thomson and E. Rutherford, *Phil. Mag.* Nov. 1896, p. 394.

† J. Zeleny, *Phil. Mag.* July 1898, p. 138.

the rays are turned on both streams of ammonium chloride particles move towards the plate from which the rays are screened.

By cutting off the rays from one side of the field the gas in the exposed part, which normally moves towards its adjacent plate, now has its motion reversed so that all the gas between the plates is moving towards the screened plate.

If the distribution of the ions in this case is considered it is seen that this is a necessary consequence. For, of the ions produced in the space exposed to the rays, those which under the electric field move towards the screened side have a longer distance to travel, and while they are in the screened space they constitute a much larger free charge than is normal, for here there are not present any of the ions of the opposite sign which usually neutralize the greater part of the effect.

The motion of this abnormally large charge produces an air current which sets into motion all of the air between the plates and even overcomes the force near the exposed plate which tends to produce motion in the opposite direction.

It has been stated that the velocity of the convection currents is accelerated for an appreciable time, so that by finding this acceleration it is possible to get a rough idea of the magnitude of the free charge necessary to produce the observed movements.

Thus in a particular case where the field was uniformly exposed to the rays and where the potential gradient was about 60 volts per centimetre, the stream of particles was observed to move 5 millimetres from rest in two seconds.

Assuming the acceleration uniform for this short period of time, this gives its value as .25 cm. per sec. per sec.

Assuming further that the charge in each cubic centimetre has only to move this volume of air although it actually has to move rather more, and calling δ the average density of electrification, we have approximately by equating the two expressions for the force acting

$$\delta \times \frac{60}{300} = .25 \times 1.2 \times 10^{-3}.$$

This gives for δ a value of about 10^{-3} , a number of the same order as has been observed for the free charges existing in these cases.

II. THE POTENTIAL GRADIENT AT THE ELECTRODES.

It has recently been shown independently by the writer* and by Child† that when conduction is going on between two plates the potential gradient between them is not uniform and that at the plates there is a rapid fall of potential.

* J. Zeleny, *Phil. Mag.* July 1898, p. 147.

† C. D. Child, *Wied. Ann.* Lxv. p. 152, 1898.

In these investigations, however, no experimental points were obtained on those parts of the gradient curves which correspond to these rapid changes at the plates, so that it is not possible to say whether the fall exists in the gas near to the electrodes or whether it is due to the formation of some kind of a double layer on the plates themselves.

If in passing from the gas to the electrode the potential changes in a continuous manner, then evidently its variations can be explained by the presence of free charges in the gas; but if on the other hand there is a sudden change of potential at the electrode it is necessary to assume the presence, at the surface, of a charged layer opposite in sign to that of the metal itself.

In the previous work the nearest point at which the potential was determined by the writer was one millimetre from the plate, while the nearest observed by Child was five millimetres distant.

And since it has been shown* that the free charges in the gas increase rapidly as the electrode is approached, it was thought possible that a determination of the potential at points nearer to the surface than had been done might throw some light upon the problem just mentioned.

For this purpose a form of apparatus was constructed which possesses some important improvements and permits of a determination of the potential at points within $\frac{1}{10}$ millimetre from the electrode.

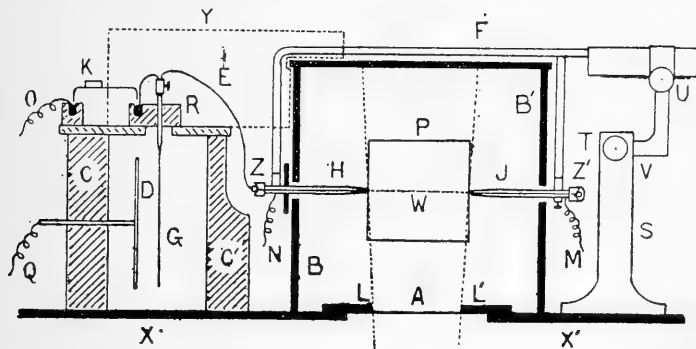

Fig. 2.

The apparatus is shown in elevation in fig. 2, as it was set up on the cover, XX' , of a lead box which contained the induction coil and Crookes tube.

The electrodes between which the potential gradient was investigated were made of brass plates, 7.3 centimetres square, which had been carefully worked flat.

* J. Zeleny, *Phil. Mag.* July 1898, p. 138.

One of these is represented by *P*, the other one being parallel to it, and both being supported by rods (not shown) which were fixed at right angles to them.

The plates were kept at a constant difference of potential by a battery of cells, and were completely surrounded by a lead box *BB'*. The potential of points between the plates was investigated, during conduction, by means of a fine brass wire *W*, $\frac{1}{10}$ of a millimetre in diameter, which was supported by a frame *F*. This frame was fastened to a microscope stand *S*, which allowed by means of the set screws *T* and *U* of two motions at right angles to each other. The position of the wire was determined by means of a verniered scale at *V*.

The parts of the wire not included between the plates were surrounded by the brass guard-tubes *H* and *J* which tapered to a small size at their ends.

The wire was stretched taut between two small insulating rods which were carried by the parts *Z* and *Z'*.

It was connected by means of the wire *E* with the gold-leaf *G* which, supported by the paraffin block *R*, hung in a box of which *C* and *C'* formed two sides, the other two being of glass.

Parallel to the gold-leaf was the adjustable brass plate *D* which was connected to earth through a high resistance by the wire *Q*.

The lead cover *Y* served as a screen for a part of the apparatus. Earth connected metal screens also covered the exposed sides, but are not shown in the figure, nor is the microscope by means of which the movements of the gold-leaf were observed, and which carried in the focus of its eye-piece a finely divided scale.

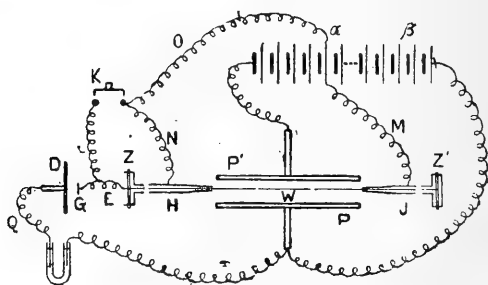

Fig. 3.

The electrical connections can be seen better from fig. 3 where the apparatus is viewed from above, and where the letters have the same significance as in fig. 2.

By pressing the key K , the wire W and the gold-leaf G can be simultaneously charged to any required potential by means of the wire O leading to a battery of cells β .

The guard-tubes H and J are also kept at the same potential by the wires N and M , and the same battery maintains the plates P and P' at a constant difference of potential.

The gold-leaf method here employed for detecting the changes of potential of the wire, although in the form used it does not detect as small differences as a quadrant electrometer, still has an advantage in that owing to the small capacity of the system it takes up the desired potential of a place much more rapidly, which is a great convenience when working with the small conductivities here concerned.

By making the distance between the plate D and the gold-leaf G such that for the voltage to be used the leaf is almost on the point of being drawn to the plate, the indications are sufficiently sensitive for the purpose in hand.

The following is the procedure for finding the potential of any place between the plates during conduction.

The investigating wire W being placed in the desired position, the wires O and M (fig. 3) are connected to the battery β to a point α which has a potential estimated to be that of the place in question.

The key K is now opened, leaving the wire W and the leaf G insulated and charged to a known potential.

The rays are now allowed to pass through the aluminium window A and to traverse the space between the plates, and according as the wire was charged to a lower or higher potential than that of the required point the gold-leaf shows an increase or decrease in deflection, the wire gaining a charge from or losing it to the gas.

The wires O and M are connected successively to different points of the battery until for two adjacent cells the gold-leaf indicates an increase in charge for one and a decrease for the other, when the rays are turned on.

By noting for the steady state in these two cases the number of divisions of displacement on the microscope scale, the desired potential is obtained by interpolation.

The presence of the guard-tubes H and J was found to be important, since, being kept at the same potential as the insulated wire W , it is impossible for this wire to gain or lose a charge by gas conduction at any point except that between the plates whose potential is desired.

Without the guard-tubes a small leakage is liable to occur from those parts of the wire which are outside of the plates, although the direct rays do not impinge upon any of the lines of

force from these parts. Ions reach these places, however, either by the convection currents described in § I. or by diffusion or by secondary radiation.

In the results obtained with this apparatus, the fall of potential at or near the plates was found to be less than that hitherto observed, and especially no approach could be made to such high values as those described by Child (*loc. cit.*).

There is good evidence of the lack of accidental leakage, for with the same potential difference between the plates the nature of the potential curve was found to be independent of the absolute potential of the plates.

The following table gives the results obtained for the potentials of some points near to the zero plate, when the plates were 1.215 centimetres apart and were kept at a difference of potential of 320 volts.

TABLE I.

Distance from zero plate	Potential observed	Potential calculated for uniform gradient	Difference
.00 cm.	+ 0 volts	+ 0 volts	0 volts
.01 "	8.7 "	2.6 "	6.1 "
.02 "	11.9 "	5.3 "	6.6 "
.03 "	14.8 "	7.9 "	6.9 "
.04 "	17.4 "	10.5 "	6.9 "

These results are shown graphically in fig. 4 where the line *AB* represents the uniform gradient existing when the rays are not acting.

For the same distance between the plates and smaller voltages which were tried down to 40 volts, the fall in the first $\frac{1}{10}$ mm. was found to be correspondingly smaller.

It is seen that in the first $\frac{1}{10}$ mm. from the plate the change of potential is about as large as in the following $\frac{3}{10}$ mm., and it thus appears that the fall of potential near the electrode is abnormally large.

The results do not permit us to say however whether this is due to a charge adhering as it were to the metal surface or whether it is due to the existence of a charge in the gas within the first $\frac{1}{10}$ mm. from the electrode.

If it were possible to measure the electric force acting upon the plates during conduction such a distinction could be made by comparing the potential gradient thus found at the plate with that obtained in the above experiments for points near to it.

The presence however of the convection currents described in § I. interferes with such a measurement.

Various attempts were made to get rid of the effects of their pressure, but no reliable method was obtained.

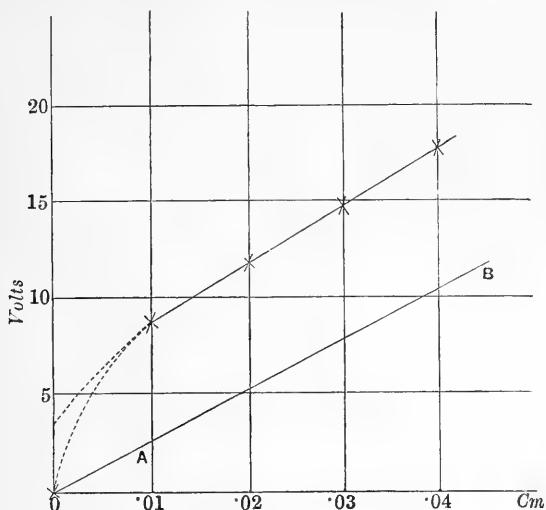

Fig. 4.

Still, it can be shown that during conduction there is an increase in the force acting upon the electrodes.

This is most readily done with a modification of the apparatus

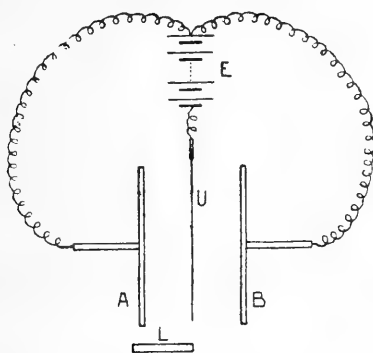

Fig. 5.

shown in fig. 1, which is represented in fig. 5, where the box PP' which encloses the plates A and B is not drawn.

U is a gold-leaf suspended midway between the plates and is connected to a pole of the battery E to the other pole of which the two plates are joined.

The motions of the gold-leaf are observed by means of a microscope.

When everything is arranged symmetrically and the rays have access to the whole space between A and B there is little or no motion of the leaf when the rays are turned on.

If by means of the lead plate L the rays are cut off from the space between the leaf and one of the plates, say A , then the gold-leaf is deflected towards the side traversed by the rays, that is towards B .

The attraction is therefore greater on the side where conduction is going on than where it is not.

When the plate B is removed altogether, the leaf is deflected towards A by the existing electrostatic attraction.

Allowing the rays to pass between the plate and the leaf increases this deflection so that, in a particular case with a distance of 1.5 centimetres between the two, the passage of the rays increased the deflection by an amount equal to that produced by an addition of ten volts to the existing potential difference of eighty volts.

This does not indicate the total increase in the potential gradient at the plate, because the leaf is also acted upon by a counteracting pressure due to the gas motion described in § I., but as it is difficult to estimate the value of this pressure all that the above experiment enables us to say is that the gradient at the leaf when the rays were acting was *more than* $\frac{2}{3}$ of the gradient existing previously.

It is possible to arrange the above apparatus so that an air current will assist the deflection of the gold-leaf.

When both plates are used, if instead of being kept at the same potential one, say B , is connected to the leaf, then if the rays are passed between the leaf and this plate, the leaf is deflected towards the plate although this is at the same potential.

Two effects combine to produce this result.

Because of the small width of the leaf some lines of force near the sides of the box extend from A to B , and others starting from A reach the leaf U on the side turned towards B .

As these latter are in the path of the rays there are some ions reaching the leaf from and producing a deflection towards B .

It was also found that the convection currents in the gas at the sides of the box were from B to A , but in the centre between A and U there was a return current directed from A towards U which on reaching the leaf went around both edges of it, thus tending to move the leaf towards B .

The results of the investigations described in this paper may be summarized as follows:—

I. During conduction through a gas under the influence of Röntgen rays, convection currents are produced in the gas which in general move towards the electrodes.

II. The convection currents are caused by the motion of the free charges existing in the gas.

III. The rapid fall of potential near to the electrodes during the conduction exists within the first $\frac{1}{10}$ mm. from the surface.

IV. The electric force acting upon the electrodes is increased by exposing the gas to Röntgen rays.

I desire, in conclusion, to express my thanks to Prof. J. J. Thomson for many valuable suggestions during the course of the investigation.

CAVENDISH LABORATORY.

(7) *On Velocity of Solidification.* By HAROLD A. WILSON, B.Sc. (Lond. and Vic.), 1851 Exhibition Scholar.

When solidification is started in a supercooled liquid such as phenol then rays of solid grow in the liquid with a definite velocity depending on the temperature of the liquid and on its purity. This velocity has been determined for a number of substances at various temperatures*.

The connection between the velocity and the supercooling for most of the substances investigated can be represented by a curve of the following general form.

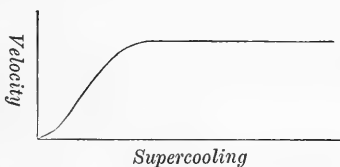

Fig. 1.

When the supercooling is very small the velocity increases very slowly with the supercooling. As the supercooling is increased the velocity increases more rapidly at first but then again more slowly and is then constant over a considerable range of temperature. When the supercooling is very great the velocity becomes very small and may even fall to zero.

* See papers by Friedländer and G. Tammann, *Zeitschrift P. C.* xxiv. p. 152, 1897, and xxiii. p. 326, 1897.

No very satisfactory explanation of the relation between the velocity and supercooling has as yet been given. Tammann (*loc. cit.*) has suggested that if the substance were quite pure the velocity would be the same whatever the supercooling, and has pointed out that when the substance is purified the constant value of the velocity is attained at a smaller supercooling than before.

To explain so many of the phenomena observed by the presence of supposed impurities is evidently unsatisfactory and the object of this paper is to explain the observed relation between the velocity and supercooling without the aid of supposed impurities in the material used.

At the melting point the solid and liquid exist together in equilibrium and their vapour pressures are equal. Below the melting point the vapour pressure of the liquid is greater than that of the solid. The internal pressure corresponding to the difference between the vapour pressures of the solid and liquid can be obtained by multiplying the difference of the vapour pressures by the ratio of the density of the liquid to that of the vapour. For water and ice at -1°C . it amounts, as I shall show below, to about 12 atmospheres. When ice and water are in contact at -1°C . therefore the internal pressure in the water is greater than that in the ice by 12 atmospheres, so that the layer of molecules at the surface of separation is urged by this pressure into the solid. It seems reasonable to suppose that the rate at which solidification takes place at the surface of separation will depend on the difference between the two internal pressures.

An expression for the difference between the two vapour pressures can be easily obtained by means of the equation

$$L = (v_2 - v_1) \theta \frac{dp_p}{d\theta},$$

where L is the latent heat of evaporation of unit mass, v_2 the specific volume of the vapour and v_1 that of the liquid, θ the absolute temperature and p_p the vapour pressure of the liquid.

Integrating and neglecting v_1 as being small compared with v_2 , this gives, putting $v_2 = \frac{R\theta}{p_p}$,

$$\frac{1}{\theta} + \frac{R}{L} \log p_p + C = 0.$$

For the solid in the same way

$$\frac{1}{\theta} + \frac{R}{L + F} \log p_s + C' = 0,$$

where F is the latent heat of fusion.

Eliminating C and C' by means of the equality of the vapour pressures at θ_0 the melting point, these equations give

$$\log \frac{p_p}{p_s} = \frac{F}{R} \left(\frac{1}{\theta} - \frac{1}{\theta_0} \right).$$

Since $p_p - p_s$ is small compared with p_s this gives very approximately

$$p_p - p_s = p_s \frac{F}{R} \left\{ \frac{1}{\theta} - \frac{1}{\theta_0} \right\}.$$

Now, according to Van 't Hoff*, the osmotic pressure of a solution can be calculated from its vapour pressure by multiplying the difference between its vapour pressure and that of pure water by the ratio of the density of water to the density of its vapour. This gives the osmotic pressure of the salt in the solution, or what is the same thing the diminution of the internal pressure due to the presence of the salt. Assuming that the internal pressure in the solid is diminished by an amount measured by the diminution of the vapour pressure in the same way as in the case of a salt solution, we get for the difference between the internal pressures in the liquid and solid

$$P = (p_p - p_s) \frac{s}{\rho},$$

where s and ρ are the densities of the liquid and its vapour respectively. Substituting the above value of $(p_p - p_s)$ this gives,

$$\text{since } \rho = \frac{p}{R\theta},$$

$$P = sF \cdot \frac{\theta_0 - \theta}{\theta_0}.$$

In getting this expression the change in density which takes place during solidification has been left out of account, so that it is not clear whether s should be the density of the liquid or that of the solid. It might be thought that the proper method of getting P would be to multiply p_p by $\frac{s_p}{\rho_p}$, and p_s by $\frac{s_s}{\rho_s}$, and subtract, so that

$$P = \left\{ p_p \frac{s_p}{\rho_p} - p_s \frac{s_s}{\rho_s} \right\};$$

but this expression is not zero at θ_0 (unless $s_p = s_s$) which is not in

* *Studies in Chemical Dynamics*, p. 232.

agreement with the fact that at θ_0 the solid and liquid are in equilibrium. It is, however, easy to obtain the formula

$$P = sF \frac{\theta_0 - \theta}{\theta_0}$$

in another way which shows that s should refer to the solid state in it.

Imagine a cylinder fitted with a piston and provided with a bottom permeable to water but not to ice. Let this be filled with ice and immersed in water all at a temperature θ below θ_0 .

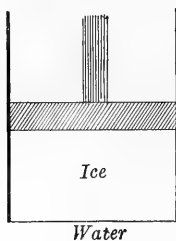

Fig. 2.

Then if the pressure on the piston is great enough the ice will be melted and forced through the bottom as water. Let P be the least pressure required for this which is evidently equal to the difference between the internal pressures in the water and ice at θ . Then if unit volume of ice is melted and squeezed through, the work done by the piston is P , and the heat absorbed is $s_s F$, and since the operation is reversible, and $P = 0$ when $\theta = \theta_0$,

$$\therefore P = s_s F \frac{\theta_0 - \theta}{\theta_0}$$

by the 2nd law of thermodynamics.

This equation is closely analogous to that usually given for the pressure required to lower the melting point of ice by a given amount. In the case usually considered, however, both the ice and the water are supposed compressed, whereas in the present case the water is supposed unconstrained. It may be remarked that in many of the cases usually cited as examples of the equation for the case where both the water and the ice are subject to the pressure the water is really unconstrained, so that the ordinary equation is not applicable and should be replaced by the one just obtained. Such cases are the melting of ice at the feet of glaciers due partly to the pressure of the ice above, and the well-known

experiment of passing a loaded wire through a block of ice. If $\theta_0 - \theta$ is one degree P for water is roughly

$$\frac{80 \times 42 \times 10^6}{273} = 12 \times 10^6 \frac{\text{dynes}}{\text{cm}^2},$$

or about 12 atmospheres. If the water is also supposed compressed the corresponding value of P is about 150 atmospheres and of course depends entirely on the change of volume during solidification. The effect when the water is unconstrained is therefore more than ten times greater than the effect usually only considered and applies equally well to all substances whether there is a change of volume on solidification or not.

The pressure P may be supposed to drive the molecules from the liquid into the solid just as the osmotic pressure of a salt solution causes it to diffuse. If A is the force required to give unit velocity to one gram of the liquid diffusing through itself, and if it is supposed that the pressure P acts on a layer of molecules at the surface of separation of thickness α , then the velocity of solidification (ω) will be

$$\omega = \frac{P}{A\alpha} = \frac{F}{A\alpha} \cdot \frac{\theta_0 - \theta}{\theta_0}.$$

Only the orders of magnitude of A and α can be estimated at present. The force required to give unit velocity to a gram molecule of HCl diffusing in water is about 10^{15} dynes (see Ostwald's *Solutions*, translated by P. Muir, p. 146), and for other substances it is of the same order of magnitude. Hence A may be taken as about 10^{15} . α is probably of the same order of magnitude as the mean distance between the molecules of the liquid, so we may take α as 10^{-8} cm. Hence if $\theta_0 - \theta = 1$ degree

$$\omega = \frac{80 \times 42 \times 10^6}{10^{15} \times 10^{-8} \times 273} = 1.2 \frac{\text{cms}}{\text{sec}},$$

which is of the right order of magnitude.

Thus for pure phenol I have found that the velocity increases by about $0.3 \frac{\text{cm}}{\text{sec}}$ for each degree of supercooling, and the velocity

calculated as above, using the same values of A and α , is $0.4 \frac{\text{cm}}{\text{sec}}$.

Since only the orders of magnitude of A and α are known, an accurate comparison between the calculated and observed velocities is impossible. Since A increases rapidly as the temperature falls,

the expression $\frac{F}{A\alpha} \cdot \frac{\theta_0 - \theta}{\theta_0}$ indicates that as the supercooling is increased the velocity of solidification will attain a maximum

value and then diminish. Let the temperature at which the velocity is a maximum be θ_1 .

Suppose first that the supercooling of the liquid is less than $(\theta_0 - \theta_1)$. Then the heat produced by the solidification will raise the temperature of the tip of the ray of solid which will make the velocity smaller, consequently the ray will grow at a somewhat smaller rate than it would if its tip were at the original temperature of the liquid. The diminution of the velocity due to this cause will probably be a larger fraction of the velocity when the supercooling is small than when it is large, which perhaps is the cause of the small rate of increase of the velocity with the supercooling when the supercooling is very small.

Suppose now that the supercooling of the liquid is greater than $(\theta_0 - \theta_1)$, then the heat produced by the solidification will raise the temperature of the tip which will make the velocity greater, consequently the velocity will continue to increase until the temperature is reached at which the velocity is a maximum. Hence when the supercooling of the liquid is greater than $(\theta_0 - \theta_1)$ the velocity will be independent of the supercooling because the tip of the ray will always be maintained at the temperature θ_1 .

If the supercooling is very great the viscosity of the liquid may be so great that practically no solidification can take place or the initial velocity may be so small that the tip will not be heated appreciably, so that the velocity will remain small. If when this is the case the supercooling is gradually diminished, a point will at length be reached at which the velocity will suddenly attain the maximum value owing to the heat generated by the solidification taking place at the original temperature having become sufficient to appreciably raise the temperature of the solid being formed. The temperature at which this takes place corresponds very closely to the temperature of ignition of an explosive gaseous mixture.

Thus the observed relation between the supercooling and the velocity can be accounted for.

I shall now consider certain cases of solidification in detail. The general problem in solidification may be stated as follows:—given the distribution of solid and liquid and the temperature throughout a given space at any time and also the boundary conditions, to find the distribution at any subsequent or previous time.

Consider a surface of separation between ice and water. The rate of solidification at the surface depends on the supercooling of the surface and for small supercoolings may be taken as proportional to the supercooling. So that $v = C(\theta_0 - \theta)$ where v is the velocity of the surface, θ_0 the melting point, and θ the temperature of the surface and C a constant.

The rate of production of heat at the surface is per unit area vsF , using the same notation as before. The rate at which heat is produced at the surface must be equal to the rate at which it is conducted away from the surface, consequently at any point on the surface

$$vsF + K_p \frac{d\theta}{du_p} + K_s \frac{d\theta}{du_s} = 0,$$

where u_p and u_s are the normals to the surface at the point in the liquid and solid respectively, and K_p and K_s are the conductivities of the liquid and solid respectively.

These two equations $v = C(\theta_0 - \theta)$ and

$$vsF + K_p \frac{d\theta}{du_p} + K_s \frac{d\theta}{du_s} = 0,$$

together with the ordinary equations for heat conduction, are sufficient to enable any problem in solidification to be solved.

The equation $v = C(\theta_0 - \theta)$ does not take into account any tendency of the solid to crystallise out in particular crystalline forms. In the case of phenol and other substances the solidification appears to be determined by the temperature alone, but this does not hold good for all cases. Thus melted sodium thio-sulphate when supercooled solidifies partly in rays like phenol, but in addition to the rays crystals are also sometimes formed which do not grow at a uniform rate like the tips of the rays.

I shall now consider the case of a long hollow circular cylinder of ice, filled with water, whose external surface is kept at a constant temperature θ_0 which is below the melting point of the ice θ_0 . Let r_1 and r_2 be the internal and external radii of the cylinder. Then if θ is the temperature at the internal surface the amount of heat conducted through the cylinder per unit length in unit time is, if the temperature of the internal surface and r_1 are supposed to vary very slowly,

$$\frac{2\pi K (\theta - \theta_0)}{\log \frac{r_2}{r_1}}.$$

When r_1 and r_2 are very nearly equal, r_1 will change rapidly, so that the above expression, which assumes that a steady state has been reached, will not be applicable. Also when the cylinder is thick θ must be very nearly equal to θ_0 , so that practically all the heat produced by the solidification is conducted away through the ice, consequently

$$-2\pi r_1 s F \frac{dr_1}{dt} = \frac{2\pi K (\theta - \theta_0)}{\log \frac{r_2}{r_1}}.$$

But
$$-\frac{dr_1}{dt} = C(\theta_0 - \theta),$$

so that
$$r_1 C_s F = \frac{K(\theta - \theta_1)}{\log \frac{r_2}{r_1}}.$$

Therefore
$$\theta = \theta_0 - \frac{K(\theta_0 - \theta_1)}{r_1 C_s F \log \frac{r_2}{r_1} + K}.$$

If $\theta_0 - \theta_1 = 10^\circ \text{C.}$, $K = 0.0015$, $F = 80$, $C = 1.2 \frac{\text{cms}}{\text{sec}}$ and $r_2 = 2 \text{ cms}$, the following table gives the values of $(\theta_0 - \theta)$ for several values of r_1 according to this formula:

r_1	$\theta_0 - \theta$
0.2 cms	0° 00034 C.
1.0	0.00023
1.8	0.00082
1.99	0.0164

Since $r_1 \log \frac{r_2}{r_1}$ is a maximum when $r_1 = \frac{r_2}{e}$, the supercooling of the water in the cylinder is a minimum for this value of r_1 .

Since
$$-\frac{dr_1}{dt} = C(\theta_0 - \theta),$$

$$\therefore -\frac{dr_1}{dt} = \frac{K(\theta_0 - \theta_1)}{r_1 s F \log \frac{r_2}{r_1} + \frac{K}{C}}.$$

I shall now consider the case of an infinite quantity of the supercooled liquid beginning to solidify all over an infinite plane. Since everything is symmetrical about the plane, the solid will form a plane slab half on each side of the original plane. Let X be half the thickness of the slab at a time t reckoned from the instant when $X = 0$. Since when the supercooling is small the latent heat of fusion is very large compared with the supercooling, practically all the heat produced goes into the liquid. Hence

$$sF \frac{dX}{dt} = -K \frac{d\theta}{dx},$$

where $\frac{d\theta}{dx}$ is the slope of temperature in the liquid at the surface of the solid.

If a quantity of heat σ per unit area is instantaneously generated over an infinite plane and left to diffuse, then after a time t the temperature at any point distant x from the plane is given by

$$\theta - \theta_1 = \frac{1}{2} \frac{\sigma \epsilon^{\frac{-x^2}{4kt}}}{\sqrt{\pi kt}},$$

where $k = \frac{K}{c}$ the diffusivity. If all the heat goes to one side of the plane this result must of course be doubled. In any element of time dt the heat produced on the surface of the solid is

$$sF \frac{dX}{dt} dt \text{ per unit area.}$$

This will raise the temperature of any point in the liquid at a subsequent time t' by

$$sF \frac{dX}{dt} dt \frac{\epsilon^{\frac{-(x-X)^2}{4k(t'-t)}}}{\sqrt{\pi k(t'-t)}}.$$

Hence if θ_1 is the original temperature of the liquid the rise in temperature at any point in the liquid at a time t' is

$$\theta - \theta_1 = \int_0^{t'} sF \frac{dX}{dt} \frac{\epsilon^{\frac{-(x-X)^2}{4k(t'-t)}}}{\sqrt{\pi k(t'-t)}} dt.$$

Differentiating this with respect to x and substituting in

$$sF \frac{dX}{dt} = -K \frac{d\theta}{dx},$$

where $x = X'$, gives

$$-sF \frac{dX}{dt} (t=t') = \int_0^{t'} sF \frac{dX}{dt} (X' - X) \frac{\epsilon^{\frac{-(X' - X)^2}{4k(t'-t)}}}{2\sqrt{k^3(t'-t)^3} \pi} dt,$$

which is an equation connecting X and t' . When $t' = 0$, this gives

$$-sF \frac{dX}{dt} = (\infty) dt.$$

Hence

$$-sF \frac{d^2X}{dt^2} (t'=0) = \infty.$$

But $\frac{dX}{dt} = C(\theta_0 - \theta)$, where θ is temperature of the solid,

$$\therefore \frac{d^2X}{dt^2} = -C \frac{d\theta}{dt},$$

$$\therefore \frac{d\theta}{dt} = \infty, \text{ when } t = 0.$$

Consequently if a curve is drawn to represent the variation of the temperature of the surface of the ice with the time it will be of the following general form.

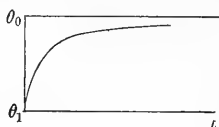

Fig. 3.

When $t = 0$ the curve touches the axis of θ , and when $t = \infty$

$$\theta = \theta_0.$$

Since

$$X = \int_0^t \frac{dX}{dt} dt = \int_0^t C(\theta_0 - \theta) dt$$

$$= C(\theta_0 - \theta_1)t - C \int_0^t (\theta - \theta_1) dt,$$

the area between the above curve and the line $\theta = \theta_0$ is proportional to X . Hence X at first increases rapidly but the rate of increase falls off very quickly as the time increases.

If a supercooled liquid is poured on to a plane layer of the solid solidification does not take place uniformly all over the solid but rays of solid grow out into the liquid. Any small projection on the solid loses heat to the liquid more easily than the rest and consequently grows quicker, so that a plane surface of the solid is unstable when in contact with supercooled liquid.

Since the rays of solid formed grow with a uniform velocity they must lose heat by conduction at the same rate that it is

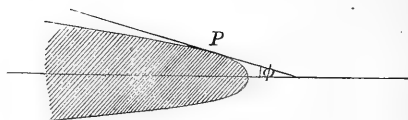

Fig. 4.

produced by the solidification. Hence round the point of the ray there is a distribution of temperature of constant type travelling through the liquid along with the point of the ray.

Everything is symmetrical about the axis of a ray, so that each ray is a solid of revolution about the axis. In the case of phenol the rays resemble paraboloids of revolution and are less finely pointed when the supercooling is large than when it is small.

If ϕ is the angle which a tangent plane to the surface of a ray at a point P makes with the axis of the ray, then

$$v \sin \phi = C (\theta_0 - \theta),$$

where v is the velocity of the point of the ray and θ the temperature at P .

At the tip of the ray $v = C (\theta_0 - \theta_p)$, where θ_p is the temperature of the tip.

When the supercooling is not too small so that v is considerable $\theta_p - \theta_1$ will be nearly zero, but when v is very small then $\theta_p - \theta_1$ may be considerable compared with $\theta_0 - \theta_1$. Consequently when the supercooling is very small the velocity will be smaller than would be expected if the tip were supposed to be at the original temperature of the liquid. This explains the small rate at which the velocity increases with the supercooling when the supercooling is very small.

Monday, November 14, 1898.

MR J. LARMOR, PRESIDENT, IN THE CHAIR.

Mr A. WILLEY and Mr E. J. BLES were proposed for election.

The following Communications were made to the Society:—

(1) *Orthogenetic variation in the shells of Chelonia.* By H. GADOW, F.R.S.

The investigation is based upon 20 newly-hatched specimens of the "Loggerhead" Turtle, *Thalassochelys caretta*, collected from one nest by Dr Willey. This material was further supplemented by 21 newly-hatched and 15 other specimens of all sizes.

The variations are very numerous and manifold. The number of median scutes varies from 8 to 7 to 6, and the lateral or costal scutes range from 7 to 6 to 5, and they are either symmetrical or uneven, there being perhaps 7 on the left and 6 on the right side, or *vice versa*.

These variations can be reduced to a system.

When there are 8 median scutes the 7th is generally the smallest, being in a half squeezed-out condition. The same applies to the 5th scute, especially where there are only 7 or 6 median scutes in all. Again, when the 5th median scute is much reduced and irregular, the 4th pair of costals exhibits all the stages from the normal size to the tiny, almost completely suppressed, vestige of a scute.

The normal shield possesses 6 median (including the so-called nuchal) and 5 pairs of costal scutes.

Of the total of 56 specimens not less than 43 are abnormal, = 76.6 %.

Of the 41 newly-hatched not less than 38 are abnormal, = 92.7 %.

The percentage of abnormalities is 4 to 5 times as great in the newly-hatched as in the adult, and it decreases gradually from the smaller to the larger and very large specimens.

We have no reason whatever to assume that those little turtles which were born with irregular scutes were doomed to perdition, while only the normal specimens were predestined to live and to propagate the race. Such an assumption is contradicted by the fact that not less than 20 to 25 % of mature turtles are wrong in their shields and do very well indeed for all we know to the contrary.

A comparative anatomical study of the carapace and shield of the *Chelonia* shows that there existed originally Tortoises with 8 median and 8 pairs of costal and dermal bones, the latter corresponding in number and position with the epidermal scutes.

The present abnormalities are atavistic reminiscences, and most of the individuals seem to grow out of those irregularities, and this reduction or squeezing-out of some of the scutes proceeds in a very regular way. It begins with the 7th and 5th median, and the 5th or 4th pair of costal scutes respectively, and ends, in the "Loggerhead," with the suppression of the originally 2nd pair of costal scutes.

This process is an instance of a widely-spread law, namely, that the number of a serial set of organs or parts has a tendency towards reduction in numbers, while the remaining parts are better developed, more neatly finished, and consequently become more effective.

Our little turtles start with many, with at least 22, dorsal scutes (leaving out the marginals), and they reduce them to 16. A further reduction to 14 (by suppression of the originally first pair of costal scutes) occurs in *Chelone imbricata* and in the majority of the Tortoises. Suppression of the nuchal or first median scute reduces the total number to 13, a condition prevailing in most of the side-neck-hiding Tortoises and in some species of *Testudo*.

All this indicates onward development; the ideal, in the case of the Loggerhead, is the 16-scuted shell. Those which start with 22 perhaps never reach the ideal, but natural selection does not interfere with them. Others start with 21, 20, 19, or 18, and most of these seem to reach the goal. Lastly, there are some few precocious individuals which are born with the right number of 16. Anyhow this is onward development, and since these variations all lie in the direct line of descent (and the more serious the variation, the further back it points) *I call this kind of atavistic variation orthogenetic.*

The full paper on this subject, with numerous illustrations, will appear in Pt. III. of Dr Willey's *Zoological Results*.

(2) *Some points in the Morphology of the Enteropneusta.* By Dr A. WILLEY.

The body-wall of Enteropneusta is characterised externally by annulations determined by the zonary disposition of epidermal glands and separated by interannular grooves. The potentialities of these structures are indicated by the external liver-saccules of Ptychoderidae which are enlargements of the annulations; and by the dermal pits of Spengelina which are intergonadial depressions of the interannular grooves.

In the Enteropneusta and in the Cephalochorda the gonads are more or less coextensive with the gill-clefts, both being primarily unlimited in number. The process of limitation may be supposed to have acted correlatively with the processes of cephalisation and regional differentiation, and the result of it is seen in the concentration both of gonads and of gill-clefts in the anterior region of the trunk which has hence been designated the branchiogenital region.

A theory of gill-slits was developed, according to which gill-slits arose in the interannular depressions while the gonads were disposed in zones corresponding with the epidermal annulations. The primary function of the gill-slits was the oxygenation of the gonads, their secondary function being the respiration of the individual. In most cases the gonads have been secondarily emancipated from the gill-clefts in correlation with the elaboration of the vascular system. In the author's opinion the evidence in support of this theory is overwhelming. A collective name, Branchiotrema, was introduced to include all animals which possess gill-slits, whether in the adult or in the embryo.

The theory outlined above will be incorporated, with other matter, in a memoir on Enteropneusta from the South Pacific to appear in Part III. *Zoological Results* (Cambridge University Press) which will shortly be published.

(3) *On Lepidodendron from the Calcififerous Sandstone of Scotland.* By Mr A. C. SEWARD and A. W. HILL, B.A., King's College.

(*Abstract.*)

A description was given of the anatomy of an unusually well-preserved stem of *Lepidodendron Wunschianum* recently found in a railway cutting at Dalmeny in Linlithgowshire. The material was generously placed in Mr Seward's hands by Mr Kidston of Stirling, and a large polished section of the fossil has been added to the Museum of Practical Geology, Jermyn Street. This species of *Lepidodendron* was originally described by Carruthers and afterwards by Williamson from specimens found in the volcanic rocks of Arran, but the Dalmeny stem is much more perfect and exhibits some important features which have not been previously observed. The stem measures nearly 40 cm. in diameter, the outer bark is well preserved, but the more delicate middle cortex was destroyed before petrification; the innermost cortex and the central cylinder show remarkably perfect structure. One of the important characters noticed in the stem was the structure of the leaf-trace bundles; these consist of a small strand of xylem more or less completely surrounded by radially disposed rows of secondary elements. The presence of numerous secretory canals in the outer cortex or phelloderm was also referred to as a feature of some interest.

Monday, 28 November, 1898.

MR J. LARMOR, PRESIDENT, IN THE CHAIR.

The following were elected Fellows of the Society :

- W. Welsh, M.A., Jesus College.
- W. McF. Orr, M.A., St John's College.
- G. T. Walker, M.A., Trinity College.
- J. Graham-Kerr, B.A., Christ's College.
- J. H. Grace, B.A., Peterhouse.
- E. W. Barnes, B.A., Trinity College.

The following communications were made to the Society:—

(1) *On the Flame-spectrum of Mercury, and its bearing on the distribution of energy in gases.* By Professor LIVEING.

Hitherto, I believe, no flame-spectrum of mercury has been described, though that metal gives a spectrum of very brilliant rays when it is one of the electrodes of a spark discharge; and some years ago Prof. Dewar and I observed a very strong, diffuse, and easily reversed ray, with wave-length 2535·8, when mercury

was introduced into the electric arc. Recently I have found that the same ray was produced by mercury heated in a flame of cyanogen burning in oxygen. As Prof. Dewar and I pointed out long ago, this flame is nearly the hottest known, on account of the endothermic character of cyanogen and the large amount of energy stored in the compound and liberated as heat when it is burnt. Besides the ultra-violet ray, λ 2535.8, I found another mercury ray developed in the cyanogen flame at wave-length 4358 in the indigo-blue.

The cyanogen was made by heating cyanide of mercury, and after passing through a spiral tube kept cool to condense the most of the mercury vapour, it was burnt at a platinum jet in the middle of a wider jet of oxygen. The spectrum was formed by a concave grating and photographed, and the wave-lengths of the rays determined by comparison with the iron spectrum.

The emission of these two rays in a flame where the stimulus appears to be only the high temperature, since mercury is not known to combine with either oxygen, carbon, or nitrogen at such a temperature, seems to be a fact of some theoretic interest. I cannot help regarding the production of spectra by an electric discharge as essentially a different process from the production by heat. The electric discharge may, not improbably, set up vibrations in the molecules directly, and the heat which attends the discharge, often only feeble, may be only a secondary phenomenon. At any rate a great many rays are given out by various elements in an electric discharge which have never been observed to result from mere heating. But the emission of light by hot mercury vapour is of interest in connexion with the fact that the ratio of the specific heats of mercury vapour, at constant pressure and constant volume, is almost exactly what it would be if none of the heat added were employed in producing any vibratory motion, or other form of motion within the molecule. The spectrum emitted by mercury in the cyanogen flame proves that heat, at a sufficiently high temperature, is, in part, transformed into vibratory motion which affects the ether; and the true inference from the ratio of the specific heats appears to be, that, at the temperature at which this ratio was measured, the amount of heat converted into vibratory motion is very small compared with the amount which remains heat. What the temperature may be in the compressed gas during the passage of a sound-wave I do not know, but it cannot be very high.

In order to find an upper limit I had a tube, similar to those used for finding the velocity of sound in gases, filled, in the dark, with a mixture of hydrogen and chlorine in equal volumes, and then the tube was sounded by drawing it through the fingers covered with a resined glove. The sounding of the tube was

repeated a good many times, but it did not, to any sensible degree, bring about a combination of the gases, for on opening the tube in a solution of soda the chlorine was absorbed and the hydrogen left in the original volume.

I think, then, that it must be allowed that, though at the temperature of the compressed gas in the sound-wave no sensible fraction of the heat is converted into vibratory motion in the molecules of mercury, this does not hold for higher temperatures.

If this be admitted we must abandon the hypothesis that, in gases, energy communicated to the molecules is distributed equally in all the degrees of freedom. I could never see any valid reason for this hypothesis, and many physicists have long ago repudiated it.

But there is another point. Some people see in the ratio of the specific heats of mercury vapour an argument for supposing that the molecules of that vapour, which are chemical atoms, are really the rigid spheres, which the old Epicurean philosophy suggested, and which have become familiar by their use as a working hypothesis for facilitating the mathematical calculations of the kinetic theory of gases. This hypothesis is untenable for other reasons besides the facts here adduced. Nevertheless it underlies the assumption that monatomic molecules are incapable of acquiring any vibratory or internal form of motion from energy communicated to them as heat, whence it has been concluded that every gas which is found to have 1.66, or thereabouts, for the ratio of its specific heats must be monatomic. It is possible that a chemically monatomic molecule may have, though it is not probable that it really has, a simpler constitution than a chemically complex molecule, and so may have not so many degrees of freedom as the latter, but still a plurality of degrees.

(2) *On the variation of intensity of the Absorption Bands of different Didymium Salts dissolved in water, and its bearing on the ionization theory of the colour of solutions of salts.* By Professor LIVEING.

In common with many others I have spent much time and trouble in trying to separate the elements of the Yttrium and Cerium groups of earths. Latterly my assistant, Mr Purvis, has for two or three years been fractionating some mixtures of these earths, and, though he has not succeeded in getting products spectroscopically pure, he has come across results which appeared to me worth following up. The investigation is yet far from complete, but a preliminary account of it may be of some interest.

The main facts are that while the absorption bands produced by solutions of the chloride and the nitrate have the same positions

and general character in both salts, and the same intensities so long as the solutions are equivalent and moderately dilute, yet more concentrated equivalent solutions shew unequal variations in the intensities of the absorptions, some being stronger with the nitrate and others stronger with the chloride.

The mixture of earths used contained praseodymia and neodymia, samaria and some other earths, but was spectroscopically free from lanthana, though not from yttria. Some of the oxide was gently ignited, and equal quantities weighed out for solution in different acids so as to give solutions of equivalent strengths when diluted to equal volumes. The sulphate is so much less soluble than the nitrate and chloride, that equivalent solutions of these three salts could only be prepared in a rather dilute condition. In the case of the nitrate and chloride the solutions were evaporated to drive off all excess of acid and then redissolved in water. They were interposed between a lime-light and the slit of the spectroscope in tubes closed with quartz lenses at their ends so as to concentrate the transmitted light on the slit. The spectroscope had quartz objectives and calcite prisms. Also the spectra to be compared were always photographed in succession on the same plate, so that inequalities in the development, as well as in the intensity of the light used, might be as far as possible avoided.

Equivalent solutions of the sulphate, nitrate, and chloride gave absorptions which were indistinguishable from each other. This is in accordance with the theory which has been worked out by Ostwald, that dilute solutions of salts which have one, and the same, coloured ion, with various colourless ions, all shew the same absorptions.

The absorptions by a thickness of 6 inches of each of a series of equivalent solutions of the chloride and nitrate were then photographed, the strength of the solutions being regularly graduated; and subsequently the absorptions by a thickness of 3 inches of the same series. The range of the spectrum photographed was from about a wave-length λ 522 to λ 365, and again, on a second set of plates, from about λ 369 to λ 315, *i.e.* nearly up to *S* of the solar spectrum.

The strongest solutions employed contained 21.6315 grms. of the oxide which, after conversion into nitrate, or chloride, was dissolved in 70 c.c. of water. The more dilute were prepared from this by successive dilutions to $\frac{1}{2}$, $\frac{1}{4}$, $\frac{1}{8}$, ... to $\frac{1}{64}$ of the original strength.

Comparing the effects of the same thickness of solutions of the various degrees of dilution, we find in the region between λ 522 and λ 365:

1. That all the bands produced by the dilute solutions are strengthened, in both chloride and nitrate, in the stronger solutions,

and also widened, the more diffuse being most widened. The narrow, sharply defined, band about λ 427 retains its character, but is nevertheless sensibly widened.

2. The difference between the nitrate and chloride is that the light on the more refrangible side falls away in the spectrum of the chloride, from about λ 420, at a more rapid rate than in the spectrum of the nitrate. It is as if a broad, weak, absorption beginning from the more refrangible part, gradually extended down to the violet region, in the chloride, but not in the nitrate.

Also the light which gets through the chloride in the green seems a little less than that which gets through the nitrate, as if the chloride had a faint, broad, absorption band in the green which the nitrate had not.

If we accept the theory that the absorptions common to the salts in dilute solutions are due to their common ions, namely, the didymium and other metallic ions, then these broad absorptions, which appear to be added when a stronger solution of the chloride is employed, may be ascribed to the undecomposed chloride, or they may possibly be due to the chlor-ion. As they have not hitherto been observed to be produced by a solution of hydrochloric acid, which must contain the chlor-ion, it is not probable that they are due to the chlor-ion.

Turning to the more refrangible section of the spectrum we find, with the weakest solutions ($\frac{1}{64}$ th the original strength), chloride and nitrate, four well-marked absorption bands between lines *N* and *O* of the solar spectrum, which may reasonably be ascribed to the didymium and other metallic ions. Light passing through the nitrate begins to fall away a little above *O* (λ 344), and thence onwards diminishes so rapidly that beyond about λ 333 nothing is seen in the photograph; while with the chloride light comes through quite to the edge of the plate (λ 315) but with diminishing intensity from λ 345 onwards.

With stronger solutions, $\frac{1}{16}$ the original strength, all the bands are expanded, and in the chloride a broad, diffuse, band shews itself between λ 333 and λ 326, and a faint, very diffuse band about λ 338. The nitrate lets hardly any light through beyond λ 338, and the light which gets through about λ 344 is very much weakened.

With still stronger solutions all light above λ 360, or thereabouts, is absorbed by the nitrate; also more and more is absorbed by the chloride, so that with the strongest solutions nothing at all is seen in the plates beyond λ 370.

In fact the fading of the light in the case of the chloride seems due to the gradual increase of a very wide and diffuse absorption extending farther and farther towards the less refrangible side.

In the case of the nitrate, there is a more marked absorption of a like kind by the dilute solutions, but it is not widened so much by the stronger solutions.

Throughout the series the absorption bands which are common to the chloride and nitrate are always, except in the most dilute solutions, a little stronger for the chloride than for the nitrate, the difference being more pronounced for stronger solutions. This may be accounted for by supposing a larger proportion of the chloride to be ionized than of the nitrate.

When the absorption produced by a thickness of three inches of a solution of the chloride is compared with that produced by a thickness of six inches of solution of half the strength, it appears that the bands in the blue, supposed to be due to the metallic ions, are stronger with the thickness of six inches of the weaker solution, whereas the effect of the broad diffuse absorption, affecting chiefly the most refrangible part of the spectrum, and supposed to be due to the un-ionized salt, is more marked with the smaller thickness of stronger solution. These effects are not very evident when the salt is nitrate; but that may be because the absorption ascribed to the un-ionized nitrate is both stronger and more sharply defined than that of the un-ionized chloride, so that shades of variation cannot be so easily observed when the nitrate is used. As far as the chloride is concerned, these observations point to a relative increase in the proportion of the salt ionized as the solution is diluted.

Generally these observations tend to confirm the theory of Ostwald, but much more extended observations are needed, and some with other salts are already in progress. The effects of temperature will be taken in hand as soon as possible.

It is difficult to see how the ionization theory of solution can be tested spectroscopically in any other way, at least until we have learnt what the spectroscopic characters of the ions are. It is not possible, with our present knowledge, to predict the properties of ions, except so far as to say that, since the ions differ in their intrinsic energies from the elements of the salts ionized, it is almost certain that they will differ in their properties too.

Ostwald speaks of their being statically charged with electricity as a cause capable of changing their chemical and other properties; but statical charges seem to be affections of the field rather than of the charged bodies, and the intrinsic properties of charged substances are not found experimentally to be different from those of the same substances uncharged. On the other hand, what are called allotropic variations of a substance differ from one another in intrinsic energy, and the changes of energy which occur when the same element enters into the formation of two salts of different types, as for example ferrous and ferric

chloride, are unequal. Hence we should expect the ferrous ion to differ in intrinsic energy from the ferric ion, and to differ also in properties, as we find solutions of ferrous and ferric salts to differ in colour. But though we may measure the changes of energy we cannot yet connect the amount of such change with any specific change of properties.

(3) *On the Comparative Colour of the Vapour of Iodine in Air at Atmospheric Pressure and in Vacuum.* By Professor DEWAR.

Recently, having had occasion to compare Iodine with other vacua in the construction of the vessels used for the storage and manipulation of Liquid Air in low temperature research, some facts about the behaviour of the vapour of iodine have been observed that deserve to be recorded.

Pure iodine in the solid state is usually represented as being perfectly opaque to light, but this is not the character of the iodine distilled and condensed on a surface of glass at temperatures between -182° and -183° C. in vacuum test-tubes or bulbs by the use of liquid air. Under such conditions it is easy to get transparent films of iodine of varying grades of thickness showing brilliantly the colours of thin plates by reflection; and to keep them permanently as long as the low temperature is maintained. The first addition of liquid air to the vacuum bulb or test-tube containing excess of solid iodine causes instant precipitation of an opaque film, but this can be avoided by cooling the crystals of iodine which have been sublimed down to the lower part of the outer test-tube or bulb by a preliminary cooling with a little solid carbonic acid. In this condition when the inner surface of the vacuum vessel is cooled with liquid air, the iodine can only deposit from an atmosphere of great tenuity, and, when a given thickness of deposit is reached, any increase can be stopped by lifting the vessel from the carbonic acid bath and placing it in liquid air. In the same way films of other substances can be deposited which may be useful in the examination of many physical problems.

Stas says pure iodine gives no visible vapour at the ordinary temperature. This observation of Stas is contrary to my experience. Samples of iodine made from subiodide of copper, from iodoform, and from solution of iodine in potassium iodide, all gave in half litre flasks when excess of iodine for saturation was present, a visible colour to the atmosphere at the ordinary temperature. When however a similar flask containing the same

iodine was exhausted of air, the colour of the atmosphere was markedly *less*, and this distinction remained even when the flasks were heated side by side in a water bath. If, instead of air, the iodine vapour diffuses into an atmosphere of carbonic acid, hydrogen or oxygen, in similar flasks, placed in a water bath, the colour remains to all appearance the same as in air; but in all cases it is much more marked than in one from which the gaseous atmosphere, other than iodine, has been in great part removed by the Fluss pump. No change in the mode of operating the filling of the air and vacuum flasks has made the difference in colour disappear, although a dozen flasks have been filled from time to time. The iodine was sublimed from anhydrous Baryta, and excess of the latter was placed in some flasks along with the iodine and kept for months without making any change in the nature of the results. The flasks containing the Baryta, even when repeatedly heated to the boiling point of water, made no apparent difference in the results. This seems to prove that vapour of water or hydriodic acid has nothing to do with the cause of the difference in the colour of the iodine vapour in the air and vacuous flasks. It is not necessary to use flasks, as two lengths of glass tubing an inch or less in diameter and about a foot in length, one exhausted the other not, when heated side by side in a steam or water vapour bath, show difference of colour.

To get an approximate value of the tension of the saturated vapour of iodine about the ordinary temperature, a Rankine formula of two terms was calculated taking the known pressure at 58.1° C. as 4.9 mm. and that at 113.8° C. as 87 mm. These gave:—

$$\log P = 9.3635 - \frac{2872}{T} \text{ mm.} \dots\dots\dots(1).$$

If however the tension at 85° and 114.1° are selected for calculation,

$$\log P = 10.0392 - \frac{3137}{T} \dots\dots\dots(2),$$

where *T* is the absolute temperature. From this formula the tensions in mm. of mercury at 0° and 11° are respectively 0.07 and 0.18 mm. The weight of iodine in the litre would thus become about 1 and 1.94 mill., at 0° and 11° C. respectively. In order to check this calculation the quantity of iodine required to saturate a litre of dry air at 0° and 11° C. was determined by passing a slow current of air over a column of iodine and subsequently absorbing the vapour of iodine out of the saturated air current in caustic potash solution. The alkaline solution on acidulation

was titrated with hyposulphide of soda and starch solution. The results of the experiments were as follows:—

	Milligrams per litre.	Pressure in mm. of mercury.
0° C.	0·24,	0·017,
11° C.	1·25,	0·087,
30° C.	4·70,	0·358.

In each case the calculated tensions are less than that deduced from the vapour pressure, equation (1). The values approach those given by Arctowski (*Zeit. Anorg. Chem.* 1895) as a deduction from his experiments on the volatilization of iodine. From this it would follow that equation (2) for the tension is the best. In the liquid state the tensions are well represented, (3) by $\log p = 7·924 - \frac{2316}{T}$ mm. From formula (2) the molecular latent heat of the solid iodine is 14430 units, and for the liquid condition from (3) the value is 10653. The experimental value of the latent heat of liquid iodine given by Favre is 6,000 units. From this it would follow that the thermal values of some of the physical constants of iodine require redetermination. It is interesting to observe that the heat units required to dissociate the molecule of iodine, viz. 28500, is roughly twice the calculated latent heat.

The various experiments recorded lead to the conclusion that the phenomenon is a real one and not due to adventitious causes. The question then remains as to its explanation. It is well known that the vapour pressure in a vacuum is often greater than in air at atmospheric pressure. On the other hand Professor J. J. Thomson in his work entitled "Application of Dynamics to Physics and Chemistry," p. 169, discusses this very question. He shows that the effect of the pressure of an inert gas must be to raise the vapour pressure above that given in a vacuum. Taking his formula as being applicable to iodine, the difference between the two conditions of pressure should amount to $\frac{1}{440}$ of the whole. Now the question arises, is this amount sufficient to explain the difference of colour or will it be necessary to bring in other factors which may operate, such as solution of solids in gas under compression, or dissociation? Further experiments will be required of a more refined character before a definite answer to this question can be given.

Hamay and Hogarth first showed that alcohol vapour above its critical point and therefore at a pressure exceeding 60 atmospheres could dissolve solids like bromide and iodide of potassium; and Cailletet a little later showed that liquid carbonic acid was dissolved by air under high compression. Dr Villard has recently

made a series of experiments on the same subject in which he proves that bromine and iodine dissolve in air or oxygen under high compression. He says, "L'Iode se dissout également en quantité sensible dans l'Oxygène, mais le phénomène n'est bien visible qu'à partir de 100 atmosphères et dans des tubes de 5 millimètres de diamètre au moins."

The experiment exhibited would appear to show that one atmosphere of pressure is sufficient to produce a sensible difference of colour in the case of iodine vapour diffused in air as compared with a vacuum; and in the meantime as a lecture illustration the experiment may be of some interest.

(4) *On the partitions of numbers which possess symmetrical graphs.* By Major MACMAHON, Sc.D., F.R.S.

[Printed in the *Transactions*, Vol. xvii. Part II.]

PROCEEDINGS

OF THE

Cambridge Philosophical Society.

On the motion of a charged ion in a magnetic field. By
Professor J. J. THOMSON.

[Received January 23, 1899. Read January 23, 1899.]

The motion of a charged particle when under the influence of a magnet has hitherto been chiefly considered when, as in the case of the cathode rays, the free path of the charged particle is so long that the effects of its collision with the molecules of the gas through which it moves are not appreciable. When, however, the free path is small and the collisions numerous the effect of the surrounding gas is to make the *velocity* of the particle proportional to the force acting upon it; when the free path is long it is the *acceleration* and not the velocity which is proportional to this force. In the following paper I have investigated the effect of a magnet on the motion of a charged particle when the free path is small.

Let X, Y, Z be the components of the electric intensity, α, β, γ those of the magnetic force, u, v, w those of the velocity,

e the charge on the particle. The components of the force on the particle are

$$Xe + e(\beta w - \gamma v),$$

$$Ye + e(\gamma u - \alpha w),$$

$$Ze + e(\alpha v - \beta u).$$

Hence, since the velocity of the particle is proportional to the force we have, k being a coefficient depending on the nature and pressure of the gas,

$$eku = Xe + e(\beta w - \gamma v),$$

or

$$ku + \gamma v - \beta w = X.$$

Similarly,

$$-\gamma u + kv + \alpha w = Y,$$

$$\beta u - \alpha v + kw = Z.$$

Solving these equations we have

$$u = \frac{k^2 X + k(\gamma Y - \beta Z) + \alpha(\alpha X + \beta Y + \gamma Z)}{k^3 + k(\alpha^2 + \beta^2 + \gamma^2)},$$

$$v = \frac{k^2 Y + k(\alpha Z - \gamma X) + \beta(\alpha X + \beta Y + \gamma Z)}{k^3 + k(\alpha^2 + \beta^2 + \gamma^2)},$$

$$w = \frac{k^2 Z + k(\beta X - \alpha Y) + \gamma(\alpha X + \beta Y + \gamma Z)}{k^3 + k(\alpha^2 + \beta^2 + \gamma^2)}.$$

We see at once from these equations that when the magnetic force is small compared with k , u, v, w are proportional to X, Y, Z , that is, the particle follows a line of electric force; on the other hand when the magnetic force is large compared with k , u, v, w are proportional to α, β, γ , that is, the particle follows a line of *magnetic force*: thus in very intense fields the paths of these particles will be the lines of magnetic force. In the general case, if H is the magnetic and F the electric force, and θ the angle between them, the velocity has a component along the line of electric force proportional to $k^2 F$; another component along the line of magnetic force proportional to $H^2 F \cos \theta$, and a third component, at right angles both to the magnetic and electric forces and proportional to $k H F \sin \theta$. In this case the path is neither along the line of electric nor magnetic force, but is a spiral.

When the electric force is radial and the magnetic field constant we can find the equation to the path of the particle. Take the

origin at the centre of force and the direction of the magnetic force as the axis of Z , our equations are

$$\frac{dx}{dt} = \frac{k^2 X + k\gamma Y}{k^3 + k\gamma^2} \dots\dots\dots (1),$$

$$\frac{dy}{dt} = \frac{k^2 Y - k\gamma X}{k^3 + k\gamma^2} \dots\dots\dots (2),$$

$$\frac{dz}{dt} = \frac{k^2 Z + \gamma^2 Z}{k^3 + k\gamma^2} = \frac{Z}{k} \dots\dots\dots (3).$$

Since $\frac{X}{Y} = \frac{x}{y}$, we get from (1) and (2)

$$k(ydx - xdy) = \gamma(ydy + xdx),$$

or if $x = \rho \cos \phi, y = \rho \sin \phi$

$$-k\rho^2 d\phi = \gamma\rho d\rho,$$

or $\rho = C\epsilon^{-\frac{k}{\gamma}\phi}$.

From 1, 2, and 3 we get

$$\frac{x dx + y dy}{x^2 + y^2} = \frac{k^2}{k^2 + \gamma^2} \frac{z dz}{z^2},$$

or $x^2 + y^2 = C' z^{\frac{2k^2}{k^2 + \gamma^2}} \dots\dots\dots (4),$

hence $z = C'' \epsilon^{-\left(\frac{k}{\gamma} + \frac{\gamma}{k}\right)\phi}$.

Thus the path of the particle is a spiral traced on the surface (4).

The relative importance of the three components of the velocity depends upon the value of H/k . Now k is the reciprocal of the velocity acquired by the ion under unit electric force; if we call this velocity v_0 the relative importance of the three components of the velocity depends upon the value of Hv_0 ; if this is large, the ions follow the lines of magnetic force; if it is small, they follow the lines of electric force, while in intermediate cases they pursue a spiral path. Thus if we keep the magnetic force constant and consider ions which move with different speeds under unit potential gradient, the more quickly moving ions may travel along lines of magnetic force, while the more slowly moving ones may travel along spirals. In the discharge of electricity through gases, whenever the velocity of the ions has been measured, the velocity of the negative ion has always been found to be

greater than that of the positive; and I have shown in a paper in the *Philosophical Magazine* for March 1899 that this difference in the velocities of the positive and negative ions would account for many of the differences between the phenomena at the positive and negative electrodes in a vacuum tube. The preceding analysis shows that the same hypothesis will account for the difference in behaviour of the negative glow and of the positive column when in a magnetic field. Plücker showed that in strong magnetic fields the negative glow follows the lines of magnetic force; the positive column on the other hand does not do so, but pursues a more or less spiral path. This is what we should expect if the negative glow marks the path of the rapidly moving negative particles for which Hv_0 is large; while in the positive column (where we have to do with the more slowly moving positive ions for which Hv_0 is not so large, not large enough to allow us to neglect the components of the velocity along the lines of electric force, and in the direction at right angles to the electric and magnetic forces in comparison with the component along the lines of magnetic force) the path of the particles will be spirals.

The formation of clouds with ozone. By JOHN S. TOWNSEND, M.A., Cavendish Laboratory, Cambridge.

[Received January 13, 1899. Read January 23, 1899.]

1. The properties of the clouds which are formed with oxygen containing ozone have been investigated by many experimenters and very different conclusions have been arrived at as to the cause of their formation. The methods by which these clouds can be obtained are very numerous, but the following experiments deal only with three of the principal cases.

When oxygen containing ozone is bubbled through a solution of potassium iodide a cloud begins to appear over the surface of the solution after the bubbling has been going on for a few minutes. No such effect is observed when the gas is passed through pure water. Meissner explains this result by supposing that there are two allotropic forms of oxygen made by the silent discharge,—ozone and antozone, the latter of which has the power of condensing water to form a cloud when the ozone is removed. Thus, when ozone is removed from oxygen by passing the gas

through a solution of potassium iodide or of sodium metabisulphite, the antozone is unaffected by the solution and forms a cloud with the water vapour present. When however sodium sulphite is used to remove the ozone no cloud is formed, which is explained by Meissner by assuming that in this case the antozone is also removed by the sodium sulphite solution. This explanation is not generally considered to be correct, but that given by subsequent experimenters who advocated the theory that the cloud consisted of hydrogen peroxide is more universally accepted. This latter theory is founded entirely upon the evidence that has been brought forward of the presence of hydrogen peroxide in the cloud, although it is extremely difficult, if not impossible, to detect the presence of hydrogen peroxide in minute quantities in a gas which contains ozone. From the experiments which are here described the following conclusions have been arrived at:

(a) The cause of the formation of the cloud is due to the action of ozone on a gas which escapes from the solution through which it is bubbled.

(b) The formation of the drops is in no way due to spray thrown up from the solution.

(c) The cloud consists mainly of water.

When a mixture of oxygen and ozone is bubbled through a solution of potassium iodide, iodine is liberated which dissolves in the potassium iodide and gives the solution a red colour; small quantities of iodine escape from the solution and diffuse through the gas above the solution and into the bubbles of the gas as they rise through the liquid. Similarly with sodium metabisulphide; sulphur dioxide is formed as the ozone acts on the salt and some of it gets mixed with the ozone. In both these cases a cloud is formed, but when sodium sulphite is used to remove the ozone from the oxygen no gas is formed by the action, and no cloud appears above the solution. The following experiments show that it is to the action of ozone on the gaseous iodine and on sulphur dioxide that the formation of these clouds must be attributed.

2. The ozone which was used was prepared from oxygen given off by the electrolysis of dilute sulphuric acid. The gas was first passed through a solution of potassium iodide to remove traces of ozone and hydrogen peroxide, and then dried by sulphuric acid. After leaving the sulphuric acid the oxygen was passed through a long tube of calcium chloride and tightly packed glass wool. The oxygen so prepared formed no cloud in the presence of moisture. The end of the tube containing the glass wool was joined to the ozoniser, which is shown in figure I. It was constructed according to Babo's pattern, and consisted of a glass tube, 67 centimetres long,

and 2 centimetres in diameter, tapering to finer tubing provided with stop-cocks. Inside the tube were two sets of finer tubes (three

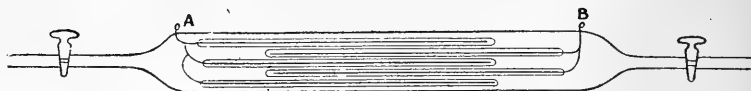

FIG. I

of one set and two of the other are shown in the diagram), having wires down their centres to which connection was made by platinum ends sealed in the glass. The platinum ends belonging to one set were twisted together and joined to the terminal *A* sealed in the large tube, and those of the other set were similarly joined to the terminal *B*. The smaller tubes were so arranged that those of one set were in contact as much as possible with those belonging to the other set. When *A* and *B* were connected to the secondary of a Ruhmkorff coil and a stream of oxygen passed through the ozonisers a large quantity of ozone was procured.

Before sending the silent discharge through the oxygen it is necessary to expel the air from the ozoniser by passing a stream of oxygen through it for about an hour. This precaution is necessary since ozone prepared from atmospheric oxygen forms a cloud in presence of moisture, which effect has been attributed to the formation of oxides of nitrogen by the discharge.

3. Having expelled the air from the ozoniser a quantity of oxygen containing ozone was prepared and introduced into the flask *F*, figure II., by means of the tube *A*, and no cloud was

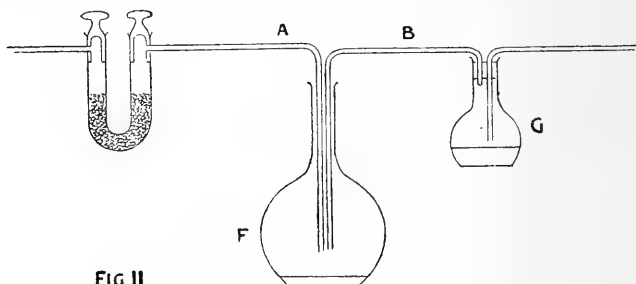

FIG. II.

observe d over the surface of the water in *F*. It is desirable to interpose a U-tube of calcium chloride between the tube *A* and the ozoniser to prevent any moisture diffusing back into the ozoniser.

A second tube *B* also led into *F*, and by means of it oxygen which had passed over a solution in *G* could be brought into contact with the ozone. The effect on the ozone of dissolving certain substances in the solution in *G* was immediately apparent by the formation of a dense cloud in *F*. Thus when *G* contained a fresh solution of potassium iodide no cloud was formed in the flask when oxygen which had passed over the solution diffused through the ozone. A small quantity of iodine was then dissolved in the potassium iodide, and on repeating the experiment it was found that a dense cloud was formed, when oxygen, which had passed over the solution of potassium iodide with iodine dissolved in it, diffused through the ozone in the flask. We have therefore strong evidence that the cloud is due to the action of ozone on the iodine vapour which the stream of oxygen carried with it from *G*, as neither the ozone nor the iodine vapour formed a cloud by itself. The tubing leading the oxygen into *G* did not dip under the solution, so that it is impossible to attribute the effect to splashing. A similar set of experiments was performed with a solution of sulphur dioxide in the vessel *G*, and it was found that a cloud was formed when oxygen containing some sulphur dioxide gas diffused through the ozone.

4. Returning to the original method of forming these clouds, by allowing the tube *A* to dip under a solution which acts on the ozone as it is passed through, additional evidence can be obtained in support of the above explanation as to the cause of the formation of the cloud. If the formation of the cloud requires the presence of a gas formed in the solution, the cloud should be much denser when an increased quantity of the gas is expelled from the solution by heating it gently. When the ozone is bubbled through a fresh solution of potassium iodide, the cloud is not formed immediately, showing that at first the quantity of iodine present in the gas is too small to give a visible effect. When however the bubbling has been going on for a while and the solution has acquired a red colour, a cloud is formed the density of which can be greatly increased by raising the temperature a few degrees. The same results were obtained with a solution of metabisulphite; the cloud did not appear at first, but when it began to be formed its density was greatly increased by heating the solution. It was found impossible to form a cloud by passing ozone through sodium sulphite and warming the solution.

In the case of the potassium iodide solution the density of the cloud is also increased by acidulating the solution with sulphuric acid. This has the effect of neutralising the caustic potash which is formed, when the iodine is set free, which tends to keep the iodine in solution.

5. The disappearance of the cloud when the gas is dried, and its reappearance in the presence of moisture, can be explained by supposing the drop to consist of water with a small percentage of a non-volatile body dissolved in it. Thus when the gas in which the cloud is suspended is passed through sulphuric acid, the water evaporates from the drops and gets absorbed in the acid. There remain behind in the gas very small particles which consist of the non-volatile body which prevented the drops forming the cloud from evaporating under the action of surface tension. These small particles on coming into contact with moisture condense water round themselves again to form drops, the size of which would depend on the relative humidity of the atmosphere. When the atmosphere in which they are suspended is saturated, the drops are largest and of a fixed size.

For example, let us suppose there is a small percentage of sulphuric acid in a drop, we can calculate what the percentage should be in order that a drop of radius 5×10^{-5} centimetres should have a vapour pressure equal to the vapour pressure near a flat surface of water.

The increase of the vapour pressure outside a drop of radius a due to surface tension is

$$\delta p = \frac{2\sigma}{\rho - \sigma} \times \frac{T}{a},$$

where σ is the density of water vapour, p the vapour pressure, ρ the density of water, and T the surface tension.

The diminution of the vapour pressure outside a solution, in which the soluble body has an osmotic pressure P , is

$$\delta p = \frac{\sigma}{\rho} \cdot P.*$$

Thus for equilibrium we get :

$$\frac{2T}{a} = P,$$

approximately, since σ is small compared with ρ .

When this condition is satisfied there will be no tendency for the drop to grow bigger or smaller when it is surrounded by a gas saturated with water vapour.

Let ω be the weight of acid per c.c. of the drop. The weight of an equal number of molecules of hydrogen would be $\frac{2\omega}{98}$.

* J. J. Thomson, *Applications of Dynamics to Physics and Chemistry*, §§ 85, 91, and 92.

Hence the pressure of the acid is $\frac{2\omega}{98} \cdot \frac{10^6}{.00009}$, assuming that each molecule of the acid exerts a pressure equal to a gaseous molecule. In this case, since each molecule of acid ionizes into two hydrogen atoms and one SO_4 group, the pressure exerted by the sulphuric acid would be three times the above amount.

Thus we get:

$$\frac{2T}{a} = \frac{6\omega}{98} \cdot \frac{10^{11}}{9}.$$

Taking $T = 74$ we get:

$$\omega = \frac{2.1 \times 10^{-7}}{a} = .4 \times 10^{-2}, \text{ when } a = 5 \times 10^{-5}.$$

Hence the ratio of the weight of acid in the drop to the weight of water is $.4 \times 10^{-2}$, so that when the water is removed from the drop its volume is reduced to $.2 \times 10^{-2}$ of its original size (sp. gr. of $\text{H}_2\text{SO}_4 = 2$, q.p.) and will consist of a drop of acid of radius 6.2×10^{-6} .

6. The cloud which is formed when ozone is bubbled through turpentine differs in some points from those which are described above. It can be shown by the method described in section 3 that the cloud is due to the action of ozone on turpentine vapour. The clouds which are formed by the potassium iodide and sodium metabisulphite solutions can be removed by bubbling the gas through sulphuric acid, but immediately the gas comes into contact with water the cloud reappears. In the case of the cloud formed with turpentine, its density is not diminished to any marked extent by bubbling through sulphuric acid; so that we see that the main constituent of the drops is turpentine and the ozone dissolved in them prevents them from evaporating.

7. We therefore conclude from the above experiments that gases evolved from the liquids through which ozone has been passed play the most important part in the formation of the cloud, and that although hydrogen peroxide may be made by the action of ozone on water vapour, its presence is not necessary to explain the phenomena. It is moreover difficult to explain the phenomena on the hydrogen peroxide theory, since there is no cloud formed when ozone comes into the presence of water vapour, which on this hypothesis would mean that hydrogen peroxide is not formed. And since the cloud is formed when iodine, sulphur dioxide or turpentine are in the atmosphere we should have to suppose that the presence of these gases facilitates the formation of hydrogen peroxide. Although, arguing from analogy, such a reaction might take place, still there is not sufficient evidence in support of this

supposition. The most reasonable explanation of the above experiments is that, in the case of the cloud formed with sulphur dioxide, the ozone oxidises the sulphur dioxide, and, with the water vapour present, forms sulphuric acid which causes water to condense and form a drop. A similar explanation holds in the case of iodine where, as is well known, ozone acts on the iodine vapour and acid is formed which plays the same part as the sulphuric acid in the other case.

A matter of interest in connection with this subject is to enquire whether the centres round which the drops begin to condense are charged. It has been shown (J. S. Townsend, *Phil. Mag.* Vol. 45, 1898) that the oxygen and hydrogen from a sulphuric acid electrolyte carry with them an electric charge, and form clouds which have the same properties as those obtained in oxygen which has been deoxygenated. All these clouds are removed by passing the gases which they contain through a drying agent. The phenomena also resemble one another in regard to the method of increasing the density of the cloud; thus with the gases from the electrolyte, the density of the cloud is increased by heating the electrolyte in the same way as the cloud obtained by passing ozone through a solution of potassium iodide is increased in density when the temperature of the solution is raised. Experiments were made in order to find whether the nuclei are charged in the latter case. For this purpose an aluminium cylinder 30 centimetres long and 3.6 centimetres in diameter was used. The cylinder was provided with an insulated metal rod down its centre, which was connected with a pair of quadrants of an electrometer. The cylinder was raised to a high potential by connecting it to a terminal of a battery of 200 lead cells, the other terminal of which was connected to earth. The quadrants to which the rod was joined were then insulated, having been to earth while the cylinder was being connected to the cells. When the oxygen containing ozone was passed along the cylinder no deflection was obtained on the electrometer scale. A similar result was obtained with oxygen which had been deoxygenated by potassium iodide solution and dried with sulphuric acid. This gas on escaping from the cylinder formed a cloud in the air of the room, although during its passage through the cylinder no conductivity could be detected by the electrometer. We therefore have no experimental evidence that the centres round which the drops condense are charged.

In conclusion, I desire to express my thanks to Professor Thomson for many valuable suggestions during the course of these experiments.

On the Symbolic Integration of certain Differential Equations in Quaternions. By H. C. POCKLINGTON, M.A., Fellow of St John's College.

[Received January 2, 1899. Read January 23, 1899.]

In this paper are discussed (§ 1) some differential equations in Quaternions of a simple type, but involving ∇ , which can be immediately integrated by the artifice of treating ∇ in all respects as a vector. Then (§ 2) some cases are considered in which this method yields a false result. This leads (§ 3) to the consideration of the general differential equation $\phi\sigma = 0$, which is analogous to the differential equation with constant coefficients of the ordinary calculus. As an example, a vector is found such that it is equal to its curl. The electromagnetic field of a vibrator in an anisotropic medium (uniaxial) is then (§ 4) worked out in full. The case when the axis of the vibration is perpendicular to that of the medium is especially interesting on account of the unusual form of the functions that enter into the solution. Finally (§ 5) the case when the constant term in the cubic in ϕ vanishes is considered.

1. Consider the equation $S\nabla\sigma = 0$, where σ is a vector function of the vector-coordinate ρ of any point.

If we replace the operator ∇ , which is a vector the constituents of which are differential operators, by a vector δ , the equation becomes $S\delta\sigma = 0$, the solution of which is $\sigma = V\delta\lambda$, where λ is any vector. If we now replace δ by ∇ we get $\sigma = V\nabla\lambda$, which should therefore be a solution of the original equation. On performing the operations indicated therein we find immediately that $\sigma = V\nabla\lambda$ is a solution; and it is clear that it possesses the requisite degree of generality to enable it to be a completely general solution.

The equation $V\nabla\sigma = 0$ can be solved in the same manner. Since the solution of $V\delta\sigma = 0$ is $\sigma = \delta P$ where P is any scalar, we may expect that $\sigma = \nabla P$ will be a perfectly general solution of $V\nabla\sigma = 0$. Here again it is easy to verify this conclusion.

If $S \cdot \alpha\nabla\sigma = 0$, α being a constant vector, we can find two forms of solution. Firstly we have $\sigma \perp V\alpha\nabla$, and therefore $\sigma = V(V\alpha\nabla \cdot \lambda)$. Secondly, σ , α , ∇ are coplanar, and hence $\sigma = P\alpha + \nabla Q$, P and Q being any scalars. It is easy to verify these results, and to show that they are equivalent to each other.

The same method can be applied to simultaneous equations. Consider, for example, two of the equations that give the magnetic

force near a Hertzian oscillator, $S\nabla\sigma = 0$, $S\alpha\sigma = 0$, where α is the axis of the oscillator. These give $\sigma \perp \nabla$ and $\sigma \perp \alpha$, therefore

$$\sigma = V\alpha\nabla \cdot P = V \cdot \alpha\nabla P.$$

This is equivalent to the first step in the Cartesian solution of the problem.

2. On the other hand, the solution of $\nabla\sigma = 0$ as obtained by the process described above is $\sigma = 0$. This is certainly not correct, unless we suppose (and we have no justification for this) the equation to hold throughout the whole of space, and further make stipulations as to the value of σ at infinity. The correct solution is $\sigma = \nabla P$, where P is subject to the condition $\nabla^2 P = 0$ throughout the space where the original equation holds. This result can be obtained by applying in turn the second and first results of § 1.

Similarly in the case of the equation $S\alpha\nabla \cdot \sigma = 0$, we expect to find as the solution, $\sigma = 0$, but the actual solution is

$$\sigma = f\left(\rho - \alpha S \frac{\rho}{\alpha}\right).$$

It is clear that before this method of integration can be safely employed, the whole subject must be carefully investigated.

3. All the equations considered above may be regarded as being of the form $\phi\sigma = 0$, where ϕ is a linear and vector function, the constituents of which contain ∇ . The last equations of § 1, for instance, may be written $\beta S\nabla\sigma + \gamma S\alpha\sigma = 0$, which is of this form, ϕ being $\beta S\nabla () + \gamma S\alpha ()$.

Let the cubic in ϕ be

$$\phi^3 - m_1\phi^2 + m_2\phi - m_3 = 0,$$

where m_1, m_2, m_3 are scalar functions of ∇ , then if $m_3 \neq 0$, we have a solution in the form

$$\sigma = \frac{\phi^2 - m_1\phi + m_2}{m_3}.$$

In evaluating this, the inverse operation $1/m_3$ must be performed first, as otherwise the result obtained is too general. We preferably write this result

$$\sigma = (\phi^2 - m_1\phi + m_2)\lambda,$$

where

$$m_3\lambda = 0.$$

As an example of this process, consider the equation

$$\phi\sigma \equiv V\nabla\sigma - \sigma = 0,$$

which expresses the condition that a vector is equal to its curl. The cubic is easily found to be

$$\phi^3 + 3\phi^2 + (3 - \nabla^2)\phi + (1 - \nabla^2) = 0,$$

giving

$$\begin{aligned} \sigma &= (\phi^2 + 3\phi + 3 - \nabla^2)\lambda \\ &= \lambda + V\nabla\lambda - \nabla S\nabla\lambda, \end{aligned}$$

where λ is any vector satisfying

$$(1 - \nabla^2)\lambda = 0.$$

As a particular case, take $\lambda = \alpha \frac{\sin T\rho}{T\rho}$, then

$$\sigma = \alpha \frac{\sin T\rho}{T\rho} - \left(\frac{\cos T\rho}{T^4\rho} - \frac{\sin T\rho}{T^5\rho} \right) (2\rho S\alpha\rho + V \cdot \rho V\alpha\rho - \rho^2 V\alpha\rho).$$

4. Another problem that can be successfully attacked by this process is that of finding the electromagnetic field in the neighbourhood of a Hertzian vibrator when the surrounding dielectric is anisotropic as regards specific inductive capacity, but has two of its principal specific inductive capacities equal (*e.g.* a uniaxial crystal).

Let the electric displacement be $\sigma e^{\omega pt}$, the electric force $(a\sigma + biSi\sigma) e^{\omega pt}$ and the magnetic force $\tau e^{\omega pt}$, where $2\pi/p$ is the period of the oscillation, i is a unit vector parallel to the direction of greatest or least specific inductive capacity, and $\omega = \sqrt{-1}$. The equations to be solved are

$$\left. \begin{aligned} V\nabla\tau &= \omega p\sigma \\ V\nabla(a\sigma + biSi\sigma) &= -\omega p\tau \\ S\nabla\sigma &= 0, \quad S\nabla\tau = 0 \end{aligned} \right\} \dots\dots\dots (1).$$

Eliminating σ from the first two, and using $S\nabla\tau = 0$, we have

$$\chi\tau \equiv (p^2 - a\nabla^2)\tau + bVi\nabla S \cdot i\nabla\tau = 0.$$

(If we leave the term $a\nabla S\nabla\tau$ in this equation the resulting solution identically satisfies $S\nabla\tau = 0$, but the working is somewhat more complicated. The final result is the same.) Now $bVi\nabla S \cdot i\nabla(\)$ satisfies a quadratic equation which is easily found, and from this equation we can immediately deduce that of χ , namely,

$$\chi^2 - (2p^2 - 2a\nabla^2 + bV^2i\nabla)\chi + (p^2 - a\nabla^2)(p^2 - a\nabla^2 + bV^2i\nabla) = 0.$$

$$\begin{aligned} \text{Hence } \tau &= (\chi - 2p^2 + 2a\nabla^2 - bV^2i\nabla)\lambda \\ &= -(p^2 - a\nabla^2 + bV^2i\nabla)\lambda + bVi\nabla S \cdot i\nabla\lambda, \end{aligned}$$

where λ satisfies $(p^2 - a\nabla^2)(p^2 - a\nabla^2 + bV^2i\nabla)\lambda = 0$.

This value of τ does not in general satisfy $S\nabla\tau = 0$. It will do so if $S\nabla\lambda = 0$, i.e. if $\lambda = V\nabla\mu$. Substituting this value of λ , we find as a completely general solution of our original equations,

$$\begin{aligned} \tau &= -(p^2 - a\nabla^2 + bV^2i\nabla) V\nabla\mu \\ &\quad + bVi\nabla (\nabla^2 Si\mu - Si\nabla S\nabla\mu) \dots\dots (2), \end{aligned}$$

$$\text{where } (p^2 - a\nabla^2)(p^2 - a\nabla^2 + bV^2i\nabla)\mu = 0 \dots\dots\dots (3).$$

There are two especially simple cases. The first is that in which $\mu = Pi$, where of course P satisfies (3). Then

$$\tau = -(p^2 - a\nabla^2) V \cdot i\nabla P.$$

$$\text{Writing } -(p^2 - a\nabla^2) P = P_1,$$

$$\text{we have } \tau = V \cdot i\nabla P_1,$$

$$\text{where } P_1 \text{ satisfies } (p^2 - a\nabla^2 + bV^2i\nabla)P_1 = 0 \dots\dots\dots (4).$$

As a particular case of this we have

$$\tau = V \cdot i\nabla \frac{e^{-\omega p R}}{R},$$

$$\text{where } R^2 = \frac{x^2}{a} + \frac{y^2 + z^2}{a - b} \dots\dots\dots (5),$$

x, y, z being the Cartesian coordinates corresponding to ρ ,

$$\text{i.e. } x = -Si\rho, \text{ etc.}$$

This solution gives the magnetic field in the case of a Hertzian vibrator with its axis parallel to the axis of the medium.

The second simple case is that in which $Si\mu = 0$, $S\nabla\mu = 0$, i.e. when $\mu = Vi\nabla \cdot P$. Substituting this value of μ , and putting $-(p^2 - a\nabla^2 + bV^2i\nabla)P = P_2$, we find

$$\tau = V(\nabla V \cdot i\nabla P_2),$$

$$\text{where } (p^2 - a\nabla^2)P_2 = 0 \dots\dots\dots (6).$$

A particular value of P_2 is $P_2 = \frac{e^{-\omega p r}}{r}$ where

$$r^2 = \frac{x^2 + y^2 + z^2}{a} = \frac{T^2\rho}{a} \dots\dots\dots (7).$$

This solution gives the magnetic field in the case of a small circular coil, placed with its axis parallel to the axis of the medium, and carrying a rapidly alternating current.

For the solution of the problem when the vibrator lies with its axis perpendicular to the axis of the medium, physical reasoning shows that it is necessary to find a value of μ (perpendicular to i) which, while otherwise suitable, is composed of two terms which respectively satisfy equations made with the factors of (3) (say $\mu = (P_1 - P_2)j$, where P_1 satisfies (4) and P_2 (6)) but separately give rise to solutions that are infinite or discontinuous along a line through the vibrator parallel to the axis of the medium. On substituting this value of μ , we find

$$\begin{aligned} \tau &= -(p^2 - a\nabla^2 + bV^2i\nabla) Vj\nabla \cdot P_2 - bVi\nabla Si\nabla Sj\nabla \cdot (P_1 - P_2) \\ &= -b \left(\frac{p^2}{a} + S^2i\nabla \right) Vj\nabla \cdot P_2 - bVi\nabla Si\nabla Sj\nabla \cdot (P_1 - P_2). \end{aligned}$$

The first term is of the required form if

$$\left(\frac{p^2}{a} + S^2i\nabla \right) P_2 = \frac{e^{-\omega pr}}{r},$$

where r is given by (7). We determine P_1 from the condition that $P_1 - P_2$ is to be finite with its differential coefficients, hence, using Cartesian coordinates x, y, z ,

$$P_1 - P_2 = \frac{\sqrt{a}}{p} \int_{-\infty}^x d\xi \left(\frac{e^{-\omega p R'}}{R'} - \frac{e^{-\omega p r'}}{r'} \right) \sin \frac{p}{\sqrt{a}} (x - \xi),$$

where R', r' are the values of R, r when ξ is substituted for x . The lower limit is taken as $-\infty$ in order that the expression may satisfy (3).

Finally, omitting the factor $-b$,

$$\tau = Vj\nabla \frac{e^{-\omega pr}}{r} + Vi\nabla \int_{-\infty}^x d\xi \frac{d}{dy} \left(\frac{e^{-\omega p R'}}{R'} - \frac{e^{-\omega p r'}}{r'} \right) \cos \frac{p}{\sqrt{a}} (x - \xi).$$

Of course, as many of the steps involved are little more than guesswork, it is necessary to verify this result. To do this we may transform the integral.

Consider the integral, where, of course, ρ is a scalar,

$$\begin{aligned} f(x, \rho) &= \int_{-h}^x d\xi \frac{e^{-\omega q \sqrt{\xi^2 + \rho^2}}}{\sqrt{\xi^2 + \rho^2}} \cos q (x - \xi) \\ &= \frac{1}{2} \left[\int_{-h}^x d\xi \frac{e^{-\omega q x} e^{-\omega q (-\xi + \sqrt{\xi^2 + \rho^2})}}{\sqrt{\xi^2 + \rho^2}} + \int_{-h}^x d\xi \frac{e^{\omega q x} e^{-\omega q (\xi + \sqrt{\xi^2 + \rho^2})}}{\sqrt{\xi^2 + \rho^2}} \right]. \end{aligned}$$

In the first integral substitute $u = q(-\xi + \sqrt{\xi^2 + \rho^2})$, and in the second $u = q(\xi + \sqrt{\xi^2 + \rho^2})$, then

$$f(x, \rho) = \frac{1}{2q} \left[e^{\omega q x} \int_{q(-h + \sqrt{h^2 + \rho^2})}^{q(x + \sqrt{x^2 + \rho^2})} \frac{e^{-\omega u} du}{u} - e^{-\omega q x} \int_{q(h + \sqrt{h^2 + \rho^2})}^{q(-x + \sqrt{x^2 + \rho^2})} \frac{e^{-\omega u} du}{u} \right].$$

Hence,

$$f(x, \lambda\rho) - f(x, \rho) = \frac{1}{2q} \left[e^{\omega q x} \int_{q(x + \sqrt{x^2 + \lambda^2 \rho^2})}^{q(x + \sqrt{x^2 + \rho^2})} \frac{e^{-\omega u} du}{u} - e^{-\omega q x} \int_{q(-x + \sqrt{x^2 + \rho^2})}^{q(-x + \sqrt{x^2 + \lambda^2 \rho^2})} \frac{e^{-\omega u} du}{u} + e^{\omega q x} \int_{q\rho^2 \lambda^2 / 2h}^{q\rho^2 / 2h} \frac{e^{-\omega u} du}{u} \right],$$

when h is put $= \infty$.

The last term, since u is very small within the limits of integration, reduces to $-e^{\omega q x} \log \lambda^2$, and thus is independent of ρ . On operating by $\frac{d}{dy}$ this term disappears, and may therefore be left out.

Substituting their values for the various quantities involved, and writing

$$\text{Ei}(-\omega u) = \int_{\infty}^{\omega u} \frac{e^{-u} du}{u} = \int_{\infty}^u \frac{e^{-\omega u} du}{u},$$

we have

$$\begin{aligned} \tau = V_j \nabla \frac{e^{-\omega p r}}{r} \\ + \frac{\sqrt{a}}{2p} \frac{d}{dy} V_i \nabla \left[e^{\omega \frac{px}{\sqrt{a}}} \left\{ \text{Ei} - \omega p \left(\frac{x}{\sqrt{a}} + R \right) - \text{Ei} - \omega p \left(\frac{x}{\sqrt{a}} + r \right) \right\} \right. \\ \left. - e^{-\omega \frac{px}{\sqrt{a}}} \left\{ \text{Ei} \omega p \left(\frac{x}{\sqrt{a}} - R \right) - \text{Ei} \omega p \left(\frac{x}{\sqrt{a}} - r \right) \right\} \right]. \end{aligned}$$

It is easy to verify that this expression represents a diverging wave at infinity, that it gives finite forces everywhere except at the origin, and that there the forces have the correct form for an oscillator.

The case of a vibrator, neither parallel nor perpendicular to i , can be solved by combining the results already obtained.

The electric force can be found immediately from $V \nabla \tau = \omega p \sigma$.

The method can be applied to the case of a medium, the principal specific inductive capacities of which are all unequal, but

the resulting scalar equation, which may be written

$$(a + \Delta^2)(b + \Delta^2)(c + \Delta^2) \left\{ \frac{a \left(\frac{d}{dx} \right)^2}{a + \Delta^2} + \frac{b \left(\frac{d}{dy} \right)^2}{b + \Delta^2} + \frac{c \left(\frac{d}{dz} \right)^2}{c + \Delta^2} \right\} P = 0,$$

where
$$\Delta^2 = \left(\frac{d}{dx} \right)^2 + \left(\frac{d}{dy} \right)^2 + \left(\frac{d}{dz} \right)^2 = -\nabla^2,$$

seems to be unintegrable.

5. Returning to the general case, $\phi\sigma = 0$, if $m_3 = 0$ the method of solution given above fails.

Let the cubic in ϕ be

$$\phi^3 - m_1\phi^2 + m_2\phi = 0 \dots\dots\dots(8),$$

and consider the equation $(\phi - g)\sigma = 0$.

We can express $\frac{1}{\phi - g}$ in powers of ϕ by dividing (8) by $\phi - g$, and obtain

$$\begin{aligned} \sigma &= \frac{1}{\phi - g} 0 \\ &= -\{(\phi^2 - m_1\phi + m_2) + g(\phi - m_1) + g^2\} \frac{0}{g(m_2 - m_1g + g^2)}. \end{aligned}$$

In general, on passing to the limit $g = 0$, the last factor becomes indeterminate, and

$$\sigma = (\phi^2 - m_1\phi + m_2)\lambda,$$

where λ is any vector, a solution containing no inverse operators. If, however, $(\phi^2 - m_1\phi + m_2)\lambda = 0$, we may cancel a g , and then

$$\sigma = (\phi - m_1)\lambda,$$

where $(\phi^2 - m_1\phi + m_2)\lambda = 0, m_2\lambda = 0$.

For example, in the case of the equation $V\alpha V\nabla\sigma = 0$, the first half of the process gives $\sigma = \nabla P$, and the second half gives

$$\sigma = V\alpha\beta \cdot f\left(\rho - \alpha S \frac{\rho}{\alpha}\right),$$

so that the completely general solution is

$$\sigma = \nabla P + V\alpha\beta \cdot f\left(\rho - \alpha S \frac{\rho}{\alpha}\right).$$

The whole of the work in this paper can be directly translated into the language of vector analysis, and the examples considered can of course be solved, though with much loss of compactness, by Cartesian methods.

On the conditions of sensitiveness in Detectors of Radiant Heat. By H. C. POCKLINGTON, M.A., Fellow of St John's College.

[Received December 19, 1898. Read February 6, 1899.]

1. The object of this paper is to discuss mathematically the sensitiveness of the two best known detectors of radiant heat, to find what conditions give a maximum of sensitiveness, and, as far as possible, to compare the values of this maximum in the two cases. In each case attention is paid only to the steady state which is reached after the apparatus has been exposed to the radiation for some time.

2. *Nobili's Thermopile.*

Let the thermopile consist of a number of pairs of bars of two metals, joined together alternately and arranged into a rectangular block with the even junctions on one face and the odd on the other. When radiant heat falls on one face, that face is warmed. The temperature to which it rises must be found by equating the gain to the loss of heat. The heat gained is that fraction of the incident heat which is absorbed. The heat is lost by radiation and convection from the same face, by conduction to the other face whence it is removed by radiation and convection, and on account of the Peltier effect. The heat lost through the sides of the pile is neglected, partly because the sides are generally surrounded by a poor conductor of heat, partly because of the difficulty with which heat is conducted from the inner bars across their insulation to the surface.

Let heat incident per sq. cm. per sec.	= H ,
area of face of pile	= A ,
number of pairs of bars	= n ,
absolute temperature of air	= T ,
rise in temperature of faces of pile	= θ_1, θ_2 ,
difference of thermoelectric powers	= ϵ ,
length of each bar	= l ,
areas of cross-section of the separate bars	= Δ_1, Δ_2 ,
specific resistances of metals	= ρ_1, ρ_2 ,
conductivities for heat	= σ_1, σ_2 ,
current	= C ,
resistance of galvanometer	= G ,
sensitiveness of galvanometer	= $\lambda \sqrt{G}$,

so that λ is a quantity that depends on the kind of galvanometer used and on the magnetic field, but not on the gauge of the wire with which the galvanometer is wound.

Also let the heat lost from a face of the pile by radiation and convection be $k\theta$ per sq. em. per sec. in accordance with Newton's law of cooling.

3. The sensitiveness is evidently increased by increasing the absorptive power of the faces, and also, on account of the diminished resistance, by increasing the cross-section of the bars at the expense of their insulation.

We will assume that the faces of the pile are perfectly black, and that the thickness of the insulation is negligible, so that

$$A = n (\Delta_1 + \Delta_2).$$

Equating the heat gained to that lost we have:—
for the face on which the heat is incident,

$$HA = k\theta_1 A + (\theta_1 - \theta_2) n (\Delta_1 \sigma_1 + \Delta_2 \sigma_2) / l + nT\epsilon C / J;$$

for the other face,

$$0 = k\theta_2 A - (\theta_1 - \theta_2) n (\Delta_1 \sigma_1 + \Delta_2 \sigma_2) / l - nT\epsilon C / J,$$

where J is Joule's equivalent, = 4.2 if ϵ is in volts.

Subtracting and rearranging,

$$\theta_1 - \theta_2 = \frac{HA - 2nT\epsilon C / J}{kA + 2n (\Delta_1 \sigma_1 + \Delta_2 \sigma_2) / l}.$$

The electromotive force is $n\epsilon (\theta_1 - \theta_2)$, and the resistance of the pile and galvanometer is

$$nl (\rho_1 / \Delta_1 + \rho_2 / \Delta_2) + G,$$

so that

$$C = \frac{HA - 2nT\epsilon C / J}{kA + 2n (\Delta_1 \sigma_1 + \Delta_2 \sigma_2) / l} \cdot \frac{n\epsilon}{nl (\rho_1 / \Delta_1 + \rho_2 / \Delta_2) + G}.$$

Solving for C and inserting in the formula for the deflection, $\delta = \lambda C \sqrt{G}$,

$$\delta = \lambda H \epsilon \frac{nA \sqrt{G}}{\{kA + 2n (\Delta_1 \sigma_1 + \Delta_2 \sigma_2) / l\} \{nl (\rho_1 / \Delta_1 + \rho_2 / \Delta_2) + G\} + 2n^2 T \epsilon^2 / J}.$$

This is of the form $\delta = \frac{a \sqrt{G}}{b + cG}$, and therefore for a maximum $cG = b$, and $\delta = a / 2 \sqrt{bc}$.

Hence in our case,

$$G = nl(\rho_1/\Delta_1 + \rho_2/\Delta_2) + \frac{2n^2T\epsilon^2/J}{kA + 2n(\Delta_1\sigma_1 + \Delta_2\sigma_2)/l} \dots(1),$$

and therefore is not equal to the resistance of the thermopile;

$\delta =$

$$\frac{\frac{1}{2}\lambda H\epsilon A \sqrt{n}}{\sqrt{\left[kA + \frac{2n}{l}(\Delta_1\sigma_1 + \Delta_2\sigma_2) \right] \left[\left\{ kA + \frac{2n}{l}(\Delta_1\sigma_1 + \Delta_2\sigma_2) \right\} l \left(\frac{\rho_1}{\Delta_1} + \frac{\rho_2}{\Delta_2} \right) + \frac{2nT\epsilon^2}{J} \right]}}$$

The expression under the radical sign is of the form

$$(a + b/l)(cl + d),$$

and hence for a minimum, we have $l = \sqrt{bd/ac}$, and its value then is $(\sqrt{ad} + \sqrt{bc})^2$.

Hence in our case,

$$l = \frac{2n(\Delta_1\sigma_1 + \Delta_2\sigma_2)}{kA} \sqrt{\left\{ 1 + \frac{T\epsilon^2/J}{(\Delta_1\sigma_1 + \Delta_2\sigma_2)(\rho_1/\Delta_1 + \rho_2/\Delta_2)} \right\}} \dots(2);$$

$\delta =$

$$\frac{\frac{1}{2}\lambda H\epsilon \sqrt{A/2k}}{\sqrt{(\Delta_1\sigma_1 + \Delta_2\sigma_2)(\rho_1/\Delta_1 + \rho_2/\Delta_2) + T\epsilon^2/J} + \sqrt{(\Delta_1\sigma_1 + \Delta_2\sigma_2)(\rho_1/\Delta_1 + \rho_2/\Delta_2)}}$$

We must make $(\Delta_1\sigma_1 + \Delta_2\sigma_2)(\rho_1/\Delta_1 + \rho_2/\Delta_2)$ a minimum. As before,

$$\frac{\Delta_1}{\Delta_2} = \sqrt{\frac{\sigma_2\rho_1}{\sigma_1\rho_2}} \dots\dots\dots(3),$$

$$\delta = \frac{\lambda H\epsilon}{2\sqrt{2k}} \frac{\sqrt{A}}{\sqrt{\rho_1\sigma_1 + \rho_2\sigma_2} + \sqrt{(\sqrt{\rho_1\sigma_1} + \sqrt{\rho_2\sigma_2})^2 + T\epsilon^2/J}} \dots(4).$$

4. It is clear from this that we must make A as large as convenient. It would be well to make k small, but, as we have already assumed the face of the pile to be perfectly black, this can only be done by diminishing the loss by convection. This might be done by enclosing the pile in an evacuated vessel, but since a diminution of k is only a gain because it permits us to use a larger pile with advantage, and, as will be seen, the pile is in any case inconveniently long, this method of increasing the resistance is impracticable. The number of bars is immaterial, only affecting the winding of the galvanometer.

The value of ϵ should be as great as possible. The metals to be used are practically determined by this condition for, on account of the approximate (if not exact) proportionality of the conductivities for heat and electricity, $\rho\sigma$ is nearly constant.

Taking the case of the Bismuth-Antimony couple, we have*

$$\epsilon = 103 \cdot 10^{-6}, \quad \rho_1 = 108 \cdot 10^{-6}, \quad \rho_2 = 41 \cdot 10^{-6},$$

$$\sigma_1 = \cdot 0177, \quad \sigma_2 = \cdot 0442, \quad k = \cdot 000252,$$

and hence

$$l = 208, \quad \Delta_1/\Delta_2 = 2\cdot 56, \quad \delta = \cdot 41\lambda H \sqrt{A}.$$

In practice, however, the length of the pile is far less than two metres, generally being about 2 cms. The sensitiveness may therefore be considerably increased by increasing the length. However, when the length exceeds a few centimetres, the assumption made at the outset, that no heat escapes from the sides of the pile, will not be even approximately true, and so the best length will fall short of that given above.

Assuming a length of 2 cms., and that $\Delta_1/\Delta_2 = 2\cdot 6$, we find that

$$\delta = \cdot 08\lambda H \sqrt{A}, \quad G = \text{Resistance of pile} \times 1\cdot 091,$$

so that even in this case the ordinary rule, to make the galvanometer resistance equal to the sum of the other resistances in the circuit, will give a result not appreciably inferior to the best obtainable. The sensitiveness of the pile is about $\frac{1}{5}$ th of the theoretical maximum.

5. Bolometer.

Let the resistance of the bolometer strip at a temperature θ degrees above that of the air be $b(1 + \eta\theta)$, and let it and the other resistances be arranged as in the diagram. The most convenient method of solution is not to use the equation deduced by

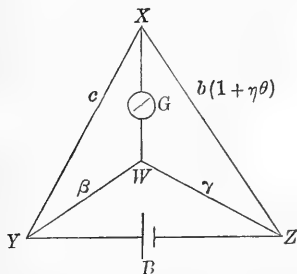

* These and other numbers are taken from the Smithsonian Physical Tables, 1896.

Maxwell for the current flowing in the galvanometer, but to proceed from first principles.

The maximum useful value of the electromotive force E of the battery is determined by the condition that the rise of temperature of the strip shall not be excessive. If the area of one face of the strip is A , the current C , and the maximum permissible rise θ_0 , we have, neglecting squares of small quantities,

$$2kA\theta_0 = bC^2 \dots \dots \dots (1),$$

since the strip radiates on both sides.

Again, assuming the bridge to be balanced when $\theta = 0$, the current in the galvanometer is, neglecting squares of small quantities, the same as that produced by an electromotive force $Cb\eta\theta$ in XZ when this arm has a resistance b .

Since XW and YZ are conjugate, this is independent of B , and therefore may be calculated on the hypothesis that B is infinite. The current thus found is

$$\frac{Cb\eta\theta}{b + \gamma + \frac{G(c + \beta)}{G + c + \beta}} \cdot \frac{c + \beta}{G + c + \beta},$$

and the deflection, eliminating C by (1), and putting for θ its value $H/2k$,

$$\delta = \frac{\lambda\eta H}{2k} \frac{(c + \beta) \sqrt{b} \sqrt{G} \sqrt{2kA\theta_0}}{G(b + c + \beta + \gamma) + (b + \gamma)(c + \beta)}.$$

For a maximum $G = (b + \gamma)(c + \beta)/(b + c + \beta + \gamma)$, the ordinary value, as might have been foreseen, and

$$\delta = \frac{\lambda\eta H}{2} \sqrt{\frac{A\theta_0}{2k}} \sqrt{\frac{b(c + \beta)}{(b + c + \beta + \gamma)(b + \gamma)}}.$$

Remembering that $b\beta = c\gamma$, since the bridge is balanced when $\theta = 0$,

$$\delta = \frac{\lambda\eta H}{2} \sqrt{\frac{A\theta_0}{2k}} \frac{1}{\sqrt{\left(1 + \frac{b}{c}\right)\left(1 + \frac{\gamma}{b}\right)}}.$$

Hence b/c , γ/b are to be made small. In this case the resistance of the galvanometer is equal to b , and

$$\delta = \frac{\lambda\eta H}{2} \sqrt{\frac{A\theta_0}{2k}}.$$

For practical reasons, however, it is usual to make a side of the bridge adjacent to b equal in resistance to it. Putting therefore either $b/c = 1$ or $\gamma/b = 1$, the other of the pair of fractions is to be made as small as possible, and then

$$\delta = \frac{\lambda\eta H}{4} \sqrt{A\theta_0}.$$

The resistance of the galvanometer should be $b/2$ in the first case, and $2b$ in the second.

6. For most metals $\eta = \cdot 0038$ and, as before, $k = \cdot 000252$, hence

$$\delta = \cdot 085\lambda H \sqrt{A\theta_0},$$

in the case of maximum sensitiveness, or

$$\delta = \cdot 060\lambda H \sqrt{A\theta_0}$$

in the practical case.

The condition that the bolometer is as sensitive as the thermopile of 2 cms. length which is discussed above, is in the first case $\theta_0 = 1$, or the strip is raised 1° C. by the passage of the current. In the practical case of equal arms in the bridge, the strip must be raised 2° C. for equal sensitiveness. The sensitiveness of the bolometer can be improved by increasing η or decreasing k . Thus we may expect a great gain by placing the bolometer in an evacuated vessel, because not only is k decreased, but also the irregularities of temperature due to convection currents are decreased, and hence we may increase θ_0 .

On the Anatomy of a supposed New Species of Coenopsammia from Lifu. By J. STANLEY GARDINER, M.A.

[Received February 6, 1899.]

The investigation is based on numerous small colonies obtained by Dr Willey from the reefs of Lifu, Loyalty Islands, at low tides. The species is described as new under the name of *Coenopsammia willeyi*. The genus is one of the simplest of the colonial perforate Madreporaria, and the species is without commensal zooxanthellae and hence feeds entirely through its stomodoeum.

For the structureless lamella or jelly, instead of a makeshift term such as mesogloea, the name *skeletogloea* is proposed, a term which agrees well with its main function, both in the Hydrozoa and in the Anthozoa, *i.e.* that of support.

The corallum lies completely outside the polyps, and is separated from them by the calciblastic ectoderm, a thin layer of tissue swollen out in places by the nuclei. The skeletogloea is at the bases of the mesenteries and of the dividing walls of the coenosarcal canals directly attached to the corallum by fibrillated bundles, which broaden out greatly at their attaching ends. The interspaces between these bundles are filled by calciblastic ectoderm. These bundles are identical with the calciblasts of von Heider, and there is no evidence to show that the corallum is formed by the complete calcification of cells. In five genera of Madreporaria no trace of organic matter was found in the corallum, and there is no reason to doubt von Koch's conclusion that the corallum lies completely outside the animal and is the result of secretion by the calciblastic ectoderm.

Two kinds of nematocysts are found, the one forming large batteries on the tentacles but found also throughout the whole free ectoderm, the other found principally in the mesenterial filaments but also in the external and stomodoeal ectoderms.

The tentacular nematocyst is about .027 mm. in length and has a fine thread, spirally coiled about 24 times under the external membrane, which is somewhat pushed out over it. The whole nematocyst is extruded and in its place appears a mass of protoplasm, the central part of which acquires a definite membrane. This is the young nematocyst and is about twice as long and broad when ripe. Its protoplasm next becomes finely granular; the granules fuse together into large granules, which arrange themselves in a spiral manner under the external membrane. Finally, by contraction of the whole nematocyst and by complete fusion of the granules the ripe nematocyst is produced. The

appearance and mode of development of the thread are strikingly similar to those of elastic fibres in the higher Vertebrates.

The mesenterial nematocysts are rather larger than the tentacular and have a very thick thread, spirally coiled with about 8 turns. The thread ends freely in an invaginated portion at the end of the nematocyst, which forms the base of the everted thread. This basal portion, when everted, is seen to be covered with a spiral row of hairs, and appears to be carried out by the basal end of the thread on eversion. The whole nematocyst is not extruded. The thread is broken off at a short distance from the base, which is then retracted, a fresh thread being formed in the nematocyst. Some of the nematocysts have well-formed nuclei. The mesenterial nematocyst, indeed, is comparable to the cnidoblast of *Hydra* together with its included nematocyst, while the tentacular nematocyst is only comparable to the nematocyst of *Hydra*.

The ectoderm of the stomodoeum is very thick and has over the attachments of the mesenteries rows of goblet-like secretory vacuoles. These are directly continuous into the middle parts of the mesenterial filaments, the lateral parts of which are sharply marked off from the endoderm of the mesenteries. The whole filaments from the anatomy appear to be ectodermic in origin and formed by down-growths from the stomodoeum.

The stomodoeum together with the mesenterial filaments performs the main digestive functions and is hence the homologue of the whole gut of the Triploblastica. The so-called endoderm, giving rise to the muscular bands and generative organs, and performing also the excretory functions, is homologous with the mesoderm.

In the terms of the larger theory the Actinozoon polyp must then be regarded as also a Triploblastic form with definite ectoderm, endoderm and mesoderm.

The full paper on this subject, with illustrations, will appear in Part IV. of Dr Willey's *Zoological Results*.

On the Conductivity of Gases exposed to Entladungsstrahlen. By Professor J. J. THOMSON.

[Communicated February 20, 1899. MS. received March 20, 1899.]

Professor E. Wiedemann discovered that many bodies became thermo-luminescent when placed near an electric spark or to the electric discharge in a vacuum tube. He attributed this effect to the emission from the region through which the discharge was passing of a kind of radiation, to which he gave the name *Entladungsstrahlen*. The properties of this effect have been investigated by E. Wiedemann and by Hoffmann (*Wied. Ann.* LX. 269). They found that the effect was propagated in straight lines, was not deflected by a magnet, and was stopped by solids or liquids and even by some gases such as carbonic acid gas.

The object of the following experiments was to see if the effect which produced the thermo-luminescence affected the electrical properties of the gas through which it passed.

The apparatus used is represented in Fig. 1. The discharge

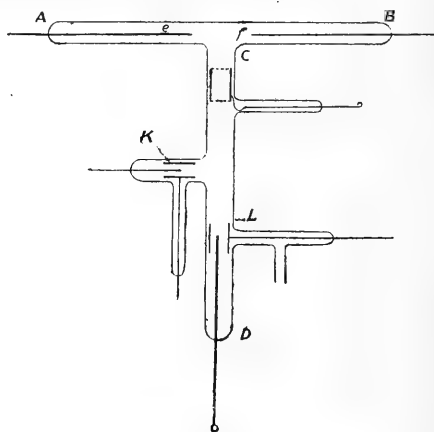

Fig. 1.

takes place between the electrodes *ef* in the horizontal tube *AB*; these electrodes can be moved along the tube, the distance between them remaining constant. In this way different portions of the discharge can be brought over the mouth of the vertical tube *CD*. In this tube, which is fused on to *AB*, two well insulated aluminium cylinders are placed; one of them faces the discharge, the other is placed in a side tube nearer to the discharge but so that no rectilinear radiation from the discharge can reach it. Along the axis of each of these is a well-insulated wire. The outer cylinders and the wires are well insulated from

each other. The wires can be connected to one of the pairs of quadrants of an electrometer, the other pair of quadrants being put to earth. A piece of wire gauze connected with earth was fastened across the top of the tube *CD*. The outer cylinders could be connected with one of the terminals of a battery of a large number of small storage cells, the other terminal of which was connected with the earth. The two pairs of quadrants of the electrometer were first connected together and the connection then broken. When no discharge passed through the upper tube, the spot of light reflected from the mirror of the electrometer remained at rest; when, however, the discharge passed through the tube, the spot of light was deflected, showing that conduction took place through the gas between the wire and the cylinder.

The gas through which a discharge passes is rendered a conductor and retains this property for a considerable time; and one of the chief difficulties of the investigation was to separate the effects due to the diffusion of the gas from the immediate neighbourhood of the spark from those that might be due to any radiation from it. At first I endeavoured to do this by placing between the cylinders and the discharge two coaxial tubes so arranged that any gas on its way from the neighbourhood of the discharge to the cylinders would have to pass between the tubes; the tubes were connected with the terminals of a battery of a large number of storage cells, so that an intense electric field was established between the tubes—this should drive to the walls of the tube the ions in any gas passing between the tubes and thus free it from any conductivity due to ions which had come from the neighbourhood of the discharge. This method did not work well in practice, and I finally relied on the comparison of the leaks through the two cylinders to separate the effects due to convection from those due to the *Entladungsstrahlen*; the effects due to convection should not be greatly different in the two cylinders (experimental evidence of this was furnished by observations at very low pressures, when the effects due to convection are very large; at such pressures the rate of leak was the same in the two cylinders); while it is only the cylinder which is directly under the discharge which will be affected by the '*Entladungsstrahlen*.' The first experiments were made with an alternating arc discharge from a high tension transformer. When the apparatus shown in Fig. 1 contained air at the pressure of a few millimetres of mercury there was no appreciable leak in the side cylinder, while there was a considerable and regular leak in the one exposed to the '*Entladungsstrahlen*.' At pressures comparable with the atmospheric pressure, there was no appreciable leak in either cylinder; at very low pressures there was a rapid leak in both cylinders due to the convection of the gas from the neigh-

bourhood of the discharge. There is considerable range of pressure in which the gas exposed to the 'Entladungsstrahlen' is a conductor, while the gas not so exposed remains an insulator. I conclude therefore that the 'Entladungsstrahlen' produce conductivity in the gas through which they pass.

The apparatus was filled with hydrogen and then with carbonic acid gas. It was found that the leak when the tube was filled with hydrogen was much more rapid than when it was filled with air, while the leak through carbonic acid was very much slower than through air. This is in accordance with the observations of E. Wiedemann and Hoffmann that the effects of the Entladungsstrahlen are much greater in hydrogen and much less in carbonic acid than in air.

If the length of the arc in the horizontal discharge tube was kept constant, and the terminals moved along the tube so that in one position the terminals were clear of the opening from the horizontal to the vertical tube, while in another position one of the terminals was above the opening, the leak in the cylinder exposed to the Entladungsstrahlen was greater in the second position than in the first; showing that the Entladungsstrahlen are emitted more copiously from the neighbourhood of the electrode than from the rest of the spark.

As the use of the alternating current from the transformer made it impossible to separate the effects at the positive from those at the negative electrode, the transformer was replaced by an induction coil and the spark gap was moved along in the top tube so that different portions of the discharge came over the opening into the tube containing the cylinders. It was found that the leak was greatest when the negative electrode was over the opening, that there was a considerable leak when the positive column was over the opening, but that there was no leak when the dark space between the positive column and the negative glow was in this position. From the experiments of Graham on the distribution of potential along the discharge we may conclude (see *Phil. Mag.*, Mar. 1899) that at the cathode and close to the anode ionization of the gas is taking place, while recombination of the ions occurs along the positive column, and very little of either ionization or recombination in the dark space between the positive column and the negative glow. Thus the ionization and recombination of a gas are accompanied by the emission of Entladungsstrahlen. These, I think, are analogous to the secondary rays which Röntgen has shown are emitted by a gas exposed to Röntgen radiation in which ionization is taking place; and to the secondary rays which are produced when Röntgen rays fall on a metallic surface. I have shown in a paper read before the Society (*Proc. Camb. Phil. Soc.*, Vol. IX. p. 393) that the sudden

ionization of a gas would give rise to pulses similar in character to those produced by the stoppage of an electrified particle. As the stoppage of the electrified particles which constitute the cathode rays is probably more abrupt than the ionization or recombination of ions in a gas, we should expect the pulses produced by the cathode rays to be thinner and more intense than those which constitute the *Entladungsstrahlen*.

The *Entladungsstrahlen* are absorbed very rapidly by air, and in order to detect any leakage produced by them at atmospheric pressure, I have found it necessary to deal with regions within a short distance of the arc. The arrangement used for experiments at atmospheric pressure is shown in Fig. 2. The cylinders

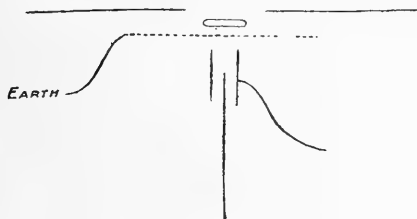

Fig. 2.

between which the leak was taken were placed close behind a piece of fine wire-gauze connected to earth; the gauze was used to prevent any ions in the part of the gas traversed by the electric discharge being dragged between the cylinders by the electric field. The arc from the transformer was about 1 cm. in front of the gauze and a strong air blast was blown between the arc and the gauze to prevent the gas from the arc reaching the cylinders by convection. Under these circumstances when the arc was passing there was a leak between the inner and outer cylinders when these were at different electric potentials.

An induction coil was then tried instead of the transformer and the leak was again obtained. Using the same length of arc the leak was greater when thin electrodes were used, which got nearly white-hot, than when the electrodes were thicker. This was not due directly to radiation arising from the high temperature to which the terminals were raised; for there was no leak when the arc was replaced by a platinum wire raised to a temperature which, as far as the eye could judge, was much higher than the temperature of the electrodes used for the arc. There was also no leak when an incandescent gas mantle was substituted for the arc, nor could I detect any from the oxy-hydrogen flame.

Notes on the inheritance of Variation in the Corolla of Veronica Buxbaumii. By W. BATESON, M.A., and D. F. M. PERTZ.

In a former paper¹ an account was given of certain variations in the form of the corolla of *Veronica Buxbaumii*. It was shewn that abnormal flowers were of common occurrence and that certain symmetrical forms of variation were especially frequent. Flowers taken at random on heavy clay arable land near Cambridge shewed about 6 per cent. of flowers with 3 petals, and about 1 per cent. of flowers with 2 petals. Occasional 5-petalled flowers having either 2 posterior petals or 2 anterior petals were also seen. Various irregular forms were found, but these were of comparatively rare occurrence.

Further observation shewed that in garden ground the 5-petalled forms were by no means rare, that with 2 posterior petals being especially common. As indicated above, there appears to be considerable differences between the variations found in different localities. These differences may possibly be connected with the nature of the soil, but this aspect of the matter has not been further examined.

It was pointed out that though the 2 posterior-petalled form may reasonably be regarded as of the nature of reversion, the other forms cannot be so regarded, though they are no less perfectly formed, and are much more common than those imperfectly formed flowers which may be described as intermediate between the type and the perfect variations.

The experiments described in this paper were undertaken to test whether there is any difference between offspring raised from abnormal flowers, and the offspring of normal flowers borne by the same plant. The possibility that there may be a difference in inheritance in such cases is referred to by some writers, especially by practical horticulturists, and the theoretical importance of the question is of course considerable. Apart however from a few cases (like that of the Peach and the Nectarine) in which seed from a sporting branch has been observed to transmit the peculiarities of the branch, it does not appear that much evidence bearing on the question exists.

It should be noticed that the analogy between the present case and that of the sporting branches is not in all respects precise, and in particular that the variations we are about to describe are essentially meristic. In the absence of evidence

¹ "On Variations in the Floral Symmetry of certain Plants having Irregular Corollas," by W. Bateson and A. Bateson. *Jour. Linn. Soc. Bot.*, xxviii. 1892, p. 386.

there does not appear to be any probability that because in a flower one or more whorls shew an abnormal division, the reproductive elements carried by that flower should produce individuals more abnormal than those proceeding from normally divided flowers on the same plant.

In the following experiments, which were entirely carried out by Miss Pertz, the evidence, though scanty, goes on the whole to shew that there is, at all events in the case investigated, no well marked difference between the offspring of normal and abnormal flowers.

Amongst plants raised from seed taken out of the same self-fertilised capsule great diversity of variability was constantly manifested, but there was no indication that families of plants raised from capsules formed by self-fertilisation of abnormal flowers in general shewed either greater variability or greater percentage of any one abnormal form than families similarly raised from normal flowers on the same plant. On the contrary the evidence tends to shew that the self-fertilised offspring of normal and abnormal flowers on the whole conform to an equal degree with the general characteristics of the parent plant, or more strictly of the strain or Race to which the parent belonged. In the course of the work a few collateral points of some interest were made out.

The forms of corolla most frequently occurring are as follows.

1. *Normal flowers* (Fig. 1). These are the ordinary flowers characteristic of the genus. The corolla consists of 4 petals. Of these one is posterior, one anterior, and two lateral. The posterior petal is wide and of a deep blue colour. Opposite to it is the narrower anterior petal, of a pale bluish-white colour. The lateral petals are of about the same size as the posterior, but in intensity of colour they are intermediate between the posterior and anterior petals.

Generally speaking these normal flowers form 80—90 per cent. of the whole but, as may be seen in the tables, they may on particular plants form a much higher or a much lower percentage than this.

2. *Corolla with two anterior petals* (Fig. 3). These corollas possess one posterior and two lateral petals like the normal, but differ in having the anterior petal represented by two petals. These two petals are like the normal anterior petal in form and colour. Like the normal also they are small petals but not unfrequently they are somewhat unequal in size.

3. *Corolla with two posterior petals* (Fig. 2). Flowers like the normal except that the posterior petal is represented by two petals, each more than half the size of the normal one.

As it may reasonably be supposed that the one posterior petal of *Veronica* represents the two posterior petals of 5-petalled Scrophulariaceae, these corollas with two posterior petals can very plausibly be considered reversions. At all events, of the various forms seen this is the one which can with most reason be supposed to represent a form actually passed through in the evolution of the species. Hence it is of interest to note that this is the only one of the common variations which is connected with the normal by any considerable number of intermediate forms. In these the posterior petal is more or less cleft into two (Fig. 19). In the lower forms of the variation the place of division is only indicated by a notch. Such a variation is of course an example of the phenomenon of division in a plane about which there is bilateral symmetry, a phenomenon constantly occurring in animals and plants¹. By reference to the Tables it will be seen that these intermediates occasionally form a fairly high proportion of the abnormal flowers, though even in these cases the complete form of the variation is as a rule the more frequent on the same plant.

4. *Corolla with six petals*, two being posterior and two anterior (Fig. 5). These flowers present the peculiarities of both the 2nd and 3rd forms of variation mentioned above. The anterior two petals here also are not infrequently unequal in size, and the division between the two posterior petals may be incomplete (see No. 3).

5. *Corolla with three petals* (Fig. 4). In this form the posterior petal is normal. There is no anterior petal, the corolla being completed by two large lateral petals. The appearance suggests that the material usually composing the two laterals and the anterior has been divided by one median division into two. Not rarely there is at the anterior edges of these two petals a band of lighter colour, shewing that the colour still follows the normal distribution of the 4-petalled flower. This is however by no means always the case.

6. *Corolla with two petals* (Fig. 20). The whole corolla is here formed of two petals, placed as anterior and posterior respectively. They are of about equal size.

7. *Corolla with four petals set obliquely* (Fig. 7). In this form the petals stand as two anteriors and two posteriors, forming

¹ See *Materials for the Study of Variation*, 1894, p. 448.

an oblique instead of an upright cross. The morphology of this flower is not quite clear, but there seems little doubt that it should be regarded as a corolla in which the posterior petal has been divided as in Fig. 2, while the anterior and lateral elements have developed in the same way as those shewn in Fig. 4.

Occasional forms. Besides the forms enumerated above, of which all are found in some quantity, there are various other forms of only occasional occurrence. Of these some are symmetrical, *e.g.* corollas having three posterior petals making six in all (Fig. 11); corollas having 7 or 8 petals, viz. 3 or 4 anterior, 3 or 4 posterior (Fig. 10). There are besides these asymmetrical forms of variation, in which for example one of the lateral petals is smaller than the other, and so forth, but none of these are found in any quantity.

Small flowers. In the previous paper mention was made of a peculiar form of flower having its parts, especially the corolla, of very small size (Fig. 18). These flowers were of occasional occurrence only.

Calyx. The calyx is also liable to numerical variations, but no record of these was kept. There are frequently variations of the calyx in correlation with those of the corolla, but not rarely the one whorl may be abnormal while the other is normal.

Stamens and Pistil. Variations in these parts were extremely rare.

METHOD. The plants selected in each year for self-fertilisation were potted and completely isolated, usually by means of a bell-jar over water, or a fine muslin net. Before covering, the flowers then open were all cut off, and the artificial self-fertilisation was not begun until the following day. The self-fertilised flowers were marked with coloured threads and the cover left on the plant until the corollas of these flowers had fallen off. The cover was then removed and the capsules ripened in the open.

The seeds were sown either in the autumn or in the early spring.

The seeds from each selected capsule were sown in separate pots, and afterwards pricked out in an open piece of ground in the Botanic Garden.

The flowers, which open in the morning, were counted during the morning hours on as many days as possible during the flowering season.

Except during the first weeks of 1892 each flower was picked as it was noted, thus all danger of repetition was avoided.

By these successive countings the relative numbers of each kind of flower borne by each plant during its flowering period were approximately obtained. In a good many cases days were missed, and in 1894 and 1895 the plants had not altogether finished flowering when the counting stopped. We have not attempted to make any correction for this, but there is no reason to suppose that the results are thereby materially affected.

In the Tables the number of each kind of flower is given as a percentage of the total number of flowers borne by the plant. This total is given in the right-hand column of each Table. In the bottom line of each Table is given the average percentage of each kind of flower borne by the whole family sprung from one capsule. This average is calculated on the grand total of flowers borne by the whole family.

It is noticeable that while there is very great diversity among the offspring of the same self-fertilised capsule, yet the *average* degree of abnormality in the family generally remains fairly constant for the descendants of each original plant.

The extraordinary irregularity in the percentages amongst these offspring of self-fertilisation is not a little remarkable. It might perhaps have been expected that as the result of successive self-fertilisation some diminution in variability would occur. So far as our figures go, there is no indication of such a result.

An attempt was made to discover whether the abnormal flowers were produced with any greater frequency at one part of the flowering period than at another. Decided evidence was found that this is so. Though there are not a few exceptions, the countings shew in a large majority of cases that the chief output of abnormal flowers takes place in the earlier part of the flowering season and especially just before the greatest output of flowers, after which time the percentage of abnormality declines. It was not thought worth while to print the detailed records on which this statement is based.

The plants studied, 135 in all, were severally descended from three original plants, and the descendants of each of these three are referred to as Race I., Race II. and Race III. respectively.

Race I. The original plant from which Race I. descended was growing wild in a plot of waste garden-land near Cambridge. On it 5 flowers were chosen, being respectively A, normal; B, 2 anterior petals; C, D and E, each having 2 posterior petals. As to the fertilisation of these flowers nothing was known.

From these flowers the first generation was raised and the succeeding generations were produced by self-fertilisation, the detailed pedigrees being given in the Tables.

The most noticeable characteristic of this Race is the high average percentage of flowers with 2 posterior petals. It will be seen that this percentage is exceedingly variable. In the first sowing there are some high percentages of 3-petalled flowers on certain plants, especially of the families C and D. It is of course possible that these were fertilised by pollen from other plants, but in the family A₅A there are also a few such plants. In subsequent generations of the Race the decline in 3-petalled flowers is rather striking and we have no indication of the reason for this.

If the 1st generation stood alone it would seem that the percentage of abnormality was greatest in the offspring of abnormal flowers. Subsequent generations nevertheless are quite at variance with such a result.

Race II. The seed was taken from the capsule of a flower of unknown form on a plant in the same locality as the parent of Race I. The Race is remarkable for a high percentage both of 2 posterior-petalled flowers and also 3-petalled flowers. It will be noticed that in the 2nd generation the percentage of 2 posterior-petalled flowers happens to be highest in a family the offspring of a normal flower.

Race III. In the summer of 1893 a plant was observed growing wild in the Botanic Garden which bore an unusual number of 3-petalled flowers. A capsule which had not been in any way protected from cross-fertilisation was gathered, and the seeds produced 4 plants. The contrast between these and Races I. and II. is very marked. The form with 2 posterior petals is here extraordinarily scarce, while the flowers with 3 petals are in the high proportion of 4 per cent. The next generation of the Race maintained the same characteristics. From this Race alone it might be inferred that an abundance of the 3-petalled form is not compatible with a considerable number of flowers having 2 posterior petals, but several plants in the other Races shew that this is not the case (*e.g.* Race II. A₁ and A₁A₂).

TABLES.

In the following Tables—

N	stands for	normal
2a	„	2 anterior petals
2pp	„	2 posterior petals
6	„	6 petals
3	„	3 „
2	„	2 „
4½	„	the form numbered 7 in the text
Int.	„	intermediates between normal and 2pp
Misc.	„	miscellaneous forms not included in the above categories.

The number of flowers of each category given in percentages of total flowers printed in right-hand column.

In the case of some of the scarcer forms the percentage is given to the second place of decimals. Most are only taken to the first place.

RACE I.

1892. *First Generation.* On one plant 5 capsules were taken, viz.:

	A	B	C	D	E
	normal	2 ant.	2 post.	2 post.	2 post.
	flower	pet. fl.	pet. fl.	pet. fl.	pet. fl.
From these grew	5 plants	3 plants	4 plants	3 plants	1 plant

Result.

	N	2a	2pp	6	3	2	4½	Int.	Misc.	Totals
A 1	91.5	2.3	4.2	.6	.5			.7	.2	1398
2	96.8	1.1	1.6	.2				.2	.1	1218
3	82.2	1.8	11.6	1	1.3		.4	1.2	.3	1050
4	88.4	2.9	4.9	.6	1.7	.02	1	1	.2	4787
5	69.4	3	17.9	4.4	2.7	.3	1.1	.4	.9	666
Averages	87.9	2.4	6.1	.8	1.3	.03	.1	.7	.3	9119
(Seed taken from A ₁ , A ₄ , A ₅ .)										

	N	2a	2pp	6	3	2	4½	Int.	Misc.	Totals
B 1	70.4	1.9	19	2.4	3.3	.2	.7	1.4	.1	3236
2	75.7	3.4	13.9	2.1	2.3	.1	.6	1.5	.3	2789
3	83.6	1.5	8.3	.9	3.6	.1	.5	1.2	.1	4781
Averages	77.7	2.1	13.1	1.7	3.1	.1	.6	1.3	.2	10806

(No seed taken.)

	N	2a	2pp	6	3	2	4½	Int.	Misc.	Totals
C 1	72.2	2.1	20	2.1	1.6	.1	.4	.5	.2	2869
2	74.1	7.4	14.9	1.9	.8		.4	.4	.5	2151
3	81.9	6	8.1	2.1		.1	.1	.2	.5	2106
4	80.9	4.2	9.9	1.3	2.1		.1	.8		2740
Averages	77.1	4.7	13.5	1.9	1.6	.1	.3	.5	.3	9866

(No seed taken.)

	N	2a	2pp	6	3	2	4½	Int.	Misc.	Totals
D 1	69.4	1.7	21.9	2.5	2.7	.2		1.4	.4	474
2	76.9	2.3	16.7	1.5	1.7		.04	.2	.3	2306
3	69.4	2.7	17.2	2.4	5.2	.4	.6	1.3	.5	1044
Averages	73.9	2.3	17.5	1.9	2.8	.2	.2	.9	.4	3824

(No seed taken.)

	N	2a	2pp	6	3	2	4½	Int.	Misc.	Totals
E	80.8	5.1	9.1	2.1	1.2		.7	.2	.6	1142

1893. *Second Generation.* On A₁ one capsule was taken, viz.:
6 pet. flower, A₁ A

From this grew 6 plants

	N	2a	2pp	6	3	2	4½	Int.	Misc.	Totals
A ₁ A 1	81.2	3.6	10.1		.5		.5	2.8	1.4	218
2	87.3		7.5	.2	1.3	.2		3.3	.2	455
3	86.6	7.3	3.7					2.4		82
4	65.9	2.3	20.4					10.2	1.1	88
5	100									8
6	91.2		8.8							34
Averages	83.9	1.8	9	.1	.8	.1	.1	3.6	.6	885

(Seed taken from A₁ A₂.)

On A₄ one capsule was taken, viz.:

6 pet. flower, A₄ A

From this grew 6 plants

	N	2a	2pp	6	3	2	4½	Int.	Misc.	Totals
A ₄ A 1	68.5	10.5	14.5	2.6		1.3		2.6		76
2	51.3	15.4	25.6	2.6		2.6		2.6		39
3	71.2	1.5	25.8			1.5				66
4	58.1	3.7	29.9	3.7	1.6			1.9	1.1	377
5	65.1	5.2	21.9	3.2	.9			3.5	.9	324
6	83.6	8.9	5.5			2.5				166
Averages	64.9	5.7	22.4	2.6	1.1	.6		2.1	.7	1048

(No seed taken.)

On A₅ one capsule was taken, viz.:3 pet. flower, A₅A

From this grew 17 plants

	N	2a	2pp	6	3	2	4½	Int.	Misc.	Totals
A ₅ A 1	84.4	2.6	7	.9	.9		.3	3.3		340
2	83.1	4.2	8.7	.4	.6			2.8	.2	528
3	80.9	2.1	10.6		4.3			2.1		47
4	87.5	2	4.2	.5	3.7		.2	1.8	.2	598
5	81.2	9.4	1.6	.8	1.1			3.2		373
6	84.9	5.3	3.4	.6	1.8			3.5		318
7	89.7	4.3	1	.5	3.8		.5			185
8	89.1	3.3	3.6	.6			.3	2.1	.6	329
9	81.4	7.8	3.9		.9			4.9	.9	102
10	97.4							2.5		39
11	90.9	5.3	3.4					.4		263
12	85.7	3.1	7.7	.7	1.7			.7	.3	287
13	92.4	2.5	1.3		2.5	.6		.6		157
14	87.4	5.8	2	.7	1		.7	2.4		294
15	92.6	2.1	.7		1.8			2.5	.3	283
16	77.7	1.9	15.5	1.9	.9			1.9		103
17	88.7	4.4	2.9		2.9			.5		211
Averages	86.6	4.1	4.4	.5	1.6	.02	.1	2.1	.3	4457

(No seed taken.)

On E two capsules were taken, viz.:

normal fl., EA

2 ant. pet. fl., EB

From these grew

7 plants

7 plants

	N	2a	2pp	6	3	2	4½	Int.	Misc.	Totals
EA 1	77	13.3	3.9	1.5	.6			3	.6	330
2	74.3	13.3	6.8	1.6	.5			2.7	.8	443
3	69.8	15.2	5.2	3.7	2.1			3.7		328
4	73	14.8	6.6	2.9	.3			1.6		379
5	64.1	9.4	9.4	1.9		1.9	1.9	11.3		53
6	60.8	12.7	15.4	5.6	1.6			3.9		306
7	67.5	13.5	9.7	4	1.6			1.6	2.4	126
Averages	70.9	13.7	7.6	2.9	1	.1	.1	3.1	.3	1965

(No seed taken.)

	N	2a	2pp	6	3	2	4½	Int.	Misc.	Totals
EB 1	87	3.2	7.3		.8	.8		.8		247
2	72.5	9.2	15	.8				2.5		120
3	93.3	3.3						3.3		30
4	65.2	11.9	13.4	1.8	2.2	.4		3.6	1.4	276
5	67.2	11.9	12.3	3.6	.6		.2	3.6	.8	530
6	81.6	7.9	2.6	2.6				5.3		38
7	72.3	17.9	5.8		.3	.3		2.5	1.1	364
Averages	72.3	11.5	9.9	1.6	.7	.2	.1	2.9	.7	1605

(No seed taken.)

1894. *Third Generation.* On A_1A_2 three capsules were taken, viz.:

		normal fl., A_1A_2A	2 post. pet. fl., A_1A_2B	3 pet. fl., A_1A_2C						
From these grew		9 plants	7 plants	6 plants						
	N	2a	2pp	6	3	2	4½	Int.	Misc.	Totals
A_1A_2A 1	93.7	.7	4.2	.1	.4			.9		1709
2	71.3		26.9	.3	.7	.1	.1	.4		897
3	91.2	.6	6.7	.2	.3		.1	.7	.1	1564
4	97.4	.4	2.1							1359
5	63.1	.2	34.5	.5	.5		.1	1.1		1288
6	95.3	.9	3.5		.2					846
7	92.9	.7	5.7		.4			.3		1163
8	85.7	1	10.2	.2	.2			1.8		1201
9	93.3	1.1	4.5		1.1					449
Averages	87.5	.6	10.8	.2	.4	.01	.02	.6		10476

(Seed taken from $A_1A_2A_3$ and $A_1A_2A_5$.)

	N	2a	2pp	6	3	2	4½	Int.	Misc.	Totals
A_1A_2B 1	98.5		.2	1.3						1152
2	94.7	.7	3.8			.2		.5		1406
3	78.9	.7	17.6	.7				2.1		142
4	81.8	4.1	12.4			.3		1.2		314
5	93.3		4.2			.4		2.1		239
6	67.9		30.4					1.7		181
7	84.5	2.1	11.7					1.6		187
Averages	92.2	.8	6.1	.02	.1			.6		3621

(Seed taken from $A_1A_2B_4$.)

	N	2a	2pp	6	3	2	4½	Int.	Misc.	Totals
A ₁ A ₂ C 1	96.7	.3	2.7	.05	.05			.2		1839
2	86.8	.8	11.1	.7	.2			.5		621
3	96.4	.8	2.3		.1	.04		.4	.04	2242
4	97.4	.2	1.7	.2	.3			.2		618
5	95.4	.5	3.3	.1	.4			.3		2401
6	97.6	.6	1.2	.1	.3			.2		1265
Averages	95.8	.5	3.1	.1	.2	.01		.31		8986

(No seed taken.)

1895. *Fourth Generation.* On A₁A₂A₃ two capsules were taken, viz.:
 normal fl., A₁A₂A₃A 2 post. pet. fl., A₁A₂A₃B

	N	2a	2pp	6	3	2	4½	Int.	Misc.	Totals	
From these grew		7 plants					4 plants				
A ₁ A ₂ A ₃ A 1	92.6	1.9	5	.2	.5			.6		967	
2	83.8	.9	12.8	.9	.2	.2		1.1		618	
3	84.8	2.1	10.6	.4	.3			.9		778	
4	84.9	1.3	10.3	.4	.2			2.8		464	
5	80.7	7.2	9	1.7	.7			.7		290	
6	80.3	5	12.9		.7			1.1		279	
7	87.4	2.5	7.3	.8	.3		.3	1.5		398	
Averages	86.	2.4	9.3	.6	.4	.02	.02	1.1		3794	

(No seed taken.)

	N	2a	2pp	6	3	2	4½	Int.	Misc.	Totals
A ₁ A ₂ A ₃ B 1	90.7	2.6	5.6	.1	.2			.7		836
2	94.1	.9	3.9		.2			.8		883
3	85.3	2	12.4		.1			.1		744
4	80.6	2.2	15.2	.4				1.4	.1	696
Averages	88.2	1.9	8.9	.1	.2			.8		3159

(No seed taken.)

On A₁A₂A₅ two capsules were taken, viz.:

	N	2a	2pp	6	3	2	4½	Int.	Misc.	Total	
normal fl., A ₁ A ₂ A ₅ A		1 plant					6 plants				
A ₁ A ₂ A ₅ A	66.2	7.2	20.9	2.6	.9			1.8		607	

(No seed taken.)

	N	2a	2pp	6	3	2	4½	Int.	Misc.	Totals
A ₁ A ₂ A ₅ B	1	92.4	1	4.7	.2			1.5		386
	2	88.3	1.5	8.5	.2	.3		1.2		661
	3	85.4	1.3	10.5	1.3	.2		1.7		604
	4	82.9	1.3	13.5	.4	.2	.2	1.5		533
	5	84.1	1.6	11.5	.2	.5	.2	2.1		634
	6	91.1	1.3	6		.4		1.1		531
Averages		87.1	1.4	9.3	.4	.3	.02	1.5		3349

(No seed taken.)

On A₁A₂B₄ two capsules were taken, viz.:

normal fl., A₁A₂B₄A 2 post. pet. fl., A₁A₂B₄B

From these grew 4 plants 4 plants

	N	2a	2pp	6	3	2	4½	Int.	Misc.	Totals
A ₁ A ₂ B ₄ A	1	93.5	.7	4.3	.4	.3		.8	.1	783
	2	92.4	1.9	3.9	.3	.7		.5		554
	3	81	1.2	15.4	.7	.3		1.2		589
	4	89.6	1.7	7.4	.2	.2		.9		527
Averages		89.4	1.3	7.5	.4	.4		.8		2453

(No seed taken.)

	N	2a	2pp	6	3	2	4½	Int.	Misc.	Totals
A ₁ A ₂ B ₄ B	1	57.5	.7	39.7	.2	.3		1.5		546
	2	79.4	1.9	16.9				1.9		373
	3	86	1.9	9.6	.2	.2		2.1		428
	4	90.9	1.1	6.9		.1		.9		539
Averages		77.8	1.3	18.9	.1	.2		1.5		1886

(No seed taken.)

RACE II.

1892. *First Generation.* On one plant one capsule was taken, viz.:
flower, form unknown, A

From this grew 2 plants

	N	2a	2pp	6	3	2	4½	Int.	Misc.	Totals
A	1	51.6		40.3	4.8	3.2				124
	2	67	.7	29.1	1.1	1.8		.4		285
Averages		62.3	.5	32.5	2.2	2.2		.2		409

(Seed taken from A₁.)

1893. *Second Generation.* On A_1 two capsules were taken, viz.:
 normal fl., A_1A 2 post. pet. fl., A_1B

From these grew		5 plants					2 plants			Int.	Misc.	Totals
	<i>N</i>	<i>2a</i>	<i>2pp</i>	6	3	2	$4\frac{2}{3}$					
A_1A	1	57.7	1.7	39.1					1.5		402	
	2	69	.9	19.7	.4	4.4		.4	4.9		223	
	3	86.7		6.6		6			.6		165	
	4	90		5					5		20	
	5	78.7	6.1	9.6		3.1	1.1		1.1		94	
Averages		68.6	1.6	24.5	.1	2.5	.1	.1	2.2		904	

(No seed taken.)

	<i>N</i>	<i>2a</i>	<i>2pp</i>	6	3	2	$4\frac{2}{3}$	Int.	Misc.	Totals
A_1B	1	76.5	.4	18.9	.4	3.3		.4		238
	2	73	.8	20		3.8		2.1		234
Averages		74.9	.6	19.3	.2	3.5		1.2		472

(No seed taken.)

RACE III.

1894. *First Generation.* On one plant one capsule was taken, viz.:
 flower, form unknown, A

From this grew		4 plants					Int.	Misc.	Totals
	<i>N</i>	<i>2a</i>	<i>2pp</i>	6	3	2			
A	1	95.8		.1		3.5	.3	.2	2592
	2	95.1		.04		4.6	.2	.04	2074
	3	94.7	.1	.1		4.5	.5		1929
	4	93.8				5.3	.7	.2	1808
Averages		95.2	.03	.1		4.4	.4	.11	8403

(Seed taken from A_4 .)

1895. *Second Generation.* On A_4 two capsules were taken, viz.:
 normal flower, A_4A 3 pet. flower, A_4B

From these grew		6 plants					9 plants			Int.	Misc.	Totals
	<i>N</i>	<i>2a</i>	<i>2pp</i>	6	3	2	$4\frac{2}{3}$					
A_4A	1	92.9	.4			5.4	1.1		.2		448	
	2	92.9	.8		.2	5.6	.2		.5		611	
	3	89.6	1.3	.2		6	1.5		1.3		461	
	4	93.5	1.3			3.9	.5		.8		618	
	5	92.1	1.8			4.9	1.1		.1		717	
	6	94.1	.7	.1		4.4	.2		.4		804	
Averages		92.6	1.1	.05	.02	4.9	.7		.54		3659	

(No seed taken.)

	<i>N</i>	<i>2a</i>	<i>2pp</i>	6	3	2	$4\frac{2}{3}$	Int.	Misc.	Totals
A ₄ B 1	94.6	.5	.2		4.4	.1		.1		1058
2	90.9	.5	.1		7.3	1.1		.1		1460
3	92.2		.1		6.8	1.7		.1		825
4	94	2.6	.4		2.2	.1		.7		737
5	91.9	.6	.2		5.9	.9		.3		1172
6	92.3	.6	.2		5.2	1.1		.5		854
7	94.5	.4	.3		3.9	.8		.1		1161
8	91.1	.7			6.8	1.4				839
9	90.7	.7	.3		7.6	.8				899
Averages	92.5	.7	.2		5.7	.8		.2		9005

(No seed taken.)

DESCRIPTION OF PLATE I. ILLUSTRATING VARIOUS
FORMS OF COROLLA FOUND IN *VERONICA*
BUXBAUMII.

- Fig. 1. Normal flower.
- Fig. 2. Two posterior petals.
- Fig. 3. Two anterior petals.
- Fig. 4. Three petals.
- Fig. 5. Six-petalled form having two posterior and two anterior petals.
- Fig. 6. Rare form with three petals.
- Fig. 7. Four petals set obliquely.
- Fig. 8. Corolla with division of posterior petal indicated by a *fold* seen from behind.
- Fig. 9. Three anterior petals.
- Fig. 10. Two posterior petals combined with three anterior petals.
- Fig. 11. Three posterior petals.
- Fig. 12. Lateral petal divided.
- Figs. 13 and 14. Irregular forms.
- Fig. 15. Corolla like fig. 7, but having imperfect division between posterior petals.
- Fig. 16. Irregular form.
- Fig. 17. A very peculiar corolla. All the petals are unusually narrow and the posterior is divided, the two halves being separated by a space.
- Fig. 18. A "small flower" (see p. 81).
- Fig. 19. *a, b, c*, various forms of notching or imperfect division of posterior petal. *d*, appearance of trifold division in posterior petal.
- Fig. 20. Two-petalled corolla.

PROCEEDINGS

OF THE

Cambridge Philosophical Society.

On the product $J_m(x) J_n(x)$. By W. M^c F. ORR, M.A.

[*Read May 15, 1899.*]

If in Bessel's equation we change x into ix it becomes

$$\frac{d^2u}{dx^2} + \frac{1}{x} \frac{du}{dx} - \left(1 + \frac{n^2}{x^2}\right) u = 0.$$

Writing $u = x^{-\frac{1}{2}} \cdot v$ this assumes its normal form

$$\frac{d^2v}{dx^2} - \left(1 + \frac{n^2 - 1/4}{x^2}\right) v = 0.$$

Replacing n by m we obtain another similar equation

$$\frac{d^2w}{dx^2} - \left(1 + \frac{m^2 - 1/4}{x^2}\right) w = 0.$$

The product vw of any two solutions of the equations

$$\frac{d^2v}{dx^2} + Iv = 0,$$

$$\frac{d^2w}{dx^2} + I'w = 0$$

satisfies the equation

$$D \left(\frac{D^2y + 2(I + I') Dy + yD(I + I')}{I - I'} \right) + (I - I') y = 0 \dots (1),$$

where D denotes d/dx . Thus, if $I_n(x) = i^{-n}J_n(ix)$, $xI_m(x)I_n(x)$ satisfies the equation

$$\{x^4D^4 + 2x^3D^3 - 2x^2(2x^2 + a)D^2 - (8x^3 - 2ax)D + b^2 - 2a\}y = 0 \dots\dots\dots(2),$$

where $a = m^2 + n^2 - 1/2$, $b = m^2 - n^2$.

If we seek for a solution of this in the form of a series

$$\sum a_r x^r$$

we obtain the relation

$$(r + 1 + m + n)(r + 1 + m - n)(r + 1 - m + n)(r + 1 - m - n) a_{r+2} = 4r(r + 1) a_r \dots\dots\dots(3).$$

This is satisfied by four hypergeometric series, always convergent, of which one is

$$x^{1+m+n} F\left(\frac{m+n+1}{2}, \frac{m+n+2}{2}; m+n+1, m+1, n+1; x^2\right) \dots\dots\dots(4),$$

and the three others may be obtained by changing the sign of m , or n , or both; it is also satisfied by two series, always divergent, unless they terminate, viz.

$$F\left(\frac{1+m+n}{2}, \frac{1+m-n}{2}, \frac{1-m+n}{2}, \frac{1-m-n}{2}; \frac{1}{2}; \frac{1}{x^2}\right) \dots\dots\dots(5),$$

and $x^{-1} F\left(\frac{2+m+n}{2}, \frac{2+m-n}{2}, \frac{2-m+n}{2}, \frac{2-m-n}{2}; \frac{3}{2}; \frac{1}{x^2}\right) \dots\dots\dots(6).$

An interpretation of such divergent series and relations connecting them with the convergent series are given in the *Camb. Phil. Trans.*, Vol. XVII., Part III.

Equation (2) is also satisfied by two other functions which for infinite values of the modulus of x tend to equality respectively with*

$$e^{-2x}, e^{+2x} \dots\dots\dots(7), (8).$$

* *Loc. cit.*, Art. 13.

We may suppose that neither m nor n is negative and will also suppose, unless otherwise stated, that none of the constants m , n , $m \pm n$, is zero or an integer. The four convergent series are then interminable; none of them contains any terms of the form $0/0$, nor can the same power of x occur in any two. We therefore have

$$I_m(x) I_n(x)^* = \frac{x^{m+n}}{2^{m+n} \Pi(m) \Pi(n)}$$

$$F\left(\frac{m+n+1}{2}, \frac{m+n+2}{2}; m+n+1, m+1, n+1; x^2\right)$$

.....(9),

and three other analogous equations.

The case in which $m = 1/2$ is of great interest, and, therefore, although the relations obtainable are well known, it may be pardonable to investigate them from this point of view. In this case it is seen that of the four convergent series (4), one consists of the terms of odd order, and another of the terms of even order of the series

$$x^{n+1/2} F(n+1/2; 2n+1; 2x).....(10),$$

a third of the terms of odd order, and the fourth of the terms of even order of the series obtained from (10) by changing the sign of n ; the series last mentioned satisfies the same linear differential equation of the second order as (10). It is also seen that of the two divergent series (5) consists of the terms of odd, and (6) is a multiple of those of even order in the series

$$\phi\left(\frac{1}{2} + n, \frac{1}{2} - n; \frac{-1}{2x}\right) = 1 - \frac{(\frac{1}{2} + n)(\frac{1}{2} - n)}{1 \cdot 2x} + \dots \dots\dots(11),$$

which is associated † with (10) and its analogue. Thus by addition and subtraction relations (9) become on division by $x^{\frac{1}{2}}$

$$e^x \cdot I_n = (\pi x/2)^{\frac{1}{2}} (I_{\frac{1}{2}} + I_{-\frac{1}{2}}) I_n = \frac{x^n}{2^n \Pi(n)} F\left(\frac{1}{2} + n; 1 + 2n; 2x\right)$$

.....(12)

$$e^{-x} \cdot I_n = (\pi x/2)^{\frac{1}{2}} (I_{-\frac{1}{2}} - I_{\frac{1}{2}}) I_n = \frac{x^n}{2^n \Pi(n)} F\left(\frac{1}{2} + n; 1 + 2n; -2x\right)$$

.....(13),

and two analogous equations obtainable by changing the sign of n .

* Schlafli, *Math. Ann.*, III., gives the equivalent formula

$$J_m(x) J_n(x) = \frac{2}{\pi} \int_0^{\frac{\pi}{2}} J_{m+n}(2x \cos \phi) \cos(m-n)\phi \cdot d\phi$$

m and n being integral.

† See the paper referred to above, Art. 3.

Making use of the equation* connecting

$$x^{\frac{1}{2}+n} F\left(\frac{1}{2} + n; 1 + 2n; 2x\right),$$

$$x^{\frac{1}{2}-n} F\left(\frac{1}{2} - n; 1 - 2n; 2x\right),$$

and

$$\phi\left(\frac{1}{2} + n, \frac{1}{2} - n; -\frac{1}{2x}\right),$$

we obtain the result

$$I_{-n} - I_n = \sqrt{\frac{2}{\pi x}} \sin n\pi e^{-x} \phi\left(\frac{1}{2} + n, \frac{1}{2} - n; -\frac{1}{2x}\right) \dots (14),$$

wherein the argument of every power x^m lies between $-m\pi$ and $+m\pi$.

And by writing $x = ye^{-\pi i}$ in this we have

$$\begin{aligned} I_{-n}(y) + I_n(y) - i \cot n\pi \{I_{-n}(y) - I_n(y)\} \\ = \sqrt{\frac{2}{\pi y}} e^y \phi\left(\frac{1}{2} + n, \frac{1}{2} - n; \frac{1}{2y}\right) \dots (15), \end{aligned}$$

wherein the argument of every power y^m lies between 0 and $2m\pi$.

If the modulus of y be large and its argument lies between 0 and $\pi/2$, (14) shows that the left-hand member is approximately the same as $I_{-n}(y) + I_n(y)$ (even when n is integral). An equation analogous to (15) may be deduced from (15) by changing the sign of i , and holds provided the argument of every power y^m lies between 0 and $-2m\pi$.

Thus, provided y is large and its real part positive, *excluding zero however*, we have the approximate equality

$$I_{-n}(y) + I_n(y) \doteq \left(\frac{2}{\pi y}\right)^{\frac{1}{2}} e^y \dots (15 a),$$

reducing when n is an integer to

$$I_n(y) \doteq (2\pi y)^{-\frac{1}{2}} e^y \dots (15 b).$$

If we define $K_n(x)$ by means of the relation

$$K_n(x) = \pi \frac{I_{-n}(x) - I_n(x)}{2 \sin n\pi},$$

* See equation (26) of the paper referred to above.

equation (14) gives, when x is large and has its argument between $-\pi$ and $+\pi$, the approximate equality

$$K_n(x) \doteq \left(\frac{\pi}{2x}\right)^{\frac{1}{2}} e^{-x} \dots\dots\dots(15 c),$$

whether n be integral or not*.

If $n - \frac{1}{2}$ is a positive integer

$$\frac{x^{-n}}{2^{-n} \prod(-n)} F\left(\frac{1}{2} - n; 1 - 2n; 2x\right),$$

considered as the limit of a function in which $n - \frac{1}{2}$ is not a positive integer, contains a number of terms which are zero, and after these the series begins again, the second set of terms being those of

$$\frac{x^n}{2^n \prod(n)} F\left(\frac{1}{2} + n; 1 + 2n; 2x\right).$$

The equation derivable from (12) by changing the sign of n is then to be replaced by

$$e^x (I_{-n} - I_n) = \frac{x^{-n}}{2^{-n} \prod(-n)} F\left(\frac{1}{2} - n; 1 - 2n; 2x\right) \dots(16),$$

wherein the series on the right is not continued beyond the zero terms. Equations (14) and (16) are now identical †.

We next suppose that in equation (9) $m = n$. We thus have

$$I_n^2 = \frac{x^{2n}}{2^{2n} \{\prod(n)\}^2} F\left(n + \frac{1}{2}; n + 1, 2n + 1; x^2\right) \ddagger \dots\dots(17),$$

another equation derivable from this by changing the sign of n ,
(18),

and $I_n I_{-n} = \frac{1}{\prod(n) \prod(-n)} F\left(\frac{1}{2}; 1 + n, 1 - n; x^2\right) \dots\dots(19).$

The differential equation (1) has now to be replaced by one of the third order of which the series (6) is no longer a solution. The

* I would suggest the desirability of making the I function the fundamental one in analysis instead of the J , at least when the variable is complex; in the case of the former i occurs less frequently explicitly, equation (14) which is fundamental is more easily remembered, and the approximate formulæ (15^b), (15^c) are more easily remembered and better adapted for use in physical problems.

† See Cayley, *Messenger of Mathematics*, Series I., Vol. v., p. 77; Glaisher, *Ibid.*, Vol. viii., p. 20; *Phil. Trans.*, 1881.

‡ This result was given by Lommel, *Math. Annal.*, III., for the case in which n is an integer.

relation connecting the series (5) with the convergent series may be written more conveniently in terms of the J functions

$$\begin{aligned}
 J_n^2(x) + J_{-n}^2(x) - 2 \cos n\pi \cdot J_n(x) J_{-n}(x) \\
 = \frac{2}{\pi} \sin^2 n\pi \cdot x^{-1} \left\{ 1 - \frac{\frac{1}{2}(\frac{1}{2} - n)(\frac{1}{2} + n)}{1 \cdot x^2} \right. \\
 \left. + \frac{\frac{1}{2} \cdot \frac{3}{2}(\frac{1}{2} - n)(\frac{3}{2} - n)(\frac{1}{2} + n)(\frac{3}{2} + n)}{1 \cdot 2 \cdot x^4} + \dots \right\} \\
 = \frac{2}{\pi} \sin^2 n\pi \cdot x^{-1} \phi\left(\frac{1}{2}, \frac{1}{2} - n, \frac{1}{2} + n; -x^{-2}\right) \dots (20),
 \end{aligned}$$

wherein every power x^m has its argument between $-m\pi$ and $+m\pi$. The left-hand member may also be written in the form

$$\sin^2 n\pi \{J_n^2(x) + Y_n^2(x)\}.$$

Thus we see that if P and Q are the divergent series such that

$$\begin{aligned}
 J_n(x) = \left(\frac{2}{\pi x}\right)^{\frac{1}{2}} [P \cos \{(2n + 1)\pi/4 - x\} + Q \sin \{(2n + 1)\pi/4 - x\}], \\
 P^2 + Q^2 = \phi\left(\frac{1}{2}, \frac{1}{2} - n, \frac{1}{2} + n; -x^{-2}\right) \dots (21),
 \end{aligned}$$

or by writing x^2 instead of $-x^{-2}$

$$\begin{aligned}
 \phi\left(\frac{1}{2} + n, \frac{1}{2} - n; 2x\right) \phi\left(\frac{1}{2} + n, \frac{1}{2} - n; -2x\right) \\
 = \phi\left(\frac{1}{2}, \frac{1}{2} + n, \frac{1}{2} - n; +x^2\right) \dots (22);
 \end{aligned}$$

the series in the left-hand member being those on the right of (14). Equations (21), (22) are to be interpreted in the sense that the coefficients of the various powers of x are equal, or in senses obvious from the paper referred to.

From (12), (13), their analogues, and (17), (18), we deduce that

$$\begin{aligned}
 [F\left(\frac{1}{2} + n; 1 + 2n; 2x\right)]^2 \\
 = e^{+2x} F\left(\frac{1}{2} + n; 1 + n, 1 + 2n; x^2\right) \dots (23),
 \end{aligned}$$

$$\begin{aligned}
 F\left(\frac{1}{2} + n; 1 + 2n; 2x\right) F\left(\frac{1}{2} + n; 1 + 2n; -2x\right) \\
 = F\left(\frac{1}{2} + n; 1 + n, 1 + 2n; x^2\right) \dots (24),
 \end{aligned}$$

and

$$\begin{aligned}
 F\left(\frac{1}{2} + n; 1 + 2n; \pm 2x\right) F\left(\frac{1}{2} - n; 1 - 2n; \mp 2x\right) \\
 = F\left(\frac{1}{2}; 1 + n, 1 - n; x^2\right) \dots (25).
 \end{aligned}$$

If $n - \frac{1}{2}$ is a positive integer equation (18) is to be replaced by

$$I_{-n}^2 - I_n^2 = \frac{x^{-2n}}{2^{-2n}(\Pi(-n))^2} F\left(\frac{1}{2} - n; 1 - n, 1 - 2n; x^2\right)^* \dots(26),$$

wherein the series on the right is not continued beyond the zero terms; this equation and (20) are now identical.

In the general case the equations connecting the two divergent series with the four convergent are equivalent to

$$\begin{aligned} & \cos \frac{(m-n)\pi}{2} (J_m J_n + J_{-m} J_{-n}) - \cos \frac{(m+n)\pi}{2} (J_m J_{-n} + J_{-m} J_n) \\ &= \frac{2 \sin m\pi \sin n\pi}{\pi x} \\ & F\left(\frac{1+m+n}{2}, \frac{1+m-n}{2}, \frac{1-m+n}{2}, \frac{1-m-n}{2}; \frac{1}{2}; \frac{-1}{x^2}\right) \\ & \dots\dots\dots(27), \end{aligned}$$

and

$$\begin{aligned} & \sin \frac{(m-n)\pi}{2} (J_m J_n - J_{-m} J_{-n}) - \sin \frac{(m+n)\pi}{2} (J_m J_{-n} - J_{-m} J_n) \\ &= \frac{(m^2 - n^2) \sin m\pi \sin n\pi}{\pi x^2} \\ & F\left(\frac{2+m+n}{2}, \frac{2+m-n}{2}, \frac{2-m+n}{2}, \frac{2-m-n}{2}; \frac{3}{2}; \frac{-1}{x^2}\right) \\ & \dots\dots\dots(28), \end{aligned}$$

wherein the argument of x^2 lies between $-\pi$ and $+\pi$.

We also have as relations equivalent to the above

$$\begin{aligned} & \phi\left(\frac{1}{2} + m, \frac{1}{2} - m; \frac{-1}{2x}\right) \cdot \phi\left(\frac{1}{2} + n, \frac{1}{2} - n; \frac{+1}{2x}\right) \\ &= F\left(\frac{1+m+n}{2}, \frac{1+m-n}{2}, \frac{1-m+n}{2}, \frac{1-m-n}{2}; \frac{1}{2}; \frac{1}{x^2}\right) \\ & + \frac{(m^2 - n^2)}{2x} F\left(\frac{2+m+n}{2}, \frac{2+m-n}{2}, \frac{2-m+n}{2}, \frac{2-m-n}{2}; \frac{3}{2}; \frac{1}{x^2}\right) \dots\dots(29), \end{aligned}$$

and another analogous obtainable by changing the sign of x .

* This result in a different form is given by Lommel, *Math. Annal.*, iv.

By the aid of (12) and (13), equation (9) may now be written in different forms.

Should $m+n$ be an integer one of the analogues of (9) is to be replaced by

$$I_{-m}I_{-n} - I_mI_n = \frac{x^{-m-n}}{2^{-m-n} \Pi(-m) \Pi(-n)}$$

$$F\left(\frac{1-m-n}{2}, \frac{2-m-n}{2}; 1-m-n, 1-m, 1-n; x^2\right) \dots (30)$$

wherein the series on the right is not continued beyond the zero terms. This equation is now identical with (27) or (28) according as $m+n$ is odd or even, the right-hand member of (27) or (28) now terminating.

Should $m-n$ be an integer a similar equation, obtainable by changing the sign of n , holds.

Particular cases of the last equations are the well-known relations

$$J_n J_{-n+1} + J_{-n} J_{n-1} = \frac{2}{\pi x} \sin n\pi,$$

$$J_{n+1} Y_n - J_n Y_{n+1} = \frac{1}{x}.$$

The limiting forms of these various results in case n or m , or both, are positive integers may be obtained in the usual way.

The function (7) is a multiple of

$$(I_{-n} - I_n)(I_{-m} - I_m),$$

and (8) may be either of the two functions obtained from this by changing the sign of x .

On The Reflection of Sound at a Paraboloid. By the Rev. H. J. SHARPE, late Fellow of S. John's College, Cambridge.

[Received June 20, 1899.]

1. A good many years ago I made some experiments on the Reflection of Sound at the surface of two conjugate Parabolic Reflectors, placed coaxially at various distances apart, with their concavities turned towards one another, a watch being placed at the focus of one, and the ear applied at the focus of the other. Fig. 1 (which as regards the paraboloids themselves is drawn to scale) represents the arrangement. For convenience the parts of the reflectors to the left of LL' and to the right of ll' were made removable. The dimensions were as follows in inches,

$$DD' = 44, \quad WA = 26, \quad LL' = 16,$$

$$dd' = 17, \quad ea = 17, \quad ll' = 4.$$

A watch placed at W was heard ticking at e —on one occasion at the extraordinary distance of 186 feet apart. This was on a still night in winter.

2. In the year 1877 I published in No. 57 of *The Quarterly Journal of Mathematics* a Paper on the Mathematical treatment of the subject. That treatment however was very imperfect, and the results, few as they were, were incompletely given.

It should be clearly understood at the outset that neither in the Paper already alluded to nor in the present one is any attempt made to solve the most interesting case of all, viz. that of a single source of sound in the focus of the reflector, a problem which is probably a long way beyond the power of our present methods.

But the present Paper appears to give the solution of the next most interesting case, viz. that in which VW is a line of sources, fig. 1, V , being the vertex of the reflector.

It will presently be seen (Arts. 6, &c.) that the cases here treated require for their full development a complete discussion of both the solutions of the differential equations

$$x \frac{d^2y}{dx^2} + \frac{dy}{dx} + y(x - A) = 0 \dots\dots\dots (1),$$

for all real positive values of x and for all real values of A ,

preference being perhaps given to certain large positive values of A (see Art. 18, &c.) which are nearly proportional to the squares

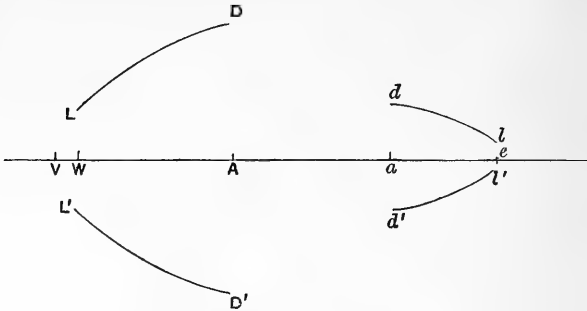

Fig. 1.

of large successive integers. We shall also want the non-logarithmic solution of

$$x \frac{d^2y}{dx^2} + \frac{dy}{dx} + y(x + A) = 0 \dots\dots\dots (2).$$

As in these solutions the ratio x/A may vary from very small to very great, it is obvious that here alone we have a large order in pure mathematical investigation, as it seems likely beforehand that these solutions would take very different forms according to the various magnitudes of the ratio. It will be found (Art. 25, &c.) that special interest, in the case of the equation (1), attaches to the case $x = A$, as this point will be found to determine a focus of reflection in the case of sound falling on the reflector from a distance.

3. From time to time I have published in the *Messenger of Mathematics* Papers discussing equation (2). A good deal of what was there said will apply also to equation (1), but a good deal is inapplicable, and will be supplied, supplemented, or superseded in what follows. To two of these Papers I shall occasionally refer. One in No. 19 of the year 1881 I shall call Paper No. 2, and one in No. 149 of the year 1883 I shall call Paper No. 5.

4. Suppose we have an infinite Parabolic Reflector—I say infinite because it is only to an *infinite* one that the present investigation applies. I shall call the semilatus rectum l . Suppose the origin of three rectangular axes to be at the focus, the axis of x being coincident with the axis of figure, and the positive direction not cutting the surface. Suppose sound motion going

on within and reflected by the reflector. I confine myself to the case where the motion is symmetrical round the axis, and the same in every plane passing through the axis, the expressions for the sound vibrations being functions of x and $(y^2 + z^2)^{\frac{1}{2}}$.

Two different cases now present themselves.

(I.) We can suppose the origin of the sound at an infinite distance along the axis, and the sound falling upon and being reflected by the parabolic surface. The problem here is to discover the law of the magnification of the sound in the reflector, and the position, if they do exist, of foci of reflection. This problem, which may be called that of the Sound-Receiving Reflector, is treated in Arts. 19, &c.

(II.) We can suppose the origin of the sound at a finite distance within the reflector. Here however I confine myself to a special case, viz. that in which (see fig. 2) OL is a line of sources,

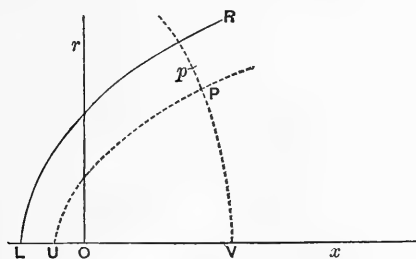

Fig. 2.

RL being the reflector, and L its vertex. Here, as in the former problem, we have to consider not only the sound from the source, but the reflected sound, and we have to find the law of intensity at different distances, especially at great distances. This problem, which may be called that of the Sound-sending Reflector, is considered in Arts. 33, &c.

It fortunately happens however that, before engaging one's self with the difficulties of these Articles, a comparatively simple case presents itself which will be treated in Arts. 1—17.

This will include simple cases of both I. and II., but the results so obtained are not so striking as some of those obtained in the later Articles.

5. In fig. 2 let LR represent a section of half the reflector, whose semilatus rectum is l , O the origin of the xyz coordinates being the focus. Or perpendicular to Ox we may call a sort of

axis of r , where r^2 stands for $y^2 + z^2$. If P be any point within the reflector, whose coordinates are x, y, z , draw through it two confocal and coaxial paraboloids PU, PV . I shall put $2OU = u, 2OV = v$, whence it is evident that u and v define the position of P as well as x, y, z .

I shall not treat the sound from the source and the reflected sound separately, but shall consider them as both included under one velocity-potential F , and if need be, afterwards discriminate between the primary and reflected sound, when it is possible to do so. F satisfies the equation

$$\frac{d^2F}{dx^2} + \frac{d^2F}{dy^2} + \frac{d^2F}{dz^2} = \frac{1}{a^2} \frac{d^2F}{dt^2} \dots\dots\dots (3).$$

We may regard F here as a function of u and v , where

$$u = \rho - x, \quad v = \rho + x, \quad \text{and} \quad \rho^2 = x^2 + y^2 + z^2.$$

For all points within the reflector v will vary from 0 to ∞ , and u will vary from 0 to l . $u = 0$ is the equation to the line $Ox, v = 0$ is the equation to the line OL .

For points on the axis to the right of $O, v = 2x$ and $u = 0$.

For points on the axis to the left of O

$$u = -2x \quad \text{and} \quad v = 0.$$

(3) when transformed becomes

$$\frac{4}{u+v} \left(v \frac{d^2F}{dv^2} + u \frac{d^2F}{du^2} + \frac{dF}{dv} + \frac{dF}{du} \right) = \frac{1}{a^2} \frac{d^2F}{dt^2} \dots\dots (4).$$

For sound motion F will be of the form

$$P \sin mat + Q \cos mat \dots\dots\dots(5).$$

P and Q will each satisfy the equation

$$\frac{4}{u+v} \left(v \frac{d^2P}{dv^2} + u \frac{d^2P}{du^2} + \frac{dP}{dv} + \frac{dP}{du} \right) + m^2P = 0 \dots\dots (6).$$

In nearly all that follows it will be found very convenient to put

$$p \equiv \frac{1}{2}m \dots\dots\dots(7).$$

A particular solution of (6) is $P = UV$ where U is a function of u only and V of v only, and

$$v \frac{d^2V}{dv^2} + \frac{dV}{dv} + (p^2v - A) V = 0 \dots\dots\dots (8),$$

$$u \frac{d^2U}{du^2} + \frac{dU}{du} + (p^2u + A) U = 0 \dots\dots\dots (9),$$

where A is an arbitrary constant.

I shall always call this A , "the original A " (see Art. 6). Throughout a great part of the following investigation, i.e. from Art. 19 to end, it will be supposed to have the *same* large value.

It is easy to shew that the velocity in the direction Pp , fig. 2, or normal to the paraboloid $u = a$ constant is $\frac{dF}{du} \left(\frac{2u}{\rho}\right)^{\frac{1}{2}}$, and as the sound has to be reflected from the paraboloid $u - l = 0$, we must have

$$\frac{dF}{du} = 0 \text{ when } u = l,$$

which leads to $\frac{dU}{du} = 0$, when $u = l$ (10).

It will be seen that the condition (10) determines a value or series of values for A . It remains to solve the equations (8) and (9) with the condition (10), and to find what kind of sound motions they represent. [It is important to notice that if we take as our units 1 foot and 1 second of time p will vary from about $\frac{1}{12}$ for low sounds to about 62 for high sounds.]

6. In nearly all that follows it will be found a great convenience to use new independent variables, and to put

$$pu \equiv u', \quad pv \equiv v', \quad pl \equiv l' \quad \text{and} \quad A/p \equiv A' \text{ (11).}$$

(8) and (9) then become

$$v' \frac{d^2 V}{dv'^2} + \frac{dV}{dv'} + (v' - A') V = 0 \text{ (12),}$$

$$u' \frac{d^2 U}{du'^2} + \frac{dU}{du'} + (u' + A') U = 0 \text{ (13),}$$

from which p has disappeared and (10), the condition of reflection, becomes

$$\frac{dU}{du'} = 0, \text{ when } u' = l' \text{ (14).}$$

In nearly all that follows we shall for convenience *drop the dashes*, but we must be always careful to remember what the new u, v, l and A mean, and in all final results we must remember to restore to the symbols their proper meaning. It will be noticed that when we are experimenting with the sound for which $p = 1$, the old and new symbols are identical. [The note indicated has 357 vibrations in a second, and is very nearly the F just above the middle C of a piano.]

7. Under the above convention then the two solutions of (9) in converging series will be found to be

$$U_1 = 1 - uA + \frac{u^2}{(2!)^2}(A^2 - 1) - \frac{u^3}{(3!)^2}(A^3 - 5A) + \frac{u^4}{(4!)^2}(A^4 - 14A^2 + 9) - \&c.....(15),$$

$$U_2 = U_1 \log u + 2uA + \frac{u^2}{4}(-3A^2 + 1) + \frac{u^3}{108}(11A^3 - 37A) + \&c.....(16).$$

The laws of formation of the coefficients of powers of u are respectively

$$(n + 1)^2 a_{n+1} + Aa_n + a_{n-1} = 0, \\ (n + 1)^2 b_{n+1} + Ab_n + b_{n-1} + 2(n + 1)a_{n+1} = 0.$$

[(13) when reduced to the symbolical form is what Boole calls a trinomial equation, but if we put in it $U = \epsilon^{iu} U_\alpha + \epsilon^{-iu} U_\beta$ where U_α is the same function of u and i which U_β is of u and $-i$, it will be found that the differential equation for finding U_α is binomial and the coefficients of the ascending series for U_α and U_β are easily obtained. When this method is applied to equation (12) I am inclined to think some interesting results might be obtained.]

The complete solution of (13) is of course

$$U = BU_1 + CU_2.....(17)$$

where B and C are arbitrary constants. We should notice that $U_1 = 1$ when $u = 0$, and that $u dU_2/du = 1$, when $u = 0$.

We shall call U_1 and U_2 the 1st and 2nd solutions respectively of (13). The complete solution of (13) in Definite Integrals is

$$U = \frac{1}{\pi} \left(\epsilon^{\frac{1}{2}\pi A} + \epsilon^{-\frac{1}{2}\pi A} \right) \int_0^{\frac{1}{2}\pi} \cos(u \cos \theta + A \log \cot \frac{\theta}{2}) \times \\ \times [B + C \log(u \sin^2 \theta)] d\theta.....(18).$$

This last equation is exactly equivalent to equation (17) the exponential factor being necessary to satisfy the conditions that $U_1 = 1$ and $u dU_2/du = 1$ when $u = 0$.

(18) is got by Laplace's Method: cf. Boole's *Differential Equations*, Chapter XVIII. For the exponential factor cf. De Morgan's *Differential Calculus*, p. 669. Of course V in (12) can be obtained from (15), (16) and (18) by changing u into v , and putting $-A$ for A . Similarly to the above we shall call V_1 and V_2 the 1st and 2nd solutions of (12).

As in what follows we shall not consider the case of $u = 0$ being a line of sources, we shall not want the second solution of (13), but as we shall consider, among other cases, the case (Arts. 13, &c. 33, &c.) of the line $v = 0$ (or OL , fig. 2) being a line of sources, we shall there require the second solution of (12). For U then we may always put $C = 0$ in (17) and (18), and then the condition of reflection (10) gives that A should be one of the roots of the equation

$$\int_0^{\frac{1}{2}\pi} \cos \theta \sin (l \cos \theta + A \log \cot \frac{1}{2} \theta) d\theta = 0 \dots\dots (19).$$

These are all real (Art. 8) and if $u_1, u_2, \&c., v_1, v_2, \&c.$ be the values of U and V corresponding to these various roots, we may put

$$\left. \begin{aligned} P &= a_1 u_1 v_1 + a_2 u_2 v_2 + \&c. \} \\ Q &= b_1 u_1 v_1 + b_2 u_2 v_2 + \&c. \} \dots\dots\dots (20), \end{aligned} \right\}$$

where $a_1, a_2, \&c., b_1, b_2, \&c.$ are arbitrary constants.

8. From (13) it is easy to shew that if u_i, u_j are two values of U corresponding to two different roots A_i, A_j of (19) then

$$\int_0^l u_i u_j du = 0 \dots\dots\dots (21),$$

from which it follows in the usual way that (19) has all its roots real.

9. It is important to remark that in the present Paper I make no attempt to deal in detail with the problem of combining together a number of different solutions given by different values of A as suggested by (20), but having selected a particular value of A generally large, I trace the varying values of a *single* term of (20) for various values of u and v . As we shall generally confine ourselves to points on the axis for which $u = 0$, the chief thing we have now to do is to find the various values of V in (12) for various values of v from 0 to ∞ .

Simple Case when $A = 0$.

10. The most interesting results are obtained, as we shall presently see (Art. 19, &c.), by using large values of A from (19), but before discussing these perhaps it will be well to see under what conditions we may have $A = 0$ in (19). Remembering that after Art. 6, l here means l' we must have

$$\int_0^{\frac{1}{2}\pi} \cos \theta \sin (l' \cos \theta) d\theta = 0 \dots\dots\dots (22),$$

and as l' is the original pl , it means that in this case, only certain sounds whose pitch depends upon the particular reflector used are experimented on. (22) as an equation in l' has an infinite number of real roots. The first 6 roots (which are given on p. 266, Vol. II. of Rayleigh *On Sound*) are 3.832, 7.015, 10.174, 13.324, 16.471, 19.616. For a given value of l the small numbers correspond to the low notes, the large numbers to the high notes, to which the present investigation applies.

11. From (15) putting $A = 0$ we get

$$U_1 = 1 - \frac{u^2}{2^2} + \frac{u^4}{2^2 \cdot 4^2} - \&c. = J_0(u) \dots\dots\dots (23).$$

By Art. 5 the velocity of an air particle normal to any paraboloid $u = a$ constant is

$$2p \frac{dU_1}{du} \times \left(\frac{u}{u+v} \right)^{\frac{1}{2}}$$

multiplied by a time factor. [We must carefully notice that we are using u and v here in the sense of the *second* part of Art. 6, that is for u' and v' .] It is readily seen from (23) that when $u = 0$, that is, when we approach and reach the axis Ox (fig. 3), this velocity vanishes. Any concentration or magnification of the sound as we approach the axis depends mainly on dV_1/dv , to which we next proceed.

12. The value of V is got from (12). We will first consider the significance of the non-logarithmic solution, which is

$$V_1 = 1 - \frac{v^2}{2^2} + \frac{v^4}{2^2 \cdot 4^2} - \&c. = J_0(v) \dots\dots\dots (24).$$

The intensity of the sound at any point on the axis is measured by the velocity along the axis, of the air particle at that point, and this is seen from Art. 5 to be $2pdV_1/dv$ multiplied by a time factor. We can readily shew from (24) that dV_1/dv has a maximum value near the point determined by $v^2 = 8/3$, but whether this gives the absolutely greatest value of dV_1/dv would require a separate investigation to discover. That there is a point on the axis of absolutely greatest sound intensity, or "focus of reflection" as we may call it, we shall see from what follows, but in the case of zero or small values of A , to determine its exact position would probably be a troublesome business, and perhaps not worth while to undertake, as in these cases the magnification of the sound appears to be small.

For large values of v the series (24) is unsuitable for calculation,

and we must substitute for it the semi-convergent series (see Todhunter's *Laplace's Functions*, p. 318),

$$V_1 = \left(\frac{2}{\pi v}\right)^{\frac{1}{2}} \cos\left(v - \frac{\pi}{4}\right) \left\{ 1 - \frac{1^2 \cdot 3^2}{4 \cdot 8} \left(\frac{1}{2v}\right)^2 + \frac{1^2 \cdot 3^2 \cdot 5^2 \cdot 7^2}{4 \cdot 8 \cdot 12 \cdot 16} \left(\frac{1}{2v}\right)^4 - \&c. \right\} + \left(\frac{2}{\pi v}\right)^{\frac{1}{2}} \sin\left(v - \frac{\pi}{4}\right) \left\{ \frac{1^2}{4} \left(\frac{1}{2v}\right) - \frac{1^2 \cdot 3^2 \cdot 5^2}{4 \cdot 8 \cdot 12} \left(\frac{1}{2v}\right)^3 + \&c. \right\} \dots (25),$$

or approximately,

$$V_1 = \left(\frac{2}{\pi v}\right)^{\frac{1}{2}} \cos\left(v - \frac{\pi}{4}\right) \dots (26),$$

but for this to be true we must have, to make the series initially convergent, v much greater than $3\sqrt{2}/16$.

In this case we have stationary vibration, the case of two equal waves which, restoring the old notation, are expressed by

$$\left(\frac{1}{2\pi p v}\right)^{\frac{1}{2}} \left\{ \cos\left(pv - \frac{\pi}{4} - 2pat\right) + \cos\left(pv - \frac{\pi}{4} + 2pat\right) \right\} \dots (27)$$

moving in opposite directions and continually reflected at OL (fig. 2). The intensity of the sound will vary roughly inversely as the distance from O . Also for a given reflector and a given distance from O , low sounds will be more magnified than high ones. Again, we see that on the right hand of a point (see fig. 2) determined, roughly speaking, by $p v = 3\sqrt{2}/16$ (using the old notation, Art. 6), it is possible to discriminate between the two waves, but not on the left, at any rate by the present method.

13. We will next consider the logarithmic solution of (12) which is from (16), putting v for u and $A = 0$

$$V_2 = \left(1 - \frac{v^2}{2^2} + \frac{v^4}{2^2 \cdot 4^2} - \&c.\right) \log v + \frac{v^2}{4} - \frac{3v^4}{128} + \frac{11v^6}{13824} - \&c. \dots (28).$$

Here LO (fig. 2) is a source of sound. We will presently find its strength, but before doing so we will find what (28) becomes when v is large. We know by Todhunter's *Laplace's Functions*, Art. 403, that the *general* solution of (12) when $A = 0$ takes the form

$$V = v^{-\frac{1}{2}} (A_0 + A_1 v^{-1} + A_2 v^{-2} + \&c.) \cos v + v^{-\frac{1}{2}} (B_0 + B_1 v^{-1} + B_2 v^{-2} + \&c.) \sin v \dots (29),$$

where the coefficients $A_1, A_2, \&c., B_1, B_2, \&c.$ can all be determined in terms of A_0 and B_0 which are arbitrary according to the laws

$$\left. \begin{aligned} 2rA_r + \left\{ (r-1)r + \frac{1}{4} \right\} B_{r-1} &= 0 \\ -2rB_r + \left\{ (r-1)r + \frac{1}{4} \right\} A_{r-1} &= 0 \end{aligned} \right\} \dots\dots\dots (30).$$

We know that when (29) is made to coincide with V_1 the non-logarithmic solution of (12) $A_0 = B_0 = \pi^{\frac{1}{2}}$. But when (29) is made to coincide with (28) they will have different values, which we proceed to find.

14. From (18) putting v for u and $A = 0$

$$\begin{aligned} V_2 &= \frac{2}{\pi} \int_0^{\frac{1}{2}\pi} \cos(v \cos \theta) \cdot (\log v + 2 \log \sin \theta) d\theta \\ &= V_1 \log v + \frac{4}{\pi} \int_0^{\frac{1}{2}\pi} \cos(v \cos \theta) \cdot \log \sin \theta d\theta \dots (31). \end{aligned}$$

The approximate value of V_1 for v large is known from (26), and we have to find the value of the last definite integral. If we divide it up into two parts, integrating first from 0 up to a small finite angle θ_1 and then from θ_1 up to $\frac{1}{2}\pi$, we shall find when v becomes large that the first part ultimately varies as $v^{-\frac{1}{2}}$, and the second part as v^{-1} . Consequently the first part is of most importance, and we shall get in the limit

$$\begin{aligned} V_2 &= \frac{\log 2}{(\pi v)^{\frac{1}{2}}} (\cos v + \sin v) + \frac{4}{\pi} \left(\frac{2}{v} \right)^{\frac{1}{2}} \times \\ &\quad \times \int_0^{\infty} \cos(v - x^2) \cdot \log x dx \dots\dots\dots (32), \end{aligned}$$

from which we notice that $\log v$ as a multiplier has disappeared. If then the value of V from (29) is to coincide with V_2 the logarithmic solution of (12) we must have

$$\left. \begin{aligned} A_0 &= \frac{\log 2}{\pi^{\frac{1}{2}}} + \frac{4 \times 2^{\frac{1}{2}}}{\pi} \int_0^{\infty} \cos x^2 \cdot \log x dx \\ B_0 &= \frac{\log 2}{\pi^{\frac{1}{2}}} + \frac{4 \times 2^{\frac{1}{2}}}{\pi} \int_0^{\infty} \sin x^2 \cdot \log x dx \end{aligned} \right\} \dots\dots\dots (33).$$

15. To evaluate the Definite Integrals in the last equations it is best to break them up into three parts, integrating from 0 up to 1, from 1 to ϵ , and from ϵ to ∞ . It is thus easy to shew that each of the integrals in (33) lies between $\pm(1 + 1/\epsilon)$. We shall find that

$$\int_0^{\epsilon} \cos x^2 \cdot \log x dx = -\frac{4\epsilon^5}{5^2 \underline{2}} + \frac{8\epsilon^9}{9^2 \underline{4}} - \frac{12\epsilon^{13}}{13^2 \underline{6}} + \&c.$$

Ten terms of this series give us, I believe, about .061.

The third part $\int_{\epsilon}^{\infty} \cos x^2 \cdot \log x dx$ is the most troublesome.

By breaking it up into two parts from ϵ to $(5\pi/2)^{\frac{1}{2}}$, and from $(5\pi/2)^{\frac{1}{2}}$ to ∞ , we can express each part in converging, but rather complicated, series. By the following plan, however, we can make a rough approximation to the value of the integral.

Integrating by parts so as to get descending powers of x we get series which soon diverge, but which begin by converging. The result is $-.164$ with an error that cannot exceed $\pm .02$.

Thus
$$\int_0^{\infty} \cos x^2 \cdot \log x dx = -.104 \text{ nearly.}$$

The other integral in (33) can be treated in a similar manner.

16. By combining equations (26) and (32) we can express

$$\cos v \cdot /v^{\frac{1}{2}} \text{ and } \sin v \cdot /v^{\frac{1}{2}}$$

as known linear functions of V_1 and V_2 . Thus restoring the original notation in (5) P and Q can be chosen as the *same known* multiple of

$$\cos pv/(pv)^{\frac{1}{2}} \text{ and } \sin pv/(pv)^{\frac{1}{2}} \text{ respectively,}$$

and we have a *single outgoing wave*. It appears from (26) and (32) that the amplitude of this wave will be larger the more nearly the integrals in (33) agree in value.

17. To get the strength of the source we must first find the rate at which air crosses an element Pp (fig. 2) of the paraboloid PV . F being the velocity potential, and using the old notation this will be found to be $2\pi v du \times dF/dv$. We must then put $v=0$ and integrate with regard to u from 0 up to the original l the semi-latus rectum of the reflector. The result will be (remembering that from Art. 7 $vdV_2/dv=1$ when $v=0$, and for brevity omitting the time factor)

$$2\pi \int_0^l U_1 du.$$

At any given point in LO the strength will be proportional to

$$u \left(1 - \frac{p^2 u^2}{2^2 \cdot 3} + \frac{p^4 u^4}{2^2 \cdot 4^2 \cdot 5} - \&c. \right).$$

The series begins to converge at once for points where $p^2 u^2 < 12$. It will be readily seen that the strength is a maximum near the point where $pu = 2$, and that this point of maximum strength is

nearer the geometrical focus, the larger be p , that is, the higher the note experimented on.

18. We observe from Art. 10 that for a given value of l we have an infinite series of values of p from small to large, for which $A = 0$. It seems very likely then that for intermediate values of p , whether small or large, we should always have some corresponding *small* values of A satisfying (19), and that the solution for these small values of A would resemble pretty much numerically that for which $A = 0$, only involving more complicated definite integrals.

Before, however, leaving the subject of the zero and small values of A we may notice another simple and interesting maximum proposition. From (15) supposing A not to be zero, and making the requisite changes, we shall get

$$V_1' = A + \frac{2v}{(2!)^2} (A^2 - 1) + \frac{3v^2}{(3!)^2} (A^5 - 5A) + \&c.,$$

$$V_1'' = \frac{2}{(2!)^2} (A^2 - 1) + \frac{6v}{(3!)^2} (A^5 - 5A) + \&c.,$$

$$V_1''' = \frac{6}{(3!)^2} (A^5 - 5A) + \&c.$$

Suppose for a moment we can have $A = 1$. What this entails will be seen presently. But if $A = 1$, V_1'' will vanish if $v = 0$, and then V_1''' is negative. So that if $A = 1$, V_1' is a maximum at $v = 0$, that is, the intensity of the sound is a maximum at the geometrical focus of the reflector. From (19) we see that if $A = 1$, then (Art. 6), restoring the original notation, we shall get

$$\int_0^{\frac{1}{2}\pi} \cos \theta \sin (pl \cos \theta + \log \cot \frac{1}{2}\theta) d\theta = 0.$$

If we regard l as given, this equation will give us an infinite number of values of p , but inasmuch as p , in the case of all *audible* sounds, is restricted between definite limits $\frac{1}{12} < p < 62$, we see that we shall only get a finite number of sounds to satisfy the equation, but of course these sounds range from the lower to the higher parts of the scale—limited of course by the value of l chosen. For all these, A being = 1, the intensity of the sound is a maximum at the geometrical focus. Of course, as in Art. 12, it does not follow that the geometrical focus is the point of absolutely greatest sound intensity.

Case of A large. Source Distant. Sound Receiving Reflector.

19. In order to get the large roots of equation (19) in A we must first find what (15) becomes for moderate values of u and large values of A . Fortunately we are able to do this with comparative ease, without even referring to the definite integral solution of (13). Drop the dashes in (13). Divide (13) by A , put

$$Au \equiv z \dots\dots\dots(34),$$

and we get

$$z \frac{d^2U}{dz^2} + \frac{dU}{dz} + \left(\frac{z}{A^2} + 1\right) U = 0 \dots\dots\dots(35).$$

Now as we here suppose u/A , that is z/A^2 , small, we see that the smaller u/A is, the more nearly does the last equation pass into

$$z \frac{d^2U}{dz^2} + \frac{dU}{dz} + U = 0 \dots\dots\dots(36).$$

This gives us the clue to the required solution of (35), for if we call Z the non-logarithmic solution of (36) we know that

$$Z = 1 - z + \frac{z^2}{(2!)^2} - \frac{z^3}{(3!)^2} + \&c. \equiv J_0(2z^{\frac{1}{2}}) \dots\dots(37).$$

But if we look at the assemblage of first terms in the brackets in equation (15) we shall see the series (37). In my Papers in the *Messenger* referred to in Art. 3, I shew that equation (15) can be arranged in the following form:

$$U_1 = [1 + u^2(\frac{1}{3}d + \frac{1}{6}d^2) + u^4(\frac{1}{18}d^2 + \frac{37}{90}d^3 + \frac{7}{360}d^4) + \&c.] Z \dots(38),$$

where d stands for d/dz . (38) is obtained thus: First collect into one sum all the 1st terms in the brackets in (15) and we get Z , then all the 2nd terms into one sum and we get $u^2(\frac{1}{3}d + \frac{1}{6}d^2)Z$, and so on with the 3rd terms, till the series (15) is exhausted. By Art. 408 of Todhunter's *Laplace's Functions (TLF)* we know that for large values of A , and therefore of z , Z can be expressed in a semi-convergent series of descending powers of z . The leading term in this expansion is

$$\cos \{2z^{\frac{1}{2}} - \frac{1}{4}\pi\} / z^{\frac{1}{4}}\pi^{\frac{1}{2}},$$

and from the form of this we see by performing a few differentiations that the larger z or A be, the more nearly does (38) coincide with the value of its 1st term Z . We see then that if A be taken large enough, we can write down

$$U_1 = \frac{\cos \{2(Au)^{\frac{1}{2}} - \frac{1}{4}\pi\}}{(Au)^{\frac{1}{4}} \times \pi^{\frac{1}{2}}} \dots\dots\dots(39),$$

and the condition of reflection (10) gives us

$$2 (Al)^{\frac{1}{2}} - \frac{1}{4}\pi = n\pi \dots\dots\dots(40),$$

where n is a large positive or negative integer.

We see thus that the large values of A are nearly proportional to the squares of large natural numbers. We must also remember (Art. 6) that Al in (40) stands for $A'l'$, and that this again is equal to the *original* Al . We see thus that the large values of the original A are nearly independent of p , that is, of the note experimented on. We say 'nearly' for a reason which will presently appear.

We note also that for a given value of n , A will be the larger, the smaller be l .

We note also that the series (38) virtually ascends by powers of $u^2/(Au)^{\frac{1}{2}}$ that is, by powers of $u^{\frac{3}{2}}/A^{\frac{1}{2}}$.

In order then that (39) should be an accurate approximation it is necessary that $u^{\frac{3}{2}}/A^{\frac{1}{2}}$ should be a small fraction. Of course from (40) the same must be true of $l^{\frac{3}{2}}/A^{\frac{1}{2}}$.

Remembering (Art. 6) what u and A here mean will account for the use of the word 'nearly' above.

The result (39) can also be obtained in a totally different manner. See end of Art. 22.

Before leaving that part of the subject connected more especially with the values of U and dU/du we may notice that by Art. 5 the velocity of an air particle normal to a paraboloid $u = a$ constant is [now using u and v in their original sense (Art. 6)]

$$= 2V \frac{dU}{du} \left(\frac{u}{u+v} \right)^{\frac{1}{2}} \times (\text{time factor});$$

when $u = 0$ this velocity vanishes, shewing that there is no discontinuity at the axis. Again, by Art. 5 the velocity normal to a paraboloid $v = a$ constant is

$$= 2U \frac{dV}{dv} \left(\frac{v}{u+v} \right)^{\frac{1}{2}} \times (\text{time factor}) \dots\dots\dots(40a).$$

Supposing that we keep on this particular paraboloid and approach the axis, it is interesting to see whether this last velocity increases or diminishes. Supposing u so small that in (15) the smallness of the u overpowers the largeness of the A , then it is plain from the 2nd term of (15) that as we approach the axis ($u = 0$) U_1 increases. Further, as u diminishes $(u+v)^{-\frac{1}{2}}$ increases, therefore on the whole as we approach the axis the velocity (40a) always increases, that is, *there is always a concentration of sound in the neighbourhood of the axis.*

20. Remembering (Art. 7) that V_1 is derived from (15) by changing u into v and A into $-A$, we will next see what V_1 becomes for moderate values of v and large value of A . Here we follow closely the method of reasoning used in the preceding article. We have

$$V_1 = 1 + vA + \frac{v^2}{(2!)^2}(A^2 - 1) + \frac{v^3}{(3!)^2}(A^3 - 5A) + \frac{v^4}{(4!)^2}(A^4 - 14A^2 + 9) + \&c. \dots\dots(41).$$

For brevity drop the dashes in (12). Divide (12) by A , put $Av \equiv z$ and we get

$$z \frac{d^2V}{dz^2} + \frac{dV}{dz} + \left(\frac{z}{A^2} - 1\right)V = 0 \dots\dots\dots(42).$$

Now the smaller we suppose v/A to be, the more nearly does the last equation pass into

$$z \frac{d^2V}{dz^2} + \frac{dV}{dz} - V = 0 \dots\dots\dots(43).$$

[If we here put $z = a$ new variable $\frac{x^2}{4}$, (43) reduces to an equation so elaborately discussed by Sir G. Stokes in Art. 20 of his Paper "On the Discontinuity of Arbitrary Constants that appear in Divergent Developments."]

If we call Z the non-logarithmic solution of (43)

$$Z = 1 + z + \frac{z^2}{(2!)^2} + \frac{z^3}{(3!)^2} + \&c. = J_0 \{2(-z)^{\frac{1}{2}}\} \dots\dots(43a),$$

and this represents the assemblage of the 1st terms in the brackets in equation (41) and V_1 takes the form

$$V_1 = [1 + v^2(-\frac{1}{3}d + \frac{1}{6}d^2) + v^4(\frac{1}{18}d^2 - \frac{3}{90}d^3 + \frac{7}{360}d^4) + \&c.] Z \dots(44).$$

For moderate values of v and large values of A this reduces to its first term Z . We can easily shew that

$$Z = \frac{1}{\pi} \int_0^\pi \epsilon^{-2z^{\frac{1}{2}} \cos \phi} \times d\phi \dots\dots\dots(45).$$

To evaluate this integral for large values of z break it up into two parts, from 0 up to $\pi/2$ and from $\pi/2$ up to π . It is readily shewn that the 1st integral = $1/2z^{\frac{1}{2}}$ and that the second integral

$$= \int_0^{\frac{\pi}{2}} \epsilon^{2z^{\frac{1}{2}} \cos \phi} \times d\phi.$$

The most important part of this integral is near $\phi = 0$. Evaluating in the usual way, we shall finally get when z is large

$$Z = \frac{e^{2z^{\frac{1}{2}}}}{2z^{\frac{1}{2}}\pi^{\frac{1}{2}}} \text{ or } V_1 = \frac{e^{2(Av)^{\frac{1}{2}}}}{2\pi^{\frac{1}{2}}(Av)^{\frac{1}{2}}} \dots\dots\dots(46).$$

We may compare (46) with (39). (46) is true only if $v^{\frac{3}{2}}/A^{\frac{1}{2}}$ is a small fraction. For some further observations on (46) see Art. 32.

21. The following is another way of getting the result (46). We see from (41) that V_1 can be expressed thus,

$$V_1 = Z_0 + v^2 Z_2 + v^4 Z_4 + \&c. + v^n Z_n + \&c.,$$

where n is even, and $Z_0 Z_2, \&c.$ are functions of z . Putting this in (12), having for brevity dropped the dashes, and being careful always to substitute z/v for A , wherever A occurs, it will be found that we shall get

$$zZ_0'' + Z_0' - Z_0 = 0 \dots\dots\dots(47),$$

$$z^2 Z_2'' + Z_2' (3 + 2z) + (4 - z) Z_2 = 0,$$

and generally

$$n^2 Z_n'' + Z_n' (n + 1 + nz) + (n^2 - z) Z_n + Z_{n-2} = 0 \dots\dots(48).$$

Now we know from (41) that $Z_0, Z_2, \&c.$ are all series ascending by positive integral powers of z , but (48) gives us the law of their connexion and formation. Comparing (47) with (43) we see that $Z_0 = Z_1$ as defined in (43 a). The rest of the argument is the same as in Art. 20.

22. But yet another way must be mentioned of obtaining the result (46), as it throws important light on the whole subject. In (12) dropping the dashes, put

$$V = C e^w \dots\dots\dots(49),$$

where C is a constant whose value will presently be found, and w is a new function of v .

We shall have

$$v \left\{ \frac{d^2 w}{dv^2} + \left(\frac{dw}{dv} \right)^2 \right\} + \frac{dw}{dv} + v - A = 0 \dots\dots\dots(50).$$

Assume, to satisfy this equation

$$w = A^{\frac{1}{2}} v_{-1} + v_0 + \frac{v_1}{A^{\frac{1}{2}}} + \frac{v_2}{A} + \frac{v_3}{A^{\frac{3}{2}}} + \&c.,$$

and, remembering that A is supposed large, determine the functions $v_{-1}, v_0, v_1, \&c.$ by the condition that the successive powers

of A shall vanish in the result. It will be found that we shall get

$$w = \pm 2 (Av)^{\frac{1}{2}} - \frac{1}{4} \log v \mp \frac{\frac{1}{3}v^2 - \frac{1}{16}}{(Av)^{\frac{3}{2}}} + \frac{\frac{1}{4}v^2 + \frac{1}{64}}{Av} \pm \&c. \dots(51),$$

the upper signs going together and the lower together. Each will be found to give solutions of (12). This may be shewn thus. Confining ourselves only for the moment to the two first or leading terms in (51), if we put for V in (12) $\epsilon^c (Av)^{\frac{1}{2}}/v^{\frac{1}{2}}$, where c is a constant, and retain only the most important terms, we shall find that the leading term in the result is multiplied by $(c^2 - 4)$, and is therefore caused to vanish by $c = \pm 2$. By comparing (51) with (46) we see that the upper sign in the leading term of (51) gives the leading term in V_1 . It follows therefore that the lower signs in (51) must give us V_2 . The value of C in (49) for the 1st solution of (12) is evidently $\frac{1}{2}\pi^{-\frac{1}{2}}A^{-\frac{1}{2}}$ as we see from (46). The result (51) suggests another method of getting (perhaps in the most convenient form for calculation) solutions of (12) adapted to the case of v moderate and A large, we might assume in (12)

$$V = C\epsilon^{\pm 2(Av)^{\frac{1}{2}} - \frac{1}{4} \log v} \times \left\{ 1 + \frac{w_1}{A^{\frac{1}{2}}} + \frac{w_2}{A} + \frac{w_3}{A^{\frac{3}{2}}} + \&c. \right\} \dots\dots(52),$$

and we could then determine $w_1, w_2, \&c.$ as functions of v .

The result (39) can also be obtained by the method employed in this Article.

23. We will now proceed to find what V_1 in (12) becomes, when v is large and A moderate, and it will be found that the method is applicable to the case of both large, but A^2/v small.

In (12) put

$$V_1 = \epsilon^{iv} w_1 + \epsilon^{-iv} w_2 \dots\dots\dots(53),$$

where w_1 is the same function of v and i as w_2 is of v and $-i$. In the result equate to 0 the coefficients of ϵ^{iv} and ϵ^{-iv} . Then

$$v \frac{d^2 w_1}{dv^2} + \frac{dw_1}{dv} (2iv + 1) + (-A + i) w_1 = 0 \dots\dots\dots(54),$$

w_2 satisfies a similar equation with the sign of i changed.

Solving (54) in descending powers of v we shall get

$$\epsilon^{iv} w_1 = \alpha_0 \epsilon^{iv} \times v^{-\frac{1}{2}(1+Ai)} \left[1 - \frac{(1+Ai)^2}{2^2} \times \frac{i}{2v} + \frac{(1+Ai)^2(3+Ai)^2}{2^4(2!)} \right. \\ \left. \times \left(\frac{i}{2v}\right)^2 - \frac{(1+Ai)^2(3+Ai)^2(5+Ai)^2}{2^6(3!)} \times \left(\frac{i}{2v}\right)^3 + \&c. \right] \dots\dots(55).$$

We thus get two independent real solutions of (12). Confining ourselves then to the leading term we may write approximately

$$V_1 = \frac{B}{v^{\frac{1}{2}}} \cos(v - \frac{1}{2}A \log v) + \frac{C}{v^{\frac{1}{2}}} \sin(v - \frac{1}{2}A \log v) \dots\dots(56),$$

where B and C are constants which must be determined by comparing (56) with the definite integral solution of (12) adapted to the case of v large. Before doing so, however, we may notice that the series (55) is adapted also to the case of A large as well as v large, provided that A^2/v be small. This remark is important because, whilst using large values of v we may at the same time use large values of A if the above condition is satisfied.

24. We now proceed to find the value of B and C in (56). From (18) we have

$$V_1 = \frac{1}{\pi} (\epsilon^{\frac{1}{2}\pi A} + \epsilon^{-\frac{1}{2}\pi A}) \int_0^{\frac{1}{2}\pi} \cos\left(v \cos x - A \log \cot \frac{x}{2}\right) dx \dots\dots(57).$$

We must find what this becomes for large values of v and moderate values of A and compare the result with (56).

If my memory serves me right, I am indebted to Sir G. Stokes for the following idea. At any rate he employs the very same method in Note * on Art. 9 of his "Numerical Calculation of a Class of Definite Integrals and Infinite Series."

Trace the curve in x and y , whose equation is

$$y = v \cos x - A \log \cot \frac{x}{2},$$

whence
$$dy/dx = -v \sin x + \frac{A}{\sin x},$$

from $x = 0$ to $x = \pi/2$. It will have some such form as is found in fig. 3. dy/dx will be everywhere numerically very large except in the immediate neighbourhood of Q , where there is a maximum ordinate. If α be the value of x at Q

$$\sin^2 \alpha = A/v \dots\dots\dots(58).$$

On account of the rapid fluctuation in other parts, the most important part of the integral for v large will be for a small range of values of x to the left and right of Q . Accordingly to get the value of V_1 for v large, put in (57) $x = \alpha + \phi$, and integrate with regard to ϕ from $-\phi_1$ to $+\phi_1$ where ϕ_1 is a small finite angle.

If I be the integral in (57) we shall get, retaining powers of ϕ not beyond the 2nd,

$$I = \int_{-\phi_1}^{\phi_1} \cos \left[v \cos \alpha - A \log \cot \frac{\alpha}{2} - v \cos \alpha \cdot \phi^2 \right] d\phi.$$

As far as this goes the terms in the bracket are accurate. To

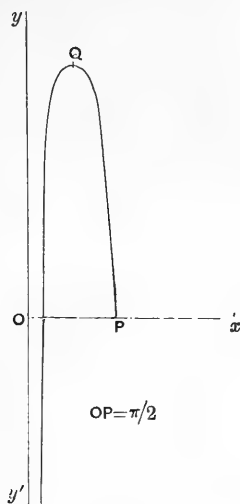

Fig. 3.

get further in the direction of (56) we must approximate, when we shall get

$$I = \int_{-\phi_1}^{\phi_1} \cos [v - \frac{1}{2}A \log v + C_1 - v\phi^2] d\phi,$$

where $C_1 = A \log (\frac{1}{2}A^{\frac{1}{2}}\epsilon^{-\frac{1}{2}}) \dots\dots\dots(59).$

The final result will be that in (56)

$$\left. \begin{aligned} B &= 2^{-\frac{1}{2}}\pi^{-\frac{1}{2}} (\epsilon^{\frac{1}{2}\pi A} + \epsilon^{-\frac{1}{2}\pi A}) (\cos C_1 + \sin C_1) \\ C &= 2^{-\frac{1}{2}}\pi^{-\frac{1}{2}} (\epsilon^{\frac{1}{2}\pi A} + \epsilon^{-\frac{1}{2}\pi A}) (\cos C_1 - \sin C_1) \end{aligned} \right\} \dots\dots(60),$$

where C_1 is given by (59). Here of course the exponential factor, if A be large (as it may be, provided that A^2/v be small) indicates the magnification of the sound at the point considered. As in Art. 12 so (56) indicates stationary vibration and we have two equal and opposite waves, which are continually reflected at OL fig. 2. The amplitude is $(B^2 + C^2)^{\frac{1}{2}}/v^{\frac{1}{2}}$ or if A be large,

$$\text{amplitude} = \epsilon^{\frac{1}{2}\pi A}/2^{\frac{1}{2}}\pi^{\frac{1}{2}}v^{\frac{1}{2}}\dots\dots\dots(61).$$

25. We will now compare together the two solutions (46) and (61).

Remembering (Art. 5) that the original A and so the present

A is supposed to remain the same large quantity throughout this investigation, in fig. 4, LR being the reflector and Ox its axis.

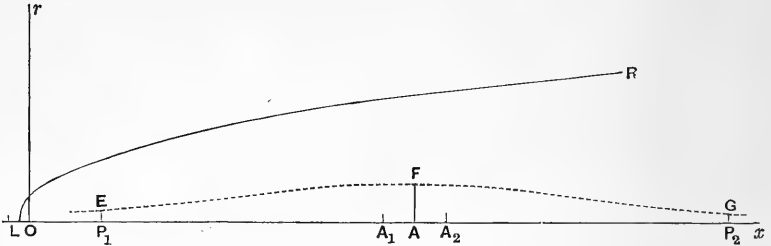

Fig. 4.

Let P_1 be a point for which v/A is small.

P_2 be a point for which v/A is large.

A_1 and A_2 points for which $v/A = \mu$ moderate, but v and A both large.

A be a point for which $v = A$.

The value of V_1 at P_1 is given by (46) which increases as v increases.

The value of V_1 at P_2 is given by (61) which decreases as v increases.

Suppose the ordinates of the curve EFG to represent roughly the values of V_1 at the various points of the axis at which they are taken, then the curve will take some such form as that shown in the figure, and we might surmise that there might be a maximum ordinate somewhere about A that is somewhere about midway between P_1 and P_2 , and we shall find presently (Art. 29) that this surmise is verified. But here a caution is necessary. In the present investigation one of the most interesting things is to endeavour to find the point on the axis where *the sound has greatest intensity*, but we must remember that this intensity is not measured by V_1 at any point, but (Art. 5) by $2dV_1/dv$, which multiplied by a time factor gives us the *velocity of the air particle* at the point considered. If then we suppose the ordinates of the curve to represent, not V_1 but dV_1/dv , it will be found that the curve will have the same general form as before, and in the following articles we will shew that dV_1/dv has its maximum value at a point a little to the left of A .

26. We will first examine the value of V_1 at a point A_1 (fig. 4) to the *left* of A . In (12) drop the dashes and put

$$v = A\mu \dots \dots \dots (62),$$

where μ is a new variable and v and A are both supposed to be large and μ of moderate value, (12) becomes

$$\mu \frac{d^2V}{d\mu^2} + \frac{dV}{d\mu} - A^2V(1 - \mu) = 0 \dots\dots\dots(63).$$

In this equation put

$$V = C\epsilon^z \dots\dots\dots(64),$$

where z is a function of μ , and C a constant to be determined. (63) becomes

$$\mu \left\{ \frac{d^2z}{d\mu^2} + \left(\frac{dz}{d\mu} \right)^2 \right\} + \frac{dz}{d\mu} - A^2(1 - \mu) = 0 \dots\dots\dots(65).$$

Assume, to satisfy this equation

$$z = Az_{-1} + z_0 + \frac{z_1}{A} + \frac{z_2}{A^2} + \&c. \dots\dots\dots(66),$$

where $z_{-1}, z_0, \&c.$ are functions of μ . Putting this in (65) and equating to 0 the various powers of A we shall have

$$\left. \begin{aligned} \mu (z'_{-1})^2 - (1 - \mu) &= 0 \\ (\mu d^2 + d) z_{-1} + 2\mu z'_{-1} z'_0 &= 0 \\ (\mu d^2 + d) z_0 + \mu \{ (z'_0)^2 + 2z'_{-1} z'_1 \} &= 0 \\ (\mu d^2 + d) z_1 + 2\mu \{ z'_{-1} z'_2 + z'_0 z'_1 \} &= 0 \\ (\mu d^2 + d) z_2 + \mu \{ (z'_1)^2 + 2(z'_{-1} z'_3 + z'_0 z'_2) \} &= 0, \&c. \end{aligned} \right\} \dots\dots\dots(67),$$

where $d = d/d\mu$ and dashes denote differentiation with regard to μ . When A is large, (66) practically reduces to its first term, so that in (12) for v and A both large and $v = A\mu$ (μ moderate) we may approximately put $V = C\epsilon^{Az-1}$. But from the 1st of equations (67) z'_{-1} vanishes when $\mu = 1$, so that V seems to be a maximum when $\mu = 1$, but we shall presently see that this is not strictly true.

Solving the equations (67) [and putting "exp. z " for ϵ^z when z is complicated] we shall get

$$V = \frac{C}{\mu^{\frac{1}{2}}(1 - \mu)^{\frac{1}{2}}} \times \exp. \left[\pm \{ \sin^{-1} \mu^{\frac{1}{2}} + \mu^{\frac{1}{2}}(1 - \mu)^{\frac{1}{2}} \} A \mp \frac{1}{48} \times \right. \\ \left. \times \frac{4\mu^2 - 12\mu + 3}{\mu^{\frac{1}{2}}(1 - \mu)^{\frac{3}{2}}} \times \frac{1}{A} + \frac{1}{64} \times \frac{4\mu^2 + 1}{\mu(1 - \mu)^3} \times \frac{1}{A^2} \pm \&c. \right] \dots\dots\dots(68).$$

We get two solutions, the upper signs going together and the lower together. It will presently be shewn that the upper signs in (68) correspond to the 1st or non-logarithmic solution of (12).

It will at once be seen that, whilst μ must lie between 1 and 0, it must not lie *excessively* near either of them or the solution (68) would fail. The case of v/A being very small was treated in Art. 20. The case of v/A being very near or equal to 1 will be treated in Art. 30.

Since from the 1st of equations (67), $(z'_{-1})^2 = \mu^{-1} - 1$, which makes the resulting value of z''_{-1} negative, we see that for points for which μ increases from near 0 to near 1, the curve for V (Art. 25) is *concave* to the axis, and z_{-1} continually increases. Again, looking at the outside factor in (68) we notice that $\mu = \frac{1}{2}$ makes $\mu(1 - \mu)$ a maximum, and that as μ increases from $\frac{1}{2}$ to near 1, $\mu(1 - \mu)$ continually decreases. For a double reason therefore, as μ approaches 1, the leading term of V continually increases. But it is important to notice that we cannot conclude that V or V' is actually a maximum when $\mu = 1$, because in that case (68) fails. We shall see what really happens further on (Arts. 29, 30).

Next, to distinguish between the two solutions (68) and to find the value of C we will compare it with the result (46). To do so, we must suppose in (68) μ to be much nearer zero than one. Keeping to the upper signs and considering only the leading term we get

$$V = \frac{C}{\mu^{\frac{1}{2}}} \epsilon^{2\mu^{\frac{1}{2}}A} = \frac{CA^{\frac{1}{2}}}{v^{\frac{1}{2}}} \times \epsilon^{2(Av)^{\frac{1}{2}}}.$$

Comparing with (46) we see that if (68) is to represent V_1 , the non-logarithmic solution of (12), we must have in (68)

$$C = 1/2\pi^{\frac{1}{2}}A^{\frac{1}{2}} \dots\dots\dots(69).$$

27. We will next examine the value of V_1 at a point A_2 (fig. 4) to the *right* of A . Proceeding exactly as in Art. 26, we put in (12) $v = A\mu$, but μ is now greater than 1, and it will be found that the solution, instead of taking an exponential, will now take a *trigonometrical* form, in which (for the 1st time since leaving O (fig. 4) and moving along the axis) we are able to distinguish between the incoming and the outgoing wave. In (64) z instead of being real, is now complex, and we shall find that $z_0, z_2, z_4, \&c.$ are pure imaginaries. The final result may be written in the following form

$$V = \frac{1}{\mu^{\frac{1}{2}}(\mu - 1)^{\frac{1}{2}}} \times \epsilon^{-\{v_2A^{-2} + v_4A^{-4} + \&c.\}} \times \left[B_2 \cos \left(Az_{-1} + \frac{z_1}{A} + \frac{z_3}{A^3} + \&c. \right) + C_2 \sin \left(Az_{-1} + \frac{z_1}{A} + \frac{z_3}{A^3} + \&c. \right) \right] \dots\dots(70),$$

where

$$\left. \begin{aligned} z_{-1} &= \mu^{\frac{1}{2}}(\mu - 1)^{\frac{1}{2}} - \log \frac{\mu^{\frac{1}{2}} + 1 + (\mu - 1)^{\frac{1}{2}}}{\mu^{\frac{1}{2}} + 1 - (\mu - 1)^{\frac{1}{2}}}, \\ v_2 &= \frac{1}{64} \times \frac{4\mu^2 + 1}{\mu(\mu - 1)^3}, \\ z_1 &= -\frac{1}{48} \times \frac{4\mu^2 - 12\mu + 3}{\mu^{\frac{1}{2}}(\mu - 1)^{\frac{3}{2}}}, \text{ \&c.} \end{aligned} \right\} \dots\dots(71).$$

The two solutions are of course indicated by the two arbitrary constants B_2 and C_2 . First we notice that, keeping A constant, if we increase μ , that is, if (fig. 4) we move from A outwards or to the right hand, V is diminished, again showing us that the *maximum value of V must be somewhere in the neighbourhood of A* . The point A is a kind of critical point. On the left of it the solution takes an exponential, on the right a trigonometrical form.

By comparing (70) with (56) we may determine B_2 and C_2 in (70) so as to make V in (70) coincide with V_1 the non-logarithmic solution of (12). This is shewn thus. By a method exactly similar to that employed in my Paper in the *Messenger* referred to in Art. 3 (viz. New Series, No. 149, Sept. 1883) it can be shewn that (70) is not only true for μ moderate and A and v large, but also for two other cases (1) for μ large and A moderate, (2) for μ large and A large. We will apply it to this second case—that is, to a point like P_2 (fig. 4). Supposing then μ large in (70) and confining ourselves only to the leading terms, outside and inside the square brackets, we shall get

$$\begin{aligned} V_1 &= \frac{1}{\mu^{\frac{1}{2}}} \left[B_2 \cos A \{ \mu - \log (2\mu^{\frac{1}{2}}) \} + C_2 \sin A \{ \mu - \log (2\mu^{\frac{1}{2}}) \} \right] \\ &= \frac{A^{\frac{1}{2}}}{v^{\frac{1}{2}}} \times \left[B_2 \cos \{ v - \frac{1}{2}A \log v + A \log (\frac{1}{2}A^{\frac{1}{2}}) \} + C_2 \sin \{ \text{ditto} \} \right], \end{aligned}$$

which practically agrees with (56). Comparing this with (60) we get

$$\begin{aligned} B_2 &= (2\pi A)^{-\frac{1}{2}} \times (\epsilon^{\frac{1}{2}\pi A} + \epsilon^{-\frac{1}{2}\pi A}) (\cos C_1 + \sin C_1) \} \\ C_2 &= (2\pi A)^{-\frac{1}{2}} \times (\epsilon^{\frac{1}{2}\pi A} + \epsilon^{-\frac{1}{2}\pi A}) (\cos C_1 - \sin C_1) \} \dots\dots(72), \end{aligned}$$

where C_1 is given by (59).

28. We will next find the values of V_1 and dV_1/dv at A (fig. 4), *i.e.* for $v = A$, both v and A being supposed large. This is best got from the definite integral solution (57).

Put W_1 for $\int_0^{\frac{1}{2}\pi} \cos \left(v \cos x - A \log \cot \frac{x}{2} \right) dx \dots\dots\dots(73)$

We make an investigation exactly like that of Art. 24. In the

present case α will be $\pi/2$ and the most important part of the integral will be near $x = \pi/2$. To get W_1 for $v = A$ and both large, we may integrate from $\frac{1}{2}\pi - \phi_1$ to $\frac{1}{2}\pi$, ϕ_1 being a small finite angle. Put $x = \pi/2 - \phi$ where ϕ is small.

Then
$$\cos x - \log \cot \frac{x}{2} = -\frac{\phi^3}{3} - \frac{\phi^5}{30} + \&c.,$$

and
$$W_1 = \int_0^{\phi_1} \cos \frac{A\phi^3}{3} d\phi = \left(\frac{3}{A}\right)^{\frac{1}{3}} \times \int_0^\infty \cos \psi^3 d\psi \dots\dots (74).$$

And
$$dW_1/dv = -\int_0^{\frac{1}{2}\pi} \cos x \sin \left(v \cos x - A \log \cot \frac{x}{2} \right) dx$$

$$= \int_0^{\phi_1} \phi \sin \frac{A\phi^3}{3} d\phi = \int_0^{\phi_1^2} \sin \frac{A\psi^{\frac{3}{2}}}{3} \times \frac{d\psi}{2} = \frac{1}{2} \left(\frac{3}{A}\right)^{\frac{2}{3}} \times \int_0^\infty \sin x^{\frac{3}{2}} dx$$

..... (75).

We have next to find

$$\int_0^\infty \cos \psi^3 d\psi \text{ and } \int_0^\infty \sin x^{\frac{3}{2}} dx.$$

By Art. 260, Todhunter's *Integral Calculus* (1857), it can be shewn that

$$\int_0^\infty e^{-k^2 y^{\frac{3}{n+1}}} \times dy = \frac{n+1}{3} \times \Gamma\left(\frac{n+1}{3}\right) \times k^{-\frac{2n-2}{3}}.$$

We may put $k = \frac{1+i}{\sqrt{2}}$ whence $k^2 = i$; and

$$\int_0^\infty e^{-iy^{\frac{3}{n+1}}} \times dy = \frac{n+1}{3} \Gamma\left(\frac{n+1}{3}\right) \times \left(\frac{1+i}{\sqrt{2}}\right)^{-\frac{2n-2}{3}},$$

whence

$$\int_0^\infty \left(\cos y^{\frac{3}{n+1}} - i \sin y^{\frac{3}{n+1}} \right) dy$$

$$= \frac{n+1}{3} \Gamma\left(\frac{n+1}{3}\right) \cdot \left(\cos \frac{\pi}{4} + i \sin \frac{\pi}{4} \right)^{-\frac{2n-2}{3}} \dots\dots (76).$$

First put $n = 0$. It will be found that the function of π on the right hand will take three possible values, which are

(1) $\cos \frac{\pi}{6} - i \sin \frac{\pi}{6}$, (2) $\cos \frac{3\pi}{2} - i \sin \frac{3\pi}{2}$, (3) $-\cos \frac{\pi}{6} - i \sin \frac{\pi}{6}$.

As $\int_0^\infty \sin y^3 dy$ is finite and positive, (2) must be rejected, and we have to discriminate between (1) and (3).

We at once get

$$\int_0^\infty \sin y^3 dy = \frac{1}{3} \Gamma\left(\frac{1}{3}\right) \cdot \sin \frac{\pi}{6} = \cdot 07132, \text{ \&c.},$$

by De Morgan's *Differential Calculus*, p. 590.

By means of a figure of the integral

$$\int_0^\infty \frac{1}{3} v^{-3} \cos v dv \text{ (which is equal to } \int_0^\infty \cos x^3 dx \text{)}$$

it can be shewn that

$$\int_0^\infty \cos x^3 dx = \int_0^{(\pi/2)^{\frac{1}{3}}} \cos x^3 dx$$

– something which is less than $\int_0^\infty \sin x^3 dx$,

from which we are able to prove that $\int_0^\infty \cos x^3 dx$ is positive.

We must therefore reject the possible value (3) above, and we get

$$\int_0^\infty \cos y^3 dy = \frac{1}{3} \Gamma\left(\frac{1}{3}\right) \cdot \cos \frac{\pi}{6}.$$

Next in (76) putting $n = 1$, we shall find that the function of π on the right of (76) will take three possible values, which are

$$(1) \cos \frac{\pi}{3} - i \sin \frac{\pi}{3}, \quad (2) \cos \pi - i \sin \pi, \quad (3) \cos \frac{\pi}{3} + i \sin \frac{\pi}{3} :$$

It is easily shewn that the first is the value to be chosen, and we get

$$\int_0^\infty \sin y^3 dy = \frac{2}{3} \Gamma\left(\frac{2}{3}\right) \cdot \sin \frac{\pi}{3}.$$

Finally,

$$\left. \begin{aligned} W_1 &= \left(\frac{3}{A}\right)^{\frac{1}{3}} \times \frac{1}{3} \Gamma\left(\frac{1}{3}\right) \cdot \cos \frac{\pi}{6} \\ dW_1/dv &= \frac{1}{3} \left(\frac{3}{A}\right)^{\frac{2}{3}} \times \Gamma\left(\frac{2}{3}\right) \cdot \cos \frac{\pi}{6} \end{aligned} \right\} \dots\dots\dots(77).$$

29. We will next get the values of v which make V_1 and dV_1/dv maxima. We will begin with dV/dv as the most important for our purpose, and first consider equation (12) which is (dropping the dashes)

$$v \frac{d^2 V}{dv^2} + \frac{dV}{dv} + (v - A) V = 0.$$

It is obvious at once from this that $v = A$ makes vdV/dv a maximum or minimum, and since V , or rather the leading term of it is, on the *left* of A , always positive, we can readily shew that $v = A$ gives a maximum. Suppose whilst the abscissas of the curve in fig. 5 represent v 's, the ordinates represent the values of vdV/dv .

Fig. 5.

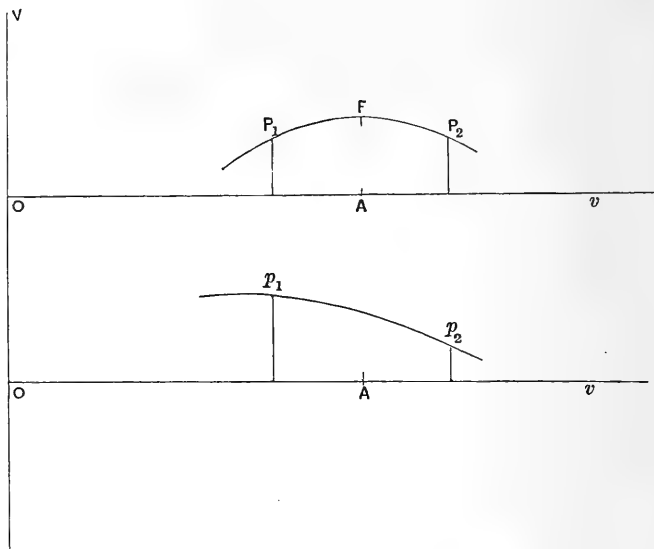

Fig. 6.

When $v = OA = A$ there is a maximum ordinate. Now make a new curve, fig. 6, in which the ordinates represent dV/dv . On the first curve take two points P_1, P_2 near F , on either side of it, such as to be equally distant from Ov . Let p_1, p_2 be the corresponding points with the same abscissas on the second curve. It is obvious that p_2 is nearer to Ov than p_1 is, and so in fig. 6 the maximum ordinate has been shifted to the *left* of A . Again, when $V'' = 0$, it is easily seen that $vV''' = V\{(v - A)^2 - 1\}$. If then V''' is to be negative (which it must be to make V' a maximum) we must have $(v - A)^2 < 1$, and since v and A are both supposed large, the point required is very near A (fig. 4). It is for this reason that it is difficult or perhaps impossible to get the required point from the solution (68) because that solution fails for values of μ very near unity. We proceed therefore to another investigation which does not seem open to any serious objection.

30. V having the value given in (41), put

$$V = f(A + v - A) = f(A) + f'(A) \cdot (v - A) + \frac{f''(A)}{2!} (v - A)^2 + \frac{f'''(A)}{3!} (v - A)^3 + \&c. \dots (78).$$

Here of course $f^n(A)$ means what $d^n V/dv^n$ becomes when in it v is put $= A$. This series is of course always convergent, but when A is large, and v not differing much from A , it is rapidly convergent, for by continually differentiating (12) with regard to v we can express $f''(A)$, $f'''(A)$ &c. as linear multiples of $f(A)$ and $f'(A)$, and these series proceed in ascending powers of A^{-1} . Moreover $f(A)$ and $f'(A)$ have been found in Art. 28. It is thus easy to get from (78) as approximately as may be desired the values of $(v - A)$ which make V' and V'' vanish.

We get

$$V' = f'(A) + f''(A) \cdot (v - A) + \frac{f'''(A)}{2!} (v - A)^2 + \&c.$$

$$V'' = f''(A) + f'''(A) \cdot (v - A) + \&c.$$

$$V''' = f'''(A) + \&c.$$

On the whole it will be found that these series descend by powers of A^{-3} sometimes more rapidly. The value of $(v - A)$ which makes V'' vanish is given approximately, using (77), by

$$v - A = -\frac{f''}{f'''} = -\frac{f'}{f} = -\left(\frac{3}{A}\right)^{\frac{1}{3}} \Gamma\left(\frac{2}{3}\right) \div \Gamma\left(\frac{1}{3}\right) \dots (79),$$

and then $V''' = f'''(A)$ which from (12) is negative, so that we have found a maximum value of V' . This shews that the position of the point on the axis of greatest sound intensity is a little to the *left* of A , fig. 4. This verifies Art. 29. Similarly we can get approximately the point where V is a maximum. V' vanishes when

$$v - A = -\frac{f'}{f''} = A \text{ from (12) or } v = 2A,$$

and then $V'' = f''(A)$ which is negative, shewing that a maximum has been obtained. The point obtained is of course on the right of A , fig. 4. It should however be carefully noticed that what has been obtained here is an *Algebraical* maximum for V , and remembering (Art. 27) that on the *right* of A (fig. 4) V may be negative it is quite possible that this algebraical maximum may be a *numerical* minimum. But we are not much interested in maxima or minima values of V . Of course the whole of this

article is correct only when A is so large that $A^{-\frac{2}{3}}$ may be regarded as a small quantity.

31. We have proved (Art. 30) that the point on the axis of greatest sound intensity or focus of reflection is a little on the left of the point A (fig. 4) given by $v = A$. As A is supposed large, we will consider it practically to coincide with it.

But (Art. 6) we must express this in terms of the *original* notation and see what it means, which is that $pv - A/p = 0$, A being a root of equation (40) which also we may consider as expressed in the original notation, so that the focus of reflection is really given by

$$v = \frac{A}{p^2} = 2OA, \text{ see fig. 4 and Art. 5} \dots\dots\dots (80).$$

This shews that if A be given, and we experiment upon a number of different notes, *the focus of reflection will be nearer the geometrical focus of the reflector for high notes than for low ones.* This perhaps accounts for the great audibility of *high* notes in experiments of the kind described in Art. 1, for we see that even if A be large (which it apparently must be, to make or to account for foci of reflection) yet the largeness of p^2 may draw the point A near to O . For instance p^2 may be as large as 3600 for very high notes (one foot and one second being taken as units).

32. We will next make some observations on the magnification of the sound produced by a sound-receiving parabolic reflector. By Art. 5, using v in the sense of the *latter* part of Art. 6, it can be shewn that the velocity of any air-particle in the axis is equal to $2pdV_1/dv$ multiplied by a time factor. In what follows we will for brevity omit the time factor. Then by (41) the air velocity at any point in LO (figs. 2 or 4) is $2pA$, and when we speak of sound magnification at any point we mean that we compare the air velocity at that point with this $2pA$.

First then at P_1 (fig. 4) by (46) we shall find that

The sound magnification = $\frac{\epsilon^{2(Av)^{\frac{2}{3}}}}{2\pi^{\frac{1}{2}}(Av)^{\frac{2}{3}}}$ nearly..... (81).

This is an interesting and remarkable result, for by Art. 6 we see that it is independent of p or *the same for all notes experimented on.* It ought however in fairness to be pointed out that (46) and so (79) were only obtained on the supposition that v/A is small, which means (Art. 6) that p^2v/A is small, so that the above statement about independence is generally *more true for low notes than for high ones*, unless A be excessively large.

Next at P_2 (fig. 4) by (56) and (61) the magnification

$$= \epsilon^{\frac{1}{2}\pi A} / (2\pi v)^{\frac{1}{2}} A.$$

As (Art. 6) A here stands for A/p and v for pv , we see that generally at such a point as P_2 (fig. 4) the magnification is greater for low notes than for high ones.

CASE OF A LARGE. SOURCE NEAR.

Sound-sending Reflector.

33. In the following Articles LO (figs. 2 and 4) is supposed to be a source of sound, or more strictly a line of sources, and the problem now before us is to find the single wave of sound, which we feel sure must at a great distance be the result of such a supposition. We shall find that such a single wave is the result of combining *both* solutions of equation (12).

We shall in fact find (Art. 37) that F , the velocity potential, takes the form $(C_1 U_1 V_1 + C_2 U_1 V_2) \times$ time factor where C_1 and C_2 are certain special constants whose values are determined in Art. 36. At present however we shall for simplicity suppose F to be of the form $U_1 V_2 \times$ time factor, V_2 being the second or logarithmic solution of (12), and we shall see afterwards in Art. 37 what the results of Art. 35 have to be multiplied by, to adapt them to our present purpose.

34. And first to find the strength of the source, and the law of this strength at various points of LO . Using at present u, v and A in their original sense (Art. 6) it will be found (Art. 5) that the rate of flow of air normal to $v = \text{constant}$ across a small piece of the paraboloid made by the revolution round Ox of Pp (see fig. 2) is equal to $2\pi du \times v dF/dv$ where F is the velocity potential. But $F = U_1 V_2 \times$ (time factor). We will for brevity omit the time factor.

Therefore the rate of flow = $2\pi U_1 du \times v dV_2/dv$.

But if we take this rate of flow normal to LO (that is $v = 0$) we have by Art. 5 $v dV_2/dv = 1$ if we use the 2nd or logarithmic solution of (12). [Of course when $v = 0$ that is at all points of LO $v dV_1/dv = 0$.]

Therefore the rate of flow normal to $LO = 2\pi U_1 du$.

U_1 will be the law of the strength, and the whole strength will

$$= 2\pi \int_0^l U_1 du.$$

35. We will now examine the value of U_1 for various values of u , and in connexion with this it is a matter of much interest

to discover if possible for what value of u , U_1 has its greatest value, that is the point in LO where the supply from the source is strongest. u varies from 0 to l . Of course l will vary according to the reflector used. If portability be chiefly regarded, perhaps we might consider the values of l chosen for my reflectors as not unreasonable, say $l = \frac{2}{3}$ for the large reflector and $l = \frac{1}{8}$ for the small (or ear) one, taking one foot as the unit of length. Any way we may perhaps practically regard l as < 1 .

If A be chosen so large that u/A is small, we have from (39) approximately

$$U_1 = \frac{\cos \{2(Au)^{\frac{1}{2}} - \frac{1}{4}\pi\}}{\pi^{\frac{1}{2}}(Au)^{\frac{1}{2}}} \dots\dots\dots (82).$$

If we take no notice of the variation of the numerator, (82) shews us that generally U_1 increases numerically as u diminishes, that is that *the strength of the source increases as we approach the geometrical focus of the reflector*, in fact when $u = 0$, (82) becomes infinite, but we must carefully notice that (82) is not and does not

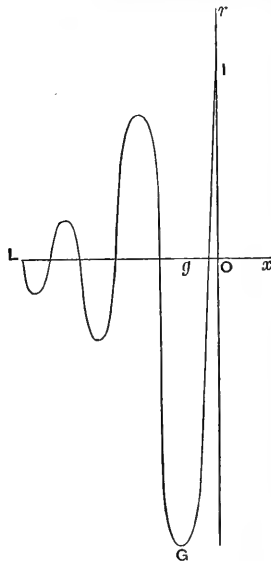

Fig. 7.

profess to be a true approximation to U_1 when u is very small or zero. When $u = 0$ (15) gives us $U_1 = 1$. It seems certain therefore that, while A remains constant and u varies from 0 up to l , U_1 must somewhere have its greatest possible value, and that this corresponds to some small value of u . We will endeavour to find

this value. The question is not easy, so the following is put forward with some hesitation. First trace the curve whose equation is (82) regarding U_1 as the ordinate and u the abscissa. The general form is represented in fig. 7, O being the origin and the u 's being measured to the left of O .

$OI = 1$, and since from (15) $dU_1/du = -A$ when $u = 0$, that accounts for the curve being drawn downwards from I .

If the curve in the figure correctly represents U_1 especially for small values of u , then the greatest numerical ordinate will obviously be at G . Next we put (as in Art. 19) z for Au and we consider z as small as possible, and yet so large that we may safely neglect its inverse powers {so as to make (82) a true approximation to U }. We have then approximately

$$\frac{dU_1}{dz} = -\frac{\sin(2z^{\frac{1}{2}} - \frac{1}{4}\pi)}{\pi^{\frac{1}{2}}z^{\frac{3}{4}}}, \quad \frac{d^2U_1}{dz^2} = -\frac{\cos(2z^{\frac{1}{2}} - \frac{1}{4}\pi)}{\pi^{\frac{1}{2}}z^{\frac{5}{4}}}.$$

U_1 will be a maximum or minimum if

$$2(Au)^{\frac{1}{2}} - \frac{1}{4}\pi = n\pi \dots \dots \dots (83),$$

n being an integer. [(83) is of exactly the same form as equation (40). Perhaps to distinguish it from (40) it will be well to write (40) thus

$$2(Al)^{\frac{1}{2}} - \frac{1}{4}\pi = n_a\pi] \dots \dots \dots (84).$$

The point G is obviously determined by putting in (83) $n = 1$. But another very important question now remains, which is—

If we put $n = 1$, is the value of u so obtained from (83) large enough to make (82) a reasonable approximation to the value of U_1 ? To answer this question we put x temporarily for $2(Au)^{\frac{1}{2}}$, and we remember that by Todhunter's *Laplace's Functions*, p. 318, (82) is only short for the following

$$U_1 = \left(\frac{2}{\pi x}\right)^{\frac{1}{2}} \cos\left(x - \frac{1}{4}\pi\right) \cdot \left\{1 - \frac{1^2 \cdot 3^2}{4 \cdot 8} \left(\frac{1}{2x}\right)^2 + \frac{1^2 \cdot 3^2 \cdot 5^2 \cdot 7^2}{4 \cdot 8 \cdot 12 \cdot 16} \left(\frac{1}{2x}\right)^4 - \&c.\right\} \\ + \left(\frac{2}{\pi x}\right)^{\frac{1}{2}} \sin\left(x - \frac{1}{4}\pi\right) \cdot \left\{\frac{1^2}{4} \left(\frac{1}{2x}\right) - \frac{1^2 \cdot 3^2 \cdot 5^2}{4 \cdot 8 \cdot 12} \left(\frac{1}{2x}\right)^3 + \&c.\right\}.$$

If the 1st term of this expansion can be used alone as a good approximation to the value of U_1 we must have $\frac{1^2}{4} \left(\frac{1}{2x}\right)$ small compared with 1. This condition is fairly satisfied by the value of x (viz. $5\pi/4$) which we get by putting $n = 1$ in (83). The final

result is that the point g (fig. 7) in LO of greatest source-strength is given by

$$(Au)^{\frac{1}{2}} = \frac{5\pi}{8} \dots\dots\dots (85),$$

so that *the larger A is the more nearly is the strength concentrated in the geometrical focus of the reflector.*

Next to get the whole strength of the source we have (Art. 34)

to find the value of $\int_0^l U_1 du$. This cannot be obtained directly from (82) because (82) is not an approximation when $u = 0$. The only way apparently is to integrate U_1 from the ascending convergent series (15) first from $u = 0$ to $u = u_1$ where u_1 is the value of u given by (85) and then from $u = u_1$ to $u = l$ using (82) for U_1 .

For the first part, we get from (15). [N.B. Before (15) can be used here we must first put in it pu for u and A/p for A .]

$$\int_0^{u_1} U_1 du = u_1 - \frac{u_1^2}{2} A + \frac{u_1^3}{3(2!)^2} (A^2 - p^2) - \frac{u_1^4}{4(3!)^2} (A^3 - 5p^2 A) + \&c.,$$

and remembering from (85) that Au_1 is finite, and that A is large this becomes in the limit

$$\int_0^{u_1} U_1 du = \frac{5\pi}{8} A^{-\frac{1}{2}} \left[1 - \frac{m}{2} + \frac{m^2}{3(2!)^2} - \frac{m^3}{4(3!)^2} + \&c. \right] \dots (86),$$

where $m = \frac{5\pi}{8}$. Of course to make this result correct we suppose A incomparably larger than p .

To get the second part of the whole strength, we have from (82)

$$\int z^{-\frac{1}{2}} \cos(2z^{\frac{1}{2}} - \frac{1}{4}\pi) du = \frac{1}{A} \{ z^{\frac{1}{2}} \sin(2z^{\frac{1}{2}} - \frac{1}{4}\pi) + \frac{1}{4} z^{-\frac{1}{2}} \cos(2z^{\frac{1}{2}} - \frac{1}{4}\pi) + \&c. \},$$

by extending the series, which descends by powers of $z^{-\frac{1}{2}}$, the integral can be got with any desired accuracy. The 2 first terms are accurate, the error being of the order $z^{-\frac{3}{2}}$. Next taking the integral from $u = u_1$ up to $u = l$ we get by (83) and (84)

$$\int_{u_1}^l U_1 du = \frac{1}{4A} [(Al)^{-\frac{1}{2}} \cos(n_a \pi) - (Au_1)^{-\frac{1}{2}} \cos \pi].$$

Whatever value the integer n_a has, the result cannot be of higher order than $A^{-\frac{1}{2}}$, so that when A is very large we see that (86) gives us approximately the whole strength of the source, but for this to be true A is supposed much larger than p .

36. We will now shew that by particular linear combinations of the two solutions V_1 and V_2 of equation (12) we are able to get a *single outgoing wave* at points distant from the reflector, i.e. at points for which v is large and A/v small. We will prove this from the Definite Integral solutions of (12). From Art. 24 we get

$$V_1 = \frac{1}{\pi} (\epsilon^{\frac{1}{2}\pi A} + \epsilon^{-\frac{1}{2}\pi A}) \int_0^{\frac{1}{2}\pi} \cos \left(v \cos x - A \log \cot \frac{x}{2} \right) dx \dots (87),$$

and from (18) we get, putting v for u and $-A$ for A ,

$$V_2 = \frac{1}{\pi} (\epsilon^{\frac{1}{2}\pi A} + \epsilon^{-\frac{1}{2}\pi A}) \times \int_0^{\frac{1}{2}\pi} \cos \left(v \cos x - A \log \cot \frac{x}{2} \right) \cdot \log (v \sin^2 x) dx \dots (88).$$

[It must, however, be carefully noticed that in this article we are using A and v in the sense of the second part of Art. 6, that is, A is for A/p and v is for pv .]

Put I_1 for the integral in V_1 and I_2 for the integral in V_2 .

From Art. 24 we get the value of I_1 for points for which A/v is small. For brevity put

$$v_1 \text{ for } \left(v \cos \alpha - A \log \cot \frac{\alpha}{2} \right).$$

Then for such points, by Art. 24,

$$I_1 = (\pi/2)^{\frac{1}{2}} (v \cos \alpha)^{-\frac{1}{2}} (\cos v_1 + \sin v_1),$$

and
$$I_2 = \int_0^{\frac{1}{2}\pi} \cos \left(v \cos x - A \log \cot \frac{x}{2} \right) \cdot (\log v + 2 \log \sin x) dx.$$

It will be found that when v is large and A/v is small the most important part of the integral I_2 is near $x = \alpha$, where $\sin^2 \alpha = A/v$. Accordingly following the method of Art. 24, that is, putting in I_2 , $x = \alpha + \phi$ and integrating with regard to ϕ from $-\phi_1$ to $+\phi_1$ where ϕ_1 is a small finite angle, and expanding $\log \sin x$ or $\log \sin (\alpha + \phi)$ in powers of ϕ as far as ϕ^2 , we shall have

$$I_2 = \int_{-\phi_1}^{\phi_1} \cos (v_1 - v \cos \alpha \cdot \phi^2) \times (\log v + 2 \log \sin \alpha + 2\phi \cot \alpha - \phi^2 \operatorname{cosec}^2 \alpha) d\phi ;$$

putting $v \cos \alpha \cdot \phi^2 = \psi^2$ we get in the limit

$$I_2 = \int_{-\infty}^{\infty} \cos (v_1 - \psi^2) \cdot \log A \frac{d\psi}{(v \cos \alpha)^{\frac{1}{2}}} - \operatorname{cosec}^2 \alpha \int_{-\phi_1}^{\phi_1} \cos (v_1 - v \cos \alpha \cdot \phi^2) \cdot \phi^2 d\phi.$$

The 1st integral on the right

$$= \left(\frac{\pi}{2}\right)^{\frac{1}{2}} (\cos v_1 + \sin v_1) \frac{\log A}{(v \cos \alpha)^{\frac{1}{2}}}.$$

In the 2nd integral put $v \cos \alpha \cdot \phi^2 = \psi^2$, then the second integral on the right

$$= -\operatorname{cosec}^2 \alpha \int_{-\infty}^{\infty} \cos(v_1 - \psi^2) \cdot \frac{\psi^2 d\psi}{(v \cos \alpha)^{\frac{3}{2}}}.$$

In this integral put $\psi^2 = x$ when it

$$= -\frac{1}{3} \operatorname{cosec}^2 \alpha (v \cos \alpha)^{-\frac{3}{2}} \times \int_{-\infty}^{\infty} \cos(v_1 - x^{\frac{2}{3}}) dx,$$

from Art. 28,

$$= -\frac{(v \cos \alpha)^{-\frac{3}{2}}}{3 \sin^2 \alpha} \times \cos\left(v_1 - \frac{\pi}{3}\right) \times \frac{2}{3} \Gamma\left(\frac{2}{3}\right).$$

Finally,

$$I_2 = \left(\frac{\pi}{2}\right)^{\frac{1}{2}} (\cos v_1 + \sin v_1) \frac{\log A}{(v \cos \alpha)^{\frac{1}{2}}} \\ - \frac{2 (v \cos \alpha)^{-\frac{3}{2}}}{9 \sin^2 \alpha} \times \left[\cos\left(v_1 - \frac{\pi}{3}\right) \right] \Gamma\left(\frac{2}{3}\right).$$

The last term

$$= -\frac{2}{9} \cdot \frac{v^{-\frac{1}{2}} (\cos \alpha)^{-\frac{3}{2}}}{A} \times \left[\cos\left(v_1 - \frac{\pi}{3}\right) \right] \Gamma\left(\frac{2}{3}\right).$$

Therefore the terms in I_2 are both of the order of $v^{-\frac{1}{2}}$.

If we solve these simple equations so as to get $v^{-\frac{1}{2}} \cos v_1$ and $v^{-\frac{1}{2}} \sin v_1$ in terms of I_1 and I_2 , as α is small and becomes smaller the larger be v (A being supposed fixed), we may, as we are investigating the state of things far from the focus of the reflector, suppose $\alpha = 0$ in the limit, and we shall get

$$v^{-\frac{1}{2}} \cos\left(v_1 - \frac{\pi}{3}\right) = \frac{9A}{2\Gamma\left(\frac{2}{3}\right)} \times (I_1 \log A - I_2),$$

$$v^{-\frac{1}{2}} \cos\left(v_1 - \frac{\pi}{4}\right) = \pi^{-\frac{1}{2}} \times I_1.$$

If we multiply each of these equations by

$$\frac{1}{\pi} (e^{\frac{1}{2}\pi A} + e^{-\frac{1}{2}\pi A}),$$

we get

$$\frac{1}{\pi} (\epsilon^{\frac{1}{2}\pi A} + \epsilon^{-\frac{1}{2}\pi A}) \frac{\cos v_1}{v^{\frac{1}{2}}} \sin \frac{\pi}{12} =$$

$$= \frac{9A \sin \frac{\pi}{4}}{2\Gamma(\frac{2}{3})} (-V_1 \log A + V_2) + \pi^{-\frac{1}{2}} V_1 \sin \frac{\pi}{3} \dots\dots(89),$$

$$\frac{1}{\pi} (\epsilon^{\frac{1}{2}\pi A} + \epsilon^{-\frac{1}{2}\pi A}) \frac{\sin v_1}{v^{\frac{1}{2}}} \sin \frac{\pi}{12} =$$

$$= \frac{9A \cos \frac{\pi}{4}}{2\Gamma(\frac{2}{3})} (V_1 \log A - V_2) - \pi^{-\frac{1}{2}} V_1 \cos \frac{\pi}{3} \dots\dots\dots(90),$$

and we see by Art. 5 that the motion of the single outgoing wave is given by such a form as

$$F = \frac{1}{\pi} (\epsilon^{\frac{1}{2}\pi A} + \epsilon^{-\frac{1}{2}\pi A}) \sin \frac{\pi}{12} \cdot \frac{\cos (v_1 - 2pat)}{v^{\frac{1}{2}}}.$$

Remembering (Art. 24) that for v large and A/v small, v_1 is approximately given by

$$v_1 = v - \frac{1}{2}A \log v + C_1,$$

this becomes

$$F = \frac{1}{\pi} (\epsilon^{\frac{1}{2}\pi A} + \epsilon^{-\frac{1}{2}\pi A}) \sin \frac{\pi}{12}$$

$$\times \frac{\cos (v - \frac{1}{2}A \log v + C_1 - 2pat)}{v^{\frac{1}{2}}} \dots\dots\dots(91).$$

37. We have now the solution of the whole problem, which may be expressed thus

$$F = Q \cos 2pat + P \sin 2pat,$$

where

$$Q = U_1 \left[\left\{ \frac{-9A \log A}{2\sqrt{2}\Gamma(\frac{2}{3})} + \frac{\sqrt{3}}{2} \pi^{-\frac{1}{2}} \right\} V_1 + \frac{9A}{2\sqrt{2}\Gamma(\frac{2}{3})} \times V_2 \right] (92),$$

$$P = U_1 \left[\left\{ \frac{9A \log A}{2\sqrt{2}\Gamma(\frac{2}{3})} - \frac{1}{2} \pi^{-\frac{1}{2}} \right\} V_1 - \frac{9A}{2\sqrt{2}\Gamma(\frac{2}{3})} \times V_2 \right] \dots\dots(93).$$

We see thus that the factors mentioned in Art. 33 are determined.

We have already found the value of F for large values of v and small values of A/v , but we might now go on to find its value for any other values of v , say, for instance, small values, in which case

we should have to use the ascending convergent series for V_1 and V_2 .

In Art. 34, beginning with an expression for F of the form U_1V_2 (omitting the time factor), we got the expression (86) for strength of source. But now, as from (92) and (93), we begin with U_1V_2 multiplied by $9A/2\sqrt{2}\Gamma(\frac{2}{3})$, we shall get for the strength (86) multiplied by this same factor. We must, however, remember that A in (86) has its original meaning, while in (92) and (93) A means A/p , so that the final result is: Strength of source

$$= \frac{45\pi A^{\frac{1}{2}}}{16\sqrt{2}p\Gamma(\frac{2}{3})} \times \left[1 - \frac{m}{2} + \frac{m^2}{3(2!)^2} - \frac{m^3}{4(3!)^2} + \&c. \right] \dots\dots(94),$$

where $m = 5\pi/8$ and A has its original meaning (Art. 6).

[Once more it may be well to remind the reader that in (91) A means A/p and v means pv , and that in (92) and (93) A means A/p , and U_1, V_1, V_2 are certain functions of u and v given by (15) and (16) where u and v stand for pu and pv .]

Comparing together (91) and (94) we observe that *if A increases, the strength of source varies as $A^{\frac{1}{2}}$, whilst the magnification varies nearly as $\epsilon^{\frac{1}{2}\pi A/p}$, that is, in a much higher ratio, unless p be comparable with A , which we do not suppose. Again, supposing in (91) we keep A constant and suppose p to vary, we see that the magnification varies as $\epsilon^{\frac{1}{2}\pi A/p}/p^{\frac{1}{2}}$, which increases as p diminishes, shewing that for a given large value of A , low notes are more magnified by a reflector than high ones.*

Putting in (91) A/p for A and pv for v , we shall readily find that the distance between the crests of two successive waves is given nearly by

$$\frac{2\pi}{p(1 - A/2p^2v)} \dots\dots\dots(95).$$

Here if v is increased the distance is diminished, consequently it would seem that *as the wave moves outwards, the note gets slightly sharper*—only *ultimately* attaining the pitch defined by the letter p . This peculiarity, if it exist, should be more observable with low notes than with high ones. We may also notice that since by (40), for a given value of n , A varies as l^{-1} , other things being the same, the more tube-like be the paraboloid the larger will be A , and so from (91) the larger will be the magnification of the sound caused by the reflector. This agrees with a remark of Lord Rayleigh's in Art. 280, Vol. II., of his *Treatise on Sound*, where he treats of conical pipes with a source at one end. The same observation might have been made at the end of Art. 32 on the Sound-receiving Reflector.

Notes on the Binney Collection of Coal-Measure Plants. By
A. C. SEWARD, M.A.

PART I. **Lepidophloios.**

Text-figures 1—5; Pls. III. and IV.

1. INTRODUCTORY.

THE object of these notes, which it is proposed to publish in parts in the *Proceedings of the Cambridge Philosophical Society*, is to draw attention to some of the more important specimens in the Binney Collection, which throw fresh light on species of Palaeozoic plants previously described, or illustrate structural features hitherto unrecorded. The Binney Collection, including the majority of the sections figured by the late E. W. Binney in his contributions to the Royal, Palaeontographical, Geological and other Societies between 1862 and 1872, was presented to the Woodwardian Museum, Cambridge, in 1892 by Mr J. Binney of Trinity Hall¹. Some of the species represented in the collection have been repeatedly investigated during the last few decades, and the material in the Woodwardian Museum does not enable us to add any facts of importance to those already known. Other species are represented by unusually well-preserved specimens, which illustrate morphological points not previously noticed or afford additional data of phylogenetic importance. In cases where the original blocks or nodules have been preserved from which Binney's sections were obtained, new slices have been cut by Mr Lomax of Bolton and Mr Chapman of London. I may here express my indebtedness to Prof. T. Mc Kenny Hughes for facilities generously afforded me in the examination of the collection and in the preparation of new sections for microscopical examination. An acknowledgment is due also to the Council of the Royal Society for contributing towards the cost of preparing the figures illustrating the specimens dealt with in these notes. It is proposed to append to the series of descriptive notes a list of the species represented in the Binney Collection.

¹ *Cambridge University Reporter*, 1891—92, p. 939.

LEPIDOPHLOIOS FULIGINOSUS (WILLIAMSON)*.

[*Proc. Roy. Soc.*, Vol. XLII., p. 6, 1887.]

1871. *Lepidodendron Harcourtii*, Binney, *Palaeont. Soc.*, p. 48. Pl. VII., fig. 6.
1872. *L. Harcourtii*, Binney, *Palaeont. Soc.*, pp. 77—80. Pls. XIII. and XIV.
Halonía regularis, *ibid.*, p. 89. Pl. xv., figs. 1—4.
Lepidodendron, Williamson, *Phil. Trans.*, Vol. 162, p. 205. Pls. xxv. and xxvi.
1880. *Lepidophloios fuliginosus*, Cash and Lomax, *Brit. Assoc. Report* (Leeds), p. 810.
1881. *Lepidodendron Harcourtii*, Williamson, *Phil. Trans.*, Vol. 172, p. 288. Pls. XLIX.—LII.
1891. *Lepidodendron Williamsoni*, Solms-Laubach, *Fossil Botany*, p. 226.
L. Harcourtii (*pars*), *ibid.*, p. 226.
L. fuliginosum, Bertrand, *Trav. Mém. Lille*, p. 14.
1893. *L. fuliginosum*, Williamson, *Phil. Trans.*, Vol. 184, p. 18. Pl. II., fig. 25.
Lepidophloios fuliginosus, Kidston, *Trans. Roy. Soc. Edinburgh*, Vol. 38, p. 548.
Lepidodendron fuliginosum, Williamson, *Mem. Proc. Lit. Phil. Soc. Manchester*, Vol. 7 [4], p. 13.
1895. *L. fuliginosum*, *ibid.*, Vol. 9, p. 49.

In the third part of the series of "Observations on the structure of fossil plants found in the Carboniferous strata," published by the Palaeontographical Society in 1872¹, Binney describes a number of specimens from his own cabinet and from that of Mr J. S. Dawes which "afford some additional information on the genus *Lepidodendron*"; these specimens are included under three species: *Lepidodendron Harcourtii* Witham, *Sigillaria vascularis* Binney, and *Halonía regularis* Lindley and Hutton. We will for the present confine our attention to four specimens described by Binney as *Lepidodendron Harcourtii* and *Halonía regularis*, but which I regard as specifically identical², and conforming to the type of structure characteristic of *Lepidophloios fuliginosus* (Will.). These four specimens, included by Binney under the numbers 18³, 31 and 34, were obtained from Mr Dawes, who found them in the Clay-

* The brackets enclosing the Author's name indicate that Williamson is responsible for the specific but not for the generic designation. *Vide* Seward (98) p. 111.

¹ Binney (72). [The numbers in brackets after the author's name refer to the date of publication of the memoir cited (*e. g.* 72=1872), as given in the bibliography.]

² Bertrand (91), p. 15, also regards Binney's specimens as identical.

³ Binney (71), p. 48.

ironstone of the Coal-Measures near Dudley. The blocks from which the sections were prepared never came into Binney's possession; indeed, he refers to them as having been lost, and the account of the external characters is based on Mr Dawes' description.

For convenience of reference the sections have been re-numbered 1—4; the following list shows the correspondence between Binney's numbers and those adopted in the notes, also between Binney's figures and those accompanying the present descriptions.

Slide 1.	{ Text-figure 1 Pl. III., fig. 3 Pl. IV., figs. 8 & 12	= Binney's specimens No. 31 ¹ & No. 18	{ Binney (71) Pl. VII., fig. 6 Binney (72) Pl. XIII., figs. 1 & 5
Slide 2.	{ Text-figures 2 & 3 Pl. III., fig. 5 Pl. IV., figs. 6 & 9	= Binney's specimen No. 31 ¹	{ Binney (72) Pl. XIII., figs. 2, 3, 4 & 6
Slide 3.	{ Text-figure 4 Pl. III., figs. 1 & 2 Pl. IV., figs. 7 & 10	= Binney's specimen No. 34	{ Binney (72) Pl. XV., figs. 1 & 4
Slide 4. (cut from the same stem as Slide 1.)	{ Text-figure 5 Pl. III., fig. 4 Pl. IV., fig. 11	= Binney's specimen No. 34	{ Binney (72) Pl. XV., figs. 2 & 3

Before describing in detail Binney's specimens, it is desirable to briefly consider the history and morphological characteristics of the two species *Lepidodendron Harcourtii* and *Halonina regularis*, so far as they concern the questions raised in the following pages.

The name *Lepidodendron Harcourtii* was proposed by Witham in 1832² for a small Lepidodendroid stem obtained from Hesley Heath near Rothbury in Northumberland, and presented by the Rev. C. G. V. Vernon Harcourt to Mr (afterwards Professor) Phillips of York, who handed it to Witham for description. In 1833 Lindley and Hutton³ published figures of the type-specimen, and in 1837 and 1839 more accurate drawings appeared in two papers by Adolphe Brongniart⁴. There has been no little confusion in the writings of later authors as to the precise specific characteristics of Witham's species; Binney and other palaeobotanists having included under the name *Lepidodendron Harcourtii* plants which differ in certain particulars from the type-specimen described by Witham. Williamson, in his earlier memoirs "On the Organization of the Fossil Plants of the Coal-Measures," described

¹ These two specimens were prepared from different stems, and not from the same stem, as Binney's numbering implies.

² Witham (32), (33).

³ Lindley and Hutton (33), Pls. xcviII. and xcix.

⁴ Brongniart (37), Pls. xx. and xxi.; (39), Pls. xxx. and xxxi.

some *Lepidodendroid* stems as examples of *Lepidodendron Harcourtii*¹, but in 1887² he contributed a note to the Royal Society in which a new specific name—*L. fuliginosum*—was proposed for certain specimens previously referred to Witham's species. This proposal was the result of an examination of sections prepared from the type-specimen of *L. Harcourtii* in the York Museum, which led Williamson to recognise some points of difference between this species and the closely allied stems which he had confused with the true *L. Harcourtii*. In describing the distinguishing features of the two plants, Williamson lays stress on "the greater uniformity in the composition of the entire cortex, the inner part of which is preserved," and "on the absence of the duplex structure of the foliar bundles" as distinctive features of the former species (*L. fuliginosum*). He goes on to say, "The small size of the cells of the inner cortex, and the dense aspect both of it and of the foliar bundles, give to the transverse sections of this form so sooty an aspect contrasted with the luminous semitransparency of the true *Lepidodendron Harcourtii*, that I propose to recognise the former (*i.e.* the specimens originally described incorrectly as *L. Harcourtii*) as *Lepidodendron fuliginosum*." In describing these two species of *Lepidodendron*, Solms-Laubach³ refers to the presence of a group of "bast-fibres" in the leaf-traces of *L. Harcourtii* (these so-called fibres give the duplex form to the bundle as described by Williamson), and to the larger and sharper projections of the corrugated face of the primary xylem of the stem (Corona of Bertrand) as distinguishing features of *L. Harcourtii*. Another recognised characteristic of Witham's species is the absence or late development of secondary xylem as compared with the comparatively early formation of secondary tissues in *L. fuliginosum*.

A leaf-trace, as seen in a transverse section of the stem, appears to consist of two small groups of dark brown elements, frequently enclosed by a small oval area from which the more delicate cells have disappeared before mineralisation of the tissues. It has been customary to describe one of the groups as the xylem of the leaf-trace, and the other as representing a strand of bast-fibres. In 1891 Prof. Bertrand of Lille published a memoir on *Lepidodendron Harcourtii*⁴, in which he describes the leaf-traces as consisting of xylem tracheids accompanied by a strand of laticiferous tubes. The examination of the Binney sections and of several other sections in the Williamson collection and elsewhere has convinced me that the term bast-fibres cannot be correctly

¹ Williamson (81), Pls. XLIX.—LII.

² Williamson (87).

³ Solms-Laubach (91), p. 226.

⁴ Bertrand (91), p. 119.

applied to the dark brown elements accompanying the tracheal strand of the leaf-trace, and I have no hesitation in expressing the view that Bertrand's suggestion of the secretory nature of these elements is nearer the truth. This is, however, a matter of secondary importance as regards the supposed distinction between *L. fuliginosum* and *L. Harcourtii* afforded by the duplex nature of the leaf-traces; one of the conclusions, based on a comparative examination of specimens of both species, is that no such difference exists, but on the contrary the structure of the leaf-traces in the two species is practically identical.

As Williamson pointed out, the true *Lepidodendron Harcourtii* differs from *L. fuliginosum* in the absence of the middle cortical tissue; that is to say, the former species possessed a cortex largely composed of very delicate cells which were always wholly or partially destroyed before the mineralising solution had time to effect their preservation; in *L. fuliginosum*, on the other hand, the corresponding region of the stem was occupied by a mass of dark coloured parenchyma which, in view of its frequent preservation, was probably of a more resistant nature than in *L. Harcourtii*. To found specific distinctions on accidents of preservation is naturally dangerous, but this difference in the cortical tissues is sufficiently constant to entitle it to careful consideration, and although we have evidence pointing to the existence of a similar cortex in both species, it would seem probable that in *L. fuliginosum* the bulk of the cortical region consisted of firmer and more durable tissue. In the Binney sections referred to *L. Harcourtii* the cortex is well preserved; in this respect, therefore, as in others, they agree with *L. fuliginosum*.

Another point of importance is the absence or late development of secondary vascular tissue in the true *L. Harcourtii*; in Binney's sections there are distinct traces of the development in its early stages of a secondary stelar tissue which agrees with the corresponding tissue in *L. fuliginosum*. In a recent account of a large Lepidodendroid stem from the Calciferous Sandstone of Dalmeny in South Scotland by Mr A. W. Hill and myself¹, the opinion is expressed that this large stem, with a considerable development of secondary wood, may perhaps be regarded as an example of *Lepidodendron Harcourtii*. Be this as it may, it is undoubtedly true that smaller examples of this species are characterised by the absence of any secondary xylem.

Williamson and others have referred to the greater prominence of the projecting ridges on the external face of the primary xylem (corona) as one of the distinguishing features of *L. Harcourtii*; but it is doubtful how far this character can be accepted as of diagnostic

¹ Seward and Hill (99); Seward (98), p. 82, fig. 15.

value in the recognition of the two allied species. These two types have been referred to as species of the genus *Lepidodendron*, the name used by Witham and Williamson in their descriptions of *L. Harcourtii* and *L. fuliginosum*. It is, however, more usual and in accordance with present methods to speak of Williamson's species as *Lepidophloios fuliginosus*, and there are reasons for applying the same generic designation to Witham's species. It is unnecessary to refer to the characteristic differences between the two genera, *Lepidodendron* and *Lepidophloios*, but brief reference may be made to the facts which have led to the adoption of the latter name for Williamson's species. In the *British Association Report* for 1880 Cash and Lomax¹ published a note in which they record the discovery of a petrified stem having the external characters of *Lepidophloios* and the internal structure of Williamson's species *Lepidodendron fuliginosum*. The specimen was afterwards examined by Kidston², who confirmed the statement of Cash and Lomax; Kidston expressed the view that this stem with the *L. fuliginosum* type of structure was identical with the plant figured in 1831 by Lindley and Hutton as *Lepidodendron acerosum*³.

The specimens referred by Binney to *Halonial regularis* were so named on evidence supplied by Mr Dawes, himself a student of Palaeozoic plants, who described the stem from which the sections were prepared as exhibiting externally the characteristic Halonial tubercles. It would occupy too much space to review at length the evidence supporting the application of the generic term *Lepidophloios* to such Lepidodendroid branches as exhibit those surface features for which the genus *Halonial* was originally proposed, or to discuss the evidence in support of the use of the genus *Lepidophloios* for stems exhibiting the type of structure which Williamson referred to the species *Lepidodendron fuliginosum*. There are indeed good grounds for the application of the generic designation *Lepidophloios* to such stems as exhibit the anatomical characteristics of Williamson's species, whether or no the stems are preserved in such a manner as to show Halonial characters.

2. DESCRIPTION OF THE SPECIMENS.

Slide 1 (Binney No. 31). Text-figure 1, Pl. III. fig. 3, Pl. IV. figs. 8 and 12.

A figure of this transverse section, magnified $3\frac{3}{4}$ diameters, is given by Binney in his Plate XIII. fig. 1⁴. The section, 3·8 cm. × 2·5 cm. in diameter, was cut from a stem in course of

¹ Cash and Lomax (80).

² Kidston (93), p. 547 and (90) p. 351.

³ Lindley and Hutton (31), Pl. VII.

⁴ Binney (72).

branching; there are two circular steles, apparently equal in size, enclosed in a common mass of ground-tissue; one of them is well preserved (Text-figure 1), but the other has been considerably crushed. The main mass of the ground-tissue consists of parenchyma, which may be spoken of as the middle cortex, and scattered through this tissue several leaf-traces are seen in slightly oblique transverse section. Near the periphery of the section there is an irregular line of tearing, represented by a light-coloured band occupied by the mineral matrix; this line is situated just external to the outer limit of the middle and the inner margin of the more compact outer cortex. The surface of the whole section does not correspond exactly with the original surface of the stem, which had lost its superficial tissues previous to petrification. At the level at which the section was cut, the elliptical and flattened form of the stem marked the approaching division into two equal branches; internally the occurrence of two separate steles and the bending inwards of the outer cortex between the vascular cylinders show that the branches must have become free from one another at a short distance above the region represented by the section.



FIGURE 1. TRANSVERSE SECTION OF ONE OF THE STELES SHOWN IN SLIDE 1.
($\times 10$.)

The dark irregular boundary of the primary xylem is clearly shown; 2 mm. external to this, as measured on the photograph, the lighter tissue with large clear spaces represents the "secretory" zone. [This stele is figured by Binney (71) in his Pl. VII. fig. 6.]

a. *The stele.* (Text-figure 1.)

The central part of each stele is occupied by a mass of compact parenchyma 3 mm. in diameter, of which several of the cells were in a state of active growth at the time of fossilisation, as shown by the presence of thin and evidently newly-formed walls. Enclosing the pith there is a continuous cylinder of primary xylem consisting of scalariform tracheids, which become smaller in diameter towards the periphery, where the xylem is irregularly corrugated and exhibits a series of more or less prominent points or teeth separated by shallow grooves, agreeing closely with the corona as described by Bertrand and others in *Lepidophloios Harcourtii*. The edge of the primary xylem is represented in the micro-photograph of Text-figure 1 by a distinct undulating dark line. Next the inner face of the xylem there occur a few isodiametric elements with reticulately pitted walls (Pl. IV. fig. 8 *t*) similar to the well-known tracheal elements met with in the inner region of the stele of *Lepidodendron vasculare* (Binney)¹. Similar short tracheae occur also in contact with the outer edge of the xylem², and here and there one of the elements is seen slightly internal to the edge of the corona associated with the ordinary scalariform tracheids. Abutting on the xylem there are 2—3 rows of very dark polygonal parenchymatous cells, with an occasional isodiametric tracheid; beyond this we have a zone, about 8 cells deep, consisting of small polygonal cells similar to those in contact with the tracheids, but of lighter colour and more distinctly preserved; this band is spoken of as the meristematic zone (Pl. III. fig. 3 *a, a*). Beyond this zone there is a conspicuous band made up in part of large sacs, more or less circular in outline and limited by very thin membranes, associated with smaller and partially disorganised parenchymatous elements; this region may be termed the secretory zone (Pl. III. fig. 3, *s, s*; Pl. IV. fig. 12 and Text-figure 1).

β. *Leaf-traces.*

The continuity of the tissues external to the corona is interrupted at intervals by oval or circular leaf-traces which traverse the cortical tissues in a gradually ascending course from the periphery of the xylem, from which they appear to be given off in the manner described in detail by Bertrand in the case of *Lepidodendron Harcourtii*³. A leaf-trace, as seen close to the edge of the xylem, is approximately circular or somewhat elliptical in outline, with an internal protoxylem group (*lt* 1 and *lt* 2, fig. 3, Pl. III.); as a leaf-trace in its outward course reaches the region of the secretory zone the latter forms a bay in front of the tracheal strand of the

¹ = *L. selaginoides* Will.

² Cf. Maslen (99), p. 362, Pl. xxxvi. fig. 2, *st*.

³ Bertrand (91) pp. 87 *et seq.*

leaf-trace (Pl. III. fig. 3, *lt* 1). In the left-hand portion of fig. 3, Pl. III. the leaf-trace *lt* 1 is seen to have considerably encroached on the secretory zone *s, s*, so that the large clear sacs of the latter tissue extend as an arched row external to the outlying trace; the other leaf-trace, *lt* 2, has advanced rather further, and here the continuity of the secretory zone is interrupted. As the leaf-trace pursues its course, the tracheal strand is accompanied by a group of elements from the secretory zone; this group is shown in fig. 3 as a dark and ill-defined patch of tissue immediately in front of the leaf-trace *lt* 2. Each leaf-trace also carries with it a small strand of parenchyma from the meristematic zone *a* (fig. 3, *etc.*). These facts may be more precisely expressed by the statement that a leaf-trace, as it appears in the cortex of a stem, consists of a group of tracheids, a group of secretory elements, and a few intervening layers of cells which are continuous, as demonstrated by longitudinal sections, with the xylem of the corona, the secretory zone *s, s*, and the meristematic zone *a* respectively. The detailed structure of the leaf-trace and the accompanying tissues is more clearly shown in sections 2 and 3.

γ Cortex.

Beyond the secretory zone (*s* fig. 3, *etc.*) there is a fairly definite layer of tangentially elongated cells (the uppermost layer in fig. 12, Pl. IV.) suggestive of an endodermal layer. Beyond this there are several layers of compact parenchyma constituting a band of tissue about equal in breadth to the secretory and meristematic zones together; the innermost part of this region is shown at the edge of fig. 3, Pl. III. This band passes outwards into a tissue composed of more radially elongated elements of the nature of fairly closely packed trabeculae, agreeing exactly with the rather loose tissue described by Bower¹ in *Lepidostrobis Brownii* and by other writers in Lepidodendroid stems. This hypha-like or trabecular middle cortex occupies the greater portion of the stem; towards the periphery of the section it is succeeded somewhat abruptly by 1—2 layers of more regularly arranged tangentially elongated elements separated by conspicuous intercellular spaces, and beyond them by a compact parenchyma, of which the cells become thicker walled towards the limits of the section where they constitute the outermost tissue; this more compact parenchyma is spoken of as the outer cortex.

The less perfect stele seen in Section 1 agrees in size and structure with that shown in Text-figure 1, but there is one feature of interest not represented in the more perfect stele. Some of the parenchymatous elements between the secretory zone

¹ Bower (93), Pl. xvii. fig. 13.

and the corona are in a meristematic condition, as indicated by the presence of short and regularly placed radial rows of small cells, separated by delicate and recently formed cell-walls (as shown also in Section 2, and represented in Text-fig. 2 *m*). These dividing cells of the meristematic zone agree exactly with the characteristic secondary tissue which is developed immediately external to the corona in *Lepidophloios fuliginosus*.

Slide 2. Text-figures 2 and 3; Pl. III. fig. 5; Pl. IV. figs. 6 and 9.

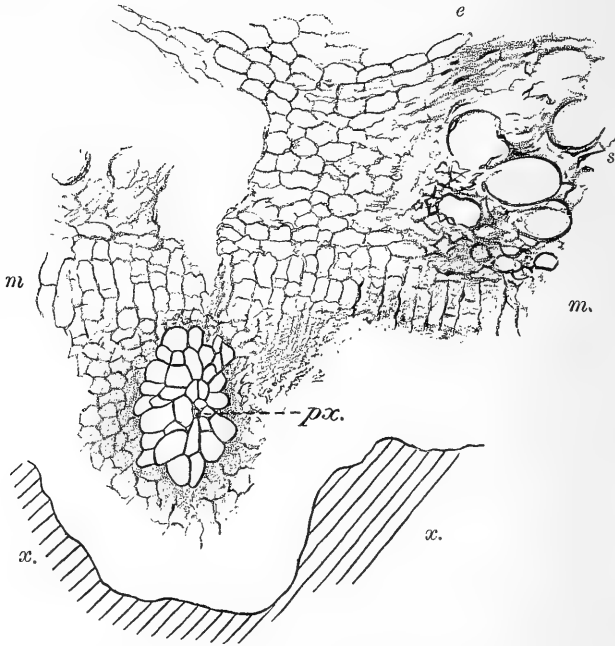

FIGURE 2. TRANSVERSE SECTION THROUGH PART OF THE SECRETORY AND MERISTEMATIC ZONES, SHOWING THE XYLEM OF A LEAF-TRACE.

x, x, primary wood (corona); *px*, protoxylem of leaf-trace; *m*, dividing cells in the outer part of the meristematic zone; *s*, secretory tissue; *e*, ? endodermis. (Slide 2, $\times 90$.)

On this slide there are two sections; one is a segment of a transverse section with a radius of 2.8 cm., and the other a longitudinal section; Binney¹ figures the latter in his Pl. XIII. fig. 2 and a small portion of the former in his Pl. XIII. fig. 6. The portion of the primary xylem ring seen in the transverse section agrees with the corona of Section 1 except in its somewhat greater

¹ Binney (72).

breadth. The tissue of the meristematic zone is imperfectly preserved, but here and there the cells of this band immediately internal to the secretory zone show a distinct tendency towards a radial arrangement, as already noticed in Section 1; the regular cross-walls are evidently the product of secondary meristematic activity, and indicate the beginning of secondary thickening (Text-fig. 2 *m*). In the drawing reproduced in fig. 2, *x, x* marks the outer edge of the corona; in front of the depression in the corona there is a leaf-trace group of tracheids with an internal protoxylem, *px*, and this is surrounded by a few of the cells of the meristematic zone *a*, most of which has not been preserved; the regular band of cells *m* marks the position of the dividing tissue; at *s* a portion of the secretory zone is represented. The secretory zone consists of large sacs and small short cells; in a few places the large spaces are occupied by ill-defined thin-walled elements, but the cells are partially disorganised and present the appearance of a tissue in course of degeneration. It is not always easy to distinguish between actual cells in the interior of the larger sacs and cracks in the mineral matrix, which have been rendered more distinct by the infiltration of a brown colouring matter.

The portion of the secretory zone shown in Text-figure 3 illustrates the occurrence of a few smaller elements enclosed by



FIGURE 3. TRANSVERSE SECTION THROUGH A PORTION OF THE SECRETORY ZONE.
(Slide 2, $\times 90$.)

the thin membranes which mark the outlines of the sacs; the latter usually appear as conspicuous empty spaces, as in Section 1 (fig. 3, Pl. III., *s*), and in the greater part of the secretory zone shown in Section 2.

The three layers of cells at the top of the drawing (fig. 3) represent part of the innermost cortex, while the few elements in the lower part of the section belong to the parenchyma of the meristematic zone.

As in Section 1 the peripheral tissue is traversed by a crack approximately corresponding with the junction of the broad middle and the narrower outer cortex; but in this section a secondary tissue or phelloderm has begun to be formed in the outer cortex (Pl. IV. fig. 6 *pl.*); the phelloderm consists of radially disposed rows of rather thicker walled cells, about six deep, and here and there the outer cortex is traversed by radially elongated spaces which were originally occupied by leaf-traces and their accompanying thin-walled parenchyma. Another feature of interest in this part of the stem is the presence of groups of dividing and partially disorganised cells (fig. 6, Pl. IV. *sc*) occurring at fairly regular intervals immediately internal to the phelloderm; these groups undoubtedly mark the position of incipient canals or secretory passages. Similar strands are represented by Bertrand¹ in *Lepidodendron Harcourtii*, and excellent examples of the same structures occur in *Lepidophloios Wunschianus* from Arran and in the large Dalmeny stem already alluded to.

The longitudinal section, which is mounted on slide no. 2 with the transverse section, was cut from the same stem. A few cells only of the pith are preserved; these are arranged in regular vertical series and their cavities are bridged across by transverse or oblique walls of recent origin. The tracheids at the edge of the corona are often characterised by a looser form of scalariform thickening or by more or less spiral bands; beyond these there are about 12 rows of very short parenchymatous cells constituting the meristematic zone, the outermost of which are in some cases radially elongated and traversed by newly formed cross-walls (*cf.* Text-fig. 2, *m*). These dividing meristematic cells pass outwards with the leaf-traces on their inner side, as shown in fig. 9, Pl. IV., where the outermost cells on the left of the drawing represent a strand of meristematic tissue accompanying a leaf-trace. The direct continuity of the strand of disorganised secretory tissue *s* (fig. 9, Pl. IV., and fig. 5, Pl. III.), which forms part of each leaf-trace, with the secretory zone of the stem (Pl. III. fig. 3, *s, s*; Pl. IV. fig. 12) is clearly demonstrated in Section 2. The leaf-traces in this section are seen to pass steeply upwards for a short distance after they become free from the corona, and then bend almost at right angles through the middle cortex, finally bending slightly upwards in the outer cortical region; their course differs from that of the leaf-traces in Sections 1 and 4 (cut from the same stem) where they follow a much steeper and obliquely vertical course. The photograph reproduced in Pl. III. fig. 5 represents an outgoing leaf-trace as seen in the transverse segment of Section 2; it is shown in oblique longitudinal view; at *x* we have the group of

¹ Bertrand (91), Pl. IV. fig. 25.

tracheids, at *s* the dark secretory elements, and between the two groups a clear space originally occupied by thin-walled parenchyma.

Slide 3. Text-figure 4, Pl. III. figs. 1 and 2; Pl. IV. figs. 7 and 10.

This transverse section, which agrees in essential characters with Sections 1 and 2, is figured by Binney in his Pl. xv. fig. 1; it is slightly crushed; the longer diameter measures 4·2 cm., and the shorter diameter 3·4 cm., the longest diameter of the elliptical stele being 1·2 cm. The pith has been to a large extent destroyed; the xylem exhibits the same characters as in the previous sections, but many of the tracheids are full of a vacuolated substance which may probably be regarded as the product of some pathological change (Text-figure 4).

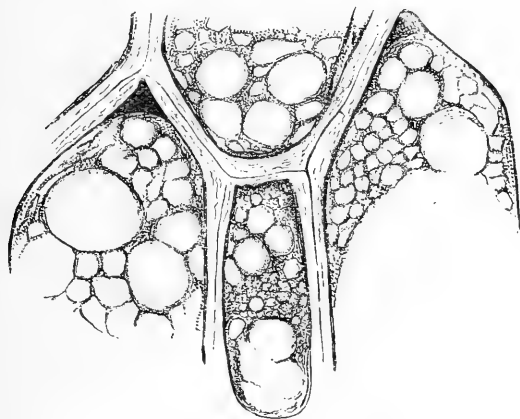

FIGURE 4. TRANSVERSE SECTION, SHOWING THE VACUOLATED CONTENTS IN THE PRIMARY TRACHEIDS. (Slide 4, $\times 100$.)

The middle lamella of the large primary tracheids is clearly preserved as a dark line, as shown in Text-fig. 4, but the greater part of the lignified wall has in many places suffered considerable decay. At the edge of the corona, or slightly internal to the xylem, a few isodiametric reticulately marked tracheids are met with, as in the other sections. The meristematic and secretory zones agree in structure with the corresponding tissues in the other sections. The broad middle cortex is particularly well preserved, and exhibits the trabecular structure of the parenchyma very clearly; there is no phelloderm, but the junction of the middle and outer cortical regions is very clearly shown,

as represented in Pl. iv. fig. 10; the irregularly shaped and more faintly drawn cells on the inner side of fig. 10 are the most external elements of the middle cortex; these are succeeded by rather darker and much more regularly disposed cells separated from one another by intercellular spaces, and beyond this we pass into the more compact outer cortex. Section 3 illustrates exceptionally well the structure of the leaf-traces (Pl. III. figs. 1 and 2; Pl. iv. fig. 7). In fig. 7, Pl. iv., the xylem strand of a leaf-trace is represented as it appears close to the point at which a trace becomes detached from the corona; the protoxylem elements, *px*, are clearly internal, thus giving to the foliar bundle a mesarch structure.

Figure 1, Pl. III.¹, represents a leaf-trace in slightly oblique transverse section in the middle cortical region of Section 3 as it ascends steeply or almost vertically towards the surface of the stem. The group of tracheids has altered its shape as compared with that shown in fig. 7, Pl. iv.; in the more flattened leaf-traces the protoxylem is not so clearly indicated, but it may sometimes be detected as a short crushed band in the interior of the tracheal strand. Between the xylem and the group of dark elements *s* (fig. 1, Pl. III.) there are 3—4 rows of slightly elongated parenchymatous cells, which agree with the tissue of the meristematic zone of the stele with which they are in continuity. The group *s* consists of polygonal elements varying in size and associated with patches of a dark brown substance, probably a product of secretion. In longitudinal sections of leaf-traces the elements of this group *s* are seen to be, in part, long cells with square ends and often partially filled with a dark brown secretion (Pl. iv. fig. 11). This tissue is usually imperfectly preserved, and the elements composing it often appear in a more or less disorganised condition.

The leaf-trace is surrounded by a few layers of parenchymatous cells, which may be spoken of as constituting a peridesm². In fig. 2, Pl. III. a leaf-trace is shown in the outer cortical region of the stem: the secretory strand *s* is less perfectly preserved than in fig. 1; but the chief difference is the presence of a well-marked crescent-shaped group of tissue which partially encloses the leaf-trace externally; this consists of the parichnos, a mass of the middle cortex which passes out with the leaf-trace in its course through the outer cortical zone. The looser and more irregular structure of the parichnos, *p*, is in marked contrast to the more compact tissue of the outer cortex as shown at the edge of fig. 2, *c*.

¹ Cf. Bertrand (91), Pl. VIII. fig. 80.

² van Tieghem (90), p. 434.

Slide 4. Text-figure 5; Pl. III. fig. 4, Pl. IV. fig. 11.

This longitudinal section is figured by Binney in his Pl. xv. figs. 2 and 3; he refers it to *Halonia regularis*, while Section 1, figured by Binney in his Pl. XIII. fig. 1, is described as *Lepidodendron Harcourtii*; but it is almost certain that both sections were prepared from the same specimen. The two diverging steles shown in Section 4 agree precisely with the two steles described in Section 1; the other tissues of the sections are also in agreement, and there can be little if any doubt that both sections were cut from one and the same piece of branching stem. Section 4 illustrates very clearly the structure of the stele and the extrastelar tissues, also the manner of origin and structure of the leaf-traces. The photograph shown in fig. 4, Pl. III. includes the edge of the corona *x*, succeeded by a few layers of short and very dark coloured cells, beyond which are several rows of very distinct parenchymatous elements, *a—a*, constituting the broad meristematic zone (cf. fig. 3, Pl. III., *a, a*); external to this there is the

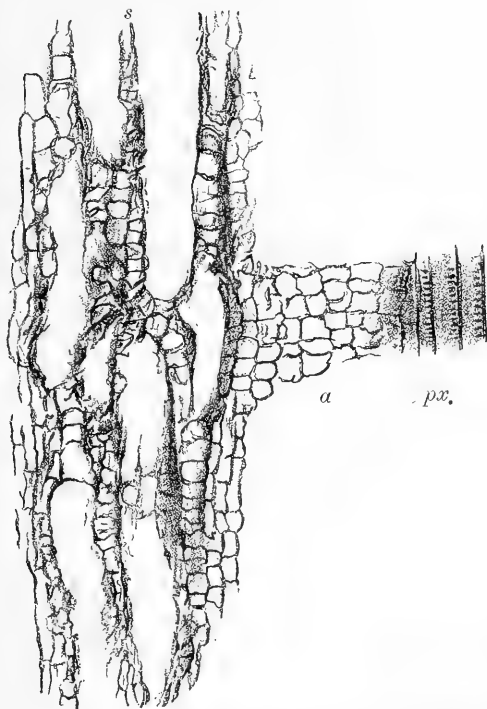

FIGURE 5. LONGITUDINAL SECTION THROUGH THE SECRETORY ZONE, *s*, THE MERISTEMATIC ZONE, *a*, AND THE EDGE OF THE CORONA, *px.* (Slide 4, $\times 90$.)

secretory zone *s* composed of large sac-like spaces and several small cells associated with patches of a dark brown substance.

Text-figure 5 illustrates more clearly the structure of the secretory zone, *s*, as seen in longitudinal view; the long clear spaces correspond to the circular or oval sacs shown in the transverse sections, fig. 3, Pl. III. and fig. 12, Pl. IV.; with these are associated groups of short parenchymatous cells, which are more or less disorganised. Part of the meristem band is represented at *a* in Text-fig. 5, and at *px* we have some of the narrow peripheral elements of the corona.

In fig. 11, Pl. IV. a few of the elements composing the secretory zone accompanying a leaf-trace are represented on a large scale; these have the form of long thin-walled cambiform cells, with straight or slightly oblique transverse walls, containing patches of secreted substance in their cavities; the appearance of the tissues suggests a comparison with the sieve-tubes of normal phloem, but the general character of the secretory-zone tissues differs considerably from that of ordinary phloem.

3. CONCLUSION AND SUMMARY.

Having described the several tissues shown in the five sections, it remains to summarise the results and to draw attention to such general morphological or physiological conclusions as are suggested by the anatomical features illustrated by the Binney specimens. As already pointed out, one of the sections (no. 3) was cut from a stem which Dawes described to Binney as exhibiting the external character of *Halonnia*, the cone-bearing branch of a *Lepidophloios*. There is no reason to doubt the accuracy of Dawes' statement. The section in question does not show any trace of the vascular strands, which, as we know from other *Halonnia* specimens, were given off from the stele to supply each strobilus borne by the fruiting branch; but the absence of these vascular strands may be easily explained by the assumption that the section was cut at a level which did not coincide with the position of the vascular axis of the cone-bearing tubercle. Binney's section of the *Halonnia* branch (no. 3) exhibits precisely the same anatomical characters as the sections referred by this author to *Lepidodendron Harcourtii*; the Sections 1—4 are anatomically identical and cannot reasonably be referred to distinct species. The reasons which lead me to refer Binney's sections to *Lepidophloios fuliginosus* are (i) the presence of a well-preserved middle cortex, and (ii) the indications of secondary thickening. The first character is probably not of primary importance; in the true *L. Harcourtii* no sign of secondary thickening has hitherto been observed in stems of so small a diameter as those which we are considering. While pointing to the identity of

Binney's stems with the *Lepidophloios fuliginosus* type, the sections also demonstrate (i) that the so-called duplex nature of the leaf-traces cannot be accepted as a distinctive feature of *L. Harcourtii*, and (ii) that the strand of tissue accompanying the xylem of the leaf-traces does not exhibit the characters of bast-fibres. A comparison of Binney's sections with examples of the true *L. Harcourtii* leaves no doubt in my mind as to the identity of the structure of the leaf-traces in the two forms. If the view elsewhere expressed that the large Dalmeny stem may be regarded as an example of *L. Harcourtii* be correct, we must speak of Witham's species as a type of Lepidodendroid stem in which secondary thickening began at an unusually late stage. In *Lepidophloios fuliginosus*, which in most respects appears to be practically identical with *L. Harcourtii*, the development of secondary stelar tissues began at an earlier period.

The chief features of more general interest exhibited by the Sections 1—4 are to be found in the structure of the tissues immediately external to the xylem, and in the nature of what has been spoken of as the secretory zone. In the above description no mention has been made of the presence of typical phloem; the excellent preservation of even the most delicate cells justifies the belief that had phloem tissue been originally present, it would not have been likely to have suffered decay to such an extent as to render its preservation or recognition impossible. The xylem of the stem is surrounded by a fairly broad band of short and slightly flattened cells constituting a tissue to which the term meristematic zone has been applied; the reason for this appellation is that in some of the sections certain cells in this region are in a state of meristematic activity, and an identical band of short-celled parenchyma in the large Dalmeny stem was found to be the seat of active cell-formation. Whether or no this tissue is appropriately named, it is clear that it bears but little resemblance to what we are accustomed to regard as cambium in recent plants. It is moreover very much broader than the ordinary cambial tissue of Dicotyledons or Gymnosperms, or of *Botrychium* among the Vascular Cryptogams. The formation of secondary tissues has scarcely begun in the sections with which we are at present concerned, but such traces as exist favour the view expressed at greater length elsewhere, that the method of secondary thickening in Lepidodendroid plants differed considerably from that with which we are familiar in recent plants, or in such fossil genera as *Calamites*, *Lyginodendron*, *Sphenophyllum* and others.

Beyond the meristematic region there is a characteristic band referred to as the secretory zone. This tissue forms a well-marked feature in stems of *L. fuliginosus*, *L. Wunschianus*, *L. Harcourtii* and other species; the elements composing it do not

conform to the structural characters of ordinary phloem. The large clear spaces or sacs which form so prominent a feature in this region cannot, I believe, be satisfactorily explained as the result of decay previous to mineralisation; their appearance is strongly suggestive of sacs or spaces formed, for the most part, during the life of the plant by the separation and partial disorganisation of thin-walled cells. The constant occurrence of patches of a dark brown substance in this zone also points to the secretory nature of the tissue. Before considering the possible function of the secretory zone, there are a few points to be emphasised in the structure of the leaf-traces. The xylem of the leaf-trace is of mesarch structure¹; as each trace passes out from the corona, the tracheal strand is accompanied by a few cell-rows of the meristematic band (*a, a* Pl. III. figs. 3 and 4), and groups of elements from the secretory zone (*s.s.*, Pl. III. figs. 3 and 4) also form part of the leaf-trace tissues. The group of secretory tissue accompanying the xylem of a leaf-trace (Pl. IV. fig. 11) may be followed, in longitudinal and in transverse sections, into direct continuity with the broad secretory zone of the stem; but the elements of this tissue which form part of a leaf-trace differ from the secretory zone in the narrower diameter of the cells and in the somewhat greater abundance of secreted substance. Neither in the structure of the main stele of the stem nor in the tissues of the leaf-trace do we find any set of elements, which exhibit histological features affording satisfactory evidence of the existence of either hard or soft phloem of the ordinary type.

The apparent absence of any well-defined phloem tissue is a fact of considerable interest; even in the large Dalmeny stem, in which the secondary xylem is 2.8 cm. in diameter², there is no indication of any tissue which can be identified anatomically with true phloem. Indeed in no stem of *Lepidodendron*, *Lepidophloios* or *Sigillaria* has typical phloem been so far satisfactorily demonstrated³. The existence of the secretory zone suggests a physiological comparison of this tissue with normal phloem, on the ground that in certain recent plants laticiferous tissue has been considered as in part at least carrying out the functions of phloem⁴; it is a probable view that this well-marked zone may have served the same purpose as the tissue which in recent plants usually presents the structural characters of phloem. In position the secretory zone corresponds to the pericycle, and this region of the stem in certain recent species is not infrequently characterised by the presence of numerous laticiferous tubes. Without discuss-

¹ Cf. Maslen (99), p. 364. Pl. xxxvi. fig. 12.

² For a figure of the stele of this stem *vide* Seward (98), p. 82.

³ Hovelacque (92) describes phloem in *Lepidodendron vasculare* (*L. selaginoides*), but the features it presents do not appear to be those of typical phloem.

⁴ Haberlandt (96), p. 295; de Bary (84), p. 187; Tschirch (89), p. 526.

ing the question at greater length, the conclusion may be briefly stated that the functions usually carried out in recent plants by elements possessing the structure of phloem, were in *Lepidodendroid* stems performed by tissue of a somewhat different type; probably the secretory zone of the stem and the secretory elements of the leaf-traces are physiologically comparable to phloem tissue, and in part to the laticiferous tissues in some recent plants. It has been shown by Strasburger¹ that under certain conditions the xylem tissues may serve as channels for the conduction of nitrogenous material; the removal of a ring of phloem from the stems of *Heracleum Sphondylium* did not prevent the conveyance to the ripening umbel of a sufficient supply of food material. In *Lepidophloios* it would seem probable that the tissue of the secretory zone took some part in the conduction of assimilated substances, but it is not wholly improbable that the xylem may have also borne a share in the functions which are usually associated with phloem in recent plants. It may be that a more intimate acquaintance with the histology of both fossil and recent Lycopodiaceous plants may demonstrate a closer agreement than is admitted in the above description between the phloem of recent Lycopods and the tissue which has been spoken of as the secretory zone in *Lepidophloios*. There is, indeed, a distinct resemblance between the comparatively wide thin-walled sieve-tubes and the accompanying parenchymatous elements in a *Lycopodium* stem and the large clear spaces and associated parenchyma of *Lepidophloios*; but the histological similarity is not, I believe, sufficient to warrant the identification of the "secretory" zone of the fossil stem with ordinary phloem.

BIBLIOGRAPHY.

- BARY, A. DE (84). Comparative anatomy of the vegetative organs of the Phanerogams and Ferns. *Oxford*, 1884.
- BERTRAND, C. E. (91). Remarques sur le *Lepidodendron Harcourtii* de Witham.
Trav. et Mém. des Facultés de Lille, Mém. vi. Lille, 1891.
- BINNEY, E. W. (71). Observations on the structure of Fossil Plants found in the Carboniferous strata.
Pt. II. *Lepidostrobus* and some allied cones. *Palaeontological Soc. London*, 1871.
- (72) *ibid.* Pt. III. *Lepidodendron. Pal. Soc.*, 1872.
- BOWER, F. O. (93). On the structure of the axis of *Lepidostrobus Brownii* Schimp.
Annals Bot., Vol. VII., p. 329, 1893.
- BRONGNIART, A. (37). Histoire des Végétaux fossiles, Vol. II. *Paris*, 1837.

¹ Strasburger (91), p. 900. I am indebted to my friend Mr Francis Darwin for calling my attention to Strasburger's experiment.

- BRONGNIART, A. (39). Observations sur la structure intérieure du *Sigillaria elegans*.
Arch. mus. d'hist. nat., Vol. I., p. 405, 1839.
- CASH, W. and LOMAX, J. (90). On *Lepidophloios* and *Lepidodendron*.
Report British Assoc. (Leeds Meeting), p. 810, 1890.
- HABERLANDT, G. (96). Physiologische Pflanzenanatomie.
Leipzig, 1896.
- HILL, A. W. (99) *vide* SEWARD, A. C.
- HOVELACQUE, M. (92). Recherches sur le *Lepidodendron selaginoides*.
Mém. Soc. Linn. Normandie, Vol. XVII., 1892.
- KIDSTON, R. (90). Notes on the Palæozoic species mentioned in Lindley and Hutton's "Fossil Flora."
Proc. R. Physc. Soc. Edinburgh, Vol. x., p. 345, 1890-91.
- (93). On *Lepidophloios*, and on the British species of the genus.
Trans. Roy. Soc. Edinburgh, Vol. XXXVII., Pt. iii., p. 529, 1893.
- LINDLEY, J. and HUTTON, W. (31). The Fossil Flora of Great Britain.
Vol. I. London, 1831-33.
- (33). *Ibid.* Vol. II. London, 1833-35.
- MASLEN, A. J. (99). The Structure of *Lepidostrobus*.
Trans. Linn. Soc., Vol. v., p. 357, 1899.
- SEWARD, A. C. (98). Fossil Plants, Vol. I.
Cambridge, 1898.
- SEWARD, A. C. and HILL, A. W. (99). On the structure and affinities of a Lepidodendroid stem from the Calciferous Sandstone of Dalmeny, Scotland, possibly identical with *Lepidophloios Harcourtii* (Witham).
Abstract in *Nature*, July 6, 1899, p. 239 (*vide* also *Proc. Phil. Soc.*, Cambridge, Vol. x., p. 38, 1899).
- SOLMS-LAUBACH, GRAF ZU (91). Fossil Botany.
Oxford, 1891.
- STRASBURGER, E. (91). Ueber den Bau und die Verrichtungen der Leitungsbahnen in den Pflanzen.
Hist. Beit., Heft III. Jena, 1891.
- TIEGHEM, PH. VAN (90). Péricycle et Péridesme.
Journ. Bot., Vol. IV., p. 433, 1890.
- TSCHIRCH, A. (89). Angewandte Pflanzenanatomie.
Wien and Leipzig, 1889.
- WILLIAMSON, W. C. (72). On the Organisation of the Fossil Plants of the Coal-Measures. (Pt. II.) *Lycopodiaceae*.
Phil. Trans., Vol. 162, p. 197, 1872.
- (81), *ibid.* (Pt. XI.), Vol. 172, p. 283.
- (87). Note on *Lepidodendron Harcourtii* and *L. fuliginosum*.
Proc. R. Soc., Vol. XLII., p. 6, 1887.
- (93¹). On the Organization, etc. (Pt. XIX.)
Phil. Trans., Vol. 184, p. 1, 1893.

WILLIAMSON, W. C. (93²). General, Morphological and Histological Index to the Author's Collective Memoirs on the Fossil Plants of the Coal-Measures. Pt. II.

Mem. Proc. Lit. Phil. Soc. Manchester, Vol. VII. [4], p. 1, 1893.

———— (95). On the light thrown upon the question of Growth and Development of the Carboniferous Arborescent *Lepidodendra* by a study of the details of their organisation.

Ibid, Vol. IX. [4], p. 31, 1895.

WITHAM, H. (32). On *Lepidodendron Harcourtii*.

Trans. Nat. Hist. Soc. Newcastle-upon-Tyne, 1832.

———— (33). The internal structure of fossil vegetables.

Edinburgh, 1833.

Explanation of Plates.

PLATE III. (Microphotographs by Mr W. Tams, Cambridge.)

FIG. 1. Transverse section of a leaf-trace in the middle cortex. x = xylem ; s = secretory tissue. (Slide 3.) $\times 50$.

FIG. 2. Transverse section of a leaf-trace in the outer cortical region. p = parichnos ; c = outer cortex ; s = secretory tissue, partially disorganised ; x = xylem. (Slide 3.) $\times 50$.

FIG. 3. Transverse section through the edge of the corona (primary xylem of the stele) and the secretory zone (s). x = primary xylem ; a = meristematic zone ; lt 1, lt 2 = leaf-traces. (Slide 1.) $\times 50$.

FIG. 4. Longitudinal section through the tissues shown in fig. 3. (Slide 4.) $\times 50$.

FIG. 5. Oblique section of a leaf-trace. x = tracheids ; s = secretory tissue. (Slide 2.) $\times 50$.

PLATE IV.

FIG. 6. Transverse section of the outer cortex. Pl = phelloderm ; sc = group of secretory cells. (Slide 2.) $\times 90$.

FIG. 7. Transverse section of the tracheids of a leaf-trace as seen near the corona. Px = protoxylem. (Slide 3.) $\times 100$.

FIG. 8. Transverse section, showing a few of the innermost tracheids of the primary xylem of the stele and a single short reticulate tracheid next the meristematic cells of the pith. (Slide 1.) $\times 200$.

FIG. 9. Longitudinal section of a leaf-trace. x = xylem tracheids ; s = elements of the secretory strand. (Slide 2.) $\times 50$.

FIG. 10. Transverse section through the junction of the lacunar middle cortex and the thicker walled cells of the outer cortex. (Slide 3.) $\times 100$.

FIG. 11. Longitudinal section through part of the secretory zone of a leaf-trace, showing some of the cells with dark contents. (Slide 4.) $\times 100$.

FIG. 12. Transverse section of the secretory zone ; the outermost (uppermost) layer of cells is probably the endodermis. (Slide 1.) $\times 100$.

PART II. **Megaloxylon**, gen. nov.

Plates V—VII and Text-figures 1—4.

I. DESCRIPTIVE.

THE following description is based on the examination of ten sections prepared from a fragment of stem in the Binney Collection. In looking through the numerous unlabelled slides I found one thick transverse section which at first sight was taken for that of a *Cordaites* stem with a thick zone of secondary wood enclosing a large pith; but a closer inspection of the slide at once revealed certain peculiarities which suggested a comparison of the specimen with the genus *Heterangium*. The block from which the single section had been obtained was fortunately found in the collection, and two additional transverse sections and seven longitudinal sections were cut from it by Mr Lomax of Bolton¹. The stem fragment occurs in a calcareous matrix associated with the shells of *Goniatites*, and was originally obtained from the Lower Coal-Measures of Lancashire. Unfortunately the specimen does not afford any indication of the nature of the cortical tissues, which had become separated from the secondary wood before the fragment was embedded in calcareous mud. The central region of the stem, which at first suggested a resemblance to a large *Cordaites* pith, consists of primary xylem; this is surrounded by a cylinder of secondary wood ending abruptly at the margin of the specimen. The complete section measures 4.8 cm. by 4.2 cm.; the greatest diameter of the central region (primary xylem) being 1.9 cm., the secondary xylem having a breadth of 2 cm.

Fig. 2, Pl. v. shows the appearance of the specimen in transverse section. The central region x^1 is occupied by tracheids and parenchyma, and surrounding this primary xylem there is a broad cylinder of secondary wood, part of which is imperfectly preserved; the reticulum of dark lines in the secondary wood—seen on the left in the photograph—is caused by secondary crystallisation in the mineral matrix, which has partially destroyed the xylem tissues². The denser oval group of elements at the periphery (fig. 2, *lt*) of the primary stele represents a leaf-trace about to pass outwards through the secondary xylem. In fig. 1, Pl. v. part of the stem is shown (natural size) in longitudinal section;

¹ The sections are referred to in these notes as I. 1, I. 2, I. 3 (transverse sections) and I. 5—I. 10 (longitudinal sections).

² Cf. Seward (98), p. 81.

the lighter primary xylem (x^1) stands out clearly in contrast to the darker secondary wood (x^2). The leaf-trace (lt) of fig. 2, Pl. v. is here seen in longitudinal view; this section demonstrates very clearly the gradual merging of the leaf-trace elements into those of the primary stele of the stem as they are traced downwards; at the top of the section—where the letters lt are printed—the strand of dark lines denotes a compact and well-defined group of tracheids, but these are seen to become more and more indistinct and to spread out laterally when traced downwards; the leaf-trace, in fact, loses its individuality and becomes indistinguishable from the main mass of the xylem. Having sketched the most obvious features of the stem, or at least of the small portion available for examination, it remains to consider in detail the several tissues.

1. Secondary xylem.

Fig. 4, Pl. v. illustrates the structure of the secondary wood as seen in transverse section; it is characterised by the presence of numerous medullary rays of parenchymatous elements, 1—5 cells in breadth, and is composed of bands of tracheids, 1—8 rows in width. There are no regular concentric rows of narrower elements marking rings of growth, but occasionally groups or discontinuous lines of narrower elements afford indications of local irregularities in the production of the secondary elements. Towards its inner margin the secondary wood becomes less dense, the bands of tracheids are reduced in width, the medullary rays gradually widen, and their parenchymatous elements become tangentially elongated towards the periphery of the primary stele (Pl. v. fig. 3, x^2 , Pl. VI., Pl. VII. fig. 8). The medullary-ray cells in transverse section have the form of narrow radially elongated elements with transverse or oblique walls, and some of them contain a dark substance, suggestive of a product of secretion. In tangential section the secondary xylem presents the appearance of a reticulum of tracheids with the spaces filled in with comparatively broad and long masses of medullary-ray parenchyma; some of the medullary rays have a length of 5 mm. as viewed in a tangential section of the stem; their slightly elongated polygonal elements are separated by small intercellular spaces. The rays vary in breadth from one to several cells as seen in tangential section (sections I. 4, I. 5). The tangential walls of the tracheids are often marked by a fine oblique striation, and occasionally two intersecting series of delicate spiral lines may be detected; this striation is probably an original structure emphasized or etched out by fermentation during decay. A radial section through the secondary xylem illustrates more clearly the abundance of parenchymatous tissue; deep plates of medullary-ray cells, with an occasional

secretory element filled with dark contents, sweep across the face of the tracheids. In the walls of some of the medullary-ray elements there are indications of the existence of a few obliquely oval simple pits¹. The tracheids are characterised by multi-seriate rows of contiguous bordered pits which cover their radial walls. Section I. 10 affords the best illustration of the structure of the secondary xylem as seen in radial longitudinal section.

The practical identity in structure of the secondary wood of this stem with that of *Lyginodendron robustum* Sew. as figured in vol. XI. of the *Annals of Botany* (Pl. v.)² renders it unnecessary to illustrate its characteristic appearance by figures. In *Lyginodendron robustum* (e.g. Section 1131 Williamson Cabinet, British Museum) the medullary rays are slightly broader and more obvious than in the plant under consideration; but the difference is very slight. The loose parenchymatous nature of the xylem agrees with the characteristic structure of recent cycadean stems and with the xylem of such fossil genera as *Lyginodendron*³, *Heterangium*³, *Medullosa*⁴, *Colpoxylon*⁵, and other Palaeozoic types.

It is of interest to note the striking difference in the structure of patches of the secondary wood, in which the more delicate medullary-ray cells have been almost obliterated by compression, as compared with the more perfectly preserved portions; in the former the wood appears to be of the more compact coniferous type, the loose cycadean character having been lost through imperfect preservation.

2. Primary xylem.

The wide primary stele of the stem presents certain features of special interest which lead me to regard the plant as the type of a new genus. The enlarged microphotograph reproduced in Pl. VI.—eight times the natural size—shows that the greater part of the primary stele consists of groups of unusually large elements, varying in size and shape, intermixed with irregular light areas, which are occupied by thin-walled parenchyma and in part by the calcareous mineral matrix which has replaced the parenchymatous tissue. The large diameter of the primary xylem elements shown in Pl. VI. (fig. 7) is at once apparent on comparing them with the tracheids of the secondary wood, which forms the periphery of the section. These wide constituents of the stele are tracheids of a peculiar character, with their walls covered with numerous bordered

¹ Cf. *Heterangium tiliaeoides*, Williamson and Scott (95), Pl. xxix. fig. 34, and *Poroxylon* [Renault (79), Pl. LXXIV. fig. 8].

² Seward (97).

³ Williamson and Scott (95), Pls. xviii., xxi., xxii., etc.

⁴ Scott (99), Pls. vi., xi., etc.

⁵ Renault (93), Pl. LXVIII.

pits (Pl. VII. fig. 9, text-figures 2—4*m*). In some places—as shown in fig. 7 (Pl. VI.)—the large tracheids extend close to the inner edge of the secondary wood, but in others we find more or less well-defined groups of narrow elements occupying a peripheral position in the primary stele (*e.g.* Pl. v. figs. 3—5, *lt* 1—*lt* 3, in fig. 7, also Pl. VII. fig. 8). The radial rows of secondary tracheids may occasionally be traced into direct continuity with the narrower peripheral elements of the primary xylem region, as shown in the upper part of fig. 8, Pl. VII.; but usually the secondary xylem is succeeded internally by rather crushed thin-walled parenchyma composed of polygonal or tangentially elongated cells, several of which contain a dark brown or black substance.

The primary tracheal elements assume various forms in different regions of the periphery of the primary stele; in some parts of the section we find groups composed of a few tracheids, considerably larger than those of the secondary xylem, traversing the parenchyma of the stele; in other regions the tracheids are more numerous, and the outermost elements are characterised by their much

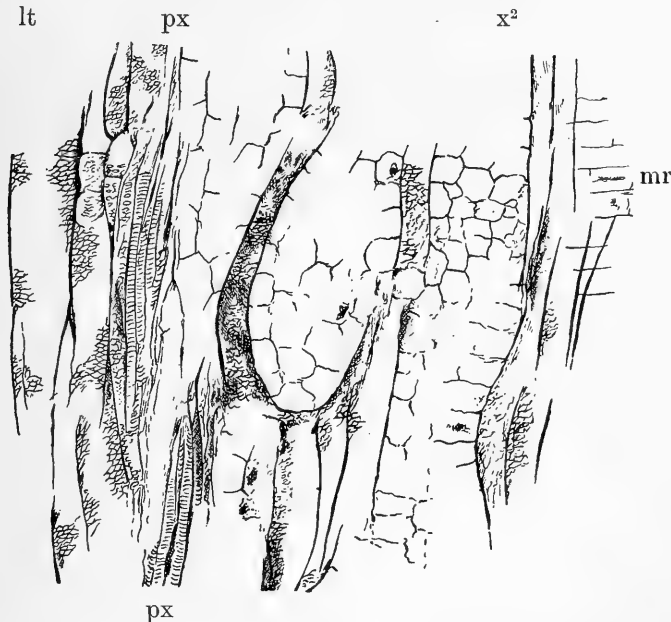

FIGURE 1. LONGITUDINAL SECTION SHOWING THE SECONDARY XYLEM x^2 , AND MEDULLARY RAYS, *mr*; THE XYLEM OF THE LEAF-TRACE *lt*, AND THE PROTOXYLEM *px*. (Section I. 9, $\times 46$.)

smaller diameter (*px*, fig. 8, Pl. VII.; figs. 3 and 6, Pl. v.),—these are the spirally pitted protoxylem tracheids. In the longitudinal section represented in text-figure 1, some of the protoxylem

tracheids are shown at px on the outer edge of the leaf-trace lt ; the curved and broader elements traversing the parenchymatous tissue to the right of the protoxylem strands belong to the innermost part of the secondary xylem of the stem, and beyond these we have the more regular reticulately pitted elements and medullary-ray tissue (mr) of the secondary wood (x^2). The further consideration of the peripheral tissues of the primary vascular axis forms part of the description of the leaf-traces.

At the periphery of the primary xylem of the stele—shown in the transverse section, fig. 7, Pl. VI.—there are rather more than 30 groups of narrow protoxylem elements.

In longitudinal sections the greater part of the primary xylem presents the appearance shown in text-figures 2, 3, and 4 m , and in Pl. VII. fig. 9; the large and characteristic tracheids are for the most part very short and somewhat horizontally elongated elements with numerous bordered pits in their walls; these are embedded in a mass of parenchyma which on contraction has given rise to fairly broad radial gaps between the firmer and more resistant tracheal groups. These spaces form a conspicuous feature in longitudinal sections of the primary xylem; they may be seen as light horizontal patches in fig. 1, Pl. v., and on a larger scale in text-figs. 2 and 3, especially in fig. 2 in the region m , also in fig. 9, Pl. VII.; they bear a striking

 x^2 lt m

FIGURE 2. LONGITUDINAL SECTION SHOWING THE EDGE OF THE SECONDARY XYLEM (x^2), A LEAF-TRACE (lt), AND THE METAXYLEM (m). (Section I. 8, $\times 16$.)

superficial resemblance to the more regular discoid pith of *Cordaites*, which it is possible may also be largely if not entirely due to

contraction of dead tissue, and not an original structure. It is no doubt the case that the large gaps in the tissue of the stem before us have been formed by secondary changes. While the large primary tracheids which constitute so considerable a portion of the stele are shorter than broad, a few of them are elongated, and one prominent feature is their striking irregularity in size and shape; they occur either singly or more frequently in groups (Pl. VII. fig. 9) and in the latter case the individual elements are closely connected by straight or curved pitted walls inclined at various angles. In size these tracheids exceed by about 8 diameters the tracheids of the secondary xylem, some of the larger examples measuring .4 mm. in breadth; with these unusually large tracheids are occasionally associated others of much smaller size. Text-fig. 4 *m* illustrates the great variation in size among the short tracheids of the primary stele, or rather of that part of it which may be termed the metaxylem.

3. *Leaf-traces.*

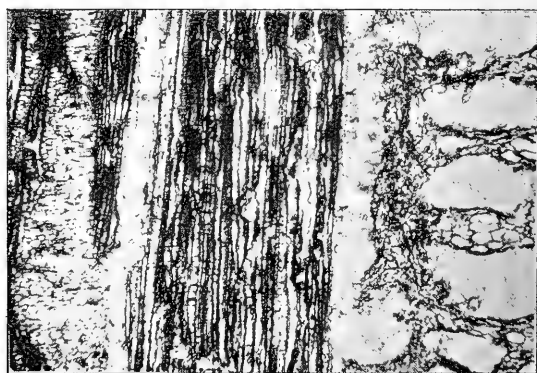
Attention has already been drawn to the occurrence of a well-defined group of tracheids, *lt*, in the section represented in Pl. v. fig. 2, as a darker patch at the periphery of the primary xylem, and in fig. 1, Pl. v. as a strand, *lt*, which gradually becomes indistinguishable from the main mass of xylem in the lower part of the section. In the large section reproduced in fig. 7, Pl. VI., there is a distinct elliptical group of elements at *lt* 1, which is shown on a larger scale in fig. 5, Pl. v. This group of slightly crushed tissue consists of tracheids interspersed with parenchyma; in transverse section the two constituents can hardly be distinguished, but in longitudinal view the tracheids appear as long tubular elements separated here and there by rows of short parenchymatous cells. The tracheids are considerably narrower than those which make up the bulk of the primary xylem, the more central region of which we may speak of as metaxylem, but somewhat wider than those of the secondary xylem. The whole group of xylem of the leaf-trace (*lt* fig. 5) is surrounded by layers of flattened parenchymatous cells, some of which contain a black secreted substance. On the outer edge of the leaf-trace, *lt*, there are several very narrow protoxylem elements situated on that side next the secondary wood of the stem (*px* fig. 5, Pl. v.). In a leaf-trace seen in such a position as that of fig. 5, the protoxylem groups are close together; it is difficult, therefore, to determine the exact number, but there appear to be at least six peripheral strands of narrow elements. In a leaf-trace seen in a lower part of its course, as in figs. 3 and 6, Pl. v., where the tissues are less compact and more extended laterally, the protoxylem groups, *px*, are more readily

distinguished. As already pointed out there are approximately 30 groups of protoxylem distinguishable in the peripheral region of the primary xylem of a complete transverse section (*e.g.* Pl. VI.); this number is in agreement with the approximate estimate of six protoxylem groups in each leaf-trace. The oval group of tissue, *lt*, of fig. 5, Pl. v. projects slightly into the secondary wood, and represents a leaf-trace on the point of passing through the secondary vascular tissues on its way to the surface of the stem. The tracheids of a leaf-trace such as that seen in transverse section in figs. 2 and 5, Pl. v., and at *lt* 1, Pl. VI., appear in longitudinal view as long reticulately pitted tracheids of the ordinary type, associated with xylem parenchyma (*lt* text-figure 2).

Returning to fig. 7, Pl. VI. we notice two other regions in the peripheral part of the primary stele which are occupied by narrow tracheids, *lt* 2 and *lt* 3, but these constitute less compact groups than *lt* 1 of the same section, and spread over a greater area, at the edges of which they merge into the larger tracheal tissue of the metaxylem. The group *lt* 2 in fig. 7 (Pl. VI.), shown more clearly in figs. 3 and 6, Pl. v., is much less compact and sharply limited than the group *lt* 1, but more compact than *lt* 3 of fig. 7, Pl. VI. Both groups *lt* 2 and *lt* 3 are leaf-traces cut through at a different level from that of *lt* 1. In addition to the traces *lt* 2 and *lt* 3 of fig. 7, there are distinct indications in other parts of the periphery of the primary stele of the same section of portions of two more such groups, in the form of strands of narrower tracheids with protoxylem elements more widely separated from one another in a lateral (or tangential) direction than the protoxylem exarch strands of the leaf-traces *lt* 1—*lt* 3. One of these more widely separated groups of leaf-trace tissue is situated a short distance to the right of *lt* 1 of fig. 7, Pl. VI.; this we may designate *lt* 4, and the other, which is still less clearly defined—the leaf-trace tracheids and parenchyma being spread over a greater area—occurs slightly to the left of *lt* 2, and may be spoken of as *lt* 5. Fig. 8, Pl. VII. shows some of the peripheral protoxylem strands of a leaf-trace as seen in a lower part of its course than in the section represented in Pl. v. fig. 3; in fig. 8 the protoxylem strands are farther apart tangentially, and this is the result of the lateral spreading of the trace in the deeper part of its course.

The disposition of the leaf-traces with their protoxylem strands, as seen in transverse section, agrees with a phyllotaxis of two-fifths. The size and degree of compactness of the leaf-trace groups afford guides as to the relative levels at which the section has intersected the leaf-traces, the more compact the foliar vascular strands the higher they are in their upward course. The transverse

section I. 3 shows the phyllotaxis very clearly, also the section reproduced in fig. 7, Pl. vi.

The explanation of the different appearance presented by the several leaf-traces seen in the same transverse section of the stem is afforded by longitudinal sections. In fig. 1, Pl. v., the leaf-trace *lt* 1 appears at the top of the section as a dark compact strand clearly differentiated from the more central metaxylem; in this position it appears as the elliptical group *lt* of fig. 5, Pl. v., and *lt* 1, figs. 2 and 7. Text-figure 2 (*lt*) shows the appearance of such a compact leaf-trace as that of fig. 5, Pl. v., in longitudinal view. The strand *lt* of fig. 1, Pl. v., when followed in its downward course is seen to widen laterally, and in the position indicated in the figure by the letters *lt* 1 it is scarcely distinguishable as a distinct strand. This gradual dying-out of the leaf-trace as shown in fig. 1, Pl. v., is the expression of the fact that the tracheids gradually spread out in a slightly fan-shaped manner as the trace passes downwards and the long and comparatively narrow tracheal elements become shorter and broader, and finally join on to the large and flat tracheids of the metaxylem.

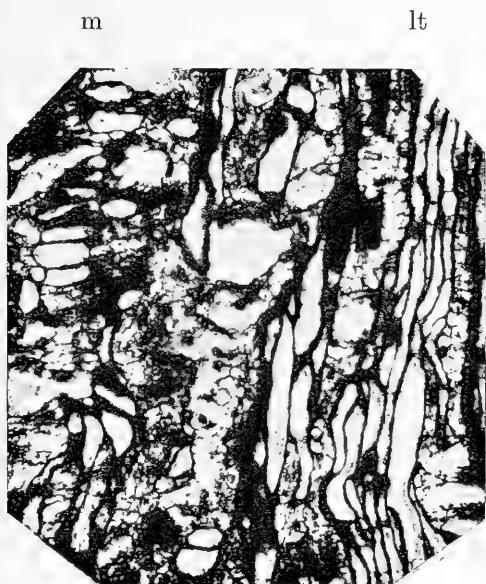

FIGURE 3. LONGITUDINAL SECTION THROUGH PART OF A LEAF-TRACE (*lt*) AND THE OUTER PORTION OF THE METAXYLEM (*m*). (Section I. 9, $\times 50$.)

The looser and less clearly limited appearance of the leaf-trace seen in figs. 3 and 6, Pl. v., shows that the transverse sections

have passed through the trace at a lower level of its downward course than in the case of the leaf-trace *lt* of fig. 5, Pl. v., which is just entering the zone of secondary wood. The greater separation of the protoxylem groups—*px*, *px*—and the relatively greater abundance of parenchyma in the leaf-trace *lt* shown in fig. 3, Pl. v., are features characteristic of a trace as seen in its gradual passage into the metaxylem of the stele. The more internal elements of a leaf-trace are the first to be replaced by shorter and broader tracheids and to place themselves into direct contact with the larger tracheal elements of the metaxylem; this is illustrated by text-figures 3 and 4, which represent a longitudinal section of a leaf-trace seen at about that part of its course indicated by *lt* 1 in fig. 1, Pl. v. In text-fig. 3 the outer leaf-trace elements *lt* retain their elongated narrow form, but on the side next the metaxylem, *m*, the tracheids are shorter, broader and more irregular, passing into direct connexion with the metaxylem elements.

Section I. 10 shows very clearly the behaviour of the tissue elements of a leaf-trace as it passes down the stem; the innermost tracheids first pass gradually into shorter and rather broader tracheids, and these are succeeded by still broader and shorter and less regular tracheids, which are often more or less strongly curved, and finally these elements become linked on to the short elements of the metaxylem with which the leaf-trace tissue is gradually merged. These changes are accompanied by the gradual spreading of the leaf-trace tissue in a radial direction—as shown in fig. 1, Pl. v., *lt*, *lt* 1. The shorter and broader tracheids which succeed the normal longer and narrower xylem elements of a leaf-trace in its downward course, are curiously irregular in width, being swollen or contracted as well as curved, as shown in the central part of text-figure 3.

At the opposite side of the primary xylem to that on which the leaf-trace *lt*, *lt* 1 is seen in fig. 1 there are a few long and broad irregular and rather twisted tracheids between the edge of the secondary xylem and the typical short or flattened metaxylem tracheids; these represent the last indications of a leaf-trace which has descended deep enough in the stem to almost entirely lose its individuality.

In the section reproduced in text-figure 4 the leaf-trace has almost died out, it is shown at a lower level than in text-figure 3; the leaf-trace tracheids are fewer in number, and are represented by a few comparatively broad and rather irregular elements.

It would appear that each leaf-trace passes through approximately four internodes of the stem before entirely losing its individuality; in the deeper part of its course it is represented only by a few elongated reticulately pitted and narrower spirally

pitted protoxylem elements, the inner elements having passed over into the large metaxylem tracheids.

x^2 lt m

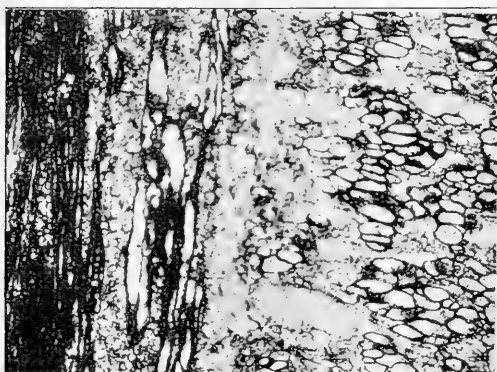

FIGURE 4. LONGITUDINAL SECTION SHOWING A FEW LEAF-TRACE TRACHEIDS *lt*, BETWEEN THE SECONDARY XYLEM x^2 AND METAXYLEM *m*. (Section I. 8, $\times 16$.)

The structure of a leaf-trace as it passes in an obliquely horizontal direction through the secondary wood is shown in fig. 10, Pl. VII.; in the upper part of the section the secondary tracheids are considerably bent and contorted; in the region *a* these begin to bend outwards and become continuous with the secondary tracheids of the leaf-trace. The central part of the trace x^1 , has practically the same form as that shown in fig. 5, Pl. V., but the primary strand is now enclosed by a zone of secondary wood, the outer elements of which are in continuity with the tracheids of the secondary xylem of the stem. The appearance of a leaf-trace as seen in fig. 10, Pl. VII., resembles that of a stem of *Heterangium*, but there are certain differences in detail to which reference is made in the comparison of the Binney specimen with other Palaeozoic genera. Section I. 7 shows the leaf-trace represented in fig. 10, Pl. VII., and Sections I. 5, I. 6, and I. 8 also illustrate the convolutions of the secondary tracheids of the stem¹ in the immediate neighbourhood of the emergent leaf-trace. The transverse Section I. 2 passes through the stem near a leaf-trace, as shown by the oblique position and generally disturbed appearance of some of the tracheids and medullary rays.

¹ Cf. *Lyginodendron robustum*, Seward (97), Pl. VI. fig. 11.

II. COMPARISON WITH OTHER GENERA.

The secondary wood of the new genus, as already pointed out, is of a type frequently met with in Palaeozoic genera; it agrees in the abundance of the medullary tissues and in the character of the tracheids, with the wood of recent Cycads and with that of various extinct genera which may be included in the class Cycadofilices of Potonié¹. In the Binney stem the wood is slightly more compact than in the stems of Cycads or in many of the Palaeozoic types, but the general structural features are essentially those which we regard as characteristic of cycadean rather than coniferous plants. In its detailed structure and in the broad continuous development of the secondary xylem we may compare the new genus more particularly with *Lyginodendron robustum* Sew.² and with the stem named by Renault—on evidence which is hardly satisfactory—*Medullosa gigas*³.

The structure of the primary wood at once recalls that of *Heterangium* and *Medullosa anglica* Scott⁴, which is practically a polystelic *Heterangium*; the parenchymatous pith of such genera as *Lyginodendron* and *Calamopitys*⁵ affords an obvious distinction between those types and the present genus. In the *Heterangium* stele, as Williamson and Scott and Renault have pointed out, we have tracheids which are confined to the stem and others which are common to leaf and stem; as the former authors have shown, there is in *Heterangium* no sharp line between the metaxylem and the primary xylem strands which constitute the leaf-trace bundles. This is another feature shared by this genus and the one under consideration. There are, however, certain important differences which render it advisable to place the Binney stem in a genus of its own. I propose to designate this new generic type of Cycadofilices *Megaloxylon*, and the type-species *Megaloxylon Scotti*, connecting it with the name of my friend Dr D. H. Scott, whose researches have so materially extended our knowledge of the Cycadofilices, and demonstrated the importance of this extinct group from a phylogenetic standpoint. The primary perimedullary strands in the stele of *Heterangium*, as also in *Medullosa anglica*, are distinctly mesarch in structure; the narrow spirally thickened protoxylem elements and the accompanying parenchymatous elements occupy an internal position, and are not external or exarch as in *Megaloxylon*. Another distinctive feature of the new

¹ Potonié (97), p. 160.

² Seward (97).

³ Renault (93), Pl. LXXI. and (96), p. 297.

⁴ Scott (99).

⁵ Solms-Laubach (96), Pl. iv.

type is the unusually large size and the peculiar short form of the metaxylem tracheids, which differ both in their size and shape, especially in the latter, from those of *Heterangium*, as well as in their somewhat more irregular grouping. The difference in size is of little importance and indeed some of the metaxylem tracheids of *Heterangium*¹ are almost equal in dimensions to those of *Megaloxylon*. The perimedullary exarch strands of tracheids in *Megaloxylon* are common to the stem and leaves and consist entirely of leaf-trace bundles; in *Heterangium* the peripheral mesarch strands are "greatly in excess of the number of orthostichies which appear to have existed²." Williamson and Scott describe the perimedullary strands in *Heterangium* as differing from those of *Lyginodendron* in not being isolated groups of tissue, but as forming part of a continuous mass of wood. The greater number of the peripheral strands in the former genus as compared with the number of orthostichies on the stem may be explained, as suggested by Williamson and Scott, in three ways:—(i) the leaf-traces on joining the cylinder may have branched, or (ii) they may have extended down through a very large number of internodes turning aside sufficiently to make room for each other, or (iii) it may be that some of the peripheral strands of the cylinder are cauline and not directly continuous with the leaf-trace bundles³." The structure of *Megaloxylon* suggests another explanation; it is not improbable that the leaf-trace bundles of *Heterangium* in their downward course became laterally extended, and in spreading gave rise to a greater number of tracheal groups as described above in the Binney stem⁴.

The fairly numerous protoxylem strands and the exarch structure constitute distinctive features of the leaf-trace of *Megaloxylon* as seen in its course through the secondary xylem (Pl. VII. fig. 10) compared with the emerging leaf-traces of *Lyginodendron*⁵ and *Heterangium*. In the large undivided leaf-trace of *Medullosa anglica* figured by Scott in his Plate XI. fig. 10⁶ there is a protoxylem strand in an apparently exarch position, and the general appearance of the *Medullosa* leaf-trace resembles that of the corresponding vascular axis in *Megaloxylon Scotti*. In *Medullosa anglica* this large leaf-trace gradually breaks up into the characteristic exarch bundles of the *Myeloxylon* type as it passes

¹ Cf. section 1619 in the Williamson Collection, British Museum; also *Heterangium bibractense*, Renault (93), p. 252.

² Williamson and Scott (95), p. 747.

³ Williamson and Scott (95), p. 748.

⁴ My friend, Dr Scott, on seeing the sections of the new genus pointed out to me the possible bearing of the structure and behaviour of the leaf-traces on the question discussed in the joint memoir on *Lyginodendron* and *Heterangium*.

⁵ Williamson (73), Pl. xxvi. fig. 18.

⁶ Scott (99).

through the periphery of the stem; in the material at present available we have no evidence as to the fate of the leaf-trace of *Megaloxylon* after it emerges from the secondary wood of the stem; it may, however, have entered the petiole in the form of several small exarch bundles, or as a single comparatively large strand.

Heterangium has been described as possessing a stem which—apart from the secondary growth—“is essentially that of a monostelic fern of the *Gleichenia* type¹.” In the case of *Megaloxylon* we may say that the primary stele agrees with that of *Lygodium*², a monostelic fern with exarch protoxylem. In *Lygodium*, however, the tracheids are all of the usual tubular form, and possess the ordinary scalariform type of pitting characteristic of ferns; but apart from these differences the stele of the Schizaceous genus affords a close parallel with that of *Megaloxylon*.

The peculiar metaxylem tracheids of the new generic type distinguish the primary xylem of the stem from that of any known plant. The nearest approach to the large and short pitted tracheids is perhaps afforded by the so-called “speichertracheiden³” described by Haberlandt, Heinricher and others as modified tracheal elements—often isodiametric in shape—which are met with in the leaves of species of *Capparis*, *Centaurea*, *Euphorbia* and other plants in which they serve as elements for the storage of water, and belong to the category of structural peculiarities associated with xerophytism. The abundance of the large metaxylem tracheids in *Megaloxylon* and their intimate connexion with the longer leaf-trace elements, lead one to entertain the opinion that this peculiarity in the anatomy of the *Megaloxylon* stele may have been connected with the function of water-storage⁴.

The fern-like features in *Lyginodendron* are exhibited in the structure of the stele of the petiole as in the form of the leaves; this resemblance to the ferns has led Prof. Zeiller⁵, while recognizing the Cycadean features, to consider the genus as a member of the Filicineae; but the striking affinities with Cycadean characters revealed by the stem render the inclusion of *Lyginodendron*, *Heterangium* and other genera in the class Cycadofilices, a matter

¹ Williamson and Scott (95), p. 767.

² Prantl (81), Pl. III. fig. 34.

³ Haberlandt (96), p. 354.

⁴ Since the above was written my attention has been drawn by Dr Scott to a paper by Rothert in the current number of the Journal of the German Botanical Society, in which parenchymatous tracheids with scattered bordered pits are described as occurring singly or in groups in the pith of a species of *Cephalotaxus*. These short tracheids are regarded as most probably water-reservoirs; they bear a close resemblance in shape and most probably in function to those of *Megaloxylon*, but in the latter genus they form a considerable portion of the primary wood, while in *Cephalotaxus* they appear to be modified elements of the pith.

⁵ Zeiller (97), p. 198.

both of convenience and of importance, as giving expression to the fact that the Palaeozoic types have furnished us with evidence of the best kind as to the common origin of the Ferns and Cycads. While *Lyginodendron* exhibits certain definite fern-like characters, the genus *Heterangium* exhibits a still more decided leaning towards the Filicineae, the structure of the primary stele being an important additional feature of marked Filicinean character. In *Megaloxylon* we have a type of stem in which the primary xylem is distinctly of the fern type; the protoxylem is external, and not internal as in *Heterangium*, but in recent ferns the xylem may be endarch, mesarch or exarch, and no great importance from the point of view of affinity to the ferns as a group should be attached to this point. On the other hand, the mesarch structure of the xylem of *Heterangium*, *Lyginodendron* and other Cycadofilices affords an important Cycadean character which is not met with in *Megaloxylon*. On the whole we may regard *Megaloxylon Scotti* as a member of the Cycadofilices possessing certain features not shared by other known genera, and as presenting in the structure of the primary xylem a more definitely Filicinean than Cycadean feature.

Megaloxylon adds another connecting link between the Palaeozoic Cycadofilices and recent ferns; in anatomical characters the two genera *Lyginodendron* and *Heterangium* approach most nearly to the Osmundaceae and Gleicheniaceae respectively, in *Megaloxylon*, on the other hand, the structure of the primary xylem affords evidence that the *Lygodium* type of stem was also represented in the Cycad-fern alliance which played so prominent a part in Palaeozoic vegetation.

III. DIAGNOSIS.

Megaloxylon, gen. nov.

The stem (probably) monostelic; the primary wood, which is partly common and in part cauline, consists of tracheids and parenchyma; the tracheids are for the most part very short and large, with their walls covered with multiseriate polygonal bordered pits. The secondary wood is of the Cycadean type, characterised by broad medullary rays. The leaf-traces, which are exarch and probably concentric in structure, consist of long tracheids associated with xylem parenchyma; each leaf-trace traverses the peripheral region of the stele through several internodes, and finally passes through the secondary wood in an obliquely horizontal direction; the primary vascular axis of the leaf-trace becomes

enclosed by a zone of secondary xylem as it traverses the secondary wood of the stem.

The phloem, cortical tissues and reproductive organs unknown.

Megaloxyton Scotti, gen. et spec. nov.

In the type-specimen the primary single stele has a diameter of 1 to 2 cm.; it consists of a peripheral leaf-trace region and a central metaxylem region; the metaxylem consists of tracheids varying in shape from isodiametric and somewhat flattened to more or less elongated elements, reaching a diameter—in the case of the shortest tracheids—of 4 mm., with numerous bordered pits on their walls. With the large isodiametric or even horizontally elongated tracheids occur some much smaller short tracheids and occasionally irregularly-shaped longer tracheal elements. The metaxylem tracheids occur in groups of varying size and form scattered through a parenchymatous ground-mass, which includes small secretory cells.

At the periphery of the primary stele numerous strands of spirally pitted protoxylem tracheids occur in an exarch position; these strands of protoxylem occupy different positions in regard to one another in different parts of the stem, according to the position in its vertical course at which a leaf-trace is seen. A leaf-trace has the form of an elliptical mass of long tracheids—with bordered pits on their walls and of somewhat larger diameter than the tracheids of the secondary wood, but much narrower than the large metaxylem tracheids—associated with short parenchymatous cells; several groups (at least 6) of protoxylem elements occur on the external edge of the trace. As a leaf-trace passes deeper into the stem the tracheids become less compactly arranged and the whole leaf-trace becomes wider and less well defined; its long and narrow tracheids are gradually replaced by shorter elements of more irregular and variable form, and these are eventually linked on to the short and large tracheids of the metaxylem region; the peripheral leaf-trace region and the axial metaxylem regions of the stele are in close organic connection.

The secondary wood of the stem is made up of regular radial rows of tracheids with multiseriate bordered pits on their radial walls, and of broad and deep medullary rays composed of short parenchymatous cells.

As a leaf-trace passes through the secondary xylem of the stem its primary tissues become enclosed by a zone of secondary tracheids and medullary rays.

[Type-specimen from the Lower Coal-Measures of Lancashire; preserved in the Binney Collection in the Geological Museum, Cambridge.]

BIBLIOGRAPHY.

- HABERLANDT, G. (96). Physiologische Pflanzenanatomie.
Leipzig, 1896.
- HEINRICHER, E. (85). Ueber einige im Laube Dikotylter Pflanzen trockenen Standortes auftretende Einrichtungen, welche muthmaasslich eine ausreichende Wasserversorgung des Blattmesophylls bezwecken.
Bot. Central. Vol. 23, p. 25, 1885.
- POTONIÉ, H. (97). Lehrbuch der Pflanzenpalaeontologie. (Lief. II.)
Berlin, 1897.
- PRANTL, K. (81). Untersuchungen zur Morphologie der Gefässkryptogamen. Heft 2. Schizaceæ.
Leipzig, 1881.
- RENAULT, B. (79) Structure comparée de quelques tiges de la Flore Carbonifère.
Nouv. Arch. Mus., Paris, 1879.
- (93). Bassin Houiller et Permien d'Autun et d'Épinac. (Atlas.)
- (96). *Ibid.* (Text.)
- ROTHERT, W. (99). Ueber parenchymatische Tracheiden und Harzgänge im Mark von *Cephalotaxus* Arten., *Ber. deutsch. bot. Ges.* vol. XVII. p. 275, 1899.
- SCOTT, D. H. (97). The anatomical characters presented by the peduncle of Cycadaceæ.
Annals Bot. Vol. 11, p. 399, 1897.
- (99). On *Medullosa anglica*, a new representative of the Cycadofilices.
Phil. Trans. R. Soc. Vol. 191, p. 81, 1899.
- SEWARD, A. C. (97). A contribution to our knowledge of *Lyginodendron*.
Annals Bot. Vol. 11, p. 65, 1897.
- (98). Fossil Plants. Vol. I.
Cambridge, 1898.
- SOLMS-LAUBACH, GRAF ZU (96). Ueber die Seinerzeit von Unger beschriebenen strukturbietenden Pflanzenreste des Unterculm von Saalfeld in Thüringen.
Abhand. k. Preuss. Geol. Land. (N. F.) Heft 23, 1896.
- WILLIAMSON, W. C. (73). *Dictyoxylon*, *Lyginodendron* and *Heterangium*. *Phil. Trans.* Vol. 163, p. 377, 1873.
- (87). *Heterangium Tiliaeoides* and *Kaloxylon Hookeri*.
Phil. Trans. Vol. 178, p. 289, 1887.
- WILLIAMSON, W. C. and SCOTT, D. H. (95). *Lyginodendron* and *Heterangium*.
Phil. Trans. Vol. 186, p. 703, 1895.

ZEILLER, R. (97). Observations sur quelques fougères des dépôts houillers d'Asie Mineure.

Bull. Soc. bot. France. Vol. 44, p. 195, 1897.

Explanation of Plates.

(Microphotographs by Mr W. Tams.)

x^1 = primary xylem ; x^2 = secondary xylem ; lt = leaf-trace ;
 px = protoxylem.

PLATE V.

FIG. 1. Radial Longitudinal section. (Nat. size.)

FIG. 2. Transverse section. (Nat. size.)

FIG. 3. Transverse section through the inner edge of the secondary xylem and the tissues of a leaf-trace. ($\times 24$.)

FIG. 4. Transverse section through part of the secondary wood. ($\times 24$.)

FIG. 5. Transverse section through a leaf-trace encroaching on the secondary wood. ($\times 24$.)

FIG. 6. Transverse section similar to fig. 3. ($\times 16$.)

PLATE VI.

FIG. 7. Transverse section through the primary xylem and the edge of the secondary xylem. lt 1— lt 3 = leaf-traces. ($\times 7$. Slide I. 1.)

PLATE VII.

FIG. 8. Transverse section through the inner edge of the secondary wood and some protoxylem groups of the primary xylem. ($\times 50$. Slide I. 1.)

FIG. 9. Longitudinal section through the metaxylem. ($\times 50$. Slide I. 8.)

FIG. 10. Tangential longitudinal section through the secondary wood showing a leaf-trace. ($\times 16$. Slide I. 7.)

The modification and attitude of Idolum diabolicum, a Mantis of the kind called "floral simulators." By D. SHARP.

Plate II.

The Insects composing the family Mantidae differ from other Orthoptera in that they are excessively voracious, eat only living animals, and have their front legs greatly modified for capturing their victims.

During the last few years various notes have appeared relating to Mantises that look like flowers, and thus attract Insects to become their prey. None of them have been figured; and as the colours of Mantidae fade greatly, and change considerably after death, and as the natural attitudes cannot be ascertained from the dead specimens in our cabinets, there is a difficulty in realising what the facts really are.

I was therefore much interested by a letter I received from an esteemed correspondent informing me that he had discovered one of these "floral simulators" shortly after taking up his residence at Mozambique on his removal from Aden. In reply to some questions I addressed to him, Mr Muir has been so kind as to send me the Insect, together with a coloured drawing representing its appearance during life. The species proves to be *Idolum diabolicum*¹, a Mantis described by de Saussure from a specimen from the interior of Africa. De Saussure had no information whatever as to the habits of the creature and was probably guided in the selection of the name he applied to it by the peculiar shape and by the great development of the instruments it is provided with for the purpose of capturing its living prey.

Mr Muir says, "like *Mantis religiosa* it assumes very peculiar attitudes, sometimes hanging by three or even two legs, and sticking one or more of the others out like twigs. The front legs are invariably extended ready to close in upon the deluded prey and are never darted out as they are by *M. religiosa*. Its food seemed to consist of flies, *Limnas chrysippus* being rejected, even when hungry, and other butterflies only taken for lack of other food. Small bits of plaintain were sucked but never eaten. Bees and wasps were left alone². The plant it is depicted on is a rose which

¹ I have to thank M. H. de Saussure for answering some questions I addressed to him, and thus enabling me to feel sure that my determination of his species is correct.

² It may be well to mention that this is contrary to the habits of various other Mantids, which respect neither bees nor wasps; while, of some of them, butterflies are a favourite food, those that are considered to be distasteful being freely eaten. The scattered observations that have been made indicate considerable variety as regards this point.

cannot be its natural plant as the only ones on the island are in our garden. I doubt if it has any special plant, but its coloured legs hanging from any tree form an attraction to flies. In order to test this I placed pieces of coloured paper on trees and noticed that flies would often fly down and at times beetles. The position given in the sketch was its favourite one whilst in captivity. The colours are fairly correct. In the dried specimen the greens have gone yellow and the fore-legs faded." In a subsequent letter Mr Muir emphasises the fact that *I. diabolicum* captures its prey, as this flies down, by closing the tibia on the femur, and not by darting out the leg as other Mantises do.

Although the appearance of *Idolum diabolicum*, as shown in the sketch (Plate II.) is very striking, yet examination shows that the modification from other Mantids is but slight; and a comparison with what we know as to other Mantidae suggests that the question of most interest is the relation of the modification to the habits of the creatures.

The points of **modification** are (1) the great size of the front legs, (2) the colour of the coxae.

(1) The front legs are remarkably large but the part of them that is most enlarged is the coxa. The increase of this part is effected not by an enlargement of the whole of the limb, but by the development on each side of it of a plate-like dilation. The slender coxa usual in Mantidae generally, and in the tribe Empusides to which *Idolum* belongs, is perfectly well-defined, but there is a large flap added on each side. These flaps appear to be similar in their nature to the large flaps on the thorax as well as to those at the tips of the middle and hind femora, and at the sides of the abdomen, and it is to be remarked that in this Insect there are also flaps on the middle and hind coxae. The possession of these appendages is a special character of *Idolum* and its immediate ally *Gongylus*; they are more largely developed in *Idolum* than in *Gongylus*, being almost absent on the hind legs of the latter genus. In addition to this the front femur of *Idolum* has also a flap-like dilatation along its inner or upper margin while the spines on the upper side of the femur are of unusual length. The great shield or hood of the thorax is found in various other Mantidae; it is seen in the family in a great variety of sizes and shapes, but it is at its maximum of development in *Idolum*. In the two allies of *Idolum*—*Empusa* and *Gongylus*—it is but little developed, there being scarcely any trace of it in *Empusa*, while in *Gongylus* it is small. Both of these Insects are floral simulators, and both of them use the prothorax as part of the simulation, but in *Idolum*, notwithstanding the great size of this part, it appears to be of not much importance in this respect. *Idolum* may therefore be described as an Empusid, with the epidermal flaps of the coxae and

thorax unusually largely developed; the size of the Insect being much greater than that of its allies.

(2) The colour of the front coxae, the second point of the special modification, is very striking. It is remarkable even in the dead specimen and has a very floral appearance during life. This special coloration is, like that of the petals of certain flowers, almost confined to one surface. The upper surface of the Insect is altogether more pallid than the under surface.

The **attitude** assumed by *Idolum* is very unusual. In Mantidae generally the normal position of the front legs is that the coxae are held together so that their inner faces are not, or are but little, displayed. *Idolum* extends the front legs to an unusual extent, and thus fully displays what is really the inner face of the coxa. It is this face that bears the petaloid coloration. If *Idolum* held the legs in the normal position the floral colour would not be seen because the two coloured surfaces would be pressed together.

In short, the attitude assumed by the Insect is thoroughly correlated with the special modification of colour and structure¹.

Comparison of *Idolum* with some other Mantidae. The flap-like dilatations of the front coxae are analogous to similar structures found on the other coxae as already remarked, and they are moreover similar to the lobes of *Empusides* and other Mantids concerning which de Saussure has made the following remarks: "The presence or absence of lobes on the abdomen may appear a rather unimportant (*artificiel*) character. But an attentive study indicates that in this family it is in direct relation with more important modifications. In fact, in those species where it is strongly pronounced all the parts of the body have a tendency to assume a lacerated appearance, often very striking. The elytra assume unusual forms (*Gongylus*); they are sometimes *découpés* (*Acanthops*) or pointed and veined like leaves (*Deroplatys*); the prothorax also is often dilated in a leaf-like manner, and the whole Insect then has a singular form that recalls the appearance of vegetable objects, and renders they Insects eminently mimetic. These external modifications are naturally one with (*solidaires*) the nature of the life of the Insects exhibiting them, and hence they postulate certain internal modifications of which they are only the visible expression²."

¹ I may add that this attitude is possibly facilitated by some small external or internal modification of structure that I am not able to detect. The insect when sent to me by Mr Muir was not in the position I now exhibit it in, and which it will be noticed is exactly that of Mr Muir's figure. When I received it the front legs were drawn together and contracted in the usual Mantid fashion. On softening it with water so as to facilitate an examination of its legs, I found that the position of extension they assumed on stretching was that shown in the drawing. In *Mantis religiosa* the legs can be brought into a corresponding position and retained there, only by aid of considerable pressure.

² *Mem. Soc. Phys. Genève*, xxi., 1871, p. 2.

Whether de Saussure's view as to this probable correlation of the flap-like projections with internal conditions of which we as yet know nothing prove to be correct or not, it is clear that the special development of the coxae in *Idolum*, is merely another example of a feature that is common in *Mantises*.

The same conclusion is true as to the petaloid coloration of the front coxae. In various *Mantises*, having the front limb of the shape usual in the family, there is a remarkable coloration of the coxa. It is well seen in the common *Mantis religiosa* of Europe where it occurs in the same position on the limb as the petaloid colour of *Idolum*. It is found in various degrees of development according to genus and species, and in some cases is variable in the individuals of the same species found in the same locality. This is the case with *M. religiosa*, where there is always a large dark mark on the inner face of the basal part of the coxa, and in some individuals this mark takes the further development of becoming ocellated, the dark colour surrounding a space of a clear yellow colour.

It is unusual for the coxa to have a rose-like or purple coloration; but in various *Mantids* a colour very similar to that of the petaloid coxa of *Idolum* is seen on other parts of the body. This is the case with the posterior wings of a *Rhombodera* from Borneo; and in a remarkably pallid *Mantis* of a new genus brought by Mr Graham Kerr from Paraguay this colour is found on the small elytra, though there is no trace of it on any other part of the body. The petaloid coloration is in *Idolum* confined to the front coxae, while in Mr Graham Kerr's genus it is even more definitely limited and confined to the elytra.

In a small *Mantid* of the genus *Paroxypilus* from Sydney the front coxae are unusually small, but they are in larger part red in colour, in striking contrast to the rest of the body and to the other parts of the front leg, which are of a metallic black tint.

In none of these cases have we any reason for believing that the peculiar and limited coloration is of any direct bionomic importance to the creatures possessing it.

This comparative review leads to the conclusion that both the peculiar coloration and structure of the front coxae of *Idolum* may be secondary or correlative characters.

If we extend our comparison to the attitudes of the known cases of floral simulators we note some remarkable facts. The following interesting account of the simulation of a flower by the European *Empusa egena*, by Krauss and Vosseler, has recently been published: "The mimicry this creature carries on is surprising. The second example, found at Saïda, sat on a stone about the size of one's hand and imitated so deceptively a greenish-white anemone (*Windensblüthe*) coloured at the edges and bottom with

rose-colour, that I should certainly have overlooked it, if it had remained quiet. The legs were widely outspread, the head and thorax were directed downwards, somewhat like the stalk of a flower, the delicately coloured and veined wings slightly spread out over the abdomen directed upwards. In this position the creature at each approach began to move the wings to and fro, evidently to act like a flower swinging in the wind. As however a perfect calm prevailed this manœuvre led to the detection of the Insect. Whenever I removed to a distance the wings and the abdomen were depressed. My companion and I several times tempted the creature to make use of this mimicry, and always with the same result¹."

The habits of *Gongylus gongylodes* in India have been described by Dr Anderson, and his account is quoted at length in the *Cambridge Natural History*, Vol. v. I need therefore only say that in it the dilatation of the thorax has a petaloid coloration, and that the insect puts itself in a position that causes it to look like a flower, and that it makes swaying movements like a flower shaken by a breeze.

The three genera, *Empusa*, *Gongylus* and *Idolum*, are closely allied. They all simulate flowers, but by means of colours placed in different positions on the body, and by structures that are also different in position and shape. All that the three have in common is the instinct or habit of using the different characters they possess for a similar purpose.

To the considerations I have adduced we may add another—subordinate, but bearing directly on the point under consideration—viz. that in each of the numerous little dramas for the capture of its prey that an *Idolum* goes through in the course of its life, the attitude must be the first act.

This study strongly suggests that in the evolution of the peculiarities of this species the attitude has played a primary part.

Let me now briefly resume the points of this examination. *Idolum diabolicum*, though apparently highly modified for its special kind of life possesses no peculiarity but such as we may assume from a study of other Mantidae to be capable of acquirement independent of their advantage for the purpose to which we see them put. The plate-like dilatations of the legs are of the kind alluded to by de Saussure as probably connected with physiological conditions of which we at present know little or nothing². The

¹ *Zool. Jahrbuch Syst.*, ix., 1897, p. 527.

² There is now some reason for supposing that the various sacs and expansions (of which wings are the highest condition) so frequent in insects are connected with the metamorphosis, and facilitate the accomplishment of that act, which is now known to be one of great difficulty and danger.

petaloid coloration is found on other Mantises in different parts of the body and in *I. diabolicum* exists on a part in which pigmentation of a purposeless nature frequently occurs.

On the other hand our comparative sketch of attitude and movement shows that they must be looked on as of more importance, and that they have probably preceded the modifications. In other words, that in the past the function of catching in a particular manner has preceded the modifications of structure for doing so.

Herbert Spencer has argued¹ that "function is from beginning to end the determining cause of structure."

In the case of *Idolum diabolicum* we have seen that the habit or instinct has preceded certain modifications. The modifications may be described as the localisation and exaggeration of certain phenomena that are of usual occurrence in Mantidae. And the further question arises as to the aetiology of this localisation. It would at present be rash to endeavour to answer this question; still I hope I may be permitted to say that I believe that this localisation of modification will ultimately be found to be due to the reactions between simple physical causes and the physiological processes of the creature.

Description of Plate.

IDOLUM DIABOLICUM, female, natural size. The plate is made by aid of a dried specimen from Mozambique and of a coloured sketch of the Insect during life by Mr Muir. The Insect is represented in its favourite attitude; the position during life is a matter of indifference, and the creature may be either suspended or erect. The tarsi of the front legs are broken in the specimen, and the restoration of them attempted in the plate is bad, as they are made to look like spines.

¹ *Principles of Biology*, 1st edition, Vol. I., p. 167. In the revised and enlarged edition of 1898, p. 211, the words quoted are altered as follows: "the achievement of function is, throughout, that for which structure arises." I think the original mode of expression is preferable as being less teleological.

On the origin of magneto-optic rotation. By Mr J. LARMOR.

[Read March 6.]

It is known (*Phil. Mag.*, Dec. 1897) that when in a material molecule there exists an independently vibrating group of ions or electrons, for all of which the ratio e/m of electric charge to inertia is the same, then the influence of a magnetic field H on the motions of this group is precisely the same as that of a rotation with angular velocity ω , equal to $\frac{1}{2}eH/mC^2$, imposed on the group around the axis of the field, on the hypothesis that the extraneous forces acting on the ions are symmetrical with respect to this axis. This result involves the main features of the Zeeman effect; it requires that the separations of the doublets representing the spectral lines arising from such a group must all be equal when measured in difference of frequency, or be inversely as the square of the wave-length in vacuum when measured in difference of wave-length, a relation which Preston has recently found to obtain for the natural series of lines in ordinary spectra.

The object of this note is to point out that it is possible to deduce the Faraday effect from the Zeeman effect by general reasoning as regards any medium in which the optical dispersion is mainly controlled by a series of absorption bands for which the Zeeman effect obeys the above law, without its being necessary to introduce any special dynamical hypothesis. For this law ensures that the effect of the magnetic field on the periods of the corresponding free vibrations of the molecules is the same as that of a bodily rotation, say with angular velocity ω , round its axis: while the complete circular polarizations of the Zeeman doublets, viewed in the direction of the axis, shew that their states of vibration are symmetrical with respect to that axis. Thus, Ω being the angular velocity of the displacement vector in a train of circularly polarized waves traversing the medium along the axis, the state of synchronous vibration which it excites in the molecules will have exactly the same formal relation to this train when the magnetic field is off, as it would have to a train with the very slightly different angular velocity $\Omega \pm \omega$ when the magnetic field is on, the sign being different, according as the train is right-handed or left-handed. Now change of this angular velocity Ω means change of period of the light: thus the propagation of a circularly polarized wave-train, when the field is on, is identical with that of the same wave-train when the period is altered by its being carried round with angular velocity $\pm \omega$ and there is no influencing magnetic field.

This last result has been employed by H. Becquerel as a single hypothesis (suggested by Maxwell's notion of a magnetic field in this connexion as a vortex in the medium), from which to deduce quantitatively both the Zeeman effect and the Faraday effect and thus correlate them,—“*Sur une interprétation applicable au phénomène de Faraday et au phénomène de Zeeman,*” *Comptes Rendus*, Nov. 8, 1897. He shows, employing chiefly the quantitative results of his own previous experimental investigations, that this hypothesis is capable of providing a satisfactory general view of the whole range of the phenomena, and in particular that it leads immediately to a simple law of dispersion for the Faraday effect, namely, rotatory power proportional to $\lambda dn/d\lambda$ when n is the refractive index corresponding to the wave-length λ measured in vacuum, a law which is in good agreement with Verdet's results for carbon disulphide and creosote.

The preceding argument forms a general dynamical justification of this hypothesis for the case of all media in which the ordinary gradient of dispersion is mainly controlled by one or more powerful absorption bands beyond the visible spectrum, for which the Zeeman constants are the same: it also shows that Becquerel's hypothesis has an approximate validity when these constants are nearly the same for all the effective bands. In the immediate neighbourhood of any single band the dispersion is anomalous, and is controlled practically by that band alone: the application will then be exact, and in Becquerel's hands it has given a complete account of the excessive and anomalous Faraday rotation first observed by Macaluso and Corbino in sodium vapour for light adjacent to the D lines. As was to be anticipated, these simple general conclusions are consistent with the results of the more special dynamical investigations by FitzGerald and Voigt.

PROCEEDINGS AT THE MEETINGS HELD DURING
THE SESSION 1898—1899.

ANNUAL GENERAL MEETING.

October 31st, 1898.

MR F. DARWIN, PRESIDENT, IN THE CHAIR.

The following were elected Associates, having been nominated by the Council :

Mr R. S. Whipple.
Mr J. C. M^cLennan.
Mr R. S. Willows.

The names of the Benefactors were read.

The officers and new members of the Council for the ensuing year were elected, the new Council being constituted as follows :

President :

Mr J. Larmor.

Vice-Presidents :

Mr F. Darwin.
Dr Gaskell.
Professor Forsyth.

Treasurer :

Mr A. E. Shipley.

Secretaries :

Mr H. F. Newall.
Mr W. Bateson.
Mr H. F. Baker.

Other Members of the Council :

Mr A. Scott.
Mr J. E. Marr.
Professor H. Marshall Ward.
Mr A. Harker.
Mr A. Hutchinson.
Professor Liveing.
Mr S. Skinner.
Mr H. Gadow.
Mr D. Sharp.
Professor J. J. Thomson.
Mr L. R. Wilberforce.
Mr A. Berry.

The President elect, Mr J. LARMOR, then took the Chair.

The following Communications were made :

1. On the Evaluation of a certain Determinant which occurs in the mathematical theory of statistics and in that of elliptic geometry of any number of dimensions. By ARTHUR BERRY, M.A., King's College.

2. (1) Metrical Relations between Linear Complexes. (2) Apolar Systems of Quadrics. By J. H. GRACE, B.A., Peterhouse.

3. Certain Systems of Quadratic Complex Numbers. By A. E. WESTERN, B.A., Trinity College.

4. On Mittag-Leffler's Theorem. By H. F. BAKER, M.A., St John's College.

5. On the connection between the Chemical Composition of a Gas and the Ionization produced in it by Röntgen Rays. By Professor J. J. THOMSON, Trinity College.

6. On Convection Currents and on the Fall of Potential at the Electrodes, in Conduction produced by Röntgen Rays. By JOHN ZELENY, B.Sc.

7. On Velocity of Solidification. By HAROLD A. WILSON, B.Sc.

November 14th, 1898.

MR J. LARMOR, PRESIDENT, IN THE CHAIR.

The following Communications were made :

1. Orthogenetic Variation in the Shells of Chelonia. By Mr H. GADOW, F.R.S.

2. Some points in the Morphology of the Enteropneusta. By Dr A. WILLEY.

3. On *Lepidodendron* from the Calciferos Sandstone of Scotland. By Mr A. C. SEWARD, and A. W. HILL, B.A., King's College.

November 28th, 1898.

In the Chemical Laboratory.

MR J. LARMOR, PRESIDENT, IN THE CHAIR.

The following were elected Fellows of the Society :

W. Welsh, M.A., Jesus College.

W. M^cF. Orr, M.A., St John's College.

G. T. Walker, M.A., Trinity College.

J. Graham Kerr, B.A., Christ's College.

J. H. Grace, B.A., Peterhouse.

E. W. Barnes, B.A., Trinity College.

The following Communications were made :

1. On the Flame-spectrum of Mercury, and its bearing on the distribution of energy in gases. By Professor G. D. LIVEING.
2. On the Variation of Intensity of the Absorption Bands of different Didymium Salts dissolved in water, and its bearing on the ionization theory of the colour of solutions of salts. By Professor LIVEING.
3. On the Comparative Colour of the Vapour of Iodine in Air at Atmospheric Pressure and in Vacuum. By Professor DEWAR.
4. On the Partitions of Numbers which possess symmetrical Graphs. By Major MACMAHON, Sc.D., F.R.S.

January 23, 1899.

MR J. LARMOR, PRESIDENT, IN THE CHAIR.

The following were elected Fellows of the Society :

- E. J. Bles, B.A., King's College.
- A. Willey, M.A., Christ's College.

The following was elected an Associate, having been nominated by the Council :

J. Burke, Trinity College.

The following Communications were made :

1. On Clouds formed by Ozone. By J. S. E. TOWNSEND, M.A.
2. (a) On Detectors of Radiant Heat, (b) on the Symbolic Integration of certain Differential Equations in Quaternions. By H. C. POCKLINGTON.
3. On the Motion of a charged Ion in a magnetic field. By Professor J. J. THOMSON.

February 6th, 1899.

MR J. LARMOR, PRESIDENT, IN THE CHAIR.

The following was elected a Fellow of the Society :

Dr E. Barclay Smith, Downing College.

The following Communications were made :

1. Notes on the Inheritance of Variation in the Corolla of *Veronica Busbaumii*. By Mr W. BATESON and Miss D. F. M. PERTZ.
2. On the Anatomy of a supposed New Species of *Cænopsammia* from Lifu. By Mr J. STANLEY GARDINER.

February 20th, 1899.

MR J. LARMOR, PRESIDENT, IN THE CHAIR.

Professor H. Lamb, M.A. (Trinity College), Victoria University, was elected a Fellow.

The following Communications were made :

1. A semi-inverse method of Solution of the equations of Elasticity. By Dr C. CHREE.
2. On Change of independent Variables and the theory of Cyclicants and Reciprocants. By Mr E. G. GALLOP.
3. On the Electro-chemical equivalent of Carbon. By Mr S. SKINNER.
4. On the Ionization of a Gas by 'Entladungsstrahlen.' By Professor J. J. THOMSON.

March 6th, 1899.

MR J. LARMOR, PRESIDENT, IN THE CHAIR.

The following Communications were made :

1. Notes on the Binney Collection of Carboniferous Plants. I. Lepidophloios. By Mr A. C. SEWARD.
2. A Note upon the way in which Bones break. By Dr JOSEPH GRIFFITHS.
3. On the origin of Magneto-optic Rotation. By Mr J. LARMOR.

May 1st, 1899.

At the Observatory.

MR J. LARMOR, PRESIDENT, IN THE CHAIR.

Sir ROBERT BALL gave a brief description of the Sheepshanks Telescope, and the following Communication was made :

Reflexion of Sound at a Parabola. By Rev. H. J. SHARPE.

May 15th, 1899.

MR J. LARMOR, PRESIDENT, IN THE CHAIR.

The text of an address to Sir GEORGE GABRIEL STOKES, conveying the Congratulations of the Society on the occasion of his Jubilee, was read from the Chair.

The following Communications were made :

1. Mr J. J. LISTER exhibited larvæ of *Branchipus* and *Estheria* reared from dried mud.
2. Notes on the Binney Collection of Fossil Plants. II. A new type of Palæozoic Plant. By Mr A. C. SEWARD.
3. On the modification and attitude of *Idolum diabolicum*, a Mantis of the kind called Floral Simulators. By Dr D. SHARP.
4. On the product $J_m(x)J_n x$. By Mr W. M^CF. ORR.

June 5th, 1899.

In the Cavendish Laboratory.

MR J. LARMOR, PRESIDENT, IN THE CHAIR.

This was a Special Meeting of the Society for the presentation of papers to be published in a volume commemorative of the long connexion of Sir G. G. STOKES with the Society.

The following papers were communicated :

1. On the analytical representation of a uniform branch of a monogenic function. By Professor M. G. MITTAG-LEFFLER.
Prof. Mittag-Leffler gave an account of the scope and aim of his paper.
2. The theory of groups. By Professor H. POINCARÉ.
3. Ueber die Bedeutung der Constante b des van der Waals'schen Gesetzes. Von Prof. BOLTZMANN und Dr MACHE, in Wien.
4. By Professor A. RIGHI.
5. On the echelon spectroscope. By Professor A. A. MICHELSON.
Prof. Michelson exhibited and described his new spectroscope, and used it to demonstrate the Zeeman effect.

6. Application of the Partition Analysis to the study of the properties of any system of consecutive integers. By Major P. A. MACMAHON, R.A.

7. On Diffraction of solitary waves. By Lord KELVIN.

8. On the Periodogram of Magnetic Declination derived from 25 years' observations at the Greenwich Observatory. By Professor A. SCHUSTER.

9. A general method of determining free electric distributions by successive approximations. By Professor W. D. NIVEN.

10. The influence of temperature on the absorption spectra of salts. By Professor G. D. LIVEING.

11. On the integrals of systems of differential equations. By Professor A. R. FORSYTH.

12. On the general theory of the optical relations of magnetism. By Mr J. LARMOR.

13. On the indirect determination of the frictional loss of energy for the flow of air along tubes, and other measurements with the pneumatic analogue of the Wheatstone Bridge. By Mr W. N. SHAW, and R. S. COLE.

14. On the solution of two differential equations which occur in the Lunar Theory. By Mr E. W. BROWN.

15. Experiments on the oscillatory discharge of an air condenser, with a determination of " v ". By Mr R. T. GLAZEBROOK and Professor O. J. LODGE.

together with papers by the Master of St John's, Mr H. M. TAYLOR, Professor J. J. THOMSON, Dr E. W. HOBSON, Mr E. H. GRIFFITHS, Mr H. M. MACDONALD, and Professor E. O. LOVETT.

Mr H. M. TAYLOR exhibited a model of the 27 straight lines on a cubic surface.

PROCEEDINGS
OF THE
Cambridge Philosophical Society.

On Semi-convergent Series. By Mr W. M^cF. ORR.

[Read 30 October 1899. v. *Transactions* Vol. XIX.]

An Experiment on the Condensation of Clouds. By Mr C. T. R. WILSON.

[Read 30 October 1899.]

The author gave an experimental demonstration of the production of cloud by the contact of layers of moist air of different temperatures.

The Skeleton of Astrosclera compared with that of the Pharetronid Sponges. By Mr J. J. LISTER.

[Read 13 November 1899.]

The structure of *Astrosclera willeyana*, the representative of a new family of Sponges, obtained by Dr Willey in the Loyalty Islands, was described, and attention was drawn to the resemblance between its skeleton and that of some members of the *Pharetrones*, a group of sponges which are found as fossils in formations ranging

from the Carboniferous to the Cretaceous period. A difference however exists in the character of the elements of which the skeleton is composed. In *Astrosclera* these are polyhedral masses, having a radial arrangement of the crystals of aragonite which compose them, while in the best preserved specimens of the *Pharetronas* the skeleton is composed of more or less modified three- or four-rotate spicules, presumably of calcite.

The case was considered of the representatives of the Pharetronids occurring in Triassic strata near St Cassian in the Tyrol, in which the skeleton often has a radiating structure, in many cases closely resembling that found in *Astrosclera*. The view generally held by Palaeontologists is that the radiating structure of the St Cassian forms is secondary, and due to a recrystallization in the fossil state, which has obliterated the original elements of the skeleton. This conclusion was held to be correct, notwithstanding the marked resemblance of the resulting structure with that of the skeletal elements of *Astrosclera*.

While their similarity in this respect was rejected as evidence of affinity, it was pointed out that the resemblance between the skeletal elements formed within the living protoplasm of *Astrosclera* and the bodies formed by purely physical processes in the St Cassian fossils may have a bearing on the problem of the mode of origin of sponge spicules.

Note on the name Balanoglossus. By S. F. HARMER, Sc.D.,
King's College.

[Received 15 November 1899.]

The generic name *Balanoglossus* (Delle Chiaje, 1829) has been shown by Carus and Spengel¹ to be synonymous with *Ptychodera* (Eschscholtz, 1825); and Spengel has accordingly accepted the earlier name, retaining *Balanoglossus*, however, in a restricted sense. The species found by Eschscholtz in the N. Pacific was named by him *Pt. flava*; while Delle Chiaje's species was the well-known Mediterranean *Balanoglossus clavigerus*. Both these species are referred by Spengel, throughout the greater part of his Monograph, to the genus *Ptychodera*, although on p. 359 he suggests a provisional breaking up of this genus into three; *Ptychodera* (s. str.), *Tauroglossus*, and *Chlamydothorax*. *B. clavigerus* is placed in *Tauroglossus*, in which *Pt. flava* is also doubtfully

¹ Spengel, J. W., "Die Enteropneusten des Golfes von Neapel," *Fauna u. Flora G. von Neapel*, 18 Monogr., 1893, pp. 12, 349.

included. It appears, however, from Willey's researches¹ that *Pt. flava* belongs to the genus (or sub-genus) *Chlamydothorax* a conclusion previously suspected by Spengel.

The name *Balanoglossus* is retained by Spengel (p. 350) for a group of species including *B. kupfferi* and *B. kowalevskii*, largely on the ground "dass die Gattung *Balanoglossus* in diesem Sinne die primitivsten Formen umfasst, denen auf diese Weise der altbekannte Name gewahrt bleibt."

Although feeling great reluctance to suggest changes in the nomenclature of the Enteropneusta, I am induced to do so by having found considerable inconvenience in using Spengel's terminology, which does not appear to be in accordance with recognised rules. *Balanoglossus* is clearly a synonym of *Ptychodera*; and although Spengel might have been justified in rejecting the older name on the ground that *Balanoglossus* had been universally accepted by Zoologists for more than half a century, it would be difficult to maintain this position since the appearance of Spengel's great monograph and the adhesion to his nomenclature of Willey and other recent writers. *Balanoglossus* ought, therefore, to disappear as a genus. I think that the restricted sense in which Spengel uses it is unfortunate, since the type-species (Delle Chiaje) is thereby excluded from the genus to which it properly belongs. Spengel's contention that the species placed by him in that genus are the most primitive of Enteropneusta is expressly controverted by Willey, and whatever conclusion (if any) might be derived from that argument thus loses its force.

The disappearance of the familiar name *Balanoglossus* would be a matter for regret; but I think that it may conveniently be retained as a semi-popular name for any species of Enteropneusta;—a practice which is commonly adopted in Zoological works. In order to facilitate its use in this way I suggest the new generic name *Balanocephalus* to include the species which are at present placed in Spengel's restricted genus *Balanoglossus*. The earliest described species belonging to this group is *B. kupfferi*, v. Willemoes Suhm, which would accordingly be the type-species. Spengel's sub-genus *Dolichoglossus* (p. 360) cannot well be accepted instead of *Balanocephalus*, as it is expressly restricted by him to the species (*B. kowalevskii* etc.) with a long proboscis, and would be misleading if applied to the other species. If it is desirable, as Spengel suggests, to subdivide the genus *Ptychodera*, the application of the strict laws of nomenclature would necessitate the use of that name for the *Chlamydothorax*-group, and the introduction of a new generic name for *Pt. minuta* and *Pt. sarniensis*.

¹ *Quart. J. Micr. Sci.*, XL., 1898, p. 165, and *Zool. Results*, Part III., 1899, p. 227.

On certain outgrowths (Intumescences) on the green parts of Hibiscus vitifolius Linn. By Miss E. DALE (presented by Professor MARSHALL WARD).

(With Plates VIII., IX., X.)

[Received 15 November 1899.]

Hibiscus vitifolius is a species widely distributed in Tropical and sub-Tropical countries. In different parts of the world it is subject to considerable variation, especially in regard to the kind and degree of hairiness of the leaves, the stems, and the green parts of the flowers.

By some authors it is regarded as an annual or biennial, by others as a perennial. Hooker¹ says that in India the lower leaves are about four inches long; on the other hand Trimén² states that in Ceylon the leaves are generally about one or two inches in length. It is possible however that Trimen may be referring to *H. truncatus* Roxb., which, according to Hooker, is a variety of *H. vitifolius* with smaller parts.

Linnaeus³ describes the species as "subtomentose."

De Candolle⁴ states that, in Oriental India, the leaves are "glubriusculis," the capsule pilose.

Roxburgh⁵, who notes that in India the species flowers in the rainy and cold seasons, says that the plant is villous.

Wright⁶, who gives the distribution of the plant in Oriental India as from Madras to Negapatam, and also in Malabar, describes the leaves as being, on the upper side, nearly smooth, or tomentose, on the under side more or less softly tomentose, and the capsules as "hairy." The same author in his "Catalogue of Dried Plants" describes one specimen, No. 210, as having "leaves very tomentose on both sides" and another, No. 211, as having "leaves more glabrous above."

Hooker⁷ notes that the species in the Niger Territory "differs from the usual East Indian state of the plant in the greater villosity and many stellate setae, or hairs, which, together with the toothing of the leaves, are very variable characters. In some varieties the plant is merely hoary."

¹ Hooker, *Flora of British India*, 1875, Vol. I., pp. 338, 339.

² Trimen, *Handbook of the Flora of Ceylon*, 1893, Part I., p. 154.

³ Linnaeus, *Mantissa Plantarum*, 1767, p. 569.

⁴ De Candolle, *Prodromus Systematis Naturalis Regni Vegetabilis*, 1824, p. 450.

⁵ Roxburgh, *Flora Indica*, 1832, Vol. III., p. 200.

⁶ Wright, *Prodromus Florae Peninsulae Indicae Orientalis*, 1834, Vol. I., p. 50.

⁷ Hooker, *Niger Flora*, 1849, p. 227.

Bentham¹, who describes the Australian form of the plant, which is common in Queensland, says that the leaves are very densely and softly villous tomentose, the capsule hirsute with scattered hairs. He also compares the hairiness of the species in different parts of the world. In India it is usually shortly tomentose, in Africa more hispid, in Australia still more beset with rigid hairs.

Grisebach² says that in the West Indies, where, in Jamaica, Dominica and S. Vincent the species has been naturalized from plants brought from the East Indies, it is "velvety" and the capsule "pilose."

Oliver³, describing the plant from Tropical Africa, says that it is "villose, hispid or even aculeate....The leaves nearly smooth or tomentose and villose. The calyx lobes are pubescent. The hairiness of the surface is subject to great variations."

Hooker⁴ states that in British India, where the plant is found from the N.W. Provinces to Ceylon, and in all the hotter parts of India, the leaves are "tomentose on both sides."

Trimen⁵, describing the form found in Ceylon, says that the stem is wholly pubescent or has a line of pubescence down one side. The leaves are glabrous or with a few stellate hairs beneath.

PART I. ANATOMICAL.

The following pages contain an account of the anatomical characters of certain outgrowths developed on the stems, the leaves, the green parts of the flower and on the young fruit of *Hibiscus vitifolius*.

The plants from which the material was obtained were raised from seeds sent by Mrs Lort Phillips to the Cambridge Botanic Garden from Somaliland. In November 1898, when the investigations were begun there were three plants all possessing outgrowths.

These outgrowths, which are entirely or partly colourless, are distributed, very irregularly, all over the green parts of the plant. In some cases they thickly cover the whole upper surface of a leaf, in others the whole under surface; or they may be distributed locally. Frequently they are more numerous near the edges or on the veins of a leaf than on other parts. A few leaves are quite devoid of outgrowths. Their size varies considerably. They may be so small as simply to cause the surface

¹ Bentham, *Flora Australiensis*, 1863, p. 215.

² Grisebach, *Flora of the British West Indian Islands*, 1864, p. 85.

³ Oliver, *Flora of Tropical Africa*, 1868, p. 197.

⁴ Hooker, *Flora of British India*, Vol. I., 1875, pp. 338, 339.

⁵ Trimen, *Handbook of the Flora of Ceylon*, 1893, Part I., p. 154.

of the leaf to appear rough, or they may be as much as a quarter of an inch in length. Their shape is also variable. Some are elongated and almost cylindrical, with a conical apex. Others are relatively short and broad; some are lobed or branched. Frequently they are massed together on a low cushion of green tissue from which they radiate outwards.

On the stem the outgrowths are all of considerable size and occur singly. On the older parts of the stem most of the outgrowths appear brown and shrivelled, but young and old stages may occur in close proximity.

The formation of outgrowths usually begins on or near the edges of the leaves, most frequently on the upper side, but sometimes on the under side, or on both. In most cases, though not invariably, the development of outgrowths is accompanied by a curling of the leaves downwards and inwards, and sometimes also by a drooping of the lamina (fig. 1).

The outgrowths on petioles and stems are usually larger and more numerous than those on the leaves. The outgrowths generally shrivel and die before the leaves, and in some cases there appears to be a succession of them, since the same leaf may at the same time have some which are dead and others which are alive. On the stem there is a regular succession of outgrowths; new ones appearing a little way below the apex and dying off lower down.

On the green capsules there are always outgrowths which are usually particularly large and numerous (fig. 3).

In addition to these outgrowths the stems and leaves are thickly covered with hairs, which even with the naked eye may be seen to be of three kinds:

- (1) simple straight hairs,
- (2) three-rayed, stellate hairs,
- (3) glandular hairs.

The two former kinds are stiff, the latter delicate. The simple hairs occur all over the plant, the stellate hairs chiefly on the under sides of the leaves, for the most part on the larger veins. The glandular hairs, which are to be found on all parts, are most numerous on the young stems and petioles. A portion of the stem (fig. 2) seen under a lens, shows a number of delicate glandular hairs of great length, whose heads are each enveloped in a drop of secretion, often considerable in amount. Even after a piece of the shoot had been kept in water in the laboratory for a fortnight, these drops still retained their original size and form. Amongst the glandular hairs and evidently serving them as a protection are many straight stiff hairs, some of which are longer even than the glandular hairs. Irregularly distributed on the surface of the stem are the colourless outgrowths of irregular shape, some simple, some lobed, but never in groups as they are on the leaves.

Microscopical characters of the outgrowths.

(α) *On the Leaves.* The outgrowths on the leaves are of two types, one purely epidermal, and therefore colourless, the other consisting partly of epidermal and partly of sub-epidermal cells.

An outgrowth of the first type, of median size, mounted as a solid object, is represented in fig. 5. It consists, in this case, of two tiers of elongated cells whose walls, considering the fact that the outgrowths are part of the epidermis, are rather thin. The cells are usually twisted round one another spirally, especially in those outgrowths which are longer than the one represented. The most remarkable point in the structure is the presence of an apical stoma beneath which there is usually no cavity. These smaller and exclusively epidermal outgrowths are colourless, but the larger ones which contain a prolongation of the underlying mesophyll are green at the base. The structure of the outgrowths is rendered clear by a comparison of transverse and longitudinal sections.

A transverse section of the leaf (figs. 4, 6 and 7) is bounded by an upper epidermis of large cells with a few stomata between them (figs. 4, 6 and 7) and a lower epidermis consisting of smaller cells with more numerous and smaller stomata (figs. 4 and 6). On both sides the cuticle is thin. The palisade tissue consists of a single row of elongated cells, and the spongy parenchyma is made up of about three rows of irregular cells. Scattered in the mesophyll are large isolated cells containing mucilage. Certain of the epidermal cells also increase in size and become mucilaginous. In addition to these cells mucilage occurs in lysigenous spaces which lie chiefly near the vascular tissue in the leaf, and also in the pith and cortex of the stem. Cells containing crystals of calcium oxalate are generally numerous, both in the leaves and in the stem, but bear no definite relation to the outgrowths (figs. 14, 15 and 16).

Figure 6 shews, in longitudinal section, a small outgrowth consisting only of epidermal cells, which are elongated and in close contact with one another. They contain large nuclei and are lined, rather sparsely, with a finely granular protoplasm. The nuclei, perhaps on account of the small quantity of protoplasm, are usually closely pressed against the wall (always the inner wall) and sometimes even appear very elongated. Imbedded in the protoplasm of the cells of the outgrowth, and also of the ordinary epidermal cells are numerous very small leucoplasts. Usually drops of oil, some minute, others as large or larger than the nuclei, are abundant in all the colourless cells¹ (figs. 15 and 16).

¹ These drops stain dark brown with 1% osmic acid, are insoluble in ether and alcohol, and swell with 5% potash. Their absence in some of the sections is due to the methods of preparation employed.

At the apex of the outgrowth are the guard cells of a stoma, which although of large size leads into no definite cavity.

A longitudinal section of an outgrowth containing chlorophyll is seen in fig. 7. The palisade cells (since in this case the outgrowth is on the upper surface of the leaf) are prolonged between the basal cells of the outgrowth, with which, as well as with one another, they are, at least in their upper parts, and usually for their whole length, in uninterrupted contact. In the same figure, to the right of the outgrowth is represented a slightly raised stoma. Between such a raised stoma and the larger outgrowths there are, in the leaves, all intermediate forms. Although in general there are no cavities whatever, a few, especially of the smaller outgrowths, have a central lumen which places the stoma in communication with the cavities of the mesophyll. In the case of the larger branched outgrowths there is a stoma at the apex of each branch, and some also possess stomata near the base.

A transverse section near the apex of an outgrowth of median size usually shews about four thin-walled cells in close contact (fig. 8). They are thinly lined with finely granular protoplasm and contain numerous leucoplasts, and, frequently, oil-drops. The section does not pass through the nuclei, because, as the longitudinal section shews, these lie about half way down the elongated cells (figs. 6 and 7).

In fig. 9 is represented a transverse section of an outgrowth in which there is a narrow but distinct lumen.

Figure 10 shews a transverse section of an outgrowth which contains a prolongation of the mesophyll, and which also has a cavity. It will be seen that the cells containing chloroplasts are much smaller in diameter than those which are colourless.

Figure 11 is a transverse section of an outgrowth in which all the cells, some coloured and others colourless, are in uninterrupted contact. This type is the more usual.

Figure 12 is a cross-section (i.e. parallel to the surface of the leaf) of a part of the green cushion from which arise some of the larger outgrowths occurring in tufts. The internal, chlorophyll-containing cells resemble in shape those of the palisade tissue, but their walls (which are of cellulose) are very thick. The section shews that the walls are strongly pitted.

β. Outgrowths on the Stem. These are all of large size, and, in their younger stages resemble the largest of those found on the leaves; i.e. those with a thickened base, and are formed in the same way.

In the course of their history the outgrowths pass through three distinct stages which may be described separately. The normal cortex of a young stem is limited by a one-celled epidermis

in which are a few stomata (figs. 14, 15 and 16). Below this is a layer, usually only one cell deep, but sometimes two or more, of thin-walled parenchyma containing chlorophyll and crystals of calcium oxalate. Within this is collenchyma, which also contains chlorophyll.

(1) The formation of the outgrowth originates in the epidermis and in the subepidermal parenchyma. The latter cells first divide by periclinal walls and elongate radially, so that the epidermis with its stomata and hairs is lifted up (fig. 14). It is noteworthy that on the outgrowths of the stem stomata are very few; probably this is to be correlated with the small number on the normal epidermis of the stem as compared with that of the leaf. The walls of the parenchymatous cells formed by these divisions subsequently become much thickened (by cellulose) and strongly pitted. This green tissue may be many (5, 6 or more) cells deep or it may be almost entirely absent. As in the leaf it forms a sort of cushion on which the upper part of the outgrowth is placed. The overlying epidermal cells also divide by periclinal walls and elongate radially, at the same time becoming considerably distended and very thin-walled. All these cells are colourless and contain numerous leucoplasts and usually also oil drops. In this condition all the cell walls consist of cellulose, and in sections treated with gentian violet and eosin they acquire a uniform pink colour.

(2) At a later stage the outgrowths begin to shew signs of degeneration; the thick-walled lower cells begin to lose their colour because the chloroplasts become smaller and paler (fig. 15). The protoplasmic contents also become somewhat reduced, but the cells of the outgrowth still retain their turgidity, their protoplasm and their large nuclei.

(3) In the last stage (fig. 16) the outgrowth becomes cut off by the formation of cork, and this before any cork is developed in the adjoining parts of the stem. The cork arises in the lowermost of the daughter cells derived from the original epidermal cells, i.e. from the lowermost of the colourless cells. In these cells a new set of periclinal walls arises and may be traced from the epidermis at one edge of the outgrowth right across to the other side. The cells which are cut off, usually about three or four in number, become suberized and thickened, but the innermost remain thin walled; the radial walls however are usually of some thickness.

After the suberization of the cell walls has taken place the thin-walled colourless cells lying beyond them, which are cut off from their water supply, speedily lose their turgidity, collapse and shrivel (fig. 16).

The Hairs.

(1) *The stiff hairs.* These are all unicellular, though as before mentioned there are also stellate hairs which are usually three-rayed, on the under side of the leaves. The usual type consists, in longitudinal section, of a square, thick-walled basal part, which is not pitted and which is inserted between the epidermal cells and narrowed into a long sharp-pointed needle. Above the basal part is a large nucleus (figs. 4 and 14).

(2) *The stellate hairs* have essentially the same structure as the simple straight hairs.

(3) *The glandular hairs* are very complicated (fig. 17). They consist of a very large basal cell with a central nucleus surrounded by protoplasm radiating outwards towards the walls. Above this is usually one cell completely filled with dense granular protoplasm. This is succeeded by twenty or more cells, which in optical longitudinal section appear either to be undivided or to be divided by one or more walls parallel to the long axis of the hair. The head of the hair consists of a group of cells of which a longitudinal section usually passes through four. The two uppermost of these are surrounded at some distance by a thin wall. Transverse sections at different levels show, near the apex but below the head, a single cell almost filled with protoplasm and containing a large central nucleus (fig. 18). A section nearer the base shews the circular area divided into four cells, each of which has the form of a quarter of a circle. In each cell the nucleus is near the innermost wall, and there is a small vacuole (fig. 19). Sections nearer the base show the section to be irregularly divided into six or more cells, and in some cases the area is divided into as many as eleven cells, as represented in fig. 20. In these cells the vacuoles are larger. Round each of these transverse sections there is a thickened cuticle. Both kinds of hairs occur on the outgrowths of the stem and leaves.

PART II. EXPERIMENTAL.

In order to determine, if possible, the nature of the outgrowths and the conditions influencing their formation, a series of experiments was undertaken in the spring and summer of 1899.

Of the three old plants from which material was obtained for the anatomical investigations, one had been raised from the seed sent from Somaliland, the other two were grown from seed of this first plant.

For the purposes of the following experiments seeds from these three plants were sown, on November 21st, 1898, in the Tropical

Pit, at the Cambridge Botanic Garden. From these seeds eight seedlings were obtained, and were, in January 1899, planted out, each in a separate pot, and allowed to grow on, at first in the Tropical, and later in the Intermediate Pit, until June 1899.

Even when the seedlings were so young that they only possessed two foliage leaves in addition to the cotyledons, these leaves began to develop small outgrowths (fig. 21) which appeared merely as a roughness on the upper surface.

On June 8th the following observations were made. The seedlings, which had been growing under identical conditions, very closely resembled one another. Each had from eight to ten leaves on the single main stem, and was beginning to put out, in the axils of the lower leaves, small branches, and in those of the upper leaves, solitary flowers.

The first five or seven leaves were entirely free from outgrowths, one or two just above these had a few, two or three still higher up were thickly, in some cases *very* thickly covered, while the youngest leaves at the top were as yet unaffected.

On June 9th the eight young plants were placed under varying conditions, viz. :—

One in the Garden in an open situation.

” ” Temperate House.

” ” Water-Lily House.

” ” Tropical Orchid House.

” ” Cactus House.

” ” Filmy Fern House.

Two were left in the Intermediate Pit.

On July 24 the plants were all again examined with a view to determining the effects produced upon them by the altered conditions.

The Plant in the open ground. The most striking results were obtained from this plant. It had completely lost all trace of outgrowths and become exceedingly vigorous and healthy. Its leaves, instead of drooping, were spread out flat and almost horizontally and were much darker in colour than those in the houses.

The Plant in the Temperate House. This differed from all the others in having outgrowths exclusively on the *under* sides of the leaves. It had however a few outgrowths upon the stem and some large ones on the green-capsules.

The Plant in the Water-Lily House. This had a few outgrowths on the under sides of the first four remaining leaves¹, a larger

¹ It should be noted that by this time some of the older leaves at the base of the stem had fallen off.

number on the next five. Of these five, the three lower had outgrowths only on the under side, and the two upper on both sides. Of the remaining three leaves two had slight outgrowths above, and the youngest leaf had none.

The Plant in the Tropical Orchid House. The lowest eight of the remaining leaves had a few outgrowths, the next three were more thickly covered, then followed a leaf with a few outgrowths and another with many. In the last six leaves the outgrowths were confined to the lower surface. The remaining four leaves had outgrowths only on the under sides, and all but the last but two had only a few.

The Plant in the Cactus House. This was more thickly but more irregularly covered with outgrowths than any of the others. The lowest remaining leaf was devoid of outgrowths. It was followed by two which were thickly covered, one on both sides, one only on the upper surface. Then came a succession of twelve leaves; all having some, in many cases numerous, outgrowths, either on both surfaces or only on the upper surface. The stem, petioles, and capsules were also thickly covered.

The Plant in the Filmy Fern House. This plant was almost entirely free from outgrowths, but was very weak and unhealthy. The stem was tall and relatively thin; the leaves small and limp; the flowers for the most part had dropped off before opening.

Plant A in the Intermediate Pit. This plant had not changed much since June 9th. At the earlier date the first seven leaves were free from outgrowths, the eighth had merely a rough surface, the ninth had many outgrowths, the tenth very few and the eleventh none. At the later date there were thirteen leaves. Some of the lower leaves which were recorded on June 12th had fallen off and all those which remained had some outgrowths. The leaves on the middle part of the stem had most outgrowths, while the young ones at the top had few or none.

The stem was fairly thickly covered and the carpels had many of large size.

Plant B in the Intermediate Pit. This was almost exactly like the one which has just been described.

It may here be noted in passing that the old plants from which the material had been obtained for the anatomical investigations and which had been growing in the Intermediate Pit, were during the spring and summer exceedingly thickly covered with outgrowths. In some cases the leaves which were small, drooping and curled, suggested those of *Mesembryanthemum crystallinum* because they were so crowded with outgrowths (fig. 22). But the nature of the outgrowths in the two plants is very

different. Kerner¹ states that a leaf of *Mesembryanthemum crystallinum*, when separated from the plant may be left without water for a long time without withering. A leaf of *Hibiscus vitifolius* was placed *in water* in the dry air of the laboratory and left for two days, when the outgrowths were found to have become quite dried up.

The stems of these old plants were long and only slightly branched. The leaves soon dropped off so that only the tops of the shoots were leafy, and the axillary branches remained small. Both plants flowered but did not ripen many capsules of seeds.

On the 16th of August the plants were all once more carefully examined. During the interval but little growth had taken place and some more of the older leaves had dropped off, so that it was not very easy to compare the condition of the plants at the two dates. All the plants except the vigorous one in the garden had nearly finished flowering, and all, except the one in the Filmy Fern House, had ripened some seed capsules. These seeds were collected and at once sown in the Tropical Pit.

The condition of each plant on August 16th may now be considered separately and as briefly as possible.

The Plant in the Garden now differed still more markedly from all the others, not only in the entire absence of outgrowths but also by its numerous strong lateral branches which gave to it a bushy habit quite distinct from that of the weaker greenhouse plants. The leaves were large, flat and of a dark-green colour.

The Plant in the Temperate House had also large leaves but of a much paler green. This plant like the other indoor plants had one main stem and only weak and comparatively small axillary branches. The outgrowths, though present on all but the two youngest leaves were still, with the exception of one leaf, exclusively confined to the under sides.

The Plant in the Water-Lily House. This had altered very little. The leaves were slightly curved round at the edges.

The Plant in the Tropical Orchid House. This was still more thickly covered than the other plants, with outgrowths, especially on and near the edges, and on the veins, of the leaves. Their distribution was, however, irregular and their size, though generally large, was unusually variable. One older leaf had a few very large conical outgrowths on the principal veins; another was densely covered above and below.

The Plant in the Filmy Fern House had altered little, but was even more unhealthy in appearance. Most of the leaves had

¹ Kerner, *Natural History of Plants*, English edition, 1894, Vol. 1., p. 329.

fallen off and those which remained were small and limp, but free from outgrowths.

Plants A and B in the Intermediate Pit. These were still almost exactly like one another. All the leaves except a few at the top had outgrowths upon them, almost exclusively on the under sides and round the edges of the laminæ. The capsules in both plants were thickly covered with outgrowths.

[NOTE. Some plants of *Ceratotheca triloba* which were being grown in the Intermediate Pit developed outgrowths similar in structure to those on the *Hibiscus* plants, but much less well marked. As in *Hibiscus*, the outgrowths began near the edges of the leaves and chiefly on the upper surface. One of these plants was placed in the garden by the side of the *Hibiscus* and here it developed no more outgrowths, while those remaining in the Pit continued to form them.]

On Oct. 9th a final examination of the plants for the current year was made.

In the interval since August 16th the weakly plant in the Filmy Fern House had died; the one in the Water-Lily House had been attacked by a fungus; the other plants had not changed essentially. In some of them one or two lateral branches had attained to a considerable size. The plant first placed in the gardens had continued to grow and was very much larger, stronger and healthier than any of the others.

One of the old plants from the Intermediate Pit, which had also (in August) been planted out in the garden, beside the younger plant, had behaved in a similar way. The ends of the original main branches which had been covered with outgrowths in the house, had died, and new, strong and healthy lateral branches had been formed in their stead. The plant had in five or six weeks made eight new shoots at the top, besides about six small ones and one or two of medium size. Most of the old leaves had dropped off and those formed on the new shoots resembled exactly those on the other out-door plant, i.e. were devoid of outgrowths.

On the 9th of October these two plants were re-potted and brought into the Intermediate Pit. The one which had only been out since August was unaffected by the removal, but the plant which had been out all summer flagged immediately and by Oct. 14th seemed as if it would at least lose all its leaves if it did not succumb entirely. In a few days the plant which had not been affected by the potting developed outgrowths on the upper sides of the leaves.

In August cuttings were made from the plant which was in the garden, and, according to the Curator, Mr Lynch, if these be

kept dry enough to remain free from outgrowths, they will not root, but if kept damp enough to strike they always develop outgrowths. By October two of the cuttings were well rooted and still appeared fairly healthy, though they had developed outgrowths.

Other cuttings were made from the same plant in October when it was brought in from the garden.

By October 9th some of the seeds sown in August had germinated. Twelve seedlings had come up from the seed of the out-door plant, two from the seed of the plant in the Temperate House, and not one from the seed of any of the other plants. Seeds had been sown from all the plants except the one in the Filmy Fern House, and that had not been able to ripen any capsules.

Comparison of the plants described above.

The eight plants, considered from the point of view of their behaviour to external influences, seem to fall into three groups, represented by the following individuals.

I. The vigorous and healthy plants, devoid of outgrowths. (In the garden.)

II. The feeble plant, with small leaves and few flowers, but practically free from outgrowths. (In the Filmy Fern House.)

III. The remaining plants, with small axillary branches and with outgrowths on most of the leaves, which are usually bent downwards and inwards.

Of this third group the plant in the Temperate House stands in some respects between the first group and the third. It resembles the plants in the garden by its large flat leaves and by the absence of outgrowths on the upper sides of the leaves, but in habit and in the possession of outgrowths it is more like the rest of the indoor plants.

Conclusions as to the nature and the conditions of formation, of the outgrowths.

At present the evidence is insufficient to furnish any certain conclusions, but as far as it goes it seems to point to the inference that the effects observed are produced by the direct influence of external conditions.

While the conditions were identical the eight plants were all essentially alike, but as soon as these conditions were changed the behaviour of the plants also began to differ; and the greater the change in external circumstances, the greater the effects produced upon the plants. For example, the change from a warm

and damp green-house to a dry¹, open, and relatively cool position in the open air resulted in a complete loss of outgrowths and a vigorous development of the plants. On the other hand, change to the cool, badly illuminated, and very damp Filmy Fern House produced unhealthy conditions in the plant, without however resulting in the formation of outgrowths.

The conditions of illumination, moisture, and (during the unusually hot summer) even of temperature, in the remaining houses, were not dissimilar, and the plants grown in them did not differ from one another essentially. In all the houses the illumination was very much lessened by white-washing the side windows and shading the roof with blinds. The Filmy Fern House, which has a North aspect, whereas all the others look South, was particularly dark and quite sunless.

It would seem therefore as if the most important factors in determining the formation or non-formation of the outgrowths were moisture, light and temperature; especially moisture and light. Dry air and a strong illumination prevent the production of outgrowths, while a moist atmosphere combined with strong illumination and a sufficiently high temperature appears to promote their development.

The absence of outgrowths in the plant placed in the Filmy Fern House seems to be explained by supposing that the plant was so enfeebled by the very unfavourable conditions that it had not the necessary strength to form outgrowths, but succumbed without being able to adapt itself to its changed environment.

These conclusions are in accordance with what might be expected from our knowledge of the habitat of the plant. Trimen² says that *Hibiscus vitifolius* is common in the low country of Ceylon, especially in the dry region.

As to the nature of the outgrowths, the evidence so far available would seem to show that they are pathological.

Kuntze³ states that in certain Malvaceae, including some species of *Hibiscus*, the epidermis is capable of swelling, and sometimes its cells even divide, to form an aqueous tissue. This swelling is promoted by the presence of mucilage. Each epidermal cell may become as many as twenty times its original size by the addition of water, which these cells can themselves absorb directly. In the very delicate leaf of *Hibiscus micranthela* the swollen epidermis on each side may be thicker than the green

¹ Note. During the past summer (1899), owing to a long-continued drought, the air was particularly dry, more especially as, besides the absence of rain, there was a great deal of sunshine and a prevalence of Northerly and Easterly winds.

² Trimen, *Handbook to the Flora of Ceylon*, 1893, Part I., p. 154.

³ Kuntze, "Beiträge zur vergleichenden Anatomie der Malvaceae," *Bot. Cent.*, 1891, pp. 198—200.

tissue lying between. A similar behaviour occurs in *Bombax erianthos*.

In some cases single cells divide, but usually they only swell. In *Chorisia asperifolia* and *Quararibea floribunda* the whole surface of the epidermis does not swell regularly, but parts of it rise up "island-like" and specially strongly.

As Kuntze does not figure any cases of swollen epidermis it is difficult to compare the appearances he describes with those which occur in *Hibiscus vitifolius*, or to determine whether there is any relation between them.

Evidently the author regards the occurrence he describes as normal and not pathological, and, as far as it is possible to judge from a description, the swellings he notes are different from those in *Hibiscus vitifolius*. Certainly the outgrowths in *Hibiscus vitifolius* are not an aqueous tissue as was shewn by the experiment recorded above (p. 14).

But the fact that the epidermis, not only in the same family, but in the same genus, is capable of swelling, apparently as a normal process, is in itself interesting and suggestive when considered in connection with the outgrowths in *Hibiscus vitifolius*. It seems not impossible that, under glass, the development of some powerfully osmotic substance may be favoured, which is not formed in the open. No such body has however been detected in the cells, and the matter needs further investigation.

Kuntze does not say under what conditions the swelling of the epidermis takes place, so that again it is impossible to compare the phenomena he describes with those in *H. vitifolius*.

It may here be noted that Haberlandt¹ describes certain plants in which the stomata are normally raised above the level of the epidermis. In some cases the lifting up is scarcely noticeable, but in others, as, for example, in the peduncle of *Cucurbita Pepo*, it is so strongly marked that the stoma is placed at the apex of a spherical or cylindrical papilla whose lumen is continuous with the respiratory cavity. The biological importance of this position of the stomata is uncertain. From the circumstance that raised stomata not infrequently occur in plants which grow in damp and shady situations, as for example in different ferns, it may in Haberlandt's opinion be inferred that the exposed position of the stomata may be a means of promoting transpiration.

Outgrowths, comparable to those of *Hibiscus*, but quite definitely pathological, and differing considerably in structure, have been described by several authors, on different plants. Amongst these may be mentioned the following:—

¹ Haberlandt, *Physiologische Pflanzenanatomie*, 1896, p. 406.

Tomaschek¹ describes on *Ampelopsis hederacea*, generally on the young twigs, the tendrils, the leaf-stalks and on the back of the leaf veins, but especially on the stipules, certain "pearl-" or "drop-like" outgrowths which were not due to parasitic plants or animals, but to external conditions. Of these conditions Tomaschek regards light as the most important, because the outgrowths occurred most abundantly on some etiolated twigs which had grown into a half-dark garret, and because on the normal parts of the plant there were only a few on the sunny side of the stem.

The outgrowths arise in the young parts of the axis which are still in the bud. They only occur below a stoma, and there is, at the apex of each outgrowth, a scarcely modified stoma. The outgrowth begins in the subepidermal parenchymatous cells below the stoma. These elongate and block the respiratory cavity. Later they increase in number and lift up the epidermis and guard-cells to form an outgrowth which becomes constricted at the base until it is nearly spherical. Later, in the autumn, Tomaschek found the place of these outgrowths occupied by lenticels.

This author considers that the outgrowths may, by blocking up the stomata, reduce the quantity of oxygen entering the plant, so that, in consequence, the formation of organic acids is diminished, and the decomposition of the chlorophyll in the dark is retarded.

The appearances described by Tomaschek resemble in many points those on *Hibiscus*, the main point of difference being that the outgrowth not only begins in, but is practically confined to the chlorophyll-bearing cells below the stoma, while the epidermis (as far as can be judged without figures) is merely lifted up, whereas in *Hibiscus vitifolius* the latter is the tissue chiefly concerned.

Also, Tomaschek does not mention the occurrence of the outgrowths on the laminae of the leaves, and in *Hibiscus* they are abundant there. As in *Hibiscus*, so in *Ampelopsis*, the outgrowths ultimately dry up.

Masters² mentions, but does not describe, some "warts" which appear on the leaves of potatoes, when grown in too close and moist an atmosphere. They resemble those which occur on vine-leaves.

Frank³ and Sorauer⁴ have described in various plants out-

¹ Tomaschek, "Ueber pathogene Emergenzen auf *Ampelopsis hederacea*," *Oester. Bot. Zeitschrift*, 1879, p. 87.

² *Gardener's Chronicle*, 1875, p. 802.

³ Frank, *Krankheiten der Pflanzen*, Bd. III., 1896, p. 313.

⁴ Sorauer, *Handbuch der Pflanzenkrankheiten*, Zweite Auflage, Bd. I., 1886, pp. 222-227, 233-237. "Die Lohkrankheit an Kirschen," *Bot. Zeitung*, 1889, p. 182.

growths which all have some points of resemblance with those on *Hibiscus* while at the same time they differ from them not a little. But they are important because in all cases the conditions of their formation seem to be identical with those in *Hibiscus*.

The outgrowths occur on leaves, or, more commonly in shoots, either of the current year or of the preceding year or years. In all cases the sub-epidermal tissue is concerned. In leaves the chlorophyll-bearing cells, in stems the cortical cells, especially those lying between the bundles of bast, as far as the cambium and sometimes even including the wood, are the parts which form the swelling.

In a leaf or young stem the sub-epidermal cells, in an older stem the cells beneath the cork-layer, begin to form the outgrowth by considerable elongation in a radial direction. In some cases this elongation is accompanied by little or no cell-division, so that the number of cells remains about the same. Sooner or later these tubular cells always *break through* the epidermis, or cork-layer, as the case may be, so that a wound is formed, by which the plant is rendered liable to the attacks of parasitic plants and animals. In many cases described by Sorauer and by Frank, the tissues are affected as far as, and including, the cambium. This inclusion of the cambium leads to a pathological development of the wood which is formed subsequently. Thus all the tissues in the stem are, or may be, included in the development of the outgrowth, and serious malformations, accompanied by splitting, are the result.

In *Hibiscus vitifolius*, on the contrary, the outgrowth is much more superficial since it either consists exclusively of the epidermis or of the epidermis and the cells immediately below it. And, since the layer of cork which cuts off the outgrowth forms an efficient protection to the deeper cortical tissue, no wound is ever formed, and no splitting takes place. The superficial tissues only are affected and these but for a time, so that, after the outgrowths have been cut off by cork, the stem simply continues its normal growth.

It would seem therefore as if the formation of outgrowths in *Hibiscus vitifolius* were a response on the part of the plant to an alteration in the surrounding conditions, a response which is in some respects more of the nature of a variation than a disease.

If, instead of the dry atmosphere which is most favourable to the growth of the plant, damp air be substituted, transpiration is checked. As a means of compensating for the reduced transpiration, the plant stores the superfluous water, which it cannot get rid of, in outgrowths on its stems and leaves. If the humidity is only temporary, as is the case in the countries of which the plant is a native, where there is an alternation of wet and dry seasons,

these efforts on the part of the plant might be sufficient, but where the change to a damp atmosphere was permanent, pathological conditions would supervene and ultimately death would ensue. These pathological conditions would not be due to the outgrowths, but to the inadequate transpiration (caused by dampness) which checks metabolism. For example, the plant grown in the Filmy Fern House became thus diseased without the formation of outgrowths.

It still remains to be proved whether, as seems most likely, a moist *atmosphere* is the important factor, or a damp *soil*. Hitherto authors do not seem to have distinguished between the effects of damp air and damp soil. It seems probable that, if the air be dry enough to allow of the necessary transpiration, a damp soil might even promote the healthy growth of the plant. If this be so then it follows that there is not actually too much water in the plant, but that the plant cannot get rid of it. The plant in the Cactus House seems to give evidence in favour of this view. In this case the roots were kept dry, but outgrowths appeared, probably because of the dampness of the atmosphere in the Cactus House at the time.

It is proposed to make further experiments next summer, in order to determine the relation between the absorption of water by the roots, and transpiration, and also to determine the relative importance of light, heat and moisture as factors in promoting or hindering the development of outgrowths.

NOTE. The great variability in the hairiness of this species in different parts of the world (see Floras of India, Africa, Australia, Ceylon, &c.) may be connected with the question of transpiration.

I would take this opportunity of expressing my grateful thanks to Professor Marshall Ward for allowing me to work in the Botanical Laboratory, and for the unfailing kindness and help which he has continually extended to me during my investigations, which were undertaken at his suggestion.

My sincere thanks are also due to Mr Lynch, Curator of the Botanic Garden, for the readiness with which he has helped me to carry out my experiments, and for the care and trouble which he has bestowed upon them.

Explanation of Plates.

(Plates VIII, IX, X.)

FIG. 1. Young shoot, natural size, with outgrowths on the stems and leaves.

FIG. 2. Part of the stem (magnified about four times) shewing outgrowths and also glandular and stiff hairs.

FIG. 3. Young capsule (natural size) covered with outgrowths.

FIG. 4. Vertical section of leaf shewing various forms of outgrowths. *M. mucilage* cell.

FIG. 5. Outgrowth from a leaf seen as a solid object.

FIG. 6. Transverse section of a leaf shewing a small outgrowth on the upper side. *M. mucilage* cell.

FIG. 7. Larger outgrowth, containing mesophyll, on the upper side of a leaf. *M. mucilage* cell.

FIG. 8. Transverse section of a small outgrowth near its apex.

FIG. 9. Transverse section of a small outgrowth, nearer the leaf than the preceding.

FIG. 10. Transverse section of a larger outgrowth, containing chlorophyll.

FIG. 11. A section similar to fig. 10, but nearer the leaf.

FIG. 12. A horizontal section of a portion of the leaf in the region of the base of an outgrowth. The chlorophyll-containing cells belong to the mesophyll; the others to the epidermis.

FIG. 13. Longitudinal section (partly optical) of an outgrowth on the stem. The outgrowth bears two simple hairs. At the base, below the epidermis of the stem, is collenchyma.

FIG. 14. Young outgrowth on the stem (more highly magnified.)

FIG. 15. Older outgrowth on the stem.

FIG. 16. Old outgrowth on the stem, shewing the formation of the cork layer.

FIG. 17. Optical longitudinal section of a glandular hair.

FIG. 18. Transverse section of a glandular hair below the head.

FIG. 19. Transverse section nearer the leaf than the previous section.

FIG. 20. A similar section still nearer the leaf.

FIG. 21. Young seedling with small outgrowths on the leaves and cotyledons.

FIG. 22. Leaf, from an old plant, densely covered with outgrowths.

N.B. Figures 1, 2, 3, 15, 16, 17, 22 are on Plate VIII; Figures 4, 6, 7, 14 are on Plate IX; Figures 5, 8, 9, 10, 11, 12, 13, 18, 19, 20, 21 are on Plate X.

On the condition that five straight lines situated in a space of four dimensions should lie on a quadric. By H. W. RICHMOND, M.A., Fellow of King's College.

[Received 22 November, 1899.]

The customary symbol S_n being used to denote a space of n dimensions, let a, b, c, d, e , stand for five straight lines situated in S_4 . Each two of the lines lie in and determine an S_3 , and each three of the lines are intersected by one line and one only, viz. the line common to the three S_3 's determined by each two of them: thus the lines a and b determine an S_3 ,—denoted hereafter by (ab) ,—which contains them; and the three lines a, b, c are met by a unique line (abc) , the intersection of the three S_3 's $(bc), (ca), (ab)$.

A quadric in S_4 , (that is to say a locus in S_4 whose points satisfy a single condition of the second order), may be made to satisfy fourteen conditions; one quadric for example will pass through fourteen arbitrarily chosen points; and again, since to contain a straight line in its entirety imposes three conditions on a quadric, one quadric will pass through four arbitrarily chosen straight lines and two arbitrarily chosen points. Clearly then the five straight lines a, b, c, d, e , do not as a rule lie on a quadric, and, in order that they may do so, a condition has to be fulfilled. It is a geometrical form in which this condition may be expressed that I propose to investigate.

Supposing that a, b, c, d, e the five lines in S_4 lie on a quadric q , I imagine the S_4 immersed in and surrounded by a space of five dimensions, S_5 . Through q there pass an infinity of quadrics in the S_5 , any one of which I select and denote by Q . Now a quadric in S_5 has properties recalling those of quadrics in space of three dimensions: there lie on it an infinite number of S_3 's, which form two distinct families: two S_2 's, one from each family, pass through every line that lies on the quadric. Two S_2 's lying

on the quadric which belong to different families sometimes have a common line, but generally have no common point whatever; but two S_2 's that belong to the same family always have one common point.

Since the lines a, b, c, d, e , lie on Q , through each pass two S_2 's that lie wholly on Q . I confine my attention to five out of these ten S_2 's which are members of the same family, and arrive at the theorem that through the five lines a, b, c, d, e , can be drawn five S_2 's in S_5 of which each two have one point common.

It is true conversely that, if five S_2 's situated in S_5 be such that each two of them have one point in common, they lie on a quadric. For a quadric in S_5 can be chosen to fulfil twenty conditions, and may therefore be made to pass through the ten points each common to one pair of the five S_2 's, and ten others taken at random, two on each of the five S_2 's. Since this quadric has been made to pass through six points on each of the five S_2 's, each of the five S_2 's must lie wholly upon it, and every S_4 in the S_5 will cut them in five straight lines which lie on a quadric in the S_4 . Thus we have the theorem:—

In order that five lines in S_4 should lie on a quadric, it is necessary and sufficient that they should be sections of five S_2 's in S_5 of which each two have one point in common.

For the sake of investigating the consequences of this property, let A, B, C, D, E , be five S_2 's situated in S_5 of which each two have a common point. It follows that each two of them lie in an S_4 ; and I shall denote the point common to A and B by $(\alpha\beta)$ and the S_4 which contains A and B by (AB) . Every space of four dimensions in the S_5 intersects A, B, C, D, E , in five lines a, b, c, d, e , which lie on a quadric, and intersects the ten S_4 's $(AB), (AC), \dots$ etc. in ten S_3 's $(ab), (ac), \dots$ etc., each of which contains two of the five lines a, b, c, d, e . The points $(\alpha\beta), (\alpha\gamma), \dots$ etc. are lost when a section is taken, but the line which joins two of them gives a single point, the S_2 containing three of them a line, ... etc. in the four-dimensional space by which the section is made. For instance, the line joining $(\alpha\beta)$ and $(\alpha\gamma)$ lies in the S_2, A and in the $S_4, (BC)$; it follows that the space of four dimensions which meets A, B, C, D, E , in the lines a, b, c, d, e , will meet the line joining $(\alpha\beta)$ and $(\alpha\gamma)$ in the point where a meets the S_3 (bc) .

Consider now the S_4 which contains the points $(\alpha\gamma), (\gamma\epsilon), (\epsilon\beta), (\beta\delta), (\delta\alpha)$, and the lines which join each pair of them: five of these lines join two points such as $(\alpha\gamma)$ and $(\beta\delta)$ represented by symbols which have no letter common and are passed over; the other five are of the kind just considered, and, since they lie in an S_4 , their sections by a space of four dimensions are five points situated in an S_3 . It is in fact established that

If five lines a, b, c, d, e , situated in a space of four dimensions, lie on a quadric, the five points which are the intersections of

the line a with (cd) , the S_3 containing c and d ,
 $b \dots (de)$, $d \dots e$,
 $c \dots (ea)$, $e \dots a$,
 $d \dots (ab)$, $a \dots b$,
 $e \dots (bc)$, $b \dots c$,

lie in a space of three dimensions.

The point of intersection of a and (cd) is the point of a where it is met by the line (acd) , the unique line which intersects a, c and d . There are six points such as this on each of the five lines a, b, c, d, e , that is to say thirty in all, and by taking the different cyclical orders of the five lines we find twelve S_3 's, each containing five of the thirty points. The twelve S_3 's fall into two groups of six, corresponding to the following arrangements of order of the five lines a, b, c, d, e ;—

First group :

$(abcde), (abdec), (abecd), (acbed), (acdbe), (adbce)$;

Second group :

$(acebd), (adcbe), (aedbc), (abdce), (adecb), (abedc)$;

one S_3 from each group passing through each of the thirty points.

Another form of the condition that the five lines a, b, c, d, e , lie on a quadric may be mentioned, viz. that the three pairs of points of the line e where it meets the S_3 's

$(ab), (cd), -(ac), (bd), -(ad), (bc)$,

should be in involution.

On the Influence of Temperature, and of Various Solvents, on the Absorption Spectra of Didymium and Erbium Salts. By Professor LIVEING.

[*Read 27 November, 1899.*]

Prof. Liveing exhibited a number of photographs prepared to illustrate his paper on the absorption spectra of solutions of salts of Didymium and Erbium in various conditions of dilution, and temperature, and in various solvents, which was communicated to the Society at the Stokes Jubilee meeting. These photographs shewed that dilution produced no increase of the intensity of the absorptions when the thickness of the absorbent was proportioned to the dilution. In strong solutions of the chlorides a diffuse continuous absorption creeps down the spectrum from the most refrangible end and extends further as the solution is more concentrated. This is not seen with most chlorides, not even with that of aluminium, but is shown by strong solutions of hydrochloric acid in water and in alcohol. The nitrates shew a somewhat similar general absorption, and also a widening of some of the bands as the solutions become more concentrated.

The effect of acidifying the solutions is to make the absorptions generally more diffuse, but not sensibly to weaken them, and to extend the general absorptions at the most refrangible end. A rise of temperature from about 20° C. to 97° or 98°, also makes the bands more diffuse, but does not increase their intensity. It seems to the author improbable that the metallic atoms should maintain such independence in combination as to have the same absorptions in such different compounds as chloride, nitrate and sulphate, and it is more probable that the common absorptions are due to common products of decomposition. These might be the metallic ions, but the facts that neither dilution nor rise of temperature increases the intensity, and that acidifying does not weaken the intensity of the common absorptions are against that supposition. Ionization implies an electrification of the ions, which again implies a communication of energy to the field, which may probably depend on the circumstances of the encounter when the molecule of salt is broken up, and so some molecules may be broken up without being charged; while there is no reason

to suppose that the absorption by a molecule would be altered by its being charged with electricity. The absorptions which are intensified by concentration and also by heat must be ascribed to the condition of the molecules during encounters, which will be more frequent in more concentrated as well as in hotter solutions. The expansion of certain bands with increased concentration by the nitrate, must be ascribed to encounters of molecules derived from the metal with those derived from the acid, which are much more massive than the molecules of water and also than those derived from the chloride. During such encounters the absorbent molecules will be as it were loaded by the influence of the other molecules. This view seems confirmed by the influence which other solvents and other acids have on the absorptions. Didymium chloride in alcohol gives the same bands as the aqueous solution, but generally more diffuse and more or less shifted a little towards the red. The same solution acidified with hydrochloric acid exaggerates greatly these modifications, almost washing out the more refrangible bands and breaking up the very strong band in the yellow into several separate bands. Glycerol as solvent gives modifications similar to, but more strongly marked than, those of alcohol. The acetate in acetic acid and the maleate in water gives similar but much less marked modifications. The tartrate and the citrate in ammoniacal solution also give similar modifications. The borate in solid glass of borax also gives bands which are unmistakably modifications of those produced by the aqueous solution. All these modifications seem to be of the same *character*, though of greater intensity, than the differences between the bands given by nitrate and chloride, and may be attributed to the influence of the comparatively complicated influences of the various molecules during the times of encounter. In such cases as the acid alcoholic solutions there will certainly be at least four chemical compounds mixed in the solvent, which may well produce a complicated modification of the bands without destroying their identity.

Researches in the Sugar Group. By Mr H. JACKSON.

[Read 27 November, 1899.]

In the present paper a summary is given of the joint researches of Mr H. J. H. Fenton and the author, which may be conveniently divided into two parts.

(a) Oxidation of the more common polyhydric alcohols.

The remarkable part which iron plays as a carrier of oxygen was first pointed out by Mr Fenton in the case of tartaric acid, and has since been extended by him to other hydroxy-compounds.

An aqueous solution of the following polyhydric alcohols, glycol, glycerine, erythrite, dulcitol, mannitol and sorbitol, was taken in turn, and after adding a small quantity of ferrous salt to each, hydrogen peroxide was added: in all cases a large evolution of heat took place. The oxidation products in the case of glycol, glycerine and erythrite quickly reduce Fehling's solution in the cold and restore the colour to an alcoholic solution of magenta, which has been decolourised by sulphur dioxide: on treatment with phenyl hydrazine acetate, osazones were obtained which, on analysis, were found to correspond respectively to glycolic aldehyde or diose, glyceric aldehyde or triose, and erythrulose or tetrose.

The oxidation compounds of dulcitol, mannitol and sorbitol do not reduce Fehling's solution in cold, but quickly on warming: they do not give the "magenta" test: facts which serve to distinguish the hexoses from the simpler members of the sugar group. On treatment with phenyl hydrazine acetate there was obtained from dulcitol the osazone of inactive galactose, from mannitol the hydrazone of mannose, and from sorbitol an osazone identical with glucosazone.

If an aqueous solution of glycol, glycerine or erythrite, to which a very small quantity of ferrous salt has been added, be exposed for a little time to the action of sunlight in the presence of atmospheric oxygen, it can be shown on examination that a certain amount of the sugar has been formed.

These experiments may perhaps give a little support to the theory that iron, which occurs in hæmoglobin and is associated so intimately with chlorophyll, may act as a carrier of atmospheric oxygen.

(β) *Isolation of Diose in a crystalline state and its condensation to a Hexose.*

When dioxymaleic acid, suspended in water, is distilled on the water bath under very diminished pressure and the distillate evaporated to small bulk in a vacuum desiccator, a syrup is left which on standing crystallizes out in flat plates of the oblique system. On analysis and examination it is shewn to be crystalline diose. A determination of its molecular weight by the depression of the freezing point of water shows the crystals to be bimolecular, but on standing and taking frequent determinations the molecular weight gradually becomes normal and corresponds to the single formula $C_2H_4O_2$ and then remains quite constant.

If a dilute aqueous solution of diose be treated with a 1% solution of soda at the ordinary temperature it quickly turns yellow and finally brown. After standing a few hours it no longer reduces Fehling's solution in the cold, but readily on warming: it no longer gives the "magenta" test: in fact it has lost all the properties of diose and assumed those of a true hexose. This is confirmed on examining the osazone which corresponds to a normal hexosazone.

The melting point and action towards solvents of the osazone prove its identity with β acrosazone which Fischer and Tafel isolated from the condensation product of glycerose.

On a New Mineral. By Mr A. HUTCHINSON.

[*Read 27 November, 1899.*]

A colourless transparent crystal of the new mineral was found on a specimen of Axinite from Cornwall in the Carne collection recently acquired by the University.

The crystallographic and optical constants of the crystal prove it to belong to the Prismatic system. The results of a quantitative chemical analysis agree well with the formula $CaSn(SiO_3)_3 \cdot 2H_2O$.

The mineral has been named Stokesite in honour of Sir George Gabriel Stokes.

Secondary Röntgen Rays. By JOHN S. TOWNSEND, M.A.,
Fellow of Trinity College.

[Received 1 December, 1899.]

1. When Röntgen rays from a Crookes tube fall upon a metal or other body a secondary radiation is given out which has properties similar to the direct rays. The existence of this secondary radiation was established by Sagnac¹, who made a series of experiments showing that the secondary radiation produces photographic effects and renders the air a conductor at a distance of several centimetres from the radiating body. The secondary radiation is weaker than the direct radiation from the Crookes tube, both as regards its intensity and its power of penetrating bodies.

Sagnac contends that the surface effect noticed by Perrin² was due to this secondary radiation, but it is difficult to reconcile Perrin's results with this theory, without some modification. This paper contains the results of some experiments made with a view to finding how the two phenomena are connected.

2. The apparatus shown in Figure 1 was used to determine

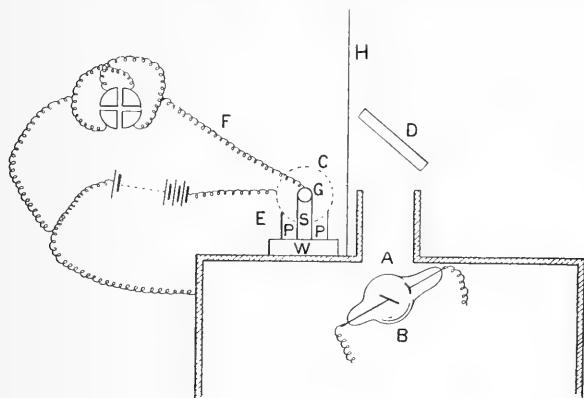

Fig. 1.

the relative intensities of the secondary radiations given out by

¹ Sagnac, *Journal de Physique*, 3rd Series, vol. VIII. Feb. 1899.

² Perrin, *Comptes Rendus*, vol. CXXIV. p. 455.

different bodies, and the intensity of the secondary radiation compared with that of the primary radiation which excites it. It is arranged in a manner suitable for examining the intensity of the secondary radiation at a distance of some centimetres from the radiating body.

The Crookes tube *B*, and the coil with which it was worked, were contained inside a box covered with lead having an aperture (4 centimetres square) at *A*. A lead pipe of square section was placed over the hole, *A*, so as to confine the rays from the bulb to a small portion of the space above the box. This space was explored by means of the apparatus *E*, which consisted of a gauze cylinder *C*, and an axial electrode *G*, fixed to a moveable piece of wood *W*, by means of insulating supports *P* and *S*. The cylinder was connected to one terminal of a battery of lead cells, the other terminal being to earth. The electrode was connected to the insulated quadrants of an electrometer.

When the rays are traversing the space outside *C* none of the ions which are produced can arrive at the electrode *G*; but when rays fall on *C* some traverse the gauze and produce ions inside the cylinder. The deflection of the electrometer in a given time is proportional to the number of ions which are produced inside *C*, if the potential of *C* is sufficiently high to produce the maximum deflection. In the present experiments the potential of *C* was 85 volts; when double that potential was used, the deflections were not increased by 2 per cent., so that the difference of potential of 85 volts suffices to collect practically all the ions of one sign produced inside *C* on the electrode *G*.

The apparatus *E* was placed in the position shown in the figure, so that no direct rays from the bulb could fall on it. A series of experiments were then made with different substances placed above the bulb at *D*. Screens, connected to earth, were put up round the wire *F* to prevent any ions that are produced in the space outside *C* from being collected on *F*. In order to avoid complicating the figure these screens are omitted.

When a heavy metal is placed at *D*, and the rays from a Crookes tube allowed to fall on it, a large deflection is obtained on the electrometer scale, showing that there are rays given off from *D* which ionize the gas inside *C*. When there is no radiator at *D*, except air, the electrometer gives a small deflection when the rays are emerging from the bulb. This small effect is probably due to the secondary rays given out by the air.

The following table gives the deflections obtained in 10 seconds with various substances at *D*. The first column gives the figures obtained when the rays from *D* arrived at *C* without passing through any other material than the air. The second column gives similar numbers obtained by cutting down the rays from

the object at *D* with a sheet of aluminium $\frac{1}{4}$ mm. thick placed in the position *H*.

Table I. Giving electrometer deflections obtained with secondary rays, in 10 seconds.

Radiator	Rays passing through Air	Rays cut down with Al.
Air ?.....	2	1
Aluminium	6	3·5
Glass	7·5	3
Lead	24	6
Paraffin block ...	30	15·5
Brass	66	2·5
Zinc.....	68	3
Copper.....	70	2·5

A rough estimate of the intensity of the primary rays was made by placing *W* at *D*, so that the direct rays should pass through the gauze cylinder. In $\frac{1}{2}$ a second the deflection exceeded 500 divisions. In order to compare the secondary radiation with Uranium radiation, a large disc of uranium, 7 centimetres in diameter, which Lord Kelvin kindly lent me, was placed at *D*. The uranium rays gave a deflection of 1·5 divisions in 15 seconds. When rays from the Crookes tube fell on the uranium, a deflection of 26 divisions was obtained in the same time. Under similar conditions a piece of copper at *D* gave a deflection of 96 divisions.

These results show the ionization which is produced by rays from various bodies at a distance of about 6 centimetres from the radiating body.

We see that there are different kinds of radiation given out by different substances. The table shows that brass, zinc and copper give out a radiation of which only a small fraction passes through a sheet of aluminium, whereas the rays from the other substances traverse aluminium comparatively well. Sagnac obtained a result similar to this.

These secondary rays, which produce an effect at a distance from the radiating body, are not much affected by the state of the surface of the body. It was found that the strength of the rays from polished brass was only two or three per cent. greater than the radiation from brass coated with oxide.

When the brass was covered with moistened filter paper, the deflections were cut down from 66 to 46.

We do not therefore consider that the radiation which extends to a distance is affected by the nature of the surface and the following experiment confirms this view.

With the same apparatus a set of experiments were made with paraffin to see whether a thin layer would give out the same amount of radiation as a block. The surface of a thin sheet of aluminium was covered with a thin layer of paraffin, and used at *D* as a radiator.

The thin sheet of aluminium coated with paraffin gave out a radiation which was only one sixth as effective in producing ionization as the radiation from a paraffin block.

We see therefore that the secondary radiation which extends to a distance from the body which emits it does not come directly from the surface, but must be considered as emanating from the substance of the material.

3. In addition to the radiation which extends to a distance there is also a radiation which is rapidly absorbed by the gas near the surface of the radiating body. In order to examine this radiation the apparatus shown in Fig. 2 was used.

It was arranged to find the maximum conductivities between the two circular plates *A* and *B*, 4.8 centimetres radius, for differ

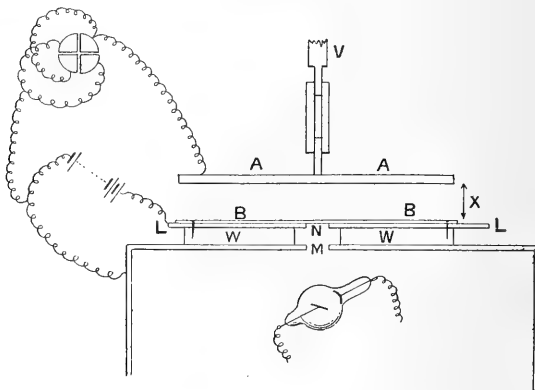

Fig. 2.

ent distances, *X*, between the plates. The lower plate *B* was of aluminium and its upper surface was turned plane. It rested on a sheet of lead *L* and was screwed through the lead to a wooden base *W*, which rested on the top of the box containing the bulb and the Ruhmkorff coil. The apertures, *M* and *N*, in the lead, through which the rays from the bulb passed were 1.4 centimetres radius. After traversing *B* and the air space, *X*, the rays fell on

the metal plate *A*, which was thick enough to prevent any rays passing through it.

(It was found that brass, zinc, or copper plates two millimetres thick prevented any radiation from passing through, but it would have required a much greater thickness of aluminium to produce a similar effect, so that the aluminium used at *A* was backed with a brass plate. The aluminium plate was two millimetres thick, which was more than sufficient to stop the secondary radiation from the brass from extending to the air between *A* and *B*.)

The plate *A* was moveable and insulated, being connected by means of an ebonite junction to a bar *V*, which moved vertically. The position of *A* could therefore be easily varied, and its distance *X* from *B* was obtained from the micrometer screw which fixed the position of *V*.

The plate *A* was connected to the insulated quadrants of an electrometer which gave a deflection of 90 scale divisions for a potential difference of 1.43 volts between the two pairs of quadrants. The plate *B* was connected to one terminal of a battery of lead cells, the other terminal being connected to earth. The number of cells used was proportional to the distance between the plates. It was found that 80 cells per centimetre was sufficient; when the force was doubled the electrometer deflections were increased by only one or two per cent.

A series of experiments were made with the plates at various distances apart and the following table gives the electrometer deflections, δ , when the rays ionized the gas between the plates for 15 seconds. The observations were made several times and the means taken so as to eliminate errors arising from variations in the strength of the rays. The distances *X* are given in millimetres.

The different columns contain the results of observations made with different metals at *A*. The same aluminium plate *B* was used in all cases. It was impossible to get exactly the same strength of rays when using different metals so that the deflections obtained with zinc, copper, and aluminium, were multiplied by factors so as to make the difference between the observations at 10 and 15 centimetres to be, in each case, 18, which was the difference obtained when a brass plate was used at *A*.

The capacity of the condenser which is connected to the insulated quadrants varies with the distance between the plates. In order to obtain numbers proportional to the charges acquired by the plate *A* the above values of δ (which are potentials in arbitrary units) must be multiplied by the capacities corresponding to the different values of *X*.

The following are the capacities in centimetres of the conductor

consisting of:—the insulated quadrants, the wire connecting the quadrants to *A*, and the plate *A*.

$$\begin{aligned} X = 1, & \quad C = 136\cdot0, \\ X = 2, & \quad C = 114\cdot5, \\ X = 5, & \quad C = 98\cdot5, \\ X = 10, & \quad C = 93\cdot5, \\ X = 15, & \quad C = 93. \end{aligned}$$

TABLE II.

<i>X</i>	Brass	Cu	Zn	Al
1	40·5	40	36	11
2	71	74	58	20·7
5	111	109	88	41·4
10	135	137	110	61
15	153	155	128	79

Multiplying the deflections δ by the corresponding capacities we obtain from Table II. a second series of numbers *N*, Table III. proportional to the number of ions produced between the plates *A* and *B* in the various cases.

TABLE III.

<i>X</i>	Brass	Cu	Zn	Al
1	55	54·4	49	15
2	81	84	66	23·7
5	109·5	107·5	87	40·8
10	126	128	103	57
15	142	144	119	73

Let us suppose for the moment that the aluminium plate *B* gives out no secondary radiation, and let us consider the numbers obtained with a brass plate at *A*. The experiments show that

when the plates are 15 millimetres apart a number of ions equal to $142 \times n$ are produced between the plate, where n is an unknown multiplier.

Of these $55 \times n$ are produced within one millimetre of the brass, $26 \times n$ in the second layer one millimetre thick, $28.5 \times n$ in the third layer three millimetres thick. After five millimetres the number per millimetre becomes constant, and the fourth and fifth layers, each 5 millimetres thick, contain $3.2 \times n$ per millimetre.

It is evident therefore that the metal emits a radiation which is rapidly absorbed by the air in contact with it. At atmospheric pressure the effect of this radiation is hardly appreciable at distances greater than five millimetres from the surface. In the present case we may consider that the effect of the direct rays is to produce an ionization equal to $3.2 \times n$ per millimetre of air traversed, and that the rest of the ionization is due to secondary radiation.

If we subtract $3.2 \times X$ from the values of N in Table III. we obtain the effect of the secondary radiation. Thus taking the last column we can find numbers proportional to the ionization produced by the secondary rays from the two aluminium plates *A* and *B*. Dividing these numbers by two we obtain the effect due to one aluminium plate, and the results can be used in order to correct for the secondary rays given out by the plate *B* in the other cases.

The results of these calculations are shown by the curves, Fig. 3. The ordinates represent the total ionization produced by

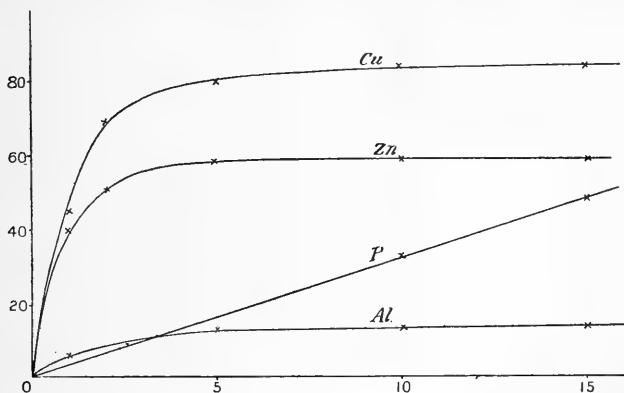

Fig. 3.

the secondary rays within a distance X of the surface. The straight line *P* gives the corresponding effect of the primary rays which excite the secondary radiation.

The curves show that this secondary radiation is rapidly absorbed by the air. The ionization produced in the first millimetre by the secondary rays is more than fifty times as great as that produced in the sixth. At a distance of 6 centimetres we should expect that the intensity of these rays would be reduced to such a small fraction of its original value that it would be quite impossible to detect the ionization they would produce.

It appears therefore that at least two kinds of rays are emitted by the radiating body; one kind, which is rapidly absorbed by the air, gives rise to the surface effect noticed by Perrin, and the other kind which is more penetrating produces the ionization at a distance.

Defining the surface effect S as the ratio of the total effect produced by the rays which are easily absorbed to the effect of the direct rays on a layer of air 1 centimetre thick, we obtain the following values of S

$$\begin{aligned} \text{For Cu, } S &= 2.5 \\ \text{,, Zn, } S &= 1.84 \\ \text{,, Al, } S &= .4. \end{aligned}$$

In this examination of the experimental results we have attributed $3.2 \times n$ ions per cubic centimetre to the primary rays. This is only approximately correct since the secondary radiation, which extends to a distance, contributes to the formation of these ions. The number $3.2 \times n$ is therefore too big an estimate of the direct effect, but is probably not more than a few per cent. in excess of its true value.

The above values of S are larger than those found by Perrin, thus in the case of zinc Perrin found the surface effect to be .7. An experiment was therefore made to test the accuracy of the above results, the method employed being similar to that used by Perrin. A beam of direct rays from the bulb was passed through the air between two parallel plates without falling on either plate. The ionization produced per centimetre of the beam was found to be 31 in arbitrary units. The same beam passing normally through a very thin sheet of aluminium and falling on a copper plate, parallel to the aluminium at a distance 1.5 centimetres from it, produced a number of ions proportional to 140 in the space between the copper and aluminium. Of these 140, 46.5 are due to the direct rays, so that the effect of the surface radiation from the copper and aluminium must be 93.5, or three times the effect of the direct rays per centimetre. This is practically what we obtained by varying the distance between the plates ($2.5 + .4$). It appears therefore that the discrepancy between these results and those obtained by Perrin must be due to differences in the nature of the direct rays.

Effect of Pressure on Conductivity.

4. When the primary rays pass through a gas and precautions are taken to exclude surface effects, the number of ions produced per cubic centimetre is proportional to the pressure of the gas. The relation between conductivity and pressure is however more complicated when the surface radiation acts on the gas. In order to obtain a curve showing this relation, some experiments were made on the conductivity of air between two co-axial cylinders. The larger cylinder, 3.2 centimetres in diameter, was of brass, and the rays entered it through an aluminium window. The inside cylinder, 1 centimetre in diameter, was made of very thin aluminium through which the rays could easily pass. After traversing the gas between the two cylinders, the rays fell on the surface of the larger cylinder opposite the window and excited a secondary radiation. The electrical arrangements for obtaining the maximum deflections were made in the ordinary way. The outside cylinder was raised to a high potential by connecting it to a terminal of a battery of lead cells, the other terminal being to earth; the small aluminium cylinder was insulated and put in metallic connection with the insulated quadrants of an electrometer. The results of observations on the maximum deflection when the rays ionize the gas for 15 seconds, are shown graphically in curve I. figure 4. The

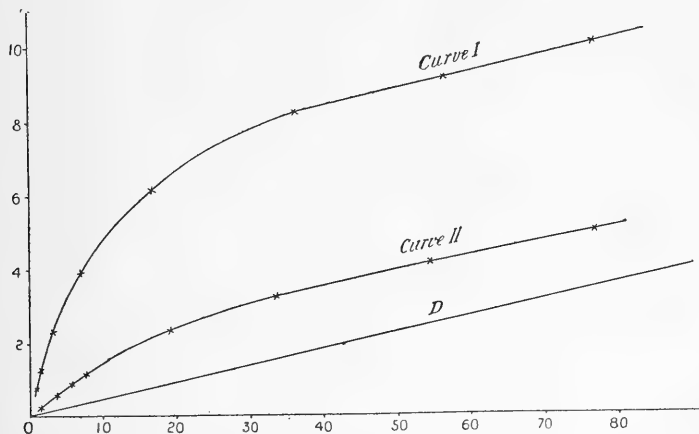

Fig. 4.

ordinates represent the deflections in arbitrary units and the abscissæ the pressures in centimetres of mercury.

In the above experiment the rays passed through a sheet of aluminium $\frac{1}{4}$ -millimetre thick before passing through the window in the brass tube. A second series of observations were taken with the brass tube coated inside with a cylinder of aluminium

$\frac{1}{2}$ -millimetre thick. The sheet of aluminium between the bulb and the window was removed so that the strength of the primary rays passing through the gas should be the same in both cases. The results of the observations made with this arrangement are shown in curve II. figure 4.

It is easy to explain the form of these curves on the supposition that the rate of absorption of radiation by a gas is proportional to the ionization. When the pressure exceeds a certain value, the effect of surface rays will be located near the surface which emits them, and for greater pressures the number of ions produced will be the same, but they will be generated nearer the surface. The effect of the primary rays is proportional to the pressure of the gas, so long as the pressure is not big enough to reduce their intensity appreciably (it would probably require a gas at many atmospheres pressure to produce this effect, so that we will consider that the ionization contributed by the direct rays is proportional to the pressure). Under these circumstances the number of ions produced in a given volume will be $S + pD$ where S is the effect of the surface rays, p the pressure, and D a constant depending on the direct rays. The quantity S is practically constant for values of p greater than a certain pressure π , which is about 50 centimetres of mercury in the present case. We conclude that if there were no surface effects, that the curve representing the connection between pressure and the total number of ions produced, would be a straight line D through the origin parallel to the portions of curves I. and II., which correspond to pressures greater than 50 centimetres.

When the pressure is reduced the rate of absorption of the secondary rays is reduced proportionally, so that when p is less than π the surface rays extend across the vessel containing the gas and part of their energy is absorbed by the opposite wall. The number of ions they generate in the gas will be no longer constant, but will diminish with the pressure, so that the formula $S + pD$ would no longer hold on the supposition that S is constant. The exact connection between S , p , and π , would depend on the shape of the vessel containing the gas.

This general explanation shows that we ought to get curves similar to those in figure 3 by subtracting from the ordinates of the curves in figure 4 lengths equal to the ordinates of the straight line D . For complete agreement it would have been necessary to have made the experiments on the variation with pressure with the apparatus shown in figure 2, but even with the results before us we can see that there would be a fairly good agreement.

In conclusion I desire to express my thanks to Professor J. J. Thomson for many suggestions in connection with this investigation.

Note on Hypotheses as to the Origin of the Paired Limbs of Vertebrates. By Mr J. GRAHAM KERR.

[Received 9 December, 1899.]

In a footnote to my paper on the "External Features in the Development of *Lepidosiren*¹" I have referred to the view that the paired limbs of Vertebrates may have arisen in Phylogeny from External Gills.

As this view does not appear to have been clearly formulated before it seems advisable to do so now, and to attempt its justification, for, as I hope will appear from the sequel such a view has in its favour sufficient probability to entitle it to rank on at least an equal footing with either of the two rival hypotheses which at present hold the field².

In order to bring this out satisfactorily it seems necessary to state in a few words each of the rival hypotheses referred to, and then to attempt a short critical examination of the points in its favour and those against it.

I need hardly say that this examination makes no claim to thoroughness, I only produce sufficient arguments to show that the position of each of the two at present predominant views is a very insecure one.

The two views referred to are these:—

(1) that the paired fins are persisting and exaggerated portions of an at one time continuous fin-fold which stretched along each side of the body, and to which they bear an exactly similar phylogenetic relation, so do the separate dorsal and anal fins to the once continuous median fin-fold.

¹ *Phil. Trans. Roy. Soc.*

² Jardine long ago (1841: *Ann. and Mag. Nat. Hist.*, Vol. VII., p. 24) referred to the vestigial external gills of the adult *Protopterus* as reduced limbs.

Goeldi (*Proc. Zool. Soc.* 1898, p. 857) after discussing the fore-limb in *Lepidosiren* as supporting the Gegenbaur hypothesis refers to "one other possibility, that the so-called fore-limb of *Lepidosiren* is in fact not yet a true anterior extremity, but a persistent rudimentary external branchia."

Clemens, in his general discussion on external gills (*Anat. Hefte Abt. I.*, Bd. v., p. 141), has a passage which may mean that he had a similar view to mine in his mind.

It is of importance to consider each of the three passages referred to, in relation to its context.

(2) the skeleton of the paired fins with their limb girdle are derived by modification from the gill rays attached to a branchial arch, and hence, by implication, the paired fins themselves are derived from the septa separating adjacent gill-clefts.

Balfour View.

(1) This view as at present held was based by Balfour on his observation that in the embryos of certain Elasmobranchs the rudiments of the pectoral and pelvic fins are at a very early period connected together by a longitudinal ridge of thickened epiblast—of which indeed they are but exaggerations. In Balfour's own words referring to these observations: "If the account just given of the development of the limb is an accurate record of what really takes place, it is not possible to deny that some light is thrown by it upon the first origin of the vertebrate limbs. The facts can only bear one interpretation, viz., that the limbs are the remnants of continuous lateral fins."

A similar view to that of Balfour was enunciated almost synchronously by Thacher and a little later by Mivart—in each case based on anatomical investigation of Selachians—mainly relating to the remarkable similarity of the skeletal arrangements in the paired and unpaired fins.

(2) The Gegenbaur view is based upon the skeletal structures within the fin.

(α) According to this the skeletal arrangements in all Vertebrate limbs are modifications of a primitive form—the biserial *Archipterygium*, which persists in a practically unmodified condition in the paired fin of *Ceratodus*.

(β) The biserial archipterygium with its limb girdle is in turn derived from a series of gill-rays attached to a branchial arch.

The Gegenbaur theory of the Morphology of Vertebrate limbs thus consists of two very distinct portions. The first, that the archipterygium is the ground-form from which all other forms of presently existing fin skeletons are derived, concerns us only indirectly as we are dealing here only with the *origin* of the limbs, i.e., their origin from other structures that were not limbs.

It is the second part of the view that we have to do with, that deriving the skeleton of the archipterygium, of the primitive paired fin, from a series of gill rays, and involving the idea that the limb itself is derived from the septum between two gill clefts.

This theory rests upon (1) the assumption that the archipterygium is the primitive type of fin, and (2) the fact that amongst the Selachians is found a tendency for one branchial ray to become

larger than the others, and when this has happened, for the base of attachment of neighbouring rays to show a tendency to migrate from the branchial arch on to the base of the larger or, as we may call it, primary ray; a condition coming about which were the process to continue rather further than it is known to do in actual fact would obviously result in a structure practically identical with the archipterygium.

Gegenbaur suggests that the Archipterygium actually has arisen in this way in Phylogeny.

Lateral fold view.

The evidence in regard to this view may be classified under three heads as Ontogenetic, Comparative Anatomical, and Paleontological. The ultimate fact on which it was founded was Balfour's discovery that in certain Elasmobranch embryos, but especially in *Torpedo*, the fin rudiments were at an early stage connected by a ridge of Epiblast. I am not able to make out what were the other forms in which Balfour found this ridge, but subsequent research, in particular by Mollier, a supporter of the lateral fold view, is to the effect that it does not occur in such ordinary sharks as *Pristiurus* and *Mustelus*, while it is to be gathered from Balfour himself that it does not occur in *Scyllium*.

It appears to me that the knowledge we have now that the longitudinal ridge is confined to the Rays and absent in the less highly specialized sharks—greatly diminishes its security as a basis on which to rest a theory. In the Rays in correlation with their peculiar mode of life—the paired fins have undergone enormous extension along the sides of the body¹ and their continuity in the embryo may well be a mere foreshadowing of this.

An apparently powerful ally from the side of Embryology came in Dohrn and Rabls' discoveries that in *Pristiurus* all the interpterygial myotomes produce muscle buds. This however was explained away by the Gegenbaur school as being merely evidence of the backward migration of the hind limb—successive myotomes being taken up and left behind again as the limb moved further back. As either explanation seems an adequate one, I do not think we can lay stress upon this body of facts as evidence in favour of the lateral fold view. The facts of the development of the skeleton can not be said to support the fold view: according to it we should expect to find a series of metameric supporting rays produced which *later* on become fused at their bases. Instead of this we find a *longitudinal* bar of cartilage developing quite continuously, the rays forming as projections from its outer side.

¹ I imagine that even supporters of the lateral fold view will admit this to be secondary.

The most important evidence for the fold view from the side of Comparative Anatomy is afforded by (1) the fact that the limb derives its nerve supply from a large number of spinal nerves, and (2) the extraordinary resemblance met with between the skeletal arrangements of paired and unpaired fins. The believers in the branchial arch hypothesis have disposed of the first of these in the same way as they did the occurrence of interpterygial myotomes, by looking on the nerves received from regions of the spinal cord anterior to the attachment of the limb as forming a kind of trail marking the backward migration of the limb.

The similarity in the skeleton is indeed most striking, though its weight as evidence has been recently greatly diminished by the knowledge that the apparently metameric segmentation of the skeletal and muscular tissues of the paired fins is quite secondary and does not at all agree with the metamery of the trunk¹. What resemblance there is may well be of a homoplastic character when we take into account the similarity in function of the median and unpaired fins, especially in such forms as *Raia* where the anatomical resemblances are especially striking.

There is a surprising dearth of paleontological evidence in favour of the view. The two creatures of which most have been made are the Devonian *Climatius*, and the Carboniferous *Cladose-lache*, each of which has been held to support it. In *Climatius* there is a remarkable series of spines behind the pectoral fin, but there appears to be little evidence to decide whether these were really fin or free skin spines. In regard to *Cladose-lache* there seems to be much in the criticisms of Jaekel and Semon, who consider that the creature is a highly specialized one and not primitive at all.

The short summary I have given is I think sufficient to show that the foundation of fact on which the lateral fold view rests is at best a precarious one. It must, so it seems to me, be looked upon and judged, just as any other view at the present time regarding the nature of the Vertebrate limb, rather as a speculation, brilliant and suggestive though it be, than as a logically constructed theory of the known facts. It is, I think, on this account allowable to apply it to a test of a character which is admittedly very apt to mislead that of "common sense":—

If there is any soundness in zoological speculation at all I think it must be admitted that the more primitive Vertebrates were creatures possessing a notochordal axial skeleton near the dorsal side, with the main nervous axis above it, the main viscera below it, and the great mass of muscle lying in myotomes along its sides. Now such a creature is well adapted to movements of

¹ Cf. Braus, *Verhand. Anat. Gesellschaft 12^{te} Versammlung in Kiel*, 1898, p. 166.

the character of lateral flexure, and not at all for movements in the sagittal plane—which would be not only difficult to achieve but would tend to alternately compress and extend its spinal cord and its viscera. Such a creature would swim through the water as does a Cyclostome, or a Lepidosiren, or any other elongated vertebrate without special swimming organs. Swimming like this, specialization for more and more rapid movement would mean flattening of the tail region and its extension into an at first not separately mobile median tail fold. It is extremely difficult to my mind to suppose that a new purely swimming arrangement should have arisen involving up and down movement and which at its first beginnings while useless as a swimming organ in itself must greatly detract from the efficiency of that which already existed.

We now return to the Gegenbaur view—that the limb is a modified gill septum.

Resting on Gegenbaur's discovery already mentioned that the gill rays in certain cases assume an arrangement showing great similarity to that of the skeletal elements of the Archipterygium, it has, so far as I am aware, up to the present time received *no* direct support whatever, of a nature comparable with that found for the rival view in the fact that in certain forces at all events, the limbs actually do arise in the individual in the way that the theory holds they did in Phylogeny. No one has produced either a form in which a gill septum becomes the limb during ontogeny: or the fossil remains of any form which shows an intermediate condition.

The portion of Gegenbaur's view which asserts that the biserial archipterygial fin is of an extremely primitive character is supported by a large body of anatomical facts¹, and is rendered further probable by the great frequency with which fins apparently of this character occur amongst the oldest known fishes. On the lateral fold view we should have to regard these as independently evolved, which would imply that fins of this type are of a very perfect character, and in that case we may be indeed surprised at their so complete disappearance in the more highly developed forms, which followed later on.

But the main thesis, and the one which concerns us now, that the archipterygium was derived from gill rays, is supported only by evidence of an indirect character. Gegenbaur in his very first suggestion of his theory pointed out, as a great difficulty in the

¹ I would recall specially the apparently transitional forms between biserial archipterygium and the fin of present day Selachians met with in the Xenacanthidae, and in *Cladodus neilsoni*, where the rays on the mesial side of the axis are in course of disappearance, and in *Acanthias* with its few mesial rays still persisting at the top of the metapterygium and *most numerous in the young animal*.

way of its acceptance, the position of the limbs, especially of the pelvic limbs in a position far removed from that of the branchial arches. This difficulty has been entirely removed by the brilliant work of Gegenbaur's followers, who have shown from the facts of Comparative Anatomy and Embryology that the limbs, and the hind limbs especially actually have undergone and in Ontogeny do undergo an extensive backward migration. In some cases Braus has been able to find traces of this migration as far forwards as a point just behind the branchial arches. Now when we consider the numbers the enthusiasm and the ability of Gegenbaur's disciples, we cannot help being struck by the fact that the *only* evidence in favour of his derivation of the limbs has been that which tends to show that a migration of the limbs backwards has taken place from a region somewhere near the last branchial arch, and that they have failed utterly to discover any intermediate steps between gill rays and archipterygial fin. And if for a moment we apply the test of common sense we cannot but be impressed by the improbability of the evolution of a gill septum, which in all the lower forms of fishes is fixed firmly in the body wall, and beneath its surface, into an organ of locomotion.

May I express the hope that what I have said is sufficient to show in what a state of uncertainty our views are regarding the Morphological nature of the paired fins, and upon what an exceedingly slender basis rest both of the two views which at present hold the field¹.

It is because I feel that in the present state of our knowledge neither of the two views I have mentioned has a claim to any higher rank than that of extremely suggestive speculations that I venture to say a few words for a third view which is avowedly a mere speculation.

Before proceeding with it I should say that I assume the serial homology of fore- and hind-limbs to be beyond dispute. The great and deep-seated resemblances between them are such

¹ In the above it will be seen that I have confined myself to a consideration of Gegenbaur's view as to the derivation of the skeleton of the free limb. The view to be drawn attention to below involves the acceptance of Gegenbaur's theory of the morphology of the limb girdles—that they are modified branchial arches. For this view there is strong evidence both in the topographical relations of the shoulder-girdle in fishes, and in the great resemblance to a branchial arch of the segmented shoulder-girdle of the Xenacanthidae.

I need perhaps hardly point out however that the evidence in favour of the shoulder-girdle being a modified branchial arch derived from the presence on it of a group of vestigial external gills in *Protopterus* ceased to exist as soon as it became known that their position there was quite a secondary one. This was shown in the first instance by the blood-supply of the three vestigial gills by three successive branchial arches, and corroborated later by the facts of Ontogeny as determined in the allied form *Lepidosiren*.

as to my mind seem not to be adequately explicable except on this assumption.

In the Urodela the External Gills¹ are well-known structures—serially arranged projections from the body-wall near the upper ends of certain of the branchial arches. When one considers the ontogenetic development of these organs, from knob-like outgrowth from the outer face of the branchial arch, covered with ectoderm and possessing a mesoblastic core, and which frequently if not always appear before the branchial clefts are open, one cannot but conclude that they are morphologically projections of the outer skin and that they have nothing whatever to do with the gill pouches of the gut wall. Amongst the Urodeles one such gill projects from each of the first three branchial arches. In *Lepidosiren* there is one on each of Branchial Arches I—IV². In *Polypterus* and *Calamoichthys* there is one on the Hyoid arch. Finally in many *Urodelan* larvæ we have present at the same time as the external gills a pair of curious structures called balancers. At an early stage of my work on *Lepidosiren* while looking over other Vertebrate embryos and larvæ for purposes of comparison, my attention was arrested by these structures, and further examination by section and otherwise convinced me that they were serial homologues of the external gills, situated on the Mandibular arch. On then looking up the literature I found that I was by no means first in this view. Rusconi had long ago noticed the resemblance and in more recent times both Orr and Maurer had been led to the same conclusion as I had been. Three different observers having been independently led to exactly the same conclusions, we may I think fairly enough regard the view I have mentioned of the morphological nature of the balancers as probably a correct one.

Here then we have a series of homologous structures projecting from each of the series of visceral arches. They crop up in the Crossopterygii, the Dipnoi, and the Urodela, i.e., in three of the most archaic of the groups of Gnathostomata. But we may put it in another way. The groups in which they do not occur are those whose young possess a very large yolk sac (or which are admittedly derived from such forms). Now wherever we have a large yolk sac we have developed on its surface a rich network of blood vessels for purposes of nutrition. But such a network *must*

¹ For a comprehensive survey of the External Gills of Vertebrates *v.* Clemens, *Anat. Hefte*, Abt. I, Bd. v.

² In *Lepidosiren* as in *Protopterus* the original relations of the external gills become somewhat obscured during Ontogeny by their becoming raised upon a common stalk on each side, the base of attachment of this coming by differential growth to lie in the region of the pectoral girdle. This relation of external gills to pectoral girdles is of course quite secondary, as is indicated by their blood-supply as well as by their development,

necessarily act as an extraordinarily efficient organ of Respiration, and did we not know the facts we might venture to prophesy that in forms possessing it any other small skin organ of respiration would tend to disappear¹.

No doubt these External Gills are absent also in a few of the admittedly primitive forms such as e.g., *Ceratodus*. But I would ask that in this connection one should bear in mind one of the marked characteristics of external gills—their great regenerative power. This involves their being extremely liable to injury and consequently a source of danger to their possessor. Their absence therefore in certain cases may well have been due to natural selection. On the other hand the *presence* in so many lowly forms of these organs, the general close similarity in structure that runs through them in different forms, and the exact correspondence in their position and relations to the body can, it seems to me, *only* be adequately explained by looking on them as being homologous structures inherited from a common ancestor and consequently of great antiquity in the Vertebrate stem^{2, 3}.

These structures have the primary function of Respiration. They are also however provided with an elaborate muscular apparatus comprising Elevators, Depressors, and Adductors, and larvæ possessing them may be seen every now and then to give them a sharp backward twitch. They are thus *potentially* motor organs. In such a Urodele as *Amblystoma* their homologues on the mandibular arch are used as supporting structures against a solid substratum, exactly as are the limbs of the young *Lepidosiren*.

I have therefore to suggest that the more ancient Gnathostomata possessing a series of potentially motor, potentially supporting structures projecting from their visceral arches, it was inherently extremely probable that these should be made use of when actual supporting and motor appendages had to be developed

¹ Maurer also correlates the presence of the yolk sac with the absence of external gills. He associates however the presence of the yolk sac not with the disappearance of the external gills, but with their non-development, external gills being according to him new formations, and homoplastic not homologous.

² Against their being new structures, secondarily developed as larval organs is their general similarity in structure, connections, and position. Maurer thinks they are secondary and would naturally develop where a large aortic trunk passed close under the skin. I do not think so. The conditions favourable for development of a dermal respiratory organ are afforded not by the presence of a large vessel whose walls are thick and in any case are of relatively very small area in proportion to cubic content, but rather of the small capillaries of the skin generally, where the walls are small in thickness and of great area as compared with the vessel's capacity.

³ The question as to whether the external gills were not the main respiratory organs of Vertebrates before the evolution of gill-slits, and whether the latter were not developed as a means of renewing the water in contact with the external gills, affords interesting subject for speculation.

in connection with clambering about a solid substratum. If this had been so we should look upon the limb as a modified external gill: the limb girdle with Gegenbaur as a modified branchial arch.

This theory of the Vertebrate paired limb seems to me I confess to be a more plausible one on the face of it than either of the two which at present hold the field¹. If untrue it is so dangerously plausible as to surely deserve more consideration than it appears to have had. One of the main differences between it and the other two hypotheses is that instead of deriving the swimming fin from the walking and supporting limb, it goes the other way about. That this is the safer line to take seems to me to be shown by the consideration that a very small and rudimentary limb could *only* be of use if provided with a fixed *point d'appui*. Also on this view the pentadactyle limb and the swimming fin would probably be evolved independently from a simple form of limb. This would evade the great difficulties which have beset those who have endeavoured to establish the homologies of the elements of the pentadactyle limb with those of any type of fully-formed fin.

Lastly this view naturally takes to itself the only important mass of actual facts which have been adduced to support the Gegenbaur view, viz.: those which have to do with demonstrating the backward migration of the limbs.

¹ The difficulty of most weight which this view has to face, that we do not know of the occurrence of a cartilaginous axis in any undoubted external gills seems to me by no means insuperable. Such a supporting axis has been developed in the barbels of *Xenopus* which (if not homodynamous with the external gills!) is probably a comparatively recently evolved structure.

Observations on Polypterus and Protopterus. By Mr J. S. BUDGETT.

[Received 9 December, 1899.]

The following observations on the Crossopterygian *Polypterus* and the Dipnoan *Protopterus* were made on the river Gambia 1898—99.

The Gambia flows due west, and lying between the 13th and 14th parallels of north latitude is tidal throughout its navigable waters, that is, to a distance of 260 miles from the sea.

a. Two species of *Polypterus* were obtained, *Polypterus lapradii*, Steind. and *Polypterus senegalus*, Steind. The former was taken 31 inches in length. The latter never more than 12½ inches.

The two species are perfectly distinct. *P. lapradii* has not fewer than 13 free dorsal finlets. The head is flattened dorso-ventrally and elongated. The body surface is variegated with dark greyish green markings on a yellow ground, taking the form of spots on the sides of the head and on the pectoral fin, but of blotches arranged in rows on the sides of the body elsewhere. The external gill is retained on the operculum until the young fish is 9 or 10 inches in length.

P. senegalus, on the other hand, has not more than 9 free dorsal finlets, the first arising on the 19th row of scales, whereas in *P. lapradii* the first arises on the 13th row. The head is shorter, round and deeper, while the body surface is a uniform dark green above and bright yellow below. The external gill in this species is lost by the time the young fish is 3½ inches in length.

In both species there is a marked difference between the *male and female*. The anal fin in the male is broad and fleshy with deep folds; in the female it is narrow, thin and pointed.

In the Gambia the rainy season begins in June and continues until October. In the early part of June *Polypterus* begins to migrate from the river to the flooded, low-lying plains; it spawns during August and September, returning to the river in October and November.

In the river *Polypterus* is one of the most difficult fish to catch. *P. lapradii* however was caught from time to time in the

river from January to May, all the specimens being about 18 or 19 inches in length and all without ova. Most of these were caught with the native cast-net, though a few were also caught with the seine-net.

In November and December when the swamps had nearly dried up large numbers were to be obtained from the mouths of the small creeks leading from the swamps to the river. This was done by damming the creeks at intervals of about 30 yards but leaving a passage for the fish to pass from pool to pool. Each time the natives wished to collect the fish they stopped up these passages and then baled out the water. In this way I was able to obtain great numbers of young *Polypteri* on their way to the river. These all measured from 4 to 8 inches, and were invariably *P. senegalus*.

At the same time I had a few *Lapradii* brought me from 8 to 10 inches in length, but am not certain where they came from; all these had external gills. When, however, these fish were kept in aquaria they soon lost their external gills, a small trace remaining for some time after the gills had been almost absorbed.

<i>P. lapradii</i> .	Nov.	Dec.	Jan.	Feb.	Mar.	Apr.	May	June	July	
♂.....	1	—	—	—	—	—	3	1	11	16
♀.....	1	—	2	—	—	—	9	3	12	27
Young.....	3	4	—	—	—	—	—	—	—	7
Undetermined	—	1	9	1	1	3	—	—	15	30
	5	5	11	1	1	3	12	4	38	80
<i>P. senegalus</i> .										
♂.....	—	1	—	—	—	—	—	17	—	18
♀.....	2	1	—	—	—	—	—	30	—	33
Young.....	15	50	—	—	—	—	—	—	—	65
Undetermined	—	—	—	—	—	3	—	—	4	7
	17	52	—	—	—	3	—	47	4	123
Total	22	57	11	1	1	6	12	51	42	203

From the table it will be seen that only 31 specimens of both species were obtained in the months from January to May, while during June and July 92 specimens were caught on their way to the swamps, and during November and December 79 young specimens were taken on their way to the rivers.

It is also seen that large numbers of *P. senegalus* were taken on their way from the river in June, while large numbers of *P. lapradii* were not taken until July. All the females taken in June and July were crowded with ripe ova, but *P. senegalus* was not taken above 13 inches, and yet no female less than 12 inches

contained ripe ova. *P. lapradii*, however, was taken 31 inches in length, but females were crowded with ova when only 18 inches in length. It would seem therefore that *P. senegalus* does not produce young until it is practically full grown.

In June and July sexually mature individuals were taken in numbers together and the sexes were noted. It appeared to be the case with both species that three-fifths of each lot taken together were females. This discrepancy can scarcely be accounted for by the greater activity of the males enabling them to elude capture, for they were caught in shallow pools connected with the river at high water. The water was baled from these pools when the tide was low.

When the fish are in the river they are always caught in the shade of the river banks, up small creeks or under the bushes at the sides of the river. For this reason it is almost impossible to catch *Polypterus* in the trammel or seine-net, and with the cast-net it is very difficult, for the habit of the fish is to spend much time lying motionless on the bottom and it does not strike upwards into the cast-net thrown over it as do most fish, but slowly wriggles off, snakelike.

Polypterus was watched in the wild state and also in captivity. It lies for long periods in the mud at the river bottom with the fore part slightly raised and resting upon its pectoral fins like a seal upon its paddles. If the water is a little stale it may be seen to move slowly forwards by the action of its pectoral fins, which are worked very much as a lady uses her fan; the ventral fringing rays are deflected first, the more dorsally placed ones later, giving the action, in which the whole shaft of the fin is involved, a screw-like appearance.

As it nears the surface, however, the whole of the body and tail is brought into action, with a dart it strikes the surface, gulps in the air with its mouth, lets out the excess by opening its spiracles, and with lightning rapidity returns to the bottom.

The only time *Polypterus* was seen to feed in the wild state there was a small shoal of *P. senegalus* making their way slowly along the river bank. One of their number seized a fresh-water crustacean, two others gave chase and, stirring up the mud, they all disappeared. When seizing young fry or tadpoles it proceeds stealthily after them, propelling itself by the flutters of its fan-like fins until within striking distance, and then with a sharp snap they are gulped down.

If the water is perfectly well aërated *Polypterus* may lie for a long time without breathing air. But a specimen which had been perfectly happy in tolerably fresh water for some days, when allowed to reach the surface, succumbed in a few hours when prevented from so doing. On the other hand one specimen lived

for 24 hours in a landing net, with no more water than the moisture of the atmosphere, and finally had to be killed.

Polypterus may be watched for a considerable time, and give the impression that it is a sluggish and inactive fish. If, however, one is lucky enough to observe a male and female sporting together, it will be seen that they are capable of wonderful activity; executing the most lithe and supple movements, turning, twisting, darting and pausing in an extremely graceful manner, they thoroughly justify the native Mandingo name of Sayo or snake-fish.

The ovary of *Polypterus* is not hollow but originally a fold of the cœlomic wall, it is early divided into compartments, both longitudinally and transversely. Each compartment contains from one to three ova, which are developed on the external wall of the ovary. Later, the external wall becomes much plicated, nevertheless at the internal and external summits of each fold the ova retain their original position, being attached to the wall of the ovary by the now pigmented pole. It thus comes about that, through the internal wall of the ovary, which is a smooth thin sheet, only the pigmentless poles of the ova are seen, while through the external much folded wall only the pigmented poles are seen.

The attachment of the ovary extends backwards obliquely across the short, thin walled and wide oviduct. The latter, about 3 inches in length in a 20 inch fish, opens to the exterior just behind the vent.

The spermatozoa in the male are extremely small; not more than $\frac{1}{8}$ the diameter of a red corpuscle in length.

It is seen then that both species of *Polypterus* found in the Gambia migrate to the flooded lands to spawn; that without doubt *Polypterus* uses its air bladder as an accessory organ of respiration and seldom as an hydrostatic organ, as a rule being unable to float, though it should be mentioned, that, preparatory to sporting near the surface, it was seen to take in several gulps of air in succession. The spiracle is used for the emission of air and not for the passage of water. The pectoral fins are important organs of propulsion and not mere balancers, as in almost all Teleostomes.

b. The dry season habits of *Protopterus* on the Gambia have long been known. Nothing however has been recorded hitherto of their habits in the rainy season.

Protopterus annectens emerges from its cocoon at the commencement of the rainy season in the early part of June, the eggs are usually ripe by the end of July.

There is no certain sexual difference, even at the height of the breeding season, except in old males in which the head is stouter

than in old females, and the pectoral limbs appear to be broader. During the breeding season, however, in both sexes the limbs and also the tip of the tail become much elongated and attenuated. In some cases the pectoral limbs extended beyond the vent and ended in extremely fine threads.

Though the nests of *Protopterus* were never actually seen in the wild state, eggs were obtained which proved to be fertilized.

The *ova* of *Protopterus annectens* measure 5 mm. in diameter, are enclosed in a thin horny capsule, and are light salmon colour above, and slightly tinted with greenish in the lower hemisphere.

Segmentation is complete, but very unequal. After the first three or four cleavages it is quite irregular, and results in an upper hemisphere of small cells, and a lower hemisphere of larger cells. The eggs were not reared beyond the beginning of gastrulation.

Larvæ two inches in length were obtained from the swamps, presumably hatched in the preceding breeding season. These had three pairs of well developed external gills, arising however apparently at a common point of origin.

In one case these external gills were as long as the head and provided with long vascular fringes. The *spermatozoa* of *Protopterus* are very large, twice the diameter of a red corpuscle in length.

As I was obliged to return to England early in the breeding season my observations on the life history of *Polypterus* and *Protopterus* are necessarily very incomplete. I hope however to return to their breeding grounds next season to complete the study.

On the Conductivity of Gases from an Arc and from Incandescent Metals. By J. A. McCLELLAND, M.A., Cavendish Laboratory.

[Received 11 December 1899.]

The first part of the following paper contains an account of experiments on the conductivity of gas through which an arc discharge has passed; the second part refers to somewhat similar experiments on gas taken from the neighbourhood of an incandescent wire. In both cases the gas has considerable conductivity, which can be shown to be due to ionisation, or a production in the gas of positively and negatively charged carriers of electricity. Both methods of producing ionisation are very suitable for a study of the nature of these carriers, as we can easily arrange to have a plentiful supply, and this supply can be maintained fairly constant.

Experiments have been made with the arc and with the incandescent wire in air, oxygen, and carbonic acid gas; the relation between current and E.M.F., the recombination of the carriers, the velocity of the carriers under electric force, and other points have been investigated.

The Arc in Air.

Relation between current and E.M.F.

(1) The arrangement in Fig. 1 was used to determine how the current in the conducting gas depended on the potential difference between the terminals; all of the apparatus shown in the figure is not required for this experiment but may be described here as it shall be referred to again.

The primary of an induction coil was connected in series with an alternating supply, and the terminals of the secondary of the coil were joined to the electrodes t and t' . These electrodes were of brass with platinum pieces inserted in their ends, so that the arc was formed between platinum terminals. The terminals were fixed in corks in a glass funnel F , and one of them provided with an ebonite handle so that it could be moved in to form the arc and then drawn out to any required distance; the length of arc used was generally 2 or 3 mms. A brass tube A 1.7 cms. in diameter was fixed in the upper end of the glass funnel, and a tube D filled with glass wool, to stop dust particles, leads into

the lower end of the funnel, and is connected to a gas bag, so that a stream of gas can be sent through the apparatus.

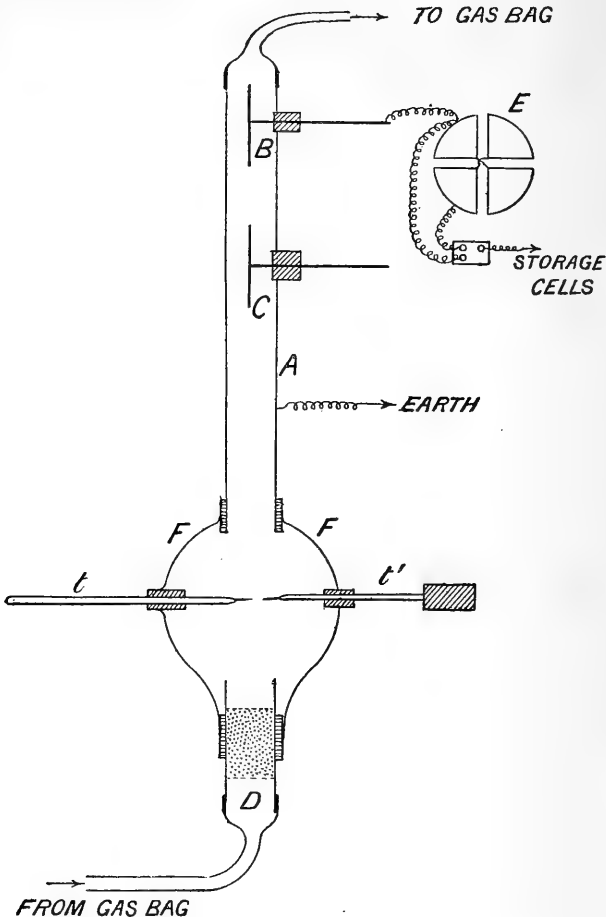

Fig. 1.

A constant flow of gas can thus be obtained from the arc through the tube *A*, and when the gas bag is properly calibrated the velocity of the stream of gas is known. When a gas other than air is being used a second bag is joined to the upper end of the tube *A*, so that the gas can be collected after passing through the apparatus and can be used again.

A terminal *B*, 7.6 cms. long and .4 cms. diameter, is inserted in

the tube *A* and insulated by an ebonite plug. This terminal is connected to a pair of quadrants of an electrometer; both pairs of quadrants are first connected together and to one pole of a battery of storage cells, the other pole of which is to earth; one pair of quadrants is kept joined to the cells, and the pair in connection with *B* is disconnected and leaks owing to the conductivity of the gas passing *B*.

C is another similar terminal used in other experiments which can be joined to earth or kept at any required potential by being joined to the storage cells.

(2) By charging the terminal *B* to any potential and observing the initial rate of leak we get the current through the gas for that potential difference between the terminal *B* and the tube *A*. The following table shows the result of an experiment :

Potential of <i>B</i> in volts	Current in arbitrary units
8	12
18	19
30	25
80	34
120	37
185	38

The curve in Fig. 2 is plotted from these numbers, and shows that as the E.M.F. increases the current approaches a maximum value.

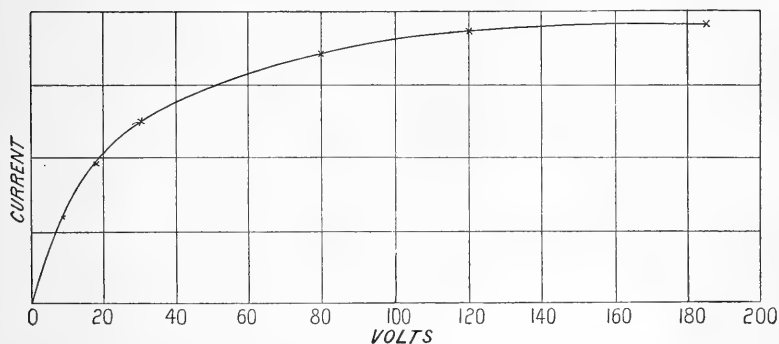

Fig. 2.

At first the current increases rapidly and is approximately proportional to the E.M.F.; when we reach an E.M.F. sufficient to discharge all the carriers before they pass the terminal the current increases but little, although a further increase of E.M.F. by discharging the carriers sooner and thereby diminishing the loss of

conductivity due to recombination of the positive and negative carriers, does slightly increase the current.

If we diminish the velocity of the stream of gas past the terminal we get the maximum current for a smaller E.M.F. because now the gas takes longer to pass the terminal and so a given E.M.F. can discharge all the carriers inside a greater radius. The conductivity of the gas is entirely destroyed after it passes the terminal *B* if this terminal has been kept at a potential sufficiently different from that of the tube *A*.

The conductivity therefore is such as can readily be explained by the ionisation of the gas.

(3) By charging the terminal *B* positively and negatively we get not quite the same rate of leak in the two cases; the terminal leaks rather more quickly when charged negatively. This would show that an excess of positive carriers comes off from the arc, but this excess is small compared with the total amount of either sign.

It is shown afterwards that the negative carriers move with a slightly greater velocity than the positive under an electric force, and this would cause more of the negative carriers to be discharged to the terminals of the arc, leaving an excess of positive in the gas. The value that we have found for the velocity of the carriers under an electric force is very small, and the difference in the velocities of the positive and negative is also small, but these determinations are made after the gas has left the arc. In the arc itself the velocities of both negative and positive are probably much greater. We know from Prof. Thomson's results¹ that probably in all cases of ionisation the mass of the negative carrier is initially very small compared with that of the positive, while their charges are the same. In gas at atmospheric pressure the carriers soon collect around themselves a very much greater mass, so that the difference in the velocities of the positive and negative under an electric force is greatly diminished. We have then in the arc the negative carrier of much smaller mass than the positive initially, but their masses soon becoming more nearly equal. In the field of force near the arc terminals the negative carriers produced by the passage of the discharge will therefore be discharged to the terminals to a greater extent than the positive. This explanation of the electrification of the gas produced by an arc would not account for the negative electrification found in hydrogen², but Prof. Thomson points out that there are reasons for ascribing the negative electrification in hydrogen to some secondary action.

¹ See *Phil. Mag.*, December, 1899.

² J. J. Thomson, *Discharge of Electricity through Gases*, p. 93.

Loss of conductivity by recombination of the positive and negative carriers.

(4) In the case of the arc in air the conductivity at different times after the gas left the arc was measured. The conducting gas was forced up the tube *A* (Fig. 1) at a steady rate, the terminals *B* and *C* were removed, and a terminal lowered down the axis of the tube from the top, and the leakage from it was measured in different positions. The terminal was charged to such a high potential that all the carriers in the conducting gas were discharged soon after meeting the terminal. The numbers below give the conductivity at different distances from the arc.

Distance from Arc.	Conductivity proportional to
38.5 cms.	10
29	14
23	21.5
15.5	38
11	86.

Fig. 3 shows the conductivity curve with distances from arc

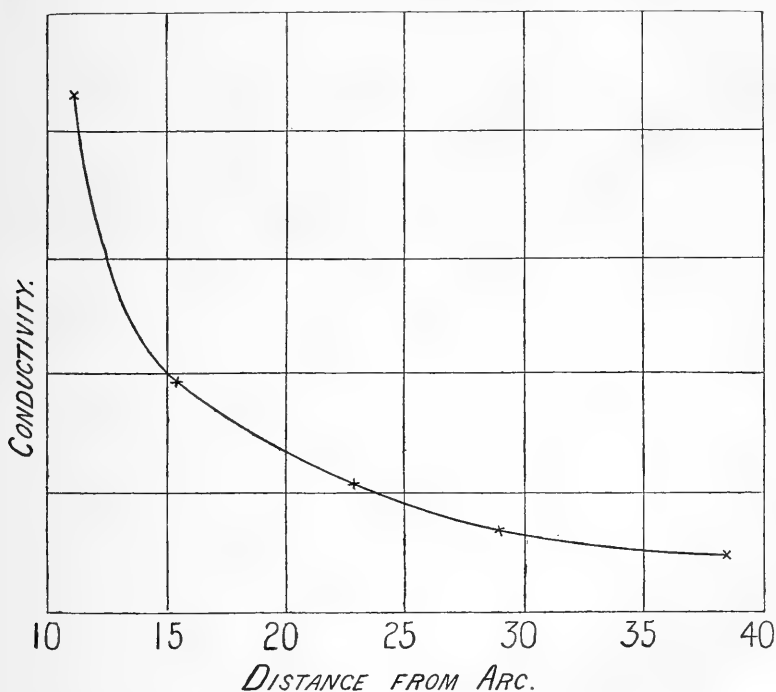

Fig. 3.

as abscissæ. The curve cannot be produced back to the arc, as that part includes the glass funnel, where the velocity of the stream of gas was different.

The loss of conductivity is principally due to the recombination of the carriers, and if we assume the number of collisions of the positive and negative carriers to be proportional to the square of the number present, we get

$$-\frac{dn}{dt} = an^2,$$

or

$$\frac{Nn}{N-n} = \frac{1}{at},$$

where N is the number of carriers when $t = 0$.

If we take $N = 86$ and measure t from that point and calculate $1/\alpha$ for each of the other readings we get

$1/\alpha$ proportional to	306
”	344
”	301
”	311.

The curve therefore agrees fairly well with that got by assuming

$$-\frac{dn}{dt} = an^2.$$

Determination of the velocity under an electric force of the carriers produced by the arc in air.

(5) The apparatus shown in Fig. 1 enables us to measure the rate at which the carriers of electricity move in an electric field of given strength.

The rate of leak from B is first measured when C is to earth, and B charged sufficiently high to discharge all the carriers before they pass it. The rate of leak from B is again determined when C is kept at such a potential that the leak from B is diminished by about one-half. Knowing these two rates of leak, the potential of C , and the velocity of the stream of air past the terminals, we can calculate the velocity of the carrier.

If V be the potential of C , v the velocity of the carrier under a force of 1 volt per cm., r_1 and r_0 the radii of the tube A and the terminal C respectively, then we can easily show that all the carriers of one sign initially inside a radius ρ are discharged to C where ρ is given by

$$t = \frac{1}{vV} \cdot \frac{\rho^2 - r_0^2}{2} \cdot \log \frac{r_1}{r_0},$$

t being the time required for the stream of gas to move through a distance equal to the length of the terminal.

We calculate ρ from the two determinations of the rate of leak from B when C is to earth and when kept at a known potential, the time t is easily found, so that we can deduce the value of v .

A large number of determinations of the velocity of the carrier was made in this way and the value found for the velocity was quite constant as long as the nature of the arc remained the same. When the arc was varied by increasing or diminishing the resistance in series with the primary of the induction coil between the secondary terminals of which the arc was formed, and therefore the amount of current through the arc changed, it was found that the velocity of the carrier also changed. When the amount of current passing through the arc was increased the velocity of the carrier was diminished and *vice versa*. The following numbers refer to one determination of the velocity of the carrier.

	Rate of heat from B .
C to earth	50 scale divisions in 21"
C at 20 volts	50 scale divisions in 52"

From these numbers we find $\rho^2 = \cdot 45$.

The velocity of the stream of air was 19 cms. per second. Substituting in the above equation we get

$$v = \cdot 015 \text{ cms. per second.}$$

(6) This determination refers to a case where the current through the arc is relatively great. The velocity of the carrier increases rapidly as the current through the arc is diminished. The current through the arc was cut down step by step and the velocity of the carrier determined for each state of the arc, and values were found increasing from that given to $\cdot 33$ cms. per second. It was difficult to maintain the arc with smaller currents than that which gave the latter velocity. The velocity of the carrier produced by the arc is small compared with that produced by the Röntgen rays; in this case Rutherford found for air a velocity of $1\cdot 6$ cms. per second. For the velocity of the carrier in the conducting gas from a flame I found the value $\cdot 2$ cms. per second, which rapidly diminished as the hot gas cooled down. In conducting gas from an electrolytic cell Townsend found as low a velocity as $\cdot 0007$ cms. per second.

It is quite likely, however, that the initial carrier may be the same in all cases, but with more uncharged masses travelling with it when the velocity is smaller; the rapid decrease of the velocity in flame gas would point to this increase of mass as the gas cools down. The variation of the velocity of the carrier in the gas from an arc may be explained in a similar way; when the

current through the arc is increased we have more matter given off from the terminals either by their disintegration or by the escape of occluded gas, and thus the conditions are rendered more favourable for the condensation of uncharged masses on the carriers.

(7) When the current through the arc is increased the density of ionisation in the gas taken from it is of course increased, and the electric force acting on the carriers in the field between the terminal *C* and the tube *A* will differ from its assumed value by an amount depending on the density of ionisation. This would make the velocity deduced for the carrier to be less than its true value, and the error would increase with the density of ionisation. The amount of the error thus introduced was examined by first determining the velocity with dense ionisation, and then cutting down the ionisation by making the gas pass through a number of layers of fine wire-gauze packed close together, before determining the velocity of the carrier. The result showed that the error introduced in this way was small.

(8) In all these determinations of the velocity of the carrier the gas is practically at the temperature of that in the room at the point where the velocity is measured; the arc is small and the hot gas from it is mixed with a large volume of cold gas so that at a short distance from the arc the temperature has fallen almost to that of the room. Some experiments were made to test the effect on the velocity of the carrier produced by heating the gas. The tube *A*, for this experiment, was not inserted directly in the funnel *F*, but was connected with it by a glass tube bent twice at right angles, so that the horizontal part of it could easily be heated by a bunsen burner. The velocity of the carrier at the terminal *C* could then be determined when the gas at that point is at various temperatures. It was found that when the current through the arc was large, so that the velocity of the carrier was small, the effect of heating the gas was to increase the velocity of the carrier; the increase of velocity produced by heating the gas was much less when the current through the arc was small, and therefore the velocity of the carrier greater. The smaller the velocity of the carrier in the cold gas the greater was the increase produced by heating it. This result would favour the view that the decrease of velocity of the carrier is produced by more uncharged material travelling with it.

(9) Some experiments were made with brass terminals for the arc in place of the platinum terminals. With the brass terminals the velocity of the carrier was less than with platinum terminals, and fell away even more rapidly when the current through the arc was increased. The disintegration of the brass

is greater than that of the platinum, and the conditions will therefore be more favourable for having a greater mass travelling with the carrier.

Difference of velocity of the positive and negative carriers.

(10) The method used to determine the velocity of the carrier under an electric force, although it may not give a very accurate result, can still be used to detect a difference in velocity of the positive and negative, since all errors enter equally into both determinations. The velocity, as we have seen, is a variable quantity and depends on the nature of the arc, but keeping the arc as steady as possible, and determining the velocity for the carriers of both sign, we always find that in the same field of electric force the negative carrier moves with a greater velocity than the positive, and for air the excess is about 20 per cent.

This difference is about the same as found for gas exposed to Röntgen rays and in flame gas, although the absolute values of the velocities are very different in these cases. Since the charges on the positive and negative carriers must be the same, the difference in their velocities must be due to a greater mass travelling with the positive carrier, and the ratio of the masses would seem to remain approximately the same in these different cases, which is perhaps to be expected.

The arc in oxygen.

(11) Experiments similar to those described above were made with oxygen. Two gas bags were used, and the gas passed from one bag to the other through the apparatus, so that the same supply of oxygen could be used for some time.

As in air there is an excess of positive electricity in the conducting gas drawn off from the arc, and this excess is greater than in the case of air, but still small compared with the amount of electricity of either sign.

The velocity of the negative carrier under electric force is, as in air, greater than that of the positive, and the excess was estimated at 25 per cent., a rather greater difference than in air.

The velocity of the carriers varied greatly with the nature of the arc, as was found for air. To compare the velocity in oxygen with that in air determinations were made for each, keeping the arc as constant as possible, and the velocity in oxygen was found to be about $\frac{2}{3}$ of that in air. Of course even when the current through the arc is the same for the air and the oxygen we do not know that the temperatures of the arc and its terminals are equal in the two cases, so that the comparison of the velocities of the

carriers in the two gases are not made in exactly similar conditions.

The arc in CO₂.

(12) When the arc is formed in CO₂ there is an important difference in the conductivity of the gas drawn from it compared with that in air or oxygen; a negative charge is discharged by the gas much more rapidly than a positive charge. The discharge is still brought about in the same way as in the previous cases; the current varies with the E.M.F. in the same manner, and the conductivity of the gas can be entirely destroyed by passing it between two terminals kept at a sufficiently great difference of potential. Since the conducting gas discharges negative electricity more readily than positive, the positive carriers are therefore present in greater number than the negative. We had a similar result in air and oxygen, but there the excess of positive was small, whereas in CO₂ the amount of positive is often many times that of the negative. In one experiment when the terminal *B* (Fig. 1) was charged negatively its rate of leak was

100 scale divisions in 15";

when charged positively it was only

10 scale divisions in 60".

The negative carriers therefore do not come away from the arc in anything approaching the same amount as the positive.

(13) The small excess of positive electricity in the gas from the arc when air or oxygen is used was explained above by the greater loss of negative carriers to the terminals on account of their greater velocity under electric force.

If this explanation can account for the great excess of positive in the case of CO₂ we must assume that in the arc itself the velocity of the negative carrier is great. We know as mentioned above that the mass of the negative carrier is always initially very small, and its velocity consequently very great, and to account for the disappearance of the negative in the CO₂ from the arc we would require to assume that in CO₂ in the arc itself the mass travelling with the carrier does not increase so rapidly as in air.

(14) The experiment was tried of directing on the arc a blast of gas so as to remove the carriers more rapidly from the neighbourhood of the arc. In place of the wide tube *D* (Fig. 1) by which the gas enters the funnel *F*, we substitute a tube of smaller bore which projects into the funnel up to near the arc so that a blast of considerable velocity impinges on the arc. With this arrangement the negative carriers came off from the arc in much

greater quantity, and the amount of negative was very little less than that of positive. We give the numbers for one such experiment; the rate of leak of the terminal *B* (Fig. 1) is measured when charged positively and negatively without the blast directed on the arc and with it. The flow of gas past the terminal *B* is the same whether the blast is used or not.

Without the blast.

Positive charge 35 scale divisions in 30".
 Negative charge 180 scale divisions in 30".

With the blast.

Positive charge 200 scale divisions in 30" (approx.)
 Negative charge 200 scale divisions in 30" (approx.)

With the blast therefore the amount of negative which comes off in the gas was approximately the same as that of the positive, while without the blast the amounts were in the ratio of 1 to 5.

This experiment would seem to favour the explanation advanced above for the great difference in the amounts of positive and negative carriers usually observed when CO_2 is used.

(15) The velocity of the carriers in CO_2 varied with the current through the arc in the same way as in air and oxygen; as the current is increased the velocity of the carrier rapidly diminishes. Thus in one series of experiments in which the current through the arc was gradually increased, values of the velocity were found diminishing from .01 cm. per second to .004 cm. per second with a force of 1 volt per cm. No doubt a much greater range of values could be obtained by varying the current through the arc through a wider range. These determinations are all made after the gas has come away from the arc and when it is at the temperature of the room.

(16) Comparing the velocity of the carrier when CO_2 is used with that in air, the arc being as nearly as possible the same in both cases, we always get a much smaller velocity in CO_2 than in air. The ratio of the velocity in CO_2 to that in air was found in different determinations with different arcs to vary from $\frac{1}{6}$ to $\frac{1}{10}$. In CO_2 therefore the carrier finally collects around itself a greater mass than it does in air.

(17) In CO_2 as in air the velocity of the negative carrier is greater than that of the positive; the difference of velocities varied considerably in a number of determinations made with different arcs, but the mean value of the difference amounted to about 40 per cent. The difference was therefore greater than in

air or oxygen. We saw above that there were reasons for supposing that in the arc itself the very great initial difference in the masses of the positive and negative carriers was longer maintained than in air or oxygen, and this result obtained from actual measurement of the velocities would point in the same direction.

(18) At this stage in these experiments the arc was discarded and an incandescent wire used to produce ionisation and render the gas conducting.

There are many points of resemblance between the conductivity of the gas and its electrification as produced by the arc and by an incandescent wire, and hence the results obtained with the wire may be given in continuation with those recorded above for the arc.

To adapt the apparatus described at the beginning of this paper to this work it is only necessary to substitute a piece of fine platinum wire a few centimetres long for the arc, and raise it to the required temperature by passing a current through it.

We shall first consider the case when the wire is heated in air.

Incandescent wire in air.

(19) By gradually increasing the current through the wire we can heat it gradually to an intense red or white heat, and we find that as soon as it reaches a dull red, in fact as soon as it is luminous, the air drawn from it has the property of being able to discharge a negatively charged body but not a body positively charged. As the temperature of the wire rises a negative charge is discharged more rapidly, and when we reach a sufficiently high temperature the gas coming from the wire will discharge a body charged either positively or negatively.

To illustrate these effects we give the following numbers obtained in one experiment. The gas is forced past the incandescent wire which is substituted for the arc in Fig. 1, and through the tube *A* past the terminal *B*, which is charged to a high potential and its rate of leak observed.

Current heating the platinum wire.	Rate of leak of terminal.	
	Charged positively.	Charged negatively.
4·4 ampères	No leak	No leak
5·4 ampères	No leak	10 divisions in 60"
6·4 ampères	No leak	70 divisions in 60"
7·4 ampères	15 divisions in 60"	90 divisions in 60"
8·4 ampères	100 divisions in 15"	100 divisions in 15"

These numbers show that the wire requires to be at a higher temperature in order to discharge positive electricity near it, than is required to discharge negative electricity. Also, at very high

temperatures the rate of discharge of positive electricity is approximately the same as that of negative.

(20) The conductivity produced by the incandescent wire is such as is produced by the ionisation of a gas; the current varies with the E.M.F. in the usual way, and the gas loses all its conductivity when the maximum current it can carry has passed through it. The numbers below refer to an experiment in which the rate of leak of the terminal *B*, Fig. 1, is measured for different values of the E.M.F. when the conducting gas is forced past it at a constant velocity. This experiment may be made with the terminal charged either positively or negatively if the wire is at a sufficiently high temperature, but with the wire at a dull red heat the terminal will leak only if charged negatively.

Volts.	Current in arbitrary units.
200	50
120	47
80	44
40	26
20	14.5
9	7

Fig. 4 shows the curve plotted from these numbers, and we see that a maximum value of the current is reached in the same way as with the conductivity produced by Röntgen rays or by the arc.

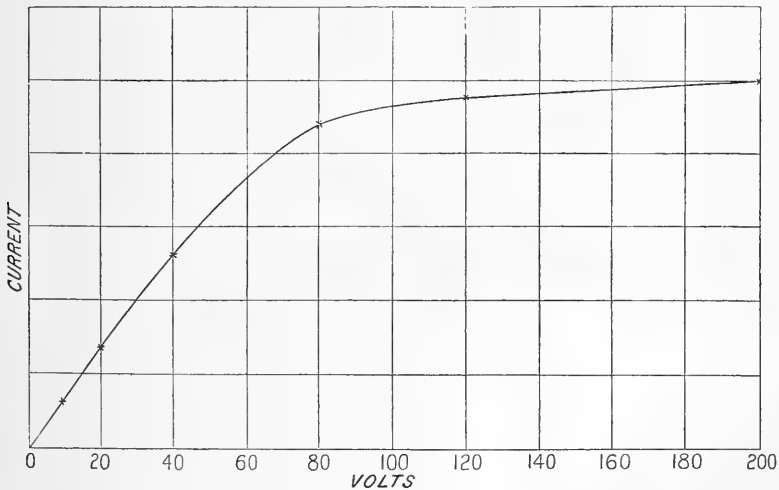

Fig. 4.

The conductivity is therefore produced by the ionisation of the

gas, and we have the positive carriers only coming away from the wire at low temperatures, and at higher temperatures those of both signs; when the wire is at a bright red heat the amount of negative is approximately the same as that of positive.

(21) These results agree with former experiments on the subject. Elster and Geitel found that when a platinum wire is heated to luminosity in air, the air acquires a charge of positive electricity. They found that the potential to which a body could be raised when placed near the wire depended on the temperature of the wire and reached a maximum when the wire was at a bright yellow heat, and was very small when the wire was at a very high temperature. This would follow because the amount of positive and negative carriers in the gas is nearly the same when the wire is very hot. Branly found that with the wire at a dull red heat the gas from it will only discharge negative electricity, but at higher temperatures both positive and negative.

(22) When the temperature of the wire is comparatively low the ionisation, no doubt, takes place in a very thin layer close to the wire, and the ions being very close to the wire are attracted towards it. Since the mass of the negative carrier is initially very much smaller than that of the positive, the negative, when the layer of ionisation is very thin, may be entirely discharged to the wire while the positive carriers come off to some extent with the gas which is drawn away from the wire. As the temperature of the wire is increased the layer of gas in which the ionisation takes place will get thicker, and when the thickness is sufficiently great all the negative ions will no longer be discharged to the wire, and we will have both positive and negative in the gas; when the temperature is very high the number of carriers discharged to the wire from a very thin layer close to it will be small compared with the total ionisation, so that the amounts of positive and negative in the gas taken from near the wire will be nearly the same.

(23) The property possessed by an incandescent wire of being able to discharge a negatively charged body near it before it can discharge one positively charged, as its temperature is gradually raised, does not depend on the sort of wire used. Iron, German-silver, and brass wires were tried and gave the same result as the platinum. When any of these wires is heated the gas drawn from it discharges negative electricity so soon as the wire is luminous, but a considerable further heating is required before positive electricity can be discharged. The following numbers refer to a German-silver wire, and the results with the others were similar

Current heating the wire	Positive charge	Leakage	Negative charge
1 ampère	No leak		No leak
1·1 ampères	No leak		12 divisions in 30"
1·2 ampères	No leak		70 divisions in 30"
1·3 ampères	40 divisions in 30"		350 divisions in 30"

Wire melted when further heated.

(24) A point in connection with these experiments with incandescent wires, which is worthy of notice, is that the positive carriers are present in the gas near the wire just as soon as it becomes luminous. If a conductor charged negatively is near the wire, and the temperature of the wire gradually raised, we always notice that leakage of the charge begins just when the wire becomes luminous. This point having been observed when working with a platinum wire, a number of experiments were made with platinum, German-silver, and brass wires, and it was always found that just when the luminosity of the wire could be observed a negatively charged body near it began to leak. It is difficult to see why the power to produce ionisation should thus accompany the luminosity, but the agreement can hardly be merely a coincidence. Perhaps we should look on the luminosity as due to the ionisation of the layer of gas close to the wire.

(25) The conductivity of the gas drawn away from an incandescent wire increases very rapidly as the temperature of the wire is raised. In the following table the current used to heat the wire is given, and also the conductivity measured by forcing the gas through the apparatus shown in Fig. 1, and observing the leakage of the terminal *B* after it has been charged to a high potential.

Current through the wire	Conductivity of gas proportional to
2·02 ampères	12
2·25 "	60
2·44 "	135
2·61 "	330
2·75 "	450
2·89 "	635

The resistance of the platinum wire when these different currents are used was obtained by measuring the difference of potential between its ends, and in this way its temperature was estimated. The numbers given in the above table would correspond to a range of temperature of from about 1300° C. to 1800° C.

The gas taken from the wire can discharge negative electricity, as we have seen, as soon as the wire is luminous, but before

positive electricity can be discharged a further heating of some 400 degrees centigrade is required.

It is intended to make further and more accurate experiments on these points.

Incandescent Wire in Air. Velocity of Carriers.

(26) Experiments were made to determine the velocity of the carriers under electric force in the same way as when the arc was used. With the incandescent wire, as with the arc, it was found that the velocity of the carrier varied as the temperature of the wire changed; the higher the temperature of the wire the smaller was the velocity of the carrier. In one set of experiments values were found ranging from .01 cms. per second to .003 cms. per second. When the arc was used values of the velocity of the carriers were found lying inside these limits, but when the currents through the arc is small the velocity of the carrier is greater than any value found when using the incandescent wire. The diminution of the velocity with increase of current in the arc would seem to be due to the heating of the terminals, and not to anything that occurs in the arc itself. The same effect is then produced by an increase of temperature of the incandescent wire.

The velocity of the negative carrier is greater than that of the positive when the incandescent wire is used, and the excess is about 20 %, the same as for the arc.

Incandescent Wire in CO₂.

(27) The effects observed with CO₂ were similar to those with air. It will be remembered that when an arc was formed in CO₂, the gas from it discharged negative electricity much more rapidly than positive; it was difficult to get the negative carriers away from the arc. The incandescent wire was tried in CO₂ to see if a similar effect occurred, but it was found that when the temperature of the wire was sufficiently high the gas from it discharged positive electricity as rapidly as negative. The cause assigned for the discharge of the negative carriers to the terminals of the arc would not apply to the incandescent wire where there is a very small electric field, all parts of the wire being nearly at zero potential. We give some numbers referring to the conductivity observed with a wire heated in CO₂.

Current heating the wire	Positive change	Leakage	Negative change
4.4 ampères	No leak		No leak
5.4 ampères	No leak		30 divisions in 60"
6.4 ampères	No leak		45 divisions in 60"
7.4 ampères	4 divisions in 60"		62 divisions in 60"
8.4 ampères	100 divisions in 28"		100 divisions in 28"

As in air, the gas from the hot wire can discharge negative electricity before it can discharge positive, while at very high temperatures the rate of discharge is the same approximately for positive and negative. With CO_2 again it is always observed that the discharge of negative electricity begins just as soon as the wire becomes luminous.

(28) The velocity of the carriers was measured for various temperatures of the wire as in the previous cases, and the same results obtained, the velocity diminishing as the temperature of the wire was raised. In one series of experiments numbers ranging from $\cdot 03$ cms. per second to $\cdot 006$ cms. per second, for a force of one volt per cm., were found.

The velocity of the negative carrier is again greater than that of the positive; one experiment gave a difference of 25 %.

Further experiments, both with the arc and with the incandescent wire, are being carried on, and it is hoped to publish further results soon. In the meantime it is better to postpone any further discussion of the results in this paper.

I wish in conclusion to thank Prof. Thomson for many valuable suggestions.

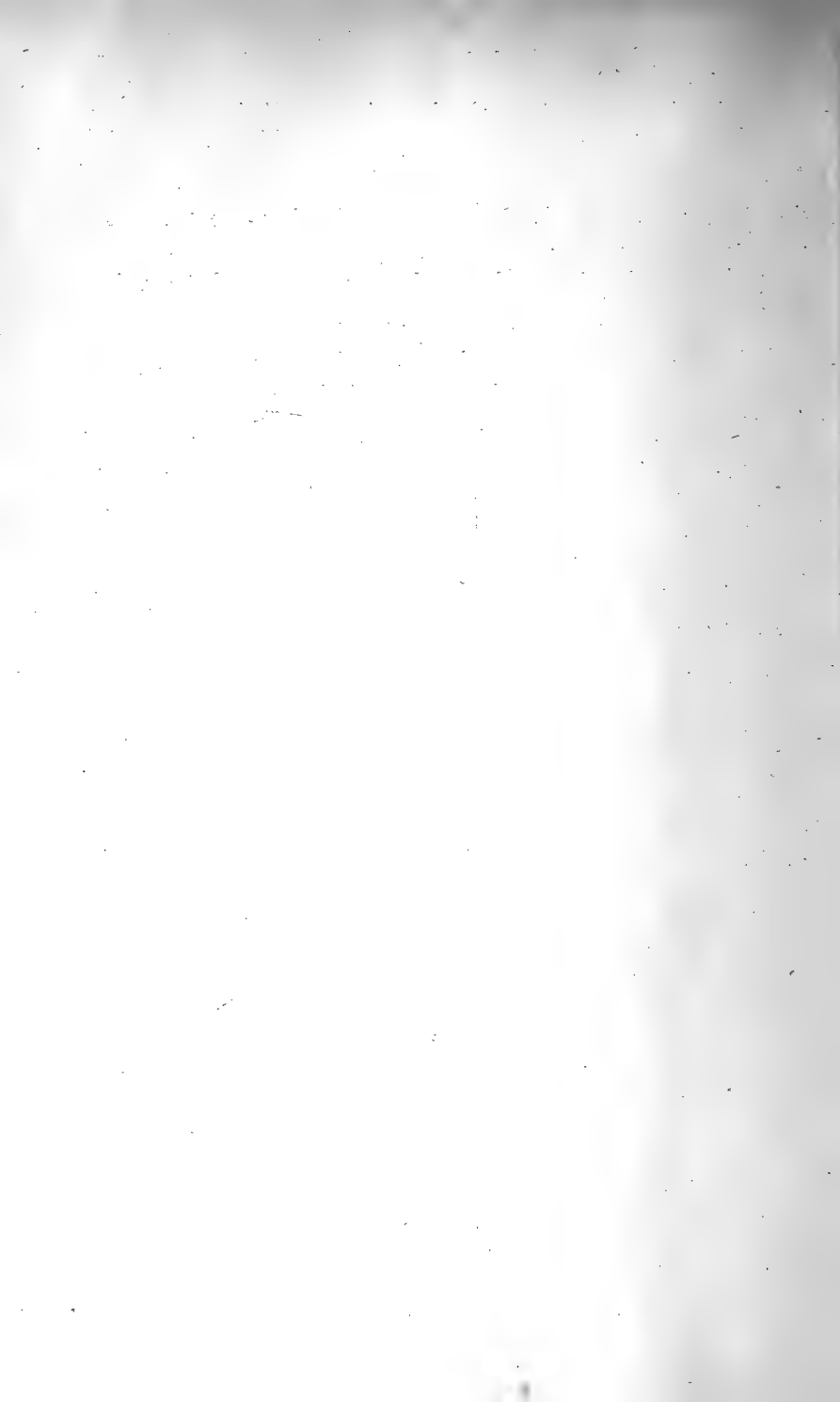

PROCEEDINGS
OF THE
Cambridge Philosophical Society.

Experiments on the Periodic Movement of Plants. By Miss D. F. M. PERTZ and Mr FRANCIS DARWIN.

[Read 22 January 1900.]

The first part of the paper is practically a continuation of the authors' research "On the artificial production of rhythm in plants" published in the *Annals of Botany*, 1891. The second part deals with a new example of periodic movement. If a "sleeping" plant is placed in a dark room after its leaves have assumed the nocturnal position, it will "awake" next morning, i.e. its leaves will return to the diurnal position, in spite of the darkness. In the experiment described, the procedure was varied by exposing the plants to one-sided illumination: under these circumstances the leaves are well known to assume certain characteristic oblique positions. The point of the experiment is that if a plant is darkened after having responded in the above manner to one-sided illumination, it returns to the oblique position on "awaking" next day in complete darkness.

Wealden Plants from Bernissart. By Mr A. C. SEWARD.

[Read 22 January 1900.]

A brief account was given of a collection of plants in the Natural History Museum of Brussels which were obtained from argillaceous rocks at Bernissart, a locality rendered famous by the discovery in 1877 of more than twenty complete skeletons of *Iguanodon*. The beds containing the *Iguanodons* and plants

occupy a gorge, 250 m. deep, bounded on either side by Carboniferous strata. A short list of species of Bernissart plants was published in 1878 by M. Dupont¹, the identifications being made by the late Marquis of Saporta.

Through the courtesy of M. Dupont, the Director of the Brussels Museum, the writer has recently examined the collection, which consists of numerous small fragments of typical Wealden species. The fragmentary nature of the fossils renders accurate determination difficult, but several species are represented by a large number of examples and can be readily identified. The following species have been recognised:—*Algites* sp., *Lycopodites* sp., *Equisetites* sp., *Onychiopsis Mantelli* (Brongn.), *Matonidium Goeperti* (Ett.), *Laccopteris Dunkeri* (Schenk.), *Ruffordia Goeperti* (Dunk.), *Weichselia Mantelli* (Brongn.), *Sphenopteris Fittoni* Sew., *Sphenopteris delicatissima* Schenk., *Sagonepteris Mantelli* (Dunk.) *Protorhipis Roemeri* (Schenk.), *Cladophlebis Dunkeri* (Schimp.), *Leckenbya valdensis* Sew., *Gleichenites* sp., *Adiantites* sp., *Pinites Solmsi* Sew., *Conites minuta* sp. nov. etc.

The Flora is represented by fragmentary samples which appear to have been transported for a considerable distance, and finally deposited in a fine freshwater argillaceous sediment. A striking feature of the flora is the scarcity of Gymnosperms; nearly the whole of the material consists of fragments of Fern fronds, *Weichselia Mantelli* being by far the commonest species. The evidence afforded by the plants points unmistakably to a Wealden age, nearly all the species being identical with those described from the Wealden rocks of the Sussex coast, the north German area, and elsewhere.

On the Biology of Bulgaria polymorpha. By Mr R. H. BIFFEN.

[Read 22 January 1900.]

The life history of this fungus has been studied in detail by means of cultures grown on blocks of sterilized oakwood. On infecting these blocks with germinating ascospores, or with conidia from the mycelium produced by the ascospores, a crop of adult ascospores was produced in about six months. At the same time the wood is attacked by the fungus and deliquesced in a characteristic manner, the process starting at the pits in the walls of the elements.

¹ *Bull. Ac. R. Belg.*, vol. xxvi. [2], 1878, p. 387.

On the Electro-chemical Equivalent of Carbon. By Mr S. SKINNER.

[Received 5 February 1900.]

§ 1. In a paper read before the Physical Section at the Bristol B.A. Meeting 1898, I described some experiments bearing on the theory of Jacques' carbon-consuming cell. This cell consists of a carbon pole dipping into hot fused caustic soda contained in an iron crucible. Through the fused caustic soda is passed a current of air, and an electromotive force is generated acting from the iron to the carbon in the external circuit. My experiments showed that the addition of sodium peroxide was more efficient than passing in air, and that the sodium peroxide acted as a depolariser when placed in a divided cell so that it came in contact with the iron alone. These results were explained by considering that the sodium ferrate which was formed acted as an electrolyte when dissolved in fused caustic soda, and that the ferrate combined with the sodium which must be set free on the iron surface by the electrolytic actions in the cell.

Attempts were made to study the consumption of carbon by weighing the carbon rod before and after current had been taken from the cell. These, however, failed as it was difficult to remove the absorbed electrolyte from the porous carbon. So the rate of consumption of carbon was left undetermined.

The new experiments in the following paper were made with the view of studying this point, and a cell acting at ordinary temperature and with aqueous solutions has been devised. The cell is described in section 3.

The experiments of Bartoli and Papasogli on the electrolysis of water (*Ann. Chim. et Phys.* 1886) and of Cohen (*Zeitschr. für Electrochemie*, 1896) on that of sulphuric acid with carbon electrodes have shown that carbon compounds are formed in solution, and also that carbon dioxide gas, carbon monoxide, and oxygen in varying proportions are given off at the anode. Further, Cohen constructed a cell in which a lead peroxide plate formed the cathode and a carbon block the anode with an electrolyte of hot sulphuric acid.

It appears from these results that a highly oxygenised substance on electrolysis may yield an anion which will attack carbon, and clearly a very good substance for this purpose would be potassium permanganate.

§ 2. When a current is passed into a solution of potassium permanganate at the ordinary temperature from a carbon anode carbon dioxide gas is given off at this electrode. If the same current be made to pass through a water voltameter the ratio of the hydrogen set free to the carbon dioxide may be determined.

To make this measurement I have found it convenient to use the apparatus described below, as it is necessary in collecting the carbon dioxide gas to avoid its loss by solution in water, or by combination with the potassium hydroxide formed at the cathode. In order to avoid the former source of loss the solution is previously saturated with carbon dioxide gas, and to prevent loss by the latter the electrolyte is kept moving from the anode towards the cathode.

The apparatus consists of a measuring tube *AB* standing vertically with an electrode of carbon formed from a piece of an arc-light carbon¹. At the side opposite the carbon is joined a horizontal tube which at the open end is bent upwards, and into

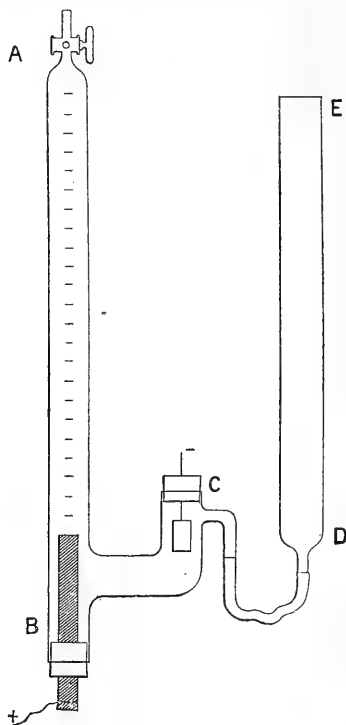

which the platinum cathode dips. A fine tube *C*, blown into the glass just above the platinum plate, serves as an outlet for gas or liquid. In commencing an experiment the tube *C* is connected by a rubber tube to a tall reservoir *DE*, and potassium permanganate solution, almost saturated, is poured in at *E* until it nearly

¹ In some experiments rods of gas-carbon cut from the part next the walls of the retort were used. The results did not differ from those obtained with arc-light carbons.

fills the gas tube *AB*, the stopcock being left open. The current is now started and bubbles of carbon dioxide form on the carbon rod. These bubbles, however, are dissolved as they ascend through the solution above the anode. At the cathode hydrogen escapes through the side tube *C*, and passes up the tube *DE*. The current is maintained until the liquid is saturated with carbon dioxide, which will then be seen escaping from the surface of the liquid through the open tap.

The apparatus is now ready to commence a measurement. The stopcock *A* is closed and the reservoir *DE* is disconnected at *C*. A water voltameter is put in series with it, so that the same current passes through the two voltameters. If the current be started carbon dioxide is collected in *AB* and displaces the permanganate solution which escapes at the side tube *C*, together with the hydrogen from the cathode. As this displacement goes on during the whole experiment the potash formed at the cathode is carried away.

TABLE I.

Current strength in ampères	Volume of gas evolved at carbon electrode in KMnO_4	Percentage of carbon dioxide.	Percentage of carbon monoxide and oxygen by difference	Volume of oxygen collected over platinum electrode in dilute H_2SO_4	Volume of hydrogen.	Difference between fifth and second columns
·15	26·8	86·0	14·0	27·0		·2
·12	10·3	85·5	14·5	10·4		·1
·12	25·3	85·5	14·5	27·8		2·5
·58	44·0	80·0	20·0			
·54	24·1	77·0	23·0			
·5	10·3			(10·05)	20·1	—·25
	Over carbon electrode in $\text{K}_2\text{Cr}_2\text{O}_7$ solution					
	20·7	78·5	21·5	22·0		1·3

The current used in some of the experiments was about .5 ampère, and as the section of the tube between *BC* is about half a square centimetre the current density on the carbon is approximately one ampère per square centimetre.

Under these conditions the readings in Table I. were obtained.

The analyses of the carbon dioxide gas were made by placing a sample of the gas over potash solution.

The residue after the absorption of the carbon dioxide was always found to be slightly explosive, showing that it consisted of carbon monoxide mixed with a little oxygen.

§ 3. When a cell is arranged with carbon in potassium permanganate solution and a lead peroxide plate in dilute sulphuric acid, the two electrolytes being separated by a porous pot, an electromotive force acts externally from the lead peroxide towards the carbon. Such a cell has an electromotive force of 0.33 volt, and in it the permanganate ion is carried against the carbon plate, and the hydrogen towards the lead peroxide which it reduces. This cell forms a self-acting system in which carbon is consumed at ordinary temperature. If the lead peroxide plate be placed in the potassium permanganate the cell has an electromotive force of 0.08 volt acting in the same direction as before.

§ 4. The chemical changes in the solution and at the carbon electrode may be represented thus:—

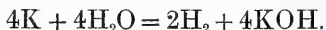
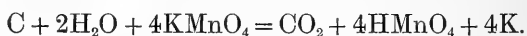

It has already been pointed out that CO_2 is given off at the anode, and it remains to prove that $HMnO_4$ or $KMnO_4$, resulting from the neutralisation of the acid, persists in solution although a quantity of electricity more than sufficient for its complete decomposition be transmitted through the solution. To prove this experiments were made with an apparatus from which the permanganate could be easily withdrawn. A glass cylinder 5 cm. in diameter had a diaphragm of parchment-paper stretched over one end, and held tightly by indiarubber bands. Into this vessel 50 c.c. of $\frac{N}{20} K_2SO_4$ was poured, and the cylinder was arranged to dip into 100 c.c. $\frac{N}{10} KMnO_4$. A carbon or platinum anode was placed in the permanganate, and a platinum cathode in the potassium sulphate. A current of known strength was then passed for an observed time. Meanwhile a standard ferrous ammonium sulphate solution was prepared and titrated against 100 c.c. of the stock permanganate solution. After passing the

current the electrolysed permanganate was collected and titrated against the ferrous solution. The change in the number of cubic centimetres of iron solution required measured the loss of permanganate.

The following results were obtained.

TABLE II.

Anode	Current	Time	Cubic centimetres of iron required		Percentage loss of Oxidising power
			Before	After	
I. Carbon	·14 ampère	50 minutes	205	183	10·7
II. Carbon	·12 „	30 „	205	190	7·3
III. Platinum ¹	·13 „	51 „	212	186	12·2

Since the current and time are known it is possible to calculate the weight of permanganate which would be decomposed by the corresponding quantity of electricity. The equivalent weight of potassium permanganate is 158, and the electrochemical equivalent of hydrogen is ·00001035 per ampère-second, and hence the E.C.E. of KMnO_4 is ·00164. This represents the amount in grammes decomposed by one ampère per second, and from it we can calculate the weight of permanganate equivalent to the quantity of electricity for each of the above experiments. This gives:—

- Experiment I. 0·69.
- Experiment II. 0·35.
- Experiment III. 0·652.

Since 100 c.c. of $\frac{\text{N}}{10} \text{KMnO}_4$ contain ·316 gramme it follows that sufficient electricity has been conveyed to decompose all the permanganate more than twice in the first experiment. The colour and oxidising power have however remained. To explain this, permanganic acid or potassium permanganate must have been reformed. According to this view the following expresses the action in the divided cell:

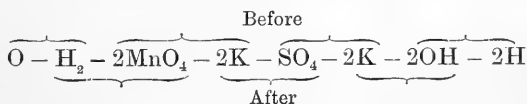

¹ The Platinum anode was bright and clean after the experiment.

In further support of this view of the persistence of the permanganate ion during electrolysis some experiments were made in which a current was passed through potassium permanganate and the escaping gases were collected.

When a current is sent through potassium permanganate using platinum electrodes, oxygen is set free at the anode and hydrogen at the cathode. The volume of oxygen is very nearly equal to that set free in an acidulated water voltameter through which the same current passes, whereas the volume of hydrogen is very variable. When the cathode is clean little hydrogen is set free, but after a time the cathode becoming coated with black manganese dioxide, the hydrogen escapes more rapidly and begins to approximate in volume to double that of the oxygen. The following measurements illustrate this, and as the current was also measured the influence of current-density at the electrode can be traced :

TABLE III.

Concentration of potassium permanganate solution	Current in ampères	Vol. of oxygen set free in KMnO_4 voltameter	Vol. of oxygen set free in dilute H_2SO_4 voltameter	Vol. of hydrogen set free in the H_2SO_4 voltameter	Remarks
strong	0.11	7.8		16.4	
„	0.15	38.5	37.8		
„	0.25	35.6	34.0		
„	0.25	25.4	22.8		
$\frac{\text{N}}{10}$ fresh	0.03	18.6	19.6		anode remained bright
$\frac{\text{N}}{10}$ fresh	0.01	12.2	13.2		
same $\frac{\text{N}}{10}$	0.04	21.0	21.0		
$\frac{\text{N}}{10}$ fresh	0.025	27.2	28.3		

§ 5. A theoretical explanation of the production of carbon dioxide is required in the case of the electrolysis of pure water (Bartoli and Papasogli, *loc. cit.*) of dilute sulphuric acid (Faraday, *Experimental Researches*, vol. I. section 744) and of potassium permanganate solution.

Bartoli and Papasogli used distilled water, and an electromotive force of 1200 volts. The ions in distilled water are OH^- and H^+ , and when the OH^- ions combine with the carbon it is possible that an orthocarbonic acid $\text{C}(\text{OH})_4$ is at first formed, and that this breaks up into CO_2 and $2\text{H}_2\text{O}$. Orthocarbonic acid has not been isolated although its ethereal salt has been prepared. In the case of dilute sulphuric acid with its ions HSO_4^- and H^+ we may suppose that an unstable compound $\text{C}(\text{HSO}_4)_4$ is formed at first, and that this immediately breaks up in aqueous solution forming CO_2 and $4\text{H}_2\text{SO}_4$. Similarly in KMnO_4 solution, where the ions are MnO_4^- and K^+ , we must suppose that $\text{C}(\text{MnO}_4)_4$ is an intermediate product which reacting with water produces CO_2 and 4HMnO_4 . The solution of carbon is here regarded as analogous to the solution of the zinc in a simple voltaic cell.

The formation of CO appears to be controlled by the current density. The results in Table I. show that with a low current density less CO is formed than with a high density. The nature of the negative ion has an influence, since Cohen found that only 70 per cent. of the gas given off from warm fairly concentrated sulphuric acid was CO_2 , and 29 per cent. was CO. The lowest percentage with permanganate and bichromate was 77 per cent. No organic compounds were found deposited or in solution in my experiments.

The solution of the quantity of zinc in a simple cell which is accompanied by the flow of a unit quantity of electricity may be regarded as the electro-chemical equivalent. In this sense these experiments give a value for the electro-chemical equivalent of carbon three times that of hydrogen, since twelve parts by weight of carbon enter into combination when four parts by weight of hydrogen are set free.

Magnetic Disturbances in the Isle of Skye. By Mr ALFRED HARKER.

[With Plates XI, XII.]

[Received 23 January 1900.]

It has long been known that in the Isle of Skye and other parts of the Inner Hebrides there are local magnetic disturbances, sometimes of such magnitude that the compass becomes useless as a guide. This fact may plausibly be connected with the geological constitution of the islands in question, the prevalent rocks being basalt, gabbro, and other igneous rocks rich in iron-compounds, largely in the form of the magnetic oxide. But although casual allusions are often met with, there seems to be little or no information available as regards the amount and distribution of these magnetic irregularities, and the probable explanation of the phenomena. This must be my excuse for offering some results of observations made during the last few years in the central part of Skye. The observations were taken incidentally in the course of geological work, and were of a very rough kind, the only instrument used being the azimuth-compass or often the ordinary pocket-compass.

In their 'Magnetic Survey of the British Isles¹' Professors Rücker and Thorpe give the magnetic elements for about a score of stations in the Western Isles and on the adjacent coast of Scotland, with their differences from the calculated normal values. The disturbances there indicated are, however, of a totally different order from those with which I proceed to deal, rarely amounting to one degree in declination and less in inclination, with a variation up to about three per cent. in horizontal force. The much larger, and at the same time much more local, disturbances, which can be observed with a compass, were outside the scope of that survey, though a special examination was made of part of the Isle of Canna, which has long had a reputation for the abnormal behaviour of the compass. Here the authors record disturbances up to as much as $25^{\circ}3$ in declination, the highest figures being for points just E. and W. of the Compass Hill. The influence diminished rapidly with distance, and was trifling at 200 yards. This is almost the only record from the Western Isles which I can find to compare with the phenomena to be described in Skye.

These phenomena are exhibited in the Cuillin Hills, composed mainly of gabbro, which occupy the central part of the island, and on the moorland plateaux, consisting of basalt, which extend thence northward and westward, covering about half the area of

¹ *Phil. Trans.* (A), vol. 181, pp. 53—328, plates 1—14; 1890.

Skye. I have found no remarkable magnetic disturbances in the Red Hills, composed of granite (a rock very poor in iron-oxides), nor do they occur, so far as my information goes, in the south-eastern part of the island, which is built mainly of stratified sedimentary rocks.

The first fact to note is that on any salient point, either of the gabbro mountains or the basalt plateaux, the rocks are permanently magnetised, and very often to such an extent that, by moving the compass about, the needle may be made to point in any direction. The disturbance affects dip as well as declination, so that, with the dial held horizontally, the needle will often jam against the card. When a rock-face forming part of such an eminence is tested more closely with the compass, it is found that certain points of the rock behave as north poles and others as south poles, such poles being irregularly distributed at intervals varying from a few inches to a few feet. A vertical and a horizontal rock-face give similar results in this respect. Attempts to measure roughly the strength of a pole (assumed to be on the surface of the rock) gave various and not very satisfactory results. One method was to select a fairly isolated north pole on a rock facing south and present the compass to it, adjusting until the needle lay in the normal magnetic meridian, but in reverse position. The compass was then withdrawn in the same direction until the needle became unsteady and swung round. In one case this did not occur until the needle was 2 feet from the rock.

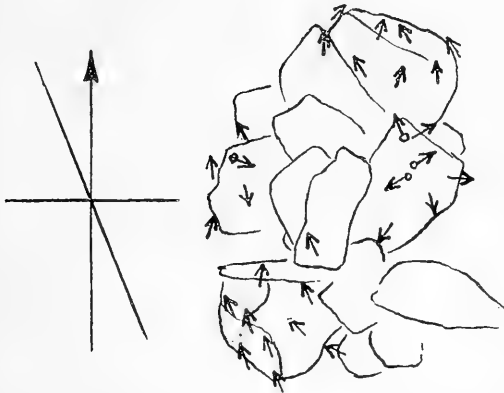

FIG. 1. Rough sketch of cairn on Sgùrr nan Gobhar, looking down on it from above. The small arrows show the positions assumed by the compass needle. When one end of the needle dips very strongly, this is indicated by a small circle. The highest point of the cairn is on the edge of the stone on the extreme left of the figure, and this behaves as a north pole. Another strong north pole is indicated towards the right, of the figure.

These phenomena are not confined to high mountain-summits, but are exhibited equally by insignificant knolls on the moorland plateaux, provided they form the highest ground in their immediate neighbourhood. The localisation of these intense magnetic disturbances in such situations seems to point very decidedly to atmospheric electricity as the cause of the magnetisation of these salient points of rock. It is not necessary to suppose that the exposed points have been struck by lightning. Indeed, the remarkable rarity of thunderstorms in Skye rather suggests that the summits act to some extent as lightning-conductors. It is easy to show too that no great lapse of time is required for rocks so exposed to become magnetised. The stones composing the cairns erected by the Triangulation Survey are invariably highly magnetic, while the loose stones lying about the base of the cairn are much less so. This is true even of small cairns erected by climbers within a few years past. (See fig. 1.)

The very violent, and at the same time very local, disturbances which have been briefly described may be styled for the sake of clearness disturbances of the *first order*. As stated, they are found generally in connection with salient points of rock all over the gabbro mountains and, so far as my examination has extended, over the basaltic plateaux of Skye. It may be taken as established that they are directly due to permanent magnetisation of the rocks in these exposed places. The enquiry naturally suggests itself, whether a like explanation is applicable to any disturbances of a lower order. My observations on this point are rather suggestive than conclusive, but some of the results may be worth putting on record. They apply to what may be called disturbances of the *second order*, affecting a larger area than the preceding, but having a smaller magnitude. Observations of declination (the only kind taken) still show large deviations from the normal magnetic meridian, but not such as involve complete rotation of the needle, except where centres of disturbance of the first order occur within the area affected. Two examples will suffice to illustrate the nature of the phenomena.

I take first the summit of Glamaig, a hill of more than 2500 feet altitude in the neighbourhood of Sligachan. The summit consists of basalt, metamorphosed by the proximity of the granite on which it rests and in which it has been involved. The hill has a round top, which falls away in smooth slopes on the south and west sides, but the north-east face is at first steep and rocky. It forms a cliff, the edge of which runs in a curved line N.W. and N.N.W., passing very near the summit. Centres of intense local disturbance due to permanent magnetisation (disturbances of the first order) occur at several places where crags project prominently on the face of the steep slope, and the summit-cairn, standing

about 10 feet S.W. of the edge of the cliff, is also highly magnetised. Observations of declination were taken at 46 points within a radius of 15 yards of the summit-cairn, and the results are shown on the accompanying ground-plan (Pl. XI.). The declination proper to the time and place is about N. 21° W., and the edge of the cliff, which is practically the crest-line of the hill, is thus roughly coincident with the normal magnetic meridian. In order to note the effect of this crest-line we will consider the deflections of the needle from the normal magnetic meridian as observed at points on opposite sides of the line. For brevity we may call deflections to west and east of north positive and negative deflections respectively. Of 28 observations at points to the (magnetic) west of the line, 2 gave the normal declination; 4 gave positive deflections, but never exceeding $2\frac{1}{2}^{\circ}$ in amount; while 22 gave negative deflections varying up to 13° , with a mean of about $6\frac{1}{2}^{\circ}$. The mean for the 28 was a negative deflection of nearly 5° . Of 18 observations at points to the (magnetic) east of the line, 7 were in the neighbourhood of highly magnetic crags, and so gave large and irregular deviations: these, for our present purpose, may be left out of account. Of the remaining 11, 3 gave negative deflections, but only of 2° , 5° , and 7° , respectively; while the other 8 gave positive deflections varying from $6\frac{1}{2}^{\circ}$ to $30\frac{1}{2}^{\circ}$, with a mean of 17° . The mean for the 11 was a positive deflection of 11° . It will be noticed that the deflections are higher and also more irregular on the steep than on the gentle slope. The irregularities, however, are not so great as to hide what appears to be the general rule governing the disturbance; viz. that the north pole of the needle is deflected eastward on the west side of the crest-line and westward on the east side.

A similar diagram of the behaviour of the compass-needle on the summit of Glamaig was given by Macculloch in a paper published in 1816¹, and one object of my own observations was to ascertain what changes, if any, had taken place in the interval of more than eighty years. The comparison is not very easily made, for the reason that Macculloch had no topographical map to guide him: he does not tell us how he fixed the points of the compass, and there would also be some small latitude possible in fixing the actual summit-point on the round top of the hill. The only differences that can be certainly verified between the two diagrams relate to places of violent local disturbance. One such is indicated on Macculloch's diagram which certainly did not exist at the time of my observations (September, 1898). It is on the smooth side of the hill, about 36 yards from the summit, in a direction a little west of N.W. Here Macculloch marks an arrow

¹ *Trans. Geol. Soc.*, vol. III., plate 3, fig. 1.

pointing nearly S.E., while at or near the same spot I found the declination nearly normal or with a very slight negative deviation¹. It appears then that a magnetic disturbance of the first order (due perhaps to a lightning-stroke) once existed at this spot, but has since died out. As regards the centres of violent local disturbance on the steep slope, it is only possible to say that the older diagram, like my own, shows some highly anomalous declinations in this part; but the rapid changes from point to point which are always found near such spots make any close comparison impossible.

The next example is of a somewhat different kind, and is selected with the view of examining the probable relation between disturbances of the second order and those of the first. It is a prominent ridge on the hill named Meall an Fhuarain, about half-way between Sligachan and Portree and a mile west of the high-road². The ridge rises abruptly about 60 feet above the fairly

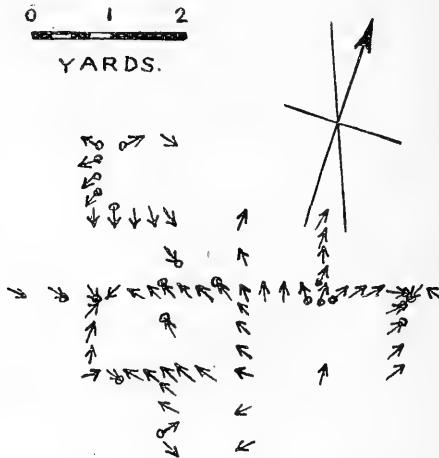

FIG. 2. Enlarged ground-plan of a small area at the summit *C* in Plate XII. Three north poles and four south poles are indicated by the behaviour of the compass needle.

level moorland immediately surrounding it, and runs in a straight line for about 160 yards with a width of about 30 yards. Like all

¹ These and some other observations made merely for comparison with the earlier ones are not included in the summarised account, because they could not conveniently be brought within the limits of the diagram. They are quite in accord with the general result as summarised.

² It is a station of the Trigonometrical Survey, marked 952-7 on the Ordnance Survey map, and is a conspicuous object directly in front of anyone approaching by road from Sligachan.

the prominent features among the moorland hills, it is formed, not by the basaltic lavas, but by a more durable rock, also of basic composition, intruded among them in the form of a sheet or sill. The long axis of the ridge bears about N. $18\frac{1}{2}^{\circ}$ W., and is therefore nearly in the normal magnetic meridian for the place and epoch (N. 21° W.). Violent local disturbances connected with intense magnetisation of the rocks occur at several spots, notably at the two summits, *C* and *E*, and at other salient points such as *F* and *H*; and these disturbances are of the character already described as distinguishing the 'first order.' Fig. 2 is a ground-plan of part of the rock-surface at *C*, the point which exhibits the strongest disturbance of this type. It may be remarked in passing that this summit, though not quite so high as *E*, is a more marked prominence: hence perhaps its more intense magnetisation.

Observations of declination were taken at intervals of a few yards, or in critical places one yard, along the crest of the ridge and also along a line at right angles to the long axis, passing through the summit *E*: the results of these are indicated in diagram (Pl. XII.). It is clear from the figures there given that the field of disturbing force is of a very complex nature, but on examination some indication of law is evolved from the apparent irregularities. Most striking are the manner in which the deflections increase towards each of the centres of strong local disturbance, and the abrupt change in sign of the deflection as we pass such a centre. The relation of all the deflections along the northern half of the ridge to the centre of disturbance at the summit *C* is very manifest. This summit produces negative deflections, diminishing with distance, at points to the north of it; and positive deflections, also diminishing with distance, at points to the south. To the north, where no other important centre of disturbance complicates the result, the effect is felt to at least a hundred yards, and probably with more delicate instruments might be proved much farther. The centres *E* and *F* produce somewhat similar effects, except that the deflections are in the opposite sense. It is interesting too to note the abrupt change of 7° at the point *B*. This may be interpreted as the superposition on the effect of *C* of an effect of the same kind but much smaller magnitude, and probably points to the existence at *B* of a centre of disturbance too feeble to be detected in a rough and hasty examination. Other irregularities may be conjectured to have a like origin.

The observations at this locality seem then to indicate that, besides the powerful local forces which cause the needle to spin rapidly about as the compass is moved over the surface, a summit magnetised in this apparently fortuitous manner exerts neverthe-

less a definite resultant force sensible, with diminishing effect, to considerable distances. Without multiplying examples, it may be stated generally that this statement is borne out at numerous other localities examined in a more cursory way. On those ridges in the Cuillins especially which trend approximately north and south, and culminate in marked summits, results showing considerable regularity were obtained, so long as subordinate centres of local disturbance residing in minor prominences were avoided. Such east and west ridges as I have examined (Sgùrr Dearg, Sgùrr nan Gobhar, and others) showed considerable deflections varying from point to point and not easily reduced to any semblance of order; a fact perhaps attributable to the rough profile of these ridges, presenting as they do numerous crags which are centres of more or less strong local disturbance.

My observations, taken on most of the peaks and ridges of the Cuillins, though numerous, were, as already intimated, of a very rough kind. They are sufficient, in my opinion, to demonstrate that magnetic disturbances, gradually varying from place to place, and of such magnitude as, in favourable circumstances, to be detected by the compass to distances of a mile or two miles, stand in relation to summits composed of highly magnetic rocks. Any attempt to specify the nature of the relation must be based on a much more thorough survey conducted with instruments of precision. The general rule on north and south ridges seems to be that the deflections of the needle from the normal magnetic

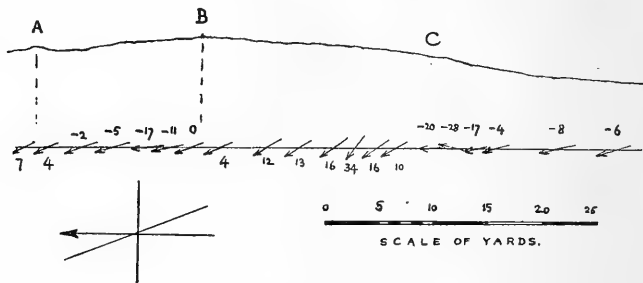

FIG. 3. Behaviour of the compass needle on part of the summit-ridge of Sgùrr na Banachdich. The observations are marked, as before, on a ground-plan, and a longitudinal profile of the ridge is added. The numbers give the deflections from the normal magnetic meridian (N. 21° W.).

meridian are in opposite directions on opposite sides of the summit, and diminish in absolute magnitude with distance from the summit. Sometimes the deflections are negative to the north of the summit and positive to the south; sometimes the reverse.

Again, there are cases in which the deflections are small or vanishing near the summit itself (the small area of magnetised rock being excluded), and reach a maximum value at some little distance from it. This may perhaps be a complex result due to the joint effect of distinct centres of local disturbance, as illustrated by the summit portion of the ridge of Sgùrr nan Banachdich (fig. 3). Here the summit-cairn (*B*) is highly magnetised, and so also are the points of rock *A*, 14 yards north, and *C*, 21 yards south. Going north from the summit, the negative deflection increases from zero to -17° (at four and five yards), then decreases towards *A*, and there changes sign. Going south from the summit, the positive deflection increases from 1° to 34° (at fourteen yards), then diminishes, and at *C* changes both magnitude and sign abruptly. I have not observed such phenomena in connection with summits which exert a sensible effect to long distances.

The next enquiry in natural sequence seems to be whether a mountain, as distinguished from a mountain summit, or (to go further) a group of mountains, composed of such rocks as gabbro and basalt, exerts an appreciable effect of the nature of magnetic disturbance over the adjacent country. Rough compass observations cannot be expected to contribute much to the solution of this question, for the disturbances contemplated will be of what may be regarded as the *third order* of magnitude, usually not exceeding a degree or two in declination and affecting a correspondingly extensive area. A large number of observations were taken on the belt of low moorland country bordering the Cuillins to the north and west, but, as might be anticipated, the results are found to be quite inconclusive. Not only are the errors of observation¹ too nearly comparable in magnitude with the actual deflections, but on this ground, composed of basaltic rocks, it is impossible to eliminate satisfactorily the disturbing effect due to slight permanent magnetisation of small knolls and ridges. Probably better results might be obtained in places where the gabbro mountains are bordered by a broad track of granite, a rock not itself susceptible to magnetisation.

In this connection we may notice the case of Garbh-bheinn, which may perhaps be regarded as supplying a connecting link between magnetic disturbances of the second and of the third order. Garbh-bheinn, the northern termination of the Blaven range, is a mountain of 2650 feet, consisting in the main of gabbro, but this rock is obliquely underlain by granite, with a small intervening wedge of volcanic agglomerate and basalt. The granite is continuous with a large tract of the same rock extending northward

¹ The method adopted in every case was to take the magnetic bearings of one or more distant objects, and to compare with the true bearings as plotted with the protractor on the Ordnance Survey map.

for some miles. Observations were taken along the northerly ridge of the mountain, avoiding magnetic crags which are not numerous or important. Beginning at the summit, the declination was found to be quite normal for the first half mile, that is, down to about 1650 feet altitude. Here a negative deflection begins, as we approach the boundary of the gabbro, and this negative deflection continues, with a steady magnitude of 5° or 6° , for a mile and a half at least along the lower (granite) portion of the ridge. Unfortunately the observations were not carried beyond this point, but they are sufficient to prove a somewhat wide-spread magnetic disturbance, changing only slowly in magnitude, and extending well beyond the limits of any possible magnetised rocks.

In the foregoing paragraphs I have, so far as is possible, avoided theoretical considerations, feeling that the data are not sufficient to warrant any strong opinion as to the precise explanation of the magnetic disturbances noted, but a few concluding remarks under this head will not be out of place. It may be taken as highly probable, if not certain, that, as regards Skye, these disturbances, small as well as large, are attributable to rock-magnetism. The alternative advocated by Naumann, viz. the effects produced in earth-currents by dislocations of the strata, can scarcely be appealed to in this case, especially in view of the fact that the district affords extremely little evidence of the existence of such dislocations. There remain the rival claims of permanent magnetisation of the rocks and the inductive action of the earth's magnetic field. As regards what I have distinguished as disturbances of the first order, the former cause is clearly indicated by the facts recorded; but whether it supplies a *vera causa* for the disturbances of lower orders is a more doubtful question.

Messrs Rücker and Thorpe, in the valuable report already cited, lay stress upon induction; but it must be remembered that they deal generally with disturbances much smaller and more wide-spread than those described above. They distinguish three different orders, as follows:—

[iii] (local) affecting only a single station or its immediate neighbourhood; *i.e.* having a range less than the average distance between the stations;

[iv] (regional) having a greater range, but small compared with the entire area under survey;

[v] involving the whole, or a considerable fraction of that area.

I have renumbered these to correspond with the orders of magnitude recognized above, on the assumption that the most local disturbances embraced by this general survey are similar to

the most wide-spread of those which I have attempted to establish within my limited area.

In these latitudes a peak magnetised by induction should attract the north pole of the needle, and this is a simple test to apply to disturbances of what have been called the second and third orders. Some peaks, such as Glamaig noticed above, conform to this rule; but it clearly affords no general explanation of the phenomena. At the same time certain considerations, and especially a comparison of N.—S. with E.—W. ridges, suggest that induction may be one element contributing to the general result. Its influence might be sought in disturbances of low order among the granite hills bordering the gabbro tract or on the low ground built of Jurassic strata near the basaltic plateaux.

Prof. Rücker¹ has endeavoured to show by calculation that induction is capable of producing regional magnetic disturbances comparable in magnitude with those detected by his survey; but the argument is open to serious criticism from the geological side. The author calculates the effect due to a large rectangular slab of rock of given magnetic susceptibility (this figure being obtained by experiments on basalts from Mull) magnetised by the earth's induction. The thickness of the slab is taken at 12 miles, it being supposed that beyond that depth, where the temperature would be about 700° C., magnetic matter does not exist. It is thus assumed that basalt, or rock of similar magnetic susceptibility, extends downward to a depth of twelve miles, an assumption not warranted by the known geological structure of any part of the globe. In Skye the basalt and gabbro are in the form of an irregular sheet, the base of which is seen in many places, the underlying rocks being sandstones, etc., for which no magnetic properties can be postulated. The base of the sheet is in some places above sea-level, in others a little below, and the average thickness of the sheet must be roughly about the same as the average elevation of the land, or probably not more than the fiftieth part of twelve miles.

It may be remarked in conclusion that, although little information has been published concerning magnetic polarity among British rocks, there are numerous records and some detailed accounts from the Harz, the Fichtelgebirge, the Eifel, and other districts on the continent of Europe. The facts are very fairly comparable with those described above. Any considerable magnetic properties are confined in general to basalts, diabases, serpentines, and other rocks rich in iron-compounds and usually in the mineral magnetite. The phenomena are such as would be produced by a large number of small magnets distributed through

¹ *Proc. Roy. Soc.*, vol. XLVIII., pp. 505—535; 1890.

the mass of the rock, without parallelism of their axes and, according to most observers, without any ascertainable law of arrangement. The property is described as residing only in the more superficial parts of a rock-mass, but the inferences drawn from this distribution are not always concordant. For example, Zaddach¹ connected the magnetic polarity with chemical alteration of the rock by atmospheric agency; a hypothesis not in itself very plausible, since one chief result of such weathering would be the conversion of the magnetic oxide to the peroxide or hydrated peroxide. The magnetic basalts and gabbros in Skye are often perfectly fresh, and the property is confined to rocks which are not only exposed to the atmosphere but exposed in prominent situations.

EXPLANATION OF PLATES.

PLATE XI. Ground-plan of the summit of Glamaig. The arrows show the positions assumed by the needle at different spots. The numbers are not declinations, but deviations from the normal magnetic meridian for the time and place (N. 21° W.), reckoned positive towards the left and negative towards the right. The asterisks mark places where violent local disturbances occur in consequence of strong polarity of the rocks.

PLATE XII. Behaviour of the compass needle on the prominent ridge of Meall an Fhuarain. The observations are marked on a ground-plan, and longitudinal and transverse profiles of the ridge are added to show the form of the ground. The numbers give, in degrees, the deflections from the normal magnetic meridian (N. 21° W.), reckoned positive towards the left and negative towards the right. Many observations have been omitted to avoid confusing the diagram: they are in all cases in accord with the observations actually shown. The asterisks mark the chief places of violent local disturbance due to strong polarity of the rocks.

On Differential Equations with two Independent Variables. By
A. C. DIXON.

[Read 5 February 1900.]

v. Transactions, Vol. XIX. Part I.

¹ *Verh. naturh. Vereins*, Bonn, vol. VIII., pp. 195—306, plates II.—IV.; 1851. Besides a minute description of certain magnetic crags of basalt, this paper contains a review of the earlier literature of the subject. For a more complete bibliography see Meli, *Boll. Soc. Geol. Ital.*, vol. IX., pp. 645—670; 1881.

A suggestion as to a possible mode of Origin of some of the Secondary Sexual Characters in Animals as afforded by Observations on certain Salmonids. By G. E. H. BARRETT-HAMILTON.

[Read 19 February 1900.]

The changes of colour or form which the males of so many vertebrates undergo in anticipation of, and often immediately before, the breeding-season are so well known that it is needless here to cite any examples of them. Not less striking than their wide prevalence amongst every class of vertebrates, is the exceedingly varied form in which these changes make their appearance. Not only may either the whole or only a part, and that by no means always the same part, of the body be affected, but in some cases changes of both colour and form may occur in the same individual, as is found in many species of the genus *Salmo*. The breeding-season past, all trace of the nuptial colouring or out-growths is lost.

Phenomena that seem to be analogous are presented by the permanent, and not merely temporary, assumption of sexual characters by the males of many animals. Here we have not only brighter coloration, but superior armature and, more frequently than all, increase of size. But, as in the case of the above, there may be also special local developments of particular organs, such as the nasal glands and appendages of certain *Chiroptera*, excess of hair, forming a shaggy mane, in several other mammals, and differences of vocal power especially noticeable in many birds.

As a rule those who have written on such phenomena leave the question of their possible origin alone; and, seeking only to understand their present uses, have been content to assign to them a combative or aesthetic cause, the latter often in default of any other apparent reason. Thus Darwin was content to trust to Sexual (which is in part the effect of Natural) Selection as the guiding and perfecting factor in their development, while Mr Wallace, without being clear as to the radical difference between their origin and subsequent perfection, believes that the greater vigour of the males over the females finds an external vent in the manner described. No attempt, so far as I know, has been made to trace their primary physiological meaning, which, nevertheless, may have been widely different from their present or secondary use.

If Darwin's explanation be of universal application it seems strange that the sexes should be alike and often dully coloured

in the case of many of the more intelligent animals such as the *Mammalia*. Again, among Birds, the sexes of the *Corvidae*, wherein we should surely have expected to find the greatest possible enjoyment of aesthetic display, are often alike. On the other hypothesis, if it be true that the males are inherently more vigorous than their females, how are we to account for the fact that in some whole families such as the diurnal Birds of Prey (*Accipitres*) the females are the larger? In the case of some other Birds—as the Hemipodes (*Turnix*) and the Phalaropes (*Phalaropus*)—and some few others it is the female and not the male which assumes the brightest breeding plumage, which exceptions to the general rule are usually explained by the fact, more or less ascertained, that there is here an exchange of function, the male performing the duty of incubation. Yet that the nuptial weapons or ornaments are mainly dependent on the condition of the sexual organs, has been asserted from the days of John Hunter. Since his time the question has been examined by many investigators, and a considerable number of cases have been recorded, principally amongst Birds, in which the alleged intimate relation between the condition of the generative organs and the external sexual characters has been usually affirmed, but sometimes questioned¹ and even denied.

But what seems to me to throw most doubt of all upon the aesthetic theory as the guiding principle and upon that which relies upon the greater vigour of the male as the primary cause is the fact that in the case of many Birds, and *those* apparently of stupid species which we cannot suppose to be capable of appreciating differences of colour-tints, both sexes share in nuptial changes which may be very striking. Such is the case, for instance, amongst many sea birds. The crest and white side-tufts of the Shags (*Phalacrocorax*) and the wonderful mandibular excrescences and facial plumes of the little Auks and Puffins (*Fratercula*, *Lunda*, *Simorhynchus* and others) are temporarily assumed by both sexes.

The wide-ranging nature of these phenomena, and their prevalence not only among vertebrates but among invertebrates, as, for instance, to quote only familiar instances, amongst the Spiders² of the family *Attidae* and many *Linyphiidae*, or amongst the *Lepidoptera*, suggests that there must be some wide-spread and fundamental causes to which all owe their origin, some primary state of things from which they all started, and which, once found,

¹ See a paper by Mr J. H. Gurney, Junior, on "Male Plumage in Female Birds," *Ibis*, 1888, p. 226, also *Zoologist*, 1894, p. 15: also a paper by the same author on a female Redstart which assumed the plumage of a male, in *Trans. Norwich Nat.* iv. p. 182.

² A piece of information for which I am indebted to my friend Mr R. I. Pocock.

would indicate the analogies of all such, and, perhaps, of many other phenomena.

I believe a clue to such a state of things is to be found in the nuptial changes of the anadromous salmonoid genus *Oncorhynchus*, the spawning of which I was recently fortunate enough to observe in Kamchatkan waters.

The facts in their broad sense have been described by Dr Guille-mard¹ and are so well known that only the briefest recapitulation of them is necessary. Each spring and summer the rivers of Kamchatka are crowded with hosts of these salmon which leave the sea for the purpose of spawning. There are several species, and each has its own particular time for running, so that during the whole summer the rivers are filled with individuals of one or more species. On their first arrival these fish present no remarkable coloration, being of a rather ordinary silvery or bluish appearance. After they have been a short time in fresh water, however, a great change comes over them. This manifests itself in the appearance of very striking colours accompanied by a strange increase in size or hypertrophy of certain parts of the body. The colours and the parts affected are different in each species. Most of the species become red, but especially *O. lycaodon* (Pall.), locally known as the Red-fish. Others turn to a livid blue or brown. All develop a formidable hooked snout, none more so than *O. sanguinolentus* (Pall.), the "Kisutch," and in one of them *O. proteus* (Pall.), the Humpback, such an extraordinary hump is produced on the back as to give rise to a belief among the natives that this deformity has its origin in the frantic efforts of the fish to ascend the rivers.

Here then we have what, at first sight, appears to be an abundant development of nuptial colours, together (in the case of the snout) with a most efficient weapon wherewith to fight a rival male². A closer examination of the facts shows, I think, that this is not all.

In the first place the alterations, whether of colour or of form, are not confined to one sex, but are (as far as we know) developed in both. In the second place the fish when thus affected are most obviously out of condition. There is in their case no heightening of the silvery glancing colours of health, but a replacement of them by utterly different sickly or livid hues. The colours, and also the strange unnatural looking hypertrophy of snout or dorsal region are indeed merely the outward symptoms of what I suggest is a pathological condition, in the

¹ See *The Cruise of the Marchesa*, Vol. I. Chap. vi.

² The facts were thus interpreted in the latter case by J. K. Lord (*The Naturalist in Vancouver Island and British Columbia*, 1866, I. pp. 40—61), from whom Darwin (*The Descent of Man*, 1871, II. pp. 4 and 5) borrowed them.

more advanced stages of which the fish becomes coated with fungus, ulcerated (Lord), and so wasted that it gradually loses all its power of movement and eventually dies, so that in late autumn the water of every Kamchatkan river or lake is polluted with rotting carcasses. Such colours and hypertrophies then can hardly be of mere aesthetic or combative use to the fish, and I look on the different tints and metamorphoses of the various species as being caused by the working of the same influence on different constitutions. The point I wish to emphasize then is that the coloration and growth are due to a pathological condition by which both sexes are affected, but the exact nature of which we cannot know until some physiologist or pathologist finds an opportunity of studying the fish in the fresh state. It may be a kind of piscine jaundice accompanied by the hypertrophy of certain organs, or it may be (and this I myself believe) that in the effort to produce as much spawn as possible the whole metabolism is so upset that the ordinary excretory organs are unable to do all the work demanded of them, and a last effort is made to get rid of the unduly increased quantity of poisonous products by depositing them in the skin. In an enormous majority of cases however, this effort is unsuccessful, and the fish (with possibly a very few exceptions) perish after spawning. Be that as it may, the nature of the disease does not concern me now. What I wish especially to emphasize is the fact that *it is* a disease which kills these fish.

And from the recent investigations of some of the specialists who have worked on this still disputed topic, it seems possible that the nuptial changes of our own Salmon are the outward symptoms of a pathological state which pervades the whole system of the fish with the result that (according to Drs Gullard and Gillespie¹) its mucous membrane is in a condition of desquamative catarrh, suggesting a cessation of function and associated with the absence of zymogen granules in the pancreas, the fatty condition of the liver, the emptiness of the gall-bladder and the absence of all trace of food, together with a low condition of the proteolytic and diastatic action of the digestive secretions, as ascertained by experiment, and an abundance of bacteria in the gut—the latter phenomena interpreted as being probably due to the diminished activity of the gastric fluids.

It is not so very hard to see that such a disease and such a death, though fatal to the individual, may in reality be the

¹ *Report of Investigations on the Life-History of Salmon* (Fishery Board for Scotland, 1898, edited by Dr Noel Parker).

I am aware that the above conclusions have been directly denied by Dr Alex. Brown (see *Zool. Anzeig.*, 1898, xxi. pp. 514, 517—23), but it is hard to suppose that the carefully-made observations above described can have been entirely without foundation, even if they be at all exaggerated.

salvation of the various species as a whole. It may be that the fish which die have, before doing so, produced more spawn than those few which survive, and if that be so, it seems probable that the production of a greater quantity of ova or milt is of far more importance to the species than the mere survival of a few individuals. Moreover, there can be little doubt that the influx into the rivers of such a jostling crowd of hungry fish would act most prejudicially to the young fry by consumption of all available food, and not only that, but by proving a stupendous cause of destruction to the fry themselves. The death, on the contrary, of the old fish should lead to the rapid appearance of a rich invertebrate life, which finding abundant sustenance on the rotting salmon carcasses, must in its turn prove an ample food-supply to the young.

Next to come to the fish that do not die—it is said that one species¹ alone, *O. orientalis* (Pall.) the King-Fish or Chervichi, survives the spawning season, and it is most significant that this is one of the species which become the least distorted and discoloured of the whole genus. Besides the King-Fish a few individuals of the other species are reported to survive the winter in some of the hot streams of the interior.

Now I would suggest that we have in these phenomena a possible source and origin of many of the highly developed sexual characters met with in other animals. We have here instances of the production in both sexes of the most gaudy colours, the most conspicuous changes in form, and all as the result of pathological conditions.

Thus there are several lines of development ready for the use of sexual selection. There are the highly discoloured and distorted species which perish to a fish, and the less highly discoloured and less distorted species which survive, although with difficulty. I suggest then that the nuptial changes characteristic of so many vertebrates may possibly be reminiscences of a former condition of things through which their ancestors passed and in which the processes of reproduction were accompanied, as in the *Oncorhynchus*, by disorganization of the metabolism resulting in vivid changes of coloration and hypertrophy or overgrowth of certain organs. There might be various degrees of such a condition, in some of which the animal, as in the case of our Salmon, recovered, retaining at the same time a varying and temporary extent of change of colour or form of certain organs.

It does not necessarily follow that death was in all cases the result of such disorganization, and it may be that in particular cases

¹ This I take from Guillemard. It is, however, not supported by B. W. Evermann and S. E. Meek's Report of observations in the Columbia River basin and elsewhere on the Pacific coast (see *Bull. U.S. Fish. Comm.*, Vol. xvii. 1897, pp. 15—84).

such as that of *Oncorhynchus* the fatal result of the spawning efforts is an acquired habit, the obvious use of which to the species I have tried to show above. There seems to be no reason why the plan adopted in the vegetable kingdom whereby we may divide plants into annuals and those which live longer than one year should not be equally successful amongst animals, so that we may have in the same family examples of the annual in *Oncorhynchus*, of the perennial in *Salmo*, with the additional advantage that in the case of *Oncorhynchus* the death of the parent supplies the offspring with food.

But I conceive, that once the existence of such a primitive state of things characterised by growth or discoloration of the whole or of part of the body is admitted we have therein the starting point whence Natural Selection by alteration, suppression or accentuation of the details, might easily produce many or all the nuptial changes of animals as we now see them, evolving in each a structure suitable to its own particular need, whether in eye as in the Eel, in snout as in the Salmon, or in hind-limb as in *Lepidosiren*.

The originally temporary assumption of colours or outgrowths under the influence of the activity of the generative organs might recur annually or be fixed as a permanent characteristic of one or both sexes of a species according to the need of each particular instance. Such colours or outgrowths need not, however, lose their connection with the generative organs, and thus (as is actually the case in many instances) would appear only when the development of these organs reached a point such as to influence the general metabolism of the body. They would therefore be absent during immaturity. Thus in most birds the breeding plumage differs from that of immaturity or of seasons when the generative organs are quiescent, and is only assumed and worn during the periods of activity of these organs. In many species it is probable that the occurrence of such changes in the breeding-season may have, under the constant action of Natural Selection, been altered or suppressed to such an extent as to be now unrecognisable, although such influence may possibly be traceable in the moults which so usually precede or follow the breeding-season, and which are not necessarily restricted to the casting off of hair and feathers, but may include the shedding of the horns, as in certain Ruminants, of the claws, as in some of the *Tetraonidae*, or of portions of the horny mandibles, as in the *Alcidae*¹.

It would seem to be a logical deduction from my theory, if it be correct, that both sexes should normally be the same in

¹ The curious seasonal changes in the forefeet of *Dicrostonyx* (= *Cuniculus*) may be analogous: see G. L. Miller, Junior, "Genera and Subgenera of Voles and Lemmings" (*North American Fauna*, No. 12, July 23, 1896, p. 39).

outward appearance, and that where the sexes differ the more powerful or highly coloured is that in which the influence of the generative organs has had its full force on the development of pigment, of muscle, or of particular regions of the body, while in the weaker or more dully-coloured sex the same processes have been restricted for protective reasons. That the latter should be usually the female is not, I think, surprising when we consider her usually different functions in the care of her offspring and in other respects, but I think I have made it clear, if proof were needed, that either sex may be the more highly developed.

The decoration of birds like the Peacock or the male Pheasant I would regard as a possibly permanent assumption by the sexually mature male of ornaments which in many species are only assumed temporarily. Even in these familiar cases, however, the decorations are not really, but only comparatively permanent, since their assumption begins and ends with the strong functional activity of the generative organs.

Lastly, if, as I suggest, each sex has naturally a similar capacity for the production of nuptial changes, we should surely need to account in some way for the failure to produce them in one or other sex of so many animals. I suggest that the excess of pigment may be disposed of, at least in the case of females, in many ways, such as in the pigmented eggs of Birds, or in the excrement, urine, and in the menstrual discharges and young of placental Mammals.

An Account of some Eskimo from Labrador. By W. L. H. DUCKWORTH, Jesus College, and B. H. PAIN, Emmanuel College. (Communicated by W. L. H. Duckworth.)

[*Read 19 February 1900.*]

In the autumn of 1899, a party of 27 Eskimo were brought from Labrador to this country by an American gentleman, Mr Ralph G. Taber, and were exhibited at Olympia¹ during the latter part of that year and in January 1900. The following account deals with the more important of their physical characteristics and we are much indebted to Mr Taber both for the opportunities he afforded us of making measurements and for his courtesy in answering numerous enquiries about Eskimo-life in Labrador. The measurements were made by means of the following instruments: Garson's Anthropometer, Martin's Anthropometer and Callipers, Cunningham's Craniometer (for radial measurements), and the strengths of "pull as archer" and of the grasp of the hands respectively were recorded by means of the instruments in use in the Anthropometric investigations of the Cambridge Philosophical Society. Finally a Phonograph was used to record some Eskimo words. The measurements are recorded in a Table which follows this communication and some of the chief results are reproduced in a diagram which is compared with similar diagrammatic representations of other human races. The latter are taken from an article on Physical Anthropology in a recent number of "Knowledge" written by Professor Arthur Thomson of Oxford, to whom we desire to acknowledge our indebtedness for such comparative material.

It is convenient to mention here that in making the measurements our work was much facilitated by one of the Eskimo women, Esther Enutsiak, who acted as an interpreter; and finally, that owing to the thick and somewhat rigid sealskin garments of our subjects, some of the measurements proved very difficult to obtain with accuracy.

These Eskimo comprise members of five families. Their native land is that part of Labrador which is situated in the region of E. long. 64° and N. lat. 58°; there has been in this neighbourhood for some eighty years a Moravian settlement called Hebron, and the missionaries have certainly influenced the Eskimo in this district very considerably: it may be added that the missionaries are also traders. To judge from the photographs of this part of Labrador, the country is of a desolate and forbidding aspect: moreover communication by land is almost impracticable and trading or fishing vessels are only able to approach Hebron during a very short period in the summer months of the year. We may

¹ The Exhibition Hall in Kensington, London.

here mention that the University Anatomical Museum received a few years ago a donation of Eskimo skulls from Hopedale (presented by Dr E. Curwen, St John's College): Hebron is as much as four hundred miles north of this place, but the physical type is probably very similar in both instances. These Eskimo thus belong distinctly to the Eastern group of their race with whom the Greenlanders are usually ranked, and so are to be compared or in some particulars contrasted with the "Central," and "Western" or Alaskan groups of this stock. There is, however, reason to believe that the Labrador Eskimo have been less subject than any of the other branches to foreign influences and admixture, and this consequently enhances the interest they possess from the standpoint of physical anthropology. It is a matter of great regret that they are so few in number: Mr Taber estimates at something under 2000 individuals the whole Eskimo population of an area in Labrador about equal to that of Great Britain: such paucity of numbers when taken into consideration together with the fact of their liability to many forms of disease may well cause the gravest apprehensions for their permanence. (For these diseases, &c., cf. Turner: *Annual Report of the American Bureau of Ethnology*, Vol. XI. pp. 187—.)

The appended figures will afford an idea of the average stature of males and females respectively, the difference being on the average about 80 mm. in favour of the former. But there is a considerable range of variety presented by the males, of whom Tapeka-Pinnit and Alukt-Mikiuk represent the highest and lowest extremes respectively. (Herein differing from the Ungava Eskimo—cf. Turner, *loc. cit.* p. 184.) The skin colour and complexion does not differ much in the two sexes, but was rather paler than might have been expected, though this is probably due to the conditions of life at Olympia, viz. in almost constant confinement indoors, and in exposure to the glare of electric arc-lamps (cf. Turner, *loc. cit.* p. 185). One or two of the men exhibit however a coppery tint. Freckling was not observed, but one woman had several moles (naevi) on the face. There was no tattooing to be noticed. In all the men, the hair of the head is abundant, thick and rather coarse, lank, and of a jet-black colour. It is cut evenly round the head just below the ears. The hair of the women is carefully braided, partings being made on the head in the transverse and antero-posterior directions, and the four masses of hair thus separated being gathered up into four plaits, which are looped around the sides of the head.

In the men, a beard appears to be developed but is comparatively late in appearing and never seems abundant. The moustache and whiskers are also of feeble development only.

These Eskimo are thus remarkably uniform in the characters

presented by the hair both in amount and distribution: an exception must be made as regards *colour* in the case of a half-breed child (Nancy) in whom the hair is lighter. In other children the hair is quite as black as in the adults.

The colour of the eyes is even more constant, there being no exception to the rule that the iris is of a dark brown tint (though not quite black, as Keane says). In several cases, some conjunctivitis has occurred, and in one instance had been very severe, for it had produced extensive corneal opacity. Epicanthus is not quite constant and is only seen in one of five females: it is distinctly more frequent in the men (6 out of 10 possessing this characteristic fold).

The ears, though large, are according to the human standard well shaped; the lobule is usually quite well developed. The indices are recorded in the table and shew quite a "high" type of ear to be the rule.

The nose is very flattened and the alae wide, and thus the index is higher than one would expect from the cranial proportions of the nose, the cranial aperture of which is, on the average, narrower than in any other human race.

In comparing our results with the records of other observers, we find but little need for comment, for the Labrador Eskimo seem to present all the features previously regarded as characteristic of this hyperborean Race. Our comparisons relate less to the external characters, such as skin and hair colour, than to the results of measurements. We have found the following the most important works of reference: (Virchow: *Zeitschrift für Ethnologie*, Band XII., 1880; Boas and Turner, in the Annual Volumes VI. and XI. respectively of the *Reports of the American Bureau of Ethnology*, also Boas, in the *Zeitschrift für Ethnologie*, Band XXVII.).

Taking these in order we note that Virchow's communication (*Zeitschrift für Ethnologie*) is of particular interest, for it records the principal characteristics of a party of eight Labrador Eskimo exhibited in Berlin in 1880: these Eskimo came from Hebron and Nackvack, and whereas five had been partially educated by the Moravians, the remainder had never been subjected to any civilizing influence of European origin. It is therefore interesting to observe that one of these more primitive Eskimo became a prey to hysterical excitement of some violence, under the ordeal of being measured. Some of the members of this party were subsequently taken to Paris and unfortunately contracted small-pox with fatal consequences. In comparing the results of our observations with those of Virchow, we have to note a general concordance, with the following exceptions only. Firstly, the average stature obtained by us is rather less than the correspond-

ing figure in Virchow's table: the smaller number of individuals at Virchow's disposal would have an important effect in determining this result. We would further suggest that the figure 1189 (mm.) which Virchow records as the span in the woman Bairngo, is very disproportionate. Secondly, Virchow notes a depth of cutaneous pigmentation which was not presented by our subjects. Finally it should be noted that Virchow's account is most elaborate, and includes psychological data: in the case of the Eskimo lately in London, Dr Rivers will publish an account of their psychology.

In comparison with the Eskimo of Ungava Bay (about 200 miles from the home of our Eskimo) described by Turner, a greater variation in stature is observed by us; the apparent shortness of the lower limbs is a feature in each case, and the toes were noticed to be somewhat turned in during walking and the hands and feet to be relatively small in the Hebron Eskimo.

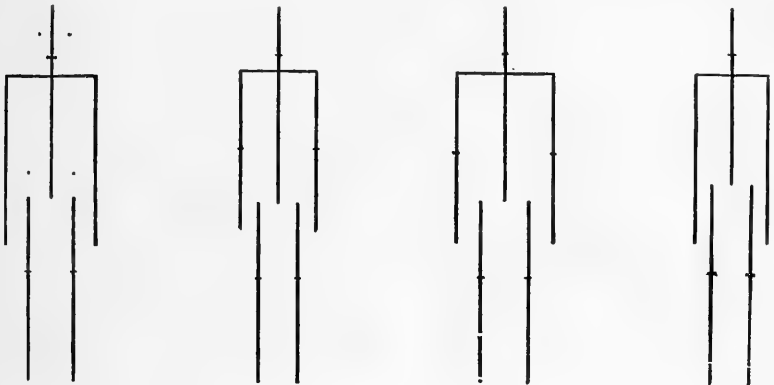

Fig. 1.

Fig. 2.

Fig. 3.

Fig. 4.

Boas' publication in the *Report of the Am. Bureau of Ethnology* is mentioned here for the sake of the valuable references to literature which it affords. The second publication, as reported in the *Zeitschrift für Ethnologie*, 1895, gives figures for the stature of Labrador Eskimo which are very similar to those we obtained for males (i.e. 1575 (Boas)—1577) though a slight difference exists in the case of the females (1480 (Boas)—1497). Boas speaks of the great elongation and great height of the skulls of Eastern Eskimo and this we noticed could be ascertained even in the living Labrador Eskimo: our figures for the Cephalic Index in the living do not however indicate so considerable a degree of dolichocephaly as the figures recorded by Boas. But we hope to deal specially with the Craniology of the Labrador Eskimo at a later date.

TABLE OF INDICES.

(From measurements of Heads, not of Skulls.)

	Male	Female
1. Cephalic (or Breadth)	77	74·5
2. Altitudinal (or Height) (n. b. from auricular radii).....	73·5	70·7
3. Alveolar (n. b. from auricular radii)	102·6	105·9
4. Orbital	81·9	85·7
5. Nasal.....	64·1	62·4
6. Nasomalar	109·6	108
7. Aural	53	47·4
8. Kollmann's Facial	51·6	50·8
9. Gonio-Zygomatic	93·1	91·4

A Description of some dental Rudiments in human crania.

By W. L. H. DUCKWORTH, M.A., Jesus College, and D. H. FRASER, Caius College.

[*Read 19 February 1900.*]

In this communication it is desired to draw attention to the occurrence in human crania of small discrete dental masses which appear with great, though not with absolute, constancy, on that portion of the alveolar margin of the upper maxilla which lies between the last premolar and the first molar teeth. These occurrences appear to us to raise some questions of interest which may be stated in the following order :

- (i) the nature of these rudiments ; which may conceivably be
 - (a) remnants of teeth of the milk or temporary dentition which have not been completely displaced and ejected by their permanent successors, or
 - (b) aborted or vestigial premolars which would correspond to the 3rd premolars of the platyrrhine apes, or
 - (c) elements bearing no homological relation to those of either of the two normal sets (temporary and permanent) of the primate dentition ;
- (ii) the frequency with which these rudiments appear : herein considering the possible influences of
 - (a) Race,
 - (b) Age,
 - (c) Sex ;

and (iii) the bearing on the preceding questions, of observations made on other primates and mammals than man, but especially on the anthropoid apes.

The general position of these rudiments has already been indicated, and the results of our observations on this point are embodied in a Table of Classification. It is necessary to note that this is not a common situation for the occurrence of ordinary supernumerary teeth, by which we mean teeth that resemble in size those immediately adjacent to them : such teeth are of most frequent occurrence in the neighbourhood of the incisors (see Fig. 1: mandible of an aboriginal Australian with a supernumerary incisor) and of the molars (see Fig. 2, for the occurrence of a 4th molar tooth in the mandible of an Orang-utan). Secondly,

these rudiments are of small size (cf. Figs. 3 and 4) and in no way comparable in this respect to the additional premolars which are described (see Tomes: *Dental Surgery*) as occasionally appearing in front of the first molar teeth. Our observations further led us to notice that small fossae or pits are not infrequent in the same position as the rudiments where these are absent: such fossae

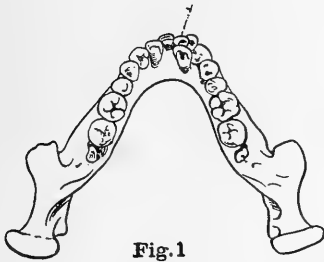

Fig. 1

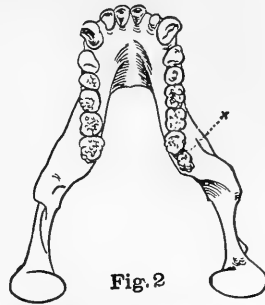

Fig. 2

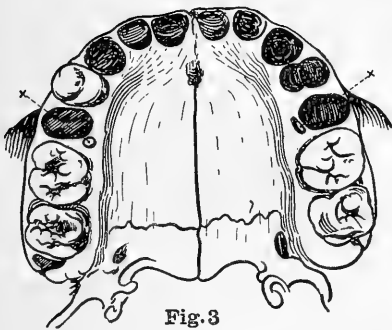

Fig. 3



Fig. 4

presumably at one time contained small dental masses similar to those we describe and they accordingly have been incorporated in the record of the Table of Classification.

It is also interesting to note that the rudimentary masses occur (rarely however) in the upper maxilla between the first and second premolars and in either case they may occupy positions on the inner or the outer border of the alveolar margin, or both, or positions of an intermediate nature. More rarely, we find indications of similar rudiments in the mandible. The fossae or pits have a similar distribution.

Turning now to the consideration of the first important question, viz. the nature of these rudiments, we recognise that their

commonest situation (between the 2nd premolar and 1st molar teeth) does not by any means preclude the possibility of their being persistent remains of the "temporary" teeth, and while we cannot consider the question as finally answered, the following considerations seem to us to discountenance the view which regards these as fragments of "temporary" teeth: viz.

(a) the comparative constancy of their position on the alveolar margin;

(b) and the rarity of their occurrence in the mandible;

(c) the differences which are exhibited by various races of Man in presenting these appearances; this will be more fitly dealt with later;

(d) the comparatively great frequency of their occurrence symmetrically on both sides of the palate;

(e) the fact that the recognisable persistent milk teeth are usually of considerably greater size than these rudiments; the rudiments are admittedly in one case (2154, Australian) of fair size;

(f) the variation in the frequency of occurrence which will be seen to characterize the different species of anthropoid apes.

On the other hand there is a slight indication of greater frequency in young adults than in senile individuals, but on the whole there is sufficient evidence to justify the view that at least some of these rudiments are not vestigial temporary teeth.

In considering the other possibilities regarding their nature, we have had the advantage of a discussion with Dr Marett Tims, to whom the specimens were submitted, and who suggests that these are examples of dental rudiments considered to belong to a third or post-permanent dentition, such as are very constantly demonstrable embedded in the alveolar arcade of certain mammals (carnivora), though they do not as a rule make their way to the surface. These are developed, however, on the lingual side of the alveolar ridge, whereas the masses are observed by us to occupy positions on the lingual or the buccal alveolar margin, or even both simultaneously, so that while a certain number of these rudiments probably fall into the category proposed by Dr Tims, on the whole we think that it is most reasonable to adopt the view that they are aborted third premolars which constitute a human type of dentition similar to that of the New World Apes. Should further investigation prove this to be a correct view, it would constitute a link connecting man more closely with these platyrrhine primates.

We do not deal at present with the occurrence of enamel on

these rudiments though this is a point which should be worked out in detail; but just now there seems to be no direct inference to be drawn from this subject in respect of the exact nature of the rudiments.

In looking at the second question, the factors influencing the frequency of occurrence, it at once appears that while Sex has no appreciable effect and Age but little, that of Race is most unmistakable. To begin with, we found *no* instances in three hundred crania of Egyptians and only one in about fifty crania of Europeans examined: whereas in the negro races and aborigines of Australia the frequency is, comparatively speaking, very great. Of all these, however, the natives of New Britain seem to present by far the greatest number, both absolutely and relatively, of cases of the abnormality. The aborigines of New Britain are followed by those of Australia and these by African negroes: the American races also appear; but whereas the number of Peruvians examined was considerably over 100, only two presented signs of these rudiments. These facts claim attention for this subject, whatever be the exact nature ascribed to the abnormalities.

Finally, on examining a large series of crania of Anthropoid Apes, the answer to the third question indicated is, that here also occurs a curious variation in the mode of occurrence: for none of the lower primates (about twelve were examined) afforded a case; no occurrence was seen in six crania of *Hylobates*, and four of Chimpanzees: among the Orang-utans available was one very important specimen which alone (out of nine skulls) shewed the occurrence, whereas no less than seven out of thirteen Gorilla skulls presented examples of various modifications of the anomaly.

The Orang-utan skull deserves a word of special mention: the rudiments occurred in the mandible, not only between the 2nd premolar and 1st molar, but also between the 1st and 2nd molars on the left side: now in the latter case there could be no question of the retention of a temporary tooth or a fragment of the same, for the temporary series does not extend backwards beyond the position of the second premolar. This we regard as evidence of the independent origin of the fragment but we recognise that it is difficult to argue from the case of an Orang-utan to that of Man.

The extraordinary frequency of the occurrence of these anomalies in Gorilla skulls certainly points in the same direction as the evidence from the Orang mandible. We would therefore conclude by expressing the belief that though a classification of these rudiments may be needed, yet some of them really represent aborted teeth which, if fully developed, would confer on Man a dentition formula identical with that of the platyrrhine apes.

In expressing this belief we admit that we are aware that there

is a strong tendency in certain quarters¹ to insist on a greater approximation of the platyrrhine apes and Man than has hitherto been regarded as justifiable, but we have tried to discuss in an impartial manner the significance of the observations we have made.

The third and fourth figures of the plate shew palates of crania of New Britain (Melanesian) aborigines of the Willey Collection which has already afforded such excellent material for research. These maxillae bear rudiments, viz. in Fig. 3, symmetrical masses on right and left sides and on the lingual margin of the alveolar border, in Fig. 4, a single intermediate mass on the left side only.

CLASSIFICATION.

The Numbers are those of the Catalogue of the Cambridge Museum.

- Class A. One rudiment between 2nd premolar and 1st molar, on one or both sides of Upper Jaw:
- Kaffir—1774 (one side).
 - New Britain—3373 (see illustration, fig. 4), (one side).
 - New Britain—3355 (one side).
 - New Britain—3338 (both sides).
 - New Britain—3354 (one side), also Class C.
- Anthropoids:
- Gorilla, no. 3 (both sides).
 - Gorilla, no. 5 (both sides), but see Class B.
 - Gorilla, no. 7 (both sides).
 - Gorilla, no. 8 (one side).
- Class B. Two rudiments, between 2nd premolar and 1st molar, on one or both sides of Upper Jaw:
- Aboriginal Australian—2134 (two on each side of upper maxilla, additional incisor in lower jaw).
 - Aboriginal Australian—2154 (one side).
 - Manitoba—1837 (one side).
- Anthropoids:
- Gorilla, no. 5 (one side).
 - Gorilla, no. 10.
- Class C. Small pits or Fossae between 2nd premolar and 1st molar, on one or both sides of Upper Jaw:
- New Britain—3334 (one side).

¹ Recent work by Dubois is particularly to be consulted.

- New Britain—3325 (both sides).
- New Britain—3328 (one side).
- New Britain—3354 (one side), cf. also Class A.
- New Britain—3379 (one side).
- Negro—1728 (one side).
- Negro—1776 (one side).
- Kaffir—1774 (one side).
- Aboriginal Australian—2113 (one side).
- Aboriginal Australian—2159 (one side).
- Aboriginal Australian—2124 (both sides).
- Aboriginal Australian—2162 (both sides).
- Peruvian—1932 (both sides).
- Peruvian—1929 (one side).
- N. American Indian—1839 (one side).

Anthropoids:

None observed.

Class D. Fossae or Dental masses elsewhere than between 2nd pre-molar and 1st molar:

- New Britain—3362 (one side), pit between two premolars.
- Peruvian—1987 (one side), pit between two premolars.
- Italian (Paestum)—1114, Dental masses (one side between canine and 1st premolar, the other between the two premolars).

Anthropoids:

- Gorilla at Hamburg, second canine (not a milk tooth) (cf. Selenka, "Menschenaffen," Part 2, Wiesbaden, 1899).
- Chimpanzee: Lübeck Museum, No. 222¹.
- Orang: Munich, No. 129¹.

Class E. Fossae or Rudiments in the Mandible:

- New Britain—3344 (pit between two premolars, dental rudiment between two premolars) one side.

Anthropoids:

- Gorilla, no. 6, dental rudiment opposite 2nd molar, one side.
- Orang—D 1, two masses on left side, one between 2nd premolar and 1st molar, the other between 1st and 2nd molars.
- Gorilla—Zool. Museum (2 small rudiments).

¹ Since writing this paper, we have found these interesting records of super-numerary teeth in Anthropoid Apes recorded by Selenka, "Menschenaffen," Part 1, Wiesbaden, 1898.

The Zoological Position of Palaeospondylus, Traquair. By
J. GRAHAM KERR.

[Read 19 February 1900.]

In the course of my work on the development of *Lepidosiren*, having occasion to examine some skeletons of larvae which had died and become macerated, and from which the heavy lower jaw had dropped off, I was struck by certain resemblances in their structure to that described by Traquair for *Palaeospondylus*¹. Although these resemblances may possibly prove to be of a superficial character I think that in the meantime, looking to the very great importance of such a form as *Palaeospondylus*, they are worth while calling attention to by a short note.

One of the most striking features about *Palaeospondylus* appears to be the pair of curious post-occipital plates or rods, projecting back from the hind end of the skull on either side of the vertebral column. These, though so conspicuous and striking, have so far received no morphological explanation. It is interesting to note then that in the young Dipnoan we have a pair of very similar structures in the so-called cranial ribs. It is suggested that the two structures are actually homologous, and in that case it would follow that *Palaeospondylus* is not a Cyclostome but a young Dipnoan. It accordingly becomes of interest to see whether the other features of *Palaeospondylus* as described by Traquair are or are not understandable on this view. A comparison of Günther's figure of the ventral surface of the skull of *Ceratodus*² with Traquair's figure of his most perfect skull of *Palaeospondylus*³ is enough to show the remarkable agreement in the general features of the two skulls in their posterior portion. In each case we have a median ridge (in *Ceratodus* covered in by the parasphenoid) flanked on either side by a deep depression and tapering backwards towards the point where it is continued into the vertebral column, and attached on each side close to the junction of skull and backbone—the cranial rib (labelled *x*, curiously enough, in each of the figures referred to!). Further forward the resemblance is less striking but even here it only requires the slight modification of the pterygo-palatine teeth in the *Ceratodus* skull, their antero-posterior axes being increased in length and becoming parallel to one another and their lateral projections becoming more prominent (by no

¹ (1) On the fossil fishes found at Achanarras Quarry, Caithness. *Ann. and Mag. Nat. Hist.*, Series 6, Vol. vi. p. 479.

(2) A further description of *Palaeospondylus Gunni*, Traquair. *Proc. Roy. Phys. Soc. Edin.* Vol. xii. p. 87.

(3) A still further contribution to our knowledge of *Palaeospondylus Gunni*, Traquair. *Proc. Roy. Phys. Soc. Edin.* Vol. xii. p. 312.

² *Phil. Trans.* 1871, Pt. II. Plate 34, Fig. 3.

³ (3) Plate ix. Fig. 5.

means an extravagant demand looking to the great variety in the teeth of Dipnoi, both in different species of the group, and in different stages of the life history of the same species) to give an appearance which would be extremely like that of *Palaeospondylus*. Finally the Dipnoi possess structures which might in a fossil well give rise to appearances suggestive of cirrhi round the mouth opening—in the cartilaginous bars of the roof of the nasal capsule, and in those other cartilaginous processes, whether representing merely labial cartilages or processes of the original lower jaw, which project upwards in the region of the lower lip in *Lepidosiren*.

In one of Traquair's figures¹ a pair of plates are shown converging forwards at an angle beneath the hind portion of the skull. These recall strongly the two moieties of the strongly developed Hyoid arch in *Lepidosiren*.

Dr Traquair says that it is only the ventral side of the skull which is exposed in all his specimens. There seems no very special reason why this should be so in a Cyclostome, while in a young Dipnoan on the other hand, the cranial roof being still incomplete, it is obvious that the dorsal side would be firmly imbedded in the matrix and would not afford a plane along which the stone would readily split.

It is to be noted that Dipnoans were abundant about the times in which *Palaeospondylus* lived (*Dipterus* is one of the most frequently occurring genera in the rocks of the quarry from which *Palaeospondylus* is obtained and the Arthrodiran *Cocosteus* and *Homosteus* also occur, Traquair), while of undoubted Cyclostomes beyond *Palaeospondylus* there is no trace.

A point apparently against the Dipnoan nature of *Palaeospondylus* lies in the highly-developed Vertebrae, though this objection tells obviously equally against its being a Cyclostome. If however the tubular centra are really, as Dr Traquair suggests, formed in the sheath of the notochord their presence would tell much more strongly against the latter view than against the former, for, as Dr Gadow² has well accentuated, while the Dipnoi are potentially chordo-centrous, the Cyclostomes are essentially arcocentrous.

I have now referred to the main points which have struck me of resemblance between *Palaeospondylus* and a young Dipnoan. In regard to the structure of *Palaeospondylus* I have preferred to depend entirely upon the data set forth by the unrivalled skill in this department of investigation by Dr Traquair himself. Whether the resemblances are superficial or not they seem to me at least sufficiently striking to deserve notice, as suggesting the possibility of *Palaeospondylus* having been either a young Dipnoan, or the young of some form closely allied to the Dipnoi.

¹ (3) Plate ix. Fig. 2.

² *Phil. Trans.* Vol. 186 (1895), B, p. 191.

On the Separation of a pure Albumen from Egg-white. By
F. GOWLAND HOPKINS.

[Read 19 February 1900.]

A very important service to the chemical study of animal proteids was rendered by Hofmeister's discovery that egg-albumen can be obtained in crystalline form when its solutions are evaporated in the presence of ammonium sulphate. Hofmeister's observation was made in 1890¹, and it was shortly afterwards shown by Gürber² that albumens from the blood serum of horses and rabbits also assumed a crystalline form under like treatment.

These observations made it reasonable to hope that material for chemical study could be thus obtained for which there would be some guarantee of chemical purity. But the crystalline products obtained by Hofmeister's process directly from egg-white or serum are almost certainly not chemical individuals. Thus in the case of the egg-proteid *Bondzynski* and *Zoja*³ prepared various crystalline fractions, and found rotatory powers for these which varied from $-25^{\circ}8$ to $-42^{\circ}54$, and I have myself repeatedly observed that more than one albumen separate in crystalline form.

Any attempt to fractionate out a product of constant rotatory power proves very laborious and involves much loss of material.

About a year ago I described, in conjunction with Dr S. N. Pinkus⁴, a method of crystallizing albumens, which, while involving only a slight modification of Hofmeister's process, makes it possible to obtain products with extreme ease and rapidity. By a further modification of this method I believe it is possible to arrive with little trouble, at an albumen well characterised as a chemical individual.

For this purpose egg-white is intimately mixed with an equal bulk of saturated ammonium sulphate solution, and the mixture is filtered. The filtrate, which is alkaline with ammonia (liberated by the fixed alkali of the native proteid) is carefully neutralised by means of dilute (10 %) acetic acid, further acid being afterwards added till one part per mill. of acetic acid is present. A precipitate separator which, though at first amorphous, becomes rapidly crystalline on standing. After a few hours, microscopical

¹ *Zeitsch. f. physiol. Chem.* xiv. s. 165.

² *Sitzungsb. d. phys.-med. Gesellsch. zu Würzburg*, 1894.

³ *Zeitsch. f. physiol. Chem.* 1894.

⁴ *Journal of Physiol.* 1894.

examination shows it to consist wholly of small circular crystals. This being separated and redissolved in water it may be re-crystallized by simply adding ammonium sulphate to the point of commencing precipitation. A product may be then many times recrystallized in the course of a few days.

After it has been once recrystallized the product exhibits upon further fractional crystallization such absolute constancy of rotatory power and percentage composition as I believe should entitle it to consideration as a chemical individual. We possess at present no better test of individuality in the case of proteids than the rotatory power and percentage content of sulphur. The former varies greatly in albumen of different origin, and, as stated above, its variations are great even among the different albumens found in egg-white. The proportion of sulphur also differs within somewhat wide limits.

Products prepared by the process described above and fractionated by repeated recrystallization show a rotatory power and a percentage of sulphur (determined by Carius' method upon washed alcohol coagula) which in different fractions vary only within the limits of experimental error.

In five successive fractions obtained from one preparation the specific rotatory power (α_D) varied only between $-30^{\circ}66$ (second fraction) and $-30^{\circ}72$ (fourth fraction), the mean being $30^{\circ}69$; and the percentage of sulphur lay between 1.577 (first fraction) and 1.568 (fourth fraction), the mean being 1.571. Another preparation was recrystallized six times and the variations in rotation were from $-30^{\circ}65$ to $-30^{\circ}72$ (mean $30^{\circ}71$) and in sulphur from 1.571 to 1.576 per cent. (mean 1.573).

The rotatory power has been determined in preparations from eleven different supplies of eggs, the original products being twice or thrice recrystallized. The extreme variations were from $-30^{\circ}64$ to $-30^{\circ}76$.

The yield is good, amounting to about 80 grammes per litre of egg-white or about 50 per cent. of the whole proteid present. The results obtained appear to offer satisfactory evidence of purity, and the product is probably better characterised as an individual than any material yet employed in chemical research upon proteids.

On the simplest algebraic minimal curves, and the derived real minimal surfaces. By HERBERT RICHMOND, King's College, Cambridge.

[Read 5 March 1900.]

v. *Transactions*, Vol. XIX. Part I.

Diophantine Inequalities. By G. B. MATHEWS, M.A., F.R.S.

[Read 5 March 1900.]

v. Transactions, Vol. XIX. Part I.

On the distance between the striae in the positive column and other phenomena connected with the discharge. By R. S. WILLOWS, B.A., B.Sc., Trinity College, Cambridge; 1851 Exhibition Science Scholar. [With Plate XIII.]

[Read 5 March 1900.]

1. The experiments described in the following paper were undertaken for the purpose of examining the manner in which the distance between the striae in the positive column varied when the pressure, current or other conditions were altered.

Although the positive column bears a much more important relation to the discharge than the phenomena connected with the kathode, the latter being merely local effects, yet, owing to the variety and importance of the effects connected with kathode, Lenard and Röntgen rays, measurements relating to the former have been relatively few. Thus, although it has been frequently noticed that a decrease in pressure causes an increase in distance between the striae, the only measurements we have on the subject appear to be those of Goldstein¹. If d is the distance between two striations, and ρ is the density of the gas, then for the same gas Goldstein found that d varies as ρ^{-n} where n is somewhat less than unity. He also found that if d be measured for the same two pressures in a large number of tubes of different diameters, then the ratio of the two values is the same for all tubes provided the striae reach nearly to the sides of the tube.

As far as I have been able to learn, no one has measured the influence of current on the distance between the striae; De la Rue and Müller² observed that, starting with an intensity of current giving steady striae, an increase in current produced unsteadiness followed afterwards, as the current was further increased, by a second steady state. This was repeated as the current was still further increased. In another paper³ they remark that "The

¹ *Wied. Annal.* 15, p. 277. 1882.

² *Comp. Rend.* 86, p. 1072. 1878.

³ *Phil. Trans.* Vol. 169, pp. 90 and 118. 1878.

effect of the current is irregular, sometimes causing an increase and sometimes a decrease in the number of the striations"; the gas under consideration was hydrogen.

Goldstein (*loc. cit.*) does not appear to have investigated the effect of current, and from the particulars given in his paper it is not clear that the alteration in the distance between the striae which would be caused by an alteration in the current is separated from the alteration due to a variation of pressure alone.

As the law connecting the distance between the striae with pressure and current must be of importance in any theory of the discharge that may be advanced, a repetition of Goldstein's work seemed desirable.

2. As the range of pressure in which the striae can be obtained in the same tube is very small (in air they appear and disappear again when the pressure is changed by less than 2 mm., in hydrogen they can be obtained over a range of 10 mm.), the alteration in pressure needs to be measured with considerable accuracy. A McLeod gauge was used for this purpose; the apparatus consisted in addition of a mercury pump, drying bulbs containing P_2O_5 , all in connection with several cylindrical tubes with aluminium electrodes.

Spottiswoode¹ succeeded in obtaining striae in a steady state by means of an induction coil with an independent break and a set of resistances. At the beginning of the experiments this method was used for the production of the striae. A six-inch coil was used and the resistance of both the primary and secondary could be altered between wide limits, that of the latter by means of a liquid rheostat. Several different interrupters were used, the most successful being a tuning-fork of frequency about 60, one prong of which carried a wire dipping into mercury, but this was unsatisfactory when the striae were separated by a distance of two or three mm. only. It was found that the striae were made more distinct by the introduction of a small air gap in the secondary, especially if the primary current was increased; a discharge which was continuous frequently showed striae when this was done. The discharge is of course brightened considerably by putting a Leyden jar in parallel with the secondary, but the striae flicker badly owing to the variation in the current at different instants of the discharge.

Using a coil, and getting some measure of the current by passing it through a water voltameter, and collecting the hydrogen given off, no appreciable variation in the distance between the striae could be observed due to alterations in the current. Owing to its smallness the current could not be measured sufficiently

¹ *Proc. Roy. Soc.* Vol. 23, p. 455.

accurately in this manner, and, in addition, it could not be varied in wide enough limits; as the method was unsatisfactory for other reasons it was abandoned as far as the quantitative part of the experiments went, and a battery of over seven hundred storage cells used instead. This entailed a shortening of the tubes as the available voltage was reduced, and this meant, of course, that a smaller number of striae could be obtained, making the accurate measurement of their mean distance less certain, but this was more than compensated for by their increased steadiness. In addition the current through the tube and the difference of potential at the terminals could now be easily measured, the former by a galvanometer in the main circuit and the latter by an electrostatic voltmeter.

As observed by Hittorf¹ a less voltage is required to maintain the discharge than to start it; in most cases it was started by wrapping the wires from the secondary of a small coil round the glass in the neighbourhood of the terminals.

Although quantitative results could not be obtained when the discharge was produced by a coil, yet some interesting qualitative results were noticed; these are given later.

3. The gases concerning which definite information can be obtained are very limited, for it is well known that most compound gases are decomposed wholly or partially by the passage of the discharge²; hence, although the distance between the striae were measured, the proportion of decomposed gas present would not be known, as it would in all probability depend on the pressure, current, &c. and therefore no accurate knowledge would be gained, especially as Crookes³ has found that when the discharge passes through a mixture of gases each gas gives rise to a separate set of striations. This instability under the electric discharge at once excludes those vapours which give rise to the finest striae, viz. the numerous organic vapours, and also the more common compound gases. Of the simple gases remaining chlorine is difficult to work with as it attacks both electrodes and the mercury in the pump, and oxygen is partially converted into ozone. If ozone were not produced, the latter gas would be very troublesome owing to the extreme feebleness of the light of the discharge, making it impossible to measure the distance between the striae with any approach to accuracy.

The gases finally used were air, hydrogen and nitrogen. The hydrogen was generally prepared electrolytically, the hydrogen peroxide produced can be taken out by passing through solution

¹ *Wied. Annal.* 20, p. 705. 1883.

² *Recent Researches*, pp. 178—9.

³ Presidential Address to the Soc. of Telegraph Engineers, 1891.

of potassium iodide. The gas was finally passed through potassium permanganate and strong sulphuric acid before passing into the apparatus.

The nitrogen was prepared by heating a mixture of potassium nitrate and ammonium chloride and passing the evolved gas through strong solution of KHO and finally strong H_2SO_4 .

When a fresh gas was to be worked with the apparatus was pumped down to a very small fraction of a mm. and refilled with the required gas. This was repeated five or six times.

It was found in working that when a tube had been running for some time impurities made their appearance, as shown by a direct vision spectroscope, necessitating the admission of fresh gas. This was no doubt owing to gas being given off from the electrodes. To get rid of this as far as possible it was found necessary each time the gas was admitted and pumped out to send a strong current through the tube at a low pressure for some hours.

Oxygen frequently allowed a large current to pass without showing any luminosity save at the electrodes.

It should be mentioned that in order to prevent injury to the battery and also to provide a means of varying the current an adjustable high resistance was placed in the circuit. This consisted of two fairly wide capillary tubes having platinum wires fused into their lower ends and nearly filled with water in which a small quantity of salt had been dissolved. A platinum wire bent twice at right angles connected the two at top and dipped into the liquid, and the resistance could be varied by raising or lowering this wire.

4. Before giving details of the results of the measurements made an account is given of the appearance presented by the discharge under different conditions, in the hope that some, at least, of the phenomena observed may be new.

A remarkable appearance is frequently presented when a tube freshly made is sealed on to the pump and the pressure reduced to about .75 mm., the gas in it being moist air from the room and not in communication with the drying bulbs. For example, in a tube of about 12 mm. diameter which had been in use some time, the striae were about 7 mm. apart when the pressure was .8 mm. the gas being dry air, but when two fresh aluminium wire electrodes were put in and the tube filled with moist air at the same pressure as previously then they were separated by a distance of 1 mm. only, were much flatter than before and hair-like in appearance; the dark spaces between were also much more distinctly marked.

To what circumstances the production of these fine striae was

due could not be exactly determined; two conditions however seemed necessary, viz. that the gas should be damp and that the electrodes should not have been used for some time previously. The latter may possibly mean that the electrodes must contain occluded gas. Thin electrodes were apparently better for their production than thick ones. These fine striae did not always appear even when these two conditions were fulfilled, showing that they were not always sufficient, although they could be proved necessary. Moist gas is certainly necessary, for they could never be obtained when it was dry; in fact, a tube which contained moist air and was presenting the appearance described, gave an entirely different appearance, and the striae several mm. apart when it was put in communication with a bulb containing P_2O_5 for a few hours. As the current which passes through a tube giving these narrow striae is increased the striae get brighter as is the case in the normal state, but this increased brightness soon gives place to a general haziness and as the current is further increased the positive column becomes continuous, although with dry air at the same pressure the striae would be quite distinct. When the pressure was reduced the normal striations then appeared, and when this had once taken place it was difficult to again produce the first state; pumping out and refilling with moist air frequently failed to do this, but if the tube was allowed to stand open for some weeks and then exhausted the fine striae generally reappeared.

It is possible that when the air is moist a large part of the current is conveyed by the water vapour and that the narrow striae are those given by this; it is well known that in a damp gas conveying a discharge the hydrogen lines are present.

If this be so, it is difficult to see why the admission of fresh moist gas should fail to reproduce the appearance.

The resistance of the tube to the passage of the discharge was considerably diminished by drying the contained gas.

This agrees with experiments of Baille¹ and Warburg², for at these pressures a considerable fall of potential takes place along the positive column and the latter observer found that moisture increased the potential differences along this.

5. De la Rue and Müller³ in one of their papers on the discharge produced by their large silver chloride battery give numerous photographs of the striated discharge. Some of these are remarkable in presenting a series of double striations. It seemed to be of interest to see whether these were due to

¹ *Annal. de Chimie et de Physique*, 25, p. 486. 1882.

² *Wied. Annal.* 31, p. 545. 1887; 40, p. 1. 1890.

³ *Phil. Trans.* 1878, Part I. p. 155; see also p. 112, *Recent Researches*.

accidental impurity or whether they may be considered a normal feature of the discharge. I have frequently been able to produce them in hydrogen, the gas in which De la Rue and Müller observed them, but, with one exception, have never seen them in any other gas. This exception was a tube which contained moist air and which was showing the fine striae described above; on greatly decreasing the current it presented the appearance shown in the accompanying photograph. In this case they may be easily explained by supposing that water vapour and air give rise to separate sets which are far enough apart to be distinguished. In every other case the discharge through moist air gave rise to striations which were perfectly regular in their spacing.

If proper precautions are taken the double striae appear to be a normal form of the discharge in hydrogen. Generally they are more easily obtained by a coil than by a battery if the interrupter works regularly; the tuning-fork mentioned earlier gave good results here. As the appearance in hydrogen differs considerably from that shown by the figure a description of the former is given which is more detailed than that given by De la Rue and Müller in the paper already referred to.

Bordering on the Faraday dark space is a very clearly defined striation which is generally blue in colour, especially just on the convex part. Next to this and nearer the anode is another slightly more convex than the former; it is usually faint red in colour. These two together make up one double striation; the distance they are separated increases slightly as the pressure diminishes and is greater in wide tubes than in narrow ones. The distance between the two parts is considerably less than that between the red part of one striation and the blue part of the one immediately behind it. The double appearance frequently, but by no means always, becomes less and less distinct as the anode is approached, due to the component parts of each double striae becoming further separated, until near the anode they are equally spaced, alternate striae being bluish and the others pink. It is not often that this appearance persists for more than a few seconds with the battery, and with either coil or battery it can only be obtained within very narrow limits of pressure. These limits depend on the diameter of the tube, the wider the tube the narrower the limits and the lower the pressure at which the double striae first appear. Wire electrodes seem to give them rather more certainly than disc; in a tube whose diameter exceeds 15 mm. they are difficult to obtain at all, but this may be due to the difficulty of producing striae in a perfectly steady state in these wide tubes.

If a battery of voltage sufficient to maintain the discharge when once it is started but not high enough to start it be

connected to the terminals of a tube in which a pressure suitable for giving the double striae has been established, then if a spark be passed from a coil, at the instant the initial discharge passes the number of striae in the tube is largely in excess of the number that finally remains. That end of the positive column next to the kathode remains fixed, while the remainder of the striae rapidly move towards the anode and some of them disappear there. While this is taking place the positive column has the appearance of a spiral spring fixed at the end nearest the kathode, compressed from the other end and then suddenly released. This appearance only lasts for an instant, when it has disappeared the column is seen to be doubly striated. If the discharge is maintained by the battery these double striae generally disappear after a few seconds; this is brought about by a movement of that component furthest from the kathode in the direction of the anode and so forming a separate striation. The whole are then equally spaced and identical in appearance. In some cases however the doubleness persists, but if the current is considerably increased the change to single striae takes place immediately. If the current is then broken and the discharge restarted the double striae again appear.

By suitably adjusting the intensity of the current the separate parts of a double stria can be made equally bright and of nearly the same colour; generally that part nearest the kathode is the brighter and in no case could it be made the weaker of the two. For very small currents the part nearest the anode was generally much the weaker of the two.

When produced by a coil the most apparent explanation of this double appearance would be to suppose that the coil discharges both ways and the separate parts of a double striation are produced by currents in opposite directions. Spottiswoode¹ found when his interrupter was changing its note that something like this did actually occur and that the dark parts when the current was passing in one direction became the bright parts when it was passing in the other direction. In such a case, however, the separate discharges can easily be distinguished in a revolving mirror. In the present case whether battery or coil was used examination by a revolving mirror showed that the separate parts were coexistent, so that this explanation will not suffice.

Further, if the coil was purposely made to discharge both ways the appearance in the tube was totally different from that presented by the double striae.

Since Crookes (*loc. cit.*) has shown that a mixture of gases gives rise to different sets of striae, the presence of impurity

¹ *Proc. Roy. Soc.* Vol. 23, p. 455.

might be adduced to explain the appearance. If that be the case it is remarkable that the doubleness should be destroyed by altering either the current or the pressure, and that above and below certain limits of pressure it cannot be produced in a given tube by the intentional introduction of an impurity. The only effect of adding impurity is to cause what were originally well-defined striae to become hazy.

In order to make certain that it was not due to gas given out by the electrodes, a tube was filled with hydrogen after the electrodes had previously been made very hot several times by running, and before a discharge was passed the pressure was reduced to an amount suitable for giving double striae. When the current was passed they immediately appeared, no matter in what way the hydrogen had been prepared, but by letting in a further amount of gas they were immediately destroyed.

An attempt was made to see if the different parts differed spectroscopically. For this purpose the vertical discharge tube was covered with black paper and a narrow horizontal slit made at one position, so that by bringing this opposite any striation the latter could be studied by means of a direct vision spectroscope which was held a centimetre away. In order to intercept light reflected from other parts of the tube, another piece of black paper with a small slit in it was placed between the tube and the spectroscope. As far as could be seen by this method both parts of a double striation gave the same spectral lines, those seen in the spectroscope being the red, green and blue of hydrogen and the green line of mercury. The only difference between the two was that the blue line was stronger in the half nearest the kathode than in the other, while for the red the reverse was true. In the case examined the halves of the striations were separated from each other by about 2 mm., in the photograph of those in moist air the distance between the two is about half this. In the latter case also a change in pressure of less than .1 mm. was sufficient to cause the double striae to disappear when well-defined single striae made their appearance.

Conditions influencing the distance between the striae.

6. The effect of altering the current on the distance apart of the striae when other conditions are kept constant was first examined; one division deflexion of the galvanometer corresponds to 2.5×10^{-5} amperes. In taking readings the current was only kept on long enough to enable the measurements to be taken as otherwise it was found that the distance apart altered, due probably to the heating effects of the discharge and consequent change in density.

Fig. 2 shows at a glance the relation between current and distance apart of the striae in a tube 12 mm. in diameter when filled with hydrogen. The abscissae are galvanometer deflexions, the ordinates distance between successive striae.

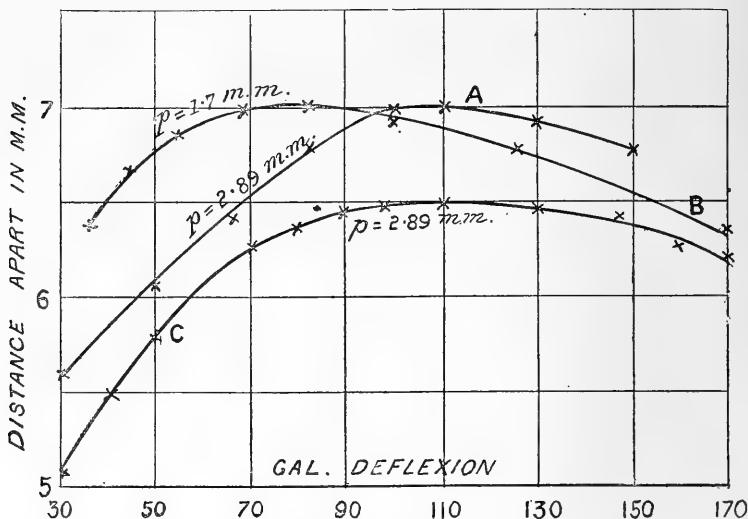

FIG. 2. Curves showing the relation between current and distance apart of the striae in hydrogen.

The figures on the curves denote the constant pressure at which the measurements were taken.

When the discharge was passing in a tube an increase of resistance in the liquid rheostat caused the current to decrease at first, without much alteration of the potential difference at the terminals, but finally a point was reached at which a large increase in resistance caused no further decrease in current; this was the minimum current required to carry the discharge. At this stage the striae were steadier than under any other conditions, and a telephone in the circuit was nearly or quite silent. Starting from this point, an increase in current causes a rapid increase in distance between the striae, the rate of increase gets less as the current gets bigger until a maximum distance is reached, after which a further increase in current causes them to approach each other.

The rate at which the striae separate or approach is different for different pressures as is shown by the cutting of curves A and B. Curve C is referred to later.

As the pressure is diminished the value of the maximum

distance increases, but the strength of current required to produce it gets less, so that at pressures of a few tenths of a mm. (see next section) that phase in which an increase in current produces a separation of the striae may be nearly absent, and the current required to produce the maximum separation is nearly equal to the smallest current required to maintain the discharge.

The presence of this maximum explains the observation of Müller and De la Rue (*loc. cit.*) that sometimes an increase in current causes the striae to separate, while in other cases the reverse effect is obtained.

With air and nitrogen the effect is rather different. Starting from a current just large enough to maintain the discharge, an increase causes a rapid separation of striae nearly proportional to the current until the latter is nearly four times its original amount, after which the distance between is constant.

The curve in fig. 3 is plotted from measurements taken on the same tube as that from which the curves in the previous figure were obtained, when it was filled with nitrogen at a pressure of 1.16 mm.

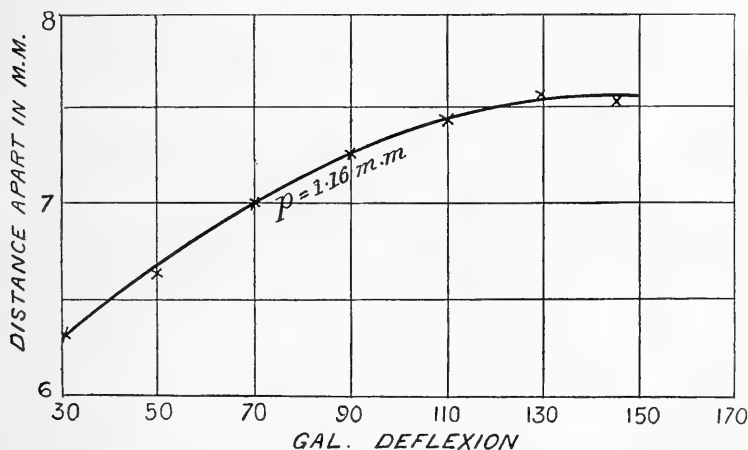

FIG. 3. Showing the relation between current and distance apart of striae in a tube 12 mm. in diameter filled with nitrogen at a pressure 1.16 mm.

Influence of the variation in pressure.

7. In taking observations on the effect of pressure, from what has just been said, it is seen that the current must be kept constant throughout. Four sets of readings were taken at each pressure, when possible, with different currents, but it was not

always possible to get the striae in a steady condition over the whole range of pressure in which they were visible when it was attempted to use the same current throughout, so that four complete series of readings could not always be obtained.

Measurements could be obtained with hydrogen over a range of about 10 mm. Starting at the highest pressure the striae were further apart for greater currents but for pressures near .5 mm. the reverse was true. This is what would be expected from what has been said in the previous section concerning the manner in which the pressure influences the amount of current required to produce the maximum separation. Hence if the observations be presented in the form of curves having distance between striae for ordinates and pressures for abscissae, the current being constant throughout one curve but different for different curves, then each of these will cut the others.

This is clearly shown in fig. 4.

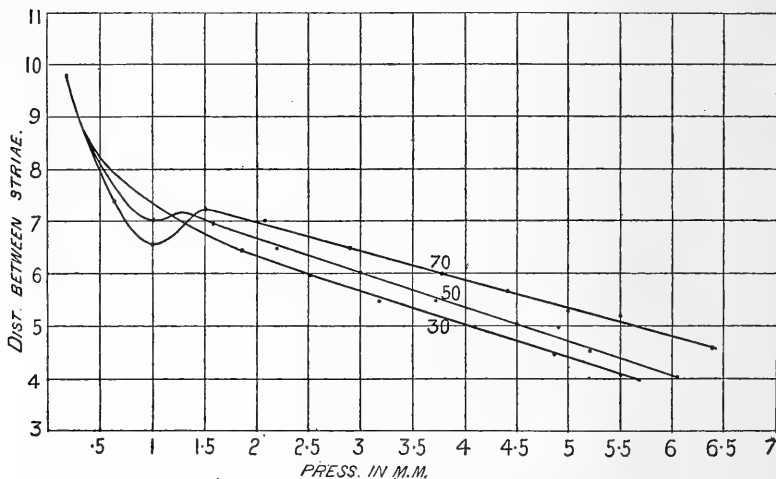

FIG. 4. Showing the relation between pressure and distance between striae in hydrogen.

The numbers on the curves give the current in galvanometer deflexions.

It is seen from the figure that at a pressure of about a mm. the striae get nearer together, and that shortly after this as the pressure is decreased, they are the same distance apart for all currents; when this holds, the rate of variation with pressure is much greater than it was before.

This appears to be due to the controlling action of the sides

of the tube as it is much more noticeable in narrower tubes, while in tubes exceeding 25 mm. diameter it was not observed at all.

The general effect of change of pressure is the same in nitrogen and air as in hydrogen. In these gases, however, as an increase in current never causes a decrease in distance between the striae, their distance apart is never less for large currents than for small ones; hence at low pressures the corresponding curves do not cross each other but merely become merged into one. The decrease in distance, due to the sides of the tube, is rather more marked than in hydrogen, and it occurs at a lower pressure.

From the results of numerous measurements it seems certain that Goldstein's law, already stated, may be replaced more accurately by the following:—If the striae do not reach to the sides of the tube, then, for the same intensity of current, their distance apart varies inversely as the pressure.

Influence of the nature of the gas.

8. The distance between the striae in different gases under the same conditions of current and pressure is not very different; it bears no simple ratio to the density. At pressures between 1 mm. and .5 mm. they are further apart in hydrogen than in nitrogen and air, for the two last gases the separation is the same. The rate at which the distance between successive striae decreases as the pressure increases is much greater in the dense gases, and is greater in wide tubes than in narrow ones. If the rates of decrease for hydrogen and nitrogen be compared it is found that their ratio is independent of the diameter of the tube and is equal to $\frac{1}{2}$ nearly. From this it follows that if striae could be obtained in nitrogen over the same range of pressure as in hydrogen, then at the higher pressures the distance apart would be appreciably greater in hydrogen.

Influence of the diameter of the tube.

9. The striae are further apart the wider the tube, but the distance between bears no simple relation to the diameter or section of the latter. Goldstein's second law (*loc. cit.*), viz. "That if d is the distance between the striae then the ratio of the two values of d at two given pressures is the same for all tubes," is very approximately true when, as Goldstein says, the discharge reaches to the sides of the tube, but does not hold when the distance between the striae varies inversely as the pressure; in this case the ratio is greater for wide tubes than for narrow ones.

From numerous curves for different gases and different tubes it appears that the limiting distance between the striae is equal to the diameter of the tube.

Influence of length of tube and shape of electrodes.

10. The distance between the striae in two tubes similar in all respects except length was the same in each case provided the external resistance be so altered that the same current passes through both. If the gas be pure, the striations are equally spaced throughout the whole column, except that that one next to the Faraday space is farther removed from the next than the mean distance.

If the gas be impure they may be very unevenly distributed. When the pressure in a tube is reduced, the positive column always becomes striated first at that end nearest the kathode, and the pressure at which this takes place seems fixed for the same tube.

The shape of the electrodes was found to have a slight influence. This is shown in curves *A*, *C* (fig. 2) where *A* was obtained from measurements taken on a tube having aluminium wires for electrodes and *C* from an exactly similar tube with discs. The striae are thus seen to be further apart in a tube having points for electrodes; the difference, however, is very small.

The discharge is different according as points or discs are used when the pressure is a few tenths of a mm. Thus in a tube with points eight striae were visible, while in an exactly similar tube in communication with it with disc electrodes only two could be seen when the current was strong, the negative glow and Faraday space filling nearly all the tube, but if the current was considerably weakened then the negative glow was considerably reduced and four striae could be seen.

A similar effect was produced in a tube 15 cm. in length having one electrode a point and the other a disc, *e.g.* at a pressure of .4 mm. there were four striae present when the point was kathode, but if it was anode and the current was strong, there was only a glow at the extreme tip of the wire to represent the positive column, while the negative glow extended from the disc half way down the tube. If the current was considerably reduced then the negative glow was weakened and two striae appeared.

These effects as well as the well-known lengthening of the positive column by a transverse magnetic field are easily explained by the ionization theory.

It has been shown¹ that in all probability the end of the

¹ J. J. Thomson, *Phil. Mag.* March, 1899, p. 267.

positive column is the position in the tube where the oppositely charged ions from the electrodes meet. The magnetic field deflects these streams, probably by different amounts since the positive and negative ions may differ in mass, charge and velocity, and so the point of meeting is shifted nearer the kathode.

When an electrode is a disc the ions produced there are propelled along the axis of the tube by the action of the electric field and a less number shot at the sides than would be the case if it were a piece of wire; hence the position in the tube where the oppositely charged streams meet will, other things being equal, be further from the disc than from the point, bearing out the observations above on a tube with a point and disc for electrodes.

In the same way it was found that when both electrodes are discs, the pressure being a few tenths of a mm., then the positive column was longer than if the anode was a point, but shorter than if both electrodes were points.

11. Other causes influencing the distance between the striae are a transverse magnetic field and gas occluded by the electrodes. When a magnetic field is produced at right angles to the tube, more striae appear from the anode. If the current is kept constant these striae are nearer together than they were originally.

Measurements could not be taken concerning this effect as the striae are distorted when the field is not uniform throughout the length of the tube.

From observations on the lengths of the positive column and the Faraday dark space it appears that these varied irregularly with the current and pressure.

12. Experiments were made to see if the distance between the striae at a given pressure was equal to the distance between the electrodes for which the sparking potential is a minimum, Peace¹ having shown that this minimum sparking potential depends on the distance apart of the electrodes.

The apparatus shown in fig. 5 was used for this purpose.

The top electrode was an aluminium disc and was fixed, the bottom electrode was a clean mercury surface whose position could be varied by means of the reservoir *A*, a wire dipping in this was connected to one of the poles of a battery. The distance between the electrodes could be measured by a small cathetometer or by placing a ruled glass mirror close behind the tube

Measurements of the sparking potential for varying distance of the electrodes were first tried but very irregular results were obtained, no doubt owing to the change in the surface of the

¹ *Proc. Roy. Soc.* 1893. *Recent Researches*, pp. 86 et seq.

electrodes caused by successive discharges, and so the further measurements were taken while the discharge was passing. The

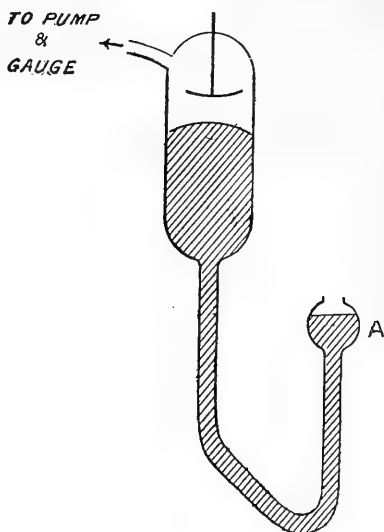

FIG. 5.

difference of potential of the terminals was taken by an electrostatic voltmeter.

On decreasing the distance between them, the difference of potential fell to a minimum and then rose rapidly, but the critical distance was always considerably less than the distance between the striae; in fact, the minimum did not occur until the anode had entered the dark space.

In conclusion I must thank Prof. Thomson for much help and encouragement.

CAVENDISH LABORATORY.

The teaching of Mechanics by experiment. By Prof. EWING.

[Read 5 March 1900.]

Prof. Ewing pointed out how by a course of suitable experiments students could not only be rendered familiar with the general principles of Mechanics but could at the same time learn

how to apply these principles to practical questions and how to detect and allow for the causes which produce aberrations from what may be called the theoretical result. He exhibited in illustration of his remarks a number of self-contained pieces of apparatus for experiments in Statics, Dynamics and Elasticity.

On the calculation of the double integral expressing normal correlation. By Mr W. F. SHEPPARD, M.A., LL.M.

[*Read 5 February 1900.*]

[*Abstract. v. Transactions, Vol. XIX. Pt. I.*]

When the measures of two organs vary about their mean value according to the normal law, and the statistical correlation of the two sets of variations is also normal, the frequency of joint variation within any selected limits is expressed by the integral considered in the paper. The integral involves five parameters, one being the angle which measures the statistical divergence of the one set of variations from the other (this divergence being a right angle when the variations are independent, and tending towards zero or two right angles for perfect positive or negative correlation); but it can be split up into eight terms, each of which is a definite function of two parameters. It is therefore only necessary to tabulate this function in terms of its two parameters. The table has not been constructed, but formulæ are given by means of which the function can be calculated in any particular case.

The integral is required in two classes of cases. In the first, the data represent actual measurements, and the object is to determine whether the correlation is normal. For dealing with these cases, in the absence of the desired table, an alternative but less convenient method is given, accompanied by a complete table. In the second class of cases the characteristics observed are not capable of quantitative measurement, but their presence or absence is regarded as dependent on the greater or less development, according to the normal law, of some physiological factor. (Some of the more important questions of assortative mating and heredity come under this head.) The data then shew the relative frequency of the presence or absence of the one characteristic in connexion with the presence or absence of the other, and the problem is to determine the divergence. This is done by expressing the double integral as a single integral, in which the divergence is the independent variable, and then applying the ordinary methods of quadrature.

Apparatus for Measuring the Extension of a Wire. By
Mr G. F. C. SEARLE, Demonstrator at the Cavendish Laboratory.

[Received 29 March 1900.]

In the study of the effects of longitudinal stress upon the length of a wire some accurate means is required for measuring the elongation of the specimen. The simplest method of magnifying the effects to be observed consists in using a wire of a considerable length, which for convenience is hung from a fixed support, the extension being produced by hanging weights to the lower end of the wire. Two chief sources of error must be avoided at the outset. These arise from the yielding of the support and the change of length of the wire due to rise of temperature. The latter cause may introduce a large error, for a rise of 2° C. will produce an increase of length of $\frac{1}{10}$ mm. in a copper wire 3 metres long. Both errors are practically eliminated if, instead of finding the displacement of the lower end of the wire relative to a fixed mark, observation is made of the displacement of the end of the wire relative to the lower end of a second wire of the same material, hanging from the same support, stretched by a constant weight and serving as a standard of comparison. It is here assumed that the coefficients of expansion of the two wires are identical in spite of their differences in stress.

It may not be out of place to consider the amount of error due to the failure of this assumption.

Let the coefficients of expansion under zero stress and under a stress of T dynes per square cm. be denoted by α and α_T respectively. Let E and E_{θ} denote the values of Young's modulus at a standard temperature and at a point θ° higher¹. Let l_0 be the length of the wire when free from strain at the standard temperature.

Then if the wire be first heated and then strained we have for the new length

$$l = l_0 (1 + \alpha\theta) \left(1 + \frac{T}{E_{\theta}} \right), \text{ approximately ;}$$

¹ The modulus E_{θ} is determined from observations on the elongation of a wire by a load, at the constant temperature θ , without regard to the causes which may contribute to that elongation. A similar remark applies to α_T .

while if the wire be first strained and then heated under strain

$$l = l_0 \left(1 + \frac{T}{E} \right) (1 + \alpha_T \theta), \text{ approximately}^1.$$

The products of small terms being neglected, the equality of these two expressions gives us

$$\alpha \theta + \frac{T}{E_\theta} = \alpha_T \theta + \frac{T}{E}.$$

Hence

$$\alpha_T - \alpha = \frac{T}{\theta} \left(\frac{1}{E_\theta} - \frac{1}{E} \right) = -\frac{T}{E^2} \cdot \frac{E_\theta - E}{\theta}, \text{ approximately.}$$

Now the experiments of Mr G. A. Shakespear (*Phil. Mag.*, Series v., vol. 47, p. 539) give the following values for $dE/Ed\theta$:

Metal	$\frac{1}{E} \frac{dE}{d\theta}$
Copper	-00041.
Hard brass	-00035.
Iron	-00019.
Steel	-00038.

Taking the case of copper we have approximately $\alpha = \cdot 000016$, $E = 1 \cdot 2 \times 10^{12}$ dynes per square cm., and thus we find for copper

$$\frac{\alpha_T - \alpha}{\alpha} = 2 \times 10^{-11} \times T.$$

For a wire 1 square mm. in section a load of 2 kilos gives approximately $T = 2 \times 10^8$ dynes per square cm. We thus find

$$\frac{\alpha_T - \alpha}{\alpha} = 4 \times 10^{-3}.$$

Hence if two copper wires each 1 square mm. in section and 3 metres long carry loads differing by 2 kilos, the expansion of either wire due to 1° rise of temperature will be about 5×10^{-3} centimetres, and the more heavily loaded wire will lengthen by $5 \times 10^{-3} \times 4 \times 10^{-3} = 2 \times 10^{-5}$ cm. more than the other wire. This quantity is hardly appreciable by the apparatus described in this communication, and thus the method may be considered to be satisfactory.

The simplest method of determining the relative displacement of the lower ends of the two wires consists in attaching a scale

¹ These expressions are only approximate since the changes in the area of the section of the wire have been neglected.

to one wire and a vernier to the other¹. By this means the changes of length may be read to $\frac{1}{20}$ mm. But since the whole extension due to the maximum load is perhaps not more than 3 or 4 mm., it is clear that no great accuracy can be expected in the use of this method.

The apparatus exhibited to the Society furnishes a much more sensitive means of measuring the relative displacement of the ends of the wires. In addition to its sensitiveness it possesses the advantage of giving direct readings.

The two wires *A, A'*, Fig. 1, have their upper ends secured to a stout piece of metal bolted to a beam. From the lower ends

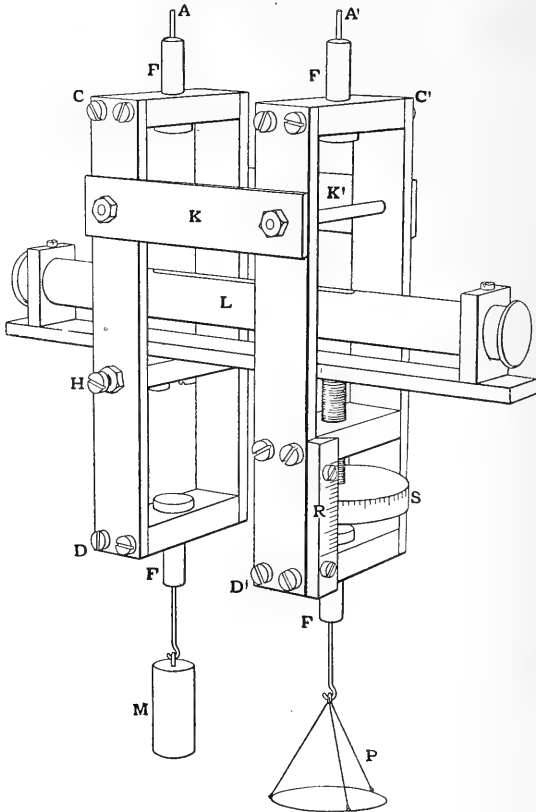

Fig. 1.

hang two brass frames *CD, C'D'* supporting the two ends of

¹ H. Tomlinson; *Phil. Trans. R. S.*, Vol. 174, p. 1.

a sensitive level L . One end of the level is pivoted to the frame CD by the pivots H ; the other end of the level rests upon the end of a vertical screw S working in a nut attached to the frame $C'D'$. The two links K, K' prevent the frames from twisting relative to each other about vertical axes, but freely allow vertical relative motion. When these links are horizontal the two wires are parallel to each other. From the lower ends of the frames $CD, C'D'$ hang a mass M and a pan P represented diagrammatically in the figure. The weights of M and P are sufficient to ensure that the wires are straight. The connexions between the wires and the frames are made by the swivels F into which the ends of the wires are soldered. The swivels enable the wires to be without torsion and thus ensure that the two wires hang in a vertical plane. Two other swivels connect M and P to the frames.

The head of the screw is divided, and a scale R engraved on the side of the frame serves to determine the number of complete revolutions made by the screw. In the instrument exhibited to the Society the pitch of the screw is $\frac{1}{2}$ mm.¹, while the head is divided into 100 parts. Each division on the head thus corresponds to $\frac{1}{200}$ mm.²

The instrument is used in the following manner. Suppose that the screw has been adjusted so that one end of the bubble of the level is at its fiducial mark. If a mass be placed in the pan P , the wire A' is stretched and the bubble moves towards H . The bubble is then brought back to its fiducial mark by turning the screw so as to raise the end of the level resting upon it. The distance through which the screw is moved is clearly equal to the increase of length of the wire A' and is determined at once by the difference of the reading of the screw in the two positions. The level is sensitive enough to enable the screw to be adjusted to $\frac{1}{5}$ of a division on its head, *i.e.* to $\frac{1}{1000}$ mm.

To steady the instrument, it is convenient to allow the two wires to press lightly against a rod fixed horizontally at a small distance above the frames $CD, C'D'$.

A brief discussion of the kinematics of the instrument may be added. In order to secure that there shall be only one possible type of displacement of one frame relative to the other, five degrees of relative freedom must be destroyed. Since only relative motion is in question we may imagine one frame, say CD , to be fixed. The other frame $C'D'$ is kept vertical by the tensions of the wires above and below it. If the links were absent it

¹ A pitch of 1 mm. would be more convenient and would give ample sensitiveness.

² The chief dimensions of the apparatus are as follows:— $CD=11$ cm. Length of links 5 cm. Diameter of screw-head = 4 cm.

would be free to move horizontally East and West, or North and South, or vertically (when the wire is stretched) and to turn about a vertical axis. It thus possesses four degrees of freedom. The two links destroy three degrees of freedom by preventing the frame from (1) rotating about its own wire A' , (2) rotating about the wire A , (3) moving towards or away from the frame CD . The frame $C'D'$ has thus but one degree of freedom remaining, viz. that which enables it to follow the stretching of the suspending wire.

One objection to the use of the links K, K' arises from the fact that when the wire A' is stretched so that the ends of the links on $C'D'$ are lower than the ends on CD , the tensions of the two wires are not the same as if the links were absent. It is here supposed that the two wires are vertical when the links are horizontal. The error due to the obliquity of the links is easily found. If a be the length of the links, l the length of the wires, and P and Q the tensions in the absence of the links, then when the links make an angle θ with a horizontal plane, the ends corresponding to P being the lower, the tensions of the wires are approximately

$$R = P - 2 \frac{PQ}{P+Q} \cdot \frac{a}{4l} \cdot \theta^2, \quad S = Q + 2 \frac{PQ}{P+Q} \cdot \frac{a}{4l} \cdot \theta^2.$$

In my apparatus $a = 5$ cm., $l = 300$ cm. approximately. Hence, when there is a difference of level of 1 cm. between the ends of the links, $\theta = \frac{1}{3}$ and $a\theta^2/4l = \frac{1}{30,000}$. Since $2PQ/(P+Q)$ is roughly the mean of the two loads, we see that the obliquity of the links in this case only alters the tensions by $\frac{1}{30,000}$ of the mean load. This error is therefore negligible.

Since increasing obliquity of the links brings the two frames closer together, it is necessary that the surface of that part of the level-holder which rests upon the screw should be part of a plane which passes through the axis of the pivots H , and is such that it is horizontal when the bubble is at its fiducial mark.

With this apparatus the students at the Cavendish Laboratory find it easy to investigate the deviations from Hooke's Law for copper wire. When a copper wire of .01186 square cm. in section is put slowly through a series of cycles of loading and unloading, well-marked hysteresis curves are obtained, even though the range of load is but 2 kilogrammes. The maximum extension in this case is only .037 cm. in a length of 286 cm. The gradual extension due to a continued load and the gradual contraction consequent on the removal of a load are also easily measured by means of the apparatus.

The apparatus was constructed by Mr F. Lincoln, second mechanical assistant at the Cavendish Laboratory; its efficient working is due to his care and skill.

The following method of destroying three degrees of relative freedom of the frames would, I think, be practically convenient, and would be free from the errors arising from the use of links. Any extent of relative vertical motion consistent with size of the apparatus might occur without giving rise to any inaccuracy.

To the frame CD fix two vertical bars of soft iron in approximately the same positions as they would occupy if their axes passed through the centres of the two links. Let one bar have a plane face, and in the other bar let a **V**-shaped groove be cut. To the frame $C'D'$ pivot two brass wheels, one with a flat edge to run on the flat iron bar, the other with a rounded edge to run in the **V** groove. These wheels must be adjusted so that when each bears upon its own iron bar the two wires A, A' are vertical. To provide the force necessary for maintaining this geometrical constraint against disturbing causes two small horse-shoe magnets may be fixed by the side of the wheels, so that their poles are within 1 mm. of the iron bars.

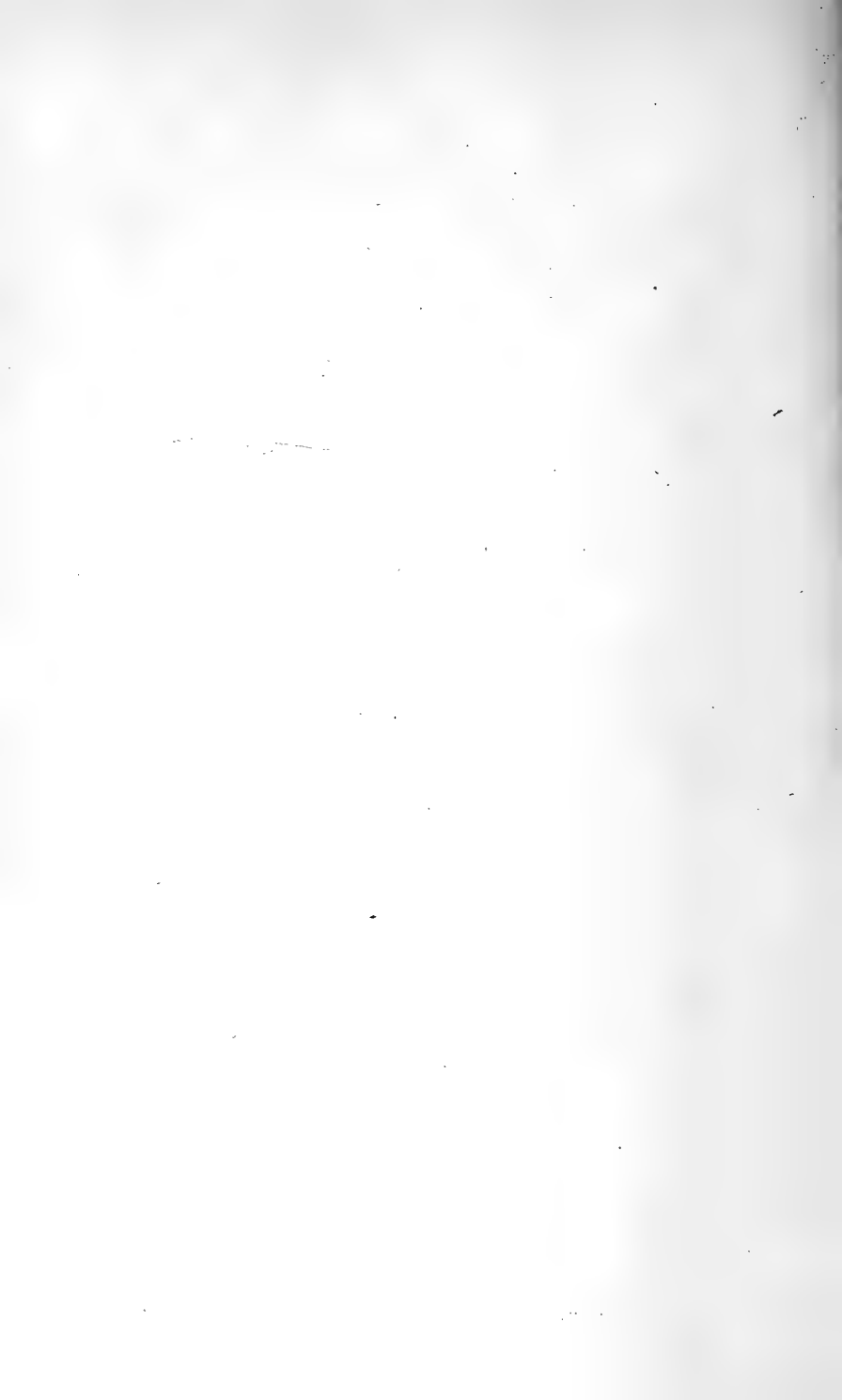

PROCEEDINGS

OF THE

Cambridge Philosophical Society.

Exhibition of Anomalous Bones from Pre-dynastic Egyptian Skeletons. By Professor MACALISTER.

[Read 7 May 1900.]

Ammocoetes a Cephalaspid. By Dr GASKELL.

[Read 7 May 1900.]

Note on some Abnormalities of the limbs and tail of Dipnoan Fishes. By Mr H. H. BRINDLEY, M.A., St John's College.

See Plate XIV.

[Read 7 May 1900.]

I AM indebted to Mr J. Graham Kerr for the opportunity of examining some cases of abnormal limbs in *Lepidosiren paradoxa* obtained by him in the Paraguayan Chaco. The specimen now shewn and these sketches of the limbs of others shew the unusual condition to be either partial duplicity of the limb or else a sudden tapering into a sharp tip. Mr Kerr informs me that among 26 adult individuals examined he found two cases of partial duplicity, and it seems certain that this condition is of fairly frequent occurrence, while the sudden sharpening of the tip is still more common.

Goeldi¹ has described and figured a case of more elaborate branching than any which are illustrated here. The branches

¹ *P. Z. S.* 1898, p. 855.

arose during captivity in an aquarium, and the author has made the suggestion that the branches are to be regarded as casual accessory respiratory organs arising in connection with the confined condition.

Albrecht¹ has described a similar duplicity in the limbs of *Protopterus*.

Boulenger², in comment of both Goeldi's and Albrecht's cases, has expressed the opinion that such abnormalities arise in connection with reproduction after injury, and with Howes has described a trifold limb in *Protopterus* which appeared after the normal limb had been nibbled by fishes in the same tank.

Serial sections through these abnormal limbs of *Lepidosiren* point to a similar conclusion. In them, whether the extremity is bifid or not, the axial row of cartilage segments (mesomeres) is present, as in Howes's *Protopterus*, and the appearance of the cartilage cells and matrix has the usual features of young tissue—the matrix is hyaline and relatively scanty and the cells are actively dividing, these appearances being in clear contrast with those of the cartilage of the thicker basal portion of the limb.

Kerr has noticed that in *Lepidosiren* the limbs and the tail appear frequently to be injured, and Budgett finds that this holds good for *Protopterus* also. Thus in Kerr's 26 *Lepidosirens* 10 exhibited signs of regeneration of the tail, while three others had bifid and probably reproduced tails.

The radiograph shews the bifidity of the tail in one of Budgett's specimens which is on the table.

There seems no doubt that both the limbs and tails of these Dipnoan fishes have considerable liability to injury and well marked power of regeneration, and also a tendency to grow in a branched condition, reminding us of the cases of double reproduced tails in Lizards and polydactyly after mutilation in Amphibians. In Lizards the extra tail is apparently sometimes a growth arising from an injured place on a normal tail.

But in some of the cases described in Lizards and in the several bifid limbs of *Lepidosiren* which have been examined by section the new growth is bifid from its commencement. The existence of a tendency towards branching after injury or section is well known in certain plants, but the idea presents itself that an unusual expression of branching in a root or stem might possibly be advantageous, while in the case of an actively moving animal it would be rather an inconvenience. In any case we can hardly call upon selection to account for such a tendency in a vertebrate animal. As has been stated bifidity in a Lizard's tail

¹ *Sitz. Akad. Berlin*, 1886, p. 545, pl. vi.

² *P. Z. S.* 1891, p. 147.

seems almost certainly in some instances to be the healing tissue of a wound assuming a special form and conspicuous dimensions, thus forming a new tail springing from the side of a normal one. Where the new growth is bifid from its commencement we have also sprouting from a wounded surface, that is, the origin of the growth differs only in position from the above. In the development of a normal limb or tail the growth proceeds with that of the whole animal, but in the repair of an injury there is a special proliferation at one point and the epidermis makes haste to cover the subjacent tissues exposed at the end of the stump. Thus the trophic events of growth proceed otherwise than in normal development and with the immediate purpose of covering the wound, while at the same time there is unusual exposure to accidental interference from external influences, such as contact with foreign bodies. Under these circumstances it seems not impossible that extremely slight circumstances of the moment may affect the direction of growth of the rapidly-extending epidermis without checking the growth as a whole in its endeavour to cover the wound, or the subjacent tissues might be interfered with before they were covered over. So in the absence of the coordination of growth holding in normal development external interference might in some cases mould the regenerating structure in a special form. The curious tendency to branch displayed by the structures described is interesting, though the suggestion made by one or two authors that abnormalities of this kind may have some phylogenetic importance appears to rest on doubtful grounds. The branched condition seems more probably explicable on the strength of accidental and local influences.

The Standardisation of Antivenomous Serum. By WALTER MYERS, M.A.; John Lucas Walker Student in the University of Cambridge.

[Read 7 May 1900.]

THE Standardisation of Antivenomous Serum is of some theoretical interest, as well as of practical importance, for the first step in studying the process of neutralisation of a toxin by its antitoxin is to obtain a reliable method of measuring the latter. As illustrating the practical bearing of the subject, the fact may be mentioned that some 20,000 persons are reported to have died from snake bite in India during the year 1898.

Now it is a matter of extreme difficulty to obtain clinical evidence of the therapeutic value of an antitoxin. Diphtheria antitoxin is one of the most successful antitoxins, and the clinicians were long undecided as to its value, and even now their opinions are not altogether in agreement. There has never to my knowledge been any doubt as to the laboratory value—if I may use the expression—of this antitoxin. In the case of snake poison however the case is different. As is shewn by the history of the therapeutics of snake-bite, there has been the greatest difficulty in determining the value of various remedies employed, as is well illustrated by the case of strychnine¹. Further, the antivenomous serum is prepared by immunisation against a mixture of venoms of which Cobra poison forms 80 %/. Calmette in whose laboratory the antitoxin is made, claims that it neutralises, and is for a certain time at least after the bite, even curative for, the bite of *all* poisonous snakes. Other observers however have not substantiated this claim. Cunningham², for instance, found that in the laboratory the antitoxin has very little if any neutralising effect even upon Cobra poison, against which it should be most efficacious. And more recently Stephens³ has shewn that its power of neutralising the venom of certain other snakes is very limited indeed.

It is possible that the results of Cunningham were due to a deterioration of the serum after leaving Lille, its place of manufacture, a deterioration doubtless in some part due to the effect of temperature on the antitoxin. It is therefore important that a reliable method of standardisation should be used for the serum which is employed clinically, both in the advantage of the patient, and in view of obtaining reliable statistics as to its

¹ Martin, *System of Medicine*, Ed. by Clifford Allbutt.

² *Sci. Mem. of Med. Off. of India*, 1896.

³ Stephens, *Journ. Path. and Bact.* 1900.

therapeutic value. So far to my knowledge, apart from a few isolated recorded cases, there are no statistics yet available.

At Lille the serum is standardised in the following way. Rabbits of about 2000 grams in weight are employed, and the test dose of the mixture of venoms that is used for immunisation is ascertained. It may be mentioned in passing that this mixture is heated to 73° C. for half-an-hour before use. The test dose chosen is that amount of the mixture which kills the animal in from 15 to 20 minutes when injected intravenously. The amount of serum which will just prevent death when injected 5 minutes before the venom is then determined. This amount of serum is said to contain 2000 units of immunity.

We now know that for snake poisons, toxin and antitoxin interact directly, and so far as our knowledge goes the process is independent of any vital action. Since the above described method was designed to permit of the supposed stimulation of the cells of the animal by the antitoxin before the toxin is introduced, but does not allow of the completion of the reaction between the two bodies before they enter the blood stream, it must be described as unscientific.

The first step in the direction of a rational method of standardisation was taken by Semple and Lamb¹. These authors determined the number of minimal fatal doses contained in Calmette's test dose, and thus gave a value for the serum in terms of its neutralising power, not as in the method above described, in terms of its preventive power. They found that Calmette's test dose for the rabbit amounted to three times the minimal lethal dose for that animal.

As has been mentioned it is important that the method of standardisation be devised such that the general practitioner may be able himself to ascertain, at all events approximately, the strength of the serum he is about to use. This method is unsuited for this purpose for several reasons. The mixture Calmette uses is complicated, and should be replaced by one single venom, which is easily obtainable.

Although intravenous injection is a simple operation, subcutaneous inoculation is simpler, and if equally accurate is for this reason to be preferred. Calmette heats his venoms to 73° C. for half-an-hour before use. This procedure may render the venom more suitable for immunisation, but as we have clinically to deal with intoxication by unheated venom, it seems *à priori* preferable to use unheated venom for standardisation. The changes that Cobra poison undergoes on heating to this temperature will be mentioned later.

¹ *Brit. Med. Journal*, Ap. 1, 1899.

A cheap and susceptible animal is desirable. Now it is clear that with equally susceptible animals, that is with animals for which the minimal lethal dose per gram weight is the same, the smaller the animal, the smaller will be the differences that can be observed in the neutralising power of the antitoxin, since with snake poison, we can only distinguish between mixtures of toxin and antitoxin that are fatal and non-fatal. The larger the maximal non-fatal dose, the greater is the error therefore. For the same reason, the test dose should be a multiple of the minimal lethal dose, and as large a multiple as possible.

Amongst common laboratory animals, guinea-pigs and mice seemed to be the most suitable. Guinea-pigs however cannot be used. For to neutralise a multiple of the minimal lethal dose, undiluted serum must be used, and, as Cobbett¹ has shewn, antivenomous serum is very often acutely toxic for these animals.

This serum is also often toxic for mice, but I have found that death from it does not occur within the first 24 hours, so that if the results be noted for this space of time, we can neglect the toxic action of the serum. Antivenomous serum, as some specimens of normal horse serum do, often kills mice in from 4—6 days.

Using mice of about 15 grams in weight then as test animals, and unheated Cobra venom, it was found possible to determine the minimal lethal dose to within 20%, that is increments of 1 in 5 could be appreciated. The minimal lethal dose I found to be 0.12 mgrms. This dose killed in from 3—4 hours.

Taking ten times this quantity, namely 1.2 mgrms., the amount of serum required to neutralise it was then determined, the mixtures being allowed to stand at room temperature for half-an-hour.

The neutralisation of ten times the lethal dose could be estimated to within 15%; when the doses of serum were made closer, the series became irregular, and it was found impossible to distinguish within this limit.

On comparing the two methods, the method of mixing *in vitro* and testing the mixtures on mice was found to be more accurate than the rabbit method as used by Calmette.

Thus with rabbits of about 2000 grams, 0.5 mgrm. per kilo of the dry venom employed killed in 20 minutes.

When 0.3 c.c. serum per kilo had been injected 5 minutes previously, the animal died in an hour and a half. With 0.4 c.c. serum and more, the animals lived and shewed no symptoms. 0.5 mgrm. of venom is here neutralised by 0.4 c.c. of serum. Hence 0.12 mgrms. would be neutralised by 0.096 c.c. of serum.

With mice, however, using the same serum, 0.2 c.c. was required

¹ *Proceedings of the Physiol. Soc.* 1899.

to neutralise 0.12 mgrms. of the poison. When 0.175 c.c. was used the animal died in 3 hours. The latter method therefore is much more accurate.

This method of standardisation with unheated Cobra poison¹ is simpler and more exact than that at present in use, and can be used by the general practitioner in testing his serum for clinical purposes. We may for convenience call a unit of immunity that quantity of antitoxin which neutralises ten times the minimal lethal dose for a mouse weighing fifteen grams. A serum, for example, of which 0.2 c.c. were required, would contain 5 units per c.c.

This method does not reach any great accuracy; and this is doubtless due to the weakness of the antitoxin. When it is possible to standardise this serum with 100 times the minimal lethal dose, much greater accuracy will probably be possible.

I wish here to express my thanks to Prof. Ehrlich, at whose suggestion this work was begun in his laboratory last year, and to whom I am indebted for much assistance and advice.

On a certain Diophantine Inequality. By Major MACMAHON, R.A., F.R.S. *v. Transactions*, Vol. XIX.

[Read 21 May 1900.]

On rational space curves of the fourth order. By Mr RICHMOND. *v. Transactions*, Vol. XIX.

[Read 21 May 1900.]

¹ The effect of heating a solution of Cobra poison (1 c.c. = 1 mgrm. in physiological saline solution) to 73° C. for half-an-hour I have found to be as follows. The minimal hæmolysing dose for human blood is raised to 20 times the previous quantity. The minimal lethal dose for mice is doubled. The power of the toxin of combining with the antitoxin is diminished, but not nearly to the same degree to which its toxic power is weakened.

Experiments on Impact. By J. H. VINCENT, D.Sc., B.A., A.R.C.Sc.

Introduction.

Newton was one of the first who performed experiments on impact. In the famous scholium on the laws of motion¹ after showing that the momentum of two impinging spheres is conserved he says: "In bodies imperfectly elastic the velocity of the return is to be diminished together with the elastic force; because that force (except when the parts are bruised by their congress, or suffer some such extension as happens under the strokes of the hammer) is (as far as I can perceive) certain and determined and makes the bodies to return one from the other with a relative velocity, which is in a given ratio to that relative velocity with which they meet."

This number is usually denoted by e and has received the name of "the coefficient of restitution." Newton found that e was independent of the size and the relative velocity of the spheres and thus depended only on the material of which the sphere was composed.

Hodgkinson² next attacked the subject. His experiments were very exhaustive, and his chief result was that although e was approximately constant for spheres of the same material or the same two materials, yet it diminished slightly when the velocity of concurrence was increased.

Newton experimented with bodies which were not permanently deformed, but Hodgkinson dealt also with bodies which suffered a permanent deformation and found that the value of e in these cases diminished more rapidly than in the case of bodies which did not undergo any such persistent change.

In this paper experiments on bodies which suffer large deformation, whether permanent or temporary, are described.

Experiments on Rubber Balls.

Fig. 1 shows the result of a series of experiments with a lawn tennis ball divested of its cloth covering. Its mass was 49 grams and its diameter 6 cm. The ball was placed at different heights above a stone bench or stone floor, and allowed to fall by means of a light wooden lever actuated by a stretched rubber band.

¹ Motte's *Principia*, vol. I. p. 31.

² *Brit. Assoc. Report*, 1834.

The end of the wooden lever had a small depression in it, and the whole was so arranged that the ball received no initial velocity when the lever was released. The height to which the

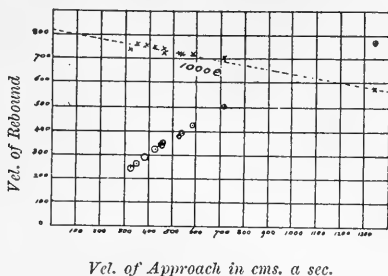

FIG. 1. Stripped Lawn Tennis Ball rebounding from stone slab.

ball bounced was determined by noting the highest reading on a millimetre scale which could be observed, the ball obscuring the readings just above this point. Parallax errors were obviated by placing the eye at the expected height on another vertical scale. If the reading was different from that expected, then a new height was taken for the eye until the eye, bottom of ball, and reading were all at the same height above the plane from which the ball rebounded.

The points surrounded by circles are obtained by plotting the velocity of rebound against the velocity of impact, both computed without any attempt being made to allow for the effect of the air. Thus it would be more accurate to say that the curve shows the relation between the square roots of the heights of fall and rebound than that of the velocities of concurrence and recession.

The points indicated by crosses show on the same figure the way in which the value of e thus calculated falls off as the velocity of approach increases. These points lie approximately on a straight line and, without assuming that the value of e thus computed is the ratio of the velocities of recession and approach, we have

$$\sqrt{\frac{h_2}{h_1}} = c - k\sqrt{h_1},$$

where h_1 and h_2 of the heights of fall and rebound and c and k are constants.

The results which would follow if such a straight line law connected e with the velocity of approach over an extensive range, are interesting.

The equation, connecting e and u the velocity of approach, is

$$e = e_0 - mu,$$

where e_0 is the coefficient of restitution for an infinitely small velocity.

$$e_0 = \cdot 82,$$

$$m = \cdot 00018,$$

and e is zero when $u = 4600$ cm. a sec. approx.

If v be the velocity of rebound,

$$v = e_0 u - mu^2.$$

This equation is that of a parabola with its axis vertical, and concave towards axis of u . Its vertex is at the point

$$u = \frac{e_0}{2m} = 2300 \text{ approx.}$$

$$v = \frac{e_0^2}{4m} = 930 \text{ approx.,}$$

while the value of e corresponding to this point would then be $\frac{e_0}{2} = \cdot 41$. This shows that if the straight line law for e held through a great range then the maximum velocity of rebound would be 930 cm. a sec.

Fig. 2 exhibits a series of experiments on another lawn tennis ball. The ball with the cloth on does not in this curve give e as

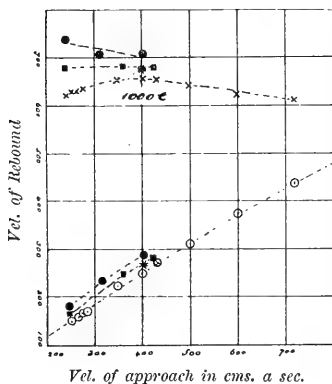

FIG. 2. Lawn Tennis Ball.

Pts * obtained next day from same ball with cloth on.

● after removing cloth.

■ ,, ,, and puncturing.

a linear function of the velocity of approach. The removal of the cloth raises the values of e , and the effect of puncturing the ball after the cloth is removed is to lower e very little¹.

Fig. 3 gives the results of some experiments on a lawn tennis ball of this season's make; the two sets of readings were taken on successive days. The difference is a temperature effect, probably on the material of the envelope and not on the contained gas, as it is greater than one would expect puncturing to cause.

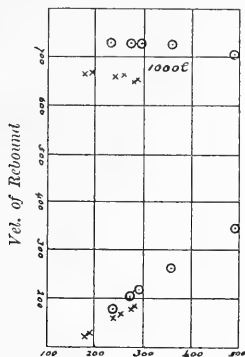

Vel. of Approach in cms. a sec.

FIG. 3. Two sets of observations.

The curves *A* on Fig. 4 were obtained from the same ball, care being now taken to handle it as little as possible, and to leave an interval of a couple of minutes between each experiment.

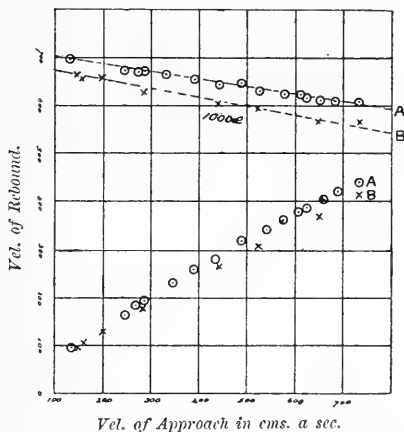

Vel. of Approach in cms. a sec.

FIG. 4.

¹ The gas escaping from the ball on puncturing smelt strongly of ammonia.

This curve shows that e (as thus computed, without allowing for air effects) is a linear function of the velocity, for a long range.

Using the same notation as before, we have

$$e_0 = \cdot 72,$$

$$m = 00016;$$

e is zero when

$$u = 4500 \text{ cms. a sec. approx.}$$

The vertex of the parabola

$$v = e_0u - mu^2$$

is at the point

$$u = \frac{e_0}{2m} = 2250 \text{ cms. a sec.},$$

$$v = \frac{e_0^2}{4m} = 810 \text{ cms. a sec. approx.},$$

while the value of e corresponding to this point would be

$$\frac{e_0}{2} = \cdot 36.$$

The curves B on Fig. 4 were drawn from results obtained with a "squash rackets" ball.

$$e_0 = \cdot 69,$$

$$m = \cdot 00018;$$

e is zero when $u = 3800$ cms. a sec. approx. The vertex of the parabola $v = e_0u - mu^2$ is at the point $u = 1900$ and $v = 670$ cms. a sec.; e is then $\cdot 35$.

Experiments with a Steel Ball and Indiarubber Bung.

Fig. 5 shows the results of two series of experiments on the bouncing of a steel ball from a large new rubber bung. The ball was of "hard" steel, brightly polished. It weighed 67 grammes and measured 2.54 cms. in diameter. The bung was of grey rubber 4.9 cms. thick, and its circular ends were 6.5 and 8.2 cms. in diameter respectively.

The larger of its two plane surfaces was cemented to a large stone block and the impacts were made to occur at the centre of the smaller surface.

The points in Fig. 5 indicated by circles were obtained as in the above described experiments, but those shown by crosses are the results of a series of experiments performed on another day

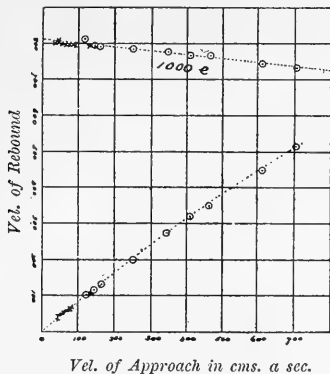

FIG. 5. Steel Ball impinging on rubber bung.

by the pendulum method. The pendulum was 245 cm. long so that the velocity on impact in cm. a sec. was numerically equal to twice the length of the chord in cms. The pendulum experiments were not easy to perform, as the thread supporting the steel ball stretched considerably even under a small tension. Thus it was found necessary to release the ball (this was done by the wooden lever apparatus described above), to let it strike the rubber surface once, to read the length of the chord for the first rebound and for the second; these last two readings were the ones used and gave fairly concordant results.

Parallax was avoided by using a scale fastened to a plane mirror parallel to the plane of motion.

The resistance of the air had so small an effect that no allowance was made for it, and the results for e are probably not appreciably different from what would have been obtained from experiments in a vacuum.

The coefficient of restitution is again a linear function of the velocity of approach.

$$e_0 = \cdot 81,$$

$$m = \cdot 00011,$$

and e is zero when $u = 7400$ cms. a sec. The maximum velocity of rebound is 1840 cms. a sec. and the velocity of approach corresponding to this is 3700, while $e = \cdot 40$.

The preceding experiments with the steel ball and indiarubber bung tend to show that e in the other cases decreased uniformly as the velocity of approach increased and to indicate that the results are not very much affected by the resistance of the air. There are practical difficulties in the accurate determination of e for large and for small velocities of approach, and it would be fallacious to lay stress on the results of wide extrapolation of such curves as are given in the figures. Yet the experiments indicate the possibility and even the probability of the existence in the above cases of a maximum value for e which occurs when the velocity of approach is vanishingly small and which is considerably less than unity. Also the existence of a maximum velocity of rebound is indicated.

Experiments with Lead.

In order to determine the circumstances of impact in which one or both of the bodies suffer permanent deformation it seemed desirable to find the relation between the deformation produced and the velocity.

In Fig. 6 we have the results obtained by dropping a "hard," highly polished steel ball, mass 67 grammes, on to a slab of lead¹. The diameter of the ball was 2.54 cm. and the slab of lead was 5 cm. thick with a surface of 15 × 20 sq. cms.

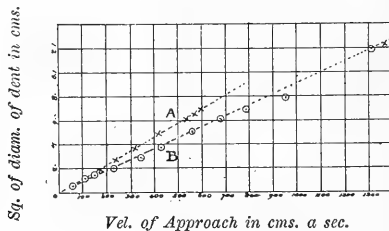

FIG. 6. Steel Ball (2.54 cms. diameter) falling on lead.

The surface of the lead blocks used in this and succeeding experiments was prepared by planing with a carpenter's plane. This tool when set so as to cut a very thin shaving will plane lead readily, if oil is used freely as a lubricant. The surface thus prepared has a remarkably beautiful appearance. The crystals composing it are seen in reflected light and if the lead has been "chilled" the sections of the crystals are on an average about a

¹ The lead was commercial plumbers' lead.

mm. across. If however the lead be cooled slowly by leaving it in the iron mould in which it has been melted, the crystals are as much as a cm. in diameter.

In these experiments with lead the one surface, planed as above and rubbed with a clean cloth, was used throughout any one set of experiments. Results shown by different curves refer to different blocks of lead or to a newly planed surface.

The character of a leaden surface varies in different parts and thus the averaging of many results is indicated; but this method is inapplicable, as one would use up the whole surface in determining a single point on a curve. Where indentations occurred near the edges of the surface or near other dents they were not measured.

The depression which the ball makes in the lead is exactly a cast of the surface of the ball. This was proved by the fact that although the ball would stand without shake in the dent which it had made, yet if a very small grain of dust were introduced into the dent, the ball would not fit exactly but would rock on the speck of dust.

The curves in Fig. 6 are drawn by plotting the squares of the diameters of the dent in cms. against the velocities of approach. By the diameter of the dent is meant the diameter of its circular edge. This was measured easily in reflected light by a traversing microscope whose vernier read to .01 cms.

From these curves we see that

$$u = bd^2,$$

where

$$d = \text{diam. of dent} = 2r,$$

$$u = \text{velocity of approach,}$$

and

$$b = \text{a constant.}$$

The volume of a spherical cup is

$$\pi l^2 \left\{ R - \frac{l}{3} \right\},$$

where l is the length of the radius R of the sphere, cut off by the plane of section. If the cup is small we may put the volume as

$$\pi l^2 R,$$

but l^2 is approximately equal to $\frac{r^4}{4R^2}$ and thus the volume is approximately

$$\frac{\pi r^4}{4R},$$

or $\frac{\pi d^4}{32D}$, where d is the diameter of the dent and D is the diameter of the sphere.

Thus the volume of the dent is proportional to the energy of the ball just before impact.

We may write then, using the above value for the volume of the dent,

$$\frac{Mu^2}{2} = p \cdot \frac{\pi d^4}{32D} \dots\dots\dots(i),$$

where

M = mass of ball,

u = velocity at impact,

p = a constant.

If the other quantities in the equation are in c.g.s. units then p is the force in dynes per sq. cm. which will make the lead flow. The quantity p is also numerically equal to the number of ergs of work done in making a dent a cubic cm. in volume.

From equation (i) we have

$$p = \frac{16MD}{\pi} \left(\frac{u}{d^2} \right)^2,$$

which may be written

$$p = ab^2,$$

where $a = \frac{16MD}{\pi}$ and may be calculated from the dimensions and mass of the ball.

The value of $b = \frac{u}{d^2}$ is obtained from the straight line A or B on Fig. 6.

For the ball used in these experiments $a = 866$; curve A Fig. 6 gives $b = 857$, thus $p = 6.4 \times 10^8$ dynes per sq. cm.

For the curve B in Fig. 6, $b = 1140$ and $p = 11 \times 10^8$. That is, the pressure which is necessary to make the specimen of lead, used for curve B , flow, is nearly twice as great as that necessary in the case of the material used in the set of experiments shown by curve A .

The total upward force of the lead on the ball at any depth of penetration l is

$$\pi p r^2 = \pi p D l,$$

and consequently varies as l . The time taken in making a dent is therefore independent of the velocity of impact. The time is

$$\frac{\pi l}{2u} \text{ or } \frac{\pi d^2}{8Du},$$

which equals $\frac{\pi}{8Db}$.

For curve *A* Fig. 6 the time is 1.85×10^{-4} secs. and for curve *D* it is 1.4×10^{-4} secs.

The law of proportionality between u and d^2 may be used to determine e . By giving the surface of the lead block a slight tilt from the horizontal we can ensure that successive dents do not occur too near each other, and if this inclination is slight the impact is still practically direct. The velocity of impact at the $(n + 1)$ th dent is the velocity of recoil from the n th dent; and knowing the value of b we can compute several values of e from the measurements of successive dents. The calculations and observations are tabulated below for the lead used in curve *B*, Fig. 6.

The values of e given in column V. are set out in Fig. 7 against the values of the velocity in column I. as the abscissæ. Alternative ordinates from column VI. are distinguished by crosses in the three cases in which any difference in the value of e occurs. The alternative values for the cases of velocities

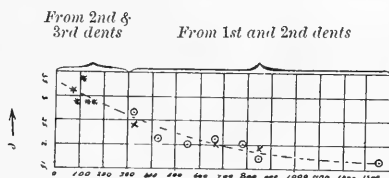

Vel. of Approach in cms. a sec.

FIG. 7.

326, 678 and 950 have now to be combined with the other values to draw a curve. This is more regular if drawn through the crosses in these cases, and these points indicate probably the better value for e in each case.

The velocity of impact in the case of second dent can be computed in two ways which are given in columns VIII. and IX., and thus to the ordinates in column XI. we have two alternative sets of abscissæ, those in columns VIII. and IX.

I	II	III	IV	V	VI	VII	VIII	IX	X	XI
Vel. at 1st impact in cms. a sec. from observation of height of fall	Diam. of 1st dent in cms. Observation.	Diam. of 2nd dent in cms. Observation	Sq. of 1st dent from reading the st. line on curve B, Fig. 6	e = Ratio of sq. of diam. of dents. From II and III Vel. of impact in column I	e computed from II and IV Vel. of impact in column I	Sq. of 2nd dent from III	Vel. of 2nd impact = $1140 \times$ sq. of 2nd dent. From B Fig. 6 and column VII	Vel. of 2nd impact computed from V	Diam. of 3rd dent in cm. Observation	e = Ratio of sq. of 3rd and 2nd dent. From III and X. These values of e correspond to vel. in columns VIII and IX
326	.55	.27	.28	.24	.26	.073	83	78	.15	.31
428	.61	.28	.37	.21	.21	.078	89	90	.15	.29
558	.70	.31	.49	.20	.20	.096	109	112	.18	.34
678	.78	.35	.59	.20	.21	.123	140	136	.19	.29
794	.83	.37	.69	.20	.20	.137	156	159	.20	.29
950	.87	.38	.83	.19	.17	.144	164	180	.20	.29
1363	1.09	.43	1.19	.16	.16	.185	211	218		

The values of e are plotted in Fig. 7. The stars are from columns IX. and XI., while points from columns VIII. and XI. are so nearly identical with the positions marked by stars that they are not indicated.

The values of e thus obtained show that e decreases as the velocity of impact increases. The curve showing the relation of e to u is convex towards the axis of u .

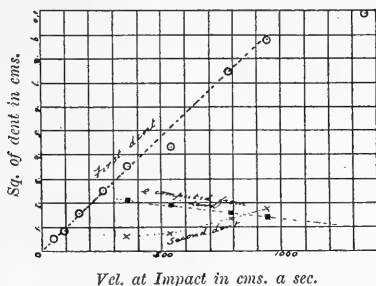

FIG. 8.

Fig. 8 gives a series of experiments similar to those exhibited in Figs. 6 and 7.

$$b = 1050,$$

$$p = 9.6 \times 10^8 \text{ dynes per sq. cm.}$$

The time taken to make any dent is

$$\frac{\pi}{8Db} = 1.5 \times 10^{-4} \text{ secs.}$$

Fig. 9 is drawn from a similar set of experiments. In this case some smaller velocities of impact were employed.

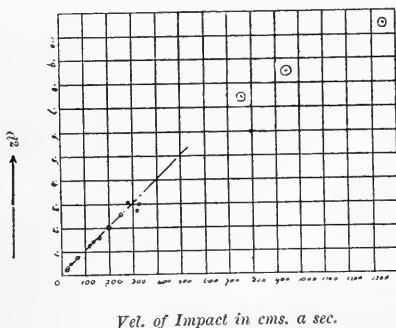

FIG. 9.

This was done by soldering a small hook of bright wire to the steel ball and hanging the ball up by this hook from the extreme point of a needle, which was horizontal. The needle could be moved quickly by a spring in the direction of its length thus releasing the ball. The height fallen through was measured by a cathetometer.

For large velocities of impact d^2 is less than that indicated by the equation

$$u = bd^2.$$

This is noticeable also in Figs. 6 and 8. The deviation from the straight line is due to two causes:

1. The ordinate d^2 is not accurately proportional to the root of the volume of the dent.

2. The volume of the dent is less than it would be if it were proportional to the energy of the ball just before impact.

It is at once seen that the latter cause is the most efficient. For the dent is still small compared with the ball so that by taking another term in the expression for the volume of the dent we get a formula of quite sufficient accuracy to test the effect of the cause 1.

We have previously taken the volume of the dent as

$$\frac{\pi d^4}{32D}.$$

It is to a nearer approximation

$$\frac{\pi d^4}{32D} \left(1 + \frac{d^2}{3D^2} \right).$$

If then we wish to make the ordinate proportional to the root of the volume we must plot

$$d^2 \left(1 + \frac{d^2}{6D^2} \right)$$

instead of

$$d^2;$$

that is, each point must be raised about $\frac{d^4}{40}$. This correction is small even for the larger dents and is not sufficient to bring the points up to the straight line through the smaller dents.

We must conclude then that the displaced volume is proportional to the initial energy of the ball for small velocities of impact; but as the velocities increase the volume of the dent is less than it should be according to this rule.

For the smaller dents

$$b = 1000,$$

so that

$$p = 8.7 \times 10^8 \text{ dynes per sq. cm.}$$

The cases in which the straight line is deviated from are those having small values for p . The specimen of lead giving

$$p = 11 \times 10^8$$

being the one in which the straight line law was obeyed over the greatest range.

The time occupied in making the small dents in Fig. 9 is

$$\frac{\pi}{8Db} = 1.5 \times 10^{-4} \text{ secs.}$$

Using the same block of lead successive dents were measured and computed as already explained. Values for e were obtained similar to those shown on Fig. 7.

In the experiments on lead described so far, we have used a steel ball 2.54 cms. in diameter.

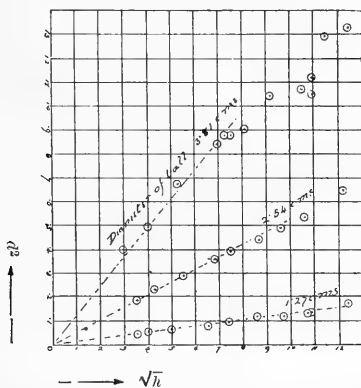

FIG. 10. Steel Balls of different diameters falling through h cms. on to lead.

In Fig. 10 the results of three sets of experiments are set out. These were performed on the same block. The lead was slowly cooled and showed large crystals on its newly planed surface. Three steel balls were used in these experiments. Their diameters were in the ratio of the numbers 1, 2, 3. The block was replaned after the largest ball was used, but the other two sets of readings were taken on the same surface.

The diameters of the balls were 1.27, 2.54 and 3.81 cms. respectively. The block measured $8.5 \times 8.5 \times 13.5$ c.cms.

In this figure the ordinates as before are proportional to the square of the diameter of the dent, while the abscissæ are proportional to the velocity of approach, the numbers being the roots of the heights of fall.

Reading the straight lines we have, when $h = 100$ cms.,

$$d^2 = 1.22, \quad .52, \quad .12,$$

or

$$d = 1.11, \quad .72, \quad .35,$$

so that the diameter of the dent is approximately proportional to the diameter of the ball which makes it, other things being the same.

$$\text{Now} \quad p = \frac{16MDu^2}{\pi d^4} \quad \text{or} \quad \frac{8\rho}{3} \left(\frac{D^2 u}{d^2} \right)^2,$$

where ρ = the density of the steel.

Thus the above results agree with the law that p is constant. Adapting the above equation for direct computation from the figure, we have

$$p = \frac{16\rho g}{3} \left(\frac{D^2 \sqrt{h}}{d^2} \right)^2 \\ = \alpha \beta^2;$$

ρ for the steel balls was determined and was found to be 7.78 grammes per c.cm.; α is thus 4.07×10^4 .

The values of β for the three balls are set out below :

<i>Diameter of ball.</i>	D^2	$\frac{\sqrt{h}}{d^2}$	β
1.27	1.61	83.33	134.2
2.54	6.45	19.23	124.1
3.81	14.52	8.20	119.1

The value of β decreases in the above table, while D increases. This is due to some fortuitous circumstance and as will be shown below the linear dimensions of the dent vary with those of the ball very accurately, even when the range of diameter of the ball is greater than in Fig. 10.

Taking the mean value of β we get, for this slowly evolved block,

$$p = 6.4 \times 10^8 \text{ dynes per sq. cm.}$$

Again, the specimen of lead has a small value for p , and the curves in this figure bend over towards axis of velocities.

The time of impact is

$$\frac{\pi d^2}{8Du} = \frac{\pi D}{8} \cdot \frac{d^2}{D^2u}.$$

Now $\frac{d^2}{D^2u}$ is a constant, thus the time of impact is directly proportional to the diameter of the impinging ball. The above expression for the time may be written

$$t = \frac{\pi}{8\sqrt{2g}} \cdot \frac{D}{\beta},$$

and thus the time of impact for a ball of 1 cm. diameter is $\cdot 745 \times 10^{-4}$. The time of impact of the three balls is thus:—

<i>D</i>	<i>t</i>
1·27	$\cdot 89 \times 10^{-4}$
2·54	$1\cdot 79 \times 10^{-4}$
3·81	$2\cdot 68 \times 10^{-4}$.

After performing the experiments described above, it was necessary to test the accuracy with which *d* and *D* are proportional. For this purpose another piece of lead was taken and three sets of experiments performed without replanning the surface. The results are set out below:—

<i>D</i>	<i>d</i>	Number of experiments of which <i>d</i> is the mean.	<i>h</i>	$\frac{1\cdot 27d}{D}$	<i>p</i>
1·27	·3033	12	100	·3033	} 12×10^8
2·54	·6117	6	100	·3058	
3·81	·8975	4	100	·2991	

The numbers in the last column are nearly the same, and thus *d* and *D* are proportional to a considerable degree of accuracy. To test this point further a number of steel spheres were obtained from the Automachinery Company of Coventry. They were made of "hard" steel, and had a highly polished surface; no difference in the density of the material could be detected by the balance.

Fig. 11 shows the results of a series of experiments with this set of spheres. The height of fall was 100 cm. in all cases. The block of lead on which the spheres fell weighed about 100 kilos. and was approximately cubical. It was a chilled casting, the lead being allowed to cool until solidification began, before it was poured into the mould. The mould consisted of four blocks of iron set up on a slab of iron. The surface which was used in the experiments was that in contact with the slab of iron forming

the bottom of the mould. On planing up, the surface showed a fine grained crystalline structure. In Fig. 11 the ordinates give the diameter of the dents in cms. but the abscissæ give the diameter of the balls in *inches*.

The points thus determined come very nearly on a straight line and this is true for a range of diameters from a quarter of an inch up to two inches. The small discrepancies would have probably disappeared if it had been practicable to have used the average of several results for each ball. This was not done, as it was desired to use the same surface throughout, and not to use it all up on one or two points, as was done in the experiments in which three balls were dropped from the same height. The points plotted are the results of one experiment for each ball.

The constant p computed from Fig. 11 is 7.3×10^8 .

Using the block of lead which gave the result $p = 12 \times 10^8$, some experiments were made to test the validity of the formula

$$pV = Mgh,$$

or

$$p = \frac{32g}{\pi} \cdot \frac{MDh}{d^4},$$

when the material of the impinging sphere was varied. The results are set out in the table below:—

Material of the sphere	M	D	h	d	$\frac{MhD}{d^4}$	$p = \frac{32g}{\pi} \cdot \frac{MhD}{d^4}$		
Stone	5.15	1.56	160	{ .31 .32 .33	1.26×10^5	13×10^8		
Steel	66.95	2.54	100	{ .60 .60 .61			1.28×10^5	13×10^8
Glass	26.28	{ 2.69 2.70 2.68	100	{ .49 .50 .50 .51 .51 .51				

If the formula had been obeyed the last two columns should each contain equal numbers. The numbers are not very different and the formula is obeyed approximately.

Fig. 11.

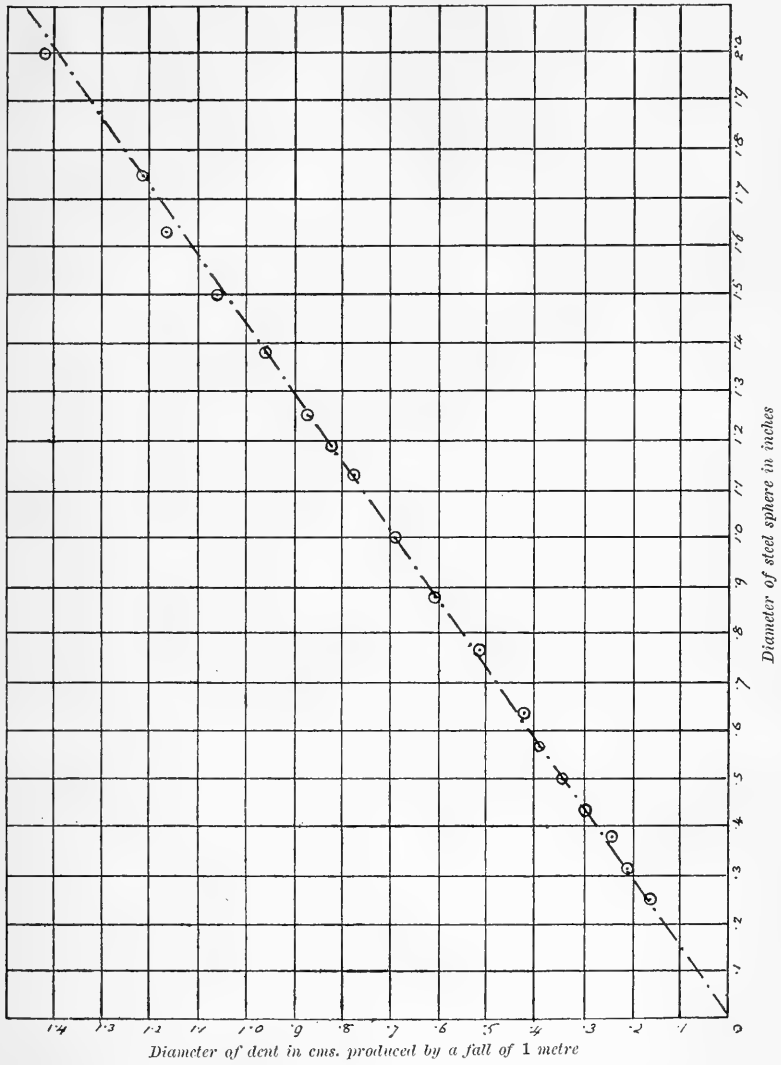

The complete formula giving the relation between the volume of the dent and the height of fall is probably more nearly approached by any of the formulæ

$$pV = Mg(h - h'),$$

$$pV = \frac{1}{2}M(u^2 - v^2),$$

$$p(V + V' + V'' + \&c.) = Mgh,$$

in which h' is the height of the first rebound, v the velocity of rebound, V the volume of the 1st dent and V' , V'' , &c., the volumes of the successive dents. It seems then that the complete law must involve a knowledge of the coefficient of restitution for different velocities of impact. But this number e is more nearly constant as the dents get smaller: that is to say the bodies suffering small permanent deformation have a nearly constant value for e ¹. Thus the laws which we have seen are nearly obeyed for lead would probably be obeyed with greater accuracy for brass, for example, if we put in a term for e . Thus for steel balls falling on brass it is probable that the formula

$$pV = \frac{1}{2}Mu^2(1 - e^2)$$

would hold.

Dents in Brass and Cast Iron.

When "hard" steel balls impinge on surfaces of brass or of cast-iron the diameters of the dents are found to be proportional to the diameters of the spheres if the height from which they fall is constant.

The fourth power of the diameter of the dent is also again proportional to the height if other circumstances are unchanged.

These results follow from the numbers set out below.

Steel ball falling on	Height of fall	Diameter of Dent in cms.	
		For ball 2.54 cms. diameter	For ball 5.08 cms. diameter
Brass	80 cm.	.37, .38, .37	.77, .77
	5 cm.	.19, .21, .21	.40, .40
Cast iron	320 cm.	.40	.79
	20 cm.	.20, .22	.38, .37

¹ Hodgkinson, *loc. cit.*

Direct determination of e for Steel Ball and Lead Block.

The ball used weighed 67 grammes, was 2.54 cms. in diameter and the pendulum was 109 cms. long. The block weighed about 80 kilos. and was slowly a cooled one, exhibiting large crystals on planing up the surface.

After obtaining the values shown in Fig. 12 by points surrounded by circles the block was hammered with a small hammer till it was quite smooth, then a block of steel was put on the surface, having a planed surface in contact with the lead. Repeated blows with a sledge-hammer were then given to the steel block

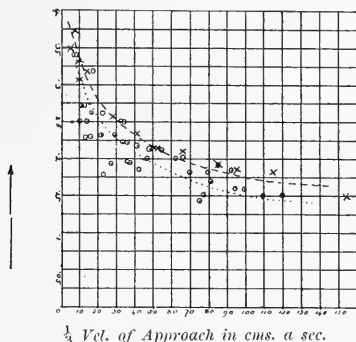

FIG. 12.

and the lead surface, this rendered quite flat was used again in determining those points in the figure indicated by crosses. It was at once noticed that hammering the lead made the results more uniform. Hammering also raises the value of the coefficient of restitution for any given velocity.

On comparison with Fig. 7 it will be seen that these results are in general agreement with those obtained by the measurement of successive dents.

In Fig. 13 some determinations are given for two lead blocks, one chilled, the other slowly cooled. These results are set out below :—

Slowly cooled lead block.

$\frac{1}{3}$ vel. of approach	e		Rise in e due to hammering.
	before	after hammering	
10	·270	·370	·100
50	·194	·262	·068
154	·146	·187	·041

Chilled lead block.

10	·200	·310	·110
50	·150	·236	·086
154	·114	·152	·038

The values of e are given to three figures because they are the mean of a number of observations.

From this experiment e is less for chilled lead than for slowly cooled lead, while the effect of hammering is to raise e (for any velocity) by approximately the same amount for both blocks.

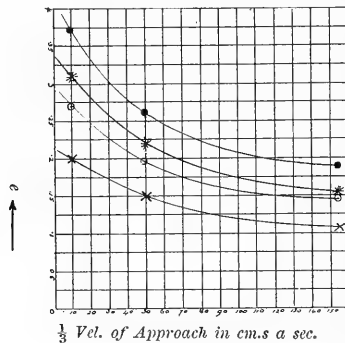

FIG. 13.

- Cooled slowly and hammered.
- „ „ (before hammering).
- * „ „ quickly and hammered.
- × „ „ (before hammering).

Before hammering the chilled block, dents for various steady loads were measured. The dents were made with a steel ball similar to that used in the pendulum experiments. This was constrained to move in a vertical direction by contact with a conical hollow tool placed in the jaws of a drilling machine. The load was applied slowly by a screw, which when turned sufficiently, lifted a scale-pan containing the weights. The pressure was thus transmitted by the vertical rod of the drilling machine to the ball. This rod moved quite freely in well lubricated bearings in a vertical direction, and thus the ball had only one degree of freedom. Some experiments in which the ball was not thus constrained were useless owing to the dents being ill-shaped. The above arrangement worked quite satisfactorily.

The results are given in Fig. 14, which shows that the square of the diameter of the dent is approximately proportional to the load. From this figure we find P the pressure which the lead can

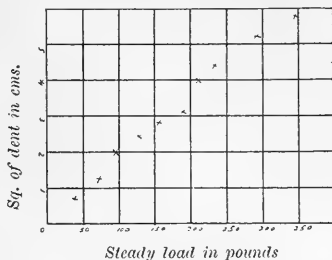

FIG. 14.

support to be $\frac{4}{\pi \times .0019}$ pounds weight per sq. cm. or nearly 3×10^8 dynes per sq. cm. Now from the impact experiments already performed we find that p has a value always much greater than this. But the dents produced by impact were measured for this piece of lead and gave:—

u	d		e	
	before	after hammering	before	after hammering.
150	.43	.42	.150	.236
462	.72	.71	.114	.152

The mean value for p before hammering is thus 6.2×10^8 .

This shows that the pressure the lead exerts on the ball during impact is about twice as great as the pressure which the lead can resist in the form of a steady load.

The results in the above table show also that the increase in the value of p due to hammering is accompanied by an increase in the value of e .

The value of P was also determined after hammering. A load of 350 lbs. before hammering gave a dent .77 cms. in diameter, but after hammering, the same load gave a dent .71 cms. in diameter. Thus P rises considerably, due to the hammering.

The block of lead used in Fig. 11 gave a dent .69 diameter with a load of 350 lbs. on a ball 2.54 cms. in diameter, so that different specimens of lead even when chilled differ considerably in the value of P measured under the same conditions.

Experiments with Paraffin Wax.

The phenomena of indentation of paraffin wax by a steel sphere seem to be very similar to those in case of lead.

Fig. 15 shows some sets of readings taken with a steel sphere falling on paraffin.

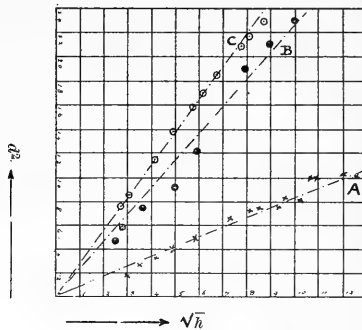

FIG. 15.

In the case of curve *A*, Fig. 12, the dents were measured on the paraffin block. The block was used as it comes from the makers except that it was planed up. It was obviously filled with air holes, and the way in which such a material obeys the straight line law is very striking.

The character of the dent itself is quite different from the dent in lead. In lead no burr is raised round the depression and the sphere fits the hole it makes. In this case there is a very obvious burr produced, and the hole has a radius of curvature greater than that of the sphere which makes it. It was found difficult to measure the dent in paraffin accurately; but the steel ball has a perfectly regular and easily measured mark on it which is easily measured. This patch is as near as could be determined equal to the dent.

Curve 15 *B* is obtained in this way from paraffin wax which had been kept melted for some time to get rid of contained gases. The diameter of the ball was 3.81 cms.

Curves 15 *A* and *B* are both for "hard" paraffin, while curve 15 *C* refers to "soft" paraffin. This block was much larger than

the rest being about $30 \times 30 \times 15$ c.cms. in volume. The values of p and t calculated from these curves are given below:—

Curve	D Diameter of Steel Ball in cms.	Kind of Paraffin	p dynes per sq. cm.	t in secs.
15 A	2.54	“Hard”	2.4×10^8	2.9×10^{-4}
15 B	3.81	“Hard” re-melted	1.7×10^8	4.1×10^{-4}
15 C	3.81	“Soft” re-melted	1.2×10^8	6.3×10^{-4}

From this table we see that though p is less than in the case of lead, it is of the same order of magnitude. For same height of fall and with balls of one material d varies with D as is shown in the following table:—

h cms.	D cms.	d cms.
21.2	1.27	.33
21.2	2.54	.66
21.2	3.81	1.03
126.6	1.27	.48
126.6	2.54	1.07
126.6	3.81	1.63

Coefficient of Restitution for Steel Spheres impinging on Paraffin, Brass, and Cast-Iron.

Experiments on the value of e for a steel ball and paraffin, brass, and cast-iron blocks were performed. The results are set

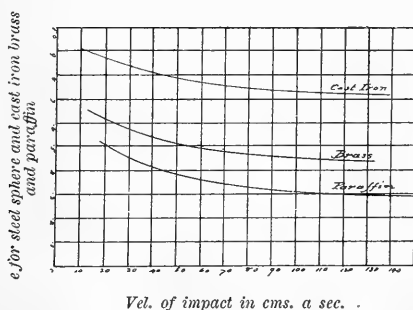

FIG. 16.

out in Fig. 16. It will be seen that paraffin although more easily deformed than lead has always a higher coefficient of restitution.

The experiments were performed on massive blocks of the materials.

Summary of Results.

In the case of indiarubber balls impinging on a non-deformable plane and also for a non-deformable sphere impinging on a block of indiarubber, the equation

$$e = e_0 - mu$$

gives the value of e for any velocity of approach u , e_0 and m being positive and constant.

For a steel ball impinging on the plane surface of a lead, paraffin, brass, or cast-iron block e rises rapidly when the velocity of approach becomes small. For large velocities of approach e is given approximately by the same formula as above.

Hammering the surface of lead increases e whether the lead be a "chilled" or a slowly cooled casting.

The dents produced by the impact of non-deformable spheres on plane surfaces of lead, paraffin, brass, and cast-iron obey the following simple rules when the velocity of impact is not great :

(1) The square of the diameter of the dent is proportional to the velocity of impact.

(2) For spheres of the same material impinging with the same velocity, the diameter of the dent is proportional to the diameter of the sphere.

From which it follows when e is small, i.e. for lead and paraffin, that :

(3) The time taken by any one sphere to produce a dent is independent of the velocity of impact.

(4) The pressure (p) between the surfaces in contact is constant during this time. The value of p for different specimens of lead varies from 6×10^8 to 13×10^8 dynes per sq. cm. While for "soft" paraffin it is about 1×10^8 dynes per sq. cm.

These results may be grouped together when the velocity of impact and the radius of the sphere both change by the rule that :

(5) The volume of the dent is proportional to the energy of motion of the sphere just before impact. This was found also to apply even when the material of which the impinging sphere was changed.

For steady loads the square of the diameter of the dent is proportional to the load. The pressure (P) between the surfaces in contact is constant, and in the case of lead is about one-half of p .

(6) The time of impact is directly proportional to the diameter of the impinging ball if other things are constant.

Conclusion.

The result (5) is in accord with Martel's¹ work on the indentation produced by a pyramidal steel tool driven into a metal block by a falling weight. He showed that the volume of the indentation was nearly proportional to the work of the falling weight. The volume was also nearly the same for tools of somewhat different form.

Unwin¹ suggests that P and p would be found to differ.

In conclusion I wish to thank Prof. J. J. Thomson for many valuable suggestions.

¹ From Unwin, *Testing of Materials of Construction*. He gives the reference to Martel's work as *Commission des Méthodes d'Essai des Matériaux de Construction*, Tome II. p. 261.

The Classification of Conics and Quadrics. By T. J. F.A. BROMWICH, M.A., Fellow of St John's College, Cambridge.

[Received 26 April 1900.]

THIS problem is one of the oldest in the theory of quadratic forms and has been handled by many writers. Until recently, however, it has not been treated by the Weierstrassian methods of classification, and this is probably due to the fact that some modifications are necessary which prevent the direct application of the method.

Hensel has attacked the problem (*Crelle*, 113 (1894), p. 303) without using metrical methods (*i.e.* without the absolute) and his results agree with what has been found in Sec. 2 of the following, but of course the reduction is not complete from a metrical point of view. Hensel's process is considerably simplified by this omission.

Timerding (*Crelle*, 122 (1900), p. 172) has recently published an investigation on the same lines as Hensel's; this follows very closely the reduction of a quadric to its centre, given in books on solid geometry.

Gundelfinger (*Vorlesungen aus Anal. Geom. Kegelschnitte*, edited by Dingeldey, 1895) has considered the problem in all its generality for conics; and Brückel (*Crelle*, 119 (1898), p. 210 and p. 313) for quadrics. The method given below differs considerably from theirs (which are essentially the same) in the case of point-coordinates. For tangential equations their method is virtually the same as mine (Sec. 3); but I have abbreviated the process by using a method of simplifying Weierstrass's solution of the case when one of the fundamental forms of the family (*Schaar*) has a zero determinant. (See a note presented to the London Math. Soc., 5th April, 1900.)

It should be remarked that the method of reduction given in Sec. 1 below ought to be capable of being applied to the case when the comparison quadric is not of the special type used in the remainder of the paper (*i.e.* is not *definite*).

1. *Preliminary consideration of bilinear forms.*

Let $A = \sum_{r,s} a_{rs} x_r y_s$, $B = \sum_{r,s} b_{rs} x_r y_s$ be two bilinear forms each of which is symmetrical, so that $a_{sr} = a_{rs}$, $b_{sr} = b_{rs}$. Then let

$$C = \sum_{r,s} c_{rs} x_r y_s = \lambda A - B,$$

so that C is also a symmetric bilinear form, and then consider the form

$$D = \frac{1}{\Delta_1} \begin{vmatrix} c_{rs} & p_r & y_r \\ p_s & 0 & 0 \\ x_s & 0 & 0 \end{vmatrix}, \quad (r, s = 1, 2, \dots, n),$$

where $\Delta_1 = \begin{vmatrix} c_{rs} & p_r \\ p_s & 0 \end{vmatrix}.$

Here the p 's are supposed to be constants and the determinants are abbreviated symbols¹ for determinants of $(n + 2)$ or $(n + 1)$ rows and columns.

Take the symbolical product CD in the sense given by Frobenius (*Crelle*, 84 (1878), p. 1)²; this is obtained by writing $\sum_t c_{tr} x_t$ instead of x_r in D . Thus

$$CD = \frac{1}{\Delta_1} \begin{vmatrix} c_{rs} & p_r & y_r \\ p_s & 0 & 0 \\ \sum_t c_{tr} x_t & 0 & 0 \end{vmatrix} = \frac{1}{\Delta_1} \begin{vmatrix} c_{rs} & p_r & y_r \\ p_s & 0 & 0 \\ 0 & -\sum p_r x_r & -E \end{vmatrix},$$

where $E = \sum x_r y_r$ is the unit-form (*Einheitsform*).

It will save a certain amount of repetition if we write

$$p_x = \sum p_r x_r, \quad p_y = \sum p_r y_r.$$

With these symbols we now have

$$CD = -E + \frac{p_x}{\Delta_1} \begin{vmatrix} c_{rs} & y_r \\ p_s & 0 \end{vmatrix}.$$

¹ This suggestion has been made both by Frobenius and by Nanson.

² This method of multiplication is really Cayley's method of combining matrices.

Similarly

$$DC = -E + \frac{p_y}{\Delta_1} \begin{vmatrix} c_{rs}, & p_r \\ x_s, & 0 \end{vmatrix}.$$

Expand D in powers of $(1/\lambda)$, and let us write

$$D = \Sigma D_m \lambda^m,$$

where m will extend from -1 to $-\infty$ and may also include a finite number of positive indices as well.

Write further, also expanding in powers of $(1/\lambda)$,

$$\frac{1}{\Delta_1} \begin{vmatrix} c_{rs}, & y_r \\ p_s, & 0 \end{vmatrix} = \Sigma \eta_m \lambda^m, \quad \frac{1}{\Delta_1} \begin{vmatrix} c_{rs}, & p_r \\ x_s, & 0 \end{vmatrix} = \Sigma \xi_m \lambda^m,$$

then by the symmetry of C , ξ_m will be the same function of x_1, \dots, x_n that η_m is of y_1, \dots, y_n . We shall suppose that $\lambda^{\alpha-1}$ is the highest power of λ which occurs in $\Sigma \xi_m \lambda^m$; and λ^β the highest in $\Sigma D_m \lambda^m$. Then we have

$$\begin{aligned} (\lambda A - B) \Sigma D_m \lambda^m & \quad (m = \beta, \beta - 1, \dots, -\infty) \\ = -E + p_x (\Sigma \eta_m \lambda^m) & \quad (m = \alpha - 1, \alpha - 2, \dots, -\infty). \end{aligned}$$

Hence $\beta \geq (\alpha - 2)$, and if $\beta > \alpha - 2$ we shall have $AD_\beta = 0$, so that $A = 0$ if $D_\beta \neq 0$. By comparing coefficients of other powers of λ , we find in general

$$AD_{m-1} - BD_m = p_x \eta_m,$$

but for $m = 0$, $AD_{-1} - BD_0 = -E + p_x \eta_0$.

It is to be noted that the products on the left are all symbolical; while those on the right give a simple product of two linear functions which will be itself a bilinear form, capable of symbolical combinations.

Similarly, from the value of DC , we find

$$\begin{aligned} D_{m-1}A - D_mB & = p_y \xi_m, & \text{in general,} \\ D_1A - D_0B & = -E + p_y \xi_0 & (m = 0). \end{aligned}$$

Hence

$$\begin{aligned} AD_{-1}A & = A(D_{-1}A - D_0B) + (AD_0 - BD_1)B + BD_1B \\ & = -A + A(p_y \xi_0) + (p_x \eta_1)B + BD_1B, \end{aligned}$$

where now $A(p_y \xi_0)$ and $(p_x \eta_1)B$ are symbolical products; to form say the former of them, we have to replace x_r in $(p_y \xi_0)$ by the

linear function $\sum_t a_{tr}x_t$ and we thus obtain $p_y\xi_0'$ where ξ_0' is the term independent of λ in the expansion of

$$\frac{1}{\Delta_1} \begin{vmatrix} c_{rs}, & p_r \\ \sum_t a_{ts}x_t, & 0 \end{vmatrix} = \sum \xi_m' \lambda^m.$$

In like manner $(p_x\eta_1)B = p_x\eta_1''$, where

$$\frac{1}{\Delta_1} \begin{vmatrix} c_{rs}, & \sum_t b_{rt}y_r \\ p_s, & 0 \end{vmatrix} = \sum \eta_m'' \lambda^m.$$

We shall use ξ_m'' , η_m' in analogy with η_m'' , ξ_m' respectively, and we now find

$$A = BD_1B - AD_{-1}A + p_y\xi_0' + p_x\eta_1'',$$

while $B = BD_0B - AD_{-2}A + p_y\xi_{-1}' + p_x\eta_0''.$

It must be observed that ξ_m' , ξ_m'' are not independent: for we have

$$\lambda (\sum \xi_m' \lambda^m) - \sum \xi_m'' \lambda^m = \frac{1}{\Delta_1} \begin{vmatrix} c_{rs}, & p_r \\ \sum_t c_{ts}x_t, & 0 \end{vmatrix} = -p_x \frac{\Delta_0}{\Delta_1},$$

where we write $\Delta_0 = |c_{rs}|.$

From these equations it appears that when Δ_0/Δ_1 is expanded in powers of $(1/\lambda)$ the highest power of λ will be λ^α ; further, if we write

$$\Delta_0/\Delta_1 = \delta_\alpha \lambda^\alpha + \delta_{\alpha-1} \lambda^{\alpha-1} + \dots,$$

we shall have

$$\xi_{\alpha-1}' = -p_x \delta_\alpha,$$

and generally $\xi_{m-1}' - \xi_m'' = -p_x \delta_m.$

Substituting, we have

$$A = BD_1B - AD_{-1}A + p_y\xi_1'' + p_x\eta_1'' - p_x p_y \delta_1,$$

$$B = BD_0B - AD_{-2}A + p_y\xi_0'' + p_x\eta_0'' - p_x p_y \delta_0.$$

These forms will be the best for our future investigation; and now write $y_r = x_r$ in each term, which will give the corresponding quadratic forms

$$A = F_1 - G_{-1} + 2p_x \zeta_1 - p_x^2 \delta_1,$$

$$B = F_0 - G_{-2} + 2p_x \zeta_0 - p_x^2 \delta_0,$$

where we write

$$F = \sum F_m \lambda^m = \frac{1}{\Delta_1} \left| \begin{array}{ccc} c_{rs}, & p_r, & \sum_t b_{rt} x_t \\ p_s, & 0, & 0 \\ \sum_t b_{ts} x_t, & 0, & 0 \end{array} \right|, \quad (m = \beta, \beta - 1, \dots, -\infty),$$

$$G = \sum G_m \lambda^m = \frac{1}{\Delta_1} \left| \begin{array}{ccc} c_{rs}, & p_r, & \sum_t a_{rt} x_t \\ p_s, & 0, & 0 \\ \sum_t a_{ts} x_t, & 0, & 0 \end{array} \right|, \quad (m = \beta, \beta - 1, \dots, -\infty),$$

$$\zeta = \sum \zeta_m \lambda^m = \frac{1}{\Delta_1} \left| \begin{array}{cc} c_{rs}, & p_r \\ \sum_t b_{ts} x_t, & 0 \end{array} \right|, \quad (m = \alpha - 1, \alpha - 2, \dots, -\infty),$$

$$\delta = \sum \delta_m \lambda^m = \Delta_0 / \Delta_1, \quad (m = \alpha, \alpha - 1, \dots, -\infty).$$

2. *Application to the principal axes problem.*

Let $A = 0$ be the equation to a quadric in homogeneous coordinates of space of $(n - 1)$ dimensions; and then $B = 0$ will be chosen to be any hyper-sphere in this space, the coefficients of B being adjusted so that for a point x not on the hyper-sphere, B will represent the square of the tangent from x to the hyper-sphere. The coordinates of any point will be connected by a relation, which is here assumed to be

$$\sum_r p_r x_r = p_x = 1,$$

so that the hyper-plane at infinity is $p_x = 0$.

Now returning to the forms found at the end of Section 1, we see that we can reduce G to the form

$$G = -\sum y_r^2 / \theta_r (\lambda - \theta_r), \quad (r = 1, 2, \dots, h),$$

by using the process given by Weierstrass¹, Darboux², and Stickelberger³. Here $(\lambda - \theta_r)$ is a typical factor of Δ_1 , y_r is a corresponding linear function of the x 's, and h is the index of the highest power of λ in Δ_1 . There may also be positive powers of λ in the expression for G , but we are not concerned with these.

¹ *Berl. Berichte*, 1868 = *Ges. Werke*, 2, p. 19.

² *Liouville* (1874), 19 (2nd Ser.), p. 347.

³ *Crelle* (1879), 86, p. 20.

It should be observed that any number of θ 's may be equal without affecting the form of G ; for all the invariant-factors of Δ_1 (*Elementartheiler*) must be linear¹, and then the form of G will still be the same though we are left with some arbitrary quantities in the y 's (two simple illustrations of the geometrical meaning of this arbitrariness are given by considering a surface of revolution and a sphere in space of three dimensions).

Expanding G we see that the negative powers of λ give

$$G_{-1}\lambda^{-1} + G_{-2}\lambda^{-2} + \dots = -\sum_r y_r^2 \left(\frac{1}{\theta_r \lambda} + \frac{1}{\lambda^2} + \frac{\theta_r}{\lambda^3} + \dots \right),$$

or
$$G_{-1} = -\sum_r y_r^2 / \theta_r, \quad G_{-2} = -\sum_r y_r^2, \quad (r = 1, 2, \dots, h).$$

We shall next require the coefficient of λ and the term independent of λ in the expansion of F in powers of $(1/\lambda)$; these can be found by a method given in my note quoted above (p. 358) which is analogous to the Weierstrass-Darboux process. Since the invariant-factors of Δ_1 which correspond to the infinite root are here linear, this will be found to give no term in λ and the term independent of λ will be

$$\sum_r z_r^2, \quad (r = 1, 2, \dots, n - h - 1).$$

From this it appears that

$$F = \sum_r z_r^2 + \text{negative powers of } \lambda,$$

and there are no positive powers of λ in F .

Thus $\beta = 0$ and hence $\alpha \equiv \beta + 2 \equiv 2$.

Now returning to the values of A, B found in Section 1, we shall find, on putting $p_x = 1$,

$$\begin{aligned} A &= \sum_r y_r^2 / \theta_r + 2\zeta_1 - \delta_1 \\ B &= \sum_r y_r^2 + \sum_s z_s^2 + 2\zeta_0 - \delta_0 \end{aligned} \quad \left(\begin{array}{l} r = 1, 2, \dots, h \\ s = 1, 2, \dots, n - h - 1 \end{array} \right),$$

¹ Δ_1 is the determinant of $(\lambda A - B)$ when the x 's are subject to the condition $\sum p_r x_r = 0$; or, more precisely, if x_n be eliminated from $(\lambda A - B)$ by this condition, the determinant of the resulting quadratic form of $(n - 1)$ variables is Δ_1 multiplied by a power of p_n . When this elimination is made in B the resulting form is *definite* (in the variables x_1, \dots, x_{n-1}); thus by a theorem due to Weierstrass (*Berl. Berichte*, 1858 = *Ges. Werke*, 1, p. 233) it is clear that the invariant-factors of Δ_1 are all real and linear. Since these are real, all our transformations will be real; and further $\Delta_1(0) \neq 0$, so that all the θ 's are different from zero. Since the invariant-factors are all linear, it follows from the investigation of Weierstrass (*Berl. Berichte*, 1868 = *Ges. Werke*, 2, p. 19) and others, that the reduced form of G is the same as if all the factors of Δ_1 were distinct. If $h < (n - 1)$ there will be infinite roots of $\Delta_1 = 0$; the corresponding invariant factors are found by taking those to base μ of the determinant obtained by writing $c_{rs} = a_{rs} - \mu b_{rs}$ in Δ_1 ; these are linear by the same argument.

$(2\xi_0 - \delta_0)$ will be a linear function of the y 's and z 's and a constant term, consequently B has now the form it would have if y_r, z_s formed an orthogonal set of Cartesians in space of $(n-1)$ dimensions; and this must therefore be the case.

Thus to complete the reduction of A we have only to find ξ_1 ; but the highest power of λ in ξ is $\lambda^{\alpha-1}$, so if $\alpha \geq 1$, $\xi_1 = 0$. Hence we find

$$\begin{aligned} \alpha = 1, \quad A &= \sum_r y_r^2 / \theta_r - \delta_1 \\ \alpha < 1, \quad A &= \sum_r y_r^2 / \theta_r \end{aligned} \quad (r = 1, 2, \dots, h),$$

for if $\alpha < 1$, $\delta_1 = 0$.

The case remaining is that of $\alpha = 2$; here we shall see that ξ_1 can be expressed by means of a z . For, using the fundamental transformation of Darboux's paper, we find

$$F = \frac{1}{\Delta_0} \begin{vmatrix} c_{rs}, & \sum_t b_{rt} x_t \\ \sum_t b_{st} x_t, & 0 \end{vmatrix} - \frac{\Delta_1}{\Delta_0} \xi^2.$$

The highest power of λ in Δ_0 is λ^{h+2} (as $\alpha = 2$) and consequently (using the same method as used before to reduce F) the part independent of λ in the first term on the right is of rank $(Rang) = (n-h-2)$, *i.e.* it can be expressed as the sum of $(n-h-2)$ squares. The term independent of λ in $-(\Delta_1/\Delta_0)\xi^2$ is clearly $-\xi_1^2/\delta_2$, so we have

$$F_0 = \sum_r z_r^2 = (n-h-2) \text{ squares} - \xi_1^2/\delta_2.$$

Thus $\xi_1^2 = -\delta_2 z_1^2$, selecting z_1 to be the particular one of the z 's to go with ξ_1 .

$$\text{Hence if } \alpha = 2, \quad A = \sum_r y_r^2 / \theta_r + 2(-\delta_2)^{\frac{1}{2}} z_1 + \delta_1,$$

and clearly the term δ_1 may be combined with z_1 without altering the form of B .

Hensel uses a number J_0 to classify his results, and defines

$$J_0 = (\text{rank of } A) - (\text{rank of quadratic terms in } A),$$

thus we find the correspondence

$$\alpha = 2, J_0 = 2; \quad \alpha = 1, J_0 = 1; \quad \alpha < 1, J_0 = 0.$$

It should be remarked that corresponding to $J_0 = 0$ we may have $\alpha = 0, -1$ or -2 . Without giving the details of the proof, I may indicate its lines; $-B$ is a form of rank n and signature

$(n - 2)$ (*Signatur*, introduced by Frobenius, *Berl. Berichte*, 1894 = *Crelle*, 114, p. 187). For clearness we give the definition,

$$\text{signature} = (\text{number of positive squares}) - (\text{number of negative squares}).$$

We can now apply a theorem due to F. Klein (Inaug. Diss. Bonn, 1868 = *Math. Annalen*, 23, p. 539)¹ and deduce that at most one invariant-factor of Δ_0 is not linear: and this one may be squared or cubed. Further the invariant-factors of Δ_1 are all linear. These facts will connect α and J_0 .

Hensel's second classifying number is $J_1 = h$ (the rank of the quadratic terms in A).

We add a classified list of conics ($n = 3$) and quadrics ($n = 4$); and we should remark that in drawing these out we have

$$0 \leq h \leq (n - 1) \text{ or } (n - \alpha).$$

Conics ($n = 3$).

Note. α is the highest power of λ in the expansion of (Δ_0/Δ_1) in powers of $1/\lambda$.

(i) $\alpha = 2, J_0 = 2$.

$$(1) \quad h = 1, \quad A = y_1^2/\theta_1 + 2kz_1, \quad \text{parabola.}$$

$$(2) \quad h = 0, \quad A = 2kz_1, \quad \left\{ \begin{array}{l} \text{pair of lines, one} \\ \text{at infinity.} \end{array} \right.$$

$$k = \text{Lt}_{\lambda=\infty} (-\Delta_0/\lambda^2\Delta_1)^{\frac{1}{2}}.$$

(ii) $\alpha = 1, J_0 = 1$.

$$(3) \quad h = 2, \quad A = y_1^2/\theta_1 + y_2^2/\theta_2 + k', \quad \text{central conic.}$$

$$(4) \quad h = 1, \quad A = y_1^2/\theta_1 + k', \quad \text{parallel lines.}$$

$$(5) \quad h = 0, \quad A = k', \quad \left\{ \begin{array}{l} \text{two lines, both at} \\ \text{infinity.} \end{array} \right.$$

$$k' = \text{Lt}_{\lambda=\infty} (-\Delta_0/\lambda\Delta_1).$$

(iii) $\alpha < 1, J_0 = 0$.

$$(6) \quad h = 2, \quad A = y_1^2/\theta_1 + y_2^2/\theta_2, \quad \text{pair of lines.}$$

$$(7) \quad h = 1, \quad A = y_1^2/\theta_1, \quad \text{two coincident lines.}$$

$$(8) \quad h = 0, \quad A = 0.$$

¹ It may be pointed out that Klein's results have been considerably extended by A. Loewy (*Math. Annalen*, 52, p. 588 and *Crelle*, 122 (1900), p. 153). These papers give inequalities connecting the numbers of various classes of invariant-factors of $\lambda A - B$ with the characteristic and signature of B .

It may be remarked that here $(\lambda - \theta_1), (\lambda - \theta_2)$ are factors of Δ_1 ; and that further subdivisions of each class may be made, by examining the signs and equalities of θ_1, θ_2 . This is done in the ordinary text-books on conics and may be omitted here. Hensel gives the subdivision according to the possible arrangements of signs (by using Sylvester's "law of inertia" of quadratic forms), but his method will not give the absolute values of θ_1, θ_2 and so does not give the subdivision $\theta_1 = \theta_2$.

Quadrics ($n = 4$).

Note. α is the highest power of λ in the expansion of (Δ_0/Δ_1) in powers of $1/\lambda$.

(i) $\alpha = 2, J_0 = 2$.

$$(1) \quad h = 2, \quad A = y_1^2/\theta_1 + y_2^2/\theta_2 + 2kz_1, \quad \text{paraboloid.}$$

$$(2) \quad h = 1, \quad A = y_1^2/\theta_1 + 2kz_1, \quad \text{parabolic cylinder.}$$

$$(3) \quad h = 0, \quad A = 2kz_1, \quad \left. \begin{array}{l} \text{two planes, one} \\ \text{at infinity.} \end{array} \right\}$$

$$k = \text{Lt}_{\lambda=\infty} (-\Delta_0/\lambda^2\Delta_1)^{\frac{1}{2}}.$$

(ii) $\alpha = 1, J_0 = 1$.

$$(4) \quad h = 3, \quad A = y_1^2/\theta_1 + y_2^2/\theta_2 + y_3^2/\theta_3 + k', \quad \left. \begin{array}{l} \text{central} \\ \text{quadric.} \end{array} \right\}$$

$$(5) \quad h = 2, \quad A = y_1^2/\theta_1 + y_2^2/\theta_2 + k', \quad \text{cylinder.}$$

$$(6) \quad h = 1, \quad A = y_1^2/\theta_1 + k', \quad \left. \begin{array}{l} \text{two parallel} \\ \text{planes.} \end{array} \right\}$$

$$(7) \quad h = 0, \quad A = k', \quad \left. \begin{array}{l} \text{two planes,} \\ \text{both at} \\ \text{infinity.} \end{array} \right\}$$

$$k' = \text{Lt}_{\lambda=\infty} (-\Delta_0/\lambda\Delta_1).$$

(iii) $\alpha < 1, J_0 = 0$.

$$(8) \quad h = 3, \quad A = y_1^2/\theta_1 + y_2^2/\theta_2 + y_3^2/\theta_3, \quad \text{cone.}$$

$$(9) \quad h = 2, \quad A = y_1^2/\theta_1 + y_2^2/\theta_2, \quad \text{two planes.}$$

$$(10) \quad h = 1, \quad A = y_1^2/\theta_1, \quad \text{two coincident planes.}$$

$$(11) \quad h = 0, \quad A = 0.$$

Here $(\lambda - \theta_1)$, $(\lambda - \theta_2)$, $(\lambda - \theta_3)$ are factors of Δ_1 ; and we can subdivide each class according to possible equalities and arrangements of sign amongst θ_1 , θ_2 , θ_3 . These subdivisions may be found in all text-books on Solid Geometry. The remark above (referring to Hensel's further subdivisions) applies here also.

3. Conics or quadrics given by a tangential equation.

There are some cases in which the point-equation does not give sufficient information to completely determine the conic or quadric. For instance, a conic in a plane has a space tangential equation, but the corresponding point-equation is simply the equation to its plane squared. It is therefore convenient to have a method of classifying by means of the tangential equation, directly.

Let then $A = \sum a_{rs}v_rv_s$ ($r, s = 1, 2 \dots n$) be the given tangential equation and let $B = \sum b_{rs}v_rv_s$ be the tangential equation to the absolute with the coefficients b_{rs} determined so that the perpendicular on the generalized plane $\sum v_r x_r = 0$ is $\sum v_r x_r / B^{\frac{1}{2}}$, when the x 's are subject to the relation $\sum p_r x_r = 1$ as before. It follows that as the absolute is a (generalized) conic in the hyper-plane at infinity $\sum p_r x_r = 0$, we shall have $|B| = 0$ and the point-equation corresponding to $B = 0$ will be $(\sum p_r x_r)^2 = 0$, i.e. the first minors of $|B|$ will be proportional to $p_r p_s$. So let us write $k p_r p_s$ as the minor of b_{rs} ; we may note that we have further

$$\sum b_{rs} p_r = 0, \quad (r, s = 1, 2 \dots n).$$

We have now to consider the simultaneous reduction of the forms A, B ; and we observe that B is a *definite* form of rank $(n - 1)$, consequently by a theorem of Weierstrass's¹ the determinant $|\kappa A + \lambda B|$ may have one invariant-factor κ^2 but no more, but under ordinary circumstances there will be the one invariant-factor κ . Besides this one, all the other invariant-factors must be linear.

The reduction of $(A - \lambda B)$ for the finite roots of $|A - \lambda B| = 0$ can be carried out by the ordinary Weierstrass or Darboux process, thus if $(\lambda - c)^l$ is a factor of $|A - \lambda B|$, $(\lambda - c)$ will be a factor of

¹ Quoted in a previous footnote (p. 363).

every minor up to the l th minors, and we shall have corresponding parts of A, B in Darboux's form

$$A = c (V_1^2 + \dots + V_l^2),$$

$$B = (V_1^2 + \dots + V_l^2),$$

where V_k is the limit for $\lambda = c$ of the function

$$\left(\frac{\lambda - c}{\Delta_{k-1} \Delta_k} \right)^{\frac{1}{2}} \begin{vmatrix} a_{rs} - \lambda b_{rs}, & q_r^{(\alpha)}, & q_r^{(k)} \\ q_s^{(\alpha)} & , & 0 \\ B_s & , & 0 \end{vmatrix}, \quad (r, s = 1, 2, \dots, n, \\ \alpha = 1, 2, \dots, k-1),$$

and

$$\Delta_{k-1} = \begin{vmatrix} a_{rs} - \lambda b_{rs}, & q_r^{(\alpha)} \\ q_s^{(\alpha)} & , & 0 \end{vmatrix}, \quad B_s = b_{1s}v_1 + \dots + b_{ns}v_n;$$

here the q 's are arbitrary constants and the value zero for c is not excluded.

But with regard to the infinite root of $|A - \lambda B| = 0$ we shall have to take special steps. I apply a method given by myself in the note quoted above (p. 358). Let us suppose first of all that λ^{n-1} is the highest power of λ that occurs in $|A - \lambda B|$, and then write U for the term independent of λ in the expansion in powers of $(1/\lambda)$ of the expression

$$\frac{1}{(-\Delta_0 \Delta_1)^{\frac{1}{2}}} \begin{vmatrix} a_{rs} - \lambda b_{rs}, & q_r^{(1)} \\ A_s & , & 0 \end{vmatrix}, \quad (r, s = 1, 2, \dots, n),$$

where we put $A_s = a_{1s}v_1 + \dots + a_{ns}v_n$.

With this notation we have the term U^2 in A and no corresponding term in B , by the results of the note quoted. Now the terms of highest degree in λ are respectively (since the minor of b_{rs} in $|B|$ is $k p_r p_s$),

in Δ_0 , $(-\lambda)^{n-1} \sum a_{rs} k p_r p_s = k (-\lambda)^{n-1} \sum a_{rs} p_r p_s$,

in Δ_1 , $-(-\lambda)^{n-1} \sum q_s^{(1)} q_r^{(1)} (k p_r p_s) = -k (-\lambda)^{n-1} (\sum p_r q_r^{(1)})^2$,

in $\begin{vmatrix} a_{rs} - \lambda b_{rs}, & q_r^{(1)} \\ A_s & , & 0 \end{vmatrix}$, $-k (-\lambda)^{n-1} (\sum p_r q_r^{(1)}) (\sum p_r A_r)$.

Thus we find $U^2 = (\sum p_r A_r)^2 / (\sum a_{rs} p_r p_s)$.

But we are to have that for the special values $v_r = p_r$, V_0 is to be unity (for $\sum p_r x_r = 1$). For these special values V_1, \dots, V_{n-1} are zero because $B_s = 0$; and then $\sum p_r A_r = \sum a_{rs} p_r p_s$.

Thus we write

$$V_0 = (\sum p_r A_r) / (\sum a_{rs} p_r p_s),$$

and then we have the term $V_0^2 (\sum a_{rs} p_r p_s)$ in the reduced form of A , with no corresponding term in B . Hence we shall have the complete forms

$$A = \sum_r c_r V_r^2 + (\sum a_{rs} p_r p_s) V_0^2, \quad (r = 1, 2, \dots, n-1),$$

$$B = \sum_r V_r^2.$$

From these it is obvious (remembering the special meaning of B) that the point-coordinates given by

$$V_0 + V_1 X_1 + \dots + V_{n-1} X_{n-1} = v_1 x_1 + \dots + v_n x_n$$

are rectangular Cartesians. We have accordingly found the principal planes of the quadric, and we can put down by inspection the lengths of the principal axes.

In the next place we may have $\lambda = \infty$ a repeated root of $|A - \lambda B|$, then the highest power of λ in $|A - \lambda B|$ is λ^{n-2} . The condition for this is at once seen to be $\sum a_{rs} p_r p_s = 0$. Let us then write

$$\Delta_0 = (-\lambda)^{n-2} [\alpha_1 + \alpha_2/\lambda + \dots],$$

$$\Delta_1 = (-\lambda)^{n-1} [\beta_1 + \beta_2/\lambda + \dots],$$

(so that $\beta_1 = -k (\sum p_r q_r^{(1)})^2$.)

$$\begin{vmatrix} a_{rs} - \lambda b_{rs} & q_r^{(1)} \\ A_s & 0 \end{vmatrix} = (-\lambda)^{n-1} [U_1 + U_2/\lambda + \dots].$$

Then expanding $-\frac{1}{\Delta_0 \Delta_1} \begin{vmatrix} a_{rs} - \lambda b_{rs} & q_r^{(1)} \\ A_s & 0 \end{vmatrix}^2$ in powers of $(1/\lambda)$,

we find

$$\frac{\lambda}{\alpha_1 \beta_1} \left[U_1 + \left\{ U_2 - \frac{1}{2} U_1 \left(\frac{\alpha_2}{\alpha_1} + \frac{\beta_2}{\beta_1} \right) \right\} \frac{1}{\lambda} + \dots \right]^2,$$

and so write $U_1 = V_1 (\alpha_1 \beta_1)^{\frac{1}{2}}$. We must next calculate the values of U_1, U_2 when $v_r = p_r$. We have that if $v_r = p_r$

$$(-\lambda)^{n-1} [U_1 + U_2/\lambda + \dots] = -\Delta_0 (\sum p_r q_r^{(1)}),$$

and so $U_1 = 0, U_2 = \alpha_1 (\sum p_r q_r^{(1)}) = \alpha_1 (-\beta_1/k)^{\frac{1}{2}}$.

If then we write

$$\alpha_1 V_0 (-\beta_1/k)^{\frac{1}{2}} = U_2 - \frac{1}{2} U_1 (\alpha_2/\alpha_1 + \beta_2/\beta_1),$$

we shall have $V_0 = 1$ when $v_r = p_r$.

Now we find

$$-\frac{1}{\Delta_0 \Delta_1} \begin{vmatrix} a_{rs} - \lambda b_{rs} & q_r^{(1)} \\ A_s & 0 \end{vmatrix}^2 = \frac{\lambda}{\alpha_1 \beta_1} \left[V_1 (\alpha_1 \beta_1)^{\frac{1}{2}} + \frac{1}{\lambda} \alpha_1 V_0 \left(-\frac{\beta_1}{k} \right)^{\frac{1}{2}} + \dots \right]^2$$

$$= \lambda V_1^2 + 2 V_0 V_1 (-\alpha_1/k)^{\frac{1}{2}} + \dots$$

According to the results in the note already quoted we now see that there is a term V_1^2 in B and $2 V_0 V_1 (-\alpha_1/k)^{\frac{1}{2}}$ in A . Hence the reduced forms are

$$A = 2 V_0 V_1 (-\alpha_1/k)^{\frac{1}{2}} + \sum_r^r c_r V_r^2$$

$$B = V_1^2 + \sum_r^r V_r^2 \quad (r = 2, 3, \dots, n-1).$$

Here again, by the form of B and the fact that $V_0 = 1$ corresponds to $v_r = p_r$, we see that the point-coordinates given by

$$V_0 + V_1 X_1 + \dots + V_{n-1} X_{n-1} = v_1 x_1 + \dots + v_n x_n$$

are rectangular Cartesians. Hence we have the quadric referred to its principal planes.

We have then the classification :

Conics (n = 3).

(i) $\Sigma a_{rs} p_r p_s \neq 0$.

$$(1) \quad A = av_1^2 + bv_2^2 + (\Sigma a_{rs} p_r p_s) v_0^2, \quad \text{central conic}$$

(*ellipse, hyperbola or circle*).

$$(2) \quad A = av_1^2 + (\Sigma a_{rs} p_r p_s) v_0^2, \quad \text{pair of points}$$

(ii) $\Sigma a_{rs} p_r p_s = 0$.

$$(3) \quad A = av_2^2 + 2v_0 v_1 (-\alpha/k)^{\frac{1}{2}}, \quad \text{parabola.}$$

$$\alpha = \text{Lt}_{\lambda \rightarrow \infty} (-\Delta_0/\lambda)$$

It will be observed that the cases (2), (4), (5), (6), (7) of the previous classification do not appear here, the tangential equation being degenerate ; on the other hand, case (2) above does not appear in the previous list, as then the point-equation is degenerate.

On the Heat generated by certain Fibrous Substances when wetted. By LOUIS COBBETT, M.D., F.R.C.S. Eng.

[Read 21 May 1900.]

It is well known that many fibrous materials readily absorb water, but it is not so well recognised that the process is attended by an evolution of heat. Dr R. E. Dudgeon¹ was I believe the first to point out that if the bulb of a clinical thermometer were surrounded by a little cotton-wool or a few turns of a silk handkerchief and placed in the mouth, and the expired air breathed through the wrappings, a temperature might be registered considerably higher than that of the walls of the mouth. From this he concluded—no doubt wrongly—that the temperature of the breath considerably exceeds that of the mouth. Sir W. Roberts² confirmed the observation, but contested the conclusion of Dr Dudgeon and attributed the rise of temperature above that of the mouth to “conversion of latent heat into sensible heat, by the rapid condensation of aqueous vapour,” and he showed that the rise of temperature was much greater when the material used to surround the thermometer was previously dried, and became less and less each time the observation was repeated with the same strip of flannel, until on the third occasion the thermometer reached 98·6° F. only.

Dr H. F. Parsons³ repeated Dr Dudgeon’s observation with the clinical thermometer, and showed that the same phenomenon takes place at a higher temperature by means of the following experiment. A few rolls of flannel enclosing a thermometer bulb were dried in hot air at 220° F. for some time, and then allowed to cool a little. As the mercury fell the index was shaken down until it stood at 212° F. The roll of flannel and thermometer was then placed in a tin cylinder and exposed for five minutes to steam at 212° F. At the end of this time the temperature within the roll was found to be 239° F. Experiments somewhat similar to this have been made by Prof. Max Rubner of Berlin⁴, who has found the temperature in the interior of a mass of wool dried and warmed, and placed in a current of saturated steam at 100° C., rise to 146° C. in ten minutes, and remain above 140° C. for over an hour.

The observations with the clinical thermometer are easily

¹ *Nature*, 1880, Vol. xxii. p. 241, and Vol. xxiii. p. 10.

² *Ibid.* Vol. xxiii. p. 55.

³ *Supplement to the Fourteenth Annual Local Government Report*, 1884.

⁴ *Hygienische Rundschau*, Berlin, 1898, 1899.

verified. Cotton, woollen, and silken materials, and paper are all effective; and if previously well dried will readily attain in the mouth a temperature of 110° F. and over in less than a minute. But it is not necessary to dry those substances, in order that their temperature may be raised above that of their surroundings, for I have frequently seen the thermometer reach 100° F. or more when simply wrapped in a few turns of my pocket-handkerchief taken directly from the pocket; and have known it attain 102° F. when enclosed in a strip of linen torn from a towel hanging in the room. I have often repeated the experiment of Dr Parsons, using woollen or cotton materials and paper, and found the temperature rise 30° C. or more above that of the steam. The following is a representative experiment.

A long strip of filter paper was weighed, and then thoroughly dried in hot air, and weighed again. It was found to have lost no less than 11 per cent. of its weight in the process of drying, although at the start it was in the ordinary sense dry. It was then rolled tightly round the bulb of a thermometer, and surrounded by a few more turns of the same kind of paper, making a roll 3 in. by $2\frac{1}{2}$. Next it was warmed to 96° C. and placed in a current of unconfined steam at 100° . The temperature within the roll rose to 125° C. in 4 minutes, and soon after to 132° C., at which point it remained for some time, and then fell slowly, so that at the end of half-an-hour it was still 128° C. The roll of paper was then taken out of the steam, and its protective cover removed. On weighing it was found to have risen in weight from 21.5 to 21.8 grms., thus gaining 1.5 per cent. Nevertheless it was still very dry and crackled when crumpled.

A similar experiment was made with asbestos fibre, which had undergone a prolonged washing in distilled water to remove salts. The asbestos was packed into a small cylinder of copper gauze, and heated all night in a gas flame in order to thoroughly dry it. It was then cooled over sulphuric acid, and when its temperature had reached 95° it was put in a current of steam at 100° . The result was very different from that obtained with fibrous materials of an organic kind. The temperature within the asbestos did not exceed that of the steam.

From this it appears that one has to do with a chemical and not merely a physical action. For though the asbestos fibres may be very different both in size and configuration from those of the other materials used, it is not probable that they would have been entirely inactive had the action in question depended on physical causes. It is therefore probable that there is some form of chemical union between the organic material and water.

The experiments just related show that when dry organic fibrous matter comes in contact with steam, heat is generated, and the temperature of the material rises above that of the steam. The following experiment shows that exactly the opposite condition of affairs prevails when these materials in their ordinary condition are placed in dry steam. Rolls of cotton or woollen bandages each containing a thermometer were placed in a current of unconfined steam which had been superheated by passing through a hot copper pipe. The temperature of the steam within the chamber was thus raised to 200° — 250° C. or more, and was frequently high enough to scorch the surface of woollen materials exposed to it. Nevertheless when rolls of fibrous material were placed in this superheated steam, the thermometers within them did not exceed 100° C., for as long a time as the observation lasted, namely an hour or more. This result was obtained when asbestos, as well as when paper, cotton or flannel was used. In some cases a rise of temperature a few degrees above 100° did indeed take place, but in others it remained exactly at the boiling point of water. It therefore seemed probable that in the former instance superheated steam must have found direct access to a portion of the thermometer bulb through some crevice in the material.

The failure of the little rolls of fibrous material to attain the temperature of the surrounding steam within the time limits of the experiments was no doubt due to the evaporation of water held in some way by the fibres; thus causing the superheat of the steam which penetrated the roll to be converted into latent heat, and stored in the steam thus generated. It moreover appears that this water was distributed mechanically over the surfaces of the fibres, and not combined chemically with their substance, because the phenomenon appeared both when asbestos and when organic fibres were used, and it has already been shown that dry asbestos does not combine with water with evolution of heat as the other substances used do, and because the process occurred precisely at 100° C., thus indicating that no energy was required to separate the water from the fibre.

It is probable therefore that in the case of fibrous materials, whether they are composed of organic or inorganic matter, one has to do with water mechanically spread over their surfaces, which prevents them for a considerable time from attaining a temperature above 100° C., when surrounded by superheated steam, and which at once converts the superheated steam which penetrates into their interstices into saturated steam. And further it is probable that in the case of fibrous materials of an organic nature, one has to do with water united in some chemical manner with their substance, and that the affinity which these

substances have for water when dry causes heat to be generated when they are surrounded by saturated steam; and thus causes the steam which penetrates into their interstices to be converted from saturated into superheated steam.

The source of the heat generated when fibrous organic materials are wetted by coming in contact with water vapour is not only the latent heat of vapour converted into the liquid state, for a generation of heat occurs when very dry filter paper, flannel or cotton is wetted with water. Thus a little roll of filter paper was thoroughly dried in hot air and cooled over sulphuric acid. A thermometer was inserted so that the bulb was in the centre of the roll. The roll was then taken out, and flooded with water at a temperature slightly lower than that of the roll. Nevertheless the thermometer rose almost immediately 5° C. Similar results have been obtained with other organic materials, but not with asbestos. It seems probable from this experiment that the source of the heat in question is to be found partly in the latent heat of water converted into the solid state. On the ground of Dr Dudgeon's experiment a similar conclusion was reached by Sir W. Roberts, who wrote (*loc. cit.*), "it is probable that with the superexsiccated flannel the first portions of the aqueous vapour condensed at the beginning of the experiment pass from the gaseous into the solid form and constitute that portion of water which is incorporated in intimate union with all organic tissues."

How far the results related in this paper are due to the salts present in the materials used has not been ascertained.

These observations have some bearing on practical disinfection. Superheated steam, as was shown by Von Esmarch¹, has a very inferior sterilising action to that of saturated steam, but some experiments which I have made in conjunction with Dr J. H. C. Dalton² have shown that this only applies to the outside of such articles as pillows, rolls of blanket, etc., for in the interior the temperature does not exceed 100° C., no matter how much higher that of the outside may be; the microbes are therefore exposed there to saturated and not to superheated steam; and in our experiments dried Anthrax Spores in the interior of the pillows etc. were always quickly killed, while those on the surface sometimes escaped.

Again, under the opposite conditions, namely when very dry organic material is put into saturated steam, the experiments have shown that Anthrax Spores within a little roll of flannel bandage may escape death, when the roll has been placed in saturated steam for 10 minutes and a thermometer in the im-

¹ *Zeitschf. f. Hygiene*, 1888, pp. 196 and 399.

² *Lancet*, Feb. 3, 1900.

mediate neighbourhood of the spores has registered over 100° C. for 9 minutes, and over 125° C. for 5 minutes. It is therefore clear that extreme dryness may interfere with the sterilisation of such things as are composed of organic fibrous material, and it is important to know whether in practice such a state of dryness ever occurs. Probably in our climate it does not, for though it has already been stated that a temperature considerably over that of the breath (37° C.) may be registered in the mouth by blowing the expired air through a few rolls of one's pocket-handkerchief enclosing a thermometer without any preliminary drying whatever, I have never seen a temperature of over 100° attained in rolls of flannel, cotton or paper, exposed to saturated steam, unless these materials have previously been artificially dried. But it must be added that the experiments were made in the damp atmosphere of an English November, and they by no means show that heat cannot be generated, and the steam thereby superheated within the material and its sterilising properties diminished in the dry atmosphere of hotter countries, or even perhaps in this country during the summer. This point is still under investigation.

A Method of Measuring the Retardation produced by a Crystal Plate. By MR L. R. WILBERFORCE.

[Read 21 May 1900.]

PROCEEDINGS AT THE MEETINGS HELD DURING
THE SESSION 1899—1900.

ANNUAL GENERAL MEETING,

October 30th, 1899.

MR J. LARMOR, PRESIDENT, IN THE CHAIR.

The following were re-elected as Associates, having been nominated by the Council :

Mr R. Bowes.
Mr R. I. Lynch.
Mr A. E. Smith.
Mr A. Deck.
Mr W. E. Pain.

The names of the Benefactors were read.

A vote of thanks to Mr Newall and Mr Bateson for their services to the Society as Secretaries was proposed and carried.

The officers and new members of the Council for the ensuing year were elected, the new Council being constituted as follows :

President :

Mr J. Larmor.

Vice-Presidents :

Mr F. Darwin.
Professor A. R. Forsyth.
Dr W. H. Gaskell.

Treasurer :

Mr H. F. Newall.

Secretaries :

Mr H. F. Baker.

Mr A. E. Shipley.

Mr L. R. Wilberforce.

Other Members of the Council :

Mr A. Harker.

Mr A. Hutchinson.

Professor Liveing.

Mr S. Skinner.

Dr H. Gadow.

Mr D. Sharp.

Professor J. J. Thomson.

Mr A. Berry.

Sir G. G. Stokes.

Mr W. Bateson.

Mr A. C. Seward.

Mr G. T. Walker.

The following Communications were made :

1. On semi-convergent series. By W. M^cF. ORR, M.A., St John's College.
2. An experiment on the condensation of clouds. By C. T. R. WILSON, M.A., Sidney Sussex College.
3. Conductivity of Gases from arcs and incandescent wires. By J. A. M^cCLELLAND, M.A., Trinity College.
4. On the Secondary Röntgen Rays. By J. S. E. TOWNSEND, B.A., Trinity College.

November 13th, 1899.

In the Cavendish Laboratory.

MR J. LARMOR, PRESIDENT, IN THE CHAIR.

The following was elected an Associate, having been nominated by the Council :

L. N. G. Filon, King's College.

The following Communications were made :

1. Intumescences on *Hibiscus vitifolius*. By Miss E. DALE (communicated by Professor Marshall Ward).
2. Note on the name *Balanoglossus*. By Dr S. F. HARMER, King's College.
3. The Skeleton of *Astrosclera* compared with that of the Pharetronid Sponges. By J. J. LISTER, M.A., St John's College.
4. Observations on *Polypterus* and *Protopterus*. By J. S. BUDGETT, B.A., Trinity College.
5. Note on Hypotheses as to the origin of the Paired Limbs of Vertebrates. By J. GRAHAM KERR, M.A., Christ's College.

November 27th, 1899.

In the Chemical Laboratory.

MR J. LARMOR, PRESIDENT, IN THE CHAIR.

The following were elected Fellows of the Society :

- J. Barcroft, B.A., King's College.
J. S. E. Townsend, B.A., Trinity College.

The following Communications were made :

1. On the influence of temperature, and of various solvents, on the absorption spectra of didymium and erbium salts. By Professor LIVEING.
2. Researches in the Sugar Group. By H. JACKSON.
3. On a new Mineral. By A. HUTCHINSON, M.A., Pembroke College.
4. On the condition that five lines in space of four dimensions should lie on a quadric. By H. W. RICHMOND, M.A., King's College.

January 22nd, 1900.

In the Optical Lecture Room.

MR J. LARMOR, PRESIDENT, IN THE CHAIR.

The following was elected a Fellow of the Society :

J. G. Leathem, M.A., St John's College.

The Balance Sheet for the year 1899 was presented and laid on the table.

Mr F. DARWIN proposed a vote of thanks to the Auditors ; this was seconded by Mr BATESON and carried unanimously.

The following Communications were made :

1. Experiments on the periodic movement of Plants. By Miss D. F. M. PERTZ and F. DARWIN, M.A., Christ's College.
2. Wealden Plants from Bernissart. By A. C. SEWARD, M.A., Emmanuel College.
3. *Bulgaria polymorpha* as a wood-destroying Fungus. By R. H. BIFFEN, B.A., Emmanuel College.

February 5th, 1900.

In the Cavendish Laboratory.

MR J. LARMOR, PRESIDENT, IN THE CHAIR.

The following were elected Fellows of the Society :

Professor W. Somerville, M.A., King's College.
 W. McDougall, M.A., St John's College.
 Hon. N. C. Rothschild, B.A., Trinity College.

The following Communications were made :

1. Ionization of Gases in the Electric Field. By Professor J. J. THOMSON, Trinity College.

2. On Differential Equations with two Independent Variables. By A. C. DIXON, Sc.D., Trinity College.
3. On the calculation of the double integral expressing normal correlation. By W. F. SHEPPARD, M.A., Trinity College.
4. On the hemihedrism and twinning of Crystals of Dolomite from the Binnenthal. By R. H. SOLLY, M.A., Downing College.
5. Apparatus for measuring the extension of Wires. By G. F. C. SEARLE, M.A., St Peter's College.
6. Magnetic disturbances in the Isle of Skye. By ALFRED HARKER, M.A., St John's College.

February 19th, 1900.

In the Physiological Lecture Room.

MR J. LARMOR, PRESIDENT, IN THE CHAIR.

The President announced that the Adjudicators of the Hopkins Prize for the period 1891-1894 have awarded the Prize to W. D. NIVEN, M.A., F.R.S., for his Memoir on Ellipsoidal Harmonics (*Phil. Trans.*, 1891) and his other valuable contributions to Applied Mathematics.

The following were elected Fellows of the Society :

- S. St Barbe Sladen, M.A., M.D., Caius College.
- R. H. Adie, M.A., Trinity College.
- T. J. P.A. Bromwich, M.A., St John's College.

The following Communications were made :

1. A suggestion as to a possible explanation of the origin of some secondary sexual characters in animals as afforded by observations on certain Salmonids. By G. E. BARRETT-HAMILTON (communicated by Professor Newton).
2. Anthropological Notes. By W. L. H. DUCKWORTH, M.A., Jesus College.
3. On the zoological position of Palaeospondylus. By J. GRAHAM KERR, M.A., Christ's College.

4. On the extraction of Gases from small quantities of Blood. By J. BARCROFT, B.A., King's College.

5. On the separation of a pure albumen from egg-white. By F. G. HOPKINS, M.A. (communicated by Mr A. E. Shipley).

March 5th, 1900.

In the Engineering Laboratory.

MR J. LARMOR, PRESIDENT, IN THE CHAIR.

The following was elected a Fellow of the Society :

A. W. Hill, B.A., King's College.

The following Communications were made :

1. Considerations regarding the Zeeman effect. By J. LARMOR, M.A., St John's College.

2. On the simplest algebraic minimal curves, and the derived real minimal surfaces. By H. W. RICHMOND, M.A., King's College.

3. On Diophantine inequalities. By G. B. MATHEWS, M.A. (communicated by Mr H. F. Baker).

4. Experiments on impact. By J. H. VINCENT, B.A.

5. On the distance between the Striae and on the Phenomena connected with the discharge of Electricity. By R. S. WILLOWS, B.A.

6. The teaching of Mechanics by experiment. By Professor J. A. EWING.

May 7th, 1900.

In the Lecture Room of Anatomy and Physiology.

PROFESSOR CLIFFORD ALBUTT IN THE CHAIR.

The following Communications were made :

1. Exhibition of Anomalous Bones from Pre-dynastic Egyptian Skeletons. By Professor MACALISTER.

2. Ammocoetes a Cephalaspid. By W. H. GASKELL, M.A., M.D., Trinity Hall.
3. Note on Abnormal Limbs in Lepidosiren. By H. H. BRINDLEY, M.A., St John's College.
4. On the Standardization of Antivenomous Serum. By W. MYERS, M.A., Caius College (communicated by Mr A. E. Shipley).

May 21st, 1900.

In the Cavendish Laboratory.

MR J. LARMOR, PRESIDENT, IN THE CHAIR.

The following were elected Fellows of the Society :

- C. G. Lamb, M.A., Clare College.
- H. Yule Oldham, M.A., King's College.

The following Communications were made :

1. On a certain Diophantine inequality. By Major P. A. MACMAHON, R.A., F.R.S.
 2. On rational space curves of the fourth order. By H. W. RICHMOND, M.A., King's College.
 3. On the reduction of quadrics. By T. J. I'A. BROMWICH, M.A., St John's College.
 4. Experiments upon the rise of temperature of Fabrics when moistened. By L. COBBETT, M.A., M.D., Trinity College.
 5. Experiments upon striated discharges. By R. S. WILLOWS, B.A.
 6. A method of measuring the retardation produced by a crystal plate. By L. R. WILBERFORCE, M.A., Trinity College.
-

HOPKINS PRIZE AWARDS.

WE beg leave to recommend that the Hopkins Prize for the period ending 1894 be awarded to W. D. NIVEN, M.A., F.R.S., late Fellow of Trinity College, for his paper on Ellipsoidal Harmonics published in the *Philosophical Transactions* of the Royal Society for 1891 and for other valuable contributions to Applied Mathematics.

G. G. STOKES.
J. J. THOMSON.
HORACE LAMB.

19 February, 1900.

WE recommend that the Hopkins Prize for the period 1894-97 be awarded to J. LARMOR, M.A., of St John's College, for his investigations on the Physics of the Ether and other valuable contributions to Mathematical Physics.

HORACE LAMB.
W. M. HICKS.
J. J. THOMSON.

June 6th, 1900.

INDEX TO THE PROCEEDINGS,

with references to the Transactions.

- Abnormalities of the limbs and tail of Dipnoan Fishes (BRINDLEY), 325.
Absorption Bands of Didymium Salts in solution (LIVEING), 40.
Absorption Spectra, influence of temperature and solvents on (LIVEING), 213.
ADIE, R. H., Elected Fellow, 381.
Albumen from Egg-white (HOPKINS), 300.
Ammocœtes a Cephalaspid (GASKELL), 325.
Antivenomous Serum, Standardisation of (MYERS), 328.
Associates Elected, 2, 185, 377, 378.
Astrosclera, Skeleton compared with Pharetronid Sponges (LISTER), 189.
- BAKER, H. F., On Mittag-Leffler's Theorem, 10.
— On the Theory of Functions of several Complex Variables (*Trans.* XVIII.).
- Balanoglossus (HARMER), 190.
BALL, Sir Robert, Description of the Sheepshanks Telescope, 186.
BARCLAY-SMITH, E., Elected Fellow, 185.
BARCROFT, J., Elected Fellow, 379.
BARNES, E. W., Elected Fellow, 38.
BARRETT-HAMILTON, G. E. H., On the origin of secondary sexual characters in animals with reference to Salmonids, 279.
BATESON, W., and PERTZ, Inheritance of Variation in corolla of Veronica Buxbaumii, 78.
BERRY, A., On the evaluation of a certain determinant which occurs in the mathematical theory of statistics and in that of elliptic geometry of any number of dimensions, 2.
— On Quartic Surfaces which admit of Integrals of the first kind of Total Differentials (*Trans.* XVIII.).
- BIFFEN, R. H., On the biology of Bulgaria polymorpha, 260.
Binney Collection of Coal-Measure Plants (SEWARD), 137.

- BLES, E. J., Elected Fellow, 185.
- BOLTZMANN, Von L., and Dr MACHE, Ueber die Bedeutung der Constante b des van der Waals'schen Gesetzes (*Trans.* XVIII.), 187.
- Bones, anomalous, from Pre-dynastic Egyptian Skeletons (MACALISTER), 325.
- BRINDLEY, H. H., Some abnormalities of the limbs and tail of Dipnoan Fishes, 325.
- BROMWICH, T. J. F.A., Elected Fellow, 381.
— Classification of conics and quadrics, 358.
- BROWN, E. W., On the solution of a pair of simultaneous linear differential equations which occur in the Lunar Theory (*Trans.* XVIII.), 188.
- BUDGETT, J. S., Observations on polypterus and protopterus, 236.
- Bulgaria polymorpha (BIFFEN), 260.
- BURNSIDE, W., On a Class of Groups of Finite Order (*Trans.* XVIII.).
- Carbon, electro-chemical equivalent of (SKINNER), 261.
- Charged Ion in a magnetic field (THOMSON), 49.
- Chemical Composition of a Gas and Ionization, relation of (THOMSON), 10.
- CHREE, C., On a semi-inverse method of Solution of equations of Elasticity, 186.
- Clouds, formation of, with ozone (TOWNSEND), 52.
- COBBETT, L., Heat generated by Fibrous Substances when wetted, 372.
- Coenopsammia from Lifu (GARDINER), 72.
- Conductivity of Gases from an Arc and from Incandescent Metals (McCLELLAND), 241.
- Conics and Quadrics (BROMWICH), 358.
- Convection Currents in Conduction produced by Röntgen rays (ZELENY), 14.
- CORNU, A., La théorie des ondes lumineuses : son influence sur la physique moderne (*Trans.* XVIII.).
- Council, 1898—1899, 1, 183.
— 1899—1900, 377.
- DALE, Miss E., Intumescences on *Hibiscus vitifolius* Linn., 192.
- DARWIN, F., Periodic Movement of Plants, 259.
- Dental Rudiments in human crania (DUCKWORTH and FRASER), 292.
- Determinant which occurs in statistics and elliptic geometry (BERRY), 2.
- DEWAR, J., Colour of the vapour of Iodine at atmospheric pressure and in vacuo, 44.
- DIXON, A. C., On differential equations with two independent variables (*Trans.* XIX.), 278.
- DUCKWORTH, W. L. H., and PAIN, Eskimo from Labrador, 286.
— and FRASER, Dental Rudiments in human crania, 292.
- Enteropneusta, some points in the morphology of the (WILLEY), 37.
- Entladungsstrahlen (THOMSON), 74.
- Eskimo from Labrador (DUCKWORTH and PAIN), 286.
- EWING, J. A., The teaching of Mechanics by experiment, 316.

- Extension of a Wire, apparatus for (SEARLE), 318.
- FORSYTH, Professor A. R., On the integrals of systems of differential equations (*Trans.* XVIII.), 188.
- FRASER, D. H., and DUCKWORTH, Dental Rudiments in human crania, 292.
- GADOW, H., Orthogenetic variation in the shells of *Chelonia*, 35.
- GALLOP, E. G., On Change of independent Variables and the theory of Cyclicants and Reciprocants, 186.
- GARDINER, J. Stanley, Anatomy of *Coenopsammia* from Lifu, 72.
- GASKELL, W. H., *Ammocoetes* a *Cephalaspid*, 325.
- GRACE, J. H., Elected Fellow, 38.
- Metrical Relations between Linear Complexes, 10.
- Apolar Systems of Quadrics, 10.
- GRIFFITHS, J., On the way in which Bones break, 186.
- HARKER, A., Magnetic Disturbances in the Isle of Skye, 268.
- HARMER, S. F., On the name *Balanoglossus*, 190.
- Heat generated by certain Fibrous Substances when wetted (COBBETT), 372.
- HILL, A. W., Elected Fellow, 382.
- and SEWARD, *Lepidodendron Wunschianum*, 38.
- HOBSON, E. W., On Green's Function for a Circular Disc, with Applications to Electrostatic Problems (*Trans.* XVIII.), 188.
- HOPKINS, F. Gowland, Separation of pure Albumen from Egg-white, 300.
- Hopkins Prize awards, 384.
- HUTCHINSON, A., *Stokesite*, a new mineral, 216.
- Idolum diabolicum* (SHARP), 175.
- Impact (VINCENT), 332.
- Inheritance of Variation in *Veronica Buxbaumii* (BATESON and PERTZ), 78.
- Intumescences on *Hibiscus vitifolius* Linn. (DALE), 192.
- Iodine, colour of vapour of (DEWAR), 44.
- JACKSON, H., Researches on Sugar Group, 215.
- KERR, J. Graham, Elected Fellow, 38.
- On the origin of paired limbs in vertebrates, 227.
- Zoological position of *Palaeospondylus Traquair*, 298.
- LAMB, C. G., Elected Fellow, 383.
- LAMB, Professor H., Elected Fellow, 186.
- An Electromagnetic Illustration of the Theory of Selective Absorption of Light by a Gas (*Trans.* XVIII.).
- LARMOR, J., On the origin of magneto-optic rotation, 181.
- On the Dynamics of a System of Electrons or Ions (*Trans.* XVIII.), 188.
- LEATHEM, J. G., Elected Fellow, 380.

- Lepidodendron Wunschianum (SEWARD and HILL), 38.
 Lepidophloios, Binney Collection, 137.
 Linear Complexes (GRACE), 10.
 LISTER, J. J., Exhibition of larvae of Branchipus and Estheria reared from dry mud, 187.
 — Skeleton of Astrosclera compared with Pharetronid Sponges, 189.
 LIVEING, G. D., Flame spectrum of mercury, 38.
 — Intensity of Absorption Bands of Didymium salts, 40.
 — On the influence of temperature and solvents on the absorption spectra of didymium and erbium salts, 213.
 — Effects of Dilution, Temperature, and other circumstances on the absorption spectra of solutions of Didymium and Erbium salts (*Trans.* XVIII.), 188.
 LODGE, O. J., and GLAZEBROOK, R. T., On the Oscillatory Discharge of an Air Condenser, with a determination of " v " (*Trans.* XVIII.), 188.
 LOVE, A. E. H., On the Propagation of Waves of Elastic Displacement along a Helical Wire (*Trans.* XVIII.).
 LOVETT, E. O., Contact Transformations and Optics (*Trans.* XVIII.), 188.
 MACALISTER, Professor A., Exhibition of Anomalous Bones from Pre-dynastic Egyptian Skeletons, 325.
 MACDONALD, H. M., Green's formula for Electric Density near the Vertex of a Right Cone (*Trans.* XVIII.), 188.
 MACMAHON, Major P. A., On a certain Diophantine Inequality (*Trans.* XIX.), 331.
 — On the partitions of numbers which possess symmetrical graphs (*Trans.* XVII.), 47.
 — On the application of partition analysis to the study of the properties of any system of Consecutive Integers (*Trans.* XVIII.), 188.
 Magnetic Disturbances in the Isle of Skye (HARKER), 268.
 Magneto-optic rotation (LARMOR), 181.
 MATHEWS, G. B., Diophantine Inequalities (*Trans.* XIX.), 302.
 M^cCLELLAND, J. A., Conductivity of gases from an arc and from incandescent metals, 241.
 M^cDOUGALL, W., Elected Fellow, 380.
 Meeting commemorative of Sir G. G. Stokes' Jubilee, 187.
 Megaloxylon, Binney Collection, 138.
 Mercury, flame spectrum of (LIVEING), 38.
 MICHELSON, A. A., On the echelon spectroscope (*Trans.* XVIII.), 187.
 MITTAG-LEFFLER, G., On the analytical representation of a uniform branch of a monogenic function (*Trans.* XVIII.), 187.
 MYERS, W., Standardisation of Antivenomous Serum, 328.
 OLDHAM, H. Yule, Elected Fellow, 383.
 Origin of paired Limbs of Vertebrates (KERR), 227.
 ORR, W. M^cF., Elected Fellow, 38.

- ORR, W. M^cF., On the product $J_m(x)J_n(x)$, 93.
 — On Semi-convergent Series (*Trans.* XIX.), 189.
- PAIN, B. H., and DUCKWORTH, Eskimo from Labrador, 286.
 Palaeospondylus, Traquair (KERR), 298.
 Periodic Movement of Plants (PERTZ and DARWIN), 259.
- PERTZ, D. F. M., and BATESON, Inheritance of Variation in corolla of
 Veronica Buxbaumii, 78.
 — and DARWIN, Periodic Movement of Plants, 259.
- POCKLINGTON, H. C., On the Symbolic Integration of certain Differential
 Equations in Quaternions, 59.
 — On sensitiveness of Radiant Heat detectors, 66.
- POINCARÉ, H., Sur les Groupes Continus (*Trans.* XVIII.), 187.
 Pterypteris and Protopteris (BUDGETT), 236.
 Potential Fall at the Electrodes in Conduction produced by Röntgen rays
 (ZELENY), 14.
- Proceedings of the Session 1898—1899, 183.
 — — 1899—1900, 377.
- Quadratic Complex Numbers (WESTERN), 10.
 Quadrics, apolar systems of (GRACE), 10.
 Quadric, five straight lines in four dimension space should lie on a (RICH-
 MOND), 210.
- Quaternions, Symbolic Integration of certain Equations in (POCKLINGTON), 59.
- Radiant Heat Detectors, Sensitiveness of (POCKLINGTON), 66.
- RICHMOND, H. W., On the condition that five straight lines situated in space
 of four dimensions should lie on a quadric, 210.
 — On Minimal Surfaces (*Trans.* XVIII.).
 — On the simplest algebraical minimal curves and the derived real minimal
 surfaces (*Trans.* XIX.), 301.
 — On rational space curves of the fourth order (*Trans.* XIX.), 331.
- Röntgen rays, secondary (TOWNSEND), 217.
 — ionization produced by (THOMSON), 10.
 — convection currents in conduction produced by (ZELENY), 14.
- ROTHSCHILD, Hon. N. C., Elected Fellow, 380.
- SCHUSTER, A., On the Periodogram of Magnetic Declination as obtained from
 the records of Greenwich Observatory 1871—1895 (*Trans.* XVIII.), 188.
- SEARLE, G. F. C., Apparatus for measuring the extension of a wire, 318.
- Secondary Sexual Characters in Animals (BARRETT-HAMILTON), 279.
- SEWARD, A. C., and HILL, Lepidodendron Wunschianum, 38.
 — On the Binney Collection of Coal-Measure Plants, 137.
 — Wealden Plants from Bernissart, 259.
- SHARP, D., Modification and Attitude of Idolum diabolicum, 175.
- SHARPE, H. J., Reflection of Sound at a Paraboloid, 101.

- SHEPPARD, W. F., On the calculation of the double-integral expressing normal correlation (*Trans.* XIX.), 317.
- SKINNER, S., On the electro-chemical equivalent of carbon, 261.
- SLADEN, S. St Barbe, Elected Fellow, 381.
- Solidification, Velocity of (WILSON), 25.
- SOMERVILLE, Professor W., Elected Fellow, 380.
- Sound Reflection at a Paraboloid (SHARPE), 101.
- Stokesite, a new mineral (HUTCHINSON), 216.
- Striae in the positive column (WILLOWS), 302.
- Sugar Group (JACKSON), 215.
- TAYLOR, C., On the Geometry of Kepler and Newton (*Trans.* XVIII.), 188.
- TAYLOR, H. M., On the construction of a model showing 27 lines on a Cubic Surface (*Trans.* XVIII.), 188.
- THOMSON, Prof. J. J., On the connection between Chemical Composition of a gas and the Ionization produced in it by Röntgen rays, 10.
- On the motion of a charged ion in a magnetic field, 49.
- On the conductivity of gases exposed to Entladungsstrahlen, 74.
- TOWNSEND, J. S. E., Elected Fellow, 379.
- On the formation of clouds with ozone, 52.
- On secondary Röntgen rays, 217.
- Variation in the shells of Chelonia, Orthogenetic (GADOW), 35.
- VINCENT, J. H., Experiments on Impact, 332.
- WALKER, G. T., Elected Fellow, 38.
- Wealden Plants from Bernissart (SEWARD), 259.
- WELSH, W., Elected Fellow, 38.
- WESTERN, A. E., Certain Systems of Quadratic Complex Numbers, 10.
- WILBERFORCE, L. R., On a method of measuring the retardation produced by a crystal plate, 376.
- WILLEY, A., Elected Fellow, 185.
- Morphology of the Enteropneusta, 37.
- WILLOWS, R. S., Striae in the positive column, 302.
- WILSON, C. T. R., Experiment on Condensation of Clouds, 189.
- WILSON, H. A., On Velocity of Solidification, 25.
- ZELNY, J., On Convection Currents and on the Fall of Potential at the Electrodes in Conduction produced by Röntgen rays, 14.



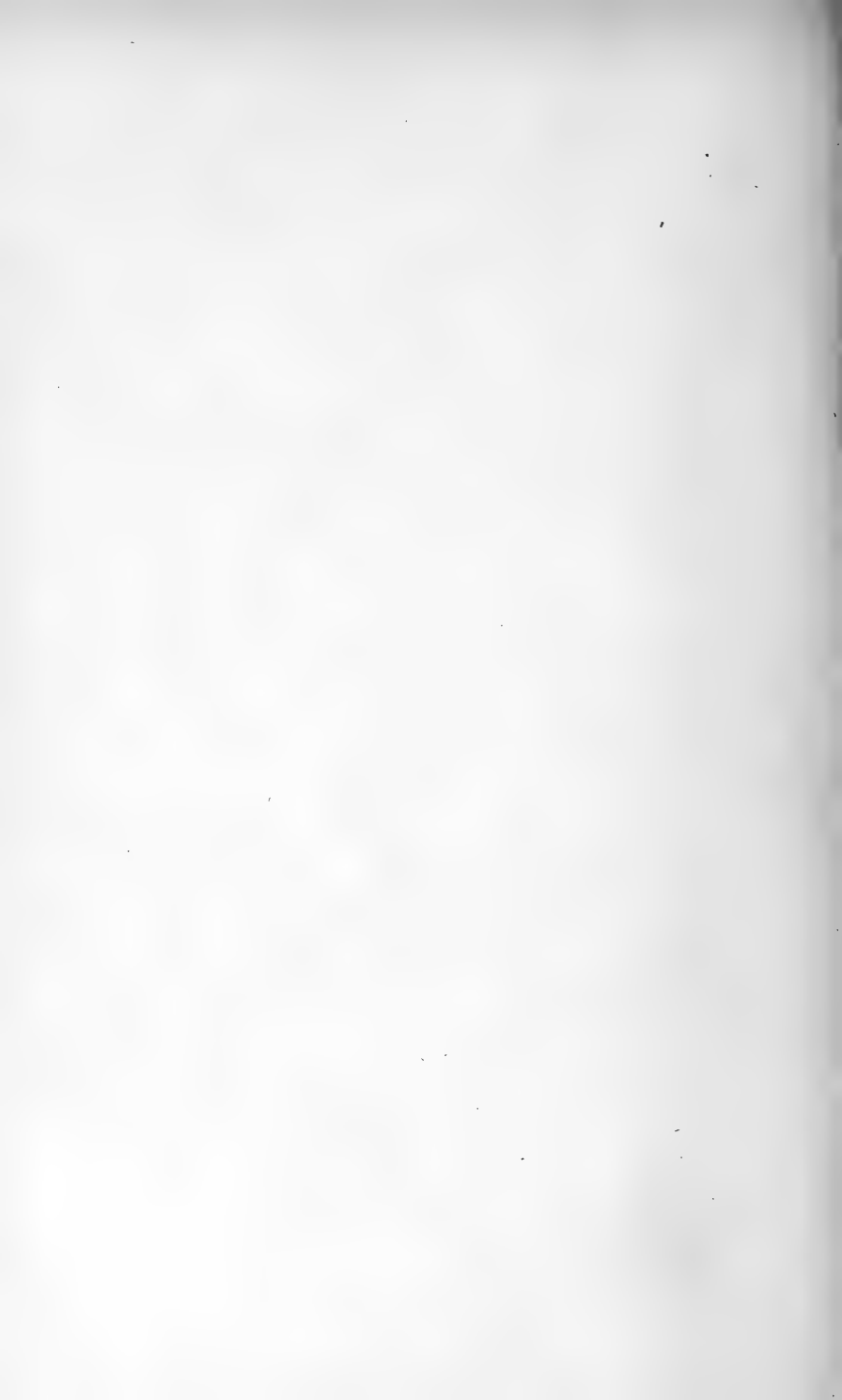



Nat size

Idolum diaboli-cum.

West. Newman chromo.

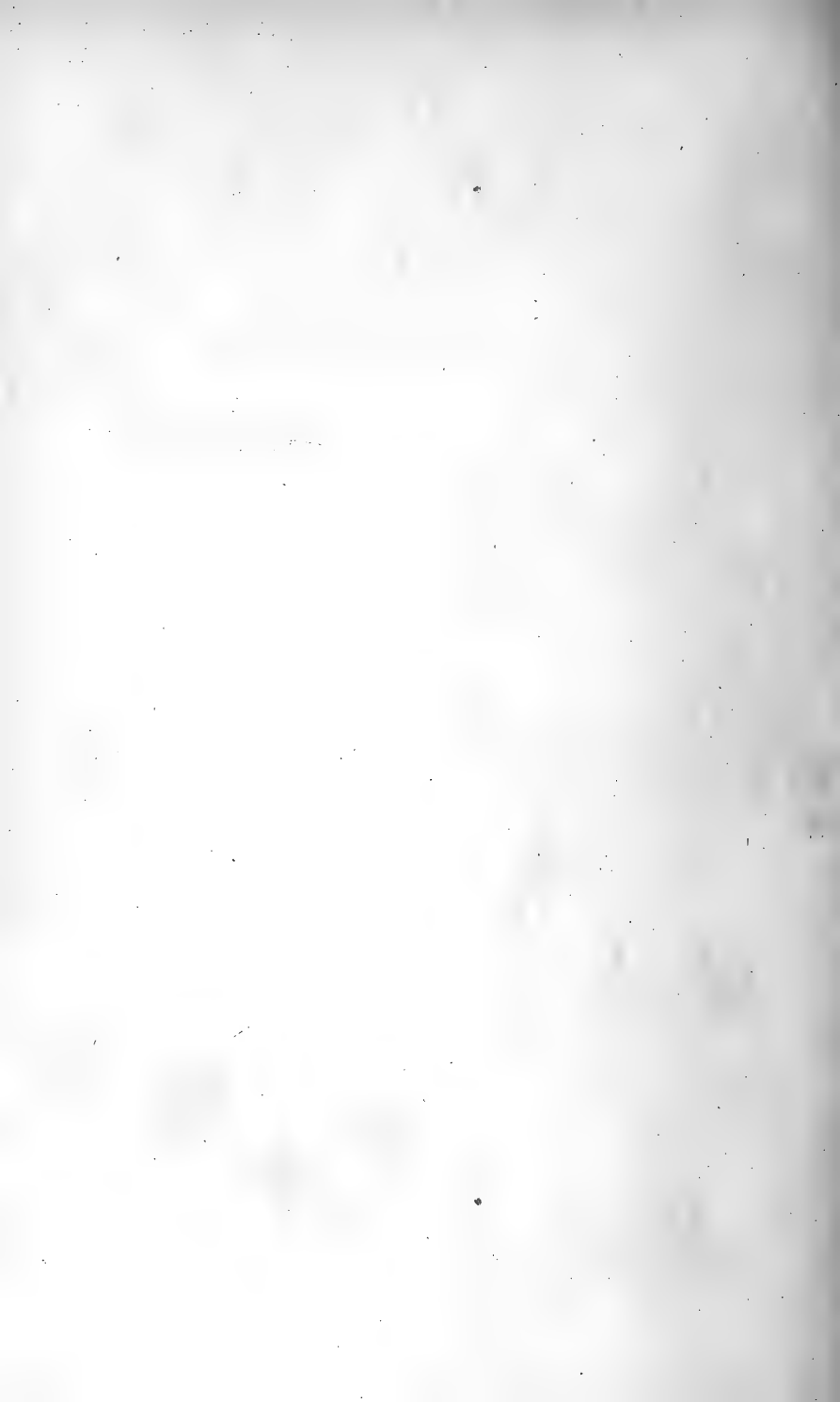

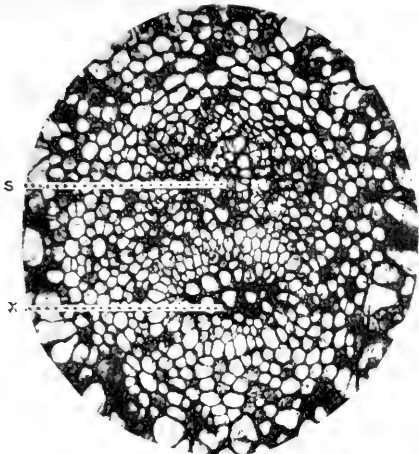

Fig. 1.



Fig. 4.

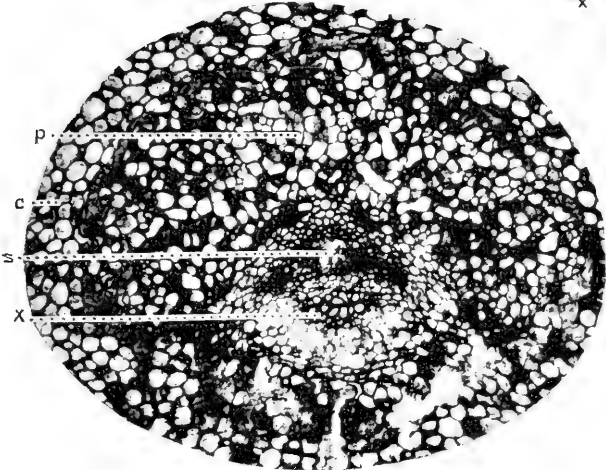

Fig. 2.

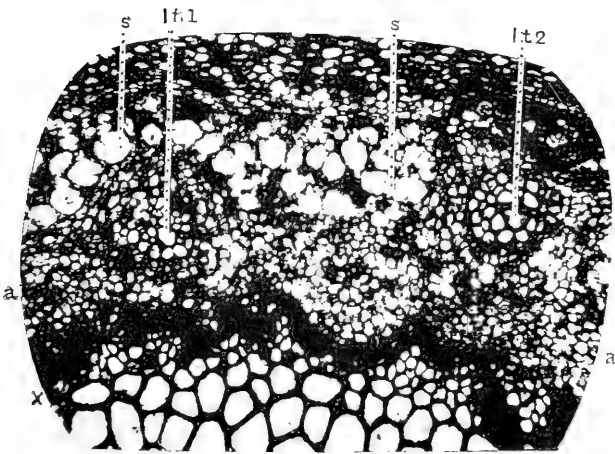
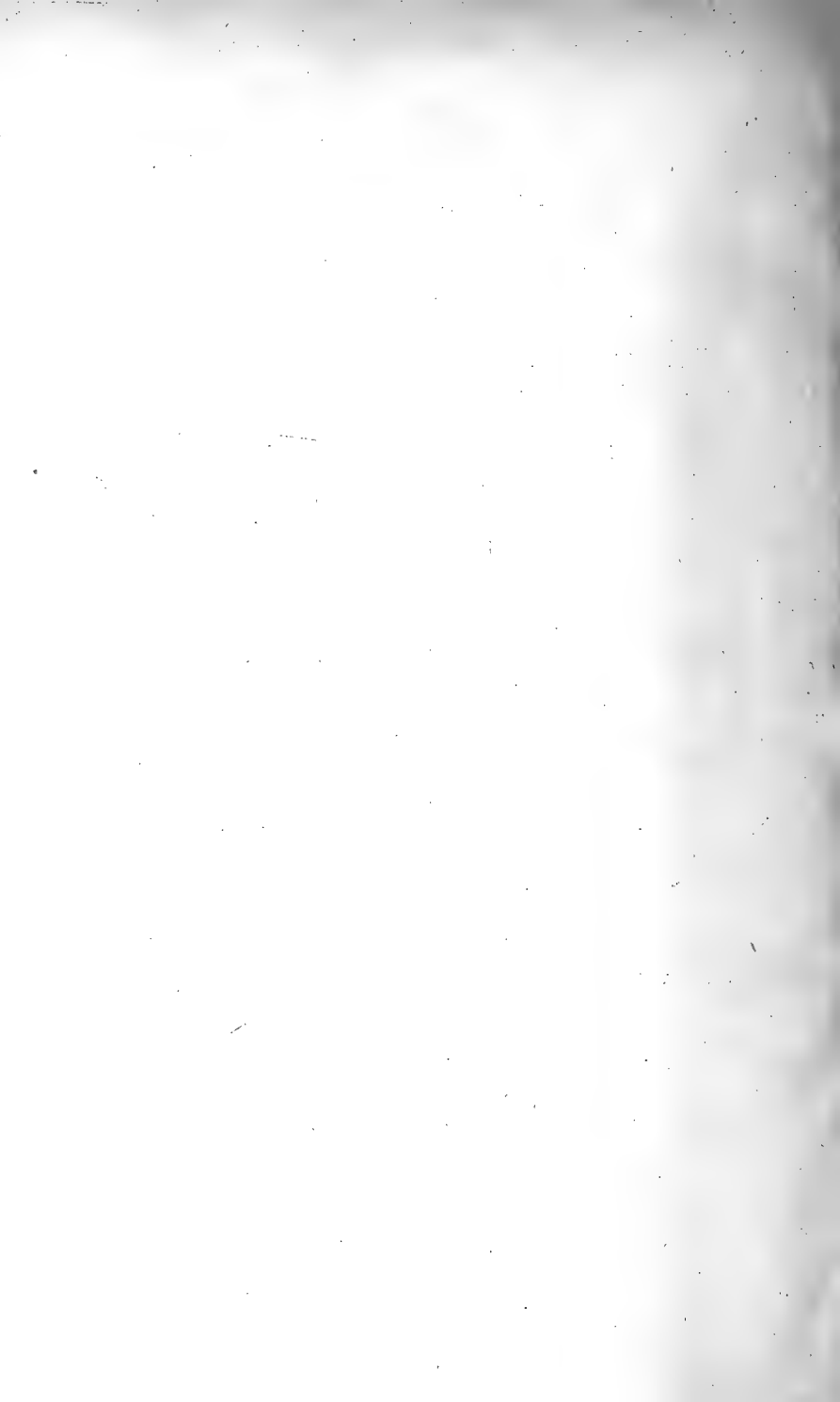
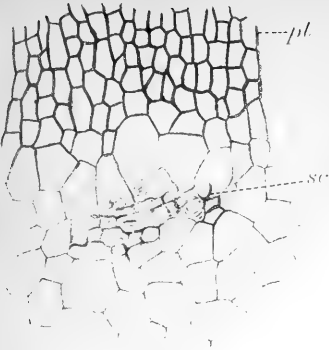

Fig. 3.

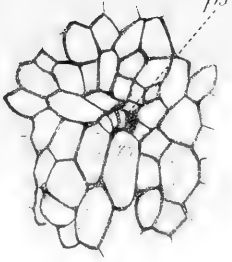

Fig. 5.





6



7

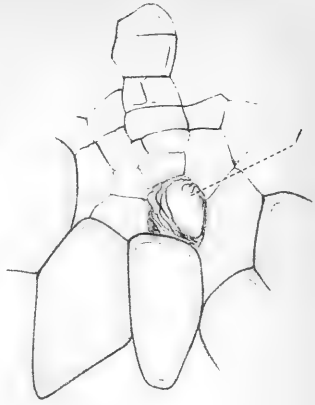

8

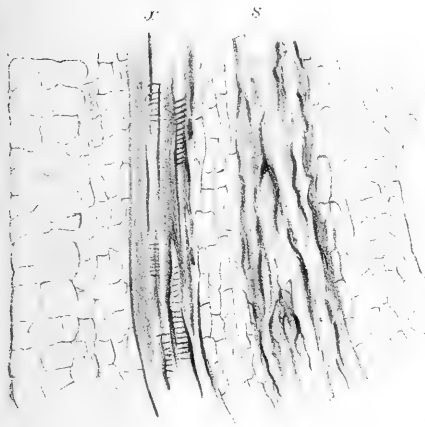

9

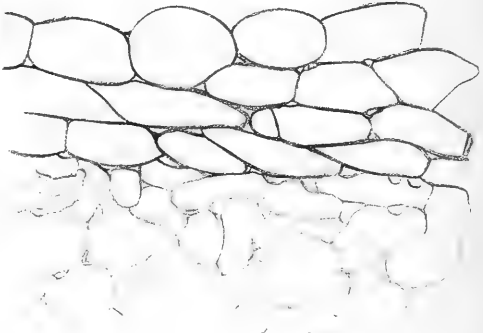

10



11

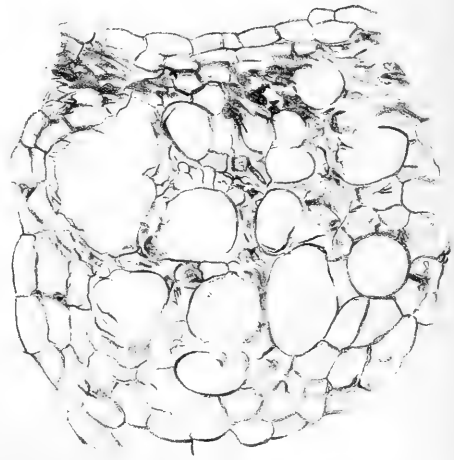

12

Lepidophloios.

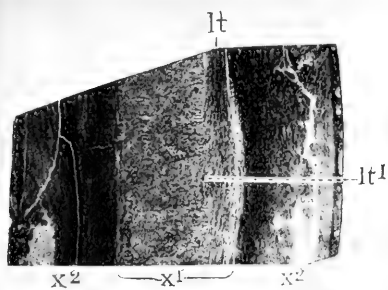

Fig. 1.

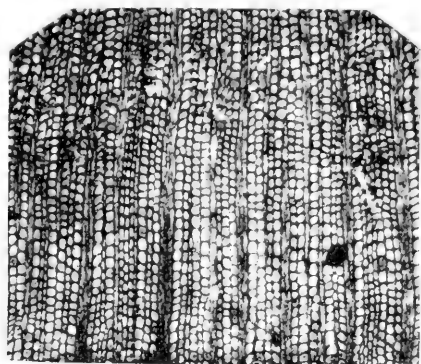
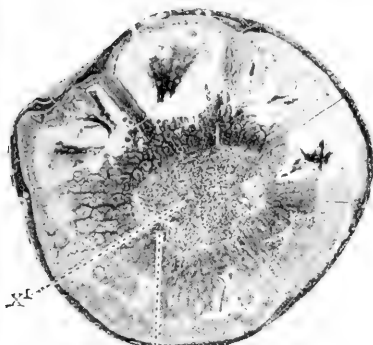

Fig. 4.



lt
Fig. 2.

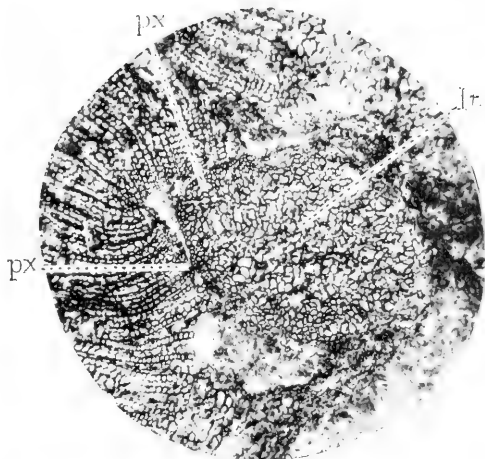

Fig. 5.

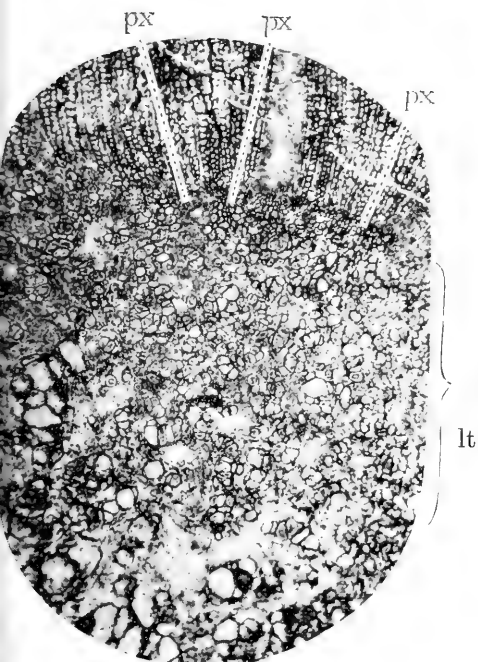

Fig. 3.

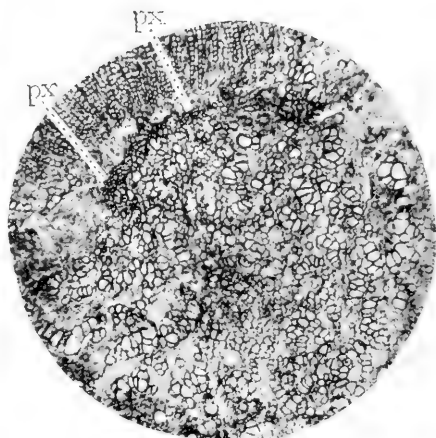

Fig. 6.

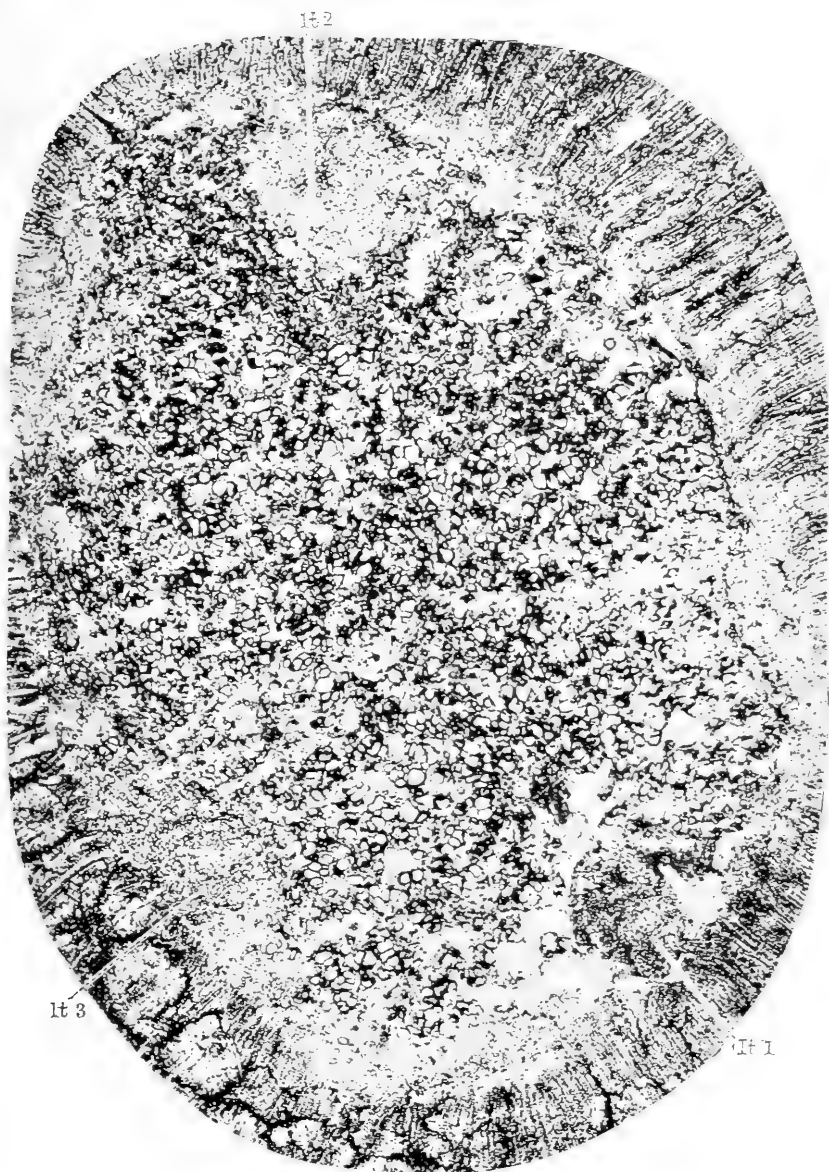
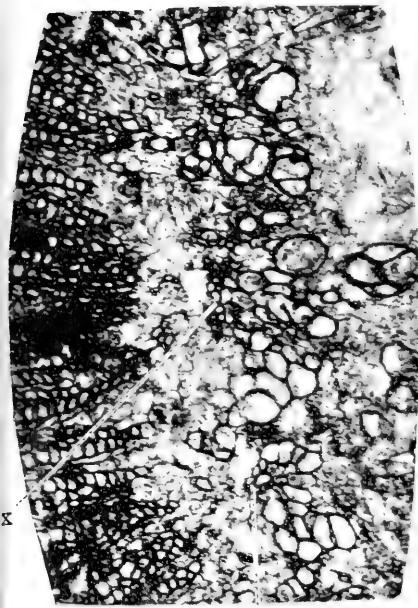

Fig. 7.

MEGALOXYLON gen. nov.



px
Fig. 8.

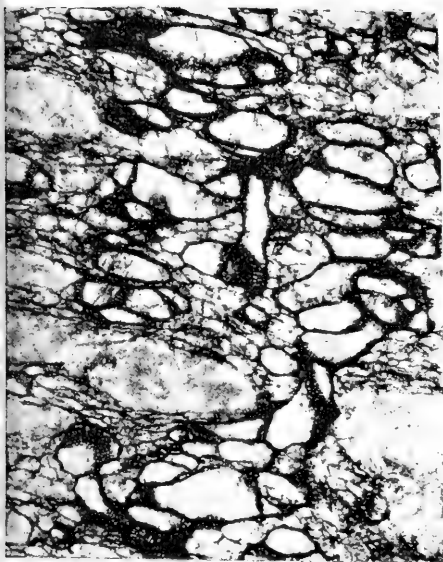
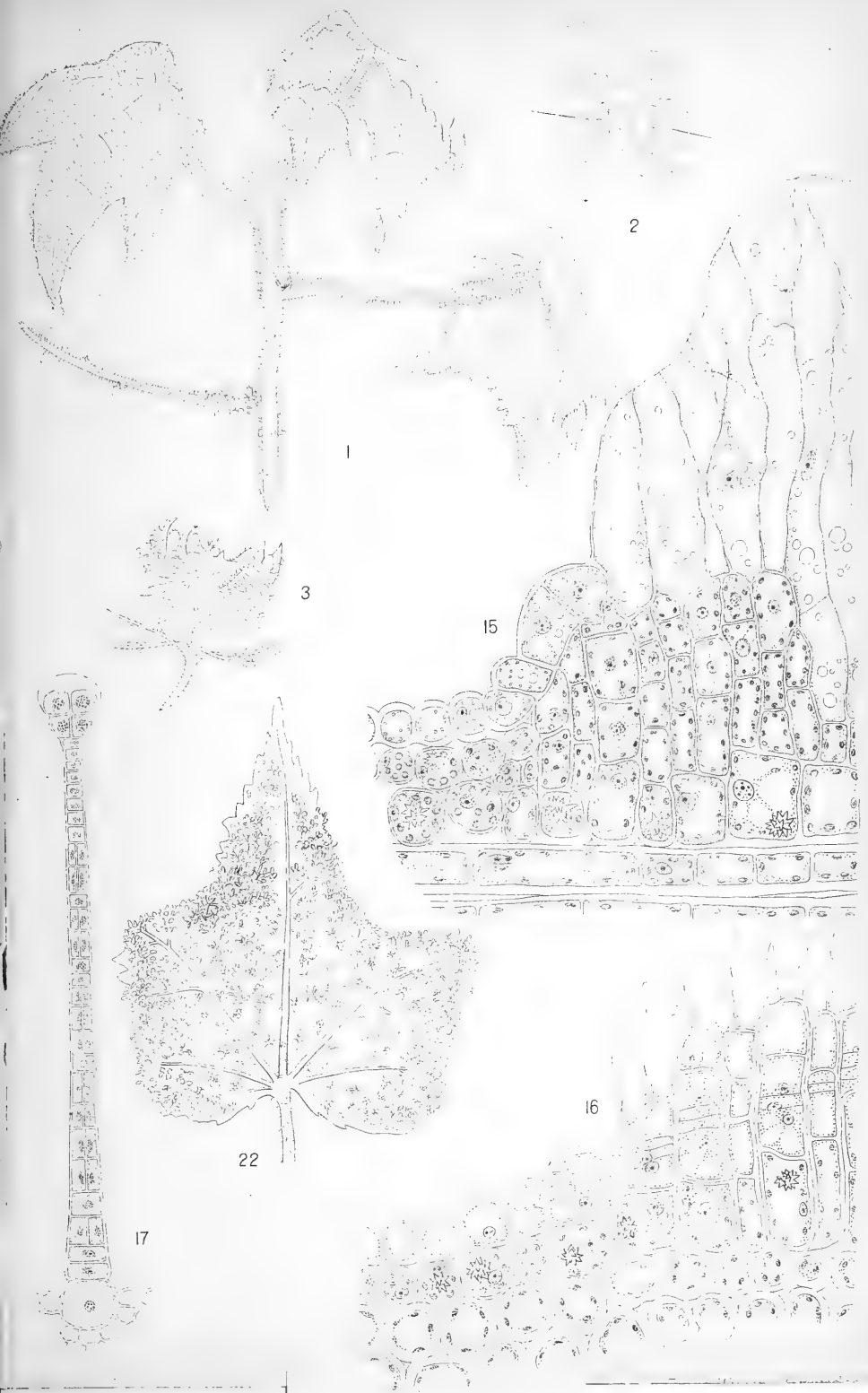

Fig. 9.



x² x¹
Fig. 10.



DALEA INTUMESCENCES

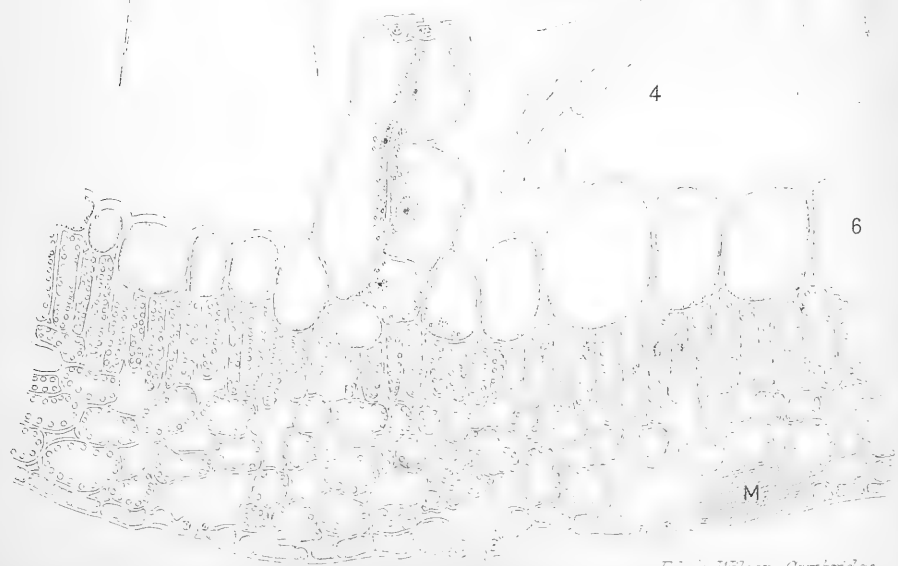



Fig. 5.

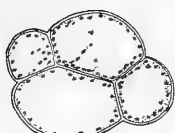

Fig. 8.

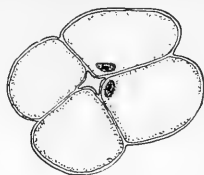

Fig. 9.

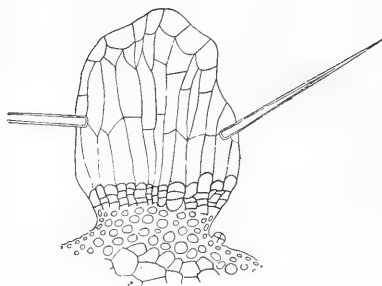

Fig. 13.

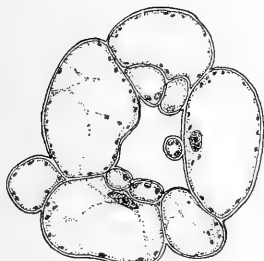

Fig. 10.

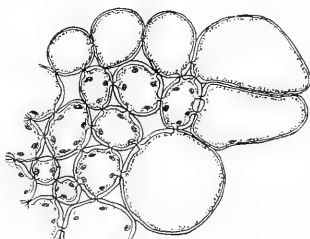

Fig. 12.



Fig. 18.

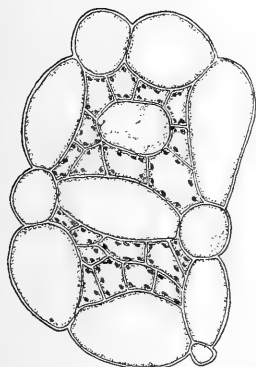

Fig. 11.

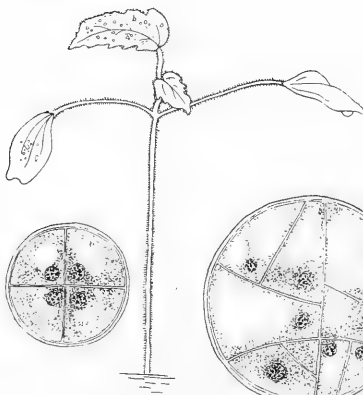
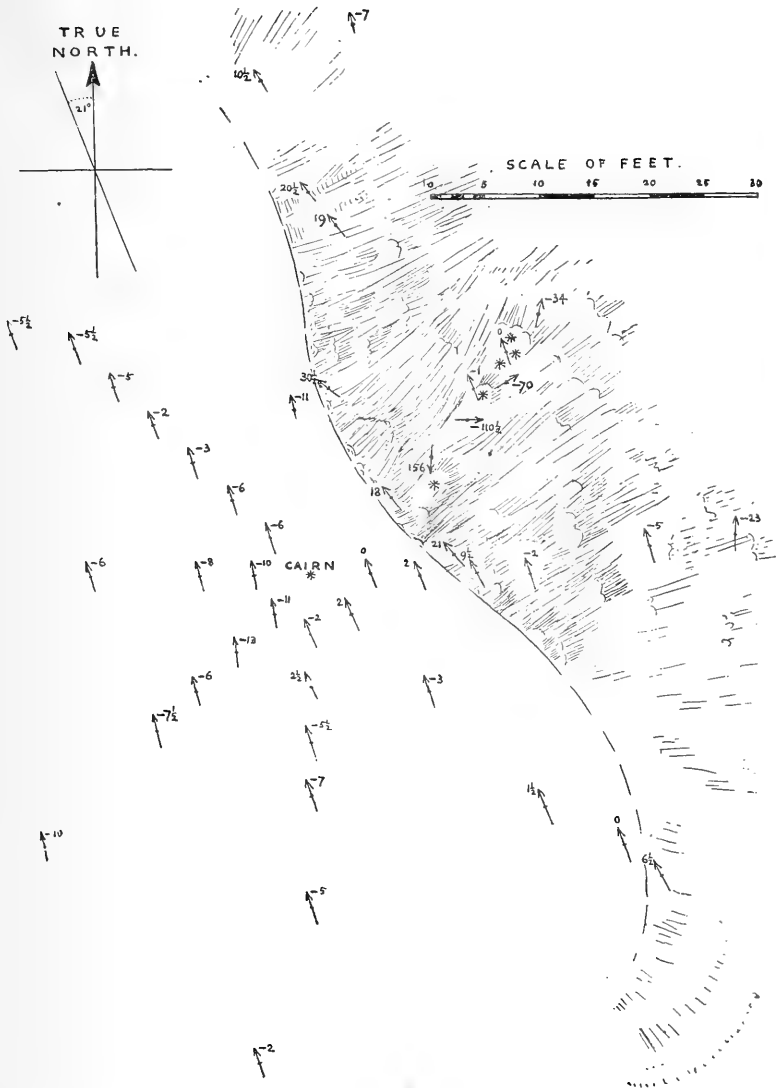

Fig. 19.

Fig. 21.

Fig. 20.





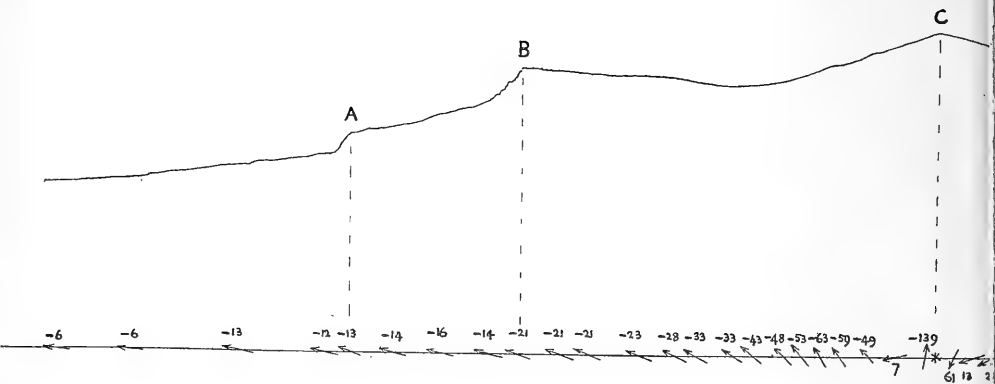

SCALE OF YARDS.



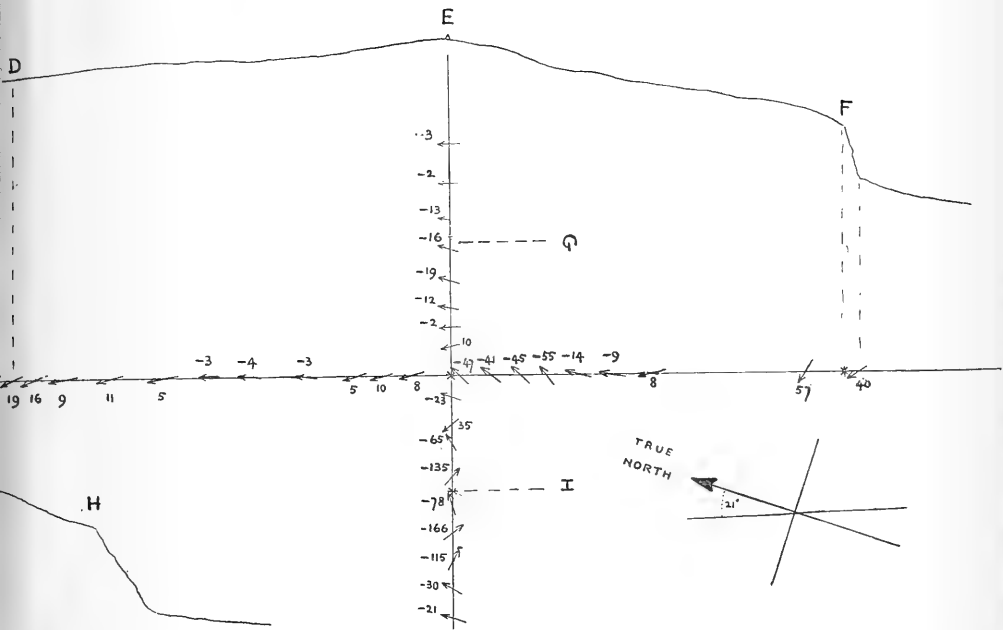



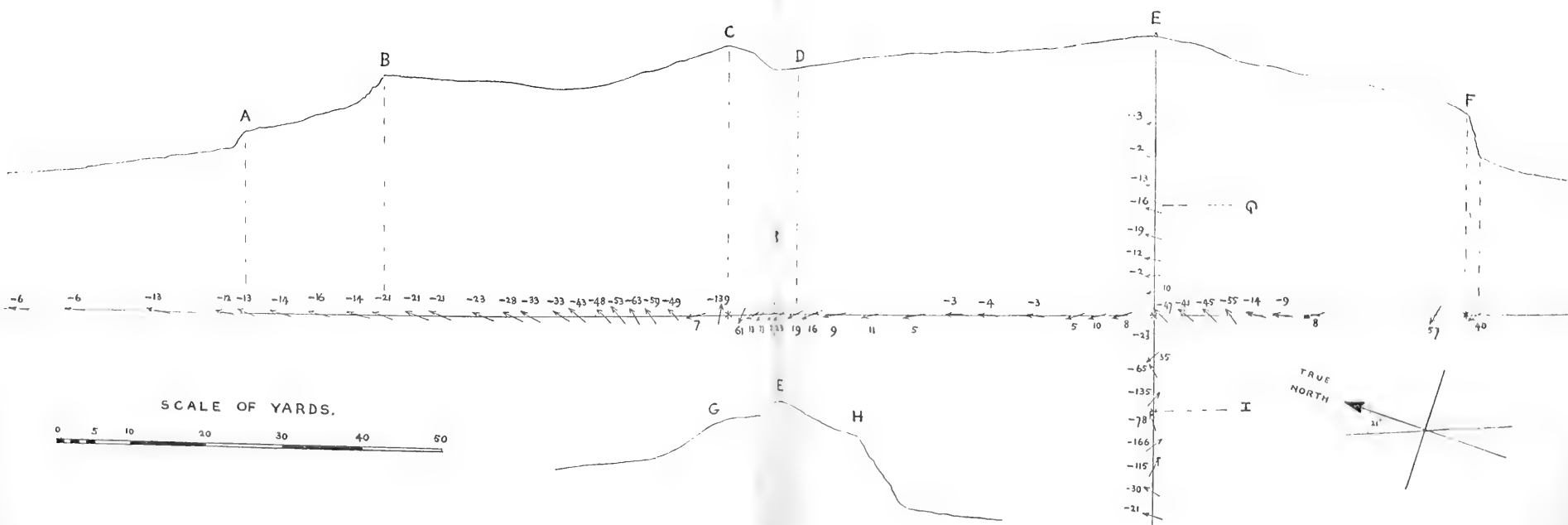

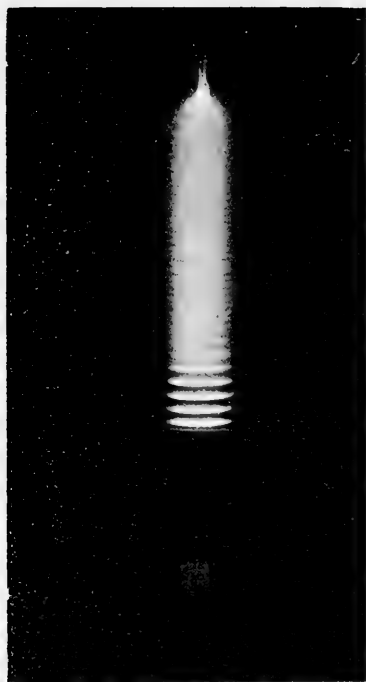

PHOTOGRAPH SHOWING DOUBLE STRIAE.

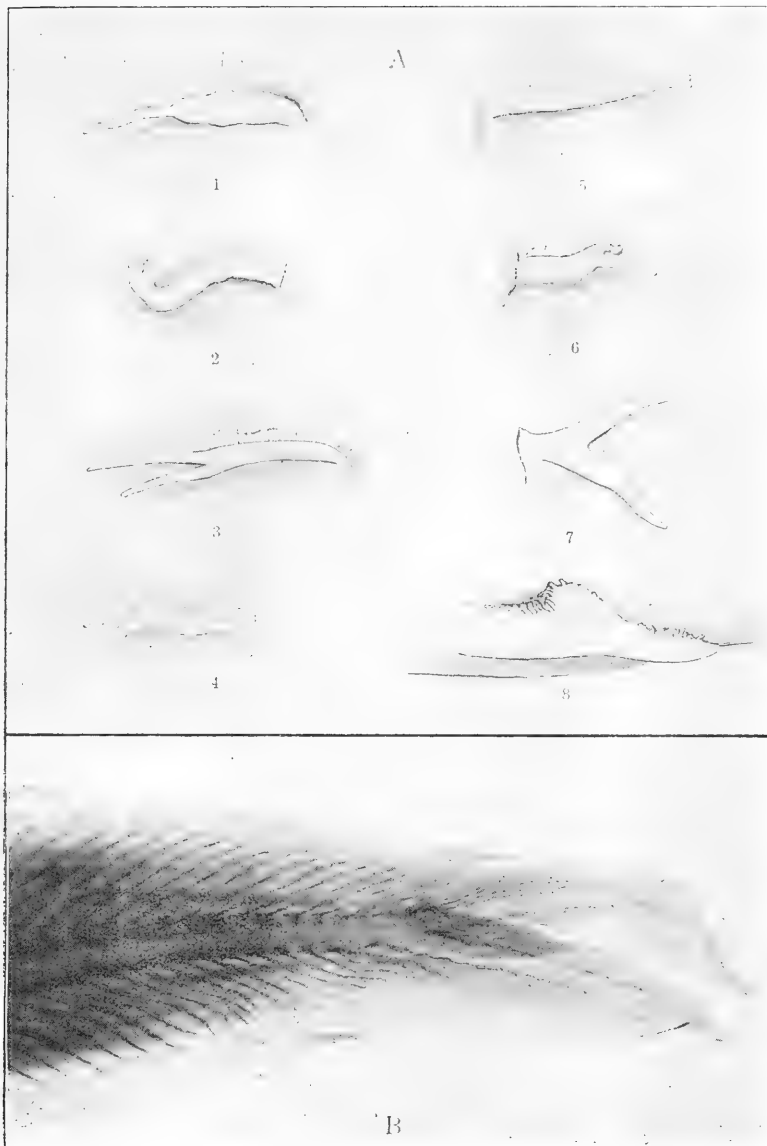

A. 1—7. FORE LIMBS OF LEPIDOSIREN.
8. HIND-LIMB OF LEPIDOSIREN.

B. TAIL OF PROTOPTERUS.

107436
PROCEEDINGS

OF THE

CAMBRIDGE PHILOSOPHICAL

SOCIETY.

VOL. X. PART I.

[MICHAELMAS TERM 1898.]

Cambridge:

AT THE UNIVERSITY PRESS,

AND SOLD BY

DEIGHTON, BELL & CO. AND MACMILLAN & BOWES, CAMBRIDGE.

C. J. CLAY AND SONS, AVE MARIA LANE, LONDON.

1899

Price Two Shillings and Sixpence.

23 January, 1899.

NOTICES.

1. A limited number of complete sets of the first Ten Volumes (thirty parts and index) of the *Transactions* is in stock; sets may be obtained on application to the Secretaries of the Society. The price is £20 a set.

2. *Transactions.*

Vol. XVII. Pt. II. is now published, and will be sent on application at the University Press; it includes the following papers:

IV. MR A. E. WESTERN, B.A., *Certain Systems of Quadratic Complex Numbers.*

V. Major P. A. MACMAHON, R.A., D.Sc., F.R.S., Hon. Mem. C.P.S., *Partitions of Numbers whose Graphs possess Symmetry.*

3. Letters and Communications for the Society should be addressed to one of the Secretaries,

MR H. F. NEWALL, Madingley Rise,

MR W. BATESON, St John's College,

MR H. F. BAKER, St John's College.

Presents for the Library of the Society should be addressed to

The Philosophical Library,

New Museums,

Cambridge.

Members of the Society are requested to inform the Secretaries of any change of address. The Secretaries will be obliged also for any corrections of the list of Members which was issued in 1898.

CONTENTS.

	PAGE
Annual General Meeting 1898, October 31	1
Mr A. BERRY, <i>On the evaluation of a certain determinant which occurs in the mathematical theory of statistics and in that of elliptic geometry of any number of dimensions</i>	2
Mr J. H. GRACE, (1) <i>Metrical Relations between Linear Complexes.</i> (2) <i>Apolar Systems of Quadrics</i>	10
Mr A. E. WESTERN, <i>Certain Systems of Quadratic Complex Numbers</i>	10
Mr H. F. BAKER, <i>On Mittag-Leffler's Theorem</i>	10
Professor J. J. THOMSON, <i>On the connection between the Chemical Composition of a Gas and the Ionization produced in it by Röntgen Rays</i>	10
Mr J. ZELENY, <i>On Convection Currents and on the Fall of Potential at the Electrodes, in Conduction produced by Röntgen Rays</i>	14
Mr H. A. WILSON, <i>On Velocity of Solidification</i>	25
Mr H. GADOW, <i>Orthogenetic Variation in the Shells of Chelonia</i>	35
Dr A. WILLEY, <i>Some points in the Morphology of the Enteropneusta</i>	37
Mr A. C. SEWARD and Mr A. W. HILL, <i>On Lepidodendron from the Calciferous Sandstone of Scotland</i>	38
Professor LIVEING, <i>On the Flame-spectrum of Mercury, and its bearing on the distribution of energy in gases</i>	38
Professor LIVEING, <i>On the Variation of Intensity of the Absorption Bands of different Didymium Salts dissolved in water, and its bearing on the ionization theory of the colour of solutions of salts</i>	40
Professor DEWAR, <i>On the Comparative Colour of the Vapour of Iodine in Air at Atmospheric Pressure and in Vacuum</i>	44
Major MACMAHON, <i>On the Partitions of Numbers which possess symmetrical Graphs</i>	47

PROCEEDINGS
OF THE
CAMBRIDGE PHILOSOPHICAL
SOCIETY.

VOL. X. PART II.

[LENT TERM 1899.]

Cambridge:

AT THE UNIVERSITY PRESS,

AND SOLD BY

DEIGHTON, BELL & CO. AND MACMILLAN & BOWES, CAMBRIDGE.

C. J. CLAY AND SONS, AVE MARIA LANE, LONDON.

1899

Price Two Shillings and Sixpence.

7 June, 1899.

UNIVERSITY OF CAMBRIDGE
—OF—
WASHINGTON.



NOTICES.

1. A limited number of complete sets of the first Ten Volumes (thirty parts and index) of the *Transactions* is in stock; sets may be obtained on application to the Secretaries of the Society. The price is £20 a set.

2. *Transactions.*

Vol. XVII. Pt. III., containing title page and index to Vol. XVII., is now published, and will be sent on application at the University Press; it includes the following papers:

- VI. Prof. W. M^cF. ORR, M.A., *Divergent (or Semiconvergent) Hypergeometric Series.*
- VII. C. CHREE, Sc.D., F.R.S., *A semi-inverse method of solution of the equations of elasticity, and its application to certain cases of aeolotropic ellipsoids and cylinders.*
- VIII. E. G. GALLOP, M.A., *The Change of a System of Independent Variables.*
- IX. Prof. W. M^cF. ORR, M.A., *Divergent Hypergeometric Series.*

3. Letters and Communications for the Society should be addressed to one of the Secretaries,

Mr H. F. NEWALL, Madingley Rise,
Mr W. BATESON, St John's College,
Mr H. F. BAKER, St John's College.

Presents for the Library of the Society should be addressed to

The Philosophical Library,
New Museums,
Cambridge.

Members of the Society are requested to inform the Secretaries of any change of address. The Secretaries will be obliged also for any corrections of the list of Members which is issued herewith.

CONTENTS.

	PAGE
Professor J. J. THOMSON, <i>On the motion of a charged ion in a magnetic field</i>	49
Mr JOHN S. TOWNSEND, <i>The formation of clouds with ozone</i>	52
Mr H. C. POCKLINGTON, <i>On the Symbolic Integration of certain Differential Equations in Quaternions</i>	59
Mr H. C. POCKLINGTON, <i>On the conditions of sensitiveness in Detectors of Radiant Heat</i>	66
Mr J. STANLEY GARDINER, <i>On the Anatomy of a supposed New Species of Coenopsammia from Lifu</i>	72
Professor J. J. THOMSON, <i>On the Conductivity of Gases exposed to Entladungsstrahlen</i>	74
Mr W. BATESON and Miss D. F. M. PERTZ, <i>Notes on the inheritance of Variation in the Corolla of Veronica Buxbaumii (Plate)</i>	78

107708
PROCEEDINGS

OF THE

CAMBRIDGE PHILOSOPHICAL

SOCIETY.

VOL. X. PART III.

[EASTER TERM 1899.]

Cambridge :

AT THE UNIVERSITY PRESS,

AND SOLD BY

DEIGHTON, BELL & CO. AND MACMILLAN & BOWES, CAMBRIDGE.

C. J. CLAY AND SONS, AVE MARIA LANE, LONDON.

1899

Price Two Shillings and Sixpence.

7 November, 1899.

NOTICES.

1. A limited number of complete sets of the first Ten Volumes (thirty parts and index) of the *Transactions* is in stock; sets may be obtained on application to the Secretaries of the Society. The price is £20 a set.

2. *Transactions.*

Vol. XVIII. is now in course of preparation. It will form a special volume commemorative of the long connexion of Sir G. G. STOKES with the Society, and will contain papers by Professor MITTAG-LEFFLER, M. POINCARÉ, Dr BOLTZMANN, Professor MICHELSON, Major MACMAHON, Professor SCHUSTER, Professor LIVEING, The MASTER OF ST JOHN'S COLLEGE, Professor FORSYTH, Mr LARMOR, Professor W. D. NIVEN, Professor THOMSON, Dr HOBSON, Mr GLAZEBROOK and Professor O. J. LODGE, Mr W. BURNSIDE, Mr SHAW, Mr E. W. BROWN, Professor E. O. LOVETT, and others.

3. Letters and Communications for the Society should be addressed to one of the Secretaries,

Mr H. F. BAKER, St John's College.

Mr A. E. SHIPLEY, Christ's College,

Mr L. R. WILBERFORCE, Trinity College,

Presents for the Library of the Society should be addressed to

The Philosophical Library,

New Museums,

Cambridge.

Members of the Society are requested to inform the Secretaries of any change of address. The Secretaries will be obliged also for any corrections of the list of Members which was issued in May, 1899.

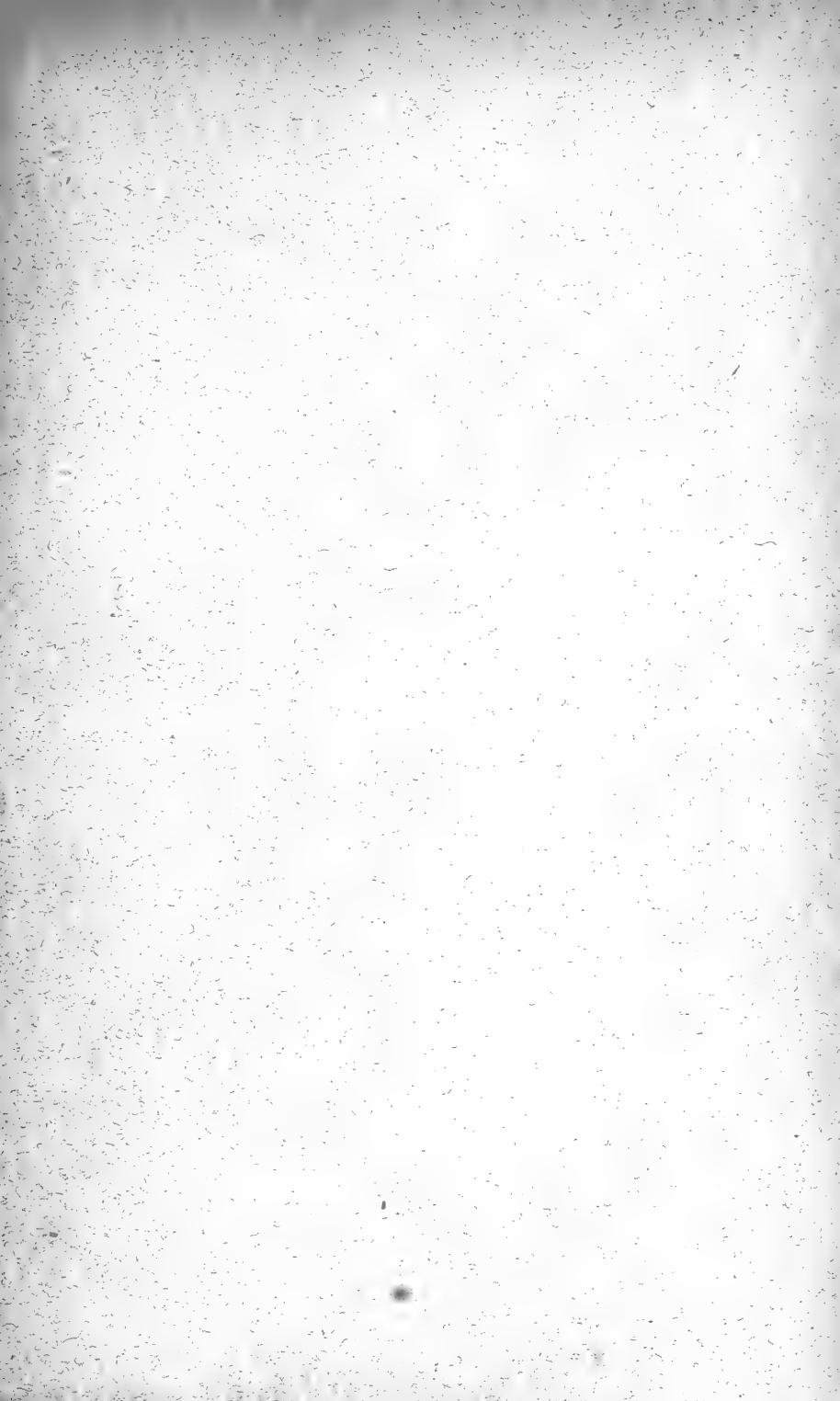

CONTENTS.

	PAGE
Mr W. M ^c F. ORR, <i>On the product $J_m(x)J_n(x)$</i>	93
Rev. H. J. SHARPE, <i>On the Reflection of Sound at a Paraboloid</i>	101
Mr A. C. SEWARD, <i>Notes on the Binney Collection of Coal-Measure Plants. Plates III. to VII</i>	137
Mr D. SHARP, <i>The Modification and Attitude of Idolum diabolicum, a Mantis of the kind called "floral simulators."</i> Plate II.	175
Mr J. LARMOR, <i>On the Origin of Magneto-optic Rotation</i>	181
Proceedings at the Meetings held during the Session 1898—1899	183

107433
PROCEEDINGS

OF THE

CAMBRIDGE PHILOSOPHICAL
SOCIETY.

VOL. X. PART IV.

[MICHAELMAS TERM 1899.]

Cambridge:

AT THE UNIVERSITY PRESS,

AND SOLD BY

DEIGHTON, BELL & CO. AND MACMILLAN & BOWES, CAMBRIDGE.

C. J. CLAY AND SONS, AVE MARIA LANE, LONDON.

1900

Price Two Shillings and Sixpence.

16 January, 1900.



NOTICES.

1. A limited number of complete sets of the first Ten Volumes (thirty parts and index) of the *Transactions* is in stock; sets may be obtained on application to the Secretaries of the Society. The price is £20 a set.

2. *Transactions.*

Vol. XVIII. is now in course of preparation, and will be sent, in paper covers, to Fellows and Honorary Members making application at the University Press, Cambridge. Bound copies will also be obtainable. It will form a special volume commemorative of the long connexion of Sir G. G. STOKES with the Society, and will contain papers by Professor MITTAG-LEFFLER, M. POINCARÉ, Dr BOLTZMANN, Professor MICHELSON, Major MACMAHON, Professor SCHUSTER, Professor LIVEING, The MASTER OF ST JOHN'S COLLEGE, Professor FORSYTH, Mr LARMOR, Professor W. D. NIVEN, Professor THOMSON, Dr HOBSON, Mr GLAZE BROOK and Professor O. J. LODGE, Mr W. BURNSIDE, Mr SHAW, Professor H. LAMB, Mr E. W. BROWN, Professor E. O. LOVETT, and others.

3. Letters and Communications for the Society should be addressed to one of the Secretaries,

Mr H. F. BAKER, St John's College,

Mr A. E. SHIPLEY, Christ's College,

Mr L. R. WILBERFORCE, Trinity College.

Presents for the Library of the Society should be addressed to

The Philosophical Library,

New Museums,

Cambridge.

Members of the Society are requested to inform the Secretaries of any change of address. The Secretaries will be obliged also for any corrections of the list of Members which was issued in May, 1899.



CONTENTS.

	PAGE
MR W. M ^c F. ORR, <i>On Semi-convergent Series</i>	189
MR C. T. R. WILSON, <i>An Experiment on the Condensation of Clouds</i>	189
MR J. J. LISTER, <i>The Skeleton of Astrosclera compared with that of the Pharetronid Sponges</i>	189
DR S. F. HARMER, <i>Note on the name Balanoglossus</i>	190
MISS E. DALE, <i>On certain outgrowths (Intumescences) on the green parts of Hibiscus vitifolius Linn. Plates VIII, IX, X.</i>	192
MR H. W. RICHMOND, <i>On the condition that five straight lines situated in a space of four dimensions should lie on a quadric</i>	210
PROFESSOR LIVEING, <i>On the Influence of Temperature, and of Various Solvents, on the Absorption Spectra of Didymium and Erbium Salts</i>	213
MR H. JACKSON, <i>Researches in the Sugar Group</i>	215
MR A. HUTCHINSON, <i>On a New Mineral</i>	216
MR JOHN S. TOWNSEND, <i>Secondary Röntgen Rays</i>	217
MR J. GRAHAM KERR, <i>Note on hypotheses as to the origin of the Paired Limbs of Vertebrates</i>	227
MR J. S. BUDGETT, <i>Observations on Polypterus and Protopteris</i>	236
MR J. A. M ^c CLELLAND, <i>On the Conductivity of Gases from an Arc and from Incandescent Metals</i>	241

PROCEEDINGS

FROM
PHILOSOPHICAL SOCIETY
--OF--
WASHINGTON.

OF THE

CAMBRIDGE PHILOSOPHICAL
SOCIETY.

VOL. X. PART V.

[LENT TERM 1900.]

Cambridge :

AT THE UNIVERSITY PRESS,

AND SOLD BY

DEIGHTON, BELL & CO. AND MACMILLAN & BOWES, CAMBRIDGE.

C. J. CLAY AND SONS, AVE MARIA LANE, LONDON.

1900

Price Two Shillings and Sixpence.

7 May 1900.

NOTICES.

1. A limited number of complete sets of the first Ten Volumes (thirty parts and index) of the *Transactions* is in stock; sets may be obtained on application to the Secretaries of the Society. The price is £20 a set.

2. *Transactions.*

Volume XVIII. is now ready and will be sent to Fellows and Honorary Members of the Society who fill up and return the notice issued with this Part of the Proceedings.

Volume XIX., Part I. is in the Press, and will be issued when ready. Fellows and Honorary Members who desire that the parts of Vol. XIX. should be sent to them as they appear should state this in returning the enclosed notice.

3. Letters and Communications for the Society should be addressed to one of the Secretaries,

Mr H. F. BAKER, St John's College,

Mr A. E. SHIPLEY, Christ's College,

Mr L. R. WILBERFORCE, Trinity College.

Presents for the Library of the Society should be addressed to

The Philosophical Library,

New Museums,

Cambridge.

4. Members of the Society are requested to inform the Secretaries of any change of address. The Secretaries will be obliged also for any corrections of the list of Members which was issued in May, 1899.

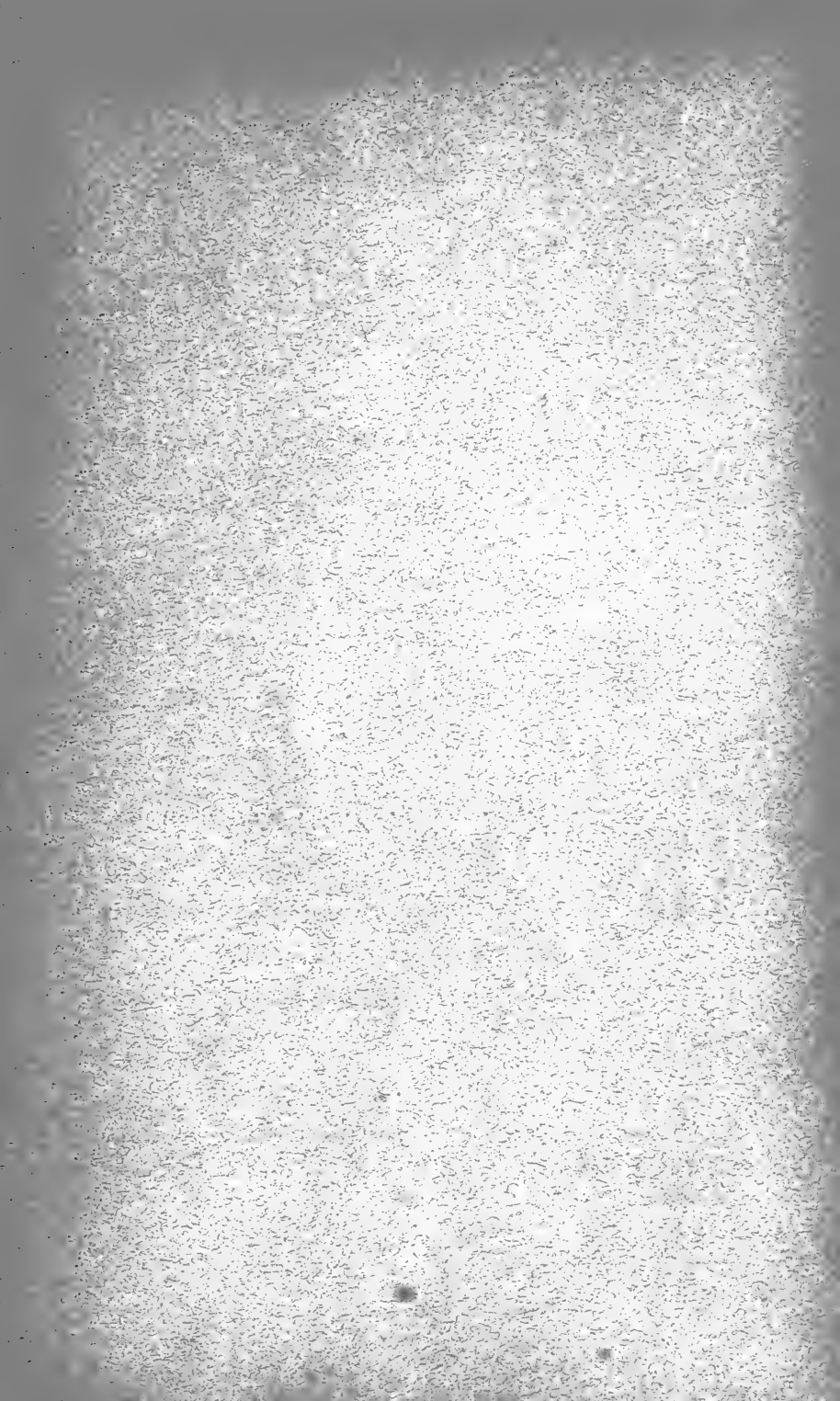

CONTENTS.

	PAGE
MISS D. F. M. PERTZ and MR FRANCIS DARWIN, <i>Experiments on the Periodic Movement of Plants</i>	259
MR A. C. SEWARD, <i>On the Wealden Plants from Bernissart</i>	259
MR R. H. BIFFEN, <i>On the Biology of Bulgaria polymorpha</i>	260
MR S. SKINNER, <i>On the Electro-chemical Equivalent of Carbon</i>	261
MR ALFRED HARKER, <i>On the Magnetic Disturbances in the Isle of Skye</i> (with Plates XI, XII).	268
MR A. C. DIXON, <i>On Differential Equations with two Independent Variables</i>	278
MR G. E. H. BARRETT-HAMILTON, <i>A suggestion as to a possible mode of Origin of some of the Secondary Sexual Characters in Animals as afforded by Observations on certain Salmonids</i>	279
MR W. L. H. DUCKWORTH and MR B. H. PAIN, <i>An Account of some Eskimo from Labrador</i>	286
MR W. L. H. DUCKWORTH and MR D. H. FRASER, <i>A Description of some dental Rudiments in human crania</i>	292
MR J. GRAHAM KERR, <i>On the Zoological Position of Palaeospondylus, Traquair</i>	298
MR F. GOWLAND HOPKINS, <i>On the Separation of a pure Albumen from Egg-white</i>	300
MR HERBERT RICHMOND, <i>On the simplest algebraic minimal curves, and the derived real minimal surfaces</i>	301
MR G. B. MATHEWS, <i>Diophantine Inequalities</i>	302
MR R. S. WILLOWS, <i>On the distance between the striae in the positive column and other phenomena connected with the discharge</i> (with Plate XIII).	302
PROFESSOR EWING, <i>The teaching of Mechanics by experiment</i>	317
MR W. F. SHEPPARD, <i>On the calculation of the double integral expressing normal correlation</i>	317
MR G. F. C. SEARLE, <i>Apparatus for Measuring the Extension of a Wire</i>	318

PHILOSOPHICAL SOCIETY
--OF--
WASHINGTON.
PROCEEDINGS

OF THE

CAMBRIDGE PHILOSOPHICAL
SOCIETY.

VOL. X. PART VI.

[EASTER TERM 1900.]

Cambridge :

AT THE UNIVERSITY PRESS,

AND SOLD BY

DEIGHTON, BELL & CO. AND MACMILLAN & BOWES, CAMBRIDGE.

C. J. CLAY AND SONS, AVE MARIA LANE, LONDON.

1900

Price Two Shillings and Sixpence.

13 August 1900.

NOTICES.

1. A limited number of complete sets of the first Ten Volumes (thirty parts and index) of the *Transactions* is in stock; sets may be obtained on application to the Secretaries of the Society. The price is £20 a set.

2. *Transactions.*

Volume XIX., Part I., was published on June 19. Fellows and Honorary Members of the Society, not having already applied, who desire that the various Parts of Volume XIX. should be sent to them as they appear are required to make application at the University Press, Cambridge. A separate application is, by order of the Council, necessary for each Volume, but not for each Part of a Volume.

3. Letters and Communications for the Society should be addressed to one of the Secretaries,

MR H. F. BAKER, St John's College,

MR A. E. SHIPLEY, Christ's College,

MR L. R. WILBERFORCE, Trinity College.

Presents for the Library of the Society should be addressed to

The Philosophical Library,

New Museums,

Cambridge.

4. Members of the Society are requested to inform the Secretaries of any change of address. The Secretaries will be obliged also for any corrections of the list of Members which was issued in May, 1899.

CONTENTS.

	PAGE
Professor MACALISTER, <i>Exhibition of Anomalous Bones from Pre-dynastic Egyptian Skeletons</i>	325
Dr GASKELL, <i>Ammocoetes a Cephalaspid</i>	325
Mr H. H. BRINDLEY, <i>Note on some Abnormalities of the limbs and tail of Dipnoan Fishes</i>	325
Mr WALTER MYERS, <i>The Standardisation of Antivenomous Serum</i>	328
Major MACMAHON, <i>On a certain Diophantine Inequality</i>	331
Mr RICHMOND, <i>On rational Space Curves of the fourth order</i>	331
Mr J. H. VINCENT, <i>Experiments on Impact</i>	332
Mr T. J. P. A. BROMWICH, <i>The Classification of Conics and Quadrics</i>	358
Dr LOUIS COBBETT, <i>On the Heat generated by certain Fibrous Substances when wetted</i>	372
Mr L. R. WILBERFORCE, <i>A Method of measuring the Retardation produced by a Crystal Plate</i>	376

--OF--
WASHINGTON.
PROCEEDINGS

OF THE

CAMBRIDGE PHILOSOPHICAL
SOCIETY.

VOL. X. PART VII.

[CONSISTING OF THE PROCEEDINGS OF THE SOCIETY FOR THE
SESSION 1899—1900; AND OF THE TITLE, CONTENTS AND
INDEX TO VOLUME X.]

Cambridge:

AT THE UNIVERSITY PRESS,

AND SOLD BY

DEIGHTON, BELL & CO. AND MACMILLAN & BOWES, CAMBRIDGE.

C. J. CLAY AND SONS, AVE MARIA LANE, LONDON.

1901

Price One Shilling.

January 1901.

NOTICES.

1. A limited number of complete sets of the first Ten Volumes (thirty parts and index) of the *Transactions*, is in stock; sets may be obtained on application to the Secretaries of the Society. The price is £20 a set.

2. *Transactions*.

Volume XIX., Part I., was published on 19th June 1900. Fellows and Honorary Members of the Society, not having already applied, who desire that the various Parts of Volume XIX. should be sent to them as they appear are required to make application at the University Press, Cambridge. A separate application is, by order of the Council, necessary for each Volume, but not for each Part of a Volume.

3. Letters and Communications for the Society should be addressed to one of the Secretaries,

Mr H. F. BAKER, St John's College,

Mr A. E. SHIPLEY, Christ's College,

Mr S. SKINNER, Christ's College.

Presents for the Library of the Society should be addressed to

The Philosophical Library,

New Museums,

Cambridge.

4. Members of the Society are requested to inform the Secretaries of any change of address. The Secretaries will be obliged also for any corrections of the list of Members which is herewith issued.





35 (15)



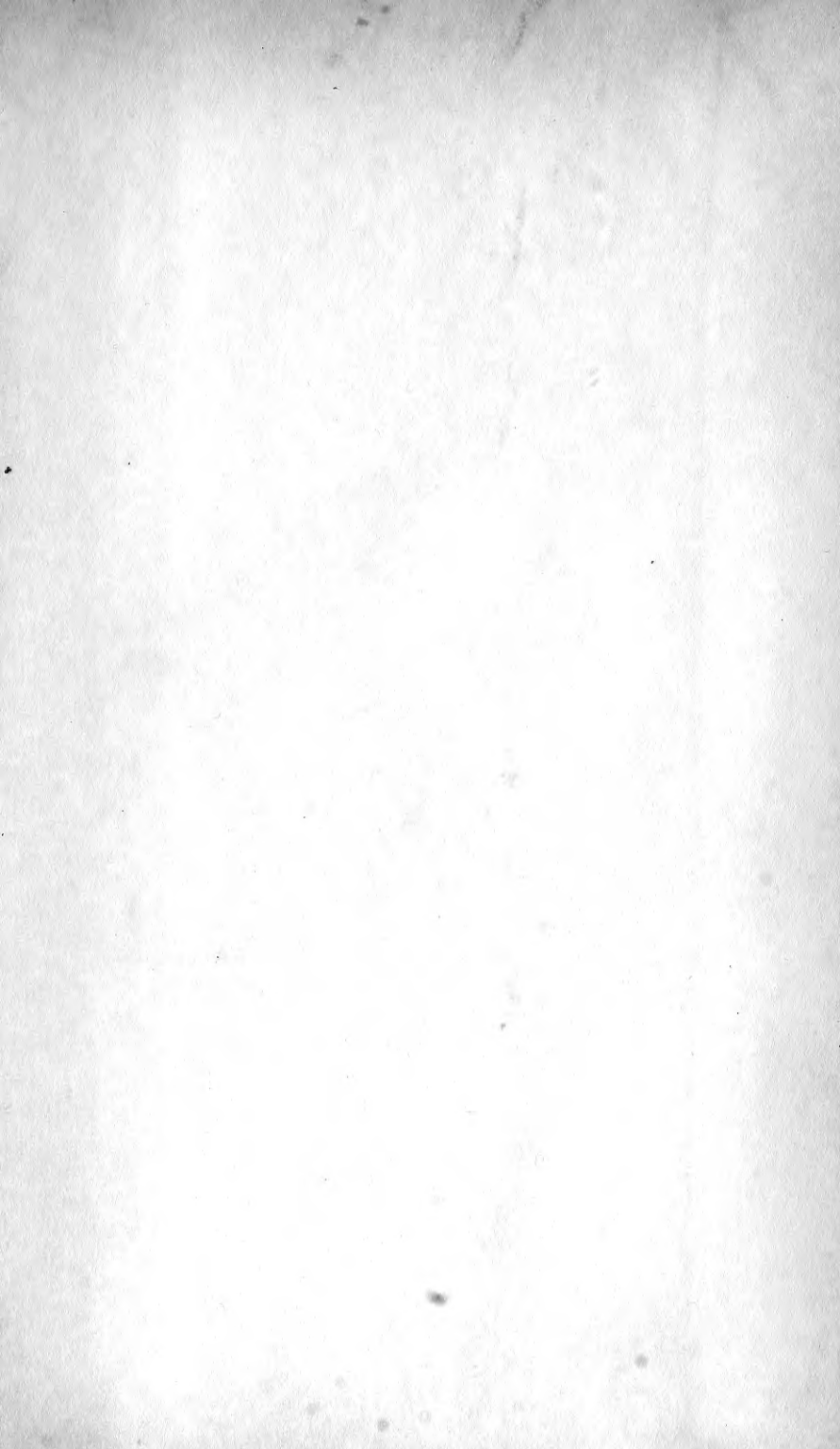



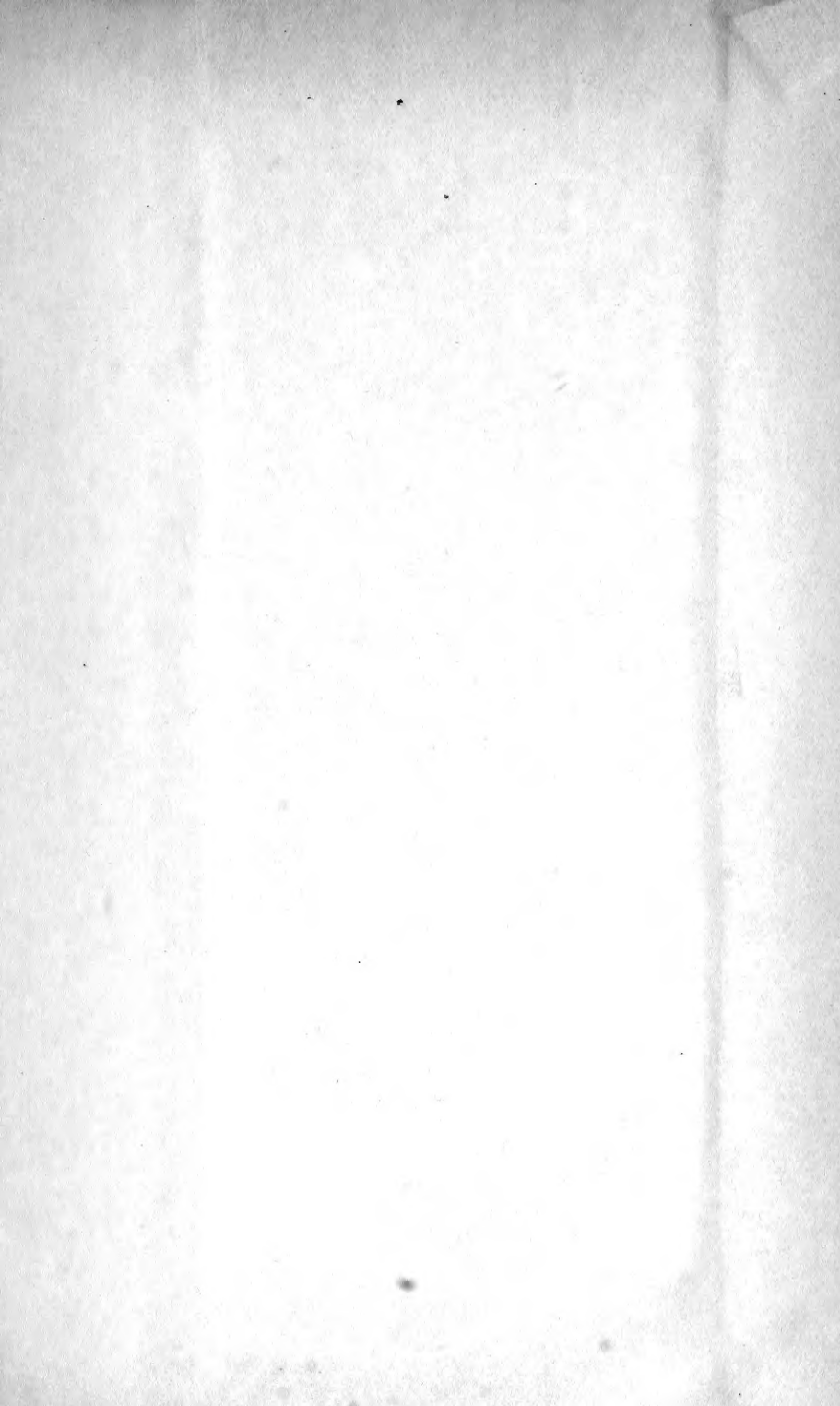

SMITHSONIAN INSTITUTION LIBRARIES



3 9088 01303 3394