

PROCEEDINGS

OF THE

Indiana Academy
of Science

1914



PROCEEDINGS

OF THE

Indiana Academy of Science

1914

H. E. BARNARD, Editor

INDIANAPOLIS :
WM. B. BURFORD, CONTRACTOR FOR STATE PRINTING AND BINDING
1915

XP
.R684

TABLE OF CONTENTS.

	PAGE
Constitution.....	5
By-Laws.....	7
Appropriation for 1913-1914.....	9
An Act for the Protection of Birds, Their Nests and Eggs.....	9
Public Offenses—Hunting Birds—Penalty.....	10
Officers, 1913-1914.....	11
Executive Committee.....	11
Curators.....	11
Committees Academy of Science, 1915.....	12
Officers of the Academy of Science (A Table of).....	13
Members.....	14
Fellows.....	14
Active Members.....	22
Minutes of the Spring Meeting.....	39
Minutes of the Thirtieth Annual Meeting.....	45
Program of the Thirtieth Annual Meeting.....	50
Science in Its Relation to the Conservation of Human Life. Severance Burrage.....	55
A Family in One Neighborhood. Amos W. Butler.....	59
The Problem of Feeble-Mindedness. G. S. Bliss.....	61
The Feeble-Minded and Delinquent Boy. Franklin C. Paschal.....	63
The Feeble-Minded and Delinquent Girl. E. E. Jones.....	71
Feeble-Mindedness in the Public Schools. Katrina Myers.....	79
The Alcohol Problem in the Light of Coniosis. Robert Hessler.....	85
Cold Storage Is Practical Conservation. H. E. Barnard.....	101
Changing Conditions in the Kentucky Mountains. B. H. Schockel.....	109
Conservation and Civilization. Arthur L. Foley.....	133
Why Do Our Birds Migrate? D. W. Dennis.....	145
Flood Protection in Indiana. W. K. Hatt.....	149
An Apparatus for Aerating Culture Solutions. Paul Weatherwax.....	157
Antagonism on <i>B. Fluorescens</i> and <i>B. Typhosus</i> in Culture. P. A. Tetrault.....	161
Notes Upon the Distribution of Forest Trees in Indiana. Stanley Coulter.....	167
Corrections to the Lists of Mosses of Monroe County, Indiana, I and II. Mildred Nothnagel and F. L. Pickett.....	179
The Mosses of Monroe County, Indiana, III. F. L. Pickett and Mildred Nothnagel.....	181
A New Enemy of the Black Locust. Glenn Culbertson.....	185
A New Leaf Spot of <i>Viola Cucullata</i> . H. W. Anderson.....	187
Oat Smut in Indiana. F. J. Pipel.....	191
Plants New or Rare to Indiana. No. V. Charles C. Deam.....	197

	PAGE
Some Peculiarities in <i>Spirogyra Dubia</i> . Paul Weatherwax.....	203
Report on Corn Pollination IV. (Final.) M. L. Fisher.....	207
Stomata of <i>Trillium Nivale</i> . F. M. Andrews.....	209
The Primrose-Leaved Violet in White County. Louis M. Heimlich.....	213
Continuous Rust Propagation Without Sexual Reproduction. C. A. Ludwig.....	219
Correlation of Certain Long-Cycled and Short-Cycled Rusts. H. C. Travelbee.....	231
Some Species of <i>Nummularia</i> Common in Indiana. Claude E. O'Neal....	235
The Genus <i>Rosellinia</i> in Indiana. Glen B. Ramsey.....	251
Some Large Botanical Problems. G. C. Arthur.....	267
The Alba B. Ghere Collection of Birds' Eggs Presented to the Museum of Purdue University. Howard E. Enders.....	273
A Note on a Peculiar Nesting Site of the Chimney Swift. Glenn Culbertson	279
Notes on Indiana Earthworms. H. V. Heimbürger.....	281
Notes on Orthoptera and Orthopteran Habitats in the Vicinity of Lafayette, Indiana. Henry Fox.....	287
Some Insects of the Between Tides Zone. Charles H. Arndt.....	323
The Snakes of the Lake Maxinkuckee Region. Barton Warren Evermann and Howard Walton Clark.....	337
Stirring as a Time Saver in Gravimetric Analysis. W. M. Blanchard.....	349
The Alundum Crucible as a Substitute for the Gooch Crucible. George L. Clark.....	351
The Correlation of High School and College Chemistry. James Brown....	355
The Chemical Composition of Virgin and Cropped Indiana Soils. S. D. Conner.....	359
Sewage Disposal. Charles Brossman.....	365
Tar Forming Temperatures of American Coals. Otto Carter Berry.....	373
Shawnee Mound, Tippecanoe County, as a Glacial Alluvial Cone. Wm. A. McBeth.....	385
Correlation of the Outcrop at Spades, Indiana. H. N. Coryell.....	389
The Paleobotany of the Bloomington, Indiana, Quadrangle. T. F. Jackson.	395
The Flatwoods Region of Owen and Monroe Counties, Indiana. Clyde A. Malott.....	399
Mechanical Device for Testing Mersenne Numbers for Primes. Thos. E. Mason.....	429
Some Properties of Binomial Coefficients. A. M. Kenyon.....	433
Radioactivity of Spring Water. R. R. Ramsey.....	453
A Tornado at Watertown, South Dakota, June 23, 1914. J. Gladden Hutton.....	473
A Simple Form of the Carey Foster Bridge. J. P. Naylor.....	485
Variation of the Emanation Content of Certain Springs. R. R. Ramsey.	489
The Construction of a Rutherford's Electroscope. Edwin Morrison.....	491

CONSTITUTION.

ARTICLE I.

SECTION 1. This association shall be called the Indiana Academy of Science.

SEC. 2. The objects of this Academy shall be scientific research and the diffusion of knowledge concerning the various departments of science; to promote intercourse between men engaged in scientific work, especially in Indiana; to assist by investigation and discussion in developing and making known the material, educational and other resources and riches of the State; to arrange and prepare for publication such reports of investigation and discussions as may further the aims and objects of the Academy as set forth in these articles.

WHEREAS, The State has undertaken the publication of such proceedings, the Academy will, upon request of the Governor, or of one of the several departments of the State, through the Governor, act through its council as an advisory body in the direction and execution of any investigation within its province as stated. The necessary expenses incurred in the prosecution of such investigation are to be borne by the State; no pecuniary gain is to come to the Academy for its advice or direction of such investigation.

The regular proceedings of the Academy as published by the State shall become a public document.

ARTICLE II.

SECTION 1. Members of this Academy shall be honorary fellows, fellows, non-resident members or active members.

SEC. 2. Any person engaged in any department of scientific work, or in original research in any department of science, shall be eligible to active membership. Active members may be annual or life members. Annual members may be elected at any meeting of the Academy; they shall sign the constitution, pay an admission fee of two dollars and thereafter an annual fee of one dollar. Any person who shall at one time contribute fifty dollars to the funds of this Academy may be elected a life member of the Academy, free of assessment. Non-resident members may be elected

from those who have been active members but who have removed from the State. In any case, a three-fourths vote of the members present shall elect to membership. Application for membership in any of the foregoing classes shall be referred to a committee on application for membership, who shall consider such application and report to the Academy before the election.

SEC. 3. The members who are actively engaged in scientific work, who have recognized standing as scientific men, and who have been members of the Academy at least one year, may be recommended for nomination for election as fellows by three fellows or members personally acquainted with their work and character. Of members so nominated a number not exceeding five in one year may, on recommendation of the Executive Committee, be elected as fellows. At the meeting at which this is adopted, the members of the Executive Committee for 1894 and fifteen others shall be elected fellows, and those now honorary members shall become honorary fellows. Honorary fellows may be elected on account of special prominence in science, on the written recommendation of two members of the Academy. In any case a three-fourths vote of the members present shall elect.

ARTICLE III.

SECTION 1. The officers of this Academy shall be chosen by ballot at the annual meeting, and shall hold office one year. They shall consist of a President, Vice-President, Secretary, Assistant Secretary, Press Secretary and Treasurer, who shall perform the duties usually pertaining to their respective offices and in addition, with the ex-presidents of the Academy, shall constitute an Executive Committee. The President shall, at each annual meeting, appoint two members to be a committee, which shall prepare the programs and have charge of the arrangements for all meetings for one year.

SEC. 2. The annual meeting of this Academy shall be held in the city of Indianapolis within the week following Christmas of each year, unless otherwise ordered by the Executive Committee. There shall also be a summer meeting at such time and place as may be decided upon by the Executive Committee. Other meetings may be called at the discretion of the Executive Committee. The past Presidents, together with the officers and Executive Committee, shall constitute the council of the Academy, and represent it in the transaction of any necessary business not especially provided for in this constitution, in the interim between general meetings.

SEC. 3. This constitution may be altered or amended at any annual meeting by a three-fourths majority of the attending members of at least one year's standing. No question of amendment shall be decided on the day of its presentation.

BY-LAWS.

1. On motion, any special department of science shall be assigned to a curator, whose duty it shall be, with the assistance of the other members interested in the same department, to endeavor to advance knowledge in that particular department. Each curator shall report at such time and place as the Academy shall direct. These reports shall include a brief summary of the progress of the department during the year preceding the presentation of the report.

2. The President shall deliver a public address on the morning of one of the days of the meeting at the expiration of his term of office.

3. The Press Secretary shall attend to the securing of proper newspaper reports of the meetings and assist the Secretary.

4. No special meeting of the Academy shall be held without a notice of the same having been sent to the address of each member at least fifteen days before such meeting.

5. No bill against the Academy shall be paid without an order signed by the President and countersigned by the Secretary.

6. Members who shall allow their dues to remain unpaid for two years, having been annually notified of their arrearage by the Treasurer, shall have their names stricken from the roll.

7. Ten members shall constitute a quorum for the transaction of business.

AN ACT TO PROVIDE FOR THE PUBLICATION OF THE REPORTS AND PAPERS OF THE INDIANA ACADEMY OF SCIENCE.

[Approved March 11, 1895.]

WHEREAS, The Indiana Academy of Science, a chartered scientific association, has embodied in its constitution a provision that it will, upon the request of the Governor, or of the several departments of the State

government, through the Governor, and through its council as an advisory board, assist in the direction and execution of any investigation within its province, without pecuniary gain to the Academy, provided only that the necessary expenses of such investigation are borne by the State; and,

WHEREAS, The reports of the meetings of said Academy, with the several papers read before it, have very great educational, industrial and economic value, and should be preserved in permanent form; and

WHEREAS, The Constitution of the State makes it the duty of the General Assembly to encourage by all suitable means intellectual, scientific and agricultural improvement; therefore,

SECTION 1. *Be it enacted by the General Assembly of the State of Indiana,* That hereafter the annual reports of the meetings of the Indiana Academy of Science, beginning with the report for the year 1894, including all papers of scientific or economic value, presented at such meetings, after they shall have been edited and prepared for publication as hereinafter provided, shall be published by and under the direction of the Commissioners of Public Printing and Binding.

SEC. 2. Said reports shall be edited and prepared for publication without expense to the State, by a corps of editors to be selected and appointed by the Indiana Academy of Science, who shall not, by reason of such service, have any claim against the State for compensation. The form, style of binding, paper, typography and manner and extent of illustration of such reports shall be determined by the editors, subject to the approval of the Commissioners of Public Printing and Stationery. Not less than 1,500 nor more than 3,000 copies of each of said reports shall be published, the size of the edition within said limits to be determined by the concurrent action of the editors and the Commissioners of Public Printing and Stationery: *Provided,* That not to exceed six hundred dollars (\$600) shall be expended for such publication in any one year, and not to extend beyond 1896: *Provided,* That no sums shall be deemed to be appropriated for the year 1894.

SEC. 3. All except three hundred copies of each volume of said reports shall be placed in the custody of the State Librarian, who shall furnish one copy thereof to each public library in the State, one copy to each university, college or normal school in the State, one copy to each high school in the State having a library, which shall make application therefor, and one copy to such other institutions, societies or persons as may be designated by the

Academy through its editors or its council. The remaining three hundred copies shall be turned over to the Academy to be disposed of as it may determine. In order to provide for the preservation of the same it shall be the duty of the Custodian of the State House to provide and place at the disposal of the Academy one of the unoccupied rooms of the State House, to be designated as the office of the Academy of Science, wherein said copies of said reports belonging to the Academy, together with the original manuscripts, drawings, etc., thereof can be safely kept, and he shall also equip the same with the necessary shelving and furniture.

SEC. 4. An emergency is hereby declared to exist for the immediate taking effect of this act, and it shall therefore take effect and be in force from and after its passage.

APPROPRIATION FOR 1913-1914.

The appropriation for the publication of the proceedings of the Academy during the years 1913 and 1914 was increased by the Legislature in the General Appropriation bill, approved March 9, 1909. That portion of the law fixing the amount of the appropriation for the Academy is herewith given in full:

For the Academy of Science: For the printing of the proceedings of the Indiana Academy of Science twelve hundred dollars: *Provided*, That any unexpended balance in 1913 shall be available in 1914, and that any unexpended balance in 1914 shall be available in 1915.

AN ACT FOR THE PROTECTION OF BIRDS, THEIR NESTS AND EGGS.

SEC. 602. Whoever kills, traps or has in his possession any wild bird, or whoever sells or offers the same for sale, or whoever destroys the nest or eggs of any wild bird, shall be deemed guilty of a misdemeanor and upon conviction thereof shall be fined not less than ten dollars nor more than twenty-five dollars: *Provided*, That the provisions of this section shall not apply to the following named game birds: The Anatidæ, commonly called swans, geese, brant, river and sea duck; the Rallidæ, commonly called rails, coots, mud-hens, gallinules; the Limicolæ, commonly called shore birds, surf birds, plover, snipe, woodcock, sandpipers, tattlers and curlew; the Gallinæ, commonly called wild turkeys, grouse, prairie chickens, quails and pheasants; nor to English or European house sparrows,

crows, hawks or other birds of prey. Nor shall this section apply to persons taking birds, their nests or eggs, for scientific purposes, under permit, as provided in the next session.

SEC. 603. Permits may be granted by the Commissioner of Fisheries and Game to any properly accredited person, permitting the holder thereof to collect birds, their nests or eggs for strictly scientific purposes. In order to obtain such permit the applicant for the same must present to such Commissioner written testimonials from two well-known scientific men certifying to the good character and fitness of such applicant to be entrusted with such privilege, and pay to such Commissioner one dollar therefor and file with him a properly executed bond in the sum of two hundred dollars, payable to the State of Indiana, conditioned that he will obey the terms of such permit, and signed by at least two responsible citizens of the State as sureties. The bond may be forfeited, and the permit revoked upon proof to the satisfaction of such Commissioner that the holder of such permit has killed any bird or taken the nest or eggs of any bird for any other purpose than that named in this section.

PUBLIC OFFENSES—HUNTING WILD BIRDS—PENALTY.

[Approved March 13, 1913.]

SECTION 1. *Be it enacted by the General Assembly of the State of Indiana,* That section six (6) of the above entitled act be amended to read as follows: Section 6. That section six hundred two (602) of the above entitled act be amended to read as follows: Section 602. It shall be unlawful for any person to kill, trap or possess any wild bird, or to purchase or offer the same for sale, or to destroy the nest or eggs of any wild bird, except as otherwise provided in this section. But this section shall not apply to the following named game birds: The Anatidae, commonly called swans, geese, brant, river and sea duck; the Rallidae, commonly known as rails, coots, mud-hens and gallinules; the Limicolæ, commonly known as shore birds, plovers, surf birds, snipe, woodcock, sandpipers, tattlers and curlews; the Gallinæ, commonly called wild turkeys, grouse, prairie chickens, quails, and pheasants; nor to English or European house sparrows, blackbirds, crows, hawks or other birds of prey. Nor shall this section apply to any person taking birds or their nests or eggs for scientific purposes under permit as provided in the next section. Any person violating the provisions of this section shall, on conviction, be fined not less than ten dollars (\$10.00) nor more than fifty dollars (\$50.00).

Indiana Academy of Science.

OFFICERS, 1914-1915.

PRESIDENT,

WILBUR A. COGSHALL.

VICE-PRESIDENT,

WILLIAM A. MCBETH.

SECRETARY,

ANDREW J. BIGNEY.

ASSISTANT SECRETARY,

H. E. ENDERS.

PRESS SECRETARY,

FRANK B. WADE.

TREASURER,

WILLIAM M. BLANCHARD.

EDITOR,

H. E. BARNARD.

EXECUTIVE COMMITTEE:

ARTHUR, J. C.,	CULBERTSON, GLENN.	MCBETH, W. A.,
BIGNEY, A. J.,	DRYER, CHAS. R.,	MEES, CARL L.,
BLANCHARD, W. M.,	EIGENMANN, C. H.,	MOTTIER, DAVID M.,
BLATCHLEY, W. S.,	EVANS, P. N.,	MENDENHALL, T. C.,
BODINE, DONALDSON,	DENNIS, D. W.,	NAYLOR, JOSEPH P.,
BRANNER, J. C.,	FOLEY, A. L.,	NOYES, W. A.,
BURRAGE, SEVERANCE,	HAY, O. P.,	WADE, F. B.,
BUTLER, AMOS W.,	HESSLER, ROBERT.	WALDO, C. A.,
COGSHALL, W. A.,	JOHN, J. P. D.,	WILEY, H. W.,
COULTER, JOHN M.,	JORDAN, D. S.,	WRIGHT, JOHN S.
COULTER, STANLEY,		

CURATORS:

BOTANY.....	J. C. ARTHUR.
ENTOMOLOGY.....	W. S. BLATCHLEY.
HERPETOLOGY }.....	
MAMMALOGY }.....	A. W. BUTLER.
ORNITHOLOGY }.....	
ICHTHYOLOGY.....	H. C. EIGENMANN.

COMMITTEES ACADEMY OF SCIENCE, 1915.

Program.

WILL SCOTT, Bloomington
 F. B. WADE, Indianapolis
 P. N. EVANS, LaFayette

Nominations.

SEVERANCE BURRAGE, Indianapolis
 W. J. MOENKHAUS, Bloomington
 A. S. HATHAWAY, Terre Haute

State Library.

W. S. BLATCHLEY, Indianapolis
 H. J. BANKER, Coldspring Harbor,
 N. Y.
 A. W. BUTLER, Indianapolis

Biological Survey.

C. C. DEAM, Bluffton
 H. W. ANDERSON, Crawfordsville
 GEO. N. HOFFER, West LaFayette
 A. O. COX, Terre Haute
 J. A. NIEUWLAND, Notre Dame

Distribution of Proceedings.

A. J. BIGNEY, Moores Hill
 JOHN B. DUTCHER, Bloomington
 A. W. BUTLER, Indianapolis
 W. M. BLANCHARD, Greencastle

Membership.

H. E. ENDERS, West LaFayette
 EDWIN MORRISON, Richmond.
 FRED A. MILLER, Indianapolis

Auditing.

E. B. WILLIAMSON, Bluffton
 GLENN CULBERTSON, Hanover

Restriction of Weeds and Diseases.

ROBERT HESSLER, Logansport
 AMOS BUTLER, Indianapolis
 J. N. HURTY, Indianapolis
 STANLEY COULTER, LaFayette
 D. M. MOTTIER, Bloomington

Academy to State.

R. W. McBRIDE, Indianapolis
 GLENN CULBERTSON, Hanover
 H. E. BARNARD, Indianapolis
 A. W. BUTLER, Indianapolis
 W. W. WOOLLEN, Indianapolis

Publication of Proceedings.

H. E. BARNARD, Indianapolis
 C. R. DRYER, Ft. Wayne
 M. K. HAGGERTY, Bloomington
 R. R. HYDE, Terre Haute
 J. S. WRIGHT, Indianapolis

OFFICERS OF THE INDIANA ACADEMY OF SCIENCE.

YEARS.	PRESIDENT.	SECRETARY.	ASST. SECRETARY.	PRESS SECRETARY.	TREASURER.
1885-1886	David S. Jordan	Amos W. Butler			O. P. Jenkins.
1886-1887	John M. Coulter	Amos W. Butler			O. P. Jenkins.
1887-1888	J. P. D. John	Amos W. Butler			O. P. Jenkins.
1888-1889	John C. Brauner	Amos W. Butler			O. P. Jenkins.
1889-1890	T. C. Mendenhall	Amos W. Butler			O. P. Jenkins.
1890-1891	O. P. Hay	Amos W. Butler			C. A. Waldo.
1891-1892	J. L. Campbell*	Amos W. Butler			C. A. Waldo.
1892-1893	J. C. Arthur	Amos W. Butler	{ Stanley Coulter { W. W. Norman.		C. A. Waldo.
1893-1894	W. A. Noyes	C. A. Waldo	W. W. Norman.		W. P. Shannon.
1894-1895	A. W. Butler	John S. Wright	A. J. Bigney		W. P. Shannon.
1895-1896	Stanley Coulter	John S. Wright	A. J. Bigney		W. P. Shannon.
1896-1897	Thomas Gray*	John S. Wright	A. J. Bigney		W. P. Shannon.
1897-1898	C. A. Waldo	John S. Wright	A. J. Bigney	Geo. W. Benton	J. T. Scovell.
1898-1899	C. H. Eigenmann	John S. Wright	E. A. Schultze	Geo. W. Benton	J. T. Scovell.
1899-1900	D. W. Dennis	John S. Wright	E. A. Schultze	Geo. W. Benton	J. T. Scovell.
1900-1901	M. B. Thomas*	John S. Wright	Donaldson Bodine.	Geo. W. Benton	J. T. Scovell.
1901-1902	Harvey W. Wiley	John S. Wright	Donaldson Bodine.	G. A. Abbott	W. A. McBeth.
1902-1903	W. S. Blatchley	John S. Wright	Donaldson Bodine.	G. A. Abbott	W. A. McBeth.
1903-1904	C. L. Mees	John S. Wright	J. H. Ransom	G. A. Abbott	W. A. McBeth.
1904-1905	John S. Wright	Lynn B. McMullen	J. M. Ransom	G. A. Abbott	W. A. McBeth.
1905-1906	Robert Hessler	Lynn B. McMullen	J. H. Ransom	Charles R. Clark	W. A. McBeth.
1906-1907	D. M. Motter	Lynn B. McMullen	J. M. Ransom	G. A. Abbott	W. A. McBeth.
1907-1908	Gleam Culbertson	J. H. Ransom	A. J. Bigney	G. A. Abbott	W. A. McBeth.
1908-1909	A. L. Foley	J. H. Ransom	A. J. Bigney	G. A. Abbott	W. A. McBeth.
1909-1910	P. N. Evans	Geo. W. Benton	A. J. Bigney	John W. Woodhams	W. J. Moenkhaus.
1910-1911	C. R. Dyer	A. J. Bigney	E. B. Williamson	Milo H. Stuart	W. J. Moenkhaus.
1911-1912	J. P. Naylor	A. J. Bigney	E. B. Williamson	Milo H. Stuart	W. J. Moenkhaus.
1912-1913	Donaldson Bodine	A. J. Bigney	C. M. Smith	F. B. Wade	W. A. Cogshall.
1913-1914	Severance Burrage	A. J. Bigney	H. E. Enders	F. B. Wade	W. A. Cogshall.
1914-1915	Wilbur A. Cogshall	A. J. Bigney	H. E. Enders	F. B. Wade	W. M. Blanchard.

*Deceased.

MEMBERS.*

FELLOWS.

- ‡‡Abbott, G. A., Grand Forks, N. Dak. †1908
 Professor of Chemistry, University of North Dakota.
 Chemistry.
- Aley, Robert J., Orono, Me. 1898
 President of University of Maine.
 Mathematics and General Science.
- Anderson, H. W., 1 Mills Place, Crawfordsville, Ind. 1912
 Professor of Botany, Wabash College.
 Botany.
- Andrews, F. M., 744 E. Third St., Bloomington, Ind. 1911
 Assistant Professor of Botany, Indiana University.
 Botany.
- Arthur, Joseph C., 915 Columbia St., Lafayette, Ind. 1894
 Professor of Vegetable Physiology and Pathology, Purdue University.
 Botany.
- Barnard, H. E., Room 20 State House, Indianapolis, Ind. 1910
 Chemist to Indiana State Board of Health.
 Chemistry, Sanitary Science, Pure Foods.
- Beede, Joshua W., cor. Wall and Atwater Sts., Bloomington, Ind. 1896
 Associate Professor of Geology, Indiana University.
 Stratigraphic Geology, Physiography.
- Benton, George W., 100 Washington Square, New York, N. Y. 1896
 With the American Book Company.

*Every effort has been made to obtain the correct address and occupation of each member, and to learn what line of science he is interested in. The first line contains the name and address; the second line the occupation; the third line the branch of science in which he is interested. The omission of an address indicates that mail addressed to the last printed address was returned as unced for. Information as to the present address of members so indicated is requested by the secretary. The custom of dividing the list of members has been followed.

†Date of election.

‡‡Non-resident.

- Bigney, Andrew J., Moores Hill, Ind. 1897
 Vice-President and Professor of Biology and Geology, Moores Hill
 College.
 Biology and Geology.
- Bitting, Catharine Golden, Washington, D. C. 1895
 Microscopic Expert, Pure Food, National Canners Laboratory.
 Botany.
- Blatchley, W. S., 1558 Park Ave., Indianapolis, Ind. 1893
 Naturalist.
 Botany, Entomology and Geology.
- Bodine, Donaldson, Four Mills Place, Crawfordsville, Ind. 1899
 Professor of Geology and Zoology, Wabash College.
 Entomology and Geology.
- Breeze, Fred J., care American Book Company, New York, N. Y. 1910
 With the American Book Company.
 Geography.
- Bruner, Henry Lane, 324 S. Ritter Ave., Indianapolis, Ind. 1899
 Professor of Biology, Butler College.
 Comparative Anatomy, Zoology.
- Burrage, Severance, care Eli Lilly Co., Indianapolis, Ind. 1898
 Charge of Biological Laboratory, Eli Lilly Co.
 Bacteriology, Sanitary Science.
- Butler, Amos W., 52 Downey Ave., Irvington, Ind. 1893
 Secretary, Indiana Board of State Charities.
 Vertebrate Zoology, Anthropology, Sociology.
- Cogshall, Wilbur A., 423 S. Fess Ave., Bloomington, Ind. 1906
 Associate Professor of Astronomy, Indiana University.
 Astronomy and Physics.
- Cook, Mel T., New Brunswick, N. J. 1902
 Professor of Plant Pathology, Rutgers College.
 Botany, Plant Pathology, Entomology.
- Coulter, John M., care University of Chicago, Chicago, Ill. 1893
 Head Department of Botany, Chicago University.
 Botany.
- Coulter, Stanley, 213 S. Ninth St., Lafayette, Ind. 1893
 Dean School of Science, Purdue University.
 Botany, Forestry.

- Cox, Ulysses O., P. O. Box 81, Terre Haute, Ind..... 1908
 Head Department Zoology and Botany, Indiana State Normal.
 Botany, Zoology.
- Culbertson, Glenn, Hanover, Ind..... 1899
 Chair Geology, Physics and Astronomy, Hanover College.
 Geology.
- Cumings, Edgar Roscoe, 327 E. Second St., Bloomington, Ind..... 1906
 Professor of Geology, Indiana University.
 Geology, Paleontology.
- Davisson, Schuyler Colfax, Bloomington, Ind..... 1908
 Professor of Mathematics, Indiana University.
 Mathematics.
- Deam, Charles C., Bluffton, Ind..... 1910
 Druggist.
 Botany.
- Dennis, David Worth, Richmond, Ind..... 1895
 Professor of Biology, Earlham College.
 Biology.
- Dryer, Charles R., Oak Knoll, Fort Wayne, Ind..... 1897
 Geographer.
- Eigenmann, Carl H., 630 Atwater St., Bloomington, Ind..... 1893
 Professor Zoology, Dean of Graduate School, Indiana University.
 Embryology, Degeneration, Heredity, Evolution and Distribution
 of American Fish.
- Enders, Howard Edwin, 105 Quincy St., Lafayette, Ind..... 1912
 Associate Professor of Zoology, Purdue University.
 Zoology.
- Evans, Percy Norton, Lafayette, Ind..... 1901
 Director of Chemical Laboratory, Purdue University.
 Chemistry.
- Foley, Arthur L., Bloomington, Ind..... 1897
 Head of Department of Physics, Indiana University.
 Physics.
- Golden, M. J., Lafayette, Ind..... 1899
 Director of Laboratories of Practical Mechanics, Purdue Uni-
 versity.
 Mechanics.

- ††Goss, William Freeman M., Urbana, Ill..... 1893
Dean of College of Engineering, University of Illinois.
- Haggerty, M. E., Bloomington, Ind..... 1913
- Hathaway, Arthur S., 2206 N. Tenth St., Terre Haute, Ind..... 1895
Professor of Mathematics, Rose Polytechnic Institute.
Mathematics, Physics.
- Hessler, Robert, Logansport, Ind..... 1899
Physician.
Biology.
- Hilliard, C. M., Simmons College, Boston, Mass..... 1913
- Hoffer, Geo. N., West Lafayette, Ind..... 1913
- Hurty, J. N., Indianapolis, Ind..... 1910
Secretary, Indiana State Board of Health.
Sanitary Science, Vital Statistics, Eugenics.
- †Huston, H. A., New York City..... 1893
- Kern, Frank D., State College, Pa..... 1912
Professor of Botany, Pennsylvania State College.
Botany.
- Lyons, Robert E., 630 E. Third St., Bloomington, Ind..... 1896
Head of Department of Chemistry, Indiana University.
Organic and Biological Chemistry.
- McBeth, William A., 1905 N. Eighth St., Terre Haute, Ind..... 1904
Assistant Professor Geography, Indiana State Normal.
Geography, Geology, Scientific Agriculture.
- †Marsters, V. F., Santiago, Chile..... 1893
- Mees, C. L., Terre Haute, Ind..... 1894
President of Rose Polytechnic Institute.
- †Miller, John Anthony, Swarthmore, Pa..... 1904
Professor of Mathematics and Astronomy, Swarthmore College.
Astronomy, Mathematics.
- Moenkhaus, William J., 501 Fess Ave., Bloomington, Ind..... 1901
Professor of Physiology, Indiana University.
Physiology.
- Moore, Richard B., Denver, Colo..... 1893
With U. S. Bureau of Mines.
Chemistry, Radio-activity.

- Mottier, David M., 215 Forest Place, Bloomington, Ind..... 1893
 Professor of Botany, Indiana University.
 Morphology, Cytology.
- Naylor, J. P., Greencastle, Ind..... 1903
 Professor of Physics, Depauw University.
 Physics, Mathematics.
- †Noyes, William Albert, Urbana, Ill..... 1893
 Director of Chemical Laboratory, University of Illinois.
 Chemistry.
- Pohlman, Augustus G., 1100 E. Second St., Bloomington, Ind..... 1911
 Professor of Anatomy, Indiana University.
 Embryology, Comparative Anatomy.
- Ramsey, Rolla R., 615 E. Third St., Bloomington, Ind..... 1906
 Associate Professor of Physics, Indiana University.
 Physics.
- Ransom, James H., 323 University St., West Lafayette, Ind..... 1902
 Professor of General Chemistry, Purdue University.
 General Chemistry, Organic Chemistry, Teaching.
- Rettger, Louis J., 31 Gilbert Ave., Terre Haute, Ind..... 1896
 Professor of Physiology, Indiana State Normal.
 Animal Physiology.
- Rothrock, David A., Bloomington, Ind..... 1906
 Professor of Mathematics, Indiana University.
 Mathematics.
- Scott, Will, 731 Atwater St., Bloomington, Ind..... 1911
 Assistant Professor of Zoology, Indiana University.
 Zoology, Lake Problems.
- Shannon, Charles W., Norman, Okla..... 1912
 With Oklahoma State Geological Survey.
 Soil Survey, Botany.
- Smith, Albert, 1022 Seventh St., West Lafayette..... 1908
 Professor of Structural Engineering.
 Physics, Mechanics.
- ††Smith, Alexander, care Columbia University, New York, N. Y..... 1893
 Head of Department of Chemistry, Columbia University.
 Chemistry.

- Smith, Charles Marquis, 910 S. Ninth St., Lafayette, Ind..... 1912
 Professor of Physics, Purdue University.
 Physics.
- Stone Winthrop E. Lafayette, Ind..... 1893
 President of Purdue University.
 Chemistry.
- ††Swain, Joseph, Swarthmore, Pa..... 1898
 President of Swarthmore College.
 Science of Administration.
- Van Hook, James M., 639 N. College Ave., Bloomington, Ind..... 1911
 Assistant Professor of Botany, Indiana University.
 Botany.
- ††Waldo, Clarence A., care Washington University, St. Louis, Mo.... 1893
 Thayer Professor Mathematics and Applied Mechanics, Wash-
 ington University.
 Mathematics, Mechanics, Geology and Mineralogy.
- ††Webster, F. M., Kensington, Md..... 1894
 Entomologist, U. S. Department of Agriculture, Washington, D. C.
 Entomology.
- Westland, Jacob, 439 Salisbury St., West Lafayette, Ind..... 1904
 Professor of Mathematics, Purdue University.
 Mathematics.
- Wiley, Harvey W., Cosmos Club, Washington, D. C..... 1895
 Professor of Agricultural Chemistry, George Washington Uni-
 versity.
 Biological and Agricultural Chemistry.
- Woollen, William Watson, Indianapolis, Ind..... 1908
 Lawyer.
 Birds and Nature Study.
- Wright, John S., care Eli Lilly Co., Indianapolis, Ind..... 1894
 Manager of Advertising Department, Eli Lilly Co.
 Botany.

NON-RESIDENT MEMBERS.

Ashley, George H., Washington, D. C.

Bain, H. Foster, London, England.

Editor Mining Magazine.

Branner, John Casper, Stanford University, California.

Vice-President of Stanford University, and Professor of Geology.
Geology.

Brannon, Melvin A., President University of Idaho, Boise, Ida.

Professor of Botany.

Plant Breeding.

Campbell, D. H., Stanford University, California.

Professor of Botany, Stanford University.

Botany.

Clark, Howard Walton, U. S. Biological Station, Fairport, Iowa.

Scientific Assistant, U. S. Bureau of Fisheries.

Botany, Zoology.

Dorner, H. B., Urbana, Illinois.

Assistant Professor of Floriculture.

Botany, Floriculture.

Duff, A. Wilmer, 43 Harvard St., Worcester, Mass.

Professor of Physics, Worcester Polytechnic Institute.

Physics.

Evermann, Barton Warren, Director Museum.

California Academy of Science, Golden Gate Park, San Francisco, Cal.

Zoology.

Fiske, W. A., Los Angeles, Cal., Methodist College.

Garrett, Chas. W., Room 718 Pennsylvania Station, Pittsburgh, Pa.

Librarian, Pennsylvania Lines West of Pittsburgh.

Entomology, Sanitary Sciences.

Gilbert, Charles H., Stanford University, California.

Professor of Zoology, Stanford University.

Ichthyology.

Greene, Charles Wilson, 814 Virginia Ave., Columbia, Mo.

Professor of Physiology and Pharmacology, University of Missouri.

Physiology, Zoology.

- Hargitt, Chas. W., 909 Walnut Ave., Syracuse, N. Y.
 Professor of Zoology, Syracuse University.
 Hygiene, Embryology, Eugenics, Animal Behavior.
- Hay, Oliver Perry, U. S. National Museum, Washington, D. C.
 Research Associate, Carnegie Institution of Washington.
 Vertebrate Paleontology, especially that of the Pleistocene Epoch.
- Hughes, Edward, Stockton, California.
- Jenkins, Oliver P., Stanford University, California.
 Professor of Physiology, Stanford University.
 Physiology, Histology.
- Jordan, David Starr, Stanford University, California.
 President Emeritus of Stanford University.
 Fish, Eugenics, Botany, Evolution.
- Kingsley, J. S., University of Illinois, Champaign, Ill.
 Professor of Zoology.
 Zoology.
- Knipp, Charles T., 913 W. Nevada St., Urbana, Illinois.
 Assistant Professor of Physics, University of Illinois.
 Physics, Discharge of Electricity through Gases.
- MacDougal, Daniel Trembly, Tucson, Arizona.
 Director, Department of Botanical Research, Carnegie Institute, Wash-
 ington, D. C.
 Botany.
- McMullen, Lynn Banks, State Normal School, Valley City, North Dakota.
 Head Science Department, State Normal School.
 Physics, Chemistry.
- Mendenhall, Thomas Corwin, Ravenna, Ohio.
 Retired.
 Physics. "Engineering," Mathematics, Astronomy.
- Moore, George T., St. Louis, Mo.
 Director Missouri Botanical Garden.
- Newsom, J. F., Palo Alto, California.
 Mining Engineer.
- Purdue, Albert Homer, State Geological Survey, Nashville, Tenn.
 State Geologist of Tennessee.
 Geology.

Reagan, A. B.

Superintendent Deer Creek Indian School, Ibapah, Utah.
Geology, Paleontology, Ethnology.

Slonaker, James Rollin, 334 Kingsley Ave., Palo Alto, California.

Assistant Professor of Physiology, Stanford University.
Physiology, Zoology.

Springer, Alfred, 312 East 2d St., Cincinnati, Ohio.

Chemist.
Chemistry.

ACTIVE MEMBERS.

Allen, William Ray, Bloomington, Ind.

Allison, Evelyn, Lafayette, Ind.

Care Agricultural Experiment Station.
Botany.

Anderson, Flora Charlotte, Wellesley College, Wellesley, Mass.

Botany.

Arndt, Charles H., Lafayette, Ind.

Biology.

Atkinson, F. C., Indianapolis.

Chemistry.

Badertscher, J. A., Bloomington.

Anatomy.

Baker, George A., South Bend.

Archaeology.

Baker, Walter D., N. Illinois St., Indianapolis, Ind.

Care Waldcraft Co.
Chemistry.

Baker, Walter M., Amboy.

Superintendent of Schools.
Mathematics and Physics.

Baker, William Franklin, Indianapolis.

Medicine.

Balcom, H. C., Indianapolis.

Botany.

- Banker, Howard J., Cold Spring Harbor, N. Y.
Botany.
- Barcus, H. H., Indianapolis.
Instructor, Mathematics, Shortridge High School.
- Barr, Harry L., Waveland.
Student.
Botany and Forestry.
- Barrett, Edward, Indianapolis.
State Geologist.
Geology, Soil Survey.
- Bates, W. H., 306 Russell St., West Lafayette.
Associate Professor, Mathematics.
- Bell, Guido, 431 E. Ohio St., Indianapolis.
Physician.
- Bellamy, Ray, Worcester, Mass.
- Bennett, Lee F., 825 Laporte Ave., Valparaiso.
Professor of Geology and Zoology, Valparaiso University.
Geology, Zoology.
- Berry, O. C., West Lafayette.
Engineering.
- Berteling, John B., South Bend.
Medicine.
- Binford, Harry, Earlham.
Zoology.
- Bishop, Harry Eldridge, 1706 College Ave., Indianapolis.
Food Chemist, Indiana State Board of Health.
- Blanchard, William M., 1008 S. College Ave., Greencastle.
Professor of Chemistry, DePauw University.
Organic Chemistry.
- Blew, Michael James, R. R. 1, Wabash.
Chemistry and Botany.
- Bliss, G. S., Ft. Wayne.
Medicine.
- Bond, Charles S., 112 N. Tenth St., Richmond.
Physician.
Biology, Bacteriology, Physical Diagnosis and Photomicrography.

- Bourke, A. Adolphus, 1103 Cottage Ave., Columbus.
Instructor, Physics, Zoology and Geography.
Botany, Physics.
- Bowles, Adam L., Terre Haute.
Zoology.
- Bowers, Paul E., Michigan City.
Medicine.
- Breckinridge, James M., Crawfordsville.
Chemistry.
- Brossmann, Charles, 1616 Merchants Bank Bldg., Indianapolis.
Consulting Engineer.
Water Supply, Sewage Disposal, Sanitary Engineering, etc.
- Brown, James, 5372 E. Washington St., Indianapolis.
Professor of Chemistry, Butler College.
Chemistry.
- Brown, Paul H., Richmond.
Physics.
- Brown, Hugh E., Bloomington, Ind.
- Bruce, Edwin M., 2401 North Ninth St., Terre Haute.
Assistant Professor of Physics and Chemistry, Indiana State Normal.
Chemistry, Physics.
- Bryan, William Lowe, Bloomington.
President, Indiana University.
Psychology.
- Bybee, Halbert P., Bloomington.
Graduate Student, Indiana University.
Geology.
- Canis, Edward N., 2221 Park Ave., Indianapolis.
Officeman with William B. Burford.
Botany, Psychology.
- Caparo, Jose Angel, Notre Dame.
Physics and Mathematics.
- Carlyle, Paul J., Bloomington.
Chemistry.
- Carmichael, R. D., Bloomington.
Assistant Professor of Mathematics, Indiana University.
Mathematics.

- Carr, Ralph Howard, Lafayette.
Chemistry.
- Caswell, Albert E., Lafayette.
Instructor in Physics, Purdue University.
Physics and Applied Mathematics.
- Chansler, Elias J., Bicknell.
Farmer.
Ornithology and Mammals.
- Clark, George Lindenburg, Greencastle, DePauw University.
Chemistry.
- Clark, Elbert Howard, West Lafayette.
Mathematics.
- Clark, Jediah H., 126 East Fourth St., Connersville.
Physician.
Medicine.
- Clarke, Elton Russell, Indianapolis.
Zoology.
- Collins, Jacob Roland, West Lafayette, Purdue University.
Instructor in Physics.
- Conner, S. D., West Lafayette.
- Coryell, Noble H., Bloomington.
Chemistry.
- Cotton, William J., 5363 University Ave., Indianapolis.
Physics and Chemistry.
- Cox, William Clifford.
- Crowell, Melvin E., 648 E. Monroe St., Franklin.
Dean of Franklin College.
Chemistry and Physics.
- Cutter, George, Broad Branch Road, Washington, D. C.
Retired Manufacturer of Electrical Supplies.
Conchology.
- Daniels, Lorenzo E., Rolling Prairie.
Retired Farmer.
Conchology.
- Davis, D. W., Greencastle.
Biology.

- Davis, Ernest A., Notre Dame.
Chemistry.
- Davis, Melvin K., Anderson.
Instructor, Anderson High School.
Physiography, Geology, Climatology.
- Dean, John C., Indianapolis.
Astronomy.
- Deppe, C. R., Franklin.
- Dewey, Albert H., West Lafayette.
Department of Pharmacy, Purdue University.
- Dietz, Harry F., 408 W. Twenty-eighth St., Indianapolis.
Deputy State Entomologist.
Entomology, Eugenics, Parasitology, Plant Pathology.
- Dolan, Jos. P., Syracuse.
- Donaghy, Fred, Ossian.
Botany.
- Dostal, Bernard F., Bloomington.
Physics.
- Drew, David Abbott, 817 East Second St., Bloomington.
Instructor in Mechanics and Astronomy.
Astronomy, Mechanics, Mathematics and Applied Mathematics.
- DuBois, Henry, Bloomington, Ind.
- Duden, Hans A., 5050 E. Washington St., Indianapolis.
Analytical Chemist.
Chemistry.
- Duncan, David Christie, West Lafayette.
Instructor in Physics, Purdue University.
- Dutcher, J. B., Bloomington.
Assistant Professor of Physics, Indiana University.
Physics.
- Earp, Samuel E., 24½ Kentucky Ave., Indianapolis.
Physician.
- Easley, Mary, Bloomington, Ind.
- Edmonston, Clarence E., Bloomington.
Graduate Student, Physiology, Indiana University.
Physiology.

- Edwards, Carlton, Earlham College, Earlham.
- Ellis, Max Mapes, Boulder, Colo.
 Instructor in Biology, University of Colorado.
 Biology, Entomology.
- Emerson, Charles P., Hume Mansur Bldg., Indianapolis.
 Dean Indiana University Medical College.
 Medicine.
- Evans, Samuel G., 1452 Upper Second St., Evansville.
 Merchant.
 Botany, Ornithology.
- Ewers, James E., Terre Haute.
 Instructor in High School.
 Geology.
- Felver, William P., 325½ Market St., Logansport.
 Railroad Clerk.
 Geology, Chemistry.
- Ferry, Oliver P., West Lafayette.
 Physiology.
- Fisher, Homer Glenn, Bloomington.
 Zoology.
- Fisher, Martin L., Lafayette.
 Professor of Crop Production, Purdue University.
 Agriculture, Soils and Crops, Birds, Botany.
- Foresman, George Kedgie, Lafayette, Purdue University.
 Chemistry.
- Frier, George M., Lafayette.
 Assistant Superintendent, Agricultural Experiment Station, Purdue
 University.
 Botany, Zoology, Entomology, Ornithology, Geology.
- Fulk, Murl E., Decatur.
 Anatomy.
- Fuller, Frederick D., 213 Russell St., West Lafayette.
 Chief Deputy State Chemist, Purdue Experiment Station.
 Chemistry, Microscopy.
- Funk, Austin, 404 Spring St., Jeffersonville.
 Physician.
 Diseases of Eye, Ear, Nose and Throat.

- Galloway, Jesse James, Bloomington.
 Instruction, Indiana University.
 Geology, Pateontology.
- Garner, J. B., Mellon Institute, Pittsburgh, Pa.
 Chemistry.
- Gatch, Willis D., Indianapolis, Indiana University Medical School.
 Anatomy.
- Gates, Florence A., 3435 Detroit Ave., Toledo, Ohio.
 Teacher of Botany.
 Botany and Zoology.
- Gidley, William, West Lafayette.
 Department of Pharmacy, Purdue University.
- Gillum, Robert G., Terre Haute, Ind.
- Glenn, E. R., Froebel School, Gary, Ind.
 Physics.
- Goldsmith, William Marion, Oakland City.
 Zoology.
- Gottlieb, Frederic W., Morristown.
 Care Museum of Natural History. Assistant Curator, Moores Hill
 College.
 Archæology, Ethnology.
- Grantham, Guy E., 437 Vine St., West Lafayette.
 Instructor in Physics, Purdue University.
- Greene, Frank C., Missouri Bureau of Geology and Mines, Rolla, Mo.
 Geologist.
 Geology.
- Grimes, Earl J., Russellville.
 Care U. S. Soil Survey.
 Botany, Soil Survey.
- Hamill, Samuel Hugh, 119 E. Fourth St., Bloomington.
 Chemistry.
- Hammerschmidt, Louis M., South Bend.
 Science of Law.
- Happ, William, South Bend.
 Botany.

- Harding, C. Francis, 111 Fowler Ave., West Lafayette.
Professor of Electrical Engineering, Purdue University.
Mathematics, Physics, Chemistry.
- Harman, Mary T., 611 Laramie St., Manhattan, Kansas.
Instructor in Zoology, Kansas State Agricultural College.
Zoology.
- Harman, Paul M., Bloomington.
Geology.
- Harvey, R. B., Indianapolis.
- Heimbürger, Harry V., 701 West Washington St., Urbana, Ill.
Assistant in Zoology, University of Illinois.
- Heimlich, Louis Frederick, 703 North St., Lafayette.
Biology.
- Hendricks, Victor K., 855 Benton Ave., Springfield, Mo.
Assistant Chief Engineer, St. L. & S. F. R. R.
Civil Engineering and Wood Preservation.
- Henn, Arthur Wilbur, Bloomington.
Zoology.
- Hennel, Cora, Bloomington, Ind.
- Hennel, Edith A., Bloomington, Ind.
- Hetherington, John P., 418 Fourth St., Logansport.
Physician.
Medicine, Surgery, X-Ray, Electro-Therapeutics.
- Hinman, J. J., Jr., University of Iowa, Iowa City, Ia.
Chemist, Dept. Public Health and Hygiene.
Chemistry.
- Hole, Allen D., Richmond.
Professor Earlham College.
Geology.
- Hostetler W. F., South Bend.
Geography and Indian History.
- Hubbard, Lucius M., South Bend.
Lawyer.
- Hufford, Mason E., Bloomington.
Physics.

Hutchins, Chas. P., Buffalo, N. Y.

Athletics.

Hutton, Joseph Gladden, Brookings, South Dakota.

Associate Professor of Agronomy, State College.

Agronomy, Geology.

Hyde, Carl Clayton, Bloomington.

Geology.

Hyde, Roscoe Raymond, Terre Haute.

Assistant Professor, Physiology and Zoology, Indiana State Normal.

Zoology, Physiology, Bacteriology.

Hyslop, George, Bloomington.

Philosophy.

Ibison, Harry M., Marion.

Instructor in Science, Marion High School.

Iddings, Arthur, Hanover.

Geology.

Imel, Herbert, South Bend.

Zoology.

Inman, Ondess L., Bloomfield.

Botany.

Irving, Thos. P., Notre Dame.

Physics.

Jackson, D. E., St. Louis, Mo.

Assistant Professor, Pharmacology, Washington University.

Jackson, Thomas F., Bloomington.

Geology.

James, Glenn, West Lafayette.

Mathematics.

Johnson, A. G., Madison, Wisconsin.

Jones, Wm. J., Jr., Lafayette.

State Chemist, Professor of Agriculture and Chemistry, Purdue University.

Chemistry, and general subjects relating to agriculture.

Jordan, Charles Bernard, West Lafayette.

Director School of Pharmacy, Purdue University.

Koezmarek, Regedius M., Notre Dame.

Biology.

Kenyon, Alfred Monroe, 315 University St., West Lafayette.

Professor of Mathematics, Purdue University.

Mathematics.

Keubler, John Ralph, 110 E. Fourth St., Bloomington.

Chemistry.

von KleinSmid, R. B., Tucson, Ariz.

Koch, Edward, Bloomington.

Physiology.

President University of Ariz.

Liebers, Paul J., 1104 Southeastern Ave., Indianapolis.

Ludwig, C. A., 210 Waldron St., West Lafayette, Ind.

Assistant in Botany, Purdue University.

Botany, Agriculture.

Ludy, L. V., 229 University St., Lafayette.

Professor, Experimental Engineering, Purdue University.

Experimental Engineering in Steam and Gas.

Malott, Clyde A., Bloomington.

Physiology.

Marshall, E. C., Bloomington.

Chemistry.

Mason, Preston Walter, Lafayette.

Entomology.

Mason, T. E., 226 S. Grant St., Lafayette.

Instructor Mathematics Purdue University.

Mathematics.

McBride, Robert W., 1239 State Life Building, Indianapolis.

Lawyer.

McCartney, Fred J., Bloomington.

Philosophy.

McClellan, John H., Gary, Ind.

McCulloch, T. S., Charlestown.

McEwan, Mrs. Eula Davis, Bloomington, Ind.

McGuire, Joseph, Notre Dame.

Chemistry.

- Mance, Grover C., Bloomington, Ind.
- Markle, M. S., Richmond.
- Middletown, A. R., West Lafayette.
Professor of Chemistry, Purdue University.
Chemistry.
- Miller, Daniel T., Indiana University, Bloomington.
Anatomy.
- Miller, Fred A., 3641 Kenwood Ave., Indianapolis.
Botanist for Eli Lilly Co.
Botany, Plant Breeding.
- Molby, Fred A., Bloomington.
Physics.
- Montgomery, Ethel, South Bend.
Physics.
- Montgomery, Hugh T., South Bend.
Physician.
Geology.
- Moon, V. H., Indianapolis.
Pathology.
- Moore, George T., St. Louis, Mo.
Director, Missouri Botanical Garden.
Botany.
- Morris, Barclay D., Spiceland Academy, Spiceland.
Science.
- Morrison, Edwin, 80 S. W. Seventh St., Richmond.
Professor of Physics, Earlham College.
Physics and Chemistry.
- Morrison, Harold, Indianapolis, Ind.
- Mowrer, Frank Karlsten, Interlaken, New York.
Cooperative work with Cornell University.
Biology, Plant Breeding.
- Muncie, F. W.
- Murray, Thomas J., West Lafayette.
Bacteriology.
- Myers, B. D., 321 N. Washington St., Bloomington.
Professor of Anatomy, Indiana University.

- Nelson, Ralph Emory, 419 Vine St., West Lafayette.
Chemistry.
- Nieuwland, J. A., The University, Notre Dame, Ind.
Professor, Botany, Editor Midland Naturalist.
Systematic Botany, Plant Histology, Organic Chemistry.
- North, Cecil C., Greencastle.
- Northnagel, Mildred, Gary, Ind.
- Oberholzer, H. C., U. S. Department Agriculture, Washington, D. C.
Biology.
- O'Neal, Claude E., Bloomington.
Graduate Student, Botany, Indiana University.
Botany.
- Orahood, Harold, Kingman.
Geology.
- Orton, Clayton R., State College, Pennsylvania.
Assistant Professor of Botany, Pennsylvania State College.
Phytopathology, Botany, Mycology, Bacteriology.
- Osner, G. A., Ithaca, New York.
Care Agricultural College.
- Owen, D. A., 200 South State St., Franklin.
Professor of Biology. (Retired.)
Biology.
- Owens, Charles E., Corvallis, Oregon.
Instructor in Botany, Oregon Agricultural College.
Botany.
- Payne, Dr. F., Bloomington, Ind.
- Peffer, Harvey Creighton, West Lafayette.
Chemical Engineering.
- Petry, Edward Jacob, 267 Wood St., West Lafayette.
Instructor in Agriculture.
Botany, Plant Breeding, Plant Pathology, Bio-Chemistry.
- Phillips, Cyrus G., Moores Hill.
- Pickett, Fermen L., Bloomington.
Botany Critic, Indiana University Training School.
Botany, Forestry, Agriculture.
- Pipal, F. J., 11 S. Salisbury St., West Lafayette.

- Powell, Horace, West Terre Haute.
Zoology.
- Price, James A., Fort Wayne.
- Ramsey, Earl E., Bloomington.
Principal High School.
- Ramsey, Glenn Blaine, Orono, Me.
Botany.
- Rhinehart, D. A., Bloomington.
Anatomy.
- Rice, Thurman Brooks, Winona Lake.
Botany.
- Schultze, E. A., Laurel.
Fruit Grower.
Bacteriology, Fungi.
- Schnell, Charles M., South Bend.
Earth Science.
- Schierling, Roy H., Bloomington.
- Shimer, Dr. Will, Indianapolis, Ind.
Director, State Laboratory of Hygiene.
- Shockel, Barnard, Professor State Normal, Terre Haute, Ind.
- Sigler, Richard, Terre Haute.
Physiology.
- Silvey, Oscar W., 437 Vine St., West Lafayette.
Instructor in Physics.
Physics.
- Smith, Chas. Piper, College Park, Md.
Associate Professor, Botany, Maryland Agricultural College.
Botany.
- Smith, Essie Alma, R. F. D. 6, Bloomington.
- Smith, E. R., Indianapolis.
Horticulturist.
- Smith, William W., West Lafayette, Genetics.
Biology.
- Snodgrass, Robert, Crawfordsville, Ind.
- Southgate, Helen A., Michigan City.
Physiography and Botany.

- Spitzer, George, Lafayette.
Dairy Chemist, Purdue University.
Chemistry.
- Stech, Charles, Bloomington.
Geology.
- Steele, B. L., Pullman, Washington.
Associate Professor of Physics, State College, Washington.
- Steimley, Leonard, Bloomington.
Mathematics.
- Stickles, A. E., Indianapolis.
Chemistry.
- Stoltz, Charles, 530 N. Lafayette St., South Bend.
Physician.
- Stoddard, J. M.
- Stone, Ralph Bushnell, West Lafayette.
Mathematics.
- Stork, Harvey Elmer, Huntingburg.
Botany.
- Stuart, M. H., 3223 N. New Jersey St., Indianapolis.
Principal, Manual Training High School.
Physical and Biological Science.
- Sturmer, J. W., 119 E. Madison Ave., Collingswood, N. J.
Dean, Department of Pharmacy, Medico-Chirurgical College of Philadelphia.
Chemistry, Botany.
- Taylor, Joseph C., Logansport.
Wholesale merchant.
- Tetrault, Philip Armand, West Lafayette.
Biology.
- Thompson, Albert W., Owensville.
Merchant.
Geology.
- Thompson, Clem O., Salem.
Principal High School.
- Thornburn, A. D., Indianapolis.
Care Pitman-Moore Co.
Chemistry.

- Travelbee, Harry C., 304 Oak St., West Lafayette.
Botany.
- Troop, James, Lafayette.
Entomology.
- Trueblood, Iro C. (Miss), 205 Spring Ave., Greencastle.
Teacher of Botany, Zoology, High School.
Botany, Zoology, Physiography, Agriculture.
- Tucker, Forest Glen, Bloomington.
Geology.
- Tucker, W. M., 841 Third St., Chico, California.
Principal High School.
Geology.
- Turner, William P., Lafayette.
Professor of Practical Mechanics, Purdue University.
- Vallance, Chas. A., Indianapolis.
Instructor, Manual Training High School.
Chemistry.
- Van Doran, Dr., Earlham College, Richmond.
Chemistry.
- Van Nuys, W. C., Newcastle.
- Voorhees, Herbert S., 2814 Hoagland Ave., Fort Wayne.
Instructor in Chemistry and Botany, Fort Wayne High School.
Chemistry and Botany.
- Wade, Frank Bertram, 1039 W. Twenty-seventh St., Indianapolis.
Head of Chemistry Department, Shortridge High School.
Chemistry, Physics, Geology and Mineralogy.
- Walters, Arthur L., Indianapolis.
- Warren, Don Cameron, Bloomington, Ind.
- Waterman, Luther D., Claypool Hotel, Indianapolis.
Physician.
- Webster, L. B., Terre Haute, Ind.
- Weatherwax, Paul, Bloomington, Ind.
- Veem, M. L., 102 Garfield Ave., Valparaiso
Professor of Botany.
Botany and Human Physiology.

- Weir, Daniel T., Indianapolis.
Supervising Principal, care School office.
School Work.
- Weyant, James E., Indianapolis.
Teacher of Physics, Shortridge High School.
Physics.
- Wheeler, Virges, Montmorenci.
- Wiancko, Alfred T., Lafayette.
Chief in Soils and Crops, Purdue University.
Agronomy.
- Wicks, Frank Scott Corey, Indianapolis.
Sociology.
- Wiley, Ralph Benjamin, West Lafayette.
Hydraulic Engineering, Purdue University.
- Williams, Kenneth P., Bloomington.
Instructor in Mathematics, Indiana University.
Mathematics, Astronomy.
- Williamson, E. B. Bluffton.
Cashier, The Wells County Bank.
Dragonflies.
- Wilson, Charles E., Bloomington.
Graduate Student, Zoology, Indiana University.
Zoology.
- Wilson, Guy West. Assistant Professor Mycology and Plant Pathology, State
University, Iowa City, Ia.
- Wissler, W. A., Bloomington.
Chemistry.
- Wood, Harry W., 84 North Ritter Ave., Indianapolis.
Teacher, Manual Training High School.
- Woodburn, Wm. L., 902 Asbury Ave., Evanston, Ill.
Instructor in Botany, Northwestern University.
Botany and Bacteriology.
- Woodhams, John H., care Houghton Mifflin Co., Chicago, Ill.
Traveling Salesman.
Mathematics.

Wootery, Ruth, Bloomington, Ind.

Yocum, H. B., Crawfordsville.

Young, Gilbert A., 725 Highland Ave., Lafayette.

Head of Department of Mechanical Engineering, Purdue University.

Zehring, William Arthur, 303 Russell St., West Lafayette.

Assistant Professor of Mathematics, Purdue University.

Mathematics.

Zeleny, Charles, University of Illinois, Urbana, Ill.

Associate Professor of Zoology.

Zoology.

Zufall, C. J., Indianapolis, Ind.

Fellows	70
Members, Active	260
Members, Non-resident	29
	<hr/>
Total	359

MINUTES OF THE SPRING MEETING
OF THE
INDIANA ACADEMY OF SCIENCE.

SOUTH BEND, INDIANA, THURSDAY, MAY 28, 1914.

Public meeting of the Academy in the auditorium of the South Bend High School. The meeting was addressed by Dr. John M. Coulter, of the University of Chicago, upon the subject "Plant Breeding and How it Will Help Solve the Problem of Our Food Supply." Attendance: About 250.

The speaker was introduced by Severance Burrage, of the Eli Lilly Drug Company of Indianapolis, President of the Academy.

BUSINESS SESSION MAY 28, 1914.

At the close of the public meeting addressed by Dr. John M. Coulter the Academy was called into business session by President Burrage.

The following committees reported:

Resolutions:

Upon motion of John S. Wright, seconded by W. S. Blatchley, and passed, "That the Secretary be instructed to wire Dr. C. H. Eigenmann our regrets at his inability to attend this meeting."

In accordance with the motion the following telegram was sent:

"Dr. Eigenmann—The members of the Indiana Academy of Science in session at the spring meeting, South Bend, May 28th, wish to express their regrets that the condition of your health prevented your attendance, and join in wishing you speedy and complete recovery."

"HOWARD E. ENDERS, Secy."

Membership:

The Membership Committee, F. M. Andrews, chairman, read the names of forty-four applicants for membership. Upon motion duly seconded and passed, the secretary cast the ballots for membership of the persons whose names were proposed.

Letters were read in acknowledgment of sympathy from Chas. W. Fairbanks; and of regrets from Dr. Harvey W. Wiley.

With the consent of the Academy, Mr. J. S. Wright was authorized to extend a special invitation to Dr. Wiley to attend the next fall and spring meetings of the Academy.

The choice of a time for the fall meeting was requested.

It was moved (Blatchley) and seconded (Cogshall) that the meeting be set for the Thanksgiving period, as heretofore for several years. The motion was amended, and passed, "to leave the time for the meeting in the hands of the Program Committee, with power to act."

(In the discussion prior to the passage of the amendment, the sentiment was against the Thanksgiving period.)

Announcements:

President Burrage announced that Professor Edward Lee Green, botanist, of the Smithsonian Institution, will be present tomorrow and will accompany the party on its excursion.

Mr. Charles Stoltz, M. D., chairman of the local committee, announced the program for tomorrow (Friday, May 29, 1914). Automobiles for the whole party leave 7:00 a. m. from the front of the Hotel Oliver; return to the same place at 4:00 o'clock in the afternoon. Banquet, 6:30 p. m., at the Hotel Oliver.

Attention was called to the fact that J. B. Garner of Crawfordsville had not received the publications and literature of the Academy. He desires his name on the mailing list.

BUSINESS SESSION MAY 29, 1914.

After the noon luncheon on the field trip—at the Adventist College, north of Berrien Springs, Michigan—the meeting was called to order by the President, Severance Burrage, for the purpose of hearing the report of the Membership Committee.

F. M. Andrews, chairman, presented the names of six persons for membership.

Upon motion, duly seconded and passed, the secretary cast the ballot for their election to membership.

Announcements concerning the further movements of the party were made by local chairman, Dr. Stoltz.

BANQUET AND BUSINESS SESSION.

HOTEL OLIVER, May 29, 1914.

An ample banquet was spread in one of the private dining-rooms of the Hotel Oliver for forty-eight persons. President Severance Burrage, as master of ceremonies, expressed pleasure with the entertainment provided by the local committee. He made a strong plea for a large attendance and an increased membership for the fall meeting.

President Burrage then called upon the following persons for toasts and for expression of their sentiments.

Rev. John Cavanagh, of Notre Dame University, extended the greetings of the city and of Notre Dame to the members of the Academy.

Professor Dennis, of Earlham College: "How the Other Man Looks at It."

Professor Edward Lee Green, of the Smithsonian Institution, Washington, D. C., "The Unchangeableness of Nature, or the Stability of Science and the future of the Academy of Science."

Amos Butler, chairman of the State Board of Charities: "The Problem of Dealing with Mental Defectives."

Judge Hubbard, of South Bend: "Geology of the Regions About South Bend."

Dr. W. S. Blatchley, former State Geologist: "Geological Rambles."

Father Nieuwland, of Notre Dame University: Invitation to members of the Academy to visit him in his laboratories.

Professor Mottier of Indiana University: "Conservation of Our Young Members."

Professor Bodine, Wabash College: "A Personal Appreciation of the Day."

Dr. J. C. Arthur. "The Influence of the Academy of Science."

Eugene Manning, City Comptroller of South Bend, in the absence of the Mayor, extended the good-will of the city.

Dr. Montgomery of South Bend, "Welcome to our Homes, and to our Town."

Dr. Stoltz, South Bend, expressed his appreciation in the name of the local committee.

The *Business Session* was called to order by President Burrage.

The Membership Committee, F. M. Andrews, chairman, reported the

names of five applicants for membership. Upon motion, duly seconded, and passed, the Secretary cast the ballot for their election to membership.

Attention was called by the President to the fact that nearly sixty members were added to the Academy during the spring meeting.

Amos Butler read several letters relative to the passage of the congressional bills on the protection of migratory birds. Attention was also called to the treaty with Canada, aimed to protect migratory birds.

The following motion was passed: "That the President of the Academy of Science be appointed a committee of one to express to Senators Shively and Kern the earnest desire that they support all efforts to make the migratory bird law effective, and support the international treaty with Canada for bird protection in every way possible."

In accordance with this motion the following telegram was sent:

"MAY 29, 1914.

"Hon. Benj. F. Shively, U. S. Senate, Washington, D. C.:

"The Indiana Academy of Science in session here heartily endorses your support of the appropriation to make the bird law effective, and relies upon you to support legislation for the protection of the birds, including the treaty with Canada. We regard these as important to all the people.

"SEVERANCE BURRAGE, President."

Mr. Butler requested all the members of the Academy to write Senators Kern and Shively relative to the bird legislation. Many members pledged to do so.

A resolution, introduced by Professor Bodine, was passed: "That a rising vote of thanks be extended to Dr. Stoltz, Dr. Montgomery, and the other members of the local committee for the fine entertainment today."

Adjournment.

HOWARD E. ENBERS,

Assistant Secretary.

The following were elected to membership May 29, 1914:

Ethel Montgomery, South Bend, Ind. Physics.

Helen A. Southgate, Michigan City, Ind. Physiography and Botany.

Jose Angel Caparo, Notre Dame, Ind. Physics and Mathematics.

Dr. D. A. Rhinehart, 301 N. Walnut Street, Bloomington, Ind. Anatomy.

Thurman Brooks Rice, Winona Lake, Ind. Botany.

- Charles M. Schnell, South Bend, Ind. Earth Science.
- Roy H. Schierling, P. O. Box 172, Bloomington, Ind.
- Philip Armand Tetrault, West Lafayette, Ind. Biology.
- James Troop, Lafayette, Ind. Entomology.
- Charles Stech, Bloomington, Ind. Geology.
- Leonard L. Steimley, Bloomington, Ind., Indiana Club. Mathematics.
- Forest Glenn Tucker, 430 E. Fourth Street, Bloomington, Ind. Geology.
- W. A. Wissler, 415 S. Grant Street, Bloomington, Ind. Chemistry.
- Glenn Blaine Ramsey, University of Maine, Orono, Maine. Botany.
- H. C. Oberholzer, U. S. Department of Agriculture, Washington, D. C.
Biology.
- Thomas J. Murray, West Lafayette, Ind. Bacteriology.
- Fred A. Molby, 525 S. Park Avenue, Bloomington, Ind. Physics.
- Preston Walter Mason, Purdue University, Lafayette, Ind. Entomology.
- E. C. Marshall, 409 E. Fourth Street, Bloomington, Ind. Chemistry.
- Clyde A. Malott, 209 S. Dunn Street, Bloomington, Ind. Geology.
- Joseph McGuire, Notre Dame, Ind. Chemistry.
- Fred J. McCartney, Bloomington, Ind. Philosophy.
- Edward Koch, 314 N. Washington Street, Bloomington, Ind. Physiology.
- Charles Bernard Jordan, West Lafayette, Ind. Director of School of
Pharmacy, Purdue University.
- Regedius M. Kaezmarek, Notre Dame, Ind. Biology.
- Glenn James, West Lafayette, Ind. Mathematics.
- Thomas F. Jackson, 325 S. Grant Street, Bloomington, Ind. Geology.
- Thos. P. Irving, Notre Dame, Ind. Physics.
- Herbert Imel, South Bend, Ind., care Studebaker School. Zoölogy.
- George Hyslop, Bloomington, Ind., Kappa Sigma House. Philosophy.
- Chas. P. Hutchins, Buffalo, New York. Athletics.
- W. F. Hostetler, South Bend, Ind. Geography and Indian History.
- Paul M. Harman, 111 W. Dunn Street, Bloomington, Ind. Geology.
- Louis M. Hammerschmidt, South Bend, Ind. Science of Law.
- William Happ, South Bend, Ind. Botany.
- Elbert Howard Clark, West Lafayette, Ind. Mathematics.
- John B. Berteling, South Bend, Ind. Medicine.
- Homer Glenn Fisher, 727 Atwater Street, Bloomington, Ind. Zoölogy.
- David Christie Duncan, West Lafayette, Ind. Instructor in Physics Pur-
due University.

Albert H. Dewey, West Lafayette, Ind. Dept. of Pharmacy, Purdue University.

Ernest A. Davis, Notre Dame, Ind. Chemistry.

Noble H. Coryell, 330 S. Henderson Street, Bloomington, Ind. Chemistry.

Jacob Roland Collins, W. Lafayette, Ind. Instructor in Physics, Purdue University.

Flora Charlotte Anderson, Wellesley College, Wellesley, Mass. Botany.

Paul J. Carlyle, 315 N. Washington Street, Bloomington, Ind. Chemistry.

William Franklin Baker, Indianapolis, Ind., care Eli Lilly & Co. Medicine.

George A. Baker, South Bend, Ind. Archaeology.

J. A. Badertscher, 509 N. Washington Street, Bloomington, Ind. Anatomy.

William Gidley, W. Lafayette, Ind. Dept. of Pharmacy, Purdue University.

Willis D. Gatch, Indianapolis, Ind., Indiana University Medical School. Anatomy.

George Kedzie Foresman, 110 S. Ninth Street, Lafayette, Ind. Chemistry. Purdue University.

Carl Clayton Hyde, Bloomington, Ind., Kappa Sigma House. Geology.

Arthur Wilbur Henn, 821 Atwater Avenue, Bloomington, Ind. Zoölogy.

Ralph Benjamin Wiley, 1012 Seventh Street, West Lafayette, Ind., Purdue University. Hydraulic Engineering.

MINUTES OF THE THIRTIETH ANNUAL MEETING.
INDIANA ACADEMY OF SCIENCE.

CLAYPOOL HOTEL, INDIANAPOLIS, IND., DEC. 4, 1914.

The Executive Committee of the Indiana Academy of Science met in the Assembly Room, and was called to order by the President, Severance Burrage of Indianapolis, Ind.

The following members were present: Severance Burrage, Andrew J. Bigney, Howard E. Enders, W. A. Cogshall, Donaldson Bodine, J. P. Naylor, Glenn Culbertson, John S. Wright, Stanley Coulter, A. W. Butler, and Robert Hessler.

The minutes of the Executive Committee of 1913 were read and approved.

The reports of the standing committees were then taken up.

The Program Committee, John S. Wright, chairman, reported the work completed as indicated by the printed program, with three additional papers.

Amos W. Butler, member of the State Library Committee, reported that progress is being made in the way of housing books of the Indiana Academy of Science. Lack of available funds hampers the State Librarian in binding of exchanges. The State Librarian requests a ruling upon the matter of sending out proceedings to individuals upon request.

On motion, duly passed, the matter of distribution of proceedings is left to the discretion of the Committee on Distribution of Proceedings and the State Librarian.

On motion, duly passed, John S. Wright is authorized to prepare a revised membership blank and have it in order for use next year.

REPORT OF MEMBERSHIP COMMITTEE, F. M. ANDREWS, CHAIRMAN.

The following named persons are proposed for membership in the Academy:

Harry C. Travelbee, 304 Oak Street, West Lafayette, Ind. Botany.

- William J. Cotton, 5363 University Avenue, Indianapolis, Ind. Physics and Chemistry.
- Charles H. Arndt, Lafayette, Ind. Biology.
- William W. Smith, West Lafayette, Ind. Genetics.
- Oliver P. Ferry, West Lafayette, Ind. Physiology.
- Louis Frederick Heimlich, 703 North Street. Lafayette, Ind. Biology.
- Harry Creighton Pepper, West Lafayette, Ind. Chemical Engineering.
- Paul E. Bowers, Michigan City, Ind. Medicine.
- Charles P. Emerson, Hume-Mansur Building, Indianapolis, Ind. Dean Indiana University Medical College. Medicine.
- Ralph Emory Nelson, 419 Vine Street, West Lafayette, Ind. Chemistry.
- Ralph Bushnell Stone, West Lafayette, Ind., Purdue. Mathematics.
- W. H. Hanna, 828 Atwater Avenue, Bloomington, Ind. Mathematics.
- Fred Earl Robbins, 215 Waldron Street, West Lafayette, Ind. Agriculture.
- Ralph B. Stone, 307 Russell Street, West Lafayette, Ind. Mathematics.
- Frank Scott Corey Wicks, Indianapolis, Ind. Sociology.
- F. C. Atkinson, Indianapolis, Ind., American Hominy Co. Chemistry.
- Arthur Iddings, Hanover, Ind. Geology.
- Harry Binford, Earlham, Ind. Zoölogy.
- Samuel Hugh Hamill, 110 E. Fourth Street, Bloomington, Ind. Chemistry.
- Ralph Howard Carr, Lafayette, Ind. Chemistry.
- George Lindenburg Clark, Greencastle, ind., DePauw University. Chemistry.
- Dr. D. W. Davis, Greencastle, Ind., DePauw University. Biology.
- Ondess L. Inman, Bloomfield, Ind. Botany.
- Richard Sigler, Terre Haute, Ind. Physiology.
- Adam L. Bowles, Terre Haute, Ind. Zoölogy.
- John Ralph Keubler, 110 E. Fourth Street, Bloomington, Ind. Chemistry.
- Dr. Daniel T. Miller, Indiana University, Bloomington, Ind. Anatomy.
- Fred Donaghy, Ossian, Ind. Botany.
- Horace Powell, West Terre Haute, Ind. Zoölogy.
- William Marion Goldsmith, Oakland City, Ind. Zoölogy.
- Murl E. Fulk, Decatur, Ind. Anatomy.
- Michael James Blew, R. R. 1. Wabash, Ind. Chemistry and Botany.
- Harvey Elmer Stork, Huntingburg, Ind. Botany.
- Harold Orahood, Kingman, Ind. Geology.
- Dr. VanDoran, Earlham College, Richmond, Ind. Prof. of Chemistry.

- Carlton Edwards, Earlham College, Earlham, Ind.
 W. C. Van Nuys, Newcastle, Ind. Medicine.
 Barclay D. Morris, Spiceland, Ind., Spiceland Academy. Science.
 Paul H. Brown, Richmond, Ind. Physics and Manual Training.
 Bernard F. Dostal, Bloomington, Ind. Physics.
 O. C. Berry, Waldron Street, West Lafayette, Ind. Engineering.
 James M. Breckenridge, 514 S. Walnut Street, Crawfordsville, Ind. Chem-
 istry.
 Dr. V. H. Moon, Indianapolis, Ind. Pathology.
 H. C. Balcom, 1023 Park Avenue, Indianapolis, Ind. Botany.
 Elton R. Clark, Indianapolis, Ind. Zoölogy.
 A. E. Stickels, 768 Massachusetts Avenue, Indianapolis, Ind. Chemistry.
 John C. Dean, Indianapolis, Ind. Astronomy.
 Dr. G. S. Bliss, Fort Wayne, Ind., State School for Feeble-Minded. Medi-
 cine.

On motion they were recommended.

The Treasurer, W. A. Cogshall, reported as follows:

Balance from 1913	\$254 78
Collected to December 1st	133 00

Total	\$387 78
Expenses December 1st	174 79

	\$212 99

Upon motion, duly passed, the report was received and turned over to the Auditing Committee.

On publication of Proceedings, H. E. Barnard, editor, reported the publication and distribution of Proceedings for 1913.

On motion the following members were recommended as Fellows:

Fellows, Wm. L. Bryan, Indiana University, Psychology; E. B. Wilhamson, Bluffton, Biology; A. W. Kenyon, Purdue, Mathematics; J. A. Nieuwland, Botany; Wm. M. Blanchard, DePauw University, Chemistry.

The matter of avoiding duplication of reports was discussed. It is deemed desirable to have committees report at the executive session and that only the Secretary's summarized report be read at the general meetings.

The Secretary reported the binding of the minutes of previous sessions of the Academy, and the purchase of a new Secretary's book. The Secretary reported that the State Librarian has consented to deposit the bound copies of the minutes in the safe of the State Library.

President Burrage reported that he had appointed the following persons as delegates to the State Tax Association: Judge R. W. McBride, William Lowe Bryan. Alternates, E. B. Williamson, Dr. Cecil C. North.

Adjournment.

GENERAL SESSION. ASSEMBLY ROOM, 2:00 P. M.

The meeting was called to order by President Severance Burrage.

The minutes of the Executive Committee were read and approved.

On motion, duly passed, the persons who were recommended for membership were elected members of the Indiana Academy of Science.

On motion, duly passed, the five persons who were recommended by the Executive Committee were elected fellows in the Academy of Science.

The regular program was then taken up. The papers numbered 1-11 were read in general session; after which the Academy separated into two sections as follows: Section A—Bacteriology, Botany and Zoology, presided over by President Burrage and H. E. Enders being Secretary. Section B—Chemistry, Physics, Engineering, Geography, Geology, Mathematics, and Meteorology; W. A. Cogshall presiding and A. J. Bigney being Secretary.

EVENING SESSION, 8:00 O'CLOCK.

Business:

The report of the Nominating Committee was as follows: President—W. A. Gogshall, Bloomington; Vice-President—W. A. McBeth, Terre Haute; Secretary—A. J. Bigney, Moores Hill; Assistant Secretary—Howard E. Enders, Lafayette; Press Secretary—Frank B. Wade, Indianapolis; Treasurer—William M. Blanchard, Greencastle; Editor—H. E. Barnard, Indianapolis.

On motion the report was accepted, and the persons named were elected for the ensuing year.

SATURDAY, DECEMBER 5TH, 9:00 A. M.

Business:

The following resolutions were presented by the chairman of the Resolution Committee, Stanley Coulter of Purdue University:

Resolution No. 1.

Resolved, That the Indiana Academy of Science, recognizing the importance to the State and Society of the Preservation of the Public Health, hereby endorses the proposal for a thoroughly trained county health commissioner, who will give his entire time to this service, and urges the Legislature to pass a law to that end.

Resolution No. 2.

Resolved, That we extend a vote of thanks to Mr. Lawrence, manager of the Claypool Hotel, for the use of rooms for the meetings of the Academy, and for his continued kindness in aiding us in every way possible.

Resolution No. 3.

(On suggestion of R. R. Ramsey.)

Be it Resolved, That as certain periodicals, such as Science Abstracts A and B, *Baiblaita zu der Annalen der Physik* (in Physics), and in all probability other magazines in other lines are not on the list of exchanges, that such exchanges be sought and obtained if possible. If not successful, periodicals whose nature is primarily abstracting, should be put on the mailing list.

On suggestion of Will Scott that our journals should be open to foreign scientists, Stanley Coulter moved, and it was passed, that a committee be appointed to take up the matter with the Smithsonian Institution regarding the opening of our scientific journals to foreign scientists for publication of their papers.

On motion the Academy endorsed the plan of the State Geologist to cooperate with the United States Geological Survey, with a view to the prevention of floods in Indiana (see resolution of last year), and ordered that a copy of that resolution be sent to the Governor, Lieutenant-Governor, and Speaker of the House.

Adjourned to sections.

AFTERNOON SESSION, 1:00 O'CLOCK.

Section B met to complete the reading of its papers.

Adjournment.

A. J. BIGNEY, Secretary.

SEVERANCE BURRAGE, President.

PROGRAM
OF THE THIRTIETH ANNUAL MEETING OF THE
INDIANA ACADEMY OF SCIENCE,
CLAYPOOL HOTEL, INDIANAPOLIS,
FRIDAY AND SATURDAY, DECEMBER 4 AND 5, 1914.

GENERAL PROGRAM.

FRIDAY, DECEMBER 4.

Meeting of Executive Committee.....	10:30 a. m.
General Session.....	2:00 p. m.
Section Meetings.....	4:00 p. m.
Informal Dinner, Tickets \$1.00. For reservation, apply to W. M. Blanchard, DePauw University, Greencastle.....	
	6:00 p. m.
Business Session.....	7:45 p. m.
General Session.....	8:00 p. m.

Address by the Retiring President, Severance Burrage.

Symposium on Feeble-mindedness.

SATURDAY, DECEMBER 5.

General Session.....	9:00 a. m.
Section Meetings.....	9:45 a. m.
General Session, followed by Section Meetings (provided the time is required to complete the program).....	2:00 p. m.

LIST OF PAPERS TO BE READ.

Address by the Retiring President, Mr. Severance Burrage.

GENERAL SESSION AT EIGHT O'CLOCK, FRIDAY EVENING.

Subject: "Science in Its Relation to Conservation of Human Life."

Symposium: Some Scientific and Practical Aspects of the Problem of
Feeble-mindedness.

1. The Feeble-minded Family.....Amos W. Butler, Indianapolis
2. The Problem of Feeble-mindedness.....Dr. G. S. Bliss, Ft. Wayne
3. The Feeble-minded and Delinquent Boy..Dr. F. E. Paschal, Jeffersonville
4. The Feeble-minded and Delinquent Girl..Dr. E. E. Jones, Evanston, Ill.
5. Feeble-mindedness in the Public School..Miss Katrina Myers, Indianapolis

Discussion opened by Mr. F. S. C. Wicks.

GENERAL—TWO O'CLOCK FRIDAY.

6. The Alcohol Problem in the Light of Coniosis,
20 minutes.....Robert Hessler
7. Cold Storage, Practical Conservation, 20 minutes.....H. E. Barnard
8. Changing Conditions among the Cumberland Plateau Mountain
People, lantern, 20 minutes.....Bernard H. Schoeckel
9. The Conservation of Energy, 30 minutes.....Arthur L. Foley
10. Agriculture in Southern Indiana, 15 minutes.....C. G. Phillips
11. The Chief Reason for the Migration of Our Birds, 15 minutes.D. W. Dennis

BACTERIOLOGY.

12. An Aeration Apparatus for Culture Solutions, with charts,
10 minutes.....Paul Weatherwax
13. Antagonism of *B. fluorescens* and *B. typhosus* in Culture,
10 minutes.....P. A. Tetrault

BOTANY.

14. Notes on the Distribution of the Forest Trees of Indiana,
15 minutes.....Stanley Coulter
15. A New Enemy of the Black Locust, 5 minutes.....Glenn Culbertson
16. The Parasitic Fungi Attacking Forest Trees in Indiana,
10 minutes.....Geo. N. Hoffer
17. A New Disease of *Viola cucullata*, lantern, 5 minutes....H. W. Andersons
18. Oatsmut in Indiana, 15 minutes.....F. J. Pipal
- 18a. Weed Seeds in soil, 10 minutes.....F. J. Pipal
19. Additions to Indiana Flora, 3 minutes.....Chas. C. Deam
20. Some Peculiarities in *Spirogyra dubia*, 5 minutes.....Paul Weatherwax
21. Stomata of *Trillium nivale*, 10 minutes.....F. M. Andrews
22. Final Report on Cross Pollination of Corn, 3 minutes.....M. L. Fisher
23. The Primrose-Leaved Violet in White County, charts
and specimens, 10 minutes.....Louis F. Heimlich
24. Continuous Rust Propagation without Sexual Reproduction,
10 minutes.....C. A. Ludwig
25. Correlation of Certain Long-eyed and Short-eyed Rusts,
10 minutes.....H. C. Travelbee
26. Some Species of *Nummularia* Common in Indiana, 10 minutes
.....C. E. O'Neal..
27. The Genus *Rosellinia* in Indiana, 2 minutes.....Glenn B. Ramsey

28. Cultivating and Breeding Medicinal Plants, lantern,
20 minutes.....Fred A. Miller
29. Some Large Botanical Problems, 10 minutes..... J. C. Arthur

ZOOLOGY.

30. The Alba Gehre Collection of Birds' Eggs in the Museum
of Purdue University, 10 minutes.....Howard E. Enders
31. A Study of the Maturation Period in the Mole-Cricket, blackboard,
10 minutes..... F. Payne
32. Note on a Peculiar Nesting Site of Chimney Swift,
3 minutes.....Glenn Culbertson
33. Mosaics in *Drosophila Ampelophila*, chart, 5 minutes.....Horace M. Powell
34. New Mutations in the Genus *Drosophila* and their Behavior
in Heredity, chart, 10 minutes.....Roscoe R. Hyde
35. Notes on Indiana Earthworms, 10 minutes.....H. V. Heimburger
36. Insects of the Between-Tides Zone, 30 minutes.....Chas. H. Arndt
37. Regeneration in *Sagartia*, 5 minutes.....D. W. Davis
38. The Relation of Birds to Aquatic Life as Exemplified by
Observation and Studies made at Lake Maxinkuckee,
15 minutes.....Barton W. Evermann
39. The Reptiles and Batrachians of the Lake Maxinkuckee
Region, 20 minutes.....Barton W. Evermann
40. A Physical and Biological Survey of Lake Maxinkuckee,
20 minutes.....Barton W. Evermann

CHEMISTRY.

41. The Quantitative Determination of Copper, 5 minutes.....W. M. Blanchard
42. The Alundum Crucible as a Substitute for the Gooch
Crucible, 5 minutes.....George L. Clark
43. Some Recent Work in Dairy Chemistry, 20 minutes.....George Spitzer
44. Analysis of Zirconium Minerals, 10 minutes.....James Brown
45. Correlation of High School and College Chemistry,
20 minutes.....James Brown
46. Chemical Composition of Virgin and Cropped Indiana Soils,
10 minutes.....S. D. Conner

ENGINEERING.

47. Sewage Disposal, lantern, 15 minutes.....Charles Brossmann
48. Extension of Empirical Curve by the Addition of Estimated Values
to a Series of Observations, charts, 20 minutes.....Albert Smith

49. Tar-Forming Temperatures of American Coals, charts, 20 minutes
O. C. Berry

GEOGRAPHY.

50. Shawnee Mound, Tippecanoe County, A Glacial Alluvial Cone,
 charts and photographs, 10 minutes.....William A. McBeth

GEOLOGY.

51. Stratigraphic Correlation of the Outcrop at Spades, Indiana,
 15 minutes.....H. N. Coryell
52. Pennsylvania Fossil Plants of the Bloomington Quadrangle,
 5 minutes.....J. F. Jackson
53. Preliminary Geological History of Dearborn County, 10 minutes
A. J. Bigney
51. Notes on the Cause of Asterism in "Starolite" (Asteriated Quartz),
 charts and specimens, 10 minutes.....Frank B. Wade
55. The Mississippian Section of Monroe County, charts, 15 minutes
J. W. Beede
56. The Flatwoods Region of Owen and Monroe Counties, Indiana,
 25 minutes.....Clyde A. Malott

MATHEMATICS.

57. Mechanical Device for Testing Mersenne Numbers for Primes,
 5 minutes.....Thomas E. Mason
58. Some Properties of Binomial Coefficients, 20 minutes... A. M. Kenyon

METEOROLOGY.

59. The Watertown, S. D., Tornado of June 23, 1914, 10 minutes
J. Gladden Hutton

PHYSICS.

60. A New Lantern and Projector, lantern, 10 minutes.....Arthur L. Foley
61. Some Text Book Inconsistencies, 5 minutes.....Arthur L. Foley
62. The Mechanism of Light and Heat Radiations, 10 minutes
James E. Weyant
63. A Simple Form for the Carey Foster Bridge, lantern, 5 minutes
J. P. Naylor
64. The Change of the Radio Activity of Certain Springs, lantern,
 10 minutes.....R. R. Ramsey
65. Radio Activity of Spring Water, lantern, 10 minutes.....R. R. Ramsey
66. A Radio-Active Electroscop, lantern, 5 minutes.....Edwin Morrison

SCIENCE IN ITS RELATION TO THE CONSERVATION OF HUMAN LIFE.

SEVERANCE BURRAGE.

Nearly every branch of science has direct or indirect relation toward the conservation of human life. Unfortunately the appreciation of scientific work has been from the industrial rather than from the humanitarian viewpoint, and such researches as have resulted in discoveries that have commercial importance have been the ones to receive the plaudits of the public.

Chemistry, physics, geology and biology in all of their subdivisions have undoubtedly contributed in the work of saving human life. For example, we have in *chemistry* the studies of the impurities in the air, water, food and drugs, practical applications on the purification of water and sewage, and so on. In *physics* and its various branches we have the practical application of safety devices of all kinds, rescue apparatus for mines, the developments in rapid communication, climaxed by the invention of the wireless telegraph and telephone, most useful in the prevention of accidents, the various inventions which protect employes from dangerous machinery, the development of fire-fighting apparatus, and special protective devices against floods, earthquakes, cyclones and other disasters. In *geology*, the selection of proper building stone, the dangers from the corrosion of building stone in different climates, the selection of proper building sites, and, indirectly the discoveries of coal, oil, and other things essential in many phases of human existence. In *biology*, particularly in the subdivisions, bacteriology, medicine and sanitary science, we find some of the most important discoveries resulting in the prevention of disease and death. Even in entomology—the life histories of various mosquitoes and flies have important bearing on the prevention of disease. In bacteriology the discovery of the causes of transmissible diseases, through the research of Pasteur, Koch and others, methods in the rapid diagnosis of disease, protective inoculation against disease, resulting from the work of Jenner Von Behring and others, are familiar to you all. In medicine the application of asepsis and cleanliness to surgical methods has revolution-

ized this important branch of medicine and made it a most important factor in the conservation of human life; the discovery of selective chemical substances for the treatment of specific diseases, such as quinine for malaria, salvarsan for syphilis and most recently ipecac for amebic dysentery and pyorrhea.

In sanitary science the development has been most remarkable. This includes its practical applications in sewage and garbage disposal, street cleaning and the sanitary construction of pavements, the sanitation of heating and ventilation of factories, workshops and schools, the medical inspection of schools, the sanitation of railway cars, and stations, and such special sanitary devices as individual drinking cups, dental lavatories in railroad cars, and the various applications of sanitation to the farmhouse and rural dwelling.

The above outline, which is obviously incomplete, suggests some of the things which science in its various branches has done that have been and can be applied in the conservation of human life. Granting that science has done all of these things and many more, I would raise this important question: Is the public at large getting the full benefit of all of this scientific work? Is the public taking advantage of these discoveries of science? In my opinion it is not.

Notwithstanding intensive efforts on the part of state boards of health, extension departments in our universities, instruction given before farmers' institutes, educational activities of anti-tuberculosis societies and insurance companies, we find the death rate from preventable diseases decreasing very little if at all. In some communities the deaths from preventable diseases are on the increase. In our own State we find very little change in the last ten years in the deaths from preventable diseases.

This Academy is of course particularly interested in Indiana. Can not this Academy suggest or recommend ways and means to apply throughout this State the various developments of science relating to health and disease prevention in such a way as to create a healthier and longer-lived citizenship? A commission appointed recently in Massachusetts to investigate the high cost of living stated—

"The increased vital efficiency of the citizens of this State (Massachusetts) which would result from a conservation of the present waste of health would, if expended in labor, increase the earnings of those whose health is impaired and also lessen the burdens of

those who are at present unnecessarily ill. This increase in earnings would thus tend to reduce the cost of living, increase the total earnings of the citizens and make the average income larger."

Thus conservation of health means higher wages, which enables the worker to keep ahead of the increasing price of the commodities of life. Surely this is worth striving for, and in my opinion Indiana can decrease the death rate and lengthen life and thus bring about this condition. To accomplish it I would urge the adoption of a law which would provide for a full-time health commissioner in every county in the State. This commissioner must be especially trained in sanitary science and the various applications of the other sciences in so far as they affect the prevention of unnecessary deaths. If such a law were passed, and backed up by an intelligent public, we would have the healthiest State in the Union in a very short time. I state my belief because where such sanitary applications have been thoroughly carried out, we have as a result healthful conditions. I would cite as an instance of this the Panama Canal district. While the names of Goethals and Gorgas will go down to posterity as constructors of the Panama Canal, they should receive more credit for the sanitary organization and administration which made the construction of the canal possible. They converted one of the most unhealthful localities in the world, where the death rate was over 70 per 1,000, to the most healthful spot with the death rate of less than 6 per 1,000, a death rate lower than that of any other civilized community in the world.

Another instance of the practical applications of sanitary science has been in our military camps. Reports show that out of 12,000 men in these camps there was not a single case of smallpox or typhoid fever for a period covering two years. Typhoid fever has long been one of the pests of camp life, but through improved sanitation and typhoid vaccination, this disease has been absolutely eliminated. Other diseases in these camps over which there was not such perfect control showed a great reduction.

With such fine examples of successful sanitary administration it seems to me justifiable to make application to our own communities, with of course necessary modifications. I therefore would suggest that this Academy at this session pass resolutions favoring the passage of a law at the next Legislature which would provide for a competent, full-time health commissioner in each county in this State. I know of no way in which the Indiana Academy of Science can better further the best interests of the State with reference to the conservation of human life.

se words :
 ng human

istories of
 tration of
 triking by
 n running
 hat is ap-
 em whose
 ut a hun-
 fifty-seven

ubsequent

κ
 own. Total.
 57

36

1

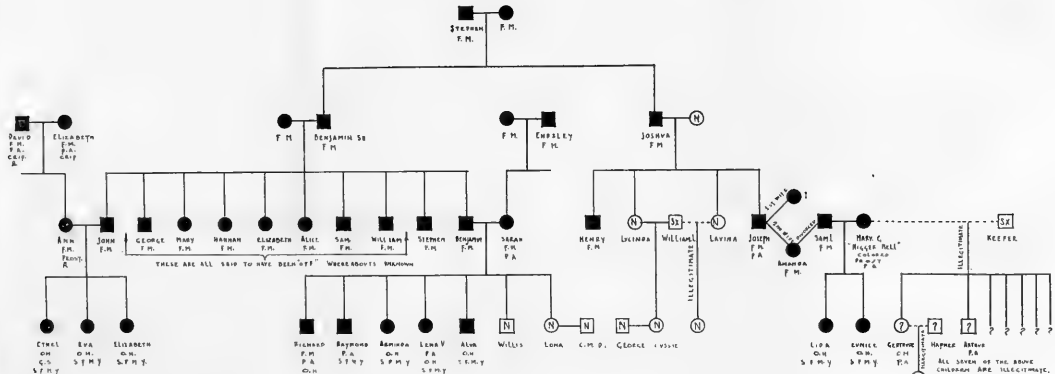
9

11

7

9

THE 'C' FAMILY



THE 'C' FAMILY

	MALE	FEMALE	SEX	TOTAL
FIVE GENERATIONS				
INDIVIDUALS RECORDED	24	20	5	53
MENTAL CONDITION				
FEARFUL	7	19		26
IMBINE	6	1		7
NORMAL	6	6		12
NEURALGIA IN QUESTION	4	2		6
SEX OFFENSES	3	4		7
ILLEGITIMATE	1	3		4
INFLUENZA	6	12		18

A FAMILY IN ONE NEIGHBORHOOD.*

AMOS W. BUTLER,

Secretary Indiana Board of State Charities,
Indianapolis.

Not long ago I had handed to me a little card containing these words:

“When shall we apply the same intelligence to breeding human beings that we apply to breeding cattle?”

It came at a time when we were investigating the family histories of some of the state's wards whose names are recorded in the registration of the Board of State Charities. The application was made more striking by having before me charts of some of these families, some of them running back five or six generations. These tell a story of degeneracy that is appalling. I have thought you would be interested in one of them whose visible beginning was in a pair of feeble-minded ancestors about a hundred years ago. It includes five generations, represented by fifty-seven individuals.

There would be some changes in the chart as a result of subsequent investigations but in the main the facts are as given.

The “C” Family.

	Sex			Total.
	Male.	Female.	Unknown.	
Individuals recorded	24	28	5	57
Mental condition:				
Feeble-minded	17	19	.	36
Insane	1	.	1
Normal	3	6	.	9
Normality in question.....	4	2	5	11
Sex offenders	3	4	.	7
Illegitimate	1	3	5	9

*Read at Indiana Academy of Science, Indianapolis 1914.

Our investigations brought to light the fact that eighteen members of this family have been at some time of their lives inmates of public institutions in Indiana. Our information as to the length of time five of these were on public support is incomplete; it was before our present registration of institution inmates was begun. Concerning the other thirteen, however, we have accurate data. To date they have spent a total of 203 years, 5 months in public institutions.

Eleven have been in county poor asylums 44 years, 3 months; 7 have been in orphans' homes 40 years, 7 months; 8 have been in the School for Feeble-Minded Youth 110 years, 11 months; one has been in the Indiana Girls' School 7 years, 8 months. If their maintenance has averaged but \$125 a year, the total cost has already amounted to more than \$25,000. This is not all. There are now five young women of this family in the School for Feeble-Minded Youth at Fort Wayne. Their ages are 22, 23, 24, 28 and 32 years, an average of 25.8 years. At the annual average per capita cost of maintenance in that institution last year (\$140.68) these five young women cost the State \$700.00 a year.

I ask this question: What are we going to do about it? It is one of our problems.

A legislative commission in New Jersey has recently made a report after a thorough investigation of the problem of mental defectiveness. Other commissions in New York, Massachusetts, and elsewhere have been, or are, engaged in this work. Is it not time that Indiana should wake up and have a commission to study the problem of mental defectiveness? What is the condition? What are the needs? How shall they be met? What is the wisest plan to follow? What are we going to do to save ourselves this continually increasing population of mental defectiveness, that is shown by this chart and could be shown by a hundred others, to be growing up in the State of Indiana without our knowledge, without our thought, without our effort to prevent it? The question comes to us: What will we do about it?

THE PROBLEM OF FEEBLE-MINDEDNESS.

G. S. BLISS.

The first recorded attempt to do something for feeble-mindedness occurred in the year 1800, when Dr. Itard, a French physician, tried to educate a so-called "wild boy" found in the woods. The attempt failed because the boy was feeble-minded, and was followed in France by several abortive attempts to educate feeble-minded persons.

The first successful attempt in this direction was made by the School for the Deaf and Dumb at Hartford, Conn., in 1836. They took several feeble-minded children and succeeded in training them a little in school work and in forming better habits of life.

In 1846 Dr. Seguin, a pupil of Dr. Itard, opened a successful school for mental defectives in France. This attempt succeeded so well that other schools were soon founded for this most unfortunate class. In 1848 Massachusetts started the first state school in the United States. This was followed by other States, and in 1879 Indiana established her present school.

All these schools were started with the idea that mental defect was curable, and that the idiot or imbecile could be educated to become a self-supporting and dependable citizen. This we now know to be an impossibility, and the fact is coming to be more generally recognized that there is no cure for mental defect. It is a condition, not a disease.

Insanity is a disease attacking a developed brain and is often cured; feeble-mindedness is never cured, but may be greatly relieved by proper training and care.

There are between 5,000 and 6,000 feeble-minded persons in Indiana needing institutional care today, and only about one-fourth of these are receiving it. These people are at large, reproducing defectives in an ever-increasing amount, like the waves from a pebble thrown into a lake. If we are to protect the coming generations of our sons and daughters, grandsons and granddaughters from this growing burden, we must wake up to the condition and *do* something about it.

What to do, and how to do it, constitutes one of the most serious problems for our State.

I presume if I were to ask any member of this body before me tonight, what in his estimation was the best measure, he would say sterilization or asexualization. And to that measure I would give a hearty amen, if it were as practical a proceeding as I wish it were. Theoretically it is good, but in practice, owing to ignorance, false sentimentality, honest disbelief in the measure by honest people, it is not as easily carried out as most of the persons here would think. If applied, it should be used on persons at large, not on those already segregated and cared for by public institutions; but the problem here is first to catch them, and then to decide where to draw the line.

I believe that for many years to come, segregation will be our best method of dealing with this problem. Mr. Butler has recommended for this State a real practical step in the establishment by this Legislature of a commission to investigate this condition throughout the State and report to our next Legislature.

I have also recommended a large farm, 2,000 acres or more, somewhere in the south central part of the State where the adult boys and men can live as useful and happy as may be; and also another smaller farm where the older women could care for chickens, turkeys, and small fruits, living their lives apart from the world, where they are such complete failures.

I believe that better marriage laws, permitting no one to marry without a clean bill of health, would be a help.

Whenever alcohol and vice are abolished in this world the feeble-mindedness from those causes will cease, and the public registration of venereal disease would prove a potent weapon against mental defect. I believe, that every case of syphilis and gonorrhoea should be registered with the health officer as well as smallpox or typhoid fever.

I hope Indiana will realize in the near future the momentousness of this problem, and by meeting it and better preventing the reproduction of defect, place herself where she belongs, at the pinnacle of those States who prevent, as well as provide for this burden of feeble-mindedness on her community.

THE FEEBLE-MINDED AND DELINQUENT BOY.

FRANKLIN C. PASCHAL.

In an examination of the relation of feeble-mindedness to delinquency, we find ourselves in the realm of the higher degrees of mental defect, the moron and the borderline cases. These, not the imbeciles, are the ones who present the difficult problem to the student of delinquency, for when those of the lower grade come into contact with the law, their antisocial behavior is recognized as but a manifestation of the deficiency. But the delinquent whom we classify as a high grade defective is not so easily disposed of, and it is this class with which this paper deals.

Only within the past few years have the courts begun to recognize that each case is an individual case and that an understanding of the violator is fully as important as an understanding of the law violated. This has come about largely through the appreciation that a great many of these persons have grave mental defects which were not of a sufficient degree to be recognized by the community. As a result, the juvenile courts of the larger cities and many penal institutions are depending upon the findings of the clinical laboratories to guide them in the disposition of the cases which appear before them. These institutions are finding extremely difficult, almost hopeless, the task of readjusting in society those who from congenital or early developmental causes are equipped with inadequate mental machinery.

A delinquency is an abnormal reaction to stimuli furnished by the environment. There are many conditions which operate to produce abnormal reactions, such as mental depressions, a craving for excitement, instability and, very frequently, a mind not completely unfolded. If judgment, foresight, and moral appreciation are undeveloped, then inhibitions are deficient and the resulting anomalies of behavior will quite likely become criminal acts or delinquencies. The feeble-minded boy is the tool of his environment. He can not see his way forward in the situations that arise, nor can he control his environment. The more complex the situation in which he is placed, the less liable he is to solve his own problems and the greater the probability that his reactions will be construed as antisocial.

The types of delinquencies of boys of the feeble-minded class, then, are many and depend upon the peculiar combinations of circumstances which chance may throw about them in their environments.

The feeble-minded boy is usually a member of a family of degenerate type. This degeneracy may be due to feeble-mindedness itself, to intemperance, or other causes may be to blame, but at least the family has fallen into the lowest strata of society. What mental defect the boy may be given is then of a lower instead of a higher order. The instruments for the implanting of the higher ideas and ideals, the church and the school, are either absent or ineffectual. If the family in its descent has become criminal, the boy is trained in the criminal paths, into which he falls quite readily. If not actually trained, he is encouraged by a family attitude which countenances this sort of thing.

Even though the family is not directly responsible, it has thrown him among associates of the lowest kind and surrounded him by the atmosphere of the slums or, in the small town, of the saloon and the gang. These people will train him, will assist him and will encourage him in starting upon a career of antagonism to law and order. A high level of intelligence is required to rise of itself above surroundings such as this, but our feeble-minded boy stays where he is put. He makes an excellent tool; he does not reason, nor appreciate the full nature of his acts, but he can be induced to perform quite difficult feats for those whose only labor is his instruction and who receive the lion's share of the profits. And, of course, having performed the act, he is the one who pays the penalty if caught, while the real criminal remains hidden.

The public schools, the churches and the charitable organizations have long fought the various instruments of suggestion, the dime novel, the yellow periodical, the moving picture film of similar nature, *et cetera*, most potent factors in the production of juvenile delinquency; but how much more influence do these things have when the mentality is so low that the counterbalancing elements are not present. When the environment is of the slum type, how much additional material for suggestion is presented that can not be controlled other than by the removal of the boy from these surroundings. He does not possess the wider and deeper mental interests, so seeks the activities, which even the feeble-minded demand, in some lower form.

Only recently have we recognized that weak-mindedness is present in a great portion of those boys who fail to progress in school and soon

begin to practice truancy, itself a delinquency. From this it is but a step to the gang with its series of petty thieving. The feeble-minded boy is often the oldest and largest boy in his room and consequently a leader. Under his guidance the younger normal boys learn to play truant, to smoke cigarets, to steal and to practice sexual vices. It is through the moral deterioration of these unfortunate followers that this defective does the greatest damage.

Not being capable of being aroused by the interests that are presented to the normal boy, our defective is looking about for excitement, and this he finds in stealing or other delinquencies. We often find in a good home a boy of this kind, who, although his parents do all that seems possible, is continually getting into trouble and eventually finds himself in some serious situation. Such a case is particularly hard for our juvenile courts, as it is not easy to take the boy from his home, yet the parents are seldom able to deal with him. A mother will overlook the faults of this boy because she feels that he is not to blame, yet she will not acknowledge even to herself that his is an incurable deficiency. She makes allowances and covers up his faults instead of enforcing the discipline that she would give a normal son. The feeble-minded boy is even more in need of strong and rigid discipline, for even this child may learn the effects of fire if it is hot enough.

Space will not permit a discussion of what is called Moral Imbecility, but a few words are necessary at this point. By moral imbecility is meant, to quote Tredgold, "that class of persons who are so constituted that they are utterly devoid of any real moral sense, and of the consciousness that any obligation is morally due from them to their fellows. Such defect is inherent and it may rightly be called moral deficiency. . . . Their moral defect is in fact, latent But although latent, moral defectives of this kind are not of necessity actual criminals; they may well be described as potential criminals."

Many psychologists declare that moral imbecility does not appear independent of grave mental deficiency, some say that it may appear with a deficiency which is slight, while others say that it may be present without accompanying defect of mentality. That portion who have unquestionable mental defects fall within the range of this paper. The moral sense, sympathy, benevolence or social instincts may be lacking, and if the boy is without the intelligence to simulate these instincts or to de-

termine what society considers to be the correct attitude, delinquencies will quite likely result. These are the ones who commit the acts of violence, malicious destruction, assault, rape, sodomy, and other sexual abnormalities and perversions. No hope can be held out in these cases.

Many there are, even of feeble-minded families, who living in the less exacting environment of the thinly populated districts, exist unaided by tilling their small plot or by performance of the tasks of drudgery and attract not even the notice of the communities in which they live. But when the unusual occurs, hardships or difficulties arise, they lack the judgment and foresight necessary to carry them through. Then the easiest way out is the only way, and they come into conflict with the law. This is not the class of the delinquent boy, but is the class into which the delinquent boy often later falls, and this element of his future must be considered in handling his case. This is the class found in large numbers in our reformatories and prisons.

A few cases from our own laboratory will serve to make concrete some of these types:

A colored fellow of very low mentality is serving a sentence for petit larceny. He had once been committed to an Illinois prison for cutting a white foreman who had attempted to take advantage of him by withholding a portion of his pay. While traveling to a point in Indiana at which he expected to find work, he fell in with a white man who took some railroad brass and told this fellow to carry it into the next town where they would sell it and divide the money. Not appreciating the nature of his act, he walked into town with the brass under his arm and when arrested, his director, who had followed at a distance, disappeared. Under a controlled environment and cared for, this subject is a very hard worker at the menial tasks and says that the only mar to perfect happiness is that he can not have tobacco.

One boy of sixteen years is but eight years of age mentally and comes from a feeble-minded family and a vicious environment. His brother has been in our institution and other relations have been incarcerated. When he was eight years old, his mother refused longer to own him and at that age he was thrown upon his own resources. But he soon provided for his future care by performing certain acts which obtained admission for him into the reform school, and he has been a ward of the State almost continually since that time. Besides his mental incapacity, he is physically subnormal and distinctly unstable. He is also a pervert and is a contam-

inating influence even in a reformatory. With such a background as this, a favorable prognosis is impossible.

One boy of sixteen years comes from a family that we have reason to believe is mentally subnormal. The mental examination shows him to be a moron, and our information is to the effect that his environment has not been particularly bad. Though employed, he stole a wheel which he traded for a billy-goat he had long desired.

Another boy is now with us for the second time. His congenital defect is of syphilitic origin and he presents many physical malformations, among which is a nose quite small and deformed. He had previously been in the reform school and was sent to us first for continuing his petty thievery after returning to his home, a small town in western Indiana. He was not long absent upon parole before he returned with a new sentence for horse-stealing, which act was without purpose but probably was due to the suggestion of associates. He recently appeared at our office with a smile upon his face and informed us that he had made a discovery. Upon being supplied with a nail, he passed it in one side of his nose and out the other. It afforded him great pleasure to exhibit this accomplishment to a clinic before a medical association.

One boy of about eighteen, whom the psychological examination showed to be of low level, was convicted upon a charge of petit larceny. In the institution he was a hard worker both in the shop and in the school, but he could not accomplish a great deal. He explained in the most pleading terms to me at the time of his entrance, that he had been without work and while sleeping in a barn he found a fur overcoat which he took because he was so cold. Rather a delinquency than a crime is it not? And the cause? Mental incapacity, the inability to compete on equal terms with his fellows.

From a scientific point of view, one of the most interesting cases we have had was that of a young man of the borderline class, having sufficient intellect to appear normal and about whose home life and environment we have not been able to obtain sufficient data. He stabbed and killed a fellow inmate, almost a total stranger to him, for the sole reason that he wished to obtain a transfer to the State prison, where he would be given tobacco. Even a prison is not a complete protection against a mentality such as this.

Many more instances could be given from this one institution which

are of great interest because of the light they throw upon the essential relations of feeble-mindedness to delinquency, and many more yet must be recorded before the subject will be fully understood.

What shall we do with these feeble-minded and delinquent boys? It is the duty of society to develop their scant capacities and prepare them for things they will be able to do, then to surround them with an environment in which they will be able to do their part and thus get the greatest happiness out of their narrow lives, while society is freed from the menace.

There has been for some time a movement on foot in several States looking toward the establishment of state institutions for defective delinquents where they may be given permanent custodial care. Massachusetts now has such a law, and in New York the Governor last year vetoed a similar bill. Our reformatories are not feeble-minded institutions and can not hold these boys indefinitely. Our feeble-minded institutions have more than they can do with a lower class and are not suited to the requirements of these. In an institution such as suggested, provision could be made for the effective development of the abilities of each one. Each could be given duties that could be made to appeal to his interests and which are within his capabilities. Removed from the competition to which he is not equal, his planning done for him, the cares and troubles to which he is subjected in the world eliminated, his life could be guided so as to give him the maximum of happiness. Furthermore, he would be beyond the power of those who seek such as he to further their own ends. And, again, he would no longer be able to bring into the world others of his kind, to endure a difficult life and to furnish more cases with which society would have to deal.

But since we do not have such an institution at the present time, it is our duty now to do all that we can to assist them with our present machinery. Many of these delinquents have special abilities which can be developed, if we will find them. Already there have been many instances in which the finding of an adaptability has furnished an outlet for the hitherto recalcitrant individuality. We must develop them mentally as far as possible, teach them to read and write, if they prove able to learn, for here some mental interests may be aroused. Closely related to the mental defect in many of the cases, is a physical defect due often to malnutrition and improper care during infancy or early childhood. So far as is possible, these physical handicaps must be removed. The training in

any trade can only be a matter of learning a certain number of movements, yet this may be sufficient to enable them to earn a living on the outside when we are forced to release them. Agricultural pursuits are especially advantageous, as here the demands of the community are not so complex. At such a time as we release them, it is our duty to see that they are placed in environments to which they are best adapted and where the effects of our care and guidance may be such as to insure for them peaceful lives which for society is the greatest protection.

The investigation of delinquents is now being carried on through departments of research in a number of penal institutions throughout the country. In the Indiana Reformatory we are gathering much valuable material of all phases of this subject, but there is one thing which interferes with our efficiency. Every psychologist and psychiatrist recognizes that feeble-mindedness, as well as insanity, is evidenced in other ways than by intelligence alone, and while a psychological analysis will bring forth the defect in the majority of cases, there are a great many of the borderline type that can be rightly understood only by careful investigation of the heredity, family history, developmental history and environmental conditions of the subject. This work presupposes trained field agents upon whom a great amount of work would necessarily fall. In most cases our laboratory now has no information as to those particulars other than that which we have been able to obtain from the inmate, and this is unreliable often because of false representation, but more often from a lack of knowledge of the things desired. Our men know pitifully little about themselves or their families, especially in those cases in which we are the most anxious to obtain accurate information. Many a man has considered it strange that we should expect him to know the year of his mother's death, the number of years he spent in school, the number of times he failed there or whether he was six or twelve at the time of an illness. This developmental period, which is very important to us, exists for him only as a hazy portion of his existence. It is only as legislatures will provide for such needs of our state clinical laboratories that we will be able to contribute to the fullest extent to the thorough understanding of the relation of feeble-mindedness to delinquency.

THE FEEBLE-MINDED AND DELINQUENT GIRL.

E. E. JONES.

It is a signal victory for the cause of education and social service in Indiana that the Indiana Academy of Science has seen fit to place on its program a symposium on "Some of the Scientific and Practical Aspects of the Problem of Feeble-Mindedness." My part in this symposium is to discuss the "Feeble-Minded and Delinquent Girl." She presents a separate and distinct problem in the social and educational development of a State, simply because she is a girl. To her sex belongs the important function of bearing the offspring of the race, and through maternal functionings, mental and physical qualities of the race are propagated. Thus, the feeble minded girl occupies a most strategic position in the problem of race improvement and development, a matter in which scientists have been profoundly interested since 1869, the date when Fances Galton published his wonderful work—Hereditary Genius.

It is fitting that the science of this age devote itself assiduously to the problems of racial improvement, for by no other means than that of science can such a program of civilization be accomplished.

My first problem this evening is to define the feeble-minded girl. What is she? What qualifications, limitations, and possibilities does she possess? What is her type of mind? What is her physical endowment? How much does she know? How far can she be educated? In what sense can she ever become self-sustaining? We must have a comprehension of these facts before we can fully define the feeble-minded girl. At the present time we have numerous scales such as the Binet-Simon Scale for measuring quantitatively and qualitatively general intelligence; and in defining the feeble-minded girl, we must bring into play the use of all such instruments of measurements as will determine her mental and physical endowments. Such scales have been employed in the feeble-minded institutions and with feeble-minded children in the public schools with marked success, and we are looking to a time in the near future when these and other scales will be perfected and refined until it will be possible for us, early in the

life of the individual, to determine the mental and physical defects that produce delinquency and feeble-mindedness.

Feeble-mindedness is a term used to describe individuals who have not attained a normal mental status when compared with individuals of the community. If their mental status is of such a character that they are not able to make the necessary adjustments in a complex social life they are deemed feeble-minded. This does not mean that there are no adjustments that they can make, but that they are able to react only to the simpler situations in life. Some feeble-minded children display remarkable alertness and acute sensitivity, and superficially one would not expect that there is any mental defect; but upon closer examination and study such an individual is found to be deficient in all matters that require complex associations and comparisons. By applying any one of the numerous scales for determining intelligence to such an individual, parts of the scales are answered with very great ease—namely, those parts that pertain to fineness of discrimination in sense impression, either visual or auditory. But when any part of the scale that requires reasoning, associations, comparisons, or complex mental processes is applied to her, she fails miserably. If a child is six years of age and only measures three years in intelligence there is some reason to expect feeble-mindedness. If a child is seven years of age and only measures three years, it becomes quite evident that development is so far retarded that the individual may be very well classified as feeble-minded. Between the ages of seven and sixteen, if the mental age is found to be four years or more below the biological age, there is reason to expect that you are dealing with a feeble-minded person. This is an arbitrary standard that is fairly well adopted by psycho-clinicians in the United States. It is possible, however, to find individuals sixteen years of age who only measure twelve years of age psychologically whose mental retardation is due to disease or other causes than native weakness. Such individuals would form exceptions and should not be regarded as feeble-minded, for there would be a possibility of their very rapid development at a later period; but on the whole we are pretty safe in defining a feeble-minded individual as one whose mental development is as much as four or more years below the normal of a child of his age.

Since having defined the feeble-minded girl, I shall endeavor to treat my topic from three different standpoints. First, how to discover her; second, what are her symptoms? and, third, what shall we do with her?

As to the first question of how we may discover the feeble-minded girl in the elementary schools, and indeed in the homes, I have this to offer. It is my belief that the public schools will have to provide themselves with psycho-educational clinics for the determination early in the life of the child of any sort of mental deficiency. There should be available to every school in the State such a clinic, for no school of a hundred or more children is so fortunate as to be without those whose mental deficiency may be low enough to be designated as feeble-minded. Recent statistics from the New York City schools, Chicago, New Orleans, Omaha and elsewhere, show that about two per cent. of all the children in the public schools are feeble-minded. It is possible that this is too high a percentage, but even if only one child in a hundred is feeble-minded it is extremely important that that fact be determined very early in its life. The psycho-educational clinic will perform the important function in a community of determining, not only all stages of mental deficiency, but also all the stages of mental acceleration; and it is extremely important that those individuals whose rank in intelligence is considerably above the average should also be known and the educational needs adapted to them in a suitable manner. Without such scientific aid in the diagnosis of the child early in her life much energy is wasted in trying to train and educate the child who may be uneducable. Psycho-educational clinics would also serve as a means for determining all grades of mental development in all children and would thus serve as a corrective agency in the proper development of all children. Teachers are generally unskilled in the matter of mental diagnosis of their pupils. They teach upon the assumption that all children have mental capacity about equal. Upon this assumption many a feeble-minded child has suffered punishment and humiliation for laziness, indifference, lack of zeal, inattention, etc., when as a matter of fact the child did not possess more than a third or a half of the mental capacity to do the task assigned. It is my belief that the State should support enough psycho-educational clinics in different parts of the commonwealth as to be available for the use of all teachers and parents. By this agency the feeble-minded girl would be detected early in her life and would be under close observation for a number of years and could finally be disposed of to the best advantage of the public schools, the parents, and the social interests of the State.

My second point is, "What are the symptoms of feeble-mindedness?"

It is safe to say that there are no two cases precisely alike, and it is rare that we find mental conditions that are strikingly the same in different individuals; however, it is possible to name some of the more general characteristics. One of the most prominent characteristics of the feeble-minded girl is mental stupor. She apparently dreams, sits in the presence of certain powerful stimuli unmoved. She is lethargic, inactive and apparently mentally depressed. My own experiments show that the sense organs of feeble-minded girls are about normal, their eyes may be deficient and they may have defective hearing, but this does not seem to be any more a characteristic of the feeble-minded girl than the average high school girl. My data show that the percentage of such defects are about the same for the two classes of girls. It should be said, too, that many feeble-minded girls are supersensitive; their vision is very sharp, their hearing is extremely acute and other senses seem to be abnormally developed. It is only in the organization of this sense material in the higher brain centers that their mental weakness is discovered. The feeble-minded girl normally does not like to play; complex games are difficult for her to comprehend and she can only be taught them with very great patience and much repetition. By the use of the Bergstrom kronoscope, I have secured the reactions of several hundred feeble-minded children. These reactions are both slow and irregular. There is no reliability in the response to a stimulus. Reactions may not be slow in some instances, but they are invariably inconsistent and show great mean variations. I also have the records of several hundred girls as to their vital index which is found by dividing the weight by the vital capacity. The median of the vital index of these feeble-minded girls is several points lower than the median for high school girls. Feeble-minded girls are usually below normal in height and weight. The feeble-minded girl is irresponsible morally, she is not mentally capable of knowing the nature of crime or its ultimate results. She sees in her own acts, which may be immoral, no social significance whatever. She is in no sense responsible for her acts of immorality. Feeble-minded girls are subject to fits of anger and lack of control. This seems to be merely a phase of retardation in her development and is the line of least resistance through which she reacts upon an unfavorable environment. Her acts are nearly all upon the low level of response to sense stimuli. The feeble-minded girl is only educable to a very small degree; she may learn to read, but she can not comprehend

very well what is read; she simply pronounces the words and they are for her the names of peculiar visual stimuli closely akin to the names of persons whom she knows; but these words as groups of words have really no meaning for her.

It frequently happens in feeble-minded girls that there is some special line of action or work in which they can excel; this frequently offers possibilities for education which may be fruitful. These possibilities are easily discovered by the psycho-clinician who may have the girl under observation for a considerable length of time. Frequently feeble-minded girls can do simple sewing, cooking, cleaning, occasionally manifest talent in art or industrial work to a certain extent. Feeble-minded girls are usually strongly sexed. For this reason they are easily brought under the influence of lewd men and are led into immorality. It should be said, however, that in the cases of this kind that have come under my own observation the girl has not comprehended at all the nature of her crime. For her the immorality has been a mere species of play, and she is not at all responsible for her act. Juvenile courts, however, rarely take this into consideration in disposing of the feeble-minded girl. Such girls are usually spoken of in the juvenile courts as sexual perverts. This characterization, however, is a sample of the looseness with which many courts exhibit scientific knowledge in their ministration of justice. It is my belief that many of the girls of this character who are sent to corrective institutions as sexual criminals possess only the normal sex development of the race, and are in no sense abnormal. They have been led into their immorality by men of low character who are ever ready to take advantage of mental weakness, and such girls are so constituted that they cannot possibly comprehend the ulterior results of the sexual act. It is considered no more seriously by them than the gratification of another sensual pleasure. It must be borne in mind, too, that mere response to sense stimuli is one of the predominant characteristics of the feeble-minded girl, which fact places her far down in the scale of human intelligence, more nearly in the category of the lower animals than that of human beings, who respond to complex situations with judgment and high discriminative powers. The latter she cannot do, because she has not the cerebral connections for such reactions.

My third question is: "What shall we do with her?" This can be answered only in the light of her diagnosis. We must know her mental

and physical possibilities, her powers to respond intelligently to complex situations, such as we find in our own civilization, and whether or no she is able to be self-conservative in a social mechanism such as our State affords. We have already answered this question negatively. We know positively that the feeble-minded girl cannot survive intelligently in the State of Indiana. She will fall if left to herself. She will end in prostitution and crime unless she is protected. The State cannot afford to turn her loose upon society, for obvious reasons. Then what shall we do for her? My statement of the case will be straightforward and above board. First of all she should not be allowed to attend the public school. As soon as she is discovered by the psycho-clinician, when all the expert evidence is in with reference to her and it is positively determined that she comes well within the class of feeble-minded, she should be taken from the public school and placed in a school which is equipped for the careful treatment of such cases. This school should be centrally located for a large territory in the community, and every means should be employed to protect such children to and from school. Parents should be warned of the dangers to which the feeble-minded girl is subjected on the streets, on the playground, in alleys, outhouses and barns and on vacations; and in cases where there is any possibility that parents will not adequately protect the feeble-minded girl from immorality, she should be taken from them and placed in an institution for such mental delinquents for life. She should never marry, for under no circumstances should she be allowed to propagate her kind. In my judgment, as a perfect safeguard to society, she should be sterilized at the pubescent period.

Her education should proceed in such an institution according to lines of her interests. She should be made happy in the work that her likes demand, and should remain protected throughout her lifetime. The State of Indiana probably has at the present time several hundred feeble-minded girls at large, attending no school, under poor parental supervision, running the streets, responding to sense stimuli, gradually going into prostitution, giving birth to illegitimate children, and placing upon society some of her heaviest burdens. It is the duty of the State to bring them under control and save them from the life of social degeneracy which inevitably awaits them if they are allowed to mingle freely with licentious men and are afforded no protection from their sexual suggestions. Her only salva-

tion is in protection from the State, and that protection should continue throughout her whole lifetime.

The question is frequently asked if feeble-minded girls should ever be allowed to marry. In my judgment no feeble-minded girl should ever marry, even though she has been sterilized at pubescence. For the danger lies in the fact that she has not the intelligence adequately to comprehend the meaning of the nuptial tie. The obligations of this relationship would mean nothing to her, and she could not be held responsible for violations of those obligations. If she were free from state control, and should be permitted to marry, even though she had been sterilized at puberty, there would still be the tendency to fall into prostitution and crime which would be unavoidable. It would afford the means of spreading venereal disease and stimulating prostitution, which I feel no State can afford to permit.

One of the greatest social problems of the day for Indiana and all other States is the proper control and education of the feeble-minded delinquent girl. If she is not brought under control, she will propagate her kind, and it is probable that the percentage of feeble-mindedness will increase. With its increase comes added expenditure for state institutions, juvenile courts, medical aid, and waste in education, etc., which increases with leaps and bounds. But if the State takes under its protection and care all feeble-minded girls and boys, there will soon be a great decline in many of the social wastes which at present are sapping the resources of the State. It is difficult to estimate the whole cost to the State of the offspring from one degenerate woman. Fortunately we have a few statistics on this point. The Germans have studied with care the long line of descendants from a few degenerate women, and have calculated their cost to the state. For example, a Margaret Siler, who is characterized as a weak-minded prostitute, was the mother of six children. After 180 years the history of her progeny is as follows: She had 1,286 descendants; of these there were 200 criminals, 280 adult paupers, 300 died of congenital diseases, there were 50 tramps, and she cost Germany \$150,000,000 in legal proceedings alone. Another instance is that of Ada Joirk, a feeble-minded prostitute and drunkard. Seven hundred nine of her descendants have been accounted for. There were 141 beggars, 64 in the poorhouse, 287 vagabonds, and 76 sexual criminals. She cost Switzerland \$1,250,000 in 120 years, and through the lines of con-

genital heredity the terrible work of this one deficient and diseased woman is still going on. It gives us a new phase of the problem of eternal life, and makes it an educational and social problem, rather than a theological one.

Compare such statistics with that of the descendants of Jonathan Edwards, the great New England theologian. One thousand three hundred ninety-four of his descendants were identified in 1900, of whom 295 were college graduates; 13 presidents of our greatest colleges; 65 professors in colleges, besides many principals of other important educational institutions; 60 physicians, many of whom were eminent; 100 or more clergymen, missionaries, or theological professors; 75 were officers in the army and navy; 60 prominent authors and writers; 100 or more were lawyers of whom one was our most eminent professor of law; 30 were judges; 80 held public office, of whom one was a vice-President of the United States; 3 were United States senators; several were governors, members of congress, framers of state constitutions, mayors of cities, and ministers to foreign courts; one was president of the Pacific Mail Steamship Company; railroads, banks, insurance companies, and large industrial enterprises have been indebted to their management. Almost if not every department of social and intellectual progress has felt the impulse of this healthy and long-lived family. It is not known that any of them ever committed a crime, or died in a poorhouse.

Let us protect for life every feeble-minded girl in the commonwealth, and thus cut off one of the most potent influences for social corruption which now embarrasses the State.

FEEBLE-MINDEDNESS IN THE PUBLIC SCHOOLS.

— —
KATRINA MYERS.
— —

“Education,” says Seguin, “is the right of every child, the duty of every parent, the bond of the community.”

In ideal conditions natural talent is allowed to form the basis for training for social usefulness; to each child is given the bent of his natural genius or trade.

For many years our public schools were organized to fill the needs of the mediocre or average pupils. Educational plans that include children at opposite ends of the intelligence scale belong to very recent history. Elastic grading now permits brilliant pupils to skip grades; while an increasing number of slow-witted and even defective minds have special schools adjusted to their needs.

Imagine one hundred ordinary first or second grade pupils. Here investigators find: one stutterer; two or three who lisp; one seriously anaemic; several badly spoiled children; one immature, a year or two retarded in mental and moral growth; one morally weak; two imbecile or feeble-minded. Then, there is one passive, inactive child; several over-sensitive, nervous children; one superficially precocious child, and several superior—eager, ardent, imaginative, social. Four suffer from defective hearing; twenty-six now, or will very soon, show eye strain or have defective vision; about a dozen have asymmetries or deformities; about thirty have nasal obstruction or diseased throats; and several others possess serious peculiarities of temperament. Only twenty-five of the hundred are physically and mentally without blemish.

All these children represent an actual, positive asset in human society. If they are not saved for constructive activity, many of them will become a destructive force later on.

The question arises: How are the powers of individual pupils to be definitely known, so that schools may measure to their greatest efficiency?

Some of these peculiarities are related to the size and shape, observable defects; some are alterations of internal structure, not apparent to

the untrained observer. Many pupils, who have observable peculiarities, are very capable mentally and give normal response to training; while many, who baffle the most conscientious teaching, present no outward signs of disordered organizations at all.

To remedy all cases of mental and physical deviation, there must be definite localization of the defects, which only thorough medical, psychological and pedagogical examination will reveal.

The earlier suspected abnormalities are discovered, and proper corrective treatment and training are given, the greater chance these children have to become more nearly like normal beings. Brain energies are broken by physical irritations and other strains. This is why certain conditions produce retardation and an arrest or paralysis of the inhibitory or moral sense, and explains why removal of disturbances is often closely related to moral and mental regeneration.

For years psychologists have been endeavoring to formulate some intelligence measuring scale that could be applied to the age and grade of the average pupil. The great benefit that would accrue to both pupils and teachers from an accurate intelligence standardization can hardly be estimated. Then, only, can training be given each child that will insure full individual development.

The Binet-Simon Measuring Scale of Intelligence is a series of questions "arranged in groups according to their difficulty as determined by age difference in performance". The questions relate to general intelligence, to information that the average normal child should absorb from every day associations and not to what he is taught at school. The insufficiency or retardation of backward children is later estimated by comparison of their results with those of normal children. The series is merely a sorting test; but, in the hands of experts, it has been amply demonstrated that it is very valuable, and gives a surprisingly close estimate of a child's mentality.

A child who has for no adequately known reason fallen behind two years in his school work, should be carefully tested and watched. He may be ill; his mind may be "slowing down". When children are found three or four years behind children of their age, the intelligence tests will undoubtedly disclose more serious conditions. It is well recognized that minds of most educated persons reach the limit of intellectual development between the ages of twenty and forty. Minds of the great mass of

mankind reach the limit of development between fourteen and twenty-one. A mind that never gets beyond thirteen is just able to make a living. Above eight and below thirteen comes the moron, a person between normal and imbecile. He can be taught routine tasks, lay bricks, make parts of shoes, do tailoring, farm work, etc., as well as any one, provided some one else does the directing and planning; he never gets beyond twelve years old. True imbeciles never develop beyond seven. The mind of an idiot closes before three.

When the brain stops developing—and it may occur as early as the third year—the time is practically past when it is possible to give a training that will help the child to earn a living.

Any one who deals with a large number of persons realizes how intelligence varies from those with practically none to the very gifted, and that responsibility varies according to the intelligence. Some of these persons, under simple environment, seem to function normally; but when placed where the environment becomes too complex normal functioning becomes impossible.

Among a number of misfit pupils observed in grade classes and recently tested, were two, thirteen years old, who had made no real progress for five years; two, eleven years old who had lost four years; a girl of thirteen who had made no real progress for six years; but all had been promoted, though the work accomplished had been, at best, mere rote work, with no more real intelligence than that of a parrot taught to say a rhyme. Two girls of seven years were mentally less than three.

To attend a class where normal children are receiving instruction does not help the undeveloped child. "Learning can not penetrate like a cold storage chill." "Mind building is like house building; there must be a foundation on which it rests."

Undoubtedly all intelligent persons agree that, no matter what a child's lack of mentality, the hopelessly idiotic and imbecile types should be trained in the schools the States maintain for their segregation and care. These most deficient children comprise only a very small per cent. of the school membership ($\frac{1}{2}$ of 1%). Often the most troublesome public school cases are pupils of the borderland types: those just between normal and subnormal.

Since the compulsory education law exempts children, mentally and physically disabled from its operation, these pupils, and those of lower

mentality, having become annoying, in the past had been habitually excluded from school. These excluded, subnormal children, untrained and undisciplined, have often become the men and women scourges of society. Many teachers, principals and physicians consider such pupils as merely slow, and earlier in their school life, fondly expect them to brighten up; but, the incapacity once recognized, the problem is an altogether different one; for, when we measure the intelligence, we have measured the degree of the irresponsibility. Their right to a training is the same as is that of their better endowed brother, and their need is greater. To attempt to lead a feeble-minded child along the school way of the normal child can result only in failure.

How would you feel if you were fourteen years old, with a mental capacity of a child of seven, obliged to sit in a 5A grade class, absolutely incapable of understanding the work? Can you blame a child for rebelling against such an overburdening "education"?

Misfit children are naturally affectionate, kind, and tractable. Maliciousness and carelessness are not their inherent traits but are acquired from lack of capacity to understand required conditions. Continued misunderstanding and rejections make them hopeless and rebellious.

A desire for greater school efficiency is demanding that classification must be made on a basis of native ability. For hundreds of our public school pupils, the hope of escape from a life of utter inefficiency lies in the ungraded schools of our public schools. For here only can they *now* be given training and treatment adapted to their subnormal, individual capacities. Destroyed brain tissue can never be renewed. We know our limitations. It is not possible to make good out of a poor thing; but wonderful things can be done.

The widespread need of such schools can be estimated when you consider that reliable investigators compute the number of feeble-minded pupils to be from two to four per cent. of all children of public school age. All cities, in our country, of 100,000 population and over, and many small towns, now maintain separate schools for feeble-minded and defective children, in care of more or less specially trained teachers. Indianapolis now has two such schools, in which thirty-one pupils are enrolled. According to the lowest expert estimate, this is $4\frac{1}{2}$ per cent. of the feeble-minded and defective children now in the grade classes that need to be given special opportunities.

Perhaps it is well nigh impossible for most persons to become as little children who live under the crushing conviction that they have no brains. Failures and rejections burn deep gloom into sensitive child minds. Their errors should be corrected by putting in their place more practical, simple truths.

Since books spell discouragement to the dull, inapt mind, it is generally wise to excite an interest in things unrelated to failure; for expected failure creates a hopeless habit of thought. For these pupils there should be an abundance of stimulating devices to excite an interest. These minds have lain dormant for years, or have *never* been awakened to natural child curiosity. This varied stimulation should be thought provoking, not nervously exciting.

Frequent change in manner of presenting old forms, and gradual introduction of new material arouses confidence. Successes create assurance; and, even if the progress be slow, it surely follows. Success is a relative term; but it carries the highest valuation in mental and character development.

Manual work offers great variety and simplicity in subjects and employs and trains more faculties than any other school work—observation, attention, concentration, comparison, coördination, decision, judgment, all are involved in its simplest problems. So, it is admirably adapted to the needs of the undeveloped child.

Almost every child's best is good in something; and it is only by our honest trying that we shall be able to draw a finer and better efficiency from the unused and often ill-directed capacities of children who possess limited possibilities.

Having discovered an underlying trait, something for which the child has liking and ability, the worst struggle is over. Then, thru the newly discovered aptitude, it is comparatively easy to bring the pupil into natural association with other school duties. Tasks and lessons coördinate. He reads to learn, and even numbers have a new meaning. He enters with zest into games, songs and all school exercises. In the natural life of the schoolroom the child is socialized.

The training requires the hand of iron in the glove of velvet—thoroughness, patience, resourcefulness, open-mindedness, sympathy, hope. The wisdom of Solomon, perhaps, could not always solve the problems these children present. That is why failure now so frequently attends our ef-

forts. But we know that everything that makes these children—who never can become men and women in intelligence—more capable with their hands, more reasonable, better self-controlled, more helpful to themselves and to others, will assure them a more certain degree of success as individuals and in their relation to society.

I summarize under six headings:

1. The State should demand and provide careful medical and psychological examination of all children in the grade schools, who are two or more years retarded in school work.

2. The State should provide for correction of all physical defects in children diagnosed as having *remediable* defects.

3. School systems should be obliged to organize and maintain separate schools for all feeble-minded and mentally defective children now in grade classes.

4. Schools for feeble-minded and mentally defective children should be in charge of specially trained teachers and supervisors.

5. The Compulsory Education Law should be amended so as to include in its operation children *not* in good mental condition.

6. The State Institution for Feeble-minded should organize and maintain a department where teachers for feeble-minded and mentally defective pupils can receive practical and theoretical training.

NOTE. Acknowledgment is made, for some valuable statistics used, to Dr. H. H. Goddard, Dr. W. J. E. Wallin and Dr. M. Groszmann.

THE ALCOHOL PROBLEM IN THE LIGHT OF CONIOSIS.¹

ROBERT HESSLER.

The alcohol problem is a very important one, so important that it has entered politics. Men vote wet or dry, and women are seeking suffrage. If women vote and vote "dry", will we have prohibition? Will the passing of a prohibition law free the State from the alcohol problem?

There are all sorts of factors that enter into the question, and there are all sorts of problems connected with the alcohol problem. Here I desire to call attention to one that is usually neglected, the dust problem or the bad air factor. (How to develop the subject in a 20-minute paper is in itself a problem. Technical details must be omitted.)

The study at first was one of individuals and then one of the family, and finally of the entire relationship. I shall show a number of charts. Some represent several hundred individuals and are so full of details that it would require considerable time to go over them. Most of these charts will be referred to very briefly in order to give as much time as possible to the deductions or conclusions.

A word regarding the charts that were shown: On account of the difficulty of reproducing them properly in colors they are omitted here; only one is given to illustrate the general idea, how the data were diagrammed. Perhaps the few references to charts will be understood in the light of the diagrams. In the original charts, or genealogies, males were indicated by blue lines; females by red lines. Black lines represented members whose sex was unknown. Short lines indicated individuals who died young. The children, sibs, are given in the order of age, beginning at the left.

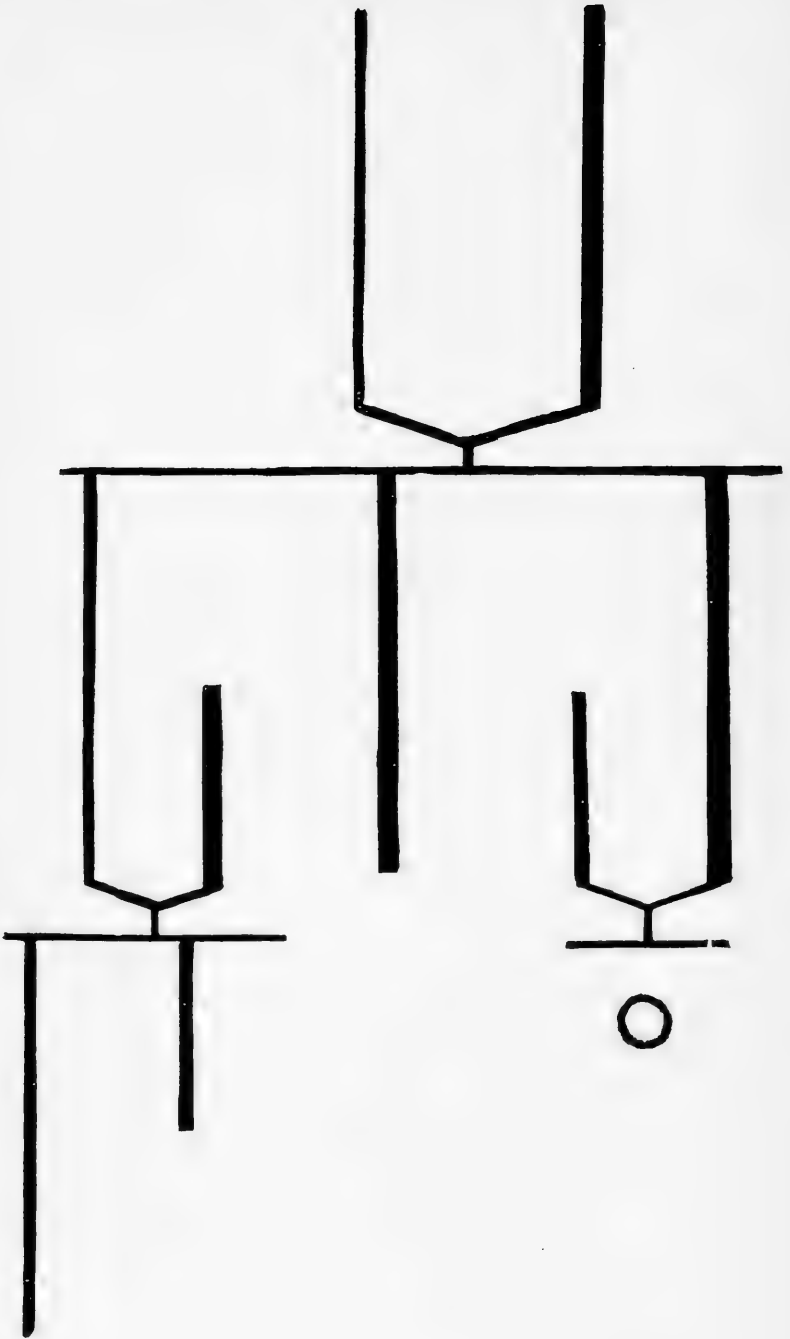
Intermarriages are shown by short lines, drawn upwards.

No offspring (that is, race suicide,) is indicated by a circle.

The accompanying diagram represents three generations.²

¹Coniosis. For an explanation of the term and of the theory of Coniosis see Proc. Ind. Acad. Science, 1911.

²The original blue lines (males) are here represented by light lines, and the red (females) by heavy black lines.



1. A father and a mother.
2. The three children: a son married (with one son living and one son dead); a daughter, unmarried; a daughter married but childless.
3. The young generation.

A number of charts were shown, some of five or six generations and representing several hundred individuals. As a rule those living under simple life conditions, as in the Northwest, still have old time fertility, while those living in towns and cities show a gradual decline and even total extinction.

Among charts shown may be mentioned that of a family where for several generations, after coming to America, the sibs of each generation numbered about twelve. The parents being two, a family of twelve children of course means a six-fold increase. The moment the more recent descendants began to live under town and city conditions, the death rate increased, many did not reach maturity at all, and some of the living have no offspring, race suicide appeared with a vengeance; also narcomania, i. e., the desire for strong drink and narcotics.

Why do men drink? There are all sorts of reasons. The three chief classes of drinkers are:

Social drinkers, keeping up old-time customs.

Habit drinkers, some think they require an appetizer; others, something to settle their dinner, to aid digestion, etc.

Relief drinking, as where a man feels bad but feels better, or thinks he does, after a drink or after several in succession. It is with this class that this paper is mostly concerned. Such men as a rule "pour it down," they are not particular about flavor or taste, they drink for the effect; they do not take strong drink as a "stimulant," just the opposite, as a sedative. Writers usually speak of this sort of drinking as "Misery drinking." Relief drinking is a better name in most instances.

We must constantly ask of the man who drinks or who drinks to excess, Where, when, why?

The man living in isolation, the moonshiner, or the farmer, who can drink alcohol with impunity, may find it a powerful poison when he removes to the city. Alcohol and infective matter in the air (and of course also in water and food) make a bad combination. The body may be unable to overcome their combined influences.

Reliable data concerning people who use narcotics are difficult to ob-

tain. If one asks directly many become offended. Some hesitate to speak of the "black sheep" in the family; and the black sheep themselves may magnify the failings of others. Often black sheep are not as black as painted. Without knowing the facts in the case, we should not be too severe on the man who drinks or the man who requires the use of tobacco for his well-being, as he believes.

A large chart was shown of six generations since the original English immigrants, the relationship now consisting of several hundred, but only a few branches are more or less known.

Here we are at once in the midst of things. There are all sorts of deteriorating factors, including narcomania. The alcohol problem crops out all over one-half of the chart.

Some remember the days of "free whiskey" when everybody drank and when it was no disgrace to be drunk. Today there is a different sentiment and one may well ask, Why does an apparently sensible man drink and drink to excess? Why does he drink to excess occasionally or not quite to excess at all times? To say a man drinks because he wants to is not a satisfactory reply.

Many patent medicines are full of alcohol and their effect on the body is that of alcohol. Some men who are ashamed to go into a saloon, or to call for plain whiskey, use nostrums that are compelled to pay the whiskey tax. Such preparations are used because they give ease; the man or woman using them "feels better". As in the case of plain alcohol, the dose must gradually be increased, or more frequently repeated, to get the desired effect, that of a sedative.

Many of the subjective complaints of the men and women who use alcohol are similar to those of neurasthenics and hysterics, so called. Many complain of "fear, moods, depression, sleeplessness, restlessness, tremors, general weakness, tearing pains, anorexia, palpitation, etc." According to my observations many individuals who are regarded as neurotics or neuropathics are dust victims, and because narcotics give relief, they use them. A study of the chart will show this.

Red squares in the chart indicate a victim of narcomania. At times the habit of using alcohol or morphia or even aspirin was acquired through a doctor's prescription. Physicians nowadays are careful for whom they prescribe narcotics; they fear habit-forming drugs. Many physicians themselves are said to be victims; long and irregular hours, loss of sleep,

etc., including attendance on patients living in unsanitary homes, even their own ill-ventilated offices, may lead a doctor to seek relief.

A green square indicates country life, or good air life, in contrast to the yellow, or polluted city air life. The half and half squares at the bottom mean that some members are living in the country, others in villages, town and cities.

Black lines indicate no definite data regarding individuals.

There are eleven children in the first generation in this country. Today the descendants of one seem to outnumber those of all the others: this was a man who married a strong-minded German catholic. The chart showed that these lead mainly a simple country life, with large families and a practical absence of narcomania.

TIME SPENT IN GOOD AND IN BAD AIR.

Primitive man	0/24	0/7	0/365	} 8 hours of labor. } 8 hours of recreation. } 8 hours of sleep. } Under what air conditions?
Hunter and trapper	0/24	0/7	x/365	
Squatter	0/24	0/7	x/365	
Farmer	0/24	x/7	x/365	
Villager	x/24	x/7		
Townsmen				
Cityman				
Slum dweller	24/24	7/7	365/365	

This chart (table) is an attempt to express in a general way time spent in good and in bad air. At one extreme is the savage, living say in the mild tempered South Sea Islands, with good air at all times; at the other extreme is the slum dweller with 24 hours of bad air, 7 days a week, 365 days a year.

Air conditions under which people live can not be considered collectively; each individual must be studied separately. Ordinarily we assume that a farmer is leading the good air life, but when the farmer comes to town every Saturday, or perhaps daily in spring and fall, and loaf's for hours on street corners, with clouds of infected dust blowing about, he may carry home enough infection to last him for days.

The ideal of the union labor man is the eight-hour day. But we must question where? Under what air conditions—good, bad, indifferent—

are the eight-hour periods spent? Is the recreation time spent at home in the suburbs making garden or in outdoor air; or is the time spent in the heart of a dirty city, in a saloon, pool rooms, or loafing on the dusty street corners? The five-cent theater habit is only too often accompanied by the bad habit of "going out to see a man" and chewing a clove after it. In short, the time spent in recreation under bad air may be the real factor for inefficiency and premature breakdown and not the work in a clean and well-ventilated shop.

Eight hours of sleep: In what sort of bedroom? With good air, free ventilation? Or closely housed and with perhaps no daylight coming into the room at any time?

The slum dweller of course represents the worst conditions in all respects. Naturally the weeding out process is actively at work. To see the end results at their best one must turn to the overcrowded cities of China and India—with bodily adaptation at the expense of mentality. Our unsanitary cities in time produce a class of people little different from John Chmaman, with all that that implies, including the use of narcotics and sedatives, if not opium then tobacco and alcohol, or cheaper coal tar preparations.

THE WHERE, WHEN, WHY OF DRINKING.

A question, or rather several questions, a student must constantly ask is, Why do men drink? Why does an apparently sensible, decent sort of man have a craving for strong drink? Why do some demand it more or less constantly, some periodically? Under what conditions is the craving most marked? In short, Where, When, and Why do men drink?

Here are a few representative cases. The figures are of course only relative; one can not express the complex life of a man mathematically, there are too many exceptions.

GOOD AND BAD AIR AND THE DESIRE FOR DRINK.

Mr. W., farmer	0/24	0/7	4/365	(4 times a year to town = sick)
Mr. H., farmer	0/24	1/7	75/365	(visits to church and town)
Mr. X., professional	8/24	6/7	290/365	(15 days in wildwoods)
Mr. X., businessman	8/24	6/7	300/365	($300 \times 8 = 2400$ out of 8760 hours)
Mrs. X., the wife	x/24	1/7	75/365	($75 \times 2 = 150$ out of 8760 hours)
Mr. B., mechanic	24/24	7/7	365/365	("Always thirsty")

Explanations of the chart (table) must be brief.

Mr. W. leads a quiet isolated life on the farm; has retired from active work; is well-to-do. He lives in good air twenty-four hours a day. In the summer when doors and windows are open he attends a country church; in winter when doors and windows are closed he remains at home; says he can not bear close air. In recent years he comes to town about four times a year; formerly he got sick on or after every trip, "would get faint and dizzy and feel like falling," and friends only too often offered him a drink of whiskey, to which he was opposed. When it was pointed out to him that he was a marked dust victim he in time learned how to guard himself; he no longer comes to town when dust clouds blow about and spends little time in dusty buildings.

Mr. H., an active farmer, lives in good air twenty-four hours a day, that is as far as infection, found in city dust, is concerned. Sundays he attends a village church. Occasionally he comes to town, perhaps fifteen times a year; his absences from home he thinks amount to about seventy-five a year, varying from an hour or less to several hours. Formerly when he came to town he had an almost irresistible craving for strong drink, i. e., on dusty days, as I soon found. He felt bad, was miserable; he learned that one or more drinks made him feel good, and only too often the one or two drinks increased to a sufficient number to make him drunk; and then there was great remorse and he vowed never to drink again. But until he learned *why* he had such a craving, how it depended on inhaling infected dust, he only too often could not resist the use of alcohol. In the country when he was tired and would "spit cotton," water would quench his thirst, but the phlegm due to spit dust required something stronger "to cut it."

Mr. X, a professional man, works in the heart of a city eight hours a day for six days in the week. He wants to smoke all the time and frequently wants a drink; at times he is on the verge of being drunk. The desire for strong drink is almost irresistible "when there is strong mental strain", as he supposed, but as a matter of fact it was at times of close confinement to ill-ventilated offices and public buildings. Now the most interesting phase in this man's history, the where, when and why, is this: For two weeks or so every year he goes off to the northern wildwoods; then he has no desire for strong drink, scarcely touches it, and there is little desire for smoking, that is, there is no excessive smoking.

Mr. X, a business man, working, as he believed, "under high pressure."

Certainly he was always "steaming up," constantly smoking and many times a day taking a drink. He did not give me an opportunity to study him fully but I found he had a blood pressure of over 200 mm., nearly twice the pressure an open air or pure air man carries. To such men alcohol gives relief; their drinking must be looked upon as "relief drinking." When he came to understand the danger from a high blood pressure he wanted to know what to do. The proper thing is to reduce hours indoors, offset bad air influences as much as possible by good air influences. But he was the sort of man who took something rather than do something. Is there any drug that will keep down the pressure that can be taken in place of alcohol? Why yes, a host of them. The question here arises: To what extent shall a physician recommend the substitution of one drug for another? Is any drug at all harmless? To depress the bodily activity, to depress the blood pressure artificially is not good medical treatment.

In connection with this business man should be mentioned his wife. She had chronic ill health when she first came to me. She was "low pressure," "could not keep up steam" in fighting off infection. She now lives up to *good* air advice and has reduced her ills, her reactions, her symptoms, to a minimum. There are perhaps seventy-five annual "exposures," as by going to church, shopping, theater in summer, etc. If the average length is two hours, there would be about 150 hours of more or less polluted air inhalation in a year.

The husband stays at home Sundays in good air, but his eight hours of weekday exposure amount to at least 2,400 hours a year, out of a total of 8,760 hours.

Mr. B. is a mechanic, almost a "mere laborer," who works with his hands; little mentality is required. He lives in the heart of the city over a store where rent is cheap. He works in a dirty shop. He gets bad air, air contaminated by infection, twenty-four hours a day for seven days a week and for nearly the whole year, the only time he gets good air is when four times a year he and his family visit "the old folks on the farm." This man is "always thirsty;" he "always needs something to cut the phlegm." Many patent medicines full of alcohol serve the same purpose as alcohol in the form of whiskey, brandy, gin, etc. His only objection to beer is "It takes too much to get relief." Such a man will scarcely listen to a physician who tries conscientiously to help him. The

evolutionist will say nature still weeds out those who can not resist using alcohol excessively.

There are all sorts of reasons why men drink. I am here only calling attention to a neglected factor. Alter the environment or remove a man from the abnormal environment and, unless he has deteriorated too far, he will likely cease to drink or to drink to excess.

Many of you are teachers. Apply the formula to yourselves: Under what air conditions do you spend your time? How good or how bad is the air under which you work, and must work, and the air at home and on your vacations? The teacher has a limited number of hours a day at school, with two days of rest a week, with holidays now and then and an annual vacation of several months—time for lymphatics to empty themselves, ready for the next season's work.

At what time do you feel "fagged out?" At what time do you feel the need or the desire for a sedative (tobacco, alcohol, opiate, coal tar preparations, etc.)? When is there a call for a stimulant (coffee and tea especially)?

Today we hear much of efficiency. Under what conditions is a man most efficient? To what extent is the air factor considered in estimating efficiency? The above formula might perhaps be of service in working out some cases; and similarly in the matter of longevity. How many reach a possible hundred out of the many born in country, village and city? Is a relatively short "high pressure life" of forty-five or fifty more desirable than a longer life under less strenuous conditions? Is fifty years (or often much less) better than "a cycle of Cathay?" Is the attempt to become adapted to dirty cities worth while—when it is at the expense of mentality?

In a study of the alcohol problem and its evils one is constantly reminded of the fact that man is an outdoor animal and that he thrives poorly in houses and cities. Geologically speaking it was only day before yesterday that he attempted to live in houses; yesterday in cities; and today he is undergoing the weeding out process as never before. Man of course will not die out, there will not be complete race suicide.

Man afflicted by the ills of domestication and urbanization seeks relief. There are two methods:

Take something, usually some drug that gives temporary relief.

Do something, alter an unfavorable environment, or if that is not feasible, remove to a better one.

Only the physician knows how prone people are to take something and how they hesitate to do something.

The history of medicine itself is one long search for panaceas, for "cures." We are only beginning to realize that the search is futile. We more and more see that the proper method of securing survival of the best is to annihilate the pests and parasites that prey on us. Just as weeds and pests do not thrive under clean culture, in the same way disease germs do not thrive in a clean city among clean people; quack remedies are as useless in the city as they are useless on the farm.

There are always some who will survive most adverse conditions; this can be seen in the crowded unsanitary cities of China¹ and India, and in our own slums. But such a type is not what the believer in a better humanity has in mind. People who constantly battle with infection have so little mentality left that they are but little above unreasoning brutes. Fittest to live under an unsanitary environment, abnormal in the light of man's past history, does not mean best mentally.

Man in his search for cures in time has found means for relief. He has discovered a series of substances that give ease; they may be grouped under the name of narcotics.

Many plants have such properties, from the poppy with its opium and codeine and morphine, down to mild ones like hops. In time man has learned to prepare alcohol, varying in strength from mild, as in fermented milk and fermented honey and fruit juice, up to distilled alcohol in its pure form.

Alcohol is an old remedy. It constantly appears in new disguises, under the fanciful name of some nostrum or patent medicine. Recently a number of so-called synthetics have come into use, made from coal tar. Their number is constantly increasing. An individual in search of ease soon learns which suit best; unfortunately many are of the habit-forming kind.

NARCOTICS OF THE METHANE SERIES.²

Hydrocarbons: Pentane, Octane.

Hydrocarbons, unsaturated: Amylene, Pental.

Alcohols: Methyl, Ethyl, Propyl, Butyl, Amyl. Amylene hydrate.

¹Even the supposed adapted or immune Chinese have their ills and their means of transient relief. Now that the opium trade is imperilled they will likely resort to the white man's remedies, alcohol and tobacco and synthetics.

²This list was compiled from Cushney.

Ethers: Ethyl, Ethyl acetate, Ethyl nitrite. Amyl nitrite.

Aldehydes: Paraldehyde, Methylal, Acetal, Sulphonal, Trional, Tetronal.

Ketones: Hypnone.

Esthers: Urethane.

Acids: Butyric, Bromacetic, Chloracetic, Formates, Propionates, etc.

Halogen Substitutions: Chloroform, Ethylene chloride, Ethylidine chloride, Chloral, Buthyl or Croton Chloral, Chloretone (Trichlorpseudo-butylalcohol), Chloralamide, Chloralose, Bromoform, Ethyl bromide, etc.

Ethyl alcohol is the alcohol used for drink in the various alcoholic preparations. Chemically and pharmacologically alcohol is in suspicious company, among chloroform, chloral, ethers, and so forth. Some preparations are solids, as chloretone, whose chemical name ends in alcohol.

There is an almost endless variety of synthetics and new ones are constantly appearing "Made in Germany"—and we are the best customers.¹

One can scarcely speak of any as real "cures," but they are palliatives; they give ease from the ills of civilization. The more people are massed under unsanitary conditions the greater the demand for them, indeed the sanitary condition of any community can be estimated by the demand for such remedies.

In connection with this Methane series should be mentioned the Aromatic series; among the chief are: Terepene, Menthol, Guaiacol, Resorcin, Phenacetin, Lactophenin, Sedatin, Phenocoll, Salicylic acid, Salicylates, Salol, Aspirin, Salophen, Analgen, Antipyrine, Salipyrine, Hypnal, Cocaine, Eucaine, Novacaine, Holocaine, etc.

These have a reputation for relieving pains and aches variously referred to as rheumatic or neuralgic, including many forms of headache. Although some are obtained from plants, the great majority are synthetically prepared from coal tar; new ones are constantly appearing.

As already mentioned, individuals differ greatly. Those who do not

¹Twenty years or so ago, when engaged in work among the insane, I tried many of these preparations. At times sheriffs who brought in new patients preceded me in experimenting, as where alcohol was given to make obstreperous lunatics tractable; more than once patients were "dead drunk" and of course offered no resistance.

Chloral, paraldehyde and sulphonal, etc., were used when patients were restless and sleepless; some readily acquired habits and demanded a "nightcap." Chlor form and ether were of course used in surgical cases.

One of the most interesting of the series is Amyl nitrite a vasodilator much more effective than alcohol, acting almost instantaneously. Among the insane it was used in cases of continued epileptic convulsions, often with doubtful results.

get the desired relief or ease from alcohol, or who have enough pride not to resort to its use, or who fail to get relief from opiates, or who fear taking such on account of habit-producing effects, may find a suitable remedy among this Aromatic series.

That some acquire the aspirin habit has already been mentioned. There are all kinds of dope fiends and new ones appear every now and then.

I have not looked up the statistical aspects of this matter. In the case of the most commonly used narcotics or sedatives we all know that the annual bill for alcohol and tobacco in our country is enormous.

It appears that in 1912 the United States used 135,826,000 gallons of distilled spirits, and 1,925,367,000 gallons of beer.

There may be some justification for the use of beer, a mild alcoholic drink, but there is little to be said in favor of strong alcohol, of which only a few ounces can be consumed by the body in 24 hours. It seems some European countries have diminished the consumption of strong alcohol, while in our own country the amount consumed seems to be increasing. With increasing sanitation in old world cities there is less demand for strong drink, less need or demand for relief or misery drinking. Although there is a greater consumption of alcohol in our own cities, there is less actual "drunkenness," using the term in its old significance, i. e., being completely overpowered.

A chart with hundreds of individuals was shown where race suicide was strongly operative, and, although there was narcomania, there were practically no individuals who drank to the point where they would fall into the hands of the police.

Although at times a family may be reduced to one individual, that individual may be worth more to the community than half a dozen in the slums. The fable of the fox and lion applies.

In contrast to the last chart was shown a large one of a family which is in the main still rural, and yet there is gradual disappearance of the old colonial stock. There are all sorts of factors for race suicide. The bad air factor is usually overlooked. Domestication and urbanization and coniosis are usually not considered.

The botanist constantly speaks of "naturalized plants." In the case of annuals it does not require many years of observation to determine whether a plant is really naturalized, that is, whether it can continue itself successfully year after year.

From a study of many family histories, one may question whether the white man, the European, is truly naturalized in this country.

How the use of alcohol and opiates crops out in biographies, also the matter of race suicide, is an interesting subject. In the light of my study of people who drink it is not difficult for me to understand why a man like Poe drank.

The family chart of Herbert Spencer is interesting (chart shown). He was a dust victim, and so were his parents; he was the single survivor out of nine children. He experimented more or less with narcotics and sedatives in his search for relief from symptoms of ill health.

THE EVOLUTION OF DRINK AND NARCOMANIA.

Hunting and Fishing Stage:

- "Home life" very simple.
- Absence of fermented drink.
- Use of vegetable narcotics at ceremonials and festivals.

Pastoral Stage:

- Nomadic tent life.
- Use of leather bottles and fermented milk, a weak alcoholic drink.
- No special desire for "stimulants" under simple life conditions or by outdoor people.

Agricultural Stage:

A fixed home implies domestication, the ability to live under indoor conditions for successive generations.

Domestication means:

- | | | |
|-----------------|---|--------------------------------------|
| Re-breathed air | } | Attended by "ills of domestication." |
| Soil pollution | | |
| Water pollution | | |
| Stored food | | |

Many "incurable ills" or "diseases" are preventable reactions.

Invention of pottery and fermented drinks from fruit juices and grains, wine, cider, beer.

Use of alcohol for relief from disagreeable symptoms. ("Symptomatic treatment" survives today).

Additional use of various narcotics: Opium, henbane, hasheesh, etc.

Handicraft Stage:

Town and city life means urbanization.

Great increase in house and town ills.

The "ills of civilization" are reactions, largely preventable.

International commerce and introduction of cosmopolitan diseases, that is, specific diseases of definite etiology.

The search for remedies or "cures" for ills and diseases incident to house and town life.

Discovery of distilled spirits.

Alcohol regarded as a panacea, first by physicians, then by the people.

Names used: Aqua vitae, Au de vie.

The role of religions, favorable or unfavorable to alcohol.

Severe weeding out and adaptation of humanity to unsanitary city conditions.

Tobacco (introduced into Europe about 1586) a factor of increasing importance in prevalence of ills and diseases and race suicide.

Industrial Stage:

Cities and manufacturing towns the graveyard of man.

Constant need of fresh country blood.

Overcrowding and lack of sanitation = prevalence of specific diseases

Daily and constant exposure to dusty air = prevalence of coniosis.

Excessive use of strong drink and "dope" = narcomania.

The Alcohol Problem a serious one in dirty cities and complicated by the tobacco habit = the "Tobacco Problem."

The tobacco habit produces a "spitting habit" and sets a low standard of cleanliness.

"Spit Dust" is responsible for the prevalence of so-called "American Diseases."

Catarrh, dyspepsia and nervous prostration are mainly reactions to an abnormal environment to "bad air."

Speeding automobiles an important factor; make clouds of dust.

Blood pressure an important factor in the ultimate fate of the individual.

Alcohol, sedatives and narcotics give relief and lead to "relief drinking," to inebriety and drug habits.

Such a chart could be extended indefinitely; here are some additional observations:

Pure air people are temperate people.

People living in good air do not crave alcohol or dope, not even a cathartic pill.

The number of saloons, tobacco shops, drug stores, of patent medicine advertisements in newspapers and of doctors, shows an unhealthy state of affairs. Another sign of national decay and race suicide is the reversion to primitive beliefs, faith and mind cures—a mode of treatment resorted to by people when in despair at the medical profession failing to cure or benefit. Many ills are incurable, they should be looked upon as reactions, not diseases.

Narcomania is exceedingly prevalent in our cities and towns, but men who are reeling drunk are less and less in evidence. The vicious are rapidly eliminated.

"A sound mind in a sound body" fails to consider the influence of environment, how an abnormal environment weeds out the best mentally. The robust teacher fails to understand the delicate child that reacts to an abnormal environment. The best barometer or thermometer for a school-room is a teacher who is not too robust. The best physician for prevalent ills is the one who himself is not too robust, not too immune.

Survival of the fittest does not mean survival of the best when applied to unsanitary city conditions. If this were true the people of crowded Chinese or Indian cities would head civilization.

It still holds true that "the good die young" on account of unsanitary life conditions. Many are killed off by alcohol and narcotics. Many a young man of promise finds his death in the cup.

Several charts were shown to illustrate how the tobacco habit and the spitting habit are related to the alcohol problem, and in turn to the race suicide problem, how unsanitary air conditions lead to prevalent ill health and to terminal infections that kill. Charts were shown based on the census reports, from which it appears that in our State today the rate of decennial increase is constantly diminishing, and likely at the next census there will be a deficiency, in other words, the loss will be greater than the gain. In Northern Indiana only a few counties have gained in population, those with industrial cities.

Industrial cities, like unsanitary cities, have been compared to huge parasites that drain the country of its best blood. Such cities have little use for a man over 45 or 50. Yet such cities may point with pride to their low death rates. The explanation is of course simple: Worn out men go away to their old homes, to die.

Some cities, really overgrown villages, have a bad water supply, and the brewers advertise their clean or pure beer; yet the Prohibitionists are making little or no effort to get good water. Is it any wonder that many cities vote "Wet?" The first effort of the Prohibition advocate should be to give the people clean water and clean air. Fresh water does not necessarily mean pure water, nor does fresh air mean clean air. Saloons flourish in proportion to their unsanitary surroundings and the patronage of low grade laboring men.

The solution of the Alcohol Problem depends upon education and cleanliness—clean people, clean homes, clean cities, clean streets, clean water, clean air. In the light of Coniosis the greatest of these is clean air.

COLD STORAGE IS PRACTICAL CONSERVATION.

H. E. BARNARD.

Cold storage is essentially the application of scientific temperature control in the solution of an economic problem, a practice that regulates prices without increasing them and prevents deterioration while eliminating waste.

But to the average consumer there is no hint of conservation in cold storage and little reason for the practice except that born of greed. June butter in January, spring chicken at Christmas, fresh eggs months after they were taken from the nest, summer fruit in winter weather—do these reversals of the season's horn of plenty, this carrying the products of flush markets over the time of scant production, increase the cost of food to the consumer, reduce its value to the producer or in any way injure the masses of the people who by its consumption and in its production find health and wealth?

The world's development has been along the lines of easy and abundant food production and the most progressive nations have been the best fed. No people living in a hand-to-mouth fashion have lifted themselves above the poverty of their surroundings; no man can be an efficient member of society whose life is an alternate feast and famine. That is why the savage, ignorant of methods for conserving his food supply, is still a savage.

The food supply is perishable. Fruits and vegetables are seasonable; that is, for the most part suitable for use only during the months in which they reach maturity. Meats cannot be kept after slaughter except by special treatment; even the cereals deteriorate with age and the store is depleted by vermin. And so we have a season of plenty when food fresh from the fields and orchards gluts the markets and later seasons of scarcity when natural causes have destroyed the surplus of earlier months. These seasonal variations in the food supply are also subject to yearly fluctuations, for the abundant crop of one year may be succeeded by the scant crop of another. The fact that foods are perishable makes it necessary, if they

are not to be wasted, to supply some adequate means for holding in check the processes of decay which, if allowed to operate, would make them unfit for use.

Cold storage is the modern way for arresting food spoilage. It is the latest and most successful method of storing the surplus of one season against the want of the next, and of preventing the fluctuation of prices from below the cost of production at harvest to a point beyond the resources of the purse the rest of the year.

It is of especial interest to the health officer, both because of this phase, which, in so far as it affects the available food supply, touches the great problem of nutrition, and because of the general impression that goods held beyond what may be termed a natural period of usefulness are not suitable for food. Whether food deteriorates and to what extent should be understood by him in order that he properly may draft and enforce cold storage laws. During the last few years extensive investigations have been made to determine the deterioration of food in cold storage. The results of these investigations are the more interesting because, in some instances, at least, they upset generally accepted theories. Ever since cold storage has been practiced, cold storage chicken has been viewed with askance by the public, and cold storage food has been held accountable for every unexplained illness.

The flood of ill-designed, crudely drawn bills presented to the lawmakers of the various States during the last few years was without doubt a well-intentioned attempt to meet the demand for a careful regulation of the business of cold storage, both with the idea of protecting the health of the consumer, and, in some little-understood way, reducing the cost of living. In effect, however, the passing of many of the bills suggested would have meant the destruction of a most important industry. Yet the value of cold storage is clear to everyone who has given intelligent study to the subject. Even where cold storage facilities are not available, the necessity for them is recognized, and in Canada, at least, the government, appreciating the need of cold storage plants, has adopted the policy of subsidizing the construction of refrigerating warehouses. A committee appointed by the French government to study the recent increase in the prices of food stuffs has pointed out that this is in no small measure due to the fact that France has as yet practically no system of holding food stuffs in cold storage. Unfortunately, men who should be thoroughly famil-

iar with the practice of cold storage still appreciate neither its purpose nor its effect. The Commission on Cold Storage appointed by the Governor of Massachusetts to investigate the subject, addressed a circular of inquiry to secretaries of Boards of Health in the different States, asking for opinions or suggestions as to the need of regulation of the industry and the form which it should take. Twenty-one state boards answered the inquiry and in every instance recorded a belief that legislation for the regulation of cold storage of food and food products is necessary. That the information, however, was not on the whole of great value was shown by the fact that one official recommended restricting the time limit of storage to ten days, another to ninety days, several did not think storage for more than three months desirable. When the information of those we count as sanitary experts is so limited, need we wonder at the fear of cold storage products so long held by the average consumer? Before satisfactory legislation is enacted we must know why we need regulation and what, if any, bounds of restriction are necessary. The business should be regulated by practical laws which do not have for their purpose its destruction and which are intended rather to put a stop to the practice of the storing of food unsuitable for refrigeration, and which has, even before its entry into storage, deteriorated and become unfit for food, and to insure the withdrawal of all goods before they have been held sufficiently long to undergo such physical change as may render them undesirable for human consumption.

The report of the Massachusetts Commission referred to recognizes in cold storage a fundamental necessity in the distribution of the food supply of the nation. It finds that cold storage enables perishable food products to be brought to market with the least possible deterioration, and that it enables the surplus of one season to be carried over to meet the demand during the season of natural scarcity. In this way, by distributing the seasonal output of perishable food stuffs evenly through the market year, it helps to equalize supply and demand. The price of the food supply to the consumer is not materially influenced by cold storage. It has been argued that the possibility of storing food products against a rising market may lead to speculation on the part of the middleman, and no doubt the facilities offered by cold storage may be abused to manipulate prices. This possibility, however, is more theoretical than actual, because of the enormous practical difficulties in the way of artificially controlling the supply of food. It is impossible to determine in advance, for instance, whether

January and February will be relatively warm months as during the winter of 1911, or bitter cold months as during the winter of 1912. In 1911 the warm months brought about a very large production of eggs, and consequently eggs in storage were taken out at a loss to the owners. The possibility of such conditions obtaining acts as a deterrent to the speculator, and all data at hand shows that the manipulation of food prices is not materially increased by the practice of cold storage.

As above suggested, there have been desultory attempts to regulate the cold storage industry by legislation. The government of the United States, although it has discussed the enactment of such legislation for several years, has as yet taken no action. Several States, however, have enacted cold storage laws of varying character. The first cold storage law of record, in the United States at least, was enacted by the State of Indiana in 1911, similar legislation following in the States of New York and New Jersey in the same year. In 1912 the National Association of Food Officials gave to a committee the task of drafting a model cold storage bill. After many months of careful work and investigation and after the revision of several tentative drafts, the committee recommended as a model bill for enactment in the several States a draft which during the legislative sessions of 1913 was enacted in approximately its original form as a law in the states of California, Iowa, Nebraska and North Dakota, and by authority conferred upon it adopted by the Louisiana State Board of Health as the law for that State. In 1912 the Massachusetts legislature enacted a cold storage law, drafted after a most comprehensive investigation of the subject by a committee of the legislature appointed for that purpose. The latest law at the time of writing is that enacted in the state of Pennsylvania. The Pennsylvania law differs in several points from the model bill and indeed from the early legislation upon the subject, which will be referred to in detail later.

At the present time eleven States regulate the cold storage industry by law. The State of Kansas regulates the storing of certain food products, but has no general law. The Canadian government, appreciating the necessity for developing a cold storage industry, in 1907, passed a cold storage act entitled, "An act to encourage the establishment of cold storage warehouses for the preservation of food products." This act, while primarily not intended as a regulative measure, but rather drafted for the purpose of subsidizing the construction of warehouses, is in effect regulative in that

the application for subsidy is limited to warehouses which are constructed under plans subject to the approval of the Department of Agriculture.

Cold storage is defined as the holding of food products at or below the temperature of 40° F. in warehouses refrigerated for that purpose. A cold storage or refrigerating warehouse is held to be an establishment employing refrigerating machinery or ice for the purpose of refrigeration in which articles of food are stored for thirty days or more at a temperature of 40° F. or below. This provision varies somewhat in the several States. The State of Nebraska, for instance, requires that goods must be held in storage for sixty days before being legally cold-stored, while a bill pending in the State of Connecticut holds that eggs must be labeled "Cold Storage" if held for more than fifteen days. The time limit imposed by most of the laws is the natural limit of twelve months, that is, from one productive season to the next. The time limit, however, is not uniform in the several States. The State of Pennsylvania fixes a different limit for different articles of food. It limits the storage of whole carcasses of beef or parts thereof to four months, whole carcasses of pork or parts thereof, of sheep or parts thereof and of lamb or parts thereof to six months, the whole carcasses of veal or parts thereof to three months, of dressed fowl drawn to five months, of dressed fowl undrawn, ten months, eggs eight months, butter nine months and fish nine months. As a rule the law requires that goods which have been in cold storage shall be sold under a label advising the purchaser of their character. The Pennsylvania law even goes so far as to require that food sold from labeled containers must be wrapped in a package stamped on the outside with the words, "Wholesome Cold Storage Food." The Massachusetts, Iowa, Louisiana, Nebraska and North Dakota laws require the display of a sign marked "Cold Storage Goods Sold Here." The Indiana law requires only that eggs taken from cold storage be sold from a receptacle bearing the words, "Cold Storage." All laws are uniform in requiring that goods be marked with the date of entry into storage and the date of withdrawal therefrom, except that the laws of New Jersey and Delaware require only the marking with date of entry and the Nebraska law does not require the date of withdrawal on goods to be shipped outside the State. In nearly every case the warehouseman is required to report the quantity of goods in storage to the proper officials at the end of each three months' period. The Massachusetts law, however, requires the report but three times a year. This provision, while not in any way affecting the character of the goods in storage, is undoubtedly an attempt on the part of

the legislatures to minimize the possibility of the cornering of the food supply by giving all information concerning stocks on hand to the public. As an additional protection under certain conditions the officials of several of the states are authorized to call for more frequent reports than are specifically authorized in the statutes.

In six of the eleven States enforcing a cold storage law, the State Board of Health and its executives and inspectors are charged with the enforcement of the act. In five States the work is done under the supervision of the food commissioner or dairy and food commissioner, as the case may be. In every case, except the State of Delaware, it is made the duty of the official or executive board to issue licenses for the operation of cold storage plants. These licenses are issued after an inspection has shown them to be sanitary and properly equipped and operated, and the board or officials charged with the enforcement of the act have power to withdraw the license if the plant becomes unsanitary or is operated in violation of the law. An important provision of practically every law is that authorizing the officials to extend the time of storage if inspection at the end of the storage period shows the goods still to be in satisfactory condition and suitable for use as food.

Unquestionably the public has the impression that prices are artificially and arbitrarily raised by reason of withholding goods from market in storage warehouses. The special committee of the Chicago Association of Commerce, which made a thorough study of cold storage in its many phases, says of this argument against storage:

“Exhaustive examination of the statistics compiled under the directions of your committee, and a comparison of these statistics with the facts obtained by the department of agriculture, after an exhaustive research demonstrates clearly that the prices of butter, eggs, poultry and fish have been more uniform during the year since cold storage has become a factor in the care of food products than before that period. These statistics also show that taking an average for a period of years, prices on the whole have been lower than during the years when cold storage was unknown.”

This statement is in substantial agreement with the conclusions reached by the Massachusetts committee and undoubtedly is an accurate gauge of the effect of cold storage upon the price of food. Nevertheless, in view of the persistent criticism of the new industry and of the too general impres-

sion that high prices are the result of manipulation somewhere between the farm and the consumer rather than a decreasing supply for an increasing demand, the legislation enacted may be assumed to have definite value both to the warehouseman and to the consumer in that on the one hand the consumer knows where and how much goods are being held for future use and the warehouseman is protected from a criticism which, if persistently indulged in, must prove a serious injury to his business. This statement may, indeed, be applied to all the phases of cold storage legislation, and where the laws have been in force the longest, I believe that without question the industry receives most credit from the consumer, and cold storage food properly handled in storage and sold under an open label out of storage is not only viewed without suspicion, but indeed purchased and consumed with greater satisfaction.

The cold storage industry is not a local business, but is very largely a feature of interstate commerce. Public warehouses could not be maintained for the convenience of local trade. They must depend upon the large shipments collected in one part of the country to be distributed at centers of population. For this reason legislation affecting the industry should properly originate at Washington instead of as at present in the several States. It is perhaps unfortunate that the Federal government did not point the way to uniform and reasonable state legislation by itself enacting a fair and equitable law. The bills proposed for enactment by Congress have, however, been framed without a proper understanding of the subject, and for that reason have not met the favor of those engaged in the industry, the states' officials charged with the regulation of the food supply, the retail trade dependent so largely for a supply upon the warehouse, or the consumer, who wishes only to be protected against unfit food, manipulated prices and deception.

The regulations drafted by officials charged with the enforcement of the laws have been generous and pertinent. The laws have been construed liberally and with regard for the warehouseman. In general, goods held at low temperature in process of manufacture, such as beer and meats in cure, have not been held to be in storage. The technical features of the stamping and tagging have been made as simple as possible and in practice the dating of the time of entry and withdrawal is easily and economically done. There is still some dispute as to whether the small dealer, as for instance the butcher, who may carry small stocks of meats longer than the usual thirty-day period, and the hotel and restaurant, should be held to be

operating cold storage or refrigerating warehouses. In so far as storage may affect the quality of food stuffs there is no difference between the large public warehouse and the private ice box, except that in all probability goods cannot be handled as successfully at the smaller plant. However, the stock of goods held at the hotel or butcher shop for local consumption is never so great as to influence the market, and for that reason the generally recognized necessity for the publication of storage holdings does not obtain. Moreover, unless legislation presumes to label cold storage goods all the way from the warehouse to the consumer's table, there is no necessity in the case of the individual plant for the system of marking followed by the warehouseman. Goods taken from storage are sent to the hotel kitchen or to the home of the consumer without delay, and deterioration is avoided, as might not be the case with the careless handling of goods drawn from cold storage for distribution over a larger area.

Recognizing a strong sentiment for cold storage regulation and the fact that such legislation is already in force, not only in Western States where no warehouses are in operation, but in the populous Eastern States of Massachusetts, New York, New Jersey and Pennsylvania, it behooves the industry to demand adequate protection by federal legislation, protection against unwise state legislation, protection against the loudly expressed yet admittedly erroneous statement that the cold storage industry is employed to manipulate prices to the detriment of the consumer, protection against the firmly established impression that goods deteriorate markedly in storage, protection against the oft-repeated tale that food-poisoning follows the ingestion of cold stored goods. Legislation that accomplishes these facts will not operate to curb the development of the industry, but rather to stabilize and encourage the use of refrigeration by the producer and of cold stored foods by every consumer.

With the passage of adequate cold storage legislation and the development of a practice of labelling which declares the character of the goods to the purchaser, the idea now held that cold storage is an artifice used by the speculator to force higher prices and a practice which spoils food instead of preserving it will no longer obtain.

And when cold storage is no longer feared, our markets will be widened and the food supply enlarged by the thousands and hundreds of thousands of tons of edible products which now rot on the ground for want of facilities to preserve them to such a time that they can find a profitable market.

CHANGING CONDITIONS IN THE KENTUCKY MOUNTAINS.

B. H. SCHOCKEL.

(Illustrations by the author.)

This summary of changing conditions in the plateau of eastern Kentucky is based upon a month's field work, supplemented by previous and subsequent studies. To refresh the reader's general conception of the region an introductory review is made of its topography, surroundings, and settlement.

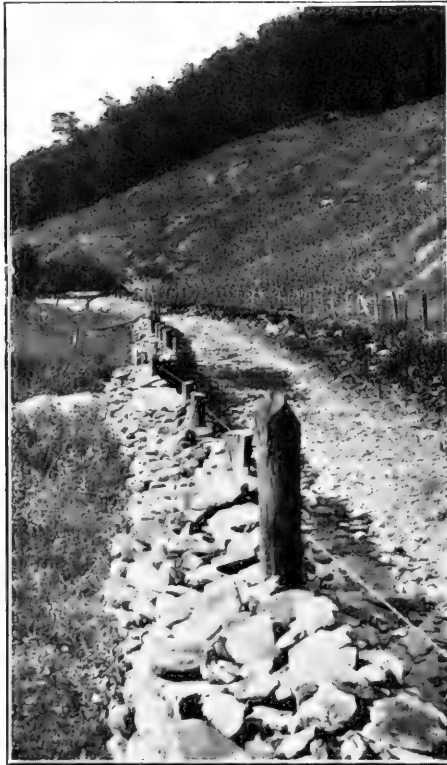
TOPOGRAPHY AND SURROUNDINGS.

Eastern Kentucky is a part of the Cumberland Plateau and consists of thirty-five counties with an area of some 12,943 square miles, that is, about one-third of Kentucky. It is a part of the Southern Appalachian Highlands. To the east of it are the parallel ridges and valleys of the Greater Valley of the Appalachians; to the west is the Blue Grass region. The top of the plateau is a part of the Cretaceous Peneplain, with monadnocks on it, and slopes gently westward in Kentucky from an elevation of about 2,000 feet to a height of 1,200 to 1,500 feet. This peneplain has been dissected by dendritic drainage to a topographic stage of maturity, the valleys being from 500 to 800 feet deep with narrow bottom lands, and the tops of the ridges averaging in many instances from 10 to 50 feet in width. The ridges, locally known as mountains, in general bear on their shoulders and crests hardwood forests sprinkled with conifers. Most of the lower slopes are cleared. From the top of Pine Mountain the Kentucky country appears to be a billowy wilderness. One cannot see any valleys, nor any sign of life; but beneath those forested waves are sylvan slopes to enchant one, and a sinister labyrinth of gashed valleys to enthral one in mountain poverty.

Owing to the topography the roads are serpentine; since the bed rock is of shale and friable sandstone chiefly, good road material is scarce; furthermore, the people are poor, and what we term shiftless and ignorant; therefore, their highways are in a most wretched condition.

SETTLEMENT.

In the sixteenth century James I introduced Scotch settlers into northern Ireland, who became the Scotch-Irish. Some of them emigrated to America; and their descendants, augmented by English, native Irish, Pennsylvania Dutch, and others, formed the van of the 300,000 frontiersmen who passed through Cumberland Gap, from 1775-1800, to settle in Kentucky.



1. Creek-road, "upright farm," and forested ridge, near Pine Mountain Postoffice, Ky.

Some of these found a home in the plateau region, which offered clear springs, magnificent forests, abundant game, and good valley land sufficient for that first generation of hunter-farmers. No one could have foretold then the coming of canal and railroad.

The first permanent settlements in the Kentucky mountains were made in the decade 1790 to 1800. Inlay's map of Kentucky (1793), shows "settlements" on Rockcastle River, the upper Louisa Fork, and a fork of Red River. By 1800 the population was 7,964, which was about four per cent. of the population of the State; it is now about 600,000, which is about twenty-five per cent. of Kentucky. Genealogical records of this people are utterly lacking. Their names and survivals in customs and language point to English and Scotch-Irish ancestry in general, although a few German and Huguenot names are found.

Between 1800 and 1840 the mountain region was an integral part of the State, for various reasons. Four interstate, transmontaine routes trav-



2. An example of the poorest highways in the mountains, near Pine Mountain Postoffice, Ky.

ersed the plateau in leading from the Ohio and the Blue Grass countries on the west to the Big Sandy and Kanawha region on the east, and thus on to the tide water settlements. The plainsmen bought lean cattle in the Blue Grass and sent them in droves of from 200 to 300 through the mountains to the Potomac, where they were fattened and sold in Baltimore and Philadelphia. Large droves of hogs followed the same routes. The hog and cattle drivers bought corn at the homes of the mountain people and brought news from the outside world. The slender state appropriations for roads were impartial, the mountain counties being favored equally with the lowland.

But between 1830 and 1850 the four interstate roads declined gradually to a wretched condition and state of non-use; for the Blue Grass and Ohio regions were finding other routes to market, by use of steamboats, etc. Therefore, the mountain counties lost their market and received little outside help for roads. As a result the people have lived isolated by topography and social antipathy.

During the Civil War thousands of the mountaineers, whose ancestors had fought in the Revolution and the War of 1812, joined the Union army and received a practical education. Some received similar training as soldiers of the South. After the war many returned home. But the growth of formal education and broader outlook thus stimulated has been slow.

In 1878, Shaler, of the Kentucky Geological Survey, saw in the eastern, and then most inaccessible portion of the region, men hunting squirrels and rabbits with old English "short-bows" and wrote: "These were not the contrivances of boys of today but were made and strung, and the arrows hefted, in the ancient manner. The men, some of them old, were admirably skilled in their use; they assured me that, like their fathers before them, they had ever used the bow and arrow for small game, reserving the costly ammunition of the rifle for the deer and bear."

Recently outside capital has begun to develop the coal and timber resources of the region, a fact which is bringing about many changes in the mountain country rapidly. As a result, the inhabitants are facing the crisis brought about by the sudden mingling of a primitive people with the exploitative phase of modern civilization.

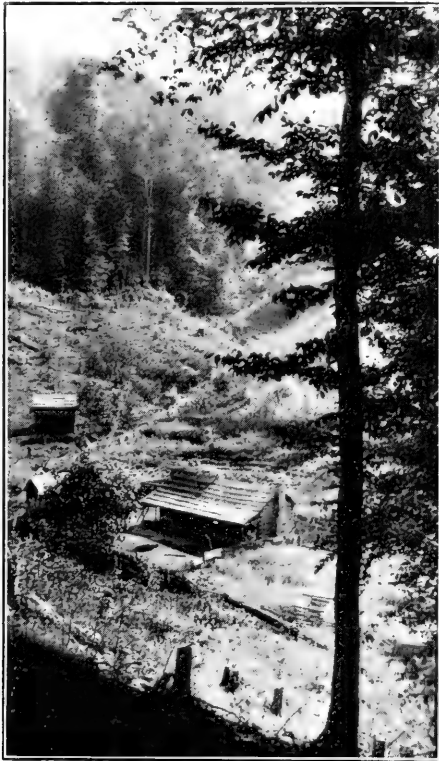
CHANGING CONDITIONS.

Mineral Resources.

Coal is the chief mineral resource of the region. The seams occur in every county, increasing in number and thickness towards the southeast and reaching their climax in the Black Mountain region. The layers are favorably disposed for mining, except in the Pine and Cumberland mountains, where complex structure renders mining difficult. The coal is bituminous, the most desirable varieties being as follows: Cannel, found in limited basins throughout the field; coking, appearing in large amounts only in the vicinity of Pound Gap; and high class steaming coals, occurring in quantity in the southeastern counties and at a few places along the western margin.

Coal was exported in 1827, probably earlier; but until the railroad came, the output was insignificant. Though production is rather small at the present time, and limited to a few mines scattered along the railroads, the region is beginning to become an important coal center.

The first extensive exploitation began in the region about Middlesboro, in 1892. At present most of this coal is shipped south. Some two years



3. A primitive mountain home, near Buckhorn, Ky.

ago a branch of the L. & N. railroad was pushed up the North Fork Kentucky River to Hazard, and extensive coal mining began. Hazard is now in its Ugly Duckling stage, has a population of about 2,000, boasts one of 3,500, and altogether is a scar upon the beautiful landscape, like a "boom"

town of the west. But the most spectacular development is taking place at Jenkins, on the headquarters of the Elkorn Creek, at the foot of Pound Gap, Pine Mountain, known in literature as "The Trail of the Lonesome Pine." Eighteen months ago a branch of the B. & O. Railroad reached the site, where a few months prior there had been but one mountain cabin. Jenkins now has brick buildings three stories high; a great power plant; palatial residences; a splendid hospital; a concrete dam causing an artificial lake, upon which are pleasure boats; and a town reservoir, into which spring water is filtered from the mountain. Indeed it is growing as fast as Gary, Indiana, in its early days. Most of this coal is shipped across Indiana to Gary.

At a shaft mined by two mountaineers near Booneville, good cannel coal sells for seven cents per bushel. Cause, poor transportation.

Essentially all of the mineral rights have been bought by outside capital, much for \$1.50 per acre, and in some cases for fifty cents. Sometimes the mountain people made the further mistake of giving up the farming rights also.

At an early period iron and salt within the region were the source of considerable traffic, but not now. Oil, gas, and clays, although in progress of exploitation for the last two decades, do not promise to become important.

Forest Resources.

The primitive forests were splendid. But since an early day, lumber has been shipped to an outside market; therefore, the timber area has been reduced, and, although it remains the chief source of wealth, the end is almost in sight. About thirty per cent. of the region was in wood in 1910, not all of which was primitive.

The mountaineer's way of lumbering is to cut a few choice trees and "snake" them down to the creek, where as logs, rafts, or railroad ties, they await the coming of the flood, or "tide", to be floated down stream. Thus a man can produce ten ties per day, for which he received thirty-eight cents apiece, this summer, near Beattyville. But lumbering corporations are beginning to attack the two remote corners of the Southern Appalachian Highlands—the Smoky Mountains and the Kentucky Plateau—and after the onslaught, in which stumps three and one-half feet in diameter are left to rot, the hills are gaunt with slash, or black from resultant forest fires. Consequently increased erosion is resulting on the slopes, with augmented

harmful deposition on the flats below. Furthermore, within and below the plateau, the streams increasingly are characterized by short periods of flood, and long intervals of low stage. Also, the supply of drinking water and water power is becoming less constant.

Most of the timber is owned by outside capital. The United States government is seeking to buy wooded land for forestry having completed the first step last September, when it purchased the 60,000-acre Biltmore estate, near Asheville, N. C.

A passing forest industry is the digging of ginseng and other roots. The normal market price for the first is five dollars to seven dollars per



4. Snaking logs in the Southern Appalachian Highlands.

pound, but now, owing to the war, the price has fallen. One old man and his wife, digging "sang" in the woods, wanted to know why it is that the Chinese cannot live without the root, and what would happen to that people when the supply shortly would give out in America, but then consoled themselves with the thought that probably the Chinese have enormous amounts of it stored away in anticipation.

Animal Resources.

Wild game is becoming surprisingly scarce, due to overhunting, and lax observation of hunting laws. In general the supply of fish is low, some causes being: Dynamiting and seining, lack of restocking, and inconstant

and turbid streams resulting from deforestation. What little meat is eaten, is chiefly swine and chicken. Sheep continue to suffer from exposure and dogs. Beef is walked to market to obtain cash with which to pay taxes. The Ayrshire stock is giving way to a fine short-horn type of cattle, owing to the opening of stock yard cattle markets, as at Mt. Sterling. The mountain mule and pony are being displaced by larger types. Goats suffer from the rough, wet, winter climate.

The development of pasturage for live stock would prove to be a fundamental advantage. Timothy is the chief forage crop; clover is second. A diminutive Japanese clover has filtered into the mountains, and takes possession of deserted fields. It is good for grazing, but it is too small to be cut.

Agriculture.

About 80 per cent. of the land is in farms, of which 45 per cent. is improved, and 23.5 per cent. in woodland. The average size of the farm is 85.7 acres, of which about thirty-nine acres are improved (Kentucky: 85.6; 55.4—Indiana: 98.9; 78.6). The average value of all crops per farm in 1910 was \$310.70. (Kentucky: \$536.20—Indiana: \$947.60). The average value of implements and machinery per farm in 1910 was \$32.3. (Kentucky: \$80—Indiana: \$190). About 6.6 cents worth of fertilizer was used per improved farm acre in 1909. (Kentucky: 8.7—Indiana: 12.8).

The total value of all crops in 1909 was 24.8 million dollars, of which cereals amounted to 12.2 million, vegetables 3.8, hay and forage 1.1, and fruits and nuts 1.1. The total area in cereals was 921,538 acres, of which corn constituted 841,744 acres; oats, 39,341; wheat, 36,403; rye, 1,579; and barley, 510. Some 21,397 acres were devoted to potatoes, 5,673 to sweet potatoes and yams, and 10,713 to edible beans (a staple food in the mountains). Sorghum was raised on 21,970 acres, and hay and forage on 162,944 acres. There were 1,825,895 apple trees out of a total of 2,425,047 fruit trees. Peaches ranked second to apples.

The average production of corn per acre in 1909 in the region was 18.7 bushels; in Kentucky, 24.2; in Indiana, 40. The corresponding figures for wheat were 9.9; 12.8; and 16.3. Similar data for potatoes were 76.6; 91.8; and 99.4. The respective figures in tons of forage per acre were .8; .9; and 1.2.

The shale soil, which is most common, is fairly fertile, and produces good crops of corn under good cultivation, on gentle slopes. The chief

causes for the low productivity are steep slopes, poor cultivation, and lack of crop rotation. The shale soil washes less than almost any other soil under like circumstances. The wonder is that the soil produces as much as it does.

A few years ago Berea College, with the help of the United States government, employed a special investigator and demonstrator to work with the mountain farmers within reach of Berea. The success was such that a number have been appointed in other localities. About Berea, heavy breaking plows are replacing the one-mule plow, and the disk harrow is pushing back into the mountains. More than twice as many shallow culti-



5. Stumpage and slash which will invite forest fires in the Southern Appalachian Highlands.

vators as single shovel and double shovel ploughs were sold in Berea last spring. The practice of sowing cow peas and rye for forage and turning under is spreading, as is the use of commercial fertilizer. Crop rotation is displacing the fallow system.

Further education in agriculture is being given at the missionary and settlement schools, as at Oneida, Hindman, Buckhorn, and Blackie. But agriculture in the interior of the region is yet primitive, and improvements are slow in penetrating. A common sight is corn growing among girdled trees.

The few gardens which are being introduced about the settlements and mining and lumbering camps are giving favorable results.

Naturally, the region is a splendid fruit country, especially for apples; but spraying is unknown, and the stock has degenerated. Therefore the trees bear abundant crops of gnarled, sour fruit. One mountain woman told us to take as many apples as we wished, since they were of no value except to sharpen the teeth on. Often apples are sold for ten cents per bushel, are given away, or rot; cause, poor transportation.

Manufacture.

Manufacturing within the region always has been meagre, primitive, and for local use, except in the case of salt in the early days.

In 1901 Bell and Boyd counties contained 172 manufacturing establishments, with an aggregate capital of \$5,201,489, an amount which was more than one-half of that invested in manufactures in all the thirty-five counties in 1910. The cause for the emergence of these two counties is the recent growth of Ashland and Catlettsburg on the Ohio River, and Middlesboro near Cumberland Gap, a local supply of coal being the factor in each case. Hazard and Jenkins soon will rank as manufacturing cities.

The status of manufacturing for 1900 is indicated in the following table:

	Establishments.	Capital Per Establishment.	Men, 16 Years and Over.	Women, 16 Years and Under.	Children Under 16.	Capital.	Value of Products.
Kentucky Mountains..	1,156	\$7,221	4,853	44	85	\$8,347,993	\$11,993,195
Kentucky.....	9,560	10,886	51,101	9,174	2,687	104,070,791	154,166,365

The mills are small and are driven by water, animal, and hand power. Machine made goods from the outside have supplanted the linsey-woolsey cloth, counterpanes, and baskets formerly made in the cabins. But, recently, the missionary and settlement schools have begun to sell such goods outside of the mountains for the people, to supply cash, and therefore the industries are reviving, in part. The W. C. T. U. Settlement School at Hindman, for example, sold \$1,800 worth of such goods last year.

Distilling always has been a widespread industry in the mountains, since thereby corn, the chief crop, is converted into a product which can be marketed with profit, and since the custom has been inherited. Illicit distilling increased greatly after the imposition of the liquor tax of the Civil

War. In 1877 the government began to suppress "moonshining" in the region. By 1882 the supremacy of the law had been established. But in 1894 the liquor tax was increased from ninety cents to one dollar and ten cents, which resulted in increased "moonshining". The counties have been voted "dry", which encourages the illicit traffic. About the coal mining centers, "blockading" is increasing greatly, the whiskey being brought to town under vegetables and in milk cans.

Transportation.

Transportation is the basic problem of the region. Poor communication within it has influenced greatly every phase of life always, and bad connections with the outside have isolated the country since 1850.



6. A primitive mill, near Cornettsville, Ky.

Of a total of 17,432 miles of road, there were within the entire region, in 1904, eighty-three miles surfaced with stone, and four miles with gravel. The present wagon freight is said to be about 44 cents per ton-mile. The average haul for a load of cross-ties is from eight to ten miles, and eight to twelve ties constitute a load.

Logs delivered at the railroad for twenty dollars per load are said to consume sixteen dollars in transportation. From Buckhorn to the railroad is eight miles. A team will make this trip for four dollars in good weather.

The charges in this case are about 88 cents per ton-mile. The average cost of transportation in the United States by wagon is 23 cents per ton-mile.

The old law that every man must work on the roads six days annually is enforced feebly. By a statute passed in 1894, road taxes can be levied by the county and a road commissioner appointed. But this new law is proving a failure in the mountains and is giving way to the old custom because the mountain county is too poor to pay the commissioner's salary, and because the mountain man may pay the tax in work, a fact which introduces again the old problem of road-work enforcement. In 1904 the total expenditures upon the highways in a number of rugged mountain counties amounted to about \$24 per mile. The average expenditure for the State, much less dissected, was \$43.57. The history of the mountain roads emphasizes the inability of the people to provide themselves with efficient highways, and manifests the great need for outside help, state or federal. In general, road material would have to be imported at great expense. The costs of roads steadily increase as the forest retreats towards the headwaters.

In 1907 the United States Department of Public Roads, as an object lesson, built and macadamized in Johnson County, 5,780 feet of road, and constructed through Cumberland Gap, 12,300 feet of macadam pike, and graded 900 feet more, at a total cost of \$7,050 per mile. This work demonstrates again that the construction of good highways in the mountain region, while possible, cannot be done without outside help. Besides the government routes there is a short stretch of macadam road (1 to 20 miles) in five marginal counties, of which, however, Boyd County alone lies strictly within the mountain region. The coal company at Jenkins has surveyed and built six miles of well-graded dirt road connecting Jenkins and McRoberts. Owing to the enforcement of the road laws in Knott County, a fairly good ungraded dirt road extends thirty miles between Hazard and Hindman. Immediately west of Pine Mountain in Leslie County, no wagon roads were attempted till 1890, and few exist now.

Before the advent of railroads, highway improvements were negligible, but the past twenty years have seen progress. Numerous stretches of road, eight to ten miles in length, afford somewhat fair transportation for wagons to the railroads. Where the development of coal and timber has increased the wealth of the community greatly, substantial bridges have been built. Progress has been slowest in the rugged, extreme southeastern

section of the region, even though railroads have begun to penetrate. There the primitive saddle and sleds drawn by oxen are still in use.

Except for lumbering, the streams are used but little. The North, Middle and South forks of the Kentucky River penetrate into the interior. They join at Three Forks, near Beattyville. Thence to Carrollton are 350 miles of good waterway. In 1853 some five locks were completed by Kentucky at a cost of \$4,000,000, which assured good navigation for 300-ton steamers for a distance of over 100 miles. The Federal Government made improvements at the close of the Civil War. Since then the waterways have been declining. In 1887 there were passing Three Forks annually, 50,000,000 feet of lumber, in logs.

Railroad building began in 1856, but made no headway until between 1870-90. The progress has been slow and confined to marginal counties until recently. Within the past five years it has penetrated the North Fork Kentucky River to McRoberts, a few miles west of Pine Mountain, and up the Poor Fork of the Cumberland River, by way of the gap at Pineville. The railroads have been built for the coal and lumber, and not primarily for general traffic. Since the advent of railroads, the conditions which have made possible "the mountaineer" have been passing away.

But in general the region is still landlocked.

Population.

In 1910 the total mountain population was 561,881, representing an increase of 18 per cent. over that of 1900. (Kentucky: 2,289,905; 6.6 per cent.) There was an average of 43.4 people per square mile (Kentucky: 56:9; Indiana: 74:9). The density is greatest along the main river routes and in mining sections. The people continue to be distributed as clans in valleys, which are surprisingly heavily populated. Of necessity the people depend upon the lower slopes of the hills to an extent equal to or greater than on the limited bottom lands, their "shoe-string farms" being found strung along little gullies as well as in broader valleys. A few farms are on the mountain sides, especially on benches or "coves" of somewhat gently sloping land, formed above some massive sandstone ledge. The average size of the mountain family is about 5.2. (Kentucky: 4.6; Indiana: 4.1.) The rural population increased 17.1 per cent. in the last decade. There was no urban population (towns of 2,500 or more) in 1870. In succeeding decades, as Ashland and Middlesboro developed as centers of coal mining, it numbered 3,280; 7,466; 17,428; and 24,004. These two

cities are unique in the region in having a population greater than 5,000; but they soon will be joined by Jenkins and Hazard, about which coal mining is developing rapidly. In 1910 less than one-half of one per cent. of the total population was foreign born. These people were chiefly skilled miners from England, Sweden, Germany, and Switzerland, who drifted in by way of Pennsylvania. In seven counties there were no farmers of foreign birth; and in only one county did the foreign born exceed 21. Recently, Southern Europeans have begun to come, particularly Italians and Hungarians. By 1920 the number of foreign born will have increased greatly. In 1900 about two per cent. of the population were negro, and in 1910 two and one-half per cent. In three counties there were no negroes; and in sixteen, less than twenty.

The problem presented in the region by the rapid increase in population with no corresponding increase in foodstuffs, probably is not greatly overdrawn in the following statements by a mountain graduate of Berea College: "The pioneer of 1850 who sat in his front door watching the deer rove the unbroken forest, today sitting in the same place can see acres of spoiled farm land. A few years ago the people produced enough on their farms to support themselves. Today one-half of the food consumed is brought in by the merchants. Twenty-five years ago our hill-sides produced forty bushels of corn per acre. Today the average yield of corn per acre is a little less than twenty-five bushels. (In 1909 it was 18.7.) The independent farmer of yesterday has been transformed in the last few years to a man dependent upon his staves and ties for support. Now, his farm has grown up in bushes, and his timber is almost exhausted. . . . Such is the condition of a vast number of our mountain farmers."

There is an emigration of the mountain families, or of sons and daughters, particularly from the marginal counties, where a fringe of mountain territory has been put in touch with outside progress and humanity, and where mountain peoples are buying adjacent lowlands. Some are moving to Oklahoma and the Far West. This in part accounts for a decrease in population of five counties.

Public health is not as good as might be expected at first thought. The situation has been summarized by Miss Verhoeff (in "The Kentucky Mountains") as follows: "Endurance and muscular strength are common, but a strong constitution is exceptional. Bad housing and sanitation, ill-cooked and insufficient food, exposure to weather, and . . . poverty, have

had their detrimental effects, which have been augmented by a close inter-marriage of families and by an inordinately large use of liquor."

In general the mountain man is quicker than the Indiana plainsman, but not as strong. A month's field work did not bring to note any of the storied giants of the hills, though there probably are some. Not all of the people are lank.

About two generations ago trachoma penetrated into the mountains, and is spreading rapidly, despite the efforts of the state and settlement schools, and the Federal Government. Of over 4,000 people examined in five counties, 12.5 per cent. had this disease. A report from the W. C. T. U. Settlement School at Hindman names twenty-five per cent. for that locality. Adenoid and turbinate cases are common. Several clinics held at Buckhorn revealed that 90 per cent. of those examined were afflicted with hookworm. Splendid work is being done, but the area to be covered is a vast one, and assistance is needed greatly. Superstitions that diseases are visitations of the Lord to be borne with resignation are disappearing slowly.

The people continue to be poor. In 1900 land was worth \$5.00 per acre, and in 1910 \$9.66. (Kentucky: \$13.24 and \$21.83; Indiana: \$31.76 and \$62.36.) The average value of all farm property per farm in 1900 was \$860; and in 1910 it was \$1,359. (Kentucky: \$2,007; and \$2,986; Indiana: \$4,410 and \$8,396.) The average value of farm buildings per farm in 1910 was \$247. (Indiana: \$1,230.)

Institutions.

There is great need of education. In 1900, 24.3 per cent. of the voters were illiterate, and a decade later, 20.7 per cent. (Kentucky: 15.3 and 13; Indiana: 5.6 and 4.1.) In eight counties in 1900, the illiterate voters constituted from 30.5 per cent. to 35.8 per cent. of the total. In 1910, 61.6 per cent. of the children, ages 6 years to 20, were in school. (Kentucky: 60.8; Indiana: 66.) Corresponding figures for children from 6 years to 14 years were 73. (Kentucky: 76.)

However, improvement is being made. In 1900, there were more than 20 counties without a local publication. Now, there are but few counties without a press, and several have more than one.

Formerly, the term of school lasted but three months in the year. The teachers received no training except in the common schools. The buildings were tiny, two or three teachers in some cases teaching in the same room.

But now, the term lasts six months (closing at Christmas owing to bad roads.) Also, many of the teachers receive some training in the normal department of the settlement and missionary schools. Furthermore, there is but one teacher in each room, though in it is no library, few modern desks, and little equipment. In one mountain school visited by the writer in 1914, the pupils were sitting in rough board pews, the boys on one side of the room and the girls on the other. The walls, floors, and seats were dirty. Some of the children wore but one garment. Two of them were suffering from trachoma. The equipment owned by the school consisted of one wall map and three calendars. The only object on the desk was a small switch. The girl-teacher, who was a graduate of the institute at Oneida, had charge of 69 pupils and, besides, without pay, was teaching a "moon-light" school of evenings, to which people of all ages were coming. She did not show any surprise or nervousness when our group of ten men in nailed boots filed in. Nor did the children pay much attention to the visitors. The third grade droned out its reading lesson, and then the second grade carried out its solemn program in spelling. There was a solemnity about it all which the outsider does not understand until he becomes acquainted with the gravity of these people in their gatherings. Progress was being made, though it seemed a pity that the children should have to learn the definition of some words which probably they never will have occasion to use. The day of the "shouting school" (in which the pupils indicate that they are studying by reading aloud) has passed in the mountains. In a second school, a girl, younger than the teacher above, was in charge. She had had no training beyond the common school. There were a few modern desks, but also some rough hewn pews. When I tip-toed to the door and took a photograph of the interior she showed less surprise than an Indiana school mistress would have exhibited, but she smiled when some of her children awakened to the situation. In some sections a holiday week is declared during the corn harvesting season. Mission and W. C. T. U. settlement schools are coming into the country, as at Buckhorn, Hindman, Pine Mountain Postoffice, and Blackie.

Berea College, on the western margin of the region, serves as a university for the mountains, and is sending its extension department with wagon and camp into the remote sections. The reader is referred to the December, 1912, number of *The American Magazine*, for the story of the heroic foundation of Oneida Baptist Institute, and is reminded of Bulletin Number 530 of the United States Bureau of Education for the story of the

opening of "moon-light" schools in the Kentucky mountains in 1911 for children, parents, and grandparents. When the feud breaks out, mountain mothers from the section in which blood is shed, anxious to get their sons out of danger, are wont to urge them to attend school at Berea College and elsewhere.

Though in some sections enthusiasm for education is becoming great, in others there is great apathy, because of lack of interest on the part of the people, lack of practical teaching, illiterate teachers, poverty, poor roads, and political interference in school affairs. In some districts it is still thought by the school trustee that "the lickinest teacher makes the



7. "The telephone whispers through the silent hills," near Booneville, Ky.

knowinest younguns". Changing conditions are indicated by an incident in which two teachers appeared in the same schoolroom, each determined to become the sole teacher. The following among the pupils was about equally divided at first, but presently they moved away from the teacher using the "A. B. C." method and grouped themselves about the more progressive instructor who was following the sentence method. The broad effort is being made to teach the people how to work and live according to modern ideas, and yet to retain the desirable traits of their own civilization. This is a delicate task, involving much more than merely academic training.

Religion is undergoing transition slowly. Formerly if a speaker did

not shout and gesticulate he might be termed a good *speaker* but not a good *preacher*. The early attitude towards the settlement workers was indicated in a mountain sermon in which the congregation was told to "beware of the fetched on women who come in here wearing gold watches, and their shirt fronts starched so slick that a fly would slip off and bust out his brains". But, a year later, the same mountaineer said that since these women were administering to the needy under conditions so harsh that even the mountain people would not venture out, "I allow as how they are welcome to stay in the mountains as long as I live." One mountain patriarch, who has given his farm and essentially his all in founding a settlement school in the valley of his home, gives some of his reasons as follows: That there was much whiskey and wickedness in the community where his grandchildren must be reared, was a serious thing for him to study about. He heard two of his neighbors say that there is neither heaven nor hell. One of them said that when a man is dead he is just the same as a dumb beast. Another said that he could not rear his large family of children to be as mean as he wished. The founder's idea was that a good school "would help moralize the country." Formerly the Presbyterian religion was most prevalent, but it gave way to the "Hardshell" Baptist creed, since in the mountains the educational qualifications for the latter were less severe than for the former. The disciples of this religion have in turn given way before the "Missionary Baptists." Methodists are also numerous. The most vivid disputes in the mountains were wont to be about religion. But now there is a significant change toward toleration in that preachers frequently exchange pulpits with pastors of other denominations, and that the use of a church is often tendered to another denomination which temporarily is without a place of worship. The following can be interpreted as a groan of growth: "The church in eour holler, hits about dade. Part ov the folks wants an eddicated preacher, an parts wants an old-timer, an so they don't get nary one". The funeral preaching had become the sole opportunity for social gathering until the recent advent of "camp meeting week", and the coming of the extension school on wheels.

Changing conditions have not yet affected greatly the political situation in the mountains. Since the Civil War so many of the inhabitants have been Republicans that party arguments have been one-sided, and the contests have been within the organization. Unity of feeling gives the representatives considerable power in the State Legislature. Political discussions are said to be confined in general to stump speeches con-

cerned with national issues, and hence are of little help concerning local problems. However, since the mountain men are good at politics, some make of the local contests a profitable business. Recently in some sections such men have turned their attention to the school, for the sake of profit in the appointment of teachers. There the trustee runs for office upon a platform statement of which teachers he favors. In some sections the vote runs high in school elections, while it is light on other matters. An increasing number of women vote on school affairs. Another favorite field of the politician is the handling of road taxes.

Deep seated prejudice, due to poverty, exists against taxation of any kind. In 1906 the per capita state and county tax was \$4.62 for Woodward County, in the Blue Grass, while in the mountains it ranged from \$0.40 in Elliott County to \$1.75 in Harlan. Little returns are obtained by taxation of lumber and mineral resources.

The feud was transplanted from Europe into the Blue Grass, the Kentucky mountains, and elsewhere. It survived among the isolated valleys of the mountains, where it was fostered by folk-song, the flaring resentment of the Indian fighter and pioneer, and the habits of thought natural in isolated communities where for a long time there was neither sheriff nor jury and where, even to this day, the government hardly has been able to inspire confidence or dread. The Civil War greatly increased and intensified the feud: Prior to 1860 few weapons had been used in the mountains, and few deaths had resulted. In the region in 1860 there were 10,098 slaves and 1,280 free colored people. The lines grew sharp between the Union and Confederate counties, as well as between opposing families, and between opposing members of a family. Modern arms were introduced into the region. The physiography of the land favored bush-whacking. During the war the Kentucky mountaineers suffered more sharply than the mountain people of any other State, except Tennessee. Also, many of the principals of the post-war feuds were boys during the Civil War, whose imaginations were filled with all of these horrors. It is said by the mountain people that the actual numbers engaged in the feuds has ranged from 10 to 60 on a side; that the duration has been from 1 to 40 years; that perhaps not 10 per cent. of the mountain people have had a personal difficulty sufficient to cause fighting; probably not 40 per cent. of them have gone to a court house to prosecute or defend a case; and that half of the enlisted partisans never have faced the

music in a show down fight, the number actually having figured in the ambuscades being small.

In some parts of the region, as about Oneida, education is causing the decline of the feud: but in other sections it flourishes, as near Pound Gap (Trail of the Lonesome Pine), near where, it is said, some eleven men were killed in three months during the spring of 1914.

The home, also, is changing. One still can see the windowless log cabin with its "dog-trot"; but some roofs are of shingles, and some of tin, while frame structures are appearing, and brick.

Mountain simplicity and hospitality are illustrated by one man who said, "I want a good house; two rooms—one for the family and one for company, each big enough for a bed in every corner—and a lean-to cook room."

The following is a description from Professor Penniman's unpublished tales of the mountains: "Three days are ample to build a log-cabin twenty feet square. The part before the roof is called a 'pole pen'. This is run up in a few hours. The trees sufficient to build a cabin complete are often standing on an acre. With the roof up, and stone chimney on the outside, and the big fireplace opening into the room, the young people can begin housekeeping. A few saplings will make a bed frame fastened to the logs in one corner, and a bed without a tick, two feet thick, of fresh pine needles, gives a sense of luxury to the newly married pair."

Customs and Habits.

It must be remembered that there are all grades of society in the mountains, and that no general description can be applied to a specific case.

Woman is inferior to man in both number and position. Not only is she a household drudge, but a field hand as well (out-of-door work in itself, of course, does not constitute drudgery). She still follows behind him as they trudge over the mountain. A mountain boy, upon being asked how many brothers he had, answered promptly: "Two." But concerning the number of sisters, he drawled: "Oh, three or four." The modern woman movement hardly has penetrated into the hills, and when it does, it will meet orthodox opposition. However, women increasingly vote in school affairs in some districts. Furthermore, here and there a girl returns from Berea, or some other college, with ideas strange to her people.

Perhaps this explains the wide girdle, or other bit of modern adornment, now seen sometimes on the quaint costumes.

We were pushing through a deep forest in toiling over a ridge. Before us were two children, walking in single file, a boy of fourteen and a girl a year younger. Our youthful guide pointed in their direction and remarked, "They were married last spring. Some of us do get married that early hereabouts; but we who have been to the settlement school don't calculate to get married that soon."

"Store clothes" have displaced the homespun garments, the result being unfavorable in the appearance of the men. However, the settlement schools are reviving the home-weaving industry to some extent. The belt is beginning to rival the suspender on "Sunday" garments.

The quaint old English language also is disappearing, though slowly. It is becoming crystallized and is losing its flexibility whereby it was wont to be bent this way or that, to suit the fancy or fit the occasion. In a reminiscence of his boyhood, Professor Dizney tells of a minister in Dizney's valley, who, in preaching about apostasy, took as his text: "If they shall fall away", and who concluded in a high key: "If they shall fall away", means that they cannot fall away, for anybody who knows anything about the English language knows that it is a verb *in the impossible mood and everlasting tense.*" There also comes to mind the following expression: "Law me, Honey, I'm glad to be back from the plains. Wooded mountains make the restinest place to lay your eyes on."

There is about to pass away a most interesting folk-song based upon English and Scotch ballads, and preserved verbally in the mountains with slight modification, from generation to generation. These songs of romantic love, hate, sacrifice, and revenge are sung in almost all of the log cabins. Thereby the visitor, who may have thought that the mountaineers neither weep nor smile, learns with delight that their natures are intensely fluid. The songs are sung in slow time, and in minor tones difficult to express in written music. An effort is being made to collect the words and write the music before it becomes too late.

The open hospitality, once common, is shrinking. An old man in his watermelon patch put it thus: "I used to raise melons for the whole valley, so that the folks would come to sit and talk with me on the porch while we ate them. But now too many foreigners have come in; they

would eat me out of home." Sometimes the mountaineer is disappointed in his hospitality to strangers.

There is a kindly, affectionate courtesy for one another among the people, which, it is hoped, will survive.

There is such a great need for improvement in sanitation that what has taken place is negligible.

The native is accustomed to work in his fields by seasons, with periods of rest between. During an "off" period in September but two men were seen at work in the field during eleven days of travel. It has been his wont to work during the favorable time, or when the larder is empty; or to rest during the unfavorable season, or while provisions are at hand. Therefore, in general, the population is unsuited to the routine of work in the mines, the manufacturing plant, and the lumbering camps, now appearing in the region under the control of outside capital. Furthermore, it is without a disposition to cooperate. Hence such workers are at once the despair and menace of the employer and the labor union. Consequently, foreign labor is imported, and the mountain man is in the way, as was the Indian. He will not necessarily become happy if, to meet modern industrial conditions, he throws off lightly his old attitude toward life gained through centuries of adaptation in the mountains. A few of the most versatile natives are profiting by the rapid changes; but the great majority, formerly independent land-owning farmers, are not. Many are seeking employment in mill or mine, or are contracting to the headwaters. It is significant that the leaders in the mountains, native and mission, deplore the *rapid* advance of industry into the region, and that they are bending every effort to prepare a civilization over a century in arrears, to meet the rude shock of the worst of our culture. In the 1911 term of court, Perry County, being invaded rapidly by railway construction, had nearly 600 cases; Owsley County, without access to railways, had less than 40 cases. A mountain guide in Pound Gap lamented, "The devil is coming into the mountains on wheels." Eight years ago I rejoiced with a clean cut, delightful, energetic man who was returning home from the Kentucky mountains buoyant because he had doubled his fortune by securing some of the primitive forest at an absurdly low price. He was bringing wealth and good cheer to his northern family. Now, with those slopes in mind, deforested, gullied, scorched, and sold ("unloaded"), I am glad that I did not smoke then, for I probably should have accepted some of his fine Hayanas. The *rapid exploitation* of the natural

resources of a region by outside capital tends to harm the native, especially if his civilization is not modern. In this case the outcome is in the balance.

THE FUTURE.

If exploitation pure and simple continues, twenty-five years will bid fair to bring about the following results: The disappearance of this race of true Americans as a unit; the passing of the valuable timber; numerous forest fires in the region slashed over; greatly increased erosion of the steep hillsides with their soil already thin; short periods of flood within and below the region; long intervals of low water within and below the region; the reduction of fish and game; the introduction of a foreign mining element, also a foreign manufacturing body; and a region of great natural beauty changed to a region of squalidness. Presently, with the increase of population and the value of land in the United States, the region may be reclaimed at great cost.

Outside aid might do the following things: Regulate the exploitation of the coal and timber so that it will be gradual; aid the counties in building good roads; assist in educating the mountain people along broad lines to close the gap between them and us; help them to develop stock raising, fruit growing, scientific agriculture, and scientific forestry. Some of the results would be: The saving of the mountain race as a unit; the addition of a happy, prosperous, food supplying area to the United States; the prevention of the disasters of soil erosion and of flood, and the utilization of water power.

It is being pointed out that men break down under the tension of modern industrialism, unless they, somehow, are brought into contact with the beautiful, and get away for frequent moments of change and recreation. The government owns our national parks; but they are far out West, beyond the financial reach of the average worker. The government might also establish numerous small parks in the Southern Appalachian Highlands, which would become the recreation ground of millions of workers east of the Mississippi River.

CONSERVATION AND CIVILIZATION.

ARTHUR L. FOLEY, Head of the Department of Physics, Indiana University.

Not until recently has man begun to think of nature's resources in the light of the old saying that "one can not eat his cake and have it." Today the subject of the conservation of these resources is being discussed by men of science in every civilized country on the globe. Nevertheless it must be admitted that the full import of the question is not yet appreciated by many science men, while the public generally scarcely knows what the discussion is about. A few years ago the writer heard an address in which the speaker pointed out the importance of conserving the soil. A fellow citizen in speaking of the address said he did not understand what the speaker meant, that the earth is made of mud and that no one need be fearful of a shortage. The observation led to the reflection that people too are made of mud, some of it not very fertile. Perhaps our citizen did not know that the average productivity of the unfertilized soil of Indiana is but half of what it was when he was a boy. Perhaps he does not know that all animal life is dependent on plant life, and that plant life is dependent on a few soluble constituents of the soil which form but a small and diminishing per cent. of what he calls mud. Perhaps he does not know that the removal of timber and the cultivation of hillsides permit the rains to dissolve and carry away the soluble constituents and so impoverish the soil, and that every year thousands of acres of land, here in his own State, Indiana, are ruined in this manner. He does not know that every year the Mississippi River robs the Mississippi Valley of hundreds of millions of tons of that upon which its fertility depends, and that all other streams are doing relatively the same thing.

But I am not to discuss the conservation of our soil, nor the conservation of our timber or our food supply. I shall not discuss the conservation of air or water, although the time has passed when we can say "as free as the air we breathe or the water we drink." Good pure air is not free to everybody, by any means. If it were there would be no

“white plague.” Nor is good pure water free. Sometimes it can not be obtained at a price, as some of us well know. New York City is just now completing an additional water system, this last system alone costing one hundred and eighty millions of dollars.

I wish to direct your attention to a phase of conservation that receives less consideration than is generally accorded the conservation of timber, food, and soil. I wish to consider our fuel supply, and its relation to civilization.

I shall begin by defining the word energy as the capacity for doing work; that is, the capacity for exerting force through space. Anything that can do work has energy stored in it, the quantity of energy being measured by the amount of work the thing can do. For instance, a clock spring or a clock weight has energy which it expends as it runs the clock; a battery has chemical energy which it expends when it rings a bell or drives a motor; a head of water has energy which it expends when it drives a turbine; gasoline has energy which it gives out as it heats a kettle or drives a motor car; a chunk of coal has energy which it expends when it heats our home or produces the pressure to drive a steam engine.

If we represent all the heat energy in the universe by the letter “h”, all the chemical energy by “c”, all the electrical energy by “e”, and so on, using a different symbol for each and every one of the many forms of energy, then we may express the law of the conservation of energy in the form of an equation— $h+c+e+\text{all other kinds of energy}=\text{a constant}$.

This law expresses the fact that energy is indestructible. We can neither create it nor destroy it. What then do we mean when we say that we should conserve and save our energy? To answer the question we shall need to consider two other laws or principles of energy, known as the Principle of Transformation of energy, and the Principle of Dissipation or Degradation of energy.

By transformation of energy we mean the conversion of energy of one form into energy of some other form. For instance, the energy of the coal is transformed in the boiler into the heat and pressure energy of steam, the engine converts this into a mechanical energy of motion; this may be used to drive a dynamo which converts it into electric energy, this may be passed through a lamp and be converted into light energy or it may be used to drive a motor which converts it again into mechanical energy, and so on. There is known no kind of energy that man can not

transform into any other form of energy. He may change almost at will the relative value of the energy terms on the left side of his energy equation, but he can not change their sum. No energy is lost in any transformation. The total remains constant.

In actual practice, however, when we attempt to transform or use energy, we find that more or less heat energy is generated in the process, and that this heat energy is dissipated through space. No machine is frictionless, no wire is without its electrical resistance. There is no motion of matter or electricity that does not result in the generation of heat which can not be utilized, heat which soon disappears forever in space. This energy is not destroyed, it is lost. It is easy to transform energy of any kind into heat energy, but it is impossible to transform all of any quantity of heat energy into energy of other kinds. Our best steam engines have an efficiency of some twenty per cent., the efficiency of the usual engine is not over ten per cent. This means that we waste from 80 to 90 per cent. of the coal and utilize from 10 to 20 per cent. Our best tungsten lamps give us only about 10 per cent. of the energy of the electric current required to operate them, and since the engine that drives the dynamo has an efficiency of, say 10 per cent., the tungsten lamp gives us as light only 1 per cent. of the energy of the coal, 99 per cent. being wasted in the form of dissipated heat. So we have the principle of the dissipation of energy; however we transform energy, a fraction of it—usually a large fraction of it—is always dissipated as heat and is forever lost. Thus while the total quantity of energy in the universe remains constant, the useful or available energy is rapidly diminishing. All forms of energy are tending to go into the form of heat, to run down hill as it were, as heat is regarded as the lowest form of energy. Consequently this Principle of the Dissipation is sometimes called the Principle of the Degradation of energy. It makes no difference what the final temperature of the universe may be; when all other forms of energy have been transformed into heat the heat energy will be useless. We can not use heat energy except as it runs down hill, from points of high temperature to points of low temperature. It is doing this all the time. Diffusion is a property of heat, and must result sooner or later in a state of uniform temperature and consequently in the disappearance of all available energy.

Perhaps you ask why we should worry about the condition of things a million years hence? The reply is that we need not do so, but that we may well take thought of what the condition may be before the twentieth

century shall have ended. No doubt the disappearance of all available energy is a matter of millions of years, perhaps of billions of years. But the disappearance of so much of our available energy that what remains may be entirely inadequate to supply the demands of a civilization such as we now have, is not a matter of millions of years, not even of thousands of years.

The progress of man has been proportional to his mastery of, and use of, Nature's resources. Thus we have the Stone Age, the Bronze Age, the Iron Age, and the Steel Age—the age of today. A 1914 model automobile, if made of bronze or iron, would not run a mile. The invention of the automobile could not have preceded the invention of steel. Steel made possible the light weight engine of high power, without which flying machines would be impossible. Without steel most of the weapons, and instruments, and machines of today would be impossible. Without power they would be useless. So this has been called the Age of Power or the Age of Energy, or better still, the Age of Coal Energy, for coal supplies almost all the energies required to do the work of the world. King Coal reigns with a lavish hand. We feast at the table, apparently unmindful of the fact that we are nearing the dessert course of his final banquet.

Our boasted triumphs over past generations are due to the fact that we have learned to use energy freely. We are not superior to those of earlier ages, in art, in architecture, in music, in intellect. We are vastly superior to them in our ability to make use of Nature's mineral resources. I might even say in our ability to use coal, for without coal the production of iron and steel would be practically impossible and the mineral resources of the world would remain undeveloped.

It is high time that we were awaking to the fact that civilization as we know it must disappear from the earth when the available energy has been exhausted. Concern over the social, intellectual, religious, and political state of future generations is of secondary moment compared with the question of the existence of civilization itself.

Each individual knows that he must die. But if he thinks the event somewhat remote he scarcely gives the matter a thought. He may even indulge in things that he knows will surely hasten the event. So with a race. We give no thought for the morrow, but continue to use and to waste Nature's resources, knowing full well that the death of the race is the inevitable result, and that our prodigality is speeding the day. We make the mistake of supposing that the day is indefinitely removed. We

calm ourselves with the thought that the human race has inhabited the world for thousands, perhaps millions of years, and still Nature is bountiful. But we should remember that not until this century has there been any considerable draft upon Nature's store of energy in the form of coal.

Coal was not discovered in the United States until some two hundred years after the discovery of America. It was seventy years after its discovery before it was commercially mined. For many years the output of the mines was very small. Lately, the disappearance of our forests and the astonishing increase in the use of machinery have combined to make enormous demands on our mines. The coal used in the United States during the past nine years is in amount equal to the total consumption up to the year 1895. The output of the mines for the year 1912 was 535 million tons—about five tons for each man, woman, and child in the United States. The figures relating to petroleum are just as significant. The industry began in 1859, and it was twenty-four years before the entire output was equal to that of one year now. The output of the last eight years equals all that produced before.

Natural gas is all but a thing of the past. When scientists foretold the speedy exhaustion of the supply and cried out against its criminal waste, their cry was unheeded and the waste went on. If all the gas wells had been properly cared for, and if all gas had been sold through meters, we should have had the blessings of natural gas for a century to come. People scoffed at the idea of natural gas failing. So did the newspapers throughout the entire gas belt. The introduction of meters was fought by papers and patrons, until the finish of natural gas was in sight. Instead of educating the people to economy and care, the papers incited them to extravagance and indifference.

We are now passing through a somewhat similar experience with petroleum and coal. Many of our oil fields have been exhausted and abandoned. No wonder, when we note that the production of petroleum of a single year is a quarter of a billion barrels. This enormous production has been made possible only because of the discovery of new fields to replace the exhausted fields. The discovery of new fields can not continue indefinitely. Most of our territory has been explored. It is only a question of time, and not a very long time, when oil too will have become a thing of the past. There will remain but one natural fuel, coal, to stand between us and a return to a primitive type of civilization.

The life of the coal beds has been variously estimated at from one hundred to five hundred years. The time will be longer or shorter, depending on our frugality or our prodigality. Yet our newspapers, among them the same ones that fought the use of meters for natural gas, fight the utilization of the power of Niagara Falls, calling upon state and national governments to preserve this wonder of Nature, the inference being that the use of the power of the Falls would mean the destruction of the Falls. Of course Niagara should not be exploited for the profit of individuals or corporations, nor should the Falls be destroyed. It might be arranged to permit, at certain times, all the water to go over the Falls for the delight of man. But in the opinion of the writer it is short-sighted, it is almost criminal, to permit millions of horse power of energy to go to waste, continually and continuously, merely for our enjoyment. Does the reader think it right to burn millions of tons of coal each year that might be saved for future generations, all in order that we—some of us—may see the glory of Niagara? Who is sordid? The man who is willing to forego a magnificent spectacle for the good of future generations, or the man who would feast his eyes and let future generations freeze? How does the Niagara waste differ in principle from the uncapping and lighting of a natural gas well with the gas under a pressure of hundreds of pounds per square inch, in order that people might hear the roar of escaping gas and see the heavens illuminated by a giant flame?

I remember that when the American Association for the Advancement of Science met in Indianapolis in 1890, the committee on entertainment arranged for an excursion through the Indiana gas belt and a natural gas display. At one city pipes were laid in the river and the gas liberated under the water. We saw the river, in appearance, converted into a seething cauldron. The sight was grand, but not pleasing. A man of science could not avoid the thought that we were being entertained at a fearful cost to future generations. Recently the writer's attention was called to the possibility of that display in the end conserving the gas supply instead of hastening its exhaustion. The display may have served to arouse sentiment against such wanton waste and consequently to hasten legislation prohibiting it. This may have been true in this particular instance, for those who saw the waste were those to whom such a thing would make a strong appeal. But people generally saw reckless extravagance on every hand and were a party to it. The writer recalls

a gas well within six miles of his father's home that was permitted to burn almost a year before the flow was stopped. The gas wasted from that well alone would be sufficient to supply a city of moderate size for a hundred years. Truly we are reaping where we have not sown, and are leaving but little of the harvest for future generations. To realize the truth of this statement you have but to consider the enormous development in the use of mechanical energy during this generation, and the necessarily enormous consumption of oil and coal required to supply that energy.

The one-horse buggy has been superseded by the thirty horsepower runabout, the two-horse carriage by the forty-horse touring car, the two-horse wagon by the sixty-horse auto truck, the two-horse stage coach by the five-hundred horsepower locomotive. The horse car has given place to the electric car, the sail ship to the steamship or dreadnought, the canoe to the motor boat, the bicycle to the motorcycle, the foot or hand press to the power press, the typesetter to the linotype, the tallow candle to the electric lamp.

Once man ate what his own fields produced; now much of his food comes to him from the ends of the earth. Once man was content to worship in the little church at the cross-roads; now he must attend conventions in Boston or Los Angeles. Once he thought twenty miles a journey; now he travels a thousand miles to see a ball game.

Now the house wife must have her electric irons and cookers, power washing machines, and vacuum cleaners. The farmer must have his feed choppers, shredders, threshers, and pumps, all operated by power, lately by gas engine power. The thousands of windmills that dotted the country twenty years ago have disappeared—replaced by gas motors. The grocer grinds the coffee by electricity and delivers it with an automobile. The absurd extremity to which we have gone in the application of power is illustrated when an auto delivery wagon calls for and delivers a ten cent package of laundry. These things are little things, but they illustrate the spirit of the age. We do nothing ourselves that we can get Nature to do for us. We give no consideration to the fact that we are burning the condensed sunshine of bygone ages. Our only question is, "What does it cost?" What does it cost *us*? Not what it has cost Nature, or what it will cost future generations.

The value of coal is fallaciously reckoned on what it costs to mine and transport it. The fact that coal represents energy stored by Nature

through countless ages of time is not given a moment's thought. Figuring this way, if we can manufacture ice a penny a ton cheaper than we can harvest the natural ice, we proceed to burn coal to make it. Think of the waste. Burning coal to make ice, when all the ice we need could be had for the harvesting. You say that natural ice is not produced in the tropics. Neither is artificial ice, in any quantities.

We flood our streets with oil, because we think it a cheap way of keeping down the dust; cheap only because we fail to consider the energy content of the oil and what it has cost Nature to produce it. The time will come when such extravagance will be prohibited by statute.

The fact is that we fail to realize that oil and coal are a legacy that has come to us from bygone ages, deposited in Nature's bank. We are spending our substance in riotous living, but unlike the prodigal have no place to go when it is all spent. Doubtless something will fall on our neck, but there will be no fatted calf.

The writer has painted a gloomy picture, such a picture as would have been painted twenty years ago, with dark clouds hanging everywhere about the horizon. However, the picture needs but one change to represent the conditions today. There is a rift, a small rift, in the clouds; a rift that may close and leave us again with leaden and ever darkening skies; a rift that may open wider and wider and leave us finally with the glorious sunshine of a cloudless sky. Whence the rift?

The energy content of matter depends on position and motion, not only on the position and motion of the mass as a whole, but upon the position and motion of the constituent parts. Experience tells us that the energy liberated during any change is relatively greater the smaller the parts taking part in the change. For instance: the energy required to change a gram of water into steam, a change of position of the molecules, is twenty times as great as the energy of a speeding rifle bullet of the same mass. To effect an atomic change, that is, to separate the hydrogen and oxygen atoms which form the water molecules, requires five times the energy involved in the molecular change. When the atom itself breaks up, disintegrates, relatively enormous quantities of energy are liberated.

Radium is a substance in which this electronic or sub-atomic change is going on continuously and spontaneously. It is continually throwing off or radiating minute particles, and so we say that radium is radioactive. A mass of radium gives off enough energy every hour to melt more than

its own weight of ice; and it does this day after day, year after year, and it will continue to liberate energy until the last trace of the radium has disappeared, a process that we have every reason to believe will require ages of time.

Many other substances beside radium are known to be radioactive. All substances may be more or less radioactive, the difference being one of degree rather than of kind. However this may be, we now know that there is stored within the atoms of matter quantities of energy, intra-atomic energy, beyond the powers of man to estimate. This is the rift in the clouds. It was produced by the discoveries of Becquerel and the Curies.

The rift in the clouds is not quite as wide as it was a few years ago, for so far man has failed absolutely to influence these radioactive processes in the slightest degree. Whether at the temperature of liquid air or the electric furnace, in boiling acids or alkalis, whether in a vacuum or at a pressure of a thousand atmospheres, whether inside or outside the strongest electric and magnetic fields man can produce, the rate of disintegration and consequently the rate of liberation of energy appears to be absolutely constant. Perhaps we may not hope to be able to control a change in the atoms themselves, for have not the atoms existed through countless ages and successfully withstood pressures and temperatures in Nature's laboratory exceeding any that man can bring to his service in the chemistry or physics laboratory?

That this intra-atomic energy exists is not theory. It is a fact that is as well established as any fact in science. Man hopes some day, somehow, somewhere, to unlock this infinite storehouse of energy. Today Nature stubbornly holds the key. The probability of man being able to wrest it from her is anything but bright. But we should not be, we must not be, discouraged, for it is our only hope. If the secret is ever discovered and we succeed in tapping this supply of energy no mind can imagine the heights to which civilization will mount by leaps and bounds. If the secret eludes us civilization is doomed to return to a primitive state from which it can never emerge.

Perhaps you urge that our estimate of the life of the coal beds is too short. If it were in error by one hundred per cent., and no authority claims as much, the depletion of our coal supply is simply moved forward a few generations. The ultimate outcome is unchanged.

Perhaps you say that the writer has failed to consider the possibility

of using the energy of the sun's rays. You should remember that sometimes we do not have enough sunshine in Indiana in a week to supply heat for a cup of coffee. It is a fact that where heat is most needed, and when it is most needed, to heat our homes and run our factories, there and then is the least sunshine. Imagine London depending on sunshine for heat and power. In winter when we need the most heat the sun shines the fewest hours per day, the fewest days per week, and the sun's rays are most oblique. Taking into consideration the necessarily low efficiency of any engine working between the temperature limits of an engine for using the sun's radiation, and the very large surface from which the energy would have to be gathered, men of science are agreed that the prospect of a practical sunshine engine are exceedingly remote.

Finally it may be argued that the writer has failed to see a rift in the clouds arising from the possibilities of water power. The answer is, there is no rift there. No doubt the use of water power will postpone the gathering of the clouds, but it will not disperse them. Leaving out of consideration the fact that water power is usually most abundant where least needed, that the available power varies greatly with the seasons, that the available water power is diminishing from year to year with the removal of forests and the draining of swamp lands, let us remember the fact that the total water power of the world is almost nothing compared with man's demands.

A single ocean liner burns fifty car loads of coal per day. To supply the power for such a liner would require ten such water power plants as the one on White River at Williams, near Bedford, which cost several hundred thousand dollars. Then, too, it would require all the ten plants to operate at full capacity, which the Williams plant can not do a considerable portion of the year, the supply of water being insufficient. The writer is informed that it is not using water power at all as this is being written.

Every fifteen days the new automobiles marketed by a single manufacturer of cars of low horsepower equals the entire water power development of the Mississippi River, at Keokuk. Every thirty days the new engines turned out by this one firm equal in power the total water power developed at Niagara. The total horsepower of the automobiles now registered in the United States is greater than the estimated total available water power of the country.

It would appear that one need not go further to show the utter

inadequacy of water power as a substitute for oil and coal. Those who think otherwise usually consider the question from the standpoint of factory power only, leaving out of consideration the enormous quantities of energy required to heat our homes, and to supply heat for such processes as ore smelting, cement manufacture, brick, tile and glass making, and thousands of others. To equal one ton of coal per month for heating purposes one would require the entire output of a fourteen horse-power plant, running twenty-four hours per day thirty days per month. If there are five hundred thousand families in Indiana and if each family consumes an average of two tons of coal per month during the winter season, the consumption is the heat equivalent of fourteen million horsepower. Remember, too, that Indiana is not a very populous State and that its climate is not severe.

Professor Soddy states the facts in his little volume on "Matter and Energy" when he says that "the age in which we live, the age of coal, draws its vivifying stream from a dwindling puddle left between the comings and goings of the cosmical tide."

We are to "witness a race, a race between science on the one hand and the depletion of our natural resources on the other hand." This race will be run chiefly by pure science, not by applied science. Engineers and inventors make their reputations and their fortunes by devising new and improved methods of using our natural resources; they are not concerned with the atom, the latest and the greatest energy reservoir discovered by man. We must look to such scientists as Becquerel, Curie, Rutherford, Ramsay. We must look to the humble, overworked, underpaid scholar toiling away in his laboratory. If he fails us, darkness comes.

WHY DO OUR BIRDS MIGRATE.

D. W. DENNIS.

It is insectivorous and "therefore" a migrant, is a common phrase in literature about migrants; it is the purpose of this brief paper to take the therefore out of of this sentence: to maintain that what a bird eats has nothing to do with the great bird movement from the south to the north in the spring and back again in the fall after breeding.

The Pennsylvania reed bird, the bobolink, doubtless stops at the reed swamps in Pennsylvania for refreshments on its way south; the South Carolina rice bird, another name for the bobolink, takes toll of the rice swamps; but no one thinks that the reeds or the rice are the cause of the migrations. Surely if they had not wings, they could hardly fly from the equator to Manitoba, but this does not make their wings the cause of the journey; nor is their food the cause.

It is stoutly maintained that climate is the cause. This, like wings and food, renders the journey possible; but it cannot in all cases cause it, for many water birds, like the gannet and the petrel, go to their breeding grounds from colder to warmer water and many from warmer to colder. They go to inhospitable, inaccessible rocks that they may nest in a place of safety, as I believe.

I was impressed at Wood's Hole in the summer of 1901 to see tern flying by in great numbers every morning. Later I visited their breeding grounds at Penikese; they were flying by Wood's Hole to get food for the day; they had not come to Penikese for food, for they came in such numbers that they overtaxed the fishing grounds for more than twenty miles to the eastward. They had not come for climate, for they had come from all available areas, colder as well as warmer. Perhaps it is admitted that they came to lay their eggs and rear their young safe from destructive mammals, including boys.

The facts about the blackpoll warbler sustain this theory almost as well as those about the tern, the gannet or any other water species.

The Blackpoll. It winters south of the equator and nests north of the Arctic Circle; its journey to its breeding grounds is a 10,000 miles round trip. It passes through Richmond about May 15 and returns September 15; its movements as it passes by us are deliberate. It cannot spend more than two months in its northern habitat; these must be very busy months. Nest making and family rearing are its chief business during these two months.

In a few minutes, or at least hours, the salmon prepares his nest and lays his eggs 1,000 miles up the Columbia from the Pacific, and we conclude he came for this.

In two months the blackpoll prepares its nest, lays its eggs, hatches its young, and rears them beyond the most critical periods of their existence, and starts back. Did it come to eat insects on the way, or to discharge this race duty? It is a ground nester; on or near the ground in that high latitude its eggs and family are safe from nest-robbing reptiles which abound in the warmer districts where it makes its winter home. Does it not make it wisdom's child, if it makes this long journey to nest in safety? If, as Aristotle said 2,500 years ago, the study of zoology is a study of fitness, it is real zoology to study the migrations of such birds as the blackpoll.

This argument applies to the water birds, which in countless numbers and numerous species fly over Indiana in early spring. The great majority of these nest on the ground near lakes and streams; some of them on floating islands in lakes, just the places where the eggs and young would be unsafe in their winter homes on account of reptiles.

The young of these birds swim almost from the shell, and would be reasonably sure to be eaten in southern waters.

The argument applies with almost the same force to all indefensible ground and low bush nesters, among which are the field sparrows, the vesper sparrow, dick-cissel, grasshopper sparrow, Savannah sparrow, bobolink, meadow lark, ground robin, brown thrasher, etc.

Nearly all our migratory birds show protective coloration, or sexual dimorphism; these are a confession of inability to take care of themselves or their homes, in fight. Those that exhibit sexual dimorphism are—

Bluebird,	Tennessee warbler,
Robin,	Orange crowned warbler,
Redstart,	Nashville warbler,
Canadian warbler,	Golden-winged warbler,
Wilson's warbler,	Blue-winged warbler,
Hooded warbler,	Prothonotary warbler,
Yellow-breasted chat,	Black and white warbler,
Maryland yellow-throat,	Summer tanager,
Mourning warbler,	Scarlet tanager,
Connecticut warbler,	Dickeissel,
Kentucky warbler,	Indigo bunting,
Prairie warbler,	Blue grosbeak,
Pine warbler,	Cardinal,
Kirtland warbler,	Towhee,
Black-throated green warbler,	Junco,
Blackburnian warbler,	American goldfinch,
Blackpoll warbler,	Redpoll,
Bay-breasted warbler,	Purple finch,
Chestnut-sided warbler,	Pine grosbeak,
Cerulean warbler,	Evening grosbeak,
Magnolia warbler,	Baltimore oriole,
Myrtle warbler,	Orchard oriole,
Black-throated blue warbler,	Redwing,
Yellow warbler,	Yellowheaded blackbird,
Cape May warbler,	Cow bird,
Northern parula warbler,	Bobolink,
Parula,	Humming bird,

fifty-four in all. The proof which all of them furnish is the same which the blackpoll warbler furnishes. They have, perhaps, come a less distance in all cases, and stayed a somewhat longer time.

All the balance of our migrating birds exhibit protective coloration, or are very inconspicuously colored—a confession of inability to protect the nest and an argument that birds migrate to protect it. A few conspicuous examples are:

Meadow lark,	Night hawk,
Vesper sparrow,	Whippoorwill,
Little brown creeper,	Rails,
Field sparrow,	Quail.

Our birds which build protected nests, or which are able to protect their nests are not migratory birds as a rule. I know of but one clear exception, the sapsucker. Our birds which build unsafe nests or which cannot protect them are migratory birds as a rule. I know of no exception that is clear. The Phoebe arrives when its food is scarce, and it leaves a land of plenty, a land of insects; food cannot be the attraction. That climate is not the compelling cause is shown by the fact that many birds arrive when the climate is very severe; it even kills thousands of them sometimes.

That birds are indigenous in the north; that they are migrating in the fall instead of the spring; that in the spring they are just going to their preglacial home; and that nostalgia is the real cause requires us to believe that birds have a way of preserving a record of their lost Atlantis that we do not possess, and may be dismissed as wholly psychological.

The salmon goes a thousand miles up the Columbia to spawn; the eel question has at last been solved; it goes to the deep sea to spawn. Sea-birds go to isolated rocks for the same purpose. It is the conclusion of this paper—there being no shred of evidence against it, and many weighty reasons for it—that our migratory birds go north for safety in nesting.

FLOOD PROTECTION IN INDIANA.

W. K. HATT.

Organized effort to study the causes and to lessen the effect of floods in Indiana begins with the appointment of the Indiana Flood Commission by Governor Ralston on April 20, 1914.

This commission is composed of one member from each congressional district and the personnel is as follows:

Mr. E. W. Shirk, Peru, Chairman.

Professor W. K. Hatt, Purdue University, Lafayette, Chief Engineer.

Mr. Frank C. Ball, Muncie.

Mayor Benjamin Bosse, Evansville.

Mr. William Cronin, Terre Haute.

Mr. Stephen B. Fleming, Ft. Wayne.

Mr. J. H. Frederick, Kokomo.

Mr. S. J. Gardner, New Albany.

Mr. Victor M. O'Shaughnessy, Lawrenceburg.

Mr. Joseph C. Schaf, Indianapolis.

Mr. W. N. Showers, Bloomington.

Dr. Chas. K. Stoltz, South Bend.

Mr. Herman Trichler, Brookville.

The commission met first in Indianapolis, on April 30, 1914.

The purpose of this commission is to consider the extent of damages due to floods in the State of Indiana, and to report to the Governor what measures should be taken to provide relief in the future.

The commission expects to issue its final report in 1915. This report will contain a full presentation of the history of floods in Indiana, a summary of the causes of floods, a collection of available data on rainfall, river discharge and topography, a discussion of flood protection works and a discussion of the principles of legislation to provide for flood relief.

This present pamphlet is an abstract of the forthcoming report of the commission, prepared in non-technical style for general information.

FLOOD OF MARCH, 1913.

The appointment of this commission was the direct result of the flood of March, 1913, in which 467 lives were lost and over \$160,000,000.00 of property destroyed in the United States. The memory of this catastrophe is still fresh in the minds of the people of Indiana, in which State thirty-nine lives were lost, and over \$18,000,000 of property destroyed.

The total loss in the flood of March, 1913, can never be known. The interruption of transportation and of business, the destruction to farm lands by cutting of banks of rivers and covering of bottom lands with gravel, the loss of productive capacity of manufacturing plants, and the sickness following exposure, are not susceptible of exact computation.

Professor Beede of Indiana University reports a total damage of approximately one-half million dollars in seven counties in the lower White River basin, in which also nearly eight thousand acres of agricultural land were denuded of soil and some sixteen thousand acres of river bottoms were covered with soil and silt. He estimates the loss to agricultural land in this region as nearly \$250,000.00.

The loss reported by county auditors to county roads and bridges alone, was over \$3,000,000.00. Other tangible losses that have been determined are shown in Table 1. It is probable that the loss during the flood of March, 1913, in Indiana, may be estimated at over \$25,000,000.00.

Indeed the catastrophe was so general over the Ohio Valley that it excited the sympathy and support of the entire nation. The Governor of the State of Indiana received \$———— in subscriptions for the relief of flood sufferers in this State.

PART OF DAMAGES SUSTAINED IN THE FLOOD OF MARCH, 1913.

1. County highways and bridges.....	\$2,825,240 00
2. Railroads—steam	5,299,810 00
3. Electric railways	788,000 00
4. Buildings and personal property.....	8,104,250 00
5. Telephone and telegraph.....	17,510 00
6. Crops	735,700 00
7. Livestock	149,380 00
8. Farm lands	264,700 00
9. Suspension of business.....	582,000 00
Total	\$18,766,590 00

Counties not included in (1)—Cass, Clinton, Fayette, Floyd, Miami, Sullivan.

Railroads not included in (2)—Central Indiana R. R., Chicago and Wabash R. R., Cincinnati, Hamilton & Dayton R. R., Toledo, Peoria & W. R. R., Toledo, St. L. & W. R. R.

Electric lines not included in (3)—Marion and Bluffton Traction Co., Bluffton, Geneva & Celina Traction Co., Central Indiana Lighting Co., Indianapolis Street Railway Co., Louisville and Southern Traction Co., Louisville and Northern Railway and Light Co., Vincennes Traction Co., Washington Street Railway Co.

(5) Includes Indianapolis Telephone Company only.

Counties in flood districts not included in (4), (6), (7), and (9)—Adams, Blackford, Cass, Clark, Clay, Clinton, Fayette, Floyd, Fountain, Franklin, Gibson, Grant, Greene, Harrison, Howard, Huntington, Jay, Jefferson, Ohio, Parke, Perry, Putnam, Randolph, Ripley, Scott, Sullivan, Switzerland, Tippecanoe, Vanderburg, Vermillion, Vigo, Wabash, Warrick, Wells, White, Whitley.

(8) Includes loss only in 230 miles of East and West Forks of the White River through Morgan, Owen, Greene, Daviess, Knox, Jackson, Lawrence, and Martin counties.

First there are six main problems to be solved before our Indiana communities can protect themselves against floods.

FIRST PROBLEM.

Flood Flow.

First there must be proper information as to the amount of water carried safely in a channel. To determine this amount we must first know the rainfall that may reasonably be expected at a time not too remote, and the rapidity with which this rainfall runs down the watershed.

In considering flood protection in Indiana we are barred at the outset from a sure solution at present, first, on account of a lack of rainfall records over a sufficiently long time; second, by a lack of stream gaging to determine the amount of water which does run down our streams during heavy rains; and third, by a lack of surveys of watersheds.

In other words, a heavier storm than any that has been recorded in the last thirty years of our rainfall records, may come in the future, but our records do not serve to determine the probable extent of this storm.

Again, we have not gaged our streams to know the relation between the runoff and the rainfall. Such records as are gathered in other communities will not apply to our peculiar conditions, that is, two watersheds of equal area, one long, narrow and V-shaped, and the other broad and flat, will yield very different flows in the streams. Again, the character of the surface, whether of rocky formation or swamps or farmland, will change the conditions.

Therefore, to obtain an exact solution of our flood problems we must first of all get accurate surveys and determine the flow of our streams. This cannot begin too soon. For this reason, the Indiana Flood Commission recommends an early beginning of this work of surveys and stream gaging.

These surveys are most important for another purpose, namely, to determine if the water of the upper reaches of the rivers can be held back for a time in reservoirs. For instance in the case of the Wabash River at Logansport, which carries the floods from the upper Wabash, the Mississinewa, the Salamonie, and the Eel River, we would like to know if it is possible to find reservoir sites in the valleys of these tributaries, so that the flood flows may be controlled. Each tributary flood might be held back to the proper amount, and for the proper time, so as to let these flood flows by Logansport one by one.

For example, in Ohio, it was found that by reservoir control, flood protection could be obtained for the cities of the Great Miami Valley at a cost of \$17,000,000.00, whereas the total sum of the cost of the individual protection schemes gotten up by each city acting separately was over \$100,000,000.00. The study of reservoir protection for the Miami Valley was made by the use of the topographic maps of the State of Ohio from which reservoir sites were planned and preliminary estimates worked up. Later on, detailed surveys showed that the preliminary work was accurate to within one per cent. The topographic survey of Ohio is 87 per cent. complete, whereas the Indiana survey is only 9 per cent. complete. If we were fortunate enough to possess topographic maps of the State of Indiana, we could go ahead immediately to study flood protection in a more complete manner.

The topographic map of the State is not only necessary for complete flood protection studies, but it is of use in the following:

(1) As a preliminary map for planning extensive drainage projects, showing areas of catchment for water supply, sites for reservoirs, routes of canals, etc.

(2) For laying out highways, electric roads, railroads, aqueducts and sewerage systems, thus saving the cost of preliminary surveys.

(3) In improving rivers and smaller waterways.

(4) In determining and classifying water resources, both surface and underground.

(5) In determining routes, mileage, location of road-building material, and topography in country traversed by public highways.

(6) In classifying lands and in plotting the distribution and nature of the soils.

(7) As base maps for the plotting of information relating to the geology and mineral resources of the country.

Our first problem is therefore to gather reliable information as to stream flow and topography.

The Indiana Flood Commission, however, realizes that critical conditions exist in several cities which can not wait the ten or twelve or fifteen years required for the completion of such surveys. The commission has therefore made the best solution it can, and has studied all available records, has computed rainfall and runoff, and determined to the best of its ability, the amount of water which an Indiana city may expect to take care of during future flood time.

Briefly, the records of the heaviest storms in the Ohio Valley region have been studied and the relation between the drainage area and the inches of rainfall worked out for these storms. Several of these storms have been studied, notably those of October, 1910; January, 1913, and February, 1884. For instance, it was found that the center of the storm in January, 1914, was over Southwestern Kentucky; the center of the storm of March, 1913, was over a line from Mt. Carmel, Ill., to Richmond, Ind. It is reasonable to expect as a matter of chance, that similar storms in the future will be centered fifty to one hundred miles from its former center. Cities must therefore reasonably expect to take care of such storms.

The result of the study is equivalent to fixing a future expected rainfall as equal to that of the storm of March, 1913, plus one-third additional in the White River Valley, and one-fourth additional in the Wabash watershed. Small drainage areas are yet to be studied. The river dis-

charge resulting from the specified rainfall is determined from river gagings at selected points during the flood stages of March, 1913. Adjustments are made for various rainfall and channel slopes directly as the rainfall and as the one-fourth power of the slope.

To determine the area of channel or bridge opening to carry this flow, the commission suggests tentatively six feet per second as a flood velocity through an improved channel, and not over eight feet per second as a velocity through bridge openings. In any particular case, special study of channel conditions must be made. The Indiana Flood Commission has thus proceeded with the compilation of recommended bridge openings throughout the various parts of the State, as an approximate solution of our present difficulties. A survey of actual bridge openings through the State accompanies this study.

SECOND PROBLEM.

Design of Works.

The second problem is to design flood protection works to take care of the water which is recommended to be carried. This is not a difficult problem, involving only good engineering knowledge and judgment.

These flood improvements will consist in improvement of the channels of the rivers involving cleaning and straightening the river bed and lengthening the bridges, and removing obstructions, and secondly the building of levees to retain the flood heights. If proper surveys exist, reservoir control may be studied.

The Indiana Flood Commission has gathered together a number of plans that have been drawn for the Indiana cities, and it is in a position to assist communities that desire advice on the nature of flood protection works.

THIRD PROBLEM.

Construction Work.

After complete information has been gathered, and the best engineering skill has been operating, a third and most important step must be taken. There must be some organization to finance and build flood protection works. In other words some legislative action must be taken, some so-called enabling legislation. In any community some agency must be created to determine the necessity of improvements, to direct their construction, and to establish an assessment roll for benefits and damages

within a district defined in advance. And this agency must be appointed and directed by the courts or by a State board.

This is the crucial problem. It involves the coördination of several, at present unrelated agencies, as for instance the city government, the county commissioners, and the railways.

Of what benefit is it to a city like Peru, to spend \$350,000.00 on a levee, if this scheme demands for its proper action the lengthening of a county or railway bridge, when the county commissioners or railway officials refuse to coöperate.

It must also be remembered that we all have gone ahead creating new obstructions in the flood plain and in the channel which interfere with the flow of our flood waters. Railways, cities and county commissioners are responsible for the conditions. Channel obstructions must be removed, and either the State or the Federal Government must take action. Some control must be exercised over present as well as future constructions in the channels.

FOURTH PROBLEM.

Valley Protection.

When we take a wider view than that of the specific problem of a single city, we must consider a flood protection scheme from the standpoint of the watershed as a whole. One city in Indiana has made flood protection plans which deflect the water around the city, and throw it around in increased volume on its neighboring down stream. Cities often content themselves with sluicing the water through the cities and pile them up on communities below. Here is again the problem of state action to protect the whole people. Fortunately this is not merely an action of control, but means a wider viewpoint that may disclose a cheaper and better method of protecting the whole valley.

FIFTH PROBLEM.

Maintenance.

After these works have been constructed, we have a fifth problem in their maintenance. It must be recollected that these works are built to protect against floods which happen only once or twice in a generation. Naturally such works as levees and reservoirs will tend to be neglected during this unused interval. If people construct dwellings and operate industries in a space supposedly protected by improperly maintained reser-

voirs, or levees, they are in jeopardy. In this case the State must exercise some power to protect the people and see that these works are maintained.

SIXTH PROBLEM.

Federal Action.

In considering the question of floods the view is successively of city, of county, of watershed, of State; and finally the rights and duties of the Federal Government come into view. Our present problem is to delimit and properly apportion the action and responsibility as between the States and the Federal Government. At present the Federal Government controls all openings and obstructions in navigable streams. The logic of the situation would extend this to the upper reaches, because what happens there will affect navigation below.

For instance, if, due to obstructions, bars pile up on bridges and soil is washed down and creates bars below, there is a real connection between the upper reaches and the lower parts of the river.

Again, the Weather Bureau is in the best position to take observations of rainfall, and the Geological Survey can best and does make the topographic surveys, and the stream gagings.

Thus in this problem, the complex question of the division of water control, as between the States and the Federal Government, is to be determined in the future. A watershed is a natural unit, and not a political unit. There should be some coördination between the States in the Ohio Valley, whose problems are very similar.

AN APPARATUS FOR AERATING CULTURE SOLUTIONS.

PAUL WEATHERWAX.

A number of experiments on various phases of plant physiology, in each of which it was necessary to secure a constant stream of air continuing for several days, has led to the construction of a very efficient piece of apparatus for that purpose. The apparatus used by Prof. D. M. Mottier several years ago for aerating artificial cultures of algæ was modified by F. L. Pickett and used in a series of experiments on desiccation; and the writer has made some further changes in the construction of the apparatus shown in the figure and described below. This is now being used very successfully in the aeration of culture solutions.

The principle employed is that of the Sprengel mercury pump (water being used as a liquid in this case) by which bubbles of air are entangled in a stream of liquid which flows into a closed vessel. The only thing that remains to be done is to separate the air and the liquid, which are under slight pressure, and convey them from the reservoir by separate tubes.

The first problem is that of getting a stream of water that will flow uniformly. An attachment to a water pipe is usually sufficient for this. If this is not satisfactory, however, a siphon may be arranged to give a uniform flow. D, in the figure, is an ordinary battery jar provided with a siphon, B, which has an adjustable stopcock. A, which taps a water pipe and has an adjustable stopcock, supplies the jar with water a little faster than it is taken out by the siphon, B. Another siphon, C, removes the excess and keeps the water always at the same level, determined by its outer end, thus assuring an even flow, which should be just fast enough to cause the water to fall as a succession of drops.

The funnel, E, made by fitting a stopper into the end of a short piece of glass tubing about 1 cm. in diameter, has the end of the slender tube, F, extending 2 or 3 mm. above the cork. By means of this arrangement the water dropping into the funnel is caused to descend through the tube as a series of drops separated by spaces filled with air. Thus, if no escape is allowed, the reservoir, K, is filled with water and air under a pressure

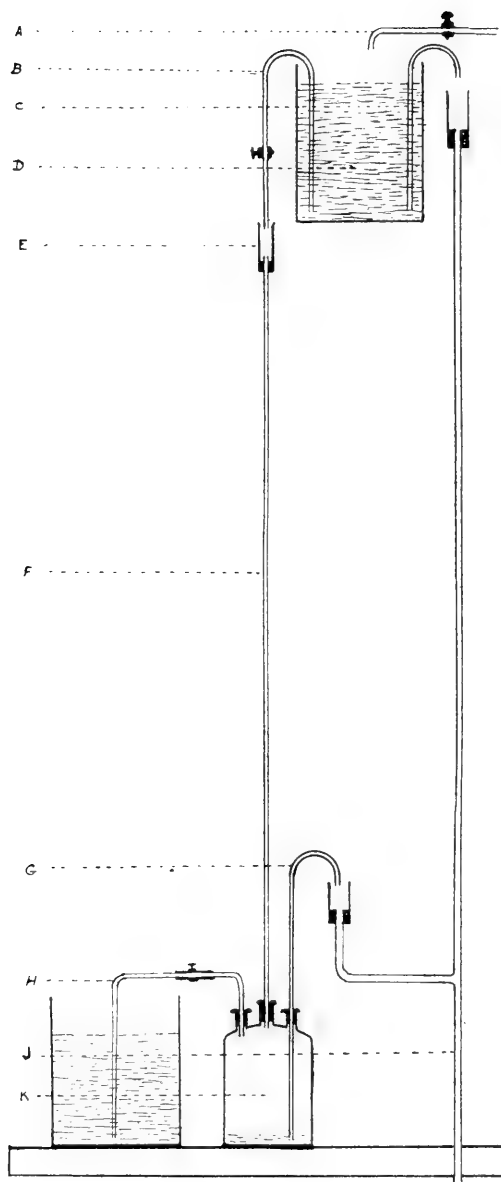
equal to that of the aggregate length of all the water drops in E at any one time. But the air escapes through H, under control of a pinchcock, and the water is forced out through G. The waste water escapes through J.

The flow of air through H must be so regulated that water is forced out through G just a little faster than it enters from F. This provides for an occasional release of surplus pressure by the escape of air through G and prevents the filling of K with water, as will be the case if the air is allowed to escape too fast through H. The only irregularity of flow is at the time of the release of pressure through G; but the air stream is seldom interrupted for more than a few seconds, and by careful adjustment the frequency of these interruptions may be reduced to a minimum. Perfect adjustment would entirely eliminate these irregularities by allowing the water to escape through G just as fast as it enters through F; but, perfection being impossible, it is better to have the interruption occur as an escape of air through G than of water through H.

Theoretically the pressure of the air issuing from H, and consequently the depth to which a solution can be aerated, is determined by the vertical distance from the level of the water in K to the outlet of G. In practice, however, the apparatus falls somewhat short of this, due to friction of the air through H and the capillarity of the liquid to be aerated. The density of the culture solution is, of course, a determining factor also.

The efficiency of the apparatus depends largely upon the nature of the tube F. If it is of too small bore, the friction is too great; and if it is too large, the water has a tendency merely to run down the inside surface and fails to carry any air with it. A very satisfactory size of tube is one having an internal diameter of 2 to 4 mm. If a larger quantity of air is needed at H, the pressure to remain the same, it is better to use two tubes for F than to try to increase the capacity by substituting one larger tube. If the pressure is to be increased and the amount of air to be delivered in a given time is to remain the same, G must be lengthened, and this may necessitate the lengthening of F also, for F will carry air only so long as the aggregate length of its water column is greater than that in G. In adjusting the apparatus, glass or metal stopcocks have been found more satisfactory where the flow of water is to be regulated, while pinchcocks on pieces of rubber tubing have been found best for regulating the stream of air.

When well adjusted and in good working condition the apparatus is economical. Tests on the one now in use have shown that it can be made



An Apparatus for Aerating Culture Solutions.

to deliver 50. c. c. of air per minute at a depth of 15 cm. in a $\frac{1}{2}$ per cent. Knops solution at the expense of 50 c. c. of water. At this rate less than 20 gallons of water per day would be used with the apparatus running continually.

The apparatus as now in use is designed for the aeration of water cultures, but its wide range of adjustment and its economy will permit its being used for many other purposes. Various devices may be attached at H for changes of temperature, humidity, or chemical nature of the air, provided that allowance be made for the increased pressure that may be necessary.

Where it is desired that the stream of air be carefully guarded from outside contamination, this apparatus is clearly the superior of any by means of which the air is drawn through tubes by an aspirator at the end, for it is a decided advantage in such cases to have the pressure, which determines the direction of any possible leakage, outward rather than inward.

Indiana University,
Bloomington, Indiana.

ANTAGONISM ON *B. FLUORESCENS* AND *B. TYPHOSUS* IN CULTURE.

P. A. TETRAULT.

It is a fact long established that when two organisms live together in close relationship, the association will be one of tolerance, of mutual benefit or of one-sided injury. The term antagonism as used in this paper has more the meaning of one-sided injury. The phenomenon, for the bacteria, was recognized as far back as 1888 when Freudenreich and Garre, working independently, demonstrated specific antagonisms between given bacterial forms. The last named worked especially with *B. typhosus*. It was found that the typhoid organism did not thrive in a medium where certain other bacteria had previously grown; in other words, the cell secretions were toxic for *B. typhosus*.

W. D. Frost,* working on this same problem, discusses a number of theories advanced to account for this phenomenon.

One theory is that of the exhaustion of the food supply. All the available food has been extracted from the medium by the first organism growing on it. This was controverted by Olitzky by demonstrating that *Micrococcus aureus* would grow on a medium which had nourished a previous crop of bacteria but which did not permit the growth of *B. typhosus*.

Another theory was that of enzyme action. This, Frost says, could not hold in this case because enzymes are colloidal in nature and could not pass through a collodion membrane.

A history and comparison of the different cultures used in my work is given below.

All the cultures came from The Museum of Natural History, New York. No. 29 was obtained originally from the University of Chicago and was isolated from the swimming pool. No. 469 came from the Kral laboratories, Germany. No. 31 also came from the University of Chicago.

*The Antagonism Exhibited by Certain Saprophytic Bacteria against the *B. typhosus* Gaffky. Jour. of Inf. Diseases. Nov. 5, 1914.

was isolated from the Mississippi River and was labeled *B. fluorescens liquefaciens*.* No. 502 came from the University of Vermont and was labeled *B. fluorescens tenuis*.

When grown on various media these cultures gave the following reactions:

TABLE I.

Media.	No. 29.	No. 469.	No. 502.	No. 31.
L. milk	Digested.	Digested.	No reaction.	No reaction.
Lac. broth	No gas.	No gas.	No gas.	20%.
Nitrate broth.	Nitrates reduced.	Nitrates reduced.	Nitrates reduced.	Nitrates reduced.
Pep. broth	No indol.	No indol.	No indol.	No indol.
Gelatin.	Liquefied.	Liquefied.	Not liquefied.	Not liquefied.†

The only appreciable differences between these two groups of cultures lie in the litmus milk and gelatin reactions. This would suggest that the process was one of digestion, but by direct microscopic methods it could not be determined. When *B. typhosus* was mounted in some of the sterilized *B. fluorescens* filtrate and examined under the microscope, no agglutination was observed.

When the two organisms *B. fluorescens* and *B. typhosus*, are grown in parallel streaks on solid media, it is found that there always remains a zone between the two where no growth occurs, *B. fluorescens* gives off a pigment which facilitates the study of this phenomenon by microscopic methods. *B. typhosus* never trespasses over the green border line put up by *B. fluorescens*. This suggested a further study of the two organisms in liquid media. The method was practically the same as that used by W. D. Frost in his work on "The Antagonism Exhibited by Certain Saprophytic Bacteria against the *B. Typhosus Gaffky*" and described in his article on "Collodion Sacs."‡

A gelatin capsule is fastened onto the end of a glass tube by heating the tube slightly before applying the capsule. The capsule and part of the tube are then dipped into collodion and allowed to harden. After a few dippings the sac is strong enough to stand without the aid of the gelatin. The gelatin is dissolved by means of hot water and the sac is ready for use. The sac is filled with nutrient broth and inserted into a flask con-

*Although labeled *B. f. liquefaciens*, No. 31 failed to liquefy gelatin.

‡Reports and Papers of the Am. Pub. Health Assn. Vol. 28.

taining the same kind of medium. After sterilization in the autoclav, the sac and flask are inoculated with the different cultures to be studied. The sac prevents the bacteria from mingling but, being permeable, permits the diffusible products of metabolism to distribute themselves uniformly throughout the liquid medium. By taking samples from both tube and flask and plating, it becomes a rather simple matter to determine whether the life or the growth of either organism is affected by the manufactured products or wastes of the other.

The experiments were run in series. Each series consisted of five flasks. Four of these contained *B. typhosus* in the sac and one of the cultures of *B. fluorescens* in the flask. The fifth was used as a control and contained only *B. typhosus*. Four of these series were run simultaneously. The temperature was 37 degrees Centigrade. The experiments ran through a period of twelve weeks.

Of the strains of *B. fluorescens* used, cultures No. 29 and No. 469 imparted a very deep color to the medium after growing for twenty-four hours; No. 31 and No. 502 imparted very little color.

The next table shows a certain correlation between the elimination of *B. typhosus* by *B. fluorescens* cultures secreting a deep colored pigment as compared with those cultures secreting very little pigment.

TABLE II.

Flask-containing <i>B. fluorescens</i> .	Sac containing <i>B. typhosus</i> .
After twenty-four hours incubation.	
No. 29	Growth.
No. 469	Growth.
No. 502	Growth.
No. 31	Growth.
After forty-eight hours incubation.	
No. 29	No growth.
No. 469	No growth.
No. 502	Growth.
No. 31	Growth.
After seventy-two hours incubation.	
No. 29	No growth.
No. 469	No growth.
No. 502	Growth.
No. 31	Growth.

The above table shows that the secretions of *B. fluorescens* in the flask penetrate the collodion sac containing the typhoid culture. There takes place, then, not merely an inhibitory action, but an actual bactericidal one. The secretions have to be of a certain concentration before this action takes place. It is found that the above is not true for the cultures showing slight chromogenesis.

In the next experiment, *B. fluorescens* was planted and allowed to grow before *B. typhosus* was introduced into the sac. The following table shows the results obtained.

TABLE III.

After growing *B. fluorescens* for twenty-four hours, inoculating the sac with *B. typhosus*, and again incubating for twenty-four hours :

<i>B. fluorescens.</i>	<i>B. typhosus growth.</i>
No. 29	Absent.
No. 469	Absent.
No. 502	Present.
No. 31	Present.

After growing *B. fluorescens* for forty-eight hours, inoculating the sac with *B. typhosus*, and again incubating for twenty-four hours :

<i>B. fluorescens.</i>	<i>B. typhosus growth.</i>
No. 29	Absent.
No. 469	Absent.
No. 502	Present.
No. 31	Present.

This table shows that once the toxic substances are produced in sufficient quantities and time enough is given for them to penetrate the sac, the typhoid organisms will not grow.

In the next experiments the fluorescens organisms were grown for ten days, then filtered and the filtrate sterilized for ten minutes at a pressure of fifteen pounds in the autoclav. The sterilized filtrate was then inoculated with *B. typhosus* and at the end of twenty-four hours samples were plated with plain agar and incubated.

The results are shown in the following table :

TABLE IV.

<i>B. fluorescens.</i>	<i>B. typhosus growth.</i>
No. 29	Absent.
No. 469	Absent.
No. 502	Present.
No. 31	Present.

The active substance is not destroyed at the temperature of live steam under fifteen pounds pressure for fifteen minutes.

CONCLUSIONS.

The specific antagonism of *B. fluorescens* for *B. typhosus* is due to a substance secreted by the first named organism.

This antagonism is not characteristic of all *B. fluorescens* cultures. There seems to be a correlation between the intensity of the color and this property.

The action is bactericidal.

B. fluorescens cultures with slight pigment production do not prevent the growth of *B. typhosus*.

The metabolic substances must reach a certain concentration before they become effective.

The toxic substances secreted by *B. fluorescens* have the following properties:

1. They are thermo-stabile.
2. They are diffusible through a collodion sac.

Although the growth of *B. fluorescens* in milk would suggest a digestive process, the typhoid bacilli are not agglutinated when grown in a sterilized filtrate of the first named organism.

NOTES UPON THE DISTRIBUTION OF FOREST TREES IN INDIANA.

STANLEY COULTER.

It is recognized at the outset, that even in a restricted area, such as that under consideration, much of uncertainty is given to any conclusions drawn because of lack of exact data covering every part. The richness of the tree flora in a given county as contrasted with that of adjoining counties, is usually to be explained by the presence of a skilled and persistent worker. It is very certain that no county in the State is entirely destitute of trees, in spite of the fact that not a single species may be reported as occurring within its bounds in any published report.

It frequently happens, also, that reports covering certain counties have been based upon the work of untrained observers who have failed to discriminate closely related species or who have made incorrect determinations, in either case confusing the situation and necessitating a careful revision of the data. While effort has been made to eliminate errors arising from such causes it is more than probable that some have escaped detection, but in the main as regards the species discussed the data seem accurate and complete.

Of the one hundred twenty-six indigenous species mapped in connection with this study, the larger part by far are probably of general distribution throughout the State. Variation in the density of the stand and in the size and form of individual trees are of course found, but the non-occurrence of any one of the species of this group in any county, under favorable conditions, would be more notable than its presence.

A relatively small group is confined to the extreme northeastern counties of Lake, Porter and Laporte.

Quite a large group is restricted to the southern counties or those lying in the first three tiers north of the Ohio River. A peculiar tree flora within this group is that of Posey, Gibson and Knox counties, lying along the lower stretches of the Wabash River. Some of the trees reported from this subdivision no doubt are of wider range than indicated, since few

counties in the State have been worked with such persistence and with such painstaking accuracy. Others of the species are doubtless restricted to the rich alluvial soils of the lower Wabash Valley.

To these might be added a small group showing a distribution so unconnected as to be extremely difficult of explanation. An instance is found in *Pinus Strobus* L., which is found in Lake, Porter and Laporte, extreme northwestern counties; Warren and Montgomery, western-central counties; and in Clark in the southeastern part of the State. Its occurrence in the northwestern counties affords no difficulty; the western-central location might be explained as a continuation of the former area; but the recurrence of the species in Clark County on the Ohio River in the eastern part of the State furnishes a difficult problem. In the case, also, of *Cratagus coccinea* L., we find equally unrelated areas, this species being reported only from Noble and Steuben, extreme northeastern counties, and Floyd, a southern county on the Ohio River. The genus *Cratagus*, however, presents such difficulties in the discrimination of species that the case just cited may possibly be due to lack of accuracy in determination.

The species limited to Knox, Gibson and Posey counties or to some part of the area are as follows:

Taxodium distichum (L.) L. C. Richards.

Hicoria Pecan (Marshall) Britton.

Quercus lyrata Walter.

Quercus Michauxii Nuttall.

Quercus falcata Michaux.

Celtis mississippiensis Bose.

Cratagus viridis Linneus.

Cratagus nitida (Engelmann) Sargent.

Gleditsia aquatica Marshall.

Ilex decidua Walter.

Forestiera acuminata (Michaux) Poinet.

In addition to these species, which seem strictly limited to the region named, two others have been reported from a single additional county:

Catalpa speciosa Warder. Gibson, Knox, Posey and Vigo.

Fragaria Michauxii Britton. Gibson, Posey and Marion.

The Bald cypress (*Taxodium*) is a southern swamp form, which finds in the Indiana locations its extreme northeastern limits. In Indiana it is

found only along the wet (often submerged) banks of streams or in river swamps or sloughs. The local distribution has been carefully worked out by Deam.¹ While not as large a tree as in the South Atlantic and Gulf States the species as found in Indiana often reaches a height of 145 feet and a diameter of six feet. The species may be regarded as having entered the State in the period of flooded streams, maintaining its foothold in situations unfavorable for the ordinary species of this latitude. The areas in which the species occurs in the State are being rapidly reduced by agricultural operations and its disappearance from the tree flora of the State seems inevitable.

The Pecan (*Hicoria Pecan*) nowhere wanders far from the lowlands adjoining river courses. The species has been so largely cultivated in the State both for ornament and fruit that its original locations in the State are difficult to make out. Unquestionably its mass occurrence was in Knox, Gibson and Posey counties. Its occurrence in Vigo County, reported by W. S. Blatchley, is unquestionable, but may be regarded as exceptional. A record of its occurrence in Fountain County recorded in Indiana Geological Report, 1882. Vol. 11, p. 122, is of doubtful validity and may safely be disregarded. The remaining citation from Jefferson County (A. H. Young) is based upon a single tree located in the river bottoms near Hanover. It stood alone in a large bottom land, otherwise destitute of trees. It was near a dwelling and for this reason and because of its small size, it is a fair inference that it was a cultivated form. It is to my mind certain that the pecan as a member of the Indiana tree flora is mainly confined to the three southwestern counties, but extending in greatly reduced numbers northward as far as Vigo County. In any event, the northeastern limit of the species is reached in these locations. The trees are smaller than those of more southern and western localities and according to Deam, "only about one-fourth of the native trees ever bear fruit and only about one out of every ten trees is a profitable nut-bearing tree."² This southern and western form probably entered our area at about the same time and under the same physical conditions as the Bald cypress.

The Over Cup Oak (*Quercus lyrata* Walt.) according to Sargent occurs in "river swamps and small deep depressions on rich bottom lands, usually wet throughout the year."³ This would explain the close restriction of the

¹Eleventh Annual Report. Indiana State Board of Forestry, 1911. p. 108.

²Deam:—Op. cit. p. 138.

³Sargent. Manual of the Trees of North America. p. 269.

species to Gibson, Knox and Posey counties. The species is mainly coastal, occurring along the Atlantic and Gulf coasts, finding its way into the interior along the valley of the Mississippi and its tributaries. The occurrence of this coastal species, and of others which might be cited, in regions so markedly interior, suggests the thought that they entered our flora at the time when the great northward arm of the Gulf of Mexico practically divided the area of the United States into distinct eastern and western regions. A comparison of the boundaries of this arm of the Gulf of Mexico with the distribution of many species of plants gives striking support to such an explanation. In Indiana, the species is not ordinarily separated from the Burr oak (*Quercus macrocarpa* Michx., which it closely resembles.

The Cow or Basket Oak (*Quercus Michauxii*, Nuttall) so far as our records go occurs only in Knox and Gibson counties, where it is found in low, rich bottom lands. This restriction of area may be due in part to the close resemblance in size and habit of this species to the Swamp White Oak (*Quercus bicolor* Willdenow) and a consequent failure to distinguish it from that species. This oak, also, is more or less coastal in its mass distribution, finding its way into the interior along the valley of the Mississippi; while the Indiana localities represent its northeastern limit the species maintains its normal size and habit. Its ability to maintain a foothold in localities often covered with water serves to explain its persistence in the counties named.

The Spanish Oak (*Quercus falcata* Michaux) is reported definitely from Knox, Gibson and Posey counties, with an additional citation from Fountain County (Brown) which the writer has not had opportunity to verify. Some difficulty arises in this case because of the question of the validity of the species. According to Sargent *Quercus falcata* is separable into two species, *Quercus digitata* Sudworth, and *Quercus pagodaefolia* Ashe. According to Gray's Manual¹ *Q. falcata* is found on dry or sandy soil; upon the authority of Sargent *Q. digitata* grows in similar soils on dry hills; while *Q. pagodaefolia* occurs on rich bottom lands and alluvial banks of streams. In Indiana the form in question "is usually found in low ground, associated with *Quercus bicolor*, *Q. palustris*, *Q. Schenckii*, *Q. stellata* and *Q. velutina*. The whole of the township is low."² The habitat as well as considerations of distribution would seem to indicate the species to be *Q. pagodaefolia* Ashe instead of *Q. falcata* Michaux. In the Proceedings of

¹Gray's New Manual of Botany. Seventh Edition. p. 343.

²Deam. Op. cit. 207.

the Indiana Academy of Science, Vol. 11, page 142, and Vol. 12, page 299, I have previously expressed the opinion that the species in question is *pagodwfolia*. If this is true, this southern form came into our area along the valley of the Mississippi, and a species which is a large and valuable "timber tree in the river-swamps of the Yazoo basin, Mississippi, and of Eastern Arkansas"⁶ might reasonably be expected in the low, wet bottom lands of the lower Wabash Valley. The Indiana station represents the northeastern limit of the species, a fact reflected in its sparing occurrence and reduced size. Deam's collection of 1915 show the occurrence of this species in Jefferson County.

The Yellow Hackleberry (*Celtis Mississippensis* Bosc.) is frequent or common along streams and in the lowlands of Gibson, Knox and Posey counties. It is a southern and western form, reaching a height of from 60 to 80 feet and a diameter of from 2 to 3 feet in the basin of the lower Ohio River. In Indiana which represents its northern limit the tree "is inclined to grow scrubby and crooked." (Deam.) It is medium sized, rarely exceeding a diameter of 18 inches. Its occurrence within our area is easily explained, since the counties named are not especially far removed from the center of its maximum development both as to size and numbers. It is a little difficult, however, to explain why it has not spread more widely in the State.

The Southern Thorn (*Crataegus viridis* Linnaeus) is distinctly southern and somewhat western in its mass distribution, reaching its greatest abundance and largest size in western Louisiana and eastern Texas. It is found along stream borders and the margins of swamps in moist soils, doubtless finding its way into our area when such conditions were practically continuous.

The Shining Thorn (*Crataegus nitida* (Eng.) Sargent) is said in Sargent's "Trees of North America" to occur on the "bottoms of the Mississippi River in Illinois opposite the city of St. Louis." The species occurs in rich bottom lands in both Gibson and Posey counties in fair abundance as a small tree, from 20 to 30 feet high and with a broad and handsome crown. As a result of the recent work in the segregation of species in the genus *Crataegus* it is practically impossible to form any definite notion as to the range of any particular form. Much field work will be necessary before we can determine just what species of this puzzling genus are members of our flora. No opinion is expressed, therefore, regarding the source from

⁶Sargent. Op. Cit. 245.

which *C. nitida* came into the State. There is as much reason for regarding the Illinois station as the westward extension of the Indiana station as the reverse.

The Water Locust or Thorn Tree (*Gleditsia aquatica* Marshall) is found in a few localities in Gibson, Knox and Posey counties in sloughs and cypress swamps. This is a northern and eastern extension of a definitely southern species which must have entered our flora at a time when the swamp areas of the river bottoms were practically continuous and which has been able to maintain itself only in occasional deep river swamps within our boundaries. In Indiana the species is both rare and local and one which will, in all probability, soon disappear.

One of the Hollies (*Ilex decidua* Walter) occurs occasionally in the three southwestern counties, being invariably restricted to the borders of ponds and sloughs near water courses. Although at times it forms fairly dense thickets, it rarely, in our region, reaches tree size. The distribution as given in Sargent's "Trees of North America," p. 618, is significant in this connection: "Borders of streams and swamps in low moist soil; southern Virginia to western Florida in the region between the eastern base of the Appalachian Mountains and the neighborhood of the coast, and through the Gulf States to the valley of the Colorado River, Texas, and through Arkansas and Missouri to southern Illinois; usually shrubby east of the Mississippi River and only arborescent in Missouri, southern Arkansas and eastern Texas." It is merely another instance in which an essentially coastal form has found its way deep into the interior. When considered in connection with other cases, some of which have been cited, the conclusion is almost inevitable—that the only adequate explanation is to be found in relating it to the northward stretching arm of the Gulf of Mexico.

Pond-bush (*Forestiera acuminata* (Michaux) Poiré) is another species strictly limited to Gibson, Knox and Posey counties where "it is found in swamps, on the borders of ponds and on low river banks. It is very tolerant of shade and is frequently found growing in a thick stand of tall trees."⁷ The Indiana stations represent the extreme northeastern limit of this species, which extends westward to Missouri and south to Texas. In Indiana it is ordinarily a shrub, at times forming almost impenetrable thickets. It is impossible to determine from the data at hand as to whether this is a western or southern form. In either case its habitat,

⁷Deam. Op. Cit. 342.

"low, wet river banks and swamps" suggest the same reasons for its occurrence in the Indiana flora as has been suggested for the preceding species.

Hardy Catalpa (*Catalpa speciosa* Warder) is a tree of the borders of streams and ponds and of fertile often flooded bottom lands. According to Sargent it is probably found in its greatest abundance and of the largest size in southern Illinois and Indiana, extending to western Kentucky and Tennessee, southeastern Missouri and northeastern Arkansas. In Indiana it is confined to Knox, Gibson, Posey and Vigo counties as a member of the original forests. Its occurrence in other counties is due to its widespread cultivation for post material or for ornamental purposes. Deam says,⁸ "In Indiana it was found along the valley of the Ohio River as far east as Rockport and in the valley of the Wabash as far north as Vigo County. The mass of its distribution was west of a line connecting Terre Haute and Rockport." The citations given are, however, all that can be considered as verified. In the catalpa we evidently have another case in which the distribution is easily explained if it is related to a northward extension of the Gulf or to a condition of flooded rivers.

The Swell-butt Ash (*Fraxinus Michauxii* Britton) usually grows in low grounds which are inundated for several months during the year. As its common name indicates the swollen base is characteristic of this species. It has been collected in Gibson, Posey and Marion counties by C. C. Deam. The Gibson and Posey County stations represent normal conditions for the species; the Marion County collection is in different case. The tree, which was of medium size, was growing in moist soil by the roadside. The known care and accuracy of Mr. Deam preclude any doubt as to the determination, so that the occurrence of the species in this station must be referred to some accidental means of transportation or to what is perhaps more probable, the incorrect labelling of material furnished by some nursery for roadside planting. As a component member of our native forests the species is undoubtedly confined to Gibson and Posey counties. As this is a species but recently segregated its distribution is not yet thoroughly known. It, however, is known to range from New York to North Carolina and Louisiana and west to Missouri.

This is very evidently another case of a species of coastal distribution with a seeming extension well into the interior.

If we summarize these thirteen species, peculiar to our southwestern counties we find them all to be swamp forms or those growing in bottom

⁸Deam. Op. Cit. pg. 347.

lands frequently inundated during the year, or in low moist localities. We find that the larger part of them, in their mass distribution follow the swamps of the Atlantic or Gulf coast, or of both. It is very evident also that the extension of range northward must have occurred when similar physical conditions existed; that is, either at the time the Gulf of Mexico stretched an arm far into the north, or if a later date is preferred in the time of the flooded rivers and lakes of the Champlain period. Occasional means of transportation may serve to explain occasional cases, but where species become component parts of a forest in a region apparently remote from their mass distribution a different explanation must be sought.

Six species, so far as the records go, are confined to Lake, Porter and LaPorte counties or to some one of them. In this region, also, extremely skillful and persistent work has been done by Rev. E. J. Hill, a fact which should be taken into account. The species peculiar to this region are the following:

- Pinus Banksiana* Lambert.
- Thuja occidentalis* Linnaeus.
- Betula populifolia* Marshall.
- Betula papyrifera* Marshall.
- Alnus incana* (Linnaeus) Muenchhausen.
- Celtis pumila* (Muhlenberg) Pursh.

The Jack or Scrub Pine (*Pinus Banksiana* Lambert) occurs in Lake and Porter counties, where it is fairly common on the sand dunes bordering Lake Michigan. The general range of this species is decidedly northern, the Indiana stations representing in all probability its extreme southern limit. In our area it is an undersized, rather shrubby form, maintaining itself with difficulty. The continuity of waterways is the evident explanation of the occurrence of this species in the Indiana tree flora.

The Arbor-Vite or White Cedar (*Thuja occidentalis* Linnaeus) apparently occurs native only in Lake County. This characteristic species of northern swamp regions is found only in cold swamps of our area. There seems no good reason why it should not be found in similar situations in other counties bordering Lake Michigan. The form has been so extensively planted for windbreaks and for ornament that many incorrect citations are on record. Its presence as a member of our flora is evidently referable to continuous waterways furnished by the Great Lakes.

The Gray or White Birch (*Betula populifolia* Marshall) is found in

scant numbers and of small size in Lake, Porter and Laporte counties. This typical northern species may also be regarded as one that has retained a foothold in isolated localities after the recession of the shores of Lake Michigan and the disappearance of the bordering swamps. The reported occurrence of the species in Tippecanoe County (Golden) "in sparing numbers along the Wabash River" demands further study. The well-known difficulty of discriminating the species of *Betula*, due to seasonal and age changes in appearance and habits, suggests that a closer study may prove the reference an error.

The Paper or Canoe Birch (*Betula papyrifera* Marshall) is found in Lake and Porter counties, always being reported as rare and of small size. This is another species definitely northern in its mass distribution, the Indiana stations standing as its extreme southern limit. It is probably another of the species which entered our area in the time of flooded rivers and lakes of the Champlain but one which has been able to maintain a precarious foothold up to the present time. Its early disappearance from the tree flora seems inevitable.

The Tag or Speckled Alder (*Alnus incana* (Linnaeus) Mueenchhausen) is found in Lake and Porter counties between dunes near to the lakes. This is the common alder found in swamps and on the borders of streams further north. It has been able to maintain itself in our area in greater numbers and with less reduction of size than any other one of these extreme northern species.

A dwarf shrubby form of Hackberry (*Celtis pumila* (Muhlenberg) Pursh) is included. In both Gray and Sargent the form is regarded as a variety of *C. occidentalis* Linnaeus. Its general range is in the South Atlantic States ranging westward to Missouri, Colorado, Utah and Nevada. It has been reported only from Lake County near the Calumet River at Millers. Its occurrence in such a restricted locality is rather puzzling and as yet no satisfactory explanation has been reached. The form in the greater part of its range occurs on rocky banks of streams—a condition not even approximated at its Indiana station. The temptation to regard it as an ecologic variant of the very common *Celtis occidentalis* is almost irresistible.

Of the six species just discussed, five are definitely northern in their mass distribution. Their presence as members of our flora is very evidently referable to the continuity of waterways existing during the

Champlain period. The more difficult problem is the explanation of their persistence.

A consideration of a few other species will serve to emphasize the point in mind.

The Larch or Tamarack (*Larix laricina* (DuRoi) Koch) is found in Porter, Marshall, Kosciusko, Noble, Steuben, DeKalb and Blackford. An examination of the older shore lines of Lake Michigan gives a sufficient explanation. Even the Blackford County citation, which seems well to the south, is made clear when the ancient bay of Lake Michigan extending southward through Allen County in the neighborhood of Fort Wayne is recalled.

Thus also the eastern Peach-leaved Willow (*Salix amygdaloides* Anderson) found in Lake and Kosciusko finds ready interpretation, as does also the case of the Wild Red Cherry (*Prunus Pennsylvanica* Linnaeus fil.) occurring in Lake, Porter and Kosciusko counties.

Any one who maps some of the more widely ranging species of the State will be immediately impressed by the close relations existing between the distribution of the species and the course of waterways. In some instances the distribution follows a single waterway, in others it seems to follow not merely the main stream but also all of the tributaries. Indeed, by far the most striking feature in the series of one hundred twenty-six maps is the definite way in which this relationship stands out. The most cursory inspection of the maps reveals it and serves to suggest at least a possible causal relation.

In the opinion of the writer the occurrence of given species in widely separated localities without intervening stations will be found to be due to the existence at some time in the past of practically continuous waterways connecting these now separated localities. Further, that such connections, in so far as the region under consideration is concerned, are mainly to be found in the Champlain period, although perhaps in some cases this connection was furnished by the northward stretching arm of the Gulf of Mexico. If the shore lines of streams and lakes of the Champlain period could be drawn upon our present maps many of our problems in Phytogeography would solve themselves. In confirmation of this view is the dominating influence of continuous waterways or of streams in the distribution of species clearly shown by any careful study of present range extensions.

In the main, widely ranging species, at least among trees, do not have

this wide range because of any perfection of seed dissemination, nor because of occasional means of transportation. It has more probably been brought about by a former connection of these separate regions, making them practically continuous. Such practical continuity may have been secured by means of the flooded rivers and swollen lakes of the Champlain period. This is not offered as a solution of all of the problems of plant distribution, but in the firm belief that in many of these problems the solution is to be sought in former physical conditions.

It was the original intention that the present paper should also include a discussion of the species restricted to the southern tiers of counties, but the time required to work our former shore lines and water-levels for that region was too great. The preliminary work, however, seemed to indicate confirmation of the conclusions indicated in this paper.

CORRECTIONS TO THE LISTS OF MOSSES OF MONROE COUNTY, INDIANA, I AND II.

MILDRED NOTHNAGEL AND F. L. PICKETT.

At the winter meetings of the Indiana Academy of Science in 1912 and 1913, the authors presented lists of the Mosses of Monroe County, Indiana. Since the publications of these lists, several corrections in identification have been made and these will be listed below. The correct names will appear first, the former name in parentheses after the accession number.

Corrections to the 1912 list of Monroe County Mosses, I.

Fissidens minutulus Sull. (44.) (*F. bryiodes.*)

Determined by G. B. Kaiser.

Orthotrichum lescurii Aust. (3). (*O. portori.*)

Determined by G. B. Kaiser.

Brachythecium campestre B. & S. (16). (*B. plumosum.*)

Determined by G. B. Kaiser.

Eurynchium hians (L.) B. & S. (17). (*Brachythecium rutabulum.*)

Determined by G. B. Kaiser.

Plagiothecium geophilum Aust. (22): (*P. deplanatum.*)

Determined by G. B. Kaiser.

Corrections to the 1913 list of Monroe County Mosses:

Barbula unguiculata (Huds.) Hedw. (71). (*Didymodon ru-beillus.*)

Determined by G. B. Kaiser.

Funaria hygrometrica (L.) Sibth. (79). (*F. flavicans.*)

Determined by G. B. Kaiser.

Aphanorhegma serratum Sull. (122). (*Physcomitrium immer-sum.*)

Determined by G. B. Kaiser.

Amblystegium orthocladon (Pb.) Lindb. (98). (*A. fluviatile.*)

Determined by G. B. Kaiser.

Amblystegium varium (Hedw.) Lindb. (93). (*A. serpens.*)

Determined by G. B. Kaiser.

Hypnum curvifolium Hedw. (85). (*H. fertile.*)

Determined by G. B. Kaiser.

H. curvifolium Hedw. (88). (*H. pratense.*)

Determined by G. B. Kaiser.

Indiana University Botanical Laboratory.

THE MOSSES OF MONROE COUNTY, INDIANA, III.

F. L. PICKETT AND MILDRED NOTHNAGEL.

The collection and classification of the mosses of Monroe County, as has been reported by the authors at the winter meetings of the Indiana Academy of Science for 1912 and 1913, was again resumed in the spring of 1914. The present list will include a few forms from Hamilton and Lake counties of Indiana, and Berrien County of Michigan.

The 1914 list of mosses includes twenty-nine new species, from eleven families and twenty-six genera, of which are representatives of one family and thirteen genera not reported in former reports. Material has been prepared, as described in former lists and left in the herbarium of the Botany Department at Indiana University with notes as to time, place, and habitat of the collection as well as condition of specimens. The entire collection in the herbarium now contains specimens, many of them in duplicate from different collections of ninety-five species and five varieties, representing fifty-three genera and seventeen families of the Bryales. In this report, as in former ones, the numbers within the parentheses after the name of the specimen is the accession number.

A great number of the specimens collected this year have been sent to A. J. Grout of Brooklyn, N. Y., or to G. B. Kaiser of Germantown, Pa., for verification or identification and the credit of such will be given in the list.

Order SPHAGNALES.

Family *Sphagnaceae*.

Sphagnum aentifolium Ehrh. (189). Determined by G. B. Kaiser.

In swamps south of Gary, Lake County, Ind. Sterile.

Order BRYALES.

Suborder NEMATOCONTEAE.

Family *Buxbaumiacae*.

Buxbaumia aphylla L. (134).

Matures spores from December to April. On sandy soil in moist ravine.

I. U. pond. Fruiting.

Webera sessilis (Schmid.) Lindb. (145).

Matures spores in spring and early summer. On clay in moist ravine,
I. U. pond. Fruiting.

Suborder ARTHRODONTEÆ.

Family *Dicranaceæ*.

Ceratodon purpureus (L.) Brid. (163, 199). Verified by G. B. Kaiser.
Matures in spring and early summer. On sandy soil about Gary, Lake
County, Ind. Common. Fruiting.

Dicranella heteromalla var. *orthocarpa*. (Hedw.) E. G. B. (136). Ver-
ified by A. J. Grout.

Capsules mature in November and December. On clay on hillside
northeast of Bloomington, Ind. Fruiting.

Dicranum fulvum Hook. (151). Determined by G. B. Kaiser.

Yellowish green mats on beech tree on south side of Griffy Creek,
north of Bloomington, Ind. Sterile.

Family *Grimmiaceæ*.

Hedwigia albicans (Web.) Lindb. (142, 160). Verified by G. B.
Kaiser.

Matures spores in spring. All material collected was sterile. In dark
brownish green mats on decaying wood near I. U. pond.

Grimmia doniana Smith. (130). Determined by G. B. Kaiser.

In thin hoary patches on limestone, I. U. Campus.

Family *Tortulaceæ*.

Tortella cespitosa (Schwaegr.) Limp. (291). Verified by G. B. Kaiser.
Matures spores in spring. Specimen robust and fruiting. Found on
moist rocks above spring, Clear Creek, Ind., Monroe County.

Family *Orthotrichaceæ*.

Drummondia clavellata. Hook. (120, 135).

Matures spores in spring and summer. Found fruiting on bark of tree.
Hamilton County and Monroe County, Ind.

Orthotrichum porteri Aust. (123). Determined by Mrs. E. G. Britton.
Matures spores in the spring. In black-green mats upon limestone.
Fruiting. Rare.

Orthotrichum schimperii Hamm. (173). Determined by G. B. Kaiser.
Matures spores in spring. In dark green cushions upon trees and
stumps in dry places.

Family *Bartramiaceæ*.

Philonotis fontana (L.) Brid. (186). Determined by G. B. Kaiser.

Matures spores in May and June. Found on moist rocks above spring, Clear Creek, Monroe County, Ind.

Family *Bryaceae*.

Mniobryum albicans (Wahl.) Limp. (178). Determined by G. B. Kaiser.

In thick green mats or tufts on rocks near water, northwest of Harrodsburg, Monroe County, Ind. Sterile. Fruits infrequently.

Bryum caespiticium. L. (172). Determined by G. B. Kaiser.

Spores mature in spring. On a decayed log in tufts. Bloomington, Ind. Common.

Family *Leskeaceae*.

Anomodon minor (P. B.) Förn. (133). Verified by G. B. Kaiser.

Sterile specimen. Found on retaining wall along north pike, Bloomington, Ind.

Family *Hypnaceae*.

Rhytidium rugosum (L.) Kindb. (141). Verified by G. B. Kaiser.

Sterile form. In dense light green masses on stone, Harrodsburg, Monroe County, Ind.

Brachytbecium rivulare B. S. (132, 185). Verified by G. B. Kaiser.

Sterile, never found fruiting here. In very moist places or in water.

Bryhnia graminicolor (Brid.) Grout. (154). Determined by A. J.

Grout. Sterile form, rarely found fruiting. On moist clay and stones just above water line in Griffy Creek, northeast of Bloomington, Ind.

B. Novae-angliae (S. & L.) Grout. (197). Determined by G. B. Kaiser.

On edge of swamp, north of Gary, Ind., in loose light green mats. Sterile.

Cirrophylllum boscii (Schwaegr.) Grout. (138, 181, 182). Verified by G. B. Kaiser.

Spores mature in autumn. Found on soil in moist ravine in bright green mats. Sterile form.

Cratoneuron filicinum (L.) Roth. (179). Determined by G. B. Kaiser.

Sterile specimen found in bluish green tufts just above water line in shaded spring.

Amblystegium irriguum (Wils.) B. HS. (180). Verified by G. B. Kaiser.

Sterile specimen. Found just above water line in shaded spring in deep olive to blackish green mats on rocks and clay.

Hypnum molluscum Hedw. (166). Determined by G. B. Kaiser.

Sterile form. On soil on wooded hillside, I. U. dam.

H. patientiae Lindb. (176). Verified by G. B. Kaiser.

Matures spores in spring. Fruiting. Yellowish green mats on decayed log, near Buchanan, Berrien County, Mich.

Plagiothecium deplanatum (Sch.) Grout. (170). Determined by G. B. Kaiser.

Sterile. On limestone in open ravine north of Bloomington, Ind.

Amblystegiella adnata. (Hedw.) Nichols. (170, 184). Determined by G. B. Kaiser.

Matures in summer. Specimen sterile. Found on limestone and on base of tree in dark green mats, about Bloomington, Ind.

Family *Leucodontaceae*.

Leucodon brachypus Brid. (152).

Matures spores in winter. Specimen sterile. In blackish green mats resembling *Hedwigia albicans*. Found on log north of Bloomington, Ind.

Forsstroemia trichomitrium var. *immersum* (Sulliv.) Lindb. (204). Verified by G. B. Kaiser.

Matures spores in summer. Fruiting. On tree in ravine southeast of I. U. dam.

Indiana University Botanical Laboratory.

A NEW ENEMY OF THE BLACK LOCUST.

GLENN CULBERTSON.

During the latter part of June and during July of 1914, the leaves of the greater number of the locust trees in Switzerland, Jefferson, Clark, and Floyd counties, of southern Indiana, were observed to be losing their greenish appearance, and upon closer examination the chlorophyll of the leaflets was found to have been largely consumed. The foliage appeared as though dried up as a result of a severe drouth. Here and there individual trees, at a distance from groves, were unaffected, but the trees of practically every grove, at least among the hills of the Ohio and tributaries were seriously affected. So evident was this that the brown and sere appearance of the groves was noticeable as far as they could be seen.

The infected trees were found to be alive with a small beetle, which Professor Enders of Purdue classified as *Chalcopus dorsalis* of Blatchley's "Coleoptera of Indiana": "This beetle is from 6 to 6.5 mm. long, wedge shaped and rather broad, bluish black, thorax red, with black sutural stripe. Found throughout the State, but much more abundant in the southern counties. Occurs on flowers of black locust, in the leaves of which the larvæ mine. Hibernates beneath the locust bark."

On striking the trees the beetles could be heard falling to the ground by the scores. They could be seen in large numbers on the foliage, as many as five were counted on a single leaflet.

The eggs of this beetle are deposited late in April or early in May, and by the 20th of May the young larvæ are at work between the coverings of the leaflets, destroying all the inside portion. In some cases several larvæ may be seen at work within a leaflet. When mature the larvæ stop eating and remain enclosed within the leaf coverings until metamorphosis is completed, when they emerge, usually about the 20th or 25th of June, and for several days feed upon the upper leaf surface of any green foliage that may remain.

The writer is of the opinion that many of the locust groves in the northeastern part of Jefferson County were badly infected with this beetle

during the summer of 1913, and possibly previous to that, as several groves of that region were observed with foliage that seemed to be drying up, as though injured by a serious drouth. The infected area seems to be rapidly increasing, and the annual defoliation of the trees must in time prove a serious injury, since the foliage on the majority of the infected trees was practically useless by the first of July and in many cases even earlier. What the favoring circumstances have been that have caused this remarkable increase in the numbers of this insect is at present a mere conjecture. It may be that the unusual heat and drouth of May, 1914, and of the summer of 1913, may have caused their rapid multiplication, or that the relatively rapid increase of locust trees, their favorite food supply and breeding place, has augmented their numbers.

What the future may bring no one knows, but if this beetle continues in as great numbers in succeeding years, they will prove a very serious menace to locust groves, and the fence and telephone post industry of southern Indiana. Judging from the undoubted rapid increase in the past, the future is not promising.

As a remedy Professor Enders and others recommend spraying with arsenate of lead or other arsenical compounds. This no doubt would be in a measure effective, if applied within a few days after the emergence of the mature beetle June 25th to July 5th, and could be done on level or moderately level ground, but since the tens of thousands of volunteer locusts are on slopes so steep that they are almost inaccessible, it would prove a difficult task indeed to get at them with a spraying outfit. It is not probable that the pest, if it proves to be a serious one, will be eradicated in that way. It is very difficult to get farmers to spray orchards, much less locust trees scattered far and wide over rough, hilly land. It is to be hoped that an efficient remedy may be provided, for, if not, this defoliator, in addition to the borer, will probably end the locust industry.

A NEW LEAF SPOT OF VIOLA CUCULLATA.

H. W. ANDERSON.

A leaf spot on *Viola cucullata* has been prevalent in Indiana and neighboring States for a number of years. It is especially noticeable during the early spring months. Collections of leaf spots on this host in different parts of the country have been made from time to time and have been filed away in the herbarium without being classified or wrongly labeled as the *Phyllosticta* leaf spot. A careful examination during the past year has revealed the fact that this particular leaf spot is caused by a *Colletotrichum* which has never been described as occurring on this species. Since this disease is widespread it was thought worth while to make a careful study of the causative organism.

Of the violets which occur in this region only *Viola cucullata* has been found to be attacked by this particular fungus. It is interesting to note that while this species is attacked *V. palmata* is apparently immune. *V. cucullata* was formerly considered a variety of *V. palmata* and the immunity of the latter emphasizes the specific difference. However, only a limited number of plants of *V. palmata* have been observed and these in a region where the disease was not common on the other species.

Cultivated violets have been examined only in the local greenhouses. It is probable, however, that all cultivated species are immune, otherwise the disease would have been observed and reported by those especially interested in violet diseases.

Macroscopical Appearance.—The fungus produces a typical leaf spot. The earliest indication of infection is a pale area with a definite dark green border. Later the area in the center of the spot dies, turns white, grey or light brown, a dark brown ring appears about the edge, forming a definite, regular spot. At an early stage the acervuli appear as dark brown dots on the lighter central area. They are irregularly arranged and occur on both sides of the leaf. The dark color of the acervuli is due, in part, to the numerous setæ. Later the center of the spot becomes very thin and papery and may fall out, thus giving a shot hole effect. When badly in-

fects the spots are occasionally confluent. Usually there are only a few spots on a leaf.

Etiology.—The fungus gives rise to numerous acervuli, which are dark brown or black, irregularly scattered, varying greatly in size (50-200 microns). They are beset with dark brown setae. The setae are numerous, arising from any part of the acervulus, 1-4 septate, dark brown, sharp-pointed, straight or slightly curved above the base. The base is usually bent or curved in various ways.

The spores are hyaline, non-septate, slightly curved averaging 4.5×2.5 microns. They are borne on short, hyaline conidiophores. In some cases at germination a delicate septum was observed in the middle of the spore. This is by no means always present.

Nomenclature.—There has been, in the past, some confusion in regard to the limits of the genera *Colletotrichum*, *Vermicularia*, *Volutella* and *Chaetostroma*. This has been due, largely, to the lack of care exercised by investigators when species of these genera have been studied. Sections carefully made clear up generic confusion very easily. The fungus described above is undoubtedly a *Colletotrichum* since there is no pycnidium, the spores being borne on short conidiophores in a setose acervulus.

In 1899, Dr. Ralph Smith¹ described a leaf spot of pansy caused by a *Colletotrichum*. The type material of this fungus has been examined and found to differ from the *Colletotrichum* under discussion in the size and shape of the spores, the shape of the setae and the character of the spot produced.

Dr. Peck² in 1878 described a leaf spot of *Viola rotundifolia* as follows:

"*Vermicularia concentrica* Peck and Clinton n. sp. Perithecia small, black, beset with straight, rigid bristles, concentrically placed on arid, orbicular spots: spores oblong, slightly curved, pointed at each end, colorless, .0008'-.001' long.

"Living leaves of *Trillium erythrocarpum*. Pine Valley, Clinton, July:

"The tissues at length fall out from the affected spot, leaving apertures through the leaf. The perithecia are less regularly disposed near the center of the spots. Judge Clinton also sends a variety on the leaves of *Viola rotundifolia* in which the concentric arrangement of the perithecia is not at all preceptible, but I detect no other difference."

(1) Botanical Gazette. 27: 203-204, Mar. 1899.

(2) Report of the N. Y. State Botanist 1878. 29th Annual Report of the N. Y. State Museum of Natural History, pps. 47-48.

In his "Sylloge", Saccardo³ changed the specific name of the fungus to *Peckii*. His nomenclature is as follows:

"*Vermicularia Peckii* Sacc.

V. Concentrica Peck, 29th Ann. Rep. N. Y. State Mus. Nat. Hist. 47-48, 1878. (Not Lev., Ann. Soc. Nat. 66. 1845.)

"*V. Peckii* var. *Viola rotundifolia* Sacc."

Through the kindness of Dr. H. D. House, State Botanist of New York, I was able to secure authentic specimens, collected and determined by Dr. Peck subsequent to his description of the fungus. These specimens were from *Trillium erythrocarpum* Michx. (*T. undulatum* Willd.) and from *Viola rotundifolia*. A careful examination of these specimens, together with some recently collected material from Dr. House, was made. Some of the spots were embedded in paraffin, sectioned and stained. From these examinations it was concluded that the fungus occurring on *Viola rotundifolia* was not a *Vermicularia* but was identical with the *Collectotrichum* occurring on *V. cucullata*. The spore measurements and general characters of the acervulus, setae and conidiophores of the fungus on *Trillium* were also identical but, as stated by Dr. Peck, the acervuli of the former occur in definite concentric circles in the spot, while in the latter no such arrangement is noticeable. Whether or not the species on *Viola cucullata* is identical with the one on *Trillium* can only be determined by cross-inoculation. Up to the present time the author has not had an opportunity to complete his investigations along this line. It would be unusual, however, to have a fungus of this type parasitic on hosts so widely separated as *Trillium* and *Viola*. The identity of the fungi on the two violet species can hardly be questioned. The nomenclature of the fungus on *Viola rotundifolia* is so awkward and incorrect that a change should be made. However, this is not advisable until the relationship to the fungus occurring on *Trillium* is definitely settled.

Life History of the Fungus.—The field observations of this fungus have been limited to a single year. The disease appears at a very early period in the spring on leaves that have evidently lived over winter. The earliest collections were made in the first week in April before the plants had time to develop leaves. It is probable therefore that the fungus lives over winter on the old leaves of the plant, although it has not been observed during the winter months.

(³) Saccardo, P., Sylloge Fungorum. 3: 232. 1884.

The spread of the disease in the early spring is evident from an observation of an infected plant. A single plant often has at first only one or two infected spots. As the new leaves develop they are seen to be free from the disease, but a few days after a damp period these leaves are badly infected. This disease is, in many respects, an early spring one, for the most luxurious growth of this species of violet is during April and May and the fungus seems to thrive best during cold, damp weather. At no time do the number of spots become so great as to kill the leaf. The damage done by this fungus is evidently negligible so far as this species is concerned.

The fungus spores are probably distributed through the usual agents. They are produced in great numbers on both sides of the leaf and they germinate readily in tap or rain water.

Artificial Inoculations.—A detailed report of the experiments on inoculations made would be out of place at this time. Summarizing these, it was found that infection by sprayed spores on the leaves was readily brought about if the plants were kept very moist for several days. The number of infections were small on each plant. Cross-inoculations on *V. pubescens* and *V. striata* gave negative results.

Cultural Characters.—The fungus is easily isolated by poured plates of the spores. Cultures were made on various media, but a description of the development on dextrose-potato agar will be sufficient to show the general character of the growth. The mycelium is at first hyaline, mostly confined to a thick growth on the surface of the agar, with scanty aerial mycelium. At the edge of the advancing mycelium the agar takes on a pink and then a red color which is very striking. Later the mycelium darkens and in some cases within four days conidia are to be found. The darkening of the mycelium continues and within two weeks a heavy, black, stroma-like crust is formed over the surface of the agar. On this stroma hyaline, gelatinous areas of conidia are developed.

Conclusion.—This preliminary report on a leaf spot of *Viola cucullata* is given in order to stimulate others to examine the plants of this species during the coming spring, thus establishing more definitely its range and determining whether or not it is confined to this one host. An effort will be made by the writer to determine the relationship of this species to the one occurring on *Trillium* and on *V. rotundifolia*.

OAT SMUT IN INDIANA.

F. J. PIPAL.

In the winter of 1914, the writer, representing the Botanical Department of the Indiana Agricultural Experiment Station, conducted, in cooperation with the Extension Department of Purdue University and the county agricultural agents, a series of meetings at which demonstrations were given of the formaldehyde treatment of seed oats and potatoes. The meetings were held in Benton, Lake, Porter, Jasper, Pulaski, Laporte, Elkhart, Grant, Madison, Randolph, Clinton and Montgomery counties, which are among the largest oat-growing counties in the State. According to the report of the last census these twelve counties raised over thirty-two per cent., in acreage, of the entire oat crop of the State. It may be of interest, therefore, to report some facts resulting from these meetings, since they furnish fairly reliable data as to the oat smut situation throughout the State.

A most striking thing has come to light in connection with this campaign. It has been learned that out of 3,168 persons reached through the meetings less than a dozen farmers previous to that time had ever used the formaldehyde treatment for their seed oats. The use of formaldehyde as a general disinfectant and a specific fungicide for potato scab was originated, about eighteen years ago, in the Botanical Department of the Indiana Agricultural Experiment Station, by Dr. J. C. Arthur. It was then applied as a disinfectant for oat smut and the stinking smut of wheat by Professor H. L. Bolley, formerly assistant to Dr. Arthur. It remains to the present date the simplest, cheapest and most effective seed grain disinfectant in use. A large majority of the farmers of the State, however, evidently have not, for some reason, taken advantage of this discovery, and still allow the smut disease to reduce the oat yield by several million bushels every year.

One of the reasons for this neglect evidently is the fact that most farmers do not fully realize the extent to which the oat smut occurs in their crops. About thirty years ago, Dr. Arthur, then a botanist for the

New York Agricultural Experiment Station, at Geneva, demonstrated that oat smut is not readily visible to the unpracticed eye unless ten or more per cent. of the crop is affected. The smutted stalks are, to a large extent, considerably shorter than the sound stalks, and can not usually be seen except upon close examination of the field. And again, most of the smutted masses are blown away by harvest time and only bare stalks remain, leaving nothing conspicuous to indicate the amount of damage done.

Dr. Arthur found nine and one-half per cent. of smutted plants in fields at the Geneva Station in which the presence of smut could scarcely be detected without close examination. In the third annual report of the New York Experiment Station he remarks in this connection: "The appearance of smut as one passed through the fields was no greater than is usually to be seen in any part of the country, * * * and the result of the count * * * is as much a surprise to the writer as it will doubtless be to others."

E. S. Goff, of the Wisconsin Experiment Station, estimated the loss from oat smut in that State, in 1896, at about nine per cent.

Bowman and Burnett, of the Iowa Experiment Station, found, in 1907, an average of seven and nine-tenths per cent. of smutted heads in twenty fields examined.

Kellerman and Swingle estimated, in 1888 and 1889, that Kansas lost annually over eleven per cent. of the oat crop from smut.

In bulletin No. 37, of the Ohio Experiment Station, J. F. Hickman says: "In passing through one of our oat fields last summer I observed what seemed to be a smutted head here and there, but upon careful examination I found more than seven per cent. of this variety smutted."

In order to demonstrate the importance and the value of the formaldehyde treatment as effectively as possible the county agents in a number of counties made arrangements with some of the farmers to treat all their seed oats except a small portion to serve as a check on the treatment. It may be well to state here that most of the farmers who agreed to make the tests were under the impression that their oat crops of the previous seasons were comparatively free from smut. The test fields were distributed over Madison, Grant, Laporte, Pulaski and Benton counties.

When the oats headed out the county agents counted the smutted heads and figured out the percentage of smut on the treated and untreated plots. In Madison County, where the writer assisted the county agent,

Mr. W. R. Butler, in this work, counts of smut were also made in several fields where no treatment had been tried.

The following table shows the results of the tests as reported by the county agents.

TABLE 1.

RESULTS OF THE FORMALDEHYDE TREATMENT FOR OAT SMUT ON TEST FIELDS
IN FOUR COUNTIES.

COUNTY.	Number of Test Fields.	Reported by.	Average Per Cent. of Smut on Treated Fields.	Average Per Cent. of Smut on Untreated Fields.
Madison.....	15	W. R. Butler...	.3	12.0
Grant.....	4	O. Crane.....	.8	13.0
Pulaski.....	7	W. V. Kell.....	.1	11.7
Benton.....	6	J. W. McFarland	.2	11.0
Average.....			.3	11.9

In Laporte County, Mr. L. B. Clore, the county agricultural agent, arranged for a test of the formaldehyde treatment on the county poor farm. The manager of the farm was very reluctant at first to make the test, claiming that there never had been any oat smut on the farm. When the smut was counted, however, it was found that fifty-two per cent. of the crop was smutted on the untreated field and only about one per cent. on the treated field.

The results demonstrated to the farmers beyond any doubt the value of the treatment. The treated fields were practically free from smut, while those not treated had, individually, from one to fifty-two per cent. of the crop destroyed by the disease. Three fields in Madison County had thirty or more per cent. of smutted heads, and one field in Pulaski County showed a loss of forty-five per cent. The average percentage reported from Madison, Grant, Pulaski and Benton counties correspond closely, indicating that the prevalence of oat smut is fairly uniform throughout the sections these counties represent.

In addition to the data obtained from the test fields further reports on the prevalence of oat smut were received from seven counties as shown in the next table. The figures submitted in these reports were secured by the county agricultural agents and other men who made, in most cases, careful observations and counts of oat smut in their respective counties.

TABLE 2.

AVERAGE PERCENTAGE OF SMUT FOUND IN THE OAT CROP OF 1914 IN SEVEN COUNTIES.

COUNTY.	Reported by.	Average Per Cent. of Smut.
Randolph.....	C. A. Mahan.....	15
Whitley.....	W. C. Dilts.....	01
Montgomery.....	R. A. Chitty.....	15
Starke.....	H. R. Smalley.....	10
Lake.....	S. J. Craig.....	20
Gibson.....	H. F. Buk.....	10
Jefferson.....	G. Culbeertson.....	15
Average.....		13.5

As shown in the table the average per cent. of smut reported from the seven counties corresponds closely with the average figures from the counties mentioned in Table 1. Leaving out the report from Laporte County, which can not be considered representative owing to the high per cent. of smut obtained in the single test, the grand average for the counties under consideration is practically 13 per cent. This no doubt is a fairly accurate figure representing the loss from oat smut in the State. It corresponds closely with the estimate of Dr. Arthur who placed the loss in the State, figured from general observations, from eight to twelve per cent.

According to the crop statistics, compiled by the United States Department of Agriculture, Indiana devotes annually about 1,735,000 acres (average of 1909 to 1913 seasons) to the production of oats. The average yield for the State has been about thirty bushels per acre. It may be considered, therefore, that the average annual production of oats in Indiana is, in round figures, about 52,000,000 bushels. Considering that smut destroys about thirteen per cent. of the crop the above yield represents

only eighty-seven per cent. of the full crop. Figuring on this basis the annual loss from oat smut amounts to 7,770,113 bushels. This is more than the total yield of Benton, Allen and Tippecanoe, three of the largest oat-growing counties in the State. At the average price of oats of thirty-five cents per bushel the loss in cash value equals \$2,719,539. The cost of treating seed oats with the formaldehyde solution would be about two cents per acre, or \$34.00 for all seed sown in the State. The net profit resulting from the treatment would be, therefore, considerably over two and one-half million dollars. To gain this amount every year by practicing the treatment is certainly worth the effort, and practical instructions and demonstrations along this line in all oat growing sections of the State are highly desirable.

The formaldehyde treatment of seeds oats, as recommended by the Indiana Agricultural Experiment Station, is briefly as follows:

Spread out the seed on a floor and sprinkle with a solution of one pint of 40 per cent. formaldehyde to 50 gallons of water until thoroughly moist. Shovel over repeatedly to distribute the moisture evenly, then shovel into a pile and cover with sacks or canvas for at least two hours. The seed may be sown as soon as dry enough to run without clogging the drill. If to be kept longer than one day, grain should be dried as rapidly as possible by spreading in a thin layer and stirring occasionally with a rake. Avoid reinoculating with smut from smutting sacks or bins after treatment. One gallon of the solution will treat a little more than one bushel of oats.

In order to facilitate the work of treating the grain, machines have been invented which much simplify the labor and enable one to treat large quantities of grain in a comparatively short time. Several types of these machines are now on the market selling for twenty dollars or more each.

If total destruction of the oat crop in three counties occurred, it would arouse the farmers of the State to action. Why should not the loss of more than two and one-half million dollars distributed over the State do so? If all farmers in Benton County treated their seeds oats they would save enough in one season to build at least eight township schoolhouses, each costing not less than twelve thousand dollars. And then they could save enough every year to pay the salaries of all their school teachers. Many other counties in the oat-growing sections could do equally well.

In some townships the formaldehyde treatment would save the farmers enough money to pay for the building of miles of stone roads. Should not these facts stir the farmers to some concerted action by which they would banish the smut disease from the State? The grain treatment is simple, cheap and easy of application. It is up to the oat growers in the State to make up their minds and do the right thing. A man in Madison County, on whose farm a test of the formaldehyde treatment was made this spring, was very much pleased with the results, and he said in substance: "Why it's a very simple thing. There's very little work connected with the treatment and the cost can almost be disregarded. I treated my seed for less than twenty cents. I wonder why I haven't been practicing it long before."

PLANTS NEW OR RARE TO INDIANA. NO. V.

 CHAS. C. DEAM.

Specimens of the species reported are deposited in my herbarium under the numbers indicated. The Gramineæ were determined by A. S. Hitchcock; the Carices by K. K. Mackenzie; the *Juncus* by H. H. Bartlett; and the Antennariæ by M. L. Fernald.

Panicum Werneri Scribn.

Floyd County, June 8, 1913. No. 13,256. In a sterile white and black oak woods on the "knobs" about one mile west of New Albany.

Muhlenbergia foliosa Trin.

Grant County, September 4, 1914. No. 15,279. Low border of the lake located about five miles northeast of Fairmount.

Whitley County, August 23, 1914. No. 14,562. Low border on the west side of Round Lake.

The only reference to this species occurring in the State is in *Rhodora*, Vol. 9:19:1907, in an article by Lamson-Scribner on "Notes on *Muhlenbergia*", in which he refers to "No. 68, by H. B. Dorner from Indiana."

Apera spicaventi (L.) Beauv.

Orange County, August 1, 1914. No. 15,561. Frequent over an area of five or six acres about one mile west of Leipsic. Reported by Prof. M. L. Fisher of Purdue University.

Bromus arvensis L.

Jefferson County, May 28, 1911. No. 8,486. In a woods along the roadside about one-half mile south of North Madison.

Bromus hordeaceus L.

Laporte County, May 28, 1913. No. 13,031. Frequent along the roadside east of the water works at Michigan City.

Carex Leavenworthii Dewey.

Shelby County, June 8, 1913. No. 13,193. Collected by Mrs. Chas. C. Deam in a dry woods one and a half miles west of Morristown.

Vermillion County, May 8, 1910. No. 5,819. In dry soil in a wooded ravine about one mile northwest of Hillsdale.

Carex louisiana Bailey.

Gibson County, June 10, 1913. No. 13,297. In a low flat woods on the east side of Foote's pond.

Carex projecta Mack.

Hendricks County, July 13, 1913. No. 13,677. Collected by Mrs. Chas. C. Deam in a swamp about five miles northwest of Danville.

Carex suberecta (Olney) Britt.

Noble County, June 26, 1914. No. 14,350. Low border of Engle Lake.

Shelby County, June 8, 1913. No. 13,204. Collected by Mrs. Chas. C. Deam in the Milburn Swamp about one mile west of Morristown.

Tipton County, May 24, 1913. No. 12,909. Collected by Mrs. Chas. C. Deam in a low place along the Lake Erie Railroad about two miles west of Goldsmith.

Carex picta Steud.

Brown County, May 21, 1910. No. 6,412. Somewhat frequent on the oak ridges between Helmsburg and Nashville. This sedge has the habit of growing in bunches. When established for some time it advances in the form of a circle, the center of which is bare. Areas two feet in diameter have been noted with a ten-inch bare center.

Morgan County, August 12, 1913. No. 13,958. Collected by Mrs. Chas. C. Deam on a wooded hillside about one and a half miles northeast of Martinsville.

Gray's text-book of botany gives this species as occurring in a ravine near Bloomington upon the authority of Dudley.

Carex impressa (S. H. Wright) Mack.

Allen County, June 14, 1914. No. 14,258. Creek bottom about seven miles south of Ft. Wayne.

Gibson County, June 9, 1913. No. 13,339. In a low flat woods about four miles west of Patoka.

Grant County, June 16, 1907. No. 2,057. Along a creek about two miles northeast of Van Buren.

Hamilton County, May 19, 1912. No. 10,549. Collected by Mrs. Chas. C. Deam in a swamp near Carmel.

Hancock County, June 2, 1912. No. 10,892. Collected by Mrs. Chas. C. Deam in a ditch along the C. H. & D. Railroad near Reedsville.

Huntington County, July 4, 1907. No. 2,141. In a wet woods about two miles north of Buckeye.

Johnson County, June 8, 1912. No. 11,088. Collected by Mrs. Chas. C. Deam along Young's Creek south of Franklin.

Marion County, May 30, 1911. No. 8,522. Collected by Mrs. Chas. C. Deam in a ditch near Irvington.

Posey County, May 24, 1911. No. 8,350. In a wet woods near Goose Pond.

Wells County, May 22, 1908. No. 3,040. Abundant in a wet woods just south of Bluffton.

Carex atherodes Spreng.

Tipton County, July 9, 1913. No. 13,632. Collected by Mrs. Chas. C. Deam in a prairie habitat along the Lake Erie Railroad about two miles west of Goldsmith.

Juncus brachycarpus Engelm.

Crawford County, July 13, 1899. In a valley near Wyandotte Cave.

Marshall County, July 2, 1911. No. 9,021. In a ditch along the railroad about one mile south of Culver.

Alsine graminea (L.) Britt.

Laporte County, May 22, 1910. No. 6,440. On the bank of an open ditch through the prairie just west of the State Prison.

Ranunculus cymbalistes Greene.

Floyd County, April 20, 1913. No. 12,565. Type locality about one-half mile south of the Southern Railroad on the top of the first wooded ridge west of New Albany. Associated with *Pinus virginiana* Mill. and *Quercus Prinus* L.

Physocarpus opulifolius var. *intermedius* (Rydb.) Rob.

Starke County, September 1, 1914. No. 15,152. A large colony on the south side of Bass Lake.

Sanguisorbia minor Scop.

Lawrence County. Introduced in grass seed in a field about 80 rods from the boundaries of Orange and Washington counties. Reported by Prof. M. L. Fisher of Purdue University.

Meibomia illinoensis (Gray) Kuntze.

Benton County, July 31, 1912. No. 11,839. Roadside about four miles north of Fowler.

Jasper County, July 30, 1912. No. 11,789. Roadside about four miles west of Remington.

Lagrange County, August 29, 1914. No. 14,939. Roadside about three miles northeast of Howe. Associated with *Kuhnia cupatoroides*, and *Drymocallis agrimonioides*.

Lake County, July 29, 1912. No. 11,750. Roadside about four miles southeast of Cedar Lake.

Marshall County, July 2, 1911. No. 8,995. Open wooded hillside about a half mile south of Culver.

Steuben County, August 11, 1903. In woods near Gage Lake. In the same county on a gravelly wooded hill on the east side of Hog-back Lake in 1906. No. 1,265.

Hartmannia speciosa (Nutt.) Small.

Floyd County, June 8, 1913. No. 13,260. Abundant in an alfalfa field and on both sides of an adjoining road on the "knobs" west of New Albany, just beyond the terminal of the traction line to Silver Hills.

Solidago hispida Muhl.

Steuben County, September 20, 1914. No. 15,504. In white oak woods and along a wooded roadside on the east side of James Lake.

Antennaria neodioica Greene.

Wells County, May 28, 1914. No. 14,190. Growing with white oak and *Antennaria fallax* on the high clay bank of the Wabash River about one mile below Vera Cruz.

Antennaria Parlinii Fernald.

Brown County, May 21, 1910. No. 5,985. Frequent on sterile wooded hills between Helmsburg and Nashville.

Clark County, May 8, 1912. No. 10,496. In sterile white and black oak woods on the Forest Reserve.

Decatur County, May 5, 1912. No. 10,479. Abundant on the top of the sterile wooded bank of Flat Rock River about half a mile above St. Paul.

Jennings County, April 28, 1912. No. 10,429. Top of the high bank of the Muscatatuck River between Vernon and North Vernon.

Martin County, May 20, 1913. No. 12,872. On top of a wooded bluff along White River about two miles above Shoals.

Montgomery County, May 16, 1913. No. 12,750. In a white oak woods along Sugar Creek near the "Shades".

Ripley County, May 19, 1912. No. 10,570. On dry clay bank of Baupst Creek about one mile west of Morris.

St. Joseph County, May 29, 1914. No. 14,204. Dry woods about five miles southwest of South Bend.

Antennaria Parlinii var. *arnoglossa* (Greene) Fernald.

Vermillion County, May 8, 1910. No. 5,837. Top of the bank of a wooded ravine about a mile and a half northwest of Hillsdale.

Antennaria solitaria Rydb.

Floyd County, April 20, 1913. No. 12,552. Growing under a beech tree in the "knobs" about a mile west of New Albany, also on the top of one of the "knobs" with *Quercus Prinus*.

SOME PECULIARITIES IN SPIROGYRA DUBIA.

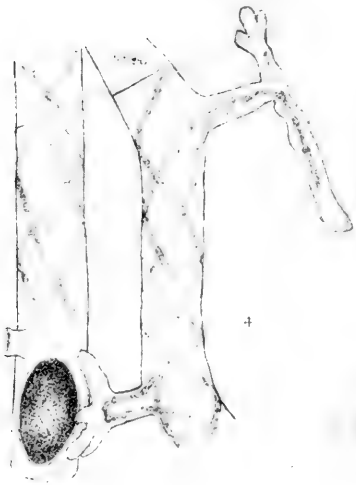
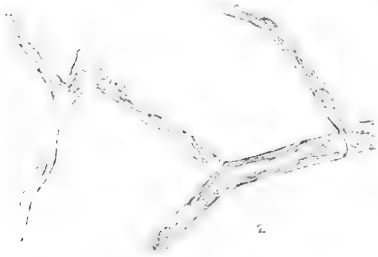
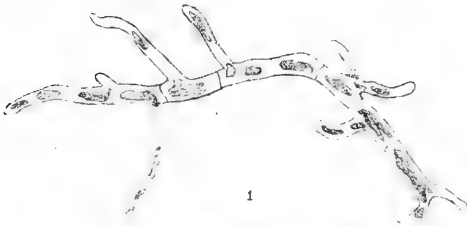
PAUL WEATHERWAX.

A form of *Spirogyra* found on the campus of Indiana University early in the spring of 1913 has shown, in its natural habitat, as well as when subjected to new physiological conditions, some phenomena of growth that are not only irregular for *Spirogyra* but also seem to be confined rather closely to the one species.

The plant does not agree exactly with the description of any species given in the literature available, but it conforms fairly well with the description given by Wolle (1) and also the one given by Collins (2) for *S. dubia* Kg. This species, according to these descriptions, has two spirals, or "more rarely three", and the fruiting cell is described as being slightly inflated. The plant observed here had regularly three chloroplasts, and the fruiting cells were not at all swollen. Wood (3) notes this same difference in the sporangial cell and suggests other variations but concludes that these characteristics are not sufficiently different to justify the description of a new species. A form showing a physiological peculiarity similar to one shown by this plant, and probably from the same general location, is identified by Pickett (4) as *S. elongata* (Berk.) Kg.

When first found the plant formed a thin, green coating on a piece of rusty sheet iron lying in running water. Most of the filaments were only one to three cells in length and were probably developing from zygotes, but the striking thing noted was the highly differentiated basal cells (Fig. 3) by which the filaments were attached to the mud on the iron, and, in many cases apparently to the rough surface of the iron itself.

Conditions were favorable for rapid growth, and ten days later the filaments were three or four inches in length and composed of many cells, but still as firmly attached as would have been filaments of *Cladophora* of the same size. The root-like basal cells had grown very much longer and had assumed a variety of peculiar shapes. Their walls had thickened, and their contents were just beginning to show signs of decomposition (Fig. 5).



A quantity of the material was put into a shallow dish of distilled water and placed in a north window in an attempt to cause it to conjugate, but indications of an unhealthy condition soon became apparent. As a first indication of this condition the chlorophyll bands became more slender and the pyrenoids very prominent. Soon after this the filaments began to break up by the decay of some of the cells, so that but few segments could be found that were more than seven or eight cells in length, and the majority of them were made up of but one or two cells. In the meantime these cells that seemed to have greater vitality began to develop a number of branches as shown in Figs. 1 and 2. The cytoplasm usually followed out into these branches, often taking a loop or an end of a chloroplast with it. In many filaments that showed the peculiarity the branches all arose from the same end of the cells, suggesting a continuation of the condition of base and apex that was made so evident by the highly specialized basal cells of the younger plants. So far as was observed, the branches always remained continuous with the cells from which they arose, no new cells being cut off on branches. Filaments of other species of *Spirogyra* often broke up into segments on being put into similar conditions, but no branching was observed.

The decay of the plant was probably started, in some instances at least, and very evidently greatly aided, as soon as the vitality of the alga had been slightly impaired, by the growth of a fungus, *Aphanomyces phycophilus* De Bary, one of the few parasitic forms of the *Saprolegniaceae*, which has already been described (5). Other species of *Spirogyra* seemed immune to the attack of this fungus.

In some conjugating material of this same species of *Spirogyra* similar physiological peculiarities were noted. This latter material had been preserved for class use, and the exact locality of its collection is not known, but it was probably found in the same general locality as was that first mentioned. The filaments of this material showed also, but in a less marked degree, the same unhealthy condition. Some typical branches found are shown in Fig. 4. These branches seemed to serve as "hold-fasts" for attaching the filament to other filaments of *Spirogyra* or probably to other things in the water.

Any attempt to get at the meaning of the branches found in either instance must maintain a degree of consistency with two or three prominent points observed. The branching described is associated with a pathological condition and is characteristic of this to a more marked

degree than of any other species of *Spirogyra* that was tested. Since the phenomenon was observed once in a physiological condition that had been made favorable for conjugation and again where conjugation was actually taking place, it was at first thought that the branches were exaggerated attempts at conjugation, and, in some instances, this may have been the case. But the filaments were usually close enough together that such long tubes would not have been necessary, and no actual union of gametes as a result of any such activity was at any time observed. Moreover, the filaments shown in Fig. 4 illustrate a condition noted in two or three cases, where filaments having mature zygotes in some of their cells were attached by these branches to others also containing zygotes. The filament shown in this figure as holding to another by means of the foot-like branch was a long one and had at another place mature zygotes that had been formed as a result of conjugation with some other filament. If these branches were modified conjugating tubes, a relation of this sort would be out of harmony with the tendency toward bisexuality that is usually exhibited by the plant.

Indiana University,

Bloomington, Indiana.

LITERATURE CITED:

- (1) Wolle, Rev. Francis. Fresh water algae of the United States. 1887.
- (2) Collins, Frank S. Green algae of North America.
Tufts College Studies, Vol. II, No. 3. 1909
- (3) Wood, Horatio C. Jr. A contribution to the history of the fresh water algae of North America.
Smithsonian Contributions, No. 241, Vol. 19. 1872.
- (4) Pickett, F. L. A case of changed polarity in *Spirogyra elongata*.
Bul. Tor. Bot. Club, Vol. 39. 1912.
- (5) Weatherwax, Paul. *Aphanomyces phycophilus* De Bary.
Proc. Ind. Acad. of Sc. 1913.

REPORT ON CORN POLLINATION IV. (FINAL).

M. L. FISHER.

The work under this head has been reported in the 1908, 1910, and 1911 proceedings. The reports have dealt mostly with cross-pollinating with pollen from a variety of a different color or race. One of these crosses—sweet, male, and Reid's Yellow Dent, female—was selected to be carried out to the end to see if a new variety could be produced.

In the third year two types of sweet corn were distinguishable, one a large ear with whitish kernels and white cobs like the original Stowell's Evergreen, and the other, a smaller ear with yellowish kernels and red cobs. These two types were planted the season of 1911, but through poor management no seed was saved. Enough ears were obtained to see that the types were fairly well fixed. Old seed was used in 1912 and hand pollinations were made on each type. A few good ears of each kind were obtained. The kernel and cob characters came true to the original selections. Upon being cooked as roasting ears, both types were found to be of excellent quality—the yellow kernel and red cob type being slightly sweeter. The mature ears showed some dent kernels, but not many. A good quantity of seed was obtained. It may be said further that the yellow-kernel red-cob type was somewhat earlier than the white-kernel white-cob type, the latter inclining to be late.

In the season of 1913 three plantings were made, one in the writer's garden, another in the garden of the foreman of the Station Experimental plats, and the third in the trial gardens of D. M. Ferry & Co., Detroit, Mich. In the two garden trials, the white-kernel white-cob type was used on account of its promising greater prolificacy. The corn in the writer's garden was almost ruined by a hail storm, and that in the foreman's garden was somewhat injured. Such ears as were obtained for use as roasting ears were declared to be of superior quality. The writer saved no seed, the foreman was able to save a good quantity and planted again in 1914.

The corn planted on the plats of Ferry & Co., was reported on as follows:

"The salient features of our reports are to the effect that neither of your selections seems as yet well enough fixed in type to be ready for presentation. Both show a large percentage of reversion to plain parent stock. They are both late and half of the ears in our trial were irregularly and poorly filled. Quality seems excellent, but the color of the red cob shows badly in cooking.

From a seedsman's standpoint we do not believe the strains to be as yet of any value."

The foreman mentioned above planted a small patch the past season (1914), but drouth and hot winds ruined the entire planting. However, enough seed remains for another planting and a replenishment is hoped for. Although results have been somewhat discouraging, it is believed that a successful and fixed variety may yet be developed.

STOMATA OF TRILLIUM NIVALE.

 F. M. ANDREWS.

Gümbel¹ was the first to make known the presence of twin stomata. Since that time Pfitzer² and others have shown the presence of stomata in groups of two or more on the leaves of various plants. In *Saxifraga sarmetosa* stomata are arranged "in circular groups"³ in considerable number. In various species of *Begonias*, as De Bary states⁴ in *Begonia manicata*, *B. spathulata*, *B. Dregci* and *B. herculeifolia* two or more stomata are arranged over one respiratory cavity.

This occasional grouping of the stomata in certain plants is even more strikingly shown in *Trillium nivale*. The stomata are often found on the leaves in pairs over a common respiratory cavity, but frequently in numbers up to ten or more. In opening and closing they act just as a single stoma does.

The presence of more than one stoma over a common respiratory cavity is also shown on the sepals and petals. Figure 1 shows part of a sepal of *Trillium nivale* in which the stomata are in pairs in one case and in threes in another case over a common respiratory cavity. These arise from the successive division of a common mother cell. The stomata on the sepals and petals are frequently lateral or diagonal as regards one another, but in every case their origin from one mother cell is the same. The arrangement in groups of as many as ten or more over one respiratory cavity on the sepals or petals is also met with.

Figure 2 shows a case, taken from the outside of a sepal, where only one guard cell, A, is fully formed. There is only a remnant of a second guard cell, B. The same thing has also been observed on the inside of the petal.

¹Gümbel. *Jahr. für wiss. Bot.* Bd. 7, p. 551.

²Pfitzer, E. *Jahr für wiss. Bot.* Bd. 7, pp. 532-560.

³*Treviranus. Verm. Schriften*, IV. 30. Quoted from DeBary, A. *Comparative Anatomy of Phanerogams and Ferns*. 1884 p. 47.

⁴Vivani. Quoted from DeBary as above.

In Figure 3 a pair of stomata is shown in which only three guard cells were formed. In this case the apertures are closed by the movement of the two outer guard cells only.

These deviations from the general order, position and number of stomata in *Trillium nivale* also obtains, but to a less extent, in other species of the genus *Trillium*. It is also in keeping with other deviations, for which the genus *Trillium* is noted, such as monstrosities in the leaves themselves and in the parts of the flower. Interesting questions are connected with the twin, triple and grouped stomata of *Trillium nivale* and other plants as to their complete development, the real causes of their arrangement and their physiological reactions.

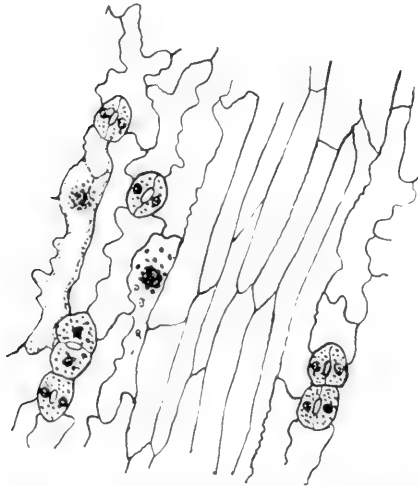


FIG. 1. *Trillium Nivale*. Stomata from outside of sepal showing double and triple groups over one respiratory cavity. x ca. 100.

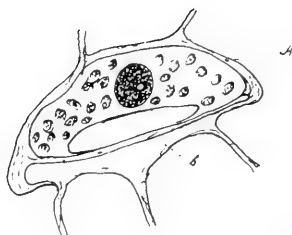


FIG. 2. *Trillium Nivale*. Stoma with only one fully developed guard-cell x 45

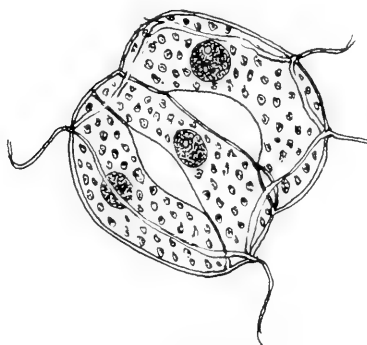


FIG. 3. *Trillium Nivale*. Stomata from sepal. x 450.

THE PRIMROSE-LEAVED VIOLET IN WHITE COUNTY.

LOUIS F. HEIMLICH.

On the afternoon of June 2d last, I started out from Reynolds, Indiana, to add a few specimens to my herbarium. Following the Pennsylvania lines east, I noticed many familiar plants, among them being *Viola lanceolata* L., the lance-leaved violet, growing in great abundance in the wild grass along the right of way. A goodly number of *Viola sagittata* Ait. were often close neighbors to *lanccolata*.

After digging up a few very fine specimens of these two violets I climbed over the fence and went up on one of the sand ridges so characteristic of the country about Reynolds. I had crossed this area very often and knew that *Viola pedata* L., the bird-foot violet, grew here. Only a few of their flowers remained, the seedpods on some being already of good size.

Passing over the edge of this oak-forested sand ridge, I descended into what was once a swamp area. The soil suddenly becomes mucky, mixed with sand and late decayed leaves. Here, to my surprise, I discovered a violet which I had never seen before. I knew it was a violet. I felt sure of that, and so remarked to my two companions. We looked and found more of them nearby. They spread from the lower limit of the sand ridge out to a little beyond a fence-row, covering an area of about 40 by 125 feet.

These violets, which I later found to be *Viola primulifolia* L., the primrose-leaved violet, seemed to seek the shade. Most of them grew along the fence-row in wild grass, together with some weeds and small brush. Those which grew out in the open short grass were low spreading and less succulent plants. The season for flowering was about over and the cleistogamous capsules were making their appearance.

Viola primulifolia L., varies from about 5 cm. to 20 cm. in height, bearing from a few to a dozen or more primrose-like leaves. The plant is stemless, the leaves rising from a medium sized rootstock or runner. The lower leaves are oval to almost round. The upper, larger leaves are ovate.

Viola
Primulifolia L.

—DRAWN FROM A
MOUNTED SPECIMEN—

$\frac{3}{4}$

NATURAL SIZE



I Heimlich 14
Nov. 17. 1914.

some oblong-ovate, with acute apexes and long tapering bases. Some of the leaves may be somewhat sub-cordate. Both lower and higher leaves are more or less crenate, mostly glabrous, with slight pubescence along the midrib and the edges of the petiole.

The flowers are small, the largest being hardly a centimeter in width when full blown. The petals are white with several purple stripes on their inner surfaces. The pedicels may be 15 cm. or 18 cm. long or as long as the leaves. One or two small bract-like leaves appear about half way up the pedicels. If two are present they may be opposite each other or a little apart. The various botanies do not mention these structures nor does the

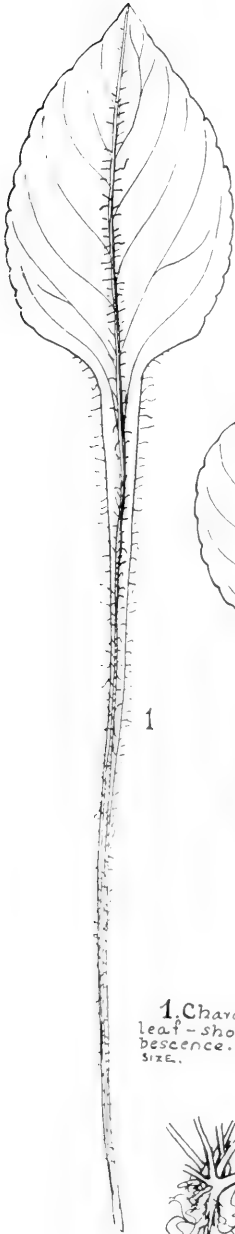


illustration in Britton and Brown show them on this particular violet, although they are shown on a number of the other acaulescent species.

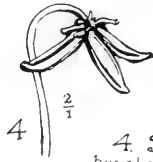
Stolens are common and give off vigorous new plants. The small reddish-brown seeds are scarcely more than a millimeter in length.

Viola primulifolia L., occurs in the eastern United States. Its range is given in the various botanies as in moist or almost dry soil from New Brunswick to Florida along the coast. In so far as I know it has not been reported in any other place in this botanical region. How it happened in White County, Indiana, or how general its distribution here is, I do not know. Mr. Deam, who later visited the place with me, thought it might occur also farther north in the State. I have looked for it, specifically,

SOME DETAILS CONCERNING VIOLA PRIMULIFOLIA L.



1. Characteristic leaf - showing pubescence. NATURAL SIZE.



4 Seed-pod bursted. TWICE NATURAL SIZE.



2 & 3 Lower leaves - showing variation in outline. NATURAL SIZE.

6-7-5-A Bract-like leaves on pedicels - varying from 1 to 3 in number.



7



5. Pedicel and flower. Flower - white with purple stripes. NATURAL SIZE.



8. Seeds - color, reddish-brown. FOUR TIMES NATURAL SIZE.

9. Stolon - showing formation of a new plant.



L. J. Heimlich '4
- NOV. 17, 1914 -

several times since in different localities where I thought it might occur, but so far have not found it. It was rather abundant in the very limited area during the early summer, but the drouth which followed killed every one of them. At present I have several potted specimens growing nicely along with several other species of violets.

This paper does not aim to give a complete study of the plant. It is intended to give merely a brief account and description of the plant as I know it, and to announce definitely that *Viola primulifolia* L., does occur in Indiana.

CONTINUOUS RUST PROPAGATION WITHOUT SEXUAL REPRODUCTION.

—————
C. A. LUDWIG.
—————

With the demonstration of heteroecism in the rusts, the teliospore came to be looked upon as primarily a resting spore, for heteroecism was first proved for the black rust of grasses, in which the teliospore is a true resting spore. It was therefore believed by implication, indeed often stated, that the teliospore is the means of carrying rust fungi over unfavorable weather conditions and is especially equipped structurally for that function. The other spore forms and the mycelium, except in the comparatively rare cases of a mycelium diffused through and perennial in the tissues of the host, were not supposed to be able to survive such adverse conditions. Later when modern cytological methods were applied to the rusts, it was found, as some leading uredinologists had already suspected in a rather vague way, that the essential feature of the teliospore is that it is the structure in which is begun the series of nuclear phenomena which close the sporophytic stage and precede the gametophytic stage with its resulting sexual fusions. With this latter idea goes the rather common belief that no type of life, plant or animal, except perhaps the very lowest, can long maintain a high degree of vigor without at least occasional sexual fusions. It is this idea that has given rise to the belief held in many places that if all the barberry bushes could be destroyed, the black rust of cereals would not be able to maintain itself more than a few years. Thus we have superimposed one upon the other in the minds of many men these two ideas: (1) that the teliospore is necessary to the continued existence of the rust because it is the means of passing the winter or other unfavorable season, and (2) that it is necessary to the vigor of the fungus because it is the structure in which are initiated those changes which culminate in sexual fusions and without which such fusions would not take place. The continued prevalence early in the season of the grain rusts at great distances from any possible æcia of the species, however, led some investigators to doubt the validity of the beliefs just recorded. In consequence, a number

of investigations were made which showed, as suspected, that the rusts in question do have other means than the teliospore of surviving the winter and that in all likelihood they are able to propagate themselves indefinitely in an asexual manner, and that without serious impairment of vigor. In this paper it is proposed to give the results of this work and to present some field data, chiefly from Indiana, which was made available to the writer by his access to the Arthur herbarium. This data goes to indicate that what is true of the grain rusts is equally true of some others which because of their lack of economic importance have thus far escaped this sort of investigation.

DURATION OF VIABILITY OF UREDINIOSPORES.

Before entering on the discussion proper, however, it seems best to treat here two points which have a bearing on what is to follow; namely, the duration of the viability of urediniospores and the distance to which they may be blown and produce infection. As to the duration of germinability in the urediniospore, more work has been done with the grain rusts perhaps than with any other. In the case of *Puccinia graminis* Hungerford reports¹ finding germinable urediniospores at Madison, Wis., on timothy in October, November, December, January, and March; but it does not seem to be at all certain that the spores used on the last named date were wintered spores. On the contrary, it is altogether possible that they were but recently produced. Mercer,² however, was not able to find germinable urediniospores of the same rust on the same host during the winter in North Dakota; and Eriksson and Henning,³ as the result of several experiments with the rust on different hosts, came to the conclusion that the fungus does not pass the winter in the uredinial stage in Sweden. They also came to the same conclusion in regard to *P. glumarum*.⁴ Bolley⁵ reported the germination of 8-15% of urediniospores of *P. graminis* after twenty-one days in dry air in August. The same investigator has shown⁶ that the urediniospores of the leaf rust of wheat can be used for successful infection material after thirty days' exposure to the outside air in July, while Freeman and Johnson consider it possible for urediniospores of *P. graminis* and *P. rubigo-vera* to survive the winter in Minnesota, North

¹Phytopathology 4:337-338. 1914.

²l. c. 20-22.

³Die Getreideroste 38-47. 1896.

⁴l. c. 153-159.

⁵Centralblatt für Bakt. Par. und Infekt. 4: 893. 1898.

⁶Agricultural Science 5:263. 1891.

Dakota, and Wisconsin.⁷ Fromme has shown⁸ that the period of viability in the leaf rust of oats, *P. coronata*, may be as extended as eighty-four days. The spores in this case were stored dry in a gelatin capsule. Marshall Ward⁹ succeeded in securing germination of unrediniospores of *P. dispersa* which had been for sixty-one days in dry air in the diffused light from a north window. Thus, while urediniospores are capable of germinating as soon as mature, they are capable under proper conditions of maintaining their viability for a period of two to three months and probably more. One of these conditions seems to be dryness. Probably the most common limiting factor to long life of urediniospores in nature is a combination of warmth and moisture. In such a case germination probably takes place, thus of course forestalling any long duration of life in the spore. There seems to be no good reason, however, if germination can be avoided, why urediniospores might not survive the winter. That coldness of weather does not destroy ability to germinate is attested by the fact that a number of investigators—Hungerford,¹⁰ Ward,¹¹ Carleton,¹² and others—have collected viable urediniospores of various grass rusts during the winter months.

DISTANCE WHICH WIND BLOWN SPORES TRAVEL AND PRODUCE INFECTION.

It seems to be a fact, although from the nature of the case not fully proved, that urediniospores of the rusts may travel long distances by the wind and produce infection. This, of course, is to be expected of a structure which can stand drying for so long a time and is so light in weight. Klebahn¹³ calls attention to a sand storm which arose in northern Africa and progressed northward over Europe, transporting various mineral particles to various places in Europe. He adds that without doubt the rust spores, which are much lighter than the mineral particles, are much easier transported by air currents. Under the circumstances they would remain suspended much longer and could be carried at least as far and perhaps farther than the mineral particles. The same investigator¹⁴ proved the presence of spores in the air high off the ground by constructing traps for the spores and exposing them in trees and on buildings. He was able in

⁷Bur. Plant Ind. Bull. 216:52. 1911.

⁸Bull. Torrey Club 40:518. 1913.

⁹Ann. Mycol. 1:138. 1903.

¹⁰Phytopathology 4:337-338. 1914.

¹¹Ann. Myc. 1:132. 1903.

¹²Div. Veg. Phys. and Path. Bull. 16:44. 1899.

¹³Die wirtswechselnden Rostpilze 68. 1904.

¹⁴l. c. 68.

this way to capture a large number of spores, many of which were urediniospores of the rusts. It is clear, therefore, that urediniospores may be carried many miles in the air; and there is apparently no reason for thinking that they may not then start infection. Doubtless they do start infection and in this way produce a number of isolated areas of rusted plants.

As for epidemics, however, there is evidence that they are not caused by spores brought from a great distance. One item of this evidence is furnished by Pritchard,¹⁵ who was unable to capture any urediniospores of *P. graminis* at Fargo, North Dakota, in a series of trials extending over a period of nearly a month, until the rust was common on wheat in the neighborhood. Pritchard's trap was a dish set on a five-foot post and containing a little water. Another item is the fact that in the spring, as described by Christman,¹⁶ the earliest outbreak of leaf rust on wheat is a rather heavy one on the old, wintered leaves. The old leaves then die and a period of approximately four weeks follows in which little or no rust can be found, followed by another free infection. If the epidemic were initiated by spores blown from far away, we would not expect a heavy infection early in the spring. Instead we should expect a very light early infection increasing gradually to the full epidemic later on. Further evidence of the limited distance to which spores blow in anything like sufficient quantity to produce an epidemic is found in recorded observations where it was possible to know the source of the spores producing the infection. Perhaps the species which are most limited in this respect so far as observations recorded up to the present time go are *Uromyces andropogonis*, *Puccinia andropogonis*, and *P. ellisiana*, all of which, according to observations made by Long¹⁷ are limited to an area within six feet distant from the aecia. These observations are in harmony with our own general experience in collecting rusts near Lafayette and elsewhere. The aeciospores cause free infection to a distance from their source depending upon the height of the source from the ground, but the distance is almost always small. As to the distance to which aeciospores of *P. graminis* blow in considerable quantity there are published observations by Arthur,¹⁸ Pritchard,¹⁹ Mercer,²⁰

¹⁵Bot. Gaz. 52:183. 1911.

¹⁶Trans. Wis. Acad. Sci. 15:106. 1905.

¹⁷Jour. Agr. Res. 2:303-304. 1914. Phytopathology 5:170. 1912.

¹⁸The aecidium as a device to restore vigor to the fungus. Proc. 23rd meeting Soc. Prom. Agr. Sci. p. 3. 1903.

¹⁹Bot. Gaz. 52:178. 1911.

²⁰Phytopathology 4:22. 1914.

and others. The greatest of these values is that reported by Pritchard, whose statement is here quoted: "The rust was abundant within 25 yards of the barberry bushes, but practically disappeared at a distance of 60 yards. The most persistent searching was required to discover a single pustule beyond 80 yards." Another observation by Pritchard²¹ indicated that urediniospores of *P. graminis* are carried only short distances in sufficient number to cause an epidemic. We have the published record, however, of rust spores having been blown as much as a mile and producing infection; and, strange as it may seem, the spores in question are the smallest, most delicate ones in the life cycle of the rusts if we omit the non-functional pycniospores, namely, the basidiospores. E. T. Bartholomew²² gives a table which shows that 59.1% of the leaves on apple trees near cedars were infected with rust. A quarter of a mile away it was 55.4% and a mile away it was 6.5%. All this does not show, of course, that rust spores are not carried by the wind for long distances in a vigorous condition, but it does show that the distance for abundant infection from any spore producing center is not great.

With this as a basis it should be possible to obtain an idea of the maximum distance a rust might be expected to progress in a season. The greatest distance recorded above is one mile, but those spores would doubtless travel a mile and a half farther (or two and a half miles) and produce infection. As a factor of safety, let us double this value; and as a further factor of safety, let us double this latter value. This gives us ten miles. A rust generation, according to Freeman and Johnson,²³ takes eight to twelve days, and more in cold, bad weather; and our own results at the Purdue Experiment Station agree very well with those figures. Assuming, then, ten days for a rust generation, ten miles of migration per generation, a growing season from the middle of April to the middle of October, approximately 180 days, and good weather with no interruption to the growth of the fungus, we should expect it to migrate for a distance of 180 miles. This value will be used presently in comparing the telial distribution of some of the rusts with their possible æcial distribution.

PROPAGATION OF INDIVIDUAL SPECIES.

The black rust of grasses was among the first to be observed living, and apparently thriving, at long distances from any of its æcia. There

²¹Bot. Gaz. 52:184 1911.

²²Phytopathology 2:255-6. 1912.

²³Bur. Plant Ind. Bull. 216:45. 1911.

seems now not to be the least doubt but that it can pass the winter in the uredinial stage; in fact, McAlpine²⁴ claims that in Australia the æcia of the rust do not exist and that the rust will not infect the barberry. As to the exact method of wintering there is some difference of opinion. The contention by Pritchard²⁵ that teliospores or mycelium in the seed grain have something to do with its propagation in wheat is different from all the others in the suggestiveness that a sexual process may be involved even in the absence of the æcium. All other theories which have been advanced assume a strictly asexual propagation, and probably Pritchard's theory does not really assume otherwise either. Perhaps the most famous theory is Henning's now discredited mycoplasma theory. The real means by which the rust passes the winter is probably mycelium in the leaves of the host plant. The presence of this mycelium during the winter months has been shown by Hungerford²⁶ and by Johnson²⁷ in the leaves of timothy.

That the leaf rust of wheat is carried through the winter in the same way is shown by the findings of Bolley,²⁸ Carleton,²⁹ and Christman.⁶⁰ This method of carrying the fungus over accounts satisfactorily for the heavy early infection, followed by a period of little or no infection, which is in turn followed by the epidemic proper. The old leaves, which are infected from the autumn, carry the first epidemic and then die, the mycelium, of course, dying with them. In the meantime the new leaves have been infected; and in about four weeks, which as has been shown by Freeman and Johnson,³¹ and by Christman,²² is the approximate incubation period for that time of year, the uredinial stage breaks out freely on them.

Aside from the work with the grain rusts, not much has been done in the way of determining the method of passing the winter by rusts in regions remote from their æcia. Carleton,³³ however, states that *Puccinia montanensis* on *Elymus* winters in the uredinial stage, and calls attention to the situation with regard to the bluegrass rust. This rust, *Puccinia Pourum*, is found over most of North America. Only in the far west, however, does it produce teliospores, and so only in this region can it have

²⁴Rusts of Australia 66-67. 1906.

²⁵Bot. Gaz. 52:169-192. 1911. Phytopathology 1:150-154. 1911.

²⁶Phytopathology 4:337-338. 1914.

²⁷Bur. Plant Industry Bull. 224:12-13. 1911.

²⁸Microscopical Journal Mech., 1890: 59-60.

²⁹Div. Veg. Phys. and Path. Bull. 16:21. 1899.

³⁰Trans. Wis. Acad. Sci. 15:98-107. 1905.

³¹Bur. Plant Ind. Bull. 216:56. 1911.

³²Trans. Wis. Acad. Sci. 15:106-107. 1905.

³³Bur. Plant Ind. Bull. 63:20. 1904.

æcia. It is so common throughout central and eastern regions early in the season, as well as later, that the idea of any seasonal migration from its region of possible æcia is clearly absurd. It must pass the winter in the uredinial stage, and it probably does so as mycelium in the leaves of the host. We have here a case of a rust which certainly maintains itself in a fair state of vigor for some years without the intervention of æcia and probably maintains itself indefinitely. Of course it is possible that it is constantly being renewed in vigor in the west by the presence of the æcia, and that the fungus thus renewed in vigor is slowly but continuously migrating eastward; but such a hypothesis strikes one as being fanciful rather than likely to be true.

Puccinia Sorghi, the corn rust, is another species with a wide distribution. It is usually not difficult to collect in any field of corn after tasseling time. The infection is usually not heavy, however. The æcia occur on *Oxalis*, but they occur so seldom that they seem to have little to do with the actual propagation of the rust. It is probably carried over from one year to the next by urediniospores which survive the winter or by the uredinial stage in living plants in southern regions. The latter source of infection seems more likely for this rust than for wheat rust because of its later appearance and less severity.

Puccinia Asperifolii, the leaf rust of rye, is a rust which has no known æcia in this country. Its case in America is therefore comparable with that of the bluegrass rust in this region or of *P. graminis* in Australia. It has to maintain itself by the sporophytic stage only.

Uromyces caryophyllinus on carnation is another rust which has no æcia in this country. There is no direct evidence that it can maintain itself over winter, for it usually appears in greenhouses; but it must have passed through thousands of uredinial generations since it was introduced, yet it seems to show no particular loss of vigor.

Puccinia Chrysanthemi is a Japanese species which has been introduced into America and Europe. It attacks cultivated chrysanthemums, chiefly in greenhouses. It has now been known in this country for about a decade and a half, and during this time it has never, so far as is known, produced a teliospore, although in northern Japan and in the mountains of Japan they are common. During this time no great impairment of vigor seems to have taken place, although chrysanthemum growers are able to keep it in check by the use of resistant varieties and by the exercise of care in watering.

The rusts so far considered are some of the more ordinary species, belonging to the Aecidiaceæ. There are species in both the Uredinaceæ and the Coleosporiaceæ, however, which seem to have the same ability to maintain themselves indefinitely in the uredinial stage.

Among the Uredinaceæ two of the most common rusts are *Melampsora Medusæ* on *Populus* and *M. Bigelovii* on *Salix*, both of which have æcia on *Larix*. The æcia are so much alike that it is impossible with our present knowledge to tell them apart. It seems well here, therefore, to consider the two species together, although there are definite morphological characters in the urediniospores which mark them as clearly distinct from each other. The collections of *M. Bigelovii* in the Arthur herbarium show its presence in nine counties of the State, the first collection being made in 1887 and the last one in 1914, both in Tippecanoe County. The rust is common and the epidemic is usually severe. The only explanation which seems reasonable for not having collections from all counties in the State is in the lack of collectors being at work in those not represented. *M. Medusæ* is represented by collections from five counties in Indiana, and the same remarks as to prevalence and severity that were applied to *M. Bigelovii* apply to this species also. Both of these rusts have a range also far to the southward and westward of this region. Their æcia, to the present time, have not been collected nearer this region than New York and Wisconsin. However, it is likely that they do occur nearer because the larch has a range extending as far south as northern Illinois and northern Pennsylvania. It also occurs occasionally as an ornamental tree at various places in the State. The æcia probably occur within the hundred eighty mile distance from the northern half of the State and perhaps from all parts of the State. It does not seem reasonable to think, however, that æcia occur within several hundred miles of the southern range of the fungi. The natural assumption is, therefore, that they are able to pass the winter in the uredinial stage.

Bubakia Crotonis, on *Croton monanthogymus*, has been taken four times in Indiana, from at least three counties, and over a period of time extending from 1896 to 1912. It also extends as far north and west as Nebraska. No æcium is known for the rust, but the nature of the fungus suggests a Pinaceous host and a caecoid æcium. *Cwoma strobilinum* on *Pinus palustris* and *Pinus taeda* has been suggested by Arthur.²¹ Neither of

²¹Bull. Torrey Club 33:519. 1906.

these species of pine, according to Sudworth,³⁵ has a range extending farther north than the southern border of Tennessee. This distribution is well outside the 180 mile limit established earlier in this paper. Two other species of pine, *P. echinata* and *P. virginiana*, have a distribution which might possibly meet the requirements, but there seems to be no evidence other than their distribution that they carry the æcia of this rust. Since *Crouton monanthogynus* is an annual, the evidence seems to favor the idea that the urediniospores are able to survive the winter.

Two species of *Pucciniastrum* occur in Indiana, *P. Agrimoniae*, on *Agrimonia*, and *P. Hydrangeae*, on *Hydrangea*. The former has been taken in five counties in the State at various times since 1896, and usually the infection is severe. *P. Hydrangeae* has been taken three times in Tippecanoe county only. No æcia are known as yet for either of these species, but the æcia of the different species of *Pucciniastrum*, so far as known, are species of *Peridermium* on leaves of *Abies* and *Tsuga*. Judging by the distribution for these trees given by the manuals, Indiana is probably just outside of a 180-mile zone south of their distribution. These trees are often planted for ornament, however, and the possibility exists that the æcia are to be found in the State. The rust occurs, however, as far south and west as the state of Mexico in the country of Mexico, and it is not to be expected that a species can travel so far in a season.

Among the Coleosporiaceæ, there are at least four species which have been collected in the State under conditions which lend color to the idea that they were carried over the winter in the uredinial generation. The rusts of the genus, *Colcosporium*, have their uredinia and telia on various broad leaved plants. Their æcia are leaf inhabiting species of *Peridermium* on pines. *Colcosporium Terebinthinaceæ* was collected in the autumn of 1912 and 1914 on *Silphium terebinthinaceum* in a restricted area near Lafayette. In the latter season, the species was limited to a patch a few rods in extent; other *Silphium* plants in the same patch were unaffected; and no affected *Silphium* plants could be found across a small ravine, although unaffected ones occurred in abundance. Other plants a mile or so away in two directions were examined but were found unaffected. The æcial stage of this rust is not known, and so it is impossible to say positively how near to this locality the æcia may approach. The nearest collection of *Peridermium* on pine leaves to be found in the Arthur herbarium is an undetermined collection on *Pinus virginiana* from Mammoth

³⁵Forest Atlas. Geographic distribution of North American Pines. Part 1, Maps 25 and 35. 1913.

Cave, Ky. Mammoth Cave, as well as can be told by scaling on the map, is approximately 215 miles from Lafayette. It is conceivable, of course, that a wind-borne spore from such a *Peridermium* could have started the infection of *Silphium* plants each year; but when we consider the likelihood that the two species do not belong together, and the fact that the rust was found in practically the same place both times, together with the fact that the host is a perennial plant, it seems more reasonable to think that the original infection was started by a stray spore, and that its further propagation and carrying over the winters was accomplished in the uredinia! stage, either by surviving spores, or by mycelium in the living host.

A somewhat similar case is that of *Coleosporium Ipomoea*, which has been collected repeatedly in Tippecanoe County since 1895 on *Ipomoea pandurata*. It occurs in great abundance and is doubtless to be found in practically all parts of the State where this host is found. The same thing is true for this species as for the preceding regarding the alternate stage and the possibility of the epidemics being started by aeciospores, with this addition, that because of the more general distribution and greater commonness of the fungus, it is much less likely to be started each year by aeciospores.

Coleosporium Vernoniae, on different species of *Vernonia*, has for its aecial stage *Peridermium carneum* on *Pinus Elliottii* and *P. palustris*. It has a very wide distribution in the State, being represented in the Arthur herbarium from eight counties. The hosts of the aecia according to Sudworth³⁶ and Small³⁷ are both confined to an area south and east of central North Carolina and the north third of Alabama. This distance from Lafayette, as scaled on the map, is approximately 430 miles, a distance about 2.5 times as large as our maximum distance which we might expect a rust to migrate in a season. Moreover, it has been collected at Lafayette in different years as early as July 18 and July 24, which dates are early enough in the season to render it even more unlikely that the infections were developed, even indirectly, from aeciospores of the same season.

Coleosporium Campanulae is a species occurring in Indiana on *Campanula americana*. The aecium is known as *Peridermium Rostrupi* and occurs on *Pinus rigida* in eastern Ohio. The closest approach of the range of the host to Lafayette, according to Sudworth's map³⁸ is in eastern Ohio, which is

³⁶l. c. Map 35.

³⁷Flora of the Southeastern United States 33. 1913.

³⁸Forest Atlas. Geographic distribution of North American Pines. Part 1. Map 26. 1913.

approximately 250 miles distant. That the fungus at least sometimes winters over is evidenced by the fact that it has been collected in the vicinity of Lafayette on rosettes of the host as early in the season as May 6. There is little or no doubt that it had wintered in the unredinal stage, probably as mycelium in the living leaves of the host.

Perhaps the clearest indication of the survival of the winter by urediniospores or mycelium outside of the Aecidiaceae occurs in *Colcosporium Solidaginis*, on *Solidago*, *Aster*, and a few other Carduaceous hosts. This species is very widespread throughout the United States and is exceedingly common. Its exceeding commonness is attested by the fact that its Indiana distribution is represented in the Arthur herbarium by 44 mounted collections and a few unmounted ones, from 10 counties, and extending over a period of time from 1890 to the present. The aecial stage, *Peridermium acicolum*, occurs on *Pinus pungens* and *P. rigida*, with a distribution from Massachusetts and central New York to central North Carolina. According to Sudworth's maps³⁹ *Pinus rigida* is the one of these two aecial hosts which is nearer this section. Its nearest approach, as already shown, is eastern Ohio, which is approximately 250 miles distant from Lafayette. This is a greater distance than we would expect the fungus to migrate in one growing season; but the fungus extends also much farther to the west and northwest, so far, in fact, that it seems almost absurd to think it could have spread so far from its aecial base in a season. Furthermore, the writer on the first and second of July in 1912 made collections in eastern Indiana which show that the species was already well established for the season in a region a mile or more in extent. For such an infection, spores must be present in some quantity or must be present very early. But this is not the most convincing evidence at hand. There is a collection from Lafayette on *Solidago ulmifolia*, made June 25, 1896, and one on *S. scrotina* made May 15, 1901. There is also one on *Aster cordifolius* made May 30, 1896, and one on *Aster* sp. indet. made May 12, 1902. This last collection is on the rosette leaves of the plant which were practically in contact with the ground, and the rust is well developed. The collection was actually made earlier in the season than any aecial collection of the rust at hand except one, which was made at Durham, N. C., May 3, 1910. The range for the aecial collections is May 3 to July 6; and it was clearly impossible for this specimen to have resulted from infection tracing back to aeciospores of the same spring. The circumstance seems to be much more easily ex-

³⁹I. c. Maps 26, 30.

plainable by assuming that some urediniospores or mycelium survived the winter.

It seems fair, then, to judge from the foregoing that a good many rusts can pass the winter and propagate themselves for a long time, and probably indefinitely, without the intervention of sexual reproduction. This is in line with the experience of Freeman and Johnson,⁴⁰ who carried *Puccinia graminis*, *P. rubigo-vera*, and *P. simplex* through 52 uredinial generations without apparent degeneration, and of Fromme,⁴¹ who similarly carried *P. coronifera* on oats through thirty-seven uredinial generations, and of carnation raisers generally, who still find the carnation rust an enemy to be fought although it has in all probability never produced an æcium on this continent.

The evidence, therefore, which is to be gained from the behavior of the rusts concerning the question as to whether or not a plant species can long maintain a high degree of vigor without sexual reproduction is quite definitely in favor of the idea that it can. True it is that in the long cycled rusts an effect of stimulation follows the stage in which the sexual fusions take place, but this effect becomes dispelled by one or two uredinial generations, so that the rust is then back at the old level of vigor; and it remains there through an indefinite number of uredinial generations.

Purdue University,
Lafayette, Indiana.

⁴⁰Bur. Plant Ind. Bull. 216:34. 1911.

⁴¹Bull. Torrey Club 40:510-511. 1913.

CORRELATION OF CERTAIN LONG-CYCLED AND SHORT-CYCLED RUSTS.

H. C. TRAVELBEE.

When in 1897 Dietel, in his work "The Uredinales" for "Die natürlichen Pflanzenfamilien" of Engler and Prantl, pointed out the remarkable similarity between the teliospores of *Puccinia Mesneriana* Thüm., on *Rhamnus* and those of *Puccinia coronata* Cda. and *Puccinia coronifera* Kleb. on grasses, which have their æcia on *Rhamnus*, he established the first observation on correlations between rusts of widely different species. He also called attention to the fact that a similar condition obtains between the teliospores of *Puccinia ornata* Arth. & Holw. on *Rumex* and the teliospores of the grass rust, *Puccinia Phragmitis* (Schum.) Körn. which has *Rumex* for its æcial host. In both of these cases we note the teliospores of a short-cycled rust appearing on the æcial host of a long-cycled heterecious rust. The teliospores of the two species are morphologically alike although appearing on host plants of quite different families.

About this same time (1898) Fischer stated* that quite independently of Dietel, he found by his researches a list of similar relationships. He reported five heterecious species of *Puccinia*, two of *Chrysomyxa*, one of *Melampsora* and one of *Colcosporium*, all having short-cycled forms appearing on their æcial hosts, agreeing with their teliospores. He also listed three *Uromyces* and one *Puccinia* which show this sort of a relationship with certain micro- or hemi-forms.

It is worthy of note here that the complete life history of all the forms correlated in this manner were known at the time the observations were made.

When in 1903 and 1904 Tranzschel connected into a heterecious life history two rust forms which until that time had never been suspected of bearing any relationship to each other, he made a wonderful advance along the line of this sort of investigation. His method was as unique as it was important, and on account of the interesting field it opens for investigators is worthy of detailed mention.

He had an unconnected *Accidium*, *A. punctatum* Pers., on *Anemone ranunculoïdes*, and was endeavoring to find its alternate host. He observed that on *Anemone nemorosa* there appeared a short-cycled *Puccinia*, *P.*

*Beiträge zur Kryptogamenflora der Schweiz. 1:109. 1898.

fusca (Pers.) Wint., whose morphological aspects were strikingly similar to those of the *Accidium*, i. e., the sori of the two rusts were arranged in the same manner; the effects on the host plant were the same, and the macroscopic characters of the two were alike. He concluded that the two forms were closely related phylogenetically. Then his problem was: How find the alternate stage of the *Accidium* form?

On examining the teliospores of the short-cycled form microscopically he found them to possess very striking features, having a roughly warty wall, and being strongly constricted at the septum. A careful examination of his unconnected *Puccinias* revealed one having spores similar to those of the short-cycled form on *Anemone*, *Puccinia Pruni-spinosa* Pers., the plum rust. He cultured the aeciospores from *Anemone* on the leaves of plum and peach trees and grew the uredinia and telia of the plum rust. In his investigations at this time he combined, in this way, five heteræcious species. Three of these species he proved by cultures; namely,

1. *Puccinia Pruni-spinosa* Pers. with *Accidium punctatum* Pers.

2. *Uromyces Veratri* (DC.) Schroet. with *Accidium Adenostylis* Sydow.

3. *Uromyces Rumicis* (Schum.) Wint. with *Accidium Ficariæ* Pers.

The correlation, then, of two rusts of distinct species depends upon several things: first the family relationship of the host plants. The rusts are usually on the same or closely allied species of host plants. The macroscopic characters of the two rusts are also of decided importance. They can usually be expected to have similar effects on the common host plant; and the location and disposition (i. e., whether they are amphigenous, epiphyllous, hypophyllous, caulicolous; numerous or few, scattered or crowded; circular, oblong or irregular, etc.) of the sori are important factors.

The most important thing, however, is the agreement of the microscopic characters of the analogous spore forms. The teliospores of the short-cycled and long-cycled forms are compared for thickness, color and markings of the walls; the condition of the apex (thickened or not); measurements of the spores; length, color and type of pedicels; and the general conformation of the spores.

Owing to the fact that the knowledge of the rust fungi of very many regions is not complete, the geographic distribution can not be considered as extremely important. Nevertheless many interesting comparisons are shown by a study of the distribution of the correlated forms.

For some time past the writer has had access to the Arthur herbarium, and at the suggestion of Dr. J. C. Arthur, made a list of the heteroecious species of *Puccinia* having their teliospores on grasses, whose complete life histories are known. The teliospores of the short-cycled forms appearing on the aëcial hosts of these rusts were compared with the teliospores of the long-cycled forms with the intention of compiling such a list as Fischer published. The following combinations were found to appear as good correlations:

LIST OF CORRELATIONS.

	RUST.	TELIAL HOST.	AECIAL HOST.
1.	{ <i>Puccinia Crandallii</i> Pammel & Hume <i>Puccinia Symphoricarpi</i> Hark.	{ <i>Festuca</i> <i>Poa</i> <i>Symphoricarpos</i>	{ <i>Symphoricarpos</i>
2.	{ <i>Puccinia simillima</i> Arth. <i>Puccinia Anemones-virginiana</i> Schw.	{ <i>Phragmitis</i> <i>Anemone</i>	{ <i>Anemone</i>
3.	{ <i>Puccinia Stipæ</i> Arth. <i>Puccinia Grindelie</i> Peck.	{ <i>Koeleria</i> <i>Oryzopsis</i> <i>Stipa</i> <i>Bigelovia</i> <i>Chrysopsis</i> <i>Chrysothamnus</i> <i>Grindelia</i> <i>Gutierrezia</i>	{ <i>Aster</i> <i>Bigelovia</i> <i>Chrysopsis</i> <i>Chrysothamnus</i> <i>Erigeron</i> <i>Grindelia</i> <i>Gutierrezia</i> <i>Lygodesmia</i> <i>Nothocalais</i> <i>Senecio</i> <i>Solidago</i>
4.	{ <i>Puccinia Andropogonis</i> Schw. <i>Puccinia Seymerie</i> Burrill.	{ <i>Andropogon</i> <i>Dasystema</i>	{ <i>Castilleja</i> <i>Dasystema</i> <i>Penstemon</i>
5.	{ <i>Puccinia pustulata</i> (Curt.) Arth. <i>Puccinia Comandra</i> Peck.	{ <i>Andropogon</i> <i>Comandra</i>	{ <i>Comandra</i>
6.	{ <i>Puccinia monoica</i> (Peck) Arth. <i>Puccinia Holboellii</i> (Horn.) Rostr.	{ <i>Koeleria</i> <i>Trisetum</i> <i>Arabis</i>	{ <i>Arabis</i> <i>Parrya</i> <i>Schænocrambe</i> <i>Smelowskya</i>
7.	{ <i>Puccinia Agropyri</i> Ell. & Ev. <i>Puccinia DeBaryana</i> Thuem.	{ <i>Agropyron</i> <i>Anemone</i>	{ <i>Anemone</i>
8.	{ <i>Puccinia rubella</i> Arth. <i>Puccinia ornata</i> A. & H.	{ <i>Phragmitis</i> <i>Rumex</i>	{ <i>Rheum</i> <i>Rumex</i>
9.	{ <i>Puccinia rhamni</i> Wettst. <i>Puccinia Mesneriana</i> Thuem.	{ <i>Avena</i> <i>Rhamnus</i>	{ <i>Rhamnus</i>

The last two combinations in this list are the ones noted by Dietel.

Orton¹ dealt with quite a different type of correlation when he reported in detail the similarities between six species of heteroecious *Uromyces* and six species of heteroecious *Puccinia*. He also extended this study to include autoecious species of *Uromyces* and *Puccinia*. In every instance the host plants of the two rusts are of the same species, or of species closely related morphologically and phylogenetically. Because of the cellular difference in the teliospores (*Uromyces*, one-celled; *Puccinia*, two-celled) Orton laid special emphasis on the agreement of the microscopic characters of the aeciospores and urediniospores of the two rusts, remarking only in a general way similarities between the teliospores.

When we consider the differences in the number of spore forms in the life cycles of the various species of rusts, and take into consideration the morphological variation of the analogous spores, it is apparent that the possibilities of correlation are numerous. There are many problems presented in connection with such correlations. The choice of host plants, the similarity of analogous spore forms, and the like effects on the host all point to a common ancestor. What then is the primitive form? What is the evolutionary history of the derivative species? How great a range may be expected in the variations of correlated species? These and similar questions arise when a theoretical consideration of the condition is undertaken.

The practical application of knowledge gained by correlation studies will be along the lines of culture work, especially in forecasting the alternate host plants of unconnected aelial or telial forms.

Mycologia, IV: No. 4, July, 1912.

Purdue University,

Lafayette, Ind.

SOME SPECIES OF NUMMULARIA COMMON IN INDIANA.

CLAUDE E. O'NEAL.

The difficulty of distinguishing the various species of *Nummularia*, and even the genus itself from the genus *Hypoxylon*, is quite evident to anyone who has made any attempt at their classification. In a paper entitled "A Monograph of the Common Indiana Species of *Hypoxylon*",* C. E. Owens, by the aid of plates and an artificial key, sets forth the characteristics of the common species of the latter genus. The purpose of this paper is to do a similar work with the available species of the genus *Nummularia*.

In the study of *Nummularia*, attention is first directed toward the stromata, which appear as blackish or brownish incrustations on the dead trunks and limbs of our common deciduous trees. In form, the stromata vary greatly, but in general, they belong to two types, one of which may be described as cup-shaped, and the other as convex. The former type is usually orbicular or elliptical in shape, while the latter may be either orbicular, elliptical, or broadly effused with an irregular outline.

The stromata arise beneath the epidermis of the substratum where they may remain concealed for some time, but sooner or later, the epidermis is broken through and the spore-bearing surface is exposed. Sometimes in old specimens the entire epidermis may be removed and the erumpent characteristic overlooked. In some cases the entire cortex may decay and fall away, leaving the stromata standing out on the decorticated surface. Again, some of the more resistant ones may be found in good condition on a log that is ready to drop to pieces from decay.

In width the various Indiana species range from a few millimeters in the cup-shaped forms to several centimeters in the broadly effused types. The thinnest ones that the author has found have been about one-half millimeter thick while some of the cup-shaped forms may have a thickness of

*Proceed. Ind. Acad. Sci. 1911, p. 291.

half a centimeter or more. In the early stages of development in the species described the stromata may be lightly colored, but when the sporidia are mature the color of the fertile layer is black. Sometimes the substratum is stained by the fungus. One species is readily recognized by the characteristic orange color imparted to the wood beneath the stromata. Another species gives a peculiar ring-like marking to both wood and bark.

If a stroma be cut through, the flask-like perithecia are found deeply embedded in it. They are arranged in a single row and open by minute pores (ostiola) on the upper side of the stroma. The ostiola in some species may be rather prominently raised giving the fertile surface a pimpled appearance, or they may be sunken; while in some forms they may be so obscure as to be passed over unnoticed. The edges of the stromata are usually sterile.

The perithecia contain many eight-spored asci. These asci are cylindrical in shape and bear the spores in a single row. They are readily distinguished from the paraphyses with which they are found by their shorter length and the spores which they contain.

The spores of the *Nummularias* vary greatly in size, color, and shape. The largest ones that the author has observed were about 16 microns long and one-half as broad, while the smallest were about 5 microns long and about $2\frac{1}{2}$ microns wide.

The shape varies from elliptical to orbicular. When the spores are young they are usually hyaline, but as they become older, they turn brown and in some species they finally become opaque.

In general, the Indiana species of *Nummularia* are saprophytic in habit and consequently have but little economic importance. Under certain conditions, however, *N. discreta** becomes parasitic and causes considerable damage to poorly kept apple trees. To many fruit growers it is known merely as apple canker; others distinguish it as the blister canker. The fungus gains a footing in a wound or in a decayed portion of the tree and spreads to the living parts. The stromata arise upon the mycelia beneath the epidermis of the host. The overlying epidermis shortly becomes dry and papery and sooner or later it is torn and drops away leaving the

*Canker of Apple—Hasselbring, Ill. Exp. Sta. Bull. 70.

Fungous Diseases of Plants—Duggar, pp. 282-284.

Apple Blister Canker and Methods of Treatment—W. O. Gloyer, Ohio Exp. Sta. Cir. 125.

The New York Apple Tree Canker. Bulls. N. Y. Ag. Ex. Sta. Nos. 163 and 185. Paddock.

The Control of Canker in the Orchard—J. R. Cooper, Neb. Hort., Vol. 3, 1913.

cankerosus stromata exposed. Since a great deal of damage is done before the stromata are formed, it is necessary to identify the disease from other characteristics. The remedy for this parasite is obviously the proper treatment of wounds and the removal and destruction of affected parts. Care in pruning would in many cases prove a sufficient preventive.

This fungus has been reported on several other hosts including *Ame-lanchier* but in these cases the economic importance is insignificant.

KEY TO THE COMMON INDIANA SPECIES.

- I. Stroma cup-shaped with perithecia opening on the concave side. (A).
- II. Stroma convex or plane. (B).
 - A. Stroma prominent, orbicular, with a thick, raised margin; stroma 4 to 7 mm. across; spores globose or subglobose, 10-16 microns1. *N. discreta*.
 - A. Stroma erumpent-superficial, either orbicular or elliptical; margin not so thick nor so regularly bulging as in the preceding species; concave part $\frac{1}{2}$ to 1 cm. across. Spores subinequilateral, 10-15x5-6 microns2. *N. repanda*.
 - B. Stroma dull black, orbicular, elliptical, or broadly effused; ostiola rather prominently raised, 3-5 per linear mm. Spores 12-16x6-8 microns3. *N. bulliardi*.
 - B. Stroma shiny black, more or less furrowed, staining the wood of the substratum orange color. Spores 12-16x5-7 microns. . .4. *N. tinctor*.
 - B. Stroma thin, orbicular, suborbicular or linear; ostiola depressed; ranging from $\frac{1}{2}$ to 1 cm. across. Spores $4\frac{1}{2}$ -5x2-2 $\frac{1}{2}$ microns.....5. *N. microplaca*.

DESCRIPTIONS.

1. *Nummularia discreta*, (Schw.) Tul. Plates I and II.

Sphaeria discinola, Schw. Syn. Car. No. 63.

Sphaeria discreta, Schw. Syn. N. Am. 1249.

Sphaeria excavata, Schw. l. c. 1250 (Sec. spec. in herb. Schw.)

Nummularia discreta, Tul. Sel. Carp. II, p. 45.

Stroma erumpent, circular or subcircular, sometimes uniting to form elongated patches, cup-shaped when mature, with a thick raised margin; ashen or grayish yellow, becoming black; the concave surface at first white

punctate from the minute ostiola which are hardly visible when mature. The bark and wood beneath the stromata are marked with a black circumscribing line. Perithecia arranged in a single row, oval or ovate-cylindrical, about one millimeter long, usually rather abruptly contracted above into a short neck and extending to the base of the stroma. Asci cylindrical, 140-170x10-15 microns (E. & E., 110-120x10-12); spore bearing part, 110-125x10-15 microns. Paraphyses, long and filiform. Sporidia subglobose, almost hyaline at first, finally becoming opaque, 10-16 microns in diameter. (11-13 Gloyer, 10-12 E. & E.)

On dead trunks and branches of *Pyrus malus*: quite common on the living trees as well. Practically every orchard visited in Hendricks, Putnam and Monroe counties, Indiana, as well as Delaware County, Ohio, showed traces of this fungus. Gloyer reports it especially abundant in southern Ohio. Reported on *Amelanchier canadensis*, Newfield, N. J., and on *Gleditschia triacanthos*, Ohio, (Morgan); also (See Saccardo in Syll.) on *Sorbus*, *Ulmus*, *Cercis* and *Magnolia*.

On apple trees this fungus usually attacks the trunks and larger limbs, making somewhat sunken, cankerous areas several inches in length. The dead bark is separated from the sound by a distinct line and cracks occur along this boundary. At the beginning, living spots within the cankerous area give the affected parts a mottled appearance. This distinguishes it at this stage from other cankers.

2. *Nummularia repanda*, (Fr.) Nke.

Sphaeria repanda, Fr. S. M. II, p. 346. Obs. Mycol. I, p. 168.

Hypoxyton repandum, Fr. Summa Veg. Sc. p. 383.

Nummularia pezizoides, E. & E. Bull. Torr. Club, XI, p. 74.

Nummularia repanda, Nitsch. Pyr. Germ. p. 57.

Exsic. Fekl. F. Rh. 2178. Thum, M. U. 1460.

Stroma erumpent-superficial, orbicular or subelliptical, $\frac{1}{2}$ to 1 cm. in diameter, concave and often with a thin, erect, rather broad margin, reddish-gray at first, finally black; disk mammillose from the projecting ostiola. Perithecia monostichous, immersed, ovate-oblong, $\frac{1}{2}$ to $\frac{3}{4}$ mm. long, crowded, causing the sides to be somewhat compressed. Asci cylindrical, sessile, eight-spored, 110-120x8 microns, with long filiform paraphyses. Sporidia obliquely uniseriate, narrow ovate, obtuse, subinequilateral, dark brown, $8\frac{1}{2}$ -14x4-7 $\frac{1}{2}$ microns. (E. & E. 11-14x4-5 microns; Sacc. in Syll., 15-16x6-7 microns.) Readily distinguished from *N. discreta* by its differently shaped spores and its mammillose disk.

On *Hicoria*, Clark County, Indiana, (Van Hook); on wood and bark, Topeka, Kans. (Craigin), and on bark, Ottawa, Canada (Macoun); on bark of *Ulmus americana* Missouri, (Demetrio). On *Sorbus aucuparia* in Europe.

3. *Nummularia bulliardi*, Tul. Plate III, Figs. 1, 2 and 3.

Hypoxylon nummularium, Bull. Champ. tab. 468, fig. 4.

Sphaeria nummularia, D. C. Flore Fr. II, p. 290.

Sphaeria anthracina, Schm. & Kze. Mycol. Hefte 1, 55.

Sphaeria clypeus, Schw. Syn. N. Am. 1219.

Nummularia clypeus, Cke. IX, 597.

Exsicc. Ell. N. A. F. 85. Rab. F. E. 2956. Rehm, Asc. 977.

Illustrations. (See Sacc. XX, p. 202, for list of.)

Stroma at first covered by the epidermis, soon erumpent, almost superficial and free, convex, orbicular or oval, sometimes irregular in shape or broadly effused, black inside and out, punctulate from the slightly prominent ostiola, clothed at first with a reddish or rusty layer of conidia. Perithecia rather large, ovate, black, loosely included in the packed cells of the stroma. Asci cylindrical with very short stalks, spore-bearing part 115-140x7-10 microns (E. & E. 100-115x10 microns), with long, stout paraphyses. Spores eight, uniseriate, elliptical, hyaline becoming opaque, 10-23x5-10 microns, mostly about 15-20x6-8 (E. & E. 12-15x7-9. Sacc. 12-14x9-10 microns.

In the field this species is liable to be confused with certain species of *Diatrype* (Fig. 2, Plate III) but may be readily distinguished from them by the color of its spores. Collected in abundance in Brown, Clark, Hendricks, Monroe and Putnam counties, where it usually attacks the beech and more rarely the maple. Reported common on the dead trunks and limbs of various deciduous trees in Europe and North America. According to Ellis and Everhart, it occurs for the most part on oak in the vicinity of Newfield, N. J.

4. *Nummularia microplaca*, (B. & C.) Cke. Plate IV, Fig. 4.

Diatrype microplaca, B. & C. Journ. Linn. Soc., X, p. 586.

Anthostoma microplacum, Sacc. Syll. I, p. 298.

Nummularia microplaca, Cke. Syn. 837.

Exsicc., Rav. Fungi Car. IV, 39. Rav. Fung. Am. 355. E. & E.

N. A. F. Second Ser. 1556.

Illus., Revue Myc. VII, (1885) tab. 52, fig. 3.

Stroma orbicular to subelliptical, $\frac{1}{2}$ to 1 cm. across, or elongated 1-4x $\frac{1}{2}$ -1 cm. or by confluence extending for long distances in grooves of the bark. It forms a thin carbonaceous crust, black, arising beneath the epidermis but soon becoming bare, surface even, faintly punctulate from the minute ostiola, which are not prominent but slightly depressed, the opening at first filled with a white farinaceous matter. Perithecia ovate-globose, small (less than one-half mm. across), arranged in a single row. Spore-bearing part of the ascus 40-50x4 microns (E. & E. 25x3 microns), or with the base about 60-80 microns long (Sacc. 37-50x4-5. E. & E. 45-50 long). Spores uniseriate, ends mostly slightly overlapping, elliptical, inequilateral, pale brown, 5-7 $\frac{1}{2}$ x2 $\frac{1}{2}$ -3 microns (E. & E. 4 $\frac{1}{2}$ -5x2-2 $\frac{1}{2}$. Sacc. 5-6x3 $\frac{1}{2}$ -4).

Should not be confused with *Hypoxylon* *Sassafras* which has very prominent perithecia while *N. microplaca* appears smooth and has stroma depressed.

Abundant near Bloomington, Indiana, on *Sassafras officinale*; reported on the same host in South Carolina (Ravenel) and in Ohio (Morgan and Kellerman); on *Persea*, Georgia (Ravenel).

5. *Nummularia tinctor*, (Berk.) E. & E. Plate IV, Figs. 1-3.

Sphaeria tinctor, Berk. Lond. Jour. Bot. IV, p. 311.

Hypoxylon tinctor, Cke. Syn. 996.

Diatrype?? tinctor, (Berk.) Sacc. Syll. I. 200.

Exsic., E. & E. N. A. Fungi. Second Ser. 1789.

Stroma very hard and brittle, much effused, showing the irregularities of the surface on which it grows, 1mm. thick, black, with surface almost smooth, but distinctly papillose from the projecting ostiola as seen under the hand-lens, wood beneath the stroma stained a beautiful reddish-orange color, and rendered very hard. Perithecia monostichous, crowded, elongated ($\frac{3}{4}$ mm. in length), covered above with the stromatic layer. Asci 100-140x6-10 microns (E. & E. 112x7-8). Spore-bearing part of ascus 75-120 long (E. & E. 90-100). Filiform paraphyses in abundance. Spores uniseriate, pale brown, conspicuously uniguttulate, oblong navicular, 13-20x5-8 microns (E. & E. 15x6).

On *Platanus*, *Fagus*, *Acer*, *Ulmus* and *Cercis* in the vicinity of Bloomington, Indiana (Van Hook). Occurs throughout the Mississippi valley and in the south as far east as Florida.

In this paper, free use has been made of North American Pyrenomycetes by Ellis and Everhardt. The descriptions have been re-written to suit the material at hand. Especially has it been found necessary to revise the measurements of parts as seen under the microscope. The author wishes also to make due acknowledgment to Prof. J. M. Van Hook, of Indiana University for material and valuable assistance in the preparation of this paper.

*Indiana University,
Bloomington, Indiana.*

PLATE I.

Figures 1 and 2. Where *Nummularia discreta* thrives. Much of this is due to *N. discreta*. (From photos by the author in Hendricks County, Indiana.)



PLATE II.

Figure 1. *Nummularia discreta* on decorticated apple limbs. (Reduced.)

Figure 2. Same natural size.

Figure 3. Same before the bark has fallen away. (Natural size.)

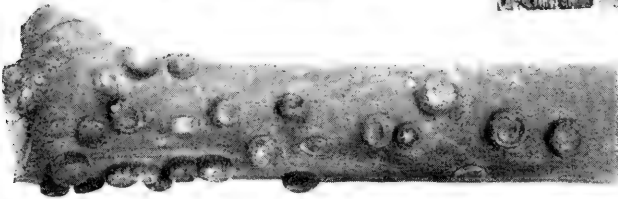
Figure 4. Under side of a piece of bark showing white stains of the fungus. (Natural size.)



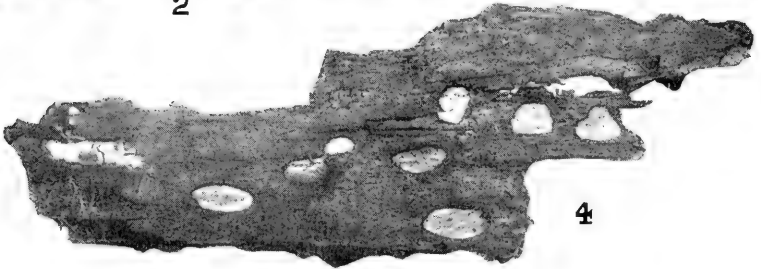
1



3



2



4

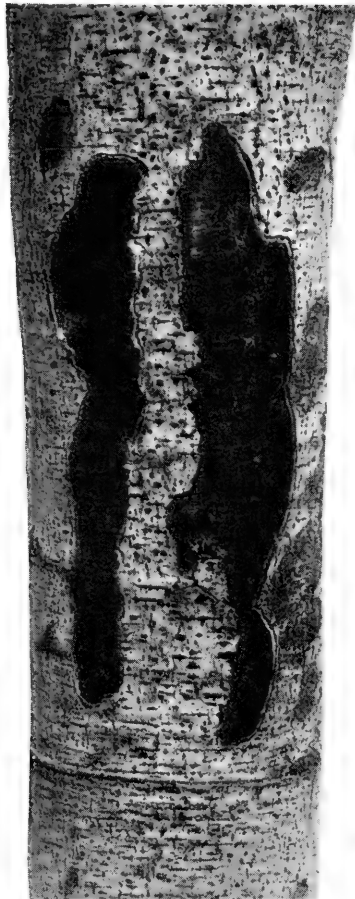
PLATE III.

Figure 1. *Nummularia Bulliardii* on beech, showing a common form of stroma. (Natural size.)

Figure 2. A stroma of a fungus (*Diatrype*) very similar to *N. Bulliardii*. (Natural size.)

Figures 3 and 4. Orbicular stromata of *Nummularia Bulliardii* on beech. (Natural size.)

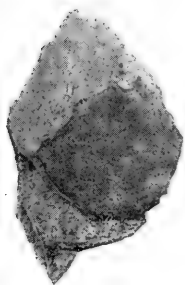
Figure 5. Stroma taken from a log which was falling to pieces. (Natural size.)



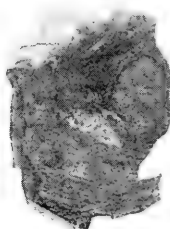
1



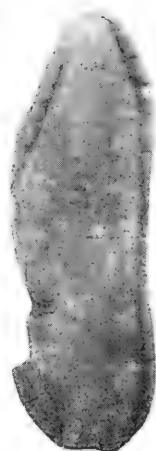
2



3



4



5

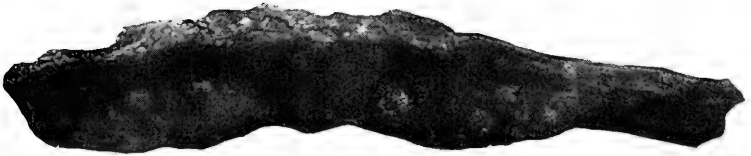
PLATE IV.

Figure 1. *Nummularia tinctor*. (Natural size.)

Figure 2. Same showing section of the wood beneath stroma. The dark colored parts are a beautiful orange.

Figure 3. Same showing furrowed stroma. (Natural size.)

Figure 4. *Nummularia microplaca* on *Sassafras*. Closely resembles *Hypoxylon Sassafras*. (Natural size.)



2



3



4

THE GENUS ROSELLINIA IN INDIANA.

GLEN B. RAMSEY.

In this paper it is the author's purpose to present the genus *Rosellinia* as found in Indiana. Limited means for collecting and the unfavorable weather conditions during the past year for the growth of this class of fungi render an exhaustive treatise on the genus *Rosellinia* impossible. Only those species that have been found in Indiana, together with their descriptions and an account of their habits and habitat have been included. A description of some of the more common parasitic species has also been appended.

There are now over one hundred seventy species described, the most of them being saprophytic. As in other genera of the Pyrenomycetes, *Rosellinia* has a vegetative phase which is found in the substratum or host. The white thread-like mycelium may readily be found in decaying logs and stumps. There are, however, some species that seem to flourish in wood that is quite firm. In most cases the actively parasitic stage is found on the roots and consists of a great abundance of white mycelium which does the greatest harm to the plant. This mycelium growing into the root system stops up the xylem cells, prevents the roots and rootlets from performing their functions, thus finally starving the plant to death.

The fruiting parts of *Rosellinia* do not develop until late in the season, the conidial stage being found in late summer or early autumn, with the perfect or ascigerous stage following and maturing in late fall or early winter. The perithecia with their abundant asci and filiform paraphyses are found in good condition for collecting from October to February. The spring rains and warm weather, together with the frost action during the winter, cause the perithecia to disintegrate rapidly when spring comes. Most of the specimens at hand were collected during the early winter months.

In *Rosellinia* the perithecia are more or less crowded or gregarious and superficial, but often having the base sunken in the matrix. Perithecia ovate to sub-globose, papillate, sub-carbonaceous, black, bare

or bristly, with a distinct ostiolum. The asci are cylindrical, eight spored. Spores continuous, broadly ovate, elliptical, oblong or fusiform, brown or black, with or without hyaline appendages. Paraphyses filiform. Stroma tomentose, often wearing off with age and exposing the perithecia as round, brownish black heads with their papilla-like ostiola in the center.

In studying the species of *Rosellinia* we are confused at times when we find forms which closely resemble certain forms of the genus *Hypoxylon*. In such cases a clear distinction seems impossible, yet these two genera are clear cut in their separation by botanists, being separated on the ground of the presence of a stroma in *Hypoxylon*, and the absence of a distinct stroma in *Rosellinia*. To anyone that has made a study of either of these two genera, the superficiality of this basis of separation is quite evident. Students of the genus *Hypoxylon* know that the perithecia of certain forms become scattered, and especially with age, the stroma is wanting.

The genus *Rosellinia* is placed under the *Sphaeriaceae* by both Lindan and Ellis and Everhart. This separates it widely from *Hypoxylon*. Saccardo puts it under the brown spored one-celled forms of *Xylariaceae* along with *Hypoxylon*. The author likes this position on account of the great similarity of spores, asci and perithecia, as well as the above mentioned similarity of forms where the absence of stromata is noticeable.

Variation within a given species often makes it almost impossible to formulate a key that will hold in all cases. In order to eliminate this difficulty the species are made to run in two ways. The species *R. subiculata* for example has in the earlier stage a decided waxy sulphur-yellow subiculum and the perithecia are scattered, but as it grows older the subiculum finally disappears so that one might readily confuse it with other species that never have a subiculum. The ascis and spore measurements are probably the most constant and reliable in forming a basis for a key. The second key, it is hoped, will prove helpful in determining any doubtful species that do not run satisfactorily in the key of external characteristics.

The accompanying figures from photographs will assist in determining the species. In order to get the greatest contrast possible, time exposures were made in a subdued light and a special contrast developer was used.

The description of species have been adapted for the most part from

the original descriptions as given by Ellis and Everhart in "North American Pyrenomycetes", and Saccardo's "Sylloge Fungorum." Practically all of the descriptions have been rewritten and additional data added from specimens at hand. All measurements are original. Where asci and spore measurements by Ellis and Everhart differ, their figures are also given.

KEY TO SPECIES.

(Based on external characteristics.)

- I. Perithecia large ($\frac{3}{4}$ - $1\frac{1}{2}$ mm.), seated on a subiculum.
- A. Subiculum usually prominent.
1. Brown or purplish brown, persistent.....1. *R. aquila*
 2. Sulphur-yellow, evanescent6. *R. subiculata*
- B. Subiculum scanty.
1. Dark brown, perithecia crowded.....2. *R. medullaris*
 2. Black, perithecia confluent3. *R. mammiformis*
- C. Subiculum wanting, perithecia more or less scattered.
1. Base glandular-roughened4. *R. glandiformis*
 2. Not glandular-roughened5. *R. mutans*
- II. Perithecia small ($\frac{1}{3}$ - $\frac{1}{2}$ mm).
- A. Perithecia gregarious, often crustaceous, not bristly.7 *R. pulveraceæ*
- B. Perithecia usually scattered, bristly, dark brown....8. *R. ligniaria*

(Based largely on microscopic characteristics.)

- A. Perithecia large ($\frac{3}{4}$ - $1\frac{1}{2}$ mm).
- B. Spores more than 18 microns long.
- C. Asci more than 150 microns long.....1. *R. aquila*
- CC. Asci less than 150 microns.
- D. Asci 7-8 microns wide.....2 *R. medullaris*
- DD. Asci 8-10 microns wide.....3. *R. mammiformis*
- BB. Spores less than 18 microns long.
- C. Asci more than 95 microns long.....4. *R. glandiformis*
- CC. Asci less than 95 microns.
- D. Perithecia $\frac{1}{2}$ - $\frac{3}{4}$ mm.5. *R. mutans*
- DD. Perithecia $\frac{3}{4}$ -1 mm6. *R. subiculata*
- AA. Perithecia small ($\frac{1}{3}$ - $\frac{1}{2}$ mm).
- B. Asci more than 70 microns long.....7. *R. pulveraceæ*
- BB. Asci less than 70 microns long.....8. *R. ligniaria*

1. *R. aquila* (Fr.) De Not.

Sphaeria aquila Fr.

Sphaeria byssiseda Meekl.

Rosellinia aquila De Not.

Perithecia large, globose, 1-1.25 mm. in diameter, gregarious, crowded or sometimes confluent, with a distinct black, conic-papilliform ostiolum; dark brown at first with a thin tomentose coating, finally becoming bare. Subiculum rather thick and prominent, dark to purplish brown, nearly enveloping the perithecia at first but finally disappearing to a greater or less extent. Outer walls of the perithecia thick, brittle and carbonaceous. Inner wall coriaceous. Asci long, cylindrical (p sp.) 10-12.5 x 165-190 microns. Spores uniserrate, oblong, brown, 10-11 x 22.5-27.5 microns. (E & E) gives asci (p sp.) 8-10 x 100-130 microns. Sporidia 6-9 x 16-27 microns, with or without a short, obtuse, hyaline apiculus, 2-2.5 microns long at each end.

Common on decaying and fallen limbs, near Bloomington, Ind. Specimens at hand are on *Fagus*, *Acer*, *Quercus* and *Juglans*.

2. *R. medullaris* (Walls) Ces. & De Not.

Sphaeria medullaris Walls.

Rosellinia medullaris Ces. & De Not.

Rosellinia macouniana E. & E.

Perithecia more or less erumpent, large 1-1.5 mm. in diameter, ovate to sub-globose, covered at first with a pruinose-pubescent coat of a dull red or brick color, becoming black with age; loosely adnate, apex convex to conic-papilliform, surface dirty-roughened with a finely powdered sooty covering; very fragile. Wall double and intermediate in thickness between *R. aquila* and *R. thelena*. Subiculum slight.

Spores 7.5-12 x 20-25 microns. E. & E. give asci (p sp.) 7-8 x 100-120 microns. Sporidia 6-7 x 19-20 microns; ovoid, somewhat acute, brown, broader but not pointed as in *R. mammiformis*.

On *Cercis canadensis* and *Juglans*, Monroe County, Ind.

On examining a great number of perithecia the most of them were found to contain a white, granular mass such as described in *R. medullaris* by Saccardo, but close observation showed this material to be a fine powder of wood that had been brought into the perithecia from the bottom by a small larva that probably feeds upon the contents of the perithecia.

3. *R. mammiformis* (Pers.) Ces. & De Not.

Sphaeria mammiformis Pers.

Hypoxyton mammæformæ Berk.

Hypoxyton globulare (Bull.) Fekl.

Rosellinia mammiformis Sacc.

Perithecia gregarious, crowded or confluent, globose, large, 1-1.5 mm. in diameter, fragile, black and bare but not shining. Ostiolum abrupt, papilliform.

Asci (p sp.) 8-10 x 100-115 microns (E. & E).

Spores 10-12 x 20-25 microns, oblong, elliptical, sometimes slightly curved. E. & E. give sporidia 7-9 x 19-25 microns, without any distinct apiculus. It can be easily distinguished from *R. aquila* by the blacker, thinner walled and more fragile perithecia and the lack of a decided subiculum.

On bark of *Acer*, near Bloomington, Ind.

4. *R. glandiformis* E. & E.

Perithecia scattered, the base sunk in the wood about one-fourth, ovate-globose, roughened with glands, with a reinforcement around the lower half similar to the cup of an acorn. This thickening is, however, sometimes reduced to a mere granular coat. Ostiolum papilliform, small, sometimes obsolete, the apex being evenly rounded.

Asci not present in specimens at hand. E. & E. give (p sp.) 8-10 x 100-114 microns; paraphyses abundant. Spores 7-10 x 13.75-17.5 microns. E. & E. give 7-8 x 14-15 microns. Common on *Loriodendron Juglans* and *Fraxinus*, Monroe County, Indiana.

5. *R. mutans* (C. & P.) Sacc.

Sphaeria mutans C. & P.

Rosellinia mutans Sacc.

Perithecia more or less crowded or gregarious, rather small, about .5-.75mm. in diameter, at first clothed with a thin, tawny, evanescent tomentum, finally becoming smooth, black and shining; mostly globose with a papillate ostiolum. In the specimen at hand the region about the ostiola showed a distinct tendency to depress.

Asci subcylindrical (p sp.) 6.5-7.5 x 80-92.5 microns.

Spores uniserrate, elliptical, brown, 4.25-5.5 x 9-12.5.

Common on decaying *Juglans*, near Bloomington, Indiana.

6. *R. subiculata* (Schw.) Sacc.

Sphaeria subiculata Schw.

Hypoxyton subiculosum Berk.

Rosellinia subiculata Sacc.

Perithecia thin, usually gregarious or crowded but often more or less scattered in the early stages; globose, brownish-black and shining, mostly superficial, about .75-1 mm. in diameter. Ostiolum small and papilliform. Perithecia seated on a sulphur-yellow, waxy-pruinose subiculum which disappears with age leaving the black, shining perithecia closely resembling *R. mutans*.

Asci cylindrical (p sp.) 6.25 x 90 microns.

Spores inequilateral, elliptical, brown, 5-6.25 x 10-12.5.

Ellis and Everhart give asci 6-7 x 80-90. Spores 5-5.5 x 10-12 microns.

Common on *Quercus*, *Loriodendron*, and other rotten deciduous wood near Bloomington, Ind., and Jolietville, Ind.

7. *R. pulveracea* (Ehr.) Fekl.

Sphaeria pulveracea Ehr.

Sordaria Friesii Niessl.

Rosellinia pulveracea Fekl.

Rosellinia Friesii Niessl.

Sphaeria millegraria Schw.

Sphaeria transversalis Schw.

Perithecia very small and minutely roughened, about $\frac{1}{4}$ mm. in diameter, densely gregarious, often forming a continuous crustaceous layer or scattered and tending to follow the check marks in the wood. Ostiolum papilliform, soon perforated.

Asci cylindrical (p sp.) 9-16 x 70-75 microns.

Spores elliptical, brown, 7.5-8.75 x 11-13.25 microns. E. & E. give asci 10-12 x 60-70 microns. Sporidia 6-9 x 8-15 microns, mostly 7-8 x 10-12.

Common on water beech and sycamore near Jolietville, Ind. Normally found on decorticated wood while it is yet more or less firm.

8. *R. ligniaria* (Grev.) Nke.

Sphaeria ligniaria Grev.

Rosellinia ligniaria Sacc.

Perithecia gregarious or crowded, sometimes forming a crust similar to *R. pulveracea* and in some cases tending to follow the check marks in

the wood. Perithecia ovate-conical, very black and superficial, about $\frac{1}{4}$ mm. in diameter, clothed with very minute black bristles about 20-30 microns in length.

Asci (p sp.) 8-10 x 65-70 microns.

Spores 7-8.75 x 10-14 microns.

Common on Fraxinus and Ostrya near Bloomington, Ind. Found on decorticated wood and underneath loosened bark.

ROSELLINIA AS A PARASITE.

Unlike Hypoxylon and Nummularia, Rosellinia is of great economic importance on account of several of its species being active parasites. Of the one hundred seventy species now described, at least eight are known to be injurious and destructive to living plants. No doubt many other species will be found to be parasitic when a more thorough study is made of them. The following is a brief account of some of the most destructive species:

Rosellinia quercina Hart. Perithecia scattered, seated on a black mycelium, black globose, about 1 mm. in diameter. Asci sub-cylindrical, eight spored, 8-10 x 160-170 microns. Spores brown, acute at both ends, 6-7 x 28 microns.

This species is called the oak root fungus, and attacks the roots of seedling oaks that are from one to three years old. The mycelium spreads rapidly through the ground from one plant to another and is especially destructive during warm, damp weather. This mycelial form was formerly referred to a special genus, Rhizoctonia. The effects of the fungus are first shown by the wilting and drying of the leaves near the top, the lower ones following in order until the whole plant is killed. If a seedling so affected is pulled up and the roots examined, a fine, thread-like mass of white mycelium will be found completely enveloping the roots. The tap root will have dark ovoid bodies about the size of a pin head where the lateral roots join. The tap root is often quite rotten where the mycelium has enveloped it, and especially in the neighborhood of the black tubers. Numerous black sclerotia are found on the surface of the dead roots. The strands of mycelium readily penetrate the young rootlets not yet protected by a layer of periderm and may kill the plant in from ten to fifteen days. Slender hyaline conidiospores are usually found near the base of the stem and on the adjoining soil. Later the perithecia are formed on the dense mass of mycelium covering the superficial roots.

Rosellinia aquila (Fr.) De Not. This species attacks many kinds of trees but is probably best known for its activity on mulberry roots. As a rule the trees are killed by the dense mycelium enveloping the roots. The mycelium penetrates every part of the root and is especially abundant in the medullary rays. When the host is quite dead the dark brown perithecia are found crowded together on the brownish velvety patches that previously bore the conidia. The conidial form of this species is known as *Trichosporium fuscum*. This is one of our most common species, and a description is found elsewhere in this paper.

Rosellinia necatrix (Hart.) Berl. This fungus produces a disease known as the "white root rot." This species is, however, rather rare in this country. One of the peculiar characteristics of the disease is its power of attacking practically every plant with which it comes in contact. It is especially disastrous in vineyards, orchards, etc. Some of its more common victims are vines, fruit trees, oaks, maples, beeches, pines, beans, potatoes and beets.

The mycelium of this fungus travels underground and attacks the rootlets, killing them and gradually working its way up to the larger roots and from them to the body of the plant proper. Here in some instances it breaks through the cortex as a white fluffy mass of mycelium. Sclerotia are formed on the exposed parts of the infected roots, which give rise to dark, bristle-like conidiophores which bear numerous conidia at their tips. Globose swellings on the exposed portions of the mycelium are sometimes formed, which, according to Viala, are capable of emitting mycelium which forms a new plant. The ascigerous stage has been discovered by Viala, appearing only on trees that are well decayed.

Rosellinia radiciperda Mass. This is the cause of the disease known as the "New Zealand white root rot" and is very closely allied to the fungus causing the "white root rot" of Europe, *R. necatrix*. It attacks the roots of the apple, peach, pear, etc., and also such plants as docks, ferns, sorrel, cabbage and potatoes. Sometimes the trees are killed here and there, but often whole areas are swept away.

The white filamentous mycelium attacks the roots and the bark just under the ground. This eventually gives rise to sclerotia which later produce the conidial stage. Next the mycelium becomes dark colored and gives origin to the black globose pycnidia containing stylophores. The ascigerous stage is found on dead tree trunks and stumps that have been dead for considerable length of time.

Rosellinia ligniaria (Nitschke) has been found to attack living ash trees by Mr. W. Carruthers.

Rosellinia massinkii (Sacc.) is reported by Halstead on hyacinth bulbs.

Rosellinia bothrina (B. & Br.) Sacc. is the cause of the tea root rot.

Rosellinia echinata (Mass.) is reported on almost all kinds of trees and shrubs.

The works most freely drawn upon regarding parasitic species are the following:

Hartig—Unters. Forsbot. Inst. Münschen.

Hartig—Diseases of trees.

Massee—Kew Bulletin (1816).

Massee—Diseases of Cultivated Plants and Trees.

Viala—Mon. du Pourridié des Vignes et des Arbres Fruitiers.

Prillieux—Malad. des Plantes.

Wright—Journal Mycol. 5, p. 199.

All species figured and described in this paper have been verified by Dr. Charles H. Peck, or compared with specimens in the New York State Museum by H. D. House, acting State Botanist of New York. I take this opportunity to express my thanks for their assistance.

For valuable material and aid in formulating this paper, I am greatly indebted to Prof. J. M. Van Hook of Indiana University.

Indiana University,

Bloomington, Ind.

EXPLANATION.

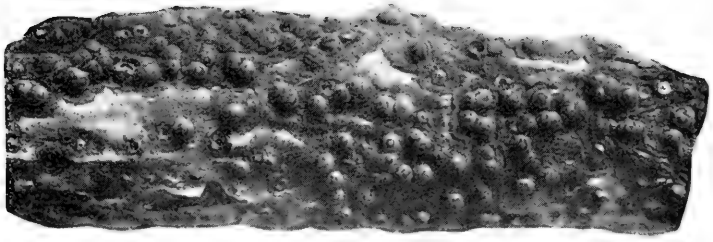
A Bausch and Lomb Microtessar 72 mm. lens was used in making all photographs. All figures are twice natural size.

PLATE I.

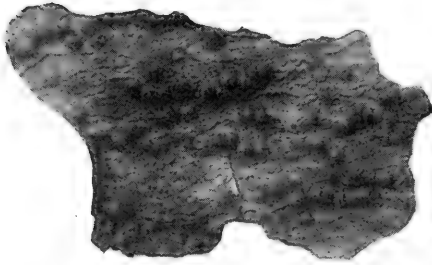
Figure 1. *R. aquila*.

Figure 2. *R. medullaris*.

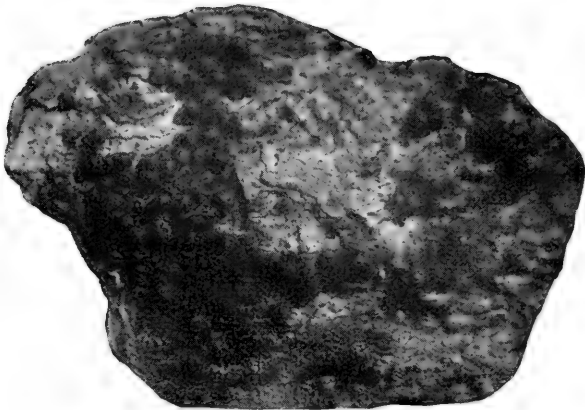
Figure 3. *R. mammiformis*.



1



2



3

PLATE II.

Figure 4. *R. glandiformis*.

Figure 5. *R. mutans*.

Figure 6a. *R. subiculata*, old stage showing crowded condition of the perithecia and the absence of the subiculum.



4



5



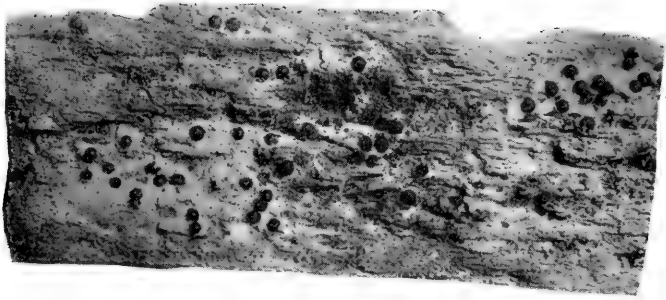
6a

PLATE III.

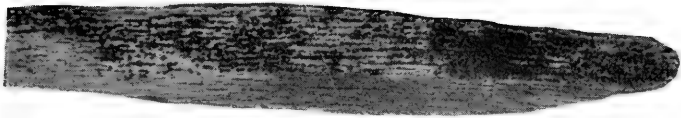
Figure 6b. *R. subiculata*, young stage showing scattered perithecia seated in a sulphur yellow subiculum.

Figure 7. *R. pulveracea*.

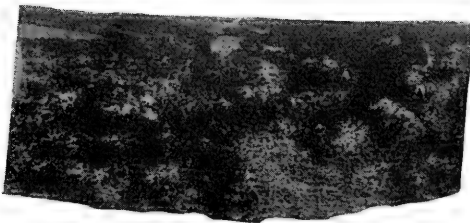
Figure 8. *R. ligniaria*, showing crustaceous form resembling *R. pulveracea*.



6b



7



8

SOME LARGE BOTANICAL PROBLEMS.

J. C. ARTHUR.

Every farmer, without doubt, desires to produce bumper crops. As agriculture is one of the large factors in national prosperity, it is to the interest of every person in whatever walk of life that bumper crops should be produced. The Experiment Station in each State has been established to assist the cultivator, whether farmer, orchardist, gardener, or any other grower, to solve the problems that hinder maximum production. Some of the problems fall naturally to the botanist. It is well to review them, and not only recognize where the problems lie, but have some idea of their importance. As there are plenty of urgent botanical problems in the home State, it will not be necessary to go outside of Indiana to find illustrative material.

Probably the associated problems that give greatest concern to the cultivator, but which are obscure and little understood, and therefore much in need of study, are the plant diseases which most botanists believe to be connected with soil sanitation. Often they occasion great loss in a crop without the cause being apparent. The soil seems to be all right and proper cultivation has been given, but the plants fail to make their best growth or even dwindle and die. Reference is made to a variety of diseases caused by minute fungi or bacteria, and which attack various garden, truck and field crops. Some instances may be cited without pretending to give them in the order of their importance.

Soil Fungi Attacking Vegetables.—A conspicuous set of diseases, given the name of wilt, is due to certain fungi or bacteria, in which the plants develop normally and may even be bearing, when within a few days they wilt and die as completely as if the roots had been severed. The wilt of watermelons, usually due to a species of *Fusarium*, and of cantaloupes, more often due to bacteria, has often carried off a large part or even all of these crops, so extensively grown in the southern half of the State. The same or similar diseases extend to cucumbers, squashes, and other cucurbits. The partial remedies so far used are rotation of crops and disease-resistant varieties. The germs in certain cases are known to have

remained in the soil in viable condition for eight years without a suitable host in the meantime, and the extent to which rotation of crops serves to check the disease is yet uncertain. The disease-resistant varieties of melon so far provided do not equal the others in flavor, so say our Indiana growers, and are consequently not much used. It is, therefore, still a large problem for the plant pathologist to find means for protecting the melon crop and others of like nature from the attack of such destructive germs.

A similar disease of the tomato has been very injurious at times in Indiana. Mr. W. H. Dyer of Vincennes reports a loss during the one season of 1913 of 6,000 bushels of fruit, some thirty acres of his field being entirely destroyed by the *Fusarium* wilt. Other soil diseases, like leaf spot, fruit rot, etc., also prove destructive at times.

Some of the leaf diseases of potato may be checked by spraying with Bordeaux mixture, while for scab on the tubers a serviceable and practical remedy is known in formaldehyde, showing that some good work has been accomplished along this line. But there are a number of other diseases, often causing heavy loss, that are little understood, and whose method of control is yet to be discovered. Mr. W. A. Orton of the United States Department of Agriculture stated recently before the Wisconsin Potato Growers' Association that six million dollars were lost to the country during the present year of 1914 from potato diseases.

There are a number of damping-off diseases to be classed here. They attack the young plants and cause them to die before becoming established. In the field the disease will spread from plant to plant over large areas. One season a field of beets was reported as largely destroyed in this way. But it is in cutting beds and seed beds under glass where such ravages are most marked.

The growing of vegetables under glass has become a large industry in Indiana. It is a kind of intensive culture where every individual plant bears an important relation to the final profits. Complaints are frequently received of losses in the cucumber and lettuce crops, which prove to be due to the inroads of the fungus, *Sclerotinia libertiana*, sometimes called lettuce-drop.

These diseases, and many similar ones are believed to be harbored in the soil from year to year, and in some cases to be carried from crop to crop by the seed, and possibly by other yet undetected means. How many kinds of germs are concerned in such diseases is not yet known.

They are certainly bewilderingly numerous. The study of any one of them requires much research, and in no case has such a study been fully carried out. Two remedial methods are especially advocated, rotation of crops, and the breeding of disease-resistant varieties. Neither of these methods is yet much or substantially developed. The disinfection of seed and direct destruction of the germs in the soil have yet scarcely been tried out. Spraying of the crop may be found in some cases to serve a good purpose, but so far not much help has been secured in this direction.

Soil Fungi Attacking Forage Crops.—A soil disease, which may become a serious enemy of the alfalfa crop, has been reported from a number of places during the past season. In Clark County, in the southeastern part of the State, eighteen fields were examined during an alfalfa tour, and every one, as reported by Mr. Hutchins, the county agent, was found infested with *Sclerotinia trifoliorum*, a fungus much to be dreaded, that sometimes attacks clover as well. As alfalfa culture is just in its beginning in this State the disease presents an important problem. A banker from another part of the State in writing to the Experiment Station regarding his experience with this disease said in substance: I always thought that the three sure things in this world were death, taxes and alfalfa, but I am afraid that I must leave out alfalfa, possibly quit growing it, on account of the disease.

Other root diseases caused by *Fusarium*, *Rhizoctonia* and *Ozonium*, as well as less severe leaf diseases, are known to damage the alfalfa crop, and may be expected to increase, unless measures are taken to hold them in check. Outside a rotation of crops little has yet been suggested by way of control for any of these pests.

Soil Fungi Attacking Grain.—In seeking the cause why grain, especially wheat, does not yield as well as it once did, and as everyone believes it should continue to do, there is no longer any doubt that much stress should be laid upon soil fungi, especially species of *Fusarium*, *Macrosporium*, *Alternaria*, *Helminthosporium* and *Colletotrichum*. These fungi, sometimes one of them at a time, sometimes more than one, attack the roots of the grain, and work their way into the upper parts of the plant, the stem, leaves and heads. If the attack is light the grain is somewhat less vigorous than it otherwise would be, and the harvest correspondingly lighter, but there is no appearance of disease. *Fusarium* sometimes becomes so active that it causes what is called scab, or pink mold, and

the head of wheat is a total loss, but the soil is usually not suspected as the source of the trouble.

When grain is grown continuously on the same fields the soil tends to accumulate germs of this character. Such an infested soil may be likened to a house long used by sick people without cleaning. What is needed is a thorough disinfection. Unfortunately, at present we know no satisfactory way of disinfecting soils, and we do not even know the kinds and virulence of the diseases to any extent. Our chief reliance so far has been in crop rotation. Possibly something might be done by disinfecting the seed, which is known to harbor the germs. Mr. Hoffer found, as reported in last year's Proceedings of this Academy, that out of thirty-four varieties of wheat examined by him twenty showed germs of this sort, most of them being *Fusarium*.

The subject is a large one of the highest economic importance, and in very great need of study.

Diseases Not Associated With the Soil.—There is no need of specifying where work is needed in this class of troubles, the subject has been before the public too long. Many such diseases are now well understood and efficient remedies already put into use, as in the case of oat and wheat smut, corn smut, and some fruit rots. But there are many rusts, mildews and blights yet to be worked out, and their economic importance rated.

Weeds.—As a rule weeds have not been regarded with sufficient seriousness. But many farmers appreciate the advantages of clean culture, and would like to exterminate the more pernicious kinds. There is a group of weeds, including especially the bindweeds, wild sweet potato, horse nettle and trumpet creeper, that need careful investigation as to the best methods for their control. Field experiments along this line are needed. Horse nettle is now infesting thousands of acres of land in the southern and central parts of the State and is gradually gaining ground northward. Trumpet creeper is becoming so pestiferous on account of its heavy, woody roots, as to make the work of cultivating the infested land a difficult and tedious task. Bindweeds and wild sweet potato are proving to be a bane to corn culture, especially on bottom lands. Large fields can be found where nearly every corn plant is entwined by some one of these kinds of weeds. It is safe to say that in such cases the crop yield is reduced by at least one-third. Aside from reducing the yield such weeds also increase the cost of field operations and harvesting and in other ways depreciate the value of land.

It is quite possible that suitable investigation would produce as marked and practical results in the case of most of these weeds, as has been reached in the recent study of the wild garlic situation in southern Indiana. An intensive study of this weed has resulted in a special method of eradication that promises to be a boon to owners of land where garlic has been established, and to render its complete extermination entirely feasible.

Poisonous Plants and Molds.—The subject of plants and molds, which are or may be poisonous to stock needs careful investigation. Many plants and various molds have been suspected of poisonous action of which there is little definite knowledge available. In the majority of cases the evidence is based on reports obtained from farmers, with no scientific investigation or actual tests to support them.

The botanical department of the Experiment Station often receives letters, with specimens of plants, stating that those particular kinds of plants are believed to have been responsible for the death of several head of stock, usually cattle. It is known that some of the wild larkspurs of the State are poisonous, and that loss of stock has been due to them, but no very exact information is at hand.

Certain silage molds have been under suspicion, and moldy corn is quite definitely known to act in a poisonous way.

The importance of careful study of authenticated cases of poisoning from the botanical standpoint will not be gainsaid.

Conclusion.—Probably enough has been said by way of citing examples, and pointing out lines of work to show that there is much valuable investigation for the benefit of the cultivator that falls naturally to the trained botanist. Most such work must be done by the technical man who is supplied with suitable equipment. That the State should properly provide the means for carrying forward work of this character seems to require no argument.

*Purdue University,
Lafayette, Indiana.*



THE ALBA B. GHERE COLLECTION OF BIRDS' EGGS PRESENTED TO THE MUSEUM OF PURDUE UNIVERSITY.

HOWARD E. ENDERS.

Alba B. Ghere of Frankfort, Indiana, was born in 1870 and died March 25, 1904, at the age of thirty-four years.

It is said of him that he was a born naturalist, an enthusiastic student of birds, their eggs and their nests. To this line of endeavor he gave all of the spare time of his life from the fourteenth year to the end. A careful list of the spring and fall migrations was recorded for a period of years, and at the end of each season was forwarded to the U. S. Department of Agriculture for record. The incomplete list of the spring migration of 1904, in which he entered notes to a day or two before his death, accompanies the collection of eggs.

That Mr. Ghere was a careful observer is attested to by the fact that his notes, among those of many other persons, are quoted at five or more points by Dr. C. H. Merriam in the Bulletin No. 1, on The English Sparrow in North America (1889), Division of Economic Ornithology and Mammalogy, Washington, D. C.

Through the kindness of his mother, Mrs. India S. Cottingham, of Frankfort, Indiana, the complete collection of eggs, the oölogical instruments, and his oölogical books were presented to Purdue University in October, 1914.¹ The collection numbers somewhat more than four hundred specimens of eggs from about one hundred and thirty species of birds, some of which are western or marine species that were acquired by exchange or by purchase. It may be of special interest to know that one egg is said to be from the once abundant passenger pigeon.²

¹Among the books are government publications on birds; Davis and Baker's Oologist's Directory, 1885; Davies' Nests and Eggs of North American Birds, 1886; Capen's Oology of New England, 1886. The latter is an elaborate quarto in natural colors, and is one of a limited small edition.

²Its measurements and diagnostic characteristics seem to correspond with the descriptions given for this species.

Order I. PYGOPODES.

A. O. U.

Family *Podicipidæ*.

3. Horned Grebe.....
- Colymbus auritus*
- .

Family *Gaviidæ*.

7. Loon.....
- Gavia imber*
- .

Family *Alcidæ*.

27. Black Guillemot.....*Cephus grylle*.
 30. Murre.....*Uria troile*.
 30a. California Murre.....*Uria troile californica*.

Order II. LONGIPENNES.

Family *Laridæ*.

41. Red-legged Kittiwake.....*Rissa brevirostris*.
 47. Great Black-backed Gull.....*Larus marinus*.
 49. Western Gull.....*Larus occidentalis*.
 51. Herring Gull.....*Larus argentatus*.
 51a. American Herring Gull.....*Larus argentatus americanus*.
 54. Ring-billed Gull.....*Larus delawarensis*.
 58. Laughing Gull.....*Larus atricilla*.
 59. Franklin Gull.....*Larus franklini*.
 60. Little Gull.....*Larus minutus*.
 70. Common Tern.....*Sterna hirundo*.
 74. Least Tern.....*Sterna antillarum*.
 75. Sooty Tern.....*Sterna fuliginosa*.
 77. Black Tern.....*Hydrochelidon nigra surinamensis*.

Family *Rhynchopidæ*.

80. Black Skimmer.....
- Rhynchops nigra*
- .

Order IV. STEGANOPODES.

Family *Phalacrocoracidæ*.

122. Brant Cormorant.....
- Phalacrocorax penicillatus*
- .

Order VII. HERODIONES.

Family *Ardeidæ*.

191. Least Bittern.....*Ardetta exilis*.
 196. American Egret.....*Herodias egretta*.
 197. Snowy Heron.....*Egretta candidissima*.

199. Louisiana Heron.....Hydranassa tricolor ruficollis.
 200. Little Blue Heron.....Florida coerulea.
 201. Green Heron.....Butorides virescens.
 202. Black-crowned Night Heron.....Nycticorax nycticorax naevius.

Order VIII. PALUDICOLÆ.

Family *Rallidæ*.

212. Virginia Rail.....Rallus virginianus.
 214. Carolina Rail; Sora.....Porzana carolina.
 218. Purple Gallinule.....Ionomis martinica.
 221. American Coot.....Fulica americana.

Order IX. LIMICOLÆ.

Family *Phalaropodidæ*.

224. Wilson Phalarope.....Steganopus tricolor.

Family *Scolopacidæ*.

261. Bartramian Sandpiper.....Bartramia longicauda.
 263. Spotted Sandpiper.....Actitis macularia.

Family *Charadriidæ*.

269. Lapwing.....Vanellus vanellus.
 274. Semipalmated Plover.....Aegialitis semipalmata.
 280. Wilson Plover.....Oethodromus wilsonius.

Order X. GALLINÆ.

Family *Tetraonidæ*.

289. Bob-white.....Colinus virginianus.

Order XI. COLUMBÆ.

Family *Columbidæ*.

315. †Passenger Pigeon; Wild Pigeon....Ectopistes migratorius.
 319. White-winged Dove.....Melopelia leucoptera.

Order XII. RAPTORES.

Family *Cathartidæ*.

325. Turkey Vulture; Turkey Buzzard..Cathartes aura.

†Its measurements and diagnostic characteristics seem to correspond with the descriptions given for this species.

Family *Falconidæ*.

337. Red Tailed Hawk..... *Buteo borealis*.
 339. Red-shouldered Hawk..... *Buteo lineatus*.
 357. Pigeon Hawk..... *Falco columbarius*.
 360. Sparrow Hawk..... *Falco sparverius*.
 364. American Osprey; Fish Hawk..... *Pandion haliaetus carolinensis*.

Family *Strigidæ*.

365. Barn Owl..... *Strix patrincola*.

Family *Bubonidæ*.

366. American Long-eared Owl..... *Asio wilsonianus*.
 367. Short-eared Owl..... *Asio accipitrinus*.
 375. Great Horned Owl..... *Bubo virginianus*.

Order XIV. COCCYGES.

Family *Cuculidæ*.

387. Yellow-billed Cuckoo..... *Coccyzus americanus*.

Family *Alcedinidæ*.

390. Belted Kingfisher..... *Ceryle alcyon*.

Order XV. PICI.

Family *Picidæ*.

- ?? Undetermined species.
 412. Southern Flicker..... *Colaptes auratus*.
 412a. Northern Flicker..... *Colaptes auratus luteus*.

Order XVI. MACROCHIRES.

Family *Caprimulgidæ*.

420. Nighthawk..... *Chordeiles virginianus*.
 425. White-throated Swift..... *Aeronautes melanoleucus*.

Family *Trochilidæ*.

428. Ruby-throated Hummingbird..... *Trochilus colubris*.
 429. Black-chinned Hummingbird..... *Trochilus alexandri*.
 431. Anna Hummingbird..... *Calypte anna*.

Order XVII. PASSERES.

Family *Tyrannidæ*.

- ?? Flycatcher.
 461. Wood Pewee *Contopus virens*.
 466a. Alder Flycatcher *Empidonax traillii alnorum*.
 467. Least Flycatcher *Empidonax minimus*.

Family *Alaudidæ*.

- ?? Larks, undetermined.

Family *Corvidæ*.

488. American Crow *Corvus americanus*.

Family *Icteridæ*.

497. Yellow-headed Blackbird *Xanthocephalus xanthocephalus*.
 ??? Oriole Undetermined.
 506. Orchard Oriole *Icterus spurius*.
 507. Baltimore Oriole *Icterus galbula*.

Family *Fringillidæ*.

- 519a. Crimson House Finch *Carpodacus mexicanus frontalis*.
 546. Grasshopper Sparrow *Coturniculus savannarum passerinus*.
 552a. Western Lark Sparrow *Chondestes grammacus strigatus*.
 584. Swamp Sparrow *Melospiza georgiana*.
 585. Fox Sparrow *Passerella iliaca*.
 598. Indigo Bunting *Cyanospiza cyanea*.
 601. Painted Bunting; Nonpareil *Cyanospiza ciris*.

Family *Hirundinidæ*.

612. Cliff Swallow *Petrochelidon lunifrons*.
 613. Barn Swallow *Hirundo erythrogastra*.

Family *Ampelidæ*.

619. Cedar Waxwing *Ampelis cedrorum*.

Family *Vireonidæ*.

631. White-eyed Vireo *Vireo noveboracensis*.
 ?? Unidentified species.

Family *Mniotiltidæ*.

683. Yellow-breasted Chat *Icteria virens*.

Family *Troglodytidae*.

703. Mockingbird..... *Mimus polyglottos*.
 705. Brown Thrasher..... *Toxostoma rufum*.
 713. Cactus Wren..... *Heleodytes brunneicapillus*.
 718. Carolina Wren..... *Thryothorus ludovicianus*.
 721. House Wren..... *Troglodytes aedon*.
 722. Winter Wren..... *Olbiorchilus hiemalis*.
 724. Short-billed Marsh Wren..... *Cistothorus stellaris*.
 725. Long-billed Marsh Wren..... *Telmatodytes palustris*.

Family *Turdidae*.

758. Russet-backed Thrush..... *Hylocichla ustulata*.
 761. American Robin..... *Merula migratoria*.
 761a. Western Robin..... *Merula migratoria propinqua*.
 766. Bluebird..... *Sialia sialis*.
 767. Western Bluebird..... *Sialia mexicana*.
 768. Mountain Bluebird..... *Sialia arctica*.

Unidentified, about thirty species, chiefly of the common native birds.

Purdue University,

West Lafayette Ind.

A NOTE ON A PECULIAR NESTING SITE OF THE CHIMNEY SWIFT.

GLENN CULBERTSON.

As an illustration of the ability of birds to adapt themselves to new conditions, the chimney swift is a striking example. Driven from the hollow tree as a nesting site by the woodman's axe and fires, the swift adapted itself to the broad open chimneys of the settlers' cabins, and later to the narrow flues of a later day. The projecting spines of the tail feathers fortunately answered the same purpose in a soot-lined chimney that they had done in the soft decayed wood of a hollow tree.

During the past summer the writer's attention was called to a still greater change in the nesting site of a pair of swifts. Near the residence of Mr. James Storie, one and one-half miles north of Moorefield, Switzerland County, a pair of swifts, being excluded from the chimneys by wire netting, have nested for two seasons in an old-fashioned dug well walled with stone.

The well is some twenty feet deep and three feet in diameter, and has over it a square curb about three feet high, one-half of which was permanently left open. The nests were built in each case at a distance of some seven or eight feet below the level of the ground, and at approximately the same distance above the water. The young were matured and brought forth in safety both seasons.

NOTES ON INDIANA EARTHWORMS.

H. V. HEIMBURGER.

The great group of animals known commonly as earthworms, comprises four families of the order Oligochaeta: the Moniligastridæ, the Megascolecidæ, the Glossoscolecidæ and the Lumbricidæ. Three of these families are represented in our fauna.

At the present time there are more than a thousand well recognized species of earthworms known. By far the larger number of these species have been described during the last twenty years. Most of the work on this group has been done by Europeans, chief among whom is Michaelsen of Hamburg, whose publications make up the bulk of the recent literature on the group. Professor Frank Smith of the University of Illinois has worked on the group in this country and Eisen, a Swede who lived for several years in San Francisco, has worked on West and Central American species.¹ Very little is known of the earthworm fauna of the Central States. Only about fifty species are known to occur in the United States, this scarcity of forms being due in part to lack of study and partly to the actual scarcity of species.²

It has been pointed out by Beddard³ and Michaelson⁴ that the earthworms are an important group for the Zoögeographer. Arldt,⁵ in a recent paper, shows the value of the group for the paleo-geographer and gives many of the facts of distribution now known as well as indicating the value of the group in theoretical considerations within the fields of geography and geology.

The Moniligastridæ is a small family limited to Borneo, Ceylon, Southern India and neighboring islands. This family is regarded as the most ancient of the group.

¹Eisen; American Oligochaetes with special reference to those of the Pacific Coast and Adjacent Islands. Proceedings Calif. Acad. Science Vol. II, No. 2, 1900.

²Frank Smith; Earthworms From Illinois. Trans. Ills. Acad. Science. 1912.

³Beddard; A Textbook of Zoögeography. Cambridge, 1895.

⁴Michaelsen; Die geographische Verbreitung der Oligochaeten. Berlin, 1903.

⁵Arldt; Die Ausbreitung der terricolen Oligochaeten in Laufe der erdgeschichtlichen Entwicklung des Erdreliefs. Zool. Jahrb. Abt. f Syst. Geog. u Biol. Bd. 26, pp. 285-318. 1908.

The Megascolecidae are supposed to have arisen from the same root as the Moniligastridae but at a later period, and dates back at least to the Triassic. This is the largest of the earthworm families and contains more than half the known species. The family is widely distributed, chiefly in tropical regions and the southern hemisphere. But one genus, *Diplocardia*, is represented in our fauna. According to Michaelsen, this genus probably appeared in Mexico or Central America during the Jurassic. Derivatives from this genus have spread into Africa, but the genus itself spread northward and is known from Mexico, Lower California, Texas, Florida, Nebraska and Illinois.

The Glossoscolecidae seem to have developed as early as the Jurassic in the northern continental area. The genus *Sparganophilus* of this family is found in Mexico and various parts of the United States. Related forms are known from Central and South America, where many species are recognized.

The Lumbricidae is recognized as the most recent family of the group and is derived from the Glossoscolecidae, probably in southwest Asia. The family is thought to have invaded Europe in the Eocene and North America in the Oligocene. But few endemic species are known from the United States.

In the glaciated regions of the world, it is probable that the endemic species have been destroyed during the Ice Age. These regions have been repopulated by species which have migrated from the south and the earthworm fauna in such places is largely composed of forms carried in by man. In the southern part of Europe are found many endemic species while northern Europe is occupied almost wholly by forms also found further south. The line separating the northern territory with peregrine forms from the southern territory with endemic forms, corresponds very closely to the line of the most southern extension of the glacial ice sheet. It would be interesting to know if a similar condition exists in America.

Last year, under the direction of Professor Frank Smith of the University of Illinois, I began a study of the earthworms of Illinois and Indiana. I received, last fall, some material from Mr. C. E. Allen, of Wabash College, and some from my brother at Kewanee. During the past summer I made some collections in several counties of the State but was unable to make as extensive collections as are desirable. The materials I have contain some forms that may have to be described as new species and I believe that careful collecting in the State will disclose

several species new to science. It is my intention to make several collecting trips through the State during June and July, 1915, but the task of making a complete collection for the State is not to be completed in a few weeks by one man.

Earthworms are easy to collect and no great difficulty is experienced in caring for the collections. The most interesting forms are to be expected in uncultivated areas such as woodlands, stream banks, and the margins of swamps and lakes. Many interesting forms may be taken under logs and under the bark of old logs. The worms are especially easy to collect in the spring when driven from their burrows by the heavy rains. At such times they may be picked up in large numbers from roads and sidewalks. I wish to gain a more extended knowledge of the distribution of *Diplocardia* in the State and to know what forms are found in the unglaciated areas of the State. If any members of the Academy will aid in securing materials, I shall be very glad to have the material and to return named specimens in exchange. I shall be glad to correspond with any one who may be interested in such work.

Following is a list of species I have taken in Indiana together with some notes as to the habitats in which the worms were found. The space of this paper is not sufficient for descriptions of the species. The monograph by Michaelsen is the most authentic single work on the group.¹ The nomenclature used in this list is that of Michaelsen's monograph, except where the nomenclature has been modified in his later papers.²

Family MEGASCOLECIDÆ.

Genus *Diplocardia* (Garman).

1. *Diplocardia communis* var. *typica* Garman.

This form is quite common about Urbana and in other parts of Illinois. I have not found it in Indiana.

D. communis var. *singularis* Ude.

Collected under logs in recently cleared land near Culver, Marshall County. I have other specimens collected in Putnam and Vigo counties, which are very similar to *singularis* but very much larger and differing in minor points.

¹Michaelsen; Oligochæta. Vol. 10 in Schulze's Thierreich. Berlin, 1900.

²See particularly.

Michaelsen;—Zur Kenntnis der Lumbriciden und ihrer Verbreitung. Ann. Zool. Mus. Imp. Acad. Sciences, St. Petersburg. 1910.

2. *Diplocardia riparia* F. Smith.

Collected at Terre Haute in a wooded pasture land.

3. *Diplocardia udei* Eisen.

Collected at Terre Haute together with *riparia*. The specimens are somewhat larger than Eisen's species and differ in details of setal modifications. If not *udei* this form is probably to be regarded as a variety of *udei*. The species was described from North Carolina and has not been reported outside that State.

I have other specimens of *Diplocardia* from Indiana, of which the classification is still uncertain.

Family GLOSSOSCOLECIDÆ.

4. *Sparganophilus cisni* F. Smith.

This species is amphibious, and is found in very wet mud or among the roots of aquatic plants. Collected at Culver, on roots of Eel grass and in mud at margin of Lake Maxinkuckee. Very abundant in mud of small stream near Kewanna, Fulton County.

Family LUMBRICIDÆ.

5. *Helodrilus tetradrus* var. *typicus* Sav.

Collected at Culver, in vegetable drift at edge of lake. An amphibious species found usually in wet soil along margins of streams or among vegetable detritus in very moist places.

6. *Helodrilus roseus* Sav.

Collected at Culver, Greencastle, Terre Haute. This species is probably to be found in all parts of the State. It is very commonly found in lawns and cultivated fields. My specimens were collected in woods and along stream banks.

7. *Helodrilus constrictus* Rosa.

Collected at Kewanna, under logs at handle factory: Culver under logs in woods.

8. *Helodrilus subrubicundus* Eisen.

Collected at Culver and Kewanna, under logs. The identification of this species is not absolutely certain as no sections have been made. However, this form is fairly well determined from external characters.

9. *Helodrilus chloroticus* Sav.

Collected at Culver, Lake Maxinkuckee, in moist soil at edge of lake. Greencastle, in moist clay soil in abandoned quarry hole. Crawfordsville, in moist clay soil, banks of small stream.

10. *Helodrilus foetidus* Sav.

Collected at Kewanna and Culver. This is the common evil smelling, barnyard or manure worm. Collected at Culver in decaying straw near ice houses. At Kewanna this worm was found in large numbers, in moist soil along a stream just below the outlet of a sewer. The whole locality was quite offensive because of the sewage.

11. *Helodrilus caliginosus* Sav.

Collected in Fulton, Marshall, Putnam, Madisen and Vigo counties. This is perhaps our most cosmopolitan species. It is a European species that has spread wherever Europeans have settled. Perhaps 90% of any random collection in the State would consist of this species.

12. *Helodrilus longus* Ude.

Collected at Greencastle, in woods.

13. *Helodrilus zeteki* Smith and Gittins. (Mss.)

Collected at Kewanna, Culver, Summitville. All of my specimens were collected in loose sandy loam under logs, and under the bark of logs. In June I took about thirty-five specimens of adult worms in a woods near Kewanna. At this time I obtained many cocoons of the species, the worms being in the height of sexual maturity. This species was described by one of Professor Smith's students from specimens collected in a woods near Urbana, Ill. The description of the species is not yet in press.

14. *Ocotasium lacteum* Oerley.

Collected at Crawfordsville, Culver, Greencastle, Summitville, Kewanna. My Crawfordsville specimens were sent me by C. E. Allen, and were collected in the banks of Sugar Creek. This species is very common under logs and in moist soil everywhere I have collected. It is very widely distributed throughout the world. I have never found it in cultivated fields.

NOTES ON ORTHOPTERA AND ORTHOPTERAN HABITATS IN THE VICINITY OF LAFAYETTE, INDIANA.

HENRY FOX.

(Assistant, Cereal and Forage Insect Investigations,
U. S. Bureau of Entomology.)

Between September 3, 1912, and November 30 of the following year I was stationed in pursuance of official duties at Lafayette, Tippecanoe County, Indiana. At intervals during my stay there I made a series of observations on the *Orthoptera* and Orthopteran habitats of the surrounding country which, incomplete as they are, nevertheless constitute a distinct positive contribution toward an accurate knowledge of the faunal features of the region. My earlier studies on the distribution of *Orthoptera* in Pennsylvania and New Jersey¹ had impressed me with the importance of detailed local lists of species in a scientific study of distribution. The usual distribution as given in most works of reference is entirely too general for accurate study, no regard being paid to local peculiarities of distribution or to the relative abundance of the species in different parts of its range. Take, for example, such a form as *Psinidia fenestralis*. Its range, as usually given, extends from Massachusetts to Florida, Texas, northern Indiana and southern Minnesota. Such a statement would incline one to think that the entire region south of say a line drawn from Cape Cod to the southern extremities of the Great Lakes and thence to the southern border of Minnesota would be characterized by the presence of this species. As a matter of fact such is very far from being the case. In the East, for instance, *Psinidia fenestralis* is regularly found only in the low sandy belt fringing the coast, while in the interior it is of extremely local occurrence, being met with only on widely scattered, isolated deposits of loose sand. All positive data on this species indicates that its distribution is conditioned by the presence of areas of loose sand.

¹Data on the Orthopteran Faunistics of Eastern Pennsylvania and Southern New Jersey. Proc. Acad. Nat. Sci., Phila., 1914, pp. 441-534.

Wherever these are lacking the species is absent. In southern New Jersey where sandy deposits are of practically universal occurrence *Psiniidia* is common, while on the opposite side of the Delaware River in Pennsylvania it is unknown. A case like this shows us how essential it is that we should have accurate local data before we can be certain of the exact range of a species.

The studies of Morse, Hancock, Rehn, Hebard, Vestal and others have clearly shown the intimate relation between the distribution of numerous *Orthoptera* and certain features of the environment. As Shelford has so well pointed out the success or failure of a species in any place will depend on how closely the environmental complex approximates to that condition at which the normal physiological activities of the species can be carried on to the best advantage. Where this state of affairs obtains the species will attain its maximum abundance; if one or more of the factors of the environmental complex are less favorable it will be present in diminished numbers, while if any essential factor is prohibitive the species will be absent. It is the aim of biogeography to explain the facts of organic distribution in terms of physiology, as an expression of the reactions of organisms to the varying conditions of their surroundings. In the case of the *Orthoptera* this can be done only when we know much more than we do now about the intrinsic qualities of the species and their ability to accommodate their activities to varying intensities of environmental factors. To acquire such knowledge will require much experimental investigation. In the absence of such knowledge we must meanwhile be content to record the facts of distribution as actually observed and to point out any correlation which may exist between the range of species and the different types of environments. By the accumulation of data along these lines a good foundation will be laid for the ultimate causal interpretation of distribution and kindred biological problems.

In the present article I have endeavored not only to give a full list of the species observed about Lafayette, but in addition to point out the more evident physical and botanical features of the region with which the local distribution of the *Orthoptera* is correlated. Most of the facts here given were gathered by myself, but I am also indebted for some valuable additional data to Mr. P. W. Mason, Instructor in Entomology at Purdue University, whose kindness in placing his notes at my disposal I here take pleasure in acknowledging.

GENERAL DESCRIPTION OF THE REGION.

Most of my observations were made on the west side of the Wabash River extending from Battle Ground on the north to the mouth of Indian Creek on the south. (For these and other localities a good map to consult is the map accompanying the report of the soil survey of Tippecanoe County in the field operations of the U. S. Bureau of Soils for 1905.) On the east side of the river a few observations were made from the mouth of Wild Cat Creek, about two miles north of the city, to a spot east of Battle Ground, about a half mile south of the mouth of Buck Creek. Only one trip was taken on the east side south of Lafayette. It was limited to the line of the Wabash Railroad and extended about three miles below the city.

According to the Bureau of Soils' report on the soils of Tippecanoe County the general altitude of the country is about 750 feet above sea level. Back from the Wabash River and its tributaries the country forms a nearly level, or at most slightly undulating, plain. Near the river it is much more rugged, a relatively steep line of bluffs leading down to the valley of the Wabash which is about 100 feet below the general level of the upland. Similar conditions prevail along the main tributaries, such as Burnett, Wild Cat and Indian Creeks.

The valley of the Wabash forms a nearly level tract varying according to location from a half to two miles in width. It is formed of what are known as bottom lands, or more specifically "first bottoms" to distinguish them from the older bottoms which are no longer covered by the overflow from the river. The surface of these first bottom lands is according to the report already mentioned between 10 and 20 feet above low water mark. They are "subject to overflow during periods of high water." During the destructive floods of March, 1913, these bottom lands were completely submerged.

The margin of these bottom lands is formed by the line of steep bluffs already mentioned as forming the edge of the upland. Locally, as is the case in the vicinity of West Lafayette and of Battle Ground, these bluffs recede a mile or two back from the river and in the embayments thus formed "second bottoms" are developed, that is, "fossil" floodplains or terraces representing an earlier, prehistoric stage of deposition. The surface of these "second bottoms" is level or slightly rolling and on the side facing the river is marked by a gentle slope rising from forty to

fifty feet above the present bottoms. They are never covered by overflow from the river at the present time.

The whole region about Lafayette is deeply buried under glacial deposits, the depth of these deposits being usually very great (at least 150 feet), though in limited areas they may be quite thin or lacking. Only rarely, however, do the underlying Palæozoic limestones reach the surface. One such outcrop I have seen on the upland near Montmorenci where the Lake Erie and Western Railroad crosses Indian Creek. Outside of these rare and insignificant cases, the whole country is underlaid by a very coarse glacial gravel. Overlying this is usually a layer of loess varying in thickness from an inch to several feet. From this loess are derived the representative soil types of the region.

The drainage of the region is in general good. The streams are few and in periods of protracted drought frequently dry up entirely in their upper courses. Most of the rainfall, however, is carried off by underground drainage, the underlying gravel allowing the ready percolation of water. Locally, as in upland swales and depressions and at the base of the river bluffs, where the seepage of underground water takes place, the ground is, except in seasons of drought, more or less completely saturated with water resulting in the formation of swamps. At the present time most of these naturally wet areas, especially on the upland, have been artificially drained and the land utilized for growing crops. The bottom lands are at present well drained, the cultivation of the soil breaking it up into a loose condition which allows the water to flow off readily beneath the surface.

On the upland the dominant soil is a fine-grained, silty loam, varying in color from light brown to almost black, the color depending upon the amount of organic matter present, which is usually considerable. Of this soil the Bureau of Soils recognizes two categories which are termed respectively Marshall silt loam and Miami silt loam. Both are nearly alike in mineral content, being characterized by relatively high percentage of silt and clay and extremely low percentage of sandy constituents, but differ in their organic content, the Miami being as a rule much poorer in this respect than the Marshall. The table shows the mechanical composition of the soils, the data being taken from the Bureau of Soils report.

SOIL.	Fine Gravel.	Coarse Sand.	Medium Sand.	Fine Sand.	Very Fine Sand.	Silt.	Clay.
Marshall Silt Loam.....	0.2	1.1	1.3	3.9	5.7	67.2	20.0
Miami Silt Loam.....	0.4	1.8	1.0	2.2	7.3	68.4	18.9

On the "second bottoms" the soils contain a much greater percentage of sand and are correspondingly poor in silt and clay. The quantity of organic matter is variable depending upon location and drainage conditions. Typical examples of "second bottom" soils are the Sioux sandy loam and Miami sand the composition of which, as given by the Bureau of Soils, is shown in the following table:

SOIL.	Fine Gravel.	Coarse Sand.	Medium Sand.	Fine Sand.	Very Fine Sand.	Silt.	Clay.
Sioux Sandy Loam.....	2.2	9.8	10.2	28.5	10.3	27.1	11.2
Miami Fine Sand.....	.0	3.0	13.3	52.0	11.5	13.8n	6.4

The characteristic soil of the river bottoms is the Wabash silt loam. This is the material deposited during periods of high water. It resembles the upland soils in its high silt-clay content, but differs in having a considerable percentage of sand. The mechanical composition of this soil as given by the Bureau of Soils is as follows:

SOIL.	Fine Gravel.	Coarse Sand.	Medium Sand.	Fine Sand.	Very Fine Sand.	Silt.	Clay.
Wabash Silt Loam.....	0.0	Trace.	0.3	27.0	2.1	66.1	28.4

These, as well as the other soils of the region not herein specifically mentioned, are all characterized by their prevailing fine texture, a rule that holds even in the case of the sandy soils in which the major constituent is the fine sand, so that, in spite of the rapid drainage afforded

by the underlying boulder drift, the capacity of the soil to retain moisture is quite high. For this reason all the soils are very productive and are in consequence in a high state of cultivation. About Lafayette, with insignificant exceptions, practically all the land is under cultivation. On the upland the principal crops are corn, oats, clover and wheat, while the bottom lands form one unbroken stretch of corn. The only waste places—oases for the naturalist—are on the upland an occasional grove or more rarely a swampy depression, on the bottoms frequent, though small, bogs marking the places where the underground waters ooze out from the marginal bluffs. In such places the rarer and more interesting *Orthoptera* are to be found.

ORTHOPTERAN HABITATS.

No attempt at an exhaustive study of the various Orthopteran habitats was made owing to the limited time that could be spared for that purpose. Consequently in the following pages only the grosser features of the habitats are mentioned. About Lafayette, owing to the intense cultivation of the region, nearly all the country is open, in consequence of which the dominant *Orthoptera* are campestral types. Where the ground is untilled it is usually covered with a close growth of blue grass (*Poa pratensis*), which in damper spots is replaced by foxtail (*Chatochloa viridis* and *glauca*). In such situations the grasshoppers usually encountered include the following species:

Syrbaia admirabilis, *Arphia xanthoptera*, *Chortophaga viridifasciata*, *Encoptolophus sordidus*, *Dissosteira carolina*, *Melanoplus atlantis*, *Melanoplus femur-rubrum*, *Orchelimum vulgare*, *Conocephalus strictus* and *Nemobius fasciatus*.

In cultivated lands this assemblage is largely characteristic of the grassy borders of roads, paths and fence-rows. Most of the species named continue abundant in such places with the possible exception of *Arphia xanthoptera* and *Chortophaga viridifasciata*, both of which appeared to be rather scarce in the particular cultivated tracts examined by me.

A second group of *Orthoptera* is characteristic of dry upland woods. On the level uplands woodland is represented only by widely scattered groves, in most of which the trees have been thinned out. This allows a rich growth of blue grass which is largely utilized as pasturage for cattle. Such pastured woodlands are almost invariably very barren in *Orthoptera*, those that do occur being similar to those found in the open

country. The most nearly continuous and undisturbed areas of woodland are those which clothe the tops and sides of the bluffs which, as already mentioned, form the outer margins of the river-bottoms. These are exclusively hardwood formations, the dominant tree at higher levels being the white oak (*Quercus alba*), with which are commonly associated the sugar maple (*Acer saccharum*), pig-nut hickory (*Hicoria glabra*), red oak (*Quercus rubra*), shell-bark hickory (*Hicoria ovata*), bass-wood (*Tilia americana*), elm (*Ulmus* sp. not det.), beech (*Fagus ferruginea*), dogwood (*Cornus florida*) and aspen (*Populus tremuloides*). Wherever these woodlands are sufficiently open to admit sunlight blue grass usually springs up and forms a continuous cover to the ground or, if the soil is exceptionally dry, an aggregation of more or less scattered tufts with interspaces of bare earth. Where the grass is thick one usually finds *Mcclanoptus scudderi*, while in places where it is short and scattered *Spharagmon bolli* and *Mcclanoptus luridus* are usually encountered. Along the edges of the woods in undisturbed ground these more strictly sylvan types were observed to meet and to intermingle with a campestral assemblage which usually included *Syrbula admirabilis*, *Arphia xanthoptera*, *Chortophaga viridifasciata* and *Encoptolophus sordidus*. In scrubby areas and in tall herbaceous growths *Atlantius testaceus* was fairly common.

In strong contrast to the foregoing group is an assemblage characteristics of moist areas. Such areas most frequently occur at the outer margin of the river bottoms where the seepage from the neighboring bluffs keeps the ground perpetually moist and soggy. The soil in such places is a typical muck, frequently intermixed with gravel and silt. In nearly all the swamps I have visited the vegetable content of the soil appeared to be thoroughly decomposed. At one place (1) in a wet depression in the midst of a fairly large woods on the upland about one and a half miles northwest of West Lafayette the substratum was a true peat. In the bottomland swamps, however, the soil appears in all cases where I have examined it to be a muck. Such a swamp harbors a rich vegetation of which the dominant member in wetter spots is rice cutgrass (*Homalocenchrus oryzoides*) with which are often associated cat-tails (*Typha latifolia*) and jewel-weeds (*Impatiens biflora*). Surrounding the cutgrass areas in slightly dryer ground is usually a dense thicket composed of tall herbaceous plants, especially composites, among which I noted the taller ragweed (*Ambrosia trifida*), ironweed (*Vernonia fasciculata*), joe-pye-

weed (*Eupatorium purpurcum*), boneset (*Eupatorium perfoliatum*) and a bewildering variety of members of the sunflower tribe (*Helianthus*, *Bidens*, etc.). Where this thicket is sufficiently open there frequently occur patches of wild rye (*Elymus virginicus*, *E. canadensis*).

The central portion of these swamps dominated by *Homalocenchrus* appeared to be characterized by a rather different assemblage of Orthoptera than that typical of the surrounding thickets, though, owing to the usually restricted size of the swamps, it was not possible in all instances to clearly distinguished the two groups. In general, however, the *Homalocenchrus* areas appeared to be characterized by such Orthoptera as *Orchelimum nigripes*, *Neoconocephalus palustris*, *Stauroderus curtispennis*, *Conocephalus attenuatus* and *Paroxya hoosieri*. The surrounding thickets were especially characterized by the short-winged *Melanopli*, such as *Melanoplus obovati-pennis*, *M. scudderi*, *M. gracilis* and *M. viridipes*, together with numerous examples of *Melanoplus differentialis*, *Conocephalus nigropleurum* and *Conocephalus memorialis*. Two forms that appeared to occur indifferently in both zones were *Orchelimum vulgare* and *Conocephalus brevispennis* (incl. *ensiformis*).

RELATIVE FREQUENCY OF THE SPECIES.

As regards numbers the most abundant grasshopper in this region is *Melanoplus femur-rubrum* which appears to swarm everywhere on both upland and lowland, though it appeared to be less frequent in wooded areas than in more open situations. Next to it in point of numbers I would place *Melanoplus atlantis* which is common, but more local than *femur-rubrum*. Other species which appeared to be present in what may be regarded as abundance were *Encoptolophus sordidus*, *Dissosteira carolina*, *Melanoplus differentialis*, *Orchelimum vulgare*, *Conocephalus strictus* and *Nemobius fuscatus*. Much less frequent, but on the whole rather common were such species as *Syrbula admirabilis*, *Arphia xanthoptera*, *Chortophaga viridifasciata*, and *Melanoplus femoratus*. Some species appeared to be of frequent or regular occurrence locally wherever the special conditions making up their normal environment prevailed. Thus *Spharagemon bolli* and *Melanoplus scudderi* and *luridus* occurred, usually in considerable numbers, wherever there were dry open woodlands, while in the swamps, or their borders, three species, *Melanoplus differentialis*, *Orchelimum nigripes* and *Conocephalus brevispennis* were in all but one or two instances abundant. Associated with the last three were frequently

considerable numbers of *Dichromorpha viridis*, *Sturoderus* (*Stenobothrus*) *curtipennis*, *Melanoplus scudderi*, *Melanoplus obovatipennis*, *Melanoplus femoratus*, *Conocephalus fasciatus*, and *Conocephalus nigropleurum*. Certain species were scarce in most places, but were found to be common or even abundant in one or two restricted areas. Thus *Hippiscus rugosus* was found in only one place, but was there quite common. *Paroxya hoosieri* was taken in numbers in a swamp (16) in the Wabash bottoms opposite Battle Ground but was not observed elsewhere. A peculiar variety of *Orchelimum nigripis* and *Conocephalus attenuatus* literally swarmed in a boggy depression (14) on the upland about 2 miles northwest of West Lafayette. The former variety I did not find in any other place, while of the latter I noted elsewhere only a single individual which I captured in a bog in the Wabash bottoms (6) about half a mile south of Lafayette.

Certain species were observed to be of rather infrequent occurrence but could hardly be called rare. Among these were *Schistocerca americana*, *Melanoplus viridipes*, *Melanoplus gracilis*, *Scudderia texensis*, *Scudderia furcata*, *Neoconocephalus palustris*, *Conocephalus nemoralis* and *Atlanticus testaceus*. The following species appeared to be quite scarce: *Truxalis brevicornis*, *Orphulella speciosa*, *Chlocallis conspersa*, *Schistocerca alutacea*, *Melanoplus walshii*, *Neoconocephalus robustus crepitans* and *Conocephalus saltans*.

DESCRIPTION OF LOCALITIES WHERE COLLECTIONS WERE MADE.

1. A fairly extensive bit of woodland on the edge of the upland about a mile northwest of West Lafayette. The timber was in part rather dense, but there were a number of open spots well fitted for sylvan Orthoptera. There had been no grazing in the portion of the woods where the collecting was chiefly done, so there was considerable undergrowth. Most of the land which these woods covered was dry or only moderately humid, but it included one or two depressions where the ground was either soggy or covered with standing water. One of these, a very limited tract, was included in the northwestern edge of the wood and was occupied by an almost pure growth of button-ball bush (*Cephalanthus occidentalis*); the other was slightly larger and occupied by a mixed growth of sapling silver maples (*Acer saccharinum*) and red-berried elder bushes (*Sambucus racemosa*) together with a variety of other plants. Both of these swampy areas proved to be quite barren in Orthoptera. The best collecting was done along a path entering the woods at its northwest corner and in the

neglected clearings adjoining it. This path was nearly overgrown with grassy and sedgy thickets in which were numerous tall composites. Among the grasses I recognized *Brachyelytrum erectum*, *Panicularia nervata*, *Bromus purgens* and *Hystrix hystrix*; the sedges were species of *Carex*, one of which appeared to be *C. lupulina*. In these grassy areas and the rank herbage bordering it I found on July 27 a considerable number of nymphs of *Melanoplus scudderi*, also smaller numbers of adults of *Melanoplus gracilis*, *Dichromorpha viridis* and *Chlwahtis conspersa*. Near the edge of the wood, in a grassy opening not far from the button-bush bog, I found a single female nymph of *Truxalis brevicornis*. At various points along the edges of the woods and in cut-over areas *Dissosteira carolina*, *Melanoplus atlantis* and *Spharagemon bolli* were of frequent occurrence.

2. This was on the west bank of Burnett Creek in the stream bottoms about two and one-half miles southwest of Battle Ground. The surface is elevated only a few feet above the level of the stream and forms a nearly flat tract between the stream and the neighboring terrace. It is well wooded, the larger trees being chiefly cottonwood (*Populus deltoides*) and buttonwood (*Platanus occidentalis*). The larger trees were much scattered and beneath them the marshy ground supported a rich undergrowth of small trees, shrubs and tall herbage. The principal shrubs were hazel (*Corylus americana*) and Pussy-willows (*Salix discolor*). In the more open bogs the vegetation consisted of a reedy herbaceous growth in which I noted such plants as *Typha latifolia*, *Homalocenchrus oryzoides*, *Cinna arundinacea*, *Panicularia nervata*, *Scirpus atrovirens*, *Ambrosia trifida*, *Sagittaria latifolia*, *Vernonia fasciculata*, *Eupatorium purpureum*, *Eupatorium perfoliatum* and the usual host of sunflower-like composites (species of *Helianthus*, *Bidens* and allies). The soil at this place is mapped by the Bureau of Soils as Wabash fine sandy loam, but in these bogs it was almost a true peat. This place was visited twice, on August 9th and September 13. On the former date thirteen species were taken. Of these the most common in or about the bogs were *Conocephalus brevipennis* and *Melanoplus differentialis*. With them were smaller, but not inconsiderable numbers of *Melanoplus obovatipennis* and *Conocephalus nigropleurum*, while only a few examples of each of the following species were taken in similar haunts: *Melanoplus scudderi*, *Melanoplus gracilis*, *Melanoplus femoratus*, *Scudderia furcata* and *Orchelimum vulgare*. One individual of *Truxalis brevicornis* was observed and captured along the edge of a rather extensive growth of cat-tail (*Typha latifolia*). *Melanoplus femur-rubrum*,

which abounded in the surrounding country, appeared to be scarce in this place as only a single individual was observed. In a relatively dry part of the woods, where the ground was slightly damp, but by no means wet, were observed in a few specimens of *Dichromorpha viridis* and a single male *Spharagemon bolli*, the latter doubtless a stray individual from the dryer groves of the adjoining upland. On September 13 the fauna had much the same character, but was evidently poorer in both individuals and species. Of the latter only nine were recorded and of these only two, *Orchelimum nigripes* and *Chlocallis conspersa* had not been taken on the earlier date. The former species is usually the most abundant of the bog "long-horned" grasshoppers, but at this place it was exceptionally scarce. Of *Chlocallis conspersa* only a single male was taken along the edge of the cat-tail bog close to the spot where the *Trurialis* was taken on the earlier date. Besides these other species taken or observed on September 9 were *Dichromorpha viridis* (10), *Melanoplus aboratipennis*, *M. differentialis*, *Scudderia furcata* (10), *Orchelimum vulgare*, *Conocephalus brevipennis* and *C. nigropleurum*.

3. The Purdue Experimental Farm in West Lafayette is located on "second bottom" land. The soil is the Sioux loam. Nearly all the land is under cultivation, the principal crops being corn, wheat, rye, oats, clover, cow-peas, alfalfa and soy beans. Where the land is untilled, as along fences and the borders of paths, there is a firm blue-grass sod in which scattered patches of clover (*T. pratense*) are frequent; also the usual weeds, such as witch-grass (*Panicum capillare*), spreading panic-grass (*P. dichotomiflorum*), crab-grass (*Echinochloa crus-galli*), foxtail (*Chactochloa viridis*, *C. glauca*), Orchard grass (*Dactylis glomeratus*) and *Eragrostis major* and *purshii*. In the more fully cultivated portion the "home" of the Orthoptera was in this relatively undisturbed grassy sod, although they spread from this in large numbers into the neighboring plats. The most abundant species here was naturally *Melanoplus femur-rubrum*; other common forms were *Encoptolophus sordidus*, *Dissosteira carolina*, *Melanoplus atlantis*, *Orchelimum vulgare* (specially in the taller grasses, such as fox-tail, etc.) and *Conocephalus strictus*, the latter very common in the denser areas of blue grass. Other species of frequent occurrence, but not so abundant as those just mentioned, were *Syrbula admirabilis*, *Chotophaga viridifasciata*, and *Melanoplus differentialis*. Occasionally a specimen of *Schistocerca americana* would be taken or observed in the rank weedy growth bordering the experimental plats and in the more thickly

planted plats themselves. Once two individuals of *Conocephalus robustus crepitans* were taken and another heard in the corn fields; both of those captured were taken on corn in the early evening.

The most interesting collecting on the Purdue grounds, however, was done in a small waste lot not far from the Lake Erie and Western Railroad. About half of this lot was occupied by a nearly pure growth of timothy (*Phleum pratense*), while the remaining half had at some time or other been used as a dumping place for manure or other refuse and was now occupied by a rich growth of *Elymus virginicus*, with which were intermixed some areas of *Bromus (ciliatus?)* and a few clumps of a taller species of *Elymus*, probably *canadensis*. On one side near a fence row was a rank growth of sumac (species not determined). In another part of the field at one end of the *Elymus* formation in a shallow gully was a rank growth of green foxtail (*Chactochloa viridis*). Collections were made here at intervals throughout the summer. The species were much the same as those occurring in the cultivated areas, but in addition a number of species were taken which were absent or very rare in the latter. In this waste land most of the collecting was done in the timothy, which had recently been cut, a circumstance which made it relatively easy to capture the grasshoppers. *Melanoplus femur-rubrum*, *Melanoplus atlantis*, *Encoplophus sordidus* and *Conocephalus strictus* were here abundant, while both *Syrbula admirabilis* and *Arphia ranthoptera* were of frequent occurrence. Early in July *Melanoplus femoratus* was fairly common in this tract, but it soon ceased to be an evident component of the fauna. Two ♀♀ of *Orphulella speciosa* were taken on July 22; repeated search failed to reveal any additional specimens of this apparently very rare species. A single male *Scudderia terensis* was also captured here the same date. In the *Elymus* patch a solitary male *Conocephalus fasciatus* was taken also on the same date; while much later in the season—September 13—a small colony of *Conocephalus nemoralis* was found in a place where the *Elymus* was encroached upon by the sumac thickets. *Melanoplus differentialis* was also frequent here. Outside of these three species, the forms in the *Elymus* area were the same as those in the timothy with the exception of *Arphia ranthoptera* which appeared to be limited to the latter. The foxtail growth formed the favorite habitat of *Orchelimum vulgare*. The same grass also yielded a female of *Stenobothrus curtipennis*.

A short distance west of this lot in the adjoining field, which had been

planted in clover, I captured a female specimen of *Schistocerca alutacea*. The capture was made close to the railroad, along which there was a mixed growth of elder (*Sambucus*) and white melilot (*Melilotus alba*). The latter formed a very rank growth in some abandoned gravel pits on the opposite side of the railroad. The color of this specimen was much duller than that of examples from the New Jersey sphagnum bogs, being an olive brown or pale leather color with hardly a trace of green, and with the dorsal stripe, although easily recognizable, by no means conspicuous.

4. At this point some roadside collecting was done. The place is on the slope leading from the "second bottom" at West Lafayette to the upland immediately north of the town. The roadside vegetation consisted in the dryer parts of a mixture of blue grass and timothy and in the gullies of a rank growth of *Melilotus alba*. The Orthoptera were all of common types. *Melanoplus femur-rubrum* swarmed everywhere, while its congener, *M. differentialis*, was almost entirely limited to the thickets. In the blue-grass-timothy areas *Conocephalus strictus* was common, while *Syrphula admirabilis* was of frequent occurrence.

5. This place, locally known as "the tank" from the presence of the storage tank of the West Lafayette water company, is on the edge of the upland at the head of a deep ravine known as Happy Hollow. It overlooks the Wabash bottoms, "second bottoms" being absent from this point north. The soil is Miami silt loam. The land was untilled the past season and had evidently not been in cultivation for a long period. It was open, but at its southern edge where it meets the steep slopes leading down into Happy Hollow was bordered by the relatively dense woods which clothe these slopes. The open areas were closely covered with blue grass with which were locally intermixed small areas or scattered clumps of wiregrass, *Poa compressa*, and foxtail, *Chactochloa glauca*. There were also considerable clover and some low trailing briars. Close to the woods the blue grass became rather sparse and grew only in short scattered clumps with open places between where the bare soil was exposed or where certain hardy herbs, mostly composites, grew. In one or two places on the higher land where the blue grass was very thin, were formations of *Andropogon scoparius* with *A. furcatus* as a minor constituent. At one place immediately adjoining the woods was an extensive patch of *Tridens flava*. Within the outer edge of the woods on some level stretches where the less eroded parts of the bluff project out into the ravine, were a few scrubby

areas containing only scattered grasses, but with many low saplings and some herbaceous undergrowth. The woods on the upper portions of the ravine slopes adjoining the upland were of the mixed hardwood type. The dominant tree was the white oak, but with it were many hickories, elms, sugar maples, lindens, red oaks, beeches and dogwoods.

Collections were made in the open fields above the woods, along the borders of the woods and in the woodland scrub areas. In the more open areas, farthest from the woods, wherever the blue grass or its congener, *Poa compressa*, was thick and luxuriant, common species were *Melanoplus femur-rubrum*, *Encoptolophus sordidus* and *Conocephalus strictus*; *Syrbula admirabilis* was of frequent occurrence. Where the grass was shorter and coarser with some interspaces a number of additional species were common such as *Melanoplus allanisi*, *Arphia xanthoptera*, *Dissosteira carolina* and *Hippiscus rugosus*. Of *Arphia xanthoptera* and *Hippiscus rugosus* both the yellow-winged and the red-winged types appeared to be about equally frequent. Both of these species were common in the more barren areas along the very edge of the woods, where they were associated with *Spharagemon bolli* and *Melanoplus luridus*, each of which was of frequent occurrence, but did not appear to spread any appreciable distance from the immediate vicinity of the trees. Within the woods in the scrub areas previously referred to the two last-mentioned species were the only ones found. Other species occurring at this locality were *Chortophaga viridifasciata* and *Orchelimum vulgare*, long-winged phase. Nymphs of the former were frequent in some areas of dwarfed blue grass in spring and again in the fall, while a smaller number of the latter were found in a scrub area along the borders of the woods.

6. This includes the outer edge of the Wabash bottoms a short distance south of West Lafayette. The outer edge of the bottoms at this point is marked by a gently sloping bluff which leads up to the second bottoms of West Lafayette. Near the base of the bluff is a road and below the road, between it and the level surface of the present bottom, is a short slope which was partially wooded, the common trees being cottonwoods, honey-locust, hackberry, elm and shingle oak. The woodland here formed a narrow fringe and beyond it, occupying all the level areas, were the usual corn fields of the bottoms. Beneath the trees was a fairly dense undergrowth of shrubs and tall grasses of which species of *Elymus* were most frequent, especially *E. virginicus*. The soil was a mixture of the gravel derived from the material of the bluff itself and alluvium depos-

ited by the river during periods of overflow. Owing to its position, the presence of the rank vegetation and of the resulting humus the soil was in most places moderately damp, but not actually wet. This, however, was not the case in one spot where the ground was perpetually moist on account of the constant seepage from the bluff. The substratum at this spot was a black or dark grey muck with much gravel in its deeper levels. Trees were absent from these wetter areas and they were accordingly occupied by a rank growth of the usual herbaceous swamp plants the more conspicuous of which in this swamp were *Typha latifolia*, *Homalocenchrus oryzoides* and *Ambrosia trifida*. South of the swamp was a small bit of open woodland in which there was a rich undergrowth of grasses. Of these the species of *Elymus*, chiefly *E. virginicus* with some *canadensis*, occupied the better lighted areas while in the more shaded spots such forms as *Homalocenchrus virginicus*, *Muhlenbergia* apparently *M. tenuiflora*, *Korynepus arundinaceus* and *Hystrix hystrix* were common. Adjoining this woodland on the south was an open pasture in which there was a good stand of *Tridens flava*.

Quite a number of interesting Orthoptera were taken in this locality. In the drier situations the patches of *Elymus canadensis* yielded such species as *Dichromorpha viridis*, *Melanoplus viridipes*, *Melanoplus atlantis*—an unusually humid environment for this form—*Melanoplus femur-rubrum*, *Melanoplus femoratus*, *Amblycorypha rotundifolia* and *Conocephalus nemoralis*. With the exception of *Melanoplus femur-rubrum* none of these were common or widespread, being in most cases represented only by scattered individuals or an occasional colony. Other grasses besides the *Elymus* were searched for Orthoptera, but, excepting *Tridens*, proved to be barren. In the dense thickets of ragweed, *Ambrosia trifida*, surrounding the more boggy spots *Melanoplus femur-rubrum* and *Melanoplus differentialis* were abundant, while in the same tracts a few examples of *Melanoplus scudderi* were also taken. In the swamp the Orthoptera were most numerous in the *Homalocenchrus oryzoides* and the immediately adjoining thickets; they were apparently quite infrequent in the cat-tails. The most abundant swamp species were in order of relative numbers *Melanoplus femur-rubrum*, *Conocephalus bevipennis*, *Melanoplus differentialis*, *Orchelimum nigripes*, *Orchelimum vulgare* and *Conocephalus nigropteurum*; in much smaller numbers were found such species as *Occanthus fasciatus*, *Occanthus quadripunctatus*, *Scudderia furcata* *Neoconocephalus palustris*, *Orchelimum gladiator*, *Conocephalus fasciatus*, *Conocephalus nemoralis*

and *Conocephalus attenuatus*. In the pasture in which *Tridens flava* was a common plant *Syrbula admirabilis* and *Conocephalus strictus* were of frequent occurrence along with larger numbers of the ubiquitous *Melanoplus femur-rubrum*. Close to the border of the same field, where there were some extensive patches of *Elymus virginicus*, several examples of *Dichromorpha viridis* were observed.

7. This was a level tract of very open woodland located on top of the bluff overlooking the bottom lands included in locality 6. The ground here had been used for pasturing cattle and the herbaceous vegetation was accordingly quite short and scanty. Orthoptera were scarce. Each *Melanoplus atlantis* and *Melanoplus femur-rubrum* were frequent, while in one place where there was considerable slope and a fair amount of scrub growth a few examples of *Spharagemon bolli* were seen. Late in June *Atlantius testaceus* occurred in small numbers, several being captured one night on low shrubs and tall weeds.

8. This locality was a small open grove at the top of the highest line of bluffs at the north end of a ravine situated nearly half way between West Lafayette and the mouth of Indian Creek. The soil was the Miami silt loam which in this exposed situation was quite dry and barren and had a decided sandy appearance. Along a recently cut roadside I found at this point a young specimen of the black-jack oak, the presence of which naturally indicates the barren character of the location. The soil here at the time of my visit—August 24th—was formed of blue-grass sod with occasional patches where the ground was bare or but sparsely covered with vegetation. In such places the common woodland Panicum, *P. huachuca*, was frequent. In two or three places erosion had worn slight gulleys from which most of the finer soil particles had been washed away leaving a very hard and stony soil on which very little vegetation had as yet obtained a foothold. These gulleys were the favorite habitats of the more geophilous Orthoptera such as *Arphia xanthoptera*, *Spharagemon bolli* and *Dissosteira carolina*.

Only about a half hour was spent in collecting at this spot, during which examples of the following species were taken or identified: *Syrbula admirabilis*, *Arphia xanthoptera*, both yellow-winged and orange-winged types, *Encoptolophus sordidus*, *Spharagemon bolli*, *Dissosteira carolina*, *Melanoplus femur-rubrum* and *Melanoplus luridus*.

9. This locality is about half a mile southeast of Battle Ground in a region covered by Miami fine sand. Practically the whole country is under

cultivation. The only collecting was done in a limited bit of roadside where the banks were occupied by a mixed growth of two tall bunch-grasses, *Tridens flava* and *Andropogon furcatus*. My visit to this spot was made August 30. At that time the following species were taken or observed, all being fairly frequent: *Melanoplus femur-rubrum*, *Melanoplus atlantis*, *Conocephalus strictus*, *Dissosteira carolina*, *Syrbula admirabilis* and *Arphia xanthoptera*.

10. This locality is on the east side of the Wabash about three miles north of Lafayette and a mile southwest of Wild Cat Creek. At this point there is a well-marked bluff marking the dividing line between the upland, here formed by Sioux sandy loam, and the Wabash bottoms. At the base of the bluff is an extensive marsh, shown on the Bureau of Soils map as a crescent-shaped patch of muck. The upland immediately bordering the bluff is occupied by a cemetery in which there are many large trees, the whole forming an open grove with no undergrowth except the ordinary blue-grass sod. In this cemetery, frequenting the relatively dry blue grass were numerous examples of *Melanoplus scudderi* and *Melanoplus luridus* along with the usual *Melanoplus femur-rubrum* and *Encoptolophus sordidus*. On the steeper slopes, where there was a considerable amount of herbaceous undergrowth and some patches of *Andropogon furcatus*, a few examples of *Spharagemon bolli* were seen and, near the base of the slope, in a shallow depression, where there was a thick growth of a bright green, succulent grass, a small number of *Stauroderus curtipennis* were found. *Dissosteira carolina* was as usual common on paths and drive-ways both on the upland and in the bottom. The swamp at the base of the bluff was quite open and was of the type usual to the bottoms with rice cut-grass, *Homalocenchrus oryzoides*, forming the dominant vegetation of the wetter areas. On the side toward the bluff this growth was bordered by a thicket formed mostly by tall herbaceous plants among which sunflowers and goldenrods were conspicuous; while on the opposite side toward the open bottom lands it was bordered by a weed vegetation in which a tangled growth of smart-weed (*Polygonum*) predominated. In the rice cut-grass the common Orthoptera were *Melanoplus femur-rubrum*, *Conocephalus brevipennis*, *Orchelimum nigripes*, *Orchelimum vulgare* and *Melanoplus differentialis*. Both of the last-named species and also *Conocephalus nigropleurum* were frequent in the surrounding thickets, while *Orchelimum vulgare* and *Melanoplus femur-rubrum* swarmed in the *Polygonum* areas. In addition to the two forms last mentioned other species tak-

en in the bordering thicket in fair numbers were *Melanoplus obovatipennis* and *Conocephalus nemoralis*. With them were found occasional examples of *Dichromorpha viridis*, and *Melanoplus femoratus*. In the *Homalocenchrus oryzoides* two specimens of *Neoconocephalus palustris* and one each of *Scudderia texensis* (a ♂ apparently this species) and *Orchelimum vulgare* long-winged type were taken. Collecting was done at this place on September 6th.

11. At this place collections were made on July 19 and October 3. The locality was the low alluvial tract along the Wabash at the mouth of Wild Cat Creek. Most of the land is under cultivation, but there is some open woodland on the adjoining bluffs. Along the roadside were the usual weedy tracts inhabited by *Melanoplus atlantis* and *Melanoplus femur-rubrum*, the latter being by far the most abundant. In the ranker herbage and weedy tracts *Melanoplus differentialis* was of frequent occurrence. On the bare paths and in the plowed fields *Dissosteira carolina* was common. The remaining species were few in number and were found only in grassy depressions close to the river. In one of these which contained an almost pure stand of *Elymus virginicus* a few examples of *Stauroderus curtipennis* were observed on July 19; in the same place a single specimen of each of the following was taken: *Melanoplus walshii*, *Orchelimum gladiator*, *Conocephalus fasciatus* and *Conocephalus nigropleurum*. In another depression, examined on October 3, the dominant growth was a species of *Muhlenbergia*; in this *Orchelimum vulgare* and *Conocephalus brevipennis* were common, a single specimen of *Conocephalus nigropleurum* was also taken here.

12. While on an inspection trip on the upland between West Lafayette and Montmorenci on August 12 I made a rapid examination of several small areas in which the ground was more or less damp and covered either with thick succulent blue grass or species of *Carex*. Orthoptera did not appear to be very common in such places, except such ubiquitous forms as *Melanoplus femur-rubrum* and *Orchelimum vulgare*. In one rather wet depression, where there was a nearly pure growth of *Carex*, *Conocephalus fasciatus* was rather common; it also occurred, though in small numbers, in blue-grass depressions. In one of the latter bordering a small grove a small number of *Stauroderus curtipennis* were observed. A male *Scudderia furcata* was taken near here in some thick grass at the side of a small stream.

13. This was a very limited tract on the edge of the bluff overlook-

ing the Wabash valley about three miles southwest of Lafayette. Collecting was done only along the right of way of the Wabash Railroad. This locality was visited only once, and that on October 12, when many species had died out or become very scarce. Only five species were noted, four of which were common in the waste lots adjoining the railroad. They were *Melanoplus femur-rubrum*, *Encopitophus sordidus*, *Dissosteira carolina* and *Melanoplus atlantis*, the last-named being the least frequent. The only other species observed on this trip was a male *Schistocerca americana* which was found in a local growth of *Andropogon furcatus*.

14. This was a very interesting undrained depression of considerable size situated in an open field on the upland about two miles northwest of West Lafayette. The substratum in the depression was a dark muck. At the time of my visit, October 13-14, it was quite dry and crisp at the surface, but within a fraction of an inch below was still quite moist and sticky. The centre of the swamp was nearly devoid of vegetation; doubtless in times of normal rainfall it is submerged. Surrounding this is a wide fringe of reedy vegetation formed of cat-tails, *Typha latifolia* and a tall species of rush, which was similar in general aspect to *Juncus effusus*, though owing to the lateness of the season I was unable to certainly identify it. Intermixed with both of these was a luxuriant growth of rice cut-grass, *Homalocenchrus oryzoides*. Surrounding these again was an outer thicket of tall herbaceous plants, such as asters, goldenrods, iron-weeds, sunflowers and their associates.

The Orthoptera of this swamp were unlike any found elsewhere in the extreme abundance of two Tettigoniids, a peculiar color-phase of *Orchelimum nigripes* and *Conocephalus attenuatus*, both of which simply swarmed throughout the *Typha-Homalocenchrus* areas although they largely avoided the rush and were entirely lacking in the herbaceous marginal thicket. The large numbers of *Conocephalus attenuatus* in this place was surprising, for, although it has been known for a long time to be native to the state, I had, previous to my discovery of this marsh, been able to procure only a single example in the region about Lafayette and was accordingly inclined to look upon it as a very rare species in this particular part of the State.

Other species associated with the two species just mentioned in the cut-grass-cat-tail formation were *Conocephalus nigropleurum*, *Conocephalus saltans* and a small *Orchelimum* which Mr. Rehn has assigned to *O. agile*. All of these were quite scarce at the time I examined the place, only a

single example of each of the last two species being seen and only a single pair of *Conocephalus nigropleurum*. Noteworthy was the entire absence in this marsh of the two most frequent marsh "long-horned" grasshoppers of this region, *Conocephalus brevipennis* and the typical phase of *Orchelimum nigripes*.

In the herbaceous thickets forming the marginal vegetation of the marsh Orthoptera were not very common, the only species taken there being *Melanoplus differentialis* and *Melanoplus obovatipennis*, both of which were only moderately common. In the open clover field surrounding the marsh the only species observed was *Melanoplus femur-rubrum*.

15. This was a small lateral ravine which opened into the valley of Indian Creek close to where it empties into the Wabash. It was visited June 28. Orthoptera were very scarce at this time, but on a steep wooded slope where there was much bare ground with scattered growth of the woodland *Panicum*, *P. huachucae*, I captured a male *Melanoplus fasciatus*. The woods here were denser than usual and were cool and shady with only few scattered openings where the direct rays of the sun reached the ground. The soil at this spot is mapped as Miami silt loam.

16. This includes the east bank of the Wabash and the adjoining bottoms about 2½ miles southeast of Battle Ground examined August 30th. The river bank here slopes very gently and at the time of my visit was covered next the river with a growth of sedge, apparently *Scirpus americanus*, and landward of this by *Homalocenchrus oryzoides*. Above this on higher ground was a fringe of woodland with a dense undergrowth of *Muhlenbergia*. Beyond this were the flat cultivated lands of the bottoms. At this point the bottoms are about a quarter of a mile wide. At their outer edge—the edge away from the river—they are characterized by the usual line of high bluffs forming the edge of the neighboring upland. At the base of the bluffs was the usual seepage zone, which at this place was represented by an extensive marsh in which *Homalocenchrus oryzoides* formed the bulk of the vegetation. Bordering it were the accompanying thickets of tall composites.

The Orthoptera of the river bank at this place were disappointingly scarce. The only species at all common was *Orchelimum nigripes* which was observed only in the cut-grass. A single specimen of *Neoconocephalus palustris* was taken in the sedge, but it had apparently strayed there from the cut-grass areas. No other species were noted on the river margins. On the cultivated parts of the flood plain there were in several places rank

growths of common weeds and in these *Melanoplus femur-rubrum* and *Melanoplus differentialis* were abundant. The best collecting from the standpoint of variety was afforded by the marsh at the base of the bluffs. Here in the cut-grass I found considerable numbers of *Paroxya hoosieri*, the only place where I obtained this interesting species. With it were large numbers of *Orchelimum nigripes*, *Conocephalus brevipennis* and *Conocephalus nigropleurum*. In the marginal thickets were observed such forms as *Melanoplus differentialis*, *Conocephalus fasciatus*, *Melanoplus scudderi* and *Melanoplus obovatipennis*.

17. This was a small open groove on rather dry barren soil. It is located on a gentle slope just above the Wabash bottoms on the west side of the river about three miles southwest of West Lafayette. The soil is Sioux sandy loam. In the groove at this point it supports a rather weak growth of blue grass. In the driest parts the blue grass is sparse and in such places *Panicum huachuca* becomes a noticeable constituent of the herbaeous flora. The Orthoptera taken here were the usual species of dry open woodland. In July and early August *Spharagemon bolli* was quite frequent while later in the season *Melanoplus scudderi* and *Melanoplus luridus* were common.

ANNOTATED LIST OF SPECIES.¹

Diapheromera femorata Say. A single specimen, a male, taken in low woods on Burnett Creek near Battle Ground (2), August 9.

Acrydium (Tettix) ornatus Say. Moderately frequent in spring on dry hillsides and in stubble fields on the upland near West Lafayette.

Truxalis brevicornis (Linnaeus). Two specimens: a female nymph taken July 27 in upland deciduous woodland about one mile northwest of West Lafayette (1) in a grassy tract a short distance from a bog dominated by buttonbush, *Cephalanthus occidentalis*; a mature male taken August 9 in low woods along Burnett Creek (2) near Battle Ground at the edge of a bog containing cat-tail (*Typha latifolia*), sedges (species of *Carex*, *Scirpus atrovirens*), *Sagittaria*, *Panicularia nervata*, *Helianthus* spp. Species apparently quite scarce as no other examples were seen.

Syrbula admirabilis (Uhler). Of frequent occurrence in all relatively dry grassy areas at higher levels and locally at least, where conditions are suitable, not uncommon in bottom lands. The species is prevaillingly campestrial in its habitat, being especially fond of open grass lands; less fre-

¹The nomenclature used here is that given in an unpublished list of unsynonymized terms compiled by Mr Morgan Hebard.

quently it may occur along the grassy borders of open woodland. I have taken it in areas occupied by blue grass (*Poa pratense*), timothy (*Phleum pratense*), red-top (*Tridens flava*) and bunch-grass (*Andropogon scoparius* and *furcatus*). I have the following records: July 23, 2 nymphs in dense patch of *Bromus* on Purdue Experimental Grounds (3); July 26, nymphs fairly frequent in timothy stubble on Purdue Experimental grounds (3); August 1, adults, especially males, frequent and nymphs common in grassy roadside patch (timothy-blue grass) on upland slope (4) north of Lafayette; also in dry blue grass and *Poa compressa* in field at "the tank" (5); August 20, several males in open field dominated by *Tridens flava* along outer margin of the Wabash bottoms below West Lafayette (6); August 24, frequently within the borders of dry open woodland on the top of the bluffs at the head of a ravine (8) about half-way between West Lafayette and the mouth of Indian Creek, chiefly in dry blue-grass, and associated with *Arphia ranthoptera*, *Spharagemon bolli*, *Encoptolophus sordidus* and *Melanoplus luridus*; August 30, frequent in roadside and fence-row grasses, especially in a patch of *Tridens flava* and *Andropogon furcatus* about a half mile southeast of Battle Ground (9); September 1, of common occurrence in grassy uplands at head of "Happy Hollow" (5) occurring in blue grass, wire-grass (*Poa compressa*) and *Andropogon furcatus* and *scoparius*; October 4, appears to be getting scarce now on the Station grounds (3); October 26, a single female seen in dense patch of *Poa compressa* in locality 5; October 31, a dead female found on cement sidewalk on Experimental Station grounds (3).

Orphulella speciosa (Scudder). Apparently very rare, only four specimens having been seen or taken throughout the entire season. These occurred in dry, open, grassy tracts on untilled land.

July 22, two females taken in timothy stubble in waste lot on Purdue Experimental Grounds (3); in both of these the tegmina are longer than the abdomen and their tips reach the tips of the hind femora. One female has the discoidal area of the tegmina occupied in part by a double row of cells, a character of its congener *pelidna*; the specimen, however, is unquestionably *speciosa*. August 1, a male taken in *Poa compressa* in a field at "the tank" (5). September 1, a male taken in patch of *Andropogon* on upland at the head of Happy Hollow (5).

Dichromorpha viridis (Scudder). Appears to be only moderately frequent and is largely restricted to damp situations within or along the

edges of open woodlands. It is more frequent in bottom lands than in more elevated tracts.

July 27, frequent in grassy and sedgey spots in humid upland woods (1); August 9, in small numbers in low woods and thickets along Burnett Creek (2); August 20, occasional in a low field along the outer edge of the Wabash bottom near West Lafayette (6) occurring in *Tridens flava* and *Elymus virginicus*; September 6, occasional in the undergrowth on a wooded slope near a *Homalocenchrus oryzoides* marsh (10); September 13, a female taken in low woods along Burnett Creek (2).

Chlaenius conspersa Harris. Occasional in grassy spots in damp woodlands; very local.

July 27, several males and one female observed in humid upland woods northwest of West Lafayette (1), in a grassy clearing where the prevailing herbaceous vegetation consisted of *Carex*, *Elymus* and *Hystrix*; September 13, a single male taken in low woods along Burnett Creek (2), at the edge of a cat-tail bog.

Stauroderus (Stenobothrus) curtipennis (Harris). Apparently only moderately frequent and rather local, occurring in humid tracts well covered with succulent grasses.

July 19, in small numbers in the bottoms near the mouth of Wild Cat Creek (11), in dense growth of *Elymus virginicus*; August 12, a female taken in patch of fox-tail (*Chytocloa viridis*) in a waste lot on the Purdue Experimental Grounds (3); July 12, a small colony in a moist grassy depression along the edges of woodland on the upland between Lafayette and Montmorenci (12); September 6, quite scarce in grassy areas on a wooded slope south of Wild Cat Creek (10).

Arphia sulphurea (Fabricius). Found only once in late April in a sparse growth of blue grass (*Poa pratense*) at the top of a high bluff at Happy Hollow (5). It was at this time in the nymph stage. No others were observed during the season, but it is doubtless more frequent in the spring months than my very meagre field observations made at that season would indicate.

Arphia xanthoptera (Burmeister). Frequent in untilled areas in numerous dry situations, chiefly in upland localities. Both yellow-winged and orange-winged examples occur in nearly equal numbers. The species appears to occur only occasionally on fully cultivated land.

August 1, frequent on the bluffs at the head of Happy Hollow (5), occurring in dry grassy areas and on bare ground on the gentle inclines

adjoining the wooded ravine slopes. Both sexes were represented, also yellow-winged and orange-winged examples in approximately equal numbers; August 24, several examples of both color types observed in open woodland at the head of the ravine between West Lafayette and the mouth of Indian Creek (8), occurring in blue grass areas and in a dry gully; August 28, several of the orange-winged type observed in timothy stubble on a waste lot of the Purdue Experimental Grounds (3); August 30, several observed in an open clover field on dry sandy ground about a half mile east of Battle Ground (9); September 1, both yellow-winged and orange-winged individuals nearly equally common on the bluffs at the head of Happy Hollow (5); October 4, scarce in cultivated ground on Purdue Experimental Grounds (3).

Chortophaga viridifasciata (DeGeer). Only moderately frequent, chiefly in dry upland grass lands. Nymphs were observed in late April, adults from early May to late June and nymphs from early October to the end of November. The species appeared to be most frequent in sparse blue grass areas on the barren slopes at the top of the bluffs.

Encoptolophus sordidus (Burmeister). Abundant in all open dry areas or in quite open woodland.

July 22, nymphs common in timothy stubble in a waste lot on the Purdue Experimental Farm (3); August 1, nymphs common in dry blue grass and *Poa pratensis* areas on the bluffs at the head of Happy Hollow (5); August 19, adult males observed today for the first time on the Purdue University Farm (3) in blue grass areas; August 24, occasional in open woodland on the bluffs at the head of a ravine between West Lafayette and the mouth of Indian Creek (8) in blue grass; September 1, both sexes common in open grassy fields on the bluffs at the head of Happy Hollow (5); September 6, occasional in an open grove on bluffs (10) near Wild Cat Creek; September 13, common in blue grass borders of paths and fences on Purdue Experimental Farm (3); October 4, common on Purdue Experimental Farm (3); October 12, common in waste ground along Wabash Railroad south of Lafayette (13); October 25, occasional on roadside vegetation at the outer edge of the Wabash bottoms near West Lafayette (6); October 26, November 2, small numbers in grassy fields at head of Happy Hollow (5).

Hippiscus rugosus (Scudder). Common in one locality, but not observed elsewhere. It was found August 1 and again on September 1 on the tall bluffs at the head of Happy Hollow (5) where it occurred on untilled

ground in short blue grass and *Poa compressa* areas in dry fields and along the edges of woodlands. It was represented by both yellow-winged and vermilion-winged individuals, the two forms being present in apparently equal frequency.

Spharagmon bolli (Scudder). Frequent in dry open woodland in scrubby and grassy clearings; also along woodland borders, but never in open country.

July 12, a few observed on a hillside covered with open scrub near the borders of woods south of West Lafayette (7); July 23, moderately frequent in an open oak woods south of West Lafayette (17); August 1, frequent along the borders of woods on the bluffs at the head of Happy Hollow (5) in sparse grass and scrub areas; August 9, a male taken in low, humid woods on Burnett Creek (2), probably a stray example from the neighboring upland; August 24, several, in open woodland on the bluffs at the head of the ravine between West Lafayette and the mouth of Indian Creek (8); September 1, several observed in clearings in the woods on top the bluffs at the head of Happy Hollow (5); September 6, few seen in a dry grassy area, largely occupied by *Andropogon furcatus*, on a wooded slope (10) near Wild Cat Creek.

Dissosteira carolina (Linnaeus). Common everywhere on bare ground and in dry grassy areas, where the grass is short, with patches of bare earth intervening. Appeared as adults about July 7 and persisted until the end of October.

Schistocerca americana (Drury). Of sporadic occurrence from late March until at least the middle of October, apparently most frequent in early fall.

March (late), a male taken on a building lot at West Lafayette, in blue grass (3); July 22, a female taken in a field of soybeans on Purdue Experimental Farm (3); September 10, observed a female on Purdue Experimental Farm (3) in blue grass; September 30, a male observed on Purdue Experimental Farm (3); October 4, a male observed on roadside in West Lafayette (3); October 12, a male observed in bunch grass, *Andropogon furcatus*, on bluff along Wabash bottoms south of Lafayette (13).

Schistocerca alutacca (Harris). Evidently very rare and sporadic. I captured a female on August 5 in a field on the Purdue Experimental Farm (3) near the Lake Erie and Western R. R., at a point where there was a fence border growth of elder (*Sambucus*) and melilotus (*M. alba*).

Subsequently, September 24, another specimen, also female, was taken near the same spot by Mr. P. W. Mason.

The specimens were of a much duller tint than those which I have taken in the New Jersey cedar bogs. The latter are typically a bright greenish-olive with a very conspicuous bright yellow mid-dorsal stripe and purplish tegmina. The Lafayette specimens were of a dull olive-brown or leather color with a distinct, but not especially conspicuous, mid-dorsal stripe of pale yellow. The place where the specimens were taken was relatively quite dry.

Melanoplus scudderi (Uhler). Moderately common, at least, locally, in grassy tangles and herbaceous undergrowth in or near woodland.

July 27, nymphs common in grassy clearings in upland woods (1), northwest of West Lafayette; August 9, an adult male taken in low woods in a thicket at the edge of a bog on Burnett Creek (2); August 20, a male taken in tall herbaceous thicket near a bog at the outer margin of the Wabash bottoms near West Lafayette (6); August 30, a male taken in open thicket at the edge of a bog at the base of a bluff on the outer margin of the Wabash bottoms opposite Battle Ground (16); September 6, frequent in blue grass in an open grove on the bluff near Wild Cat Creek (10), associated with *M. luridus*; October 4, several observed in the grassy thickets of roadside adjoining an open patch of woodland (17), south of West Lafayette; October 26, two females observed in grassy fields on the bluff at the head of Happy Hollow (5).

Melanoplus viridipes Scudder. Apparently very local, only a single specimen, a male, having been taken on June 24 in a patch of *Elymus virginicus* in the fringe of trees marking the outer limits of the Wabash bottoms near West Lafayette (6).

Melanoplus obovatipennis (Blatchley). Frequent locally in the herbaceous thickets surrounding marshes or damp spots generally.

August 9, an adult male and female and four nymphs taken in the thickets surrounding a small bog in low woods on Burnett Creek (2); August 30, a male taken at the edge of a marsh characterized by *Homalocenchrus oryzoides*, *Impatiens* and *Ambrosia trifida* at the base of a bluff at the outer edge of the Wabash bottoms opposite Battle Ground (16); September 6, fairly common in herbaceous thickets (goldenrod, sunflowers, etc.) along the edge of a *Homalocenchrus oryzoides* marsh at the base of a wooded bluff near Wild Cat Creek (10); September 13, a pair taken in swamp border thicket. (*Eupatorium purpureum*, *Solidago* spp., etc.) in

low woods on Burnett Creek (2); October 13-14, frequent in herbaceous thickets (asters, goldenrod, ragweed, etc.) surrounding a cat-tail marsh on the upland northwest of West Lafayette (14).

Melanoplus gracilis (Bruner). Apparently moderately frequent locally in moist or slightly humid woodland locations, frequenting grassy and sedgey tangles and herbaceous thickets in the vicinity of bogs.

July 27, males moderately frequent in grassy and sedgey areas and surrounding thickets in humid upland woods northwest of West Lafayette (1); August 9, adults of both sexes found in small numbers in a bog occupied by *Homalocenchrus oryzoides*, *Carex* spp., *Scirpus atrovirens*, *Sagittaria* sp., *Salix* thickets, etc., in low woods on Burnett Creek (2); September 13, a female taken in a bog border thicket in the same locality (2), associated with *M. obovatipennis*.

Melanoplus fasciatus (Walker). Probably quite rare. A single male specimen was taken June 28 in an exceptionally dense bit of woodland near the base of a steep bluff not far from the mouth of Indian Creek (15). The ground where it was taken was quite bare, except for a few scattered plants of *Panicum huachucae* and a few other forms not determined. My determination of this specimen was kindly verified by Prof. Blatchley.

Melanoplus walshii Scudder (*M. Blatchleyi* Scud.). Only a single specimen, a female, was taken July 19 in a dense growth of *Elymus virginicus* on the flood plain of the Wabash near the mouth of Wild Cat Creek (11).

Melanoplus atlantis (Riley). Abundant, though somewhat local, in open grassland in relatively dry situations. Most frequent in upland localities, but it also occurs in small numbers in the bottoms wherever the conditions allow the formation of dry grassland. The species reaches maturity the latter part of June and persists through the summer and well into the fall. The adults appeared to be most abundant about July 20; they apparently decreased in numbers in late summer and early September, but in some places they seemed to increase again in early October. At the latter period a number of copulating pairs were taken and the individuals were found in localized groups, facts which would perhaps indicate the recent maturing of the specimens and the possibility of a second or fall brood of adults. It is conceivable at least that some of the earlier laid eggs might under favorable conditions hatch out in the fall and thus pro-

duce the apparent increase of adults at this time. Mature examples of this species were seen as early as June 16 and as late as October 25.

Melanoplus femur-rubrum (DeGeer). The most abundant grasshopper, swarming everywhere, except in woodland locations and on very dry and barren ground. Its predilections are for relatively humid areas, and it is in consequence especially abundant in the bottom lands, and about ditches and other moist spots. It avoids dense herbaceous thickets and favors open grasslands and clover fields. It reached maturity by the last of July and was found continuously from then until frost. The last record I have is November 2.

Melanoplus luridus (Dodge). Of regular occurrence, though not always common on grassy spots in dry woods or in their immediate vicinity. Usually associated with *Spharagemon bolli*.

August 1, a male taken in blue grass close to the edge of the woods on the bluffs at the head of Happy Hollow (5), nymphs also found here; August 24, several of both sexes found in mixed blue grass and *Panicum huachucae* in open woods on a bluff at the head of the ravine (8) between West Lafayette and the mouth and Indian Creek; September 1, a small number in a clearing in the woods on the bluff at the head of Happy Hollow (5); September 6, frequent in blue grass in a dry open grove on the bluffs near Wild Cat Creek (10), associated here with *Melanoplus scudderi*.

Melanoplus bivittatus (Say). All specimens seen were of the red-legged or *femoratus* type. The species is only moderately frequent and more or less local. It was found in fair numbers about the middle of July on the grounds of the Purdue Experiment Station, but it soon became quite scarce and after the early part of August only occasional individuals were noted and that only in the more or less rank vegetation that flourishes in neglected spots along the stream bottoms.

July 22, moderately frequent in timothy in a waste lot and in the nearby corn and soybean patches on the Purdue Experimental farm (3); August 9, fairly common in thickets in or near low woods on Burnett Creek (2); August 20, occasional in marshes and surrounding thickets at outer margin of Wabash bottoms below West Lafayette (6); September 6, a female observed in tall herbaceous thickets at the base of a bluff near Wild Cat Creek (10).

Melanoplus differentialis (Thomas). Abundant in sheltered situations in all humid situations; less frequent, but not uncommon in upland

localities. The species is especially characteristic of the dense thickets of tall ragweeds, *Ambrosia trifida*, which abound in all moist areas and are especially frequent about the boggy spots at the foot of the bluffs along the outer edge of the stream bottoms. The earliest nymph stages appear to be limited entirely to bogs and the surrounding thickets, but as the grasshoppers increase in size they wander from these haunts into the adjoining fields and uplands. The adults appeared early in August and persisted to about the middle of October.

August 9, adults noted in thickets bordering a bog along the outer edge of the Wabash bottoms near West Lafayette (6); also in thickets of *Melilotus alba* on the upland (3); August 9, common in bog border vegetation in or near low woods on Burnett Creek (2); August 20, common in *Homalocenchrus oryzoides* bog and adjoining thickets of *Ambrosia trifida* and associated plants at the base of the bluff at outer margin of the Wabash bottoms near West Lafayette (6); August 30, abundant in similar situations and corn fields on the Wabash bottoms near Battle Ground (16); September 6, abundant in the same kind of environment at the base of the bluffs near Wild Cat Creek (10); September 13, common in thickets and grassy tangles along Burnett Creek (2); October 13, common in herbaceous thickets surrounding a cat-tail swamp on the upland northwest of West Lafayette (14).

Paroxya hoosieri (Blatchley). Found August 30 in considerable numbers in a bog dominated by *Homalocenchrus oryzoides* and *Impatiens* at the base of a bluff along the outer margin of the Wabash bottoms opposite Battle Ground (16); not found elsewhere.

Scudderia texensis Saussure-Pictet. Apparently scarce as only a few specimens were secured.

July 22, a male taken in timothy patch on waste lot on Purdue Experimental Farm (3); July 26, a female taken, location not recorded; September 6, a female, apparently this species, taken in high thicket at the base of wooded bluff near Wild Cat Creek (10).

Scudderia furcata Brunner. Only a few examples found. August 9, two males taken in tall herbaceous thickets about the edge of a small bog in low woods along Burnett Creek (2); August 12, a male taken in a grassy roadside ditch near a small stream between Lafayette and Montmorenci (12); August 20, two males and an equal number of females taken in a *Homalocenchrus oryzoides* bog at outer edge of Wabash bot-

toms near West Lafayette (6); September 13, a male taken in a swamp border thicket in low woods on Burnett Creek (2).

Amblycorypha oblongifolia (DeGeer). Only a single specimen, a male, was taken on the night of July 23 in a grove of young silver maples at a nursery two miles southeast of Lafayette. The species is, however, much more frequent than the single capture would indicate since its notes were frequently heard at night throughout midsummer.

Amblycorypha rotundifolia (Scudder). A female specimen was taken July 12 in a patch of *Elymus virginicus* in a narrow fringe of woodland at the base of the bluff on the outer edge of the Wabash bottoms below West Lafayette (6).

Microcentrum laurifolium (Linnaeus). This, or the related species, *retinerve*, appears to be common in trees at Lafayette since its notes were heard continuously throughout late July and August. Only one specimen was actually taken and identified as belonging to *laurifolium*.* It flew into the office at the Experiment Station.

Neoconocephalus robustus crepitans (Scudder). Late in August three males were heard stridulating in the corn plats on the Purdue University Farm (3) and on the evening of August 26 two of these were captured, one being taken in some crab grass (*Syntherisma sanguinalis*), the other on a corn tassel. According to Blatchley this species has hitherto been noted in Indiana only in Laporte County along the shore of Lake Michigan.

Neoconocephalus palustris (Blatchley). Of regular occurrence in open *Homalocenchrus oryzoides* bogs, but not especially frequent.

August 20, one male, two females, in *Homalocenchrus oryzoides* bog at base of bluff on Wabash bottoms near West Lafayette (6); August 30, a female taken in mixed *Scirpus americanus* and *Homalocenchrus oryzoides* on low banks of the Wabash River opposite Battle Ground (16); September 6, one specimen of each sex taken in *Homalocenchrus oryzoides* bog at base of bluff near Wild Cat Creek (10).

Orchelimum vulgare Harris. Abundant everywhere in tender succulent grasses; uncommon in woodland situations.

July 22, males and nymphs abundant in growth of *Chatochloa viridis* on a waste lot of the Purdue Experiment Farm (3); August 9, one male and a female taken in woodland bog in low woods on Burnett Creek (2), far from common here; August 20, common in *Homalocenchrus oryzoides* at base of bluffs along margin of the Wabash bottoms near West Lafayette

*Based on description in Blatchley, Orthoptera of Indiana.

(6) ; August 28, common in tall roadside vegetation, about ditches, etc., at West Lafayette; September 4, abundant in mixed growth of *Muhlenbergia* sp. and *Chatochloa viridis* in a neglected field at West Lafayette; September 6, common in *Homalocenchrus oryzoides* bog and in adjoining weed areas at base of the bluffs near Wild Cat Creek (10) ; September 13, small numbers observed in swamp border thickets in low woods on Burnett Creek (2) ; October 13, rather scarce at West Lafayette (3).

Orchelimum vulgare, long-winged phase. This is the form which has commonly been called *glaberrimum* by Blatchley and the majority of recent writers. Rehn and Hebard, however, have recently reached the conclusion that this term correctly applies to the entirely different red-faced *Orchelimum* of the Middle and South Atlantic States which Davis has called *erythrocephatum* and which I have so designated in my paper on New Jersey Orthoptera. In the last-mentioned work the form termed *glaberrimum* has since been recognized to be a distinct species which Rehn and Hebard are about to describe. Occurs in the same situations as the preceding species, but is much less frequent though by no means uncommon.

July 22, a male taken in patch of *Chatochloa viridis* in a waste lot on the Purdue Experimental Farm (3) ; August 20, a male and female taken in a *Homalocenchrus oryzoides* bog at the base of the bluffs on the edge of the Wabash bottoms near West Lafayette (6) ; August 24, a male taken in corn plat at Purdue Experimental Farm (3) ; August 28, several males observed at night while stridulating on young trees and tall herbs on the bluff at the head of Happy Hollow (5) ; September 4, one female taken in thick grass on a neglected lot at West Lafayette; September 6, a male taken in *Homalocenchrus oryzoides* at base of bluff near Wild Cat Creek (10) ; October 4, several seen on Purdue University Farm (3).

Orchelimum gladiator (Bruner). Only two specimens, both males, taken during the season. Both were found in bottom lands in thick grass.

July 12, a male taken in a *Homalocenchrus oryzoides* bog at the base of the bluff on the outer edge of the Wabash bottoms below West Lafayette (6) ; July 19, a male taken in a thick growth of *Elymus virginicus* on the east bank of the Wabash at the mouth of Wild Cat (11). Professor Blatchley kindly verified my determination of these specimens.

Orchelimum agile (DeGeer). A single individual (female) was taken October 14 in the cat-tail marsh on the upland northwest of West Lafayette.

ette. It was in the company of large numbers of *O. nigripes*. Professor Blatchley, to whom the specimen was submitted, assigned it to his *O. campestris*. Mr. Rehn, to whom the same specimen was also sent and who with Mr. Hebard has recently revised the entire genus, informs me it is *O. agile*.

Orchelimum nigripes Scudder. An abundant and characteristic species of open grassy bogs and damp situations generally, being especially abundant in rice cut-grass, *Homalocenchrus oryzoides*.

August 20, moderately frequent in a *Homalocenchrus oryzoides* bog at the base of a bluff along the Wabash bottoms near West Lafayette (6); August 30, abundant in wet places covered with *Homalocenchrus oryzoides* on river bank and bottoms on the east side of the Wabash opposite Battle Ground; September 6, common in *Homalocenchrus oryzoides* in a marsh at the foot of the bluff near Wild Cat Creek (10); September 13, a few specimens observed in a sedgey bog in low woods along Burnett Creek (2); October 3, a few observed in a humid depression covered with *Muhlenbergia* near mouth of Wild Cat Creek (11).

Orchelimum nigripes Scudder (variety). On October 13 and 14 I found a form of this genus in the cat-tail marsh on the upland northwest of Lafayette which I was unable to determine, but which Mr. Rehn to whom I submitted specimens informs me is a race of *O. nigripes* from the typical form of which it differs in the absence of black from the tibiae and, so far as my Lafayette material is concerned, in its somewhat greater size. On the dates mentioned it literally swarmed in the mixed cat-tail and rice cut-grass areas of the marsh, but was entirely lacking in the marginal thickets.

Conocephalus (Xiphidium) fasciatus (DeGeer). Local and, as a rule, not very common; found typically in open wet or damp locations thickly covered with succulent grasses and sedges.

July 19, a male taken in a thick growth of *Elymus virginicus* on the east bank of the Wabash near mouth of Wild Cat Creek (11); July 22, a male taken in a patch of *Elymus virginicus* on a waste lot on the Purdue Experimental Farm (3); August 12, both sexes moderately common in roadside gulleys and in wet depressions covered with low sedges (*Carex* spp.) on the upland between Lafayette and Montmorenci (12); August 20, a female taken on *Homalocenchrus oryzoides* in a bog at the foot of the bluffs along the margin of the Wabash bottoms below West Lafayette (6); August 30, several examples observed along the margin of a *Homalocen-*

chrus oryzoides bog at the base of the bluffs on the Wabash opposite Battle Ground (16).

Conocephalus (Xiphidium) brevipeennis (Scudder) (incl. *ensiferum* Scudder). Abundant in the bottom land marshes, in both open and wooded situations.

August 9, adult males and nymphs frequent in grassy and sedgey swamps in low woods along Burnett Creek (2); August 20, abundant in open *Homalocenchrus oryzoides* bog at foot of the bluffs along edge of Wabash bottoms near West Lafayette (6); August 24, common in a similar type of bog in a ravine near the mouth of Indian Creek (15); August 30, common along the margin of a *Homalocenchrus oryzoides* bog at the base of bluffs on the edge of the Wabash bottoms opposite Battle Ground; September 6, common in a *Homalocenchrus oryzoides* bog at the foot of the bluffs near Wild Cat Creek (10); September 13, frequent in bogs and bog border thickets in low woods along Burnett Creek (2); October 3, common in swamps and humid situations generally on the bottoms near the mouth of the Wild Cat (11), occurring in thick growths of *Muhlenbergia* and *Elymus*.

Conocephalus (Xiphidium) nemoralis (Scudder). Locally present in moderate frequency, occurring in grassy and herbaceous tangles usually in the vicinity of woodlands.

Aug. 20, a male taken in dense growth of *Homalocenchrus oryzoides* in a bog at the foot of the bluffs along the margin of the Wabash bottoms near West Lafayette (6); also nine other individuals composed of both sexes taken in a small patch of *Elymus virginicus* along the border of an adjoining woods; September 6, moderately frequent in thicket undergrowth at the foot of a wooded bluff near Wild Cat Creek (10); September 13, several observed in a thick growth of sumac and *Elymus virginicus* on a waste lot on Purdue University Farm (3).

Conocephalus (Xiphidium) nigropleurum (Bruner). Frequent in herbaceous thickets, especially those forming the margins of bogs dominated by *Homalocenchrus oryzoides*, in both open and woodland situations and usually associated with *Orchelimum nigripes*.

July 19, an immature male taken in a thick growth of *Elymus virginicus* on the east bank of the Wabash at mouth of Wild Cat Creek (11); also an adult male at the edge of a *Homalocenchrus oryzoides* bog at the foot of the bluffs along the east side of the Wabash about half way between localities 11 and 16; August 9, both sexes moderately frequent in the herb-

aceous thickets bordering a small bog in low woods along Burnett Creek (2); August 20, in small numbers in a *Homalocenchrus oryzoides* bog along the outer edge of the Wabash bottoms below West Lafayette (6); August 30, frequent in a *Homalocenchrus oryzoides* marsh at the base of the bluffs on the east side of the Wabash opposite Battle Ground (16); September 6, several observed in border thickets surrounding a *Homalocenchrus oryzoides* bog at base of the bluff near Wild Cat Creek (10); September 13, frequent in border thickets (joe-pye weed, boneset, etc.) surrounding a grassy bog in low woods on Burnett Creek (2); October 2, a male taken in *Muhlenbergia* patch on east bank of Wabash near mouth of Wild Cat (11); October 14, a male and a female taken along the edge of a mixed *Typha latifolia* and *Homalocenchrus oryzoides* marsh on the upland northwest of West Lafayette (14).

Conocephalus (Xiphidium) strictus (Scudder). Abundant in dry, open grass land; most frequent at higher elevations, but occasionally in suitable locations in the bottoms. A common associate of *Syrbula admirabilis*.

July 22, nymphs abundant in timothy and *Elymus virginicus* in waste lot on the Purdue Experimental Farm (3); July 31, adults and nymphs common in tangles of blue grass and bindweed along a fence on the Purdue Farm (3); August 1, nymphs and adults common in blue grass on roadside north of West Lafayette (4); August 5, common in thick blue grass and foxtail areas on Purdue Farm (3); August 20, frequent in an open pasture, dominated by *Tridens flava*, on the outer edge of the Wabash bottoms near West Lafayette (6); August 30, common in a roadside growth of *Tridens flava* and *Andropogon furcatus* near Battle Ground (9); September 1, frequent in grassy fields on bluffs at the head of Happy Hollow (5); October 3, now scarce on Purdue University Farm.

Conocephalus (Xiphidium) saltans (Scudder). Only a single specimen, a male, taken October 14 in a cat-tail cut-grass marsh on the upland (14) northwest of West Lafayette. It was associated with *Xiphidium attenuatum*.

Conocephalus (Xiphidium) attenuatus Scudder. Abundant October 13 and 14 in the upland marsh (14) just referred to, where it swarmed in the mixed cat-tail and *Homalocenchrus oryzoides* formation, but appeared to be entirely lacking in the surrounding herbaceous thickets of asters, goldenrods and associated plants. Only a single specimen was seen elsewhere, a female taken August 20 in a rice cut-grass bog at the foot

of the bluffs on the outer edge of the Wabash bottoms below West Lafayette (6).

Atlanticus testaceus (Scudder) [*pachymerus* Burm.]. Moderately frequent locally in open undergrowth of dry upland woods.

June 17, a male taken by J. J. Davis in a scrub area on the bluff at the head of Happy Hollow (5); June 26, three males taken on tall weeds in open woods on "second bottom" south of West Lafayette (7).

Oecanthus fasciatus Fitch. August 20, several taken in grassy bog at base of the bluffs bordering the Wabash bottoms near West Lafayette (6).

Oecanthus quadripunctatus Beutenmüller. Several taken in same locality and on the same date as the preceding.

Nemobius fasciatus DeGeer. Abundant in grassy places in both dry and moist areas.

Nemobius carolinus Scudder. A female collected October 9 by Mr. P. W. Mason on a road near West Lafayette was identified as this species by Mr. Morgan Hebard.

SOME INSECTS OF THE BETWEEN TIDES ZONE.

CHARLES H. ARNDT.

All insects, except a few species which live entirely in the water and have functional gills, are air breathing animals, breathing by means of tracheae. Thus we may desire to know how air breathing insects living in a zone which is submerged twice a day, prevent themselves from being drowned; or, if breathing by means of gills, they protect themselves from superoxygenation during the low tide. We may further be interested in any adaptations, or unique instincts, which make the inhabitants of such a locality especially adapted to their environment.

The following observations on the habits of the insects of the between tides zone, were made in the region directly north of Jones' bath house at the head of Cold Spring Harbor Bay; which is included in the lines drawn from 600 E., 200 S., to 200 N., 400 E.; and 200 N., 800 E., on map of Inner Harbor made by Johnson and York. Many observations were made on the extreme outer limit of the *Spartina cynosuroides* 275 N., 400 E. The slope of the shore to the west of the boat landing from the outer limit of the *Spartina* to within two feet of the inner limits of the *Spartina* is about 6%. From the latter point to the inner limit of the *Spartina* the slope is more abrupt. The *Spartina* is here replaced by a short (about six inches high), densely matted grass, *Juncus Gerardi*. This covers the entire region around the bath house with the exception of a few pebble-covered areas on which there is a sparse growth of *Spergularia Marina*. (Map 2.)

The highest tides of the summer, July 8, 9.2 feet; August 3, 8.8 feet; submerged the region as far as the bath house. From July 11 to July 29 the *Spartina* area was never entirely submerged, due to the low tides and the absence of any strong easterly winds. The observations extended from July 1, to August 5, 1913.

INSECTS OF THE SPARTINA REGION.

MEGAMELUS MARGINATUS.

This yellowish brown, 2.5 cm. long, leaf-hopper is a common inhabitant of the salt marshes from Connecticut to Florida (Van Duzee). This insect I found only in the *Spartina* area, never more than a few feet from the inner limit. Due to the alertness of this leaf-hopper on sunny days and its inconspicuousness, many hours of observation failed to reveal its whereabouts during high tide, until one rainy morning, while watching their actions from a boat, I found them resting head downwards on the inner part of the shallow "U's" formed by the grass blades. They remained in this position as they were slowly covered by the incoming tide. Their position on the blade is especially advantageous as it encloses large bubbles of air under their wings which serve the double purpose of supplying them with air and of making them inconspicuous by giving them a silvery appearance which makes them resemble closely the stem of the *Spartina* on which they rest, which also has a silvery appearance due to bubbles of air on its surface. On a cloudy day they cling so tenaciously to the blades of the *Spartina* that the blades may be cut off and placed in a jar of water. On July 18, 9 a. m., I put eight of them under sea water by this method. I kept them submerged for twenty-seven hours. On lowering the water in the jar they were still able to fly. I kept them submerged for two days on several occasions, with apparently no ill effect.

Besides this reaction to the tides, which prevents them from being washed away, and their inconspicuousness, which makes them invisible to their natural enemies, the inhabitants of the sea, they have a spur on the third pair of legs which is peculiarly modified to secure their survival in a region at times covered with water. To secure a larger contact area with water to allow them to remain at rest on its surface as well as to hop upon it, this spur has been developed until it is as long as the proximal tarsal segment. The prominent hoods at the distal end of the tibia and also on each tarsal segment, are other modifications for the same purpose. They never walk on the surface of the water, but can hop on it with great ease. The two hooks on the terminal segment of the leg enable it to secure a firm hold on the *Spartina* blade at the time of submergence.

This leaf-hopper was never found further inward than the inner limit of the *Spartina* area. It can be readily distinguished from the leaf-hoppers inhabiting the higher regions of the salt marsh by the prominent

hoods on its legs, by the greatly developed spur, and by the great length of the proximal tarsal segment in comparison to the tibia. In the other species the tibia is at least four times the length of the proximal tarsal segment, while in this species it is only twice as long.

See Plate I, figures 1, 2, and 3. 1, *Megamelus*; 2, Leaf-hopper from the *Juncus* area; 3, Leaf-hopper from the area never covered by ordinary tides. The species whose hind leg is figured in 2 retreated before the tide, but on no occasion during the summer was the region it inhabited completely submerged. These figures show a peculiar development of structures of advantage in each particular environment. No. 3 has no hoods, No. 2 has them somewhat developed, in No. 1 we find the greatest development. If, as I have suggested, these hoods have been developed to aid in hopping on the surface of water, No. 3 would have no use for them and they would necessarily be useless structures.

The chief enemy of the *Megamelus marginatus*, is the only other permanent resident of the *Spartina* area, a small spider, *Grammonata trivittata*. Its principal source of food is this leaf-hopper.

The hoods on its feet, the greatly developed proximal tarsal segment, and the spur, are the peculiar modifications which determined that this leaf-hopper should inhabit this particular region. But why it is only found in the *Spartina* region, is not as easily answered. It may have been the severer competition in the other regions of the marsh, or perhaps the *Spartina* grass is its favorite food, the one on which it is especially adapted to live; or, again, the habits necessary for its continued existence in the tidal zone may make it the easy prey of its natural enemies living in the other areas.

I could not compare the resistivity of this leaf-hopper to drowning with that of those farther back on the marsh, because I could not get any of them to remain under water without placing them in vials covered with cheesecloth. Two to four hours submergence usually killed them. Even the leaf-hopper of the *Spartina* could only survive for several hours when submerged in this manner. This may suggest that the leaf-hopper may secure its air supply from the *Spartina* by piercing the blade to the air channels. I have no experimental evidence to prove this.

GRAMMONATA TRIVITTATA.

This spider inhabits the salt marshes from Long Island to Maine (Emerton). The females are about 3.5 mm. long. Their color is a dark

reddish brown. These spiders are very abundant in the *Spartina* region. A short search will reveal a number of them running up and down the *Spartina* blades or resting head downward on them.

As the tide comes in, they retreat up the *Spartina* grass. When the tide has once chased them out on the isolated blades of *Spartina* (6 to 8 inches from the tip), they retreat to within about two inches of the tip where they remain head downward until the water almost touches them. Then they begin to run wildly up and down the blade, from tip to water, from water to tip, as if they were very much afraid of the water. After doing this a number of times they will calmly walk down the blade under the surface of the water until they come to the pit formed by the union of the stem and the blade. Here they remain until the tide retreats. The pit furnishes them protection from aquatic enemies and supplies them with air, for there is always a considerable amount of air left in the pit. That this reaction is due to an effort to secure protection and air, was shown in several experiments. When they were placed on blades of grass weighted to the bottom of the jar which was slowly filled with water, they went down the blades and attempted to crawl under objects at the bottom of the jar. However, to get under some object did not satisfy them, they kept on moving until they came to a bubble of air. Their actions were especially interesting when safety pins were used to weight down the blades. They would walk entirely around the wire part of the pin until they came to the sheath where there was a quantity of air. Into this they crawled. They always cling tightly to the wire, never attempting to leave it. It is however not essential for them to find a bubble of air. I kept a number of them submerged for three days without any noticeable bubbles being present. When they go below the surface, they always entangle numerous small air bubbles in their short, dense hairs, which are curved backward seemingly for this special purpose. I performed many experiments to compare the resistance of this spider to drowning with that of other species by submerging them in water. In my experiments I used practically all species found farther back on the marsh; *Tetragnatha*, *Lycosa*, *Epeira*, *Attidae*, *Themsidae*. This was the only species, with the exception of the young *Clubonia*, which could be submerged in water when resting on a grass blade: i. e. the other species did not hold fast, but tried to escape on the surface of the water. The most striking difference between these spiders when they were placed in small vials whose mouths were covered with cheesecloth and then submerged in a large glass jar of sea

water, was the difference in the size of the air bubbles clinging to the different species. No prominent bubbles were noticed on the Grammonata, while the other species entangled large bubbles in their comparatively long hair which made them almost entirely helpless. Regardless of the disparity in the size of the air bubbles, the Grammonata could withstand a much longer submergence without causing death. The limit for the hardiest of the other species was twelve hours. When placed in vials in a similar manner and the air bubbles withdrawn by means of a pipette, the *Lycosa communis*, the hardiest of all other species, did not survive more than three hours submergence, while the Grammonata could remain for twenty-four hours in the same jar with no ill effect. This would seem to indicate that this species must have some special modification, as perhaps greatly developed air sacs, "lungs", to enable them to resist drowning so successfully. None of the other marsh spiders, with the exception of the crab spiders, are as free from long flimsy hair, which greatly impedes an animal's movements in water, as the Grammonata. Even the *Lycosa Communis*, whose habitat borders on the between tides zone, has comparatively few long hairs, and these are comparatively stiff.

The food of this spider, Grammonata, consists chiefly of leaf-hoppers, but it also captures the small flies which frequent its habitat during the low tide. It is always attached to the tip of the grass blade by a thread which enables it to run on the surface of the water after food without being washed away.

This spider, as the leaf-hopper, *Megamelus marginatus*, is found only in the *Spartina* area. Its great resistance to drowning, its unique covering of hair, and the instinct which causes it to seek safety by clinging to the object on which it rests, instead of seeking safety in flight as other species, all have determined that it could survive in the *Spartina* area; but as to the reason it is only found there, I cannot explain.

CLUBONIA Sp.

This was an immature spider, light tan in color, largest specimen 7 mm. The first specimen was found August 1 after a period of very low tides, at which time I found them in practically the entire *Spartina* area (rare in other areas). The frequent use of a sweep net as well as searching on the ground, failed to reveal an adult spider of this species. The probable solution is that they had hatched, during the low tide period, from eggs laid the previous year. I was very unfortunate in that they

first appeared during my last week at the laboratory, so that my observations did not extend over a period long enough to determine if they were permanent inhabitants of the area, or whether they had just migrated there as several species of Tetragnatha had. This last supposition I consider very improbable, as I found no Clubonias in any other part of the marsh.

Their reactions to the tides were such as would prevent them from drowning or being washed away, but they afforded little protection from their aquatic enemies save that secured from their inconspicuousness. When the tide came in, they crawled to the under side of the *Spartina* blades. When resting in this position with their long legs stretched out along the edges of the blade, they are difficult to see. That they are not destroyed by the tide was shown by the fact that on August 5, after the *Spartina* area had been submerged by the tides of three successive days, I still found them in abundance. I placed several of them, in the position I found them on the grass when covered by the tide, in a jar of sea water and kept them submerged for thirty hours. They were apparently unaffected, showing that this spider, as well as the Grammonata trivittata, must have some unique modification to prevent drowning. This spider, however, entangled more air bubbles in its longer, flimsier hair. Its feet are provided with toothed claws, perhaps developed to secure a firm hold on the grass blade.

I am anxious to secure more data concerning this spider. Is it a permanent resident of the *Spartina* area? What accounts for its sudden appearance? Where were the adults, or when? Its resistance to drowning is great enough to allow it to be a permanent inhabitant, but I doubt if it is sufficiently well protected from the inhabitants of the sea. However, the pads on its feet, which resemble those of a water strider and the one large toothed claw as well as several smaller ones on each foot may be structures of particular value to a resident of a between tides zone. The pads would enable it to move on the surface of the water, while the claws would enable it to secure such a firm hold on the grass blade that it could not be washed away.

INSECTS OF THE OUTER JUNCUS AREA.

BEMBIDIUM CONSTRUCTUM.

Of all the insects whose habits I observed, this brownish-black, 5 mm. long, beetle had the widest range. It was the only one to live in both

places that are daily covered by the tides and in places that are not. Its outer limit is 14 N., 4 E. (map 2). They are very abundant in the gravel which covers the wooden platform and also in the region of the tidal drift, especially under the newly washed up sea-lettuce (*Ulva*). In regions daily covered by the tide it is rarely found except in gravel covered areas. By crawling under the gravel it prevents itself from being washed away and protects itself from aquatic enemies. Its actions may be readily observed by hunting for them as the tide rises and the digging a channel around the place where they are found. As the water rises, they will run from place to place, darting under one stone only to leave it for another. They may approach the channel, but will rarely attempt to cross it. Before the tide has completely submerged the place, the bembida will crawl under the gravel to remain there until the tide retreats. When the place is covered by the tide, they may be found at a depth of from three or four inches. The water, when it covers them, encloses a large bubble of air under their wings.

Their action may be easily determined under artificial conditions by placing them in jars containing moist sand and gravel and slowly filling them with water. Several times, when filling the jars, I poured the water in so rapidly that some were swept to the surface. They would then swim wildly on the surface; but when a grass stem was thrust into the sand so as to extend above the surface of the water, they would swim to it and crawl down into the sand. The bubble of air under their wings is so large that should they lose their footing, they will immediately rise to the surface. Their ability to withstand submergence is wonderful. At the end of one day the bubble of air will have almost disappeared and they will have become stupid. By the above gravel jar I kept eight out of ten specimens alive for three days in sea water. Several recovered after five days' submergence, showing a great resistivity to drowning.

This beetle, as well as the *Heterocerous undatus* and *Salda* sp(?) lives on the carrion of the small animals so abundant in the between tides zone.

HETEROCERUS UNDATUS.

This beetle is very rare in this area. Several were found between 4 and 6 N., to 12 and 16 E. (Map 2.) They live in burrows in the ground, only venturing out for food at low tide. Their resistance to drowning is equal to that of the *Bembidium*.

SALDA Sp(?).

This shore bug is very active and very difficult to catch and hard to find except on sunny days, when their shiny black wings make them rather conspicuous. They are found chiefly in the area covered by the *Spergularia Marina*. They live in burrows in the ground, and only venture forth in search of food on sunny days at low tide.

Their resistance to drowning is not nearly as great as that of the beetles; twenty-four hours submergence usually being sufficient to kill them. Twelve hours had very little effect. Like the beetles, they enclose large bubbles of air under their wings. On several occasions I placed several of them on the surface of the water when the area was covered by the tide. They swam on the surface until they came to floating fucus thallus (other floating materials being rejected). They would then crawl to one of the deepest submerged branches, where they would remain. They were almost invisible on the thallus, due to the resemblance of the fucus to their wings with the enclosed air bubble. This, undoubtedly, is a protective instinct.

BOELIDE Sp(?).

This reddish-brown plant louse (2 to 3 mm. long) is widely distributed throughout the salt marsh. Their outer limit borders on the inner limit of the prevailing tides. They are never found beyond the inner *Spartina* limit, 6½-foot level. Their mouth parts are especially adapted to sucking plant juices and they live on decaying plants. They are especially abundant on fresh drift weed.

As stated, they are seldom found in the areas covered by the prevailing tides, yet on occasions of a sudden rise in tide levels, they may be found walking on the ground when it is covered by the tide. They do not seem to have any objections to such unusual conditions as they apparently make no effort to escape. They are easily washed away by the tide when once lifted from their feet, as their long slender legs are to their disadvantage. After the retreat of such an unusually high tide, they are not as numerous as they were previous to it, due perhaps to the fact that they have no protection from aquatic enemies, and also because many of them are washed away. There is little danger of drowning. One morning, at 6:45, I placed six of them in vials and submerged them in sea water. At 5 p. m. they were all lying on their backs, apparently dead, but on exposure to the air they all revived. I also placed several in an un-

covered glass cylinder and placed it where it would be covered by the tide. As the tide filled the jar they made no effort to change their positions. Those on the grass blades remained in the same position, as did also those on the ground. The Bdeliidae were still alive in the cylinder after it had been submerged by two tides; i. e., two periods of submergence of five hours each, one period of terrestrial conditions of four hours.

LYCOSA COMMUNIS.

Although the inner limit of the tidal drift, with its myriads of flies should furnish abundant food for spiders, this is the only species prevalent in the drift covered areas. This is a greyish spider from 4 mm. to 5 mm. in length. They venture out beyond the high tide limit, but will always retreat before the incoming tide. Their long, strong legs, which enable them to run rapidly, make them especially adapted to a region where safety lies in retreat. I often found them running inward on the *Juncus* when the ground was already covered by the tide. On several I found them isolated on the blades of *Spartina* grass. When this position was no longer conducive to dryness, they would run rapidly inward over the surface of the water. This is the only insect without wings, frequenting the between tides zone, which retreats before the tide. The *Lycosae* are not only the most rapid runners among the spiders, but can also withstand several hours more submergence than the other spiders of the salt marsh, *Grammonata* and *Clubonia*, of course, excepted.

Many winged insects, beetles, flies, etc., are found on the *Spartina* during the low tide; but, although I made no especial study of them, they seem to be only temporary residents. They are never abundant, or even present, immediately upon the retreat of the tide. I never found any submerged on the grass when covered by the tide. They are all good fliers and most undoubtedly retreat before the tide.

On the morning of August 5, when we had the first high tide which covered the outer *Spartina* area entirely for several weeks, I noticed many *Tetragnatha* spiders retreating up the *Spartina* blades because of the rising tide. As the water chased them to the tip of the blade they spun out a long thread which the north wind carried to the higher areas. They ran inward on the thread. When they accidentally became wetted by the water they became helpless. Should the wind have come from the south, they would have been destroyed. No *Tetragnatha* were found in areas that had once

been submerged by the tide. They had migrated to the outer *Spartina* areas during the low tide period. They are very abundant in the higher marsh areas.

It would be extremely interesting to know something of the life histories of the insects of the between tides zone, especially as to where they spend the winter, as to the methods of egg laying, and as to the types of larvæ.

CONCLUSION.

In almost every insect of the between tides zone there appears to be some peculiar protective feature; as, unique instincts, especially adapted external parts, or a greater resistivity to drowning.

Unique instincts, to prevent themselves from being washed away by the tides, are well shown in the tenacious clinging to the blades of *Spartina* by the *Grammonata trivittata*, *Megamelus marginatus*, and *Clubonia* sp (?). Another feature of the same type is the crawling of the *Bembidium constructum* under the gravel. That the environment has undoubtedly led to the formation of these instincts is illustrated by the comparison of the habits, when submerged, of the spiders of the *Spartina* area with those found higher on the marsh. Another instinct which serves the same purpose is the venturing forth for food by the *Salda* only on sunny days at low tide. The *Grammonata trivittata* and *Megamelus marginatus* undoubtedly rest head downward on the *Spartina* grass to prevent themselves from being caught unawares by the rising tide.

Inconspicuousness as a means of protection from aquatic enemies is shown by the swimming of the *Salda* to the *Fucus* thallus when disturbed during high tide. Other reactions serving the same purpose, are illustrated by the resemblance of *Megamelus* to the *Spartina* blade, the crawling the *Grammonata* into the pits at the junction of blade and stem, and the living of the beetles in burrows.

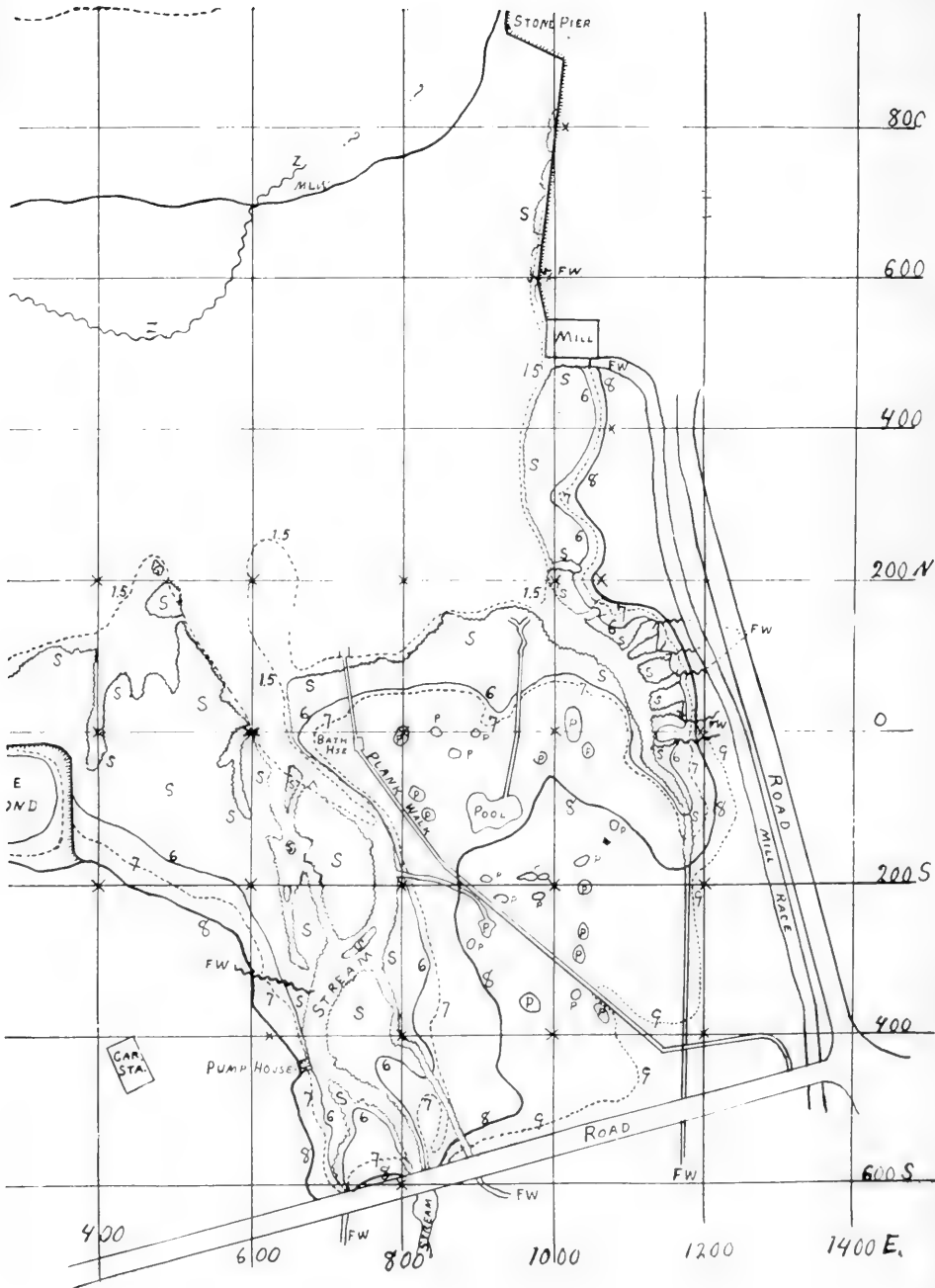
That one of the factors which determines the surviving species in a between tides zone is an ability to resist drowning, is shown by a comparison of the resistivity of *Grammonata* and *Clubonia* with that of other spiders.

A modification of the external features as an adaptation, is shown in the greatly modified legs of the *Megamelus marginatus* and in the short, stiff hair of the *Grammonata trivittata*. The legs of *Lycosa communis* are not essentially different from those of other *Lycosæ*; yet their long,

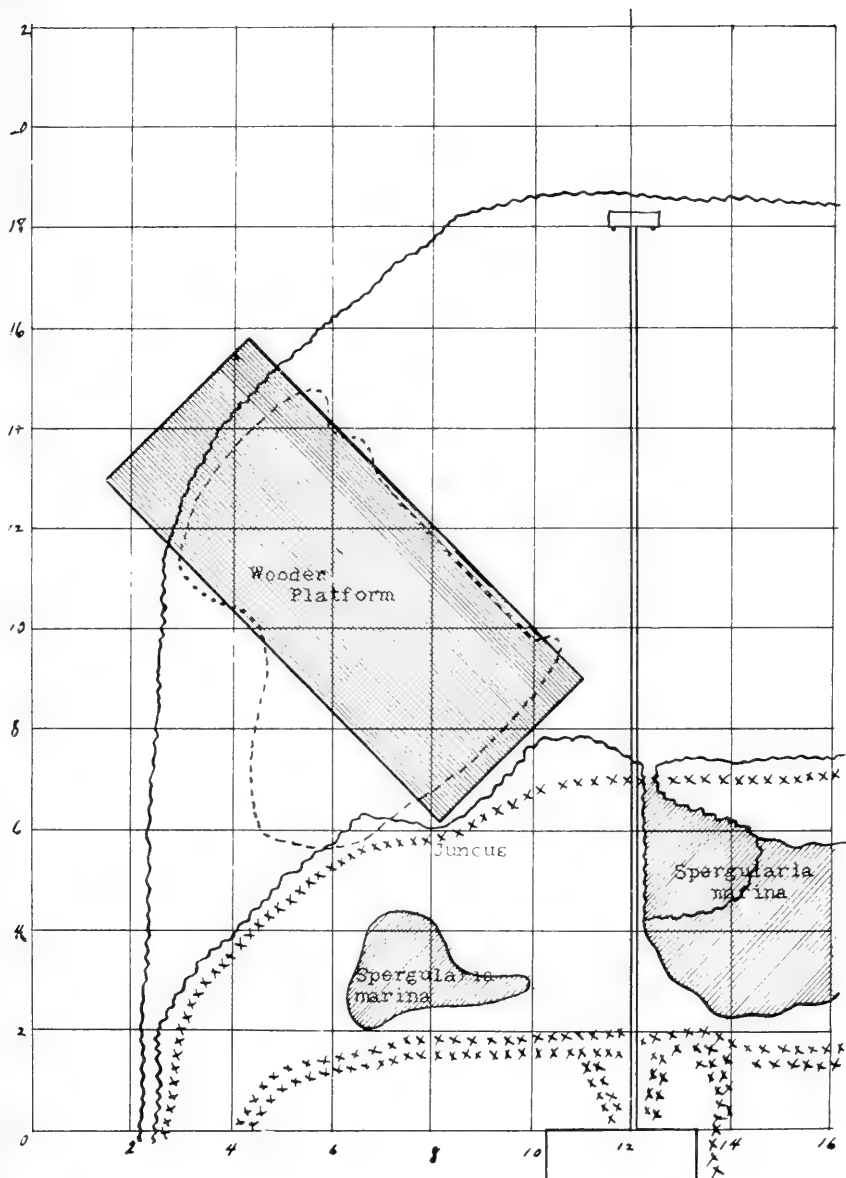
strong legs, which are conducive to swift movements and which give them the designation of running spiders, make them especially fitted to inhabit a zone in which safety may lie in retreat.

The terrestrial conditions which prevail for one-half of the time in the between the tides zone, make it necessary that the permanent inhabitants of such a zone be insects which breathe not by means of gills, but that they be air breathing insects. Terrestrial conditions are the normal ones for their activities. They are inactive during the high tide, or the period of submergence. The most striking phenomena is the strictly zonal distribution of the insects of the between the tides zone. Each species is undoubtedly specialized in some way to fit it to inhabit this area, and this specialization has rendered it incapable of surviving in other zones. Even the *Megamelus marginatus*, which travels with comparative rapidity, never migrates to the *Juncus* areas. To determine the exact reasons why the insects of this zone cannot survive in the higher areas of the salt marsh, more extensive studies of their life histories and habits must be made. Further observations concerning these features, I believe, will add much to the already extensive and fascinating data relating to adaptation among insects.

*Purdue University,
Lafayette, Ind.*



MAP I.



Map 11
 Bath
 House

Map II. Region between 650-750 E, and 20 S-123 N. Scale 1:173.
 ~~~~~ Spartina limits.  
 XXXXX Tide drift.  
 - - - - - Boundary gravel covered area.

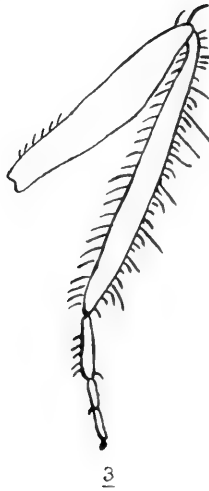
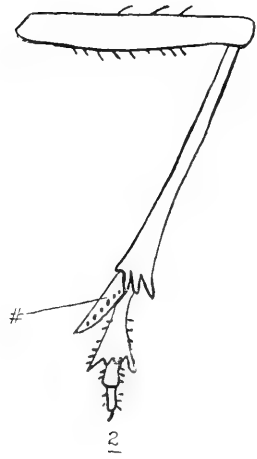


PLATE I



## THE SNAKES OF THE LAKE MAXINKUCKEE REGION.\*

BARTON WARREN EVERMANN AND HOWARD WALTON CLARK.

The total number of species of snakes known from the vicinity of Lake Maxinkuckee is ten. This number is not large; doubtless more thorough field work would increase the number slightly. While the species are not numerous, several of them are fairly abundant in individuals. This is particularly true of the common garter snake and the water snake. The former of these may be seen in suitable situations on almost any warm day from early spring until late in the fall, while the latter is almost equally frequent from the middle of summer to early fall about the borders of Lost Lake and along the Outlet.

Nearly all, perhaps all, of the species bear some relation to the life of the lake, some of them feeding on fishes when opportunity offers, and all feeding upon frogs. Only one of the species of snakes known from the Lake Maxinkuckee region is poisonous; that is the little prairie rattlesnake which, fortunately, is not abundant.

### SPECIES OF SNAKES.

#### 1. *Storeria dekayi* (Holbrook).

##### DE KAY'S SNAKE.

This pretty little snake occurs sparingly throughout the eastern United States and westward to Colorado and Wyoming. At Lake Maxinkuckee it is one of the rarest species. Our collection from about the lake contains only three examples, viz., one, No. 33529, U. S. National Museum, obtained October 8, 1900, and two others taken on October 17, 1907, one near the Outlet, the other on the east side of the lake.

This species is known also as Brown Snake and Ground Snake, the former because of the color, the latter because it is so frequently found burrowed in the ground.

It is not only a harmless little snake, but it is useful, its diet con-

---

\*Published by permission of Hon. Hugh M. Smith, U. S. Commissioner of Fish and Fisheries.

sisting chiefly of crickets, grasshoppers, and other noxious insects. It is also fond of earthworms and slugs.

It reaches a length of only a foot or less. Its color is a grayish brown, with a lighter band or line along the back, on each side of which is a dotted line; there is also a dark patch on each side of the occiput, and the under parts are grayish. Scales in 17 rows; ventral plates 120-138.

## 2. *Thamnophis proxima* (Say).

### RIBBON SNAKE.

This species is found from Wisconsin to Mexico. At Maxinkuckee it is one of the rarer snakes. The only example (No. 02779, or 33545, U. S. Nat. Mus.) in our collection was secured September 21, 1900, near Lost Lake, southwest of Mr. Green's house. Another was seen nine days later south of the lake.

It is a very slender, graceful snake. It is probably not rare in the weedy patches west of Culver, particularly about old, drained lake-beds where the ground is still wet and where there are occasional pools. In the spring of 1901, four were seen, two on April 9 at the drained lake west of Culver, one April 30 at Culver Creek, and one May 20 in Hawk's marsh.

In habits this species does not differ greatly from other garter snakes. It delights in marshy situations and is not averse to an occasional short stay in the water. Its food consists chiefly of small frogs, toads and insects, with an occasional small fish.

This snake may be known by the following characters:

Lateral stripe on third and fourth rows of scales; scales in 19 rows, little or not at all spotted; color chocolate brown, with three yellow stripes; light brown below lateral stripes; ventral plates 150 to 160; tail about one-third the total length which rarely exceeds thirty-six inches.

## 3. *Thamnophis sirtalis* (Linnaeus).

### COMMON GARTER SNAKE.

This is one of the most variable as well as one of the most widely distributed of all snakes. It or its subspecies may be found in nearly all parts of the United States, and it is by far the most abundant snake about Lake Maxinkuckee; it is probably more numerous than all other species combined.

It may be found in all sorts of situations; in cultivated fields and

gardens, about yards and barn lots, in grassy meadows and in open woodland, in marshy ground along streams and about lakes, and particularly along paths and public highways. It perhaps most delights in reedy, boggy places and lake margins. It is the first snake to be abroad in the spring and one of the last to go into hibernation in the fall. The first warm days of spring will rouse them from their winter's sleep and bring them forth to bask in the sun. Then they may be found usually lying at full length on a mass of dead grass along a fence-row or in some such situation, well exposed so as to get the full effect of the sun's warmest rays. Here they will lie quietly through the middle of the day soaking out the accumulated chill of the long winter. Thus they will pass several days before they begin to move about or to seek food.

In the fall they appear to be active to the last, continuing to eat until they go into winter quarters. At this season they seem to move about more than usual, perhaps because searching for suitable hybernacula. It is at this season that one so frequently observes their tracks across the dusty highway and when so many are run over and crushed on the public roads and by railroad trains.

Numerous examples were noted about the lake and in the surrounding country, and many specimens were collected. Examples were noted in April, July, August, September, October and November, the earliest date being April 9 and the latest November 22.

A female 3 feet long was killed July 26 and 40 young, each 6 to 7 inches long, were taken from her body. This and all other species of the garter snakes are viviparous, bringing forth their young alive. Dr. J. Schenck, of Mt. Carmel, Ill., reports that 78 young, 3 to 7 inches long, were taken from a female 35 inches long.

The garter snake has quite a varied menu. They are known to feed upon insects, insect larvæ, small rodents, young birds and bird eggs, toads, frogs, angleworms, small mollusks, tadpoles, salamanders, and small fish. Frogs, toads, fish, shrews and field mice doubtless constitute the major portion of their diet. One found dead on the railroad tracks near the elevator in the late autumn of 1906 was examined. It was quite fat, as snakes are likely to be at that time of year. The stomach was empty of food, but contained a few ascaris-like parasites.

One the whole, however, this snake is beneficial to the farm and should be protected. The disposition which most people have to kill every snake on sight is entirely irrational and wholly unjustifiable.

This creature, like many other snakes, is protected by an abominably sickening odor, not noticeable at a distance, but as disagreeable a smell as one is apt to encounter. This odor, however, is noticeable only when the snake has been annoyed and has become angered. When angry it sometimes flattens out after the fashion of the blowing adder.

There is a great variation among the individuals of this species found about the lake, and two or more subspecies should probably be recognized. We, however, have grouped them all under the species.

From all other snakes found about the lake, particularly the ribbon snake which it most resembles, this species may be readily known by its having the lateral stripe on the second and third instead of the third and fourth rows of scales. This species is also stouter, the tail being one-fourth the entire length. Color olivaceous, dorsal stripe narrow, obscure; three series of small dark spots on each side, about 70 between head and vent; side and belly greenish; lateral stripe rather broad, but not conspicuous; colors generally duller than in other species; ventral plates 130 to 160. Length 2 to 4 feet.

#### 4. *Thamnophis butleri* Cope.

##### BUTLER'S GARTER SNAKE.

This is the rarest of the species of garter snakes which occur at the lake. The only example we have seen was found freshly killed just south of the Indiana boathouse on the east side of the lake July 23, 1900. It is No. 33544 (02716), National Museum.

It may be known from other garter snakes of the region by the location of the side stripes which are on the second, third and fourth rows of scales, which is not the case with either of the other species.

#### 5. *Natrix sipedon* (Linnaeus).

##### WATER-SNAKE.

The water-snake is a common and well-known snake throughout the whole eastern United States as far westward as Kansas, and is tolerably abundant throughout its range in wet places, such as streams, ponds and lakes. About Lake Maxinkuckee it is to be found along low bits of shore such as that about Norris Inlet and the various other inlets of the lake, and near the Outlet. One of its favorite haunts is that portion of the Outlet between the two lakes. Next to the common garter snake this water snake or "moccasin" is the snake most frequently seen about the lake.

We have records of numerous examples seen, the earliest date being May 3 and the latest August 29. It is probably most abundant in June. Definite dates are as follows: In 1899, one seen July 11 and another August 29. In 1900, one seen July 13, 17 and 20, all on the west side; one seen on east side of Lost Lake August 1, one at Fish Commission Station August 7, and one near the Inlet August 16. In 1901, one in Culver Bay May 3; a large one on west side May 6, one near Farrar's May 23; a large one on Long Point June 2; another on Long Point June 16; one at Outlet June 19; one 3 feet 9 inches long on west side June 22; and a small one on Long Point June 24. In 1906 a large one found dead on Long Point August 15, a small one in Green's marsh, one at the Outlet and one on Yellow River August 16. During the summer of 1906, after the dam was thrown across the Outlet at the railroad bridge the water in the Outlet below the dam became very low, and water snakes could be found along the edge of the water almost any time a visit was made to that place.

This is the species more often seen in the water than any other. It delights to lie coiled on some old log or root in or at the edge of the stream, or on the timbers at the dam or the logs of drift material. It inhabits rather open woodland ponds in great abundance, and in such places they often collect several together on projecting logs. In such situations it lies in wait, basking in the sun, making short excursions now and then into the water after fish or frog, or dropping quietly into the stream when disturbed by the near approach of any one. Then it hides under the bank, only its head being out of the water, or else swims swiftly away and out of reach. While swimming it usually keeps its head above water, but when closely pressed or annoyed it will go entirely under and swim along on or near the bottom.

The water-snake is frequently called "moccasin" or "redbelly" and is by many believed to be deadly poisonous. Its bite is, however, entirely harmless, and it is very different from the venomous "water-moccasin" or cotton-mouth of the south.

Although the water-snake is non-venomous, it has very little to commend it. It is repulsive in appearance and spiteful in temper. It is more destructive to fishes than any other of our snakes; indeed, it seems to subsist chiefly on fish. It will eat any kind of fish it can catch, though it doubtless prefers the soft-rayed species, such as the minnows, suckers and the like; it surely finds them easier to handle than the spiny-rayed species such as the bass and perch. We have found many different fishes

in the stomach of the water-snake: among them we may mention suckers of various species, various minnows, bass, rock-bass, sunfish, eel, carp and catfish. One large water-snake was found that had attempted to swallow a large catfish but the catfish straightened out and set its pectoral spines, and the snake, being unable to get the fish either up or down, perished, a victim of his own greed.

Besides fish the water-snake feeds also on frogs, crawfish and young birds.

The water-snakes mate early in spring, soon after coming out of their winter quarters, and then sometimes congregate in numbers of four or five together. The species is viviparous. In August, 1899, an old snake was found on the railroad track near the ice-houses. It had been run over by a train and ten young, which it contained, were prematurely liberated.

The water-snake probably comes out and basks on bright days in autumn after it has ceased taking food. One found dead near Farrar's in the autumn of 1906, October 20, was cut open and the stomach found to be empty, except for some ascarid-like parasites. The mesenteries were well loaded with a supply of fat, probably for the subsistence of the snake during its winter hibernation. It contained 30 ova, 15 on each side.

Color, brownish; back and sides each with a series of large, square, dark blotches alternating with each other, about 80 in each series; belly with brown blotches; rows of scales 23; ventral plates 130 to 150. Length 2 to 4 feet.

#### 6. *Collopettis vulpinus* (Baird & Girard).

##### FOX SNAKE.

This large and beautiful snake ranges from New England westward to Kansas and northward. It does not appear to be common about Lake Maxinkuckee, as our notes record but eight examples, as follows: A fine example on the west shore of Lost Lake early in July, 1900, and another large one near the same place July 8; one seen near Lost Lake, September 3, and a large one gotten on Long Point September 25; one in Walley's woods August 25; another on Long Point September 25; one about 6 feet long August 14, 1906, west of Culver near the beaver-dam prairie on the road to Bass Lake; and a large one near the Gravel Pit early in June, 1907. Individuals seem most frequent in late summer or early fall.

The fox snake, often called the pine snake, frequents the dry, open woods and the neighborhood of briar patches and copses. We have never

observed it in the water or on the immediate lake shore. It is often called the pilot snake and is supposed to have some mysterious connection with the rattlesnake. Though entirely harmless, it is one of the most viciously disposed snakes. When provoked, as Dr. Hay observes, it shows its irritation by vibrating the tip of its slender tail, which, when striking a crumpled leaf or any other small object, may produce a rattling noise very much like that made by a rattlesnake under similar circumstances. A large example caught near Bass Lake August 14, bit Professor Wilson on the hand, causing blood to flow freely but producing no serious effect.

While entirely harmless, its habits are not unlike those of the black-snake and it doubtless destroys many eggs and young of ground-nesting birds. Besides these, its food consists of mice and other small rodents, the larger insects and their larvæ. It probably feeds to some extent on frogs and toads, but we have no evidence that it ever catches fish.

This is a large, light brown snake, with squarish, chocolate-colored blotches about 60 in number; scales in 25 rows; ventral plates 200 to 210; vertical plate broader than long.

7. *Bascanion constrictor flaviventris* (Linnaeus).

BLUE RACER.

This common and familiar reptile, also known as the black snake or black racer, is found pretty generally distributed throughout the eastern United States and southward. It frequents open woodland, old fence rows and all places where dead leaves are common. It is the largest of the snakes of this region. It is an active, vigorous snake, moving over the ground with great rapidity. It is not a coward, as are most snakes, but will, on occasion, attack a person when disturbed, coming toward one rapidly and with head raised one or two feet. Cope says "the constricting power of the black snake is not sufficient to cause inconvenience to a man, but might seriously oppress a child. The pressure exercised by a strong individual wound round the arm is sufficient to compress and close the superficial veins, and cause the muscles to ache, but it is easy to unwind the snake with the free hand and arm." The black snake is harmless, and its bite, which it rarely inflicts, only amounts to a serious scratch.

The black snake is, in some respects, a useful species. Its food consists chiefly of field mice, white-footed mice, and other noxious animals. It also feeds upon frogs, toads, birds' eggs and young birds, and probably does more harm than good. The greatest objection to it is its disposi-

tion to rob birds' nests of their eggs and young. Ground-nesting birds are particularly apt to suffer from the depredations of the black snake; and those species such as the song sparrow, catbird, thrasher, robin, dove and redwing, which place their nests not far above the ground, and the bluebird, chickadee, and downy woodpecker, which deposit their eggs in holes in trees or snags not many feet up, are often despoiled of their eggs or young by this snake.

We have often seen black snakes coiled up on limbs of trees or crawling about among limbs several feet above the ground evidently searching for birds' nests. One of us remembers seeing a bluebird greatly disturbed by a large black snake which was apparently about to climb to the bluebird's nest which was in a hole only 3 or 4 feet up in an old elm snag. Coiled up at the foot of the snag, its head elevated perhaps a foot or 18 inches, the snake watched the bird intently, its head moving this way and that and following closely the movements of the bird which fluttered incessantly about the snake and was probably as completely "charmed" or under the power of the snake as birds ever get. When approached the snake became frightened and crawled away among the bushes; and then the bird flew to a limb near by.

A friend who is a close observer of animals tells us that he once saw a ruffed grouse fighting a black snake which was endeavoring to rob the grouse's nest. He shot the snake, and the grouse, after showing some astonishment, feigned lameness to lead him away from the nest.

Another friend says that he once saw a chipmunk "charmed" by a large black snake. The chipmunk was on a log about 12 feet long, the snake at one side near the middle of the log and with head elevated somewhat more than the height of the top of the log. The chipmunk when first seen was uttering the well-known chirping note so expressive of solicitude and running back and forth on the log, at first the full length of the log, then less and less until it ran but a few inches each way from the snake whose head all the time moved to the right and to the left, following closely the movements of the little rodent. At the same time the snake's tail, elevated and rigid, was rapidly vibrating and making a noise not unlike that made by a rattlesnake. Unfortunately the observer shot the snake without waiting to learn if the chipmunk were really in any manner under the control of the reptile.

The black snake is not rare about Lake Maxinkuckee. Our notes record seven or eight individuals seen at different times. The earliest rec-



ord is the last week in May and the latest October 14. A large example seen east of Lost Lake on the latter date was quite stupid and declined to move. A 4-foot individual seen in Walley's woods was evidently blind, due to shedding its skin which was so loose that it slipped off when the snake was handled. The eyes were white, and the snake instead of seeing, apparently listened. Another was seen in Walley's woods September 21, 1900. On August 13, 1906, a very large one was seen half-concealed in the briars near the ice-houses. When approached it made its tail rattle among the dry leaves precisely like a rattlesnake. On August 14, 1906, a large one was caught near Bass Lake. Another, 5 to 6 feet long, was seen in Walley's cornfield September 20, 1907. It was coiled loosely at the base of a corn-stalk and seemed disinclined to move, though it stuck out its tongue repeatedly.

This snake is usually lustrous blue-black or pitch-black above and greenish below; chin and throat white. Young olive, with rhomboid black blotches. Body very slender; eye large, scales in 17 or 19 rows; ventral plates 170 to 190. Length 4 to 5 feet.

#### 8. *Lampropeltis doliatu*s (Linnaeus).

##### HOUSE SNAKE.

This is the common house snake or milk snake so abundant in most of the upper Mississippi Valley States. It does not appear to be very common, however, about Maxinkuckee. The only example seen by us was obtained July 28, 1899, at our station near the Arlington Hotel. It is one of the mildest and most useful of snakes and feeds largely upon the various species of small noxious mammals. Its habits, however, are not entirely beneficial, as it will, on occasion, eat such hens' eggs and birds' eggs as it may find.

We have never seen it swimming in the water and do not know whether it ever feeds on fishes or other aquatic animals.

Color, grayish, with 3 series of brown, rounded blotches bordered with black, about 50 in the dorsal row; an arrow-shaped occipital spot; belly yellowish-white, with square black blotches; dorsal scales in 21 rows. In the young the dorsal blotches are bright chestnut-red inside of the black margins, and the spaces between are sometimes white or clear ash.

9. *Heterodon platyrhinus* Latreille.

## HOG-NOSED SNAKE.

This interesting reptile, also known as spreading adder and blowing viper, is found throughout the eastern United States. It is a common and well-known species in most parts of Indiana.

It frequents dry situations such as cultivated fields, old fence-rows, open pastures and roadsides; also dry hillsides and the banks of streams. At times it may be seen along water-courses and the shores of ponds and lakes. We have rarely observed it in meadows or on wet or marshy ground; nor have we noted it often about human habitations.

Although not often seen in the immediate vicinity of this lake, it is probably not uncommon in suitable situations, especially in dry sandy regions. It appears to be very well known among the inhabitants of the region, and is held in great dread by most of them; even its breath is supposed to be fatal. From its method of defending itself by appearing very terrible, a habit which has perhaps given its evil repute, it is one of the most interesting snakes in the region.

One was taken in Walley's woods on a bright day in the spring of 1901. When first approached it assumed a threatening attitude and gave vent to loud hisses; it then broadly flattened out the neck, and the bright colors and color-pattern, which had been more or less concealed by the scales, now stood out vividly, the color markings on the back of the neck standing out with especial clearness. When the snake found that none of those tactics availed, it stiffened out and appeared to be dead, and was easily picked up and placed in the collecting can.

During the summer of 1906 a large example of this species was seen on the shore of Lost Lake, but it escaped into a hole in the bank. In the autumn of the same year a young example about 5 inches long was captured near the ice office: and frequent reports of the species having been seen, were heard.

The bite of this snake is entirely harmless—even if it could be induced to bite. From the nature of its food, it is one of our beneficial snakes; it eats very few fishes, but subsists on frogs, mice, and insects, and their larvæ, or grubs. Instead, therefore, of meriting the persecution which it meets almost everywhere, it is well worthy of protection.

From all other snakes of this part of the State, this species may be known by its habit of flattening out both its head and body marvelously.

In color, it is brownish or reddish, with about 28 dark dorsal blotches, besides lateral ones and half-rings on the tail; sometimes the color is nearly uniform black. Vertical plate longer than broad, about equal to the occipitals; ventral plates 120 to 150; scales in 23 or 25 rows. Maximum length about 2 feet.

10. *Sistrurus catenatus* (Rafinesque).

PRAIRIE RATTLESNAKE.

This species, known also as the Massasauga, is likely to occur in all prairie regions from Ohio to Minnesota and southward. In Indiana it is known only from the northern portions of the State. It is the only poisonous snake occurring about Lake Maxinkuckee. All the other species found in that region or elsewhere in northern Indiana are entirely harmless. Formerly the Massasauga was abundant throughout this part of the State, but with the settling up of the country and the draining of the prairie grass-land and the marshes, it has become wholly exterminated in many places and practically so in many others. About Maxinkuckee, however, and elsewhere in Marshall County, it is far from extinct. It is apt to be found in any and all suitable places such as prairie meadows, about the borders of vanishing lakes, and in prairie marsh-ground anywhere.

In May, 1891, when the spring meeting of the Indiana Academy of Science was being held at Lake Maxinkuckee, several specimens were caught by members in attendance, chiefly in marshy ground about the lake. About 1896 a young man on the eastern side of the lake was bitten on the leg by one. The leg remained swollen for some time and complete recovery was very slow. On August 6, 1899, one was caught on Long Point between the Scovell and Walter Knapp cottages. It was 23 inches long and had five rattles. On August 3, 1900, one was killed two and one-fourth miles south of Arlington station. It was 18 inches long and had two rattles and a button. Several weeks earlier, near the same place, a dog was bitten by one, without fatal results. On August 26 a small one was killed on the east side of the lake near the T. W. Wilson cottage. On the same day one was killed in a field on the Hawk farm south of Culver. It was about 2 feet long and had nine rattles. Another young individual was killed September 3 on the east side, two and one-half miles southeast of the Maxwell cottage, and one with nine rattles was killed September 26, 1907, in a meadow on the Newman farm, four miles southeast of Culver.

These are all the records we have of the occurrence of the prairie

rattlesnake in the immediate vicinity of Lake Maxinkuckee. We have heard, however, of numerous examples being killed in marshy meadows northwest, west and south of the lake. In those regions there are numerous and considerable meadows of the wild grass or sedge, *Carex stricta*, which are cut in the early fall by farmers and others for hay or for use in the ice-houses, and other purposes. It is then that this venomous snake is met with most frequently.

Though habitually dwelling in marshy situations it is sometimes seen on higher, open ground. It is rarely seen in open woods or dry thickets.

We know but little about the habits or food of this snake. It apparently does not wander far but remains close about the particular marsh in which it makes its home. They are quiet and not easily disturbed or angered. When observed they will be still or quietly glide away unless interfered with. Then they will usually coil, assume a threatening attitude and rattle more or less. The rattling, however, soon ceases, to be renewed only when again provoked.

The Massasauga is known to feed on frogs, crawfish, meadow mice and shrews. We do not know that it ever feeds on fishes, but it is more than probable that it would not disdain to eat mud minnows or any other small fishes it might find in its swampy habitation.

The one fact that this is a venomous snake is sufficient reason for its extermination.

The species is viviparous, the young being brought forth alive. There are usually about six in a brood, each 4 to 6 inches in length when born. The birth of the young generally takes place about the first of September.

The prairie rattlesnake may be known from others of this region by the large, flat, triangular head on a slender neck, the presence of a deep pit between the eye and the nostril, the long, erectile, perforated poison-fang on each side of the upper jaw, and, usually, the presence of a rattle on the tail.

Color, brown or blackish, with about 7 series each of about 34 deep chestnut blotches, blackish exteriorly and edged with yellowish; a yellowish streak from pit to neck; body sometimes all black; scales in 23 or 25 rows; ventral plates 135 to 150. Length  $2\frac{1}{2}$  to 3 feet.

## STIRRING AS A TIME SAVER IN GRAVIMETRIC ANALYSIS.

---

W. M. BLANCHARD.

---

While making experiments recently on the deposition of metals with a rotating anode, it occurred to me that various gravimetric analyses might be greatly facilitated by rapid stirring of the precipitate. That stirring greatly facilitates precipitation is known to every one, but I do not know that any data have been recorded to show just how efficient the stirrer may be, hence these experiments. These results are very surprising.

A stirrer was made from a small glass rod about two millimeters in diameter. It had the shape of the letter T, the arms, each about eighteen millimeters long, being flattened at the ends and turned so as to resemble an ordinary propeller. The stem was about ten centimeters long and was attached to a wheel run by a small electric motor, which in turn was connected with an ordinary 110 volt lighting circuit. There was thrown in the circuit a small lamp bank so that the speed of the motor might be varied. The following analyses were carried out with the stirrer making an average of 900 revolutions per minute.

1. *Estimation of barium in crystallized barium chloride.* The sample of the pure salt, 0.2330 gram, was weighed out in a 150 c. c. beaker, diluted to about 50 c. c., acidified with hydrochloric acid, heated to the boiling point, treated with slight excess of dilute sulphuric acid, *stirred four minutes*, immediately filtered, washed, ignited, cooled, and weighed. Found for barium 56.25%; calculated, 56.23.

2. *Estimation of calcium in pure calcium carbonate.* A small sample of the purest calcium carbonate, 0.2225 gram, was transferred to a 150 c. c. beaker, converted into the chloride, diluted to about 50 c. c., heated to boiling, treated with slight excess of ammonium oxalate, made alkaline with ammonia, *stirred four minutes*, then filtered, washed, ignited, heated over the blast lamp, cooled and weighed. Found for calcium oxide 56.04%; calculated 56.03.

3. *Estimation of copper in cupric sulphate.* A small sample of recrystallized pure sulphate, 0.2000 gram, was weighed in a 150 c. c. beaker,

diluted to about 50 c. c., heated to boiling, treated with a few drops of sodium bisulfite solution and then with slight excess of ammonium sulphocyanate, *stirred three minutes*, filtered (Gooch), washed, dried at 130°, cooled and weighed. Found for copper, 25.42%; calculated, 25.46.

4. *Estimation of chlorine in sodium chloride.* A small sample of Kahlbaum's purest sodium chloride, 0.2162 gram, was dissolved in about 50 c. c. of water in a 150 c. c. beaker, acidified with a few drops of nitric acid, treated with slight excess of silver nitrate solution, *stirred two minutes*, filtered (Gooch), washed, dried at 130°, cooled and weighed. Found for chlorine 60.64; calculated 60.63.

*DePauw University.*

## THE ALUNDUM CRUCIBLE AS A SUBSTITUTE FOR THE GOOCH CRUCIBLE.

GEORGE L. CLARK.

In order to test the efficiency of the recently introduced unglazed Alundum crucible, when used for the purposes in quantitative analytical chemistry generally assigned to the ordinary Gooch crucible, four different series of analyses were undertaken. These involved the determination of silver by precipitation as silver chloride, copper as cuprous sulpho-cyanate, aluminium as aluminium oxide from ignited aluminium hydroxide, and barium as barium sulphate. Such a selection was made in order to obtain as widely different precipitates as possible, as regards size of particles, ease of filtration and media in which produced, and at the same time be in general usage.

Both the Alundum and Gooch crucibles permit filtration, drying and weighing without disturbing the precipitate, but the porous nature of the former of course does away with the preparation of an asbestos mat. To discover whether or not such an advantage as well as others claimed for the Alundum crucible by its manufacturers, such as capability of withstanding very high temperatures, is sufficient to warrant its wide adoption for use in accurate quantitative analysis, was therefore the object in view in this study.

One crucible only was used for the determinations in one series, in order to discover what would be the effect of continuous usage and how thoroughly it might be cleaned in preparation for the next analysis. In each case the empty crucible was heated thoroughly for one hour in the drying oven at the temperature at which the precipitate was later to be dried. The apparatus for the filtration was that used with the Gooch crucible, since any more complicated or expensive apparatus would *per se* be a distinct disadvantage.

### I. The determination of $\text{AgNO}_3$ as $\text{AgCl}$ .

In these analyses 50 c. c. portions of a solution, each containing .2432 grams of pure  $\text{AgNO}_3$  were used. In the first trials a solution of Kahlbaum's chemically pure  $\text{NaCl}$  was used to precipitate the  $\text{AgCl}$  from the hot solution of  $\text{AgNO}_3$  while rapidly stirred. Stirring was continued for two minutes, the precipitate allowed to settle, filtered through the crucible, washed with water and then dried at  $140^\circ$ .

First analysis: Percent Ag in  $\text{AgNO}_3$  calc. 63.50, found 65.24. No. of washings, 8.

The crucible was then washed thoroughly with pure water until all apparent traces of  $\text{AgCl}$  had been removed, dried at  $140^\circ$  and again weighed. Gain in weight, .0162 gr.

Second analysis: Percent Ag calc. 63.50, found 64.04. The crucible was now thoroughly washed by suction with  $\text{NH}_4\text{OH}$  to remove all  $\text{AgCl}$  and water to remove all  $\text{NaCl}$  from the pores. Weighing gave the original value for the crucible.

Pure dilute  $\text{HCl}$  was substituted for  $\text{NaCl}$  so that the error might not be due to the precipitating agent.

First analysis: Percent Ag calc. 63.50, found 63.52.

Second analysis found 63.60.

Finally a solution of purified  $\text{KCl}$ , a slightly more soluble salt than  $\text{NaCl}$  was tried. The empty crucible was in all cases washed with  $\text{NH}_4\text{OH}$  and water and it varied in weight by only one-tenth milligram.

Percent Ag calc. 63.50, found 63.98.

In all the analyses the  $\text{AgCl}$  precipitate was easily handled, the difficulty arising in the seeming impossibility of washing out of it and the pores of the crucible the  $\text{NaCl}$  and the  $\text{KCl}$ .

## II. Determination of Cu in $\text{CuSO}_4 \cdot 5\text{H}_2\text{O}$ as $\text{CuSCN}$ .

This analysis seemed particularly adaptable because of the extensive use of the Gooch crucible necessitated in it. A solution of crystals of very pure  $\text{CuSO}_4 \cdot 5\text{H}_2\text{O}$  was made such that each 50 c. c. contained .2136 grams. Precipitation of  $\text{CuSCN}$  was effected from the hot solution in the presence of an excess of  $\text{H}_2\text{SO}_3$  by means of  $(\text{NH}_4)_2\text{SCN}$ . Drying was at  $140^\circ$ .

Percent Cu in  $\text{CuSO}_4$  calc. 25.46 found (1) 26.80 (Stirred 2 minutes and not permitted to settle.)  
 (2) 25.24 (Stirred 4 minutes rapidly and digested 15 minutes.)  
 (3) and (4) 25.39 (Stirred 4 minutes rapidly and digested 30 minutes.)

By thoroughly washing with water, drawn both ways through by suction and drying at  $140^\circ$ , the crucible maintained a weight varying only by



one-tenth milligram. Although the particles of  $\text{CuSCN}$  are much smaller than those of  $\text{AgCl}$ , they were retained by the pores of the crucible.

### III. Determination of Al in $\text{Al}_2(\text{SO}_4)_3$ as $\text{Al}_2\text{O}_3$ .

The effect of high temperature upon the Alundum crucible as well as its applicability for filtration of gelatinous precipitates, were discovered by this analysis. Chemically pure  $\text{Al}_2(\text{SO}_4)_3 \cdot 18\text{H}_2\text{O}$  was dehydrated by gentle dessication and final heating for  $4\frac{1}{2}$  hours at  $140^\circ$ . A solution was prepared such that each 50 c. c. contained .2154 grams of  $\text{Al}_2(\text{SO}_4)_3$ .  $\text{Al}(\text{OH})_3$  was precipitated from the hot solution in the presence of  $\text{NH}_4\text{Cl}$  by just a sufficient amount of  $\text{NH}_4\text{OH}$ . After boiling, stirring and allowing to stand, the precipitate was filtered through the crucible previously heated in the flame of a blast lamp for several minutes, and washed with water containing small amounts of  $\text{NH}_4\text{Cl}$  and  $\text{NH}_4\text{OH}$ . In seven attempts however in spite of all precautions and lengthened time of treating the precipitate, part was drawn through the crucible with the filtrate. The last three determinations were made with an entirely new solution of  $\text{Al}_2(\text{SO}_4)_3$ , each 50 c. c. containing .2001 grams.

#### EFFECT OF HEATING ON THE CRUCIBLE.

Except in one case where the change was negligible, the crucible lost in weight consistently from one analysis to the next. The first crucible was pulled apart by suction while cleaning with water following the third analysis, and the second in exactly similar fashion after the fourth analysis in which it was employed, showing that the material becomes extremely brittle after heating several times in the blast lamp.

### IV. The determination of Ba in $\text{BaCl}_2$ as $\text{BaSO}_4$ .

The extremely small size of the particles of  $\text{BaSO}_4$  under ordinary conditions recommended a further test of the crucible. The pure  $\text{BaCl}_2$  was thoroughly dried by heating three hours at  $140^\circ$  and a solution made such that 50 c. c. contained .2007 grams. The hot solution slightly acidified with  $\text{HCl}$  was treated with pure dilute  $\text{H}_2\text{SO}_4$  while vigorous stirring was maintained for five minutes, after which the  $\text{BaSO}_4$  was allowed to settle for five minutes.

|                                     |       |       |     |       |
|-------------------------------------|-------|-------|-----|-------|
| Percent Ba in $\text{BaCl}_2$ calc. | 65.96 | found | (1) | 65.86 |
|                                     |       |       | (2) | 65.98 |
|                                     |       |       | (3) | 65.79 |

The crucible was washed with water under suction and maintained

practically a constant weight. A final trial of the effect upon the weight of rubbing simply with the finger was made. The crucible lost .0039 grams.

#### SUMMARY OF ADVANTAGES.

(1) The crucible was used to advantage in determining Cu as  $\text{CuSCN}$ , Ba as  $\text{BaSO}_4$  and Ag in  $\text{AgCl}$  when  $\text{HCl}$  was used as the precipitating agent.

(2) Manipulating was found to be surprisingly simple and rapid when an analysis was once under way.

(3) Nearly a constant weight was maintained by the crucible if not heated over  $140^\circ$  when washed with water.

#### SUMMARY OF DISADVANTAGES.

(1) It was found difficult at best to wash precipitates free from precipitating agent, especially if the latter should be left as a solid residue upon evaporation of the solution.

(2) Suction was necessary, and, in the case of  $\text{AgCl}, \text{NH}_4\text{OH}$ , to thoroughly cleanse the crucible.

(3) It was found unadapted to filtration of such gelatinous precipitates as  $\text{Al}(\text{OH})_3$ .

(4) Heating six or eight times in the blast lamp was sufficient to render the crucible so brittle as to be broken even by suction, and a consistent loss in weight was observed.

(5) In three cases the first use of crucibles led to results greatly in error.

(6) Abrasion or friction was found to have a marked effect upon the weight of the crucible.

(7) The ordinary digestion of fine precipitates to be filtered was not avoided when it was used.

Like the Gooch crucible therefore, the Alundum crucible apparently has only a limited field of usage but within that field it should be of considerable worth to the analyst.

## THE CORRELATION OF HIGH SCHOOL AND COLLEGE CHEMISTRY.

JAMES BROWN.

---

This subject I submit for consideration, not as one who has anything final to offer, but as a teacher who has considered several different systems and has tried some of them.

Inasmuch as the objects sought in the various high schools and college courses differ, it is difficult or impossible to devise any system of correlation which will suit all cases with the maximum of efficiency. Local conditions and previous training of students, as well as the future plans of the students, so far as these are definite, must be determining factors. In any case, efficiency rather than convenience should be our guide.

In considering this question I have found it convenient to propose three alternatives for students who have completed a high school course in chemistry and elect to continue the subject in college. The alternatives are as follows: First, to admit the student at once to second year chemistry, usually qualitative analysis; second, to give the student the same course as those who have had no previous work in chemistry; third, to give to such students a special course in general chemistry.

The first alternative—to admit the student at once to second year chemistry—I do not favor for theoretical reasons and because my experience has found it unsatisfactory. In this case you have high school students, the nature of whose courses in chemistry has differed widely, subjected to the same prescription as college students whose courses have usually been more uniform and deeper. This is apt to be especially true because the college recitations and laboratory periods are usually longer and because, in a great many colleges courses in general chemistry more or less qualitative analysis is introduced. This enables the college student to start qualitative analysis at a somewhat advanced point.

On the theoretical side we find similar differences. The time is past, if it ever did really exist, when a course in qualitative analysis conducted in a mechanical way may be considered properly taught. The theory of the

subject is presented in our best text-books from the point of view of ionic equilibrium, the periodic system, and the electro-chemical series. Our best college text-books and laboratory manuals in general chemistry emphasize these same subjects. This, it seems to me, gives the correlation between general chemistry and qualitative analysis which is not secured by courses which do not place emphasis on these three subjects. Equations also must be well learned throughout all chemistry courses. We must not, to be sure, give too much time to equations to the exclusion of other parts of the science. But have you ever known a good chemistry student who could not write equations? I often wonder if equations are being neglected.

The second alternative—to put all students into the same course in general chemistry—admits of several interpretations. Shall we give full credit for the course to the student who has received an entrance credit in chemistry? This may mean duplication of credit. Such duplication exists in one form or another in some subjects. Shall we do the same in chemistry? This question is variously answered by different institutions.

Duplication of credit may be avoided by requiring different laboratory experiments and different written work in the laboratory and in connection with the text-book, from the two classes of students. This is rendered difficult by the different contents of the high school courses. Or we may avoid this duplication by giving only part credit for the college work to those who have entrance credit in chemistry. This may appear to the student to be work without credit, and is often opposed on those grounds.

The third alternative—to give a different course to the two classes of students—may be accepted in different forms. In some cases students have totally omitted the first part of the course, and taken the latter part entire. This I think is objectionable because of sins of omission and commission. The student should have much of what he omits in the first part, and duplicates much that is familiar to him in the second part. We may on the other hand give a shorter course covering the whole subject to our students with entrance credit, avoiding duplication of work which may be supposed to be familiar, and giving only what we think will impart the advanced point of view which we consider advisable.

This accomplishes in another way much the same end as the plan of assigning different work under the second alternative. These two plans are subject to the same difficulty. The students have had quite different courses in high school and do not well admit of the same diagnosis.

Will not a satisfactory solution of our problem be accomplished by the introduction into our high schools of the new courses in general science now being advocated? This would leave the specialization along different branches of science in the hands of the colleges and would enable us to treat all classes of students alike without fear of duplicating credit, or of omitting anything essential. Probably our high school science should be conducted with the purpose of enabling the student to interpret his daily environment. In college, however, while considering fully the interest of the student whose object in chemistry is cultural, we must be guided mainly by the professional student and by those who, for various reasons, wish to specialize in chemistry.



## THE CHEMICAL COMPOSITION OF VIRGIN AND CROPPED INDIANA SOILS.

---

S. D. CONNER.

---

In November, 1913, the Soils and Crops Department of the Purdue Agricultural Experiment Station collected samples of a large number of typical virgin and cropped soils, with a view to determine the chemical composition, to see if there was any appreciable difference in them. The samples were taken with an auger and each sample represented not less than five borings to a depth of six and one-half inches. Subsoil samples were taken at the same time and represented the layer from a depth of 12 to 18 inches. Great care was taken to select fields where uniform and typical samples could be secured. The samples in each case represent a heavily cropped soil and an adjacent virgin soil of the same type which had never been cropped. The virgin soil samples were taken from a line fence row, or from a woodlot which had never been cultivated. The separate samples were properly prepared and analyzed for various elements. Also composite samples were prepared from the virgin soils, the virgin subsoils, the cropped soils and the cropped subsoils. The composites were made by taking equal weights of the separate samples and thoroughly mixing them. The analyses of the separate samples not being completed up to the present time, the analyses of the composite samples only are given in this paper.

There is a rather widespread idea that the chemist can take a sample of soil and by making a complete analysis, determine without any other information just what element is deficient in the soil and needed as a fertilizer. This is not true, and it is very seldom that an analysis alone will indicate the needs of a soil. The chemist can tell with a fair degree of accuracy just how much of each element is present in the soil, but he is not able from a chemical analysis alone, to say what various crops are able to extract from the soil. The ability to determine the fertilizer needs of various crops on different types of soil is more or less a matter of

experience and is based largely upon the results of field fertilizer tests. However, a chemical analysis of a soil is often of great benefit in studying problems of soil fertility.

It is generally recognized that the removal of plant food by crops is not the only factor which may change the composition of a cultivated soil. The agencies of wind and water play a very great part in effecting changes. Insects, worms and animals often work through the soil and subsoil, causing variations and intermixtures. The crops themselves bring up from below quite a little plant food and deposit it near the surface in the decaying roots and stubble. In spite of the fact that the tendency of nature is to build up and replenish the fertility of soil, there is no question but that the destructive system of cultivation that has been followed by the farmers of this country has more than counter-balanced nature's tendency to upbuild, and as a consequence the soil has become more or less depleted. It is believed that the analyses presented in this paper show what chemical changes have been effected in the average soil of Indiana by cropping it for from sixty to eighty years.

TABLE I.

*Analysis of Composite (31) Virgin and Cropped Soils.*

| MATERIAL.                                                                                                                      | Virgin Soil. | Virgin Subsoil. | Cropped Soil. | Cropped Subsoil. |
|--------------------------------------------------------------------------------------------------------------------------------|--------------|-----------------|---------------|------------------|
| Insoluble silica, etc.....                                                                                                     | 88.49%       | 87.30%          | 89.59%        | 86.37%           |
| Potash (K <sub>2</sub> O) (Acid soluble).....                                                                                  | .26          | .36             | .23           | .34              |
| Soda (Na <sub>2</sub> O) (Acid soluble).....                                                                                   | .20          | .20             | .17           | .21              |
| Lime (CaO) (Acid soluble).....                                                                                                 | .43          | .34             | .43           | .51              |
| Magnesia (MgO) (Acid soluble).....                                                                                             | .41          | .60             | .40           | .60              |
| Manganese oxid (Mn <sub>3</sub> O <sub>4</sub> ) (Acid soluble).....                                                           | .14          | .08             | .07           | .09              |
| Ferric oxid (Fe <sub>2</sub> O <sub>3</sub> ) (Acid soluble). Alumina (Al <sub>2</sub> O <sub>3</sub> )<br>(Acid soluble)..... | 5.03         | 8.01            | 5.31          | 8.60             |
| Phosphoric acid (P <sub>2</sub> O <sub>5</sub> ) (Acid soluble).....                                                           | .12          | .07             | .11           | .07              |
| Sulphur trioxid (SO <sub>3</sub> ) (Acid soluble).....                                                                         | .06          | .05             | .06           | .04              |
| Volatile matter.....                                                                                                           | 5.28         | 3.20            | 3.88          | 3.25             |
| Total.....                                                                                                                     | 100.42       | 100.21          | 100.22        | 100.08           |
| Total nitrogen.....                                                                                                            | .18          | .07             | .13           | .06              |
| Total potash (K <sub>2</sub> O).....                                                                                           | 1.83         | 1.88            | 1.94          | 1.92             |
| Total humus.....                                                                                                               | 1.98         | .60             | 1.04          | .40              |
| Acid humus.....                                                                                                                | 1.16         | .44             | .84           | .48              |



A glance at the analyses in Table I will show that although most of the soil ingredients have not changed enough to make any great difference in the chemical composition of the virgin and cropped soils, there are some notable exceptions.

The most serious losses from the standpoint of soil fertility are those of nitrogen, which shows a loss of 28%, and the organic matter, which shows a loss in the volatile matter of 26%, and in the humus of 47%. These losses are without doubt the main reason why our cropped soils are no longer as fertile as they formerly were. Fortunately the remedy for replacing nitrogen and organic matter is not beyond the means of the average farmer. Greater care in utilizing crop residues and barnyard manure, also the growing of legumes in a good crop rotation are necessary steps in replacing these vital losses. The purchase of organic matter, other than farmyard manure, is out of the question, while the use of nitrogenous fertilizers which often give profitable returns, can only be recommended as a temporary resort.

While the phosphoric acid and potash show only about 10% loss, it should be remembered that this 10% was the most available portion of these important elements. Fertilizer practice in the older and more worn lands of Indiana shows that there has been a loss in these elements and that in a great many cases their use as fertilizers is very profitable. Due to the fact already mentioned that the soil through natural agencies is constantly in motion, it should be pointed out that the addition of one or two tons of rock phosphate per acre to the land for the purpose of increasing the phosphorus content of it for a long time to come, is a practice of doubtful efficiency. There is a strong probability of loss of such fertilizer, due to removal by wind or water, or to being buried out of reach of the plants by these or other natural agencies. Smaller amounts of more available phosphorus or potash fertilizers, on the other hand, will be quickly utilized by the crops and hence not so liable to be lost. Experiments which have been conducted by the Purdue Experiment Station show greater profit from the use of acid phosphate than from raw rock phosphate. (Bul. 155, Purdue Experiment Station and the 27th Annual Report, Purdue Experiment Station, 1914.)

The analyses of calcium and magnesium in the virgin and cropped soils show no apparent change. This is rather surprising as we have been led to think of these elements, especially calcium, as being very soluble. The loss of lime, as reported by the Rothamsted Station, has been shown

to be from 500 to 1,000 pounds per acre per year. There is one important difference in the Rothamsted soil and the average Indiana soil, and that is in the fact that the Rothamsted soils in the experiments reported have from two to four per cent. calcium carbonate. The Indiana soils shown in these analyses, on the other hand, have no calcium carbonate. The calcium and magnesium in these Indiana soils are in the form of more or less insoluble silicates. The inference to be drawn, therefore, would be that there is no great loss of calcium or magnesium in acid soils in which these elements are in the form of silicates. This does not mean that these soils do not need lime for, as a matter of fact, they respond readily to the application of lime, which is needed for the proper growth of clover. The need for lime is greater now than it was in the virgin soils because the organic matter has been burned out of the cropped soil. Given two soils with the same calcium and magnesium content and the same degree of acidity but with different amounts of organic matter, the one with the greater organic matter content will grow better crops of clover and will not be in so great a need of lime as the other.

The virgin and cropped soils show no great difference in the content of sulphur. Experiments in Wisconsin and Kentucky have shown that in a number of instances sulphur has been reduced in soils by cropping.

Manganese shows quite a loss in the cropped soil. The effect of manganese on soil fertility is attracting more or less attention among soil investigators, and although nothing definite seems to be known about its action, it is possible that it does play an important part in agriculture.

The changes in the content of silica, iron and aluminum are believed to be of no importance as plant foods. They do, no doubt, have a very important bearing upon the physical constitution of the soil. The writer believes that the constitution of the silicates of iron, and especially of aluminum, has more to do with injurious soil acidity than any other factor.

The method of determining soil acidity (limestone required) in this work is that given in Bulletin 107 (Revised edition), Bureau of Chemistry, U. S. Department of Agriculture. This method shows a relative acidity in soils that is believed to more nearly represent toxic acidity than any other method, especially in soils containing much organic matter. It is interesting to note that while the acidity of the cropped soil has increased, the acidity of the cropped subsoil has decreased.

TABLE II.

## FERTILITY IN VIRGIN AND CROPPED SOILS.

*Pounds Per Acre in Two Million Pounds of Surface Soil and Four Million Pounds of Subsoil.*

| MATERIAL.                                     | Virgin Soil. | Virgin Subsoil. | Cropped Soil. | Cropped Subsoil. |
|-----------------------------------------------|--------------|-----------------|---------------|------------------|
| Volatile matter.....                          | 105,600      | 128,000         | 77,600        | 130,000          |
| Humus.....                                    | 39,600       | 24,000          | 20,800        | 16,000           |
| Nitrogen.....                                 | 3,600        | 2,800           | 2,600         | 2,400            |
| Potassium (Total).....                        | 32,464       | 66,702          | 34,416        | 68,121           |
| Potassium (Acid soluble).....                 | 4,615        | 12,773          | 4,080         | 12,063           |
| Phosphorus (Acid soluble).....                | 1,046        | 1,221           | 959           | 1,221            |
| Calcium (Acid soluble).....                   | 6,864        | 9,724           | 6,864         | 14,586           |
| Magnesium (Acid soluble).....                 | 4,953        | 14,496          | 4,832         | 14,496           |
| Manganese (Acid soluble).....                 | 2,016        | 2,304           | 1,008         | 2,592            |
| Sulphur (Acid soluble).....                   | 480          | 800             | 480           | 640              |
| Limestone require <sup>d</sup> (Acidity)..... | 60           | 2,600           | 100           | 1,120            |

Table II gives the pounds of the different elements in the plowed soil of 2,000,000 pounds per acre, and in the subsoil of 4,000,000 pounds per acre. It shows the same relative differences as given in Table I, but in different terms.

The writer wishes to acknowledge the assistance of Mr. J. C. Beavers of the Soils and Crops Department, also of Mr. J. B. Abbott, formerly of the same department, who collected most of the soil samples analyzed.



## SEWAGE DISPOSAL.

---

CHARLES BROSSMANN, Consulting Engineer, Indianapolis.

---

Civilization and education has been accompanied by a wonderful growth of cities and has made the problem of sewage disposal one of civic, state and national importance.

Sanitation becomes of greater importance as communities become more congested.

It is only of late years that this question has received proper attention, the greatest progress having been made in the last few decades. The combined efforts of the scientist, chemist and engineer have been called upon to help solve this problem of ever-increasing importance.

Improper disposal of sewage has caused directly or indirectly a large percentage in the typhoid mortality rate.

The gathering of large numbers of people calls for additional safeguards and means of sanitation. In some instances sewage can be disposed of by dilution, discharging direct into large bodies of running water; but most streams are as a rule not of sufficient size, or are already so polluted that additional sewage would increase the burden already too large.

Generally sewage is diluted with the entire water supply of a city and is a dirty appearing water, containing a greater or less percentage of organic matter. There is usually enough organic matter present to make it disagreeable and to cause odors. The presence of various disease germs also make it a source of pollution to water bodies.

In general all methods of sewage treatment employ the principle of reduction through microscopic organisms. Bacteria of various kinds attack the organic compounds reducing them to simpler forms, doing so through successive stages. Reduction takes place through two classes of bacteria, namely aerobic (thriving in the presence of oxygen), and anaerobic (thriving in the absence of oxygen). These two processes occur in septic, Imhoff or other tanks and in various forms of filters.

The most prevalent form of getting rid of sewage is by dilution. Where the stream is sufficient in size to allow proper oxidation the sewage

will be properly taken care of without objectionable odors. Such a stream however should have a flow of about 300 cubic feet per minute for each 1,000 inhabitants. Instances where disposal by dilution alone is sufficient are not many and usually some additional treatment is necessary, suitable to local conditions.

If the stream into which the sewage is to be discharged allows of partial dilution, treatment by some properly designed form of tank may be

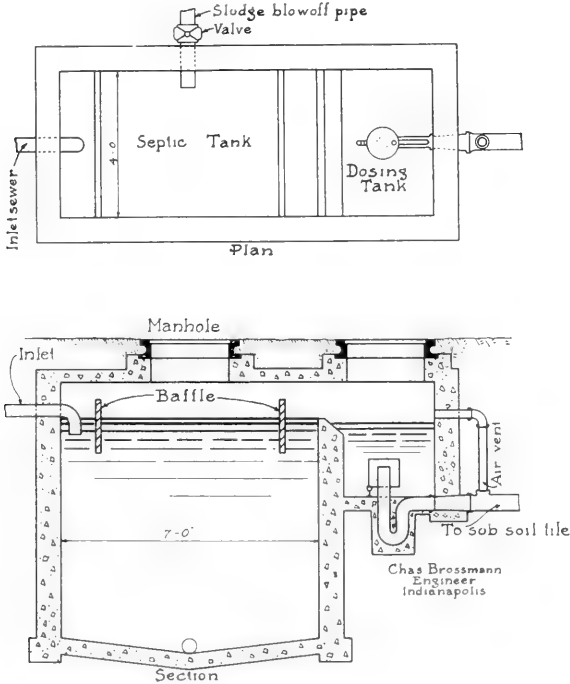


FIG. 1.

Type of Septic Tank Suitable for Ordinary Dwelling.

sufficient, but tank treatment alone will not always suffice. Tank treatment is but a step in the purification of sewage and should usually be followed by some form of filtration or after treatment. Various forms of tanks can be used but the type and size that insures the best results can only be determined after proper investigation of all conditions—as the number of people, amount of sewage, the rate and the time of flow, the

location of adjacent property and the size of the water course into which the treated sewage is finally discharged; all are important and enter into the proper solution of this important question. ?

Tank treatment, therefore, is essential as the first step in sewage reduction, and is necessary in order to retain and break down the solids, but it must not be supposed that it purifies the remaining sewage liquor. The tank treatment is necessary in preparing the sewage liquor for further purification. Such tanks can be made in the form of plain settling tanks, a septic tank, or a combination of both.

The public will universally call any tank (even a cesspool) a septic tank, and usually they believe that a septic tank absolutely purifies the sewage. Such is not the case, a reduction from thirty to sixty per cent. of

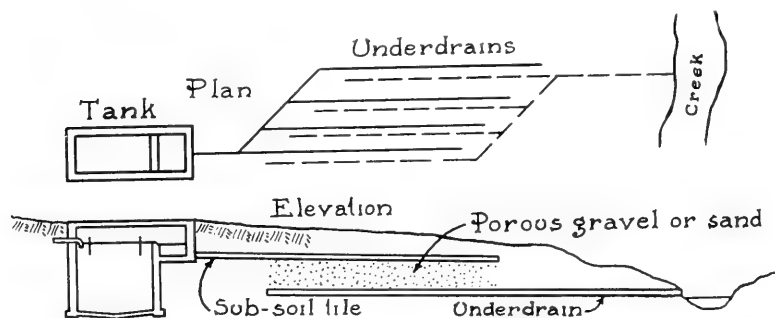


FIG. 2.

#### Septic Tank and Natural Sand Filter for Small Installations.

suspended matter and around thirty per cent. in organic matter is usually what takes place. The tank will not take care of very fine particles or colloidal matter. Such matter (colloidal) being in condition just between suspension and solution. The best results are obtained when the solids are taken out or retained as quickly as possible and the subsequent liquor remaining immediately treated. It is important that liquor be not retained too long or it will become in a toxic condition. Time is an important element in the proper design of a tank, also the state of the sewage in reaching the tank.

Septic tanks are usually designed for a rate of flow, of from eight to sixteen hours. The more modern type of tank with two compartments, one for settling and one for sludge digestion, are usually designed with a rate of flow of half (or even less) than the above.

The septic tank is usually a rectangular shaped chamber with several baffle boards, extending across to break the flow of the sewage. Such tanks should be covered as the organisms that break down the solids (known as anaerobic bacteria) thrive best in the absence of air and light. Septic tanks usually take some time to become operative, a scum mat forming at the top and sludge at the bottom. At intervals such tanks must be cleaned of the sludge. It was formerly supposed that just as much solid matter was turned to liquid and gas to offset the amount of solids

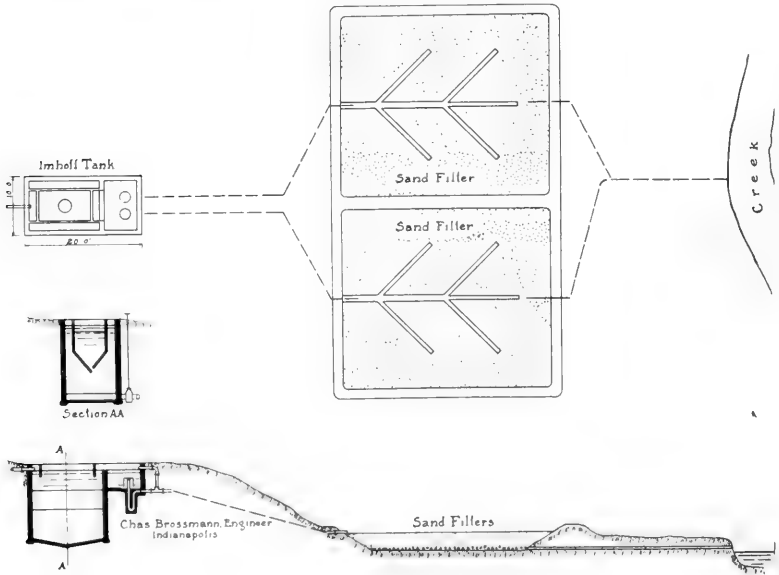


FIG. 3.

**Imhoff Tank and Sand Filters Installed at Indianapolis Country Club**

coming in, however, it has usually been found necessary to clean out the resultant sludge at intervals. (See figure 1.)

The Imhoff type of tank consists of two chambers, one for settling and one for the deposit and digestion of sludge. Such a tank, while somewhat more expensive than the plain tank is smaller and will give more uniform results, besides offering better means for after-treatment of the liquid and assuring a better solution of the sludge problem. (See figure 4.)

This type of tank has an upper settling chamber with a slotted opening at the bottom. The sewage in flowing through the upper chamber deposits



the solids into the sludge chamber below. In the sludge or digestion chamber below, the solids and organic matter is gasified and liquified independent of and without disturbing the settling matter above.

The gases of decomposition and the constant agitation in the lower part does not disturb the sewage in the settling chamber, furthermore albumen from the fresh sewage is not constantly added to the septic sludge; hence there is less odor and the sewage liquor is delivered in a fresher condition for after-treatment. The sludge from this type of tank dries out quicker, is in better condition for disposal, has less water content, and has different characteristics than sludge from a shallow tank which is kept in



FIG. 4.

Imhoff Tank, Julietta, Ind. Note Formation of Sludge on Sides.

constant contact with the sewage. Such double tank sludge soon becomes spadable like garden compost.

The tank treatment should be followed by dilution or some form of filtration. In some cases the sewage liquor from tanks can be discharged into a water-course. Usually it is necessary to use some form of filter or nitrification bed. This can be done in the following manner:

(1) In small plants by discharging the sewage into tile laid near the surface of the ground. Such ground must be suitable for the sewage to percolate through to a subdrainage system below. Such ground should be gravelly or of sand. (See figure 2.)

(2) By discharging the sewage into contact beds, viz., a water-tight bed, filled to a depth of several feet with broken stone or other hard

material, the sewage being automatically discharged on to the bed, retained a fixed period, and then discharged from the bed. In such a bed absorption and oxidation of the organic matter is accomplished by aerobic bacteria, viz., those which thrive in the presence of air. (See figure 5.)

(3) Sand filters: As the sewage from tanks can be discharged on sand filters—automatically dosed as in contact beds. Such sewage covers the surface of the bed and gradually works through to the underdrains below, the action being that of filtration and nitrification. If a very pure effluent is desired the sewage can be discharged from the tank to the con-

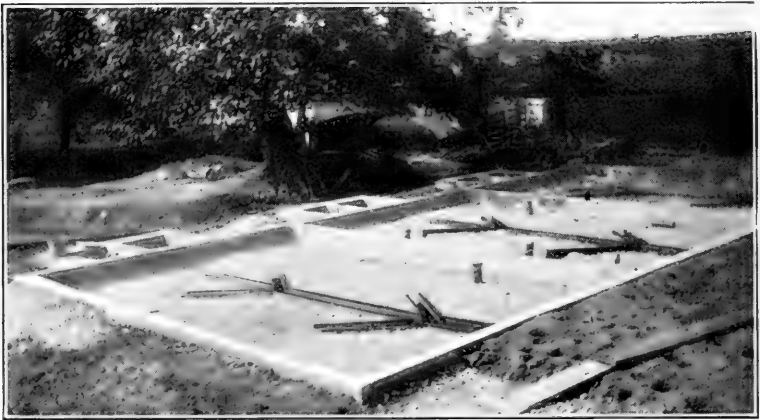


FIG. 5.

Contact Beds, Julietta, Ind.

fact bed and then be treated through the sand filters. In a properly designed plant this will give a very clear effluent. (See figure 6.)

**Sprinkling Filters:** In the larger plants sprinkling filters are largely used. These consist of beds of broken stone, usually of a depth of six feet or more and are arranged for good underdrainage. The sewage is automatically discharged over the top of the bed by sprinkling nozzles; trickles down through the stone and out through the underdrains. Such beds can be worked at a higher rate than any of the preceding methods, hence a smaller area is required, which makes this method more adaptable for large installations.

## DISPOSITION OF SLUDGE.

The real problem in sewage disposal plants is the sludge problem. Engineers are just learning how to make sludge but in most cases have not found a satisfactory solution in disposing of it. In larger plants the sludge question is the stumbling block.

Sludge may be roughly divided in two classes, that from shallow tanks and that from deep tanks. Sedimentation tank sludge is a black semi-

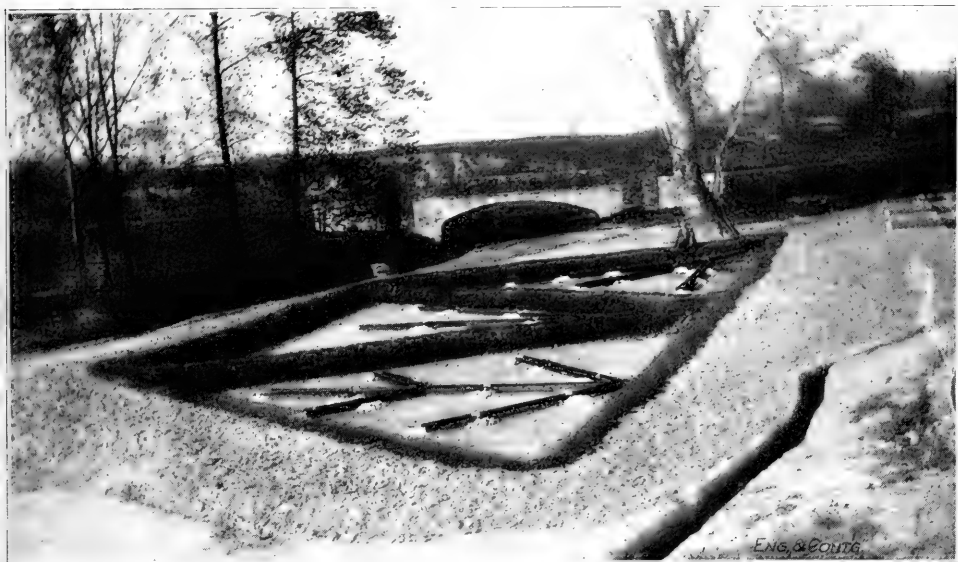


FIG. 6.

Sand Filters, Julietta, Ind.

liquid mass which on being exposed to the air becomes offensive, giving off much gas and odor. The water contained from such sludge is usually 90 to 95%.

The sludge from septic tanks ranges all the way from 8 to 45 cubic yards per million gallons of sewage. Septic sludge which has been retained in tanks for a number of months undergoes a great change. The organic matter is attacked and partly gasified and liquified, which reduces the amount of sludge. Such sludge in well operated tanks is a con-

centrated mass containing from 80 to 90% of water; there is not as much odor to septic tank sludge as to the fresh sludge from the plain settling tanks.

The above outlines the principal methods of sewage disposal. It must however be borne in mind that the proper method is wholly decided by local conditions. Care must be exercised in order that the various factors affecting the problem be carefully considered.

A fuller realization of the sewage disposal problem is being evidenced throughout the country as the years go by, both by the state and health officers and city officials. The State has done a great deal of preliminary work in the way of sanitary surveys and this work should be heartily indorsed and commended. However, there is still much to be done, and

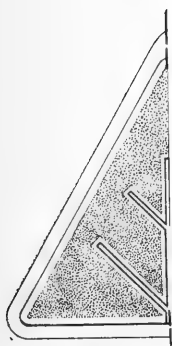


FIG. 7.

Water Fowl in Stream, Julietta, Ind., 100 Feet Below Sewage Plant. Photo taken 2 years after plant was installed. Formerly all waterfowl died from drinking water.

undoubtedly some method of maintaining public control of the streams will have to be devised before the question of pollution can be properly taken care of.

There are so many different factors entering into this question that the best solution can only be worked out with a proper organization which will take into consideration every phase of the question and which can reach every district, affected, whether this territory be in one or more States. The state authorities should be given the power to pass upon every sewage disposal problem and they should have the proper means and support for doing this.



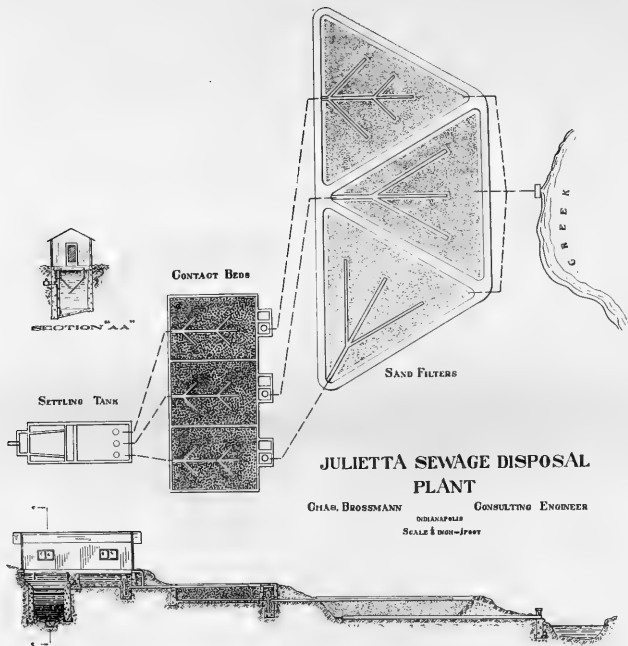


Fig. 8.

General Plan. Section of Julietta Sewage Plant Showing Imhoff Tank, Contact Beds and Sand Filters.

## TAR FORMING TEMPERATURES OF AMERICAN COALS.

OTTO CARTER BERRY, ASSISTANT PROFESSOR OF EXPERIMENTAL ENGINEERING.

The material presented in this paper is the result of a series of investigations started in the laboratories of the University of Wisconsin and later continued at Purdue University. In form the paper is a brief of a part of a bulletin of the University of Wisconsin published by the author in 1914, with the addition of the results of the subsequent work.

The nature of the volatile matter in bituminous coal is attracting considerable attention at the present time. This is due not only to the enormous amount of coal annually used in the United States, but also to the important part volatile matter plays in determining how the coal must be handled in order to obtain the best results.

One of the most important and troublesome constituents of the volatile matter is tar, especially when the coal must be used in boiler furnaces or in power gas producers.

The investigations to be discussed in this paper had in view: (1) the determination of the temperature limits between which tars are distilled from the various classes of coal; (2) the temperature limits of the maximum rate of evolution of tars; (3) the relative quantities of tars distilled from the various general classes of coal; and (4) the lowest temperature at which one may be certain that the last trace of tar has been driven off from the coal.

Briefly stated, the results show that the temperature at which the first trace of tar appears will range from about 200°C. to about 385°C. usually falling quite near 300°. The maximum deposit will start at a temperature varying between 330° and 450°C. and will end between 430° and 530°C. The last trace of tar will appear between 530° and 680°C. The amount of tar produced seems to vary not so much with the amount of volatile matter in the coal as with the ratio of the carbon to the hydrogen as shown by the ultimate analysis of the coal.

When fresh coal is supplied to a furnace the volatile matter commences to distill off and if properly mixed with air and burned there is no

heat loss. The tarry products do not give trouble in gas producers when the gas is burned hot in ovens or furnaces. If however, the gas is allowed to cool, these products condense and stop up the piping, and unless removed, will clog up the engine valves if used for power purposes. The removal of these tarry products not only involves special and expensive apparatus and the expenditure of power, but also results in a loss of the available heat from the gas.

The problem as here presented is the outgrowth of an attempt to adapt the suction gas producer to the use of bituminous fuel. The type of producer used is what is known as the re-circulating producer such as is represented by the Whitfield and Pintsch patents. In this type of producer an attempt is made to draw off the tarry vapors from the top of the fuel column and introduce them again into the fire at the very bottom of the producer. The finished gas is drawn from the central portion of the fuel column. This location must be chosen with at least three points in mind:

- (1) It must be far enough down in the fuel column to be below the point at which the last trace of tar is driven off from the coal.

- (2) It must not be any farther down than is necessary, or the loss due to the sensible heat in the gas will be excessive. This loss, in percentage of the total heat value of the coal, will equal approximately the number of hundreds of degrees F. at which the gas leaves the producer. Thus, if the gas leaves at 1,200°F., the loss will approximate 12 per cent. of the total heat value of the coal burned.

- (3) The point of exit must be high enough above the bottom to allow ample opportunity for the  $\text{CO}_2$  and  $\text{H}_2\text{O}$  resulting from the combustion of the distilled volatile matter to be reduced to free  $\text{H}_2$  and  $\text{CO}$ .

To fulfill these several requirements, it is necessary to know exactly when each factor is operative. The depth of the incandescent zone that is necessary for a producer of a given size and capacity, and the precautions that are necessary to prevent a concentration of draft at any part of the producer, are fairly well known from practice. The most important item that is left for investigation is therefore to ascertain the exact temperature at which the last trace of tar is driven off from the coal.

An attempt was made to follow the temperature conditions met with in the gas producer, in these laboratory tests. This made it necessary to place the following list of requirements on the laboratory apparatus:

- (1) The coal must be heated very slowly and at a uniform rate.
- (2) The heat must be conducted from the outside to the center of



the body of coal by some good conductor, as the coal itself is a very poor conductor of heat and all particles in the body of coal must always be at a uniform temperature during the heating.

(3) The temperature of the coal must be accurately known at all times.

(4) The gases driven off from the coal must be swept out as soon as formed.

(5) The gases must be cooled down and continuously tested for tar.

(6) Any tar deposited in the pipes at a low temperature must not be allowed to re-distill at a higher temperature and then appear in the gas.

1. *The Furnace.* After considering the various possible means of heating the coal it was decided to use an electric resistance furnace. By this means the coal could be heated at any rate desired and the rate of heating could be controlled at all times, or the coal held at any desired temperature for any length of time. The furnace used is shown in cross section in Fig. 1 of the accompanying drawing, and was made as follows: A cylinder, (1),  $3\frac{1}{2}$ " inside diameter and 20" long was made out of 16 B. & S. gage sheet iron, riveted at the seam. Around this was wound four thicknesses of wet asbestos paper (2). About 75 feet of 12 B. & S. gage nichrome resistance wire (3), was wound around this, four turns to the inch. The asbestos paper insulated the wire from the cylinder. Around this was wound more wet asbestos paper, to hold the wire in place, and the whole was covered by a layer of asbestos pipe covering (7), about 2" thick. The ends of the resistance wire were fastened to electric terminals on the furnace. The current passed through this furnace was taken from a 110 volt alternating current circuit, and was varied by means of a small water rheostat. The amount of current was measured by an ammeter in the circuit, as is shown in the sketch of the apparatus.

Six or seven amperes were required to bring the temperature up from 20° C. to 600° C. in four or five hours. Direct current would have been somewhat preferable had it been available, but the alternating current used did not jar the coil sufficiently to do any damage.

2. *The Coal Cartridge.* The cartridge in which the coal was placed to be heated was about  $2\frac{1}{2}$ " inside diameter by 6" long. It was made up as shown in Fig. 1. (4) is a  $2\frac{1}{2}$ " short nipple, having  $2\frac{1}{2}$ " couplings (5) screwed on to both ends. Into these couplings pipe plugs (6) were screwed, thus forming a closed cartridge. One plug was drilled and

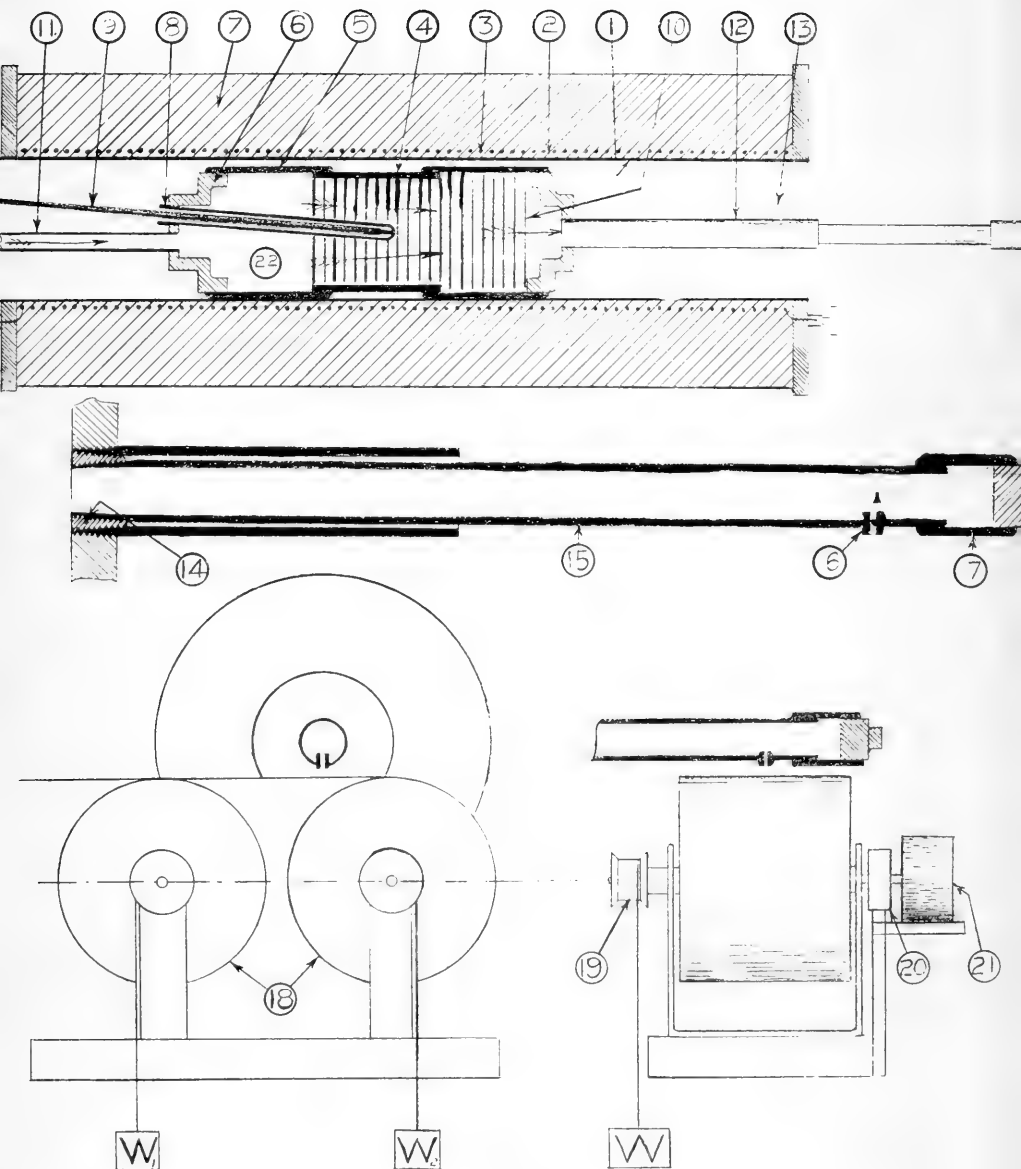


Fig. 1.

tapped for the  $\frac{1}{2}$ " pipe (12), through which the gas from the coal could pass out. The other was drilled and tapped for a thermometer well (8) and  $\frac{3}{4}$ " pipe (11). The body of coal heated each time was therefore  $2\frac{1}{2}$ " in diameter, and it was necessary to have all the particles of coal in this mass at the same temperature. As coal is a very poor conductor of heat, it was decided to place iron disks (10)  $\frac{1}{4}$ " apart throughout the entire length of the cartridge. These disks were large enough to touch the iron cartridge all around, thus taking on its temperature, and were drilled full of small holes to allow the gas to pass through them. As they were  $\frac{3}{4}$ " apart, the heat had to be conducted through only  $\frac{1}{8}$ " of coal. This fact, together with the very slow rate of heating employed, led us to expect the temperature throughout to be the same, within very close limits. The temperature was read at the very center of the coal body, by means of a thermo couple, the end of which extended down to and touched the end of the thermometer well (8).

3. *Means of measuring the temperature.* The thermo couples used were made of iron and nichrome wires welded together in an electric arc. The couples were used with a Brown millivolt meter, with a resistance of 85 ohms. It was carefully calibrated and checked at the time the experiments were completed. The couples were correct to within  $10^{\circ}$  C. throughout the range of temperatures here reported. The couples were left in place throughout each entire test, and the temperature readings made whenever desired.

4. *To keep the gases swept out as formed.* To sweep the gases out as they were formed gas free from tar was forced into the cartridge under pressure, through the  $\frac{3}{4}$ " pipe (11), and allowed to pass out through (12) in a constant stream. The pressure of this gas inside the cartridge was measured by a mercury manometer, and was kept at about  $2\frac{1}{2}$ " of mercury. This gas could not be allowed to contain any  $O_2$ , as it might then burn the coal or tar vapors at the higher temperatures, so air with the  $O_2$  burned out was used. The arrangement of the apparatus as used is shown in Fig. 2. The air was burned in a small furnace made of a piece of 6" pipe about 2' 6" long. This pipe had grates at the bottom and a coupling and plug at the top. The coupling was drilled and tapped  $\frac{1}{2}$ " pipe size on one side, and connected to a large coil of  $\frac{1}{2}$ " pipe which rested in a tank of cold water. The small furnace thus constructed was filled with an anthracite fire and the plug at the top put in. The air pump then pumped air through the furnace and cooling coil and compressed

it into the large air tank, where it was stored for use. By this means the supply of gas for a complete test could be stored up before the test itself was started. One more precaution had to be taken in using this gas, as it could not be allowed to affect the temperature of the coal as it passed through. To prevent this, a coil of pipe was placed over a gas flame and the gas passed through and heated up to the temperature of the coal, before it was allowed to enter. The temperature of the gas was measured by a thermo couple which extended into it through a tee in the pipe line. To make assurance doubly sure the end of the cartridge itself was filled with steel chips, as is shown at 22 in the sketch in Fig. I. The entering gas was thus forced to pass through a considerable volume of these chips before coming into contact with the coal. It was found difficult to heat the gas up to the highest temperature of the producer. This might tend to affect the seeming temperature at which the last traces of tar appear. The tendency of the gas would always be to be lower than that of the coal. For this reason the end of the thermocouple was placed in the coal at the end where the gas enters it, and therefore at its cooler end, in case there should be any difference at all. Thus the temperature reported as the one at which the last trace of tar appears is as accurate as it is possible to make it.

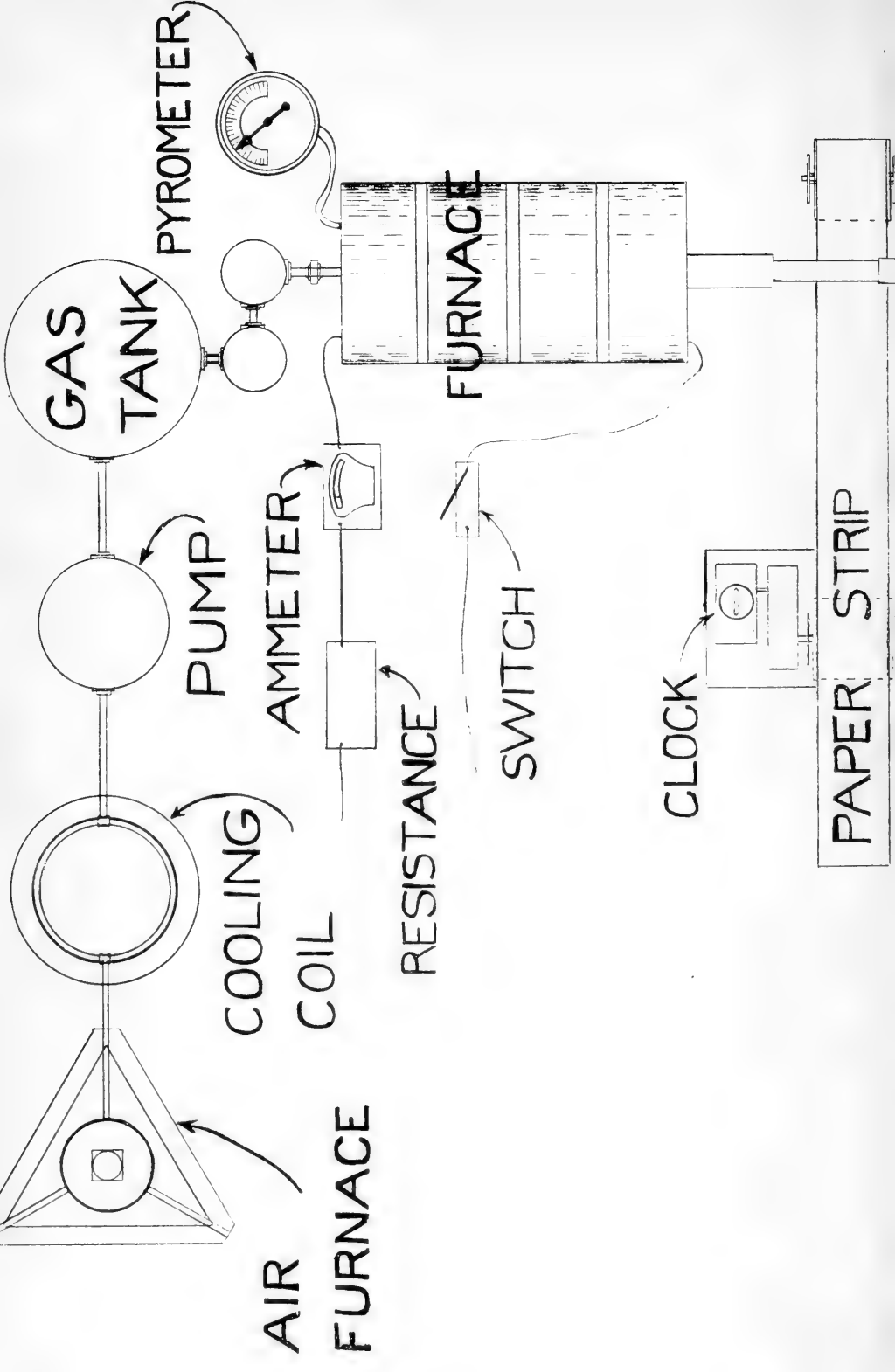
5. *To test the gases for tar.* The next problem was to find a means of subjecting the gases from the coal to a continuous test for tar. The most searching and satisfactory test known to the author, and the one used by the gas companies over the country, is to allow a small stream of the gas to strike a piece of white paper at a high velocity. If there is any trace of the tar at all in the gas, it soon leaves a spot on the paper. This test was adopted. To use it, the gas must be cooled down before it strikes the paper. This was accomplished by keeping a cloth filled with cold water constantly lying on pipes (12) and (18). It was desired to have the test continuous. The device used to accomplish this is shown in Figs. 1 and 2. The rollers (18) are about 10" in diameter and are supported by steel rods through their centers which turn freely in iron supports at either side. On one end of each of these steel rods was placed a small wooden spool, around which was wound a cord, supporting weights  $W_1$  or  $W_2$ . A long strip of cloth was wound around one of these rollers and its end started around the other. A piece of paper ribbon was wound on with the cloth.  $W_1$  and  $W_2$  tend to turn the rollers in opposite directions, thus keeping the cloth and paper strip tight.  $W_1$  is enough heavier than

$W_2$  to cause both to turn, unless held back in some way. The key of an alarm clock (21) was fastened to a train of gears (20), and these in turn to the stem of roller (18), so that the rate of motion was held back to a speed governed by the running of the clock. In this case the speed was 30" an hour. The rollers were set in such a way as to cause the paper to pass about  $\frac{1}{4}$ " under the end of the orifice (16) in pipe (15). The strip of paper was marked at the beginning and end of the test, so that the exact time when any point on the paper was under the orifice could be determined. Thus a continuous record was kept of the amount of tar in the gas.

It might be well to state here that all of the tar is not taken out of the gas by this means. The tar particles in the cooled gas are very fine and light, and many of them are cushioned off from the paper, and never touch it to stick. Consequently the tar deposited on the paper does not represent all of the tar content of the coal. On the other hand, the slightest trace of tar in the gas will quickly black the paper, and the deposit is probably very nearly proportional to the entire tar content of the gas.

6. *To prevent re-distillation of tar once deposited in exit pipe.* The remaining problem was that of making sure that no tar could be deposited in pipe (15) at a low temperature and be later re-distilled, to show up on the paper at too high a temperature. To accomplish this a large number of duplicate pipes were made and carefully fitted into the threaded bushing (14). By changing these pipes (15) every five or ten minutes, the effect of such a tendency was quite completely eliminated.

The coals tested were chosen to represent the different American grades. They were first ground and screened over a mesh of 20 wires per inch and through one of 10 wires per inch. About 315 grams of coal will fill the cartridge, and it was put in in layers  $\frac{1}{4}$ " thick between iron disks. The cartridge was then placed in the middle of the furnace, the thermo couple put in place, and the asbestos packed in against both ends, cutting off the radiation here, and causing the ends and middle, all to keep at the same temperature. A current of 6 amperes was then passed through the resistance wire of the furnace. While the latter was coming up to the temperature where the light oils start to come off, the thermo couples were connected up, the flame placed under the gas pre-heating coil, the gas from the storage tank turned on, the paper rolls connected up to the clock and the clock started. The pipes (15) were cleaned and prepared for immediate use, and the data sheet prepared. As soon as



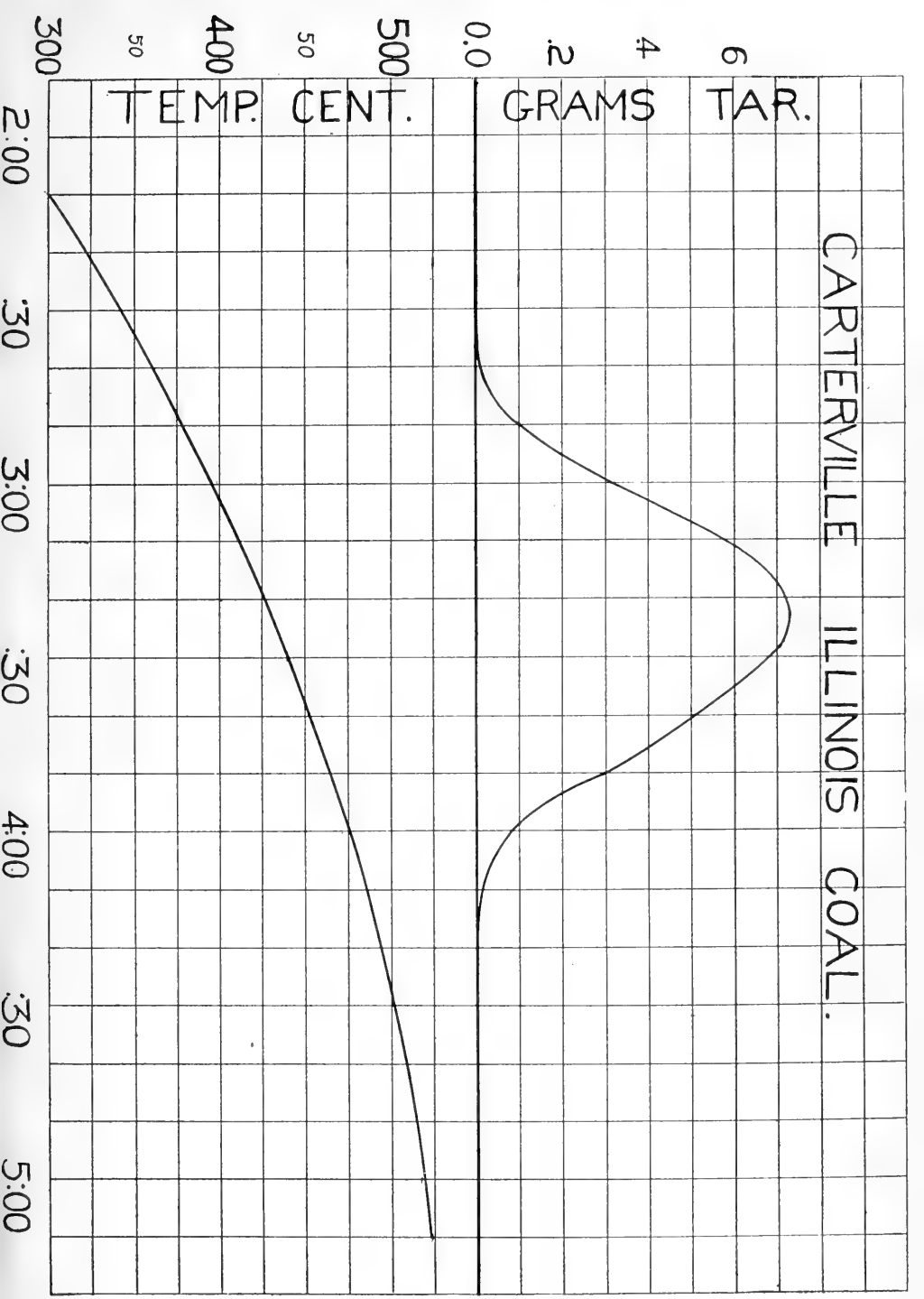
the thermo couple indicated a temperature close to that at which there was prospect of an oily deposit, the paper rolls were put in place, the paper marked and the test started. When the tar commenced to show up the temperature of the furnace was recorded and the pipe (15) changed every 10 minutes. As the temperature of the furnace rose to 300° C. the current was increased  $\frac{1}{4}$  of an ampere, at 400° C  $\frac{1}{2}$  of an ampere more, and at 500° C.  $\frac{3}{4}$  of an ampere. This was done to take care of the increased radiation, and to keep the rise in temperature at a constant rate. When the paper ceased to show any signs of a tar deposit it was again marked and timed and the current shut off. The strip of paper was then cut up into lengths corresponding to 10 minute periods, and carefully weighed. As the weight of the paper per inch was very constant, the excess in weight over that of clean paper was in each case due to the tar. From this two curves could be drawn, with time plotted horizontally, while one had temperature centigrade and the other grams of tar plotted vertically. These curves when placed one right over the other, as here given in Fig 3, indicate the amount of tar coming off at each temperature. The points where the tar starts and stops can not be indicated by this curve, as the ends of the deposit are too thin to have appreciable weight. They are consequently separately noted elsewhere.

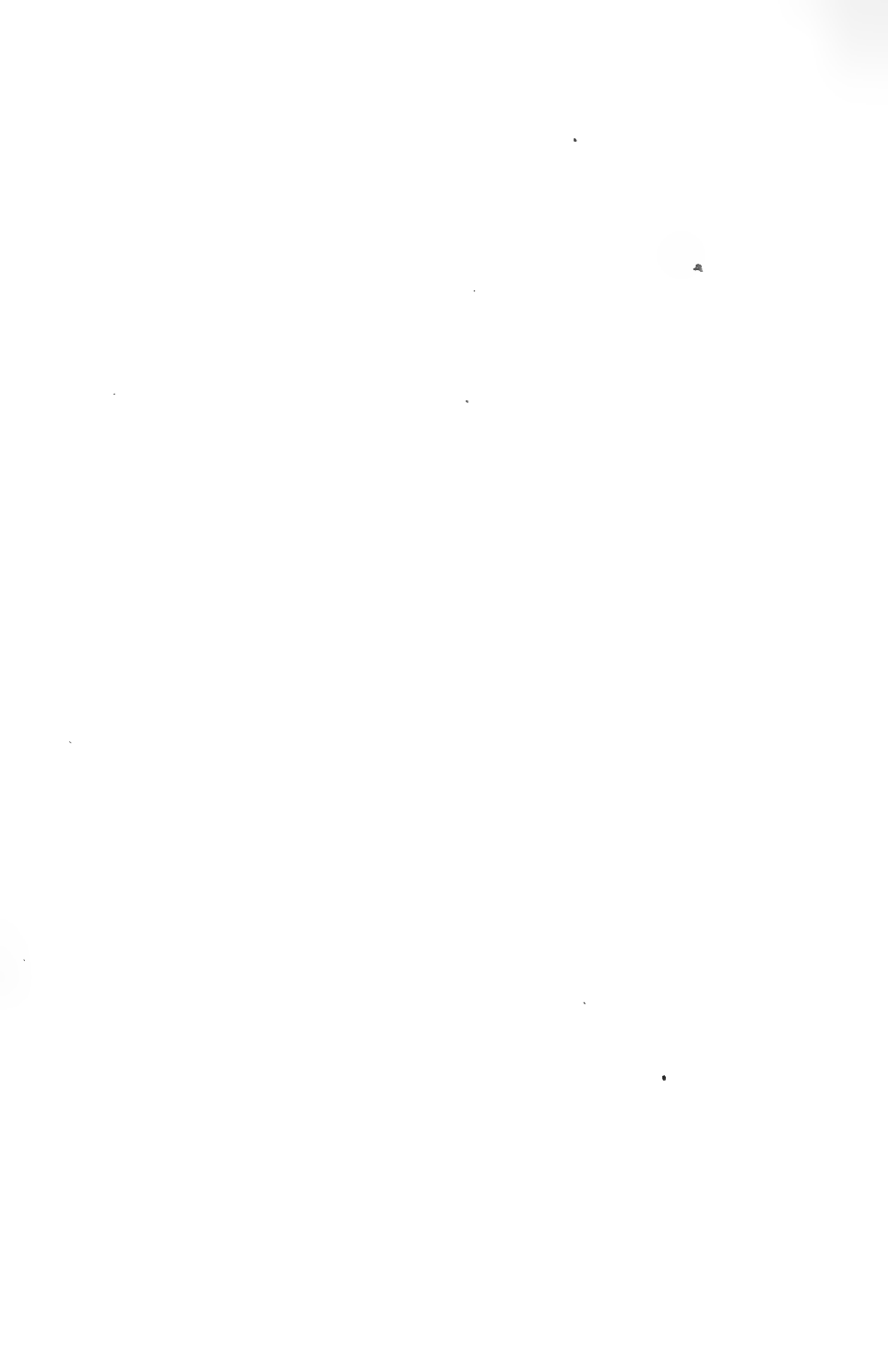
The first condensible gas to be driven off from the coal and appear on the paper record is water vapor. After the last of the water has disappeared there is quite a temperature range through which there is no deposit at all. Then the paper will begin to show a slight trace of oil. This will gradually increase in amount and give the paper the appearance of having been parafined. The deposit will then gradually assume a brownish color, as though engine oil were appearing. Later a temperature will be reached at which the deposit will increase very rapidly in amount, and will assume a distinctly tarlike appearance. The first tar to be deposited is usually very soft and sticky at room temperature. As the temperature rises the tar becomes steadily stiffer, until it is finally hard and brittle when cooled. The temperature range through which the maximum deposit occurs will vary from about 100° C., for some western coals, to 175° for some of the samples from the east. At the higher limit of this range the deposit becomes rapidly smaller in amount until it is too small to weigh, but the paper is still distinctly browned. This discoloration becomes less and less plain, until it finally disappears entirely. There is no definite temperature at which the first and the last

trace of the tar appears, in the same sense that water has a boiling temperature. The first deposit is so indistinct that it is almost impossible to tell whether there is a deposit or not. The increase is also so very gradual that it is difficult to choose the temperature at which to report the first appearance of a deposit. This gradual increase will extend over a temperature range of from 50° to 150° C. before there will be a sufficient deposit of tar to feel sticky to the finger. The determination of the temperatures between which the maximum deposit occurs is likewise an arbitrary matter, and also the temperature at which the last trace of tar appears. Therefore the results as here reported must not be too literally interpreted. However they are a very careful estimate of the facts as they are and the highest temperature reported is one at which one may feel assured that the very last trace of tar has disappeared from the coal.



CARTERVILLE ILLINOIS COAL.





## SHAWNEE MOUND, TIPPECANOE COUNTY, AS A GLACIAL ALLUVIAL CONE.

---

WM. A. MCBETH.

---

There stands at the northwest corner of section twenty-three (23), town, twenty-one (21) north, range six (6) west, a locally well known hill, quite unusually large and prominent for that part of the country, which generally is a moderately undulating, and, over extensive areas, a quite monotonous plain.

The area of the hill is about thirty-five (35) acres. Its height at the apex is seventy-five (75) feet above the steps of the front door of the residence (facing the road) located near the southwest edge of the hill on the general level of the country. A creek channel at the northwest edge is eighty (80) feet or more below the summit. The long axis of the hill is east west, in which direction it is nearly one hundred (100) rods long, with varying cross-distances averaging a little more than half its length. The high part is near the east end, where the steepest slopes occur. A small basin lies at the foot of this east slope. The distance of the highest point is almost one-third ( $\frac{1}{3}$ ) of the length of the pile from the east end, whence the slopes are much gentler to the western edge. The outline and form of this feature may be properly described as lobate, four leaves, including the west end, showing on the south side, and three on the north side not symmetrical with or opposite those on the south side.

In structure and material the hill is composed of sand, gravel, silt, clay lumps and a very few boulders. The rock fragments are igneous, or crystalline material in great variety, rounded and polished after the manner of stream-worn waste. It is very irregularly bedded with a generally abrupt pitch to the west, or in the direction of the long slope of the hill. The pebbles are not in many cases larger than apples or baseballs, very few exceeding four or five inches in any diameter. Beds of fine sand,



Shawnee Mound. Excavation in North Side showing Material and Arrangement.



Shawnee Mound. (From the South.)

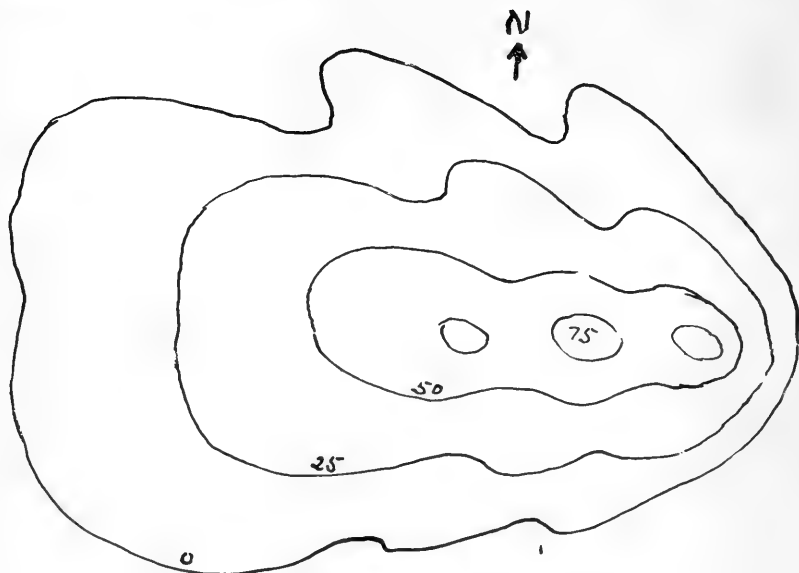
or even silt, are interstratified with layers containing the coarsest materials.

The best, probably the only, interpretation of the observed facts is, that this is a great alluvial cone built in or at the edge of the retreating ice sheet when its edge lay at the prominent Independence-Darlington Moraine, in the range of which this feature stands, although no other of its strong elevations appear in the immediately surrounding landscape, and not within two or three miles.

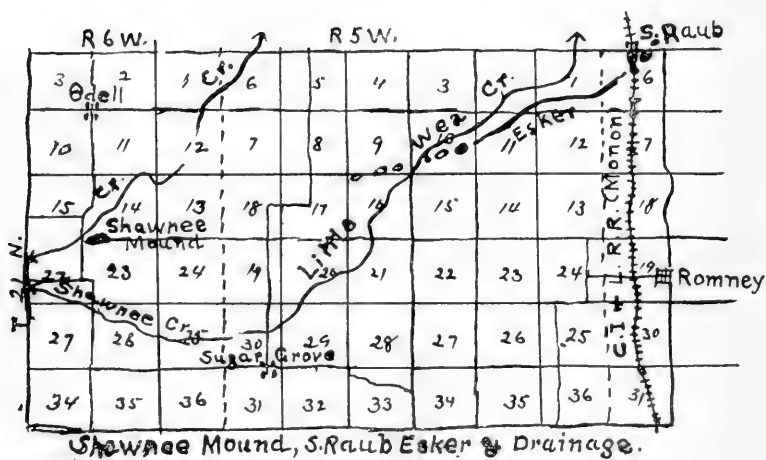
This great pile, for it is really quite impressive, represents the deposit of a stream of considerable volume flowing off or out of the ice at the time when the height or depth of the ice at this southwestern edge must have been not less than one hundred (100) and possibly several hundred feet. This stream flowed in a channel deep enough to confine it for a long time to this particular place. Possibly the channel was a deep canyon in the ice or a tunnel under it. As it heaped up the material at one point its course was diverted and a new direction of flow and construction was begun in true cone or delta building fashion.

An interesting question arises as to a possible relation between this hill and the gigantic South Raub Esker lying a few miles to the east northeast. The trend of this Esker is directly toward Shawnee Mound and the direction of the esker stream was southwest, but there is a gap of nearly five (5) miles, a distance as great as the length of the esker itself, between the west end of the esker and the Shawnee Mound cone, and no sufficient intermediate correlating features have as yet been found.

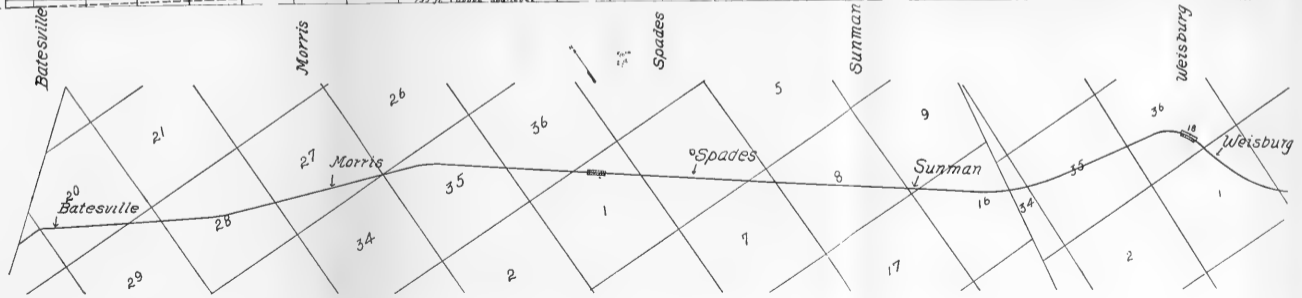
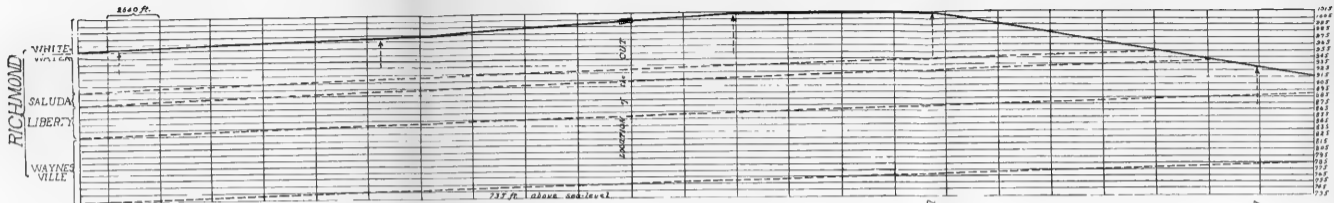
This discussion is presented to show the importance of detail work in interpreting the complex and little known phenomena of the great ice sheet.



Shawnee Mound.  
Contours Generalized









## CORRELATION OF THE OUTCROP AT SPADES, INDIANA.

H. N. CORYELL.

### INTRODUCTION.

The collections forming the basis for the present paper were carefully made by the Rev. T. A. Bendrat, M. S., during the autumn of 1913, from the exposure one mile west of Spades, Indiana. His careful description of the outcrop has been of considerable value in the correlation.

The identifications of the species were made in the laboratories of the Department of Geology of Indiana University under the supervision and direction of Professor E. R. Cumings and Dr. J. J. Galloway. Their assistance and suggestions have been of great value.

### THE PRESENT DIVISIONS OF THE RICHMOND.

#### *Richmond*—

- Elkhorn (*Platystrophia moritura* zone).
- Whitewater (*Homotrypa wortheni* zone).
- Saluda (*Tetradium minus* zone).
- Liberty (*Strophomena planumbona* zone).
- Waynesville (*Dalmanella meeki* zone).

### DESCRIPTION AND STRATIGRAPHY.

The reconstruction of the Cincinnati Division of the C., C., C. & St. L. Railroad through Ripley County, Indiana, in 1902-04 made available for study a section of strata high in the Cincinnati one mile west of Spades. The exposure at present is from five to six feet high and in places partially covered with debris, leaving, however, distinct ledges outcropping. The strata are approximately horizontal. The limestone at the base of the exposure weathers to a bluish-gray; it is very variable in texture, some portions being very finely crystalline, others containing quite large calcite crystals, as well as geode formations and iron concretions. Above this limestone the strata become more argillaceous, thinly bedded and present a distinct shaly structure.

This section possesses a distinct similarity to the upper part of the Whitewater section exposed at Richmond, Indiana, in being a very nodular, shaly limestone.

Though similarity in lithology is not a conclusive proof that two or more separated sections are parts of the same formation, yet the fact that there is a distinct resemblance does tend to lead favor to that decision.

A detailed description of this locality is given in the following section, taken from "The Stratigraphy and Paleontology of the Cincinnati Series of Indiana."\*

SECTION ALONG THE WEST FORK OF WHITEWATER RIVER AT  
RICHMOND, INDIANA.

(Number 1 is at the top of this section.)

1. Exposures in the bank above Thistlewaite Falls on the west fork of Whitewater River, about one and one-quarter miles north of the National road bridge across Whitewater River. Thin, lumpy limestone. *Rhynchotrema dentata* (aa). Several species of gastropode, including *Salpingostoma richmondense* (c). *Strophomena sulcata* (r)..... 8 feet.
2. Layer in the breast of the falls. Heavier layer at the top. Limestone. *Monticulipora epidermata* (e). *Platystrophia acutilirata senex* (c). *Homotrypa wortheni*..... 5 feet
3. West side of creek just below the falls. Bryozoa (aaa), *Monticulipora epidermata*, etc..... 5 feet.
4. Just north of the C. R. & M. R. R. bridge. Thin, shaly limestone, *Rhynchotrema capax*, the highest specimens. *Plectambonites sericeus* (rr)..... 5 feet.
5. Just south of the C. R. & M. R. R. bridge. *Rhynchotrema capax* (aa) ..... 4 ft. 8 in.
6. About one-eighth of a mile north of the road bridge across the west fork. *Ptylodictya plumaria*, etc..... 5 feet.
7. A short distance north of the junction of the east and west forks of the river. Limestone and intercalated shale. *Hallopora*, very similar to *H. rugosa*. No specimens of *Rhynchotrema dentata* 4 feet.

\*Prof. E. R. Cumings. Indiana Dept. Geology and Nat. Resources, 32d Ann. Rept. 1907.

## RELATION OF THE SPADES SECTION TO CUT 18 NEAR WEISBURG.

In all parts of the Tanner's Creek section there is a general dip of five feet to the mile, and we may assume that this dip holds over the five miles from Weisburg to Spades. This places the base of the Whitewater, which is exposed in the cut 18 just north of the station at Weisburg, seventy-five feet below the railway grade at Spades. In the Richmond section of the Whitewater, where the whole of the formation is exposed, a similar thickness is found, leading us to conclude that the outcrop one mile west of Spades represents the upper strata of the Whitewater. The position of the latter outcrop in reference to the Whitewater in the Ripley County locality is shown on the accompanying chart. The lines of dip have been extended to Batesville, five and one-half miles northwest of Spades, where there is sixty feet of Whitewater, portions of which are exposed in the stream gullies a few miles south of Batesville.

## RANGE OF THE SPECIES FOUND AT SPADES, INDIANA.\*

*Byssonychia grandis* Ulrich, Upper Richmond.

*Byssonychia obesa* Ulrich, Whitewater.

*Calymene callicephalo* Green. Common throughout the Cincinnati, especially at the top of the Waynesville.

*Dalmanella meeki* (Miller). Coryville-Arnheim and Waynesville.

*Platystrophia laticosta* (Meek). McMicken, Maysville and Richmond.

*Lophospira trophidophora* (Meek). Whitewater.

*Platystrophia acutilirata* (Conrad), Waynesville, Liberty and Whitewater.

*Platystrophia acutilirata senex* (Cumings). Upper Whitewater.

*Platystrophia laticosta* (Meek). McMicken, Maysville and Richmond.

*Protarea richmondensis* (Foerste). Waynesville, Liberty and Whitewater.

*Rafinesquina alternata* (Emmons). Throughout the Cincinnati.

*Streptelasma rusticum* (Billings). Waynesville, Liberty, Saluda and Whitewater.

*Arthropora shafferi* (Meek). Throughout the Cincinnati.

*Bythopora delicatula* (Nicholson). Coryville-Arnheim and Richmond.

*Dicranopora emacerata* (Nicholson). Maysville and Richmond.

*Hallopora* cf. *ramosa*. Richmond.

*Helopora elegans* Ulrich. Liberty and Whitewater.

\*See "Stratigraphy and Paleontology of the Tanner's Creek Section of the Cincinnati Series of Indiana."

Heterotrypa sp. undescribed. Upper Whitewater.  
 Homotrypa wortheni (James). Richmond and Whitewater.  
 Homotrypella hospitalis (Nicholson). Waynesville to Whitewater.  
 Nematopora cf. lineata (Billings). Middle and Upper Ordovician.  
 Rhinidictya lata (Ulrich). Waynesville.  
 Rhombotrypa sp. undescribed. Upper Whitewater.  
 Stigmatella sp.

SPECIES FROM NUMBERS ONE AND TWO OF THE WHITEWATER SECTION AT  
 RICHMOND, IND. (See section above.)\*

- Anomalodonta gigantis Miller.  
 Byssonychia grandis Ulrich.  
 \*Byssonychia obesa Ulrich.  
 Byssonychia suberecta Ulrich.  
 Ischyrodonta modioliformis Ulrich.  
 Pterinea demissa (Conrad).  
 \*Protarea richmondensis Foerste.  
 \*Streptelasma rusticum (Billings).  
 Cyclonema bilix (Conrad).  
 \*Lophospira tropidophora (Meek).  
 Salpingostoma richmondensis Ulrich.  
 Cytoceras sp.  
 Amplexopora sp.  
 \*Bythopora delicatula (Nicholson).  
 Bythopora meeki (James).  
 Ceramoporella ohioensis (Nicholson).  
 Corynotrypa inflata (Hall).  
 \*Dicranopora emacerata (Nicholson).  
 Hallopora subnodosa (Ulrich).  
 Heterotrypa prolifica Ulrich.  
 Heterotrypa subramosa (Ulrich).  
 Homotrypa austini Bassler.  
 Homotrypa flabellaris Ulrich.  
 Homotrypa flabellaris spinifera Bassler.  
 \*Homotrypa wortheni (James).  
 Monticulipora epidermata Ulrich and Bassler.  
 Peronopora pavonia (d'Orbigny).

\*The species marked with an asterisk are found in the section at Spades, Indiana.

*Homotrypella rustica* Ulrich.  
*Rhombotrypa crassimuralis* (Ulrich).  
*Dinorthis subquadrata* (Hall).  
*Hebertella occidentalis* (Hall).  
 \**Platystrophia acutilirata* (Conrad).  
 \**Platystrophia acutilirata senex* Cumings.  
 \**Rafinesquina alternata* (Emmons).  
     *Rhynchotrema denatatum* (Hall).  
*Strophomena vetusta* James.  
*Strophomena planumbona* (Hall).  
*Strophomena sulcata* (Verneuil).  
*Zygospira modesta* (Hall).

In comparing the fauna of this cut with the numbers, one and two, of the Richmond type section, we find that many species that appear in the type locality are not found at Spades, but those that do appear at Spades are undoubted Whitewater species. Those that are limited to and characteristic of, the Whitewater, are: *Homotrypa wortheni* (James?) *Platystrophia acutilirata senex*, Cumings. *Byssonychia obesa* Ulrich, and *Lophospira trophidopora* (Meek).

Twenty-four species were identified from Spades, three of which are new and undescribed. The description and discussion of their morphological structure will be given in a subsequent paper.



## THE PALEOBOTANY OF THE BLOOMINGTON, INDIANA, QUADRANGLE.

---

T. F. JACKSON.

---

The fossil plants herein discussed are, with three exceptions, Pennsylvania forms and were collected principally from two localities in the Bloomington, Indiana, Quadrangle. The greater part of them were obtained from a shale bed about one-fourth mile southeast of the Yoho School. This bed was made up of a succession of thin, bluish-gray clay-shales interstratified with thin sandy layers, with nodules of iron ore irregularly distributed throughout the entire bed. The shale layers were very soft and plastic when wet and both the shale layers and sandy layers were rather hard and very brittle when dry. One of the shale layers was very highly impregnated with iron oxides, and from this layer the best fossils were obtained. The entire bed attains a thickness of eight to nine feet.

The remainder of the Pennsylvanian forms were obtained from a thin, ferruginous sandstone layer and an overlying sandstone layer, about one-fourth mile southeast of Cincinnati. Molds and casts of *Lepidodendron* and *Calamite* forms were collected from the latter. The ferruginous sandstone layer contained a number of *Trigonocarpon* and a few *Carpolithes* forms.

Loose sandstone fragments of fossil plants, apparently of Pennsylvanian age, were noted in a number of places in the southwestern part of the Quadrangle, but, as their exact horizon could not be ascertained, those forms are not included in the following lists of species.

A few fragments of Mississippian forms were noted in the central and northern part of the west half of the Quadrangle. Those plants were very poorly preserved and at but one place were fossils obtained in a state of preservation such that identification was possible. Three species in a fair state of preservation were found in a sandstone layer a few feet above the Mitchell limestone, about one-half mile west of Whitehall.

Although a few of the Pennsylvanian plants examined represent new species and several others differ more or less from previously described forms it is not thought to be advisable to figure and describe those new forms at this time inasmuch as it is planned to include them in a later paper on the flora of the entire Pottsville section as represented in the State.

List of plants from the Yoho School locality :

- Sphenophyllum cuneifolium* (Stb.) Zeill.
- Sphenophyllum bifurcatum* Lx.
- Sphenophyllum tenerrimum?* Ett.
- Asterophyllites erectifolius* And.
- Asterophyllites gracilis* Lx.
- Calamostachys* sp.
- Lepidodendron clypeatum* Lx.
- Lepidodendron* sp.
- Alethopteris Evansii* Lx.
- Alethopteris grandifolia* Newb.
- Alethopteris louchitica* (Schloth.) Brongn.
- Alethopteris* sp.
- Pecopteris plumosa?* Brongn.
- Pecopteris* sp.
- Neuropteris Elrodi* Lx.
- Neuropteris Jenneyi?* D. W.
- Neuropteris* sp.
- Neuropteris fimbriata* Lx.
- Neuodontopteris?* sp.
- Pseudocopteris decipiens* Lx.
- Sphenopteris* sp.
- Sphenopteris communis* Lx.
- Zeilleria* sp.
- Cardiocarpon annulatum* Newb.
- Cardiocarpon cornutum* Dn.
- Cardiocarpon pachytesta?* Lx.
- Cardiocarpon* sp.
- Rhabdocarpus* sp.
- Carpolithes* sp.



A mere casual inspection of the above list will show the Pottsville aspect of the plants. Of these forms *Sphenophyllum cuneifolium*, *S. bifurcatum*, *S. tenerrimum?*, *Asterophyllites erectifolius*, *A. gracilis*, *Alethopteris Evansi*, *A. grandifolia*, *A. lonchitica*, *Neuropteris Elrodi*, *N. fimbriata*, *N. Jenneyi*, *Pseudopteris decipiens*, *Shenopteris communis*, *Cardiocarpon annulatum*, *C. cornutum*, *C. pachytesta?*, have not been reported, I believe, from formations younger than Pottsville age. Of those Pottsville forms *Sphenophyllum bifurcatum*, *Alethopteris Evansi*, *A. lonchitica*, *Neuropteris Elrodi*, *N. fimbriata*, and *Cardiocarpon cornutum* were reported by White\* as being confined to the Upper Lykens Coal group of the Pottsville type section. *Sphenophyllum cuneifolium* and *Cardiocarpon annulatum* were reported from both the Upper Lykens Coal group and the Upper Intermediate group of the type section. *Alethopteris grandifolia* was reported from the Lower Intermediate group in the type section. The vertical range of several of the remaining forms is either not definitely known or is too great for correlation purposes; the rest of the forms are too poorly preserved for specific classification. Therefore only those forms reported from the Pottsville type sections are considered of value for correlation. A comparison of the list of Pottsville plants from the Yoho School locality with the list of plants from the Pottsville type section indicates that the Pennsylvanian of the Yoho School area represents an horizon in the upper part of the Middle Pottsville of the type section.

List of plants from the Cincinnati locality:

- Calamites approximatus* Schloth.
- Calamites* sp.
- Lepidodendron clypeatum* Lx.
- Lepidodendron* sp.
- Neuropteris lunata?* D. W.
- Lepidophloios* sp.

Of the above listed forms *Calamites approximatus* and *Neuropteris lunata?* have been reported from the Upper Lykens Coal group of the type section of the Pottsville. *Lepidodendron clypeatum* has too great a vertical range to be of value as a horizon marker. The other forms were too

---

\*White, David. The Stratigraphic Succession of the Fossil Floras of the Pottsville Formation in the Southern Anthracite Coal Field, Pennsylvania. 20th Ann. Rep't. U. S. G. S. Part II, 1900.

poorly preserved for accurate classification. Considering only the forms first mentioned it would appear that the Pennsylvanian of the Cincinnati locality would fall within the Middle Pottsville of the type section.

Three Mississippian fossil plants, *Lepidodendron Volkmannianum* St., *Lepidodendron* sp., and a variety of *Stigmaria ficoides* were obtained from the Chester sandstone a few feet above the Mitchell limestone, about one-half mile west of Whitehall.

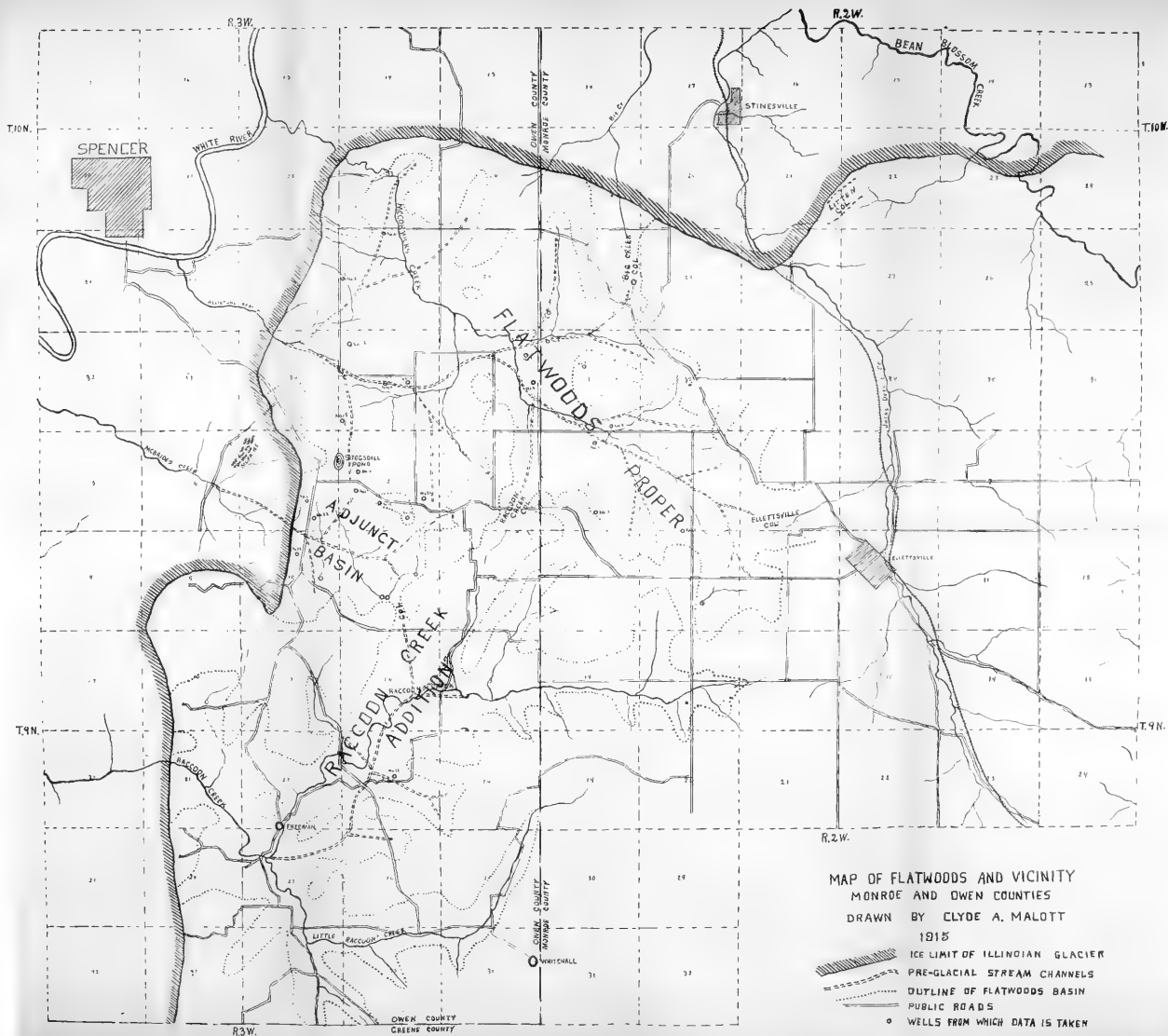
:OE

ounty,  
 ut two  
 study.  
 several






ne tex-  
 at the  
 basin,  
 ing the  
 re most  
 d there  
 and out  
 nto the

uniform  
 at the  
 he Flat-  
 ewhere,  
 uddenly  
 he slope  
 abrupt.  
 iscussed

5. This  
 at seven  
 Elletts-  
 re basin,  
 ; W., the



MAP OF FLATWOODS AND VICINITY  
 MONROE AND OWEN COUNTIES  
 DRAWN BY CLYDE A. MALOTT  
 1915

-  ICE LIMIT OF ILLINOIAN GLACIER
-  PRE-GLACIAL STREAM CHANNELS
-  OUTLINE OF FLATWOODS BASIN
-  PUBLIC ROADS
-  WELLS FROM WHICH DATA IS TAKEN

## THE FLATWOODS REGION OF OWEN AND MONROE COUNTIES, INDIANA.

---

CLYDE A. MALOTT.

---

### EXTENT AND TOPOGRAPHY.

Lying between Ellettsville, Monroe County, and Spencer, Owen County, Ind., is a strip of territory some six miles long and averaging about two miles wide, which has been the object of considerable curiosity and study. It is a low level basin nearly surrounded by higher land, yet having several openings in the surrounding periphery of hills.

The surface of the region is mainly an ash-colored soil of a fine texture, containing very little sand. It is in reality a silt region at the surface, and its outline is clearly discernible at the margin of the basin. This silt region, or its outline, is the principal means of determining the margin of the region, as indicated by the map. It coincides for the most part with the foot of the hills surrounding the basin. Here and there in the basin a hill rises out of the silt region somewhat as an island out of the water, and frequently a hill-like peninsula protrudes out into the region, rising high above the ash-colored silt margin.

The silt margin lying about the foot of the hills is rather uniform in height, averaging close to the 760-foot contour line, excepting at the northeast margin, where it extends much higher. This region of the Flatwoods area is also exceptional in regard to the periphery. Elsewhere, except at the openings, the hills surrounding the area rise rather suddenly above the basin; but here the margin is scarcely discernible, as the slope is very gradual and seems rather to fade out instead of being abrupt. This phenomenon is one of considerable importance and will be discussed later.

Lying in the long axis of the region is McCormicks Creek. This stream drains about nine-tenths of Flatwoods. Its head is about seven hundred fifty feet above sea level, one and one-half miles west of Ellettsville. The first few miles of its course is over the flat plain of the basin, which gives it but little fall. After leaving Section 36, T. 10 N. R. 3 W., the

fall increases slightly, and soon after entering Section 26, T. 10 N., R. 3 W., the stream has cut down to bed rock. The road leading east and west along the north side of Section 26 is practically the margin of Flatwoods in this vicinity. On this road a shallow ford crosses the creek on the 700-foot contour line, over a solid rock floor. From the source of the stream to this ford, a distance of about five miles, the stream has a fall of about fifty feet. It enters White River about two miles below, at an elevation of 540 feet above sea level. Thus the last two miles of the stream have a fall of 160 feet. Practically the entire last two miles of the course is over a solid rock bed. The region presents some of the most rugged and beautiful scenery in the State. The stream courses down a veritable gorge which is but little wider than the stream itself. Many cascades occur, and about a mile below the ford a fall of about 12 feet occurs. In low water the stream cascades over this fall, but when the water is high it rushes over with a roar that can be heard for some distance. Above the falls the floor of the gorge is swept clean of debris, but below, the gorge is wider, and in many places is chocked with the rock debris that has been carried from above or has fallen from the almost vertical walls on either side.

Just east of the source of McCormicks Creek is the source of a small branch which leads northeast through an opening in the rim of the basin and empties into Jacks Defeat Creek. This stream drains but little of Flatwoods, as indicated by the map. Its source is about the same height as the McCormicks Creek source, and its mouth, one and one-third miles northeast, comes out at about 670 feet above sea level, thus giving it a fall of eighty feet.

Another break in the rim of the basin occurs in Section 30, T. 10 N., R. 2. W., about two miles southwest of Stinesville. This opening is narrow and its surface is below the 700-foot contour line. To the north of the narrow opening is a wide flat plain similar to the Flatwoods, having a silt surface of the same nature. This flat is drained into Big Creek. The narrow opening itself is practically bed-rock at the surface. Sinks occur in it. A small portion of Flatwoods is drained into a deep sink near the northwest part of this section. The water that goes into this sink undoubtedly passes under the narrow opening and comes out into Big Creek below, as several springs occur in the upper part of this creek. Just to the west of this narrow opening is a high hill capped with sandstone, which is at least sixty feet higher than the opening. The silt line

can be distinctly seen on practically all sides of this hill, coming slightly above the 760-foot contour line.

About one and one-half miles southwest of Ellettsville in the southeast corner of Section 8, T. 9 N., R. 2 W., is a sink which has a small stream entering it, and draining about one-half square mile of Flatwoods. This stream has lowered this corner of Flatwoods considerably below the general level. The water that goes into the sink flows out about a half mile to the southwest from a couple of large springs which drain into Raccoon Creek.

Perhaps the most interesting opening in the periphery of the basin occurs in Section 1, T. 9 N., R. 3 W. This opening leads into a tributary of Raccoon Creek, and is at least a third of a mile wide. To the east of it is a high hill or ridge attaining a maximum height of 910 feet, and on the west another ridge reaches above the 880-contour line. The floor of the opening itself is twenty-five feet or more below the silt-line on the sides of the hills. This opening is really a connection between Flatwoods proper and a continuation of it in the Raccoon Creek Valley. Consideration will be given it later.

There is yet another outlet to the Flatwoods region, which at first was very puzzling to the writer. At the western extremity of the basin Allistons Branch reaches into it by many deep and narrow tributaries. These tributaries are almost invariably headed by seepage springs which come out into the sandy material in which the tributaries are cut. The basin itself is some higher at this western part. The basin cannot be said to have a margin at this western limit; it ends more or less abruptly in the tributaries of Allistons Branch. If it ever had a peripheral margin at this end it has been effaced by the V-shaped valleys leading into Allistons Branch. The writer intends to prove that this western end never had a distinct margin, that is, like the so clearly identified ones on the southern and northern periphery of the region.

From the silt line at the foot of the hills, the slope of the basin is generally inward toward the mathematical center. The lowest part of the basin (not considering the valley and channel of McCormicks Creek) is along the Monroe-Owen County line, between sections 31 and 36, T. 10 N., and branching off from this along the southern part of section 31 and along the northern part of section 36. This region is very fertile, being almost entirely a black loamy soil. The white silt of the bordering

regions passes under this black soil. But farther out into the black soil, the silt underneath almost pinches out. The low region containing the black soil was undoubtedly the centre of the basin in former times, even as it is now. This low-lying, fertile region is very near the 720-foot contour line; thus it is some forty feet below the silt line at the foot of the hills surrounding.

It was said that the slope of the basin is generally toward the mathematical center; this is not true specifically, as there are some exceptions. Several places considerably elevated occur. The large one in Section 31, T. 10 N., R. 2 W. reaches to the height of 795 feet, approximating the peripheral regions. A well shows that bed rock is near the surface of this old monadnock. In section 36, west of the above, a long arm-like island projects out into the basin, and near the south of the middle of the section a notch occurs in the arm, which almost separates the north end, leaving a round-like knob projecting some forty feet above the basin. This elevation also has bed-rock in it near the surface. Section 25, T. 10 N., R. 3 W. has two elevations some twenty feet above the general level of the basin. It was not determined whether these had bed-rock near the surface, but indications are, especially in the western one, that it is there at a shallow depth. The elevation on the section line between sections 26 and 35, T. 10 N., R. 3 W. is a rounded knoll about twenty-five feet above the general level of the basin. Indications are that it contains no bed-rock. The northern part of Section 6, T. 10 N., R. 2 W., contains a slight elevation, perhaps twelve feet above the low-lying area adjacent. A deep well proves that it contains no bed-rock. Southeast in section 5, and entering section 8, is a long elevation parallel to the long axis of the basin and about twenty feet high. A well proves that this one also contains no bed-rock.

While dealing with the irregularities of the surface of the basin, attention must be called to the depression at the southwestern edge of Flatwoods, on the section line between sections 2 and 3, T. 9 N., R. 3 W. This depression, containing about two acres, is the site of a small lake which is being rapidly filled by in-wash and vegetation. The elevation of the surface of this small lake, bearing the name of Stogsdill Pond, is about 770 feet. It is enclosed on three sides by sloping banks which reach thirty feet above the water. It is open on the north.

The south bank of Stogsdill Pond is the lowest opening to a sort of an adjunct to the Flatwoods basin. The surface of this adjunct slopes



gradually from the bank of the pond for about one and one-fourth miles to the south, and in its lowest place, a series of sinks jutting against the bed-rock hills at the south, comes down to the 700-foot contour line. This adjunct basin is about as broad as long. It is drained mainly by two southward extending streams that come to the series of sinks at the south end. A third but much smaller southward flowing stream drains the western side. It also disappears in a sink in the southwest corner of the region. The western edge, near the middle of sections 3 and 10, ends abruptly in the rapidly headward-etching streams of the headwaters of McBrides Creek. The eastern rim is the ridge of highland which has been mentioned as the western rim of the opening extending into the Raccoon Creek Valley. This same ridge turns to the west and forms the southern rim of the adjunct basin also, and beneath which the waters of the region flow in their underground passage. This small adjunct basin undoubtedly once had a smooth and gentle slope from the southern rim of the western part of Flatwoods proper to the high ridge at the south, but subsequent drainage through sinks at the southern end has eroded it into three main grooves with many smaller tributary grooves. The slope began at the north at an elevation of more than 800 feet, and ended at the southeastern corner at 740 feet. The west part of the southern end was somewhat higher, perhaps 760 feet. It was lowest at the southeast corner, because at this place there is an opening in the bed-rock ridge, which leads to Raccoon Creek. This opening will be called into account later.

We are now ready to go back to the broad opening in the middle of the southern periphery of the basin, and see the extension of the Flatwoods basin to the south. As has been said before, the floor of this opening is slightly below 740 feet, and that the silt line extends as high as 760 feet. Soon after leaving the opening, the silt line on the side of the ridges becomes more or less indistinct, since erosion has either erased it or covered it over. Still farther south not only the silt line is removed, but much of the one-time basin-flat itself is removed. The flat, however, can be traced for four and one-half miles south and some west down the valley, or rather above the valley of Raccoon Creek. The creek here turns abruptly and flows to the northwest, at a right angle to the course above. Modified portions of the old flat are distinct for two or more miles northwest of the sharp turn.

It is understood, then, that this Raccoon Creek addition is very much eroded by the present stream and its tributaries. But it is important to

notice the elevation of the flat itself. Where it leaves Flatwoods proper, it is somewhat below the 740-contour. The slope is gradually downward from this place to the south. In the vicinity of Freeman the elevation of the flat is 700 feet. This makes a gentle slope down the valley southwest of a little less than ten feet to the mile. The Raccoon Creek addition extends up the creek almost as far east as the eastern margin of Flatwoods proper. The old flat is recognizable for three and one-half miles up Little Raccoon Creek, which enters Raccoon Creek from the southeast near Freeman. The extent and shape of the addition can be seen by consulting the map. It contains in all about eight square miles. Thus this addition and the adjunct south of Stogsdill pond make an area approximating that of Flatwoods proper.

While dealing with the Raccoon Creek addition of the Flatwoods basin, it must be emphasized that it occurs only in remnants. There are, however, quite large areas, sometimes a quarter-section or more, that have suffered little erosion. In such cases, or in cases where much smaller areas are preserved, there occurs the same flat, ash-colored, crawfish soil that is so characteristic of Flatwoods proper. Second to these flats, the most striking physiographic feature is the terraces resulting from the streams cutting down into the flat. The terraces begin almost immediately after entering the gap from Flatwoods proper. Here they begin at zero, but soon become quite a distinct feature. They grow higher very rapidly, so to speak, as the stream cuts down into the flat to the south. At Freeman, four and one-half miles below the gap, the stream has cut down one hundred feet below the old flat, and the terraces are accordingly one hundred feet above the stream. But in this vicinity there are many places where the terraces are indistinct, as they are so eroded that they no longer appear as terraces. This condition occurs in the immediate vicinity of Freeman. Beyond a slight bed-rock hill to the east of Freeman, however, the flat is distinctly discernible, and the terraces show beautifully above the small tributary streams that are etching their way into it.

#### UNDERGROUND INFERENCES AS REVEALED BY WELLS AND BORDERING REGIONS.

Having dealt somewhat with the extent and topography of the Flatwoods region, we shall now turn to a slightly different phase. Perhaps the most interesting particulars of the region are the underground inferences as they are revealed by the wells of the region and by the places along the western margin, which have suffered erosion by the rapidly

encroaching streams from the west. Data from shallow wells, while revealing interesting sub-surface particulars, are not sufficient to give the shape of the pre-existing basins of the region. The deep wells, the wells which reach bed-rock, are important in this respect. There are only a few such wells; enough, however, were found to reveal an intelligent idea of the shape of the pre-existing basins, and the character of the material filling them. These things are of the utmost importance for working out the history of the region, which was the chief reason of time and attention being given to the area.

The easternmost part of the region is very probably not filled to a great depth. The sinks that abound indicate that bed-rock is near the surface. Sections 4, 9 and 8 contain sinks; these sections are at the eastern margin, and it might be easily deduced that the bed-rock is near the surface.

*Well No. 1.* Out some distance in the basin, on the southern line of Section 5, T. 8 N., R. 2 W., near the headwaters of McCormick's Creek, is a well at Mr. Fife's which is twenty odd feet deep. This well furnishes a copious supply of water which comes from sand underlying a shallow surface stratum of soil. This well proves that the elongated elevation is a product of the forces which made the topography of the region, and not a remnant or hill in the former basin.

*Well No. 2.* This well is situated in the middle southern part of Section 6, T. 9 N., R. 2 W., and is on the edge of the silt line at the foot of the hill. It is sixteen feet deep and reaches solid stone. The material through which it passes seems to be entirely the outwash or talus from the hill rising up behind it.

*Well No. 3.* Middle northern part of Section 6, T. 9 N., R. 2 W., at W. Stone's. Surface elevation 730 feet. The depth of this well was not ascertained but reports indicate that it is of considerable depth to bed-rock.

*Well No. 4.* Southwestern part of Section 31, T. 10 N., R. 2 W., at H. Heady's. Surface elevation, 723 feet. Depth, 14 feet. Soil, with streaks of yellow and blue containing fine sand, 12.5 feet. Caked sand, of a yellowish sugary appearance when wet, becoming like brittle sandstone upon drying, 1.5 foot.

*Well No. 5.* This well is in the high hill to the north of well No. 4. It reaches bed-rock at a shallow depth.

*Well No. 6.* On the county line, middle eastern part of Section 36,

T. 10 N., R. 3 W., at Mr. Whitsell's. Surface elevation, 720 feet. Depth, 12 feet. Under a shallow surface soil occurs a blue clay which contains very fine, angular sand grains. These grains are invisible to the eye, though they may be felt when the dry material is rubbed between the finger and thumb. This very fine sandy clay is very tough, tenacious, and slightly sticky when wet, and of a distinct blue color. On exposure to the air it takes on a brownish-grey hue. When dry it is an ash color. Application of muriatic acid shows that it is highly charged with calcium carbonate. (This detailed description is given because this material is often encountered in the lower parts of wells. Hereafter it will be designated as blue clay. It will be further discussed later.)

*Well No. 7.* One-fourth mile north of well No. 6, at the residence of B. Smith, is a well which reaches bed-rock at a depth of 12 feet. The surface elevation is 720 feet.

*Well No. 8.* One-eighth mile northeast of well No. 7, N. W. corner of Section 31, T. 10 N., R. 2 W., at C. Wampler's. Surface elevation, 720 feet.

|                      |          |
|----------------------|----------|
| Soils .....          | 17 feet. |
| Imbedded logs.....   | 1 foot.  |
| Clay .....           | 8 feet.  |
| Gravel and sand..... | 1 foot.  |
| Limestone .....      |          |

*Well No. 9.* One-eighth mile north of No. 8, southwest corner of Section 30. Surface elevation, 720 feet. Depth to stone, 51 feet.

|                      |          |
|----------------------|----------|
| Soil and clay.....   | 18 feet. |
| Sand and gravel..... | 4 feet.  |
| Blue clay.....       | 29 feet. |
| Limestone .....      |          |

In the northwest corner of Section 25 and leading far into Section 24, T. 10 N., R. 3 W., is an arm or extension of the Flatwoods basin, which is filled very little. Sinks are very numerous, showing limestone in many places. The general elevation of this extension is 740 feet.

*Well No. 10.* In the northwest part of Section 26, T. 10 N., R. 3 W., at Frank Marshall's. Surface elevation, 725 feet. Depth to stone, 47 feet.

|                      |          |
|----------------------|----------|
| Sandy clay soil..... | 40 feet. |
| Sand and gravel..... | 4 feet.  |
| Soil .....           | 3 feet.  |
| Limestone .....      |          |

Mr. Marshall also has a dug well; it is twenty feet deep. It seems to be in clay soil except near the bottom, where sand occurs. A stick was found in this sand.

Some twenty-five rods east of Mr. Marshall's drilled well is the ford on the road across McCormicks Creek, where rock outcrops at 700 feet. Bed-rock was struck at least twenty-two feet lower than this in the Marshall well. Farther up McCormicks Creek, about three-quarters of a mile, bed-rock is to be seen in the creek bed, and just above, two remarkably large springs pour forth clear, cool limestone water, indicating that bed-rock is near the surface.

*Well No. 11.* Middle western part of Section 26, one-half mile southwest of No. 10. Surface elevation, 740 feet. Depth to stone, 110 feet.

|                 |          |
|-----------------|----------|
| Soil .....      | 20 feet. |
| Sand .....      | 16 feet. |
| Blue clay.....  | 74 feet. |
| Limestone ..... | 21 feet  |

*Well No. 12.* Northwest corner Section 35, one-half mile south of No. 11. Surface elevation, 740 feet. Depth to stone, 74 feet.

*Well No. 13.* East of the center of Section 35, T. 10 N., R. 3 W. Surface elevation, 735 feet. Depth, 22 feet. This well seems to be entirely in a reddish sand.

*Well No. 14.* Center of Section 35, one-eighth mile west of No. 13, at John Leonard's. Surface elevation 735 feet. No stone reached at a depth of 116 feet.

|                                               |          |
|-----------------------------------------------|----------|
| Soil .....                                    | 1 foot.  |
| White sand, with small pebbles infrequently.. | 80 feet. |
| Blue clay .....                               | 36 feet. |

*Well No. 15.* Southwest corner of Section 35, one-half mile southwest of No. 14, in an open field. Dug well. Surface elevation, 745 feet. Depth, 41 feet.

*Well No. 16.* One-eighth mile east of Stogsdill Pond, Section 2. Surface elevation, 820 feet. This well is 40 feet deep, and is entirely in a reddish sand containing some water-worn gravels. This well contain no water.

*Well No. 17.* One-sixteenth mile south of No. 16. Surface elevation, 795 feet. This well was reported by two persons to be 80 feet deep, in a reddish sand its entire depth. The writer is inclined to believe there is some mistake regarding its depth. It is not likely over 50 feet deep.

*Well No. 18.* One-eighth mile southeast of No. 17, at Geo. Myers'. Surface elevation, 825 feet. Depth to stone, 25 feet, in seemingly the residual limestone soil.

*Well No. 19.* One-fourth mile southeast of No. 18, on high, rounded hill, at Amos Barker's residence. Surface elevation, 860 feet. This well encountered Chester sandstone at a shallow depth.

*Well No. 20.* One-fourth mile northeast of No. 19. Surface elevation, 825 feet. This well penetrates almost pure sand to a considerable depth.

*Well No. 21.* Middle of southeast  $\frac{1}{4}$  Section 3, T. 9 N., R. 3 W., at A. Evans'. Surface elevation, 780 feet. Depth, 42 feet.

|                                |          |
|--------------------------------|----------|
| Soil .....                     | 18 feet. |
| Reddish sand (quicksand) ..... | 24 feet. |

*Well No. 22.* One-fourth mile south of No. 21, at C. R. Ellis's. Surface elevation, 775 feet. Depth to stone, 51 feet.

|                                  |          |
|----------------------------------|----------|
| White to yellow soil .....       | 18 feet. |
| Water-worn gravel and sand ..... | 6 feet.  |
| Quicksand .....                  | 27 feet. |
| Limestone .....                  | 92 feet. |

*Well No. 23.* Middle of northern one-half Section 10, one-half mile south of No. 22, at the County Farm. Surface elevation, 765 feet. This well penetrates soil and sand nearly fifty feet.

*Well No. 24.* Center of Section 23, T. 9 N., R. 2 W., at A. O. Collins'. Surface elevation, 690 feet. Depth to stone, 88 feet.

|                         |          |
|-------------------------|----------|
| Red sand and clay ..... | 35 feet. |
| Blue clay .....         | 53 feet. |
| Limestone .....         | 1 foot.  |

This completes the number of wells from which data was secured. The reader can see at once that the greater number of them reveal the fact that Flatwoods was in former times a basin much deeper than it is now. It seems that the basin was rather deep at the northern part of Section 6, as indicated by well No. 3. This deep portion extended north-west, entering Section 36, and thence northward, but went northward for only a short distance, along the present channel of McCormicks Creek, until it turned westward as indicated by the shallow bed-rock in well No. 7. Wells No. 8 and No. 9 indicate that a tributary channel passed near the southwest corner of Section 30. This channel probably entered the

main channel near the northern middle of Section 36. The bed-rock outcrop along McCormicks Creek in the southeast part of Section 26 indicates that the region to the northeast was high, very probably a divide between the tributary just mentioned and the one that undoubtedly came from the northeast of section 24. Wells Nos. 10, 11 and 12, by their depth to bed-rock; reveal a channel region running south and southwest from section 23, from near where McCormicks Creek leaves the Flatwoods region. A small tributary in bed-rock flowing its water in the up-stream direction, just west of where McCormicks Creek turns west in section 23, also indicates that a channel once went southwest from this region. There is no doubt in the mind of the writer that this region and also the long extension north into section 24, was drained to the west and north through a well developed underground system. Well No. 14 shows that the ancient surface was more than 116 feet below the present surface, and more than eighty-five feet below the bed of McCormicks Creek a mile to the north. At this place the old stream channel must not have been far from the 600 foot contour line.

The western border of Flatwoods in the region of the headwaters of Allistons Branch reveals facts in harmony with those shown by the wells. The tributaries of this creek are etching their way slowly into the Flatwoods region. The etching is slow because the slope is away from them, thereby causing practically all the water, except that which falls immediately into them, to flow in the opposite direction. These tributaries are deep, V-shaped valleys or ravines in the sandy material at this margin of the region. A typical ravine may be found just south of the middle of section 27. It begins at an elevation of 760 feet, and descends rapidly to a depth of sixty feet or more. The sandy banks on either side are very steep. Small erratic boulders may be found in the narrow bottom, amid which trickles water seeping from the sandy banks near the bottom. The descent continues rapidly until near the 620 foot contour. A small valley flat then begins to appear, and soon the main stream is reached. The entire length of this ravine is less than one-fourth mile, and a descent of at least 150 feet has been made. The slope away from the Flatwoods region towards White River, much cut up by etching ravines, is very rapid; this makes the banks or sides of the etching ravines higher near their heads than farther down.

The great amount of sandy material at the head waters of Allistons Branch indicates that the old channel found and traced westward by the

wells had its course entering Allistons Branch near its head-waters. The present Allistons Branch, then, is the lower part of the main stream that in former times principally drained the area now occupied by Flatwoods. The map shewing the main drainage, the main channel and its tributaries, are inferences that can scarcely be avoided. There are indications, however, that portions were drained by underground channels to other streams; as, for instance, the extreme southeast corner, the eastern part of section 30 and the portions already mentioned near the northwest corner of the region. The sinks of these portions are evidences that their drainage was as it is now, and was only temporarily interfered with by the forces that destroyed the old drainage. Very probably other portions of considerable area were drained into the main channel from underground passages, the water coming to the surface farther down in the form of springs.

Next, the relation of Flatwoods proper with the adjunct south of Stogsdill Pond will be considered. The lack of any deep well immediately west of Stogsdill Pond leaves the data somewhat incomplete, but this portion has an elevation of 820 feet, and it seems likely that bed-rock is much higher here than either to the north or to the south. Bed-rock outcrops at 760 feet one-half mile west of this portion, and it is found at 800 feet in Mr. Myer's well one-half mile southeast. Thus it is very probable that there was a divide between Flatwoods proper and the small adjunct to the south. It must have been very low near Stogsdill Pond, for wells Nos. 16 and 17 penetrate sand their entire depth, and No. 17 was said to be eighty feet deep, but, as said before, the writer doubts the reputed depth of this well.

The region east of the Myer's well seems to have been considerably filled, as indicated by well No. 20, and the sharp ravines which are etching their way in the flat area near by. Examinations of these ravines show that they contain no bed-rock, but were rather grooved into the stratified sand and fine gravel of which the flat area is composed.

In the extreme southwest corner of section 1 is also a filled area, but farther east bed-rock is found, and on top of the ridge there is no sign of silt or sandy material. Undoubtedly the head of a stream reached into this corner, near where the present stream is endeavoring to clean out the filled-in material. Thus the evidence shows that a divide with a very irregular summit once separated the adjunct basin from Flatwoods proper.

Turning to the western edge of the adjunct basin, we find sharp V-shaped valleys or ravines of McBrides Creek etching their way into the



body of the flat in the same manner that the tributaries of Allistons Branch are etching their way into the western edge of Flatwoods proper. These ravines descend almost suddenly a hundred feet below the level of the flat. In several places the structure of the material can be seen. The upper fifteen to twenty feet is a fine, white soil, characteristic of the surface of the Flatwoods region. Underneath this, is reddish sand with layers of fine gravel alternating with the much thicker layers of sand. Water comes from the sand and gravel into the ravine, making them miry in the bottom. These ravines, in conjunction with the wells (Nos. 21, 22, and 23) clearly reveal that the region has been filled, and that the adjunct basin had a broad outlet, or opening, to the west. McBrides Creek must have extended much farther east, draining in all probability the greater part of the adjunct, and having its tributaries reaching to the divide between the adjunct and Flatwoods proper.

It might be mentioned that the streams in section 11 have cut themselves down into the filled material at least fifty feet and leave the old flat above as a beautiful terrace. The material of this terrace is shown in an excellent manner along the steep western side of the middle stream. It is as follows:

|                |         |
|----------------|---------|
| Soil .....     | 12 feet |
| Red sand.....  | 25 feet |
| Blue clay..... | 5 feet  |

McBrides Creek undoubtedly had its upper portion and upper tributaries taken away from it by the forces that remade the topography of the region. But it is rapidly working its way back into its old domain in the same manner that Allistons Branch is trying to recapture its old basin. The rapidity with which these tributaries etch back into the filled material can be seen in a single ravine just north of C. R. Ellis' house in the middle of the southeast quarter section 3. The main stream flows parallel with the road, and the short tributaries come into it at right angles. These tributaries are, in fact, just immense gullies only a few rods long, but with the depth easily forty feet. The water during showers gushes into these ravines and carries away the easily transported sand at the bottom, leaving the soil above to slump into the ravine, which is then in turn rapidly carried away. These ravines grow directly in proportion to the amount of water entering them at their head. Mr. Ellis stated that eleven years ago, the head of the particular ravine mentioned above was at least sixty feet

west of the road. Now, it is at the very road ditch, and immediately descends twenty-five feet. If nothing should interfere with it, it would in a short time destroy the road here by etching into it.

There is no doubt in the mind of the writer that McBrides Creek at one time extended eastward to the very divide between the adjunct basin and Raccoon Creek, but evidence shows that probably most of the water that fell into its upper portion was carried by underground drainage either to the lower part of the stream or to the east and to the south to Raccoon Creek. At present practically all the water falling into the adjunct basin goes into Raccoon Creek, mainly through the sinks at the southeast corner of the adjunct region. Two very large springs come out about a mile south of where the water enters these sinks, which in all probability are outlets of underground channels beginning at the sinks in section 11.

The Raccoon Creek addition of Flatwoods may be treated in a few words. This region was the site of an old stream which followed the same valley that the present stream does. The present stream, as stated before, has cut itself down into the old flat and in some places has removed much of the filled-in material. Raccoon Creek, however, does not reach bed-rock until it is at least 100 feet below the old flat, as found in the southern part of section 26. Yet there is a short distance that the stream passes over rock in a rather constricted place in the middle northeast part of the same section. This portion of the stream has evidently been cut since the time that the old valley was filled. The old stream evidently passed to the east of this place, as indicated on the map.

The faces of the terraces have but few portions that show the material of the terraces, but the few that are shown, and the rock structure of the higher areas, along with the sinks in the terrace flat, reveal the ancient drainage lines in a very able manner. The small tributary entering Raccoon Creek just north of the mouth of Little Raccoon Creek once extended nearly three-fourths of a mile farther east than it does now. It is making heroic efforts to recapture its old drainage basin: it is being aided by underground drainage, much material having been carried away leaving great sinks in the one-time flat. A small tributary no more than one-fourth mile long enters Raccoon Creek from the east in the middle of section 23. This tributary is a very small one in comparison to its predecessor. The old tributary extended nearly two miles eastward. Practically all of this region is now drained by sinks, which have caused the old flat to be considerably depressed locally. Well No. 24 is near the site of this old

tributary. It shows the filled-in material to be eighty-eight feet deep; that makes the old tributary somewhat below the present level of Raccoon Creek, where the present tributary enters. But not more than thirty rods to the northeast of the well, limestone outcrops. This indicates that the long hill protruding westward from section 24 was continued as the northern divide of the old tributary.

#### THE PRE-GLACIAL GEOLOGY OF FLATWOODS.

In considering the geology of the Flatwoods region, it is thought best to divide it into two main divisions. The first division includes the rock structure of the region and the subsequent history up to the Pleistocene. The second division begins with the Pleistocene and takes in all up to the present. The rock structure of the region and immediate vicinity is of Middle Mississippian age with some Pennsylvanian bordering closely on the west. The stratigraphy of the region will be given a brief treatment.

*Knobstone Group.* Just to the east of the region in the valley of Jacks Defeat Creek, are the upper portions of the thick Knobstone Group of shales and sandstones. The area of its outcrop in Indiana is a strip of territory some twenty-five miles wide, extending north, northwest from Floyd County to Benton County. This formation consists of compact, insoluble, impervious sandstones and shales, aggregating a thickness from 400 to 600 feet. The topography of the outcrop, resulting from the peculiar weathering of the rocks, is of a distinct type. The rocks absorb water readily, but transmit it poorly, so that they are easily shattered by freezing and thawing. The region is weathered and eroded into deep, steep-sided valleys of very pronounced relief. Brown County affords a typical example of Knobstone topography. Another characteristic of this group of rocks is the general absence of fossils, such being present only very locally. It seems that the shales and sandstones were laid down in impure, muddy waters, which were not on the whole very favorable for the life of water-breathing animals.

*Harrodsburg Limestones.* Overlying the Knobstone is the Harrodsburg limestone, with a thickness varying from sixty to 100 feet. This limestone consists of several heavy bedded layers of hard, gray to blue, often highly crystalline stone. There are occasional intercalated thin beds of shale. In some sections a very cherty layer occurs. The top member of this stone often is very massive, and its texture is very similar to the oölitic bed overlying. Geodes are characteristic. The limestone as a whole is

very fossiliferous, showing that life was abundant when it was laid down. The area of outcrop is narrow and intermingles with the western edge of the Knobstone, often capping outliers of the latter. It has no distinct topography outside of the fact that sinks occur in it, which never occur in the Knobstone, and rarely in the formation above it.

*Salem Limestone.* Superior to the Harrodsburg formation is the famous Salem limestone known as the Oölitic, or Bedford limestone. It is an excellent building stone, and is known as such all over the United States. Typical outcrops of it occur along the valley of Jacks Defeat. The stone is usually massive, with few indications of bedding, varying from a few feet up to eighty and ninety feet in extreme cases. The stone typically is a porous stone composed of nearly pure calcium carbonate. It is made up principally of broken animal remains and several species of Protozoa, among which the main one is *Endothyra baileyi*. These have all been cemented together in a loose manner. The area of its outcrop is characterized by long, gentle slopes, rounded hills and general undulating topography.

*Mitchell Limestone.* The Mitchell limestone is the one that we are mostly concerned with, since practically the entire basin of the Flatwoods region is in this stone. It ranges in thickness from a few feet in its northern outcrop to 250 feet in the southern part of the State. The stratigraphy of this formation is rather varied, as there are rarely two successive layers alike. In general it consists of impure limestones and calcareous shales, usually thin. Many layers are very hard, and weather white, sometimes small slabs having the appearance of bleached bone, and on being struck have a metallic ring. Such layers usually have numerous right-angled joint cracks, and are semi-lithographic, breaking with a sub-concoidal fracture. The upper members of this formation are usually a beautiful oölitic structure. As a rule the limestone is fossiliferous. The area of the outcrop of the Mitchell limestone extends over a broad plain which narrows to the north and pinches out in Montgomery County. It is essentially a cave-bearing formation, containing some of the most famous caves in the world. Wyandotte and Marengo caves of Crawford County and Mammoth cave of Kentucky are in this stone. The region of its outcrop is pitted with sinks, and underground drainage is a distinct and noticeable feature. Lost River of Orange County is a typical example of an underground stream in the Mitchell area. Hundreds of sinks occur on the borders of the Flatwoods region, where the filled material is relatively

thin. These sinks connecting with under-channels are the sources of many springs that abound in and at the borders of the region.

*Chester Group.* On the high hills at the borders of the Flatwoods region shales and shaley sandstones overlie the Mitchell. These are usually about twenty-five feet thick, and upon them is a limestone usually about three feet thick in the Flatwoods exposures. This group is known as the First, or Lower Chester. On top of the First Chester limestone occur a series of shales and sandstones, consisting of a portion of the Second Chester group. This group is capped by a limestone, its last member. At no place in the immediate vicinity of Flatwoods was the top of the Second Chester found.

The above general outlined stratigraphy is found in the Flatwoods region and portions directly connected with it. Some attention now will be given to local details.

The general dip of the rock of the Bloomington Quadrangle, in which a portion of Flatwoods occurs, is on the average twenty feet to the mile to the west, southwest. In regard to the dip of the rock structure in the Flatwoods region, the following data reveal an interesting feature:

Contract of Mitchell and First Chester, south side Flatwoods:

|                                                                       |     |
|-----------------------------------------------------------------------|-----|
| In 920-foot hill, N. W. $\frac{1}{4}$ , sec. 16, T. 9 N., R. 2 W..... | 870 |
| In 900-foot hills, S. $\frac{1}{2}$ , sec. 7, T. 9 N., R. 2 W.....    | 845 |
| In W. part of hill N. W. $\frac{1}{4}$ , sec. 7, T. 9 N., R. 2 W..... | 820 |
| In centre of S. $\frac{1}{2}$ , sec. 1, T. 9 N., R. 3 W.....          | 800 |
| One-half mile N. of above.....                                        | 805 |
| S. W. side of hill, S. E. $\frac{1}{4}$ sec. 2, T. 9 N., R. 3 W.....  | 800 |
| Middle N. of N. W. $\frac{1}{4}$ sec. 3, T. 9 N., R. 3 W.....         | 720 |

North side of Flatwoods:

|                                                                  |     |
|------------------------------------------------------------------|-----|
| In 810-foot hill, Middle sec. 30, T. 10, N., R. 2 W.....         | 790 |
| Chambers Hill, middle of line, sec. 24-25, T. 10 N., R. 3 W..... | 810 |

The data along the southern side of Flatwoods reveals an average dip of thirty-feet to the mile along a line which is as much in the direction of the strike as in the direction of the dip. Again, going from the eastern contacts toward the western, the data indicates that the first two-thirds of the distance has a dip of twenty feet to the mile, and the remaining distance a dip of fifty feet to the mile. The data on the north side is very meagre, as there are only a few hills high enough to reach the Mitchell and Chester

contact. Only the eastern half of the north side is represented by contacts. Here, two contacts were found, but these reveal a rather striking feature. The two contacts are one and one-fourth miles apart, the west one being a mile west and one-half mile north of the eastern contact. Judging from the general dip of the rock structure, one would expect the western contact to be several feet lower than the eastern one. But the reverse is true, the eastern contact is actually twenty feet lower.

Having absent contacts for the western part of the north side, the data does not give absolute information, but the indications point decidedly to the fact that a monocline or an anticline, with its long axis extending parallel with McCormicks Creek, exists in the Flatwoods region. This means that Flatwoods proper is an eroded anticline. This interesting structure indicates that the possibilities for oil are much stronger than a guess. However, it is possible and even probable that the anticline is superficial, and does not extend to strata of oil-bearing properties. The only sure method for determining the presence of oil is the drilling of a hole the required depth. The writer, however, is of the opinion that the Flatwoods region has sufficient superficial indications of oil to warrant an experimental hole being made.

An interesting chapter in the pre-glacial geology of the Flatwoods region is found in the physiographic development. Several million years of time lapsed between the time when the later Mississippian deposits of the region were first lifted above sea level and the advent of the glacier in quaternary times. During this time, no deposits were made, indicating that the region was never again subject to such a depression that would reduce it below sea level. There is no rock structure present representing the late Paleozoic, the entire Mesozoic and the early Cenozoic systems. During the lapse of all this time, the area was subject to all the forces of weathering and erosion. Undoubtedly much must have been accomplished in that long interval of time.

It is very likely that the new land surface of the upper Mississippian strata was not raised to any great height above sea level for a long time. The old sea in which the Pennsylvanian rocks west of the area were deposited came and went many times before it left the region forever. In the ages that followed the withdrawal of the old sea, perhaps several peneplains were formed, and each, in turn, destroyed by the subsequent erosion, following the successive uplifts of the area. Only the later of these would be preserved in any recognizable degree.

A study of the topography of the Bloomington Quadrangle shows that there are several rather flat-topped, isolated hills and several long, irregular, flat-topped ridges, all of practically the same height. The hills reaching the 900-foot contour and forming the southern rim of Flatwoods proper, are examples of the isolated hills. A typical example of the flat-topped ridges is found in the region of Kirksville, where the irregular ridge extends for several miles in a north and south direction. These high, flat-topped hills and ridges are undoubtedly the remnants of a former peneplain, which may be correlated; but not absolutely beyond doubt, with that at the base of the Cumberland Plateau, and with its continuation southward and westward into Tennessee, thence northward into Kentucky, where it becomes known as the Lexington Plain. This correlation makes it of early Tertiary age. (J. W. Beede, Features of Subterranean Drainage in the Bloomington Quadrangle. Proceedings of the Indiana Academy of Science 1910. Ditney Folio, Indiana, U. S. Geol. Sur.) Beede has named the peneplain, which these isolated heights represent, the Kirksville peneplain, after the typical development of it at the little village of Kirksville in southwestern Monroe County. Representatives of it occur along the south side of Flatwoods and between the two main branches of Raccoon Creek. Chambers Hill on the north side is also a representative of it.

Succeeding this peneplanation there was an uplift of the region of about 175 feet. The streams went to work again, cutting deep valleys in the Kirksville peneplain. In time the stream reached base-level, and by lateral erosion and beveling by the minor tributaries, local peneplains were developed. The wide expanse west of Bloomington, which continues southward through Lawrence, Washington and Crawford Counties, is the best and most strikingly preserved area representing this peneplanation. This plain is in the Mitchell limestone, and is well represented at Mitchell, Lawrence County. It had its maximum development in late Tertiary times, and is the Mitchell plain of Beede, being so designated by him. (Features of Subterranean Drainage in the Bloomington Quadrangle. The Proceedings of the Indiana Academy of Science, 1910.) Flatwoods at this time was peneplaned, the rim of the higher land and the monadnocks being the remnants of the old Kirksville peneplain. Flatwoods is really a portion of the Mitchell plain. The drainage in late Tertiary times was into White River. The main stream was probably in the long axis of the

region with its outlet through Allistons Branch. This main stream and its principal tributaries were in their old age, and were wandering about the plain, being separated from each other and adjoining stream basins by low divides, except locally where remnants of the preceding peneplain persisted.

Near the end of Tertiary time there occurred another upheaval; this time of about 300 feet. The streams immediately began to corrade their channels, and in the course of time the main streams cut their channels to base level in their upper and middle courses. In early Pleistocene times there occurred a depression of about 150 feet, which caused the base level portions of the streams to become filled. Wabash and the White rivers, show this in an ideal manner. Bean Blossom and Jacks Defeat creeks are excellent examples of smaller streams which have their lower and middle courses filled as a result of the depression of the land. But even these streams are still corradating their channels in their upper courses. Examples of streams which are still cutting their channels, down in the late Tertiary or the Mitchell plain are found in Stouts Branch and Rocky Branch, north of Bloomington, Clear Creek south of Bloomington, and many other small streams reaching into the Mitchell plain. However, such streams are confined to the margins of this plain, because of the peculiarity of the Mitchell limestone in its tendency for the formation of sinks and subterranean drainage. Only the major drainage lines cross this formation with an open channel. Beede has treated this subject thoroughly in the paper referred to above.

In the Flatwoods region the main stream and main tributaries were about as indicated on the map showing the pre-glacial drainage. Considerable portions of the region, however, were drained by sinks and under-channels, as is characteristic of the Mitchell plain west and southwest of Bloomington. But despite underground drainage, the lower part of the main streams and principal tributaries were cut down to base-level. No doubt many springs came into the streams, being the outlets of the underground channels. At the margins underground drainage undoubtedly carried water to other streams. Instances of this kind have already been given.

At this point it is deemed advisable to give some attention to White River, near the lower end of Flatwoods. Collet in his report on the geology of Owen County (Seventh Annual Report Indiana Geol. Sur., 1875), makes note of the extreme narrowness of the White River valley between Romona



and Spencer. He accounts for "The Narrows", as this very constricted portion of the river valley is called, by asserting that this portion of the valley is new, having been formed since the Illinois glaciation. The old channel, he says, was up McCormicks Creek, through the Flatwoods basin, and back to the present channel by way of Raccoon Creek. Leverett says: "The stream (White River) is now occupying a pre-glacial valley for a few miles in southwest Morgan County, and is also in a pre-glacial valley throughout much of its course below Owen County. But in its passage across Owen County it is opening a new valley. It has been suggested that this stream had a subterranean passage across the sink-hole region of Owen County, in which case no well-defined surface channel may have been opened prior to the glacial invasion." (The Illinois Glacial Lobe pp. 104, Monograph XXXVIII, U. S. Geol. Surv.)

Both Collet and Leverett have expressed their belief that White River in its present passage across the Mitchell limestone region is in a new valley. Collet says that the old channel was through McCormicks Creek, Flatwoods basin and Raccoon Creek. Siebenthal, in regard to Collet's idea, says: "The Pleistocene terraces of Bean Blossom Creek clearly prove the pre-glacial valley of that creek to have been practically as it is at present. It is impossible to imagine how it could be cut down to its present depth, while White River, into which it emptied, was running at a level 150 feet higher than now, as it is alleged to have done. Moreover the gorge of McCormicks Creek is clearly post-glacial. And further, it empties into White River at least a mile below the upper end of the "Narrows," whose existence it was brought forward to explain." (Twenty-first Annual Report, Ind. Geol. Surv., 1896, pp. 302). Thus Seibenthal makes it clear that Collet was in error in regard to the ancient channel of White River in the Mitchell limestone region.

Leverett asserts that White River in Owen County is post-glacial, and suggests that the pre-glacial drainage was a series of channels through the limestone region. The writer in his examination of the area found no evidence of an ancient channel on either side of the present river in the limestone region of Owen County; and there is little, if any, evidence of its passage through the region ever having been subterranean.

The constriction of the river just above Spencer is undoubtedly remarkable, and not geologists alone have asked the why of it. Puzzling as the "Narrows" are, they have a rather simple explanation. The valley here is very narrow in comparison to the extremely wide portions above

and below. The valley is wide in Morgan County because of the easily eroded Knobstone sandstones and shales, through which the valley has been cut. It is wide in Greene County again on account of the same fundamental reason. Here the valley is in the soft sandstones and shales of the Chester Group and the Coal Measures. In this county, however, the Illinois glacier undoubtedly was an important factor in widening the valley. In Owen County the strata in which the "Narrows" occur, are hard, resisting limestones, which are little disintegrated by weathering and suffer even less by abrasions. The widening of the valley in this region must be carried on mainly by solution, which is a much slower process than those involved in the region above and below. This narrowing of the valley is identical with the appearance of the limestone bluffs in the vicinity of Gosport. The same condition is to be seen on the East Fork of the White River, where the valley is exceedingly wide in the Knobstone region, and becomes almost gorge-like in the limestone region.

Furthermore, if the valley in the limestone region were post-glacial there would be very little alluvium below the present channel. This is not the case. Wells at Spencer prove that the alluvium is at least 100 feet deep, just as it is in the wide regions of the valley.

White River Valley, then, in its passage across the limestone region of Owen County is not a new opening. It is the same valley that is seen in the wide portions of both Morgan and Greene counties. It is the same valley that has carried the waters of the basin above since the time that the present fundamental topographic features were initiated. In fact this part of the valley and channel is more nearly where it has always been than any part either above or below, for the simple reason that at this point the Illinois glacier but little more than crossed the valley, while both above and below, it crossed for many miles farther, and deranged the drainage accordingly.

We are now ready for the final chapter of the history of the Flatwoods region, the chapter which really gives the explanation of the Flatwoods phenomena.

#### THE GLACIAL HISTORY OF FLATWOODS.

It is not the writer's purpose to give here a treatise on glaciers and glaciation, nor to give an intricate and detailed history of the period of glaciation known to have been present in the Flatwoods region. The purpose here rather is to show the relations of the edge of the Illinois ice-

sheet to the Flatwoods region and immediate vicinity, and show how it was responsible for the peculiar phenomena of the area. For an intimate knowledge of glaciology and its broad relationships, the reader's attention must be given to the many text-books and matter dealing specifically with such phases. That glaciation has taken place over very large areas of the world is no longer a theory. The most obtuse have long been convinced of that fact. The most important phase concerning glaciation before the scientific world today, is the manner in which it took place in specific areas. The most interesting features of this phase of glaciation occur in the phenomena existing along the border, or near the border, of the one-time ice-sheet edge. The Flatwoods region belongs to this phase.

Leverett has given a detailed account of the drift border in southwestern Indiana. The drift border through Greene, Owen and Monroe counties, he credits to C. E. Siebenthal. "From near Scotland (southern Greene County) it has a course slightly east of north to the valley of Plummers Creek, in section 9, T. N., R. 4 W. North of this creek it makes an eastward protrusion of about two miles into a lowland tract known as the American Bottom, reaching section 36, T. 7 N., R. 4 W. North of this lowland the course of the boundary is west of north to the valley of Richland Creek, in section 9, T. 7 N., R. 4 W. It follows the east bluff for about three miles and crosses to the west side of the creek in section 35, T. 8 N., R. 4 W. It follows nearly the west bluff to section 17, T. 8 N., R. 3 W., passing about a mile southeast of the village of Newark. The boundary makes an eastward protrusion of about a mile into Richland Creek valley in section 16, from which the course is northward into Owen County. Entering Owen County in section 33, T. 9 N., R. 3 W., the boundary leads northeastward past Freeman post office and crosses into Monroe County in section 6, T. 9 N., R. 2 W. The course continues northeastward through northern Monroe County, the boundary being about two miles north of Ellettsville and one mile north of Modesto, and coinciding nearly with Indian Creek valley from mouth to source." (Monogr. XXXVIII, U. S. Geol. Surv., pp. 34-38.)

The above detailed line of the glacial limit places the whole of the Flatwoods region well within the limits of the drift line. While it is not the intention of the writer to disprove the general limit of the drift as interpreted by Leverett, there must be some variation made in the Flatwoods region. Perhaps it should be made clear that in the detailed work done by the writer, searching attention was given to the probable advance

of the ice-sheet itself, rather than to the exact drift line. In interpreting the Flatwoods phenomena the position of the advance of the ice-sheet itself is of fundamental importance. This line of advancement, as given below, was determined not only by the presence of erratic boulders and rocks, but by stratified outwash material as well. Of the two phenomena, perhaps the latter is the more important.

A close examination of the hills or rather ridge extending eastward along the northern part of section 15, T. 9 N., R. 3 W., thence northeast through section 11 and into section 1, shows that the ice-sheet never crossed beyond. Evidence is plentiful in showing that the ice rested against this ridge and remained close to it for some time. The west side of the small adjunct is an outwash plain, which in the headwaters of McBrides Creek shows the coarse layers of stratified gravel alternating with both coarse and fine sand. About a mile west of the Stogsdill Pond is the remnants of an old moraine, showing the last stand made by the ice front. The coarse sand found in the ridge, dividing Flatwoods proper from the adjunct, is partly outwash material and partly the result of the ice-front itself in pushing material against the ridges, which the water later worked over. Undoubtedly a tongue of the ice-front pushed up to the very upper tributaries of the old stream, the lower part of which is now represented by McBrides Creek, but that it never crossed the ridge between the old stream and Raccoon Creek to the east is certain.

To the north the ice came up the White River slope and pushed up the old stream, draining the region now occupied by Flatwoods proper. It may have come up this old stream as far east as the Owen-Monroe County line, and even some distance farther, but for the most time it must have remained near the western border of the present Flatwoods. Alliston's Branch has been eating its way into an old outwash plain since the withdrawal of the ice from the region. It has erased the moraines, if any were formed, and has taken considerable of the head of the outwash plain. It is this outwash material, covered with later silt, that makes the slope of the western part of Flatwoods toward the centre of the region. It is evident from this that the ice-front for the most part did not extend beyond the headwaters of Alliston's Branch, in sections 26 and 35, T. 10 N., R. 3 W.

No outwash material or erratic boulders were found in the extension of the Flatwoods basin into section 24, or on Chambers Hill, but erratic boulders were found in the northern part of section 23 on the White River

slope, away from the high periphery at this part of Flatwoods. It is improbable that this immediate portion was ever covered with ice, or if it was, only for a short time.

The headwaters of Big Creek in sections 24, T. 10 N., R. 3 W., and 19, T. 10 N., are in outwash material, and erratic boulders are common. But these conditions are not found on the Flatwoods side of the divide. It is very probable that the ice-front never got over this divide, although the waters came freely into the Flatwoods region over this divide in the southwest corner of section 19.

But little attention was given to the probable front of the ice east of Big Creek, but indications are that it pushed up Jacks Defeat valley to near the middle of section 28, T. 10 N., R. 2 W. Its maximum advance east of Jacks Defeat was probably where indicated by Leverett. Yet it seems to the writer, for reasons that will appear later, that for the greater time it must not have been farther south than the middle of sections 21 and 22, T. 10 N., R. 2 W.

The line of the advance of the ice-sheet south of Freeman was probably as indicated by Leverett. The advance was somewhat east of Freeman and continued northeast to near the southwest corner of section 23, T. 9 N., R. 3 W., where it turned northwest, jutting against the high ridge extending northward and northwest to the southeast corner of section 9. Here the ice crossed the ridge and protruded eastward, as already described. But it is not likely the ice-front was east of Freeman during the time of the formation of the basin flat. The material of the flat west of Freeman is principally sand, and quite likely is the lower end of an outwash plain.

Although the above details show the tracing of a line for the advance of the ice-front, it must be continually borne in mind that the ice-front was not irregular in outline, but that it was constantly changing in a sort of backward and forward movement, due to the seasonal changes in temperature. This line, as described above, has practically all of the Flatwoods region outside of the ice limit, and in some places several miles within the limit placed by Leverett. Some glacial material was found well outside the limit as traced above, but it was material carried there by currents of water, and is not to be interpreted as being direct evidence of the presence of ice. Again, it is possible that the extreme limit of the ice-sheet came as far as indicated by Leverett. But it is quite evident that it

was not advanced that far when the flat topography of Flatwoods was formed.

Having determined the advance of the ice-front, it is easy to picture the fluvial conditions that existed during the presence of this great ice barrier. Streams of water, sometimes constricted and sometimes in broad sheets, poured out from the ice sheets in the summer seasons, and worked over the sandy debris, which the ice continually brought forward from the nearby sandstone hills. This debris was made into the outwash plains already mentioned as being along the headwaters of Alliston's Branch and McBride's Creek. In the adjunct basin the water from the ice carried material south and southeast from the region of accumulation, filling this basin to the level of the narrow outlet south of section 11. The water in being concentrated through this opening undoubtedly cut it down considerably. The material in the wide terrace southeast of this opening contains but little material foreign to the immediate vicinity, but there is an abundance of limestone, chert and sandstone material in the debris. Where the stream has cut a fresh place in the terrace these materials are shown in abundance.

Turning to the eastern side of the region, we find conditions which aided greatly in the making of the Flatwoods region as it appears today. White River was within the ice limit of the glacier and was at this time frozen with all of its upper tributaries, and incorporated within the glacier itself. Practically all of the tributaries beyond Bean Blossom were within this great ice clasp. The greater part of the Bean Blossom area, however, was free to gather its waters before the ice-front in the summer seasons at least. But the outlet and a few miles of the lower portion of this stream were within the ice limit. Consequently a lake gathered before the ice-front, both from the melting ice and the drainage of Bean Blossom basin. The water soon reached the height of the lowest point in the divide between Bean Blossom and Jacks Defeat Creek. This seems to have been about one and a half miles southeast of Stinesville, near the middle of sections 21 and 22, T. 10 N., R. 2 W., on the farm of Jack Litten. Here occurs a col nearly one-fourth mile wide, which comes down at least 100 feet below the height of the divide south of this place. The elevation of the col is 715 feet. Locally this col is known as the "Valley." Since it is on the farm of Mr. Litten, the writer proposes to call it the Litten Col.

The water on passing through the Litten Col came into Jacks Defeat valley, but again it had to lodge against the ice wall until it had found an

outlet. This was found just northwest of Ellettsville through the deep col, which has been described as the southeastern opening of the Flatwoods region. This opening shall be henceforth called the Ellettsville Col. The water however was not confined to this col alone; it came over the divide to the north, especially through the region where a small stream leads from the extreme southwest corner of section 33, T. 10 N., R. 2 W. This brought the water coming from the Bean Blossom region and also that coming from the melting ice into the Flatwoods region. In the first part of this paper it was mentioned that the slope of the eastern Flatwoods region was very gentle from the periphery, and that the deposits extended much higher at this side of the basin than anywhere else. These features, along with the presence of geode fragments in Raccoon Creek valley, were instrumental in the investigation of the possibility of the entrance of the Bean Blossom waters.

After entering the Flatwoods region an outlet for the inflowing waters, mingling with that which was coming from the western ice-front, was found through the opening near the Owen-Monroe County line in section 1. This outlet, which might be designated as the Raccoon Creek Col, has already been described. But again the waters were to be checked by the ice-front in the Raccoon Creek Valley near Freeman. There must have been an outlet, either under the ice or around it, in the vicinity of Freeman near the 700-foot contour line; but such an outlet was not discovered. The terraces come to that height here, and slope from the above regions, indicating that the outlet at the time that the terrace-flat was formed could not have been either higher or lower.

Since the outlet in the Freeman vicinity was at the 700-foot contour line, it is easy to see the terraces representing the old lake bottom would not be any higher at this point, but that they should be higher above this point. This is true, as has already been described. The terraces up Little Raccoon Creek also get twenty-five or thirty feet higher in the upper region, where they fade out into the recent alluvium.

It is quite probable that for some time the waters entered Raccoon Creek just south of the Reeves School through a col on the section line, between sections 8 and 17, T. 9 N., R. 2 W. This col is about 770 feet in elevation, and is barely above the level of the silt line on the periphery of the region. During the time the water went through this col, the ice was advanced far enough east to obstruct the passage-way through the Raccoon Creek col.

In section 30, T. 10 N., R. 2 W., there is a connection through a narrow opening in the periphery of the Flatwoods basin to the outwash plain at the headquarters of Big Creek. No doubt waters came through this opening into the Flatwoods region. The silt flat on the Big Creek side of the opening comes up to the level of the opening, while on the Flatwoods side it is much lower, due to the sinks at this place. No doubt that at one time the slope was gradually away from this opening on the south side.

It is evident that the fluviatile conditions existed for a long time, long enough to fill practically the entire stretch from the place of the entrance of the waters into the region to where they left in the vicinity of Freeman, with the material which has been described. These waters, being so intimately connected with the glacier, carried much of its material, and it is possible that at times large pieces of floating ice carried glacial material; thus one may expect to find glacial pebbles and even small boulders in any part of the region covered by these waters.

Indications show that for a long time there were no rapidly flowing waters in the Flatwoods region. In nearly all of the deeper wells and in many of the shallow ones the very fine sandy blue clay, which has been described in well No. 6 is characteristic of the lower material. This blue clay is thicker, perhaps, than any other material laid down. It can be seen in the bottom of the middle branch in the small adjunct of the Flatwoods region. Here it is as described, but reveals another feature quite important. Where it has weathered, or has been eroded, it shows laminae, indicating that it is a water-laid material. This delicate bedding of lamination cannot be detected in the clay when it is cut into. The elevation of this material as found in the wells is as follows (See map for location of wells):

|                           |     |
|---------------------------|-----|
| Well No. 5.....           | 715 |
| Well No. 7.....           | 690 |
| Well No. 10.....          | 680 |
| Well No. 11.....          | 700 |
| Well No. 14.....          | 660 |
| Well No. 24.....          | 655 |
| In Flatwoods Adjunct..... | 705 |

In other wells it never occurred, or was not identified as such. These figures show that the surface of this material was not actually flat, but that it was even flatter than the present surface of Flatwoods. It is very probable that before later material was deposited upon it, it was eroded in



places and in other places was entirely washed away. Generally, either sand or gravel overlies it, indicating that rapid flowing waters followed the long period of quiet waters in which the clay was deposited.

The next step in the history of the Flatwoods region comes with the deposition of the loess material. This fine, close-textured, ash-gray-to-white material composes the present surface of the region, except where the long duration of swamps has built up a black soil, which in some places is several feet deep over the top of the loess. The loess is somewhat uncertain as to its exact time and manner of deposition, and also as to the origin of the material. It was in all probability deposited not so very long after the disappearance of the Illinois glacier. Its thickness varies greatly in the Flatwoods region. Usually it is very thick at the margin of the old lake, being as much as twenty or even thirty feet; but in the centre of the region it is much thinner, at times being scarcely discernible. It is thicker at the margin because it has been washed from the hills adjacent. In the interior, perhaps much of it has been incorporated with organic material in the making of the black soils.

In connection with the history of Flatwoods, McCormicks Creek adds a very fascinating chapter. After the withdrawal of the ice, the lowest outlet was still the Raccoon Creek col. The region in the vicinity of the headwaters of Alliston's Branch was thirty feet or more higher than the Raccoon Creek col, having been built up by a possible moraine and the outwash plain already described. Therefore, the waters lowered to the level of the Raccoon Creek col. The water within the region was the site of a shallow lake, not being any deeper than the lowest place below the Raccoon Creek col. But the waters soon fell below the level of this opening, because of the opening of the old sinks near the margin of the region. These sinks were not covered deeply by the silt and sand, and consequently soon opened their old channels which had been filled or partly filled. It is very likely that the sinks formed in the northwestern margin or portion of the region in section 23, T. 10 N., R. 3 W., were the lowest and were, perhaps, the first to be opened on account of the static head at this place. These sinks had been draining this immediate portion of the Flatwoods basin long before the advent of the Illinois glacier, and it is quite likely that a thorough drainage, though underground, was already established along the line of the present McCormick's Creek Gorge. It can be easily seen that below the lower part of the gorge the valley becomes wider, and on approaching the river it is a filled valley. This clearly shows

that a pre-glacial tributary of White River occupied the region below the gorge of McCormick's Creek. The underground drainage merely had to develop through the narrow divide, composed entirely of Mitchell limestone. The great static head given the waters which reached into the southern part of section 23, in connection with a favorable dip of the rock, insured underground drainage. Moreover, the nature of the rock as exposed in the gorge would make this drainage not only apt, but very rapid. The hard Mitchell limestone in the upper part of the gorge is a continual occurrence of small irregular folds and dips, and even small faults, all being more or less disrupted and broken. Then below comes in a structure of loose, brecciated, highly argillaceous limestone, which is very easily eroded and carried away. This material is so loose that it can actually be torn from place by the bare hands. It is exposed in the falls and in the sides of the perpendicular cliffs below.

Thus, the present drainage of Flatwoods was initiated through the present McCormick's Creek by underground drainage. On account of the peculiar structure of the rock and the great fall, the drainage soon became open, somewhat as it is at present.

While the above outlined drainage through McCormick's Creek was in progress the middle part of Flatwoods remained a shallow lake. But finally the stream cut down enough to drain the region, with the exception of the middle portion and several small isolated depressions. Stogsdill Pond is one of the remaining representatives of these isolated depressions. The middle portion remained a great swampy morass for ages, and was even such at the time of the coming of the white man. It has since had the timber removed and better drainage instituted. The fine muck soil resulting from the long continued swampy conditions is now the most fertile part of the Flatwoods region.

(NOTE 1. The writer wishes to acknowledge his indebtedness to Dr. J. W. Beede, and Dr. E. R. Cumings, of the Department of Geology of Indiana University, under whose general charge the work of securing the data for the above report was carried on, as part of the work of the Department of Geology, Indiana University. The writer was also aided by his brother, Burton J. Malott, who proved himself valuable in the gathering of certain data.)

(NOTE 2. It was the writer's intention that a contour map accompany this paper, and data was gathered with that end in view, but press of time has precluded its preparation.)

## MECHANICAL DEVICE FOR TESTING MERSENNE NUMBERS FOR PRIMES.

THOS. E. MASON.

Lucas,\* in a note in "Récréations Mathématiques," gives a method of testing numbers of the form  $2^{4q+3}-1$  for primes. The purpose of this note is to show how the labor of that method can be shortened, and how a machine could be constructed which would do most of the labor. If such a machine were constructed the labor of verifying the Mersenne numbers would be reduced to hours where it now requires weeks and months, for example, for numbers like  $2^{127}-1$ .

Lucas makes use of the following theorem: In order that the number  $p=2^{4q+3}-1$  shall be prime, it is necessary and sufficient that the congruence

$$\sqrt{-1} \equiv 2 \cos \frac{\pi}{2^{4q+2}}, \pmod{p},$$

shall be satisfied, that is, that

$$\sqrt{-1} \equiv \sqrt{2 - \sqrt{2 + \sqrt{2 + \sqrt{2 + \dots}}}}, \pmod{p},$$

shall be verified after the successive removal of the radical. In other words, if we form the set of numbers  $V_n$ ,

$$V_0=1, V_1=3, V_2=7, V_3=47, V_4=2207, \dots,$$

such that each after the second is the square of the preceding diminished by 2 units, and then consider only the residues, modulo  $p$ , if the residue of the number  $V_n$ , where  $n=4q+2$ , is zero the number  $p$  is prime.

The process of Lucas makes use of the binary system of numeration. In this system multiplication consists simply in the longitudinal displacement of the multiplicand. It is evident also that the residue of the division of  $2^m$  by  $2^n-1$  is equal to  $2^r$ ,  $r$  designating the residue of the division of  $m$  by  $n$ ; consequently, in trying  $2^7-1$ , it is sufficient to operate upon numbers having at most 7 of the figures 0 or 1. Figure I gives the calculation of  $V_4$  deduced from the calculation of  $V_3$  by the formula

$$V_4 = V_3^2 - 2 \pmod{2^7-1};$$

the dark squares represent the units of different orders of the binary system

\*Lucas, Récréations Mathématiques, Vol. 2, pp. 230-235.

and the white squares the zeros. The first line is the residue of  $V_3$ ; the 7 lines numbered 0 to 6 represent the residues (mod  $2^7-1$ ) of the partial products in

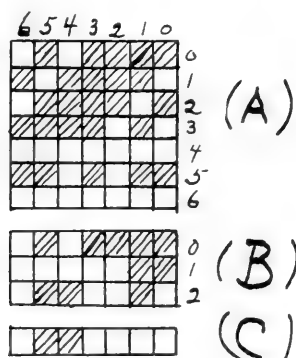


FIG. 1.

squaring  $V_3$ ; the lines below, numbered 0 and 1 represent the addition of the partial products above and reduction modulo  $2^7-1$ , and line 2 represents the addition of 0 and 1; the single line below gives the residue of the square of  $V_3$  with 2 subtracted, which is the residue of  $V_4$ . In order to complete the test of  $2^7-1$  it is necessary to find  $V_6$ . If the residue of  $V_6$  is zero, then  $2^7-1$  is prime. This briefly is the plan as given by Lucas except that he used a different illustrative example.

In order to test a large number, say  $2^{127}-1$ , it would be necessary to make 126 of these square tables such as Figure I, each having  $127^2$  small squares. This would entail considerable labor and require a great deal of time. A simple device will reduce the labor of writing each line in the large square (A) to counting. Let us set down the work of squaring a number written in the binary system, for example, 13, which in the binary system is 1101.

$$\begin{array}{r}
 \hline
 1011 \\
 1101 \\
 1101 \\
 \hline
 1101 \\
 1101 \\
 1101 \\
 \hline
 10101001
 \end{array}
 \quad (S)$$

Now, if we write the number with the digits in reverse order on a slip of paper (S) and place it above the number itself as shown above, we see that the digits which occur in the third column of the partial products are the digits which come together, or correspond, when the slip of paper (S) is placed so that the first digit of the number, when digits are reversed, is placed over the third column. This is possible in no other scale, because the product of two digits in the binary scale does not give a number of more than one place. We can give the following rule for squaring a number written in the binary scale:

*Write the number with the digits equally spaced and write the same number with the digits reversed on a slip of paper, using the same spacing. Place the slip of paper above the number so that the first digit in the reversed order comes above the last digit of the number. Move the slip of paper a single space to the left each time. Count the correspondences at each step. The number of correspondences at each step is the number which belongs in that place in the result which is immediately beneath the first digit on the slip. Continue this until there are no more correspondences.*

It is easily seen that by means of the above rule the process described by Lucas can be followed out by counting the correspondences and will lead to the result in the lines marked (B) in Figure I, without having to write the part (A).

It would be possible to construct a machine which would have two parallel bars in which could be set pins for the places where 1 occurs in the number. The pins on one bar would be in reverse order. The bars could be turned over and the number of pins striking could be recorded automatically. At the same time one bar could be moved along one place and be in readiness for the next turn. From the machine then would come the data for compiling the part (B) of Figure I. Or, a more complicated machine could be constructed which would give the part (C) at once. This would so shorten the work of testing the Mersenne numbers that it would be possible to check the results on all of them again with a reasonable expenditure of time.

*Purdue University,  
LaFayette, Indiana.*



# SOME PROPERTIES OF BINOMIAL COEFFICIENTS.

A. M. KENYON.

## §1.

The binomial coefficients of the expansion

$$(x + y)^k = \binom{k}{0}x^k + \binom{k}{1}x^{k-1}y + \binom{k}{2}x^{k-2}y^2 + \dots + \binom{k}{k}y^k$$

were known to possess a simple recursion formula

$$(1) \quad \binom{k}{n} + \binom{k}{n+1} = \binom{k+1}{n+1} \quad k, n = 0, 1, 2, 3, \dots$$

by means of which Pascal's Triangle\*

|             | $n = 0$ | $n = 1$ | $n = 2$ | $n = 3$ | $n = 4$ | <i>etc.</i> |
|-------------|---------|---------|---------|---------|---------|-------------|
| $k = 0$     | 1       |         |         |         |         |             |
| $k = 1$     | 1       | 1       |         |         |         |             |
| $k = 2$     | 1       | 2       | 1       |         |         |             |
| $k = 3$     | 1       | 3       | 3       | 1       |         |             |
| $k = 4$     | 1       | 4       | 6       | 4       | 1       |             |
| <i>etc.</i> | —       | —       | —       | —       | —       | —           |

could be built up, before Newton showed that they are functions of  $k$  and  $n$ :

$$(2) \quad \left. \begin{aligned} \binom{k}{n} &= \frac{k(k-1)\dots(k-n+1)}{n!}, \quad n=1, 2, 3, \dots \\ \binom{k}{n} &= 1 \quad n=0 \end{aligned} \right\} k=0, 1, 2, \dots$$

A great number of relations involving binomial coefficients have been discovered\*\*; some of the most useful of these are

$$(3) \quad n \binom{k}{n} = k \binom{k-1}{n-1}; \quad \binom{k}{n} = \frac{k}{k-n} \binom{k-1}{n}; \quad \binom{k}{n} = 0 \text{ if } n > k.$$

\*See Chrystal: Algebra I, p. 81.

\*\*See Chrystal: Algebra II, Chaps. XXIII, XXVII. Hagen: Synopsis der hoeheren Mathematik, p. 64; Pascal: Repertorium der hoeheren Mathematik I, Kap. II, Sec. 1.

From (1) and (3) it follows that  $\binom{k}{n}$  satisfies the linear difference equation

$$(n + 1)f(n + 1) + (n - k)f(n) = 0$$

It is well known that the sum of the coefficients  $(x + y)^k$  is  $2^k$  and that the sum of the odd numbered coefficients is equal to the sum of the even numbered ones; the following are perhaps not so well known:

(4) If, beginning with the second, the coefficients of  $(x - y)^k$  be multiplied by  $c^n, (2c)^n, (3c)^n, \dots, (kc)^n$  respectively;  $c$  being arbitrarily chosen different from zero, the sum of the products will vanish for  $n = 1, 2, 3, \dots, k - 1$  but not for  $n > k$ , e. g.

$$\begin{array}{cccccccc} k = 8 & -8, & 28, & -56, & 70, & -56, & 28, & -8, & 1 \\ c = 2 & 2^n, & 4^n, & 6^n, & 8^n, & 10^n, & 12^n, & 14^n, & 16^n \end{array}$$

The sum of the products vanishes for  $n = 1, 2, \dots, 7$ ; but not for  $n > 7$ ; for  $n = 8$  it is 10,321,920.

(5) If the first  $k$  coefficients of  $(x - y)^{k+1}$  be multiplied term by term, with  $k^n, (k - 1)^n, (k - 2)^n, \dots, 1^n, (n, k = 1, 2, 3, \dots)$  the sum of the products will be

$$(-1)^{k+n} \text{ if } n < k \quad \text{and } (k + 1)! - 1 \quad \text{if } n = k + 1;$$

in particular

$$k^k \binom{k+1}{0} - (k-1)^k \binom{k+1}{1} + (k-2)^k \binom{k+2}{2} + \dots + (-1)^{k-1} \binom{k+1}{k-1} = 1$$

e. g. take  $k = 5$ .

$$\begin{array}{cccccc} 1, & -6, & 15, & -20, & 15, \\ 5^n, & 4^n, & 3^n, & 2^n, & 1^n, \end{array}$$

The sum of the products is +1, -1, +1, -1, +1, 719, for  $n = 1, 2, 3, 4, 5, 6$ , respectively.

Both (4) and (5) are special cases of

(6) If the coefficients of  $(x - y)^k, (k = 1, 2, 3, \dots)$  be multiplied term by term by the  $n$ th powers ( $n = 0, 1, 2, \dots$ ) of the terms of any arithmetic progression with common difference  $d \neq 0$ , the sum of the products will vanish if  $n < k$ ; will be  $(-d)^k (k!)$  if  $n = k$ ; and if  $n = k + 1$  will be the product of this last result and the sum of the terms of the arithmetic progression.

e. g. take  $k = 6, d = -1$ , a. p., 4, 3, 2, etc.

$$\begin{array}{ccccccc} 1, & -6, & 15, & -20, & 15, & -6, & 1 \\ 4^n, & 3^n, & 2^n, & 1^n, & 0^n, & (-1)^n, & (-2)^n \end{array}$$



The sum of the products vanishes for  $n = 1, 2, 3, 4, 5$ , but not for  $n > 5$ ; for  $n = 6$ , it is  $(-1)^6 (6!) = 720$ ; and for  $n = 7$ , it is  $720(4 + 3 + 2 + 1 + 0 - 1 - 2) = 5040$ .

The third conclusion of (6) shows that if

$$(I) \quad a + (a + d) + (a + 2d) + \dots + (a + kd)$$

and

$$(II) \quad \binom{k}{0} a^k - \binom{k}{1} (a + d)^k + \binom{k}{2} (a + 2d)^k - \dots + (-1)^k \binom{k}{k} (a + kd)^k$$

be multiplied term by term and the  $(k + 1)$  products be added, the result will be the same as though (II) be multiplied through by the terms of (I) in succession and the  $(k + 1)^2$  products be added; e.g. take  $k = 4, a = 1, d = 2$

$$(I) \quad 1 \quad , \quad 3 \quad , \quad 5 \quad , \quad 7 \quad , \quad 9$$

$$(II) \quad 1 \cdot 1^4 \quad , \quad -4 \cdot 3^4 \quad , \quad 6 \cdot 5^4 \quad , \quad -4 \cdot 7^4 \quad , \quad 1 \cdot 9^4$$

$$1 \quad - \quad 972 \quad + \quad 18750 \quad - \quad 67228 \quad + \quad 59049 = 9600$$

|   | $1 \cdot 1^4$ | $-4 \cdot 3^4$ | $6 \cdot 5^4$ | $-4 \cdot 7^4$ | $1 \cdot 9^4$ |      |
|---|---------------|----------------|---------------|----------------|---------------|------|
| 1 | 1             | - 324          | 3750          | - 9604         | 6561          | 384  |
| 3 | 3             | - 972          | 11250         | -28812         | 19683         | 1152 |
| 5 | 5             | -1620          | 18750         | -48020         | 32805         | 1920 |
| 7 | 7             | -2268          | 26250         | -67228         | 45927         | 2688 |
| 9 | 9             | -2916          | 33750         | -86436         | 59049         | 3456 |
|   | 25            | -8100          | +93750        | -240100        | +164025       | 9600 |

§2.

The properties noted above, and many others, can be made to depend upon those of the sum

$$(1) \quad S(k, n) = \sum_{i=0}^k (-1)^i \binom{k}{i} i^n \quad k, n = 0, 1, 2, 3, \dots$$

It is readily shown that

$$(2) \quad S(k, n) \text{ vanishes for } k > n$$

$$(3) \quad \left. \begin{aligned} S(k, n) &= -k \sum_{i=k}^n \binom{n-1}{i-1} S(k-1, i-1) \\ &= - \sum_{i=k}^n \binom{n}{i-1} S(k-1, i-1) \end{aligned} \right\} k, n = 0, 1, 2, 3, \dots$$

whence  $S(k, n)$  is divisible by  $k!$  and in fact  $S(n, n) = (-1)^n n!$  Also, since  $S(1, n) < 0$ , it follows that for fixed  $k$ ,  $S(k, n)$  preserves a constant sign (or vanishes) for all values of  $n$ ; and this sign is the same as that of  $(-1)^k$ .

These numbers possess a recursion formula

$$(4) \quad S(k, n) = k[S(k, n-1) - S(k-1, n-1)] \quad n, k = 0, 1, 2, \dots$$

by means of which may be constructed,

A TABLE OF VALUES OF  $S(k, n)$

|       | $k=0$ | $k=1$ | $k=2$ | $k=3$ | $k=4$ | $k=5$   | $k=6$  | $k=7$   | $k=8$ |
|-------|-------|-------|-------|-------|-------|---------|--------|---------|-------|
| $n=0$ | 1     |       |       |       |       |         |        |         |       |
| $n=1$ | 0     | -1    |       |       |       |         |        |         |       |
| $n=2$ | 0     | -1    | 2     |       |       |         |        |         |       |
| $n=3$ | 0     | -1    | 6     | -6    |       |         |        |         |       |
| $n=4$ | 0     | -1    | 14    | -36   | 24    |         |        |         |       |
| $n=5$ | 0     | -1    | 30    | -150  | 240   | -120    |        |         |       |
| $n=6$ | 0     | -1    | 62    | -540  | 1560  | -1800   | 720    |         |       |
| $n=7$ | 0     | -1    | 126   | -1806 | 8400  | -16800  | 15120  | -5040   |       |
| $n=8$ | 0     | -1    | 254   | -5796 | 40824 | -126000 | 191520 | -141120 | 40320 |

Subtract any entry from the one on its right, multiply by the value of  $k$  above the latter.

$$(5) \quad \sum_{k=0}^n S(k, n) = (-1)^n \quad \sum_{k=2}^n S(k, n) = 1 + \cos n\pi$$

$$(6) \quad \sum_{k=1}^n \frac{S(k, n)}{k} = 0 \quad n = 2, 3, 4, \dots$$

$$(7) \quad \sum_{i=k}^n \binom{n+1}{i} S(k, i) = (k+1) \sum_{i=k}^n \binom{n}{i} S(k, i)$$

$$(8) \quad \sum_{i=k}^n \binom{n}{i} S(k, i) = S(k, n) - S(k+1, n)$$

Setting  $n = k + 1$  in (7) we obtain

$$(9) \quad S(k, k+1) = \binom{k+1}{2} S(k, k)$$

and similarly we can express  $S(k, k+2)$ ,  $S(k, k+3)$ , etc. in terms of  $S(k, k)$ .

From (4)

$$S(k, n) = S(k+1, n) - \frac{1}{k+1} S(k+1, n+1) \quad k, n = 0, 1, 2, 3, \dots$$

By applying this  $m$  times, we obtain

$$(10) \quad S(k, n) = \sum_{i=0}^m (-1)^i H_i S(k + m, n + i)$$

$k, n = 0, 1, 2, \dots ; m = 1, 2, 3, \dots$

where  $H_i$  is the sum of the products of the fractions  $1/(k + 1), 1/(k + 2), 1/(k + 3), \dots, 1/(k + m)$ , taken  $i$  at a time;  $H_0 = 1$ .

The proof of (6) §1 is as follows. If the first term of the arithmetic progression is zero,

$$\sum_{i=0}^k (-1)^i \binom{k}{i} (di)^n = d^n S(k, n)$$

and this vanishes if  $n < k$ ; is  $(-d)^k (k!)$  if  $n = k$ ; and is

$$(-d)^k (k!) [d + 2d + 3d + \dots + kd] \quad \text{if } n = k + 1.$$

If the first term of the arithmetic progression is  $a \neq 0$ ,

$$\sum_{i=0}^k (-1)^i \binom{k}{i} (a + di)^n = d^n \sum_{i=0}^k (-1)^i \binom{k}{i} (x + i)^n$$

where  $x = a/d \neq 0$ .

If we use the notation

$$f(n, x, k) \equiv \sum_{i=0}^k (-1)^i \binom{k}{i} (x + i)^n$$

expand  $(x + i)^n$  by the binomial formula and reverse the order of summation, we obtain

$$(11) \quad f(n, x, k) = \sum_{i=0}^n \binom{n}{i} x^{n-i} S(k, i)$$

Therefore

$$\begin{aligned} f(n, x, k) &= 0 \quad \text{when } n < k, \text{ since all the summands vanish} \\ &= S(k, k) \quad \text{when } n = k \\ &= \sum_{i=k}^n \binom{n}{i} x^{n-i} S(k, i) \quad \text{when } n > k \end{aligned}$$

In particular, when  $n = k + 1$

$$f(k + 1, x, k) = (x + \frac{k}{2}) (k + 1) S(k, k) \quad \text{and on putting } a/d \text{ for } x,$$

$$d^{k+1} f(k + 1, x, k) = d^k S(k, k) [a + (a + d) + (a + 2d) + \dots + (a + kd)]$$

and from these follow the three conclusions\* of (6) §1.

\*Chrystal: Algebra II, Sec. 9, p. 183, gives the proof of a slightly less general theorem.

Cauchy: Exercices de mathematiques, 1826, I, p. 49 (23), obtains as a by-product the second conclusion of the theorem for the case  $d = -1$ , and remarks that it is well known.

§3.

In finding the sum of certain series by the method of differences\*\* it is convenient to express positive integral powers of  $x$  in terms of the polynomials

$$(1) \quad \begin{aligned} x^{(n)} &= x(x-1)(x-2)\dots(x-n+1) & n &= 1, 2, 3, \dots \\ x^{(0)} &= 1 \end{aligned}$$

If we set

$$(2) \quad x^n = A(0, n)x^{(0)} + A(1, n)x^{(1)} + \dots + A(k, n)x^{(k)} + \dots + A(n, n)x^{(n)}$$

it is easily shown that

$$(3) \quad A(k, n) = S(k, n)/S(k, k)$$

whence

(4)  $A(k, n)$ ,  $k, n = 0, 1, 2, 3, \dots$ , vanishes if  $n < k$ ; is always positive if  $n \geq k > 0$ ; in particular  $A(n, n) = 1$ ; and the following relations come from those given in §2 for  $S(k, n)$ :

$$(5) \quad A(k, n) = \sum_{i=k}^n \binom{n-1}{i-1} A(k-1, i-1) = \frac{1}{k} \sum_{i=k}^n \binom{n}{i-1} A(k-1, i-1)$$

The recursion formula

$$(6) \quad A(k, n) = k A(k, n-1) + A(k-1, n-1)$$

by which may be constructed

A TABLE OF VALUES OF  $A(k, n)$

|         | $k=0$ | $k=1$ | $k=2$ | $k=3$ | $k=4$ | $k=5$ | $k=6$ | $k=7$ | $k=8$ |
|---------|-------|-------|-------|-------|-------|-------|-------|-------|-------|
| $n = 0$ | 1     |       |       |       |       |       |       |       |       |
| $n = 1$ | 0     | 1     |       |       |       |       |       |       |       |
| $n = 2$ | 0     | 1     | 1     |       |       |       |       |       |       |
| $n = 3$ | 0     | 1     | 3     | 1     |       |       |       |       |       |
| $n = 4$ | 0     | 1     | 7     | 6     | 1     |       |       |       |       |
| $n = 5$ | 0     | 1     | 15    | 25    | 10    | 1     |       |       |       |
| $n = 6$ | 0     | 1     | 31    | 90    | 65    | 15    | 1     |       |       |
| $n = 7$ | 0     | 1     | 63    | 301   | 350   | 140   | 21    | 1     |       |
| $n = 8$ | 0     | 1     | 127   | 966   | 1701  | 1050  | 266   | 28    | 1     |

To any entry add the product of the one on its right and the value of  $k$  above the latter.

\*\*See for example Boole's Finite Differences, Chap. IV.

$$(7) \quad \sum_{i=k}^n \binom{n}{i} A(k, i) = A(k + 1, n + 1) \quad n > k = 0, 1, 2, \dots$$

$$(8) \quad \sum_{k=1}^n A(k, n) S(k - 1, k - 1) = 0 \quad n = 2, 3, 4, \dots$$

Inversely, since

$$x^{(n+1)} = x(x - 1)(x - 2) \dots (x - n) \quad n = 0, 1, 2, \dots$$

if we set

$$(9) \quad x^{(n+1)} = x[B(0, n)x^n - B(1, n)x^{n-1} + \dots + (-1)^k B(k, n)x^{n-k} + \dots + (-1)^n B(n, n)]$$

it is evident that  $B(0, n) = 1, n = 0, 1, 2, \dots, B(k, n) =$  the sum of the products of the numbers  $1, 2, 3, \dots, n$ , taken  $k$  at a time; in particular  $B(k, k) = k! = (-1)^k S(k, k)$  and  $B(k, n) = 0$  if  $k > n$ . For convenience define  $B(p, n) = 0$ , if  $p$  is a negative integer.

If we multiply both sides of

$$x^{(n)} = x[B(0, n - 1)x^{n-1} - B(1, n - 1)x^{n-2} + \dots + (-1)^{n-1} B(n - 1, n - 1)]$$

by  $x - n$ , and equate the coefficients of  $x^{n-k}$ , we obtain the recursion formula

$$(10) \quad B(k, n) = B(k, n - 1) + n B(k - 1, n - 1)$$

by means of which may be constructed

A TABLE OF VALUES OF  $B(k, n)$

|         | $k=0$ | $k=1$ | $k=2$ | $k=3$ | $k=4$ | $k=5$ | $k=6$  | $k=7$  | $k=8$ |
|---------|-------|-------|-------|-------|-------|-------|--------|--------|-------|
| $n = 0$ | 1     |       |       |       |       |       |        |        |       |
| $n = 1$ | 1     | 1     |       |       |       |       |        |        |       |
| $n = 2$ | 1     | 3     | 2     |       |       |       |        |        |       |
| $n = 3$ | 1     | 6     | 11    | 6     |       |       |        |        |       |
| $n = 4$ | 1     | 10    | 35    | 50    | 24    |       |        |        |       |
| $n = 5$ | 1     | 15    | 85    | 225   | 274   | 120   |        |        |       |
| $n = 6$ | 1     | 21    | 175   | 735   | 1624  | 1764  | 720    |        |       |
| $n = 7$ | 1     | 28    | 322   | 1960  | 6769  | 13132 | 13068  | 5040   |       |
| $n = 8$ | 1     | 36    | 546   | 4536  | 22449 | 67284 | 118124 | 109584 | 40320 |

Multiply any entry by the number  $(n+1)$  of the next row, and add to the entry on its right.

$$(11) \quad B(k, k+n) = \sum_{i=k}^{n+k} \binom{i}{k} B(k + n - i, k + n - 1) \quad k, n = 0, 1, 2, 3, \dots$$

The equation

$$B(0, n) x^n - B(1, n) x^{n-1} + \dots + (-1)^n B(n, n) = 0$$

has 1, 2, 3, . . . . n, for roots. If we set

$$S_k = 1^k + 2^k + 3^k + \dots + n^k \quad k = 1, 2, 3, \dots$$

and solve Newton's formulae\* we obtain

$$B(k, k) B(k, n) = \begin{vmatrix} S_1 & 1 & 0 & 0 & \dots & 0 \\ S_2 & S_1 & 2 & 0 & \dots & 0 \\ S_3 & S_2 & S_1 & 3 & \dots & 0 \\ S_4 & S_3 & S_2 & S_1 & \dots & 0 \\ \dots & \dots & \dots & \dots & \dots & \dots \\ \dots & \dots & \dots & \dots & \dots & \dots \\ S_k & S_{k-1} & S_{k-2} & S_{k-3} & \dots & S_1 \end{vmatrix} \quad k, n = 1, 2, 3, \dots$$

This determinant vanishes when  $k > n$ .

Inversely,

$$S_k = \begin{vmatrix} B(1, n) & B(0, n) & 0 & \dots & 0 \\ 2B(2, n) & B(1, n) & B(0, n) & \dots & 0 \\ 3B(3, n) & B(2, n) & B(1, n) & \dots & 0 \\ \dots & \dots & \dots & \dots & \dots \\ \dots & \dots & \dots & \dots & \dots \\ kB(k, n) & B(k-1, n) & B(k-2, n) & \dots & B(1, n) \end{vmatrix} \quad k, n = 1, 2, 3 \dots \text{ (even if } k > n)$$

These sums of the powers of the first  $n$  natural numbers are connected by the following relations, in which  $I(k/2)$  signifies the integral part of  $k/2$ :

$$\sum_{i=0}^{I(k/2)} \binom{k}{2i+1} S_{2k-1-2i} = 2^{k-1} S_1^k$$

$$\sum_{i=0}^{I(k/2)} \frac{2k+1-2i}{1+2^i} \binom{k}{2i} S_{2k-2i} = (2n+1) 2^{k-1} S_1^k$$

whence

$$\sum_{i=0}^k c_i \binom{k}{i} S_{2k-i} = 0 \quad \text{where } c_i = \frac{2k+1-i}{1+i} \text{ when } i \text{ is even}$$

$$= -(2n+1) \text{ when } i \text{ is odd}$$

\*See, for example, Ca'jori's Theory of Equations, pp. 85-86.  
 †Stern, Crelle's Journal, Vol. 84, pp. 216-218.

Also

$$\sum_{i=0}^k \binom{k+1}{i} S_i = ** (n+1)^{k+1} - 1$$

Relations between the A's and the B's:

$$x^m = \sum_{i=1}^m A(i, m) x^{(i)} \quad m = 1, 2, 3, \dots$$

$$x^{(i)} = \sum_{j=0}^{i-1} (-1)^j B(j, i-1) x^{i-j} \quad i = 1, 2, 3, \dots$$

Therefore

$$x^m = \sum_{i=1}^m A(i, m) \sum_{j=0}^{i-1} (-1)^j B(j, i-1) x^{i-j}$$

the coefficient of  $x^k$  on the right is

$$\sum_{i=0}^{m-k} (-1)^i A(k+i, m) B(i, k+i-1)$$

and this must vanish  $k = 1, 2, 3, \dots, m-1$ , and be equal to 1, for  $k = m$ .

Whence, setting  $n$  for  $m - k$ ,

$$\sum_{i=0}^n (-1)^i A(k+i, k+n) B(i, k+i-1) = 0, \quad \begin{cases} k = 0, 1, 2, \dots \\ n = 1, 2, 3, \dots \end{cases}$$

or, setting  $i$  for  $k + i$ , and  $n$  for  $m$ ,

$$(12) \quad \sum_{i=k}^n (-1)^i A(i, n) B(i-k, i-1) = 0. \quad \begin{cases} k = 0, 1, 2, \dots, n-1 \\ n = 1, 2, 3, \dots \end{cases}$$

Similarly, starting from

$$x^{(m)} = \sum_{i=0}^{m-1} (-1)^i B(i, m-1) x^{m-i}$$

we obtain

$$(13) \quad \sum_{i=0}^n (-1)^i A(k, k+n-i) B(i, k+n-1) = 0, \quad \begin{cases} k = 0, 1, 2, \dots \\ n = 1, 2, 3, \dots \end{cases}$$

This relation may be generalized as follows:

Set

$$C(k, n, p) = \sum_{i=0}^n (-1)^i A(k, k+n-i) B(i, k+n-p)$$

---

\*\*Prestet, Elements de Mathematique, p. 178.

then directly and by (13)

$$(a) \quad \left. \begin{aligned} C(k,0,p) &= 1 & p &= 0, 1, 2, \dots \\ C(k,n,1) &= 0 & n &= 1, 2, 3, \dots \end{aligned} \right\} k = 0, 1, 2, \dots$$

making use of (10) we obtain

$$(b) \quad C(k,n,p) = C(k,n,p-1) + (k+n-p-1) C(k,n-1,p-1)$$

The left side vanishes when  $p = 1$ ; therefore

$$C(k,n,0) = -(k+n) C(k,n-1,0)$$

By repeating this  $(n-1)$  times and noting that  $C(k,0,0) = 1$ , we obtain

$$(c) \quad C(k,n,0) = (-1)^n (k+1) (k+2) \dots (k+n) \quad \left\{ \begin{aligned} k &= 0, 1, 2, \dots \\ n &= 1, 2, 3, \dots \end{aligned} \right.$$

Setting  $p = 2, 3, 4, \dots, n$ , in (b), we find

$$(d) \quad \begin{aligned} C(k,n,p) &= 0 && \text{for } p = 1, 2, 3, \dots, n \\ &= k^n && \text{when } p = n + 1 \end{aligned}$$

Therefore for all values of  $k = 0, 1, 2, \dots$ ; and  $n = 1, 2, 3, \dots$

$$(14) \quad \sum_{i=0}^n (-1)^i A(k, k+n-i) B(i, k+n-p) = \begin{aligned} &(-1)^n (k+1) (k+2) \dots (k+n) && \text{when } p = 0 \\ &= 0 && \text{when } p = 1, 2, 3, \dots, n \\ &= k^n && \text{when } p = n+1 \end{aligned}$$

Example illustrating (14) for  $k = 2, n = 3$ .

|         |            | $i=0$ | $i=1$ | $i=2$ | $i=3$ |                            |
|---------|------------|-------|-------|-------|-------|----------------------------|
|         | $A(2,5-i)$ | 15    | -7    | 3     | -1    | sums of products           |
| $p = 0$ | $B(i,5)$   | 1     | 15    | 85    | 225   | $(-1)^3 3 \cdot 4 \cdot 5$ |
| $p = 1$ | $B(i,4)$   | 1     | 10    | 35    | 50    | 0                          |
| $p = 2$ | $B(i,3)$   | 1     | 6     | 11    | 6     | 0                          |
| $p = 3$ | $B(i,2)$   | 1     | 3     | 2     | 0     | 0                          |
| $p = 4$ | $B(i,1)$   | 1     | 1     | 0     | 0     | $2^3$                      |

In particular, when  $p = n$ ,

$$\sum_{i=0}^n (-1)^i A(k, k+n-i) B(i, k) = 0$$



or, setting  $n-k$  for  $n$

$$(15) \quad \left. \begin{aligned} \sum_{i=0}^{n-k} (-1)^i A(k, n-i) B(i, k) &= 0 \\ \sum_{i=0}^k (-1)^i A(k, n-i) B(i, k) &= 0 \end{aligned} \right\} \text{provided } n > k = 0, 1, 2, 3, \dots$$

The two sums are equivalent since for  $i > k$ ,  $B(i, k)$  vanishes and for  $i > n-k$ ,  $A(k, n-i)$  vanishes.

From (15)

$$A(k, n) = \sum_{i=1}^k (-1)^{1+i} A(k, n-i) B(i, k), \quad n > k = 0, 1, 2, \dots$$

whence

$$B(k, n) = \sum_{i=1}^k (-1)^{1+i} B(k-i, n) A(n, n+i), \quad n > k = 0, 1, 2, \dots$$

Solving for the successive  $A$ 's and  $B$ 's, and for brevity writing  $A_1, A_2$  for  $A(n, n+1), A(n, n+2)$  etc., and  $B_1, B_2$ , for  $B(1, k), B(2, k)$  etc.,

$$\begin{aligned} A(k, k) &= 1 \\ A(k, k+1) &= B_1 \\ A(k, k+2) &= B_1^2 - B_2 \\ A(k, k+3) &= B_1^3 - 2B_1B_2 + B_3 \\ A(k, k+4) &= B_1^4 - 3B_1^2B_2 + 2B_1B_3 - B_4 + B_2^2 \\ A(k, k+5) &= B_1^5 - 4B_1^3B_2 + 3B_1^2B_3 - 2B_1B_4 + B_5 + 3B_1B_2^2 - 2B_2B_3 \\ &\text{etc., etc.} \end{aligned}$$

$$\begin{aligned} B(0, n) &= 1 \\ B(1, n) &= A_1 \\ B(2, n) &= A_1^2 - A_2 \\ B(3, n) &= A_1^3 - 2A_1A_2 + A_3 \end{aligned}$$

etc., etc., in exactly the same form as the  $B$ 's.

$S(k, n)$  satisfies the linear difference equation of order  $k$ ,

$$(16) \quad S(k, n+k) - B(1, k) S(k, n+k-1) + \dots + (-1)^i B(i, k) S(k, n+k-i) + \dots \\ \dots + (-1)^k B(k, k) S(k, n) = 0$$

of which the characteristic equation has for roots  $1, 2, 3, \dots, k$ ; and the conditions

$$S(k, n) = 0; \quad n = 1, 2, 3, \dots, k-1; \quad S(k, k) = (-1)^k k!$$

are exactly sufficient to determine the constants. These two equations, therefore, completely characterize

$$S(k, n) = \sum_{i=0}^k (-1)^i \binom{k}{i} i^n$$

In like manner, the difference equation

$$(17) \quad A(k, n+k) - B(1, k) A(k, n+k-1) + \dots + (-1)^i B(i, k) A(k, n+k-i) \\ + \dots + (-1)^k B(k, k) A(k, n) = 0$$

and the conditions

$$A(k, n) = 0, \quad n = 1, 2, 3, \dots, k-1; \quad A(k, k) = 1$$

completely characterize  $A(k, n) = \frac{1}{S(k, k)} \sum_{i=0}^k (-1)^i \binom{k}{i} i^n$

$B(k, n)$  satisfies the difference equation of order  $2k + 1$ ,

$$(18) \quad B(k, n + 2k + 1) - \binom{2k+1}{1} B(k, n + 2k) + \dots + (-1)^i \binom{2k+1}{i} \\ B(k, n + 2k + 1 - i) + \dots - B(k, n) = 0$$

of which the characteristic equation is

$$(x - 1)^{2k+1} = 0$$

Whence  $B(k, n)$  is a polynomial of degree  $2k$  in  $n$ , but the  $k + 1$  obvious conditions

$$B(k, n) = 0, \quad n = 0, 1, 2, 3, \dots, k-1, \quad B(k, k) = k!$$

are not sufficient to determine the constants. It is possible, however, by the successive application of the method of differences, since

$$\Delta B(k, n) = (n + 1) B(k - 1, n)$$

to determine these constants for any particular value of  $k$ .

Thus:

$$B(1, n) = \frac{1}{2} (n+1)n$$

$$B(2, n) = \frac{1}{24} (n+1)n(n-1) (3n+2)$$

$$B(3, n) = \frac{1}{48} (n+1)^2 n^2 (n-1) (n-2)$$

etc., etc.

§4.

The properties of

$$f(n, x, k) = \sum_{i=0}^k (-1)^i \binom{k}{i} (x+i)^n \tag{§2}$$

and an application of  $\sum_{i=0}^k (-1)^i \binom{k}{i} \frac{1}{x+i}$  in the theory of gamma functions suggests the generalization:

$$(1) \quad f(t, x, k, n) = \sum_{i=0}^k (-1)^i \binom{k}{i} i^n (x+i)^t$$

$k, n = 0, 1, 2, 3 \dots \dots \dots ; t = 0, \pm 1, \pm 2, \dots \dots \dots$

Whence

- (2)  $f(0, x, k, n) = S(k, n) \quad k, n = 0, 1, 2, \dots \dots \dots$
- (3)  $f(t, x, 0, n) = x^t \quad \text{when } n = 0$   
 $\quad \quad \quad = 0 \quad \quad \quad \text{when } n > 0$
- (4)  $f(t, x, 1, n) = x^t - (x+1)^t \quad \text{when } n = 0$   
 $\quad \quad \quad = -(x+1)^t \quad \quad \quad \text{when } n > 0$

When  $t < 0$ , this function has poles at  $x = -1, -2, \dots \dots \dots -k$ , and also when  $n + t < 0$ , at  $x = 0$ .

Since  $f(t, x, k, n) = \sum_{i=0}^k (-1)^i \binom{k}{i} i^n (x+i)^{t-n} (x+i)^m$

we have the recursion formula

$$(5) \quad f(t, x, k, n) = \sum_{i=0}^m \binom{m}{i} x^i f(t-m, x, k, m+n-i)$$

$t = 0, \pm 1, \pm 2, \dots \dots \dots ; k, n = 0, 1, 2, 3, \dots \dots \dots ; m = 1, 2, 3, \dots \dots$

If  $t$  is not negative, we have on setting  $t$  for  $m$  in (5)

$$(6) \quad f(t, x, k, n) = \sum_{i=0}^t \binom{t}{i} x^i S(k, t+n-i) \quad k, n, t = 0, 1, 2, 3 \dots \dots$$

If  $0 < n < k$

$$\sum_{i=0}^k (-1)^i \binom{k}{i} i^{(n)} (x+i)^t = (-1)^n k^{(n)} f(t, x+n, k-n, 0) \quad n = 1, 2, 3 \dots \dots k$$

Whence, making use of (2) §3,

$$(7) \quad f(t, x, k, n) = \sum_{i=0}^n (-1)^i A(i, n) k^{(i)} f(t, x+i, k-i, 0) \quad n = 1, 2, 3 \dots \dots k.$$

In (5), setting  $n = 0, m = 1$ , and  $t+1$  for  $t$ :

$$f(t+1, x, k, 0) = f(t, x, k, 1) + x f(t, x, k, 0)$$

but by (7)

$$f(t, x, k, 1) = -k f(t, x+1, k-1, 0)$$

Therefore,

$$(8) \quad x f(t, x, k, 0) = f(t+1, x, k, 0) + k f(t, x+1, k-1, 0), \quad k = 1, 2, 3, \dots$$

In (5) setting  $t = 0$ :

$$(9) \quad \sum_{i=0}^m \binom{m}{i} x^i f(-m, x, k, n+m-i) = S(k, n)$$

$$k, n = 0, 1, 2, \dots; \quad m = 1, 2, 3, \dots$$

Now  $S(k, n)$  vanishes if  $k > n$ ; therefore  $f(-m, x, k, n)$  satisfies the linear homogeneous difference equation of order  $m$ :

$$(10) \quad \sum_{i=0}^m \binom{m}{i} x^i f(-m, x, k, n+m-i) = 0,$$

$$k > n = 0, 1, 2, \dots; \quad m = 1, 2, 3, \dots$$

of which the characteristic equation is

$$(r + x)^m = 0$$

whence the complete solution is

$$(11) \quad f(-m, x, k, n) = (c_0 + c_1 n + \dots + c_{m-1} n^{m-1}) (-x)^n$$

$$m = 1, 2, 3, \dots; \quad n = 0, 1, 2, \dots, k-1; \text{ not for } n > k;$$

however, the equation (10) itself will give  $f(-m, x, k, n)$  for

$$n = k, k+1, \dots, k+m-1.$$

For  $m = 1$ , we have

$$f(-1, x, k, n) = c_0 (-x)^n \quad n = 0, 1, 2, 3, \dots, k.$$

and setting  $n = 0$ , we determine

$$c_0 = f(-1, x, k, 0).$$

setting  $t = -1$  in (8)

$$f(-1, x, k, 0) = \frac{1}{x} [S(k, 0) + k f(-1, x+1, k-1, 0)]$$

$$= \frac{1}{x} \text{ when } k = 0$$

$$= \frac{1}{x} f(-1, x+1, k-1, 0) \quad k = 1, 2, 3, \dots$$

whence by repetition, and noting (3)

$$f(-1, x, k, 0) = \frac{k!}{x(x+1)(x+2)\dots(x+k)}^*$$

and

$$f(-1, x, k, n) = \frac{(-x)^n k!}{x(x+1)\dots(x+k)} \quad n = 0, 1, 2, 3 \dots k-1$$

therefore, since by (10),  $f(-1, x, k, k) = -x f(-1, x, k, k-1)$ ,

$$(12) \quad f(-1, x, k, n) = \frac{(-x)^n k!}{x(x+1)\dots(x+k)} \quad n = 0, 1, 2, 3 \dots k, \text{ but not } n > k.$$

Example:

$$\begin{aligned} x(x+1)(x+2)(x+3)(x+4) \sum_{i=0}^4 (-1)^i \binom{4}{i} \frac{i^n}{x+i} &= 24 && \text{when } n = 0 \\ &= -24x && n = 1 \\ &= 24x^2 && n = 2 \\ &= -24x^3 && n = 3 \\ &= 24x^4 && n = 4 \\ \text{but} &&& = 240x^4 + 840x^3 + 1200x^2 + 576x, \quad n = 5 \end{aligned}$$

To find the value of  $f(-1, x, k, n)$  for  $n > k$ , set  $m = 1$  in (9) and multiply through by

$$(x+1)(x+2) \dots (x+k)/S(k, k) = \sum_{i=0}^k B(i, k) x^{k-i}/S(k, k)$$

and set

$$\begin{aligned} g(-1, x, k, n) &\text{ for } f(-1, x, k, n) \sum_{i=0}^k B(i, k) x^{k-i}/S(k, k): \\ g(-1, x, k, n+1) &= A(k, n) \sum_{i=0}^k B(i, k) x^{k-i} - xg(-1, x, k, n) \\ &&& k, n = 0, 1, 2, \dots \end{aligned}$$

Setting  $n = k, k+1$ , we verify that

$$(13) \quad g(-1, x, k, k+n) = \sum_{j=1}^n (-1)^{j-1} A(k, k+n-j) \sum_{i=j}^k B(i, k) x^{k+j-i-1}$$

holds for  $n = 1, n = 2$ ; and a complete induction shows, on taking account of (14) §3, ( $p = n$ ), that it holds for all positive integral values of  $n$ . On

\*See Chrystal: Algebra II, Ex. 26, p. 20.

changing the order of summation and replacing  $g(-1, x, k, n)$  by its value, we have

$$(14) \quad f(-1, x, k, n) = \frac{\sum_{j=1}^k x^j \sum_{i=1}^j (-1)^{i-1} B(k-j+i, k) S(k, n-i)}{x(x+1)(x+2) \dots (x+k)}$$

$n > k = 0, 1, 2, \dots$

the numerator being a polynomial arranged according to ascending powers of  $x$ ; on arranging this in descending powers of  $x$ , taking account of (14) §3,

$$(15) \quad f(-1, x, k, n) = \frac{\sum_{j=0}^{k-1} x^{k-j} \sum_{i=0}^j (-1)^i B(j-i, k) S(k, n+i)}{x(x+1)(x+2) \dots (x+k)}$$

$n > k = 0, 1, 2, 3 \dots$

It is obvious that (14) does not hold for  $n < k$ , since in that case  $S(k, n-i)$  vanishes,  $i = 1, 2, \dots, n$ ; on the other hand, noting that  $B(k, n)$  and  $S(k, n)$  both vanish if  $k > n$  and taking account of (15), §3, it results that in the numerator on the right side of (15), when  $n < k$ , the coefficient of every power of  $x$  vanishes except that of  $x^n$  and this turns out to be

$$(-1)^{k-n} B(0, k) S(k, k) = (-1)^n k! \text{ which agrees with (12).}$$

Therefore,

$$(16) \quad \sum_{i=0}^k (-1)^i \binom{k}{i} \frac{i^n}{x+i} = \frac{\sum_{j=0}^{k-1} x^{k-j} \sum_{i=0}^j (-1)^i B(j-i, k) S(k, n+i)}{x(x+1)(x+2) \dots (x+k)}$$

$k, n = 1, 2, 3 \dots$

but for the case where  $n < k$ , (12) is simpler.

Setting  $m = 2$  in (11)

$$(17) \quad f(-2, x, k, n) = (c_0 + c_1 n) (-x)^n \quad n = 0, 1, 2, \dots, k-1.$$

Put  $n = 0, n = 1$ , and determine

$$\begin{aligned} c_0 &= f(-2, x, k, 0) \\ c_1 &= -\frac{1}{x} f(-2, x, k, 1) - f(-2, x, k, 0), \quad \text{which by (7)} \\ &= \frac{k}{x} f(-2, x+1, k-1, 0) - f(-2, x, k, 0) \end{aligned}$$

In (8) set  $t = -2, k = 1$

$$x f(-2, x, 1, 0) = f(-1, x, 1, 0) + f(-2, x+1, 0, 0)$$

whence by (12) and (3)

$$\begin{aligned} f(-2, x, 1, 0) &= \frac{1}{x^2(x+1)} + \frac{1}{x(x+1)^2} \\ &= \frac{1!}{x^2(x+1)^2} \sum_{i=0}^1 (1+i) B(1-i, 1) x^i \end{aligned}$$

Again, setting  $k = 2$  in (8)

$$\begin{aligned} f(-2, x, 2, 0) &= \frac{1}{x} f(-2, x, 1, 0) + \frac{2}{x} f(-2, x+1, 1, 0) \\ &= \frac{2!}{x^2(x+1)^2(x+2)^2} \sum_{i=0}^2 (1+i) B(2-i, 2) x^i \end{aligned}$$

Assume

$$(18) \quad f(-2, x, k, 0) = \frac{k!}{x^2(x+1)^2 \dots (x+k)^2} \sum_{i=0}^k (1+i) B(k-i, k) x^i$$

and a complete induction, on taking account of (11) §3, shows that this holds for all positive integral values of  $k$ .

Therefore:

$$\begin{aligned} c_0 &= \frac{k!}{x^2(x+1)^2 \dots (x+k)^2} \sum_{i=0}^k (1+i) B(k-i, k) x^i \\ -c_1 &= \frac{k!}{x^2(x+1)^2 \dots (x+k)^2} \sum_{i=0}^k B(k-i, k) x^i \end{aligned}$$

and

$$(19) \quad f(-2, x, k, n) = \frac{(-x)^n k!}{x^2(x+1)^2 \dots (x+k)^2} \sum_{i=0}^k (1+i-n) B(k-i, k) x^i$$

$$k = 0, 1, 2, \dots; n = 1, 2, 3, \dots, k-1$$

On computing, by means of (10), the values of  $f(-2, x, k, k)$  and  $f(-2, x, k, k+1)$ , we verify that (19) holds for  $n = 1, 2, 3, \dots, k+1$  but not for  $n > k+1$ ,

Therefore,

$$(20) \quad \sum_{i=0}^k (-1)^i \binom{k}{i} \frac{i^n}{(x+i)^2} = \frac{(-x)^n k!}{x^2(x+1)^2 \dots (x+k)^2} \sum_{i=0}^k (1+i-n) B(k-i, k) x^i$$

$$k = 0, 1, 2, \dots; n = 0, 1, 2, \dots, k+1; \text{ not } n > k+1$$

The corresponding results for  $n = k + 2, k + 3, \text{ etc.}$ , may be found by putting these values successively for  $n$  in

$$(21) \quad f(-2, x, k, n+2) = S(k, n) - 2x f(-2, x, k, n+1) - x^2 f(-2, x, k, n)$$

which results from setting  $m = 2$  in (9). The general result may be put into the form

$$(22) \quad f(-2, x, k, n) = \frac{\sum_{j=0}^{2k-2} x^{2k-j} \sum_{i=0}^{k-1} D(i, j, k) S(k-i, n)}{x^2(x+1)^2 \dots (x+k)^2}; \quad k, n = 1, 2, 3 \dots$$

in which the coefficients  $D$ , are independent of  $n$ :

$$\begin{aligned} D(i, 0, k) &= 1 \quad \text{when } i = 0 \\ &= 0 \quad \quad \quad i = 1, 2, 3 \dots \dots \dots \\ D(0, j, k) &= \sum_{t=0}^j B(t, k-1) B(j-t, k-1) \quad \quad \quad j = 1, 2, 3 \dots \end{aligned}$$

but I have not been able to determine a general formula for  $D(i, j, k)$  by means of which to calculate the coefficients of  $f(-2, x, k, p), p > k+1$ , without first calculating successively those for  $n = k+2, k+3, \dots \dots p-1$ .

By making use of (10) § 2, (21) may be reduced to

$$(23) \quad f(-2, x, k, n) = \frac{\sum_{j=0}^{2k-2} x^{2k-j} \sum_{i=0}^{k-1} E(i, j, k) S(k, n+i)}{x^2(x+1)^2 \dots (x+k)^2}; \quad k, n = 1, 2, 3 \dots$$

with which compare (16)

Example:

$$\begin{aligned} x^2(x+1)^2(x+2)^2(x+3)^2(x+4)^2 \sum_{i=0}^4 (-1)^i \binom{4}{i} \frac{i^n}{(x+i)^2} &= S(4, n) x^8 + \\ [12 S(4, n) + 8 S(3, n)] x^7 + \\ [58 S(4, n) + 76 S(3, n) + 36 S(2, n)] x^5 + \\ [144 S(4, n) + 272 S(3, n) + 288 S(2, n) + 96 S(1, n)] x^5 + \\ [193 S(4, n) + 460 S(3, n) + 780 S(2, n) + 720 S(1, n)] x^4 + \\ [132 S(4, n) + 368 S(3, n) + 840 S(2, n) + 1680 S(1, n)] x^3 + \\ [36 S(4, n) + 112 S(3, n) + 312 S(2, n) + 1200 S(1, n)] x^2 \\ n = 1, 2, 3 \dots \dots \dots \end{aligned}$$



also:

$$\begin{aligned}
 &= S(4,n) x^8 + [20 S(4,n) - 2 S(4,n+1)] x^7 + \\
 &[170 S(4,n) - 40 S(4,n+1) + 35 S(4,n+2)] x^6 + \\
 &[800 S(4,n) - 340 S(4,n+1) + 60 S(4,n+2) - 4 S(4,n+3)] x^5 + \\
 &[2153 S(4,n) - 1350 S(4,n+1) + 335 S(4,n+2) - 30 S(4,n+3)] x^4 + \\
 &[3020 S(4,n) - 2402 S(4,n+1) + 700 S(4,n+2) - 70 S(4,n+3)] x^3 + \\
 &[1660 S(4,n) - 1510 S(4,n+1) + 476 S(4,n+2) - 50 S(4,n+3)] x^2 \\
 &\quad n = 1, 2, 3 \dots \dots
 \end{aligned}$$

These results are consistent with (20) for  $n = 1, 2, 3, 4, 5$  and for  $n = 6$  give

$$\begin{aligned}
 &1560 x^8 + 14400 x^7 + 51672 x^6 + 59520 x^5 + 100320 x^4 + 57600 x^3 \\
 &\quad + 13824 x^2.
 \end{aligned}$$

*Purdue University.*



## RADIOACTIVITY OF SPRING WATER.

---

R. R. RAMSEY.

Since the discovery of the Becquerel rays in 1896 by Henri Becquerel a great amount of work has been done on radioactive bodies; i. e., bodies which give out a radiation which, among other things, renders the air conducting. Madam Curie discovered polonium and radium in 1898. After the discovery of radium a great many workers contributed to our knowledge of radioactive bodies. Radium and polonium are now known to be transformation products in the radioactive series headed by uranium. Besides the uranium-radium series we have the thorium series, the actinium series, and the potassium series in the radioactive list.

Very early in the history of radioactivity, tests were made on ordinary matter to see if all matter is radioactive. Although there is some evidence to show that all matter is radioactive, i.e., is disintegrating, it has been found that a great part of the effect is due to slight traces of radium and other radioactive substances which are mixed with matter. Thus the surface of the earth is covered with slight traces of radium. The exact distribution of radium on the surface of the earth is not known, determinations having been made in a relatively few localities. Besides the scientific interest in the distribution of radium there is another. It has been found that a great many of the celebrated European springs and baths show an unusual amount of radioactivity. The theory has been advanced that the curative properties of these springs are due to the radioactivity of the water.

Table I gives a partial list of the measurements made on noted springs also a short list of ordinary springs, etc.

TABLE I.  
RADIOACTIVITY OF NOTED SPRINGS, ETC.

|                                           |           |                                              |
|-------------------------------------------|-----------|----------------------------------------------|
| Kings well, Bath, Eng. ....               |           | 173. X10 <sup>-12</sup> Gm. Ra. per liter.   |
| Brembach (Saxe.).....                     | 36000. to | 720000. X10 <sup>-12</sup> Curies per liter. |
| Schweizergang, Joachimsthal.....          |           | 98000.                                       |
| Lake Balaton, Hungary.....                | 10300. to | 36000.                                       |
| Potable waters of Mulhause (Alsace).....  |           | 2800.                                        |
| Evaux-les-Bains.....                      | 1060. to  | 2340.                                        |
| Evaux-les-Bains gas.....                  | 3440. to  | 80090.                                       |
| Japanese hot springs.....                 | 237. to   | 13800.                                       |
| Colorado Springs, Manitou.....            | 120. to   | 4730.                                        |
| Colorado Springs, Manitou, gas.....       | 470. to   | 20500.                                       |
| West Canada, Fairmount, Sinclair.....     | 3500. to  | 4000.                                        |
| Yellowstone Park.....                     | 2.26 to   | 10.4 Mache units.                            |
| Yellowstone Park gas.....                 | 6.25 to   | 118.3 Mache units                            |
| Sixty Springs, Tyrol.....                 | .06 to    | 89. Mache units.                             |
| Saratoga, N. Y., springs.....             | 39. to    | 880. X10 <sup>-12</sup> Curies per liter.    |
| Saratoga, N. Y., springs gas, Max.....    |           | 847.                                         |
| Williamstown, Mass.....                   | 13. to    | 216.                                         |
| Williamstown, Mass., gas.....             | 759. to   | 7290.                                        |
| Caledonian Springs, near Ottawa, Can..... |           | 15.                                          |
| St. Lawrence River.....                   | .25 to    | 1.1                                          |
| Sea water.....                            |           | .9                                           |
| Air, Montreal, Cambridge, etc.....        |           | .1                                           |

One Mache unit equals 364.X10<sup>-12</sup> (Curies per liter).

The radioactivity of water may be due to traces of radium salts dissolved in the water. It may be due to some other product of the uranium-radium series, to radium emanation, usually, or to some product of the thorium or actinium series. The greater amount is usually due to radium or radium emanation dissolved in the water.

In the uranium-radium series (Table No. 2), it will be noted that when one substance changes into another a radiation of  $\alpha$ ,  $\beta$ , or  $\gamma$  rays, in some cases all three, are given off. This radiation ionizes the air and renders it conducting. The conductivity of the air becomes a measure of the radioactivity of the substance. This is proportional to the rate which a charged body loses its charge.

The ionization produced by the three sets of rays is about in the following proportions:  $\alpha = 100\%$ ,  $\beta = 1\%$ ,  $\gamma = .01\%$ . The penetrating powers are in the inverse proportion. Electroscopes for radioactive measurements are known as  $\alpha$  ray electroscopes,  $\beta$  ray electroscopes,  $\gamma$  ray electroscopes according to the amount of material that must be penetrated by the radiation in order to get into the electroscope. Thus in an  $\alpha$  ray electroscope the substance tested is placed in the electroscope or very near to a window covered with a very thin sheet of aluminum or paper. The rays pass in

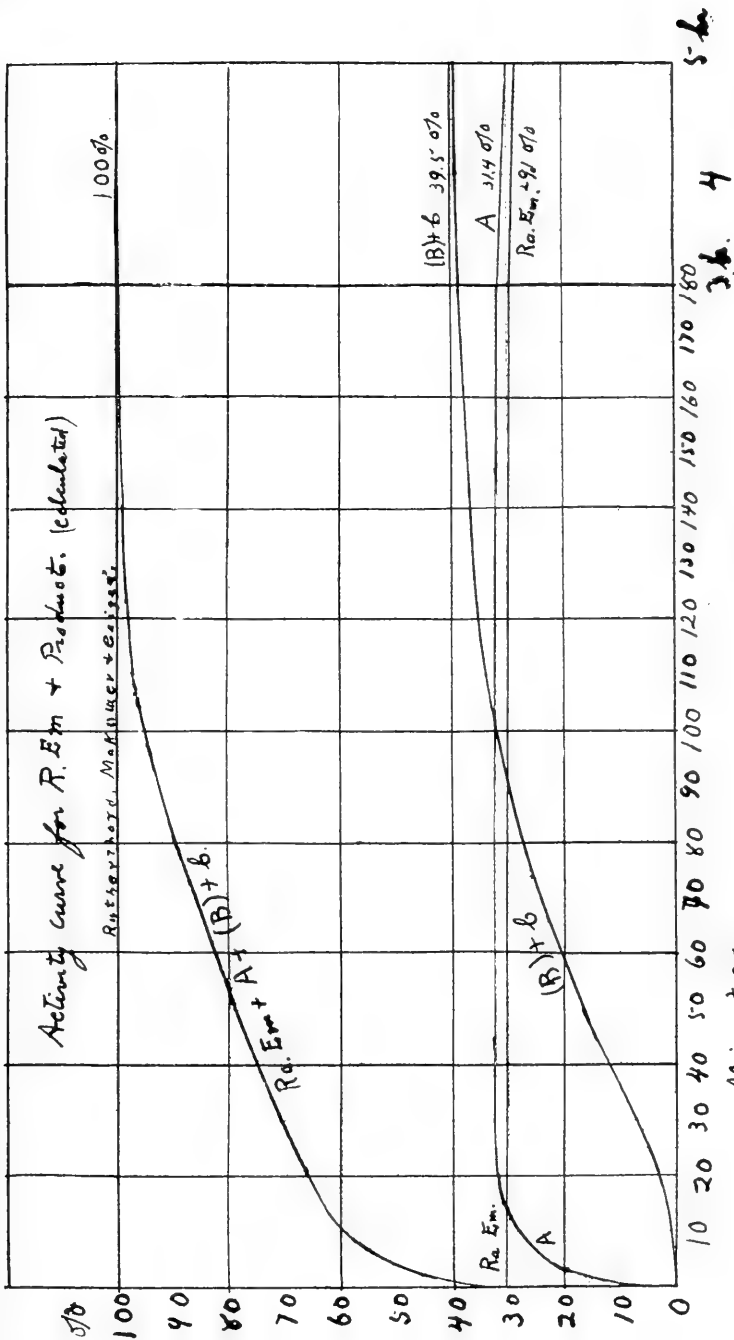


Figure I.

without absorption and practically all, at least 99%, of the ionization is produced by the  $\alpha$  rays. In the  $\beta$  ray electroscop the radiation must pass through .05 mm. aluminum, which absorbs all the alpha rays and the ionization is produced by the  $\beta$  rays. In the  $\gamma$  ray electroscop the radiation must pass through 2 mm. of lead, which completely absorbs the  $\alpha$  and  $\beta$  radiation leaving the  $\gamma$  rays to produce the ionization. Thus for very weak radioactive bodies the  $\alpha$  rays are used, to produce the ionization.

TABLE 2.  
URANIUM RADIUM SERIES.

| SUBSTANCE.                    | Radiation.              | Half-value Period.     | Transformation Constant sec <sup>-1</sup> . | Range of $\alpha$ rays in cms. (15° C.). | Absorption Coefficients.              |                                       |
|-------------------------------|-------------------------|------------------------|---------------------------------------------|------------------------------------------|---------------------------------------|---------------------------------------|
|                               |                         |                        |                                             |                                          | $\beta$ rays Alum. cm <sup>-1</sup> . | $\gamma$ rays Lead cm <sup>-1</sup> . |
| Uranium 1.....                | $\alpha$                | $5 \times 10^8$ years. | $4.6 \times 10^{-18}$                       | 2.50                                     |                                       |                                       |
| Uranium 2.....                | $\alpha$                | $2 \times 10^7$ years. | $1.1 \times 10^{-14}$                       |                                          |                                       |                                       |
| Uranium X.....                | $\beta, \gamma$         | 24.6 days.             | $3.26 \times 10^{-7}$                       |                                          | 14.4 and 510                          | 72                                    |
| (Uranium Y).....              | $\beta$                 | 1.5 days.              | $5.34 \times 10^{-6}$                       |                                          | 360                                   |                                       |
| Ionium.....                   | $\alpha$                | $2 \times 10^8$ years. | $1.1 \times 10^{-13}$                       | 3.00                                     |                                       |                                       |
| Radium.....                   | $\alpha, \beta$         | 2000 years.            | $1.1 \times 10^{-11}$                       | 3.30                                     | 200                                   |                                       |
| Radium Emanation.....         | $\alpha$                | 3.85 days.             | $2.085 \times 10^{-6}$                      | 4.16                                     |                                       |                                       |
| Radium A.....                 | $\alpha$                | 3.0 min.               | $3.85 \times 10^{-5}$                       | 4.75                                     |                                       |                                       |
| Radium B.....                 | $\beta, \gamma$         | 26.7 min.              | $4.33 \times 10^{-4}$                       |                                          | 13 and 91                             | 4-6                                   |
| Radium C <sub>1</sub> .....   | $\alpha, \beta, \gamma$ | 19.5 min.              | $5.93 \times 10^{-4}$                       | 6.94                                     | 13 and 53                             | 50                                    |
| (Radium C <sub>2</sub> )..... | $\beta$                 | 1.4 min.               | $8.25 \times 10^{-3}$                       |                                          | 13                                    |                                       |
| Radium D.....                 | $\beta$                 | 16.5 years.            | $1.33 \times 10^{-9}$                       |                                          | very soft.                            |                                       |
| Radium E.....                 | $\beta, \gamma$         | 5 days.                | $1.60 \times 10^{-6}$                       |                                          | 43                                    | very soft.                            |
| Radium F (Polonium).....      | $\alpha$                | 136 days.              | $5.90 \times 10^{-8}$                       | 3.77                                     |                                       |                                       |

The substances in parentheses are products not in the direct line of transformation.

Makower & Geiger's Practical Measurements in Radioactivity.

One notes in the radioactive series (Table 2), that the disintegration product of radium is emanation, a gas, which gives off an  $\alpha$  particle and changes into Rad. A. This emanation is a gas and obeys all the gas laws. Rad. A has a half value period of three minutes and gives off an  $\alpha$  particle and changes into Rad. B. Rad. B has a half value period of 26.8 minutes and gives off  $\beta$  and  $\gamma$  radiation and changes into Rad. C. Rad. C has a half value period of 19.5 minutes, gives off  $\alpha$ ,  $\beta$  and  $\gamma$  particles and changes into Rad. C<sub>2</sub> and Rad. D. Rad. D has a slow half value period of 16.5 years. This is so slow that the ionization produced by this change can be neglected in com-

parison with the others. Thus some time, about three hours, after the emanation has been placed in a vessel we have Rad. Em. changing through the intermediate products into Rad. D. giving off three  $\alpha$  particles, one from Rad. Em.; one from Rad. A; and one from Rad. C. This complex radiation has after the first few hours the half value period of the longest of the series, which is that of Rad. Em., 3.85 days. Thus if a quantity of radium emanation gas is placed in an electroscopes the rate of "leak" of the electroscopes in-

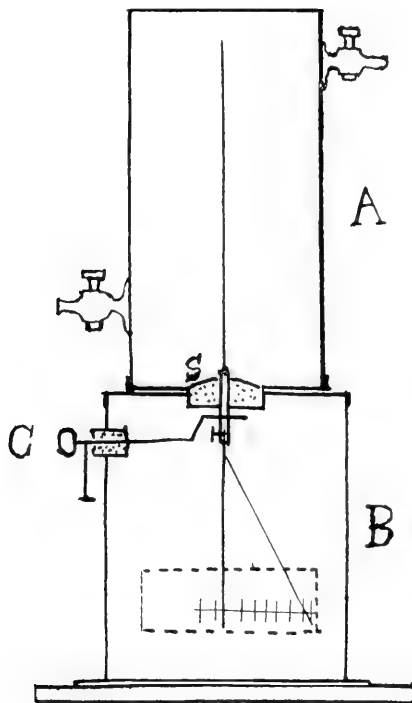


FIG. 2.

creases for three hours and then slowly decreases, dropping to one-half value of the maximum in 3.85 days from the time it reached the maximum.

The rise of activity during the first few hours is shown by the curves in Fig. 1. These curves are plotted from data given in Rutherford's *Radioactive Substances and Their Radiations*, and in Makower & Geiger's *Practical Measurements in Radioactivity*. The final values (4 hours) are based on the number of ions produced by  $\alpha$  particles from the various products. Thus

Rad. Em., 29.1%, Rad. A, 31.4%, Rad. (B) and C, 39.5%. Total, 100%. The line marked Rad. Em. starts initially at 30.% and in four hours has diminished to 29.1% according to the half period of 3.85 days. Rad. A. initially is zero, because initially emanation alone is placed in the chamber. Curve A rises to half value in three minutes and in 20 or 30 minutes becomes in equilibrium, that is, it disintegrates into Rad. B as fast as it is formed from the emanation. The latter part of the curve is practically a straight line parallel to the curve for emanation.

Rad. B does not give off  $\alpha$  particles. The ionization due to the  $\beta$  radiation can be neglected. Rad. B changes into Rad. C whose half period is 19.5 minutes. Thus the curve (B) and C depends upon the amount of Rad. C present. This initially depends upon the formation of Rad. A and B. The

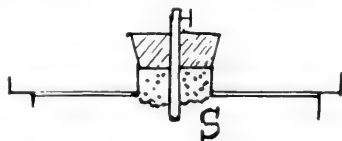


FIG. 3.

curve starts from zero and reaches its equilibrium in about four hours. The total ionization depends upon all three, so the current in the chamber, assuming that all ions capable of being produced by the  $\alpha$  particles are used, increases according to the curve  $Em. + A + B + C$ , which is formed by summing the ordinates of the three curves. This reaches 100% in about three hours. In a chamber of smaller dimensions the effect of the slower electrons will be greater than the above, since a greater number of the high velocity ones will be absorbed by the walls of the chamber before they have produced their maximum number of ions.

The quantity of emanation gas associated with or occluded in, or in equilibrium with, a quantity of radium has been found to be directly proportional to the mass of radium. This is so true that the amount of emanation in equilibrium with one gram of radium has been measured very exactly and is called the curie. Thus one gram of old radium contains or is in equilibrium with one curie of radium emanation gas. The volume of this gas under standard conditions is .62 cu. mm.

To collect this gas the radium is put into solution, boiled and the gas diluted with air is collected over mercury and then introduced into the electro-scope. The radium solution after standing one month is again in equi-



librium with the emanation and can be used again. By noting the ionization current or the "leak" of the electroscope other samples of radium can be compared with the first by putting sample No. 2 through the same process. The Bureau of Standards at Washington is prepared to standardize radium solutions by comparing them with a standard in its possession.

If no standard is at hand the electroscope can be standardized by using Duane's empirical formula. (Le Radium Vol. XI, P. 5, 1914; Ann. der Phys. Vol. 38, P. 959, 1912; Compt. Rendus Vol. 150, P. 1421, 1910; Jour. de Phys. Vol. 4, P. 605, 1905), which is,

$$e = \frac{i_0}{2.49 \times 10^6 (1 - 0.517 S/V)} \text{ curies.}$$

or,

$$e = \frac{i_{\max.}}{6.31 \times 10^6 (1 - 0.572 S/V)} \text{ curies.}$$

Where,  $e$  = amount of emanation in the electroscope.

$i_0$  = initial current, expressed in E. S. units.

$i_{\max}$  = maximum current (current at end of three hours) expressed in E. S. units.

$S$  = inside surface of ionization chamber of electroscope.

$V$  = volume of ionization chamber.

This equation applies to a cylindrical ionization chamber with a central rod. The volume of the chamber must be about one liter and the height is from one to three times the diameter.

The ionization chamber can be a cylindrical metallic chamber with an insulated rod extending through the center. This rod can be connected to an electrometer or to an electroscope in order to determine the potential of the rod. For very delicate measurements of small amounts of emanation a sensitive electroscope is better than an electrometer. In an electroscope the ionization current,  $i$ , is measured by knowing the capacity,  $C$ , of the electroscope; the change of potential,  $dV$ , of the insulated rod, in the time,  $t$ ; according to the equation,

$$i = \frac{C dV}{t}.$$

In order to measure a small current in a short time,  $C$ , the capacity of the electroscope must be small and  $dV$ , the change of potential, must be

small. Therefore we wish a sensitive electroscopé of small capacity. The cylindrical chamber is in reality a cylindrical condenser. Therefore we want the diameter of the rod small compared to the diameter of the cylinder, also the collar holding the insulating material should be short and have a large diameter compared to the rod. In short the dimensions of the insulated system should be as small as rigidity and other considerations will permit.

To make the electroscopé sensitive the "gold leaf" should be very light and narrow. With Dutch leaf a strip between one and two millimeters wide will give a change of one mm. for a change of potential of five volts. By

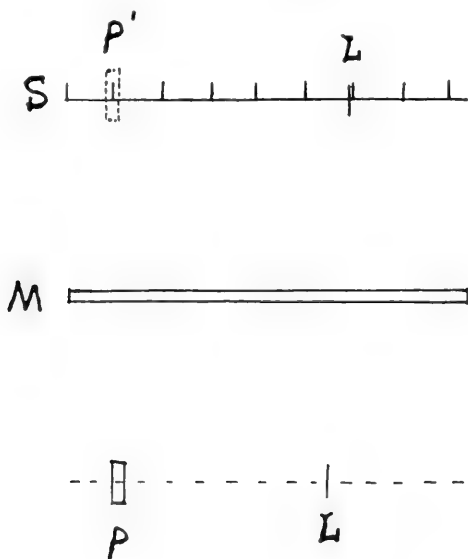


FIG. 4.

using a reading microscope with graduated eye piece a fraction of a volt can be detected. The electroscopé should be made of brass tubing the thickness of whose walls is one mm. or more. Where such material is not to be had sheet tin can be used and will give satisfactory results, especially if used in a laboratory free from penetrating radiation. I will describe one which I made at a cost of a few cents and have found to give consistent results when compared with one made in Germany which cost \$50.

The cylinder A, Fig. 2, is a 1 lb. coffee can. B, is a tin can made in a local tin shop, 3x3x5 inches with a lid at the top. The lid of the coffee can and the lid of the rectangular can are soldered together and a short cylinder

of brass, S, is soldered in a hole in the center. In this short cylinder the central rod system, which can be made of two or more sections, is insulated by pouring melted sulphur into the cylinder while the rod is supported in proper position by a cork, Fig. 3, which extends a short distance into the cylinder. After a few hours the cork can be removed, leaving the sulphur plug. In melting the sulphur care must be used not to get the sulphur too

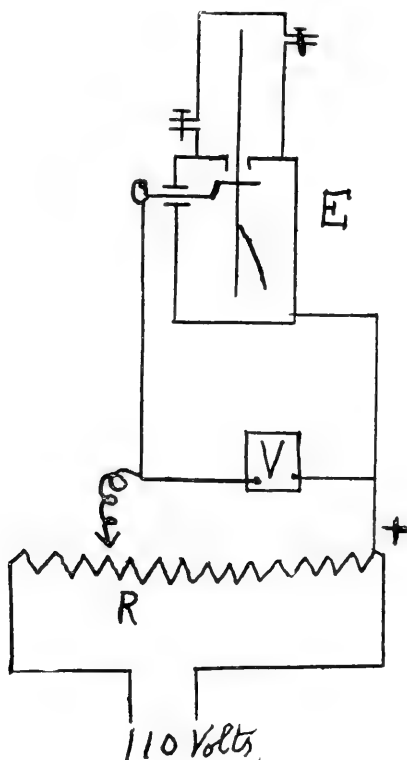


FIG. 5.

hot or to burn it. The melted sulphur should be a clear amber liquid. If the sulphur takes the waxy condition it should be discarded. The leaf is attached to a narrow plate which is attached to the lower end of the rod. The leaf which is a narrow strip of Dutch foil should be attached to the plate so as to be straight and to swing freely bending at a point near the plate.

The deflection of the leaf is observed through a small window at one

side. A similar window should be placed on the opposite side to admit light. To read the amount of deflection a scale *S*, as shown in Fig. 4, is mounted on one side on or near the back window. A strip of cross-section paper stuck to the glass with paraffin while hot will answer. The paraffin serves two purposes: it sticks the paper and renders the scale translucent. Half way between the scale and the plane of the leaf system a mirror, *M*, is mounted. Through the front window one sees in the mirror images of the plate, *P*, and the foil, *L*, at  $P^1$  and  $L^1$ . These images are in the same plane as the scale, *S*, which can be viewed by looking over the mirror, *M*. The position of  $L^1$  can be read on the scale, *S*, and at the end of a convenient interval of time its position can be noted again. By comparing the two positions with the calibration curve of the electroscopes the change of potential,  $dV$ , can be obtained.

The system is charged by means of a rubber rod through the charging system, *C*, Fig. 2. This consists of an insulated rod with a bent wire connected so as to be in contact with the central rod while charging. While not in use this rod is rotated so as to break connection with the rod and then to come into metallic contact with the case of the electroscopes.

Two  $\frac{1}{4}$ -inch brass drain cocks are soldered to the emanation chamber to admit the emanation.

The data of the following experiment, Table 3, carried out by two students using the "tin electroscopes" and a Schmidt electroscopes made by Spindler & Hoyer, Göttingen, will give an idea of the accuracy of this electroscopes and also the accuracy of Duane's formula.

TABLE 3.

|                                           |                                  |                            |
|-------------------------------------------|----------------------------------|----------------------------|
| Electroscopes.....                        | "Tin".....                       | Schmidt.                   |
| Observer.....                             | F. G. T.....                     | W. D. S.                   |
| Diameter of chamber.....                  | 10.8 cm.....                     | 7.8 cm.                    |
| Height of chamber.....                    | 12.1.....                        | 20.3                       |
| Volume of chamber.....                    | 1102 cc.....                     | 968 cc.                    |
| Surface of chamber.....                   | 594 sq. cm.....                  | 586.6 sq. cm.              |
| Capacity of electroscopes.....            | 17.1 cm.....                     | 6.3 cm.                    |
| Observed emanation, Curies per liter..... | 206000. X10 <sup>-12</sup> ..... | 200000. X10 <sup>-12</sup> |

The two electroscopes were connected together and connected to a vessel containing emanation and pumped causing the air and emanation to pass in a circle through the three chambers until the three contained emanation of the same density.

*Calibration of Leaf.*—The instrument can be calibrated by connecting to known potentials and noting the deflections of the leaf. A storage battery of three or four hundred volts is convenient. Readings should be taken for every few volts from 0 to the maximum and a curve plotted.  $X$  = deflection,  $Y$  = volts. If a large voltage battery is not at hand a 110 volt D. C. circuit can be used making connection to a resistance as in Fig. 5. The voltmeter,  $V$ , should be read at the same time that the deflection of the leaf is read. A calibration curve from 0 to 110 volts can then be obtained. For the higher points proceed as follows: Charge the leaf to maximum voltage by means of a rubber rod. A body of small capacity, small compared to the capacity of the electroscope, 1 or 2 cm., say, is mounted on an insulated handle. A coin on a small rubber rod will answer. This is first grounded and then touched to the charged system. The gold leaf falls. The capacity is removed, grounded, and the position of the leaf noted. The operation is repeated until the leaf falls to 0 on the scale.

If  $C$  is the capacity of the electroscope, and

$c$  is the capacity of the coin,

$Q$ , the quantity of electricity,

$V_1 V_2$  is 1st, 2nd, . . . . potential of the leaf,

$d_1 d_2$  is 1st, 2nd, . . . . deflections of leaf,

then,  $Q_1 = CV_1 = (C + c)V_2$

$Q_2 = CV_2 = (C + c)V_3$

$Q_n = CV_n = (C + c)V_{(n+1)}$

$$\frac{C + c}{C} = \frac{V_1}{V_2} = \frac{V_2}{V_3} = \frac{V_n}{V_{(n+1)}}.$$

The last three or four deflections should be on the part of the scale already calibrated. That is, the potentials should be less than 110 volts. If  $V_n$  and  $V_{n+1}$  are known by comparing with  $d_n$  and  $d_{n+1}$  on the calibration curve. Since,

$$\frac{V_n}{V_{n+1}} = \frac{V_{n-1}}{V_n}$$

then,

$V_{n-1}$  can be calculated.  $V_{n-1}$  being known, then  $V_{n-2}$  can be determined. In like manner all  $V$ s can be determined up to  $V_1$ . Knowing  $V$  and the corresponding deflection,  $d$ , the curve can be extended up to the maximum deflection.

*Determination of Capacity.*—In the same equations if  $c$  is known, that is, if  $c$  is a cylindrical condenser, then  $C$  can be obtained. Note that  $C$  is the capacity of the “leaf” system plus the charging system. Knowing the sum, the capacity of the “leaf” can be had by getting the ratio of the two by an operation similar to the above.

*Removing the Emanation Gas from the Solution.*—The emanation can be removed from a solution by the boiling method. The solution is boiled, driving off the dissolved gases with the steam. The steam is condensed and the gases are trapped in suitable glass tubes over mercury. The ionization chamber is then evacuated and the emanation is sucked into the electroscop. The entire amount of emanation is placed in the chamber by washing the

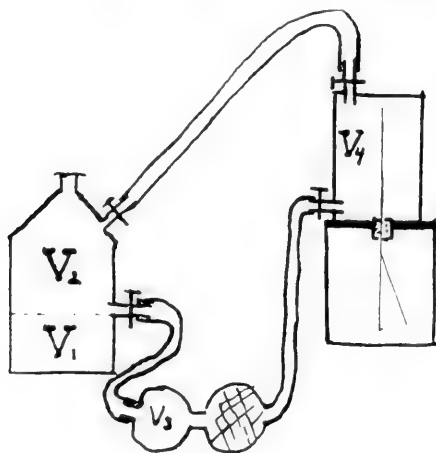


FIG. 6.

glass tube with air until the pressure of the ionization chamber of the electroscop is at normal pressure. This method is accurate but requires elaborate apparatus which can be used only in the laboratory.

Where the greatest accuracy is not wished Schmidt's shaking method can be used. (Phys. Zeit., Vol. 6, p. 561, 1905.) This method admits of determinations being made at the spring with apparatus which easily can be carried by the observer. The shaking method consists of taking a known volume of water and shaking it vigorously for two minutes in a closed vessel with a known volume of air. Then the emanation which was originally dissolved in the water is mixed in the air and water in a known proportion, depending upon the temperature of the water. Then this air is pumped through

rubber tubing from the shaking vessel into the ionization chamber and back again to the shaking vessel until the emanation is mixed through the air of both chambers in the same proportion. Knowing the constants of the electroscopes and the observed change of deflection of the leaf, the amount of emanation in the ionization chamber is known. Knowing this and the various volumes of air and water the amount of emanation per liter of water can be calculated. The shaking vessel is made of a can with two brass stop cocks soldered into it. One cock is placed near the top the other is placed on the side about half way up. For convenience the position of the lower stop cock can be calculated so that the vessel will hold a certain quantity of water when the vessel is filled full and then placed on a level stand with both stop cocks open. In this manner the volume of the water is determined easily and can be made the same in each experiment. The volume of the air above the water can be had by determining the total volume of the can. To pump the air around a rubber bulb pump such as is used in pyrography outfits answers well. The volume of the air in the tubes and pump must be estimated and used in the calculations.

The formula for calculating the amount of emanation per liter, which can be derived easily in connection with Fig. 6, is as follows:

$$E = \frac{I}{V_1} \left( \frac{V_2 + z V_1}{V_1} \right) \left( \frac{V_2 + V_3 + V_4}{V_4} \right) e,$$

Where  $V_1$  = Volume of water in shaking can, expressed in liters.

$V_2$  = Volume of air in shaking can, expressed in liters.

$V_3$  = Volume of bulb, pump, and connection tubes.

$V_4$  = Volume of ionization chamber.

$z$  = Absorption coefficient of water for radium emanation.

$e$  = Amount of emanation in chamber,  $V_4$ .

$E$  = Amount of emanation per liter of water.

The quantity alpha,  $z$ , has been determined experimentally and has been found to depend upon the temperature. The value at any temperature can be had by referring to the curve (Fig. 7). The data for this curve is taken from M. Kofler (Akad. Wiss. Wien, Ber. 121, 2a pp. 2193; Sci. Abs. Vol. 16, 1742, 1913), and Boyle (Phil. Mag., 22, p. 840, 1911.)

As a test of the above equation the following will serve (Table 4). Three tests were made at the spring under the ordinary conditions. The

same electroscope was used, but two shaking cans were used, the larger of which had three stop cocks so that two volumes of water could be had.

TABLE 4.

C. J. S. Spring. August 5, 1914. Temperature of water 12.5° C. Temperature of air 30° C.

|                                    | I.                      | II.                     | III.               |
|------------------------------------|-------------------------|-------------------------|--------------------|
| Time of beginning .....            | 11.03 a. m. ....        | 11.46 a. m. ....        | 2.00 p. m.         |
| Volume of water .....              | .707 liters. ....       | 3.00 liter. ....        | 5.00 liter.        |
| Volume of air .....                | .943. ....              | 4.10. ....              | 2.10.              |
| Curies $X10^{-12}$ per liter ..... | 425. $X10^{-12}$ . .... | 435. $X10^{-12}$ . .... | 443. $X10^{-12}$ . |

These observations were taken every minute and the mean deflection from 15 minutes to 20 minutes from the time of putting the emanation in the ionization chamber, was used. By referring to an experimental curve (Fig. 8), the maximum deflection per minute or the deflection at the end of three hours was calculated. A better agreement could have been obtained if the interval from the end of one experiment to the beginning of the next had been three hours or more.

Fig. 8 is a curve showing actual observations during a period of three hours taken with a sample of water from Hottle Spring. The observations have been reduced to a scale of 100% for the maximum. The curve marked "Decay A and C" is made by observing the deflections after the emanation has been pumped out. By means of this experimental curve observations at any time can be reduced to the maximum or three-hour values. For exact work the emanation should be placed in the electroscope and allowed to stand for three hours and several observations made and the mean used. The curve is for all practical purposes horizontal from three to four hours.

In all these observations the deflections have been corrected for the natural leak of the electroscope due to the natural ionization of the air.

Before giving results, I shall speak of some factors which may influence the results. Since the emanation gas is dissolved in the water and is removed by boiling or by shaking, care should be used in filling the shaking can. Immerse the can in a pool as close as possible to the source and allow the water to flow in gently. Filling by dipping and pouring with a smaller vessel removes some of the gas. If before the water issues from the ground it trickles over rocks in the presence of air which is not charged with emana-



Absorption Coefficient,  $\alpha$ .

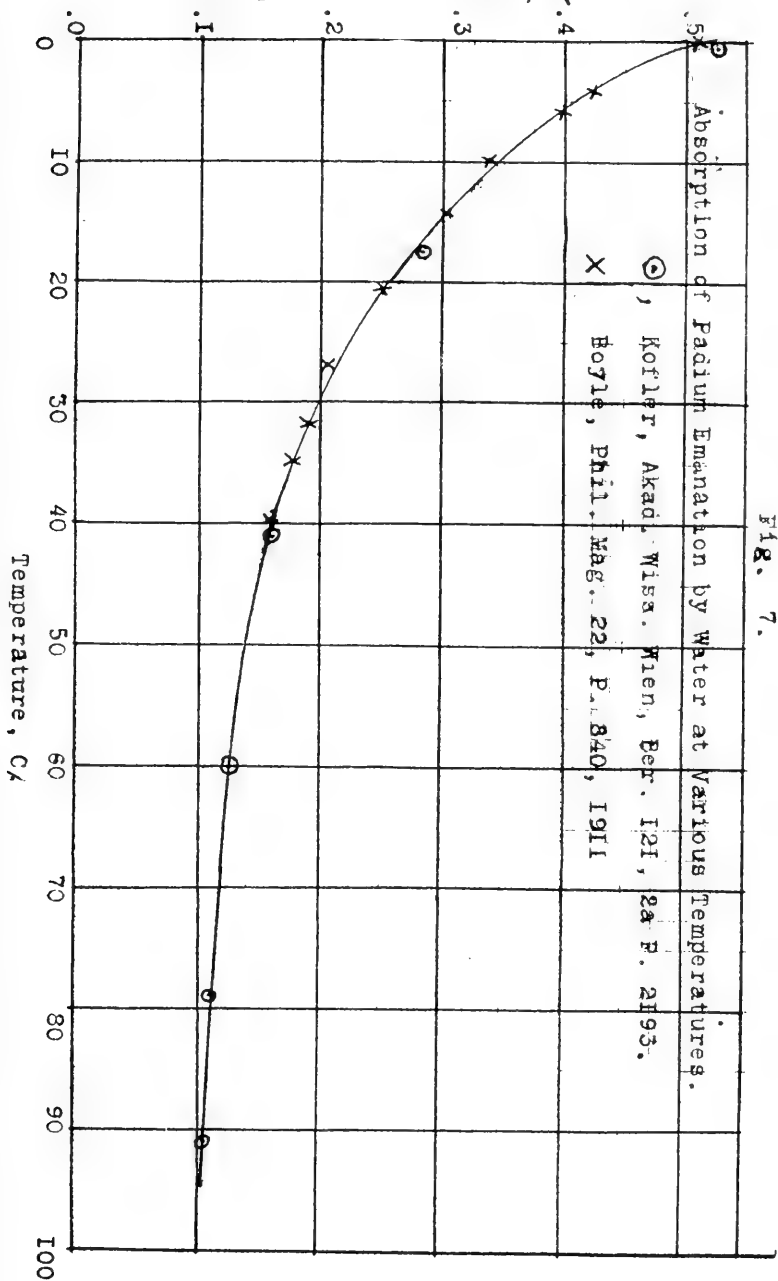


Fig. 7.

tion it must lose some of the emanation. This may explain the variation of springs in the same locality.

Observations made at the spring simply show the emanation content of the water. This may be due to three things. The emanation which is continually forming from traces of radium in the soil and rocks through which and over which the water passes is dissolved in the water and passes out with the water. It may be due to radium salts dissolved in the water. Or it may be due to some product of the thorium or actinium series. In the first case the water will show radioactivity by the emanation method and after standing in a closed vessel for a month will not show any emanation. In the second case it may show radioactivity the same day as taken from the spring and after standing a month in a closed vessel it will show more or less emanation than at first. In any case the emanation content after standing one month is equal to the amount of radium dissolved in the water, since one curie is the amount of emanation which is in equilibrium with one gram of radium.

All the observations given below are for the emanation content of the water as taken from the spring or well. These observations were taken from time to time on various springs and wells in Indiana and Ohio. The date of observation, approximate location of the spring, and temperature of the water at the spring is given.

TABLE 5.  
SPRINGS.

| NAME.         | Location.                            | Date.           | Temp. C. | Curies,<br>Per<br>Liter. |
|---------------|--------------------------------------|-----------------|----------|--------------------------|
| Ill. Cent.    | Bloomington                          | Mar. 4, 1914.   | 12.5°    | 600.X10 <sup>-12</sup>   |
| Youno.        | Brown County, Indiana                | Mar. 6, 1914.   | 16.°     | 355                      |
| J. C. S.      | Two miles southeast of Bloomington   | Mar. 13, 1914.  | 10.3°    | 430                      |
| J. C. S. Old. | Two miles southeast of Bloomington   | Mar. 14, 1914.  | 11.5°    | 660                      |
| J. C. S.      | Two miles southeast of Bloomington   | May 16, 1914.   | 11.5°    | 170                      |
| Ill. Cent.    | Bloomington                          | May 23, 1914.   | 12.2°    | 265                      |
| Stone         | Two miles southwest of Bloomington   | May 23, 1914.   | 11.°     | 77                       |
| Weimer.       | Three miles southwest of Bloomington | May 23, 1914.   | 12.3°    | 175                      |
| Hottle.       | Bloomington                          | Sept. 24, 1914. | 13.°     | 650                      |
| South.        | Morning Sun, Ohio.                   | Aug. 24, 1914.  | 13.°     | 429                      |
| C. McQ.       | One mile southeast of Morning Sun    | Sept. 2, 1914.  | 16.°     | 560                      |
| I. B.         | One-half mile west of Morning Sun    | Sept. 7, 1914.  |          | 100                      |
| C. D. McQ.    | One mile west of Morning Sun         | Sept. 7, 1914.  | 15.8°    | 250                      |
| C. D. McQ.    | (Wood) one mile west of Morning Sun  | Sept. 7, 1914.  | 19.5°    | 300                      |
| W. P. McQ.    | One mile west of Morning Sun         | Sept. 7, 1914.  | 17.°     | 610                      |
| C. W.         | Two miles west of Morning Sun        | Sept. 7, 1914.  | 19.5°    | 140                      |
| Tal. No. 1.   | One mile northeast Col. C. O.        | Sept. 7, 1914.  | 17.°     | 350                      |
| Tal. Upper.   | One mile northeast Col. C. O.        | Sept. 7, 1914.  | 17.°     | 356                      |

## CITY WATER.

| Location.               | Date.          | Temp. C. | Curies<br>Per<br>Liter. |
|-------------------------|----------------|----------|-------------------------|
| Bloomington, Ind. ....  | Feb. 24, 1914. | 5°       | 27. X10 <sup>-12</sup>  |
| Bloomington, Ind. ....  | Mar. 2, 1914.  | Hot.     | 41.                     |
| Indiana University .... | Mar. 2, 1914.  | 5°       | 45.                     |
| Oxford, Ohio. ....      | Aug. 12, 1914. | 10°      | 70.                     |
| Union City, Ind. ....   | Aug. 18, 1914. | 19°      | 45.                     |
| Celina, Ohio. ....      | Aug. 20, 1914. | 26°      | 7.                      |

## WELLS.

|                                                        |                |     |      |
|--------------------------------------------------------|----------------|-----|------|
| S. R. R., Morning Sun, Ohio. ....                      | Aug. 27, 1914. | 15° | 95.  |
| J. S. R., Farm. One mile north Morning Sun, Ohio. .... | Aug. 27, 1914. |     | 70.  |
| C. McQ. One mile south Morning Sun, Ohio. ....         | Sept. 2, 1914. | 13° | 200. |
| Forest Park. Six miles east Union City, Ind. ....      | Aug. 18, 1914. | 12° | 185. |
| Melted snow water. ....                                |                |     | 6.   |
| Boiled water. ....                                     |                |     | 00.  |

In some papers the radioactivity of springs is given in Mache units. One mache unit =  $364. \times 10^{-12}$  curies per liter. (Le Radium, Vol. XI, p. 5, 1914.) In several papers higher ratios have been used,  $500. \times 10^{-12}$  in some cases.

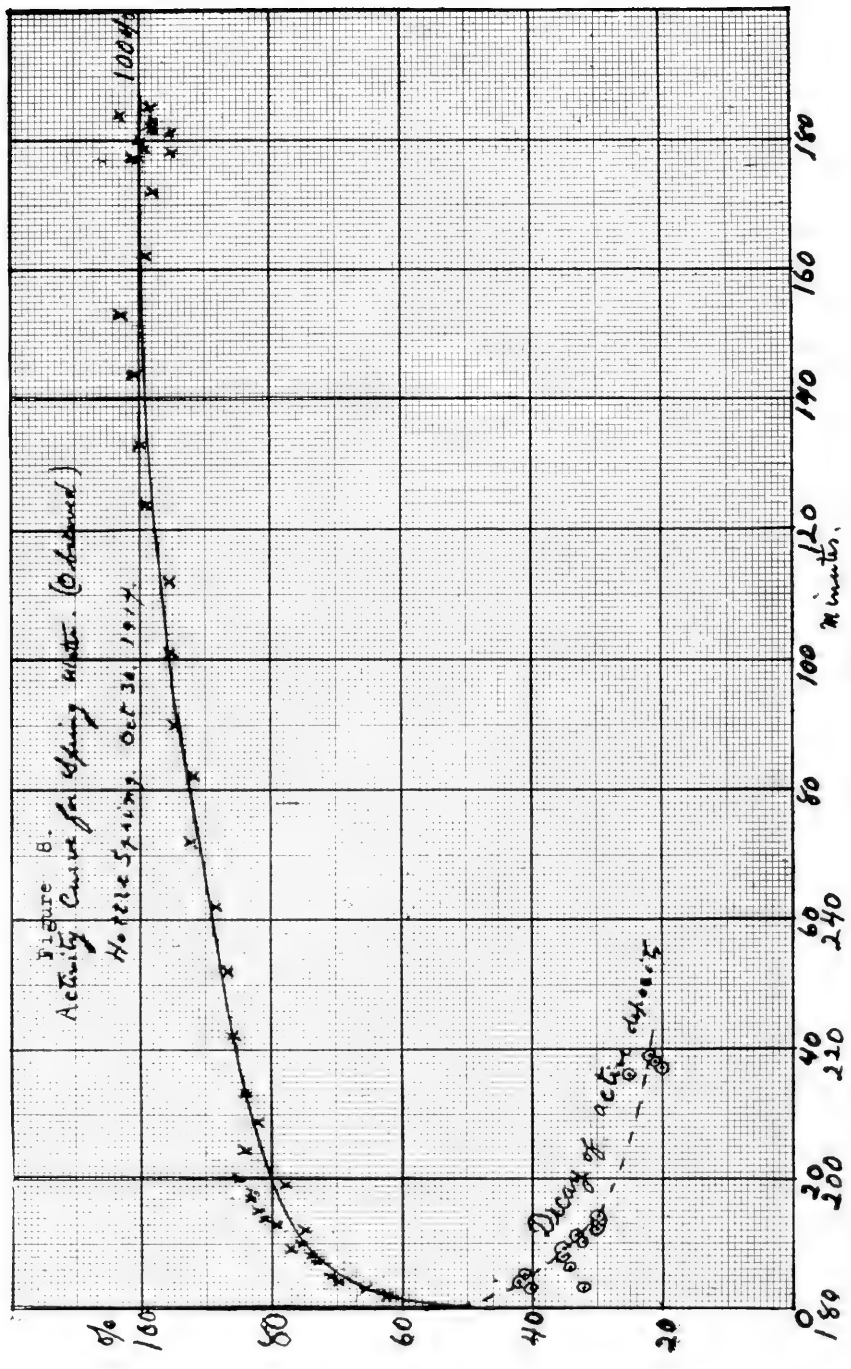
The radioactivity of these springs is not great, but it is high compared with ordinary springs of some localities. There is a great deal of variation from spring to spring, but this may be explained by assuming that some emanation has been given up before issuing from the ground. The variation of the same spring from time to time is dealt with in another paper.

*Department of Physics,*

*Indiana University, December 21, 1914.*

Figure B.  
Activity Curve for Spring White. (Continued)

Ho. 212 Spawning. Oct. 30, 1917.



## A TORNADO AT WATERTOWN, SOUTH DAKOTA, JUNE 23, 1914.

J. GLADDEN HUTTON.

A tornado occurred at Watertown, South Dakota, late in the afternoon of June 23, 1914. A large number of dwelling houses and barns were destroyed, telephone and telegraph poles were razed and many gardens ruined. More than a score of people were more or less seriously injured and a number of others were slightly hurt by flying debris. No one was killed outright, though one child was reported to have died of its injuries.

The writer was passing through the city on June 25th and spent the day collecting data relative to the storm. Had more time been available, further information could have been secured. However, it seems worth while to give a brief report of the tornado, notwithstanding the fact that the data are incomplete.

The Watertown Daily Public Opinion issued June 24th said: "People watched the approach of what looked like an ordinary thunder storm following a hot day\* yesterday afternoon. Wind clouds formed about 6:30 o'clock and gradually developed into a heavy line to the north. The first indication of the formation of a cyclone was noticed in the continuous change of the light wind. Those watching next turned their attention to clouds forming fast in the northwest, and as a twister was developing the approach of the cyclone which went through the city was noticed.

"The path of the storm embraced an area about three blocks wide the entire length of the city east and west. The worst section in the south part of town was in the three blocks north and east of the corner of Seventh avenue and Maple street S. From there the cyclone took a course east and a little northerly sweeping everything in its path and wrecking homes and barns between Third and Fourth avenues and Fifth and Sixth streets almost entirely. It continued across Seventh, Eighth, Ninth and Tenth streets E. and between Ninth and Tenth streets reached as far

---

\*Mr. R. Q. Wood cooperative observer at Watertown reported the maximum temperature for June 23, 1914, as 83° and the minimum temperature 54°.

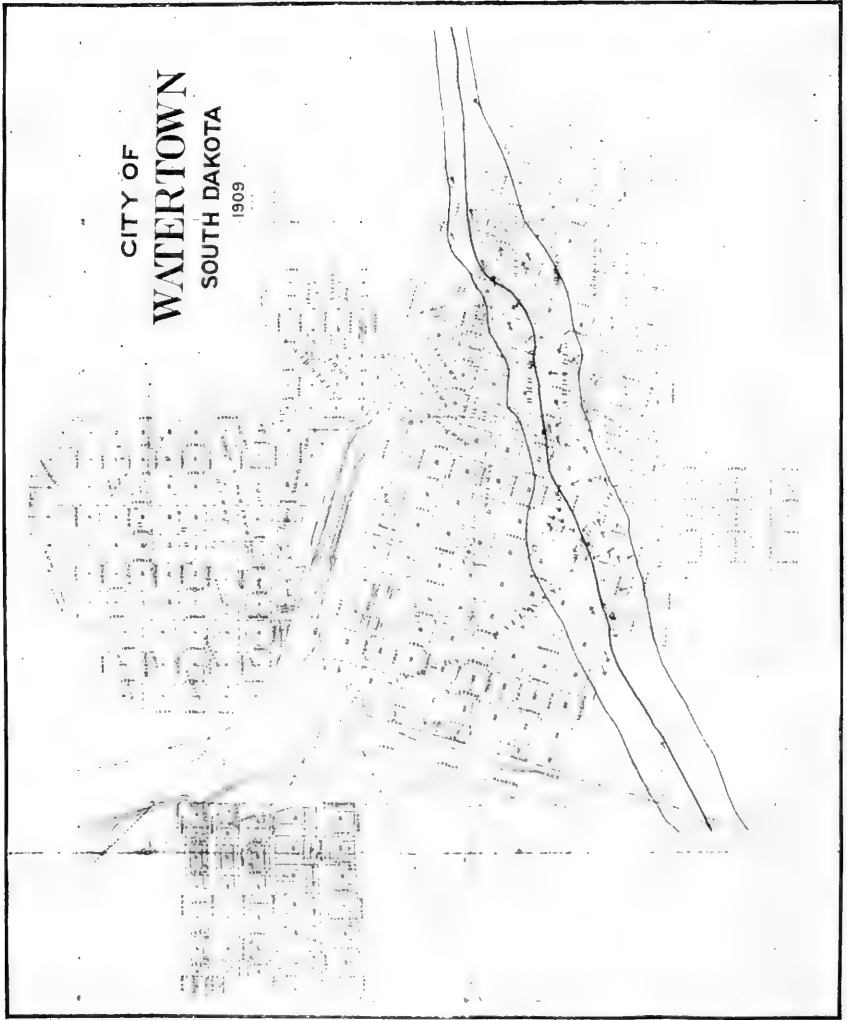


FIG. 1. Map of Watertown, S. D., showing path of tornado of June 23, 1914. See text for explanation.

north as First avenue N., badly wrecking homes on First avenue and Kemp avenue E."

In the issue of the same paper for June 25th there is a brief account of the storm at Goodwin, fourteen or fifteen miles a little south of east of Watertown where houses and barns were damaged. Some damage was also reported at Altamont, about ten miles south of east of Goodwin.

Mr. Ray stated that a thunder storm was approaching against a light east wind. At about 6:30 p.m. some hail fell, after which the temperature rose and a light east wind was blowing. About thirty minutes after the hail ceased falling, he noticed a great turmoil in the clouds and a funnel formed which struck the earth near the South Dakota Central roundhouse. (From this point the course of the tornado is indicated on the map shown in Fig. 1.)

When the tornado passed through the city Mr. Ray was at the Elks' Hall, four blocks north of the path of the storm. He stated that there was no wind where he was standing. After the tornado passed the wind changed to the northwest and blew hard. Fifteen minutes later a heavy shower occurred. The tornado passed through the city in ten or fifteen minutes. Mr. Ray had previously witnessed storms of this kind in Iowa.

Mr. Mitchell, agent for the Rock Island Railroad, stated that he first observed the storm over Pelican Lake, about one mile southwest of Watertown. It was traveling in a northeasterly direction and was drawing up water from the lake. Rock Island train No. 417 was pulling into town from the east at 7:05 p.m. The engineer saw the funnel and backed his train hoping to miss it. The train, however, was caught in the storm and had twenty-five panes of glass broken and the coaches were unroofed. One passenger who jumped from the train was injured by flying debris. The storm struck the city at 6:50 p.m. and was twenty minutes in passing through the city, a distance of one and one-fourth miles.

A number of persons corroborated these statements as to the length of time required for the tornado to pass through the city. Mr. H. Dietz stated that the hail came while a gentle southeast breeze was blowing and that there was little or no wind just before the tornado appeared. He saw the twister coming like a black smoke and it appeared to be about ten feet in diameter at the bottom. There was no rain or thunder or lightning accompanying the storm according to his testimony and this statement was verified by other persons questioned concerning it.

There were varying statements as to the presence of more than one

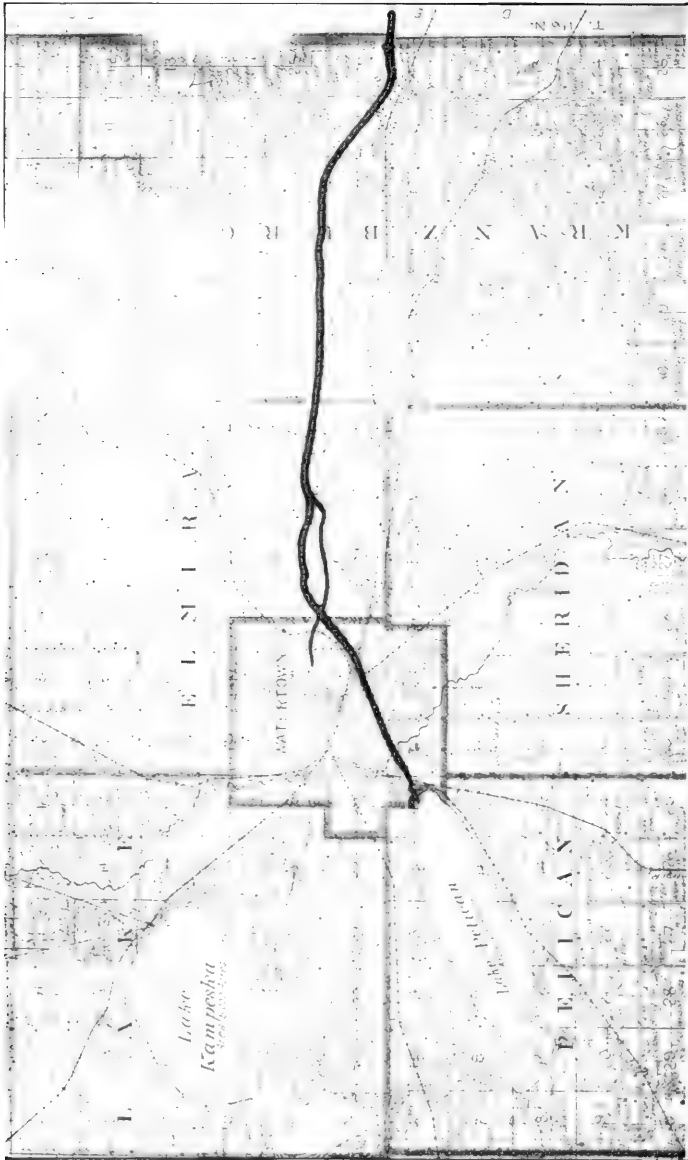


FIG. 2. Map of eastern Colington County, S. D., showing path of tornado. The heavy dark line beginning at the northeast end of Lake Pelican indicates the path of the principal tornado. A lighter line crossing the heavy line at the eastern boundary of the city represents the path of the second funnel referred to in the text. Mapped for the writer by Mr. H. Mathiesen.



funnel, though a number of people said they observed one or more funnels which did not reach the earth. Mr. Dietz said that after the funnel left the city there was another one southeast of it which was white instead of black and that it dipped up and down but did not reach the earth. Mr. Mathiesen, who prepared the map of the storm's path through Codington County (Fig. 2), said that there were two funnels and his map shows the path of the second one, which, peculiarly, seems to have crossed the path of the main storm. He was at his farm about three miles east of Watertown and witnessed the storm as it passed by.

Mr. J. B. Kintsley saw the cloud just before it reached the city and he said that it seemed to be about the size of a box car and looked like a

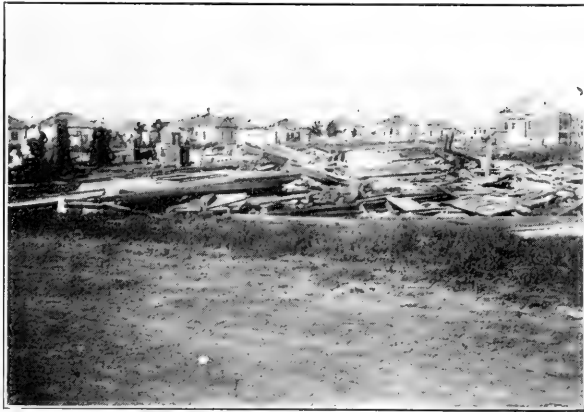


FIG. 3. View showing wreckage of house in southwest part of Watertown, S. D. General character of houses indicated.

whirling column of mud. After the tornado passed by all of the clouds in the sky seemed to be rushing after it.

The writer carefully examined the path of the storm from the point where it entered the city to the point where it left the city and passed out into the open prairie. The two outside lines shown in Figure 1 indicate the boundaries of the zone of damage, while the middle line is the locus of points where the greatest destruction occurred. The small arrows indicate the direction in which objects moved as assumed from their position before and after the storm. The writer is aware of the fact that in cases where objects were moved for some distance the arrows may not indicate the direction of movement, but where houses were only moved slightly

from their foundations, and in similar cases, the arrows indicate the actual direction of movement. On the right of the axis of the path objects seem to have moved forward and to the left, while on the left side of the path they moved generally backward and to the right with reference to the advance of the tornado, although there are exceptions to this general statement.

Houses on the edges of the path had their chimneys damaged. In fact the outside lines might be designated the chimney lines. Inside the chimney lines, shingles were removed in patches and usually on the side of the house nearest the axis of the storm. Farther in more shingles were removed, porches were blown away, roofs entirely removed and in



FIG. 4. House with end blown outward.

the middle of the path total destruction occurred, though not at all points. Greater destruction seems to have occurred on the right side of the storm path than on the left, and at some points the axis lies to the left of the middle of the path. The destruction seems to have been greatest where the storm entered the city and where it left it. The light construction of many of the houses in the part of the city traversed seems partly responsible for the damage. (See Fig. 3.)

The following incidents are of interest and may be briefly noted: The violent expansion of air in closed buildings was observed everywhere. Shingles were blown from roofs by the sudden expansion of air in the garrets. Windows were blown outward. Mr. Kintsley, who was in a cellar, said that the southwest window was the first one to blow outward.

Hollow cylindrical porch posts were split in at least one instance. Walls or foundations made of hollow cement blocks or hollow tile failed in many instances. (See Figures 9 and 10.)

The entire end of the house shown in Figure 4 was blown outward. The end of the house may be seen lying in the foreground.

Figure 5 shows a similar condition, though the house was greatly damaged otherwise.

Two boys who were in Oak Park in the southwest part of the city just outside the path of the storm said that when the funnel passed by it



FIG. 5. House in east Watertown, S. D., showing explosive effect of air during passage of tornado.

looked like an elephant's trunk and that hot and cold blasts of air passed over them "sometimes hot enough to roast them and sometimes cold enough to freeze them."

At Goodwin, east of Watertown, clouds of soot rushed from the chimneys "as if everyone had a roaring fire." Here "the storm appeared to stay higher up in the air, though chimneys toppled and smaller buildings were overturned."

Figure 6 is from a photograph taken by Mr. Ward Carr who was at a farm house three miles west of Watertown. The tornado is moving toward the left and seems to be at the forward point of a crescent-shaped cloud. The writer does not know whether this is the squall cloud of the thunder storm or not. The hour-glass shape of the tornado is notable.

Figure 7 is from a photograph said to have been taken by a traveling salesman at the corner of Maple street and Second avenue south. This point is about four blocks north of the axis of the storm path. The other photographs were made by the writer.

The weather map of June 23, 1914, reproduced herewith (Fig. 8), shows the weather conditions prevailing on the morning preceding the storm. A trough of low pressure extends toward the southwest from a low central in Canada between an area of high pressure central in southern Alabama and an area of high pressure on the South Pacific States.



FIG. 6. View of tornado Watertown, S. D., June 23, 1914. Photo by Ward Carr.

All students of meteorology are familiar with the atmospheric conditions which prevail when tornadoes occur as well as with the usual freakish behavior of storms of this type. The writer has not discussed these points for this reason, nor does he wish to make a comparative study of this storm in this report. He has aimed only to state as many of the facts concerning this one meteorological event as he was able to ascertain in the brief time at his disposal, trusting that they may add a small part to the great fund of information already recorded concerning these small but violent atmospheric disturbances.

*State College,*

*Brookings, South Dakota.*

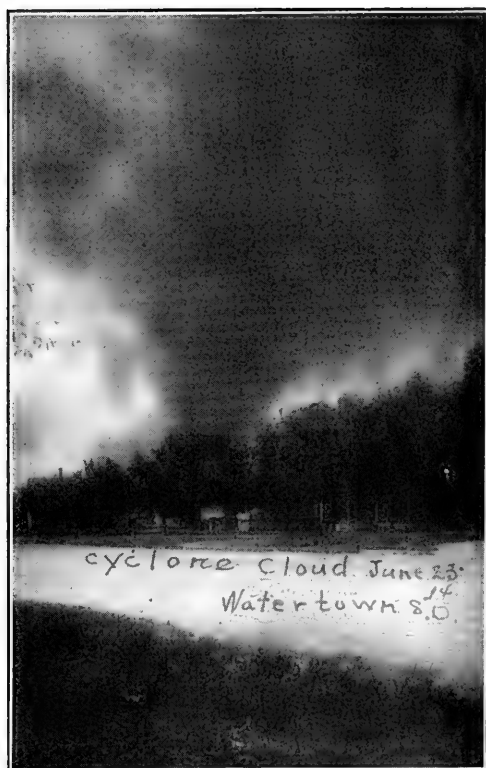


FIG. 7. View of tornado cloud, Watertown, S. D., June 23, 1914. Name of photographer unknown

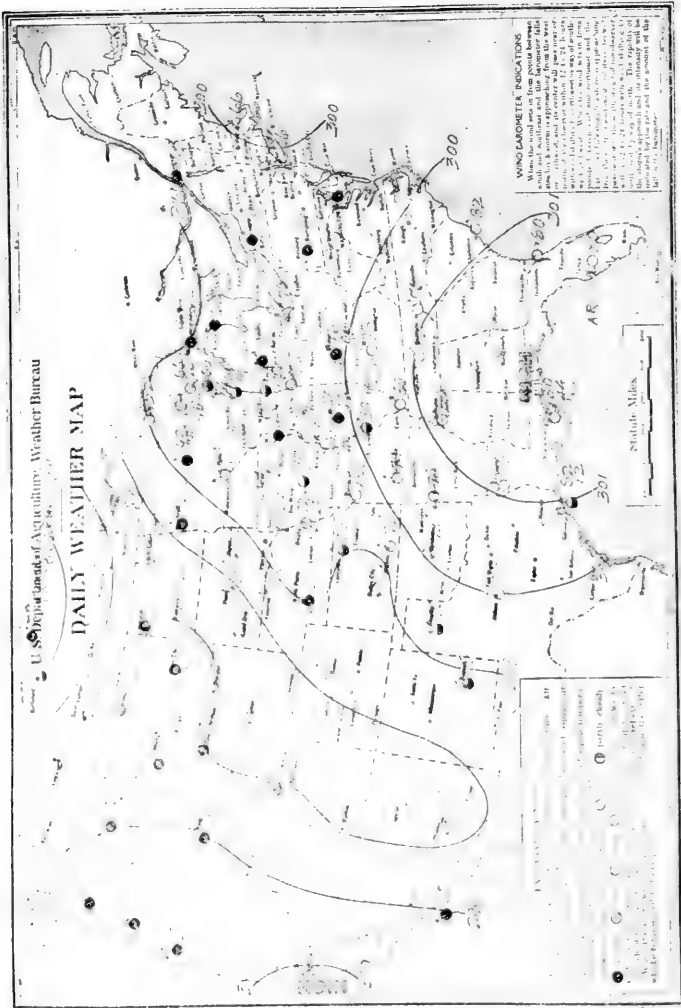


FIG. 8. Weather map of June 23, 1914. Conditions preceding Watertown, S. D., tornado



FIG. 9. Collapse of hollow tile structure. Watertown, S. D., June 23, 1911.



Fig. 10. The house from the foundation in the foreground was carried bodily across the street and then dropped to the earth and broken to bits. Wreckage may be seen in front of cottage on the right.



FIG. 11. General view of wreckage where destruction was greatest. Watertown, S. D., June 23, 1914.



FIG. 12. House moved from foundation. Watertown, S. D., June 23, 1914.





FIG. 13. House moved from foundation. Watertown, S. D., June 23, 1914.



FIG. 14. Effects of tornado, Watertown, S. D., June 23, 1914.



FIG. 15. The tornado passed to the left of this house moving toward the reader. The porch was torn away and deposited in the rear of the house. Watertown, S. D., June 23, 1914.



FIG. 16. House moved from its foundation. Shingles stripped from roof. Tornado passed to the right of it. Watertown, S. D., June 23, 1914.

## A SIMPLE FORM OF THE CAREY FOSTER BRIDGE.

J. P. NAYLOR.

Probably there is no better method than the Carey Foster method for comparing nearly equal resistances or for measuring small changes in resistances such, for instance, as those due to change of temperature. While many arrangements have been devised for interchanging the resistances, as is necessary in this method, the following arrangement is believed to be sufficiently novel to make it worth while to present it to the Academy and it is also thought to possess some advantages over other forms of the apparatus.

Its advantages are that it is readily adapted to any width of resistance terminals; the arrangement of connections and relative position of the resistances is such that they can be seen at a glance; and the apparatus is so simple in construction that it can easily be made by anyone who can solder a little and can drill a few screw-holes in the straight copper strips of which it is made up. The whole apparatus can be built up on well varnished hardwood as a base, the copper strips being fastened to the wood base with wood screws. To help the insulation, it has been found to be a good plan, after the screws have been screwed home, to remove them, one at a time, put a drop or two of thick shellac in the hole, and then put the screws back again.

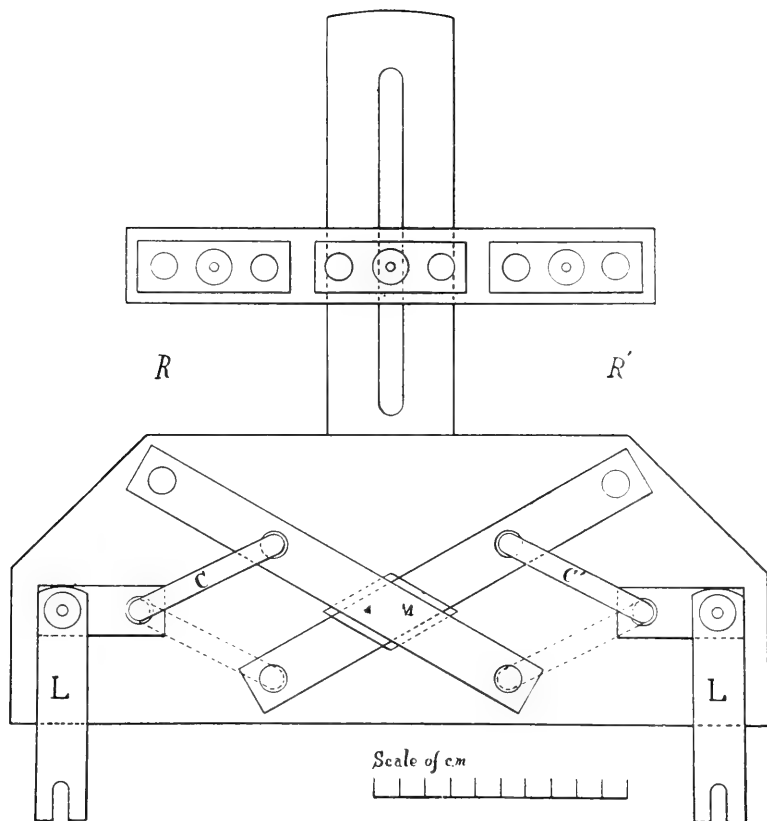
No. 10 or 12 gauge copper strip, two centimeters wide, can be used for the conductors. In the figure, the double, concentric circles represent binding posts and the single circles mercury cups. The latter are made from .41 copper rim-fire cartridge shells.

It may not be generally known that these shells, although quite thin, make very satisfactory mercury cups if soldered directly on top of such copper strips as here mentioned. If blank shells cannot be obtained, the charges may be drawn from the loaded shells. The charges should not be shot out, for the firing pin will nick the shells and cause them to leak. In order to prevent any mercury from coming in contact with the solder and loosening the shells, they and the strips, after soldering is done,

should be thickly coated with shellac varnish which, after drying, should be baked on by heating until it begins to smoke. Mercury cups made in this way have been in use in our laboratory for twenty years and are still doing good service.

The figure practically explains itself. By means of the links, L and L prime, the apparatus can be connected with any calibrated bridge wire, thus adapting it to the Carey Foster method. By changing the thick connectors, C and C prime, to the dotted positions it will be seen, by tracing the connections, that the resistance in the gaps, R and R prime, are interchanged to opposite ends of the bridge wire. These gaps can be adjusted to any width by means of the slotted support shown in the figure. A piece of mica, M, is used to separate the strips at the point of crossing.

As the conductors are so arranged that the arms of the bridge are at all times symmetrical, the dimensions of the apparatus are immaterial. However, a scale of centimeters is added as a suggestion of size for those who may care to construct apparatus of the size figured. It might be added, that apparatus similar to the above has been used at the DePauw physics laboratory for a number of years and has proved very satisfactory for student work.



· A Simple Form of the Carey Foster Bridge.



## VARIATION OF THE EMANATION CONTENT OF CERTAIN SPRINGS.

R. R. RAMSEY.

While measuring the radioactivity of springs in the neighborhood of Bloomington, Indiana, I found that the measurements made at certain times did not agree with those made at other times. The discrepancy was so great I set out to see if the difference was due to errors or was a real difference. I selected two springs and have tested them once a week for about three months. One, the Hottle Spring, is due north of the square near the corporation line. The other is due west of the square a little beyond the corporation line, across the Illinois Central Railroad from the railroad pumping station. These springs are 1.3 miles apart. Each has a flow of about 15,000 gallons per day. The flow of the Illinois Central Spring has perceptibly lowered during October and November. The Illinois Central Spring issues from the ground at the root of a beech tree through coarse gravel or stones. The Hottle Spring issues from a crack in solid rock.

The results are shown in the following table :

VARIATION OF EMANATION CONTENT OF CERTAIN SPRINGS NEAR BLOOMINGTON, IND. EXPRESSED IN CURIES PER LITER.

| Date.    | Temp. C.     | J. C. S.            | Hottle.             | Ill. Cent.               |
|----------|--------------|---------------------|---------------------|--------------------------|
| Mar. 4   | 12.0°        | X 10 <sup>-12</sup> | X 10 <sup>-12</sup> | 600. X 10 <sup>-12</sup> |
| Mar. 13  | 10.3°        | 430.                | .....               | .....                    |
| May 16   | 11.5°        | 170.                | .....               | .....                    |
| May 23   | 12.2°        | .....               | .....               | 265.                     |
| July 24  | .....        | .....               | .....               | 330.                     |
| Aug. 5   | 12.5°        | 425.                | .....               | .....                    |
| Sept. 24 | 13 and 13°   | .....               | 650.                | 445.                     |
| Oct. 9   | 15°          | 530.                | .....               | .....                    |
| Oct. 16  | 13 and 12.8° | .....               | 695.                | 166.                     |
| Oct. 23  | 13.3 and 13° | .....               | 700.                | 120.                     |
| Oct. 30  | 13 and 12.7° | .....               | 665.                | 20.                      |
| Nov. 6   | 13 and 12.6° | .....               | 650.                | 40.                      |
| Nov. 13  | 13 and 12.6° | .....               | 705.                | 20.                      |
| Nov. 20  | 13 and 13°   | .....               | 520.                | 20.                      |
| Nov. 26  | 13 and 13°   | .....               | 550.                | 33.                      |
| Dec. 3   | 13 and 13°   | .....               | 535.                | 60.                      |
| Dec. 11  | 13 and 13°   | .....               | 510.                | 20.                      |
| Dec. 18  | 13 and 13°   | .....               | 450.                | 00.                      |

The Hottle Spring has remained almost constant, while the Illinois Central has fallen from 600, X  $10^{-12}$  curies to almost zero. Four readings taken on another (J. C. S.) spring are added. Taken all together it is noted that in May there was a low value and an increase during September and another decrease October and December. In a rough way an increase coincides with a season of rain and a decrease with dry weather. It may be that due to a small flow there is more splashing and trickling over rocks near the mouth of the spring and the emanation is lost.

*Indiana University,*

*December 21, 1914.*



## THE CONSTRUCTION OF A RUTHERFORD'S ELECTROSCOPE.

---

EDWIN MORRISON.

---

### INTRODUCTION.

At the suggestion of Dr. R. A. Millikan the author recently undertook the problem of constructing an electroscope for general laboratory work in radio-active measurements. The general outlines and plans suggested by Dr. Rutherford in his original papers published in the *Philosophical Magazine* and in his work entitled *Radio-active Transformations* have been followed. Suggestions have also been taken from the following works: *Studies in Radio-activity*, by Bragg; *Conduction of Electricity Through Gases and Radio-activity*, by McClung; and *Practical Measurements in Radio-activity*, by Makower and Geiger.

The purposes have been, first, to show, in greater details than the original papers give, the methods of constructing a successful electroscope; and, second, to embody in one instrument as wide a range of experimental work as possible.

### CONSTRUCTION.

A diagram of the electroscope is shown in Fig. 1. The dimensions of the gold leaf chamber (E) are  $10 \times 10 \times 10$  cm. This chamber is constructed from sheet brass 1.7 mm. in thickness. The four plates for the sides, top and bottom are first carefully jointed by means of a file and then soldered together as shown in Fig. 2 (A). To facilitate the process of soldering two right angle pieces of metal are joined together forming a right angle frame as shown in Fig. 2 (B). When two pieces of the box are to be joined together they are carefully adjusted upon the frame, a few small pieces of solder and soldering fluid are placed along the joint and a pointed flame is directed along the joint in the inside angle until the solder is thoroughly fused. In this way the parts of the electroscope box can be joined together square and straight.

The front side of the electroscope box is a hinged door. This door has a window in it 6.5 cm. square covered with mica. Through this window the gold leaf may be observed by means of a reading microscope. A dia-

gram on the back side of the door is shown in Fig. 3 (A). The mica is held in place by means of four pieces of brass, 1.7 mm. thick and 1.5 cm. wide. These pieces are screwed onto the door in such a way that they not

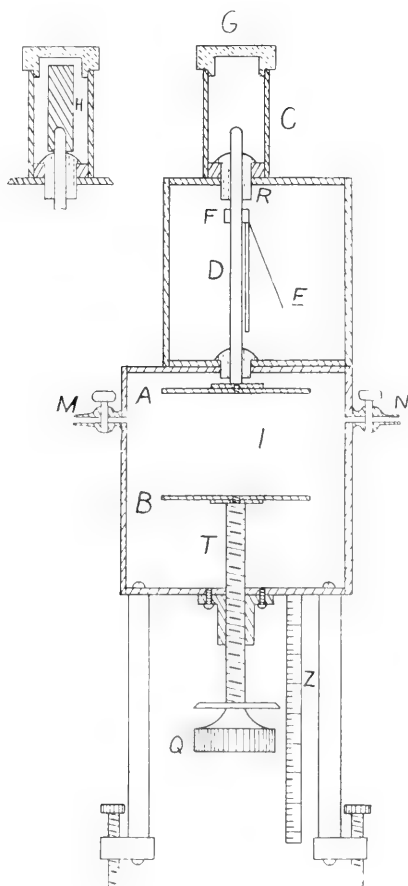


FIG. 1.

only hold the mica in place over the window but they also form a close fitting rabbeted joint of the door to the box.

The back side of the electrostatic induction experiment is constructed like the front side, with a mica window of the same dimensions for illumination. This side may be either hinged to the box or it may be held in place by means of two little hooks.

Using the same methods as described above, the ionisation chamber (I) is constructed. No mica windows are needed in the front door or the back side of (this ionisation) chamber. The dimensions of (I) are 12 x 12 x 12 cm., and the thickness of the walls is 1.7 mm. With the exception of the

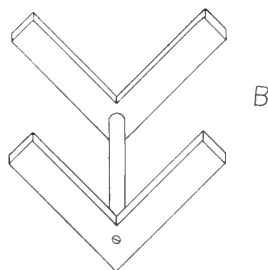
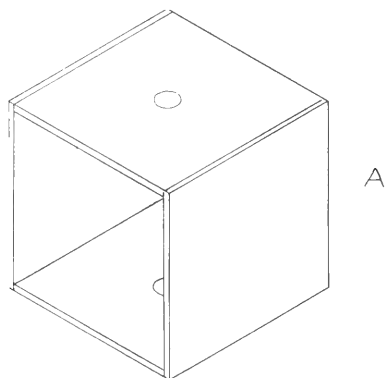


FIG. 2.

mica window the door to the ionisation chamber is constructed like that of the door to the gold leaf box. The front door should be hinged to the box and the back side can either be permanently soldered to the box or it can be fastened by means of hinges.

The two boxes (E) and (I) are fastened together by screws, the right hand sides being flush with each other as shown in Fig. 1. This arrange-

ment places the condenser in the center of the ionisation box and the gold leaf support is on one side of the box thus giving more free space to the gold leaf.

Through openings in the top and bottom of the electroscop box (E), and the top of (I) a brass rod (D), about 4 mm. in diameter is adjusted being insulated from the boxes by means of two amber plugs (R) and

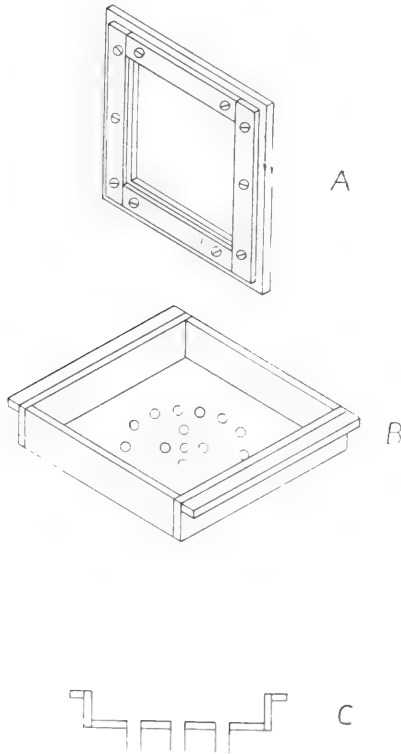


FIG. 3.

(S). The upper end of the rod (D) is covered by a metal cap (C). The upper opening of the cap is closed by means of an ebonite plug (G). The cap can be removed for charging purposes. The rod (D) may be extended and enlarged by fitting to the upper end a brass cylinder (H). This cylinder acting with the metal cap (C) forms a condenser which increases the capacity of the electroscop. Upon the side of (D) a brass

strip (S), which is about 6 mm. in width, is fastened by means of a small screw at (F). To this strip the gold leaf is fastened by means of wax or shellac. The rod (D) is terminated at its lower end by means of a

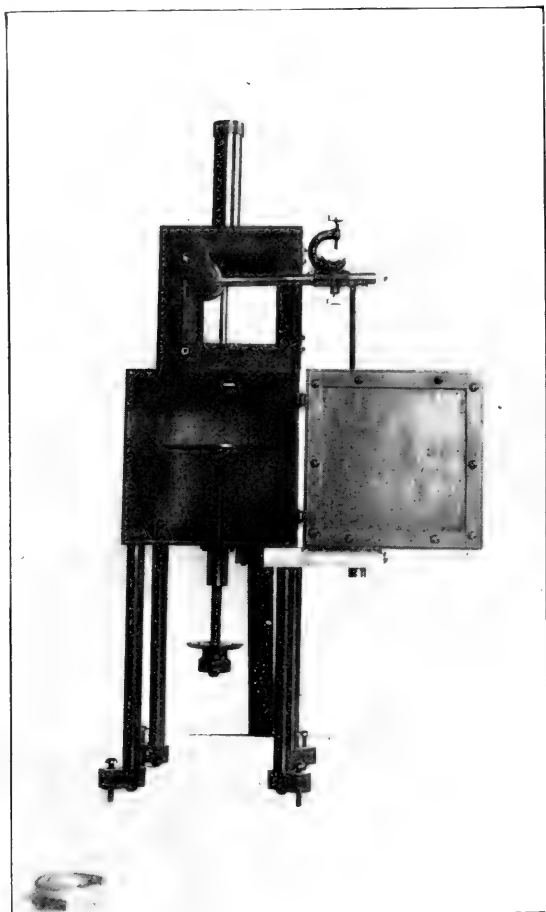


FIG. 4.

disk (A), which is 8 cm. in diameter. This disk is screwed onto the end of (D), and larger or smaller disks may be used, thereby varying the capacity of the electrostatic balance. Supported upon a screw (T) which passes through the bottom of the ionisation chamber is a disk (B) the same

size as that of (A). By turning the screw (T) the position of (B) can be made to change through a range of about 8.5 cm. Its distance in cm. or mm. from (A) can be determined by reading the position of the disk (Q) with reference to the scale (Z).

To the bottom of the ionisation chamber four brass rods 1.2 cm. in diameter and 15 cm. in length are securely fastened by means of screws for legs. Leveling screws are adjusted to the lower ends of these legs.

The electroscopes can be converted into an emanation electroscopes by placing stopcocks (M) and (N) in the sides of the ionisation chamber. The active gas can be admitted to the electroscopes by exhaustion through one stopcock and attaching the source of gas to the other stopcock. Or the active gas can be forced into the ionisation chamber by means of a pressure bulb. In testing active gases it is usually necessary to reduce the capacity to the lowest amount possible. This can be done by removing the cylinder (H) and the condenser plate (A). A small rod should be screwed onto the end of (D) in place of the disk (A). Figure four shows the instrument mounted ready for use.

The instrument can be changed into one for measuring the "Variations of the ionisation produced by an alpha particle along its path," by enclosing the condenser plate (A) in a metal box which has a number of short, small, brass tubes passing through the bottom. (See Makower and Geiger's Practical Measurements in Radio-activity, article 32, page 46.) A drawing of the box is shown in Fig. 3 (B) and a cross section in Fig. 3 (C).

After a thorough test it has been shown that this one instrument with its attachments can be used for a wide range of radio-active measurements, and that it is well adapted to general laboratory work.

*Physical Laboratory,  
Earlham College.*

## INDEX

## A.

|                                                                                         | PAGE |
|-----------------------------------------------------------------------------------------|------|
| Active Members .....                                                                    | 22   |
| Alcohol Problem, The, In the Light of Coniosis. Robert Hessler.....                     | 85   |
| Alundum, The, Crucible as a Substitute for the Gooch Crucible. George<br>L. Clark ..... | 351  |
| Apparatus, An, for Aerating Culture Solutions. Paul Weatherwax...                       | 157  |
| Appropriation for 1913-1914.....                                                        | 9    |

## B.

|                                                                                                                      |     |
|----------------------------------------------------------------------------------------------------------------------|-----|
| B. Fluorescens and B. Typhosus, Antagonism on, in Culture. P. A.<br>Tetrault .....                                   | 161 |
| Binomial Coefficients, Some Properties of. A. M. Kenyon.....                                                         | 433 |
| Birds' Eggs, The Alba B. Ghere Collection of, Presented to the Museum<br>of Purdue University. Howard E. Enders..... | 273 |
| Birds, Public Offenses—Hunting Wild,—Penalty.....                                                                    | 10  |
| Birds, Their Nests and Eggs, An Act for the Protection of.....                                                       | 9   |
| Birds, Why Do Our, Migrate. D. W. Dennis.....                                                                        | 145 |
| Black Locust, A New Enemy of the. Glenn Culbertson.....                                                              | 185 |
| Botanical Problems, Some Large. J. C. Arthur.....                                                                    | 267 |
| Business Session, May 29, 1914.....                                                                                  | 40  |
| By-laws .....                                                                                                        | 7   |

## C.

|                                                                                        |     |
|----------------------------------------------------------------------------------------|-----|
| Carey Foster Bridge, A Simple Form of the. J. P. Naylor.....                           | 485 |
| Chemistry, The Correlation of High School and College. James Brown                     | 355 |
| Chimney Swift, A Note on a Peculiar Nesting Site of the. Glenn<br>Culbertson .....     | 279 |
| Civilization, Conservation and. Arthur L. Foley.....                                   | 133 |
| Coals, Tar Forming Temperatures of American. Otto Carter Berry...                      | 373 |
| Cold Storage is Practical Conservation. H. E. Barnard.....                             | 101 |
| Committees, Academy of Science. 1915.....                                              | 12  |
| Conservation and Civilization. Arthur L. Foley.....                                    | 133 |
| Conservation of Human Life, Science in its Relation to the. Severance<br>Burrage ..... | 55  |
| Constitution .....                                                                     | 5   |
| Contents, Table of .....                                                               | 3   |
| Corn Pollination, Report on, IV. (Final). M. L. Fisher.....                            | 207 |
| Curators .....                                                                         | 11  |

## E.

|                                                                             | PAGE |
|-----------------------------------------------------------------------------|------|
| Earthworms, Notes on Indiana. H. V. Heimburger.....                         | 281  |
| Electroscope, The Construction of a Rurtherford's. Edwin Morrison..         | 491  |
| Emanation Content, Variation of the, of Certain Springs. R. R. Ramsey ..... | 489  |
| Executive Committee .....                                                   | 11   |

## F.

|                                                                                    |     |
|------------------------------------------------------------------------------------|-----|
| Feeble-minded and Delinquent Girl, The. E. E. Jones.....                           | 71  |
| Feeble-minded and Delinquent Boy, The. Franklin C. Paschal.....                    | 63  |
| Feeble-mindedness in the Public Schools. Katrina Myers.....                        | 79  |
| Feeble-mindedness, The Problem of. G. S. Bliss.....                                | 61  |
| Fellows .....                                                                      | 14  |
| Flatwoods Region, The, of Owen and Monroe Counties, Indiana. Clyde A. Malott ..... | 399 |
| Flood Protection In Indiana. W. K. Hatt.....                                       | 149 |
| Forest Trees, Notes Upon the Destruction of, in Indiana. Stanley Coulter .....     | 167 |

## G.

|                                                                     |     |
|---------------------------------------------------------------------|-----|
| Genus Rosellinia, The, in Indiana. Glenn D. Ramsey.....             | 251 |
| Gravimetric Analysis, Stirring as a Time Saver in. W. M. Blanchard. | 349 |

## I.

|                                                               |     |
|---------------------------------------------------------------|-----|
| Insects, Some, of the Between Tides Zone. Chas. H. Arndt..... | 323 |
|---------------------------------------------------------------|-----|

## K.

|                                                                    |     |
|--------------------------------------------------------------------|-----|
| Kentucky Mountains, Changing Conditions in the. B. H. Schockel.... | 109 |
|--------------------------------------------------------------------|-----|

## M.

|                                                                                                                    |     |
|--------------------------------------------------------------------------------------------------------------------|-----|
| Members .....                                                                                                      | 14  |
| Members, Active .....                                                                                              | 22  |
| Mersenne Numbers, Mechanical Device for Testing, for Primes. Thos. E. Mason .....                                  | 429 |
| Minutes of the Spring Meeting.....                                                                                 | 39  |
| Minutes of the Thirtieth Annual Meeting.....                                                                       | 45  |
| Mosses, Corrections of the Lists of, of Monroe County, Indiana. I and II. Mildred Nothnagel and F. L. Pickett..... | 179 |
| Mosses, The, of Monroe County, Indiana, III. F. L. Pickett and Mildred Nothnagel .....                             | 181 |

## N.

|                                                                   |     |
|-------------------------------------------------------------------|-----|
| Nummularia, Some Species of, Common in Indiana. Claude E. O'Neal. | 235 |
|-------------------------------------------------------------------|-----|



## O.

|                                                                                                      | PAGE |
|------------------------------------------------------------------------------------------------------|------|
| Oat Smut in Indiana. F. J. Pipal.....                                                                | 191  |
| Officers 1914-1915 .....                                                                             | 11   |
| Officers of the Indiana Academy of Science, 1885-1915.....                                           | 13   |
| Orthoptera and Orthopteran Habitats, Notes on, in the Vicinity of Lafayette, Indiana. Henry Fox..... | 287  |
| Outcrop, Correlation of the, at Spades, Indiana. H. N. Coryell.....                                  | 389  |

## P.

|                                                                                |     |
|--------------------------------------------------------------------------------|-----|
| Paleobotany, The, of the Bloomington, Indiana, Quadrangle. T. F. Jackson ..... | 595 |
| Plants New or Rare to Indiana. No. V. Chas. C. Deam.....                       | 197 |
| Program of the Thirtieth Annual Meeting.....                                   | 70  |
| Public Offenses—Hunting Wild Birds—Penalty.....                                | 10  |

## R.

|                                                                                   |     |
|-----------------------------------------------------------------------------------|-----|
| Radioactivity of Spring Water. R. R. Ramsey.....                                  | 453 |
| Rust Propagation, Continuous, Without Sexual Reproduction. C. A. Ludwig .....     | 219 |
| Rusts, Correlation of Certain Long-cycled and Short-cycled. H. C. Travelbee ..... | 231 |

## S.

|                                                                                                  |     |
|--------------------------------------------------------------------------------------------------|-----|
| Science in its Relation to the Conservation of Human Life.....                                   | 55  |
| Sewage Disposal. Chas. Brossmann.....                                                            | 365 |
| Shawnee Mound, Tippecanoe County, as a Glacial Alluvial Cone. William A. McBeth.....             | 385 |
| Snakes, The, of the Lake Maxinkuckee Region. Barton Warren Evermann and Howard Walton Clark..... | 337 |
| Soils, The Chemical Composition of Virgin and Cropped Indiana. S. D. Conner .....                | 359 |
| Spirogyra Dubia, Some Peculiarities in. Paul Weatherwax.....                                     | 203 |
| Springs, Variation of the Emanation Content of Certain. R. R. Ramsey .....                       | 489 |
| Spring Water, Radioactivity of. R. R. Ramsey.....                                                | 453 |

## T.

|                                                                                |     |
|--------------------------------------------------------------------------------|-----|
| Table of Contents.....                                                         | 3   |
| Tornado, A, at Watertown, South Dakota, June 23, 1914. J. Gladden Hutton ..... | 471 |
| Trillium Nivale, Stomata of. F. M. Andrews.....                                | 209 |

## V.

|                                                                     |     |
|---------------------------------------------------------------------|-----|
| Viola Cucullata, A New Leaf Spot of. H. W. Anderson.....            | 187 |
| Violet, The Primrose-leaved, in White County. Louis F. Heimlich.... | 213 |



PROCEEDINGS

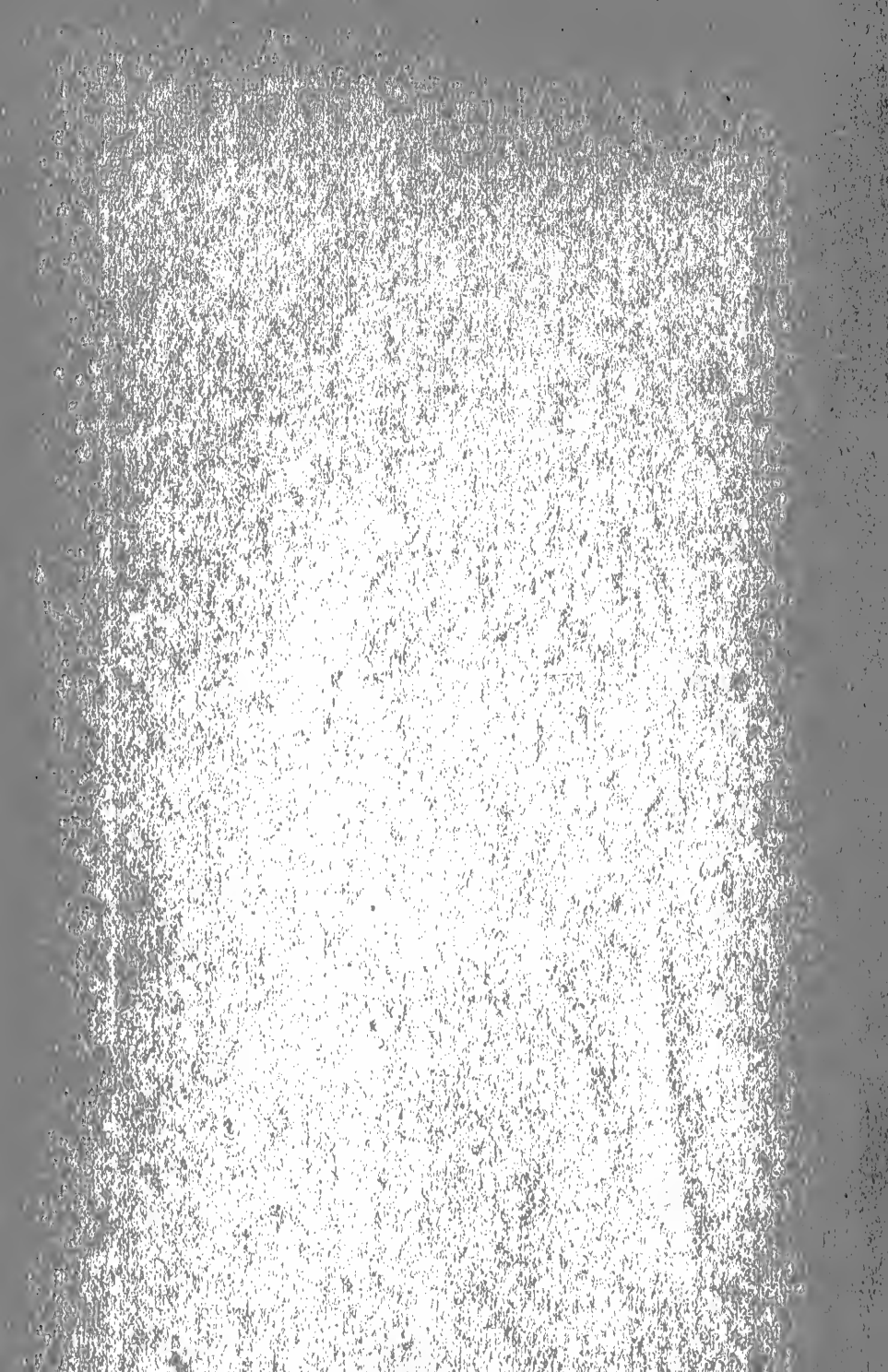
OF THE

INDIANA ACADEMY  
OF SCIENCE

—

1915

—



PROCEEDINGS

OF THE

Indiana Academy of Science

1915

---

H. E. BARNARD, Editor

---

FORT WAYNE PRINTING COMPANY  
CONTRACTORS FOR STATE PRINTING AND BINDING  
1916



## TABLE OF CONTENTS.

---

|                                                               | PAGE |
|---------------------------------------------------------------|------|
| Constitution.....                                             | 5    |
| By-Laws.....                                                  | 7    |
| Appropriation for 1914-1915.....                              | 7    |
| An Act for the Protection of Birds, Their Nests and Eggs..... | 9    |
| Public Offenses—Hunting Birds—Penalty.....                    | 10   |
| Officers, 1914-1915.....                                      | 11   |
| Executive Committee.....                                      | 11   |
| Curators.....                                                 | 12   |
| Committees Academy of Science, 1916.....                      | 12   |
| Officers of the Academy of Science (A Table of).....          | 14   |
| Members.....                                                  | 15   |
| Fellows.....                                                  | 15   |
| Active Members.....                                           | 24   |
| Minutes of the Spring Meeting.....                            | 41   |
| Minutes of the Thirty-first Annual Meeting.....               | 43   |
| Program of the Thirty-first Annual Meeting.....               | 49   |





# CONSTITUTION.

---

## ARTICLE I.

SECTION 1. This association shall be called the Indiana Academy of Science.

SEC. 2. The objects of this Academy shall be scientific research and the diffusion of knowledge concerning the various departments of science; to promote intercourse between men engaged in scientific work, especially in Indiana; to assist by investigation and discussion in developing and making known the material, educational and other resources and riches of the State; to arrange and prepare for publication such reports of investigation and discussions as may further the aims and objects of the Academy as set forth in these articles.

WHEREAS, The State has undertaken the publication of such proceedings, the Academy will, upon request of the Governor, or one of the several departments of the State, through the Governor, act through its council as an advisory body in the direction and execution of any investigation within its province as stated. The necessary expenses incurred in the prosecution of such investigation are to be borne by the State; no pecuniary gain is to come to the Academy for its advice or direction of such investigation.

The regular proceedings of the Academy as published by the State shall become a public document.

## ARTICLE II.

SECTION 1. Members of this Academy shall be honorary fellows, fellows, non-resident members or active members.

SEC. 2. Any person engaged in any department of scientific work, or in original research in any department of science, shall be eligible to active membership. Active members may be annual or life members. Annual members may be elected at any meeting of the Academy; they shall sign the constitution, pay an admission fee of two dollars and thereafter an annual fee of one dollar. Any person who shall at one time contribute fifty dollars to the funds of this Academy may be elected a life member of the Academy, free of assessment. Non-resident members may be elected from those who have been active members but who have removed from the

State. In any case, a three-fourths vote of the members present shall elect to membership. Application for membership in any of the foregoing classes shall be referred to a committee on application for membership, who shall consider such application and report to the Academy before the election.

SEC. 5. The members who are actively engaged in scientific work, who have recognized standing as scientific men, and who have been members of the Academy at least one year, may be recommended for nomination for election as fellows by three fellows or members personally acquainted with their work and character. Of members so nominated a number not exceeding five in one year may, on recommendation of the Executive Committee, be elected as fellows. At the meeting at which this is adopted, the members of the Executive Committee for 1894 and fifteen others shall be elected fellows, and those now honorary members shall become honorary fellows. Honorary fellows may be elected on account of special prominence in science, on the written recommendation of two members of the Academy. In any case a three-fourths vote of the members present shall elect.

### ARTICLE III.

SECTION 1. The officers of this Academy shall be chosen by ballot at the annual meeting, and shall hold office one year. They shall consist of a President, Vice-President, Secretary, Assistant Secretary, Press Secretary and Treasurer, who shall perform the duties usually pertaining to their respective offices and in addition, with the ex-presidents of the Academy, shall constitute an Executive Committee. The President shall, at each annual meeting, appoint two members to be a committee, which shall prepare the programs and have charge of the arrangements for all meetings for one year.

SEC. 2. The annual meeting of this Academy shall be held in the city of Indianapolis within the week following Christmas of each year, unless otherwise ordered by the Executive Committee. There shall also be a summer meeting at such time and place as may be decided upon by the Executive Committee. Other meetings may be called at the discretion of the Executive Committee. The past Presidents, together with the officers and Executive Committee, shall constitute the council of the Academy, and represent it in the transaction of any necessary business not especially provided for in this constitution, in the interim between general meetings.

SEC. 3. This constitution may be altered or amended at any annual meeting by a three-fourths majority of the attending members of at least one year's standing. No question of amendment shall be decided on the day of its presentation.

---

## BY-LAWS.

---

1. On motion, any special department of science shall be assigned to a curator, whose duty it shall be, with the assistance of the other members interested in the same department, to endeavor to advance knowledge in that particular department. Each curator shall report at such time and place as the Academy shall direct. These reports shall include a brief summary of the progress of the department during the year preceding the presentation of the report.

2. The President shall deliver a public address on the morning of one of the days of the meeting at the expiration of his term of office.

3. The Press Secretary shall attend to the securing of proper newspaper reports of the meetings and assist the Secretary.

4. No special meeting of the Academy shall be held without a notice of the same having been sent to the address of each member at least fifteen days before such meeting.

5. No bill against the Academy shall be paid without an order signed by the President and countersigned by the Secretary.

6. Members who shall allow their dues to remain unpaid for two years, having been annually notified of their arrearage by the Treasurer, shall have their names stricken from the roll.

7. Ten members shall constitute a quorum for the transaction of business.

### AN ACT TO PROVIDE FOR THE PUBLICATION OF THE REPORTS AND PAPERS OF THE INDIANA ACADEMY OF SCIENCE.

(Approved March 11, 1895.)

WHEREAS, The Indiana Academy of Science, a chartered scientific association, has embodied in its constitution a provision that it will, upon the

request of the Governor, or of the several departments of the State government, through the Governor, and through its council as an advisory board, assist in the direction and execution of any investigation within its province without pecuniary gain to the Academy, provided only that the necessary expenses of such investigation are borne by the State; and,

WHEREAS, The reports of the meetings of said Academy, with the several papers read before it, have very great educational, industrial and economic value, and should be preserved in permanent form; and,

WHEREAS, The Constitution of the State makes it the duty of the General Assembly to encourage by all suitable means intellectual, scientific and agricultural improvement; therefore,

SECTION 1. *Be it enacted by the General Assembly of the State of Indiana,* That hereafter the annual reports of the meetings of the Indiana Academy of Science, beginning with the report for the year 1894, including all papers of scientific or economic value, presented at such meetings, after they shall have been edited and prepared for publication as hereinafter provided, shall be published by and under the direction of the Commissioners of Public Printing and Binding.

SEC. 2. Said reports shall be edited and prepared for publication without expense to the State, by a corps of editors to be selected and appointed by the Indiana Academy of Science, who shall not, by reason of such service, have any claim against the State for compensation. The form, style of binding, paper, typography and manner and extent of illustration of such reports shall be determined by the editors, subject to the approval of the Commissioners of Public Printing and Stationery. Not less than 1,500 nor more than 3,000 copies of each of said reports shall be published, the size of the edition within said limits to be determined by the concurrent action of the editors and the Commissioners of Public Printing and Stationery: *Provided,* That not to exceed six hundred dollars (\$600) shall be expended for such publication in any one year, and not to extend beyond 1896: *Provided,* That no sums shall be deemed to be appropriated for the year 1894.

SEC. 3. All except three hundred copies of each volume of said reports shall be placed in the custody of the State Librarian, who shall furnish one copy thereof to each public library in the State, one copy to each university college or normal school in the State, one copy to each high school in the State having a library, which shall make application therefor, and one copy to such other institutions, societies or persons as may be designated by the

Academy through its editors or its council. The remaining three hundred copies shall be turned over to the Academy to be disposed of as it may determine. In order to provide for the preservation of the same it shall be the duty of the Custodian of the State House to provide and place at the disposal of the Academy one of the unoccupied rooms of the State House, to be designated as the office of the Academy of Science, wherein said copies of said reports belonging to the Academy, together with the original manuscripts, drawings, etc., thereof can be safely kept, and he shall also equip the same with the necessary shelving and furniture.

SEC. 4. An emergency is hereby declared to exist for the immediate taking effect of this act, and it shall therefore take effect and be in force from and after its passage.

#### APPROPRIATION FOR 1915-1916.

The appropriation for the publication of the proceedings of the Academy during the years 1915 and 1916 was increased by the Legislature in the General Appropriation bill, approved March 9, 1915. That portion of the law fixing the amount of the appropriation for the Academy is herewith given in full.

For the Academy of Science: For the printing of the proceedings of the Indiana Academy of Science twelve hundred dollars: *Provided*, That any unexpended balance in 1915 shall be available for 1916, and that any unexpended balance in 1916 shall be available in 1917.

#### AN ACT FOR THE PROTECTION OF BIRDS, THEIR NESTS AND EGGS.

SEC. 602. Whoever kills, traps or has in his possession any wild bird, or whoever sells or offers the same for sale, or whoever destroys the nest or eggs of any wild bird, shall be deemed guilty of a misdemeanor and upon conviction thereof shall be fined not less than ten dollars nor more than twenty-five dollars: *Provided*, That the provisions of this section shall not apply to the following named birds: The Anatidae, commonly called swans, geese, brant, river and sea duck; the Rallidae, commonly called rails, coots, mud-hens gallinules; the limicolae, commonly called shore birds, surf birds, plover, snipe, woodcock, sandpipers, tattlers and curlew; the Gallinae, commonly called wild turkeys, grouse, prairie chickens, quails and pheasants;

nor to English or European house sparrows, crows, hawks or other birds of prey. Nor shall this section apply to persons taking birds, their nests or eggs, for scientific purposes, under permit, as provided in the next section.

SEC. 603. Permits may be granted by the Commissioner of Fisheries and Game to any properly accredited person, permitting the holder thereof to collect birds, their nests or eggs for strictly scientific purposes. In order to obtain such permit the applicant for the same must present to such Commissioner written testimonials from two well-known scientific men certifying to the good character and fitness of such applicant to be entrusted with such privilege, and pay to such Commissioner one dollar therefor and file with him a properly executed bond in the sum of two hundred dollars, payable to the State of Indiana, conditioned that he will obey the terms of such permit, and signed by at least two responsible citizens of the State as sureties. The bond may be forfeited, and the permit revoked upon proof to the satisfaction of such Commissioner that the holder of such permit has killed any bird or taken the nest or eggs of any bird for any other purpose than that named in this section.

#### PUBLIC OFFENSES—HUNTING WILD BIRDS—PENALTY.

(Approved March 15, 1913.)

SECTION 1. *Be it enacted by the General Assembly of the State of Indiana,* That section six (6) of the above entitled act be amended to read as follows: Section 6. That section six hundred two (602) of the above entitled act be amended to read as follows: Section 602. It shall be unlawful for any person to kill, trap or possess any wild bird, or to purchase or offer the same for sale, or to destroy the nest or eggs of any wild bird, except as otherwise provided in this section. But this section shall not apply to the following named game birds: The Anatidae, commonly called swans, geese, brant, river and sea duck; the Rallidae, commonly known as rails, coots, mud-hens and gallinules; the Limicolae, commonly known as shore birds, plovers, surf birds, snipe, woodcock, sandpipers, tattlers and curlews; the Gallinae, commonly called wild turkeys, grouse, prairie chickens, quails, and pheasants; nor to English or European house sparrows, blackbirds, crows, hawks or other birds of prey. Nor shall this section apply to any person taking birds or their nests or eggs for scientific purposes under permit as provided in the next section. Any person violating the provisions of this section shall, on conviction, be fined not less than ten dollars (\$10.00) nor more than fifty dollars (\$50.00).

# Indiana Academy of Science.

---

## OFFICERS, 1915-1916.

---

PRESIDENT,

ANDREW J. BIGNEY.

VICE-PRESIDENT,

AMOS W. BUTLER.

SECRETARY,

HOWARD E. ENDERS.

ASSISTANT SECRETARY,

E. B. WILLIAMSON.

PRESS SECRETARY,

FRANK B. WADE.

TREASURER,

WILLIAM M. BLANCHARD.

EDITOR,

H. E. BARNARD.

---

### EXECUTIVE COMMITTEE:

|                     |                    |                    |
|---------------------|--------------------|--------------------|
| ARTHUR, J. C.,      | CULBERTSON, GLENN, | McBETH, W. A.,     |
| BIGNEY, A. J.,      | DRYER, CHAS. R.,   | MEES, CARL L.,     |
| BLANCHARD, W. M.,   | EIGENMANN, C. H.,  | MOTTIER, DAVID M., |
| BLATCHLEY, W. S.,   | ENDERS, HOWARD E., | MENDENHALL, T. C., |
| BRANNER, J. C.,     | EVANS, P. N.,      | NAYLOR, JOSEPH P., |
| BURRAGE, SEVERANCE, | DENNIS, D. W.,     | NOYES, W. A.,      |
| BUTLER, AMOS W.,    | FOLEY, A. L.,      | WADE, F. B.        |
| COGSHALL, W. A.,    | HAY, O. P.,        | WALDO, C. A.,      |
| COULTER, JOHN M.,   | HESSLER, ROBERT,   | WILEY, H. W.,      |
| COULTER, STANLEY,   | JOHN, J. P. D.,    | WILLIAMSON, E. B., |
|                     | JORDAN, D. S.,     | WRIGHT, JOHN S.    |

## CURATORS:

|                  |                      |
|------------------|----------------------|
| BOTANY.....      | J. C. ARTHUR.        |
| ENTOMOLOGY.....  | W. S. BLATCHLEY.     |
| HERPETOLOGY      | }..... A. W. BUTLER. |
| MAMMALOGY        |                      |
| ORNITHOLOGY      |                      |
| ICHTHYOLOGY..... | H. C. EIGENMANN.     |

## COMMITTEES ACADEMY OF SCIENCE, 1915-1916.

*Program.*

STANLEY COULTER, Lafayette  
 L. F. BENNETT, Valparaiso  
 SEVERANCE BURRAGE, Indianapolis

*Membership.*

E. R. CUMMINGS, Bloomington  
 EDWIN MORRISON, Richmond  
 H. L. BRUNER, Indianapolis

*Nominations.*

WILBUR A. COGSHALL, Bloomington  
 W. A. MCBETH, Terre Haute  
 A. S. HATHAWAY, Terre Haute

*Auditing.*

J. P. NAYLOR, Greencastle  
 GLENN CULBERTSON, Hanover

*State Library.*

W. S. BLATCHLEY, Indianapolis  
 A. W. BUTLER, Indianapolis  
 JAMES BROWN, Indianapolis

*Restriction of Weeds and Diseases.*

ROBERT HESSLER, Logansport  
 F. M. ANDREWS, Bloomington  
 J. N. HURTY, State House, Indianapolis  
 STANLEY COULTER, Lafayette  
 D. M. MOTTER, Bloomington

*Biological Survey.*

C. C. DEAM, Bluffton  
 H. W. ANDERSON, Crawfordsville  
 GEORGE N. HOFFER, West Lafayette  
 U. O. COX, Terre Haute  
 J. N. NIEUWLAND, Notre Dame

*Academy to State.*

R. W. MCBRIDE, Indianapolis  
 GLENN CULBERTSON, Hanover  
 H. E. BARNARD, Indianapolis  
 A. W. BUTLER, Indianapolis  
 W. W. WOOLLEN, Indianapolis



*Distribution of Proceedings.*

H. E. ENDERS, West Lafayette  
JOHN B. DUTCHER, Bloomington  
A. W. BUTLER, State House, Indianapolis  
W. M. BLANCHARD, Greencastle

*Publication of Proceedings.*

H. E. BARNARD, Editor, Indianapolis  
C. R. DRYER, Fort Wayne  
M. E. HAGGERTY, Bloomington  
R. R. HYDE, Terre Haute  
J. S. WRIGHT, Indianapolis

## OFFICERS OF THE INDIANA ACADEMY OF SCIENCE.

| YEARS.    | PRESIDENT.           | SECRETARY.        | ASST. SECRETARY.  | PRESS SECRETARY.  | TREASURER.       |
|-----------|----------------------|-------------------|-------------------|-------------------|------------------|
| 1885-1886 | David S. Jordan.     | Amos W. Butler.   |                   |                   | O. P. Jenkins.   |
| 1886-1887 | John M. Coulter.     | Amos W. Butler.   |                   |                   | O. P. Jenkins.   |
| 1887-1888 | J. P. D. John.       | Amos W. Butler.   |                   |                   | O. P. Jenkins.   |
| 1888-1889 | John C. Branner.     | Amos W. Butler.   |                   |                   | O. P. Jenkins.   |
| 1889-1890 | T. C. Mendenhall.    | Amos W. Butler.   |                   |                   | O. P. Jenkins.   |
| 1890-1891 | O. P. Hay.           | Amos W. Butler.   |                   |                   | A. C. Waldo.     |
| 1891-1892 | J. L. Campbell*      | Amos W. Butler.   |                   |                   | C. A. Waldo.     |
| 1892-1893 | J. C. Arthur.        | Amos W. Butler.   | (Stanley Coulter) |                   | W. P. Shannon.   |
| 1893-1894 | W. A. Noyes.         | C. A. Waldo.      | W. W. Norman)     |                   | W. P. Shannon.   |
| 1894-1895 | A. W. Butler.        | John S. Wright.   | A. J. Bigney.     |                   | W. P. Shannon.   |
| 1895-1896 | Stanley Coulter.     | John S. Wright.   | A. J. Bigney.     |                   | W. P. Shannon.   |
| 1896-1897 | Thomas Gray*         | John S. Wright.   | A. J. Bigney.     | Geo. W. Benton.   | J. T. Scovell.   |
| 1897-1898 | C. A. Waldo.         | John S. Wright.   | E. A. Schultze.   | Geo. W. Benton.   | J. T. Scovell.   |
| 1898-1899 | C. H. Eigenmann.     | John S. Wright.   | E. A. Schultze.   | Geo. W. Benton.   | J. T. Scovell.   |
| 1899-1900 | D. W. Dennis.        | John S. Wright.   | E. A. Schultze.   | Geo. W. Benton.   | J. T. Scovell.   |
| 1900-1901 | M. B. Thomas*        | John S. Wright.   | Donaldson Bodine. | Geo. W. Benton.   | J. T. Scovell.   |
| 1901-1902 | Harvey W. Wiley.     | John S. Wright.   | Donaldson Bodine. | G. A. Abbott.     | W. A. McBeth.    |
| 1902-1903 | W. S. Blatchley.     | John S. Wright.   | Donaldson Bodine. | G. A. Abbott.     | W. A. McBeth.    |
| 1903-1904 | C. L. Mees.          | John S. Wright.   | J. H. Ransom.     | G. A. Abbott.     | W. A. McBeth.    |
| 1904-1905 | John S. Wright.      | Lynn B. McMullen. | J. H. Ransom.     | G. A. Abbott.     | W. A. McBeth.    |
| 1905-1906 | Robert Hessler.      | Lynn B. McMullen. | J. H. Ransom.     | Charles R. Clark. | W. A. McBeth.    |
| 1906-1907 | D. M. Mottier.       | Lynn B. McMullen. | J. H. Ransom.     | G. A. Abbott.     | W. A. McBeth.    |
| 1907-1908 | Glenn Culbertson.    | J. H. Ransom.     | A. J. Bigney.     | G. A. Abbott.     | W. A. McBeth.    |
| 1908-1909 | A. L. Foley.         | J. H. Ransom.     | A. J. Bigney.     | G. A. Abbott.     | W. A. McBeth.    |
| 1909-1910 | P. N. Evans.         | Geo. W. Benton.   | A. J. Bigney.     | John W. Woodhams. | W. J. Moenkhaus. |
| 1910-1911 | C. R. Dryer.         | A. J. Bigney.     | E. B. Williamson. | Milo H. Stuart.   | W. J. Moenkhaus. |
| 1911-1912 | J. P. Naylor.        | A. J. Bigney.     | E. B. Williamson. | Milo H. Stuart.   | W. J. Moenkhaus. |
| 1912-1913 | Donaldson Bodine*.   | A. J. Bigney.     | C. M. Smith.      | F. B. Wade.       | W. A. Cogshall.  |
| 1913-1914 | Severance Burrage.   | A. J. Bigney.     | H. E. Enders.     | F. B. Wade.       | W. M. Blanchard. |
| 1914-1915 | Willbur A. Cogshall. | A. J. Bigney.     | H. E. Enders.     | F. B. Wade.       | W. M. Blanchard. |
| 1915-1916 | A. J. Bigney.        | Howard E. Enders. | E. B. Williamson. | F. B. Wade.       | W. M. Blanchard. |

## MEMBERS.\*

## FELLOWS.

- ††Abbott, G. A., Grand Forks, N. Dak. . . . . †1908  
 Professor of Chemistry, University of North Dakota.  
 Chemistry.
- Aley, Robert J., Orono, Me. . . . . 1898  
 President of University of Maine.  
 Mathematics and General Science.
- Anderson, H. W., 1 Mills Place, Crawfordsville, Ind. . . . . 1912  
 Professor of Botany, Wabash College.  
 Botany.
- Andrews, F. M., 744 E. Third St., Bloomington, Ind. . . . . 1911  
 Assistant Professor of Botany, Indiana University.  
 Botany.
- Arthur, Joseph C., 915 Columbia St., Lafayette, Ind. . . . . 1894  
 Professor of Vegetable Physiology and Pathology, Purdue University.  
 Botany.
- Barnard, H. E., Room 20 State House, Indianapolis, Ind. . . . . 1910  
 Chemist to Indiana State Board of Health.  
 Chemistry, Sanitary Science, Pure Foods.
- Blanchard, William M., 1008 S. College Ave., Greencastle, Ind. . . . .  
 Professor of Chemistry, DePauw University, Greencastle, Ind.  
 Organic Chemistry.
- Beede, Joshua W., cor. Wall and Atwater Sts., Bloomington, Ind. . . . . 1896  
 Associate Professor of Geology, Indiana University.  
 Stratigraphic Geology, Physiography.

\*Every effort has been made to obtain the correct address and occupation of each member, and to learn what line of science he is interested in. The first line contains the name and address; the second line the occupation; the third line the branch of science in which he is interested. The omission of an address indicates that mail addressed to the last printed address was returned as uncalled for. Information as to the present address of members so indicated is requested by the secretary. The custom of dividing the list of members has been followed.

†Date of election.

††Non-resident.

- Benton, George W., 100 Washington Square, New York, N. Y. . . . . 1896  
 Editor in Chief, American Book Company.
- Bigney, Andrew J., Moores Hill, Ind. . . . . 1897  
 President and Professor of Biology and Geology, Moores Hill  
 College.  
 Biology and Geology.
- Bitting, Catharine Golden, Washington, D. C. . . . . 1895  
 Microscopic Expert, Pure Food, National Canners Laboratory.  
 Botany.
- Blatchley, W. S., 1558 Park Ave., Indianapolis, Ind. . . . . 1893  
 Naturalist.  
 Botany, Entomology and Geology.
- Bodine, Donaldson, Four Mills Place, Crawfordsville, Ind. . . . . 1899  
 Professor of Geology and Zoology, Wabash College.  
 Entomology and Geology.
- Breeze, Fred J., care American Book Company, New York, N. Y. . . . . 1910  
 With the American Book Company.  
 Geography.
- Bruner, Henry Lane, 324 S. Ritter Ave., Indianapolis, Ind. . . . . 1899  
 Professor of Biology, Butler College.  
 Comparative Anatomy, Zoology.
- Bryan, William Lowe, Bloomington, Ind. . . . .  
 President Indiana University.  
 Psychology.
- Burrage, Severance, care Eli Lilly Co., Indianapolis, Ind. . . . . 1898  
 Charge of Biological Laboratory, Eli Lilly Co.  
 Bacteriology, Sanitary Science.
- Butler, Amos W., 52 Downey Ave., Irvington, Ind. . . . . 1893  
 Secretary, Indiana Board of State Charities.  
 Vertebrate Zoology, Anthropology, Sociology.
- Cogshall, Wilbur A., 423 S. Fess Ave., Bloomington, Ind. . . . . 1906  
 Associate Professor of Astronomy, Indiana University.  
 Astronomy and Physics.
- Cook, Mel T., New Brunswick, N. J. . . . . 1902  
 Professor of Plant Pathology, Rutgers College.  
 Botany, Plant Pathology, Entomology.

- Coulter, John M., care University of Chicago, Chicago, Ill. . . . . 1893  
 Head Department of Botany, Chicago, University.  
 Botany.
- Coulter, Stanley, 213 S. Ninth St., Lafayette, Ind. . . . . 1893  
 Dean School of Science, Purdue University.  
 Botany, Forestry.
- Cox, Ulysses O., P. O. Box 81, Terre Haute, Ind. . . . . 1908  
 Head Department Zoology and Botany, Indiana State Normal.  
 Botany, Zoology.
- Culbertson, Glenn, Hanover, Ind. . . . . 1899  
 Chair Geology, Physics and Astronomy, Hanover College.  
 Geology.
- Cumings, Edgar Roscoe, 327 E. Second St., Bloomington, Ind. . . . . 1906  
 Professor of Geology, Indiana University.  
 Geology, Paleontology.
- Davisson, Schuyler Colfax, Bloomington, Ind. . . . . 1908  
 Professor of Mathematics, Indiana University.  
 Mathematics.
- Deam, Charles C., Bluffton, Ind. . . . . 1910  
 Druggist.  
 Botany.
- Dennis, David Worth, Richmond, Ind. . . . . 1895  
 Professor of Biology, Earlham College.  
 Biology.
- Dryer, Charles R., Oak Knoll, Fort Wayne, Ind. . . . . 1897  
 Geographer.
- Dutcher, J. B., Bloomington, Ind. . . . .  
 Assistant Professor of Physics, Indiana University.  
 Physics.
- Eigenmann, Carl H., 630 Atwater St., Bloomington, Ind. . . . . 1893  
 Professor Zoology, Dean of Graduate School, Indiana University.  
 Embryology, Degeneration, Heredity, Evolution and Distribution  
 of American Fish.
- Enders, Howard Edwin, 105 Quiney St., Lafayette, Ind. . . . . 1912  
 Associate Professor of Zoology, Purdue University.  
 Zoology.

- Evans, Percy Norton, Lafayette, Ind. . . . . 1901  
 Director of Chemical Laboratory, Purdue University.  
 Chemistry.
- Foley, Arthur L., Bloomington, Ind. . . . . 1897  
 Head of Department of Physics, Indiana University.  
 Physics.
- Golden, M. J., Lafayette, Ind. . . . . 1899  
 Director of Laboratories of Practical Mechanics, Purdue University.  
 Mechanics.
- ††Goss, William Freeman M., Urbana, Ill. . . . . 1893  
 Dean of College of Engineering, University of Illinois.
- Haggerty, M. E., Bloomington, Ind. . . . . 1913
- Hathaway, Arthur S., 2206 N. Tenth St., Terre Haute, Ind. . . . . 1895  
 Professor of Mathematics, Rose Polytechnic Institute.  
 Mathematics, Physics.
- Hessler, Robert, Logansport, Ind. . . . . 1899  
 Physician.  
 Biology.
- Hilliard, C. M., Simmons College, Boston, Mass. . . . . 1913
- Hoffer, Geo. N., West Lafayette, Ind. . . . . 1913
- Hurty, J. N., Indianapolis, Ind. . . . . 1910  
 Secretary, Indiana State Board of Health.  
 Sanitary Science, Vital Statistics, Eugenics.
- †Huston, H. A., New York City. . . . . 1893
- Hyde, Roscoe Raymond, Terre Haute. . . . .  
 Assistant Professor, Physiology and Zoology, Indiana State Normal.  
 Zoology, Physiology, Bacteriology.
- Kenyon, Alfred Monroe, 315 University St., West Lafayette, Ind. . . . .  
 Professor of Mathematics, Purdue University.  
 Mathematics.
- Kern, Frank D., State College, Pa. . . . . 1912  
 Professor of Botany, Pennsylvania State College.  
 Botany.
- Lyons, Robert E., 630 E. Third St., Bloomington, Ind. . . . . 1896  
 Head of Department of Chemistry, Indiana University.  
 Organic and Biological Chemistry.

- McBeth, William A., 1905 N. Eighth St., Terre Haute, Ind. . . . . 1904  
 Assistant Professor Geography, Indiana State Normal.  
 Geography, Geology, Scientific Agriculture.
- †Marsters, V. F., Santiago, Chile . . . . . 1893
- Mees, C. L., Terre Haute, Ind. . . . . 1894  
 President of Rose Polytechnic Institute.
- Middleton, A. R., West Lafayette, Ind. . . . .  
 Professor of Chemistry, Purdue University.  
 Chemistry.
- †Miller, John Anthony, Swarthmore, Pa. . . . . 1904  
 Professor of Mathematics and Astronomy, Swarthmore College.  
 Astronomy, Mathematics.
- Moenkhaus, William J., 501 Fess Ave., Bloomington, Ind. . . . . 1901  
 Professor of Physiology, Indiana University.  
 Physiology.
- Moore, Richard B., Denver, Colo. . . . . 1893  
 With U. S. Bureau of Mines.  
 Chemistry, Radio-activity.
- Morrison, Edwin, 80 S. W. Seventh St., Richmond . . . . .  
 Professor of Physics, Earlham College.  
 Physics and Chemistry.
- Mottier, David M., 215 Forest Place, Bloomington, Ind. . . . . 1893  
 Professor of Botany, Indiana University.  
 Morphology, Cytology.
- Naylor, J. P., Greencastle, Ind. . . . . 1903  
 Professor of Physics, Depauw University.  
 Physics, Mathematics.
- Nieuwland, J. N., The University, Notre Dame, Ind. . . . .  
 Professor of Botany, Editor Midland, Naturalist.  
 Systematic Botany, Plant Histology, Organic Chemistry.
- †Noyes, William Albert, Urbana, Ill. . . . . 1893  
 Director of Chemical Laboratory, University of Illinois.  
 Chemistry.
- Pohlman, Augustus G., 1100 E. Second St., Bloomington, Ind. . . . . 1911  
 Professor of Anatomy, Indiana University.  
 Embryology, Comparative Anatomy.

- Ramsey, Rolla R., 615 E. Third St., Bloomington, Ind. . . . . 1906  
Associate Professor of Physics, Indiana University.  
Physics.
- Ransom, James H., 323 University St., West Lafayette, Ind. . . . . 1902  
Professor of General Chemistry, Purdue University.  
General Chemistry, Organic Chemistry, Teaching.
- Rettger, Louis J., 31 Gilbert Ave., Terre Haute, Ind. . . . . 1896  
Professor of Physiology, Indiana State Normal.  
Animal Physiology.
- Rothrock, David A., Bloomington, Ind. . . . . 1906  
Professor of Mathematics, Indiana University.  
Mathematics.
- Scott, Will, 731 Atwater St., Bloomington, Ind. . . . . 1911  
Assistant Professor of Zoology, Indiana University.  
Zoology, Lake Problems.
- Shannon, Charles W., Norman, Okla. . . . . 1912  
With Oklahoma State Geological Survey.  
Soil Survey, Botany.
- Smith, Albert, 1022 Seventh St., West Lafayette . . . . . 1908  
Professor of Structural Engineering.  
Physics, Mechanics.
- ††Smith, Alexander, care Columbia University, New York, N. Y. . . . . 1893  
Head of Department of Chemistry, Columbia University.  
Chemistry.
- Smith, Charles Marquis, 910 S. Ninth St., Lafayette, Ind. . . . . 1912  
Professor of Physics, Purdue University.  
Physics.
- Stone, Winthrop E. Lafayette, Ind. . . . . 1893  
President of Purdue University.  
Chemistry.
- ††Swain, Joseph, Swarthmore, Pa. . . . . 1898  
President of Swarthmore College.  
Science of Administration..
- Van Hook, James M., 639 N. College Ave., Bloomington, Ind. . . . . 1911  
Assistant Professor of Botany, Indiana University.  
Botany.



- Wade, Frank Bertran, 1039 W. Twenty-seventh St., Indianapolis, Ind.  
 Head of Chemistry Department, Shortridge High School.  
 Chemistry Physics, Geology and Mineralogy.
- ††Waldo, Clarence A., care Washington University, St. Louis, Mo. . . . 1893  
 Thayer Professor Mathematics and Applied Mechanics, Wash-  
 ington University.  
 Mathematics, Mechanics, Geology and Mineralogy.
- ††Webster, F. M., Kensington, Md. . . . . 1894  
 Entomologist, U. S. Department of Agriculture, Washington, D. C.  
 Entomology.
- Westland, Jacob, 439 Salisbury St., West Lafayette, Ind. . . . . 1904  
 Professor of Mathematics, Purdue University.  
 Mathematics.
- Wiley, Harvey W., Cosmos Club, Washington, D. C. . . . . 1895  
 Professor of Agricultural Chemistry, George Washington Uni-  
 versity.  
 Biological and Agricultural Chemistry.
- Woollen, William Watson, Indianapolis, Ind. . . . . 1908  
 Lawyer.  
 Birds and Nature Study.
- Wright, John S., care Eli Lilly Co., Indianapolis, Ind. . . . . 1894  
 Manager of Advertising Department, Eli Lilly Co.  
 Botany.

*NON-RESIDENT MEMBERS.*

- Ashley, George H., Washington, D. C.
- Bain, H. Foster, London, England.  
 Editor Mining Magazine.
- Branner, John Casper, Stanford University, California.  
 Vice-President of Stanford University, and Professor of Geology.  
 Geology.
- Brannon, Melvin A., President University of Idaho, Boise, Ida.  
 Professor of Botany.  
 Plant Breeding.
- Campbell, D. H., Stanford University, California.  
 Professor of Botany, Stanford University.  
 Botany.

- Clark, Howard Walton, U. S. Biological Station, Fairport, Iowa.  
 Scientific Assistant, U. S. Bureau of Fisheries.  
 Botany, Zoology.
- Dorner, H. B., Urbana, Illinois.  
 Assistant Professor of Floriculture.  
 Botany, Floriculture.
- Duff, A. Wilmer, 43 Harvard St., Worcester, Mass.  
 Professor of Physics, Worcester Polytechnic Institute.  
 Physics.
- Evermann, Barton Warren, Director Museum.  
 California Academy of Science, Golden Gate Park, San Francisco, Cal.  
 Zoology.
- Fiske, W. A. Los Angeles, Cal., Methodist College.
- Garrett, Chas. W., Room 718 Pennsylvania Station, Pittsburgh, Pa.  
 Librarian, Pennsylvania Lines West of Pittsburgh.  
 Entomology, Sanitary Sciences.
- Gilbert, Charles H., Stanford University, California.  
 Professor of Zoology, Stanford University.  
 Ichthyology.
- Greene, Charles Wilson, 814 Virginia Ave., Columbia, Mo.  
 Professor of Physiology and Pharmacology, University of Missouri.  
 Physiology, Zoology.
- Hargitt, Chas. W., 909 Walnut Ave., Syracuse, N. Y.  
 Professor of Zoology, Syracuse University.  
 Hygiene, Embryology, Eugenics, Animal Behavior.
- Hay, Oliver Perry, U. S. National Museum, Washington, D. C.  
 Research Associate, Carnegie Institute of Washington.  
 Vertebrate Paleontology, especially that of the Pleistocene Epoch.
- Hughes, Edward, Stockton, California.
- Jenkins, Oliver P., Stanford University, California.  
 Professor of Physiology, Stanford University.  
 Physiology, Histology.
- Jordan, David Starr, Stanford University, California.  
 President Emeritus of Stanford University.  
 Fish, Eugenics, Botany, Evolution.

- Kingsley, J. S., University of Illinois, Champaign, Ill.  
Professor of Zoology.  
Zoology.
- Knipp, Charles T., 915 W. Nevada St., Urbana, Illinois.  
Assistant Professor of Physics, University of Illinois.  
Physics, Discharge of Electricity through Gases.
- MacDougal, Daniel Trembly, Tucson, Arizona.  
Director, Department of Botanical Research, Carnegie Institute, Wash-  
ington, D. C.  
Botany.
- McMullen, Lynn Banks, State Normal School, Valley City, North Dakota.  
Head Science Department, State Normal School.  
Physics, Chemistry.
- Mendenhall, Thomas Corwin, Ravenna, Ohio.  
Retired.  
Physics. "Engineering," Mathematics, Astronomy.
- Moore, George T., St. Louis, Mo.  
Director Missouri Botanical Garden.
- Newsom, J. F., Palo Alto, California.  
Mining Engineer.
- Purdue, Albert Homer, State Geological Survey, Nashville, Tenn.  
State Geologist of Tennessee.  
Geology.
- Reagan, A. B.  
Superintendent Deer Creek Indian School, Hapah, Utah.  
Geology, Paleontology, Ethnology.
- Slonaker, James Rollin, 334 Kingsley Ave., Palo Alto, California.  
Assistant Professor of Physiology, Stanford University.  
Physiology, Zoology.
- Springer, Alfred, 312 East 2d St., Cincinnati, Ohio.  
Chemist.  
Chemistry.

*ACTIVE MEMBERS.*

- Aldrich, John Merton, M. D., S. Grant St., West Lafayette, Ind.  
Zoology and Entomology.
- Allen, William Ray, Bloomington, Ind.
- Allison, Evelyn, Lafayette, Ind.  
Care Agricultural Experiment Station.  
Botany.
- Anderson, Flora Charlotte, Wellesley College, Wellesley, Mass.  
Botany.
- Arndt, Charles H., Lafayette, Ind.  
Biology.
- Atkinson, F. C., Indianapolis.  
Chemistry.
- Baderscher, J. A., Bloomington, Ind.  
Anatomy.
- Baker, George A., South Bend.  
Archaeology.
- Baker, Walter D., N. Illinois St., Indianapolis, Ind.  
Care Waldercraft Co.  
Chemistry.
- Baker, Walter M., Amboy.  
Superintendent of Schools.  
Mathematics and Physics.
- Baker, William Franklin, Indianapolis.  
Medicine.
- Baleom, H. C., Indianapolis.  
Botany.
- Baldwin, Russell, Richmond, Ind.  
Physics.
- Banker, Howard J., Cold Spring Harbor, N. Y.  
Botany.
- Bareus, H. H., Indianapolis.  
Instructor, Mathematics, Shortridge High School.
- Barr, Harry L., Waveland.  
Student.  
Botany and Forestry.

- Barrett, Edward, Indianapolis.  
State Geologist.  
Geology, Soil Survey.
- Bates, W. H., 306 Russell St., West Lafayette.  
Associate Professor, Mathematics.
- Beals, Colonzo C., Russiaville, Ind.  
Botany.
- Bell, Guido, 431 E. Ohio St., Indianapolis.  
Physician.
- Bellamy, Ray, Worcester, Mass.
- Bennett, Lee F., 825 Laporte Ave., Valparaiso.  
Professor of Geology and Zoology, Valparaiso University.  
Geology, Zoology.
- Berry, O. C., West Lafayette.  
Engineering.
- Berteling, John B., South Bend.  
Medicine.
- Binford, Harry, Earlham.  
Zoology.
- Bisby, Guy Richard, Lafayette, Ind.  
Botany.
- Bishop, Harry Eldridge, 1706 College Ave., Indianapolis.  
Food Chemist, Indiana State Board of Health.
- Blew, Michael James, R. R. 1, Wabash.  
Chemistry and Botany.
- Bliss, G. S., Ft. Wayne.  
Medicine.
- Blose, Joseph, Culerville, Ind.  
Physics.
- Bond, Charles S., 112 N. Tenth St., Richmond.  
Physician.  
Biology, Bacteriology, Physical Diagnosis and Photomicrography.
- Bourke, A. Adolphus, 1103 Cottage Ave., Columbus.  
Instructor, Physics, Zoology and Geography.  
Botany, Physics.
- Bowles, Adam L., Terre Haute.  
Zoology.

- Bowers, Paul E., Michigan City.  
Medicine.
- Breckinridge, James M., Crawfordsville.  
Chemistry.
- Brossman, Charles, 1616 Merchants Bank Bldg., Indianapolis.  
Consulting Engineer.  
Water Supply, Sewage Disposal, Sanitary Engineering, etc.
- Brown, James, 5372 E. Washington St., Indianapolis.  
Professor of Chemistry, Butler College.  
Chemistry.
- Brown, Paul H., Richmond.  
Physics.
- Brown, Hugh E., Bloomington, Ind.
- Bruce, Edwin M., 2401 North Ninth St., Terre Haute.  
Assistant Professor of Physics and Chemistry, Indiana State Normal.  
Chemistry, Physics.
- Butler, Eugene, Richmond, Ind.  
Physics and Mathematics.
- Bybee, Halbert P., Bloomington.  
Graduate Student, Indiana University.  
Geology.
- Canis, Edward N., 2221 Park Ave., Indianapolis.  
Officeman with William B. Burford.  
Botany, Psychology.
- Caparo, Jose Angel, Notre Dame.  
Physics and Mathematics.
- Carlyle, Paul J., Bloomington.  
Chemistry.
- Carmichael, R. D., Bloomington.  
Assistant Professor of Mathematics, Indiana University.  
Mathematics.
- Carr, Ralph Howard, Lafayette.  
Chemistry.
- Carter, Floyd R., Frankport, Ind.  
Botany.

- Caswell, Albert E., Lafayette.  
 Instructor in Physics, Purdue University.  
 Physics and Applied Mathematics.
- Chansler, Elias J., Biacknell.  
 Farmer.  
 Ornithology and Mammals.
- Clark, George Lindenburg, Greencastle, DePauw University.  
 Chemistry.
- Clark, Elbert Howard, West Lafayette.  
 Mathematics.
- Clark, Jediah H., 126 East Fourth St., Connersville.  
 Physician.  
 Medicine.
- Clarke, Elton Russell, Indianapolis.  
 Zoology.
- Collins, Jacob Roland, West Lafayette, Purdue University.  
 Instructor in Physics.
- Conner, S. D., West Lafayette.
- Coryell, Noble H., Bloomington.  
 Chemistry.
- Cotton, William J., 5363 University Ave., Indianapolis.  
 Physics and Chemistry.
- Cox, William Clifford.
- Crampton, Charles, Bloomington, Ind.  
 Psychology.
- Crowell, Melvin E., 648 E. Monroe St., Franklin.  
 Dean of Franklin College.  
 Chemistry and Physics.
- Cutter, George, Broad Branch Road, Washington, D. C.  
 Retired Manufacturer of Electrical Supplies.  
 Conchology.
- Daniels, Lorenzo E., Rolling Prairie.  
 Retired Farmer.  
 Conchology.
- Davis, A. B., Indianapolis, Ind.  
 With Eli Lilly and Company.  
 Chemistry.

- Davis, D. W., Greencastle.  
Biology.
- Davis, Ernest A., Notre Dame.  
Chemistry.
- Davis, Melvin K., Anderson.  
Instructor, Anderson High School.  
Physiography, Geology, Climatology.
- Dean, John C., Indianapolis.  
Astronomy.
- Deppe, C. R., Franklin.
- Dewey, Albert H., West Lafayette.  
Department of Pharmacy, Purdue University.
- Dietz, Harry F., 408 W. Twenty-eighth St., Indianapolis.  
Deputy State Entomologist.  
Entomology, Eugenics, Parasitology, Plant Pathology.
- Dolan, Jos. P., Syracuse.
- Donaghy, Fred, Ossian.  
Botany.
- Dostal, Bernard F., Bloomington.  
Physics.
- Downhour, 2307 Talbot Ave., Indianapolis, Ind.  
Geology and Botany.
- Drew, David Abbott, 817 East Second St., Bloomington, Ind.  
Instructor in Mechanics and Astronomy.  
Astronomy, Mechanics, Mathematics and Applied Mathematics.
- DuBois, Henry, Bloomington, Ind.
- Duden, Hans A., 5050 E. Washington St., Indianapolis.  
Analytical Chemist.  
Chemistry.
- Duncan, David Christie, West Lafayette.  
Instructor in Physics, Purdue University.
- Dutcher, J. B., Bloomington,  
Assistant Professor of Physics, Indiana University.  
Physics.
- Earp, Samuel E., 24½ Kentucky Ave., Indianapolis.  
Physician.
- Easley, Mary, Bloomington, Ind.



- Edmonston, Clarence E., Bloomington.  
 Graduate Student, Physiology, Indiana University.  
 Physiology.
- Edwards, Carlton, Earlham College, Earlham.
- Ellis, Max Mapes, Boulder, Colo.  
 Instructor in Biology, University of Colorado.  
 Biology, Entomology.
- Emerson, Charles P., Hume-Mansur Bldg., Indianapolis.  
 Dean Indiana University Medical College.  
 Medicine.
- Essex, Jesse Lyle, 523 Russell st., West Lafayette, Ind.  
 Chemistry.
- Evans, Samuel G., 1452 Upper Second St., Evansville.  
 Merchant.  
 Botany, Ornithology.
- Ewers, James E., Terre Haute.  
 Instructor in High School.  
 Geology.
- Felver, William P., 325½ Market St., Logansport.  
 Railroad Clerk.  
 Geology, Chemistry.
- Fisher, Homer Glenn, Bloomington.  
 Zoology.
- Fisher, Martin L., Lafayette.  
 Professor of Crop Production, Purdue University.  
 Agriculture, Soils, and Crops, Birds, Botany.
- Foresman, George Kedgie, Lafayette, Purdue University.  
 Chemistry.
- Frier, George M., Lafayette.  
 Assistant Superintendent, Agricultural Experiment Station, Purdue  
 University.  
 Botany, Zoology, Entomology, Ornithology, Geology.
- Fulk, Murl E., Decatur.  
 Anatomy.
- Fuller, Frederick D., 215 Russell St., West Lafayette.  
 Chief Deputy State Chemist, Purdue Experiment Station.  
 Chemistry, Microscopy.

- Funk, Austin, 404 Spring St., Jeffersonville.  
Physician.  
Diseases of Eye, Ear, Nose and Throat.
- Galloway, Jesse James, Bloomington.  
Instruction, Indiana University.  
Geology, Paleontology.
- Garner, J. B., Mellon Institute, Pittsburgh, Pa.  
Chemistry.
- Gatch, Willis D., Indianapolis, Indiana University Medical School.  
Anatomy.
- Gates, Florence A., 3435 Detroit Ave., Toledo, Ohio.  
Teacher of Botany.  
Botany and Zoology.
- Gidley, William, West Lafayette.  
Department of Pharmacy, Purdue University.
- Gillum, Robert G., Terre Haute, Ind.
- Glenn, E. R., Froebel School, Gary, Ind.  
Physics.
- Goldsmith, William Marion, Oakland City.  
Zoology.
- Gottlieb, Frederic W., Morristown.  
Care Museum of Natural History. Assistant Curator, Moores Hill  
College.  
Archaeology, Ethnology.
- Grantham, Guy E., 437 Vine St., West Lafayette.  
Instructor in Physics, Purdue University.
- Graybook, Irene, New Albany, Ind.  
Botany.
- Greene, Frank C., Missouri Bureau of Geology and Mines, Rolla, Mo.  
Geologist.  
Geology.
- Grimes, Earl J., Russellville.  
Care U. S. Soil Survey.  
Botany, Soil Survey.
- Hamill, Samuel Hugh, 119 E. Fourth St., Bloomington.  
Chemistry.

- Hammerschmidt, Louis M., South Bend.  
Science of Law.
- Happ, William, South Bend.  
Botany.
- Harding, C. Francis 111 Fowler Ave., West Lafayette.  
Professor of Electrical Engineering, Purdue University.  
Mathematics, Physics, Chemistry.
- Harman, Mary T., 611 Laramie St., Manhattan, Kansas.  
Instructor in Zoology, Kansas State Agricultural College.  
Zoology.
- Harman, Paul M., Bloomington.  
Geology.
- Harmon, Paul, Bloomington, Ind.  
Physiology.
- Harvey, R. B., Indianapolis.
- Heimburger, Harry V., 701 West Washington St., Urbana, Ill.  
Assistant in Zoology, University of Illinois.
- Heimlich, Louis Frederick, 703 North St., Lafayette.  
Biology.
- Hendricks, Victor K., 855 Benton Ave., Springfield, Mo.  
Assistant Chief Engineer, St. L. & S. F. R. R.  
Civil Engineering and Wood Preservation.
- Henn, Arthur Wilbur, Bloomington.  
Zoology.
- Hennel, Cora, Bloomington, Ind.
- Hennel, Edith A., Bloomington, Ind.
- Hetherington, John P., 418 Fourth St., Logansport.  
Physician.  
Medicine, Surgery, X-Ray, Electro-Therapeutics.
- Hinman, J. J., Jr., University of Iowa, Iowa City, Ia.  
Chemist, Dept. Public Health and Hygiene.  
Chemistry.
- Hoge, Mildred, Kirkwood, Bloomington, Ind.  
Zoology.
- Hole, Allen D., Richmond.  
Professor Earlham College.  
Geology.

- Hostetler, W. F., South Bend.  
Geography and Indian History.
- Hubbard, Lucius M., South Bend.  
Lawyer.
- Huber, Leonard L., Hanover, Ind.  
Zoology.
- Hufford, Mason E., Bloomington.  
Physics.
- Hurd, Cloyd C., Crawfordsville, Ind.  
Zoology.
- Hutchins, Chas. P., Buffalo, N. Y.  
Athletics.
- Hutchinson, Emory, Atwater St., Bloomington, Ind.  
Zoology.
- Hutton, Joseph Gladden, Brookings, South Dakota.  
Associate Professor of Agronomy, State College.  
Agronomy, Geology.
- Hyde, Carl Clayton, Bloomington, Ind.  
Geology.
- Hyslop, George, Bloomington, Ind.  
Philosophy.
- Ibison, Harry M., Marion.  
Instructor in Science, Marion High School.
- Iddings, Arthur, Hanover.  
Geology.
- Imel, Herbert, South Bend.  
Zoology.
- Inman, Ondess L., Bloomfield.  
Botany.
- Irving, Thos. P., Notre Dame.  
Physics.
- Jackson, D. E., St. Louis, Mo.  
Assistant Professor, Pharmacology, Washington University.
- Jackson, Herbert Spencer, 127 Waldron St., Lafayette, Ind.  
Botany.
- Jackson, Thomas F., Bloomington.  
Geology.

- James, Glenn, West Lafayette.  
Mathematics.
- Johnson, A. G., Madison, Wisconsin.
- Jones, Wm. J., Jr., Lafayette.  
State Chemist, Professor of Agriculture and Chemistry, Purdue University.  
Chemistry, and general subjects relating to agriculture.
- Jordan, Charles Bernard, West Lafayette.  
Director School of Pharmacy, Purdue University.
- Koezmarek, Regedius M., Notre Dame.  
Biology.
- Keubler, John Ralph, 110 E. Fourth St., Bloomington.  
Chemistry.
- vonKleinsmid, R. B., Tucson, Ariz.
- Koch, Edward, Bloomington.  
Physiology.  
President University of Arizona.
- Krewers, H., Crawfordsville, Ind.  
Chemistry.
- Liebers, Paul J., 1104 Southeastern Ave., Indianapolis.
- Ludwig, C. A., 210 Waldron St., West Lafayette, Ind.  
Assistant in Botany, Purdue University.  
Botany, Agriculture.
- Ludy, L. V., 229 University St., Lafayette.  
Professor Experimental Engineering, Purdue University.  
Experimental Engineering in Steam and Gas.
- Malott, Clyde A., Bloomington.  
Physiology.
- Marshall, E. C., Bloomington.  
Chemistry.
- Mason, Preston Walter, Lafayette, Ind.  
Entomology.
- Mason, T. E., 226 S. Grant St., Lafayette, Ind.  
Instructor Mathematics Purdue University.  
Mathematics.
- McBride, John F., 340 S. Ritter Ave., Indianapolis, Ind.  
Chemistry.

McBride, Robert W., 1239 State Life Building, Indianapolis.

Lawyer.

McCartney, Fred J., Bloomington.

Philosophy.

McClellan, John H., Gary, Ind.

McCulloch, T. S., Charlestown.

McEwan, Mrs. Eula Davis, Bloomington, Ind.

McGuire, Joseph, Notre Dame.

Chemistry.

Mance, Grover C., Bloomington, Ind.

Markle, M. S., Richmond.

Miller, Daniel T., Indiana University, Bloomington.

Anatomy.

Miller, Fred A., 3641 Kenwood Ave., Indianapolis.

Botanist for Eli Lilly Co.

Botany, Plant Breeding.

Molby, Fred A., Bloomington, Ind.

Physics.

Montgomery, Ethel, South Bend.

Physics.

Montgomery, Hugh T., South Bend.

Physician.

Geology.

Moon, V. H., Indianapolis.

Pathology.

Moore, George T., St. Louis, Mo.

Director, Missouri Botanical Garden.

Botany.

Morris, Barclay D., Spiceland Academy, Spiceland.

Science.

Morrison, Harold, Indianapolis, Ind.

Mowrer, Frank Karlsten, Interlaken, New York.

Co-operative work with Cornell University.

Biology, Plant Breeding.

Muncie, F. W.

Murray, Thomas J., West Lafayette.

Bacteriology.

- Myers, B. D., 321 N. Washington St., Bloomington.  
Professor of Anatomy, Indiana University.
- Nelson, Ralph Emory, 419 Vine St., West Lafayette.  
Chemistry.
- North, Cecil C., Greencastle.
- Northnagel, Mildred, Gary, Ind.
- Oberholzer, H. C., U. S. Department Agriculture, Washington, D. C.  
Biology.
- O'Neal, Claude E., Bloomington, Ind.  
Graduate Student, Botany, Indiana University.  
Botany.
- Orahood, Harold, Kingman.  
Geology.
- Orton, Clayton R., State College, Pennsylvania.  
Assistant Professor of Botany, Pennsylvania State College.  
Phytopathology, Botany, Mycology, Bacteriology.
- Osner, G. A., Ithaca, New York.  
Care Agricultural College.
- Owen, D. A., 200 South State St., Franklin.  
Professor of Biology. (Retired.)  
Biology.
- Owens, Charles E., Corvallis, Oregon.  
Instructor in Botany, Oregon Agricultural College.  
Botany.
- Payne, Dr. F., Bloomington, Ind.
- Peffer, Harvey Creighton, West Lafayette.  
Chemical Engineering.
- Petry, Edward Jacob, 267 Wood St., West Lafayette.  
Instructor in Agriculture.  
Botany, Plant Breeding, Plant Pathology, Bio-Chemistry.
- Phillips, Cyrus G., Moores Hill.
- Pickett, Fermen L., Bloomington.  
Botany Critic, Indiana University Training School.  
Botany, Forestry, Agriculture.
- Pipal, F. J., 11 S. Salisbury St., West Lafayette.
- Powell, Horace, West Terre Haute.  
Zoology.

- Prentice, Burr, N. 216 Sheetz, West Lafayette.  
Forestry.
- Price, James A., Fort Wayne.
- Ramsey, Earl E., Bloomington.  
Principal High School.
- Ramsey, Glenn Blaine, Orono, Me.  
Botany.
- Reese, Charles C., 225 Sylvia St., West Lafayette.  
Botany.
- Rhinehart, D. A., Bloomington.  
Anatomy.
- Rice, Thurman Brooks, Winona Lake.  
Botany.
- Schaeffer, Robert G., 508 E. Third St., Bloomington.  
Chemistry.
- Schnell, Charles M., South Bend.  
Earth Science.
- Schultz, E. A., Laurel.  
Fruit Grower.  
Bacteriology, Fungi.
- Schierling, Roy H., Bloomington.
- Shimer, Dr. Will, Indianapolis.  
Director, State Laboratory of Hygiene.
- Shockel, Barnard, Professor State Normal, Terre Haute, Ind.
- Showalter, Ralph W., Indianapolis.  
With Eli Lilly & Company.  
Biology.
- Sigler, Richard, Terre Haute.  
Physiology.
- Silvey, Oscar W., 437 Vine St., West Lafayette.  
Instructor in Physics.  
Physics.
- Smith, Chas. Piper, College Park, Md.  
Associate Professor, Botany, Maryland Agricultural College.  
Botany.
- Smith, Essie Alma, R. F. D. 6, Bloomington.



- Smith, E. R., Indianapolis.  
Horticulturist.
- Smith, William W., West Lafayette, Genetics.  
Biology.
- Snodgrass, Robert, Crawfordsville, Ind.
- Southgate, Helen A., Michigan City.  
Physiography and Botany.
- Spitzer, George, Lafayette.  
Dairy Chemist, Purdue University.  
Chemistry.
- Stech, Charles, Bloomington.  
Geology.
- Steele, B. L., Pullman, Washington.  
Associate Professor of Physics, State College, Washington.
- Steimley, Leonard, Bloomington.  
Mathematics.
- Stiekles, A. E., Indianapolis.  
Chemistry.
- Stoltz, Charles, 530 N. Lafayette St., South Bend.  
Physician.
- Stoddard, J. M.
- Stone, Ralph Bushnell, West Lafayette.  
Mathematics.
- Stork, Harvey Elmer, Huntingburg.  
Botany.
- Stuart, M. H., 3223 N. New Jersey St., Indianapolis.  
Principal, Manual Training High School.  
Physical and Biological Science.
- Sturmer, J. W., 119 E. Madison Ave., Collingswood, N. J.  
Dean, Department of Pharmacy, Medico-Chirurgical College of Philadelphia.  
Chemistry, Botany.
- Taylor, Joseph C., Logansport.  
Wholesale merchant.
- Terry, Oliver P., West Lafayette.  
Physiology.

- Tetrault, Philip Armand, West Lafayette.  
Biology.
- Thompson, Albert W., Owensville.  
Merchant.  
Geology.
- Thompson, Clem O., Salem.  
Principal High School.
- Thornburn, A. D., Indianapolis.  
Care Pitman-Moore Co.  
Chemistry.
- Travelbee, Harry C., 504 Oak St., West Lafayette.  
Botany.
- Troop, James, Lafayette.  
Entomology.
- Trueblood, Iro C. (Miss), 205 Spring Ave., Greencastle.  
Teacher of Botany, Zoology, High School.  
Botany, Zoology, Physiography, Agriculture.
- Tucker, Forest Glen, Bloomington.  
Geology.
- Tucker, W. M., 841 Third St., Chico, California.  
Principal High School.  
Geology.
- Turner, William P., Lafayette.  
Professor of Preactical Mechanics, Purdue University.
- Vallance, Chas. A., Indianapolis.  
Instructor, Manual Training High School.  
Chemistry.
- Van Doran, Dr., Earlham College, Richmond.  
Chemistry.
- Van Nuys, W. C., Newcastle.
- Voorhees, Herbert S., 2814 Hoagland Ave., Fort Wayne.  
Instructor in Chemistry and Botany, Fort Wayne High School.  
Chemistry and Botany.
- Walters, Arthur L., Indianapolis.
- Warren, Don Cameron, Bloomington, Ind.
- Waterman, Luther D., Claypool Hotel, Indianapolis.  
Physician.

- Webster, L. B., Terre Haute, Ind.
- Weatherwax, Paul, Bloomington, Ind.
- Weems, M. L., 102 Garfield Ave., Valparaiso.  
 Professor of Botany.  
 Botany and Human Physiology.
- Weir, Daniel T., Indianapolis.  
 Supervising Principal, care School office.  
 School Work.
- Weyant, James E., Indianapolis.  
 Teacher of Physics, Shortridge High School.  
 Physics.
- Wheeler, Virges, Montmorenci.
- Whiting, Rex Anthony, 118 Marsteller St., West Lafayette.  
 Veterinary.
- Wiancko, Alfred T., Lafayette.  
 Chief in Soils and Crops, Purdue University.  
 Agronomy.
- Wicks, Frank Scott Corey, Indianapolis.  
 Sociology.
- Wiley, Ralph Benjamin, West Lafayette.  
 Hydraulic Engineering, Purdue University.
- Williams, Kenneth P., Bloomington.  
 Instructor in Mathematics, Indiana University.  
 Mathematics, Astronomy.
- Williamson, E. B. Bluffton.  
 Cashier, The Wells County Bank.  
 Dragonflies.
- Wilson, Charles E., Bloomington.  
 Graduate Student, Zoology, Indiana University.  
 Zoology.
- Wilson, Mrs. Etta, 1044 Congress Ave., Indianapolis, Ind.  
 Botany and Zoology.
- Wilson, Guy West, Assistant Professor Mycology and Plant Pathology,  
 State University, Iowa City, Ia.
- Wissler, W. A., Bloomington.  
 Chemistry.

Wood, Harry W., 84 North Ritter Ave., Indianapolis.  
Teacher, Manual Training High School.

Wood, Harvey Geer, West Lafayette, Ind.  
Physics.

Woodburn, Wm. L., 902 Asbury Ave., Evanston, Ill.  
Instructor in Botany, Northwestern University.  
Botany and Bacteriology.

Woodhams, John H., care Houghton Mifflin Co., Chicago, Ill.  
Traveling Salesman.  
Mathematics.

Wootery, Ruth, Bloomington, Ind.

Yocum, H. B., Crawfordsville.

Young, Gilbert A., 725 Highland Ave., Lafayette.  
Head of Department of Mechanical Engineering, Purdue University.

Zehring, William Arthur, 303 Russell St., West Lafayette.  
Assistant Professor of Mathematics, Purdue University.  
Mathematics.

Zeleny, Charles, University of Illinois, Urbana, Ill.  
Associate Professor of Zoology.  
Zoology.

Zufall, C. J., Indianapolis, Ind.

|                            |     |
|----------------------------|-----|
| Fellows.....               | 80  |
| Members, Active.....       | 277 |
| Members, Non-resident..... | 29  |
| Total.....                 | 386 |

MINUTES OF THE SPRING MEETING  
OF THE  
INDIANA ACADEMY OF SCIENCE.

BLOOMINGTON, INDIANA, THURSDAY—SATURDAY, MAY 20-22, 1915.

---

The Spring meeting of the Indiana Academy of Science was held at Bloomington, Thursday to Saturday, May 20-22, 1915.

The first session was held in the Physics Lecture room in Science Hall at 8 o'clock P. M. May 20th to listen to a lecture on Electrical Discharges by Dr. A. L. Foley, Head of the Department of Physics in Indiana University. It was fully illustrated. It was very interesting and instructive and greatly appreciated by the crowded house. After this lecture, the Faculty Club of the University entertained the Academy with a "Get-Acquainted Hour" which was very pleasant.

The annual tramp had been planned for eight o'clock the next morning, but on account of a heavy rain we could not start until ten o'clock. The remainder of the day was beautiful. The route was up Rocky Branch to Griffey Creek, then up that creek and one of its branches to the University Reservoir. Examining the reservoir and pumping station was full of interest.

A special committee of the University Faculty arrived in advance with a picnic lunch. The meat was roasted over the blazing fires. The fifty-one persons present testified to the superior quality of this picnic dinner.

After lunch, the Academy was met by automobiles which took them to the stone district south of Bloomington. Visiting some of the quarries and mills was particularly instructive.

At seven o'clock the members had a complimentary dinner at the Commons. The members lingered till a late hour telling stories and making speeches.

On Saturday morning a number of the members took the train at 6:20 for Cave farm near Mitchell. On arriving at Mitchell, they encountered a severe rain-storm which continued until noon. This prevented them from going to the farm.

ANDREW J. BIGNEY,  
Secretary.



MINUTES OF THE THIRTY-FIRST ANNUAL MEETING  
INDIANA ACADEMY OF SCIENCE,

CLAYPOOL HOTEL, INDIANAPOLIS, IND.,

December 3, 1915

---

The executive committee of the Indiana Academy of Science met in the Moorish Room of the Claypool Hotel and was called to order by the President, W. A. Cogshall. The following members were present: W. A. Cogshall, W. A. McBeth, A. W. Butler, Glenn Culbertson, Stanley Coulter, A. L. Foley, Severance Burrage, R. W. McBride, Will Scott, F. B. Wade, W. M. Blanchard, C. R. Dryer, J. S. Wright and A. J. Bigney. The minutes of the executive committee meeting of 1914 were read and approved.

The President called for reports from the standing committees:

*Program*—Will Scott, chairman, reported work performed as indicated by printed program.

On motion, \$100 was appropriated for the services and traveling expenses of Dr. C. B. Davenport of Cold Spring Harbor, New York, the principal speaker at the evening session.

*Treasurer*—W. M. Blanchard reported as follows:

|                                      |          |
|--------------------------------------|----------|
| Received from Treasurer of 1914..... | \$241.02 |
| Collected—1915.....                  | 225.00   |
|                                      | <hr/>    |
| Total.....                           | \$466.02 |
|                                      | <hr/>    |
| Expenditures —1915.....              | 139.02   |
| Balance.....                         | 327.00   |
|                                      | <hr/>    |
|                                      | \$466.02 |

*State Library*—A. W. Butler reporting—Some progress had been made toward binding exchanges. Two hundred fifty copies of the Proceedings go to Libraries. Many copies had to be returned. On motion, the committee was ordered to go over the list of applications for Proceedings so as to ascer-

tain those who are in good standing, and such could receive copies. F. B. Wade reported a set of Chemical Journals at City Library.

After much discussion, on motion, the committee decided that as far as possible the Proceedings should be sent only to those who pay their dues.

*Biological Survey*—No report.

*Distribution of Proceedings*—A. J. Bigney reporting. The copies were in the hands of the State Librarian and would be mailed in a few days. Copies would be sent to the meeting so the members present could receive them.

*Membership*—Report to be made at general session.

*Auditing*—No report.

*Restriction of Weeds and Diseases*—No report.

*Relation of the Academy to the State*—R. W. McBride reporting. The appropriation of \$1,200 had been made by the State.

*Publication of Proceedings*—Editor was not present. Dr. C. R. Dryer reported that the work had been done and that they were ready for distribution. On motion, it was decided that no paper should be received for publication after February 1st.

Attention was called to the Pan-American Scientific Congress that would be held by the U. S. Government in Washington beginning December 29, 1915.

The incoming president, later, appointed C. H. Eigenmann of Bloomington as delegate, and A. W. Butler of Indianapolis as alternate.

#### GENERAL SESSION—1:30.

ASSEMBLY HALL, CLAYPOOL HOTEL,

December 3, 1915.

The Indiana Academy of Science met for its regular program, W. A. Cogshall, President, in the chair.

The minutes of the Executive Committee were read and approved. Dr. H. E. Barnard, Editor, reported that the Proceedings for 1914 had been published. He stated the great difficulty of securing the papers from the members.

On motion of A. W. Butler, the following resolution was adopted:

WHEREAS, the Scientific investigations and accurate records kept by representatives of the United States Fish Commission, concerning Lake Maxinkuekee, Ind., in our opinion make the report that has been made by



Dr. B. W. Evermann one of the most valuable compilations that has been prepared, and

WHEREAS, we learn that the Commission is unable to publish it out of its funds, therefore

BE IT RESOLVED, By the Indiana Academy of Science, in regular session, that we express our belief in the great value of this work, in its importance to scientific students, not only in America, but throughout the world, and in the desirability of having it published at an early date so as to be accessible, and

BE IT FURTHER RESOLVED, That a committee of five (5) members be appointed to represent the Academy in an endeavor to secure the early publication of this report.

On motion, the Academy appointed the following Committee: Amos W. Butler, Dr. Charles B. Stoltz, C. C. Deam, D. M. Mottier, and Glenn Culbertson.

The General Papers were then called for; "1" to "6" responded, after which the Academy went into Sectional Meetings as follows:

Section A.—Chemistry, Geology, Mathematics, Physics. W. A. Cogshall, Chairman, A. J. Bigney, Secretary.

Section B.—Anatomy, Bacteriology, Botany, Zoology. Stanley Coulter, Chairman, H. E. Enders, Secretary.

Adjourned at 5:30 for dinner at the Claypool at 6:15 at which the President's address was read on the "Origin of the Universe."

9:00 A. M. December 4.

#### GENERAL SESSION.

Business—

On motion of W. M. Blanchard the following resolutions was adopted:

RESOLVED, as the sense of the Indiana Academy of Science that the Commission having in charge the matter of adequate and proper celebration of the State's Centennial, could do no more fitting and practical thing in the way of a permanent memorial of the one hundredth anniversary of the State's admission to the Union, than to inaugurate at this time and carry to consummation a plan to purchase, through action by the General Assembly several tracts of land in Indiana for public park purposes for the people.

On motion the following committee was appointed to carry out the pro-

visions of the resolution: Stanley Coulter, W. W. Woolen, and R. W. McBride.

As the Historical Commission was in session in the State House, the Committee at once presented the resolution to the Commission, also to the County Chairmen of the Commission, which was also in session. It was heartily endorsed by both bodies and the Academy thanked for its interest in the proposed Centennial celebration.

A copy of this resolution to be mailed to Mr. Harlow Lindley, Department of Archives and History, Indiana State Library.

Prof. L. F. Bennett, of Valparaiso College, extended an invitation to the Academy to hold the Spring meeting of 1916 at Valparaiso. On motion, the invitation was unanimously accepted.

On motion of A. W. Butler the Academy urged that all members and all organizations with which they are connected, use their influence to prevent any legislation for changing our present Fish and Game Laws.

The Membership Committee reported the following new members:

Dr. John Merton Aldrich, S. Grant St., W. Lafayette, Ind., Zoology and Entomology.

Russell Baldwin, Richmond, Ind., Physics.

Colonzo C. Balls, Russiaville, Ind., Botany.

Guy Richard Bisby, Lafayette, Ind., Botany.

Joseph Blose, Culerville, Ind., Physics.

Eugene Butler, Richmond, Ind., Physics and Mathematics.

Charles Crampton, Bloomington, Ind., Psychology.

A. B. Davis, Eli Lilly & Co., Indianapolis, Ind., Chemistry.

Elizabeth Downhour, 2307 Talbott Ave., Indianapolis, Ind., Geology and Botany.

Jesse Lyle Essex, 523 Russell St., W. Lafayette, Ind., Chemistry.

Leonard L. Huber, Hanover, Ind., Zoology.

Cloyd C. Hurd, Crawfordsville, Ind., Zoology.

H. Kremers, Wabash College, Crawfordsville, Ind., Chemistry.

John F. McBride, 340 S. Ritter Ave., Indianapolis, Ind., Chemistry.

Burr N. Prentice, 216 Sheetz, W. Lafayette, Forestry.

Charles C. Rees, 225 Sylvia St., W. Lafayette, Ind., Botany.

Robert G. Schaeffer, 508 E. Third St., Bloomington, Ind., Chemistry and Botany.

Ralph W. Showalter, Eli Lilly & Co., Indianapolis, Ind., Biology.

Rex Anthony Whiting, 118 Marsteller St., W. Lafayette, Ind., Veterinary.

Mrs. Etta Wilson, 1044 Congress Ave., Indianapolis, Ind., Botany and Zoology.

Herbert Spencer Jackson, 127 Waldron St., Lafayette, Ind., Botany.

Emory Hutchison, Atwater St., Bloomington, Ind., Zoology.

Harvey Geer Wood, West Lafayette, Ind., Physics.

Floyd R. Carter, Frankfort, Ind., Botany.

Irene Graybook, New Albany, Ind., Botany.

Paul Harmon, Bloomington, Ind., Physiology.

Mildred Hoge, Kirkwood, Bloomington, Ind., Zoology.

On motion they were elected.

The Committee on the nomination of officers, Severance Burrage, Chairman, reported as follows:

President—Andrew J. Bigney, Moores Hill College, Moores Hill.

Vice-President—Amos W. Butler, Indianapolis, Ind.

Secretary—Howard E. Enders, Purdue University, West Lafayette.

Assistant Secretary—E. B. Williamson, Bluffton.

Treasurer—W. M. Blanchard, Greencastle.

Press Secretary—F. B. Wade, Indianapolis, Ind.

Editor—H. E. Barnard.

On motion the report was adopted and the officers elected.

On motion of Prof. John M. Aldrich the following resolution was adopted:

WHEREAS, Thomas Say was one of the great entomologists of the world in his time, prominent among the men who made New Harmony, Ind., the scientific center of the United States about 1825, his grave at that place is one of the shrines of Indiana history, the Indiana Academy of Science therefore feels an especial interest in the project to establish a memorial to Say's name in the form of a publishing foundation for works in entomology. It is an ideal memorial to an unselfish and deserving scientific man, and at the same time promises great value in the cause of entomology for the present and future.

THEREFORE BE IT RESOLVED, That we commend the plan of the Say Foundation to the consideration of the people of Indiana as especially worthy of consummation in the Centennial year of our state.

Sections A and B then continued their programs until they were completed.

Adjourned.

W. A. COGSHALL,

President.

A. J. BIGNEY,

Secretary.



PROGRAM OF THE THIRTY-FIRST ANNUAL MEETING  
INDIANA ACADEMY OF SCIENCE,

CLAYPOOL HOTEL—INDIANAPOLIS

FRIDAY AND SATURDAY

DECEMBER 3 AND 4, 1915

---

GENERAL PROGRAM.

---

FRIDAY

|                                         |             |
|-----------------------------------------|-------------|
| MEETING OF THE EXECUTIVE COMMITTEE..... | 10:30 A. M. |
| GENERAL SESSION.....                    | 1:30 P. M.  |
| SECTIONAL MEETINGS.....                 | 3:45 P. M.  |
| INFORMAL DINNER.....                    | 6:00 P. M.  |
| SYMPOSIUM ON HEREDITY.....              | 8:00 P. M.  |

SATURDAY

|                         |            |
|-------------------------|------------|
| GENERAL SESSION.....    | 9:00 A. M. |
| SECTIONAL MEETINGS..... | 9:45 A. M. |

THE PRESIDENTIAL ADDRESS

The address of the retiring president, WILBUR A. COGSHALL, will be delivered at the informal dinner.

THE SYMPOSIUM ON HEREDITY

A Resumé of the Work on Heredity. DR. C. H. EIGENMANN, Dean of the Graduate School, Indiana University.

Fifteen years of Mendelism; Mendelism, the Key to the Architecture of The Germ-plasm. DR. ROSCOE R. HYDE, Professor of Zoology, Indiana State Normal School.

Heredity in Man. DR. CHARLES B. DAVENPORT, Director of the Station for Experimental Evolution, Cold Spring Harbor, New York.

## PAPERS TO BE READ

## GENERAL

1. A Memoir of Donaldson Bodine . . . . . H. W. ANDERSON
2. Memoir of Josiah T. Scovel, 20 min. . . . . CHARLES R. DRYER
3. Twelve of Nature's Beauty Spots in Indiana, 45 min., lantern,  
EDWARD BARRETT
4. Concerning the Report of the Survey of Lake Maxinkuckee,  
10 min . . . . . AMOS W. BUTLER
5. A Field Trip in General Science, 15 min. . . . . B. H. SCHOCKEL
6. The Tobacco Problem (abstract) 20 min. . . . . ROBERT HESSLER

## ANATOMY

7. Histological Changes in Testes of Vasectomized Animals,  
10 min. . . . . BURTON D. MYERS

## BACTERIOLOGY

8. The Minimum Lethal Infecting Dose of Trypanosomes,  
25 min. . . . . C. A. BEHRENS
9. Tolerance of Soil Bacteria to Media Variations, 20 min. . . H. A. NOYES

## BOTANY

10. Some Methods for the Study of Plastids in Higher Plants,  
10 min. . . . . D. M. MOTTIER
11. The Morphology of *Riccia fluitans*, 5 min. . . . . FRED DONAGHY
12. Plants not Hitherto Reported from Indiana. VI.  
3 min. . . . . CHAS. C. DEAM
13. Indiana Fungii. III. 5 min. . . . . J. M. VAN HOOK
14. The Second Blooming of *Magnolia soulangiana*, 5 min. . D. M. MOTTIER
15. Additional Notes on Rate of Tree Growth, 10 min. . STANLEY COULTER
16. The Effect of Centrifugal Force on Plants, 15 min. . . . F. M. ANDREWS
17. Some Preliminary Notes on the Stem Analyses of White Oak,  
10 min. . . . . BURR N. PRENTICE
18. Botanic vs. Biologic Gardens. Illustrated by Specimens,  
10 min. . . . . ROBERT HESSLER

## CHEMISTRY

19. Soluble Salts of Aluminum in Water from an Indiana Coal  
Mine, 5 min. . . . . S. D. CONNER

20. Detection of Nickel in Cobalt Salts, 8 min.,  
A. R. MIDDLETON and H. L. MILLER
21. The Use of the Spectrophotometer in Chemical Analysis,  
10 min. . . . .GEORGE SPITZER and D. C. DUNCAN
22. The Different Methods of Estimating Protein in Milk. . . . .GEORGE SPITZER

## GEOLOGY

23. A New Cave Near Versailles, 5 min. . . . .A. J. BIGNEY
24. Loess Deposits in Vigo County, Indiana, 10 min. . . . .WM. A. MCBETH
25. Volume of the Glacial Wabash River, 10 min. . . . .WM. A. MCBETH
26. A Geologic Map of the Terre Haute Region, 5 min. . . . .B. H. SCHOCKEL
27. A Bibliography of Geographical Material, 10 min. . . . .B. H. SCHOCKEL
28. Settlement and Development of the Lead and Zinc Mining Region  
of the Upper Mississippi, 20 min. . . . .B. H. SCHOCKEL
29. A Few Science Wonders of the Cement Age, 15 min.,  
lantern . . . . .F. W. GOTTLIEB
30. The Fauna of the Trenton and Black River Series of New  
York . . . . .H. N. CORYELL

## MATHEMATICS

31. Gamma Coefficients with Applications to the Solution of Dif-  
ference Equations and Determination of Symmetric Func-  
tions of the Roots of an Equation in the Terms of the  
Coefficients, 25 min. . . . .ARTHUR S. HATHAWAY
32. Some Determinants Connected with the Bernoulli Numbers,  
K. P. WILLIAMS
33. Some Relations of Plane to Spheric Geometry,  
10 min. . . . .DAVID A. ROTHROCK

## PHYSICS

34. Some Notes on the Mechanism of Light and Heat Radiations,  
15 min. . . . .JAMES E. WYANT
35. A Standard for the Measurement of High Voltages,  
10 min. . . . .C. FRANCIS HARDING
36. Ionization Produced by Different Thicknesses of Uranium  
Oxide, 5 min. . . . .EDWIN MORRISON
37. Radioactivity of Richmond Water, 5 min. . . . .EDWIN MORRISON

38. A Student Photographic Spectometer, 5 min.,  
lantern ..... EDWIN MORRISON
39. An Experimental Determination of the Velocity of Sound  
Waves of Different Intensities, 10 min., lantern. ARTHUR L. FOLEY
40. A Simple Method of Harmonizing Leyden Jar Discharges,  
5 min., lantern.....ARTHUR L. FOLEY
41. An Electroscope for Measuring the Radioactivity of Soils,  
10 min., lantern.....R. R. RAMSEY
42. Some Photographs of Explosions in a Gas, 10 min.,  
lantern ..... JOHN B. DUTCHER
43. The Cause of the Variation in the Emanation Content of Spring  
Water, 10 min., lantern.....R. R. RAMSEY
44. A Standard Condenser of Small Capacity, 10 min.,  
lantern .....R. R. RAMSEY
45. A Comparison of Calculated and Experimental Radii of the  
Ring System by Diffraction and an Extension of Lommel's  
Work in Diffraction, 10 min., lantern.....MASON E. HUFFORD

## SOILS

46. Rate of Humification of Manures, 15 min.....R. H. CARR

## ZOOLOGY

47. An Instance of Division by Constriction in the Sea-Anemone,  
*Sagartia luciae*, 5 min.....DONALD W. DAVIS
48. Data on the Food of Nestling Birds, 15 min.  
WILL SCOTT and H. E. ENDERS
49. Two New Mutations and Their Bearing on the Question of  
Multiple Allelomorphs, 5 min.....ROSCOE R. HYDE
50. A Study of the Oxygenless Region of Center Lake, 10 min  
WILL SCOTT and H. G. IMEL
51. The Lakes of the Tippecanoe Basin.....WILL SCOTT



## ADDRESS OF THE PRESIDENT.

WILBUR A. COGSHALL

The question of Evolution has long occupied the attention of scientists. Especially has this been true in biological lines, and we are apt to think of the probable (or certain) changes that have taken place, either in plants or animals, in connection with the word evolution. As soon as biological investigation had proceeded to a point where significant differences and likenesses were well established among certain forms, the laws underlying the changes were sought, and are being sought. We have now a more or less satisfactory theory built up based on certain fundamentals, though it contains in part some elements of the speculative and the probable. One of these truths that seems established is that some organisms have existed in the very remote past, in a quite different form from what they now have, and that it is very probable, if not certain, that they will change their forms, habits, etc., still more as time goes on.

In a little broader way we may say that evolutionary changes are just as certain in the earth as a whole, or in the entire system of planetary bodies, or for that matter, in the whole visible universe. This conclusion is based on several physical laws which man has discovered and believes to be true. If the law of conservation of energy is true, then we have no alternative but to believe that the continued radiation of heat from the sun and the earth will eventually result in these bodies coming to a lower temperature, and that the sun will at some future date become dark, cold and dense. We must also believe that its power to radiate heat and light was very different in the remote past from what it is now. In as much as the sun is not essentially different from a million other stars in the sky, it seems very probable that the whole visible universe has undergone very great changes in past time, and will undergo changes just as great in the future.

There is really no more reason to suppose that the stars and the moon have always been as we see them now, than to suppose that because an oak tree has stood for a year without sensible change it has always been that way and will continue so indefinitely. The oak goes through its life history, or certain phases of it, in so short a time that we can see its whole history in less than a life time, but the changes in the tree while faster, are no more certain than those in the sun or earth.

There have been many attempts to formulate a theory of evolution for the earth, the solar system, and indeed the whole sidereal universe. Unfortunately, most of these were based on comparatively little scientific data and any actual proofs of reliability or truth were lacking. Most of them might better be called speculations, pure and simple, and were produced largely from analogy. For example, we have known for some three hundred years that the planets circulate about the sun in nearly the same plane, the ones near the sun moving faster than those farther away. The visible universe is apparently arranged more or less in one plane or at least is very much extended in the plane of the Milky Way, the solid figure that would enclose the solar system not being greatly different, except in size, from the one which would enclose all the stars. What would be more natural than to suppose that the whole universe was built up on a large scale much as the planetary system, the sun being in revolution with many others about some distant center. These, in turn, perhaps, revolving about another center till the whole Universe is accounted for. Some such idea was advanced by Kant who had only the Law of Gravitation upon which to base his speculations. Unfortunately he knew nothing of the distances of the stars. At that time no one knew from actual observation that the stars had any real motions of their own through space.

We know little enough of these things now, but a few facts have been established with certainty in the last hundred years, indeed most of our accurate knowledge of the stars being attained in much more modern times. It was not till 1839 that we knew the distance of a single star in the whole sky, and only in the last fifty years has it been possible to measure their motions in any very precise way.

Following the above general theory it was supposed for a while that the central point about which the whole sidereal system revolved had been located in Aleyone, the brightest of the Pleiades. It is sufficient to say that there is not a particle of evidence to sustain this conclusion, or the conclusion that the stars, as a whole, revolve about any center whatever. As far as we know the stars move in all sorts of directions and with all sorts of velocities. We are lacking now as much as a thousand years ago any theory of the evolution of the system of the stars, which is based upon observed changes in the stars themselves. The theories and speculations regarding the origin and history of the planetary system are more numerous and in some cases as improbable and impossible as those regarding the universe. The best

known of these and the one which has had the most influence on philosophic thought is known as the Nebular Hypothesis of La Place. It was first announced about a hundred years ago and has been accepted as probably representing planetary evolution until recent years although based largely on assumptions. La Place was one of the greatest of astronomers and mathematicians since the time of Newton and doubtless his name alone carried conviction where a little independent investigation and reasoning would have been more profitable. It is quite evident that La Place never regarded this theory as seriously as it was regarded by others after his death.

You are all familiar with the main outlines of the theory. It assumes that the matter now composing the sun, the planets and their satellites was once diffused though a sphere perhaps as large as the present orbit of Neptune, that in some way (unknown) the mass started to revolve and therefore to flatten at the poles and extent at the equator, and that with the radiation of heat and consequent shrinkage in volume, the revolution had been hastened and soon a point had been reached where the gravitational force at the equator was balanced by the centrifugal force due to the revolution. At this point, according to the theory, a more or less broad ring was abandoned by the revolving mass. It went on shrinking, and increasing its velocity of motion till the same process was repeated. Each ring was then supposed to collect into a sphere and go through the same process in a small way, thus accounting for satellite systems of the various planets, although there was no investigation to establish the way in which this was done, or even to show that it was possible. No doubt this whole scheme was suggested by the planet Saturn which shows a ring system very much as La Place supposed existed around the sun, but which we now know differs very materially from any of his hypothetical rings.

As stated above, this theory implies that the planets should all be very nearly, if not exactly, in one plane, that they should travel in the same direction around the sun, that the satellites of each planet should all go in the same direction and in one plane, and that the periods of revolution of the satellites should be longer than the rotation periods of their primaries. These conditions seemed nearly fulfilled at the time of La Place, but since then we have had the discovery of Neptune with its satellite very much inclined to the orbit of the planet, and revolving backward at that, we have had the discovery of the satellites of Uranus also revolving retrograde and very much out of the planet's plane of revolution. We have had, moreover,

the discovery of the two satellites of Mars, one of which revolves very much faster than Mars rotates on its axis.

A theory that perfectly explains all the known facts may get a hearing and acceptance without any great amount of demonstration, but when many important facts appear at variance with a theory it becomes necessary to show how these facts may be accounted for by the theory, or to look with suspicion on the theory as a whole.

There are many other facts than those just mentioned which cause distrust. Take for example the probable density of the ring that is supposed to have formed Neptune. If all the matter now in the Solar system were expanded till it formed a sphere the size of the orbit of this planet its average density would be about  $\frac{1}{216,000,000,000}$  the present density of the sun. The density at the center would probably be many times that at the equator, which would make the density of the abandoned ring much less than  $\frac{1}{216,000,000,000}$  th of the present density of the sun. This would be many times as rare as the best vacuum yet obtained. To suppose that any such mass of matter, spread out in a ring whose diameter must have been at least thirty times the diameter of the earth's orbit, ever collected in one place to form Neptune is a very great tax on the imagination. As a matter of fact it can be shown that this is physically impossible. This process involves long intervals of time and would make the outer planets much older than the earth, and other nearer planets. There is no observational data to support this idea; all that there are directly contradict it. On the supposition that the sun has radiated heat in the past as it does now, and that the shrinkage of the sun is responsible for the development of its energy, it is possible to tell how many years ago the sun was large enough to fill the orbit of the earth. The earth must therefore be younger than this. All evidences in the earth itself point to an age of a least sixty million years, and on the above assumptions upon which the theory of La Place rests, the sun, sixty million years ago, was much larger than the earth's orbit. The probability is then that the assumptions are wrong. Other more technical objections, some of which are even more conclusive, I must pass over.

Another theory of Evolution based on tidal relations among sun, planets and satellites has been elaborated in more recent years, and either by itself or in connection with the foregoing has been used to explain our present system. The application of this theory to the Earth—Moon system has been elaborated by Professor George Darwin. He supposes that the earth

and moon were originally one fluid mass, that oscillations set up in the mass by the tidal effects of the sun resulted in the separation of the mass into two parts, that the two parts raised tides each in the other and that the friction of these large tidal waves resulted in the separation of the two bodies to their present distance and the lengthening of their rotation periods to their present values.

It is, no doubt, true that tidal friction does tend to lengthen the period of rotation of the earth, and, if the fundamentals of mechanics are to be trusted, this effect must result in an increased distance between the two bodies. Some observational data in support of this theory appears in the fact that the period of revolution of the moon about the earth coincides with its period of rotation, and that probably the two planets nearest the sun keep the same face to the sun. On the other hand we know that tidal friction or any other force has failed to change the length of our day by one-tenth of a second in five thousand years. There has more recently come into general favor another and a totally different theory, from Professors Chamberlain and Moulton, of the Departments of Geology and Astronomy, of Chicago University.

They suppose that the solar system took its form from a nebula, but from a spiral and not from a spherical or spheroidal nebula. Observationally this supposition is sound. There is not in the sky, as far as I know, a nebula of the sort assumed by La Place. There are thousands, perhaps hundreds of thousands of the spiral sort. Of all the nebulae that have any regular shape the spirals outnumber all others. There are a few so called planetary nebulae which in the telescope look spherical, but which in a long exposure photograph show some other form. Some of them may be hollow spheres, but none appears as La Place's nebula was supposed to be. There are a few in the form of a ring with a star at the center, but again it must be remarked that this form is not the required form.

In a spiral nebula the matter forming the arms of the spiral is usually the smaller part of the whole mass, the greater part being at or near the center. If the law of gravitation holds among them, and we have never found an exception to it, then the particles in the arms of the spiral must be in motion in elliptical orbits about the central mass, the parts nearer the center moving faster than the more remote parts. This means that the arms must with time become more closely wrapped about the central mass and that any one

particle is, in time, bound to come close to many others, and eventually to collide with many.

If any one particle were large enough to start with, it would therefore grow by collision with other particles, and the more it grew the more power of growing it would have by reason of its increasing mass. It seems likely then, that loose, widely extended nebulae of this sort must eventually come into a system of small bodies revolving about a large central mass. It can be shown that a mass revolving in this way and suffering collision with other masses must move in an orbit whose eccentricity is continually diminishing. We should therefore expect to find, if our system has been formed in this way, that the more massive planets have the least eccentric orbits and that the smaller ones have the greatest eccentricity. As a matter of fact all of the large outer planets have low eccentricity and the smaller planets a higher amount. The greatest eccentricity is found among the planetoids, or asteroids, many of which are only a few miles in diameter.

It has also been shown that a close approach of two masses in the arms of the spiral might not result in collision, but under conditions which might easily arise, the smaller might be made to revolve in an elliptical orbit about the larger, thus giving rise to a satellite or system of satellites, and these satellites might revolve in one direction as easily as another. We can therefore account for the retrograde motion of the satellite of Neptune, those of Uranus, for the fact that Jupiter has some going in one direction and others in the reverse direction, for the widely scattered zone of the Asteroids and even for the very rapid motion of the inner satellite of Mars.

These, and many other features are not speculations as to what may have happened. They have all been made the subject of rigorous mathematical calculations, and with the supposed initial conditions are all entirely possible.

As to whether these initial conditions that we have supposed, actually existed or not—whether or not our earth and the other bodies revolving about the sun ever developed from a spiral nebula, we can not be so sure. Here it is a question of what is most probable. We are practically certain that it did not come about as La Place supposed. There are too many things mathematically impossible about that. By this theory, the development into the present system was entirely possible, and certainly no more probable evolution has been proposed.

La Place did not and could not account for his nebula. On this plan we can. I have said that the spirals far outnumber any other class in the sky.

It has been shown that it is entirely possible for a spiral to be formed and that it is probable that more spirals would be formed *than any other kind*. Here we approach the speculative a little closer and I would remind you that we have no record of any permanent form of nebula ever being formed. Of course the time over which we have any accurate record of the nebulae is very short, only the last few years in fact. Very few of these objects can be recognized in the telescope, and it is only since the invention of the rapid photographic dry plate, and the perfection of the large reflecting telescopes, that their true form and number have been found. Even with our present equipment and resources if one should be recorded on a plate tonight it might be impossible to say that it was there a year ago, or that it was not, unless it should be exceptionally bright.

With this class of objects then we will not expect much observational confirmation. From mathematical investigation we know that it is possible for a spiral nebula to be formed from the close approach of two stars. We know of about two hundred million stars in the sky and there are probably many more that we can get no direct evidence of. We know that they are all in motion with velocities ranging up to 300 or even 400 miles per second. Under these conditions we will at times have collisions. These will be relatively rare because the average distance between stars is large, thickly as they seem to be sown in the heavens. A close approach without actual contact will be much more frequent, and it is from such an encounter that a spiral nebula might easily arise.

The moon with only  $\frac{1}{80}$  the mass of the earth and at a mean distance of over a quarter of a million miles has enough attraction for the earth to cause a distortion of figure, the liquid surface showing the effect of course more easily than the solid parts. Under the action of the moon there are two tides raised in the earth, one of which tends to stay directly below the moon and the other at the opposite side. That is to say, the moon causes the earth to assume an ellipsoidal form, the long axis of which would point toward the moon if it were not for the rapid rotation of the earth. What would this effect be if the moon were as massive as the earth, or perhaps twenty times as massive? If, in addition to this increased mass, we should decrease the distance between the bodies to a few thousand miles, the tides would be many times as great as they are now.

When we remember that the stars for the most part are gaseous, in many cases with an average density less than that of air at sea level, and at the

same time have very large diameters, it will be evident that the near approach of another massive body would be sufficient to cause great disturbance. The attraction of the foreign body would cause the star to elongate, the gravitational attraction at the ends of the longer axis would be decreased and the highly compressed gases of the interior would cause great eruptions toward the disturbing body and away from it. Even with the slight disturbances to which our sun is subjected we have these outbursts of material from the interior, by which material is thrown out at times, to distances of a hundred thousand miles.

If another star were to come within a few hundred thousand miles of our sun this effect would be produced on a scale many times greater. While the star was a considerable distance away these ejections of matter would be less violent, increasing in violence as the distance decreased, and, what is just as much to the point, they would be in a slightly different direction as time went on. The first masses ejected would be drawn out of a straight line and would eventually fall back toward the sun, some of them striking the surface and some of the rest so far drawn to one side as to miss the surface as they came back, in which case they would continue to revolve in elliptical orbits about the sun. Those masses, thrown off a little later, would travel farther and in slightly different directions, and would be diverted still more and move in longer orbits. After a maximum disturbance was reached the same process would go on with decreasing violence as the disturbing body retreated into space. It has been shown that the masses thrown off which did not go back to form part of the sun again, might under these conditions form themselves into two spiral arms, the whole, of course, being in one plane, as the motion of the two stars would be in a plane. That material which did fall back into the sun would give to the part where it fell a certain velocity of rotation, and we find in the sun a higher rate of rotation for the equator than for any other part. The direction of motion of the matter composing the arms of the spiral is not along the arms but across them, each particle moving in an ellipse around the central mass. If masses of different sizes were ejected, the large ones would tend to annex the smaller ones in the immediate neighborhood, and the process before described would result in a system of planets and satellites much as we have in the solar system.

We have this process still going on in a small way. The Earth attracts to itself several million small particles every day and occasionally there is a



larger one. Many of these, perhaps most of them, are in all probability matter which left the sun when the rest did and which are now for the first time brought near enough the earth to be permanently annexed. In a region where no large masses existed, the matter would continue to revolve in a finely divided state, such as we actually find in the zone of the minor planets. This zone lies between the orbits of Mars and Jupiter. In it have been found some 800 planets large enough to make a record on a photographic plate, and there is little reason to doubt that the whole number is many times greater and the size of most of them so small that we can never see them except as they collectively make a faint band of light across the sky. In this zone we find what we should expect with small sizes—that is, *very* elliptical orbits and very high inclinations. One of these planets has an orbit of such eccentricity that while its mean distance is considerably greater than that of Mars, yet in one point in its orbit it comes much closer to the earth than any body, except the moon, and two others have perihelion distances less than that of Mars.

Thus it is entirely possible that our planetary system resulted from a spiral nebula, and it is entirely possible that spirals may result from close approaches of two stars and we may even say that it is all probable, at least more probable than any other plan yet proposed.

There are still some difficulties. We must say that if our system resulted from a spiral, this spiral was not at all on the scale observed among the spirals in the sky. Such a nebula, having a radius equal to that of Neptune's orbit, were it no farther away than the nearest star, would be a very insignificant object and might fail of detection entirely. At the probable distance of most of these objects it would certainly be invisible. We can see how a star might be torn apart so as to scatter material over a space the size of Neptune's orbit, but the case is different when we consider some of the large spirals in the sky. The largest is known as the Great Nebula of Andromeda. It covers an arc of over a degree in the sky. Assuming a parallax of  $0''.1$ , which is probably larger than the real value, this nebula from end to end must extend over a space more than 1,800 times the size of Neptune's orbit, or 54,000 times the size of the Earth's orbit.

We have never determined accurately the distance of a single nebula and so do not know the real size of any one of them, compared to the solar system, but there is no reason to suppose they are nearer than many of the faint stars. If this is true, their volumes are vast beyond comprehension and their density an inconceivably small fraction of the density of our best vacuum. It has

been computed that if the Andromeda nebula had a density  $\frac{1}{20,000,000}$  that of the sun it would have mass enough to attract the earth as strongly as the sun does. It attracts the earth not at all. Nor does it attract any other body as far as we know, many of them being much closer to it than we are.

We do not know the chemical composition of the nebulae, except that it seems to be different from every thing else in the sky. Not one has ever been seen to change its shape, size or brightness. We have always assumed that stars result from the contraction of nebulae and this is based on the idea that the nebulae radiate heat. It is not at all certain that these rare gases shine because of their heat. A mass of gas of such extreme rarity would have a comparatively small amount of heat and it would seem that this ought to be radiated into space very rapidly, and could not be maintained without rapid contraction. It is quite possible that nebular matter instead of being the raw material of stars and planets is matter in some final form after having gone through its life history. We have no observational data either way and will probably not have any for many centuries to come. There does not seem to be any very good reason for believing that matter is not being created now as much as it ever was nor for thinking that it must always endure in some of the forms we now know.

We think of space as infinite in extent. Whether or not matter, in the forms we know, is to be found in all parts of space, we do not know. That is to say we are not yet sure whether the universe is finite or infinite. There are some reasons for thinking that the system of the stars is as infinite as space itself, but it may also be possible that what we call matter is some manifestation peculiar to this part of space. The mere appearance or disappearance of matter in space would in itself be no more remarkable than the precipitation and evaporation of water would be if we knew nothing of the atmosphere, and perhaps not as remarkable as the production of water from two invisible and unknown gases would seem to people who know nothing of chemistry.

The most probable source of information it seems to me, will be the researches of the physicists and chemists on the real nature of matter. When they shall have told us what matter really is, what all of its possible forms may be and what all the sources of energy are, then we may be able to state with certainty what the life history of a star is, what relation the nebulae have to other bodies, and what in reality has been the past history of our planet and other planets.

## A MEMOIR OF DONALDSON BODINE.

---

H. W. ANDERSON

---

To those of us who knew Professor Donaldson Bodine the news last August of his sudden death was a terrible shock. We knew him as a man of great activity and rugged constitution, one who never seemed to be troubled with physical weakness. His taking was so sudden that the shock seemed all the greater, yet those who knew him best realized that it was as he wished, for he had often expressed a desire to have life end suddenly, without pain, prolonged illness, or weakening of mental faculties. So all was well with him.

Donaldson Bodine was born in Richboro, Pennsylvania on December 13, 1866. His father, a Presbyterian minister, died at an early age, leaving the young son to support his widowed mother and a sister. After graduating from a preparatory academy, he entered Cornell University and received his A. B. degree from this institution in 1887. For several years following graduation he was principal of the Academy at Gouverneur, New York. Returning to Cornell on a Fellowship he secured a Doctor of Science degree in the spring of 1895. His major was in the subject of Entomology, his first minor in Zoology and second minor in Botany. His thesis, presented in the spring of 1895, was entitled, "The Taxonomic Value of the Antennae of Lepidoptera".

Professor Bodine came to Wabash in the fall of 1895 to fill the chair of Zoology and Geology which was established at that time. This chair he occupied during the remainder of his life. Thus he had given, at the time of his death, twenty years of loyal and efficient service to this Institution.

As a student of Professor Bodine's I can speak with some authority when I say he was a wonderfully inspiring teacher. He had a very clear and interesting manner of presenting his subject and this, combined with an unusually pleasant voice, made the presentation of his lectures all that could be desired. It was a real pleasure to listen to him. The students were always loyal to him and they were especially impressed with his perfect fairness. He did not make his subject difficult but he expected his students to make an earnest effort to get that which was presented.

As a man, I cannot better express the opinion of all who knew him than give you the words of appreciation of one of his former students, "Professor Bodine was a man among men, a teacher among teachers seldom, if ever, equalled. He was a true gentleman who would be classified as 'One who carefully avoided whatever may have caused a jar or jolt in the minds of those with whom he was cast; who avoided all clashing of opinion or collision of feeling or restraint, or suspicion of gloom, or resentment, his great concern being to make everyone at his ease and at home. He was tender toward the bashful, gentle towards the distant and merciful towards the absurd; he guarded against unseasonable allusions or topics which irritated and was seldom prominent in conversation—and never wearisome. He made light of favors while he did them and seemed to be receiving when conferring. He never spoke of himself except when compelled, had no ear for slander or gossip, was scrupulous in imputing motives to those who interfered with him and interpreted everything for the best.'"

Professor Bodine published little—not from lack of ability to do research work or unfamiliarity with his subject, but because he was primarily a teacher and believed in giving all there was in him to his students. He was unusually well informed on all subjects whether or not connected with his work. His sense of fairness and his desire for accuracy and truth were so acute that to those who were given to the expression of opinions hastily formed, he seemed at times over critical; but he was equally sincere in his enthusiastic praise of work well done.

Professor Bodine was a lover of music and always took an active interest in the development of this art in the college and in the community. He also interested himself in the civic welfare of the city of Crawfordsville and stood for everything that was best regardless of political or other affiliations. Although for many years an officer in the Presbyterian church he was not "orthodox" in the narrower sense of the term. In this as in other affairs of life he followed the apostolic injunction, "Prove all things; hold fast that which is good." He believed thoroughly in the rule of Reason and would not accept any statement unless supported by and based upon facts, scientifically established. He was especially desirous of eliminating from religious teaching all superstitions and traditions. At the same time he was deeply religious by nature and was a thorough believer in the Church as an institution.

The members of this Society will remember with what great pleasure Professor Bodine attended the spring meeting. He was a lover of nature and delighted in the open air meeting held by the Society, not only because of the long tramps over the hills, but also because of the chance for companionship and discussion with his fellow scientists. He has often told me that his chief interest in the Society was the fellowship it afforded and his cordial hearty greetings are well remembered by all the older members of this Society.

As a scientist and a student of science he was recognized throughout the country. He was a Fellow both of the American Association and of the Indiana Academy and served as the president of the latter organization during the year 1913. His presidential address was one of unusual interest.

In 1914 Professor Bodine was married to Mrs. Emma Clugston of Crawfordsville. In the early days of August of the past summer they went to northern Michigan to plan a summer home. They selected a site for their cottage and on the day when the fatal end came had been busily engaged with their final plans. In the evening while visiting some friends and in the midst of a lively conversation death came without the slightest warning.

H. W. ANDERSON.



## MEMOIR OF JOSIAH THOMAS SCOVELL.

---

CHARLES R. DRYER.

---

Josiah Thomas Scovell was born at Vermontville, Mich., July 29, 1841. His parents, Stephen D. and Caroline (Parker) Scovell were of New England stock dating from the 17th century. He was educated first at Olivet College and later at Oberlin, graduating A. B. in the class of 1866 and M. A. in 1875. While at Olivet he went home to spend a week-end, and in his determination to get back to college for Monday morning, forded a swollen river with his clothes tied in a bundle on his head. In 1864 he served one hundred days in Company K, 150th Ohio National Guards. His comrades speak highly of his services as company cook. During the defense of Fort Stevens at Washington against the attack of General Early, he was given command of a gun. President Lincoln stood on the parapet beside Scovell's gun to watch the progress of the battle, and was dislodged only by the command of General Wright. Visits to an uncle living at Lewiston, N. Y., were occasions for a study of Niagara Falls and gorge. A fellow student at Oberlin, now Professor J. E. Todd of the University of Kansas, tells how he and Scovell were overtaken by nightfall in the gorge and compelled to escape by climbing a pine tree and a pole reaching from its top to the edge of the cliff. He had field work in geology at Oberlin with Professor Allen, and in 1867 was one of a party which accompanied Professor Alexander Winchell from Ann Arbor to the mines of Marquette, Houghton and Hancock. He was boss of the crew which secured and shipped the famous boulder of jasper conglomerate from Marquette to the University campus at Ann Arbor. In 1866-7 he took a special course in chemistry and mineralogy in the Medical Department of the University of Michigan and was graduated M. D. from Rush Medical College, Chicago, in 1868. He practiced medicine a year or two at Central City, Colo., then a lumber camp near Middle Park. He found the Garden of the Gods, the over blow of snow from the Pacific slope, the sound of running water under summer snows, the milky glacial streams, a storm in Platte Cañon seen from above, a flood in Cherry Creek, and the phenomena of mountains and forest more instructive than anything at college. In 1871-2 he was instructor in Chemistry at Olivet College, and in

1872 came to the Indiana State Normal School at Terre Haute as head of the Department of Natural Science. He at first taught only physiology and geography. The woman who had been teaching geography had spent fourteen weeks on the Great Western Plains using them as an instrument for teaching pedagogy. "the law in the mind" being illustrated by "the fact in the thing." Scovell had actually seen the Great Plains and was able to arouse greater interest in the facts in the thing. The use he made of pictures and specimens was an innovation and they had to be shown outside the regular class period. With the permission of the President, he introduced some instruction in physics, chiefly in meteorology, using home made apparatus. He also used the Wabash in field lessons on rivers, and his advent at Terre Haute marked one of the early inoculations of the Indiana schools with the scientific virus.

In 1873 he joined Todd at Portland, Me., as a volunteer assistant with the U. S. Fish Commission and visited Nova Scotia to study the tides. In 1880 he visited Cuba and Mexico to familiarize himself with tropical nature, corals and Aztec civilization.

He was married in 1876 to Joanna Jameson of Lafayette, who survives him. In 1881 he resigned from the Normal School and during the next ten years was engaged in the business of abstractor of titles at Terre Haute. During this period he acted as friend, companion and guide to a succession of younger men who came to teach and study science in the schools of the city. Among these Jenkins, Evermann, Rettger, Blatchley, Cox and Dryer are well known members of this Academy. Dr. Scovell's buckboard and horse, "Jim" were always ready for a Saturday and Sunday excursion anywhere within fifty miles. Every one of his proteges can testify to the genial, enthusiastic and scientific spirit with which he was thus introduced to the features and problems of the Terre Haute field.

In the summer of 1891 Scovell organized a party for the ascent and scientific study of the volcano, Orizaba, in Mexico. It consisted of H. M. Seaton, botanist, U. O. Cox, ornithologist, A. J. Woodman, ichthyologist, and W. S. Blatchley, entomologist, while Scovell acted as director, topographer, geologist and geographer. The general expenses were paid from his own pocket, but railroad transportation in the United States was otherwise secured. He was abetted and perhaps financially assisted by Dr. F. C. Mendenhall, then Superintendent of the U. S. Coast and Geodetic Survey. On Orizaba spirit levels were extended from the railroad up to 14,000 feet, whence



aneroid readings to the summit made the height 18,179 feet. Considerable collections were made by the naturalists of the party and reported in various journals. In April, 1892, Seovell returned to Orizaba, and by triangulation from the 13,000 feet level, determined its height to be 18,314, which was accepted by the Coast and Geodetic Survey. A rather full general report of results was published in *Science* of May 12, 1893.

In the autumn of 1891, Seovell joined Evermann, then of the U. S. Fish Commission, in a study of the rivers of Texas. In 1894 he was sent by the Commission to study the whitefish of Lake Huron, and later assisted Evermann in a study of the spawning habits of salmon in the mountain streams of Idaho. About this time he did some work on the geological survey of Arkansas under Franer.

In 1894 Seovell returned to teaching as the head of the science department of the Terre Haute High School, a position which he held until his death twenty-one years later.

In 1895 he contributed an elaborate report on the geology of Vigo County to the 21st Report of the Indiana Geological Survey, the result of twenty years of study in that field. He assisted Ashley in his report on the coal deposits of Indiana, published in 1898, and in 1905 made a report on the Roads and Road Materials of Western Indiana.

In 1899 he began his work in cooperation with Evermann on the physical and biological survey of Lake Maxinkuckee, which was carried on for fifteen successive seasons. His best work was done at home in Vigo County and at his summer cottage on Maxinkuckee. He never wearied of the features and problems of his home field and returned to them with fresh interest whenever any one started a new question. The writer was surprised to note after twenty years of study of the Terre Haute field how little he could add to what Seovell had shown him at the beginning.

I can best sum up the estimates of Dr. Seovell contributed by all his intimate colleagues and pupils, among whom I am glad to enroll myself, by saying that he was a naturalist rather than a specialist in any one department of science. He was more deeply interested in botany than in zoology and his interest in plants was more ecological than taxonomic. He had the most complete and beautiful collection ever made of the mussels of the Wabash River, representing forty-seven species. He gave considerable attention to the Indian mounds of western Indiana, and in 1912 sent his notes and collections to the Bureau of Ethnology, which accepted them as

material for a projected *Handbook of Aboriginal Remains*. The catholicity of his taste was indicated by the collection of minerals, fossils, corals, shells, ferns and implements in his house and the pile of rare glacial boulders in his yard, both of which were well worth going to see. He was most of all interested in topography, land forms and the weather. I should classify him as primarily a geographer of broad sympathies. He was always at his best in the field. "His mind," says one of his most intimate associates, "was essentially analytical and judicial. He was not apt to reach conclusions hastily. After having arrived at a tentative conclusion, he was always disposed to try to discover objections, which he would examine critically and modify his conclusions accordingly. He was a keen observer and his comments on what he saw were always interesting and illuminating. A day spent with him in the field was sure to be a day filled with interest and profit." "In disposition," says another, "he was genial and kindly, and gave freely to his companions of the varied store of knowledge which he had accumulated during his life time of study of the great out-of-doors."

He was a charter member of this academy and at its first meeting gave a resumé of geographical studies in Indiana. He contributed to the programs twenty-two titles, of which ten papers were published in the Proceedings.

In 1874 he published *Lessons in Geography* which were re-written and re-issued as a *Commercial Geography* in 1910, and in 1879, *Lessons in Physiology*, all of which had more than local use as text-books. In 1894, he contributed *Practical Lessons in Science* to the Werner series. In 1912 he prepared an account of *Fort Harrison in 1812* for the centennial celebration. He was a student to the last, making credits at the University of Chicago in 1909.

Dr. Seovell's death from pneumonia on May 8, 1915 removes perhaps the last survivor of those who could be called pioneers of science in Indiana. He was one of the "old guard," whose place can never be filled, but whose memory

"Smells sweet and blossoms in the dust".

#### *Bibliography.*

1874. *Lessons in Geography.*

1879. *Lessons in Physiology.*

1890. An Old Channel of the Niagara River, Proceedings Am. Asse. for Advancement of Science, Vol. 39, p. 245.

1893. Mount Orizaba or Citlaltepētī, Science, Vol. 21, pp. 253-7.

1894. Practical Lessons in Science, p. 399, The Werner Co.

1895. In Proceedings of Ind. Acad. of Science. Some Minor Eroding Agencies, p. 54.

Kettle Holes in Lake Maxinkuckee, p. 55.

The Fishes of the Missouri River Basin. Evermann & Seovell, pp. 126-30.

Recent Investigations Concerning the Redfish, *Oncorhynchus nerka*, at its Spawning Grounds in Idaho, Evermann & Seovell, pp. 131-4.

1895-8 The Mound Builders. Inland Educator, Vol. 1, pp. 81, 159, 294, Vol. 2, p. 199.

1896. The Geology of Vigo County, Indiana. Indiana Department of Geology and Natural Resources, 21st Report, pp. 507-76.

1897. Lake Maxinkuckee Soundings. Proceed. Ind. Acad. of Sci., pp. 56-9.

1898. Lake Maxinkuckee. Proceed. Ind. Acad. of Sci., p. 70. Terraces of the Lower Wabash, *ibid.* pp. 274-7.

1900. The Flora of Lake Maxinkuckee, *ibid.* pp. 124-31.

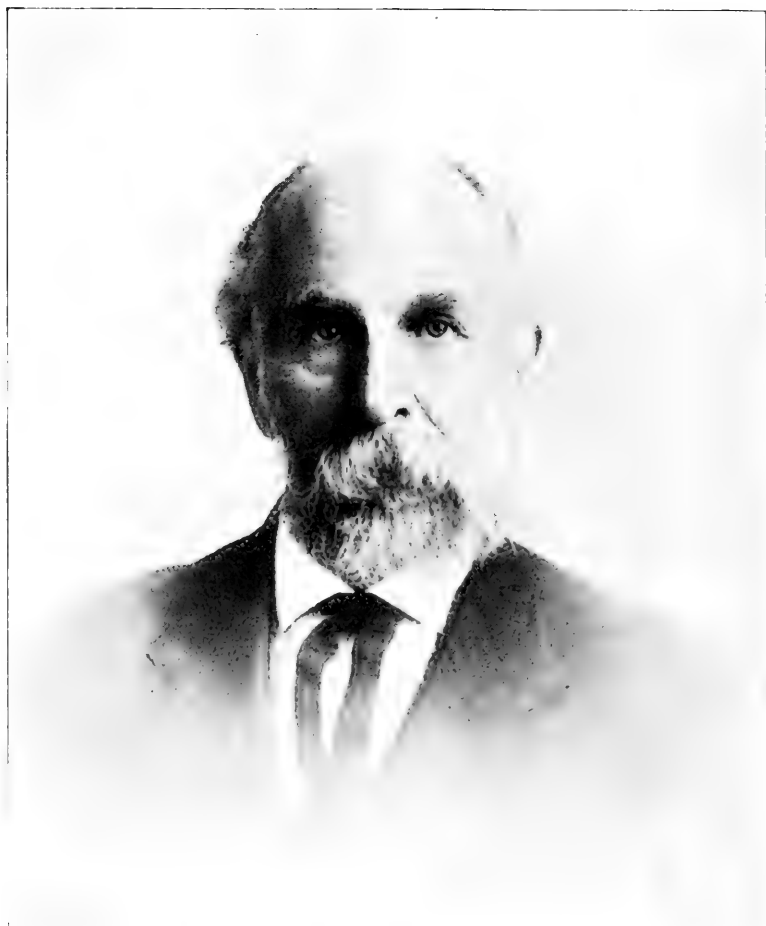
1905. The Roads and Road Materials of a Portion of Western Indiana. Ind. Dept. of Geol. and Natl. Res. 30th An. Rep. pp. 571-655.

1908. The Headwaters of the Tippecanoe River. Proceed. Ind. Acad. of Sci. pp. 167-74.

The Indiana Academy of Science. *ibid.* p. 209.

1910. A Commercial Geography for Use in High Schools.

1912. Fort Harrison in 1812.



DR. SCOVALL  
TERRE HAUTE

## THE TOBACCO PROBLEM.

(Abstract)

ROBERT HESSLER.

In going over a large mass of notes on the Tobacco Problem, I arranged them for convenience of classification into periods of my own life. After 1900 notes are grouped under papers published since, such papers forming "nest eggs," so to speak. In practically every paper I have had before this Academy during the last fifteen years the tobacco problem can be read between the lines. Here I intend to go over the subject very briefly in the light of observations and work done, merely a note here and there.

As a boy I saw others smoke and tried it myself, with the usual result—an acute tobaccosis. Should a teacher use tobacco and set a bad example? Practically all my boy friends smoked and a few years later I became a pipe smoker—influence of example. At the age of seventeen years there was a change of environment; I came in contact with boys and young men who did not smoke, and so I quit and bought books: Again influence of example.

Then came a year in the southern mountains in which I saw many things; others I did not see then but "saw" that is, understood, later. For instance, why the mountaineer can use tobacco and alcohol with seeming impunity. He takes these in pure air, without an admixture of infection of all kinds.

Next came college days. At that time few of the instructors set a "horrible example" by smoking. Students with few exceptions, did not use tobacco.

Then came medical college days in a large city under horribly bad air conditions, due to the many sick and diseased who visited the clinics. Here for the first time I saw the vicious circle that exists between bad air and tobacco, and, I might add, alcohol and sedatives and narcotics generally. The building was gloomy and dirty; artificial light was used all day long. Patients spat on the floor; students reacted more or less; they got relief by the use of tobacco, and in turn spat on the floor and thereby set a bad example to the patients who did not hesitate to add their catarrhal and tubercular

sputum. The students reacted still more and chewed and smoked more; more filth meant less care on the part of the patients. And so on, you can readily see this vicious circle.

I myself soon reacted, I felt bad; fellow-students advised the use of tobacco. Instead I frequently bolted lectures and took open air vacations. While sitting on the benches I formulated a theory regarding my own ills and of those about me; I thought I saw why I felt bad and why I felt so well in the mountains a few years before, without having usual winter colds. I saw too why the mountaineers are so healthy and live long in spite of alcohol and tobacco. In the course of time this theory was elaborated; a brief account was given before this Academy in my paper on Coniosis, in 1911.

The following year was spent in a smaller and comparatively clean medical college, and I got along very well. Next came observations on hospital and dispensary cases, noting the influence of environment: How poor people taken from the heart of the city promptly recover under good sanitary surroundings. I clearly saw that in order to reduce the ills of a city more hospitals was not the remedy—clean up and stay clean.

Then came one or two minor periods, followed by a prolonged period of observation among the insane, especially at the Northern Indiana Hospital for Insane. Did time permit I should like to tell of efforts made to keep buildings and wards in good sanitary condition. Even the insane with few exceptions can be taught not to spit on the floor. When you see a man so greedy for a chew of tobacco that he will take a quid out of a cuspidor and rechew it with a relish you begin to realize what a hold tobacco has. The same may be said regarding alcohol when you consider the stories of English sailors draining the casks in which bodies of dead English sailors and soldiers were sent home. In cities gutter snipes can be seen picking up stubs, and there are women who apparently inhale tobacco smoke of others with pleasure, at least they make no objection. Suppose Aristotle, Plato, Socrates, or old Hippocrates came back and could see our men smoking and meeting under bad air conditions, what would they say? Has the world gone tobacco mad? Should a hospital physician smoke and set a bad example?

During a year in Europe I acquired a stock of comparative data. It was a surprise not to see any tobacco juice on sidewalks. The only time I saw a splotch in Continental Europe was in front of the medical school at

Vienna—evidently some American student had left his mark.\* Moreover men smoked slowly and in moderation and spat very little. Any of you who have travelled in the Old World know the difference in cleanliness between European cities and our own. On getting back home I saw things I never really had noticed before, especially the sort of air we breathe habitually.

In 1900 I took up a systematic study of dusty air and prevalent ill health, and gradually enlarged the scope of inquiry to the domestication and urbanization of man. What this means can in a general way be seen from my various papers before the Academy. This period from 1900 to 1915 may be divided into subperiods:

The period from 1900 to 1906 may be characterized as one of disgust and contempt for the tobacco user, in the light of the harm he does to others, especially to women and children. I held to the old belief that men smoked (and drank) because they wanted to. But I found that to neglect the tobacco users means to get little data, and beginning with 1906 I gave some men and boys considerable attention, trying to find out why tobacco had such a hold and why some could readily discontinue the habit and others only with the greatest difficulty, if at all. Naturally one is apt to pity the man who sees the harm the tobacco habit does to others and yet can not quit, to whom tobacco is a sedative. Some of these men found that by using it "medicinally" a very small quantity sufficed. I believe if there were a high tax on tobacco it would be used very sparingly; old habitues could get along with a small quantity.

Up to the close of 1905 I had been accustomed to call patients who reacted to bad air Dust Victims. Then a bright woman said, "Why not call them Tobacco Victims? The tobacco user is the one who is responsible for air pollution, directly or indirectly." I kept a record for the year 1906 and at least every other patient was what may be called a Tobacco Victim. This included those dust victims who used tobacco, who had ill health on account of infected air. I trust you see the distinction.

In time one gets all sorts of data and all sorts of reasons why a man uses

---

\*How do you know it was an American student? I was asked after the paper was read. I did not know; I only inferred, for I had not seen a single continental medical student chew and spit. A few days later I spoke to an observant German physician about this. The moment I mentioned "in front of the medical school," he interrupted, "Some American student did that; German students don't chew tobacco; the man who would chew and spit would be ostracized." He thus confirmed my own opinion.

tobacco. In such a study there is the eternal Where, When and Why. If a man says he feels better through the use of tobacco, then the question arises, Why do you feel bad? Why do you feel bad in the winter time, during the closed door season, and feel comparatively well in the summer? Why do you feel well when you leave the city and go on a vacation to the country or spend a winter in the South, where you do not care for sedatives, neither tobacco nor alcohol and can readily do without them?

Where a man smokes and drinks, and one might say eats, is an important question. One realizes it after keeping individuals under observation for a long series of years, particularly men and women who are willing to keep a daily record.

As long as tobacco is used sparingly and produces no evil results, neither in the user nor in those about him, there is no occasion to speak of a Tobacco Problem; the same is true of alcohol. Men who drink sparingly and "can leave it alone" do not create an alcohol problem. But the man who uses tobacco or alcohol sparingly may still be setting a bad example to those who can not use them, that is, in moderation and without injury to themselves and others.

I shall now briefly comment on some of my papers presented before this Academy. This is not a medical paper; remarks will be along the line of Coniosis.

MOSQUITOES AND MALARIA. 1900. The chief reason for writing that paper was to clear the field of work of an affection frequently confounded with malaria, an affection very common in our State, under various names, such as False Malaria, Atypical Malaria, Latent Malaria, a Touch of Malaria, Mal-aria, and others, including "bilious attacks" and "auto-intoxication".

This paper could be re-written, by one who has access to all the old literature, under the title, Indiana: A Redemption from Malaria. It would be appropriate for the Centennial next year. As a companion volume the man with ample leisure could write a volume on False Malaria, that is, dust infection.

Real malaria, that is malarial fever, is transmitted through the bite of the anopheles mosquito; false malaria, or Coniosis, is transmitted through infected dust. The proper season for malaria is late summer and autumn; that of false malaria from autumn through the winter to late in spring,



in other words, throughout the closed door season. In early days malaria dominated everything; there was comparatively little other sickness. Agricultural communities as a rule were healthy if there was no malaria about. Today false malaria dominates wherever people are massed, as indicated in my cases for 1906. The student who desires to study malaria will find little opportunity in Indiana today. I have not seen a case for about thirteen years. But for material for a study of False Malaria Indiana can not be excelled.

Just as malaria has disappeared by cleaning up the breeding places of the rural anopheles mosquito, so false malaria will also disappear when we begin to clean up generally, when we get clean air to breathe. When once an overgrown town begins to be on e a real city by putting in sewers, paved streets, getting filtered water and a clean high school, a sort of civic center, you can readily see why people become less tolerant of the chewer and spitter and in time of the smoker. The smoker, it should be noted, is usually also a spitter.

If I had time I should like to review briefly several medical papers in which I developed the theory of dust infection or coniosis, and show how one can distinguish between other affections and diseases. One can treat the subject from two viewpoints, medical and biological. Medically, coniosis can be considered as a disease; biologically, coniosis is a reaction. Regard it as a disease and at once there come to mind treatment, medicine, remedy, cure. Regard it as a reaction, then naturally there comes to mind prevention. From the physicians' standpoint, there are two classes of people, those who Take Something and those who Do Something. Some when feeling bad will take all sorts of drugs, including tobacco and alcohol. Others will take a change of environment, of occupation, or of residence. The latter are the wise; there will be more of these when the relationship of cause and effect is once properly understood.

The second viewpoint, the biological, is to regard coniosis or false malaria as a reaction. Now how can a reaction be cured in the constant presence of a cause? Why are there so many isms and pathies, so many pseudo remedies and new ones constantly arising? Looked at in this light you knock the props out from under the patent medicine man and the symptom-prescribing doctor and quack.

COLD AND COLDS. 1903. It is scarcely necessary to comment

on this paper because the tobacco factor stands out all over.\* The inhalation of tobacco smoke, especially in those wholly unaccustomed to it, produces a depressed circulation; it may be expressed as "reduced vitality," allowing the germs of infection, of colds and various inflammations, to take hold.

CITY DUST, CAUSE AND EFFECT. 1904. This paper was aimed to bring out the relationship between infected dust and the size and number of patent medicine ads. in newspapers, how the number and size of these depend on the amount of infected dust in the community. Such ads are indicators. In the light of later observations, the list of "dust ads" should be enlarged to include other ads, notably health food ads and ads relating to teeth and skin, similarly tobacco ads.

Tobacco along with alcohol must be considered a sedative. Both give ease. The Chinese get ease through opium; the East Indian through hasheesh. People the world over use certain drugs for ills that accompany life under unsanitary house and town conditions. They are pseudo remedies. The proper remedy is to clean up. This can not be over-emphasized.

Did time permit here should come a review of tobacco ads, how they can be classified. It is interesting to study these. Some are sensible, they are worth studying; on the other hand some are downright drivel, evidently written by old men in their dotage. Which are "the best" tobaccos, cigars and cigarettes? Men who must use tobacco find less need for smoking or chewing constantly if strong brands are used. I could tell how men who used two-for-a-quarter cigars and smoked constantly changed to "tufers" and smoked less, and at a greatly reduced cost.

I could tell of men who "came back," men who had lost health, perhaps not so much by the use of tobacco itself as through the infected air they inhaled while using it. I have in mind men whom I advised to get ease by the use of good air rather than attempt to get ease through tobacco. In other words, offset bad air by good air and reduce the reaction and thus reduce ills. (Tables to show how this works out were given in my paper on The Alcohol Problem, last year.)

---

\*Those desiring further details can be referred to a number of my papers, such as the Anti-Spitting Ordinance, in the Bulletin Indiana State Board of Health. (August, 1901.) Dust, A Neglected Factor in Ill Health, in the Proceedings of the Indiana State Medical Association for 1904, and to Atypical Cases and Dust Infection in American Medicine for October, 1904.

On the other hand I could tell of women who did not object to the husband smoking, in fact enjoyed tobacco. When you consider under what conditions some women spend their time, perhaps in a flat with bad air, with visits down town, to theatres or clubs or shopping, living under "high tension", which often though not necessarily means a high blood pressure, you can readily see why they get ease from inhaling the smoke of others. It is only one step further for them to take up smoking. Such homes are usually childless; if there is a child the physician may be called late at night to find an acute attack of tobaccosis, especially after a friend has visited the father and they have "smoked up" and filled the house, to which those not accustomed react acutely. The anaphrodisiac effect of tobacco and its influence on divorce and on race suicide can not here be discussed.

THE CHRONIC ILL HEALTH OF DARWIN, HUXLEY, SPENCER AND GEORGE ELLIOT. 1905. This was an attempt to interpret, through their biographies, the ill health of those no longer living, in the light of a study of living people who seemed to have similar ill health. What can the living learn from the lives of the dead? I shall refer to this again.

Parenthetically I might refer to a paper, vintage of 1905, on NEURASTHENOID CONDITIONS, in other words, American Nervousness, presented before the American Medical Association, at Portland, Oregon. On that trip I saw all sorts of people and noted the environment under which they lived, from the simple Indian in the open air to John Chinaman in Chinatown. The Indian in former days, and still in isolation and away from the white man, uses tobacco sparingly. People living under slum conditions use sedatives to excess. John Chinaman at home smoked opium, but since occidental pressure has practically forced him out of that, he has taken up tobacco. From the standpoint of coniosis, that is worse, for the tobacco user is a greater germ distributor than the opium smoker.

1906. At this place I would have to review my Presidential Address on the EVOLUTION OF MEDICINE IN INDIANA. I could amplify the five pages on Malaria into many chapters and similarly the five pages on Tuberculosis. The tobacco habit and the chewing habit are referred to but I did not like to mention these too frequently; it rather grates on the ear. Malaria has practically disappeared from Indiana by cleaning up the breeding places of the anopheles mosquito. Tuberculosis will disappear when our cities are clean. Today one in every seven or eight of us dies of tuberculosis. This rate should be enormously reduced, not by erecting more

hospitals and putting them in charge of doctors who chew and smoke, but by teaching the people the necessity, the importance, of clean air.

The ills of civilization call for more civilization. The man who is constantly seen with a cigar in his mouth or whose clothes reek with tobacco surely does not represent the highest type. The people have suffered much at the hands of the tobacco using doctor, usually a robust individual who uses tobacco because he gets ease. He does not understand the ills of his patients, and so they apply elsewhere; as a consequence he has all sorts of competitors. There are all sorts of isms and pathies, with new ones springing up.

Here should come a review of several papers relating to high blood pressure, a very interesting subject, especially in the light of coniosis. What causes a rise in blood pressure, and how can it be reduced? Why do seemingly robust men drop off suddenly and prematurely? I have at times discussed these things with physicians who smoke and who in their ignorance advised me also to smoke or to become accustomed to bad air conditions, to become acclimated, or, to put it in still another way, to develop an antitoxin, an antitoxin that will enable one to live under unsanitary conditions.

A physician constantly speaks of Case Reports.\* In the course of time some of my own short case reports have developed into biographies. They cover a series of years. At first one may be greatly in doubt as to interpreting facts, but in time one sees the reason. For instance, I have in mind a physician who for a number of years practised in a small country town; he made long drives; he had perfect health; he did not use tobacco nor alcohol, had no desire for either. Then he removed to the heart of a medium sized city, that means he exchanged good air for bad air. He began to feel bad; the symptoms of dust infection appeared, finally to such an extent that he was almost disabled. I advised him to get out; others advised him to stay and become accustomed, become adapted. We use the term adaptation to a great extent, but if you look at it properly adaptation comes about in the race, phylogenetically, not ontogenetically. The unadapted are constantly killed off. This doctor concluded to follow the advice of the many rather than of the one. In time he did develop an "anti-toxin." He even took

---

\*To quote illustrative case reports in a short paper is not satisfactory; one cannot go into details and there is a danger of a reader drawing wrong conclusions in the absence of details. Often brief case reports are worse than none, and one may hesitate to give any at all.

up smoking and enjoyed a roomful of tobacco smoke. He did not know until I examined that he had developed a high blood pressure. When I tell you that my own pressure under good air conditions runs from 100 to 110 m. m. while his under bad air runs about 200, you will realize that the life of such a man hangs on a mere thread and that at any time he may break a blood vessel, resulting in an apoplexy, or, if that does not occur, the kidneys will give out. Such men die suddenly as a rule and prematurely.

But the most interesting phase of the subject is the mental reactions, especially such as go under the terms irritability, nervousness and overwork. The efforts some men make to feel better are pathetic. For instance, I have in mind a captain of industry who did his planning in the early morning hours, usually from four to five, in bed. He saw things very clearly at that time. Then he would go down town and soon begin to feel dull and irritable, but would feel better by smoking, and he smoked one cigar after another. The single evening cigar and the postprandial cigar in time increased in number (as the blood pressure went up) until he wanted to smoke all the time. If alcohol were not taboo he would of course use that. When I examined I found he had a blood pressure of nearly 200 m. m. I pointed out that his pressure was due to the life down town, and that if he would reduce that to a minimum, and offset bad air by good air, likely he would have twenty-four hours a day for mental work, so to speak, rather than only one or two hours in the early morning, and that instead of tobacco being a stimulant to him during the day, which enab'ed him to think, it really did nothing of the sort; what it did was to lower the tension and the mind no longer ran riot. It enables him to pick out thoughts and ideas that he had seen very clearly in the early morning, after he had had no tobacco at all for a number of hours.

The newspaper cartoons, such as of "Abe Martin" and "Roger Bean," are interesting. The one might represent the low pressure type in the country with a family of children; he is seen only occasionally with a cigar. The other, Roger Bean, might represent the high pressure city man, with a cigar in his mouth almost constantly and usually childless. Race suicide and the use of tobacco under crowded conditions go hand in hand.

In early days Uncle Sam was represented as a lean, lank country man. The cartoonists nowadays are filling him out, in other words, making a hearty, robust Uncle, one is almost inclined to say grandfather. To the initiated he is a "high blood pressure case," with attendant ills, including race suicide.

THE INFLUENCE OF ENVIRONMENT. 1907. This paper appeared in a brief abstract; it took up in detail some of the things here mentioned. I repeatedly refer to John Chinaman who is adapted to live under slum conditions, who thrives in large city slums where even the white man can not live. Now if we look at it from the proper angle, we may conclude that our educators are reducing us to the condition of John Chinaman. They give no attention to the air conditions under which children live and meet. Instead of having teachers who react and who can tell by their own senses whether air conditions are good or bad, who are living barometers or thermometers, our schools are supplied with teachers of the robust kind (but who nevertheless react and readily use tobacco, as a sedative, to get ease, to feel less irritable). Under unsanitary conditions the susceptible are constantly weeded out, killed off, and what remains? In the end the John Chinaman type survives, a type which thrives bodily but at the expense of mentality; all the energy being required to ward off infection, leaving nothing for the brain.

Indiana today is stationary in population, as I attempted to show a year ago. It is due mainly to bad air conditions which lead to the use of sedatives and narcotics. As long as a country is thinly settled, alcohol and tobacco can be used with impunity, but under massed conditions these become racial poisons. The individual who reacts wants a sedative and (as I attempted to show a year ago) there are many that can be used. The most universally used today is tobacco. Tobacco leads to the spitting habit, alcohol not.

Here I shall not take up the statistics of our sedative and narcotic bill, the cost of tobacco and alcohol, and opium and patent medicines, and the various expenses that accompany life under unsanitary conditions, including needless doctor bills, the increased expense for fuel required to feel comfortable under bad air conditions, the desire for "overheated" houses, public buildings, railway coaches and trolleys, etc. It must suffice to say the cost runs into the billions of dollars annually in our country.

FLORA OF CASS COUNTY. 1908. I mentioned in the beginning that the tobacco factor can be traced into practically every paper I have given before this Academy. Does that apply to the flora of a particular region? People who feel bad want ease, they want relief from distressing symptoms; they will experiment, they will try anything and everything. An old belief was that every plant has a use, particularly a medicinal use, if we could only discover it. Today we know this is not true, that very few

have any medicinal properties at all, and that practically none cure; at best they can give but transient relief. Relieving is not curing. Our native plants are chiefly remarkable in what they will not cure. The man who gets the most benefit is the one who gathers them. Some of you may recall O. Henry's story.

**BIOGRAPHY AND THE INFLUENCE OF ENVIRONMENT.** 1908. Short case reports there cited have been continued into biographies. You will readily understand that the longer a history, a biography, is continued the more valid the conclusions that can be drawn. Two of the individuals mentioned have since died, and died just as predicted, not to them however. The value of a theory is in enabling one to predict. By the way, Case 3 was a man who could not do without tobacco. He had used it all his life. He readily saw my reasoning, how, if he did not harm himself, he at least harmed others. He attempted to quit but found it impossible; he had to use a little tobacco, shall one say medicinally?\*

**THOUGHT STIMULATION.** 1909. The reference to tobacco is very brief, but there is a relatively long mention of high blood pressure. This is a very interesting phase of the tobacco problem, especially to those who use their brains rather than their hands to make a living. Under what conditions can a man work at his best and when is he disabled? What will tide him over? I have already referred to this.

Years ago I had a discussion with a physician who did more or less surgery. He was a warm advocate of tobacco; even advised me to use it—the old story of “Take Something” in place of “Do Something.” Whenever he did work under high tension tobacco soothed him, he said. When he had an unusual case he would be under high tension, very nervous, and tobacco would steady his nerves, he asserted, or, in other words, steady his hand when he operated. On investigating I found this state of affairs:

Ordinarily he was not under “high tension,” but this was produced when he locked himself in a small room full of dusty books for several hours, looking over the latest literature regarding such operations, and at the same time filling himself with infected dust. Then his mind would run riot during the night, he was sleepless, of course thinking about the operation in the morning.

---

\*Coming down on the interurban with me was an old patient. We had a discussion of dust victims and tobacco victims. He is a low pressure man. His observations bore out my own. The advantage of discussion over a printed paper is that one can answer questions and make obscure points clear.

He would be practically unfitted for work but for the steadying effect of tobacco. It acted as a sedative. Why not prevent the reaction and make the use of tobacco unnecessary? When you point out these things you knock the props from under the tobacco argument. Doctors are notorious smokers. When they meet, especially at a banquet, the air is usually full of smoke, so full that you can not see across the room. Naturally those who do not smoke stay away, as they do from other "smokers."

In a general way in youth and up to middle age individuals may be grouped under three classes according to the blood pressure—low, medium or high, under unsanitary city conditions. At middle age and after there are really only two groups, those with a low pressure and those with a high pressure. Ordinarily we speak of the action of tobacco on man; in reality it is the reaction of man to tobacco. When the low pressure individual is exposed to tobacco smoke his pressure declines still more, his pulse may become imperceptible, he feels bad, and he gets out: He is a victim of tobacco-sis. On the other hand is the high blood pressure individual: To him tobacco smoke may act as a sedative, it lowers the tension, he feels better. He is the one who attends "smokers;" he does not object to tobacco. But as a rule he does not realize the significance of high blood pressure and the danger he is in, how his very life hangs on a thread.\*

Moreover mental changes are marked. The low pressure man is stupefied by tobacco smoke, he can not think. The bright things he might have said come to him the next day. On the other hand the high blood pressure man whose mind is constantly running riot is steadied. Such a statement taken without the context might be considered as a plea for the use of tobacco!

How do these two classes, the high and the low pressure, react from the standpoint of coniosis under infected dust conditions and without tobacco effects, say in the poorly ventilated church, as during the closed door season when some leave early because they feel bad? As a general rule those who leave "deathly pale" are low pressure with the pressure still further reduced, while those who go out with flushed face are high pressure, with the pressure heightened. We thus see the two-sided effect of bad air, air with infected dust.

\*In my search for original data I have questioned many physicians, including both smokers and non-smokers, as well as an occasional chewer. Strange to relate I have met men whom I suspected to have a high blood pressure who refused to have the pressure taken; they preferred to live on in ignorance and smoke. The average physician knows as little about the effect of tobacco as the man on the street who has no education and in whom one does not expect any matured opinion.



The subject of thought stimulation is intimately connected with the subject of the Air of Places, a subject on which Hippocrates wrote 2,500 years ago, but that was long before the days of bacteriology. The old chemical standard for purity of the air was based on the amount of carbonic acid gas. From the standpoint of coniosis it is the amount of infection in the air that counts. Need I again refer to the role of the tobacco chewer and spitter and smoker?

PLANTS AND MAN. 1910. This was a paper made up largely of analogies, tracing living conditions between plants and their "ills and diseases" and of man and his ills and diseases, and the need of clean air, need of placing a man under good surroundings.

Today we hear much of eugenics, of the influence of heredity. It is a very important subject. But still more important is eutherics, the influence of environment, because we have little control over heredity but we have a far reaching influence over our environment. If a man does not feel well, is ill at ease under a given environment, he should change it; instead of getting drugs, or advice about the use of drugs, he should understand the situation so he can Do Something rather than Take Something. But because people are unwilling to pay a doctor for his time but are willing to pay for his medicine, you readily see the result. The less a physician tells his community about unsanitary conditions, the smoother his sailing, and the better for his purse. (Naturally when a physician offends and antagonizes chewers and spitters they stay away, ditto the man who smokes and drinks; when they do apply they may be so far advanced in actual disease that the student of ill health can do little for them, he may have in mind the opinion or verdict of the mechanical engineer: Not worth while, consign to the scrap heap; but he does not say that aloud.)

Where the medical man keeps still and says nothing, the newspaper reporter is apt to run wild. From simple statements "The health of the city is good," there soon appear claims, at a time when there are few cases of "contagious disease" and few deaths, of "The healthiest city in the State." At the same time a city may be "full of ill health," of people who complain, who are neither actually sick and yet are not at all well. The newspaper itself may be full of patent medicine ads, for ills that are indicators of unsanitary city conditions. Patent medicine men are shrewd, they advertise only where there is a demand for their wares, for their nostrums.

To the physician and especially to the student of prevalent ill health there

are all sorts of symptoms of diagnostic import: Does an applicant for professional service use sedatives and narcotics (alcohol, tobacco, opium, etc.) and use them to excess, or, on the other hand, does he use stimulants (notably coffee and tea)? What does such use indicate? The statement is sometimes made that tobacco is the poor man's friend, that after a hard day's work he enjoys his pipe; it calms him. But when you study the poor man and the conditions under which he works, you can see that the great trusts may well make an effort to keep tobacco as cheap as possible. Offering Mr. Common People a cigar, especially one with a colored band, only too often makes him tolerate what are really intolerable conditions. Men working for some of the great trusts twelve hours a day, seven days a week, may be even too tired to smoke. Tobacco is also a great solace to the soldier in the trenches; it makes him contented, it dulls his mind and keeps him from thinking.

CONIOSIS. 1911. As already mentioned, this paper is a general statement of the dust theory. My time limit is running to a close and I must refer you to the paper itself, which among other things treats our Triad of American Diseases (catarrh, dyspepsia, and nervous prostration) as reactions, similarly regarding blood pressure changes. The term disease at once brings to mind treatment, medicine, while reaction brings to mind prevention.

CONIOLOGY. 1912. This paper was a plea for a new science and the need for an institution for working out problems. The dust particles emitted by the tobacco smoker are included.

In 1913 I was unable to present my paper on RACE SUICIDE, in which the subject was also traced into the schools. There I asked, as this paper has already asked, regarding the use of tobacco by the teacher: Is he justified in using it? If he feels cross and irritable, shall he take something or do something—seek better air conditions, the proper construction of school buildings and proper ventilation and general cleanliness? Child mortality today is enormous. It should be greatly reduced, many bright children who now die could be saved to a life of usefulness. There is much truth in the old saying, *The good die young.*

THE ALCOHOL PROBLEM IN THE LIGHT OF CONIOSIS. In my paper for 1914 the Tobacco Problem comes up on every page, and I believe after the remarks I have made you will readily see it. I mentioned how on entering medical school I found horribly bad air conditions. The drinking water was equally bad; it was raw muddy river water. A number

of students contracted typhoid fever. Some who had never used beer resorted to clean beer; which is the greater evil?

The first duty of the prohibitionist should be to give the people clean water; it is useless to argue with people who are compelled to drink muddy water. The next step is to give people clean air. That takes away the craving for a sedative, be that tobacco or alcohol or opium.

This paper properly should close with a questionnaire, asking for more data, especially from men who lead a mental life. Why do you use tobacco? Why do you not use it? Under what conditions do you demand it? When do you not care for it? Are you keeping down a high blood pressure by the excessive use of tobacco? Can you stop long enough, under bad air conditions, to find out what your real pressure is?

It is difficult to get good data; observations should cover at least one year. I am not inclined to draw conclusions from case reports which cover a period of less than a year, and as already mentioned, the longer the series of years, the more valuable data become.



## TOLERANCE OF SOIL MICRO ORGANISMS TO MEDIA CHANGES.

H. A. NOYES.

Our text books all give space to the discussion of the food requirements of bacteria. The discussion, although general, is liable to lead us to believe that most organisms may not grow if we change the composition of media slightly. Just what is the minimum ration for most bacteria is not known. Our knowledge of the effects of modifying the composition of culture media is meager, especially when environmental factors are considered.

The Horticultural Research Chemistry and Bacteriology Laboratories, of the Purdue Agricultural Experiment Station have been investigating media for the platings and subsequent culturing of soil bacteria. This paper reports a part of this investigation.

### SOIL USED.

Two types of soil were used in this work, silty clay from the Experimental orchard at Laurel, Indiana, and brown loam from the Station orchard where a cover crop investigation is under way. All samples reported on in this paper contained from 16 to 20 per cent. of moisture at time of sampling. The method of sampling was by means of Noyes' sampler for soil bacteriologists. Samples were taken of the upper nine inches of soil.

### MEDIA USED.

Lipman and Brown "synthetic" agar.

15 gms. *best* agar.

10 gms. Dextrose.

.05 gms. Witte Peptone.

.2 gms. Magnesium sulphate.

.5 gms. Di potassium hydrogen phosphate.

Trace Ferrous sulphate.

1,000 cc. Distilled water.

H. J. Conn's sodium asparaginate agar.

15 gms. *best* agar (used instead of 12).

- 1 gm. Sodium asparaginate.
- 1 gm. Dextrose.
- .2 gm. Magnesium sulphate.
- 1.5 gm. (NH<sub>4</sub>H<sub>2</sub>PO<sub>4</sub>) ammonium biphosphate.
- .1 gm. Calcium chloride.
- .1 gm. Potassium chloride.
- Trace Ferrous chloride.
- 1,000 cc. Distilled water.

#### SOIL EXTRACT (UNHEATED).

15 grams of *best* agar dissolved in 1,000 cc. of solution made as follows:

Two kilos of the brown loam soil were placed in a glass bottle, and 5 liters of distilled water added, the bottle was shaken at intervals and at end of 16 hours the mixture was filtered. One thousand cc. of the filtrate was used in place of distilled water in making up this media.

#### SOIL EXTRACT (AUTOCLAVED).

Fifteen grams of *best* agar dissolved in 1,000 cc. of solution made the same as the soil extract (unheated), except that the two kilos of soil were wet well and heated under 25 lbs. pressure in the autoclave for three hours.

Soil and agar, leaf extract and agar, and wheat straw extract.

These three media were made as follows: To 15 gms. of the *best* agar were added 10 gms. of the material desired and 1,000 cc. distilled water. The mixture was heated in a double boiler until the agar was dissolved. After making up to volume the media was filtered and tubed.

#### OTHER MEDIA.

To 15 gms. of *best* agar was added 1 gm. per liter of chemicals appearing as part of the name of the media and 1,000 cc. of distilled water.

Figure 1 expresses graphically the acidity of the various media. The procedure in titrating was as follows: To about 125 cc. of distilled water that has been boiling about 3 minutes in a Jena erlenmeyer flask was added 50 cc. of the media by means of a tall 50 cc. graduate (of small cross-section). Two drops of phenolphthalein solution was added and titration made with tenth normal sodium hydroxide. The only media neutralized at all was H. J. Conn's sodium asparaginate agar, and this was done with half normal soda, using a pipette graduated to one-twentieth of a cc.

## TUBE MEDIA TEST I.

Sample of 6/14, 1915.

Sample from Tree XIII—13 Plot F.

Laurel.

One cc. portions of the 1-400,000 dilution of the sample were plated on the following media:

Lipman and Brown agar.

Conn's sodium asparaginate agar.

Agar alone.

Soil and agar (Purdue soil).

Soil extract (autoelaved) and agar.

Soil extract (unheated) and agar.

(15 gms. agar in all media.)

Transfers were made from best colonies on each media to slants of other media. Tables give results of growth on these agar slants at end of 5 and 14 days' incubation at 22° C.

*8 Colonies from L and B agar to*

|                             | 5 Days.        | 14 Days.    |
|-----------------------------|----------------|-------------|
| Na. asp. agar.....          | { 8 g.*<br>0 — | 8 g.<br>0 — |
| Soil ext. (unheated).....   | { 6 g.<br>2 —  | 7 g.<br>1 — |
| Soil ext. (autoelaved)..... | { 5 g.<br>3 —  | 5 g.<br>3 — |
| Agar alone.....             | { 5 g.<br>3 —  | 5 g.<br>3 — |
| Agar and soil.....          | { 4 g.<br>4 —  | 5 g.<br>3 — |

\*S = growth. — = no growth unless otherwise specified.

8 Colonies from *Na. asp.* agar to

|                             | 5 Days.     | 14 Days.    |
|-----------------------------|-------------|-------------|
| L and B agar.....           | 7 g.<br>1 — | 7 g.<br>1 — |
| Soil ext. (unheated).....   | 5 g.<br>3 — | 7 g.<br>1 — |
| Soil ext. (autoclaved)..... | 5 g.<br>3 — | 7 g.<br>1 — |
| Agar alone.....             | 7 g.<br>1 — | 7 g.<br>1 — |
| Agar and soil.....          | 6 g.<br>2 — | 7 g.<br>1 — |

## 3 Colonies from Soil Extract (unheated) to

|                             | 5 Days.     | 14 Days. |
|-----------------------------|-------------|----------|
| L and B agar.....           | 3 g.        | 3 g.     |
| <i>Na. asp.</i> agar.....   | 2 g.<br>1 — | 3 g.     |
| Soil ext. (autoclaved)..... | 3 g.        | 3 g.     |
| Agar alone.....             | 3 g.        | 3 g.     |
| Agar and soil.....          | 3 g.        | 3 g.     |

## 3 Colonies from Soil Extract (autoclaved) to

|                           | 5 Days.     | 5 Days.     |
|---------------------------|-------------|-------------|
| L and B agar.....         | 3 g.        | 3 g.        |
| <i>Na. asp.</i> agar..... | 3 g.        | 3 g.        |
| Soil ext. (unheated)..... | 3 g.        | 3 g.        |
| Agar alone.....           | 3 g.        | 3 g.        |
| Agar and soil.....        | 2 g.<br>1 — | 2 g.<br>1 — |



## 3 Colonies from Agar Alone to

|                             | 5 Days.      | 14 Days.    |
|-----------------------------|--------------|-------------|
| L and B agar.....           | 3 g.         | 3 g.        |
| Na. asp. agar.....          | 3 g.         | 3 g.        |
| Soil ext. (unheated).....   | (2 g.<br>1 — | 2 g.<br>1 — |
| Soil ext. (autoclaved)..... | 3 g.         | 3 g.        |
| Agar and soil.....          | (2 g.<br>1 — | 2 g.<br>1 — |

## 3 Colonies from Agar and Soil to

|                             | 5 Days.      | 14 Days.    |
|-----------------------------|--------------|-------------|
| L and B agar.....           | (2 g.<br>1 — | 2 g.<br>1 — |
| Na. asp. agar.....          | (2 g.<br>1 — | 2 g.<br>1 — |
| Soil ext. (unheated).....   | (2 g.<br>1 — | 2 g.<br>1 — |
| Soil ext. (autoclaved)..... | (2 g.<br>1 — | 2 g.<br>1 — |
| Agar alone.....             | (2 g.<br>1 — | 2 g.<br>1 — |

## Summary 5 Day Results.

|                                             |                 |
|---------------------------------------------|-----------------|
| 20 transfers to L and B agar.....           | 18 made growth. |
| 20 transfers to Na. asp. agar.....          | 18 made growth. |
| 25 transfers to Soil ext. (unheated).....   | 18 made growth. |
| 25 transfers to Soil ext. (autoclaved)..... | 18 made growth. |
| 25 transfers to Agar alone.....             | 20 made growth. |
| 25 transfers to Agar and soil.....          | 17 made growth. |

## Summary 14 Days.

|                                           |                 |
|-------------------------------------------|-----------------|
| 20 transfers to L and B agar.....         | 18 made growth. |
| 20 transfers to Na. asp. agar.....        | 19 made growth. |
| 25 transfers to Soil ext. (unheated)..... | 21 made growth. |

|                                             |                 |
|---------------------------------------------|-----------------|
| 25 transfers to Soil ext. (autoclaved)..... | 20 made growth. |
| 25 transfers to Agar alone.....             | 20 made growth. |
| 25 transfers to Agar and soil.....          | 19 made growth. |

*Notes.*

When tubes of organisms grown originally on same media were put side by side the following differences were noted.

- (1) Agar alone supported very poor growths.
- (2) Agar and soil supported fully as poor growths as agar alone.
- (3) The two extracts acted about the same, although the heated extract grew the organisms originally grown on Na. asp. agar a little the best.
- (4) L. and B. agar and Na. asp. agar supported good growths.
- (5) From any macroscopic test the growths on the L. and B. agar were far superior to those on the Na. asp. agar.

TUBE MEDIA TEST II.

Samples of 6/14, 1915.

Samples from Tree VI—24. Plot C.

Laurel.

One cc. portions of the 1-400,000 dilution of the sample were plated on the following media:

- Lipman and Brown agar.
- Conn's sodium asparaginate agar.
- Agar alone.
- Soil and agar (Purdue soil).
- Soil extract (unheated) and agar.
- Soil extract (autoclaved) and agar.
- (15 gms. agar in all media.)

Transfers were made from best colonies on each media to slants of other media. Tables give results of growth on these agar slants at end of 5 and 14 days' incubation at 22° C.

## 8 Colonies from L and B agar to

|                             | 5 Days.       | 14 Days.    |
|-----------------------------|---------------|-------------|
| Na. asp. agar.....          | { 7 g.<br>1 — | 7 g.<br>1 — |
| Soil ext. (unheated).....   | { 6 g.<br>2 — | 5 g.<br>3 — |
| Soil ext. (autoclaved)..... | { 5 g.<br>3 — | 6 g.<br>2 — |
| Agar alone.....             | { 4 g.<br>4 — | 6 g.<br>2 — |
| Agar and soil.....          | { 4 g.<br>4 — | 4 g.<br>4 — |

## 8 Colonies from Na. asp. agar to

|                             | 5 Days.       | 14 Days.    |
|-----------------------------|---------------|-------------|
| L and B agar.....           | 8 g.          | 8 g.        |
| Soil ext. (unheated).....   | { 7 g.<br>1 — | 6 g.<br>2 — |
| Soil ext. (autoclaved)..... | 8 g.          | 8 g.        |
| Agar alone.....             | 8 g.          | 8 g.        |
| Agar and soil.....          | { 8 g.<br>4 — | 6 g.<br>2 — |

## Summary 5 Days.

|                                             |                 |
|---------------------------------------------|-----------------|
| 8 transfers to L and B agar.....            | 8 made growth.  |
| 8 transfers to Na. asp. agar.....           | 7 made growth.  |
| 16 transfers to Soil ext. (unheated).....   | 13 made growth. |
| 16 transfers to Soil ext. (autoclaved)..... | 13 made growth. |
| 16 transfers to Agar alone.....             | 12 made growth. |
| 16 transfers to Agar and soil.....          | 12 made growth. |

## Summary 14 Days.

|                                             |                 |
|---------------------------------------------|-----------------|
| 8 transfers to L and B agar.....            | 8 made growth.  |
| 8 transfers to Na. asp. agar.....           | 7 made growth.  |
| 16 transfers to Soil ext. (unheated).....   | 11 made growth. |
| 16 transfers to Soil ext. (autoclaved)..... | 14 made growth. |
| 16 transfers to Agar alone.....             | 14 made growth. |
| 16 transfers to Agar and soil.....          | 10 made growth. |

*Notes.*

When tubes of organisms grown originally on same media were put side by side the following differences were noted:

- (1) Agar alone supported very poor growths.
- (2) Agar and soil supported fully as poor growths as agar alone.
- (3) The two extracts acted about the same, although the heated extract grew the organisms originally grown on Na. asp. agar a little the best.
- (4) L. and B. agar and Na. asp. agar supported good growths.
- (5) From any macroscopic test the growths on the L. and B. agar were far superior to those on the Na. asp. agar.

## TUBE MEDIA TEST III.

Samples of 6/25, 1915.

Sample No. 6. Rye Plot.

Cover Crop Investigations.

One cc. portions of the 1 to 400,000 dilution of this sample were plated on the following media:

Lipman and Brown agar.

Conn's sodium asparaginate agar.

Agar alone.

Soil and agar (Purdue soil).

Soil extract (unheated) and agar.

Soil extract (autoclaved) and agar.

(15 gms. agar in all media.)

Colonies developing well on first two media listed were put on other media and growth noted at end of 5, 11, and 15 days' incubation at 22° C.

*From 4 Colonies on L and B agar to*

|                           | 5 Days. | 11 Days. | 15 Days. |
|---------------------------|---------|----------|----------|
| Na. asp. agar.....        | 3 g.    | 4 g.     | 4 g.     |
|                           | 1       |          |          |
| Soil ext. (unheated)..... | 2 g.    | 2 g.     | 3 g.     |
|                           | 2 —     | 2 —      | 1 —      |
| Plain agar.....           | 3 g.    | 3 g.     | 3 g.     |
|                           | 1 —     | 1 —      | 1 —      |

## From 4 Colonies on Na. asp. agar to

|                           | 5 Days. | 11 Days. | 15 Days. |
|---------------------------|---------|----------|----------|
| L and B agar.....         | 4 g.    | 4 g.     | 4 g.     |
| Soil ext. (unheated)..... | { 2 g.  | 3 g.     | 4 g.     |
|                           | { 2 —   | 1 —      |          |
| Plain agar.....           | { 3 g.  | 3 g.     | 3 g.     |
|                           | { 1 —   | 1 —      | 1 —      |

*Summary 5 Days.*

|                                          |                |
|------------------------------------------|----------------|
| 4 transfers to L and B agar.....         | 4 made growth. |
| 4 transfers to Na. asp. agar.....        | 3 made growth. |
| 8 transfers to Soil ext. (unheated)..... | 4 made growth. |
| 8 transfers to Agar alone.....           | 6 made growth. |

*Summary 15 Days.*

|                                          |                |
|------------------------------------------|----------------|
| 4 transfers to L and B agar.....         | 4 made growth. |
| 4 transfers to Na. asp. agar.....        | 4 made growth. |
| 8 transfers to Soil ext. (unheated)..... | 7 made growth. |
| 8 transfers to Agar alone.....           | 6 made growth. |

*Notes.*

When tubes of different media containing the same organism from the same original colony were put side by side, the following was noted:

(1) The growth on agar alone, soil and agar or on soil extract (unheated) was small.

(2) The soil extract carried a better growth than the soil alone.

(3) L. and B. agar and Na. asp. agar carried a good growth.

(4) There was more development of distinguishing characteristics as to form of streaks and chromogenesis present, with the L and B agar.

## TUBE MEDIA TEST IV.

Samples of 6/25, 1915.

Sample No. 7. Clean Culture Plot.

Cover Crop Investigation.

One cc. portions of the 1 to 400,000 dilution of this sample were plated on the following media:

Lipman and Brown agar.

Conn's sodium asparaginate agar.

Agar alone.

Soil and agar (Purdue soil).

Soil extract (unheated) and agar.

Soil extract (autoclaved) and agar.

(15 gms. agar in all media.)

Colonies developing well on each media were transferred to slants of other media. Tables give results of growth on these agar slants at end of 5, 11, and 15 days. Incubation at 22° C.

*From 4 Colonies on L and B agar to*

|                           | 5 Days.        | 11 Days.     | 15 Days.     | Shown in Plate |
|---------------------------|----------------|--------------|--------------|----------------|
| Na. asp. agar.....        | { 2 gr.<br>2 — | 2 gr.<br>2 — | 3 gr.<br>1 — | I              |
| Agar alone.....           | { 3 gr.<br>1 — | 3 gr.<br>1 — | 3 gr.<br>1 — |                |
| Soil ext. (unheated)..... | { 2 gr.<br>2 — | 3 gr.<br>1 — | 3 gr.<br>1 — |                |

*From 4 Colonies on Na. asp. agar to*

|                           | 5 Days.        | 11 Days.     | 15 Days.     | Plate. |
|---------------------------|----------------|--------------|--------------|--------|
| L and B agar.....         | 4 g.           | 4 g.         | 4 g.         | II     |
| Agar alone.....           | { 3 gr.<br>1 — | 3 gr.<br>1 — | 3 gr.<br>1 — |        |
| Soil ext. (unheated)..... | { 3 gr.<br>1 — | 4 g.         | 4 g.         |        |

*From 3 Colonies on Plain Agar to*

|                           | 5 Days.       | 11 Days.    | 15 Days.    |
|---------------------------|---------------|-------------|-------------|
| L and B agar.....         | { 2 g.<br>1 — | 2 g.<br>1 — | 2 g.<br>1 — |
| Na. asp. agar.....        | { 2 g.<br>1 — | 2 g.<br>1 — | 2 g.<br>1 — |
| Soil ext. (unheated)..... | { 2 g.<br>1 — | 2 g.<br>1 — | 2 g.<br>1 — |

*From 3 Colonies on Soil and Agar to*

|                           | 5 Days.       | 11 Days.    | 15 Days.    |
|---------------------------|---------------|-------------|-------------|
| L and B agar.....         | { 2 g.<br>1 — | 2 g.<br>1 — | 2 g.<br>1 — |
| Na. asp. agar.....        | { 2 g.<br>1 — | 3 g.        | 3 g.        |
| Soil ext. (unheated)..... | 3 g.          | 3 g.        | 3 g.        |
| Agar alone.....           | { 2 g.<br>1 — | 3 g.        | 3 g.        |

*From 3 Colonies on Soil Extract (unheated) to*

|                    | 5 Days. | 11 Days. | 15 Days. |
|--------------------|---------|----------|----------|
| L and B agar.....  | 3 g.    | 3 g.     | 3 g.     |
| Na. asp. agar..... | 3 g.    | 3 g.     | 3 g.     |
| Agar alone.....    | 3 g.    | 3 g.     | 3 g.     |

*From 3 Colonies on Soil Extract (autoclaved) to*

|                           | 5 Days.       | 11 Days.    | 15 Days.    |
|---------------------------|---------------|-------------|-------------|
| L and B agar.....         | 3 g.          | 3 g.        | 3 g.        |
| Na. asp. agar.....        | 3 g.          | 3 g.        | 3 g.        |
| Agar alone.....           | { 2 g.<br>1 — | 2 g.<br>1 — | 2 g.<br>1 — |
| Soil ext. (unheated)..... | 3 g.          | 3 g.        | 3 g.        |

*Summary (5 Days Results).*

|                                           |                 |
|-------------------------------------------|-----------------|
| 16 transfers to L and B agar.....         | 14 made growth. |
| 16 transfers to Na. asp. agar.....        | 12 made growth. |
| 17 transfers to Plain agar.....           | 13 made growth. |
| 17 transfers to Soil Ext. (unheated)..... | 13 made growth. |

*Summary (15 Day Results).*

|                                           |                 |
|-------------------------------------------|-----------------|
| 16 transfers to L and B agar.....         | 14 made growth. |
| 16 transfers to Na. asp. agar.....        | 13 made growth. |
| 17 transfers to Plain agar.....           | 14 made growth. |
| 17 transfers to Soil ext. (unheated)..... | 15 made growth. |

*General Notes.*

When tubes of different media containing the same organism from the same original colony are put side by side, the following is noted:

- (1) The growth on agar alone, soil and agar or on soil extract (unheated) is small.
- (2) The soil extract carries a better growth than the soil alone.
- (3) L. and B. agar and Na. asp. agar carry a good growth.
- (4) There is more development of distinguishing characteristics as to form of streaks and chromogenesis present, with the L. and B. agar.

## TUBE MEDIA TEST V.

Sample of 7/16, 1915.

Sample No. 8. Millet Plot.

Cover Crop Investigations.

One cc. portions of the 1 to 400,000 dilution of this sample were plated on the following media:

- A. Wheat straw extract.
  - B. Leaf extract.
  - C. Starch.
  - D. Agar alone.
  - E. Ammonium nitrate.
  - F. Conn's sodium asparaginate.
  - G. Soil.
  - H. Soil and starch.
  - I. Lipman and Brown agar.
  - J. Ammonium nitrate and starch.
- (15 gms. agar is basis of all media.)

Colonies developing well on each media, plates III and IV, were transferred to slants of other media. Tables give results of growth on these slants at end of 6, 10 and 14 days' incubation at 22° Centigrade.



## 4 Colonies from L and B agar to

|                                  | 6 Days.      | 10 Days.     | 14 Days.     | Shown<br>in Plate |
|----------------------------------|--------------|--------------|--------------|-------------------|
| Wheat Straw Ext.....             | 3 g.<br>1 —  | 3 g.<br>1 —  | 3 g.<br>1 —  | V                 |
| Leaf Ext.....                    | 1 g.<br>3 —  | 1 g.<br>3 —  | 1 g.<br>3 —  |                   |
| Starch.....                      | 4 g.<br>3 g. | 4 g.<br>4 g. | 4 g.<br>4 g. | VI<br>VII         |
| Agar alone.....                  | 1 —          |              |              |                   |
| Ammonium Nitrate.....            | 4 g.         | 4 g.         | 4 g.         | VIII              |
| Na. asp. agar.....               | 3 g.<br>1 —  | 3 g.<br>1 —  | 4 g.         | IX                |
| Soil.....                        | 3 g.<br>1 —  | 3 g.<br>1 —  | 3 g.<br>1 —  | X                 |
| Soil and Starch.....             | 2 g.<br>2 —  | 2 g.<br>2 —  | 2 g.<br>2 —  |                   |
| L and B agar.....                | 4 g.         | 4 g.         | 4 g.         | XI                |
| Ammonium Nitrate and Starch..... | 3 g.<br>1 —  | 3 g.<br>1 —  | 4 g.         |                   |
| Soil and Ammonium Nitrate.....   | 2 g.<br>2 —  | 2 g.<br>2 —  | 3 g.<br>1 —  |                   |
| Soil Extract (unheated).....     | 2 g.<br>2 —  | 3 g.<br>1 —  | 4 g.         |                   |

4 Colonies from *Na. asp. agar* to

|                                  | 6 Days. | 10 Days. | 14 Days. | Plate. |
|----------------------------------|---------|----------|----------|--------|
| Wheat Straw Ext.....             | 4 g.    | 4 g.     | 4 g.     | V      |
| Leaf Ext.....                    | { 3 g.  | 3 g.     | 3 g.     |        |
|                                  | { 1 —   | 1 —      | 1 —      |        |
| Starch.....                      | 4 g.    | 4 g.     | 4 g.     | VI     |
| Agar alone.....                  | 4 g.    | 4 g.     | 4 g.     | VII    |
| Ammonium Nitrate.....            | 4 g.    | 4 g.     | 4 g.     | VIII   |
| <i>Na. asp. agar</i> .....       | 4 g.    | 4 g.     | 4 g.     | IX     |
| Soil.....                        | 4 g.    | 4 g.     | 4 g.     | X      |
| Soil and Starch.....             | 4 g.    | 4 g.     | 4 g.     |        |
| L and B agar.....                | 4 g.    | 4 g.     | 4 g.     | XI     |
| Ammonium Nitrate and Starch..... | 4 g.    | 4 g.     | 4 g.     |        |
| Soil and Ammonium Nitrate.....   | { 3 g.  | 3 g.     | 4 g.     |        |
|                                  | { 1 —   | 1 —      |          |        |
| Soil Ext. (unheated).....        | 4 g.    | 4 g.     | 4 g.     |        |

*4 Colonies from Starch to*

|                                  | 6 Days.       | 10 Days.    | 14 Days.    |
|----------------------------------|---------------|-------------|-------------|
| Wheat Straw Ext.....             | { 2 g.<br>2 — | 2 g.<br>2 — | 2 g.<br>2 — |
| Leaf Ext.....                    | { 1 g.<br>3 — | 1 g.<br>3 — | 1 g.<br>3 — |
| Starch.....                      | { 3 g.<br>1 — | 4 g.        | 4 g.        |
| Agar alone.....                  | { 3 g.<br>1 — | 3 g.<br>1 — | 3 g.<br>1 — |
| Ammonium Nitrate.....            | 4 g.          | 4 g.        | 4 g.        |
| Na. asp. agar.....               | 4 g.          | 4 g.        | 4 g.        |
| Soil.....                        | { 4 g.        | 4 g.        | 3 g.<br>1 — |
| Soil and Starch.....             | { 2 g.<br>2 — | 2 g.<br>2 — | 2 g.<br>2 — |
| L and B agar.....                | 4 g.          | 4 g.        | 4 g.        |
| Ammonium Nitrate and Starch..... | { 3 g.<br>1 — | 3 g.<br>1 — | 3 g.<br>1 — |
| Soil and Ammonium Nitrate.....   | 4 g.          | 4 g.        | 4 g.        |
| Soil Ext. (unheated).....        | { 3 g.<br>1 — | 3 g.<br>1 — | 4 g.        |

*4 Colonies from Agar alone to*

|                    | 6 Days.       | 10 Days.    | 14 Days.    | Shown<br>in Plate. |
|--------------------|---------------|-------------|-------------|--------------------|
| Starch.....        | { 2 g.<br>2 — | 2 g.<br>2 — | 2 g.<br>2 — |                    |
| Na. asp. agar..... | { 2 g.<br>2 — | 3 g.<br>1 — | 3 g.<br>1 — | XII                |
| L and B agar.....  | { 3 g.<br>1 — | 4 g.        | 4 g.        | XII                |

*4 Colonies from Ammonium Nitrate to*

|                    | 6 Days. | 10 Days. | 14 Days. | Shown<br>in Plate |
|--------------------|---------|----------|----------|-------------------|
| L and B agar.....  | 4 g.    | 4 g.     | 4 g.     | XII               |
| Na. asp. agar..... | 4 g.    | 4 g.     | 4 g.     | XII               |
| Starch.....        | 4 g.    | 4 g.     | 4 g.     |                   |

*4 Colonies from Soil and Starch to*

|                    | 6 Days. | 10 Days. | 14 Days. |
|--------------------|---------|----------|----------|
| L and B agar.....  | 4 g.    | 4 g.     | 4 g.     |
| Na. asp. agar..... | 4 g.    | 4 g.     | 4 g.     |
| Starch.....        | 2 g.    | 2 g.     | 2 g.     |
|                    | 2 —     | 2 —      | 2 —      |

*4 Colonies from Soil alone to*

|                      | 6 Days. | 10 Days. | 14 Days. |
|----------------------|---------|----------|----------|
| L and B agar.....    | 3 g.    | 3 g.     | 4 g.     |
|                      | 1 —     | 1 —      |          |
| Na. asp. agar.....   | 4 g.    | 4 g.     | 4 g.     |
| Starch.....          | 4 g.    | 4 g.     | 4 g.     |
| Soil and starch..... | 4 g.    | 4 g.     | 4 g.     |

*4 Colonies from Ammonium Nitrate and Starch to*

|                      | 6 Days. | 10 Days. | 14 Days. |
|----------------------|---------|----------|----------|
| L and B agar.....    | 4 g.    | 4 g.     | 4 g.     |
| Na. asp. agar.....   | 3 g.    | 4 g.     | 4 g.     |
|                      | 1 —     |          |          |
| Starch.....          | 4 g.    | 4 g.     | 4 g.     |
| Soil and starch..... | 3 g.    | 3 g.     | 3 g.     |
|                      | 1 —     | 1 —      | 1 —      |

*Summary 6 Days.*

|                                                         |                  |
|---------------------------------------------------------|------------------|
| 12 transfers to Wheat Straw Ext.....                    | 9 made growth.   |
| 12 transfers to Leaf Ext.....                           | 5 made growth.   |
| 32 transfers to Starch.....                             | 27 made growth.  |
| 12 transfers to Agar alone.....                         | 10 made growth.  |
| 12 transfers to Ammonium Nitrate.....                   | 12 made growth.  |
| 32 transfers to Na. asp. agar.....                      | 28 made growth.  |
| 12 transfers to Soil.....                               | 10 made growth.  |
| 20 transfers to Soil and Starch.....                    | 15 made growth.  |
| 32 transfers to L and B agar.....                       | 30 made growth.  |
| 12 transfers to $\text{NH}_4\text{NO}_3$ and St.....    | 10 made growth.  |
| 12 transfers to Soil and $\text{NH}_4\text{NO}_3$ ..... | 9 made growth.   |
| 12 transfers to Soil Ext.....                           | 12 made growth.  |
| <hr/>                                                   | <hr/>            |
| 212 transfers.....                                      | 177 made growth. |

*Summary 14 Days.*

|                                                         |                  |
|---------------------------------------------------------|------------------|
| 12 transfers to Wheat Straw Ext.....                    | 9 made growth.   |
| 12 transfers to Leaf Ext.....                           | 5 made growth.   |
| 32 transfers to Starch.....                             | 28 made growth.  |
| 12 transfers to Agar alone.....                         | 11 made growth.  |
| 12 transfers to Ammonium Nitrate.....                   | 12 made growth.  |
| 32 transfers to Na. asp. agar.....                      | 31 made growth.  |
| 12 transfers to Soil.....                               | 10 made growth.  |
| 20 transfers to Soil and Starch.....                    | 15 made growth.  |
| 32 transfers to L and B agar.....                       | 32 made growth.  |
| 12 transfers to $\text{NH}_4\text{NO}_3$ and St.....    | 11 made growth.  |
| 12 transfers to Soil and $\text{NH}_4\text{NO}_3$ ..... | 11 made growth.  |
| 12 transfers to Soil Ext.....                           | 12 made growth.  |
| <hr/>                                                   | <hr/>            |
| 212 transfers.....                                      | 187 made growth. |

*Notes.*

(1) In this set of tests, as in those run previously, there was very little growth on the agar alone, the soil, and the soil extract slants. Practically all the organisms tested made some growth on these media.

(2) Ammonium nitrate furnishing nitrogen both in  $\text{NH}_4$  and  $\text{NO}_3$  did not grow better cultures than agar alone. This latter is from observations made after fourteen days' incubation.

(3) Wheat straw extract grew but little better cultures than the soil extract, while leaf extract was a total failure as a media.

(4) Starch furnishing sources of energy, and being capable of being

split in many ways by enzymatic action, grew good cultures both alone and in combination with other materials.

(5) As noted in all other tests the Lipman and Brown agar grew the best cultures and apparently developed their distinguishing chromogenic characteristics much better than the sodium asparaginate agar.

(6) From macroscopic comparisons the starch media seemed to be the real competitor of the Lipman and Brown agar.

#### TUBE MEDIA TEST VI.

*Testing Organisms from Laurel Soils.*

*Plated on Lipman and Brown Agar.*

When transferred to slants of different media.

Samples taken 7/27/1915.

Description of colonies from which transfers were made:

No. 1. Round, curled edge, wrinkled in structure, green in color, a mold 1.5 cm. in diameter.

No. 2. Elliptical, curled edge, wrinkled in structure, green in color, a mold 1.5 cm. long.

No. 3. Round, lobate edge, wrinkled structure, brown (pale) in color, a mold 1 cm. in diameter.

No. 4. Round, entire edge, granular structure. White raised center with brown ring outside, apparently a mold about .5 cm. in diameter.

No. 5. Discoid, crenate edge, smooth structure, milk white in color, .5 cm. in diameter, a mold.

No. 6. Round, entire edge, smooth structure, salmon red in color, 3 mm. in diameter.

No. 7. Round, ciliate edge, granular structure. Yellow in color, deep yellow at center, about 1 cm. in diameter.

No. 8. Round, ciliate edge, granular center and fibrant outer portion describes structure. Center dark green, border light green, about 4 mm. in diameter.

No. 9. Round, plain edge, smooth in structure, salmon red with yellowish outside ring, produces yellow pigment soluble in media, about 4 mm. in diameter.

No. 10. Round though dented, crenate edge, spotted structure, white in color, about 8 mm. in diameter.

No. 11. Discoid, lobate edge, spotted structure, white in color with heavy black center, about 6 mm. in diameter.

No. 12. Round, entire edge, granular structure, heavy center, milk white in color, about 1 cm. in diameter.

No. 13. Round, entire edge, smooth structure, yellow in color, about 3 mm. in diameter.

No. 14. Round, entire edge, smooth structure, dark red in color, about 4 mm. in diameter.

No. 15. Round, entire edge, spotted structure, white with brown center, about 8 mm. in diameter.

No. 16. Discoid, lobate edge, wrinkled structure, yellowish white in color, about 8 mm. in diameter.

Observations of Growth and Relative Growth were made at end of 5th, 7th, and 15th days. Temperature of incubation, 22° to 23° C. on following media:

Lipman and Brown agar.

Conn's sodium asparaginate agar.

Ammonium nitrate agar.

Starch agar.

Ammonium nitrate and starch agar.

*Observations of Growth and Ranking 5 Days.*

| No.            | L and B<br>agar. | Na. asp.<br>agar. | NH <sub>4</sub> NO <sub>3</sub><br>agar. | Starch<br>agar. | NH <sub>4</sub> NO <sub>3</sub> and<br>Starch. |
|----------------|------------------|-------------------|------------------------------------------|-----------------|------------------------------------------------|
| 1. ....        | - 5%             | * 1               | * 4                                      | * 3             | * 2                                            |
| 2. ....        | * 4              | * 1               | * 3                                      | * 2             | - 5                                            |
| 3. ....        | - 5              | * 1               | - 5                                      | * 2 or 3        | * 2 or 3                                       |
| 4. ....        | - 5              | * 3               | * 1                                      | * 5             | * 2                                            |
| 5. ....        | * 5              | * 1               | * 3                                      | - 5             | * 2                                            |
| 6. ....        | * 2              | * 1               | * 5                                      | * 4             | * 3                                            |
| 7. ....        | * 3              | * 1               | - 5                                      | * 2             | * 4                                            |
| 8. ....        | * 1              | * 2               | * 4                                      | * 3             | * 5                                            |
| 9. ....        | * 2              | * 1               | * 4                                      | * 5             | * 3                                            |
| 10. ....       | * 1              | * 4               | * 3                                      | * 2             | - 5                                            |
| 11. ....       | * 1              | * 3               | - 5                                      | * 2             | - 5                                            |
| 12. ....       | * 1              | * 1               | * 1                                      | * 1             | * 1                                            |
| 13. ....       | * 5              | * 2               | * 3                                      | * 4             | * 1                                            |
| 14. ....       | * 1              | * 4               | * 5                                      | * 3             | * 2                                            |
| 15. ....       | * 4              | * 3               | * 5                                      | * 2             | * 1                                            |
| 16. ....       | * 2              | * 1               | * 3                                      | - 5             | * 4                                            |
| Av. all. ....  | 2.94             | 1.87              | 3.69                                     | 3.16            | 2.97                                           |
| Av. 6-16. .... | 2.10             | 2.10              | 3.91                                     | 3.00            | 3.10                                           |

\* = Growth.

- = No growth.

(%) No growth, ranked lowest so that a relative general average may be made.



*Observations of Growth and Ranking 7 Days.*

| No.           | L and B<br>agar. | Na. asp.<br>agar. | NH <sub>4</sub> NO <sub>3</sub><br>agar. | Starch<br>agar. | NH <sub>4</sub> NO <sub>3</sub> and<br>Starch Agar. |
|---------------|------------------|-------------------|------------------------------------------|-----------------|-----------------------------------------------------|
| 1.....        | - 5%             | * 1               | * 3                                      | * 2             | * 4                                                 |
| 2.....        | * 3              | * 2               | - 5                                      | * 1             | - 5                                                 |
| 3.....        | - 5              | * 1               | * 4                                      | * 2             | * 3                                                 |
| 4.....        | * 4              | * 1               | * 5                                      | * 3             | * 2                                                 |
| 5.....        | - 5              | * 2               | * 1                                      | - 5             | * 3                                                 |
| 6.....        | * 5              | * 4               | * 2                                      | * 1             | * 3                                                 |
| 7.....        | * 1              | * 2               | * 5                                      | * 3             | * 4                                                 |
| 8.....        | * 2              | * 1               | * 4                                      | * 3             | * 5                                                 |
| 9.....        | * 1              | * 2               | * 5                                      | * 4             | * 3                                                 |
| 10.....       | * 1              | * 2               | * 1                                      | * 3             | - 5                                                 |
| 11.....       | * 2              | * 1               | * 5                                      | * 4             | * 3                                                 |
| 12.....       | * 1              | * 2               | * 1                                      | * 1             | * 1                                                 |
| 13.....       | * 1              | * 2               | * 5                                      | * 4             | * 3                                                 |
| 14.....       | * 1              | * 4               | * 5                                      | * 3             | * 2                                                 |
| 15.....       | * 1 or 2         | * 1 or 2          | * 5                                      | * 4             | * 3                                                 |
| 16.....       | * 2              | * 1               | * 4                                      | - 5             | * 3                                                 |
| Av. all.....  | 2.50             | 1.81              | 3.76                                     | 3.00            | 3.25                                                |
| Av. 6-16..... | 1.64             | 2.00              | 3.72                                     | 3.18            | 3.18                                                |

\* = Growth.

- = No Growth.

(%) No growth, ranked lowest so that a relative general average may be made.

## Observations of Growth, Color of Growth and Ranking 15 Days.

| No.            | L and B agar.   | Na. asp. agar.     | NH <sub>4</sub> NO <sub>3</sub> agar. | Starch agar.      | NH <sub>4</sub> NO <sub>3</sub> and Starch Agar. |
|----------------|-----------------|--------------------|---------------------------------------|-------------------|--------------------------------------------------|
| 1. ....        | - 5             | * 1<br>Bl. Br. Gr. | * 4<br>White                          | * 2<br>Li. Green  | * 3<br>Bl. Gr.                                   |
| 2. ....        | * 1<br>Bl. Gr.  | * 3<br>Li. than 2  | * 4                                   | * 2<br>Li. than 1 | * 5                                              |
| 3. ....        | - 5             | * 1<br>Green       | - 5                                   | * 2<br>Green      | * 3<br>Wh.-Gr.                                   |
| 4. ....        | * 4<br>Cream    | * 1<br>White       | * 3<br>White                          | * 5<br>Li.-Gr.    | * 2<br>D.-Brown                                  |
| 5. ....        | - 5             | * 1<br>Heavy Wh.   | * 3<br>White                          | * 4<br>White      | * 2<br>White                                     |
| 6. ....        | * 4<br>Red      | * 3<br>Red         | * 5<br>White                          | * 1<br>Red        | * 2<br>White                                     |
| 7. ....        | * 1<br>Y.-White | * 3<br>Green       | * 5<br>White                          | * 4<br>Y.-Green   | * 2<br>Yellow                                    |
| 8. ....        | * 2<br>Green    | * 1<br>Green       | * 4<br>White                          | * 3<br>Y.-Green   | * 5<br>White                                     |
| 9. ....        | * 1<br>Y.-Red   | * 4<br>R.-Yell.    | * 5<br>White                          | * 3<br>Y.-White   | * 2<br>Y.-White                                  |
| 10. ....       | * 1<br>White    | * 3<br>White       | * 4<br>White                          | * 2<br>White      | - 5                                              |
| 11. ....       | * 3<br>Brown    | * 1<br>Brown       | * 5<br>White                          | * 4<br>White      | * 2<br>White                                     |
| 12. ....       | * 4<br>Br.-Wh.  | * 5<br>White       | * 3<br>Br.-Wh.                        | * 2<br>Br.-Wh.    | * 1<br>Br.-Wh.                                   |
| 13. ....       | * 1<br>P.-Gr.   | * 4<br>P.-Gr.      | * 5<br>P.-Gr.                         | * 3<br>P.-Gr.     | * 2<br>P.-Gr.                                    |
| 14. ....       | * 1<br>Red      | * 4<br>Cream       | * 5<br>D.-Wh.                         | * 3<br>Red        | * 2<br>Red                                       |
| 15. ....       | * 1<br>Br.-Wh.  | * 2<br>D.-Wh.      | * 5<br>D.-Wh.                         | * 4<br>Br.-Wh.    | * 3<br>Br.-Wh.                                   |
| 16. ....       | * 2<br>Br.-Wh.  | * 3<br>Y.-Wh.      | * 4<br>Br.-Wh.                        | - 5               | * 1<br>Br.-Wh.                                   |
| Av. all. ....  | 2.56            | 2.50               | 4.31                                  | 3.06              | 2.56                                             |
| Av. 6-16. .... | 1.91            | 3.00               | 4.55                                  | 3.09              | 2.45                                             |

\* = Growth.

- = No growth.

*Summary.*

## Average All Sixteen Organisms.

|              | L and B<br>agar. | Na. asp.<br>agar. | NH <sub>4</sub> NO <sub>3</sub><br>agar. | Starch<br>agar. | NH <sub>4</sub> NO <sub>3</sub> and<br>Starch Agar. |
|--------------|------------------|-------------------|------------------------------------------|-----------------|-----------------------------------------------------|
| 5 days.....  | 2.94             | 1.87              | 3.69                                     | 3.16            | 2.97                                                |
| 7 days.....  | 2.50             | 1.81              | 3.76                                     | 3.00            | 3.25                                                |
| 15 days..... | 2.56             | 2.50              | 4.31                                     | 3.06            | 2.56                                                |

*Summary.*

## Average Organisms 6 to 16 Inc.

|              | L and B<br>agar. | Na. asp.<br>agar. | NH <sub>4</sub> NO <sub>3</sub><br>agar. | Starch<br>agar. | NH <sub>4</sub> NO <sub>3</sub> and<br>Starch Agar. |
|--------------|------------------|-------------------|------------------------------------------|-----------------|-----------------------------------------------------|
| 5 days.....  | 2.10             | 2.10              | 3.91                                     | 3.00            | 3.10                                                |
| 7 days.....  | 1.64             | 2.00              | 3.82                                     | 3.18            | 3.18                                                |
| 15 days..... | 1.91             | 3.00              | 4.55                                     | 3.09            | 2.45                                                |

*Notes.*

(1) The comparisons between the growth of an organism on the different media were practically as marked at 5 days as they were at 15.

(2) The five molds Nos. 1, 2, 3, 4, 5, were more easily transferred to sodium asparaginate agar than to some of the media.

(3) Where molds are included the greatest number of failures of growth occurred on Lipman and Brown agar.

(4) Studying Nos. 6 to 16 inclusive, it was found that the Lipman and Brown and the Sodium asparaginate agar were about alike in amount of growths produced on slants, and that the ammonium nitrate agar was the poorest media considered.

(5) When chromogenesis is considered, Starch alone and in combination with the Ammonium nitrate brought out as much chromogenesis as the Lipman and Brown agar.

*Summary of Investigation.*

This paper gives the results of tests made on agar slants where the two media most commonly used for plating soils are compared. The results

of comparisons between these media, and comparisons of them—with agar alone, with soil, wheat and leaf extract media, with ammonium nitrate and starch media, both alone and in combination—showed that organisms once grown on media will generally grow when transferred to other media.

The rate of development seemed more important than the fact that the organism grew. Comparisons of growth at end of different periods of incubation were usually the same. Where growth was good it developed slowly enough so that it could not be termed a flash growth. Where growth was poor, distinguishing characteristics peculiar to the organism were rarely apparent.

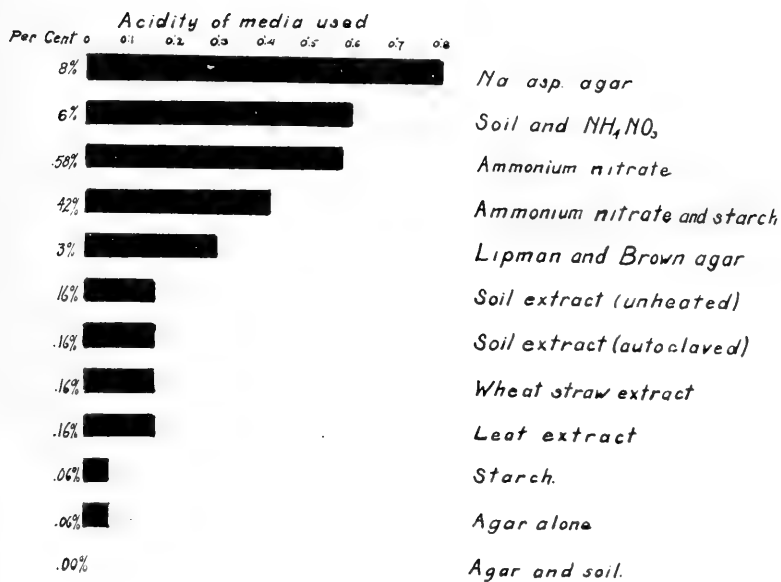
The explanation of the tolerance observed is not that those organisms growing when soil is plated on inferior media are probably the same organisms that yield the best colonies on better media. Picking out organisms plated on the best media and growing them on poorer media supports the above statement. Chromogenesis was augmented by the presence of carbohydrate in the media.

#### *Comment.*

Many expect that soil biology will explain results for which chemical and physical causes have not been found. Many look to the control of plant growth through the application of principles of microbiology.

Soils with their large or small amounts of decaying organic matter, of both plant and animal origin, must be a possible medium for the growth of all kinds of bacteria. One reason why the number of bacteria in our prairie soils has not been found to vary with the crop-producing power of the soil may be the tolerance of many kinds of bacteria to all present chemical and physical differences between types of prairie soil. In sandy and poor soils some believe that there is a relationship between the number of bacteria and the crop-producing power of the soil. The factors of temperature, aeration and moisture are more constant in the rich soil, and for this reason the changes in soil moisture, the variation in soil temperature, and the movement of soil gases must exert a more marked influence on the presence of and the activities of certain micro-organisms than the food factor does.

FIGURE 1



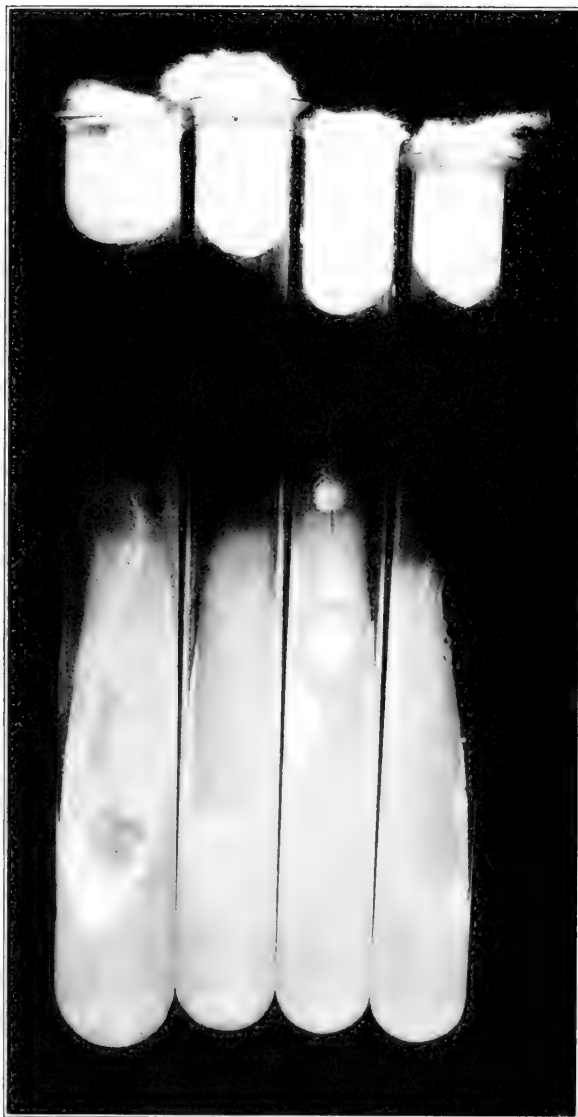


PLATE I.

4 Colonies from L. and B. agar on Na. asp. agar.

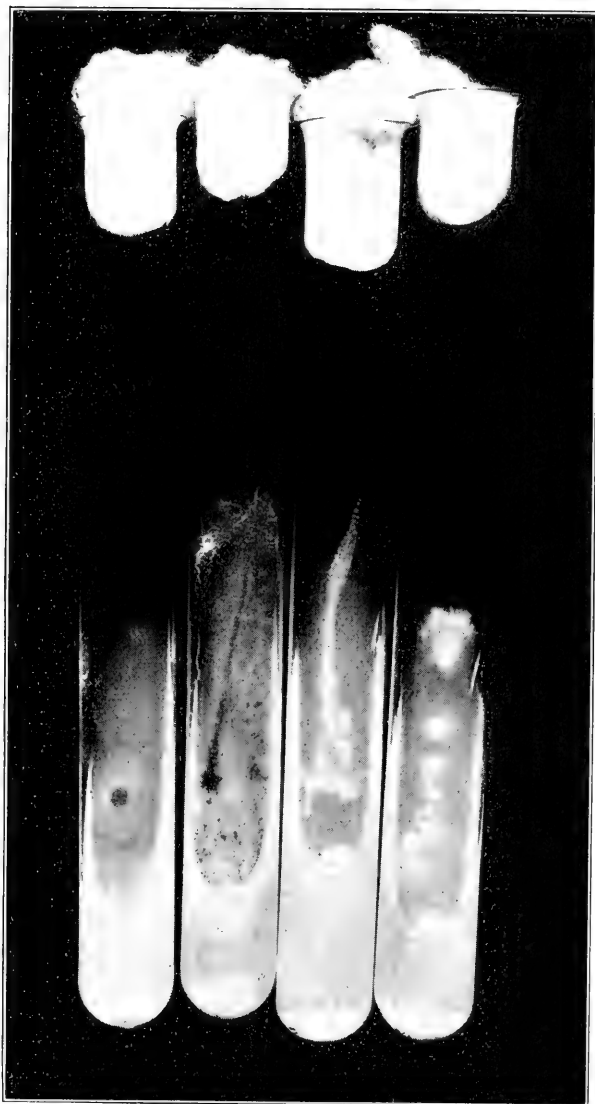


PLATE II.

4 Colonies from Na. Asp. agar on L. and B. agar

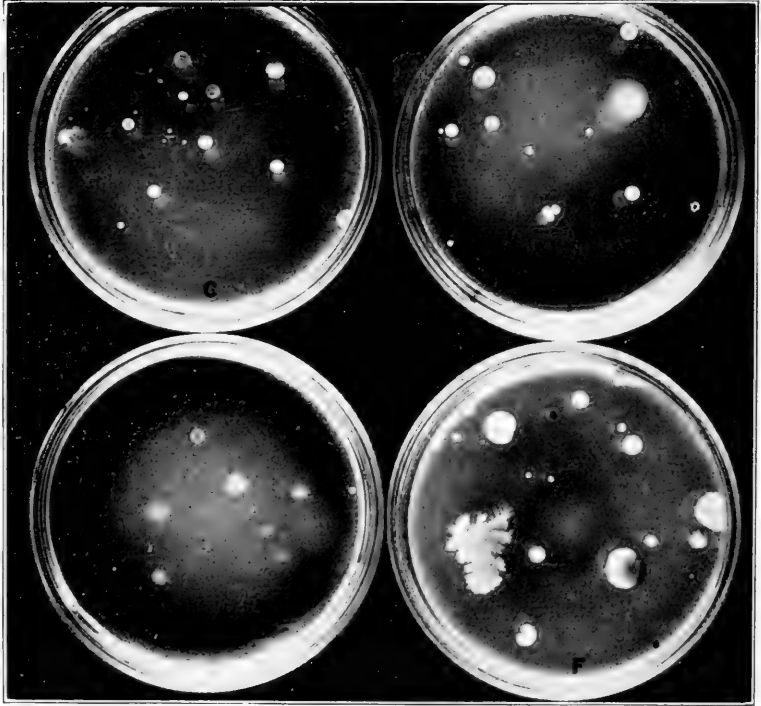


PLATE III.

Some of the plates from which organisms were obtained for tube media test V.



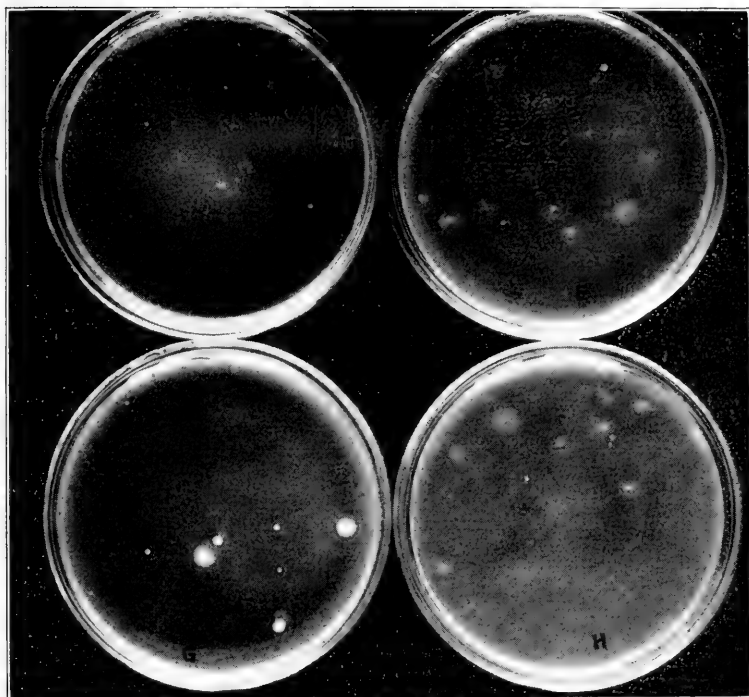


PLATE IV.

Some of plates from which organisms were obtained for tube media test V.

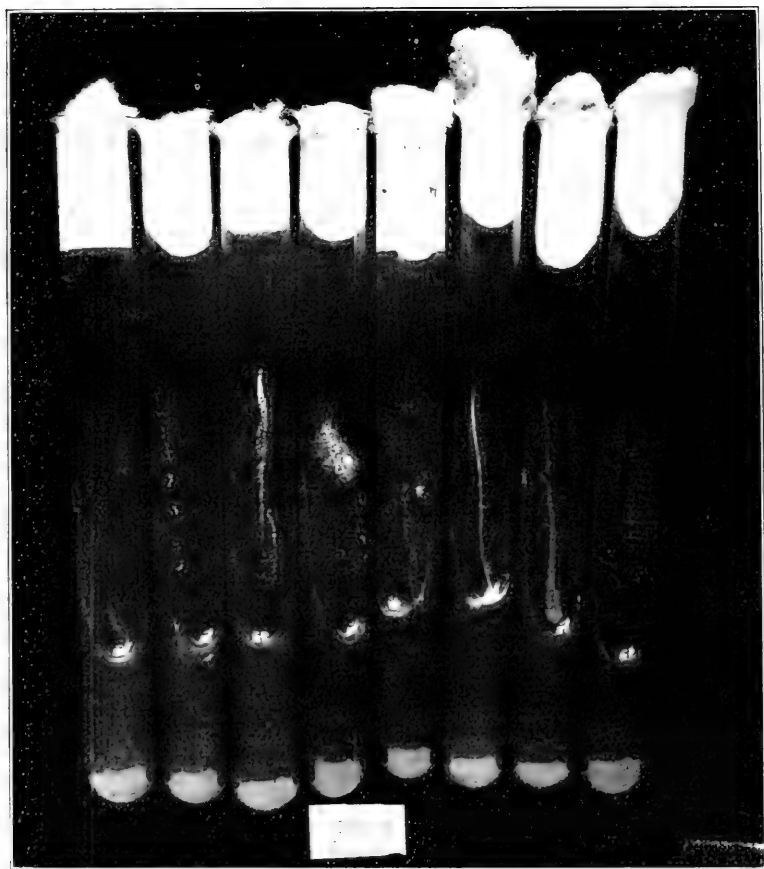


PLATE V.

At left: 4 organisms from L. and B. agar to wheat straw extract agar.  
At right: 4 organisms from Na. asp. agar to wheat straw extract agar.



PLATE VI.

At left: 4 organisms from L. and B. agar to starch agar.  
At right: 4 organisms from Na. asp. agar to starch agar.

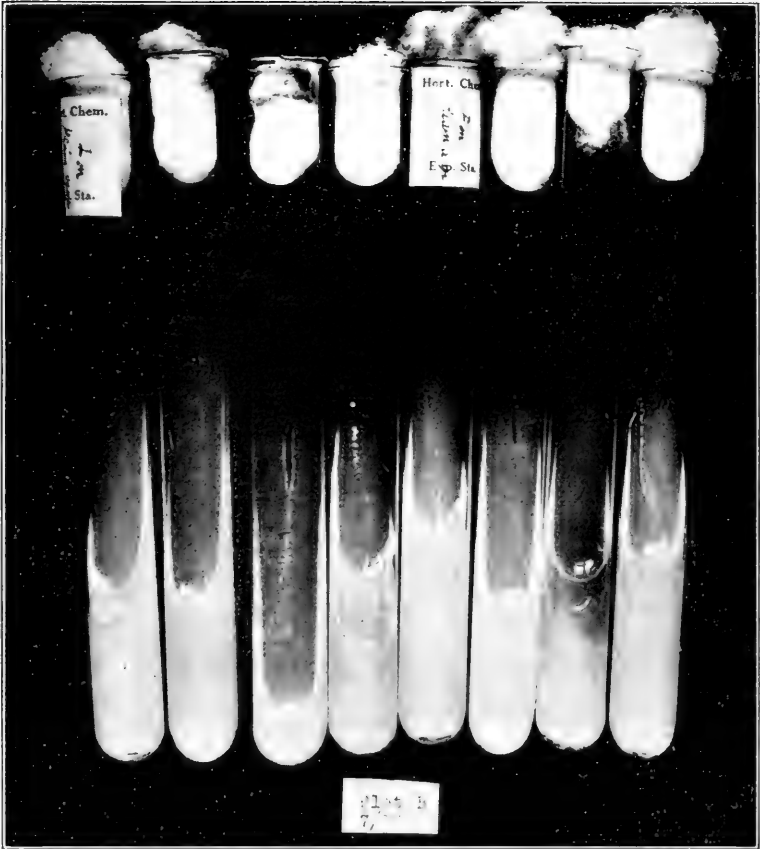


PLATE VII.

At left: 4 organisms from L. and B. agar to agar alone.  
 At right: 4 organisms from Na. asp. agar to agar alone.

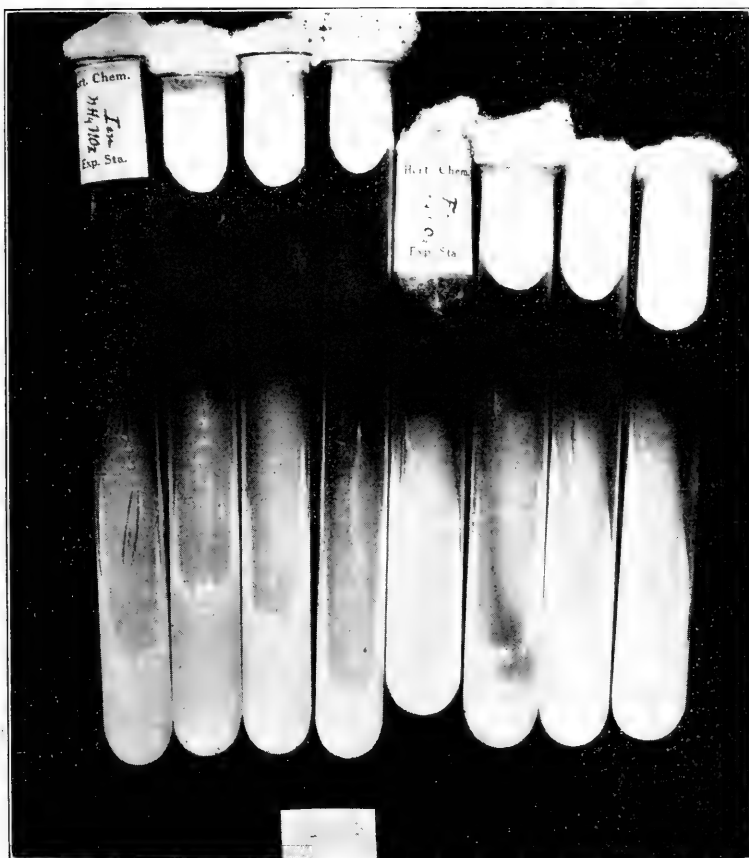


PLATE VIII.

At left: 4 organisms from L. and B. agar to ammonium nitrate agar.  
 At right: 4 organisms from Na. asp. agar to ammonium nitrate agar.

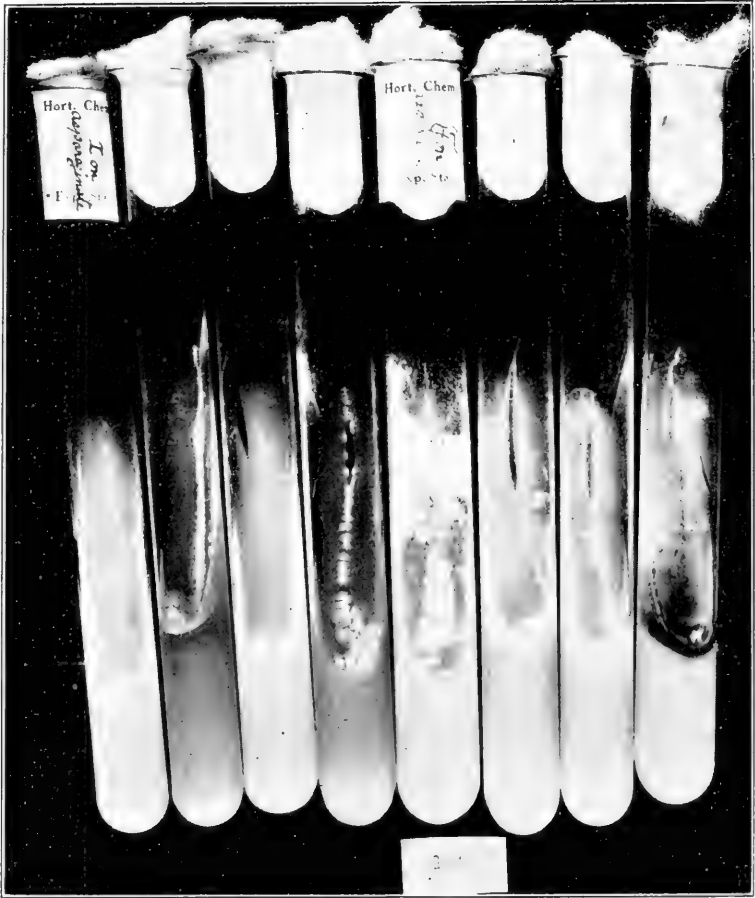


PLATE IX.

At left: 4 organisms from L. and B. agar to Na. asp. agar.  
At right: 4 organisms from Na. asp. agar to Na. asp. agar.

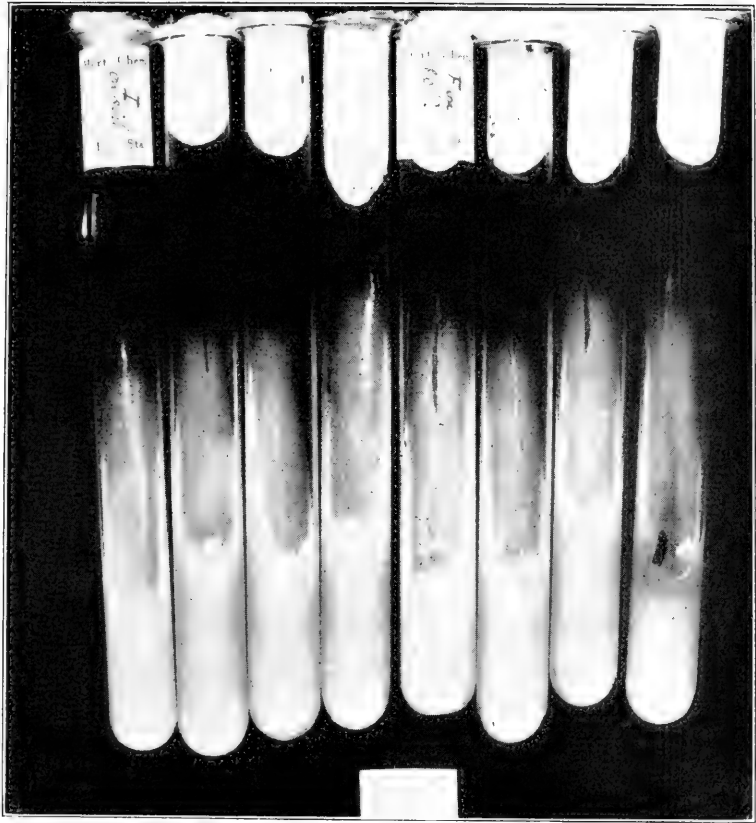


PLATE X.

At left: 4 organisms from L. and B. agar to soil and agar.  
At right: 4 organisms from Na. asp. agar to soil and agar.

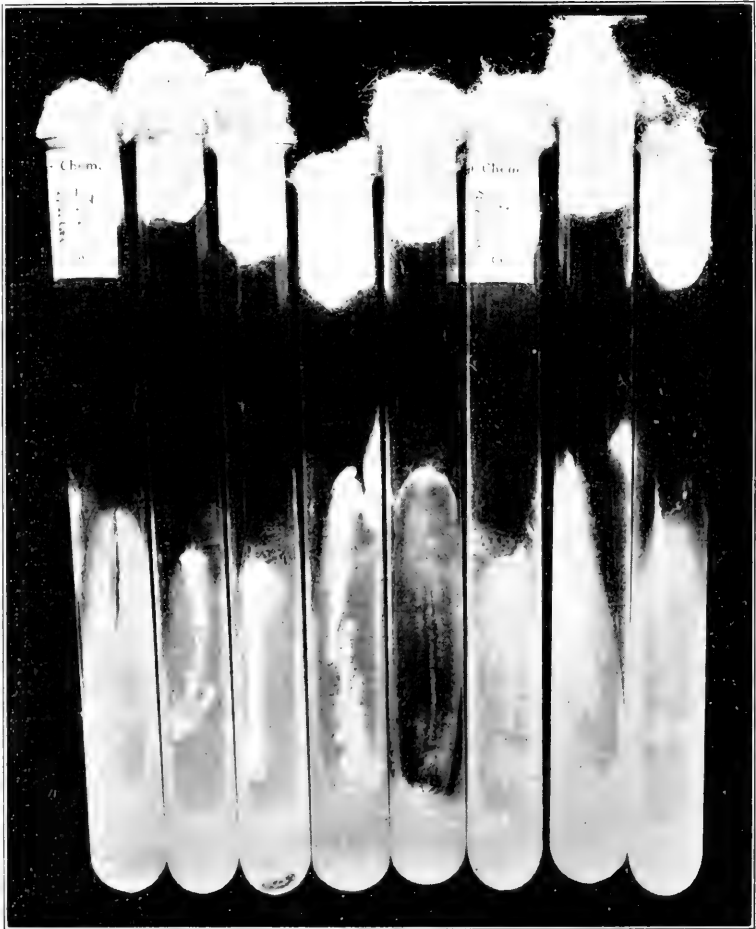


PLATE XI.

At left: 4 organisms from L. and B. agar to L. and B. agar.

At right: 4 organisms from Na. asp. agar to L. & B. agar.





## PLATE XII.

Extreme left: 4 organisms from agar alone on Na. asp. agar.  
 Left center: 4 organisms from agar alone on L. and B. agar.  
 Right center: 4 organisms from Na. asp. agar on Na. asp. agar.  
 Extreme right: 4 organisms from Na. asp. agar on L. & B. agar.



## SOME METHODS FOR THE STUDY OF PLASTIDS IN HIGHER PLANTS.

D. M. MOTTIER.

The following methods have been found to be satisfactory in the study of the primordia of chloroplasts, leucoplasts, and other apparently similar bodies in cells of liverworts and higher plants that are known under the name of chondriosmes.

### FIXING.

Chrom-osmic acid is the fixing agent chiefly used, and in the following proportions:

|                          |         |
|--------------------------|---------|
| Chromic acid, 1 %.....   | 17 cc.  |
| Osmic acid, 2 %.....     | 3 cc.   |
| Glacial acetic acid..... | 3 drops |

The specimens remain in this fluid from 36 to 48 hours, after which they are washed 12 to 24 hours in flowing water, or in several changes of water if flowing water is not available.

After careful dehydration the specimens are brought into paraffin, using chloroform as the solvent. Sections from 3 to 5 microns in thickness are cut, depending upon the nature of the tissue under consideration, and stained in the well-known iron-alum-haematoxylin stain. As a counter stain orange G dissolved in clove oil is sometimes very desirable.

### PROCEDURE WITH THE IRON-HAEMATOXYLIN.

After the preparations have been freed from paraffin and from the solvent used in removing the paraffin (turpentine or xylol) by means of absolute alcohol, they are allowed to stand in the mordant from two hours to over night. As a mordant a 3 per cent. aqueous solution of the double iron salt is used (ferrie ammonium sulphate  $(\text{NH}_4)_2 \text{Fe}_2(\text{SO}_4)_4 \cdot 24 \text{H}_2\text{O}$ ). The preparations are now poured off with water and stained over night in a  $\frac{1}{2}$  per cent. aqueous solution of haematoxylin. From the stain they are again poured off with water and destained with the above iron salt. The destaining is watched under the microscope. After the desired stain has been reached, and this

is determined by trial, the preparations are washed for about 15 minutes in gently flowing water. They are now dehydrated by treating with absolute alcohol, after which they may be counter stained with clove oil orange G or merely cleared in clove oil and cedar oil and mounted in balsam.

In case counter staining is desired, the process should be watched in order to avoid over-staining with the orange. In some cases the clove oil orange G need remain on the sections but half a minute. This stain may be removed by xylol, cedar oil, or pure clove oil, when the preparation is ready to be mounted in balsam.

By this method the primordia of chloroplasts and leucoplasts and other similar bodies are stained black or a blue-black.

The foregoing is much simpler than Benda's procedure, and it gives results that are as satisfactory. However, since it is desirable in cytological studies to check up one method with another, the procedure devised by Benda is recommended, although it is more tedious and time-consuming. The following modification of Benda's method has been used with excellent results:

1. Fix in chrom-osmic acid of the above-mentioned composition 24 to 48 hours.
2. Wash in water 1 to 2 hours.
3. Treat objects with equal parts pyroligneous acid (rectified) and 1 per cent. chromic acid 24 hours.
4. Treat with 2 per cent. solution bichromate of potassium 24 hours.
5. Wash in water 24 hours.
6. Bring into paraffin and section in case sections are to be made.
7. Treat with the iron mordant 12 to 24 hours.
8. Pour off with water and treat 10 to 20 minutes with alizarin.
9. Pour off with water and let dry in the air.
10. Stain now with Benda's crystal violet by warming gently to the point of forming vapor. Allow the preparation to cool for 5 to 10 minutes, after which pour off with water and let the preparation dry in air, standing the slide on end.
11. Destain with 5 per cent. acetic acid under microscopic control. This requires from a few seconds to a minute.
12. When the desired stain is reached, pour off with water, dehydrate with absolute alcohol, and counter stain, if desirable, with clove oil orange G. This stain is now removed with xylol or cedar oil, and the preparation is mounted in balsam.

As a result, the chloroplasts, chondrisomes, etc., are stained a deep blue, the cytoplasm a light orange or almost colorless, and the cell walls varying intensities of orange.

The writer has never been able to see the use of the treatment with alizarin, and this part of the process may be omitted. However, Benda's solution of alizarin is made as follows: Make a saturated solution of Kahlbaum's alizarin-sulfo-saurem Natron (mono.) in 70 per cent. alcohol. One cc. of this solution is added to 80 to 100 cc. of water.

Benda's crystal violet solution is made as follows:

|                                                            |          |
|------------------------------------------------------------|----------|
| Saturated solution crystal violet in 70% alcohol . . . . . | 1 part.  |
| 1% hydrochloric acid in 70% alcohol . . . . .              | 1 part.  |
| Anilin water . . . . .                                     | 2 parts. |



## THE MORPHOLOGY OF RICCIA FLUITANS L.

---

FRED DONAGHY.

---

Since 1835 the Riccias have received more or less attention by the botanists. Bischoff, Lindenburg, Hoffmeister, Leibgeb, Garber, Lewis, Campbell, Black and Atwell, have in turn made many valuable contributions to our knowledge of this group. Still many problems of morphology and ecology confronts us. Several species common to Indiana remain almost unstudied as to detail. Among these none seem more interesting than the study of *R. fluitans*.

This species is widely distributed over the temperate zone and over glaciated Indiana. Botanists recognize two forms, an aquatic and a terrestrial type. The aquatic form is very abundant around Angola, Fort Wayne, Logansport and Terre Haute. During the summer and autumn mats of aquatic *R. fluitans* can be found floating in the ponds and sluggish streams. In winter these mats sink to the bottom of the ponds and remain there till spring. The continued cold does not seem to injure the plants which lie below the ice, but those plants which are frozen in the ice are much winter-killed, the apical ends alone remaining green. During the warm spring these plants make rapid growth, and by summer patches of thalli again dot the ponds and streams, showing that under favorable weather conditions the thalli reproduce vegetatively very rapidly.

Aquatic *R. fluitans* is sterile, branches dichotomously, the sprouts diverging widely, and often become recurved. The apical ends are deeply notched, and truncate. Both dorsal and ventral surfaces bear chlorophyll. Rhizoids and ventral scales are absent.

When evaporation is excessive and the ponds are low, the narrow thalli widen at their apical ends somewhat, and lose some of their characteristic color. This is especially noticeable in those plants which grew in unshaded ponds. The thalli which grew in ponds bordered by forest trees did not show a marked change in width and color, due no doubt to the protection afforded by the overhanging boughs and leaves. When single thalli are washed ashore they generally die. More often, mats of plants are washed upon the wet edges of the ponds. In favored places the thalli coming in con-

tact with the wet soil develop rhizoids, ventral scales, and open air chambers, while those whose apical ends do not touch the soil dry and soon die, giving some shade to the delicate plants below. My observations have not been conducted over a sufficient period of time to determine fully whether these plants produce sex organs and fruit as some observers would have us think, actually occurred. In the Deming ponds east of the city limits of Terre Haute aquatic *R. fluitans* grows abundantly. During the summer and autumn of 1913 these loess encircled ponds became dry due to the long continued drought; however, many thalli remained alive in wet shaded places throughout the dry season. These plants remained in contact with the earth sufficiently long to fruit, judging from experiments made upon other *Riccia*, however, no sporophytes were found. When weather conditions were more favorable for hepatic growth searches were made for rosettes and thalli typical of terrestrial *R. fluitans* but none were found, indicating that spores had not been produced or had not had time to germinate. Weather conditions of 1914 were similar to those of the fall of 1913. At intervals during the autumn frequent observations were made but yielded no satisfactory evidence. Again in 1915 careful searching was done, without gaining additional results. Similar observations were made at Rosedale in the "Nigger Lake" region, no rosettes or thalli on the mud were found. Judging from these observations it seems very doubtful if the aquatic form ever changes into the terrestrial form or fruits but reproduces vegetatively only. It is very doubtful if the so-called terrestrial *R. fluitans* and the aquatic *R. fluitans* belong to the same species.

The terrestrial *R. fluitans* is not common in this region; however, it occurs in small patches on mud flats and wet fields during the autumn. It generally grows in rosettes due to the fact that the spores are not scattered but held within the archegonium pit, and that the sporophyte is generally buried in the mud. The thalli are about one-quarter inch long and less than an eighth of an inch wide. The plants have a characteristic green which is tinged with purple late in the autumn. Numerous rhizoids develop from the ventral side. A single row of scale leaves which split into two rows grow just beneath the apical cell. The most prominent ventral mark of identification is the protruding sporophyte. The dorsal surface is cut by a furrow which deepens at the apical end into which the pores of the alternating sex organs open, and down which the sperms are carried by moisture. Above the fertilized egg develops a tongue-like projection which covers the mouth of the archegonium.



gonial pore, much the same as a similar structure does in *Pellia*. Stoma each being surrounded by four cells open into deep air chambers.

The thallus develops from one or more apical cells as do other Riccians described. This is a large triangular cell in longitudinal section, situated at the forward end of the growing thallus. The thallus is only three or four cells thick beneath the dorsal furrow. In section air chambers appear very large and numerous. They develop probably in three ways: (1) by internal splitting; (2) by the parting of cell rows for long distances; and (3) by the process so well described by Leibgeb for the hepatics.

The sex organs develop in general in the same way as described for other liverworts. The mature archegonium consists of two base cells, ventral and neck cells, four cover cells, four neck canal cells, ventral canal cell and an egg. The funnel-shaped mouth of a mature archegonium opens often just below the pore of a mature antheridium or recurves away from the growing point. This is a fine adaptation to catch the sperm as they come from the antheridium.

The antheridium consists of a stalk, a sterile coat of tabular cells, and a mass of deeply staining cubical cells. It never protrudes above the surface of the thallus but lies buried deeply in the thalloid tissue.

The sporophyte develops rapidly. In its early stages it is oval but as it matures it becomes spheroid. The sporogenous tissue round off and tetrads are produced in the usual manner. The mature spore varies much in size, being 75-90 microns wide. Its outer surface is deeply areolate, the other faces being less areolate. Three distinct walls can be seen in cross-section, an inner wall that does not stain well, a middle deeply-staining wall, and an outer which seems to separate readily. The nucleus containing a distinct nucleolus is small. Starch and oil are stored throughout cytoplasm.

#### CONCLUSIONS.

Botanists recognize two distinct forms of *R. fluitans*, a terrestrial and an aquatic form. It seems very doubtful if the aquatic ever changes into the terrestrial and fruits as observers have portrayed, but always reproduces vegetatively.

The thallus, sex organs, and sporophytes develop in general as described for other liverworts. The spores remain within the archegonial pit, are not generally scattered by the elements, and vary much in size.



## PLANTS NOT HITHERTO REPORTED FROM INDIANA. VI.

---

 C. C. DEAM.
 

---

The following plants have not been recognized as members of the Indiana flora. Specimens of the species reported are in the writer's herbarium. The species in *Rubus* and *Viola* were determined by Ezra Brainard. The *Parthenocissus* and *Vitis* were determined by C. S. Sargent. The Gramineae were determined by Agnes Chase. The determination of the remaining species was checked by the Gray Herbarium. The species in *Rubus* and *Viola* have been made possible by the breaking up of aggregates and the recognition of hybrids.

*Paspalum pubescens* Muhl.

Martin county, July 11, 1915. No. 17,161. In a woods pasture about three miles north of Shoals near Cedar Bluffs along White River. In Sullivan county, August 25, 1915. No. 18,229. On the border of a woods road in a beech woods about three miles northeast of Grayville.

*Sorbus Aucuparia* L.

Laporte county, May 2, 1911. No. 7,992. In a sandy black oak woods about three miles north of Laporte. This tree upon my authority was reported by J. A. Nieuwland in the *Midland Naturalist*, Vol. 4, 175, 1915, as *Sorbus americana* Marsh.

*Prunus Mahaleb* L.

Jefferson county, September 9, 1915. No. 18,862. In a woods pasture along Thrifty Creek about one mile above Clifty Falls. Martin county, August 31, 1915. No. 18,403. Several trees about four inches in diameter along the roadside about half a mile north of Loogootee. Ripley county, June 18, 1915. No. 16,129. A tree six inches in diameter on the rocky wooded slope of Laugherty Creek just east of Versailles.

*Rubus allegheniensis* Porter.

Allen county, June 3, 1906. No. 1,051. Wooded bank of the St. Joe River near Robison Park. Fountain county, June 4, 1905. In a woods just west of Veedersburg. Lagrange county, June 6, 1915. No. 15,946.

In sandy soil along the road on the east side of Pretty Lake. Steuben county, June 12, 1904. In a woods near Clear Lake. Wells county, May 21, 1903. Along a rail fence about two miles east of Bluffton.

*Rubus allegheniensis x argutus.*

Lagrange county, June 6, 1915. No. 15,883. On the low border of a marsh which is just south of Twin Lakes which are about two miles northwest of Howe.

*Rubus argutus Link.*

Clarke county, July 30, 1909. In a fallow field on the Forest Reserve. Decatur county, May 26, 1912. No. 10,777. Wooded slope along Flat Rock River about a half mile north of St. Paul. Dubois county, July 6, 1912. No. 11,621. Roadside bordering a woods a half mile north of Birdseye. Greene county, May 26, 1911. No. 10,711. In an open woods one mile southeast of Bushrod. Harrison county, June 24, 1915. No. 16,365. In a sandy woods about three miles east of Elizabeth. Marion county, May 30, 1913. No. 8,513. Along the C. H. & D. Railroad near Irvington. Monroe county, July 17, 1915. No. 17,471. Roadside five miles south of Bloomington. Perry county, July 4, 1912. No. 11,501. Along a rail fence about six miles west of Derby. Pike county, July 7, 1915. No. 16,967. In a beech woods one mile east of Union. Posey county, May 23, 1911. No. 8,277. Roadside bordering a woods three miles west of Hovey Lake. Ripley county, June 19, 1915. No. 16,136. In a beech and sugar maple woods two miles northwest of Cross Plains. Shelby county, June 29, 1912. No. 11,337. Taken by Mrs. Chas. C. Deam in a woods southwest of Morristown. Spencer county, June 28, 1915. No. 16,588. Roadside one mile south of St. Meinard. Wells county, July 26, 1914. No. 14,468. In a beech woods eleven miles northeast of Bluffton.

*Rubus argutus x invisus.*

Hendricks county, June 1, 1912. No. 10,825. Taken by Mrs. Chas. C. Deam on the flood plain bank of Little Walnut Creek about two and a half miles south of North Salem.

*Rubus argutus x procumbens.*

Decatur county, July 15, 1911. No. 9,210. Wooded bank of Flat Rock River about a half mile north of St. Paul.

*Rubus invisus* Bailey.

Brown county, June 16, 1912. No. 11,144. Along the road between Helmsburg and Nashville about one mile from Helmsburg. Clarke county, July 30, 1909. No. 5,418A. In a fallow field on the Forest Reserve.

*Rubus procumbens* Muhl.

Allen county, June 3, 1906. No. 994. In a sandy clearing about two miles south of Fort Wayne. Greene county, May 26, 1911. Frequent in fields and along the railroad near Bushrod. Perry county, July 4, 1912. No. 11,499. Roadside about six miles west of Derby. Ripley county, May 19, 1912. No. 10,611. Common in fields south of Morris. Steuben county, May 28, 1905. In a low thicket on the east side of Clear Lake.

*Rubus recurvans* Blanchard.

Elkhart county, June 4, 1912. No. 10,935. In an open woods two miles northwest of Middlebury. Lagrange county, June 5, 1915. No. 15,981. In a dry sandy clearing along Pigeon River about ten miles northeast of Lagrange. Whitley county, July 19, 1914. No. 14,426. On the wooded bank of the south side of Round Lake.

*Stylosanthes biflora* var. *hispidissima* (Michx.) Pollard & Ball.

Knox county, July 8, 1915. No. 17,068. In the Knox sand along the railroad about three miles south of Vincennes.

*Tragia macrocarpa* Willd.

Crawford county, September 4, 1915. No. 18,583. Roadside at the base of the Ohio River Bluffs a quarter of mile west of Leavenworth. Orange county, July 14, 1915. No. 17,387. Rocky bluff along Lick Creek about two miles west of Paoli. This species was noted in other Ohio River counties but no specimens were taken.

*Euphorbia Peplus* L.

Wells county, August 5, 1915. No. 17,913. Abundant in the side ditch and in the yard of E. Y. Sturgis at the north end of Johnson street in Bluffton. It has been established here several years.

*Vitis cinerea* Engelm.

Bartholomew county, September 15, 1912. No. 12,412. On the wooded border of a gravel pit three miles north of Columbus. Gibson county, Sep-

tember 4, 1911. No. 9,945. Wooded bank of White River about five miles northwest of Patoka. Johnson county, September 15, 1915. No. 19,081. Dry sandy bank along the roadside three miles north of Edinburg. Marion county, September 5, 1911. No. 10,058. Wooded bank of White River near Buzzard's Roost. Scott county, June 22, 1915. No. 16,303. In a clearing one mile south of Scottsburg. Shelby county, July 14, 1912. No. 11,666. Taken by Mrs. Chas. C. Deam along Brandywine Creek one mile east of Fairland. Vermillion county, September 29, 1912. No. 12,469. In an open woods two miles west of Hillsdale. Also along the Wabash River two miles south of Hillsdale.

*Parthenocissus vitacea Hitch.*

Blackford county, July 9, 1910. No. 7,032. Along a fence two miles northeast of Hartford City. Miami county, July 23, 1915. No. 17,903. Limestone ledge of the Mississinewa River about five miles southeast of Peru. Porter county, August 22, 1915. No. 18,043. On top of a wooded dune bordering Lake Michigan at a point five miles north of Chesterton. Steuben county, July 5, 1914. No. 14,384. On a roadside fence about two miles northwest of Pleasant Lake. Tippecanoe county, July 22, 1915. No. 17,742. Roadside fence seven miles north of Battle Ground. Wayne county, July 3, 1913. No. 13,548. In a woods one and a half miles west of Centerville. Wells county, June 24, 1906. No. 1,127. On a rail fence forty rods east of Bluffton.

*Viola affinis LeConte.*

Allen county, May 2, 1915. No. 15,569. In a sandy clearing on the Godfrey Reserve about three miles south of Fort Wayne. Grant county, May 22, 1915. No. 15,760. Low border of a lake about five miles northeast of Fairmount. Lagrange county, May 17, 1915. No. 15,641. In a tamarack swamp three miles east of Howe. Noble county, May 17, 1915. No. 15,673. In a wooded swamp about one mile southwest of Rome City. Wells county, May 12, 1915. No. 15,633. In sphagnum on the south side of the lake in Jackson Township.

*Viola affinis x triloba.*

Clarke county, May 25, 1910. No. 6,460. In a woods just west of Tract thirty-three on the Forest Reserve.

*Viola cucullata x sororia.*

Lagrange county, June 5, 1915. No. 15,998. Growing in sphagnum in a low woods bordering Pigeon River about four miles east of Mongo. My numbers 15,881, 15,915, 15,993 and 16,002 are the same species and taken in different parts of the same county.

*Viola incognita var. Forbesii Brainard.*

Allen county, May 9, 1915. No. 15,606. In an old tamarack swamp on the south side of Lake Everett about ten miles northwest of Fort Wayne. Lagrange county, May 17, 1915. No. 15,650. In a tamarack swamp about three miles east of Howe. Wells county, May 12, 1915. No. 15,619. In the low border of the small lake in Jackson Township associated with *Acer saccharinum* and *Populus tremuloides*.

*Viola nephrophylla Greene.*

Grant county, May 22, 1915. No. 15,745. In a boggy creek bottom near the bridge over the Mississinewa River about four miles southeast of Gas City. Noble county, May 17, 1915. No. 15,674. In the low marl border of Deep Lake one mile south of Wolf Lake.

*Viola papilionacea x triloba Brainard.*

Clay county, May 4, 1913. No. 12,613. Frequent along the bank of Crox Creek about one mile east of Harmony.

*Viola pedatifida x sororia Brainard.*

Wells county, May 12, 1915. No. 15,626. In rather dry soil on the shaded bank of the lake in Jackson Township.

*Viola sagittata x triloba Brainard.*

Whitley county, May 17, 1915. No. 15,682. In a white oak woods about four miles east of Columbia City.

*Viola triloba Schwein.*

Clarke county, May 11, 1910. No. 5,882. In a wooded ravine at the base of the "knobs" on the Forest Reserve. Decatur county, May 5, 1912. No. 10,459. Taken by Mrs. Chas. C. Deam on a wooded slope along Flat Rock River about a half mile north of St. Paul. Hancock county, May 14, 1912. No. 10,517. Taken by Mrs. Chas. C. Deam in a wet woods one and

a half miles southeast of Juliette. Henry county, May 10, 1911. No. 8,117. In a moist rich woods one mile northeast of Spiceland. Jefferson county, September 9, 1915. No. 18,855. In a woods one mile west of Chelsea. Johnson county, May 8, 1910. No. 5,782. Wooded hillside about three miles south of Franklin. Lagrange county, June 6, 1915. No. 15,865. In a woods on the north side of Cogg Lake about four miles south of Lagrange. Vermillion county, May 8, 1910. No. 5,840. Wooded hillside one mile northwest of Hillsdale. Whitley county, August 23, 1914. No. 14,543. In a white oak woods about four miles east of Columbia City.

*Verbena bracteosa* Michx. *x* *urticaefolia* L.

Lawrence county, July 13, 1915. No. 17,287. In sandy soil along the roadside about a half mile north of Lawrenceport.

*Bacopa rotundifolia* (Michx.) Wetts.

Orange county, July 14, 1915. No. 17,376. In a pond near the Washington county line along the Paoli and Salem road one and a half miles south of Bromer. Also noted in a pond near the road about three miles south of Orleans. Washington county, September 12, 1915. No. 18,983. In a pool in a pasture field about six miles west of Pekin. Also noted in a pond about four miles west of Salem.

*Solidago erecta* Pursh.

Clarke county, September 11, 1915. No. 18,946. On a *Quercus Prinus* Ridge about two miles southwest of Borden. Harrison county, September 6, 1915. No. 18,720. On a *Quercus Prinus* ridge about a half mile west of Stewart's Landing, which is three miles east of Elizabeth. Washington county, September 12, 1915. No. 19,000. On a *Quercus Prinus* ridge about ten miles north of Salem, and about one mile south of the Museatatuck River. In all the locations where this species was noted it was growing in sterile soil, associated with *Solidago bicolor*.



## INDIANA FUNGI—III.

---

 J. M. VAN HOOK.
 

---

The fungi recorded in the following list, were for the most part collected from 1911 to 1914. Two of these years (1913 and 1914) were so dry that the collecting of certain groups of fungi was practically abandoned. The year 1915 was a record one for the growth of all kinds of fungi and large collections were made for future study.

A limited number of fungi already recorded occur herein, as these have been found on new hosts.

Great care has been exercised in determining the host species, a thing too much neglected by collectors in the past.

Most of the species have been collected in Monroe county. Where the name of the county is not given, it is understood that the specimen was found in Monroe county. All collections were made by myself unless otherwise specified.

## PHYCOMYCETES.

*Albugo bliti* (Biv.) O. Kuntze. On living leaves of *Amaranthus retroflexus*. Common. Monroe county, September, 1915.

*Albugo ipomoea-panduratae* (Schw.) Swingle. On leaves and stems of *Ipomoea hederacea*. Monroe county, August 2, 1915.

*Chaetocladium jonesii* Fresenius. Parasitic on *Mucor* in culture, in the greenhouse. December 28, 1912. C. E. O'Neal.

*Piptocephalis freseniana* De Bary. On *Mucor*. Greenhouse, December 28, 1912. O'Neal.

*Phycomyces nitens* (Ag.) Kze. On horse dung brought into greenhouse, January 7, 1913. O'Neal.

*Plasmopara viticola* (B. & C.) Berl. & DeToni. On leaves of *Vitis cordifolia*. July, 1915. Very destructive.

*Thamnidium elegans* Link. On dung in greenhouse, December 22, 1912.

## BASIDIOMYCETES.

## USTILAGINEAE.

*Ustilago neglecta* (Niessl.) Rab. On *Chaetochloa*, Montgomery county, 1913. Flora Anderson.

*Ustilago rabenhorstiana* (Kuehn.) Hedw. On *Syntherisma sanguinale*. Montgomery county, 1913. Anderson.

## TILLETIINEAE.

*Entyloma lobeliae*. Farlow. On living leaves of *Lobelia inflata*. October 16, 1915. Forms discolored (light yellow) spots on the upper surface of the leaves.

*Urocystis anemones* (Pers.) Wint. On *Hepatica acutiloba*. Brown county. May 16, 1915. Donaghy. University Farm, Lawrence county, June, 1915.

## POLYPORCEAE.

*Spongipellis occidentalis* Murr. On dead oak log. Helmsburg, Brown county, May 16, 1915. Donaghy.

*Spongipellis unicolor* (Schw.) Murr. On *Acer*, Cascades, fall of 1914. Donaghy.

## AGARICACEAE.

*Crepidotus fulvotomentosus* Pk. On decayed log, Brown county, October 24, 1914.

## LYCOPERDINEAE.

*Bovistella ohioensis* Morg. On the ground in an open field. November, 16, 1914. Donaghy.

## ASCOMYCETES.

## HELVELLINEAE.

*Helvella elastica* Bull. On the ground. University Water Works, May 19, 1915. Harvey Stork.

## PEZIZINEAE.

*Pseudopeziza medicaginis* (Lib.) Sacc. On alfalfa. Autumn of 1912.

*Sarcoseypha occidentalis* Schw. On buried sticks. University Water Works, May 19, 1915. Stork.

## HYSTERIINEAE.

*Hysteriographium gloniopsis* Gerard. On dead wood of *Acer saccharinum*. Huckleberry Hill, November 25, 1910.

*Hysteriographium mori* (Schw.) Rehm. On rails of *Liriodendron tulipifera* and *Juglans nigra*, East campus, October 26, 1915.

## PYRENOAMYCETINEAE.

## PERISPORIALES.

*Erysiphe cichoracearum* D. C. On living leaves of *Plantago rugelii*, *Vernonia noveboracensis*, *Ambrosia trifida* and *Solidago*. Summer of 1911. Sutton.

*Microsphaera alni* (D. C.) Wint. On leaves of *Platanus occidentalis*. Summer of 1912. Sutton.

*Microsphaera elevata* Burr. On leaves of *Catalpa speciosa*. Autumn of 1911. Sutton.

*Phyllactinia corylea* (Pers.) Karst. On *Fraxinus sambucifolia*, Ladoga, Montgomery county, September 16, 1913. Anderson.

*Sphaerotheca castagnei* Lev. On living leaves of *Taraxicum officinale*, 1911. Sutton.

*Uncinula necator* (Schw.) Burr. On cultivated grapes. September, 1912.

*Uncinula adunca* Lev. On leaves of *Salix nigra*, autumn of 1911. Sutton.

## HYPOCREALES.

*Gibberella saubinetii* (Mont.) Sacc. On wheat, 1911.

## SPHAERIALES.

*Hypoxylon annulatum* (Schw.) Mont. On *Fraxinus americana*. January 17, 1914. Ramsey.

*Hypoxylon effusum* Nitschke. On *Fagus ferruginea*, March 4, 1909; *Quercus*, November 20, 1913. Ramsey.

*Hypoxylon perforatum* (Schw.) Fr. On *Juglans nigra*. January 17, 1914. Ramsey.

*Massaria inquinans* (Tode) Fr. On *Acer*. December 8, 1911.

*Rosellinia aquila* (Fr.) DeNot. On *Acer*. March 6, 1902. Mutchler; on *Juglans*, Unionville, 1911; on *Ostrya*, November 20, 1913, and on *Fagus ferruginea*, December 16, 1913. Ramsey.

*Rosellinia glandiformis* E. & E. On *Liriodendron tulipifera*, 1907; on *Juglans*, November 20, 1913; and on *Fraxinus*, Boone county, January 17, 1914. Ramsey.

*Rosellinia ligniaria* (Grev.) Nke. On *Ostrya virginica*, January 28, 1914, J. M. V. & Ramsey; on *Fraxinus*, Boone county, March 28, 1914. Ramsey.

*Rosellinia medullaris* (Wallr.) Ces. & DeNot. On *Cercis canadensis*, February 4, 1911; on *Juglans cinerea*, 1914. Ramsey.

*Rosellinia mutans* (Cke. & Pk.) Sacc. On *Juglans*, 1914. Ramsey.

*Rosellinia pulveracea* (Ehr.) Fekl. On *Carpinus caroliniana* and *Platanus occidentalis*, November 20, 1913; on the same hosts in Boone county, December 18, 1913. Ramsey.

*Rosellinia subiculata* (Schw.) Sacc. On *Liriodendron tulipifera*, 1911. On *Quercus*, 1914, J. M. V. & Ramsey.

*Venturia pomi* (Fr.) Wint. On leaves and fruit of *Pyrus malus*, July 19, 1912. Common.

*Xylaria corniformis* Fr. On rotten *Acer*. Harrodsburg, August 7, 1915.

## FUNGI IMPERFECTI.

### SPHAEROPSIDALES.

*Ascochyta mali* E. & E. On living leaves of *Pyrus malus*, 1911. Sutton.  
*Ascochyta rhei* E. & E. On living leaves of *Rheum rhaponticum*. September, 1912.

*Cicinobolus cesatii* DeBary. Parasitic on *Erysiphe cichoracearum* on leaves of *Rudbeckia* or *Helianthus*. Campus, October 5, 1915.

*Darlucella filum* (Biv.) Cast. Parasitic on *Phragmidium potentillae* and *Uredo biglowii*, 1911. Sutton.

*Phoma limbalis* Passer. On leaf veins of *Platanus occidentalis*, 1912.

*Phyllosticta celtidis* Ell. & Kell. On leaves of *Celtis occidentalis*, October 5, 1915. These leaves were also affected with a leaf mite. Spores of fungus, bacteria-like, 2 to 3 by 1 micron.

*Phyllosticta fraxini* Ell. & Mart. On leaves of *Cornus florida*, autumn of 1912. Spores, 4 by 9.5 microns. On leaves of *Fraxinus americana*, Unionville, October 3, 1914. J. M. V. & Paul Weatherwax.

*Phyllosticta grossulariae* Sacc. On leaves of *Ribes cynosbati*, October 3, 1914. J. M. V. & P. W.

*Phyllosticta hammamelidis* Pk. On living leaves of *Hammamelis vir-*

giniana, Campus, October 5, 1915. Associated with *Pestalozzia funerea* Desm. Peck reports *Phyllosticta consocia* Pk. as being associated with this *Pestalozzia* and describes the spot as the same and the *Phyllosticta* as the cause. However, *P. consocia* is described as having six cells with four middle ones colored and as being 30 to 35 microns long; setae, 22.5 to 27.5 long. Our spores are about 25 microns long with short setae. Spores, five-celled, the three inner being colored. This *Phyllosticta* is very similar if not identical with *P. sphaeropsidea* E. & E. (Bull. Torr. Bot. Club. 1883, p. 97.) Reported on *Aesculus hippocastanum*.

*Phyllosticta kalmicola* (Schw.) E. & E. On living leaves of *Kalmia latifolia*, one-half mile northeast of Borden, Clark county, February 20, 1915.

*Phyllosticta linderae* E. & E. On *Lindera benzoin*, Brown county, July, 1912.

*Phyllosticta sambuci* Desm. On leaves of *Sambucus canadensis*, Campus, October 5, 1915. The pycnidia are described as being very minute. In our specimens, they measure from 90 to 200 microns with spores 4 to 7 by 2 to 2½ microns.

*Phyllosticta sambucicola* Kalchbr. On the same host as the above and associated with it as was also *Cercospora sambucina* and a *Septoria*. The pycnidia are 50 to 90 microns and spores 2½ to 5 microns. The spores are subglobose. Kalchbrenner describes them as being very minute.

*Septoria evonymi* Rabh. On *Evonymus atropurpureus*, Campus, October 5, 1915. Our species is undoubtedly identical with the one described by Rabenhorst, though differing somewhat. The following is a description of our fungus: Spots epiphyllous, 3 to 10 microns in diameter or by confluence, covering large areas, irregular in shape, often limited by veins making them angular in outline, olive brown, bounded by a dark purplish line, lighter colored on the lower surface of the leaf; pycnidia 75 to 125 microns in diameter, black, protruding and with a large irregular opening; spores 15 to 30 by 2 to 3 microns, for the most part one-septate, straight, crescent-shaped or irregularly curved.

*Septoria helianthi* Ell. & Kell. On *Helianthus annuus*, autumn of 1912.

*Septoria laetueae* Pass. Common on *Laetuea scariola*, Harrodsburg, August 7, 1915. Spores filiform, 20 to 35 by 1½ to 2 microns.

*Septoria mimuli* Wint. On leaves of *Mimulus alatus*, summer of 1911. Sutton.

*Septoria oenothera* West. On *Oenothera biennis*, Harrodsburg, August 7, 1915.

*Septoria polygonorum* Desm. On *Polygonum persicaria*, July 29, 1915. This fungus was very common and very destructive to its host throughout the summer. It varies slightly from the description as follows: Spots 2 to 3 mm. in diameter. Leaf fades to yellow, curls, dries on the plant or falls to the ground. Some spores exceed 25 microns in length.

*Septoria rubi* West. On cultivated raspberries. September, 1912. Also common on blackberries.

*Septoria scrophulariae* Pk. On *Scrophularia nodosa* or *marylandica*. Summer of 1911. Sutton.

*Septoria verbascicola* B. & C. On *Verbascum blattaria*, autumn of 1912.

*Sphaeropsis asiminae* E. & E. On dead twigs of *Asimina triloba*, Boone county, December, 1913. Ramsey.

#### MELANCONIALES.

*Cylindrosporium capsellae* E. & E. On leaves of *Capsella bursa-pastoris*, 1911. Sutton.

*Cylindrosporium padi* Karst. On *Prunus serotina*, summer of 1911. Sutton.

*Gloeosporium caryae* Ell. & Dear. Common on leaves of *Carya alba*, Harrodsburg, August 7, 1915.

*Gloeosporium intermedium* Sacc., var. *poinsettiae* Sacc. On dead stems of *Poinsettia pulcherrima*, greenhouse, March 16, 1915. Plants grown from Florida stock.

*Marsonia juglandis* (Lib.) Sacc. On leaves of *Juglans cinerea*, Helmsburg, Brown county, July, 1912; Unionville, Monroe county, October 3, 1914. On leaves of *Juglans nigra*, Unionville, October 3, 1914. On leaves of *Juglans sieboldiana*, Campus, October 5, 1915.

*Marsonia martini* Sacc. & Ell. On leaves of *Quercus acuminata*, Harrodsburg, July 7, 1915.

*Pestalozzia funerea* Desm. On leaves of *Hammamelis virginiana*, Campus, October 5, 1915.

#### HYPHOMYCETES.

*Cereospora ampelopsidis* Pk. On living leaves of *Ampelopsis quinquefolia*, October 5, 1915. The conidiophores of this fungus measure 30 to 112 by 5 to 6 microns and are 2 to 4 septate; the spores are 25 to 125 by 6 to 8

microns and are 4 to 9 septate. There seems to be no doubt as to the identity of the fungus as the remainder of the description corresponds admirably.

*Cercospora bartholomaei* Ell. & Kell. On living leaves of *Rhus glabra*, summer of 1911. Sutton.

*Cercospora condensata* Ell. & Kell. Summer of 1911. Sutton.

*Cercospora elongata* Pk. On *Dipsacus sylvestris*, Harrodsburg, July 7, 1915. Spores attain a length of 275 microns. Peck gives 50 to 150 microns.

*Cercospora kellermani* Bubak. On leaves of *Althaea rosea*, October 5, 1915. This species seems too closely related to *C. malvarum* Sacc. and to *C. althaeina* Sacc. Conidiophores to 110 microns long and spores from 20 to 152 microns.

*Cercospora plantaginis* Sacc. On leaves of *Plantago rugelii*, Campus, October 5, 1915. Very common. Forms brown spots. Conidiophores as much as 250 microns long. Spores, 75 to 175 microns long.

*Cercospora rhoina* E. & E. On leaves of *Rhus glabra*, Unionville, October 3, 1914. J. M. V. & P. W.

*Cercospora ribis* Earle. On cultivated *Ribes rubrum*, autumn of 1912. Very severe on its host.

*Cercospora rosicola* Pass. On *Rosa carolina*, Campus, October 26, 1915. The description of this species gives the measurement of the conidiophores 20 to 40 by 3 to 5 microns and spores, 30 to 50 by  $3\frac{1}{2}$  to 5 and 2 to 4-septate. Our conidiophores are 20 to 75 by 4 to 5 and spores 30 to 80 by 5 to 7 microns and are mostly 3-septate. The very dark hemispherical base from which the conidiophores arise, is very characteristic of this species.

*Cercospora sambucina* Ell. & Kell. On leaves of *Sambucus canadensis*, Campus, October, 1915.

*Cercospora septorioides* E. & E. On leaves of *Rubus villosus*, Harrodsburg, August 7, 1915. This species has many characters which place it near *C. rubi* Sacc., *C. rubicola* Thuem. and *C. rosicola* Pass. The spots are very characteristic and the resemblance of the spores to those of a *Septoria* is very striking.

*Cercospora toxicodendri* (Curt.) E. & E. On leaves of *Rhus toxicodendron*, Harrodsburg, August 7, 1915.

*Haplographium apiculatum* Pk. On leaves of *Hamamelis virginiana*, Griffey Creek, October 3, 1914.

*Macrosporium catalpae* Ell. & Mart. On leaves of  *Catalpa speciosa*.

Campus, 1911 and 1912. Common. This fungus seems to follow the injury produced by an insect—a very characteristic brown spot.

*Macrosporium sarciniaeforme* Cav. On *Trifolium pratense*, Campus, October 6, 1915. The swollen nodes of these conidiophores somewhat resemble those of *Polythrincium trifolii* so common on clover.

*Macrosporium solani* Ell. & Mart. Common on *Datura stramonium*, Griffey Creek and Harrodsburg, July and August, 1915.

*Piricularia grisea* (Cke.) Sacc. On leaves of *Panicum sanguinale*, autumn of 1915. Very common every year.

*Tubercularia vulgaris* (Tode.) Meekl. On twigs of *Asimina triloba*, Boone county, December, 1913. Ramsey.

---

(In conforming with the original plan, the following Myxomycetes are here appended, though out of the sphere of fungi.)

#### MYXOMYCETES.

*Areyria incarnata* Pers. On rotten wood, Griffey Creek, October 29, 1914. Donaghy.

*Diderma crustaceum* Pk. On dead leaves, Brown county, October 24, 1914. Donaghy.

*Enteridium splendens* Morg. On rotten wood, Brown county, October 24, 1914.

*Lyecogola flavo-fuseum* (Ehr.) Rost. On sawed end of maple log, November 16, 1914. Donaghy.

*Mucilago spongiosa* (Leyss.) Morg. On stems of living weeds, November 12, 1914. Donaghy.

*Physarum cinereum* (Batsch.) Pers. On living grass, Campus, June 4, 1915. Mottier.

*Stemonitis caroliniana* Maobr. On rotten wood, 1915.

*Stemonitis morgani* Pk. On rotten wood. Griffey Creek, October 29, 1914. Donaghy. Also on dead maple log, Campus, June 1, 1915. Donaghy.

*Stemonitis nigrescens* Rex. Greenhouse under bottom of palm tub. Sporangia on the sand. May 20, 1915.

*Tilmadoche polycephala* (Schw.) Maobr. On bark of fallen elm. Running over moss and bark. Griffey Creek, June 5, 1915.

Indiana University,  
January, 1916.



## A SECOND BLOOMING OF MAGNOLIA SOULANGIANA.

---

D. M. MOTTIER.

---

This note is to call attention to the fact of a second blooming in the same year of a purple variety of *Magnolia Soulangiana*. On the campus of Indiana University a group of thrifty magnolias is cultivated. Among these there are two varieties of *M. Soulangiana*, one with pink flowers and the other bearing blossoms of a deep purple color. Last spring at the usual time all trees of the two varieties bloomed profusely and, from a number of the flowers, fruits and seeds were developed. In midsummer (July 25 to August 10) three trees of the purple variety bore each two or three fine large flowers, which were normal in every respect. No flowers were seen on the variety bearing pink blossoms. This is the first time the writer has observed the occurrence of a second crop of blossoms on a magnolia. It has been learned through acquaintances that the purple variety bloomed a second time this year in one of the eastern states.

As the blossoms were removed from the trees by children or by unscrupulous admirers, it was impossible to know whether such flowers would develop fruits.



## THE EFFECT OF CENTRIFUGAL FORCE ON OSCILLATORIA.

FRANK M. ANDREWS.

Filaments of *Oscillatoria* were centrifuged in order to ascertain if it were possible to displace the contents to any extent. First I used a force of 1,738 gravities. This force did not change the position of the contents in any respect, although the plants were centrifuged two days and four hours. The growth of the filaments also had not ceased and the movements so characteristic of the plant had not been interrupted. The filaments were not harmed in any way by such centrifugal action as a comparison with control specimens showed.

In a second experiment the filaments were subjected to 4,400 gravities for two hours and later to 5,843 gravities for three hours, but no displacement of the contents was caused.

In a third experiment 13,467 gravities were used transversely on the filaments for one hour with no change in the position of the contents; neither cessation of the growth nor of the usual movements. When *Oscillatoria* was centrifuged between the slide and cover-glass the filaments were usually broken, yet very short pieces consisting of a few cells often withstood a force of 1,738 gravities. For the use of very high centrifugal forces, as indicated above, it was necessary to place the filaments directly on the bottom of the glass cylinders and centrifuge them transversely as stated above. The filaments were then broken apart into their disk-like cells and observed from the end, but no displacement of the contents could be seen. The amount of resistance of such delicately constructed plants is rather surprising. It is also interesting to note that in all the experiments with centrifugal force on *Oscillatoria*, the characteristic movements were not stopped or apparently retarded by a force varying from 1,738 gravities to as much as 13,467 gravities. This was shown by specimens of *Oscillatoria* which were placed directly on the bottom of the glass cylinders on the outside of which was fastened a graduated scale. The machine was stopped in a few seconds and by observation it could be seen that the specimens that had been centrifuged for one hour or more and with any amount of centrifugal force had moved or radiated as far as the control specimens had in the same time. These movements

may therefore be carried out under great difficulty and against great resistance, at least of certain kinds such as centrifugal force when applied laterally. In the first experiment on the study of movements when 1,738 gravities were used for one hour, the centrifuged filaments during that time moved or radiated away from the center of the small mass of filaments equally in all directions. Actual measurements showed that the filaments had moved out in the usual way to a distance of 5 mm. The control specimens had also moved 5 mm. during the same time. There was absolutely no difference between the centrifuged specimens and the controls as to the general arrangement or appearance of the filaments which had, in each case, radiated from the very small central mass. In all cases the only requisite was the presence of a very shallow film of water about the specimens.

When the specimens were centrifuged for one hour with a force of 5,000 gravities instead of 1,738 gravities, the amount of movement in both centrifuged and control specimens was exactly the same. Both moved away in a radiating direction from the small central mass 5 mm. during the one hour of experimentation. This shows the amount of movement to be as great, as far as could be determined, in the presence of a force of 5,000 gravities as when 1,738 gravities was used. Longer periods of time than one hour, using 5,000 gravities, were not used, and it has not yet been investigated what effect, if any, this might have on the movements.

In the third experiment, where 13.467 gravities were used, both the centrifuged specimens of *Oscillatoria* and the controls moved 2 mm. during the half-hour of centrifuging. So far then as experiments have been performed, it has not been found possible to stop, or apparently retard, the amount or kind of movements of *Oscillatoria princeps* by centrifugal force. Indiana University.

## SOME ELEMENTARY NOTES ON STEM ANALYSES OF WHITE OAK.

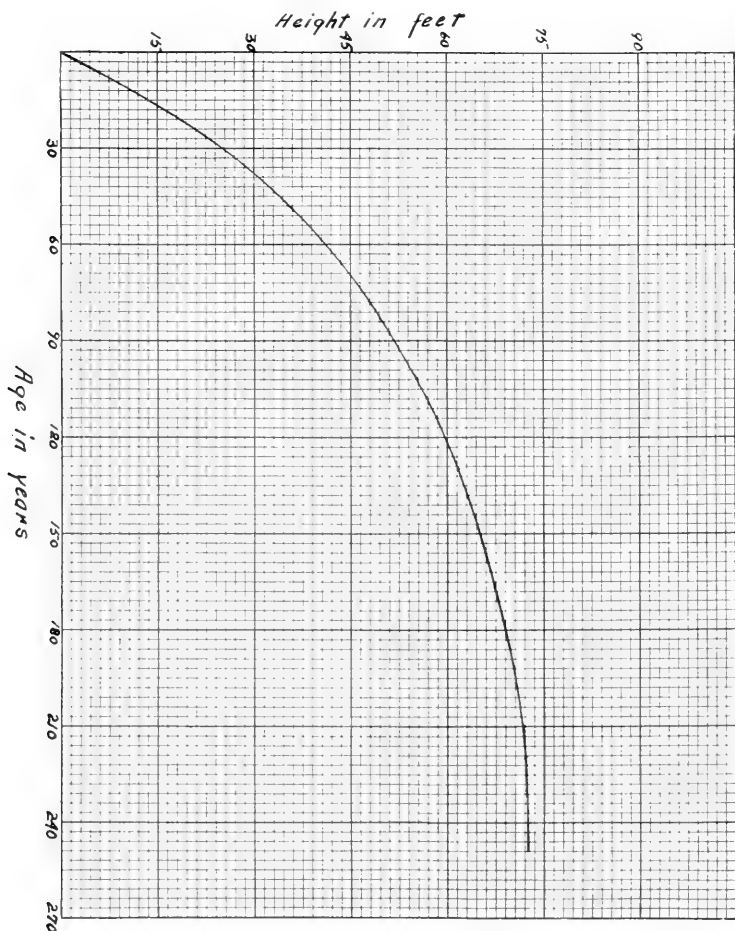
BURR N. PRENTICE.

In the fall of 1915 I had the opportunity to gather some facts concerning the growth of White Oak (*Quercus alba*). The opportunity was in the form of a small logging operation which took place in a woodlot of mature White Oak belonging to Mr. George Justice, in Tippecanoe county, Indiana, about seven miles north of Lafayette. The woodlot is located on rolling to flat land only a short distance from the Wabash river. The soil is typical of that region, being a sandy loam underlain with gravel. The cutting was not a large one, only covering about thirty trees, but the majority of the trees were old and fully mature, so that a good idea of the life history and growth of White Oak on similar situations in Indiana could be gained by a study of their stems.

Complete stem analyses of the trees were taken. These included the following measurements on each bole; the diameter at the stump, together with the distance from the center to each tenth ring, counting from the outside in, and similar measurements at each of the other crosscuts on the tree, thus getting the diameter of each section at any decade throughout the life of the tree. The diameter at breast height, i.e., four and one-half feet from the ground, was taken in each case. The following height measurements were also included; height of stump, length of each section above the stump, length of tip above the last section, and the length and width of crown. Careful record was kept of the number of rings in decades at each section since by these are determined the various periods of growth.

From this data was worked out the mean annual volume growth of the average tree of the stand for the entire period of its life. The method outlined by Mlodjianski, as modified by Graves, was followed. This requires the construction of a height growth table showing the average time required for the trees to grow from the ground to the various crosscuts. The accompanying curve drawn from plotting height in feet against age in years shows how such a table was obtained. This height table is given as a part of table three.

The next step is the determination of the average stump height. By averaging the heights of the stumps of the entire plot, this height was determined as one and one-half feet.



Curve based on age and total height of White Oak (*Quercus alba*), showing time required to grow to any specified height. Based on measurement of thirty trees.

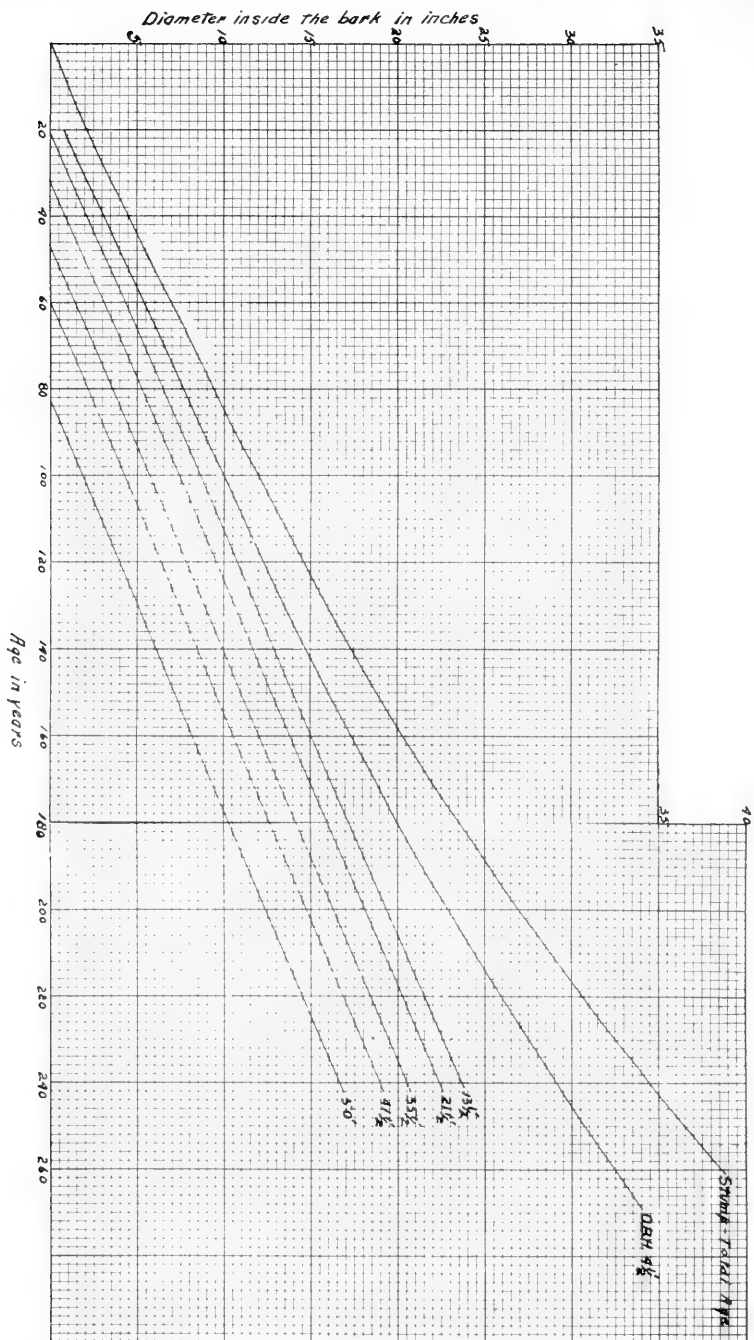
A curve based on diameter and age at the stump was then drawn, to show the average diameter growth at the stump for each decade. This curve smoothed out any irregularities in growth at the stump for the entire number

of trees measured. A similar curve was drawn for each of the other crosscuts above the stump. It has already been noted that the average stump height was one and one-half feet. Therefore the curve for the top of the first twelve-foot log represents the diameter growth at a point thirteen and one-half feet above the ground. The same is, of course, true for the other curves as well.

These curves were then all transferred to one sheet in such a manner that the growth at the respective crosscuts was shown on the basis of total age, i.e., each curve begins as many years to the right of the intersection of the two axes as it took the tree to grow to the height of the crosscut in question. These points are determined from the height growth table.

These curves represent the diameter growth at their respective distances above the ground, on the basis of total age (age at the ground), and not on the basis of the age at the respective crosscuts. We are able to get from this series of curves, for any age, the average total height and the dimensions of the trees inside the bark at various points along the bole.

A diameter breast height curve was also constructed in the following manner. On the same sheet with the stump curve a second curve was drawn, letting the ordinate represent diameter breast height values instead of diameter inside the bark at the stump. Since there were but a small number of trees, all of uniformly large diameter, it was impossible, as yet, to continue this curve into the early age of the trees. But when the curves for the other points on the bole were also transferred thus to a single sheet, the diameter breast height curve was prolonged by a process of interpolation to the younger ages of the trees.



Series of curves based on age at the ground and diameters at various cross cuts, showing time required for the tree to grow from the ground to any specified diameter at various points up the bole. Based on the measurement of thirty White Oak trees.



From this series of curves Table No. 1 was taken. The cubic contents (Table 2) of the average tree at ten year periods throughout its life, was computed according to the Schiffel formula, which is  $(.16B + .66b)h = V$ , in which B represents the area of cross section at breast height, b represents the area of cross section at mid-height, h represents the total height of the tree, and V represents the volume.

TABLE I.—Diameters at various points along the bole for every decade throughout the life of the tree; white oak.

| Height of Section Above Ground, in Feet. | AGE IN YEARS.                        |     |     |     |     |     |     |     |      |      |      |      |      |
|------------------------------------------|--------------------------------------|-----|-----|-----|-----|-----|-----|-----|------|------|------|------|------|
|                                          | 10                                   | 20  | 30  | 40  | 50  | 60  | 70  | 80  | 90   | 100  | 110  | 120  | 130  |
|                                          | Diameter inside the bark, in inches. |     |     |     |     |     |     |     |      |      |      |      |      |
| (Stump) 1½.....                          | 1.0                                  | 2.2 | 3.3 | 4.5 | 5.8 | 6.9 | 8.2 | 9.5 | 10.7 | 12.0 | 13.2 | 14.5 | 15.9 |
| D.B.H. 4½.....                           |                                      | 1.0 | 2.0 | 3.2 | 4.3 | 5.4 | 6.5 | 7.5 | 8.6  | 9.8  | 10.9 | 12.2 | 13.4 |
| 13½.....                                 |                                      |     | 1.0 | 2.2 | 3.4 | 4.3 | 5.3 | 6.5 | 7.5  | 8.6  | 9.8  | 10.7 | 11.8 |
| 21½.....                                 |                                      |     |     | .9  | 2.0 | 3.0 | 4.2 | 5.3 | 6.3  | 7.4  | 8.5  | 9.6  | 10.6 |
| 35½.....                                 |                                      |     |     |     | .4  | 1.4 | 2.5 | 3.4 | 4.6  | 5.7  | 6.7  | 7.8  | 8.9  |
| 41½.....                                 |                                      |     |     |     |     |     | 1.1 | 2.2 | 3.3  | 4.3  | 5.3  | 6.4  | 7.5  |
| 50.....                                  |                                      |     |     |     |     |     |     |     |      | 1.8  | 2.8  | 3.9  | 5.0  |

TABLE I—Continued.

| Height of Section Above Ground, in Feet. | AGE IN YEARS.                        |      |      |      |      |      |      |      |      |      |      |
|------------------------------------------|--------------------------------------|------|------|------|------|------|------|------|------|------|------|
|                                          | 140                                  | 150  | 160  | 170  | 180  | 190  | 200  | 210  | 220  | 230  | 240  |
|                                          | Diameter inside the bark, in inches. |      |      |      |      |      |      |      |      |      |      |
| (Stump) 1½.....                          | 17.4                                 | 18.8 | 20.3 | 22.0 | 23.8 | 25.4 | 27.2 | 29.0 | 30.7 | 32.7 | 35.0 |
| D.B.H. 4½.....                           | 14.6                                 | 16.0 | 17.4 | 18.7 | 20.2 | 21.5 | 23.0 | 24.5 | 26.0 | 27.6 | 29.3 |
| 13½.....                                 | 13.0                                 | 14.0 | 15.2 | 16.3 | 17.4 | 18.4 | 19.4 | 20.5 | 21.5 | 22.6 | 23.6 |
| 21½.....                                 | 11.7                                 | 12.8 | 13.9 | 15.0 | 16.0 | 17.1 | 18.2 | 19.3 | 20.3 | 21.4 | 22.6 |
| 35½.....                                 | 10.0                                 | 11.0 | 12.2 | 13.2 | 14.2 | 15.3 | 16.3 | 17.4 | 18.4 | 19.5 | 20.5 |
| 41½.....                                 | 8.5                                  | 9.6  | 10.6 | 11.6 | 12.7 | 13.7 | 14.8 | 15.8 | 16.9 | 17.9 | 19.0 |
| 50.....                                  | 6.0                                  | 7.2  | 8.3  | 9.3  | 10.3 | 11.4 | 12.4 | 13.4 | 14.5 | 15.6 | 16.6 |

TABLE II.—Total height and \*cubic volume of white oak for each decade of the life of the tree.

| Age, Years. | Height, Feet. | Volume, Cu. Ft. | Age, Years. | Height, Feet. | Volume, Cu. Ft. |
|-------------|---------------|-----------------|-------------|---------------|-----------------|
| 10.....     | 10.0          | .003            | 130.....    | 61.6          | 29.691          |
| 20.....     | 18.2          | .054            | 140.....    | 63.2          | 36.846          |
| 30.....     | 25.5          | .178            | 150.....    | 65.0          | 45.330          |
| 40.....     | 31.8          | .668            | 160.....    | 66.5          | 54.397          |
| 50.....     | 37.4          | 1.159           | 170.....    | 67.9          | 63.962          |
| 60.....     | 41.8          | 2.590           | 180.....    | 69.0          | 75.348          |
| 70.....     | 45.6          | 4.332           | 190.....    | 70.0          | 87.220          |
| 80.....     | 49.2          | 6.494           | 200.....    | 71.0          | 100.678         |
| 90.....     | 52.1          | 9.482           | 210.....    | 71.8          | 115.885         |
| 100.....    | 54.8          | 13.481          | 220.....    | 72.4          | 128.076         |
| 110.....    | 57.2          | 20.821          | 230.....    | 72.8          | 146.037         |
| 120.....    | 59.4          | 23.522          | 240.....    | 73.0          | 156.658         |

\*Volumes computed according to Schiffel:  $V = (.16B .66b)h$ , where,  
 $V$  = Volume.

$B$  = Basal area of cross section at breast height.

$b$  = Area of cross section at middle height.

$h$  = Total height of tree.

TABLE III.—Volume in board feet of Merchantable stem for even decades.

| Age, Years. | Volume, B. M. | Age, Years. | Volume, B. M. | Age, Years. | Volume, B. M. |
|-------------|---------------|-------------|---------------|-------------|---------------|
| 70.....     | 10            | 130.....    | 170           | 190.....    | 535           |
| 80.....     | 15            | 140.....    | 225           | 200.....    | 630           |
| 90.....     | 40            | 150.....    | 275           | 210.....    | 725           |
| 100.....    | 65            | 160.....    | 335           | 220.....    | 830           |
| 110.....    | 100           | 170.....    | 405           | 230.....    | 955           |
| 120.....    | 140           | 180.....    | 460           | 240.....    | 1,095         |

It must be remembered that these figures are based on trees growing under an entire absence of management. Proper management should easily materially increase the rate of growth shown here. Even among these trees there were many that were above the average rate here given. A curve drawn for the maximum growth in diameter at the stump showed the following comparison:

| Age at<br>Stump. | Average<br>D. I. B. | Maximum<br>D. I. B. | Age at<br>Stump. | Average<br>D. I. B. | Maximum<br>D. I. B. |
|------------------|---------------------|---------------------|------------------|---------------------|---------------------|
| 20               | 2.5                 | 3.0                 | 140              | 18.0                | 21.5                |
| 40               | 5.0                 | 5.8                 | 160              | 21.0                | 25.0                |
| 60               | 7.0                 | 8.0                 | 180              | 24.4                | 28.8                |
| 80               | 10.0                | 11.9                | 200              | 28.0                | 32.5                |
| 100              | 12.4                | 15.0                | 220              | 31.4                | 36.4                |
| 120              | 15.0                | 18.2                | 240              | 35.2                | 40.6                |

It will be noticed that there is a difference of approximately 20 per cent. in diameter for any given age, between the average maximum growth and the average growth. Allowing for a proportionate increase throughout the stem, this would give a maximum volume for table three as follows:

| Age<br>Years. | Volume<br>B. M.<br>(Maximum). | Age<br>Years. | Volume<br>B. M.<br>(Maximum). | Age<br>Years. | Volume<br>B. M.<br>(Maximum). |
|---------------|-------------------------------|---------------|-------------------------------|---------------|-------------------------------|
| 70            | 12                            | 130           | 205                           | 190           | 642                           |
| 80            | 18                            | 140           | 270                           | 200           | 756                           |
| 90            | 48                            | 150           | 330                           | 210           | 870                           |
| 100           | 78                            | 160           | 402                           | 220           | 996                           |
| 110           | 120                           | 170           | 486                           | 230           | 1,146                         |
| 120           | 168                           | 180           | 552                           | 240           | 1,314                         |

This 20 per cent. increase could hardly be regarded as reliable, however, when applied to later life of the tree. Artificial plantations both at home and abroad show that it is not at all out of proportion with what may be expected during the early life of well managed plantations.

A study of the crowns of this plot showed the average width of crown to be forty feet. This would allow in a fully stocked stand, about forty mature trees to the acre. During the extremely early years of the stand, an acre would bear upwards of one thousand trees. \*Mr. Earl Frothingham, Forest Assistant in the Forest Service, shows that from observed plots an acre is able to support seven hundred and twenty-four oak trees to the age of forty-

\*Second Growth Hardwoods in Connecticut. Bulletin 96, U. S. Forest Service by Earl H. Frothingham, Forest Assistant.

five. Our analyses show that the trees in the present study did not attain a diameter breast height of six inches until they were seventy years of age. If we allow approximately one-half of the seven hundred and twenty-four, or three hundred and fifty, to remain at the age of seventy, and reduce this number by a series of intermediate acceleration thinnings, to the final forty at the age of one hundred and fifty, we get the following result:

| Number<br>Trees<br>Per Acre. | Age,<br>Years.                                                   | Number<br>Feet<br>B. M.                                                   | Number<br>Trees<br>Per Acre. | Age,<br>Years.                                                            | Number<br>Feet<br>B. M. |        |
|------------------------------|------------------------------------------------------------------|---------------------------------------------------------------------------|------------------------------|---------------------------------------------------------------------------|-------------------------|--------|
| 350                          | $\left\{ \begin{array}{l} 70 \\ 80 \\ 90 \end{array} \right.$    | 3,500                                                                     | 40                           | <i>Thinning.</i>                                                          |                         |        |
|                              |                                                                  | 5,250                                                                     |                              | 160                                                                       | 13,400                  |        |
|                              |                                                                  | 14,000                                                                    |                              | 170                                                                       | 16,200                  |        |
| <i>Thinning.</i>             | $\left\{ \begin{array}{l} 100 \\ 110 \\ 120 \end{array} \right.$ | $\left\{ \begin{array}{l} 11,375 \\ 17,500 \\ 24,500 \end{array} \right.$ |                              | 180                                                                       | 18,400                  |        |
|                              |                                                                  |                                                                           |                              | 190                                                                       | 21,400                  |        |
|                              |                                                                  |                                                                           |                              | 200                                                                       | 25,200                  |        |
|                              | <i>Thinning.</i>                                                 | $\left\{ \begin{array}{l} 130 \\ 140 \\ 150 \end{array} \right.$          |                              | $\left\{ \begin{array}{l} 14,450 \\ 19,125 \\ 23,375 \end{array} \right.$ | 210                     | 29,000 |
|                              |                                                                  |                                                                           |                              |                                                                           | 220                     | 33,200 |
|                              |                                                                  |                                                                           |                              |                                                                           | 230                     | 38,200 |
| 85                           |                                                                  |                                                                           |                              | 240                                                                       | 43,800                  |        |

While the problem of reforestation with oak is somewhat more difficult than that connected with coniferous plantations, nevertheless these figures look interesting, to say the least. It is true that there is little material that is actually merchantable that can be looked for under one hundred years. There are many poor plots of land, however, on nearly every farm in Indiana which at present detract from the value of the whole property. If these plots were planted with even so slow growing a tree as the white oak the result would be an increase in the value of the entire property many years before the trees themselves actually attained merchantable size.

ANALYSIS OF WATER CONTAINING ALUMINUM SALTS  
AND FREE SULPHURIC ACID FROM AN  
INDIANA COAL MINE.

S. D. CONNER.

Within the past year the writer was called upon to test some drainage water from a coal mine for the Vandalia Coal Company of Terre Haute with a view of determining whether such water could be used for irrigation purposes.

A qualitative examination indicated only a trace of chlorides and nitrates, but an abundance of sulphates.

The following substances were quantitatively estimated:

|                                    |                |
|------------------------------------|----------------|
| $\text{Al}_2(\text{SO}_4)_3$ ..... | .016 per cent. |
| $\text{CaSO}_4$ .....              | .141 per cent. |
| $\text{MgSO}_4$ .....              | .074 per cent. |
| Free $\text{H}_2\text{SO}_4$ ..... | .005 per cent. |

---

Total solids..... .42 per cent.

Contrary to expectations, no soluble iron was found, although a slight flocculent precipitate of iron (probably basic ferric sulphate) was noted in the bottom of the bottle, indicating that originally some iron had been in solution.

In the mining of coal more or less iron pyrites ( $\text{FeS}_2$ ) is exposed to the air. This pyrites in the presence of oxygen and moisture is oxidized, forming ferrous sulphate and sulphuric acid. The sulphuric acid coming in contact with clay, shale, etc., would dissolve calcium, magnesium, aluminum and other basic elements which might be present. Upon continued exposure to air the ferrous sulphate ( $\text{Fe SO}_4$ ) in solution would be oxidized to basic ferric sulphate ( $\text{Fe}(\text{OH})\text{SO}_4$ ) and precipitated.

Water such as the writer analyzed is acid in reaction, due to the presence of free sulphuric acid and also to the hydrolysis of the aluminum sulphate. Such water would be injurious to vegetation and consequently unfit for irrigation purposes.

The presence of soluble aluminum instead of soluble iron is a condition similar to that found in the acid soil of the Wanatah experiment field in Laporte county (as reported by Abbott, Conner and Smalley in Bul. 170 of the Ind. Exp. Station).

There is little danger of soluble salts of iron being present in well-drained and aerated soils or in irrigation water which has been exposed to the air for any length of time. This is due to the fact that soluble salts of iron readily oxidize and are precipitated on exposure to air. Soluble salts of aluminum are not readily precipitated and there is danger of these being present in injurious amount in acid soils either drained or undrained and in mine waters.

On the Wanatah field it was necessary to apply some form of lime to neutralize the acidity before crops could be grown. It was also found that aluminum nitrate was just as injurious to corn grown in water cultures as was an equivalent amount of nitric acid. It would undoubtedly be necessary to neutralize the acidity of the coal mine water with some form of lime before it could be utilized for irrigation purposes.

## DETECTION OF NICKEL IN COBALT SALTS.

A. R. MIDDLETON AND H. L. MILLER.

The use of dimethylglyoxime as a reagent for the detection and determination of nickel, discovered by Tschugaev<sup>1</sup> in 1905 and developed by Brunk,<sup>2</sup> has become a general practice. For simplicity of manipulation and freedom from interference this reagent is unrivalled; the brilliant scarlet color and extreme insolubility of the nickel glyoximine renders possible the detection of one part of nickel ion in at least 350,000 parts of water. By a modified method of applying the reagent, which was developed in the course of this investigation, we found it possible to detect one part of nickel ion in more than 4,000,000 parts of water.

For detection of traces of nickel in cobalt salts this reagent, hitherto, has not been very satisfactory. Cobalt combines with dimethylglyoxime to form an extremely soluble compound of brown color. Either because the nickel salt is soluble in this compound, or, as is much more probable, because the cobalt appropriates most of the reagent, no nickel is precipitated by ordinary amounts of reagent from cobalt salt solutions, even though a considerable amount is present. The object of this investigation was to devise a method by which the cobalt ion should be suppressed, thus permitting the reagent to react with nickel only thus avoiding the necessity for large amounts of reagent. Treadwell,<sup>3</sup> following a suggestion of Tschugaev, accomplishes this result by transforming the cobalt salt into a cobaltic ammin by strong ammonia and hydrogen peroxide before adding dimethylglyoxime. We shall show that this method is unsatisfactory and fails when much cobalt is present.

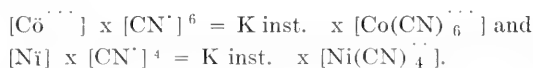
The most striking differences in the chemical behavior of nickel and cobalt are (1) the greater readiness of oxidation to the trivalent condition and (2) the greater stability of the complex ions, both positive and negative, of cobalt. Of the various complex ions formed by cobalt the most stable are the complex cyanides, that of trivalent cobalt being decidedly more stable than that of bivalent cobalt. Nickel forms soluble complex cyanides of a

<sup>1</sup>Ber. 38, 2520.

<sup>2</sup>Z. angew. Chem., 20, 3444.

<sup>3</sup>Analyt. Chem., Vol. I. 151. (7te Aufl.)

different type, resembling those of bivalent copper, whereas the cobalt cyanides are analogous to the iron cyanides. In the classic method of Liebig<sup>4</sup> for detecting nickel in cobalt salts, the inferior stability of nickelocyanide ion together with the ready oxidizability of cobaltocyanide to cobalticyanide ion has long been used to effect a separation. For a solution containing cobalticyanide, nickelocyanide and cyanide ions the following equilibria are involved:



The values of the instability constants are not accurately known, but it is certain that that of cobalticyanide ion is extremely small and that of nickelocyanide ion much larger. Any reduction of the concentration of cyanide ion in the solution must result in decomposition of the nickelocyanide ion and considerable increase of nickel ion concentration while the much more stable cobalticyanide ion is less affected. In Liebig's method as modified by Gauhe,<sup>5</sup> cyanide ion is removed by oxidation with alkaline hypobromite or hypochlorite, the nickelous ion being simultaneously oxidized and precipitated as  $\text{Ni}(\text{OH})_3$ . This method is not altogether satisfactory, first, because, owing to the necessity of adding an excess of the oxidizing agent, cobaltic hydroxide is also precipitated invariably so that the appearance of a brown precipitate is not *per se*, proof of the presence of nickel; second, because the manipulation, particularly the amounts of reagents, requires experience and care.

Nickel glyoximine is decomposed by cyanide ion. Our problem, then, was to remove the cyanide ion so gradually that the cobalticyanide ion should remain practically unaffected. For this purpose we made use of the great stability of complex silver cyanide ions, together with the high insolubility of silver argenticyanide,  $\text{Ag} \cdot \text{Ag}(\text{CN})_2$ , 0.0004 g. per liter<sup>6</sup> at 20°. For argenticyanide ion,  $[\text{Ag}] \times [\text{CN}]^2 = 1.7 \times 10^{-21} \times [\text{Ag}(\text{CN})_2^-]$ . The comparative insolubility of silver cobalticyanide,  $\text{Ag}_3\text{Co}(\text{CN})_3$ , accurate data for which are lacking, should also tend to prevent decomposition of cobalticyanide ion. When dimethylglyoxime is added to very dilute solutions of nickel salts,

<sup>4</sup>Ann., 65, 244 (1848); 87, 128 (1853).

<sup>5</sup>Z. analyt. Chem., 5, 75 (1866).

<sup>6</sup>Bredig, Z. physik. Chem., 46, 602.



a yellow color at once develops and the red precipitate flocculates after a brief interval. At extreme dilutions where no precipitate forms, a yellow tint is observable. This was suspected to be due to colloidal glyoximine which should be flocculated by another precipitate, in which case, since both silver cyanide and silver cobalticyanide are white, the red nickel glyoximine would be readily detectable and the delicacy of the test increased. The correctness of this view seems to be confirmed by the experimental results detailed below.

#### EXPERIMENTAL.

**Solutions and Reagents.**  $\text{NiSO}_4$  solution, approx. 0.05 molar, from Kahlbaum's "Kobalt-frei" salt, was standardized by electrolysis (0.05008 molar) and by precipitation and weighing as nickel glyoximine (0.0496 molar). The discrepancy is due probably to a trace of iron which was detected, the removal of which appeared unnecessary for our purpose. The more dilute solutions used were prepared from this by accurate dilution.

7) Bodlander, Z. anorg. Chem, 39, 227.

$\text{CoSO}_4$ , approx. 0.1 molar, was prepared by working up residues from cobaltammin salts. Nickel was removed by dimethylglyoxime according to the method we have developed and the solution as used gave no evidence of nickel by any of the tests applied. Electrolysis showed this solution to be 0.0921 molar. Potassium cyanide, 10 per cent. solution. Dimethylglyoxime, 1 per cent. solution in alcohol. Silver nitrate, 1 per cent. solution.

#### SENSITIVENESS OF DIMETHYLGLYOXIME AS A REAGENT FOR NICKEL IN PRESENCE AND IN ABSENCE OF CYANIDE ION.

Ten cc. of  $\text{NiSO}_4$  solution of molarity stated in the table below was warmed to about  $80^\circ$  and 1 cc. of the reagent added and a drop or two of dilute ammonia. To the same volume of each  $\text{NiSO}_4$  solution two or three drops of KCN were added. At these high dilutions no precipitate was formed. The solution was warmed to  $80^\circ$ , 1 cc. of reagent added and then the  $\text{AgNO}_3$  solution dropwise until a permanent white or pink precipitate formed. The more concentrated solutions gave at once a pink precipitate; the more dilute ones a white precipitate which turned pink on standing. In those solutions which required more than one hour to form a precipitate the exact

time required for the pink precipitate to appear was not recorded. The samples were observed after standing 24 hours. From the results tabulated below it is apparent that the test is at least as delicate in the presence as in the absence of cyanide and that the results are obtainable much more quickly from the complex than from the simple ion. In the extreme dilutions of the simple ion the precipitate was frequently a single red crystal very minute and difficult to see.

TABLE I.

| Molarity. | TIME.             |                                    | Mg. Ni per cc. | Ratio Ni : H <sub>2</sub> O |
|-----------|-------------------|------------------------------------|----------------|-----------------------------|
|           | NiSO <sub>4</sub> | K <sub>2</sub> Ni(CN) <sub>4</sub> |                |                             |
| 0.0005    | Immediate         | Immediate                          | 0.02934        | 1 : 34,000                  |
| .00005    | 1 hour            | 3 min.                             | .002934        | 1 : 340,000                 |
| .00001    | 24 hours          | 5 min.                             | .000587        | 1 : 1,700,000               |
| .000009   | 24 hours          | 10 min.                            | .000528        | 1 : 1,900,000               |
| .000008   | 24 hours          | 20 min.                            | .000470        | 1 : 2,130,000               |
| .000007   | 24 hours          | 30 min.                            | .000411        | 1 : 2,430,000               |
| .000006   | 24 hours          | 1 hour                             | .000352        | 1 : 2,840,000               |
| .000005   | 24 hours          | 24 hours                           | .000293        | 1 : 3,400,000               |
| .000004   | No ppt.           | 24 hours                           | .000235        | 1 : 4,260,000               |
| .000003   | No ppt.           | No pink color                      | .000176        | 1 : 5,700,000               |
| .000002   | No ppt.           | No pink color                      | .000117        |                             |

### 3. OXIDATION OF COBALTCYANIDE ION TO COBALTCYANIDE ION.

When KCN is added to a solution of cobalt salt, brown-red  $\text{Co}(\text{CN})_2$  is first precipitated and then redissolved to a brown solution of  $\text{K}_4\text{Co}(\text{CN})_6$ . On heating this soon changes to a pale yellow and the color change is generally assumed in manuals of analysis to indicate the completion of oxidation to cobalticyanide. We at first proceeded upon this assumption, but when the first drops of  $\text{AgNO}_3$  were added to some of our complex cyanide solutions, soon after the color change took place, the solution darkened and addition of more  $\text{AgNO}_3$  produced a dark-gray precipitate while solutions which had stood for several hours did not darken and gave a pure white precipitate. When one of the darkened solutions became distinctly opalescent, we suspected that colloidal silver had been formed. This was explainable by the assumption that  $\text{AgNO}_3$  had been reduced by cobaltocyanide which was still present according to  $\text{K}_4\text{Co}(\text{CN})_6 + \text{AgNO}_3 = \text{K}_3\text{Co}(\text{CN})_6 + \text{Ag} + \text{KNO}_3$ .

By adding  $\text{AgNO}_3$  to freshly prepared solutions of cobaltoeyanide we found that this reaction takes place very slowly in cold but rapidly in hot solutions. When the  $\text{AgNO}_3$  was added dropwise, the hot solutions first became lighter in color, then gradually turned orange and darkened until a gray precipitate was formed. If the addition of  $\text{AgNO}_3$  was stopped when the orange tint appeared, no precipitate formed, but the solution darkened on standing and became opalescent, showing that colloidal silver had formed. We found that this phenomenon was regularly reproducible in solutions of cobaltoeyanide not less than 0.005 molar. These experiments clearly show that the oxidation of cobaltoeyanide is by no means complete when the color change takes place. We next investigated the time required to complete the oxidation, taking the failure to form metallic silver as evidence that the oxidation was essentially complete.

10 cc. of 0.1 molar  $\text{CoSO}_4$  solution was treated in a casserole with just enough KCN to dissolve the  $\text{Co}(\text{CN})_2$ , the solution heated nearly to boiling and continuously rotated in the casserole for a definite time to promote oxidation. The solution was then diluted to 100 cc. with water at  $85^\circ$  and  $\text{AgNO}_3$  added dropwise with vigorous stirring. Results are given below.

TABLE II.

| Cc. 0.1 molar $\text{CoSO}_4$ | Time Heated. | Result.                            |
|-------------------------------|--------------|------------------------------------|
| 10.....                       | 2 min.....   | Colloidal Ag.                      |
| 10.....                       | 3 min.....   | Orange soln.; gray ppt.            |
| 10.....                       | 4 min.....   | Orange soln.; gray ppt.            |
| 10.....                       | 5 min.....   | No darkening of soln.; ppt. white. |

These results show that heating with constant agitation must be continued for some time after the change of color. Presumably the time required increases with the amount of cobalt present.

#### DETECTION OF NICKEL IN COBALT SALTS.

We next determined the minimum amount of nickel that could be detected in varying amounts of cobalt by our silver method and, for comparison, by Treadwell's and the modified Liebig.

## A. THE SILVER METHOD.

Definite volumes of solutions of  $\text{NiSO}_4$  and  $\text{CoSO}_4$  of known concentration were measured from burets into a casserole, KCN added until the precipitate just dissolved, and the solution heated and rotated until complete oxidation was effected. The solution was then diluted with water at  $85^\circ$  to 50 cc., 1 cc. of dimethylglyoxime solution added, and then  $\text{AgNO}_3$  dropwise with vigorous stirring until a permanent precipitate was produced. The time required for the pink color of nickel glyoximine to appear was observed. In cases where the time exceeded one hour, observations were made at the end of 24 hours. The results are given below.

TABLE IV.

In each expt. 10 cc.  $\text{CoSO}_4$  0.0921 molar, equivalent to 54.31 mg. Co, was used.

| $\text{NiSO}_4$ |             | Mg. Ni. | Ratio<br>Ni : Co. | Ratio<br>Ni : $\text{H}_2\text{O}$ | Results.             |
|-----------------|-------------|---------|-------------------|------------------------------------|----------------------|
| Vol.            | Conc. molar |         |                   |                                    |                      |
| 2 cc....        | 0.0005      | 0.0587  | 1 : 925           | 1 : 852,000                        | Ppt. pink immediate. |
| 1.5 cc....      | 0.0005      | .0440   | 1 : 1234          | 1 : 1,140,000                      | Ppt. pink 4 min.     |
| 1.0 cc....      | 0.0005      | .0293   | 1 : 1851          | 1 : 1,707,000                      | Ppt. pink 6 min.     |
| 4.5 cc....      | .0001       | .0264   | 1 : 2054          | 1 : 1,894,000                      | Ppt. pink 10 min.    |
| 4.0 cc....      | .0001       | .0235   | 1 : 2314          |                                    | Ppt. pink 20 min.    |
| 3.5 cc....      | .0001       | .0205   | 1 : 2644          | 1 : 2,440,000                      | Ppt. pink 30 min.    |
| 3.0 cc....      | .0001       | .0176   | 1 : 3085          |                                    | Ppt. pink 24 hours.  |
| 2.5 cc....      | .0001       | .0137   | 1 : 3702          | 1 : 3,650,000                      | Ppt. pink 24 hours.  |

Taking the minimum amount of nickel that could be detected in cobalt in 30 minutes, 0.0205 mg., we observed the effect of larger proportions of cobalt. The procedure and final total volume of solution were the same as in the preceding experiments.

TABLE V.

| $\text{CoSO}_4$ 0.0921 molar | Mg. Co. | Ratio Ni : Co | Results.          |
|------------------------------|---------|---------------|-------------------|
| 15 cc.....                   | 81.47   | 1 : 3966      | Ppt. pink 30 min. |
| 20 cc.....                   | 108.62  | 1 : 5288      | Ppt. pink 30 min. |
| 25 cc.....                   | 135.78  | 1 : 6610      | Ppt. pink 30 min. |
| 30 cc.....                   | 162.93  | 1 : 7932      | Ppt. pink 30 min. |

These results show that the sensitiveness of the test is not impaired by the presence of large amounts of cobalt.

#### B. THE TSCHUGAEV-TREADWELL METHOD.

10 cc. portions of 0.0921 molar  $\text{CoSO}_4$ , equivalent to 54.31 mg. Co., with varying small amounts of  $\text{NiSO}_4$  were heated with ammonia until a clear solution was obtained, hydrogen peroxide added and the solutions heated till excess of peroxide and ammonia was removed, diluted to 50 cc., 1 cc. of dimethylglyoxime solution added and the time required for the red precipitate to appear was observed. Results below.

TABLE VI.

| $\text{NiSO}_4$ |             | Mg. Ni. | Ratio Ni : Co. | Results.           |
|-----------------|-------------|---------|----------------|--------------------|
| Vol.            | Conc. molar |         |                |                    |
| 10 cc.....      | 0.0005      | 0.2934  | 1 : 185        | Red ppt. 1 hour.   |
| 9 cc.....       | 0.0005      | .2641   | 1 : 206        | Red ppt. 1 hour.   |
| 8 cc.....       | 0.0005      | .2347   | 1 : 231        | Red ppt. 1 hour.   |
| 7 cc.....       | 0.0005      | .2052   | 1 : 264        | Red ppt. 24 hours. |
| 6 cc.....       | 0.0005      | .1760   | 1 : 309        | Red ppt. 24 hours. |
| 5 cc.....       | 0.0005      | .1467   | 1 : 370        | Red ppt. 24 hours. |
| 4 cc.....       | 0.0005      | .1172   | 1 : 462        | Red ppt. 24 hours. |

Taking the minimum amount of nickel that could be detected in 1 hour, 0.2347 mg., we observed the effect of larger proportions of cobalt. The procedure and final volume were the same as in the experiments recorded in Table VI.

TABLE VII.

| $\text{CoSO}_4$ 0.0921 molar | Mg. Co | Ratio Ni : Co | Results.             |
|------------------------------|--------|---------------|----------------------|
| 10 cc.....                   | 54.31  | 1 : 231       | Red ppt. after 1 hr. |
| 15 cc.....                   | 81.47  | 1 : 346       | No ppt. after 1 hr.  |
| 20 cc.....                   | 108.62 | 1 : 462       | No ppt. after 1 hr.  |
| 25 cc.....                   | 135.78 | 1 : 577       | No ppt. after 1 hr.  |
| 30 cc.....                   | 162.93 | 1 : 693       | No ppt. after 1 hr.  |

These results indicate that this method is not very sensitive and fails when much cobalt is present.

### C. THE LIEBIG-GAUHE METHOD.

10 cc. portions of  $\text{CoSO}_4$ , 0.0921 molar, with varying amounts of  $\text{NiSO}_4$  were treated with a slight excess of KCN over that required to dissolve the precipitate, and heated and rotated until complete oxidation of the cobaltocyanide had taken place. They were then diluted to 50 cc. and freshly prepared sodium hypobromite added. After the precipitate had flocculated, it was filtered off, washed, dissolved in dilute HCl, neutralized with ammonia and tested for Ni with dimethylglyoxime. Results below.

TABLE VIII.

| $\text{NiSO}_4$<br>0.0005 molar | Mg. Ni. | Ratio Ni : Co | Ratio Ni : $\text{H}_2\text{O}$ | Results.               |
|---------------------------------|---------|---------------|---------------------------------|------------------------|
| 9 cc.....                       | 0.2641  | 1 : 206       |                                 | Blk. ppt. Ni confirmed |
| 6 cc.....                       | .1760   | 1 : 309       |                                 | Blk. ppt. Ni confirmed |
| 4 cc.....                       | .1172   | 1 : 462       |                                 | Blk. ppt. Ni confirmed |
| 3 cc.....                       | .0880   | 1 : 617       | 1 : 568,000                     | Blk. ppt. Ni confirmed |
| 2 cc.....                       | .0587   | 1 : 925       | 1 : 852,000                     | Blk. ppt. No Ni        |
| 1 cc.....                       | .0293   | 1 : 1850      |                                 | Blk. ppt. No Ni        |
| None.....                       | None    |               |                                 | Blk. ppt. No Ni        |

This method is shown to be capable of detecting 0.1 mg. nickel in a volume of 50 cc., but a confirmatory test must in every case be applied as the ppt. contains  $\text{Co}(\text{OH})_3$ .

Comparing the results of the three methods, the minimum amount of nickel detectable within one hour in a volume of 50 cc. is found to be:

|                          |          |
|--------------------------|----------|
| Silver.....              | 0.02 mg. |
| Tschugæev-Treadwell..... | .23 mg.  |
| Liebig-Gauhe.....        | .09 mg.  |

These figures do not adequately convey the relative merits of the three methods, for it should be noted in addition that the Liebig method requires a confirmatory test to make the result trustworthy; the Treadwell method failed to show the stated minimum amount of nickel when so little as 231 times as much cobalt as nickel was present, while the silver method appears

to retain its full sensitiveness in presence of any amount of cobalt; and that it has been shown to increase the effectiveness of dimethylglyoxime about eight times and to be able to detect within 24 hours less than 0.002 mg. of nickel in a volume of 50 cc.

#### SUMMARY.

1. A modified method of using dimethylglyoxime for detecting traces of nickel in cobalt salts is proposed which (1) avoids the use of large amounts of the reagent; (2) makes possible the detection of considerably smaller quantities of nickel than has been possible heretofore.

2. The sensitiveness of the test is shown to be unaffected by the presence of cobalt even in large quantities. The proposed method increases the ordinary sensitiveness of dimethylglyoxime about eight times and is capable of detecting about one-fifth the amount of nickel detectable by any of the previously known methods.

Chemical Laboratory,  
Purdue University.





## THE DIFFERENT METHODS OF ESTIMATING PROTEIN IN MILK.

GEORGE SPITZER.

It is often desirable to estimate the proteids in milk other than the official method. This is especially true in cheese factories where it is desirable to know the percent of casein in milk, since it is the casein in milk that gives it its nutritive value, as far as the proteins are concerned. It is frequently desirable to know the protein content in milk for infant and invalid feeding. With the present method of determining the fat by the Babcock method, which is quite accurate and can be done in all creameries, a rapid method for estimating the percent of casein and fat in milk gives us the necessary data to control the ratio of casein to fat in milk for feeding. Frequently a chemist is requested to determine the fat and casein in human milk where a physician has reason to believe that there exists an unbalanced ratio of fats and proteids.

There are three methods for rapid estimation of casein or proteids in milk, all of which possess merits worthy of consideration and could be used in a great many laboratories that are equipped with the apparatus necessary to determine the proteids by the official method. Although such equipment is at hand, when only a few determinations are to be made, the methods reviewed in this paper save time and the results obtained are sufficiently accurate. For the volumetric estimations of milk proteids, two standard volumetric solutions are required, besides a few beakers and flasks, apparatus found in any laboratory, or if one wishes to fit up for this purpose only, the expense is quite nominal.

In discussing the different methods, the order in which they are taken up, is no indication of their priority. Since 1892 various attempts have been made in devising a volumetric method for the estimation of casein in milk, but most were unsatisfactory, either owing to the extensive equipment or to the complicated indirect methods used. The main characteristics that a method should possess are: first, it should be accurate; second, it should require only a short time in making an estimation; third, the apparatus should be simple; fourth, materials and apparatus used should be easily obtainable.

L. L. Van Slyke and A. W. Bosworth in 1909 published their volumetric method (Technical Bulletin, N. Y. Ag. Exp. St.). The method worked out in their publication mentioned is briefly as follows: "A given amount of milk, diluted with water, is made neutral to phenolphthalein by the addition of a solution of sodium hydroxide. The casein is then completely precipitated by the addition of standard acetic acid, the volume is then made up to 200 cc. by the addition of distilled water and then filtered. Into 100cc. of the filtrate a standard solution of sodium hydroxide is run until neutral to phenolphthalein. These solutions are so standardized that 1 cc. is equivalent to 1 per cent. casein, when a definite amount of milk is used. Therefore, the number of cubic centimeters of standard acid used, divided by 2 less the amount of standard alkali used in the last titration gives the percentage of casein in the milk."

This method is based on the well known facts in chemistry and shows quite clearly the casein molecule has a constant molecular weight. First, uncombined casein is insoluble in milk serum, water or very dilute acids. Second, it has properties of an acid and combines with alkalis to form definite chemical compounds, neutral to phenolphthalein.

Now, if we know the molecular weight of casein or its equivalent in terms of a standard alkali, we can at once devise a definite method for estimating the casein by titration. Casein exists in milk in a colloidal condition combined with bases, upon addition of an acid sufficient to combine with salts in combination with casein, free casein is formed, insoluble in the serum (it must be remembered that casein and other albuminoids are soluble in excess of acids, the solubility depends on the kind of acid and temperature). There exists a definite relation between the amount of acid required to form free casein and the amount of casein present. It has been found that one gram of free casein neutralizes 8.8378 cc. of  $\frac{N}{10}$  sodium hydroxide, or 1 cc. of  $\frac{N}{10}$  sodium hydroxide neutralizes .11315 grams of casein. From this data the molecular weight of casein can be calculated.

From the above facts it is easy to determine the quantity of milk required, so that each cc. of  $\frac{N}{10}$  acid used shall correspond to percents or fraction of a percent. Since 1 cc. of NaOH neutralizes .11315 grams of casein, it must require an equivalent amount of acid to set free the casein from its original combination in milk. If we wish to know the quantity of milk to be taken so that 1 cc. of acid used to separate the casein from its combination shall equal 1 per cent. of casein, we make use of the above equivalent, i.e.

---

1 cc.  $\frac{N}{10}$  acid = .11315 grams casein, or in other words .11315 grams of casein is capable of neutralizing as much alkali as 1 cc. of  $\frac{N}{10}$  acid, so if we take 11.315 grams of milk we see from the relation above that every cc. of  $\frac{N}{10}$  acid used equals 1 per cent. casein. By using different quantities of milk we need only change the normality of our acid.

If by using 11.315 grams of milk (or 11 cc.) where each cc. of  $\frac{N}{10}$  acid corresponds to 1 per cent., by using a greater or larger quantity of milk the normality would have to be correspondingly less or greater. When we use 8.75 cc. or 9 grams of milk the normality would not be  $\frac{N}{10}$  but 795 cc.  $\frac{N}{10}$  acid plus water to make 1,000 cc. which equals  $\frac{N}{12.56+}$ . Upon the above facts the volumetric method of Van Slyke and Bosworth is based.

Procedure in carrying out in detail the volumetric estimation of casein: "A given amount of milk, diluted with water, is made neutral to phenolphthalein by the addition of a solution of sodium hydroxide. The casein is then completely precipitated by the addition of the standardized acetic acid; the volume of the mixture is then made up to 200 cc. by the addition of water, thoroughly shaken and then filtered. Into 100 cc. of the filtrate a standard solution of sodium hydroxide is run until neutral to phenolphthalein. The solutions are so standardized that 1 cc. is equivalent to 1 per cent. of casein when a definite amount of milk is used. The number of cc. standard acid used, divided by two (since only 100 cc. of the 200 cc. is used), less the standard alkali used in the last titration gives the percentage of casein in the milk examined." When 17.5 or 18 grams of milk are used the strength of acetic acid and alkali are made by diluting 795 cc. of  $\frac{N}{10}$  to 1,000 cc. The same normality as was derived above. Since only 100 cc. of the 200 cc. were titrated this then represents the acid required to liberate the casein in 8.75 cc. or 9 grams of milk. Likewise by using 22 cc. or 22.6 grams of milk treated as above, then 1 cc. of  $\frac{N}{10}$  acid equals 1 per cent of casein. By the use of a factor any convenient quantity can be used. Example, by the use of 20 cc. of milk and  $\frac{N}{10}$  solution, adjustment is made by multiplying the final result by 1.0964.

Apparatus and reagents necessary to carry on the volumetric estimation of casein in milk are, first, two 50 cc. burettes, graduated to 1/10 cc. or better 1/20 cc., these must be accurate. One of the burettes should be supplied with a glass stop cock for the acid, and one with a pinch cock for the alkaline solution. Second, flasks, volumetric, holding 200 cc. At least two of these are needed and where a number of estimations are to be made more are required to do rapid work; ten to twelve are necessary for rapid work. The

necks of these flasks should have an internal diameter of at least three-fourths of an inch. The reason for this diameter is necessary if the milk is neutralized in the flask. This neutralization can be done in the beaker into which the milk is weighed, if weights are taken. Third, pipettes, a Babcock milk pipette accurately graduated to deliver 17.5 cc. of milk, when 17.5 cc. or 18 grams of milk are used. When 22 cc. or 22.6 grams of milk are used it will be necessary to have a volume pipette graduated to deliver the above amounts or a 25 cc. Mohr pipette graduated into 1/10 cc. will be required. Fourth, one 100 cc. pipette or a volumetric flask graduated to hold 100 cc. Fifth, beakers of convenient sizes holding at least 200 cc. Sixth, if standard solutions are to be made, measuring cylinders or volumetric flasks holding 1,000 cc. are needed.

In regard to the making of the solutions it is best to prepare both the sodium hydroxide and the acetic acid as tenth normal. The accuracy of the succeeding work depends primarily on the correctness of the standard alkali and acetic acid. When it is desirable to make dilutions for different quantities of milk it can be made from the tenth normal stock solution. The *phenolphthalein solution* is prepared by dissolving one gram of phenolphthalein powder in 100 cc. of 50 per cent. alcohol. This should be neutralized by the use of a few drops of  $\frac{N}{10}$  NaOH to a very slight pink color.

*Carrying out the operation.* Weigh out 22.66 grams of milk, or measure out 22 cc., neutralize in the beaker in which the weighing has been made, using only enough alkali to give a very faint pink, then transfer to a 200 cc. flask and wash out beaker with 75 to 80 cc. of distilled water, free from carbon dioxide, shake and warm to 22° to 25° C. At this point observe the color of the diluted milk. Frequently on dilution the pink color becomes quite pronounced; if so, add a few drops of  $\frac{N}{10}$  acetic acid to a light pink. Run in from a burette 25 cc. of a  $\frac{N}{10}$  acetic acid, frequently shaking, for milk rich in casein it would require 30 to 40 cc. of acid. Then fill up to the 200 cc. mark, insert stopper and shake thoroughly. After standing for 5 or 10 minutes, filter, after filtration pipette or measure 100 cc. of the filtrate into a 250 cc. or 300 cc. beaker and titrate to a permanent faint pink color, record the cc. used. Since 25 cc. were added to the total volume and only one-half titrated, we only take 12.5 cc. into consideration. From what has been said a portion of the 25 cc.  $\frac{N}{10}$  acetic acid has been used in forming free casein, therefore the difference between 12.5 cc. and the amount of  $\frac{N}{10}$  NaOH used to neutralize the acid in the 100 cc. filtrate equals the number

of cc. acid used in liberating the casein. Since a quantity of milk has been taken so that each cc. of acid used equals 1 per cent. casein, then each cc. represents 1 per cent. of casein in the sample of milk. For example, it required 9.4 cc. to neutralize 100 cc. of the filtrate, and since it represented 12.5 cc. of the acid added to the 200 cc. of the diluted milk, we have  $12.5 \times \frac{9.4}{100} = 3.10$  per cent. casein.

Below are some of Van Slyke's results obtained by this method in comparison with the official method.

## PERCENT CASEIN.

| Volumetric Method<br>(Van Slyke-Bosworth). | Official Method. |
|--------------------------------------------|------------------|
| 3.00                                       | 3.00             |
| 3.40                                       | 3.36             |
| 3.30                                       | 3.21             |
| 3.20                                       | 3.16             |
| 2.90                                       | 2.95             |
| 2.70                                       | 2.60             |

The second volumetric method which I wish to consider is that of E. B. Hart, of the University of Wisconsin, published in Research Bulletin, No. 10, 1910. For speed and accuracy this method offers no advantage over that of Van Slyke's and Bosworth's, just mentioned. However, the method is unique and sound in principle. The fact that free casein has the properties of an acid and can combine with an alkali in a definite proportion, it seems rational that if we dissolve casein in excess of alkali and the uncombined alkali is estimated by titration, using phenolphthalein as an indicator, we are in a position to calculate the casein equivalent per cc. of standard alkali used. This is true, and upon this principle rests Hart's volumetric method. Hart found the casein equivalent for each 1 cc.  $\frac{N}{10}$  KOH to be .108 grams. Therefore, if we titrate the casein obtained from 10.8 grams of milk, we see that each cc. of alkali used must represent 1 per cent. of casein.

*Details of the method.* Measure 10.5 cc. or weigh 10.8 grams of milk into a 200 cc. Erlenmeyer flask, add 75 cc. of distilled water at room temperature and add to this 1 to 1.5 cc. of a 10 per cent. solution of acetic acid. The flask is given a quick rotary motion, usually 1.5 cc. of acetic acid gives

a clear and fast filtering separation, but if the milk is low in casein a little less acetic acid should be used. The separated precipitate is now filtered through a filter (9-11 cm. filter), the flask rinsed out thoroughly and poured on the filter, preferably cold. If a strong stream of water is directed against the filter, the casein washing is facilitated. About 250 to 300 cc. of water should pass through the filter to insure the removal of all traces of acetic acid. The precipitate, together with the filter paper, is now returned to the Erlenmeyer flask in which the precipitation was made. To this is now added 75 cc. of distilled water, *free from carbon dioxide*, and then a few drops of phenolphthalein and 10 cc. of  $\frac{N}{10}$  potassium hydroxide. A rubber stopper is placed in the flask and the contents shaken vigorously. Complete solution is easily indicated by the disappearance of the white casein particles. After solution the stopper is rinsed off into the flask with carbon dioxide free water and immediately titrated with  $\frac{N}{10}$  acid to the disappearance of the red color. It is necessary that a blank be run parallel with the determination. For example, suppose it required 7.20 cc. of acid to make the pink color just disappear and the blank amounted to .2 cc., the percent of casein would be  $10 - 7.4 = 2.60$  per cent. casein. *Precautions necessary.* First, water free from carbon dioxide, must be used. Second, the titration should be made as soon as solution of casein has taken place. This will be from half an hour to an hour after adding the  $\frac{N}{10}$  alkali. Repeated shaking hastens solution.

Results obtained by Hart as compared with the official method.

PERCENT CASEIN.

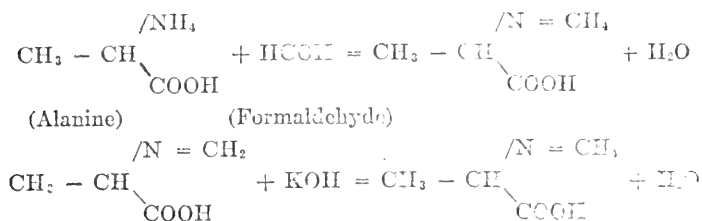
| Official Method. | Volumetric Method<br>(Hart). |
|------------------|------------------------------|
| 3.78             | 3.75                         |
| 3.12             | 3.05                         |
| 2.87             | 2.85                         |
| 1.90             | 1.85                         |
| 2.30             | 2.25                         |
| 2.37             | 2.30                         |

The next volumetric method to be considered is the Formol titration method. This is perhaps the most rapid method of the three volumetric methods, for estimating the proteids in milk. It was pointed out in 1900 by Hugo Schiff that when formaldehyde was added to amino acids, the acid

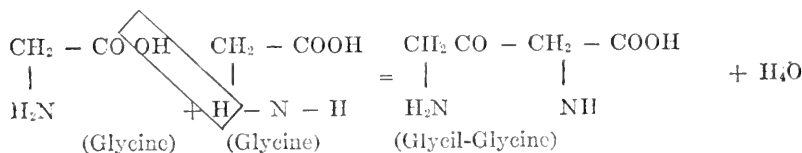
properties of the acid were developed and could be titrated as any organic acid.

S. P. L. Sorensen worked out the details and made it possible to estimate amino acids quantitatively by means of formaldehyde. It is well known that amino acids, such as are formed by the hydrolysis of proteins, especially milk proteids, are neutral to phenolphthalein, have both an acidic group, carboxyl and a basic (amino) group. These exist in the same molecule and being the alpha amino acids neutralize each other, or in other words we have an amphoteric molecule, but as soon as formaldehyde is added, it reacts with the alkaline or basic group forming a methylene compound and leaving the acid group free to act.

For example:



From Emil Fisher's researches on protein and polypeptids there is no doubt that the protein molecule is composed of amino acid units. The carboxyl group ( $-\text{COOH}$ ) of one amino acid is combined with the amino group ( $-\text{NH}_4$ ) of another amino acid, forming peptids, di, tri, etc., to polypeptids. For example, glycy-l-glycine composed of two units of glycine.



Likewise different units may combine, as example, alanyl-glycyl-tyrosine from which we see that each peptid has one carboxyl group ( $-\text{COOH}$ ) acidic and one amino group ( $-\text{NH}_2$ ) basic. Now if the protein molecule is built up from amino acids, we can expect it to split up into simpler mole-

cules, by hydrolysis either with an acid or ferment into peptones, etc. Then we would expect the formol number to increase, double, if each protein molecule were split into two simpler ones. This is true, so formol titration gives a measure of the hydrolytic cleavage. We know that the proteids of milk are neutral to indicators, but on the addition of the formaldehyde become decidedly acid to these indicators.

Now if we can determine a factor or equivalent of the acidity produced on the addition of the formaldehyde to milk proteids, we can at once determine the percent of proteids in milk by titrating the acidity with a standard alkali.

In 1912, E. Holl Miller, of England, worked out a method for estimating the proteids in butter, and the same method is used in determining the proteids in milk.

*Directions for estimating the proteids in butter.* Weigh into a tared beaker exactly 10 grams of butter, which is placed in a water bath at 60° to 70° C. until the butter is completely melted. Twenty-five cc. of carbon dioxide free water is then added at about 60° C. and 1 cc. of phenolphthalein solution. The contents are well agitated. Run in  $\frac{N}{20}$  NaOH until a faint permanent pink color is formed. It is found that the end point is masked by the yellow color of butter fat, the contents of the beaker should be allowed to settle and the bottom aqueous layer observed, and the addition of alkali continued until the pink tint is obtained. Five cc. of formaldehyde (40 per cent.) is added. The formaldehyde must either be neutralized before addition or its acidity equivalent for 5 cc. obtained and afterwards deducted. After the formaldehyde has been added the beaker is well shaken and again  $\frac{N}{20}$  NaOH run in until a permanent faint pink color is produced in the aqueous layer. The number of cc.  $\frac{N}{20}$  alkali used in the second titration less the amount equivalent to the acidity of the formaldehyde. No deduction is necessary if the formaldehyde was neutralized before being added to the butter. Now the number of cc.  $\frac{N}{20}$  alkali used to neutralize the acidity produced on the addition of the formaldehyde is proportional to the protein present. One cc. of  $\frac{N}{20}$  alkali is equivalent to .01355 grams of protein nitrogen or .0864 grams milk protein, assuming a definite proportion of casein and albumen. Then to calculate the percent of protein we have  $\frac{.0864 \times 100 \times \text{cc.}}{10} = \text{per-}$   
cent protein if 10 grams of butter were taken.



The following table shows the percent protein in butter by the Formol titration and official method:

| Official Method. | Formaldehyde. |
|------------------|---------------|
| .65              | .59           |
| .48              | .47           |
| .46              | .42           |
| .48              | .50           |
| .60              | .68           |
| .45              | .42           |
| .42              | .40           |
| .41              | .41           |
| .49              | .52           |

*Procedure to estimate the protein in milk.* To estimate the proteids in milk, weigh out 10 or 20 grams, preferably 20 grams, in a tared beaker, about 150 to 200 cc. capacity. Add 1 cc. of phenolphthalein solution, then run in from a burette  $\frac{N}{20}$  NaOH until decided pink color is produced, a little practice will enable one to carry the shade of color in mind. Then add 10 cc. of neutralized formaldehyde, stir with a glass rod, when well mixed add  $\frac{N}{20}$  NaOH until the same shade of pink is produced as that before the formaldehyde was added (note this last addition of alkali). For example, if 7 cc. of  $\frac{N}{20}$  NaOH were required to neutralize the acidity produced on addition of formaldehyde to 20 cc. of milk, then as in the case of butter:

$$\frac{.0864 \times 100 \times 7}{20} = \text{percent protein} = 3.024$$

If we wish to estimate the casein alone and assuming the casein and albumen are in proportion of 3 per cent. casein and .5 per cent. albumen, then by using the equivalent of .075, we have as above:

$$\frac{.075 \times 100 \times 7}{20} = \text{percent casein} = 2.62$$

The following table gives the results of the three volumetric methods compared with the official methods on the same sample of milk:

## PERCENT CASEIN.

| Official. | Van Slyke-Bosworth. | Hart. | Formol Titration. |
|-----------|---------------------|-------|-------------------|
| 2.98      | 3.05                | 2.95  | 2.99              |
| 2.96      | 3.05                | 2.90  | 2.98              |
| 2.45      | 2.45                | 2.40  | 2.50              |
| 2.40      | 2.40                | 2.35  | 2.48              |
| 1.79 (d)  | 1.80                | 1.80  | 1.85              |
| 1.77 (d)  | 1.75                | 1.85  | 1.83              |
| 3.28      | 3.25                | 3.18  | 3.18              |
| 3.29      | 3.20                | 3.15  | 3.20              |
| 2.46      | 2.49                | 2.40  | 2.46              |
| 3.77      | 3.80                | 3.65  | 3.70              |
| 2.90      | 2.90                | 2.80  | 2.96              |
| 2.47      | 2.50                | 2.45  | 2.48              |
| 3.71      | 3.70                | 3.70  | 3.74              |
| 2.85      | 2.85                | 2.85  | 3.01              |
| 2.80      | 2.74                | 2.70  | 2.76              |
| 2.89      | 2.85                | 2.90  | 2.91              |

Note.—The two samples marked (d) were diluted milk.  
 Samples were taken on different days from the same source.

The above table shows the relative accuracy of the different methods. For the estimation of casein in milk the choice of the methods mentioned depends on the purpose for which the analysis is made. If total proteids are to be estimated, the Van Slyke-Bosworth and Hart methods must be excluded, unless an assumption is made as to the average amount of albumen in milk. This could be done on the same basis as that for the formol method and which would introduce only a slight error for normal milk and from a mixed herd.

In reviewing these methods and considering speed, and ease of carrying out the work, the formol titration method is to be preferred. In all three volumetric methods it is very essential that the water used for dilution should be free from carbon dioxide. Very little distilled water found in laboratories is free from carbon dioxide. This factor alone may introduce errors to vitiate the results. Titration after the addition of the formaldehyde should be carried to a sharp pink color and remain so for at least five minutes.

GEORGE SPITZER.

Purdue University.

## NEW CAVE NEAR VERSAILLES.

ANDREW J. BIGNEY.

It is known as the cave of Dr. Jim Sale of Dillsboro. It is situated one mile northeast of Versailles. It is located near the top of a high hill overlooking Laughery valley. The view from this position is most picturesque. The lover of nature is enchanted by the richness of the scenery. The climb up the hill from the Fallen Timber creek to the mouth of the cave is most exhilarating.

The entrance is guarded by an iron gate. Excavations have been made and walls built, so as to open a passage to the cave proper, thus making it convenient for the visitor. A stream of water had been passing through the cave. Now a pipe carries off the water. About thirty feet from the mouth of the cave is the main room, which is very beautiful because of the numerous pillars, stalactites and stalagmites. The ceiling is high enough for the tallest man to walk in freely, and in some places could not touch the ceiling with outstretched arms. Some of the pillars are four to five feet in height. The ceiling is decorated artistically with stalactites in great numbers and in various sizes, with many corresponding stalagmites. Passing to the right there is a smaller room also covered with typical cave formations. A passage extends about thirty feet beyond in the clay and limestone rocks with only a few stalactites. Extending from the main room is a narrow passage about seventy feet long where there is a spring from which flows a moderate stream in rainy weather. The ceiling and crevices above are likewise decorated with the stalactites. Undoubtedly there must be other rooms, but they have been naturally filled up with dirt and stone. Even outcropping on the side of the hill are large formations of stalactites and stalagmites. It is certainly a very interesting place.

The region round about Versailles has many caves, but this is the only one that has the cave formations. While it is not a large cave like the Marengo and Wyandotte, yet its geological structures are just as typical and interesting as in the larger caves. It is instructive, for it is near the margin of the cave region of southern Indiana and northern Kentucky. Geologically speaking, it is in the lower Silurian or Ordovician formation. It will be instructive for the schools to visit the cave so as to get some accurate information of cave structures. The entire region is most fascinating.



## LOESS AND SAND DUNE DEPOSITS IN VIGO COUNTY, INDIANA.

W. M. A. MCBETH.

Loess deposits are mentioned in various places as occurring along the bluffs of the lower Wabash river. Dr. J. T. Seovell, who in the twenty-first annual report of the State Geologist has given the most extended and detailed description of the geography and geology of Vigo county yet published,



Looking west along National Road from upland along east side of Wabash Valley.

mentions in a single sentence that "Along the eastern margin of the main valley there are extensive areas of dune sand and at some localities in the eastern bluffs there are thick beds of loess." So far as I have observed slight reference has been made to the distribution, appearance and extent of the loess or loess-like deposits of the lower Wabash valley. The loess is so involved with sandy material that it is difficult to distinguish between the two and interstratified clay. The inclination in examining these materials is to consider them but different phases of the same thing. The interstratified clay does not contain boulders and may be weathered or chemically decomposed loess, while the sandy covering may be due to wind assortment.

Occasional gasteropod shells of very small size are found. The deposits occur in ridges and dunes usually within less than a mile from the crest of



Dune in Highland Lawn Cemetery. North side National Road. Note ridge beyond building at left and opposite a cross roads at right.



Dunes south of National Road  $\frac{1}{4}$  mile. Looking west from level upland. The valley is just beyond.

the east bluff and often within a few rods. Sometimes a single continuous ridge of uniform height and width crowns the bluff. In places there are

successive ridges two or three and in instances four. In still other places the topography takes the form of dunes, low domes with no characteristic order or grouping. The gradients of the ridges on the leeward or east side if often remarkably steep. The height of the ridges is in a few cases as much as twenty-five feet. In most instances the height is not more than half the figure stated. An interesting observation is that the dunes and ridges extend along the north sides of tributary valleys still keeping a north-south direction in the ridges, which in some places are arranged in etchelon. This is noticed on the north side of Honey creek. The surface on the north side of Otter creek valley appears as one long wave after another, cloaking the bluff front



Blake Hill. A sand dune north side National Road.

and crest. This arrangement of ridges along the re-entrant valleys indicates that the valleys were made before the deposits. The direction of the bluffs has evidently influenced the deposition of the material as a section of the river bluffs running directly east-west on the south side of Honey creek shows no dunes or ridges. The deposits also show a marked relation to the terrace area in the valley. Where a broad stretch of terrace lies below the bluffs the ridges and dunes are more strongly developed. Where flood plains approach the bluffs the deposits on the crest and bordering uplands decrease or disappear. Conclusions as to the cause of the deposits and their source seems to be amply justified by the evidence that the deposits are wind

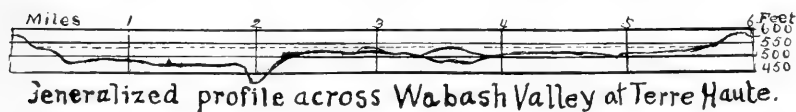
blown, the materials, including the shells being collected from the terrace surface from the silts deposited by the valley-wide stream. This deposition probably occurred soon after the stream abandoned the terrace level and withdrew to the present deeper third of the valley width. The work was done mainly before the invasion by vegetation of the terrace, bluff front and upland border, after the retreat of the ice sheet from the region. The loess may be a wind deposit from the bare valley at the close of the Illinoian ice invasion. This dust may have weathered through a long interglacial period of time to be covered with later deposits of dust and fine sand swept over the valley from the border of the Late Wisconsin ice which did not reach the present site of Terre Haute, but whose strong moraine lies fifteen or twenty miles upstream near Clinton and Rockville.



## VOLUME OF THE ANCIENT WABASH RIVER.

WM. A. MCBETH.

The Wabash valley at Terre Haute has a width of five to six miles. One-third this width has a depth of approximately one hundred feet, embracing a flood plain tract through which the river meanders in a channel averaging one thousand feet wide and twenty feet deep. The remaining half is a terrace about half the depth of the deeper part. The whole valley bottom shows the effects of stream deposition, the pre-glacial trench of two hundred to two hundred and fifty feet in depth being half-full of sand and gravel. A point



of interest in connection with the stream and valley is the question of volume of water by which various phases of the work was done. The size and weight of pebbles in the gravel indicate a volume and velocity much greater than that of the present stream either in average volume or flood. Some suggestion as to the width and depth of the stream at its stage of greatest flow is furnished by features of the terrace surface consisting of sandbars and delta deposits. This terrace surface is marked with numerous shallow current lines or channels. The bars form ridges of greater length than width, often many times longer. They trend northeast, southwest, the direction of the valley and have the characteristic stratified structure of such features, the layers of finer or coarser sand dipping steeply down stream. Extensive areas of the terrace surface lie at an elevation of four hundred and ninety feet a.t.l. Some places are five feet lower while some of the ridge tops rise to the five hundred and thirty foot level. Low water in the present stream is four hundred and forty-five feet. Points in sections 3, 23 and 24 and a bluff side delta of a brook crossed by Fruitridge avenue at the south edge of Section 24, Town 12 N. Range 9 W., rise to nearly the five hundred thirty foot level. Sandbars and deltas are built under water and the surface of the stream in which these deposits were made must have been a few inches and possibly several feet above the ridge and delta tops when they were

completed. The range of elevation four hundred ninety to five hundred thirty equals forty feet over large areas with places of forty-five feet or more. A cross profile from bluff to bluff shows these ridge tops to be the highest points between bluffs. Water covering these ridges must have covered the valley from side to side making a stream of from five to six miles wide and forty to fifty feet deep. Just how much of the year or for how long periods the water maintained such a volume it would seem impossible to say, but probably the maximum volume was reached in summer and maintained through the summer months, declining as winter came on. The assumption is that the largest volume of water was produced by the summer melting of the Great Ice Sheet that formerly overspread the Northern United States and much of Canada. Whether the west deeper side of the valley was then lower than the terrace portion cannot be stated certainly, deeper water probably covered the part of the valley that now shows the greatest depth. A depth of twenty feet of water is shown for the highest parts of the site of Terre Haute.

## A BIBLIOGRAPHY OF GEOGRAPHIC LITERATURE CONCERN- ING FOREIGN COUNTRIES.

Taken from Non-geographical Magazines 1900-1914; Government Documents;  
and Geographical Magazines.

B. H. SCHOCKEL.

### INTRODUCTION.

This bibliography is submitted in the hope that it will be of some value to teachers of geography below the University, even though it is incomplete, and loosely organized. Each article has at least been briefly scanned. There are included many articles not written from a geographic standpoint, but it is thought that these also will be of some value to the geography teacher.

The accompanying key is employed to save space. The first reference under South America, for example, according to the key is *Bulletin of the Pan American Union*, volume 32, pages 240 to 251.

Acknowledgement is due to C. O. McFarland and Mrs. E. E. Rullman for assistance in preparing the bibliography.

### KEY.

- I. American Journal of Archaeology.
- II. American Journal of Science.
- III. Annals of the American Academy of Political and Social Science.
- IV. Atlantic Monthly.
- V. Bookman.
- VI. Bulletin of the American Geographical Society (Journal).
- VII. Bulletin of the Pan American Union.
- VIII. Bulletin of the Geographical Society of Philadelphia.
- IX. Bureau of American Republics. (Pan American Union.)
- X. Century Magazine.
- XI. Chautauqua.
- XII. Engineering.
- XIII. Everybody's Magazine.

- XIV. Forum.
- XV. Geographical Journal.
- XVI. Harper's Magazine.
- XVII. Harper's Weekly.
- XVIII. Harvard Graduate's Magazine.
- XIX. Independent.
- XX. Johns Hopkins University Studies.
- XXI. Journal of Geography. (Journal of School Geography.)
- XXII. Journal of Geology.
- XXIII. National Geographic Magazine.
- XXIV. New England Magazine.
- XXV. North American Review.
- XXVI. Popular Science Monthly. (Scientific Monthly.)
- XXVII. Records of the Past.
- XXVIII. Review of Reviews.
- XXIX. Science.
- XXX. Scientific American Supplement.
- XXXI. Scribner's Magazine.
- XXXII. Scottish Geographical Magazine.
- XXXIII. Smithsonian Institute Reports.
- XXXIV. The Trend.
- XXXV. University of Chicago Magazine.
- XXXVI. Westminster Review.
- XXXVII. World Today.
- XXXVIII. World's Work.
- XXIX. Yale Review.
- XL. Yearbook Department of Agriculture.
- XLI. Bay View Magazine.
- XLII. Journal of School Geography.
- XLIII. Journal of Political Economy.
- XLIV. Geographical Teacher.

#### SOUTH AMERICA.

- Sears, J. H.: Trade and Diplomacy between Latin America and the United States.—VII; 32; 240-51.
- Baralt, B.: The literature of Spanish America.—VII; 36; 30-37.

- Chandler, C. L.: World race for the rich South American trade.—XXXVIII; 25; 314-22.
- Freeman, L. R.: Hydro-electric operations in South America.—VII; 37; 633-56.
- Reid, W. A.: Railways of South America.—VII; 37; 165-191.
- Latin American foreign trade in 1911—general survey.—VII; 36; 225-244.
- Ward, R. D.: Climate of South America.—VI; 351; 353-60.
- Posey, C. J.: Points in the geography of South America.—XXI; 12; 65.
- Pepper, M.: South America fifty years hence.—XXIII; 17; 427-32.
- Barrett, J.: Our manufacturers' greatest opportunity.—III; 34; 520-531.
- Sears, A. F.: German influence in Latin America.—XXVI; 72; 140-52.
- What the Latin-Americans think of, and why United States should encourage the Pan-American conferences.—XXIII; 17; 474-9; 497-80.
- Ogg, F. A.: German interests and tendencies in South America.—XXXVIII; 5; 3169-3170.
- Bowman, J.: Geographical aspects of the new Madeira-Mamoré railroad.—VI; 45; 275-81.
- Rice, H.: Further exploration in the Northwest Amazon basin.—XV; 44; 137-64.
- Furlong, C. W.: South America's first transcontinental.—XXXVIII; 20; 13535-55.
- Humphrey, W. E.: Shipping facilities between the United States and South America.—III; 38; 621-637.
- Bowman, I.: Physiography of the central Andes.—II; 178; 197-373.
- Bulfin, W.: United States in Latin America.—XXXVIII; 4; 2533-2550.
- Denuci, J.: The discovery of the north coast of South America according to an anonymous map in the British Museum.—XV; 36; 65-80.
- Smith, J. R.: Western South America and its relation to American trade.—III; 18; 446-468.
- Emory, F.: Causes of our failure to develop South American trade.—III; 22; 153-156.
- Tower, W. S.: Notes on the commercial geography of South America.—VI; 45; 881-901.
- The quest of El Dorado.—VII; 34; 55-66; 165-176; 317-27; 447-58; 607-621; 732-43.
- South America: Its general geographic features and opportunities.—VIII; 8; 47-53.

- Forteseue, G.: South American trade hints.—VII; 32; 261-69.
- Bulletins of the International Bureau of American Republic.—House Doc.; 267; Vol. 68-72; 58 Cong., 3rd Sess.; Serial Nos. 4847-50.
- Ibid: House Doc. Vol. 75-76; 56th Cong., 1st Sess.; Serial Nos. 3972-3.
- Ibid: House Doc. Vol. 86-89; 59th Cong., 1st Sess.; Serial Nos. 5026-29; 49; 49-54.
- Dr. Koch: Grünberg's explorations in the Northern Amazon basin and the Guiana Highlands (map).—VI; 45; 664-66.
- Dunn, A. W.: Beef from South America and Australia.—XXVIII; 49; 49-54.
- Hammond, J. H.: The expansion of our Latin American trade.—XIX; 80; 406.
- Brown, C. M.: Cocoa-nuts in the Americas.—VII; 32; 17-39.
- Tin mining in the Americas.—VII; 31; 983-94.
- Millward, R. H.: Petroleum in the Americas.—VII; 31; 756-78.
- Cacao of the world.—VII; 34; 75-85.
- Church, G. E.: Aborigines of South America.—VII; 38; 360-69.
- Savage-Landor, A. H.: Across unknown South America.—VII; 38; 204-13.
- Reid, W. A.: Coca, the wonder plant of the Andes.—VII; 38; 640-56.
- A commercial traveler in South America.—VII; 38; 37-53; 183-203; 329-47; 516-35; 657-78; 810-830.
- Wight, W. F.: South American fruit production.—VII; 38; 9-26.
- Reid, W. A.: Furs in the Americas.—VII; 38; 157-169.
- Bowman, I.: Results of an expedition to the Central Andes.—VI; 46; 161-83.

#### ARGENTINE REPUBLIC.

- Argentine Republic.—VII; 31; 2-26.
- Brandon, E. E.: Argentine universities.—VII; 34; 223-230.
- Commerce of Argentine Republic.—VII; 36; 445-49.
- Attwell, J. S.: Argentine and its capital.—XLI; Jan., 1913.
- Argentine plains and andine glaciers, with a description of the South American locust.—VII; 33; 1082-94.
- Hale, A.: Crossing the Andes by aero and auto.—VII; 38; 313-21.
- Cultivation of cotton in Argentina.—VII; 33; 751-59.
- The Argentine Republic.—VII; 33; 9-46.
- Albes, E.: The strait of Magellan, Pinita, Arenas, and the Tierra del Fuegiaus.—VII; 35; 989-1002.

- Albes, E.: Buenos Aires and vicinity.—VII; 35; 816-335.
- Chandler, C. L.: The Argentine southward movement.—VII; 38; 489-98.
- Townsend, C. H.: Naturalist in Straits of Magellan.—XXVI; 77; 1-18.
- Wheat supply.—XLIII; 12; 5-35.
- Indian corn in Argentina.—XLIII; 12; 255.
- Tower, W. S.: A journey through Argentina.—VIII; 12; 89-113.
- Kuezywski, R. R.: Wheat growing in Argentina.—XLIII; 10; 266-281.
- Wilcox, M.: Argentine Patagonia: A land of the future.—VI; 42; 903.
- Grubb, W. B.: The chaco-boreal: The land and its people.—XXXII; 16; 418-429.
- Smith, J. R.: The economic geography of the Argentine Republic.—VI; 35; 130-143.
- O'Driscoll, F.: A journey to the north of the Argentine Republic.—XV; 24; 384-408.
- Smith, W. G.: A visit to Patagonia.—XXXII; 28; 456-75.
- Wellington, C. W.: Among the titans of the Patagonian pampas.—XVI; 122; 813-827.
- Bowman, I.: Northern Patagonia.—VI; 45; 357-59.
- Corthell, E. L.: Two years in Argentina as the consulting engineer of national public works.—VI; 35; 439-471.
- Albes, E.: Across the pampas of Argentina; a day in Mendoza, and over the Andes; VII; 35; 506-21.
- Hirst, W. A.: Argentine.—XXXI; 1911.
- Furlong, C. W.: Vanishing people of the land of fire.—XVI; 120; 217-29.
- Report on trade conditions in Argentina, Paraguay, and Uruguay.—United States Commerce and Labor; Miscellaneous Reports, Vol. 2, article 5.
- Hatcher, J. B.: Some geographic features of Southern Patagonia, with a discussion of their origin.—XXIII; 11; 41-55.
- Steffen, H.: The Patagonian cordillera and its main rivers.—XV; 16; 14-39; 185-211.
- Willis, B.: Recent surveys in Northern Patagonia.—XV; 40; 607-15.
- Holdich, Sir T. H.: The Patagonian Andes.—XV; 23; 153-76.
- Barrett: Argentina, Uruguay and Paraguay.—XIX; 66; 88-96.

## BOLIVIA.

## BOLIVIA.

- Brandon, E. E.: Higher education in Bolivia.—VII; 33; 1124-30.  
 Bolivia.—VII; 33; 206-224.  
 Picturesque La Paz, the capital of Bolivia.—VII; 37; 209-19.  
 Bowman, I.: The distribution of people in Bolivia.—VIII; 8; 74-93; 159-84.  
 Explorations in Bolivia.—XV; 35; 513-532.  
 Horn, R. C.: The historic foundations of Coleha, in Bolivia.—XXVII;  
 12; 116-22.  
 Further explorations in Bolivia: The River Heath.—XV; 37; 377-398.  
 Bolivia: VII; 31; 27-41.  
 Adams, H. C.: Liberation of Bolivia.—XXVIII; Jan., 1913.  
 The geography and natural resources of Bolivia.—XXXII; 27; 6-13.  
 Hoek, Dr. H.: Explorations in Bolivia.—XV; 25; 498-513.  
 Hill, A. W.: Notes on a journey in Bolivia and Peru around Lake Titicaca.—  
 XXXII; 21; 249-260.  
 Adams, C.: Kaleidoscopic view of La Paz.—XXIII; 20; 119-42.  
 Calderon, S. Y.: A country without a debt.—XXIII; 18; 573-86.  
 Bowman, I.: Trade routes in the economic geography of Bolivia.—VI;  
 42-22-90-180.  
 Handbook of Bolivia.—House Doc., No. 145, V. 67; 51 Cong., 3rd Session;  
 Serial No. 4846.  
 Riviere, A. De: Explorations in the rubber districts of Bolivia.—VI; 32;  
 432-440.  
 Bingham, H.: Potosi.—VI; 43; 1-13.  
 Travels on the boundary of Bolivia and Argentina.—XV; 21; 510-25.  
 Evans, J. W.: Expeditions to Bolivia.—XV; 22; 601-46.  
 Barrett: The western republics of South America.—XIX; 66; 515-23.  
 Commerce of Bolivia for 1912.—VII; 38; 110-117.

## BRAZIL.

- Ward, D.: The economic climatology of the coffee district of Sao Paulo,  
 Brazil.—VI; 43; 428-445.  
 Branner, J. C.: The geography of northeastern Bahia.—XV; 38; 139-152;  
 256-269.  
 Brazil.—VII; 33; 47-80.



- All-rail route between Montevideo and Rio De Janeiro.—VII; 33; 1095-1114.
- Astimead, P. H.: Madeiro-Mamore railway.—VII; 32; 432-52.
- Iron ores of Brazil.—VII; 32; 652-65.
- Brazil.—VII; 31; 42-73.
- Hale, A.: Developing the Amazon valley.—VII; 36; 38-47.
- Wright, M. R.: The mighty Amazon.—XLI; Feb., 1913.
- Hale, A.: A trip through Brazil.—XLI; Feb., 1913.
- Sugar in Brazil.—VII; 34; 205-211.
- Albe, E.: The beautiful capital of Brazil and its environment.—VII; 36; 1-26.
- Albes, E.: Bahia and Papa, two great ports of Brazil.—VII; 36; 165-182.
- Post, C. J.: From frontier to frontier through the rubber country.—X; 83; 352-64.
- Brandon, E. E.: Higher education in Brazil.—VII; 34; 636-45.
- Peniambico: Sao Paulo and Santos, in eighty days with the Bluecher party.—VII; 35; 55-72.
- Hale, A.: The port of Para.—VII; 35; 682-98.
- Col. Roosevelt's exploration of a tributary of the Madeira.—VI; 46; 512-19.
- Hale, A.: Madeiro-Mamore railway company.—VII; 35; 1124-41.
- Hale, A.: Valley of the river Amazon.—VII; 35; 1116-24.
- Post, C. J.: Shooting the canons of the Eastern Andes.—X; 83; 273-84.
- Danson, T. C.: The Caucasian in Brazil.—XXVI; 64; 550-56.
- Keller, A. J.: Portuguese colonization in Brazil.—XXXIX; 14; 374-410.
- Branner, J. C.: Palm trees of Brazil.—XXVI; 60; 387-412.
- Furniss, H. W.: Diamonds and carbons of Brazil.—XXVI; 69; 272-280.
- Lome, H. M.: An American sanitary triumph in Brazil.—XXXVIII; 20; 12951-56.
- Ward, R. D.: A visit to the coffee country of Brazil.—XXIII; 22; 908-31.
- Ward, R. D.: The southern campos of Brazil.—VI; 40; 652.
- Cobb, D. A.: Tales from Brazil.—XXIII; 20; 917-21.
- A trip up the lower Amazon.—XXXII; 45; 881-901.
- Koettlitz, R.: From Para to Manaos: A trip up the lower Amazon.—XXXII; 17; 11-30.
- Ruhl, A.: Where the coffee comes from.—XXXI; 43; 739.
- Roosevelt, T.: A hunter naturalist in the Brazilian wilderness.—XXXI; 55; 407-539-667.

Hutchinson: Trade conditions in Brazil.—Senate Doc. 164; 59th Cong., 1st Sess.; Serial No. 4912.

Brazil.—House Doc. 557; 57th Cong., 1st Sess.; Serial No. 4357.

#### CHILE.

Smith, J. R.: The economic geography of Chile.—VI; 36; 1-21.

Gibson, H.: The boundary dispute between Chile and Argentina.—XXXII; 18; 87-90.

Tower, W. S.: Nitrate fields of Chile.—XXVI; 83; 209-230.

Argentina-Chile boundary dispute.—XXIII; 13; 27-28.

Bertrand, A.: Methods of survey employed by the Chilean boundary commissions.—XV; 16; 329-45.

Ward, R.: Climatic control of occupation in Chile.—XLII; 1; 289-92.

Gormaz, T. V.: Depressions and elevations of the southern archipelagoes of Chile.—XXXII; 18; 14-24.

Young, E. C.: A journey among the highlands of Chile.—XV; 26; 307-18.

Bowman, I.: The regional population groups of Atacama.—XXXII; 26; 1-9; 57-67; also VI; 41; 142-93.

Van Dyke, H. W. V.: Chile.—XI; 66; 54-79.

Albes, E.: Santiago and Valparaiso.—VII; 35; 703-21.

Brandon, E. E.: University of Chile.—VII; 34; 67-74.

Hale, A.: The city of Valparaiso, Chile.—VII; 36; 653-667.

Chile.—VII; 31; 74-96.

Bituminous coal of Chile.—VII; 32; 684-88.

Chile.—VII; 33; 421-53.

Tower, W. S.: The economic resources of Chile.—VII; 36; 207-224.

Ross, W. H.: Origin of nitrate deposits.—XXVI; 85; 134-45.

Barrett: The western republics of South America.—XIX; 66; 515-23.

Linking the ends of Chile.—VII; 38; 27-36.

#### COLOMBIA.

Colombia.—VII; 33; 224-245.

Colombia.—VII; 31; 97-115.

Coal on the Pacific coast of Colombia.—VII; 37; 97.

Alexander, T. S.: Colombia: The government; the people, and the country. XXXVIII; 7; 4336-4343.

- Barrett: The northern republics of South America.—XIX; 66; 789-96.  
 The emerald mines of Colombia.—VII; 38; 839-44.  
 Pearse, A. S.: Tropical nature in Colombia.—XXVI; 84; 290-305.

## ECUADOR.

- Ecuador.—VII; 31; 166-88.  
 Commerce of Ecuador.—VII; 36; 92-97.  
 Bennett, F. W.: Guayaquil and Quito railway.—VI; 35; 361-364.  
 Ecuador.—VII; 33; 246-67.  
 Lee, J.: Beautiful Ecuador.—XXIII; 18; 81-91.  
 Barrett: The northern republics of South America.—XIX; 66; 789-96.  
 Handbook of Ecuador.—IX; Bulletin 64.  
 Commerce of Ecuador for 1911.—VII; 38; 259-64.  
 Moore, C. H.: Railway construction in Ecuador.—VII; 38; 170-82.

## GUIANA.

- Percival, J. B.: Resources of Dutch Guiana.—VII; 37; 818-26.  
 Villers, J. A. J. de: The foundation and development of British Guiana.—  
 XV; 38; 8-26.  
 Heilprin, A.: An impression of the Guiana wilderness.—XXIII; 18; 373-85.  
 Eigenmann, C. H.: Notes from a naturalist's experiences in Guiana.—  
 XXIII; 22; 859-70.  
 Rodway, J.: The forest problem in British Guiana.—VI; 34; 211-16; 283-94.  
 Furlong, C. W.: Through the heart of the Surinam Jungle.—XVI; 128;  
 327-39.

## PARAGUAY.

- Paraguay.—VII; 31; 294-306.  
 Paraguay in prospect.—VII; 36; 785-802.  
 Grubb, W. B.: An unknown people in an unknown land.—VII; 36; 532-44.  
 Fitzhugh, E.: Paraguay and the Paraguayans.—XLI; Jan., 1913.  
 Paraguay.—VII; 33; 356-76.  
 Bibliography of Paraguay.— House Document, Vol. 65, No. 145; 58th Cong.  
 3rd Session; Serial No. 4844.  
 Hale, A.: Yerba Mate: Paraguayan tea.—VII; 32; 469-87.  
 Barrett: Argentina, Uruguay, and Paraguay.—XIX; 66; 88-96.

## PERU.

- Howland, S. S.: Cuzco, the sacred city of the Incas.—XXXI; 51; 205-19.  
Peru.—VII; 33; 454-77.
- Gregory, H. E.: A geographical sketch of Titicaca, the island of the sun.—  
VI; 45; 561-575.
- Brandon, E. E.: Technical schools of Lima, Peru.—VII; 33; 942-46.  
The ancient ruins of Tiahuanacu.—VII; 37; 513-32.
- Todd, M. L.: Ancient temples and cities of the new world.—VII; 31; 967-77.
- Todd, M. L.: The Cordillera of Peru.—XIV; 51; 119-23.  
Peru.—VII; 31; 307-24.
- Commerce of Peru for 1911.—VII; 36; 113-122.
- Peixotto: Down the west coast of Lima.—XXXI; 53; 421-38.  
Commerce of Peru for 1912.—VII; 38; 265-273.
- Beasley, W.: Remarkable civilization of the ancient Incas.—XLI; Jan., 1913.
- Peixotto, E.: The land of the Incas.—XXXI; 53; 699-713.
- Guiness, G.: Descendants of the Incas.—XLI; Jan., 1913
- Barrett: The western republics of South America.—XIX; 66; 515-23.
- Bowman, I.: Buried walls at Cuzco and its relation to the question of a pre-  
Inca race.—II; 184; 497-509.
- Bingham, H.: Prehistoric human remains, investigation of, found near  
Cuzco.—II; 186; 1-5.
- Vernier, W.: Chan-Chan, the ruined Chimu capital.—VII; 38; 348-359.
- Wilson, L. L. W.: Climate and man in Peru.—VIII; 8; 79-97.
- Adams, H. C.: Cuzco, America's ancient mecca.—XXIII; 19; 669-94.
- Hardy, O.: Cuzco and Apurimac.—VI; 46; 500-12.
- Bingham, H.: In the wonder land of Peru. —XXIII; 24; 386-573; 23; 417-23.
- Hall, F. M.: Ancient and modern Peru.—XXXIV; Nov., 1913, p. 303.
- Adams, H. C.: Along the old Inca highway.—XXIII; 19; 231-50.
- Bailey, S.: A new Peruvian route to the plains of the Amazon.—XXIII;  
17; 332-49.
- The new boundary between Bolivia and Peru.—VI; 42; 435-437.
- Post, C. J.: Across South America.—X; 83; 41-53.
- Markham, Sir C. R.: The land of the Incas.—XV; 36; 381-401.

## URUGUAY.

- Uruguay.—VII; 33; 167-184.  
Uruguay.—VII; 31; 357-72.

- Albes, E.: The republic east of the Uruguay and its fine capital, Montevideo.—VII; 35; 1142-58.
- Brandon, E. E.: University instruction in Uruguay.—VII; 34; 512-19.
- Barrett: Argentina, Uruguay, and Paraguay.—XIX; 66; 88-96.

## VENEZUELA.

- Venezuela.—VII; 33; 185-202.
- Manning, J. A.: La Guaira, the picturesque.—VII; 31; 642-50.
- Venezuela.—VII; 31; 373-89.
- Brandon, E. E.: Education in Venezuela.—VII; 34; 759-66.
- Totten, R. J.: Lake and city of Marocailo.—VII; 34; 361-75.
- Austin, J. B.: Venezuela's territorial claims.—VIII; 2; 2-20.
- Lyle, E. P.: Venezuela and the problems it presents.—XXXVIII; 2; 6943-54.
- Notes on Venezuela.—XXIII; 14; 17-21.
- Handbook of Venezuela.—House Doc., V. 65; 58th Cong., 3rd Session; Serial No. 4844.
- Furlong, C. W.: Across the Venezuela Llanos.—XVI; 128; 813-25.
- Barrett: The northern republics of South America.—XIX; 66; 789-96.
- Lafferts, W.: The cattle industry of the Llanos.—VI; 45; 180-87.

## CENTRAL AMERICA.

- Notes on Central America.—XXIII; 18; 272-80.
- Seffer, H. O.: Isthmus of Tehuantepec.—XXIII; 21; 991-1002.
- Foster, J. W.: The Latin-American constitution and revolution.—XXIII; 12; 169-176.
- Showalter, W. J.: Countries of the Caribbean.—XXIII; 24; 227-49.
- Map of Central America.—XXIII; 24; 256.

## COSTA RICA.

- General sketch.—VII; 31; 116-134.
- Brandon, E. E.: Education in Costa Rica.—VII; 35; 45-54.
- General sketch.—VII; 33; 81-99.
- Methods of obtaining salt in Costa Rica.—XXIII; 19; 28-35.
- Rittier, H.: Costa Rica, Vulcan's smithy (A treatment of volcanoes).—XXIII; 21; 494-525.

## GUATEMALA.

- Tisdell, T.: Guatemala, the country of the future.—XXIII; 21; 596-624.  
 Sands, W. F.: Prehistoric ruins of Guatemala.—XXIII; 24; 325-61.  
 Eisen, G.: Notes during a journey in Guatemala (includes climate).—VI; 1903; 231-252.  
 General sketch, 1910.—VII; 31; 189-202.  
 Commerce of Guatemala.—VII; 35; 404-17.  
 Brandon, E. E.: Education in Guatemala.—VII; 35; 535-41.  
 General sketch, 1910.—VII; 33; 268-80.  
 Cutter, V. M.: Ancient temples and cities of the new world.—VII; 32; 40-55.  
 Tisdell, E. T.: Lakes of Guatemala.—VII; 31; 651-63.

## HONDURAS.

- Commerce of Honduras for 1911.—VII; 36; 101-106.  
 Avery, M. L.: British Honduras.—VI; 32; 331-333.  
 General sketch, 1910.—VII, 33; 298-315.  
 General sketch, 1910.—VII; 31; 221-36.  
 MacClintock, L.: Resources and industries of Honduras.—VIII; 11; 224-39.  
 MacClintock, L.: Honduras.—VIII; 10; 177-84.  
 Handbook of Honduras.—House Doc. No. 145, Vol. 66; 58th Cong., 3rd Sess.; Serial No. 4845.

## NICARAGUA.

- Commerce of Nicaragua.—VII; 36; 107-112.  
 Davis, A. P.: The water supply for the Nicaragua canal.—XXIII; 11; 363-6.  
 The Nicaragua Canal (map and discussion of proposed route).—XXIII; 12; 28-32.  
 Davis, A. P.: Location of the boundary between Nicaragua and Costa Rica.—XXIII; 12; 22-28.  
 Turbulent Nicaragua.—XXIII; 20; 1103-1117.  
 General sketch, 1910.—VII; 33; 316-34.  
 General sketch.—VII; 31; 267-78.  
 Nicaragua commerce for 1912.—VII; 38; 424.

## PANAMA.

- Page, J.: The sailing ship and the Panama Canal.—XXIII; 15; 167-176.
- Pittier, H.: Little known parts of Panama.—XXIII; 23; 627-62.
- Burr, W. H.: The Republic of Panama.—XXIII; 15; 57-74.
- Panama Canal: Its construction and its effect on commerce.—VI; 45; 241-254.
- Goethals, G. W.: The Panama Canal.—XXIII; 20; 334-56.
- Johnson, E. R.: Comparison of distances by the Isthmian Canal and other routes.—VI; 35; 163-176.
- Kirkaldy, A. W.: Some of the economic effects of the Panama Canal.—XXXII; 29; 585-97.
- Harrison: The Panama Canal in construction. (Good pictures.)—XXXI; 54; 20-37.
- Vose, E. N.: How Panama will alter trade.—XXXVIII; 24; 418.
- General sketch, 1910.—VII; 33; 335-355.
- Latone, J.: The Panama Canal and Latin America.—III; 54; 84-91.
- Downie, E. M.: A visit to the Panama Canal and Cuba.—XXXII; 30; 404-12.
- Collins: Agricultural development in Panama.—VII; 37; 469-77.
- Lindsay, F.: The timber lands of Panama.—VII; 36; 499-510.
- General sketch, 1910.—VII; 31; 279-93.
- Hill, D. J.: Supremacy in the Panama Canal.—XXVIII; 49; 722-25.
- Davis, A. P.: The Isthmian Canal.—VI; 34; 132-138.
- Morison, G. S.: The Panama Canal.—VI; 35; 24-43.
- Haeselbarth, A. C.: Culebra Island.—VI; 35; 125-130.
- Chester, C. M.: The Panama Canal.—XXIII; 16; 445-67.
- Notes on Panama and Colombia.—XXIII; 14; 458-67.
- Showalter, W. J.: Panama Canal.—XXIII; 23; 195-205.
- Hazlett, D. M.: Farming on the Isthmus of Panama.—XXIII; 17; 229-36.
- Weir, H. C.: The romance of Panama.—XLI; October, 1912.
- Showalter, W. J.: Battling with the Panama slides.—XXIII; 25; 133-53.
- Cornish, V.: Condition and prospects of the Panama Canal.—XV; 44; 189-203.
- Sibert, W. L.: The Panama Canal.—XXIII; 25; 153-183.
- Map of Panama Canal ("Bird's-eye view").—XXIII; 23; 104.
- Johnson, E. R.: What the canal will accomplish.—XXXI; 54; 37-43.

- Balboa and the Panama celebration.—VII; 38; 477-88.  
 Panama's new railway.—VII; 38; 683.  
 Commerce of Panama for 1912.—VII; 38; 118.  
 Going through the Panama Canal.—XXVIII; 49; 718-21.  
 The attitude of the United States towards an interoceanic canal.—XXXIX;  
 9; 419.  
 Nelson, L.: The practical side of the Panama Canal.—XXXVII; 20; 670-76.

## NORTH AMERICA.

(Except the United States.)

- Dryer, C. R.: The North America of today and tomorrow and Indiana's place in it.—Proceedings Indiana Academy of Science; 1911.  
 Huntington, E.: The fluctuating climate of North America.—XV; 40; 264-80; 392-94.  
 Nansen, F.: Norsemen in America.—XV; 38; 557-80.  
 Unstead, J. F.: The climatic limits of wheat cultivation, with special reference to North America.—XV; 39; 347-366; 422-46.  
 Macdougall, D. T.: North American deserts.—XV; 39; 105-123.  
 Hubbard: Influence of precious metals in America.—VI; 44; 97-112.  
 Hahn, W. L.: The future of North American fauna.—XXVI; 83; 169-77.  
 Penek, A.: North America and Europe: A geographic comparison.—XXXII; 25; 337-46.  
 Jefferson, M.: The anthropography of North America.—VI; 45; 161-80.  
 Trotter, S.: The Atlantic forest regions of North America: A study in influences.—XXVI; 75; 370-92.  
 Commercial America in 1905. Showing commerce, production, transportation, finances, area, and population, of each of the countries of North, South, and Central America and the West Indies.—U. S. Bureau of Census; Bulletin 2 to 4; pages 1 to 117.  
 Harper, R. M.: The coniferous forests of Eastern North America.—XXVI; 85; 338-61.  
 Marvin, J.: The greater America.—XXXVIII; 28; 22-31.

## CANADA.

- Bryant, H. G.: A journey to the grand falls of Labrador.—VIII; 1; 33-80.  
 McFarland, R.: Beyond the heights of land.—VIII; 9; 23-33.



- Bryant, H. G.: An exploration in S. E.—VIII; 11; 1-16.  
 The possibilities of the Hudson Bay country.—XXIII; 18; 209-13.
- Wileox, W. D.: Recent explorations in the Canadian Rockies.—XXIII; 13; 151-69; 185-200.
- Wolcott, C. D.: The monarch of the Canadian Rockies.—XXIII; 24; 626-40.
- Lant: The Twentieth Century is Canada's.—XXXVIII; 13; 8499-8517.
- Russell, I. C.: Geography of the Laurentian basin.—VI; 30; 226-54.
- Paynd, A. M.: Halifax, Nova Scotia.—XXIV; 35; 356-375.
- Weaver, E. P.: What Arcadia owed to New England—XXIV; 30; 423-434.
- Laurier, W.: The forests of Canada.—XXIII; 17; 504-9.  
 Forests of Canada.—XXIII; 14; 106-109.
- Hughes, James L.: Toronto.—XXIV; 23; 305-322.
- Stewart, G.: Quebec.—XXIV; 21; 33-51.
- Oxley, J. M.: Ottawa, the capital of Canada.—XXIV; 24; 181-200.
- Goode, R. U.: The northwestern boundary between the United States and Canada.—VI; 32; 465-470.
- Vreeland, F. R.: Notes on the sources of the Peace River, British Columbia.—VI; 46; 1-24.
- Whitlock, R. H.: A geographical study of Nova Scotia.—VI; 46; 413-19.
- Cadell, H. M.: The new city of Prince Rupert.—XXXII; 30; 237-50.
- McGrath, P. T.: Canada in 1914.—XXVIII; 49; 594-98.
- Smith, C. S.: What will become of Canada?—XIV; 51; 855-65.
- Leith, C. K.: Iron ore reserves.—XXX; 65; 162-163.  
 Ibid.—XXXII; 1906; 207-214.
- Lumsden, H. D.: Canada's new transcontinental railroad.—XXXI; 40; 73.  
 The Canadian climate.—House Doc., Vol. III, p. 294; 58th Cong., 3rd Sess.; Serial No. 4890.
- Map of Labrador.—XV; 37; 476. (See also 407-20.)
- Lant: Hudson Bay Fur Company and the raiders of 1670-97.—XVI; 112; 768-79.
- Duncan, N.: The codfishes of Newfoundland.—XXXVIII; 6; 3617-3638.
- Twenhofel, W. H.: Physiography of Newfoundland.—II; 183; 1-24.
- McGrath, P. T.: The first American colony, Newfoundland.—XXIV; 27; 617-632.
- Willey, D. A.: Newfoundland of today.—XXIV; 29; 762-771.
- Cross, A. L.: Newfoundland.—XXXII; 22; 147-158.

- Semple, E. C.: The influence of geographic environment on the Lower St. Lawrence.—VI; 36; 449-466.
- Burpee, L. J.: How Canada is solving the transportation problem.—XXVI; 67; 455-464.
- The Hudson Bay route; a new outlet for Canadian wheat.—XXXIX; 20; 438-452.
- White, A. S.: Newfoundland: A study in regional geography.—XXXII; 30; 113-28.
- The Georgian Bay ship canal.—XXXII; 26; 25-30.
- Bell, R.: The Hudson Bay route to Europe.—XXXII; 26; 67-77.
- Parkin, Dr. G. R.: The railway development of Canada.—XXXII; 25; 225-250.
- Stupart: The climate of Canada.—XXXII; 14; 73-80.
- Wadsworth, M. E.: The mineral wealth of Canada.—XXIX; 37; 839-841.
- Waleote, C. D.: A geologist's paradise.—XXIII; 22; 509-37.
- Montgomery, R. H.: Our industrial invasion of Canada.—XXXVIII; 5; 2978-2998.
- The new administration in Canada.—XXXIX; 6; 151-168.
- Osborne, J. B.: Commercial relations of the United States with Canada.—III; 32; 330-340.
- Curwood, J. O.: Effect of American invasion. XXXVIII; 10; 6607-13.
- Why Canada rejected reciprocity.—XXXIX; 20; 173-187.
- Skelton, O. and others: Canada and reciprocity. XLIII; 19; 550; 411; 527; 513; 542; 726.
- Trade combinations in Canada.—XLIII; 14; 427.
- Hanbury, D. T.: Through the barren ground of N. E. Canada and the Arctic coast.—XV; 22; 178-191.
- Grenfell, Sir T.: A land of eternal warring.—XXIII; 21; 665-690.
- Hubbard, M. B.: Labrador, my explorations in unknown.—XVI; 112; 813-823.
- Through trackless Labrador.—XXXII; 28; 265-268.
- MacFairsh, N.: East and West in Canada.—XXXVI; 179; 597-603.
- White, A.: The Dominion of Canada: A study in regional geography.—XXXII; 29; 524-548; 566-80.
- Grant, W. L.: Geographical conditions affecting the development of Canada.—XV; 38; 362-381.
- Tupper: The economic development of Canada.—XXXII; 11; 1-16.

- Bell: The geographical distribution of forest trees in Canada.—XXXII; 13; 281-295.
- Across the Canadian border.—XXXVIII; 4; 2394-2412.
- Henshaw, Mrs.: A new Alpine area in British Columbia.—XXXII; 30; 128-32.
- Ruddick, J. H.: Dairying and fruit-growing industries in Canada.—XXI; 11; 241-245.
- Honeyman, H. A.: Lumbering industry of Canada.—XXI; 11; 246-250.
- Dresser, J. H.: Clay belt of Northern Ontario and Quebec.—XXI; 11; 250-255.
- Brittain: Geographical influences in the location of leading Canadian cities.—XXI; 11; 256-260.
- Green: Canadian commerce.—XXI; 11; 260-262.
- Cooke, H. C.: The mineral industries of Canada.—XXI; 11; 262-265.
- O'Neil: Canadian railway development.—XXI; 11; 265-267.
- Uglow: Canadian fisheries.—XXI; 11; 267-269.
- Allan: Resources and development of British Columbia.—XXI; 11; 269-274.
- The Canadian Boundary.—XXIII; 14; 85-91.
- Donald, W. J. A.: The growth and distribution of Canadian population.—XLIII; 21; 296-312.
- Butman, C. H.: The pinnacle of the Canadian Alps.—XXX; 78; 183-85.
- Longstaff, Dr. T. G.: Across the Purcell range of British Columbia.—XV; 37; 589-600.
- Palmer, H.: Tramp across the glaciers and snowfields of British Columbia.—XXIII; 21; 457-487.
- Palmer, H.: Explorations about Mt. Sir Sanford, British Columbia.—XV; 37; 170-179.
- Talbot, F. A.: Economic prospects of new British Columbia.—VI; 44; 167-183.
- Knappen, T. M.: Winning the Canadian West.—XXXVIII; 10; 6595-6606.
- Ogg, F. A.: Vast undeveloped regions.—XXXVIII; 12; 8078-8082.
- The colonization of Western Canada.—XXXII; 27; 196-200.
- East and West in Canada.—XXXVI; 179; 597-603.
- Bishop: Development of wheat production in Canada.—VI; 44; 10-16.
- D., W. M.: Tides in the Bay of Fundy.—XXIII; 16; 71-76.

## MEXICO.

- Lumholtz, C.: The Sonora Desert.—XV; 40; 503-518.
- Darton, N. H.: Mexico, the treasure house of the world.—XXIII; 18; 493-519.
- Collins & Doyle: Notes on South Mexico.—XXIII; 22; 301-21.
- Map of Mexico.—XXIII; 22; 410-11.
- Birkinbine, J.: Our neighbor, Mexico.—XXIII; 22; 475-509.
- Foster: The new Mexico.—XXIII; 13; 1-24.
- Huntington, E.: The shifting of climatic zones as illustrated in Mexico.—VI; 45; 1-12; 107-116.
- Navarro: Mexico of today.—XXIII; 12; 152-157; 176-179; 235-238.
- Barrett, J.: A general sketch.—VII; 1911.
- Foster, J. W.: The new Mexico.—XXIII; 13; 1-25.
- Mexico: a geographical sketch, 1910.—VII; 31; 237-266.
- Brandon, E. E.: University education in Mexico.—VII; 36; 48-56.
- Mexico:—a general sketch, 1910.—VII; 33; 119-149.
- Seffer, P. O.: Agriculture possibilities in tropical Mexico.—XXIII; 21; 1021-40.
- Thompson, E. H.: Henequen (The Yucatan Fiber).—XXIII; 14; 150-158.
- Rubber plantations in Mexico and Central America.—XXIII; 14; 409-14.
- Janvier, T. A.: A little Mexican town.—XVI; 113; 500-513.
- Paul, G. F.: Vera Cruz, past and present.—XXIV; 31; 722-727.
- Zimmerman, J.: Hewers of stone.—XXIII; 21; 1002-1020.
- Paul, G. F.: Ruins of Mitla, Mexico.—XXIV; 33; 73-79.
- Paul, G. F.: The Mexican hacienda; its place and people.—XXIV; 30; 1982-96.
- Galloway, A. C.: An interesting visit to the ancient pyramids of San Juan Teotihuagan.—XXIII; 21; 1041-50.
- A winter expedition in Southern Mexico.—XXIII; 15; 341-356.
- Some Mexican transportation scenes.—XXIII; 21; 985-91.
- The oil treasure of Mexico.—XXIII; 19; 803-5.
- Lyle, E. P.: Mexico at high tide.—XXXVIII; 14; 9179-9196.
- Lumholtz, C.: The Huichol Indians of Mexico.—VI; 35; 79-93.
- Scenes in the byways of Southern Mexico.—XXIII; 25; 359-64.
- Lyle, E. P.: The American influence in Mexico.—XXXVIII; 6; 3843-60.
- Nelson, E. W.: A day's work of a naturalist.—XXXVIII; 1; 372-380.

- Copan, the mother of the Mayas.—VII; 32; 863-879.
- Kirkwood, J. E.: A Mexican hacienda.—XXIII; 25; 563-584.
- Kirkwood, J. E.: Desert scenes in Zacatecas.—XXVI; 75; 435-51.
- Howarth, O. H.: The Cordillera of Mexico and its inhabitants.—XXXII; 16; 342-352.
- Unknown Mexico.—XXXII; 19; 291-297.
- Cadell, H. M.: Some old Mexican volcanoes.—XXXII; 23; 281-312.
- The volcanoes of Mexico.—XXXII; 23; 25-28.
- The greatest volcanoes of Mexico.—XXIII; 21; 741-760.
- Dandberg, H. O.: Ancient temples and cities of the new world: Palenque.—VII; 34; 345-360.
- Ayme, L. H.: Ancient temples and ruins of the new world: Mitla.—VII; 33; 548-567.
- Thompson, E. H.: The home of a forgotten race: Mysterious Chicken Itza, in Yucatan, Mexico.—XXIII; 25; 585-648.
- Palmer, F.: Mexico.—XIII; 30; 806-820.
- Mason, A. B.: Mexico and her people.—III; 54; 186-190.
- Huntington, E.: The mystery of the Yucatan ruins.—XVI; 128; 755-66.
- Lloyd: The story of Guayule.—VII; 34; 177-195.
- Laut, A. C.: Taos, an ancient American capitol.—Travel; February and March, 1913.
- Showalter, W. J.: Mexico and Mexicans.
- Romero, M.: Mexico.—Jr. Am. Geog. Soc.; 28; 327.
- Handbook of Mexico.—House Doc. No. 145, Vol. 66; 58th Cong., 3rd Sess.; Serial No. 4845.
- Physical Geography of Mexico.—House Doc., Vol. 111, p. 765; 58th Cong., 3rd Sess.; Serial No. 4890.
- Dunn, H. H.: How the Aztecs fought.—Illustrated World and Recreation; Jan., 1913.
- Huntington, E.: The peninsula of Yucatan.—VI; 44; 801-822.
- Colf, L. J.: The caverns and peoples of Northern Yucatan.—VI; 42; 321.
- Geology and topography of Mexico.—Am. Geologist; 8; 133-44.
- Bain: A sketch of the geology of Mexico.—XXII; 5; 384-90.
- Wilson: Topography of Mexico.—Jr. Am. Geog. Soc.; 29; 249-260.

## EUROPE.

- Geikie, Jas.: The architecture and origin of the Alps.—XXXII; 27; 393-417.
- Garwood, E. J.: Features of Alpine scenery due to glacial protection.—XV; 36; 310-39.
- Geikie, J.: The Alps during the glacial period.—VI; 42; 192-205.
- Fischer, T.: The Mediterranean peoples.—XXXIII; 1907; 497-521.
- Peddie, H. J.: The development of the inland waterways of Central Europe.—XXXII; 26; 293-298.
- Plant distribution in Europe and its relation to the glacial period.—XXXII; 19; 302-311.
- Myers, J. L.: The Alpine races in Europe.—XV; 28; 537-560.
- Price, H. C.: How European agriculture is financed.—XXVI; 82; 252-263.
- European grain trade. Bull. 69, U. S. Dept. of Ag., Bureau of Statistics.
- Cereal production in Europe.—Bull. 68, U. S. Dept. of Ag., Bureau of Statistics.
- Penek, A.: The valleys and lakes of the Alps.—House Doc., Serial No. 4890.
- Bray, F. C.: The classic Mediterranean basin.—XI; 72; 3-12.
- Brooks, S.: The new Europe.—XXV; 200; 663-667.
- Austin, O. P.: The remarkable growth of Europe during forty years of peace.—XXIII; 26; 272-275.
- Statistics of populations, armies and navies of Europe.—XXIII; 26; 191-193.
- War-words of Europe and their meaning.—Literary Digest; March 20, 1915.

## AUSTRIA-HUNGARY.

- Townley, Fullman C.: Magyar origins.—XXXVI; 176; 52-60.
- The ancient geography of Galacia.—XXXII; 22; 205-208.
- Koeh, F. J.: In quaint, curious Croatia.—XXIII; 19; 809-832.
- Richardson, Ralph: The ethnology of Austria-Hungary.—XXXII; 22; 1-9.
- Iddings, D. W. & A. S.: The land of contrast: Austria-Hungary.—XXIII; 23; 1188-1219.
- Conditions of agriculture in Bohemia.—XLIII; 8; 491.
- Townley, F. C.: Hungary: A land of shepherd kings.—XXIII; 26; 311-93.

## BALKANS AND TURKEY.

- Hogarth, D. C.: The Balkan peninsula.—XV; 41; 324-340.
- Moore, F.: The changing map in the Balkans.—XXIII; 24; 199-227.
- Moore, F.: Rumania and her ambitions.—XXIII; 24; 1057-1086.
- Eastern Turkey in Asia and Armenia.—XXXII; 12; 225-241.
- Grosvenor, E. A.: Constantinople.—XLII; 90; 673-685.
- Richardson, R.: New railway projects in the Balkan peninsula.—XXXII; 24; 254-259.
- Map of Bulgaria, Servia, and Macedonia.—XXIII; August, 1914; p. 1153.
- Territorial changes in the Balkans.—XXI; 12; 156.
- Warner, A. H.: A country where going to America is an industry.—XXIII; 20; 1063-1103.
- Damon, T. J.: Albanians.—XXIII; 23; 1090-1103.
- Bourchier, J. D.: The rise of Bulgaria.—XXIII; 23; 1105-1118.
- Villari, L.: Races and religions of Macedonia.—XXIII; 23; 1118-32.
- Bryce, J.: Two possible solutions for the eastern problem.—XXIII; 23; 1149-1158.
- Notes on Rumania.—XXIII; 23; 1219-25.
- Notes on Macedonia.—XXIII; 19; 799-802.
- Servia and Montenegro.—XXIII; 19; 774-90.
- Coffin, M. C.: When east meets west.—XXIII; 19; 309-44.
- Low, D. H.: Kingdom of Serbia: Her people and her history.—XXXII; 31; 303-15.
- McKenzie, K.: East of the Adriatic.—XXIII; 23; 1159-1188.
- Bulgaria, the peasant state.—XXIII; 19; 760-773.
- Hitchens, R.: Skirting the Balkan peninsula.—X; 85; 643-657; 884-898.
- Bosnia-Herzegovina.—XXXII; 25; 71-84.
- Bray, F. C.: Before and after the Balkan war.—XI; 72; 163-73.
- Moore, F.: The changing map in the Balkans.—XXIII; 24; 199-226.
- Newbiggin, M. I.: The Balkan peninsula: Its peoples and its problems.—XXXII; 31; 281-303.
- Joerg, W. L. J.: The new boundaries of the Balkan states and their significance.—VI; 45; 819-830.
- Dominian, L.: The Balkan peninsula—VI; 45; 576-84.
- Pears, Sir E.: Grass never grows where the Turkish hoof has trod.—XXIII; 23; 1132-49.

- Curtis, W. E.: The great Turk and his lost provinces.—XXIII; 14; 45-61.  
 Chester, C. M.: The young Turk.—XXIII; 23; 43-89.  
 Dominian, L.: Geographical influences in the determination of spheres of foreign interests in Asiatic Turkey.—VIII; 12; 165-77.  
 Bray, F. C.: Constantinople: Imagination and fact.—XI; 72; 595-606.  
 Dwight, H. G.: Life in Constantinople.—XXIII; 26; 521-546.  
 Constantinople.—VIII; 11; 45-50.  
 Symons, A.: Constantinople: An impression.—XVI; 106; 863-870.

## BELGIUM.

- George, W. L.: Problems of modern Belgium.—XXXVI; 177; 597-606.  
 Gregmore, H.: Antwerp, the hub of Europe.—XXIV; 35; 67-73.  
 Showalter, W. J.: Belgium, the innocent bystander. XXIII; 26; 223-265.  
 Antwerp, the water side of.—XXXI; 50; 257.

## DENMARK.

- Flux, A. W.: Denmark and its aged poor.—XXXIX; 7; 434-448.  
 Wehrwein, G. S.: The message of Denmark.—XXI; 12; 58-60.  
 Horygaard, W.: How planting trees saved Jutland.—XXXVIII; 20; 12967-69.

## FRANCE.

- Greely, A. W.: The France of today.—XXIII; 26; 193-223.  
 Economic life of France.—XXVI; 58; 287-95.  
 Welch, D.: Marseilles.—XVI; 121; 1-12.  
 Lanson, G.: France of today.—XXV; 195; 456-478.  
 Bosson, Mrs. Geo. C., Jr.: Notes on Normandy.—XXIII; 21; 775-782.  
 Hyde, W. W.: Ascent of Mt. Blanc.—XXIII; 24; 861-942.  
 Life in French upland region.—XXXII; 28; 532-537.  
 Housing of the working classes in France.—XXXIX; 8; 233-254.  
 Braeq, J. C.: The colonial expansion of France.—XXIII; 11; 225-239.  
 O'Laughlin, J. C.: Industrial life in France.—XXXVIII; 9; 5969-5972.  
 Arnold: The population of France.—XXIX; 30; 171.  
 Agricultural education in France.—XL; 1900; 115.  
 Norman, Sir H.: The Alpine Road of France.—XXXI; 55; 137-59.  
 The city of the Seine.—XI; 72; 75.  
 Gallienne, R. L.: Avignon, legendary and real.—XVI; 129; 277-284.



## GERMANY.

- The German nation.—XXIII; 26; 275-311.
- Lazenby, W. R.: Forests and forestry of Germany.—XXVI; 83; 590-98.
- Muensterburg, Hugo: Germans at school.—XXVI; 79; 602-614.
- Clapp, E. J.: Rhine and Mississippi river terminals.—XXXIX; 19; 392-7.
- The industrial capacity of the German.—XLIII; 13; 452.
- Geiser, K. F.: Forestry results in Germany.—XXXVIII; 13; 8642-50.
- Bernstorff, Count J. H. Von: The foundation of the German Empire.—XXXV; 3; 261-272.
- The story of the Bagdad railway.—Nineteenth Century Magazine; 75; 958—; 1312—.
- Germany's world-war for trade.—Literary Digest, July 11, 1914; p. 57.
- Agricultural imports of Germany.—Department of Agriculture; Div. of Foreign Markets; Bulletin No. 30.
- Traffic policy of Germany.—XXXIX; 1; 10-34.
- Colonial policy of the Germans.—XXXIX; 11; 57-82.
- Spencer, C. E.: Waterways.—XXI; 12; 1-14.
- Haldane, Lord: Great Britain and Germany.—XIX; 71; 1382-1386.
- Buxton, B. H.: A corner of old Wurttemberg.—XXIII; 22; 931-47.
- Campbell, J. A.: In a Prussian school.—XIX; 68; 810-813.
- Rhone—Saone Valley.—XXI; 12; 80.
- Geiser, K. F.: Peasant life in the Black Forest.—XXIII; 19; 635-49.
- The industrial progress of Germany.—XXXIX; 14; 6-17; 134-154.
- Lotz, W.: The present significance of German inland waterways.—III; 31; 246-261.
- German school system in Germany.—House Doc., No. 243, V. 57; 58th Cong., 3rd Sess.; Serial No. 4836.
- Rise and development of German colonial possessions.—House Doc., Vol. III; p. 823; 58th Cong., 3rd Sess.; Serial No. 4890.
- Howe, F. C.: City building in Germany.—XXXI; 47; 601.
- Forestry in all lands.—U. S. Forest Service; Circular 140.
- Making rivers work.—XIII; 20; 443-53.
- Davis, W. M.: The Rhine gorge and the Bosphorus.—XXI; 11; 207-15.

## GREECE.

- Campbell, O. D.: From Messina to Tyndris.—XXIV; 40; 413-421.  
 Zaborowski, S.: Ancient Greece and its slave population.—XXXIII; 1912; 597-608.  
 Young, C. H.: Peloponnesian journeys.—VI; 32; 151-157.  
 Moses, G. H.: Greece and Montenegro.—XXIII; 24; 281-310.  
 Wace, A. J. B. & Thompson, M. S.: The distribution of early civilization in Northern Greece.—XV; 37; 631-642.  
 Hall, E.: Archaeological research in Greece.—XIX; 69; 1143-48.  
 Richardson, R.: Athens: Notes on a recent visit.—XXXII; 23; 422-427.  
 Chamberlayne, L. R.: A visit to Euboea.—XI; 72; 151-2.  
 Corinth and her citizens.—XI; 72; 635.  
 Dingelstedt, V.: The Greeks and Hellenism.—XXXII; 30; 412-27.

## HOLLAND.

- Matthes, G. H.: The dikes of Holland.—XXIII; 12; 219-235.  
 Gore, Jas. H.: Holland as seen from a Dutch window.—XXIII; 19; 619-634.  
 Smith, H. M.: A north Holland cheese market.—XXIII; 21; 1051-66.  
 Agricultural imports of Holland. U. S. Department of Agricultural; Bureau of Statistics, Bull. 72.  
 Griffis, Wm. E.: The heaths and hollows of Holland.—VI; 32; 308-21.

## ITALY.

- Mayer, A. E.: Gems of the Italian lakes.—XXIII; 24; 943-956;  
 Carr, J. F.: The Italian in the United States.—XXXVIII; 8; 5593-5404.  
 Wright, C. W.: The world's most cruel earthquake.—XXIII; 20; 373-396.  
 Van Vorst, M.: Naples.—XVI; 121; 489-504.  
 Symons, A.: Verona.—XVI; 108; 876-881.  
 Cortesi, S.: The campanile of Venice.—XIX; 68; 922-927.  
 Willis, V. B.: The roads that lead to Rome.—XI; 71; 191-192.  
 Scenes in Italy.—XXIII; 21; 321-33.

## NORWAY.

- Howe, J. L.: Notes on Norwegian industry.—XXVI; 80; 36-50.  
 Brigham, A. P.: A Norwegian landslip.—VIII; 4; 292-296.

- Barrett, R. L.: The Sundal drainage system in central Norway.—VI; 32; 199-219.
- Brigham, A. P.: The fiords of Norway.—VI; 38; 337-348.  
A chapter on Norway.—XXIV; 22; 233-243.
- A new industrial nation.—XXI; 12; 24-24; Sept., 1913.
- A comparison of Norway and Sweden.—XXIII; 16; 429-432.
- Jefferson, N.: Man in West Norway.—XXI; 7; 86-96.

## PORTUGAL.

- Crawford, Oswald: The greatness of little Portugal.—XXIII; 21; 867-894.

## RUSSIA.

- Greely, A. W.: The land of promise.—XXIII; 23; 1078-90.
- Sarolea, C.: Geographical foundations of Russian politics.—XXXII; 22; 194-205.
- Mockinder: The geographical pivot of history.—XV; 23; 421-444.
- Hovey, E. O.: Southern Russian and the Caucasian Mountains.—VI; 36; 327-341.
- Grosvenor, G. H.: Young Russia: The land of unlimited possibilities.—XXIII; 26; 423-521.
- Hourwich, I. A.: Russia as seen in its farmers.—XXXVIII; 13; 8679-8686.
- Dingelstedt, V.: The riviera of Russia.—XXXII; 20; 285-306.
- Dingelstedt, V.: A little-known Russian people; the Setukesed on Esths of Pskov.—XXXII; 22; 490-493.
- Curtis, Wm. E.: The revolution in Russia.—XXIII; 18; 302-17.
- Grosvenor, E. A.: Evolution of the Russian government.—XXIII; 16; 309-333.
- Nansen, F.: Sea route to Siberia.—XV; 43; 481-98.
- The black republic.—XXIII; 18; 334-43.
- Smith, C. E.: Russia.—XXIV; 32; 114-123.
- Paekard, L. O.: Russia, her expansion and struggle for open ports.—XXI; 12; 33-39.
- Windt, H. D.: Through Siberia to Bering Strait.—XVI; 105; 821-831.
- Korff, A.: Where women vote.—XXIII; 21; 487-494.
- The Russian Tibet expedition.—XV; 19; 576-98.
- O'Laughlin, J. C.: Industrial life in Russia.—XXXVIII; 4913-18.

- Gibbon, P.: The church's blight on Russia.—XXXVIII; 10; 6243-54.  
 Markov, E.: The sea of Aral.—XV; 38; 515-519.  
 The territory of Anadyr.—VI; 32; 260-263.  
 Grosvenor: Siberia.—XXIII; 12; 317-24.  
 Hill, E. J.: A trip through Siberia.—XXIII; 13; 37-55.  
 Smith, C. E.: Russia.—XXIII; 16; 55-63.  
 Hourwich, I. A.: The crisis of Russian agriculture.—XXXIX; 1; 411-33.  
 Hornburg, F.: Village towns and cities of Russia.—XXI; 10; 13-15.  
 Wright, H. O. S.: Russian village life.—XXXVI; 173; 79-85.  
 Grosvenor, Edw. A.: The growth of Russia.—XXIII; 11; 169-186.  
 Chapin, Wm.: Glimpses of the Russian empire.—XXIII; 23; 1043-78.  
 Greely, A. W.: Russia in recent literature.—XXIII; 16; 564-8.  
 Hsdlikea, A.: Recent explorations in Siberia.—XXIX; 37; 13-14.  
 Siberia: A review.—XXXII; 21; 652-659.  
 Dingelstedt, V.: The mussulman subjects of Russia.—XXXII; 19; 4-20.  
 Mumford, J. K.: Conquest of Asia.—XXXVIII; 2; 704-719.  
 Simpson, J. Y.: The new Siberia.—XXXII; 16; 17-29.  
 Wheat growing in Russia.—XLIH; 12; 256.  
 Dingelstedt, V.: Cossacks and Cossackdom.—XXXII; 23; 239-261.  
 Barnaby, C. W.: Russian absorption of Asia.—XXXVIII; 7; 4118-25.  
 Brudno, E. S.: The emigrant Jews at home.—XXXVIII; 7; 4471-4479.  
 Makaroff, Vice-Admiral: The yermak ice breaker.—XV; 15; 32-46.  
 Hourwich, I. A.: Situation in Finland.—XLIH; 11; 290-99.  
 Scott, Leroy: Russia as seen in its workingmen.—XXXVIII; 13; 8557-8567.  
 Whelpley, D. W.: The rise of Russia.—XIX; 79; 407-8.  
 Huntington, E.: Life in the great desert.—XIII; 20; 749-61.  
 Mavor, J.: The economic history of Russia.—XXXII; 30; 518-27.  
 Richardson, R.: Modern Russia.—XXXII; 30; 624-31.

## SPAIN.

- Riggs, A. S.: The commerce of Spain.—X; 81; 257-270.  
 Howells, W. D.: First days in Seville.—XVI; 126; 568-581.  
 A little-known mountain pass in the Pyrenees.—XXXII; 22; 545-546.  
 Clark, C. U.: Romantic Spain.—XXIII; 21; 187-215.  
 Guijarro, L. G.: Spain since 1898.—XXXIX; 18; 6-20.

- Guijarro, L. G.: The religious question in Spain.—XXXIX; 19; 226-34.  
 Super, C. W.: The Spaniard and his peninsula.—XXXVI; 175; 418-434.  
 Jones, C. L.: Madrid: Its government and municipal services.—III; 27;  
 120-131.  
 Ardzrooni, L.: Commerce and industry in Spain during ancient and mediaeval  
 times.—XLIII; 21; 432-53.

## SWEDEN.

- Andrews, M. C.: Sweden vally ice mine and its explanation.—XXVI; 82;  
 280-288.  
 Winslow, E. D.: The Lapps of Sweden.—VI; 32; 430-431.  
 Hitchcock, F. H.: Our trade with Scandinavia, 1890-1900.—U. S. Dept.  
 of Ag.; Bull. No. 22.

## . SWITZERLAND.

- A study of a Swiss valley.—XXXII; 22; 648-653.  
 Newbigin, M. I.: The Swiss Valais: A study in regional geography.—XXXII;  
 23; 169-192; 225-239.  
 Murray, L.: In Valais (Switzerland).—XXIII; 21; 249-69.  
 Avebury, Lord: The scenery of Switzerland.—XXXII; 25; 1-12.  
 Avebury, Lord: The scenery of Switzerland.—XXXII; 24; 617-627.  
 Stoddard, F. W.: Winter sports in Switzerland and Tyrol.—XIX; 72;  
 559-63.  
 Dingelstedt, V.: The republic and canton of Geneva.—XXXII; 24; 225-  
 238; 281-291.  
 The fauna of Switzerland in relation to the glacial period.—XXXII; 18;  
 236-243.  
 The Swiss banking law.—XLIII; 18; 309.  
 Henry, O. H.: The problem of sick to accident insurances in Switzerland.—  
 XXXIX; 19; 235-54.  
 Dingelstedt, V.: The Swiss abroad.—XXXII; 25; 126-37.  
 Transfigured Switzerland.—XI; 72; 140.  
 Scenes in Switzerland.—XXIII; 21; 249-69.  
 Howe: The white coal of Switzerland.—Outlook; 94; 151-58.

## UNITED KINGDOM

- Usher, R. G.: England: The oldest nation of Europe.—XXIII; 26; 393-423.
- Forbes, U. A.: The inland waterways of Great Britain.—III; 31; 228-245.
- Smith, Dr. W. G.: The origin and development of heather moorland.—XXXII; 18; 587-597.
- Cunningham, W.: Cambridgeshire rivers.—XV; 35; 700-705.
- Mill, H. R.: A fragment of the geography of England.—XV; 15; 205-27; 353-78.
- Moss, C. E.: Peat moors of the Pennines, their age, origin, and use.—XV; 23; 660-71.
- Grierson, R.: Ireland before the Union.—XXXVI; 179; 666-75.
- Crawford, O. G. S.: The distribution of early bronze age settlements in Britain.—XV; 40; 184-203.
- Shippard, T.: Changes on the east coast of England within the historical period.—XV; 34; 500-514.
- Whelpley, J. D.: Commercial strength of Great Britain.—X; 82; 159-174.
- Yeats, J. S.: Ireland to be saved by intellect.—XIX; 72; 191-94.
- Knowles, Harry: Bristol and the land of Pokanoket.—XXIV; 35; 609-628.
- Bridgman, S. E.: Northampton.—XXIV; 21; 581-604.
- Holden, S. C.: Old Boston in England.—XXIV; 21; 387-406.
- Watt: Climate of British Isles.—XXXII; 24; 169-187.
- MacManus, S.: A new Ireland.—XXXVIII; 8; 5279-5286.
- Johnson, C.: Life on the Irish boglands.—XXIV; 24; 259-268.
- Mill, H. R.: England and Wales viewed geographically.—XV; 24; 621-36.
- Mead, E. D.: The expansion of England.—XXIII; 11; 249-264.
- Johnson, E. R.: A study of London.—VIII; 5; 15-29.
- The unrest of English farmers.—XXXIX; 2; 54-63.
- The tower of London.—XI; 72; 43.
- Lennie, A. B.: Geographical description of the county of Sutherland.—XXXII; 27; 18-34; 128-142; 188-196.
- Peddie, H. J.: The development of the inland waterways of the United Kingdom.—XXXII; 26; 544-548.
- Wallace, B. C.: Nottinghamshire in the 19th Century.—XV; 43; 34-61.
- McFarlane, J.: The port of Manchester: The influence of a great canal.—XV; 32; 496-503.
- Allen, W. H.: Rural sanitation in England.—XXXIX; 8; 483-19.

- Parritt, E.: The Manchester ship canal.—XXXIX; 3; 295-310.
- Meyer, H. R.: Municipal ownership in Great Britain.—XLIII; 13; 481; 14; 257.
- Howells, W. D.: Kentish neighborhoods including Canterbury.—XVI; 113; 550-63.
- Cossar, J.: Notes on the geography of the Edinburg district.—XXXII; 27; 574-600; 643-654.
- Richardson, R.: The port of London: A French review.—XXXII; 20; 196-202.
- Brooks, S.: London and New York.—XVI; 104; 295-303.
- A history of Scotland.—XXXII; 16; 657-661.
- M. Paul Private-Deschmel: The influence of geography on the distribution of population of Scotland.—XXXII; 18; 577-587.
- Geikie, A.: The history of the geography of Scotland.—XXXII; 22; 117-34.
- Saunders, L. J.: A geographical description of Fife, Kinross, and Clackmannon.—XXXII; 29; 67-87; 133-48.
- Kermack, W. R.: The making of Scotland: An essay in historical geography.—XXXII; 28; 295-306.
- Edinburg.—XI; 71; 217.
- Kermack, W. R.: A geographical factor in Scottish independence.—XXXII; 28; 31-35.
- Cossar, J.: The distribution of the towns and villages of Scotland.—XXXII; 26; 183-192; 298-318.
- Steven, T. M.: A geographical description of the county of Ayr.—XXXII; 28; 393-414.
- Tarr, R. S.: Glacial erosion in the Scottish highland.—XXXII; 24; 575-588.
- Cadill, H. M.: The industrial development of the Forth Valley.—XXXII; 20; 66-85.
- Botanical survey in Yorkshire.—XXXII; 19; 417-422.
- Murray, Sir John: A bathymetrical survey of the lochs of Scotland.—XV; 15; 309-53.
- Scotland and her educational institutions.—XXXVI; 178; 573-582; 667-676.
- Chisholm, G. G.: Density of population, Scotland, 1911.—XXXII; 27; 466-470.
- Chisholm, G. G.: The development of the industrial Edinburgh and the Edinburg district.—XXXII; 30; 312-21.

- Hinxman, L. W.: The rivers of Scotland: The Beanly and Conon.—XXXII; 23; 192-202.
- Richardson, R.: The physiography of Edinburgh.—XXXII; 18; 337-358.
- Mort, F.: The southern highlands from Gourrock.—XXXII; 22; 435-438.
- Frew, J., and T. Mort: The southern highlands from Dungoyn.—XXXII; 22; 322-24.
- Bathymetrical survey of the fresh water lochs of Scotland.—XXXII; 22; 355-65; 407-423; 459-473.
- Hardy, M.: Botanical survey of Scotland.—XXXII; 22; 229-241.
- Frew, J., and Mort, F.: The southern highlands from Glasgow.—XXXII; 23; 367-372.
- Bathymetrical survey of the fresh water lochs of Scotland.—XXXII; 23; 346-360.
- Gregory, J. W.: The Loch Morar basin and the tectonic associations of the Scottish sea lochs.—XXXII; 30; 251-59.
- Murray, Sir J.: Bathymetrical survey of the fresh water lochs in Scotland.—XXXII; 19; 449-480; 21; 20; 1-47; 169-96; 235; 247; 449-460; 628-640.
- History of the highlands.—XXXII; 17; 40-43.
- Niven, W. N.: On the distribution of certain forest trees in Scotland, as shown by the investigation of post glacial deposits.—XXXII; 18; 24-30.
- Geddes, P.: Edinburgh and its region, geographic and historical.—XXXII; 18; 302-312.
- Fortune, E. C.: A royal Scottish burgh.—XVI; 121; 661-669.
- Smith, W. G.: Botanical survey of Scotland.—XXXII; 21; 4-24; 57-84; 117-126; 20; 617-628.
- Richardson, R.: Scottish place-names and Scottish saints.—XXXII; 21; 352-361.
- Richardson, R.: The influence of the natural features and Geology of Scotland on the Scottish people.—XXXII; 24; 449-464.
- Ewing, C. M.: A geographical description of East Lothian.—XXXII; 29; 23-35.

## ASIA.

- The uttermost East.—XXXII; 20; 247-253.
- Davis, W. M.: A summer in Turkestan.—VI; 36; 217-228.
- Warner, L.: Narrative of a perilous journey over the Kara Kum sands of Asia.—X; 73; 1-18.



- Capenny, S. H. F.: An Indo-European highway.—XXXII; 16; 523-534.
- Riekmers, W. R.: Bokhara, Asia.—XXXII; 16; 357-368.
- McGee, W. J.: Asia, the cradle of humanity.—XXIII; 12; 281-91.
- Neve, A.: The ranges of the Karakoram.—XV; 36; 571-577.
- Stein, M. A.: Explorations in Central Asia.—XV; 34; 5-36; 242-271.
- Bruce, C. D.: A journey across Asia from Leh to Peking.—XV; 29; 597-626.
- Kropotkin, P.: Geology and botany of Asia.—XXVI; 65; 68-73.
- Huntingdon, E.: Beyond the Dead Sea.—XVI; 120; 419-430.
- Huntingdon, E.: Life in the great desert of Central Asia.—XXIII; 20; 749-61.
- Deasy, H. H. P.: Journeys in Central Asia.—XV; 16; 141-64; 501-27.
- Stiffe, A. W.: Ancient trading centers of the Persian Gulf.—XV; 16; 211-15.
- Kozloff, P. K.: Through Eastern Tibet and Kam.—XV; 31; 402-15; 522-34.
- Hedin, S.: Three years' exploration in Central Asia.—XV; 21; 221-260.
- Crosby, O. T.: From Tiflis to Tibet.—VI; 37; 703-716.
- Forrest, G.: The land of the crossbow.—XXIII; 21; 132-57.
- Williams, T.: The link relations of South-Western Asia.—XXIII; 12; 249-66; 291-300.
- Huntington, E.: Mediaeval tales of the Lop Basin in Central Asia.—XXIII; 19; 289-295.
- Brown, A. J.: Economic changes in Asia.—X; 67; 732-737.
- Austin, O. P.: Commercial prize of the Orient.—XXIII; 16; 400-423.
- Huntington, E.: The valley of the Upper Euphrates River and its people.—VI; 34; 301-10; 384-93.
- Binstead, J. C.: Some topographical notes on a journey through Barga and North-East Mongolia.—XV; 44; 571-77.
- Huntington, E.: Problems in exploration—Central Asia.—XV; 35; 395-419.
- Richardson, R.: The expedition to Lhasa.—XXXI; 21; 246-249.
- Chuan, L. H.: Notes on Lhasa, the mecca of the Buddhist faith.—XXIII; 23; 959-66.
- Geddes: Three years' exploration in Central Asia.—XXXII; 19; 113-141.
- Dominian, L.: The origin of the Himalaya mountains.—VI; 44; 844-6.
- Bryan, J. J.: The paramount problem of the East.—XIV; 51; 535-41.
- Bray, F. C.: Islam: Races and religion.—XI; 72; 83-92.
- Sherwood, E.: Asia awake and arising.—XXXVIII; 28; 401-13.

Workman, F. B.: The exploration of the Siachem, or Rose Glacier, Eastern Karakoram.—XV; 43; 117-48.

Ward, F. K.: Wanderings of a naturalist in Tibet and Western China.—XXXII; 29; 341-350.

## ARABIA.

Forder, A.: Arabia, the desert of the sea.—XXIII; 1039-63.

A new map of Arabia.—VI; 42; 362.

Zwemer, S. M.: Oman and eastern Arabia.—VI; 39; 597-607.

Leachaman, G. E.: A journey in Northeastern Arabia.—XV; 37; 265-274.

Leachaman, G. E.: A journey through Central Arabia.—XV; 43; 500-12.

Fairechild, D. G.: Travels in Arabia and along the Persian gulf.—XXIII; 15; 139-151.

Miles, S. B.: On the border of the great desert: A journey in Oman.—XV; 36; 159-178; 405-425.

Carruthers, D.: A journey in Northwestern Arabia.—XV; 35; 225-248.

Huntington, E.: The Arabian desert and human character.—XXI; 10; 169-76.

## ASIA MINOR.

Huntington, E.: The fringe of verdure around Asia Minor.—XXIII; 21; 761-75.

Huntington, E.: The Karst country of Southern Asia Minor.—VI; 43; 91-106.

Huntington, E.: The lost wealth of the kings of Midas.—XXIII; 21; 831-46.

Trowbridge, S.: Impressions of Asiatic Turkey.—XXIII; 26; 598-609.

Dodd, I. F.: An ancient capital.—XXIII; 21; 111-25.

Harris, E. L.: Some ruined cities of Asia Minor.—XXIII; 19; 833-58.

Harris, E. L.: The buried cities of Asia Minor.—XXIII; 20; 1-18.

Harris, E. L.: The ruined cities of Asia Minor.—XXIII; 19; 741-60.

Dingelstedt, V.: The Armenians or Haikans: An ethnographical sketch.—XXXII; 29; 413-29.

Scenes in Asia Minor.—XXIII; 20; 173-94.

The most historic spot on earth.—XXIII; 26; 615.

Dominian, L.: Geographical influences in the determination of spheres of foreign interests in Asiatic Turkey.—VIII; 12; 160-76.

## CHINA.

- Tsaa, L. Y.: A wedding in South China.—III; 39; 71-73.
- Tsaa, L. Y.: The life of a girl in China.—III; 39; 62-71.
- Ho, L. Y.: An interpretation of China.—III; 39; 1-11.
- Ling, P.: Causes of Chinese emigration.—III; 39; 74-83.
- Barrett, J.: China, her history and development.—XXIII; 12; 209-19; 266-72.
- Blackwelder, E.: The geologic history of China and its influence upon the Chinese people.—XXVI; 82; 105-124.
- Bone: The revolution in China.—XIX; 71; 1332-1337.
- Hinckley, F. E.: Extra territoriality in China.—III; 39; 97-109.
- Aylward, W. J.: Hong-Kong.—XVI; 121; 392-403.
- Stein, M. A.: A journey of geographical and archaeological exploration in Chinese Turkestan.—XXXIII; 1903; 747-74.
- Chamberlin, T. C.: China's educational problem.—XIX; 69; 646-49.
- Huntington, E.: Archaeological discoveries in Chinese Turkestan.—VI; 39; 268-272.
- Gage, C.: My experiences in the Chinese revolution.—XIX; 72; 129-135.
- Sand buried ruins of Khotan.—XXXII; 19; 581-589.
- Marburg, T.: The backward nation.—XIX; 72; 1365-1370.
- Seidmore, E.: Mukden, the Manchu home, and its Great Art Museum.—XXIII; 21; 289-320.
- Edmunds, C. K.: A visit to the Hangehou Bore.—XXVI; 72; 97-115; 224-243.
- Ohlinger, F.: New journalism in China.—XXXVIII; 20; 13529-13534.
- Edmunds, C. K.: Science among the Chinese.—XXVI; 79; 521-31.
- Edmunds, C. K.: Contents of Chinese education.—XXVI; 68; 29-41.
- Roorbach, G. B.: Some significant facts in the geography of China.—XXI; 12; 45-51.
- The port of Shanghai.—XXI; 12; 51-55.
- Martin, Dr. W. A. P.: The siege in Peking: Its causes and consequences.—VI; 33; 19-30.
- Suo, Tai-Chi: The Chinese revolution.—III; 39; 11-17.
- Read, T. T.: China's great problem.—XXVI; 81; 457-64.
- Boggs, L. P.: The position of woman in China.—XXVI; 82; 71-76.
- Chadin, Wm. W.: Glimpses of Korea and China.—XXIII; 21; 895-934.

- Junor, K. T.: Curious and characteristic customs of China.—XXIII; 21; 791-806.
- Little, A.: The irrigation of the Chentu Plateau.—XXXII; 20; 393-405.
- Little, A.: Hanoi and Kwang-Chow-Wan: France's lost acquisition in China.—XXXII; 22; 181-188.
- Chew, N. P.: How the Chinese republic was born.—XXXVIII; 24; May-Oct., 1912; p. 108-111.
- Fischer, E. S.: Through the silk and tea districts of Kiangnan and Chekiang province.—VI; 32; 334-340.
- Jones, C. L.: Republican government in China.—III; 39; 26-39.
- Rockhill, W. W.: The 1910 census of the population of China.—VI; 44; 668-673.
- Ross, J.: Trade routes in Manchuria.—XXXII; 17; 303-310.
- The currency of China.—XXXIX; 5; 403-27.
- Harwood, W. S.: The passing of the Chinese.—XXXVIII; 9; 5626-31.
- Turly, R. T.: Climatic and economic conditions of northern Manchuria.—XV.; 40; 57-59.
- Carruthers, D.: Exploration in northwest Mongolia and Dzungaria.—XV; 39; 521-553.
- Ryder, C. H. D.: Exploration in western China.—XV; 21; 109-126.
- Brindle, E.: The future of Manchuria.—XXXVIII; 12; 7901-7903.
- Carruthers, D.: Exploration in northwest Mongolia.—XV; 37; 165—170.
- Kozloff, P.: The Mongolia-Sze-Chuan expedition of the Imperial Russian Geographic Society.—XV; 34; 384-408.
- Carey, F. W.: Journeys in the Chinese Shan states.—XV; 15; 486-517.
- Chamberlin: Travel in the interior of China.—XXXV; 2; 150-155.
- Seidmore, E. R.: The marvelous bore of Kang-Chan.—X; 59; 852-59.
- Weale, P.: The one solution of the Manchurian problem.—III; 39; 39-56.
- Ligendre, A. F.: The Lolos of Kientchang, Western China.—XXXIII; 1911; 569-586.
- Bainbridge, O.: The Chinese Jews.—XXIII; 18; 621-32.
- Lessons from China.—XXIII; 20; 18-29.
- Liang-Chang, C.: China and the United States.—XXIII; 16; 554-58.
- Smith, A. H.: Certain aspects of Chinese reconstruction.—III; 39; 18-26.
- Gammon, C. F.: China in distress.—VI; 44; 348-351.
- Anderson, G. E.: The wonderful canals of China.—XXIII; 16; 68-69.
- The great wall of China.—VI; 42; 438-441.

- Ross, E. A.: Industrial future.—X; 82; 34-39.
- Ross, E. A.: A struggle for existence in China.—X; 82; 430-41.
- Williams, F. W.: Chinese folklore and some western analogies.—XXXIII; 1900; 575-600.
- Edmunds, C. L.: Science among the Chinese.—XXVI; 80; 22-35.
- Parsons, Wm. B.: Chinese commerce.—XXVI; 58; 193-207.
- Edmunds, C. K.: The college of the White Deer Grotto.—XXVI; 67; 515-27.
- Ross, E. A.: The race fiber of the Chinese.—XXVI; 79; 403-08.
- Hudson, C. B.: The Chinaman and the foreign devils.—XXVI; 71; 258-66.
- Edmunds, C. K.: Passing of China's ancient system of literary examinations.—XXVI; 68; 99-118.
- Edmunds, C. K.: China's Renaissance.—XXVI; 67; 387-98.
- Parsons, Wm. B.: China.—XXVI; 58; 69-80.
- Iyenaga, T.: China as a republic.—XXXVIII; 23; 706-712.
- Webster, H.: China and her people.—XXIII; 11; 309-319.
- Bent, T.: Explorations in the Yafei and Fadhli countries.—XV; 12; 41-63.
- Hazard, S. T.: New China in the making.—Munsey Magazine, Oct., 1914; 72-82.
- McCormick, F.: The open door.—III; 39; 56-61.
- Pott, T. L. H.: China's method of revising her educational system.—III; 39; 83-96.
- Edwards, D. W.: The Chinese Y. M. C. A.—III; 39; 109-23.
- Cadbury, W. W.: Medicine as practiced by the Chinese.—III; 39; 124-29.
- Roorbach, C. B.: China: Geography and resources.—III; 39; 130-153.
- Munro, D. C.: American commercial interests in Manchuria.—III; 39; 154-68.
- Amderson, M. P.: Notes on the mammals of economic value in China.—III; 39; 167-178.
- Chinese pigeon whistles.—XXIII; 24; 715-16.
- Wilson, E. H.: The kingdom of flowers.—XXIII; 22; 1003-35.
- Chamberlin, R. T.: Populous and beautiful Szechuan.—XXIII; 22; 109-19.
- McCormick, F.: Present conditions in China.—XXIII; 22; 1120-38.
- Conner, J. E.: The forgotten ruins of Indo-China.—XXIII; 23; 209-72.
- King, F. H.: The wonderful canals of China.—XXIII; 23; 931-958.
- McCormick, F.: China's treasures.—XXIII; 23; 996-1042.
- Fenneman, M. N.: The geography of Manchuria.—XXI; 4; 6-12.

- Cushing, S. W.: The east coast of China.—VI; 45; 81-92.  
 The independence of China.—XVII; 58; 8.  
 The rebellion in China.—XVII; 58; 25.  
 Articles on China.—XXI; 12; 45-58; 5.  
 Ross, E. A.: Christianity in China.—X; 81; 754-64.  
 Ross, E. A.: Sociological observations in inner China.—Am. Jr. of Soc.;  
 16; 721-33.  
 Ross, E. A.: Young China at school.—XIII; 24; 784-95.

## INDIA.

- Rose, A.: Chinese frontiers of India.—XV; 39; 193-223.  
 Bentinck, A.: The abor expedition: Geographical results.—XV; 41; 97-  
 114.  
 Varley, F. J.: On the water supply of hill forts in western India.—XV; 40;  
 178-183.  
 Kellas, A. M.: The mountains of northern Sikkim and Garhwal.—XV;  
 40; 241-263.  
 The prevention and relief of famine in India.—XXXIX; 6; 123-39.  
 Curzon, Lord: The future of British India.—XXXVIII; 9; 5589-93.  
 Zumbro, W. M.: Temples of India.—XXIII; 20; 922-71.  
 Foreign policy of the government of India.—178-366-371.  
 Sunderland, J. T.: The cause of Indian famines.—XXIV; 23; 56-64.  
 Ancient and modern Hindu gilds.—XXXIX; 7; 24-42; 197-212.  
 The coal fields of India.—XV; 44; 82-85.  
 Bailey, F. M.: Exploration on the Tsangpo, or Upper Brahmaputra; XV;  
 44; 341-60.  
 Creighton, C.: Plague in India.—XXXIII; 1905; 309-338.  
 Zumbro, W. M.: Religious penances and punishments self-inflicted by the  
 Holy men of India.—XXIII; 24; 1257-1314.  
 Holdich, T. H.: Railway connection with India.—XXXII; 17; 225-39.  
 Medley, E. J.: India to England via Central Asia and Siberia.—XXXII;  
 17; 281-292.  
 Huntington, E.: The Vale of Kashmire.—VI; 38; 657-82.  
 Chandler, J. S.: The Madura temples.—XXIII; 19; 218-222.  
 Scidmore, E. R.: The bathing and burning Ghats at Benares.—XXIII;  
 18; 118-29.  
 A little-known country of Asia, Mepaul (Mepal).—X; 62; 74-82.

- Morrison, C.: Some geographical peculiarities of the Indian peninsula.—XXXII; 21; 457-463.
- Fee, U. T.: The Parsees and the towers of silence at Bombay.—XXIII; 16; 529-54.
- Whie, J. C.: Journeys in Bhutan.—XV.; 35; 18-42.
- Munson, A.: Kipling's India.—V; 39; 30-45; 153-71; 255-68.
- Whiting, M.: Behind the shutters of a Kashmir zenana.—XVI; 129; 823-31.
- Overland to India.—XXXII; 27; 71-78.
- Trade conditions in India.—House Doc. 762; Vol. 53; 59th Cong., 2nd Sess.; Serial No. 5156.
- Smith: Pearl fisheries of Ceylon.—XXIII; 23; 173-94.
- The Indian census.—XXIII; 22; 633.
- Banninga, J.: The marriage of the gods.—XXIII; 24; 1314-30.

#### JAPAN.

- Latani: Our relations with Japan.—XXXV; 6; 9-18.
- Kaneko, K.: The characteristics of the Japanese people.—XXIII; 16; 93-100.
- Deforest, J. H.: Why Nik-ko is beautiful.—XXIII; 19; 300-08.
- Bellows: Agriculture in Japan.—XXIII; 15; 323-6.
- Hioka, E.: A chapter from Japanese history.—XXIII; 16; 220-29.
- Starr, F.: Japanese scenery.—XIX.—71; 1132-1136.
- Forest, J. H.: Moral purpose of Japan in Korea.—XIX; 70; 13-17.
- Ronin, H.: Religious indifference and anarchism in Japan.—XXXVI; 176; 154-63.
- Chapin, W. W.: Glimpses of Japan.—XXIII; 22; 965-1033.
- Whelpley, J. D.: Are we honest with Japan?—X; 88; 105-8.
- Kawakami, K. K.: Japan and the European war.—IV; 114; 708-13.
- Kishimoto, M.: Shinto, the old religion of Japan.—XXVI; 41; 206-16.
- Semple, E. C.: Japanese colonial methods.—VI; 45; 255-75.
- Lee, C. K.: Glimpses of festal Japan.—VIII; 12; 113-120.
- Seidmore, E. R.: Young Japan.—XXIII; 26; 36-38.
- Hitchcock: Our trade with Japan, China, and Hongkong.—U. S. Dept. of Ag., Section of Foreign Markets; Bulletin No. 18.

## KOREA.

- Scenes and notes from Korea.—XXIII; 19; 498-508.  
 Andrews, R. C.: The wilderness of northern Korea.—XVI; 126; 828-9.  
 Griffis, W. E.: Korea, the pigmy empire.—XXIV; 26; 455-470.  
 Hulbert, H. B.: Korea's geographical significance.—VI; 32; 322-27.  
 Scenes from the land where everybody dresses in white.—XXIII; 19; 871-7.  
 Keir, R. M.: Modern Korea.—VI; 46; 756-69; 817-30.  
 Smith, F. H.: The resurrection of Korea.—XIX; 77; 413.

## MESOPOTAMIA.

- Willcocks, Sir W.: The garden of Eden and its restoration.—XV; 40; 129-148.  
 Willcocks, Sir W.: Mesopotamia: Past, present, and future.—XV; 35; 1-18.  
 Cadoux, H. W.: Recent changes in the course of the lower Euphrates.—XV; 28; 266-77.  
 Willcocks, W.: Mesopotamia: Past, present, and future.—XXXIII; 1909; 401-416.  
 Huntington, E.: Through the great canon of the Euphrates.—XV; 20; 175-201.  
 Thompson, R. C.: Tavernier's travels in Mesopotamia.—XXXII; 26; 141-48.  
 Sunpich, F. & M.: Where Adam and Eve lived.—XXIII; 26; 546-89.  
 Smith, J. R.: The agriculture of the Garden of Eden.—IV; 114; 256-62.

## PALESTINE.

- Whiting, J. D.: From Jerusalem to Aleppo.—XXIII; 24; 71-113.  
 Forder, A.: Damascus, pearl of the desert.—XXIII; 22; 62-82.  
 Prentice, S.: Sunrise and Sunset from Mt. Sinai.—XXIII; 23; 1242-83.  
 Oberhummer, Dr. E.: The Sinai Problem.—XXXIII; 669-677.  
 Huntington, E.: Climate of ancient Palestine.—VI; 40; 1908; 513-522; 577-586; 641-652.  
 Gottheil, R.: Palestine under the new Turkish regime.—XIX; 69; 1369-1372.  
 Hichens, R.: From Nazareth to Jerusalem.—X; 80; 2-17.  
 Hichens, R.: From Jericho to Bethlehem.—X; 80; 231-247.



- Hiehens, R.: Jerusalem.—X; 80; 558-572.
- Hiehens, R.: Holy week in Jerusalem.—X; 80; 854-870.
- Huntington, E.: Fallen queen of the desert.—XVI; 120; 552-63.
- Dingelstedt, V.: The people of Israel: Their numbers, distribution, and characteristics.—XXXII; 28; 414-29.
- Clapp, H. A.: From Jerusalem to Jericho in ninety minutes.—XXIV; 23; 406-12.
- Daly, R. A.: Palestine as illustrating geological and geographical controls.—VI; 31; 444-458; 32; 22-31.
- Maunsell, F. R.: One thousand miles of railroad built for pilgrims and not for dividends.—XXIII; 20; 156-73.
- Cady, P.: The historical and physical geography of the dead sea region.—VI; 36; 577-589.
- Hoskins, F. E.: The route over which Moses led the children out of Egypt.—XXIII; 20; 1011-1039.
- Huntington, E.: Across the Ghor to the land of Og.—XVI; 120; 667-78.
- Brown, G. T.: A visit to the Sinai peninsula.—XXXII; 20; 591-95.
- Spafford, J. E.: Around the dead sea by motor boat.—XV; 39; 37-40.
- Messerschmidt, L.: The ancient Hittites.—XXXIII; 1903; 681-703.
- Franck, H. A.: Tramping in Palestine.—X; 79; 434-441.
- Macalister, A.: Uncovering a buried city in Palestine.—XVI; 107; 83-88.
- Whiting, J. D.: Village life in the Holy Land.—XXIII; 249-314.

#### PERSIA.

- Sykes, P. M.: A fourth journey in Persia.—XV; 19; 121-173.
- Sykes, E.: Life and travel in Persia.—XXXII; 20; 403-415.
- Diekson, B.: Journeys in Kurdistan.—XV; 35; 357-379.
- Huntington, E.: The depression of Sistan in Eastern Persia.—VI; 37; 271-281.
- Cresson, W. P.: Persia: The awakening East (an extract of books by above title by J. B. Lippincott Co., at Philadelphia).—XXIII; 19; 356-86.
- Persia, past and present.—XXIII; 18; 91-95.
- Sykes, E. C.: A talk about Persia and its women.—XXIII; 21; 847-66.
- Sykes, P. M.: The geography of Southern Persia as affecting its history.—XXXII; 18; 617-626.
- Ten thousand miles in Persia.—XXXII; 18; 626-631.
- Shedd, W. A.: The Syrians of Persia and Eastern Turkey.—VI; 35; 1-7.

- Huntington, E.: The Persian frontier.—XXIII; 20; 866-77.  
 Huntington, E.: The depression of Sistan in Eastern Persia.—XXXII; 21; 379-385.  
 Gibbons, H. A.: The passing of Persia.—XIX; 70; 614-616.  
 Yate, A. C.: The proposed trans-Persian railway.—XXXII; 27; 169-180.  
 Huntington, E.: The Anglo-Russian agreement as to Tibet, Afghanistan, and Persia.—VI; 39; 653-58.  
 Sykes, P. M.: A sixth journey in Persia.—XV; 37; 1-19; 149-165.  
 Sykes, P. M.: 'Twenty years' travel in Persia.—XXII; 30; 169-91.

## SOUTHEAST ASIA.

- Annandale, N.: The Siamese Malay states.—XXXII; 16; 505-523.  
 Annandale, N.: The peoples of the Malay peninsula.—XXXII; 20; 337-348.  
 The pagan races of the Malay peninsula.—XXXII; 23; 33-39.  
 Cadell, H. M.: A sail down the Irrawaddy.—XXXII; 17; 239-65.  
 Barbour, T.: Notes on Burma.—XXIII; 20; 841-66.  
 Bastlett, C. H.: Untouched Burma.—XXIII; 24; 835-60.  
 Conner: The forgotten ruins of Indo-China.—XXIII; 23; 207-72.  
 Pritchard, B. E. A.: A journey from Myitkyina to Sadiya via the M'mai Hka and Hkamti Long.—XV; 43; 521-35.

## TIBET.

- Views of Lhasa.—XXIII; 16; 27-39.  
 Explorations in Tibet.—XXIII; 14; 353-5.  
 Younghusband, Sir F.: The geographical results of the Tibet Mission.—XXXII; 21; 229-246.  
 Central Asia and Tibet.—XXXII; 20; 202-212.  
 Younghusband, Sir F.: Geographical results of the Tibet Mission.—XXXIII; 1905; 265-277.  
 Tsybikoff, G. T.: Lhasa and Central Tibet.—XXXIII; 1903; 727-46.  
 Bailey, F. M.: Journey through a portion of Southeastern Tibet and the Mishmi Hills.—XXXII; 28; 189-204.  
 Hedin, S.: Journeys in Tibet.—XXXII; 1906-1908; 25; 169-195.  
 Western Tibet and the British borderland.—XXXII; 23; 28-33.  
 Williamson, N.: The Lohit-Brahmaputia River between Assam and South-eastern Tibet.—XV; 34; 363-383.

- Landon, P.: Into Tibet with Younghusband.—XXXVIII; 9; 5907-5925.  
 Roberts, C.: Into mysterious Tibet.—XXXVIII; 8; 5263-5271.  
 Bailey, F. M.: Journey through a portion of Southeastern Tibet and the  
 Mishmi Hills.—XV; 39; 334-347.  
 Rose, A.: The reaches of the upper Salween.—XV; 34; 608-613.

## AFRICA.

- Fock, A.: The economic conquest of Africa by the railroads.—XXXIII; 1904; 721-735.  
 Luder, A. B.: Building American bridges in Africa.—XXXVIII; 6; 3657-3670.  
 Behrens, T. T.: Most reliable values of heights of African lakes and mountains.—XV; 29; 307-326.  
 Stanley, H. M.: A great African lake.—XXIII; 13; 169-72.  
 Hotchkiss, C. W.: Some points to emphasize in the teaching of the geography of Africa.—XXI; 10; 175-84.  
 Grogan, E. S.: Through Africa from Cape to Cairo.—XV; 16; 164-85.  
 Grogan, E. S.: Through Africa from the Cape to Cairo.—XXXIII; 1900; 431-448.  
 Adams, C. C.: Foundations of economic progress in tropical Africa.—VI; 43; 753-766.  
 Cannon, W. A.: Recent explorations in the Western Sahara.—VI; 46; 81-99.  
 Verner, S. P.: White man's zone in Africa.—XXXVIII; 13; 8227-36.  
 Map of African railroads.—House Doc., Serial No. 3944; p. 200.  
 Johnson, F. E.: Here and there in Northern Africa.—XVIII; 25; 1-132.  
 Johnson, F. E.: The railways of Africa.—XXXII; 22; 621-637.  
 Frederick, A.: A land of giants and pygmies.—XXIII; 23; 369-89.  
 Akeley, C. E.: Elephant hunting with gun and camera.—XXIII; 23; 779-810.  
 Norman, Sir H.: The automobile in Africa.—XXXI; 51; 257-83.  
 Lander, H. S.: Across wildest Africa.—XXIII; 19; 694-737.  
 Roberts, C.: A wonderful feat of adventure.—XXXVIII; 1; 304-308.  
 The mysteries of the desert.—XXIII; 22; 1856-60.  
 Bauer, L. A.: The magnetic survey of Africa.—XXIII; 20; 291-303.  
 Camera adventures in the wilds of Africa.—XXIII; 21; 385-97.  
 Rabot, C.: Recent French explorations in Africa.—XXIII; 13; 119-33.

- The black man's continent.—XXIII; 20; 312-13.
- Cana, F. R.: Problems in exploration.—XV; 38; 457-469.
- Roosevelt, T.: Wild man and wild beast in Africa.—XXIII; 22; 1-34.
- Greely, A. W.: Recent geographic advances.—XXIII; 22; 383-99.
- Oswald, F. G. S.: From the Victoria Nyanza to the Kisü Highlands.—XV; 41; 114-130.
- Nevinson, H. W.: Through the African Wilderness.—XVI; 113; 26-36.
- The vegetation of Africa.—XXXII; 27; 375-377.
- The climatology of Africa.—XXXII; 17; 582-595.
- The vegetation of Africa.—XXXII; 25; 144-146.
- Alexander, B.: From the Niger to the Nile.—XXXII; 24; 20-34.
- White, S. E.: On the way to Africa.—XVI; 126; 218-230.
- Shumway, H. L.: In darkest Africa.—XXIV; 33; 350-355.
- Patterson, J. H.: Hunting the rhinoceros and the hippopotamus in Africa.—XXXVIII; 17; 11228-11238.
- Peddie, H. J.: Amphibious steam navigation for African rivers.—XXXII; 26; 195-198.
- Schillings, C. B.: Gun and camera in African wilds.—XXXVIII; 11; 6928-6942.
- Verner, S. P.: Africa fifty years hence.—XXXVIII; 13; 8726-37.
- Verner, S. P.: A trip through Africa.—XXXVIII; 16; 10768-10773.
- Wollaston, A. F. R.: Amid the snow peaks of the equator.—XXIII; 20; 256-78.
- Roosevelt, T.: African game trails.—XXIII; 21; 953-62.
- Roosevelt, T.: African game trails.—XXXI; 47; 1; 129; 257; 385; 515; 641.  
Also Vol. 48; 1; 142. Also Vol. 46; 385; 513; 652. Also Vol. 54; 279; 430; 580; 681.

#### ABYSSINIA.

- Gwynn, C. W.: A journey in Southern Abyssinia.—XV; 38; 113-139.
- A journey to the capital.—XVI; 101; 141-152.
- At the court of the king of kings.—XVI; 101; 244-254.
- Among Central African savages.—XVI; 101; 366-376.
- Crosby, C. T.: Abyssinia, the country and the people.—XXIII; 12; 89-103.
- Montandon, G.: A journey in southwestern Abyssinia.—XV; 40; 372-391.
- Skinner, R. P.: Many pictures—Making a treaty with Menelik.—XXXVIII; 9; 5795-5812.

A journey through Abyssinia to the Nile.—XV; 15; 97-121.

Whithouse, W. F.: Through the country of the king of kings.—XXXI;  
32; 286.

#### ALGERIA.

From Algeria to the French Congo.—XV; 17; 135-50.

Archibald, J. F. J.: In civilized French Africa.—XXIII; 20; 303-12.

Schmidt, N.: The new Latin Africa.—XIX; 71; 1440-1445.

Kearney, T. H.: Country of the ant men.—XXIII; 22; 367-83.

Kearney, T. H.: The date gardens of the Jerid.—XXIII; 21; 543-68.

Lessauer, A.: The Kabyles of North Africa.—XXXIII; 1911; 523-38.

Cannon, W. H.: Some features of the physiography and vegetation of the  
Algerian Sahara.—VI; 45; 481-9.

#### CENTRAL AFRICA.

Johnston, H.: The protectorates of Great Britain in tropical Africa.—  
XXXII; 18; 57-76.

Robertson, P.: The commercial possibilities of British Central Africa—  
XXXII; 16; 235-46.

Sharpe, A.: Trade and colonization in British Central Africa.—XXXII;  
17; 129-48.

Angus, H. C.: On the frontier of Western Shire, British Central Africa.—  
XXX; 23; 72-86.

Capenny, S. H. F.: The Anglo-Portuguese boundary in Central Africa.—  
XXXII; 21; 440-45.

Bright, R. J. F.: Survey and exploration in the Ruwenzori and lake region.—  
XV; 34; 128-56.

Woosman, R. B.: Ruwenzori and its life zones.—XV; 30; 616-30.

#### CONGO.

Torday, E.: Land and people of Kasai Basin.—XV; 36; 26-57.

Johnston, H.: The pygmies of the great Congo forest. . XXXIII; 1902;  
479-91.

Neave, S. A.: A naturalist's travels on the Congo.—Zambezi watershed.—  
XV; 35; 132-146.

Sarolea, C.: The economic expansion of the Congo Free State.—XXXII;  
21; 182-197.

- Lewis, T.: The life and travel among the people of the Congo.—XXXII; 18; 358-369.  
 The northeastern territories of the Congo Free State.—XXXII; 22; 315-22.  
 Verner, S. P.: Belgian rule on the Congo.—XXXVII; 13; 8568-75.

## EAST AFRICA.

- Genthe, M. K.: Progress of tropical East Africa.—VI; 44; 682-84.  
 Davis, A.: British East Africa Protectorate.—VI; 44; 1-10.  
 Parkinson, J.: The east African trough in the neighborhood of the Soda Lakes.—XV; 44; 33-46.  
 Collie, G. L.: The plateau of British East Africa and its inhabitants.—VI; 44; 321-334.  
 Aylmer, L.: The country between the Juba River and Lake Rudolf.—XV; 38; 289-296.  
 Elliott, F.: Jubaland and its inhabitants.—XV; 41; 554-561.  
 Hardy, R. A.: Somaliland.—XXXII; 20; 225-235.  
 Colonization and immigration in East Africa Protectorate.—XV; 21; 349-75.  
 Hobley, C. W.: The alleged desiccation of East Africa.—XV; 44; 467-77.  
 Somaliland.—XXXII; 19; 95-97.  
 An ivory trader in North Kenia.—XXXII; 19; 364-70.  
 Hunting big game in East Africa.—XXXII; 18; 723-31.  
 Davis, R. H.: Along the east coast of Africa.—XXXI; 29; 259.  
 Barrett, O. W.: Impressions and scenes of Mozambique.—XXIII; 21; 807-30.  
 Capenny, S. H. F.: The economic development of Nyasaland.—XXXII; 20; 371-76.  
 Henderson, J.: The Nyasa coal bed.—XXXII; 19; 311-15.  
 Moore, J. E. S.: Tanganyika and the countries north of it.—XV; 17; 1-37.  
 The Tanganyika problem.—XXXII; 19; 190-195.

## EGYPT.

- Baker, B. B.: Nile dams and reservoir.—XXVI; 62; 550-61.  
 The irrigation of Egypt.—XXXII; 18; 637-645.  
 Naville, E.: The origin of Egyptian civilization.—XXXIII; 1907; 549-64.  
 Means, T. H.: The Nile reservoir dam at Assuan.—XXXIII; 1902; 531-35.  
 Wiedeman, A. W.: The excavation of Abusir Egypt.—XXXIII; 1903; 669-780.

- Milne, A. D.: The dry summer on the upper Nile.—XXXII; 16; 89-92.  
 Erving, W. G.: From Cairo to Khartum.—X; 65; 340-350; 559-577.  
 Monierieff, Sir C. S.: Egyptian irrigation.—XV; 35; 425-428.  
 Hichens, R.: Old Cairo.—X; 77; 82-95.  
 Baikie, J.: Resurrection of ancient Egypt.—XXIII; 24; 957-1020.  
 Stearns, W. N.: Reconstructing Egypt's history.—XXIII; 24; 1021-42.  
 Jaekal, I.: Sacred cemetery of catacombs.—XXIII; 24; 1042-56.  
 Richardson, R.: Britain's success in Egypt.—XXXII; 17; 300-303.  
 White, A. S.: The rehabilitation of Egypt.—XXXII; 20; 348-354.  
 American discoveries in Egypt.—XXIII; 18; 801-811.  
 Czarnomska, M. E. J.: The Assuan dam.—XXXVIII; Nov.-April, 1912-13;  
 332-37.

## LIBERIA.

- Wallis, B.: A tour in the Liberian Hinterland.—XV; 35; 285-295.  
 Johnston, H.: Liberia.—XXXIII; 1905; 247-264.  
 Johnston, Sir H.: Liberia. —XV; 26; 131-53.  
 Collins, G. M.: Dumboy, the national dish of Liberia.—XXIII; 22; 84-89.

## Morocco.

- Morocco, the land of the extreme west.—XXIII; 17; 117-57.  
 Furlong, C. W.: The French in North Africa.—XXXVIII; 15; 9555-66.  
 Furlong, W.: The French conquest of Morocco.—XXXVIII; 22; 14989-  
 15000.  
 Ogilvie, A. G.: Notes on Moroccan geography.—XV; 41; 230-239.  
 Ogilvie, A. G.: Morocco and its future.—XV; 39; 554-575.  
 Edwards, A.: Conflicting interests in Morocco.—XIX; 71; 1121-1126.  
 Fischer, T.: Morocco.—XXXIII; 1904; 355-372.  
 Borrks, S.: The Morocco question.—XIX; 71; 176-181.  
 Letters from Morocco. —XXXII; 21; 37-41; 84-96.  
 Letters from Morocco.—XXXII; 20; 640-649.  
 Blayney, T. L.: A journey in Morocco.—XXIII; 22; 750-777.  
 Harris, W.: The Berbers of Morocco.—XXXI; 36; 353.  
 Holt, G. E.: Two great Moorish religious dances.—XXIII; 22; 777-85.

## NIGERIA.

- The mineral survey of Southern Nigeria.—XXXII; 27; 34-37.
- Kitson, A. E.: Some considerations of its structure, people, and natural history.—XV; 41; 16-38.
- Lugard, Sir F.: Northern Nigeria.—XV; 23; 1-29.
- Talbot, P. A.: The land of the Ekol, Southern Nigeria.—XV; 36; 637-657.
- Watt, J.: Southern Nigeria.—XXXII; 22; 173-181.
- Temple, C. L.: Northern Nigeria.—XV; 40; 149-168.
- Whitlock, G. F. A.: The Yola-Cross River boundary commission, Southern Nigeria.—XV; 36; 426-437.
- The tailed people of Nigeria.—XXIII; 21; 1239-42.
- Macallister, D. A.: The Aro country of Southern Nigeria.—XXXII; 18; 631-37.

## RIVERS.

- Seaman, L. L.: The falls of the Zambesi.—XXIII; 22; 561-72.
- The Victoria Falls of the Zambezi.—VI; 37; 213-216.
- Lyons, H. G.: Dimensions of the Nile and its basin.—XV; 26; 198-201.
- Prince, A. T.: Bridging the gorge of the Zambezi.—XXXVIII; 12; 7637-7647.
- Hume, W. F.: Notes on the history of the Nile and its valley.—XV; 27; 52-60.
- Reid, R. L.: The river Aruwimi.—XV; 38; 29-34.
- Pearson, H. D.: The Pibar River.—XV; 40; 486-501.
- Talbot, P. A.: The Macloed Falls on the Mao Kabi, French Equatorial Africa.—XV; 37; 420-424.
- Johnston, Sir H. H.: The Niger basin and Mungo park.—XXXII; 23; 58-72.
- Lamaire, C.: The Congo-Zambezi water parting.—XV; 19; 173-189.
- Battye, H. T.: Above Victoria Falls.—XXIII; 24; 193-200.
- The snows of the Nile.—XV; 29; 121-148.

## RHODESIA.

- Melland, F. H.: Bangwenly swamps and the Wa-Unga.—XV; 38; 381-95.
- Monbray, J. M.: The upper Kafue and Lusenfwa rivers, Northwest Rhodesia.—XV; 34; 166-171.



- Larpent, G. de H.: The development and progress of Rhodesia.—XXXII; 28; 337-361.
- Heatley, J. T. P.: The development of Rhodesia and its railway system in relation to oceanic highways.—XXXIII; 1905; 279-292.
- Rhodesia.—XXXII; 16; 92-105.
- Capenny, S. H. F.: Colonel Harding in the remotest Barotseland.—XXXII; 21; 484-90.

## SUDAN.

- Bridgman, H. L.: The new British empire of Sudan.—XXIII; 17; 241-68.
- France and the penetration of the central Sudan.—XXXII; 17; 414-429; 480-492.
- Progress in the Sudan; the international map.—XV; 40; 420-430.
- Foulkes, C. H.: The new Anglo-French frontier between the Niger and Lake Chad.—XXXII; 22; 565-575.
- Thompson, F. S.: Among the Shillucks of Southern Sudan.—XIX; 68; 139-47.
- Crowfoot, J. W.: Some Red Sea ports in the Anglo-Egyptian Sudan.—XV; 37; 523-50.
- Lloyd, W.: Notes on the Kordofan province.—XV; 35; 249-67.
- Watson, C. M.: The exploration of the Sudan.—XXXII; 28; 505-17.
- Pearson, H. D.: Progress of survey in the Egyptian Sudan.—XV; 35; 532-41.
- Breasted, J. H.: The University of Chicago on the Nubian Nile.—XXXV; 1; 193-202.

## SOUTH AFRICA.

- Lagden, G.: Basutoland and the Basutos.—XXXII; 17; 347-63.
- Pearson, H. H. W.: The travels of a botanist in Southwest Africa.—XV; 35; 481-513.
- Hamilton, J. S.: Mining diamonds in South Africa.—XXXVIII; 12; 7904-7907.
- A former ice age in South Africa.—XXXII; 17; 57-74.
- Watermeyer, F. S.: Geographical notes on South Africa south of Limpopo.—XXXII; 21; 625-37.
- Watermeyer, F. S.: Geographical notes on South Africa south of the Limpopo.—XXXII; 22; 29-38.

- Simpson, W. A.: Influence of geographical conditions on military operations in South Africa.—XXIII; 11; 186-192.
- Gibbons, A. St. H.: The transition of British Africa.—XXXII; 23; 122-141.
- Sharpe, Sir A.: The geographic and economic development of British Central Africa.—XV; 39; 1-22.
- Hilder, F. F.: British South Africa and the Transvaal.—XXIII; 11; 81-97.
- McConnell, A. B.: African bush, alone in the.—VIII; 12; 31-39.
- Brown, E. W.: With the British association in South Africa.—XXVI; 68; 1-20; 145-160.
- Elliott, J. A. G.: Notes and observations on an expedition in Western Cape Colony.—XXXII; 23; 393-422.
- Schwarz, E. H. L.: Plains in Cape Colony.—II; 174; 185.
- The history and ethnography of South Africa.—XXXII; 26; 86-89.
- Williams, G. F.: The diamond mines of South Africa.—XXIII; 17; 344-56.
- Whigham, H. I.: The Boer war.—XXXI; 27; 201; 259; 469; 573.
- The climate of Kimberley.—House Doc., Vol. III; 58th Cong., 3rd Sess.; Serial No. 4890; p. 308.
- Harvey-Gibson, R. J.: Some aspects of the vegetation of South Africa.—XXXII; 30; 225-37.

## TRIPOLI.

- Heawood, E.: The commercial resources of tropical Africa.—XXXII; 16; 651-657.
- Mathnesient, V. De: An expedition to Tripoli.—VI; 36; 736-744.
- Furlong, C. W.: The taking of Tripoli.—XXXVIII; 23; 165-76.
- Furlong, C. W.: The Greek sponge: Divers of Tripoli.—XVI; III; 275-284.
- Norton, R.: Tripoli.—XIX; 72; 26-29.
- Vischer, A. L.: Tripoli.—XV; 38; 487-494.
- Vischer, A. L.: Tripoli, a land of little promise.—XXIII; 22; 1035-48.

## TUNIS.

- Johnson, F. E.: The mole men (of Tunisia).—XXIII; 22; 787-846.
- Johnson, F. E.: The green bronzes of Tunisia.—XXIII; 23; 89-104.
- Johnson, F. E.: The sacred city of the sands (Kairgwan).—XXIII; 1061-94.

## WEST AFRICA.

- From the Niger by Lake Chad to the Nile.—XV; 30; 119-152.  
 Angola, the last foothold of slavery.—XXIII; 21; 625-30.  
 Lieut. Boyd Alexander's expedition in West Africa.—XV; 34; 51-55.  
 Speak, S. J.: The gold-producing region of West Africa.—XXXII; 18; 30-34.  
 Morel, E. D.: The economic development of West Africa.—XXXII; 20; 134-143.  
 A view of West Africa.—XXXII; 29; 113-133.  
 Gaunt, M.: A new view of West Africa.—XXXII; 29; 113-33.

## AUSTRALIA.

- Rainfall in Australia.—XXXII; 3; 161-173.  
 Mead, E.: Irrigation in Australia.—XIX; 69; 756-763.  
 Thomson, J. P.: The physical geography and geology of Australia.—XXXII; 19; 66-80.  
 The artesian water supply of Australia from a geological standpoint.—XV; 19; 560-76.  
 MacDonald, R. M.: Some features of the Australian interior.—XXXII; 20; 577-584  
 The vegetation of Western Australia.—XXXII; 23; 363-67.  
 Bryant, J.: The making of Australia.—XXXII; 18; 139-142.  
 MacConald, R. M.: The opal formation of Australia.—XXXII; 20; 253-61.  
 Gregory, J. W.: The flowing wells of Central Australia.—XV; 38; 34-59; 157-179.  
 Mr. Canning's expeditions in Western Australia in 1906-7 and 1908-10.—XV; 38; 26-29.  
 Taylor, G.: The evolution of a capitol: A physiographic study of the foundation of Canberra, Australia.—XV; 43; 378-95; 536-50.  
 The geographical factors that control the development of Australia.—XV; 35; 658-682.  
 United Australia.—XXXIX; 9; 129-63.  
 Arbitration in Australia.—XXXIX; 19; 32-54.  
 The progress of the New South Wales.—XXXII; 22; 539-545.  
 The dead heart of Australia.—XXXII; 23; 19-25.  
 Duncan, M.: Australian bypaths.—XVI; 128; 123-36; 207-223.  
 Wallis, B. C.: The rainfall regime of Australia.—XXXII; 30; 527-32.

The future of Australia.—XXXII; 30; 635-42.

Gregory, J. W.: The lake system of Westralia.—XV; 43; 656-64.

#### ISLANDS.

Bristol, C. L.: Notes on the Bermudas.—VI; 33; 242-248.

Whitefield, C. T.: England's "half-way" house to Panama.—XXXVIII; 12; 7939-7949.

Greene, J. M.: Bermuda (Somers Island); historical sketch.—VI; 33; 220-242.

Beebe, M. B.: With the Dyaks of Bornea.—XVI; 124; 264-278.

Hose, C.: In the heart of Borneo.—XV; 16; 39-63.

Burt, A.: Notes on a journey through British North Borneo.—XXXII; 21; 312-315.

Stigand, J. A.: Some contributions to the physiography and hydrography of Northeast Borneo.—XV; 37; 31-42.

Quincy, E. S.: Catalina, the wondrous isle.—XXIV; 31; 283-289.

Smith, H. M.: Pearl fisheries of Ceylon.—XXIII; 23; 173-95.

The Veddas (Ceylon).—XXXII; 27; 426-429.

Cross, A. L.: Ceylon.—XXXII; 29; 397-405.

Cross, A. L.: Ceylon in 1913.—XXXII; 29; 396-405.

Hall, E. H.: Crete, explorations in.—XXIII; 20; 778-88.

Baikie, J.: The sea-kings of Crete.—XXIII; 23; 1-25.

Boyd, H. A.: Excavations at Gournia, Crete.—XXXIII; 1904; 559-571.

Lindsay, Forbes: Future farming in Cuba.—VII; 36; 183-192.

Key West and Cuba.—VII; 34; 212-222.

Vaughan, T. W., & Spencer, A. C.: The geography of Cuba.—VI; 34; 105-116.

Brandon, E. E.: National University of Cuba.—VII; 36; 511-518.

General sketch, 1910 (Cuba).—VII; 31; 135-152.

The great Roque canal of Matanzas, Cuba.—VII; 36; 668-674.

Gannett, H.: Conditions in Cuba, as revealed by the census.—XXIII; 20; 200-3.

Wileox, W. D.: Among the mahogany forests of Cuba.—XXIII; 19; 485-98.

Lindsay, T.: Cuba, for the man of moderate means.—VII; 37; 32-40.

General sketch, 1910 (Cuba).—VII; 33; 377-409.

General sketch, 1910 (Haiti).—VII; 33; 282-97.

American progress in Habana.—XXIII; 13; 97-108.

- Fernow, B. E.: Cuba, the high Sierra Maestra.—VI; 39; 257-268.
- Brooko, S.: Some impressions of Cuba.—XXV; 199; 735-45.
- Robinson, A. G.: Cuban railways.—XXIII; 13; 108-110.
- Cuba, the pearl of the Antilles.—XXIII; 17; 535-68.
- Immigration to Cuba.—XXIII; 17; 568-9. Dominican Republic.—VII; 33; 118; also Vol. 31; 152-68.
- Cyprus of today.—XXXII; 17; 292-300.
- Reed, A. C.: Going through Ellis Island.—XXVI; 82; 1-18.
- Currie, J.: The Faeroe Islands.—XXXII; 22; 61-76; 134-147.
- Palmer, H. R.: Fisher's Island, a former bit of New England.—XXIV; 28; 567-584.
- The Island of Formosa.—XXIII; 14; 468-71.
- Campbell, W.: Formosa under the Japanese.—XXXII; 18; 561-77.
- Fortoseue, G. F.: The Galopagos Islands.—VII; 32; 222-39.
- Hovey, E. O.: The Grande Soufriere of Guadeloupe.—VI; 36; 513-30.
- Safford, Wm. E.: Our smallest possession.—XXIII; 16; 229-37.
- Born, E. J.: Our administration in Guam.—XIX; 71; 636-42.
- The Island of Guam.—VI; 35; 475-477.
- Cox, L. M.: The Island of Guam.—VI; 36; 385-395.
- Safford, W. E.: Guam and its people.—XXXIII; 1902; 493-508.
- Lyle, E. P.: Our mix-up in Santo Domingo.—XXXVIII; 10; 6737-59.
- Chester, C. M.: A degenerating island; Haiti past grandeur and present decay.—XXIII; 19; 200-18.
- Lyle, E. P.: What shall Haiti's future be?—XXXVIII; 11; 7151-62.
- Packard, W.: Facts about Santo Domingo.—XXIV; 34; 1-16.
- Stoddard, T. L.: Santo Domingo; our unruly ward.—XXVIII; 49; 726-31.
- General sketch, 1910 (Haiti).—VII; 31; 204-19.
- Commerce of Haiti for 1911.—VII; 36; 98-100.
- McCandless, H. H.: The cross-roads of the Pacific.—XXXVIII; 13; 8611-8628.
- Perkins, G. O.: The key to the Pacific.—XXIII; 19; 295-8.
- Agricultural resources and capabilities of Hawaii.—House Doc., 386; Vol. 43; 56th Cong., 2nd Sess.; Serial No. 4117.
- Wood, H. P.: Hawaii for homes.—XXIII; 19; 298-300.
- Makenzie, W. C.: Pigmies in the Hebrides: A curious legend.—XXXII; 21; 264-68.

- Stefansson, J.: Iceland: Its history and inhabitants.—XXXIII; 1906; 275-94.
- Noyes, P. H.: A visit to lonely Iceland.—XXIII; 18; 731-41.
- Russell, W. S. C.: Physiographical features of Iceland.—VI; 43; 489-500.
- Gratacap, L. P.: A trip around Iceland.—XXVI; 72; 79-90.
- Gratacap, L. P.: A trip around Iceland.—XXVI; 71; 289-302; 421-32; 560-68.
- The Isle of Pines.—XXIII; 17; 105-8.
- Baldwin, M.: Jamaica as a summer resort.—XXIV; 30; 449-64; 577-90.
- Lyle, E. P.: Captain Baker and Jamaica.—XXXVIII; 11; 7295-7308.
- Graves, C. M.: The pompeii of America (Jamestown Island).—XXIV; 33; 277-84.
- The Dutch in Java.—XXXII; 20; 460-474; 538-543.
- Bryant, H. G.: A traveler's notes on Java.—VIII; 6; 33-47.
- Yeld, G.: In the Lipari Islands.—XXXII; 21; 347-352.
- Oliver, P.: The land of parrots (Madagascar).—XXXII; 16; 1-17; 68-82; 583-597.
- Hunt, W. H.: Madagascar.—VI; 32; 297-307.
- Laeroix, A.: A trip to Madagascar, the country of Beryls.—XXXIII; 1912; 371-82.
- Fairehild, D.: Madeira; on the way to Italy.—XXIII; 18; 751-71.
- Richardson, R.: Malta: Notes on a recent visit.—XXXII; 22; 365-73.
- Eldridge, G. W.: Martha's Vineyard, the gem of the North Atlantic.—XXIV; 40; 163-179.
- Bruce, Sir C.: The evolution of the crown colony of Mauritius.—XXXII; 24; 57-78.
- Hoffs, W. H.: The Maltese Islands: A testonietopographic study.—XXXII; 30; 1-13.
- Brown, R. M.: The Mergin Archipelago: Its people and products.—XXXII; 23; 463-84.
- Lorentz, H. A.: An expedition to the snow mountains of New Guinea.—XV; 37; 477-500.
- Rawling, C. G.: Explorations in Dutch New Guinea.—XV; 38; 233-55.
- Barbour, T.: Further notes on Dutch Guinea.—XXIII; 19; 527-45.
- Smith, M. S.: Explorations in Papua.—XV; 39; 313-334.
- Barbour, T.: Notes on a zoological collecting trip to Dutch New Guinea.—XXIII; 19; 469-84.

- Bell, J. M.: Some New Zealand volcanoes.—XV; 40; 8-25.
- Kitson, A. E. and Thiele, E. O.: The geography of the upper Waitaki Basin, New Zealand.—XV; 36; 537-553.
- Ford, A. H.: The tourist in New Zealand.—XIX; 68; 404-409.
- Bell, J. M.: A physiographic section through the middle island of New Zealand.—VI; 38; 273-281.
- Mossman, R. C.: The South Orkneys in 1907.—XXXII; 24; 348-355.
- Warren, M. R.: The Orkney Islands.—XVI; 122; 344-355.
- Thompson, G. A.: The smiling isle of Passamaquoddy.—XXIV; 39; 67-78.
- Chinch, B. J.: The formation of the Filipino people.—XXXIX; 10; 53-69.
- The peoples of the Philippines.—House Doc., Vol. 111; 671; 58th Cong., 3rd Sess.; Serial No. 4890.
- Smith, W. D. P.: Geographical work in the Philippines.—XV; 34; 529-544.
- Ten years in the Philippines.—XXIII; 19; 141-9.
- Vassal, G.: A visit to the Philippines.—XXXII; 27; 57-71.
- Worcester, D. C.: Head hunters of Northern Luzon.—XXIII; 23; 833-931.
- Tower, W. S.: The climate of the Philippines.—VI; 35; 253-60.
- Gannett, H.: The Philippine census.—VI; 37; 257-271.
- Crandall, R.: The riches of the Philippine forests.—XXXVIII; 16; 10228-35.
- Champlin, J. D.: The discoverer of the Philippines.—VI; 43; 587-97.
- Barrett, J.: The Philippine Islands and their environment.—XXIII; 11; 1-15.
- Grosvenor, G. H.: The revelation of the Filipinos.—XXIII; 16; 139-192.
- Putnam, G. R.: Surveying the Philippine Islands.—XXIII; 14; 437-41.
- Gannett, H.: The Philippine Islands and their people.—XXIII; 15; 91-113.
- Benguet, the garden of the Philippines.—XXIII; 14; 203-10.
- American development of the Philippines.—XXIII; 14; 197-203.
- Atkinson, F. A.: An inside view of Philippine life.—XXXVIII; 9; 5571-5589.
- The conquest of the bubonic plague in the Philippines.—XXIII; 14; 185-195.
- The Negritos of Zambales.—XXXII; 21; 539-543.
- Atlas of Philippine Islands.—Senate Doc. No. 138; Vol. 47; 56th Cong., 1st Sess.; Serial No. 3885.
- Worcester, D. C.: The non-Christian peoples of the Philippine Islands.—XXIII; 24; 1157-1255.

- Worcester, D. C.: Field sports among the wild men of Northern Luzon.—XXIII; 22; 215-67.
- Worcester, D. C.: Taal volcano, its recent destructive eruption.—XXIII; 23; 314-67.
- Banskett, F. M.: The Philippine cocoanut industry.—XXXVII; 20; 332-39.
- Filipino capacity for self-government.—XXV; 199; 65-78.
- Adams, H. C.: Snapshots of Philippine America.—XXXVIII; 28; 31-43.
- Torbes, E. A.: The United States in Porto Rico.—XXXVIII; 14; 9290-9311.
- Wilson, H. M.: Porto Rico: Its topography and aspects.—VI; 32; 220-238.
- Keye, P. L.: Suffrage and self-government in Porto Rico.—XXXIX; 12; 167-190.
- Alexander, W. A.: Porto Rico: Its climate and resources.—VI; 34; 401-409.
- Osborne, J. B.: The Americanization of Porto Rico.—XXXVIII; 8; 4759-4766.
- Larrinaga, T.: The needs of Porto Rico.—XIX; 70; 356-59.
- Detailed discussion on Porto Rico.—XXIII; 13; 466-70.
- Lyle, E. P.: Our experience in Porto Rico—Strategic value of.—XXXVIII; 11; 7082-94.
- Agricultural resources and capabilities of Porto Rico.—House Doc. No. 171; Vol. 43; 56th Cong., 2nd Sess.; Serial No. 4117.
- Hulbert, H. B.: The island of Quelpart.—VI; 37; 396-408.
- Slosson, E. E.: Rarotonga (an island in the Southern Pacific).—XIX; 72; 1403-1408.
- The islands of St. Pierre and Miquelon.—XXXII; 19; 297-302.
- Hawes, C. H.: A visit to the island of Sakhalin.—XXXII; 19; 183-190.
- General sketch, 1910—Salvador.—VII; 31; 325-38.
- Chambers, F. T.: American Samoa.—VI; 37; 641-647.
- Kellogg, V. L.: American Samoa.—XXI; 5; 18-30.
- Churchill, W.: Geographical nomenclature of American Samoa.—VI; 45; 187-93.
- The ruins of Selinus.—XXIII; 20; 117-19.
- Bosson, G. C.: Sicily, the battlefield of nations and of nature.—XXIII; 20; 97-117.



- Perrine, C. D.: An eclipse observer's experiences in Sumatra.—XXVI; 67; 289-305.
- Church, J. W.: Tangier Island.—XVI; 128; 872-82.
- Richardson, C.: Trinidad and Bermudez asphalts.—XXVI; 81; 19-35; 170-182.
- Keller, A. G.: Notes on the Danish West Indies.—III; 22; 99-110.
- Physical history of Windward Islands.—House Doc., Vol. 111; 244; 58th Cong., 3rd Sess.; Serial No. 4890.
- Powell, E. A.: In Zanzibar.—XIX; 71; 974-980.
- Powers, S.: Floating Islands.—VIII; 12; 1-27.
- Powers, S.: Floating Islands.—XXVI; 79; 303-308.
- Childs, H. P.: Zanzibar, story of trade, traffic, etc.—XXIII; 23; 810-24.

#### POLAR REGIONS.

- Stefansson, V.: Misconceptions about life in the Arctic.—VI; 45; 17-32.
- Stefansson, V.: The technique of Arctic winter travel.—VI; 44; 340-347.
- Stefansson expedition.—VI; 46; 184-91.
- Reid, H. F.: How could an explorer find the pole? XXVI; 76; 89-97.
- Chamberlin, T. C.: Topography of Greenland.—VIII; 1; 167-194.
- Scenes from Greenland.—XXIII; 20; 877-91.
- Talman, C. T.: The outlook in polar explorations.—XXVIII; 49; 179-88.
- Researches in the Greenland Sea.—XXXII; 26; 77-80.
- Kikkelsen: Expedition to East Greenland.—XV; 41; 313-324.
- Aspects of the coasts of Northeast Greenland.—VI; 41; 92-94.
- Comer: A geographical description of Southampton Island and notes upon the Eskimo.—VI; 42; 84-90.
- Mossman: The Greenland Sea: Its summer climate and ice distribution.—XXXII; 25; 281-310.
- The northeast passage.—VI; 38; 25-27.
- Seton, E. T.: The Arctic prairie.—XXXI; 48; 513; 725; also Vol. 49; 61-207.
- Amundson's northwest passage.—VI; 38; 27-9.
- Wellman's polar trip and polar air ship.—XXIII; 17; 205-28.
- Fleischman, M.: Seventy-five days in the Arctics.—XXIII; 18; 439-46.
- The discovery of the pole.—XXIII; 20; 892-6; 896-16.
- Keen, D.: Arctic mountaineering by a woman.—XXXI; 52; 64.
- Honors to Peary.—XXIII; 18; 49-60.

- Stone, A. J.: Camp life in Arctic America.—XXXI; 34; 613.  
 European tributes to Peary.—XXIII; 21; 536-540.  
 The discovery of the North Pole.—XXIII; 21; 63-83.  
 Tarr, R. S.: Human life in the Arctic.—XXI; 10; 144-51.  
 Stokes, F. W.: Aurora Borealis.—X; 65; 488-495.  
 Discoveries in Arctic regions, animals, etc.—XXXVIII; 1; 149-156.  
 Stone, A. J.: A day's work of an Arctic hunter.—XXXVIII; 1; 85-92.  
 Stefansson, V.: The distribution of human and animal life in Western Arctic America.—XV; 41; 449-460.
- Peary, R. E.: Field work of the Peary Arctic Club.—VIII; 4; 1-48.  
 MacRitchie, D.: Kayaks of the North Sea.—XXXII; 28; 126-133.  
 Amundsen, R.: The Norwegian South Polar Expedition.—XXXII; 29; 1-13.  
 Evans, E. R.: The British Antarctic Expedition.—XXXII; 29; 621-637.  
 Riggs, T.: Our Arctic boundary.—XXXVII; 20; 417-26.  
 Baleh, E. S.: Antarctic names.—VI; 44; 561-581.  
 Baleh, E. S.: Recent Antarctic discoveries.—VI; 44; 161-67.  
 Baleh, E. S.: Scott's second Antarctic Expedition.—VI; 44; 270-77.  
 South Polar exploration.—XXIII; 22; 407-9.  
 Amundsen's attainment of the South Pole.—XXIII; 23; 205-8.  
 Bruce, W. S.: The area of unknown Antarctic regions compared with Australia, unknown Arctic regions and British Isles.—XXXII; 22; 373-374.
- The Amundsen expedition to the magnetic pole.—XXXII; 22; 38-42.  
 Baleh, E. D. S.: The heart of the Antarctic.—VI; 42; 9-21.  
 Littlehales, G. W.: The south magnetic pole.—VI; 42; 1-8.  
 Peary, R.: The struggle for the south pole.—XXXVIII; 24; 113-16.  
 Priestley, R. E.: Work and adventures of the northern party of Captain Scott's Antarctic expedition, 1910-13; XV; 43; 1-14.  
 Honors for Amundsen.—XXIII; 19; 55-76.  
 An ice-wrapped continent.—XXIII; 18; 95-117.  
 The scientific results of the National Antarctic expedition.—XXXII; 21; 318-322.
- Baleh, E. S.: The British Antarctic expedition.—VI; 41; 212-14.  
 Shackleton: Antarctic, the heart of.—XXIII; 20; 972-1007.  
 The south polar expedition.—XXIII; 21; 167-170.  
 Pillsbury, J. E.: Discoveries in Wilkes land.—XXIII; 21; 171-3.  
 Gannett, H.: The great sea barrier.—XXIII; 21; 173-4.

- David, T. W.: *Antarctica and some of its problems.*—XV; 43; 605-27.
- Greely, A.: *American discoverers of the Antarctic continent.*—XXIII; 23; 298-314.
- Mawson, Sir D.: *Australasian Antarctic expedition, 1911-14.*—XV; 44; 257-86.
- Baleh, E. S.: *Wilkes land.*—VI; 38; 30-32.
- Nordenskjold, O.: *Antarctic nature, illustrated by a description of North-west Antarctic.*—XV; 38; 278-289.
- Markham, C. R.: *Review of the results of twenty years of antarctic work originated by the Royal Geographical Society.*—XV; 39; 575-80.
- The form of the Antarctic continent.*—XXXII; 26; 262-65.
- Hoffs, W. H.: *Scott's last expedition.*—VI; 46; 281-5.
- The German Antarctic expedition.*—VI; 45; 423-30.
- Amundsen, R.: *The Norwegian south polar expedition.*—XXXII; 29; 1-13.
- Bruce, W. S.: *Shackleton's transarctic expedition of 1914.*—XXX; 77; 84-85.
- Taylor, J.: *Physiography and glacial geology of East Antarctica.*—XV; 44; 365-82; 452-67; 553-65.

## OCEANS.

- Austin: *Problems of the Pacific: Commerce of the great ocean.*—XXIII; 13; 303-18.
- Damas, D.: *The oceanography of the Sea of Greenland.*—XXXIII; 1909; 369-383.
- Church: *Interoceanic communication on the Western Continent.*—XV; 19; 313-54.
- Murray, J.: *Exploring the ocean's floor.*—XVI; 541-550.
- Cornish: *Dimensions of deep sea waves.*—XV; 23; 423-44.
- Fryer, J. C. F.: *The Southwest Indian Ocean.*—XV; 36; 249-71.
- Murray: *Articles on oceanography.*—XV; 12; 113-37.
- Gardiner, J. S.: *The Indian Ocean.*—XV; 28; 313-333; 454-471.
- Murray: *The deep sea.*—VI; 43; 119-126; also XXXII; 26; 617-24.
- Peterson, O.: *On the influence of ice-melting upon oceanic circulation.*—XV; 24; 285-333.
- Kirchoff, A.: *The sea in the life of the nations.*—XXXIII; 1901; 389-400.
- Holder, C. F.: *The glass bottom boat.*—XXIII; 20; 761-78.
- The pageant of the mastery of the sea.*—XXXVI; 177; 155-67.

- Page, J.: Ocean currents in 1902.—XXIII; 13; 135-43.
- Thunn, Sir J.: The Western Pacific: Its history and present condition.—XV; 34; 271-89.
- Blockman, L. G.: The Pacific, the most explored and least known region of the globe.—XXIII; 19; 546-63.
- Geikie, J.: The "deeps" of the Pacific Ocean and their origin.—XXXII; 28; 113-126.
- Murray, Sir J.: Deep sea deposits and their distribution in the Pacific Ocean.—XV; 19; 691-711.
- Hepworth, W. W. C.: The Gulf Stream.—XV; 44; 429-52; 534-48.
- Seiple, E. C.: Oceans and enclosed seas.—VI; 40; 193-209.
- On the importance of an international exploration of the Atlantic Ocean in respect to its physical and biological conditions.—XXXII; 25; 23-28.
- Temperature on the eastern and western coasts of the North Atlantic Ocean.—XXXII; 24; 171-173.
- Seiple, E. C.: A comparative study of the Atlantic and Pacific Oceans.—XLII; 3; 121-29; 172-79.
- Putnam, G. R.: Hidden perils of the deep.—XXIII; 20; 822-37.
- Thompson, B.: Lost explorers in the Pacific.—XV; 44; 12-29.

## A STUDY OF THE COLLECTIONS FROM THE TRENTON AND BLACK RIVER FORMATIONS OF NEW YORK.\*

BY H. N. CORYELL.

The Trenton limestone in general is a formation made up of thin bedded, dark bluish gray, compact limestone separated by thin shaly layers, except the upper 25 to 35 feet which consist of a coarse crystalline, thick bedded limestone with thin shaly partings. This formation is everywhere very fossiliferous.

The type locality for the Trenton limestone is in the southwest part of the Remsen quadrangle, along West Canada creek, at Trenton Falls. A detailed section of the formation shown here is given by Prosser and Cummings, who have measured the entire thickness of 270 feet with great care. The upper portion does not appear in the Trenton Falls section, yet the work of W. J. Miller shows that there is only a few feet omitted, since the crystalline beds are at no place more than 35 feet thick upon which rest the Canajoharie shale.

The bottom of the Trenton formation is not shown in the Trenton Fall gorge, still the dip of the strata and the presence of the Lowville limestone a few miles to the southeast makes it seem very probable that the lowest beds in the gorge are not far from the base of the Trenton formation. Thus allowing for the necessary addition to the top and the bottom, the thickness of the complete section is at least 280 to 300 feet. The measurements taken at Rome and at the Globe Woolen Mills at Utica show a greater thickness of the Trenton to the southward and southwestward.

The formations during the early Paleozoic were deposited upon a sinking ocean bottom. The coast line receded to the northward. Younger formations overlap the older ones everywhere along the coast line and lay upon the Precambrian rocks. The Trenton is 510 feet in the Globe Woolen Mills well at Utica, 575 feet in the Chittenango well, and 435 feet (including the Lowville) in the well at Rome. In the vicinity of Trenton Falls it has a maximum thickness of 300 feet. Along the Precambrian boundary there are indications that it is much less. Considering the slope of the Precambrian floor and differ-

\*A summary of the literature is given by Prof. E. R. Cummings in the Bulletin of the New York State Museum, No. 34, Vol. 7, May, 1900.

ence of elevation between Bardwell Mill where the upper Trenton is shown, and the mouth of Little Black creek where the Precambrian outcrops, no such great thicknesses can be present. The Trenton at Bardwell Mill is probably not more than 150 feet.

To the south of Trenton Falls there is an increase in the thickness of about 20 feet per mile southwestward. Between the Globe Woolen Mills and Trenton Falls there is a difference in thickness of 210 feet in the distance of 14 miles. In the well at Rome the Trenton is 375 feet, and 20 miles to the northeast it is from 200 to 250 feet. The general fact drawn from these indicates a sloping floor on which the Trenton was deposited, of 6 to 20 feet per mile to the southwestward; the slope being less in the northwestern part.

The narrow gorge cut by the West Canada river extends for two and one-half miles up the river from Trenton Falls to the village of Prospect. Its walls are nearly vertical, varying in height from 100 to 200 feet. Throughout the entire course there are six waterfalls: the Sherman fall, near the southern end of the gorge, is about 30 feet high and a short distance above the power house; High falls is one-fourth mile south of the railroad bridge; it consists of an upper and a lower part with a total of 128 feet; the fall at the dam, just north of the railroad bridge, is about 40 feet high; and the Prospect falls at the upper end of the gorge is 25 or 30 feet high. The total fall of the stream within the two- and one-half miles is about 360 feet, according to the topographic map. In spite of the steep slope of the stream bed the southward dip of the strata permits an exposure of only 270 feet of the formation.

Two systems of joints predominate in the Trenton, which are distinctly indicated by the appearance of the walls of the gorge. Nearly everywhere the joints are vertical, at least at a very high angle, and extend in an east-west and a north-south direction. The east-west system can be seen extending across the gorge, especially at the falls, which are caused by the existing joints. When large blocks of stone are removed by the current during high water, a new perpendicular surface is exposed over which the water falls. Thus the falls recede. This is especially seen in the case of Sherman Falls. During high water, the water falls over one joint plane on the east and another on the west, while during low water the entire stream falls over the rear joint on the west. The block of limestone between them will eventually be removed.

The vertical walls of the gorge are maintained by the breaking off of large blocks of limestone along the north-south joints.

In the bed of the Cincinnati creek the joints are enlarged and forms an underground course. The stream disappears for several hundred yards.

The contorted layers in the Trenton Falls section are in two distinct horizons. The lower one is from 4 to 6 feet thick and lies at the crest of the lower part of High Fall. It outcrops also in the upper end of the gorge near Prospect. According to the measurements of Prosser and Cummings it lies 144 feet below the top of the Trenton.

The second layer is from 8 to 15 feet thick and shown along the path opposite High Fall and may be traced to Prospect. It lies 65 to 70 feet below the top of the Trenton.

Such contortion of strata does not appear in the outcrop of Trenton exposed along Mill Creek.

Vanuxem suggested that as the folded layer was more crystalline than the layers above or below, the expansion of crystallization was manifested in the contortion of the crystalizing layer.

T. G. White discovered overturned fold, cross-bedded, channel filling structures that must be explained by other means which would yield a considerable expansion in excess of the crystallization.

W. J. Miller states that it is thought that the folded structure at Trenton Falls was in reality caused by a differential movement within the mass of the Trenton limestone. That the whole body of the limestone has been moved is clearly demonstrated by the existence of the thrust fault at Prospect. It is easy to see how when the force of compression was brought to bear in the region there would be a tendency for the upper Trenton beds on the upthrow side to move more easily and consequently faster than the lower Trenton beds. A similar explanation would apply to the lower folded zone. The folded zones thus indicate horizons of weakness along which the differential movement has taken place. As thus explained it is evident why the strike of the minor folds, the strike of the fault, and the strike of the large low folds of the region should be parallel, and why the contorted strata should be so local in occurrence, because all the phenomena were produced by the same local pressure. The differential movement would also readily account for the rubbed or worn character of the upper and lower sides of the contorted zone.

The topography of the limestone region, underlain by the Trenton, Black river, Tribes Hill and Little Falls dolomite is given by E. R. Cummings, who states in describing the Mohawk valley near Amsterdam, that the limestone region is characterized by a low, rolling relief and shallow stream val-

leys, except where the streams have been forced to cut new courses through morainic material or because of the obstructions offered by such material have been turned aside to make new rock cuts. The latter is probably the case with the lower courses, at least of the north Chuctanunda and Evakill, for while they are at present making rock cuts, their banks show deep cuts through boulder clay, and their beds are in no respect those of mature streams, both from the abundance of water-falls and the irregularity of their slope. The northwestern portion of this region is heavily covered with drift and the topography is more angular on this account. The limestone area is sheared off by the Hoffman ferry fault, along a line running nearly straight from the western central part of Charlton township to a point about one mile southwest of Pattersonville. The topography is also distinctly different upon the adjacent shales (Canajoharie and Schenectady) that abut the entire east face of the fault as shown on the Amsterdam sheet, except at the north where a small area of Trenton is found east of and adjacent to the fault.

#### TRENTON FALLS SECTION.

##### 1. *Sherman Fall.*

The lowest strata that outcrop in the Trenton Falls gorge are those at the water level of the pool at the base of the Sherman Fall. They are compact, bluish grey, thin bedded limestones interstratified with coarser-grained layers containing numerous well preserved specimens of *Prasopora simulatrix*. The *Prasopora* beds form the entire fall. The upper layers of this fall are thin strata, 3 to 5 inches thick, which form a somewhat clearly defined band  $2\frac{1}{2}$  feet thick. About the middle of the breast of the falls the *Prasopora* are much larger than elsewhere, forming a distinct layer. The second *Prasopora* zones are the fossiliferous layers just above the crest of Sherman Fall and forming the base of High Falls.

The lists of fossils below were identified from the collections made by Prof. E. R. Cummings in the summer of 1914.

a = abundant

c = common

r = rare

- |                                           |   |
|-------------------------------------------|---|
| 1. <i>Calymene senaria</i> Conrad.....    | c |
| 2. <i>Corynotrypa inflata</i> (Hall)..... | r |
| 3. Crinoid segments.....                  | a |



- |     |                                   |          |
|-----|-----------------------------------|----------|
| 4.  | Dalmanella testudinaria (Dalman)  | .....a   |
| 5.  | Hemiphragma tenuimurale Ulrich    | .....r   |
| 6.  | Isotelus gigas deKay              | .....c   |
| 7.  | Orthoceras junceum Hall           | .....r-c |
| 8.  | Plectambonites sericeus (Sowerby) | .....a   |
| 9.  | Prasopora simulatrix Ulrich       | .....aaa |
| 10. | Rafinesquina alternata (Emmons)   | .....c   |
| 11. | Schizoerania filosa Hall          | .....r   |
| 12. | Stigmatella n. sp.                | .....r   |
| 13. | Trematis terminalis (Emmons)      | .....r   |

2. *Below crest of the lower portion of High Fall.\**

The strata, thin and shaly, lies at the base of the contorted layer. The following species were collected:

- |    |                                        |          |
|----|----------------------------------------|----------|
| 1. | Crinoid segments                       | .....a   |
| 2. | Dalmanella testudinaria (Dalman)       | .....r-c |
| 3. | Eridotrypa aedilis minor (Ulrich)      | .....r-c |
| 4. | Prasopora simulatrix orientalis Ulrich | .....aaa |

3. *A collection at the crest of High Falls yielded the following species:*

- |    |                                        |          |
|----|----------------------------------------|----------|
| 1. | Bythopora sp.                          | .....r   |
| 2. | Crinoid segments                       | .....c   |
| 3. | Dalmanella testudinaria (Dalman)       | .....a   |
| 4. | Hallopora ampla (Ulrich)               | .....r-c |
| 5. | Hallopora goodhuensis (Ulrich)         | .....a   |
| 6. | Plectambonites sericeus (Sowerby)      | .....r-c |
| 7. | Prasopora simulatrix orientalis Ulrich | .....aa  |
| 8. | Rhinidietya exigua Ulrich              | .....r   |

4. *Upper High Fall.*

The rocks are thin bedded both in the upper and lower portion of upper High Fall. The contorted stratum lies at the base. The following species were collected:

- |    |                                |        |
|----|--------------------------------|--------|
| 1. | Arthoclema cornutum Ulrich     | .....a |
| 2. | Calymene senaria Conrad        | .....c |
| 3. | Corynotrypa delicatula (James) | .....r |

---

\*From a collection made by Mr. T. F. Sayer, five feet below the crest of the lower portion of High Falls.

|     |                                             |     |
|-----|---------------------------------------------|-----|
| 4.  | Crinoid segments.....                       | aaa |
| 5.  | Dalmanella testudinaria (Dalman).....       | aaa |
| 6.  | Hemiphragma tenuimurale Ulrich.....         | a   |
| 7.  | Isotelus gigas de Kay.....                  | c   |
| 8.  | Mitoclema? mundulum Ulrich.....             | r-c |
| 9.  | Nematopora ovalis Ulrich.....               | r-c |
| 10. | Pachydietya acuta (Hall).....               | c   |
| 11. | Pachydietya fimbriata Ulrich.....           | r   |
| 12. | Platystrophia trentonensis n. sp.....       | c   |
| 13. | Plectambonites sericeus (Sowerby).....      | r-c |
| 14. | Prasopora simulatrix orientalis Ulrich..... | a   |
| 15. | Rafinesquina alternata (Emmons).....        | r   |
| 16. | Rhinidietya exigua Ulrich.....              | r   |
| 17. | Rhinidietya paupera Ulrich.....             | r-c |

#### 5. *Mill Dam Falls.*

The Mill Dam Falls or Fourth Falls is formed of thin bedded, rather coarse-grained and fossiliferous limestone. The following species were identified:

|    |                                        |     |
|----|----------------------------------------|-----|
| 1. | Chasmotopora reticulata (Hall).....    | c   |
| 2. | Crinoid segments.....                  | a   |
| 3. | Dalmanella testudinaria (Dalman).....  | a   |
| 4. | Plectambonites sericeus (Sowerby)..... | a   |
| 5. | Rhinidietya paupera Ulrich.....        | r-c |

#### 6. *Power Dam Interval.*

The Power Dam Interval includes almost all of the division of the Prosser and Cummings report except the upper few feet, which were collected from separately. The base of this interval is marked by a heavy stratum of limestone. Above this lies thin-bedded compact limestone, part of the strata somewhat crystalline, separated by shaly layers. At the upper end of the gorge the layers show the greatest amount of folding visible anywhere in the Trenton Falls section. The strata are very fossiliferous and the following species were collected:

|    |                                     |     |
|----|-------------------------------------|-----|
| 1. | Calymene senaria Conrad.....        | a   |
| 2. | Ceramoporella distincta Ulrich..... | c   |
| 3. | Chasmotopora reticulata (Hall)..... | aaa |

|     |                                                |     |
|-----|------------------------------------------------|-----|
| 4.  | <i>Corynotrypa delicatula</i> (James)          | a   |
| 5.  | <i>Corynotrypa inflata</i> (Hall)              | a   |
| 6.  | <i>Corynotrypa turgida</i> Ulrich              | a   |
| 7.  | Crinoid segments                               | aa  |
| 8.  | <i>Dalmanella testudinaria</i> (Dalman)        | aaa |
| 9.  | <i>Diplolema trentonense</i> Ulrich            | r   |
| 10. | <i>Eridotrypa</i> cf. <i>exigua</i>            | r   |
| 11. | Gastropod fragments                            | r-e |
| 12. | <i>Hallopora angularis</i> (Ulrich)            | r   |
| 13. | <i>Hemiphragma tenuimurale</i> Ulrich          | r-e |
| 14. | <i>Isotelus gigas</i> de Kay                   | r-e |
| 15. | <i>Leptaena charlottae</i> W. & S.             | a   |
| 16. | <i>Leptaena unicostata</i> (M. & W)            | aa  |
| 17. | <i>Liolema vetustum</i> (Bassler)              | r   |
| 18. | <i>Mitolema?</i> <i>mundulum</i> Ulrich        | e   |
| 19. | <i>Nematopora ovalis</i> Ulrich                | r-e |
| 20. | Orthoceras fragments                           | r   |
| 21. | Ostracod fragments                             | r-e |
| 22. | <i>Pachydietya acuta</i> (Hall)                | r-e |
| 23. | <i>Pachydietya pumila</i> Ulrich               | r   |
| 24. | <i>Pianodema subaequata conradi</i> (Winchell) | r   |
| 25. | <i>Platystrophia trentonensis</i> n. sp.       | e   |
| 26. | <i>Plectambonites sericeus</i> (Sowerby)       | a   |
| 27. | <i>Prasopora</i> n. sp.                        | e   |
| 28. | <i>Prasopora conoidea</i> Ulrich               | r-e |
| 29. | <i>Prasopora insularis</i> Ulrich              | aa  |
| 30. | <i>Prasopora simulatrix</i> Ulrich             | a   |
| 31. | <i>Rafinesquina alternata</i> (Emmons)         | e   |
| 32. | <i>Rafinesquina deltoidea</i> (Conrad)         | a   |
| 33. | <i>Rhinidietya</i> sp.                         | 2   |
| 34. | <i>Rhinidietya paupera</i> Ulrich              | e   |
| 35. | <i>Rhynchotrema increbescens</i> (Hall)        | r   |
| 36. | <i>Stigmatella</i> n. sp.                      | aa  |

7. *Interval from top of High Falls to top of Mill Dam Falls.*

From these thin-bedded fossiliferous strata were collected the following species:

|     |                                   |     |
|-----|-----------------------------------|-----|
| 1.  | Arthoclema cornutum Ulrich        | e   |
| 2.  | Calymene senaria Conrad           | r-e |
| 3.  | Chasmodopora reticulata Hall      | r-e |
| 4.  | Crinoid segments                  | e   |
| 5.  | Dalmanella testudinaria (Dalman)  | aaa |
| 6.  | Escharopora recta (Hall)          | r   |
| 7.  | Hemiphragma tenuimurale Ulrich    | r   |
| 8.  | Leptotrypa sp.                    | r   |
| 9.  | Mitoclema? mundulum Ulrich        | a   |
| 10. | Nematopora ovalis Ulrich          | r-e |
| 11. | Pachydietya acuta (Hall)          | e   |
| 12. | Platystrophia trentonensis n. sp. | a   |
| 13. | Plectambonites sericeus (Sowerby) | e   |
| 14. | Prasopora conoidea Ulrich         | e   |
| 15. | Rafinesquina alternata (Emmons)   | r-e |
| 16. | Rhinidietya exigua Ulrich         | r-e |
| 17. | Rhinidietya mutabilis (Ulrich)    | r-e |

8. *Prospect Quarry, below the crystalline layers.*

Below the heavy gray crystalline layer that caps the Trenton limestone and in a very thin parting of 8 to 10 inches, that outcrops on the east side of the gorge at Prospect in an old abandoned quarry opposite the large crusher quarry, bryozoa are exceedingly abundant and are weathered out from the matrix. A small *Prasopora* is very abundant.

The crystalline layers above contain a few bryozoa, but difficult to prepare for study.

The species collected from the weathered parting are as follows:

|     |                                   |     |
|-----|-----------------------------------|-----|
| 1.  | Corynotrypa inflata (Hall)        | r   |
| 2.  | Crinoid segments                  | a   |
| 3.  | Dalmanella testudinaria (Dalman)  | e   |
| 4.  | Eridotrypa exigua Ulrich          | e   |
| 5.  | Hallopora goodhuensis (Ulrich)    | a   |
| 6.  | Hemiphragma tenuimurale Ulrich    | a   |
| 7.  | Isotelus gigas de Kay             | e   |
| 8.  | Pachydietya acuta (Hall)          | e   |
| 9.  | Platystrophia trentonensis n. sp. | e   |
| 10. | Plectambonites sericeus (Sowerby) | r-e |

- 11. *Prasopora* n. sp. . . . . e
- 12. *Proboscina tumulosa* Ulrich . . . . . r
- 13. *Stigmatella* n. sp. . . . . aa
- 14. *Zygospira recurvirostris* (Hall) . . . . . r-c

9. *In the collection from the Quarry in the crystalline layers at Prospect were the following species:*

- 1. *Cyrtodonta obtusa* (Hall) . . . . . r
- 2. *Arthoclema* sp. . . . . r
- 3. *Arthoclema cornutum* Ulrich . . . . . r
- 4. *Calymene senaria* Conrad . . . . . r-c
- 5. *Chasmodontopora reticulata* (Hall) . . . . . e
- 6. Crinoid segments . . . . . a
- 7. *Dalmanella testudinaria* (Dalman) . . . . . r-c
- 8. *Hallopora goodhuensis* (Ulrich) . . . . . e
- 9. *Helopora quadrata* Ulrich . . . . . r
- 10. *Isostelus gigas* de Kay . . . . . e
- 11. *Mitoclema?* *mundulum* Ulrich . . . . . r
- 12. *Pachydietya acuta* (Hall) . . . . . e
- 13. *Pianodema subaequata* (Conrad) . . . . . r-c
- 14. *Platystrophia trentonensis* n. sp. . . . . e
- 15. *Plectambonites sericeus* (Sowerby) . . . . . r-c
- 16. *Prasopora* n. sp. . . . . e
- 17. *Prasopora sewyni* (Nich.) . . . . . e
- 18. *Rafinesquina alternata* (Emmons) . . . . . r-c
- 19. *Rhinidietya* sp. . . . . e
- 20. *Rhynchotrema increbescens* (Hall) . . . . . r-c

#### TRENTON AND BLACK RIVER OF THE PATTERSON QUARRIES.

At the east end of the quarries, about forty rods from the house of Joe Jeffers, is the following section in descending order:

- 6. *Mesotrypa-Plectambonites* bed, thin limestone. Trenton.
- 5. *Strophomena* bed, crystalline, massive limestone.  
Amsterdam ls.
- 4. Massive crystalline bed with some *Strophomena*, and containing numerous light grey pebble-like masses of *Stromatocerium* and *Solenopora*. The layer rests directly with a sutured contact upon the Black river.  
Amsterdam ls.

3. About like No. 2 but even darker, more fossils, and containing numerous large fragments of a yellowish, sandy limestone. . . 1 ft. 3 in.
2. More massive than No. 1 and lighter colored. Very hard. Few fossils, some gastropods separated by rather uneven contact from No. 1. . . . . 1 ft. 6 in.
1. Drab, hard limestone, fine grained, light, weathering to rather thin layers. Columnaria abundant throughout. Batostoma varium abundant.

The Trenton in this section lies below the base of the Trenton of the Trenton Falls gorge, and is known as basal Trenton. The beds are massive, crystalline and contain light weathering "pebbles," (Solenopora and Stromatopora). The Black river also contains similar pebbles and many angular masses of hard, blue, unfossiliferous limestone. The Lowville (Birdseye) is either absent or represented by a thin layer only. The Black river contains a large branching Batostoma (Batostoma varium) in considerable abundance, together with Tetradium and Columnaria. The latter is sometimes in very large masses.

The Strophomena is especially abundant in the massive lower part of the Trenton.

There is a disconformity between Nos. 1 and 2 and between 3 and 4.

The upper layers of the quarry are thin, very dark colored, with black shaly partings. They are very fossiliferous, containing especially Pleetambonites, Mesotrypa and Cryptolithus. Small Bryozoa are abundant.

The dip of the rock is variable but is generally about two degrees southwest.

The Amsterdam limestone of Cushing includes the massive beds of the so-called Trenton and the Black river at this outcrop. The following species were collected:

1. Batostoma? decipiens Ulrich . . . . . r
2. Batostoma varium Ulrich . . . . . r
3. Bythopora herricki (Ulrich) . . . . . e
4. Calymene senaria Conrad . . . . . e
5. Chasmotopora reticulata (Hall) . . . . . a
6. Columnaria halli Nicholson . . . . . e
7. Crinoid segments . . . . . a
8. Cryptolithus tessellatus Green . . . . . e

|     |                                                     |     |
|-----|-----------------------------------------------------|-----|
| 9.  | <i>Dalmanella testudinaria</i> (Dalman)             | r-e |
| 10. | <i>Escharopora confluens</i> Ulrich                 | e   |
| 11. | <i>Escharopora?</i> <i>limitaris</i> Ulrich         | r-e |
| 12. | <i>Escharopora recta</i> Hall                       | e   |
| 13. | <i>Escharopora subrecta</i> (Ulrich)                | e   |
| 14. | <i>Liospira subtilistriata</i> (Hall)               | r   |
| 15. | <i>Mesotrypa whiteavesi</i> (Nicholson)             | a   |
| 16. | <i>Mitoclema?</i> <i>mundulum</i> Ulrich            | r-e |
| 17. | <i>Nematopora ovalis</i> Ulrich                     | r-e |
| 18. | <i>Pachydietya acuta</i> (Hall)                     | e   |
| 19. | <i>Pachydietya fimbriata</i> Ulrich                 | r-e |
| 20. | <i>Pachydietya pumila</i> Ulrich                    | e   |
| 21. | <i>Phaenopora incipiens</i> Ulrich                  | r-e |
| 22. | <i>Platystrophia trentonensis</i> n. sp.            | r-e |
| 23. | <i>Plectombonites sericeus</i> (Sowerby)            | a   |
| 24. | <i>Prasopora simulatrix</i> Ulrich                  | r-e |
| 25. | <i>Rafinesquina alternata</i> (Emmons)              | rr  |
| 26. | <i>Rhinidietya mutabilis</i> (Ulrich)               | e   |
| 27. | <i>Rhinidietya paupera</i> Ulrich                   | r-e |
| 28. | <i>Rhynchotrema increbescens</i> (Hall)             | r-e |
| 29. | <i>Solenopora compacta</i> (Billings)               | aa  |
| 30. | <i>Stietoporella cribrosa</i> Ulrich                | e   |
| 31. | <i>Stromatocerium canadense</i> Nicholson and Murie | e   |
| 32. | <i>Strophomena incurvata</i> (Shepard)              | aa  |

The collection from the Black river of the Pattersonville section (Lower Amsterdam) formation, contains the following species:

|     |                                          |    |
|-----|------------------------------------------|----|
| 1.  | <i>Batostoma superbum</i> (Foord)        | a  |
| 2.  | <i>Batostoma varium</i> Ulrich           | aa |
| 3.  | <i>Calymene senaria</i> Conrad           | a  |
| 4.  | <i>Ceramoporella interporosa</i> Ulrich  | r  |
| 5.  | <i>Columnaria halli</i> Nicholson        | a  |
| 6.  | Crinoid segments                         | a  |
| 7.  | <i>Eridotrypa aedilis minor</i> (Ulrich) | r  |
| 8.  | <i>Escharopora subrecta</i> (Ulrich)     | e  |
| 9.  | <i>Isotelus gigas</i> de Kay             | r  |
| 10. | <i>Lichenalia</i> sp.                    | r  |

11. *Leperditia fabulites* (Conrad) . . . . . r
12. *Rhynidietya mutabilis* (Ulrich) . . . . . aa
13. *Rhynidietya mutabilis senilis* Ulrich . . . . . e
14. *Rhynchotrema increbescens* (Hall) . . . . . r-e
15. *Solenopora compacta* (Billings) . . . . . aa
16. *Streptelasma* (*Petraia*) *profundum* (Conrad) . . . . . a
17. *Strophomena incurvata* (Shepard) . . . . . a
18. *Zygospira recurvirostris* (Hall) . . . . . r-e

The Trenton B\* in the Pattersonville section contains well preserved fossils from which were collected the following species:

1. *Batostoma?* *decipiens* Ulrich . . . . . r
2. *Batostoma varium* Ulrich . . . . . r
3. *Kloedenia initialis* (Ulrich) . . . . . r
4. *Bollia subaequata* Ulrich . . . . . e
5. *Bythopora herricki* (Ulrich) . . . . . e
6. *Halloporina* n. sp. . . . . r
7. *Calymene senaria* Conrad . . . . . e
8. *Ceramoporella distincta* (Ulrich) . . . . . r-e
9. *Ceramoporella interporosa* Ulrich . . . . . r-e
10. *Ceraurus pleurexanthemus* Green . . . . . e
11. *Chasmotopora reticulata* (Hall) . . . . . a
12. *Chasmotopora sublaxa* (Ulrich) . . . . . e
13. *Coelodema trentonensis* (Ulrich) . . . . . r-e
14. *Cornulites flexuosus* (Hall) . . . . . r
15. Crinoid segments . . . . . a
16. *Cryptolithus tessellatus* Green . . . . . e
17. *Dalmanella testudinaria* (Dalman) . . . . . e
18. *Dinorthis pectinella* (Emmons) . . . . . r
19. *Eseharopora angularis* Ulrich . . . . . e
20. *Eseharopora confluens* Ulrich . . . . . e
21. *Eseharopora?* *limitaris* Ulrich . . . . . r-e
22. *Eseharopora recta* Hall . . . . . a
23. *Eseharopora subrecta* (Ulrich) . . . . . e
24. *Graptodictya proava* (Eichwald) . . . . . r
25. *Homotrypa subramosa* Ulrich . . . . . r

---

\*B<sup>6</sup> New York State Museum No. 34, Vol. 7.



|     |                                            |     |
|-----|--------------------------------------------|-----|
| 26. | <i>Isotelus gigas</i> de Kay               | r-c |
| 27. | <i>Mesotrypa regularis</i> (Foord)         | a   |
| 28. | <i>Nematopora ovalis</i> Ulrich            | r-c |
| 29. | <i>Pachydietya</i> sp.                     | r   |
| 30. | <i>Platystrophia trentonensis</i> n. sp.   | r-c |
| 31. | <i>Plectambonites sericeus</i> (Sowerby)   | a   |
| 32. | <i>Plectorthis plicatella</i> (Hall)       | r   |
| 33. | <i>Prasopora simulatrix</i> Ulrich         | c   |
| 34. | <i>Primitia mammata</i> Ulrich             | r-c |
| 35. | <i>Protoerisina exigua</i> Ulrich          | a   |
| 36. | <i>Rhindietya mutabilis</i> (Ulrich)       | a   |
| 37. | <i>Rhindietya mutabilis major</i> (Ulrich) | c   |
| 38. | <i>Rhindietya paupera</i> Ulrich           | c   |
| 39. | <i>Rhynchotrema increbescens</i> (Hall)    | r-c |
| 40. | <i>Schizoerinus nodosus</i> Hall           | c   |
| 41. | <i>Stictoporella cribrosa</i> Ulrich       | c   |
| 42. | <i>Stictoporella angularis</i> Ulrich      | c   |
| 43. | <i>Strophemna incurvata</i> (Shepard)      | aa  |
| 44. | <i>Tetradella subquadrans</i> Ulrich       | r-c |
| 45. | <i>Trematis terminalis</i> (Emmons)        | r   |
| 46. | <i>Turrilepas canadensis</i> Woodward      | r-c |
| 47. | <i>Zygospira recurvirostris</i> (Hall)     | r-c |

#### MORPHY CREEK SECTION.

About one and one-half miles down the Mohawk river from Port Jackson on the south side of the river is an outcrop of the Trenton, Black river and Calciferous (Tribes Hill and Little Falls dolomite).

The basal Trenton resting on the Black river in this outcrop contains the pebble-like masses of *Stromatoporoids* (*Stromatocerium canadense* Nicholson and Murie) as at Pattersonville, and consisting of compact beds of dark crystalline limestone in which *Strophomena* abound. The difference in appearance of this section and that at Pattersonville quarries is chiefly due to weathering.

The Black river is underlain by a compact, nearly unfossiliferous blue limestone, which is probably the Birdseye (Lowville).

Collections were made only from the thin-bedded Trenton above the crystalline bed. *Mesotrypa* and *Prasopora* are most abundant about ten feet be-

low the Canajoharie shale contact, but are common throughout the upper 10 feet. In the layers of hard limestone just below the Canajoharie (Utica) shale *Cryptolithus* is common and about the only fossil. *Plectambonites* is common in the upper thin Trenton.

At the Amsterdam waterworks just north of the city of Amsterdam, *Mesotrypa whiteavesi* (Nicholson) and *Cryptolithus tessellatus* Green are very abundant 10 feet or more below the top of the exposed Trenton. The portion outcropping extends almost to the top of the Trenton formation, but the contact with the Canajoharie shale is not shown. The creek flows in a syncline for some distance below the dam.

At the Barge canal dam across the Mohawk river just above Amsterdam station, there is a quarry, mentioned by Prof. E. R. Cummings, in the New York State Museum Bulletin No. 34, as showing a splendid section of the Birdseye, Lowville and Black river. The latter is of the same general character as at Pattersonville, being black, fossiliferous and thin-bedded. The most abundant fossils are *Streptelasma* (*Petraia*) *profundum* Conrad and *Stromatocerium canadense* Nicholson & Murie.

The following species were collected at Morphy's creek from the Trenton layers:

1. *Bollia subaequata* Ulrich . . . . . r-e
2. *Calymene senaria* Conrad . . . . . e
3. *Chasmotopora reticulata* (Hall) . . . . . r-e
4. *Chasmotopora sublaxa* (Ulrich) . . . . . r-e
5. Crinoid segments . . . . . a
6. *Cryptolithus tessellatus* Green . . . . . r-e
7. *Cytherella?* *rugosa* (Jones) . . . . . r
8. *Dalmanella testudinaria* (Dalman) . . . . . e
9. *Eridotrypa aedilis minor* (Ulrich) . . . . . e
10. *Eridotrypa exigua* Ulrich . . . . . r-e
11. *Isotelus gigas* de Kay . . . . . e
12. *Leperditia fabulites* (Conrad) . . . . . e
13. *Mesotrypa whiteavesi* (Nicholson) . . . . . aa
14. *Mitoclema?* *mundulum* Ulrich . . . . . r-e
15. *Monotrypa* n. sp. . . . . aa
16. *Nematopora ovalis* Ulrich . . . . . r-e
17. *Pachydietya acuta* (Hall) . . . . . e
18. *Pachydietya pumila* Ulrich . . . . . e

|     |                                          |     |
|-----|------------------------------------------|-----|
| 19. | <i>Plectambonites sericeus</i> (Sowerby) | c   |
| 20. | <i>Prasopora simulatrix</i> Ulrich       | c   |
| 21. | <i>Rafinesquina alternata</i> (Emmons)   | r-c |
| 22. | <i>Rhinidietya paupera</i> Ulrich        | c   |
| 23. | <i>Rhynchotrema increbescens</i> (Hall)  | r-c |
| 24. | <i>Turrilepas</i> sp.                    | r   |
| 25. | <i>Zygospira recurvirostris</i> (Hall)   | r-c |

#### SECTIONS IN THE VICINITY OF LOWVILLE.

The Lowville limestone capped by the Black river is exposed in a quarry near Mill creek at the corner of Church and Water Streets. It is exposed also in the bed and banks of Mill creek both above and below this point for some distance. This is the type section of the Lowville. Up stream just below where the exposure is covered by the heavy drift, the basal Trenton, with immense numbers of *Dalmanella* and Bryozoa, is exposed. The collections were made at this place. In several layers the Bryozoa are abundant. The following are the species collected:

|     |                                          |    |
|-----|------------------------------------------|----|
| 1.  | <i>Aparchites fimbriatus</i> (Ulrich)    | r  |
| 2.  | <i>Bythopora</i> sp.                     | aa |
| 3.  | <i>Calymene senaria</i> Conrad           | c  |
| 4.  | <i>Conularia</i> sp.                     | r  |
| 5.  | Crinoid segments                         | c  |
| 6.  | <i>Ctenobolbina ciliata</i> (Emmons)     | r  |
| 7.  | <i>Dalmanella testudinaria</i> (Dalman)  | c  |
| 8.  | <i>Escharopora recta</i> (Hall)          | r  |
| 9.  | <i>Hallopora ampla</i> (Ulrich)          | aa |
| 10. | <i>Hallopora splendens</i> (Ulrich)      | aa |
| 11. | <i>Helopora</i> sp.                      | r  |
| 12. | <i>Pachydietya acuta</i> (Hall)          | r  |
| 13. | <i>Plectambonites sericeus</i> (Sowerby) | c  |
| 14. | <i>Prasopora simulatrix</i> Ulrich       | a  |
| 15. | <i>Rafinesquina deltoidea</i> (Conrad)   | c  |
| 16. | <i>Rhinidietya</i> sp.                   | r  |
| 17. | <i>Stictopora elegantula</i> Hall        | r  |
| 18. | <i>Tentaculites</i> sp.                  | r  |
| 19. | <i>Trematis terminalis</i> (Emmons)      | r  |

The best exposure of the Lowville with overlying Black river and underlying Pamelia is on the State Road about one mile northeast of Lowville and in the several quarries nearby in the field along the limestone scarp. The country from here slopes southwest exactly with the dip of the rocks. Nothing higher than Black river is exposed. The Lowville weathers to a light drab or dove color, but some of the layers are darker and occasionally almost as dark as the Black river. The calcite tubes are always present in the Lowville except towards the base. In most of the layers they are extraordinarily abundant; usually perpendicular within the strata and lying horizontally at the surface. They are probably plants.

Fossils other than plant tubes are rare. Some of the thinner layers are ripple marked.

The whole mass of the Lowville must be 30 or 40 feet thick. Very little of the underlying Pamelia is seen.

The low country to the east and north of the exposure shows bosses of the Pre-Cambrian, and several of these are very near the bottom of the limestone serap, so that the base of the limestone cannot be far below the lowest exposure on the State Road locality.

The Black river (Leray) is dark colored and lumpy, thick-bedded, weathering to a light color but not so light as the Lowville limestone. It is massive in fresh exposure, showing the characteristic yellow streaks and blotches.

Columnaria, Tetradium and Stromatocerium are abundant. Silicified Bryozoa of large size are present. Near the base Strophomena is common. Leperditia is usually common throughout. In fact, the characteristics are practically the same as in the Mohawk Valley and at Valeour Island. The contact between the Black river and Lowville is usually very even and in unweathered masses appears merely as a slight change of color accompanied by the disappearance of the calcite tubes. Sometimes the contact is somewhat uneven. It is evidently a disconformity.

#### SPECIES FROM THE WATERTOWN SECTION.

A short distance up the river from Watertown a collection was made from the lower Trenton, containing the following species:

1. *Batostoma winchelli spinulosum* Ulrich.....c
2. *Dalmanella testudinaria* (Dalman).....c
3. *Hallopora ampla* (Ulrich).....a

4. *Hallopora goodhuensis* (Ulrich).....a
5. *Hallopora splendens* Bassler.....a
6. *Homotrypa callosa* Ulrich.....e
7. *Prasopora simulatrix orientalis* Ulrich.....a

The similarity of the New York fauna to that of upper Mississippi basin as given by Ulrich is shown by the following lists. Of the 108 species identified, 68 appear in the Trenton and Black river of the upper Mississippi Valley. The collections were made with special reference to the Bryozoan fauna, which accounts for the small number of species reported from the other classes. It is interesting to note the small number of new species found, especially among the Bryozoa, notwithstanding the fact that very little work had been done on that class from collections of the Trenton and Black river of New York. A description of these will be given in a successive paper.

#### SPECIES FROM TRENTON AND BLACK RIVER OF NEW YORK.

(Those marked with an asterisk appear in the Trenton and Black River of the upper Mississippi Valley. T-Trenton. B-Black River.)

##### *Bryozoa.*

1. *Arthoclema* sp. (T)
- \*2.       *cornutum* (T, B)
- \*3. *Batostoma?* *decipiens* (T, B)
- \*4.       *varium* (T, B)
- \*5.       *supberbum* (B)
- \*6.       *winchelli spinulosum* (T, B)
7. *Bythopora* sp. (T, B)
- \*8.       *herricki* (T, B)
- \*9. *Halloporina* n. sp. (T)
- \*10. *Ceramoporella* *distineta* (T, B)
- \*11.       *interporosa* (T, B)
- \*12. *Chasmatopora* *reticulata* (T, B)
- \*13.       *sublaxa* (T)
- \*14. *Corynotrypa* *delicatula* (T)
- \*15.       *turgida* (T)
- \*16.       *inflata* (T)
- \*17. *Coeloclema* *trentonensis* (T, B)

- \*18. *Diplocelema trentonense* (T)
- \*19. *Eridotrypa exigua* (T)
- \*20.         *aedilis minor* (T, B)
- \*21. *Escharopora angularis* (T, B)
- \*22.         *confluens* (T, B)
- \*23.         ? *limitaris* (T, B)
- \*24.         *recta* (T)
- \*25.         *subrecta* (T, B)
- 26. *Graptodietya proava* (T)
- \*27. *Hallopora ampla* (T, B)
- \*28.         *angularis* (T, B)
- \*29.         *goodhuensis* (T)
- 30.         *splendens* (T)
- 31. *Helopora* sp. (T)
- \*32.         *quadrata* (T)
- \*33. *Homotrypa callosa* (T)
- \*34.         *subramosa* (T, B)
- \*35. *Hemiphragma tenuimurale* (T)
- 36. *Leptotrypa* sp. (T)
- 37. *Liocelema vetustum* (T)
- 38. *Mesotrypa regularis* (T)
- 39.         *whiteavesi* (T)
- \*40. *Mitoelema?* *mundulum* (T)
- 41. *Monotrypa* n. sp. (T)
- \*42. *Nematopora ovalis* (T)
- 43. *Pachydietya* sp. (T)
- \*44.         *acuta* (T)
- \*45.         *fimbriata* (T, B)
- \*46.         *pumila* (T, B)
- \*48. *Phaenopora incipiens* (T)
- 49. *Prasopora* n. sp. (T)
- \*50.         *conoidea* (T, B)
- \*51.         *insularis* (T)
- \*52.         *selwyni* (T)
- \*53.         *simulatrix* (T, B)
- \*54.         *simulatrix orientalis* (T, B)
- \*55. *Proboscina tumulosa* (T, B)

56. *Protocrisina exigua* (T)  
 \*57. *Rhinidietya exigua* (T, B)  
 \*58.           *mutabilis* (T, B)  
 \*59.           *mutabilis major* (T, B)  
 \*61.           *mutabilis senilis* (B)  
 \*62.           *paupera* (T, B)  
 63. *Stictopora elegantula* (T)  
 \*64. *Stictoporella cribrosa* (T, B)  
 \*65.           *angularis* (T, B)  
 66. *Stigmatella n. sp.* (T)

*Brachiopoda.*

- \*67. *Dalmanella testudinaria* (T, B)  
 \*68. *Pianodema subaequata* (T, B)  
 \*69. *Pianodema subaequata conradi* (T, B)  
 \*70. *Dinorthis pectinella* (T, B)  
 \*71. *Leptaena charlottae* (T, B)  
 72.           *unicostata* (T)  
 74. *Platystrophia trentonensis* (T)  
 \*75. *Plectambonites sericeus* (T)  
 \*76. *Plectorthis plicatella* (T, B)  
 \*77. *Rafinesquina alternata* (T, B)  
 \*78.           *deltoidea* (T, B)  
 \*79. *Rhyncotrema increbescens* (T, B)  
 80. *Schizocrania filosa* (T)  
 \*81. *Strophomena incurvata* (T, B)  
 82. *Trematis terminalis* (T)  
 \*83. *Zygospira recurvirostris* (T, B)

*Crinoidea.*

- \*84. Crinoid segments (T, B)  
 85. *Schizocrinus nodosus* (T)

*Pelecypoda.*

86. *Ambonychia cf. obtusa* (T)

*Ostracoda.*

87. *Aparehites fimbriatus* (T)  
 \*88. *Kloedenia initialis* (T, B)  
 \*89. *Bollia subaequata* (T)  
 90. *Ctenobolbina ciliata* (T)  
 \*91. *Cytherella?* *rugosa* (T)  
 \*92. *Leperditia fabulites* (T, B)  
 \*93. *Primitia mammata* (T, B)  
 94. *Tetradella subquadrans* (T)

*Trilobita.*

- \*95. *Calymene senaria* (T, B)  
 \*96. *Ceraurus pleurexanthemus* (T, B)  
 97. *Cryptolithus tessellatus* (T)  
 \*98. *Isotelus gigas* (T, B)

*Cirripedia.*

99. *Turrilepas canadense* (T)  
 100. *Cornulites flexuosus* (T)

*Gastropoda.*

101. *Liospira subtilistriata* (T)  
 102. *Tentaculites* sp. (T)  
 \*103. *Conularia* sp. (T)

*Coelentrata.*

- \*104. *Columnaria halli* (T, B)  
 105. *Solenopora compacta* (T, B)  
 \*106. *Streptelasma* (*Petraia*) *profundum* (B)

*Stromatoporoidea.*

107. *Stromatoecium canadense* (T)

*Cephalopoda.*

- \*108. *Orthoecras junceum* (T, B)



## GAMMA COEFFICIENTS AND SERIES.

### I. THE COEFFICIENTS.

1. The function.

$$(axy^{\dots}) = (ax+by+\dots) \frac{\Gamma(x+y+\dots)}{\Gamma(x+1)\Gamma(y+1)\dots}$$

will be called a *gamma coefficient of coördinates*  $x, y, \dots$ , and *parameters*  $a, b, \dots$ , and a *multinomial coefficient* when each parameter is unity. We shall use Greek letters to denote coördinates taken from the series 0, 1, 2, 3,  $\dots$ .

At points of discontinuity, the sum of the coördinates is zero or a *negative integer*. These points are excluded in the following properties.

2. A *gamma coefficient with a negative integral coördinate is zero*.

3. *Zero coördinates and their parameters may be omitted, as  $(axy^{\dots}0) = (axy)$ .*

4. *The gamma coefficient of a point upon an axis equals the parameter of that axis, as  $(ax) = a$ .*

5. *The gamma coefficient of any point is the sum of the gamma coefficient of the preceding points (a preceding point being found by diminishing one coördinate by a unit). Let  $E_{\eta}$  operate to diminish the  $n$ 'th coördinate by a unit, then in symbols, \*(Note)*

$$(axy^{\dots}) = (E_1 + E_2 + \dots)(axy^{\dots})$$

This may be extended to the  $n$ 'th repetition of  $E_1 + E_2 + \dots = 1$ , where the  $E$ 's combine by the laws of numbers.

6. The above property furnishes an immediate proof of the multinomial theorem. Thus let

$$F_n = \Sigma(1\alpha 1\beta^{\dots}) p^{\alpha} q^{\beta^{\dots}}, \alpha + \beta + \dots = n$$

i. e. the summation extends to every point the sum of whose coördinates is  $n$ , there being a given number of variables  $p, q, \dots$ , and corresponding integral coördinates  $\alpha, \beta, \dots$ . Applying art. 5 to the coefficients of  $F_n$ , we find  $F_n = (p+q+\dots)F(n-1)$ , and since  $F_1 = p+q+\dots$ , therefore  $F_n = (p+q+\dots)^n$ .

7. *Zero parameters and corresponding coördinates may be omitted, if the result be multiplied by the multinomial coefficient of the omitted coördinates and one other, the sum, less 1, of the retained coördinates, as,*

$$(0x0ybczw) = (bczw) (1x1y1w'), w' = z+w-1$$

8. *Equal parameters and their coördinates may be omitted, except one to*

\* (Note) Read  $n$  for  $\eta$  throughout this paper.

a coördinate the sum of the omitted coördinates, if the result be multiplied by the multinomial coefficient of the omitted coördinates, as

$$(axaybz) = (ax'bz)(1x1y), x' = x + y.$$

9. The coefficient of a parameter of a gamma coefficient is the multinomial coefficient of the corresponding preceding point. In symbols,

$$(axy\dot{\cdot}) = (aE_1 + bE_2 + \dot{\cdot})(1x + 1y\dot{\cdot})$$

II. GAMMA SERIES.

10. Let there be  $m$  variables,  $p_1, p_2, \dots$ , of weights  $1, 2, \dots$ , and  $m$  corresponding parameters,  $a_1, a_2, \dots$ . The gamma series of weight  $n$  is the sum of all terms in the variables of weight  $n$ , each multiplied by the gamma coefficient of its exponents and the corresponding parameters:

$$(a) \quad (ap)n = \Sigma(a_1\alpha_1 a_2\alpha_2 \dots) p_1^{\alpha_1} p_2^{\alpha_2} \dots, \alpha_1 + 2\alpha_2 + \dots = n.$$

This series is not a function of an  $r$ 'th variable and parameter for  $r > n$ , since the simultaneous exponent and coördinate  $\alpha_r$ , is zero.

By applying art. 5 to the coefficients of  $(ap)n$ , we have,

$$(b) \quad (ap)n = p_1 (ap) (n - 1) + \dots + p_{r-1} (ap) 1 + a_{\eta} p_{\eta}$$

where, if  $r > m$ ,  $p_r = 0$ .

The last term  $a_{\eta} p_{\eta}$ , which cannot exist if  $n > m$ , is determined by the fact that it is given by the coördinate  $\alpha_{\eta} = 1$ , and the other coördinates, zero.

11. The difference equation 10(b) has no solution except the gamma series, since all values of  $(ap)n$  are determined from it by taking  $n = 1, 2, 3, \dots$ , successively. It is an equation of permanent form only for  $n > m$ , when it is the general linear difference equation of  $n$ 'th order with constant coefficients  $p_1, p_2, \dots$ , whose general solution with  $m$  arbitrarily constants is therefore found in the form of a gamma series. The equation whose roots determine its solution (in the ordinary theory of linear difference equations) is,

$$(a). \quad x^m = p_1 x^{m-1} + p_2 x^{m-2} + \dots + p_m$$

Symmetric functions  $F^n$  of the roots of this equation will also satisfy the difference equation and can therefore be expressed as gamma series by certain values of the parameters.

Since the roots of (a) are constants, the parameters will in general be certain functions of the roots, but we propose here to determine the symmetric functions that may be expressed by gamma series with parameters independent of the roots; and find two sets of such functions  $m$  in each set,

which can be linearly expressed in terms of each other, and either of these sets suffice to express in linear form all of the symmetric functions sought.

12. The parameter  $a_\eta$  of  $(ap)n$ ,  $n = 1, 2, \dots, m$ , is the coefficient of  $p_\eta$ . Thus to determine the possible parameters of a given symmetric function,  $F_n$ , we must take  $a_\eta$  as the value of  $F_n$  for the roots of the equation  $x^\eta = 1$ , this being what 11 (a) becomes when we put  $p_\eta = 1$ , and other  $p$ 's equal to zero. It remains to test the resulting equations,

$$F1 = a_1 p_1, F2 = p_1 F1 + a_2 p_2, F3 = p_1 F2 + p_2 F1 + a_3 p_3, \text{ etc.}$$

13. *The sum of the n'th powers,  $s_\eta$ .*

By art. 12, we find  $a_\eta = n$ , for the function  $s_\eta$ , and the difference equations are Newton's equations. Hence

$$s_\eta = \Sigma(1\alpha_1 \dots n\alpha_\eta) p_1^{\alpha_1} \dots p_\eta^{\alpha_\eta}, \alpha_1 + \dots + n\alpha_\eta = n$$

This is Waring's formula for  $s_\eta$ .

14. *The homogeneous products,  $\pi_\eta$ .*

Here,  $a_\eta = 1$ , giving the correct difference equations,

$$\pi_1 = p_1, \pi_2 = p_1 \pi_1 + p_2, \pi_3 = p_1 \pi_2 + p_2 \pi_1 + p_3, \text{ etc.}$$

Hence,  $\pi_\eta = (1p)n$ , i. e. the coefficient of a term is the multinomial coefficient of its exponents. Since the equations are symmetrical in  $\pi$ ,  $-p$ , we have also,  $p_\eta = -(1[-\pi])n$ . These formulas seem to be new, as also those which follow.

15. *The homogeneous products, k at a time,  $\pi_{nk}$ .*

Here  $a_\eta$  is a binomial coefficient of the n'th power, whose value is zero for  $n < k$ , and 1 for  $n = k$ , and,

$$\pi_{nk} = (ap)n, a_\eta = (-1)^{k-1} (1K1.n - k.)$$

16. By applying art. 9 to the coefficients of  $(ap)n$ , and substituting  $\pi_\eta = (1p)n$ , we have.

$$(a). (ap)n = a_1 p_1 \pi_{\eta-1} + a_2 p_2 \pi_{\eta-2} + \dots + a_\eta p_\eta$$

We have therefore,

|            |                   |                    |                    |                    |                    |                           |             |
|------------|-------------------|--------------------|--------------------|--------------------|--------------------|---------------------------|-------------|
|            |                   | $p_1 \pi_{\eta-1}$ | $p_2 \pi_{\eta-2}$ | $p_3 \pi_{\eta-3}$ | $p_4 \pi_{\eta-4}$ | $p_5 \pi_{\eta-5}$ , etc. |             |
|            | $\pi_\eta =$      | 1                  | 1                  | 1                  | 1                  | 1                         | <i>etc.</i> |
| $s_\eta =$ | $\pi_{\eta_1} =$  | 1                  | 2                  | 3                  | 4                  | 5                         | <i>etc.</i> |
|            | $-\pi_{\eta_2} =$ |                    | 1                  | 3                  | 6                  | 10                        | <i>etc.</i> |
|            | $\pi_{\eta_3} =$  |                    |                    | 1                  | 4                  | 10                        | <i>etc.</i> |
|            | $-\pi_{\eta_4} =$ |                    |                    |                    | 1                  | 5                         | <i>etc.</i> |
|            | $\pi_{\eta_5} =$  |                    |                    |                    |                    | 1                         | <i>etc.</i> |
|            |                   |                    |                    |                    |                    |                           | <i>etc.</i> |

From the top line and the diagonal of units, we continue adding a number to the one above for the next number in the same line (a particular case of art. 5). When  $n > m$ , the number of functions in each set is  $m$ .

The solution of these equations for the second set in terms of the first is found by interchanging corresponding functions,  $\rho k \pi n - k$  and  $\pi n k$ .

ROSE POLYTECHNIC INSTITUTE.

## SOME RELATIONS OF PLANE AND SPHERIC GEOMETRY.

DAVID A. ROTHROCK.

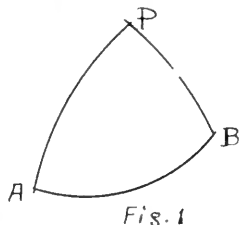
Our notions of *plane analytic geometry* date to the publication by Descartes of his philosophical work: "*Discours de la méthode . . . dans les sciences,*" 1637, which contained an appendix on "*La Geometrie.*" In this work Descartes devised a method of expressing a plane locus by means of a relation between the distances of any point of the locus from two fixed lines. This discovery of Descartes led to the analytic geometry of the plane, and the extension to three dimensional space gave rise to geometry of space figures by the analytic method. A single equation,  $f(x,y) = 0$ , between two variables represents a plane curve; a single equation,  $F_1(x,y,z) = 0$ , in three variables represents a surface in space; and two equations,  $F_1(x,y,z) = 0$ ,  $F_2(x,y,z) = 0$ , represent a curve in space.

In the Cartesian system of coördinates, a space curve is determined by the intersection of two surfaces. If we wish to investigate the curves upon a single surface, that is, if we wish to devise a geometry of a given surface, it may be possible to discover a system of coördinates upon the surface, such that any surface-locus may be expressed by a single equation in terms of two coördinates, as in plane geometry. The sphere furnishes a simple example in which a locus upon its surface may be represented by a single equation connecting the coördinates of any point upon the locus.

Toward the end of the eighteenth century a fragmentary system of analytic geometry of loci upon the surface of the sphere was developed. This early work on *Spheric Geometry* seems to have originated with Euler (1707-1783), but many of the special cases of spherical loci were investigated by Euler's colleagues and assistants at St. Petersburg. In the present paper are enumerated a number of the early investigations on spherical loci, and a derivation of the equations of sphero-conics in modern notation. The correspondence of the *spheric equations* to the similar equations of plane analytics is shown.

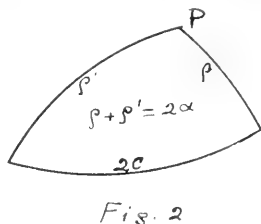
## HISTORICAL.

One of the first problems involving a locus upon a sphere to be solved by use of spherical coördinates was the following: *Find the locus of the vertex of a spherical triangle having a constant area and a fixed base.* With the base AB fixed, Fig. 1, and the area of the spherical triangle APB constant, the



locus of P was shown to be a small circle. This result was derived by Johann Lexell (1740-1784), an astronomer at St. Petersburg, in 1781. The problem was found to have been solved earlier, 1778, by Euler.<sup>1</sup> The result is sometimes known as Lexell's theorem.

A second spherical locus appeared as the solution of the problem: *To find the locus of the vertex of a spherical triangle upon a fixed base, such that the sum of the two variable sides is a constant.* This problem defines a locus



upon the sphere analogous to the ordinary definition of an ellipse in the plane. The locus of P is called the *Spherical Ellipse*. The solution of this problem was found in 1785 by Nicholas Fuss (1755-1826), a native of Basel, and an assistant to Euler at St. Petersburg from 1773 until Euler's death in 1783.

Frederick Theodore Schubert, a Russian astronomer, a contemporary of Fuss, published solutions to a number of spherical loci, types of which

<sup>1</sup> Cantor, Vol. IV, p. 384, p. 416.

are shown in the following: Given a triangle with a fixed base, find the locus of the vertex P such that the variable sides,  $\rho$ ,  $\rho'$ , Fig. 2, satisfy:

$$(1) \sin \rho = k \sin \rho',$$

$$(2) \cos \rho = k \cos \rho',$$

$$(3) \sin \frac{\rho}{2} = k \sin \frac{\rho'}{2},$$

$$(4) \cos \frac{\rho}{2} = k \cos \frac{\rho'}{2}.$$

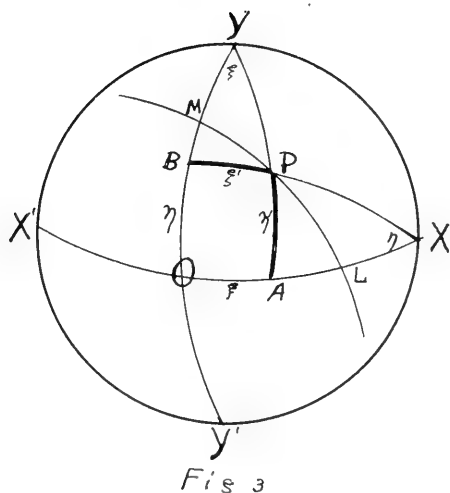
In Crelle's Journal, Vol. VI, 1830, pp. 244-254, Gudermann published an article "*Ueber die analytische Spharik*," which contains a collection of spherical loci connected with *sphero-conics*, for example, such as: (1) *The locus of the feet of perpendiculars drawn from the focus of a spherical ellipse upon tangents to the spherical ellipse*; (2) *The locus of the intersection of perpendicular tangents to a spherical ellipse*; and other problems similar to those of plane analytics. The notation employed by Gudermann is not fully explained, and is an adaptation from that used by him in a private publication of his work "*Grundriss der analytischen Spharik*," to which the present writer does not have access.

Thomas Stephens Davies published, 1834, in the Transactions of the Royal Society of Edinburgh, Vol. XII, pp. 259-362, and pp. 379-428, two papers, entitled, "*The Equations of Loci Traced upon the Surface of a Sphere*." In these extensive papers the author uses a system of polar coördinates upon the sphere, and derives the equations of many interesting curves, the spherical conics, cycloids, spirals, as well as many properties of these curves. The polar equations of Davies may be transformed into *great-circle coördinates*, giving equations of spherical loci in a form similar to the Cartesian equations of corresponding loci in the plane.

#### SPHERICAL ANALYTICS.

A system of analytic geometry upon the sphere may be derived in direct correspondence to that of the plane by a proper choice of axes of coördinates.

1. *Coördinates*. Let us select as axes two great circles  $XX'$ ,  $YY'$  perpendicular to each other at O, Fig. 3. The spherical coördinates of any point P are the intercepts,  $OA = \xi$  and  $OB = \eta$ , cut off upon the axes by perpendiculars drawn from P. Let the length of the perpendiculars from P be  $PB = \xi'$ , and  $PA = \eta'$ .



From the right spherical triangles  $PBY$  and  $PAX$  we have the following fundamental relations:

$$(1) \tan \xi = \frac{\tan \xi'}{\sin BY} = \frac{\tan \xi'}{\cos \eta}, \quad \tan \eta = \frac{\tan \eta'}{\sin AX} = \frac{\tan \eta'}{\cos \xi}$$

## 2. Equation of the Spheric Line $LM$ in Terms of its Intercepts.

The arc of a great circle we will call a *spheric straight line*. Let the intercepts be  $OL = \alpha$ ,  $OM = \beta$ , and the angle  $OLM = \phi$ , Fig. 3. Then from the right triangles  $MOL$  and  $PAL$  we have

$$\tan \phi = \frac{\tan \beta}{\sin \alpha}, \quad \text{and} \quad \tan \phi = \frac{\tan \eta'}{\sin AL} = \frac{\tan \eta'}{\sin(\alpha - \xi)}$$

Equating these values of  $\tan \phi$ , and substituting the value of  $\tan \eta'$  from (1),

$$\frac{\tan \beta}{\sin \alpha} = \frac{\tan \eta \cos \xi}{\sin \alpha \cos \xi - \cos \alpha \sin \xi} = \frac{\tan \eta}{\sin \alpha - \cos \alpha \tan \xi}$$

Expressing each function in terms of tangents and reducing, we find the equation of the spheric line in the intercept form:

$$(2) \quad \frac{\tan \xi}{\tan \alpha} + \frac{\tan \eta}{\tan \beta} = 1.$$



(1) *Special Cases.* (a) *Parallels to the axes.* A spheric line parallel to the OY-axis passes through the pole of the axis OX. Hence for a parallel to the OY-axis  $\beta = 90^\circ$  and the equation of the line becomes

$$(3) \quad \tan \xi = \tan \alpha$$

and for a parallel to the OX-axis,  $\alpha = 90^\circ$ , and

$$(4) \quad \tan \xi = \tan \beta$$

(b) *A line through one point.* If a line (2) is to pass through  $(\xi_1, \eta_1)$ , we have

$$(5) \quad \frac{\tan \xi - \tan \xi_1}{\tan \alpha} + \frac{\tan \eta - \tan \eta_1}{\tan \beta} = 0.$$

(c) *A line through two points*  $(\xi_1, \eta_1)$ ,  $(\xi_2, \eta_2)$ , is given by

$$\frac{\tan \xi - \tan \xi_1}{\tan \xi_2 - \tan \xi_1} = \frac{\tan \eta - \tan \eta_1}{\tan \eta_2 - \tan \eta_1}$$

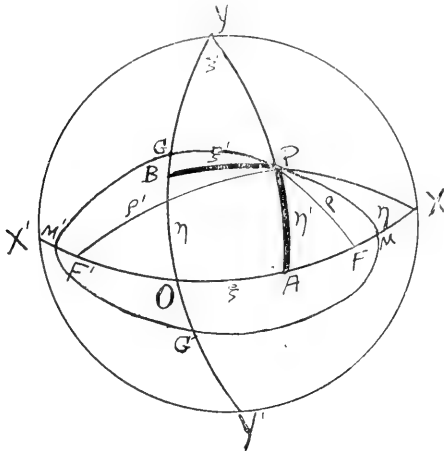


Fig. 4

Conditions of *perpendicularity*, *parallelism*, *angles of intersection* of spheric straight lines may also be expressed, but will not be included here.

(2) *Correspondence to plane geometry.* The intercept form of the spheric straight line is similar to the corresponding equation in plane geometry, and may be reduced to that form by letting the radius of the sphere increase without limit.

3. *The Spheric Ellipse.* Find the locus of the vertex  $P$  of a spherical triangle with fixed base  $FF'$ , such that the sum of the sides is a constant,  $\rho + \rho' = 2\alpha$ . Fig. 4.

This definition defines the Spheric Ellipse  $MGM'G^1$ .

Take the origin at the center  $O$  of the base  $FF'$ . Let  $FF' = 2c$ ,  $\rho + \rho' = 2\alpha$ ,  $OM = \alpha$ ,  $OG = \beta$ . When  $P$  falls at  $G$ ,  $FG = \alpha = F'G$ .

Then from the right triangle  $FOG$  (hypotenuse not drawn), we have

$$(1) \quad \cos\alpha = \cos\beta \operatorname{cose};$$

and from  $PAX$ ,

$$(2) \quad \tan\eta' = \cos\xi \tan\eta.$$

From the right triangles  $PAF'$  and  $PAF$ , we have

$$(3) \quad \cos\rho = \cos\eta' \cos(c - \xi), \quad \cos\rho' = \cos\eta' \cos(c + \xi).$$

Adding equations (3) and using  $\rho + \rho' = 2\alpha$ ,

$$(4) \quad \cos\alpha \cos \frac{\rho - \rho'}{2} = \cos\eta' \operatorname{cose} \cos\xi.$$

and subtracting (3),

$$(5) \quad \sin\alpha \sin \frac{\rho - \rho'}{2} = \cos\eta' \operatorname{sine} \sin\xi$$

Eliminating  $\frac{\rho - \rho'}{2}$  and  $c$  from (1), (4), (5) and reducing, we find the

symmetrical equation of the spheric ellipse

$$\frac{\tan^2\xi}{\tan^2\alpha} + \frac{\tan^2\eta}{\tan^2\beta} = 1,$$

$\alpha$ , and  $\beta$  being the intercepts on the axes,  $OM$ , and  $OG$ , respectively.

*Special Cases.* (1) Let  $\alpha = \beta$ , and we have a circle

$$(A) \quad \tan^2\xi + \tan^2\eta = \tan^2\alpha,$$

with center at  $O$  and radius  $\alpha$ . With  $\alpha = 90^\circ$ , this circle becomes the boundary of the hemisphere on which our geometry is located, corresponding to the circle with infinite radius in plane geometry.

(2) Let  $\alpha = 90^\circ$ , and the ellipse becomes the two "parallel lines",  $\tan^2\eta = \tan^2\beta$ , passing through the poles of the  $OY$ -axis.

(3) The equation of a circle upon a sphere may be derived quite readily, but the resulting equation is somewhat unsymmetrical. Let  $\xi_1, \eta_1$  be the

coördinates of the center, and let  $\alpha$  be the radius. Then the equation may be derived from the fundamental equations

$$\begin{aligned}\tan \eta_1' &= \cos \xi_1 \tan \eta_1, \quad \tan \xi_1' = \cos \eta_1 \tan \xi_1, \\ \tan \eta' &= \cos \xi \tan \eta, \quad \tan \xi' = \cos \eta \tan \xi,\end{aligned}$$

and the polar equation

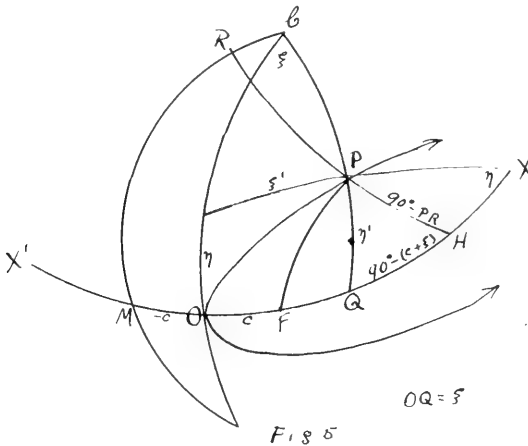
$$\cos \alpha = \sin \eta_1' \sin \eta' + \cos \eta_1' \cos \eta' \cos (\xi - \xi_1),$$

by the elimination of  $\xi_1'$ ,  $\eta_1'$  and  $\xi'$ ,  $\eta'$ .

The resulting equation is

$$\begin{aligned}(\tan \xi - \tan \xi_1)^2 + (\tan \eta - \tan \eta_1)^2 + (\tan \xi \tan \eta_1 - \tan \xi_1 \tan \eta)^2 \\ = \tan^2 \alpha (1 + \tan \xi \tan \xi_1 + \tan \eta \tan \eta_1)^2.\end{aligned}$$

When  $\xi_1 = \eta_1 = 0$ , this equation reduces to that given in (A) above.



4. *The Spheric Hyperbola.* This spherical curve may be defined as the locus of a point which moves so that the difference of its distances from two fixed points is constant,  $\rho - \rho' = 2\alpha$ .

Using the notation of Fig. 4, but with  $\rho - \rho' = 2\alpha$ , this definition leads to the equation

$$\frac{\tan^2 \xi}{\tan^2 \alpha} - \frac{\tan^2 \eta}{\tan^2 \beta} = 1.$$

which is the spheric hyperbola. The locus does not intersect the OY-axis; the conjugate spheric hyperbola may be defined by

$$\frac{\tan^2 \xi}{\tan^2 \alpha} - \frac{\tan^2 \eta}{\tan^2 \beta} = -1,$$

and the spheric asymptotes to either by

$$\frac{\tan \xi}{\tan \alpha} = \pm \frac{\tan \eta}{\tan \beta}$$

5. *The Spheric Parabola.* A Spheric Parabola may be defined as the locus of a point moving upon the surface of a sphere so as to be equally distant from a fixed point  $F$  and a fixed great circle  $CM$ , Fig. 5.

From the definition  $PR = PF$ ; let  $O$  bisect  $MF$ . Then from Fig. 5,

$$(1) \tan \eta' = \cos \xi \tan \eta.$$

$$(2) \cos PH = \sin PR = \cos \eta' \sin (c + \xi),$$

$$(3) \cos PF = \cos \eta' \cos (\xi - c).$$

Squaring and adding (2), (3)

$$1 = \cos^2 \eta' \{ \sin^2 (\xi + c) + \cos^2 (\xi - c) \},$$

or

$$1 + \tan^2 \eta' = 1 + 4 \sin c \cos c \sin \xi \cos \xi.$$

Substituting from (1),

$$\tan^2 \eta = 2 \sin 2c \tan \xi,$$

which is the required equation.

6. *Correspondence to Plane Geometry.* The above equations of the spheric straight line, ellipse, hyperbola, parabola, and circle, show a marked similarity to the corresponding equations in the plane. These equations may be reduced to the equations in plano by considering the radius of the sphere to increase without limit. This may be done by expressing the arcs in terms of the radius, and finding the limit of the functions in each equation as  $r \rightarrow \infty$ .

For example, in the spheric ellipse,

$$(1) \frac{\tan^2 \xi}{\tan^2 \alpha} + \frac{\tan^2 \eta}{\tan^2 \beta} = 1,$$

let  $(\xi, \eta)$ ,  $(\alpha, \beta)$  be radian measure of arcs on a unit sphere; then on a sphere of radius  $r$ , we have arcs  $(x, y)$ ,  $(a, b)$  determined by

$$\xi = \frac{x}{r}, \quad \eta = \frac{y}{r}, \quad \alpha = \frac{a}{r}, \quad \beta = \frac{b}{r}.$$

Equation (1) becomes

$$\frac{\tan^2 \left\{ \frac{x}{r} \right\}}{\tan^2 \left\{ \frac{a}{r} \right\}} + \frac{\tan^2 \left\{ \frac{y}{r} \right\}}{\tan^2 \left\{ \frac{b}{r} \right\}} = 1.$$

Expand the tangents into infinite series according to the law

$$\tan Z = Z + \frac{Z^3}{3} + \frac{2Z^5}{15} + \frac{17Z^7}{315} + \dots$$

and we find

$$\frac{\left\{ \frac{x}{r} + \frac{x^3}{3r^3} + \dots \right\}^2}{\left\{ \frac{a}{r} + \frac{a^3}{3r^3} + \dots \right\}^2} + \frac{\left\{ \frac{y}{r} + \frac{y^3}{3r^3} + \dots \right\}^2}{\left\{ \frac{b}{r} + \frac{b^3}{3r^3} + \dots \right\}^2} = 1.$$

Dividing  $r^2$  from each fraction, and passing to the limit  $r \rightarrow \infty$ , and we have the equation of an ellipse in the plane,

$$\frac{x^2}{a^2} + \frac{y^2}{b^2} = 1.$$

Any equation in the "rectangular spheric" coördinates will reduce, in the limit when the sphere is made to increase infinitely, to the equation of a corresponding locus in the plane.



## SOME NOTES ON THE MECHANISM OF LIGHT AND HEAT RADIATIONS.

JAMES E. WEYANT.

In all the realm of the natural sciences there has been no more fascinating and elusive problem than that relating to the mechanism involved in the transmission of light and heat. How energy may be transmitted at a distance; what action is involved at its source; what properties matter may possess that this may proceed over vast spaces; what atomic and molecular changes are involved in the emission and absorption of light and radiant heat, are all questions involving the ultimate structure of matter and are as yet incapable of complete solution.

Some of the familiar types of wave motion we observe in nature; for instance, wave motion in water; the transmission of sound waves through air, water and various solids are of such a character as to be easily reproduced under conditions whereby they can be accurately measured, their origin determined and their mode of propagation analyzed. In case of vibratory motion in matter capable of affecting the auditory nerve or in other words of producing sound, the mechanism is comparatively simple. As to source we have a material body, executing some form of simple harmonic motion; these vibrations being "handed on" to adjacent particles in a periodic disturbance or wave. This propagation stops, however, when the limit of matter has been reached, i. e., sound waves cannot traverse a vacuum. In all this process, matter has been concerned, both in the origin and the propagation of the wave motion. In light and heat waves, matter is concerned, also both in its production and absorption; but in its propagation they do not appear to depend in any way upon the presence of matter, as they pass readily through the best vacua and traverse the vast interstellar spaces with apparently the greatest ease.

Since we find that all radiations of light and heat energy originate in matter we must find the mechanism necessary for their production intimately involved in the constitution of matter itself. The kinetic theory served to give an incomplete mental picture of this mechanism and upon it was based many of the hypotheses of the past.

Various electrical and optical phenomena have been explained upon the ground of ether disturbances. These disturbances have been inter-

preted in different ways, but the consensus of opinion is to assign them to one of two kinds: first, magnetic and electro-static phenomena caused by strains in the ether and, second, based upon a dynamic disturbance; disturbances which can be propagated through the ether at the rate of three times ten to the tenth cm. per sec. ( $3 \times 10^{10}$  cm.) These ether waves proceeding radially from the source carrying with them, not matter, in its old sense, but energy.

It is an established fact that all bodies emit radiant energy in some degree; the intensity of this radiation being dependent upon the character of the body, its surface peculiarities and upon its temperature. Kirchoff gave us a law which states a relation between the emissive and absorptive power of bodies, "that the ratio between the absorptive power and the emissive power is the same for all bodies at the same temperature and that the value of this ratio depends only on the temperature and the wave length." For a "black body" this ratio is considered unity in as much as it absorbs all the radiant energy which falls upon it. While we know of no substance which may be considered a "black body" in this sense, the radiations within a uniformly heated enclosure may be considered to approximate those emanating from a perfectly "black body."

Stefan's law takes us a step further and gives us a relative measure of the radiation of a black body emitted at different temperature. The law states that "the total energy radiated by a black body is directly proportional to the fourth power of the absolute temperature of the radiating body,"

$$\text{i. e. } E = CT^4 \text{ or } \frac{\Psi}{\Psi_0} = \left\{ \frac{\Theta}{\Theta_0} \right\}^4 \text{ whence } \frac{\Theta}{\Theta_0} = \frac{\lambda_0}{\lambda} \text{ or } \Theta\lambda = \text{constant.}$$

Observation shows that the color of a "black body" is a function of its temperature; for instance at  $530^\circ$  C. it glows with a dull red; at  $1000^\circ$  C. the red gives place to a yellow and when  $1200^\circ$  C. to  $1250^\circ$  C. has been reached it has grown white hot or incandescent. In the spectrum of a black body we find the distribution of energy to be dependent upon its temperature. Wien has shown "that as the temperature of the body rises that the peak of the energy curve is displaced towards the shorter wave length." While Wien's law and his proposed revision stated in his second law satisfied the conditions obtaining in a limited area of the visible spectrum it was found not to hold true with respect to facts relating to wave lengths lying in the



region beyond the visible red. To satisfy these conditions Professor Max Planck proposed a modification as follows:

$$E = \frac{C \lambda^{-5}}{e^{\theta \lambda} - 1}$$

C and e are constant.  
where  $\varphi$  base of natural log.

As far as recent determinations have been carried out, this law holds true and gives practically a complete energy curve of a black body for desired temperatures. Not only did the statement of this law serve to reconcile purely theoretical conclusions with experimental determinations but paved the way for a more advanced step toward the explanation of the mechanism involved in radiation.

It is evident that we have yet to establish the connecting link between the thermal condition of a body and the radiant energy sent out into space by that body. If we go back to the theory developed by Maxwell we can easily see how this energy is propagated when once started in the ether. This theory clearly accounts for its speed, for interference and diffraction phenomena, but it apparently fails to closely associate thermal condition and the subsequent radiant energy. Planck found that this formula did not satisfactorily represent the relation existing between the frequency and the amount of energy involved, i. e. why, as a body grows hotter, does its color change from dull red to yellow and then white, unless there was some definite mathematical relation existing between the frequency and amount of energy given out by each vibratory particle. In an endeavor to determine this relation, Planck was led to advance the Quantum theory or hypothesis wherein he develops a type of function which apparently agrees with the facts better than any theories previously held. In doing this he has made a unique assumption, leaving the idea of the equi-partition of energy so necessary to the former theories, he has put forth the idea of the distribution of energy among the molecules of a substance through a mathematical consideration of probability. It is interesting to note in this connection that Planck states that the reason why no absolute proof of the second law of thermo-dynamics has ever been given is that it rests not on unchangeable mathematical relations, but upon mere probability or chance. Following out this idea he assumes that there may not be a steady, uniform flow of energy from a heated body, but that this may be propelled outward in quantities which

are integral multiples of some fundamental unit of energy. This implies that energy is emitted from a body in some definite, finite unit and is closely related to his idea that the entropy of a body is a function of the probability of its present state.

Conceiving the emission of radiant energy as explosive in type and not continuous, Planck concludes that these energy units may not be necessarily of the same magnitude. When a system is vibrating with high frequency, a large amount or large unit of energy is associated with it, whereas one of low frequency gives out smaller quantities or units of energy, thus giving us an explanation why so little energy is found in one end of the spectrum. The fact that some bodies have low thermal capacities at low temperatures and that these increase with rise in temperature is indicative of the value of this theory. In this connection it is interesting to note that an explanation of the hydrogen lines in the spectrum has been proposed, based on the idea that no radiations take place except when one electron vibrating changes the form of its orbit, at which instant the energy change of the system is the same. Take the case of the line spectra; it has been asserted that the lines in the spectrum of hydrogen are due to various electronic vibration frequencies in the hydrogen atom, when the equilibrium of this atom has been disturbed; but when this electron is vibrating about the so-called positive core of the atom that we have an entire system in equilibrium. As long as these vibrations are regular no energy can be sent forth, inasmuch as by this, the equilibrium of the system would be disturbed. With this disturbance there would be a change in its vibration frequency and assuming the radiation emission to be continuous it follows that the frequency change will likewise be continuous; but this at once results in the destruction of the lines in the spectrum. An ingenious explanation of these hydrogen lines has been proposed based on Planck's Quantum theory. The electron is conceived of as vibrating about the central core in some form of a stable orbit, probably elliptical in shape. At the instant that one of these orbits changes form radiation will take place. At this instant the radiation will be of one frequency and the energy change will be represented by  $E = hn$  where  $n$  is frequency of vibrations and  $h$  is the universal constant of radiation and is termed by Planck the "operating quantity."

The problem is a very complex one and has been approached from many angles. The Zeeman effect produced when a light and heat center is placed in a magnetic field offers additional evidence relative to the shifting of line

spectra. It was found that the line spectra was materially changed when the center in question was placed in a strong magnetic field. Later this was shown to be related to the vibration of a negative charge of small magnitude, giving additional confirmation of the electron theory of radiation. We know that when a particle or particles of matter execute some form of simple harmonic motion with sufficient frequency that a note of definite pitch is produced. Why can not we carry the sound analogy over into the realm of electronic motion and conceive of one of these electrons executing some form of simple harmonic motion with, of course, some definite period, its frequency bearing some definite relation to its temperature, as proposed by Planck.

If the sound analogy referred to applies to combined waves of varying frequency and wave length so as to produce "spectral harmonics" to coin such a phrase, the center producing them must of necessity be very complex. Take for instance the fluorescent effects noted when the vapors of certain metals is examined; or the luminosity of a gas when a small portion of its molecular aggregate has been ionized. It has been found that when  $\frac{1}{10,000,000}$  part of the molecules of a gas has been ionized that it becomes luminous. Likewise it has been observed that dissociation of some of the halogen group is accompanied by changes in its absorption spectrum. Many experiments also show that fluorescence and likewise phosphorescence are due to or accompanied by dissociation or ionization.

Considerable light has been shed upon this problem by the study of the emission of heat by radioactive substances. Curie and Laborde found in 1903 that the temperature of a radium compound was maintained by itself several degrees higher than its surroundings. It was found that radium emitted heat at a rate sufficient to more than melt its own weight of ice per hour. According to Rutherford the emission of heat from radioactive substances is a measure of energy of the radiation expelled from the active matter which are absorbed by itself and the surrounding envelope. This heating effect was supposed to be a measure of the kinetic energy of the expelled  $\alpha$  particles; the heating effect was calculated by determining the kinetic energy of the  $\alpha$  particles expelled from one gram of radium per second.

$$\text{K.E.} = \frac{1}{2} mn \Sigma V^2 \quad m = \text{mass of particle.}$$

$n$  = no. emitted by each group per second.

$v$  = the velocity of the different group of particles

considering the energy of the recoil as equal and opposite that of the  $\alpha$  particle, the energy of recoil of mass  $M$  is  $\frac{1}{2} \frac{m}{M} MV^2$ , therefore total energy is  $\frac{1}{2} mn[1 + \frac{m}{M}] \Sigma V^2 + E$  where  $E$  is the energy of the  $\beta$  and  $\lambda$  rays absorbed under these conditions.

$1.38 \times 10^9$  ergs per second corresponds to heat emission of 118 grams calories per hour.

Heating effect of emanations 94.5 calories per hour.

Observed values 94 calories per hour; calculated 94.5 calories per hour.

Rutherford and Robertson made an experimental determination to see how accurately this theoretical value harmonized with the experimental value and found a very close correspondence between the two values. This agreement led Rutherford to say that "there thus appears to be no doubt that the heat emissions of radium can be accounted for by taking into consideration the energy of the radiations absorbed." (The heat emitted is  $2.44 \times 10^9$  calories per gram).

He gives an interesting comparison as to the amount of energy set free in the action accompanying the expulsion of the rays, as follows: "the heat emitted during the combination of 1 cc. of H and O to form  $H_2O$  is about 2 gram calories; the emanation during its successive transformations thus gives out more than ten million times as much energy as the combination of an equal volume of H and O to form water although the latter reaction is accompanied by a larger release of energy than that of any other known to chemistry."

Further, "the energy emitted by radioactive substances is manifest during the transformation of the atom and is derived from the initial energy of the atoms themselves. The enormous quantity of energy released during the transformation of active matter shows unmistakably that the atoms themselves must contain a great store of internal energy;" "undoubtedly this is true of all but it is only perceived in the case of those which undergo atomic transformation."

Experiments conducted within the past three years at Munich in determining the interference effects produced by the passage of X-rays through crystalline substances have shown that X-rays possess many of the properties

of light waves except in regard to their wave length, these being approximately 1/10000 the length of ultra-violet waves; these and the foregoing phenomena accompanying the ionization and dissociation of various gases; the disintegration of radioactive substances have given the champions of the undulatory theory of light some reason for alarm; the phenomena of interference was formerly considered as explainable only in the light of the wave theory, but the behavior of the X-rays when examined for interference effects in crystals seems to pave the way for a revision of this. Not only can the wave lengths of X-rays be measured by the method suggested but the atomic structure of the crystal itself is revealed and the motion of the atoms outlined. The importance of this discovery in relation to thermal effects and heat emissions accompanying chemical reactions and rearrangements can hardly be overestimated.

As to the seriousness of the attempts to get at the ultimate constitution of light and heat centers and thereby gain a clearer knowledge of the mechanism of radiation, we have but to note the trend of thought as presented in recent papers read before the British Association for the Advancement of Science. At the recent Birmingham meeting of this association, a vigorous discussion arose as to the fundamentals involved in this question of radiation. At the meeting, J. H. Jeans, F. R. S., gave a very interesting and comprehensive summary of the facts relating to this fruitful topic; while he sets forth the new idea involved he retains faith in the truth of Maxwell's equations, but suggests that these equations can be made of more general application by the addition of the expression representing the unit quantities employed by Planck in his development. These quantities being respectively  $E$  and  $h$ . The magnitude of  $h$  has been determined to be  $6.415 \times 10^{-27}$  gm. cm./sec., an exceedingly small quantity. We might quote from Einstein in support of the quantum theory; he approached the problem from the standpoint of the theory of relativity. It may be necessary to revise our ideas of an all-pervading ether so essential to the working of the undulatory theory. We are just beginning to realize that we may have arrived at a point in our knowledge of light and heat centers where the wave theory fails to carry us any farther and that whereas it serves us well in explaining difficulties of elementary problems it does not carry us to an ultimate solution. We may conclude that as there are unmistakable evidences derived from different sources that the undulatory theory fails to give satisfactory solution to many of the newer problems that have

arisen. The additions which it must receive are in the region of photo-magnetic or photo-electric manifestations as evidenced by the Zeeman effect and the connection existing between ionization and light centers.

Perhaps some investigator in the field of electro-magnetic oscillations will be able some day to devise an oscillator of such frequency that not only will he be able to produce radiant heat but run the gamut of a photo-chromatic scale not of sounds and their overtones and harmonics but create for us the gorgeous colors of a sunrise or a sunset; or perhaps there may arise a counterpart of modern orchestral music executed not in a concord of harmonious sounds but of color, with shades and tints more marvelously beautiful than any the human mind has yet conceived.

## A STANDARD FOR THE MEASUREMENT OF HIGH VOLTAGES.

C. FRANCIS HARDING.

Modern developments in the generation, transmission, distribution and utilization of electricity at high voltages have greatly outstripped the accurate measurement of such voltages. Those familiar with the very accurate standards and measurements of voltage, current and power at low potentials may be surprised to learn that the recognized standard for the determination of high voltages is the needle or sphere spark gap. In other words the voltage if measured simply by the distance that it will cause a spark to jump in air between needle points or spheres under specified conditions.

It is hardly necessary to point out that such a standard is readily affected by temperature, humidity and barometric changes, not to mention the presence of other conductors which may be in the immediate vicinity. It is therefore not readily reproducible and it is most difficult to make the two standards agree at 50 kilovolts at which voltage both should be accurate.

With these facts in mind, an attempt is being made in the electrical laboratories of Purdue University to develop a more satisfactory standard for the measurement of high voltages which is based upon the fundamental principles of the electrostatic field. Although many forms of electrostatic voltmeters have been developed in the past, in the endeavor to commercialize them and make them compact, the very uniform field upon which their accuracy depends has been sacrificed. No attempt has been made to make the standard voltmeter described herein portable or a thing of beauty, for it is believed that such qualities are quite subordinate in the consideration of a primary standard.

If a perfectly uniform electrostatic field is produced between two parallel metal plates it can be readily shown that the force action between such plates expressed in dynes is

$$P = \frac{AE^2K}{8\pi t^2}$$

where A = area of plate in square centimeters

E = potential expressed in electrostatic units

K = dielectric constant (unity for air)

t = distance between plates in centimeters.

The following relation exists, therefore, between the electro-motive force applied to the plates expressed in volts and the force in grams exerted between the plates.

$$E = 47098 t \sqrt{\frac{P}{A}}$$

If the plates are made of very great area, it may be assumed that the electrostatic field at their center is uniform provided that the plates are not far apart.

In the apparatus constructed at Purdue University a circular disc of very small area was cut from the center of the lower horizontal plate and this disc was mounted upon a float supported in a tank filled with oil in such a manner that its surface is horizontal and concentric with the stationary plate but with its plane a small fraction of an inch below that of the stationary plate.

When an electromotive force is impressed upon the two stationary plates the movable disc is attracted by the upper plate and may be lifted into the plane of the lower plate by raising the voltage to the proper value. This condition can be readily detected by means of a telescope sighted along the surface of the lower stationary plate.

With the plates very near together, and a voltage sufficiently low to be readily standardized, the force necessary to raise the disc may be calculated from the above equation. If now an unknown high voltage be impressed upon the plates which have in the meantime been sufficiently separated to bring again the disc into alignment with the lower plate, the force will of course be the same as before and the new voltage may be determined by the relation

$$t^1 E$$

$E^1 = \frac{t^1 E}{t}$  — the voltages being directly proportional to the distances between plates.

Such a voltmeter has been constructed and the ratio of impressed voltages to distance between plates required for a balance has been found to follow surprisingly close to a straight-line law when a previously determined and constant value of force is used. Further studies are now being made to determine the range within which this apparatus may be considered standard for given dimensions of plates and further refinements are being made in its construction, method of reading, and calibration.



The writer is under obligation to Professor C. M. Smith for many helpful suggestions and to Messrs. Wright and Holman of the 1915 class in electrical engineering at Purdue University for the working out of details of design, construction and test.



## IONISATION STANDARDS.

EDWIN MORRISON.

It is very important under certain conditions in radioactive measurements to have an ionisation standard. (See Rutherford's *Radioactive Substances and their Transformation*, page 111, article 49.) It is also interesting and profitable for students to study the ionising effects of different thicknesses of radioactive substances. (See McClung's *Conduction of Electricity Through Gases and Radioactive*, page 131, article 86. Makower and Giger's *Practical Measurements in Radioactivity*, page 42, article 30, and Millikan and Milles' *Electricity, Sound and Light*, page 350, experiment 28.)

McCoy describes a method of making an ionisation standard in the *Phil. Mag. May. XI* page 176, 1906, and such a standard as determined by Geiger and Rutherford was found to emit  $2.37 \times 10^4$   $\alpha$  particles per second per one gram of uranium oxide. (See Geiger and Rutherford, *Phil. Mag. May. XX* page 391, 1910.)

The following is a very convenient modification of McCoy's process of making such an ionisation standard and a method of preparation of material for student work. A brass rod 36 centimeters in length has a series of shelves



Fig. 1.

arranged spirally about it from bottom to top as shown in Fig. 1. These shelves are about four centimeters apart, and are designed to support small brass disks. The brass disks should each be accurately weighed and arranged in order upon the spiral shelves. Uranium oxide is carefully powdered in a

mortar and then thoroughly mixed with alcohol in a tall graduate or glass cylinder. The rod supporting the brass disks is next carefully lowered into the mixture of alcohol and uranium oxide. The uranium oxide settles to the bottom, and in doing so deposits a layer upon each disk, the thickness and amount of deposit depending upon the height of the shelf from the bottom.

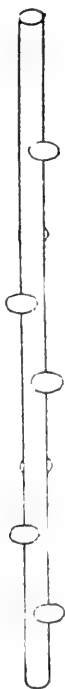


Fig. 1

After all the oxide has settled to the bottom the rod is removed and the disks allowed to dry. By again weighing the disks the weight of the oxide upon each one can be determined. Also by determining the density of the uranium oxide the thickness of the films can be calculated. These disks can now be mounted upon metal plates for permanent use as ionisation standards, or for student use in determining the fact that ionisation currents depend upon the thickness of the layer of material up to a certain maximum thickness.

## A SIMPLE PHOTOGRAPHIC SPECTROMETER.

EDWIN MORRISON.

Photographic spectrometers of several different types can be purchased from instrument makers. Attachments to convert ordinary prism spectrometers into photographic spectrometers can also be found upon the market. It is the purpose of this article to describe a method of constructing a simple photographic attachment for a prism spectrometer that can be constructed at slight expense in any well equipped laboratory.

Figure one shows a diagram of the camera attachment. The dimensions have to do with the one I have constructed, and would need to be modified to meet the conditions of available material. That is, the length and diam-

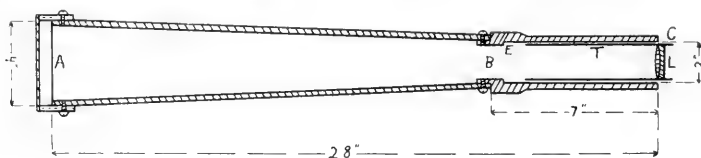


Fig 1

eter of the camera tube is determined by the focal length and diameter of the objective lens used. The figure is largely self explanatory. The section of the tube from C to B is constructed from a piece of wood 3x3x7 inches. A hole is bored lengthwise through this piece. From C to E this hole is 2 inches in diameter, and in order to shut out the stray light from around the focusing tube the remainder of the distance from E to B is  $1\frac{3}{4}$  inches. A brass tube T, 2 inches in diameter is carefully fitted into the hole in this piece so that it can be slipped freely inward or outward for focusing purposes. At the outer end of this tube a  $1\frac{3}{4}$ -inch, 28 inches focal length, achromatic lens L is mounted. The tube from B to A is a tapering box,  $2\frac{1}{2}$  inches square at B and 4 inches square at A. This section is constructed from  $\frac{3}{8}$ -inch lumber, the joints being carefully glued and reënforced by screws to make the box

light tight. At A an attachment is arranged to hold a ground glass for focusing purposes, and a common camera plate holder for making the exposures.

The camera tube is mounted on a common prism spectrometer in place of the telescope as shown in Fig 2. The collimator slit, prism, and light source to be studied are adjusted in the usual way. When all adjustments, together

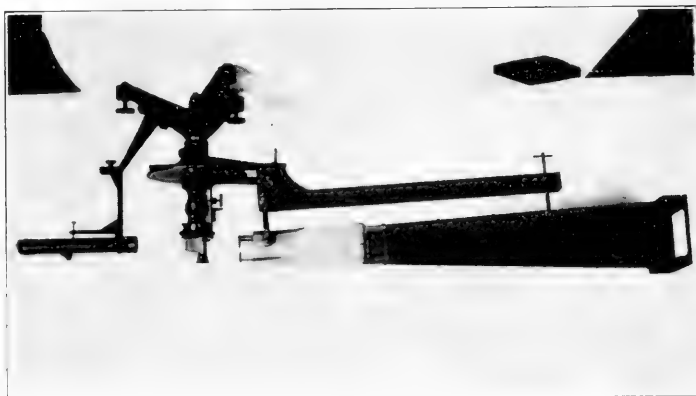


Fig. 2.

with focusing the objective lense of the camera, have been made, a clearly defined spectrum image, including the Fraunhofer lines, may be seen upon the ground glass. In the usual procedure a plate holder containing an unexposed plate may be substituted for the ground glass and the exposure made.

The instrument constructed in our laboratory has proven to be very successful for student work.

## ON THE RELATIVE VELOCITIES OF SOUND WAVES OF DIFFERENT INTENSITIES.

ARTHUR L. FOLEY, Head of the Department of Physics, Indiana University,  
Publication No. 42.

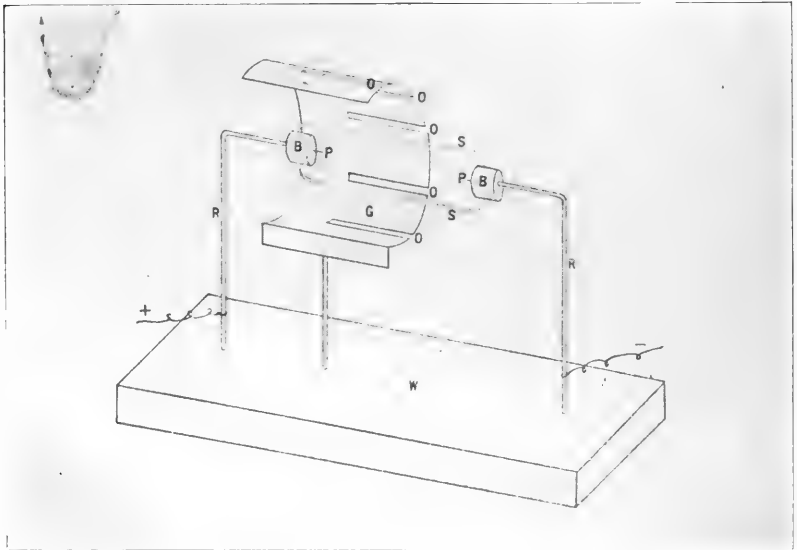
It appears that the first determination of the velocity of sound that can lay claim to any accuracy was made by Cassini, Maraldi, and LaCaille, of the Paris Academy, in 1738. By noting the time interval between seeing the flash of a cannon and hearing the report, with different distances between gun and experimenter, they arrived at the conclusion that the velocity of sound is independent of the intensity. This conclusion seems to have been accepted for more than a century. In 1864 Regnault determined the velocity of sound by firing guns reciprocally and using an electrical device for recording the instant of firing the gun and the arrival of the sound wave at the distant station. He found a small difference, about six parts in three thousand, in the velocities measured when the stations were 1,280 meters apart and when they were 2,445 meters apart, the former being the greater. The difference he attributed to the fact that the average intensity of the sound when the stations were nearest was much greater than when farthest apart, thus reaching the conclusion that the velocity of sound is a function of its intensity.

Regnault's conclusion accords with theory and with experimental results obtained by several later experimenters. Among these may be named Jacques at Watertown, Mass., 1879, who obtained velocities of 1,076 feet per second, and 1,267 feet per second, at points 20 feet and 80 feet respectively to the rear of a cannon fired with a charge of one and one-half pounds of powder. Wolfe and others have found varying velocities for explosion waves, a wave from an electric spark being of this nature. A fuller consideration of these experiments will be given when the writer has completed his experimental work on this subject.

The apparatus in use in this investigation, which is still in progress, is practically the same as described by the writer in a paper published three years ago under the title "A New Method of Photographing Sound Waves."<sup>1</sup> But three changes have been made in the apparatus there shown. One is the short-circuiting of the capacity by a high resistance and inductance to give better regulation of the time interval between the sound and illuminating

<sup>1</sup>Physical Review, Vol. XXXV, No. 5, Nov., 1912.

sparks, a method described elsewhere in these Proceedings. A second is a considerable increase in the two capacities, to obtain waves of greater intensity. A third is a modification of the sound gap, or rather a disposition of screens about the sound spark in order to obtain waves from the same spark of both great and small intensity. These waves are photographed on the same plate, enabling one to determine their relative velocities. A few of the results are given in this preliminary paper.



The details of the sound gap and screen are shown in Figure 31. A heavy spark is passed between the platinum terminals P-P. This produces a cylindrical sound wave shown in section at S, S. G is a cylindrical metal screen, which I shall call a grating, concentric with the spark axis, and having longitudinal slits or apertures O, O, cut in it, as shown in the figure, thus forming a sort of grating. The grating is so placed that it intercepts but one end, the left end in the figure, of the cylindrical wave, the right end or half spreading out the same as if the grating were not in use. I shall call this wave the main wave. Some of the energy of the left end of the wave is reflected by the grating, but some of it passes through the apertures which thus become sound sources, the waves spreading out in every direction from these sources. I shall call these waves wavelets.



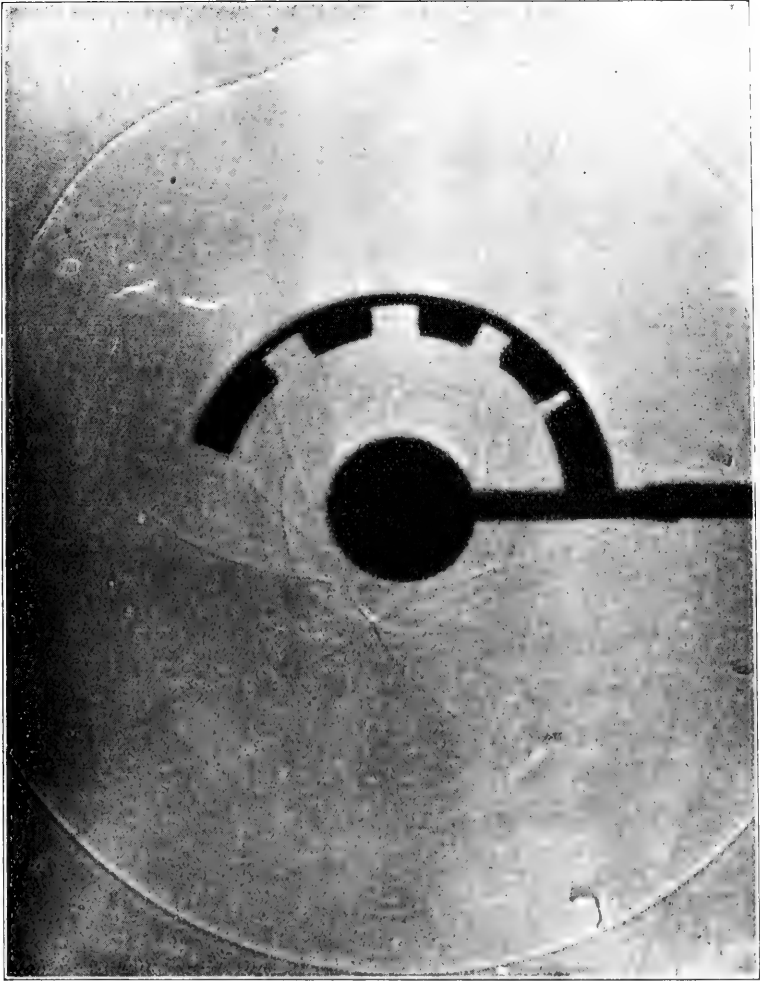
The energy at any point in the wave front of the wavelets must be small compared to the energy at any point in the main wave, for two reasons. In the first place only a fraction of the energy of the original wave passes through the apertures. In the second place, what does get through spreads out to form the wavelets and thus greatly reduces the energy propagated in a particular direction. If the speed of propagation decreases with the energy of the sound wave, and, therefore, with the intensity, it would seem that our photographs should show two results: the velocity of a wavelet should be less than that of the main wave, and the wave front of a wavelet should not be circular, because the energy at a point in the wavelet falls off rapidly as the distance from the pole of the wave increases. One need not cite Stokes's law, for the pictures clearly indicate a variation in intensity along the front of the wavelets. Yet, taking into consideration the breadth of the apertures the wavelets are circular, showing that the velocity of the pole of the wave is not greater than the velocity tangent to the grating surface. Nor does the breadth of the aperture, and, therefore, the energy passing through, appear to make any difference in the velocity. It will be noted that the photographs show apertures of four different sizes.

The photographs show that the main wave and the poles of all the wavelets are tangent to one another, and since the wavelets are circular, that the velocity of the attenuated wavelet propagated tangent to the grating surface is not less than the velocity of the main wave of much greater intensity.

Physics Laboratory, Indiana University, December, 1915.





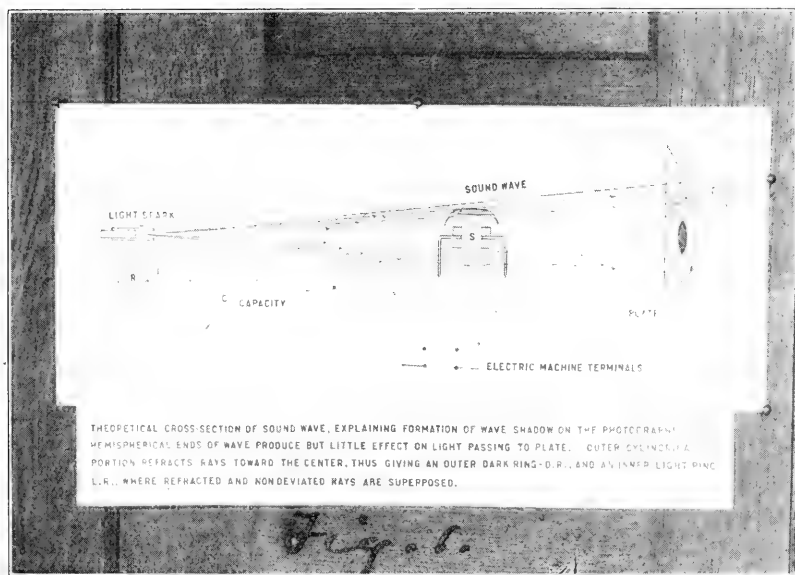


## A SIMPLE METHOD OF HARMONIZING LEYDEN JAR DISCHARGES.

ARTHUR L. FOLEY, Head of the Department of Physics, Indiana University.

*Publication No. 41.*

In the photography of sound waves<sup>1</sup> one of the chief difficulties is to secure the proper time interval between the sound producing spark and the illuminating spark which pictures the wave. A spark gap is always apparently more or less erratic. When one places two gaps in series, Figure 1, and en-



deavors to adjust the condenser C to make the spark L, occur at a definite time after the spark S, he finds that the time interval is far from constant. The interval varies, not merely because of variations in the spark gaps themselves, but because of the charge remaining in the capacity C after a spark

<sup>1</sup>A New Method of Photographing Sound Waves. *Physical Review*, Vol. XXXV, No. 5, November, 1912.

has taken place. This spark is due to two causes. One is the tendency of the Leyden jars forming the capacity  $C$  to take on what is known as a residual charge. The other results from the oscillatory character of a Leyden jar discharge, the jars having a charge after each spark depending on the direction of the last oscillation. With a charge on the capacity  $C$  varying as to both sign and magnitude, one can not expect a constant time interval between the sparks  $L$  and  $S$ . In my later experiments I have been able to eliminate much of this trouble by short-circuiting the terminals of the capacity  $C$  through a high resistance  $R$  and an inductance  $I$ . The resistance  $R$  is merely a tube of water with wires passing through corks at either end of the tube. The inductance  $I$  is an electromagnet of about a thousand turns of wire. The result may be obtained with either a resistance or an inductance, if sufficiently large. Using both one can, without reducing the intensity of the illuminating spark, reduce the resistance  $R$  by shortening the water resistance until the jars discharge themselves completely very soon after every spark. Thus the condenser is brought into the same electrical condition before every spark and consequently the time required to charge it to sparking potential is made constant.

The arrangement here described does not completely eliminate all variations in the time interval between the sparks because much of the variation is due to change in the effective resistance of the spark gaps themselves, something the writer has been unable to control. The arrangement does, however, reduce the variation about 50 per cent.

Physics Laboratory, Indiana University, November, 1915.

## AN ELECTROSCOPE FOR MEASURING THE RADIOACTIVITY SOILS.

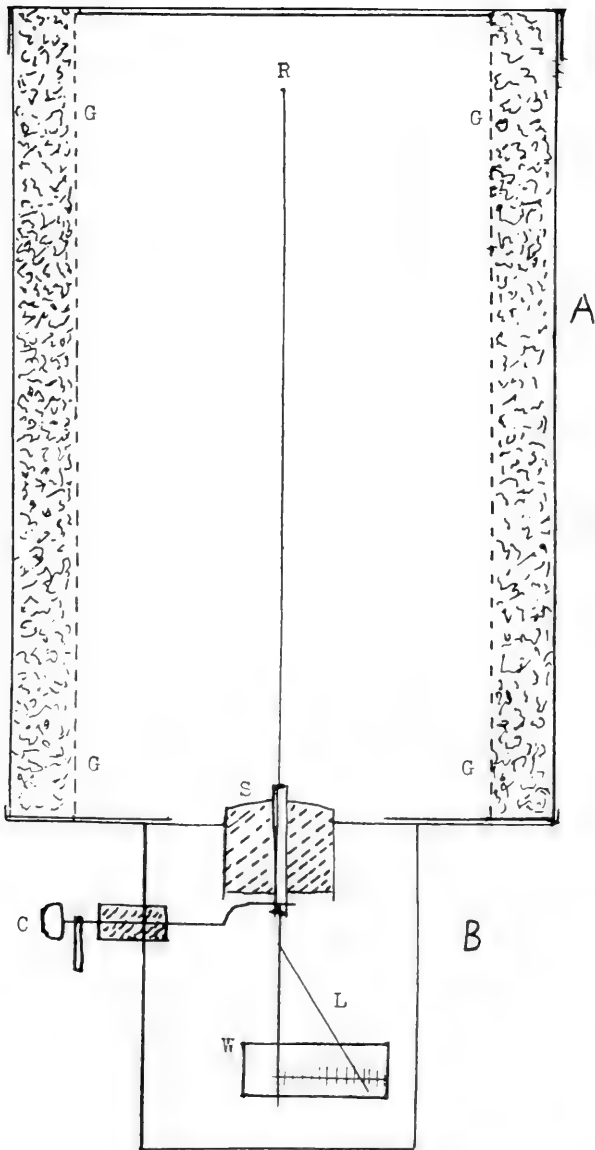
BY R. R. RAMSEY.

In measuring the radioactivity of soils if extreme accuracy is desired it is necessary to dissolve the sample and then determine the amount of radium or thorium by means of the emanation method. The getting the sample in solution is a long tedious process. For a description of this method I shall refer to Joly's Radioactivity and Geology.

For an approximate determination of the radioactivity one can use an  $\alpha$  ray electroscopes provided that the sample is fairly active. The standard being uranium oxide,  $U_3O_8$ , a "thick" layer, one gram to 10 square centimeters say, gives a current of  $5.8 \times 10^{-13}$  amperes or  $17.4 \times 10^{-4}$  E.S.U. per square centimeter surface if the plates of the electroscopes are 4 cm. or more apart. The amount of radium in the oxide may be determined by dissolving it and then determining the amount of emanation in the solution after it has stood 30 days. The sample is placed in the  $\alpha$  ray electroscopes and compared with the uranium oxide. It will be evident that an assumption is made here that the absorption coefficient of all samples for  $\alpha$  rays is the same as the absorption coefficient of uranium oxide for  $\alpha$  rays. This assumption is only approximately true.

The radioactivity of soil is very slight and in order to get an appreciable current a large area must be exposed. This necessitates large plates in the ordinary form of  $\alpha$  ray electroscopes. The large plates increases the capacity of the electroscopes and thus diminishes the sensitiveness of the electroscopes. Instead of an ionization chamber with plates I have hit upon the plan of using a cylindrical chamber with a central rod. The material to be tested is packed between the wall of the cylinder and an inside cylinder made of wire gauze. The space between the two walls is made as small as the ease of filling will permit. One or two centimeters, say.

In this form of electroscopes the amount of surface exposed can be increased at will by increasing the size of the cylinder, and as the diameter of the cylinder is increased the capacity is decreased. Thus the sensitiveness of the electroscopes is increased in two ways as the ionization chamber is increased; by increasing the surface exposed and by decreasing the capacity of the instru-



Soil Electroscope.



ment. The size of the chamber will be limited only by the potential of the central rod. The potential must be at least the saturation potential, that is the potential must be great enough to pull out the ions as fast as they are formed. With the usual potential, about 300 volts, the diameter may be made 15 or 20 centimeters. The height may be made as great as is convenient to use.

The general plan of the instrument is shown in the figure. A, is the ionization chamber, B, is the chamber containing the gold leaf. L, is the leaf, W, is the window through which the leaf is read on the scale. C, is the charging system. S, is the sulphur plug and R, is the central rod. For a more detailed description of the method of making and reading an electroscopes I will refer to my paper on The Radioactivity of Spring Water. (Ind. Acad. Proc. 1914.)

The top of the chamber, B, has a disc with a flange fastened to it. The diameter of this disc is such as to fit the ionization chamber. The lower end of the chamber, A, is closed and a hole is cut large enough to let the sulphur plug, S, pass. The gauze cylinder, G, is soldered to a disc which will fit the inside of the large cylinder and pass the plug, S. A disc of diameter of the gauze cylinder is soldered in the top. A lid fits over the top of the large cylinder.

To fill in the material to be tested the chamber A, is removed from off the chamber B, the gauze cylinder is placed inside and the material is packed lightly between the two walls. The lid is placed on and the chamber A, is placed on the chamber B.

Correction must be made for the absorption of  $\alpha$  rays by the gauze. This can be determined by getting the ionization current of uranium nitrate when free and when covered with a sample of the gauze, using an ordinary  $\alpha$  ray electroscopes.

Or the electroscopes may be calibrated by filling in a material of known activity between the gauze and the outside cylinder. Or uranium nitrate may be mixed with an inactive substance in known proportions and placed in the electroscopes.

In testing soils the sample should be allowed to dry for a few days as fresh damp soil contains a large amount of radium emanation which has come up from the lower material.

Indiana University, December 1, 1915.

## THE CAUSE OF THE VARIATION OF THE EMANATION CONTENT OF SPRING WATER.

BY R. R. RAMSEY.

Last year at the annual meeting of this Society I presented a paper on "Radioactivity of Spring Water" in which I called attention to the fact that there was a variation of the radioactivity from time to time. During nine months of the past year I have measured the emanation content of two springs once every week. In a short time I discovered that there was a connection between the radioactivity and the flow of the springs. The flow of one of the springs was measured every week during six months.

The springs are about 1.3 miles apart. One issues out of coarse gravel the other issues from a crevice in the solid rock. Both springs are known as never failing springs, however the flow of both are affected by the rain fall. They both vary in the same manner but not to the same degree. The variation of the Ill. Cent. spring, the one measured, is much more than the Hottle spring. The method of measuring the flow was by means of a horizontal weir, the depth being measured and computed according to the usual formula.

The radioactivity was measured by means of the Schmidt shaking method and an emanation electroscope. The electroscope was standardized by means of an emanation standard secured from the Bureau of Standards. The Schmidt shaking method can be carried out at the spring. The accuracy of the method when the measurements are made at the spring in 15 to 30 minutes is about 5 per cent. The observations for the nine months are shown in the table I. The date of observation, the temperature, the flow in gallons per day, and the emanation content of the water is given for each spring.

It will be noted that the radioactivity of the Hottle spring is higher and more constant than the Ill. Cent. spring. In the same manner the flow of the Hottle spring is more constant than the Ill. Cent. spring but it is not always greater than the Ill. Cent. It will be noted that the fluctuations of the radioactivity are in the same general manner for both springs.

This is better shown by means of curves Figure II. The full lines are for the radioactivity the dotted line is for the flow. The curves have a general

<sup>1</sup>Indiana Academy of Science Proceedings, 1914.

fall towards low values and then a rather sudden rise. An increase in flow is accompanied by an increase in radioactivity.

The increase of flow follows the melting of a heavy snow or a heavy rain. Thus the radioactivity of the spring depends upon the rain fall. The radioactivity of rain water is very small compared to the values obtained at the springs. It can not be due to the radioactivity of rain water.

The above results, together with the fact that "wet weather" springs are very radioactive and that one on the campus of Indiana University measured  $1920 \times 10^{-12}$  a short time after a heavy rain fall, lead to the conclusion that the variation of the emanation content of Indiana springs is due to the rain water percolating through the soil and dissolving and carrying down with it some of the emanation which is continually moving upwards from the interior of the earth to the surface. During dry weather when the flow of the water is not rapid a large per cent of the emanation which was dissolved in the water is transformed into radium A, B, C, and D before the water issues from the ground.

This conclusion is in accord with the observations of Wright & Smith (Phys. Rev. Vol. 5, p. 459, 1915) in which they find that the amount of emanation which issues from the soil is decreased as much as 50 per cent at times after heavy rains.

To recapitulate, the variation of the emanation content of spring water is due to the rain water dissolving emanation as it percolates through the soil.

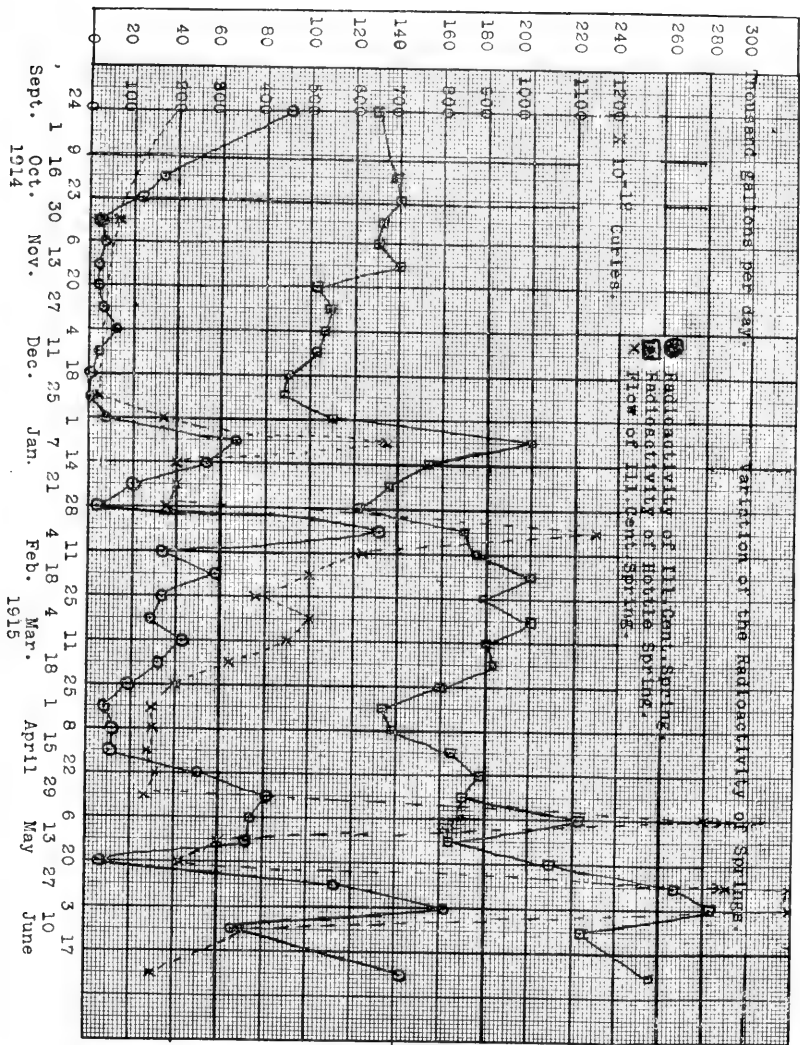
Department of Physics, Indiana University, December 1, 1915.

TABLE I.

Variation of the Emanation Content of Certain Springs near Bloomington Indiana. (Flow given in gallons per day.)

| DATE.             | HOTTELE SPRING. |       |                       | ILLINOIS CENTRAL SPRING. |        |                       |
|-------------------|-----------------|-------|-----------------------|--------------------------|--------|-----------------------|
|                   | Temp<br>C.<br>° | Flow. | Curies<br>per Liter.  | Temp.<br>C.<br>°         | Flow.  | Curies<br>per Liter.  |
| 1914.             |                 |       |                       |                          |        |                       |
| Sept. 24. . . . . | 13              |       | $650 \times 10^{-12}$ |                          |        | $445 \times 10^{-12}$ |
| Oct. 16. . . . .  | 13              |       | 695                   | 12.8                     |        | 166                   |
| Oct. 23. . . . .  | 13.3            |       | 700                   | 13                       |        | 120                   |
| Oct. 30. . . . .  | 13              | 10000 | 665                   | 12.7                     | 130000 | 20                    |
| Nov. 6. . . . .   | 13              |       | 650                   | 12.6                     |        | 40                    |

| HOTTELE SPRING. |             |       |                      | ILLINOIS CENTRAL SPRING. |        |                      |
|-----------------|-------------|-------|----------------------|--------------------------|--------|----------------------|
| DATE.           | Temp.<br>C. | Flow. | Curies<br>per Liter. | Temp.<br>C.              | Flow.  | Curies<br>per Liter. |
| Nov. 13.....    | 13          |       | 705                  | 13                       |        | 20                   |
| Nov. 20.....    | 13          |       | 520                  | 13                       |        | 20                   |
| Nov. 26.....    | 13          |       | 550                  | 13                       |        | 30                   |
| Dec. 3.....     | 13          |       | 535                  | 13                       |        | 60                   |
| Dec. 11.....    | 13          |       | 510                  | 13                       |        | 20                   |
| Dec. 18.....    |             |       | 450                  | 13                       |        | 00                   |
| Dec. 26.....    | 13          |       | 445                  | 12.8                     | 5000   | 00                   |
| 1915.           |             |       |                      |                          |        |                      |
| Jan. 1.....     |             | 20000 | 560                  |                          | 32000  | 40                   |
| Jan. 7.....     | 12.6        |       | 1020                 | 12                       | 136000 | 340                  |
| Jan. 14.....    | 13          |       | 770                  | 13                       | 39500  | 272                  |
| Jan. 21.....    | 13          |       | 680                  | 12.8                     | 40000  | 100                  |
| Jan. 18.....    | 12          |       | 610                  | 12                       | 32000  | 20                   |
| Feb. 4.....     | 12          | 62000 | 850                  | 12                       | 250000 | 750                  |
| Feb. 11.....    | 12          |       | 875                  | 12.6                     | 123000 | 166                  |
| Feb. 18.....    | 11.8        |       | 915                  | 12                       | 100000 | 350                  |
| Feb. 25.....    | 11.3        |       | 890                  | 12                       | 75000  | 170                  |
| Mar. 5.....     | 11.5        |       | 1010                 | 12                       | 100000 | 143                  |
| Mar. 11.....    | 11.5        |       | 900                  | 12                       | 85000  | 220                  |
| Mar. 18.....    | 11.3        |       | 920                  | 12                       | 62500  | 160                  |
| Mar. 25.....    | 11.3        |       | 800                  | 12                       | 40000  | 90                   |
| April 1.....    | 11          |       | 670                  | 12                       | 30000  | 45                   |
| April 8.....    | 11.3        |       | 690                  | 12                       | 30000  | 30                   |
| April 15.....   |             |       | 830                  | 12                       | 28000  | 60                   |
| April 22.....   | 12          |       | 890                  | 12                       | 30000  | 6                    |
| April 28.....   |             |       | 750                  | 12.2                     | 25000  | 410                  |
| May 7.....      | 11.4        |       | 1140                 | 12                       | 110000 | 365                  |
| May 13.....     | 11.9        |       | 825                  | 12.4                     | 60000  | 365                  |
| May 21.....     | 11          |       | 1050                 | 12.3                     | 42000  | 25                   |
| May 27.....     | 12          |       | 1340                 | 12                       | 500000 | 750                  |
| June 3.....     | 11.6        |       | 1420                 | 12                       | 400000 | 820                  |
| June 10.....    | 11.8        |       | 1120                 | 12                       | 76000  | 355                  |
| June 25.....    | 12          |       | 1280                 | 12.5                     | 30000  | 715                  |



No. 293-M. THE H. COLE CO., COLUMBUS, OHIO.

FIG. 11.

## A STANDARD CONDENSER OF SMALL CAPACITY.

BY R. R. RAMSEY.

In radioactive measurements of substances which are very feebly radioactive it is necessary to have an electroscope which is very sensitive. One of the conditions to obtain this result is, the electroscope must have a very small capacity. A capacity of one to ten centimeters. A sphere has a capacity equal to its radius when far removed from other objects but when brought near to the electroscope its capacity changes to a value which depends upon the position, size and shape of the electroscope.

It is customary to use a cylindrical condenser. The capacity of a cylindrical condenser is

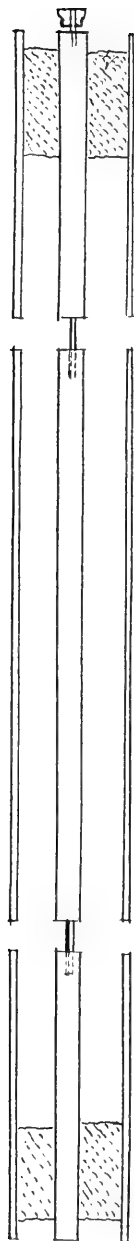
$$C = \frac{L}{2 \log_e R_1/R_2}$$

where C is the capacity; L is the length;  $R_1$  is the inside radius of the outside cylinder;  $R_2$  is the radius of the inside cylinder. This formula gives the capacity if the effect of the ends can be neglected. This requires that the length should be great compared to the difference of the two radii. When these conditions are met the capacity will be 100 em. or more.

In order to correct for the end effects I have made a condenser in three sections, the construction of which is illustrated in the cross sectional drawing. The middle cylinder is made of a brass rod about 9 millimeters in diameter. The outside cylinder is made of brass tubing whose inside diameter is about 3.6 cm. The diameters are chosen large in order that the accuracy of measurement may be great. The ratio of the diameters is made large in order that the capacity per unit length may be small.

The length of the end sections is 10 cm. The length of the middle section is 20 cm. The middle rod is held in place in the end sections by means of sulphur. This was accomplished by means of two wooden discs which were accurately turned to fit in the ends of the large cylinder and hold the middle rod in the center. These discs were placed in the ends of the end sections. The end section was stood upon the outside end and melted sulphur was poured through a hole in the top disc until the cylinder was about one-third filled. The discs were removed after the sulphur had hardened. Dowel pins are placed on the middle rod to hold the middle section in place.

Standard Condenser.



The capacity of the middle section is calculated by the formula. The electroscopes is charged to a potential  $V_1$ . The charge on the electroscopes is divided with the condenser, all sections being used.

If  $C_1$  is the capacity of the electroscopes.

$C_2$  is the capacity of the end sections.

$C_3$  is the capacity of the middle section.

$V_1$  is the initial potential.

$V_2$  is the final potential.

then since

$$Q = C_1 V_1 = (C_1 + C_2 + C_3) V_2$$

$$V_1/V_2 = (C_1 + C_2 + C_3)/C_1 = r_1$$

The electroscopes is again charged to a potential  $V'_1$ . The charge is again divided with the condenser, the end sections being used.

Then we have

$$V'_1/V'_2 = (C_1 + C_2)/C_1 = r_2$$

combining the two equations involving  $r_1$  and  $r_2$  we get

$$C_1 = C_3 (r_1 - r_2)$$

In case that one has a steady ionization current as in the case of radium emanation in an emanation electroscopes after three or four hours, one can allow the electroscopes to discharge through a certain potential difference,  $dV$ , first with the electroscopes alone, then with the ends of the condenser connected to the electroscopes, and then with the entire condenser connected. Since  $i = C dV/t$  and  $dV$  is constant, we have,

$$C_1/t_1 = (C_1 + C_2)/t_2 = (C_1 + C_2 + C_3)/t_3 = C_3/(t_3 - t_2)$$

Care must be taken to see that the current is constant during the observations. If the current is due to  $\beta$  or  $\gamma$  rays there is danger of the air inside of the condenser being ionized and thus producing a variable current.

The capacity of the middle section of the condenser which I have is 8.06 em. The capacity of the end sections is found by experiment to be about 17 em. Thus, since the combined length of the ends is the same as the middle section, the end effects plus the dielectric effect of the sulphur is about 9 em.

Department of Physics, Indiana University, December 1, 1915.



## RATE OF HUMIFICATION OF MANURES.

---

R. H. CARR.

---

It has been recognized for a long time that organic matter is an important constituent of the soil, but as to just what way it aids in crop production, there seems to be considerable difference of opinion. Some maintain that it is valuable only for the plant food it carries, while others value it more especially for the plant food in the soil which may be made available by its decomposition. The following paragraph from the Iowa Station, found in the September, 1915, Journal of the American Chemical Society expresses the sentiment of many soil investigators as to the value of humus, and the rate of humification. "The organic matter extracted by alkali is of no very different character than the organic matter of the soils as a whole. This together with the fact proved by Fraps and Hammer, Texas Bul. 129, that upon adding organic matter to soil, at the end of a years time there is no more material extracted with diluted ammonia than at the beginning of the period, proves quite conclusively that the determination of the amount of humus as found by the various methods is of no particular value in the study of a soil." This statement seems rather unreasonable to the author of this article, since the elements that are of value as fertilizers are locked up in most farm manures, green manures, cotton seed meal, etc., as complex compounds and hence are unavailable to the growing plant which must have its food supplied in a very simple form. In well rotted manures these complex molecules are largely broken down to simpler substances containing the same elements, but with a different arrangement in the molecule. They are quite soluble in water and if not leached by rains are very effective as a fertilizer compared with fresh manure.

Therefore, since fertility is so closely related to the unlocking of these complex plant molecules in the manures, an effort was made to measure the rate of humification of the more common ones.

## PLAN OF PROCEDURE.

A clay soil was chosen that was very deficient in organic matter and was, therefore, humus-hungry. With this soil were mixed different manures so

that each double box, holding about 1 cubic foot, contained the same amount of organic matter. The contents of the boxes were as follows:

TABLE I.

|        |                                                                           |
|--------|---------------------------------------------------------------------------|
| Box 1  | contained 2 lbs. hen manure + 50 gr. $\text{CaCO}_3$ .                    |
| Box 2  | contained 3.2 lbs. sheep manure.                                          |
| Box 3  | contained 2.4 lbs. hog manure.                                            |
| Box 4  | contained 3.0 lbs. horse manure.                                          |
| Box 5  | contained 6.6 lbs. steer manure + 50 gr. $\text{CaCO}_3$ .                |
| Box 6  | contained 6.0 lbs. cow manure + 50 gr. $\text{CaCO}_3$ .                  |
| Box 7  | contained 4.0 lbs. horse manure + 101 gr. $\text{CaO}$ , $\text{MgO}$ .   |
| Box 8  | contained 4.0 lbs. horse manure + 171 gr. $\text{CaO}$ .                  |
| Box 9  | contained 4.0 lbs. horse manure + 179 $\text{CaCO}_3$ , $\text{MgCO}_3$ . |
| Box 10 | contained 4.0 lbs. horse manure + 175 gr. $\text{CaCO}_3$ .               |
| Box 11 | contained no treatment.                                                   |

On May 30, 1914, the manure, limestone and soil were well mixed and the boxes were placed in the ground out of doors in order to approximate field conditions. At the same time samples of the mixed soil were taken for humus determinations. Other samples were taken on the following dates: November 25, 1914; February 16, 1915, after winter freeze; April 13, 1915, after a period of quite warm weather; June 1, 1915, October 15 and November 22, 1915.

#### HUMUS DETERMINATION.

Effort was made to follow the course of changes brought about by bacteria and the weathering agencies, etc., by determining the amount of humus present at the various periods. The term *humus*, as used by American soil investigators, does not refer to the total organic matter present in a soil, but only to that which is soluble in 4 per cent  $\text{NH}_4\text{OH}$ , the calcium and magnesium having been removed. The Official Method as modified by Smith was used in all the determinations. The following tables give averages for the different periods:

TABLE II.

GRAMS OF HUMUS AND ASH IN 1 GRAM SOIL.

|                           | Hen +<br>50 CaCO <sub>3</sub><br>1 |       | Sheep +<br>50 CaCO <sub>3</sub><br>2 |       | Pig +<br>50 CaCO <sub>3</sub><br>3 |       | Horse +<br>50 CaCO <sub>3</sub><br>4 |       | Steer +<br>50 CaCO <sub>3</sub><br>5 |       | Cow +<br>50 CaCO <sub>3</sub><br>6 |       |
|---------------------------|------------------------------------|-------|--------------------------------------|-------|------------------------------------|-------|--------------------------------------|-------|--------------------------------------|-------|------------------------------------|-------|
|                           | Humus.                             | Ash.  | Humus.                               | Ash.  | Humus.                             | Ash.  | Humus.                               | Ash.  | Humus.                               | Ash.  | Humus.                             | Ash.  |
| Soils, manures unexposed. |                                    |       |                                      |       |                                    |       |                                      |       |                                      |       |                                    |       |
| May 30-Feb. 16.           | .0057                              | .0083 | .0068                                | .0080 | .0051                              | .0088 | .0058                                | .0087 | .0092                                | .0076 | .0079                              | .0087 |
| Feb. 16-April 13.         | .0039                              | .0080 | .0078                                | .0065 | .0081                              | .0060 | .0061                                | .0065 | .0093                                | .0076 | .0092                              | .0074 |
| April 13-June 1.          | .0073                              | .0112 | .0072                                | 0.100 | .0083                              | .0107 | .0063                                | .0101 | .0094                                | .0100 | .0096                              | .0115 |
| June 1-Oct. 15.           | .0078                              | .0096 | .0066                                | .0096 | .0073                              | .0096 | .0068                                | .0088 | .0097                                | .0098 | .0097                              | .0102 |
| Oct. 15-Nov. 22.          | .0071                              | .0073 | .0075                                | .0087 | .0064                              | .0083 | .0089                                | .0080 | .0092                                | .0094 | .0091                              | .0086 |
| Check.....                | .0049                              | .0097 |                                      |       |                                    |       | No treatment.                        |       |                                      |       |                                    |       |

TABLE 3.

|                           | Horse + 101<br>CaO, MgO |       | Horse + 171<br>CaO |       | Horse + 179<br>CaCO <sub>3</sub> ,<br>MgCO <sub>3</sub> |       | Horse + 175<br>CaCO <sub>3</sub> |       |
|---------------------------|-------------------------|-------|--------------------|-------|---------------------------------------------------------|-------|----------------------------------|-------|
|                           | 7                       |       | 8                  |       | 9                                                       |       | 10                               |       |
|                           | Hu-<br>mus.             | Ash.  | Hu-<br>mus.        | Ash.  | Hu-<br>mus.                                             | Ash.  | Hu-<br>mus.                      | Ash.  |
| Soil, manure unexposed... | .0055                   | .0085 | .0048              | .0078 | .0055                                                   | .0075 | .0055                            | .0072 |
| May 30 to Feb. 16.....    | .0064                   | .0084 | .0051              | .0065 | .0067                                                   | .0087 | .0051                            | .0065 |
| Feb. 16 to April 13.....  | .0070                   | .0090 | .0061              | .0096 | .0066                                                   | .0099 | .0061                            | .0103 |
| April 13 to June 1.....   | .0072                   | .0094 | .0058              | .0093 | .0123                                                   | .0062 | .0069                            | .0096 |
| June 1 to Oct. 15.....    | .0090                   | .0072 | .0081              | .0083 | .0093                                                   | .0087 | .0074                            | .0090 |
| Oct. 15 to Nov. 22.....   |                         |       |                    |       |                                                         |       |                                  |       |
| Check.....                | .0049                   | .0097 | No treatment       |       |                                                         |       |                                  |       |

TABLE 4.

PERCENT OF INCREASE OR DECREASE IN HUMUS.

| Hen.  | Sheep. | Pig.  | Horse. | Steer. | Cow.  |                                                                    |
|-------|--------|-------|--------|--------|-------|--------------------------------------------------------------------|
| 1     | 2      | 3     | 4      | 5      | 6     |                                                                    |
| .08   | .20    | .02   | .09    | .43    | .30   | NH <sub>4</sub> OH soluble humus—before ex-<br>posure. Over check. |
| .12   | .09    | .30   | .03    | .01    | .13   |                                                                    |
| .04   | — .06  | .02   | .02    | .01    | .04   |                                                                    |
| .05   | — .06  | — .10 | .05    | .03    | .01   |                                                                    |
| — .07 | .....  | — .09 | .15    | — .05  | — .06 |                                                                    |
| ..... | .....  | ..... | .....  | .....  | ..... |                                                                    |
| 601.9 | 443    | 1174  | 165.9  | 928    | 620.9 | Grams of corn and stalks produced 1915<br>produced 1916            |
| 456   | 401    | 281   | 222    | 260    | 249   |                                                                    |

TABLE 5.  
PERCENT OF INCREASE OR DECREASE IN HUMUS.

| Horse<br>7<br>CaO, MgO | Horse<br>8<br>CaO | Horse<br>9<br>CaCO <sub>3</sub> ,<br>MgCO <sub>3</sub> | Horse<br>10<br>CaCO <sub>3</sub> |                                                                      |
|------------------------|-------------------|--------------------------------------------------------|----------------------------------|----------------------------------------------------------------------|
| .06                    | — .01             | .06                                                    | .06                              | NH <sub>4</sub> OH soluble humus be-<br>fore exposure Over<br>check. |
| .09                    | .03               | .12                                                    | — .04                            | May 30 to Feb. 16.                                                   |
| .06                    | .10               | — .01                                                  | .10                              | Feb. 16 to April 13.                                                 |
| .02                    | — .03             | .57                                                    | .04                              | April 13 to June 1.                                                  |
| .18                    | .23               | — .30                                                  | .05                              | June 1 to Oct. 15.                                                   |
| .....                  |                   |                                                        |                                  | Oct. 15 to Nov. 22.                                                  |
| 123.1                  | 46.6              | 637.6                                                  | 386                              | Grams of corn and stalks<br>produced 1915                            |
| 308                    | 392               | 347                                                    | 320                              | produced 1916                                                        |
| Check box              |                   |                                                        |                                  |                                                                      |
| 145.4.....             |                   |                                                        |                                  | Grams of corn and stalks<br>produced 1915                            |
| 151.....               |                   |                                                        |                                  | produced 1916                                                        |

It will be noticed in Table 4 that fresh steer manure is quite soluble in NH<sub>4</sub>OH and the solubility is not increased appreciably on exposure in the soil. The same is true to a large extent of cow manure, but less of pig manure while horse manure is only broken down after about 12 to 18 months' exposure, except in the case of Box 9 which was treated with dolomitic limestone. It will also be noticed in Table 5 that when the acidity was corrected with 171 grams of CaO in Box 8 and 101 grams of CaO, MgO in Box 7, the rate of humification was retarded—the CaO and CaO, MgO both having an antiseptic action when more is added than is needed to correct the soil acidity. Chemically equivalent amounts of Ca and Mg (in neutralizing power) were added to Boxes 7, 9 and 10. It would seem that the growth of corn obtained in Box 9 was due to the early humifying of the manure (June 1). While in Boxes 4, 7 and 8 the humification came too late to benefit this year's crop. The yields in Boxes 3 and 5 were the largest of all but it is probable that the higher nitrogen content was the main cause.

## CONCLUSIONS.

1. Growth of corn, other factors being constant, seems to be proportional to the rate of humification of manures.
2. The ammonia soluble matter in cow and steer manure is not appreciably increased on 18 months' exposure, but hog, sheep and horse manure humify less rapidly and in the order named.

## THE FOOD OF NESTLING BIRDS.

HOWARD E. ENDERS AND WILL SCOTT.

The surprisingly rapid growth of fledgling birds is a matter of common observation but the activities of the parents in the collection of food and the care of the young is scarcely realized by persons who have not carried on observations throughout the whole of a bird's working-day.

It has been the practice of the authors, each summer, for a period of years,\* to assign students in groups of four to the work of observing the activities of birds and their fledgling young from dawn until nightfall. The work was carried on in relays such that two persons were at the nest at all times, one to make the observations at close range with the aid of field-glasses, and the other to make the notes. By this method it was possible to observe, time and note in considerable detail, the activities of the birds, also the character and number of pieces of food brought at each trip to the nest.

Observations, many in duplicate, have thus been made upon seventeen different species of the birds common to Winona Lake, Indiana. In the several instances, the birds were under observation for a period of several consecutive days, and we have reason to believe, without markedly modifying their activities after the first hour or two.

The object of the present paper is to indicate the nature, quality and *quantity* of food brought to the young throughout a bird's full working-day. A transcript of a single example is given in full while others are given in summaries to indicate the number of feeds, number of pieces. Both "soft" and "hard" food are fed to the young birds in proportions which change somewhat with the age of the nestlings.

It is contended that the stomach contents afford the only accurate and reliable method of study of the food of birds. We believe that this method is not applicable to the food of nestling birds for two reasons: first, the food is soft and not readily identifiable; and the second and more important reason is that the food is digested very rapidly. The stomach contents do not serve as a criterion of the *quantity* of food that is eaten in the course of a day.

---

\*Biological Station of Indiana University at Winona Lake, Ind.

## OBSERVATIONS ON THE BROWN THRASHER.

*Toxostoma rufum.*

There were four young in the nest. They remained in the same position throughout the day and were, therefore, indicated ( $\frac{1-2}{3-4}$ ). The nest was on the ground in a clump of weeds. The day was bright, warm and calm.

- 4:00 A. M. Parents off the nest.  
 25 Female fed (unidentified)—cleaned the nest.  
 26 Male fed (unidentified).  
 39 Male fed apparently a caterpillar.  
 55 Male and female fed apparently caterpillars.  
 57 Male fed caterpillar.  
 59 Male fed (unidentified)—brooded until 5:11.  
     (7 feeds during the hour.)
- 5:27 Female and male fed—earthworm.  
 27 to :40 female brooded.  
 40 Male fed—earthworm.  
 45 Female fed—earthworm.  
 47 Male fed (unidentified.)  
     (5 feeds during the hour.)
- 6:05 Male fed.  
 6:05 Male fed.\*  
 06 Female fed.  
 09 Female fed.  
 17 Male fed—earthworm.  
 17 to :40 the male brooded.  
 40 Female fed and carried away excrement.  
 50 Female fed.  
 50 to :53 the female brooded.  
 55 Male fed and carried away excrement.  
     (7 feeds during the hour.)
- 7:03 Male fed—brooded till :26.  
 26 Female fed.

---

\*Food not identified where name is not given.



- 30 Female and male fed insects.  
 37 Female fed.  
 38 Female fed—caterpillar.  
 44 Male fed—brooded till :56.  
 56 Female fed and carried away excrement.  
 (8 feeds during the hour.)
- 8:01 Female fed.  
 12 Male fed—worms.  
 14 Female fed—worms.  
 15 Male fed—worms.  
 24 Male fed—large green larva.  
 26 Female fed.  
 28 Male fed.  
 32 Female fed and brooded till :53.  
 53 Male fed—insects and brooded till :58.  
 58 Female fed—caterpillar.  
 59 Male fed—caterpillar.  
 (11 feeds during the hour.)
- 9:08 Female fed—caterpillar.  
 09 Male fed—caterpillar.  
 18 Female fed—worm.  
 20 Male fed—worm.  
 25 Female fed—grasshopper, and brooded till :47.  
 52 Male fed and brooded till 10:19.  
 (6 feeds during the hour.)
- 10:19 to 10:29 the nest was vacant.  
 29 Male fed—caterpillar.  
 30 Female fed—insect.  
 33 Female fed—dragonfly.  
 33 Male fed—worm.  
 36 Female fed—worm.  
 42 Female fed—cutworm.  
 53 Male fed—cutworm and ate the excrement.  
 59 Male fed—cutworm and ate the excrement.  
 (8 feeds during the hour.)

- 11:02 Female fed—worm and beetle—carried away excrement.  
 03 Male fed—cutworm.  
 05 Male fed—dragonfly.  
 14 Male fed—caterpillar.  
 20 Female fed—caterpillar.  
 27 Male fed—caterpillar to bird No. 3.  
 33 Female fed—caterpillar to bird No. 1.  
 34 Male fed—caterpillar to bird No. 2, and brooded till :39.  
 43 Female fed—caterpillar to bird No. 2.  
 44 Male fed—caterpillar to bird No. 2.  
 47 Male fed—caterpillar to bird No. 2—ate excrement.  
 52 Female fed—caterpillar to bird No. 3.  
 53 Male fed—2 insects to bird No. 1.  
 58 Female fed—caterpillar to bird No. 4.  
 58 Male fed—caterpillar to bird No. 4.  
 (15 feeds during the hour.)

- 12:04 Male came but did not feed—brooded till :11.  
 12 Female fed—caterpillar to No. 1.  
 21 Male fed—caterpillar to No. 2 brooded till :30.  
 30 Female fed—cut-worm to No. 1.  
 40 Male fed green larvae to No. 2 and No. 3.  
 40 to :45, the nest was vacated.  
 45 Female fed larvae to No. 3 and No. 4, and ate excrement.  
 46 Chased blackbirds away from the tree; flicker and other birds.  
 48 Male fed—dragonfly to No. 2.  
 (6 feeds during the hour.)

- 1:00 Female fed—dragonfly to No. 2.  
 08 Male fed—larvae to No. 1 and No. 3—carried away excrement.  
 09 Female fed—larvae to No. 2.  
 11 Female fed—larvae to No. 2.  
 16 Female fed—larvae to No. 3.  
 21 Female fed—cut-worm to No. 2.  
 25 Female fed—cut-worm to No. 4.  
 29 Male fed—cut-worm to No. 3 and No. 4.  
 43 Female fed—cutworm to No. 2.  
 44 Male fed—larva to No. 2.

47 Male fed—larva to No. 3.

50 Male fed—larva.

51 Male fed—larva.

58 Male fed—larva.

(14 feeds during the hour.)

2:02 Female fed—larva to No. 1.

14 Male fed—larva to No. 2.

14 Female fed—larvae to No. 1 and No. 3.

23 Female fed—beetle to No. 4.

24 Male fed—beetle to No. 3 and No. 4.

24 Female fed—to No. 1 and No. 2.

37 Male fed—larva to No. 4—ate the excrement.

40 to :45 male brooded, and ate the excrement.

45 Male fed—larva to No. 4.

46 Female fed—larva to No. 3.

51 Male fed—larva to No. 1.

54 Female fed—larva to No. 1.

57 Female fed—beetle to No. 1.

58 Female fed—cut-worm to No. 2.

(13 feeds during the hour.)

3:00 Female fed—cut-worm to No. 2, No. 3, and No. 4.

05 Female fed—cut-worm to No. 3 and ate the excrement.

10 Male fed insect to No. 1.

15 to :25 Male fed—cut-worm, rested, ate excrement.

26 Male fed—insect to No. 2.

28 Male fed—2 insects to No. 4.

37 Female fed—to No. 3, and ate excrement.

38 Male fed—to No. 2, and ate excrement.

51 Male fed—cut-worm to No. 2.

52 Female fed—cut-worm to No. 1.

56 Female fed—cut-worm to No. 4.

57 Female fed—cut-worm to No. 3 and No. 4.

(12 feeds during the hour.)

4:01 Male fed—cut-worm to No. 4 and ate excrement.

09 Female fed—cut-worm to No. 1.

- 17 Male fed—cut-worm to No. 2.
- 20 Female fed—cut-worm to No. 4 and ate excrement.
- 21 Female fed—dragonfly to No. 1, and ate excrement.
- 28 Male fed—insect to No. 4.
- 32 Male fed—cut-worm to No. 3.
- 36 Female fed—dragonfly to No. 3.
- 37 Female fed—dragonfly to No. 1.
- 42 Female fed—cut-worm to No. 4.
- 44 Male fed—dragonfly to No. 3.
- 50 Female fed—beetle to No. 3.
- 51 Male fed—dragonfly to No. 3.
- 51 to 54, rested at the nest.

(13 feeds during the hour.)

- 5:02 Female fed—dragonfly to No. 3.
- 03 Female fed—dragonfly to No. 3.
- 05 Male fed—cut-worm to No. 3.
- 09 Female fed—winged ant to No. 1.
- 10 Female fed—beetle to No. 2.
- 11 Female fed—cut-worm to No. 1.
- 14 Female fed—cut-worm to No. 2 and No. 3.
- 16 Female fed—ants to No. 1 and No. 3; ate excrement.
- 20 Male fed—ants to No. 1.
- 25 Female fed—ants to No. 4.
- 26 Female fed—ants to No. 1.
- 27 Male fed—ants to No. 1 and No. 4.
- 32 Female fed—ants to No. 2, rested till :40 at nest.
- 43 Female fed—ants to No. 3.
- 49 Male fed—ant to No. 4.

(15 feeds during the hour.)

- 6:02 Male fed—beetle to No. 2.
- 07 Female fed—three ants to No. 1.
- 17 Female fed—beetle to No. 2, and ate excrement.
- 24 Male fed—cut-worm to No. 4.
- 24 Female fed—ants to No. 3.
- 29 Male fed—moth to No. 3; brooded till :33.
- 35 Male fed—ants to No. 3.

- 42 Female fed—cut-worm to No. 3.  
 42 Male fed—cut-worm to No. 3; brooded till 7:00.  
     (9 feeds during the hour.)
- 7:04 Male fed—cut-worm to No. 1 and No. 3.  
 13 Male fed—beetle to No. 2.  
 25 Female fed—cut-worm to No. 3.  
 27 Female fed—beetle to No. 4.  
 30 Female fed—worm to No. 1; carried away excrement.  
 35 Male fed—cut-worm to No. 1; ate excrement.  
 42 Male fed.  
 47 Male returns without feed: broods.  
     (7 feeds during the hour.)
- 8:00 Still brooding on the nest for the night.

The young were weighed on the following day, as indicated below. The weight of the young was 40 grams.

The weight of  $\left. \begin{array}{l} 1 \text{ beetle} \\ 7 \text{ ants} \\ 1 \text{ dragonfly} \end{array} \right\}$  is 1 gram.

Weight of 308 pieces (estimated number of pieces), 35 grams. Approximately this weight of food was consumed by four birds in a single day. Thus each bird consumed approximately one-fourth its weight of insects and worms.

Total number of feeds, 156.

Average number of feeds per hour, 9 5-8.

Individual feeds during the day:

To No. 1, 43 feeds (about).

To No. 2, 42 feeds (about).

To No. 3, 48 feeds (about).

To No. 4, 40 feeds (about).

Feeds by the male.....78 times.

Feeds by the female.....78 times.

Age of young not determined.

Classified list of food:

150 cutworms.

- 9 "worms."
- 5 earthworms.
- 11 dragonflies.
- 10 beetles.
- 50 ants.
- 1 grasshopper.
- 72 or more other insects.

---

308 or more.

# SUMMARIES OF ACTIVITIES OF AMERICAN ROBINS

*Merula migratoria* (Ten Nests.)

|                  | Number of Visits to the Nest by Parent Birds. | Number Young in the Nest. | Total Number Feeds. | Total Number Pieces. | Number of Feeds. |         | List of Food: Classified.                                                                                                                                                                                   | Enemies Driven Away.     |
|------------------|-----------------------------------------------|---------------------------|---------------------|----------------------|------------------|---------|-------------------------------------------------------------------------------------------------------------------------------------------------------------------------------------------------------------|--------------------------|
|                  |                                               |                           |                     |                      | Male.            | Female. |                                                                                                                                                                                                             |                          |
| July 3,<br>1912  | 136                                           | 4                         | 130                 | 130                  | 51               | 79      | 35 earthworms.....<br>1 caterpillar.....<br>2 grasshoppers.....<br>42 other insects.....<br>27 berries (blackberries, raspberries, gooseberry)<br>1 bread.....<br>22 unidentified.....                      | None.                    |
| July 10,<br>1913 | 140                                           | 2 (4-days old)            | 140                 | 140                  | 60               | 72      | 86 earthworms.....<br>6 caterpillars.....<br>10 grasshoppers and crickets.....<br>21 other insects.....<br>5 berries.....<br>12 unidentified.....                                                           | Other robin.<br>Cowbird. |
| July 10,<br>1913 | 105                                           | 2 (8-days)                | 101                 | 126                  | .....            | 101     | 21 earthworms.....<br>12 caterpillars.....<br>7 grasshoppers and crickets.....<br>43 other insects.....<br>40 berries.....<br>1 cherry.....<br>1 seed.....<br>1 unidentified.....<br>Water three times..... | Chased sparrows twice.   |

SUMMARIES OF ACTIVITIES OF AMERICAN ROBINS—Continued.

|               | Number of Visits to the Nest by Parent Birds. | Number Young in the Nest.           | Total Number Feeds. | Total Number Pieces. | Number of Feeds. |         | List of Food: Classified.                                                                                                                   | Enemies Driven Away.                                                                                                                                     |
|---------------|-----------------------------------------------|-------------------------------------|---------------------|----------------------|------------------|---------|---------------------------------------------------------------------------------------------------------------------------------------------|----------------------------------------------------------------------------------------------------------------------------------------------------------|
|               |                                               |                                     |                     |                      | Male.            | Female. |                                                                                                                                             |                                                                                                                                                          |
| July 10, 1914 | 202                                           | 4                                   | 211                 | 211                  | 200              | 1       | 101 earthworms.<br>7 caterpillars.<br>9 grasshoppers and crickets.<br>42 other insects.<br>6 berries.<br>46 unidentified.                   | Domestic difficulties; male <i>drove female from the nest</i> ; did not permit her to return. He drove blackbirds and also other unidentified bird away. |
| July 10, 1914 | 77                                            | 2 (left nest before end of the day) | 77                  | 77                   | 48               | 29      | 25 earthworms.<br>1 caterpillar.<br>5 grasshoppers and crickets.<br>11 other insects.<br>20 berries.<br>15 unidentified.<br>Water one time. | Purple grackle three times.                                                                                                                              |
| July 10, 1914 | 60                                            | 2                                   | 52                  | 53                   | 31               | 21      | 38 earthworms.<br>4 grasshoppers.<br>11 other insects.                                                                                      | None.                                                                                                                                                    |
| July 10, 1914 | 110                                           | 2 (5-days) about                    | 107                 | 107                  | 57               | 50      | 58 earthworms.<br>6 grasshoppers.<br>18 other insects.<br>25 berries (chiefly mulberries)<br>Water two times.                               | None.                                                                                                                                                    |



|                 |                                                                               |                   |     |     |    |    |                                                                                                                                                            |                                                                                         |
|-----------------|-------------------------------------------------------------------------------|-------------------|-----|-----|----|----|------------------------------------------------------------------------------------------------------------------------------------------------------------|-----------------------------------------------------------------------------------------|
| July 7,<br>1915 | 70                                                                            | 2                 | 57  | 63  | 54 | 3  | 45 earthworms.<br>3 caterpillars.<br>3 grasshoppers and crickets.<br>1 other insect.<br>5 mulberries.<br>6 unidentified.<br>Several flies and a few seeds. | Young robin; red squirrels period of fifteen minutes.                                   |
|                 | Showers during the morning. Very heavy rain during last half of the afternoon |                   |     |     |    |    |                                                                                                                                                            |                                                                                         |
|                 | Male covers young. His wings hang over nest; drains rain from the nest        |                   |     |     |    |    |                                                                                                                                                            |                                                                                         |
| July 7,<br>1915 | 96                                                                            | 2 (5-days)<br>old | 84  | 87  | 56 | 28 | 54 earthworms.<br>1 centipede.<br>5 grasshoppers.<br>15 other insects.<br>1 berry.<br>10 cherries.<br>1 bread.                                             | None.                                                                                   |
|                 | Showers during the morning. Very heavy rain during last half of the afternoon |                   |     |     |    |    |                                                                                                                                                            |                                                                                         |
| July 6,<br>1915 | 205                                                                           | Not<br>recorded   | 196 | 188 | 85 | 91 | 26 earthworms.<br>18 caterpillars.<br>3 grasshoppers.<br>53 other insects.<br>2 spiders.<br>84 berries (77 mulberries).                                    | Drove yellow hammer 4 times, flickers twice, red squirrel once, 3 robins, sparrow once. |

SUMMARY OF THE ACTIVITIES OF TWO WOOD PEWEEES.

(*Contopus virens.*)

|                                        | Number of Visits to Nest by Parent Birds. | Number of Young in the Nest. | Total Number of Feeds and Pieces. | List of Food Classified.        | Enemies Driven Away.                                                                                                                                                   |
|----------------------------------------|-------------------------------------------|------------------------------|-----------------------------------|---------------------------------|------------------------------------------------------------------------------------------------------------------------------------------------------------------------|
| <i>Clean Day.</i><br>July 3, 1912..... | 477                                       | 3 (age?)                     | 369                               | 369 +                           | 2 Cowbirds. Blackbird 4 times. Six Blackbirds at one time. Nuthatch, Woodpecker, Downy Woodpecker, Blue Jay, Yellow Hammer. Cowbird again. 2 Flickers. Squirrel twice. |
| <i>Rainy Day.</i><br>July 7, 1915..... | 670                                       | 3                            | 65                                | 65 +                            | None.                                                                                                                                                                  |
|                                        |                                           |                              |                                   | 2 caterpillars.....             |                                                                                                                                                                        |
|                                        |                                           |                              |                                   | 3 butterflies.....              |                                                                                                                                                                        |
|                                        |                                           |                              |                                   | 1 fly.....                      |                                                                                                                                                                        |
|                                        |                                           |                              |                                   | 7 dragonflies.....              |                                                                                                                                                                        |
|                                        |                                           |                              |                                   | 1 winged ant.....               |                                                                                                                                                                        |
|                                        |                                           |                              |                                   | 1 grasshopper.....              |                                                                                                                                                                        |
|                                        |                                           |                              |                                   | 354 + unidentified insects..... |                                                                                                                                                                        |
|                                        |                                           |                              |                                   | 7 caterpillars.....             |                                                                                                                                                                        |
|                                        |                                           |                              |                                   | 1 butterfly.....                |                                                                                                                                                                        |
|                                        |                                           |                              |                                   | 9 flies.....                    |                                                                                                                                                                        |
|                                        |                                           |                              |                                   | 5 dragonflies.....              |                                                                                                                                                                        |
|                                        |                                           |                              |                                   | 1 beetle.....                   |                                                                                                                                                                        |
|                                        |                                           |                              |                                   | 1 black wasp.....               |                                                                                                                                                                        |
|                                        |                                           |                              |                                   | 41 + other insects.....         |                                                                                                                                                                        |

## SUMMARY OF THE ACTIVITIES OF A KINGBIRD.

*Tyrannus tyrannus.*

The same nest, with *two* young, was under observation for a period of six days beginning with the morning on which the eggs hatched. The data of the first day were imperfectly recorded and are, therefore, not included in the summary. The data cover the 3rd, 4th, 6th, 7th, and 8th day after the hatching of the eggs.

## SUMMARY OF THE ACTIVITIES OF A KINGBIRD

|                                   | Number of Visits to the Nest by Parent Birds. | Total Feeds. | Number of Feeds |            | List of Food.                                                                                                                                                                                                                                                                                                               | Enemies Driven Away. |
|-----------------------------------|-----------------------------------------------|--------------|-----------------|------------|-----------------------------------------------------------------------------------------------------------------------------------------------------------------------------------------------------------------------------------------------------------------------------------------------------------------------------|----------------------|
|                                   |                                               |              | By Male.        | By Female. |                                                                                                                                                                                                                                                                                                                             |                      |
| July 12, 1913, 3rd day, . . . . . | 102                                           | 60           | 37              | 23         | 2 earthworms, . . . . .<br>2 caterpillars, . . . . .<br>1 white grub, . . . . .<br>2 damselflies . . . . .<br>2 dragonflies, . . . . .<br>1 moth, . . . . .<br>6 grasshoppers, . . . . .<br>8 beetles, . . . . .<br>2 other insects, . . . . .<br>14 seeds, . . . . .<br>20 unidentified, . . . . .                         | Woodpecker.          |
| July 13, 1913, 4th day, . . . . . | 102                                           | 92           | 69              | 23         | 7 earthworms, . . . . .<br>16 caterpillars, . . . . .<br>2 grubs, . . . . .<br>12 grasshoppers, . . . . .<br>2 crickets, . . . . .<br>2 katydids, . . . . .<br>2 damselflies . . . . .<br>12 dragonflies, . . . . .<br>1 bee, . . . . .<br>2 beetles . . . . .<br>12 other insects, . . . . .<br>19 unidentified, . . . . . | None.                |
| July 14, 1913, . . . . .          |                                               |              |                 |            | Rain. No observations, . . . . .                                                                                                                                                                                                                                                                                            |                      |

|                             |     |     |    |    |                                                                                                                                                                                                                                 |                                         |
|-----------------------------|-----|-----|----|----|---------------------------------------------------------------------------------------------------------------------------------------------------------------------------------------------------------------------------------|-----------------------------------------|
| July 15, 1913. 6th day..... | 78  | 74  | 40 | 34 | 10 earthworms.....<br>1 caterpillar.....<br>2 grubs.....<br>3 grasshoppers.....<br>1 cricket.....<br>2 damselflies.....<br>12 dragonflies.....<br>1 beetle.....<br>20 other insects.....<br>1 seed.....<br>21 unidentified..... | Robin.<br>Blue jay.                     |
| July 16, 1913. 7th day..... | 74  | 61  | 39 | 22 | 2 earthworms.....<br>9 grubs.....<br>1 damselfly.....<br>18 dragonflies.....<br>1 moth.....<br>13 other insects.....<br>19 unidentified.....                                                                                    | None.                                   |
| July 17, 1913. 8th day..... | 111 | 100 | 40 | 60 | 16 earthworms.....<br>8 grubs.....<br>3 damselflies.....<br>15 dragonflies.....<br>1 moth.....<br>1 beetle.....<br>1 grasshopper.....<br>38 other insects.....<br>1 centipede.....<br>17 unidentified.....                      | Blackbird,<br>Sparrow.<br>3 Blackbirds. |

HOWARD E. ENDERS, Purdue University, West Lafayette, Indiana.  
WILL SCOTT, Indiana University, Bloomington, Indiana.



## ON THE CHANGE THAT TAKES PLACE IN THE CHROMOSOME IN MUTATING STOCKS.

ROSCOE R. HYDE.

Two new eye mutations, tinged and blood have appeared in my cultures of the fruit fly that throw light upon the question as to the nature of the change that takes place in the chromosome when a new character appears. Both mutations show typical sex-linked inheritance, consequently they are expressions of changes in the X chromosome. Both mutants give the same linkage values when measured with other sex-linked characters. When measured with yellow body color a linkage of 1.2 results; with miniature wings 33; with bar eyes 44. Morgan has described three sex-linked eye mutants, white, eosin and cherry, which give the same linkage values. Consequently, we now have five sex-linked eye mutants, namely, white, tinged, eosin, cherry and blood, which give an increasing color series from white to the bright red of the wild fly. A study of their linkage relations shows that they either lie very closely together on the X chromosome or that they are but different modifications of the same gene. The two possibilities involve the question of the origin of mutations as well as the fundamental make-up of an hereditary factor.

Mendel evidently thought of something in the germ cell that stood for round (R) and something that stood for wrinkled (W) and that these two things could not coexist in the same gamete. That is, (W) is allelomorphic to (R).

The origin of mutation in the light of the above assumption would seem to depend upon the splitting up of more complex hybrids—the bringing to the surface of units already created. Evolution in the light of such a conception would seem to depend upon the shifting together of desirable units.

Bateson viewed the matter in a different light. He knew of the origin of new forms by mutation. He postulated a definite something in the germ cell that stands for the character, as for example (T) which stands for the tallness in peas, which when lacking makes the pea a dwarf (t). In other words, instead of two separate factors he regards the tallness and dwarfishness merely as an expression of the two possible states of the same factor,—

its presence and its absence. . Hence his well-known Presence and Absence theory. In this case (T) is allelomorphic to its absence (t). The inheritance of combs in chickens is a beautiful application of such a conception. Mutations according to this theory appear as the result of losses.

Bateson pushed this idea to its logical conclusion in his Melbourne address where he speculates on the possibility that evolution has come about by the loss of something. These somethings he assumes to be inhibitors. (Science, August 28, 1914).

" . . . As I have said already, this is no time for devising theories of evolution, and I propound none. But as we have got to recognize that there has been an evolution, that somehow or other the forms of life have arisen from fewer forms, we may as well see whether we are limited to the old view that evolutionary progress is from the simple to the complex, and whether after all it is conceivable that the process was the other way about.

" . . . At first it may seem rank absurdity to suppose that the primordial form or forms of protoplasm could have contained complexity enough to produce the divers types of life.

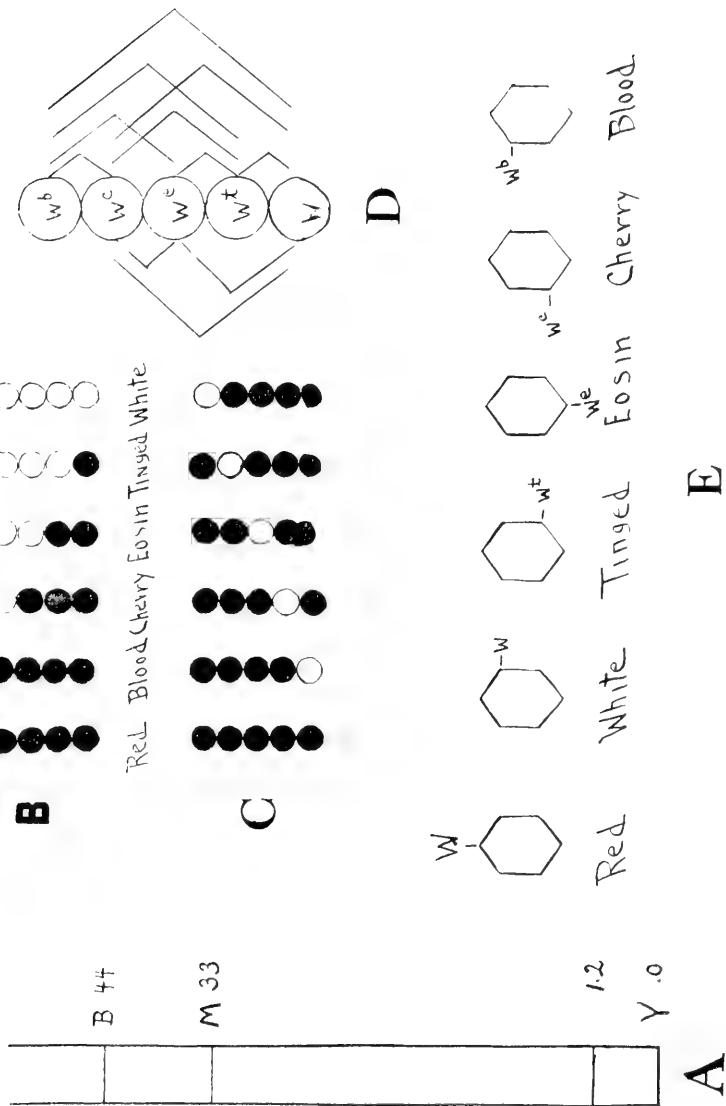
" . . . Let us consider how far we can get by the process of removal of what we call 'epistatic' factors, in other words those that control, mask, or suppress underlying powers and faculties.

" . . . I have confidence that the artistic gifts of mankind will prove to be due not to something added to the make-up of an ordinary man, but to the absence of factors which in the normal person inhibit the development of these gifts. They are almost beyond doubt to be looked upon as *releases* of powers normally suppressed. The instrument is there, but it is "stopped down." The scents of flowers or fruits, the finely repeated divisions that give its quality to the wool of the merino, or in an analogous case the multiplicity of quills to the tail of the fantail pigeon, are in all probability other examples of such releases.

" . . . In spite of seeming perversity, therefore, we have to admit that there is no evolutionary change which in the present state of our knowledge we can positively declare to be not due to loss. When this has been conceded it is natural to ask whether the removal of inhibiting factors may not be invoked in alleviation of the necessity which has driven students of the domestic breeds to refer their diversities to multiple origins."

Another idea as to the way these factors may find expression in the germ cells has been advanced by Morgan under the heading of Multiple Allelo-





FIGURES A, B, C, and E.--Explanation given in Text.

morphs. According to this conception there is a definite something (W) located at point 1.2 on the X chromosome which stands for the red eye of the wild fly. (Fig. A.) This gene underwent some kind of change and gave rise to white eyes (w). In another stock the same particle mutated and gave rise to eosin ( $w^e$ ). In still another stock the same particle changed and gave rise to cherry ( $w^c$ ). (W) is allelomorphie to (w), to ( $w^e$ ) and to ( $w^c$ ). each of these in turn is allelomorphie to each other; hence they form a system of Multiple Allelomorphs. This view is supported by a large amount of experimental data by Morgan and his co-workers, but strange as it may seem the numerical results can be interpreted in terms of the Presence and Absence theory provided the mutants are the result of losses of several factors that stand for red in a completely linked chain of loci.

The assumption that these three mutants are the result of changes in loci lying very closely together on the chromosome as demanded by the Presence and Absence theory has been tested by Morgan and others by means of their linkage relations in three possible combinations as given in Fig. D. (Shown by the broken lines on the left.) The discovery of the two new mutants has made it possible to carry out the test in eight additional ways. The evidence which involves data from something like a half-million animals weighs heavily against the Presence and Absence theory and is entirely in accord with the assumption that something analogous to isomerism may change an hereditary factor resulting in the production of a new form. I have attempted to visualize this in Fig. E. If this is the correct interpretation the possibilities locked in a small amount of chromatin may be almost infinite, for a great many different arrangements are possible from a few things.

There are some points worthy of consideration as tending to give weight to the Multiple Allelomorph theory.

1. On the Presence and Absence theory, it is necessary to assume that in the region of 1.2 on the X chromosome there is a chain of five completely linked loci (very close together) upon which the color of the red eye of the wild fly depends. Multiple Allelomorphs accounts for all of the facts while postulating but one locus.

2. Gratuitous to the Presence and Absence theory let us assume that the loci are in juxtaposition. If we assume that blood, cherry, eosin, tinged and white have appeared as a result of successive losses as shown in Fig. C, we encounter a difficulty. When any two of these mutants are crossed the

two chromosomes are brought together in the female, each restores the missing part to the other and a red-eyed female should result in the  $F_1$  generation. As a matter of fact no red-eyed female appears. She is invariably a compound, that is, in each case she is intermediate between the eye colors of the two stocks used as parents.

Again the evidence is fairly conclusive that when the two X chromosomes are brought together in the female they break and reunite at apparently all levels on the chromosome. Accordingly, it would seem that a break and reunion would occasionally take place between the members of this chain of loci. If such a phenomena should occur a complete chain of loci would result like the chain in Fig. C (on the extreme left), which would express itself in the  $F_2$  generation in the production of a red-eyed male. But in all the possible attempts to break up such a line, as shown in Fig. D, no such a red-eyed male has been found. To be sure the loci may be so close together that crossing over would take place infrequently, but the evidence from such large counts as have been made in which the red-eyed male has been specifically looked for would weigh heavily against its ever taking place.

3. The mutations may be due to losses according to the scheme represented in Fig. B., one loss produced blood, two losses produced cherry, and so on. Such an assumption would seem to accord with the fact that when any two of these stocks are crossed no red females are produced in the  $F_1$  generation. On the other hand it should be expected that the chromosome in which the least number of losses had occurred would act as a dominant. For example, when blood and tinged are crossed, the females should be like blood. But no such result is obtained. The female is intermediate in color.

Again we should expect from the phenomena of crossing-over that, in a cross for example between blood and white occasionally a cherry, or an eosin, or a tinged male would appear in the  $F_2$  generation, but none has been observed.

4. The history of the appearance of the members of this multiple allelomorph system shows that they are rare phenomena. Careful observation by Morgan, Sturtevant, Muller, Bridges, myself and others show these mutants to have appeared but a few times. It would be safe to say, I think, that only one has occurred in five million times. I have represented blood by one loss from the chromosome. Tinged is the result of four losses in this completely linked chain of loci. The possibility of such mutants appearing involves so many simultaneous losses that there would be one chance

in millions. It seems almost impossible to believe that we should have ever found such a mutant.

5. The experimental evidence shows there are many factors arranged in a linear series on the X chromosome. Some affect wings, some body colors, others the shape of the eye, and so forth. Sturtevant has pointed out the significance of the fact in light of the above statement that the characters which behave as members of a multiple allelomorph system are closely related physiologically.

6. If the mutants are the result of changes as shown in Fig. D it would seem as if a mutated stock would more readily give rise to subsequent mutations, since fewer simultaneous losses are necessary. As a matter of fact four of the members mutated directly from red while eosin came from white.

7. Morgan has emphasized the idea that it is difficult to account for reverse mutations on the assumption of losses from a completely linked chain of loci, as the Presence and Absence theory postulates. On the other hand it is conceivable how such a reaction could come about if the mutant is the result of an expression of something analogous to an isometric change.

8. Is chromatin such simple material that the only change conceivable is a loss?

#### LITERATURE CITED.

1. Morgan, Sturtevant, Muller and Bridges. Mechanism of Mendelian Heredity. Henry Holt. 1915.
2. Bateson, William. The Address of the President of the British Association for the Advancement of Science. Science. August 28, 1914.
3. Hyde, Roscoe R. The new members of a Sex-Linked Multiple (Sextuple) Allelomorph System. Genetics. November 1916. Princeton Press.

## SOME PRELIMINARY OBSERVATIONS ON THE OXYGENLESS REGION OF CENTER LAKE, KOSCIUSKO CO., IND.

HERBERT GLENN IMEL.

It has been found that some of our lakes contain no free oxygen during the summer months.

Birge and Juday ('11) found that Beasley and Mendota Lakes not only had such oxygenless regions but that animal life existed in these regions. They report sixteen genera of living, active protozoa, three of worms, two rotifers, two crustacea and one mollusc.

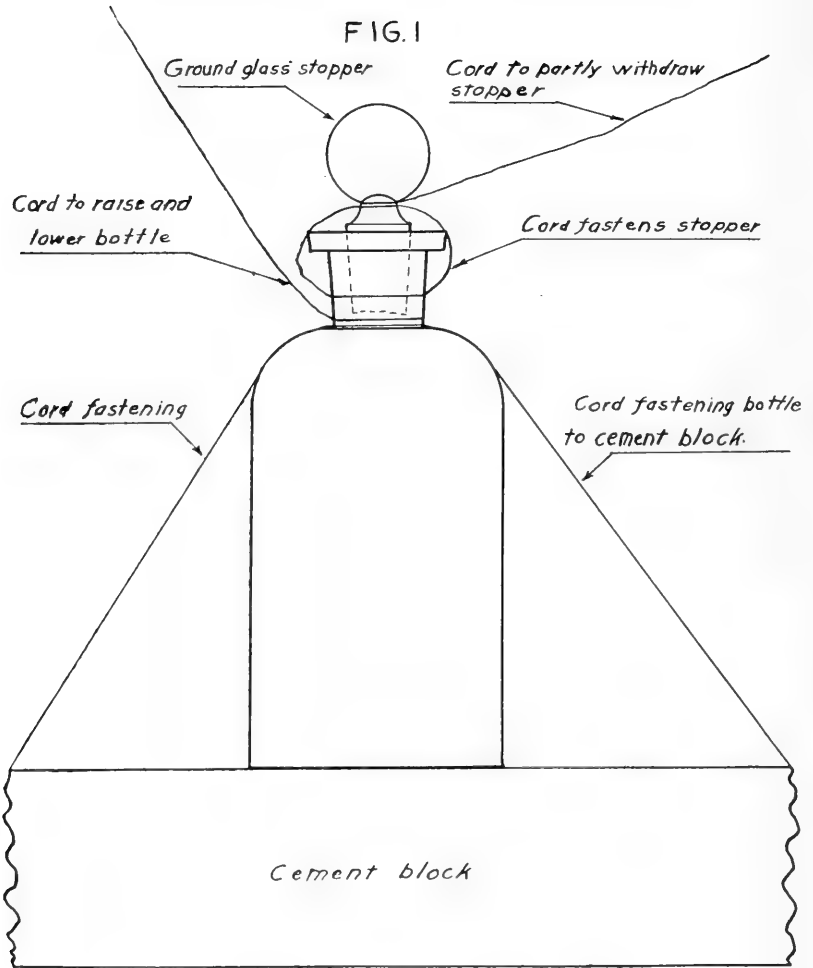
Scott found in his studies of lakes of northern Indiana that Center Lake, Kosciusko county, had such a region, and under his direction the writer undertook, during the summer of 1915 to find out what forms of animal and plant life existed in this region.

According to Birge and Juday ('11), after the autumnal overturn, during the winter, and until the approach of spring, the gas conditions are very nearly uniform throughout the lake, but with the approach of spring, and through the spring and summer, the oxygen content becomes less and less in the lower strata while the carbon dioxide, both free and fixed, becomes greater and greater until by July 15 or August 1, the free oxygen is zero while the carbon dioxide is very great. (See Figs. 6, 7, 8.)

This condition is brought about in three ways: (1) by the respiration of the plants and animals in it; (2) lack of surface contact with the air; (3) decomposition of the dead organisms in it.

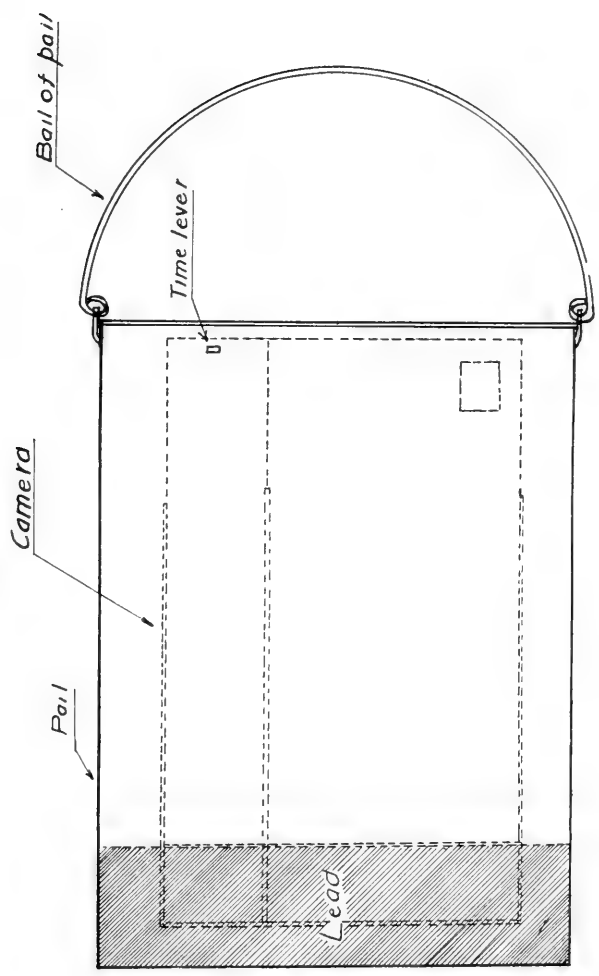
Determinations of the temperature, free oxygen, free and fixed carbon dioxide, were made at the beginning and the end of the observation period, July 28 and August 26. The oxygen was determined by the Winkler method and the temperature was read by means of a thermophone. The results of these readings are shown on graphs attached hereto. (See Fig. 5.)

A pump, with a hose marked off in meters, was used in the collection of the water. The samples of plankton were collected by pumping a quantity of water through a plankton net at the desired depth and then rinsing off with the last stroke into a collecting bottle. This method was used for

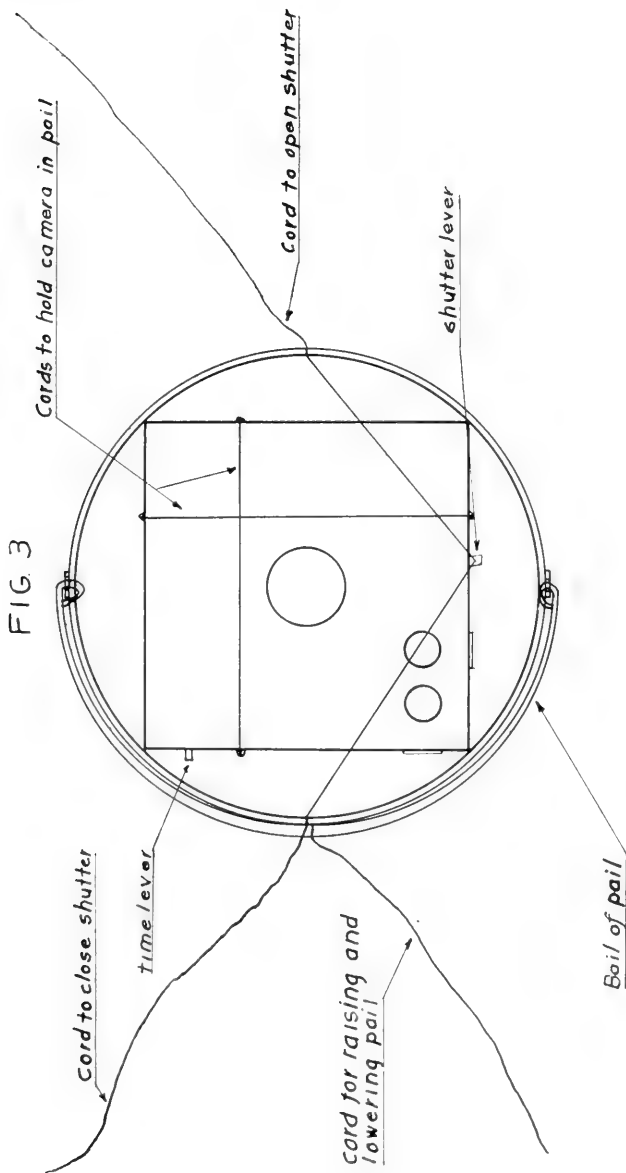


BOTTOM COLLECTING OUTFIT

FIG 2



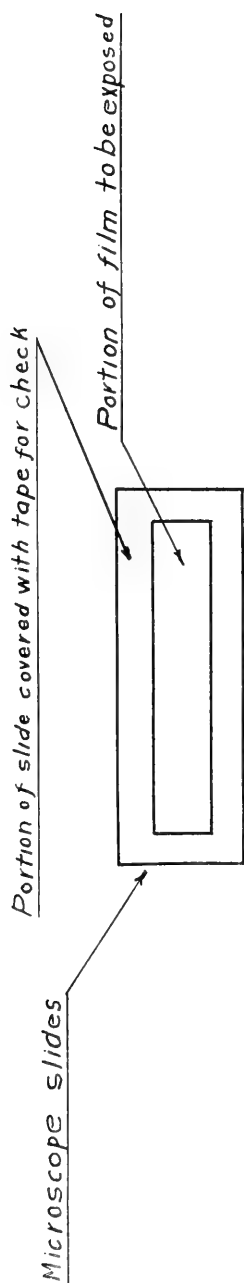
*Side view of under water camera apparatus showing camera in position and means of operating.*



Top view of under water camera apparatus showing camera in position and means of operating.

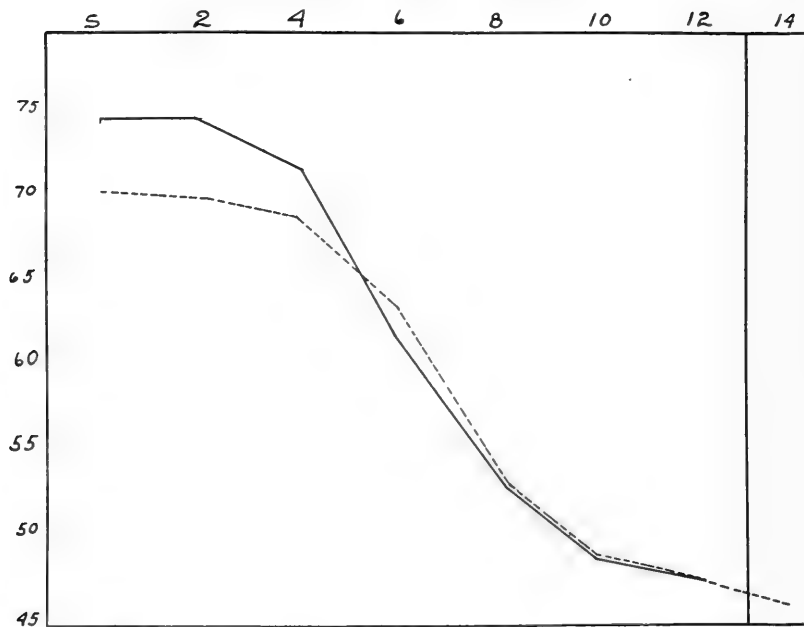


FIG. 4.



Camera plate made of two  
microscope slides with film of  
same size between Edges taped  
to prevent wetting and act as a check

FIG 5  
TEMPERATURE CURVE



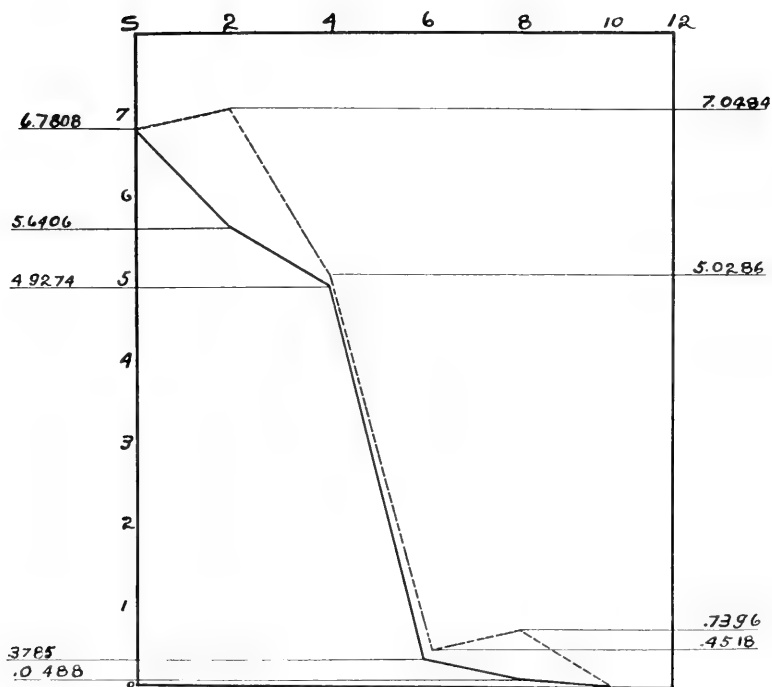
————— READING JULY, 28.

- - - - - READING AUG. 26

READ DEGREES FROM TOP TO BOTTOM.

READ METERS FROM LEFT TO RIGHT.

FIG. 6  
FREE OXYGEN CURVE

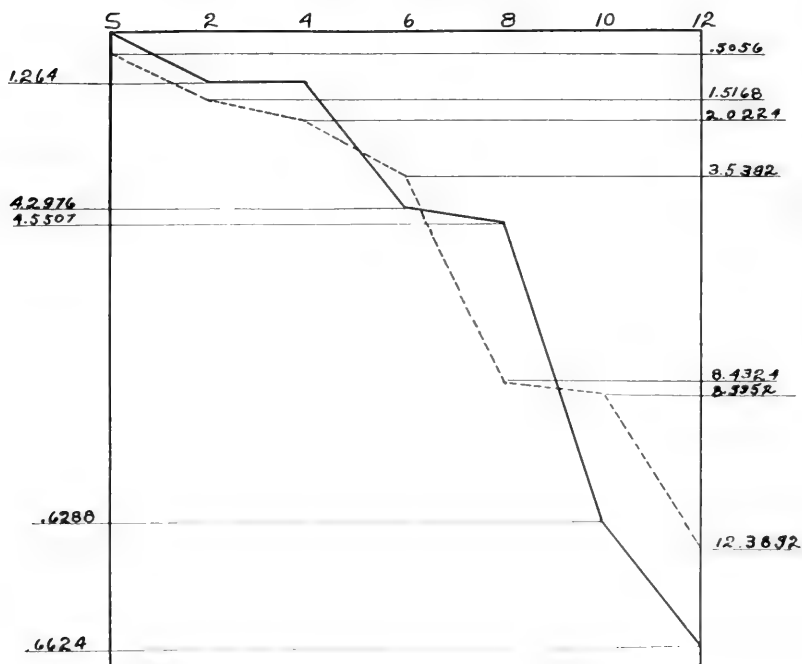


————— READING JULY, 28

----- READING AUG. 29

FIGURES AT TOP REPRESENT METERS DEEP.  
FIGURES AT SIDE REPRESENT C C FREE O. PER LITER

FIG 7

FREE CO<sub>2</sub> CURVE

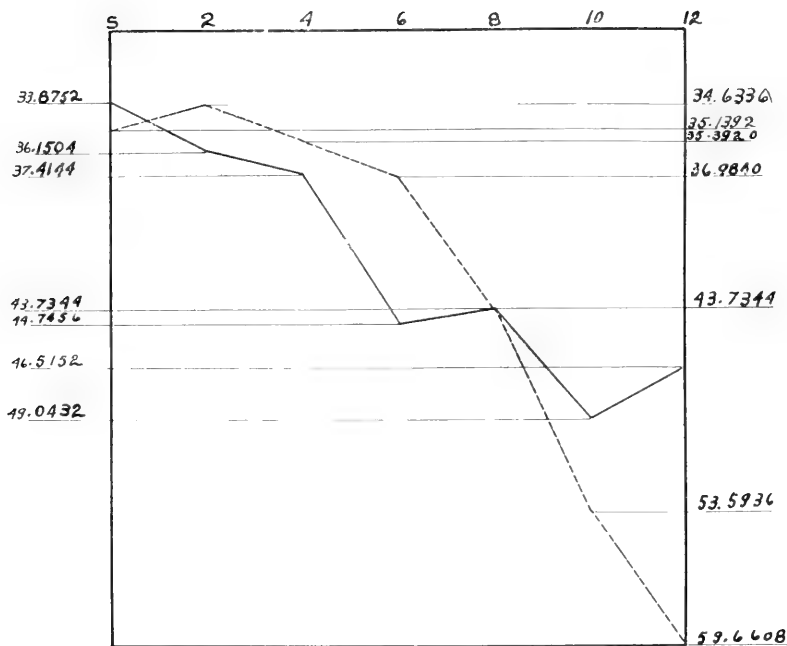
————— READING JULY, 28

- - - - - READING AUG 26

FIGURES AT TOP REPRESENT METERS DEEP

FIGURES AT SIDES REPRESENT CC FREE CO<sub>2</sub> PER LITER

FIG 8  
FIXED CO<sub>2</sub> CURVES



——— READING TAKEN JULY, 28  
 - - - - - READING TAKEN AUG. 26  
 FIGURES AT TOP REPRESENT METERS DEEP  
 FIGURES AT SIDES REPRESENT C C

all but the bottom collection, which was taken in the manner described below and as illustrated by the figures.

A sixteen-ounce reagent bottle (see Fig. 1) with a ground glass stopper was securely fastened to a block of cement weighing approximately 30 lbs. The stopper was so tied that it could be partly pulled out. A strong cord was attached to the neck of the bottle to permit raising and lowering the bottle. A second cord was attached to the stopper so that when the empty bottle was at the bottom the stopper could be pulled as far as its fastenings would permit, allowing the bottle to be filled with the bottom ooze. When the bottle was filled the cord attached to the stopper was loosened, thus allowing it to snap back in place and securely close the bottle, and with the cord around the neck the bottle was drawn to the surface. The stopper and neck of the collecting bottle were rinsed off first with alcohol, then distilled water. The contents were then transferred to smaller reagent bottles, corked and sealed with paraffin to insure their being air tight.

The contents of the collections, especially the bottom collection, were examined microscopically and the plants and animals that seemed alive were listed. As a check, some bottles of the same collection were kept fifteen days in darkness and at approximately the same temperature as the lake bottom. Their contents were then examined and the plants and animals found therein were apparently as active as when first collected. The animals were all seen moving with more or less rapidity, the protozoans quite rapidly, the higher forms not so much so. Their activity increased with exposure to light and air.

From the total examinations made, the following were found, demonstrated to be alive and classified. Nine protozoa, one rotifer, one crustacea, twenty algae and fourteen diatoms.

*Animals Classified after Conn and Webster.*

Protozoa:

Dactylasphaerium radiosum Ehr.

Diffugia globostoma Leidy.

Amoeba proteus Ehr.

Heliozoa:

Actinosphaerium eichornii.

Mastigophora-flagellata:

Peranema sp.(?)

## Ciliata:

*Colpidium* sp.(?)

*Paramoecium Bursaria* Ehr.

*Stentor coeruleus* Ehr.

*Vorticella* sp.(?)

Gastrotrocha: One form belonging to this group was abundant.

## Crustaceae:

Copepoda—

*Cyclops biënspidatus*.

Algae —classified after Conn and Webster.

## Cyanophyceae (Blue-green):

*Oscillatoria subtilissima* Kütz.

*Oscillatoria aeruginoso caerulea*.

*Merismopedia nagelii*.

*Microcystis aeruginoso* Kütz.

*Nostoc rupestre* Kütz.

*Nostoc rupestre* sp.(?)

## Chlorophyceae (Green Algae):

*Scenedesmus caudatus*.

*Pediastrum pertusum* var. *clarthratum* A. Br.

*Pediastrum Boryanum* Turp. (two types).

*Pediastrum Boryanum* Turp. var. *granulatum* Kütz.

*Ulthorix* sp.(?)

*Zygnemeae stellium* var. *genuinum* Kirch.

*Spirogyra variens* (Hass) Kütz.

## Heterokontae (Yellow green):

*Tribonema minus* (Wille) Raz.

## Bacillariaceae (Diatomaceae) classified after Wolle:

*Navicula Sillimanorum* Ehrb.

*Navicula Tabellaria*.

*Navicula Tabellaria* var. *Macilenta*.

*Gomphonema Geminatum* (two types).

*Asterionella Formosa*.

*Asterionella Formosa* var. *Ralfsii* (two types)

*Asterionella Formosa* var. *Bleakeleyi*.

*Asterionella Formosa* var. *Gracillima*.

*Fragalaria Capucina* Desmaz.

*Stephanodiscus Niagara* Ehr. (two types).

Thus far we have established the following: (a) Center Lake, during part of the year, has a region devoid of free oxygen. (b) A number of living organisms are found in it during this time.

Many of these organisms are chlorophyll bearing. This made it desirable to determine, if possible, whether or not any light reached the bottom of this rather turbid lake.

To answer this question a Brownie No. 0 camera, boiled in paraffine to make it impervious to water, was fastened into a pail weighted in the bottom with lead to sink it. (See Fig. 2.) The lever of the shutter was arranged with strings running through opposite sides of the top of the pail (see Fig. 3), so that when the camera was sunk to the desired depth the shutter could be opened, exposing a bit of film arranged between two microscopic slides which were taped around the edges, serving the double purpose of keeping the film dry and acting as a check. (See Fig. 4.)

After an exposure of five minutes, the shutter was closed by means of the other cord and the camera raised to the surface. The film was developed. The exposed part of the film was distinctly darkened, showing that there is some light at the bottom of the lake. The intensity and quality of this light remains to be determined.

#### BIBLIOGRAPHY.

Birge, E. A., and Juday, C.:

(11) The Inland Lakes of Indiana. Wisconsin Survey Bulletin No. 22.

Conn. H. W., and Webster, L. W.:

(08) A Preliminary Report on the Algae of the Fresh Waters of Connecticut. Conn. State Geology & Nat. History Surv., pp. 1-78.

(05) The Protozoa of the Fresh Waters of Connecticut.

Edmondson, C. H.:

(06) The Protozoa of Iowa. Proceedings of the Davenport Academy of Science. Vol. XI, pp. 1-24.

Wolle, F.:

(94) The Diatomaceae of N. A. Comenius Press, Bethlehem, Pa.

Sedgwick, A.:



THE OCCURRENCE OF MORE THAN ONE LEAF  
IN OPHIOGLOSSUM.

It is usually stated that in the Ophioglossales one leaf develops each year. In collecting material of *Ophioglossum vulgatum* near Gary, Ind., during the summer of 1914, it was observed that there was a large proportion of plants with more than one leaf, so a count was made. Of a total of two hundred plants, selected at random, ninety-one had one leaf above ground, one hundred and five had two leaves, and four had three leaves. A similar proportion was found the same year in plants collected in a wood adjoining the Earlham College campus. Material collected during the summers of 1913 and 1915 showed few plants with more than one leaf.

M. S. MARKLE.

Earlham College,  
Richmond, Ind.



## THE PHYTECOLOGY OF PEAT BOGS NEAR RICHMOND, INDIANA.

M. S. MARKLE.

### LITERATURE USED FOR REFERENCE.

(<sup>1</sup>) Transcau, E. N., On the geographical distribution and ecological relations of the bog plant societies of northern North America. *Bot. Gaz.* 36: 401-420, 1908.

(<sup>2</sup>) Leverett, F., The glacial formations and drainage features of the Erie and Ohio basins. *Mon.* 41, U. S. G. S.

(<sup>3</sup>) Dachnowski, M., A cedar bog in central Ohio. *Ohio Naturalist*, 11: No. 1, 1910.

While the peat bog is a common feature of the landscape in northerly latitudes, the presence of a bog as far south as Central Indiana or Ohio excites considerable interest. It is the belief of modern botanists (<sup>1</sup>), that these bogs originated during the period immediately following the glacial period, when the area abutting on the edge of the ice approximated arctic conditions, and gradually emerged from this condition after the recession of the ice. Since the retreat of the ice began at its southern border, areas retaining any of the primitive conditions incident to the original arctic climate increase in rarity southward. In Indiana and Ohio, the Ohio river formed the approximate southern boundary of the ice sheet at the time of its greatest extension; so these bogs are within sixty or seventy miles of the southernmost limit of glacial action and even nearer the edge of the most recent ice sheet. No doubt many bogs formerly existed in central Indiana and Ohio, but, with changed conditions, practically all have disappeared.

The principal features of interest involved in an ecological study of the vegetation of peat bogs are, first, the presence of a large number of xerophytic forms, a situation not to be inferred from the well-watered condition of the habitat; second, the existence of many plants characteristic of arctic and subarctic regions. Little study was made of the anatomy of these xerophytic forms, as they are not nearly so well represented here as in the northern bogs.

The presence of boreal forms may be accounted for as follows: During the glacial period, the flora of the area bordering on the ice was arctic, such a flora having been able to retreat southward before the slowly-advancing ice, and consisted of such forms as were able to withstand the many north-

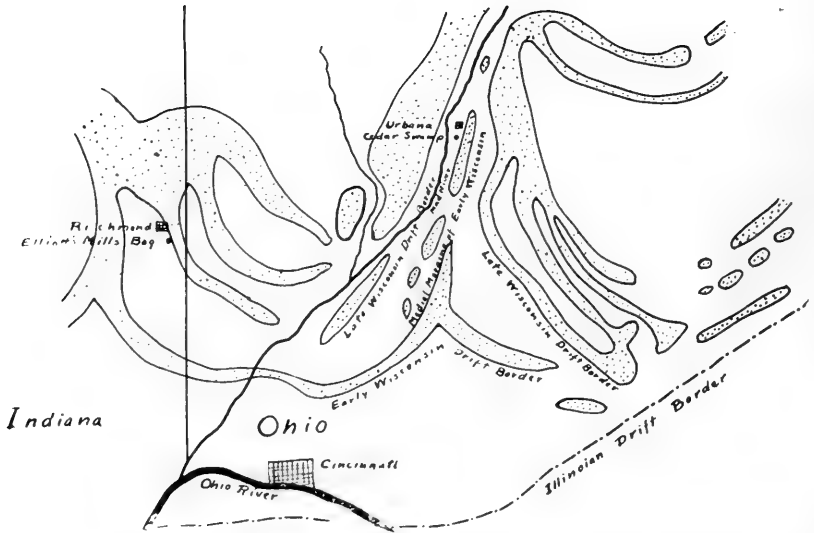


FIG. 1. Map of part of southeastern Indiana and southwestern Ohio, showing glacial moraines of the Early and Late Wisconsin Ice Sheets and the boundary of the Illinoian drift; also the location of the bogs near Richmond, Indiana and Urbana, Ohio. Adapted from Leverett and supplemented by observation.

and-south oscillations of the ice. When the ice finally retreated, the plants followed. As any area became warmer and drier, some species perished. The southern flora, long held in check by the glacier, began to crowd in and where conditions were favorable for its growth, replaced the arctic flora, which remained only in such situations as were unsuitable for the growth of the southern plants, such as bogs and cool, shady ravines. Such places as these are islands of northern plants left in our now southern and south-eastern flora.

The physiographic cycle of a bog differs from that of an ordinary swamp in several particulars; while both are ephemeral features of the landscape, soon being destroyed by sedimentation or by drainage, they differ in the manner in which they are filled; a swamp fills up from the bottom by the gradual accumulation of sediment deposited by incoming streams and that formed by decaying plant and animal matter; while a bog fills largely from the top by the formation, beginning at the edge, of a gradually thickening and settling floating mat of partially decayed vegetation, which is finally capable of supporting a rich flora. Bogs are more likely to develop in undrained or poorly drained depressions, though there are partially drained bogs and undrained swamps.

The glacial age was not a unit, but was characterized by alternate advances and recessions of the ice, repeated no one knows how often. The last few advances were, in general, less extensive than their predecessors, so the terminal moraine of each was not, in every case, destroyed by its successor. The moraines of three of these successive advances of the ice can be distinguished in Ohio (2). The oldest, the Illinoian, extended almost to the Ohio river. The second, the Early Wisconsin, extended nearly as far, and was divided by an elevation of land into two lobes, the Scioto on the east and the Maumee-Miami on the west. The Late Wisconsin sheet followed the same course as did its predecessor. The terminal moraines of the two sheets are roughly parallel. The medial moraine of the two lobes of the Early Wisconsin Sheet was not destroyed by the Late Wisconsin, and the outwash plain between the medial moraine of the Early Wisconsin and the lateral moraine of the Late Wisconsin formed a broad valley, now drained by the Mad river. In this valley is located a bog, known locally as the Cedar Swamp. See accompanying map, Fig. 1.

Cedar Swamp is in Champaign county, Ohio, about five miles south of Urbana. It is between the river and the east bluff of the valley. There is

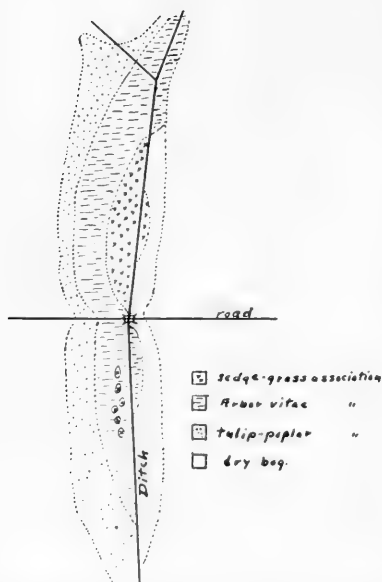


FIG. 2. Map of Cedar Swamp, showing relation of the plant associations. The birch-alder association is not shown.



FIG. 3. Panoramic view of Cedar Swamp, looking northward from near the road. Made from two photographs. Sedge-grass association in foreground, arbor vitae association in background, with birch-alder association between. The sedge-grass association had recently been burned over.

no evidence that it occupies a former bed of the stream. The bog probably occupies what was originally a small lake on the valley floor, fed by springs in the underlying gravel. The former area of the bog was no doubt much greater than its present area, as is shown by extensive outlying deposits of peaty soil. The area of the bog has been greatly reduced during the last few years by artificial means. From natives of the vicinity, it was learned that the bog was formerly much wetter and more impenetrable. A story is told of an "herb-doctor" who entered the bog on a collecting expedition and never returned. A skeleton recently unearthed was supposed to be that of the unfortunate doctor.

The bog is now artificially drained by a large ditch, but the natural drainage was evidently very sluggish.

The bog in its present condition throws no light on the question of the origin of the floating mat of plants characteristic of the earlier stages. Four rather distinct plant associations, representing four stages in the plant succession in a bog formation, are represented here. These are the sedge-grass association, the birch-alder association, the arbor vitae association and the maple-tulip association.

The quaking mat, occupied by the sedge-grass association, has almost disappeared, and exists only in isolated patches, the largest of which is shown on the accompanying map, Fig. 2. One of the smaller patches appears in a photograph, Fig. 7. The areas that are left are quite typical. Walking about over the mat is to be conducted with some caution, especially in the wetter seasons. By jumping on the mat, one can shake it for many feet around. A stick can be thrust down with little resistance to a depth of four to six feet. The burning over of the largest of these areas has destroyed many of the typical plants. The principal species found in the association are as follows:

- Drosera rotundifolia.*
- Parnassia caroliniana.*
- Carex* spp.
- Lophiola aurea.*
- Solidago ohioensis.*
- Solidago Riddellii.*
- Calopogon pulchellus.*
- Liparis Loeselii.*
- Habenaria paramoena.*



FIG. 4. Arbor vitae trees two feet in diameter with the logs upon which they germinated still remaining. The ends of the logs near the trees do not show. The hatchet is stuck in the nearer log. Cedar Swamp.



*Equisetum arvense.*  
*Typha latifolia.*  
*Utricularia minor.*  
*Lobelia Canbyi.*  
*Cardamine bulbosa.*  
*Scirpus americanus.*  
*Geum rivale.*  
*Aspidium thelypteris.*

The birch-alder association occupies the smallest area of any of the associations, since it forms merely a narrow fringe between the areas of quaking mat and the areas occupied by the arbor vitae association. Some of the same plants are found intermingled with the trees and others on the mat. The tendency is for these bordering shrubs gradually to close in upon the mat areas they enclose until the mat is covered. The shrubs may gain a foothold upon higher points in the mat association from which they spread outward. The principal plants of the birch-alder association are as follows:

*Potentilla fruticosa.*  
*Aldus incana.*  
*Betula pumila.*  
*Hypericum prolificum.*  
*Salix cordata.*  
*Physocarpus opulifolius.*  
*Cephalanthus occidentalis.*  
*Steironema quadrifolia.*  
*Silphium terebinthinaceum.*  
*Ulmaria rubra.*  
*Phlox glaberrima.*

By far the largest part of the bog is occupied by the arbor vitae association. The association is noticeable from a distance, on account of the presence of these trees of arbor vitae, or white cedar, which gave the bog its name. Trees two feet in diameter are common. A stump, oblong in cross-section, was found to be twenty feet in circumference and five by eight feet in diameter. The stump was hollow, so that its age could not be determined, but the outer six inches showed about one hundred growth rings, so the tree must have been several hundred years old. Under natural conditions, this association would probably persist for a very long time, as invasion from without goes on very slowly. The Thuyas have very com-



FIG. 5. Stump of an arbor vitae tree 40 years old, and the log upon which it germinated. Cedar Swamp.

plete possession of the habitat. Shade conditions are such as to exclude light-demanding forms. First attempts at photography under the arbor vitae resulted in failures, on account of uniform under exposures. The vegetation of the forest floor is not abundant, except in early spring. The herbs are largely shade-enduring species. The mat of roots and fallen branches and leaves is another factor that deters invasion from without. If the toxicity of the substratum is a factor, it exerts its maximum influence here, under present conditions. Then, too, the plants of the association are reproducing themselves very efficiently, all stages of seedlings and saplings being found. Nearly all the Thuyas germinate on stumps and logs. A specimen four or five inches in diameter and twenty-five feet in height was found growing on a stump four feet high. Even the oldest trees, which must be hundreds of years old, are still grasping in their roots the partially decayed remains of the logs upon which they germinated. The fact that the logs are lying in a position that subjects them to the greatest exposure to decay shows the resistant qualities of arbor vitae wood. The logs shown in the photograph (Fig. 4) are still fairly sound, though the trees which grew upon them are two feet in diameter.

One of the commonest undergrowth shrubs is *Taxus canadensis*, which is here a prostrate, creeping shrub, seldom more than one or two feet in height. No traces of seed formation were observed, but the plant reproduces abundantly by layering. What at first glance seems to be a group of plants is found to be a series of layered branches from a common central plant. This habit is of considerable ecological importance here, since it seems to be the only means of reproduction of the species.

As the accompanying list shows, the arbor vitae association is the habitat of a large number of species of ferns, which form a prominent part of the flora of the association. *Camptosorus* was found in four widely-separated situations, growing luxuriantly upon fallen logs. Plants of *Pteris* more than four feet in height are rather common. *Osmunda cinnamomea* is common, but only two specimens of *O. regalis* were seen. *Botrychium virginianum* is abundant. *Prothallia* of *O. cinnamomea* are common.

A single plant of *Lycopodium lucidulum*, probably the last representative of its species, was found. The disappearance of this species is indicative of what has occurred in the case of many other northern forms and of the eventual fate of those that remain. Another disappearing species is



FIG. 6. A fallen arbor vitae tree, showing shallow rooting. Trees are frequently uprooted. Cedar Swamp.

*Vaccinium corymbosum*, only one specimen of which was seen. The principal species of the association are as follows:

- \**Thuja occidentalis*.
- \**Taxus canadensis*.
- \**Alnus incana*.
- Populus deltoides*.
- \**Populus tremuloides*.
- Rhus vernix*.
- Rhus cotinus*.
- Rhus glabra*.
- Lindera benzoin*.
- Ribes Cynosbati*.
- Rubus idaeus*.
- \**Rubus triflorus*.
- \**Vaccinium corymbosum*.
- Cornus paniculata*.
- Cornus alternifolia*.
- Acer rubrum*
- Pyrus arbutifolia*.
- Ampatiens biflora*.
- Laportea canadensis*.
- Aselepias incarnata*.
- Caltha palustris*.
- Symplocarpus foetidus*.
- Cypripedium parviflorus*.
- Cypripedium hirsutum*.
- Aralia racemosa*.
- Polygonatum biflorum*.
- Dioscorea villosa*.
- Polymnia canadensis*.
- Mitchella repens*.
- Anemonella thalictroides*.
- Anemone quinquefolia*.
- Pedicularis lanceolata*.
- Polemonium reptans*.
- Uvalaria perfoliata*.
- Mitella diphylla*.



FIG. 7. One of the small areas occupied by the sedge-grass association, with *Silphium* and *Typha* in the foreground, and *Thuya* in the background. The birch-alder association is not well developed here. Cedar Swamp.

- Hydrophyllum appendiculatum.*  
*Hydrophyllum virginianum.*  
*Arisema triphylla.*  
*Trillium grandiflorum.*  
*Trillium cernuum.*  
 \**Trientalis americana.*  
 \**Maianthomum canadense.*  
*Senecio aureus.*  
*Botrychium virginianum.*  
*Osmunda regalis.*  
*Osmunda cinnamomea.*  
*Pteris aquilina.*  
*Cystopteris fragilis.*  
*Aspidium spinulosum.*  
*Aspidium cristatum.*  
*Aspidium thelypteris.*  
*Adiantum pedatum.*  
*Anoclea sensibilis.*  
*Camptosorus rhizophyllus.*  
*Asplenium acrosticoides.*  
 \**Lycopodium lucidulum.*

On the west side of the arbor vitae association is an almost undisturbed tree association, differing greatly in composition from that just described. The arbor vitae zone is made up largely of plants of northern origin or plants characteristic of bogs, while the plants of the other group, called the maple-tulip association, are those typical of the climax mesophytic forest of the region and are distinctly southern in their origin. A comparison of the distribution of the more distinctly boreal forms of the arbor vitae association, indicated thus (\*) in the list, with those given below for the maple-tulip association, will make the difference in origin very striking. Practically all these boreal forms occur outside the limits of distribution given by the best manuals. The beech is usually a member of the climax mesophytic forest of this region, but since for some reason it is absent from all the forests of this vicinity for several miles around, it is also absent in the bog. The principal trees of the maple-tulip association follow:

*Liriodendron tulipifera*.  
*Acer saccharinum*.  
*Acer rubrum*.  
*Fraxinus nigra*.  
*Fraxinus americana*.  
*Juglans cinera*.  
*Ulmus americana*.  
*Ulmus racemosa*.  
*Platanus occidentalis*.  
*Lindera benzoin*.  
*Xanthoxylum americanum*.  
*Pilea pumila*.  
*Urticastrum* sp.  
*Thalictrum dasycarpum*.

We have in the cedar swamp a formation of plants of a decidedly boreal aspect, maintaining itself, but for the influence of man, in the midst of a flora predominantly southern. Ability to maintain itself in the struggle with the southern flora was probably due originally to differences in the habitat. Just what the factors are that make bog conditions unsuitable for the growth of most plants have not been fully determined; but some combination of edaphic conditions permitted the northern plants to remain and removed them very largely from competition with the southern forms. In the later stages of the development of the bog, many of these conditions have probably been modified or removed. Many of the southern plants could undoubtedly maintain themselves under the present conditions; but the bog plants have such complete possession of the habitat that invasion is practically precluded. But for the influence of man, the formation would no doubt have been able to maintain itself for many centuries to come.

About two miles southeast of Richmond, Ind., lies a small remnant of a formerly much more extensive peat bog. It is known as the Elliott's Mills bog and is in such an advanced state in the physiographic cycle of bogs that little resemblance to a typical bog remains. But the characteristic peat soil and the presence of certain bog and boreal plants indicate its former character. The bog lies in a broad, shallow valley between morainic hills. It evidently occupies a shallow, undrained depression scooped out in a softer part of the underlying Niagara limestone. The bog is crossed by a public



highway and is now drained by the roadside ditch. It was necessary to blast through rock in order to get an outlet for the bog, showing that it is a rockbound depression. Tile drains from the bog carry streams of cold water throughout the year. Galleries supplying part of the water for the city of Richmond occupy a drier part of the bog.

The very advanced state of the bog is due, no doubt, to its nearness to the southern limit of glaciation and its consequent great age. Few typical bog plants remain. The following, however, are more or less characteristic of bogs: *Rhus vernix*, *Salix pedicellaris*, *Hypericum prolificum*, *Parnassia caroliniana*, *Potentilla fruticosa*. Only one specimen of *Rhus vernix* remains and it is dying—a fate typical of that of many bog plants which must formerly have existed here.

Nearly all boreal forms have likewise disappeared. The following species have a range reaching far into the north: *Potentilla fruticosa*, *Salix rostrata*, *Populus tremuloides*. Only one specimen of *Salix rostrata* was found. No other specimen is known in the region. *Populus tremuloides* occurs sparingly thru central Indiana, but is common in the bog.

A very striking fact is the presence of a large number of species characteristic of prairies. This is somewhat strange when it is remembered that the prairie is a formation not at all characteristic of eastern Indiana, which was originally heavily forested. Eastern Indiana is, however, not far from the tension line between the forest formation characteristic of the east and southeast and the prairie formation characteristic of the west and southwest. No doubt after the retreat of the glacial ice there was a migration of plants of both of these formations and a consequent struggle between them for the possession of the new territory. In some instances the pond-swamp-prairie succession or the pond-bog-prairie succession may have occurred, while in other cases the pond-swamp-forest or the pond-bog-forest succession may have taken place. The last named is the succession that occurred at Cedar Swamp. In Eastern Indiana, the condition that finally prevailed over the entire area was the mesophytic forest, but it is not likely that the patches that may have followed the succession toward the prairie would have entirely disappeared. This hypothesis would account for such islands of prairie plants in a forested area as we find in this bog. This is not an isolated case, for other such situations are found in eastern Indiana and western Ohio and are known locally as "quaking prairies." The writer hopes to make further studies of these areas.

The following plants occur in the Elliott's Mills bog:

- Rhus vernix.*
- Cornus stolonifera.*
- Potentilla fruticosa.*
- Parnassia caroliniana.*
- Hypericum prolificum.*
- Salix pedicellaris.*
- Salix rostrata.*
- Gerardia paupercula.*
- Populus tremuloides.*
- Aster Nova-Angliae.*
- Aster oblongifolius.*
- Phlox glaberrima.*
- Physostegia virginica.*
- Ulmaria rubra.*
- Solidago ohioensis.*
- Solidago Ridellii.*
- Solidago stricta.*
- Solidago rugosa.*
- Rudbeckia hirta.*
- Desmodium paniculata.*
- Monarda fistulosa.*
- Rosa setigera.*
- Koellia virginica.*
- Chelone glabra.*
- Cirsium muticum.*
- Salix nigra.*
- Salix cordata.*
- Lobelia siphilitica.*
- Lobelia Kalmii.*
- Aspidium thelypteris.*
- Selaginella apus.*
- Physocarpus opulifolius.*
- Inula Helenium.*
- Geum canadense.*
- Symplocarpus foetidus.*
- Eupatorium perfoliatum.*

*Eupatorium purpureum*.

*Sagittaria latifolia*.

*Alisma plantago*.

*Carex* spp.

*Cuscuta* sp.

*Ludwigia palustris*.

*Bidens trichosperma*.

*Oxypolis rigidior*.

*Campanula americana*.

M. S. MARKLE.

Earlham College,  
Richmond, Ind.



## A REPORT ON THE LAKES OF THE TIPPECANOE BASIN.\*

---

WILL SCOTT.

---

This paper presents the first section of the results of the survey of the Indiana lakes. The lakes herein described all lie in the Tippecanoe basin. This basin contains 1,890 square miles. The plan of the survey has been to construct a hydrographic map of the lakes; and to determine at critical levels the temperature together with the amount of oxygen, free carbon-dioxide, carbonates and plankton.

The following lakes have been mapped: Manitou, Yellow Creek, Beaver Dam, Silver, Plew, Sawmill, Irish, Kuhn, Hammon, Dan Kuhn and Ridinger.

Gas determinations and plankton collections have been made in the following lakes: Manitou, Yellow Creek, Pike, Eagle (Winona), Little Eagle (Chapman), Tippecanoe, Plew, Hammon (Big Barbee).

All of the lakes in this basin have been caused by irregularities in the great Erie-Saginaw interlobate moraine which was formed by the Erie and Huron-Saginaw lobes of the Wisconsin ice sheet. The basins are either kettle holes, irregularities in the ground moraine, channel lakes, or a combination of these.

In the lakes that we have mapped the area varies from 85,084 sq. M. in Sawmill lake to 3,265,607 sq. M. in Manitou. The volume varies from 284,716 cu. M. in the former to 9,787,024 cu. M. in the latter. Their maximum depth varies from 7.9 M. in Dan Kuhn lake to 22 M. in Yellow Creek lake. The average depth of Dan Kuhn lake is 2.588 M. and that of Yellow Creek lake is 10 M. These are the maximum and the minimum for the lakes mapped.

The bottom temperatures vary from 5.3° C. in Tippecanoe lake to 15° C. in Little Eagle (Chapman). The amount of wind distributed heat (i. e. in excess of 4° C.) has been calculated in gram calories per square centimeter of surface. This varies from 5,361 gram calories in Manitou to 10,563 calories in Yellow Creek lake.

The oxygen is always abundant in the epilimnion. In six observations it was found to exceed the saturation point at one or more levels. The

---

\*A complete report of this work, with maps, tables, and other data, will be published as the July number of the Indiana University Studies for 1916.

oxygen is always reduced in the hypolimnion. The following lakes have no free oxygen in their lower levels: Hammon, Lingle, Little Eagle, Pike, Center and Webster.

All lakes that have been examined are hard water lakes. The maximum amount of carbon dioxide as carbonates varies in the different lakes from 27 cc. per liter to 60 cc. per liter. They are all increasingly acid in their lower levels, but in the epilimnion they are sometimes alkaline. This is due to photosynthesis.

The above statements in this discussion apply only to summer conditions.

No very general correlation has been found between the plankton and the dissolved gases. Some of the lakes are much richer in plankton than others. It seems probable at the present stage of the investigation that this is related to, and possibly caused by the varying amount of phanerogams that are produced in their littoral region.

# A LIST OF PLANT DISEASES OF ECONOMIC IMPORTANCE IN INDIANA WITH BIBLIOGRAPHY.

F. J. PIPAL.

## INTRODUCTION.

Plant diseases cost Indiana considerably more every year than the maintenance of all public schools in the State. In other words, they exact an annual tax of over \$15,000,000. The loss on the grain crops alone amounts to about \$11,000,000. The above estimates are based upon the results of the experimental and demonstrational work conducted for a number of years with grain smuts over a large section of the state, upon special reports from coöperators in plant disease survey, general correspondence, and personal investigations and observations by the members of the Botanical and other departments of the Agricultural Experiment Station.

A considerable proportion of this damage to growing crops can be readily and cheaply prevented by employing certain well-established, precautionary measures. This has been clearly demonstrated in the disinfection of seed grain by the formaldehyde treatment and in the spraying of fruit trees. Other effective sanitary measures and methods of control are available, which, if put into practice, will save yearly a neat sum of money.

It is highly desirable, therefore, that Indiana farmers realize these facts and avail themselves of the knowledge regarding plant diseases and their control. A greater interest of the farmer in this phase of work will also add stimulus to further and more extensive investigations of plant diseases so that new and more practical measures of prevention and control can be evolved and made available for general practice.

In order to bring together the accumulated information regarding the plant diseases that occur within the State the writer has made an attempt in this paper to present a list and a bibliography of plant diseases in Indiana. It is far from complete, however, and when a thorough survey is completed many additions will be made to it. This list is merely intended to serve as a foundation for plant disease surveys to be made in the future.

With a few exceptions the list includes all plant diseases that have been reported heretofore in various publications, and other diseases of which

specimens have been collected or received from correspondents by former and present members of the Department of Botany, Indiana Agricultural Experimental Station, or by Professor G. N. Hoffer, of the School of Science, Purdue University. Unless otherwise stated in the list the specimens are in the phytopathological collection of the Station Department of Botany, or in the collection of Professor Hoffer. The distribution of the diseases is given either by counties, together with the dates of collections when known; or by sections of the State in which they are prevalent. If they occur generally over the State they are mentioned as common.

The bibliography includes articles written by Indiana workers and pertaining to Indiana plant diseases, published mostly in the bulletins and reports of the Indiana Agricultural Experiment Station, Proceedings of the Indiana Academy of Science, Transactions of the Indiana Horticultural Society, and the Annual Reports of the State Entomologist. It also includes several papers presented at meetings by out-of-state scientists, but pertaining to diseases common to Indiana and printed in the State publications. References to the articles dealing with the diseases mentioned in the following list are given by number, in the chronological order in which they were published.

In order to make the plant disease survey as complete as possible, cooperation is solicited, and the Department of Botany, Agricultural Experiment Station, Lafayette, will be pleased to receive specimens, especially of the less common or unreported diseases. Any valuable information as to the prevalence of such diseases, the extent of damage caused, relation to weather conditions, etc., will also be appreciated.

The writer wishes to express his gratitude to Prof. H. S. Jackson, Chief of the Department of Botany, Indiana Agricultural Experiment Station, for valuable advice and assistance in the preparation of this list.



## LIST OF DISEASES.

**Alfalfa (*Medicago sativa* L.)**

Downey Mildew, *Peronospora Trifoliorum* DeB. Tippecanoe, 1915.

Leaf Spot, *Pseudopeziza Medicaginis* (Lib.) Sacc. Common. 78.

Rust, *Uromyces Medicaginis* Pass. Putnam, 1907.

Violet Root Rot, *Rhizoctonia Crocorum* (Pers.) DC. Referred to formerly as *R. Medicaginis* D.C. St. Joseph, 1915. County agent, J. S. Bordner, reported a number of affected spots in one field, each spot being as much as 10 feet across and enlarging at the rate of 1 foot every 30 days during the growing season. So far as known to the writer this disease has been reported on alfalfa only from Nebraska, Kansas and Virginia.

Wilt, *Sclerotinia Trifoliorum* Eriks. Clark, Fulton and Henry, 1914. Especially prevalent in Clark county.

**Apple (*Pyrus Malus* L.)**

Bitter Pit (cause physiological). Common on Baldwin variety. Baldwin Fruit Spot, caused by *Cylindrosporium Pomi*, has been reported but no definite determination of it has yet been made. References to Baldwin Fruit Spot: 58, 59, 84, 36.

Bitter Rot, *Glomerella rufomaculans* (Berk.) Spaul. and von Sehr. Prevalent in the southern half of the State. 46, 76, 78, 57, 58, 84, 100, 36, 40.

Black Rot, *Sphaeropsis Malorum* Peck. Shear's studies indicate genetic connection with Melanops. Prevalent in the southern half of the State. 78, 58, 59, 84, 100, 67, 36, 40, 117.

Blister Canker, *Nummularia discreta* (Schw.) Tul. Becoming serious in the southern part of the State. 36, 40, 39, 117, 86.

Blotch, *Phyllosticta solitaria* E. & E. Common. 78, 58, 59, 84, 37, 40.

Brown Rot, *Sclerotinia cinerea* (Bon.) Wor. Common. 58, 59, 84.

Crown Gall, *Pseudomonas tumefaciens* E. F. Smith & Towns. Reported serious occasionally on nursery stock. 57, 59, 84, 36.

European Canker, *Nectria ditissima* Tul. Found injurious to nursery stock. 57, 58, 59.

Fire Blight, *Bacillus amylovorus* (Burr.) DeToni. Common. 76, 78, 57, 58, 59, 34, 36, 38, 117, 62. See also under Pear.

Fly Speck, *Leptothyrium Pomi*. (Mont. & Fr.) Sacc. Usually found together with sooty blotch. 78, 58, 84, 36, 40.

Jonathan Fruit Spot (cause unknown). Serious on Jonathan apples in storage.

Leaf Spot, *Phyllosticta limitata* Pk. Tippecanoe, 1915.

*Pestalozzia concentrica* B. & Br. Monroe, Franklin and Martin, 1912.

Mildew, *Podosphaera oxyacanthae* (D.C.) DeB. Floyd, 1906, and *Podosphaera leucotrichia* (E. & E.) Salm. Sullivan, 1915. 84.

Pink Rot, *Cephalothecium roseum* Cda. Common. 58, 84.

Root Rot, *Clitocybe parasitica* Wilcox and *Armillaria mellea* (Vahl.) Qual. Serious in some orchards in the southern counties.

Rust, *Gymnosporangium Juniperi-virginianae* Schw. Common. 133, 94, 78, 57, 58, 84, 100, 36, 40, 39, 117.

Scab, *Venturia inaequalis* (Fr.) Wint. Common. 76, 78, 57, 58, 84, 59, 100, 36, 40, 39.

Soft Rot, *Penicillium* spp. Common. 58, 59, 84.

Sooty Blotch, *Phyllachora pomigena* (Schw.) Sacc. Most abundant in unusually moist seasons and in damp situations. 78, 58, 84, 36, 40.

Trunk Rot, *Fomes applanatus* (Pers.) Wallr. Kosciusko, 1914.

#### Ash (*Fraxinus* spp.)

Mildew, *Phyllactinia corylea* (Pers.) Karst. Johnson, 1890. Montgomery and Putnam, 1893. 132.

White Heart Rot, *Fomes fraxinophilus* Peck. 132, 71.

#### Asparagus (*Asparagus* sp.)

Rust, *Puccinia Asparagi* D.C. Rather common. 110, 21, 142, 76, 77, 136, 25.

#### Aster, Chinese (*Callistephus hortensis* Cass.)

Fusarium Wilt, *Fusarium* sp. Tippecanoe, 1912; Clinton, 1914; Allen and Marion, 1915.

Rust, *Coleosporium Solidaginis* (Schw.) Thum. Jefferson, 1914.

**Barley (*Hordeum* sp.)**

Black Stem Rust, *Puccinia poeciliformis* (Pers.) Wettst. Common.

Covered Smut, *Ustilago Hordei* (Pers.) Kell. & Sw. Rather common.  
132, 42.

Loose Smut, *Ustilago nuda* (Jens.) Kell. & Sw. Rather common.

Stripe Disease, *Helminthosporium gramineum* (Rag.) Erik. Tippecanoe,  
1910.

**Bean (*Phaseolus vulgaris* L.)**

Anthracnose, *Colletotrichum Lindemuthianum* (Sacc. & Magn.) Bri. &  
Cav. Common. 78, 128.

Rust, *Uromyces appendiculatus* (Pers.) Lev. Common. 132, 142, 78.

Stem Rot, *Corticium vagum* B. & C. var. *Solani* Burt. Laporte, 1911.

**Beech (*Fagus* sp.)**

Heart Rot, *Steccherinum septentrionale* (Fr.) Banker. Rather common.  
132, 71.

Leaf Spot, *Phyllosticta faginea* Pk. Monroe, 1909. 137.

Mildew, *Microsphaera Alni* (D.C.) Wint. Johnson, 1890. 132.

**Beet (*Beta vulgaris* L.)**

Bacterial Disease. While the cause of this disease has been ascribed to a bacterial origin, the matter has not been definitely settled. The general characteristics of the diseased plants are similar to those caused by the curly top disease described by Townsend (U. S. Dept. of Agr. B. P. I. Bul. 122). The curly top disease, however, appears to be caused, as indicated by Shaw (U. S. Dept. of Agr. B. P. I. Bul. 181) and Ball (U. S. Dept. of Agr. Bur. Ent. Bul. 66), by the beet leafhopper (*Eutettix tenella*). As this insect is claimed to be confined to the southern states and therefore is not likely to be found in Indiana, it is doubtful if the Indiana disease is the same as the curly top. 65,  
31, 55.

Leaf Blight, *Cercospora beticola* Sacc. Probably common. 128, 78.

Leaf Spot, *Septoria Betae* West. Tippecanoe, 1896.

Scab, *Oospora scabies* Thaxter. Common. 65, 31.

**Birch, Yellow (*Betula lutea* Michx. f.)**

Rust, *Melampsorium betulinum* (Pers.) Kleb. Steuben, 1913. 25.

**Blackberry (*Rubus* spp.)**

Anthraxnose, *Gloeosporium venctum* Speg. Burkholder reported genetic connection with *Plectodiscella*. Common. 128, 78, 57, 36, 40.

Crown Gall, *Pseudomonas tumefaciens* E. F. Smith and Townsend.

Rather serious in some localities. 76, 57, 40.

Leaf Spot, *Septoria Rubi* West. Common. 78, 40.

Rust, *Gymnoconia interstitialis* (Schlecht.) Lagh. Common. 64, 128,

142, 78, 57, 36. *Puccinia Peckiana* Howe. Tippecanoe, 1895.

*Kuehneola Uredinis* (Link) Arthur. Common.

**Blue-grass (*Poa pratensis* L.)**

Anthraxnose, *Colletotrichum cereale* Manns. Tippecanoe, 1914.

Leaf Spot, *Scoletotrichum graminis* Fekl. Johnson, 1890. 132.

Mildew, *Erysiphe graminis* D.C. Common in wet seasons. 132.

Rust, *Puccinia epiphylla* (L.) Wettst. Common. 132.

Slime Mold, *Physarum cinereum* (Batsch) Pers. Tippecanoe, 1913.

Marion, 1915.

**Cabbage (*Brassica oleracea* L.)**

Black Leg, *Phoma oleracea* Sacc. Elkhart, 1915. Large percentage of the crop in two fields was severely affected.

Black Rot, *Pseudomonas campestris* (Pammel) E. F. Smith. Common.

108, 76, 78, 42.

Club-root, *Plasmodiophora Brassicae* Wor. Rather common. 77.

Drop, *Sclerotinia libertiana* Fekl. Tippecanoe, 1915. No specimen preserved.

Leaf Blight, *Alternaria Brassicae* (Berk.) Sacc. Clark, 1908. One field almost ruined. No specimen preserved.

Wilt or Yellows, *Fusarium conglutinans* Wr. Pike and Decatur, 1914.

**Canteloupe (*Cucumis Melo* L.)**

Anthraxnose, *Colletotrichum Lagenerium* (Pass.) Ell. & Halls. Becoming common. 78.

Leaf Blight, *Alternaria Brassicae* (Berk.) Sacc. Common. 123, 78, 144.  
 Wilt, *Bacillus tracheiphilus* E. F. Smith. Very serious in many localities.  
 76, 78, 144.

#### Carnation (*Dianthus Caryophyllus* L.)

Bacteriosis, *Bacterium Dianthi* Arth. & Boll. Serious in greenhouses.  
 30.  
 Bud Rot, *Sporotrichum anthophilum* Peck. Marion, 1909. 58.  
 Leaf Spot, *Alternaria Dianthi* S. & H. Monroe, 1912. 138.  
 Rust, *Uromyces caryophyllinus* (Schrank) Wint. Common. 132, 138.

#### Catalpa (*Catalpa* spp.)

Heart Rot, *Collybia velutipes* Fr. and *Polyporus versicolor* Fr. Tippecanoe,  
 1913. 71.  
 Leaf Spot, *Cladosporium* sp. Common. 58. *Macrosporium Catalpae*  
 Ell. & Mart., Koseiusko, 1914, and *Phyllosticta Catalpae* Ell. & Mart.,  
 Koseiusko, 1914. 71.  
 Mildew, *Microsphaera vaccinii* (Schw.) Salm. Reported as *Microsphaera*  
*elevata* Burrill. Putnam, 1891. Owen, 1893. Tippecanoe, 1890.  
*Phyllactinia suffulata* (Reb.) Sacc. Montgomery, 1893. 132.

#### Cauliflower (*Brassica oleracea* L. var. *botrytis* D. C.)

Black Rot, *Pseudomonas campestris* (Pammel) E. F. Smith. No locality  
 mentioned. 77.

#### Celery (*Apium graveolens* L.)

Leaf Spot, *Septoria Petroselini* Desm. var. *Apii*. Br. & Cav. Tippecanoe,  
 1915. *Cercospora Apii* Fr. Marshall and St. Joseph, 1915.

#### Cherry (*Prunus* spp.)

Black Knot, *Plowrightia morbosa* (Schw.) Sacc. Common. 127, 10, 130,  
 57, 36, 40, 117.  
 Brown Rot, *Sclerotinia cinerea* (Bon.) Wor. Common. 57, 58, 36, 40.  
 Leaf Spot, *Cylindrosporium Padi* Karst. Higgins has reported genetic  
 relation with *Coccomyces hiemalis* Higgins. Common. 78, 57, 36,  
 38, 40.  
 Powdery Mildew, *Podosphaera oxycanthae* (D.C.) DeB. Common.  
 Scab. *Venturia cerasi* Aderh. Koseiusko, 1913.

**Chestnut (*Castanea* spp.)**

Blight, *Endothia parasitica* (Murrill) Anders. Marion and Benton, 1915.  
 Leaf Spot, *Mycosphaerella maculiformis* (Pers.) Schw. Martin, 1915.

**Chrysanthemum (*Chrysanthemum* spp.)**

Rust, *Puccinia Chrysanthemi* Roze. Tippecanoe, 1900. 24.

**Clover (*Trifolium* spp.)**

Anthraxnose, *Colletotrichum Trifolii* Bain. Monroe, 1908, on red clover.

137. *Gloeosporium caulivorum* Kirchner. Tippecanoe, 1915, on red clover.

Black Mold, *Phyllachora Trifolii* (Pers.) Fekl. Johnson, 1890, on red clover. 132.

Rust, *Uromyces fallens* (Desm.) Kern and *Uromyces Trifolii* (Hedw.) Lev. Common. 132, 25, 142, 98.

Sooty Spot, *Polythyrium Trifolii* Kze. Franklin, 1912, on red and white clover.

Wilt, *Sclerotinia Trifoliorum* Eriks. Gibson, 1915, on red and crimson clover.

**Corn (*Zea Mays* L.)**

Dry Rot, *Fusarium* sp. Common. 77, 78.

Rust, *Puccinia Sorghi* Schw. Common. 132, 142.

Smut, *Ustilago Zeae* (Beckm.) Ung. Common. 49, 12, 56, 107, 33, 111, 113, 45, 76, 78.

**Cucumber (*Cucumis sativus* L.)**

Angular Leaf Spot, *Bacterium lachrymans*. E. F. Smith & Bryan. Pulaski, Marshall and Fulton, 1915.

Anthraxnose, *Colletotrichum Lagenerium* (Pass.) Ell. & Hals. Marshall, Laporte, St. Joseph, Starke, Pulaski and Fulton, 1915.

Bacterial Wilt, *Bacillus tracheiphilus* E. F. Smith. Marshall, Tippecanoe, Laporte, Fulton, Starke, Pulaski and St. Joseph, 1915.

Downy Mildew, *Peronosplasmopara cubensis* (B. & C.) Clinton. Marshall, 1915.

Powdery Mildew, *Erysiphe Cichoracearum* D.C. Marshall, 1915.  
 White Pickle or Mosaic Disease (cause not known). Marshall, Laporte,  
 Tippecanoe, Fulton, Pulaski, St. Joseph and Starke. 1915.

**Current (*Ribes* spp.)**

Anthracnose, *Pseudopeziza Ribis* Kleb. Rather common. 138, 40.  
 Leaf Spot, *Septoria Ribis* Desm. Common. 78, 40.  
 Powdery Mildew, *Sphaerotheca Mors-uvae* (Schwein.) Berk. & Curt.  
 Common. 40.

**Eggplant (*Solanum Melongena* L.)**

Leaf Spot, *Ascochyta Lycopersici* Brun. Tippecanoe, 1915.

**Elm (*Ulmus* spp.)**

Leaf Spot, *Mycosphaerella Ulmi* Kleb. Johnson, 1890. *Dothidella  
 ulmea* (Schw.) E. & E. Montgomery, 1893. Koseiusko, 1912. 132,  
 135, 71.  
 Mildew, *Uncinula macrospora* Pk. Rather common. 132.  
 Rot, *Pleurotus ulmarius* Bull. Common. 71.

**Ginseng (*Panax quinquefolium* L.)**

Wilt, *Acrostalagmus albus* Preuss. Brown, 1909. 58.

**Gooseberry (*Ribes grossularia* L.)**

Anthracnose, *Pseudopeziza Ribis* Kleb. Becoming common. 40.  
 Leaf Spot, *Septoria Ribis* Desm. Common. 78, 138, 40.  
 Mildew, *Sphaerotheca Mors-uvae* (Schw.) Berk. & Curt. Common. 128,  
 78, 40.

**Grape (*Vitis* spp.)**

Anthracnose, *Gloeosporium ampelophagum* Sacc. Rather common. 58,  
 60, 36, 40.  
 Black Rot, *Guignardia Bidwellii* (Ell.) Viala & Ravaz. Common. 8,  
 128, 78, 60, 36, 40.  
 Crown Gall, *Pseudomonas tumefaciens* E. F. Smith & Towns. No locality  
 mentioned. 38.

- Downy Mildew, *Plasmopara viticola* (B. & C.) Berl. & DeToni. Common. 132, 58, 60, 36, 40.  
 Powdery Mildew, *Uncinula necator* (Schw.) Bull. Common. 8, 127, 36, 40.  
 Necrosis, *Fusicoccum viticolum* Red. Tipton, 1907. 60.

#### Hickory (*Hicoria* spp.)

- Leaf Spot, *Bacterium* sp. Common. 71.  
*Marsonia* sp. Koseiusko, 1913.  
 Mildew, *Microsphaera Alni* (D.C.) Wint. Johnson, 1890; Marshall, 1893. 132.  
 Root Rot, *Armillaria mellea* Vahl. Tippecanoe, 1915. 71.

#### Hollyhock (*Althaea rosea* Cav.)

- Rust, *Puccinia malvacearum* Mont. St. Joseph, Montgomery, Marshall, Huntington, Marion, and Tippecanoe, 1915.

#### Horse Chesnut (*Aesculus Hippocastanum* L.)

- Mildew, *Uncinula flexuosa* Pk. Johnson, 1890; Montgomery. 132.

#### Japanese Ivy (*Ampelopsis tricuspidata* Sieb. & Zucc.)

- Cladosporium Wilt, *Cladosporium herbarum* Link. Tippecanoe, 1914.

#### Lettuce (*Lactuca sativa* L.)

- Downy Mildew, *Bremia Lactucae* Regel. Found frequently in greenhouses. 143.  
 Drop, *Sclerotinia libertiana* Fekl. Common in greenhouses.  
 Leaf Spot, *Septoria Lactucae* Pass. Johnson, 1890. Koseiusko, 1913. 132.

#### Lilac (*Syringa vulgaris* L.)

- Mildew, *Microsphaera Alni* (Wollr.) Wint. Common. 102.

#### Linden (*Tilia americana* L.)

- Mildew, *Uncinula Clintonii* Peck. Montgomery, 1890; Putnam, 1893. 132.



**Locust, Black (*Robinia Pseudacacia* L.)**

Yellow Heart Rot, *Fomes rimosus* Berk. Rather common. 71.

**Locust, Honey (*Gleditsia triacanthos* L.)**

Leaf Spot, *Melasmia hypophylla* Sacc. Marion, 1890; Tippecanoe, 1892; Putnam, 1893. 132.

Mildew, *Microsphaera Alni* (Wallr.) Wint. Common. 71.

**Maple (*Acer* spp.)**

Anthraxnose, *Gloeosporium apocryptum* E. & E. Marion, Floyd, Vanderburg and Boone, 1914. 39.

Bark Canker, *Schizophyllum commune* Fr. Rather common. 71.

Canker, *Nectria cinnabarina* (Tode) Fr. Carroll, 1913. 71.

Leaf Spot, *Phleospora Aceris* Lib. Johnson, 1890, on red maple. *Stagonospora collapsa* (C. & E.) Sacc. Putnam, 1893, on soft maple. 132.

Leaf Tar Spot, *Rhytisma acerina* (Pers.) Fr. Common in some localities. 132, 137, 39, 71.

Mildew, *Uncinula circinata* C. & P. Montgomery, 1885; Johnson, 1890; Marshall, 1893, on red and soft maple. 132, 102.

Sun Scald. This trouble, thought to be due to drouth and storm injury has been quite prevalent over the State during the past few seasons. 38, 39.

White Heart Rot, *Fomes igniarius* (L.) Gillet. Common. 71.

White Rot, *Polyporus squamosus* (Huds.) Fr. Tippecanoe. 71.

**Millet (*Chaetochloa italica* (L.) Scribn.)**

Smut, *Ustilago Crameri* Koern. Rather common but not serious. 112.

**Oak (*Quercus* spp.)**

Leaf Spot, *Ceratophorum uncinatum* (Cl. & Pk.) Sacc. Johnson, 1890, on bur-oak. *Didymella lephosphora* Sacc. & Speg. Monroe, 1911, on red oak. *Gloeosporium septorioides* Sacc. Montgomery, 1890; Monroe, 1909, on red oak. *Marsonia Martini* Sacc. & Ell. Common on several species. *Phyllosticta Quercus* Sacc. & Speg. Montgomery, 1893, on bur-oak. 132, 137, 71.

Brown Heart Rot, *Fomes Everhartii* Ell. & Gall. = (*Pyropolyporus Everhartii* (Ell. & Gall.) Murrill). Common in the northern counties. 71.

Mildew, *Microsphaera Alni* (Wallr.) Wint. Frequently on leaves of coppice growth of red and white oaks. *Phyllactinia suffulta* (Reb.) Sacc. Shelby, 1890; Vigo, 1893, on swamp and red oaks. 132, 71.

Piped Rot, *Polyporus pilotae* Schw. = (*Aurantiporus pilotae* (Schw.) Murrill). In the southern part of the State. 71.

Red Heart, *Polyporus sulphureus* (Bull.) Fr. = (*Laetiporus speciosus* (Batt.) Murrill). Common. 71.

Root Rot, *Armillaria mellea* Vahl. Common. *Polyporus Berkeleyi* Fr. = (*Grifolia Berkeleyi* (Fr.) Murrill). Tippecanoe and Monroe. *Polyporus dryadeus* Fr. Tippecanoe and Monroe. 71.

Speckled Rot. *Stercum frustulosum* Pers. Putnam, 1891. 132.

Straw-colored Rot, *Polyporus frondosus* Fr. = (*Grifolia frondosa* (Fr.) Murrill.) Common, although it does not frequently attack living trees. 71.

White Rot or Coral Fungus, *Hydnum erinaceus* Bull. Common. 71.

#### Oats (*Avena sativa* L.)

Covered Smut, *Ustilago levis* (Kell. & Sw.) Magn. Common.

Loose Smut, *Ustilago Avenae* (Pers.) Jens. Common. 3, 6, 9, 132, 56, 122, 109, 20, 123, 115, 26, 27, 76, 78, 42, 32, 75, 91.

Rust, *Puccinia Rhamni* (Pers.) Wettst. Common. 132, 25, 142, 76, 78.

#### Ohio Buckeye (*Aesculus glabra* Willd.)

Mildew, *Uncinula flexuosa* Pk. Johnson, 1890; Montgomery. 132.

Leaf Spot, *Phyllosticta Pariac* Desm. Montgomery and Johnson, 1890; Brown, 1893. 132.

#### Onion (*Allium Cepa* L.)

Blaek Mold, *Macrosporium parasiticum* Thuem. Starke, 1912.

Smut, *Urocystis cepulae* Frost. Becoming serious locally in the north central counties. 135.

Soft Rot, *Bacillus* sp. Occasionally causes considerable loss in storage.

#### Pea (*Pisum* sp.)

Blight, *Ascochyta Pisi* Lib. Common. 42, 136.

**Peach (*Amygdalus persica* L.)**

- Bacterial Leaf Spot, *Bacterium Pruni* E. F. Smith. Vanderburg, 1915.
- Blight, *Coryneum Beyerinkii* Oud. Reported in several localities in the peach-growing districts. 61, 40.
- Brown Rot, *Sclerotinia cinerea* (Bon.) Wor. Common. 76, 57, 58, 61.
- Crown Gall, *Pseudomonas tumefaciens* E. F. Smith & Towns. Probably not common. 57, 61.
- Leaf Curl, *Exoascus deformans* (Berk.) Fekl. Common. 132, 128, 17, 76, 78, 57, 61, 40.
- Powdery Mildew, *Sphaerotheca pannosa* (Wallr.) Lev. Common. 58, 61.
- Scab, *Cladosporium carpophilum* Thuem. Common. 2, 98, 58, 61, 40.
- Yellows. Common. 76, 78, 57, 58, 61, 40, 117.

**Pear (*Pyrus communis* L.)**

- Black Rot, *Sphaeropsis Malorum* Pk. Shear's studies indicate genetic connection with Melanops. Tippecanoe, 1915.
- Blight, *Bacillus amylovorus* (Burr.) DeToni. Common. 43, 57, 81, 92, 93, 97, 121, 52, 53, 51, 105, 128, 99, 63, 95, 76, 78, 59, 84, 36, 38, 40, 117, 62. See also under Apple.
- Leaf Blight, *Entomosporium maculatum* Lev. Perfect stage = *Fabrea maculata* (Lev.) Atk. Rather common. 36, 40.
- Leaf Spot, *Septoria pyricola* Desm. Rather common. 135. *Mycosphaerella sentina* (Fr.) Schw. Kosiussko, 1914.
- Scab, *Venturia pyrina* Aderh. Rather common. 123, 78.

**Pepper (*Capsicum annum* L.)**

- Black Rot, *Macrosporium Solani* Ell. & Mart. Tippecanoe, 1912.

**Plum (*Prunus* spp.)**

- Black Knot, *Plowrightia morbosa* (Schw.) Sacc. Common. 127, 10, 128, 130, 76, 78, 57, 58, 36, 40, 117.
- Brown Rot, *Sclerotinia cinerea* (Bon.) Wor. Common. 128, 76, 78, 57, 58, 36, 40.
- Leaf Spot, *Cylindrosporium Padi* Karst. Common. 128, 78, 57, 36, 40.
- Plum Poeket, *Exoascus Pruni* Fekl. Common. 17, 38, 117.

**Poplar (*Populus* spp.)**

Leaf Spot, *Marsonia Populi* (Lib.) Sacc. Tippecanoe, 1910.

Mildew, *Uncinula Salicis* (D.C.) Wint. Common. 132.

Rust, *Melampsora Medusae* Thuem. Common. 142, 71. *Melampsora Abietis-canadensis* (Farl.) Ludwig. Tippecanoe, Jasper, Steuben, Putman.

**Potato (*Solanum tuberosum* L.)**

Bacterial Wilt, *Bacillus solanacearum* E. F. Smith. Serious locally. 78.  
Early Blight, *Macrosporium Solani* Ell. & Mart. Common. 128, 119, 78.

Fusarium Rot, *Fusarium* sp. Common.

Late Blight, *Phytophthora infestans* (Mont.) DeB. Common. 128, 119, 78.

Scab, *Oospora scabies* Thaxter. Common. 11, 13, 14, 15, 20, 76, 78, 54.  
Tipburn. Probably sunscald injury. Tippecanoe, 1907.

**Privet (*Ligustrum vulgare* L.)**

Anthraxnose, *Glocosporium cingulatum* Atk. Marion, 1908. 58.

**Quince (*Cydonia vulgaris* Pers.)**

Black Rot, *Sphaeropsis malorum* Pk. Shear indicates genetic connection with Melanops. Common. 76, 78.

Blight, *Bacillus amylovorus* (Burr.) DeToni. Common. 76, 78, 36, 40.  
See also under Apple and Pear.

Leaf blight, *Eutomosporium maculatum* Lev. Common. 128, 58, 36, 40.  
Perfect stage = *Fabrea maculata* (Lev.) Atk.

Mildew, *Podosphaera oxyacanthae* (D.C.) DeB. Montgomery, 1885. 102.

Rust, *Gymnosporangium germinale* (Schw.) Kern. Perry, 1914. 77.

**Radish (*Raphanus sativus* L.)**

Downy Mildew, *Peronospora parasitica* (Pers.) DeB. 143.

White Rust, *Albugo candida* (Pers.) Roussel. Common. 132, 143.

**Raspberry (*Rubus* spp.)**

Anthraxnose, *Gloeosporium venetum* Speg. Burkholder reported genetic connection with *Plectodisceella*. Common. 128, 76, 78, 58, 36, 40.

Cane Blight, *Coniothyrium Fuckelii* Sacc. No locality mentioned. 40.

Crown Gall, *Pseudomonas tumefaciens* E. F. Smith & Towns. Common. 40.

Leaf Spot, *Septoria Rubi* West. Common. 78, 40.

Rust, *Gymnoconia interstitialis* (Schlecht.) Lagh. Common. 78, 36.

**Rhubarb (*Rheum Rhaponticum* L.)**

Leaf Spot, *Ascochyta Rhei* E. & E. Tippecanoe, 1912 and 1915.

**Rose (*Rosa* spp.)**

Black Spot, *Actinonema Rosae* (Lib.) Fr. Wolf reported perfect stage, *Diplocarpon Rosae* Wolf.

Leaf Spot, *Dicoccum Rosae* Bon. Howard, 1911.

Mildew, *Sphaerotheca pannosa* Wallr. Common. 132.

Rust, *Phragmidium americanum* Dietel. Probably common. 132.

*Phragmidium disciflorum* (Tod) J. F. James. St. Joseph, 1915.

*Phragmidium subcorticium* (Schrank) Wint. Tippecanoe, 1915.

**Rubber Plant (*Ficus elastica* Roxb.)**

Leaf Spot. *Macrosporium* sp. Tippecanoe, 1910.

**Rye (*Secale cereale* L.)**

Ergot, *Claviceps purpurea* (Fr.) Tul. Common. 132.

Leaf Rust, *Puccinia asperifolia* (L.) Wettst. Common.

Stem Rust, *Puccinia poculiformis* (Jasq.) Wettst. 25.

**Sorghum (*Sorghum* spp.)**

Kernel Smut, *Sphacelotheca Sorghi* (Lk.) Clinton. Common. Collected on several members of the sorghum group.

**Snapdragon (*Antirrhinum majus* L.)**

Anthraxnose, *Colletotrichum Antirrhini* Stew. Tippecanoe, 1915.

Rust, *Puccinia Antirrhini* Diet. & Holw. Montgomery, Lagrange, Hendricks and Wabash, 1915.

**Strawberry (*Fragaria* spp.)**

Leaf Spot, *Mycosphaerella Fragariae* (Tul.) Linden. Common. 128, 58, 40, 90, 39.

Mildew, *Sphaerotheca Humuli* (D.C.) Burr. Common. 38, 40.

**Sweet Pea (*Lathyrus* spp.)**

Root Rot, *Fusarium Lathyri* Taubenhaus. Tippecanoe, 1912.

**Sweet Potato (*Ipomoea Batatas* Lam.)**

Black Rot, *Sphaeronema fimbriatum* (Ell. & Hals.) Sacc. Rather common. 77, 83.

Dry Rot, *Diaporthe batatas* Harter & Field. Tippecanoe, 1912. 83.

Fusarium Rot, *Fusarium* sp. Tippecanoe, 1912. 83.

Stem Rot, *Nectria Ipomoeae* Hals. Tippecanoe, 1912. Monroe. 83.

**Swiss Chard (*Beta* sp.)**

Leaf Spot, *Cercospora beticola* Sacc. Tippecanoe, 1910.

**Sycamore (*Platanus occidentalis* L.)**

Leaf Spot, *Stigmina Platani* Fekl. Tippecanoe, 1914. 71.

Mildew, *Microsphaera Alni* (DC.) Wint. Johnson, 1890; Putnam, 1891; Montgomery, 1893. 132.

*Phyllactinia Corylea* (Pers.) Karst. Common. 71.

**Timothy (*Phleum pratense* L.)**

Anthraxnose, *Colletotrichum cereale* Manns. Hamilton and Bartholomew, 1909.

Leaf Spot, *Scoletotrichum graminis* Fekl. Johnson, 1890. 132.

Rust, *Puccinia poculiformis* (Jacq.) Wettst. Common. 79, 80, 74.

Silver Top, *Sporotrichum Poae* Pk. Kosciusko, 1914.

Smut, *Ustilago striaeformis* (West.) Niess. Common. 132.

**Tomato (*Lycopersicon esculentum* Mill.)**

Anthraxnose, *Colletotrichum phomoides* (Sacc.) Chest. Common.

Bacterial Blight, *Bacillus solanacearum* E. F. Smith. Serious locally. 78, 39.

Black Rot, *Alternaria* sp. Tippecanoe, 1912.

Blossom End Rot (cause not known). Common, especially during dry weather. 76, 78, 131.

Fusarium Wilt, *Fusarium Lycopersici* Sacc. Knox, 1913; Tippecanoe, 1914 and 1915.

Leaf Mold, *Cladosporium fulvum* Cke. Wabash, 1915, in greenhouse.

Leaf Spot, *Septoria Lycopersici* Speg. Common. 128, 78, 131.

Mosaic Disease (cause not definitely known). Common in greenhouses.

Oedema. Cause physiological. Tippecanoe, 1912, in greenhouse.

#### Walnut, Black (*Juglans nigra* L.)

Leaf Spot, *Marsonia Juglandis* (Lib.) Sacc. Perfect stage = *Gnomonia leptostyla* (Fr.) Ces. & d. Not. Tippecanoe, 1914.

Mildew, *Microsphaera Alni* (D.C.) Wint. Johnson, 1890. Putnam, 1893. 132.

#### Walnut, White (*Juglans cinerea* L.)

Mildew, *Phyllactinia Corylea* (Pers.) Karst. Carroll, 1913. 71.

#### Watermelon (*Citrullus vulgaris* Schrad.)

Anthraxnose, *Colletotrichum Lagenarium* (Pass.) Ell. & Hals. Common. 128, 78.

Fusarium Wilt, *Fusarium vasinfectum* Atk. var. *niveum* Sm. Common. 78, 144.

Leaf Blight, *Alternaria Brassicae* (Berk.) Sacc. var. *nigrescens* Pegl. Common.

#### Wheat (*Triticum vulgare* L.)

Anthraxnose, *Colletotrichum cereale* Manns. Posey, 1912.

Ebony Point, *Alternaria* sp. Common.

Fusarium Blight, *Fusarium* sp. Unusual outbreak of Fusarium trouble occurred during the past season (1915) in Orange, Washington, Jefferson and Green counties. The maturing heads had a dull grayish-brown color instead of the normal golden brown. The kernels were small, shrunken, and in many cases covered with mycelial growth. Prof. G. N. Hoffer, who co-operated in the investigation of this disease, found many kernels internally infected with Fusarium.

Leaf Rust, *Puccinia triticina* Eriks & Henn. Common. See under Stem Rust.

Loose Smut, *Ustilago Tritici* (Pers.) Jens. Common. 82, 35, 91a, 132, 19, 109, 23, 116, 76, 78, 42, 32.

Scab, *Fusarium* sp. Common, 7, 18, 76, 78.

Septoria Spot, *Septoria graminum* Desm. Common. Another species of Septoria which agrees closely with *S. glumarum* Sacc. was found associated with the Fusarium blight disease. Pyrenidia were found in abundance not only on glumes but on sheaths and nodes as well. In one of the fields examined by the writer every wheat plant was severely affected.

Stinking Smut, *Tilletia foetans* (B. & C.) Trel. Common. 82, 3, 5, 91a, 9, 56, 20, 76, 78, 42, 57, 32, 88. *Tilletia Tritici* (Beij.) Wint. Franklin, 1912.

Stem Rust, *Puccinia poeciliformis* (Jacq.) Wettst. Common. 82, 50, 4, 47, 48, 142, 76, 78, 57.

#### Willow (*Salix* spp.)

Mildew, *Uncinula Salicis* (D.C.) Karst. Common. 132, 71.

Rust, *Melampsora Bigelowii* Thuem. Common. 71.

Wood Rot, *Daedalea confragosa* (Balt.) Pers. Tippecanoe, 1912.

#### Yellow Poplar (*Liriodendron tulipifera* L.)

Mildew, *Erysiphe Liriodendri* Schw. Putnam, 1891 and 1893; Montgomery 1893. *Phyllactinia suffulta* (Reb.) Sacc. Johnson, 1890; Montgomery, 1893. 132.



## BIBLIOGRAPHY.

## 1. Anderson, H. W.

- 1914 A new leaf spot of *Viola cucullata*. Proc. Ind. Acad. Sci. 1914:187-190. Description of leaf spot diseases caused by *Colletotrichum*.

## 2. Arthur, J. C.

- 1889 Spotting of peaches and cucumbers. Ind. Agr. Exp. Sta. Bul. 19:5-10, figs. 1-6. Description and brief discussion of *Cladosporium carpophilum* Thuem. and *Cladosporium cucumerinum* E. & A.

## 3. ————

- 1889 Smut of wheat and oats. Ind. Agr. Exp. Sta. Bul. 28:3-23, figs. 1-7. Detailed discussion of the stinking smut of wheat and briefer reference to the loose smuts of wheat, oats, barley and rye.

## 4. ————

- 1889 What is common wheat rust? Proc. Soc. Prom. Agric. Sci. 7:11-12.

## 5. ————

- 1890 Treatment of smut in wheat. Ind. Agri. Exp. Sta. Bul. 32:3-9. Discusses copper sulfate and hot water treatments for preventing stinking smut.

## 6. ————

- 1891 The loose smut of oats. Ind. Agr. Exp. Sta. Bul. 35:81-97, figs. 1-4. Discussion of the occurrence of oat smut in the State and its prevention by the hot water treatment.

## 7. ————

- 1891 Wheat scab. Ind. Agr. Exp. Sta. Bul. 36:129-132. Observations on the occurrence of scab, caused by *Fusarium* sp., in the vicinity of Lafayette.

8. \_\_\_\_\_

1892 Treatment of powdery mildew and black rot on grapes. Ind. Agr. Exp. Sta. Bul. 38:17-18, pl. 1. Results on spraying with a solution of potassium sulphide and dusting with sulphur for mildew and spraying with bordeaux for black rot.

9. \_\_\_\_\_

1892 Grain smut and the use of hot water to prevent it. Agric. Sci. 6:393-397. Abstract in Proc. Soc. Prom. Agr. Sci. 9:135. Experiments with the stinking smut of wheat.

10. \_\_\_\_\_

1894 Black knot and other excrecences. Trans. Ind. Hort. Soc. 1894:76-80. Discussion of the nature and control of *Plowrightia morbosa* on plums and cherry and of similar excrecences on other trees, as poplar, oaks, peach, apricot, etc.

11. \_\_\_\_\_

1895 Potato scab and its prevention. Ind. Agr. Exp. Sta. Bul. 56:69-80. Same in Ind. Agr. Rep. 1895:537-545. Corrosive sublimate treatment recommended.

12. \_\_\_\_\_

1895 Treatment of corn smut. Ind. Agr. Exp. Sta. Newsp. Bul. 16. Gathering and destroying of smut recommended.

13. -

1896 Prevention of potato scab. Ind. Agr. Exp. Sta. Newsp. Bul. 24. Discussion of the corrosive sublimate treatment.

14. \_\_\_\_\_

1897 A new remedy for potato scab. Ind. Agr. Exp. Sta. Newsp. Bul. 43. First announcement of the formaldehyde treatment.

15. \_\_\_\_\_

1897 Formalin for prevention of potato scab. Ind. Agr. Exp. Sta. Bul. 65:19-32, pls. 2.

16. \_\_\_\_\_  
1897 Distinction between health and disease in plants. Trans. Ind. Hort. Soc. 1897:26-30.
17. \_\_\_\_\_  
1898 Peach leaf curl and plum pockets. Ind. Agr. Exp. Sta. Newsp. Bul. 60. General description and suggestions on preventive measures.
18. \_\_\_\_\_  
1898 Scab in heads of wheat. Ind. Agr. Exp. Sta. Newsp. Bul. 62. General discussion and suggestion on measures of control.
- 19.\* \_\_\_\_\_  
1898 Loose smut of wheat. Ind. Agr. Exp. Sta. Newsp. Bul. 65. General discussion and recommendation of the hot water treatment.
20. \_\_\_\_\_  
1899 Formalin for grain and potatoes. Ind. Agr. Exp. Sta. Bul. 77:38-44. Discussion of smut of corn, wheat, oats and of potato scab. Preventive measures recommended.
21. \_\_\_\_\_  
1900 Asparagus rust. Ind. Agr. Exp. Sta. An. Rep. 1900:10-14. Same in Ind. Agr. Rep. 1900:520-524. General discussion of the nature of this disease with suggestions on methods of control.
22. \_\_\_\_\_  
1900 Damping off of beets in the field. Ind. Agr. Exp. Sta. An. Rep. 1900:15-16. Same in Ind. Agr. Rep. 1900:524-526. Beet seedlings were observed killed in the field by some parasitic organism whose identity had not been established.
23. \_\_\_\_\_  
1900 Formalin and hot water as preventive of loose smut of wheat. Ind. Agr. Exp. Sta. An. Rep. 1900:17-24. Same in Ind. Agr. Rep. 1900-526-532.

---

\*Article 19 should be credited to Wm. Stuart.

24. \_\_\_\_\_  
1900 Chrysanthemum rust. Ind. Agr. Exp. Sta. Bul. 85:143-150.  
Same in Ind. Agr. Rep. 1900:637-643. Reports detailed  
study of the rust. Preventive measures suggested.
25. \_\_\_\_\_  
1903 Revised list of Indiana plant rusts. Proc. Ind. Acad. Sci.  
1903:141-152.
26. \_\_\_\_\_  
1905 Rapid method of removing smut from seed oats. Ind. Agr.  
Exp. Sta. Bul. 103:257-264. Description of method of  
treating oats with formaldehyde solution on a large scale.
27. \_\_\_\_\_  
1906 Treatment for oat smut. Ind. Agr. Exp. Sta. Newsp. Bul.  
125. Brief discussion of the formaldehyde treatment.
28. \_\_\_\_\_  
1909 Right and wrong conception of plant rusts. Proc. Ind. Acad.  
Sci. 1909: 383-390.
29. \_\_\_\_\_  
1914 Some large botanical problems. Proc. Ind. Acad. Sci. 1914:  
267-271. Reference to a number of serious diseases affecting  
cereal, vegetable and forage crops.
30. **Arthur, J. C., and Bolley, H. L.**  
1896 Bacteriosis of carnations. Ind. Agr. Exp. Sta. Bul. 59:17-39  
pls. 1-8. Detailed description and discussion of carnation  
disease caused by *Bacterium Dianthi* Arth. and Bol. n.sp.
31. **Arthur, J. C., and Golden, Katherine.**  
1892 Diseases of the sugar beet root. Ind. Agr. Exp. Sta. Bul. 39:  
54-62, pl. 1. Description of beet scab, bacterial disease,  
and water-core spots.
32. **Arthur, J. C., and Johnson, A. G.**  
1910 Loose smut of oats and stinking smut of wheat and their  
prevention. Ind. Agr. Exp. Sta. Cir. 22:1-15, figs. 1-9.  
Formaldehyde treatment recommended.

33. **Arthur, J. C., and Stuart, Wm.**

1899 Corn smut. Ind. Exp. Sta. An. Rep. 1899:84-135, pls. 10-13, fig. 1. Detailed account of corn smut, including its early records, life history, modes of dissemination, methods of control and chemical properties.

34. **Baldwin, C. H.**

1912 Fungicides and spray calendars. Rep. Ind. State Entomol. 1911-1912:26-36. Spray calendar includes treatments for diseases of apple, pear, quince, cherry, plum and grape.

35. \_\_\_\_\_

1912 Some points on the control of plant diseases. Rep. Ind. State Entomol. 1911-1912:237-238.

36. \_\_\_\_\_

1912 Some important diseases of apple, pear, quince, stone fruits, grapes, raspberry and blackberry. Rep. Ind. State Entomol. 1911-1912:239-281, figs. 27.

37. \_\_\_\_\_

1912 Shade tree troubles. Rep. Ind. State Entomol. 1911-1912:282-284, fig. 8. Discussion of root suffocation, malnutrition, and other causes as gas, drouth, smoke and fungi. Also gives an account of tree surgery methods.

38. \_\_\_\_\_

1913 Plant diseases. Rep. Ind. State Entomol. 1912-1913:61-73, fig. 5. Discussion and partial list of diseases of the maple, apple, pear, cherry, peach, plum, currant, gooseberry, grape, blackberry, raspberry and strawberry.

39. \_\_\_\_\_

1914 Diseases of the year. Rep. Ind. State Entomol. 1913-1914:59-67, fig. 5. Account of some diseases of the maple, apple, tomato and strawberry.

40. **Baldwin, C. H. and Dietz, H. T.**

1913 A program for the treatment of orchard insect pests and plant diseases. Office Ind. State Entomol. Bul. 3:119-123 and 145-200, fig. 33. Discussion of fungicides and diseases

of and spray calendars for apple, pear, quince, stone fruits, grape, currant, gooseberry, raspberry, blackberry, strawberry, potatoes and cucurbits.

41. **Banker, H. J.**

1910 *Steccherinum septentrionale* (Fr.) Banker, in Indiana. Proc. Ind. Acad. Sci. 1910:213-218, fig. 1. Detailed description and discussion as to its occurrence on hosts and in the State.

42. **Barrus, M. F.**

1908 The dissemination of disease by means of the seed of the plant host. Proc. Ind. Acad. Sci. 1908:113-126, figs. 1-7. The host list includes bean, pea, wheat, barley, oats, flax, cabbage and sweet corn.

43. **Beecher, H. W.**

1844. Fire blight. Trans. Ind. Hort. Soc. 1902:263-275. An interesting paper on fire blight read before the Society in 1844, by Henry Ward Beecher, the famous preacher.

44. **Bitting, A. W.**

1899 The effects of eating moldy corn. Ind. Agr. Exp. Sta. An. Rep. 1899:44-45. Tests conducted with two horses.

45. \_\_\_\_\_

1901 Corn smut and disease. Ind. Agr. Exp. Sta. Newsp. Bul. 98. Brief account of the tests in feeding corn smut to livestock.

46. **Blair, J. C., and Burrill, J. T.**

1902 Prevention of bitter rot. Trans. Ind. Hort. Soc. 1902:290-292. Same in Ind. Agr. Rep. 1902:437-439. Bordeaux mixture recommended.

47. **Bolley, H. L.**

1889. Sub-epidermal rusts. Bot. Gaz. 14:139-145, pl. 1. Notes on various species of *Puccinia* in Indiana.

48. \_\_\_\_\_  
1889 Wheat rust. Ind. Agr. Exp. Sta. Bul. 26:5-19, figs. 1-9. Detailed description and discussion of the nature of wheat rust.
49. **Brown, Ignatius.**  
1856 Enemies and diseases (of corn). Ind. Agr. Rep. 1856:354-355. Brief description of corn smut with suggestion on control.
50. **Brown, R. T.**  
1868 Rust (on wheat). Ind. Agr. Rep. 1868:364-365. Brief account of wheat rust with suggestions on measures of preventing damage.
51. **Budd, J. K.**  
1885 Blight. Trans. Ind. Hort. Soc. 1885:31. Brief discussion of blight of apple and pear.
52. **Burrill, J. T.**  
1880 Blight, or bacteria ferments in fruit trees. Trans. Ind. Hort. Soc. 1880:84-92. Discussion of bacteria causing fire blight.
53. \_\_\_\_\_  
1881 Bacteria and pear blight. Trans. Ind. Hort. Soc. 1881:20-24. Report on inoculation experiments.
54. **Conner, S. D.**  
1913 Irish potato scab (*Oospora scabies*) as affected by fertilizers containing sulfates and chlorides. Proc. Ind. Acad. Sci. 1913:131-137, figs. 1-5.
55. **Cunningham, C. A.**  
1899 A bacterial disease of the sugar beet. Bot. Gaz. 28:177-192, pls. 16-20. Review and further investigation of the disease reported on by Arthur and Golden.
56. **Davis, E. W.**  
1895 Rust and fungus diseases of plants. Ind. Agr. Rep. 1895:450-455. General discussion of the nature of fungi, especially of grain smuts and potato diseases. Preventive measures suggested.

57. **Douglas, B. W.**

1908 The diseases of plants. Rep. Ind. State Entomol. 1907-1908: 170-189, fig. 12. Discussion of the diseases of apple, pear, blackberry, cherry, cucumber, grape, maple, peach, raspberry and wheat.

## 58. —————

1909 Plant diseases. Rep. Ind. State Entomol. 1908-1909:129-168, fig. 36. Discussion of the diseases of apple, catalpa, cherry, chesnut, carnation, ginseng, grape, peach, plum, privet, pear, quince, raspberry and strawberry.

## 59. —————

1909 Some diseases of the apple. Trans. Ind. Hort. Soc. 1909: 92-101. Description and recommendation of methods of control.

## 60. —————

1910 Grape diseases. Report Ind. State Entomol. 1909-1910: 205-210, fig. 3. Description and recommendation of methods of control.

## 61. —————

1911 Diseases of the peach. Rep. Ind. State Entomol. 1910-1911: 53-66, fig. 10. Description and recommendation of methods of control.

62. **Durham, C. B.**

1915 Fire blight of apples and pears. Purd. Univ. Dept. Agr. Ext. Leaflet 63:1-4, fig. 1. Suggests methods of control.

63. **Flick, W. B.**

1903 Shall the fire blight remain unconquered? Trans. Ind. Hort. Soc. 1903:96-101. Same in Ind. Agr. Rep. 1903:360-364. General discussion of the fire blight problem.

64. **Furnas, A.**

1874 Rust in blackberries. Trans. Ind. Hort. Soc. 1874:74. Fourteenth report. Account of personal experience with the disease.



**65. Golden, Katherine.**

1891 Diseases of the sugar beet. Proc. Ind. Acad. Sci. 1891: 92-97. Discussion of scab and a new disease thought to be caused by bacteria.

**66. Goodrich, C. E.**

1856 Potato disease. Ind. Agr. Rep. 1856:49-59. Account of mildew rot (blight?). Conducted experiments to prevent it.

**67. Hesler, L. R.**

1911 The New York apple tree canker. Proc. Ind. Acad. Sci. 1911:325-339, figs. 1-7. Detailed description and discussion of *Sphaeropsis Malorum* and its economic importance.

**68. Hobbs, C. M., Reed, W. C., and Flick, W. B.**

1906 Spray calendar of the Indiana Horticultural Society. Trans. Ind. Hort. Soc. 1906:284-285.

**69. Hoffer, G. N.**

1913 A test of Indiana varieties of wheat seed for fungous infection. Proc. Ind. Acad. Sci. 1913:97-98. Reports isolation of a number of imperfect fungi.

**70. —————**

1913 *Polyporus Everhartii* (Ellis & Gall.) Murrill as a wound parasite. Proc. Ind. Acad. Sci. 1913:99-101, pls. 1-4.

**71. —————**

1914 The more important fungi attacking forest trees in Indiana. Rep. State Board Forest. 1914:84-97. Figs. 5. Description and discussion of parasitic fungi attacking the wood, leaves and roots of forest trees.

**72. Huston, H. A.**

1895 Sugar beet. Bacterial disease: Effect on sugar content. Ind. Agr. Rep. 1895:523-524.

**73. Johnson, A. G.**

1908 On the heteroecious plant rusts of Indiana. Proc. Ind. Acad. Sci. 1908:87-94. Account of what has been done and what remains to be done in connecting the various forms.

74. \_\_\_\_\_  
1910 Further notes on timothy rust. Proc. Ind. Acad. Sci. 1910: 203-204. Notes on distribution of the rust in the State.
75. \_\_\_\_\_  
1911 What about oat smut this year? Ind. Agr. Exp. Sta. Newsp. Bul. 173. Brief account of the formaldehyde treatment.
76. **Kern, F. D.**  
1906 Indiana plant diseases in 1905. Ind. Agr. Exp. Sta. Bul. 111: 121-134. Brief description and discussion of diseases reported by correspondents.
77. \_\_\_\_\_  
1906 Parasitic plant diseases reported for Indiana. Proc. Ind. Acad. Sci. 1906:129-133, fig. 1. List of diseases reported by correspondents.
78. \_\_\_\_\_  
1907 Indiana plant diseases in 1906. Ind. Agr. Exp. Sta. Bul. 119: 424-436. Brief description and discussion of diseases reported by correspondents.
79. \_\_\_\_\_  
1908 The rust of timothy. Proc. Ind. Acad. Sci. 1908:85. Brief note on the occurrence of timothy rust in the State.
80. \_\_\_\_\_  
1909 Further notes on timothy rust. Proc. Ind. Acad. Sci. 1909: 417-418. Additional notes on distribution.
81. **Kirtland, J. P.**  
1866 Pear tree blight—concerning its cause and cure. Trans. Ind. Hort. Soc. 1866:62-65.
82. **Lemmon, A. W.**  
1856 (Brief reference to wheat diseases.) Ind. Agr. Rep. 1856: 398. Apparently refers to the stinking smut of wheat. Blue vitriol treatment is recommended.
83. **Ludwig, C. A.**  
1912 Fungous enemies of the sweet potato in Indiana. Proc. Ind. Acad. Sci. 1912:103-104. Notes on several fungi causing rots.

84. **M'Cormack, Edna F.**

1910 Fungous diseases of the apple. Rep. State Entomol. 1909-1910:128-165. fig. 29. Description and recommendation of methods of control.

85. **Newby, T. T.**

1888 Spraying fruit trees. Trans. Ind. Hort. Soc. 1888:18-19. Discussion of spraying apple trees in particular.

86. **O'Neal, Claude E.**

1914 Some species of *Nummularia* common in Indiana. Proc. Ind. Acad. Sci. 1914:235-241. Description and key to five species of *Nummularia*, including *N. discreta*, a serious parasite.

87. **Orton, C. R.**

1910 Disease resistance in varieties of potatoes. Proc. Ind. Acad. Sci. 1910:219-221.

## 88. \_\_\_\_\_

1911 The prevalence and prevention of stinking smut in Indiana. Proc. Ind. Acad. Sci. 1911:343-346.

89. **Osner, G. A.**

1911 Diseases of ginseng caused by *Sclerotinias*. Proc. Ind. Acad. Sci. 1911:355-364, figs. 1-6. Description of black and crown rots.

90. **Oskamp, J.**

1913 Strawberries. Ind. Agr. Exp. Sta. Bul. 164:764. **Brief** reference to leaf spot and mildew of strawberry.

91. **Pipal, F. J.**

1914 Oat smut in Indiana. Proc. Ind. Acad. Sci. 1914:191-196. Reference to oat smut demonstrations conducted in cooperation with county agents and data on prevalence of the smut in the State.

91a. **Plumb, C. S.**

1891 How to prevent smut in wheat. Hot water treatment **recom-**mended.

92. **Ragan, W. H.**  
 1874 Pear blight, its prevention and cure. Trans. Ind. Hort. Soc. 1874:55-57 and 102-109. Thirteenth report.
93. \_\_\_\_\_  
 1874 The pear blight. Trans. Ind. Hort. Soc. 1874:37-38. Fourteenth report. General discussion of the blight problem.
94. \_\_\_\_\_  
 1896 The relations of the red cedar to our orchards. Trans. Ind. Hort. Soc. 1896:85-88.
95. \_\_\_\_\_  
 1906 Pear blight—frozen sap blight. Trans. Ind. Hort. Soc. 1906:150-151. Mentions the origin of the theory that frozen sap is responsible for pear blight.
96. **Ramsey, Glen B.**  
 1914 The genus *Rosellinia* in Indiana. Proc. Ind. Acad. Sci. 1914:251-265, pls. 1-3. Description of a number of saprophytic and parasitic species. Key to species.
97. **Ratcliff, J. C.**  
 1874 (Remarks on pear blight.) Trans. Ind. Hort. Soc. 1874:20.
98. **Richards, M. W.**  
 1912 Orchard spray calendar. Ind. Agr. Exp. Sta. Cir. 34:1-12, figs. 1-8.
99. **R. J. B.**  
 1902 Pear blight. Trans. Ind. Hort. Soc. 1902:294-295. Same in Ind. Agr. Rep. 1902:441-442. General discussion of the blight problem.
100. **Roberts, J. W.**  
 1910 Some apple diseases common to the middle west. Trans. Ind. Hort. Soc. 1910:48-51. Discussion of scab, bitter and black rots, and rust.
101. \_\_\_\_\_  
 1910 The dilute lime-sulphur sprays versus bordeaux mixture for apple diseases—is bordeaux to be abandoned? Trans. Ind. Hort. Soc. 1910:82:90.

102. **Rose, J. N.**  
 1886 The mildews of Indiana. Bot. Gaz. 11:60-63. Enumerates twelve species of Erysiphaceae.
103. **Selby, A. D. and Manns, T. F.**  
 1908 A new anthraenose attacking certain cereals and grasses. Proc. Ind. Acad. Sci. 1908:111. Colletotrichum cereale n. sp. is reported as being found throughout the State of Ohio.
104. **Simpson, R. A.**  
 1902 Spraying. Trans. Ind. Hort. Soc. 1902:237-240. Same in Ind. Agr. Rep. 1902:385-389. Discussion of orchard spraying.
105. **Snyder, Lillian.**  
 1897 The germ of pear blight. Proc. Ind. Acad. Sci. 1897:150-156, fig. 1. Account of cultural studies of the bacterial organism causing pear blight.
106. **Stahl, Wm.**  
 1891 Spraying: Why, how, when. Trans. Ind. Hort. Soc. 1891:101-103. Discussion of orchard spraying.
107. **Stuart, Wm.\***  
 1895 Fungicides for the prevention of corn smut. Proc. Ind. Acad. Sci. 1895:96-99. Spraying tests with bordeaux mixture and a solution of ammoniacal copper carbonate.
108. \_\_\_\_\_  
 1898 Bacterial rot of cabbage. Ind. Agr. Exp. Sta. Newsp. Bul. 69. Preventive measures recommended.
109. - \_\_\_\_\_  
 1898 The resistance of cereal smuts to formalin and hot water. Proc. Ind. Acad. Sci. 1898:64-70. Tests with spores of Ustilago Triticæ and Ustilago Avenæ.
110. \_\_\_\_\_  
 1899 Asparagus rust, a serious menace to asparagus culture. Ind. Agr. Exp. Sta. Newsp. Bul. 80. Discussion of the nature of the disease and recommendation of preventive measures.

---

\*See, also, No. 19.

111. \_\_\_\_\_  
**1900** Corn smut, its cause, remedy, effect upon cattle. Ind. Agr. Rep. 1900:315-318.
112. \_\_\_\_\_  
**1900** Formalin as a preventive of millet smut. Ind. Agr. Rep. 1900:532-533.
113. \_\_\_\_\_  
**1900** A study of the constituents of corn smut. Proc. Ind. Acad. Sci. 1900:148-152. Same in Ind. Agr. Rep. 1900:533-538.
114. \_\_\_\_\_  
**1900** A bacterial disease of tomatoes. Proc. Ind. Acad. Sci. 1900:153-157, figs. 1-3. Same in Ind. Agr. Rep. 1900:539-543. Notes on greenhouse inoculation studies of rot supposed to be caused by bacteria.
115. \_\_\_\_\_  
**1901** Formalin as a preventive of oat smut. Ind. Agr. Exp. Sta. Bul. 87:1-26.
116. \_\_\_\_\_  
**1901** Spore resistance of loose smut of wheat to formalin and hot water. Proc. Ind. Acad. Sci. 1901:275-282.
117. **Swallow, A. P.**  
**1914** Pruning and the care of trees in relation of disease and insect control. Rep. State Entomol. 1913-1914:71-101, figs. 23.
118. **Taft, L. R.**  
**1900** The philosophy of spraying. Trans. Ind. Hort. Soc. 1900:153-160. Discussion of orchard spraying.
119. \_\_\_\_\_  
**1905** The potato and potato blight. Trans. Ind. Hort. Soc. 1905:143-148. Same in Ind. Agr. Rep. 1905:523-528. Discussion of the early and late blights.
120. **Templin, L. J.**  
**1873** Diseases of potato. Trans. Ind. Hort. Soc. 1873:59-60. Brief account of "rot," suggesting probable causes and remedies.

121. \_\_\_\_\_  
 1874 Pear blight. *Trans. Ind. Hort. Soc.* 1875:89-91. General discussion of the fire blight problem.
122. **Thomas, M. B.**  
 1897 The effect of formalin on germinating seeds. *Proc. Ind. Acad. Sci.* 1897:144-148. Tests with seeds of oats, rye, corn, buckwheat, millet, beans and others.
123. \_\_\_\_\_  
 1900 Experiments with smut. *Proc. Ind. Acad. Sci.* 1900:123-124. Field tests in the formaldehyde treatment for preventing oat smut.
124. **Trans. Ind. Hort. Soc.**  
 1888 (Discussion on black rot of grapes.) 1888: 102-104.
125. \_\_\_\_\_  
 1903 (Discussion on root rot of apple.) 1903:121-125.
126. \_\_\_\_\_  
 1903 (Discussion on anthracnose of raspberry.) 1903:217-219.
127. **Troop, J.**  
 1893 Spraying as a means of protecting our fruits from insects and fungi. *Trans. Ind. Hort. Soc.* 1893:46-52.
128. \_\_\_\_\_  
 1897 Formulas for making insecticides and fungicides and directions for spraying. *Trans. Ind. Hort. Soc.* 1897:272-277.
129. \_\_\_\_\_  
 1898 Insecticides, fungicides and spraying. *Ind. Agr. Exp. Sta. Bul.* 69:33-40. Same in *Ind. Agr. Rep.* 1898:530-535.
130. \_\_\_\_\_  
 1901 Black knot of the plum and cherry. *Ind. Agr. Exp. Sta. Newsp. Bul.* 90. Same in *Trans. Ind. Hort. Soc.* 1901: 245-246, and in *Ind. Agr. Rep.* 1901:425-426. Account of the nature and control of this disease.
131. **Troop, J., Woodbury, C. G., and Boyle, J. G.**  
 1910 Growing tomatoes for the canning factory. *Ind. Agr. Exp. Sta. Bul.* 144:509-528, figs. 1-8. Reference to point rot, anthracnose and leaf spot of tomato.

132. **Underwood, Lucien M.**

1893 Report of the Botanical Division of the Indiana State Biological Survey. Proc. Ind. Acad. Sci. 1893:13-67. Includes list of fungi collected in the State.

133. \_\_\_\_\_

1894 The relations of the red cedar to our orchards. Trans. Ind. Hort. Soc. 1894:81-84.

134. \_\_\_\_\_

1894 An increasing pear disease of Indiana. Proc. Ind. Acad. Sci. 1894:67. Abstract on the occurrence and description of *Septoria pyricola*.

135. \_\_\_\_\_

1894 Report of the Botanical Division of the Indiana State Biological Survey for 1894. Proc. Ind. Acad. Sci. 1894:144-156. Includes additions to the list of Indiana fungi.

136. **Van Hook, J. M.**

1910 Indiana fungi. Proc. Ind. Acad. Sci. 1910:205-212. List of species in the collection at Indiana University.

137. \_\_\_\_\_

1911 Indiana fungi—II. Proc. Ind. Acad. Sci. 1911:347-354, fig 2. Additional list of species collected.

138. \_\_\_\_\_

1912 Indiana fungi—III. Proc. Ind. Acad. Sci. 1912:99-101. Further report on additional collections.

139. **Webster, F. M.**

1901 Spraying and spraying mixtures. Trans. Ind. Hort. Soc. 1901:115-124. Directions for spraying orchards.

140. **Whetzel, H. H.**

1901 Notes on apple rusts. Proc. Ind. Acad. Sci. 1901:255-260.

141. **White, F. D.**

1893 Spraying fruit for the control of fungi and insects. Trans. Ind. Hort. Soc. 1893:116-118.

142. **Wilson, G. W.**

1905 Rusts of Hamilton and Marion counties, Indiana. Proc. Ind. Acad. Sci. 1905:177-182.



143. \_\_\_\_\_  
    **1907** The Peronosporales of Indiana. Proc. Ind. Acad. Sci. 1907:  
        80-84. List of species collected to date.
144. **Woodbury, C. G.**  
    **1907** (Discussion of rust (*Alternaria* leaf spot) and wilt of melons.)  
        Trans. Ind. Hort. Soc. 1907:190-192.
145. \_\_\_\_\_  
    **1910** Spraying the orchard. Ind. Agr. Exp. Sta. Cir. 21:1-20,  
        figs. 1-17. Directions for spraying apple, pear, peach,  
        plum and cherry trees.

Purdue University Agricultural Experiment Station,  
Lafayette, Indiana.



## THE OLYMPIC COAL FIELDS OF WASHINGTON.

BY ALBERT B. REAGAN.

The Olympic Peninsula covers an area of about eight thousand square miles. It is approximately a right angle triangle in shape with its hypotenuse on the Pacific side. Its shorter limb faces the "Sound," the longer limb of the triangle faces the Strait of Juan de Fuca. This peninsula consists of a moderately benched area forming a coastal bench surrounding a high central area termed the Olympic Mountains which are situated somewhat southeast of the center of the peninsula. And from this high area there extends northwestward to Cape Flattery a gradual declining ridge. The most commonly heard-of places of the region are LaPush and Quillayute on the Pacific front and Neah Bay, Clallam Bay, Port Angeles, and Port Townsend on the Strait of Fuca side.

The region is much fissured and faulted and much of the strata are tipped at a high angle. The core of the Olympic Mountains is supposed to be pre-Cretaceous in age. The exposed rocks along the Strait of Fuca are Pleistocene and Tertiary. The Pleistocene is the Country rock from Port Townsend to Fresh Water Bay north of Port Angeles. Eocene rocks are exposed at Port Crescent, and from there northward to Cape Flattery and then down the Pacific front as far south as the Point of Arches, the exposed rock is Oligocene-Miocene. The Point of Arches appears to be pre-Cretaceous in age, as do also the rocks at Point Elizabeth, one hundred twenty miles further south, while the intervening coast exposures appear to be Cretaceous in age. The troughs of the Quillayute river and its tributaries are incised in Tertiary strata.

Coal is exposed in the Oligocene-Miocene from Pyscht to Clallam Bay on the Strait of Fuca, a distance of about eight miles. Coal is also found inland near Fresh Water Bay. Small stringers of coal are also exposed in the Hoko Canyon. Small seams of coal were also observed at Strawberry and Johnson Points and near Portage Head on the Pacific Coast. Coal is also found in the Quillayute trough. The three principal coal areas will receive special mention.

*The Quillayute River Field.* About two miles southeast of Mora P. O. on the east bank of the Quillayute River a coal seam runs in an east and

west direction with nearly a vertical dip. A thirty-foot tunnel was driven into this seam some years ago. The coal was found to be good quality of lignite, but the vein being less than a foot in thickness, the work was abandoned.

Another exposure in this field is near the Bogachiel river, about eight miles southwest of Forks P. O. Some years ago a company, said to be the Narrow Gauge Railroad Company, drove a thirty-foot tunnel into the exposed coal seam here. The coal was found to be a good quality of lignite, but as the vein was less than a foot in thickness, the work was abandoned. Below is an analysis of a specimen of coal from the headwaters of the Quilayute river, likely from the above tunnel:<sup>1</sup>

|                                  |                  |
|----------------------------------|------------------|
| Moisture.....                    | 5.10 per cent.   |
| Volatile combustible matter..... | 39.15 per cent.  |
| Fixed carbon.....                | 47.01 per cent.  |
| Ash.....                         | 7.77 per cent.   |
| Sulphur.....                     | .97 per cent.    |
| <hr/>                            |                  |
| Total.....                       | 100.00 per cent. |

*The Fresh Water Bay Field.* Drilling inland from the bay has exposed several seams of coal, some of workable size. The coal is in the Oligocene-Miocene formation. So far no development work has been done. Below is a drill record from a hole in a deep gulch in a broad synclinal trough about one mile south of the eastern end of Fresh Water Bay:

|                                          | Feet.            |
|------------------------------------------|------------------|
| Dark sandstone.....                      | 39 $\frac{2}{3}$ |
| Coal.....                                | $\frac{1}{3}$    |
| Gray sandstone.....                      | 24               |
| Soft white sandstone.....                | 17               |
| Sandstone containing oyster shells.....  | 10               |
| Sandstone containing green boulders..... | 10               |
| Sandstone.....                           | 40               |
| Fireclay.....                            | 20               |
| Gray sandstone.....                      | 40               |
| Hard blue shale.....                     | 30               |

<sup>1</sup>Mines and Minerals of Washington. Ann. Report, First State Geological Survey pp. 15, 16, Olympia, 1891.

|                     | Feet.             |
|---------------------|-------------------|
| Gray sandstone..... | 50                |
| Coal.....           | 2 $\frac{1}{6}$   |
| Gray sandstone..... | 420               |
| Coal.....           | 4 $\frac{2}{3}$   |
| <hr/>               |                   |
| Total.....          | 527 $\frac{5}{6}$ |

*The Clallam Bay Field.* This field lies in a synclinal trough between Pillar Point at Pyscht and Slip Point on Clallam Bay on the Strait of Fuca and extends inland about seven miles, but is interrupted on the east and south by sharp faults and is truncated at the north by the Strait of Fuca. The coal is in the Oligocene-Miocene formation. The formation here consists of six hundred feet of coarse, thick-bedded, massive sandstone, interbedded with an occasional bed of conglomerate. In it are also interbedded several workable seams of coal.

This field was discovered in the early 50's of last century. Of a specimen of coal obtained at Slip Point then, Prof. J. S. Newberry gave the following analysis:<sup>2</sup>

|                      |                  |
|----------------------|------------------|
| Fixed carbon.....    | 46.40 per cent.  |
| Volatile matter..... | 50.97 per cent.  |
| Ash.....             | 2.63 per cent.   |
| <hr/>                |                  |
| Total.....           | 100.00 per cent. |

Later, in about 1865, a mine was opened up 2 $\frac{1}{2}$  miles east of Slip Point, known as the Thorndike Mine. At this place there were six leads of coal, ranging in thickness from one to three feet, all having a dip of ten degrees. The formation was sandstone and the coal seams were found to be from twelve to one hundred feet apart. The coal was one of the best coals found in the State of Washington. Mining at this time was continued till a fault cut off the veins, or they pinched out.

Coal is now being mined from other locations in the sea-front of the same field. The work is being done by the Clallam Bay Coal Company. Prospecting in 1904 discovered veins as follows: One seam exposed along the coast was forty inches in thickness, another eighty feet stratigraphically below this one was twelve inches in thickness, and another, a twenty-two

<sup>2</sup>Pacific Railroad Report, Vol. IV, Part II, p. 67.

inch seam, is about one hundred feet below this one. This was near Slip Point. Other seams have been discovered farther down the sea-cliff to the eastward of these.

A tunnel has been driven more than 600 feet along the line of the 40-inch seam near Slip Point. The mouth of this tunnel is on the beach, so that coal can be loaded right onto ships from it.

The coal of this mine breaks with a conchoidal fracture and shows extreme sharp edges. It is clean, hard, glossy black lignite, with small quantities of pyrite. This pyrite is often included in the coal in veinlets, but not in quantity to damage the coal. The coal leaves no clinkers. Until recently the output of this mine was said to be 200 tons per month. An analysis of a specimen of this coal gave the following:<sup>3</sup>

|                                  |                  |
|----------------------------------|------------------|
| Moisture.....                    | 5.55 per cent.   |
| Volatile combustible matter..... | 34.25 per cent.  |
| Fixed carbon.....                | 47.80 per cent.  |
| Ash.....                         | 11.40 per cent.  |
| <hr/>                            |                  |
| Total.....                       | 100.00 per cent. |

Thorough prospecting will likely disclose more and large coal seams.

<sup>3</sup>Analysis by Prof. N. W. Lord of the Department of Metallurgy and Mineralogy, Ohio State University, Columbus, Ohio.

## THE OLYMIC FOREST AND ITS POTENTIAL POSSIBILITIES.

BY ALBERT B. REAGAN.

The Olympic Peninsula lies west of Puget Sound in the State of Washington. It comprises a wide, somewhat benched coastal strip bordering both the Strait of Juan de Fuca at the north, the Pacific Ocean at the west, and the "Sound" on the east. This coastal strip surrounds a central high area termed the Olympic Mountains. These mountains are wholly isolated. They form an eroded, domed area in the central-northeastern part of the peninsula. From this main mass there extends a western limb in declining altitude to Cape Flattery at the entrance of the Strait of Fuca, Mounts Constance, Meany, and Olympus of the central area approximate 8,150 feet in height, while the immediate region exceeds 6,000 feet in elevation, while the ridge towards the Cape recedes to less than 2,000 feet in altitude. As a result of the practically domed area the drainage is radial in all directions, but the larger streams flow into the Pacific.

This peninsula, with its lofty peaks, stands first in the path of the moisture bearing winds from the Pacific. As a result, the precipitation is very heavy; at the coast it is usually rain, in the mountains snow. The precipitation averages about 40 inches east and north of the mountains, as far up the Strait of Fuca side as Port Angeles. West of the mountains at an elevation of 3,000 feet the precipitation averages 80 inches and in Upper-Strait-Flattery region and along the Pacific front 100 to 120 inches annually. The climate, also, is controlled by the prevailing southwesterly winds from the Pacific. Notwithstanding this, however, the valleys of the upper mountain districts are filled with glaciers. At the coast, however, especially on the Pacific front, snow seldom stays on the ground any length of time.

Growing under this equable climate with such an abundance of rainfall (enough in amount to preserve the forest and shrubbery from general destruction by fire), the peninsula, with few exceptions, is the most densely forested region in North America, and smaller plants do also equally well. Of course, as one approaches the mountains, the forest becomes less dense till the timber line is reached; but in the reverse proportion the flowering herbs at the same time increase in number and beauty. The open country at timber line in summer is one of nature's flower gardens. The region in

the lower levels is a jungle of trees, shrubs, and entangled vines, which must be seen to be appreciated.

The plants identified in the region to date number 687. The trees and plants most noticeable in the peninsula are fir, cedar, spruce, hemlock, red elder, "Shallon," "Rubes," salal, "Vaccinum," "Ribes," Selaginella ("S. oregona"), crab-apple, devil's club, "usnea," bearded lichens, bearberry, dogwood ("Cornus nuttallii"), and oregon grape. Here Douglas fir, tideland spruce, and red cedar reach gigantic proportions. The available timber per township averages 3,000 feet B. M. per acre amid the high mountains up to 59,000 feet B. M. per acre often in the Quillayute region. There is estimated to be 32,890,717 M. feet B. M. lumber in the region according to the estimate of Henry Gannett, Chief of Division of Forestry (1899).<sup>1</sup> This estimate has been more than doubled by Dodwell and Rixon at a later date; they give 69,000,000 M. feet B. M.<sup>2</sup> And the close measurement now used would likely double that amount. One quarter section in the Quillayute country cruised both by the Lacy Company cruisers and by the Clallam county cruisers for purpose of tax-estimating, aggregated more than 30,000,000 feet B. M. There is enough timber in the region to supply the whole United States' demand for considerable over two years.<sup>3</sup>

The timber by species is approximately as follows: Spruce, 6 per cent.; cedar, 10 per cent.; Lovely fir, 18 per cent.; Red fir, 24 per cent.; hemlock, 42 per cent.

Geographically, the Olympic Peninsula is parcelled out in the following county divisions: Chehalis county, Mason county, Jefferson county, and Clallam county. For convenience the area of the timber in each and the timber of same will be considered separately.

#### MASON COUNTY.

This county includes the southeastern part of the Olympic Mountains, from which it extends eastward so as to include much of the Hood Canal country. The portion within the mountains contains but little timber of present merchantable value. the "low country" of the county, however,

<sup>1</sup>Twentieth Annual Report, U. S. G. S. (1898-1899), Part V, pp. 12-37.

<sup>2</sup>Arthur Dodwell and Theodore F. Rickson: Forest Conditions in the Olympic Forest Reserve, Washington. Professional paper, U. S. Geol. Surv., No. 7, 110 pages, 20 plates, 1 map, 1902.

<sup>3</sup>See Reagan: Transactions of the Kansas Academy of Science, p. 136, in article, "Some Notes on the Olympic Peninsula, Washington."



with the exception of a few small prairie tracts, was originally heavily timbered, but the timber is now more than half logged.

*Area of timbered and other lands in Mason county, Washington.*

|                                       |                  |
|---------------------------------------|------------------|
| Total area.....                       | 996 square miles |
| Present merchantable timber area..... | 395 square miles |
| Logged area.....                      | 493 square miles |
| Naturally barren area.....            | 6 square miles   |
| Burned area.....                      | 112 square miles |

*Estimate of timber in Mason county, Washington.*<sup>4</sup>

|              |                         |
|--------------|-------------------------|
| Fir.....     | 2,055,648 M. feet B. M. |
| Spruce.....  | 492 M. feet B. M.       |
| Cedar.....   | 25,970 M. feet B. M.    |
| Hemlock..... | 8,955 M. feet B. M.     |

Total.....2,091,065 M. feet B. M.

Average per acre of timbered land, 5,600 feet B. M.

CHEHALIS COUNTY.

This county borders upon the Pacific Ocean, and on the north extends far up into the Olympic Mountains. The mountainous part is high and rugged and contains but little merchantable timber, and in other parts there are numerous prairie tracts. Barring these areas, the county was originally heavily forested, mainly with fir in the interior and with spruce and cedar upon the coast. There have been but few fires in this county and the burned area is trifling. The county, however, lies in the Grays Harbor lumber district and an approximate third of it has been denuded of its forests.

*Area of timbered and other lands in Chehalis county, Washington.*

|                                       |                    |
|---------------------------------------|--------------------|
| Total area.....                       | 2,104 square miles |
| Present merchantable timber area..... | 1,000 square miles |
| Logged area.....                      | 831 square miles   |
| Naturally bare area.....              | 47 square miles    |
| Burned area.....                      | 236 square miles   |

<sup>4</sup>After Gannett. Loc. cit., p. 28. It is well to add that under the present close cruising of timber, however, Mr. Gannett's figures should be multiplied by 3.

*Estimate of timber in Chehalis county, Washington.*<sup>5</sup>

|                                                      |                          |
|------------------------------------------------------|--------------------------|
| Fir.....                                             | 9,799,418 M. feet B. M.  |
| Spruce.....                                          | 3,068,307 M. feet B. M.  |
| Cedar.....                                           | 3,474,350 M. feet B. M.  |
| Hemlock.....                                         | 2,236,983 M. feet B. M.  |
| Total.....                                           | 18,579,058 M. feet B. M. |
| Average per acre of timbered land, 21,300 feet B. M. |                          |

## JEFFERSON COUNTY.

This county stretches from Hood's Canal upon the east to the Pacific Ocean. Its central portion, comprising three-fourths of it, lies within the Olympic Mountains. Scattered here and there in this area there are considerable timber in the below-timber-line districts, but on account of the inaccessibility of the district it is of no value at present for milling purposes. Barring the mountain area, the county was formerly heavily forested, on the west with cedar and spruce, on the east with fir. The timber in the eastern part of the county has been largely destroyed either by ax or fire, mainly the latter. The timber in the western part of the county is yet virgin, being untouched by fire or ax. The most abundant species represented in this county is the cedar.

*Area of timbered and other lands in Jefferson county, Washington.*

|                                       |                    |
|---------------------------------------|--------------------|
| Total area.....                       | 1,688 square miles |
| Present merchantable timber area..... | 430 square miles   |
| Logged area.....                      | 296 square miles   |
| Naturally bare area.....              | 100 square miles   |
| Burned area.....                      | 215 square miles   |
| Non-merchantable timber area.....     | 647 square miles   |

*Estimate of timber in Jefferson county, Washington.*<sup>6</sup>

|                                                      |                         |
|------------------------------------------------------|-------------------------|
| Fir.....                                             | 794,232 M. feet B. M.   |
| Spruce.....                                          | 267,427 M. feet B. M.   |
| Cedar.....                                           | 2,124,725 M. feet B. M. |
| Hemlock.....                                         | 1,043,776 M. feet B. M. |
| Total.....                                           | 4,230,160 M. feet B. M. |
| Average per acre of timbered land, 15,300 feet B. M. |                         |

<sup>5</sup>Loc. cit., p. 19. Remarks above apply.<sup>6</sup>Loc. cit., p. 24. Remarks above apply.

## CLALLAM COUNTY.

This county extends from the top of the Olympic Mountains north to the Strait of Fuca and from near Dungeness on that strait to a little to the south of LaPush on the Pacific coast, occupying a large area both to the north and to the west of the Olympics. The mountainous part of the county is not regarded as containing any timber of present merchantable value. The remainder of the county is heavily forested; but the ax has made inroads in these forests along the shores of the Strait of Fuca as far west as Crescent Bay, and millions of feet of logs have been cut at Clallam Bay and in the Hoko district on the same side of the peninsula. In addition, fires have extended inland from these cuttings to the mountain districts, destroying large areas of timber. The western part of the county is still in the virgin state. In this county hemlock and fir vie with each other in amount of merchantable log-lumber.

*Area of timbered and other lands in Clallam county, Washington.*

|                                          |                    |
|------------------------------------------|--------------------|
| Total area.....                          | 1,824 square miles |
| Present merchantable timber area.....    | 1,000 square miles |
| Logged area.....                         | 217 square miles   |
| Burned area.....                         | 181 square miles   |
| Bare and unmerchantable timber area..... | 426 square miles   |

*Estimate of timber in Clallam county, Washington.*<sup>7</sup>

|              |                         |
|--------------|-------------------------|
| Fir.....     | 3,045,297 M. feet B. M. |
| Spruce.....  | 1,758,845 M. feet B. M. |
| Cedar.....   | 547,617 M. feet B. M.   |
| Hemlock..... | 3,719,840 M. feet B. M. |

Total.....9,071,599 M. feet B. M.  
Average per acre of timbered land, 15,700 feet B. M.

Below is a description of the merchantable timber species as they occur in the peninsula.

<sup>7</sup>Loc. cit., p. 20. Remarks above apply.

## FAMILY PINACEAE: PINE FAMILY.

Genus *Chamaecyparis*.

*C. nootkatensis* (Lamb) Spach: Alaska Cedar. This tree is found on all the mountain ridges below 3,500 feet elevation. It is a conspicuous tree on the ridges at the headwaters of the Soleduck and Bogachiel rivers and in the vicinity of the Soleduck Hot Springs. It is often called Yellow Cedar. It is also more abundant in the swamp regions near the Pacific coast, bordering the rivers near their mouths. It is a medium tree in height for this region, but exceeds the Red Fir in girth. Its greatest development is usually where it stands the heaviest. It averages about 140 feet in height and 50 inches in diameter. This tree is subject to rot; half of the stand is injured by this disease.<sup>8</sup>

Genus *Thuja*.

*T. plicata* Donn: Red Cedar; Giant Cedar. This cedar is found in all parts of the peninsula, except in the high mountain districts. It is of larger growth near the coast, where it often measures from 40 to 50 feet in circumference; some trees in the Elwa valley are said to measure even 80 feet in circumference.

This tree differs from *C. nootkatensis* above in its wood being reddish in color, in its larger size in circumference-measurements, and in the scales of its cones being oblong, not plicate.<sup>9</sup>

<sup>8</sup>The juice of the bark of this tree and that of the Giant Cedar is used by the natives in dyeing basket straw. The other coloring matter used by these Indians is burned yellow clay, black earth, blood, soot and charcoal.

<sup>9</sup>Of this giant cedar the Indians make their dug-out canoes, canoes ranging from the size of a little river canoe to an ocean-whaling canoe that will hold ten whale hunters, or three tons of freight. These canoes are in each case made from a single piece (section) of log and the canoe is in each case one continuous piece when finished, except just the front totem (river-deer) part. In making these canoes in the old time it was a slow process of burning and scraping with clam shells, and a possible chiseling with some wedge-shaped stone. Today they are hewed out with ax and Indian adz. A canoe for ocean use is now worth about \$100.

The cedars are used for many purposes by the Indians of the coast. The juice of the green bark is used as medicine, after being boiled. The outer bark is used in making wigwams. In the old times they also shredded the inner bark of these species and wove it into a sort of cloth. Of this cloth they then made skirts for the women, and other wearing apparel both for the men and the women. They also lined their cradles with this bark and wrapped their babies up in it before tying them in the cradles. A peculiar raincoat was made from this bark to be worn by the men while fishing in stormy weather.

Genus *Pinus*.

*P. monticola* Dougl.: Western White Pine. This tree is found on the western slopes of the Olympics, above 500 feet elevation, usually in swamps and wet places.

Description: Cones oblong-cylindrical; scales of cones unarmed; leaves five in each fascicle.

Genus *Abies*.

*A. nobilis* Lindl.: Lovely Fir; Noble Fir. This tree is found at considerable elevations; but rarely at elevations less than 1,500 feet.

Description: This is a tall, silvery-barked, noble-looking tree. It differs from the other firs principally in the color of its bark and in its having cones with conspicuous reflexed bracts.

*A. lasiocarpa* (Hook) Nutt.: Alpine Fir; Subalpine Fir. This tree is found only on the higher parts of the mountains, rarely below 5,000 feet.

Description: A tree of 60 to 80 feet in height; bark pale, thin, smooth, ash-gray in color; leaves dark-green above, with two resin-ducts about equi-distant between the upper and lower face; cones oblong-cylindrical, puberulent, with bracts concealed.

*A. amabilis* (Dougl.) Forbs.: Lovely Fir; Amabilis Fir. This tree is found only on the high ridges adjacent to the mountains, rarely below 1,200 feet elevation. It is one of the large lumber-producing trees of the region, producing more than 11,000,000 M. feet B. M.

Description: This tree is distinguishable from *A. lasiocarpa* above by its cones not being puberulent and by the greater length of the cones.

*A. grandis* Lindl.: White Fir. This tree is occasionally met with in the Soleduck Hot Spring region.

Genus *Pseudotsuga*.

*P. mucronata* (Raf.) Sudw.: Douglas Fir; Red Fir. This tree grows in abundance. It reaches its greatest development in the Quillayute-middle-upland region. In its growth, however, it extends up the mountain slopes to the altitude of 3,500 feet. In the high mountains and in the neighborhood of the Pacific coast, this species is practically entirely wanting. It grows to its greatest dimensions where the stand is heaviest. Throughout the region it averages 240 feet in height; 77 feet clear of limbs, with a diameter

of 55 inches. This tree is everywhere free from disease. The stand of timber of this species is estimated to be more than 15,000,000 M. feet B. M.

Description: Tree large; in youth, spruce-like and pyramidal, more spreading in old age; leaves somewhat two-ranked by a twist at base.

#### Genus *Tsuga*.

*T. heterophylla* (Raf.) Sarg.: Western Hemlock. This tree is found throughout the region.

Description: This is a lowland tree, with cones 1 to 2 cm. long.

*T. mertensiana* (Bong.) Carr: Black Hemlock; Merten's Hemlock. This tree is found almost everywhere in the forest from the shore line up to 4,500 feet elevation. With the Western Hemlock above, it is by far the most abundant tree in the region, being found in every part of it to timber line. It is not so large a tree as the other merchantable trees, either in height or diameter, the amount of clear trunk is also less. In the high mountain regions the tree is greatly affected by disease, but as the shore line is approached the percentage of diseased trees diminish to the minimum. This tree with the Western Hemlock estimate 26,000,000 M. feet B. M.

Description: Characteristically, this tree differs from the Western Hemlock above in its having appreciably longer cones.<sup>10</sup>

#### Genus *Picea*.

*Picea sitchensis* (Bong.) Traut: Sitka Spruce. This species is found only in the neighborhood of the coast, seldom ever found thirty miles inland. It is densest a little way back from the coast, the immediate coast seeming to be too damp for its best development. The tree averages 225 feet in height, 81 feet of which is often clear of limbs. Its diameter exceeds 5 feet on the average. This tree seems to be less affected by disease than any other merchantable tree in the region. It aggregates over 4,000,000 M. feet B. M. in merchantable timber.

Description: Trees tall, pyramidal, with soft, white, tough timber; leaves flattened, somewhat two-ranked, and spirally arranged around the branchlets.

*P. engelmanni* Parry: Engelmann Spruce. This spruce is only scattered

<sup>10</sup>The Indians use the bark of this tree in tanning hides. Hemlock bark tea is also used as an emetic.

here and there and in too small quantities, usually, to be of much value in a merchantable way.

Description: Tree subalpine, with height averaging about 90 feet; branches horizontal; bark thin, scaly, reddish to purplish brown; branches pubescent; leaves quadrangular.





## THE UREDINALES OF INDIANA.

BY H. S. JACKSON.

The first authentic record of the collection of any species of plant rust in Indiana of which we have any knowledge was made by Dr. J. M. Coulter in the *Botanical Bulletin* (*Botanical Gazette*) 1:20, 1876. In a short article he noted the common occurrence of *Uromyces lespedezae* Schw. on *Lespedeza violacea*, presumably in the vicinity of Hanover.

The first account of the rusts of the State presented before the Indiana Academy of Science was included in a paper by E. M. Fisher on the Parasitic Fungi of Indiana, which was read at the annual meeting for 1890. This paper listed a considerable number of species of Uredineae, but unfortunately was not published and is unavailable. The specimens on which the paper was based were deposited in the herbarium of the United States Department of Agriculture. A list of the species was, however, obtained by Dr. L. M. Underwood and included in his "List of the Cryptogams at present known to inhabit the State of Indiana," which was printed in the Proceedings for 1893.

The latter list forms the basis of our knowledge of the cryptogamic flora of the State and enumerates 88 species of Uredinales including the unattached aecial and uredinial forms. Supplementary lists by various authors have appeared in the Proceedings from time to time since that date, only the most noteworthy of which need be mentioned.

In 1896 Miss Lillian Snyder presented a list of the rusts of Tippecanoe county, supplementing the work in 1898 with lists from Madison and Noble counties. The rusts of Hamilton and Marion counties were listed by G. W. Wilson in 1905.

Two complete State lists have been presented to the Academy by Dr. J. C. Arthur. The first was read in 1898 and enumerated 80 species; the second was presented in 1903 and included 105 species. Both these lists were prepared in such form as to illustrate the latest developments in revised nomenclature. The unattached aecial and uredinial forms were omitted.

The present list is based on the information contained in all the preceding ones which have appeared in the Proceedings of the Academy, together with the wealth of material collected in all parts of the State contained in the

Arthur herbarium at the Purdue Experiment Station. An attempt has been made to show the distribution within the State by counties. Under each host is given a list of the counties within which the species has been collected, together with the name of the person making the *first* collection and the year in which the collection was made. A considerable number of the collections which have been recorded in the first lists were not available to the writer. These have been included in the distribution only when there seemed to be no chance of mistaking their identity. A few species evidently wrongly determined of which no specimens were available, have been omitted.

The nomenclature followed is that of Dr. J. C. Arthur as used in the N. Am. Flora, volume 7, in so far as that admirable work has been completed, or as proposed for the unpublished portion. The nomenclature of the hosts in general conform to that of Britton & Brown, Illustrated Flora, 2nd edition.

For convenience in consulting the list, the species not previously recorded are marked \*. Hosts not previously recorded are printed in black-faced type. References are inserted following the host name to the year and page of preceding volumes of the Proceedings, where additional information may be obtained. Wherever Indiana rusts have appeared in published sets of exsiccati reference is made following the collector's name. Reference by number is made to the rusts included in the set of Parasitic Fungi distributed by the Indiana Biological Survey, December, 1894. Series 1. (See Proceedings 1894:154-156. 1895.)

It is the plan of the writer to submit additions and corrections to this list as material is collected. It would be greatly appreciated if collectors would send duplicates of their collections to the writer.

The writer wishes to acknowledge his indebtedness to Dr. J. C. Arthur for the unrestricted use of his herbarium and notes in the preparation of this list without which any approach to completeness would have been impossible. Dr. Arthur has also kindly read the manuscript and offered many helpful suggestions.

**COLEOSPORIACEAE.**

- \*1. COLEOSPORIUM CAMPANULAE (*Pers.*) *Lev.*  
 On **Campanula americana** L.  
 Delaware, 1915 (Jackson); Hamilton, 1907 (Wilson); Tippecanoe,  
 1907 (Arthur & Kern).
- \*2. COLEOSPORIUM DELICATULUM (*Arth. & Kern*) *Hedg. & Long*  
 On **Euthamia graminifolia** (L.) Nutt.  
 Harrison, 1915 (Fogal); Jefferson, 1914 (Demaree); Johnson,  
 1915 (Pipal); Orange, 1915 (Jackson).
- \*3. COLEOSPORIUM ELEPHANTOPODIS (*Schw.*) *Thum.*  
 On **Elephantopus carolinianus** Willd.  
 Gibson, 1915 (Hoffer); Jefferson, 1915 (Demaree); Orange, 1915  
 (Jackson).
- \*4. COLEOSPORIUM HELIANTHI *Schw.*  
 On **Helianthus decapetalus** L.  
 Owen, 1893 (Underwood); Tippecanoe, 1915 (Ludwig).  
 On **Helianthus hirsutus** Raf.  
 Orange, 1915 (Jackson).
5. COLEOSPORIUM IPOMOEAE (*Schw.*) *Burrill.*  
 On *Ipomoea pandurata* (L.) Mey. 1896:171, 218.  
 Tippecanoe, 1895 (Arthur); 1896 (Snyder); 1914 (Ludwig in  
 Barth. *Fungi Col.* 4519).
6. COLEOSPORIUM SOLIDAGINIS (*Schw.*) *Thum.* 1908:89.  
 On *Aster azureus* Lindl. 1893:50.  
 Montgomery, 1890 (Fisher), 1893 (Olive).  
 On *Aster cordifolius* L. 1893:51.  
 Montgomery, 1890 (Fisher); Tippecanoe, 1896 (Snyder).  
 On **Aster Drummondii** Lindl.  
 Tippecanoe, 1904 (Arthur).  
 On *Aster ericoides* L. 1905:179.  
 Delaware, 1915 (Jackson); Hamilton, 1905 (Wilson); Orange,  
 1915 (Jackson); Tippecanoe, 1915 (Mrs. Emily Arthur).  
 On **Aster longifolius** Lam.  
 Putnam, 1907 (Wilson).

- On *Aster Novae-angliae* L. 1893:51.  
Johnson, 1890 (Fisher); Montgomery, 1890 (Fisher); Tippecanoe, 1904 (Arthur).
- On *Aster paniculatus* Lam. 1893:51, 1905:179.  
Franklin, 1912 (Ludwig); Hamilton, 1905 (Wilson); Montgomery, 1890 (Fisher); Tippecanoe, 1896 (Snyder).
- On *Aster puniceus* L. 1893:51.  
Henry, 1915 (Jackson); Johnson, 1890 (Fisher); Steuben, 1903 (Kellerman); Tippecanoe, 1896 (Snyder).
- On *Aster sagittifolius* Willd. 1893:51.  
Delaware, 1915 (Jackson); Johnson, 1890 (Fisher); Tippecanoe, 1896 (Snyder).
- On *Aster salicifolius* Lam. 1893:51.  
Henry, 1915 (Jackson); Johnson, 1890 (Fisher).
- On *Aster Shortii* Hook. 1893:51.  
Montgomery, 1890 (Fisher).
- On *Aster Tradescanti* L. 1893:51.  
Johnson, 1890 (Fisher).
- On ***Callistephus hortensis*** Cass.  
Jefferson, 1914 (Demaree).
- On *Solidago arguta* Ait. 1893:51.  
Montgomery, 1890 (Fisher).
- On *Solidago caesia* L. 1893:51.  
Johnson, 1890 (Fisher); Montgomery, 1890 (Fisher); Tippecanoe, 1912 (Pipal).
- On *Solidago canadensis* L. 1893:51. 1905:179.  
Hamilton, 1905 (Wilson); Johnson, 1890 (Fisher); Marion, 1905 (Wilson); Montgomery, 1890 (Fisher); Orange, 1915 (Jackson); Tippecanoe, 1915 (Jackson); Tipton, 1915 (Pipal); Wabash, 1890 (Miller).
- On *Solidago flexicaulis* L. (*S. latifolia* L.) 1893:51 1896:218.  
Montgomery, 1890 (Fisher); Owen, 1893 (Underwood Ind. Biol. Survey No. 54); Tippecanoe, 1896 (Snyder).
- On *Solidago patula* Muhl. 1893:51.  
Montgomery, 1890 (Fisher); Tippecanoe, 1906 (Kern).

On *Solidago rugosa* Mill. 1893:51.

Johnson, 1890 (Fisher); St. Joseph, 1904 (Cunningham); Tippecanoe, 1904 (Arthur).

On *Solidago serotina* Ait. 1893:51.

Johnson, 1890 (Fisher); Owen, 1893 (Underwood Ind. Biol. Survey, 54 in part); Steuben, 1903 (Kellerman).

On *Solidago ulmifolia* Muhl.

Montgomery, 1907 (Fitzpatrick); Tippecanoe, 1896 (Snyder).

Following the usage of earlier American authors this species has often erroneously been referred to the European *C. Sonchiarvensis* (Pers.) Lev.

\*7. COLEOSPORIUM TEREBINTHINACEAE (*Schw.*) *Arth.*

On *Silphium integrifolium* Michx.

Tippecanoe, 1915 (Ludwig).

On *Silphium terbinthinaceum* Jacq.

Tippecanoe, 1912 (Hoffer); 1914 (Ludwig, in Barth. N.Am. Ured. 1109).

8. COLEOSPORIUM VERNONIAE *B. & C.*

On *Vernonia fasciculata* Michx. 1893:51. 1905:179.

Hamilton, 1905 (Wilson); Montgomery, 1893 (Olive); Orange, 1915 (Jackson); Putnam, 1891 (Underwood); Tippecanoe, 1896 (Snyder).

On *Vernonia noveboracensis* (L.) Willd. 1893:51.

Jefferson, 1915 (Demaree); Johnson, 1890 (Fisher).

On *Vernonia altissima* Nutt.

Delaware, 1915 (Jackson); Hamilton, 1905 (Wilson); Henry, 1915 (Jackson); Orange, 1915 (Jackson); Tippecanoe, 1905 (Kern).

UREDINACEAE.

\*9. BUBAKIA CROTONIS (*Cooke*) *Arth.*

On *Croton monanthogynus* Michx.

Franklin, 1912 (Oskamp); Lawrence, 1915 (Hoffer); Putnam, 1907 (Wilson).

## 10 HYALOPSORA POLYPODII (DC.) Magn.

*Uredo polypodii* DC.

On *Felix fragilis* (L.) Underw. (*Cystopteris fragilis* (L.) Bernh.  
1893:56. 1903:143.

Putnam, 1893 (Underwood Ind. Biol. Survey 53).

## \*11. MELAMPSORA ABIETIS-CANADENSIS (Farl.) Ludwig.

On **Populus deltoides** Marsh.

Jasper, 1913 (Arthur & Fromme).

On *Populus grandidentata* Michx. 1893:51.

Putnam, 1893 (Underwood Ind. Biol. Sur. 50).

On **Populus heterophylla** L.

Tippecanoe, 1914 (Ludwig).

On **Populus tremuloides** Michx.

Steuben, 1903 (Kellerman).

Some of above collections were previously recorded in the  
Proceedings as *M. Medusae* Thüm.

## 12. MELAMPSORA BIGELOWII Thüm. 1908:89.

On *Salix amygdaloides* Anders. 1903:143.

Lagrange, 1907 (Arthur); Steuben, 1903 (Kellerman).

On *Salix cordata* Muhl. 1893:51. 1905:180.

Hamilton, 1905 (Wilson); Montgomery, 1893 (Olive); Tippecanoe,  
1904 (Arthur).

On *Salix discolor* Muhl. 1893:51. 1896:218.

Montgomery, 1890 (Fisher); Tippecanoe, 1896 (Snyder).

On *Salix interior* Rowlee (*S. longifolia* Muhl.) 1893:51. 1905:180.

Hamilton, 1905 (Wilson); Johnson, 1890 (Fisher); Montgomery,  
1893 (Olive); Marion, 1905 (Wilson); Owen, 1893 (Under-  
wood Ind. Biol. Sur. 49); St. Joseph, 1904 (Cunningham);  
Steuben, 1903 (Kellerman); Tippecanoe, 1898 (Stuart).

On *Salix nigra* Marsh. 1893:51.

Henry, 1915 (Jackson); Montgomery, 1890 (Fisher); Tippecanoe,  
1887 (Arthur).

On **Salix Wardii** Bebb. (1893:51 as *S. nigra* Marsh.)

Johnson, 1890 (Fisher).

Following frequent usage of American authors this species  
has been variously referred to in the Proceedings as *Melampsora*

*Salicina* Lev., *M. farinosa* (Pers.) Schroet. and *M. Salicis-cupreae* (Pers.) Wint., all of which apply to European species.

13. MELAMPSORA MEDUSAE *Thüm.* 1908:89.

On *Populus balsamifera* L. 1893:51.

Montgomery, 1890 (Fisher).

On *Populus deltoides* Marsh. (*P. monilifera* Ait.) 1893:51. 1896:218. 1905:180.

Hamilton, 1905 (Wilson); Johnson, 1890 (Fisher); Marion, 1905 (Wilson); Montgomery, 1893 (Olive); Putnam, 1891 (Underwood); Tippecanoe, 1914 (Ludwig, in Barth. Fungi Col. 4737 and in Barth. N. Am. Ured. 1122); 1888 (Bolley), 1896 (Snyder); Warren, 1909 (Kern & Johnson).

On *Populus grandidentata* Michx. 1893:51.

Montgomery, 1890 (Fisher); Putnam, 1890 (Underwood).

On *Populus tremuloides* Michx. 1893:51. 1898:188.

Marshall, 1893 (Underwood); Noble, 1897 (King).

This species has occasionally been erroneously referred in the Proceedings to *M. populina* (Jacq.) Lev., a European species.

14. MELAMPSORIDIUM BETULAE (*Schum.*) *Arth.*

*Melampsorium betulinum* (Pers.) Kleb.

On *Betula lutea* Michx. 1903:143. 1908:89.

Steuben, 1903 (Kellerman).

15. PUCCINIASTRUM AGRIMONIAE (*Schw.*) *Tranz.*

*Cacomis Agrimoniae* Schw.

On *Agrimonia hirsuta* (Muhl.) Bickn. (*A. Eupatoria* Am. Auct.) 1893:50.

Montgomery (Rose); Owen, 1893 (Underwood); Putnam, 1891 (Underwood); 1907 (Wilson).

On *Agrimonia mollis* (T. & G.) Britton. 1893:50. 1896:218. 1905:180.

Delaware, 1915 (Jackson); Hamilton, 1905 (Wilson); Johnson, 1890 (Fisher); Orange, 1915 (Jackson); Tippecanoe, 1896 (Snyder).

On *Agrimonia parviflora* Soland. 1893:50.

Jefferson, 1915 (Demaree); Marshall, 1893 (Underwood); Putnam, 1893 (Underwood, Biol. Surv. 51); Tippecanoe, 1913 (Travelbee).

16. PUCCINIASTRUM HYDRANGEAE (*B. & C.*) *Arth.*

*Uredo Hydrangeae* *B. & C.*

*Coleosporium Hydrangeae* (*B. & C.*) *Snyder.*

*Thecopsora Hydrangeae* (*B. & C.*) *Magn.*

On *Hydrangea arborescens* L. 1893:56. 1896:218. 1903:143.

Marion, 1890 (Tracy); Montgomery, 1890 (Fisher); Putnam, 1891 (Underwood); Tippecanoe, 1896 (Snyder).

AECIDIACEAE.

17. ALLODUS AMBIGUA (*A. & S.*) *Arth.*

*Puccinia ambigua* (*A. & S.*) *Lagerh.*

*Dicaeoma ambigua* (*A. & S.*) *Kuntze.*

On *Galium Aparine* L. 1896:172. 1903:146.

Jefferson, 1903 (Arthur); Tippecanoe, 1896 (Snyder).

\*18. ALLODUS CLAYTONIATA (*Schw.*) *Arth.*

*Cacoma (Aecidium) Claytoniatum* *Schw.*

*Puccinia Mariac-Wilsoni* *G. W. Clinton.*

On *Claytonia virginica* L.

St. Joseph, 1904 (Cunningham).

19. ALLODUS PODYPHYLLI (*Schw.*) *Arth.*

*Puccinia Podyphylli* *Schw.*

*Dicaeoma Podyphylli* (*Schw.*) *Kuntze.*

On *Podyphyllum peltatum* L. 1893:54. 1896:221. 1898:184, 189. 1905:182.

Brown, 1893 (Underwood); Dearborn, 1889 (Bolley); Fayette, 1914 (Ludwig in Barth. N. Am. Ured. 1166 and in Barth. Fungi Col. 4760); Franklin, 1912 (Ludwig); Hamilton, 1905 (Wilson); Jasper, 1915 (Arthur); Jefferson, 1910 (Johnson); Johnson, 1890 (Fisher); Montgomery, 1893 (Olive); Monroe, 1893 (Underwood); Noble, 1897 (King); Owen, 1893 (Underwood); Posey, 1906 (Arthur & Kern); Putnam, 1892; 1893



(Underwood, Ind. Biol. Sur. 15); St. Joseph, 1905 (Cunningham); Tippecanoe, 1896 (Snyder); Wabash, 1890 (Miller); Vigo, 1893 (Underwood).

20. ALLODUS TENUIS (*Schw.*) *Arth.*

*Caeoma (Accidium) tenue* Schw.

*Puccinia tenuis* Burr.

*Dicaeoma tenue* (Burr.) Kuntze.

On *Eupatorium urticaefolium* Reich. (*E. agratoides* L.) 1893:55.  
1896:221. 1903:151.

Putnam, 1893 (Underwood); Tippecanoe, 1896 (Snyder).

\*21. BULLARIA BARDANAE (*Cda.*) *Arth.*

*Puccinia Bardanae* Corda.

On **Arctium Lappa** L.

Carroll, 1915 (Hoffer); Delaware, 1915 (Jackson); Henry, 1915 (Jackson); Tippecanoe, 1915 (Jackson).

\*22. BULLARIA BULLATA (*Pers.*) *Arth.*

*Puccinia bullata* (Pers.) Wint.

On **Taenida integerrima** (L.) Drude.

Tippecanoe, 1915 (Ludwig).

23. BULLARIA CHRYSANTHEMI (*Roze*) *Arth.*

*Puccinia Chrysanthemi* Roze.

*Dicaeoma Chrysanthemi* (Roze) *Arth.*

On *Chrysanthemum Sinense* Sabine. 1903:147.

Tippecanoe, 1899 (Dorner); 1900 (Arthur).

\*24. BULLARIA GLOBOSIPES (*Pk.*) *comb. nov.*

*Puccinia globosipes* Pk.

*Uredo similis* Ell.

On **Lycium halimifolium** Mill.

Shelby, 1890 (Fisher); Type of *Uredo similis* Ell. *Jour. Myc.* 7:275. 1893.

\*25. BULLARIA HIERACII (*Schum.*) *Arth.*

*Puccinia Hieracii* (Schum.) Mart.

On **Hieracium scabrum** Michx.

Montgomery, 1913 (Arthur).

26. **BULLARIA KUHNIAE** (Schw.) comb. nov.*Puccinia Kuhniae* Schw.*Dicacoma Kuhniae* (Schw.) Kuntze.On *Kuhnia eupatorioides* L. 1893:54. 1896:220.

Harrison, 1915 (Fogal); Tippecanoe, 1888 (Bolley); 1900 (Arthur).

27. **BULLARIA TARAXACI** (Reb.) Arth.*Puccinia Taraxaci* (Reb.) Plowr.*Dicacoma Taraxaci* (Reb.) Kuntze.On *Leontodon Taraxacum* L. (*Taraxacum Taraxacum* (L.) Karst. 1893:53. 1896:219. 1898:188. 1903:51. 1905:182.

Franklin, 1915 (Ludwig); Henry, 1915 (Jackson); Hamilton, 1905 (Wilson); Jefferson, 1910 (Johnson); Johnson, 1890 (Fisher); Marion, 1905 (Wilson); Miami, 1915 (Ludwig); Montgomery, 1893 (Olive); Noble, 1897 (King); Putnam, 1893 (Underwood); Tippecanoe, 1888 (Bolley), 1896 (Snyder); Vigo, 1893 (Arthur).

On *Leontodon erythrospermum* (Andrz.) Britton (*Taraxacum erythrospermum* Andrz.)

Hamilton, 1909 (Kern &amp; Johnson); Jefferson, 1910 (Johnson); Tippecanoe, 1907 (Arthur).

Reported erroneously in the Proceedings as *Puccinia flosculosorum* (A. & S.) Wint. and *Dicacoma flosculosorum* (A. & S.) Martins.28. **DASYSPORA ANEMONES-VIRGINIANAE** (Schw.) Arth.*Puccinia Anemones-virginianae* Schw.*Dicacoma Anemones-virginianae* (Schw.) Arth.On *Anemone cylindrica* A. Gray. 1896:219.

Tippecanoe, 1892 (Arthur).

On *Anemone virginiana* L. 1903:146.

Steuben, 1903 (Kellerman); Tippecanoe, 1903 (Arthur).

29. **DASYSPORA ASTERIS** (Duby) Arth.*Puccinia Asteris* Duby.*Dicacoma Asteris* (Duby) Kuntze.On *Aster azureus* Lindl.

Tippecanoe, 1896 (Stuart).

On *Aster cordifolius* L. 1893:52.

Montgomery, 1890 (Fisher).

On *Aster longifolius* Lam.

Putnam, 1907 (Wilson); Tippecanoe, 1905 (Wilson).

On *Aster Novae-angliae* L.

Tippecanoe, 1910 (Johnson & Orton).

On *Aster paniculatus* Lam. 1893:52. 1896:219. 1905:181.

Hamilton, 1905 (Wilson); Montgomery, 1890 (Fisher); Tippecanoe, 1896 (Snyder).

On *Aster punicens* L.

Tippecanoe, 1905 (Kern).

On *Aster sagittifolius* Willd.

Delaware, 1915 (Jackson).

30. DASYSPORA CIRCAEAE (*Pers.*) *Arth.*

*Puccinia Circaeae* Pers.

*Dicaeoma Circaeae* (Pers.) Kuntze.

On *Circaea Lutetiana* L. 1893:53. 1896:219. 1905:181.

Hamilton, 1905 (Wilson); Johnson, 1890 (Fisher); Putnam, 1893 (Underwood, Ind. Biol. Sur. 28); Tippecanoe, 1896 (Snyder); Wabash, 1886 (Miller).

31. DASYSPORA DAYI (*Clint.*) *Arth.*

*Puccinia Dayi* Clinton.

*Dicaeoma Dayi* (Clint.) Kuntze.

On *Steironema ciliatum* (L.) Raf. 1893:53. 1905:181.

Hamilton, 1905 (Wilson); Johnson, 1890 (Fisher); Kosciusko, 1913 (Hoffer); Putnam, 1893 (Underwood, Ind. Biol. Sur. 25).

32. DASYSPORA GLECOMATIS (*DC.*) *Arth.*

*Puccinia verrucosa* (Schultz) Lk.

On *Agastache nepetoides* (L.) Kuntze. 1905:181.

Hamilton, 1905 (Wilson); Johnson, 1915 (Pipal); Sullivan (Hoffer); Tippecanoe, 1910 (Johnson).

33. DASYSPORA LOBELIAE (*Ger.*) *Arth.*

*Puccinia Lobeliae* Ger.

*Dicaeoma Lobeliae* (Ger.) *Arth.*

On *Lobelia syphilitica* L. 1893:54. 1896:220.

Fulton, 1893 (Underwood); Johnson, 1890 (Fisher); Putnam, 1893 (Underwood, Ind. Biol. Sur. 20); Tippecanoe, 1883 (Arthur); Vermillion, 1889 (Arthur) Vigo, 1893 (Underwood).

\*34. **DASYSPORA MALVACEARUM** (Bert.) Arth.

*Puccinia malvacearum* Bert.

*Dicaeoma malvacearum* (Bert.) Kuntze.

On *Althaea rosea* L.

Huntington, 1915 (Miller); Marion, 1915 (Dietz); Marshall, 1915 (Arthur); Montgomery, 1915 (Anderson); St. Joseph, 1915 (Bordner).

On *Malva rotundifolia* L.

Marshall, 1915 (Arthur); St. Joseph, 1914 (Anderson).

35. **DASYSPORA PHYSOSTEGIAE** (P. & C.) comb. nov.

*Puccinia Physostegiae* P. & C.

*Dicaeoma Physostegiae* (P. & C.) Kuntze.

On *Dracocephalum virginianum* L. (*Physostegia virginiana* (L.) Benth.) 1894:151. 1896:220.

Marshall, 1893 (Underwood, Ind. Biol. Sur. 13); Tippecanoe, 1895 (Arthur).

36. **DASYSPORA RANUNCULI** (Seymour) Arth.

*Puccinia Ranunculi* Seymour.

*Dicaeoma Ranunculi* (Seym.) Kuntze.

On *Ranunculus septentrionalis* Poir. 1893:55.

Montgomery, 1893 (Olive); 1903 (Hughart).

\*37. **DASYSPORA SAXIFRAGAE** (Schlecht.) Arth.

*Puccinia Saxifragae* Schlecht.

On *Micranthes pennsylvanica* (L.) Han. (*Saxifraga pennsylvanica* L.)

Porter, 1913 (Deam).

\*38. **DASYSPORA SEYMERIAE** (Burr.) Arth.

*Puccinia Seymeriae* Burr.

On *Azelia macrophylla* (Nutt.) Kuntze.

Tippecanoe, 1907 (Dorner).

The combination *D. Seymeriae* (Burr.) Arthur was made in Result. Sci. Congr. Bot. Vienne 347. 1906. By a typographical error the specific name was written "Seymouriae." *Puccinia Seymeriae* Burr. not *Puccinia Seymourii* Lindl. was clearly intended. The latter is probably not a Dasyspora and in any case is a synonym of *P. muscuii* E. & E.

39. DASYSPORA SILPHII (Schw.) Arth.

*Puccinia Silphii* Schw.

*Dicaeoma Silphii* (Schw.) Kuntze.

On *Silphium integrifolium* Michx. 1903:151.

Tippecanoe, 1901 (Dorner).

On **Silphium perfoliatum** L.

Tippecanoe, 1906 (Wilson, Olive, Kern).

On *Silphium* sp. 1893:55.

Putnam, 1891 (Underwood).

40. DASYSPORA XANTHII (Schw.) Arth.

*Puccinia Xanthii* Schw.

*Dicaeoma Xanthii* (Schw.) Kuntze.

On *Ambrosia trifida* L. 1896:222. 1905:182.

Gibson, 1915 (Hoffer); Hamilton, 1905 (Wilson); Tippecanoe, 1896 (Snyder).

On *Xanthium americanum* Walt. 1893:56.

Johnson, 1890 (Underwood); Montgomery, 1893 (Olive); Orange, 1913 (Arthur & Ludwig); Putnam, 1891 (Underwood); Tippecanoe, 1905 (Wilson).

On **Xanthium communis** Britton.

Allen, 1911 (Orton); Montgomery, 1910 (Jennison); Tippecanoe, 1914 (Travelbee).

On *Xanthium pennsylvanica* Wallr. 1893:56. 1896:222. 1905:182.

Fountain, 1914 (Arthur); Hamilton, 1905 (Wilson); Marion, 1905 (Wilson); Montgomery, 1890 (Fisher); Putnam, 1893 (Underwood); Tippecanoe, 1896 (Snyder).

On **Xanthium spinosum** L.

Tippecanoe, 1895 (Arthur).

The earlier collections recorded in the Proceedings were mainly

referred to as occurring on *Xanthium canadense* Mill. and *X. strumarium* L. The exact identity of the host can not now be determined and the collections so referred are here placed under *X. pennsylvanicum* and *X. americanum* respectively.

41. DICAEOOMA(?) ALETRIDIS (B. & C.) Kuntze.

*Puccinia Aletridis* B. & C.

On *Aletris farinosa* L. 1903:146.

Lake, 1884 (Hill).

42. DICAEOOMA ANDROPOGONIS (Schw.) Kuntze.

*Aecidium Penstemonis* Schw.

*Puccinia Andropogi* Schw.

I. On *Penstemon hirsutus* (L.) Willd. 1896:217. 1908:90.

Tippecanoe, 1896 (Stuart in Arth. & Holw. Ured. Exsicc. et Icones, 39a).

III. On *Andropogon furcatus* Muhl. 1896:219.

Tippecanoe, 1896 (Stuart, Snyder).

On *Schizachyrium scoparium* (Michx.) Nash (*Andropogon scoparius* Michx.) 1896:219.

Tippecanoe, 1896 (Snyder in Arth. & Holw. Ured. Exsicc. et Icones, 39f); 1898 (Stuart in Arth. & Holw. Ured. Exsicc. et Icones, 39e).

43. DICAEOOMA ANGUSTATUM (Pk.) Kuntze.

*Puccinia angustata* Peck.

*Aecidium Lycopi* Gerard.

I. On *Lycopus americanus* Muhl. (*L. sinuatus* Ell.) 1893:50. 1898:189; 1908:91.

Jasper, 1903 (Arthur); Tippecanoe, 1898 (Snyder); Vigo, 1893 (Underwood).

On *Lycopus uniflorus* Michx.

Jasper, 1903 (Arthur); Tippecanoe, 1908 (Johnson).

III. On *Scirpus atrovirens* Muhl. 1893:52. 1896:219. 1905:181.

Hamilton, 1905 (Wilson); Jefferson, 1914 (Demaree); Johnson, 1890 (Fisher); Putnam, 1891 (Underwood); Owen, 1911 (Pipal); Tippecanoe, 1889 (Bolley); 1896 (Snyder).

On *Scirpus cyperinus* (L.) Kunth. 1893:52.

Fulton, 1893 (Underwood); Putnam, 1891, 1893 (Underwood, in Ind. Biol. Sur. 32); Steuben, 1903 (Kellerman).

\*44. **DICAEOMA(?) ANTIRRHINII** (*D. & H.*) *comb. nov.*

*Puccinia Antirrhinii* Diet. & Holw.

On *Antirrhinum majus* L.

Hendricks, 1915 (Miller); Lagrange, 1915 (Hissong); Montgomery 1914 (Rees).

45. **DICAEOMA ASPARAGI** (*DC.*) *Kuntze.*

*Puccinia Asparagi* DC.

On *Asparagus officinalis* L. 1903:146. 1905:181.

Fountain, 1900 (Beatty); Franklin, 1913 (Ludwig, in Barth. Fungi Col. 4255); Hamilton, 1905 (Wilson); Jefferson, 1914 (Demaree); Lake, 1899 (Breyfogle); Steuben, 1903 (Kellerman); St. Joseph, 1915 (Balzer); Tippecanoe, 1900, 1901 (Arthur)

46. **DICAEOMA ASPERIFOLII** (*Pers.*) *Kuntze.* 1908:91.

*Aecidium Asperifolii* Pers.

*Puccinia rubigo-vera* (DC.) Wint. p.p.

On *Secale cereale* L. 1896:221.

Carroll, 1913 (Pipal); Marion, 1896 (Chapman); Posey, 1910 (Johnson); Tippecanoe, 1889 (Arthur); Vigo, 1914 (Cox.)

\*47. **DICAEOMA CALTHAE** (*Grev.*) *Kuntze.*

*Aecidium Calthae* Grev.

*Puccinia Calthae* (Grev.) Link.

On *Caltha palustris* L.

Tippecanoe, 1914 (Hoffer).

48. **DICAEOMA CANALICULATUM** (*Schw.*) *Kuntze.*

*Sphaeria canaliculata* Schw.

*Puccinia Cyperi* Arth.

*Puccinia nigrovelata* Ell. & Tracy.

*Dicaeoma Cyperi* (Arth.) Kuntze.

1. On *Ambrosia trifida* L.

Tippecanoe, 1896 (Snyder).

On *Xanthium americanum* Walt.

Tippecanoe, 1903 (Arthur).

On **Xanthium commune** Britton.

Montgomery, 1899 (Arthur); Tippecanoe, 1895 (Arthur).

III. On **Cyperus Engelmannii** Steud.

Newton, 1913 (Arthur & Fromme).

On **Cyperus esculentus** L. 1896:220 (as *C. strigosus* L.)

Tippecanoe, 1896 (Snyder).

On **Cyperus filiculmis** Vahl. 1896:219 (as *C. strigosus* L.)

Tippecanoe, 1896 (Snyder).

On *Cyperus strigosus* L. 1893:53, 54. 1894:154, 157. 1905:181.  
1908:94.

Hamilton, 1905 (Wilson); Marion, 1890 (Earle); Putnam, 1893  
(Underwood); Tippecanoe, 1904 (Arthur).

On **Cyperus Schweinitzii** Torr.

Montgomery, 1893 (Underwood).

\*49. **DICAEOMA CEPHALANTHI** (*Seym.*) *comb. nov.*

*Aecidium Cephalanthi* Seymour.

*Puccinia Seymouriana* Arth.

I. On **Cephalanthus occidentalis** L.

Jasper, 1915 (Arthur).

III. On **Spartina Michauxiana** Hitchc.

Jasper, 1913 (Arthur & Fromme); Starke, 1903 (Arthur).

50. **DICAEOMA CNICI** (*Mart.*) *Arth.*

*Puccinia Cnici* Mart.

*Puccinia Cirsii-lanceolati* Schroet.

*Jackya Cirsii-lanceolati* (Schroet.) Bub. 1898:182.

On *Cirsium lanceolatum* (L.) Hill (*Carduus lanceolatus* L.) 1893:  
53. 1898:182. 1903:152.

Marion, 1890 (Bolley); Marshall, 1893 (Underwood); Putnam,  
1893 (Underwood); Steuben, 1903 (Kellerman); Tippecanoe,  
1904 (Arthur).

Previously reported in the Proceedings (1893:53; 1898:182) as  
*P. flosculosorum* (A. & S.) Roehl and *Dicaoma flosculosorum*  
(A. & S.) Mart.



## 51. DICAEOOMA CLEMATIDIS (DC.) Arth.

*Accidium Clematidis* DC.*Accidium Aquilegiae* Pers.*Puccinia tomipara* Lagerh.*Puccinia Agropyri* E. & E.*Puccinia Paniculariae* Arth.I. On *Aquilegia* sp. 1893:49.

Tippecanoe, 1889 (Bolley).

On *Clematis virginiana* L.

Tippecanoe, 1907 (Arthur).

On *Syndesmon thalictroides* (L.) Hoffmg. 1894:151.

Montgomery, 1894. (Olive).

III. On *Agropyron repens* (L.) Beauv.

Miami, 1912 (Holman); Tippecanoe, 1898 (Arthur, Stuart).

On *Bromus ciliatus* L.

Tippecanoe, 1898 (Stuart).

On *Bromus japonicus* Thunb.

Tippecanoe, 1914 (Roberts).

On *Bromus purgans* L.

Tippecanoe, 1903 (Arthur).

On *Bromus secalinus* L.

Franklin, 1912 (Ludwig).

On *Hordeum jubatum* L.

Tippecanoe, 1910 (Johnson).

On *Panicularia grandis* (S. Wats.) Nash.

Jasper, 1913 (Arthur &amp; Fromme).

## \*52. DICAEOOMA CONOCLINII (Seymour) Kuntze.

*Puccinia Conoclinii* Seymour.On *Eupatorium coelestinum* L.

Orange, 1915 (Jackson &amp; Pipal).

## 53. DICAEOOMA CONVULVULI (Pers.) Kuntze.

*Puccinia Convolvuli* (Pers.) Cast.On *Convolvulus sepium* L. 1893:53. 1896:219. 1905:181.

Carroll, 1912 (Ludwig); Hamilton, 1905 (Wilson); Marion, 1905 (Wilson); Montgomery, 1899, Putnam, 1891, 1893 (Underwood, Ind. Biol. Sur. 21); Tippecanoe, 1895 (Stuart); Tipton, 1915 (Pipal).

## \*54. DICAEOOMA(?) CYPRIPEIDII (Arth.) Kuntze.

*Puccinia Cypripedii* Arth.On **Limodorum tuberosum** L.

Kosciusko, 1914 (Hoffer).

## 55. DICAEOOMA EATONIAE Arth.

*Aecidium Ranunculi* Schw.*Puccinia Eatoniae* Arth.I. On *Ranunculus abortivus* L. 1893:50. 1908:91.

Brown, 1893 (Underwood); Decatur, 1889 (Arthur); Putnam, 1892, 1893, 1894 (Underwood, Ind. Biol. Sur. 55); St. Joseph, 1904 (Cunningham); Tippecanoe, 1894 (Golden).

III. On *Sphenopholis pallens* (Spreng.) Scribn. (*Eatonia pennsylvanica* A. Gray). 1903:148.

Jasper, 1915 (Arthur); Tippecanoe, 1903 (Arthur).

## 56. DICAEOOMA ELEOCHARIDIS (Arth.) Kuntze.

*Puccinia Eleocharidis* Arth.I. On **Eupatorium maculatum** L.

Tippecanoe, 1908 (Johnson).

On *Eupatorium perfoliatum* L. 1894:151. 1896:217. 1908:91.

Jasper, 1903 (Arthur); Montgomery, 1894 (Olive); Tippecanoe, 1896 (Snyder).

On **Eupatorium purpureum** L.

Tippecanoe, 1899 (Arthur).

III. On *Eleocharis palustris* (L.) R. & S. 1893:53. 1896:219. 1908:91.

Lagrange, 1907 (Arthur); Montgomery, 1907 (Dorner); Tippecanoe, 1888 (Bolley), 1896 (Snyder).

## 57. DICAEOOMA ELLISIANUM (Thum.) Kuntze.

*Puccinia Ellisiana* Thum.I. On **Viola papilionacea** Pursh.

Tippecanoe, 1897 (Arthur).

III. On *Schizachyrium scoparium* (Michx.) Nash (*Andropogon scoparius* Michx.) 1903:148.

Tippecanoe, 1898 (Stuart).

## 58. DICAEOOMA EMACULATUM (Schw.) Kuntze.

*Puccinia emaculata* Schw.On *Panicum capillare* L. 1893:53. 1896:220. 1905:181.

Fayette, 1912 (Ludwig); Franklin, 1913 (Ludwig); Grant, 1915 (Pipal); Hamilton, 1905 (Wilson); Henry, 1897 (Pleas); Jasper, 1903 (Arthur); Montgomery, 1893 (Olive); Noble, 1906 (Whetzel); Putnam, 1892 (Underwood, Ind. Biol. Sur. 29); Tippecanoe, 1896 (Snyder).

On *Panicum miliaceum* L.

Tippecanoe, 1910 (Orton).

## 59. DICAEOOMA EPIPHYLLUM (L.) Kuntze.

*Puccinia Poarum* Niels.On *Poa pratensis* L. 1893:57. 1898:189. 1908:91.

Fayette, 1912 (Ludwig); Franklin, 1912 (Ludwig); Hamilton, 1909 (Kern &amp; Johnson); Henry, 1915 (Jackson); Johnson, 1890 (Fisher); Owen, 1911 (Pipal); Putnam, St. Joseph, 1904 (Cunningham); Tippecanoe, 1896 (Snyder).

On *Alopecurus geniculatus* L.

Clinton, 1910 (Maish).

Reported erroneously in the Proceedings (1893:57) as *Uromyces dactyloides* Otth.

## 60. DICAEOOMA ERIOPHORI (Thun.) Kuntze.

*Puccinia Eriophori* Thun.On *Eriophorum angustifolium* Roth. (*E. polystachyon* L.) 1903:146.  
Noble, 1884 (Van Gorder).On *Eriophorum virginicum* L. 1903:146.

Lake, 1914 (Hoffer); Noble, 1884 (Van Gorder); Wells, 1905 (Deam).

## 61. DICAEOOMA EXTENSICOLA (Plowr.) Kuntze. 1908:92.

*Puccinia extensicola* Plowr.*Puccinia Dulichii* Syd.*Puccinia vulpinoïdis* D. & H.*Dicaeoma Caricis-erigerontis* Arth.*Dicaeoma Caricis-asteris* Arth.*Dicaeoma Caricis-solidaginis* Arth.*Dicaeoma Dulichii* (Syd.) Arth.

- I. On *Aster cordifolius* L. 1893:49.  
 Montgomery, 1893 (Olive); Tippecanoe, 1897 (Arthur).  
 On *Aster Drummondii* Lindl. 1903:147.  
 Tippecanoe, 1901 (Arthur).  
 On *Aster paniculatus* Lam. 1903:147. 1905:181.  
 Hamilton, 1905 (Wilson); Tippecanoe, 1901 (Arthur).  
 On *Aster sagittifolius* Willd. 1893:49.  
 Montgomery, 1893 (Olive).  
 On *Aster salicifolius* Lam.  
 Tippecanoe, 1901 (Arthur).  
 On *Doellingeria umbellata* (Mill.) Nees.  
 Jasper, 1903 (Arthur).  
 On *Erigeron annuus* (L.) Pers. 1894:151.  
 Montgomery, 1889 (Arthur), 1894 (Olive); Posey, 1906 (Arthur);  
 Tippecanoe, 1899 (Arthur).  
 On *Erigeron ramosus* (Walt.) B. S. P. 1903:147.  
 Jasper, 1903 (Arthur).  
 On *Leptilon canadense* (L.) Britt. 1903:147.  
 Jasper, 1903 (Arthur).  
 On *Solidago caesia* L. 1893:49.  
 Montgomery, 1893 (Olive).  
 On *Solidago canadensis* L. 1893:49.  
 Jasper, 1915 (Mrs. J. C. Arthur); Laporte, 1893 (Arthur); Tippecanoe, 1896 (Snyder).  
 On *Solidago flexicaulis* L. (*S. latifolia* L.) 1893:49.  
 Putnam, 1893 (Underwood); Tippecanoe, 1894 (Golden).  
 On *Solidago patula* Muhl. 1903:147.  
 Tippecanoe, 1902 (Arthur).  
 On *Solidago scrotina* Ait.  
 Vigo, 1899 (Arthur).  
 On *Solidago ulmifolia* Muhl.  
 Putnam, 1896 (Wilson); Tippecanoe, 1894 (Golden).
- III. On *Carex cephalophora* Muhl. 1903:147.  
 Newton, 1913 (Arthur & Fromme); Tippecanoe, 1898 (Snyder);  
 1902 (Arthur).  
 On *Carex cephaloidea* Dewey(?)  
 Tippecanoe, 1898 (Snyder).

- On *Carex conoidea* Schk. 1905:181.  
Hamilton, 1905 (Wilson); Tippecanoe, 1900 (Stuart).
- On *Carex festucacea* Schk. 1903:147.  
Marion, 1913 (Overholtz & Young); Tippecanoe, 1899, 1901 (Arthur).
- On *Carex foenea* Willd. 1903:147.  
Lagrange, 1912 (Arthur); Tippecanoe, 1901 (Arthur).
- On *Carex nebraskensis* Dewey (*Carex Jamesii* Torr.) 1903:147.  
Fayette, 1913 (Ludwig); Jefferson, 1913 (Arthur); Tippecanoe, 1902 (Arthur).
- On *Carex oligocarpa* Schk.  
Fayette, 1915 (Ludwig).
- On *Carex Pennsylvanica* Lam.  
Tippecanoe, 1906 (Kern & Olive).
- On *Carex sparganioides* Muhl.  
Lagrange, 1907 (Arthur); Tippecanoe, 1897 (Arthur).
- On *Carex straminea* Willd. 1893:52.  
Johnson, 1890 (Fisher).
- On *Carex tetanica* Schk. 1903:147.  
Tippecanoe, 1899 (Arthur).
- On *Carex vulpinoidea* Michx. 1893:56. 1896:221.  
Fayette, 1912 (Ludwig); Lagrange, 1907 (Arthur); Orange, 1913 (Arthur & Ludwig); Tippecanoe, 1888 (Bolley); 1896 (Snyder).:
- On *Dulichium arundinaceum* (L.) Britt. 1893:52.  
Jasper, 1915 (Arthur & Ford); Marshall, 1893 (Underwood).

\*62. DICAEOOMA FRAXINI (Schw.) Arth.

*Aecidium Fraxini* Schw.

*Puccinia peridermiospora* Arth.

On *Spartina Michauxiana* Hitchc.

Lagrange, 1907 (Arthur); Jasper, 1913 (Arthur & Fromme).

63. DICAEOOMA GROSSULARIAE (Schum.) comb. nov. 1908:92.

*Aecidium Grossulariae* Schum.

*Puccinia albiperidia* Arth.

*Puccinia quadriporula* Arth.

*Puccinia uniporula* Orton.

- I. On *Grossularia Cynosbati* (L.) Mill. (*Ribes Cynosbati* L.) 1893-50. 1898:188.  
 Montgomery, 1893 (Olive); Noble, 1897 (King); Putnam, 1892 (Underwood); Tippecanoe, 1906 (Kern).
- On *Grossularia missouriensis* (Nutt.) Cov. & Britt. (*Ribes gracile* Pursh).  
 Tippecanoe, 1906 (Kern).
- On *Grossularia oxyacanthoides* (L.) Mill. (*Ribes oxyacanthoides* L.)  
 Montgomery, 1899 (Arthur).
- On *Grossularia rotundifolia* (Michx.) Cov. & Britt. (*Ribes rotundifolium* Michx.) 1893:50.  
 Putnam, 1893 (Underwood, Ind. Biol. Sur. 58).
- On *Grossularia setosa* (Lindl.) Cov. & Britt. (*Ribes setosum* Lindl.)  
 Tippecanoe, 1909 (Johnson).
- III. On *Carex crinita* Lam.  
 Jasper, 1915 (Arthur & Ford); Tippecanoe, 1904 (Arthur).
- On *Carex digitalis* Willd.  
 Franklin, 1912 (Ludwig).
- On *Carex hirtifolia* MacKenzie (*C. pubescens* Muhl.) 1903:145.  
 Tippecanoe, 1901 (Arthur).
- On *Carex Hitchcockiana* Dewey.  
 Fayette, 1912 (Ludwig).
- On *Carex laxiflora* Lam.  
 Fayette, 1915 (Ludwig); Tippecanoe, 1897 (Arthur).
- On *Carex squarrosa* L.  
 Tippecanoe, 1906 (Kern).
- On *Carex stricta* Lam.  
 Lagrange, 1912 (Arthur).
- On *Carex tetanica* Schk.  
 Tippecanoe, 1899 (Arthur).
64. DICAEOMA HELIANTHI (Schw.) Kuntze.  
*Puccinia Helianthi* Schw.  
 On *Helianthus annuus* L. 1893:55. 1905:181.  
 Delaware, 1915 (Jackson); Hamilton, 1905 (Wilson); Henry, 1915 (Jackson); Jefferson, 1914 (Demaree); Johnson, 1890

(Fisher); Marion, 1905 (Wilson); Montgomery, 1893 (Olive);  
Putnam, 1891, 1892 (Underwood); Tippecanoe, 1906 (Kern).

On *Helianthus divaricatus* L. 1893:55.

Jasper, 1903 (Arthur); Montgomery, 1890 (Fisher); Steuben,  
1903 (Kellerman); Tippecanoe, 1905 (Kern).

On *Helianthus giganteus* L. 1903:148.

Steuben, 1903 (Kellerman); Tippecanoe, 1907 (Arthur).

On *Helianthus grosse-serratus* Mart. 1893:55. 1896:221.

Montgomery, 1893 (Olive); Steuben, 1903 (Kellerman); Tippe-  
canoe, 1906 (Snyder).

On ***Helianthus hirsutus*** Raf.

Harrison, 1915 (Fogal); Orange, 1915 (Jackson).

On *Helianthus mollis* Lam. 1903:148.

Jasper, 1903 (Arthur); Tippecanoe, 1896 (Snyder).

On ***Helianthus occidentalis*** Riddle.

Harrison, 1915 (Fogal).

On ***Helianthus petiolaris*** Nutt.

Tippecanoe, 1905 (Wilson).

On *Helianthus strumosus* L. 1893:55.

Johnson, 1890 (Fisher); Putnam, 1903 (Underwood); Tippe-  
canoe, 1888 (Bolley); 1894 (Golden).

On *Helianthus tuberosus* L. 1905:181.

Jefferson, 1914 (Demaree); Marion, 1905 (Wilson).

On *Helianthus trachelifolius* Mill. 1893:55.

Montgomery, 1890 (Fisher); Shelby, 1890 (Fisher).

65. DICAEOOMA HELIOPSISIDIS (*Schw.*) *Kuntze.*

*Puccinia Heliopsisidis* Schw.

On *Heliopsis helianthoides* (L.) Sweet. 1893:54.

Johnson, 1890 (Fisher); Tippecanoe, 1901 (Stuart).

66. DICAEOOMA HIBISCIATUM (*Schw.*) *Arth.*

*Caeoma Hibisciatum* Schw.

*Accidium Napaeae* Arth. & Holw.

*Puccinia Muhlenbergiae* Arth.

I. On *Napaea dioica* L. 1894:151.

Tippecanoe, 1889 (Arthur).

III. On *Muhlenbergia mexicana* (L.) Trin.

Henry, 1915 (Jackson); Johnson, 1915 (Pipal); Lake, 1913 (Pipal); Lawrence, 1905; Tippecanoe, 1896 (Stuart, Snyder).

On *Muhlenbergia Schreberi* Gmel. (*M. diffusa* Schreb.) 1893:53, 55. 1905:181.

Delaware, 1915 (Jackson); Hamilton, 1905 (Wilson); Johnson, 1890 (Fisher); Owen, 1911 (Pipal); Tippecanoe, 1896 (Snyder in Arth. & Holw. Exsic. et Icon. 50a).

On *Muhlenbergia tenuiflora* (Willd.) B. S. P.

Montgomery, 1915 (Mrs. J. C. Arthur).

On *Muhlenbergia umbrosa* Schreb. (*M. sylvatica* Torr.) 1896:221.

Johnson, 1915 (Pipal); Tippecanoe, 1896 (Snyder).

## 67. DICAEOOMA IMPATIENTIS (Schw.) Arth.

*Accidium Impatientis* Schw.

*Puccinia perminuta* Arth.

I. On *Impatiens biflora* Walt. (*I. fulva* Nutt.) 1893:50.

Jefferson, 1915 (Demaree); Johnson, 1890 (Fisher); Montgomery (Rose); Putnam, 1893 (Underwood); Tippecanoe, 1914 (Ludwig in Barth. Fungi Columb. 4757, and Barth N. Am. Ured. 1254).

On *Impatiens pallida* Nutt. (*I. aurea* S. Wats.) 1896:217.

Carroll, 1910 (Hoffer); Fayette, 1913 (Ludwig); Putnam, 1903. (Wilson); Tippecanoe, 1896 (Snyder).

III. On *Agrostis perennans* (Walt.) Tuckerm.

Delaware, 1915 (Jackson); Fayette, 1912 (Ludwig); Johnson 1890 (Fisher).

On *Elymus canadensis* L.

Tippecanoe, 1896 (Snyder).

On *Elymus striatus* Willd.

Jefferson, 1903 (Arthur); Tippecanoe, 1902 (Arthur).

On *Elymus virginicus* L. 1893:55. 1896:221. 1908:91.

Tippecanoe, 1888 (Bolley), 1900 (Arthur).

On *Hystrix Hystrix* (L.) Millsp. 1893:52.

Jefferson, 1914 (Demaree); Johnson, 1890 (Fisher).



## \*68. DICAEOOMA IRIDIS (DC.) Kuntze.

*Uredo Iridis* DC.On *Iris versicolor* L.

Marshall, 1893 (Underwood, Ind. Biol. Sur. 52).

## 69. DICAEOOMA MAJANTHAE (Schum.) Arth.

*Accidium Majanthae* Schum.On *Phalaris arundinacea* L. 1903:149. 1909:90.

Tippecanoe, 1899 (Stuart).

## 70. DICAEOOMA MELICAE (Syd.) Arth.

On *Melica mutica* Walt. 1903:149.

Tippecanoe, 1899 (Stuart).

## 71. DICAEOOMA MENTHAE (Pers.) S. F. Gray.

*Puccinia Menthae* Pers.On *Blephila ciliata* (L.) Raf.

Hamilton, 1905 (Wilson).

On *Blephilia hirsuta* (Pursh) Torr. 1893:54. 1896:220. 1905:181.

Hamilton, 1905 (Wilson); Johnson, 1890 (Fisher); Montgomery, 1890 (Fisher); Posey, 1906 (Arthur); Tippecanoe, 1899, 1901 (Arthur), 1896 (Snyder); Vermillion, 1889 (Arthur).

On *Cunila origanoides* (L.) Britton (*C. mariana* L.) 1893:54.

Martin, 1915 (Hoffer); Monroe, 1886 (Blatchley).

On *Koellia pilosa* (Nutt.) Britton (*Pycnanthemum muticum pilosum* A. Gray). 1893:54.

Vigo, 1893 (Underwood).

On *Koellia virginiana* (L.) MacM. (*Pycnanthemum lanceolatum* Pursh). 1893:54. 1896:220.

Marshall, 1893 (Underwood); Tippecanoe, 1896 (Snyder).

On *Mentha canadensis* L. 1893:54. 1905:181.

Grant, 1915 (Pipal); Hamilton, 1905 (Wilson); Johnson, 1890 (Fisher); Marshall, 1893 (Underwood, Ind. Biol. Sur. 11); Steuben, 1903 (Kellerman); Tippecanoe, 1883 (Arthur).

On *Mentha spicata* L.

Hamilton, 1915 (Pipal).

On *Monarda fistulosa* L. 1893:54. 1896:220. 1905:181.

Carroll, 1912 (Ludwig); Hamilton, 1905 (Wilson); Jefferson, 1914 (Demaree); Marion, 1905 (Wilson); Marshall, 1893 (Underwood); Montgomery, 1890 (Fisher); Steuben, 1903 (Kellerman); Tippecanoe, 1894 (Golden); 1896 (Snyder); Vigo, 1893 (Underwood).

\*72. **DICAEOMA MINUTISSIMUM** (Arth.) *comb. nov.*

*Aecidium Nesaeae* Ger.

*Puccinia minutissima* Arth.

I. On *Decodon verticillatus* (L.) Ell.

Jasper, 1915 (Arthur).

III. On *Carex lasiocarpa* Ehrh. (*C. filiformis* Good).

Fulton, 1893 (Underwood); Jasper, 1913 (Arthur & Fromme).

\*73. **DICAEOMA MONTANENSE** (Ellis) *Kuntze.*

*Puccinia montanensis* Ellis.

On *Elymus canadensis* L.

Tippecanoe, 1896 (Arthur).

74. **DICAEOMA ARGENTATUM** (Schultz) *Kuntze.*

*Puccinia nolitangeris* Corda.

*Uredo Impatientis* Rehb.

*Puccinia argentata* (Schultz) Wint.

III. On *Impatiens biflora* Walt. (*I. fulva* Nutt.) 1893:52. 1896:220. 1903:146.

Johnson, 1890 (Fisher); Tippecanoe, 1896 (Snyder).

\*75. **DICAEOMA OBSCURUM** (Schroet.) *Kuntze.*

*Puccinia obscura* Schroet.

On *Juncoides campestre* (L.) *Kuntze* (*Luzula campestris* DC.)

Montgomery, 1913 (Arthur).

76. **DICAEOMA OBTECTUM** (Pk.) *Kuntze.* 1908:91.

*Puccinia oblecta* Pk.

On *Scirpus americanus* Pers. 1894:151.

Marshall, 1893 (Underwood, Ind. Biol. Sur. 12); Tippecanoe, 1906 (Kern).

On *Scirpus validus* Vahl. (*S. lacustris* L.) 1894:151.

Montgomery, 1893 (Olive); Vermillion, 1889 (Wright).

77. **DICAEOMA ORBICULA** (Peck & Clinton) Kuntze.*Puccinia orbicula* Peck & Clinton.On *Nabalus albus* (L.) Hook. 1893:55. 1896:221.

Putnam, 1890 (Arthur); Tippecanoe, 1895 (Golden); Vigo, 1893 (Arthur).

Erroneously reported in the Proceedings as *P. Pseudanthus* (Pers.) Fekl., which is a Brachy-form (*Bullaria*) not recorded for Indiana.78. **DICAEOMA PAMMELII** (Trel.) Arth.*Accidium Pammelii* Trel.*Puccinia Panici* Diet.I. On *Tithymalopsis corollata* (L.) Kl. & Garcke (*Euphorbia corollata* L.) 1893:49. 1901:284. 1903:149. 1908:90.

Johnson, 1890 (Fisher); Tippecanoe, 1901 (Stuart).

III. On *Panicum virgatum* L. 1901:283. 1903:149. 1908:90.

Jasper, 1903 (Arthur); Lake, 1910 (Johnson); Newton, 1913 (Arthur &amp; Fromme); Starke, 1905 (Arthur); Tippecanoe, 1901 (Stuart).

79. **DIAECOMA PATRUELIS** (Arth.) comb. nov.*Accidium compositarum lactucae* Burrill.*Puccinia patruelis* Arth.I. On *Lactuca canadensis* L. 1894:151.

Jasper, 1906 (Arthur); Lagrange, 1912 (Arthur); Montgomery, 1894 (Olive); Tippecanoe, 1903 (Seaver).

On ***Lactuca floridana*** (L.) Gaertn.

Tippecanoe, 1906 (Olive).

On ***Lactuca sativa*** L.

Tippecanoe, 1902 (Burrage).

On ***Lactuca virosa*** L. (*L. scariola* L.)

Jasper, 1910 (Kern &amp; Billings).

III. On *Carex* sp.

Jasper, 1903 (Arthur).

80. **DICAEOMA PECKII** (DeT.) Arth.*Accidium Peckii* DeToni.*Puccinia ludibunda* Ell. & Ev.

- I. On *Oenothera biennis* L. 1893:50. 1896:217. 1908:92.  
 Jasper, 1910 (Kern & Billings); Laporte, 1883 (Arthur); Putnam,  
 1896 (Wilson); Tippecanoe, 1896 (Snyder), 1902 (Arthur);  
 Vigo, 1893 (Underwood).
- III. On *Carex lanuginosa* Michx.  
 Lagrange, 1912 (Arthur); Tippecanoe, 1911 (Johnson).
- On *Carex sparganioides* Muhl.  
 Lagrange, 1907 (Wilson).
- On *Carex stipata* Muhl. 1903:149.  
 Tippecanoe, 1902 (Arthur), 1912 (Overholts & Orton).
- On *Carex trichocarpa* Muhl. 1903:149.  
 Hamilton, 1909 (Kern & Johnson); Jasper, 1906 (Arthur & Kern);  
 Madison, 1898 (Snyder); Tippecanoe, 1901 (Arthur).
81. DICAEOMA POCULIFORME (*Jacq.*) *Kuntze.*  
*Accidium Berberidis* Pers.  
*Puccinia graminis* Pers.  
*Puccinia phlei-pratensis* Erikss. & Henn.
- I. On *Berberis vulgaris* L. 1893:49. 1908:92.  
 Lagrange, 1889 (Arthur).
- III. On *Agrostis alba* L. 1893:53. 1903:150. 1905:182.  
 Hamilton, 1905 (Wilson); Jasper, 1906 (Arthur); Jefferson, 1914  
 (Demaree); Marshall, 1893 (Underwood, Ind. Biol. Sur. 14);  
 Putnam, 1893 (Underwood); Steuben, 1903 (Kellerman);  
 Tippecanoe, 1898 (Stuart); Wayne, 1910 (Johnson).
- On *Arrhenatherum elatium* (L.) Beauv.  
 Tippecanoe, 1898 (Stuart).
- On *Avena sativa* L. 1893:53. 1896:220. 1905:182.  
 Hamilton, 1905 (Wilson); Montgomery, 1893 (Olive); Putnam,  
 1893 (Underwood); Steuben, 1903 (Kellerman); Tippecanoe,  
 1888 (Bolley), 1896 (Snyder).
- On *Bromus secalinus* L.  
 Franklin, 1912 (Ludwig).
- On *Cinna arundinacea* L. 1903:150.  
 Tippecanoe, 1899 (Stuart); 1901 (Arthur).
- On *Dactylis glomerata* L. 1896:220, 223.  
 Franklin, 1912 (Ludwig); Tippecanoe, 1896 (Snyder).

On *Hordeum jubatum* L. 1896:220, 224.

Tippecanoe, 1896 (Snyder); 1898 (Arthur).

On *Hordeum vulgare* L.

Tippecanoe, 1898 (Stuart).

On *Phleum pratense* L. 1909:417. 1910:203.

Bartholomew, 1909 (Hunter); Cass, 1910 (Johnson); Delaware, 1915 (Jackson); Franklin, 1912 (Ludwig); Hamilton, 1910 (Wilson); Henry, 1915 (Jackson); Jefferson, 1910 (Johnson); Posey, 1910 (Johnson); Spence, 1910 (Johnson); Tippecanoe, 1910 (Johnson); Tipton, 1915 (Pipal); Wayne, 1910 (Johnson); Wabash, 1910 (Johnson); Whitley, 1910 (Johnson):.

On *Secale cereale* L.

Clay, 1910 (Ringo).

On *Triticum vulgare* Vill. 1893:54. 1898:188. 1905:182.

Carroll, 1912 (Pipal); Decatur, 1912 (Moor); Franklin, 1912 (Ludwig); Hamilton, 1905 (Wilson); Johnson, 1890 (Fisher); Marion, 1914 (Hameisen); Noble, 1897 (King); Posey, 1912 (Pipal); Putnam, 1893 (Underwood); Tippecanoe, 1890 (Arthur); Wayne, 1910 (Johnson).

## 82. DICAEOMA POLYGONI-AMPHIBII (*Pers.*) *Arth.*

*Puccinia Polygoni-amphibii* Pers.

*Aecidium sanguinolentum* Lindr.

I. On *Geranium maculatum* L. 1893:40. 1896:217. 1898:188. 1908:92.

Laporte, 1915 (Cotton); Noble, 1893 (King); Tippecanoe, 1894 (Golden); Vigo, 1893 (Underwood, Arthur).

III. On *Persicaria amphibia* (L.) S. F. Gray (*Polygonum Hartwrightii* A. Gray). 1903:150.

Steuben, 1903 (Kellerman).

On *Persicaria hydropiperoides* (Michx.) Small (*Polygonum hydropiperoides* Macouni). 1898:184. 1898:189.

Noble, 1897 (King); Tippecanoe, 1898 (Stuart).

On *Persicaria lapathifolia* (L.) S. F. Gray (*Polygonum lapathifolium* L.) 1898:184.

Tippecanoe, 1898 (Arthur).

On *Persicaria Muhlenbergii* (S. Wats.) Small (*Polygonum Muhlenbergii* S. Wats., *P. emersum* Britt.) 1893:55. 1905:182.

- Fulton, 1893 (Underwood); Hamilton, 1905 (Wilson); Huntington, 1915 (Troop); Jasper, 1903 (Arthur); Lagrange, 1907 (Arthur); Tippecanoe, 1904 (Arthur); Wabash, 1890 (Miller).  
 On *Persicaria pennsylvanica* (L.) Small (*Polygonum pennsylvanicum* L.) 1898:184.
- Henry, 1915 (Jackson); Putnam, 1893 (Underwood, Ind. Biol. Sur. 26); Tippecanoe, 1898 (Arthur); Tipton, 1915 (Pipal).  
 On *Persicaria punctata* (Ell.) Small (*Polygonum punctatum* Ell., *P. acre* H. B. K.) 1893:55, 57.
- Johnson, 1890 (Fisher); Putnam, 1891 (Underwood).
83. DICAEOA POLYGONI-CONVOLVULI (*Hedw.*) *Arth.*  
*Puccinia Polygoni-convolvuli* Hedw.  
 On *Tiniaria Convolvulus* (L.) Webb. & Moq. (*Polygonum convolvulus* L.) 1898:184. 1905:182.  
 Delaware, 1915 (Jackson); Hamilton, 1905 (Wilson); Marion, 1905 (Wilson); Tippecanoe, 1898 (Arthur).  
 On *Tiniaria scandens* (L.) Small (*Polygonum scandens* L.) 1896:223.  
 Putnam, 1907 (Wilson); Tippecanoe, 1900 (Arthur).
84. DICAEMOA PUNCTATUM (*Link*) *Kuntze.*  
*Puccinia punctata* Link.  
*Dicaeoma Galiorum* (Lk.) *Arth.*  
 On *Galium asprellum* Michx. 1893:53.  
 Johnson, 1890 (Fisher).  
 On *Galium concinnum* Torr. & Gray. 1893:53. 1905:182.  
 Delaware, 1915 (Jackson); Hamilton, 1905 (Wilson); Johnson, 1890 (Fisher); Montgomery, 1893 (Olive); Owen, 1893 (Underwood, Ind. Biol. Sur. 17); Steuben, 1903 (Kellerman); Tippecanoe, 1909 (Arthur).  
 On *Galium tinctorum* L. 1905:182.  
 Hamilton, 1905 (Wilson).  
 On *Galium triflorum* Michx. 1893:53.  
 Montgomery, 1893 (Underwood); Putnam, 1891 (Underwood).
85. DICAEOA PUSTULATUM (*Curtis*) *Arth.*  
*Accidium pustulatum* Curtis.  
*Puccinia pustulata* (Curtis) *Arth.*

- I. On *Comandra umbellata* (L.) Nutt. 1893:50. 1908:90.  
 St. Joseph, 1914 (Arthur); Montgomery, 1893 (Olive); Tippe-  
 canoe, 1897 (Arthur); Vigo, 1893 (Underwood, Ind. Biol.  
 Sur. 57).
- III. On *Andropogon furcatus* Muhl. 1903:150.  
 Jasper, 1903 (Arthur); Lagrange, 1907 (Arthur); Starke, 1905  
 (Arthur); Tippecanoe, 1896 (Snyder in Arth. & Holw. Ured.  
 et Icones 39h); Vigo, 1893 (Underwood, Ind. Biol. Sur. 33).  
 On *Schizachyrium scoparium* (Michx.) Nash (*Andropogon scoparius*  
 Michx.) 1903:150.  
 Tippecanoe, 1902 (Arthur).
86. DICAEOOMA RHAMNI (*Gmel.*) *Kuntze.*  
*Aecidium Rhamni* Pers.  
*Puccinia coronata* Corda.  
*Puccinia Lolii* Niels.
- I. On **Rhamnus caroliniana** Walt.  
 Tippecanoe, 1904 (Arthur).  
 On *Rhamnus lanceolata* Pursh. 1898:184. 1908:90.  
 Tippecanoe, 1897 (Arthur).
- III. On *Avena sativa* L. 1893:55. 1896:219. 1898:188. 1905:182.  
 Clay, 1910 (Ringo); Delaware, 1915 (Jackson); Fayette, 1912  
 (Ludwig); Hamilton, 1905 (Wilson); Johnson, 1890 (Fisher);  
 Noble, 1897 (King); Tippecanoe, 1896 (Stuart); Wayne, 1910  
 (Johnson).
- On **Cinna arundinacea** L.  
 Tippecanoe, 1901 (Arthur).  
 On *Calamagrostis canadensis* (Mx.) Beauv. 1893:53.  
 Tippecanoe, 1888 (Bolley).
87. DICAEOOMA RUELLIAE (*B. & Br.*) *Kuntze.*  
*Uredo Ruelliae* B. & Br.  
*Diorchidium lateripes* (B. & Rav.) Magn.  
*Dicaeoma lateripes* (B. & Rav.) Kuntze.
- On **Ruellia ciliosa** Pursh.  
 Tippecanoe, 1904 (Marquis).  
 On *Ruellia strepens* L. 1893:54. 1896:218. 1905:181.  
 Delaware, 1915 (Jackson); Hamilton, 1905 (Wilson); Johnson,

1890 (Fisher); Owen, 1893 (Underwood, Ind. Biol. Sur. 31);  
Tippecanoe, 1895 (Stuart), 1896 (Snyder); Wabash, 1887  
(Miller).

88. DICAEOOMA SAMBUCI (Schw.) Arth.

*Accidium Sambuci* Schw.

*Puccinia Bolleyana* Sacc.

*Puccinia Atkinsoniana* Diet.

I. *Sambucus canadensis* L. 1895:50.

Brown, 1893 (Underwood); Fayette, 1913 (Ludwig); Franklin,  
1914 (Ludwig); Johnson, 1890 (Fisher); Montgomery, 1893  
(Olive); Putnam, 1892, 1893 (Underwood, Ind. Biol. Sur.  
56); Tippecanoe, 1899 (Arthur); Vigo, 1893 (Underwood).

III. On *Carex Frankii* Kunth. 1893:55. 1898:187.

Boone, 1891 (Arthur); Franklin, 1912 (Ludwig); Fulton, 1893  
(Underwood); Hamilton, 1909 (Kern & Johnson); Johnson,  
1890 (Fisher); Madison, 1898 (Snyder); Orange, 1913 (Arthur  
& Ludwig); Owen, 1911 (Pipal); Parke, 1900 (Snyder); Putnam,  
1893 (Underwood).

On *Carex lupulina* Muhl.

Noble, 1904 (Whetzel).

On *Carex lurida* Wahl. 1893:52.

Lagrange, 1907 (Arthur); Marion, 1890 (Arthur); Orange, 1913  
(Arthur & Ludwig); Tippecanoe, 1896 (Snyder).

On *Carex trichocarpa* Muhl. 1893:52. 1896:219.

Bartholomew, 1909 (Kern); Jasper, 1906 (Arthur & Kern); Tippe-  
canoe, 1889 (Bolley).

89. DICAEOOMA SANICULAE (Grev.) Kuntze.

*Puccinia Saniculae* Grev.

On *Sanicula canadensis* L. 1893:55.

Montgomery (Rose).

\*90. DICAEOOMA SMILACIS (Schw.) Kuntze.

*Accidium Smilacis* Schw.

*Puccinia Smilacis* Schw.

On *Smilax glauca* Walt.

Lawrence, 1915 (Hoffer); Orange, 1913 (Ludwig)



91. **DICAEOMA SORGHI** (*Schw.*) *Kuntze.**Puccinia Sorghi* Schw.*Puccinia Maydis* Bereng.I. On **Xanthoxalis cymosa** Small (*Oxalis cymosa* Small).

Tippecanoe, 1904 (Arthur).

III. On *Zea Mays* L. 1893:54. 1898:188. 1905:182. 1908:90.

Dearborn, 1889 (Bolley); Delaware, 1915 (Jackson); Franklin, 1913 (Ludwig); Hamilton, 1905 (Wilson); Henry 1915 (Jackson); Marion, 1905 (Wilson); Montgomery, 1893 (Olive); Noble, 1897 (King); Putnam, 1893 (Underwood, Ind. Biol. Sur. 23); Tipton, 1912 (Ludwig); Tippecanoe, 1887 (Arthur).

92. **DICAEOMA TRITICINUM** (*Erikss.*) *comb. nov.**Puccinia triticina* Eriksson.On *Triticum vulgare* Vill.

Carroll, 1913 (Pipal); Decatur, 1912 (Moor); Franklin, 1912 (Ludwig); Jefferson, 1910 (Johnson); Laporte, 1910 (G. C. Cook); Orange, 1915 (Pipal); Posey, 1906 (Arthur &amp; Kern); Pulaski, 1898 (Arthur); Putnam, 1896 (Wilson); Tippecanoe, 1890 (Arthur); Vigo, 1899 (Arthur); Wayne, 1906 (Hiatt).

93. **DICAEOMA (?) TROGLODYTES** (*Lindr.*) *comb. nov.**Puccinia troglodytes* Lidr.On **Galium triflorum** Michx.

Hamilton, 1905 (Wilson).

94. **DICAEOMA URTICAE** (*Schum.*) *Kuntze.**Aecidium Urticae* Schum.*Puccinia Carici*, Schröt. not Reb.I. On *Urtica gracilis* Ait. (*U. Lyallii* S. Wats.) 1898:185. 1908:92.

St. Joseph, 1904 (Cunningham); Lagrange, 1912 (Arthur); Tippecanoe, 1905 (Kern).

III. On *Carex lacustris* Willd. (*C. riparia* Muhl.) 1903:151.

Jasper, 1903 (Arthur); Steuben, 1903 (Kellerman).

On **Carex stipata** Muhl.

Tippecanoe, 1905 (Arthur);

On *Carex stricta* Lam. 1903:151.

Jasper, 1906 (Arthur & Kern); Steuben, 1903 (Kellerman);  
Tippecanoe, 1896 (Snyder).

Many of the collections reported in previous lists of Indiana  
rusts as belonging to this species are now included elsewhere.

95. DICAEOOMA VERBENICOLUM (*Ell. & Kell.*) *Arth.*

*Accidium verbenicolum* Ellis & Kellerman.

*Puccinia Vilfae* Arth. & Holw.

*Dicaeoma Vilfae* (A. & H.) Arth.

I. On *Verbena stricta* Vent. 1896:218. 1908:90.

Tippecanoe, 1896 (Snyder).

III. On *Sporobolus asper* (Michx.) Kunth. 1896:221.

Tippecanoe, 1896 (Snyder).

Erroneously reported in Proceedings for 1896:221 as *Puccinia*  
*Sporoboli* Arth.

96. DICAEOOMA (?) VERNONIAE (*Schw.*) *Kuntze.*

*Puccinia Vernoniae* Schw.

On *Vernoniae fasciculata* Michx. 1893:55.

Putnam, 1893 (Underwood).

This collection is on the stems and has been distributed in the  
following exsiccati: Ind. Biol. Sur. 30; Barth. N. Am. Ured.  
578; Ell. & Ev. N. Am. Fungi 2988; Seymour & Earle Economic  
Fungi Supl. B20.

97. DICAEOOMA VEXANS (*Farl.*) *Kuntze.*

*Puccinia vexans* Farl.

On *Atheropogon eurtipendulus* (Michx.) Fourn. (*Bouteloua curti-*  
*pendula* (Michx.) Torr.) 1901:283.

Tippecanoe (Stuart).

No specimens of this collection are now available and the  
determination is somewhat doubtful. Since the species is rep-  
resented in the Arthur herbarium only from the western plains.

98. DICAEOOMA VIOLAE (*Schum.*) *Kuntze.*

*Puccinia Violae* (Schum.) DC.

On *Viola eriocarpa* Schwein. 1903:152.

Decatur, 1889 (Arthur); Montgomery, 1906 (Olive).

On *Viola papilionacea* Pursh (*V. obliqua* Hill) 1893:56.

- Johnson, 1890 (Fisher); Montgomery, 1893 (Olive); Putnam, 1890 (Arthur); Tippecanoe, 1898 (Arthur); Vigo, 1893 (Arthur)
- On *Viola pubescens* Ait. 1903:152  
Fayette, 1915 (Ludwig); Tippecanoe, 1898 (Arthur).
- On *Viola sororia* Willd.  
Tippecanoe, 1906 (Kern).
- On *Viola striata* Ait. 1893:56.  
Montgomery, 1890 (Fisher); Owen, 1893 (Underwood. Ind. Biol. Sur. 18); Putnam, 1893 (Underwood); Tippecanoe, 1912 (Pipal).

99. DICAEOMA WINDSORIAE (*Schw.*) *Kuntze.*

*Puccinia Windsoriae* Schw.  
*Aecidium Pteleae* Berk. & Curt.

I. On *Ptelea trifoliata* L. 1893:50. 1896:217. 1908:90.

Montgomery, 1893 (Olive); Tippecanoe, 1896 (Snyder).

III. On *Tridens flava* (L.) Hitchc. (*Sieglingia seslerioides* (Mx.) Schrib. 1894:154, 1896:221.

Harrison, 1915 (Kopp); Orange, 1915 (Jackson); Owen, 1911 (Pipal); Tippecanoe, 1896 (Snyder).

100. EARLEA SPECIOSA (*Fr.*) *Arth.*

*Aegma speciosa* Fr.  
*Phragmidium speciosum* (Fr.) Cooke.

On *Rosa carolina* L. 1896:219.

Tippecanoe, 1895 (Arthur).

On *Rosa virginiana* Mill. (*Rosa humilis* Marsh). 1898:179.

Fulton, 1894 (Arthur); Putnam, 1900 (Wilson); Tippecanoe, 1898 (Arthur).

101. GYMNOCONIA INTERSTITIALIS (*Schlecht.*) *Lagerh.*

*Aecidium nitens* Schw.  
*Puccinia interstitialis* (Schlecht.) Tranz.

On *Rubus alleghaniensis* Porter. 1893:54.

Jefferson, 1910 (Johnson); Marion, 1901 (Dickey); Putnam, 1893 (Underwood, Ind. Biol. Sur. 19); St. Joseph, 1909 (Cunningham); Tippecanoe, 1894 (Golden); 1896 (Snyder); Vigo, 1893 (Underwood).

On *Rubus occidentalis* L. 1893:54.

Montgomery, 1893 (Olive).

On *Rubus procumbens* Muhl. (*R. villosus* Ait.) 1893:54. 1896:220. 1898:188.

Montgomery, 1893 (Olive); Noble, 1897 (King); Tippecanoe, 1899 (Stuart); 1896 (Snyder).

On *Rubus strigosus* Michx. 1893:54.

Marshall, 1889 (Parks).

\*102. GYMNOSPORANGIUM GERMINALE (*Schw.*) *Kern.*

On *Crataegus mollis* (T. & G.) Scheele.

Shelby (Brezze).

On *Cydonia vulgaris* L.

Perry, 1914 (Odell).

103. GYMNOSPORANGIUM GLOBOSUM *Farl.*

*Roestelia lacerata* (Sow.) Fr. (in part).

*Puccinia globosa* (Farl.) Kuntze.

*Accidium globosum* (Farl.) Arth.

I. On *Crataegus coccinea* L. 1893:56.

Montgomery, 1893 (Olive); Henry, 1909 (Gardner).

On *Crataegus Crus-galli* L. 1894:153.

Montgomery, 1894 (Olive).

On *Crataegus mollis* (T. & G.) Scheele (*C. subvillosa* T. & G.) 1898:186, 188.

Allen, 1911 (Orton); Clay, 1910 (Ringo); Marion, 1896 (B. M. Davis); Noble, 1897 (King); Tippecanoe, 1898 (Arthur).

On *Crataegus punctata* Jacq. 1893:56. 1896:222. 1905:182.

Hamilton, 1905 (Wilson); Montgomery, 1893 (Olive); Putnam, 1893 (Underwood, Ind. Biol. Sur. 60); Tippecanoe, 1896 (Snyder).

On *Crataegus Pringlei* Sarg.

Tippecanoe, 1898 (Arthur).

III. On *Juniperus virginiana* L. 1893:51. 1908:89.

Clinton, 1907 (Kern); Jefferson, 1903 (Arthur); Owen, 1893 (Underwood); Putnam, 1893 (Underwood Ind. Biol. Sur. 45); Tippecanoe, 1888 (Arthur).

## 104. GYMNOSPORANGIUM JUNIPERI-VIRGINIANAE Schw.

*Roestelia pyrata* Thax.*Gymnosporangium macropus* Lk.*Puccinia Juniperi-virginianae* (Schw.) Arth.*Aecidium Juniperi-virginianae* (Schw.) Arth.I. On *Malus coronaria* (L.) Mill. 1893:56. 1896:218.

Hamilton, 1907 (Wilson); Henry, 1909 (Gardner); Marion, 1907 (Shell); Putnam, 1907 (Wilson); Spencer, 1910 (Johnson); Tippecanoe, 1896 (Snyder); Wabash, 1891 (Miller).

On *Malus ionensis* (Wood) Britton.

Tippecanoe, 1892 (Arthur).

On *Malus Malus* (L.) Britt. 1898:186. 1901:255.

Carroll, 1913 (Kerlin); Clark, 1912 (Richards); Fayette, 1912 (Richards); Floyd, 1890 (Latta); Franklin, 1903 (Klein). Greene, 1912 (Richards); Howard, 1902 (Armstrong); Jasper, 1913 (Coe); Jackson, 1912 (Richards); Jefferson, 1914 (Demaree); Martin, 1912 (Richards); Montgomery, 1901 (Whetzell); Morgan, 1911 (Lewis); Newton, 1898 (Griggs); Orange, 1912 (Brown); Putnam, 1907 (Wilson); Ripley, 1902 (Ferris); Rush, 1911 (Smiley); Spencer, 1900 (Johnson); Wayne, 1904 (Helm); Wabash, 1911 (Fisher); Warrick, 1912 (Alltz); White, 1913 (Pipal); Whitley, 1911 (More).

III. On *Juniperus virginiana* L. 1893:51. 1896:218. 1901:255. 1908:89.

Clay, 1910 (Ringo); Franklin, 1912 (Ludwig); Henry, 1914 (Travelbee); Monroe, 1898 (Arthur); Montgomery, 1893 (Olive); Orange, 1915 (Jackson); Owen, 1893 (Underwood); Putnam, 1892, 1893 (Underwood Ind. Biol. Sur. 46); Tippecanoe, 1889 (Bolley), 1898 (Arthur); Warren, 1908 (Davis).

## 105. KUEHNEOLA OBTUSA (Strauss) Arth.

On *Potentilla canadensis* L. 1893-52. 1896:218. 1898:179.

Delaware, 1915 (Jackson); Fulton, 1893 (Underwood, Ind. Biol. Sur. 47); Jefferson, 1914 (Demaree); Johnson, 1890 (Fisher); Marshall, 1893 (Underwood); Orange, 1913 (Arthur); Owen, 1893 (Underwood); Tippecanoe, 1889 (Bolley), 1896 (Snyder);

1901 (Arth. in Barth. N. Am. Ured. 313); Vigo, 1893 (Arthur, Underwood).

Previously reported in the Proceedings as *Phragmidium Fragariae* (DC.) Wint. and *Aegma Fragariae* (DC.) Arth.

106. KUEHNEOLA UREDINIS (*Link*) *Arth.*

*Chrysomyxa albida* Kuhn.

*Coleosporium Rubi* E. & H.

On **Rubus allegheniensis** Porter.

Delaware, 1915 (Jackson); Hamilton, 1907 (Wilson); Montgomery, 1913 (Kern); Warrick, 1906 (Heim).

On *Rubus cuneifolius* Pursh. 1893:50.

Johnson, 1890 (Fisher).

On **Rubus hispidus** L.

Jasper, 1913 (Arthur & Fromme).

On *Rubus procumbens* Muhl. (*Rubus villosus* Ait.) 1893:50.

Johnson, 1890 (Fisher).

107. NIGREDO AMPHIDYMA (*Sydow*) *Arthur.*

*Uromyces glyceriae* Arth.

On *Panicularia septentrionalis* (Hitch.) Bicknell. 1893:57. 1898:180.

Johnson, 1890 (Fisher).

Previously reported as *Uromyces graminicola* Burr. on *Panicum virgatum* L.

108. NIGREDO APPENDICULATA (*Pers.*) *Arth.*

*Uromyces appendiculata* (Pers.) Lev.)

*Caomurus Phaseoli* (Pers.) Arth.

On *Phaseolus vulgaris* L. 1893:56 in part. 1905:180.

Hamilton, 1905 (Wilson); Henry, 1915 (Jackson); Putnam, 1892 (Underwood Ind. Biol. Sur. 40); Tippecanoe, 1905 (Wilson); Tipton, 1915 (Pipal).

On *Stropostyles helvolva* (L.) Britt. (*Phaseolus angulosus* Ell., *P. diversifolius* Pers.) 1893:56. 1896:172. 222. 1905:180.

Franklin, 1914 (Roy Allen); Laporte, 1915 (L. B. Clore); Marion, 1905 (Wilson); Montgomery, 1893 (Olive); Putnam, 1907 (Wilson); Tippecanoe, 1895 (Arthur), 1896 (Snyder).

On **Strophostyles pauciflora** (Benth.) S. Wats.  
Putnam, 1896 (Cook).

On **Strophostyles umbellata** (Muhl.) Britton.  
Sullivan, 1915 (Hoffer).

On *Vigna sinensis* (L.) Endl. 1903:145.  
Tippecanoe, 1902, 1903 (Arthur in Barth. N. Am. Ured. 381).

109. NIGREDO CALADII (*Schw.*) *Arth.*

*Uromyces Caladii* (Schw.) Farl.

*Caecomurus Caladii* (Schw.) Kuntze.

On *Arisaema Dracontium* (L.) Schott. 1893:56. 1896:222. 1905:  
180.

Brown, 1893 (Underwood); Fayette, 1913 (Ludwig); Hamilton,  
1905 (Wilson); Jasper, 1915 (Arthur); Kosciusko, 1915 (Hoffer);  
Montgomery, 1893 (Olive); Putnam, 1897 (Cook); Tippe-  
canoe, 1896 (Snyder); Vigo, 1893 (Underwood).

On *Arisaema triphyllum* (L.) Torr. 1893:56. 1896:222. 1898:  
189. 1905:180.

Fayette, 1913 (Ludwig); Hamilton, 1905 (Wilson); Jasper, 1915  
(Arthur); Johnson, 1890 (Fisher); Monroe, 1893 (Underwood);  
Montgomery, 1893 (Olive); Noble, 1897 (King); Owen, 1893  
(Underwood); Posey, 1906 (Arthur & Kern); Putnam, 1893  
(Underwood); Tippecanoe, 1894 (Golden), 1896 (Snyder);  
St. Joseph, 1904 (Cunningham); Vigo, 1893 (Underwood, Ar-  
thur).

On **Peltandra virginica** (L.) Kunth.

Jasper, 1915 (Arthur); Lake, 1881 (A. B. Seymour).

110. NIGREDO CARYOPHYLLINA (*Schrank.*) *Arth.*

*Uromyces Caryophyllinus* (Schrank.) Wint.

*Caecomurus Caryophyllinus* (Schrank.) Kuntze.

On *Dianthus caryophyllus* L. 1893:56. 1898:180. 1912:99.

Marion, 1892 (Arthur); Monroe, 1912 (Von Hook); Tippecanoe,  
1898 (Arthur).

111. NIGREDO FABAE (*Pers.*) *Arth.*

*Uromyces Fabae* (Pers.) DeBy.

On *Lathyrus venosus* Muhl. 1896:222. 1898:181. 1903:145.  
Tippecanoe, 1896 (Snyder).

Previously reported in the Proceedings as on *Vicia americana* Muhl. and erroneously referred to *Uromyces Orobis* (Pers.) Wint., *Caecomurus Pisi* (Pers.) Gray, *Caecomurus Orobis* (Pers.) Arth., which refer to European species not yet recorded in America.

\*112. NIGREDO FALLENS (*Desmaz.*) Arth.

*Uromyces fallens* (Desmaz.) Kern.

On *Trifolium pratense* L. 1893:58. 1896:223. 1898:187, 189.

Delaware, 1915 (Jackson); Franklin, 1912 (Ludwig); Hamilton, 1905 (Wilson); Johnson, 1890 (Fisher); Kosciusko, 1913 (Hoffer); Madison, 1898 (Snyder), Marion, 1905 (Wilson); Miami, 1915 (Ludwig); Montgomery, 1890 (Fisher), 1893 (Underwood Ind. Biol. Sur. 38); Noble, 1897 (King); Owen, 1911 (Pipal); Putnam, 1891 (Underwood); Steuben, 1903 (Kellerman); Tipton, 1912 (Ludwig); Tippecanoe, 1891 (Arthur), 1896 (Snyder); Wabash, 1891 (Miller);

113. NIGREDO HEDYSARI-PANICULATI (*Schw.*) Arth.

*Uromyces Hedysari-paniculati* (Schw.) Farl.

*Caecomurus Hedysari-paniculati* (Schw.) Arth.

On *Meibomia bracteosa* (Michx.) Kuntze.

Delaware, 1915 (Jackson).

On *Meibomia canescens* (L.) Kuntze. 1893:57. 1903:144.

Johnson, 1890 (Fisher); Montgomery, 1893 (Olive); Tippecanoe, 1907 (Dorner).

On *Meibomia Dillenii* (Darl.) Kuntze. 1893:57. 1896:222. 1903:144. 1905:180.

Hamilton, 1905 (Wilson, reported as on *M. sessilifolia* (Torr) Kuntze); Martin, 1915 (Hoffer); Montgomery, 1893 (Underwood Ind. Biol. Sur. 35); Tippecanoe, 1896 (Snyder), 1914 (Ludwig in Barth. Fungi Columb. 4592).

On *Meibomia laevigata* (Nutt.) Kuntze. 1893:57.

Montgomery, 1890 (Fisher).

On *Meibomia paniculata* (L.) Kuntze. 1893:57. 1896:222.

Hamilton, 1905 (Wilson); Johnson, 1890 (Fisher); Jefferson, 1914 (Demaree); Tippecanoe, 1896 (Snyder, reported as on *Desmodium canadense* DC.)

On *Meibomia viridiflora* (L.) Kuntze. 1893:57. 1905:180.



Hamilton, 1905 (Wilson); Marion, 1905 (Wilson); Putnam, 1893 (Underwood); Tippecanoe, 1904 (J. C. Marquis).

114. NIGREDO HOWEI (*Pk.*) *Arth.*

*Uromyces Howei* Pk.

*Cacomurus Howei* (Pk.) Kuntze.

On *Aselepias incarnata* L. 1893:57. 1896:222.

Montgomery, 1893 (Olive); Tippecanoe, 1896 (Snyder).

On *Aselepias purpurascens* L. 1893:57.

Montgomery, 1890 (Fisher).

On *Aselepias Syriaca* L. (*A. cornuti* Dec.) 1893:57. 1896:222. 1898:187. 1905:180.

Dearborn, 1888 (Bolley); Delaware, 1890 (Arthur); Hamilton, 1905 (Wilson); Henry, 1915 (Jackson); Johnson, 1890 (Fisher); Madison, 1898 (Snyder); Marion, 1890 (S. M. Tracy), 1905 (Wilson); Montgomery, 1890 (Fisher), 1893 (Underwood Ind. Biol. Sur. 36); Putnam, 1891 (Underwood); Steuben, 1903 (Kellerman); Tippecanoe, 1887 (Arthur), 1896 (Snyder); Tipton, 1915 (Pipal); Wabash, 1891 (Miller).

On *Vincetoxicum Shortii* (A. Gray) Britton.

Crawford, 1915 (C. C. Deam).

115. NIGREDO HYPERICI-FRONDOSI (*Schw.*) *Arth.*

*Uromyces Hyperici* (Schw.) M. A. Curtis.

*Cacomurus Hyperici-frondosi* (Schw.) *Arth.*

On *Hypericum canadense* L. 1893:57.

Johnson, 1890 (Fisher).

On *Hypericum mutilum* L. 1893:57.

Marshall, 1893 (Underwood); Putnam, 1891, 1893 (Underwood Ind. Biol. Sur. 42); Spencer, 1910 (Johnson).

On *Triadenum virginicum* (L.) Raf. (*Elodea camoanulata* Pursh). 1893:57.

Marshall, 1893 (Underwood).

116. NIGREDO LESPEDEZAE-PROCUMBENTIS (*Schw.*) *Arth.*

*Uromyces Lespedezae* (Schw.) Pk.

*Cacomurus Lespedezae-procumbentis* (Schw.) *Arth.*

On *Lespedeza capitata* Michx. 1903:145.

Jasper, 1903 (Arthur); Tippecanoe, 1903 (Arthur).

On *Lespedeza frutescens* (L.) Britton.

Lagrange, 1907 (Arthur).

On *Lespedeza hirta* (L.) Hornem. 1903:145.

Jasper, 1913 (Arthur & Fromme); Marshall, 1893 (Underwood)  
Ind. Biol. Sur. 39); Martin, 1915 (Hoffer); Orange, 1915  
(Jackson).

On *Lespedeza procumbens* Michx. 1893:57.

Montgomery, 1890 (Fisher).

On *Lespedeza repens* (L.) Bart. 1896:222.

Tippecanoe, 1894 (Snyder).

On *Lespedeza Stuevei* Nutt.

Harrison, 1915 (Fogal).

On *Lespedeza virginica* (L.) Britton (*L. reticulata* S. Wats.) 1893:  
57.

Lagrange, 1907 (Arthur); Montgomery, 1910 (Fisher).

\*117. NIGREDO MEDICAGINIS (*Pass.*) Arthur.

On *Medicago lupulina* L.

Grant, 1915 (Pipal); Tipton, 1915 (Pipal).

On *Medicago sativa* L.

Putnam, 1907 (Wilson).

\*118. NIGREDO MINUTA (*Diet.*) Arth.

On *Carex lanuginosa* Michx. 1903:144.

Jasper, 1903 (Arthur).

On *Carex virescens* Muhl. 1893:57.

Putnam, 1890 (Arthur).

The former collection erroneously reported as *Cacomurus*  
*Solidagini-caricis* Arth. in Proceedings (1903:144) and the latter  
(1893:57) as *Uromyces perigynius* Hals. on *C. virescens*.

119. NIGREDO PERIGYNIA (*Halst.*) Arth.

*Uromyces perigynius* Halsted.

*Cacomurus perigynius* (Halst.) Kuntze.

*Cacomurus Solidagini-Caricis* Arth.

On *Carex tribuloides* Wahl.

Newton, 1913 (Arthur & Fromme).

On *Carex varia* Muhl. 1903:144.

Jasper, 1903 (Arthur, type of *Uromyces Solidagini-Caricis* Arth.):

Lake, 1899 (Hill).

## 120. NIGREDO PLUMBARIA (Pk.) Arth.

*Uromyces gaurina* (Pk.) Snyder.*Caenomurus plumbarius* (Pk.) Kuntze.*Caenomurus gaurinus* (Pk.) Arth.On *Gaura biennis* L. 1896:222. 1898:180. 1903:145.

Hamilton, 1907 (Wilson); Tippecanoe, 1896 (Snyder).

On **Oenothera biennis** L.

Tippecanoe, 1912 (Orton).

## 121. NIGREDO POLYGONI (Pers.) Arth.

*Uromyces polygoni* (Pers.) Fuckel.*Caenomurus Polygoni* (Pers.) Kuntze.On *Polygonum aviculare* L. 1893:57. 1896:223. 1905:181.

Franklin, 1912, 1914 (Ludwig, in Barth. N. Am. Ured. 1196);

Hamilton, 1905 (Wilson); Kosciusko, 1909 (Funk); Montgomery, 1893 (Olive); Putnam, 1893 (Underwood); Tippecanoe, 1888 (Bolley); 1896 (Snyder).

On *Polygonum erectum* L. 1893:58.

Boone, 1911 (Miller); Henry, 1915 (Jackson); Johnson, 1890 (Fisher); Putnam, 1893 (Underwood Ind. Biol. Sur. 41); Tippecanoe, 1888 (Bolley); 1895 (Snyder).

## 122. NIGREDO POLEMONII (Pk.) Arth.

*Accidium Polemonii* Pk.*Uromyces acuminatus* Arth.*Caenomurus acuminatus* (Arth.) Kuntze.I. On **Polemonium reptans** L.

Tippecanoe, 1901 (Arthur).

III. On *Spartina Michauxiana* Hitch. (*S. cynosuroides* (L.) Roth).  
1903:144. 1908:89.

Jasper, 1903, 1915 (Arthur); Lake, 1913 (Arthur); Starke, 1905 (Arthur); Steuben, 1903 (Kellerman).

## 123. NIGREDO PROEMINENS (DC.) Arth.

*Uromyces Euphorbiae* (Schw.) C. & P.*Caenomurus Euphorbiae* (Schw.) Kuntze.On *Chamaesyce humistrata* (Engelm.) Small (*Euphorbia humistrata* Engelm.) 1903:144. 1905:180.

Hamilton, 1905 (Wilson); Montgomery, 1906 (Thomas); Putnam, 1911 (Banker); Tippecanoe, 1902 (Arthur).

On *Chamaesyce maculata* (L.) Small (*Euphorbia maculata* L.) 1893:49. 1896:217. 1905:180.

Hamilton, 1905 (Wilson); Marion, 1905 (Wilson); Montgomery, (Rose); Tippecanoe, 1887 (Arthur).

On *Chamaesyce Preslii* (Guss.) Arth. (*Euphorbia Preslii* Guss., *E. hypericifolia* A. Gray). 1893:57. 1896:222. 1898:187. 1905:180.

Franklin, 1913 (Ludwig); Fulton, 1909 (Kern); Hamilton, 1905 (Wilson); Henry, 1915 (Jackson); Jefferson, 1914 (Demaree); Johnson, 1890 (Fisher); Madison, 1898 (Snyder); Marion, 1905 (Wilson); Putnam, 1891 (Underwood); Tippecanoe, 1888 (Bolley), 1896 (Snyder), 1914 (Ludwig in Barth. Fungi Col. 4594, 4595).

On *Poinsettia dentata* (Michx.) Small (*Euphorbia dentata* Michx.) 1893:49, 57. 1896:217, 222. 1905:180.

Franklin, 1914 (Alley); Hamilton, 1905 (Wilson); Marion, 1905 (Wilson); Putnam, 1891, 1893 (Underwood, Ind. Biol. Sur. 43, 59); Tippecanoe, 1896 (Snyder).

On *Poinsettia heterophylla* (L.) Kl. & Garke (*Euphorbia heterophylla* L.)

Tippecanoe, 1904 (Arthur).

#### 124. NIGREDO RHYNOSPORAEE (Ellis) Arth.

*Uromyces Rhynosporae* Ellis.

*Cacomurus Rhynosporae* (Ellis) Kuntze.

On *Rhynospora alba* (L.) Vahl. 1903:145.

Tippecanoe, 1894 (King).

#### \*125. NIGREDO SCIRPI (Cast.) Arth.

*Uromyces Scirpi* (Cast.) Burrill.

*Accidium sili-latifolii* Wint.

I. On *Cicuta maculata* L.

Tippecanoe, 1903 (Arthur).

III. On *Scirpus americanus* Pers.

Jasper, 1913 (Arthur & Fromme); Montgomery, 1895 (Olive).

On *Scirpus validus* Vahl.

Jasper, 1913 (Arthur & Fromme).

126. NIGREDO SILPHII (*Burr.*) *Arth.*

*Aecidium compositarum Silphii* Burr.

*Uromyces Junci-tenuis* Sydow.

I. On *Silphium perfoliatum* L.

Vigo, 1899 (Arthur).

III. On *Juncus Dudleyi* Wieg.

Posey, 1910 (Johnson); Steuben, 1903 (Kellerman).

On *Juncus tenuis* Willd. 1896:222. 1898:187. 1905:180. 1908:  
90.

Fayette, 1914 (Ludwig); Franklin, 1912 (Ludwig); Hamilton,  
1905 (Wilson); Jefferson, 1914 (Demaree); Madison, 1898  
(Snyder); Marion, 1905 (Wilson); Marshall, 1893 (Underwood,  
Ind. Biol. Sur. 37); Newton, 1913 (Arthur); Orange, 1913  
(Arthur); Owen, 1911 (Pipal); Pulaski, 1912 (Ludwig); Starke,  
1905 (Arthur); Tippecanoe, 1896 (Snyder).

\*127. NIGREDO SPERMACOCES (*Schw.*) *Arth.*

*Uromyces Spermacoces* (Schw.) M. A. Curtis.

On *Diodia teres* Walt.

Harrison, 1915 (Fogal).

128. NIGREDO TRIFOLII (*Hedw.f.*) *Arth.*

*Uromyces Trifolii* (Hedw.f.) Lev.

*Cacomurus Trifolii* (Hedw.f.) Gray).

On *Trifolium hybridum* L. 1893:58. 1905:181.

Hamilton, 1905 (Wilson); Wabash, 1886 (Miller).

On *Trifolium medium* L. 1893:58.

Johnson, 1890 (Fisher).

On *Trifolium repens* L. 1893:58.

Montgomery, 1893 (Olive); Tippecanoe, 1888 (Bolley), 1893  
(Golden).

\*129. NIGREDO VALENS (*Kern*) *Arth.*

*Uromyces valens* Kern.

On *Carex lupulina* Muhl. 1893:58.

Johnson, 1890 (Fisher).

On *Carex rostrata* Stokes (*Carex utriculata* Boot.) 1905:180.

Hamilton, 1905 (Wilson, type collection of *Uromyces valens* Kern).

\*130. PHRAGMIDIUM AMERICANUM *Diet.*

On *Rosa* sp. cult. 1893:52.

Putnam, 1892 (Underwood, Ind. Biol. Sur. 48).

On *Rosa virginiana* Mill. (*R. lucida* Ehrh.) 1893:52.

Johnson, 1890 (Fisher).

131. PHRAGMIDIUM DISCIFLORUM (*Tode*) *J. F. James.*

*Aegma disciflora* (Tode) Arth.

On *Rosa* sp. cult.

St. Joseph, 1915 (Emery).

\*132. PHRAGMIDIUM ROSÆ-SETIGERÆ *Diet.*

On *Rosa carolina* L. (?) 1893:52.

Putnam, 1893 (Underwood).

On ***Rosa rubiginosa*** L.

Monroe, 1914 (Van Hook).

On *Rosa setigera* Michx. 1893:52.

Hamilton, 1907 (Wilson); Jefferson, 1914 (Demaree); Johnson, 1890 (Fisher); Madison, 1907 (Wilson); Tippecanoe, 1896 (Snyder).

133. PHRAGMIDIUM SUBCORTICIUM (*Schrank.*) *Wint.*

On *Rosa* sp. cult.

Tippecanoe, 1897 (Arthur).

134. PILEOLARIA TOXICODENDRI (*Berk. & Rav.*) *Arth.*

*Pileolaria brevipes* Berk. & Rav.

On *Toxicodendron radicans* (L.) Kuntze (*Rhus radicans* L.) 1893:58. 1896:223. 1898:181.

Laporte, 1883 (Arthur); Jefferson, 1915 (Demaree); Montgomery, 1890 (Fisher); Owen, 1893 (Underwood); Putnam, 1893 (Underwood, Ind. Biol. Sur. 34); Tippecanoe, 1893 (Golden); 1896 (Snyder).

Commonly but erroneously referred to *Uromyces Terebinthi* DC. by American authors.

135. POLYTHELIS FUSCA (*Pers.*) *Arth.*  
*Puccinia fusca* (*Pers.*) *Wint.*  
*Dicaeoma fuscum* (*Pers.*) *Kuntze.*  
*Dicaeoma Anemones* (*Pers.*) *Arth.*  
 On *Anemone quinquefolia* L. 1894:151. 1898:181.  
 Fulton, 1894 (*Arthur*).
136. POLYTHELIS THALICTRI (*Chev.*) *Arth.*  
*Puccinia Thalictri* *Chev.*  
*Dicaeoma Thalictri* (*Chev.*) *Kuntze.*  
 On *Thalictrum dioicum* L. 1893:55.  
 Montgomery, 1893 (*Olive*); *Tippecanoe*, 1912 (*Hoffer*).
- \*137. RAVENELIA EPIPHYLLA (*Schw.*) *Diet.*  
 On *Cracca virginiana* L.  
 Harrison, 1915 (*Kopp*); White, 1911 (*Bushnell*).
138. TELEOSPORA RUDBECKIAE (*A. & H.*) *Arth.*  
*Uromyces Rudbeckiae* *Arth. & Holw.*  
*Caeomurus Rudbeckiae* (*A. & H.*) *Kuntze.*  
 On *Rudbeckia laciniata* L. 1894:152. 1898:187. 1903:145.  
 Madison, 1898 (*Snyder*); Montgomery, 1894 (*Olive*).
139. TRANZSCHELIA PUNCTATA (*Pers.*) *Arth.*  
*Aecidium punctatum* *Pers.*  
*Aecidium hepaticatum* *Schw.*  
*Puccinia Pruni-spinosae* *Pers.*  
 On *Hepatica acutiloba* DC. 1893:50.  
 Jennings, 1912 (*C. C. Deam*); Montgomery, 1892, 1893 (*Thomas*);  
 Tippecanoe, 1898 (*Arthur*).
140. TRIPHAGMIUM ULMARIAE (*Schum.*) *Link.*  
 On *Filipendula rubra* (*Hill*) *Robinson* (*Ulmaria rubra* *Hill*). 1903:  
 43.  
 Tippecanoe, 1899 (*Arthur*, in *Barth. N. Am. Ured.* 83).
141. UROPYXIS AMORPHAE (*M. A. Curtis*) *Schröl.*  
 On *Amorpha canescens* *Pursh.* 1893:58.  
 Marshall, 1893 (*Underwood*, *Ind. Biol. Sur.* 44).
- Purdue University,  
 Agricultural Experiment Station,  
 Lafayette, Ind.





# INDEX

. . . . .

## A.

PAGE

|                                                        |    |
|--------------------------------------------------------|----|
| Address of the President. Wilbur A. Cogshall . . . . . | 53 |
| Appropriation for 1915-1916. . . . .                   | 9  |

## B.

|                                                                    |    |
|--------------------------------------------------------------------|----|
| Birds, Their Nests and Eggs, An Act for the Protection of. . . . . | 9  |
| Bodine, Donaldson, A Memoir of, H. W. Anderson. . . . .            | 63 |
| By-Laws. . . . .                                                   | 7  |

## C.

|                                                                                                                             |       |
|-----------------------------------------------------------------------------------------------------------------------------|-------|
| Cave, A New, near Versailles. Andrew J. Bigney. . . . .                                                                     | 183   |
| Center Lake, Kosciusko Co., Ind., Some Preliminary Observations on<br>the Oxygenless Region of. Herbert Glenn Imel. . . . . | 345   |
| Chromosome in Mutating Stocks, On the Change That Takes Place in.<br>Roscoe R. Hyde . . . . .                               | 339   |
| Coal Fields, The Olympic, of Washington. Albert B. Reagan. . . . .                                                          | 415   |
| Collections, A Study of, from the Trenton and Black River Formations<br>of New York. H. N. Coryell. . . . .                 | 249   |
| Committees of the Indiana Academy of Science, 1915-1916. . . . .                                                            | 11-13 |
| Condenser, A Standard, of Small Capacity. R. R. Ramsey. . . . .                                                             | 315   |
| Constitution of the Indiana Academy of Science. . . . .                                                                     | 5     |

## D.

|                                                                                   |     |
|-----------------------------------------------------------------------------------|-----|
| Deposits, Loess and Sand Dune, in Vigo County, Indiana. Wm. A.<br>McBeth. . . . . | 185 |
|-----------------------------------------------------------------------------------|-----|

## E.

|                                                                                       |     |
|---------------------------------------------------------------------------------------|-----|
| Electroscope, An, for Measuring the Radioactivity of Soils. R. R.<br>Ramsey . . . . . | 307 |
|---------------------------------------------------------------------------------------|-----|

## F.

|                                                                             |     |
|-----------------------------------------------------------------------------|-----|
| Food, The, of Nestling Birds. Howard E. Enders and Will Scott. . . . .      | 323 |
| Forest, The Olympic, and Its Potential Possibilities. Albert B. Reagan. . . | 419 |
| Fungi, Indiana, LII. J. M. Van Hook. . . . .                                | 141 |

| G.                                                                                             | PAGE |
|------------------------------------------------------------------------------------------------|------|
| Gamma Coefficients and Series.....                                                             | 269  |
| Geographical Literature, A Bibliography of, Concerning Foreign Countries. B. H. Schoeckel..... | 191  |
| Geometry, Plane and Spheric, Some Relations of. David A. Rothroek..                            | 273  |
| H.                                                                                             |      |
| Harmonizing Leyden Jar Discharges, A Simple Method of. Arthur L. Foley.....                    | 305  |
| High Voltages, A Standard for the Measurement of. C. Francis Harding.                          | 291  |
| I.                                                                                             |      |
| Ionisation Standards. Edwin Morrison.....                                                      | 295  |
| L.                                                                                             |      |
| Lakes, A Report on, of the Tippecanoe Basin. Will Scott.....                                   | 377  |
| M.                                                                                             |      |
| Magnolia Soulangiana, A Second Blooming of. D. M. Mottier.....                                 | 149  |
| Manures, Rate of Humidification of. R. H. Carr.....                                            | 317  |
| Micro-Organisms, Soil, Tolerance of, to Media Changes. H. A. Noyes..                           | 89   |
| Members.                                                                                       |      |
| Active.....                                                                                    | 24   |
| Fellows.....                                                                                   | 15   |
| Non-Resident.....                                                                              | 21   |
| Minutes of Spring Meeting.....                                                                 | 41   |
| N.                                                                                             |      |
| Nickel, Detection of, in Cobalt Salts. A. R. Middleton and H. L. Miller.....                   | 163  |
| O.                                                                                             |      |
| Officers Indiana Academy of Science, 1915-1916.....                                            | 11   |
| Officers Indiana Academy of Science, 1885-1916.....                                            | 14   |
| Ophioglossum, The Occurrence of More Than One Leaf in. M. S. Markle.....                       | 357  |
| Oscillatoria, The Effect of Centrifugal Force on. Frank M. Andrews...                          | 151  |

| P.                                                                                   | PAGE |
|--------------------------------------------------------------------------------------|------|
| Peat Bogs, The Phytocology of, near Richmond, Ind. M. S. Markle...                   | 359  |
| Plants not Hitherto Reported from Indiana, VI. C. C. Deam.....                       | 135  |
| Plant Diseases, A List of, of Economic Importance in Indiana. F. J.<br>Pipal.....    | 379  |
| Plastids, Some Methods for the Study of, in Higher Plants. D. M.<br>Mottier.....     | 127  |
| Proceedings General Session Indiana Academy of Science.....                          | 45   |
| Program of the Thirty-first Annual Meeting of the Indiana Academy of<br>Science..... | 49   |
| Protein, The Different Methods of Estimating, in Milk. George<br>Spitzer.....        | 173  |
| Public Offences, Hunting Wild Birds, Penalty.....                                    | 10   |

### R.

|                                                                                                   |     |
|---------------------------------------------------------------------------------------------------|-----|
| Radiations, Light and Heat, Some Notes on the Mechanism of. James<br>E. Weyant.....               | 283 |
| Reports and Papers, the, An Act for the Publication of, of the Indiana<br>Academy of Science..... | 7   |
| Riccia Flutians L., The Morphology of. Fred Donaghy.....                                          | 131 |

### S.

|                                                                                               |     |
|-----------------------------------------------------------------------------------------------|-----|
| Scovell, Josiah Thomas, Memoir of. Charles R. Dryer.....                                      | 67  |
| Scovell, Josiah Thomas, Portrait of.....                                                      | 72  |
| Sound Waves, On the Relative Velocities of, of Different Intensities.<br>Arthur L. Foley..... | 299 |
| Spectrometer, A Simple Photographic. Edwin Morrison.....                                      | 297 |
| Spring Water, The Cause of the Variation of the Emanation Content of.<br>R. R Ramsey.....     | 311 |

### T.

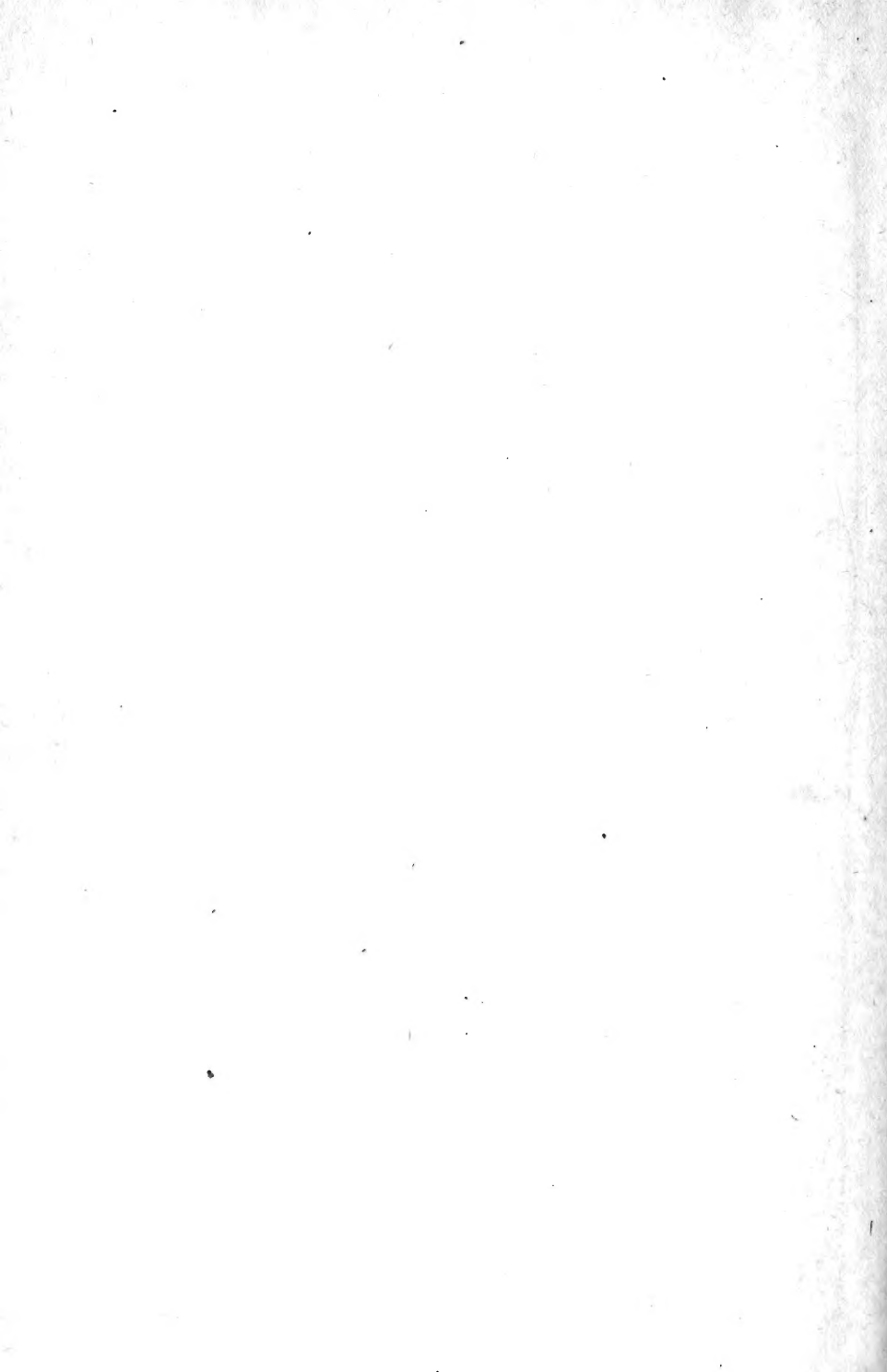
|                                           |    |
|-------------------------------------------|----|
| Tobacco Problem, The. Robert Hessler..... | 73 |
| Table of Contents.....                    | 3  |

### U.

|                                                 |     |
|-------------------------------------------------|-----|
| Uredinales, The, of Indiana. H. S. Jackson..... | 429 |
|-------------------------------------------------|-----|

| W.                                                                                                                          | PAGE |
|-----------------------------------------------------------------------------------------------------------------------------|------|
| Wabash River, Volume of the Ancient. Wm. A. McBeth . . . . .                                                                | 189  |
| Water, Analysis of, Containing Aluminum Salts and Free Sulphuric Acid,<br>from an Indiana Coal Mine. S. D. Connor . . . . . | 161  |
| White Oak, Some Elementary Notes on Stem Analysis of. Burr N.<br>Prentice . . . . .                                         | 153  |





New York Botanical Garden Library



3 5185 00278 2603

