





THE
PROCEEDINGS
OF THE
LINNEAN SOCIETY
OF
NEW SOUTH WALES

FOR THE YEAR

1917

Vol. XLII.

WITH FIFTY PLATES.

SYDNEY:

PRINTED AND PUBLISHED FOR THE SOCIETY

BY

W. A. PEPPERDAY & CO., 119A PITT STREET

AND

SOLD BY THE SOCIETY

1917-18.

W. A. PEPPERDAY AND CO.,
GENERAL PRINTERS,
119a PITT STREET, SYDNEY.



CONTENTS OF PROCEEDINGS, 1917.

PART I. (No. 165).

(Issued 11th July, 1917).

	PAGES
Presidential Address delivered at the Forty-second Annual Meeting, March 28th, 1917, by ALEX. G. HAMILTON	1-25
On the Morphology of the Caudal Gills of the Larvæ of Zygopterid Dragonflies. Introduction, Part i. (General Morphology), and Part ii. (Studies of the Separate Types). By R. J. TILLYARD, M.A., B.Sc., F.L.S., F.E.S., Linnean Macleay Fellow of the Society in Zoology. (Plates i.-vi., and 32 text-figures)	31-112
Hydrocyanic Acid in Plants. Part iii. By JAMES M. PETRIE, D.Sc., F.I.C., Linnean Macleay Fellow of the Society in Biochemistry	113-117
The Chemical Investigation of some Poisonous Plants of the N.O. Solanaceæ. Part iv. The Chemistry of the Duboisias. By JAMES M. PETRIE, D.Sc., F.I.C., Linnean Macleay Fellow of the Society in Biochemistry	118-135
The Chemical Investigation of some Poisonous Plants of the N.O. Solanaceæ. Part v. The Alkaloids of <i>Duboisia Leichhardtii</i> F.v.M. By JAMES M. PETRIE, D.Sc., F.I.C., Linnean Macleay Fellow of the Society in Biochemistry	137-145
The Percentage of Carbon Dioxide in Expired Alveolar Air. By ETHEL C. PINKERTON, B.Sc., Government Research Scholar in the University of Sydney	146-161
Contributions to our knowledge of Soil-Fertility. No. xv. The Action of certain Micro-organisms upon the numbers of Bacteria in the Soil. By R. GREG-SMITH, D.Sc., Macleay Bacteriologist to the Society	162-166
The Wing-Venation of <i>Lepidoptera</i> (Preliminary Report). By R. J. TILLYARD, M.A., B.Sc., F.L.S., F.E.S., Linnean Macleay Fellow of the Society in Zoology. (Seven text-figures)	167-17

PART I. (<i>Continued</i>).		PAGES
Mesozoic Insects of Queensland. No.1. <i>Planipennia</i> , <i>Trichoptera</i> , and the new Order <i>Protomecoptera</i> . By R. J. TILLYARD, M.A., B.Sc., F.L.S., F.E.S., Linnean Macleay Fellow of the Society in Zoology. (Plates vii.-ix., and seven text-figures).	175-200	
Descriptions of two new Tiger-Beetles from the Northern Territory. By T. G. SLOANE. [Title]	201	
Australian <i>Neuroptera</i> . Part iii. By ESBEN-PETERSEN. (<i>Communicated by W. W. Froggatt, F.L.S.</i>). (Plates x.-xv.) ...	203-219	
Hon. Treasurer's Financial Statement and Balance Sheet ...	25-29	
Elections and Announcements	30, 136	
Notes and Exhibits	201	

PART II. (No. 166).

(*Issued 3rd October, 1917*).

		PAGES
The Single Cell Cultivation of Yeast. By R. GREIG-SMITH, D.Sc., Macleay Bacteriologist to the Society	220-222	
The Geology and Petrology of the Great Serpentine Belt of New South Wales. Part vi. A General Account of the Geology and Physiography of the Western Slopes of New England. By W. N. BENSON, D.Sc., B.A., F.G.S., Professor of Geology, University of Otago, N.Z.; formerly Linnean Macleay Fellow of the Society in Geology. (Plates xviii.-xx.; and ten Text-figs.)... ..	223-245, 250-283	
Studies in Australian <i>Mecoptera</i> . No. i. The new Family <i>Nannochoristidae</i> , with descriptions of a new Genus and four new Species; and an Appendix descriptive of a new Genus and Species from New Zealand. By R. J. TILLYARD, M.A., B.Sc., F.L.S., F.E.S., Linnean Macleay Fellow of the Society in Zoology. (Plates xvi.-xvii.; and three Text-figures)	284-301	
Revision of Australian <i>Lepidoptera</i> , vi. By A. JEFFERIS TURNER, M.D., F.E.S.	304-336	
Description of a new Tiger-beetle from the Northern Territory. By T. G. SLOANE	337-338	
On the Endoskeleton of the Head, the Anterior Coxæ, and the Anterior Coxal Cavities in the Families <i>Carabidae</i> and <i>Cicindellidae</i> [COLEOPTERA]. By T. G. SLOANE	339-342	

PART II. (*Continued*).

PAGES

Revision of Australian <i>Lepidoptera</i> , vi. (continued). By A. JEFFERIS TURNER, M.D., F.E.S.	344-390
On the Genera <i>Echinuvia</i> and <i>Rhabdosigma</i> [PORIFERA]. By E. F. HALLMANN, B.Sc., Linnean Macleay Fellow of the Society in Zoology. (Plates xxi.-xxii.; and two Text-figures) ...	391-405
Elections and Announcements	249, 303, 343
Notes and Exhibits	246-248, 302, 303, 343

CORRIGENDA.

Page 47, line 7, and p.48, line 17— <i>for</i> Text-fig.1, <i>read</i> Text-fig.3.
Page 60, line 7— <i>for</i> formation, <i>read</i> function.
Page 70, last line of note— <i>for</i> nucleus of <i>end.</i> , <i>read</i> nucleus of alveolar tissue.
Page 98, line 5 } <i>for</i> <i>Agriocnemis</i> , <i>read</i> <i>Argiocnemis</i> .
Page 99, line 29 }

PART III. (No. 167).

(*Issued 22nd December, 1917*).

PAGES

<i>Carabidae</i> from Tropical Australia. (New Genera and Species, Notes and Synonymy, and Synoptic Tables. Tribes SCARITINI, HARPALINI, ODACANTHINI, LEBINI, and HELLUONINI). By THOMAS G. SLOANE	406-438
On a new Species of <i>Acacia</i> . By W. F. BLAKELEY, National Herbarium, Botanic Gardens, Sydney	441-444
Notes on the Genus <i>Lepidium</i> [N.O. CRUCIFERÆ] from the National Herbarium, Sydney. By A. A. HAMILTON	445-449
On some new Dragonflies from Australia and Tasmania [Order Odonata]. By R. J. TILLYARD, M.A., B.Sc., F.L.S., F.E.S., Linnean Macleay Fellow of the Society in Zoology. (Plate xxiii., and ten Text-figures)	450-479
The Silurian Trilobites of New South Wales, with References to those of other Parts of Australia. Part vi. The <i>Calymeneidae</i> , <i>Cheiruridae</i> , <i>Harpidae</i> , <i>Bronteidae</i> , &c., with an Appendix. By R. ETHERIDGE, Junr., Director and Curator of the Australian Museum, and JOHN MITCHELL, late Principal of the Newcastle Technical College. (Plates xxiv.-xxvii.)	480-510
Australian <i>Tabanidae</i> [DIPTERA]. No. iii. By FRANK H. TAYLOR, F.E.S. (Plate xxviii.)	513-528

PART III. (<i>Continued</i>).		PAGES
<i>Odonata</i> , <i>Planipennia</i> , and <i>Trichoptera</i> from Lord Howe and Norfolk Islands. By R. J. TILLYARD, M.A., B.Sc., F.L.S., F.E.S., Linnean Macleay Fellow of the Society in Zoology (Ten Text-figures)		529-544
Descriptions of new Species of Australian Coleoptera. Part xiii. By ARTHUR M. LEA, F.E.S. (Plate xxix.)		545-582
Notes on the "Common Nightshade" (<i>Solanum nigrum</i> Linn.) and some closely related Forms and Species that have been confused with it By EDWIN CHEEL, Botanical Assistant, National Herbarium, Sydney. (Plates xxx.-xxxiii.)... ..		583-602
On the Morphology of the Caudal Gills of the Larvæ of Zygopterid Dragonflies. Part iii. (Ontogeny), and Part iv. (Phylogeny). By R. J. TILLYARD, M.A., B.Sc., F.L.S., F.E.S., Linnean Macleay Fellow of the Society in Zoology. (Fifteen Text-figures)		606-632
Elections and Announcements		439, 511, 603
Notes and Exhibits		439-440, 511-512, 603-605

PART IV. (No. 168).

(*Issued 3rd April, 1918*).

	PAGES
Rhizopods of Sydney and Lismore. By G. I. PLAYFAIR, Science Research Scholar of the University of Sydney. (Plates xxxiv.-xli.; and seven Text-figures)	633-675
Mesozoic Insects of Queensland. No.2. The Fossil Dragonfly <i>Æschuidopsis</i> (<i>Æschua</i>) <i>flindersiensis</i> (Woodward) from the Rolling Downs (Cretaceous) Series. By R. J. TILLYARD, M.A., B.Sc., F.L.S., F.E.S., Linnean Macleay Fellow of the Society in Zoology. (Plates xlii.-xliii.)	676-692
The Geology and Petrology of the Great Serpentine Belt of New South Wales. Appendix to Part vi. The Attunga District. By Professor W. N. BENSON, B.A., D.Sc., F.G.S., formerly Linnean Macleay Fellow of the Society in Geology. (One Text-figure)... ..	693-700
Some new <i>Heteromera</i> , and a new <i>Stigmodera</i> from Tropical Australia. By H. J. CARTER, B.A., F.E.S. (Ten Text-figures)	701-719
Permian and Triassic Insects from New South Wales, in the Collection of Mr. John Mitchell. By R. J. TILLYARD, M.A., B.Sc., F.L.S., F.E.S., Linnean Macleay Fellow of the Society in Zoology. (With seventeen Text-figures)	720-756

PART IV. (*Continued*).

	PAGES
On the <i>Chertosomatula</i> , with Descriptions of new Species, and a new Genus from the coast of New South Wales. By VERA A. IRWIN-SMITH, B.Sc., Science Research Scholar in the University of Sydney. Plates xlv.-l.; and fifty-nine Text-figures) 757-814	757-814
The Variability of Cows' Milk. Part i. By H. S. HALCRO WARDLAW, D.Sc., Linnean Macleay Fellow of the Society in Physiology. (Six Text-figures) 815-865	815-865
The Composition of expired alveolar Air. By ETHEL C. PINKERTON, B.Sc., Science Research Scholar in the University of Sydney 866-872	866-872
Donations and Exchanges, 1916-17 873-890	873-890
Title-page i.	i.
Contents iii.	iii.
Corrigenda vii.	vii.
List of new Generic Names... .. viii.	viii.
List of Plates... .. viii.	viii.
Index i.-xxviii.	i.-xxviii.

CORRIGENDA.

- Page 47, line 7, and p.48, line 17—for Text-fig.1, read Text-fig.3.
- Page 60, line 7—for formation, read function.
- Page 70, last line of note—for nucleus of end, read nucleus of alveolar tissue.
- Page 98, line 5 } —for *Agriocnemis*, read *Argiocnemis*.
 Page 99, line 29 }
- Page 113, line 18—for *Heterodendron oleifolia*, read *Heterodendron olefolium*.
- Page 247, line 5—for Mr. Cleland, read Dr. Cleland.
- Page 391, line 14—for *Hetercetya*, read *Hetercetya*.
- Page 702, line 26—for *tasmanicum* Mass., read *tasmanum* Mars.
- Page 705, lines 13 and 17—for *O. leta*, read *O. letus*.
- Page 708, line 26—for obolescent, read obsolescent.
- Page 719, line 4—for $14 \times 10\frac{1}{2}$, read $14 \times 5\frac{1}{2}$.
- Page 870, line 5—for diminished, read increased.
- Page 863, line 33—for 638, 1859, read 15, 535, 1896.
- Page 867, line 20—for cotton-wool, read glass-wool.
- Page 869, line 22, second column—for 1290, read 1200.

LIST OF NEW ORDINAL, FAMILY, AND GENERIC NAMES
PROPOSED IN THIS VOLUME (1917).

	PAGE		PAGE
<i>Adelidium</i> (Coleoptera) ...	752	<i>Mesopanorpa</i> (Mecoptera) ...	747
<i>Æschnidiopsis</i> (Odonata) ...	690	MESOPANORPIDÆ (Mecoptera)..	746
<i>Anomoctena</i> (Lepidoptera) ...	319	<i>Mesopsyche</i> (Trichoptera) ...	181
<i>Aprosita</i> (Lepidoptera) ...	387	MESOPSYCHIDÆ (Trichoptera)...	180
<i>Archipanorpa</i> (Protomecoptera)	191	<i>Nannochorista</i> (Mecoptera) ...	292
ARCHIPANORPIDÆ (Protome-		NANNOCHORISTIDÆ (Mecoptera)	289
coptera)	191	<i>Notochaetosoma</i> (Nemathelmin-	
<i>Archipetalia</i> (Odonata) ...	455	thes)	798
<i>Anstrogymnocnemia</i> (Neuroptera)	206	<i>Palimnecomyia</i> (Diptera) ...	518
<i>A. vinectya</i> (Porifera) ...	393	<i>Permochorista</i> (Mecoptera) ...	732
<i>Catophrus</i> (Coleoptera) ...	713	PERMOCHORISTIDÆ (Mecoptera)	732
<i>Ceratoleon</i> (Neuroptera) ...	207	<i>Permofulgor</i> (Hemiptera) ...	730
<i>Choristella</i> (Mecoptera) ...	298	PERMOFULGORIDÆ (Hemiptera)	729
<i>Cyphoderiopsis</i> (Rhizopoda) ...	669	<i>Permoscarta</i> (Hemiptera) ...	726
<i>Cystameba</i> (Rhizopoda) ...	636	<i>Procara</i> (Coleoptera) ...	415
<i>Dictyochrysa</i> (Neuroptera) ...	214	PROTOMECOPTERA (ord. nov.)	188
<i>Elateridium</i> (Coleoptera) ...	751	<i>Protopsychopsis</i> (Neuroptera)...	178
<i>Heterectya</i> (Porifera) ...	394	<i>Syneora</i> (Lepidoptera)...	363
<i>Heteroptila</i> (Lepidoptera) ...	369	<i>Synthemiopsis</i> (Odonata) ...	463
<i>Larophylla</i> (Lepidoptera) ...	389	<i>Triassopsyche</i> (Trichoptera) ...	182
<i>Leptocystis</i> (Rhizopoda) ...	641	<i>Triassopsylla</i> (Hemiptera) ...	753
<i>Lophosema</i> (Lepidoptera) ...	377	<i>Xylophilostenus</i> (Coleoptera) ...	563
<i>Lychnographa</i> (Lepidoptera) ...	387		

LIST OF PLATES.

- Plates i.-vi.—Caudal Gills of the Larvæ of Zygopterid Dragonflies.
- Plates vii.-ix.—Wing-venation of Mesozoic Insects of Queensland.
- Plates x.-xv.—Australian *Neuroptera*.
- Plates xvi.-xvii.—Australian *Mecoptera* (*Nannochorista* spp.).
- Plate xviii.—Topographical Map of the Western Slopes of New England, N.S.W.
- Plate xix.—Geological Map of the Western Slopes of New England.
- Plate xx.—Geological Sections.
- Plates xxi.-xxii.—*Rhabdosigma mummillata*, and *Echinavia frondula*.
- Plate xxiii.—Appendages of new Australian Dragonflies.
- Plates xxiv.-xxvii.—Silurian Trilobites of New South Wales.
- Plate xxviii.—Australian *Tabanida*.
- Plate xxix.—Australian *Coleoptera*.
- Plates xxx.-xxxiii.—*Solanum opacum*, *S. pterocaulon*, *S. guineense*.
- Plates xxxiv.-xli.—Rhizopods of Sydney and Lismore.
- Plates xlii.-xliii.—Wing-venation of *Æschnidiopsis hindersiensis* (Woodward).
- Plates xliv.-xlv.—*Chaetosoma falcatum*, n.sp.
- Plates xlvi.-xlvii.—*Chaetosoma haswelli*, n.sp.
- Plates xlviii.-xlix.—*Notochaetosoma tenuis*, g. et sp.n.
- Plate l.—*Notochaetosoma cryptocephalum*, n.sp.

PROCEEDINGS
OF THE
LINNEAN SOCIETY
OF
NEW SOUTH WALES.



WEDNESDAY, MARCH 28TH, 1917.

The Forty-second Annual General Meeting, and the Ordinary Monthly Meeting, were held in the Linnean Hall, Ithaca Road, Elizabeth Bay, on Wednesday evening, March 28th, 1917.

ANNUAL GENERAL MEETING.

Mr. A. G. Hamilton, President, in the Chair.

The Minutes of the preceding Annual General Meeting (March 29th, 1916) were read and confirmed.

The President delivered the Annual Address.

PRESIDENTIAL ADDRESS.

The past year has been a sobering time for the serious-minded among us. We have had another year's enlightenment on various aspects of the terrible war—clearer ideas as to what led up to it, a better understanding of the great issues that are at stake, and of the spirit in which, on the side opposed to us, it was begun, and is being carried on; some inkling of its staggering financial import; and, not least, what nations can accomplish in the way of co-ordination and concentration, when the need for it becomes compulsory. Our soldiers and sailors, doctors and nurses, notwithstanding a much more severe winter than they are accustomed to, have maintained the fine reputation for courage, resourcefulness, cheerfulness amidst danger and difficulties, which characterised those who first entered the war-zone at Gallipoli, and co-operated so efficiently with their

comrades from other countries. At home, the efforts of those who have earnestly devoted themselves—and especially the women—to the tasks of providing for the reinforcement and support, for the encouragement and comfort of our splendid representatives in the trenches, in hospitals and training-camps, and, alas, in some cases in prison-camps, as well as for those who are getting ready to leave us to enter upon active service abroad, have been beyond praise. The War Loans have been well supported, and the response has been wide-spread. We are well aware that the critical stage of the gigantic struggle is approaching; and that though the Allies are now thoroughly awakened, resolute, and in earnest about settling it in the right way, the task may be expected to be arduous, and the cost heavy.

And yet here, in New South Wales especially, keeping all this in mind, when have we, in other respects, contributed so poor and sordid a chapter to our annals, as the record of the last twelve months? It has been said that the whole art of politics is the art of seeing, and that party is the dust which gets into the eyes of the politicians' understanding, and mars their intellectual vision. But politics cannot claim a monopoly of the art of seeing straight as the prelude to going straight and acting straight. Every other department of human activity is just as much in need of this accomplishment. The intrusion of the party-spirit, degenerating at times into the faction-spirit, has been responsible for a deplorable deterioration in the standards and methods of our public life, and has culminated in depriving Australia of representation on the Imperial War Conference. We have failed to rise whole-heartedly to important occasions in a very great crisis, apparently because we happen to be geographically situated on the outer edge of the outer war-zone, instead of inside the inner war-zone.

I would remind you of our absent Soldier-Members. Eight of those mentioned in my last address are still abroad on active service, and were all well when he heard last. At the Meeting in September, we had the pleasure of welcoming back Mr. C. F. Laseron, who had seen service in Gallipoli and elsewhere, and is

still suffering inconvenience from a wound. Another Member, Mr. C. O. Hamblin, B.Sc., left during the year for the front, and carries with him our good wishes. Mr. L. M. Harrison, B.Sc., some time ago suspended his studies at Cambridge, in order to join the British forces in Mesopotamia, as entomologist. May we have the pleasure of welcoming them all back in due time!

The 7th of December, 1916, was the twenty-fifth anniversary of the death of Sir William Macleay, who for the Members of this Society, should never be numbered with the "unremembered or forgotten dead." Twenty-five years have brought about considerable changes in the personnel of the Society, so that the number of those to whom Sir William was personally known has gradually diminished. As one of this minority, and also as this is our first Meeting since the date mentioned, I am glad of the opportunity of calling to remembrance the Society's indebtedness to the large-hearted, far-seeing man who made this Society possible in its present developed form. The Society of to-day, as compared with the Society at the time of its foundation in October, 1874, affords a very fair indication of the progressive development of the branches of Science, in which it is particularly interested, in the interval, in this State. Forty-two years ago, the University of Sydney was without a Medical School, and consequently there was no provision for the teaching of biology. The Australian Museum had no scientific staff other than the Curator. The Geological Survey Branch of the Department of Mines was the only Government Institution in Sydney with a scientific staff. The Department of Agriculture and the Technological Museum had not been established. The forerunner of the Department of Public Health was without a laboratory or scientific staff. Under scientific conditions of so rudimentary a character as that outlined, this Society was inaugurated, by men with faith in the future. The number of the original Members who were actively interested in Natural History was very small, but they were in earnest, and they were backed up by a very creditable number of sympathetic supporters desirous of seeing an advance in the status of Natural Science in New South Wales.

These conditions gave Sir William an opportunity, for which if he was not actually looking, he was quite ready to accept when it offered. For the rest of his life, he became forthwith, in the most unostentatious manner, "the head and the heart of the Society," as the late Dr. Norton, himself an original Member, and for many years a member of the Council, and Hon. Treasurer, on one occasion aptly described him. That is to say, in the capacity of Hon. Secretary, Sir William, privately and without at any time giving publicity as to the extent of his liberality, even to the Council, took upon himself the responsibility of providing the Society with a temporary home, until it was accommodated in the Garden Palace; of providing, out of his own resources, for the acquisition of the nucleus of a valuable library; of defraying so much of the office-expenses and of the cost of publishing the Proceedings as the limited income of the Society was unable to meet; and of taking charge of the whole of the executive work, except in the Hon. Treasurer's department. Soon after the conflagration, which completely destroyed the Garden Palace and its contents, in September, 1882, Sir William, at his own expense, placed at the Society's disposal, a more commodious and comfortable, rented house than it had ever before occupied; and then, without saying anything about it, he took the lead and contributed the largest share in remedying the damage and destitution caused by the fire, as well as in keeping the current work of the Society going, as if nothing had happened. His next important step was to provide the Society with a permanent home—the building in which we are now assembled—which it has occupied for more than thirty-one years; and also to make provision, of a permanent character, for the oversight of the executive work of the Society under the direction of the Council; meanwhile continuing his generous support in the way of financing the Society, of enlarging the library, and of improving generally its status. This part of his programme having been privately carried into effect, there remained the settlement of the questions of converting temporary into permanent conditions for securing a firm financial basis for the

Society, and the settlement of the details of his scheme for the future encouragement of research.

The Society's history then is naturally divisible into two chapters—a first period of seventeen years, during the whole of which, except for the few months of the illness which ended his labours, Sir William voluntarily and without saying anything about it that he could avoid, personally undertook the responsibility of the management of the Society's affairs in the way I have indicated; and the subsequent period of a little more than twenty-five years to date, during which the service and the assistance which he voluntarily rendered during his lifetime, automatically, one may say, by means of trusts committed to the Council, became operant after his decease. Every member is in a position to know what these amount to, now that Sir William's plans have been realised completely. But the realisation did not come about quite so simply or so soon as he expected, the most important deterrent being the financial crisis of 1893. Just about the time that all difficulties had been overcome, the war broke out; and the Society's immediate future is likely to be affected as possible new conditions may arise and require. In 1925, only eight years ahead, the Society, if all goes well, will attain its jubilee; and this we may expect to be celebrated in an appropriate manner. It will also furnish occasion for a more detailed account of the Society's history than has hitherto been possible, and for an analysis of its fifty years' work. Just at present, what I wish to do is to call to mind an anniversary that is not without interest to us; to point out, to new Members especially, that the Society has a history that is, in large measure, bound up with that of a broad-minded, far-seeing, generous man, without whose fostering care and help there would have been no such Society as we know it, and whose memory should not be allowed to be dimmed by the lapse of time; and that, in addition to the material benefits which he conferred on the Society, it may be said to have inherited not only his example, but the spirit in which he did what he accomplished. Sir William was under no sort of obligation to do any-

thing that he did for the Society. He had evidently grasped the idea that, at bottom, Ignorance is the millstone round the neck of mankind, that it is primarily ignorance which retards human progress, and that mistakes, though made in ignorance, have to be paid for in some way or another. He had the knowledge, the leisure, and the resources; and he might have chosen the "safe disgrace" of being affluently idle. Instead, he chose to regard these as a trust to be used for the enlightenment of ignorance, and the advancement of knowledge; and so he served. This is his claim upon our forgetfulness, upon our regard, and upon our co-operation. And we may say of him, as Lowell said of Jeffries Wyman,

He widened knowledge, and escaped the praise,
for this was his twofold aim; and in so far as he was personally concerned, he accomplished it.

Notwithstanding the abnormal conditions which still prevail, the Society has been able to continue its work in the customary manner as well as circumstances have permitted. The serious effect of the war upon our exchange-relations with Societies in Europe, of course, continues. The total number of exchanges and donations received for the Session 1916-17 amounts to 1243 additions to the library (received from 146 Societies, Institutions, etc., and 12 private donors), as compared with 1028 for 1914-15, and 1285 for 1912-13 before the war. The apparent improvement on the receipts for 1914-15, however, is merely incidental, for our communications with over forty Societies or Institutions, from which, under normal conditions, we are accustomed to hear at least once during the year, remain in a condition of complete suspension. We have lost one lot of despatches for England by the sinking of the s.s. "Arabia," but fortunately a smaller lot than is often sent.

The concluding Part of the forty-first volume of the Proceedings for 1916 (945 pp., and fifty-nine Plates, besides numerous text-figures) is almost ready for issue. It comprises thirty-seven papers, of which eleven were contributed by Linnean Macleay Fellows of the Society, read at the Meetings during the Session.

Allowing for the distracting conditions under which the work it records has been carried out, it may fairly be considered to be an important addition to the Series.

Eleven Ordinary Members were elected during the Session, four resignations have been received, and one Corresponding Member and one Ordinary Member have been lost by death. Moreover, the names of eighteen Members, whose obligations have remained undischarged for unduly long periods, will be removed prior to the publication of a new issue of the List of Members. The effective membership of the Society, therefore, stands a little below the usual level.

Edgar Albert Smith, I.S.O., F.L.S., F.Z.S., the Society's senior Corresponding Member, was born in 1847, and entered the service of the British Museum in his boyhood. At the age of twenty, he was placed in charge of the conchological department, and rose to be Senior Assistant Keeper in Zoology. His life-work lay in the naming and arranging of the vast collection of more than forty thousand species under his charge. Though he made no large generalisations or startling discoveries, by patient industry he extended a knowledge of the Mollusca. His contributions to scientific literature range from brief notes to weighty monographs, and amount to nearly four hundred publications. A keen memory and long experience were ever at the disposal of others at home or abroad, so that his help and kindness are acknowledged by every conchological writer of the present generation. Mr. Smith retired from the British Museum in 1913. He was elected a Corresponding Member in the early days of the Society; and never failed to supply reprints of his papers. He died on July 22nd, 1916, aged 68 years.

Dr. J. H. May, a Member since 1901, died towards the end of the year at Bundaberg, Queensland, where he had long resided, and practised as a medical man.

The death of Dr. Edward Pierson Ramsay, on 16th December, 1916, aged 74, well known in Sydney as Curator of the Australian Museum from 1874-1895, removed another interesting link with the past. He was a Foundation-Member of both the

Entomological Society of New South Wales and of this Society; and, as the only official representative of Zoology in this State in those early days, he was a most useful Member. As a Member of Council, a contributor of numerous papers, and as an exhibitor of zoological and other specimens of interest, he rendered most important aid in support of the Society, and in furthering its interests during the critical early stages of its history. He is well represented in the first fourteen volumes of the Proceedings (1875-1889). In 1892, shortly before his retirement from the Australian Museum on account of ill health, he gave up his membership, and ceased to take an active part in the studies in which he had taken an enthusiastic interest for so long. He was well acquainted with the fauna from his boyhood, especially with the birds. His early knowledge of it covered a very interesting period, when it had not been anything like so seriously interfered with by settlement as it unfortunately is now. His contributions to knowledge, in the branches in which he was particularly interested, are numerous and valuable, because he belonged to the era when local workers, with personal knowledge of the fauna, were beginning to study it. A record of his collecting experiences and of his knowledge of the gradual growth of Zoological Science, from very small beginnings, in this State, would be most valuable and interesting. It is to be hoped, that during the leisure of the later period of his life, he may have been moved to record his reminiscences from this point of view. It is not necessary for me to anticipate the historian of the Australian Museum by attempting to give a more detailed account of Dr. Ramsay's life and work.

In July last, in consequence of the threatened shortage of paper, the Council decided to suspend, for the present, the publication of the Monthly Abstract of Proceedings, after the issue of No.339 for the month named. This will result in the saving of the equivalent of 10,800 pages for the Session—a matter of some importance just now. The first of the series made its appearance in June, 1882, three months before the Garden Palace Fire; and the issue had continued uninterruptedly for just

over thirty-four years. The Society has one copy only of each of the first three numbers, and consequently only one complete set. The destruction of the Society's records up to September, 1882, has deprived us of any knowledge of the circumstances which led up to the adoption of the practice of publishing a Monthly Abstract; and the matter is not referred to in the address of the President, at the following Annual Meeting in January, 1883. It was doubtless intended to keep Members and Societies at a distance in touch with the Society's work; and this it certainly did, because the "Zoologischer Anzeiger," up to the time of the outbreak of war, very kindly was accustomed to republish the zoological portion of each monthly number. "Nature," also, for many years has helped us in a similar manner by publishing the abstracts of the papers read. The Society's indebtedness to these two journals, for their co-operation in diffusing a knowledge of the work done by the Society, is considerable, and may here be gratefully acknowledged. When conditions again become normal, the question of the resumption of the publication of the Monthly Abstract may be expected to receive the consideration of the Council.

As regards the Proceedings, the Society's printer has been able to obtain the necessary amount of paper so far required, but at a substantial increase in cost. Printing paper is not manufactured in Australia and we are dependent on British supplies. Now that the nation is mobilised for war, and the Government has placed restrictions on the production of various commodities for the sake of economy in man-power and tonnage, we are likely to feel the effect: and, just at present, the Council does not know what are the prospects of being able to carry on our publishing work on the usual scale in the immediate future. At any rate, I take the opportunity of reminding Members of the Council's appeal for all possible curtailment in the size of papers and in the notices of exhibits, otherwise it may necessitate their being declined, or being subdivided, and taken in instalments. The ability to deal with long papers is deteriorating until conditions again approach the normal; and, meantime, economy in space is

becoming more and more pressing so that we may prepare for any stringent conditions that may arise.

The year's work of the Society's research-staff may be summarised as follows:—

Dr. R. Greig-Smith, Macleay Bacteriologist to the Society, has continued his investigation of the problem of soil-fertility. The fifteenth of his series of papers treating of this subject, as well as a short paper on the single cell cultivation of yeast, have been completed and handed in; and will be taken, in their turn, during the coming Session.

Dr. J. M. Petrie, Linnean Macleay Fellow of the Society in Biochemistry, has extended his observations on poisonous Solanaceous plants, and on the occurrence of hydrocyanic acid in plants. Two papers dealing with the alkaloids of Native Tobacco, and of *Solantra longiflora*, being Nos. ii. and iii. of the series on the Chemical Investigation of Poisonous Plants of the N.O. Solanaceae, will be found in the Proceedings of last year. Nos. iv. and v. of the same series, which deal with the chemistry of the three species of *Duboisia*, together with No. iii. of the series on hydrocyanic acid in plants, have been completed and submitted for publication. These will be taken in their turn during the coming Session. Meanwhile, Dr. Petrie has in view the further elucidation of certain problems relating to cyanogenesis in plants.

Mr. E. F. Hallmann, Linnean Macleay Fellow in Zoology, completed his second contribution to a revisional knowledge of Australian Sponges early in the year. This, like its predecessor, was taken in three sections for convenience. Two of these appeared in Part 3 of last year's Proceedings; the third will be found in the concluding Part of the Volume. Mr. Hallmann has since been at work upon the Desmospongiæ collected by the Australasian Antarctic Expedition.

Mr. R. J. Tillyard, Linnean Macleay Fellow in Zoology, has successfully carried on his studies on Australian Neuroptera, and on the larval respiration, and the wing-venation of Odonata. Nos. ii., iii., and iv. of the series devoted to the Order Neuroptera,

together with a paper treating of the emergence of dragonfly larvæ from the egg, with special reference to the problem of respiration, and another recording important conclusions respecting the radial and zygopterid sectors in Odonata and the formation of bridge-veins, are contained in the Proceedings for 1916. In addition to these, three other important papers, including one upon fossil insects from Queensland, have been completed and submitted for publication. These will be taken in their turn during the coming Session. Mr. Tillyard purposes continuing his work on the Odonata and Neuroptera; and taking up also the study of the Orders Perlaria and Trichoptera on similar lines. In January, Mr. Tillyard visited Cradle Mountain, in N.W. Tasmania, and discovered there a remarkably rich alpine fauna, the greater part of which is new to science. The ancient Orders of the Trichoptera (Caddis-flies) and Perlaria (Stone-flies) are dominant in this region; about thirty new species of the former and twelve of the latter were obtained, besides a number of new and rare Lepidoptera and Diptera. Mr. Tillyard's book on "The Biology of Dragonflies" was published early this year by the Cambridge University Press. The volume is one of the Cambridge Zoological Series, edited by Dr. Shipley. Copies have not yet reached Australia, but may be expected in April or May.

Dr. H. S. Halcro Wardlaw, Linnean Macleay Fellow in Physiology, has completed his first year's work. An important paper on the change of composition of alveolar air after the stoppage of normal breathing, was read at the last Meeting; and will be found in the concluding Part of the Proceedings for last year. Dr. Wardlaw has also been engaged upon a very promising investigation of the range of variation of the composition, and of the values of certain physical properties of the milks of individual cows.

I have now the pleasure of making the first public announcement of the Council's reappointment of Dr. J. M. Petrie, Mr. E. F. Hallmann, Mr. R. J. Tillyard, and Dr. H. S. H. Wardlaw to Linnean Macleay Fellowships for a period of one year from 1st

proximo; and, on behalf of the Society, of wishing them a successful and profitable period of important work.

In my address last year, I alluded to the many problems for the Australian field-biologist, and to the fact that the opportunities for research of this kind are every day becoming more restricted. The subject to which I directed attention particularly was the pollination of flowers by birds. But the whole question of the pollination-methods of Australian plants affords an opportunity for interesting and valuable field-work. It is remarkable, when the unique character of the endemic flora is considered, how little has been done; and on looking into what has been accomplished, I was impressed with the amount of supplementary work which still remains to be done in relation to the species examined by authors. In most of the papers on the pollination of Australian flowers, we find that the writers only examine the structure of the flowers, and conjecture what is the method of pollination, with perhaps a guess at the order of insects likely to supply the pollinators. In many instances, no field-work was attempted. Of course, in the case of authors like Darwin, Delpino, Hildebrand, and Henschel, field-observations on the plants in their natural habitats were quite out of the question. But for those of us who worked at the plants in Australia, there is less excuse. At the same time, workers who have paid some attention to this kind of research, know that, in most cases, it is rare to see native insects, except Lepidoptera, visit flowers. There are exceptions, such as *Angophora cordata*, and some of the tea-trees, which have very large numbers of visitants. I have found, however, that any of our flowers that have such a large number of visitors, are of a generalised type with large quantities of nectar freely exposed, and available alike to almost any insect. There is no special mechanism for securing cross-pollination. When we examine Knuth's *Pollination of Flowers*(1), and notice the huge lists of insects recorded as visiting a single species, it is evident that European, and especially Alpine, conditions differ very much from ours. One thing is certain, any one desiring to observe the insects at our plants,

must be an early riser. Both insects and birds go to work in the early morning, when their appetites are sharpest, and when, perhaps, a larger supply of nectar, secreted during the night, is available.

There are a good many general points which would reward research. There is some difference of opinion as to whether insects notice colour, or are attracted by it. But, personally, I consider that the point is beyond dispute. I believe that colour does undoubtedly act as a signal. On one occasion I saw two ladies on the lawn at the Sydney Cricket Ground, one of whom had some brilliant artificial flowers in her hat. They were followed up and down by two examples of *Papilio Sarpedon*, which hovered over the flowers for a considerable time. I have also repeatedly seen hawk-moths, which had flown into a room about dusk, approach the patterns of flowers on the wall-paper, and on cretonne-cushions, and extending their probosces, attempt to probe them. And, when collecting hawk-moths, I once succeeded in attracting numbers to a plant on which I had fastened pieces of coloured paper roughly tied to the shape of tubular flowers. Probably bees and butterflies have the colour-sense in a higher degree than any other insects, but I am convinced that most insects which frequent flowers are attracted by the colour.

Some days after writing the above, I saw a small electioneering ticket on a telegraph-pole, exhorting the electors to vote for Mr. So-and-so. It was green with red lettering, and a butterfly (*Papilio Sarpedon*) was hovering round it, touching it with its proboscis, and now and then alighting on it. It is, I think, quite safe to infer that the colour attracted the insect. It has been said that insects are guided more by form than colour, but I think an instance like this is a sufficient answer to that objection. The oblong shape in no way resembles the form of any flower.

It has been objected that we should not take for granted this purpose for colour, on the ground that we cannot conceive any other explanation. But I think the probabilities favour the theory. A species of *Brunfelsia* is cultivated in the Botanic Gardens. The leaves are bright green, but every leaf which

subtends the small blue flowers has its apical half pure white, thus throwing up the flowers by contrast. And again, while calyces are usually dull in colour, we often find that where there is no corolla, the calyx is brilliantly coloured: and where both calyx and corolla are wanting, bracts and spathes (as in *Bougainvillea* and Aroids) have conspicuous colours. I certainly think that the theory of colour-recognition by insects is supported by sufficient evidence.

In Darwin's *Forms of Flowers*(2), there is a list of fifty genera of plants having cleistogamous flowers. Fifteen of these genera extend to Australia, but, so far as I know, cleistogamous flowers have been recorded in only two of them, *Thelymitra*(3), and *Pavonia*, and in addition, in *Hypoxis*(4). Among the Orchids, there are one or two other genera which are either cleistogamous or chasmogamous (*Calochilus*). Are cleistogamous flowers found in any of our native species of *Eranthemum*, *Ruellia*, *Viola*, *Ocalis*, *Lepedeza*, *Glycine*, *Drosera*, *Juncus*, or *Commelyna*? I have not been able to find any in *Eranthemum* *Viola*. or *Ocalis*.

Little, that is definite, is on record about the pollination of *Eucalyptus*, or, with one exception, of *Acacia*. I looked up both Orders in Hermann Müller's and Knuth's books, and was greatly astonished to find that neither book has any reference at all to the Myrtaceæ. The Order seems to have been passed over by inquirers into pollination-methods. And very few observations are recorded on *Acacia*. In the case of *Eucalyptus*, we know that the flowers are visited by the brush-tongued lories, and by some of the honey-eaters. In a paper by Mr Swinnerton(5) "On Short Cuts by Birds to Nectaries," being observations made in South Africa, he mentions *E ficifolia* as being visited by Sun-birds, and also by other birds, as well as insects. He believes that, in South Africa, this species is chiefly pollinated by hive-bees, and Sphingidæ. The *Eucalyptus* flower being of a shallow, open type, with much nectar, it seems rather extraordinary that it should be pollinated by Sphinges. The lories, having a short tongue, are certainly well adapted for the work, but I should have thought that slender-billed birds, and long-tongued moths would not be likely to pollinate the flowers.

Nowadays, introduced hive-bees are usually the most conspicuous visitors, both to garden-plants, and, in localities not too remote from settlement, also to native plants, including Eucalypts, Banksias, and Grevilleas. Bee-keepers are glad to have Eucalypt forest in proximity to their apiaries. In some cases, doubtless, the hive-bees are instrumental in effecting pollination. But in others, they merely deprive the flower-frequenting birds of their birthright, without accomplishing anything for the benefit of the plants.

The only observation on the pollination of *Acacia* that I have been able to discover, is a paper on *A. celastrifolia* (6), by Mr. O. Sargent. There is a reference in Hermann Müller to an *Acacia* in which the central flower of the head is converted into a great nectary; and some observations on the relation between extrafloral nectaries and the flowering period of several of our *Acacias*, are recorded in the *Australian Naturalist* (7).

The earliest references I can trace to the pollination of Australian flowers are those of Henschel, 1820 (8), Hildebrand, 1867-70 (9), and Delpino, 1868-73 (10). They appear to have contained references to the fertilisation of the *Proteaceæ* and *Goodeniaceæ*; but as I cannot consult these, I am unable to speak definitely about them. It is tolerably certain, however, that they were merely observations on the mechanisms of the flowers as seen in cultivated plants. In R. Brown's (not *the* R. Brown) *Manual of Botany* (11), there is a very good account of indusiate stigmas in the *Goodeniaceæ*. He says, "This arrangement of the stigma . . . favours fecundation. The five anthers are in the form of an arch under which lies the indusiate stigma. Accordingly, when the anthers dehisce introrsely, the pollen falls directly into the cup-shaped indusium, and there performs its functions towards fecundation." Brown falls into the trap, as several of us did, of supposing that, when the pollen was in the cup, the process was at an end.

In 1867, Bentham read a paper before the Linnean Society on the Stigmatic Apparatus in *Goodenovieæ*, in which he says, "It is in order to call to the subject the attention of any observers who may have any species in cultivation, and still more of those

of our Fellows who may be resident in Australia, that I lay before the Society the peculiarities which I have observed." And he follows this up in the *Flora Australiensis* (Vol. iv.) by saying: - "Goodenovieæ are readily known by the remarkable indusium, which evidently, together with the peculiar surrounding hairs of the style or of the corolla, acts a considerable part in assisting the proper impregnation of the stigma. The contrivances by which this impregnation is impeded, retarded, or promoted, appear to be very different in different genera, as, for instance, in *Goodenia*, *Leschenaultia*, and *Dampiera*, and are well worthy of careful observation on the part of botanists resident in Australia, where the flowers can be observed subject to the natural operations of insects, as well as of climatological and other external influences." His account of the mechanisms in the former paper is extremely good, really wonderful when we consider that he saw only dried specimens of the great majority of the species. Notwithstanding the very curious nature of the floral arrangements, his pious aspirations were many years without fulfilment.

It was natural that Darwin should be attracted by the unusual floral mechanism described, and, in 1860, he had the opportunity of observing *Leschenaultia formosa*, publishing a short paper in 1871. The part of the Gardener's Chronicle in which it appeared does not seem to be in any of the Sydney libraries.

The next attempt to solve the riddle is due to the late Mr. E. Haviland, who, in 1882, began a series of papers on plants in the neighbourhood of Sydney. Among them was one on the fertilisation of *Goodenia ovata* (13). In this paper, Mr. Haviland gave an account of the floral mechanism, but missed one or two of the most important points. In the buds, the anthers are arranged arching over the open mouth of the indusium, at the bottom of which is the immature stigma. The bud is then in an upright position, and the style lengthens very rapidly. The membranous edges of the petals are folded so as to keep the anthers closely pressed over the style and indusium; and, as the latter grows up, the anthers dehisce and shed their pollen into the indusium. Then the indusium closes, the flower changes to a horizontal

position, and the style takes up such a position that the open mouth of the indusium is behind the two upper petals. At this time, the stigma begins to grow up from the bottom of the indusium, and pushes the pollen out through the fringe of hairs on its edge. An insect (and, so far as I have seen, only beetles visit the flowers) pushing its way into the flower, causes the two upper petals to part, and the elasticity of the style causes it to bend downwards, the mouth touching the back of the insect, and depositing the pollen thereon. At a later stage, the stigma emerges from the cup, and then matures; and when a pollen-dusted visitor arrives, the pollen is taken up in the same way by the now sticky stigma.

Mr. Haviland does not seem to have seen the pollen packed in the indusium, nor the emergence of the stigma. I followed up Mr. Haviland's paper by one on another species (14), in which I gave an account of the process up to the closing of the indusium; and came to the not inexcusable conclusion that it was a case of self-pollination. Mr. Haviland wrote a note criticising my paper, and reiterating his opinion that pollination was effected by insects receiving pollen from the anthers, and afterwards placing it on the stigma. But in two later papers (15), I gave my experience of a large number of flowers of *Scaevola*, *Selliera*, *Brunonia*, and *Dampiera*, in all of which the process is just as I have described above, although there are minor differences in details. Since then, Archdeacon Haviland, Mr. E. Haviland's son, has described the pollination of *Goodenia cycloptera* (16). His observations, in the main, agree with what I have stated, but he found that, at the stage when the pollen ripened in the indusium, the mouth of the latter opened. This is a feature that I have not observed in any of the species examined by me. One of the conclusions in my first paper was, that *G. hederacea* was self-pollinated. Evidently, in the later papers, I have not made it quite plain that I had abandoned that idea, for Archdeacon Haviland, knowing that *G. hederacea* was a decumbent species while *G. ovata* was an erect species, cross-pollinated, looked into the question as to whether the erect species might be cross- and the decumbent species self-pollinated.

But he found that this was untenable for *G. cycloptera*. I, for my part, am confident that all species of Goodeniaceæ are cross-pollinated. Archdeacon Haviland also observed that a native bee was the pollinating agent in this species.

Mr. E. Haviland's papers included observations on *Lobelia* and *Wahlenbergia*, and I also worked out the pollination of these, and of three species of *Candollea* (*Styloidium*). Comparing the methods of pollination in these three families and Compositæ, (the four being closely related and placed together in the series Campanulatæ of the Sympetaleæ), we find that a very similar arrangement of the stamens and pistil is so modified in each family as to secure cross-pollination in very different ways. The Cucurbitaceæ, belonging to the same series, having separate staminate and pistillate flowers, necessarily do not present the peculiarities which follow. In all the families, at some stage of flowering, the stamens form a close ring or rather tube, enclosing the style. In Compositæ, they are higher than the closed stigma, which grows out through the tube, pushing the pollen before it. Insects visiting the flower-heads remove the pollen: later on, the stigma opens and curls back, and is then likely to be pollinated by visitors. But if not, it always has the chance of getting its own pollen or that of neighbouring flowers when the stigmatic lobes curl round, as they do later.

In Lobeliaceæ, the stamens also form a tube, with the closed stigma at the base of the tube. When the anthers are about to dehisce, the style lengthens rapidly, and the pollen is pushed out of the anther-tube, a process assisted by the fact that the outside of the stigma is covered with delicate, beaded hairs. When the closed stigma finally emerges from the tube, the hairs wither and drop off, carrying any adherent pollen, and then the bifid stigma opens, and is ready to receive pollen from visitors. In this case, there is no provision for self-pollination if cross-pollination does not ensue, and the ovaries, in that case, do not develop.

In *Wahlenbergia*, the stamens are arranged so that the anthers dehisce, and leave the pollen attached to the style, which is provided with sticky glands. The trifid stigma is, at this time,

closed. Insects making their way down the tube, gradually remove all the pollen. Then the stigma opens, exposing the stigmatic surface, and pollen-laden insects are certain to deposit some of it on that surface.

In the Goodeniaceæ, the stamens again form a ring round the style, having the open indusium on a level with the base of the anthers. The style grows rapidly upwards, and, aided by its rim of stiff hairs, brushes out all the pollen which falls into the cup. The indusium then closes tightly, after which the style and indusium take up a position in the tube of the flower, so that when an insect forces its way into the tube of the flower, the indusium comes down on its back. Later, the enclosed pollen is forced out through the hairs, which act like a sieve, by the upward growth of the stigma in the cup. Finally, the stigma comes out, matures, and is ready to receive pollen.

In the Candollaceæ, the ring of stamens is no longer found; they unite with the style, so that the stigma and anthers form a disc on the end of a long, bent arm, which is sensitive. The anthers mature first, and cover the stigma, which is then very minute, and immature. When insects visit the flower, the arm flies over and deposits pollen on their backs. When all the pollen is exhausted, the anthers shrivel, and the stigma grows rapidly and matures. In this stage, when visited by a pollen-bearing visitant, the stigma picks it up when it reflexes.

Another family—the Proteaceæ—is well worthy of attention, not only because it is largely Australian, but also on account of the peculiarities of the floral structure. Bentham(17) recognised that the structure was significant, and drew attention to it in the vain hope that local observers would investigate the subject. Delpino, in the same year(10), gave some account of the mechanism, and hazarded the opinion that, in several species, honey-sucking birds are the pollinators. Hildebrand also refers to the subject(9). There are several distinct types of floral mechanism. In the Suborder Nucamentaceæ, the flowers are simple and regular, and pollination is effected both by birds and by insects.

In Conospermum, the flowers are small, but clustered together. The anthers burst open when touched, and fling the pollen on

the visitor, which, in this case, is always an insect—mostly a fly or a bee. At the same time, the style takes up a new position. In *Grevilleæ*, *Embothriæ*, and *Banksiæ*, the flowers are mostly irregular and generally bird-pollinated, *Lomatia* being an exception in the second of those tribes. (*Lomatia*, by the way, makes a poor recompense to insect-workers. Some years ago, I recorded the fact that flies feeding on the nectar died in numbers, and Dr. Petrie thought that hydrocyanic acid was the cause. Recently a correspondent has drawn Mr. Maiden's attention to a similar case. It is only at certain stages of flowering, that the insects are killed). Among these, there is considerable diversity, although the general plan is the same in all—the pollen is deposited in the bud-stage on the disc surrounding the stigma. Then the style pulls itself free, and stands up. Birds visiting the flowers remove the pollen and transfer it to the minute stigmas of other flowers. Mr. Fletcher has drawn attention to a very interesting case of crossing between *Grevillea laurifolia* and *G. acanthifolia*; but he has not yet completed his observations. Hybrids among the *Proteaceæ* are only possible when both parents have flower-heads of such a kind that the pollinators approach them in the same way, and styles of such a length that the style-summit of each touches the bird in the same place. Thus a species with a secund raceme would not be likely to be pollinated from a species with a round head of flowers. The only observations on Australian *Proteaceæ* by local botanists that I have been able to trace are by Dr. Shirley(18), and a note on *Telopea* and *Stenocarpus* by myself(19). Mr. W. M. Carne favoured me with some MS. notes on *Grevillea robusta*, of which the following is a précis. The flowers grow in a long, horizontal raceme, and the basal ones open first. At the tip will be found(1) unopened flowers, or partly open, but with the stigma still attached to the perianth. Proceeding towards the base of the raceme, we find (2) the style free, with the pollen attached all round the small, central stigma, which is not yet mature. Then follow (3) flowers with the perianth bent away from the style, pollen becoming dry, and a drop of nectar appearing in the angle between the perianth and the stipes of the ovary. The

stigma is now probably receptive. Near the base, (4) the perianths have fallen, nectar is present, and the stigma mature, and ready for pollen. The last stage (5) is the setting of seed, or the fall of the flower if pollination has not taken place.

The flowers are freely visited by Hymenoptera and Diptera. Owing to the height of the stigma, however, it is only rarely that insects pollinate the flowers. Silver-eyes and sparrows also visit the flowers. The former cling to the lower side of the raceme, inserting the tip of the beak in the nectary at the base of the ovary, pulling the flower over on its stalk. In pulling the flowers down, the stigmas of stages 3 and 4 are sometimes rubbed against those in stages 2 and 3, and thus cross-pollination may ensue. Sparrows alight in the middle of the raceme, and, in moving about, probably cause pollination. Observation of seeding racemes shows that, as a rule, the flowers near the base only are pollinated, probably from the other flowers near by. Those near the tip, if pollinated at all, receive the pollen from the flowers of other racemes.

In Dr. Shirley's paper, he mentions that, in *Grevillea* (species not mentioned) the tube of the style appears first at the base, and develops upwards. It is lined with cells resembling those of the stigmatic tissue, and it is only when the tube-development reaches the tip of the style, that a true stigma is formed. The interior of the tip of the style is lined with peculiar, large, thick-walled, dotted cells, probably a nutritive tissue absorbed by the living tissue of the style-tube. A. S. Wilson(20) has speculated on the likelihood of the loose, cellular substance of the interior of styles, acting like a plug of cotton-wool in a culture-flask, in keeping out fungus-spores from the cavity of the ovary.

Enough has been said, however, to show that both field- and laboratory-work well worth while can be found in this thoroughly Australian Order.

I have already alluded to the want of systematic observations on the method of pollination in *Acacia* and *Eucalyptus*. It is a very lamentable thing that no one has taken these genera up. Here we have two very large and, from either the scientific or the economic points of view, very important and characteristic

genera, and yet no one seems to have attempted to solve these important problems. Certainly some observations have been made in America and South Africa, but it is obvious that these are of little value from an Australian point of view. The agents of pollination are not the same, though of course we may get suggestive hints which will assist the local worker when he arrives.

Dr. Brandis(21) has recorded some interesting notes on the flowering-season of *Acacia dealbata* in India. Trees planted in 1845, up till the year 1850, flowered in October, corresponding with the Australian flowering-time. About 1860, they were observed to flower in September, in 1870 in August, in 1878 in July, and, in 1882, they began to flower in June, the spring month there, and corresponding with October in Australia. Dr. Brandis goes on to say: - "Having watched the flowering of these trees for nearly forty years, there cannot be any doubt in the matter, and it is a curious fact that it should have taken the trees nearly forty years to regain their habit of flowering in the spring. . . . I have tried to see if any similar change of season can be traced at Kew." Plants there are grown under glass, and flower in early spring or towards the end of winter, say February. "The evidence then, so far as it goes, would seem to indicate that the flowering-time had also progressively worked back in England, though under more artificial conditions."

Mr. Howard Fox, of Falmouth, writing on January 29th, 1885, reported that several trees of *Acacia dealbata*, 30 ft. high, in the open air, had been in flower for ten days, but not so fully as they might be expected to be in a fortnight's time(22).

This bears only indirectly on pollination-problems. A large majority of our plants flower in winter, and it is possible that the scarcity of insects at that season may have resulted in the modification of the flower towards bird-pollination. An interesting observation connected with this is recorded by Mr. J. G. Cooper(23), who states that the nesting-season of the Anna humming-bird (*Calypte anna*) had altered from March 15 to Feb. 15-20 since the extensive cultivation of Eucalypts in California. "The extensive cultivation of Australian trees, perhaps, may

have helped to make this early nesting more general, as in this climate, such trees, as well as other subtropical garden-plants, are covered with flowers, supplying winter-food for these humming-birds more plentifully than the native plants formerly did. But whether or not, my boy (eight years old) found three nests of this species within a stone's throw of our house, all on low branches of Eucalyptus (or Australian blue-gum) between February 15th and 20th. The trees are covered most of the winter with large flowers, in which there is much honey, and the Acacias of several species, also blooming at this season (like most antipodal trees) have been very attractive to the hummers as well as to the minute insects on which they feed. They have likewise utilised the long, silky stamens of some Acacias in building their nests, though still using chiefly the down from various native plants." He mentions having found young birds of the species mentioned, which must have been hatched as early as March 1st.

In any review of work on the pollination of Australian plants, one cannot omit that done by Mr. R. D. Fitzgerald on the Australian Orchids. In this work, begun in 1875, there are many references to the pollination of Australian species. I would like to say here that I think it is a distinct loss to science that the publication of this work has been discontinued. I had the honour, and the very great pleasure of knowing Mr. Fitzgerald, and of collecting orchids for him for many years. I know that his work was a labour of love, and that a large part of it still remains unpublished. Every one who has studied the orchids knows how valuable his book is, particularly for its clearing up the confusion which arose from the description and naming of plants from dried specimens. Any description of an orchid which is not based on the examination of fresh specimens is not of much value. I would urge that the question of the continuation of Mr. Fitzgerald's great work, as a State undertaking of a special character, should not be lost sight of.

Before closing, I would like to once more draw attention to the subject of bird-destruction. Consideration of the problems of pollination of Australian plants shows that many of the most

characteristic species, particularly of the Proteaceæ, depend entirely on birds, chiefly the Meliphagidæ and the honey-eating lorries. The former birds are particularly confiding, and so are easily destroyed; and the lorries have always been considered fair game, and also are very liable to be slaughtered because of their gregarious habits. The consequence may be that, if these birds die out, many of our endemic trees and plants will cease to produce seeds, and in time will become extinct. I would ask our Members to become active propagators of the "Spare the Birds" doctrine.

In conclusion, I would like to express the wish, in which all of us may join, that the Linnean Society of New South Wales may continue to flourish, and do as good work in the future, as it indubitably has in the past.

BIBLIOGRAPHY.

- (1). KNUTH, A.—Handbook of Flower-Pollination (1909).
- (2). DARWIN, C.—The Different Forms of Flowers (1877).
- (3). FITZGERALD, R. D.—Australian Orchids, 1875.
- (4). TATE, R.—"On a Winter-flowering State of *Hypoxis pusilla* J. Hooker." Trans. Roy. Soc. S. Aust., Vol. v., p.76 (1882).
- (5). SWINNERTON, C. F. M.—"Short-Cuts by Birds to Nectaries." Journ. Linn. Soc., Bot., Vol. xliii.
- (6). SARGENT, O. H.—"Biological Notes on *Acacia chloristifolia*." Proc. Nat. Hist. Soc. West Australia, 1907.
- (7). CARNE, W. M.—"The Secretion of Nectar in Extra-floral Glands of Acacia." Aust. Nat., 1915.
- (8). HENSCHEL.—Von der Sexualität der Pflanzen (1820).
- (9). HILDEBRAND, F.—Delpino's "Weitere Beobachtungen" (1870).
- (10). DELPINO, F.—Ulteriori Osservazioni sulla dichogamia nel regno vegetale (1869).
- (11). BROWN, R., Campst.—A Manual of Botany (1874).
- (12). BENTHAM, G.—"Note on the Stigmatic Apparatus of *Goodenioriceæ*." Journ. Linn. Soc., Bot., Vol. x., p.203.
- (13). HAVILAND, E.—"Occasional Notes on the Inflorescence and Habits of Plants indigenous in the immediate neighbourhood of Sydney." Proc. Linn. Soc. N. S. Wales, vii.-x.
- (14). HAMILTON, A. G.—"On the Fertilisation of *Goodenia hederacea*." Proc. Linn. Soc. N. S. Wales, ix.
- (15). ————— "Notes on Methods of Fertilisation of Goodeniaceæ," Pts. i.-ii. *Op. cit.*, ix.-x.

- (16). HAVILAND, Archdeacon F. E.—“The Pollination of *Goodenia cycloptera*.” *Op. cit.*, xxxix. (1914).
- (17). BENTHAM, G.—“Notes on the Styles of Australian *Proteaceae*.” *Journ. Linn. Soc., Bot.*, Vol. xiii., p.58 (1873).
- (18). SHIRLEY, Dr. J.—“Peculiarities of Flowers of *Proteaceae*.” Report Aust. Assoc. Adv. Science, Vol. vii.
- (19). HAMILTON, A. G.—“The Fertilisation of some Australian Plants.” Report Aust. Assoc. Adv. Sci., Vol. vi.
- (20). WILSON, A. E.—Abstract of Paper “On the closed condition of the Seed Vessel in Angiosperms.” *Nature*, xxviii. (1883).
- (21). BRANDIS, Dr.—“Influence of ‘Environment’ upon Plants.” *Nature*, xxvii., p.82 (1882).
- (22). FOX, H.—*Nature*, xxvii., p.315 (1883).
- (23). COOPER, J. G.—“Early History of the Anna Humming-bird.” *American Naturalist*, Vol. x.

Mr. J. H. Campbell, Hon. Treasurer, presented the balance sheets for the year 1816, duly signed by the Auditor, Mr. F. H. Rayment, F.C.P.A., Incorporated Accountant; and he moved that they be received and adopted, which was carried unanimously. The income accounts are summarised in the following table:—

Heads of Expenditure.	General.	Bacteriology.	Fellowships.	Total.
	£	£	£	£
Administration ...	514	33	2	549
Maintenance ...	102	28	—	130
Publication ...	239	—	197	436
Research (Salaries) ...	—	400	1,600	2,000
Capital Accounts ...	616	—	300	916
Totals ...	1,471	461	2,099	4,031
Income (all sources) ...	1,241	533	2,099	3,873

No nominations of other Candidates having been received, the President declared the following elections for the Current Session to be duly made:—PRESIDENT: Dr. H. G. Chapman, B.S. MEMBERS OF COUNCIL (to fill six vacancies): Mr. J. E. Carne, F.G.S., Prof. T. W. E. David, C.M.G., D.Sc., F.R.S., Mr. W. S. Dun, Prof. W. A. Haswell, D.Sc., F.R.S., Messrs. A. H. S. Lucas, M.A., B.Sc., and J. H. Maiden, I.S.O., F.R.S. AUDITOR: Mr. F. H. Rayment, F.C.P.A.

On the motion of Mr. A. H. S. Lucas, a very cordial vote of thanks to the retiring President, was carried by acclamation.

	£	s	d	£	s	d
To Salaries and Wages	465	0	0	By Balance from 1915
" Printing (Publications)	238	16	9	" Subscriptions
" Rates	32	13	5	1916	...	116 11 0
" Insurance	7	17	9	Arrears	...	15 15 0
" Repairs and painting	61	11	0	In advance	...	1 1 0
" Postage, Advertising and Petty Cash	102	2	2	Entrance Fees	...	133 7 0
" Printing (smudgies), Stationery, etc.	31	16	0	Interest on Investments	...	11 11 0
" Maintenance Fee, Sir William Macleay's grave	10	19	6	Sales (including 100 copies of Proceedings purchased by the Govt. of N.S.W.)	...	979 2 4
" Audit Fee (proportion of)	1	10	0	Rent (Bacteriology A/c)	...	101 4 9
" Telephone	1	15	0	Fellowships A/c; surplus income applied in reduction of Society's Freehold A/c as per contra	...	16 0 0
" Bank Charges	2	5	6		...	60 11 5
" Bank Charges	1	2	10		...	
" Bookbinding A/c	49	8	10		...	
" Appropriations to Society's Freehold A/c	11	11	0		...	
Income A/c	304	8	7		...	
Fellowships A/c	60	11	5		...	
Capital A/c	365	0	0		...	
Appropriations on account of Probate Duty paid	300	0	0		...	
Balance to 1917	548	5	11		...	
	£2,080	4	8		...	£2,080 4 8

BACTERIOLOGY ACCOUNT
Balance Sheet at 31st December, 1916

LIABILITIES.	£	s	d	ASSETS.	£	s	d
Capital: Amount bequeathed by Sir William Macleay, £12,000, less Probate Duty, £600	11,400	0	0	Investments:			
Accumulated Interest ordered by Council to be added to Capital	1,600	0	0	New South Wales Inscribed Stock	13,900	0	0
				Cash: Current A/c	45	9	11
Interest invested	£13,000	0	0				
Income A/c at 31st December, 1916	900	0	0				
	45	9	11				
	£13,945	9	11		£13,945	9	11

INCOME ACCOUNT, year ended 31st December, 1916

Dr.	£	s	d	Cr.	£	s	d
To Balance from 1915	25	19	9	By Interest on Investments	521	4	2
Salary	400	0	0	Tuition Fees	36	6	0
Rent	16	0	0	Less Bacteriologist's proportion	24	4	0
Rates	10	17	9		12	2	0
Insurance	1	6	0				
Gas	7	13	4				
Journals and Printing	15	0	7				
Audit Fee (proportion of)	1	15	0				
Petty Cash and Expenses	9	3	10				
Balance to 1917	45	9	11		£533	6	2
	£533	6	2				

Audited and found correct. Securities produced.
 F. H. RAYMENT, F.C.P.A., Auditor.
Sydney, 6th March, 1917.

J. H. CAMPBELL, Hon. Treasurer.
Sydney, 31st January, 1917.

LINNEAN MACLEAY FELLOWSHIPS' ACCOUNT.
Balance Sheet at 31st December, 1916.

	£	s	d	
LIABILITIES.				
Capital: Amount bequeathed by Sir William Macleay, £35,000, less Probate Duty, £1,750	33,250	0	0	
Balance of Income A/c to 31st Dec., 1916, capitalised in terms of bequest	9,510	3	7	
Surplus Income capitalised in 1916	239	16	5	
	9,750	0	0	
	£43,000	0	0	

ASSETS.				
Investments:				
War Loan				2,835
N.S.W. Inscribed Stock				7,715
Loans on Mortgage				32,450
				£43,000

Dr. INCOME ACCOUNT, year ended 31st December, 1916. Cr.

	£	s	d	
To Salaries of Linnean Macleay Fellows	1,600	0	0	
" Cost of publishing Fellows' Papers	196	17	11	
" Audit Fee (proportion of)	1	15	0	
" Transfer to General A/c	60	11	5	
" Transfer to Capital A/c	239	16	5	
	£2,099	0	9	
By Interest on Investments				2,099
				£2,099

Audited and found correct. Securities produced.

F. H. RAYMENT, F.C.P.A., Auditor.

Sydney, 6th March, 1917.

J. H. CAMPBELL, Hon. Treasurer.

Sydney, 31st January, 1917.

ORDINARY MONTHLY MEETING.

MARCH 28th, 1917.

Dr. H. G. Chapman, President, in the Chair.

The Donations and Exchanges received since the previous Monthly Meeting (29th November, 1916), amounting to 33 Vols., 206 Parts or Nos., 47 Bulletins, 15 Reports, and 10 Pamphlets, received from 92 Societies, etc., and one private donor, were laid upon the table.

ON THE MORPHOLOGY OF THE CAUDAL GILLS OF
THE LARVÆ OF ZYGOPTERID DRAGONFLIES.

INTRODUCTION, PART I. (GENERAL MORPHOLOGY), AND PART II.
(STUDIES OF THE SEPARATE TYPES).

BY R. J. TILLYARD, M.A., B.Sc., F.L.S., F.E.S., LINNEAN
MACLEAY FELLOW OF THE SOCIETY IN ZOOLOGY.

(Plates i.-vi.; and 32 Text-figs.).

INDEX.		PAGE
INTRODUCTION	...	31
PART I.—GENERAL MORPHOLOGY OF THE GILLS.		
Historical Summary	...	34
Material Studied	...	37
Methods of Study	...	39
Nature of the Caudal Gills	...	44
The Hypodermis and Cuticle	...	46
The Basal Pieces and Breaking-Joint	...	48
The Alveolar Meshwork	...	50
The Internal Laminae	...	57
The Blood-Canals	...	60
The Nervous System	...	65
The Tracheal System	...	69
PART II.—STUDIES OF THE SEPARATE GILL-TYPES.		
A. The Saccoid Type	...	72
B. The Triquetro-Quadrato Type	...	79
C. The Lamellar Type	...	83
<i>a.</i> The Vertical Lamellar Sub-type	...	84
(i.) The <i>Lestid</i> Form	...	85
(ii.) The <i>Agrionid</i> Form	...	89
<i>a</i> The Constricted Lamella	...	92
<i>β</i> The Nodate Lamella	...	93
<i>γ</i> The Subnodate Lamella	...	96
<i>δ</i> The Denodate Lamella	...	98
<i>b.</i> The Horizontal Lamellar Subtype	...	100
D. The Reduced (Non-functional) Type	...	103
Bibliography	...	107
Explanation of Abbreviations used in Text-figures and Plates	...	109
Explanation of Plates	...	110

INTRODUCTION.

In the year 1913, I began an extended study of the various organs which function as gills in the body of the Dragonfly larva. As is well known, one great division or sub-order of the Odonata

(the Anisoptera) possesses larvæ which breathe chiefly—one may say, almost entirely—by means of delicate gills situated in the rectum. The second sub-order (the Zygoptera) is remarkable in possessing larvæ in which the caudal processes are very conspicuously developed. These processes vary much in size and shape, but in general they serve as one of the principal means of respiration, though by no means the only one. These organs are now generally known as the *caudal gills*, though it is by no means certain that they function as such in all cases, since in some genera they appear to have undergone reduction from disuse. During 1913-14, I completed my study of the morphology of the rectal gills of Anisoptera, in a paper which was sent to the Linnean Society of London in November, 1914, but which, through the unforeseen delays caused by the war, has only recently appeared in print.* A sequel to this, dealing with the physiology of the same organs, appeared in the Proceedings last year (Vol. xl, Part 3, pp.422-437, Plate xlvii.). With the completion of these two papers, I passed on to the study of the Zygoptera. The state of affairs in connection with this sub-order offers a remarkable contrast with that existing for the Anisoptera. In the latter, the unique beauty and high complexity of design of the rectal tracheal gills have been sufficient to attract the attention of workers from many fields of Biology, and the study of these organs stands well advanced. But, in the Zygoptera, the condition is one of comparative neglect, so that at present no general study of the morphology of the gills has been attempted, nor is there as yet any clear idea as to how respiration is carried on. As the case stands at present, it would appear that at least *five* parts of the body of a Zygopterid larva may function as organs of respiration, viz., (1) the general integument, (2) the spiracles (on certain occasions only), (3) the rectum, albeit lacking in the highly specialised gills of the Anisoptera, (4) paired lateral abdominal processes or gills (in certain *Calopterygidae* only), and (5) the so-called "caudal gills."

* "On the Rectal Breathing-Apparatus of Anisopterid Larvæ." Journ. Linn. Soc. London, Zool., xxxiii., No.223, 1916, pp.127-196. Plates xviii.-xxii.

To deal with all five of these possibilities would take us beyond the limits of a single paper. Leaving aside entirely the consideration of the functions of the general integument, as well as that of the spiracles, which, even if they are really permeable, can only be used for breathing *in air*, and not in water, we still have three sets of organs demanding our attention. Specially projecting folds of the rectum, assumed to have a respiratory function in cases where direct experiments have shown the existence of regular movements of impulsion and expulsion of water in the rectal cavity, have so far only been found in the case of a few genera, though it does not follow that they may not be universally present in the sub-order, if carefully sought for. Paired lateral processes or gills are known to be confined to a few genera in the subfamilies *Epallaginae* and *Thorinae*. There remain, then, for the Zygoptera, the universally present organs known as the *caudal gills*, clearly of the highest importance to a right understanding of the respiratory processes of the larvæ of this sub-order. I have, therefore, decided that the first step necessary in the solution of this latter problem is a careful study of the morphology of these organs. This paper is confined entirely to that one object, and will only touch upon other aspects of the problem when their introduction appears to be necessary for the development of the main purpose of the paper.

I had originally intended to confine my study to Australian forms. However, it soon became apparent that the *triquetral* form of gill, which does not occur in any Australian genus, must be included in any general study of these organs. I therefore sought to obtain gills of this form from various European and American correspondents. Dr. P. P. Calvert, of the University of Pennsylvania, Philadelphia, U.S.A., very kindly provided me with the required material, in the form of fixed larvæ of *Calopteryx* and *Heterina*. To him, I desire to express my best thanks and appreciation of his kindness. I desire, also, to thank Professor W. A. Haswell, F.R.S., Professor of Biology in the University of Sydney, and Dr. S. J. Johnston, Lecturer in Biology, for much valuable advice concerning the technical difficulties which have been met with during the course of my work.

The scope of the present paper is sufficiently large to make it advisable that it should be divided into four parts. Part i. deals with the General Morphology of the Gills, and includes also a Historical Summary of the work of previous authors, a list of the material studied, and a short account of the biological methods used. Part ii. deals only with the Morphology of the Separate Gill-Types. Part iii. deals with the Ontogeny, and Part iv. with the Phylogeny of the Caudal Gills. It was originally intended to publish the paper as a complete whole. However, certain problems connected with Part iv. have made it imperative that the Ontogeny should be studied in much greater detail than was originally intended; in fact, it will be necessary to study by sections all instars of the growing larva from the time of hatching up to the attainment of the complete gill-form. To include this would mean a delay of at least six months more. As Parts i. and ii. include the principal results of more than eighteen months' work, it seems best to publish these without further delay, leaving Parts iii. and iv. to appear together later on.

In the Bibliography, placed at the end of Part ii., there will be found all the publications known to me which deal with the problems of respiration in Zygopterid larvæ. Most of these have little bearing upon the actual problem of the *morphology* of the caudal gills, but it seemed advisable to offer as complete a list as possible. References to the Bibliography are given in brackets in heavy type.

PART I.—GENERAL MORPHOLOGY OF THE CAUDAL GILLS. HISTORICAL SUMMARY.

The first author to give a definite name to the caudal appendages of Zygopterid larvæ was Réaumur(26), who called them *pins* ("nageoires"), but did not commit himself to any opinion of their possible functions. A few years later, Roesel von Rosenhof(30) spoke of them as "*rudder-feathers*" ("Ruder-Federn")—again, without making any suggestion as to their function. Both these authors were evidently speaking of the common type of gill found in *Lestidae* and most *Agrionidae*, which I shall designate in this paper as the *lamellar* type. The first suggestion

that I can find as to their supposed respiratory function seems to have been thrown out by Carus(7), who, while describing the blood-circulation in these organs in the larva of an *Agrionid*, applied, amongst other terms, the name *gill-like leaflets* ("kiemenartigen Blättchen") to them. This may, or may not, have conveyed a hint that he thought of them as possible gills. Some twenty-five years later, we find Dufour(9, 10) and Hagen(12) using names for them which show us that they accepted their respiratory function without question. The former—to whom, by the way, we must credit undoubtedly the first discovery of rectal folds, with a possible respiratory function, in the larvæ of *Calopteryx*—termed the lamellar appendages of *Agrionid* larvæ *external or caudal gills* ("branchies extérieures ou caudales"), adding (in agreement with Réaumur) that they were also in the nature of *finis*. This author's disagreement with the observation of Réaumur on the question of the position of the spiracles is well-known, and the fact that we now know that Réaumur was completely in the right does not add to our confidence in Dufour's capacity for judgment. Hagen, who accepted Dufour's determination of the rectal folds in *Calopteryx* larvæ as gills, speaks of the lamellar appendages of *Agrionid* larvæ as *tail-gills or caudal gills* ("Schwanzkiemen"), the name which appears to have remained in common use ever since.

It would be out of place here to attempt to give a complete list of the authors who have used the term *caudal gills* for these organs since Hagen first invented it. It seems to have come into general use, not only in scientific treatises, but also in text-books, encyclopædias, and works of a popular nature. The reason for this ready acceptance would appear to be the form of the organs themselves, in which the richly-branching tracheæ at once suggest a respiratory function. We must note, however, the observations which appeared from time to time as to the well-known ability of *Agrionid* larvæ to live without their caudal gills. Such observations may be found in von Rosenhof(30), Hagen(12), Sharp(35), Tillyard(37) and others. Taken together, they amount to a growing recognition that the caudal gills could not possibly be the only organs of respiration for Zygop-

terid larvæ, since their loss causes little or no inconvenience to the growing larva. This has led to the beginnings of the study of the rectum of Zygopterid larvæ, as a possible respiratory organ. On this question, Ris(29) appears to have favoured a negative attitude, though Calvert(6) has quite recently made observations on the larvæ of *Calopteryx* and *Heterina*, which support the original views of Dufour and Hagen. I may add that unpublished experiments of my own on the larvæ of *Diphlebia* and *Austrolestes* agree closely with Calvert's results. This question must, however, remain over to be dealt with on a future occasion, as much more work needs to be done before we can generalise with any prospect of finality.

If we turn to the more immediate problem of this paper, the *morphology* of the caudal gills, we find very little work published on it. Leaving out of account the numerous descriptions of the external form of the gill, in various genera and species (a large number of which have been described, chiefly from Europe and North America), I am only able to indicate one exhaustive study of the morphology of a caudal gill, viz., that by Ris(28) on the large bladder-like gills of *Pseudophava*. This is the form of gill which will be dealt with in this paper under the name of *saccus* or *saccoid gill*. As Ris' account is by far the most important piece of work so far published on these organs, a full comparison between his results and my own will be given in the section devoted to Saccoid Gills. Quite recently, Calvert(6, p.391) has sectioned the peculiar gills of *Thaumtoneura*, and given a short but excellent account of their internal structure, agreeing in many points with that given by Ris for *Pseudophava*. I have not been able to find any detailed account of the morphology of the *triquetral gills* of the subfamily *Calopteryginae*, nor of the commoner *lamellar gills* of the *Lestidae* and most *Agrionidae*. Nor is there, as far as I know, any published work, in which a comparative study of the various forms of caudal gills known to exist has been undertaken, with a view to indicating the phylogenetic course of development of these organs. The only paper that can claim to offer any ontogenetic results is that by Balfour-Browne(1). This paper, however, does not go

beyond noting the changes in the external form of the gill during the growth of the larva. Before a satisfactory solution of the phylogenetic problem can be attempted, the ontogeny of the internal structures of the gill must be fully understood. These gaps in our knowledge it will be my chief endeavour to fill in the course of this paper.

MATERIAL STUDIED.

For the purposes of this paper, a very large amount of material has been gathered together, from many widely separated localities. In this connection, I desire to record my deep appreciation of the valuable help afforded me by Mr. F. W. Carpenter, M.A., Science Master at Sydney Grammar School. He has accompanied me on many of my collecting expeditions, and it has only been through his zeal and energy that many of the rarest and most valuable larval forms have been obtained. In particular, I desire to thank him for the discovery of a fine series of larvæ of *Diphlebia lestoides* from Wentworth Falls, N.S.W., and many larvæ of *Neosticta canescens* from Heathcote, N.S.W. Both these larvæ are rock-dwellers, and can only be obtained by wading into very cold water, and lifting out a large number of heavy rocks. Mr. Carpenter has also wielded the dredge-net for me with great success, and most of the specimens taken in this manner at National Park must be credited to his energy. To my brother, the late Lieut. S. J. Tillyard, 5th Royal Berks., I am indebted for a fine series of fixed larvæ of *Diphlebia euphroides*, from rocky streams at Kuranda and Yungaburra, N. Queensland, as well as for my only two specimens of the rare larva of *Nososticta solida*. My thanks are also due to Professor P. P. Calvert, of Philadelphia, U.S.A., for larvæ of *Calopteryx* and *Heterina*, to Mr. G. Howes, of Dunedin, N.Z., for larvæ of *Austrolestes colenisonis* and *Xanthocnemis zelandica*, and to Mr. J. Bridwell, of Honolulu, Hawaii, for a number of larvæ of *Agriouastelia*, a very peculiar form with reduced caudal gills.

I append herewith a tabular list of all the forms studied. The names given under the type of gill-system are those used in this paper, and will be found defined in their respective sections.

Fam.	Subfamily.	Genus and Species.	Locality.	Type of Gill-System.
CALOPTERYGIDÆ	Epallagina	<i>Diphlebia lestoides</i> Selys <i>Diphlebia nymphioides</i> Tillyard <i>Diphlebia euphrocoides</i> Tillyard	Wentworth Falls, N.S.W. Maleny, Q. Kuranda and Yungaburra, N.Q.	Saccoid, simple.
	Calopterygina	<i>Calopteryx</i> sp. <i>Heterina</i> sp.	Philadelphia, Pa., U.S.A. Philadelphia, Pa., U.S.A.	Triquetto-quadrate.
LESTIDÆ	Lestina	<i>Austrolestes cingulatus</i> Burm. <i>Austrolestes analis</i> Ramb. <i>Austrolestes colsonis</i> White	Heathcote, N.S.W. Gisborne, Vic. Dunedin, N.Z.	Lamellar, simple, vertical.
	Synlestina	<i>Austrolestes leda</i> Selys <i>Austrolestes psyche</i> Selys <i>Synlestes regersi</i> Selys <i>Synlestes albicauda</i> Tillyard	National Park, N.S.W. National Park, N.S.W. Mount Tambourine, Q. Maleny and Mt. Tambourine, Q.	Lamellar, simple, vertical.
AGRIOSIDÆ	Megapodagrioninæ	<i>Argiolestes icteromelas</i> Selys <i>Argiolestes griseus</i> Selys <i>Xososticta solida</i> Selys	Hornsby, N.S.W. Medlow, N.S.W. Yungaburra, N.Q.	Lamellar, simple, horizontal.
	Protoneurine	<i>Xososticta canescens</i> Tillyard <i>Isosticta simplex</i> Martin <i>Callagrion billinghami</i> Martin	Heathcote, N.S.W. National Park, N.S.W. National Park, N.S.W.	Saccoid, constricted. Lamellar, constricted, vertical.
AGRIOSIDÆ	Agrionina	<i>Pseudagrion australasic</i> Selys <i>Pseudagrion aurifrons</i> Tillyard <i>Austroagrion cyane</i> Selys <i>Ceragrion erubescens</i> Selys <i>Ischnura heterosticta</i> Burm. <i>Ischnura aurora</i> Br.	Brisbane, Q. Pallal, N.S.W. National Park, N.S.W. National Park, N.S.W. Brisbane, Q.	Lamellar, nodate, vertical.
		<i>Xanthocnemis zelandica</i> Selys <i>Argioicnemis rubescens</i> Selys <i>Austroicnemis splendida</i> Martin <i>Agrion astellæ</i> Perkins	Dunedin, N.Z. National Park, N.S.W. Brisbane, Q. Hawaii	Lamellar, subnodate, vertical. Lamellar, denudate, vertical. Reduced (non-functional).

Total:—18 genera and 28 species.

METHODS OF STUDY.

A. *The living larva.*

For studying the living larvæ, I used two large aquaria, and eight smaller observation jars. All these were provided with a bottom of clean sand, in which *Fallisneria* and other water-weeds were grown. For the rock-dwelling larvæ, I used two puppy's drinking-tins, about three inches deep and one foot in diameter. In these was placed a layer of fine sand, with a number of small rocks, leaning against one another at various angles. A depth of only about two inches of water is required in these pans. As no water-weed is grown in them, the water was allowed to evaporate, and fresh water added every two or three days.

The larvæ of *Diphlebia*, *Neosticta*, and *Argiolestes*, being rock-dwellers, were left in the tin pans. All the rest were kept in the large aquaria, except when a particular species was under observation; in which case it was removed to one of the observation jars for closer study. The aquaria, jars, and pans were covered with cages of mosquito-netting on wire frameworks. By this means I was enabled to breed out the imagines of every Australian species made use of in this paper, and so to determine every larval form with certainty.* Full descriptions of these larvæ will be given in a future paper.

In studying the gill-system, it is necessary to use the living larva in order to determine the following points:—

(i.) The natural position of the three gills, *i.e.*, whether pressed against one another or held wide apart, and, if the latter, the approximate angles between them; also, whether each separate gill is held in a vertical or horizontal plane, and whether, in the case of the lateral gills, the mid-rib, or *thickened* edge of the gill, is placed externally or internally, dorsally or ventrally.

(ii.) Whether the gills are an aid or a hindrance during locomotion.

* The larvæ of *Ceriatgrion* and *Austrocnemis* were bred out in the Queensland Museum, where the Director, Dr. R. Hamlyn-Harris, very kindly lent me a room and aquaria during September, 1915.

B. *Whole Mounts of the Gills.*

Cleared unstained whole mounts of the separate gills can be made use of in all cases, except for the very thick and opaque saccoid gills of *Diphlebia*. The larva should be taken preferably near the middle of an instar; *not* just after ecdysis, when the cuticle is weak and liable to shrivel, and *not* just before ecdysis, when there are two cuticles, and the new inner cuticle is liable to shrink away from the old hard outer cuticle.

The gills should be cut off from the living larva, at the break-joint, and allowed to drop into some fixing fluid, or simply into 70 per cent. alcohol; the object being simply to study the external form of the gill, and the courses of the main and branch tracheæ. By passing rapidly up through 90 per cent. to absolute alcohol, clearing in clove oil, and mounting in Canada Balsam in the usual way, the tracheal system can usually be preserved intact for months or even years. Saccoid and triquetral gills require a longer time than lamellar gills for dehydrating and clearing, and must be mounted within a raised ring.

Stained whole mounts are best made from gills fixed for 24 hours in Carls' Fixative (see below, section C). The fixative must be thoroughly washed out of the tissues (several changes of 70 per cent. alcohol during 24 hours or more), and the gill passed down through 50 per cent. alcohol to 35 per cent. alcohol. It should then be stained for 24 hours or longer in 35 per cent. alcoholic solution of Grenacher's borax carmine, and the stain differentiated out for 24 hours or more in acid alcohol (0.5 per cent. HNO_3 in 70 per cent. alcohol). Dehydrate, clear and mount as usual. The stained gill shows very clearly the hypoderm cell-layers and nuclei, as well as the courses of the dorsal and ventral blood-canals.

C. *Serial Sections.*

It is not easy to obtain good serial sections of the caudal gills, chiefly because of the chitinous cuticle, which not only resists the knife, but also makes it very difficult to find a suitable fixative, which will penetrate the gill thoroughly, and yet, at the

same time, cause the least deformation of the cell-layers within the gill.

Fixation:—I find the two best fixatives are the well-known Gilson's Fixative (mercurio-nitric), and Carls' Fixative (Formula: 2 parts glacial acetic acid, 6 parts concentrated formol, 15 parts absolute alcohol, and 30 parts distilled water). Both fixatives give equally good fixation of all the internal parts of the gill; but neither of them is quite satisfactory as regards the fixation of the hypoderm-layer, which is often found to be somewhat shrunken. In addition, if Gilson's Fixative be used, it is very difficult to remove all traces of mercuric chloride from the innermost of the alveoli, in the case of large saccoid gills. The remarkable structures described by Ris(28) in some of the alveoli of the saccoid gill of *Pseudophora*, in the form of moss-like tufts of fibrils, appear to me to have been undoubtedly caused by incomplete washing-out of some mercuric or other fixative. I have never found any structures remotely resembling these in any sections that I have examined.

The fixative may be employed either hot or cold. The former gives the quicker fixation, but has the disadvantage of generally causing the hypoderm-layer to shrink away from the cuticle. The cold fixative, too, can be carried into the field, and larvæ fixed on the spot when necessary.

The gills may be cut off and fixed at any stage of larval growth; but really good sections can only be surely obtained if the larva is taken fairly soon after an ecdysis, when the cuticle is still moderately soft. For this reason, all larvæ dredged out from ponds or rivers while in this condition should be fixed on the spot, since such larvæ do not carry well; and, even if they can be kept alive, the delay in returning home means a corresponding increase in the hardness of the cuticle. Unsuitable larvæ should be left in the aquarium until they undergo an ecdysis, when they should be immediately taken and fixed.

In all cases, fixation should be carried out by cutting the gills off the living larvæ, and allowing them to fall directly into the fixative. For transverse sections, it is advisable to make two

cuts across the larva with a pair of fine scissors; the first across the three gills at a level about one-third of their total length from the base, and the second across the seventh abdominal segment of the larva. For this method, I am indebted to Dr. Calvert, of Philadelphia. Its great advantage is that in one series one can study the general structure of the gills, while in the other series one combines the structure of the rectum, which is of great importance in the general question of the respiration of these larvæ, with the structure of the basal portions of the gills themselves. For longitudinal sections, I find it best to sever the gills at the breaking-joint. If the gills are too long, they may be cut across the middle. The last three segments of the larval abdomen may also be cut off separately, if it is desired to study the rectum and basal pieces in longitudinal sections.

If it is desired to employ the fixative hot, it should be heated in a test-tube to just on boiling-point. Some of the hot fixative is then poured into a large watch-glass, over which the larva is held, while its gills are cut off with the scissors. The cut off portions usually sink immediately; if any of them float, they should be at once submerged by means of a camel's-hair brush. Leave the gills in the fixative until it has cooled to about the temperature of the room. They should be transferred to 70 per cent. alcohol (either directly, from Carls' Fixative, or indirectly, from Gilson's Fixative, through grades of 17, 35, and 50 per cent). In addition, if Gilson's Fixative be employed, the mercuric chloride must be thoroughly removed by means of iodised alcohol, in the usual manner. In both cases, wash well in several changes of 70 per cent. alcohol over a period of 24 hours.

If used cold, the fixative should be poured into a crystal dish, and the gills cut off and allowed to fall into it as described above. The dish must then be covered over, and the gills left in the fixative for from 12 to 24 hours (not longer) according to the state of the cuticle. Transfer to 70 per cent. alcohol as described above, and wash well.

Softening:—Before dehydrating, the gills should always be subjected to a certain amount of softening, by immersion in a

solution of soft soap in 70 per cent. alcohol. A good rule to follow is to make the time of softening equal to the time of fixation, *e.g.*, in the majority of cases, 24 hours for both. The soap will remove the fat from the cells of the fat-body in the larval abdomen, but will not affect the gill-tissues in the slightest, except perhaps by a removal of fat from a wandering fat-cell or two in the blood-canals. In the case of very tough gills, taken from larvæ just before ecdysis, a little warming (by standing the solution on the bath) will expedite the softening.

After softening, the gills must be thoroughly washed in several changes of 70 per cent. alcohol over a period of at least two days. The last change, when poured off into a small tube and shaken up, should not show the slightest sign of forming a lather.

Dehydration:—Pass up into 90 per cent. alcohol for 6 hours, then into absolute alcohol for 6 hours at the most.

Embedding:—In studying the rectal gills of Anisoptera, excellent sections were obtained by single-embedding in paraffin. This method is not recommended for the caudal gills of Zygoptera. Owing to the thickness of the cuticle, the method of *double-embedding* should always be employed. Some of the larger and tougher gills resist considerably the penetration of celloidin. Gills of ordinary thickness should be left 24 hours in each successive stage, beginning with a 1:1 mixture of alcohol and ether, and passing up through $\frac{1}{2}$ per cent., $2\frac{1}{2}$ per cent., and 5 per cent. celloidin. Very tough gills may be left 48 hours in each successive stage of celloidin solution. The hardening of the celloidin block in chloroform vapour must be very carefully carried out, the block being cut out and shaped when, if anything, it is *slightly harder* than it would be allowed to become if it contained softer tissues, but still not hard enough to cause any contraction in the gill. Hardening is then completed by immersion in liquid chloroform, and the hardened block is infiltrated with, and embedded in, paraffin in the usual manner. The cutting and mounting of the sections present no features of special difficulty, other than those usually attendant on dealing with somewhat tough material.

Staining.:—The gill-tissues, excepting perhaps the hypoderm-layer, take up stains very slowly. If a series of sections, running from the rectal region of the abdomen into the basal third of the gills, be arranged on one side, and stained in hæmatoxylin, it will be found that the body-sections become deeply over-stained before the gill-sections are sufficiently stained to allow of differentiation. Consequently, sections of gills require to be left in the stain for a long time, until the hypoderm-layer is strongly overstained. In the subsequent differentiation in acid alcohol, the hypoderm may be allowed to remain slightly overstained, in order to obtain the best differentiation in the internal tissues.

Two double-stains may be recommended as almost equally good for gill-sections, viz. :—

(1) Ehrlich's Hæmatoxylin with Eosin. The Eosin only stains the cuticle and the endotracheæ.

(2) Heidenhain's Iron Hæmatoxylin with Orange G. The Hæmatoxylin should be used as a purely nuclear stain, the Orange G as a general cytoplasmic stain. The combination of the two differentiates out the endotracheæ and the outer layer of cuticle in *black*, the nuclei in brown or greyish-black, and the cytoplasm in dull orange.

For the purposes of this paper, about 40 series of sections have been prepared and stained by one or other of the above methods. Many of these sets are serial transverse sections taken right through from the region of the rectum to near the end of the gill, and thus running into more than one thousand sections of 10μ thickness. Much labour may be saved by embedding the three cut-off ends of the gills close together in one block. In the case of very long gills (e.g., *Austrolestes*), the three cut-off ends may be arranged close together alongside the piece containing the rectal region and the gill-bases, thus reducing the number of sections to one-half.

NATURE OF THE CAUDAL GILLS.

In all Zygopterid larvæ, the caudal gills are three in number, viz., a single unpaired *median gill*, placed dorsally, and a pair of *lateral gills*, placed latero-ventrally, to right and left of the

median gill respectively. The median gill is bilaterally symmetrical about the mid-sagittal plane of the larva. The lateral gills are asymmetrical in themselves, but the two gills are symmetrically placed, to right and left, with respect to the mid-sagittal plane.

The *median gill* is formed from the *appendix dorsalis* of the larva. This is a median outgrowth from the eleventh abdominal tergite. In position, it corresponds with the *telson* of Crustacea, and may be considered analogous with that organ. It is not, however, a true homologue of the telson, since there is strong evidence that the appendix dorsalis of the Odonate larva is a more recent development than the archaic cerci.

The *lateral gills* are formed from the two *cerci* of the larva. These are the original abdominal appendages of the last or eleventh segment, *i.e.*, outgrowths from the bipartite sternite of that segment. They are, therefore, the true homologues of the *uropods* of Crustacea.

Although the cerci, and the appendix dorsalis (when present), in other insect-larvæ, are frequently many-jointed, yet in the Dragonfly larva they are always either unjointed or only two-jointed. Throughout the Sub-Order Anisoptera, where caudal gills are not developed, these three processes are always comparatively short, hard, and unjointed, forming together a strong *anal pyramid*, which guards the anal opening, and can be opened or closed at will. In the Zygoptera, as we shall see later, the two-jointed forms appear to be the older, and we are able to establish the descent of certain unjointed forms from older two-jointed forms. There are, however, other unjointed forms which show no evidence of an ancestral two-jointed form. Further, reductions from a two-jointed to an unjointed form appear to have taken place along several separate lines of descent. Hence we cannot divide the gills into two main types according to the number of joints, but must search for a more natural method of classifying them.

Each gill is attached to a short *basal piece*, *viz.*, the reduced remnant of the eleventh tergite in the case of the median gill,

the bipartite remnant of the bipartite eleventh sternite in the case of the two larval gills. The muscles which control the movements of the gills are small but strong, and are inserted into the walls of these basal pieces. The nature of the joint between the basal piece and the gill is such that, if the gill be seized by an enemy, it can be cast off without injury to the basal piece. Such a joint is known as a *breaking-joint* (8, 18).

Morphologically, each caudal gill is a hollow outgrowth of the body-wall, lined by a tough, chitinous integument or *cuticle*, beneath which lies a continuous layer of *hypoderm-cells*. The space enclosed by the gill-walls always carries one or more large *longitudinal tracheæ*, from which more or less numerous branch-tracheæ pass outwards to all points of the gill-wall. Within the gill, also, there are always developed two *blood-canals*, or prolongations of the hæmocœle. One of these is placed dorsally, the other ventrally. These two canals become confluent distally within the gill, so that there is a continuous circulation of blood corpuscles, passing into the gill and out of it again. The tracheæ and blood-canals are supported in a more or less strongly developed meshwork of *alveolar tissue*, which fills up all the rest of the space in the interior of the gill.

The Hypodermis and Cuticle.

The wall of the gill, like that of the body of the larva, is formed of a tough, chitinous *cuticle* (*cu*, *cu'*), beneath which lies a single layer of polygonal cells, the *hypodermis*.

The *cuticle* varies in thickness from 5μ to as much as 15μ , according to the type of gill. It is thinnest and most delicate in Saccoid Gills, stoutest and strongest in Lamellar Gills. Along the mid-ribs of the Triquetro-quadrangle and Lamellar Gill-systems it is especially thickened, and is in such places often armed with stout spines.

The cuticle can always be separated into two distinct parts, an inner, softer part (*cu*), apparently formed of a number of thin parallel layers, and not stainable with eosin, and an outer harder part (*cu'*) of quite uniform structure, easily stainable to a deep red with eosin. Of the total thickness of the cuticle, the outer

hard layer seldom exceeds one-fourth, though along the mid-rib of a Lamellar Gill it may occupy as much as one-half the total thickness.

The cuticle appears to be everywhere clear and unpigmented, though granules of pigment (*pg*) can frequently be seen adhering to its inner surface at places where the hypodermis has shrunk away from it (Text-fig.1).

At ecdysis, the whole cuticle of the gill is cast off with the body-cuticle of the larva. A study of the morphology of the cuticle during ecdysis was not one of the objects of this paper; but one cannot pass over this question without calling attention to the remarkable little ball-like bodies or secretions (also seen by Ris) which accumulate between cuticle and hypodermis just prior to ecdysis, and which certainly appear to be the first depositions of a new cuticle, underneath the old one which is soon to be cast off.

The *hypodermis* is everywhere a single layer of cells, except at the extreme base of the gills, and, exceptionally, under the mid-rib of Lamellar Gills, where it sometimes becomes two or three layers of cells deep. The typical epithelium forming the hypodermis is a layer of rather flat, polygonal cells from 4μ to 6μ in thickness (Text-fig.3, *hy*). The cell-boundaries are generally indicated by pale intervals separating the darkly pigmented cells, it being a general rule that the pigment-granules, whether few or abundant, are most numerous around the cell-nucleus, and tend to be absent from the outer border of the cell. The whole hypodermis may be deeply pigmented (as in *Diphlebia*), or almost without pigment (as in *Argiocnemis*). Between these two extremes lie the larger number of gill-types, in which the pigment is chiefly collected into certain areas of dense pigmentation, as, for instance, in the gills of *Austrolestes psyche* (Plate i., fig.1), *Argiolestes icteromelas* (Plate i., figs.8-9), *Pseudagrion australasia* (Plate ii., fig.13), and *Austrocnemis splendida* (Plate ii., figs.18-19). This arrangement often gives a beautiful pattern to the gills, and may be of value for the protection of the larva in its natural haunts.

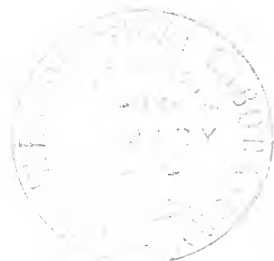

The *nuclei* of the hypoderm-cells are large prolate spheroids, usually lying with their major axes parallel to the cuticle, but sometimes standing up more or less at right angles to it. When the hypodermis is exceptionally thin, the nuclei bulge inwards, so that the inner border of the hypodermis has a wavy outline. The average size of the nucleus is about 8μ long, by 4μ wide. Usually, the nuclei are all of about one size everywhere in the gill. In the Lamellar Gills, however, the thinnest portions of the blade, situated towards the distal end of the gill and beyond the rachis, is bordered internally by hypoderm-cells of smaller size, with smaller nuclei averaging only 5μ to 6μ long.

Beneath the mid-rib, in gills of the *Lestid* type, the hypoderm-cells tend to become columnar, and may attain to as much as 30μ in height. This is particularly noticeable in the genus *Synlestes*, where the alveolar meshwork is greatly reduced.

A very typical section of cuticle and hypodermis is shown in Text-fig.1, from the lateral (triquetral) gill of *Calopteryx*.

The Basal Pieces and Breaking-joint.

Each gill is attached to the tenth abdominal segment by means of a short, cylindrical *basal piece*. Heymons(17) has shown that, in the case of the median gill, the basal piece represents the reduced tergite of the eleventh abdominal segment; while, in the case of the two lateral gills, the two basal pieces represent the two parts (right and left) of the reduced bipartite sternite of the same segment. A section across the basal piece reveals a large lumen formed of the undifferentiated hæmocœle, partially filled by the large tracheæ, a small accumulation of fat-cells around them, and the small muscles by means of which the gills are moved.

Between the basal piece and the gill proper lies the *breaking-joint*, of which sections are shown in Plate iii, figs.21, 22 (*Neosticta*). It is along the transverse plane formed by this joint that the gill is cast off, if seized by an enemy or otherwise entangled, so that the larva desires to free itself. The ingenious arrangement by means of which this can be done, without sufficient loss of blood to be fatal to the larva, can be made out

by a comparison of Text-fig.1 with Plate iii., figs.21, 22. From Text-fig.1, we see that, at the line of junction of the gill-base with the eleventh segment (which is the line of the breaking-joint), the cuticle becomes suddenly narrowed, and, in particular, the tougher *outer* portion of the cuticle, which is particularly thick on the basal piece and at the extreme base of the gill. is

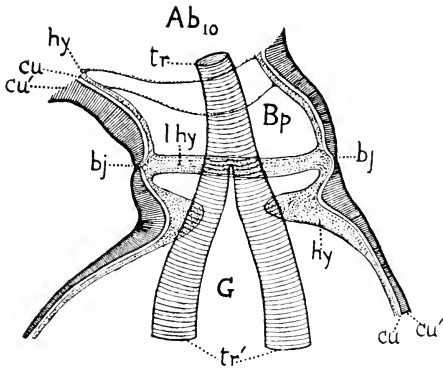

Text-fig. 1.

Basal piece (*Bp*) and breaking-joint (*bj*) of right lateral gill of *Argiolestes icteromelas* Selys, ($\times 87$). Drawn from a cleared whole mount. *Ab₁₀*, tenth abdominal segment; *G*, base of gill; *l hy*, hypoderm-layer across breaking-joint; *tr*, single main trachea approaching gill; *tr'*, its two divisions within the gill. Rest of lettering as given on p.109.

greatly reduced. Thus the gill is not only *flexible* about this joint, but fairly easily detachable also, by reason of the ease with which the thin cuticle can be torn away.

Now if we examine the breaking-joint in transverse section (Plate iii., figs.21, 22), we shall see that, just at this point, the hypodermis grows out into a delicate transverse layer of elongated columnar or spindle-shaped cells, which almost completely close in the lumen of the organ. The hæmocœle, which, in the basal piece, is broad and undifferentiated, is here reduced to two narrow canals (*dh*, *ch*), which are the beginnings of the dorsal and ventral blood-canals of the gill itself. The rest of the hæmocœle is closed up, except for the excessively narrowed channels in which the main tracheæ (*tr*) run. When the gill is

thrown off, the tracheæ and blood-canals are torn away at their narrowest portions, leaving an almost continuous sheet of hypodermis to cover the wound. Before any blood could be lost, the contraction of the muscles of the basal piece will have drawn the wound together, so that the blood-canals and tracheæ are closed up. A rapid overgrowth of hypoderm-cells then takes place, forming a bulge or tubercle upon which a new cuticle is rapidly developed. From this bulge, by further growth of the hypodermis, a *regenerated* gill will be reconstructed at the following ecdysis.

The Alveolar Meshwork (Plate iv., figs.30-33).

This peculiar structure fills the greater part of the interior of the gill in the Saccoid and Triquetro-quadrato Types, and persists also in the central area or *rachis* of the Lamellar Types. It was first discovered and described by Dr. F. Ris, in his study of the saccoid gills of *Pseudophæa* (28). A translation of his opening sentences on this formation offers us an excellent word-picture of it :—

The interior of the bladder under the hypodermis is filled with a very queer web-like body (“sehr eigentümlichen Gewebekörper”): it is of quite regular alveolar construction, and the individual alveoli are spheroids flattened against each other. The alveoli possess genuine partition-walls (“ächte Wandungen”) made from a substance which, as far as my optical aid (Leitz Imm. 1/12) went, is structureless and only weakly colourable with hæmatoxylin; examination in series shows that in each alveolus there lies one firm cell-nucleus, and only one, so that the supposition arises that each alveolus is the product of a single cell.

A careful study of the alveoli in numerous sections through gills of *Diphlebia*, *Neosticta*, and *Calopteryx* convinces me that Ris' description is correct, except in one point. It is true, as a general rule, that if one follows a single alveolus through a number of sections, from the point at which it first appears as a minute area between two larger alveoli, to the point at which it finally disappears, *one and only one* nucleus can be seen upon its

wall. The exceptions to this occur so seldom (I have seen *one* alveolus with *three* nuclei upon its wall, a few with two, and perhaps a score or more with none at all, out of thousands examined) that they are scarcely worth considering. But it is also true that the nucleus that does duty for one alveolus is frequently the same nucleus that counts for an adjoining alveolus, or even for two other alveoli. This fact seems to have escaped Ris' attention; but it is nevertheless a very important piece of evidence when we come to discuss the true nature of the alveoli. I find that, as a general rule, the nucleus is situated at a point of union between the wall of one alveolus and the walls of one or more adjoining ones. In other words, the walls of separate alveoli are not distinct structures, each the product of a single cell, but are formed by fusion of a number of branching cells having nuclei at their centres. Consequently each alveolus is not, as Ris' supposition would indicate, the hollow interior of a single cell, but merely a small portion of the original hæmocœle, closed off by the ingrowth and fusion of cell-processes around it.

If my interpretation of the structure of the alveoli be correct, we should expect to find nothing actually inside the alveoli themselves except blood-plasma and, perhaps, an occasional amœbocyte; whereas, if Ris' interpretation be the true one, it would be reasonable to expect some internal structure *sui generis* within the alveolar cavity.

Now Ris has figured (28, Plate 6, figs.17-20) and described at some length, some extraordinary structures from the interior of the alveoli. He says (I translate from the original German):—

One part of the above-mentioned alveoli is full of very rich and delicate ramifications in moss-like branching tufts of standing fibrils (“reichen und zierlichen Verzweigungen in moosartig verästelten Büscheln stehender Fibrillen”). . . . In one alveolus one single fibrillar tuft of this kind appears to be predominant; but formations are not lacking in which a number of smaller tufts are found in near or distant parts of the same alveolus. Other formations are also to be noticed as stages in the development of these fibril-tufts: button-shaped and closely packed together, running out from a narrow base in countless threads,

as yet stout and unbranched: or else the length of the threads is considerably greater, but the resolution ("Auflösung") of the tufts is not yet complete, not yet filling up the alveoli. . . . The individual fibrils of these tufts seem to be very regular in thickness and of extreme fineness: I cannot discover any other formation in them with my aids: the individual pale hæmatoxylin colouring for a single cell is quite uniform. It has already been said that only one part of the alveoli contains these tufts: the division is by no means regular: but, in reality, both in the case of the median as well as the lateral gills, there is a central zone of empty alveoli surrounded by a peripheral zone of alveoli filled with fibrils: towards the distal end of the organ the number of empty alveoli decreases more and more, so that at the spot where the two large blood-vessels unite only very few are left empty. . . . The alveoli containing blood lie predominantly on the periphery of the organ near the hypodermis. The alveoli containing fibril-tufts contain these only, and are otherwise empty. At first sight *the appearance in a few places of suspended fragments of fibril-tufts in the middle of the lumen of the big blood-vessel seems to be very striking*: but in at least one place (the series is not quite without a break) it is possible to refer this phenomenon back to *a group of fibril-tufts which is here clinging to the wall of the big blood-vessel*, in all other respects as on the wall of the alveolus ("wie sonst der Alveolenwand").

I have placed in italics two statements near the end of this quotation, because it seems to me that they, taken in conjunction with Ris' excellent figures, three of which are reproduced on Plate iv., figs.31-33, give us the obvious solution of this extraordinary formation. Having carefully studied numerous series made from carefully fixed and prepared gills of the saccoid type, and one of which (*Diphlebia*) is closely enough allied to *Pseudophæa* to admit of no doubt as to the unity of structure in the gills of the two genera, I have no hesitation in saying that the formation so carefully described by Ris is *entirely absent* from all sections which I have examined. I am bound to conclude, therefore,—and I must call as evidence for my conclusion both the two statements in italics and Ris' own figures— that

these structures are undoubtedly artefacts, being nothing more nor less than a crystallisation of some ingredient used in the preservation of the gills studied by Ris.

Ris himself says of these structures:—I shall not disguise the fact that my first impression on seeing them was that of an artificial product, at first of crystals of a fatty acid, then of a fungoid growth. Neither of these impressions stood the light of clear observation, and I am convinced that we are dealing with a certainly extremely curious structure peculiar to this organ.

The reasons for concluding that Ris' first impression was the right one, *i.e.*, that the fibril-tufts are artefacts, may be briefly stated as follows:—

1. They do not occur in any type of saccoid gill, so far studied, which is known definitely to have been properly fixed, and to have had the fixative completely extracted.

2. They do not occur in the lateral abdominal gills of *Pseudophoca*, the internal structure of which, on Ris' own showing, is a miniature reproduction of the saccoid gills as far as the alveoli are concerned.

3. They occur just in those parts of the organ (*viz.*, the peripheral alveoli) where they would be found if (*a*) the larva had been partially fixed, and the fixative not washed out; or if (*b*) the larva had been greatly over-fixed, so that only the more open central portion, with the blood-canals, had subsequently been freed of fixative.

4. The fact that fibril-tufts are found adhering to the wall of the large blood-canal, and some even suspended in its lumen (see the italicised portions of the quotation from Ris given above) seems to me to be fatal to the argument that they are a special or peculiar structure found only in this type of gill. Either they are a formation produced within the alveoli as part of the living cell (it is clear that Ris was inclined to regard each alveolus as a single cell), or they are a foreign body. If the former, they could not occur also on the wall of the blood-canal, or free within its lumen; for there is no connection between the blood canal and the alveoli.

5. The tufts figured in Ris' photograph, shown on Plate iv., fig.33, undoubtedly extend just beyond the limits of the alveolus shown.

6. Ris' own photographs show a structure quite unlike anything known to occur in the animal kingdom, and bearing on their very face the stamp of artefacts.

I may add that these photographs were submitted to both Professor Haswell and to Dr. S. J. Johnston, of the Zoological Department, University of Sydney, and both of them pronounced them to be artefacts without any doubt whatever.

It seems necessary to go into this matter at some length, in order to prevent further speculations as to the *function* of these fibril-tufts. The fascinating theory that each alveolus might be a single cell, in which special end-organs (*i.e.*, the fibril-tufts) were developed, for the purpose of extracting oxygen from the alveolar contents (water, air, or blood?) and passing it into the tracheal system, can no longer be entertained. We must look for some simpler, though more prosaic, explanation of the physiology of the caudal gills.

Let us now return to the question of the structure of the alveoli themselves. Here a study of these organs in all positions within the gill, and in all different types of gill available, is essential to a right understanding of their nature. Of particular value is a careful study of those alveoli, few and comparatively large in number, which lie in the rachis of a lamellar gill; since in this case the mind is not confused by their immense number, and their relationship with the hypodermis is easily made apparent.

In those alveoli which lie closest to the hypoderm-layer, it is easily seen that the wall of the alveolus merges into the innermost stratum of the hypoderm-layer, as shown in Text-fig.9. It would appear that the hypoderm-cell is capable of throwing off a portion of its substance in the form of a delicate layer, either from its inner or outer border. The continuous layers so thrown off along the whole hypoderm-layer upon its outer border form the separate *strata* of which the cuticle is composed. Between the layer last thrown off, and the living hypoderm-cells, one finds

a layer of dust-like pigment interposed. Now an examination of the alveolar wall shows (as far as magnification by a 1/12th oil-immersion lens is able to show) a very uniform, lightly-staining substance closely resembling the innermost stratum of the cuticle, but without any pigmentation. One would not hesitate to pronounce this delicate layer to be chitin, were it not for the presence of the alveolar nuclei. These, however, give the key to the structure. If one follows carefully through a series of transverse sections of a complete gill from the base outwards, it

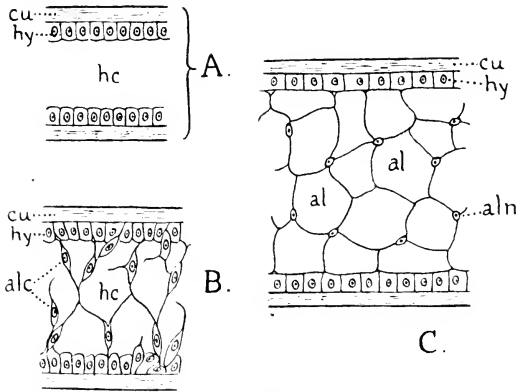

Text-fig.2.

Diagrammatic representation of formation of alveolar meshwork. A, the two walls of the gill separated by the hæmocele (*hc*). B, migration of hypoderm-cells (*alc*) into the hæmocele, with outgrowth and union of their processes. C, the alveolar meshwork completed by differentiation of the same cells into alveolar nucleus (*aln*) and alveolar wall. *al*, a single alveolus enclosing a portion of the original hæmocele. Rest of lettering as on p. 109.

is clearly to be seen that, near the base, a number of hypoderm-cells do not lie in the regular epithelium, but project out across the gill-cavity, with their nuclei placed irregularly within it. These cells unite across the interior of the gill, where, indeed, at the breaking-joint, they form an almost complete transverse layer. Passing further into the gill, we find these same cells becoming exceedingly irregular and attenuated, with the nuclei few and far between, and large spaces of the hæmocele lying

enclosed within the fused network formed by the cells. *These are the first alveoli.* In Text-fig.2, I have attempted to show how the formation of the alveoli is brought about.

It would be difficult to decide the question as to the exact composition of the alveolar wall, were it not for a fortunate circumstance in connection with the fixation of the hypoderm-layer. Within the gill, the hypodermis carries on its inner margin a fine basement-membrane, which, luckily, becomes detached in places, either by the action of the fixative, or perhaps during sectioning. This delicate membrane closely resembles the innermost stratum of the cuticle before it becomes hardened up. Now, in many places it can be seen that the alveolar wall is continuous with this basement-membrane, and there is no change in structure as we pass from the basement-membrane proper into the interior of the gill.

Again, if we examine the nuclei upon the alveolar walls (Plate iv., fig.30), we find them to be exactly similar in size, shape, staining qualities, and contents, to the hypoderm-nuclei found along the epithelial layer. We must conclude, therefore, that *the alveolar meshwork is the product of numerous hypoderm-cells which have grown into the interior of the gill, and have enclosed within their folds a number of spheroidal chambers (alveoli) whose interiors were originally portion of the hæmocoel.*

The fact that blood-coagulum, with an occasional amœbocyte (but never, as far as I have seen, any miocytes) is often seen within the alveoli, bears out the above statement. If the alveolar cavity were the interior of a single cell, how indeed could blood-plasma become enclosed within it? But if the meshwork grows, as I have indicated, by the branching and fusion of numerous cells throughout the hæmocoel, then it becomes a certainty that some at least of the blood must become enclosed within it. As the miocytes continue to travel regularly in the course of the main blood-circulation, which becomes closed off, as the meshwork grows, in the form of two blood-canals, it is not surprising that we do not meet with these corpuscles in the alveoli. Even if one were accidentally enclosed, we may be fairly sure that it would cease to keep its oat-shaped

form, and would settle down near the alveolar wall in the form of an amoebocyte. The absence of miocytes within the alveoli simply proves the absence of any definite circulation of blood within them.

The Internal Lamina.

In all caudal gills which I have examined, except the *Lestid* and Reduced Types, the alveolar meshwork is seen to be strengthened, along certain definite zones, by a series of thicker ingrowths from the hypoderm-layer. These ingrowths were first noticed in the larva of *Pseudophora* by Ris (28), who termed them "lamellen." As, however, the term "lamella" has already been employed more generally for the flat, blade-like gills of *Lestida* and *Agrionidae*, I propose to substitute the term *internal lamina* for these ingrowths, in order to avoid confusion.

In all forms of caudal gill, the internal laminae occur chiefly along two well-marked longitudinal zones. One of these zones would be represented, in all median gills except those of the Horizontal Lamellar Type, by a plane perpendicular to the plane of symmetry of the gill, at a level slightly dorsad from the dorsal blood-canal. Dorsad from the first plane, and ventrad from the second, more scattered internal laminae are developed; but I have not found any general development of laminae in the more central area between the two blood-canals. Only in the *Agrionid* gills of the Vertical Lamellar Type have I found laminae developed just ventrad from the dorsal blood-canal, or dorsad from the ventral blood-canal.

In lateral gills of the Vertical Lamellar Type, the zones of laminae agree with those of the median gill. But in lateral gills of the Triquetral Type, the zones may best be described as being developed along two planes which cut off, in any given cross-section, the upper and inner corners of the triangle representing the section. These two planes are therefore not parallel, but somewhat inclined to one another inwards. The same holds good in the lateral gills of the Saccoid Type. The positions of the two principal zones of laminae are in all cases clearly represented in the series of diagrammatic sections in Text-figs. 11, 17, 22 (*dl*, *rl*).

In the Horizontal Lamellar Type, the horizontal flattening undergone by the gill has resulted in a more or less complete suppression of the principal zones of laminae. Numerous secondary short laminae are developed at intervals across the interior of the narrow blade of the gill (Plate vi., fig.43, *il*, *il'*). In the *Lestid* form of Vertical Lamellar Gill, the two walls of the lamella lie mostly so close together that the internal laminae are not developed at all (Plate v., figs.36, 37).

I propose to call all the laminae developed along either of the principal zones of the gill the *principal internal laminae*. All the rest I shall term the *secondary internal laminae*. There is no difference in their structure. But, along the principal zones, the laminae occur more regularly and in greater number, forming a kind of open fence across the gill. If a lightly-pigmented Vertical Lamellar Gill (*e.g.*, that of *Ischnura heterosticta* Burm.) be stained *in toto* with borax-carmines, cleared and mounted, the two sets of principal internal laminae will appear like two long straight rows of slender colonnades, rising from the "floor" to the "roof" of the gill.

The two principal zones of laminae separate off the central thicker portion of the gill, termed the *rachis*, with its main tracheae, nerves, and blood-vessels, from the two narrower outer portions, which, in the case of Lamellar Gills, together form the *blade*.

A section along an internal lamina is shown in Text-fig.3. The lamina appears to be an ingrowth of the *whole* hypoderm-layer at a given point. The lamina itself exhibits a kind of stratified structure, being apparently formed of a number of closely appressed parallel layers, the sections of which resemble strongly-developed fibrillae. Minute pigment-granules lie between (or upon) each separate layer, but they are of such small size that their exact positions are not easily determinable. Hypoderm-nuclei, together with a certain amount of undifferentiated cytoplasm from the hypoderm-layer, can often be seen supporting the bases of the laminae on either side.

Ris described the internal laminae of *Pseudophæa* as being *chitinous* (28). But Ris' larva, as he clearly shows, was just at

the end of an instar, and about to cast its skin. The connection between the internal lamina and the cuticle, so clearly shown in Ris' larva, is not to be made out in the majority of the larvæ which I have studied. In fact, it can only be seen in two larvæ which were sectioned (as Ris' larva was) just before undergoing ecdysis. The normal state of the lamina is shown in Text-fig.3 and in Plate iv., fig.29. It remains thus for the greater part of an instar, and only acquires connection with the cuticle just

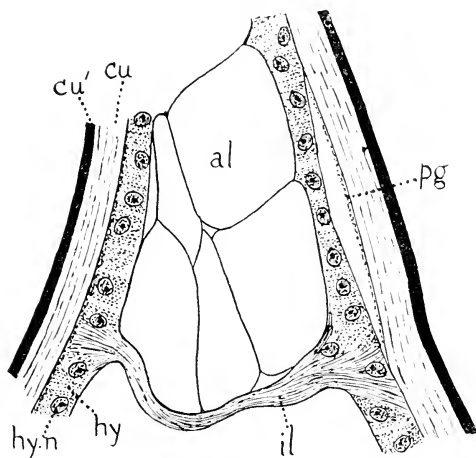

Text-fig.3.

T.S., through cuticle, hypodermis, and an internal lamina (*il*) from the lateral triquetral gill of *Calopteryx* sp. ($\times 370$). *al*, an alveolus; *pg*, pigment-granules adhering to the inner wall of cuticle at a point where the hypodermis is pulled away. Rest of lettering as on p.109.

before ecdysis. At the same period, the innermost strata of the lamina become definitely hardened, so as to appear quite chitinous, and these would seem to be actually withdrawn from the lamina at ecdysis, by means of their connection with the cuticle. Normally, the structure of the lamina resembles most closely the formation seen in the cytoplasm of the hypoderm-cells at their points of connection with muscle-fibres, and may therefore be considered as *fibrillar*. The fibrillar material of the lamina stains with hæmatoxylin as deeply as the hypoderm-cytoplasm

itself, and remains unstained by eosin. Also, it is bordered, in the hypodermis itself, by a fine basement-membrane, seen as a dark line under high magnifications. Further, in all larval stages except just before ecdysis, a definite pigment-layer intervenes between the cuticle and the base of the internal lamina, as shown in Text-fig.3.

As to the formation of these internal laminae, I must express my agreement with Ris' opinion that this lies partly upon the mechanical side, viz., that they act as additional supports for the alveolar meshwork in the interior of the gill. But they do not exist for this purpose only. They carry the basement-membrane of the hypodermis along their entire length; and they show, at frequent intervals, connections with the alveolar walls themselves. It seems almost certain, though it cannot be proved by actual examination, owing to the excessive fineness of the meshwork, that a thin layer of hypoderm-cytoplasm must connect all the nuclei of the alveolar meshwork, and that the laminae are the principal bearers of this cytoplasm into the gill-interior. In other words, where single or few hypoderm-cells have passed inwards and helped to form the meshwork, their points of connection with the hypoderm-layer are indicated simply by the passage of the basement-membrane into the alveolar wall. But at those points where masses of hypoderm-cells have been thrown inwards, a *lamina* is formed, and much of the surrounding meshwork is probably due to the further ingrowth of the cells carried in along the lamina. Whether the cytoplasmic connections between the scattered nuclei of the meshwork persist throughout larval life or not, we know that they must have existed during the *formation* of the meshwork, and that they must continue to exist so far as additions to the membrane are made with the growth of the larva at each ecdysis. I see, therefore, in the internal laminae, not only a mechanical device for the support of the meshwork, but also the principal carriers of the hypodermis inwards for the formation of that meshwork.

The Blood-Canals.

In the abdomen of the larva, the blood travels *forwards* through the heart and aorta, *backwards* in the general body-cavity

or hæmocoële. This backward movement occurs both dorsally and ventrally. The main stream runs backwards ventrally, above the ventral nerve-cord, but below and latero-ventrally to the alimentary canal. A smaller stream runs backwards more dorsally, just below and on either side of the heart itself.

The change from backward to forward current takes place in the last three segments of the abdomen, and is entirely due to the suctional pull through the ostia of the heart. These ostia are situated in the eighth and ninth segments. Thus some of the blood will not travel ventrally backwards beyond the eighth segment, being sucked into the ostia of that segment. Similarly, some more blood will not get beyond the ninth segment. A portion of this circulates only around the confines of the anal area, before it returns to the ostia of the ninth segment. The rest, comprised in three distinct streams, passes into the caudal gills, and circulates along almost their entire length (*i.e.*, to the confluence of the two blood-canals, and back again).

This circulation, and the vessels in which it takes place, can best be seen from Text-fig.4. In the *basal piece* of each gill, the hæmocoële is large, and continuous with the general body-cavity. As, however, it approaches the level of the breaking-joint (*bj*), it narrows rapidly, and finally passes through the extensive hypoderm-layer at the breaking-joint as *two minute canals*, one situated dorsally, the other ventrally. On entering the gills, these two canals widen out considerably, and become the closed-in *blood-canals of the gill*. Of these two, that which carries the blood into the gill may be termed *afferent* and *primary*, the latter term indicating (as we shall discover when we study the ontogeny and phylogeny of the gill) that it was in existence long before the second blood-channel was formed, at a time when the *effluent* part of the circulation was effected (like the backward circulation in the abdomen), merely along the undifferentiated hæmocoële of the gill. The other blood-canal, which carries the blood away from the gill, may be termed *effluent* and *secondary*.

In order to examine the circulation of blood in the gills, it is necessary to select a transparent, lightly pigmented larva. For this purpose, amongst the Australian species available, the larva

of *Ischnura heterosticta* is easily the most suitable. If placed in a small dish or watch-glass, this larva will persist in resting with its gills in a vertical plane (their natural position). To overcome this difficulty, I found it best to remove the larva altogether from water, and place it sideways upon a glass-slide. A cover-slip was then let down upon the gills, and water from a pipette was run into the wedge-shaped space between the slide and the cover-slip. Thus the gills were enclosed in water, while the rest of the larva was in air. In such a position, the larva will live for some hours, and seldom makes any attempt to move.

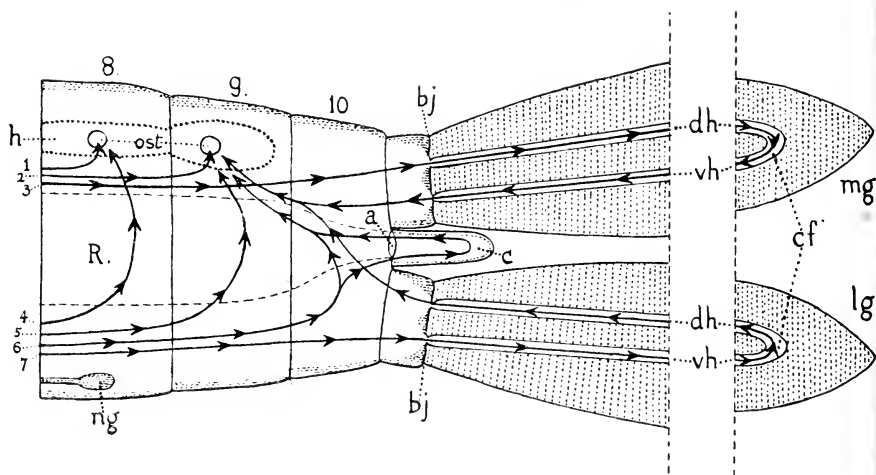

Text-fig. 4.

Diagram of the blood-circulation in the caudal gills and last three abdominal segments of *Ischnura heterosticta* Burm. (Middle portions of gills cut away). The seven currents shown are as follows:—1, dorsal circulation in seg. 8; 2, ditto in seg. 9; 3, circulation in median gill (*mg*); 4, ventral circulation in seg. 8; 5, ditto in seg. 9; 6, ditto in seg. 10, with extension to left cercoid (*c*); 7, circulation in left lateral gill (*lg*). *a*, anus; *bj*, breaking-joint; *c*, cercoid; *cf*, confluence of blood-canals in gill; *dh*, dorsal blood-canal; *h*, heart; *ng*, ganglion of seg. 8; *ost*, ostia; *vh*, ventral blood-canal; 8-10, abdominal segments.

The circulation of blood in the gills is very remarkable. I had naturally expected to find the blood entering the gills by the ventral canal, and passing out of them dorsally. But I

found that this is only true for the lateral gills. In the median gill, the circulation is reversed, the blood passing in dorsally, and passing out again ventrally. As will be seen in Text-fig.4, the blood that enters the median gill (the line of arrows marked 3 in the figure) is part of the *dorsal* backward blood-stream. On reaching the base of the gill, a single pulsation of the heart causes it to shoot sharply along the narrow dorsal blood-canal for some considerable distance. It then travels by a series of shorter jerks (each corresponding with one heart-beat) along the dorsal canal, and round the distal confluence (*c'*) into the ventral canal. Along the ventral canal it passes forwards again by short jerks, until at last it passes out of the gill in the same sharply shooting manner as that by which it entered. The distance covered by a given corpuscle in the jerks of entry and exit appeared to me to be between two and three times as long as the distance covered in a single ordinary jerk. I think the increase must be wholly due to increased pressure forcing the blood along at the breaking-joint, where the canals become suddenly narrowed—just in the same way that a river flows fastest in the narrowest part of its bed.

Thus we see that, *in the median gill, the dorsal blood-canal is afferent and primary, the ventral blood-canal efferent and secondary.*

Turning now to the lateral gills, the course of the blood in the left lateral gill is marked by the line of arrows marked 7 in Text-fig.4. This is part of the main ventral backward stream of the blood along the left side of the abdominal hæmocoel. A similar stream along the right side supplies the right lateral gill. Each of these streams enters the lateral gill on its own side by the *ventral canal*, in the same sudden shooting manner as that already noticed for the median gill. Passing, by a series of jerks, distally to the confluence (*c'*), the blood returns along the dorsal canal. On passing out from the gill, the blood passes obliquely upwards and forwards towards the heart, and meets with one portion of the blood-stream emerging *ventrally* from the median gill, since this latter stream is constrained, on approaching the heart, to divide into two in order to avoid the blind end

of the heart itself, and the ligaments connecting it posteriorly to the wall of the tenth segment. Thus, finally, the blood from all three gills enters the ostia of the ninth segment in two streams, one from the right, the other from the left of the heart.

In the lateral gills, therefore, the ventral blood-canal is afferent and primary, the dorsal blood-canal efferent and secondary.

In Text-fig.4, the seven lines of arrows numbered 1-7 are intended to show all possible courses for any blood-corpuscle entering the eighth segment from in front. Of these, only Nos. 3 and 7 concern the gills. It should be noticed that portion of No.6 (the ventral circulation of seg. 10) passes into and out of the larval *cercoids* (*c*), in which no blood-canals are developed.

The difference in the circulation of blood in the median and lateral gills puzzled me greatly, and I could find no explanation to account for it, until I thought of studying the caudal processes of the May-flies (Plecoptera). Then, as I hope to explain more fully in Part iv., I discovered that, in this Order, each process possesses only one blood-canal, which is dorsal in the median process and ventral in the lateral process. Also, in these caudal processes of the May-fly, the blood passes *into* the process along the closed canal, the return journey being made along the open hæmocœle of the process-cavity. Thus it became evident that the *afferent* canal, whether dorsally or ventrally placed, must always be the *primary* canal, originally present in the organ before it took on the form now seen in the Zygoptera: whereas the *efferent* canal is only a secondary formation, being in fact nothing more nor less than what is left of the original open hæmocœle of the gill, after the elaboration of the alveolar meshwork, which occupies by far the greater volume of the hæmocœle. Further interesting evidence along the same lines may be expected from the study of the Ontogeny of the Caudal Gills themselves.

The actual circulation of the blood-corpuses in the gill seems to be entirely confined to the two blood-canals. That is to say, although blood-plasma is to be found in the nerve-canals, some of the alveoli, and occasionally in the small spaces of the hæmocœle around or near the tracheæ (Text-fig.9, *blp*), and although

occasional large amœbocytes (Text-fig.9, *ac*) may also be found in these positions, being probably caught and imprisoned during an ecdysis, yet the travelling oat-shaped corpuscles or *miocytes* (*mc*) are never found, in sections, anywhere in the gills except in the blood-canals. A typical group of blood-corpuscles, including both miocytes and amœbocytes, is shown, greatly enlarged, collected near the wall of a blood-canal, at a point where it impinges upon the hypodermis, in Text-fig.5.

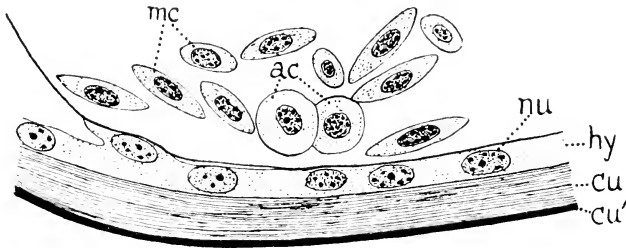

Text-fig.5.

Blood-corpuscles in blood-canal near base of gill of *Austroagrion cyane* (Selys). From a transverse section ($\times 1000$). Lettering as on p.109.

The Nervous System.

The Nerve-Supply of the Caudal Gills is, as might be expected, of very uniform structure throughout the whole Sub-order, and appears to be but little affected by changes in the form of the gill itself, or in the number of principal tracheæ supplying it. The typical distribution of nerves to the gills, here described, was found in all forms examined by me in the families *Calopterygidae* and *Agrionidae*. In the *Lestidae*, the distribution is altered by the suppression of one pair of principal nerves, in the median gill only. The nerve-supply of the lateral gills remains the same in all three families.

The last abdominal ganglion of the ventral nervous system of the Dragonfly Larva is the large ganglion lying in the eighth segment. This ganglion is formed by the fusion of three original pairs of ganglia, viz., those of the eighth, ninth, and tenth abdominal segments. It gives off four pairs of principal nerves, viz., the genital nerves, the eighth segment nerves, the ninth segment nerves, and the tenth segment nerves, the last being the

most posterior pair. The whole nerve-supply of the caudal gills is supplied from these last.

On entering the tenth segment, the tenth segment nerves lie latero-ventrally on either side of the rectum. At about one-third of the distance through the segment, each nerve divides into two strong branches, one passing slightly more dorsad, the other slightly more ventrad, and the former bending slightly outwards away from the level of the original nerve. Of these two branches, the ventral soon gives off a strong nerve to the wall of the rectum, the *posterior rectal nerve* (Text-fig.6, *rn*), and

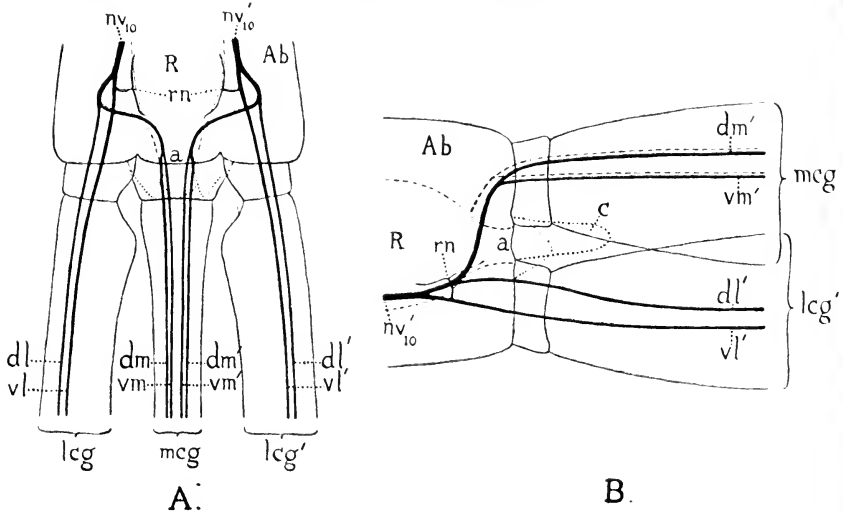

Text-fig.6.

Diagrams to show positions of principal nerve of the gills, A dorsal, B lateral view. *a*, anus; *Ab*, abdomen; *c*, cereoid; *dl*, dorsal nerve of left lateral gill; *dl'*, ditto of right lateral gill; *dm*, left, and *dm'* right dorsal nerve of median gill; *lcg*, left, and *lcg'* right caudal gill; *mcg*, median caudal gill; *nr₁₀*, left, and *nr'₁₀*, right tenth segment nerve; *R*, rectum; *rn*, posterior rectal nerves; *vl*, ventral nerve of left lateral gill; *vl'*, ditto of right lateral gill; *vm*, left, and *vm'*, right ventral nerve of median gill. Reconstructed from series of transverse sections.

then, running straight on, it enters the base of the lateral caudal gill of its own side, forming the *ventral nerve of the lateral gill* (*vl*, *vl'*). This is a large nerve, lying very conspicuously upon

the wall of the ventral blood-canal, on the side farthest from the plane of symmetry of the gill-system. The other, or dorsal, branch divides into two a little further on, one branch continuing a fairly straight course, a little outside and dorsad of the level of the nerve *vl*, to enter the base of the lateral gill of its own side, as the *dorsal nerve of the lateral gill* (*dl, dl'*)—a nerve considerably smaller than *vl*, but placed in a similar position to it upon the wall of the dorsal blood-canal.

The second branch passes rapidly upwards and inwards over the anal opening, and branches into two just before entering the base of the median gill. Its two branches form the *dorsal and ventral nerves of the median gill* (*dm, vm*) respectively, of its own side. A corresponding pair of nerves enters the median gill from the other side. Thus, the nerve-supply of the median gill, like that of the median ocellus, is a double one, symmetrical about the plane of symmetry of the larva.

In sections of the gills of *Synlestes* and *Austrolestes*, I can find no trace of the two ventral nerves of the median gill. It would appear, therefore, that these nerves are suppressed, in the family *Lestidae*. On the other hand, it is easy to trace several strong nerves arising from the dorsal nerves at various levels along the gill-length, and passing closely around one or other of the two main longitudinal tracheæ, to supply the ventral portion of the gill-blade.

The structure of one of the main dorsal or ventral gill-nerves may be seen from Plate vi., figs. 44, 45. A cross-section passes through a considerable number of parallel nerve-fibres, the nuclei of which are found at fairly frequent intervals along the course of the nerve. Frequently the same section will intercept two nuclei, as in Plate vi., fig. 45, and occasionally three. The nuclei occur in all positions, either near the centre, or upon the circumference, but seldom project beyond the regular periphery of the nerve.

The main gill-nerves retain their position either in, or very close to, the walls of the main blood-canals, throughout the whole length of the gill. Only in the Saccoid Gill-type are they removed any distance from these canals. In this type, also, their

courses appear to be far more irregular, and their branchings more numerous and more difficult to follow, than in the other types. If we examine a cross-section of one of the main nerves lying upon the wall of the blood-canal, in any gill-type, we shall see that it may either project well into the hæmocœle, or it may lie almost flush with the wall, or it may be closed off and lie just outside the canal. One need not attach any importance to

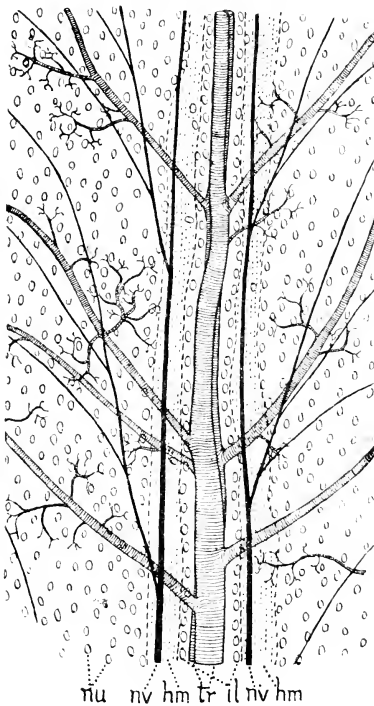

Text-fig. 7.*

variations in this respect, since they would appear to be mainly due to the condition of the blood-canal (and, indeed, of the whole gill) at the moment of fixation. For if the blood-canal be distended, the nerves will appear as if projecting into it, whereas if it be collapsed, they may appear to be outside its wall. The important point to notice is that, in any case, the nerve runs in a small *nerve-canal* of its own, as shown in Plate vi., figs. 44, 45. The wall of this canal is similar in structure to the wall of the blood-canal.

By referring to Text-fig. 7, we may follow the courses of the main nerves

and their principal branches throughout the gill. The nerve-branches, in the case of a vertical lamellar gill of the *Agrionid* type, are much less numerous than the tracheal branches, and

* Portion of stained whole mount of gill of *Austroagrion cyane* (Selys), to show hypoderm-nuclei (*nu*), blood-canals (*hm*), main nerves (*nr*) and their branches, internal laminae (*il*) and main tracheae (*tr*), with their branches: $\times 100$.

come off from the main stem usually at a much sharper angle, especially along the narrower side of the gill-blade. Such nerve-branches themselves branch once or twice externally, so that the whole system of nerves, arising from the single branch, innervates an area of the gill supplied by two, or even three, tracheal branches from the main stem. As they extend outwards, these branch-nerves finally divide up into single nerve-fibres, which are easily followed out under a high power, in a freshly cut-off transparent gill. Each single nerve-fibre is finally destined to supply a small sensilla, in the form of a tactile hair or spine, standing upon the edge of the gill.

Besides the nerves shown in Text-fig.7, one can also detect occasional single nerve-fibres running outwards from the main nerve. There is also a series of stout, short branches, which pass inwards from the main nerves to supply the central region, or rachis, with its large tracheal trunks. Short single nerve-fibres from these branches pass to the bases of the spines and hairs of the midrib.

As already indicated, in the *median* vertical lamellar gills of the *Lestid* type, all the branches arise from the two dorsal nerves, the ventral nerves being apparently suppressed.

The Tracheal System.

The whole tracheal system of the caudal gills is derived from the dorsal tracheal trunks. Each of these divides into two in

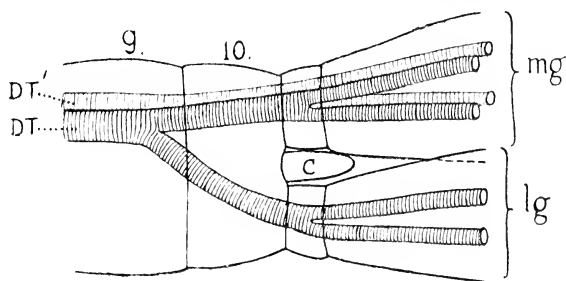

Text-fig.8.

Diagram to show courses of main tracheæ at base of Triquetro-quadrata Gill-system (right lateral gill omitted). Lettering as on p.109.

the ninth abdominal segment. Of the two branches, the more

ventral one passes slantingly downwards to enter the base of the lateral gill of its own side. On entering the gill, this branch again divides into two, in all except the *Lestid* sub-type of gill. The more dorsal branch runs straight back through the tenth segment to enter the base of the median gill, alongside its fellow from the other dorsal trunk. Thus the median gill receives *two* main tracheal stems at its base. In all Lamellar Types of gill, these two trunks run alongside one another through the gill, giving off numerous branches. In the Saccoid and Triquetrouadrate Types, however, each divides, on entering the gill proper, into two large tracheæ, of which one is placed dorsally above the other. Thus, in these types, the median gill has four parallel main tracheæ running through it. This arrangement is shown diagrammatically in Text-fig.8.

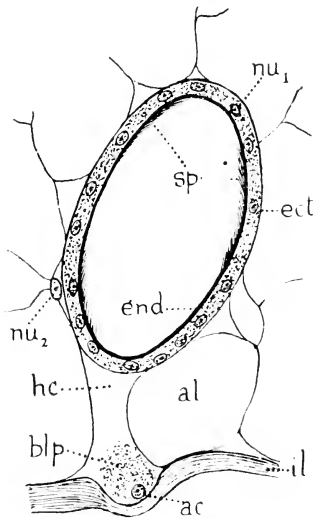

Text-fig.9.*

The courses of the main tracheæ, their manner and frequency of branching, and the form of their smaller branches or "twigs," vary so much that it seems advisable to leave the description of these parts under the sections dealing with the separate types of gills.

The structure of the tracheæ in the caudal gills does not differ in any respect from that of tracheæ in any other part of the larval body. Being derived from the dorsal trunks, they are, like these latter, always deeply pigmented, the pigment-granules lying in the ectotrachea. This pigmentation is found throughout the tracheal

system, from the main stems down to the final branches from

* T.S., through a main trachea in gill of *Calopteryx* sp. ($\times 370$), to show reduced portion of hæmocele (*hc*), [containing blood-plasma (*blp*) and amebocytes (*ac*)], in which the trachea lies. *al*, alveolus; *ect*, ectotrachea, *end*, endotrachea; *il*, internal lamina; *nu*₁, nucleus of *ect*; *nu*₂, nucleus of *end*.

which the capillaries arise. Only in the capillaries themselves is there no pigmentation. The capillaries also differ from the larger tracheæ in lacking the spiral thread of the endotrachea, which is quite conspicuously visible in sections of the larger tracheæ. The nuclei of the ectotrachea closely resemble those of the hypodermis, and their structure is practically the same. A transverse section through one of the main tracheæ of *Calopteryx* is shown in Text-fig.9, while a comparison of the ectotrachea with the hypodermis in *Argiolestes* can be made by referring to Plate vi., fig.44.

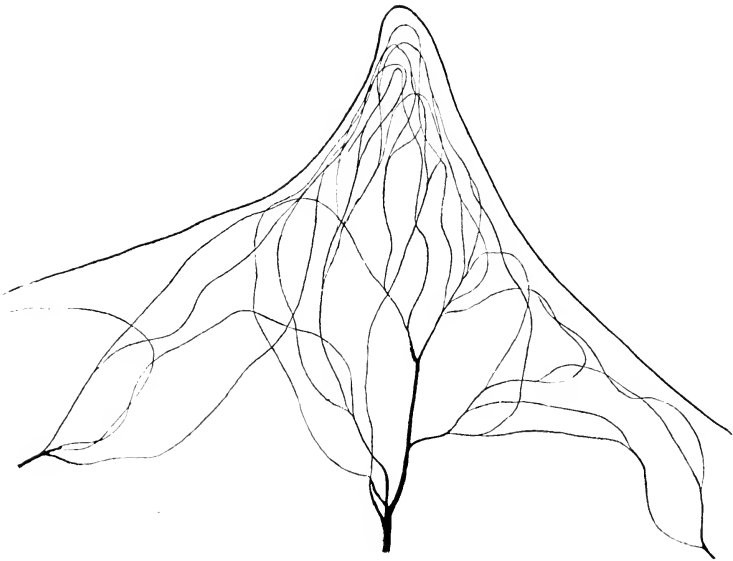

Text-fig.10.

Capillary loops of tracheal system at extreme tip of gill of *Austrocyprion cyane* (Selys); (\times 370). Drawn from the freshly cut-off gill.

Each trachea lies in a narrow portion of the hæmocele, closed off, usually, by the alveolar meshwork, sometimes in part by the internal laminae or the hypodermis. This narrow channel is not easily discovered in most sections, but when it encloses some blood-plasma, as it sometimes does, it can then be clearly determined, as in Text-fig.9.

The Capillary System.—The capillaries, which are the end-terms in the series of branchings from the main tracheæ, are always quite unpigmented, and very difficult to follow. They are best examined in a freshly-cut-off gill, soon after an ecdysis. They do not form clear simple loops, like the capillaries of the rectal gills of Anisoptera, though a close approximation to such a condition may be examined at the *extreme tip* of a lamellar gill, as in Text-fig. 10. Here one can follow out the complete course of each separate capillary, and it will be seen that most of them make a fairly simple complete loop from one branch-trachea to another. In other parts of the gill, the capillaries cannot be easily followed throughout their entire courses. Though an occasional one can be followed through in a course of varying directness from one branch to another, yet the general rule would appear to be that they form an irregular anastomosing network within the gill, lying for the most part close to the hypodermis upon its inner side. I have not been able to demonstrate the existence of any capillaries *ending blindly* in any part of the gill, and do not think that any such are likely to occur. The condition shown at the tip of the gill (Text-fig. 10), probably represents, in a somewhat simplified form, the general method of linking-up of the smaller branch-tracheæ by means of the capillaries.

PART II.

STUDIES OF THE SEPARATE GILL-TYPES.

A. The Saccoid Type.

(Text-figs. 11-16; Plate i., fig. 6; Plate iii., figs. 21, 22; Plate iv., figs. 28-33.)

In this type, each gill is in the form of a swollen sac or bladder, more or less sausage-shaped, and usually tapering posteriorly to a fine point. Text-fig. 11 shows an ideal section of a saccoid gill-system taken across the basal third of the gills. Both cuticle (*cu*) and hypodermis (*hy*) are very thin compared with the size of the gill. The cuticle, however, may become fairly tough, especially during the last larval instar. The hypoderm cells are deeply pigmented, except at their boundaries, which are usually clear. Their nuclei are fairly regularly placed, and

of about equal size in all parts of the gill, this being also the size of the alveolar nuclei. Dorsal and ventral blood-canals (*dh*, *vh*) are well-developed, symmetrically placed in the median saccus, unsymmetrically in the lateral sacci.

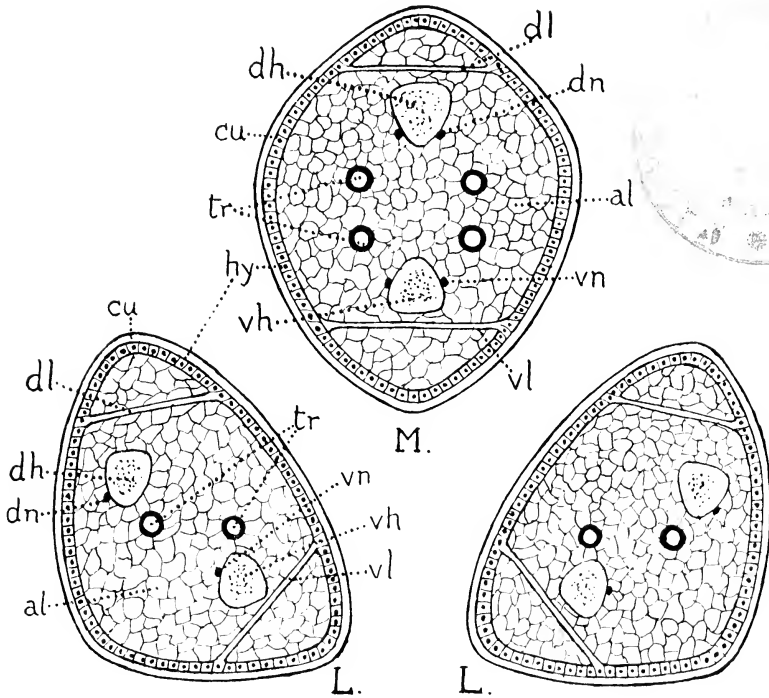

Text-fig. 11.

Ideal (semi-diagrammatic) T.S. across the Saccoid Gill-system of *Diphlebia*, to show the internal structure of the gills. Lettering as on p. 109.

The large interior of the saccus is chiefly occupied by the immense development of the alveolar meshwork, containing hundreds of spheroidal chambers, or alveoli, of somewhat varying size. This meshwork is supported, along two well-marked zones, by the internal laminae (*dl*, *vl*), which close off small longitudinal dorsal and ventral portions from the main central portion of the gill. In these outer portions, in which we must see the first beginnings of the blade-portions of the Lamellar Gill-

types, there is nothing but a weakly-formed meshwork, supported by occasional secondary laminae, and a few branch tracheæ of very small size.

The tracheal plan of a saccoid gill is always somewhat irregular, the main longitudinal tracheæ being free to take a tortuous course in the alveolar meshwork. As in all caudal gills, two main tracheæ penetrate the base of the median gill, while one only passes through the base of each lateral gill. But, in the median gills belonging to the *Epallaginæ*, it is usual to find each main trachea giving off a strong ventral longitudinal branch, so that, in nearly all cross-sections of the gill, there appear to be four longitudinal tracheæ in the gill. In the lateral gills, likewise, the single main trachea divides into two soon after entering the gill, and, fairly frequently, one of these branches may again divide, so as to give *three* longitudinal tracheæ in this gill. In the median saccoid gills belonging to the *Protoneurinae* (*Neosticta*), one sometimes finds only two main tracheæ in all three gills, yet I have frequently noted four in the median, and sometimes three in the laterals. These gills are so frequently cast off and regenerated, that it is not easy to determine whether any of this variation is due to such a cause, or whether the number of main tracheæ is essentially variable.

In all cases examined by me, there are four longitudinal nerves in the median gill, and two in the laterals, as shown in Text-fig. 11 (*du, vn*).

The two following sub-types have been studied:—

(i.) *The Simple Saccus* (Text-figs. 12, 13). This is found in the genera *Pseudophæa* and *Diphlebia* both belonging to the *Epallaginae*, and in the genus *Cora* (*Thorinae*). I have only studied the gills of *Diphlebia*. Ris' work on *Pseudophæa* (28) shows that the gills in this genus are closely similar to those of *Diphlebia*, differing principally in being even more tensely swollen, and much less pointed at the tips. The gills of *Cora*, as studied by Calvert (3), differ from those of the other two genera in being sharply truncated posteriorly.

The gills of *Diphlebia* (Text-figs. 12, 13) are large, cumbersome sacs, which clearly impede the movements of the larva. These

larvæ are rock-dwellers in fast mountain-streams, being only found in the shallow rapids, and never in the deep still pools. They cling to the under-surface of flat rocks lying in the main current, in company with large (undescribed) *Perlid* larvæ, which they somewhat resemble, except for their gills. They are, however, unlike the *Perlid* larvæ, very sluggish, and are only capable of rapid movements when in the water. When a rock is lifted up with a *Diphlebia*-larva beneath it, the dragging of the huge gills upon the wet rock-surface effectually prevents any speedy movement.

The gills can be fixed and kept in 70 per cent. alcohol, without collapsing; but, when dehydrated and cleared, they almost invariably collapse. They are, therefore, exceedingly difficult to section satisfactorily. They are very opaque, dull grey, brownish, or blackish, according to the locality and the colour of the rocks inhabited. In sandstone or ironstone creeks, a brownish colour prevails; in granitic or basaltic creeks, grey or blackish. Their shape varies somewhat in different individuals. Sometimes the gills are so tense as to be definitely sausage-shaped; in other cases, the gills are not so tense, and there is just a suspicion of the formation of longitudinal edges or midribs. In the latter case, the lateral gills may be described as triquetral, but with extremely convex faces.

The whole cuticle of the gill is covered by irregularly placed hairs, most of which are long and slender. They are especially long and numerous upon the posterior pointed portion of the gill, giving it a somewhat shaggy appearance.

The cuticle itself is quite clear and unpigmented. It is composed of numerous exceedingly thin parallel strata, the outermost of which differs from the rest in staining deeply and easily with eosin. The total thickness of the cuticle only averages about 8μ .

The hypodermis is a very thin epithelial layer, only about

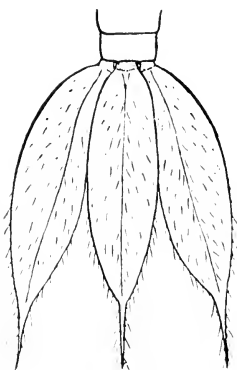

Text-fig. 12. *

Gills of *Diphlebia lestoïdes* Selys, in natural position, dorsal view; ($\times 4$).

half the thickness of the cuticle, *i.e.*, averaging only 4μ in thickness. It is everywhere so deeply pigmented that it is almost impossible to distinguish either cell-boundaries or nuclei. This pigment consists of minute granules of a blackish substance deposited in all parts of the cytoplasm of the hypodermis. It is only when the hypodermis is cut tangentially, so as to expose the polygonal outline of its cells, that it can be seen definitely

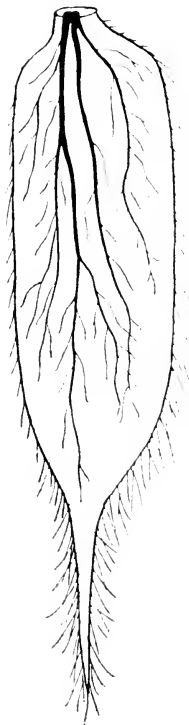

□ Text-fig. 13.*

that the pigment is less dense along the cell-boundaries, and densest towards the middle of each cell, especially around the nuclei. The latter are of the usual oval shape, and vary from 8 to 10μ in length.

The distribution of tracheæ can be seen from Text-fig. 13. The main trunks pursue a somewhat tortuous course, often coiling round one another. They give off large irregular branches, which run obliquely outwards towards the margin of the gill. These large branches again break up very irregularly into numerous smaller branches, which approach the hypodermis at all points of the gill, and finally turn to run parallel with it, giving off numerous capillaries. The courses of these latter cannot be followed owing to the density of the hypodermis pigment-layer.

The differences between the gills in the three known larvæ are only small, but appear to be of sufficient value to separate the species. *D. lestoides* Selys, has the longest gills (10.5-11 mm.), with the tips more slenderly pointed, and less hairy, than in the other two species.

The lateral gills of *D. lestoides* are also usually distinctly triquetral, the inner faces being definitely flattened against the median gill. *D. nymphoides* Tillyard, has hairier gills, 9.5-10 mm. long, somewhat less pointed, and generally much

* Left lateral gill of *Diphlebia lestoides* Selys, cleared to show tracheal system; ($\times 8$).

more swollen or sausage-shaped. In *D. euphœoides* Tillyard, the gills are shorter still, 8.5-9 mm. long, shaggy, shortly pointed, and tensely swollen.

(ii.) *The Constricted Saccus* (Text-fig.14). This very remarkable form of gill is found in the genera *Neosticta* and *Nososticta* among the *Protoneurinae*. Both larvæ are rock-dwellers, with habits closely similar to those of *Diphlebia*, except that they are often found on the sides of larger rocks in deep, still pools. These larvæ can move fairly quickly under water, and their gills are certainly not as cumbrous as those of *Diphlebia*.

The shape of the gill may be roughly described as that of a rather short candle surmounted by a flame, the basal joint representing the candle, the distal joint the flame. The constriction between the two joints is very strongly marked, and is only just sufficiently wide to allow of the passage of the main tracheæ and the blood-canals. The cuticle is covered everywhere with small, scattered hairs, which become longer and more abundant upon the distal end of the basal

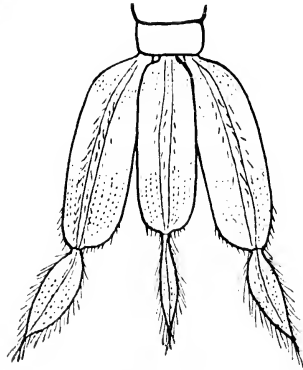

Text-fig. 14.*

joint, and also over the whole of the distal joint. As in the gills of *Diphlebia*, the cuticle is quite clear and unpigmented. The hypodermal pigment, unlike that of *Diphlebia*, is not distributed equally all over the gill, but is chiefly confined to three transverse zones, viz., around the base of the gill, around the distal third of the basal joint, and upon all except the extreme base and tip of the distal joint. This is well shown in Plate i., fig. 6. The hypodermis is of about the same thickness, 4μ , as in *Diphlebia*, and its nuclei are also of the same size as in that genus. The cuticle, however, is only 5μ in thickness, though otherwise closely resembling that of *Diphlebia* in structure.

Internally, the structure of the basal joint of the gill resembles very closely the structure of the gill of *Diphlebia*, except that

*Gills of *Neosticta canescens* Tillyard, in natural position, dorsal view; ($\times 5$).

the size of the individual alveoli is smaller. The positions of the blood-canals, nerves, and internal laminae, and the distribution of the larger tracheæ, are very similar in both forms. The branch tracheæ, however, are more numerous, and come off less obliquely from the main stems. Their branchings towards the hypodermis are also of a more dendritic character, as can be seen in Pl. i., fig. 6. In the less pigmented parts of the gill, it is possible to see bundles of capillaries starting out from the somewhat "knobby" and deeply pigmented ends of the dendritic branches. These capillaries seem to run in all directions upon the inner border of the hypodermis, and their general distribution closely resembles that seen in the Nodate Lamellar type of gill.

T.S. through the constriction of the median gill of *Neosticta canescens* Tillyard; ($\times 233$). Lettering as on p. 109.

At the constriction, the alveolar meshwork is reduced to a minimum. The two blood-canals pass through it with their inner walls almost in contact, separating the main tracheæ to left and right. A transverse section through the constriction in the median gill of *Neosticta* is shown in Text-fig. 15.

Text-fig. 15. T.S. through the constriction of the median gill of *Neosticta canescens* Tillyard; ($\times 233$). Lettering as on p. 109.

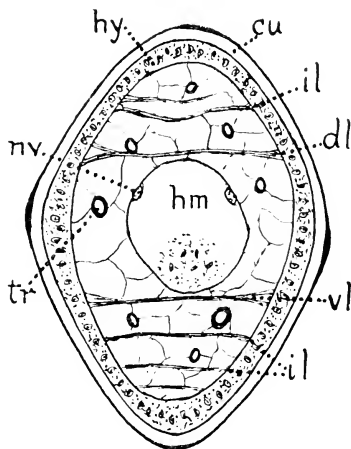

Text-fig. 15.

Text-fig. 16.* T.S. through distal joint of the median gill of *Neosticta canescens* Tillyard; ($\times 130$). *hm*, confluence of the two blood-canals; *nr*, nerve; other lettering as on p. 109.

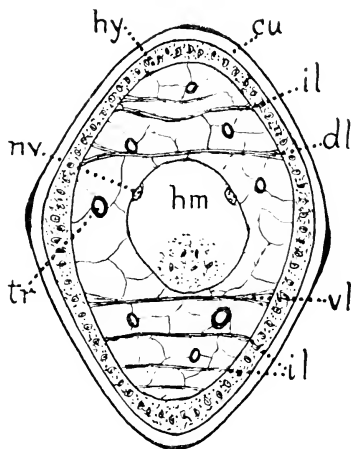

Text-fig. 16.*

* T.S. through distal joint of the median gill of *Neosticta canescens* Tillyard; ($\times 130$). *hm*, confluence of the two blood-canals; *nr*, nerve; other lettering as on p. 109.

The structure of the distal joint, examined in sections, is seen to be rather peculiar. It is, in fact, intermediate between the true saccoid type and the triquetro-quadrate type, being slightly flattened laterally, as seen in Text-fig.16. The alveolar mesh-work is present, and is supported by numerous horizontally-placed internal laminae (*il*). The tracheæ in this joint are all of small size, the main stems quickly breaking up into numerous small branches. The two blood-canals unite soon after entering the basal part of the joint.

The length of the gills in *Neosticta* is 5-6 mm., of which the distal joint occupies at the most one-third. Their greatest breadth is about 1.2 mm. The gills of *Nososticta* closely resemble those of *Neosticta* in size and shape, but may be distinguished, in common with the whole larva, by being of a more definite black-and-white banded pattern, the pattern in *Neosticta* being banded dark brown and pale yellowish-brown.

B. The Triquetro-Quadrate Type.

(Text-figs.17-18; Plate iii., figs.23-24; Plate v., figs.34-35.)

This type is not represented in Australia, being confined to the *Calopterygineæ*, which are absent from our continent (though the genus *Neurobasis* occurs in Papua). Through the kindness of Dr. P. P. Calvert, of Philadelphia, I have been able to section and study a number of gills of this type taken from larvæ of undetermined species of *Calopteryx* and *Heterina*. The importance of this type of gill is that it forms a connecting-link or intermediate stage between the Saccoid and Lamellar Types. I shall not, therefore, attempt to elucidate specific or even generic differences, which are of no importance for the purposes of this paper. An ideal transverse section of this type of gill, taken at about one-third of the total length of the gill from the base, is shown in Text-fig.17.

The term *triquetro-quadrate*, which I have suggested as suitable to denote the type of gill-system found in the *Calopterygineæ*, is intended to suggest the form of the transverse section across the three gills. The lateral gills, which are always considerably longer than the median, might be best described as triangular

prisms except that they become gradually enlarged towards the tip, and finally taper to a rather blunt point. Their transverse sections are everywhere triangular. The term "triquetral" is frequently used to describe these gills, and seems to be the most suitable term available.

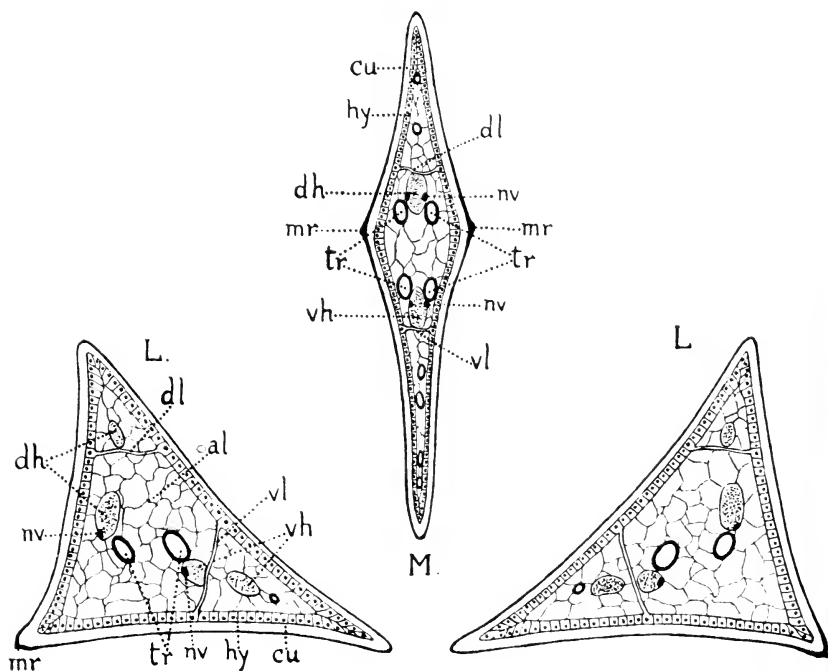

Text-fig. 17.

Ideal (semi-diagrammatic) T.S. across the Triquetro-quadrato Gill-system of *Calopteryx*, to show the internal structure of the gills. Lettering as on p. 109.

The shorter median gill has all the appearances of a vertical lamella, except that it is somewhat thickened. This gill also increases in width towards the tip, and then tapers to a point. The distal part of the gill appears to be curved over downwards, giving it a somewhat "nodding" appearance. This curvature is shown also in the blood-canals, which are also slightly down-

curved towards the tip (Text-fig.18). Now if a transverse section be made anywhere along the gill, it will be seen to be definitely diamond-shaped, with the two upper sides of the section equal and shorter than the two lower ones, which are also equal. Thus it is *quadrangular* in section. The complete gill-system, therefore, might be described as "triquetro-quadrangular," a cumbersome term which I have shortened to *triquetro-quadrate*.

Owing to their long immersion in alcohol, I can find little or no traces of the tracheal system in whole mounts of my gills, though the collapsed tracheæ are easily seen in sections. As far as I am able to make it out, the general arrangement of the tracheal system appears to be very similar to that described in *Synlestes* (p. 87). The following account of the Triquetro-quadrate Type is made almost entirely from a study of transverse and longitudinal sections.

i. *The Median or Quadrate Gill* (Plate iii., fig.23; Plate v., fig.34). The cuticle is unpigmented, and considerably thicker than in the saccoïd type. This thickening is especially noticeable at the two lateral angles of the cross section (*mr* in Text-fig. 17).

Here the total thickness is 15μ or more, of which the hard, outer structure, staining deeply with eosin, may occupy 3μ or more. The cuticle throughout the portions of the gill lying close above the lateral angles is somewhat thicker than that below them.

Seen from outside, in the whole mount, the thickened cuticle of the lateral angles forms a kind of *mid-rib* for the gill, on either side of it. In the distal portion of the gill, the central area between the two midribs stands out clearly thickened, in contrast with the outer portions, which become thin and blade-like. This closely approximates to the condition seen in the median gills of the Vertical Lamellar type, in which I have termed the thickened central portion, with the two midribs, the *rachis*, the thin outer portions the *blade*.

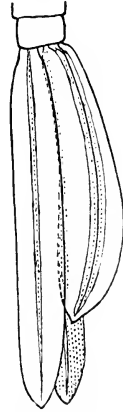

Text-fig. 18.*

* Gills of *Calopteryx* sp., lateral view, from a specimen in alcohol: ($\times 6$).

Hairs are absent from the cuticle. Stiff spines or bristles are developed along each mid-rib, also along the dorsal and ventral edges of the blade.

The hypodermis is, on the whole, a very thin, somewhat irregular layer of cells, usually only $3-4\mu$ in thickness. Around the four angles of the cross-section, it is thicker, especially beneath the two mid-ribs. Pigmentation is only of moderate density. There appear to be two transverse zones in the distal half of the gill (*Calopteryx*) where the pigmentation is much less dense than elsewhere.

The central portion or *rachis* of the gill may be considered to be bounded by the two zones of principal internal laminæ (*dl*, *rl*), which bound the two blood-canals externally. Within the cavity of the rachis, all the more important structures of the gill are collected. There are well-defined, oval, dorsal and ventral blood-canals (*dl*, *rl*). In the walls of each canal, there runs a pair of longitudinal nerves (*nv*), of which the dorsal pair are considerably larger than the ventral pair. A little nearer to the centre of the gill, and almost touching the blood-canals, lie the two pairs of main longitudinal tracheæ (*tr*). The rest of the rachis is occupied with the alveolar meshwork, which is much less abundant than in the more capacious saccoid gills.

The interior of the blade of the gill, both dorsally and ventrally, is occupied by a small amount of alveolar meshwork, supported at irregular intervals by short, transverse, *secondary internal laminae* (Plate v., fig. 34, *dl'*). Branch tracheæ of considerable size are to be seen traversing this part of the gill obliquely.

ii. *The Lateral or Triquetral Gills* (Plate iii., fig. 24; Plate v., fig. 35). The cuticle and hypodermis resemble those of the median gill, but are considerably thicker, the cuticle averaging 13μ or more in thickness, the hypodermis 6μ or more. The cuticle is thickened along all three edges, and carries spines or bristles there. The thickening is, however, especially noticeable along the *outer* edge (Text-fig. 17, *mr*), which forms the true mid-rib of the gill, corresponding with the mid-rib seen in the lateral gills of *Lestideæ*.

Internally, the structure of the triquetral gill closely resembles that of a lateral saccoid gill, except for the shape. There is a very great development of the alveolar meshwork. The zones of principal internal laminae are arranged in such a way as to cut off, in cross-section, the upper and the lower inner corners of the triangle, the dorsal laminae lying almost horizontally, and the ventral ones not far from vertically. This arrangement, again, is paralleled in the obliquity of these laminae in the lateral gills of the saccoid type.

In the central part of the gill, the two blood-canals, the two main longitudinal tracheae, and the two main nerves, run unsymmetrically, the ventral set being placed at a lower and inner level compared with the dorsal. A very peculiar development, confined, as far as I can ascertain, to gills of this type, is the splitting-up of the blood-canals, each of which gives off an important longitudinal branch to run in the outer portion of the gill, on the other side of the principal internal laminae (Text-fig. 17, *dh*, *vh*). All four branches become confluent again near the distal end of the gill.

Secondary internal laminae are developed at frequent intervals, within the two portions of the gill cut off by the principal laminae. These laminae lie parallel with the corresponding principal laminae, but not all at the same level, so that sometimes two or more of them may be cut in the same section.

C. The Lamellar Type.

(Text-figs.19-29; Plate i., figs.1-5, 7-11; Plate ii., figs.12-20; Plate iii., figs.25-27; Plates v. and vi., figs.36-39.

In this type, all three gills are reduced to flattened lamellar organs, with consequently a great reduction in the volume of the interior of the gill. The alveolar meshwork becomes much reduced in amount, and is principally confined to the thickened portion of the gill, lying beneath the mid-rib. This thickened central portion, I propose to term the *rachis*, using the term *blade* for the outer and flatter portions of the lamella.

The *rachis* is always bounded, either on one or both sides, by a thickened ridge of cuticle, forming a strong mid-rib (*mr*). In the interior of the *rachis* run the longitudinal tracheal trunks,

the longitudinal nerves, and the blood-canals. In Vertical Lamellar Types, the original rachis, bounded laterally by the two zones of principal laminæ, is not entirely confined to the thickest part of the gill, under the mid-rib, but extends slightly outwards both dorsally and ventrally. The principal longitudinal tracheæ then occupy the middle portion, under the mid-rib, while the blood-canals and their accompanying nerves lie dorsally and ventrally within the outer portions. This arrangement is carried even further in the *Lestidæ*, where the rachis becomes divided, by two longitudinal constrictions, into three parts, viz., a greatly swollen central portion carrying mid-rib and tracheæ, and dorsal and lateral extensions, only slightly swollen, each carrying a blood-canal and its accompanying nerve or nerves. This is well seen in Text-fig.19.

In Horizontal Lamellar Gills, the rachis remains undivided, carrying the blood-canals and nerves ventrally, the main tracheæ being arranged one on either side of the blood-canals (Text-fig.28).

We shall deal with the various forms of Lamellar gills under two main headings or sub-types, the first of which will again be divided into a number of separate sections. These two sub-types are (a) the Vertical Lamellar, and (b) the Horizontal Lamellar Sub-type.

(a) *The Vertical Lamellar Sub-Type* (Text-figs.19, 22).

This form is clearly a specialisation from an older Triquetro-quadrate Type. The quadrate median gill of this latter type is already practically a vertical lamella as regards its more distal portion. It only requires slight further flattening, and a further differentiation between rachis and blade, to make it a true lamellar type. The change which will produce a lamellar gill from the triquetral lateral gill is, however, more profound, since it must undergo, not only much greater flattening, but also a definite change in the direction of its main axial plane. The triquetral gill is suitable for resting upon a flat horizontal surface, with its mid-rib outwards. In a triangular section, we consider the mid-rib to occupy the vertex, so that the base is the long side facing the median gill. The triangle is then nearly, but not quite, isosceles. The lamellar form has been pro-

duced by gradual lengthening of the base, concurrently with a flattening down upon it of the mid-rib and its two adjacent sides. At the same time, the larva ceased to rest the gill upon the ground, but held it out freely into the water, so that the plane of the base gradually changed from oblique to vertical, as in the median gill. The vertical portion is, however, never actually *fully* attained, as may be seen from Text-figs.19, 22.

Under this sub-type, we have to deal with two very distinct groups of gill-forms, one found in the *Lestidæ* only, the other in the *Agrionidæ*. These must now be dealt with separately.

(i.) *The Lestid Form of Vertical Lamellar Gill.*

(Text-figs.19-21: Plate i., figs.1-5; Plate iii., fig.25: Plate v., figs.36, 37).

These are always simple, unjointed, vertical lamellæ. They vary much in external appearance. But a study of them by means of sections shows the following characters to be constant throughout the group.—

1. The median gill has two mid-ribs, right and left; the lateral gills have only one mid-rib, on the outer face.

2. The median gill carries two main longitudinal tracheæ; the lateral gills only one apiece.

3. The rachis is constricted off into a swollen central portion carrying the main tracheæ, and dorsal and ventral outer portions, not much thicker than the blade of the gill, each carrying one of the blood-canals.

4. In connection with the above constrictions, the principal internal laminae are excessively shortened, and can only just be made out as short remnants connecting the closely approximated hypoderm-layer of right and left sides.

5. In the median gill, only the two dorsal longitudinal nerves are present, lying upon the wall of the dorsal blood-canal. No nerves can be seen on the wall of the ventral canal. This reduction is unique for functional caudal gills, all other forms showing two pairs of longitudinal nerves.

6. The alveolar meshwork is reduced to a minimum, its remnants surrounding the large tracheæ in the central portion of the rachis.

Except at the mid-rib, the *cuticle* is only of moderate thickness, about $8-9\mu$; but nearly half of this is usually occupied by

the tough outer stratum which stains deeply with eosin. Along the mid-rib, this tough outer stratum becomes twice as thick. Small spines or bristles are arranged regularly along the mid-ribs, as well as along the dorsal and ventral edges of the gill-blade, right up to its distal end, where, also, a few hairs may be present.

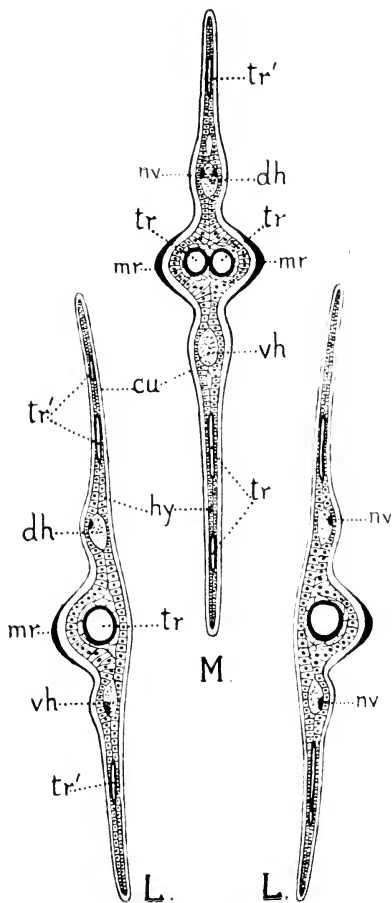

Text-fig. 19.*

Some of the columnar or spindle-shaped cells may be as much as 30μ in height, but they are much narrower than the ordinary flattened cells, and much

* Ideal (semi-diagrammatic) T.S. across the Vertical Lamellar Gill-system of *Austrolestes* (*Lestid* Form of Gill) to show the internal structure of the gills. Lettering as on p. 109.

closer together. Their nuclei do not exceed $8\text{-}9\mu$ in length. Pigmentation of the hypodermis is usually only moderately dense, but, in some forms, dense bands of black pigment run across the gill at definite levels.

The *Lestid* gill-form is divisible into two very distinct sub-groups, each representative of a single sub-family.

In the *Synlestinae* (genus *Synlestes*, Text-fig.20; Plate i., figs. 4-5; Plate iii., fig.25), the gills are short, or only of moderate length. The branch-tracheæ come off from the main longitudinal stems *obliquely*. Bands of dense black pigment are absent.

Synlestes weyersi Selys (Text-fig.20; Plate i., fig.4) has the gills about 6 mm. long when full-grown, distinctly pointed at tips, and carrying a few long, slender hairs distally. The median gill is slightly shorter than the laterals.

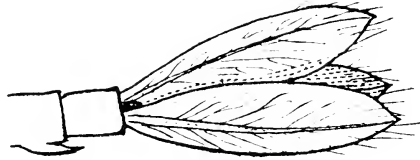

Text-fig.20.

Gills of *Synlestes weyersi* Selys, in natural position, lateral view; ($\times 6$).

The three gills are held fairly close together, the angle between the two laterals being about 20° , and the median gill being raised only about 15° above them.

Synlestes albicauda Tillyard (Plate i., fig.5) has the lateral gills barely 4 mm. long when full-grown, broad and evenly rounded at the tips, and without any long hairs. The median gill is 0.5 mm. shorter, closely similar in shape to the laterals, but somewhat more oval. The gills are held fairly close together in life, as in *S. weyersi*.

In the *Lestinae* (genus *Austrolestes*, Text-fig.21; Plate i., figs. 1-3) the gills are excessively elongated, and usually with well-rounded tips. No long hairs are present, but there may be a few short ones near the tip. The branch-tracheæ come off from the main longitudinal stems *practically at right angles*, a character peculiar to this subfamily. Transverse bands of dense black pigment are frequently developed on these gills. The lateral gills are usually quite straight, and of nearly the same width throughout; the median gill is usually slightly shorter, a little

curved downwards towards the tip, and a little broadened at the base. Three transverse zones of dense pigmentation are usually to be distinguished, viz., one about one-fourth the length of the gill from the base, another about half-way, and a third not far from the tip.

It is interesting to note that *regenerated Lestine* gills take on a form closely resembling the gills of *Synlestes*, being much shorter, pointed at the tips, and with the branch-tracheæ running obliquely out from the main stem. The number of main longitudinal tracheæ is usually doubled in the regenerated gill. This would appear to be strong evidence in favour of the descent of the *Lestine* gill-form from the older *Synlestine* form, and of both of these from the still older Triquetro-quadrata type, with double the number of main tracheæ.

In life, the larvæ of *Lestina* hold their gills very wide apart, the laterals at an angle of from 45° to 60° to one another, the median being held high above them at an angle of from 60° to 75° . As in all vertical lamellar gills, the mid-ribs do not divide the gills into two *equal* portions, but run asymmetrically—in the lateral gills, nearer to the ventral edge; in the median gills, nearer to the dorsal edge, as shown in Text-fig.21.

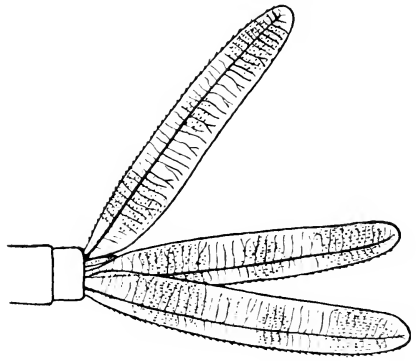

Text-fig.21.

Gills of *Austrolestes ciugulatus* (Burm.), in natural position, lateral view: ($\times 4\frac{1}{2}$)

The larvæ of four Australian species of *Austrolestes* are known to me. Their gills can be distinguished as follows:—

- | | | |
|---|--|---------------------------|
| { | Lateral gills about 9 mm. long when full-grown, with well-pointed tips; much longer than median gill (6·8 mm.), which is wider, with rounded tip. The three dark pigment-bands only faintly indicated..... | 1. <i>A. analis</i> Ramb. |
| | Lateral gills with well-rounded tips, only slightly longer than median..... | 2. |

2. { The three dark pigment-bands barely indicated; lateral gills 10 mm.
long, median 9 mm. *A. cingulatus* Burm.
3. { The three dark pigment-bands very conspicuous..... 3.
3. { Lateral gills 9 mm. long, median slightly less..... *A. psyche* Selys.
{ Lateral gills 7 mm. long, median slightly less..... *A. lela* Selys.

In addition, the New Zealand *A. colenisonis* White, has the gills very long and narrow, with pointed tips; the median gill is longer and more pointed than in *A. analis*.

In Plate i., I have figured the lateral gill of *A. psyche* (fig.1) and the median gill of *A. cingulatus* (fig.2), together with the tip of the same gill of *A. colenisonis* for comparison.

(ii.) *The Agrionid Form of Vertical Lamellar Gill.*

(Text-figs.22-26; Plate i., fig.7; Plate ii., figs.12-20; Plate iii., figs.26, 27; Plate v., figs.38, 39).

These gills exhibit immense variety in shape and appearance, but all show the same internal structure. All the Vertical Lamellar Gills of *Agrionidæ* so far examined by me are either two-jointed, or show undoubted signs of having been so originally. The principal characteristics which separate the *Agrionid* gills from the *Lestid* forms are as follows:—

1. Both median and lateral gills have *two* mid-ribs, right and left.

2. Both median and lateral gills carry *two* main longitudinal tracheæ. But, whereas both these pass through the base of the median gill, only one enters the base of the lateral gill, the bifurcation occurring just inside the gill itself.

3. Although the blood-canals lie dorsally and ventrally on either side of the main tracheæ (as in the *Lestidæ*), yet the rachis is not so definitely constricted off into three portions as it is in the *Lestid* gill. Large secondary internal laminae are sometimes developed in the rachis, between the blood-canals and the main tracheæ.

4. The principal internal laminae are well-developed. Numerous secondary laminae are developed in both dorsal and ventral portions of the gill-blade.

5. In the median gill, all four principal nerves are present, in

their usual positions (as in all functional gills except those of *Lestidæ*).

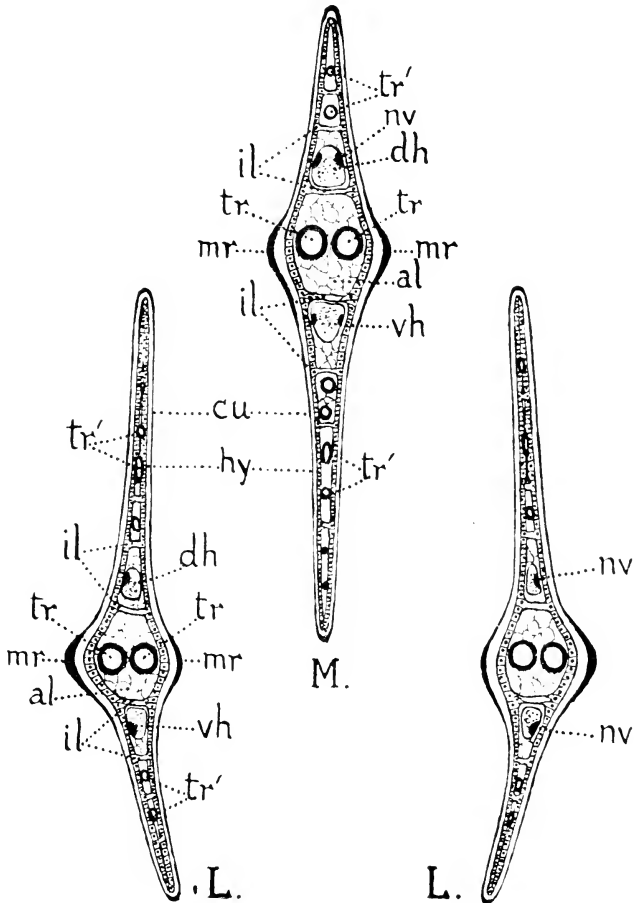

Text-fig. 22.

Ideal (semi-diagrammatic) T.S. across the Vertical Lamellar Gill-system of *Austroagrion* (*Agrionid* Form of Gill), to show the internal structure of the gill. Lettering as on p. 109.

6. The alveolar meshwork is reduced, but less so than in the *Lestidæ*; traces of it still existing in the gill-blades as well as in the rachis.

The *cuticle* averages about 9μ in thickness, but the tough outer stratum is usually not more than 2μ in thickness. Along the mid-rib, this outer stratum becomes thickened to 4μ or 5μ ; it is also somewhat thickened along the dorsal and ventral edges of the gill. Spines are present upon the mid-ribs and edges of the gill, but usually only from the base to some definite point, marking the end of the original basal joint of the gill.

The *hypodermis* is not modified into columnar or spindle-shaped cells as in the *Lestidæ*, but remains everywhere a flat epithelium, with the nuclei lying parallel to the cuticle. There is, however, a very distinct difference in size between the nuclei found in the basal joint of the gill, and most of those found in its more distal portion. The former average about 8μ in length, and are even larger (up to 10μ) in those cells from which the principal internal laminae are developed; the latter only average 6μ in length, and do not stain with the same intensity. In many places, the hypoderm-layer is exceedingly thin, only $3-4\mu$ in thickness, so that the nuclei, even though lying parallel with the cuticle, cause periodical bulgings in the hypodermis. In spite of the narrowness of the gill-blade, many of the cells of the hypodermis seem to take part in forming alveolar tissue; if the gill be stained *in toto*, this meshwork can be seen lying everywhere within the basal portion of the gill (except at the extreme edges), and even in the more distal part, the meshwork can be seen running along both sides of the rachis, nearly to the tip.

In some gills, hypodermal pigment is almost absent; in others, the pigment may occur either in transverse bands, or in irregular patches. A few are deeply pigmented all over.

The tracheal system varies much in details, but the branches never come off from the main stems perpendicularly (as in *Lestinæ*), but always obliquely.

In naming and describing the sub-groups into which I propose to divide these gills, I have had in mind their descent from an original two-jointed gill. Four phylogenetic stages can be seen in this process, and I have classified the gills accordingly, as follows:—

a. The Constricted Vertical Lamella. In this, the two original joints are present, separated by a very distinct suture or constriction.

β. The Nodate Vertical Lamella. The two original joints have fused into one, but their point of union is marked by a *node* of the type described below (p.94), which is formed by the reduction of the original suture or constriction.

γ. The Subnodate Vertical Lamella. The node is only indicated by a change in the thickness of the gill, together with the stopping short of the cuticular spines at the point where the node once was.

δ. The Denodate Vertical Lamella. All traces of the node are lost, except, perhaps, for a slight change in the thickness of the gill.

a. The Constricted Vertical Lamella (Text-fig.23; Plate i., fig.7).

This form of gill only occurs, to my knowledge, in the genus *Isostricta* of the *Protomenurinae*. It is of very great interest, not

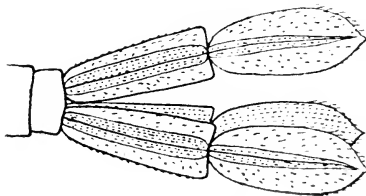

Text-fig.23.

Constricted gills of *Isostricta simplex* Martin, in natural position, lateral view: (x 8).

only because it is a *definitely two-jointed lamella*, but also because it stands exactly half-way between the constricted or two-jointed saccus of *Neosticta* and the Nodate Vertical Lamella found in the tribe *Pseudagrionini*. This change in the habits of the larvæ. *Neosticta*

is, as we have seen, a rock-dweller in running water. *Isostricta* dwells in trash, twigs, or matted roots, on the bottoms of slowly-moving streams. In the position of rest, it holds its gills well away from the resting-surface. Occasionally it climbs up into clumps of water-weed, in which case the larva becomes brown instead of almost jet-black (its natural colour). In slenderness of form, it is a typical *Agriionid* larva.

Our original simile of the "candle and flame," used to describe the appearance of the gills of *Neosticta*, would hold fairly well for *Isostricta*, if we add that, in this case, the flame is as big as

the candle, and both it and the candle itself have become flattened. This is well seen in Plate i., fig. 7. The gill is opaque throughout, deeply pigmented in brown or black. Consequently the tracheal system is very difficult to follow: but it can be seen, in specimens fresh from ecdysis, to be very similar to that of *Neosticta*, except that there are always *only two* main tracheæ in each gill. The cuticle is covered with short, shaggy hairs, especially upon the distal joint. The length of the median gill is 4.5 mm., that of the laterals 5 mm.; the former is slightly wider, and its tip more rounded than in the latter. These gills are held well apart from one another, the angle between the two laterals being from 20° to 30°, while the median gill projects above them at an angle of from 30° to 40°.

β. The Nodate Vertical Lamella. (Text-fig. 24; Plate ii., figs. 12-14).

This form of gill occurs in the three allied Australian genera *Caliagrion*, *Pseudagrion*, and *Austroagrion* (also in the Palearctic genus *Erythromma*). It is the most beautiful type of caudal gill known, principally because of the wonderful dendritic arrangement of the terminal tracheal branchlets from which the capillaries are given off. These branchlets are short, knobby, and densely pigmented, giving the effect of the short, bent branches of a densely branching oak tree. The pigment is especially dense at their ends, and gives them the "knobby" appearance already mentioned, as may be seen in Text-fig. 24.

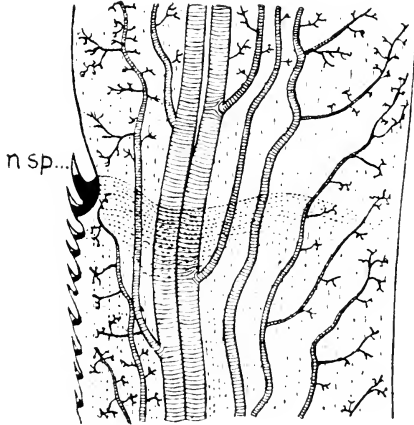

Text-fig. 24.

Portion of gill of *Caliagrion billinghursti* (Martin), to show the node and nodal line. *n.sp.* nodal spine. From a cleared whole mount; ($\times 28$).

Though not so distinctly two-jointed as the constricted form of gill, the nodate form is easily seen to consist of two parts, viz., a basal thickened portion, in which the hypoderm-nuclei are almost all of the larger size, and a distal thinner portion, with hypoderm-nuclei mostly of the smaller size. The boundary between these two parts is not equally distinct across the gill from one edge to the other. On that edge of the gill which faces outwards in the natural position (*i.e.*, the dorsal edge of the median gill, and the ventral edges of the laterals), there is a very distinct notch or depression of the edge, bordered basally by a very conspicuous spine, which is the last, and the largest, of a series of spines running along this edge from the very base of the gill. This notch I have termed the *node*.

From the node, the division between the two portions of the gill is marked by the *nodal line*, which runs inwards to the rachis, usually somewhat obliquely towards the base, until it reaches the mid-rib, which is generally spineless. Fairly dense pigmentation along the distal border of the thick basal portion renders the nodal line very clearly marked in this part of the gill. From the mid-rib onwards to the inner edge of the gill, the division is not so clearly marked. It can usually be traced, either transversely across the gill, or slightly obliquely, for at least two-thirds of the distance from mid-rib to inner edge. On approaching the latter, it becomes faint, and may disappear completely. This is due to the fact that the basal portion is not swollen along the part bordering the inner edge, but is thin like the distal portion, and merges into it without any definite boundary line. There are either no spines along the inner margin, or only small ones running from the base to the division-line.

These gills are always somewhat narrowed at the base, whence they gradually broaden out until the node is reached. Beyond the node, after the slight constriction, the gill-blade either again broadens out, ending in a very broadly rounded tip, or the two edges remain parallel, with the tip well rounded off, but not broadened. The rachis and mid-ribs always lie much closer to the outer than to the inner edge of the gill, and are only poorly developed beyond the level of the node.

In the position of rest, these gills are held in the same manner as those of *Isosticta* (see Text-fig.23).

The three Australian genera having nodate gills may be separated as follows :—

- | | | |
|------|---|---|
| { | Node situated well before half-way. Distal portion of gill with the well-rounded tip not enlarged. Inner edge of gill with spines suppressed, except at extreme base..... | 1. <i>Caliagrion</i> Tillyard; (Pl. ii., fig.12). |
| | Node situated at about half-way. Distal portion of gill considerably widened towards tip. Inner edge of gill with spines present up to nodal line..... | 2. |
| 2. { | Tip quite rounded. Spines of the inner edge slender, much smaller than those of the outer edge..... | <i>Pseudagrion</i> Selys; (Pl. ii., fig.13). |
| | Tip with a tiny sharp point. Spines of the inner edge stout, almost as large as those of the outer edge..... | <i>Austroagrion</i> Tillyard; (Pl. ii., fig.14). |

The following are short descriptions of the gills of the known larvæ:—

1. *Caliagrion billinghami* Martin. Length of gills when full-grown, median 8.5, laterals 8.5 mm.; median gills slightly broader than laterals, and slightly bent at node. Nodal spines enormous; nodal line oblique from outer edge to rachis, thence to inner edge either transverse or slightly inclining distad. Colour of gills either bright green, or orange-pink (apparently according to the colour of the leaves of the reed on which the larva dwells). Pigmentation very beautiful, arranged as shown in Plate ii., fig.12.

2. *Pseudagrion australasie* Selys. Length of gills when full-grown, median 6 mm., laterals 6 mm., median broader than laterals. Nodal spines large; nodal line oblique right through to inner edge. Colour of gills usually rich brown, more rarely greenish or yellowish; pigmentation in dark brown, as shown in Plate ii., fig.13.

3. *Pseudagrion aureofrons* Tillyard. Very similar to those of *Ps. australasie*, but shorter (5 mm. when full-grown); colour pale yellowish-brown, with less distinct pigmentation.

4. *Austroagrion cyane* Selys. Length of gills when full-grown, median 3.7 mm., laterals 4.3 mm., median broader than laterals.

Nodal spines only moderately large, those of inner border almost as large; nodal line oblique, especially so from mid-rib to inner edge. Colour of gills dull brownish or yellowish, crossed with two bands of brown or grey pigment, one at node, and the other half-way between node and tip (Plate ii., fig.14).

The gills of the Palearctic *Erythromma najas* Hansemann, appear to resemble most closely those of *Caliagrion*. Under the present classification, *Erythromma* falls into the Tribe *Agrionini*, on account of its wing-venation, whereas the three Australian genera belong to the Tribe *Pseudagrionini*. It is interesting, therefore, to note that, in its wing-venation, *Caliagrion* approaches most closely of the three to the venational stage which separates the *Agrionini* from the *Pseudagrionini*.

γ. *The Subnodate Vertical Lamella*
(Text-fig.25; Plate ii., figs.15, 16).

A stage further on in the process of the elimination of the suture of the originally two-jointed lamella may be seen in the *subnodate* form of gill, which occurs in the genera *Ischnura* and

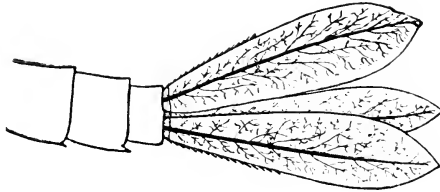

Text-fig.25.

Subnodate gills of *Ischnura heterosticta* Burm., in natural position, lateral view; ($\times 6$).

Ceriagrion. Here the original nodal constriction is lost, but the position of the node is still clearly marked by the sharp ending of the row of spines along the outer edge of the gill. Concurrently with this, the gill becomes definitely pointed, with the branch tracheæ coming off from the main stems very obliquely, and more regularly than in the nodate form of gill; while the dendritic form of the end-branches, though still present, is not by any means so noticeable. Small spines are present on the

inner edge of the gill, but only for a short distance from the base. In the resting position, the gills are held much as in the constricted and nodate forms.

The two genera with subnodate gills may be separated as follows:—

- | | |
|---|--|
| { | Gills short and broad, not much pointed; nodal spines large; no spines developed along the mid-ribs.... <i>Ceriagrion</i> Selys; (Pl. ii., fig.15). |
| | Gills rather long and slender, moderately well pointed; nodal spines rather small; spines developed along the mid-ribs as far as the level of the node..... <i>Ischnura</i> Charp.; (Pl. ii., fig.16). |

The gills of the following species are known:—

1. *Ceriagrion erubescens* Selys. Length of both median and lateral gills 2·5 mm.* Median gill wider and less pointed than laterals. Base of gill rather narrow, stalk-like, distal half broadened out. Node situated about half-way along gill. Colour dull greyish, a touch of yellowish-brown near bases; no pigment-bands. Branch tracheæ very closely crowded together (Plate ii., fig.15).

2. *Ischnura heterosticta* Burm. Length of gills when full-grown, median 5·7 mm., laterals 6 mm.; median gill slightly wider and less pointed than laterals, and a little bent. Gills lanceolate, the base only slightly narrowed; the width of the gill increasing up to about three-fourths of the total length, when the width quickly narrows as the edges approach the pointed tip. Node situated at about two-fifths of the gill-length. Colour pale yellow, cream, or pale green; no pigment-bands, but sometimes slight patches of brownish pigment may be seen at intervals along the rachis. Branch tracheæ very regularly arranged, not closely crowded together (Text-fig.25; Plate ii., fig.16).

3. *Ischnura aurora* Br. Closely resembling those of *I. heterosticta* in structure and shape, but much smaller when full-grown (only 4 mm.). Colour greyish-black. (The larva is black, while that of *I. heterosticta* is green or yellow).

* Both the larvæ taken and preserved by me were at the end of the penultimate instar; a third larva was bred out, but the gills of the exuvie shrivelled up.

δ. *The Denodate Vertical Lamella.*

(Text-figs.26, 27: Plate ii., figs.17-20).

As the final stage in the process of reduction from a two-jointed to a secondarily simple lamella, we have the *denodate* form of gill, found in the Australian genera *Agrionnemis* and *Austrocnemis*, and in the New Zealand genus *Xanthocnemis*. These are all characterised by *complete loss of the node*. The original position of the node is no longer indicated, as in the

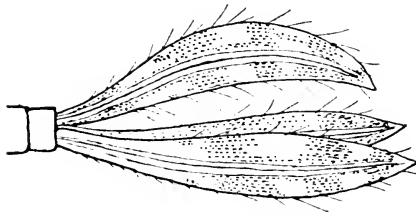

Text-fig.26.

Denodate gills of *Austrocnemis splendida* (Martin), in natural position, lateral view: ($\times 6$).

subnodate form, by a point at which the row of spines along the outer edge stops short; for in these gills, the spines, if present, are developed along the whole outer border of the gill, from base to tip. The spines are, however, always small and weakly formed, and

are more usually replaced by slender hairs.

In the three Australasian genera in which denodate gills are known to occur, the shape of the gill is long, narrow, and well pointed. The distinction between the thicker basal portion and the thinner distal portion can be seen, but is not as clearly marked as it is in the shorter and broader denodate gills in the larvæ of some Palearctic species. Ris(27) has called attention to this peculiarity in the gills of *Agrion mercuriale* Charp., and *Pyrrosoma nymphula* Selys, without offering an explanation of it. In *Agrion puella* Linn., and *A. pulchellum* Vanderl., on the other hand, as Ris' figures well show, the gills are of the true nodate form.

The three Australasian genera with denodate gills may be separated as follows:—

- | | | |
|---|--|----|
| { | Gills pale, transparent, not heavily pigmented, not as long as the abdomen of the larva..... | 1. |
| | Gills heavily pigmented, semi-opaque, quite as long as the abdomen of the larva... <i>Austrocnemis</i> Tillyard; (Text-fig.26; Pl. ii., figs.18-20). | |

1. { (Gills exceedingly narrow, quite unpigmented, the pointed tip not formed by sudden narrowing-in of the gill-edges.....
 *Argiocnemis* Selys; (Pl. ii., fig.17).
 (Gills moderately narrow, lightly pigmented near tip; the tip very sharply pointed, and formed by sudden narrowing-in of the gill-edges from the broadest part of the gill.....
 *Xanthocnemis* Tillyard; (Text-fig.27).

The gills of the following species are known:—

1. *Austrocnemis splendida* Martin. Length of gills, when full-grown, median 7.6 mm, laterals 8 mm. Median gill strongly bent like a bow, basal third narrowed to a stalk, the rest broadly falcate, crossed by three very irregular transverse bands of chocolate-brown pigment. Lateral gills much narrower, not bent; basal third narrowed to a stalk, the rest lanceolate, with three pigment-bands as in median gill. Tracheal system not easily followed out, owing to the semi-opacity of the gill. The broad portions of the gills edged with some long, delicate hairs (Plate ii., figs.18-19).

Of the three specimens of this rare larva secured, one was bred out, the other two preserved. One of these had a regenerated lateral gill, which I have figured in Plate ii., fig.20. This gill is only 3.4 mm. long, very narrow, and has three main longitudinal tracheæ. The great point of interest about it, however, is that it shows, not far from the tip, the very distinct transverse division into two parts seen in the gills of *Agrion mercuriale* and *Pyrrosoma nymphula*. This appears to me to afford definite proof of the descent of this remarkable gill-form from the true nodate type.

2. *Argiocnemis rubescens* Selys. Length of gills, when full-grown, median 5.6 mm., laterals 5.6 mm., the median slightly wider and less pointed than the laterals. Base of gill narrowed to a stalk, rest narrowly lanceolate. Colour pale yellowish or creamy, rarely slightly greenish; no pigment-bands. Tracheal system closely resembling that of *Ischnura*, but the branch tracheæ inclined at a somewhat less angle to the main stem. Spines of the outer edge reduced to short bristles; from base up to about two-fifths of the gill-length, these bristles are set in

strong chitinous bases, indicating the original set of spines ending at the node; on the inner edge, there is a set of strong chitinous bases carrying small bristles along the basal fourth of the gill, corresponding with the series of spines in the same position in *Ischnura*. (Cf. Plate ii., figs.16, 17).

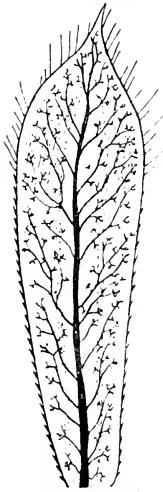

Text-fig. 27.*

This gill-form is obviously a simple reduction from the subnodate form seen in *Ischnura*, and is very closely allied to it.

3. *Xanthocnemis zelandica* Selys. Length of gill, when full-grown, about 4 mm. Gills lanceolate, broadest near tips, then suddenly narrowing to form the sharply-pointed tips. Colour pale brownish, yellowish or greenish, a band of medium brownish pigment across the broad part near the tip. Tracheal system much as in *Ischnura*, but with fewer branches, more regularly placed. Outer edge of gill furnished from base to near tip with short bristles, set in a regular series of strongly-projecting chitinous bases. A few irregularly placed bristles along basal portion of inner edge. Towards tip, both edges carry some long, delicate hairs (Text-fig. 27).

(b) *The Horizontal Lamellar Sub-type.*

(Text-figs. 28-29; Plate i., figs. 8-11; Plate vi., figs. 40-45).

This extraordinary form of gill is only found, as far as I am aware, in the Australian genus *Argiolestes*, belonging to the subfamily *Megapodagrioninae*. I do not think that it will prove to be typical of that ancient subfamily, in which we might reasonably expect to find a more generalised form of gill dominant, when the larvæ of many genera become known.

The gills are broad, leaf-like structures spread out in the horizontal plane, so as to resemble closely in form the "tail-fan" of Decapod Crustacea. In life, they are held out extended at an angle of from 10° to 20° to the plane of rest. When walking,

* Denodate median gill of *Xanthocnemis zelandica* (Selys). From a cleared whole mount; ($\times 15$).

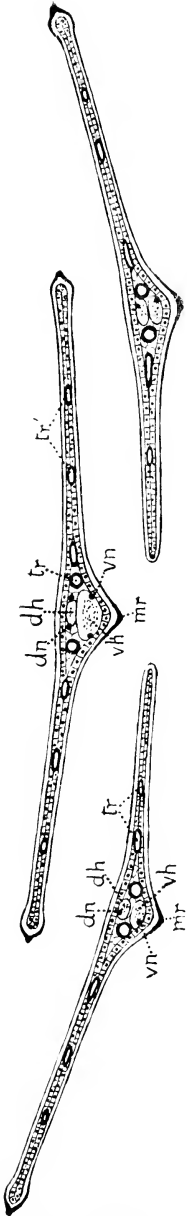

Text-fig. 28. *

the larva often raises these gills considerably, together with the terminal part of the abdomen. When resting on a rock-surface, the larva, if alarmed, at once depresses the gills closely against the rock. A curious point about these gills is that they are slightly *concave* on their upper surfaces. This is well seen in the cross-section in Text-fig. 28. It is due to the almost complete suppression of the dorsal mid-rib in all three gills, the ventral mid-ribs being strongly developed. The median gill is symmetrical, and lies quite horizontally. The laterals are asymmetrical,—the outer portion of the blade being wider than the inner,—and are held at a slight angle to the horizontal, slanting upwards and outwards.

The transverse section of one of these gills may be described as an extremely flattened triangle, except near the base of the gill, where the cavity is wider, as shown in Plate vi., figs. 40-41. The vertex of the triangle is represented by the ventral mid-rib, the base by the wide upper surface of the blade. The rachis is small, subtriangular, and carries along its middle line the blood-canals, which lie practically in contact with one another. The dorsal blood-canal is smaller and more regularly formed than the ventral. On either side of the blood-canals, towards the lateral limits of the rachis, run the two main longitudinal tracheae. The nerve-supply is as usual, the

* Ideal (semi-diagrammatic) T.S. across the Horizontal Lamellar Gill-system of *Argiostes*, to show the internal structure of the gills. Lettering as on p. 109.

median gill possessing a pair of dorsal longitudinal nerves and a pair of ventral ones, while the lateral gills have only one of each, placed on the outer wall of the corresponding blood-canal.

The rachis of the median gill is bounded internally on either side by a series of *secondarily developed internal laminae* (Plate vi., fig.43, *il*) passing from the dorsal to the ventral side of the gill. Similar but less strongly developed laminae occur at intervals at different levels along the blade of the gill (*il'*). These laminae are not, of course, the original laminae of the gill before it became horizontally flattened. The remnants of the original series of principal laminae, running horizontally across the gill, are to be seen only in a set of slender laminae crossing the rachis below the ventral blood-canal (Plate vi., fig.42, *vl*). These laminae mark off ventrally what was the original rachis of the gill from the remnant of its ventral blade, which has now become the portion just above the mid-rib. The present blade of the gill, to right and left of the new rachis, is purely an extension of the old rachis itself, due to intense flattening and widening in the horizontal plane. As will be seen from Text-fig.28, the original right and left mid-ribs of the gill, before it became horizontal, are still preserved as the swollen, somewhat knobbed, edges of the new blade.

The cuticle is rather thin, averaging about 6μ in thickness, of which the tough outer stratum occupies from 2 to 3μ . The hypodermis is slightly thinner than the cuticle, averaging about 5μ in width, but somewhat irregular. The nuclei mostly lie with their long axes parallel with the cuticle. They are of small size, only $5-6\mu$ in length, except near the base of the gill, where many of the nuclei are considerably larger. The hypodermis is almost everywhere pigmented, but in certain transverse zones the pigment-granules are exceedingly abundant, almost hiding the nuclei from view.

Considering how narrow the space in the interior of these gills is, it is rather surprising to find the alveolar meshwork present, not only in the rachis, but also throughout the blade. The meshwork is most extensively developed in the space between

the two main tracheæ and the mid-rib. The nuclei of the mesh-work closely resemble those of the hypodermis in size and shape.

The tracheal system is moderately well developed, but the branch tracheæ are neither so abundant nor so regularly placed as in Vertical Lamellar Gills.

These gills are frequently lost or cast off by the larvæ, the breaking-joint being very perfectly formed. Consequently larvæ are very commonly found with one or more *regenerated* gills. In these there will always be found *four* main longitudinal tracheæ, in the case of the median gill, and usually three (rarely four) in the laterals. The regenerated gill is stouter and less expanded than the normal gill, and more resembles a rather flattened saccus (Plate i. fig. 11). Usually a transverse band of dark pigment separates a thicker basal portion from a thinner distal portion, and suggests the origin of this type from an originally two-jointed form.

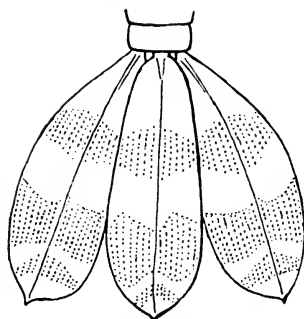

Text-fig.29. ⁶

The larvæ of only two species are known, and their gills may be distinguished as follows:—

- | | |
|---|--|
| { | Length of gills, when full-grown, 6-7 mm., the median gill 1.5-2 mm. wide, the laterals slightly less. Colour pale brownish, semi-opaque, the distal half crossed by a very wide band of chocolate-brown pigment: slight irregular pigmentation of the same colour is present also at about two-fifths from the base (Pl. i., figs.8-9).
..... <i>A. icteromelas</i> Selys. |
| { | Length of gills, when full-grown, 3.5-4 mm., the median gill very wide, 1.8-2 mm., the laterals nearly as wide. Colour pale brownish, semi-opaque, with slight irregular darker pigmentation towards tip (Pl. i., fig.10).
..... <i>A. griseus</i> Selys. |

D. The Reduced (Non-functional) Type (Text-figs.30-32).

The Saccoid, Triquetro-quadrato, and Lamellar Types of Caudal Gills are all characterised, morphologically, by the pos-

⁶ Horizontal lamellar gills of *Argiolestes icteromelas* Selys, in natural position, dorsal view; ($\times 6$).

session of an internal structure which fits them to act more or less effectively as respiratory organs. They all possess a well-developed tracheal system, two large blood-canals, and a definite accompanying nervous-system. Of these, the most important, from the point of view of respiration, is undoubtedly the tracheal system. I propose, therefore, to restrict the term Reduced (Non-functional) Type to those gills in which, of whatever form they may be otherwise, the tracheal system is so reduced that we may reasonably claim that they no longer function as tracheal gills.

The only gills of this type which have come under my notice are the extraordinary gills of the plant-dwelling larva of *Agrion asteliae* Perkins, from Hawaii. We have already seen (p.98) that, in the genus *Agrion*, we find certain larvæ with well-developed, vertical, lamellar gills of the *nodate* form, while others have their gills of *denodate* form. The members of the genus *Agrion* which have colonised the Hawaiian Islands all appear to have adopted a

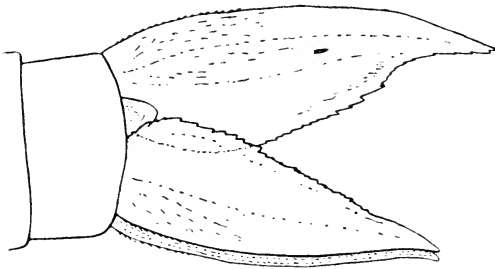

Text-fig. 30.

Reduced (non-functional) gills of *Agrion asteliae* Perkins, in natural position, lateral view; ($\times 18$).

new habit of larval life. Their larvæ no longer dwell in permanent waters, such as rivers and pools, but pass their lives hiding at the bases of the leaves of various forest-plants, where water from the heavy rains collects, and where, apparently, a plentiful supply of smaller insect-larvæ is also to be found for food. The best known of these larvæ is that of *Agrion asteliae*, of which I have fortunately been able to examine a large number, sent to me by Mr. J. C. Bridwell, of Honolulu.

Viewed externally (Text-fig.30), the gills are striking in their shortness and stoutness; indeed, they do not, even at first sight, at all suggest true caudal gills, but rather a somewhat enlarged form of *anal pyramid* such as we find in the larvæ of Anisoptera. In actual shape, as revealed by cross-sections, they might be classed as Triquetro-quadrangle, or intermediate between this and the Saccoid Type. The median gill is broadly diamond-shaped in section, the laterals convexly triquetral. This shape is evidently brought about by the habit of resting the median gill upon the laterals, and the laterals upon the resting-surface. The larva is, to all intents and purposes, a ground-dweller, like those of the *Calopterygidae*; but the "ground," in this case, is not the river-bed, but the debris collected in the little leaf-pools. The return to the triquetro-quadrangle *outward* form is, therefore, a very interesting example of the effect of change of habit on the form of the gills.

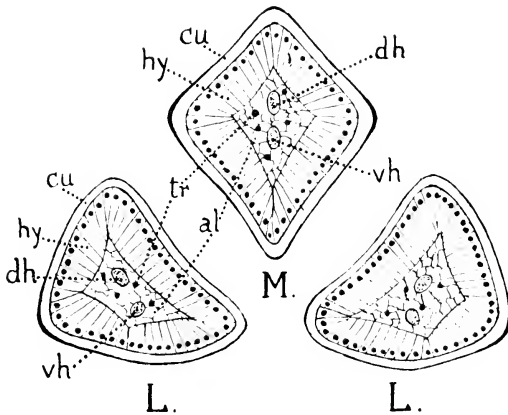

Text-fig.31.

Ideal (semi-diagrammatic) T.S. across the Reduced (non-functional) Gill-system of *Agrion astelia* Perkins, to show the internal structure of the gills. Lettering as on p.109.

Internally, these gills differ greatly from all others studied in this paper. The cuticle is exceedingly thick, from 12-16 μ , of

which the tough outer stratum occupies from 2-4 μ . The hypodermis is formed of a regular layer of high pyramidal cells, 24 μ or more in height, terminating upon an inner basement-membrane. The nuclei of these cells are of normal size, and are nearly all situated at the base of the cells, close to the cuticle. These cells are moderately pigmented, chiefly along their bases and around their nuclei. The boundaries between the cells are not pigmented.

Internally, the hypoderm-layer completely bounds the reduced cavity of the gill, which is chiefly filled with an alveolar meshwork of the usual kind. Supported in this meshwork, one can

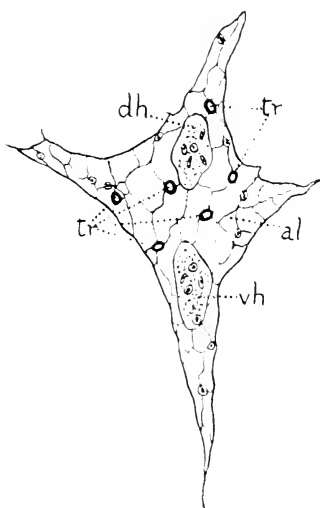

Text-fig. 32. *

distinguish two blood-canals, small in many sections, but in some places swollen out and containing much blood. Longitudinal nerves are either absent, or so fine as not to be traceable in sections. No tracheæ of large size are visible, but, in each section, five or six tracheæ of smaller calibre are cut; these would appear to represent the reduced main longitudinal tracheal system with its branches.

Taking into consideration the great increase in thickness in the cuticle and hypodermis, and the marked reduction of the tracheal system, it would seem quite

justifiable to class these gills as a separate type, under the name proposed above. It would be interesting to section the anal pyramid of a large *Eschmid* larva, so as to compare the internal structure of that organ with gills of the type here discussed.

* Actual T.S. across interior of median gill of *Agrion ustulio* Perkins, for comparison with Text-fig. 31. Hypodermis and cuticle omitted. (p. 258). Lettering as on p. 109.

BIBLIOGRAPHY.

1. BALFOUR-BROWNE, F., 1909.—"The Life-History of the Agrionid Dragonfly." Proc. Zool. Soc. London, 1909, pp.253-285. Pls. xxxiii.-iv.
2. CALVERT, P. P., 1893.—"North American Odonata." Trans. Amer. Ent. Soc., xx., 1893, pp.153-268. three plates. [Part i. General Account of Odonata].
3. —————, 1911-15.—"Studies on Costa Rican Odonata." Ent. News, Philad. i. "The Larva of *Cora*." xxii., 1911, pp.49-64.
4. —————, iii. "Structure and Transformation of the Larva of *Mecistogaster modestus*." *Op. cit.*, xxii., 1911, pp.449-460.
5. —————, vi. "Transformation, External Features and Attached Diatoms of the Larva of *Thaumatoneura*." *Op. cit.*, xxvi., 1915, pp.295-305, Pl. xi.
6. —————, vii. "Internal Organs of the Larva of *Thaumatoneura*, and the Respiration and Rectal Tracheation of Zygopterid Larvæ in general." *Op. cit.*, xxvi., 1915, pp.385-395. 435-447, Pls.xv.-xvii., and bibliography.
7. CARUS, C. G., 1827.—"Entdeckung eines einfachen vom Herzen aus beschleunigten Blutkreislaufes in den Larven netzflügllicher Insecten." Leipzig, L. Voss, 1827. pp.1-40, three plates.
8. CHILD, C. M., and YOUNG, A. N., 1903.—"Regeneration of the Appendages in nymphs of the *Agrionidae*." Arch. Entwicklmech. xv., 1903, pp.543-602. Pls. xx.-xxii.
9. DUFOUR, L., 1849.—"Des divers modes de respiration aquatique dans les Insectes." C. R. Acad. Sci. Paris, xxix., 1849, pp.763-770.
10. —————, 1852.—"Etudes anatomiques et physiologiques, et observations sur les larves des Libellules." Ann. Sci. Nat., 3^{me} Sér., Tome xvii., 1852, pp.65-111, three plates.
11. EAST, A., 1900.—"Notes on the Respiration of the Dragonfly Nymph." Entomologist, London, xxxiii., 1900, pp.211-12.
12. HAGEN, H. A., 1853.—"Léon Defour über die Larven der Libellen mit Berücksichtigung der früheren Arbeiten." Stutt. ent. Zeit. xiv., 1853, pp.98-106, 237-8, 260-270, 311-325, 334-346.
13. —————, 1880.—"Essai d'un Synopsis des Larves de Caloptérygines." C. R. Soc. Ent. Belg. xxiii., 1880, pp. lxx.-lxxvii.
14. —————, 1880.—"Beitrag zur Kenntnis des Tracheensystems der Libellen-Larven." Zool. Anz. iii., 1880, pp.157-161.
15. HANDLIRSCH, A., 1903.—"Zur Morphologie des Hinterleibes der Odonaten." Ann. Hofmus. Wien, xviii., 1903, pp.117-122.
16. —————, 1904.—"Bemerkungen zu der Arbeit des Herrn Prof. Dr. Heymons über die Abdominalanhänge der Libellen." *l.c.*, xix., 1904, pp.59-63.

17. HEYMONS, R., 1904.—“Die Hinterleibsanhänge der Libellen und ihrer Larven.” Ann. Hofmus. Wien, xix., 1904, pp.21-58, Pl. i.
18. HUBNER, O., 1902.—“Neue Versuche aus dem Gebiet der Regeneration und ihre Beziehungen zu Anpassungserscheinungen.” Zool. Jahrb. Syst. xv., 1902, pp.461-498, Pls.28-29. (Summary in Zool. Centralbl. 1902, pp.427-8).
19. MARTIN, J., 1892.—“Sur la respiration des larves de Libellules.” Bull. Soc. Philomath. Paris, (8) Tome 4, 1892, pp.122-4.
20. MIALL, L. C., 1895.—“The Natural History of Aquatic Insects.” London, Maemillan and Co., 1895, (Dragonflies, Chap. ix., pp.328-345).
21. NEEDHAM, J. B., 1911.—“Descriptions of dragonfly nymphs of the subfamily *Calopterygida*.” Ent. News, Philad., xxii., 1911, pp.145-154, two plates.
22. ———, 1911.—“Notes on a few Nymphs of *Agriionix* of the Hagen Collection.” *l.c.*, xxii., 1911, pp.341-5, one plate.
23. PERKINS, R. C. L., 1897.—“Notes on some Hawaiian Insects.” Proc. Cambridge Soc., Mass., ix., 1897, pp.373.-380. (Terrestrial Nymphs).
24. PORTIER, P., 1911.—“Recherches physiologiques sur les Insectes Aquatiques.” Arch. Zool. Exp. Gén. (5) viii., 1911, pp.89-379, Plates i.-iv. (*Calopteryx*, pp.216-7).
25. PURSER, G. L., 1915.—“Preliminary Notes on some problems connected with respiration in Insects generally, and in aquatic forms in particular.” Proc. Cambridge Phil. Soc., xviii., Pt. ii., 1914, pp.63-70.
26. REAUMUR, R. A., 1734-42.—“Mémoires pour servir à l'histoire naturelle et à l'anatomie des Insectes.” 6 vols., Paris, 267 plates. (See Vol. 6, mémoire xi., “Des mouches à quatre ailes nommés Demoiselles,” pp.387-456, Pls.35-41).
27. RIS, F., 1909.—“Die Süßwasserfauna Deutschlands.” Jena, G. Fischer, 1909, iv., pp.1-67.
28. ———, 1912.—“Ueber Odonaten von Java und Krakatau.” Graenhage, Tijdschr. Ent., iv., 1912, pp.157-183, Pls. 6-8. (Morphology of larva of *Euphaea*).
29. ———, 1913.—“Die Atmungs-Organen der anisopteren Libellenlarven.” Mitt. schweiz. ent. Ges. xii., 1913, pp.92-99. (Reference to rectal respiration in *Calopteryx*, p.95).
30. ROESEL VON ROSENHOF, 1749.—“Der Wasser-Insecten zweyete Klasse. Der monatlich-herausgegebenen Insecten-Belustigung.” Part 2. Nürnberg.
31. ROSTER, D. A., 1886.—“Cenno Monographico degli Odonati dei Gruppo *Ischnura*.” Bull. Soc. Ent. Ital., xviii., 1886, pp.239-258, Pls. ii.-vi.

32. ROSTER, D. A., 1888.—“Contributio allo studio delle forme larvali degli Odonati.” Cenzo Iconographico della Larve-Ninfe dei Caudobranchiati.” *I.c.*, xx., 1888, pp.159-176, Pls. i.-iv.
33. ROUSSEAU, E., 1909.—“Etude monographique des larves des Odonates d'Europe.” *Ann. Biol. lacustre, Bruxelles.* iii., 1909, pp.300-366.
34. SCHMIDT-SCHWEDT, E., 1891.—“Kerfe u. Kerflarven d. süssen Wassers, besonders der stehenden Gewässer.” In “Die Tier u. Pflanzenwelt d. Süsswassers,” von Dr. O. Zacharias, Bd. ii., 1891, pp.51-122. Leipzig, J. J. Weber.
35. SHARP, D., 1901.—“Cambridge Natural History. Insects, Part i.” Chap. xviii.; dragonflies, pp.409-428.
36. TILLYARD, R. J., 1909.—“Studies in the Life-Histories of Australian Odonata. No.2: *Diphlebia testoides* Selys.” *Proc. Linn. Soc. N. S. Wales, Sydney*, xxxiv., 1909, pp.370-383, Pl. xxxiii.
37. —————, 1912.—“On the genus *Diphlebia*. with descriptions of new species, and life-histories.” *I.c.*, xxxvi., 1911 (1912), pp.584-604, Pls. xix.-xx.
38. —————, 1916.—“Further Observations on the Emergence of Dragonfly-Larvæ from the Egg. With special Reference to the Problem of Respiration.” *I.c.*, xli., 1916, pp.388-416. (Zygoptera, pp.410-414).
39. TUMPEL, R., 1898-9, 1908.—“Die Geradflügler Mitteleuropas.” 1st Ed., Eisenach, M. Wilckens. 2nd Ed., Gotha, F. E. Perthes (p.66).

EXPLANATION OF ABBREVIATIONS USED IN TEXT-FIGURES AND PLATES.

a, anus—*ac*, amœboeyte—*al*, alveolus—*aln*, alveolar nucleus—*blp*, blood-plasma—*c* or *c'*, cercoid—*cu*, soft inner layer of cuticle—*cu'*, hard outer layer of cuticle—*dh*, dorsal blood-canal—*dl*, principal dorsal internal lamina—*dn*, dorsal longitudinal nerve of gill—*DT*, *DT'*, dorsal tracheal trunks—*ect*, ectotrachea—*ent*, or *end*, endotrachea—*h*, hair (on cuticle)—*hc*, hæmocœle—*hy*, hypodermis—*il*, internal lamina—*il'*, secondary internal lamina—*l_{cg}*, *l_g*, or *L*, lateral caudal gill—*mc*, micocyte (oat-shaped corpuscle)—*mc_g*, *mg*, or *M*, median caudal gill—*sp*, spiral thread of endotrachea—*tr*, main longitudinal trachea of gill—*tr'*, branch trachea of gill—*vh*, ventral blood-canal—*vl*, principal ventral internal lamina—*vn*, ventral longitudinal nerve of gill—*S-10*, abdominal segments.

EXPLANATION OF PLATES I.-VI.

Plate i.

- Fig. 1.—Lateral caudal gill of *Austrolestes psyche* (Selys); ($\times 11$).
 Fig. 2.—Median caudal gill of *Austrolestes cingulatus* (Burm.); ($\times 9$).
 Fig. 3.—Pointed tip of same gill of *Austrolestes colenonis* (White); ($\times 13$).
 Fig. 4.—Lateral caudal gill of *Synlestes weyersi* Selys; ($\times 13$).
 Fig. 5.—Lateral caudal gill of *Synlestes albicauda* Tillyard; ($\times 13$).
 Fig. 6.—Lateral caudal gill of *Neosticta canescens* Tillyard; ($\times 11$).
 Fig. 7.—Median caudal gill of *Isosticta simplex* Martini; ($\times 11$).
 Fig. 8.—Lateral caudal gill of *Argiolestes icteromelas* Selys; ($\times 6$).
 Fig. 9.—Median caudal gill of same; ($\times 6$).
 Fig. 10.—Lateral caudal gill of *Argiolestes griseus griseus* Selys; ($\times 13$).
 Fig. 11.—Regenerated median caudal gill of same; ($\times 13$). The basal border of the transverse band of pigment indicates the division between the thicker basal portion of the gill and the thinner distal portion. Note the *four* main tracheæ.

Plate ii.

- Fig. 12.—Median caudal gill of *Caliagrion billinghami* (Martini); ($\times 9$).
 Fig. 13.—Lateral caudal gill of *Pseudagrion australasia* Selys; ($\times 11$).
 Fig. 14.—Median caudal gill of *Austroagrion cyane* (Selys); ($\times 13$).
 Fig. 15.—Median caudal gill of *Ceriagrion erubescens* Selys; ($\times 18$).
 Fig. 16.—Median caudal gill of *Ischnura heterosticta* Burm.; ($\times 11$).
 Fig. 17.—Lateral caudal gill of *Argiocnemis rubescens* Selys; ($\times 11$).
 Fig. 18.—Lateral caudal gill of *Austrocnemis splendida* (Martin); ($\times 13$).
 Fig. 19.—Median caudal gill of same; ($\times 13$).
 Fig. 20.—Regenerated lateral caudal gill of same; ($\times 11$). The transverse pigment-band situated one-fourth of the gill-length from the tip indicates the division between the thicker basal portion of the gill and the thinner distal portion. Notice the *three* main tracheæ.

Plate iii.

(Transverse sections through the basal portions of the caudal gills.)

- Fig. 21.—T.S. through the breaking-joint of the median gill of *Neosticta canescens* Tillyard; ($\times 207$).
 Fig. 22.—T.S. through the breaking-joint of the lateral gill of same larva (a specimen possessing three main tracheæ); ($\times 207$).
 Fig. 23.—T.S. through median gill of *Calopteryx* sp., close up to base; ($\times 87$).
 Fig. 24.—T.S. through left lateral gill and left cercoid (*c'*) of same larva; ($\times 87$).
 Fig. 25.—T.S. through the complete gill-system and cercoids of *Synlestes weyersi* Selys, close up to base; ($\times 87$).

- Fig.26.—T.S. through median gill of *Austroagrion cyane* (Selys), 0·06 mm. distad from the breaking-joint; ($\times 207$).
- Fig.27.—Another T.S. through same gill, but 0·15 mm. distad from the breaking-joint; ($\times 207$).
- (For T.S. of same gill much further distad, see Plate v., fig.38).

Plate iv.

- Fig.28.—T.S. through median gill of *Nosticta canescens* Tillyard. Saccoid Type; ($\times 130$).
- Fig.29.—Small portion of cuticle and hypodermis from same series of sections as Fig.28, to show formation of the internal lamina (*il*) in a larva approaching ecdysis; ($\times 490$).
- Fig.30.—Small portion of alveolar meshwork from same series of sections, to show two of the alveolar nuclei in situ; ($\times 490$).
- Fig.31.—T.S. through alveolar meshwork of Dr. Ris' larva of *Pseudophana variegata* (Ramb.), to show tufts of moss-like fibrils in the alveoli. The two dark rounded masses are amœboocytes imprisoned in two of the alveoli. Photomicrograph from Ris [28]. (Magnification not stated, but appears to be about 250).
- Fig.32.—The two middle alveoli from Fig.31, much enlarged, to show tuft and amœboocyte. From Ris [28]; (\times Leitz Imm. 1/12).
- Fig.33.—Another alveolus from same gill, much enlarged, to show tufts. From Ris [28]; (\times Leitz Imm. 1/12).

Plate v.

(Transverse sections through caudal gills, taken far from base).

- Fig.34.—T.S. through median gill of *Calopteryx* sp. Triquetro-quadrangle Type; ($\times 87$).
- Fig.35.—T.S. through left lateral gill of same; ($\times 87$).
- Fig.36.—T.S. through median gill of *Austrolestes leda* (Selys), showing central portion or rachis only. Vertical Lamellar Type, *Lestid* form; ($\times 207$).
- Fig.37.—T.S. through left lateral gill of same, showing rachis and most of the blade; ($\times 207$).
- Fig.38.—T.S. through median gill of *Austroagrion cyane* (Selys), showing rachis and part of the blade. Vertical Lamellar Type, *Agryonid* form; ($\times 207$).
- Fig.39.—T.S. through left lateral gill of same, showing rachis only; ($\times 207$).

Plate vi.

(Transverse sections of Horizontal Lamellar Type of Gill).

- Fig.40.—T.S. through median gill of *Argiolestes icteromelas* Selys, close to base; ($\times 87$).

- Fig. 41. — T.S. through right lateral gill of same, at same level as fig. 40; ($\times 87$).
- Fig. 42. — T.S. through median gill of same, at about one-third of the gill-length from the base; rachis and small portion of blade only; ($\times 207$).
- Fig. 43. — T.S. through same gill as fig. 43 taken far distad. to show confluence of dorsal and ventral blood-canals; much of the blade omitted; ($\times 207$).
- Fig. 44. — A detail from same series of sections as figs. 40-43, much enlarged, to show portion of hypodermis and cuticle, ecto- and endotrachea of the left main trachea, two nuclei in the alveolar meshwork and the right dorsal longitudinal nerve. The figure is shown inverted, as drawn under the microscope. It corresponds with the part of the gill marked *x* in fig. 40; ($\times 833$).
- Fig. 45. — T.S. through a longitudinal nerve (*nc*) and neighbouring alveolar nucleus (*alu*). The section cuts the nerve so as to pass through two nuclei; ($\times 1250$).

N.B. — With the exceptions of Figs. 31-33 (from Ris), all the figures in Plates iii.-vi., are wash-drawings made from camera-lucida drawings of double-stained, 10μ sections.

HYDROCYANIC ACID IN PLANTS.

PART iii.

BY JAMES M. PETRIE, D.Sc., F.I.C., LINNEAN MACLEAY FELLOW
OF THE SOCIETY IN BIOCHEMISTRY.

(From the Physiological Laboratory of the University of Sydney.)

SOME NEW CYANOGENETIC PLANTS.

The names of the plants included in this paper are additional to those tabulated in Parts i. and ii. of this subject (see these Proceedings, xxxvii., 1912, 220; and xxxviii., 1913, 624).

The following plants gave positive reactions for hydrocyanic acid when tested with sodium picrate paper in chloroform vapour; and the reactions were afterwards confirmed by the prussian blue test.

(Native) *Alocasia macrorrhiza* Schott.

Cardamine dictyosperma Hook.

Dysphania littoralis R.Br.*

Juncus prismatocarpus R.Br.

Heterodendron olecefolia Desf.

(Introd.) *Alocasia macrorrhiza* var. *variegata* (Nich., Dict. of Gard.).

Alocasia augustiana Lindl. and Rod.

Alocasia Sanderiana (Bailey's Cyclop. of Amer. Hort.).

Alocasia intermedia (sp. unconfirmed).

Alocasia spectabilis (sp. unconfirmed).

Passiflora alba Link and Otto.

Tacsonia mixta Juss.

The following is a brief account of some experiments on the *Alocasias*:—

* Smith and White, of Brisbane, obtained hydrocyanic acid from *D. myriocephala* Benth., which is probably the same plant (Queensl. Agric. Gaz., 1915, 264).

(1.) *Alocasia macrorrhiza* Schott, (Prod. Syst. Aroid., 1860, 146) Index Kew., the "cunjevoi" of the aborigines. Specimens of plants, growing wild in the bush, and cultivated in private gardens, were tested for hydrocyanic acid. In all the fresh leaves, the colour-change with picrate paper was observed to take place within a few seconds. When the newly-cut leaves were placed in a bottle without any reagent, the test-papers quickly changed colour.

Leaves which had become yellow and completely withered still showed the reaction.

Distribution in the plant:—The various parts and organs of this plant were next examined separately. Uniform conditions were observed throughout, as to quantity of material, size of bottle, temperature, etc., and the time noted after which the colour-change in the picrate paper was observed.

Parts of one plant tested:—

1. Leaves	Red in 1-5 minutes
2. Leaf-stalks	Orange in 3 hours.
3. Bulb at base	Pale orange in 3 hours.
4. Rhizome	Negative after 24 hours.
5. Roots	Red in 5 minutes.

Stalks alone tested:—

1. Midrib at tip	Red in 1 hour.
2. Midrib at middle	Orange in 1 hour.
3. Midrib at base	Pale orange in 1 hour.
4. Stalk at middle	Negative after 12 hours.
5. Stalk at base	Negative after 12 hours.

Distribution in one plant, from summit to base:—

1. Leaves	Red in 5 minutes, dark red in 3 days.
2. Green spathe	Red in 1 hour, dark red in 3 days.
3. Ovary	Red in 1 hour, dark red in 3 days.
4. Seeds	Red in 1 hour, dark red in 3 days.
5. Leaf-stalk, top	Orange in 1 hour, dark red in 3 days.
6. ,, lower	Orange in 1 hour, dark red in 3 days.
7. ,, ,,	Orange in 5 minutes, dark red in 3 days.
8. ,, ,,	Red in 5 minutes, dark red in 3 days.
9. ,, ,,	Red in 5 minutes, dark red in 3 days.
10. ,, base	Red in 5 minutes, dark red in 3 days.



11. Bulb, pink cone	Orange in 1 hour, orange in 3 days.
12. Rhizome	Negative after 3 days.
13. ,,	Negative after 3 days.
14. ,, next roots	Negative after 3 days.
15. Roots	Red in 1 hour, dark red in 3 days.

The glucoside disappears on exposure to air:—When fresh green leaves were exposed by being spread out openly on the table, and tested at intervals, it was found that the reaction was slower in starting as time proceeded, and after the fifth day of exposure no more positive results were obtained.

When this stage was reached, the addition of emulsin produced no effect, but after addition of a few drops of amygdalin, a positive reaction was again obtained.

These experiments prove that the enzyme still existed in the plant after drying in air for five days, but that the cyanogenetic glucoside had disappeared.

That the glucoside should have such a short period of existence after the plants are cut and collected, is unfortunate, since the collection of a large quantity of material for the purpose of extraction is thus rendered difficult.

Summary:—The results of these experiments showed:—

(a) That this *Alocasia* contained a cyanogenetic glucoside and an enzyme.

(b) Glucoside is contained in the leaves, stalks, roots, spathe, ovary, and seeds, but it appeared to be quite absent from the rhizomes, even from those portions of the latter immediately contiguous to the roots. In some of the stalks it appeared to decrease downwards towards the base till the bulbs were reached. These bulbs gave indications of traces only of glucoside.

The part of the plant used by the aborigines as food is the soft pink core of these bulbs or swellings at the base of the stalks, where the latter join the rhizome. The acrid juice is first removed by washing or heating. It is important to note, in this respect, that the suspected poisonous nature of the bulbs does not appear to be due to hydrocyanic acid.

(c) The cyanogenetic glucoside rapidly disappeared from the leaves when they were left to dry in the air for a few days.

(2.) *Alocasia macrorrhiza* var. *variegata* (Nicholson's Dict. of Gardening). This is grown as an ornamental plant in the Botanic Gardens. The leaves are green and white in large patches; some of the leaves showed one half green and the other half white. It was noted in testing these leaves that the green portions always gave rapidly the hydrocyanic acid reaction with the yellow paper, while the white portions showed either negative results, or only a faint colour-change after some time had elapsed. The green stalks also gave rapid positive reactions.

(3.) Another variety of this *Alocasia*, known as the "black variety," and possessing dark green leaves, with veins and stalks of a dark purple colour, was obtained from the Botanic Gardens. When tested, the leaves and stalks of this plant showed absence of hydrocyanic acid.

(4.) *Alocasia augustiana* Lindl. and Rod., (Nicholson's Dict. of Gardening). This plant resembles (1) but has mottled stalks. It yielded hydrocyanic acid when tested, and the reactions took place rapidly with the leaves, more slowly with the stalks.

(5.) *Alocasia Sanderiana* Bull, (Bailey's Cyclop. of Amer. Hort.). The large arrow-head leaves, with undulating margins and green veins, when tested, gave a red and dark purple colour-change in a few minutes; the mottled stalks also reacted very rapidly.

Two other *Alocasias* were tested, whose names still await botanical confirmation, but which are apparently well-known to horticulturists:—

(6.) *Alocasia intermedia*, with leaves very similar to (5), but with white veins, and red stalks, gave, with these organs, very rapid and very strong reactions for hydrocyanic acid.

(7.) *Alocasia spectabilis*, whose leaves resemble (1), but with brown under-surface, and white veins, also gave strong and rapid reactions with leaves and stalks.

(8.) *Alocasia metallica* Schott, (syn., *A. indica*, Index Kew.), (Bot. Mag.—description and coloured plate) gave negative results in leaves and stalks.

(9.) *Alocasia zebrina* Koch and Veitch (Index Kew.). The leaves and stalks resemble (4), but contain no cyanogenetic glucoside.

(10.) *Colocasia antiquorum* Schott, (Prodr. Syst. Aroid., 1860, p.138), Index Kew. Cyanogenetic glucosides are absent from the leaves and stalks.

(11.) *Colocasia antiquorum* Schott, var. *esculenta*, Index Kew., the "Taro" cultivated for food in the tropics, was also found to be free from cyanogenetic glucosides. Samples of these plants were obtained from the Botanic and University Gardens, and also from a few private gardens.

Those plants, in which it has just been stated that no cyanogenetic glucoside was found, were afterwards tested by adding a solution of amygdalin to the macerated material. In this way, it was proved that all contained, in their leaves and stalks, an emulsin-like enzyme capable of rapidly hydrolysing amygdalin.

The Author desires to express his thanks to Sir Thomas Anderson Stuart for the use of the laboratories for these experiments, and to Mr. E. Cheel, of the Botanic Gardens, for confirming the names of the species.

THE CHEMICAL INVESTIGATION OF SOME POISON-
OUS PLANTS IN THE N.O. SOLANACEÆ.

PART IV.—THE CHEMISTRY OF THE DUBOISIAS.

BY JAMES M. PETRIE, D.Sc., F.I.C., LINNEAN MACLEAY FELLOW
OF THE SOCIETY IN BIOCHEMISTRY.

(From the Physiological Laboratory of the University of Sydney.)

The genus of Australian plants known as *Duboisia* consists of three or possibly four species. Two of these are well known—*D. myoporoides* and *D. Hopwoodii*, and have formed the subject of numerous investigations by chemists, pharmacologists, and physicians during forty years. In regard to their active principles, they are perhaps the most interesting of all our native flora, and have received greater attention than any others. The third—*D. Leichhardtii*—is a Queensland species, and nothing is known of its chemical composition or active constituents. *D. Campbelli* has been recorded as probably a new species, but apparently it has never been botanically described. It was found in Western Australia ten years ago, and since the first record appeared (Journ. W. Aust. Nat. Hist. Soc., 1906) nothing further concerning it has been made known.

DUBOISIA MYOPOROIDES R.Br.

i. This evergreen tree is native to Eastern Australia and the islands to the north. Its range extends from the Shoalhaven River in the south to Cape York, and is continued into New Guinea, the Philippine Islands, and New Caledonia. It was described in 1810 by R. Brown(17), who named the genus after the French botanist Dubois. Brown placed it in the family Solanaceæ; Bentham transferred it to Scrophulariaceæ; and when

its poisonous properties had been discovered, von Mueller replaced it among the familiar poison-plants of the Solanaceæ.

ii. It was well known to the aborigines as a poison-plant, and we have the first intimation of its powerful properties from Woolls(18), about 1860. "The aborigines make holes in the trunk and put some fluid in them, which when drunk on the following morning produces stupor. . . . Branches are thrown into pools for the purpose of intoxicating the eels and bringing them to the surface. . . . Branches hung up in a close room have had the effect of producing giddiness and vomiting."

iii. About this same time, another and somewhat similar plant had been brought back from the interior of Australia by the Burke and Wills Expedition, and this plant was described by von Mueller(1a) as *Anthocercis Hopwoodii* (Hopwood being the chief subscriber to this expedition). Bancroft, in 1872, obtained from travellers in the interior, specimens of a plant greatly prized by the aborigines, and which they called "pituri"; and in 1876 von Mueller and Bailey identified pituri with *Anthocercis Hopwoodii*, by the microscopic structure of the leaves. Previous to this, Bentham had doubted the position given to this plant by von Mueller, and in 1876 the latter, after receiving fruiting-specimens from the Giles Expedition(1c), transferred it, at Dr. Bancroft's suggestion, to the genus *Duboisia*.

Bancroft, having learned that pituri was used by the aborigines as a narcotic, made extracts and tried the effects on animals(19). His interesting results at once suggested the examination of the other species of *Duboisia*, which was apparently never suspected of having valuable properties. Von Mueller wrote, in 1877, that *D. myoporoides* probably shares the same properties as *D. Hopwoodii*, since both have the same burning acrid taste; and that the properties of both *Duboisias* will prove similar to those of stramonium.

iv. At von Mueller's suggestion, Bancroft then made watery extracts of the leaves of *D. myoporoides*, and after injecting small amounts into domestic animals, he observed that the "pupil of the eye was always widely expanded, that the animals

walked as if blind, and if let alone fell asleep"—properties quite different from those he had observed in pituri. He then tried the effect of dropping the extract into the eye of animals and also into the human eye, and again after a few minutes wide dilation was observed. Bancroft then sent some of his aqueous extracts to ophthalmic practitioners in Brisbane, Ipswich, and Sydney hospitals. By them, his observations were confirmed, and the midriatic properties were carefully studied on the human eye. The reports of their work are contained in Bancroft's paper on "Pituri and Duboisia" (3). Bancroft used the Duboisia regularly instead of atropia in his ophthalmic practice, and also used it in cases of asthma. The main effects observed were midriasis, confusion of intellect, thirst, and loss of taste.

v. It was in 1877 that Staiger, then Queensland Government Analyst, first prepared the active principle of *D. myoporoides*, from Bancroft's material (6). He found it to be "a yellow oily-looking substance, which refused to crystallise either alone or with acids, and not volatile at 212°F."

vi. At the end of 1878, Bancroft visited England, and took with him specimens of the plant and a few pounds of the extract, which he distributed among various experts for further investigation.

Ringer and Tweedie (20) made a detailed study of the properties of *the extract*, and of the effects on the eye. Tweedie first brought the drug before the medical world in England. Holmes (21) gave a general account of all the previous work before the Pharmaceutical Society, and at the discussion of the paper, Gerrard stated that "the extracts used were bad pharmaceutical preparations, having the appearance of resinous watery extracts, very acid, therefore likely to be irritating." Gerrard (22) afterwards prepared the active principle from the extracts supplied to him through Holmes. His method was solution in alcohol, evaporation, and removal of the alkaloid with chloroform, solution in acid water, and precipitation by ammonia. The precipitated alkaloid quickly formed heavy oily drops which were left as a yellow viscid mass. Its chemical reactions were then compared with those of atropine, and found to be different.

Drs. Ringer and Murrell(23), working with Gerrard's alkaloid, made careful experiments on its physiological action. They observed dilatation of the eye, the action on the skin in arresting perspiration, headache and drowsiness, the antagonism to muscarine, and the production of tetanus in frogs. The authors concluded, from both physiological and chemical evidence, that the alkaloid was not atropine.

Paul(24), in 1878, further examined the alkaloid prepared by Gerrard, and confirmed the latter's results.

vii. Petit, of Paris(11), in 1879, identified the alkaloid of pituri as nicotine, and also prepared the alkaloid of *D. myoporoides* from an aqueous extract of the leaves. In a letter to Holmes, which is included in Paul's paper, Petit pointed out the differences from atropine.

In the Lancet for 1879, eight cases of poisoning from the use of duboisia were described by Davidson(25): the symptoms were giddiness and delirium. Tweedie ascribed the cause to impurities, but he afterwards found that his own pure solutions, which he had used with Dr. Ringer, produced the same toxic symptoms.

Dr. Norris(26) found the therapeutic action similar to atropine, but more energetic. Ringer(27) also described the action as far more powerful than atropine.

viii. Baron von Mueller and Rummel(28), in January, 1879, described their preparation and the properties of "Duboisine," the alkaloid of *D. myoporoides*. They state that the alkaloid was prepared like nicotine from the leaves and twigs, that it was a *volatile*, yellow, oily liquid, lighter than water, having a strong odour of tobacco and cantharides, and probably identical with "piturine" from *D. Hopwoodii*. The reaction was strongly alkaline.

In another paper, dated September, 1879, the above account is confirmed(29). Von Mueller says: "Piturine is in some respects allied to nicotine, but more closely akin to duboisine (of *D. myoporoides*), the latter being lighter in colour, of bitter, not acrid, taste, and of fainter odour."

In Czapek's text-book—*Biochemie der Pflanzen*, p.311—the statement occurs that "*Duboisia Hopwoodii* contains 1.1% of an alkaloid, earlier known as piturine, which is identical with hyoscyamine." And again, in Wehmer's text-book—*Die Pflanzenstoffe*, p.695, the same erroneous statement is found. There is no doubt that the name "duboisine" has been used for the alkaloid of both plants.

ix. About this time, Ladenburg was investigating the constitution of the atropine group of alkaloids, and their relation to one another. After reading the account of Gerrard's work, he concluded that a more accurate chemical investigation was necessary to decide the true nature of duboisine. Since only two strongly midriatic alkaloids were known to occur naturally—atropine and hyoscyamine,—Ladenburg set out to determine whether duboisine was identical with one of these, or a new tropeine alkaloid. This was all the more interesting as "daturine," the alkaloid in *Datura stramonium*, had already been shown to be atropine, by Planta, but was subsequently proved by Ladenburg (34) himself to be identical with its isomer hyoscyamine. Ladenburg received from Merck, in 1880, a few grams of duboisia sulphate in the form of a resinous residue. By carefully purifying the gold salt, he finally obtained the very characteristic crystals of gold hyoscyamine, m.p. 159°C.(33).

Shortly after this, in 1880, Gerrard (36) announced to the Pharmaceutical Society of London that he had succeeded in preparing crystallised duboisine. This he obtained in two different forms by a certain solvent (which he does not mention), and he was unable to say whether these were of the same or different constitution.

In 1882, Gibson (37) studied the action of *Duboisia* on the circulation, and his results showed the typical action of the atropine group.

Professor Harnack (39), the pharmacologist, subsequently challenged Ladenburg's statement that duboisine and hyoscyamine are identical, and affirmed that the former was much stronger. Ladenburg (40) was accordingly induced to return to the subject, and, in 1887, having obtained a few grams of the commercial

duboisine from Merck, he prepared the gold salt of lysosine, m.p. 197-8°C. The mother-liquor yielded no other alkaloid, so that this time no hyoscyamine was present. The author attributed the different results to variations in the method of manufacture.

Shortly afterwards (1890), Messrs. Schering and Co. (41) treated a quantity of the leaves of *D. myoporoides* for alkaloid, and obtained the sulphate of a base showing identical properties with hyoscyamine sulphate, while, from the mother-liquor, hyoscyne was obtained.

According to Schmidt (42) and Merck, Ladenburg's hyoscyne, which he discovered in the henbane in 1880 and in Duboisia in 1887, was identical with scopolamine, and Schmidt identified his scopolamine in small quantities in the leaves of *D. myoporoides* in 1888. The next account is that of Bender, who obtained samples of the leaves from two different sources. He obtained scopolamine in one, and hyoscyamine in the other. Bender brought his samples to Schmidt, who immediately confirmed these results. Schmidt (42) also obtained, at this time, large quantities of leaves from Schuchart, of Görlitz. He prepared the gold salt, and could find no hyoscyamine or atropine, but only the brilliant, serrated needles of the salt of inactive scopolamine (m.p. 208°C.). Schmidt here states that the previous assumption of Ladenburg is incorrect, but the variation is due to the fact that duboisia leaves of commerce sometimes contain one and sometimes the other base.

x. In 1892, E. Merck (45) discovered in *D. myoporoides* a new midriatic alkaloid which he named pseudo-hyoscyamine. He identified the bases scopolamine and hyoscyamine, and showed that the new base was different from these (m.p. of gold salt, 176°C.). He also stated that the analytical data suggested the probability that the gold salt contained an admixture of still another base with lower molecular weight.

In the large quantities of uncrystallisable aurichloride residues, Merck recognised considerable amounts of amorphous bases which contained none of the alkaloids mentioned.

xi. In 1895, Dr. Lauterer (47), of Brisbane, gave an account of some tests on the alkaloids which he extracted from this

plant. He found, by Gerrard's colour-test with mercuric chloride solution, that hyoscyamine alone was present in old leaves and twigs, but that the fresh young leaves contained mostly scopolamine.

From this period, the chemistry of *Duboisia* was neglected for seventeen years, till, in 1912, the Wellcome Research laboratories received a large supply of the plant from the Philippine Islands. Carr and Reynolds (50) obtained from this material 1.1% of hyoscyamine and 0.15% of pseudo-hyoscyamine. The latter alkaloid was found by them to possess the constitution of nor-hyoscyamine, but they detected no scopolamine in this material.

DUBOISIA HOPWOODII F.v.M.

xii. The poisonous principle of the "pituri" plant was studied by medical specialists in Great Britain in 1878, and the chemist Gerrard(7) found an alkaloid present which he named "piturine." In 1879, Petit, of Paris (11), showed that the alkaloid was nicotine. In 1880, Professor Liversidge revised the analytical work, and obtained a formula for the alkaloid, of lower molecular weight than nicotine: the difference lay in the determination of the nitrogen. It stood thus doubtfully as a new alkaloid under the name of "piturine" for thirty years. Petit's results were recently confirmed by the late Dr. Rothera, of Melbourne (15), and the base has been shown to be identical with nicotine in its chemical, physical, and pharmacological properties. Hartwich (14) in 1910, and Senft (16) in 1911, wrote good descriptive accounts of the plant, including the histology of the leaves and stems, and showing a number of sections. Hartwich compares the histology of the two species. In both accounts, the chemical data show all the positive reactions of nicotine, although the alkaloid is referred to as "piturin." Senft obtained his pituri and information from two Austrian scientists, Domin and Danes, who visited Australia in 1910. All these were unacquainted with Rothera's results. This plant is a shrub or small tree growing to an average height of about eight feet. It is found only in the interior of the continent; it crosses the border on the east

into New South Wales and Queensland; and, on the other side, it extends into Western Australia almost to the centre of that State (J. H. Maiden).

CRITICAL REVIEW OF THE CHEMISTRY OF THE DUBOISIAS.

xiii. The earlier investigators of the Duboisias were apparently impressed by the very great similarity in the general appearance and morphology of the two species. This is evident in their methods of working as well as in their manner of writing; and one sees in their chemical investigations that they suspected the poisonous principles, too, would be found similar in nature. Accordingly, we find it stated that Staiger first isolated the two *volatile* alkaloids "piturine and duboisine." An alkaloid was prepared from *D. myoporoides* by von Mueller and Rummel, in the same way as nicotine from tobacco. It was a volatile, oily, liquid alkaloid, having a strong odour of tobacco, and was considered as probably identical with piturine. Branches of *D. myoporoides* hung up in a close room produced giddiness and vomiting. Von Mueller and Rummel described the alkaloid obtained by them from *Duboisia Hopwoodii* (pituri) under the name "Duboisine" (10).

On the other hand, the more recent investigations show that *D. myoporoides* contains only the non-volatile alkaloids of the atropine group.

One can only conclude from this conflicting evidence regarding the nature of the active principles, that the earlier workers obtained in their researches, certain incomplete results which were wrongly interpreted by them, and that some authors confused the two plants, or were unaware of the existence of two Duboisias.

A few experiments are now described, which were suggested by the above statements, chiefly to decide the question as to whether in *D. myoporoides* there is present any volatile active principle.

EXPERIMENTAL.

xiv. *Method*:—Fresh plants of *D. myoporoides* were ("treated in the same way as for the extraction of nicotine from tobacco")

crushed, and placed in a distillation flask fitted with a spray-trap. Lime or soda in excess was added, and the whole mass distilled in a current of steam for five or six hours. The ammoniacal distillate was neutralised with acid and concentrated on the water-bath to small volume. The remaining fluid was shaken out, first with ether in presence of acid, then with chloroform after making alkaline. The chloroform was carefully washed and dried, and distilled to remove the solvent. The residue was then weighed and titrated.

Material was obtained from the Sydney Botanic Gardens, the National Park, the North Coast district of New South Wales, and from Queensland. The plants were collected at different seasons throughout the year.

Results :—The ether extracts contained a volatile essential oil of most disagreeable odour.

From eleven separate distillations of the above material, there was obtained, on evaporating the chloroform extract, a small residue, which contained alkaloid in every case. The amounts roughly correspond to 1-2 mgs. per hour of distillation.

xv. *Composition of the volatilised substance* :—

(a) Titration, with centinormal solutions and iodeosin indicator, showed that each of these residues left on evaporation of the chloroform, consisted of about half its weight of an alkaloid.

(b) The residues were yellowish-brown syrups. They were dissolved in a little acidulated water, and the following tests applied. The solutions possessed an intensely bitter taste, and alkaline reaction to litmus.

(c) The general reagents for alkaloids, viz., Wagner's, Mayer's, and Sonnenschein's solutions, picric, tannic, and phosphotungstic acids all gave dense precipitates with the solution. The substance, therefore, contained an alkaloid.

(d) The specific tests for the identification of the known volatile alkaloids, such as nicotine, in all cases gave negative results.

(e) Vitali's test gave a brilliant red colour, which indicated the presence of an alkaloid of the atropine group.

(f) The solution was diluted to 1 part of residue in 500 normal saline (1 in 1000 alkaloid), and when one drop of this was in-stilled into the eye of a dog, wide dilatation was produced in about 20 minutes. The alkaloid was therefore of the midriatic group.

Evidence was thus obtained from these results that the alkaloids assumed to be non-volatile, had distilled over in small quantities, under the conditions stated. The next step, therefore, was to ascertain the behaviour of pure atropine, when treated in the same way.

xvi. *Control experiment.*—*Method*:—Pure atropine sulphate solutions with excess of lime, with and without sawdust, were distilled in a current of steam, from a flask fitted with a Kjeldahl spray-trap. At the end of each hour, the distillate which reacted alkaline to litmus, was shaken out with chloroform. The chloroform extract was then washed and dried, and the solvent distilled off. The residues were weighed and titrated, and afterwards examined.

Results:—Very erratic results were obtained. In some, the amount of residue decreased to nothing in the five successive hours. In others, they varied much, even increasing at the end. In general, a total weight of 20 mgs. was obtained after five hours. This yield was apparently independent of the amount of alkaloid taken, which was between 0.1 and 1.0 mg. The addition of sawdust did not alter the result. All the residues contained alkaloid.

When a distillate, without previous neutralisation, was evaporated in an open basin over a bunsen flame, the residue contained only a trace of alkaloid.

(a) By titration of these residues as in the previous series, the amount of alkaloid (as atropine) in five hours' distillation was 11 mgs. If the latter be taken as representing the actual amount of alkaloid in each total distillate, then the alkaloid has distilled over under the conditions of these experiments at a rate of 2 mgs. per hour. From these titrated solutions, the alkaloid was recovered and examined.

(b) The aqueous solution, faintly acidulated, possessed a very bitter taste, and alkaline reaction to litmus.

(c) Dense precipitates were obtained with all the general alkaloid reagents.

(e) On applying Vitali's test for atropine, a deep red colour was shown.

(f) The solution was brought to 1 in 1000 with normal saline, and one drop of this instilled into the eye of a dog. Almost complete dilatation was produced within 30 minutes.

The distillate therefore contained atropine, and the results showed that when solutions of atropine are distilled in a current of steam, the alkaloid volatilises. Also, when very dilute solutions of atropine are evaporated by boiling in an open basin, the alkaloid may be almost entirely lost.

APPLICATION OF THE RESULTS.

xvii. *The Statement.*—The foregoing experiments afford conclusive evidence that, when leaves of *Duboisia myoporoides* were distilled with alkali in a current of steam, an alkaloid volatilised and was obtained in the distillate. This alkaloid was a minute proportion of the atropine and hyoscyamine, which are known to be present in the leaves, and which have always been assumed to be non-volatile.

When solutions of pure atropine were distilled in the same apparatus, and under the same conditions, atropine distilled over, and almost at the same rate as from the plant, 1-2 mgs. per hour.

The Interpretation.—We are now enabled by these results to interpret some of the contradictory statements of the earlier investigators. *D. Hopwoodii*, the first to be examined chemically, had yielded nicotine, and from the closely related *D. myoporoides* an alkaloid was obtained in the same way as nicotine. In the extraction of the midriatic alkaloids, even with modern improvements, the crude product first obtained is invariably a viscous, oily liquid, or syrupy residue. One must not, however, assume that it contains any of the liquid alkaloids, such as nicotine, since the residue will eventually crystallise when properly puri-

fied. Even pure atropine, when dissolved in chloroform, alcohol, or water, and the solution evaporated on the water-bath, is left as a syrupy residue. If these viscous semi-fluid residues be distilled, as described, the distillates will yield all the tests for the alkaloid, and so the isolation of the "volatile, liquid alkaloids, piturine and duboisine," is explained.

The early experimenters were thrown off the track again, in their attempt to solve this difficult problem, by another factor—the "strong odour of tobacco." This is stated frequently in the literature, and no doubt played a large part in setting the bias towards nicotine. During the chemical investigation of many other solanaceous plants, especially *Solandra*, the *Solanums*, and *Nicotiana* species, the author has noted the strong odour which makes itself prominent at certain stages. It is particularly strong when a solution is evaporated to dryness, and when the chloroform is distilled off from the last extract; and a syrupy residue is left, which contains the crude alkaloids. This residue, in all the cases just mentioned, possessed this peculiar odour—powerful, nauseous, and disagreeable. It somewhat resembles very stale nicotine or conine, but is due to a volatile essential oil which is probably present in all these plants. It was isolated from the steam-distillates previously described, by acidulating and shaking out with ether. When the ether was slowly removed at air-temperature, the residue exhibited all the objectional properties described. This residue gave no alkaloidal reactions.

It is thus shown that the statements "a volatile, liquid alkaloid possessing the odour of tobacco," and "consisting of atropine or hyoscyamine," are both correct, and in accordance with experimental facts.

" DUBOISINE."

xviii. The chemical history of the midriatic alkaloids, which have been isolated from *Duboisia myoporoides*, possesses peculiar interest and importance. "Duboisine," the commercial crude drug, is still extracted, and is found in commerce as the total mixed alkaloids. In 1912, Merck's pure crystallised duboisine

How are these variations to be explained? Ladenburg has stated that they were due to different methods of manufacture, but he believed that his hyoscyine was a true isomer of hyoscyamine, and therefore his opinion was legitimate. We are now certain that these two bases possess a different chemical composition, and therefore cannot be transformed in this way, so that Schmidt's view was nearer the truth—that the leaves sometimes contained hyoscyamine, and at other times scopolamine. Our present biochemical knowledge, however, will scarcely admit of this view, that a plant under variable conditions may alter its fundamental chemical products. But it is quite possible that variations in the conditions of growth influence the relative amount of each of these bases, by stimulating and causing a predominance of one, or by reducing the production of another to a minimum amount. The plants probably contain all the alkaloids in question, and none is entirely absent at any time. The detection of the small amounts of one of these alkaloids in the mixture requires the greatest skill and patience, and in most of the papers cited the authors omit the details of manipulation by which alone the value of their results can be estimated.

This example of the variation of the tropeines in the *Duboisia* is analogous to that of the cocaines in *Erythroxylon*, and to the strychnine and brucine in the *Strychnos* plants.

CHEMICAL COMPOSITION COMPARED.

xix. The two *Duboisias*, whose history we have been tracing, are thus shown to contain the widely different active principles, nicotine and hyoscyamine, while the original botanical descriptions of the two plants have much in common.

In order to bring ont any further points of interest in the comparison of these two plants, a complete chemical analysis of the proximate constituents was made.

In each case, the air-dried leaves were submitted to successive extractions with organic solvents, and the extracts further analysed. The results of these analyses are given in the accompanying table.

	(1) Air-dried leaves.			(2) Dried at 100°C. ash-free.			(3) Fresh leaves.
	<i>D. Hop-woodii.</i>	<i>D. myopo-roides.</i>	<i>D. Leich-hardtii.</i>	<i>D. Hop-woodii.</i>	<i>D. myopo-roides.</i>	<i>D. Leich-hardtii.</i>	<i>D. myopo-roides.</i>
Water lost at 100°C., less volatile constituents	8.10%	10.8%	10.53%	—	—	—	79.48%
Crude ash	18.35	8.0	6.40	—	—	—	1.84
Organic portion (by difference)	73.55	81.2	83.07	100	100	100	18.68
Extracted by petroleum spirit	6.63	4.90	2.72	9.01	6.04	3.28	1.13
Volatile oils	0.70	0.08	0.24	0.95	0.10	0.29	0.02
Fatty oils	4.88	4.30	1.30	6.63	5.30	1.57	0.99
Resins ...	1.00	0.52	1.18	1.36	0.64	1.42	0.12
Alkaloid	0.05	—	—	0.07	—	—	—
Extracted by ether	2.82	5.21	3.61	3.83	6.42	4.35	1.20
Water-soluble:—organic acids, etc.	0.55	0.31	0.20	0.75	0.38	0.24	0.07
Alkaloid	0.02	trace	—	0.03	trace	—	trace
Alcohol-soluble:—resins, chlorophyll	2.25	3.49	2.73	3.05	4.30	3.29	0.80
Alcohol-insoluble resins	trace	1.41	0.68	—	1.74	0.82	0.33
Extracted by alcohol	13.15	3.750	4.220	17.86	5.480	5.08	0.86
Water-soluble portion	9.69	3.525	3.182	13.18	—	—	—
Tannins	8.76	0.383	0.048	11.90	—	3.83	—
Acid-ether extract	0.14	0.011	0.066	0.19	0.472	0.06	0.09
Alkali-chloroform extract—non-alkaloidal	—	0.300	0.936	—	0.013	0.08	—
alkaloidal	—	—	—	1.105	1.14	—	—
Water-insoluble portion	0.93	0.173	0.411	1.27	0.213	0.50	0.04
Tannin decomposition-products—soluble in ammonia	3.46	0.575	1.038	4.68	—	—	0.13
Alcohol-soluble resins	—	0.500	0.055	—	0.616	0.07	0.11
Alcohol-insoluble resins	—	0.070	0.750	—	0.086	0.90	0.02
Extracted by water	13.62	11.29	8.71	18.51	13.06	10.49	2.59
Mucilage	4.92	1.86	1.04	6.69	2.29	1.25	0.43
Glucose	4.09	1.00	—	5.56	1.23	small	0.23
Saccharose	1.06	1.00	0.06	1.44	1.23	0.07	0.23
Total extracted by solvents	36.22	25.15	19.26	49.21	31.00	23.20	5.78
Cellulose, lignin, etc. (by difference)	37.33	56.05	63.81	50.79	69.00	76.80	12.90
Total organic portion	73.55	81.20	83.07	100.00	100.00	100.00	18.68

The *Duboisia Hopwoodii* was part of a stock in the possession of Sir Thomas Anderson Stuart, to whose kindness the author is much indebted. After its long journey from the interior, the pituri plant is received in the form of very dry leaf-fragments mixed with broken stalks and twigs. The leaf-portion, constituting 50% of the whole, was carefully separated from the sample, and finely powdered for the analysis.

The *Duboisia myoporoides* was collected in the National Park by the kind permission of the Trustees. The leaves were taken from trees about 25 feet high and at the time of flowering.

The *Duboisia Leichhardtii* F.v.M., is a third species, whose chemical composition is yet unknown. It was collected by the author, near the Stuart River in Queensland, at the same time of year as in the preceding specimen, and while in flower.

The total alkaloids in each plant were also estimated, and the results are given in the accompanying table.

The author desires to express his thanks to Sir Thomas Anderson Stuart for laboratory facilities afforded during this investigation.

AMOUNT OF TOTAL ALKALOIDS.

	Air-dried.	Dried at 100°, ash-free.	Fresh.
<i>Duboisia Hopwoodii</i> , leaves ..	1.00%	1.36%	0.27%
<i>D. Leichhardtii</i> , leaves ...	1.28	1.42	0.28
<i>D. myoporoides</i> , mature leaves ...	0.17	0.21	0.04
<i>D. myoporoides</i> , seedling leaves ...	0.073	0.082	0.017
<i>D. myoporoides</i> , bark	0.027	...

REFERENCES TO LITERATURE.

Duboisia Hopwoodii.

- MUELLER—Fragmenta phytographia, (a) Vol. ii., 1860-1, 138; (b) Vol. ix., 1875, 168; (c) Vol. x., 1876-7, 20.
- BANCROFT—The Pituri Poison. Journ. Queensland Phil. Soc., 1872.
- Pituri and Duboisia. *Ibid.*, 1877.

4. BANCROFT, Further Remarks on the Pituri Group of Plants. *Ibid.*, 1878.
5. —————-Pituri and Tobacco. *Ibid.*, 1879.
6. —————-Duboisia Pituri. Wing's Southern Sc. Rec., ii., 1882, 221.
7. GERRARD—Exam. of Pituri. Pharm. Journ., ix., 1878, 251.
8. RINGER and MURRELL—On Pituri. Journ. Physiol., i., 1879, 377; and ii., 132.
9. FRASER—The Pituri Poison of Australia. Proc. Roy. Soc. Edin., x., 1879, 200.
10. MUELLER and RUMMEL—Ueber Duboisin u. Duboisinsäure. Zeit. der Allgem. Ostert. Apoth. Ver., xviii., 1880, 20; (thro. Just, i., 1880, 375).
11. PETIT, A.—Pituri. Pharm. Journ., ix., 1879, 819.
12. LIVERSIDGE—The Alkaloid from Pituri. Journ. Roy. Soc. N. S. Wales, 1880, 123.
13. LANGLEY and DICKINSON—Physiol. Action of Pituri and Nicotine. Journ. Physiol., xi., 1890, 265.
14. HARTWICH—Ueber Pituri. Apoth. Zeit., 1910, S.679 (thro. abstract).
15. ROTHERA—The Alkaloid from *D. Hopwoodii*. Biochem. Journ. v., 1910, 193.
16. SENFT—D. Hop., Die Stamm-pflanze des sogenannten "Pituri." Pharmaz. Praxis, Wien, x, 1911, Heft 1, Separatabdruck.

Duboisia myoporoides.

17. BROWN, R.—Prod., 1810.
18. WOOLLS—A Contribution to the Flora of Australia. 1860, pp.178, 206.
19. BANCROFT—See refs. 3 and 4.
20. RINGER and TWEEDIE—The Midriatic Props. of *D. myop.* Lancet. i., 1878, 304.
21. HOLMES—Pharm. Journ., viii., 1878, 705, 720.
22. GERRARD—*Ibid.*, p.787.
23. RINGER and MURRELL—Physiol. Action of *D. myop.* *Ibid.*, p.788.
24. PAUL—The Alkaloid of *D. myop.* *Ibid.*, p.797.
25. DAVIDSON—The Lancet, ii., 1879, 352, 441.
26. NORRIS—Therapeutic Action of *D. myop.* Amer. Journ. of Med. Sc., 1879 (thro. The Practitioner, xxiii., 1879, 221).
27. RINGER—Relative Action of Duboisia and Atropia. *Ibid.*, 247.
28. MUELLER and RUMMEL—Duboisin. Journ. Chem. Soc., xxxv., 1879, 32.
29. MUELLER—See ref.12.
30. LADENBURG—Die natürlich vorkommenden mydriatisch wirkenden Alkaloide. Liebig's Annal. d. Chem., ccvi., 1880, 274.

31. LADENBURG, Sur les alkaloides naturels et midriatiques de la Belladonna, du Datura, de la Jusquiame, et de la Duboisia. C.R., xc., 1880, 874.
32. ————— Ueber das Hyoscyamin. Ber., xiii., 1880, 254.
33. ————— Ueber das Duboisin. *Ibid.*, 257.
34. ————— Ueber das Daturin. *Ibid.*, 380.
35. ————— Die Alkaloide aus Bell., Dat., Hyos., u. Duboisia. *Ibid.* 909.
36. GERRARD—Crystallised Duboisine. Pharm. Journ., xi., 1880, 383.
37. GIBSON—Action of Duboisia on the Circulation. Journ. Anat. Physiol., 1882, 16.
38. BENDER—Pharm. Cent., xxvi., 1885, 38 (thro. Ber., xviii., Ref. 119).
39. HARNACK—Duboisin. Chem. Zeit., xi., 52 (thro. abst.).
40. LADENBURG u. PETERSEN—Ueber das Duboisin. Ber., xx., 1887, 1661.
41. SCHERING AND Co.—Duboisin. Thro. Pharm. Journ., xx., 1890, 709.
42. SCHMIDT—Scopolamine in *D. myop.* Arch. d. Pharm., cccxx., 1892, 207, 689,
43. LADENBURG—Ueber das Hyosein und Skopolamin. Ber., xxv., 1892, 2388, 2601.
44. HESSE—Zur Kenntniss einiger Solanaceenalkaloide. Liebig's Annal. d. Chem., cclxxi., 1892, 100.
45. MERCK—Pseudohyoscyamine in *D. myop.* Merck's Annual Rep., 1892, 11.
46. MAIDEN—*D. myop.* Agric. Gaz. N. S. Wales, iv., 1893, 845.
47. LAUTERER—*D. myop.* Australasian Med. Gaz., xiv., 1895, 457.
48. SHARP—*D. myop.* Pharm. Journ., v., 1897, 161.
49. BAEKURTS—Duboisia. Apoth. Zeit., xxvii., 1912, 683, thro. Year-Bk. of Pharm., 1913, 18.
50. CARR and REYNOLDS—Journ. Chem. Soc., ci., 1912, 950.

ORDINARY MONTHLY MEETING.

APRIL 25th, 1917.

Dr. H. G. Chapman, President, in the Chair.

MR. KEITH COLLINGWOOD MCKEOWN, Leeton, N.S.W.; and MR. ROBERT VEITCH, Natova, Nadi, Fiji, were elected Ordinary Members of the Society.

The President announced that the Council had elected Messrs. C. HEDLEY, F.L.S., W. W. FROGGATT, F.L.S., W. S. DUN, and A. G. HAMILTON to be Vice-Presidents; and Mr. J. H. CAMPBELL [Royal Mint, Macquarie Street] to be Honorary Treasurer—for the current Session, 1917-18.

The Donations and Exchanges received since the previous Monthly Meeting (28th March, 1917), amounting to 4 Vols., 43 Parts or Nos., 17 Bulletins, and 12 Pamphlets, received from 37 Societies, etc., and one private donor, were laid upon the table.

THE CHEMICAL INVESTIGATION OF SOME POISON-
OUS PLANTS IN THE N.O. SOLANACEÆ.

PART V.—THE ALKALOIDS OF *DUBOISIA LEICHHARDTII* F.V.M.

BY JAMES M. PETRIE, D.SC., F.I.C., LINNEAN MACLEAY FELLOW
OF THE SOCIETY IN BIOCHEMISTRY.

(From the Physiological Laboratory of the University of Sydney.)

Duboisia Leichhardtii is a small evergreen tree, endemic in Eastern Australia. It was discovered by Leichhardt in his travels, and sent by him to Baron von Mueller, who described it in 1867. Leichhardt's specimens are in the Melbourne Herbarium, but no locality is given other than "extra-tropical Eastern Australia." The first specimens bearing a definite locality were obtained from Mt. Playfair, near Springsure in Central Queensland. These were sent by a squatter to von Mueller in 1890, and are also in the Melbourne Herbarium. In the same year, it was found by Dr. J. Shirley growing along the Stuart River, 140 miles north-north-west of Brisbane, and specimens were placed in the Queensland National Herbarium. The only other record of this plant is that in Moore and Betche's Flora of New South Wales, where it is stated to have been found in the Gray Ranges, which cross the extreme north-west corner of New South Wales into Queensland. But there are no corresponding specimens from this locality in Australian collections.

Though so very little is known, and the records are so few, concerning *Duboisia Leichhardtii*, the three localities given lie in a great inverted crescent, 800 miles long, stretching across Queensland from the south-west corner, through the central area, and down to the south-east.

Von Mueller described the plant under the name of *Anthocereis*, in his *Fragmenta phytographia* (Vol. vi., 1867-8, p.142),

and ten years later the name was transferred to *Duboisia* (Wing's Southern Science Record, ii., 1882, 222). Of the three described species of *Duboisia*, *D. Hopwoodii* is confined to central Australia, *D. myoporoides* extends along the eastern coastline, and *D. Leichhardtii* apparently occupies the intervening country, which joins up the areas occupied by the other two species.

Although in their essential features they exhibit fundamental differences which characterise them as distinct species, they possess a peculiar similarity in their general aspect, and the writer, familiar with the species *D. myoporoides* only, had no difficulty in recognising *D. Leichhardtii* when first seen in the forests of central Queensland. In some respects *D. Leichhardtii* may be regarded as intermediate between the other two, for example, in the average heights of adult trees—*D. Hopwoodii* 8 feet, *D. Leichhardtii* 15 feet, and *D. myoporoides* 25 feet; or in the relative sizes of their mature leaves—2, 3, and 4 inches in length respectively. On the other hand, in comparing the details of the original botanical descriptions, one can hardly say that *D. Leichhardtii* inclines towards one or the other species. It is differentiated chiefly by the flowers possessing long, acute corolla-lobes. Much interest was aroused by the speculation as to whether, in regard to its active principle, this third species would resemble *D. Hopwoodii* or *D. myoporoides*, or differ from both. We have seen (Part iv. of this series) that *D. Hopwoodii*, the pituri plant, contains nicotine, and that *D. myoporoides*, the cork-tree, contains hyoscyamine and nor-hyoscyamine. This point was soon settled, but only after the completion of the investigation, a casual reference was found in a Medical Journal, to an account of some tests by Lauterer, of Brisbane, (Aust. Med. Gaz., xiv., 1895, 457) which he made on the alkaloids of *Duboisia myoporoides*. He states that, in this plant, he found hyoscyamine and scopolamine, and that "*D. Leichhardtii* contains mostly scopolamine." With the exception of this statement of a single line, no other information has been found regarding the chemical constituents. It is doubtful whether Lauterer ever worked on *D. Leichhardtii* at all; if he did, it was wholly unknown to his

friends of the Royal Society of Queensland (private communication from Dr. J. Shirley).

The results which Lauterer entirely depended upon for his conclusion in the case of *D. myoporoides* were obtained from qualitative tests only, and chiefly Gerrard's mercuric chloride reaction. The author, in repeating these tests with pure alkaloids, obtained results which did not agree with the statements of Gerrard (Pharm. Journ., xxi., 1891, 898). For instance, pure atropine and hyoscyamine were dissolved in chloroform and evaporated on a watch-glass. A 2 per cent. solution of mercuric chloride in 50 per cent. alcohol was then added drop by drop, when a yellow precipitate was obtained in both cases. These remained yellow for some hours, though they became red on heating. Atropine is stated by Gerrard to be distinguished from hyoscyamine by giving a red colour at once, without heat. Scopolamine was found to give a white precipitate, and nor-hyoscyamine also gave a white precipitate when tested in the same manner. In this way certainly hyoscyamine may be distinguished from scopolamine when separate; but, in a mixture of alkaloids, the observation of a white precipitate in Gerrard's reaction does not justify the conclusion that only scopolamine is present. The author obtained a white precipitate in the mixture of alkaloids obtained from *Solandra longiflora* (Part iii. of this series) in which no scopolamine was found, but which contained hyoscyamine, nor-hyoscyamine, and atropine.

SOURCE OF THE MATERIAL.

The material for this investigation was collected in Queensland by the author, accompanied by Mr. C. White, Assistant Government Botanist. The starting point for the Duboisia country was the North-West Railway terminus at Nanango, and directions had been obtained from Dr. Shirley, who discovered the trees in this region in 1890. Far up the Stuart River and about 10 miles from Taabinga cattle-station, the first specimens of *D. Leichhardtii* were seen; and after two days' driving through open forest-country, they were still observed stretching away to the south-west towards the Bunya Bunya Mountains.

As far as can be ascertained, they are not found south of the mountains which form the watershed of the Brisbane Valley.

The trees were always observed in small clusters, growing on red volcanic soil, and only on the edge of the thin scrubs in the open brush forests.

They were invariably associated with certain prominent iron-bark and acacia trees, among which the following species were noted:—*Eucalyptus crebra* (narrow-leaved ironbark), *E. paniculata* (white ironbark), *E. melanophloia* (silver-leaved ironbark), *E. tereticornis* (red gum), *E. hemiphloia* (gum-top box); *Angophora lanceolata* and *A. subvelutina*. Among the acacias were *A. penninervis*, *A. Cunninghamii*, *A. implexa*, a variety of *A. decurrens*, and *A. aulacocarpa*.

EXPERIMENTAL.

(i.) *Preliminary Examination for Alkaloids*:—A small quantity of the material was extracted in a Soxhlet extraction-apparatus and treated by the Stas-Otto process for the separation of active principles. A substance was obtained which gave positive reactions with the following reagents:—Iodine in potassium iodide, potassium mercuric iodide, phosphomolybdic, picric, tannic, and phosphotungstic acids, platinum and auric chlorides.

The solution possessed an intensely bitter taste and alkaline reaction.

When diluted to 1 in 1000 with normal saline and instilled into the eye of a dog, wide dilatation was produced in about 30 minutes.

It gave a strong positive reaction with Vitali's test.

The substance is thus shown to be an alkaloid of the atropine group; and since the aurichloride salts were observed under the microscope to consist of several kinds of crystals, the probability is that they contain a mixture of associated alkaloids of the midriatic group.

(2.) *Distillation for Volatile Constituents*:—About 100 gms. of air-dried leaves were powdered and mixed with milk of lime in a large flask. The mass was distilled in a current of steam

for seven hours. The alkaline distillate was shaken out with ether, and this ethereal liquid, after separating and drying, was distilled at a low temperature to dryness. This residue was dissolved in water and titrated, when it required 23 ccs. of centi-normal acid to neutralise. The fluid was then acidified and shaken out with ether, when about 11 mgs. of an oily substance were separated. On making faintly alkaline with ammonia and agitating with chloroform, a substance was removed which was afterwards obtained as a viscous residue. This weighed about 55 mgs., which is equivalent to 8 mgs. per hour. It gave precipitates with all the alkaloidal reagents, and also the characteristic Vitali's reaction for the atropine group; while a solution in normal saline 1 in 1000, widely dilated the eye of a dog in about 20 minutes.

It is apparent from these results that a minute quantity of the atropine alkaloids has distilled over, as has already been proved by the author to take place with other plants containing alkaloids of this group (Part iv. of this series).

(3.) *Extraction of the Alkaloids:*—The air-dried leaves containing 9·7 per cent. of water were ground to a fine powder, and extracted with cold methylated spirit. At weekly intervals, the latter was removed until only traces of alkaloid were dissolved. The voluminous alcoholic extracts, obtained by draining and pressing the material, were distilled under reduced pressure, and below 60°C., when there remained a dark-coloured viscous residue. This was removed by washing with successive small quantities of warm water slightly acidulated, and filtered. For the removal of colouring matter and resins, this dark brown fluid was next treated with lead acetate. The lead precipitate was carefully washed free from alkaloid, and the aqueous fluid and washings freed from lead. The solution, now only slightly coloured, was concentrated at 60°C. to a small volume. Wagner's iodine reagent was then used to precipitate the alkaloids. This iodine precipitate was decomposed by sulphurous acid, and the solution was shaken out with ether. This solvent removed a considerable amount of impurity. The aqueous solution was next made

alkaline with a very slight excess of ammonia, which separated the alkaloids in a dense white precipitate. The alkaloids were then removed in solution by agitating repeatedly with equal volumes of chloroform. The chloroform was removed by distilling under diminished pressure, when there was left in the flask a semi-solid mass, which, after standing some days, crystallised in beautiful white radiating needles.

The original plant-material was not treated in one large bulk, but in a number of small portions as required. In one of these, which yielded the maximum weight of alkaloids, the following data were recorded:—300 gms. of air-dried plant extracted for 24 days altogether. The aqueous extract was concentrated to 350 c.cs., and precipitated with one litre of Wagner's decinormal iodine solution. Ether removed from this acid solution about 2 gms. of impurities, and chloroform from the alkaline liquid yielded 5 gms. of crude alkaloid. A portion of the latter in solution was titrated with decinormal acid and iodeosin indicator, and the result showed that 81 per cent. consisted of pure alkaloid. The yield was, therefore, 1.42 per cent. of alkaloids in the dried (at 100°C.) plant-leaves, or 0.28 per cent. in the fresh plant.

The optical activity of a solution of this crude alkaloid in 50 per cent. alcohol was determined, $[\alpha]_D -18^\circ$.

(4.) *Separation of the Alkaloids*:—The mixed alkaloids were converted directly into aurichlorides, by the addition of gold chloride to the solution of alkaloids in dilute hydrochloric acid. The yellow precipitate was dissolved in sufficient warm water, and set aside to slowly crystallise spontaneously. At regular intervals, the crystals were removed by decanting the superfluid. These crystals were washed and the melting-points determined, then redissolved in dilute hydrochloric acid and again set aside to crystallise. After a long and tedious process of fractional crystallisation, the various fractions being placed together, or separated, according to their melting-points, the latter were observed to concentrate near certain definite temperatures. These fractions were finally obtained with melting-points which did not change after further recrystallisation. A summary is

given in the following table of only the principal stages in the separation of these salts.

Fractional Crystallisation of the Aurichloride Salts.

a	{	1. Brown viscous deposit.
	{	2. Yellow crystals, m.p. 135-178°.
	{	3. Amorphous yellow mass.
b	{	a1 was washed and found to be non-alkaloidal.
	{	a2 was recrystallised.
	{	a3 was decomposed and the alkaloids recovered by shaking out with chloroform. The gold salts were then reformed and crystallised.
c	{	(a2 + a3) when recrystallised gave (1) yellow crystals, m.p. 174-179°
		(2) ,, ,, 136-162
		(3) ,, ,, 180-190
		(4) uncrystallisable portion.
d	{	e1 when dissolved and recrystallised yielded 1. f177-179°
		2. f135 small amt.
	{	e2 ,, ,, ,, 3. f165-167 greater part.
		4. f135-150
	{	e3 ,, ,, ,, 5. f197-199 greater part.
		6. f186
e	{	d1 when dissolved and recrystallised yielded (1) 178, 179, 179°
	{	d3 ,, ,, ,, (2) 165-166
	{	d2 + d4 ,, ,, ,, (3) 137, 137
	{	d5 ,, ,, ,, (4) 198, 198, 197
f	{	e1 when dissolved and recrystallised yielded 179, 179, 179°
	{	e2 ,, ,, ,, 165-166
	{	e3 ,, ,, ,, 137, 136, 137
	{	e4 ,, ,, ,, 197-198

(5.) *Identification of the Alkaloids.*—The most recent work on the fractional crystallisation of the midriatic alkaloids is that of Carr and Reynolds (*J.C.S.*, ci., 1912, 950). These authors give the following figures for the melting-points of the salts of the pure alkaloids:—

Atropine aurichloride	m.p.137-139°
Lævo-hyoscyamine aurichloride	m.p.165°
Nor-hyoscyamine	,,	...	m.p.178-179°
Lævo-scopolamine	,,	...	m.p.198°

A portion of the pure aurichloride crystals thus obtained were then converted into picrates, by boiling their solutions with

sulphurous acid, filtering off the deposit of metallic gold, and treating with a saturated solution of picric acid. These were allowed to stand, the crystals were separated, recrystallised, washed and dried, and their melting points taken.

- | | | | | |
|------|--------------|------------|---------------------|----------------|
| (1.) | Aurichloride | m.p.179°C. | yields picrate with | m.p.219-220°C. |
| (2.) | „ | 165 | „ „ „ | 163-166 |
| (3.) | „ | 136 | „ „ „ | 176 |
| (4.) | „ | 197 | „ „ „ | 180 |

The above authorities have given the melting points of the picrates of the pure alkaloids as follows:—

Atropine picrate...	m.p.175-176°C.
Lævo-hyoscyamine picrate	m.p.165
Nor-hyoscyamine	„	...	m.p.220
Lævo-scopolamine	„	...	m.p.180-181

From one gram of the crude alkaloid there was obtained 0.5 gm. of crystals of the gold salts. This quantity at the end of the fractional crystallisation yielded approximately 0.1 gm. of scopolamine salt, 0.1 gm. of nor-hyoscyamine salt, and 0.2 gm. of lævo-hyoscyamine salt. In other experiments, larger amounts were obtained, but considerable proportions of a viscous uncrystallisable substance always separated.

In the initial stages of the above crystallisation process (a, b, and c), when the crystals had been separated as much as possible, the mother-liquors deposited yellow, amorphous, sticky particles. When the solution was gently warmed, the amorphous substance melted and floated on the surface like oily drops. This portion, which contained part of the alkaloids, could not be induced to crystallise, and further attempts to purify it did not alter its viscous nature.

SUMMARY.

The leaves of *Duboisia Leichhardtii* contain a mixture of the midriatic alkaloids, amounting to 1.4 per cent. of the dried (at 100°C.) material or 0.28 per cent. of the fresh plant. By the fractional crystallisation of their aurichlorides, the mixed alkaloids were separated into nor-hyoscyamine, lævo-hyoscyamine,

levo-scopolamine, and small amounts of atropine and nor-atropine. These were identified by the melting points of their gold salts and of the picrates.

D. Leichhardtii, therefore, closely resembles *D. myoporoides* in its alkaloids, and these two species are in marked contrast to the only other species known—*D. Hopwoodii*, the pituri-plant, which contains nicotine.

The thanks of the author are due to Sir Thomas Anderson Stuart, in whose laboratory this work was carried out.

THE PERCENTAGE OF CARBON DIOXIDE IN
EXPIRED ALVEOLAR AIR.

BY ETHEL C. PINKERTON, B.Sc. (SYD.), GOVERNMENT RESEARCH
SCHOLAR IN THE UNIVERSITY OF SYDNEY.

(From the Physiological Laboratory of the University of Sydney.)

Introduction.—Since it first appeared probable to physiologists that the exchange in the lungs between the gases of the air and of the blood were governed by the laws of diffusion, attempts have been made to ascertain the composition of the air in contact with the respiratory epithelium of the pulmonary alveoli. The early attempts made by Pflüger(1), Wolffberg(2), and Nussbaum(3) with an inflated balloon surrounding a catheter, by means of which a bronchus could be blocked, and samples taken from the enclosed area, yielded uncertain results under the same conditions. The figures for carbon dioxide were also lower than those obtained by determinations of the tensions of carbonic acid gas in blood and serum. In 1890, Ch. Bohr(4) showed that the tensions of gases in the alveoli could be ascertained from a knowledge of the volume of the expired air, A , and of the volume of the “dead space”, a . If the percentage of carbon dioxide in the inspired air be designated by J , the percentage of the same gas in the expired air as E , and in the alveolar air as X ,

$$AE = (A - a)X + aJ$$

$$\text{whence } X = \frac{AE - aJ}{A - a}$$

As the figure for the percentage of carbon dioxide in inspired air is negligible, the equation may be simplified to

$$X = \frac{AE}{A - a}$$

Zuntz, his co-workers and pupils, have made use of this method. Owing to the difficulty in measuring the volume of the “dead space”, this method is of limited application. It was not until the publication of a method by Haldane and Priestley in 1905(5),

that physiologists accepted the possibility of ascertaining, with some approach to accuracy, the composition of alveolar air. This method was of great simplicity. The breath was forcibly expelled through a long rubber tube connected with the mouth, and the end of the tube at the mouth was closed with the tongue at the termination of the act of expiration. By means of an inlet in the side of the tube close to the mouth, a sample of the last portion of the expired air could be withdrawn from the tube for analysis. This sample was held to be of the same composition as the alveolar air. In order to obtain the mean composition of the alveolar air, the breath was expelled at the close of a normal inspiration, and later at the end of a normal expiration. The mean of the analyses of the last part of these two samples was considered to represent the average composition of the gases of the alveoli. The proof of the nature of the last portion of the air driven out of the lungs in a forced expiration, consisted of analyses of the samples collected after the expulsion of different quantities of expired air. Haldane considered that, if any of the relatively pure air filling the bronchial tubes of the lungs, was mixed with the last part of the air of the sample, there would be a higher concentration of carbon dioxide in the sample collected from a deep expiration than would be present in the sample taken after an ordinary expiration. He gave the results obtained from an experiment in which four samples were collected after sharp expirations of varying depths immediately following the completion of inspiration. The amount of expired air breathed out, by the subject of this experiment, as tidal air, had been found previously to measure 600 c.c. The figures of the analyses of the samples taken under these conditions are given in Table i.

TABLE i.

No. of experiment.	Volume of expired air.	Percentage of carbon dioxide in sample.
1	262	4.42
2	377	5.17
3	492	5.71
4	1050	5.72

The uniformity in the figures yielded in the last two analyses was considered as a proof that the air was derived from the alveoli unmixed with that of the "dead space" of the trachea and respiratory passages lying between the atmosphere around the body, and the alveoli of the lungs.

Haldane further presented a number of analyses (about 54 in all) made on two subjects with the object of measuring the mean composition of the alveolar air. The figures were obtained with the subject at rest in a sitting position, while breathing fresh air at normal atmospheric pressure. The mean concentrations of carbon dioxide were 5.62%, and 6.28% for the two persons, the maximal and minimal variations being 5.40% and 5.87%, and 5.985% and 6.845% respectively. Haldane commented on the constancy of these figures, which he considered clearly suggested that the ventilation of the lungs during rest was regulated so as to maintain the percentage of carbon dioxide in the alveolar air at an almost fixed level.

In 1893, W. S. Miller (6) made a study of the structure of the human lung, after he had studied the morphology in *Necturus*, the frog, the snake, the crocodile, the turtle, *Heloderma* (lizard), the fowl, cat, dog, rabbit and sheep. He employed dried specimens of the lungs, corrosion-preparations in wax or Wood's metal, and reconstructions from sections. The paper, which remained little recognised for many years, now forms the basis of our conception of pulmonary structure. The terminal bronchiole opens out into a club-shaped expansion, from which five or six openings, or "vestibula", lead to secondary expansions known as "atria", which communicate with central cavities or "air-sacs" set about with the small, irregular cubicles or "air-cells". The "air-cells" correspond to the alveoli of physiological writers. These structures are found not only in the walls of the air-sacs, but also in those of the atria. Alveolar air, as understood by physiologists, represents that part of the gaseous contents of the lungs filling the "air-cells" belonging to the "air-sacs".

The composition of the alveolar air has been made the subject of repeated investigations by Krogh and Lindhard. Lindhard(7)

measured the percentage of carbon dioxide in the alveolar air by a method worked out in the laboratory of the Finsen Institute at Copenhagen. He took a series of samples at the end of a number of respirations, and analysed the mixed sample. Lindhard pointed out that Haldane's method presupposed that the last air expired, had the same content in carbon dioxide as the alveolar air at the end of an expiration. This, he considered, was not the case, as the last air to leave the alveoli remained in the upper air-passages in what is known as the "dead space". The error produced in this way always tended in one direction. The percentage of carbon dioxide in the expired portion would be smaller than that in the alveoli. The value of the error would vary with the length of the expiration. Not only so, but the "form" of a respiration varied with its depth.

Krogh(8) pointed out that the term "average alveolar air", or simply "alveolar air", had two distinct meanings. It might refer to the air in the pulmonary air-cells, or it might refer to the last air expired during expiration. He proposed, therefore, to designate the latter air as "the alveolar expired air". He concluded that the average alveolar tension of carbon dioxide could not be determined with certainty by any method hitherto employed. During rest, Haldane and Priestley's method yielded the nearest approximation, but, during work, the results obtained by this method were much too high. The percentage of carbon dioxide in the "alveolar expired air" was not identical with the average tension of carbon dioxide in the alveoli, but generally lower. Krogh and Lindhard(9), using mechanical methods of sampling the expired air, made a careful study of the distribution of carbon dioxide in expired air under conditions of work and rest. They showed that, during work, the carbon dioxide increases directly with the time at which the sample of expired air is taken for analysis. Each successive portion of expired air contained more carbon dioxide than the portion which preceded it, and less than the portion which followed it. With the body at rest, they found that the percentage of carbon dioxide in the expired air increased rapidly at first, and later more slowly, the curve showing a marked tendency to become asymptotic.

In a critical examination of the methods for measuring the volume of the "dead space", Henderson, Chillingworth and Whitney(10) determined the composition of successive portions of the expired air. They found that the concentration of carbon dioxide in the expired air increased in each successive portion expelled from the air-passages. Their experiments ceased when the volume of expired air amounted to 400 c.c., possibly because they were concerned with tidal respiration, and did not wish to produce dilatation of the small bronchioles by forcible expiration. They state that 400 c.c. are sufficient to remove the whole of the air from the "dead space", and that the final samples of expired air consisted of undiluted alveolar air. Their published curve shows, however, that the concentration of carbon dioxide was still rising when their experiments ceased. To this publication, Haldane(11) appended a paper, in which he discussed again the evidence in support of the determination of the composition of alveolar air by the method of 1905. He stated that "it now appears that the air of constant carbon dioxide pressure is alveolar air from the 'air-sacs' of Miller's nomenclature, and that the air from the alveoli of the 'atria' is of a different and more variable composition." A series of 17 analyses was given to extend the observations on the concentration of carbon dioxide after the expiration of different amounts of air. The average figures are published in a table, reproduced as Table ii.

TABLE ii.

Depth of respiration.	Percentage of CO ₂ in air issuing from the mouth.
190	3.03
335	4.37
510	5.04
650	5.19
950	5.51
1350	5.48

In a further series on a different day, the results of six successive determinations gave the mean percentage of carbon dioxide as 5.39 with an expiration of 900 c.c., and 5.36 with an

expiration of 1750 c.c. Haldane concluded that the deeper part of the expiration contained no more carbon dioxide than the middle part.

Scope of Research.—The experiments to be described in the present paper are designed to estimate the percentage of carbon dioxide in successive portions of expired air. They were undertaken in consequence of repeated failures in the Physiological Laboratory to obtain any close agreement in the concentration of carbon dioxide in different samples of alveolar air, collected after the method of Haldane and Priestley. Instead of observing any constancy in these values, even when averaged results were obtained of five samples taken at the close of inspiration, and of five taken at the close of expiration, as described by H. G. Chapman(12), the values obtained showed variations of $5\frac{1}{2}$ or even more. It became necessary to ascertain whether the percentage of carbon dioxide increased in the last 600 c.c. of air expressed from the air-passages in a forcible expiration.

The air issuing from the mouth was passed along a brass tube of sufficient length to accommodate the greater part of the expired air. The mouthpiece was of such a size and shape as to be closed readily by the lips, so that the whole of the air discharged from the air-passages entered the tube without admixture with the atmosphere. At the conclusion of the expiration, the mouthpiece could be securely shut by the tongue. The expired air was collected from different subjects and under varying conditions. As a rule, no attempt was made to get uniform results by resting in a chair for some minutes with regular breathing. The air was expelled forcibly, sometimes at the end of inspiration, and sometimes at the end of expiration, sometimes after shallow breathing, and sometimes after several deep breaths. As it was only desired to know how the percentage varied in the successive parts of the later portions of the expired air, it became unnecessary to pay attention to these factors, when it was found that none of them caused any variation in the character of the results. Small, metal, capillary tubes inserted into the sides of the brass tube served for withdrawing samples for

analysis. These capillary tubes were placed at intervals of 25 cm. along the first two metres of the tube. Sampling was performed by attaching burettes in which a vacuum of 50 to 100 c.c. was produced by lowering the mercury reservoir, and clamping the tube connecting the reservoir to the burette. The upper nozzles of the burettes were connected by short pieces of pressure india-rubber-tubing controlled with strong spring clamps. The analyses were made in a Hempel's pipette with a sample of 50 c.c. contained in a gas burette graduated in fifths of 1 c.c. The readings were made to the nearest tenth. These readings were easily possible as the divisions on the scale were 1 mm. apart. As the change in volume during absorption varied from 1.5 c.c. to 4 c.c., the analytical error might amount to 0.2 on the calculated percentage of carbon dioxide. A number of analyses were done in duplicate, and the figures show the agreement between the duplicates to be good. In no case did the difference in the calculated percentage amount to more than 0.1. In the opinion of Krogh(13), it is misleading to give the average alveolar tension of carbon dioxide with an accuracy of more than 0.5 mm. Hg., as the analytical figures should not be strained too far.

Control of Experimental Method.—The air leaving the alveoli of the lung traverses the tubular air-passages before reaching the mouth. It is recognised that a certain amount of alveolar air must be passed through these tubes before the air present in them is dislodged. When the air issuing from the mouth travels through a long tube, the same general conditions will prevail. A considerable amount of expired air will be diluted with the air in the tube before the whole of this is removed. It is now known that, when a stream of gas is passed along a tube, an axial stream traverses the centre of the tube, and that a "spike" of the entering gas is thrust into the air that is present. The "spike" is more slender and elongated the more rapid the speed of the entering gas.

A series of experiments has been carried out to ascertain what amount of gas was needed to wash out the tube, when passed into the brass tube, in a small fraction of a second. Since a

column of gas passes through a straight tube for a long distance in the form of a spike when there is no resistance in the tube, the tube employed was lightly packed with glass wool for three inches. The brass tube used in the experiment had a bore of 20 mm., and was 5 metres long. It was perfectly straight. A brass mouthpiece, 5 cm. long and of 15 mm. bore, was soldered at one end of it, and a coiled rubber-tube, 2 metres long, was attached to the opposite end, the end of the rubber-tubing dipping into a vessel of water. The total volume of the brass and rubber tubes was approximately 2,200 c.c. Just beyond the mouthpiece and at intervals of 25 cm., capillary brass tubes were securely soldered with silver into the main tube. These served for the withdrawal of samples. The gas to be used in the experiment was placed in a strong air-tight vessel. This vessel was fitted with a cork through which passed two bent glass tubes, by means of which the vessel could be connected to the water-supply, and also to the mouthpiece of the brass tube. The vessel was completely filled with water, which was displaced by a mixture of air and carbon dioxide. The rubber tubing, connecting the vessel to the mouthpiece of the brass tube, was tightly clamped with a strong spring clip, and the interior of the vessel was connected with the water-supply so that the gas in the vessel was strongly compressed. When the pressure was sufficient, the connection with the water-supply was clamped off. The clamp connecting the gas with the tube was released for a fraction of a second, and at once retightened. As the far end of the tube was under water, no air could be sucked in as a result of any change in the volume of the air in the tube. The volume of the vessel containing the gaseous mixture in the first set of experiments was three litres, which was compressed to half its volume by the water-pressure. Later, a larger vessel holding 11,750 c.c. was employed. In this, the amount of compression of the gaseous mixture was varied. In the later series, the end of the hose was so placed that the volume of gas passed through the tube, could be measured. The results of the first sets of experiments are recorded in Table iii.



TABLE III.

No. of experiment.	Volume to which the gas was compressed in cubic centimetres.	Percentage of CO ₂ in samples of the gas collected at distances from the mouthpiece of			
		25 cm.	50 cm.	175 cm.	200 cm.
1	2500-1500	4.1	4.0	4.1	4.2
2	3000-1500	3.2	3.3	3.3	3.3
3	3000-1500	3.7	3.7	3.8	3.7
4	3000-1500	3.7	3.7	3.7	3.7
5	3000-1500	2.7	2.7	2.8	2.8
6	3000-1500	32.0	32.1	32.0	32.1

The analyses show the percentage of carbon dioxide in the two successive samples taken near the mouthpiece, and the two samples withdrawn at 175 cm. and 200 cm. from the mouthpiece. The samples farthest from the mouthpiece were taken first. The volume of the tube, to the outlet at 200 cm., was 625 c.c. approximately. These analyses show that the percentage of carbon dioxide in the air along the tube was constant for the distance tested. Such differences as do appear in the figures are within the error of analysis. In the first five experiments, the percentage of carbon dioxide was varied between 2.7 and 4.1. In the sixth experiment, the percentage of carbon dioxide was 32. In the second series of experiments, recorded in Table iv., the volume of the gas driven into the tube was measured. This was found necessary, as the brief release of the spring-clamp did not permit of the whole of the compressed gas passing into the tube.

TABLE IV.

No. of expt.	Volume of gas passed through tube in c.c.	Volumes to which the gas was compressed in c.c.	Percentage of CO ₂ in samples of the gas collected at distances from the mouthpiece of			
			25 cm.	50 cm.	175 cm.	200 cm.
1	...	11000-8750	34.4	34.7	34.7	34.6
2	800	11250-8750	23.7	23.6	23.6	23.6
3	700	11000-9750	14.2	14.0	14.1	14.2
4	1150	11250-8750	23.4	23.3	23.4	23.4
5	1150	11250-8750	15.8	15.8	15.8	15.6
6	1000	10750-8750	21.6	21.6	21.7	21.5
7	1200	11250-8750	13.2	13.3	13.2	13.3
8	1300	11500-8750	9.3	9.4	9.3	9.3
9	1200	11500-8750	5.9	6.0	5.9	6.0

The figures show that the percentage of carbon dioxide, in the 600 c.c. passed last into the tube, remained constant within the analytical error of the experiment, even when such small quantities as 700 or 800 c.c. were released into the tube. The percentage of carbon dioxide was varied from 6 to 34.6. These results show that quantities of gas, of similar volume to that expelled from the lungs by a forcible expiration, wash out the air from the last 200 cm. of the brass tube.

Results.—Numerous experiments were carried out after samples of expired air had been passed along the brass tube. As an example, some experiments carried out, with the author as subject, may be described in some detail. The brass tube used was that employed in the control-experiments with the gaseous mixture. The samples withdrawn in the first series were taken at 25 cm. and 200 cm. from the mouthpiece. Each sample measured about 80 c.c., and was analysed in two portions. The samples distant from the mouthpiece were collected before those nearer to it. The volume of the air driven from the tube was measured in a spirometer. A number of breaths were discharged into the brass tube before the particular breath from which the sample was taken. The results are recorded in Table v.

TABLE v.

No. of expt.	Date.	Time of sample given.	Volume of expired air in c.c.	Percentage of CO ₂ in samples of alveolar expired air collected at distances from the mouthpiece of			
				25 cm.		200 cm.	
1	15.v.16	a.m.	2400	4.2	4.3	4.0	4.0
2	16.v.16	a.m.	2400	5.0	4.9	4.4	4.5
3	16.v.16	p.m.	2400	4.3	4.4	4.4	4.5
4	16.v.16	p.m.	2200	4.4	4.5	4.3	4.3
5	16.v.16	p.m.	2200	4.5	4.5	4.2	4.1
6	17.v.16	a.m.	2200	4.5	4.4	4.4	4.5
7	17.v.16	p.m.	2400	4.0	4.1	4.1	4.1

The two metres of the brass tube in connection with the mouthpiece contained the last 625 c.c. expelled from the air

passages. One sample represented the last 150 c.c. of expired air to leave the mouth, while the other represented the composition when half a litre less was expelled. The figures show that the composition had not changed on four occasions when an extra half litre had passed along the tube: while, on three occasions, the last part of the expired air contained a greater amount of carbon dioxide. The mode of sampling was then varied slightly, two samples being taken at 25 cm. and 50 cm. from the mouthpiece, and two at 175 cm. and 200 cm. The volume of air expelled was also diminished. The results are recorded in Table vi.

TABLE VI.

No. of expt.	Date.	Time sample given.	Volume of expired air in c.c.	Percentage of CO ₂ in samples of alveolar expired air collected at distances from the mouthpiece of			
				25 cm.	50 cm.	175 cm.	200 cm.
1	23.v.16	a.m.	12500	3.4	3.5	3.5	3.5
2	25.v.16	a.m.	1900	4.5	4.4	4.4	4.4
3	25.v.16	a.m.	1900	4.2	4.2	4.1	4.2
4	25.v.16	p.m.	1750	4.1	4.2	3.7	3.8
5	30.v.16	p.m.	1250	4.5	4.5	4.5	4.5
6	30.v.16	p.m.	1400	4.6	4.6	4.5	4.6
7	30.v.16	p.m.	1500	4.3	4.2	4.1	4.1
8	31.v.16	a.m.	1550	4.4	4.4	4.4	4.3
9	1.vi.16	a.m.	1550	4.5	4.4	4.4	4.3
10	1.vi.16	a.m.	1400	4.6	4.5	4.6	4.5
11	1.vi.16	a.m.	1200	4.9	4.9	4.8	4.8
12	1.vi.16	p.m.	1400	4.4	4.3	4.4	4.3
13	1.vi.16	p.m.	1350	4.7	4.7	4.7	4.7
14	2.vi.16	a.m.	1550	5.3	5.2	5.1	5.1
15	2.vi.16	p.m.	1300	4.4	4.5	4.3	4.4
16	6.vi.16	p.m.	1200	4.6	4.7	4.6	4.6
17	6.vi.16	p.m.	1250	4.7	4.7	4.7	4.7

† After a deep inspiration.

These results show that the gas along the tube did not vary in thirteen out of the seventeen experiments: while, in experiment No. 4, there was distinctly more carbon dioxide in the air near the mouthpiece; and, in experiments Nos. 7, 9, and 14, there seemed to be slightly more carbon dioxide in the air breathed

later from the mouth. In these three experiments, the difference in composition is so slight as not to be detectable with certainty by the method of analysis. If Tables v. and vi. be compared, it will be seen that there is a decided change in the results. When the quantity of air expelled from the mouth was over two litres, the amount of carbon dioxide in the tube was more often higher near the mouthpiece than when the quantity of expired air was less. The fact demonstrated in these Tables, that the more air expelled from the lungs, the greater was the tendency for the percentage of carbon dioxide to increase continuously as the air left the mouth, suggested that the time occupied in breathing out the air affected the result. Experiments, therefore, were carried out in which the air was expelled slowly during several seconds, and others during which the air was expelled more rapidly. Two seconds represent the minimal time in which the subject could expel two litres of air. The experiments in which the air was expired less quickly may be recorded first. In these experiments, the conditions were exactly similar to those of the experiments recorded in Table vi. The results appear in Table vii.

TABLE VII.

No. of expt.	Date.	Volume of expired air in c.c.	Percentage of CO ₂ in samples of alveolar expired air collected at distances from the mouthpiece of			
			25 cm.	50 cm.	175 cm.	200 cm.
1	25. x. 16	1800	4.7	4.7	4.5	4.4
2	26. x. 16	1700	5.3	5.2	5.0	4.9
3	26. x. 16	1800	4.9	4.9	4.7	4.7
4	26. x. 16	1600	5.4	5.4	5.2	5.0
5	30. x. 16	1800	4.9	4.8	4.5	4.3

These results show that, when the air leaves the lungs during several seconds, the alveolar expired air contains more carbon dioxide the longer the expiration continues. The successive portions of the expired air thus show an increased concentration of carbon dioxide, the later they leave the air-passages.

As it was thought that removing the samples from the brass tube might bring about a mixing of the contents, which might obscure any slight difference in the composition of the air in the several portions of the brass tube, the apparatus was varied by making the brass tube in separate portions connected together by rubber-tubing, which could be clamped so that each part of the brass tube could be isolated. Four portions of brass tubing, of 12 mm. bore and 79 cm. length, holding about 100 c.c., were fitted near the centre with capillary tubes for withdrawing samples of the gas. These tubes were placed in series as *a*, *b*, *c*, and *d*, and connected with a mouthpiece 5 cm. long. The last portion (*d*) was connected with a brass tube similar to that used in the earlier experiments. This brass tube was one metre long, and, to its end, two metres of rubber-tubing were attached. These later experiments were performed in the same way as the earlier ones. As soon as the subject had breathed into the tube, the clamps between the successive brass tubes were tightened, and the samples collected. The results of some experiments are recorded in Table viii.

TABLE viii.

No. of expt.	Date.	Time sample given.	Volume of expired air in c.c.	Percentage of CO ₂ in samples of alveolar expired air collected from			
				a	b	c	d
1	30.vi.16	...	900	4.6	4.4	4.3	4.3
2	3.vii.16	...	1000	4.2	4.1	4.1	4.2
3	16.x.16	a.m.	1650	4.2	4.3	4.3	4.4
4	16.x.16	a.m.	2000	*5.7	5.7	5.6	5.6
5	16.x.16	a.m.	2000	4.0	3.9	4.0	4.0
6	16.x.16	p.m.	2100	†3.6	3.6	3.5	3.7
7	16.x.16	p.m.	2300	4.1	4.1	4.1	4.1
8	16.x.16	p.m.	2200	4.2	4.2	4.2	4.1
9	17.x.16	a.m.	2000	†3.3	3.4	3.3	3.3
10	17.x.16	p.m.	2100	4.5	4.5	4.6	4.5
11	17.x.16	p.m.	2000	4.5	4.5	4.6	4.5
12	17.x.16	p.m.	1800	4.4	4.3	4.4	4.3

* After exercise.

† After a deep inspiration.

In most experiments, the expired air was expelled as rapidly

as possible by the subject (time of expiration ascertained to be two seconds for the deep expiration, and one second for the shallow expiration), but in one experiment (1), the expulsion occupied two seconds.

The results show that, when the expulsion was made rapidly in the times mentioned above, the last portions of the expired air contained a similar percentage of carbon dioxide. When, however, the expiration was less rapid, the successive samples showed an increase in concentrations of carbon dioxide.

The time occupied in breathing out various amounts of air as quickly as possible from the lungs was found approximately with the aid of a stop-watch. The figures obtained from sixty experiments, in which the time was noted, are:—

For 1000 c.c. expired, the average 0.5 sec., max. 0.6 sec., min. 0.4 sec.

For 1200 c.c. expired, the average 0.65 sec., max. 0.8 sec., min. 0.5 sec.

For 1500 c.c. expired, the average 1.1 secs., max. 1.5 secs., min. 0.9 sec.

For 1800 c.c. expired, the average 1.9 secs., max. 2.2 secs., min. 1.8 secs.

For 2000 c.c. expired, the average 2.0 secs., max. 2.5 secs., min. 1.4 secs.

For 2200 c.c. expired, the average 2.5 secs.

A study of a graph constructed from these figures shows that, after 1300 c.c. had been expelled from the lungs, the rate of expulsion became distinctly slower; and that the speed of expulsion was approximately diminished to one-half its former value.

Discussion.—These results, which are confirmed by those with two other subjects, show that the last air expired is of uniform composition within the error of analysis, provided that the expiration was made quickly. When the total expired air amounted to one litre, the last 625 c.c. contained a uniform percentage of carbon dioxide after the air had been expelled from the mouth in less than one second. It would thus appear that this last 625 c.c. was not mixed with any part of the air of the "dead space." While it is no doubt true that the percentage of carbon dioxide in the pulmonary air-cells is continuously increasing during the expiratory phase, it is not possible, when the subject is not doing heavy work, to obtain any evidence of an increase in the percentage of carbon dioxide during a deep,

forcible expiration unless this is unduly prolonged. Even when much deeper expirations were made, which occupied two seconds, it still remained impossible to detect any increased tension of carbon dioxide in the air last expired. In the light of these results, it seems unlikely that the expired air remaining in the "dead space" differs in composition from that last expelled from the mouth or nose during a quick, forcible expiration. Whether the air was forcibly expelled at the end of an inspiration, after deep breathing or after shallow respiration, the same results were obtained. The last 625 c.c. expired appeared to be of uniform composition. The bearing of these results on the conclusion of Krogh and Lindhard, that the percentage of carbon dioxide in the alveolar expired air is not identical with that in the pulmonary alveoli, will be discussed in a later paper dealing with alveolar expired air.

Conclusions.

(1.) The forcible expulsion of the breath into a straight brass tube of 20 mm. bore serves to wash out the whole of the air from two metres of the tube.

(2.) Analysis of the last 625 c.c. of expired air shows that the difference in percentage of carbon dioxide, in any portion of it, does not exceed the error in the analytical method, when the expulsion is performed within two seconds for amounts of two litres and over, and within one second for quantities of one to two litres of expired air.

(3.) When the air is expelled more slowly, the successive portions of expired air continue to show higher percentages of carbon dioxide.

Finally, I wish to thank Sir Thomas Anderson Stuart, in whose laboratory this work has been carried out, and Dr. H. G. Chapman for the advice and assistance which he has given me in the course of this research.

REFERENCES.

1. E. F. W. PFLÜGGER—Pflüger's Arch. f. d. ges. Phys., iv., p.467, 1871.
2. S. WOLFFBERG—Pflüger's Arch. f. d. ges. Phys., vi., p.23, 1872.
3. M. NUSSEBAUM—Pflüger's Arch. f. d. ges. Phys., vii., p.296, 1873.
4. CH. BOHR—Skand. Arch. f. Phys., 11, p.236, 1891.
5. J. S. HALDANE and PRIESTLEY—Journ. Phys., xxxii., p.225, 1905.
6. W. S. MILLER—Journ. Morphol., viii., p.165, 1893.
7. J. LINDHARD—Skand. Arch. f. Phys., xxvi., p.221, 1912; Journ. Phys., xlii., p.337, 1911.
8. A. KROGH—Skand. Arch. f. Phys., xxx., p.375, 1913.
9. A. KROGH and J. LINDHARD—Journ. Phys., xlvii., p.30, 1913; p.430, 1914.
10. Y. HENDERSON, E. P. CHILLINGWORTH, and J. L. WHITNEY—Amer. Journ. Phys., xxxviii., p.1, 1915.
11. J. S. HALDANE—Amer. Journ. Phys., xxxviii., p.20, 1915.
12. H. G. CHAPMAN—Journ. Proc. Roy. Soc. N. S. Wales, l., Abst. Proc., p.18, 1916.
13. A. KROGH—Skand. Arch. f. Phys., xxx., p.390, 1913.

CONTRIBUTIONS TO OUR KNOWLEDGE OF SOIL
FERTILITY, xv.THE ACTION OF CERTAIN MICRO-ORGANISMS UPON THE NUMBERS
OF BACTERIA IN THE SOIL.BY R. GREIG-SMITH, D.SC., MACLEAY BACTERIOLOGIST TO THE
SOCIETY.

In making counts of soil-bacteria, it is not uncommon to find colonies of *Bac. mycoides* or of races of *Bac. vulgatus* spreading over the surface of the nutritive agar. Very often it will be noted that, while the majority of the colonies are covered by the spreading growths, there are a few that are untouched. The *mycoides*-colony may approach to within two, five, or ten millimetres, and then spread out and surround the colony, leaving a ring of clear agar medium. It is evident that there is some product secreted by these colonies which is obnoxious to the spreading colony, whether it be *Bac. mycoides*, *Bac. vulgatus*, or to spreading moulds such as *Penicillium* or *Aspergillus*.

An examination of the colonies producing this toxic effect showed that the majority consisted of Actinomyces or Streptothrix, as they have been called. Some of these darkened the medium and were apparently *Act. chromogenus*. Certain of these colonies were selected, and spotted upon fresh plates, in the centre of which bacteria with spreading colonies were planted. The white forms were found to be very toxic, while the dark forms were feebly toxic to the spreading *Bac. vulgatus*.

The apparent toxicity of these Actinomyces-forms is interesting when one is considering the nature of the limiting factor in soils. This is considered to be protozoal by Russell and others, but as the infection of sterilised soils with protozoa alone, does not introduce the limiting factor, as has been shown by Russell, by Goodey, and by the writer, there are doubts regarding the validity of Russell's contention. Whatever the cause of the

limitation may be, it is apparently something which is slow-growing, for an infection with 5% of raw soil only begins to show a limiting action upon the fortieth day. It is also something, like the larger protozoa, which can be retained by cotton-wool filters. These characters would apply to the Actinomycetes which have the property of growing slowly in felted masses capable of being retained by cotton-wool with the particles of soil and the larger protozoa. It appeared possible, therefore, that, in the Actinomycetes, and possibly in an excessive growth of them, we might find the limiting factor for which bacteriologists have been seeking.

Russell and Hutchinson's researches would appear to negative this possibility, for they found that the Actinomycetes were less affected than other forms by toluening; in fact, that immediately after toluening they were the predominating species of micro-organisms, and they retained this position for nine days. Of the two forms of Actinomyces, the white and the brown, the latter predominates in raw soil, while the former is conspicuous in toluened soil. Owing to the presence of the white form in toluened soil, in which the limiting factor had been destroyed, Russell and Hutchinson naturally did not test the Actinomycetes to see if they could functionate as the limiting factor. Their apparent toxicity upon agar plates, however, was so conspicuous, that I considered a test was necessary to make their position definite.

Among the species which appeared to be most toxic, three were picked out as being the most promising. Two of these, Nos. 10 and 14, were much the same, and grew as dirty white crusts on nutrient agar; 14 was a trifle darker than 10. Both adhered firmly to the agar surface. The third, No. 11, formed a loose, yellow growth, part of which came away easily from the agar; microscopically, it appeared as a rod with a tendency to grow in threads. At first, it produced a yellow pigment, especially upon Lipman-Brown agar, which diffused through the medium. Cultural experiments showed that ordinary nutrient agar was the best for obtaining growths of these species: fluid media were quite unsuitable for growing them in any quantity.

While using the Lipman-Brown medium for enumerating soil-bacteria, certain colonies were found growing on the under-surface of the agar, and preventing the growth of bacterial colonies upon the upper surface. These toxic bacteria, termed provisionally T.P.2, grew scantily upon the surface of the Lipman-Brown agar, but well upon ordinary nutrient agar. This bacillus and the three Actinomycetes were tested upon sterilised soil to determine their possible toxic action upon the soil-flora.

A quantity of garden-soil was heated for an hour at 100°, and divided into portions which, after having had the moisture-content raised to 10% with suspensions of the micro-organisms, were put into wide-mouthed, sterile bottles which were plugged with cotton-wool, weighed, and set aside in the laboratory. The temperature varied from 22° to 26° except towards the end of the experiment, when it fell gradually to 16°. The moisture-content was maintained by the occasional addition of sterile water, and portions were abstracted from time to time, and the bacteria counted in the usual manner. The medium employed for the enumeration was Lipman-Brown agar with the addition of 0.05% of Lemco meat-extract, which gave a more uniform count in the triplicate plates.

BACTERIA IN MILLIONS PER GRAM OF DRY SOIL.

Days.	1	11	18	31	40	49	56	63	88	125	357
Control soil ...	0.1	95	95	78	65	102	89	63	36	46	8
Actino. 10 ...	0.5	98	81	54	40	54	33	49	26	38	6
Actino. 11	62	51	33	41	39	46	30	21	2
Actino. 14 ...	0.4	104	104	80	58	65	75	64	41	36	12*
Bac. T.P.2...	...	102	260	54	63	58	43	44	23	40	4

* By an accident, the water-content was raised to 14%.

In counting the colonies, it is not always easy to distinguish a bacterial colony from a mould; especially is this the case with the Actinomycetes-colonies when they are deep in the agar, but, so far as was possible, the moulds were excluded in the counts. The colonies of Actino. No.10 were easy to recognise on account of their yellowish colour.

The numbers show that the addition of the moulds and of the toxic bacteria had a small though consistent effect in reducing the numbers of bacteria after an interval of some thirty days; for when the counts are plotted, the control-curve is generally higher than the others. The reduction of the numbers, however, was not pronounced, and we must therefore conclude that the moulds and bacteria used in the experiment do not constitute what is recognised as the limiting factor. This had not been completely eliminated from the soils, for its effect was made evident between the 125th and the 357th day.

Shortly after the start of the last experiment, another was prepared to determine the effect of three of the micro-organisms upon raw, toluened and heated soils. The moisture of a garden-soil was raised to 6% with sterile distilled water, and the soil was divided into three portions. One was treated for two days with 2% of toluene, and aired off. A second was heated for two and a half hours at 97°, and, with the third portion, was aired so as to give all three portions the same air-treatment. The portions were subdivided, treated with the respective organisms, and had the moisture-contents raised to 10%.

BACTERIA IN MILLIONS PER GRAM OF DRY SOIL.

Days.		1-2	15	21	28	43	78	94	317
Raw soil.	Control	10	...	22	26	...	6	6	3
	Actino. 10	10	...	20	21	...	5	4	4
	Actino. 14	9	...	32	17	...	7	5	3
	Bac. T.P.2	12	...	17	18	...	7	5	3
Toluened soil.	Control	10	...	56	47	...	66	59	49
	Actino. 10	10	...	61	58	...	86	71	47
	Actino. 14	11	...	115	78	...	71	41	53
	Bac. T.P.2	12	160	110	59	...	66	49	41
Heated soil.	Control	1	81	...	84	...	45	44	31
	Actino. 10	1	52	...	57	...	66	56	26
	Actino. 14	1	98	...	108	...	44	35	27
	Rac. T.P.2	4	356	...	107	...	71	35	24
Raw soil.	Acetone, 2%	29	40	...	36	46	19
	Acetone, 5%	12	67	...	50	94	45

The experiment confirms the previous one in showing that the

organisms have little or no action in bringing about a pronounced limiting effect upon the numbers of bacteria in the soil. The untreated soil had recovered from its air-drying by the 78th day, and had become normal; while the toluened and heated soils had not arrived at this condition by the close of the experiment on the 317th day. From a general glance at the numbers, we see that, in the heated soil, the numbers rapidly rise to a maximum and then fall; while, in the toluened soil, the numbers slowly rise, and the height of the curve is maintained for a longer time. I have already suggested that the effect of toluening appears to be to liberate nutrients, while heat seems to destroy toxins; but this is only a suggestion, for there is undoubtedly some other factor which is more potent. Possibly this is the alteration of the flora, which masks anything but a general difference between the results of the two methods of treatment.

The small experiment with acetone was introduced to test the contention of Buddin,* who said that it did not act as a volatile disinfectant, that is, it did not produce any partial sterilisation-effect, until 5.8% by weight had been added to the soil. From his experiment with acetone, which is a fat-solvent, he concluded that the volatile disinfectants do not influence the soil by reason of their power of dissolving the fatty matter (*agricere*) and facilitating the solution of the soil-constituents, as was suggested by me. Small as my experiment is, it shows that Buddin's assertion is too sweeping, for the action of acetone is one of degree, its action being much the same, though more feeble than toluene. The addition of 5% (by volume = 4% by weight) to the soil brought about an effect similar to that of 2% of toluene, and 2% of acetone had a less pronounced action. The high count on the second day, with the smaller amount, is peculiar and points to a stimulating effect. With regard to the fat-dissolving action of the volatile disinfectants, I have already said that the action is only one of many, and that it plays a part, though probably a small one, in the greater question of soil-fertility.

* Journ. Ag. Sci., vi., 418.

THE WING-VENATION OF LEPIDOPTERA.
(PRELIMINARY REPORT).

BY R. J. TILLYARD, M.A., B.Sc., F.L.S., F.E.S., LINNEAN
MACLEAY FELLOW OF THE SOCIETY IN ZOOLOGY

(Seven Text-figs.)

This short paper is an outline of one portion of a paper upon which the author is engaged, to be entitled "The Panorpid Complex: a critical study of the phylogeny and inter-relationships of the Holometabolous Insects, with special reference to the four Orders Mecoptera, Trichoptera, Lepidoptera, and Diptera." The genesis of the paper was the discovery of a remarkable large fossil insect, of a generalised type, from the Trias of Ipswich (Q.). In the structure of the wing-venation and wing-membrane of this insect, the writer recognises the nearest known approach to the true ancestor of these four Orders. The complete paper will be an attempt to show the diverging lines of descent of the four Orders from their common ancestor.

The fossil wing-form, which may be termed the *Protomecopteros* form, is exceedingly complicated, both in the actual venation, and in the structure of the membrane. The essentials of the type may be defined as follows:—

(i.) *Wing-membrane* with an abundant but *obsolescent* polygonal meshwork of small areolets or cellules, of Palæodictyopterous origin. Upon the angles of the areolets (and also upon the main veins), large hairs or bristles were developed. These are termed *macrotrichia*. Upon the whole wing-surface, much smaller and more abundant minute hairs, or *microtrichia*, are arranged.

(ii.) *Wing-venation* of Panorpid type, fore- and hindwings subequal. The essential characters of this venation are, (*a*) the

symmetrical dichotomous forkings of the main veins, Rs, M, and Cu₁; (b) the formation of large elongated polygonal (usually hexagonal) cells; (c) the formation of sessile apical forks upon the distal ends of the two principal cells (viz., the discoidal cell, *dc*), and the median cell, *mc*); and (d) the capture by Cu_{1a} of the fourth or last branch of the media (M₄).

Reduced to its essentials by the removal of numerous excess cross-veins and irregularities in the courses of the main veins, the Protomecopterous Venational Plan is shown in Text-fig.1 (forewing). For those readers who are not familiar with the

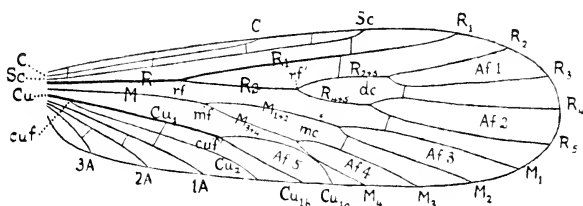

Text-fig.1.

Diagram of the Protomecopterous scheme of venation, with all excess cross-veins removed. Notice the partial fusion between Cu_{1a} and M₄. (In Mecoptera and Lepidoptera, this fusion becomes complete).

Comstock-Needham system of nomenclature, an explanation of the notation used is given at the end of this paper. The costal vein C is present in the Protomecoptera, but becomes entirely fused with the anterior border of the wing in the four descendant Orders (as, indeed, in all recent Insecta). The only differences between fore- and hindwings are:—

- (a) Sc is reduced in length in hindwing.
- (b) M tends to fuse basally with R in forewing, with Cu in hindwing.
- (c) Cu₁ (like Sc) is shorter in hindwing than in forewing.

The main object of this short outline is to indicate the interpretation of the Lepidopterous venational scheme as a *direct derivative* from the Protomecopterous. Putting aside the *Micropterygidae* (which will be dealt with as an archaic side-

branch derived by extreme reduction from the very base of the Lepidopterous stem, and having no near relatives within the Order as now existing), the author selects the *Hepialid* type of wing as the most archaic. Text-fig.2 shows the interpretation of the forewing of *Hepialus eximius* Scott.

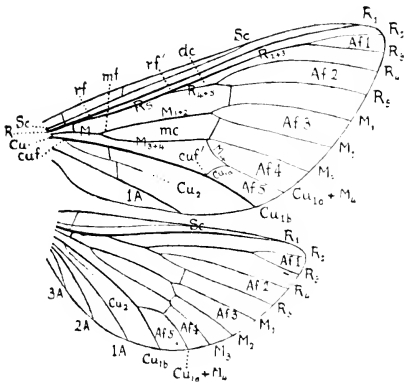

Text-fig. 2. *

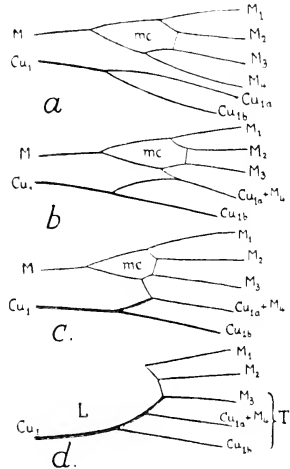

Text-fig. 3. †

In this wing, the capture of M_4 by the upwardly arching Cu_{1a} (which is not a mere cross-vein, as hitherto supposed, but a true branch of the main vein Cu_1) is beautifully shown. The possession of this character is the essential basis for the production of the closed Lepidopterous cell. After the capture of M_4 by Cu_{1a} ,

* Wing-venation of *Hepialus eximius* Scott. Note the close correspondence in venations in fore- and hindwings (homoneurism).

† Four phylogenetic stages in the formation of the trigamma (T)—*a*, primitive stage, with no fusion between Cu_{1a} and M_4 ; *b*, fusion between Cu_{1a} and M_4 completed (N.B., the wing in Text-fig. 1 lies phylogenetically between *a* and *b*); *c*, beginning of alignment of the trigamma-stem; *d*, completion of the trigamma (T), with its strong stem and triple fork. (In *d*, the media, M , and its first dichotomy are omitted, as in most Lepidoptera).

near the base of the former, the small basal portion of M_4 , left uncaptured, tends to become straightened out into line with the ascending base of Cu_{1a} . Thus there becomes formed a *strong three-pronged fork*, the *trigamma*, which forms the posterior closure of the Lepidopterous cell. The prongs of the trigamma are, from above downwards, M_3 , $Cu_{1a} + M_4$, and Cu_{1b} , respectively; and the method of its formation is indicated in Text-fig. 3.

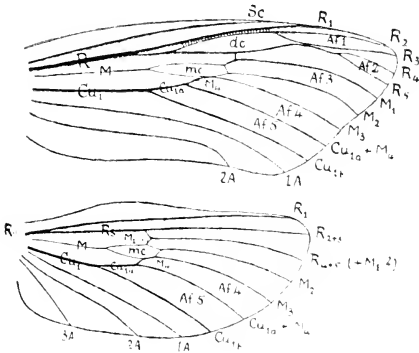

Text-fig. 4.*

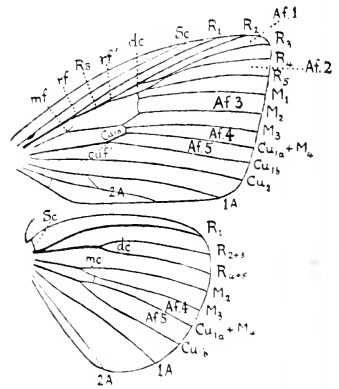

Text-fig. 5.†

The *trigamma* is the key which unlocks the homologies of all Lepidopterous wing-venational types. In Text-figs. 4-6, the author has applied it to *Zeuzera*, *Castnia*, and a butterfly, (*Euphlea*) representing three important and outstanding types of venation. In Text-fig. 7, the author has taken Hampson's "typical moth-venation" (p.318 in Sharp's *Insects*, Vol. ii.), and, by slight alterations, has transformed it into a "typical moth-

* Wing-venation of *Zeuzera d'arcillei* H.-Sch. In the forewing, R_{2+3} is quite fused with R_1 above dc , so that R_2 appears to be a *second* radial sector arising from R_1 . Notice the difference in venation of fore- and hindwings (heteroneurism).

† Wing-venation of *Castnia* sp., (from Sharp). Notice the presence of the archaic Cu_2 in forewing, also the incomplete formation of M at mf . An example of heteroneuric venation.

venation" based on the Protomecopterous wing-type, and solved by means of the trigamma-key.

Two of the main objects of this paper are, (a) the establishment of the homology of each Lepidopterous vein with a vein of the archaic Protomecopterous wing-type, and hence with a corresponding vein in all other Orders of Insects; (b) the establishment of correct homologies between the veins of the fore- and hindwings in Lepidoptera. The former object is illustrated in Text-figs. 1-6. The latter may be shown by drawing up a

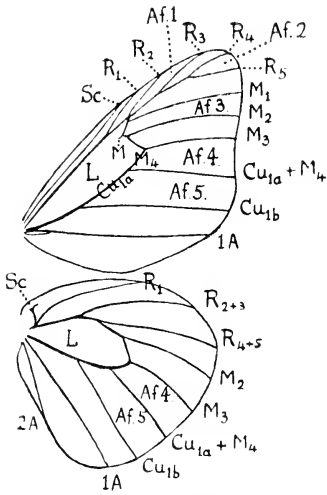

Text-fig. 6.*

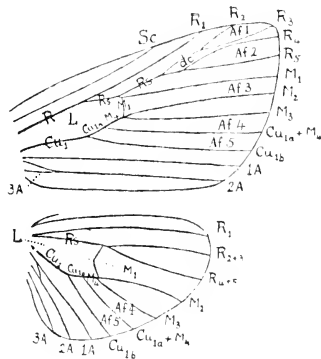

Text-fig. 7. †

table showing the true homologies of the veins and their designations in fore- and hindwings under (1) the numerical system in use at the present time by British Lepidopterists, and (2) the Staudinger-Schatz notation.

* Wing-venation of the butterfly *Euploea corinna* MacL., (from Waterhouse and Lyell). The Lepidopterous cell (L) is completely formed in both wings. An example of heteroneuric venation.

† Hampson's diagram of typical Moth-venation (from Sharp). The formation of the radial branches towards apex of forewing has been corrected (in many forms *de* closes completely up). Heteroneuric venation.

Table of Homologies of the Wing-Veins of Lepidoptera.

Correct Name (Comstock-Needham).	Numerical Notation.		Standing-Schatz Notation.	
	Forewing.	Hindwing.	Forewing.	Hindwing.
Costal vein (C)
Subcostal vein (Sc)
Radius (main stem) R ₁ ...	12	(in all recent Insects, fused with wing-border)	C	(missing)
Radial Sector, Rs: -	11	8	Sc ¹	C
First branch, R ₂ ...	10)	Sc ²)
Second branch, R ₃ ...	9)	Sc ³)
Third branch, R ₄ ...	8)	Sc ⁴)
Fourth branch, R ₅ ...	7)	Sc ⁵)
Media, M: -
First branch, M ₁ ...	6	(missing)	OR	(missing)
Second branch, M ₂ ...	5	5	UR	UR
Third branch, M ₃ ...	4	4	M ³	M ³
Fourth branch, captured by Cu _{1a} = Cu _{1a} + M ₄ ...	3	3	M ²	M ²
First cubitus, Cu ₁ : -	2	2	M ¹	M ¹
Upper branch (captures M ₄) = Cu _{1a} + M ₄	SM	SN
Lower branch, Cu _{1b} ...	1c	1c	1A	1A
Second cubitus, Cu ₂ ...	1b	1b	2A	2A
First analis, 1A ...	1a	1a
Second analis or axillary, 2A
Third analis or basilar, 3A

The Trigramma

It will be seen that, in the Numerical Notation, the veins numbered from 6 to 11 are falsely homologised in fore- and hind-wings. The same fault is apparent in the Staudinger-Schatz Notation. The author believes that the true scientific spirit will no longer tolerate false homologies in the interpretation of wing-venations, and the systems that perpetuate them must give way to a system of correct homologies. This alone would be sufficient justification for the adoption of a new system. If we add to this, that the system here offered has two other great advantages, viz., (a) that it brings the Lepidopterous venation into line with that of all the primitive Orders to which the Comstock-Needham System is readily applied, and (b) that, by the use of the *trigamma* as a key, the veriest tyro can unlock the secrets of the Lepidopterous wing with ease, while supposedly aberrant forms like *Castnia* fall simply and readily into their proper places, the case for the adoption of the new system becomes irresistible.

Believing that the question of jugum and frenulum is of less importance than the actual wing-venational scheme, the author proposes to subdivide the Order Lepidoptera into two primary divisions.

A. *Lepidoptera Homoneura*, with venations of fore- and hind-wings closely similar and of primitive design. (This includes *Micropterygidae* and *Hepialidae*).

B. *Lepidoptera Heteroneura*, with the venation of the hind-wing reduced, and differing widely from that of the forewing. (This includes all the rest).

Explanation of Notation used in the Text-figures.

All the main veins (C, Sc, R, M, Cu, and A) and their branches, as named in the Table of Homologies on p.172. In addition:—

Closed cells (primary): *dc.*, discoidal or radial cell; *mc.*, median cell. (Secondary): L., the Lepidopterous "cell."

Junctions or forkings of main veins: *cuf.*, first forking of Cu; *cuf'*, second forking of Cu (Cu_1); *mf.*, the thyridium, or median forking; *rf.*, first forking of R; *rf'*, second forking of R (R_s).

The five primary *Apical Forks*: *Af1* (between R_2 and R_3); *Af2* (between R_4 and R_5); *Af3* (between M_1 and M_2); *Af4* (be-

tween M_3 and M_4); Af_5 , between Cu_{1a} and Cu_{1b} —*pt.* = pterostigma.

POSTSCRIPT (*added April 16th, 1917*).—Since the above was written, I have carried out an exhaustive study of the Australian Mecoptera (Scorpion-flies) in my collection. These consist of representatives of the families *Bittacidae*, *Choristidae*, and a remarkable new family of very small Scorpion-flies, which will be dealt with in a separate paper. As these last are strong-flying insects, in which the wings appear to be connected during flight, I examined their wings for signs of a coupling-apparatus. I found that they all possessed a well-formed basal coupling-apparatus of the type described for the Neuroptera Planipennia, viz., a *jugal lobe* near the base of the forewing posteriorly, and a *jugal process* anteriorly on the base of the costa of the hindwing. From this jugal process there arise *two strong bristles directed obliquely outwards*, so as to constitute a true frenulum, exactly homologous with that found in Planipennia, and in the females of many moths. The same structures are present in *Choristidae*, but smaller, while their vestiges can be seen even in the *Bittacidae*.

Since, therefore, the *frenulum* has been shown now to occur normally in *three* Orders, while the *jugum* (as developed in the *Hepialidae*) is not to be paralleled outside the Order Lepidoptera, it is clear that we must revise our ideas of the relative archaism of the Jugatæ and Frenatæ. The original or ancestral Lepidopteron must have possessed a frenulum derived from an ancestor common to the Lepidoptera, Mecoptera, and Planipennia. On the other hand, the jugum of *Hepialidae* must have been a very early specialisation developed from the ancestral jugal lobe of the forewing, with complete loss of the original frenulum on the hindwing. The *Micropterygidae* must have followed a somewhat similar (possibly even earlier) line of specialisation.

The Frenatæ or Heteroneura, then, are the main stem of the Lepidoptera, while the Jugatæ or Homoneura are an archaic side-branch, from which no other existing families of the Order can possibly have been derived.

R.J.T.

MESOZOIC INSECTS OF QUEENSLAND.

NO.1. PLANIPENNIA, TRICHOPTERA, AND THE NEW ORDER
 PROTOMECOPTERA.

BY R. J. TILLYARD, M.A., B.Sc., F.L.S., F.E.S., LINNEAN
 MACLEAY FELLOW OF THE SOCIETY IN ZOOLOGY.

(Plates vii.-ix., and seven Text-figs.)

INTRODUCTION.

The present paper deals with a portion of the very interesting fossil insects recently obtained from the Ipswich Beds by Mr. B. Dunstan, Chief Government Geologist of Queensland, to whom I am much indebted for the opportunity of studying such fine and, in many respects, unique material. This collection may be looked upon as the *third* collection of insect fossils made at Ipswich. The first, or Simmonds Collection, was made in 1890 by Mr. T. H. Simmonds, of Brisbane, and the specimens were described by Etheridge and Olliff in the same year.* In 1909, Mr. Dunstan made a second collection of insects from the same locality. These were sent to me for study in 1913, together with some fossil insects from other beds in Queensland and New South Wales. All these were dealt with in a paper published last year by the Queensland Geological Survey.† In this paper,

* The Mesozoic and Tertiary Insects of New South Wales [and Queensland]. Geol. Survey of N.S.W. Memoirs, Palaeontology, No. 7, pp.9-22, two plates, 1890.

† Mesozoic and Tertiary Insects of Queensland and New South Wales. Queensland Geol. Survey, Publication No.253, pp.1-47, nine plates, six text-figs, 1916. (Stratigraphical Features, by B. Dunstan, pp.1-13).

the total of *named* Ipswich fossils was brought up to twenty-two, representing the following Orders:—

Order.	Genera.	Species.
Blattoidea	1	1
Protorthoptera	2	2
Coleoptera	5	14
Odonata	1	1
Mecoptera	1	1
Lepidoptera	1	1
Protohemiptera	1	1
Hemiptera	1	1
Total, 8	13	22

In dealing with the stratigraphy of the Ipswich Beds,* Mr. Dunstan places the fossil insect bed as most probably Upper Triassic. The assemblage of insects so far revealed from these beds comprises a series of forms which, judged by the succession of strata in the Northern Hemisphere, range from Upper Carboniferous to Jurassic; some of the latter differing very little from forms still living in Australia to-day. It would seem to be useless to discuss, at present, the question of the exact age of the Ipswich fossil insect bed, since the data required for correlation with beds of known age are not yet available. What is of importance to entomologists, however, is the fact that the Ipswich Insects are undoubtedly, in most respects, more specialised than the Upper Carboniferous and Permian Insects of the Northern Hemisphere; while, at the same time, they are, on the whole, undoubtedly more archaic than the assemblage of forms known from the Lower Lias. To give a striking example, the dragonfly *Mesophlebia antinodalis* Tillyard, from Ipswich, is intermediate between the Carboniferous Protodonata, in which no nodus was formed, and the Liassic Odonata, in which the same structure of the wing was completely formed. In other words, the intermediate condition of nodus-formation, seen in

* *Op. cit.*, No.253, pp.1-13.

Mesophlebia, is the condition that would be expected to be found in Triassic dragonflies from the Northern Hemisphere, if such were available. Similarly, it will be seen that the Caddis-flies described in this paper are definitely more archaic than the known Liassic forms. The value of the Ipswich fossils, therefore, lies in this, that they are gradually filling up the gaps left in Insect Phylogeny, by the unfortunate hiatus in the Trias of the Northern Hemisphere. Whether we designate these fossils as Triassic or Trias-Jura matters little, in comparison with the fact that they contain, amongst their number, forms which, if they were ever present in the Northern Hemisphere, could only have been Triassic.

Chiefly as a result of the interest attached to the specimens described by me from Mr. Dunstan's 1909 collection, further work was carried on at Ipswich in 1915-16. Owing to the sharp angle of dip, the fossil bed cannot be followed down very far without removing a great deal of overburden. Under Mr. Dunstan's close supervision, this has been carefully carried out by Mr. Wilcox, the shale being removed in large pieces to the Geological Survey in Brisbane, where it was delaminated with great care. The rock taken from some distance below the originally exposed surface has proved hard, and not easily delaminable. It would also appear to be much poorer in insect fossils than the rock nearer the surface; but this may be, in reality, only due to the difficulty of splitting it up sufficiently. The result of the examination of a considerable quantity of this rock has been the formation of the new collection of Ipswich fossil insects, which I hope to deal with in this series of papers. Mr. Dunstan informs me that the total number of specimens approaches two hundred. Most of these, however, are either Coleopterous elytra, Blattoid tegmina, or fragments of wings that do not merit a name; so that the number of recognisable new forms will be very much smaller. The study of these forms is a matter of great difficulty, requiring much care and maturity of thought. With an entirely new type of wing, it is much wiser to withhold publication for at least a year, while the peculiarities of the venation can be turned over and over in one's

mind, and a matured judgment given. Thus I have found it impossible to offer a complete account of these fossils in a single paper, without serious delay in the writing of it. The alternative is to deal with each Order separately, and to publish the results in a series of shorter papers. This I have determined to do. The present paper, dealing with the Orders Planipennia and Trichoptera, and the new Order Protomecoptera, is the first of this series.

Order NEUROPTERA PLANIPENNIA.

Family PROHEMEROBIDÆ Handlirsch.

Genus PROTOPSYCHOPSIS, n.g. (Plate vii., fig.3).

Wings broad, moderately pointed, with a large number of forked apical veins. Costal margin moderately broad (not as broad as in *Psychopsis*), with numerous costal cross-veins, some forked. Sc and R separated by cross-veins; distally, Sc and R approach close to one another some little distance before the apex, and are there joined by the last of a series of cross-veins; at this point, the end of Sc turns obliquely upwards as a slanting forked vein to the costal border, while R runs almost straight on, to end somewhat above the apex. R and Rs more widely separated than are Sc and R; numerous cross-veins traverse the space between them, and continue well beyond the last cross-vein from Sc to R. Rs gives off at least twelve branches (S_1 - S_{12}), running longitudinally through the wing at a slight inclination from Rs, and subparallel to one another. The cross-veins between these branches of Rs are exceedingly delicate, and only discernible in strong oblique light. There are two rows of gradate veins arranged into almost complete transverse lines across the wing; the more distal series lies below the extreme ending of Sc on the wing-margin, and runs from R down to S_{12} ; the more proximal series lies twice as far from the apex as does the former series, and runs from S_3 to S_{12} . Between these lies an intermediate series, forming a set of steps from S_2 to below S_{12} ; this series starts close to the outer series, then curves away from it, and ends up below S_{12} very close to the inner series.

Some other scattered cross-veins are present, but are not easily discernible. [Rest of wing missing].

Genotype, *Protopsychopsis venosa*, n.sp.

This genus would appear to be very closely allied to *Brongniartiella* Handlirsch, and *Mesopsychopsis* Handlirsch, both Jurassic forms, but differs from them in possessing a broader costal field apically, and in the presence of the three gradate series. It is also undoubtedly closely allied to our Australian genus *Psychopsis*, which is one of the most archaic forms of Planipennia still existing. The arrangement of the gradate series, some as complete straight lines across the wing, and some as step-veins, is exactly that found in *Psychopsis*. *Protopsychopsis*, however, differs from *Psychopsis* in not having the costal field unduly widened, and in lacking (as far as we can see in the fragment preserved) the multiple forkings of the costal cross-veins, and their breaking up by cross-veinlets, which is characteristic of *Psychopsis*. Also, in *Psychopsis*, Sc and R stand further apart, and there is a linking-up of Sc, R, and Rs distally by two strong cross-veins, which close off the closely-veined marginal area

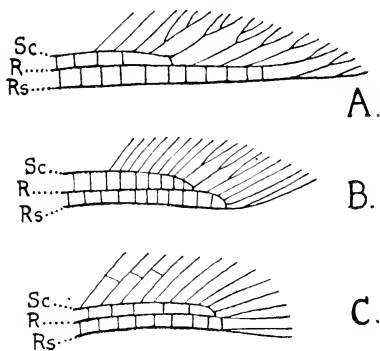

Text-fig. 1.*

from the three strong main veins with their intermediate cross-veins. In *Psychopsis illidgei*, however, this arrangement remains only partially completed, so that *Protopsychopsis venosa*, *Psychopsis illidgei*, and *Ps. elegans*, for instance, form (for this character) a phylogenetic series, as shown in Text-fig. 1.

There can be little doubt that our recent genus *Psychopsis* is a direct descendant from a form similar to *Protopsychopsis*.

* Phylogeny of the distal ends of Sc, R, and Rs in *Protopsychopsis* and *Psychopsis*. A, oldest stage (*Protopsychopsis venosa*, n.g. et sp.). B, intermediate stage (*Psychopsis illidgei* Froggatt). C, final stage (*Psychopsis elegans* Guér.), with the three veins strongly linked together by cross-veins.

That being so, it becomes questionable whether Handlirsch's family *Prohemerobiidae* ought to be retained, especially as the name is misleading, and suggests that they were ancestors of the *Hemerobiidae*, with which they almost certainly had nothing to do. All these forms might well be classed as *Psychopsidae*.

PROTOPSYCHOPSIS VENOSA, n.sp. (Plate viii., fig.3).

Characters as for the genus. [Only the apical portion of the wing preserved]. All the venation beautifully preserved, except for the more basal portion above Sc, which is indistinct. The furrows between the sectors are very clearly shown, but have not been drawn in the plate, in order to keep the venational scheme quite obvious.

Measurements of fragment: greatest length 9.5 mm., greatest breadth 7.3 mm. The complete wing would probably be 30 mm. long, and 15 mm. across at its greatest width.

Type, Specimen No.160a. (Coll. Queensland Geol. Survey).

Order TRICHOPTERA.

Family *MESOPSYCHIDÆ*, fam.nov. (Plate vii.).

Characters of Forewing.—A long pterostigmatic region present, not strongly chitinised, closed off proximally by a cross-vein between Sc and R. Costal space with extra cross-veins present. R₁ joined to R₂ near apex by means of a cross-vein or oblique posterior branch. All five apical forks present, *and at least one of them divided into two or more separate cells, by cross-veins not present in recent forms.* Apical fork 2 with wing-point present. Discoidal and median cells present, completely closed, separated by an extra closed (subdiscoidal) cell between R₅ and M₁. Thyridium-cell present or absent. Cubital veins variable. [Anal area not preserved].

With the above definition of the family, the two beautiful forewings represented in the present collection may be placed in two separate genera as follows:—

- Thyridium-cell absent: apical fork 2 divided into three polygonal cells, by means of two cross-veins and zig-zagging of R₄ and R₅,.....
 Genus *MESOPSYCHE*, n.g.
- Thyridium-cell present: apical fork 3 divided into two cells.
 Genus *TRASSOPSYCHE*, n.g.

Genus *MESOPSYCHE*, n.g. (Text-fig.2, and Plate vii., fig.1).

To the characters of the family, as given above, we add the following generic characters:—Two costal cross-veins preserved (probably three or more in complete wing). *Sc* and *R* run parallel and very close together. Pterostigmatic region long and narrow, the proximal cross-vein descending obliquely from *Sc* at its distal end. *R*₁ joined to *R*₂ by a single backwardly

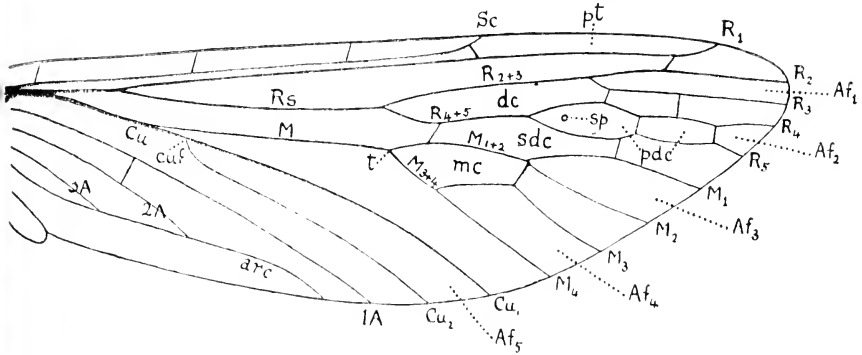

Text-fig.2.

Restoration of forewing of *Mesopsyche triarcolata*, n.g. et sp., (x7) For lettering, see Explanation of Plates.

slanting cross-vein above *Af*.1. Discoidal cell (*dc*) elongated, hexagonal, with *Af*.1 and *Af*.2 both sessile upon it. Beyond distal side of *dc*, an extra cross-vein connects *R*₃ with *R*₄. In *Af*.2, three separate cells (Text-fig.2, *pdc*) are formed by means of two connecting cross-veins and weak zig-zagging of *R*₄ and *R*₅. Wing-point (*sp*) placed in *Af*.2 not far from the forking of *R*₄ from *R*₅. Subdiscoidal cell (*sdc*) elongated, hexagonal. Median cell (*mc*) an irregular pentagon, with *Af*.4 strongly sessile upon it, *Af*.3 just arising from its upper distal angle. Thyridium (*t*) placed directly under the main forking of *Rs*. Thyridium-cell (*tc*) absent. *Cu* apparently fused with *M* basally, *cnf* placed well basad (under second costal cross-vein) and consequently *Af*.5 of great length.

So much of this wing is preserved, with the details of venation beautifully clear, that there is no difficulty in restoring it to

its complete form. This I have done in Text-fig.2. The only doubtful point is as to the form of the anal area, which I have restored on the typical Trichopterous plan of a long curved arculus (*arc*), with veins 2A and 3A falling obliquely upon it from above.

G e n o t y p e, *Mesopsyche triareolata*, n.sp.

MESOPSYCHE TRIAREOLATA, n.sp.

(Text-fig.2, and Plate viii., fig.1).

Forewing elongated, rather narrow, the anterior border scarcely curved at all right from base to tip. Distal half of wing tapering to a bluntly pointed tip. Af.1 at apex of wing, Af.2 well below it.

Greatest length of fragment, 13 mm.; greatest breadth, 5·8 mm. Total length of restored wing, about 16·5 mm. Probable expanse of wings in the original insect, 33 mm.

T y p e, Specimen No.110 (Coll. Queensland Geol. Survey).

A discussion of the relationship of the genus *Mesopsyche* with recent forms will be found on p. .

Genus TRIASSOPSYCHE, n.g. (Text-fig.3, and Plate vii., fig.2).

To the characters of the family *Mesopsychidae*, we add the following:—Numerous costal cross-veins present (three preserved distally in a short space). Sc and R not close together, subparallel. Towards its distal end, Sc throws off an oblique cross-vein to C, and takes a short sharp bend downwards to the point at which it is connected to R₁ by a cross-vein; it then continues in a gentle curve onward, finally uniting with C at a point lying nearly half-way along the total length of the pterostigmatic region (as measured from the proximal cross-vein to apex of R₁). Consequently, pterostigmatic region very long, of irregular shape, narrowed proximally and broadened out in middle. R₁ connected with R₂ by a cross-vein descending from middle of *pt* on to *dc*. R₁ also forks distally, the lower branch running slantingly into R₂ well before the margin of the wing. Discoidal cell (*oc*) elongated, hexagonal, distinctly broader than in *Mesopsyche*, but of very similar general shape, with Af.1 and Af.2 both sessile

upon it. Apparently a small extra apical forking of R_5 in Af.2. Beyond *dc*, no extra cross-vein between R_5 and R_4 . No cross-veins in Af.2; the wing-point (*sp*) not clearly shown, but apparently present just below the distal side of *dc*. Subdiscoidal cell (*sdc*) present, shaped as in *Mesopsyche*, but considerably broader. Median cell (*mc*) present, of more regular shape than in *Mesopsyche*. Af.4 strongly sessile upon it. Af.3 either slightly sessile, or just arising from its upper distal angle (as in *Mesopsyche*). Af.3 divided into two cells by an extra cross-vein joining M_1 and M_2 . Thyridium (*t*) placed directly under the main forking of R_s (as in *Mesopsyche*). Thyridium-cell (*tc*) present, elongated, pentagonal, closed off distally by a strong cross-vein from M_4 to the weakly zig-zagged Cu_1 . A second cross-vein, parallel to this, separates off a post-thyridial cell (*ptc*) between M_4 and Cu_1 . Only the distal portion of Cu is preserved; apparently Cu_2 fuses with 1A not far from the wing-border, and the very irregularly formed Af.5 is divided into two cells by means of a cross-vein dropped from Cu_1 obliquely on to 1A + Cu_2 almost at the wing-margin.

G e n o t y p e , *Triassopsyche dunstani*, n.sp.

Though not so well preserved as the wing of *Mesopsyche*, yet this fossil shows most of the details necessary for a reconstruction to be possible. Several of the cross-veins are not completely preserved (see Plate vii., fig.2). There is a roughly raised linear mark extending between $M-M_4$ and $Cu-Cu_1$, which at first sight looks as if it might be covering a main vein. Fortunately, as Cu_1 is always a well-marked convex vein, it was possible to determine this question definitely. For, in the fossil, the vein marked Cu_1 is definitely convex, and hence there can be no main vein between it and $M-M_4$. The vein marked 1A is so determined because, at the point where it is broken off proximally in the fossil, it is definitely *diverging proximad* from Cu . Had it been converging, it would have been determined as Cu_2 , and the vein marked Cu_2 in the figures would have been considered a specialised cross-vein.

In Text-fig.3, I have attempted the restoration of this fine wing, which must be reckoned among the largest Trichopterous

wings known to have existed outside the *Phryganeida* and *Limnephilidae*. The provisional restoration of the missing anal area is drawn on the same lines as that for *Mesopsyche*.

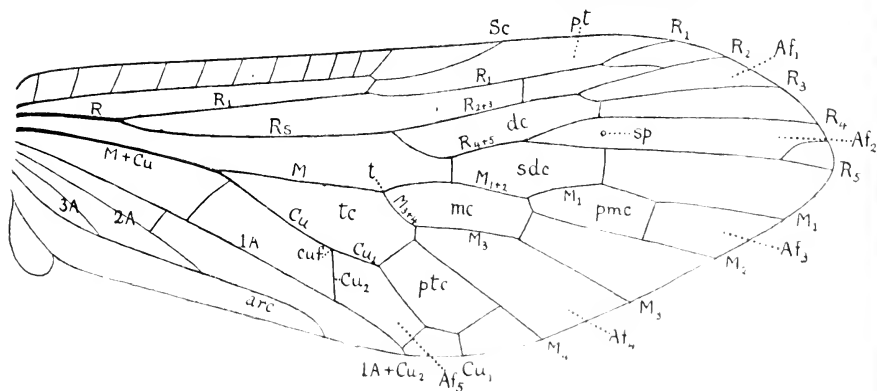

Text-fig. 3.

Restoration of forewing of *Triassopsyche dunstani*, n.g. et sp. ($\times 5\frac{1}{4}$).

For lettering, see Explanation of Plates.

TRIASSOPSYCHE DUNSTANI, n.sp. (Text-fig. 3, and Plate vii., fig. 2).

Forewing elongated, moderately broad, both anterior and posterior borders well curved distally. Apex moderately pointed. Af.2 at apex of wing, Af.1 placed well before it.

Greatest length of fragment, 13.5 mm.; greatest breadth, 6.8 mm. Total length of restored wing, about 19 mm. Probable expanse of wing in the original insect, 40.5 mm.

Type, Specimen No. 128a. (Coll. Queensland Geol. Survey).

These two fossil wings, *Mesopsyche* and *Triassopsyche*, are of very great interest, not only because they are the oldest fossil Trichoptera yet discovered, but also because they are, in actual wing-venational structure, very much more archaic than anything yet discovered in this Order. The Liassic *Necrotauliidae*, described from the beds of Dobbertin (Mecklenburg) and Aust (England), are a series of very small wings, ranging from 3 mm. to 7 mm. in length, the forewings possessing either four or five apical forks, the hindwings four. Most of these wings have no cross-veins, and, consequently, no closed cells of any kind. One

or two, however, have a closed discoidal cell, and one of the largest forms, *Necrotaulius major* Handlirsch, probably possessed a median cell as well. This latter form would come nearest to our Ipswich fossils, since it agrees with them in having both Af.1 and Af.2 sessile upon *dc*, and Af.4 sessile upon *mc*, while Af.3 appears to be just sessile upon the upper distal end of the same cell. In all other respects, the *Necrotauliidae* must be considered as considerably specialised by reduction, and loss of the archaic cross-venation inherited from Panorpid ancestors.

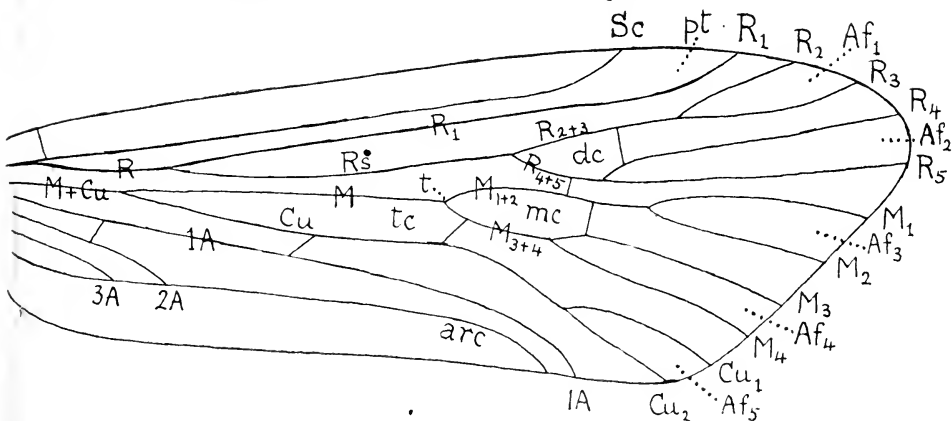

Text-fig. 4.

Forewing of *Hydropsyche* sp., for comparison with Text-figs. 2 and 3.
(After Ulmer).

Thus our new fossils are seen to stand in a much closer ancestral relationship with some of the more archaic present-day families than they do with the Liassic *Necrotauliidae*; and it seems exceedingly probable that we have in Australia, alive to-day, genera directly descended from them. Unfortunately, the Australian Trichopteroan fauna, though both abundant and remarkable, has so far been hardly touched,* so that we are compelled to make a more general comparison with known forms from other parts of the world. On these lines, I must indicate

* Only thirteen species have, so far, been described from Australia and Tasmania; but I have, in my own collection alone, nearly a hundred species, many being closely related to New Zealand forms.

the *Hydropsychinae* as being the closest existing relatives of the *Mesopsychidae*, both in the general shape of the forewing, the relationships of the main veins and branches *inter se*, and, in particular, the structure of the discoidal and median cells (*cf.* Text-figs. 2, 3, 4).

If we compare the forewings of *Mesopsyche* and *Triassopsyche* with that of *Hydropsyche* (Text-fig. 4), we shall notice the following resemblances and differences:—

(1) The general shape of *Hydropsyche* closely resembles that of *Triassopsyche*. *Mesopsyche* has a wing distinctly narrower than that of most *Hydropsychinae*.

(2) *Hydropsyche* has lost all but the most basal of the costal cross-veins. There are, however, a number of recent genera of *Hydropsychinae* possessing one or more extra costal cross-veins, e.g., *Chloropsyche*, *Ethaloptera*, *Amphipsyche*, *Phanostoma*, and *Polymorphanisus*. We may see in this a persistent archaic character handed down from ancestors closely resembling our two Ipswich genera.

(3) In *Hydropsyche*, the pterostigmatic area has become reduced and left incomplete proximally, by loss of the cross-vein below Sc. There are other genera of *Hydropsychinae*, however, in which the cross-vein still persists (e.g., *Smicridea*).

(4) In *Hydropsyche*, Af.1 is no longer sessile upon *dc*, but has become distinctly stalked. Similarly, Af.3 is stalked from *mc*. Af.2 and Af.4 remain sessile upon *dc* and *mc* respectively, but not so completely as in the *Mesopsychidae*. The character of possessing all four forks (Af.1-Af.4) sessile upon their respective cells is retained in a few recent genera, e.g., *Anisocentropus* in the *Calamoceratidae*. In this latter genus, the structure of *dc* and *mc* and the forks arising from them very closely resembles that seen in *Triassopsyche*. The importance of this character, from a phylogenetic standpoint, may perhaps be emphasised by a phylogenetic diagram (Text-fig. 5), in which all stages are shown, from the original archaic formation (A) down to the most advanced cænogenetic form (D), in which the two forks are stalked. In this diagram, the cell may be taken either as *dc* or *mc*: if the former, the upper fork is Af.1, the lower Af.2; if

the latter, the forks are Af.3 and Af.4 respectively. Besides this direct phylogenetic line, one or both of the forks may be lost at any stage of the reduction, by suppression of a branch. Thus, in the *Leptoceridae*, *Oecetis* (N. Zealand) keeps *dc* present and Af.1 sessile, but Af.2 is completely lost; while the allied *Triplectides* (Australia) has progressed one stage further, having Af 1 strongly stalked.

(5) The thyridium-cell (*tc*) is present in *Hydropsyche* and *Triassopsyche*, absent in *Mesopsyche*. If, however, the latter had a single cross-vein from M_{3+4} to Cu_1 , its *tc* would closely resemble that of *Hydropsyche* in shape and position.

(6) The excess cells of *Mesopsychidae*: here the *Mesopsychidae* offer a contrast, not only with the *Hydropsychinae*, but with all recent Trichoptera. In the marine caddis-fly, *Philaniscus plebejus* Walker (Australia and N. Zealand), there is a small subdiscoidal cell which

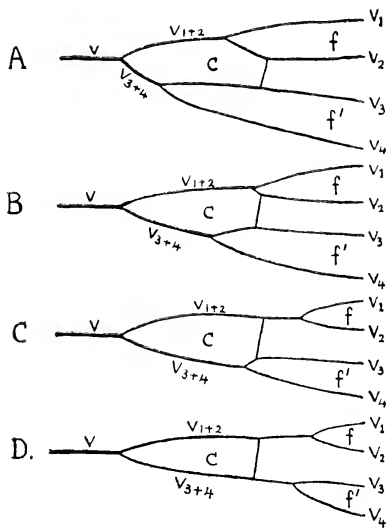

Text-fig.5.*

may be comparable with the large *sdc* of *Mesopsychidae*; but, in nearly all recent genera, there is nothing comparable with it. The three post-discoidal cells (*pdc*) of *Mesopsyche*, the post-median cell (*pmc*) of *Triassopsyche*, and the complicated cell-

* Phylogeny of a principal cell in the wings of Trichoptera. A, oldest stage, with both end-forks sessile upon the cell. B-C, successive reduction-stages towards D, the cænogenetic stage, with both end-forks stalked. At any stage, the cross-vein completing the cell distally may be lost, or one of the forks may be reduced to a simple vein.—*c*, the cell; *v*, the main vein, v_{1+2} , v_{3+4} , its branches enclosing the cell basally; v_1 , v_2 , the branches enclosing the upper fork, *f*; v_3 , v_4 , the branches enclosing the lower fork, *f'*; (*c* represents either *dc* or *mc*; *v*, either Rs or M).

formation distally upon Cu_1 in the same genus, appear to be the archaic remains of an originally denser cross-venation, long since lost, and not seen in any recent forms.

Order PROTOMECOPTERA, ordo nov.

Large insects, with venation of the same type as the Mecoptera, but much denser. The whole of the wing-membrane, except the pterostigma, is covered with an abundant meshwork of polygonal cellules, at the junctions of which are developed strong hairs, so that the whole of the wing is densely hairy. Hairs are also present upon the main veins and transverse veins.

Between Sc and anterior border of wing, a strong costal vein (C) is present, supported above and below by cross-veins, and ending at least half-way along the anterior border. Upon the apical border of the wing, between the end of R and the end of Cu_1 , no less than *seventeen* longitudinal veins abut (only *nine* in Mecoptera). Venation of fore- and hindwings closely similar. Apical half of wing with many elongated polygonal cells of large size present (five- to seven-sided). A smooth membranous pterostigma present upon the distal end of R in both wings, and extending into the space between R and R_s , where it ends posteriorly upon a distinct *pterostigmatic furrow* (*ptf*), parallel to R_s .

The principal differences between the Orders Mecoptera and Protomecoptera may be best exhibited in the following table:—

	Protomecoptera.	Mecoptera.
Size...	Expanse 100mm. or over	Expanse 15-50 mm.
Costal vein...	present	absent
Fine polygonal network of cellules	present	absent
Hairs	present, both on veins and membrane	absent, or only very minute hairs present
Number of longitudinal veins abutting on apical portion of wing-margin, between R and Cu_1	seventeen	nine
Number of apical forks in same area	eight	five

This new Order is proposed for the reception of a very remarkable fossil from the Ipswich beds, represented by fore- and hindwings, very beautifully preserved. The insect forms the direct connecting link between the Palaeozoic Palaeodictyoptera on the one hand, and the recent Mecoptera on the other. The Palaeodictyopterous character is seen in the primitive, almost Blattoid, scheme of venation (which is, of course, preserved also better in Mecoptera than in any other recent Order, but with great reduction), and the presence, in its last stage of evolution, of the dense reticular meshwork of polygonal cellules so characteristic of this ancient Order. In the Protomecoptera, as exemplified by this Ipswich fossil, the development of hairs upon both veins and membrane is very pronounced; and the wings exhibit, in a remarkable manner, the method by which hairs first appeared upon the wing-membrane; just as *Mesogereon*, another Ipswich fossil, exhibits the first formation of tubercles in the Hemipteroid wing. Another exceedingly archaic character, long since lost in most insect-wings, is the presence of a true *costal vein*, not fused with the costal border of the wing.

The Mecopterous characters are very obvious, for the wings are clearly built upon the Panorpid venational plan. The essentials of this are—

(1) Close similarity between fore- and hindwings, with only slight differences in venation.

(2) Symmetrical dichotomous branchings (bilateral forks) of Rs and M, as opposed to the unilateral or unsymmetrical forkings of these same veins seen in the Odonata, Neuroptera, etc.

(3) Transverse veins few, and so arranged as to support the bilateral forks. Thus are formed the typically Panorpid *elongated polygonal cells* of large size, and varying from five to seven sides. The true Mecoptera have, typically, *twelve* of these cells lying completely within the wing between Rs anteriorly and M-M₁ posteriorly, but the number may be reduced by suppression of cross-veins. In some fossil Mecoptera, the number may be greater. In the Protomecoptera, there are *twenty* of these same cells.

In view of the fact that some of the present-day Mecoptera,

(e.g., *Panorpodes*, and a new genus recently discovered in Australia) have generalised mouth-parts, with only the barest beginnings of the tendency towards the formation of the prominent *beak*, usually supposed to be typical of the Order, we may reasonably claim that the mouth-parts of the Protomecoptera were normally mandibulate, though they are not actually preserved for us in the fossil state.

It is important to bear in mind that true Mecopterous wings, allied to the Australian genus *Taniochorista*, have already been found in the Ipswich beds. Further, I am able to state definitely that very similar forms occur in the Permo-Carboniferous strata of Newcastle, N.S.W., and are being studied by me at the present time. None of these wings show the Protomecopterous characters seen in the fossil under consideration. This is a strong argument for the erection of a new Order. For it is evident that these Protomecopterous wings are far older, evolutionarily, than are the Mecopterous wings of the Permo-Carboniferous. Since, however, the Mecoptera must have descended, by reduction, from Protomecopterous forms, it follows that our Ipswich fossil must be a representative of a much older race, that not only existed side by side with the true Mecoptera in Permo-Carboniferous times, but *preceded them* in the Carboniferous. That is, the dichotomy between Protomecoptera and Mecoptera took place in Palæozoic times. Thus the erection of a new Order is justified on palæontological as well as on morphological grounds; for the differences between the two Orders are, both in time and degree, just such as Handlirsch has relied upon in forming most of his other fossil Orders.

We must remember, too, the composite character of the Ipswich fauna. I have already shown that Protorthoptera exist there alongside forms differing scarcely at all from insects alive at the present day, and that Protohemiptera and Homoptera lived side by side. Alongside a true Dragonfly, there has recently been found another new type that is undoubtedly a Protodonate! Thus there is nothing surprising in the existence of Protomecoptera and true Mecoptera side by side in these fossil beds.

Family ARCHIPANORPIDÆ, fam.nov.

Characters as for the Order, with the following additions. Large insects, with a wing-expanse of 100 mm. or over. Pterostigma longer and narrower in hindwing than in forewing, not reaching proximally to Sc in either wing. Sc ends up on the anterior margin of the wing beyond half-way in both wings, but not so far in hindwing as in forewing. Cu₁ ends up on posterior margin a little before the level of the pterostigma in forewing, considerably before the same level in hindwing. Cu₂ probably present in both wings.

Genus ARCHIPANORPA, n.g.

(Plate viii., figs.4-6; Plate ix.)

Characters as for the family, with the following additions. Forewing broadest at or near pterostigma, hindwing broadest just before half-way, and having the apical third distinctly narrower than in forewing. Pterostigma of forewing rather short, irregularly shaped, with R arching up within it, convexly to the wing-border. Pterostigma of hindwing long and narrow, with R running almost straight through it.

Genotype, *Archipanorpa magnifica*, n sp.

ARCHIPANORPA MAGNIFICA, n.sp. (Plate viii., figs.4-6; Plate ix.)

This species is represented by two fine fossil wings, Nos. 106*a* and 120*a*, in the Queensland Geological Survey's Collection. Of these, No.106*a* is the better preserved specimen. It shows the whole of the wing from the apex to a level slightly distad from the origin of Rs. A transverse fracture of the rock has destroyed the base. The total length of this fragment is 33 mm., its greatest breadth 13 mm. The specimen represents a *cast* of a *left hindwing*.

No.120*a* is not so well preserved, there being two pieces cut out from the posterior margin, and two slight cracks running across the wing. The main fracture, which appears to be the same break that cut off the base of No.106*a*, (the two wings were found very close together) has cut off this wing more obliquely, and a little further from the base (see Plate viii., figs.4-5). The

total length of the fragment is 30 mm., its greatest breadth 14 mm. It represents the *mould* of a *right forewing*.

The method of determining what wing a given specimen represents may be briefly stated as follows. In the Panorpoid wing, there are two strong and highly convex veins, viz., R and Cu_1 . If such a wing became fossilised, and a cleavage of rock later on reveals it, there should be a *cast* of the wing showing R and Cu_1 as high convex ridges, and a *mould* showing them as concave furrows. In the mould, also, *all* the veins will be concave grooves *in themselves*; whereas, in the cast, they will be convex rods, quite apart from whether they stand high up on ridges of the wing (as R and Cu_1 do), or not. Now in 106*a*, R and Cu_1 lie upon high ridges, and all the veins are convex rods; hence it must be a *cast*; and, as the apex lies to the left, it must be a *left* wing. In No.120*a*, R and Cu_1 lie at the bottom of furrows, and all the veins are concave grooves: hence it must be a *mould*; and, as the apex lies to the left, it must have been formed by a *right* wing turned over, so that its underside lay uppermost.

Further, the fore- and hindwings of all Panorpid, though closely similar, differ in the following points:

(1) Sc always extends further towards the apex in the forewing than in the hindwing.

(2) In the hindwing, M tends to become fused basally with Cu_1 , but this tendency is not so much in evidence in the forewing.

(3) In the forewing, Cu_1 ends up on the posterior margin of the wing somewhat beyond half-way. In the hindwing, it reaches only about half-way, or less.

Now, if we compare Nos.106*a* and 120*a*, we see at once that Sc ends up much further from the apex in 106*a* than it does in 120*a*. Further, although only a small remnant of Cu_1 is left in No.120*a*, yet the slant of this vein to the wing-axis is measurably less than in 106*a*. The measurements, carefully determined, give an angle of 23° for No.120*a*, 31° for No.106*a*. Measurements made to determine the obliquity of *corresponding* portions of Cu_1 in *Panorpa confusa* give 22° for the forewing,

33° for the hindwing. Hence we must conclude, from the combined evidence of both Sc and Cu₁, that No.106*a* represents a *hindwing*, No.120*a* a *forewing*.

Unfortunately, not quite enough of the main stem of M is preserved to enable us to say definitely with what vein it tends to fuse basally. But, as the condition stated above in (2) is universally present in Panorpid wings (even in the archaic *Merope*, which has been claimed, with good reason, to be a Palæozoic remnant), there is no reason to suppose that the same rule did not hold for our fossil wings. Thus, in the restoration of these wings given in Plate ix., I have correlated character (2) with (1) and (3), so that fore- and hindwings are to be distinguished by three differences, as in recent Mecoptera.

The Structure and Hairiness of the Wing-membrane.—In the figures given of the two wings (Plate viii., figs.4, 5), and in their restoration (Plate ix.), I have purposely omitted the finer structure of the wing-membrane, which requires to be studied under a higher power. The structure is not everywhere equally well preserved in all parts of the wing; but a careful search soon reveals a number of places at which, by careful use of oblique light, the remarkable formation of the wing-membrane can be well studied and interpreted. Such a place is figured in Plate ix., fig.6, where I have drawn the structures seen upon and above one of the smaller main veins. These may be described as follows:—

(1) *Hairs upon the veins.*—Following up any vein under a moderate power, there will be found, at fairly regular intervals, the typical circular-based tubercles which indicate the bases of insertion of original *stiff hairs* or *bristles* upon the veins. A comparison with a cleared and mounted wing of *Myrmeleon* shows that these tubercles in *Archipanorpa* closely resemble those of *Myrmeleon* in size and position; if anything, those of *Archipanorpa* are the larger in proportion to the size of the veins, and of the wing as a whole. Thus we see that *Archipanorpa* had *hairy veins*, as in the Planipennia. Recent Mecoptera also possess these hairs, but they are not usually so large as in Planipennia, and they are generally more abundant and closely set.

(2) *Polygonal meshwork of the wing-membrane* — Turning from the vein to the membrane alongside it, we notice at once that this is not smooth, but is thrown into innumerable pits and ridges, with tubercles appearing upon the latter in many places. In places where this structure is well-preserved, it will be seen that the ridges form an *irregular polygonal meshwork*, enclosing sunken areas or *cellules* (shaded in Plate viii., fig.6). The large tubercles, which resemble those of the veins, are seated principally upon the swollen junctions of the ridges. The ridges are not as well-defined as actual veinlets would be, except here and there (Text-fig.6*b*, *cv*), where a particularly strong and straight ridge may be seen running out for some distance from a main vein. Nor are their tubercles usually as well-defined as are those of the main veins.

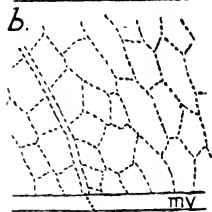
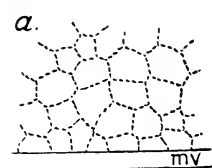

Text-fig.6.*

The area shown diagrammatically in Plate viii., fig.6, was selected from near one of the main veins on the basal portion of the preserved part of the wing. It is a typical unspecialised meshwork. But, in most parts of the wing, and especially towards the distal end, the polygons of the meshwork tend to become stretched out transversely and somewhat obliquely to the main veins. This is represented diagrammatically in Text-fig.6*b*, whereas Text-fig.6*a* corresponds with the unspecialised portion shown in Plate viii., fig.6.

The only conclusion that I can come to, from a study of these peculiar structures, is that the ridges represent *the original Palaeodictyopterous meshwork of veinlets in a degenerating stage*. The

* Diagrams of the Palaeodictyopterous meshwork upon the membrane of the wing of *Archiparacera magnifica*, n.g. et sp.,—*a*, from near base of preserved portion of wing (corresponding with Plate viii., fig.6); *b*, from distal portion of wing, showing tendency of the mesh to become stretched transversely and somewhat obliquely across the wing, ($\times 20$); *cv*, a strong cross-vein, not yet obliterated; *mv*, main vein, with macrotrichia omitted. The figure is intended to show only the *position*, and not the *structure* of the meshwork.

most probable cause of degeneration would be the using-up of the veinlet-chitin in the formation of the accumulated masses or tubercles in which the hairs are inserted. Thus *Archipanorpa* would illustrate an intermediate stage in the evolution of a wing with a hairy membrane from an ancient net-veined or *Palaeodictyopterous* wing-type, and would give us the clues both as to the method whereby an open-veined wing, such as that of the Lepidoptera or Diptera, has been evolved from a closely-veined type, and also as to the method whereby the hairs (or, later on, the scales) become seated upon the membrane as well as upon the main veins.

(3) *Hairs upon the wing-membrane.*—In those places where the structure of the tubercles of the wing-membrane can be most clearly made out, they are seen to be very closely similar to those upon the wing-veins, both in size and form. We can distinguish an outer raised rim (indicated by the outer circles in Plate viii., fig.6), and an inner depression or hollow (indicated by the inner circles in the same figure). There can be no doubt that these structures represent the tubercular bases of insertion of stiff bristle-like hairs; for the insertions of such hairs in the wings of recent *Planipennia* are exactly similar to them. I propose to call these hairs *macrotrichia*.

Besides these tubercles, a careful examination of the wing-membrane shows that it is covered all over with minute pits, mere depressions without any visible raised rim, and of a size so small as to be rather easily confused with the grain of the rock on which the fossil is impressed. These, I consider, represent the insertions of minute hairs, several times smaller, and far more numerous, than the *macrotrichia*. These hairs may be termed *microtrichia*. In most parts of the wing, they run in closely-set parallel lines, passing alike over ridge and hollow.

The structure of the pterostigma differs from that of the rest of the wing-membrane only in lacking the polygonal ridges, and in being of a single thickness throughout. This makes it appear very smooth in comparison with the rest of the wing. On examination under a moderate power, both *macrotrichia* and *microtrichia* can be seen to be present upon it.

The polygonal meshwork of ridges is absent from all recent Mecoptera. Microtrichia, however, are abundant all over the wing-membrane, though excessively minute in some genera (e.g., *Panorpodes*). Macrotrichia are present only towards the distal end of the wing, especially in the pterostigmatic region. In the polygonal cells formed between R_s and Cu_1 , there may be seen, in certain genera (e.g., *Panorpa*), two or three irregular rows of macrotrichia.

In the figures given in Plates viii-ix., I have purposely shaded-in the pterostigma, in order to distinguish it from the rest of the wing-membrane. In the actual fossils, it is not darkened in colour.

Type, forewing, Specimen No.120a; hindwing, Specimen No.106a (Coll. Queensland Geol. Survey).

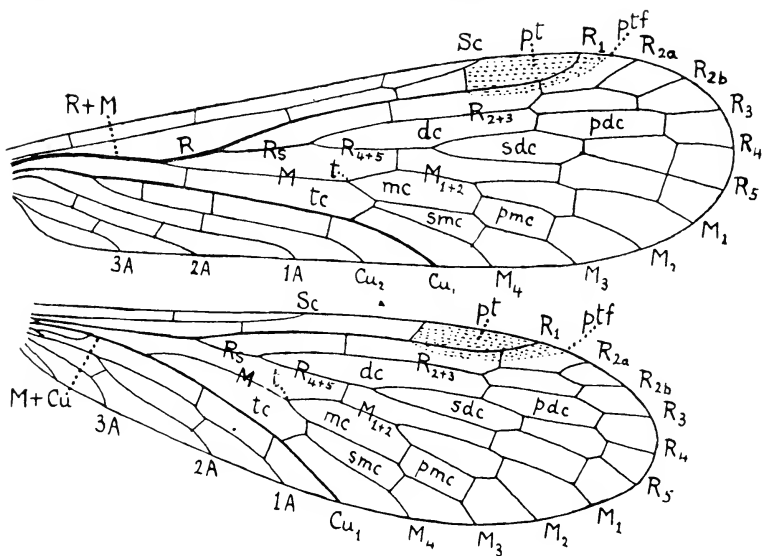

Text-fig.7.

Wings of *Panorpa confusa* Westwood, with colour-pattern omitted, to show venational scheme. ($\times 9$). For lettering, see p.200.

Corrigenda: for M_4 read $M_4 + Cu_1a$, and for Cu_1 read Cu_1b .

In Text-fig.7, I have drawn the wings of *Panorpa confusa* Westwood, (omitting colour-pattern), for comparison with those

of *Archipanorpa magnifica*. The pterostigma is shaded in, as in the figures of *Archipanorpa*. A comparison of the two forms enables us at once to fix the limits of the main veins in *Archipanorpa*, and to name the principal cells of the wing. The steps of the determination may be briefly outlined as follows:—

(1) The radius (R) is a strongly-built, highly convex vein running *through* the pterostigma (*pt*). Therefore I searched first of all for the pterostigma, which was easily located, both from its smoothness compared with the rest of the wing-membrane, and because of the *pterostigmatic furrow* (*ptf*) bordering it posteriorly. Having found it, the radius was at once determined. There were then *two* other veins ending up on the anterior wing-border between the radius and the base of the wing: whereas, in *Panorpa*, as in all recent insects, there is only *one* (the subcosta, Sc). It became clear, therefore, that *Archipanorpa* possessed not only a subcostal vein, Sc, but also an archaic costal vein, C, separated from the costal or anterior border, as in some of the larger Carboniferous fossils (e.g., the *Meganeuridae* of the Order Protodonata).

(2) Turning next to the area of the wing below R, in specimen No. 106a (hindwing), the cubitus, Cu₁, is easily determined as a strongly convex, obliquely-running vein, ending about half-way along the posterior border. Between this and R, basally, there lie two main stems, of which the upper must be the radial sector, Rs, (its point of union with R is not preserved in the fossil), and the lower must be the media, M.

(3) The first forking of Rs is preserved in the fossil. Here Rs divides into R₂₊₃ above, and R₄₊₅ below. The cell enclosed between these two veins basally is the *discoidal cell* (*dc*). R₂₊₃ again forks into R₂ and R₃, R₄₊₅ into R₄ and R₅, and both are sessile upon *dc*, as in the two Trichopterous wings already dealt with. The area enclosed between R₂ and R₃ would be, in Trichoptera, the *first apical fork* (Af.1 in Text-figs. 2-4). But, in most Mecoptera, R₂ forks again into R_{2a} and R_{2b} (Text-fig. 7). This occurs in *Archipanorpa*: but, above and beyond this, R_{2b} forks a second time into R_{2b1} and R_{2b2}. Moreover, R₃, which remains unforked in both Trichoptera and Mecoptera, in *Archip-*

panorpa divides into R_{3a} and R_{3b} , and each of these again divides* before reaching the wing-border.

(4) The area enclosed between R_4 and R_5 would be, in Trichoptera, the *second apical fork* (Af.2 in Text-figs.2-4). In Mecoptera, this area is often subdivided by a cross-vein (Text-fig.6). In *Archipanorpa*, both R_4 and R_5 divide into two again before reaching the wing-border. Thus R_5 , which in Trichoptera sends *four* veins to the apical wing-border, and in Mecoptera *five*, sends no less than *nine* such veins to the border in the hindwing of *Archipanorpa*, *eight* in the forewing.

(5) Turning next to the media (M), we see that the *thyridium* (*t*), or *median fork*, is clearly preserved in both wings, lying just below the first forking of R_5 . As this is its position also in the two Trichopterous wings already dealt with, we are probably right in assuming that it is the archaic condition, and that a shifting of the thyridium to a level distad from the level of the first forking of the radius (as in *Panorpa*, Text-fig.7; and in many recent Caddis-flies) is a cænogenetic character. The cell below *t* is the *thyridial cell* (*tc*), and is only partially preserved in both wings. At *t*, M forks into M_{1+2} above and M_{3+4} below, and the two branches enclose between them the *median cell* (*mc*). M_{1+2} then divides into M_1 and M_2 , and M_{3+4} into M_3 and M_4 ; and the forks thus made are sessile upon *mc*, as in the two fossil Trichopterous wings already studied, and in recent Mecoptera (Text-fig.7).

(6) The area enclosed between M_1 and M_2 would be, in all Trichoptera and true Mecoptera, the *third apical fork* (Af.3, in Text-figs.2-4). In *Archipanorpa*, both M_1 and M_2 fork again; in the hindwing, the two middle branches fuse together, so that only *three* separate veins reach the wing-border, instead of *four* as in the forewing. This difference offsets the difference in the behaviour of R_3 in the two wings (see above), and makes the total number of apical end-veins the same in both wings (viz., seventeen between R and Cu_1).

(7) The area enclosed between M_3 and M_4 would be, in all Trichoptera and true Mecoptera, the *fourth apical fork* (Af.4 in Text-figs.2-4). The archaic condition of this fork is that it is

* In the hindwing; in the forewing, only the lower fork divides.

very strongly sessile upon *mc*; in other words, M_{3+4} again divides before it has passed far from *t* round the border of *mc*. M_3 continues on as the lower border of *mc*, and passes on to the wing-border without branching, in *Archipanorpa* as in all Trichoptera and Mecoptera. M_4 , in *Archipanorpa* and all Mecoptera, behaves differently from what it does in most Trichoptera (see, however, the formation in Text-fig.3). Diverging strongly from M_3 , it picks up a branch Cu_{1a} thrown out anteriorly from Cu_1 . In Mecoptera (Text-fig.7), the two fuse and continue on to the wing-border as $M_4 + Cu_{1a}$. In *Archipanorpa*, they only fuse for a short distance, and then run separately to the wing-border.

(8) Thus far, the structure of the wing is clear. Below and basad from Cu_1 , not enough is preserved for us to be sure of the structure of the anal area. In all recent Mecoptera, Cu_2 is present in the forewing (arising from Cu_1 very close to the wing-base), but absent in the hindwing. It would appear that the original *Cu* is completely altered in the hindwing, Cu_1 having become fused with *M*, and Cu_2 with *1A*. The remnants of the base of Cu_1 are to be seen as a short, weak, waved vein running in a curve from the base to join *M* a short distance beyond the base (Text-fig.7). Bearing in mind the archaic structure of *Archipanorpa*, the presence of many longitudinal veins, and especially the presence of the costal vein *C* in both wings, I think the probabilities are all in favour of a normal Cu_2 being present in the hindwing of *Archipanorpa*. I have, therefore, restored the wing on that supposition. The suggested anal area calls for no comment. The complete restoration of both wings is given in Plate ix.

With regard to the question of the wing-coupling apparatus, it has generally been assumed that the Mecoptera are descended from forms in which the wings were free and unconnected in flight. But, in a new family of the Order which I have recently discovered in Tasmania, I was surprised to find a well-developed wing-coupling apparatus present, consisting of jugal lobe on the forewing, and jugal process with frenulum on the hindwing. As in the Planipennia and in the females of most moths, the frenulum consists of two strong bristles directed obliquely outwards. Following up this discovery, I examined other genera of

Panorpid, and discovered that the frenulum is present in all forms examined by me, though only vestigial in the highly specialised *Bittacidae*. Hence it is clear that the ancestors of the Mecoptera must have possessed the wing-coupling apparatus in a well-developed form; so that its inclusion in the restoration of the wing of *Archipanorpa* (Plate ix.: *jl*, jugal lobe; *jp*, jugal process; *fr*, frenulum) needs no further apology or explanation.

WING-NOTATION USED IN PLATES AND TEXT-FIGURES.

1A, first anal vein—2A, second anal vein, or axillary vein—3A, third anal vein, or basilar vein—4A, fourth anal vein (rarely present)—Af₁, Af₂, Af₃, Af₄, Af₅, the five apical forks, or end-forks, formed between the final bifurcations of the main veins—C, costal vein—cs, costal space—Cu, cubitus—Cu₁, Cu₂, its primary branches—Cu_{1a}, upper branch of Cu₁ in Mecoptera; Cu_{1b}, continuation of Cu₁—*cu**f*, cubital fork—*dc*, discoidal cell—*fr*, frenulum—*jl*, jugal lobe—*jp*, jugal process—M, media—M₁, M₂, M₃, M₄, its four main branches. (Further branchings are denoted by Cu_{1a} suffixes *a* and *b*).—*mc*, median cell—*pos*, precostal space (in Protomecoptera)—*ptc*, post-discoidal cell—*pmc*, postmedian cell—*pt*, pterostigma—*ptc*, post-thyridial cell—*ptf*, pterostigmatic furrow—R, radius; R₁, its main stem—*r**f*, radial fork—Rs, radial sector; R₂, R₃, R₄, R₅, its four main branches. (Further branchings are denoted by suffixes *a* and *b*, and branchings of these by *a*, *a'*, or *b*, *b'*).—S₁-S₁₂, branches of Rs in Planipennia—Sc, subcosta—*scs*, subcostal space—*sdc*, subdiscoidal cell—*smc*, submedian cell—*t*, thyridium (= median fork)—*tc*, thyridial cell.

EXPLANATION OF PLATES VII-IX.

Plate vii. (Trichoptera).

Fig. 1.—*Mesopsyche triarcolata*, n.g. et sp. Forewing; ($\times 7.5$).

Fig. 2.—*Triassopsyche daustani*, n.g. et sp. Forewing; ($\times 7.5$).

Plate viii. (Planipennia and Protomecoptera).

Fig. 3.—*Protopsycheopsis venosa*, n.g. et sp. Portion of wing; ($\times 5$).

Fig. 4.—*Archipanorpa magnifica*, n.g. et sp. Forewing; ($\times 5$).

Fig. 5.—*Archipanorpa magnifica*, n.g. et sp. Hindwing; ($\times 5$).

Fig. 6.—*Archipanorpa magnifica*, n.g. et sp. A small portion of the hindwing, showing part of a main vein carrying the basal tubercles of three macrotrichia, and the membrane above it, with its polygonal meshwork (the ridges left unshaded), basal tubercles of eleven macrotrichia (double concentric circles), and small pits for insertions of microtrichia (in black). Semi-diagrammatic; ($\times 7.5$).

Plate iv.

Restoration of fore- and hindwings of *Archipanorpa magnifica*, n.g. et sp.; ($\times 1.5$).

DESCRIPTIONS OF TWO NEW TIGER-BEETLES FROM
THE NORTHERN TERRITORY.

BY T. G. SLOANE.

(Withdrawn for amendment, by permission of the Council.)

NOTES AND EXHIBITS.

Mr. Maiden showed a flowering-twig, and drawings of *Eucalyptus erythrocorys* F.v.M., a remarkable species, grown for the first time in New South Wales. It is locally rare in Western Australia. Some seed was obtained from Mr. W. D. Campbell, who collected it about 20 miles from Dongarra. Sown on 10th October, 1913, it threw off its first operculum on 11th April, 1917. It is at present a slender, small, smooth-barked tree of 16 feet, with a girth of 7 inches. It has remarkable fleshy, rugose, biretta-like, quadrangular opercula, old carmine-red in colour, which contrast sharply with the bright green calyx-tubes. The filaments were greenish-yellow as they opened, and are now a bright yellow. Apart from its scientific interest, the species has obviously considerable horticultural value.

Mr. Tillyard exhibited a collection of insects from, and gave a short lecture on, Cradle Mt., N. W. Tasmania, and its natural history, illustrated by lantern-slides. On a visit to this locality in January last, accompanied by Mr. G. H. Hardy, of the Tasmanian Museum, Hobart, an interesting insect-fauna was discovered, the majority of the species captured being new to science. The ancient Orders Perlaria (Stone-flies) and Trichoptera (Caddis-flies) were particularly abundant, about twelve new species of the former and thirty of the latter being taken. Three very fine new Dragonflies were found, two of which are closely allied to Chilean forms. A new family of small Scorpion-flies (Order Mecoptera) closely resembling Diptera, was also discovered, and some very rare Lepidoptera and Diptera were taken. Hymenoptera and Coleoptera were almost completely absent. Collecting was chiefly carried on in the Cradle Valley, at the 3000-4000 feet levels, the best localities being the shores of Lakes Dove, Lilla, and Crater Lake, and the mountain-streams in the vicinity.

ORDINARY MONTHLY MEETING.

MAY 30th, 1917.

Dr. H. G. Chapman, President, in the Chair.

Mr. ERNEST G. JACOBS, Sydney, and Mr. G. H. HURLSTONE HARDY, Hobart, were elected Ordinary Members of the Society.

The President made regretful reference to the decease of two Members—Mr. Dene B. Fry, elected in 1913, a young biologist of great promise, killed in action in France on April 9th, 1917; and Mr. Alfred James North, elected in 1886, Ornithologist of the Australian Museum, who died on May 6th, 1917. On the President's motion, it was resolved that letters expressive of the regret and of the sympathy of Members should be sent to Mr. Fry, senr., and to Mrs. North.

The President offered the Society's congratulations to Mr. R. J. Tillyard, M.A., B.Sc., F.L.S., on the recent award of the Crisp Medal and Prize of £30 to him by the Council of the Linnean Society of London.

The President gave a brief summary of the pendulum-investigations in a disused mine at Cobar, N.S.W., initiated by the Rev. Father Pigot, of Riverview College; and pointed out that, in order to complete the work, a sum of £60 per annum for the next two years, was required, to provide photographic paper, and the services of a local assistant to attend to the necessary changes thereof. It was proposed to establish a fund for this purpose; and he appealed for contributions, which might be sent to the Secretary or to himself.

The Donations and Exchanges received since the previous Monthly Meeting (25th April, 1917), amounting to 6 Vols., 79 Parts or Nos., 18 Bulletins, 2 Reports, and 4 Pamphlets, received from 43 Societies, etc., were laid upon the table.

AUSTRALIAN NEUROPTERA. PART iii.

By ESBEN-PETERSEN, Silkeborg.

(Plates x.-xv.)

(Communicated by W. W. Froggatt, F.L.S.)

The material dealt with herein, with the exception of a few specimens, belongs to Mr. W. W. Froggatt, Government Entomologist of New South Wales. His success in finding interesting material of this Order is very gratifying; and I would here express my best thanks to him for his kindness in allowing me to examine it.

MYRMELEONIDÆ.

In his two papers, "Studies in Australian Neuroptera," Nos. i.-ii. (these Proceedings, 1915 and 1916), Mr. R. J. Tillyard gives a number of very valuable contributions to the knowledge of the Neuroptera, especially as to the Australian fauna. I was much surprised to see the fine result, his study of the wing-tracheation, in the pupal stage of the Myrmeleonidæ, has brought forth; and I agree very well with the conclusions he arrives at, and the proposals he makes. But I should like to supplement his remarks on certain structures in the venation. I propose to name the area between Cu_1 (more correctly termed $M_2 + Cu_1$), Cu_2 and the hind-margin of the wing the "Intercubital area"; and the line, formed in the same manner as the Banksian line, and often present in the area named, the "Intercubital line." With regard to the systematic part of Tillyard's work, I may say that it much advances the study of the Australian Myrmeleonidæ. I have only a single objection to make. His Tribe *Protoplectrini* is the same as the Navasian Tribe *Creagrini*, and, therefore, the Navasian Tribus-name ought to have priority, being the older.

Tribe **Creagrini**.

In this Tribus, the Australian genera *Protoplectron* Gerstaecker, *Pseudoformicaleo* Weele, and *Escura* Navás may be placed. I know the last-named genus only from the description, and from a somewhat schematic figure of the forewing of the single species referred to the genus, *Escura divergens* Navás (Revista d. l. Real Academia d. Cienc., Madrid, p.468, 1914). In the same paper (p.467), Navás has founded a new genus, *Pseudoplectron*, for *costatum* Banks. As I have stated in my "Australian Neuroptera," Part ii. (these Proceedings, 1915, p.67), *costatum* Banks, is synonymous with *nubeculus* Gerst., and must be placed in the genus *Pseudoformicaleo* Weele. The synonymic list of the species will stand as follows:—

Pseudoformicaleo nubeculus Gerst.

Creagrís nubecula Gerst.

Pseudoformicaleo jacobsoni Weele.

Protoplectron costatum Banks.

Tahulus caligatus Navás.

Pseudoplectron costatum Navás.

I have, at hand, material of the species from Japan, Formosa, and Java; and I have seen a specimen of *Ps. nubeculus* Gerst., from Australia. Therefore, I am quite sure that my determinations are correct. The figure of the head and prothorax of *Pseudoformicaleo jacobsoni*, given by Weele (Notes from Leyden Mus., Vol. xxxi., p.26, 1909), is, unfortunately, not quite correct: the markings on the prothorax, for instance, are figured too distinctly.

P R O T O P L E C T R O N .

Gerstaecker, Mitth. naturw. Verein f. Neuropom. u. Rügen. p.15, 1884.

PROTOPLECTRON STRIATELLUM, n.sp. (Plate x, fig.1).

Face yellowish. Apical joint of maxillary and labial palpi brown or blackish. Vertex black, with an oblong, transversely placed, yellow spot above each antenna, and behind with two yellowish spots, forming a semicircular figure. Antennæ

clavate, blackish, brownish-annulated, as long as head and thorax united. Prothorax a little broader than long, with a deep transverse furrow one-third from its front margin; front angles rounded; a brownish, indistinct, narrow, longitudinal, median streak; at each side, a longitudinal indistinct pale streak from the transverse furrow to the hind-margin, broadened towards its base. A pale, small spot near the hind angles. Meso- and metathorax black. Abdomen black; hind-borders of the segments narrowly yellowish-margined. Thorax with long, white bristles; abdomen* shortly whitish-haired. Legs stout and rather short, whitish-haired, and with long, black bristles. Femora and tibiæ brownish-black; intermediate- and hind-tibiæ with brownish basal parts; tarsi blackish; spurs and claws brownish. First tarsal joint a little longer than fifth, which is as long as second, third, and fourth united. Spurs as long as first tarsal joint. Wings hyaline, long and slender; forewing somewhat falcate at tip. Nervures mostly whitish, but several longitudinal veins in the forewings blackish-banded or blackish-shaded. The basal cross-veins in the forewing mostly whitish, each with one or two blackish spots. The Banksian line hardly indicated. Costal area in the forewing with two rows of cells in its basal half. Pterostigma indicated by an oblong greyish-brown streak.

Length of fore- and hindwings, 23 mm.

Brewarrina, N.S.W.; one specimen, 1914 (W. W. Froggatt leg.); Coll. Froggatt.

The species is nearly allied to *Protoplectron eremiae* Till.: but, as far as I can see, a distinct and good species.

Tribe **Dendroleonini.**

GLENOLEON Banks.

Trans. Amer. Ent. Soc., xxxix., p.223, 1913.

GLENOLEON ANNULICORNIS.

Esbén-Petersen, Proc. Linn. Soc. N. S. Wales, 1915, p.72.

Brewarrina, N.S.W.; one specimen, 1914, (Froggatt leg.); and Inglewood, Victoria; one specimen, 1902 (Froggatt leg.).

GLENOLEON INDECISUS.

Banks, Trans. Amer. Ent. Soc., xxxix., p.225, 1913.

One specimen from New South Wales, 12/2/1910 (Froggatt leg.).

Tribe **Distoleonini.**

In this Tribus, a rather large number of Australian genera must be placed, as Tillyard has already pointed out. Here I may propose a new generic name for the Australian species hitherto attributed to the genus *Gymnocnemia* Schn. I have examined the European species, *Gymn. variegata* Schn., which species is the genotype; and, as will be seen in the photo (Plate x., fig.2), the Australian species necessarily must be referred to a new genus. In *Gymn. variegata*, the legs are long and slender, the first tarsal joint much longer than any of the others. In the forewing, Rs arises at a level much further out than that of the cubital fork. No Banksian or intercubital line. The antennæ are as long as the head and the thorax united, and distinctly clavate.

AUSTROGYMNOCNEMIA, n.gen.

Body rather stout. Antennæ clavate. Abdomen shorter than the wings. Legs rather short, strongly haired; tarsi almost as long as tibiae. Fifth tarsal joint the longest; first as long as second and third united; fourth the shortest. No spurs. Wings rather long and narrow, the hindwing shorter than the forewing. In the forewing, Rs arises at the same level as that of the cubital fork; in the hindwing, nearer to the base (only one cross-vein before the origin of Rs). Banksian line present, and the intercubital line, as a rule, also more or less distinct. Veins 2A and 3A are separate, but united by cross-veins.

Genotype, *Gymnocnemia bipunctata* Esb.-Peters.

To this genus I would refer also four other known species from Australia—*G. tipularia* Gerst., *G. pentagramma* Gerst., *G. interrupta* Esb.-Peters., and *G. maculata* Till.

AUSTROGYMNOCNEMIA MACULATA.

Gymnocnemia maculata Tillyard, Proc. Linn. Soc. N. S. Wales, 1916, p.57.

Brewarrina, N.S.W.; one fine specimen (W. W. Froggatt leg.); Coll. Froggatt.

The species occupies an isolated position within the genus in regard to the shape of its wings.

CERATOLEON, n.g.

Body very stout. Abdomen much shorter than the hindwings. Vertex very raised. Antennæ almost fusiform. Legs short and very stout. Tarsi shorter than tibiæ. Fifth tarsal joint the longest; first joint not so long as second and third united; fourth the shortest. No spurs. Costal area in the forewings with two rows of cells in its basal third. In forewing, Rs arises at a level much before that of the cubital fork; in the hindwing, one cross-vein before origin of Rs. Veins 2A and 3A separate; in the forewing, they are united with two cross-veins; in the hindwing, with one. Banksian line present in both pairs of wings; intercubital line distinct in the forewing.

Genotype, *Ceratoleon brevicornis*, n.sp

This genus is a very distinct one, easily recognised by the peculiar shape of the antennæ; and by the nervature of the wings, which differs in many points from that in *Austrogymnocnemia*.

CERATOLEON BREVICORNIS, n.sp. (Plates x.-xi., figs.3, 3A).

Head black. Labrum and clypeus yellowish. The strongly elevated vertex with several irregular yellowish spots. Palpi yellowish-brown, basal part of apical joint darker. Antennæ black, fusiform, yellowish-annulated; basal joint short and stout, second joint somewhat smaller than first, third joint as long as first and second united, but very narrow at base, and thickened towards apex; the following joints several times broader than long. Prothorax as long as broad, blackish, with a transverse furrow at one-third from the front margin, and with some yellowish-brown spots and streaks. Lateral margins with dark bristles. Meso- and metathorax blackish, with a few paler spots. Abdomen blackish, with a few whitish bristles near its base. Legs short and stout. Hind- and intermediate-femora blackish-brown, fore-femora brown; all the femora with long whitish and

a few blackish bristles. Tibiæ pale brown, with blackish bands and spots, especially the intermediate fore-ones, and with long white and black bristles, the hind tibiæ only with black ones. Tarsi blackish, once and one-half shorter than the tibiæ. Fifth tarsal joint the longest, as long as fourth and third united; second joint a little longer than third, and first a little longer than second.

Wings with rather obtuse and rounded apex. Nervature in the forewing whitish, dark brownish-banded; most of the cross-veins brownish-shaded, especially three in the radial area. In the subcostal area, in front of the three last-named cross-veins, a short dark streak; nearer to the base of the same area, a longer dark streak. Pterostigma blackish; a blackish streak near the tip of M and Cu₁ and on the hind-margin where 1A and Cu₂ unite. Many of the veins along the hind-margin with small dark dots. Most of the nervures in the hindwings blackish, especially in the front and apical part. Pterostigma, a small spot nearer to the apex of the wing, and a larger one, opposite to the pterostigma, blackish; the latter with a dark shadow extending to the hind-margin of the wing.

Length of forewing, 17-18 mm.; of hindwing, 14-15 mm.

Brewarrina, N.S.W.; one female specimen (type), 1914 (W. W. Froggatt leg.); Coll. Froggatt. Narromine, N.S.W.; one specimen [abdomen and antennæ lost], 1905 (W. W. Froggatt leg.); Coll. Esben-Petersen.

ALLOFORMICALEON.

Esben-Petersen, Proc. Linn. Soc. N. S. Wales, 1915, p.69.

ALLOFORMICALEON CANIFRONS. (Plate xi., fig.4).

Formicaleo canifrons Navás, Revista d. l. Real Acad. d. Cienc., Madrid, p.473, fig 5, 1914.

This species was described from a specimen (Mus. Vienna) with no other statement of locality than Australia. The face of the insect is covered with a dense whitish pilosity, and, in the hindwing, it has two cross-veins before the origin of Rs.

One specimen from New South Wales (W. W. Froggatt leg.); Coll. Froggatt.

Tribe **Myrmeleonini.**

M Y R M E L E O N .

Linné, Syst. Nat., xii., p.913, 1767.

M Y R M E L E O N N I G R O M A R G I N A T U S , n. sp. (Plate xi., fig. 5).

Brownish-yellow. Clypeus, labrum, genæ and palpi brownish-yellow; face below, between and above the antennæ brownish-black. Hind part of vertex yellowish, with a longitudinal, median, black streak. Antennæ brownish-black, the antennal insertions yellowish-margined. Prothorax almost as long as broad, brownish-yellow, with rounded front angles, and with a narrow, longitudinal, median, brownish-black streak; one-third from front margin, a transverse furrow. Mesothorax brownish-yellow; in front with a triangular, brownish-black, median spot; and, at each side, in front of the base of the forewings, a brownish-black spot. Metathorax with a smaller spot at each side in front of the base of the hindwings. Underside of thorax brownish-yellow, with a few brownish-black spots. Abdomen brownish-yellow, with a brown and rather broad, longitudinal, median streak above, and with the apical half of each segment pale brown below. Thorax and abdomen with rather long and whitish hairs. Legs brownish-yellow. Fore-femora dorsally with a dark brown spot at the tip; intermediate-femora with a dark brown longitudinal streak in front; hind-femora with a broad blackish band near the tip; hind-tibiæ with a narrow blackish streak ventrally. Tip of tibiæ and tarsal joints faintly brownish-coloured. Wings with a yellowish tinge, and with a yellowish nervature, the margin of the wings, with the exception of the basal fourth to one-third, dark brown to blackish. Pterostigma in the forewing with a faintly greyish-yellow tinge; in the hindwing, hardly indicated.

Body, 35 mm.; forewing, 33 mm.; hindwing, 29 mm.

One specimen from West Australia; 20/xii./02 (W. W. Froggatt leg.); Coll. Froggatt.

MYRMELEON LOWERI.

Tillyard, Proc. Linn. Soc. N. S. Wales, 1916, p.65.

Brewarrina, N.S.W.; a fine male specimen (W. W. Froggatt leg.); Coll. Froggatt.

In the male, the appendages are rather long, yellowish, provided with long, black bristles; their tips somewhat curved.

Acanthaclisini.

COSINA.

Navás, Broteria, Braga, p.47, 1912.

In my "Australian Neuroptera," Part ii., p.58, 1915, I expressed some doubt with regard to the validity of the Navasian genus *Cosina*. I have since altered my opinion concerning this question. *Cosina* may be regarded as a good and distinct genus, the main characters of it being the oblong wings, the dense reticulation, and the great number of cross-veins before the origin of Rs in the hindwing (*i.e.*, Rs arises further out than in the other genera of the Tribe).

COSINA MACLACHLANI.

Weele, Notes Leyden Museum, p.210, 1904.

One female specimen from Queensland, 20/xii./1912 (W. W. Froggatt leg.).

This species is the type of the genus. *Acanth. annulata* Esb.-Peters., should also be placed in the genus.

NYMPHIDÆ.

NESYDRION FUSCUM.

Gerstaecker, Mitth. naturw. Verein für Neuorpom. und Rügen, p.48, 1884; Esben-Petersen, Proc. Linn. Soc. N. S. Wales, 1914, p.638, Pl. lxxii., fig.3.

Mackay, Queensland; one specimen of this very rare insect, 1905 (Turner leg.); Coll. Froggatt.

MYIODACTYLUS OSMYLOIDES.*

Brauer, Verhandl. k.-k. zool.-bot. Gesell., Wien, 1866, p.991.

* I can not follow Handlirsch in regarding *Myiodactylus* and *Osmylops* as forming a family *Myiodactylidae*. Although these genera in several points differ from the true Nymphid genera, *e.g.*, in the form of the wings, the absence of spurs, etc., I think it is the most natural arrangement to place them in the *Nymphidae*.

Thursday Island: one example of this rare insect, originally described from a specimen (Vienna Mus.) from Moreton Bay. It agrees very well with the description and figure given by Brauer.

MYIODACTYLUS ROSEISTIGMA, n.sp. (Plate xii., fig.6).

Head yellowish-green; clypeus blackish-brown in front, becoming reddish towards base. Palpi yellowish-green. On the vertex from the base of the antennæ, and on the pro- and mesothorax a median, pale purple-red streak. Antennæ yellowish-red with a purplish tinge, especially on the dorsum. Between each antenna and the eyes, a reddish-brown spot. Thorax yellowish-green, with the exception of the mentioned median streak. Abdomen pale yellowish-brown, some of the apical segments with a purple-red, median streak above, and a few lateral yellowish spots (the colour of the abdomen probably changed by drying). Legs yellowish-green. Body and legs with long, pale pilosity.

Wings very broad, and with an acute, parabolic apex. Membrane hyaline; nervature pale green, and with long, pale hairs. In the forewing, the costal and apical areas are very broad; some of the cross-veins before the pterostigma forked once or twice, behind the pterostigma all cross-veins are forked, once, twice, or thrice. In the subcostal area, a number of complete or incomplete cross-veins. Near the base of Sc in the forewing, a sooty-black spot. Some of the costal cross-veins in the forewing with sooty-black spots at their forks. The cross-vein between R and Rs below the pterostigma blackish-brown. At the origins of the first six branches from Rs, a small dark spot. The cross-vein at the end of M_1 , Cu_1 , and Cu_2 blackish-shaded. The four or five cross-veins in the gradate series just below the tip of R blackish and blackish-shaded. A few cross-veins in the disc are faintly blackish-shaded. In the apical area, a few of the forkings are blackish. In the hindwing, no marked cross-vein, with the exception of a few forkings in the apical area. Pterostigma distinct and red; where it touches Sc, the red colour is changed to a sooty-black.

Length of forewing, 23 mm.; that of hindwing, 21.5 mm.

Cape York, Queensland; one specimen (Elgner leg.); Coll. Froggatt. Darnley, Cape York, Queensland; one specimen; Coll. Tillyard. Type in Coll. Froggatt; cotype in Coll. Tillyard.

OSMYLOPS.

Banks, Trans. Amer. Ent. Soc., 1913, p.214.

This genus was established by Banks, with *Myiodactylus placidus* Gerstaecker (Mitth. naturw. Ver. Neuvorpom. u. Rügen, p.49, 1884) as genotype.

OSMYLOPS SEJUNCTUS. (Plate xii., figs.7-7A).

Nymphes sejunctus Walker, Cat. Neur. Ins. Brit. Mus., p.230, 1853; MacLachlan, Journ. Linn. Soc. London, Zoology, ix., p.263, 1867.

I have seen a male specimen, collected at Hornsby; 2/xi./1912 (Coll. Tillyard), of what I consider to be Walker's above-named species. The specimen agrees very well with the re-description given by MacLachlan. I give here a photo of the wings, and figures of the anal appendages.

OSMYLOPS ARMATUS.

Myiodactylus armatus MacLachlan, Journ. Linn. Soc. London, Zoology, ix., p.264, 1867.

In Ent. Mo. Mag., xiv., pp.85-86, 1877-78, MacLachlan mentions that *M. armatus* and *M. sejunctus* are possibly different sexes of one species. In my collection, I have a male specimen from New South Wales, 1906, of what I consider to be *M. armatus*. The specimen is different from the foregoing specimen.

OSMYLIDÆ.

CONCHYLOSMYLUS TRISERIATUS. (Plate xiii., fig.8).

Spilosmylus triseriatus Banks, Trans. Amer. Ent. Soc., p.214, 1913.

The type-specimen (♂) of this species is from Herberton, Queensland (Coll. Banks). Present is a fine specimen from Stannary Hills, Queensland, 1905 (Brown leg.); Coll. Froggatt.

I place the species provisionally in *Conchylosmylus* Krüger (Stett. ent. Zeit., p.20, 1914), although I can see that the species is not totally covered by the generic characters: but it seems to me that it is better placed in this genus than in *Spilosmylus* (restr. by Krüger).

BEROTHIDÆ.

BEROTHA NEUROPUNCTATA, n.sp. (Plate xiii., fig.9).

Head reddish-yellow; palpi darker: vertex with small brownish-red dots. Antennæ brownish-yellow, basal joints yellowish, stout, long, cylindrical, almost as long as second, third, and fourth joints united. Prothorax once and one-half as broad as long, with rounded front angles, with many small reddish-brown dots, and a larger oblong dark streak parallel and near to the lateral margins; a median line along prothorax and vertex clear yellowish. Meso- and metathorax yellowish, with greyish-brown spots. Sides of thorax greyish-brown, with yellowish streaks and spots. Abdomen [shrivelled and destroyed] yellowish(?). Thorax and abdomen with long, dark bristles. Male appendages of the same shape, and held in the same position as in the other species of the genus. Legs yellowish, with brown bands and spots. Forewings with a yellowish tinge, hindwings almost hyaline. In the forewings, all the longitudinal nervures are yellowish, brownish-spotted, the cross-veins brownish-black and shaded. In the hindwing, the longitudinal nervures are yellowish, but the apical part of the branches from Rs are brownish. The cross-veins (only few in number) in the disc, and all the cross-veins in the pterostigmatic area brownish. Cross-veins in the costal area of forewing forked, and with two or three branches.

Brewarrina, N.S.W.; one male specimen, 1914 (W. W. Froggatt leg.); Coll. Froggatt.

Besides this species, one more is known from Australia, viz., *B. rufä* Navás, from Queensland. The two species may be separated thus:—

Nervures without dark spots. Hind-margin of forewings strongly excavate at apex. Radial area in forewings with four cross-veins. Forewing, 13 mm.; hindwing, 11 mm. *rufä*.

Nervures of forewing with dark spots. Hindmargin of forewing hardly excavate at apex. Radial area in forewing with two cross-veins....
 *neuropunctata*.

CHRYSOPIDÆ.

DICTYOCHRYSA, n.gen.

Antennæ longer than forewings. Costal area rather broad in the forewing, but gradually narrowed towards pterostigma. Subcostal area broad in its basal fourth. The cross-vein between Sc and R placed a little before origin of Rs. M forks regularly, and its branches do not coalesce as in *Chrysopa*, nor form cellules as in *Nothochrysa*. M forks behind the origin of Rs. Cu forks a little further out than the cross-veins between M and the stem of Cu. In the hindwing, the costal and subcostal areas are of the usual form. In the discal area of the fore- and hindwings, all the cells are of hexagonal form. No series of gradate cross-veins. No forks along the apex of wings.

Genotype, *Dictyochrysa fulva*, n.sp.

This genus is a very interesting one, especially with regard to the peculiar and unusual nervature of the wings.

DICTYOCHRYSA FULVA, n.sp. (Plate xiii., fig.10).

Head fulvous. Palpi brown. Vertex with a short, narrow, dark, transverse streak above the antennæ. Antennæ fulvous at base, blackish at the tip; basal joint very stout. Prothorax fulvous, almost as long as broad, and with rounded front angles. A very narrow, longitudinal, dark, median streak, not reaching the hind-margin: and a narrow, lateral one in the middle between the median streak and the side-margins, and of the same length as the median ones. Along the lateral margins, an indistinct dark streak. Mesothorax fulvous. Metathorax brown, its scutellum fulvous. Sides of thorax fulvous, with brownish spots and streaks. Abdomen [somewhat shrivelled in the specimen] castaneous at base, paler towards apex. Legs fulvous. Hind-femora brown in their apical parts; fore- and intermediate-tibiæ darker on their upper side, and hind-tibiæ with a dark band at apex. Tarsal joints pale brownish. First tarsal joint as long

as second and third united, and equal to fifth, which is rather broad, almost cordiform. Second joint a little longer than third, which is equal to fourth. Claws simple, and somewhat curved at apex.

Apex of wings elliptical. Nervature dark brown. C, Sc, and R yellowish for about their whole length; the other nervures yellowish between base of wings and the origin of Rs or the fork of M. Pterostigma dark reddish-brown, long and very distinct; in the pterostigmatic area, Cu bent somewhat outwards. Membrane of the wings hyaline, at base strongly yellowish, especially in the forewings. Nervures with short, blackish hairs.

Length of forewing, 17 mm.; of hindwing, 15 mm.

Queensland; one specimen; Coll. Froggatt.

NOTHOCHRYSA.

MacLachlan, Trans. Ent. Soc. London, 1868, p.195.

NOTHOCHRYSA CHLOROMELAS.

Girard, Ann. Soc. Ent. France, 1862, p.607.

In "Australian Neuroptera," Part i., I mentioned two specimens of this species from the Solomon Islands. In the material at hand, one specimen is present from Darnley Island, Queensland, 1910 (W. W. Froggatt leg.); Coll. Froggatt.

NOTHOCHRYSA INSIGNATA.

Navás, Ann. Soc. scient. Bruxelles, 1914, p.323.

Mackay, Queensland; one specimen, 1905 (Turner leg.); Coll. Froggatt. Navás has described the species on specimens from Queensland, and from Hermansburg, Central Australia.

NOTHOCHRYSA NIGRINERVIS, n.sp. (Plate xiv., figs.11, 11A).

Head, thorax, and abdomen yellowish. Tip of apical joint of labial and maxillary palpi brownish. At each side of the clypeus, a brownish spot; and below each antenna, but near to the eye-margins, a greyish-brown, short, transverse streak. Vertex with a V-shaped black figure. Antennæ at least as long as the wings, pale brown at base, and becoming dark brown at apex basal joint very stout and yellowish. Prothorax about twice as

broad as long, with rounded front angles, and with blackish front and lateral margins; two black, irregular, oblique streaks on its disc. Mesothorax with ten small black spots, and metathorax with four small ones. The hind-borders of each abdominal segment narrowly blackish-marginate dorsally; some of the segments with indistinct and irregular brownish spots dorsally. Legs greyish-yellow. The nervature of wings more or less brownish-black. Sc and R in the forewing, and C, Sc, and R in the hindwing, yellowish. Pterostigma indistinct, greyish-yellow.

Length of forewing, 14 mm.; of hindwing, 12 mm.

Brewarrina, N.S.W.; one specimen, 1914 (W. W. Froggatt leg.); Coll. Froggatt.

CHRYSOPA.

Leach, Edinb. Encycl., p.138, 1810.

CHRYSOPA RAMBURI.

Schneider, Symbolæ, etc., p.107, tab. 34, 1851.

Wagga, N.S.W.; one specimen: 7/xi./1899 (W. W. Froggatt leg.); Coll. Froggatt.

CHRYSOPA SIGNATA.

Schneider, Symbolæ, etc., p 109, tab. 35, 1851.

Kenthurst, N.S.W.: one specimen: 9/x./1903 (W. W. Froggatt leg.); Coll. Froggatt.

CHRYSOPA EXTRANEA, n.sp. (Plates xiv.-xv, figs.12-12A).

Rufous. Apical joint of maxillary palpi blackish at base. Face yellowish; clypeus with a darker spot on its middle part. A short, black streak between the antennæ, which are reddish-yellow at base [the greater part of the antennæ wanting]; basal joint very stout. Prothorax rufous, twice as broad as long, with an irregular black streak near each lateral margin: on its disc, two narrow, black streaks forming an abrupt, longitudinal, median streak: a small dark spot at each side of the median streak. Meso- and metathorax rufous, with some black spots.

Abdomen rufous. Legs reddish-yellow. Membrane of wings hyaline. Longitudinal nervures yellowish to pale brown; base of Rs and fork of M darker; cross-veins dark brown. M_2 coalesces with M_1 , and a triangular cell is formed by these two veins; first cross-vein between Rs and M_1 joins M_1 at the apical end of the triangular cell. Pterostigma greyish-yellow, rather indistinct.

Length of forewing, 23 mm.; of hindwing, 20 mm.

Colo Vale, N.S.W.: one specimen, 1902 (R. Corrie leg.): Coll. Froggatt.

I have placed this interesting species in the genus *Chrysopa*, although the nervature of the wings suggests some resemblance to the genus *Leucochrysa*, from America; but as the antennæ are defective, it may be best to wait, for a definite fixation of position, until more material is available.

MANTISPIDÆ.

EUCLIMACIA.

Enderlein, Stett. ent. Zeit., p.362, 1910.

EUCLIMACIA FLAVICOSTATA, n.sp. (Plate xv., fig.13).

Head reddish-yellow. Labial and maxillary palpi yellowish-brown. Each of the antennal insertions circumscribed by a narrow black line, united with a blackish-brown, transverse streak in front of the antennæ. Eyes bronze-green. Vertex smooth; the carina hardly indicated; face coarsely punctuate. Antennæ short and thick, yellowish-red, 46-jointed, the joints short, and very broad. Prothorax yellowish-red, divided by a deep transverse groove about one-third from front margin. The front part a little broader than the distance between the eyes, and about twice as broad as the hind part, which is somewhat longer than broad. At each side of the transverse furrow a tubercle. Meso- and metathorax brownish-red; meso- and metascutellum a little paler. Abdomen brownish-red, a little darker ventrally and at the base. Legs reddish-brown, the fore-coxæ a little darker.

Wings long and slender, with rather acute tips. The nervature reddish-brown. The membrane hyaline, but along the front and apical part of the wings is found a strong brownish-yellow tinge, which also, in the forewing, occupies the basal part of the wing and the area between M and Cu¹. Pterostigma reddish.

Length of forewing, 19 mm.; of hindwing, 16 mm.

Cape York, Queensland; one specimen (H. Elgner leg.): Coll. Tillyard.

This species has great likeness to *Euclimacia nuchalis** Gerstaecker (Mitth. naturw. Verein Neuvorp. u. Rügen, Bd. xvi., p.38, 1884), the type-specimen of which (in the Hamburg Museum) I have examined. In *E. nuchalis*, the femora and the coxæ are blackish-brown. The transverse groove on the prothorax blackish; hind-border of prothorax, meso- and meta-thorax blackish-brown. Abdomen yellowish-red, ventrally almost blackish-brown, with the exception of the hind-margin of the apical segments, which is yellowish-red. The first dorsal segment almost totally blackish-brown, the following three segments with blackish-brown front margin.

MANTISPA ERYTHRÆA. (Plate xv., fig.14).

Brauer, Abh. k.-k. zool.-bot. Gesell., Wien, Bd. xvii., p.506, 1867.

Euclimacia erythræa Stitz, Mitt. Zool. Mus. Berlin, p.42, 1913.

Two specimens of this species, from Brisbane, are placed in the Hamburg Museum, both specimens being designated as types. One of them also has a label as formerly belonging to the Mus. Godeffroy. I give a photo of one of the type-specimens.

EXPLANATION OF PLATES X.-XV.

Plate x.

Fig.1.—*Protoplectron striatellum*, n.sp. Photo. Coll. Froggatt.

Fig.2.—*Gymnocnemia variegata* Schn. Photo. Coll. Esb.-Petersen.

Fig.3.—*Ceratoleon brevicornis*, n.gen. et n.sp. Photo. Coll. Froggatt.

* *Euclimacia torquata* Navás, Mem. Real Acad. Cienc. y Art. Barcelona, p.95, 1914, is the same as *E. nuchalis* Gerst.

Plate xi.

- Fig. 3A.—*Ceratoleon brevicornis*. Figures of head and antennæ.
 Fig. 4.—*Alloformicaleon canifrons* Navás. Photo. Coll. Froggatt.
 Fig. 5.—*Myrmeleon nigromarginatus*, n.sp. Photo. Coll. Froggatt.

Plate xii.

- Fig. 6.—*Myiodactylus roseistigma*, n.sp. Photo. Coll. Froggatt.
 Fig. 7.—*Osmylops sejunctus* Walk. Photo. Coll. Tillyard.
 Fig. 7A.—*Osmylops sejunctus* Walk. Figures of anal appendages.

Plate xiii.

- Fig. 8.—*Conchylosmylus triseriatus* Banks. Photo. Coll. Froggatt.
 Fig. 9.—*Berotha neuropunctata*, n.sp. Photo. Coll. Froggatt.
 Fig. 10.—*Dictyochrysa fulva*, n.gen. et n.sp. Photo. Coll. Froggatt.

Plate xiv.

- Fig. 11.—*Nothochrysa nigrirostris*, n.sp. Photo. Coll. Froggatt.
 Fig. 11A.—*Nothochrysa nigrirostris*, n.sp. Figure of head and prothorax.
 Fig. 12.—*Chrysopa extranea*, n.sp. Photo. Coll. Froggatt.

Plate xv.

- Fig. 12A.—*Chrysopa extranea*, n.sp. Figure of head and prothorax.
 Fig. 13.—*Enclimacia flavicostata*, n.sp. Photo. Coll. Tillyard.
 Fig. 14.—*Mantispa erythroa* Brauer. Photo of type-specimen. Mus. Hamburg.

THE SINGLE CELL CULTIVATION OF YEAST.

BY R. GREIG-SMITH, D.Sc., MACLEAY BACTERIOLOGIST TO THE SOCIETY.

The method of isolating single cells of yeast by means of the pen, and growing them in tiny drops of nutrient fluid on cover-glasses in a moist chamber, as recommended by Paul Lindner, was a great advance upon the older gelatine process as practised by Hansen. The Lindner-method is in general use at the present time. It has some disadvantages, however, as will be recognised when the method, which I am about to describe, has been tried.

The pen acts by the capillary nature of its split, and it is a simple step to adopt a glass capillary, such as may be obtained by drawing out a heated piece of glass tubing until the tube is of the necessary bore. A four-inch piece of glass tubing of 4mm. bore, heated in the bunsen flame until soft, and drawn out to about thirty inches, will furnish several suitable capillaries. The heating sterilises the glass, and the capillary is ready for use when broken or cut into short lengths of, say, five inches. It is better to cut the capillary with a fine file to ensure a clean cut. A broken end will not make a good contact with the cover-glass, when the yeast-suspension is spotted. If the hand is used to cut or break the tube, the capillary can be sterilised by passing it rapidly through the flame before using.

The capillary is dipped into the suspension of yeast-cells, and inclined at an angle. The liquid rushes up the capillary but soon stops. The capillary is withdrawn, and 16 to 20 spots are dotted upon a sterile cover-glass, just as in the Lindner-method. The size of the spot can be regulated by inclining the capillary more or less to the vertical, and by the duration of contact with the cover-glass. The aim is to have the spot of such a size as can be included in the field of the microscope.

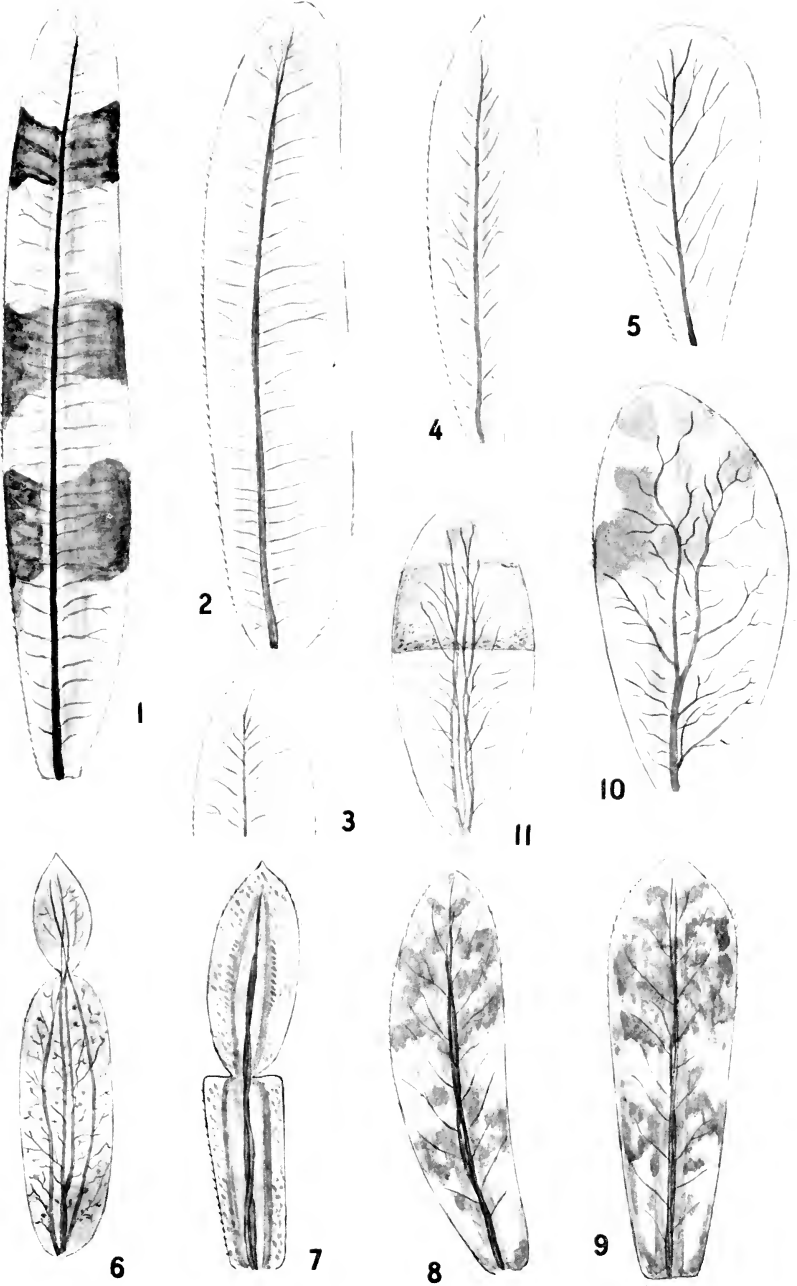

R.J.T. del.

Caudal Gills of Zygopteran Larvae: 1-5, *Lestidae*; 6-11, *Agrionidae*.

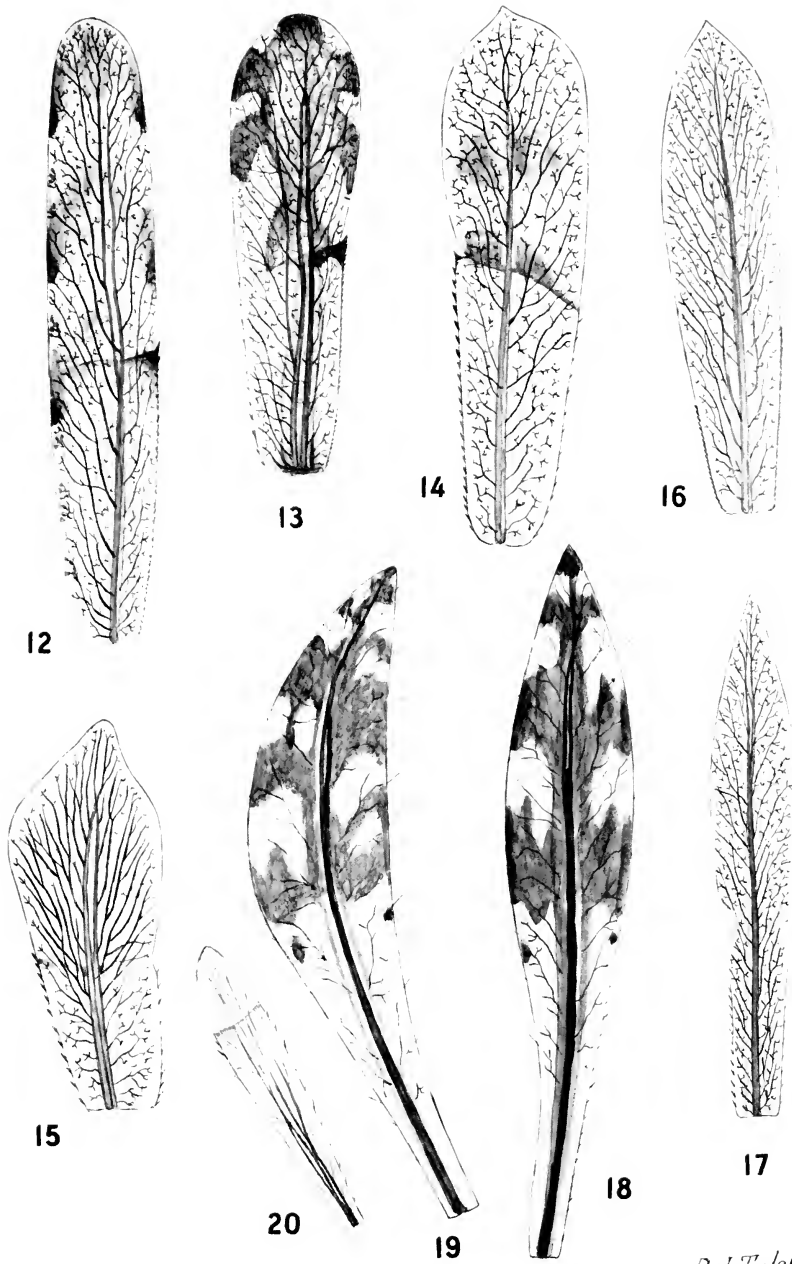

R. J. T. Jel.

Caudal Gills of Zygopteran Larvæ: 12-20, *Agriionidae*.

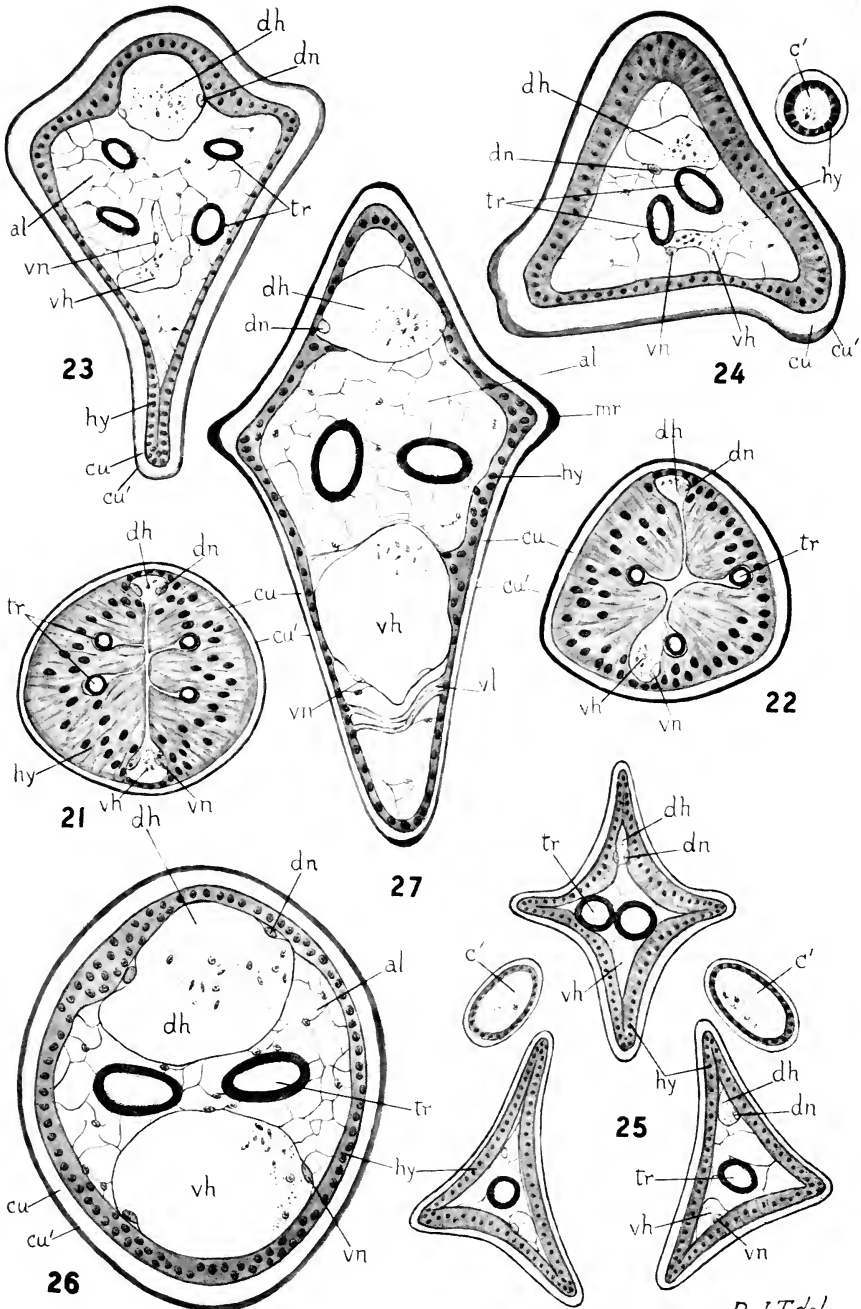

R.J.T del.

Transverse sections through caudal gills near bases.

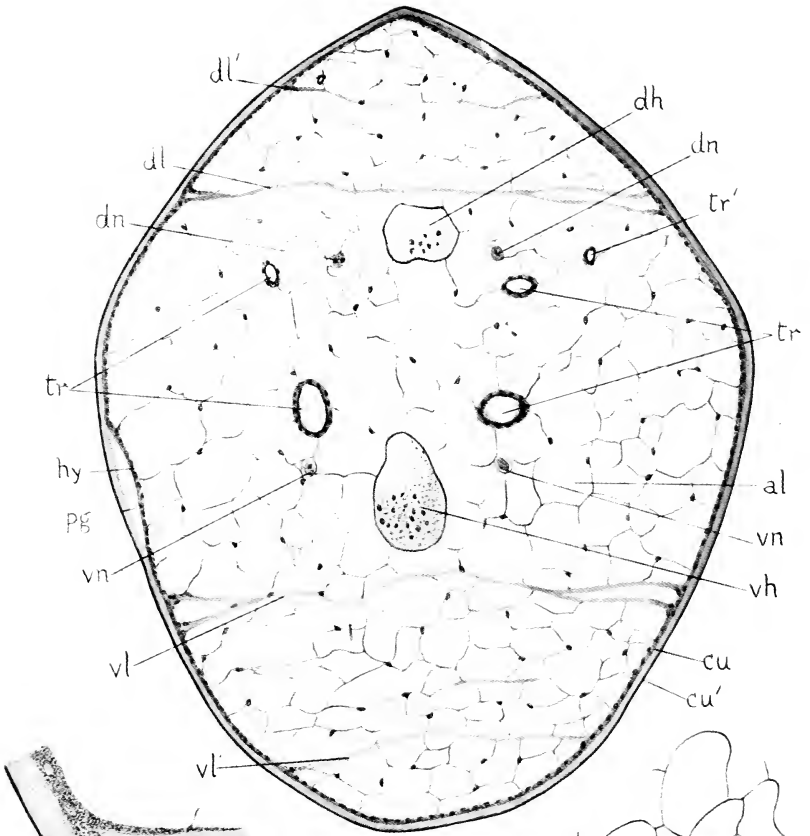

28

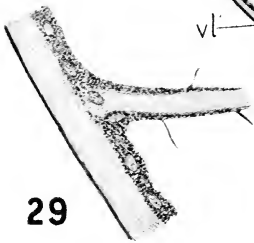

29

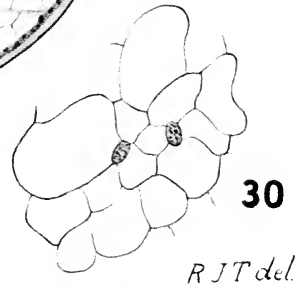

30

RJT del.

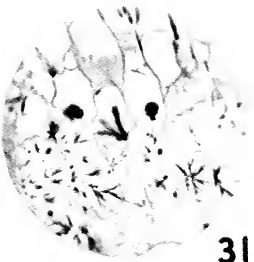

31

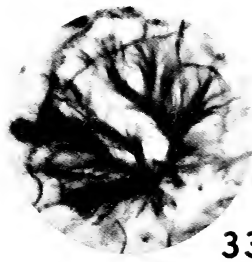

33



32

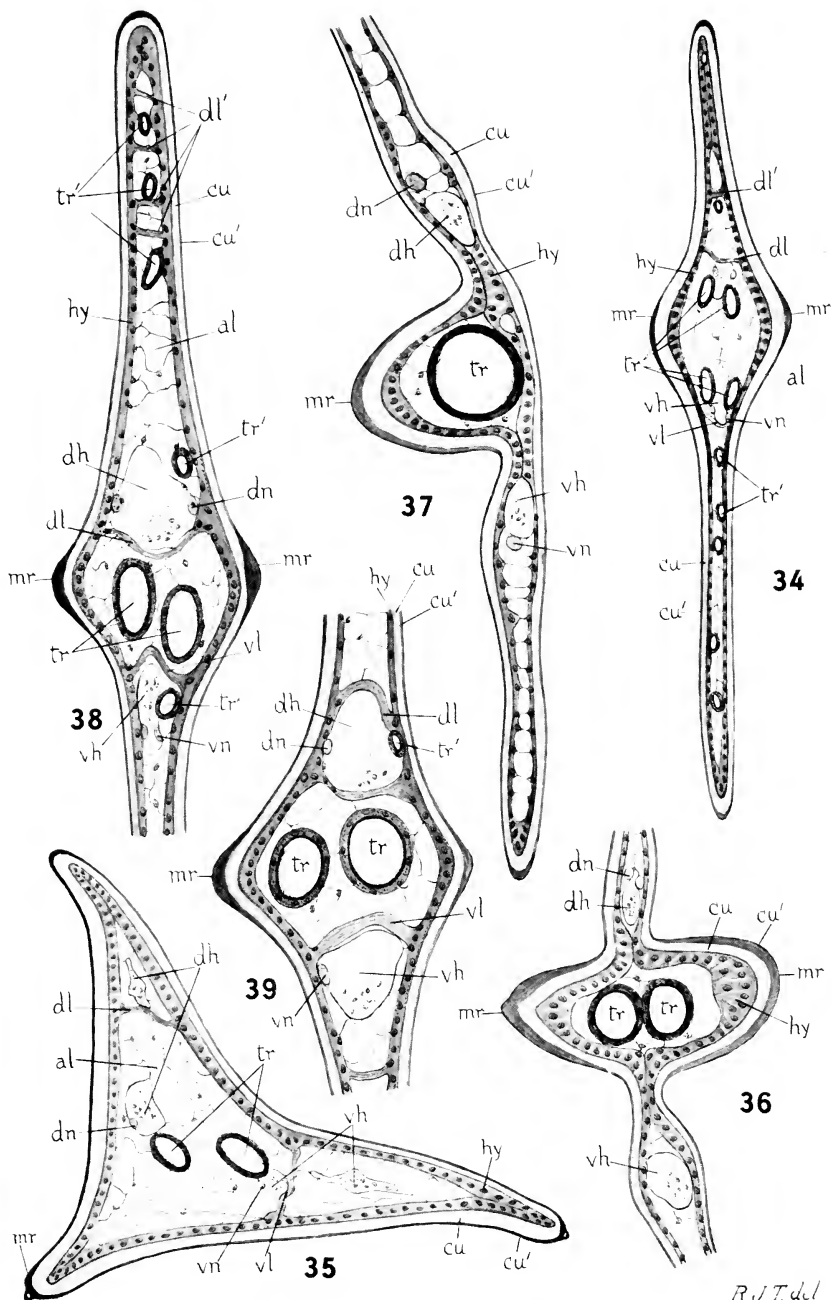

Figs. 34-35. Triquetro-quadrate Type.

Figs. 36-39. Vertical Lamellar Type.

R. J. T. del

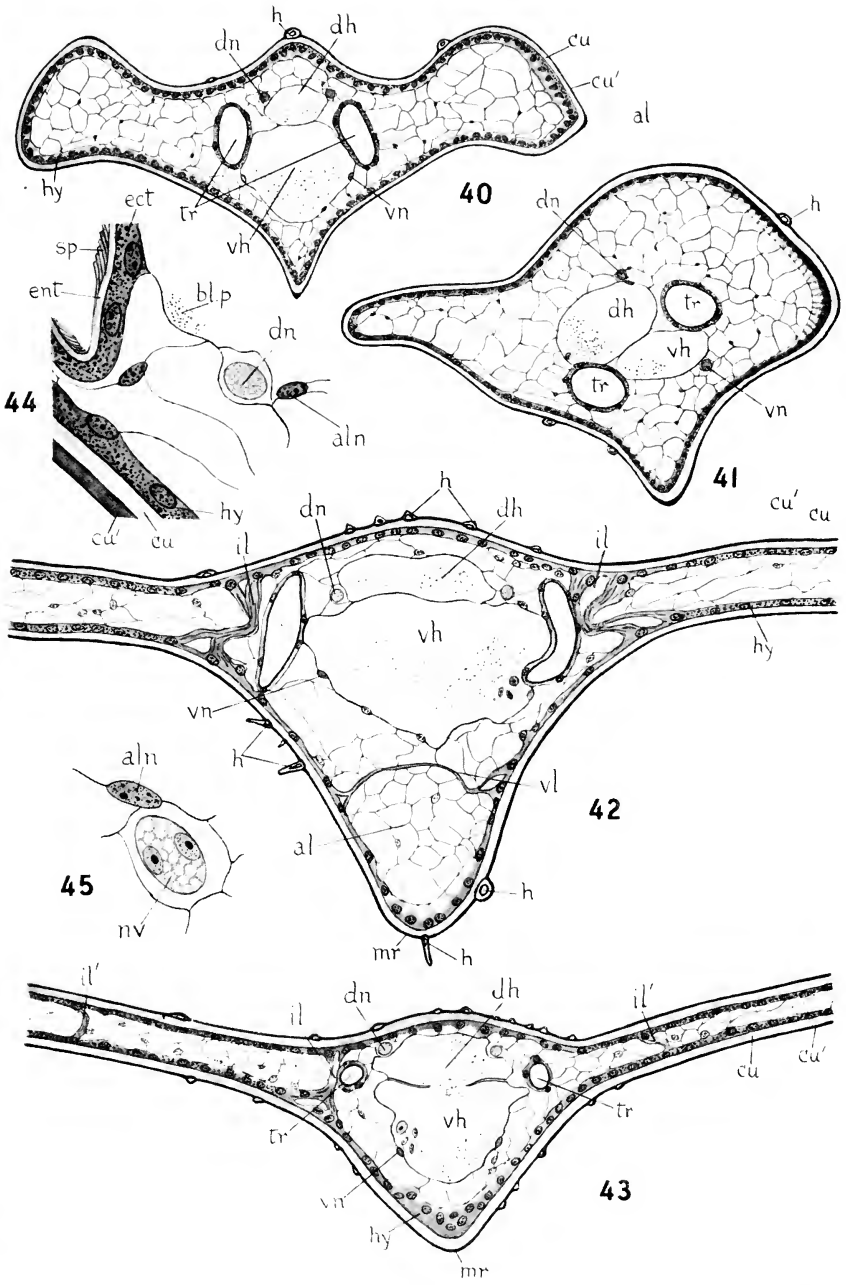

R. J. T. del.

Horizontal Lamellar Gill-type.

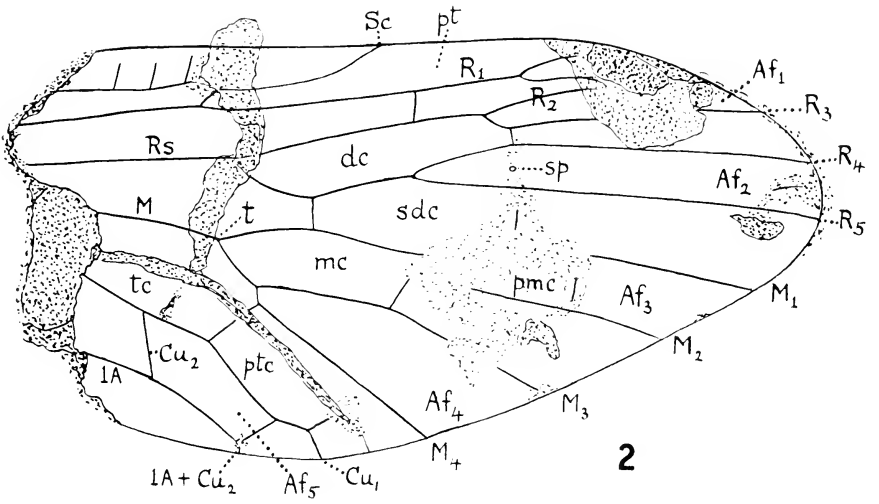
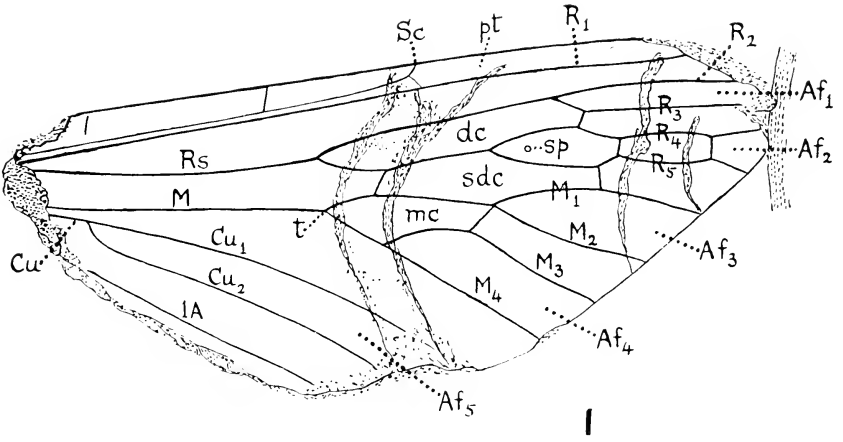

R. J. T. del

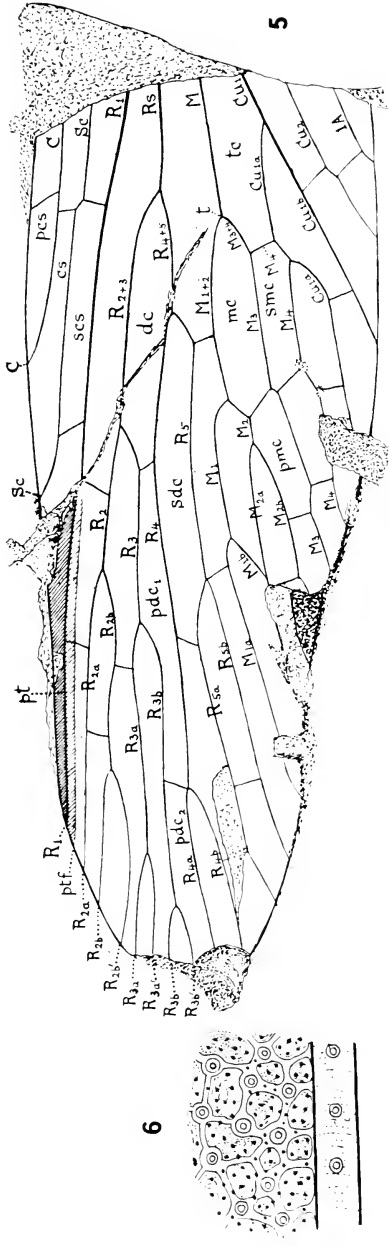

3

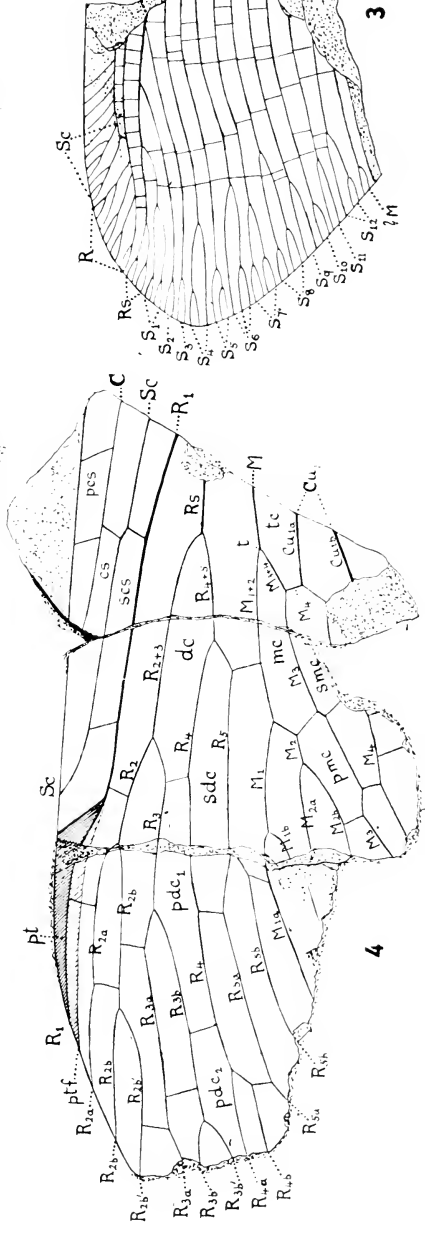

4

Fig. 3. Fossil Planipennia.

Figs. 4-6. Fossil Protomecoptera.

R. J. T. del.

6

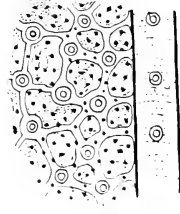

5

3

R. J. T. del.

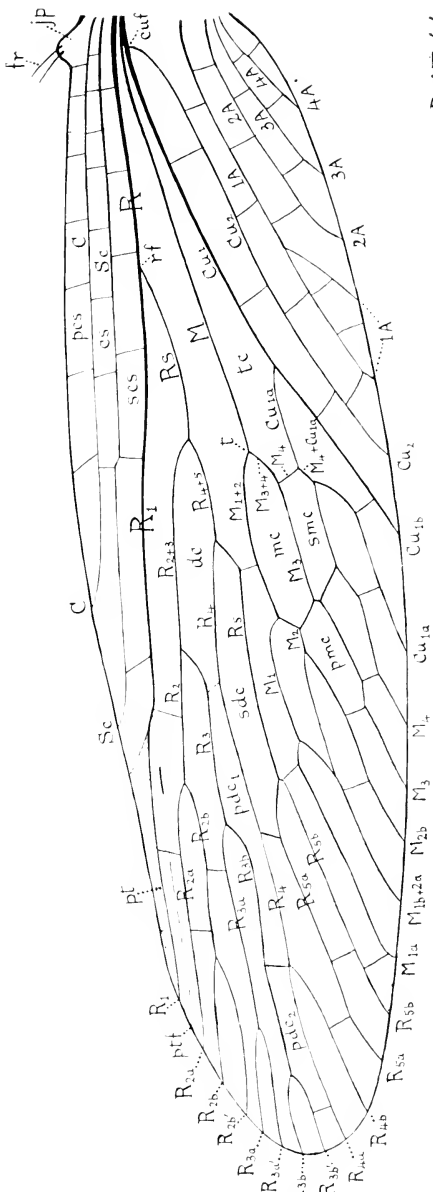
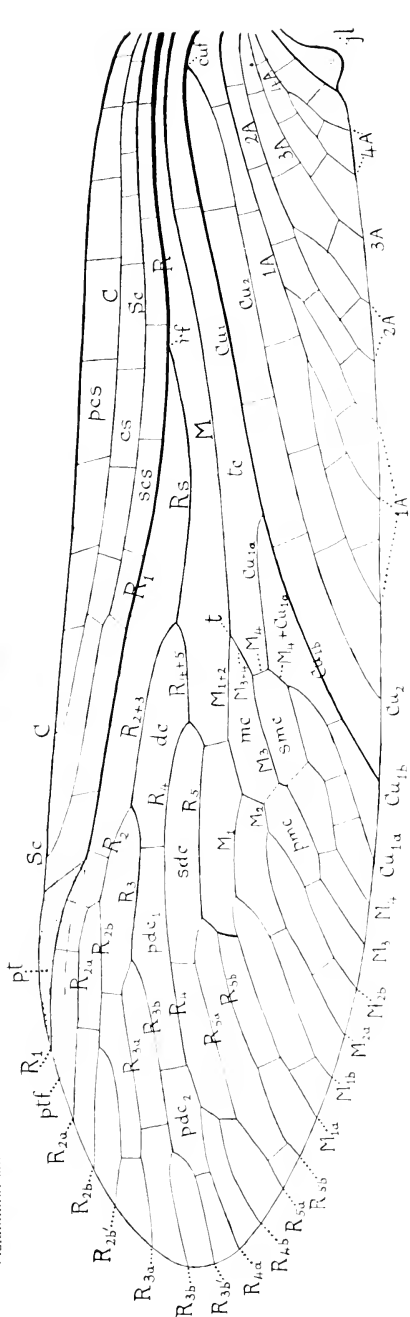

R. J. T. del

Restoration of wings of *Archiparatorpa magnifica* (Protonocoptera).

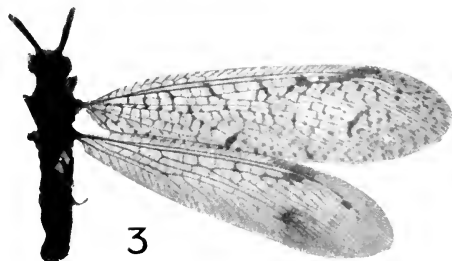
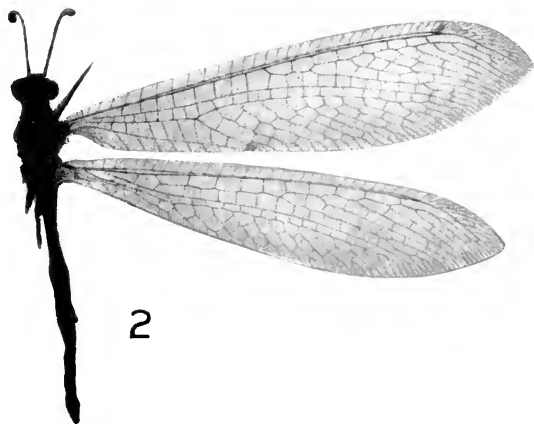
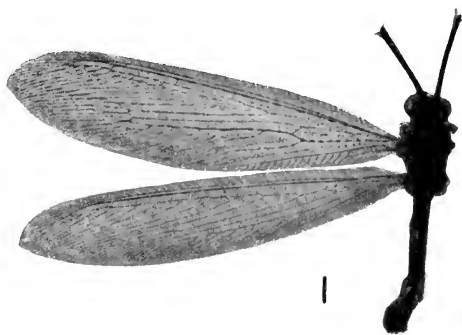

1. *Protoplectron striatellum*, n.sp.

2. *Gymnocnemia variegata* Schm.

3. *Ceratoleon brevicornis*, n.g. et n.sp.

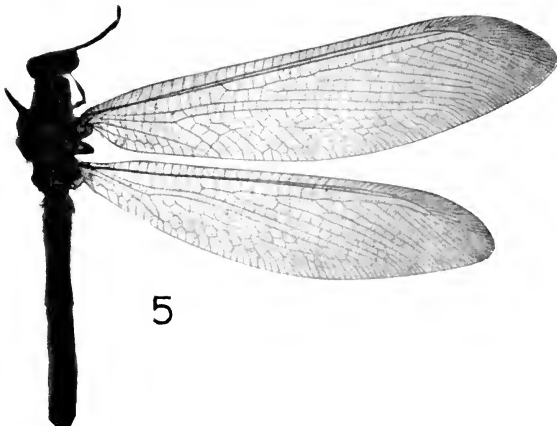
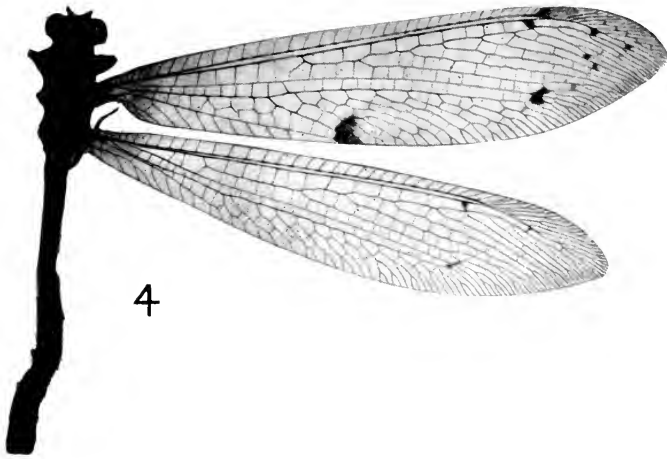
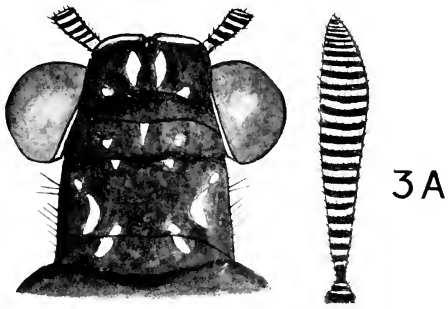

3A. *Ceratoleon brevicornis*, n.g. et n.sp.

4. *Alloformiceleon canifrons* Navas.

5. *Myrmelcon nigromarginatus*, n.sp.

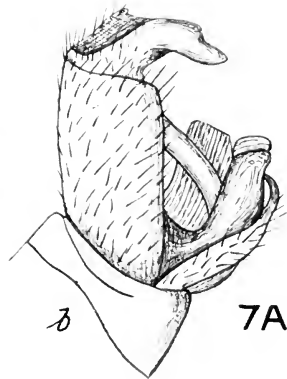
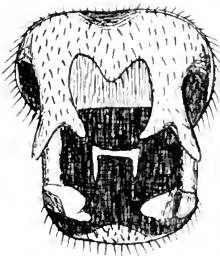
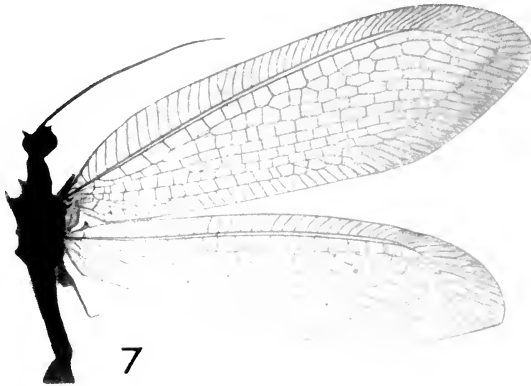
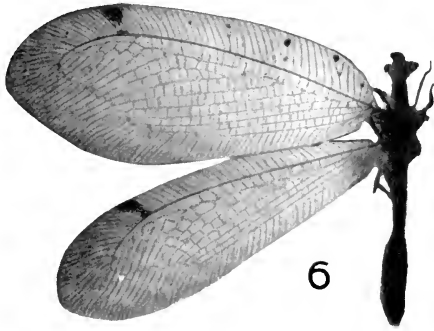

6. *Myiodactylus roseistigma*, n.sp.

7-7A. *Osmolyops sejunctus* Walk.

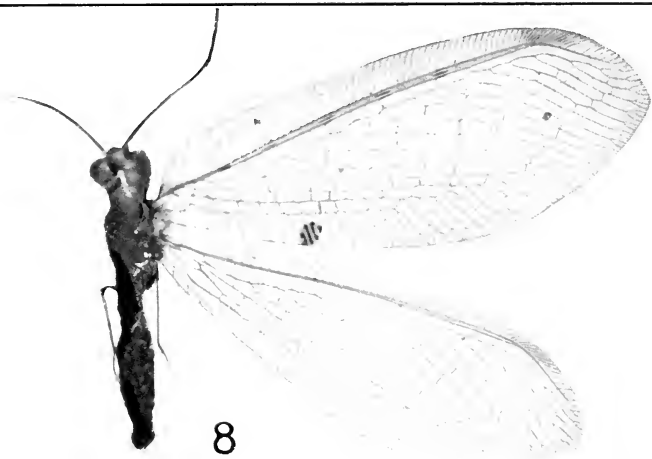

8

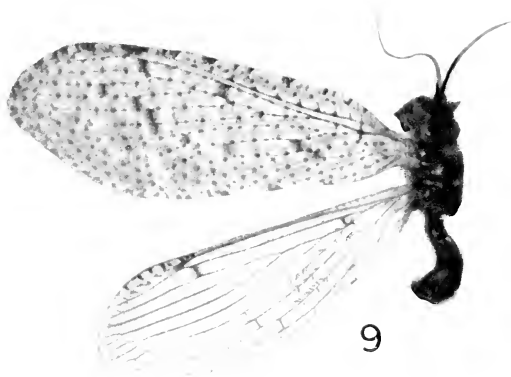

9

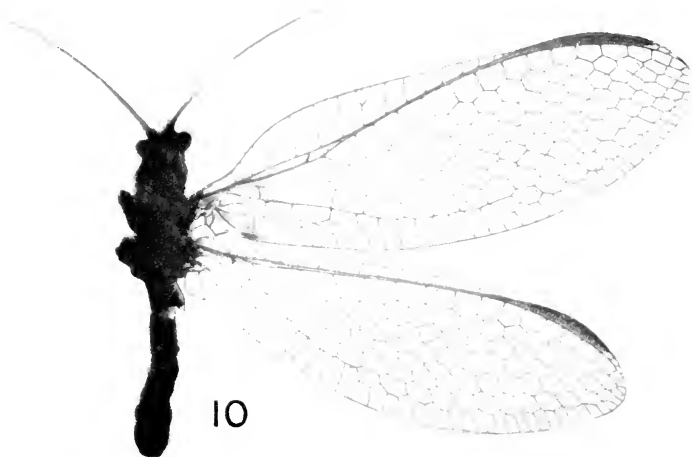

10

8. *Concyclosmylus triserialis* Banks.

9. *Berotha neuropunctata*, n.sp.

10. *Dictyochochrysa fulca*, n.g. et n.sp.

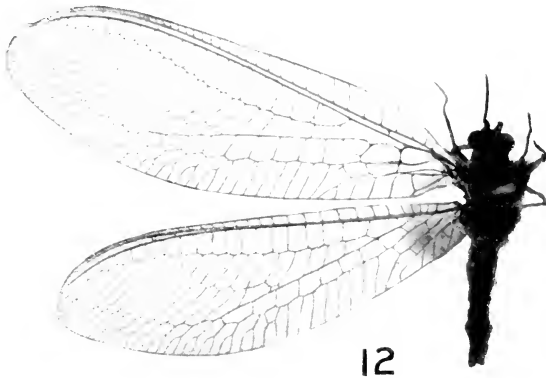
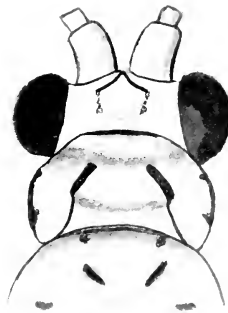

11-11A. *Nothochrysa nigrinervis*, n.sp.

12. *Chrysopa extranea*, n.sp.

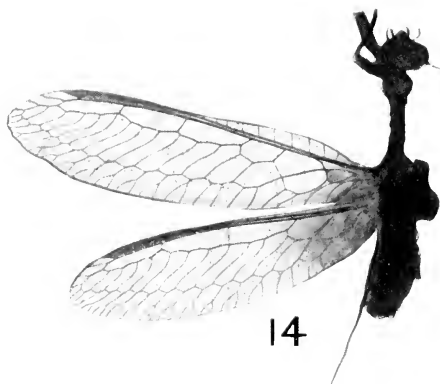
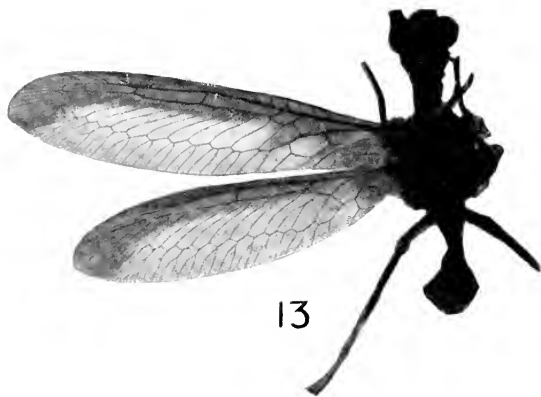
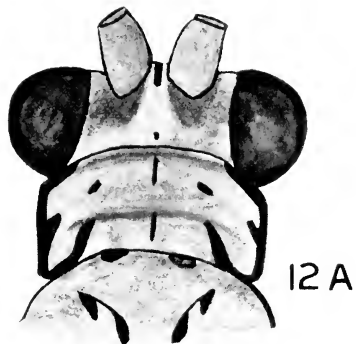

12A. *Chrysopa extranea*, n.sp.

13. *Euclimacia flavicostata*, n.sp.

14. *Mantispa erythroa* Brauer.

Previous to spotting the cover-glass, the moist chamber has been prepared by passing a metal or glass ring, 1 cm. deep, through the flame, painting the lower end with vaseline, and placing it in the centre of a glass-slide. As the ring cools, the vaseline sets and forms a firm junction. In hot weather, the ring is dipped into solid beeswax, withdrawn with the adhering molten wax, and placed on the slide. The sterilisation of the slide is rarely necessary. A drop of water is introduced by means of a capillary pipette, such as is used in opsonic work, and a clean cover-glass is flamed and placed upon the top of the ring. The chamber is taken as being sterile. The cover-glass is spotted with the yeast-suspension, the ring of the chamber is painted with vaseline, and the cover-glass inverted and pressed down. The preparation is then examined, and the drops containing a single cell noted. It is rarely necessary to examine the droplets before fixing the slide to the ring, when the method of preparing the suspension, which I am about to describe, is followed.

The method is that used by Sir A. E. Wright* for the dilution of microbic fluids. A wide capillary pipette is prepared by heating a six-inch length of glass-tubing of 4 mm. bore until soft, in the flame of a wing-attachment of the bunsen, and drawing the whole to twelve inches. When cold, it is cut across the middle, and blind teats are attached to the broad ends of the two pipettes. The pipette is marked with a blue pencil at 1 inch from the point. A more or less milky suspension of yeast-cells is drawn up to the mark, then an air-bubble is drawn up, then a length of sterile nutritive medium, such as wort, then another air-bubble followed by a length of medium. Thus we have an inch of the charge, of the first and second dilutions, each separated by an air-bubble. The second dilution is gently blown upon a sterile glass-slide, and is used for spotting the cover-glasses with the capillary. The remarkable point about this method of dilution is that, however opalescent the original suspension of cells may be, the second dilution contains them in so

* Brit. Med. Journ., Oct. 30th, 1915. p.633.

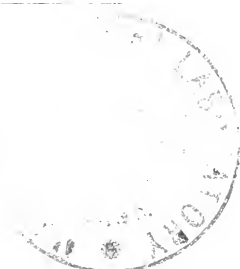

distributed a condition that one cell can generally be found in every second drop. It is as if the cells had been counted automatically. There will naturally be limits to the method; I have not tried a yeast-paste, nor yet a very dilute suspension, but, with an ordinary opalescent suspension, my students have always been successful with the second dilution.

It is sometimes advisable to break down the yeast-agglomerates by Wright's method of breaking down bacterial clumps. A ball-pipette, drawn out to a capillary point and furnished with a strong rubber-bulb, is used for alternately sucking and blowing the suspension. This is followed by a gentle centrifugalisation, so that the heavier clumps are sedimented while the single cells remain in the fluid.

When the single cells have produced a sufficient progeny, the cover-glass is removed, and the droplet touched with a capillary. The fluid runs up the tube with the yeast-cells and the capillary is then inserted into a flask of wort, and the end broken off. It is usual to pick up the capillary with sterile forceps, pass it rapidly through the flame, allow it to cool, touch the droplet, insert into the flask, and snap off the capillary with a pressure of the forceps against the side of the flask.

The use of the capillary and the tube-method of dilution have been very successful in reducing the time occupied in preparing single-cell cultures.

THE GEOLOGY AND PETROLOGY OF THE GREAT
SERPENTINE BELT OF NEW SOUTH WALES.

PART VI. A GENERAL ACCOUNT OF THE GEOLOGY AND PHYSIO-
GRAPHY OF THE WESTERN SLOPES OF NEW ENGLAND.

BY W. N. BENSON, D.Sc., B.A., F.G.S., PROFESSOR OF GEOLOGY,
UNIVERSITY OF OTAGO, N.Z.; FORMERLY LINNEAN MACLEAY
FELLOW OF THE SOCIETY IN GEOLOGY.

(Plates xviii.-xx.; and ten Text-figures.)

CONTENTS.

PREFACE	223
HISTORICAL INTRODUCTION	224
STRATIGRAPHY AND TECTONICS	227
REGIONAL GEOLOGY	228
i. The Eastern Zone...	228
ii. The Serpentine Line	233
iii. The Near Western Zone	238
iv. The Middle Western Zone	250
The Blue Knob Laccolite	259
v. The Far Western Zone	264
vi. Upper Rocky Creek and the Nandewar Mountains	271
PHYSIOGRAPHY	272
i. Features due to Differential Elevation...	272
ii. Features due to Volcanic Eruptions	273
iii. Features due to Differential Erosion	274
Evolution of the Mapilla River-System	275
ACKNOWLEDGMENTS	280
BIBLIOGRAPHY	281
EXPLANATION OF PLATES	283

PREFACE.

Though the presence of Carboniferous and Devonian rocks in the northern portion of the Serpentine Belt has been recognised for sixty years, very little was known till recently of their delimitation, subdivision, and tectonic relationships. In the first of these articles, there is a brief statement of the subdivisions and tectonic structure of the Palæozoic rocks, together with an

account of the later sedimentary rocks and the numerous igneous rocks. This was accompanied by a map and sections which are reproduced herewith [Plates xix. and xx.](1, i.). In the third article (1, iii.), a detailed petrological description was given of most of the rock-types developed in the area: but, so far, no account has appeared of the field-observations upon which these general descriptions and map were based. The area is large (over 1000 square miles), the survey was perforce rapid, and it was intended to revise it in more detail. But since work in other portions of the Serpentine Belt has confirmed the general correctness of the conclusions reached, and has opened up so many new questions, for the solution of which there seems little evidence in the district between Manilla and Bingara, it has seemed best to publish the following account of the exploratory survey of that district, while detailed investigation will be confined, for some time, to the regions further to the south.

HISTORICAL INTRODUCTION.

The earliest references to this region are apparently Sir T. L. Mitchell's brief notes on the trachytic ranges about Mount Lindesay, near which he passed in the summer of 1831-2(2). Eleven years later, Dr. Leichhardt passed down the Horton River, noting the occurrence of *Lepidodendron*, the crinoidal and brachiopod limestones, the Rocky Creek conglomerates, and describing the volcanic rocks of the Nandewar Mountains(3). The discovery of gold brought a rush to the Bingara district in 1851, and Commissioner Bligh wrote a brief account (with map) of the geology of that neighbourhood in 1852(4). In the following year, the Rev. W. B. Clarke passed through the north-eastern and central parts of the region, noted most of the formations here described, and, in particular, recognised the similarity between the geology of Bingara and Nundle, and the probably Devonian age of the limestones at Bingara(5). In the same year, Stutchbury investigated the Horton River valley, and the regions west of it, obtaining a large fauna from the beds now considered to belong to the Carboniferous Burindi series, but

which he termed Devonian. He also recognised the occurrence of coal in the Derra Derra Gap, west of Pallal, and described the trachytes and basalts of the Nandewar Range. A sketch geological map accompanied the report(6). Considering the conditions of their work, the reports of Clarke and Stutchbury are remarkably accurate and comprehensive.

In 1873, Professor Liversidge visited the then newly-discovered diamantiferous drift near Bingara, and described its mineralogical content(7). In 1876-7, Professor De Koninck described a number of marine fossils from Pallal, probably from the beds discovered by Stutchbury. These he referred to the Carboniferous period(8). In 1881, Mr. Pittman gave an account of the diamantiferous drifts of Bingara and the diatomaceous earth near Barraba, referring them to the Miocene period(9). Wilkinson reported on the Bingara drifts in 1886(10); and Anderson carefully mapped them, as well as those near the junction of Cope's Creek and the Gwydir River(11). He gave a general account of the geology of the Bingara district, the Paling Yard, Woods' Reef, and Tea-Tree Creek, together with a sketch map in 1887(12). In 1891, Mr. Etheridge described the Tertiary Drifts of Bingara(13), and Professor (then Geological Surveyor) David noted the occurrence of cinnabar, where serpentine invades limestone near Bingara(14). The last-mentioned geologist, in 1893, suggested that the red jaspers of Bingara (and of Nundle) might be abyssal deposits(15); and, three years later, announced the presence of radiolaria in them(16), giving further particulars of the jaspers near Barraba in his classic paper of 1899(17).

Mr. G. A. Stonier re-examined the Bingara diamond-field in 1894, and added a most useful sketch map of the region between the Horton River and New England. He noted further instances of the Carboniferous marine fossils(18), and the presence of a plant, probably *Rhacopteris* sp., in the Slaughterhouse Creek Range(18. 19. 20). Mr. Pittman found further Carboniferous marine fossils at Rocky Creek(23), and *Tauuiopteris* in the sandstones of the Slaughterhouse Creek Range. Stonier noted the

unconformity between these sandstones and the underlying Carboniferous rocks. He also described and mapped the neighbourhood of Crow Mountain, and obtained, both there and at Burindi, a further series of Carboniferous marine fossils. He concluded that the intrusion of serpentine at Crow Mountain was probably of Carboniferous age(21). He also discovered a series of Jurassic leaf-fossils in the sandstones of Warialda(22).

Professor Judd described specimens of massive garnet-rock and picotite-rock obtained from Barrack Creek(24), the former probably analogous to a garnet-rock described, with other minerals from the Bingara district, by Mr. D. A. Porter(25), which the present writer has shown to be a highly altered gabbro(1, iii.). Rev. J. Milne Curran described the garnetiferous basalt from Ruby Hill near Bingara(26), which locality was later studied in detail by Mr. Pittman in 1900; and the petrology of the remarkable series of eclogites and breccias he obtained there, was described by Mr. Card(28). The diatomaceous earth of Barraba was studied microscopically by Messrs. Card and Dun, who found *Melosira* and *Spongilla* to be present(29). Mr. Carne briefly described the geology of Gulf Creek and adjacent cupriferous areas in 1899, and again in 1908(30).

Mr. Andrews discussed the physiography of the whole region in 1903(32), and outlined the sequence of plutonic intrusions in New England in 1905(33). He briefly described the limestones of Bobby Whitlow and Warialda in 1908(34). Dr. Jensen, in 1907, gave an account of the Nandewar Mountains, with full petrological detail, and a geological map and section embracing the western portion of the area here considered(31). Mr. Harper, in 1909, traced the Mesozoic sandstone around the foot of the Nandewar Ranges; and Mr. Carne collected a series of Carboniferous marine fossils near Gravesend, which were determined by Mr. Dun(36). In 1909, 1910, and 1913, Mr. Cotton studied the region around the junction of Cope's Creek with the Gwydir River(35).

The present writer's observations were made in 1911: a general statement of the stratigraphical succession, and a geological map

and sections were given in the first part of this series in 1913(1). These are reproduced in the present article. Constant reference will be made to this first paper, and to the third part of the series, which deals with the petrology of the rocks collected.

STRATIGRAPHY AND TECTONICS.

The stratigraphical succession in this region has been described in previous papers(1). Briefly, it consists of (i.) the Devonian System, comprising (*a*) some possibly Lower Devonian phyllites and jaspers in the general complex known as the Eastern Series, *i.e.*, the rocks lying east of the Serpentine Line; (*b*) the Middle Devonian, Tamworth Series of radiolarian cherts, claystones, tuffs, breccias, and limestones occurring on the Namoi River and to the south and west of Bingara, and forming a great part of the Eastern Series; (*c*) the Baldwin Agglomerates (the lower portion of the Upper Devonian Series), which form the central portion of the region mapped, and extend for eighty miles north and south, and fifteen miles east and west; and (*d*) the Upper Devonian, Barraba mudstones with interbedded tuffs, conglomerates, and, rarely, doleritic sills. The last three formations are conformable one with the other, and are conformably overlain by (ii.) the Lower Carboniferous System, consisting of (*e*) a lower series of marine mudstones and limestones, the Burindi mudstones; followed by (*f*) the Rocky Creek Conglomerates with interbedded felsitic tuffs and some felsites. The whole series has been folded by forces thrusting from the east, which have produced close packed folds and much faulting in the eastern portion of the region, with the formation of one pre-eminent and continuous line of fault, into which has been injected an almost continuous mass of ultrabasic rock. West of this "Serpentine Line," the folding decreases in intensity, passing from isoclinal folds dipping steeply to the east, to mere undulations, more or less broken by faults. This folding took place before Permo-Carboniferous times, and may have been continued at intervals till near the close of the Permo-Carboniferous period, but died out before the deposition of the Upper Permo-

Carboniferous Coal-Measures, which rest unconformably on the Rocky Creek conglomerates. Jurassic(?) sandstones overlie these, and extend over the Devonian formations: and Tertiary gravels, clays, and diatomaceous earth follow, together with a complex series of alkaline lavas in the Nandewar Mountains, and much basalt, both there and elsewhere.

With the exception of the Baldwin Agglomerates, and the dolerite-sills of the Barraba mudstones, all these formations have been noted by earlier writers: but their distribution, and stratigraphical relationships, and the tectonics of the district, were imperfectly known.

REGIONAL GEOLOGY.

In our discussion of the regional geology, it will be most convenient to divide the area into a series of zones, each of which is characterised by a fairly uniform tectonic structure. These are: (i.) the Eastern Zone, consisting of the marginal portion of the New England granites, and the highly disturbed complex east of the Serpentine Line; (ii.) the Serpentine Line; (iii.) the Near Western Zone, consisting chiefly of isoclinally folded Tamworth, Barraba, and Burindi rocks adjacent to the Serpentine Line; (iv.) the Middle Western Zone, chiefly consisting of a broken anticline of Baldwin Agglomerate and Barraba mudstone; (v.) the Far Western Zone, an undulatory but chiefly westerly dipping series of Barraba, Burindi, and Rocky Creek rocks: and (vi.) the Nandewar Mountains, consisting of Tertiary volcanic rocks. The distinction must be clearly made between the Nandewar Mountains and the Nandewar Range, which is merely the ridge between the Gwydir and Namoi River watersheds.

i. The Eastern Zone.

We commence the description in the south. The Namoi River is confined to a gorge by a ridge of red jasper passing into jasperised slates and ferruginous phyllites, immediately west of the Serpentine Line, which crosses the river about fourteen miles above Manilla. Dykes of lamprophyre intersect this ridge (1, Pt. iii., p.698). East of the ridge, which is two miles wide,

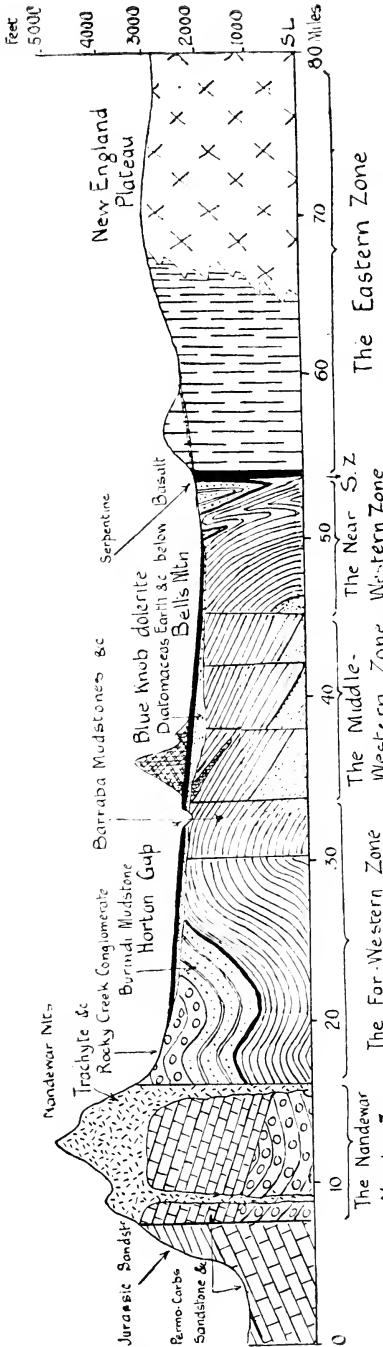

• Text-fig. 1.

is a depression occupied partly by the Old Mundowey Station (and Ukolan on Half's Creek), in which the rocks are phyllites, silicified tuffs, lenticular masses of limestone, the two latter apparently of Lower Middle Devonian age, a conglomerate, recalling conglomerates occurring west of Nundle, and a long band of serpentine, which has a maximum width of half-a-mile, and strikes due north, forming an acute angle with the direction of the main Serpentine Line. East of this low region, the land rises rapidly to a height of about 3600 feet. The face of the scarp is composed of an intimate mixture of phyllites and jaspers, with probably Middle Devonian banded cherts and altered tuffs, broken by faults and much contorted. Above the scarp, with its rugged valleys and waterfalls, the land-surface is generally undulating, with poor outcrops of the same types of rocks as formed the scarp. Two miles to the east,

* Generalised Section from the New England Plateau through the Nandewar Mountains to the Western Plains.

is an acid granite, with small aggregates of tourmaline. (See the eastern portion of Section 1, Plate xx.).

On Yellow Rock Gully, eight miles north of the Namoi River, the Eastern Zone, immediately adjacent to the Serpentine Line, contains two small lenses of limestone with traces of fossils resembling *Syringopora*, and a dendroid *Favosites*. These probably belong to the Middle Devonian Series. Between them and Crow Mountain, six miles further to the north, the Eastern Series, immediately adjacent to the Serpentine Line, contains frequent occurrences of a spilitic tuff filled with fragments of limestone, like that which elsewhere represents the Nemingha limestone horizon(1. Pt. v., p.553).

East of Crow Mountain, which consists of red jasper, there is a gentle slope leading up on to the New England plateau. The rocks are chiefly indurated claystones and phyllite, with altered tuffs and a large amount of sheared and often vesicular spilite. Near the mountain are several narrow bands of serpentine. At the head of Eumur Creek, five miles east of the mountain, is a lens of limestone, 800 yards long, and 50 yards wide, associated with altered tuff. It is doubtless a continuation of the Middle Devonian (Nemingha ?) limestone of the Mundowey region. The rocks developed east of Woods' Reef, within three miles of the serpentine, are similar to those at Crow Mountain.

Stonier has recorded the presence of Tertiary gravels, which commence at the head of Back Creek, south-east of Crow Mountain, and pass across the Serpentine Line through the low gap south of the mountain(21), and similar gravels occur south of Woods' Reef. These are further discussed below (pp.240, 275).

Twenty miles to the north of Woods' Reef, a traverse was made from the serpentine eastward through Gulf Creek. Adjacent to the serpentine are two small bands of crystalline limestone formerly used for flux, of which an analysis has been given (1. Pt. iii., p.712). East of them is a zone of jasper and phyllite with abundant quartz-veins, forming the usual ridge east of the serpentine. On the eastern slope of this is the Gulf Creek Mine, described by Mr. Carne(30), and consisting of three lodges of

cupriferous pyrites and bornite in jasper and phyllite, invaded by masses of serpentine and veins of quartz. The whole ore-body dips steeply to the east, and gives evidences of considerable faulting and pressure.

Following down Gulf Creek to the north-east of the mine, the jaspers of the eastern series are banded and more like the cherts of Tamworth. They contain abundant radiolarian casts. The dip is steep to the east, but rather contorted. The creek falls rapidly, breaking into cascades over resistant bars of quartz. Between two and three miles from the mine, the slope gives place to a flat step about a mile wide. Here a large amount of spilite occurs together with intrusive dolerite, while bedded chert and tuff with limestone-fragments (the Nemingha horizon?) are also present (in Portion 17, Parish Capel). From here, the stream plunges over a bar of red jasper into the narrow gorge known as "The Gulf," from which it issues on to the floor of Keera Senkungsfeld.

The jaspers and phyllites of the Eastern Zone have been followed all the way from Gulf Creek to Bingara, and form a continuous ridge beside the serpentine. Near Upper Bingara, Anderson noted the occurrence of a small mass of basalt overlying Tertiary drift on this ridge(19). Gouron Gouron Creek, after flowing through a mature upper valley on the gabbros, strikes north at Upper Bingara through the Eastern Series, passing down through a great gorge opening on to the Keera Senkungsfeld. Further north, Borah Creek has a similar course. Near the point where it leaves the serpentine, is a mass of porphyritic spilite described previously(1, Pt. iii., p.665), and adjacent thereto, in a disused mine-shaft by the 5-Mile Peg on the Upper Bingara Bridle Track, is a strongly chloritic tuff and a very sodic albite-dolerite, of which an analysis has been given (*ibid.*, pp.667 and 704).

Following down this track, one passes the occurrence of cinnabar described by Professor David(14). Here the serpentine opens out into several northward-pointing fingers, between which, the rocks, which seem to be almost entirely Middle Devonian,

are considerably altered. The limestone, invaded by the serpentine, has been strongly metamorphosed, and (Professor David thinks) in part absorbed by the peridotite-magma. Adjacent to it, are some of the limestone-bearing spilitic tuffs, like those in the Nemingha horizon. A quarter of a mile to the south of here, the limestone contains traces of a cyathophylloid coral, and some unrecognisable brachiopods: beyond this (in Portion 184, Bingara) it has become very schistose.

Passing up the Gwydir River, the first few miles lie in a gorge cut in phyllites, altered tuffs and jaspers, which Professor David found to be radiolarian(16, 17): but beyond the junction of Gouron Gouron Creek, the banks of the river become low, and a great lowland extends far to the south, on which are low ridges of jasper, and low undulating hills of Tertiary drift capped with basalt. Somewhat higher jasper-hills occur further east at Keera Station, and, beyond these, rises the granitic region near Copeton described by Anderson(11) and Cotton(37). North of the Gwydir River, near the junction of the Gouron Gouron Creek, and again two miles north-west of Keera, are small, lenticular masses of limestone (according to local report). This area of lowland surrounded by hills has been termed the Keera Senkungsfeld(37). (See also p.273).

Between Bingara and Warialda, very little study has been made of the Eastern Series. Near Myall Creek, east of the serpentine, are large, pink lenses of limestone like those of the Nemingha horizon: but, two miles further north, the limestone has returned to the west of the serpentine, and continues thus to Warialda. At Oakey Creek (Mr. Hamilton's property), very little jasper occurs east of the serpentine, the rocks being chiefly indurated claystone. North of Kelly's Gully, the Series disappears beneath Jurassic(?) sandstones in which Stonier found *Aethopteris*, *Brachyphyllum*, and *Phyllopteris*(22). Near Warialda, these sandstones pass into arenaceous conglomerates and arkoses, which contain pebbles of black jasper and quartz. The current-bedding is well marked, and, in the small region studied, has an inclination predominantly to the north-west.

No graphite-flakes were observed, such as are commonly present in the Hawkesbury Sandstone. To the east, the sandstones lie on the eroded surface of the granites, from which they were in large measure derived. To the south-east, they are overlain by basalts. (See Plate xix.).

The boundary of the granites which form the eastern margin of the Eastern Series was, in part, based upon information obtained from the State Geological Survey, in part from observations of Mr. D. Porter and others. The writer has studied these granites near the Namoi River only.

ii. *The Serpentine Line.*

This has been defined as the well marked line of fault which separates the Eastern Series from the formations to the west, and is generally occupied by a band of serpentine of varying width. No serpentine occurs on the Namoi River, but a narrow strip may be seen two miles to the north. Eight miles north of the river, it occurs again, and may be traced thence up a branch of Yellow Rock Creek. In Portion 42, Parish of Welsh, there occurs, within the serpentine, an oval patch, about forty feet long and twenty feet wide, of a peculiar rock containing, in a white granular matrix of clinozoisite and zoisite, muscovite and oligoclase, long green masses of chlorite-spherulites that are probably pseudomorphous after hornblende or augite. Possibly this is a highly altered gabbro-pegmatite. (See 1, Pt. iii., pp.721-2).

North of this, there are massive and schistose serpentines, with small patches of enstatite-rock and anorthosite. The western side of the serpentine is transformed into a mixture of siliceous sinter, magnesite and siderite with more or less hematite, which will be given the very useful miners' term, "serpentine-gossan," in succeeding parts of this paper. It has often a marked relief.

Between Yellow Rock Creek and Crow Mountain, the land-surface is almost flat, and the serpentine is not clearly developed. Its place is taken by a little serpentine-gossan, and there are also small dykes of dolerite of a type which generally occurs with serpentine in the northern portion of the Serpentine Belt. (See 1, Pt. iii., pp.688-9). They are particularly abundant in the

serpentine at Crow Mountain. North of Crow Mountain Creek, the serpentine commences to widen out. Where it crosses Eumur Creek, the western portion is a well marked zone of serpentine-gossan, here a beautiful flesh-pink carbonate-rock with clear green chalcedonic segregations(1, Pt. iii., p.678). The cross-section of the serpentine bands, from west to east, is approximately as follows:—

Pink carbonated serpentine with limonitic bands...	20	yds.
Massive and schistose bastite-serpentine	100	..
Altered dolerite (fine-grained and green)	20	..
Highly silicified "Eastern" rocks	50	..
Grey schistose serpentine	100	..
Silicified and contorted phyllites	100	..
Black schistose serpentine	6	..
Vesicular lime-rock, etc.	4	..
	<hr/>	
	400	yds.
	<hr/>	

A quarter of a mile south of Eumur Creek is a roughly circular patch of coarsely crystalline albite-rock occurring in the serpentine(1, Pt. iii., p.691).

The serpentine gradually widens northwards near Woods' Reef, where it is two miles wide, and splits into two great lobes as shown in the map. One is crossed by Ironbark Creek in a deep gorge. The rock is chiefly schistose and bastite-serpentine, with occasional dykes of peculiarly altered dolerite(1, Pt. iii., p.690). East of Woods' Reef, and again east of Crow Mountain, are small parallel sills of serpentine. In the serpentine on Ironbark Creek, Porter has noted the occurrence of a vein of garnet with vesuvianite(25). The mapping of the Crow Mountain serpentine is a modification of Stonier's map of 1896(21); that of Woods' Reef is a modification of Pittman's unpublished map of 1881(9), for the use of which I am indebted to the Geological Survey.

North of Ironbark Creek, there is no serpentine for three miles. It commences again at the old Paling Yard Diggings, which were described briefly by Anderson in 1888(12). It is composed of schistose serpentine to the south, but reaching the Paling Yard

it becomes three-quarters of a mile wide and contains much gabbro. This belt occupies an opening between the jasper-hills to the east and the Burindi(?) tuffs to the west. Its floor is thinly covered with Tertiary(?) auriferous drift. The serpentine and gabbro are a good deal altered, some quartz-veins have been developed, and, in places, the gabbro is impregnated with pyrites. About half a mile east of the old station-building is a most interesting occurrence of chromite.* A circular area, roughly five yards in diameter, is full of spherical segregations of very minute chromite-cubes, set in a matrix of green chlorite and serpentine with the chromiferous chlorite k ammererite (See 1, Pt. iii. p.681). On either side of this is a bar of amphibolite with very interesting characteristics. (See descriptions of M.B. 189 and 186, 1, Pt. iii., p.680).

West of the serpentine is a bar of the usual serpentine-gossan, which may be traced for some distance to the north. The belt widens in this direction. Along its western side, schistose serpentine is the predominant rock, with a thin "gossany" margin, but, to the east, gabbro predominates, with bars of schistose serpentine, and massive, or poikilitic bastite-serpentine. This forms a great bulge to the east, and is bordered by the jasper-hills. Its well matured surface slopes gradually eastward to the Forrest Creek System. Northward, the area slopes rapidly down into Little Plains Creek, which escapes through a gap in the hard tuff ridge to the west. Here is an interesting igneous complex of gabbro and serpentine worthy of further study. The northern end of the mass is mostly massive bastite-serpentine, with a brown weathering surface and marked relief. The western side and southern portion are schistose, often with large massive kernels perhaps two yards in diameter, while within the mass are bands of massive and schistose serpentine. The eucrite-gabbro and anorthosite [the "diorite" of Anderson(12)] is largely gneissic (a fluxional structure having been impressed upon it during consolidation), and has been altered mineralogi-

* The Mineralogical Museum in the University of Z urich contains an analogous specimen from the Ural Mountains.

cally to a varying degree(1, Pt. iii., pp.685-6). The mass is invaded by dolerite in a few places. It pinches out to the north, but may be traced by "gossany" outcrops over the hill till it commences again by Oakey Creek, and continues, with large but varying width, to Hall's Creek.

North of Hall's Creek, the belt becomes very wide, with a very well-marked western margin of serpentine-gossan rising into the prominent peak known as Red Rock. East of this is a wide zone of schistose serpentine and a large amount of enstatite-rock(1, Pt. iii., p.680). East again is a zone of massive bastite-serpentine, rising into a well-marked ridge, followed by more foliated rocks. There seems to be a bar of serpentine striking off up Hall's Creek to the north-east, but this is not certain.

An interesting botanical point may here be noted. The abundance of grass-trees (*Xanthorrhoea*) on the massive bastite-serpentine stands in marked contrast to their comparative scarcity on the foliated rock and the adjacent eastern rocks. This has been noted wherever well-marked areas of massive serpentine occur, and is specially marked on the Little Plain.

In the serpentine near Hall's Creek occurred the only mass of noumeaite yet recorded in New South Wales. Official analyses show it to contain 13.29 per cent. of NiO, and 1.32 per cent. of CoO(38).

Northwards, gabbros commence again, very easily decomposed, and forming a wide, open flat enclosed between the jasper-ridge to the east, and the well-marked ridge of massive bastite-serpentine to the west; while, beyond the western side of this, the ridge plunges down steeply into the valley of Hall's Creek. This open flat valley on the gabbro narrows northwards to the almost deserted village of Upper Bingara, once a productive gold-mining camp. This was described by Anderson in 1888(12). As at the Paling Yard, there is a large amount of fluxion-structure among the gabbros, which are here quite coarse-grained, and often highly altered(1, Pt. iii., pp.684-687). The gold occurred in patchy "bonanzas" in reefs in the gabbro and serpentine, and in the shallow alluvium covering the valley-floor.

North of this, Gouron Gouron Creek, which flows through Upper Bingara, turns eastwards down through the Eastern Series to the Keera Senkungsfeld, just in time to prevent its capture by the head of Barrack Creek. This flows to the north-east, traversing the serpentine diagonally and exposing a section, four miles long, of alternating massive and schistose serpentine, standing out in rounded hillsides, or long crenellated ridges.

The bridle-track northwards from Upper Bingara leads on to the Eastern Series, passing the old Mount Everest copper-mine. Four miles north, a gabbro mass occurs, similar to that at Upper Bingara. At the northern end of this mass, some very interesting types of altered gabbro, some almost completely changed to garnet (rodingite), have been obtained(1, Pt. iii., p.686). The same structure prevails as to the south—a wide, open valley, with its floor covered with gabbro-detritus, is enclosed between jasper, etc., to the east, and a ridge of massive bastite-serpentine to the west; while the western side of the ridge plunges steeply down into Hall's Creek. On the eastern side of the gabbro is some schistose serpentine, but with a fibrous rather than a foliated structure. It contains auriferous calcite-quartz veins.

In Spring Creek, near Bingara, the serpentine branches into several "fingers" pointing northwards. The easternmost of these is accompanied by gabbro stained by copper carbonates. Professor David stated that the serpentine strongly invaded and altered the limestone here(14); and, near the contact-line, there is a large mass of pegmatitic albite like that near Crow Mountain (1, Pt. iii., p.691). Professor Judd has described veins of picotite and massive green garnet, the latter traceable for over a mile between Barrack Creek and the Gwydir(24). The former was probably a segregation, and has not been rediscovered; the latter, while analogous to the garnet-rock found by Porter at Ironbark Creek and Bowling Alley Point(25), is probably portion of the garnet-gabbro or rodingite mentioned above. Mr. Porter also mentions the occurrence of filiform gold in calcite-veins in the serpentine, in this neighbourhood. North of the Gwydir, the serpentine is again seen as a small lens on the Bobby Whitlow

road, and again as serpentine-gossan on Myall Creek. Two miles to the north of here, it is only a few yards wide, but, six miles further north, east of Mt. Rodd, it is 200 yards wide, and is covered by Jurassic(?) sandstone. It pinches out to the north, but occurs again on Mr. Hamilton's property on Oakey Creek, where it is 200 yards wide, consisting of massive and foliated serpentine with a little gabbro. It appears again to the north in Kelly's Gully, in the section described below (Text-fig. 2, p. 244), and thence disappears beneath the sandstone-hills to the north. This is the most northerly occurrence of the rocks of the Great Serpentine Belt.

iii. *The Near Western Zone.*

This zone lies immediately west of the Serpentine Line, and may be assumed to extend to a line which joins the east side of Pyramid Hill, near Manilla, to the east side of the Bingara Range. It is of very complex structure, consisting, for the most part, of Upper Devonian Barraba Mudstones, with Middle Devonian Tamworth Rocks to the south on the Namoi River, and to the north in the valley of Hall's Creek. The rocks are greatly folded, frequently dipping isoclinally to the east. Near the serpentine, a long strip of Carboniferous rocks has been infolded, extending from the Namoi to the head of Hall's Creek, and appearing again at Oakey Creek, south of Warialda.

We commence at the south once more. In the section (Fig. 1, Plate xx.) above the letter D, Middle Devonian rocks are shown, and mapped on Plate xix., as occurring east of the hills that bound the Manilla Valley, and forming the majority of the low land in the Parish of Veness, north-east of Manilla. While this is not definitely proved, it is the most probable explanation of the facts observed in the short time available here. The rocks are soft or cherty radiolarian claystones, which may be traced southward across the Namoi River to Yarrumbully Creek, where they contain lenticular masses of limestone, probably on the Moore Creek horizon. The western portion of the Middle Devonian beds north of the Namoi, dips gently to the west, but

in the centre is an anticline, beyond which follows a series of greatly disturbed beds dipping steeply to the east. Near Manilla, the cherty mudstones are interbedded with bands of coarse, tuffaceous breccia.

The eastern margin of the area of Middle Devonian is probably a fault. Beyond, follow the tuffs and claystones of the Barraba Series, greatly disturbed and highly tilted. Further east, the claystones take on the olive-green colour and lithological character of the Carboniferous mudstones of Burindi, and include a long lenticle of limestone made up almost entirely of crinoid-ossicles. There is, however, no unconformity between these Carboniferous mudstones and those of the Devonian system with which they are associated.

The Carboniferous belt is continuous for a long distance to the north. On Yellow Rock Creek, six miles south of Crow Mountain, and five miles north of the limestone last described, a similar lenticle of crinoidal limestone occurs, 40 feet thick and 200 feet long, dipping E. 22° N. at 55°. It occurs in soft phyllitic rock, immediately west of the serpentine, and is associated with a band of coarse conglomerate, almost of the Rocky Creek type, containing boulders of porphyry and dolerite, with a greenish jasperoid rock, set in a sandy matrix (said to be slightly auriferous).

Small lenses of crinoidal limestone, frequently very impure, occur here and there two or three miles south of Crow Mountain; and in the creek at the foot of the mountain itself, is a small mass of limestone, beside which the shales contain a typical series of Carboniferous fossils discovered by Stonier in 1896. A list of these, with additions found by the writer, has been given previously (1, Pt. i., pp. 505-507). This limestone is also associated with a bar of heavy conglomerate, which is very sharply separated from the adjacent mudstones. To the south and west of Crow Mountain, the Burindi rocks pass conformably into the mudstones and tuffs (the "felsites" of Stonier) which have characters similar to those of Barraba (Upper Devonian) rocks. A well marked horizon, that may be useful in the mapping of the Carboniferous rocks near Crow Mountain, is a peculiar conglomerate,

best seen three miles south of Eumbra homestead, and consisting of a variety of pebbles and fragments of oolitic limestone. This conglomerate forms the eastern side of "Black Mountain," the remainder of which is largely composed of green felsitic tuff.

Less than half-a-mile south-west of Eumbra homestead is a small intrusion of a very decomposed but clearly recognisable minette(1, Pt. iii., p.697, and Plate xxvii., fig.14). It forms an outcrop only a few yards in length. Near the serpentine, south of Back Creek, there also occur a few dykes of the dolerite (not albite-dolerite) usually associated with peridotite in these northern localities.

North of Crow Mountain Creek, the same sedimentary formations continue beyond the Woods' Reef Road to the Nandewar Range. Rocks, probably Carboniferous and also Devonian, occur west of Woods' Reef, but have not been examined in detail. Limestones of a blue argillaceous type, characteristic of the Barraba Series, occur here and there.

At Crow Mountain, Stonier reported the occurrence of a long line of Tertiary gravels(21). These commence, as stated previously, east of the serpentine, but may be traced through the low gap south of Crow Mountain, past Eumbra homestead, and along the western face of the mountain, where, near Eumur Creek, they form a thick, strong conglomerate with a ferruginous cement. North of this, they are represented by a large area of granitic sand. Outliers of the gravel, etc., are dotted here and there down towards the Manilla River. Again, south of Woods' Reef, the serpentine ridge is covered by Tertiary gravel filling a noticeable gap, and issuing from a still more marked opening in the jasper-hills behind.

To the north-west of Crow Mountain, the Palaeozoic and Tertiary formations are overlain by basalt, which covers much of the region between Woods' Reef and Barraba. This basalt is discussed in a later section (see p.276).

Passing to the head of Cobbadah Creek, we note that this stream, leaving the gabbro, enters a narrow gorge about a mile in length, cut through hard tuffs of various kinds, some of which

are regular diorite-arkoses (see, for instance, the description of M.B. 63, 1. Pt. iii., p.719), while others are more andesitic. Associated with these are hard, cherty layers. This continues right up to the serpentine, and may be traced northwards as far as the head of Oakey Creek, making a well-marked range of hills all the way. This formation has been doubtfully mapped as belonging to the Burindi Series. Another possible alternative is that adopted in Section 2, Plate xx., where the rocks have been classed as of Barraba age in view of the great similarity between some of the tuffs present, to some that occur in the upper part of the Barraba Series below the basalts at the head of Sheep Station Creek, near Cobbadah. The evidence as yet is entirely insufficient to come to any conclusion.

Farther down Cobbadah Creek are mudstones of the same character as those of the Burindi Series, bent into a series of sharp anticlines thrust over to the west, and broken by a fault along each anticlinal crest, in the manner usually figured in diagrams of isoclinal folding. Beyond, near Piedmont homestead, three miles east of Cobbadah, the creek is crossed by a bar of the peculiar olive-green shale, with little blebs and narrow bands of impure limestone, that is so characteristic of the Burindi Series. West of this is a well-marked fault, which separates the Burindi rocks from the Barraba Series lying to the west. A little to the south-east of the Piedmont homestead, in a tributary of Cobbadah Creek, and in or near the line of this bounding fault, is a small bar of pink carbonate-rock with a talcose matrix and a little hematite, probably the "gossan" of a small intrusion of serpentine. This is one of the very few instances of the occurrence of serpentine *west* of the main Serpentine Line.

About nine miles north of this region, the Burindi rocks have been studied immediately west of the Serpentine Line at the head of Hall's Creek (see eastern end of Section No.3, Plate xx.). Just at the corner of the road at the bottom of the Devil's Elbow, which lies on Barraba rocks, is a little tributary of Hall's Creek, beyond which rises a narrow band of unmistakable talcose, carbonated serpentine, traceable a hundred yards to the

south. This is possibly in the same line of fault as the carbonated serpentine by Cobbadah Creek, mentioned above. Directly east of it, also, the rocks are intensely folded Burindi rocks of typical dark green colour, with small calcareous bands. These are folded into sharply packed anticlines and synclines. The falls on Hall's Creek are cutting back into these mudstones, which, near them, contain pebble-bands with pebbles of the types usually present in Burindi and Rocky Creek conglomerates. Half-a-mile north-east of the falls, in Portion 46, Parish of Hall, is a band of limestone about 100 yards long, and 8 yards thick. It is almost entirely made up of *Lithostrotion* sp., but also contains traces of *Syringopora*, a cyathophylloid coral, and crinoid-stems. This rock is intercalated with Burindi mudstones, and is, perhaps, to be correlated with the *Lithostrotion-Syringopora* limestone near Eulowrie, 14 miles to the west, which has been considered to be near the base of the Carboniferous Series (see p.269). About 200 yards east of this is the serpentine.

The description of the writer's collection of fossils from Hall's Creek has kindly been undertaken by Dr. Stanley Smith, of University College, Aberystwyth.

Following the disturbed region north from here into the valley of Hall's Creek, the stratigraphy becomes very complex. The Carboniferous rocks cease, and the Upper and apparently Middle Devonian beds appear. The outcrops are extremely poor and scattered, owing to the wide spreading of the alluvial fans by the torrents that descend from the ranges on either side. In Mr. S. Wither's property (Portion 44, Parish of Hall), four miles to the north of the *Lithostrotion*-limestone, are two lenses of limestone of quite a different type. It is highly crystalline, but contains traces of corals which have been tentatively referred to the following forms:—*Stromatopora* or *Stromatoporella*, *Favosites multitabulata*, *Favosites pittmani*, *Actinocystis* or a Cystiphyllid coral, *Cyathophyllum*, *Syringopora*. The last is very abundant.

The limestone must, for the present, be referred to one of the Middle Devonian horizons, probably the Nemingha horizon. It does not lie parallel to the serpentine-boundary, but strikes N.

20° E., and its northern extremity is invaded by the serpentine. Adjacent to the limestone to the south, are other rocks of the Tamworth type dipping E.15°S. at about 85°, namely banded claystone richly radiolarian, and coarse tuff, and, in the creek, is a boulder of a vesicular rock like spilite.

For the rest of the way northwards along the eastern side of the valley, there are scarcely any good outcrops. There can be little doubt that the majority of the rock is of Tamworth age, and, as been already described, the limestone appears again about three miles south of Bingara, and passes across the Serpentine Line into the Eastern Series, fossiliferous patches lying among the long fingers of serpentine. The western side of the valley will be discussed later (pp.261-262).

One feature remains for mention. Ruby Hill, 12 miles south of Bingara, is a slight elevation in the valley-bottom, composed of volcanic breccia, cut by basalt-dykes. This is noteworthy as containing numerous garnets, surrounded by kelyphitic rings, and fragments of eclogite. The geology of this has been studied by Mr. Pittman(27), while the petrology was described very completely by Mr. Card(28). The reported occurrence of diamonds in the breccia has not been confirmed. (See also 25, 26).

Adjacent to this, there is an intrusion of felsite or microgranite into the surrounding claystones.

Only brief studies have been made of this zone north of Bingara. As has been seen, the limestone, which was east of the serpentine on Myall Creek, crossed once more to the west, two miles further to the north. It is very noticeable as a broad mass of crystalline, white and pink marble on Hamilton's property at Oakey Creek, five miles south of Kelly's Gully; and here strongly resembles the Nemingha limestone near Black Jack by Woolomin(1. Pt. ii., p.574).

About 100 yards west of this is a scarcely altered bar of grey oolitic limestone, which is probably part of a band of Burindi rocks nipped in on the folding. Another similar bar occurs by the roadside a mile north-west of here, and both closely resemble the typical crinoidal and oolitic limestones near Caroda on the

Horton River (see p.268), Five miles further north, the Nemingha(!) limestone appears again on Kelly's Gully, two miles east of the railway-station, and has been noted in several intermediate points.

Analyses of the limestones at Kelly's Gully and Oakey Creek have been cited previously (1. Pt. iii., p.712).

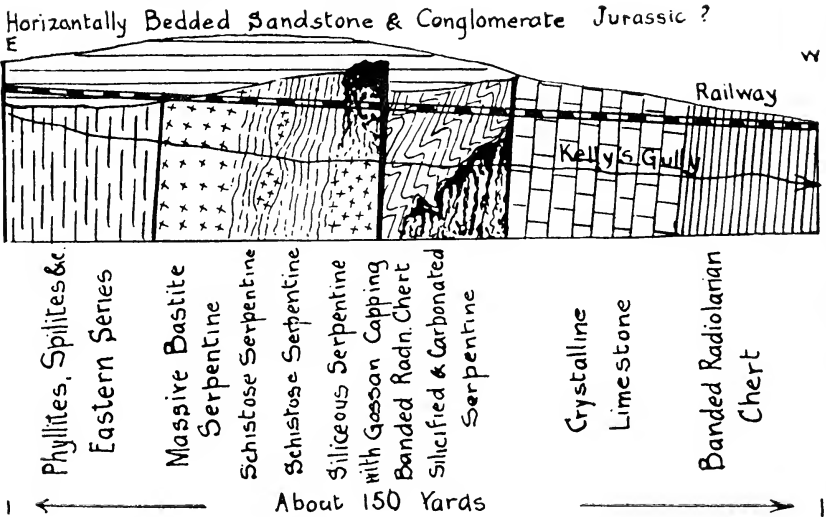

Text-fig.2.—Jurassic sandstone overlying serpentine and Devonian Rocks at Kelly's Gully, Warialda.

A very interesting section in the creek here shows the relation of the several formations. It was noted by Clarke in 1853 (5). Text-fig.2. illustrates the vertical section. To the east, the rock is probably decomposing spilite, the serpentine is massive and schistose, and locally gossany. It contains a bar of crushed green cherts. Next to the serpentine, the limestone follows, highly crystalline and pinkish in colour, like that at Hamilton's, and Bobby Whitlow. Capping this, resting on an irregular eroded surface, lies the coarse Warialda Jurassic(!) sandstone. The serpentine projects up from the general surface into the sandstone, showing its ancient relief, and, as no veins continue

from its gossany portions into the sandstone, it is evident that both the hydration and subsequent silicification of the serpentine took place before the deposition of the sandstone.

The general characters of the sandstone have already been mentioned (p.232). West of the highly disturbed belt, occur mudstones, which lithologically may belong to either the Middle or Upper Devonian Series. These bear residual caps of sandstone and (13 miles north-west of Bingara) the basalt-cap of Mt. Rodd, which rests on Tertiary drift overlying steeply dipping greenish tuffs and mudstones.

(For Explanation of Plates, etc., see p.283.)

NOTES AND EXHIBITS.

Mr. Fred Turner exhibited : (1) a flowering-specimen of *Bambusa nana* Roxb., (Syns. *B. glauca* Lodd. et Lindl., *B. glaucescens* Siebold et Munro, *B. viridi-glaucescens* Carr.) from his garden at Chatswood, a species which he had not known to produce flowers before, either in Brisbane or Sydney — (2) A specimen of *Phleum pratense* Linn., the Timothy-grass of Europe, received from Tumblong, Adelong district, and sent to him by Messrs. Anderson & Co., of Sydney. It is a valuable addition to the pasture-herbage, and appears to be spreading in different districts. It is now acclimatised in the Adelong district, though it has not been cultivated. For other records, *vide* these Proceedings, 1914, p.323. — (3) A specimen of *Gastrolobium spinosum* Benth., var. *triangulare* Benth., one of the poison-plants of West Australia, from Jindarra, forwarded by Mrs. A. E. Stephens. — (4) On behalf of Mr. F. M. Clements, a specimen of *Lobelia tupa* Linn., (Syns. *L. feuillei* Don, and *Rapuntium tupa* Presl.), a Chilian plant, attaining a height of 8 feet or more, now thriving in Mr. Clements' garden at Stanmore. According to Prof. Redwood, "*L. tupa* is poisonous in the extreme, causes emesis by simply smelling the flowers; juice caustic."

Mr. W. W. Froggatt showed mosquitoes, in quantity, from Riverina, obtained by using cyanide in tents. Also a collection of destructive insects from wheat-stacks.

Mr. R. T. Baker exhibited a specimen of California Redwood, *Sequoia sempervirens* Endl., showing remarkable growth. The tree was planted at Reefton, New Zealand, in 1876, and felled in 1903, during which period it had obtained a diameter of 2 ft. 10½ in. in secondary wood, 18 inches from the ground, developing 27 rings in 27 years. The annual rings show a fairly uniform growth, varying only between limits of ½" to 1" full. This is a very remarkable instance of tree-growth, and shows the *suita*.

bility of our Southern lands for the propagation of this valuable timber.—Also a specimen of Vegetable Wax, obtained from the branchlets of *Beyeria opaca*, which, if it could be obtained in quantity, would be of commercial importance.

Mr. Cleland exhibited some Port Jackson oyster-shells, which he had found exposed in a thick layer on one of the banks of the Namoi at Narrabri, N.S.W. Investigation and inquiry revealed that they were débris from a local oyster-shop, deposited on the river-bank, and subsequently covered by flood-silt—a possible trap for a palæontologist in the future.

Mr. A. A. Hamilton exhibited dried specimens and fruits, accompanied by a photograph, of *Tetragonia nigrescens* E. & Z., var. *maritima* Sond., an alien from South Africa, collected on the beach at Maroubra Bay, not, so far as known, previously recorded from Australia.

Mr. Fletcher showed three racemes of *Grevillea buxifolia*, from two plants, with abnormal flowers, most of them with two pistils on a common stalk, in one case also with eight stamens. [For a somewhat similar case in *G. punicea* R.Br., see Mr. Cheel's record in these Proceedings, 1911, p.158].

Dr. H. G. Chapman exhibited an example of "peptone" solution prepared from the proteins of egg-white. Egg-white containing about 15 gm. proteins, was mixed with an equal volume of 2% sodium chloride. To 300 c.cm. mixture, 300 c.cm. $\frac{N}{10}$ soda were added. The alkaline liquid was placed in the incubator at 37°C. for 15 days. At the end of this time, the fluid no longer coagulated upon heating it. It had remained sterile. The liquor was placed in a digester and heated under six atmospheres pressure for one hour. A slight precipitate formed, and the fluid became dark in colour. The fluid was resterilised by boiling it on three successive days. The solution was found to be faintly alkaline in reaction, 100 c.cm. containing 4 c.cm. $\frac{N}{10}$ alkali. It yielded 0.48% nitrogen, corresponding to 3% "peptone." The solution has been used to

make an agar-peptone medium with bouillon. On this medium, stroked with serum, meningococci grew luxuriantly. A subculture of the meningococci on the medium grew well. The remainder of the medium was used for ordinary work in the Pathological Laboratory of the University. It made a suitable medium for the culture of streptococci and other germs. Since the beginning of the war, bacteriologists in Sydney have used the stocks of German "peptone" which still remain, and are carefully husbanded. Locally made peptone can, therefore, be prepared for bacteriological work.

ORDINARY MONTHLY MEETING.

JUNE 27th, 1917.

Dr. H. G. Chapman, President, in the Chair.

Mr. H. G. McQUIGGIS, B.Sc., Sydney, was elected an Ordinary Member of the Society.

Letters of thanks for sympathy in bereavement, from Mrs. A. J. North and Mr. A. Fry, were read to the Meeting.

The Donations and Exchanges received since the previous Monthly Meeting (30th May, 1917), amounting to 2 Vols., 29 Parts or Nos., 9 Bulletins, 5 Reports, and 2 Pamphlets, received from 32 Societies, etc., and one private donor, were laid upon the table.

THE GEOLOGY AND PETROLOGY OF THE GREAT
SERPENTINE BELT OF NEW SOUTH WALES.

PART VI. A GENERAL ACCOUNT OF THE GEOLOGY AND PHYSIO-
GRAPHY OF THE WESTERN SLOPES OF NEW ENGLAND.

BY W. N. BENSON, D.Sc., B.A., F.G.S., PROFESSOR OF GEOLOGY,
UNIVERSITY OF OTAGO, N.Z.; FORMERLY LINNEAN MACLEAY
FELLOW OF THE SOCIETY IN GEOLOGY.

(Continued from p.245.)

iv. *The Middle Western Zone.*

In this zone, we will consider the belt of country between the zone last described and a line running west of Black Mountain, Blue Knob, and the Bingara Range. It consists of Barraba Mudstones and Baldwin Agglomerates, with some Tertiary Drift and Basalt. The Agglomerate forms most of the high land of the region except Blue Knob, a great dolerite-sill. Structurally, the region consists of beds dipping gently to the east, for the most part merging gradually into the steep, easterly-dipping, isoclinal folds to the east, or sharply divided therefrom by a fault. On the western side, the sediments dip gently to the west for the most part. The whole series is broken by a group of faults, running between N. and N.N.E., and sometimes branching, throwing the beds down to the west, as a rule, in the southern portion of the zone, but also to the east in the northern portion.

Commencing in the south—The Lower Manilla River runs in a syncline of Barraba Mudstones (see Plate xx., fig.1). To the east, the Baldwin Agglomerate rises to form Pyramid Hill, which is cut off by a fault to the east, beyond which lies the more steeply dipping Middle Devonian Series. Traced to the north, the agglomerates disappear, and also the Middle Devonian beds wedge out, and the Barraba Mudstones extend, with ever increas-

ing disturbance and development of easterly dipping, isoclinal folding, from the Manilla River to the Carboniferous rocks of the zone last described. They are interbedded with cherty radiolarian bands (as at Black Springs), and with thick zones of fine breccia and tuff which form prominent ridges, such as the Aberdeen and Thunderbolt's Gap Ranges, or with coarse angular breccias, such as those at the Rocks Crossing of the Manilla River on the Barraba-Crow-Mountain Road. Between these resistant zones, the Manilla River winds back and forth as it crosses them obliquely. Between the Aberdeen and Thunderbolt's Gap Ranges is a patch of Tertiary drift about 80 feet thick, capped by basalt 160 feet thick, which extends for a mile in a S.S.E. direction. It was described by Mr. Pittman(9). See also p.277).

We return to Manilla—West of the river, the Baldwin Agglomerate, dipping to the east, rises to form the Baldwin Range, which is cut off by a series of faults which throw-down to the west. The same feature occurs again in the Black Mountain region, and there can be little doubt that the great group of roughly meridional faults extends far to the north and to the south of this mountain-group, but their effect is not rendered obvious owing to the soft, non-resistant character of the Barraba Shales. The structure of the Baldwin and Black Mountain Ranges is, however, rendered very clear by the great resistance offered by the Baldwin Agglomerate, and the comparative non-resistance of the overlying mudstone. Except where they are trenched by canyons, as in Borah Creek Gap, the surface of the Baldwin Agglomerates has been merely laid bare by the removal of the Barraba Mudstone; and the various faults, which cut up this region into a series of strips, are rendered quite obvious. This can be proved by following the course of Borah Creek along the Section line CBA. (See Section 1, Pl. xx.).

On the steep westerly slope of the Baldwin Range, excellent exposures of agglomerate are to be obtained, a thickness of 1,600 feet being measured. The rock is very like the agglomerates at Tamworth. (See 1, Pt. i., p.500; also Pt. v., pp.577-8). Irregular

pebble-bands are frequent, quite parallel to the bedding-plane, as is shown by comparing the inclination of the sandy layers, thin

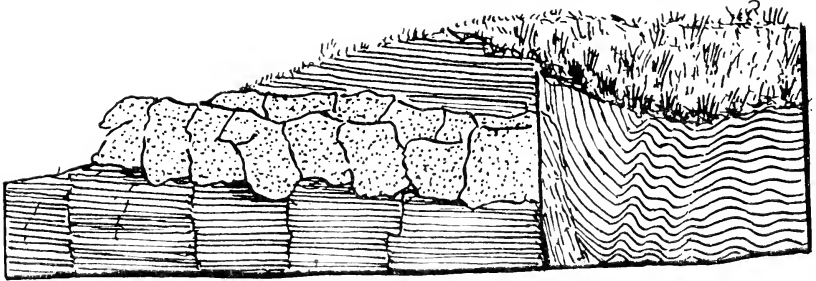

E Baldwin Fault Borah Creek W

Text-fig.3.

The Baldwin Fault, Borah Creek.

intercalated beds of cherty material, or the underlying mudstone. Continuing up Borah Creek, we may note the succession of well-marked faults; the first brings the Barraba rocks down against

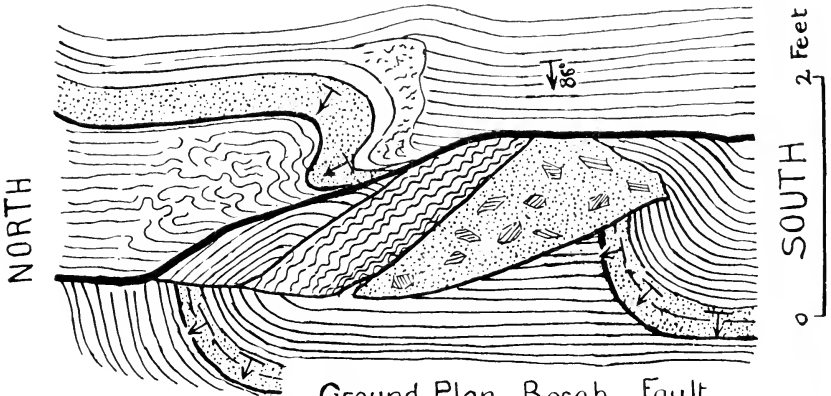

Ground Plan Borah Fault

☐ Slickensided layers of Tuff

Text-fig.4.

Ground-plan of the Borah Fault, Borah Creek.

the base of Baldwin agglomerates, and crosses the stream in Section 24, Parish of Hobden (Text-fig.3). Another very inter-

esting fault at Borah Creek Station (Portion 22A) seems to give evidence of a thrusting from the north along the fault-plane, as

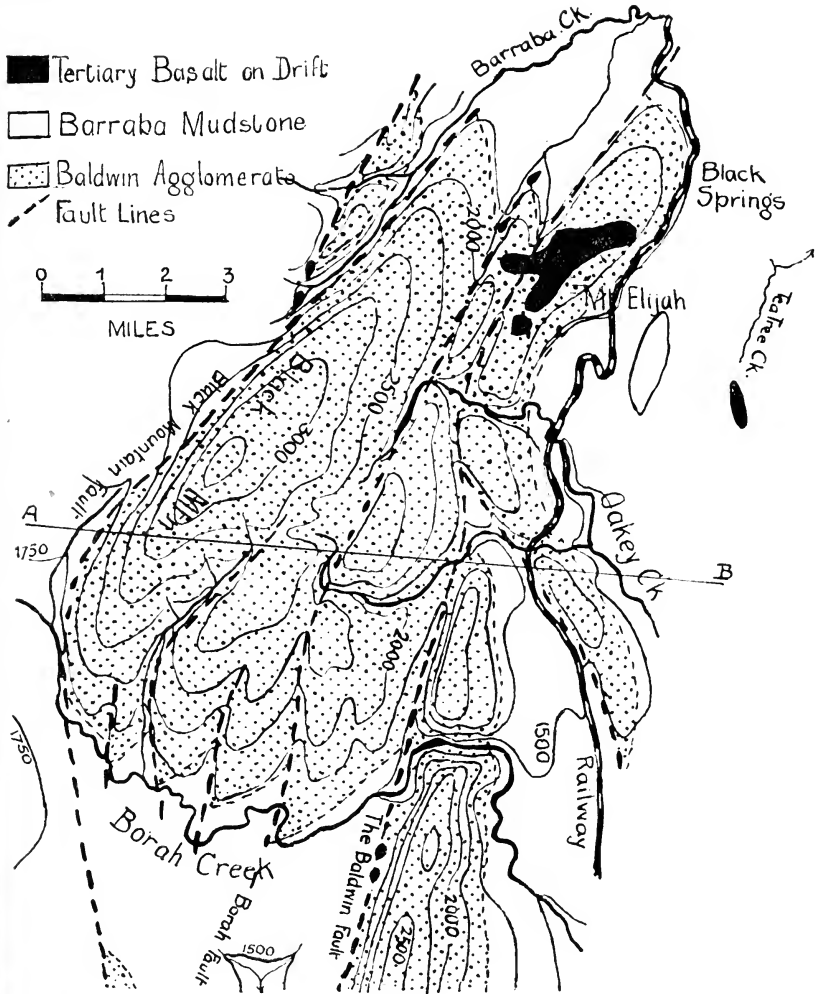

Text-fig. 5.

Topography and Geology of the Black Mountain Range.

shown by the twisting and slicken-side surfaces on either side of

the fault-plane (Text-fig.4). Various other faults are to be noted along the creek. Some attempt at arriving at their approximate throw may hereafter be made, by mapping the outcrop of a particularly thick, white, tuffaceous band full of fragments of mudstone, which occurs at various points, and, in particular, causes a small waterfall a couple of miles east of the Borah homestead. All this series of Barraba mudstone, etc., dips, more or less, to the E.S.E., and cannot be far above the Baldwin agglomerates. North of the creek, the Black Mountain group of hills rises, a succession of eastward-inclined dip-slopes, and westward-facing fault-scarps (as shown in Text-figs.5 and 6),

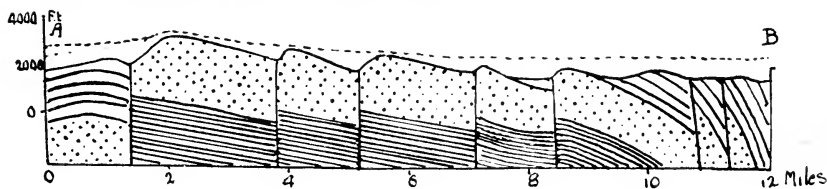

Probable Profile along AB during Tertiary Volcanic Period

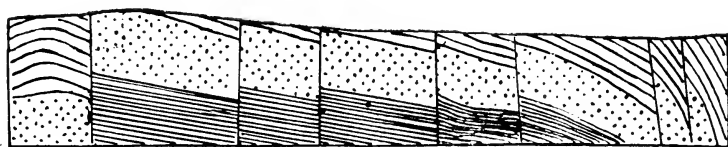

Text-fig.6.

Profiles across the Black Mountain Range (Present and Tertiary).

formed of agglomerate rising from under the mudstone; and nearly every fault-scarp has been traced down to a well-marked fault, seen where it crosses Borah Creek. The throw of these faults may thus be determined roughly by the heights of the various fault-scarps, and, on this reckoning, they vary from 300 to 1,000 feet, with the greatest western fault approaching 2,000 feet. This western fault determines the scarp of Black Mountain. These faults thus stand up in the Black Mountain Region as

clearly as if they were of recent origin, but there can be no doubt that they are at least pre-Tertiary in age, and probably pre-Permian-Carboniferous, resulting originally from the "Schuppen" faulting of the whole region during the period of the intrusion of the ultra-basic rocks. The present relief is due entirely to differential erosion. Where a mass of Tertiary basalt extends across a well-marked fault-scarp (such as that west of Mount Elijah, near Black Springs Railway Station) the basalt is quite undisturbed by the fault; and where the fault-lines extend south or north of the agglomerates into regions of uniformly soft rocks, they cause no relief, indeed cannot be traced save in chance sections. It is almost certain that some of these faults pass below the basalts of the Nandewar Range, which are quite undisturbed by them.

South of Borah Creek, the geology is not very varied. The long line of the Baldwin Range stands up a thousand feet above the Manilla Valley, its eastern dip-slope and western scarp being broken only in the small fault-complex at its southern end, while enveloping faults appear to cut off this range and that of Pyramid Hill the other side of the Manilla, for both end sharply, and the agglomerate does not cross the Namoi River. West of the Baldwin Range, the area is a gently undulating region of Barraba mudstones and tuffs, with, occasionally, argillaceous limestone. A whaleback-hill of Baldwin rocks occurs west of Spring Creek, but is cut off by a fault, and a great wall left by differential erosion looking westward over the open valley of Wongo Creek.

We now commence again from Barraba—To the east of that town lies the Jump Up Range, a hard band of agglomerate, which has been brought up into its present position by a continuation of the easternmost of the Black Mountain group of faults (traced by exposures in the railway cutting and Barraba Creek). East of the faulted agglomerate, the mudstones dip steeply to the east, and are overlain by Tertiary basalt; west of the fault, they dip much more gently. In this region of gently dipping mudstones, a small plain extends northwards from the Black Mountain Range, so flat as to suggest that it was a lake-

bottom, but, so far, no lake-deposits have been noted. To the north of this is the Barraba township, on low undulating hills of mudstone; and west of this, stretches the broad, matured valley of the Manilla River. Here and there, on the higher hills, are cappings of Tertiary river-drift, such as that on the hill by the School House, and again on the hill behind the Barraba brick-works, where fossil coniferous wood occurs among the gravels.

The rock of the Barraba district is the type for the Barraba mudstones, fine-grained, olive-green, flaggy rocks containing thin layers of whitish felsitic tuff, and numerous casts of *Lepidodendron australe*; and, in the finer portions, numerous radiolaria. There are also a few bands of conglomerate, sometimes of a normal character, more often with a strong tuffaceous base.

About four miles west of Barraba, Hawkin's Creek joins the Manilla. Here is a marked syncline; the westerly dip changes, and, for some miles further west, an easterly dip predominates, though at low angles. West, again, the river is crossed by several bands of agglomerate (or repetitions of one band), between which the river has been forced into its present extraordinarily winding course. North and south of the river, these bands rise into hills, with well-marked dip-slopes. South of Hawkin's Creek, however, the bands of agglomerate do not appear, but they are sharply cut off along the main road. This is probably due to a fault, termed the Hawkin's Creek Fault, which may be supposed to bring the mudstones to the surface on the southern side of the fault.

Practically nothing is known of the area for some miles south of this point, save that it is chiefly composed of mudstones with one or more resistant bands of tuffaceous conglomerate giving rise to hills with gentle dip-slopes.

West of the agglomerate-bands, the Manilla River traverses a gorge cut through a great sill of dolerite-porphry, which stands out as a sheet fifty or more feet thick, forming nearly vertical cliffs. This sheet has a gentle dip to the east, and, north and south of the river, the sill can be traced by the well-marked feature it makes along the line of hills. It is a continuation of

the Blue Knob laccolite, and appears from under the basalts of the Nandewar Range. In the cliffs of the Manilla gorge, contortion of the mudstones is clearly visible, not in contact with the sill, but about fifty feet below it. The sill continues south of the river around Tareela Mountain, and has been noted near the head of Hawkin's Creek. As it has not been actually mapped, however, it is impossible to say how far it has been affected by the fault which is believed to occur along Hawkin's Creek.

North of the Manilla, the Middle Western Zone is crossed by the Nandewar Range, composed of basalt covering Tertiary drifts. This will be described later (p.276). North of this is the Cobbadah district. West of the fault bounding the Carboniferous Series described above (p.241), are gently dipping, *Lepidodendron*-bearing mudstones, as at Barraba; and these may be traced along the main road to the head of Hall's Creek, nine miles to the north. Passing down Cobbadah Creek (Section 2, Plate xx.), the easterly dip of the *Lepidodendron*-mudstones gradually diminishes, and, after a small fault north of Duncie homestead, it changes rapidly to the west, and a heavy fault occurs just below the junction of the northern Oakey Creek. This is a most complex fault (see Text-fig.7), but its total character is that of a downthrow to the east, bringing the Baldwin agglomerate near to the surface on the west. The upper surface of this agglomerate is undulating, and the small plexus of faults which follows brings it to the land-surface, or leaves it covered with Barraba rocks in a manner clearly shown by map and section. The strong difference in relief of the two formations makes the tracing of fault-lines very easy.

West of this, the stream crosses another great fault with an easterly downthrow of perhaps 800 feet, bringing the agglomerate up into a great ridge, through which Cobbadah Creek cuts a gorge, in which it is joined by Anderson's Creek, before it opens out on to the Horton Valley.

This gorge affords the best section available for the study of the Baldwin agglomerates. They have a gentle variable inclina-

tion to the west, and, in the gorge, an apparent thickness of 3,000 feet is exposed, a thickness considerably greater than that exposed in the Baldwin Range. No evidence has yet been obtained to show that this has been increased by strike-faulting. The agglomerate is very coarse, containing boulders of porphyry and granite in a tuffaceous matrix, with limestones containing

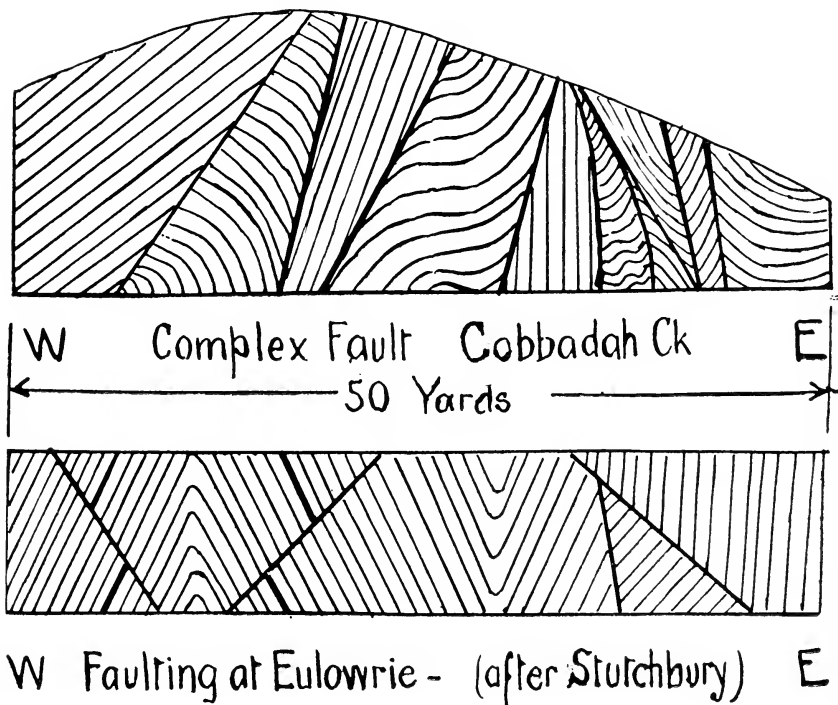

Text-fig. 7.

Complex faulting at Cobbadah Creek and at Eulowrie.

obscure traces of *Heliolites* (as also in Baldwin Mountain), and *Stromatopora*, and faint indications of a coral suggesting *Syringopora*. There are bands, in the agglomerate, of fine-grained, tuffaceous chert, both at the western end of the gorge, and in the middle near Stringy Bark Creek, the latter band being about 200 feet thick. The former contains radiolarian casts, and its

upper surface is broken by intrusions of tuff and breccia, just as described in the Nundle and Tamworth regions(1, Pts. iv., v.).

The western edge of the agglomerate is probably down-faulted. The fault is quite definite some miles to the north, but is unfortunately obscured where it should cross Cobbadah Creek. Hence, the upper surface of the agglomerate is not clearly exposed here.

As shown in Plate xx., fig.4, Cobbadah Creek lies in a syncline in the Baldwin rocks. To the north of this creek, the agglomerate dips to the south, as seen in the ranges east of Tin Hut Creek; while, to the south, the northerly dip is very clearly shown in the cuttings along the zigzag road coming down from Cobbadah to Horton.

The Blue Knob Laccolite.—The most remarkable feature south of Cobbadah Creek is the Blue Knob dolerite-laccolite. This is roughly saucer-shaped. East of it, at the head of Sheep Station Creek, the dip is south-west; but, tracing round the northern face, the dip changes to south, then to south-east, and finally to east, which we have seen to be the dip of its long continuation south of the Nandewar Range. It commences south of Dunees homestead, crosses Oakey Creek, which cuts a great gorge through it, crosses the front of Blue Knob, where it forms the steep northern face, and exposes a thickness of 700 or 800 feet of igneous rock. It appears to transgress the bedding-planes a good deal, or to have been intruded subsequently to some faulting, for the rocks adjacent to the north-western end of the intrusion are largely agglomeratic and quite different from those to the east. This, however, has not been investigated in detail. Just as in the Manilla River Gorge, there was found to be a zone of strong crumpling some distance below the dolerite, so, north of Blue Knob, at about 300 feet stratigraphically below the intrusion, there is a patch of very disturbed rock.

The southern boundary of the intrusion is no less interesting than the northern. To the east and west, it is overlapped by the Nandewar Range basalt, but, in the central portion, the Barraba rocks occur, and are eroded by the head-waters of

Oakey Creek, which has partly stripped them off the dolerite, exposing the upper surface of the sill, which is quite coarsely grained. The slope of this surface is thus clearly visible, and is bent into a fairly sharp angle near Oakey Creek Gorge, sloping south-west on the one side, south-east on the other. Minor transgressions of the dolerite into the overlying mudstone are well seen in a little eastern tributary of Oakey Creek. To the west, the face of the basalt has been exposed and its underlying gravels.

There is some variation in the dolerite throughout this mass, more particularly in the porphyritic character of the narrow, sill-like parts compared with the granitic texture of the thick mass. There appears some evidence of differentiation in the latter, but nothing definite was proved. There is little evidence to show where was the vent from which the magma issued, but as the laccolite is so thick at the northern end and tails off so gradually southwards, it is probable that the vent was near Blue Knob, and that the northern limb of the laccolite was extremely short, perhaps terminated by a fault, similarly to the Mt. Marcellina, asymmetric laccolite in Colorado(39). The period when the intrusion took place must remain unknown until the relation of the dolerite-masses to the faults traversing the rocks they invade has been carefully studied. That the dolerite is of late Palaeozoic age is most probable.

East of this intrusion, a small mass of dolerite-porphyrite occur, on the Cobbadah-Barraba Road, and, between here and the Blue Knob, the Barraba Series, at the head of Sheep Station Creeks passes up into a series of peculiar tuffaceous rocks already mentioned (p.241).

The areas north of Cobbadah Creek have been studied by traverses along Oakey Creek and Anderson's Creek. In Oakey Creek, east of the fault figured (Text-fig.7), about two miles above its junction with Cobbadah Creek, the stream lies in a deep meandering canyon cut into gently dipping mudstones and tuffs, containing numerous but obscure plant-stems. East of this, the dip changes sharply, with much shattering and faulting,

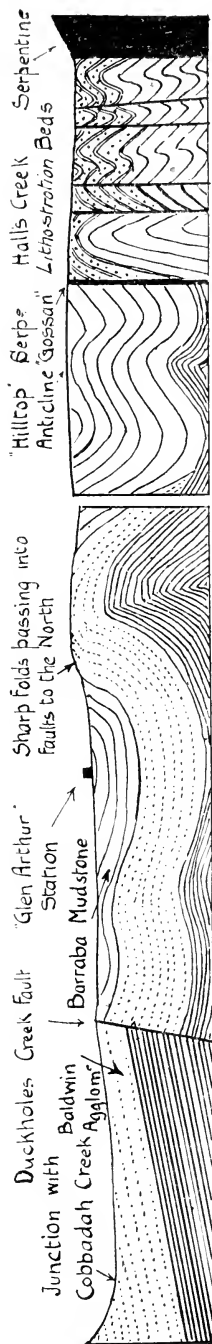

Text-fig.8.*

bringing the agglomerate to the surface. This contains cherty bands, and dips gently to the E.N.E. at from 15° to 30° , but, near the main road, it is directly overlain by the Barraba mudstones, and the dip changes sharply to E.S.E. at 47° . The mudstones here contain a very hard band of tuff quarried for road-metalling. The section has not yet been traced further east, and the mapping of the Burindi rock at its head is conjectural.

The section along Anderson's Creek is shown in Text-fig.8. Commencing at Cobbadah Creek, the valley is in agglomerates for some distance, then passes across the main fault, which continues northwards along Duckholes Creek. For a mile further, the creek is off and on the agglomerates, which are rather contorted, but then passes on to the mudstone near Glen Arthur homestead. East of this is a sharp contortion, indicating a thrust from the north-east, and the Baldwin agglomerates come to the surface again. Here they contain, intercalated, a flow of spilite-lava with large felspar-phenocrysts (1. Pt. iii., p.665). This flow is about 50 feet thick. Associated with it, is a band of grey tuffaceous chert. The dip is to the east at 7° , but, in a few yards, it rapidly increases to E. 10° N. at 54° at the eastern limit of the agglomerate, and is still steeper to the east. From here, the rocks are all steeply-dipping mudstones. A break in the section is made here, and it recommences again a mile to

* Geological section along Anderson's Creek.

the north with mudstones dipping at 75° , but this flattens out towards the roadway on the east. Crossing the roadway, the strata are seen to be intensely disturbed, and Burindi rocks are brought in by the faulting. This is adjacent to the Burindi rocks of Hall's Creek, already described (p. 241).

North of this, the Baldwin Agglomerate broadens out into the more or less level-topped Bingara Range. To the east lies the anticline of Barraba rocks on which stands Mr. Charteris' homestead, Hilltop (see Plate xx., Section 3). On the west of this lies the valley of Flaggy Creek, beyond which is a sharp scarp where the Baldwin rocks are brought to the surface by a fault. The agglomerates extend to the west of this. The dips, where obtainable, vary somewhat, but are generally small. At Pound Creek, a sharp nip increases the dip to $E.10^\circ N.$ at 45° . A mile and a half to the west, on Duckholes Creek, the close association of dips of $E.15^\circ N.$ at 20° , and $N.W.$ at 27° , is doubtless due to the presence of the fault which comes up from Cobbadah Creek. At Lickholes Creek, further west, the dip is $E.16^\circ N.$ at 15° , and at the western edge of the range it is $S. 40^\circ W.$ at 18° . Here (in Arnold's Creek) there is a layer of chert and fine tuff, and near by a flow of spilite interstratified with the agglomerate, recalling that on Anderson's Creek. A rapid descent of 1,300 feet to Boundary Creek shows a great thickness of agglomerate, dipping $W.20^\circ N.$ at 6° , full of fragments of granite, chert, etc., with an interstratified flow of porphyritic spilite-lava.

Returning to Hall's Creek—The western side of the valley, at its southern end, is a continuation of the fault-scarp of Baldwin rocks, and rises directly out of Barraba mudstone. North of a point about twelve miles south of Bingara, a spur branches out from the fault-scarp running to the north, and where this was crossed, eight miles south of Bingara, the eastern side resembled Middle Devonian rocks far more than the Barraba Series. They consisted of easterly-dipping, banded, yellow and blue shales and interbedded tuffs, with lenticles of limestone, and bands of tuffaceous breccia like that in the Tamworth Series. West, again, is a mass of andesite-tuff, such as occurs in the

lower portions of Barraba rocks, and beyond, across a small creek, the scarp of the Baldwin rocks rises up steeply. They are very full of fragments of chert and limestone.

The geology of the northern end of the Bingara Range was described by Anderson in 1888 (11, 12), and later by Stonier (19). He stated that the formation contains *Lepidodendron australe*, and various marine shells, including *Spirifer* sp. It consists of thin, bedded mudstone, sandstones occasionally conglomerates, argillaceous, oolitic and crinoidal limestones, quartzites, hard, thick-bedded, gritty, and tuffaceous mudstones and sandstones passing into volcanic tuffs. Apparently, therefore, Barraba and Burindi strata are present. In addition to the above formations, the Middle Devonian cherts, claystones, and tuff-breccias appear to be present on the eastern slopes of the mountain on the Rocky Creek Road. A sharp anticline of richly radiolarian chert was noticed, halfway up the mountain. The western slopes of the range along the same road consist entirely of Barraba rocks. Around the northern end of the range, the section exposed along the river-road consists of banded claystones, that may belong either to the Tamworth or the Barraba Series. No Baldwin Agglomerate was seen in the northern extremity of the Bingara Range, unless it be Stonier's "conglomerate"; nor is there any sign of its presence north of the Gwydir River. It is probable, therefore, that it has thinned out here, and that the Tamworth Series passes conformably up into the Barraba Series, as it does elsewhere, *e.g.*, south of Tamworth. There is, therefore, no need to trace the belt beyond the Gwydir River. It is evident that the structure of the northern end of the range is very complex, and requires further elucidation.

The Palæozoic rocks are capped by Tertiary gravels and basalts, which have been investigated in greater detail than any other portion of the area dealt with in this paper, having been visited by Liversidge(6, 7), Pittman(9), Wilkinson(10), Anderson(11), and Stonier(18, 19). The last-named, summarising all information, notes the following succession of Tertiary formations:—

Newer Basalt	350 feet.
Fluviatile sands and gravels	120 feet.

Older Basalt	300 feet.
Sands, clays, and ironstones	400 feet.

These gravels, etc., contain a few fossils, namely, *Unio Wilkinsoni*, the seed *Plesiocapparis leptocelyphis*, and *Phymatocaryon Mackayi* (13). The presence of the seed suggests that the gravels should be classed with the leads of the newer volcanics (see 40, p.479). Associated with these deposits are diamond-bearing gravels containing a number of fragments of minerals, which indicate their transportation by the ancestor of the Gwydir from the granitic area to the east; the presence of topaz, tourmaline, and wood-tin are especially suggestive.

Mr. A. Mack, of Pallal Station, informed the writer of a second mass of basalt with underlying gravels on the Bingara Range, near Pallal Creek, five miles south of the gravels, etc., mentioned above. These have not yet been investigated by any geologist.

v. *The Far Western Zone.*

This region, which includes the Upper Manilla and Horton River Valleys, is made up of rocks of Barraba, Burindi, and Rocky Creek Series, with some Blue Knob dolerite, Tertiary gravel and basalt. For clearness' sake, the description will commence with the type-section drawn east and west through Burindi. East of the Station homestead, there is a well-marked fault near the head of Hawkin's Creek, followed by an anticline of Barraba mudstone and interbedded tuffaceous breccias, beyond which the Barraba mudstones cross the Upper Manilla Valley, dipping gently to the west. In the river, casts of *Lepidodendron australe* are abundant; and a petrified stem of a zygopteroid fern obtained here, was presented to the Geological Museum of the Sydney University by the late Lieut. Brian Simpson, B.A.

Inquiry at Burindi rendered it almost certain that the specimen occurred *in situ*, probably in or near some tuffaceous rocks in the river-bed, about a mile north of the Station homestead. This remarkable fossil is being examined by Mrs. Osborne, D.Sc., F.L.S., of Adelaide, who has kindly informed the writer that it consists of three closely associated stems, each surrounded by

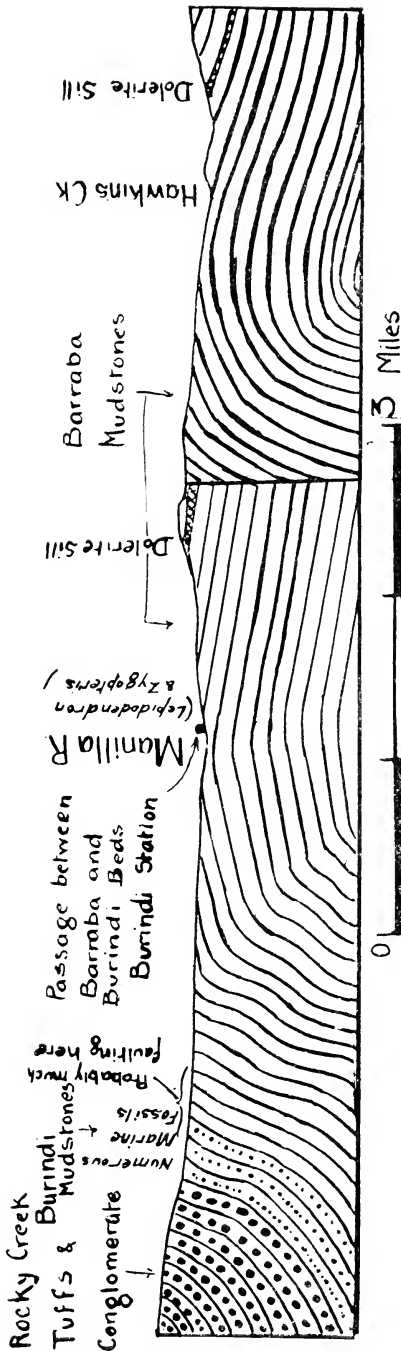

Text-fig. 9.

Geological Section through Burindi.

petioles and roots. The stem is of the type shown by *Ankryopteris grayi*, but the petioles are of the simple type seen in *Clepsydropsis* (41). *Ankryopteris* has, so far, been found only at horizons from the Lower Coal-Measures to Permian, but *Clepsydropsis* is said to be one of the most common in the Devonian beds of Thuringia. This peculiar association of Carboniferous and Devonian characters is remarkable, especially as the field-work indicates that it occurs near the top of what has been assumed to be the Upper-Devonian Series. Other evidence mentioned below (p.269) indicates that we cannot yet be sure where the line of demarcation should be drawn between the Devonian and Carboniferous series.

West of the river, the mudstones have an ever increasing westerly dip, and include a large mass of blue argillaceous limestone. Near Portion 106, Parish of Burindi (the type-locality for the Burindi mudstones), the mud-

stones are almost vertical, have a peculiar dark green colour, are splintery rather than fissile, and generally have the characters of the Carboniferous mudstones, which, though not easily described, are readily recognisable throughout the Serpentine Belt. Interstratified with them, are thin lenticular bands of limestone, with abundant crinoid remains; and, adjacent to these, the mudstone contains small cavities filled with ferruginous clay left by the solution of shells, crinoids, etc. A large marine fauna was obtained here, which has been determined by Mr. Dun and listed previously (1. Pt. i., pp.505-507). Stonier, who first noted this fossiliferous zone, reported the occurrence in it of *Lepidodendron australe* (21), but this has not been confirmed. Similar marine fossils occur in Portion 144, one mile to the south, and doubtless will be found all along the zone to the north and south.

Further west, conglomerates occur. The dips of the sandy partings in the conglomerate, the shaley bands, and intercalated mudstones show them to rest, with perfect conformity, on the Burindi mudstones. Several types of rock occur as pebbles in the conglomerate, granite, felspar and quartz-porphyrines, aplite, rhyolite, jaspers and quartzite, but, so far as has been collected, none are of the type that occur in the Tamworth or Woolomin Series. Suspicion arising about a black jasper and a red jasperoid rock has been dispelled on microscopic examination; nothing like them has been found in the lower formations. The series is of great thickness. They are portions of Rocky Creek conglomerates, the type-locality for which lies 40 miles north of here.

South of Burindi, the three formations continue. The matured contours of the valley-floor are interrupted, near the junction of Four Mile Creek with the main stream, by faults which bring to the surface some of the harder tuffaceous beds of the Barraba Series. At the head of the Manilla River, the traverse along the section-line (AB, Plate xx., fig.1) shows that the strata are undulating. The conglomerates overlie mudstones of characteristic Burindi appearance. (Want of time prevented a search for fossils). Swampy alluvium fills the head of the valley, east

of which are Barraba mudstones forming the low divide between the heads of the Manilla River and Borah Creek. East of here, the mudstones are sharply faulted and contorted, and may thence be traced gently undulating down to the Black Mountain fault. Near here is Mr. Geddes' homestead on Borah Creek, "Hobden," north of which is a thick bar of dark grey argillaceous limestone. Near here, there is also a small basalt-neck breaking through the mudstone.

South of Borah Creek, the Rocky Creek Conglomerates have been traced for a few miles. Their undulation brings mudstone to the surface in places west of the main conglomerate band, and it is probable that the fossils, which local report states occur at Rangira, are in Burindi beds in such a position. Dr. Jensen recorded the possible presence of Devonian rocks on Maule's Creek(31), which would probably be an inlier appearing beneath an anticline of Carboniferous rocks.

We now return to Burindi and follow the Far Western Zone in the opposite direction.—North of Burindi is a mass of dolerite-porphry of the Blue Knob type, cut through by the Manilla River, and here and there are other isolated sills of the same rock. Gravels, like the Tertiary gravels near Barraba, lie scattered on the tops of the small hills in the main valley, and north of Tareela Creek are capped by basalt. The valley of the Manilla west of the great dolerite-sill, and that of Little Creek, are crossed by several minor sills of dolerite-porphry containing large, white patches of prehnite.

North again, the Tertiary gravel is found below the basalt of the old Nandewar River. It is mostly gravel with a little clay. To the west, the Rocky Creek conglomerates occur approximately as shown, their position having been learned from local report (Plate xix.). Their occurrence in the two sharp hills of Byar and Coolah near Maule's Creek, just beyond the end of Tareela Creek, is proved by the observations of Dr. Jensen(31). They there consist of "massive conglomerates with interbedded sheets of tuff and rhyolite (quartz-porphry), the pebbles of the conglomerate being identical in nature with the interbedded sheets."

North of the Nandewar Range, the conglomerates continue to

make a marked feature, over which the Horton River tumbles in a high cascade. The headwaters of this river lie on basalt, but it falls from thence over a highly prismatic layer on to the conglomerate. The upper falls were described by Powell in 1889(42). Below the cascades, the floor of the Horton River Valley is of low relief, cut in Burindi and Barraba mudstones, which, north of Beeren, are invaded by quartz-porphry. To the east, the high range of the Blue Knob mass is capped by the dolerite-sill, beneath which are Barraba rocks.

The hill beside Horton Township is another sill of dolerite of the Blue Knob type, about 300 feet thick. Its boundary has not yet been mapped. The shales in the river are of the typical Barraba-type, and contain *Lepidodendron*. (See Plate xx., fig.2, G, H).

The area north of here was well described by Stutchbury in 1852(6, a, b). The structure is shown in Plate xx., fig.3. Omitting, for the present, the western portion (see p.271), we note the syncline in the Rocky Creek conglomerates, that has been traced up from Gunnedah, is maintained, and is clearly to be seen in the gorge of Rocky Creek. At the western end of this, the dip is to the east at about 25°, while, at the eastern end, the dip is westerly at 35°, and increases in the underlying Burindi mudstones still further to the east. The series is, in ascending order: Burindi tuffaceous mudstones, followed by tuffs covered by a very great thickness of coarse conglomerates with boulders of granite, porphyry, and rhyolite in a tuffaceous ground-mass, with interbedded layers of rhyolite and rhyolite-tuff. Following this, there is more tuff, and above a band, about 50 feet thick, of a hard cherty tuff, very fine-grained but including small pebbles of granite, etc. Following this, is a mass of coarse rhyolite-tuff. Altogether this series cannot be less than 2000 feet thick, and the hill, at the side, exposes at least 500 feet more, which, however, have not been studied.

East of the edge of the conglomerate, the dip rapidly increases. The rocks are chiefly mudstone, but at Caroda, near the junction of Rocky Creek and the Horton River, is a bed of oolitic crinoidal limestone, noted by Stutchbury(6), and later by

Stonier(19), and described by Mr. Card(43). This continues for some distance to the south. The area is in the zone of rapid flexing that lies east of the conglomerate all along the line. On a creek, near the bend of the river by Eulowrie, Stutchbury figured a series of steeply folded and faulted beds, and reported the discovery of *Lepidodendron* therein. (See fig.6). What is believed to have been the same section was rapidly examined by the writer, and found to be composed of rocks of the Barraba-type, with small lenticles of dark blue limestone, and a band of pebbles. Though enclosed between masses of Burindi rocks, this is probably a narrow infaulted strip of Barraba mudstone. Crossing the river, some impure limestone was found directly north of Eulowrie homestead; and this can be traced northwards to near the old Police Barracks, where Porter found *Lithostrotion*(?) *columnare* with *Syringopora syriax*, and another species of *Lithostrotion*(?)(44). This may be correlated, *pro tem.*, with the Lithostrotion-limestone at Bingara Falls. It appears to lie near the base of the Burindi Series (See p.242).

Dr. Stanley Smith has kindly pointed out to the writer that *Lithostrotion* does not elsewhere occur at the base of the Carboniferous Series proper. Dr. Vaughan(45) states, *e.g.*, "*Lithostrotion* (both massive and dendroid) enters in the early Viséan" [upper moiety of the Lower Carboniferous] "in North America, Britain, and Belgium." *It may be, therefore, that the true base of the Carboniferous System lies at some unrecognisable horizon in the Barraba mudstone. For the purpose of mapping, however, the base of the Burindi beds is the lowest recognisable horizon in the Carboniferous that can be traced.*

East of the Eulowrie limestone, the section on Boundary Creek exposes Barraba mudstones dipping gently to the west, and extending up to the foot of the scarp of the Bingara Range. Though the section appears unbroken, there is reason to think it is more or less faulted.

Returning to Caroda, and continuing to the north, there is evidence for faulting in the duplication of the oolitic, crinoidal limestone. It is interbedded with green, tuffaceous rock, and overlain by conglomerates like that at Caroda. This green

rock, which is often associated with the limestone, is doubtless that indicated in Stutchbury's statement, that the limestone becomes metamorphosed and passes into "imperfect serpentine" (6). What is probably the continuation of this limestone occurs at a small bluff at the northern end of the sharp S-bend on the Horton River, north of Pallal, which was twice visited by Stutchbury, who obtained an extensive fauna therefrom (1, Pt. i., pp.505-507). This is clearly comparable with the Burindi fauna. Though *L. australe* does not occur in this fossiliferous zone, it is present immediately to the east of it, e.g., at the mouth of Pallal Creek. East of this, we pass into typical Barraba rocks, which continue with increasingly steep westerly dip up the spurs of the Bingara Range, which are capped by basalt. About a mile north-east of Pallal homestead is another patch of basalt, at the top of a small hill, 300 feet above the river, but 1,000 feet below the base of the basalt of the Bingara Range only two miles away. This seems to be a volcanic neck.

The ridge west of the river contains the base of the Rocky Creek syncline. The dip of the conglomerate gradually changes to the east, and Burindi rocks appear again before the summit is reached. This feature probably accounts for the peculiar courses of the creeks draining the slope. At Derra Gap, on the summit of the range (called Darragh Gap by Stutchbury), this geologist noted the presence of sandstones with a seam of coal 2 feet 6 inches thick, the upper sandstone being replete with vegetable remains(6). Stonier(19) remarks of this spot, that sandstone and conglomerate lie in apparent unconformity on the Carboniferous rocks.

West of the river, and seven miles north of Pallal, the rocks are tuffaceous conglomerates, in which obscure plant-remains were obtained by Stonier, which Etheridge referred to *Rhacopteris*(?). This occurrence appeared to the writer to be merely the western limb of the faulted continuation of the Rocky Creek Syncline. Up the hill to the west, Burindi rocks appear below the conglomerates. To the east, near the river, these conglomerates are again cut out by a fault, which brings up the Burindi rocks. Further west, at the top of the Slaughterhouse Range,

Stonier reports that basalt overlies Tertiary clays resting on current-bedded sandstones of the Middle Clarence (Warialda) Series with a slight westerly dip. These rest on Carboniferous mudstones dipping E.30°N. at 35°(19). The limestones of the Burindi Series continue northwards, occurring at the head of Slaughterhouse Creek, forming little lenses a foot or eighteen inches thick, composed of crinoid stems. Associated with them are fossil beds containing (20):

<i>Spirifera convoluta.</i>	<i>Cyathophyllum</i> sp.
<i>Spirifera</i> sp.	<i>Zaphrentis</i> sp.
<i>Strophomena</i> sp.	<i>Diphyphyllum</i> sp.
<i>Fenestella</i> sp.	<i>Syringopora</i> sp.

These are doubtless related to the Burindi horizon, though the presence of the last two forms is remarkable, and may indicate that they belong to a rather lower horizon. Other limestones occur west of this, as at Tea Tree Creek, which Stutchbury refers to the same zone as that at Eulowrie. We may compare with this occurrence the presence of Burindi rocks at Rangira, west of the Rocky Creek conglomerates (See p.267).

The Carboniferous Series has been traced down to the Gwydir River at Gravesend(36).

vi. *Upper Rocky Creek, and the Nandewar Mountains.*

West of the gorge of Rocky Creek, that is cut through the conglomerate, the valley opens out into a wide plain, at the back of which rises the Mt. Lindsay group of trachytic peaks, first recognised as such by Sir T. L. Mitchell(2), and Dr. Leichhardt(3). The rocks of the plain are of the Burindi type, with some differences. They dip to the east, east of the Rocky Creek Station homestead, but, further west, are bent sharply to the west and faulted. A syncline follows, the dip changing to the east. Near the fault, they are interbedded with a peculiar, dense brown, siliceous ironstone-rock, which the writer has traced for over a mile; and there is a small plug of basalt a mile south-west of the station. About a mile north-west of the station (to judge from Stonier's map), Mr. Pittman(23) collected the fossils previously listed (1, Pt. i., pp.505-507). This indicates a bed on the same horizon as Stutchbury's collecting-ground at Pallal.

West of this, the mudstones are overlain by the Rocky Creek conglomerates; and at the head of Bobbiwaa Creek, Dr. Jensen found coal-bearing Permo-Carboniferous sandstones and shales (31). To the south, on Boomi Creek, he noted that the valley is cut in conglomerates, with rhyolitic and andesitic tuffs and quartz-porphyrries, which are the same as those seen in Maule's Creek to the south. All these, he classed as Permo-Carboniferous, following the State Geological Map of 1893. It seems most likely, however, that these are the Lower Carboniferous conglomerates of the Rocky Creek Series, and the writer's map (Plate xix.) differs from the earlier one in this respect. The new boundaries were plotted after discussion with Dr. Jensen, who has generously requested that it be added that he concurs in the changes made. In the south of this region, Dr. Jensen has noted the unconformity between the Coal-Measure sandstones and the Carboniferous conglomerates. The boundaries of the basalts east of the Nandewar Mountains are based partly on Dr. Jensen's maps, and partly on unpublished observations by Mr. L. F. Harper, F.G.S., of the State Geological Survey. The details of the other volcanic rocks of the Nandewar Mountains have been fully discussed by Dr. Jensen in the work cited (31).

PHYSIOGRAPHY.

The most accurate account of the topography of this region seems to be that given by Mr. Andrews in his first discussion of the physiography of New England (32). While the effects of uplift are noted, due importance is attached to differential erosion in hard and soft structures. To this, rather than to differential movement, warping or faulting, the local relief appears to be due. Nevertheless, the effects of differential uplift have determined the broad features of the distribution of elevated regions and plain. These will be considered first.

i. *Features due to Differential Movement.*—The plateaux of New England sink to the west, and pass out into the plains between Bingara and Warialda. Between Manilla and Tamworth, a rapidly rising series of rugged foothills carries the land-surface from the low plains of the Namoi and Peel Rivers to the

high plateaux of southern New England. These two portions of the western boundary of New England are structurally collinear, but instead of the boundary of the highland continuing the line between these two segments, there extends at right angles thereto the Nandewar Range terminating in the Nandewar Mountains, beyond which the surface-level sinks rapidly to the western plains near Narrabri. Further, the height of the Nandewar Range increases from Barraba to the west, and other evidence (to be detailed later) supports the view that the region, which protrudes to the west of the normal western boundary line of New England, has been uplifted in the Nandewar Mountains, and tilted against the flanks of the New England plateaux. Its western limit, according to Dr. Jensen's observations, must be a series of flexures or faults (See Text-fig. 1, p. 229). To the south-west and north-west, it seems to have warped down into the plain. At or near the most elevated portion of the edge of this easterly tilted region, lie the Nandewar Mountains, a fact which suggests that the elevation and volcanic activity were genetically related processes. A further feature, probably due to crust-movement, is to be found south-east of Bingara, where, stretching south of the Gwydir River, is a widely extending region of lowland, which is believed to be a senkungsfeld-region. This will be discussed further below (p. 280). It is chiefly occupied by Mr. Munro's station, Keera.

ii. *Features due to Volcanic Eruptions.*—Two main groups of features are due to volcanic eruption, namely, (a) the great dissected pile of the Nandewar Mountains, and (b) the basalt-flows which descended the ancient rivers, covering their drift-beds (often of considerable thickness). Of these, the trachytes are probably the older, but it is not certain that all the basalts are even approximately coeval. Two flows certainly occurred near Bingara, separated by 120 feet of gravel, but their outpourings are considered to have been separated by a very short period of time (19). Two important regions of basaltic rocks remain unmapped, namely, that in the Keera Senkungsfeld, and that near Myall Creek. Until these are studied, the Tertiary history of the region will be indefinite.

iii. *Features due to Differential Erosion.*—The most resistant rocks in the region are the jaspers, which form a marked series of peaks and ridges, and have been reduced to the general level only in regions of very long-continued erosion, with local differential crust-movement. Second only to the jaspers in their resistance are the Baldwin Agglomerates, which form rough ridges in the Black Mountain, but are reduced to a peneplain-level on the Bingara Range. Somewhat less resistant are the Rocky Creek conglomerates, and still less resistant than these are the tuffs in the Devonian claystones of Barraba or Tamworth age, which, however, give rise to marked ridges (*e.g.*, the Aberdeen Range) which cross the Manilla River obliquely. The phyllites, etc., of the Eastern Series vary in their resistance according to their degree of silicification. They could never be classed as readily yielding to erosion. The same holds with regard to the more siliceous radiolarian cherts of the Tamworth Series.

Of the igneous rocks, we find always, among the resistant masses, the dolerites of the Blue Knob type, the Tertiary trachytic rocks, and basalts. The granites vary greatly in resistance according to their composition, as Mr. Andrews has emphasised (in 33 and other papers). The high regions south of the junction of Cope's Creek and the Gwydir River, or that near Bendemeer, are highlands of resistant acid granite; the granites of the lower region near Cope's Creek and Bundara are more basic. The gabbros associated with the serpentine vary in their resistance to erosion, according to the nature and degree of their alteration. They are generally less resistant than the serpentine. The case of the last-mentioned rock is peculiar. As is usually the case, the serpentine, though soft, is very resistant to erosion. It forms, along the eastern side of Hall's Creek, a mountain-wall almost as steep and unbroken as that of the Baldwin Agglomerates of Bingara Range, on the opposite side of the valley. This is, doubtless, due to the chemical stability of serpentine, which, being fully hydrated, decomposes with extreme slowness under atmospheric conditions, so that disintegration is very slow: it is much less so, however, in the case of schistose than of massive

serpentine, owing, possibly, to the readier attack of frost-action on the former, or the easier access of atmospheric agencies to the inner parts of the rock. A serpentine-boulder, however, is rapidly broken up in a stream, owing to its very small resistance to mechanical attrition. Hence pebbles of serpentine are seldom carried very far from their source.

The widespread Barraba mudstones and the least siliceous of the Tamworth claystones are, in contrast to all the above rocks, very easily eroded; and consequently give little sign of relief due to differential erosion, but are almost always reduced to gently rolling, mature surfaces broken by low ridges of the more resistant interstratified tuffs. Where the Baldwin Agglomerates and Barraba mudstones are faulted together, differential erosion brings such dislocations into clear relief.

The Evolution of the Manilla River.

The manner in which the several factors cited above have co-operated in producing the present topography, seems to be most clearly illustrated by a consideration of the river-systems immediately adjacent to the Nandewar Range, namely, those of the Horton and Manilla Rivers. Dr. Taylor (46) has called attention to the curious courses of these streams, but since his study of them was based upon an inaccurate geological map, his explanation is not in accordance with that suggested by later investigations, which, however, are still incomplete.

Ancient valleys marked by river-drift break across the Serpentine Line at Paling Yard, Woods' Reef, and Crow Mountain, converging to a point east of Barraba. The elevation of the Gap at Paling Yard is approximately 2,320 feet (official map);* where the old valleys met, east of Barraba, the elevation of the upper surface of the drift must have been not more than 2,040 feet, and on this lies a thickness of 100 feet of basalt, the upper surface of which is about 2,140 feet above sea-level. North of Barraba, the upper surface of the basalt is 2,036 feet above sea-level, and below the basalt, which is about 60 feet thick, further

* The elevations cited are all based upon aneroid observations, and are thus only rough approximations.

Tertiary clays and gravels occur. Following to the west, along the basalt-capping of the Nandewar Range, the elevation steadily rises. About four miles west of Bell's Mountain, the underlying Tertiary drift reaches a considerable width. Mr. Pittman has described it (47) as follows—"The deposit, which is probably of late Tertiary age and of lacustrine origin, apparently occupies a denuded hollow in the Carboniferous rocks [here considered Upper Devonian (W.N.B.)], for the latter containing impressions of *Lepidodendron australe* are seen to outcrop around its margin. The lowest beds of the Tertiary series consist of yellowish-grey sandstones and shales with numerous impressions of *Eucalyptus* and other plant-remains; above this is a volcanic tuff consisting of impure diatomaceous earth, with rounded pebbles, sanidine crystals and fragments of pumice. In some places the tuff is very much impregnated with ferric oxide forming a hard limonite. It is succeeded by a bed of yellowish-brown sandy mudstone, about a foot in thickness, and resting upon this is the bed of pure white diatomaceous earth, nine feet six inches in thickness, with a layer of two inches of coarse sand about three feet from the top. Another bed of volcanic tuff containing numerous sanidine crystals covers the keiselguhr, and is overlain by about 100 feet of basalt. The sedimentary beds undulate considerably, and . . . it is difficult to estimate their thickness." Messrs. Card and Dun have found *Melosira* and *Spongilla* in abundance in the diatomaceous earth (29).

Tertiary drift appears again beneath the basalt at the head of Oakey Creek, and, at the Horton Gap, the basalt has been cut through, exposing a thickness of 50 feet of Tertiary drift, followed by about 100 feet of basalt, the surface of which is at an elevation of 2,450* feet. Five miles south-west of here, at the head of Little Creek, the top of the basalt is at an elevation of 2,510 feet. Across the Horton River, is the long line of basalt, which runs east of the Nandewar Mountains, and is reported to overlie gravels (19); this may well be a continuation of the old river marked by the Nandewar Range. If so, a length of

* This figure is based on a single reading of the aneroid, and is, perhaps, rather too high.

about 40 miles is preserved of the gravels of an old stream which may be termed the Nandewar River. Several former tributaries, other than those already mentioned, are also indicated. At Tea Tree Creek, ten miles S.S.E. of Barraba, a thickness of 160 feet of basalt overlies 80 feet of gravel. From here, an air-gap leads straight through the low hills to Barraba, where, on the School-house Hill, is a small capping of Tertiary drift. These may have been connected by a stream, the "Anti-Manilla," as suggested in Text-fig.10. The drifts, which underlie the Mt Elijah basalts, eight miles south of Barraba, may represent a tributary of this hypothetical stream. Probably, also, there was another stream which ran parallel to the present Borah Creek, but about a couple of miles to the north of it, the "Proto-Borah Creek" (See p.279). In addition, the basalt-capped drift near Hawkin's Creek, and that near the junction of Upper Manilla River with Little Creek, may indicate the former presence of pre-basaltic streams where are now the valleys of Upper Hawkin's Creek and the Upper Manilla River. In the latter are several low hills capped with Tertiary drift.

The phenomena of gravel-filled Tertiary valleys covered by basalts are, of course, universal throughout Eastern Australia, and no explanation of this particular valley-system would be necessary other than that put forward by Mr. Andrews, namely, that it was aggraded in a period of depression, which occurred during the general movement of uplift(40), were it not for certain special features. The elevations cited show that the slope of the valley was reversed, and that the basalt-lava must have flowed along the valleys in the opposite direction to that of the flow of the pre-existing streams. The suggestion, that the tilting of the land-surface towards the east was connected with the outbreak of volcanic activity in the Nandewar Mountains, is supported by the abundance of volcanic tuff, sanidine-crystals, and pumice occurring with the diatomaceous earth below the basalts, where a small lake was formed by the ponding-back of the stream in its valley, thus tilted. This easterly tilting, combined with the elevation of the Nandewar Range with respect to the present plains to the south and north, determined the

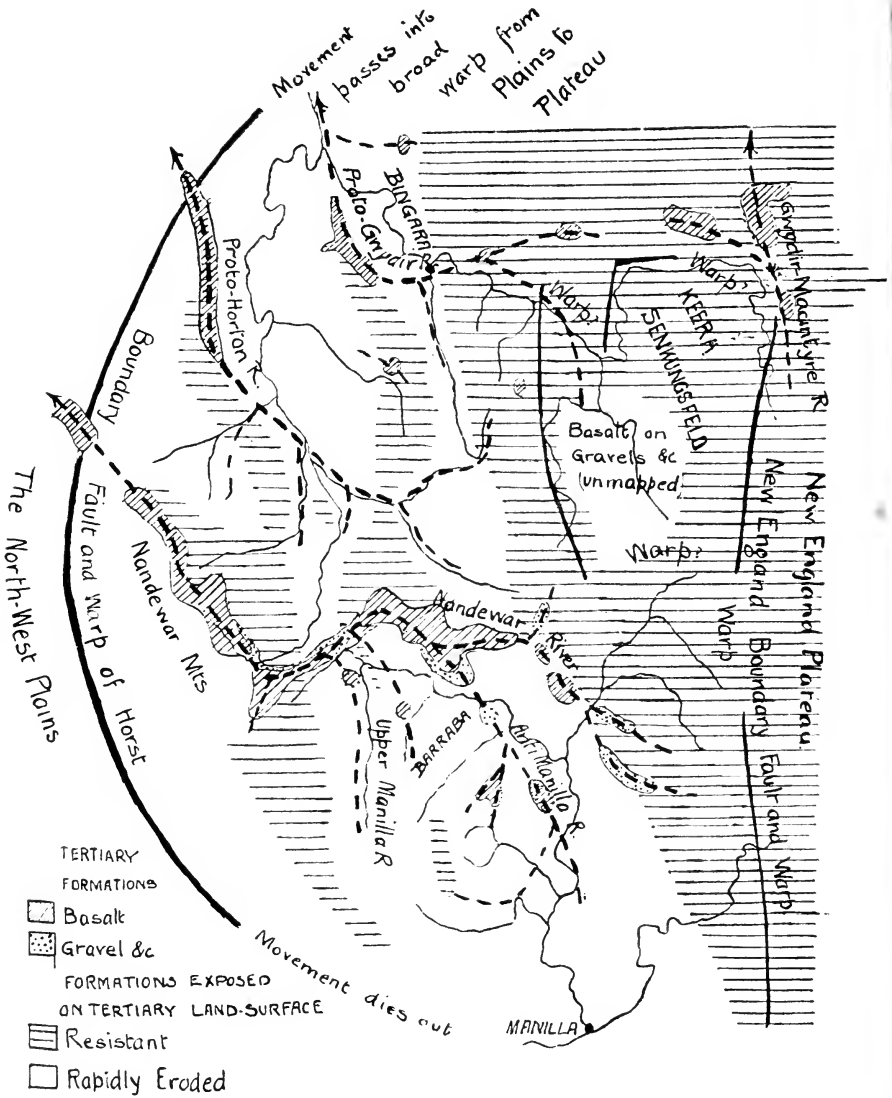

Text-fig. 10.

Attempted comparison of Tertiary and recent drainage.

manner of evolution of the former river-system into the present one. The Upper Manilla River being blocked by basalt, and reversed by the tilting, passed east "up" its old valley, as far as Barraba, the hinge-line in the tilting, and then continued "up" the now reversed Anti-Manilla River (See Text-fig.10). The waters which came down through the old gaps at Woods' Reef and Crow Mountain formed Ironbark and Crow Mountain Creeks, and joined the Lower Manilla River, which carried away the waters of the reversed Anti-Manilla River; Black Springs Creek, Tea-Tree Creek, and the intervening air-gap being the remnants of this old line of flow. The wavy course of the Lower Manilla River is due to the fact that the bars of resistant tuff run obliquely to the average direction of slope of the land-surface. The relative depression of the Namoi plains allowed the dissection of the Black Mountain and Baldwin Mountain regions, stripping off the soft Barraba mudstones, and laying bare the Baldwin Agglomerates, of which probably only a small amount was exposed in Tertiary times (See Text-fig.5). Upper Oakey Creek and Tarpoly Creek may be the entrenched descendants of the streams which formed the gravels on Mount Elijah. The lower portion of Borah Creek was deflected by the southerly slope into the Manilla River, and, as its upper portion cut lower and lower down into the mudstones covering the slopes of Black Mountain, it was pushed to the south along the sloping surface of the Baldwin Agglomerate; the point where it crossed the Baldwin Range could not move laterally, but could only cut deeper into that most resistant rock, and hence, perhaps, was produced the sharp northerly bend in the creek at the gorge. The uppermost portion of the Horton River, which flows south-east from Mt Kaputar, may be a deflection and reversal of the part of the Nandewar River now hidden beneath the adjacent basalts. Its diversion to the north, into the Horton valley, was probably the result of a capture by streams tributary to a second drainage-system produced by the modification of a Tertiary stream, the Proto-Horton, through aggradation, flooding with basalt, and differential elevation and erosion. Information to hand is insufficient to permit of discussion of this.

For a similar reason, we cannot profitably discuss the probable ancient river-systems of the regions east of the Serpentine Belt, a rough scheme for which is suggested by Dr. Taylor(46). It is evident that great rearrangements have taken place; but the investigation of these will require examination of the ancient gravels and basalts around Keera, and extensive topographic studies. It may be noted, however, that Mr. Cotton confirms Dr. Taylor's hypothesis of a former connection of the Gwydir River with the Macintyre to the north(37), and suggests that the deflection of the Gwydir into its present westerly course at Copeton, was due to the formation of the Keera Senkungsfeld. The study of this very sparsely inhabited region will yield much of interest physiographically.

ACKNOWLEDGMENTS.

It would scarcely have been possible, in the short time available for this work, to have covered so large an area of sparsely settled ground, were it not for the kind hospitality received by the writer at the different Station-homesteads. He is, on this account, greatly indebted to Mr. Capel, of Derra Derra, Miss Capel, of Rocky Creek, the late Mr. King, of Eulowrie, Mrs. Simpson, of Burindi, Mr. Geddes, of Hobden, Mr. Smith, of Borah, Mr. Glover, of Mundowey, Mr. Sutherland, of Crow Mountain, and Mr. Schloesser, of the Gulf Creek Copper Mine. For local information, he is indebted especially to Mr. Mack, of Pallal, Mr. Porter, of Tamworth, Mr. McClelland, of Dinoga, and to many others. The accounts and maps of the district given by Stonier were his constant guide, and the admirable reports of Stutchbury and Clarke, though not available while field-work was in progress, have since been most useful. Much help has been received from discussion of various points with Dr. Jensen, Mr. Andrews, Mr. Cotton, and Mr. Dun, who has greatly aided by palæontological determinations and references to literature. The information accumulated by the other officers of the Geological Survey, in some instances unpublished, has also been generously placed at the writer's disposal. Throughout, the interest and advice given by Professor David (at whose suggestion the work

was undertaken) have been a constant encouragement, for which the author is deeply grateful.

BIBLIOGRAPHY.

1. BENSON, W. N.—“The Geology and Petrology of the Great Serpentine-Belt of New South Wales.” Parts i. and iii. These Proceedings, 1913, pp.490-512, 662-724. Part v., *op. cit.*, 1915, pp.540-624.
 —————Spilite Lavas and Radiolarian Rocks in New South Wales. Geol. Mag., 1913, p.21.
2. MITCHELL, T. L.—Diary of an Exploring Expedition into the Interior of New South Wales in 1830-31. MSS. in the Mitchell Library, Sydney.
3. LEICHHARDT, L.—“Notes on the Geology of parts of New South Wales and Queensland made in 1842-3, translated by G. H. Ulrich, and edited by W. B. Clarke,” in Waugh’s Almanac, Sydney, 1867-8.
4. BLIGH, R.—“Report on the Bingara Goldfield.” Votes and Proc. Legislative Council of N. S. Wales, 1852.
5. CLARKE, REV. W. B.—“Report on the Geological Structure of the Western Slopes of New England.” Votes and Proc. Legislative Council, N. S. Wales, 1852, pp.585-612.
6. STUTCHBURY, S.—Reports on (a) The Geology of the Warrumbungle Mountains and Namoi River District; (b) Country between the Nandewar Ranges and the Condamine River. Votes and Proc. Legislative Council of N. S. Wales, 1853.
7. LIVERSIDGE, A.—“The Bingara Diamond-field.” Journ. Proc. Roy. Soc. N. S. Wales, 1873, pp.91-101.
 —————“Notes on the Bingara Diamond-field, with Notes on the Mudgee Diamond-field.” Quart. Journ. Geol. Soc., 1875, pp.489-492.
8. DE KONINCK, L. G.—“Recherches sur les fossiles paléozoïques de la Nouvelle Galles du Sud (Australie).” Mémoires de la Société Royale de Liège, 2^{me} Sér. Tome iii., 1876-7.
9. PITTMAN, E. F.—“Report on the Bingara and Ironbark Gold-fields.” Ann. Rept. Dept. Mines N.S.Wales, 1881, pp.141-143.
10. WILKINSON, C. S.—“The Bingara Diamond-field.” Ann. Rept. Dept. Mines N.S.Wales, 1886, p.129.
11. ANDERSON, W.—“Report on the Country in the immediate neighbourhood of the Bingara Diamond Mines.” Ann. Rept. Dept. Mines N. S. Wales, 1887, pp.156-159.
12. —————“The Geology of the Bingara and Barraba Gold-fields.” *Op. cit.*, 1888, pp.179-182.
13. ETHERIDGE, R., JUN., in Ann. Rept. Dept. Mines, 1891, p.268.
14. DAVID, T. W. E.—“Report on the discovery of Cinnabar at Bingara.” Ann. Rept. Dept. Mines, N. S. Wales, 1891, pp.234-239.

15. DAVID, T. W. E.—Presidential Address. Proc. Linn. Soc. N. S. Wales, 1893, p.606.
16. ————— “The Occurrence of Radiolaria in Palaeozoic Rocks in New South Wales.” Proc. Linn. Soc. N. S. Wales, 1896, pp. 555-556.
17. ————— (with PITTMAN, E. F.)—“On the Palaeozoic Radiolarian Rocks of New South Wales.” Quart. Journ. Geol. Soc., 1899, pp.18-19.
18. STONIER, G. A.—“Notes on the occurrence of Diamonds at Bingara.” Rec. Geol. Surv. N. S. Wales, 1894 (iv.), pp.51-56.
19. ————— “Report on the Bingara Diamond-Fields.” Ann. Rept. Dept. Mines N.S.Wales, 1894, pp.131-136.
20. ————— “Geological Report on the Slaughterhouse Creek District.” *Op. cit.*, 1895, pp.160-162.
21. ————— Geological Report on Crow Mt. *Op. cit.*, pp.167-170.
22. ————— Report on the Country between Moree and Warialda. *Op. cit.*, pp.171-172.
23. PITTMAN, E. F.—Report on the Country between Narrabri and Moree. *Op. cit.*, p.121.
24. JUDD, J. W.—“On some simple Massive Minerals (Crystalline Rocks) from India and Australia.” Mineralogical Magazine, 1895, p.63.
25. PORTER, D. A.—“Notes on Minerals and Mineral-Localities of Northern New South Wales.” Journ. Proc. Roy. Soc. N. S. Wales, 1884, pp.75-80; 1888, pp.78-88; 1894, pp.39-44.
26. CURRAN, REV. J. M.—“On the Occurrence of Precious Stones in New South Wales.” Journ. Proc. Roy. Soc. N. S. Wales, pp.227, 247-249.
27. PITTMAN, E. F.—The Ruby Hill Mine. Ann. Rept. Dept. Mines N. S. Wales, 1900, pp.180-181.
28. CARD, G. W.—“An Eclogite-bearing Breccia from the Bingara Diamond-Field.” Rec. Geol. Survey N. S. Wales, Vol. vii., p.39.
29. ————— and DUN, W. S.—“Diatomaceous Earth Deposits of New South Wales.” Rec. Geol. Survey N. S. Wales, Vol. v., Pt. 3, pp.128-148.
30. CARNE, J. E.—“The Copper Mining Industry of New South Wales.” Mineral Resources, Dept. of Mines of N.S.W., No.6. 1899. (Second Edition, 1908).
31. JENSEN, H. I.—“The Geology of the Nandewar Mountains.” Proc. Linn. Soc. N. S. Wales, 1907, pp.842-914, especially p.856.
32. ANDREWS, E. C.—“The Tertiary History of New England.” Records Geol. Surv. N. S. Wales, Vol. vii., Pt. 3, pp.29-31, 50-51.
33. ————— “The Geology of the New England Plateau, with special reference to the Granites of Northern New England.” *Op. cit.*, Vol. viii., Pt. 2, pp.108-129.

34. ANDREWS, E. C.—Annual Report of the Dept. of Mines of N. S. Wales, 1908, p.108.
35. HARPER, L. F.—*Op. cit.*, 1909, p.183.
36. DUN, W. S.—*Op. cit.*, 1909, p.190.
37. COTTON, L. A.—“The Diamond-Deposits of Copeton, N.S.W.” Proc. Linn. Soc. N. S. Wales, 1914, pp.803-838.
38. MINGAYE, J. C. H.—Annual Report of the Department of Mines, 1907, p.182.
39. CROSS, W.—Fourteenth Annual Report of the United States Geological Survey. Part ii., 1893, p.165.
40. ANDREWS, E. C.—“The Geographical Unity of Eastern Australia.” etc. Journ. Proc. Roy. Soc. N. S. Wales, 1910, p.479.
41. OSBORNE, MRS. E. M.—“Preliminary Observations on an Australian Zygopteris.” Proc. British Assoc. Advancement of Science, 1915.
42. POWELL, H. W.—Sketch of Columnar Basalt on the Horton River, near Lindesay Station. Rec. Geol. Survey N. S. Wales, Vol. i., p.31, Plate iv.
43. CARD, G. W.—“Oolitic Limestone from Lion Creek, Stanwell, near Rockhampton.” Geol. Survey of Queensland, Bulletin No. 12, 1900, p.31.
44. ETHERIDGE, R., JUN.—“Additions to the Middle Devonian and Carboniferous Corals in the Australian Museum.” Rec. Aust. Mus., Vol. iv., No.7, p.262.
45. VAUGHAN, A. (with Prof. S. H. REYNOLDS)—“The Avonian of Burrington Coombe, Somerset.” Quart. Journ. Geol. Soc., 1911, p.389.
46. TAYLOR, T. G.—“The Physiography of Eastern Australia.” Bulletin No. 8, Commonwealth Bureau of Meteorology, p.12, figs.16 and 18, B.C. Also TAYLOR (and WOOLSOUGH, W. G.), The Geography of New South Wales (Whitcomb & Toombs), pp.70 and 103.
47. PITTMAN, E. F.—Mineral Resources of New South Wales, 1900, p.426.

EXPLANATION OF PLATES XVIII-XX.

Plate xviii.

Topographical Map of the Western Slopes of New England.

Plate xix.

Geological Map of the Western Slopes of New England, reprinted from Part i. of this series. It must be noted that some modification of the geology of the Tamworth region has been made in Part v. of this series. See these Proceedings, 1915, Plate I.

Plate xx.

Geological Sections.

STUDIES IN AUSTRALIAN *MECOPTERA*.

NO. i. THE NEW FAMILY *NANNOCHORISTIDÆ*, WITH DESCRIPTIONS OF A NEW GENUS AND FOUR NEW SPECIES: AND AN APPENDIX DESCRIPTIVE OF A NEW GENUS AND SPECIES FROM NEW ZEALAND.

BY R. J. TILLYARD, M.A., B.Sc., F.L.S., F.E.S., LINNEAN MACLEAY FELLOW OF THE SOCIETY IN ZOOLOGY.

(Plates xvi.-xvii.; and three Text-figures.)

INTRODUCTION.

The Order Mecoptera comprises the peculiar insects commonly known as Scorpion-flies, because of the large forcipate appendages of the male. These, in some of the commonest genera, are carried curved dorsally over the end of the abdomen, thus simulating the corresponding well-known attitude of the scorpion. Originally regarded as merely a family (*Panorpidæ*) within the old heterogeneous Order Neuroptera, these insects were first raised to the dignity of a separate Order by Brauer, under the designation Panorpatæ, in 1885. The following year, Packard issued his equally famous classification of the Insecta, in which he also placed them as a separate Order, with the name, Mecoptera. It being agreed upon that all Orders of Pterygote Insects should have names terminating in “-ptera,” Packard’s name has in general been adopted in place of Brauer’s, and has been equally generally altered to Mecoptera, the original name having been badly derived (Greek *μηκος* = length). Though some of the more conservative of entomologists still refuse to recognise these insects as constituting a distinct Order (see, for instance, Sharp in “Cambridge Natural History, Insects, Part i.,” p.449), yet such an attitude is quite inconsistent with the opinions of all

close students of the Order, and with a host of striking facts now available to support them. As an example of the trend of the most advanced opinion on the subject, we may cite Handlirsch,* who not only makes out a strong case for their close relationship with the Trichoptera, Lepidoptera, and Diptera, but would even derive each of these three Orders separately from the older Mecoptera! This relationship is signalised by him in the elevation of the group comprising these four Orders into a Sub-Class, Panorpoidea. How far this is justified is a question that I hope to go into in detail in a future paper. Very weighty arguments would have to be brought forward in order to disprove the extremely strong case set out by Handlirsch. In any case, whether one accepts the Sub-Class Panorpoidea as valid or not, the separation of the Scorpion-flies into a distinct Order would seem at the present time to rest on absolutely unassailable foundations.

The Order Mecoptera, though abundant enough in some parts of the world in individuals, is yet a very small one in the number of its genera and species. Esben-Petersen, in his synonymic list published in 1915,† gives a total of three families, fifteen genera, and one hundred and sixty-two species. As most of the species are of moderate size, readily observed and easily caught, it seems unlikely that the world contains more than two hundred and fifty, or, at the most, three hundred, representatives of this ancient Order.

Comparatively scarce as they are now, yet the fossil record would lead us to believe that these insects were more abundant in past ages. Quite a number of fossil wings, of which the well-known *Orthophlebia* may be cited as an example, are now considered to be Mecopterous. They are found chiefly in the Liassic and Jurassic strata. Recently‡ I have described a wing belonging to this Order from the Triassic beds of Ipswich, Queensland,

* "Die Fossilen Insekten," pp.1252-1271.

† "A Synonymic List of the Order Mecoptera." Entom. Meddelelser, 10 Bind, 5 Hefte, 1915, pp.216-242.

‡ Queensland Geol. Survey, 1916. Publication No. 253, p.29 (*Mesochorista proavita*).



and I have others, as yet undescribed, from the Wianamatta shale-beds at Narellan, near Camden, N.S.W. More interesting still is an undoubted Mecopterous wing from the Permo-Carboniferous beds of Belmont, near Newcastle, N.S.W., which I hope to describe shortly, and which is the first record of the existence of a Holometabolous Insect in Palæozoic times.

In Australia, so far, only seven species have been recorded, belonging to four genera. In the spring and early summer, the species of the genus *Harpobittacus* are commonly to be met with flying rather lazily over bracken, grass, or low herbage, or visiting tea-tree blossom in search of insects for food. These insects are easily recognised owing to their general resemblance to the *Tipulidæ* or Crane-flies. In the autumn, the much rarer insects of the subfamily *Choristinae* appear. They are of very sluggish flight, and must be searched for in the neighbourhood of fresh water, amongst bracken or in partially dry reedy places. They are very rare in collections, and it seems probable that a number of new species still await discovery. The following is a list of the known Australian species:—

Family *Panorpidae*, subfamily *Choristinae* :

1. *Chorista australis* Klug (= *Euphania luteola* Westwood).
2. *Chorista ruficeps* Newman.
3. *Tæniochorista pallida* Esb.-Pet.

Family *Bittacidæ* :

4. *Bittacus microcercus* Gerst.
5. *Harpobittacus australis* Klug (= *Bittacus corethriarius* Ramb., = *B. intermedius* ♀ Selys).
6. *Harpobittacus tillyardi* Esb.-Pet. (= *Bittacus australis*, as used by Froggatt in "Australian Insects").
7. *Harpobittacus nigriceps* Selys (= *Bittacus intermedius* ♂ Selys).

The above list and synonymy are taken from Esben-Petersen's work. *Bittacus microcercus* Gerst., is unknown to me.

As long ago as January, 1916, I received from Dr. A. J. Turner a single female specimen of a remarkable Mecopterous insect of very small size, collected by him in Ebor Scrub (5,000

feet). This insect had the head, thorax, and abdomen of a Dipteron, and its mouth-parts also appeared to resemble those found in the same Order. Only the wings showed it to be truly Mecopterous, though even in these some striking differences were to be noted from the more typical wing-plan of the Order. For instance, the presence of a frenulum on the hindwing, and the absence of the first apical fork in both wings (a character found also throughout the Diptera Brachycera) were points of the greatest interest. It remained, therefore, to discover the male of this wonderful insect, in order to see whether it possessed the typically enlarged forcipate appendages of the Mecoptera.

In October last, Mr. G. H. Hardy, of the Tasmanian Museum, Hobart, captured a number of both sexes of a species very closely allied to the Ebor specimen, and sent them to me for determination. As these were found quite close to Hobart, I at once wrote and urged him to obtain more, and to try to observe some of the habits of the insect. Mr. Hardy became fully seized with the importance of his discovery, and spent all his available time in October and November searching for it, in company with another collector, Mr. Clive Cole. I cannot do better than quote his remarks:—

“The insects were taken near Hobart (off the Strickland Avenue) in a little water-course which flows from the leakage of a portion of the Hobart Waterworks scheme. This overflow keeps the course running throughout the year. It also drains the local land. The specimens were taken partly on the wing, and partly by sweeping. Cole, who relies upon sweeping, has taken only male specimens so far, but I have taken both sexes, both on the wing and by sweeping. One stump of a tree that has thrown out shoots seems to harbour a quantity of the insect, and from this the majority of the insects were taken.”

“They are very active and quick-running, taking to the wing readily. The only hope of taking the specimens by sweeping is to dig the net as far down to the roots of the shrub as possible. The disturbed specimens run up and may be caught on the third or fourth sweep in the same spot. One specimen, running

actively over a leaf, allowed me to place a tube over it, and did not attempt to fly or drop.

"I could see nothing to attract the insects to this particular stump more than any other, so presume they were emerging there. Nearly all the specimens were taken between 12 and 1 solar time."

The locality here described was visited by Mr. Hardy and myself towards the end of January of this year, and I can fully bear out Mr. Hardy's excellent description. The insects were evidently over, as we failed to find any of them after prolonged search. A few days later we visited a similar water-channel near the Springs on Mount Wellington (3,000 feet level), and captured a number of the same species in a closely similar situation, viz., by beating tea-tree bushes overhanging the water-channel.

On January 10th of this year, Mr. Hardy and I visited Cradle Mountain, an unworked locality in the north-west of Tasmania. The collecting-ground lies between the 3,000 and 4,000 feet levels, and contains numerous lakes and swift mountain-streams. Two new species closely allied to the Hobart form were obtained here. Some of these were obtained by sweeping bushes overhanging streams, but the majority were got by sweeping the low bushes and herbage fringing the shores of Lakes Lilla and Dove. Occasionally also, we noticed the insects on the wing. Their flight is fairly strong, and they are not easy to capture, owing to their inconspicuousness. We also noticed the peculiar method of copulation, which resembles that of the *Asilidae* very closely. If a male and a female be put alive into a glass tube, the male at once seizes the female fiercely with his anal forceps, taking hold of her in any position haphazard. He then quickly moves his appendages to the posterior end of the body of the female, opening the forceps to a great width, and then closing them quickly upon the tip of her abdomen. The result is a lock-grip, the two insects facing in opposite directions. When once the male has got his correct hold, no amount of annoyance will persuade him to let go. The pairs could even be killed in the cyanide bottle without always relaxing their grip.

Several gravid females were taken, but we could not persuade them to lay any eggs. All attempts at unravelling the life-history have so far failed. All we can be certain of is that the larval stage must be either aquatic or semi-aquatic, since the insects are confined to the neighbourhood of water. The presence of cerci in the female suggests that the eggs are carefully placed, either upon moist ground, or upon the stems of plants fringing the water-courses or the borders of lakes.

These insects differ so greatly from all existing Mecoptera that I have no hesitation in placing them in a new family, which will contain a single new genus and four new species.

Family NANNOCHORISTIDÆ, fam. nov.

(Text-fig.1).

Mecopterous insects of small size (expanse of wing 11-18mm.). *Head* small and globular, with large compound eyes and three ocelli. *Antennæ* (Plate xvii., fig.6) elongated, composed of 22-25 joints, of which the first two are stouter than the rest, the third slender and much elongated. *Mouth-parts* very remarkable (Plate xvii., figs 7-9). Labrum and epipharynx (Fig.7, *lbr*, *ep*) forming a sharply projecting beak, somewhat more prominent in the female than in the male; the epipharynx is fused basally to the underside of the labrum, but separable from it at the tip. Mandibles (Fig.7, *md*) vestigial, weakly chitinised triangular pieces at the sides of the labrum, without teeth. Maxillæ (Figs. 8, 9) well-developed, with small cardo (*c*) and elongated stipes (*st*). Maxillary palpi (*mep*) long, five-jointed, hairy, the basal and terminal joints somewhat swollen, the others subcylindrical. The third joint carries a conspicuous disk-like sense-organ (*so*) ringed with black chitin, and bearing on its face numerous minute pits. Inner lobe of maxilla (*il*) an elongated piece of delicate, almost colourless chitin, carrying rows of closely-set delicate hairs; the tip rounded. In their natural position, the two inner lobes are held with their distal ends in contact in a vertical plane, lying above and upon the proboscis, so that they may possibly help to form a sucking-tube with the latter organ. These lobes appear *in situ* as part of the proboscis, and might

well be mistaken for a hypopharynx, but dissection soon reveals their true nature. Labium (Fig.8) with well-developed submentum (*sm*) and mentum (*m*), no palpi. The distal end of the labium is produced into a very distinct proboscis, the two halves of which are only partially fused; their distal portions form a large bifid labellum (*lb*) carrying short hairs and bristles set in conspicuous chitinous pits with raised rims. The proboscis is probably formed by the two paraglossæ.

Thorax: *prothorax* rather small. *Pterothorax* large and strongly built, the mesothorax larger than the metathorax. *Legs* long and slender, the coxæ immense, the femora long and fairly broad, the tibiæ long and slender, with a pair of short spurs at the distal end; tarsi five-jointed, slender, the first joint very long, claws and empodium small.

Wings in repose held over the back of the abdomen in the form of a steep roof or tent (much as in *Hemerobiidae*). *Wing-membrane* covered all over with an immense number of minute hairs or *microtrichia*; larger bristle-like hairs or *macrotrichia* are present along all the veins, and also form a dense short fringe all round the wing, but are absent from the wing-membrane itself, except on the pterostigma, where they encroach slightly inwards from the border. *Venation* (Text-fig.1) open, regular, fore- and hindwings subequal, the distal portions closely similar, but the basal venations showing considerable differences. Sc shortened. A distinct but weakly chitinised pterostigma present between the distal end of R_1 and the wing-border. R_{2+3} unbranched, and hence first apical fork absent in both wings (*cf.* Diptera Brachycera). Discoidal (*dc*) and median (*mc*) cells present, closed. Second (Af_2), third (Af_3), and fourth (Af_4) apical forks present. Thyridium (*t*) at about middle of wing. Cubital fork (*cuf'*) near base; from it Cu_1 arches up to fuse with the main stem of M for some distance; this stem is continued in a direct line by Cu_1 as a strong convex vein, while M arches away from it anteriorly, branching into two at *t*. In hindwing, Cu_2 fuses with 1A soon after leaving *cuf'*. *Coupling apparatus of wings* (Plate xvii., fig.10) consisting of a very distinct *frenulum* (*fr*) in hindwing, formed of a small jugal process carrying two

strong bristles, and an equally strong *jugal bristle* (*jb*) on the forewing. In flight, the bristles of the frenulum engage the underside of the basal posterior portion of the forewing (as in *Planipennia* and some *Lepidoptera*), while the jugal bristle lies dorsally over the costal margin of the hindwing.

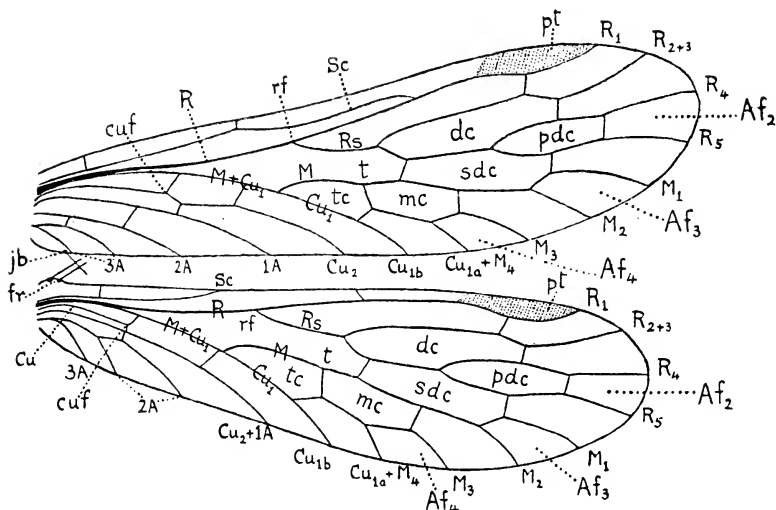

Text-fig. 1.

Wing-venation of *Nannochorista dipteroides*, n.g. et sp. Comstock. Needham nomenclature and notation. Af₂, Af₃, Af₄, second, third, and fourth apical forks; *cuf*, cubital fork; *dc*, discoidal cell; *mc*, median cell; *pdc*, post-discoidal cell; *pt*, pterostigma; *rf*, radial fork (origin of Rs); *sdc*, subdiscoidal cell; *t*, thyridium (medium fork); *tc*, thyridial cell.

Abdomen of male subcylindrical, of female somewhat enlarged towards middle, then tapering towards tip. Nine well-formed segments present, and vestiges of a tenth, with small cerci, two-jointed in male (Plate xvii., fig. 11, c), three-jointed in female (fig. 12, c). In male, seg. 9 is swollen to form the enlarged base of the *claspers*, which are of the typical *Panorpid* form, but are not arched dorsally over the abdomen, as in *Panorpa* and allied genera. *Genital pore* of male covered by a pair of

partially fused *valves* (fig.11, *v*); the ninth segment ends dorsally in a median bilobed appendage of small size, situated between the base of the claspers. In female, seg. 8 carries a pair of ventral gonapophyses (fig.12, *gp*) with pointed, curved ends; these form the ovipositor. Seg. 9 is normal; seg. 10 very short, carrying the small but distinct cerci (*c*).

Genus NANNOCHORISTA, n.g.

(Plates xvi.-xvii.)

Characters as in the family, to which may be added:— Hindwing slightly shorter and narrower than forewing; base of hindwing very distinctly narrower. Sc in forewing ending at or a little before two-thirds of the wing-length, either upon R_1 (Plate xvi., figs. 1, 3, 4) or upon C (fig.2); in the former case, the pterostigma remains open basally; in the latter, it is closed basally by the upcurved end of Sc and a small cross-vein descending from it upon R_1 . Between C and Sc in forewing, two constant cross-veins. Sc in hindwing very short, ending upon C either above or before the level of the origin of Rs (this character is variable for individuals of the same species). Pterostigma supported below by a single constant cross-vein descending upon the discoidal cell (*dc*). Second apical fork (Af_2) always divided by a single constant cross-vein, which therefore closes distally a single *post-discoidal cell* (*pdcc*) situated beyond and below *dc* close to the apex of the wing. Below *dc* and γdc , a *sub-discoidal cell* (*sdc*) is closed off by two constant cross-veins, the first descending from R_{4+5} upon M_{1+2} somewhat distad from *t*, the second descending from R_5 upon M_1 at about the middle of the length of *pdcc*. *Thyridium* or median fork (*t*) placed somewhat distad from level of *rf*, but before the beginning of *dc*. Median cell (*mc*) completely closed, with Af_3 stalked, but Af_4 sessile upon it. Below and a little before the level of *t*, Cu_1 forks, sending out an oblique upward branch Cu_{1a} which fuses with M_{3+4} , thereby completing the closure of the thyridial cell (*tc*). At the thyridium, the pigmentation of the wing-veins is interrupted for a short distance, so that there appears to be a short break in the three veins meeting at this point; this formation I propose to

term the *thyridial hiatus*. It is more conspicuous in the forewing than in the hind. In forewing, near base, there are cross-veins between Cu_2 and 1A, between 1A and 2A, and (close up to base) between 2A and 3A: 3A is branched. In hindwing, there is a cross-vein from 1A to 2A, just below *cuf*; 2A is branched, 3A simple.

Genotype, *Nannochorista dipteroides*, n.sp. (Hobart and Mount Wellington, Tasmania).

1. NANNOCHORISTA DIPTEROIDES, n.sp.

(Plate xvi., fig.1).

♂. Total length 4, abdomen 2.7, forewing 6.5, hindwing 5.7, expanse 13 mm.

Head medium brown, eyes very dark brown, vertex and ocelli black. Antennae 3 mm., scape, pedicel, and base of third joint brownish, rest black. Mouth-parts brownish, of the form described above (under characters of the family).

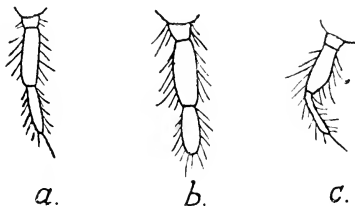

Text-fig.2.

Thorax black, a tinge of reddish-brown near wing-bases. Legs pale semi-transparent brownish, slightly darkened distally on each segment; tarsi darker.

Abdomen: 1-8 black, with a slight tinge of reddish-brown at extreme base; all segments furnished with short pale hairs. Segs. 9-10 and claspers rich brown, with hairs of same colour.

♀. Total length 6.7-5, abdomen 4.5-5.5, forewing 7-8, hindwing 6-7, expanse 14.5-17 mm.* Head and thorax as in male, except that the labrum and epipharynx are slightly longer. Abdomen shining black; cerci shaped as in Text-fig. 2, a

* In all the species, the variation in size of the females is very great, necessitating the giving of limiting measurements. On the other hand, the males vary very little in size, so that an average measurement will suffice.

Cerci of female in *Nannochorista*.—a, *N. dipteroides*; b, *N. holostigma*; c, *N. eboraca*; ($\times 46$).

Hab.—Hobart (October-November), Mount Wellington (January). On bushes at the sides of small watercourses.

Type s, ♂♀, and series of paratypes in Coll. Tillyard (Hobart, October-November, 1916, taken by Messrs. G. H. Hardy and C. Cole).

2. NANNOCHORISTA HOLOSTIGMA, n.sp.

(Plate xvi., fig.2).

Total length, ♂ 4·8, ♀ 6·8; *abdomen*, ♂ 3, ♀ 4·5-5·7; *forewing*, ♂ 6, ♀ 7·8-5; *hindwing*, ♂ 5·2, ♀ 6·7-5; *expanse*, ♂ 12·5, ♀ 14·5-17·5 mm.*

Closely resembles *N. dipteroïdes*, from which, however, it may be at once distinguished as follows:— In forewing, Sc ends up on C, not on R₁, and the pterostigma is completely closed proximally by a small cross-vein descending from Sc to R₁. Wings slightly broader and generally somewhat less hyaline than in *N. dipteroïdes*; most of the cross-veins in the forewing usually distinctly clouded. Legs with a black spot on each trochanter, a black blotch distally on each femur. Segs.9-10 and claspers of ♂ rich red-brown, larger than in *N. dipteroïdes*. *Cerci* of ♀ as in Text-fig.2, b.

Hab.—Shores of Lakes Lilla and Dove, Cradle Mountain, N.W. Tasmania (3,000 feet). Also a few specimens from bushes overhanging the creeks. January, 1917.

Type s, ♂♀, and series of paratypes, in Coll. Tillyard.

3. NANNOCHORISTA MACULIPENNIS, n.sp.

(Plate xvi., fig.3).

♂ (unique). *Total length* 4·2, *abdomen* 2·7; *forewing* 5·5, *hindwing* 4·7, *expanse* 11·4 mm.

This very distinct species differs from *N. dipteroïdes* as follows: *Head* entirely black; *antennæ* 2·7 mm, 22-jointed, black, third joint not much elongated. *Thorax* and *abdomen*: 1-8 jet black, 9-10 and claspers dark brown, large, blunter than in *N. dipteroïdes*.

* In all the species, the variation in size of the females is very great, necessitating the giving of limiting measurements. On the other hand, the males vary very little in size, so that an average measurement will suffice.

oides, somewhat hairy. *Wings* distinctly shorter and more rounded at apices than in the other species; forewing heavily clouded with greyish-black upon all the cross-veins and junctions of the veins, as shown in Plate xvi., fig.3. Hindwing with cross-veins near middle of wing lightly clouded.

Hab.—Crater Lake Creek, Cradle Mountain, N.W. Tasmania (3,500 feet). A single male, beaten out of a bush by Mr. G. H. Hardy, January 16th, 1917.

Type, ♂ in Coll. Tillyard.

4. NANNOCHORISTA EBORACA, n.sp.

(Plate xvi., fig.4).

♀ (unique). *Total length* 6, *abdomen* 4, *forewing* 7·5, *hindwing* 6·5, *expanse* 15·5 mm.

Head reddish-brown, vertex and ocelli shining black; *antennae* 4 mm., scape and pedicel reddish-brown, rest black, third joint long. Eyes black; mouth-parts blackish. *Thorax* dark shining brown. *Legs* very slender, semi-transparent pale brownish, tarsi somewhat darker. *Wings* rather elongated, slightly clouded, as shown in Plate xvi., fig.4. *Abdomen* very dark shining brown. *Cerci* with slender elongated third joint, as shown in Text-fig.2, c.

Closely resembles *N. dipteroïdes* ♀, but can be distinguished from it at once by the form of the cerci.

Hab.—Ebor Scrub, N.S.W. (5,000 feet). A single female taken by Dr. A. J. Turner, F.E.S., on January 11th, 1916.

Type, ♀ in Coll. Tillyard.

Nannochorista is an example of a highly specialised reduced type based upon a very archaic foundation. I am not able to indicate the existence of any close relatives of it at the present day, though it seems highly probable that a careful study of the small Liassic wing-types, such as *Orthophlebia*, might reveal its ancestry. In order to appreciate the value of *Nannochorista* to the student of the phylogeny of the Panorpid Orders, it would be best to deal separately with certain of the archaic and ceno-genetic characters presented by it

Archaic Characters.

1. *Method of folding the wings.* - The high roof-like manner of folding the wings is probably the original manner for the ancestor of all the Panorpoid and Neuropterous (s.str.) groups. It is still retained in the Megaloptera, most of the Planipennia, in many Trichoptera, and in some ancient Lepidoptera, e.g., the *Hepialide*.

2. *The presence of a wing-coupling apparatus, with frenulum well developed.* - I have already shown that most Planipennia possess this coupling-arrangement for the wings. As is well known, the majority of Lepidoptera also possess a well-developed frenulum. Now the same structure turns up in the Mecoptera! Although not before recorded for this Order, its presence in *Nannochorista* led me to examine carefully the other representatives of the Mecoptera in my collection. In the *Choristinae*, I find a definite jugal process present on the hindwing, with a distinct frenulum of two bristles. On the forewing, instead of the single strong jugal bristle of *Nannochorista*, there is a bunch or pencil of stiff bristles of smaller relative size. A small frenulum is present at the extreme base of the hindwing in *Panorpa*, also in *Harpobittacus*.

Two important conclusions follow from this :—

a. That the equality and independence in flight of fore- and hindwings in recent Mecoptera, such as *Bittacus*, is *not primitive*, as Handlirsch supposed, but a secondary development from an original condition in which the wings acted together in flight, the connection being made by means of the frenulum and jugal lobe.

b. That the frenulum is an archaic structure which was present in the ancestral form of the Panorpoid Orders, and consequently the main stem of the Lepidoptera must be the *Frenatae*, with the *Jugatae* as an archaic side-branch with specialised wing-connection. I shall have more to say upon this in a future paper, when dealing with the origin of the Lepidoptera.

3. *The probable aquatic or semi-aquatic life-history.*—Much evidence can be brought forward to show that the ancestors of

the Panorpid and Neuropterous (s.str.) Orders were originally semi-aquatic. The habit is still retained by *Nannochorista*, and probably also by the *Choristinae*, in Mecoptera, by the *Tipulidæ* and many other families in Diptera, by the *Chauliodinæ* in Megaloptera, and by the *Osmylidæ* in Planipennia. From such an archaic form of life-history, the development of true aquatics (e.g., *Sialinæ*, Trichoptera), of false aquatics (e.g., *Culicidæ*), and of land-dwellers is easily traceable.

Cænogenetic Characters.

1. *Reduction in size.* - *Nannochorista* is by far the smallest of all existing Mecoptera. The reduction closely parallels that of many Dipterous families, e.g., the relationship of *Nannochorista* to *Panorpodes* and allies is closely analogous to that between *Culicidæ* and *Tipulidæ*.

2. *Loss of macrotrichia from wing-membrane.*—Almost all Mecoptera show macrotrichia more or less abundantly upon the wing-membrane. In *Nannochorista*, the wing-membrane resembles that of many Diptera and Hymenoptera, a state that may also be due to the elimination of macrotrichia.

3. *Reduction of the sub-costal vein.*—This is especially evident in the hindwing. Compare the hindwing of Lepidoptera.

4. *Loss of first apical fork.*—This is unique amongst Mecoptera, but is the normal condition throughout the whole of the Diptera Brachycera.

5. *Highly specialised condition of fusion between M and Cu₁.*—The amount of fusion between these two veins, and the far distal position of the departure of M from M + Cu₁, are quite unique in Mecoptera. It seems to me that a similar condition exists in the Hymenopterous wing, and that the homologies of the veins in that Order could be determined by reference to an original Panorpid-like ancestor, in which a similar fusion had become a fixed character; and, on this fusion, all later developments must have been based.

6. *High specialisation of mouth-parts.*—The great reduction of the mandibles, the formation of the sharply-pointed labrum-

epipharynx, and the presence of a definite proboscis with bilobed labellum, are unique in Mecoptera. Here is a development closely parallel to that of the Diptera. Compare, for instance, the mouth-parts of *Nannochorista* with those of the *Blepharoceridae* (see Kellogg, "Genera Insectorum, Fasc. 56, *Blepharoceridae*").

In conclusion, it seems clear that the discovery of this remarkable new type of insect is of the greatest interest to students of all the Panorpid Orders, and cannot fail to influence very greatly our views upon the phylogeny of the Lepidoptera and Diptera, as well as radically altering our conception of the Mecoptera as an Order preserving an original freedom of action between fore- and hindwings.

APPENDIX.

After completing my work on the *Nannochoristidae*, it occurred to me that it was very likely that these remarkable insects might be found in New Zealand as well as in Tasmania. I therefore sent out pairs of cotypes from my series to several correspondents in the Dominion. In reply, I received from Mr. A. Philpott, F.E.S., of Invercargill, a pair of a very fine species, which he had taken in 1913, and had put by in his collection, thinking that it was some peculiar or aberrant form of Lacewing.

A study of these insects reveals the fact that they are very closely allied to the Tasmanian forms, but are even more reduced as regards their venation. I think it best to place them in a new genus, the definition of which is here given, together with a description of the new species, and a Text-figure of the wings (Text-fig. 3).

Genus CHORISTELLA, n.g

Insects of the general size, appearance, and structure of *Nannochorista*, but differing from that genus as follows:—

Wings somewhat broader and shorter than in *Nannochorista*: the second apical fork (between R_1 and R_2) not divided into two

cells by a cross-vein, but simple, as in Trichoptera, Lepidoptera, and Diptera. Median cell shorter and broader than in *Nannochorista*; the three veins running into the thyridium becoming hyaline at that point, (as in *Nannochorista*, but less markedly so) so as to form a *thyridial hiatus*. Sc ends up with a curve upon R, in the forewing, not far from the pterostigma; in hindwing, Sc is very short, and ends upon the costal border well before the origin of Rs.

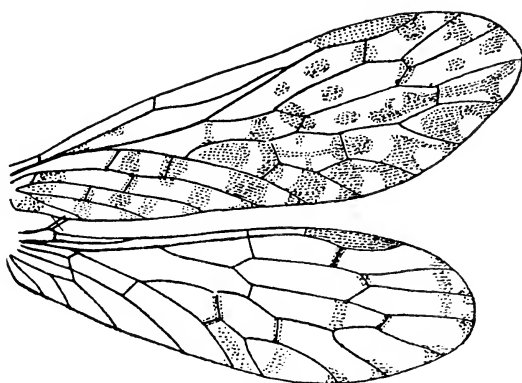

Text-fig. 3.

Choristella philpotti, n.g. et sp. Wings of male; ($\times 12$).

Antennæ with 23-24 joints, the first two short and stout, the third much longer and slenderer, the rest shorter than the third, slender and equal to one another. Maxillary palps five-jointed in both sexes, slender, slightly hairy.

Genotype, *Choristella philpotti*, n.sp.

CHORISTELLA PHILPOTTI, n.sp.

Total length, ♂ 5, ♀ 6; abdomen, ♂ 3, ♀ 4; forewing, ♂ 6, ♀ 8.5; hindwing, ♂ 5.3, ♀ 7.5; expanse, ♂ 12.5, ♀ 17.5 mm.

Head brown; eyes and antennæ dark brown. Thorax blackish. Legs brown, with darker femora. Wings hyaline, the forewing marked all over with semi-transparent blotches of dull brownish, as shown in Text-fig. 3; hindwing slightly clouded

with brown at the points of union of the veins with the apical and posterior margins, and upon the cross-veins. *Frenulum* well-developed, with two strong bristles in the male, and a third somewhat shorter bristle also present in the female

Abdomen cylindrical, shiny black with pale pubescence. Segment 9 and *anal appendages* brown, the latter shaped very much as in *Nannochorista maculipennis*.

Types, in Coll. Tillyard. A male and a female, collected by Mr. A. Philpott.

Loc.—The male from Queenstown, N.Z., taken on December 20th, 1913; the female from Longwoods, N.Z., on December 5th of same year.

Hab.—South Island of N.Z. I have little doubt that this insect would be found in any of the mountainous regions of the South Island, especially along the borders of lakes and small mountain-streams.

The insect is dedicated to Mr. A. Philpott, who is to be congratulated upon this fine discovery. No doubt other species will be found in New Zealand, as soon as collectors get to know the appearance of the insect, and its most likely haunts.

The bearing of this discovery upon the Antarctic Theory as advocated by Mr. Hedley, is obvious. A highly specialised derivative from a very ancient stock, and quite unlike anything else known to exist in any other part of the world, the *Nannochoristidae* form one of those test-groups upon which the Theory may be found either to stand or fall. The distribution of this family, so far as at present known, in Tasmania, the Eastern Highlands of Australia, and in New Zealand, can only be explained by dispersal from an original common Antarctic ancestor. If another form belonging to this family were to be found in South Chili or Patagonia, the evidence would be complete: but it seems almost hopeless to expect this region to be well searched for such out-of-the-way insects, for a very long time to come.

In the loss of the cross-vein dividing the second apical fork, *Choristella* is the most highly specialised of all Mecoptera, and approaches very closely to the venational type of the Diptera Brachycera.

EXPLANATION OF PLATES XVI.-XVII.

Plate xvi.

- Fig. 1.—*Nannochorista dipteroides* ♂, n.g. et sp.: ($\times 8\frac{1}{2}$).
 Fig. 2.—*Nannochorista holostigma* ♂, n.g. et sp.: ($\times 8\frac{1}{2}$).
 Fig. 3.—*Nannochorista maculipennis* ♂, n.g. et sp.: ($\times 8\frac{1}{2}$).
 Fig. 4.—*Nannochorista choraca* ♀, n.g. et sp.: ($\times 8\frac{1}{2}$).

Plate xvii.

- Fig. 5.—*Nannochorista holostigma* ♂, n.g. et sp.: ($\times 9\frac{1}{2}$). In position of rest.
 Fig. 6.—*Nannochorista holostigma* ♂, n.g. et sp. Antenna: ($\times 28$).
 Fig. 7.—*Nannochorista dipteroides* ♀, n.g. et sp. Labrum (*lbr*), epipharynx (*ep*), and vestigial mandibles (*md*): ($\times 83$).
 Fig. 8.—*Nannochorista dipteroides* ♀, n.g. et sp. Maxilla and labium, dissected off together and viewed from ventral side; *il*, inner lobes of maxilla; *lb*, labellum; *m*, mentum; *mcp*, maxillary palpi; *sm*, submentum; *st*, stipes; ($\times 83$).
 Fig. 9.—*Nannochorista dipteroides* ♂, n.g. et sp. Maxilla dissected off; *c*, cardo; *il*, inner lobe; *mcp*, maxillary palp; *sa*, sense-organ on third joint of palp; *st*, stipes; ($\times 83$).
 Fig. 10.—Coupling-apparatus at base of wings of *Nannochorista*; *fr*, frenulum; *Fw*, forewing; *Hw*, hindwing; *jb*, jugal bristle; ($\times 83$).
 Fig. 11.—*Nannochorista dipteroides*, n.g. et sp. Dorsal view of end of male abdomen, cleared and mounted in Canada Balsam; *c*, cerci; *v*, valves; 8-10, abdominal segments; ($\times 28$).
 Fig. 12.—*Nannochorista holostigma*, n.g. et sp. Lateral view of end of female abdomen, cleared and mounted in Canada Balsam; *c*, cerci; *gp*, gonapophyses; 8-10, abdominal segments; ($\times 28$).

NOTES AND EXHIBITS.

Mr. Turner exhibited a specimen of *Chloris divaricata* R.Br., "Star-grass," collected near Reedy Creek, Inverell district, the most easterly locality known to him for it in New South Wales, with the possible exception of a doubtful specimen collected by him in the Clarence River district. Specimen No. 29 in the list, without locality, given on p.438 of the Catalogue of the Colonial and Indian Exhibition, 1886, New South Wales Court, was found by him near Gundabooka, N.S.W.

Mr. W. W. Froggatt exhibited examples of Brachyscelid galls (*Apiomorpha pharatrata* Schr.), the male galls growing out from the side of the female galls, the winged, male coccids resting in the gall-tubes.

Mr. J. L. Froggatt showed specimens of a fourth (undescribed) Chalcid wasp, bred from the pupæ of *Pycnosoma rufifacies*, one of the green blowflies troublesome to sheep, collected at Salisbury Court, Uralla, N.S.W.

Mr. Tillyard exhibited a collection of insects belonging to the very ancient Order Mecoptera or Panorpatæ, in illustration of his paper on the new family *Nannochoristidæ*, including representatives of the *Panorpidæ* (s.str.), *Meropidæ*, *Choristidæ*, *Bittacidæ*, and *Nannochoristidæ*.

Mr. Fletcher called attention to two recent records of Australian plants escaping from cultivation in other countries, and interfering with the indigenous vegetation—*Acacia dealbata* Link, in South Africa [Henkel, J. S., South African Journal of Science, xiii., No.5, p.185 (1916)]; and *Hakea acicularis* R.Br., in New Zealand [Bell, J. M., & Clarke, C., Bulletin No.8 (N.S.) of the New Zealand Geological Survey, p.5 (1909)].

ORDINARY MONTHLY MEETING.

JULY 25th, 1917.

Dr. H. G. Chapman, President, in the Chair.

The Donations and Exchanges received since the previous Monthly Meeting (27th June, 1917), amounting to 7 Vols., 40 Parts or Nos., 8 Bulletins, 2 Reports, and 3 Pamphlets, received from 42 Societies, etc., and one private donor, were laid upon the table.

NOTES AND EXHIBITS.

Mr. E. A. Breakwell gave an outline of his application of Dr. J. C. Willis' method of studying the endemic flora of Ceylon, with reference to geographical distribution and evolution in general [Phil. Trans., ccvi., p.307 (1915)] to the Australian *Gramineae*, very similar results being shown, in respect of the average rarity of endemic species, genera, and certain sets of species of distinctive genera.

Mr. Fletcher showed examples of reversion-shoots, and Acacia-seedlings, and discussed some of their characteristics, as preliminary to a case for discussion to be offered at next Meeting—[namely, the interpretation of Mr. Bentham's statement that *Callistemon rigidus* R.Br. is "Intermediate between *C. lanceolatus* DC., and *C. linearis* DC." (Fl. Austr., iii., p.121)].

REVISION OF AUSTRALIAN LEPIDOPTERA, vi.

BY A. JEFFERIS TURNER, M.D., F.E.S.

Fam. GEOMETRIDÆ.

Subfam. BOARMIANÆ.

Forewings in ♂ often with a basal fovea; 7, 8, 9 stalked from before upper angle of cell, well separate from 6, which arises from angle, 10 and 11 arising separately from cell, or 10 out of 9, or 10 and 11 stalked or coincident, 10 often connected with 9 and 11 with 12, rarely 10 and 11 arising separately and anastomosing, rarely 11 apparently out of 12. Hindwings with 5 obsolete, 3 and 4 separate, 6 and 7 separate, 8 approximated to cell usually to about middle; cell about $\frac{1}{2}$ or $\frac{2}{3}$.

This is the largest subfamily of the *Geometridæ*, and is well characterised by the absence of vein 5 in the hindwings. Apart from this, it appears to be primitive in its structure, and, though the genera are numerous, they never depart far from the normal structure. They show an excessive variability in the development of veins 10 and 11 of the forewing, together with great constancy in the other features of the neuration. Owing to these causes, their study is unusually difficult. I had advanced far in this revision some two years ago, when, for extraneous reasons, I abandoned it. Lately, I have taken it up again, thinking it better to publish it in an incomplete state, rather than to postpone it indefinitely. So far as the Queensland element of the fauna is concerned, I have been much assisted by Mr. L. B. Prout, who has kindly examined much material, and compared it with Mr. Warren's types at Tring; and it would be a pity that his generous assistance should be wasted. I am sorry that there has been no one to do the same thing with Mr. Lower's types, and it is very possible that I have redescribed some of his species.

The curious structure known as the fovea is useful as a generic character and as indicating generic relationship. But, like all secondary male characters, it must be used with caution. It is certainly characteristic of the *Boarmia* group, though lost in some genera (*Hybernia*, *Melanodes*), and even in some species of genera in which it is usually well marked (*Ectropis*, *Heteroptila*). But it is also present occasionally in the *Casbia*-group (*Hyperythra*, *Casbia rectoria*), and in several species of *Amelora*, as well as in the closely related genera *Angelia*, *Authamon*, and *Paramelora*. It seems to have been developed independently in these two latter instances, just as a similar but differently situated structure has developed in the hindwing of *Deilimia* and the forewing of *Veritodes*.

Owing to the variability of the neuration, particularly in the *Boarmia*-group, it is necessary to examine, wherever possible, a series of each species. Only by so doing will the neuration be properly understood, and some authors have fallen into unnecessary errors by neglect of it. Under the genus *Boarmia* will be found some illustrations of this variability. It is important also to recognise that neuration may be apparently identical but morphologically distinguishable. To take a single example, in Text-fig.1, vein 10 is absent. This neuration is common in

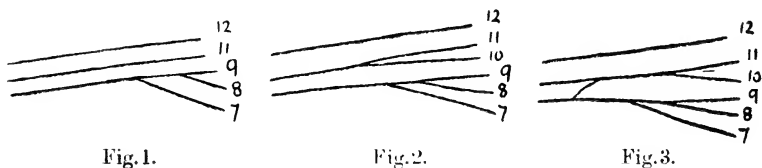

the genus *Boarmia*, and as 10 and 11 are often long-stalked in the same species, it is evident that 10 has become coincident with 11. But the same neuration occurs in *Chrostobapta*, and with anastomotic variations in *Lomographa*, in which genera, there is reason to believe, 10 is coincident with 9. Text-fig.2 occurs in *Boarmia* and many other genera, and really, as apparently, 10 and 11 arise long-stalked from cell. But in *Metrocampa*, the same neuration has not that significance. For in

other examples of *Metrocampa*, 10 arises clearly out of 9 (Text-fig 3), and anastomoses with 11. The structure in Text-fig. 2, in *Metrocampa*, has resulted from the non-development of the short basal portion of vein 10. The occasional non-development of portions of veins may give rise to very puzzling appearances in the genera *Boarmia* and *Rhinodia*. In *Rhinodia*, 11 usually anastomoses with 12, but the non-development of the basal portion of 11 causes that vein to arise apparently out of 12. In *Boarmia*, it will be shown, 11 may appear to arise from 12 in quite a different way, the basal stalk of 10 and 11 having become separated from the distal part of 11, which remains connected with 12 by what was, originally, a connecting bar.

I think it is impossible to arrange the genera in any tabular scheme, and even an artificial key would be most difficult to construct, and of doubtful value. But it is possible to give a general idea of the relationship of the genera. Firstly, there is a primitive and distinctly Australian group, of stout hairy build, the terminal joints of the palpi rather long, the thorax often crested, and veins 10 and 11 arising separately from cell. This may be called the *Chlenias*-group. From it arose the *Thalainia*-group, in which 10 arises from 9; and the *Amelora*-group, more slenderly built, with short palpi, less hairy, 10 and 11 long-stalked, and sometimes with a fovea. In all the genera of these groups, the neuration shows little variability. Secondly, a not very dissimilar form like *Cleora*, with similar neuration, but shorter palpi than *Chlenias*, and with a large fovea, gave rise to a large group of genera, in a few of which (*Lyelliana*, *Metrocampa*) 10 arises from 9, but in most 10 and 11 are long-stalked or coincident. This is the *Boarmia*-group. The *Abraaxas*-group, so different in colouration, appears to be closely correlated in structure. But there appear to have been also developed more smooth-scaled forms with a strong tendency for 10 to arise out of 9, or to become coincident with it. This is the *Deilinia*-group, represented in Australia by *Casbia* and its allies.

I have made no attempt to record unrecognised species. Species which I have been unable to examine are marked thus †. Types, unless otherwise specified, are in my collection.

Gen. I. CORYMICA.

Corymica Wlk., Cat. Brit. Mus., xx., p.230; Hmps., Moths Ind., iii., p.185.

Tongue well-developed. Palpi rather long, slender, porrect; terminal joint moderately short, obtuse. Antennæ of ♂ simple, minutely ciliated. Thorax and abdomen not crested; thorax not hairy beneath. Femora glabrous; posterior tibiæ of ♂ not dilated. Forewings with a very large fovea developed both on upper and lower surfaces; 10 and 11 coincident and anastomosing with 12. Hindwings with costa excised beyond middle; neuration normal.

Type *C. arnearia* Wlk. An isolated genus, peculiar in the exaggerated development of the fovea.

I. CORYMICA ARNEARIA.

Corymica arnearia Wlk., Cat. Brit. Mus., xx., p.231; Hmps., Moths Ind., iii., p.185.

♂. 16 mm. Head bright yellow, posteriorly brownish; face bright yellow, with a brown transverse bar below middle. Palpi 1 $\frac{3}{4}$; brown, towards base yellow. Antennæ whitish, towards base brown. Thorax yellow, with a brown transverse bar on anterior edge. Abdomen yellow, with two or three brown median dorsal spots on basal segments, and a median whitish suffusion. Legs yellow: anterior and middle femora brown; apices of tibiæ and first tarsal joints brown. Forewings triangular, costa straight from near base almost to apex, apex acute, termen slightly bowed, oblique, finely wavy; bright yellow, with a few brown strigulae, most numerous on costa; basal fifth of costa white; a large sub-basal fovea edged posteriorly with brown, its anterior part scaleless and translucent; a brown erect mark on $\frac{2}{3}$ dorsum, and a similar smaller mark midway between it and tornus; a triangular apical blotch, narrow on costa but extending to below middle of termen; cilia white, barred with brownish. Hindwings similar but without dorsal marks and apical blotch. Underside as upper.

N.Q.: Kuranda, near Cairns, in May; one specimen in Coll. Lyell, received from Mr. F. P. Dodd. Also from Borneo and India.

Gen.2. ZEHEBA.

Zeheba Moore, Lep. Ceyl., iii., p.468; Hmps., Moths Ind., iii., p.200.

Head smooth. Tongue well-developed. Palpi moderate, porrect, shortly rough-scaled; terminal joint short. Antennæ of ♂ simple, shortly ciliated. Thorax not crested; beneath hairy. Femora smooth; posterior tibiæ of ♂ dilated, with internal groove and tuft and abbreviated spurs. Forewings strongly falcate at apex and angulated in middle; in ♂ with well-marked fovea; 10 and 11 coincident, anastomosing with 12 (or free: Hampson). Hindwings with cell short (about $\frac{1}{3}$); 8 approximated nearly to end of cell.

One of the *Boarmia*-group. Type, *Z. lucidata* Wlk

2. ZEHEBA LUCIDATA.

Macaria (?) *lucidata* Wlk., Cat. Brit. Mus., xxvi., p.1651. *Evarsia marginata* Wlk., Cat. Brit. Mus., xxxv., 1561; Moore, Lep. Ceyl., iii., Pl.205, f.8. *Zeheba aureata* Moore, Lep. Atk., p.263. *Z. lucidata* Hmps., Moths Ind., iii., p.201.

♂. 44 mm. Head ochreous-whitish; face with a transverse median brown bar. Palpi 1; brown, towards base ochreous-whitish. Antennæ ochreous-whitish speckled with brown; ciliations in ♂ $\frac{1}{2}$. Thorax and abdomen ochreous-whitish. Legs ochreous-whitish; anterior pair with some brown irroration. Forewings elongate-triangular, costa straight to near apex, there strongly arched, apex strongly but obtusely falcate, termen longer than dorsum, strongly oblique, with a strong tooth on vein 4; ochreous-whitish, thinly scaled, and translucent: more densely scaled at base; a thick brown costal line from base to $\frac{1}{4}$, and a short bar about middle, with some fine brown strigulae before and beyond it; an oblique brown line from $\frac{1}{4}$ costa to near base of dorsum; an obscure brown spot in disc at end of cell; a brown spot on mid-dorsum, with some brown irroration between it and costal bar; a fine, brown, outwardly curved, wavy line from $\frac{3}{4}$ costa to dorsum before tornus; beyond this, terminal area is more densely scaled with some brownish suffusion and strigulae, and a short brownish line from dorsum; cilia ochreous-

whitish, with some brownish admixture. Hindwings long, termen rounded, sharply dentate; colour as forewings, but without basal markings. Underside similar.

N.Q.: Kuranda, near Cairns; one specimen, received from Mr. F. P. Dodd. Also from Java, Borneo, Ceylon, and India.

Gen. 3. ANISOGRAPHE.

Anisographe Warr., Nov. Zool., 1897, p.254.

Face smooth. Tongue well-developed. Palpi moderately long, ascending, shortly rough-haired; terminal joint very short. Antennæ of ♂ shortly bipectinate, towards apex simple. Thorax not crested; beneath hairy. Femora smooth; posterior tibiæ of ♂ dilated. Forewings of ♂ without fovea; 10 and 11 long-stalked from cell, their stalk anastomosing or connected with 12, 10 sometimes connected with 9. Hindwings quadrate or rhombiform, more elongate in ♂; neuration normal.

Probably a development of *Probitia*, the fovea being lost. Type, *A. dissimilis* Warr.

3. ANISOGRAPHE DISSIMILIS.

Anisographe dissimilis Warr., Nov. Zool. 1897, p.254, Pl. iv., f.1, 2. *Aspidoptera navigata* Luc., Proc. Roy. Soc. Qsld., 1899, p.146.

♂. 46 mm. Head pale brown; face with an incomplete, dark fuscous bar below middle. Palpi $1\frac{1}{4}$; pale brown. Antennæ pale brown, usually with some fuscous irroration; pectinations in ♂ $1\frac{1}{2}$, apical $\frac{1}{8}$ simple. Thorax and abdomen pale brown. Legs pale brownish spotted with fuscous. Forewings elongate-triangular, costa very slightly arched, apex acute, slightly produced, termen strongly bowed, sinuate towards tornus, oblique; 10 and 11 long-stalked, their stalk connected by a bar with 12 (1♂), or anastomosing with 12 (1♂), or in addition 10 anastomosing with 9 (1♂); pale brown, with sparse dark fuscous strigulæ; a fine transverse fuscous line at $\frac{1}{3}$; a strongly marked line from apex to $\frac{2}{5}$ dorsum, brown, near apex fuscous, succeeded by a fine, closely parallel, fuscous line; several dark fuscous terminal dots; cilia pale brown. Hindwings quadrate, long, strongly produced in

middle, acutely angled on vein 4, slightly dentate on other veins: a fuscous transverse line near base; a brownish line from $\frac{1}{3}$ costa to mid-dorsum; a dark fuscous discal dot; a faint, dentate, incomplete, postmedian line; colour as forewings but without terminal dots. Underside brown-whitish, with dark fuscous strigulae but without defined markings.

♀. 46-50 mm. Forewings with 10 and 11 long-stalked, their stalk anastomosing with 12 (1♀), or in addition 10 anastomosing with 9 (2♀); without oblique line from apex; usually with a discal dot; groundcolour paler but often with a broad brown terminal band. Hindwings not so strongly produced: colour as forewings.

Warren's figures are good, but the numbers referring to the sexes have been transposed. In Coll. Lyell is a fine ♂ aberration, with a broad, black, oblique streak across both wings.

N.Q.: Cooktown, Cairns, Mackay. — Q.: Brisbane.

4. ANISOGRAPHE SUBPULCHRA.

Gonophaga subpulchra Warr., Nov. Zool., 1897, p.400. *G. albipuncta* Warr., Nov. Zool., 1899, p.357.

♂♀. 35-45 mm. Head whitish-brown; face with three transverse fuscous lines. Palpi $1\frac{1}{4}$; whitish-brown, with a few blackish scales. Antennae whitish-brown irregularly spotted with fuscous; pectinations in ♂ $1\frac{1}{2}$. Thorax and abdomen whitish-brown, with a few fuscous scales; tegulae fuscous. Legs whitish-brown spotted with fuscous. Forewings triangular, costa straight to near apex, apex acute, termen slightly wavy, acutely angled on vein 4; 10 and 11 long-stalked, their stalk anastomosing with 12 (2♂, 1♀), similar but 10 connected with 9 (1♂); whitish-brown with sparse dark fuscous irroration and strigulae; first line indicated by dark fuscous dots, from $\frac{1}{4}$ costa to $\frac{1}{4}$ dorsum; a quadrangular fuscous-brown spot, sometimes pale-coloured, on mid-dorsum, in ♀ not developed: sometimes a dark fuscous, pale-centred, median, discal dot; a line of dots from $\frac{5}{8}$ costa, sharply bent inwards beneath costa in a straight line to dorsal spot; cilia brown-whitish with some fuscous suffusion. Hindwings subquadrate, dentate, acutely and more prominently toothed on

vein 4; colour as forewings but with a dark fuscous, pale-centred, discal dot, and a nearly straight brown line from tornus to apex, edged posteriorly with whitish. Underside similar but darker, and with pale-centred discal dots on both wings.

In this species, the two sexes are very similar.

N.Q.: Kuranda, near Cairns; Evelyn Scrub, near Herberton; Mackay. Also from Louisiades.

Gen. 4. PROBITHIA.

Probithia Warr., Nov. Zool., 1894, p.440

Frons flat. Tongue developed. Palpi moderate, porrect; second joint thickened with appressed hairs above and beneath; terminal joint moderately long, obtuse. Antennæ of ♂ serrate, shortly ciliated. Thorax not crested, beneath slightly hairy. Femora glabrous. Posterior tibiæ of ♂ dilated. Forewings of ♂ with a well-marked fovea; 10 and 11 long-stalked from cell, their common stalk connected by a bar with 12. Hindwings quadrate, angled on vein 4: cell rather short ($\frac{2}{3}$). Type, *P. exclusa* Wlk.

I have only one ♂ to examine, and the neuration may vary. A modification of the *Boarmia*-stem with specialised hindwings, it appears to be allied to the Australian genus *Anisographe*.

5. PROBITHIA EXCLUSA.

Hemerophila(?) *exclusa* Wlk., Cat. Brit. Mus., xxi., p.320. *H. pretereuns* Wlk., *op. cit.*, xxi., p.320. *Acidalia imprimata* Wlk., *op. cit.*, xxiii., p.771. *Mucaria obstataria* Wlk., *op. cit.*, xxiii., p.928. *Bithia lignaria* Wlk., *op. cit.*, xxxv., p.1600. *Luxiaria exclusa* Hmps., Moths Ind., iii., p.196.

♂. 42 mm. Head grey-whitish, with a transverse fuscous band: face fuscous, lower edge ochreous. Palpi 1; fuscous, basal joint and base and lower edge of second joint ochreous. Antennæ fuscous, towards base grey-whitish; in ♂ with well-marked serrations ($\frac{1}{2}$) towards apex, each with a short terminal bristle. Thorax grey-whitish. Abdomen pale fuscous, basal segments whitish. Legs pale ochreous; anterior pair dark fuscous anteriorly. Forewings triangular, costa straight to near

apex, apex acute, termen straight, slightly oblique: whitish with sparse fuscous irroration; markings dark fuscous; a spot on $\frac{1}{4}$ costa with indications of a fine basal line; a second spot on costa beyond middle; a third spot midway between this and apex, giving rise to a fine interrupted postmedian line, at first outwards-oblique, then sharply angled and very oblique to dorsum before middle: this is followed by a faint diffused grey shade; a fuscous terminal line: cilia fuscous. Hindwings quadrate, sharply angled on vein 4; colour as forewings; a faint fuscous transverse line at $\frac{1}{2}$; a dark fuscous, straight, dentate, median, transverse line. Underside pale ochreous; forewings with a broad, fuscous, postmedian, oblique line; hindwings irrorated only on margins, a short, dentate, fuscous line from $\frac{3}{4}$ costa, and another from dorsum before tornus.

N.Q.: Cape York (Elgner); one specimen in Coll. Lyell. Also from Java, Borneo, Ceylon, and India.

Gen. 5. MEDASINA.

Medasina Moore, Lep. Ceyl., iii., p.408; Hmps., Moths Ind., iii., p.283.

Tongue well-developed. Palpi moderate, upturned, closely appressed to frons, thickened in front with closely appressed hairs. Antennæ in ♂ bipectinate, apex simple. Thorax and abdomen not crested: thorax densely hairy beneath. Femora glabrous; posterior tibiæ of ♂ strongly dilated. Forewings in ♂ with fovea: 10 and 11 long-stalked, 11 connected with 12. Hindwings not elongate; neuration normal. Type, *M. strixaria* Gn.

Distinguished from *Boarmia* by the upturned palpi; from *Amblychia*, by the long-stalking of 10 and 11, and the much shorter hindwings.

6. MEDASINA STRIXARIA.

Hemerochloa strixaria Gn., Lep., ix, p.217. *Medasina strixaria* Hmps., Moths Ind., iii, p.286.

♂. 80 mm. Head, thorax, and abdomen brown. Palpi brown, suffused externally with dark fuscous. Antennæ brown; pectin-

ations in ♂ 7, apical $\frac{1}{2}$ simple. Legs grey-brown irrorated with fuscous. Forewings elongate-triangular, costa gently arched, apex pointed, termen bowed, rather strongly oblique, dentate: 10 and 11 long-stalked, 11 connected with 12 soon after separation (1♂); brown, with fine fuscous strigulation on veins and towards costa; a fine, dentate, blackish, median line from costa beyond middle to $\frac{1}{3}$ dorsum; antemedian represented by a blackish line from $\frac{1}{4}$ dorsum, soon confluent with median; postmedian from $\frac{3}{4}$ costa, at first fine, dentate, and directed outwards, then bent inwards as a strong, straight, very oblique, black line joining median above dorsum; a fuscous shade posterior to lower part of postmedian line; a fine, pale, dentate or wavy, subterminal line; cilia brown. Hindwings with termen but slightly rounded, dentate; colour as forewings. Underside fuscous-brown, with fuscous discal spots and postmedian lines, and whitish-ochreous, terminal bands.

♀. 100 mm. Paler, more generally strigulated, lines indistinct or obsolete, except subterminal, which is well-marked. Vein 10 from cell, 11 apparently from 12, not connected with 10 (1♀).

N.Q.: Kuranda, near Cairns; in November; one specimen, in Coll. Lyell, received from Mr. F. P. Dodd.—Q.: Brisbane; one specimen, in Queensland Museum. Also from Ceylon and India.

Gen. 6. BORBACHA.

Borbacha Moore, Lep. Ceyl., iii., p.446; Hmps., Moths Ind., iii., p.170.

Face smooth. Tongue well-developed. Palpi moderately long, ascending, rather slender, smooth-scaled; terminal joint rather long, obtuse. Antennæ of ♂ unipectinate, with long pectinations, apical $\frac{1}{2}$ simple. Thorax not crested, hairy beneath. Femora glabrous; posterior tibiæ not dilated. Forewings in ♂ with a large fovea and a bar-shaped retinaculum: 10 and 11 long-stalked, their common stalk anastomosing with 12, 10 anastomosing with 9. Hindwings with the cell rather short (less than $\frac{1}{2}$), otherwise normal. Type, *Anisodes pardaria* Gn., from Borneo and India.

The neuration may vary; I have only one ♂ for examination.

7. BORBACHA EUCHRYSA.

Onychodes euchrysa Low., Trans. Roy. Soc. S. Austr., 1894, p.82. *Borbacha parviscripta* Warr., Nov. Zool., 1896, pp. 130, 296, and 306.

N.Q.: Cairns, Townsville. Also from Louisiades and Java.

Gen. 7. DIASTICTIS.

Diastictis Hb., Verz., p.288: Meyr., Proc. Linn. Soc. N. S. Wales, 1891, p.586.

Head smooth, face usually with an inferior tuft. Tongue present. Palpi porrect, shortly rough-scaled; terminal joint moderate, tolerably acute. Antennæ shortly or moderately bipectinated. Thorax and abdomen not crested; thorax slightly hairy beneath. Femora glabrous. Posterior tibiæ of ♂ more or less dilated, sometimes with an internal groove containing a long pencil of hairs from base. Forewings in ♂ with fovea; 10 absent, 11 connected or anastomosing with 12 and 9, or free. Hindwings with termen angled on vein 4; neuration normal.

The right application of this name is not quite certain. The genus, as here defined, appears to be a very natural group.

- | | |
|---|-----------------------|
| 1. Discal spot of forewings pale-centered..... | <i>australiaria</i> . |
| Discal spot of forewings narrow, dot-like or absent..... | 2. |
| 2. Hindwings with termen strongly dentate..... | <i>odontias</i> . |
| Hindwings with termen slightly or not dentate..... | 3. |
| 3. Forewings with apex falcate..... | <i>tessellata</i> . |
| Forewings with apex not falcate..... | 4. |
| 4. Wings whitish, with dark fasciæ..... | <i>margaritis</i> . |
| Wings not whitish..... | 5. |
| 5. Wings beneath with a broad dark fascia connected with
middle of termen..... | <i>hypomochla</i> . |
| Wings without broad dark fascia beneath..... | <i>glareosa</i> . |

8. DIASTICTIS AUSTRALIARIA.

Halia australiaria Gn., Lep., x., p.91. *Selenia apamaria* Wlk., Cat. Brit. Mus., xx., p.255. *Macaria remotaria* Wlk., *op. cit.*, xxiii., p.938. *M. gratularia* Wlk., *op. cit.*, xxiii., p.939. *M. infixaria* Wlk., *op. cit.*, xxiii., p.939. *M. frontaria* Wlk., *op. cit.*, xxvi., p.1652. *M. panagraria* Wlk., *op. cit.*, xxvi., p.1653. *M.*

porrectaria Wlk., *op. cit.*, xxxv., p.1659. *M. comptata* Wlk., Char. Undesc. Lep., p.78. *Diastictis australiaria* Meyr., Proc. Linn. Soc. N. S. Wales, 1891, p.587.

Forewings with 11 anastomosing with 12 (3♂, 1♀), anastomosing with 12 and connected with 9 (1♂), or anastomosing with both 12 and 9 (1♂, 2♀).

Q.: Toowoomba, Killarney, Stanthorpe.—N.S.W.: Armidale, Ebor, Sydney, Bathurst, Orange.—Vic.: Melbourne, Gisborne.—Tasm.: Launceston, Deloraine, Swansea, Hobart.

9. DIASTICTIS ODONTIAS.

Diastictis odontias Low., Trans. Roy. Soc. S. Austr., 1893, p.158. *Semiothisa fusca* Warr., Nov. Zool., 1896, p.412. *Xenoneura tephriata* Warr., Nov. Zool., 1896, p.414.

Antennal pectinations of ♂ 5, apical $\frac{1}{5}$ simple. Forewings with 11 free (4♂, 2♀), or anastomosing with 12 (1♀).

N.A.: Port Darwin.—N.Q.: Cooktown, Cairns, Innisfail, Herberton, Stannary Hills, Townsville.

10. DIASTICTIS MARGARITIS.

Diastictis margaritis Meyr., Proc. Linn. Soc. N.S. Wales, 1891, p.588. *Tephriopsis gratiosa* Swin., Trans. Ent. Soc., 1902, p.617. N.Q.: Stannary Hills (Dr. T. Bancroft).—Q.: Rockhampton.

11. DIASTICTIS TESSELLATA.

Acadra tessellata Warr., Nov. Zool., 1899, p.57.

♀. 28-30 mm. Head and thorax ochreous-whitish, with a few fuscous scales; face fuscous, upper and lower margins ochreous-whitish. Palpi ochreous-whitish, apex of second joint and terminal joint fuscous. Antennæ whitish-ochreous, with some fuscous scales. Abdomen ochreous-whitish, with some fuscous irroration and faint brownish suffusion. Legs ochreous-whitish, with pale fuscous irroration. Forewings triangular, costa straight to near apex, then strongly arched, apex strongly produced, falcate, termen sinuate beneath apex, then bowed; 11 free (1♀). 11 anastomosing at a point with 12 (1♀): ochreous-whitish, with sparse fuscous irroration and faint ochreous suffusion; markings fuscous: an oblique streak on $\frac{1}{4}$ costa giving rise to a hardly per-

ceptible basal line; a similar streak on middle, and another at $\frac{3}{4}$, giving rise to a faint line at an angle to $\frac{3}{4}$ dorsum; subterminal represented by a dentate, suffused, fuscous line from tornus; an interrupted, fuscous, terminal line; cilia fuscous, towards tornus ochreous-whitish. Hindwings quadrate, acutely angled and produced on vein 4; colour as forewings: a blackish discal dot at $\frac{1}{3}$; sometimes a broad, fuscous, subterminal band; cilia ochreous-whitish. Underside similar; both wings with a broad, fuscous, subterminal band; forewings with a white apical blotch strigulated with fuscous.

N.Q.: Kuranda, near Cairns, in December and January; two specimens, received from Mr. F. P. Dodd, of which one is in Coll. Lyell. Also from New Guinea.

12. *DIASICTIS HYPOMOCHLA*, n.sp.

ἵππομοχλος, barred beneath.

♂♀. 28 mm. Head pale brownish. Palpi $1\frac{1}{2}$; pale brownish, towards base mixed with ochreous-whitish. Antennæ grey, pectinations in ♂ $2\frac{1}{2}$, apical $\frac{1}{10}$ simple. Thorax and abdomen pale brownish. Legs whitish-ochreous, irrorated with fuscous: anterior pair, except coxæ, middle tibiæ and tarsi, fuscous; posterior tibiæ in ♂ strongly dilated. Forewings triangular, costa nearly straight, apex pointed, termen bowed, oblique; 11 free (1♂, 1♀); brownish-grey; costal edge pale ochreous, with fuscous strigulations; an ill-defined, median fascia white strigulated with ground-colour; on outer edge of this are sometimes two fuscous spots beneath costa; cilia brownish-grey. Hindwings slightly dentate on vein 4; crenulate between this and apex; colour as forewings, but with a fuscous discal dot at $\frac{1}{4}$; dark postmedian spot, when present, more central. Underside similar, but with a broad, dark, postmedian fascia connected with termen on both wings. Type in Coll. Turner.

N.Q.: Cairns.

13. *DIASICTIS GLAREOSA*, n.sp.

Glareosus, gravelly.

♀. 30 mm. Head and palpi whitish-ochreous mixed with fuscous. Antennæ whitish-ochreous. Thorax and abdomen

pale fuscous. Legs whitish-ochreous speckled with fuscous; tarsi uniformly suffused with pale fuscous. Forewings triangular, costa nearly straight, apex round-pointed, termen bowed, oblique, wavy; whitish, faintly ochreous-tinged on veins and costa, and densely strigulated with pale fuscous: a fuscous line from $\frac{1}{4}$ costa obliquely outwards, soon bent and oblique inwards to $\frac{1}{5}$ dorsum; a fuscous discal dot at $\frac{2}{3}$; a fuscous line from $\frac{2}{3}$ dorsum towards termen beneath apex, succeeded by a subtornal fuscous suffusion; a white subapical spot, a faint interrupted fuscous terminal line; cilia whitish. Hindwings with termen wavy, angled on vein 4; colour as forewings, but first line straight, and without tornal suffusion and subapical spot, but with a narrow fuscous suffusion posterior to second line, and some subterminal white spots. Underside whitish, with patchy ochreous suffusion; otherwise as upper side. Type in Coll. Turner.

N.Q.: Kuranda, near Cairns, in April; one specimen, received from Mr. F. P. Dodd.

Gen. 8. HYPOSIDRA.

Hyposidra Gn., Lep., x., p.150; Meyr., Proc. Linn. Soc. N. S. Wales, 1891, p.588; Hmps., Moths Ind., iii., p.213.

Head and face smooth-scaled. Tongue weakly developed. Palpi rather short, porrect or slightly ascending, thickened with appressed or short rough hairs; terminal joint short, obtuse. Antennæ in ♂ with a double row of long pectinations, apex simple. Thorax and abdomen not crested; thorax hairy beneath. Femora glabrous or somewhat hairy. Forewings with apex produced and falcate; fovea in ♂ present; 10 and 11 stalked, or separate, or 10 absent, not anastomosing. Hindwings with termen angled on vein 4; neuration normal.

A small and natural genus; best distinguished from *Boarmia* by the weak tongue, falcate forewings, and angled hindwings.

The neuration varies beyond ordinary limits, and there seems to be a constant difference between the neuration of the two sexes.

Type, *H. juniaria* Gn.

1. Wings reddish-brown *juniaria*.
 Wings fuscous-grey *tulaca*.

14. HYPOSIDRA JANIARIA.

Hyposidra janiaria Gn., Lep., x., p.150; Meyr., Proc. Linn. Soc. N. S. Wales, 1891, p.588. *Lagyra agrealesaria* Wlk., Cat. Brit. Mus., xx., 59. *L. diffusata* Wlk., *op. cit.*, xxxv., 1537. *L. infusata* Wlk., *op. cit.*, xxxv., 1538. *Hyposidra australis* Feld., Reise Nov., Pl.129, f.23, 24. *H. variabilis* ab. *siccifolia* Warr., Nov. Zool., 1897, p.119.

Forewings with 10 and 11 stalked, not anastomosing (4♂), or 10 absent (3♀); in one ♀ 11 is stalked with 7, 8, 9.

N.A.: Port Darwin.—N.Q.: Cape York, Cooktown, Cairns, Innisfail, Townsville. Also from Java.

15. HYPOSIDRA TALACA.

Lagyra talaca Wlk., Cat. Brit. Mus., xx., p.59; Hmps., Moths Ind., iii., p.213. *Chizala deceptatura* Wlk., *op. cit.*, xx., p.264. *Lagyra rigusaria* Wlk., *op. cit.*, xxvi., p.1485. *L. bombycaria* Wlk., *op. cit.*, xxxv., p.1539. *L. flaccida* Luc., Proc. Linn. Soc. N. S. Wales, 1893, p.154. *Hyposidra schistacea* Warr., Nov. Zool., 1896, p.305.

A variable species, usually fuscous-grey; I have two ♂ brownish-grey, of which one has a dorsal, pale ochreous blotch. Forewings with 10 and 11 stalked (3♂), or separate (2♂), not anastomosing, 10 absent (1♀).

N.Q.: Cairns.

Gen. 9. DISCALMA.

Discalma Meyr., Proc. Linn. Soc. N. S. Wales, 1891, p.590.

Face with a short tuft of scales. Tongue present. Palpi moderate (over 1), subascending, rough scaled; terminal joint short, obtuse. Antennæ in ♂ simple, with rather long ciliations. Thorax and abdomen not crested; thorax slightly hairy beneath. Femora glabrous. Posterior tibiæ of ♂ not dilated. Forewings in ♂ with a small fovea partly covered by a basal tuft of scales; 10 and 11 stalked, their common stalk sometimes connected by a bar with 12, 10 sometimes anastomosing with 9. Hindwings normal.

16. DISCALMA NORMATA.

Tephрина normata Wlk., Cat. Brit. Mus., xxiii., p.966. *T. parallelaria* Wlk., *op. cit.*, xxvi., p.1680; Hmps., Moths Ind., iii., p.210. *Aspilates exfusaria* Wlk., *op. cit.*, xxvi., p.1683. *Tephрина dessicata* Wlk., *op. cit.*, xxxv., p.1660. *Discalma normata* Meyr., Proc. Linn. Soc. N. S. Wales, 1891, p.590.

N.Q.: Cairns, Townsville.—Q.: Brisbane, Stradbroke Island. Also from New Guinea, Java, Ceylon, India, and Africa.

Gen. 10. ANOMOCTENA, n.g.

ἀνομοκτενος, with unusual pectinations.

Face smooth. Tongue well-developed. Palpi rather short, porrect or somewhat ascending; second joint much thickened with rough scales; terminal joint short, abruptly truncate. Antennæ of ♂ unipectinate, apical $\frac{1}{5}$ simple. Thorax not crested; beneath densely hairy. Femora not hairy; posterior tibiæ of ♂ strongly dilated, posterior spurs abbreviated, and tarsi shortened. Forewings of ♂ with a basal fovea; 10 and 11 long-stalked from cell. Hindwings normal.

The dorsal antennal pectinations are completely absent, while the ventral are well-developed. The neuration seems to be constant (4♂, 4♀). While very near *Borbacha*, from which it may be distinguished by the palpi and ♂ posterior tibiæ, in structure, this genus is, I think, an independent development from the *Boarmia*-stem.

17. ANOMOCTENA TRISECTA, n.sp.

Trisectus, three times divided.

♂♀. 28-32 mm. Head grey mixed with whitish; face dark fuscous. Palpi $1\frac{1}{4}$; fuscous or grey mixed with whitish. Antennæ fuscous; pectinations in ♂ $2\frac{1}{2}$. Thorax grey, in ♂ ochreous-tinged, with a transverse dark fuscous line before middle. Abdomen grey, apices of segments whitish. Legs dark fuscous irrorated, and tarsi obscurely annulated with whitish; posterior pair mostly whitish. Forewings triangular, costa moderately arched, apex rounded, termen slightly bowed, scarcely oblique; grey, with some whitish irroration and a few blackish scales, in ♂ sometimes tinged with brownish-ochreous; markings blackish:

a line from $\frac{1}{3}$ costa to base of dorsum; a line from $\frac{1}{3}$ costa to $\frac{1}{4}$ dorsum somewhat curved outwards and slightly sinuate; a line from costa before middle obliquely outwards, sharply angled above middle and inwardly curved beneath angle: this line in ♂ is sometimes approximated and suffusedly connected with preceding line; a similar line, but with less prominent angle, from $\frac{2}{3}$ costa to $\frac{2}{3}$ dorsum; in one ♂, the whole of the median band is suffused with fuscous; a short, oblique, subapical streak; a whitish, finely dentate, subterminal line preceded by a similar blackish line, two prominent teeth of which interrupt it above middle; cilia grey mixed with whitish. Hindwings with termen rounded; fuscous-whitish, towards termen fuscous; two fine fuscous transverse lines, before and beyond middle, the former often obsolete; cilia whitish, with some obscure fuscous bars. Underside whitish, with fuscous irroration; antemedian and postmedian lines, median discal dot, and terminal band on each wing.

The ♂ is slightly variable, the ♀ appears constant.

Q: Brisbane, in October, February, March, and June; Toowoomba, in October; Nanango; eight specimees. — N.S.W.: Newcastle, one ♀ in Coll. Lyell, probably the same species, but with lines much more slender, subapical streak produced parallel to costa, and a brownish suffusion before subterminal line.

Gen. 11. APOROCTENA.

Aporoctena Meyr., Proc. Linn. Soc. N. S. Wales, 1891, p.622.

Face smooth. Tongue present. Palpi short (1), porrect, hairy; terminal joint very short. Antennæ in ♂ simple, minutely ciliated. Thorax not crested, hairy beneath. Femora glabrous; posterior tibiæ of ♂ strongly dilated, with internal groove and tuft; posterior tarsi of ♂ abbreviated. Forewings of ♂ with fovea; 10 and 11 long-stalked, 10 anastomosing with 9 beyond 7. Hindwings normal; length of cell $\frac{3}{5}$.

Differs from *Boarmia* only in the shorter palpi and simple male antennæ.

18. APOROCTENA SCIERODES.

Aporoctena scierodes Meyr., Proc. Linn. Soc. N. S. Wales, 1891, p.622.

Forewings with 10 and 11 long-stalked, 10 anastomosing with 9 (4♂, 2♀).

Q.: Brisbane; from December to March.

19. *APOROCTENA APREPES*, n.sp.

ἀπροκτενης, unbeautiful.

♂♀. 21-27 mm. Head, palpi, antennæ, thorax, and abdomen fuscous. Legs fuscous; tarsi annulated with whitish. Forewings triangular, costa straight to near apex, apex round-pointed, termen slightly bowed, oblique; 10 and 11 long-stalked, 10 anastomosing with 9 (2♂, 1♀); fuscous; lines blackish; first line at $\frac{1}{3}$, outwardly curved, very obscure; median line faintly indicated before middle; postmedian at $\frac{2}{3}$, distinct, nearly straight; traces of a whitish subterminal line; an interrupted terminal line; cilia fuscous. Hindwings with termen rounded; fuscous; a darker transverse line from tornus, not reaching costa; cilia fuscous. Underside whitish with fuscous irroration and fuscous terminal bands.

A small and most inconspicuous species, easily overlooked.

N.Q.: Innisfail, in May.—Q.: Brisbane, in February. Three examples.

Gen. 12. *SYMMETROCTENA*.

Symmetroctena Warr., Nov. Zool., 1895, p.127. *Lipogyia* Warr., Nov. Zool., 1898, p.249.

Frons smooth, rounded, more or less prominent. Tongue present. Palpi moderate, porrect, densely rough-haired beneath; terminal joint very short, concealed. Antennæ of ♂ bipectinated, apex simple. Thorax with dense bifid posterior crest, beneath hairy. Femora glabrous; posterior tibiæ of ♂ dilated. Forewings in ♂ with large fovea: 10 and 11 stalked, sometimes the stalk or 11 anastomoses with 12, and sometimes 10 with 9. Hindwings normal.

Type, *Larentia exprimataria* Wlk. Further material (I have only three specimens for examination) may show additional variability in neuration. The genus is closely allied to *Boarmia*, but I think the strong thoracic crest, with the rounded frons, sufficient points of distinction.

1. Forewings with clear whitish blotch beyond second line *capnota*.
Forewings without whitish blotch..... 2.
2. Forewings with first line single..... *exprimataria*.
Forewings with first line bifurcated towards dorsum..... 3.
3. Forewings with subterminal line nearly straight *eutheta*.
Forewings with subterminal line irregularly dentate..... *scotina*.

20. † SYMMETROCTENA CAPNOTA.

Selidosema capnota Meyr., Proc. Linn. Soc. N. S. Wales, 1891, p.605
W.A.: Albany.

21. SYMMETROCTENA EXPRIMATARIA.

Larentia exprimataria Wlk., Cat. Brit. Mus., xxvi., p.1704.
Selidosema exprimataria Meyr., Proc. Linn. Soc. N. S. Wales, 1891, p.604. *Symmetroctena fumosa* Warr., Nov. Zool., 1895, p.128.

Both Mr. Warren (Nov. Zool., 1898, p.249), and Colonel Swinhoe (Trans. Ent. Soc., 1902, p.627) assert that this species has no fovea, and both imply that Mr. Meyrick made a blunder, therefore, in putting it into the genus *Selidosema*. The fovea is present, and is exceptionally large and distinct.

Vic.: Melbourne.

22. SYMMETROCTENA EUTHETA, n.sp.

εὐθეტος, neat, orderly.

♂. 28 mm. Head and face fuscous mixed with whitish-ochreous. Palpi $1\frac{3}{4}$, with long, rough hairs beneath; fuscous. Antennæ fuscous; pectinations in ♂ 5, [apices broken]. Thorax fuscous, with some whitish scales; crest whitish above, at apex dark fuscous with metallic reflections. Abdomen fuscous, apices of terminal segments whitish. Legs fuscous, irrorated and tarsi annulated with fuscous; posterior pair mostly whitish. Forewings triangular, costa straight, towards apex gently arched, apex rounded, termen bowed, slightly oblique, slightly crenulate; 10 and 11 stalked, 11 anastomosing with 12 (1♂); ochreous-whitish suffused with pale fuscous and irrorated with dark fuscous; a dark fuscous, transverse line from $\frac{1}{3}$ costa bifurcating

before reaching dorsum; a similar line from $\frac{1}{4}$ costa bent inwards in disc to bifurcation of preceding line; a broad, dark fuscous, median shade, straight, its anterior edge well-defined, posterior edge diffused; a dark fuscous, median, discal mark beneath costa beyond this; a whitish, irregularly dentate line, partly doubly edged with dark fuscous, from $\frac{3}{4}$ costa, bent inwards, ending on $\frac{3}{5}$ dorsum; a nearly straight, dark fuscous, subterminal line, thickened beneath costa, edged posteriorly by a whitish line; a dark fuscous, interrupted, terminal line; cilia fuscous obscurely barred with whitish. Hindwings with termen rounded, slightly crenulate; whitish; a dark fuscous, median, linear, discal mark; dorsum suffused with dark fuscous, and terminal area with pale fuscous; a whitish transverse line at $\frac{2}{3}$; a fuscous subterminal line; cilia whitish, with obscure fuscous bars. Underside similar, but forewings whitish, with obsolete markings.

Type in Coll. Lyell.

N S.W.: Manning River, in March; one specimen.

23. SYMMETROCTENA SCOTINA, n.sp.

σΚΟΤΕΙΛΟΣ, dusky.

♂. 30 mm. Head, palpi, and thorax fuscous irrorated with ochreous-whitish. Antennæ fuscous; pectinations in ♂ 8, apical $\frac{1}{5}$ simple. Abdomen fuscous, apices of segments obscurely whitish. Legs whitish irrorated with fuscous; tarsi fuscous annulated with whitish. Forewings triangular, costa nearly straight, apex round-pointed, termen bowed, oblique; pale fuscous with some dark fuscous irroration; lines dark fuscous; a line from $\frac{1}{5}$ costa bifurcating towards dorsum; a line from $\frac{1}{4}$ costa bent inwards to join first line near bifurcation; a median shade from midcosta to $\frac{2}{3}$ dorsum; a transverse discal mark beyond middle: a double sinuate, interrupted, postmedian line, divided by a pale line; a subterminal line slightly waved, with a prominent outward tooth above middle and several smaller teeth, edged posteriorly by a pale line; a terminal series of dark fuscous lunules; cilia ochreous-whitish obscurely barred with fuscous. Hindwings with termen rounded, wavy; whitish; a dark fuscous, median, discal mark; termen suffused with grey; dorsum with

fuscous containing dark fuscous strigulations; a dark fuscous spot on $\frac{3}{4}$ dorsum; a fuscous subterminal line; terminal line and cilia as forewings. Underside whitish, with dark fuscous discal marks, and some fuscous terminal suffusion on both wings; costa of forewings with dark fuscous strigulations.

Q.: Gayndah, in October (Dr. Hamilton Kenny); Brisbane, in June; two specimens. Probably the specimen from Duaringa, mentioned by Mr. Meyrick under *S. exprimataria*, belongs to this species.

Gen. 13. PLEUROLOPHA.

Pleurolopha Turn., Trans. Roy. Soc. S. Aust., 1904, p.233.

Face smooth. Tongue present. Palpi moderate ($1\frac{1}{2}$), ascending, densely hairy beneath; terminal joint very short. Antennæ of ♂ dentate, with rather long ciliations in tufts. Thorax with a small bifid posterior crest, hairy beneath. Abdomen with four pairs of hair-crests in ♂, one on each side of fifth, sixth, seventh, and eighth segments, those on sixth and seventh largest; tuft in ♂ large. Femora glabrous; posterior tibiæ in ♂ dilated. Forewings in ♂ with large fovea; 10 and 11 coincident (2♂). Hindwings normal.

24. PLEUROLOPHA NEBRIDOTA.

Pleurolopha nebridota Turn., Trans. Roy. Soc. S. Aust., 1904, p.233.

N.Q.: Evelyn Scrub, near Herberton; in January.— Q.: Brisbane.

Gen. 14. HYBERNIA.

Hybernia Latr., Fam. Nat., p.477 (1825); Meyr., Proc. Linn. Soc. N. S. Wales, 1891, p.623.

Face smooth. Tongue present, but weakly developed. Palpi short, porrect, shortly rough-scaled. Antennæ of ♂ bipectinated to apex. Thorax not crested, slightly hairy beneath. Femora glabrous; posterior tibiæ in ♂ not dilated. Forewings in ♂ without fovea; 10 and 11 coincident. Hindwings normal. Female with wings rudimentary.

A small North-temperate genus. According to Mr. Meyrick, exotic species show considerable variability in veins 10 and 11 of forewings.

25. HYBERNIA INDOCILIS.

Zernizinga indociliaria Wlk., Cat. Brit. Mus., xxvi, p.1530.
Hybernia boreophilaria Gn., Ent. Mo. Mag., v., p.61. *H. indocilis* Meyr., Proc. Linn. Soc. N. S. Wales, 1891, p.623.

Q.: Brisbane, Nanango, Dalby.—N.S.W.: Glen Innes, Sydney.
 —Vic.: Melbourne, Birchip.—S.A.: Mt. Lofty. Also from New Zealand.

Gen. 15. MELANODES.

Melanodes Gn., Lep., ix., p.222; Meyr., Proc. Linn. Soc. N. S. Wales, 1891, p.621.

Face slightly rough-scaled. Tongue present. Palpi rather short, porrect, densely hairy; terminal joint very short, obtuse. Antennæ in ♂ laminate, shortly ciliated, apex simple. Thorax not crested, densely hairy beneath. Femora densely hairy; posterior tibiæ of ♂ not dilated. Forewings in ♂ without fovea; 10 arising from 9 at or near base, and free (1♂), or anastomosing with 11 and then with 9 beyond 7 (1♂), or long-stalked with 11 (1♀). Hindwings normal.

This genus appears to have lost the fovea. It presents (though my material is scanty) a dimorphism in the neuration similar to that of *Lophodes*. In the only ♀ I have examined, vein 9 is rudimentary, being represented only by a short stump arising from 8 near base.

26. MELANODES ANTHRACITARIA.

Melanodes anthracitaria Gn., Lep., ix., p.222, Pl. ix., fig.7; Meyr., Proc. Linn. Soc. N. S. Wales, 1891, p.622. *Praxis corrus* Wlk., Cat. Brit. Mus., xiii, p.1087.

The sexes are similar, but there is a very distinct, non-sexual, varietal form with whitish bands beyond postmedian lines of both wings, and before antemedian line of forewings.

N.S.W.: Sydney. Vic.: Melbourne, Fernshaw, Gisborne. — Tasm.: —.

Gen. 16. LOPHODES.

Lophodes Gn., Lep., ix., p.211; Meyr., Proc. Linn. Soc. N. S. Wales, 1891, p.620.

Face slightly rough-scaled. Tongue present. Palpi short

(about 1), porrect, rough-scaled; terminal joint minute, concealed. Antennæ in ♂ with a double row of extremely long pectinations, one pair to each joint, apex simple; in ♀ simple. Thorax not crested, densely hairy beneath. Femora hairy beneath; posterior tibiæ in ♂ not dilated. Forewing in ♂ with small fovea; 10 and 11 not anastomosing, arising separately from cell (5♂), connate (1♂), 10 from near base of 9 (1♂), 10 and 11 long-stalked (1♀), or coincident (3♀). Hindwings normal.

Near *Boarmia*, differing in the shorter palpi, hairy femora, small fovea, and non-dilated posterior femora of ♂. The sexual dimorphism, which extends to the neuration, is curious.

27. LOPHODES SINISTRARIA.

Lophodes sinistraria Gn., Lep., ix., p.212, Pl. x., fig.5; Meyr., Proc. Linn. Soc. N. S. Wales, 1891, p.620. *Calicha rufiplaga* Warr., Nov. Zool., 1899, p.348.

A common species; in Brisbane, the larvæ feed on garden-roses. Mr. R. J. Tillyard found a larva on the Cypress Pine. It is probably a general feeder.

Q.: Nambour, Brisbane, Stradbroke Island, Mount Tambourine, Coolangatta.—N.S.W.: Newcastle, Sydney.—Vic.: Melbourne, Fernshaw.

Gen. 17. ECTROPIS.

Ectropis Hb., Verz., p.316; Meyr., Proc. Linn. Soc. N. S. Wales, 1891, p.625.

Face smooth. Tongue present. Palpi moderate, porrect, rough-scaled; terminal joint short, obtuse. Antennæ in ♂ with a double row of short fine teeth or fine pectinations, two pairs of teeth or pectinations to each segment. Thorax and abdomen not crested; thorax hairy beneath. Femora glabrous. Posterior tibiæ of ♂ sometimes dilated, with internal groove and tuft. Forewings in ♂ usually with well-marked fovea; 10 and 11 long-stalked or coincident, 11 sometimes connected with 12, 10 sometimes anastomosing with 9. Hindwings normal.

Allied to *Boarmia*, but characterised by the peculiar antennal structure of ♂. Though forms with short teeth and with long pectinations may appear very different at first sight, their struc-

ture is fundamentally identical. The genus is natural, and should not be divided. In ♂ examples, the antennal structure is often the best guide to the species.

1. Forewings much narrower than hindwings *elongata*.
Forewings not narrower than hindwings 2.
2. Forewings with termen strongly toothed on veins 3 and 6 *nochloscema*.
Forewings not toothed on veins 3 and 6 3.
3. Face dark fuscous 4.
Face not wholly dark fuscous 8.
4. Hindwings with discal spot pale-centred..... 5.
Hindwings with discal spot not pale-centred 6.
5. Wings fuscous-grey *fractaria*.
Wings brown *rubibrunnea*.
6. Forewings with postmedian line twice strongly projecting *excursaria*.
Postmedian line without projections 7.
7. Wings pale brown *despicata*.
Wings without brownish tinge *pristis*.
8. Face with a distinct, transverse, dark fuscous bar ... 9.
Face not so marked 12.
9. Forewings with postmedian line twice strongly projecting *subtinctaria*.
Postmedian line finely dentate without projections 10.
10. Hindwings with discal spot obsolete *subulosa*.
Hindwings with discal spot well-marked, pale-centred .. 11.
11. Wings in ♂ grey, in ♀ grey-whitish *hemiprosopa*.
Wings with groundcolour white *camclaria*.
12. Hindwings with discal spot pale-centred..... *uniara*.
Discal spot of hindwings not pale-centred 13.
13. Forewings with postmedian line with a median, doubly
toothed projection *odontophora*.
Postmedian line not projecting 14.
14. Head and thorax whitish-ochreous *argata*.
Head and thorax not wholly whitish-ochreous 15.
15. Hindwings with lines obsolete towards costa *desumpta*.
Hindwings with lines not obsolete towards costa 16.
16. Wings with lines followed by distinct reddish-brown
shading *casaperata*.
Wings without reddish-brown shading *isombra*.

28. ECTROPIS ELONGATA.

Neogyne elongata Warr., Nov. Zool., 1898, p.256.

♂♀. 23.40 mm. Head whitish-ochreous; face brownish, with a blackish transverse bar beneath antennæ, and a blackish dot

on each side of middle. Palpi $1\frac{1}{4}$; dark fuscous. Antennæ grey; pectinations of ♂ 3 or 4. Thorax and abdomen whitish-ochreous with some fuscous scales. Legs whitish-ochreous speckled with fuscous. Forewings narrow-elongate-triangular, costa very slightly arched, apex rounded, termen oblique, strongly sinuate; 10 absent, 11 free but sometimes running very close to 9 (6♂, 2♀); whitish-ochreous more or less suffused and irrorated with fuscous; markings dark fuscous: antemedian line usually obscure, from $\frac{1}{4}$ costa to $\frac{1}{4}$ dorsum, angled beneath costa; median line rarely present; an oblong, fuscous, subcostal spot beyond middle; postmedian line from $\frac{3}{4}$ costa to $\frac{3}{4}$ dorsum, finely dentate, angled beneath costa, sometimes obscure, edged posteriorly by a whitish line; subterminal line irregularly dentate, with a subcostal posterior projection, edged anteriorly by a whitish line, and preceded by several dark fuscous spots towards costa; cilia whitish-ochreous barred with dark fuscous. Hindwings with termen rounded, wavy; pale grey; with an incomplete, fine, darker, postmedian line; cilia as forewings. Underside of hindwings whitish ochreous irrorated with fuscous; a short, wide, dentate, white line from tornus preceded by a dark fuscous suffusion.

The peculiar wing-shape might be regarded as a justification of the separation of this species from *Ectropis*, were it not for the intermediate form in the next species.

N.Q.: Kuranda, near Cairns; Evelyn Scrub, near Herberton.

—Q.: Duaringa, Gayndah, Toowoomba, Killarney.

29. *ECTROPIS MOCHLOSEMA*, n.sp.

μοχλοσημος, marked with a bar.

♂. 27-30 mm. Head and palpi brownish. Antennæ fuscous-whitish; pectinations in ♂ $2\frac{1}{2}$. Thorax brownish. Abdomen brownish, with a paler median streak and several pairs of fuscous dots on dorsum. Legs whitish-ochreous irrorated and tarsi annulated with fuscous. Forewings triangular, costa nearly straight, apex rounded, termen slightly excavated between veins 3 and 6; 10 and 11 arising from cell by a common stalk, not anastomosing (2♂); whitish irrorated with fuscous, and with patchy brownish suffusion; lines fuscous, indistinct and inter-

rupted, first from $\frac{1}{4}$ costa to $\frac{1}{4}$ dorsum acutely angled outwards beneath costa; second from midcosta to before mid-dorsum, angled outwards beneath costa; third from $\frac{3}{4}$ costa to $\frac{3}{4}$ dorsum, nearly straight; subterminal white, edged posteriorly above middle by three blackish dentations; a broad bar partly blackish, partly brownish, from angle of second line to subterminal above middle; cilia brownish, apices partly fuscous. Hindwings with termen rounded, wavy; brown-whitish irrorated with fuscous; a fuscous line at $\frac{1}{3}$; a discal dot before middle, a subterminal fuscous line from dorsum not reaching costa, edged posteriorly with white towards dorsum; cilia brownish. Underside similar, but without bar on forewings.

Allied to *E. elongata*, though with differently shaped wings.

Type in Coll. Lyell.

N.Q.: Kuranda, near Cairns; in November: two specimens, received from Mr. F. P. Dodd.

30. ECTROPIS FRACTARIA.

Tephrosia fractaria Gn., Lep., ix., p.270. *Hypochroma dissonata* Wlk., Cat. Brit. Mus., xxi., p.443. *H. nigraria* Feld., Reise Nov., Pl. 126, fig.1. *Ectropis fractaria* Meyr., Proc. Linn. Soc. N. S. Wales, 1891, p.629.

Forewings with 10 and 11 coincident, not anastomosing (3♂, 4♀).

Q.: Nambour — N.S.W.: Sydney. — Vic.: Melbourne, Gisborne. — Tasm.: Launceston, Sheffield, Hobart.

31. ECTROPIS RUFIBRUNNEA.

Ectropis rufibrunnea Warr., Nov. Zool., 1899, p.350. ♀. *Selidosema leucodesma* Turn., Trans. R. Soc. S. Aust., 1902, p.231.

Antennæ of ♂ with two pairs of tufts of cilia arising from each segment without any distinct teeth. Forewings with 10 and 11 coincident, not anastomosing (2♂, 6♀), 10 and 11 long-stalked, 11 appearing close to costa (1♀), 10 and 11 long-stalked, 10 running into 9 (2♂). This species is variable; one ♂, from Mount Tambourine, has blackish blotches on wings; one ♀, from Evelyn Scrub, near Herberton, has large whitish blotches.

N.A.: Bathurst Island. — N.Q.: Kuranda, near Cairns; Evelyn Scrub, near Herberton. — Q.: Montville, near Nambour; Brisbane, Mount Tambourine.

32. ECTROPIS SUBTINCTARIA.

Tephrosia subtinctaria Wlk., Cat. Brit. Mus. xxi., p.415. *Ectropis subtinctaria* Meyr., Proc. Linn. Soc. N. S. Wales, 1891, p.628.

Forewings with 10 and 11 stalked, not anastomosing (4♂, 5♀), 10 anastomosing with 9 (1♀). In this species, as in *E. excursaria* and *E. sabulosa*, the fovea is rudimentary.

N.Q.: Herberton (two ♀ examples, with the groundcolour whiter than usual; one ♂ presenting no peculiarity.—Q.: Brisbane.—N.S.W.: Newcastle, Sydney.

33. ECTROPIS EXCURSARIA.

Tephrosia excursaria Gn., Lep., ix., p.267. *T. exportaria* Gn., Lep., ix., p.268. *T. phibalapteraria* Gn., Lep., ix., p.268. *Hemerophila vestita* Wlk., Cat. Brit. Mus., xxi., p.322. *Bourmia attributa* Wlk., *op. cit.*, xxi., p.390. *B. decertaria* Wlk., *op. cit.*, xxi., p.391. *Tephrosia fulgurigera* Wlk., Char. Undesc. Lep., p.77. *Selidosema excursaria* Meyr., Proc. Linn. Soc. N. S. Wales, 1891, p.609.

This species has two pairs of pectinations to each segment. The pectinations being equal and equidistant, this structure is liable to be overlooked. Forewings with 10 and 11 stalked, not anastomosing (8♂, 4♀). This species is nearly allied to *E. subtinctaria*, but may be distinguished by the ♂ antennæ and colour of the face.

N.Q.: Evelyn Scrub, near Herberton.—Q.: Clermont, Gayndah, Brisbane, Blackbutt, Dalby.—N.S.W.: Sydney.—Vic.: Melbourne, Warragul, Gisborne, Hamilton.—Tasm.: Hobart.

34. ECTROPIS DESPICATA.

Tephrosia despicata Wlk., Cat. Brit. Mus., xxi., p.418. *Selidosema despicata* Meyr., Proc. Linn. Soc. N. S. Wales, 1891, p.612.

♂. 31-35 mm. Head and thorax brown; face fuscous. Palpi $1\frac{1}{4}$; fuscous, towards base ochreous-whitish. Antennæ brown-whitish; in ♂ dentate, with two pairs of tufts of moderate cilia ($1\frac{1}{2}$) on each segment. Abdomen brown irrorated with darker brown. Legs brown-whitish, with some brown irroration; anterior pair fuscous annulated with brown-whitish. Forewings

triangular, costa moderately arched, apex round-pointed; termen bowed, oblique, crenulate, 10 and 11 coincident, not anastomosing (2♂); pale brown, markings fuscous; first and median lines not apparent: an ill-defined, roundish, discal spot beneath mid-costa: postmedian line represented by minute streaks on veins, from $\frac{4}{5}$ costa to before mid-dorsum; an interrupted, whitish, dentate, subterminal line, edged anteriorly with fuscous; a terminal line interrupted on veins, thickened between veins: cilia brownish, apices whitish. Hindwings with termen slightly rounded, sharply dentate; colour as forewings, but with median line defined, and succeeded by an oval discal spot in disc before middle. Underside brown-whitish, with pale fuscous irroration: fuscous discal spots and terminal line.

Tasm.: Mt Wellington, in October: Hobart, in November: two specimens, sent by Mr. Geo. Lyell.

35. ECTROPIS PRISTIS.

Ectropis pristis Meyr., Proc. Linn. Soc. N. S. Wales, 1891, p.625.

Forewings with 10 and 11 stalked, their common stalk anastomosing (1♂), or connected (1♂) with 12, or free (2♂, 1♀), or anastomosing with 12 and 10 anastomosing with 9 (1♂, 1♀).

Q.: Duaringa, Maryborough, Caloundra, Stradbroke Island, Coolangatta.—N.S.W.: Newcastle, Sydney.—Vic.: Melbourne, Beaconsfield.

36. †ECTROPIS ARGALEA.

Ectropis argalea Meyr., Proc. Linn. Soc. N. S. Wales, 1891, p.627.

N.S.W.: Sydney.

37. †ECTROPIS ISOMBRA.

Ectropis isombra Meyr., Proc. Linn. Soc. N. S. Wales, 1891, p.627.

Q.: Duaringa, Brisbane.

38. ECTROPIS EXSUPERATA.

Boarmia exsuperata Wlk., Cat. Brit. Mus., xxi., p.393. *Tephrosia disposita* Wlk., *op. cit.*, xxi., p.421. *Ectropis exsuperata* Meyr., Proc. Linn. Soc. N. S. Wales, 1891, p.628.

Forewings with 10 and 11 coincident, not anastomosing (2♂, 6♀).

N.Q.: Herberton. — Q.: Nambour, Brisbane, Mt. Tambourine, Toowoomba. — N.S.W.: Newcastle, Sydney. — Vic.: Melbourne. — Tasm.: Ulverstone. — S.A.: Mt. Lofty.

39. ECTROPIS DESUMPTA.

Tephrosia desumpta Wlk., Cat. Brit. Mus., xxi, p.420. *Laurentia feraria* Wlk., *op. cit.*, p.1672.

♂♀. 24-29 mm. Head pale fuscous. Palpi 1½; fuscous. Antennæ pale fuscous; in ♂ with two pairs of fine, minute teeth to each segment, giving rise to tufts of long cilia (5). Thorax fuscous. Abdomen whitish irrorated with fuscous except on apices of segments. Legs ochreous-whitish; anterior pair fuscous annulated with whitish; posterior tibiæ in ♂ not dilated. Forewings triangular, costa straight to $\frac{2}{3}$, thence gently arched, apex rounded, termen slightly bowed, oblique; 10 and 11 coincident, not anastomosing (3♂, 4♀); whitish rather densely irrorated with fuscous, lines fuscous; first line at $\frac{1}{4}$, outwardly curved, indistinct; a minute, linear, discal mark at $\frac{2}{3}$; a sinuate, dentate, median line more or less distinct; a similar, more distinct, sometimes blackish line from $\frac{3}{4}$ costa to $\frac{3}{4}$ dorsum; a whitish, dentate, subterminal line edged anteriorly with fuscous; a terminal series of fuscous dots; cilia whitish, more or less barred with fuscous. Hindwings with termen rounded, crenulate; colour as forewings, but with markings obsolete on costal half of disc, which is whitish. Underside whitish, with obscure fuscous lines, and a terminal band on forewing.

Q.: Gayndah, Nambour, Brisbane; in March and April. — N.S.W.: Sydney (according to Walker).

40. ECTROPIS SABULOSA.

Ectropis sabulosa Warr., Nov. Zool., 1897, p.94.

♂♀. 32-50 mm. Head whitish-ochreous; face with a transverse fuscous bar beneath antennæ. Palpi dark fuscous, apex, internal surface, and lower edge whitish-ochreous. Antennæ whitish-ochreous; in ♂ with minute dentations bearing tufts of long cilia, two to each segment. Thorax pale greyish-ochreous.

Abdomen whitish-ochreous, with some fuscous scales on dorsum, sometimes forming transverse bars on basal segments. Legs whitish-ochreous, with some fuscous scales; internal surfaces of apical half of femora and whole of tibiæ and tarsal joints dark fuscous except at apices of each. Forewings triangular, costa gently arched, apex rounded, termen bowed, oblique; 10 and 11 stalked more shortly than usual in this genus, free (9♂), 10 and 11 coincident, free (4♀); ochreous-whitish largely suffused with pale greyish-ochreous; markings fuscous; a curved line at $\frac{1}{4}$ represented usually by three dots on costa, dorsum, and in disc; median line represented by a costal spot only; postmedian line distinct, sinuate, dentate, from $\frac{3}{4}$ costa to mid-dorsum; a fine, whitish, dentate, subterminal line, usually very indistinct, preceded by several fuscous spots, of which two above middle lie close together; a terminal series of dots; cilia ochreous-whitish. Hindwings with termen well-rounded; colour as forewings. Underside ochreous-whitish, with indistinct, pale fuscous mottling.

N.Q.: Thursday Island, Cairns, Ingham, Townsville.— Q.: Gayndah, Brisbane. Also from Celebes and Amboyna.

41. ECTROPIS HEMIPROSOPA.

Ectropis hemiprosopa Turn., Trans. Roy. Soc. S. Aust., 1904, p.230.

Closely allied to the following but greyer, the fuscous lines and dots much less pronounced, and the upper half of face dark fuscous. The neuration is also different. Forewings with 10 and 11 coincident and free (2♂), or anastomosing with 12 (1♀), or connected with 9 (1♂), or anastomosing with 12 and connected with 9 (1♂, 2♀), or anastomosing with both 12 and 9 (1♀).

N.Q.: Innisfail, Townsville.— Q: Nambour, Brisbane.

42. ECTROPIS CAMELARIA.

Boarmia camelaria Gn., Lep., ix., p.256. *Cleora velutinaria* Wlk., Cat. Brit. Mus., xxxv., p.1580. *Ectropis camelaria* Meyr., Proc. Linn. Soc. N. S. Wales, 1891, p.630.

I have one male from Herberton, in which all the pectinations are forked, except the most basal, which are double, exactly as in *E. hemiprosopa*. It is not unusual for a few of the most

apical pectinations to be forked. Forewings with 10 and 11 long-stalked, their common stalk connected with 12, and 10 connected with 9 (6♂, 4♀), or similar but 10 anastomosing with 9 (1♀).

N.Q.: Herberton —Q.: Duaringa, Bundaberg, Gympie, Caloundra, Brisbane, Blackbutt. — N.S.W.: Newcastle.

43. ECTROPIS MNIARA, n.sp.

μνιάρως, mossy.

♂. 30-33 mm. Head pale greenish; face sometimes suffused with pale fuscous. Palpi $1\frac{1}{4}$; ochreous-whitish, towards apex fuscous. Antennæ ochreous-whitish; in ♂ dentate, with two pairs of tufts of moderate cilia (1) on each segment. Thorax greenish. Abdomen greenish-ochreous: sometimes with paired, darker dots on dorsum of basal segments. Legs ochreous-whitish; anterior and sometimes middle tibiæ and tarsi broadly banded with fuscous. Forewings triangular, costa gently arched, apex rounded, termen bowed, oblique; 10 absent, 11 from cell, not anastomosing (4♂); whitish irrorated with greenish, and with obscure greenish lines; an obscurely double line at $\frac{1}{4}$, outwardly curved, somewhat dentate; a similar median line; a postmedian line from $\frac{2}{3}$ costa, becoming closely appressed to median line in mid-disc, and continued parallel to it to dorsum; an interrupted subterminal line containing a larger double spot beneath costa; a terminal series of dark fuscous dots; cilia whitish. Hindwings with termen rounded, crenulate; colour as forewings but first line single, and succeeded by a pale-centred, median, discal spot at $\frac{2}{3}$. Underside whitish.

N.Q.: Herberton and Evelyn Scrub, in December and January; three specimens, received from Mr. F. P. Dodd. — N.S.W.: Dorrigo, in November; one specimen, in Coll. Lyell, received from Mr. R. J. Tillyard; rather darker, and with some short, blackish streaks on lines.

44. ECTROPIS ODONTOPHORA, n.sp.

ὀδοντοφόρος, bearing teeth; in allusion to postmedian line of forewings.

♂. 26-27 mm. Head brown-whitish. Palpi rather long ($2\frac{1}{2}$); brown, sharply white towards base beneath. Antennæ whitish:

in ♂ with two short teeth on each segment, giving rise to tufts of long cilia (6). Thorax brown-whitish. Abdomen whitish. Legs whitish; anterior pair brownish. Forewings triangular, costa straight to $\frac{2}{3}$, thence moderately arched, apex rounded, termen slightly bowed, oblique; 10 and 11 coincident, not anastomosing (2♂); brown-whitish, markings brown mixed with fuscous: an outwardly curved line from $\frac{1}{3}$ costa to $\frac{1}{4}$ dorsum; another sinuate at first outwardly then inwardly about middle, preceded by a subcostal discal dot; a postmedian line from $\frac{2}{3}$ costa to $\frac{2}{3}$ dorsum, with a strongly marked double-tooth, posterior projection in middle; a subterminal dark line; some indistinct terminal dots; cilia whitish. Hindwings with termen rounded; colour as forewings but without first line. Underside whitish, almost without markings.

N.Q.: Kuranda, in July; and Nelson, near Cairns; two specimens, received from Mr. F. P. Dodd, and Mr. E. Jarvis.

Gen. 18. PACHYPLOCIA.

Pachyplocia Warr., Nov. Zool., 1896, p.404.

Face smooth. Tongue well-developed. Palpi moderate, porrect, densely hairy beneath; terminal joint very short, obtuse. Antennæ of ♂ bipectinate, towards apex simple. Thorax with a small posterior crest, hairy beneath. Femora glabrous; posterior tibiae of ♂ not dilated. Forewing of ♂ with large fovea; 10 and 11 coincident or long-stalked, free or anastomosing with 12 and 9. Hindwings in ♂ with dorsum thickened and rolled over on upper surface; neuration normal. Type, *P. griseata* Warr.

The peculiar hindwings of the ♂ are the chief distinguishing point from *Boarmia*.

45. PACHYPLOCIA GRISEATA.

Pachyplocia griseata Warr., Nov. Zool., 1896, p.404.

Antennal pectinations of ♂ 3, apical $\frac{1}{3}$ simple. Forewings with 10 and 11 coincident, not anastomosing (3♂), coincident and anastomosing with 12 and 9 (1♀), long-stalked and 10 anastomosing with 9 (1♀).

N.Q.: Cooktown, Cairns, Herberton.—Q.: Caloundra, Brisbane,

Gen. 19. SCIOGLYPTIS.

Scioglyptis Meyr., Proc. Linn. Soc. N. S. Wales, 1891, p.593.

Frons with a corneous, anterior projection. Tongue well-developed. Palpi rather long, porrect, shortly rough-haired beneath; terminal joint very short, concealed. Antennæ in ♂ bipectinate, apex simple. Thorax with a small, bifid, posterior crest; hairy beneath. Femora glabrous; posterior tibiæ in ♂ sometimes dilated. Forewings in ♂ with well marked fovea; 10 and 11 stalked, their common stalk connected by a bar (which may be of some length) with 12. Hindwings normal.

A simple development of the *lithina*-section of *Boarmia*, distinguished by the frontal process; there is also a small thoracic crest. I restrict this genus to *S. lithinopa* Meyr., which I regard as the type.

46. SCIOGLYPTIS LITHINOPA.

Scioglyptis lithinopa Meyr., Proc. Linn. Soc. N. S. Wales, 1891, p.593.

Palpi slightly over 2, with the apical hairs turned downwards. Forewings with 10 and 11 long-stalked, their stalk connected by a bar with 12 (2♂, 3♀).

N.Q.: Townsville, in February.—Q.: Brisbane, in November and February.—N.S.W.: Sydney, in April.

DESCRIPTION OF A NEW TIGER-BEETLE FROM THE
NORTHERN TERRITORY.

BY THOMAS G. SLOANE.

CICINDELA ÆNEODORSIS, n.sp.

Allied to *C. aurita* Sloane. ♂. Oval, convex, glabrous (including sternal sidepieces and posterior coxæ); prothorax with a stout, obtuse, subprominent, antebasal node on each side. Head, prothorax, disc of elytra and undersurface cupreous; ventral segments 1-5 with fiery reflections, sixth ventral segment testaceous; elytra with a lacteous margin (except beside scutellum), this margin narrow on sides of base, becoming wider backwards from shoulder to apex (thus causing the cupreous discal area to be triangular in shape), sutural and apical border metallic; labrum and base of mandibles lacteous; palpi pallid with apex viridescent; antennæ with two basal joints green, third and fourth joints testaceous towards base, green at apex, joints 5-11 light brown with pale pubescence; coxæ and tibiæ testaceous, apex of tibiæ viridescent, tarsi with joints 1-4 testaceous (apex viridescent), fifth joint dark with virescent tinge.

Head wide (3.5 mm. across eyes), coarsely shagreened, longitudinally striolate and lightly concave between eyes. Prothorax very coarsely shagreened, broader than long (2.15 × 3.1 mm.), hardly wider at middle than at posterior nodes (3 mm.), constricted anteriorly by the strongly marked transverse line, rather depressed on disc, lightly declivous to sides; posterior transverse line defining a depressed basal area, lightly marked; sides strongly ampliate behind anterior transverse line, subparallel (a little rounded) towards posterior nodes; apex with a well-marked border; posterior nodes a little before the base, wide, obtuse, a little prominent, not directed backwards. Elytra oval (7.5 × 4.7 mm.); discal metallic area strongly and deeply punctate, the

punctures becoming finer towards apex; lacteous lateral area covered with shallow punctures (these punctures large near metallic area, and becoming fine towards margins of elytra). Length 12, breadth 4·7 mm.

Hab.—Northern Territory. One specimen ticketed “Flooded area, King River, N.T.; W. McLennan; 24.12.15”; in National Museum, Melbourne.

This is one of the most distinct Australian species of *Cicindela*; it is the only member of the *C. tetragramma*-group with the elytra having a wide testaceous margin and a large, compact, triangular, discal, metallic area without any lacteous spots or stripes. It has the head and prothorax more strongly shagreened, and the elytra more strongly punctate than any other species of the group; the posterior nodes of the prothorax are somewhat as shown in Mr. Lea's figure of the prothorax of *C. albolineata* Macl., (Proc. Linn. Soc. N. S. Wales, 1906, Pl. xxx., fig.101), but are rather more obtuse and less prominent.

ON THE ENDOSKELETON OF THE HEAD, THE ANTERIOR COXÆ, AND THE ANTERIOR COXAL CAVITIES IN THE FAMILIES CARABIDÆ AND CICINDELIDÆ (COLEOPTERA).

By THOMAS G. SLOANE.

i. *Endoskeleton of head.*

In the Carabidæ and Cicindelidæ, there is a chitinous endoskeleton, which defines the buccal cavity behind. This endoskeleton has the form of a thin, narrow, median plate of chitin, which gives off four slender supports, one from each angle; two of these extend upwards, and attach themselves to the inner side of the front behind the clypeus; and two extend downwards, uniting with the submentum. The result is that the endoskeleton has, roughly, the form of the figure **S**, or of two arches (the upper one inverted) united in the middle by a flat, somewhat quadrangular plate. The œsophagus passes through the lower arched opening. The endoskeleton, on its anterior side, helps to support the muscles of the mouth-parts; especially, in the case of the lower arch, those of the maxillæ and labium. Attention is now drawn to the difference in the manner in which the lower supports of the endoskeleton unite with the exoskeleton in the Carabidæ and Cicindelidæ.

Carabidæ.—Lower supports attached wholly to the submentum, but not to the lobes of the mentum.

Cicindelidæ.—Lower supports attached to the submentum, and also to the lobes of the mentum, these being raised inwards to meet them.

The endoskeleton of the head in insects has been very fully treated by A. Berlèse ("Gli Insetti," chapter on 'Endoscheleton del Capo'). I am indebted to Mr. R. J. Tillyard for this information, but I have not had an opportunity of consulting this

great work. It is only as a character helping to differentiate the Carabidæ from the Cicindelidæ that reference is here made to it.

ii. *Anterior Coxæ.*

It is not proposed to go carefully into the anatomy of the anterior coxæ, with their marked difference of inset in the coxal cavities, between the Carabidæ and Cicindelidæ. The following are the main differences between these families.

Carabidæ.—Axis of anterior coxa obliquely longitudinal, points of articulation with coxal cavity at ends of joint, both these points hidden; posterior articulation-point prominent, placed beside and *behind* the socket to receive the trochanter.

Cicindelidæ.—Axis of anterior coxa transverse, points of articulation opposite one another; external articulation-point small, visible, placed above, *anterior* to, and distant from, the socket to receive the trochanter.

iii. *Anterior Coxal Cavities.*

The coxal cavities of the Cicindelidæ have been fully treated by Dr. Walther Horn;* therefore, only those of the Carabidæ are here dealt with.

There are two distinctive and well known forms of the anterior coxal cavities of this family: (1) closed cavities, where the intercoxal part of the prosternum and the epimera meet behind, and completely enclose the coxal cavities; (2) open cavities, where the intercoxal part of the prosternum and the epimera do not meet posteriorly, but leave the coxal cavities open behind.

(1) Three forms of the closed cavities are known to me, viz., (a) the *Scaritid-form* (typified in the genus *Scarites*), (b) the *Pseudomorphid-form* (typified in the genus *Silphomorpha*), (c) the *Omphron-form* (occurring only in the genus *Omphron*).

(a). *Scaritid form.*—At least two modifications of this type of the anterior coxal cavities are to be met with—the *single form*, in which the opening of the cavity inwards is single (this is the usual form in the Carabidæ), and the *double form*, in which the inward opening of the cavity is divided by a narrow, transverse,

* Cf. Dr. Walther Horn, in Wytzman's *Genera Insectorum*. Col. Adephaga, Subfam. Cicindelidæ. Fasc. 82A, pp. 19-22, Taf. 4, figs. 28-48.

chitinous strip. (The double form is more recent than the single form).

Single form of closed cavity.—Intercostal declivity present behind coxæ, its sides more or less prominent, and meeting epimeron to enclose the cavity; chitinous partition completely separating coxæ, thin in middle, explanate on upper side, and forming a wide support for the peduncle of the body, which may be called the *intercoxal plate*; anterior extremity of intercoxal plate more or less transverse, often with two, narrow, chitinous processes projecting forward (the apical parts of the intercoxal plate help to support the muscles of the legs, and are found throughout the whole of the Carabidæ).

Double form of closed cavity.—Intercostal parts of prosternum formed generally as in the closed, single form, but with the chitinous, transverse, apical piece of the *intercoxal plate* produced on each side to meet the epimeron, and dividing the inner opening of the cavity into two, viz., an anterior opening, through which the muscles and nerves of the leg pass into the prothorax, and a posterior opening between the intercoxal plate and the epimeron, the posterior opening apparently having no functional utility. The double form of closed, anterior, coxal cavities occurs throughout the family Cicindelidæ, as well as in the Tribes Lebiini, Helluonini, Brachynini, and others of the Carabidæ.

(b). *Pseudomorphid form.*—Anterior coxal cavities with a single opening inwards, intercoxal declivity present, projecting backwards and supporting peduncle of body; chitinous partition completely separating coxæ, intercoxal plate very short; epimera uniting with apex of intercoxal plate to close the cavities behind. This form occurs only in the subfamily Pseudomorphinæ.

(c). *Omophron-form.*—Anterior coxal cavities closed behind by the union of the epimera with a narrow, erect process extending from each side of the apex of the point of the prosternum; inner opening single; peduncle of body supported by the point of the prosternum; no intercoxal declivity or intercoxal plate present; intercoxal partition reduced, inner side almost vertical, narrow anteriorly, dividing into two ridges at middle, these ridges

uniting on each side with point of prosternum inward from apex; anterior coxæ contiguous. *Note*.—In the genus *Omophon*, the mesosternum has, on each side of the apex, a small cavity, which helps to support the anterior coxa.*

(2). Open anterior coxal cavities. Genus *Pamborus*. Anterior coxal cavities open behind; inner opening single; peduncle of body supported by the point of the prosternum; no intercoxal declivity or intercoxal plate present; intercoxal partition greatly reduced, inner side narrow, oblique; anterior coxæ contiguous. This is the form in the Tribes Trachypachini, Carabini, Nebriini, Pamborini, and Hiletini. *Note*.—In the Tribes with open coxal cavities, the mesosternum is keeled in the middle, and, on each side of the keel, there is a small fossa to help in supporting the anterior coxa.

The usually accepted view is, that open anterior coxæ are the primitive form in the family Carabidæ, but Lameere has published his belief that the original Carabidæ had closed anterior coxæ.† As far as I can interpret the evidence, it does not support the current view that the open anterior coxal cavities are primitive. Some facts which have weighed with me are. (1) The closed form is that of the family Cicindelidæ, and is, therefore, very ancient in that it antedates the differentiation of the Carabidæ and Cicindelidæ from the prototypic stem from which both were derived. (2) The form of the juxtacoxal parts of the prosternum in *Omophon* suggests to me a modification by reduction from the ordinary closed form. (3) In the open form of coxal cavities, the process of reduction seems carried still further. *Note*.—I cannot think that the supporting fossæ of the mesosternum are the primitive Carabid-form, seeing that similar fossæ are found in the genus *Platychila*, in the Cicindelidæ, where they are not the original type.

* Cf. Dr. Walther Horn, *op. cit.*, pp. 17 and 19, for remarks on *Omophon*; and Taf. 4, fig. 29, for a drawing of the prothorax showing the basal socket and coxal cavities in *Omophon*.

† Ann. Soc. Ent. Belg., 1900, p. 375. Quoted by Dr. Horn, *l.c.*, p. 69. I have not seen Lameere's work, which I know only from Dr. Horn's citation.

ORDINARY MONTHLY MEETING.

AUGUST 27th, 1917.

Dr. H. G. Chapman, President, in the Chair.

The Donations and Exchanges received since the previous Monthly Meeting (25th July, 1917), amounting to 5 Vols., 23 Parts or Nos., 4 Bulletins, 1 Report, and 3 Pamphlets, received from 28 Societies, etc., and two private donors, were laid upon the table.

NOTES AND EXHIBITS.

Mr. Froggatt exhibited fresh specimens of the two common grain-weevils from wheat-stacks at Melbourne and Sydney. It has been customary hitherto to record the common grain-weevil as *Calandra oryzae* Linn. This is correct as far as Sydney is concerned; but, on examining a number obtained from wheat-stacks at Port Melbourne, these were found to be all wheat-weevils, *Calandra granaria*, a distinct species, that is unknown or very rare in Sydney. *Calandra oryzae* is winged and can fly, has the wing-covers showing four light blotches on the brown, the punctures down the parallel striae close together, and the punctures on the prothorax rounded and close together. *Calandra granaria* is wingless and cannot fly, and the wing-covers are of a uniform dark brown tint, with the punctures on the prothorax oblong. Both are cosmopolitan in their range, but the first-named is the common Indian species.

Mr. Fletcher showed very complete suites of specimens of the three crimson-flowered kinds of *Callistemon* to be found in the neighbourhood of Sydney; and he pointed out how a comparison of their characters and habitats, and of the conditions under which they are usually associated, favoured the view that the correct interpretation of Mr. Bentham's statement as to one of them (*C. rigidus* R.Br.) being "intermediate" between the other two (*C. lanceolatus* D.C., and *C. linearis* D.C.) was, that it is a natural hybrid. After the President and Mr. Cheel had offered some remarks, further discussion was postponed to next Meeting.

REVISION OF AUSTRALIAN LEPIDOPTERA, vi.

BY A. JEFFERIS TURNER, M.D., F.E.S.

(Continued from p.336.)

Gen. 20. BOARMIA.

Boarmia Treit., Eur. Schmet., v., ii., p.433. *Selidosema* Hb., Verz., p.299; Meyr., Proc. Linn. Soc. N. S. Wales, 1891, p.594 (partim).

Face not projecting, smooth, or slightly hairy. Tongue well-developed. Palpi moderately long, porrect or somewhat ascending, rough-scaled or hairy beneath; terminal joint short, obtuse. Antennæ in ♂ bipectinate, towards apex simple. Thorax not crested, hairy beneath. Femora glabrous; posterior tibiæ in ♂ sometimes strongly dilated, with internal groove and tuft of hairs from base. Forewings of ♂ with well-developed fovea; 10 and 11 long-stalked or coincident, their common stalk often connected with 12, 10 sometimes connected with 9, or rarely 11 apparently from 12, not connected with 10. Hindwings normal.

Type, *B. roboraria* Schiff., from Europe.

The occasional connection of veins 9 and 10 presents no difficulty, but the relations of veins 10, 11, and 12 demand special attention. Veins 11 and 10 may be stalked, as in Fig. 4; or completely coincident, as in Fig. 5. In the first instance, 11 may

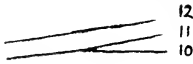

Fig.4.

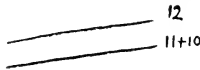

Fig.5.



Fig.6.

be connected with 12 by a short anastomosis, as in Fig. 6; or by a bar, often of considerable length, as in Fig. 7, every gradation between these two being observable. This bar unites 12 with the common stalk of 11 and 10 shortly before, or at their bifurcation; 11 is never connected with 12 after their separation

(except in one very abnormal example). Sometimes one is tempted to imagine that the base of vein 11 has disappeared, and that the long bar represents part of that vein after anastomosis with 12; but an examination of a series of specimens will show that this is not the case; the bar is merely an anastomotic union,



Fig. 7.



Fig. 8.



Fig. 9.

which has become lengthened out. When 10 and 11 are completely coincident, they may anastomose with 12, as in Fig. 8; or by a bar, as in Fig. 9. These six figures represent all the varieties present in the great majority of species. But, occasionally, a puzzling variety occurs as in Fig. 10 (*B. suasarua*); here



Fig. 10.



Fig. 11.



Fig. 12.

11 arises apparently from 12, and is not connected with 10. Fortunately the neuration of the other forewing of the same specimen, Fig. 11, explains the anomaly. Here the oblique connecting bar just touches the bifurcation of 10 and 11; in the abnormal wing, the connection has not developed, and the oblique bar has captured the origin of vein 11, which is now in two disconnected pieces, the basal portion being fused with 10. I have three examples of the new species, *B. nyctopora*, which are even more instructive. In one ♀, 10 and 11 are long-stalked and free, as in Fig. 4; in one ♂, they are connected with 12, as in Fig. 7, except that the bar is short; but, in another ♂, the neuration is of the type of Fig. 10, veins 11 and 10 being more closely approximated but not connected. In the other forewing of the same ♂, 10 and 11 are long-stalked; after their division, 11 almost immediately runs into the connecting bar with which 10 anastomoses a little further on; later, the two veins again separate (Fig. 9). This abnormality clearly demonstrates the correctness of my interpretation of figures 7, 10, and 11.

47. BOARMIA CLARISSA.

Aspilates clarissa Butl., Trans. Ent. Soc., 1886, p.438. *Cosymbia clarissa* Meyr., Proc. Linn. Soc. N. S. Wales, 1891, p.592.

Forewings with 10 and 11 coincident and free (3♂, 1♀), or anastomosing with 12 (1♂, 4♀).

N.Q.: Stannary Hills, Charters Towers.—Q.: Peak Downs, Duaringa, Bundaberg, Gayndah, Brisbane, Coolangatta, Nanango.—N.S.W.: Tabulam.

48. BOARMIA PENTHEARIA.

Selidosema penthearia Gn., Lep., x., p.146. *Tephрина adustaria* Wlk., Cat. Brit. Mus., xxxv., p.1661. *Panagra ruficolor* Butl., Trans. Ent. Soc., 1886, p.437. *Cosymbia ruficolor* Meyr., Proc. Linn. Soc. N. S. Wales, 1891, p.591. *C. penthearia* Meyr., *op. cit.*, p.592.

C. ruficolor is a common varietal form of this species. Forewings with 10 and 11 coincident and free (4♂, 7♀), or connected with 12 (1♀), or connected with 12 and 9 (1♂, 1♀).

Q.: Rockhampton, Duaringa, Peak Downs, Eidsvold, Gayndah, Brisbane, Warwick, Stanthorpe, Miles.—W.A.: Perth, York, Geraldton.

49. BOARMIA LEUCOPLECTA.

Selidosema leucoplecta Meyr., Proc. Linn. Soc. N. S. Wales, 1891, p.607.

Forewings with 10 and 11 coincident and free (1♀). Mr. Meyrick records two males in which 10 and 11 are coincident, and anastomose with 9.

Vic.: Melbourne.

50. BOARMIA LITHINA.

Scioglyptis lithina Warr., Nov. Zool., 1897, p.99.

♂♀. 32-38 mm. Head ochreous-whitish; face brownish. Palpi 1½; ochreous-whitish. Antennæ ochreous-whitish; pectinations in ♂ 6, apical ½ simple. Thorax, abdomen, and legs ochreous-whitish. Forewings triangular, costa straight to near apex, apex round-pointed, termen bowed, oblique; 10 and 11 long-stalked, their stalk connected by a bar with 12 (1♂, 2♀), or similar but 10 connected with 9 (1♂); whitish-ochreous partly suffused with

pale brownish; lines slender, brown, strongly oblique; traces of a sub-basal line; antemedian from $\frac{1}{6}$ dorsum very obliquely outwards, not reaching costa, nearly touching discal dot: a fuscous discal dot beneath midcosta; median extremely slender or obsolete, not reaching costa; postmedian from mid-dorsum very obliquely outwards, nearly straight or slightly wavy, not reaching costa; sometimes followed by a parallel line: subterminal very indistinct, whitish, dentate, preceded by some pale fuscous dentations; terminal dots minute or obsolete; cilia whitish, bases ochreous-tinged. Hindwings with termen gently rounded; colour as forewings. Underside whitish-ochreous, with fuscous discal dots and subapical blotches, and sometimes some fuscous strigulae.

N.Q. : Cairns, Mackay.—Q. : Brisbane, Southport.—N.S.W. : Sydney.

51. *BOARMIA EUDELA*, n.sp.

$\epsilon\rho\delta\eta\lambda\omicron\varsigma$, very distinct.

♀. 36 mm. Head whitish; face brown. Palpi $1\frac{1}{4}$; whitish, upper surface towards apex brown. Antennae, thorax, abdomen, and legs whitish. Forewings triangular, costa straight, apex round-pointed, termen bowed, oblique; 10 and 11 long-stalked, connected by a bar with 12 at their point of bifurcation; whitish; two very distinct, brown-fuscous, oblique lines from dorsum, not reaching costa; first from near base of dorsum, nearly straight, ending beneath $\frac{1}{3}$ costa; second from $\frac{2}{3}$ dorsum, slightly wavy, ending beneath $\frac{5}{6}$ costa; a very fine, brownish, median line from $\frac{1}{3}$ dorsum, scarcely reaching mid-disc; a short, brown, oblique streak from termen beneath costa; an indistinct terminal series of brownish dots between veins; cilia whitish. Hindwings with termen rounded; colour as forewings; a fine, brown, transverse line from $\frac{2}{3}$ dorsum not reaching costa; two, fine, parallel, brown lines from $\frac{2}{3}$ dorsum not reaching costa; terminal dots and cilia as forewings. Underside whitish; some fuscous dots on costa of forewings; fuscous discal dots and subparallel blotches on both wings.

Closely allied to *B. lithina*, though quite distinct. Type in Coll. Lyell.

N.Q.: Ingham: one specimen, received from Mr. E. T. Dunnegan.

52. *BOARMIA TEPHROLEUCA*, n.sp.

τεφρολευκος, ashy-white.

♀. 30 mm. Head grey-whitish, with a few fuscous scales. Palpi $1\frac{1}{4}$; whitish, with a few fuscous scales. Antennæ grey-whitish. Thorax grey-whitish, with a few fuscous scales, and slender, transverse, antemedian and median, fuscous lines. Abdomen grey-whitish. Legs whitish, with some fuscous irroration. Forewings rather narrowly triangular, costa straight to near apex, apex round-pointed, termen bowed, oblique; 11 apparently from 12, 10 connected with 9 (1♀); pale grey irrorated with white; some fuscous strigulations on costa, with a larger spot at $\frac{1}{4}$; lines very slender, strongly oblique, dark fuscous; antemedian from $\frac{1}{4}$ dorsum, not reaching costa; postmedian wavy, from $\frac{2}{3}$ dorsum, not reaching costa; median line faintly indicated in pale grey; a dark fuscous, discal dot beneath mid-costa; subterminal whitish, dentate; a terminal series of dark fuscous dots; cilia grey, apices and an interrupted median line whitish. Hindwings with termen nearly straight, slightly crenulate; colour as forewings, but without first line. Underside whitish, with discal dots, fine median and postmedian lines, and broad, fuscous, terminal bands, leaving whitish apical and tornal blotches.

Allied, by the neuration, to the preceding species, as already explained.

W.A.: Cunderdin; one specimen, taken by Mr. R. Illidge.

53. *BOARMIA SUASARIA*.

Boarmia suasaria Gn., Lep., ix., p.243. *B. proposita* Wlk., Cat. Brit. Mus., xxi., p.390. *Tephrosia gratularia* Wlk., *op. cit.*, xxi., p.415. *T. propinquaria* Wlk., *op. cit.*, xxi., p.415. (!) *mollisata* Wlk.

Forewings with 10 and 11 coincident and free (1♂), 10 and 11 long-stalked, their stalk connected by a bar with 12 (1♂), or similar but 10 connected with 9 (3♀). In addition, I have a ♂ with abnormal neuration on one side: on right side, 10 and 11 are long-stalked, and connected by a bar with 12 at their point

of bifurcation; while, on the left side, 11 arises apparently from 12, and is not connected with 10; as previously explained, this abnormality is due to 10 having been captured by the anastomotic bar, and the obliteration of its origin from 12.

N.Q.: Herberton.—Q.: Gympie, Brisbane, Towoomba.—N.S.W.: Newcastle, Sydney.

54. *BOARMIA ATMOCYMA*, n.sp.

ἀτμοκύμος, with smoky waves.

♀. 28 mm. Head grey-whitish; face fuscous, lower edge grey-whitish. Palpi $1\frac{1}{2}$; fuscous-grey-whitish. Antennæ fuscous. Thorax with a minute crest at each posterior angle; grey mixed with whitish. Abdomen grey mixed with whitish, apices of segments narrowly whitish; beneath white, with a few fuscous scales. Legs white irrorated and suffused with fuscous-grey. Forewings elongate-triangular, costa straight, apex rounded, termen bowed, oblique; 10 and 11 coincident, free (2♀); grey densely irrorated with white; five oblique lines from dorsum becoming indistinct towards costa; first from $\frac{1}{5}$ dorsum, very fine, blackish, ending in a large, blackish, discal dot at $\frac{1}{3}$; second from $\frac{1}{4}$, grey, running into discal dot, traceable to costa beyond middle; third from near second, blackish, to $\frac{1}{3}$ costa, becoming very fine and acutely dentate towards costa; fourth from before mid-dorsum, grey, parallel to third, but lost in disc; fifth from $\frac{2}{3}$ dorsum, fuscous, to costa near apex, dentate towards costa, immediately followed by a whitish line; a fine, blackish, terminal line, thickened between veins; cilia whitish obscurely barred with grey. Hindwings with termen but little rounded: colour as forewings; with four transverse lines; first at $\frac{1}{3}$, dark fuscous; second and third postmedian, close and parallel; fourth blackish, immediately followed by a whitish line. Underside whitish, with fuscous irroration; large, postmedian, discal spots, and broad, terminal bands on both wings, dark fuscous; the band on forewing ceases before tornus.

Type in Coll. Lyell.

N.Q.: Prince of Wales Island, Torres Straits: in June: two specimens (H. Elgner).



55. †BOARMIA AMPHICLINA.

Selidosema amphiclina Meyr., Proc. Linn. Soc. N. S. Wales, 1891, p.599.

N.S.W.: Sydney.

56. †BOARMIA EREMIAS.

Selidosema eremias Meyr., Proc. Linn. Soc. N. S. Wales, 1891, p.600.

N.S.W.: Sydney.

57. †BOARMIA THERMÆA.

Selidosema thermæa Meyr., Proc. Linn. Soc. N. S. Wales, 1891, p.600.

N.S.W.: Newcastle.

58. BOARMIA CURTARIA.

Tephrosia curtaria Wlk., Cat. Brit. Mus., xxxv., p.1592. *Selidosema curtaria* Meyr., Proc. Linn. Soc. N. S. Wales, 1891, p.602.

♂♀. 24-26 mm. Head ochreous-whitish; face fuscous. Palpi fuscous. Antennæ grey; pectinations in ♂ 8. Thorax whitish-ochreous mixed with fuscous posteriorly. Abdomen grey-whitish, with some fuscous scales, sometimes basal, antemedian, and subterminal fuscous bars on dorsum. Legs ochreous-whitish more or less irrorated with fuscous. Forewings narrowly triangular, costa slightly arched, apex round-pointed, termen bowed, oblique; 10 and 11 long-stalked, 10 connected with 9 (1♂), 10 and 11 coincident, free (3♀); ochreous-whitish with fuscous irroration and markings; a very oblique wavy line from $\frac{1}{3}$ costa to dorsum near base, sometimes outlining a basal patch; a line from midcosta, angled beneath costa, thence doubly waved to $\frac{1}{2}$ dorsum; a wavy postmedian line from $\frac{3}{4}$ costa to $\frac{2}{3}$ dorsum, sometimes connected by a bar to median line in disc, sometimes dentate beneath costa, usually closely followed by a parallel line; subterminal scarcely traceable, wavy, dentate, edged anteriorly interruptedly with fuscous; subterminal blotches beneath apex and above tornus; a fine, interrupted, blackish, terminal line; cilia ochreous-whitish, with some fuscous scales. Hindwings with termen rounded, crenulate or obtusely dentate; colour as forewings, but

without first line; usually a discal dot before middle. Underside grey, both wings with a fuscous discal dot, postmedian line, and apical blotch.

A variable species; the transverse median bar is present only in one ♀ example.

Q.: Gayndah, in September and April; Brisbane, in January; Stanthorpe, in October; four specimens.

59. *BOARMIA LOXOCYMA*, n.sp.

λοξοκυμος, obliquely waved.

♂. 26 mm. Head whitish; face dark fuscous mixed with whitish. Palpi dark fuscous. Antennæ grey, base of stalk whitish; pectinations in ♂ 4, apical $\frac{1}{3}$ simple. Thorax and abdomen whitish, with fuscous irroration. Legs whitish, with a few fuscous scales; anterior pair fuscous. Forewings narrowly triangular, costa straight to near apex, apex round-pointed, termen bowed, oblique; 10 and 11 coincident, and connected with 12; whitish, with some fuscous irroration; markings dark fuscous; a thick, dentate line from $\frac{1}{3}$ costa, becoming slender in disc and bent strongly inwards to $\frac{1}{6}$ dorsum; median line similar, and in lower half closely approximated to the preceding; postmedian line from $\frac{2}{3}$ costa to $\frac{1}{3}$ dorsum, twice waved in disc; a terminal line with triangular thickenings between veins; cilia whitish barred with grey. Hindwings similar, but without first line. Underside whitish, with some fuscous suffusion; both wings with a fuscous discal dot; forewings with a fuscous postmedian line and apical blotch; hindwings with a fuscous terminal band.

Q.: Gayndah, in October; one specimen, received from Dr. Hamilton Kenny.

60. *BOARMIA ACROTYPA*, n.sp.

ἀκροτυπος, marked at the apex.

♀. 28 mm. Head ochreous-whitish, face with transverse fuscous bars above and below middle. Palpi $1\frac{1}{4}$, projecting slightly beyond frons; dark fuscous, towards base grey-whitish. Antennæ grey, towards base whitish; in ♀ serrate. Thorax grey-

whitish. Abdomen ochreous-grey-whitish, with a few fuscous scales. Legs ochreous-whitish; anterior pair fuscous. Forewings rather elongate, costa very slightly arched, apex tolerably pointed, termen nearly straight, oblique, slightly waved; 10 and 11 long-stalked, 10 connected with 9; grey-whitish, with some fuscous irroration and brownish suffusion; a very fine, dark fuscous line from near base of dorsum very obliquely outwards, not traceable beyond middle of disc; a very faint, oblique, brownish, median line; a thick, dark fuscous, very oblique, strongly waved line from dorsum before middle to beneath $\frac{3}{4}$ costa, followed by a broad brownish suffusion, with one or two dots between its extremity and costa; a thick, dark fuscous, subapical streak nearly reaching apex of postmedian line; an interrupted, fuscous, terminal line; cilia whitish, with an interrupted, fuscous, median line. Hindwings with termen scarcely rounded, dentate; colour as forewings, but lines present towards dorsum only. Underside grey, with a fuscous postmedian line on forewing.

Q.: Eumundi, near Nambour; in October; one specimen.

61. BOARMIA EXTERNARIA.

Tephrosia externaria Wlk., Cat. Brit. Mus., xxxv., p.1591. *Selidosema externaria* Meyr., Proc. Linn. Soc. N. S. Wales, 1891, p.602.

Forewings with 10 and 11 coincident, connected with 12 (1♀). Mr. Meyrick, who had three specimens, gives 10 and 11 stalked, their stalk connected with 12.

N.Q.: Kuranda, near Cairns.—Q.: Duaringa.

62. BOARMIA CANESCARIA.

Boarmia canescaria Gn., Lep., ix., p.249. *Selidosema canescaria* Meyr., Proc. Linn. Soc. N. S. Wales, 1891, p.603. *Parathemis irrorata* Warr., Nov. Zool., 1898, p.250. *P. violescens* Warr., Nov. Zool., 1898, p.250.

Forewings with 10 and 11 long-stalked and free (1♂), or with the common stalk connected with 12 (7♂, 3♀); or, in addition, 10 connected with 9 (2♂). The connection with 12 is usually by a bar, sometimes fairly long, so that 11 appears to arise from 12.

Q.: Duaringa, Gayndah, Brisbane, Stradbroke Island.—Vic.: Gisborne.—S.A.: Mt. Lofty.—W.A.: Waroona.

63. BOARMIA LYCIARIA.

Boarmia lyciaria Gn., Lep., ix., p.250. *B. peculiaris* Gn., *op. cit.*, p.250, Pl. vi., f.1. *B. semitata* Wlk., Cat. Brit. Mus., xxi., p.389. *Selidosema lyciaria* Meyr., Proc. Linn. Soc. N. S. Wales, 1891, p.604.

Forewings with 10 and 11 long-stalked, their stalk anastomosing (3♂), or connected by a bar (1♂) with 12, 11 apparently from 12 and 10 connected with 9 (1♂), 10 and 11 coincident and connected with 12 (4♀).

Vic.: Melbourne, Gisborne.—Tasm.: Hobart.

64. BOARMIA LOXOGRAPHIA, n.sp.

λοξογραφος, obliquely marked.

♂. 43 mm. Head fuscous-grey; face black, upper edge grey, lower third whitish. Palpi blackish. Antennæ grey; pectinations in ♂ very long (10), fuscous interrupted by whitish, apical $\frac{1}{3}$ simple. Thorax grey, with whitish irroration, and two obscure, fuscous, transverse lines. Abdomen grey; basal segment and apices of other segments whitish. Legs fuscous; posterior pair ochreous-whitish. Forewings triangular, costa straight almost to apex, apex rounded, termen bowed, slightly wavy, moderately oblique; 10 and 11 long-stalked, their common stalk connected with 12; pale grey without ochreous tinge; a fine line from $\frac{1}{3}$ costa to $\frac{1}{3}$ dorsum enclosing a brownish basal area; discal dot obsolete; a broad, dark fuscous band, succeeded by a brownish shade, from $\frac{2}{3}$ dorsum very obliquely outwards, suddenly narrowing in disc to a fine line forming an outward projection, not reaching costa; a fine line from $\frac{1}{3}$ costa, interrupted beneath costa, and then joining median band; a whitish, dentate, sub-terminal line preceded by an incomplete fuscous line, and crossed by a dark fuscous, oblique streak from termen beneath apex; an interrupted, dark fuscous, terminal line; cilia whitish, with a fuscous, median line. Hindwings with termen slightly rounded, wavy; colour and markings as forewings but without basal line;

with a blackish, transverse, discal mark preceded by a straight, dark fuscous, transverse line; a fine, sinuate, postmedian line succeeded by a brownish shade; subterminal line preceded by a broad, dark fuscous line. Underside ochreous-whitish; with a dark fuscous, median spot, smaller in hindwing, and a broad terminal band becoming obsolete at tornus.

Allied to *B. lyciaria*, but abundantly distinct.

Type in Coll. Lyell.

Vic.: Emerald; in November: one specimen.

65. BOARMIA COGNATA.

Boarmia cognata Wlk., Cat. Brit. Mus., xxi., p.392. *Selidosema cognata* Meyr., Proc. Linn. Soc. N. S. Wales, 1891, p.606.

Forewings with 10 and 11 coincident, free (2♂, 3♀), or connected by a bar with 9 (1♀): or, according to Mr. Meyrick, connected also with 12.

N.Q.: Stannary Hills.—Q.: Brisbane.—N.S.W.: Sydney.—Vic.: Melbourne, Gisborne.—Tasm.: Deloraine, Hobart.—S.A.: Mt. Lofty.

66. BOARMIA SYMMORPHA.

Selidosema symmorpha Turn., Trans. Roy. Soc. S. Austr., 1904, p.231.

Forewings with 10 and 11 long-stalked and free (2♂, 1♀), or coincident and free (3♀).

N.Q.: Townsville.—Q.: Gayndah, Brisbane.

67. BOARMIA LEPTODESMA.

Selidosema leptodesma Meyr., Proc. Linn. Soc. N. S. Wales, 1891, p.606.

Forewings with 10 and 11 coincident and free (1♂), or connected with 9 (1♂).

Vic.: Birchip, Sea Lake.—S.A.: Port Lincoln.—W.A.: Perth.

68. BOARMIA LUXARIA.

Hemerophila luxaria Gn., Lep., ix., p.220. *Tephrosia dispersita* Wlk., Cat. Brit. Mus. xxi., p.416. *Selidosema luxaria* Meyr., Proc. Linn. Soc. N. S. Wales, 1891, p.609.

Forewings with 10 and 11 long-stalked and free (1♂), or their stalk connected with 12 by a short anastomosis (1♂, 1♀), or by a bar (1♂); according to Mr. Meyrick, 10 may be connected with 9.

N.S.W.: Sydney.—Vic.: Narracan, Lorne.

69. *BOARMIA DELOSTICHA*, n.sp.

δηλοστικος, with well-marked lines.

♀. 34 mm. Head brownish; face with a pair of fuscous dots. Palpi $1\frac{1}{4}$; brownish. Thorax brown-whitish; tegulae brown. Abdomen brown-whitish with some fuscous-brown irroration. Legs ochreous-whitish; middle tibiae and tarsi irrorated with fuscous; anterior tibiae and tarsi dark fuscous, with ochreous-whitish annulations. Forewings triangular, costa arched at base, thence nearly straight almost to apex, apex rounded, termen bowed, oblique, crenulate; 10 and 11 coincident, free (1♀); brown-whitish suffused with brownish; first line indicated by a few dark scales at edge of a basal brown patch; a broad dark fuscous line from midcosta obliquely outwards, then rather sharply angled inwards, and sinuate to $\frac{1}{3}$ dorsum; a much finer, slightly dentate, dark fuscous line from $\frac{2}{3}$ costa becoming approximated to median line below its angle, and thence running parallel with it to dorsum; an oblique, dark fuscous streak from termen beneath apex to postmedian line; a slender, whitish, dentate, subterminal line cutting through subapical streak; a terminal series of dark fuscous dots; cilia brown, apices brown-whitish. Hindwings with termen gently rounded, dentate; colour as forewings, but with only two lines; first straight at $\frac{1}{4}$, second postmedian, finely dentate, somewhat sinuate. Underside brown-whitish; lines faintly indicated; costa of forewings strigulated with pale fuscous; a subterminal, pale fuscous band on forewings not reaching dorsum.

Type in Coll. Lyell.

N.Q.: Herberton, in January; one specimen, received from Mr. F. P. Dodd.

BOARMIA ZALOSCHEMA, n.sp.

ζυλοσχημος, with confused pattern.

♂. 30 mm. Head and palpi ochreous-whitish, with some fuscous scales. Antennae grey; in ♂ with moderately long pectina-

tions (5), apical $\frac{1}{10}$ simple. Thorax with a bifid posterior crest: ochreous-whitish mixed with fuscous: a brownish-fuscous line across middle of patagia. Abdomen with small lateral crests on posterior segments; ochreous-whitish mixed with fuscous, which is more pronounced along dorsum. Legs ochreous-whitish strigulated with fuscous. Forewings rather elongate-triangular, costa straight, apex rounded, termen bowed, oblique: 10 and 11 stalked: ochreous-whitish with patchy brownish suffusion and fuscous irroration; markings very confused; costa strigulated with fuscous; first and median lines not traceable: postmedian line very indistinct, but presenting two, fine, acute, fuscous dentations in middle; succeeded posteriorly by some fuscous suffusion; a fine, acutely dentate, whitish, subterminal line, preceded by some fuscous suffusion and partly outlined by fuscous scales; a terminal series of dark fuscous dots; cilia whitish mixed with fuscous. Hindwings with termen slightly rounded, obtusely dentate; whitish, with brownish strigulations best marked towards dorsum; a fuscous discal dot; a wavy postmedian line from dorsum to mid-disc; subterminal line and cilia as forewings; a dark fuscous terminal line. Underside whitish, with dark fuscous, discrete irroration, discal spots, and subapical and subtornal blotches. Type in Coll. Lyell.

W.A.: Kelmescott, in May; one specimen, received from Mr. G. F. Berthoud.

70. BOARMIA AGOREA.

Selidosema agorea Meyr., Proc. Linn. Soc. N. S. Wales, 1891, p. 608.

Antennæ pectinated in both sexes to $\frac{5}{6}$, pectinations in ♂ 8 or 9, in ♀ 3. Forewings with 10 and 11 long-stalked and free (1♂, 1♀), or 10 connected with 9 (3♀).

N.Q.: Kuranda, near Cairns.—Q.: Bundaberg, Gayndah, Brisbane.—N.S.W.: Sydney.—Vic.: Melbourne.

71. †BOARMIA AGANOPA.

Selidosema aganopa Meyr., Proc. Linn. Soc. N. S. Wales, 1891, p. 610.

W.A.: Albany.

72. †BOARMIA ADELPHODES.

Selidosema adelphodes Meyr., Proc. Linn. Soc. N. S. Wales, 1891, p.611.

W.A.: Albany.

73. †BOARMIA PALLIDISCARIA.

Selidosema pallidiscaria Meyr., Proc. Linn. Soc. N. S. Wales, 1891, p.612.

N.S.W.: Sydney.

74. BOARMIA ZASCIA.

Selidosema zascia Meyr., Proc. Linn. Soc. N. S. Wales, 1891, p.613.

Forewings with 10 and 11 long-stalked and free (1♂), or 10 connected with 9 (2♂), or with the common stalk anastomosing with 12 and 10 connected with 9 (1♂).

N.S.W.: Armidale.—Vic.: Melbourne, Beaconsfield.

My two New England examples are smaller and paler than two from Victoria.

75. BOARMIA PANCONITA, n.sp.

παγκονιτος, covered with dust.

♂♀. 32-40 mm. Head white: face blackish, lower $\frac{1}{2}$ or $\frac{2}{3}$ white (in one ♀ the face is wholly blackish). Palpi $1\frac{1}{4}$; fuscous. Antennæ blackish, the stalk and in ♂ the pectinations minutely but irregularly dotted and flecked with white; pectinations in ♂ 10, apical $\frac{1}{4}$ simple. Thorax blackish irrorated with white. Abdomen whitish, with some fuscous irroration, tending to form transverse bars on dorsum. Legs blackish, ventral surface and apices of tibiæ and tarsal joints whitish: posterior pair whitish, with a few fuscous scales. Forewings triangular, costa slightly arched, apex round-pointed, termen bowed, oblique, gently crenulate; 10 and 11 long-stalked, their stalk connected by a bar with 12 (4♂), 10 and 11 coincident (4♀) and free (1♀), or connected at a point with 12 (2♀), or connected with 12 and 9 (1♀); white densely strigulated with blackish: first line represented by several blackish dots; median line represented by blackish dots, or by a broad line angulated outwards below middle: postmedian from $\frac{2}{3}$

costa, interrupted or represented by discrete dots, sharply bent inwards below middle to join median line above dorsum; sometimes a discal dot posterior to median line; subterminal partly traceable, white, finely dentate, preceded by blackish dots, which may be partly confluent; a terminal series of blackish dots; cilia whitish and blackish, variably mixed, tending to form bars. Hindwings with termen rounded, subdentate; colour as forewings but without first line, and with a terminal line; discal mark crescentic. Underside whitish, with fuscous discal spots and incomplete terminal bands; apices whitish.

The curiously speckled antennæ suggest that here protective colouration has been carried to a fine point.

Q.: Gayndah, in September and October (Dr. Hamilton Kenny); Stanthorpe, in October and November: eight specimens. Those from the former locality have the median line on both wings thickened.

76. BOARMIA DESTINATARIA.

Gnophos destinataria Gn., Lep., ix., p.297. *Boarmia attenta* Wlk., Cat. Brit. Mus., xxi., p.393. *Tephrosia indirecta* Wlk., *op. cit.*, xxi., p.418. *T. yayaria* Wlk., *op. cit.*, xxvi., p.1542. *Selidosema destinataria* Meyr., Proc. Linn. Soc. N. S. Wales, 1891, p.613.

Antennæ of ♂ pectinated to $\frac{9}{16}$, pectinations 7; of ♀ pectinated to $\frac{3}{8}$, pectinations 3. Forewings with 10 and 11 long-stalked and free (2♂, 2♀), or 10 connected with 9 (1♂, 2♀).

N.S.W.: Ebor, Sydney, Katoomba.—Tasm.: —.

77. BOARMIA PERFECTARIA.

Tephrosia perfectaria Wlk., Cat. Brit. Mus., xxi., p.418. *Selidosema perfectaria* Meyr., Proc. Linn. Soc. N. S. Wales, 1891, p.614.

Forewings with 10 and 11 long-stalked, free (1♂), or their common stalk connected by a bar with 12 and 10 connected with 2 (1♂).

N.Q.: Herberton.—Q.: Stradbroke Island, Stanthorpe.—N.S.W.: Sydney.

78. BOARMIA VIRIDARIA.

Boarmia viridaria Pagent. *Selidosema viridis* Turn., Trans. Roy. Soc. S. Austr., 1906, p.133.

Forewings with 10 and 11 long-stalked, their stalk anastomosing with 12, 10 anastomosing with 9 (1♀).

N.Q.: Kuranda, near Cairns.

79. BOARMIA EUGRAPHICA, n.sp.

εὐγραφικός, well-engraved.

♂. 28 mm. Head and palpi whitish. Antennæ grey-whitish: pectinations in ♂ very long, apical $\frac{1}{3}$ simple. Thorax whitish, a dark fuscous spot on each patagium opposite base of costa of forewing. Abdomen whitish; seven pairs of dark fuscous dots on apices of segments: tuft in ♂ large. Legs whitish: anterior and middle tibiæ and tarsi barred on dorsum with dark fuscous; posterior tibiæ in ♂ dilated. Forewings triangular, costa straight to near apex, apex rounded, termen broad, moderately oblique; 10 and 11 stalked, 10 anastomosing with 9; whitish, markings dark fuscous: two spots close to base; first line slender, crenulate, from a dot on $\frac{1}{3}$ costa to $\frac{1}{4}$ dorsum; median line slender, well-marked, from $\frac{2}{3}$ costa to mid-dorsum, bowed outwards beneath costa; a pale-centred discal dot precedes median line; postmedian line finely dentate, sinuate, from $\frac{2}{3}$ costa to $\frac{2}{3}$ dorsum; a subterminal irregular series of large dots outwardly acute, indicating a white, dentate, subterminal line; a terminal series of interneural dots; cilia whitish faintly barred with pale fuscous. Hindwings with termen rounded, crenulate: colour as forewings, but with only one dot on base of dorsum, and without first line. Under-side whitish, with fuscous discal spots, slender postmedian line, and broader subterminal line, a large, fuscous, subapical blotch on forewing, leaving a large, whitish, apical spot

Similar to *B. perfectaria*, which, however, has different ♂ antennæ, face dark fuscous, first line running to base of dorsum, discal dots not pale-centred, abdomen with only three pairs of dark fuscous dots.

Type in Coll. Lyell.

N.A.: Port Darwin: in September: one specimen, received from Mr. F. P. Dodd.

80. *BOARMIA TENIOTA*, n.sp.*ταιριος*, banded.

♀. 28 mm. Head, thorax, and palpi grey-whitish. Antennæ grey. Abdomen whitish; third and fourth segments, except apices, fuscous-brown. Forelegs whitish, with some fuscous irroration [the others broken]. Forewings rather elongate-triangular; costa straight to near apex, apex rounded, termen bowed, oblique; 11 apparently out of 12, anastomosing with 9, 10 absent; whitish; markings fuscous-brown: some fuscous irroration along costa; a basal patch extending on costa to $\frac{1}{3}$, on dorsum to $\frac{1}{6}$, its edge obliquely rounded; median line very faintly indicated, a dark fuscous, discal dot before and touching postmedian band; a broad postmedian band, its posterior edge finely and acutely dentate; a suffused dark patch between this and termen beneath apex, and another above tornus; cilia whitish, with some pale fuscous bars beneath apex. Hindwings with termen rounded: colour as forewings, but without basal patch, and with postmedian band incompletely developed, leaving a dentate postmedian line. Underside whitish, with fuscous discal spots and a broad terminal band interrupted in middle of each wing.

Probably 10 and 11 are coincident, but their basal portion before the anastomosis with 12 is not developed.

Type in Coll. Lyell.

N.Q.: Prince of Wales Island, Torres Straits; in June: one specimen, received from Mr. H. Elgner.

81. *BOARMIA CRIMNODES*, n.sp.*κρμνωδης*, floury.

♀. 29-36 mm. Head and face white. Palpi $1\frac{1}{4}$; white partly suffused with pale fuscous. Antennæ grey. Thorax white. Abdomen white, with some grey scales. Legs white; anterior tibiae and tarsi annulated with fuscous. Forewings triangular, costa moderately arched, apex rounded, termen bowed, oblique; 10 and 11 coincident, anastomosing first with 12 and then with 8, 9 beyond 7 (3♀); white sparsely irrorated with grey; markings grey; three transverse dentate lines; first from $\frac{1}{3}$ costa

to $\frac{1}{4}$ dorsum, outwardly curved; second from costa before middle to mid-dorsum, outwardly curved, obscure or interrupted below middle; third from $\frac{2}{3}$ costa to $\frac{3}{4}$ dorsum, first outwardly oblique, then bent inwards after a double dentation in middle, finally bent downwards to dorsum, with a grey mark succeeding it towards dorsum; a grey, terminal band containing a white, dentate, subterminal line; a terminal series of fuscous dots; cilia white. Hindwings with termen strongly rounded; colour as forewings but without first line. Underside whitish, with a fuscous, discal spot on forewings, and a terminal band obsolete towards tornus on both wings.

N.Q.: Herberton; in January; three specimens, received from Mr. F. P. Dodd, of which one is in Coll. Lyell.

82. *BOARMIA NYCTOPORA*, n.sp.

νυκτοπορος, travelling by night.

♂♀. 44-50 mm. Head fuscous-whitish; face dark fuscous. Palpi rather long ($1\frac{1}{2}$), projecting well beyond frons; dark fuscous, lower edge ochreous-whitish. Antennæ fuscous-whitish; pectinations in ♂ fuscous, 8, apical $\frac{1}{6}$ simple. Thorax and abdomen fuscous or dark fuscous more or less mixed with ochreous-whitish. Legs whitish-ochreous more or less infuscated. Forewings broadly triangular, costa nearly straight except towards base and apex, apex obtuse, termen strongly bowed, crenulate, oblique; 10 and 11 long-stalked, 10 connected with 9 (1♀), similar but the common stalk connected by a bar with 12 (1♂); pale fuscous strigulated, and sometimes almost wholly suffused with fuscous; markings dark fuscous, an ochreous-whitish costal streak well-marked in ♂, in ♀ ill-defined; a line from $\frac{1}{4}$ costa to $\frac{1}{4}$ dorsum, angled outwards above dorsum; a minute discal dot; a line from $\frac{2}{3}$ costa to $\frac{2}{3}$ dorsum, sinuate and finely dentate; traces of a pale subterminal line preceded by fuscous dots; a terminal series of dots; cilia ochreous-whitish more or less suffused with fuscous. Hindwings with termen rounded, dentate; colour and lines as forewings; discal mark linear.

Mr. L. B. Prout identified this for me as *B. marmorata* Warr., for which I do not know the reference, but as there is already a

marmorata of Moore, this name cannot stand. The neuration of the ♂ type is abnormal but instructive; in the left forewing, 11 arises apparently from 12, and is closely applied to 10 but does not coalesce with it (apparently the vein has split); in the right forewing, the condition is more complicated, 11 arises apparently (not really) from 12, the stalk of 10 and 11 divides, 11 immediately runs into the abnormal vein, while 10 does the same some distance further on.

N.Q.: Kuranda, near Cairns, in October and November; Herber-ton, in January; three specimens, received from Mr. F. P. Dodd.

83. BOARMIA MACULATA.

Hypochroma maculata Luc., Proc. Linn. Soc. N.S. Wales, 1889, p. 1095.

♂♀. 48 mm. Head whitish-ochreous; face with an upper and a median, transverse, fuscous bar. Palpi $1\frac{1}{2}$; whitish-ochreous externally fuscous-tinged. Antennæ fuscous towards base mixed with whitish-ochreous; in ♂ with very short pectinations ($\frac{1}{2}$), one to each segment, ending in tufts of long cilia, apical $\frac{2}{3}$ sinuate. Thorax and abdomen whitish-ochreous, greenish-tinged, with more or less brownish-fuscous suffusion. Legs whitish-ochreous more or less mixed with fuscous; anterior and posterior tarsi fuscous, with whitish annulations. Forewings triangular, costa nearly straight, apex rounded, termen slightly bowed, oblique, crenulate; 10 and 11 stalked and free (2♂, 2♀); whitish-ochreous-greenish, rather densely dotted and partly suffused with brownish-fuscous; markings more or less obsolete; sometimes a dentate, transverse line from $\frac{1}{6}$ costa to $\frac{1}{3}$ dorsum, sometimes an oblique shade from costa before middle to $\frac{1}{3}$ dorsum; a dentate, post-median line very incompletely developed; indications of a pale, dentate, subterminal line; a terminal series of dots; cilia ochreous-whitish-greenish, bases brownish-tinged. Hindwings with termen rounded, crenulate; colour as forewings. Underside ochreous-whitish, with fuscous discal spots in forewings, dots in hindwings, and broad terminal bands, leaving apex of forewings and termen of hindwings ochreous-whitish.

The antennal structure of the ♂ differs from that of any other Australian species.

N.Q.: Kuranda, near Cairns, in June and October (Dodd); Innisfail, Mackay.—Q.: Brisbane, in March (R. Illidge).

Gen. 21. PHILOLOCHMA.

Philolochma Turn., Proc. Linn. Soc. N. S. Wales, 1914, p.550.

Frons flat. Tongue well-developed. Palpi moderately long, porrect or slightly ascending; second joint densely clothed with rough hairs; terminal joint moderate, obtuse. Antennæ in ♂ thickened, simple, minutely ciliated. Thorax not crested, hairy beneath. Abdomen not crested. Femora slightly hairy; posterior tibiæ of ♂ somewhat dilated. Forewings in ♂ with fovea represented by a triangular patch bare of scales; 10 and 11 arising separately from cell. Hindwings normal.

An endemic development of *Cleora*, the fovea being imperfect, and the male antennæ not pectinate.

84. PHILOLOCHMA CELÆNOCHROA.

Philolochma celænochroa Turn., Proc. Linn. Soc. N. S. Wales, 1914, p.550.

Forewings with 10 and 11 separate, free (2♂, 2♀).

N.S.W.: Ebor.

Gen. 22. SYNEORA, n.g.

συνηρος, hanging together, united.

Face with a conical or rounded protuberance. Palpi moderate, porrected, rough-scaled; terminal joint very short. Antennæ in ♂ bipectinate, apex simple. Thorax with a small posterior crest; beneath hairy. Femora glabrous; posterior tibiæ of ♂ dilated, with internal groove containing a tuft of long hairs from base. Forewings in ♂ with a well-marked fovea; 11 out of 10 near base, anastomosing or connected with 12, or rarely 10 and 11 separate, 10 sometimes connected with 9. Hindwings normal.

Type, *S. mundifera* Wlk.

1. Face, blackish with a central, transverse, white line..... *silivaria*.
Face ochreous-whitish, with some fuscous scales 2.

2. Forewings with a fuscous spot on base of costa..... *lygdina*.
 Forewings without basal, costal spot..... 3.
3. Forewings with lines faintly marked, antennal pectinations of ♂ $3\frac{1}{2}$ *hemeropa*.
 Forewings with lines distinct except towards costa, ♂ pectinations over 6 4.
4. Forewings with first line scarcely oblique *emmelodes*.
 Forewings with first line strongly oblique 5.
5. Forewings with first line from $\frac{1}{3}$ dorsum *mundifera*.
 Forewings with first line from $\frac{1}{2}$ dorsum *striolata*.

85. †SYNEORA SILICARIA.

Hemerophila silicaria Gn., Lep., ix., p.220. *Selidosema silicaria* Meyr., Proc. Linn. Soc. N. S. Wales, 1891, p.598.

I have seen only the British Museum examples, and noted that they were of a fine species distinct from *S. mundifera*, the face blackish, with a central, transverse, white line.

86. SYNEORA MUNDIFERA.

Hemerophila mundifera Wlk., Cat. Brit. Mus., xxi., p.322. *Boarmia disrupta* Wlk., *op. cit.*, xxi., p.391. (?) *Hemerophila excursaria* Wlk., *op. cit.*, xxvi., p.1532. *Tephrosia scitiferata* Wlk., Char. Undesc. Lep., p.77.

Frons projecting slightly, rounded. Antennal pectinations of ♂ 7. Forewings with 10 and 11 short-stalked, 11 then strongly anastomosing with 12, 10 connected with 9 (2♂). In one of these, the short portion of vein 11 between 10 and 12 is feebly developed on one side; on the other, it is not traceable; thus the neuration of the abnormal side is indistinguishable from that of *Boarmia*, Text-fig.7, but is structurally and etiologically different.

Vic.: Melbourne.—Tasm.: Strahan.

87. SYNEORA EMMELODES.

Scioglyptis emmelodes Turn., Trans. Roy. Soc. S. Austr., 1904, p.232.

Forewings with 11 out of 10 near origin, connected, after bifurcation, with 12 by a short bar (1♂).

Q.: Brisbane, in August.

88. SYNEORA STRIXATA.

Phibalapteryx strixata Wlk., Cat. Brit. Mus., xxv., p.1340.
Selidosema cheleuta Meyr., Proc. Linn. Soc. N. S. Wales, 1891,
 p.598.

Frons with a strong, rounded projection. Forewings with 11 out of 10 near base, anastomosing strongly with 12 (1♂).

Vic.: Melbourne.

89. †SYNEORA HEMEROPA.

Scioglyptis hemeropa Meyr., Proc. Linn. Soc. N. S. Wales, 1891, p.594.

N.S.W.: Newcastle, Sydney.—Vic.: Melbourne.

90. SYNEORA LYGDINA, n.sp.

λυγδίνος, like marble.

♀. 32 mm. Head ochreous-whitish; with an acute, wedge-shaped, frontal process. Palpi rather long (2); ochreous-whitish with some fuscous irroration. Thorax with a small, bifid, posterior crest; ochreous-whitish. Abdomen ochreous-whitish. Legs whitish; anterior tibiæ and tarsi fuscous, with whitish annulations. Forewings triangular, costa gently arched, apex rounded, termen bowed, moderately oblique, wavy; 10 and 11 separate; whitish; lines obsolete; a fuscous spot on base of costa; a few fuscous scales or dots on costa; a few fuscous scales beneath costa at $\frac{1}{4}$ representing first line; traces of a fuscous line from termen beneath apex to before tornus, including a double, dark fuscous spot near apex; cilia white. Hindwings with termen rounded; colour and subterminal fuscous line as forewings, but without defined spot; traces of a fuscous, median, discal dot. Underside whitish; forewings with a fuscous, subapical blotch; hindwings with a fuscous, subterminal band becoming obsolete towards tornus.

Possibly the ♂ may show more defined markings.

Type in Coll. Lyell.

W.A.: Waroona; in September; one specimen, received from Mr. G. F. Berthoud.

Gen. 23. PSILOSTICHA.

Psilosticha Meyr., Proc. Linn. Soc. N. S. Wales, 1891, p.624.

A development of *Cleora*, with the neuration of *Syneora*, but the ♂ antennæ are simple.

91. PSILOSTICHA MACTARIA.

Tephrosia mactaria Gn., Lep., ix., p.270. *Boarmia attacka* Wlk., Cat. Brit. Mus., xxi., p.392. *Tephrosia integraria* Wlk., *op. cit.*, xxi., p. 420. *T. absorpta* Wlk., *op. cit.*, xxi., p. 420. *Psilosticha mactaria* Meyr., Proc. Linn. Soc. N. S. Wales, 1891, p.624.

I have only one example, a ♂, in which 11 appears to rise from 10 near base and immediately run into 12.

N.S.W.: Sydney.—Vic.: Melbourne.—Tasm.: George's Bay.

Gen. 24. AMBLYCHIA.

Amblychia Gn., Lep., ix., p.214; Hmps., Moths Ind., iii., p.241.

Tongue well-developed. Palpi moderate, upturned, closely appressed to frons, thickened in front with densely appressed hairs; terminal joint short, concealed. Antennæ in ♂ bipectinate, extreme apex simple. Thorax and abdomen not crested; thorax hairy beneath. Femora glabrous; posterior tibiæ in ♂ sometimes dilated. Forewings in ♂ with fovea, 10 and 11 separate or short-stalked, 11 sometimes anastomosing with 12, 10 sometimes connected with 9. Hindwings very long; neuration normal.

Type, *A. angeronaria* Gn. The two species differ somewhat in shape of wing, but I see no ground for generic separation. The genus *Elphos* Gn., (Lep., ix., p.285; Hmps., Moths Ind., iii., p.249. Type, *E. hymenaria* Gn.) appears to differ in vein 10 arising out of 9.

1. Hindwings angled and produced on vein 4..... *angeronaria*.
Hindwings with termen rounded, subdentate..... *subrubida*.

92. AMBLYCHIA ANGERONARIA.

Amblychia angeronaria Gn., Lep., ix., p.215, Pl. iv., f.9; Hmps., Moths Ind., iii., p.242.

♀. 88mm. Head and palpi brown. Antennæ fuscous. Thorax

brown. Abdomen brownish-ochreous. Legs brown-whitish irrorated with fuscous. Forewings broadly triangular, costa gently arched, more strongly towards apex, apex acute, termen sinuate beneath apex, then bowed, slightly oblique; 10 and 11 from cell, not anastomosing (1♀): reddish-brown with minute fuscous strigulae; suffused with whitish along costa to $\frac{3}{4}$; a rounded, dentate, fuscous line from $\frac{1}{4}$ costa to $\frac{1}{4}$ dorsum, preceded by a white spot below middle; a fuscous, subcostal, discal spot before middle; median line faintly indicated; a nearly straight, broad, fuscous line from $\frac{3}{4}$ costa to tornus; a series of white lunules on anterior margin of this line to vein 2, connected by a sinuate, white line with $\frac{2}{3}$ termen; a triangular, white blotch on costa before apex, giving off a faintly marked, strongly dentate, subterminal line, which soon becomes obsolete; cilia fuscous, apices brown. Hindwings rhombiform, produced on vein 4 in a strong tooth, and less strongly on veins 5 and 6; colour as forewings: a median, fuscous, discal spot at $\frac{1}{4}$; a fine, dentate, whitish, median line; a similar subterminal line, towards costa edged strongly anteriorly with fuscous. Underside similar but pale grey-brown.

N.Q.: Cape York; one specimen, in January (Coll. Lyell). Also from Java, Sumatra, Ceylon, and India.

93. AMBLYCHIA SUBRUBIDA.

Elphos subrubida Warr., Nov. Zool., 1896, p.300.

♂. 30 mm. Head and palpi fuscous. Antennæ fuscous; pectinations in ♂ 5. Apical $\frac{1}{2}$ simple. Thorax fuscous. Abdomen pale fuscous, with paired darker spots on dorsum of first four segments. Legs pale fuscous. Forewings triangular, costa moderately arched, apex round-pointed, termen bowed, oblique, crenulate; 10 and 11 short-stalked, 11 anastomosing with 12, 10 connected by a short bar with 12 (1♂); whitish densely dotted with fuscous throughout; lines fuscous; a curved, crenulate line from $\frac{1}{3}$ costa to $\frac{1}{4}$ dorsum, preceded by a parallel line; a line from costa before middle to mid-dorsum, obtusely angled above middle, containing a darker discal mark above angle; a dentate line from $\frac{2}{3}$ costa to dorsum near tornus, preceded by a parallel line, both lines obscured above dorsum; a dentate, whitish, subterminal

line, edged anteriorly with fuscous; a dark fuscous, terminal line; cilia fuscous barred with whitish. Hindwings with termen rounded, subdentate; colour as forewings but without first line. Underside of forewings whitish, much strigulated with fuscous, base and terminal area, except at apex, wholly fuscous, a blackish discal spot; of hindwings fuscous, with a large, dorsal, reddish-orange blotch extending from base to middle.

♀. 33 mm. Thorax and base of abdomen partly white. Wings white, with much fewer fuscous dots; underside of hindwings with a white, terminal band. Neuration of forewings as given above (1♀).

Q.: Brisbane; in September, one ♀; and a fine ♂ from Queensland without locality. Also from Louisiades.

Gen. 25. OSTEODES.

Osteodes Gn., Lep., x., p.177; Meyr., Proc. Linn. Soc. N. S. Wales, 1891, p.589.

Head smooth: face with a long, projecting tuft. Tongue present. Palpi rather long, porrect, rough-scaled; terminal joint short, acute, bent downwards. Antennæ of ♂ shortly bipectinate, with two pairs of pectinations to each segment. Thorax and abdomen not crested; thorax not hairy beneath. Femora glabrous. Posterior tibiæ of ♂ slightly dilated. Forewings with fovea in ♂ present; 10 and 11 short-stalked, 11 anastomosing with 12, 10 connected at a point with 9, (10 absent in exotic species). Hindwings normal.

Type, *O. procidata* Gn., from Africa.

94. OSTEODES PROCURATA.

Tephрина procurata Wlk., Cat. Brit. Mus., xxiii., p. 965.
Panagra jerritinctaria Wlk., *op. cit.*, xxiii., p.1002. *Osteodes procurata* Meyr., Proc. Linn. Soc. N. S. Wales, 1891, p.589.
Tephrinopsis plana Warr., Nov. Zool., 1898, p.253.

Q.: Duaringa, Caloundra, Brisbane, Stradbroke Island, Coolangatta, Blackbutt, Warwick, Stanthorpe.—N.S.W.: Sydney.—S.A.: Adelaide.—Tasm.: Hobart.

Gen. 26. HETEROPTILA, n.g.

ἑτεροπτιλος, with dissimilar wings.

Frons rounded, somewhat projecting. Tongue well-developed. Palpi moderate, porrect; second joint densely hairy beneath; terminal joint very short. Antennæ of ♂ shortly bipectinate, towards apex simple. Thorax with a dense, bifid, posterior crest, beneath hairy. Femora glabrous; posterior tibiæ of ♂ dilated. Forewings with 10 and 11 separate and free, or anastomosing with each other, and then 10 with 9. Hindwings normal. Type, *Selidosema argoplaca* Meyr.

An endemic derivative of *Cleora*, distinguished by the strong, thoracic crest. From *Symmetroctena*, it differs in the separate origin of veins 10 and 11. It is remarkable that, while the fovea is large and well-developed in *H. argoplaca*, it is obsolete in the closely allied *H. xylina*. In three males of the latter, I can distinguish a shallow fovea on one side in one example only; but, on the other hand, the posterior tibiæ are abnormally dilated so as to be almost club-shaped. The usual neuration of *H. xylina* is very exceptional.

1. Underside of fore- and hindwings with an apical, whitish spot *argoplaca*.

Underside of fore- and hindwings without an apical, whitish

spot *xylina*.

95. HETEROPTILA ARGOPLACA.

Selidosema argoplaca MEYR., Proc. Linn. Soc. N. S. Wales, 1891, p.615.

Antennal pectinations of ♂ $2\frac{1}{2}$, apical $\frac{2}{3}$ simple. Forewings with 10 and 11 separate, not anastomosing (5♂, 4♀); 10 frequently runs very close to 9, and, according to Mr. Meyrick, the two may be connected.

N.Q.: Stannary Hills.—Q.: Eidsvold, Caloundra, Brisbane.—N.S.W.: Sydney.—Vic.: Birchip.—S.A.: Quorn.

96. HETEROPTILA XYLINA, n.sp.

ξυλιος, wooden.

♂♀. 32-38 mm. Head fuscous. Palpi fuscous mixed with whitish. Antennæ fuscous: in ♂ shortly bipectinate ($1\frac{1}{2}$), apical $\frac{1}{3}$ simple. Thorax fuscous, with some ochreous-whitish scales.

Abdomen ochreous-whitish; bases of segments fuscous. Legs whitish irrorated with fuscous; tarsi fuscous annulated with whitish; posterior tibiæ of ♂ strongly dilated. Forewings with costa nearly straight, apex round-pointed, termen bowed, oblique; 10 and 11 separate at origin, then anastomosing, and 10 anastomosing with 9 (2♂, 3♀), 10 and 11 separate, not anastomosing (1♂); ochreous-whitish densely striated with fuscous throughout; a wavy blackish line from $\frac{2}{5}$ costa to $\frac{2}{3}$ dorsum; a dark fuscous discal spot, sometimes pale-centred, connected with midcosta; a blackish line from $\frac{2}{3}$ costa, at first transverse and wavy, then curved inwards, and again outwards to $\frac{2}{3}$ dorsum; a thick, inwardly oblique, short streak from costa before apex; an interrupted, fuscous, terminal line; cilia whitish obscurely barred with fuscous. Hindwings with termen gently rounded; whitish with a few fuscous strigulæ; a fuscous, discal spot preceded by an incomplete, fuscous, terminal line; a broad, dark fuscous, terminal band containing some whitish striæ towards tornus; cilia as forewings. Underside whitish; forewings with discal spot and apical blotch fuscous; hindwings as on upper surface.

Very similar to the preceding, but the lines on forewings are better marked, ♂ antennal pectinations shorter, ♂ posterior tibiæ more strongly dilated, and readily distinguished from it by the underside.

N.Q.: Townsville.—Q: Brisbane.

Gen. 27. CLEORA.

Cleora Curtis, Brit. Ent., p.88. *Alcis* Curtis, *op. cit.*, p.113.

Face flat, with anterior tuft of hairs. Tongue well-developed. Palpi moderately long, porrect or somewhat ascending, densely hairy beneath; terminal joint short, obtuse. Antennæ of ♂ bipectinate, towards apex simple. Thorax not crested, hairy beneath. Femora glabrous; posterior tibiæ of ♂ often dilated, with internal groove and tuft. Forewings of ♂ with well-marked fovea; 10 and 11 arising separately from cell, or very rarely 11 out of 10 near origin, 11 sometimes connected with 12, and 10 with 9. Hindwings normal.

Type, *C. cinctaria* Schiff., from Europe. This genus is more

commonly known as *Alcis*, of which the type is *repandata* Linn., from Europe.

- | | |
|--|-----------------------|
| 1. Forewings with 10 out of 11 near origin | <i>bathyscia</i> . |
| Forewings with 10 and 11 separate | 2. |
| 2. Male with apical $\frac{1}{5}$ of antennæ simple | 3. |
| Male with apical $\frac{2}{3}$ or more of antennæ simple | 4. |
| 3. Forewings with a dark streak from termen beneath apex | <i>euboliaria</i> . |
| Forewings without subapical streak | <i>præcisa</i> . |
| 4. Wings with discal marks dot-like, not pale-centred | <i>bitaniaria</i> . |
| Wings with discal marks pale-centred, or large and spot-like, rarely obsolete | 5. |
| 5. Forewings with postmedian line with one or two large teeth only | 6. |
| Forewings with postmedian line finely dentate | 7. |
| 6. Discal spot of forewings obscure and connected with postmedian line | <i>callicrossa</i> . |
| Discal spot of forewings distinctly marked, and separate from postmedian line | <i>perlepidaria</i> . |
| 7. Forewings with subterminal line preceded by a continuous series of fuscous spots, female antennæ pectinate | <i>pupillata</i> . |
| Forewings without a continuous series of fuscous spots preceding subterminal line, female antennæ simple | 8. |
| 8. Postmedian lines of both wings nearly straight | <i>inflexaria</i> . |
| Postmedian line of forewings with suprmedian, of hindwings with median projecting curve | 9. |
| 9. Wings with minute, scattered, fuscous strigulae | <i>acaciaria</i> . |
| Wings without strigulae except on costa of forewings | 10. |
| 10. Wings more or less dusky, with thick postmedian lines | <i>compactaria</i> . |
| Wings paler, with fine postmedian lines | 11. |
| 11. Wings whitish, antemedian line of forewings slightly oblique | <i>illustraria</i> . |
| Wings grey, antemedian line of forewings strongly oblique | <i>displicata</i> . |

97. *CLEORA BATHYSCIA*, n.sp.

βαθυσκίος, deep-shaded.

♀. 28 mm. Head, thorax, and abdomen whitish irrorated with dark fuscous. Palpi $1\frac{1}{4}$; whitish irrorated with dark fuscous. Antennæ grey-whitish mixed with fuscous. Legs whitish irrorated dorsally with fuscous. Forewings triangular, costa nearly straight except near base and apex, apex round-pointed, termen bowed, oblique; 10 and 11 short-stalked,

11 soon after origin running into 12 (1♀): whitish irrorated and terminal area thickly shaded with fuscous; markings dark fuscous; an outwardly curved line from $\frac{1}{4}$ costa to $\frac{1}{4}$ dorsum; a discal dot beneath costa before middle; a dot on midcosta; post-median line well-marked, slightly dentate, from $\frac{2}{3}$ costa first inwards, then turned outwards, forming an obtuse prominence, then bent inwards and strongly oblique to mid-dorsum; a fine, whitish, dentate, subterminal line preceded and followed by fuscous suffusion; a terminal series of dots; cilia grey, apices whitish, a median whitish line barred with fuscous. Hindwings with termen rounded, crenulate; colour as forewings. Under-side grey-whitish, with fuscous discal dots, and a broad terminal band; apex of forewings whitish.

Q.: Brisbane; in April; one specimen.

98. CLEORA EUBOLIARIA.

Tephrosia euboliaria Wlk., Cat. Brit. Mus., xxi., p.419. *Scotosia fractata* Wlk., *op. cit.*, xxv., p.1359. *Selidosema euboliaria* Meyr., Proc. Linn. Soc. N. S. Wales, 1891, p.615.

Forewings with 10 and 11 separate, free (1♂).

W.A.: Perth, Geraldton.

99. CLEORA PRÆCISA, n.sp.

præcisus, steep, abrupt.

♂♀. 38 mm. Head whitish finely mixed with grey; face, except lower edge, dark fuscous. Palpi ochreous-whitish mixed with fuscous. Antennæ grey; basal joint in ♂ whitish; pectinations in ♂ moderate (5), apical $\frac{1}{6}$ simple. Thorax grey irrorated with whitish. Abdomen whitish with some fuscous irroration towards base. Legs grey; posterior pair whitish. Forewings elongate-triangular, costa straight to near apex, then strongly arched, apex obtuse, termen bowed, wavy, strongly oblique; 10 and 11 separate, 11 sometimes anastomosing with 12; grey-whitish suffused with grey except on median area, with sparse fuscous irroration; a very oblique, blackish line from $\frac{1}{6}$ dorsum towards, but not reaching, midcosta; a fine fuscous line from $\frac{2}{3}$ dorsum parallel to preceding, not reaching costa; a twice sinuate blackish line from $\frac{3}{5}$ dorsum towards, but not reaching, apex;

followed by a fuscous shade, which is prolonged to termen beneath apex; a pale, wavy, subterminal line; a dark fuscous, terminal line; cilia whitish, with a fuscous line before middle. Hindwings with termen rounded, wavy; colour as forewings but without basal line. Underside whitish; dorsum of hindwings in ♂ suffused with ochreous; fuscous discal dots and terminal bands more or less developed.

In structure, this species resembles *C. cuboliaria*.

Type in Coll. Lyell.

Vic.: Melbourne; two specimens.

100. CLEORA BITENIARIA.

Boarmia biteniaria Le Guill., Rev. Zool., 1841, p.257; Gn., Lep., ix., p.249, Pl. iii., f.1. *Gastrina(?) erebina* Wlk., Cat. Brit. Mus., xxi., p.326. *Selidosema biteniaria* Meyr., Proc. Linn. Soc. N. S. Wales, 1891, p.616.

Forewings with 10 and 11 separate, not anastomosing (1♀), 10 connected with 9 (1♀).

Q.: Brisbane.—Vic.: Melbourne.—Tasm.: Campbelltown, Hobart.

101. CLEORA CALLICROSSA.

Boarmia callicrossa Meyr., Trans. Ent. Soc., 1889, p.498.

This species is, no doubt, variable. I have two examples, as to whose identification I am fairly certain. Good points of distinction are the rather narrow forewings, with long and strongly oblique termen; and also (though not mentioned by Meyrick) the absence of whitish spots on apices of wings on undersurface. Forewings with 10 and 11 separate, not anastomosing (1♂, 1♀).

N.Q.: Thursday Island. Also from New Guinea.

102. CLEORA PERLEPIDARIA.

Chogyada perlepidaria Warr., Nov. Zool., 1900, p.112.

♂. 36 mm. Head whitish, with some fuscous scales between antennæ; face and palpi brown. Antennæ fuscous, towards base whitish; antennal pectinations in ♂ very long, apical $\frac{1}{2}$ simple. Thorax whitish, tegulæ, except at bases, and a posterior spot brown; patagia pale grey. Abdomen whitish with fus-

cous suffusion. Legs dark fuscous with whitish annulations; posterior pair whitish, with some fuscous irroration; posterior tibiæ in ♂ dilated, with internal groove and tuft. Forewings with costa straight to near apex, apex round-pointed, termen bowed, oblique, crenulate; 10 and 11 separate, not anastomosing (1♂): whitish, with tips of scales lustrous white, some brownish suffusion; some fine, brownish, costal strigulae; first line obliquely curved from $\frac{1}{4}$ costa to $\frac{1}{3}$ dorsum, dark fuscous, preceded by a parallel brown line; discal spot rather large, white, narrowly edged with dark fuscous, connected with costa by a brown spot, and with mid-dorsum by a fine, brown, strongly dentate line; postmedian line dark fuscous, from $\frac{2}{3}$ costa to $\frac{2}{3}$ dorsum, with a strong outward tooth on vein 5, and a slighter tooth on vein 2, followed by a parallel brown line; subterminal whitish, indistinct, preceded by an interrupted, dentate, fuscous line, and followed by a brown suffusion; an interrupted, fuscous, terminal line; cilia whitish, with an obscure, brown, median line and fuscous bars. Hindwings with termen strongly rounded, crenulate; colour as forewings but without first line, median line straight, postmedian line once angled on vein 4. Underside grey-whitish, with lines and subapical blotches obscurely marked; discal spot of forewings dark fuscous.

N.Q.: Kuranda, near Cairns, in May; Innisfail.

103. CLEORA PUPILLATA.

Boarmia pupillata Wlk., Cat. Brit. Mus., xxi., p.491. *Ophthalmodes pupillata* Swin., Cat. Oxf. Mus., ii., p.285, Pl. v., f.2. *Carecomotis perfumosa* Warr., Nov. Zool., 1896, p.402.

♂♀. 38-44 mm. Head, palpi, and thorax grey, sometimes ochreous-tinged. Antennæ fuscous; in ♂ with very long pectinations, which become twisted and distorted when dried; apical $\frac{3}{5}$ simple; in ♀ with similar but shorter pectinations to about middle. Abdomen grey mixed with whitish, sometimes ochreous-tinged, bases of segments fuscous. Legs grey-whitish; anterior pair fuscous. Forewings rather narrow and elongate, costa straight to near apex, then strongly arched, apex rounded, termen bowed, oblique; 10 and 11 separate, not anastomosing

(5♂, 3♀), 10 connected with 9 (1♂); whitish partly suffused with grey, sometimes ochreous-tinged; some fuscous dots on costa; two basal fuscous dots succeeded by a subbasal dot; lines fuscous or dark fuscous, finely dentate; first from $\frac{1}{4}$ costa to $\frac{1}{4}$ dorsum, curved first outwardly then inwardly; a median line sometimes ill-defined, interrupted by a fuscous, pale-centred, discal spot; postmedian from $\frac{3}{4}$ costa to $\frac{2}{3}$ dorsum, sinuate, followed usually by a parallel grey line; a subterminal series of fuscous dots, usually well-marked; a terminal series of dark fuscous dots; cilia whitish, obscurely barred with grey. Hindwings with termen strongly rounded; colour and markings as forewings. Underside whitish, with fuscous, discal spots and subterminal blotches, obsolete towards tornus, connected with termen beneath apex, and leaving a whitish spot at apex.

N.Q.: Cape York, Cooktown, Cairns, Townsville.—Q.: Gayndah, Nambour, Brisbane. Also from Borneo.

104. CLEORA INFLEXARIA.

Boarmia inflexaria Snel. *B. epistictis* Meyr., Trans. Ent. Soc., 1889, p.499. *Selidosema epistictis* Meyr., Proc. Linn. Soc. N. S. Wales, 1891, p.619.

This species is best distinguished by the form of the postmedian lines of both wings, which are much straighter than in allied species. It varies much in the development of the median lines in both wings. These may be very fine, or even obsolete, but are often thickened to a marked degree. I have one ♀ in which the whole median area of the forewings, and the median and basal areas of the hindwings, are densely irrorated with blackish. Forewings with 10 and 11 separate, not anastomosing (5♂, 6♀).

N.A.: Melville Island.—N.Q.: Cairns, Atherton, Townsville.—Q.: Bundaberg, Gayndah, Brisbane, Stradbroke Island. Also from Lord Howe Island, New Guinea, and Malay Peninsula.

105. CLEORA ACACIARIA.

(?) *Boarmia acaciaria* Bdv., Faun. Madag., p.116, Pl. xvi., f.4; Hmps., Moths Ind., iii., p.264, f.137; *nec* Meyr., Proc. Linn. Soc. N. S. Wales, 1891, p.617.

♂♀. 45-50mm. Male with apical $\frac{2}{3}$ of antennæ simple. Wings with groundcolour white, in ♂ more or less suffused with ochreous, with generally scattered, small, transverse, fuscous strigulations, postmedian lines with strongly marked projections; 10 and 11 separate, not anastomosing (4♂, 4♀).

This is probably Boisduval's species, and has a wide distribution. I have one ♂ in which the median area of both wings is suffused with fuscous.

Q.: Gayndah, Brisbane. Also from Java, Ceylon, India, and Africa.

106. CLEORA COMPACTARIA.

Boarmia compactaria Wlk., Cat. Brit. Mus., xxvi., p. 1538. *Selidosema acaciaria* Meyr., Proc. Linn. Soc. N. S. Wales, 1891, p. 617 (? Bdv).

This species, although closely allied to the preceding, appears to be readily distinguishable. It is considerably smaller in size, and lacks the transverse strigulations except towards costa of forewings. The dark bars across face, sometimes very distinct, are not invariably present. Forewings with 10 and 11 separate, not anastomosing (6♂); according to Meyrick, 10 may be connected with 9, and 11 with 10; the latter anastomosis is so unusual as to need confirmation.

N.Q.: Townsville.— Q.: Bundaberg, Brisbane.— N.S.W.: Newcastle.— W.A.: Geraldton. Also from Borneo and Malay Peninsula.

107. CLEORA ILLUSTRARIA.

Boarmia illustraria Wlk., Cat. Brit. Mus., xxvi., p. 1539. *Selidosema illustraria* Meyr., Proc. Linn. Soc. N. S. Wales, 1891, p. 618.

♂♀. 36-43 mm. Much whiter than the preceding species, and usually, at least in the ♂, with more or less reddish-ochreous suffusion. Certainly much care is needed in distinguishing individual specimens from *C. compactaria* and *C. displicata*, but examination of good series makes me confident of their distinctness. Male with apical $\frac{2}{3}$ of antennæ simple. Forewings with 10 and 11 separate, not anastomosing (7♂, 11♀), 10 connected

with 9 (1♀). A ♂ from Port Darwin is much smaller than the average (28 mm.). An aberration of the ♀, with a strong, black, median line on both wings, is occasionally seen; in this form, the other markings may be largely obsolete.

N A.: Port Darwin.—N.Q.: Cairns, Ingham, Townsville.—Q.: Gayndah, Brisbane, Stradbroke Island.

108. CLEORA DISPLICATA.

Boarmia displicata Wlk., Cat. Brit. Mus., xxi., p.389.

♂♀. 32-45 mm. Wings uniformly suffused with grey. The postmedian line of hindwings is sinuate, and less projecting than in *C. illustraria*, and the antemedian line is more strongly oblique. Male with apical $\frac{2}{3}$ of antennæ simple. Forewings with 10 and 11 separate, not anastomosing (6♂, 6♀), 11 connected with 12 (1♂, 1♀), 11 normal at origin but obsolete soon after (1♀). This species is very uniform in colouration, and shows little variation, except in the discal spot on each wing, which is sometimes wholly dark fuscous.

N.Q.: Townsville.—Q.: Gayndah, Caloundra, Brisbane, Dalby.

Gen. 28. LOPHOSEMA, n.g.

λοφοσημος, marked with crests.

Face somewhat projecting, shortly rough-haired. Palpi moderate, porrect or slightly ascending, rough-scaled; terminal joint short. Thorax with a small, bifid, posterior crest; beneath densely hairy. Abdomen with dorsal crests on 3rd, 4th, 5th, and 6th segments. Femora glabrous. Forewings with 10 and 11 arising separately from cell and free, or 10 connected with 9. Hindwings normal.

Unfortunately, the ♂ is unknown, but I conjecture that it will have pectinated antennæ and a fovea; and that the genus is closely allied to *Cleora*, differing in the crested abdomen. It has no near relationship to *Gastrina*.

109. LOPHOSEMA CATASTICTA.

Gastrina catasticta Turn., Trans. Roy. Soc. S. Austr., 1904, p.237.

Q.: Mt. Tambourine.

Gen. 29. LYELLIANA.

Lyelliana Turn., Proc. Linn. Soc. N. S. Wales, 1916, p.252.

Face smooth, or with an anterior tuft of hairs. Tongue well-developed. Palpi rather long, porrect, shortly rough-haired; terminal joint short, concealed. Antennæ of ♂ bipectinate, apex simple. Thorax not crested, hairy beneath. Femora smooth or slightly hairy; posterior tibiæ of ♂ not dilated. Forewings oblong, base of costa very strongly arched; in ♂ with a well-marked fovea; 10 long-stalked with 9, 11 from cell, free, or connected with 12. Hindwings broader than forewings; neuration normal.

Type, *L. phæochlora* Turn. Allied, I think, to *Metrocampa*.

- | | |
|---|---------------------|
| 1. Forewings greenish | 2. |
| Forewings without greenish tinge | <i>ancyloma</i> . |
| 2. Forewings with a pale-centred, discal spot..... | <i>phæochlora</i> . |
| Discal mark of forewings dot-like, not pale-centred | <i>dryophila</i> . |

110. LYELLIANA PHÆOCHLORA.

Lyelliana phæochlora Turn., Proc. Linn. Soc. N.S. Wales, 1916, p.253.

Forewings with 11 connected with 12 by a short bar (1♂), or anastomosing with 12 (1♀).

N.S.W.: Ebor.

111. LYELLIANA DRYOPHILA, n.sp.

δρυσφιλος, a tree-lover.

♀ 38 mm. Head and palpi green-whitish. Antennæ grey. Thorax pale greenish, with an anterior, dark fuscous bar. Abdomen whitish-ochreous. Legs ochreous-whitish; anterior pair fuscous. Forewings oblong, costa very strongly arched near base, thence nearly straight, apex obtuse, termen bowed, oblique; 11 separate (1♀); green-whitish; markings dark fuscous; a blackish line from near base of costa half across wing; a thick line from bend of costa transversely to fold; a double transverse row of dots at $\frac{1}{3}$, and another from $\frac{2}{3}$ costa, sinuate and then bent outwards to dorsum before tornus; a discal dot preceding second line; some faint, fuscous strigulæ beyond second line, containing an indistinct, whitish, dentate, subterminal line; a

terminal series of dots; cilia whitish. Hindwings much broader than forewings, termen rounded, indented above middle; whitish; some scarcely perceptible, postmedian dots; cilia whitish.

The type is worn.

Q.: Mt. Tambourine; in May; one specimen, received from Mr. R. Illidge.

112. *LYELLIANA ANCYLOMA*, n.sp.

ἀγκυλωμος, with curved shoulders.

♀. 46. mm. Head, palpi, and antennæ ochreous-whitish. Thorax ochreous-whitish; tegulæ, except anterior margin, dark fuscous. Abdomen pale ochreous. Legs ochreous-whitish: anterior pair infuscated. Forewings oblong, costa very strongly arched at base, thence straight to near apex, apex rounded-rectangular, termen bowed, slightly oblique; ochreous-whitish; costa strigulated with fuscous: a dark fuscous spot on base of dorsum, a transverse, dark fuscous line close to base, and a dentate, oblique, dark fuscous line shortly beyond this: a double row of fuscous dots from $\frac{1}{6}$ costa to $\frac{1}{3}$ dorsum; a fuscous line from $\frac{2}{3}$ costa to mid-dorsum, with two, prominent, posterior teeth, one median, one subdorsal; a double row of dark fuscous dots from $\frac{3}{4}$ costa to $\frac{3}{4}$ dorsum; a terminal series of dark fuscous dots; cilia ochreous-whitish. Hindwings with termen rounded; whitish-ochreous; a fine, indistinct, dentate, fuscous, postmedian line; cilia whitish-ochreous. Underside whitish-ochreous with obsolete markings.

Type in Coll. Lyell.

Vic.: Healesville; one specimen.

Gen. 30. *METROCAMPA*.

Metrocampa Latr., Règne Animal, p 477; Meyr., Proc. Linn. Soc. N. S. Wales, 1891, p.644, and Trans. Ent. Soc., 1892, p.111.

Face smooth or with slight tuft of hairs. Tongue well-developed. Palpi moderately long, porrect, or somewhat ascending, densely rough-haired: terminal joint very short. Antennæ of ♂ shortly bipectinate almost to apex. Thorax not crested, beneath hairy. Femora smooth or slightly hairy; posterior tibiæ of ♂ sometimes dilated, with internal groove and tuft.

Forewings in ♂ with or without fovea; 10 out of 9 anastomosing with 11 which arises separately from cell, but very often the basal part of 10 is undeveloped, so that 10 appears to be long-stalked with 11, 10 usually anastomosing with 9. Hindwings normal.

In exotic species, 11 may anastomose first with 12, then with 11. With two exceptions, the specimens I have examined appear to have 10 and 11 long-stalked; this fallacy must be noted.

113. METROCAMPA BIPLAGA.

Azelina biplaga Wlk, Char. Undesc. Lep., p.75. *Metrocampa glaucius* Meyr., Proc. Linn. Soc. N. S. Wales, 1891, p.644.

Antennal pectinations of ♂ short, broad, obtuse (less than 1). Forewings in ♂ without fovea; 10 out of 9 anastomosing with 11, 10 afterwards connected with 9 (1♂), 10 apparently out of 11, anastomosing with 9 (2♂, 6♀).

Q.: Nambour, Mt. Tambourine.—N.S.W.: Sydney.—Vic.: Melbourne, Beaconsfield, Gisborne.

114. METROCAMPA ADA.

Gynopteryx ada Butl., Ann. Mag. Nat. Hist., 1882, p. 91. *Metrocampa ada* Meyr., Proc. Linn. Soc. N.S. Wales, 1891, p.645.

Forewings in ♂ with a shallow fovea; 10 apparently out of 11 and free (1♂), or anastomosing with 9 (2♂, 1♀).

N.S.W.: Sydney, Bathurst.—Vic.: Melbourne, Gisborne.—Tasm.: Hobart.

115. METROCAMPA CELÆNEPHES, n.sp.

κελαινεφης, darkly clouded.

♂. 24 mm. Head fuscous. Palpi $1\frac{1}{2}$; fuscous. Antennæ pale fuscous; pectinations in ♂ 3. Thorax and abdomen fuscous. Legs fuscous; tarsi with obscure whitish annulations; posterior pair mostly whitish; posterior tibiæ of ♂ dilated, with internal groove and tuft. Forewings triangular, costa strongly arched at base, thence slightly sinuate to apex, apex acutely dentate, termen dentate on vein 6, thence bowed and crenulate; basal half fuscous-brown, limited by a line slightly beyond middle, with an obtuse, median, posterior projection; beyond this, grey-whitish finely strigulated with pale grey; a whitish, subterminal

line faintly indicated; a dark fuscous, subapical mark; a faint, fuscous, terminal line; cilia grey-whitish. Hindwings with termen rounded, slightly crenulate; grey, with three, slightly darker, transverse lines; cilia grey-whitish. Underside pale grey; forewings with a short, whitish, transverse line from costa near apex; hindwings with a fuscous, discal dot, and obscure, antemedian and postmedian, transverse lines.

Forewings in ♂ with a small, but well-developed fovea; 10 out of 9, 11 from cell, 10 anastomosing first with 11, then with 9 (1♂). This species is interesting as illustrating the origin of *Metrocampa* (provided the Australian species are rightly referred to this genus) from the *Boarmia*-stem. In *M. ada*, the fovea is distinct though incompletely developed; in *M. biplaga*, it appears to be absent.

Q.: Mount Tambourine; in December: one specimen.

Gen. 31. HYPOCHROSIS.

Hypochrosis Gn., Lep, x., p.536: Hmps., Moths Ind., iii., p.170.

Frons flat. Tongue well-developed. Palpi moderate, porrect; second joint thickened with appressed scales. Antennæ bipeccinate in both sexes, towards apex simple. Thorax not crested, beneath slightly hairy. Anterior tibiæ with a long pencil of hairs from base beneath. Posterior tibiæ with all spurs present; in ♂ not dilated. Forewings in ♂ without fovea; 10 and 11 long-stalked from cell, their common stalk joined by a bar to 12. Hindwings normal.

116. HYPOCHROSIS CHLOROSTICHA, n.sp.

χλωροστιχος, green-striped.

♂. 35 mm. Head grey-whitish; face fuscous. Palpi ochreous, terminal joint grey. Antennæ grey-whitish; pectinations in ♂ 8, apical $\frac{1}{6}$ simple. Thorax and abdomen grey, beneath ochreous. Legs ochreous; anterior and middle tibiæ and tarsi fuscous on dorsal surface. Forewings triangular, costa straight to near apex, then strongly arched apex rounded, termen gently rounded, oblique; grey suffused with ochreous; a broad, green fascia from costa before middle obliquely outwards, not reaching costa, towards extremity dentate posteriorly; a fuscous spot on mid-

costa touching green fascia; another fuscous spot on $\frac{3}{4}$ costa; a fuscous, oblique streak from beneath apex to green fascia near dorsum; costal edge ochreous; cilia grey. Hindwings with termen rounded; colour as forewings; a transverse, green fascia before middle. Underside bright ochreous: forewings with a dark red, posterior suffusion, a fuscous blotch on dorsum connected with midcosta; fuscous spots on $\frac{3}{4}$ costa and tornus, and an oblique streak as on upperside; hindwings with a fuscous, median fascia, apical and tornal spots.

Type in Coll. Lyell.

Mr. Prout informs me that this is allied to, and may possibly be a geographical race of, *H. cryptorhodata* Wlk.

N.Q.: Cape York: one specimen.

Gen. 32. ABRAXAS.

Abraxas Leach, Edin. Encycl., ix., p.134,(1815): Meyr., Brit. Lep., p.267; Hmps., Moths Ind., iii., p.297.

Type, *A. grossulariata*, from Europe.

Face smooth. Tongue present. Antennæ of ♂ shortly laminate, ciliated in fascicles. Palpi short, slender, porrect, rough-scaled, not hairy. Thorax hairy or glabrous beneath. Femora glabrous: posterior tibiæ in ♂ dilated. Forewings in ♂ without fovea; 10 and 11 stalked, 11 running into or anastomosing with 12, or absent; 10 sometimes connected with 9.

The Australian species differ from the type only in the absence of hairiness on the underside of the thorax. The slender, short palpi are characteristic.

1. With a row of yellow spots in terminal band of both wings *flavimacula*.
Terminal band wholly fuscous. *expectata*.

117. ABRAXAS FLAVIMACULA.

Potera flavimacula Warr., Nov. Zool., 1896, p.395. *Chooreechillum distitans* Luc., Proc. Roy. Soc. Qsld., 1901, p.73.

♂♀. 50-65 mm. Head orange, with two, posterior, dark fuscous dots, and sometimes another between antennæ. Palpi short (barely 1); dark fuscous, towards base ochreous. Antennæ dark fuscous; ciliations in ♂ 1. Thorax dark fuscous: edges of patagia, a bar behind middle, and posterior edge orange. Abdomen orange, each segment with a terminal band thicker in

middle, and two basal spots dark fuscous. Legs dark fuscous; anterior coxæ partly, middle and posterior coxæ wholly ochreous. Forewings elongate-triangular, costa gently arched, apex round-pointed, termen slightly arched, oblique; dark fuscous; 10 and 11 stalked, 11 running into 12 (2♂), similar but 10 connected by a short bar with 9 (2♂, 1♀), 11 anastomosing with 12 and 10 connected with 9 (1♂): one or two orange dots at base; a broad, postmedian, white band, not quite reaching costal edge, narrowed at costal edge and in middle, anterior edge very irregular, posterior edge strongly sinuate; a narrow, whitish, ochreous-tinged, subcostal mark beyond band; a subterminal series of whitish, ochreous-tinged spots variably developed; cilia dark fuscous. Hindwings with termen strongly rounded; colour as forewings, but white band broader and median, its anterior edge nearly straight; subterminal spots sometimes absent. Underside as upperside.

N.Q.: Cooktown, Cairns, Atherton.

118. *ABRAXAS EXPECTATA*.

Abraxas expectata Warr., Nov. Zool, 1902, p.365.

♂. 45-50 mm. Head orange, with three dark fuscous dots, two posterior and one between antennæ; face with a central, dark fuscous spot. Palpi short (barely 1); dark fuscous. Antennæ dark fuscous: ciliations in ♂ 2. Thorax orange, base and apex of patagia, a central and a posterior spot dark fuscous. Abdomen orange, with seven rows of dark fuscous spots. Legs dark fuscous; coxæ partly ochreous. Forewings broadly triangular, costa strongly arched, apex rounded, termen broad, oblique; 10 and 11 stalked, 11 running into 12, 10 connected by a short bar with 9 (3♂); dark fuscous; a large, irregularly quadrate, white blotch occupying central part on disc, but well separate from costa, on dorsum extending from $\frac{1}{5}$ to $\frac{4}{5}$; a smaller quadrate blotch between this and apex; cilia dark fuscous. Hindwings with termen strongly rounded: white; base narrowly dark fuscous; a dark fuscous, terminal band with a wavy edge rather acutely angled in middle; cilia dark fuscous. Underside similar.

N.Q.: Cairns, Herberton.

Gen. 33. PRÆSOS.

Præsos Wlk., Cat. Brit. Mus., ii., p.409 (1854). *Tigridoptera* H.-Sch., (date ?); Meyr., Proc. Linn. Soc. N.S. Wales, 1891, p.631. *Craspedosis* Butl., Proc. Zool. Soc., 1876, p.767.

Face smooth or shortly rough-haired, somewhat projecting, without tuft. Tongue well-developed. Palpi moderate, porrect or ascending; first joint with long, rough hairs; second joint thickened with smoothly appressed scales; terminal joint short. Antennæ of ♂ simple, ciliated. Thorax not crested; beneath more or less hairy. Femora smooth; posterior tibiæ of ♂ not dilated. Forewings in ♂ with fovea present, but usually imperfectly developed; 10 and 11 long-stalked or coincident, their common stalk connected by a bar with 9. Hindwings with 8 diverging from cell before middle.

Type, *P. mariana* White. Mr. Meyrick states that 10 arises out of 11 and runs into 9, and this appears sometimes to be the case; but comparison with the species in which 10 and 11 are long-stalked shows, beyond doubt, that what he has mistaken for vein 10 is merely a connecting bar. I see no reason to separate the following species. The fovea is always present, but only in *P. leucosticta* and *P. catadela* is it well-developed; in the former, it is found partly developed in the ♀ also, an unusual circumstance. In *P. mariana*, vein 12 gives off two or three, short, accessory spurs towards costa, probably only a mechanical adaptation to its large size, but comparable with the accessory, costal veinlets present in the hindwings of many *Lasiocampidæ*.

- | | |
|---|----------------------|
| 1. Both wings similarly spotted with blackish | 2. |
| Wings not spotted with blackish | 3. |
| 2. Wings with a terminal series of blackish spots | <i>matutinata</i> . |
| Wings with termen not spotted | <i>rotundata</i> . |
| 3. Hindwings yellowish, with black markings | 4. |
| Hindwings grey, with central, white blotch | <i>leucosticta</i> . |
| 4. Hindwings with base fuscous | <i>mariana</i> . |
| Hindwings with base yellow | <i>catadela</i> . |

119. PRÆSOS MATUTINATA.

Panæthia matutinata Wlk., Cat. Brit. Mus., xxiv., p.1109. *Tigridoptera matutinata* Meyr., Proc. Linn. Soc. N. S. Wales, 1891, p.632.

Antennal ciliations of ♂ $\frac{2}{3}$. Forewings with fovea in ♂ imperfectly developed; 10 and 11 coincident, connected by a bar with 9 (5♂, 2♀).

Q.: Caloundra, Brisbane, Mt. Tambourine.

120. PRÆSOS ROTUNDATA.

Tigridoptera rotundata Butl., Ent. Mo. Mag., xiv., p.108; Meyr., Proc. Linn. Soc. N. S. Wales, 1891, p.632.

Forewings with 10 and 11 coincident, connected by a bar with 9 (4♀).

N.Q.: Cairns, Innisfail, Cardwell.

121. PRÆSOS MARIANA.

Eusemia mariana White, Voy. Rattlesnake. *Præsos mariana* Wlk., Cat. Brit. Mus., ii., p.409. *Tigridoptera mariana* Meyr., Proc. Linn. Soc. N. S. Wales, 1891, p.631.

Antennal ciliations of ♂ $\frac{1}{3}$. Forewings in ♂ with fovea imperfectly developed; 10 and 11 long-stalked, their stalk connected by a bar with 9 (3♂).

N.Q.: Cape York.

122. PRÆSOS CATADELA, n.sp.

καταδηλος, very conspicuous.

♂. 48 mm. Head and thorax dark fuscous. Palpi $1\frac{1}{4}$; dark fuscous. Antennæ fuscous; ciliations in ♂ $\frac{2}{3}$. Abdomen yellow. Legs grey. Forewings triangular, costa slightly sinuate, apex rounded, termen bowed, oblique; in ♂ with a well-marked fovea, visible on upper surface; 10 and 11 long-stalked (almost coincident), their stalk connected by a bar with 9; dark fuscous; markings white; a small subcostal spot at $\frac{1}{3}$; an oval blotch reaching from beneath costa at $\frac{2}{3}$ nearly to tornus; a small sub-apical spot, from which a slender, interrupted, subterminal line runs to dorsum before tornus; cilia dark fuscous. Hindwings with termen rounded, slightly wavy; bright yellow, with blackish markings; a median, discal, circular spot; a postmedian fascia at $\frac{2}{3}$, interrupted above middle; three, large, subterminal spots from costa, and two from tornus, between these series a minute dot rather further from termen; a terminal line, broader towards apex, not reaching tornus; cilia on costal half of termen blackish,

on tornal half yellow. Underside similar, but with subterminal line not developed on forewing; hindwings with a broad costal streak terminating in a large apical blotch,

Very similar to *P. mariana* in colouration, but much smaller.

N.Q.: Cape York, in March; one specimen, in Coll. Lyell; taken by the late Mr. Elgner.

123. PRÆSOS LEUCOSTICTA.

Craspedosis leucosticta Warr., Nov. Zool., 1896, p.398.

♂♀. 43-52 mm. Head and palpi grey. Antennæ fuscous; ciliations in ♂ 1. Thorax grey. Abdomen yellow-ochreous, basal $\frac{1}{4}$ grey. Legs grey. Forewings elongate-triangular, costa straight to near apex, apex rounded, termen longer than dorsum, bowed, strongly oblique; 10 and 11 coincident, connected by a short bar with 9 (3♂, 4♀): grey; a transverse, white mark, its edges suffused from mid-costa across end of cell; a grey whitish, rather broad line from tornus towards $\frac{3}{4}$ costa, but lost in disc: cilia grey. Hindwings rather long, termen strongly rounded; grey; a broad, white, median band, its anterior edge straight, posterior edge with a strong, rounded, median projection; a narrow, grey-whitish fascia beyond and parallel to this; cilia grey. Underside similar.

N.Q.: Cooktown, Cairns, Herberton.

Gen. 34. EPIDESMA.

Epidesima Hb., Verz., p.176. *Milionia* Wlk., Cat. Brit. Mus., ii., p.364; Hmps., Moths Ind., iii., p.312.

Head and face smooth-scaled. Tongue well-developed. Palpi moderate, porrect; basal joint with long, spreading hairs beneath; second and terminal joints smooth-scaled. Thorax hairy beneath. Femora glabrous. Posterior tibiæ of ♂ dilated. Forewings in ♂ with a small fovea: 10 absent (coincident with 11), 11 free. Hindwings normal.

I refer this also to the *Abraxas*-group. The genus is Indo-Malayan.

124. EPIDESMA QUEENSLANDICA.

Milionia queenslandica Roths., Nov. Zool., 1895, p.464.

♂♀. 57-65 mm. Head and palpi peacock-blue, with metallic

lustre. Antennæ blackish. Thorax ochreous-brown, loose-haired. Abdomen peacock-blue, with metallic lustre; beneath blackish; tuft ochreous-brown. Legs blackish: femora and tibiæ with peacock-blue lustre. Forewings elongate-triangular, costa straight to near apex, apex rounded, termen nearly straight, oblique: 10 and 11 coincident, free (4♂, 2♀); black; base, except costal edge, ochreous-brown, a broad, red streak from base to tornus, gradually attenuated, indented before tornus; an orange fascia from midcosta to tornus, where it blends with dorsal streak; cilia black. Hindwings with termen rounded: an orange spot on tornal side of middle of disc; a few orange scales near tornus: an orange, terminal line indented or interrupted on veins; cilia orange. Underside similar, but without dorsal, red streak on forewings, and with a short, subcostal, peacock-blue streak on each wing from base.

N.Q.: Cooktown, Cairns, Innisfail.

Gen. 35. APROSITA, n.g.

ἀπροσιτος, unapproachable.

Face smooth. Tongue well-developed. Palpi rather short and stout, porrect, rough-scaled, not hairy. Antennæ of ♂ unipectinate(?), of ♀ simple. Thorax hairy beneath. Femora glabrous. Forewings with 10 and 11 coincident and free.

Probably allied to *Epidesima*. Mr. Lower describes the antennæ of the ♀ as unipectinate. This is certainly not so, and probably his specimen was a ♂. Unfortunately I have not seen that sex.

125. APROSITA MACROCOSMA.

Satraparchis(?) macrocosma Low., Proc. Linn. Soc. N. S. Wales, 1899, p.85.

Vic.: Gisborne, in February; one ♀ specimen found dead, impaled on a thistle-prickle (Lyell).

Gen. 36. Lychno-grapha, n.g.

λυχνογραφος, brilliantly marked.

Head smooth, rounded, not projecting. Tongue well-developed. Palpi short, porrect or subascending; second joint with rough hairs beneath; terminal joint short. Antennæ of ♂

simple, minutely ciliated. Thorax without crest, beneath slightly hairy. Femora glabrous. Posterior tibiæ of ♂ dilated. Forewings of ♂ without fovea; 10 out of 7, 8, 9, 11 from cell, not anastomosing. Hindwings normal.

Type, *L. heroica*.

126. LYCHNOGRAPHA HEROICA, n.sp.

ἥρωϊκος.

♂. 50 mm. Head and thorax dark fuscous. Palpi reddish-ochreous, towards apex fuscous. Antennæ fuscous; in ♂ slightly laminate towards apex, ciliations minute ($\frac{1}{5}$). Abdomen dark fuscous; beneath reddish-ochreous. Legs fuscous; posterior pair, except tarsi, pale reddish-ochreous. Forewings triangular, costa gently arched, apex rounded, termen evenly bowed, slightly oblique; blackish-fuscous; two, straight, whitish-fuscous fasciæ; first from $\frac{1}{4}$ costa to dorsum just before tornus, broad on costa, gradually narrowing; second from $\frac{2}{3}$ costa to termen just above tornus, of nearly uniform breadth; cilia blackish-fuscous, on fasciæ whitish-ochreous. Hindwings rather long, termen scarcely rounded; blackish-fuscous, a triangular, bright reddish-orange blotch beneath costa before middle: a very irregular blotch of the same colour from tornus, forming a broad terminal band, which leaves tornus about middle and ends in disc beneath first blotch; its edge is irregularly indented and, towards tornus, it contains two blackish spots and some blackish strigulæ; cilia blackish-fuscous, on middle third of termen whitish-ochreous, on dorsum fuscous-brown. Underside similar.

Q.: Mt. Tambourine; in January. One example of this magnificent species was taken by Mr. R. J. Tillyard, flying by day in a deep gully beneath a waterfall.

127. LYCHNOGRAPHA AGAURA, n.sp.

ἀγαυρος, proud, stately.

♀. 38-40 mm. Head, palpi, and antennæ grey. Thorax grey, posteriorly whitish-grey. Abdomen ochreous. Legs pale ochreous; anterior pair grey. Forewings triangular, costa bisinuate, being arched at base, slightly concave in middle, and arched again just before apex, apex rounded, termen bowed, scarcely

oblique, slightly crenulate: fuscous-grey: markings clear white partially edged with blackish: an orange, median dot close to base, edged posteriorly with blackish, and succeeded by some whitish suffusion; an oblique, oblong, white patch from costa at $\frac{1}{3}$; a similar but less distinct patch from dorsum before middle nearly touching preceding at apex; a fascia from costa at $\frac{2}{5}$ to termen above tornus, sharply defined anteriorly, suffused posteriorly; a narrow fascia from costa before apex, sharply angulated in disc, then broadening and confluent with preceding, its anterior edge sharply defined; cilia grey. Hindwings with termen rounded, irregularly waved; bright yellow, a large, blackish, subapical blotch connected by a bar with costa near apex; some blackish scales on termen towards tornus: cilia yellow. Underside similar; but basal half of forewings yellow, apical half dark fuscous, with three, white blotches.

Type in Coll. Wyld.

N.S.W.: Sydney, in May: two specimens received from Mr. G. H. Wyld.

Gen. 37. LAROPHYLLA, n.g.

λαροφυλλος, with dainty wings.

Frons forming an obtuse, triangular, smooth projection. Tongue well-developed. Palpi moderately long, ascending; second joint shortly rough-haired above and beneath; terminal joint very short, obtuse. Antennæ of ♂ simple, with very minute ciliations. Thorax not crested; hairy beneath. Femora slightly hairy. Posterior tibiæ of ♂ dilated. Forewings in ♂ without fovea; dorsum with a prominent scale-tooth; 7, 8, 9, 10 stalked, 11 from cell, anastomosing with 12. Hindwings normal.

Differs from *Lychnographa* in the projecting frons, anastomosis of vein 11, and dorsal scale-tooth of forewing.

128. LAROPHYLLA AMIMETA, n.sp.

ἀμίμητος, inimitable.

♂. 43-45 mm. Head and thorax purple-brown. Palpi purple-fuscous, beneath white. Antennæ grey; ciliations in ♂ extremely minute. Abdomen whitish-ochreous. Legs whitish-ochreous; anterior pair suffused with fuscous on upper surface. Forewings

triangular, costa nearly straight, arched towards base and apex, apex rectangular, termen bowed, oblique, dorsum with a large, projecting, median scale-tooth; fuscous-brown usually sparsely strigulated with fuscous; dorsal edge purple-grey; sometimes with three costal blotches, ochreous-whitish reticulated with fine streaks of reddish-brown, but these are often entirely absent; first on base extending to $\frac{1}{5}$, subtriangular, projecting outwards in disc; second median, discal edge irregularly rounded; third apical, similar to second but smaller; cilia fuscous-brown. Hindwings with termen rounded; orange-yellow; a large, irregularly outlined, blackish, subapical blotch. Underside of hindwings similar; of forewings yellow, with a blackish oblique bar from $\frac{1}{3}$ costa not reaching dorsum, and a very large, blackish, subapical blotch connected with costa and termen.

Type in Coll. Wyld.

N.S.W.: Sydney, in May; one specimen, received from Mr. G. H. Wyld. Wentworth Falls, near Katoomba, in April; four specimens received from Mr. G. Lyell.

ON THE GENERA ECHINAXIA AND RHABDOSIGMA
[PORIFERA].

BY E. F. HALLMANN, B.Sc., LINNEAN MACLEAY FELLOW OF THE
SOCIETY IN ZOOLOGY.

(Plates xxi.-xxii.; and two Text-figures.)

The genera *Echinaxia* and *Rhabdosigma* were proposed, without definition, in my "Revision of the Genera with microscleres included, or provisionally included, in the Family Axinellidæ," for two species wrongly referred to the genera *Axinella* and *Sigmaxinella* respectively. I now publish definitions of these genera, together with remarks on their probable relationships, and re-descriptions of their type-species; and for the reception of certain species, apparently related to *Echinaxia*, I propose two new genera, *Axinectya* and *Hetercetya*.

Genus ECHINAXIA.

Definition.—Desmacidonidæ of erect, lamellar or ramose habit, with a skeleton consisting axially of a reticulation of spiculo-spongin fibres cored by comparatively small, smooth styli and echinated by vestigially spined acanthostyli, and extra-axially of (typically non-connected) fibres radiating outwards to the surface, composed partly of the same two kinds of styli, and partly of obliquely directed (*i.e.*, plumosely disposed) long, smooth styli—the last-mentioned spicules typically occurring only towards the outer extremities of the fibres, and forming terminal tufts which project beyond the dermal membrane; the extra-axial fibres, however, may be so reduced as to be represented by scarcely more than their terminal tufts of long styli. The acanthostyli are of characteristic form, having their basal moiety free from spines and more or less curved. Microscleres are absent.

Type, *E. frondula* Whitelegge.

Two species with a spiculation closely analogous to that of *Echinaxia frondula* have been described by Thiele(5) under the

names of *Raspailia hirsuta* and *R. folium*; but whether these also agree therewith (or with one another) sufficiently to necessitate their inclusion in the same genus is not quite certain, owing to the inadequacy of their descriptions. As, however, they certainly do not belong to *Raspailia*, and the establishment of a separate genus for their reception would be premature, I propose that they be referred (provisionally, at least) to *Echinaxia*, and have attempted to define the genus accordingly. With respect to certain features of the skeleton, the differences between the three species are rather considerable. In *E. hirsuta*, according to Thiele's description, the skeleton consists axially of a network of horny fibres cored by the smaller smooth styli and echinated by more abundant acanthostyli, and the extra-axial fibres are provided with projecting long styli apparently throughout their entire length. On the other hand, in *E. frondula* the axial skeleton is a dense and nearly subrenieroid reticulation composed almost entirely of the smaller smooth styli (spongine being present only in very minute quantity, and the acanthostyli scarce), while the extra-axial fibres are provided with projecting long styli only towards their outer extremities. Regarding the arrangement of the skeleton in *E. folium*, no definite information is available, but apparently it is reticulate throughout; in this species also, however, long smooth styli project far beyond the surface of the sponge, and it is presumable that these are the terminal spicules of fibres corresponding to the extra-axial fibres of the other species. In *E. frondula* more especially, the intrafibral smooth styli approximate rather closely both in size and shape to the acanthostyli, conveying the suggestion of their original derivation therefrom; and this view of their origin is further supported by the fact that, in *E. hirsuta*, they occasionally exhibit a slight roughness of the surface, suggestive of a vestigial spination.

Acanthostyli similar to those of *Echinaxia* are characteristic also of the genus *Raspaxilla*, lately proposed by Topsent(10) for a new species from the Antarctic; and this genus (as exemplified by its single known species) further resembles *Echinaxia* in the possession of a skeleton condensed axially and consisting extra-axially of radiating fibres terminating at the surface in a tuft of

long projecting styli. But, in *Raspaxilla*, it is these long styli also which are the coring spicules of the fibres, both axial and extra-axial (the only spicules projecting therefrom being the acanthostyli), whilst spicules corresponding to the small intra-fibril styli of *Echinaxia* are wanting; and, furthermore, there are present in *Raspaxilla* special dermal styli, disposed as in the genus *Raspailia*. On the reasonable assumption of a near relationship between the genera *Echinaxia* and *Raspaxilla*, it accordingly appears probable that the long smooth styli of the former are homologous with those coring the fibres of the latter, and hence, almost certainly, with the principal megascleres of normal Myxillinae.

Under the name of *Axinella mariana*, Ridley and Dendy* have described a species, of ramose habit, with a skeleton consisting axially of "a fairly dense core of irregularly arranged, short, bent, stylote spicules," and extra-axially of very large styli or tylostyli (up to 2200 by 30μ in size) having their bases imbedded in the confused central mass and their apices projecting far beyond the surface of the sponge. Only these two forms of spicules are present. The short styli (size about 300 by 13μ , but variable) are sharply bent near the base, finely and gradually pointed at the apex, and rarely slightly spined. It is probable, therefore, that this species is closely related to *Echinaxia*; though the differences distinguishing it therefrom appear too considerable to be regarded as of less than generic value. As the species certainly cannot be permitted to remain in the genus *Axinella*, nor yet in the genus *Syringella*, to which Topsent(9b) would assign it, I propose for its reception the new genus *Axinectya*.

Another species possessing acanthostyli similar to those of *Echinaxia* is that which Thiele(5) has described as *Raspailia(?) villosa*. This species, however, is of massive habit, without an

* Report on the Monaxonida collected by H.M.S. "Challenger." In the same report, there is also assigned to the genus *Axinella* a second species with acanthostyli, viz, *A. monticularis*. There can scarcely be any doubt that the correct position of this species is in the genus *Aulospongia* Norman, hitherto regarded as being represented only by the single species, *A. tubulatus* Bowerbank.

axially condensed skeleton, and also differs from *Echinaxia*, *Axinectya*, and *Raspaxilla* in the absence of megascleres corresponding to the long (principal) styli, and from *Raspaxilla*, furthermore, in the non-possession of special dermal megascleres. For the reception of this species, accordingly, a new genus appears also to be required, and for this I propose the name *Heterectya*.

ECHINAXIA FRONDULA Whitelegge.

(Plate xxi., figs.3, 4; Plate xxii., figs. 1, 2; and Text-fig.1).

1907. *Axinella frondula* Whitelegge, Mem. Austr. Mus., iv., Pt. 10, p.509, Pl. xlvi., fig.32.

1916. *Echinaxia frondula* Hallmann, Proc. Linn. Soc. N. S. Wales, xli., Pt. 3, p.543.

External features.—The single example of the species which has so far been obtained consists of a very thin, flabelliform lamina, gradually narrowed proximally into a (likewise much compressed) stalk-like prolongation, and divided marginally, by very wide and deep notches, into four sub-spathulate lobes. A figure illustrating the external form accompanies the original description. The specimen appears to be complete with the exception of the basal extremity of the stalk; but possibly it represents only portion of a much larger specimen, of very deeply partite, or foliose, habit. It measures 75 mm. in total height, 50 mm. in greatest width, 7 mm. in width at the lower extremity of the stalk, and only from 1 to 1½ mm. in thickness (except towards the base, where it ultimately attains a thickness slightly exceeding 2 mm.). The surface is even, and presents a densely hispid, or, rather, finely pilose appearance, due to the projection beyond the dermal membrane of the terminal spicules of the skeletal fibres; the dermal membrane, which is excessively thin, is thereby rendered quite indistinct. Oscula are not discernible. The consistency of the sponge in alcohol is moderately firm and tough, flexible and elastic; the colour, light brownish-grey.

Skeleton.—The skeleton (Plate xxii., figs.1, 2) consists (i.) of a dense and sharply delimited axial region, of reticulate pattern, composed chiefly or almost entirely of small, smooth styli, and

(ii.) of strongly developed, single fibres radiating therefrom outwards to the surface, at an average distance apart of about 200μ . Also participating in the formation of the axial skeleton, but occurring only interstitially, are from scarce to fairly numerous, singly dispersed, long slender styli, directed longitudinally: these spicules appear to be more abundant in the older portions of the sponge. The spaces between the extra-axial fibres are entirely free from spicules. The axial reticulation, as seen in longitudinal transverse section, presents an irregularly sub-renieroid pattern, not altogether unlike that characteristic of the genus *Petrosia*; examined, however, in section parallel to and in the mid-plane of the sponge (Plate xxi., figs. 3, 4) it is seen to be formed (*i.e.*, in its most central region) of somewhat ill-defined, plurispicular strands (of the already mentioned small styli) running longitudinally in close subparallelism, and interconnected by a paucispicular, plexus-like network of the same spicules, as well as by occasional single spicules directed transversely. The longitudinal spicule-strands are echinated by scarce acanthostyli, which usually project almost perpendicularly; and echinating acanthostyli also occur (sometimes rather abundantly) on the outward side of the outermost fibres of the axial reticulation. In the youngest portions of the skeleton, spongin is present only in the least possible quantity requisite to hold the spicules together: even in the oldest parts of the sponge, it seldom forms a distinct sheath to the spicule-strands, and (owing to its colourlessness) is clearly discernible only when stained.

The extra-axial fibres,—which vary in stoutness from 25 to 90μ ,—are composed, throughout the greater part of their length, almost entirely of small smooth styli (similar to those of the axial skeleton) closely packed together side by side; accompanying these spicules there are also acanthostyli, mostly located at the surface of the fibre, and in part projecting therefrom at a small angle of inclination as echinating spicules. The latter spicules (the acanthostyli) are at first relatively very few, but towards the outer extremity of the fibre (though still at some considerable distance below the dermal surface) they increase in number at the expense of the former, sometimes almost entirely

replacing them; and at the same time, also, there enter into the formation of the fibre, long, slender, smooth styli, which are directed at a greater or less angle of inclination to the fibre, projecting therefrom in plumose fashion. With the advent of the last-mentioned spicules, the others rapidly diminish in number and soon cease. Usually the total length of fibre from which the long styli project is relatively so short that they may appear to form scarcely more than a divergent tuft at the extremity of the fibre; occasionally, however, one or a few such spicules are to be found projecting from other parts of the fibre also. The terminal spicules project almost their whole length beyond the dermal membrane. These long styli of the fibres are generally not distinguishable from those occurring singly dispersed in the axial skeleton; but in some portions of the skeleton examined, taken from near the base of the sponge, a large proportion of them were found to be much stouter and relatively shorter. The mode of origin of the extra-axial fibres from the axial skeleton is most unusual; from the longitudinal spicule-strands of the axial skeleton, short lateral branches arise, which, several together, converge and become confluent. As already indicated, the extra-axial fibres are entirely unconnected by transverse fibres.

Spicules.—(i.) The small smooth styli (Text-fig. 1, *a*) are of nearly uniform diameter throughout their length to within a short distance of their apical extremity, tapering thence gradually to a sharp point, and are, without exception, more or less curved, often rather strongly so, with the point of maximum curvature situated not far below their centre. They range from 75 to 150μ in length and up to 6.5μ in diameter; but individuals below 90μ in length or above 5μ in stoutness are extremely rare except in the older portions of the sponge. Of frequent occurrence among the styli are modifications thereof in the form of oxea; these are symmetrically curved, and slightly fusiform. Transitional forms between the styli and oxea are rare or absent.

(ii.) The acanthostyli (Text-fig. 1, *b*) are likewise invariably curved, but have the curvature restricted to their basal moiety, or often even to their basal third, the remainder of the shaft being straight and gradually tapered, *i.e.*, somewhat conical; the

apical extremity is acutely pointed, and the basal end evenly rounded off. The spines are confined to the distal moiety of the

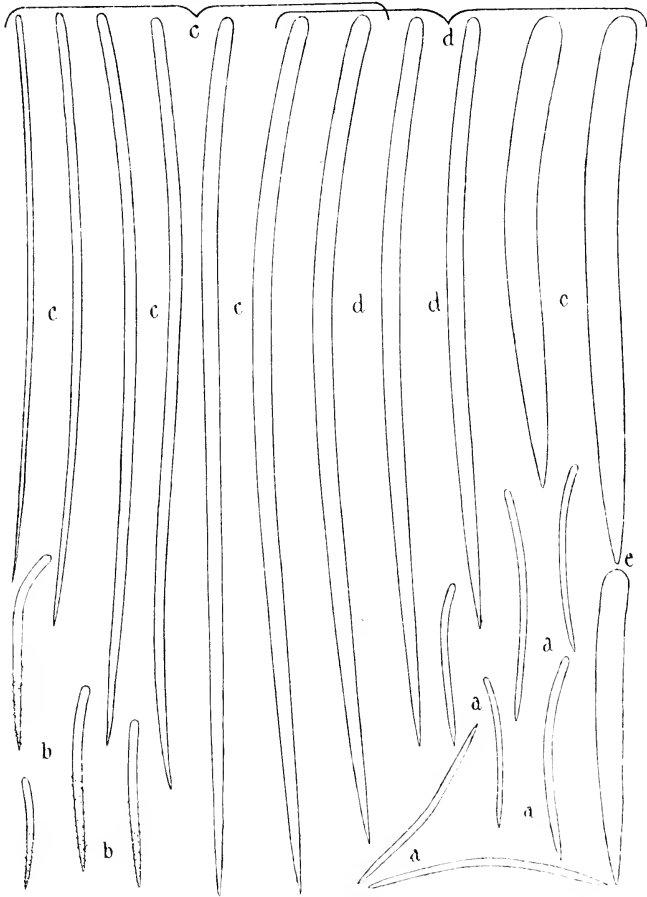

Text-fig. 1.

Echinaxia frondula.—*a*, coring styli of the fibres; *b*, acanthostyli; *c*, interstitial styli of the axial skeleton; *d*, styli projecting from the extra-axial fibres and hispidating the surface of the sponge; *e*, abnormally stout, projecting styli of the extra-axial fibres in the older portions of the sponge.

spicule, and are of minute size and closely set. The acanthostyli

range from 80 to 120 μ in length and from 4.5 to 8 μ in stoutness.

(iii.) The long smooth styli (Text fig. 1, *c*, *d*, *e*) are, almost without exception, more or less curved (though mostly only slightly so, and chiefly in their basal moiety), and are of uniform diameter to about the middle of the length, whence they taper gradually to a sharp point. A distinction should, perhaps, be drawn between those belonging to the axial region of the skeleton and those occurring in association with the extra-axial fibres. The former range from (very rarely less than) 250 to nearly 600 μ in length, and from 2 to 12 μ in diameter, but are seldom less in size than 350 by 4 μ . The latter are of about the same dimensions, both as regards length and maximum size, in the younger portions of the skeleton (but are uniformly stouter, never less than 6 or 7 μ in diameter); whilst in the older regions of the sponge they appear usually to be shorter and stouter, ranging from less than 200 to rarely more than 400 μ in length and abnormally attaining to 20 μ in diameter.

Loc.—Shoalhaven Bight, coast of New South Wales.

Genus RHABDOSIGMA.

Definition.—Desmacidonidæ in which the skeleton is a reticulation of well-developed spiculo-spongin fibres, and the only megascleres are rhabdostyli, typically exhibiting a vestigial spination, and in part projecting from the fibres as echinating spicules. The microscleres are sigmata.

Type, *R. mammillata* Whitelegge.

Though characterised mainly by the possession of megascleres similar in form to those constituting the sole common and distinctive feature of the species comprised in the genus *Rhabderemia*, *Rhabdosigma mammillata* nevertheless differs so decidedly from any of these in the structure of its skeleton that the desirability of a separate genus for its reception appears unquestionable. An adequate description of the skeleton in most of the species of *Rhabderemia* has not been given; but all of them are of encrusting or semi-encrusting habit, and apparently only in one of them, *R. indica*, are the megascleres at all aggregated into definite fibres or strands; even in this species, only a proportion of the megascleres are so arranged, and, according to

Dendy, no spongin cementing them together is detectible. Furthermore, in the typical species of *Rhabderemia*, including *R. indica*, the spiculation includes very small scattered styli,—designated microstyli by Topsent,—which, as they sometimes show traces of a vestigial spination, are probably homologous with the acanthostyli of “ectyonine” Myxillinae. The only two species of the genus without microstyli are *R. intexta* and *R. prolifera*. The former of these is imperfectly known, but it appears to be an encrusting species with a skeleton composed of rhabdostyli distributed singly; in the latter, which is also encrusting, the main skeleton consists of rhabdostyli standing separately with their heads based on the substratum, and special dermal megascleres are present in the form of slender tylostyli. The following is a list of the species of *Rhabderemia*, with the spiculation of each, and with references to their descriptions:—

R. toxigera Topsent(7). Smooth rhabdostyli, microstyli, sigmata, and toxa.

R. guernei Topsent(6). Smooth rhabdostyli, microstyli, sigmata, and “thraustoxes.”

R. pusilla Carter(2a); Topsent(9). Smooth rhabdostyli, microstyli, and sigmata.

R. indica Dendy(3). Smooth rhabdostyli, microstyli, and sigmata.

R. spinosa Topsent(8). Spined rhabdostyli, microstyli, and sigmata

R. prolifera Annandale(1). Smooth rhabdostyli, dermal tylostyli, and sigmata.

R. intexta Carter(2b). Spined rhabdostyli, and sigmata.

RHABDOSIGMA MAMMILLATA Whitelegge.

(Plate xxi., figs.1, 2; and Text-fig.2).

1907. *Sigmamaxinella mammillata* Whitelegge, Mem. Austr. Mus., iv., Part 10, p.512.

1916. *Rhabdosigma mammillata* Hallmann, Proc. Linn. Soc. N. S. Wales, xli., Part 3, p.520.

External features.—The type-specimen (which is the only example of the species so far obtained) may be described as possessing the form of a broad and low, moderately thick, erect

plate, proximally contracted into a short and stout stalk, and subdivided marginally into a series of short digitiform, or mammi-form lobes, and provided also with (a few) additional similar lobes arising adventitiously from its sides. Probably the habit of the species is often simply flabellate, or, more precisely, digito-flabellate; but in the present instance the lamina is vertically folded, and partially concrescent with itself along one edge, so that its shape in horizontal cross-section is roughly that of the figure 6. In consequence of this, and of the laterally-arising lobes, the essentially lamellar form of the sponge is considerably obscured (Plate xxi., fig.2). The specimen, which is imperfectly preserved in alcohol, measures 70 mm. in height, 65 mm. in width, and about 40 mm. in total thickness; the thickness of the lamina (as also the diameter of the lobes) varies from 10 to 15 mm.; and the length of the longest lobe is 25 mm. On the summit of each lobe are from two to seven small, circular oscula, from 1 to (rarely) 2 mm. in diameter, arranged usually in one or two straight rows; and traversing the lobe longitudinally throughout its entire length are a corresponding number of main excurrent canals. On some of the lobes there is observable, radiating towards the oscula, a series of faintly marked grooves or shallow fissures; but these are probably only accidentally-caused cracks. Owing to its abrasion, the dermal membrane is almost entirely wanting; but from traces of it remaining here and there on the less exposed portions of the surface, it would appear to have formed, when intact, a very thin and closely adherent layer, non-separable from the underlying tissues, and finely granular on the surface. Subdermal spaces are indiscernible. Where the dermal membrane is wanting, the surface presents a somewhat velvety aspect, — due to the numerous slightly projecting points of the terminal spicules of the main skeletal fibres, — and is dotted (at distances apart of about 1 mm.) with small pinhole-like “pores;” these latter are, of course, not the dermal pores (as the original description would suggest), but the (subdermally situated) orifices of the main incurrent canals. The consistency of the sponge is firm and tough, compressible and resilient; the texture, dense. The colour in alcohol is light brown.

Skeleton.—The skeleton (Plate xxi., fig. 1) is composed of well-developed spiculo-spongin fibres, echinated, as well as cored, by the characteristic megascleres, the rhabdostyli: megascleres scattered between the fibres are rare or absent. With respect to its arrangement, it presents, in keeping with the lamellar form of the sponge, a somewhat denser central, or *axial* region, of usually fairly considerable width, within which the direction of the main fibres is longitudinal or nearly so, and connecting fibres between them are numerous; and exteriorly to this (on either side of it, in the main body of the sponge), extending therefrom to the surface, an *extra-axial* region, in which the direction of the main fibres is more or less obliquely transverse (occasionally, in the lobes, nearly perpendicular to the longitudinal direction), and connecting fibres between them (excepting in the older portions of the sponge) are relatively few. The demarcation between the two regions, however, is generally by no means pronounced. In the extra-axial region, particularly, the skeleton is of very regular and simple pattern (Plate xxi., fig. 1), with the main fibres running in nearly straight courses, approximately parallel to one another, at a distance apart of about a spicule's length, and chiefly connected together by their echinating spicules in the manner presently to be described, eventually, however, in the older portions of the sponge, these connecting spicules become invested each with an ensheathing layer of spongin, thus giving rise to connecting fibres, and the pattern of the extra-axial skeleton is then rectangularly reticulate. In the axial region the main fibres are much less regularly disposed, and the pattern of the skeleton is distinctly reticulate throughout, with (except in the youngest portions of the sponge) meshes of more or less rounded shape: in the oldest portions of the sponge the meshes become reduced in size, often almost to the point of obliteration. The spicules coring the main fibres (both axial and extra-axial) are disposed, somewhat loosely, in a slightly plumose fashion, frequently with the points of some of them projecting a little beyond the spongin-sheath, and vary in number, in a cross-section of the fibre at any point, from 3 to about 8; they are generally somewhat the more numerous, and

their plumose arrangement is generally the more pronounced, towards the outermost extremities of the extra-axial fibres (*i.e.*, near the surface of the sponge). The connecting fibres contain only one or two spicules. A most unusual (possibly abnormal) circumstance in connection with the coring spicules of the axial main fibres,—apparently, however, only in the older portions of the skeleton,—is the fact that a variable (often a very considerable) proportion of them fail to grow much beyond their very earliest developmental stages,—their immaturity in many cases being such that nothing more of them can be discerned than the faint outline of their axial canal. The echinating spicules are usually directed almost or quite perpendicularly to the fibres, and stand, on the average, at a distance apart of (at the most) not more than one-half their own length. A considerable proportion, if not the majority, of the echinating spicules project from their supporting fibres in such directions as apically to impinge upon and become inserted into adjoining fibres, and thus come to play the part of connecting spicules; in the axial region of the skeleton, and also (as already mentioned) in the older portions of the extra-axial region, these connecting spicules usually become entirely ensheathed in spongin, and thus give rise to additional connecting fibres. The extra-axial main fibres are usually between 60 and 80 μ , rarely as much as 100 μ , in stoutness; the axial main fibres, owing to the greater development of their spongin-sheath, occasionally attain to over 250 μ in stoutness in the stalk of the sponge, but in the lobes seldom exceed 150 μ . The terminal spicules of the extra-axial main fibres are free from spongin except basally, and form, at the extremity of each fibre, a slightly divergent penicillate tuft, projecting into the dermal membrane. There is no dermal skeleton.

Spicules.—The rhabdostyli (Text-fig. 2) range from 160 to 280 μ in length and attain a maximum stoutness of 18 μ ; in their very earliest developmental stages they already measure 5 or 6 μ in stoutness, and the diameter of their axial canal is only slightly less. They have the shaft bent, as a rule rather sharply and angulately, at a distance of from 20 to very seldom more than 30 μ from the base, and at an angle usually much less than

(though occasionally exceeding) 45° . The basal extremity is evenly rounded off, not tylote; the portion of the shaft between it and the point of flexure is usually straight or very nearly so; the remainder of the shaft is, almost without exception, perfectly straight, and tapers gradually to a sharp point. Basally, for at

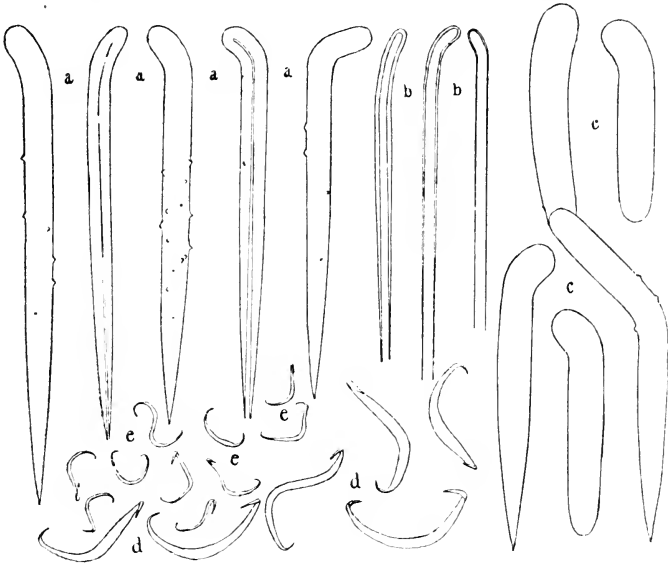

Text-fig. 2.

Rhabdosigma mammillata—*a*, fully-grown rhabdostyli; *b*, immature rhabdostyli; *c*, abnormal forms of rhabdostyli; *d*, larger sigmata; *e*, smaller sigmata.

least one-fourth of the entire length of the spicule, and also apically, for about the same distance, the shaft is invariably quite smooth; but not infrequently, over some portion of its intermediate region, there occur a few small, perpendicularly directed spines, the largest not exceeding 2μ in height. In the case of an unusually large number (at least 25%) of the (otherwise fully-grown) spicules, the axial canal remains unclosed apically, and is then frequently very conspicuous, occasionally attaining a diameter of as much as 4.5μ . Also of rather frequent occurrence are abnormal forms (Text-fig. 2, *c*), generally with the

apical (as well as the basal) extremity rounded off, and nearly always stouter and much shorter than the normally developed spicules; the extreme forms of these are short straight strongyla, ranging up to 25μ in stoutness, and occasionally down to less than 100μ in length.

The *sigmata* are of two kinds, differing in size and also somewhat in shape. The larger (Text fig. 2, *d*) invariably have their (very finely pointed) extremities recurved abruptly, in a sharply hook-like manner, and are frequently only so slightly contort as to appear more or less **C**-shaped when viewed from the side; more usually, however, their degree of torsion is such that the planes in which their opposite extremities are curved, are inclined at an angle of not less than 90° . The smaller *sigmata* (Text-fig. 2, *e*) are not very different in form from the larger, but are usually somewhat more rounded in their curvatures, and slightly more contort. Both kinds are plentifully scattered through all parts of the interior. The larger, which are the less numerous, vary from 22 to 30μ in length, and attain a maximum stoutness of 3μ ; the smaller are only from 9 to 13μ long, and never more than 1μ in diameter.

Loc.—Off Norah Head, coast of New South Wales.

REFERENCE LIST OF LITERATURE.

1. ANNANDALE, N.—“Some Sponges parasitic on Clionidae, with further Notes on that Family.” *Rec. Indian Mus.*, xi., Part vi., 1915, p.464, Pl. xxxiv., fig.3, text-fig.3.
2. CARTER, H. J.—“Descriptions and Figures of Deep-Sea Sponges and their Spicules, from the Atlantic Ocean, dredged up on board H.M.S. ‘Porcupine,’ chiefly in 1869 (concluded).” *Ann. Mag. Nat. Hist.*, (4), xviii., 1876; (*a*) p.238, Pl. xv., fig.43; (*b*) p.239, Pl. xvi., fig.51.
3. DENDY, A.—“Report on the Sponges collected by Prof. Herdman at Ceylon in 1902.” *Reports on the Pearl Oyster Fisheries in the Gulf of Manaar*, Vol. iii., 1905, p.180, Pl. xii., fig.10.
4. HALLMANN, E. F.—“A Revision of the Genera with Microscleres included, or provisionally included in the Family Axinellidae; with Descriptions of some Australian Species.” *Proc. Linn. Soc. N. S. Wales*, 1916, Vol. xli., Part 3, pp.520, 543.
5. THIELE, J.—“Studien über pazifische Spongien.” *Zoologica*, 1898, Heft. 24, pp.59, 60.

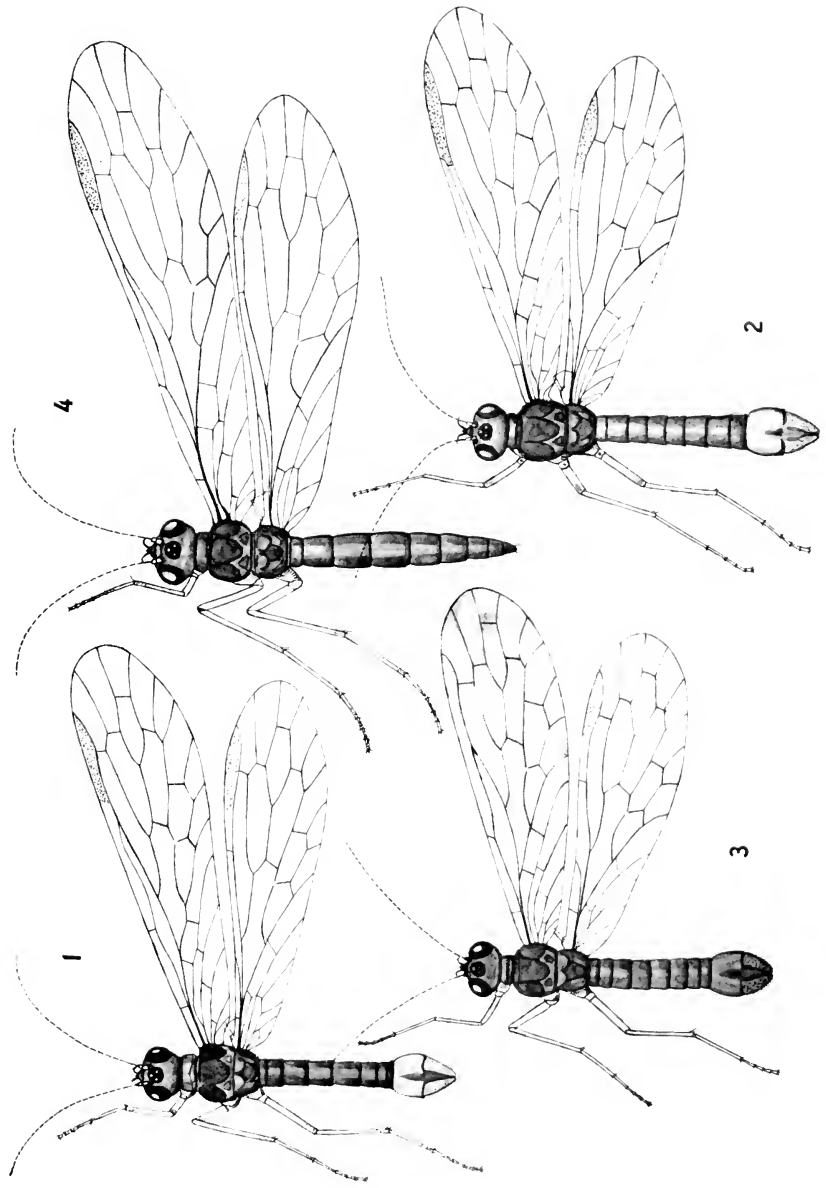

R. J. T. del.

Nannochorista spp.

5

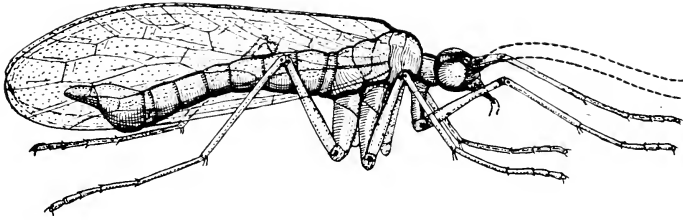

6

7

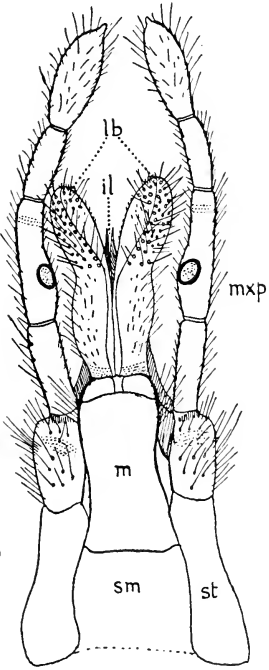
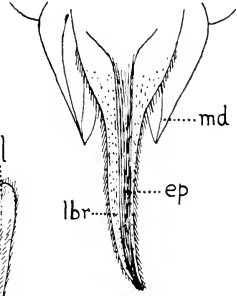

8

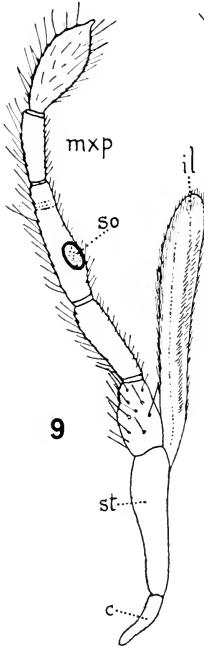

9

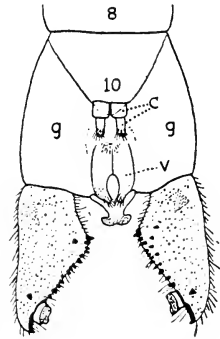

10

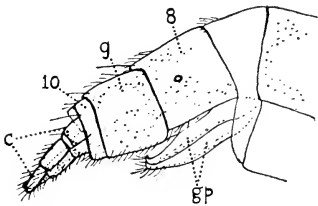

11

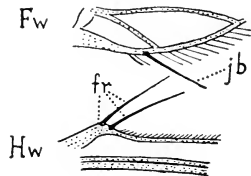

12

Figs. 5, 6, 12. *Naunochorista holostigma*

Figs. 7-9, 11. *N. dipteroïdes*

R.J.T.del

TOPOGRAPHICAL MAP

OF THE

WESTERN SLOPE
OF
NEW ENGLAND

Heights approximate. Only
Based on Official Data.
Aerial Observations, etc.

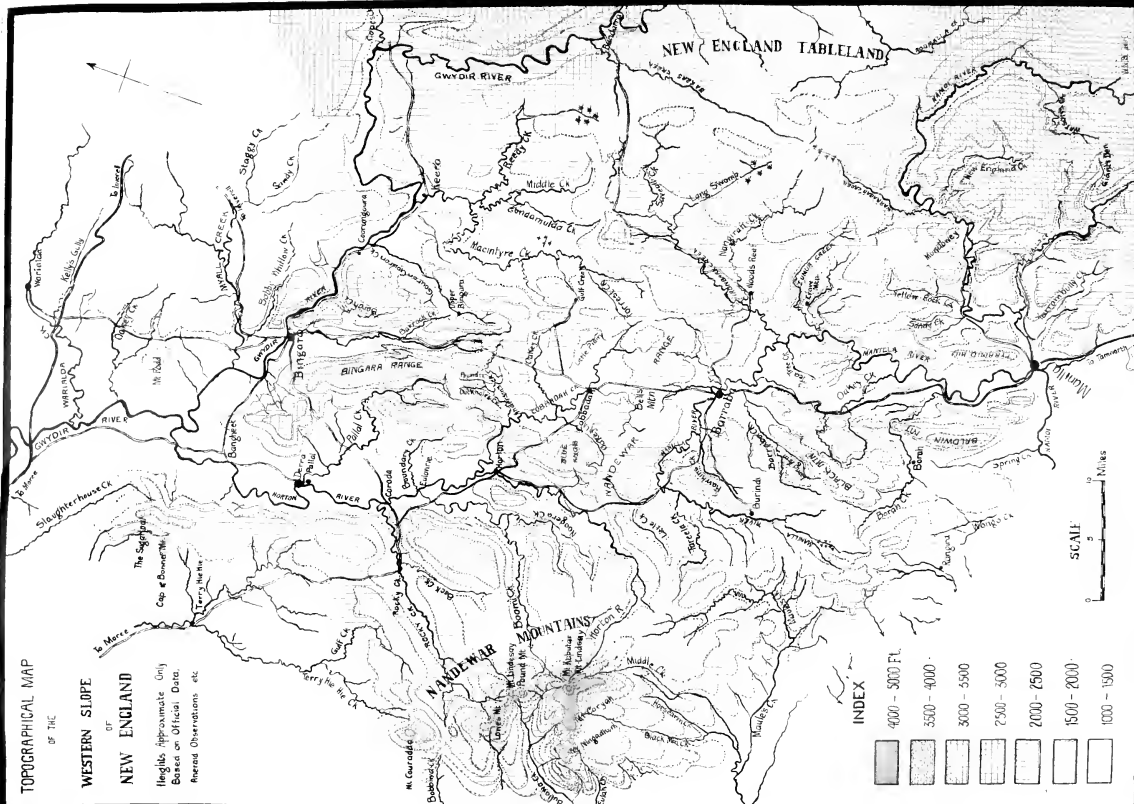

INDEX

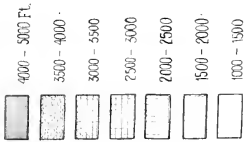

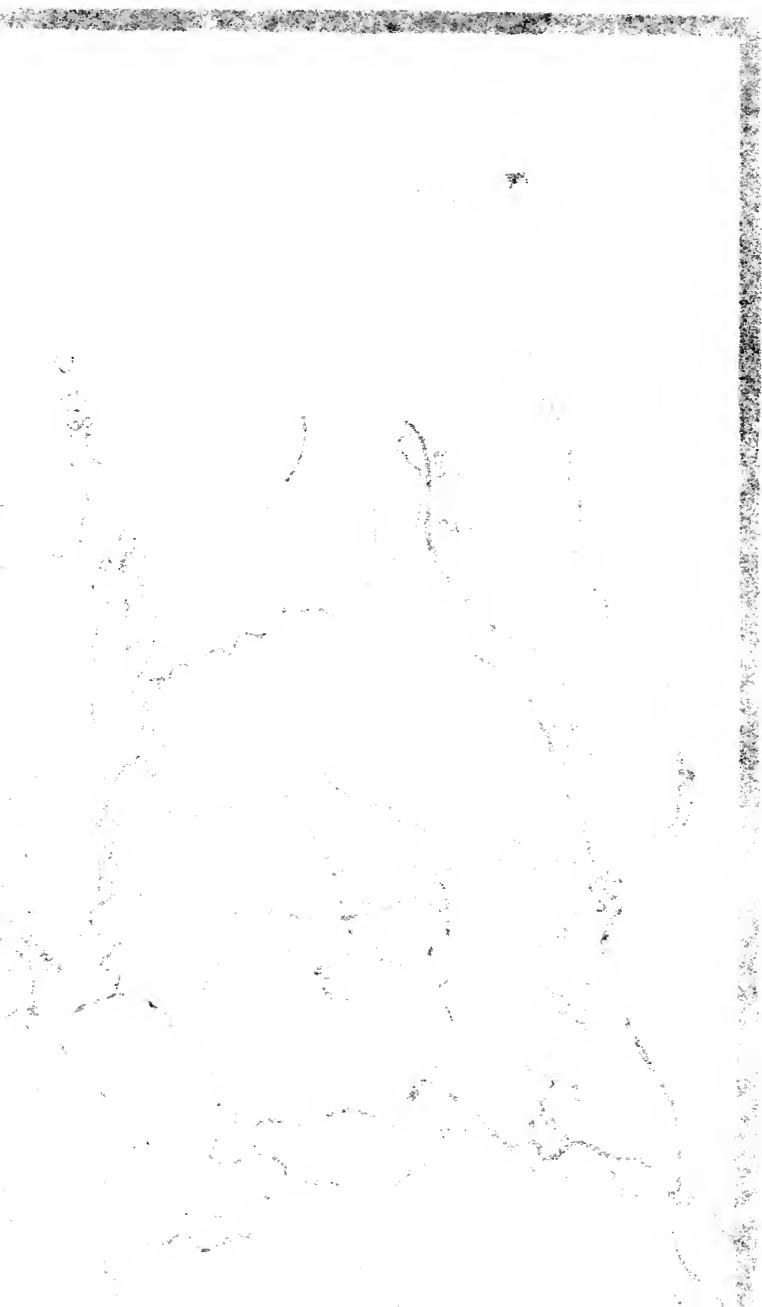

GEOLOGICAL MAP

OF THE
DISTRICTS
OF
BINCARA, BARRABA
AND
TAMWORTH

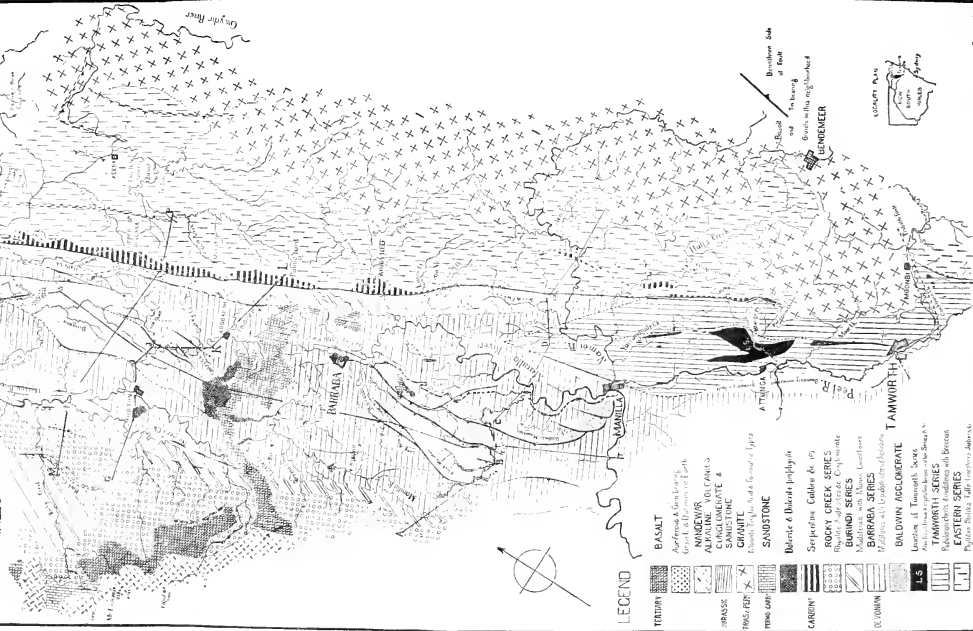
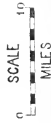

LEGEND

- TERTIARY**
 - BASALT**
Auriferous & Gem bearing
Gravel & Uplifted Earth
 - NANDEWAR**
ALKALINE VOLCANIC
SANDSTONE &
SANDSTONE
 - BASALT**
Borehole & Auriferous
Gravel & Uplifted Earth
- MESAZOIC**
 - GRANITE**
Borehole & Auriferous
Gravel & Uplifted Earth
 - SANDSTONE**
Borehole & Auriferous
Gravel & Uplifted Earth
- CARBONIFEROUS**
 - Basaltic & Olivine porphyry**
 - Serpentine Gabbro & Uplifted Earth**
 - ROCKY CREEK SERIES**
Rhyolite & andesite
Conglomerate
 - BURINDI SERIES**
Middleton with Borehole
Lacustrine
 - BARRABA SERIES**
Middleton with Borehole
Lacustrine
 - BALDWIN AGGLOMERATE**
Middleton with Borehole
Lacustrine
- DEVONIAN**
 - L.S.**
Location of Tamworth Series
Borehole & Auriferous
Gravel & Uplifted Earth
 - TAMWORTH SERIES**
Borehole & Auriferous
Gravel & Uplifted Earth
 - EASTERN SERIES**
Borehole & Auriferous
Gravel & Uplifted Earth



(The National Series with Borehole & Auriferous Gravel & Uplifted Earth.)

TERTIARY

MESOZOIC-CARBONIFEROUS

CARBONIFEROUS

DEVONIAN



BASALT



GRANITE

Several Periods of Intrusion



ROCKY CREEK

Conglomerates, Tuffs etc.



BARRABA

Mudstones &c



DRIFT

Gravel with general Diatomaceous Earth



SERPENTINE

Gabbros etc



BURINDI

Fossiliferous Mudstones Limestones etc



BALDWIN

Agglomerates



TAMWORTH

Radiolarian Chert Limestone and Breccia



EASTERN

Jaspers, Phyllites &c (Tamworth and Woolomin Rocks)

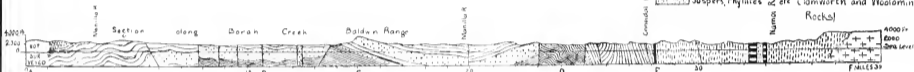

Fig 1 Section from Head of Manila R to New England Plateau



Fig 2 Section through Horton and Cobbadah



Fig 3 Section from Back Creek to Keera Senkungsfield



Fig 4. Generalised Section from the Gwydir to the Namoi

10/10/2010 10:10:10 AM



10/10/2010 10:10:10 AM

10/10/2010 10:10:10 AM

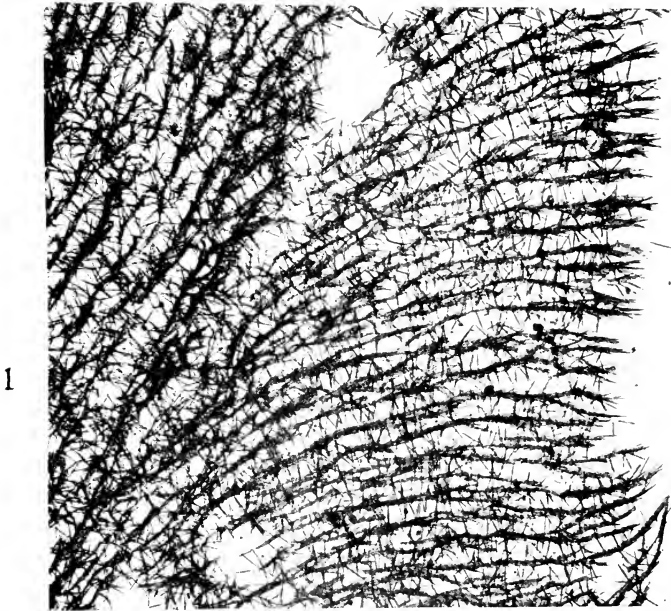

Figs. 1-2. *Rhabdosigma mammillata*.

Figs. 3-4. *Echinavia frondula*.

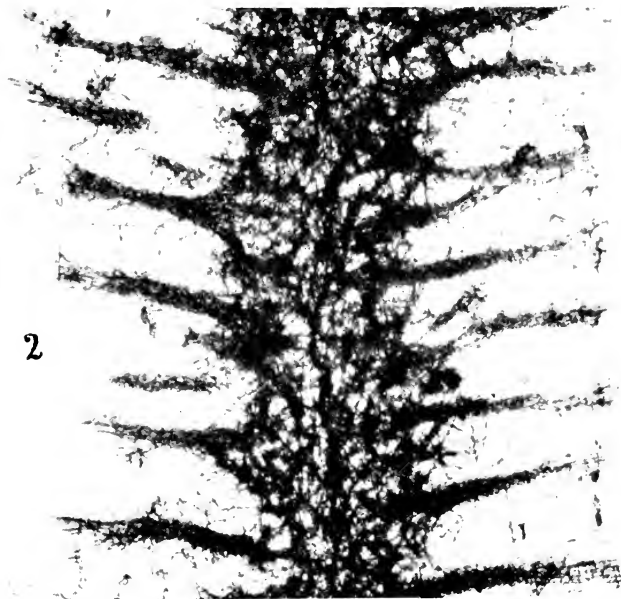
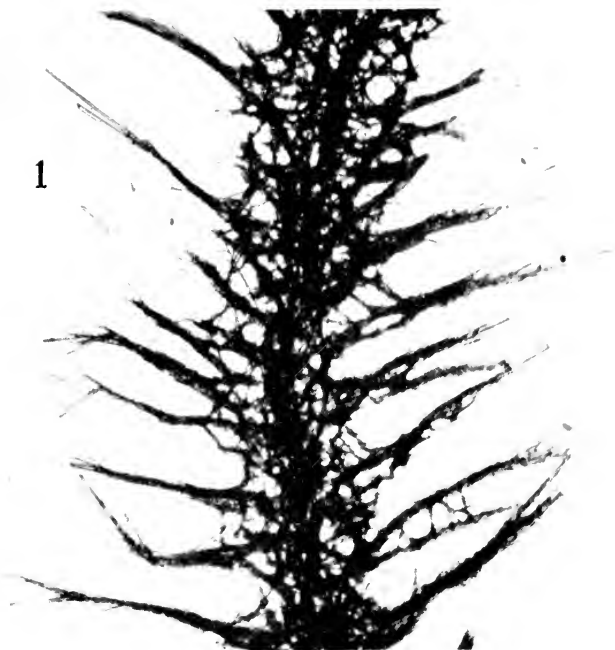

Echinacia frondula Whitelegge.



6. TOPSENT, E.—“Contributions à l'Étude des Spongiaires de l'Atlantique Nord.” *Resultats des Camp. Scient. du Pr. de Monaco*, 1892, Fasc. ii., p.116, Pl. xi., fig.7.
7. ————— “Diagnoses d'Éponges Nouvelles de la Méditerranée et plus particulièrement de Banyuls.” *Arch. Zool. Exp. et Gen.*, 1892, (2), x., Notes et Revue, p. xxv.
8. ————— “Materiaux pour servir à l'Étude de la Faune des Spongiaires de France.” *Mém. Soc. Zool. France*, 1896, ix., p.121.
9. ————— “Spongiaires des Açores.” *Resultats des Camp. Scient. du Pr. de Monaco*, 1904, Fasc. xxv.; (a) p.152, Pl. i., fig.10; Pl. xiii., fig.13; (b) p.138.
10. ————— “Spongiaires de l'Expédition Antarctique Nationale Écossaise.” *Trans. Roy. Soc. Edinburgh*, 1913, xlv., Part 3, p.616, Pl. i., fig.4; Pl. vi., fig.15.
11. WHITELEGGE, T.—“Scientific Results of the Trawling Expedition of H.M.C.S. ‘Thetis’.—Sponges, Part ii.” *Mem. Austr. Mus.*, iv., Part 10, 1907, pp.509, 512.

EXPLANATION OF PLATES XXI.-XXII.

Plate xxi.

Rhabdosigma mammillata Whitelegge.

Fig.1.—Longitudinal (desarcodised) section of the skeleton (of a digitiform lobe), showing extra-axial region thereof and also portion of the axial region; ($\times 15$).

Fig.2.—Entire specimen; ($\times \frac{2}{3}$).

Echinaria frondula Whitelegge.

Figs.3, 4.—Pattern of the skeleton as shown in longitudinal section parallel to and in the mid-plane of the (lamelliform) sponge. Fig.3 shows more distinctly the longitudinal spicule-strands; in Fig.4, which is from a thinner section, many long interstitial megascleres are also to be seen; ($\times 50$).

Plate xxii.

Echinaria frondula Whitelegge.

Figs.1, 2.—Skeleton as seen in longitudinal section perpendicular to the surface of the (lamelliform) sponge. The desarcodised section (shown in Fig.1) is from near the upper margin of the sponge; the other (undesarcodised) is from near its base; ($\times 50$).

CORRIGENDUM.

Page 391, line 14—for *Heterectya*, read *Heterectya*.



CARABIDÆ FROM TROPICAL AUSTRALIA.

(NEW GENERA AND SPECIES, NOTES AND SYNONYMY, AND SYNOPTIC TABLES. TRIBES *SCARITINI*, *HARPALINI*, *ODACANTHINI*, *LEBIINI*, AND *HELLUONINI*).

BY THOMAS G. SLOANE.

Tribe **Scaritini**.

Genus *CLIVINA*.

CLIVINA BREVISTERNA Sl., var. *MAJOR*, n. var.

Allied to *C. brevisterna* Sl., but differing by larger size; prothorax strongly narrowed to apex; elytra with striæ less coarsely punctate towards base, obsolete towards apex, interstices equally convex at base but depressed towards apex, third and fifth interstices not raised into ridges towards apex. Undersurface similar as regards pro-episterna, metepisterna, and comparative length of posterior coxæ in comparison with distance between median and posterior coxal cavities. Length, 17; head, 3 across eyes; prothorax, 4.5×4.75 , apex 3; elytra, 10×5 mm.

Hab.—Northern Territory. Types in National Museum, Melbourne. Several specimens, sent by Mr. J. A. Kershaw, ticketed "Flooded area, King River, N.T.; W. McLennan; 22.12.15."

LACCOSCAPHUS DODDI Sl., var. *TRIORDINATA*, n. var.

Oval; elytra with three rows of foveæ on each; anterior tibiae 3-dentate; black. Length, 12.2; breadth, 4.5 mm.

Differs from the typical form of *L. doddi* by shape less convex; elytra less convex, more depressed on disc, less roundly and strongly declivous on sides, three (not four) rows of foveæ on each elytron (the row next the suture wanting).

Hab.—Northern Territory. Type in National Museum, Melbourne.

One specimen ticketed "Flooded area, King River, N.T.; W. McLennan; 24.12.15." Among the specimens sent by Mr. Kershaw, as taken at the same place and time, was a specimen of *L. doddi* of typical form. In *L. doddi*, the number of foveæ in the juxta-sutural row varies (in one of my specimens there are only two foveæ); therefore it is possible they may be altogether wanting sometimes; but, even if this be the case, a varietal name for the form with only three rows of foveæ on each elytron will be convenient.

Genus *CARENUM*.*

CARENUM FULGIDUM, n.sp.

Parallel-oval, subcylindrical. Head large; frontal sulci long, divergent backwards; median space at base filling all interval between sulci; suborbital channels to receive antennæ divided longitudinally in middle by an oblique ridge; maxillary palpi moderately, labial palpi very widely securiform, penultimate joint of labial short, stout: prothorax broader than long, lobate at base; anterior angles advanced, posterior angles rounded; two marginal setigerous punctures on each side: elytra oval, quadripunctate; inflexed margin narrow behind first ventral segment: humeral angles dentate: anterior tibiæ bidentate, apical plate of lower side prominent beneath insertion of tarsus and with a seta on inner side. Head æneous, clypeus, middle of median frontal space and sides of lateral frontal spaces purplish-black; pronotum æneous (cupreous along anterior transverse impression and towards base), disc on each side of suture and anterior margin before transverse impression purple-black; elytra cupreous, (æneous in some lights) purple-black on disc; undersurface of head viridescent on each side; prosternum black in middle, green on each side, episterna green; mesosternum, metasternum, and legs black; ventral segments green, black in middle.

Head convex (3.7 mm. across eyes), transversely impressed behind frontal spaces; frontal sulci long, lightly sinuate; clypeus

* *Carenum floridum*, nom.nov., for *C. lepidum* Sloane, 1916. The name *C. lepidum* had been used by me for a species of *Carenum* in 1889. The name *C. floridum* is now proposed to replace that of the second species so named.

convex, median part wide, declivous, intermediate angles narrow, prominent; preocular sulci well-defined; eyes deeply inclosed behind, convex, most prominent near base, obliquely narrowed forward; orbits prominent, sloping strongly to head; labrum short. Prothorax convex, declivous to base, subparallel on sides (3.4×4.1 mm.); basal curve short, rounded on each side, strongly sinuate on each side of the well-defined basal lobe; apex truncate between anterior angles; border narrow, reflexed, a little wider and prominent at anterior angles. Elytra oval (6.5×4.2 mm.), depressed on disc, strongly roundly declivous on sides, strongly declivous on base above peduncle, very declivous to apex; border narrow, upturned in a short, prominent, horn-like process at humeral angles; three or four punctures on base of each elytron, the inner one near suture; a row of rather closely placed punctures along lateral margins. Intercostal point of prosternum rounded, unisetose on each side. Ventral segments 3-5 bipunctate, apical segment non-foveate on upturned edge. Length, 13.5; breadth, 4.2 mm.

Hab.—Northern Territory. Type in National Museum, Melbourne.

A single specimen was sent to me by Mr. J. A. Kershaw, of the National Museum, Melbourne, for identification, ticketed "Flooded area, King River, N.T.: W. McLennan: 24.12.15." It belongs to the *C. quadripunctatum*-group: in general appearance it resembles *C. sumptuosum* Westw., but differs very decidedly by smaller size, prothorax with basal lobe far more strongly defined by the lateral sinuosities, only two (not three) marginal setigerous punctures on each side, border projecting strongly at each humeral angle in the form of a short, horn-like prominence. It is allied to *C. nitidipes* Sl., from which it differs by the coppery tints on head, prothorax, and elytra, black legs, broader form, much more strongly dentate humeral angles of elytra, &c.

CARENUM BELLUM, n.sp.

Elongate, parallel. Head transversely impressed behind; frontal sulci long, deep, divergent posteriorly; suborbital scrobes to receive antennæ short, single; two supraorbital setæ on each

side; maxillary palpi widely, labial palpi very widely securiform, penultimate joint of labial palpi short, stout: prothorax parallel on sides, lobate; anterior angles prominent; two marginal setigerous punctures on each side: elytra not perceptibly wider than prothorax, depressed on disc, impunctate; humeral angles shortly dentate; inflexed margin narrow behind first ventral segment; anterior tibiæ bidentate. Nitid, head black, with bright green reflections on frontal lateral spaces, across occiput, in transverse impression, and on sides of gulæ; prothorax black, with wide bright green lateral margins becoming æneous at posterior curve: elytra bright green, purple-black on disc (along suture) and narrowly along basal, lateral, and apical margins: inflexed margin black with faint greenish tinge; undersurface and legs black; pro-episterna and ventral segments 3-6 with viridescent tints.

Head large (3.3 mm. across eyes), convex, constricted behind eyes; frontal spaces convex, middle space filling all the interval between frontal sulci, its posterior margin strongly defined by a transverse impression, lateral spaces narrow and strongly raised behind, defined externally for length of eyes by a deep supra-ocular sulcus; labrum small; clypeus roundly declivous, median part obsoletely trisinate, intermediate angles short, obtuse; submentum strongly raised from gulæ, foveate on each side behind genæ. Prothorax as long as broad (3.35 × 3.35 mm.), convex, declivous to basal sinuosities; sides parallel, rounded at posterior angles, strongly sinuate on each side of basal lobe; anterior margin truncate, anterior angles advanced, bordered; border very narrow. Elytra of about same width as prothorax (6.5 × 3.4 mm.), subparallel on sides, depressed on disc, strongly and roundly declivous on sides: suture strongly impressed; border narrow, thickened towards apex, upturned in a short, subacute process at humeral angles; a closely placed row of punctures along sides: about six punctures on base of each elytron (five in a transverse row, the remaining one placed before this row towards lateral border). Ventral segments 3-5 bipunctate. Anterior tibiæ strongly bidentate; apical plate without a subdentiform prominence below tarsus. Length, 13; breadth, 3.4 mm.

Hab.—Northern Territory. Type in National Museum, Melbourne.

A single specimen of this elegant and distinct species was sent to me by Mr. J. A. Kershaw, of the National Museum, Melbourne, for description, ticketed "Flooded area, King River, N.T.; W. McLennan; 24.12.15." In facies it resembles *C. splendidum* Macl., but it is not closely allied to that species (some differences are form of head, facial sulci deep and extending backwards beyond base of eye, suborbital antennal grooves short, single; elytra with several punctures on each side of base, the row of punctures along margin not few and wide apart). It probably has more affinity towards *C. longulum* Sl., than to any other described species, but differs by smaller size, elytra impunctate, &c. Comparing it with *C. eximium* Sl., which it resembles in appearance, size, and impunctate elytra, it differs by head, prothorax, and abdomen having viridescant tints; labrum bisinuate (middle a little advanced); eyes less convex, less prominent, more strongly inclosed at base, lateral spaces of front narrower and more convex behind owing to the deeper, wider, juxta-ocular sulcus, suborbital antennal groove single; prothorax with anterior angles prominent, posterior curve shorter, less oblique, more strongly sinuate on each side of lobe; elytra more flattened on disc, upturned humeral angle more acute.

Tribe **Harpalini.**

Genus **GNATHAPHANUS.**

GNATHAPHANUS WHITEI, n.sp.

♀. Elongate-oval, subdepressed. Black.

Head large (5.3 mm. across eyes). Mandibles short, right one widely rounded at apex. Prothorax transverse (4.3 × 6.3 mm.) with a large anterior area defined by an arcuate transverse line raised above plane of disc and a wide, depressed, basal area; angles obtuse, posterior rounded off. Elytra parallel-oval (11.5 × 7.4 mm.), strongly sinuate on each side of apex, strongly striate; dorsal interstices convex, third and fifth wider than second and fourth, second, fourth, and sixth narrow, pointed at apex, third with seven, shallow, foveiform punctures extending

from striole at base of second interstice to apex. Length, 18·5-20; breadth, 7·7-4 mm.

Hab.—Northern Territory. Type in National Museum, Melbourne. Dedicated to Mr. H. L. White, of Belltrees, N.S.W., the well-known ornithologist, at Mr. J. A. Kershaw's request. Two specimens ticketed "Flooded area, King R., N.T.; W. McLennan; 24.12.15," were sent to me for determination.

Allied to *Gn. vulneripennis* Macl., from Java, but larger. It differs from *Gn. philippensis* Chev., (= *Gn. laeviceps* Macl.)* by antennæ with basal joint black; prothorax with wider flattened space near each posterior angle and along sides; elytra with interstices much more convex, summits nitid, third and fifth interstices wider than first, second, and fourth, wider than in *Gn. philippensis*—especially towards apex,—seventh and ninth wider towards apex, punctures of third interstice foveiform, not ranged along third stria towards base, &c.

Genus L E C A N O M E R U S.

LECANOMERUS LUCIDUS, n.sp.

♂. Oval. Prothorax wide, rounded on sides, hardly narrowed to base; basal angles obtuse: elytra ovate, lightly striate; interstices depressed, second without striole at base, third impunctate. Black, nitid; elytra with submetallic greenish reflections in certain lights; femora piceous-brown, tibiæ and antennæ brownish; antennæ with two basal joints testaceous, third joint piceous.

Head moderate (1·1 mm. across eyes); frontal impressions feebly marked, wide, round; eyes round, convex: mandibles prominent, decussate. Prothorax short, transverse (1·5 × 2·2 mm.), widest about middle, much wider across base (2 mm.) than apex (1·3 mm.), subdepressed towards base, lightly and widely declivous on each side anteriorly; basal angles roundly obtuse; base

* I have seen a specimen of *Amblygnathus philippensis* Chev., ticketed "Manila," and have also seen the same species from Celebes and New Guinea; these specimens I cannot differentiate from *Pachauchenius laeviceps* Macl., of the mainland of Australia. It therefore seems that *Gn. laeviceps* Macl., must be regarded as synonymous with *Gn. philippensis* Chev., which ranges from the Philippine Islands to Tropical Australia.

roundly truncate; margins wide towards base; border narrow; lateral basal impressions obsolete; median line fine. Elytra widely ovate (4×3.3 mm.), hardly wider between humeral angles than base of prothorax, rather sharply widened behind humeral angles, widest about middle, lightly convex; humeral angles sub-prominent, inner humeral angles subrectangular; striæ lightly impressed on disc, deeper towards apex, sixth and seventh hardly perceptible about middle of their course, ninth with the seriate punctures widely interrupted behind basal fifth. Length, 6.5; breadth, 3.3 mm.

Hab.—Queensland: Innisfail. Type in Coll. Sloane. A single specimen occurred to me in the dense scrub in June.

Differs from all other species known to me by its more shining colour, and wider form; prothorax wider, more rounded on sides, less narrowed to base.

Genus EUTHENARUS.

EUTHENARUS BRUNNEUS, n.sp.

Elongate-oval, convex, not shagreened. Head large, front and clypeus bifoveolate: prothorax subquadrate, strongly punctate across base; basal angles obtuse: elytra oval, strongly striate; second interstice without a striole at base, third unipunctate a little behind middle: tarsi short. Light brown; legs testaceous: antennæ infusate, two basal joints testaceous.

Prothorax broader than long (1.5×1.8 mm.), widest before middle, a little wider across base (1.5 mm.) than apex (1.4 mm.): sides lightly rounded anteriorly, obliquely and lightly narrowed to base: basal angles roundly obtuse; base roundly truncate; margins narrow anteriorly, rather wide towards base; a wide, strongly punctate space across base from side to side; basal foveæ shallow, wide: median line lightly marked. Elytra considerably wider than prothorax (4×2.5 mm.), strongly declivous to sides and apex: inner humeral angles roundly open; striæ deep: inner interstices convex. Prosternum with a few fine setæ before coxæ and on point. Abdomen sparsely setulose, intercoxal fovea wanting. Male with four basal joints of four anterior tarsi dilatate; squamulæ of undersurface sparse, set in

two rows, on anterior tarsi long and near sides of joints; penultimate joint of anterior tarsi emarginate, of intermediate tarsi triangular (in ♀ short, wide, subemarginate), of posterior very small; posterior tarsi with joints successively shorter towards apex, first joint not as long as two succeeding joints together, fifth joint glabrous beneath. Length, 6·5; breadth, 2·5 mm.

Hab.—Tropical Queensland. Types in Coll. Sloane. Specimens occurred to me at King's Plains Cattle Station, on the Upper Normanby River, Cooktown District, in July.

Differs conspicuously from our other species of the genus *Euthenarus* by colour, larger size, more strongly punctate prothorax, also by the want of the basal fovea of the abdomen; this last feature has been given a high importance in recent classifications of the Harpalini, but I do not think its absence outweighs other evidences of affinity, therefore have placed *E. brunneus* in the genus *Euthenarus*.

Tribe **Odacanthini.**

The question, whether Lacordaire's tribes Odacanthides, Ctenodactylides, Trigonodactylides, and Anchonoderides should be recognised as separate tribes, or should be united in one tribe, Odacanthidæ, need not be considered here, for, in the Australian fauna, only the tribe Odacanthini occurs: but I believe that at least the Anchonoderides should be united to the Odacanthini. The position of this tribe is near the Anchomenini; the opening of the inner side of the anterior coxal cavities is single as in the Anchomenini, not double as in the Heliuonini and Dryptini. Our species have been distributed (in some cases with doubt) amongst the genera *Odacantha*, *Casnonia*, *Ophiomea*, *Lachnothorax*, and *Eudalia*. I now propose to delete the genera *Odacantha* and *Casnonia* from the Australian fauna: the species, which have been assigned to these two genera, are here referred elsewhere. *Odacantha micans* Macl., becomes the type of a new genus, *Basistichus*: and *Casnonia aliena* Pascoe, the type of a new genus, *Clarencia*: *Casnonia obscura* Cast., and *C. amplipennis* Gestro, are referred to *Eudalia*: *C. globulicollis* Macl., *C. riverinæ* Sl., and *L. formicoides* Sl., I have already placed in

Lachnothorax, where they constitute a special group endemic to Australia; (our other species, *L. palustris* Sl., is a typical species of *Lachnothorax*. Cf. Sloane, these Proceedings, 1910, xxxv., p.398).

All the Australian species of the tribe Odacanthini, which I have examined, have had, in the ♂, the anterior tarsi in some degree dilatate, with the three basal joints bearing two oblique rows of squamæ on their undersurface (in some cases, e.g., *Basistichus micans* Macl., these rows of squamæ are weak).* All our species have the apex of the abdomen unisetose on each side in ♂, bisetose in ♀; there is a notch, more or less distinct, in the middle of the apex in ♂ (sometimes this notch may be seen less developed in the ♀, e.g., *Basistichus micans*).

Table of Australian Genera.

- 1(2) Antennæ with third joint sparingly pubescent, basal joint with more than one seta. Tarsi hairy above. (Prothorax short, with distinct lateral margins)..... *Lachnothorax*.
 2(1) Antennæ with three basal joints glabrous, basal joint unisetose. Tarsi not setose on middle of upper side.
 3(4) Head not constricted behind eyes; neck very wide..... *Porocara*.
 4(3) Head more or less constricted behind eyes; neck narrow, often condyliform.

* Lacordaire reports these squamæ in *Casnonia* (Genera, p.73), but G. H. Horn (Trans. Am. Ent. Soc., 1881, p.147) says of the tribe Odacanthini, "The anterior tarsi exhibit no differences in the two sexes." I believe this remark refers to *C. pennsylvanica* Linn., in which I have not been able to detect any squamæ in ♂. Lacordaire says of the genus *Odacantha*, "tarses filiformes, simples dans les deux sexes." I am not sure whether he means by "simples" that the anterior tarsi are without squamæ beneath in ♂, but I have noticed that *O. melanura* Linn., of Europe, has the three basal joints slightly dilatate, with two rows of squamæ beneath in ♂. It may be noted in this connection that I have said, when describing *Lachnothorax palustris*, the anterior tarsi in ♂ "are not dilatate nor clothed beneath"; subsequent examination of the type (♂) showed this statement to be erroneous, for though the anterior tarsi can hardly be said to be dilatate, I have clearly perceived two narrow, feebly-developed rows of squamæ on the under side of the three basal joints: in *L. cicerina*, too, I have seen two narrow rows of squamæ on under side of tarsi in ♂.

- 5(10) Prothorax with well-developed lateral margins. Tarsi with fourth joint not bilobate.
- 6(7) Elytra fully striate, striae attaining apex. (In *E. obscura* Cast., apex of elytra nitid and faintly striate)..... *Eudalia*.
- 7(6) Striae of elytra obsolete towards apex.
- 8(9) Head short behind eyes; neck thick. Prothorax lightly ampliate at anterior third; base and apex of about equal width; lateral borders divergent forwards; median line strongly impressed. Elytra with all striae strongly marked at base; posterior three-fourths nitid, smooth; apex bisimultely truncate..... *Basistichus*.
- 9(8) Head elongate-oblique behind eyes; neck strangulate, very narrow. Antennae with third joint very long (almost as long as two succeeding joints together), fourth joint raised above fifth at apex on upper side, hardly setose. Prothorax elongate, evidently narrower at apex than at base; lateral borders parallel; disc transversely striolate, median line faint. Elytra with sixth and seventh striae obsolete, others strongly impressed only on basal third; three rows of fine setiferous pores on each elytron—on third and fifth interstices and at position of seventh interstice. Prosternum, mesosternum, and metasternum strongly punctate..... *Clarencia*.
- 10(5) Prothorax with lateral margins obsolete. Tarsi with fourth joint bilobate *Ophionea*.

Habits.—*Lachnothorax palustris* is common about salt marshes at Cairns; its range extends to the King River, Northern Territory. *L. riverinae* is found about the edges of freshwater-swamps in the Riverina district of N. S. Wales (Mulwala and Urana). *Porocara*, and the typical species of *Eudalia*, are found on riversandbanks, or stone-beds (*E. castelnavi*); but I do not know the habits thoroughly of many species of *Eudalia*, though I believe all are riparian species living beside permanent water. *Basistichus micans* is found under logs and debris away from water in Eucalyptus forests of the coastal districts of tropical Queensland. I do not know the habits of *Clarencia* and *Ophionea*, but suppose them to be frequenters of marshy places.

POROCARA, n.gen.

Robust, convex. Head large, punctate; neck short, very thick. Mentum with sinus oblique on sides; median tooth wide, triangular, prominent; lobes obtuse at apex. Ligula corneous;

apex truncate, two long setæ in middle, wide apart, and two setules—one at each angle; paraglossæ cartilaginous, narrow, free, triangular, extending greatly beyond ligula, not incurved. Palpi slender; apical joint elongate, obtuse, of maxillary longer than penultimate joint. Maxillæ slender, hooked. Prothorax not longer than broad, punctate; sides of prosternum rounded, visible from above: a short, thick seta at each anterior angle of pronotum. Elytra strongly punctate-striate; third, fifth, and seventh interstices with a single row of punctures along each—varying in number from six on third interstice to nine on seventh. Apical ventral segment in ♂ emarginate-truncate, unisetose on each side, in ♀ roundly truncate, bisetose on each side. Tarsi: anterior in ♂ lightly dilatate; three basal joints with two rows of rather sparsely set squamæ on under side; posterior with fifth joint not as long as basal joint, nor as two preceding joints together; ungues long and slender. Type, *P. punctata*, n.sp.

The position of this genus in the tribe Odacanthini is near *Eudalia*, but it is quite distinct; the form of the head not narrowed behind the eyes is sufficient to distinguish *P. punctata* from all other Australian allied species.

POROCARA PUNCTATA, n.sp.

Brown; legs, antennæ, and palpi testaceous: each elytron with a large humeral and apical area, connected on sides, more lightly coloured.

Head not narrowed behind eyes (2 mm. across eyes). Prothorax hardly broader than long (2 × 2.1 mm.); lateral borders converging lightly backwards from just behind apex to basal sixth, then a little out-turned to base. Elytra oval (5 × 3.7 mm.), convex, strongly crenulate-striate: interstices strongly convex, shagreened, third, fifth, and seventh uniseriate-punctate: apex not truncate, apical curve short, lightly sinuate on each side. Undersurface of head, sterna, and basal ventral segments punctate; fourth ventral segment sometimes punctate in middle, two apical segments glabrous. Length, 9.5; breadth, 3.7 mm.

Hab.—Queensland: Laura (Cooktown railway); Sloane, July, 1916.

Types in Coll. Sloane. I obtained a large number of specimens (many immature) on sandbanks of the Laura River (which had ceased running) beside the railway-bridge at Laura, by flooding the margins of the pools left in the river. It is very active, and, on being driven from its shelter in the sand by water, runs with great celerity, and quickly hides itself again in crevices in the sand.

The colour of the elytra is variable; looking at the elytra from the base, the dark part of the pattern, which varies in colour from brown to piceous, is seen to be a postbasal area covering the four inner interstices, constricted almost to first interstice at basal third, then spreading obliquely outwards and extending over the eighth interstice behind apical third, and forming a wide transverse area above the apical declivity: the apex (widely) and the sides (irregularly) are lighter-coloured: the more lightly coloured parts of the elytra vary from brown to pale testaceous, according to the maturity or immaturity of the specimen examined. The prothorax has a short bristle-like seta at each anterior angle, and another similar, but longer, seta beside the lateral border at widest part, but there is no basal marginal seta. The basal marginal seta is also wanting in all those species of the genus *Eudalia*, which have not the lateral margins of the prothorax plurisetose: the presence of this seta is rare in the tribe.

Genus EUDALIA.

Table of Species.

- 1(10) Head punctate.
 2(7) Posterior tarsi with fifth joint not as long as basal joint, nor as three preceding joints together.
 3(6) Elytra setose. Legs and base of antennæ testaceous.
 4(5) Elytra wholly olivaceous..... *macleayi* Bates.
 5(4) Elytra olivaceous with apex yellowish..... *latipennis* MacL.
 6(3) Elytra glabrous. Colour black (including elytra, legs, and base of antennæ *castelnavi* Sl.
 7(2) Posterior tarsi with fifth joint very long, longer than basal joint, and than three preceding joints together. (Legs with at least basal part of femora yellowish).
 8(9) Elytra with interstices sparsely setose..... *nigra* Sl.

- 9(8) Elytra glabrous, excepting for a single row series of setiferous punctures on third, fifth, and seventh interstices..... *obliquiceps* Sl.
- 10(1) Head impunctate, glabrous. (Elytra with discal punctures only on third interstice).
- 11(12) Head with neck condyliform. Prothorax narrow, convex, strongly and closely punctate; median line obsolete. Elytra strongly punctate-striate on basal half. Femora piceous at apex..... *obscura* Cast.
- 12(11) Head with neck not condyliform. Prothorax subdepressed, finely punctate; median line strongly impressed. Elytra finely punctate-striate. Legs unicolorous.
- 13(14) Prothorax not ampliate at anterior third; lateral borders parallel. Prosternal episterna visible from above..... *brunneipennis* Sl.
- 14(13) Prothorax ampliate at anterior third; lateral borders curved outwards at widest part. Prosternal episterna hardly visible from above.
- 15(16) Prothorax punctate near base and apex, not on disc. Elytra nitid..... *nitida* Sl.
- 16(15) Prothorax punctate on disc. Elytra subopaque (shagreened)..... *sublævis* Macl.

E. waterhousei Cast., of which no specimen was available, goes beside *E. latipennis* Macl. I have seen it from Central Australia and Port Darwin. *E. froggatti* Macl., is unknown to me in nature; I am not sure of its position in the genus according to the table given above. *Casnonia amplipennis* Gest., I would refer to *Eudalia*, but I am not sure where to place it.

Note.—In the genus *Eudalia*, the head has a narrow marginal channel extending backwards from each side of the base of the clypeus; in some species (e.g., *E. sublævis*, *E. nitida*, and *E. brunneipennis*) there is another, inner, narrow sulcus (at the extremity of which is the anterior supraorbital seta), and, between these two sulci, there is a narrow carina. The inner sulcus and carina do not occur in the typical species of the genus, but the carina is distinct in *E. nigra*.

EUDALIA OBLIQUICEPS, n.sp.

Elongate, subconvex. Head convex, hardly impressed across base: prothorax narrow, not ampliate behind anterior margin, punctate; lateral borders well-developed; pro-episterna a little rounded and visible from above: elytra wide, lightly convex,

strongly punctate-striate; interstices not shagreened, glabrous, third, fifth, and seventh seriate-punctate: posterior tarsi with fifth joint rather longer than first joint, about as long as three preceding joints together. Black, nitid; femora testaceous with apex black, tibiæ more or less ferruginous (base piceous); palpi and basal joint of antennæ of a clear ferruginous colour; antennæ reddish-piceous, second and third joints ferruginous at apex: labrum piceous.

Head large (1.8 mm. across eyes), gradually obliquely narrowed behind eyes, punctate on each side near eyes, impunctate in middle; neck wide: front lightly and widely bi-impressed; eyes prominent, shortly rounded in front, obliquely rounded behind. Prothorax longer than broad (1.7 × 1.5 mm.), convex; pronotum glabrous, punctate, a smooth space near each anterior angle; base truncate; posterior angles obtuse; lateral borders narrow, lightly oblique to base, gently divergent forward, terminating at anterior angles. Elytra subquadrate with angles rounded (5 × 3.3 mm.), depressed on disc, declivous to base, roundly declivous to sides: base shortly constricted to peduncle, rounded at shoulders: apex shortly rounded, widely subsinuate on each side; striæ coarsely punctate: even interstices glabrous, odd ones each bearing a row of small, widely placed, setiferous punctures. Under-surface, excepting three apical ventral segments, punctate. Length, 9.3; breadth, 3.3 mm.

Hab. – Queensland: Cooktown District, Laura (Sloane). Type, unique in Coll. Sloane. One specimen occurred to me under floated débris on the margin of the Laura River, near the railway-bridge.

A very distinct species, in colour and general appearance resembling *E. nigra* Sl.,* but differing by smaller size; head glabrous, much less strongly constricted behind eyes; prothorax far less strongly angustate to apex, lateral channel narrower and not beset with numerous long setæ, lateral border narrower, less strongly arcuate; elytra not generally setigero-punctate. It

* Mr. Dodd found *E. nigra* in Queensland, at Townsville, and on the Herbert River.

cannot be *E. froggatti* MacL., (unknown to me in nature), because the elytra are not "minutely punctate on the interstices."

EUDALIA BRUNNEIPENNIS, n.sp.

Elongate, convex, glabrous. Head convex, roundly obliquely but not strongly narrowed behind eyes: prothorax narrow, punctate: pro-episterna roundly swollen and visible from above: elytra oval, punctate-striate: interstices nitid, depressed on disc, third 3-punctate. Head and prothorax black: elytra and under-surface of body brown: legs, antennæ, and palpi ferruginous, mouth-parts reddish.

Head elongate (1.3 mm. across eyes), obliquely narrowed behind eyes, convex, impunctate, nitid; eyes prominent, shortly rounded in front, obliquely rounded behind. Prothorax as long as broad (1.3 × 1.3 mm.), convex, lightly rounded on sides, roundly and decidedly angustate to apex, lightly narrowed to base: pronotum glabrous, convex, punctate—an impunctate space on each side anteriorly; apex truncate: anterior angles touching head: base truncate: basal angles marked, obtuse: lateral channel narrow: lateral border hardly arcuate at widest part, lightly oblique to base, strongly roundly curved to apex, terminating at anterior angle. Elytra oval (4 × 2.7 mm.), convex, declivous to base: striæ well marked: interstices subconvex, third 3-punctate. Undersurface of head and body impunctate, of prothorax punctate. Length, 7.2: breadth, 2.7 mm.

Hab.—Queensland: Kuranda (Dodd): two specimens: type in Coll. Sloane.

Differs from all others by the brown colour of the elytra. In the form of its head and prothorax, it resembles *E. obliquiceps* Sl., but the absence of puncturation on the upper and lower surfaces of the head, on the mesosternum and metasternum, and the basal part of the abdomen decidedly differentiate it from that species, from which it differs also in colour, &c.

EUDALIA NITIDA, n.sp.

Oval. Head glabrous, impunctate, wide, shortly and strongly constricted behind eyes: prothorax narrow, subcordate, lightly ampliate on sides, impunctate except near margins; pro-episterna

not protuberant, hardly visible from above: elytra short, sub-oval, lightly punctate-striate; interstices depressed, glabrous, third 3-punctate. Black, nitid; legs testaceous (tibiæ and tarsi a little darker than femora): mouth-parts and antennæ ferruginous; mesosternum, metasternum, and abdomen brown.

Head wide (1.5 mm. across eyes), lævigatè; front bi-impressed between bases of antennæ; submarginal carina near eyes well-developed; eyes large, prominent. Prothorax as broad as long (1.3 × 1.3 mm.), convex, glabrous, very finely transversely striolate, a few punctures along anterior and basal margins and in lateral channel; apex truncate; anterior angles obtuse, slightly distant from neck; sides rounded, strongly narrowed to apex, lightly narrowed to base; basal angles obtuse; lateral borders narrow, reflexed, extending round anterior angles on to sides of apex; lateral channel wide, flat, sharply depressed below plane of pronotum. Elytra subquadrate with angles rounded (4 × 2.75 mm.), subdepressed, declivous to base, lightly declivous to sides; humeral angles rounded, apex shortly rounded, widely subsinuate on each side; striæ finely punctate; interstices glabrous, finely shagreened under a lens; the three setæ of third interstice placed in wide, shallow foveæ. Prosternum punctate. Undersurface of head and body impunctate. Length, 7.5; breadth, 2.75 mm.

Hab.—Queensland: Kuranda (Dodd). One specimen (type) was received from Mr. F. P. Dodd, from Kuranda; and two other specimens were among the duplicates of the Van de Poll Collection, labelled Cooktown.

Allied to *E. sublævis* Macl.,* with which it agrees in facies, impunctate head and undersurface of body; but it differs by prothorax impunctate on disc: elytra more nitid, striæ not strongly impressed, interstices not the least convex, not nearly so strongly shagreened, setiferous foveæ of third interstice less sharply defined, shallower, wider, &c. From *E. brunneipennis* Sl., it differs by colour of elytra; head more strongly and shortly constricted to neck: pronotum not punctate on disc, sides not

* Mr. F. P. Dodd sent me specimens of *E. sublævis* from Port Darwin, and these specimens I have compared with the type in the Macleay Museum.

swollen and visible from above; lateral channel wider; lateral border more arcuate, and passing round anterior angle: elytra wider, shorter, less convex, less strongly striate, &c.

Tribe **Lebiini**.

Group *Sarothrocrepides*.

In his monograph of the Masoreides and Tetragonoderides (Bull. Soc. Imp. Nat. Mosc., 1876, pp.1-84), Chaudoir indicated a separate group, Sarothrocrepides, distinguished from the Tetragonoderides by the bilobate, fourth joint of the tarsi. This character, however, fails in *Lebiomorpha gravis* Blackb., and *L. fragilis* Blackb., so that it seems likely that the group Sarothrocrepides may have to be united with the Tetragonoderides.* Be that as it may, I retain, for the present, Chaudoir's group Sarothrocrepides for the two Australian genera *Sarothrocrepis* and *Lebiomorpha*. *Ectroma* (Blackburn, 1889) is the same as *Lebiomorpha*, but it is a preoccupied name. Chaudoir's unedited name, *Lebiomorpha*, is, therefore, to be used in its place. Blackburn has dealt very fully with the genus *Lebiomorpha* in Trans. Roy. Soc. S. Aust., 1901, pp.105-110.

Genus SAROTHROCREPIS.

Table of Australian Species.

- 1(12) Prothorax with basal angles acute; base truncate on each side and with median lobe prominent.
 2(11) Elytra with humeral angles not raised or prominent.
 3(10) Prothorax unicolorous (testaceous).
 4(5) Elytra with interstices setulose (pattern as in *corticalis*).....
..... *setulosa* Sl.
 5(4) Elytra not setulose.
 6(9) Length 8.5-10 mm.
 7(8) Elytra testaceous on basal third and with a large ante-apical black area..... *corticalis* Fabr.

* Bedel has regarded the Tetragonoderini as having full tribal value, in his Cat. Raison. Col. du Nord Africa, 1905, p.229; but I think the group is rather a section of the great tribe Lebiini. The long tibial spurs, with their outer edge on the lower side serrulate, are characteristic of the Tetragonoderides and Sarothrocrepides.

- 8(7) Elytra infuscate at base, ante-apical black area extending forward to shoulders along interstices 6-8..... *infuscata* Sl.
 9(6) Length 6.7-5 mm., (pattern as in *corticalis*)..... *suavis* Blackb.
 10(3) Prothorax and elytra piceous (or black) with wide testaceous lateral margins..... *luctuosa* Newm.
 11(2) Elytra with humeral angles raised and prominent..... *humerala* Sl.
 12(1) Prothorax with basal angles more or less obtuse; base more or less oblique on each side, median lobe wide, not prominent.
 13(18) Elytra with apical curve short, hardly sinuate on each side.
 14(17) Elytra testaceous on basal half and with a transverse ante-apical black fascia.
 15(16) Ante-apical black fascia wide and continuous across interstices 1-8 *mastersi* Macl.
 16(15) Ante-apical black fascia interrupted on sixth interstice, its lateral parts narrow on interstices 6-8 *pallida* Macl.
 17(14) Elytra with posterior black area extending forward to shoulders on interstices 6-9. Length, 5.6-6 mm..... *blackburni* Sl.
 18(13) Elytra with apical curve gently oblique, decidedly sinuate on each side, apex truncate-emarginate at extremities of three inner interstices *obtusa* Sl.

Note.—*S. dimidiata* Macl., is the only typical Australian species of the genus *Sarothrocrepis* unknown to me in nature. From the description, it is allied to *S. corticalis* Fabr. *S. infuscata* Sl., I now look upon as a distinct species. I do not yet know how to differentiate satisfactorily *Lebiomorpha* from *Sarothrocrepis*. Chaudoir named *Lebia benefica* Newm., and *L. civica* Newm., as typical species of *Lebiomorpha*; and Blackburn founded *Ectroma* on *L. civica*. Two extra-Australian species of *Sarothrocrepis* have been described by Jordan, viz., *S. bimaculata* (Sumbawa), and *S. m-nigra* (Tenimber). Cf. Nov. Zool., i., 1894, p.106.

SAROTHROCREPIS OBTUSA, n.sp.

♂. Oval, depressed. Prothorax transverse (2×3.2 mm.), rounded on sides; base lightly bisinuate, basal angles obtuse. Elytra oval (7×5 mm.), striate; interstices depressed; apical curve oblique on each side, lightly emarginate at extremity of three inner interstices of each elytron. Testaceous, elytra with three black marks on apical half a little before apex—sutural mark large, triangular; anterior margin (base) extending to outer edge of fifth interstice, excised on second and fourth interstices:

lateral margins oblique, uneven; each lateral mark small, irregular, extending across interstices 6-9, produced backwards on eighth and ninth interstices, divided from central plaga by fifth interstice. Length, 10.5; breadth, 5 mm.

Hab.—North-West Australia. Unique in Coll. Sloane.

One specimen was given to me by Mr. H. M. Giles, of Perth, as from the Drysdale River [west of Cambridge Gulf, about lat. 15°, long. 127°]. Differs from all other described species of the genus by the larger oblique slope of the apical curve of the elytra, and the light sutural emargination opposite the extremities of the three inner interstices: the outer angles of the sutural emargination, though obtuse, are marked.

Group *Lebiides*.

Genus *LEBIA*.

Eulebia Macleay, 1871.

LEBIA MELANOTA Chaudoir.

Bull. Soc. Imp. Nat. Mosc., 1870, p.226. *Eulebia plagiata* Macl., Proc. Ent. Soc. N. S. Wales, ii., 1871, p.87.

Masters, in his Catalogue, furnishes the above synonymy, but gives the preference to Macleay's name. I am not sure which name was published first, but Chaudoir's paper was read several months before Macleay's; in any case, Macleay's name would fail, owing to the previous use of *Lebia plagiata* by Germar.

Hab.—Queensland: Gayndah (Masters); Townsville (Dodd)

LEBIA PICIPENNIS Macleay.

Eulebia picipennis Macleay, Proc. Ent. Soc. N. S. Wales, ii., 1871, p.87. *Lebia papuensis* Macl., Proc. Linn. Soc. N. S. Wales, 1876, i., p.167.

An examination of the type of *L. papuensis* Macl., in the Macleay Museum, in comparison with specimens of *L. picipennis* Macl., from Queensland, compelled me to regard these names as synonymous.

Hab.—Queensland: Gayndah (Masters). New Guinea: Katow (Macleay).

Group *Callidides*.

Genus XANTHOPHŒA.

Table of Australian Species.

- 1(16) Antennæ with third joint sparsely pubescent. (Tarsi with upper surface plurisetose).
- 2(11) Elytra with third interstice (sometimes also fifth) with two or more punctures.
- 3(4) Elytra with third and fifth interstices seriate-punctate.....
..... *infuscata* Chaud.
- 4(3) Elytra with only third interstice punctate.
- 5(9) Apex of abdomen in ♂ with six or more setæ, in ♀ plurisetose.
- 6(10) Elytra with black vittæ.
- 7(8) Orbits oblique behind eyes. Sutural black vitta of elytra reaching base. Length, 13 mm. *grandis* Chaud.
- 8(7) Orbits tumid behind eyes. Sutural black vitta not extending forward past scutellar striole. Length, 10 mm. ... *loweri* Blackb.
- 9(6) Colour reddish-piceous *suturata* Newm.
- 10(5) Apex of abdomen in ♂ with one, in ♀ with two setæ on each side *elongata* Sl.
- 11(2) Elytra with third interstice unipunctate towards apex.
- 12(15) Elytra testaceous, with three black vittæ.
- 13(14) Prothorax transverse, widest before middle, strongly sinuate on sides posteriorly. Elytra with interstices coarsely punctate; lateral vitta extending over interstices 6-8. Length, 8-9.5 mm.
..... *vittata* Dej.
- 14(13) Prothorax widest at middle, hardly subsinuate on sides posteriorly. Elytra with interstices minutely punctate; lateral vitta almost wholly confined to seventh interstice. Length, 11-13 mm. *ornata* Sl.
- 15(12) Elytra testaceous, a postmedian fascia from side to side (diamond-shaped at suture); ninth interstice to apical third, and margin of apical curve black *fasciata* Sl.
- 16(1) Antennæ with three basal joints glabrous—except for usual distal setæ.
- 17(38) Tarsi with upper surface setulose.
- 18(19) Elytra with third and fifth interstices punctate. (Form narrow, colour ferruginous. Apex of abdomen in ♂ 3-setose on each side) *angusticollis* Mael.
- 19(18) Elytra with only third interstice punctate.
- 20(31) Apex of abdomen in ♂ with three or more setæ on each side, in ♀ plurisetose.

- 21(24) Form comparatively wide; prothorax ampliate before middle. Elytra with disc reddish or ferruginous and a lateral and apical area infusate; interstices punctulate, eighth and ninth coarsely so.
- 22(23) Head and prothorax punctate; lateral margins of elytra wide, depressed..... *variabilis* Macl.
- 23(22) Head and prothorax impunctate; lateral margins of elytra narrow..... *marginipennis* Sl.
- 24(21) Form narrow, prothorax not ampliate on sides. Colour reddish, apex of elytra sometimes reddish.
- 25(30) Prothorax with basal angles obtuse.
- 26(29) Head oblique, not tumid, behind eyes.
- 27(28) Prothorax evidently narrowed to base, sides lightly rounded at anterior marginal puncture, sinuate posteriorly. Elytra with third interstice unipunctate near apex... *tweedensis* Blackb.⁶
- 28(27) Prothorax not perceptibly narrowed to base, sides straight. Elytra with third interstice bipunctate... *quadrifollis* Sl.
- 29(26) Head tumid behind eyes..... *cylindricollis* Blackb.
- 30(25) Prothorax with basal angles acute, or subacute, sharply marked..... *ferruginea* Chaud.
- 31(20) Apex of abdomen in ♂ with one, in ♀ with two setæ on each side.
- 32(33) Prothorax straight on sides, widest at basal angles. (Elytra reddish-brown with apex red)..... *doddi* Sl.
- 33(32) Prothorax rounded on sides, evidently narrowed to base.
- 34(37) Prothorax with sides straightened or subsinuate posteriorly; basal angles not prominent.
- 35(36) Elytra piceous with apex red..... *apicalis* Sl.
- 36(35) Elytra ferruginous with margins (widely on basal half of sides, narrowly at apex) and first interstice black..... *nigricincta* Sl.
- 37(34) Prothorax with sides ampliate before middle, strongly sinuate posteriorly; basal angles acute, prominent. (Elytra piceous, with three inner interstices ferruginous except at apex)... *dorsalis* Sl.
- 38(17) Tarsi with upper surface glabrous.
- 39(40) Apex of abdomen plurisetose. Prothorax evidently narrower at base than apex; basal angles obtuse, near peduncle. Elytra with third interstice bipunctate. Testaceous, striæ of elytra infusate..... *brachinoderus* Chaud.
- 40(39) Apex of abdomen in ♂ with one, in ♀ with two setæ on each side. Prothorax wider at base than apex; basal angles subrectangular, marked. Elytra with third interstice unipunctate. Elytra black, with interstices 5-7 and marginal channel testaceous..... *plagiata* Germ.

⁶ Described as a species of *Demetrius*.

Notes on species omitted from the above Table.

X. brachinoderus Chaud., (*Demetrius*) is a well-known, large, testaceous species, with which *X. pallida* Olliff, is conspecific.

Cymindis longicollis Macl., is a species of *Xanthophœa* allied to *X. ferruginea* Chaud.: the type has the third elytral interstice unipunctate, only the type-specimen in the Macleay Museum is known, as yet.

Xanthophœa chaudiroidi Macl., has the third interstice of the elytra tripunctate, from type. It has not been found since Masters got the original specimens at Gayndah.

The following species named by Chaudoir have not yet been identified by me:—*X. angustula* (very near *X. infusata* Chaud.); *X. lineolata*; *X. parallela* (very close to *X. ornata* Sl.); *X. picipennis* (very near, and perhaps not different from *X. suturata* Newm.); *X. pilosula*.

X. lissodera Chaud., I look upon as conspecific with *X. vittata* Dej.

X. rufescens Macl., (*Demetrius*) is closely allied to *X. ferruginea* Chaud., but I do not feel convinced it is the same.

X. filiformis Blackb., *X. satelles* Blackb., *X. concinna* Blackb., and *X. constricticeps* Sl., are species of which specimens have not been available for reference when compiling this table.

XANTHOPHŒA MARGINIPENNIS, n.sp.

Elliptical, depressed. Head lævigata, a little tumid behind eyes: antennæ with three basal joints glabrous: prothorax cordate: elytra lightly obovate, crenulate-striate: interstices punctulate, first interstice with an elongate striole at base, third tripunctate, tarsi setose on upper surface. Ferruginous, elytra with disc lighter-coloured than head and prothorax, seventh, eighth, and ninth interstices and apex piceous.

Head elongate (1.85 mm. across eyes), depressed, impunctate: front widely impressed on each side: sides strongly obliquely constricted to neck: posterior supraorbital seta in a foveiform depression just behind base of eye. Prothorax hardly wider than head with eyes, a little broader than long (1.75 × 2 mm.), slightly narrower across base than apex: disc lævigata, depressed,

a wide subdepressed space along sides forming a wide concavity posteriorly: apex lightly emarginate; anterior angles not marked or protuberant: sides ampliate and rounded anteriorly, strongly sinuate posteriorly, straight before basal angles: base truncate, sloping obliquely forward on each side to angles, these marked but obtuse; lateral channel wide, border narrow, slightly reflexed; median line deep. Elytra depressed, widest behind middle (5×3.6 mm.); sides lightly rounded; apex truncate: external angles well-marked, obtuse at summit: interstices 2-7 finely and sparsely punctate, eighth and ninth coarsely punctate; lateral channel wide, punctate. Length, 9; breadth, 3.6 mm.

Hab.—Northern Territory: Port Darwin (Dodd). Two specimens in Coll. Sloane.

Allied to *X. variabilis* MacL., from which it differs by head and disc of prothorax not punctate; puncturation of elytral interstices much finer; head more elongate, tumid behind eyes, posterior supraorbital seta in a depression, eyes a little less prominent; prothorax longer, narrower, apex less emarginate, anterior angles nearer sides of head, sides less strongly rounded anteriorly, less strongly sinuate posteriorly, hardly the least out-turned to basal angles, these not acute and prominent; elytra with marginal channel narrow, external angles more strongly marked, &c

XANTHOPHŒA QUADRICOLLIS, n.sp.

♀. Elongate. Prothorax depressed, subquadrate, hardly narrowed to base; base truncate, wider than apex: elytra truncate-oval, striate; interstices depressed near suture, lightly convex near sides, first interstice with an elongate stria at base, third bipunctate: apex of abdomen with four or five setæ on each side. Brownish-red; elytra a little darker than head and prothorax; undersurface of body and femora testaceous, of head and prothorax reddish.

Head large (1.7 mm. across eyes), lightly oblique behind eyes; front depressed, lightly bi-impressed: antennæ with three basal joints glabrous. Prothorax hardly wider than head (1.7×1.9 mm.), lævigata; apex truncate; anterior angles rounded, not

marked: sides lightly ampliate behind anterior angles, almost straight on posterior two-thirds: base emarginate above peduncle: basal angles obtuse but marked: lateral margins wide, depressed: border a little upturned. Elytra much wider than prothorax (6×3.3 mm.), subdepressed, declivous to sides: apex with outer angles marked; apical truncature lightly and widely bisinuate: striae simple: interstices nitid, a row of minute punctures along every one (under a lens); anterior puncture of third at anterior fourth, posterior puncture at apical fifth. Length, 10.5: breadth, 3.3 mm.

Hab.—Queensland: Kuranda (Dodd). Unique in Coll. Sloane.

Allied to, and resembling *X. tweedensis* Blackb., but differing by prothorax more depressed, lateral margins wider, sides straight posteriorly and more strongly narrowed to apex, basal angles far less sharply marked, base much more strongly bisinuate on each side; elytra with third interstice bipunctate, abdomen in ♀ with fewer setæ at apex.

XANTHOPHGEA DODDI, n.sp.

Narrow, elongate, depressed. Head large, convex: prothorax narrow, parallel, widest at base: elytra subparallel on sides, widest behind middle, truncate at base, widely margined, striate: interstices lightly convex, first interstice with a short, lightly impressed striole at base, third unipunctate about apical fifth: abdomen in ♂ with one, in ♀ with two setæ on each side of apex: anterior tarsi in ♂ a little dilatate, clothed beneath with ashen-coloured squamæ—squamæ arranged in two mesial rows, with a fringe on outer side on three basal joints, fourth joint bilobate, and clothed beneath (also in posterior tarsi) with a cinereous hair-pad. Brownish-red; elytra darker than head and prothorax, apex of elytra a lighter and brighter red; undersurface of body and femora testaceous, of head and prothorax reddish.

Head wider than prothorax (1.5 mm. across eyes), obliquely narrowed behind eyes, lævigata; front lightly impressed on each side; antennæ with three basal joints glabrous. Prothorax subquadrate (1.4×1.3 mm.), nitid, more or less transversely striolate especially towards sides; apex subemarginate; anterior angles sub

prominent, narrow, obtuse; sides not ampliate behind anterior angles, subangulate at anterior third, almost straight on anterior two-thirds, a little out-turned to basal angles; base truncate: basal angles strongly marked, rectangular (obtuse at summit): lateral margin wide, depressed, a little concave near base. Elytra lævigata, about twice as wide as prothorax (5×2.7 mm.), rather depressed, declivous to sides; apex with outer angles rounded; apical truncature lightly bisinuate; striae simple. Length, 8.9.5: breadth, 2.7 mm.

Hab.—Queensland: Kuranda (Dodd). Four specimens received from Mr. F. P. Dodd. Type in Coll. Sloane.

This species has the prothorax proportionately narrower than any other, and actually wider across the base than anywhere else, characters which differentiate it from all its congeners. It may be noted that the slightly out-turned basal angles are more prominent in ♂ than in ♀. It resembles *X. quadricollis* Sl., but can be readily distinguished by ♀ with only two (not four or five) setae on each side of apex of abdomen; the prothorax is somewhat similar in shape, but less narrowed to apex, and with posterior angles more prominent and more sharply marked, &c.

NANTHOPHEA APICALIS, n.sp.

♂. Elongate, convex. Head large: prothorax truncate-cordate, lightly convex, widest before middle, decidedly narrowed to base; apex and base of equal width; lateral margins narrow: elytra truncate oval, punctate-striate; interstices depressed, first interstice with a faintly marked elongate striole at base, third unipunctate about apical fourth: apex of abdomen unipunctate on each side: tarsi with upper surface glabrous (not more than one or two setae on upper side of each joint). Head and prothorax reddish; elytra piceous with apical third dull red: abdomen reddish: femora and mouth-parts testaceous: antennae ferruginous, two basal joints testaceous.

Head wider than prothorax (1.6 mm. across eyes), lævigata, obliquely narrowed behind eyes, transversely impressed behind orbits; front decidedly impressed on each side; eyes convex, prominent: antennae with three basal joints glabrous. Prothorax

a little broader than long (1.25×1.45 mm.), widest before middle, convex, nitid, impunctate; apex truncate: anterior angles near head, not marked: sides rounded anteriorly, subsinuate posteriorly; base lightly bisinuate: basal angles subrectangular, obtuse at summit; marginal channel wide, not explanate, deep and foveiform at base; border narrow, reflexed, subangulate and bearing anterior marginal seta a little before middle; median line strongly impressed. Elytra almost twice as wide as prothorax (4.3×2.7 mm.), convex; humeral angles rounded; interstices nitid, with a row of minute punctures along middle (under a strong lens), three inner striæ obsolescent near base. Length, 7.5; breadth, 2.7 mm.

Hab. — Queensland: Kuranda (Dodd). Unique, in Coll. Sloane.

Allied to *X. nigricincta* Sl.; head and prothorax of similar form (*X. nigricincta* also has apex of abdomen in ♂ unipunctate on each side); but differing by colour, prothorax wider and shorter, basal angles more marked, lateral basal foveæ deeper and longer; external angles of elytra less widely rounded, &c.

XANTHOPHŒA DORSALIS, n.sp.

♀. Narrow, elongate. Prothorax strongly sinuate posteriorly; basal angles prominent, acute: clytra crenulate-striate; interstices convex, finely punctulate, first interstice with a strongly marked striole at base, third unipunctate at apical fifth. Head and prothorax ferruginous: legs, antennæ, mouth-parts, and metasternum yellow; elytra piceous, with a wide, testaceous, sutural area, abdomen piceous.

Head wide (1.1 mm. across eyes), lightly obliquely narrowed behind eyes: orbits not swollen behind eyes; vertex levigate; front with an irregular impression on each side; eyes large; antennæ with three basal joints glabrous. Prothorax hardly as wide as head with eyes (1×1.05 mm.), subdepressed, transversely striolate on each side; disc nitid, impunctate; apex truncate: anterior angles widely rounded: sides roundly ampliate on anterior two-thirds, strongly sinuate posteriorly, out-turned to basal angles, these acute: base truncate on each side, median part widely and lightly rounded; a wide, subdepressed space

along each lateral margin, becoming wider and deeper on basal third: border wide, reflexed: median line strongly impressed. Elytra parallel (3.5 × 1.7 mm.). Abdomen with apex bisetigerous on each side. Tarsi with upper side glabrous (not more than one or two setæ on upper side of each joint). Length, 5.5; breadth, 1.7 mm.

Hab.—Northern Territory: Port Darwin (Dodd). Unique, in Coll. Sloane.

A thoroughly distinct species, differing from all others by its small size, and the pattern of the elytra, which are piceous, with an elongate, testaceous, dorsal area not reaching apex: the testaceous, dorsal area extends across the three inner interstices at the base, but spreads over the fourth as well, for most of its length: the puncture of the third interstice is on the pale, dorsal area.

Group *Coptoderides*.

DOLICHOCHTIS TETRASTIGMA Chaudoir.

Ann. Soc. Ent. Belg., xii., 1869, p.248. *Mochtherus macleayi* Sl., Proc. Linn. Soc. N. S. Wales, 1907, xxxii., p.377.

Mochtherus macleayi Sl., is a species of *Dolichochtis*, which I identify with *D. tetrastigma* Chaud., from Celebes.

Hab.—Celebes (*vide* Chaudoir); New Guinea: Queensland. Kuranda (Dodd), Normanby River (Sloane).

GENUS PLATIA.

PLATIA FROGGATTI Macleay.

Philophlaeus froggatti Macleay, Proc. Linn. Soc. N. S. Wales, (2), iii., 1888, p.455.

I consider *Ph. froggatti* Macl., to be a species of *Platia*. Mr. F. P. Dodd sent me specimens from Port Darwin.

PLATIA QUEENSLANDICA, n.sp.

Oval, depressed. Piceous-black: elytra variegated with numerous yellowish stripes and longitudinal maculæ: lateral channel, border, extreme apex, and apical extremity of first interstice yellowish; labrum and legs brown.

Head large, punctate, longitudinally rugulose near eyes. Prothorax short, transverse, widest about anterior third (at position

of anterior marginal seta), punctate, apex truncate (subemarginate); angles widely rounded, distant from neck: base hardly as wide as apex, shortly sublobate, angles marked, obtuse at summit: sides lightly rounded anteriorly, oblique posteriorly; lateral margins wide, depressed: median line strongly impressed. Elytra wide, subquadrate; base truncate: humeral angles rounded: striae lightly impressed: interstices depressed, finely and closely setulose-punctate. Length, 5·2; breadth, 2·5 mm.

Hab.—Tropical Queensland: Kuranda (Dodd); Normanby River (Sloane). I found this species at King's Plains Station, 43 miles south west from Cooktown, beneath loose bark on a river-gumtree (*Eucalyptus* sp.) in July.

I consider this to be a species of *Platia*: and that *Agonochila minima* Macl., (= *A. litterata* Chaud), *Philophlæus froggatti* Macl., and *Agonochila lineella* Sl. (from New Guinea) should also be placed in the genus *Platia*. *P. queenslandica* is closely allied to *Agonochila lineella* Sl., from which it differs chiefly in the pattern of the elytra. In *P. papuana* (nom. nov. for *P. lineella* Sl., preoccupied) the third, fifth, seventh, and eighth interstices are occupied by yellow stripes, which all extend beyond the middle of the elytra, and there are nine other maculae on the elytra (two each on the second, sixth, and eighth interstices, and one each on the third, fifth, and seventh); in *P. queenslandica*, the fifth, seventh, and eighth interstices have basal stripes which do not extend behind the middle, and there are thirteen narrow maculae defined in all cases by the striae, which are black, viz., two each on the second and sixth interstices, three each on the third and fourth interstices, and one posterior macula on each of the fifth, seventh, and eighth interstices.

Genus PHLÆOCARABUS.

PHLÆOCARABUS ANCHORALIS, n.sp.

Oval, depressed. Prothorax transverse, widest about middle (a little behind anterior marginal seta); basal margin truncate (a little oblique on each side, lightly curved backwards in middle); elytra much wider than prothorax, striate: interstices subconvex, minutely punctate, third interstice bipunctate. Tarsi with

penultimate joint entire. Head and prothorax (including under-surface) reddish-brown: pronotum with wide testaceous lateral margins; elytra of a light testaceous colour, with a postmedian irregular black fascia (black area occupying about one-third of elytra, anchor-shaped, reaching forward to the scutellum along first interstice and extending forward considerably on each elytron on interstices 6-8); metasternum testaceous; abdomen somewhat infuscate; femora pale testaceous, tibiæ, tarsi, and antennæ ferruginous.

Head (1.4 mm. across eyes), finely punctate; front depressed; vertex declivous to occiput (especially near eyes); a slightly raised longitudinal carina beside each eye; eyes large, hemispherical; orbits laminate, truncate behind eyes. Prothorax transverse (1.15 × 1.63 mm.); disc rather convex, rugulose, minutely punctate under a lens; margins wide, flat, explanate at basal angles: sides rounded off from just behind anterior marginal seta to apex, very slightly obliquely narrowed to base: apex truncate-emarginate: base much wider than apex, basal angles subrectangular (not prominent or acute, summit obtuse). Elytra subquadrate with angles rounded (4 × 2.7 mm.), much wider at base than prothorax: base emarginate behind peduncle, widely rounded on each side: sides lightly rounded; striæ simple, strongly impressed, seriate punctures of ninth large, not widely interrupted in middle. Anterior tarsi in ♂ squamulose beneath four, intermediate beneath first two joints. Length, 6.3-7: breadth, 2.6-2.7 mm.

Hab.—Queensland: Kuranda (Dodd), Cooktown District (Sloane). Type in Coll. Sloane. The type-specimen occurred to me under loose bark on the trunk of a river-gumtree (*Eucalyptus* sp.) on the banks of the upper Normanby River at King's Plains cattle-station in July, 1916.

Differs conspicuously from its nearest allies (e.g., *Ph. nigricollis* Macl., and *Ph. farinæ* Blackb.) by not having the basal testaceous area of the elytra divided from the sides by a black stripe along sixth and seventh interstices. Though its elytral pattern is peculiar to itself, its general appearance resembles that of *Ph. semivittatus* Macl.; but *Ph. semivittatus* is isolated in the genus

by the form of its prothorax, which is wide towards base with obtuse basal angles.

Group *Cymindides*.

As far as the Australian fauna is concerned, the Cymindides may be defined briefly as follows:—

Head convex between eyes, postocular prominences large; mesosternum wide and oblique between intermediate coxæ; labial palpi securiform in ♂; tarsi with fourth joint not bilobed, claws usually pectinate (simple in *Phloeocarabus unimaculatus* Blackb.).

The Australian genera of the Cymindides are *Anomotarus*, *Lithostratus*, and *Nototarus*.

Genus ANOMOTARUS.

For the present, all the Australian Cymindides which are characterised by having the following characters may be put in Chaudoir's genus *Anomotarus* (1875). Antennæ with three basal joints glabrous; mentum with median tooth; metepisterna elongate. As thus constituted, *Anomotarus* would include *Urea* (Fauvel, 1882).*

ANOMOTARUS HUMERALIS, n.sp.

Narrow, depressed. Prothorax elongate-cordate, widest about anterior fourth; base strongly sinuate on each side; posterior angles subprominent; elytra oval, not covering apex of abdomen, crenulate-striate; interstices lightly convex, first wide at base and with a well-marked elongate striole, third bipunctate; labial palpi with apical joint in ♂ widely securiform; in ♀ stout, truncate, not securiform. Black; elytra with a testaceous humeral macula on sixth and seventh interstices, ninth interstice and marginal channel, in middle of sides, and a small ante-apical macula on second or second and third interstices testaceous; undersurface piceous; legs and metasternum testaceous; antennæ ferruginous.

Head convex, opaque, punctate between eyes; front lightly

* Taking *Anomotarus* in the sense indicated above, the following described Australian species would come into the genus—*Cymindis æneus* Mael., (? = *C. illawarra* Mael.) = *Anomotarus olivaceus* Chaud.; *Dromius crudelis* Newm.; *Diabaticus minor* Blackb.; *D. tumidiceps* Blackb.; *Phloeocarabus unimaculatus* Blackb.; *Ph. umbratus* Blackb.

obliquely impressed on each side near antennæ: eyes with orbits reniform, eyes convex, orbits protuberant behind eyes, less than half the size of eyes. Prothorax hardly broader than long (1.2 × 1.25 mm.); pronotum opaque, transversely striolate, closely punctulate: apex truncate-emarginate; anterior angles obtuse, advanced; sides lightly arcuate, subsinuate before basal angles: base rounded in middle, roundly sinuate on each side: basal angles marked, summit obtuse, unisetigerous: border narrow anteriorly, raised at basal angles: median line well-marked, stronger and reaching base posteriorly. Elytra much wider than prothorax (3.2 × 2.25 mm.), widest rather behind middle, hardly narrowed to base: base emarginate, widely rounded at shoulders: apex a little roundly truncate, lightly subsinuate on each side, lateral margin explanate (formed by the subdepressed ninth interstice and wide depressed marginal channel). Tarsi with claws denticulate on basal half: in ♂, anterior without squamules beneath joints 1-4. Length, 6; breadth, 2.25 mm.

Hab.—Queensland: Cooktown District. Several specimens occurred to me under leaves and débris in dry situations in the open Eucalyptus-forest at King's Plains Station, south-west from Cooktown, in July.

A. humeralis is congeneric with *Cymindis stigmula* Chaud., (India and New Caledonia) on which Fauvel founded the genus *Urea*, but I cannot differentiate it generically from *Anomotarus*: and I think, therefore, that *Urea* (I have examined *U. stigmula* from India) is not more than, at most, a subgenus of *Anomotarus*. Chaudoir had intended to formulate a group Dromiides, to which he would have referred his *Cymindis stigmula*,* but to me it seems truly a member of the group Cymindides

ANOMOTARUS RUFICORNIS, n.sp.

Oval, depressed. Prothorax subcordate: elytra obovate, striate (striae finely crenulate); interstices hardly convex, first wide at base and with a short, well-marked stria: tarsi with claws serrate. Black, elytra brown; undersurface piceous; metasternum, legs, and antennæ testaceous.

Head convex, front decidedly obliquely impressed on each

* *Cy. Bull. Soc. Imp. Nat. Mosc.*, 1875, p.61.

side near antennæ; eyes subprominent; orbits protuberant behind eyes, about half length of eyes. Prothorax broader than long (0.8×1 mm.), widest at anterior fourth; pronotum very finely transversely striolate, not punctulate; apex emarginate; anterior angles widely obtuse, hardly advanced; sides rounded, subsinuate before basal angles; base rounded in middle, strongly sinuate on each side; basal angles marked, summit obtuse, unisetigerous; border narrow anteriorly, wide and raised at basal angles; median line lightly impressed on disc, strongly impressed towards base. Elytra ovate (2.3×1.85 mm.), widest about apical third; base wide, emarginate behind peduncle, widely rounded on each side; apex wide, rounded, subsinuate on each side; lateral margin not explanate. Length, 4.5; breadth 1.85 mm.

Hab.—Northern Territory: Darwin (Dodd). Unique, in Coll. Sloane.

Allied to *A. humeralis* Sl., but differing by size smaller; prothorax shorter, wider, upper surface not punctulate; elytra wider, more narrowed to base, lateral channel narrower, striæ more finely crenulate, scutellar striole shorter; antennæ lighter-coloured; elytra without humeral and apical maculæ, &c.

NOTOTARUS PUNCTICOLLIS, n.sp.

♂. Oval, depressed. Head large, finely punctate, except on occiput; prothorax short; pronotum punctate; elytra truncate-oval, punctate-striate; interstices lightly convex, shagreened, minutely punctate. Black; elytra opaque; antennæ, coxæ, tibiæ, and tarsi ferruginous.

Head large (1.7 mm. across eyes), convex; upper surface covered with a fine puncturation, except near posterior margin; clypeus convex, minutely punctate, a narrow ferruginous border along apex; eyes round, convex; postocular part of orbits large, prominent, inclosing eyes at base. Prothorax hardly wider than head (1.15×1.8 mm.). subconvex, widest about half-way between anterior and posterior angles; sides lightly rounded, subsinuate just before posterior angles; apex very lightly emarginate; anterior angles widely rounded; posterior angles subacute, not prominent; basal curve rounded in middle, lightly and

widely sinuate on each side; border narrow, rather widely reflexed at posterior angles. Elytra widely oval (3.8×2.7 mm.); base emarginate in middle; shoulders rounded; apex lightly excised at suture, inner angles obtuse, outer angles rounded off; striæ finely punctate; interstices lightly convex on disc, third bipunctate; border narrow, decidedly reflexed towards base. Length, 7; breadth, 2.7 mm.

Hab.—Northern Territory. Type in National Museum, Melbourne.

A single specimen is in the National Museum, Melbourne, ticketed "King River, N.T.; W. McLennan: 4.1.16; caught in tent." Allied to *N. morosus* Sl., but differing by size larger; femora black; prothorax proportionately smaller with wider borders, pronotum with whole surface densely and coarsely punctate, &c. *Cymindis crassiceps* Macl., which is a species of *Nototarus*, is not available for comparison, but *N. puncticollis* does not agree with the description, e.g., head not "entirely and closely covered with long strioles," pronotum not "with small punctures and fine transverse striolæ."

Tribe **Helluonini.**

HELLUODEMA BRUNNEUM, n.sp.

Parallel. Ferruginous-brown.

Head as in *H. unicolor* Hope, as wide as prothorax (2.6 mm. across eyes). Prothorax longer than broad (3×2.6 mm.), narrower at base than apex, widest before middle, hardly narrowed to apex, lightly angustate to base; sides very lightly rounded, lightly sinuate to base; surface punctate. Elytra parallel (6.5×3.5 mm.), strongly striate; interstices convex, biseriately punctate. Length, 12-14; breadth, 3.2-3.5 mm.

Hab.—Northern Territory. Type in National Museum, Melbourne. Two specimens have been examined, ticketed "Flooded area King R., N.T.; W. McLennan; 24.12.15"; one of these was presented to me from the National Museum, and is in my collection. *H. brunneum* differs from *H. unicolor* Hope, (which has also been found at East Alligator River, N.T.) by its reddish-brown colour, legs ferruginous; prothorax more elongate, less rounded on sides, less decidedly narrowed to base.

ORDINARY MONTHLY MEETING.

SEPTEMBER 26th, 1917.

Dr. H. G. Chapman, President, in the Chair.

The Donations and Exchanges received since the previous Monthly Meeting (27th August, 1917), amounting to 6 Vols., 40 Parts or Nos., 13 Bulletins, 6 Reports, and 2 Pamphlets, received from 46 Societies, etc., were laid upon the table

NOTES AND EXHIBITS.

Mr. Froggatt exhibited some remarkable Lepidopterous galls on the stems of the "Wild Tea-plant" (*Eremophila latifolia*), sent from Cobar, by Archdeacon F. E. Haviland. Out of 23 galls, all in the green state, only two contained perfect, living moth-caterpillars, the others having died through infestation by minute, chalcid wasp-parasites. Under such circumstances, the percentage that reach the moth-stage must be very small. How the moth is ever able finally to emerge from a gall of the type shown is difficult to understand. In a number of instances, the chalcid parasites hatched out, but died in the gall cavity, being apparently unable to find a means of exit.

Mr. Fred Turner exhibited—(1) Fruits of the Red Quandong (*Fusanus acuminatus* R.Br.), with a basal elongation of the pericarp, such as is sometimes seen in the Yellow Quandong (var. *chrysocarpus*), but which he had not seen before in the former; the specimens shown were forwarded by Mr. K. M. Niall, Buckiinguy Station, Nyngan district.—(2) A specimen of *Triteleia uniflora* Lindl., (syn. *Milla uniflora* Grah.), a Liliaceous plant, a native of Buenos Ayres, sent to him by Mr. R. Gowland, Pine Grove, Tooyal, Coolamon district, where it is reported to be spreading, principally on rocky ground: it is a

prolific seedbearer, which seems to have escaped from cultivation.—(3) For Mr. Clements, of Stanmore, a fasciated branch of *Rhus succedanea* Linn., the “Red Lac-Sumach” of Japan, from his garden at Stanmore, not seen in this condition before.

Mr. E. Cheel exhibited some interesting, abnormal specimens of the common Waratah (*Telopea speciosissima* R.Br.). One, from Gosford, cultivated by Mr. A. E. Keen, communicated by Mr. A. F. Basset Hull, had a terminal raceme, which measured 11 inches across the outspreading bracts, and $5\frac{3}{4}$ inches across the globular raceme of flowers, the latter being about $5\frac{1}{2}$ inches in depth, from apex to base. In addition to the terminal raceme, there were four well-formed racemes in the axils of the upper leaves, immediately beneath the terminal or main one on the same stem. The leaves were also of an uncommon character, being about 7 inches long and 4 inches wide, more or less wedge-shaped, with the apex almost truncate.* A second, from Hill Top, main Southern Line, 69 miles from Sydney (E. Cheel), had eight well-formed panicles in the axils of the upper leaves, immediately beneath the main, terminal raceme, the latter measuring $7\frac{1}{2}$ inches across the bracts, and the unexpanded raceme of flowers $3\frac{3}{4} \times 2\frac{3}{4}$ inches.

Mr. Fletcher showed specimens of a fourth, rare, crimson-flowered *Callistemon* from the Lane Cove district, which he was unable to identify. Mr. Cheel expressed the opinion that De Candolle's name, *C. linearifolius*, should be revived for these, and some other similar specimens from the County of Cumberland, which he had seen, Mr. Bentham having rejected it as applicable apparently only to one of several garden-varieties.

* For a previous note on the measurements of leaves, see these Proceedings, 1914, p.325.

ON A NEW SPECIES OF ACACIA.

BY W. F. BLAKELY, NATIONAL HERBARIUM, BOTANIC GARDENS,
SYDNEY.

(Communicated by J. H. Maiden, I.S.O., F.R.S.)

ACACIA CHEELII, n. sp.

Frutex, nonnunquam ad arborem minorem auctus, 12-35-pedalis, glaber, ramis junioribus angulatis mox teretibus, glaucis. Phyllodia glauca, anguste ad late falcata, utrinque attenuata, apice ferrugineo aliquanto prominenter mucronato, 10-18 cm. (4-7") longa, 1½-3 cm. lata, tenuiora, 3-6 plus minusve prominentibus nervis inter quos videntur multæ subtiles paralleleæ venæ. Glandula in basi insita.

Spicæ binæ vel ternæ, nunc paniculatæ, rhachi glauca glabraque, pedunculatæ, crebris floribus, 4-5 cm. longæ. Flores 5-, nonnunquam 4- vel 6-meri. Calyx brevis simus, aureus, pubescens vel subglaber, lobis minutis. Corolla longior, glabra, petalis acutis semicohærentibus. Stylus longus, glaber. Ovarium canescens.

Legumen breviter stipitatum, glabrum, anguste lineare, rectum vel paullo arcuatum, coriaceum, marginibus incrassatis, 12-15 cm. longum; semina oblonga, nigra, 4-6 mm. longa; funiculus albus, e basi dilatatus, generans arillum semel vel bis vel raro triplicatum super extremitatem seminis eminentem; areola utrinque notata, oblonga, semen ipsum longitudine vix æquans.

A glabrous shrub or small tree, 12-35 feet high, with glaucous angular young branches, soon becoming terete. Phyllodia glaucous, narrow to broad falcate, attenuate at both ends, tipped with a somewhat prominent ferruginous point, 10 to 18 cm. long (about 4-7 inches), 1½ to 3 cm. broad, rather thin, with 3 to 6 more or less prominent nerves, and numerous fine parallel veins between them. Gland basal.

Spikes in pairs or threes, sometimes paniculate, the rachis glaucous and glabrous, pedunculate, dense, 4 to 5 cm. long. Flowers 5 merous or occasionally 4-6-merous. Calyx very short, golden-pubescent or nearly glabrous, the lobes minute. Corolla glabrous, rather long; petals acute, united to the middle. Style long, glabrous; ovary hairy.

Pods shortly stipitate, glabrous, narrow-linear, straight or nearly so, flat, coriaceous, with thickened margins, 12-15 cm. long, 5 mm. broad, slightly contracted between the seeds. Seeds oblong, black, 4-6 mm. long, funicle white, dilated from the base, forming an aril of 1-2, rarely 3, folds over the end of the seed. Areola visible on both sides of the seed, oblong, and nearly as long as it.

Type-locality.—Manilla, New South Wales (L. H. Preston and H. Stoddart; flowers, September; and fruits, December, 1916).

Systematic position.—The new species belongs to the Julifloræ-Falcate Section. Its nearest affinity is *A. glaucescens* Willd., from which it differs in the longer, uniformly narrow and more falcate and glabrous phyllodia: in the larger and yellower flower-spikes; the glabrous corolla; also in the longer and thicker pod, and larger seeds. It is readily separated from *A. glaucescens* Willd., by the glabrous and glaucous phyllodes, and the ferruginous young tips. The phyllodes of *A. glaucescens* Willd., are minutely silvery-pubescent, or, in the very young stage, golden-pubescent.

It would appear that this new species is often associated with *A. Cunninghamii* Hk., and has been confused with it in many instances; but the free nerves and the shape of the phyllodia enable one to separate it at a glance from that species. In carpological characters, it is also different.

Bark.—The bark is brownish, and flaky, inclined to be ribbony, hence the name "Stringybark-Wattle" applied to it by bushmen. The bark of *A. glaucescens* Willd., and *A. Cunninghamii* Hk., is hard and rugged.

Size.—It is a much smaller tree than *A. glaucescens* Willd., attaining a height of about 35 feet, though usually only 15 to

20 feet high; while *A. glaucescens* Willd., very often exceeds 50 feet in height.

Timber.—The timber, when fresh, has a very pleasant odour. It is not very heavy when green, and rarely exceeds 9" in diameter. Sapwood white and tough; heartwood brown, of a satiny lustre; grain free and straight.

Fodder-value.—Mr. T. W. Seaward, of Miranee, Gundy, writes (in August, 1902, during the severe, Upper Hunter drought) that specimens of this wattle, which grows on the spurs of the Lagoon Mountain, Page River, had been handed to him by a teamster, who was trying to keep his bullocks alive by lopping. The bullocks were leaving the Kurrajong and eating these twigs in preference.

Mr. Gordon Burrows, Narrabri, writes (September, 1912), "Curracabah, an *Acacia* highly valued in this district as a fodder-plant. I have even heard it rated as better for cattle than Kurrajong." And again (in December, 1916), "Edible for stock, locally known as 'Curracabah'."

Mr. E. H. Gall, Waipanuko, Pallamallawa, writes, (August, 1917): "Owing to the dry spell, I am still feeding cattle on the bush, and they appear to be doing well."

Range.—It is chiefly confined to the north-west parts of New South Wales. Its geographical range, as shown by herbarium specimens, extends from Murrurundi north to Warialda, westward to the Pilliga, and thence southward as far as Mudgee.

Localities.—Mudgee (W. S. Campbell); Murrurundi, small tree up to 20 feet high, growing in semi-exposed situations, on the sides and near the summit of steep stony hills (W. F. Blakely); summit of Mt. Duri, 3150 feet, andesite formation; Currabubula (R. H. Cabbage, No. 3546); spurs of the Lagoon Mountain at Page River (W. T. Seaward); Gunnedah (M. H. Simon); Quirindi (W. McDonald); Chilcott's Creek, Warrah (J. Gregson); Manilla, about 10 miles from town (L. H. Preston, H. Stoddart) [Mr. Preston writes, from the type-locality, Manilla, that "The trees are growing on a poor, stony, steep hill-side, for the most part facing the north, and formed originally a very

thick scrub, but bush-fires and ringbarking have reduced their numbers. They are to be found in other parts of this district, on the top of the Borah range of mountains, as well as in the locality known as the 'Mud Hut' Paddock, 'Kir Konel,' being some 10 miles up stream from Manilla, on the right bank of the River Namoi.": Tia Falls, Walcha (W. Forsyth & E. Cheel); Baan Baa (J. L. Boorman); Nemingha, near Tamworth, on serpentine-outcrop (W. M. Carne); Gulf Creek, Barraba (J. Batey); Barber's Pinnacle, Boggabri (R. H. Cambage, No.2470); Bingara (J. L. Boorman); on sand-ridges, near Baradine (J. Winters and G. Burrows); Narrabri (J. L. Boorman and G. Burrows); Warrumbungle Ranges (W. Forsyth); Pilliga Scrub, local name "Motherumbah," 10 feet high, in Pine scrub (E. H. F. Swain); Ashford (J. L. Boorman); Warialda (E. J. Hadley, Rev. H. M. R. Rupp), the most northerly locality.

Named in honour of Mr. Edwin Cheel, Senior Botanical Assistant, National Herbarium, Sydney, who has devoted many years to the study of the native flora.

NOTES ON THE GENUS *LEPIDIDIUM* [N.O. CRUCIFERÆ].
FROM THE NATIONAL HERBARIUM, SYDNEY.

BY A. A. HAMILTON.

In a monograph of the genus *Lepidium* ("Die Gattung *Lepidium* (Linn.) R.Br.," von A. Thellung, 1906), the author, under *L. ruderale* Linn., (p.139) represents *L. ruderale* Hook. f., Fl. Tasm., i. (1860), p.25), as = *L. Desvauxii* Thell., *L. pseudo-tasmanicum* Thell., et *L. tasmanicum* Thell. He also depicts (*loc. cit.*) *L. ruderale* Benth., Fl. Austr., i., (1863) p.86, as a composite species, consisting of *L. puberulum* Bunge, + *L. hyssopifolium* Desv., + *L. Desvauxii*, *L. fasciculatum*, *L. pseudo-ruderale*, *L. pseudo-tasmanicum*, et *L. sagittulatum*, all of Thell., + *L. Merralli* F.v.M., + *L. foliosum* Desv., var. *fruticulosum* (Desv.); and shows that *L. ruderale* var. (?) *spinescens* (l.c.) = *L. Ascheronii* et *L. dubium* Thell.

An examination of the material in the National Herbarium was undertaken, for comparison with Thellung's species; and seedlings were grown in the Sydney Botanic Gardens, with a view to obtaining the radical leaves, which, in some species, are fugacious, and consequently absent from many of our herbarium specimens. The resultant foliage has materially assisted in the identification of a number of specimens.

Of the species enumerated above, the research disclosed the following to be represented in the National Herbarium: - *L. Desvauxii* Thell., *L. pseudo-tasmanicum* Thell., *L. hyssopifolium* Desv., *L. fasciculatum* Thell., *L. pseudo-ruderale* Thell., and *L. dubium* Thell.

L. ruderale Linn., according to Thellung, (*loc. cit.*) is not represented in Australia.

L. DESVAUXII Thell.

Seedling-leaves pinnate, with few distant leaflets, lobed, deeply incised, or serrate at the apex, the lamina oblong-cuneate in out-

line, tapering into an elongated petiole. The leaves of the adult plants are narrow-linear for the greater part of their length, dilated towards the apex, which is toothed or lobed, and occasionally with a few marginal teeth, the margins sparsely sprinkled with short, flat, triangular hairs.

This species is recorded from West Australia, Victoria, and Tasmania by Thellung, who quotes (p.308) the following specimens under his var. *a. typicum*, from various European Herbaria. West Australia: Swan River, (1848?) Drummond, ser.4, n.126.—Victoria: Herb. Olfield (? Oldfield, A.A.H.).—Tasmania: Gunn. (ex herb. Hook.), Archer (ex herb. Hook., cum. var. *β.*), and under his var. *γ. gracilescens* (p.309).—Swan River (1840?) Drummond, ser.2, n.51.

We have, in the National Herbarium, an example of Drummond's n.126, from W.A., and one of his n.51, 2nd coll., 1844, representing Thellung's vars. *a. typicum* and *γ. gracilescens*, respectively. The var. *a. typicum* is also represented in the National Herbarium by specimens from near Claremont and Subiaco, W.A., herb. W. V. Fitzgerald; a specimen labelled "Common about Melbourne, 3, 1853, S. G. Hannaford's Herb. of Tasmanian and Victorian Plants, and from numerous localities in N. S. Wales."

L. PSEUDO-TASMANICUM Thell.

Apparently confined to Tasmania. Thellung (p.307) quotes one specimen only for this species, viz., Tasmania: leg. W. Archer ex herb. Hook.), Herb. Deless.

We have a specimen from Archer's Herb. of Tasmanian Plants, without locality, date, or collector's name, which agrees with Thellung's description of this species.

L. HYSSOPIFOLIUM Desv.

Seedling-leaves simple, broad linear to lanceolate, apex acute to acuminate, tapering at the base into a petiole, the margin serrate: tomentum cylindrical, sparse. The basal leaves of the adult plants, which are early deciduous, are similar to the seed-leaves, the cauline leaves gradually becoming narrower and

entire, or, occasionally, with a few remote teeth. Some forms of this species, when the basal leaves have fallen, simulate *L. Desvauxii* Thell., but the flat, triangular, marginal hairs of the latter provide a useful distinction. It is recorded by Thellung (p.305) from New South Wales, Victoria, and S. Australia. In the National Herbarium, it is represented from New South Wales only, its distribution ranging from the coast to the interior, but chiefly in the southern parts of the State; and includes a specimen collected by Banks and Solander, New Holland, 1770, named, as above, by the British Museum authorities.

A bundle of dry stems of this species was forwarded to the National Herbarium, by Messrs. Dalgety & Co., from the manager of a Station at Brewarrina, with the following information:—
“The only feed here at present, eaten greedily, when dry, by sheep and cattle; yields good milk.”

L. FASCICULATUM Thell.

Seedling-leaves pinnate, finely dissected, the basal leaves similar, present only on young plants.

This species, which is readily distinguished by its corymbose inflorescence, is quoted by Thellung (p.306) from one locality only, viz., Victoria: Swan Hill, leg. ?, distrib. F. v. Mueller (pro *L. rudérale*) - herb., Petersbg.

Our herbarium-material shows that it is widely distributed in New South Wales, particularly in the interior; and we have several specimens from Queensland, including an example from Warwick, December, 1912; collected and named as above by the Acting Govt. Botanist of that State, Mr. C. T. White. It is also recorded for S. Australia by Mr. J. M. Black, in a recent publication, “Additions to the Flora of S. Australia, No.9.” Trans. Roy. Soc. S. Austr., xl., p.62, 1916.

L. PSEUDO-RUDERALE Thell.

The radical leaves of this species are pinnately lobed, as in *L. rudérale* Linn., but the cauline leaves retain their dissection—which is gradually decreased upwards—longer than those of the typical *L. rudérale* Linn. The siliqua of *L. pseudo-rudérale* is

elliptical, and slightly emarginate, as opposed to the ovate siliqua of *L. ruderale* Linn., with its broadly emarginate apex.

Thellung (p.303) quotes the following specimens of the above—S. Australia: Mount Lyndhurst, 1898, Max Koch, n.324; *ibidem*, 1899, Max Koch, n.272.—West Australia: Gascoyne, Carnarvon, L. Diels, n.3683. We have a co-type specimen of Max Koch's n.324, Mt. Lyndhurst, August, 1898, from the collector; and the following examples from New South Wales—Wyalong, Rev. J. W. Dwyer, 9.1915; Nyngan, J. L. Boorman, 8.1903; West Maitland, J. C. Burgess, 1.1911.

L. DUBIUM Thell.

Easily recognised by its spine-tipped branches and compact habit. This is the *L. ruderale* Linn., var. (?) *spinescens* of Bentham, Fl. Austr. (in part), quoted from S. Australia.

One locality only is recorded by Thellung (p.311) for this species, viz., Victoria: near Lake Corangamike (Corangamite, A.A.H.), leg ?, distrib. F. v. Mueller.

In "Contributions to the Flora of Australia," No.25 (Proc. Roy. Soc. Vict., xxix., N.S., p.142, 1917), Professor Ewart records Bentham's var (?) *spinescens* from Camperdown, Victoria, incidentally questioning its relationship to *L. ruderale* Linn. Professor Ewart's locality is some 12 miles west of Lake Corangamite. It was recorded in Proc. Linn. Soc. N. S. Wales, xxiv., p.64 (1899), from Narrabri in "Notes from Sydney Botanic Gardens, No.5" by Messrs. Maiden and Betche. Other specimens in the National Herbarium are from Temora, N.S.W., Rev. J. W. Dwyer, 10.1915; and an example from West Australia, Dr. F. Stoward, n 274, 12.1913.

In addition to the above, we have a co-type specimen of *L. Muelleri Ferdinandi* Thell., from the collector, Max Koch, n.388, Mt. Lyndhurst, S.A., 1898, the only record given by Thellung (p.290).

L. Howei insulæ Thell., (p.291) is also represented by specimens from Lord Howe Island, J. H. Maiden, 4.1898, and other collectors.

L. LEPTOPETALUM F.v.M.

The following extracts are taken from a letter accompanying a series of specimens, including the above, forwarded to the National Herbarium for identification and report, by Mr. Walter Gill, Conservator of Forests, South Australia:—"Herewith some specimens which I found early this month (November) north-east of the Burra, about 70 miles in the dry district, with small uncertain rainfall. Nos. 47, *L. leptopetalum* F.v.M., and 48, *Cratystylis conocephala* Sp. Moore, (*Pluchea conocephala* F.v.M.) which, I find, are regarded as valuable fodder-plants by the owner of the sheep-station on which I secured them."

ON SOME NEW DRAGONFLIES FROM AUSTRALIA
AND TASMANIA [Order Odonata].

BY R. J. TILLYARD, M.A., B.Sc., F.L.S., F.E.S., LINNEAN
MACLEAY FELLOW OF THE SOCIETY IN ZOOLOGY.

(Plate xxiii., and ten Text-figures.)

During the past two or three years, some interesting new material in the Order Odonata has accumulated in my collections. Pressure of more important work has hitherto prevented me from working this up; but it seems time that this task should be undertaken at last, and the descriptions are now offered in this paper.

Two new genera are here proposed, and eight new species described, together with one new subspecies. Besides these, the female and mature male of the very rare species, *Argiolestes chrysoïdes* Tillyard, are described for the first time, the species having been originally described from a unique male, which subsequently proved to be somewhat immature, and not fully coloured.

The most interesting of the species dealt with in this paper are two forms from Cradle Mountain, N.W. Tasmania, taken at an altitude of about 4,000 feet, in a very cold and wet climate. Two new genera are proposed for their reception. They are undoubtedly Antarctic derivatives, linking up the fauna of Tasmania (and, incidentally, of the south-eastern highlands of Australia) with the fauna of the Andean slopes in Southern Chili. One of them, *Archipetalia auriculata*, n.g. et sp., is probably the most archaic *Æschnine* Dragonfly yet discovered, and appears to represent a type ancestral, in many of its characters, to *Austropetalia* of the Blue Mountains on the one hand, and to the three Chilian genera *Petalia*, *Phyllopetalia*, and *Hypopetalia* on the other. These five genera, forming the tribe *Petaliini*, are a very distinct group, evidently of great age, but so specialised in several

important respects, notably in the approximation of the triangle to the arculus, and in the remarkable colour-scheme of the wings, that it seems highly improbable that they ever existed in any other parts of the world. All the species are evidently closely allied, so that one is bound to postulate for them, not so very long ago in geological time, a common ancestor of a type not far removed from *Archipetalia*. The only satisfactory explanation of this problem, as it seems to me, is to be found in the Antarctic Theory, as elaborated by Hedley;* indeed, the group offers almost as fine a vindication of the theory as one could have hoped to find at the present day. Assuming that the common ancestor of the group existed on the Antarctic Continent at a time when the climate was sub-alpine, then, with the lowering of the temperature to the minimum at which Odonate life was possible, either the group would have become extinct, or it would have been saved by migration along the only paths open to it. According to Hedley, this Antarctic Continent was connected at different times with (a) Tasmania and South-Eastern Australia, (b) New Zealand, and (c) Patagonia and S. Chili, by means of long, narrow strips of land. The group must, therefore, have travelled outwards from the place of origin along these three land-connections, and its descendants must be looked for in the higher altitudes of these three regions. The three Chilian genera have been known for some time, but the number of specimens obtained is still very small. The Blue Mountain species, *Austro-petalia patricia* Tillyard, was first discovered in 1903, but it was not until nine years later that another specimen was obtained, though it was carefully searched for in the interval. In dealing with this species in a previous paper,† before the discovery of the Tasmanian form, I discussed the possibility of an Antarctic origin for the group, in the following words:—"This theory would undoubtedly be strengthened by the discovery of a Tasmanian

* "The Palæographical Relations of Antarctica," by C. Hedley, F.L.S., Proc. Linn. Soc. London, Session 124, 1911-12, pp.80-90.

† "Life-Histories and Descriptions of Australian *Aeshninae*." Journ. Linn. Soc. London, Zoology, xxxiii., 1916, p.21.

species. A form that finds the climate of the Blue Mountains suitable should surely also be able to find suitable refuges in Tasmania, *if it came that way*. No such species is known at present: but, owing to the small amount of collecting of Odonata carried out there, and also to the extreme difficulty of finding these insects, we cannot be sure that one does not exist. Meanwhile, we must regard the evidence for the supposition as insufficient, however tempting and fascinating the hypothesis itself may appear."

It was, therefore, particularly gratifying that the first new species met with at Cradle Mountain should prove to be a new member of the group. Its discovery greatly strengthens the argument for the Antarctic Theory. When we add also the evidence afforded by its relationship with the other members of the group, the case becomes stronger still. For this new species is older than any other member of the group, in that it still possesses the *separated eyes* of the ancestral form, together with a very densely reticulated venation, and exceedingly large auricles. One may be fairly certain that the most specialised forms will be those that have travelled furthest from their place of origin, having become more greatly modified through undergoing a greater change in their climatic surroundings. Thus the presence of the most archaic form in Tasmania points to Tasmania as the nearest locality to the place of origin of the group: so that, on this reasoning, no other place of origin but Antarctica would be possible.

That the group is not yet known to exist in New Zealand cannot now be used against the argument. It may well be that it is represented there, and is awaiting discovery by the first collector who will search for it in the right localities. Even if this is not the case, it does not damage the argument: for, as the three connections with Antarctica did not all exist at the same time, it is quite possible that the way to New Zealand became closed off before the Odonate migration began, while the other two ways, to Tasmania and Patagonia respectively, remained open.

Turning now to the second new genus, we find a further corroboration of the views here set forth. The beautiful new genus *Sythemioptis*, from Cradle Mountain, combines in itself the principal characters of the Australian tribe *Sythemini* and the Chilean species *Gomphomacromia paradoxa* Br. With the facies of the latter species, it possesses the typical reticulate basilar space of the *Sythemini*; so that it would be difficult, from a study of the imago alone, to decide as to which of the two it was most closely related. Realising this, I searched assiduously for the larva, and was rewarded by finding two of the exuviae. These have the typical *divergent wing-sheaths* of the *Sythemini*, so that the closer relationship with this Australian group may be taken as proved. In this case, the greater divergence between the two extreme types, *Sythemis* and *Gomphomacromia*, is clearly correlated with their greater distance from the place of origin; for the *Sythemini* are spread far and wide over Australia and Papua, while *Gomphomacromia* ranges into Ecuador and Brazil!

The following is a list of the species dealt with in this paper:—

Suborder **ANISOPTERA.**

Family **ÆSCHNIDÆ.**

Subfamily **ÆSCHNINÆ.**

ARCHIPETALIA, n.g. (Type, *A. auriculata*, n.sp.).

1. *A. auriculata*, n.sp.

TELEPHLEBIA Selys. (Type, *T. godeffroyi* Selys).

2. *T. tryoni*, n.sp.

AUSTROÆSCHNA Selys. (Type, *A. parvistigma* Selys).

3. *A. hardyi*, n.sp.

Family **LIBELLULIDÆ.**

Subfamily **CORDULINÆ.**

SYTHEMIOPTIS, n.g. (Type, *S. gomphomacromioides*, n.sp.).

4. *S. gomphomacromioides*, n.sp.

C O R D U L E P H Y A Selys. (Type, *C. pygmaea* Selys).

5. *C. divergens*, n.sp.

Suborder **ZYGOPTERA**.

Family LESTIDÆ.

Subfamily SYNLESTINÆ.

S Y N L E S T E S Selys. (Type, *S. weyersi* Selys).

6. *S. weyersi* Selys.

6a. *S. weyersi nigrescens*, n.subsp.

7. *S. selysi*, n.sp.

8. *S. tropicus*, n.sp.

Family AGRIONIDÆ.

Subfamily MEGAPODAGRIONINÆ.

A R G I O L E S T E S Selys. (Type, *A. australis* Ramb.).

9. *A. chrysoïdes* Tillyard.

Subfamily AGRIONINÆ.

A G R I O N Selys et auct. (Type, *A. puella* Linn.).

10. *A. brisbanense*, n.sp.

Suborder **ANISOPTERA**.

Family ÆSCHNIDÆ.

Subfamily ÆSCHNINÆ.

Tribe **Petaliini**.

Key to the Genera of the Tribe *Petaliini*.

- | | | |
|----|--|-----------------------------|
| | 1. Eyes touching for a short space..... | 1. |
| | 1. Eyes definitely separated..... | ARCHIPETALIA, n.g. |
| | 2. Triangle 2-celled, subtriangle free..... | 2. |
| 1. | 2. Triangle 3-celled, subtriangle 3-celled in forewing,
2-celled in hindwing..... | HYPOPETALIA Selys. |
| | 3. Pterostigma short; only four spots on each wing..... | PETALIA Selys. |
| 2. | 4. Pterostigma fairly long; more than four spots on
each wing..... | 3. |
| | 5. Wing-spots brown; tibiae of forelegs without spe-
cialised bristles..... | PHYLLOPETALIA Selys. |
| 3. | 6. Wing-spots bright ruby-red; inner set of bristles
on tibiae of forelegs close-set and thickened... | ... AUSTROPETALIA Tillyard. |

Genus *ARCHIPETALIA*, n.g. (Text-figs.1-3).

Wings rather narrow, well-pointed; venation dense; seven or eight spots of a rich dark brown colour along the anterior border of each wing. Triangles two-celled. Subtriangles free, with a single cross-vein preceding them in the submedian space. M_2 slightly waved. R_{spl} and M_{spl} weakly formed.

Head narrowed antero-posteriorly; eyes distinctly separated (Text-fig.2); the frons not abnormally raised up, but broad and well rounded.

Thorax short, hairy. Legs short and thick, the inner series of bristles on the tibiae of the forelegs thicker and more closely set than the outer.

Abdomen: seg. 2 with auricles very large in ♂, present but much smaller in ♀. Anal triangle of ♂ very large and well formed, normally 4-celled.

Genotype, *Archipetalia auriculata*, n.sp. (Tasmania).

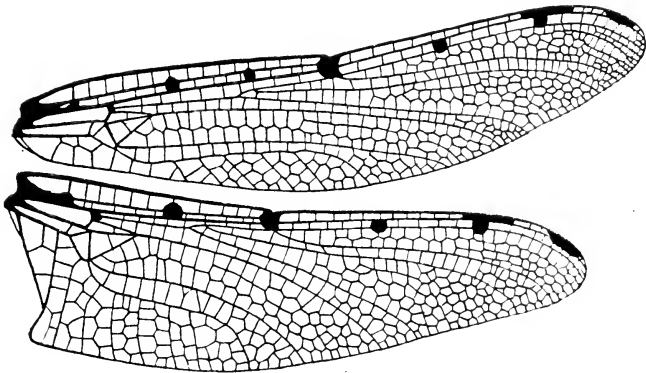

Text-fig.1.

Wings of *Archipetalia auriculata*, n.g. et sp., ♂. (Hindwing 31·5 mm.).

1. *ARCHIPETALIA AURICULATA*, n.sp. (Text-figs.1-3).

♂. Total length, 50; abdomen, 41; forewing, 32·5; hindwing, 31·5 mm.

Wings hyaline, very slightly tinged with pale brownish. The series of rich dark brown spots along the anterior border of all

four wings is placed as follows: a basal blotch running out to the first antenodal (in forewing, this may be divided into a small basal patch and a spot on the first antenodal in the subcostal space); a small patch upon the arculus; a semicircular spot upon an antenodal placed about half-way between base and nodus, followed, in the forewing only, by another similar but slightly smaller spot about half-way between it and nodus; a large irregular blotch upon nodus; a round spot beneath proximal end of pterostigma; between the two last, about half-way, another roundish spot; finally, an elongated blotch or cloud near apex of wing. At base of costa of all four wings is a tiny but conspicuous cream-coloured spot. *Pterostigma* 3 mm., dark brown, very narrow. *Antenodals* 13-15 in forewing, usually 10 in hindwing, the first and seventh somewhat hypertrophied.

Head: *eyes* dark brown, the orbits broadly yellow beneath.

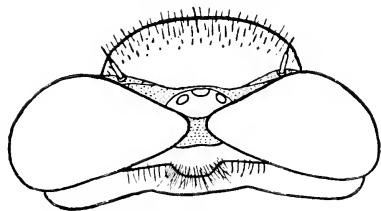

Text-fig. 2.

Head of *Archipetalia auriculata*, n.g.
et sp., ♂: ($\times 6$).

Vertex and *antennae* black; occipital tubercle large, yellow. *Frons* irregularly brownish at base, yellow above, with short black hairs; anteriorly the frons is covered by a broad dark brown band. *Anteclypeus* yellow, *postclypeus* very dark brown; *labrum* dark brown,

with two small centrally placed yellow spots; *labium* rich brown, hairy.

Thorax blackish-brown, hairy. *Prothorax* with two dorsal yellow spots. *Synthorax* with a pair of short slanting dorsal yellow stripes converging posteriad, pointed at both ends; behind these, further apart, a pair of yellow spots. Sides of thorax with well-marked lateral and sublateral bands of pale yellow; between them, a small yellow spot near wings; and another spot placed latero-ventrally close to base of abdomen. *Legs* black, except the basal half or more of the femora, which is dark brown.

Abdomen cylindrical, moderately stout, 1-2 widened, 3

scarcely pinched at all, 8-10 not enlarged. *Auricles* (Text fig.3) very large, bright yellow above, edged with dark brown outwards and posteriorly; underside brown. *Colour* of abdomen blackish-brown: 1, with a pair of lateral yellowish-green marks; 2, with three pairs of short narrow marks of the same colour; 3-6, each with a conspicuous pair of dorsal yellowish-green stripes pointed in front, placed between base and transverse carina; posterior to this carina, a pair of small basal spots wide apart, and a similar pair of small apical spots; sides with an elongated patch of bright yellow between base and transverse carina; 7-8 similarly marked, but with the pattern modified by the approach of the transverse carina nearer to base, thus shortening the anterior stripes and lengthening the apical spots; also the lateral yellow markings extend apically beyond the carina; 9, with a pair of dorsal yellow markings, triangular, with their vertices placed basally on the segment; also a pair of lateral basal yellow spots; 10, with two large yellow spots isolating an irregularly trapezoidal basal black patch. Dorsally on 6-9 are conspicuous patches of grey hairs. Beneath the inferior appendage, seg. 10 carries a rounded tubercle with two projecting teeth, sharply pointed, black.

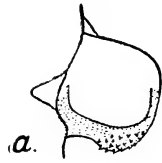

Text-fig.3.*

Appendages (Plate xxiii., figs.1-2): *superior* 1.2 mm., black, pointed, flattened, somewhat twisted; *inferior* 1.4 mm., trifid, the middle lobe very wide, truncated, yellow bordered with black; the lateral lobes black, cornute, divergent.

♀. *Total length*, 52 : *abdomen*, 36 : *forewing*, 34.5 : *hindwing*, 33.5 mm. Differs from ♂ as follows:—*Wings* broader, with more rounded tips; all the wing-spots much larger: base of hindwing narrow, the posterior border sloping gradually away almost in a straight line at an angle of 45° to the wing-axis, then curving evenly round to reach the widest part of the wing just before the termination of *Cu*₂. *Frons* and *face* darker, the yellow on the

* Auricles of *Archipetalia auriculata*, n.g. et sp.: a, male; b, female: (× 10).

upper part of the frons much reduced. *Abdomen* very wide, 4.5 mm. at seg. 2, 3 mm. at segs. 3-8, segs. 9-10 narrower; markings duller. *Appendages* short, black, conical, convergent.

Types in Coll. Tillyard (Cradle Mt., N.W. Tasmania, Jan. 18th, 1917).

Hab.—Found only at Cradle Mountain, North-West Tasmania, at an elevation of from 3,000 to 4,000 feet. Very rare. In the course of three weeks' collecting, only eleven males and three females were taken. They fly fairly fast, very close to the ground, along the tiny brooklets which drain the swampy areas on the watersheds. They were also occasionally seen flying up the steep sides of the high hills buttressing the actual peaks of Cradle Mountain itself. The captures range from January 10th to 21st. All the specimens were very mature, some being much torn; so that this species, like its ally *Austropetalia patricia*, of the Blue Mountains, is evidently a Spring species, and probably appears on the wing late in November, or early in December.

The larva was searched for, but unsuccessfully. No doubt the heavy rains and storms of this region would soon sweep away any exuviae, so that the only chance would be to visit the mountain considerably earlier in the season.

As indicated in the Introduction to this paper, this species is undoubtedly the most archaic of the tribe so far discovered. Indications of Petalurine affinity are to be found in the very pointed wings of the male, the excessively narrow pterostigma, and the separation of the eyes; all archaic characters, and perhaps derived from a common ancestor of the *Petalurinae*, *Cordulegastrinae*, and the earliest *Eschninae*, of the last of which the tribe *Petaliini* appears to be a specialised side-branch, from near the very base of the subfamily. The lines of specialisation are the remarkable colour-pattern of the wings, the close approximation of the triangles of all four wings to the arculus, and the unique structure of the anal appendages of the male. The great size of the auricles is possibly an archaic character, and raises the question as to whether these peculiar structures may not have been derived directly from the original abdominal append-

ages of the second segment. What their function is to-day, or has been in the past, we do not yet know. But we must repeat that they are never well-developed except in those males with angulated hindwings, and are seldom at all present in the females, or in males with rounded hindwings. In *Archipetalia*, they certainly bear the same relationship, in size and position, to the hindwings that the balancers or halteres of a Dipterous insect bear to the forewings; so that there is a presumption of a similar function in both cases. Watching the effect on the flight, of careful amputation of one or both of the auricles, might solve this problem—an experiment I hope to carry out in the future.

It should be borne in mind that practically no collecting in the Spring of the year has as yet been done either upon Mount Kosciusko and the other high elevations in South-Eastern Australia, or upon similar ground in New Zealand. The possibility of the existence of a new species in the former region seems to me to be very considerable. On the Blue Mountains, *Austropetalia patricia* appears in October, and is always completely over by the end of November; so that it would probably be necessary to visit Kosciusko as early as the end of November to be successful. The chances of discovery in New Zealand are more remote, since any species that might exist there should remain out until the end of December, at any rate; and might, therefore, be expected to have been found already, by collectors in suitable localities, at that time of the year.

Tribe **Brachytronini.**

Genus TELEPHLEBIA Selys.

2. TELEPHLEBIA TRYONI, n.sp. (Plate xxiii., figs.3-4).

♂. *Total length*, 69.5; *abdomen*, 55; *forewing*, 43; *hindwing*, 44 mm.

Wings densely reticulated, fairly broad, very rounded at tips; forewing distinctly shorter than hindwing. Venation very pale brownish, costa pale yellow. *Pterostigma* very long, 5.5 mm., pale ochreous, well braced, covering about ten small cellules. A brownish cloud at base of wings extends up to arculus, chiefly in

subcostal space, and continues more lightly on to the nodus, which is covered by a brownish cloud extending from 2 to 3 mm. distad between C, R, M_{1+2} , and Rs; a very light cloud is continued from nodus to pterostigma, chiefly between R and M_1 . Apparent prolongation of Sc beyond nodus extends for two cells' width. *Antenodals* about 27 in forewing, 23 in hindwing, nos. 4 and 8 hypertrophied. *Postnodals* about 27 in all wings.

Head: *eyes* and *vertex* brown; *frons* very prominently anvil-shaped, slightly darkened towards apex; rest of head a medium orange-brown.

Thorax dark brown, paler along the mid-dorsal carina; sides brown, tinged with olive-green; humeral stripes vestigial. *Legs* brown.

Abdomen pinched at seg. 3, and again at seg. 4; 5-9 cylindrical, 10 slightly widened distally, with a pyramidal dorsal tubercle. *Colour* brown.

Appendages: *superior* 3 mm., slender, slightly waved; *inferior* 2.5 mm., subtriangular, concave above, tip narrowed, slightly blunted. *Colour* pale straw.

♀. Unknown.

Type in Coll. Tillyard. (Brisbane, Q., T. Batchelor, Dec., 1901). A second male in my collection, taken by the same collector in Jan., 1901. Two other males from the same series are in the collection of the Queensland Agricultural Department, from whom the two males in my own collection were received in exchange.

Hab.—Brisbane, Q. The locality where they were taken is not exactly known, but is, in most probability, built over long ago; so that it is possible that this species is already extinct.

I dedicate this very rare species to Mr. Henry Tryon, F.E.S., Government Entomologist of Queensland, to whom I am indebted for the opportunity of studying it.

This new species closely resembles *T. godffroyi* Selys, in general appearance; but may be distinguished from it at once by the much longer pterostigma and the great difference in the form of the anal appendages.

Genus AUSTROÆSCHNA Selys.

3. AUSTROÆSCHNA HARDYI, n.sp. (Plate xxiii., figs. 5-6).

♂. *Total length*, 64; *abdomen*, 48; *forewing*, 41; *hindwing*, 40 mm.

Wings hyaline, with dense venation. *Antenodals* about 20 in forewing, about 14 in hindwing; the first and fourth hypertrophied. *Postnodals* 20-23 in all wings. *Triangles* three celled in all four wings. *Anal triangle* large, right angled, three-celled; *membranule* 3 mm. in hindwing, whitish. *Pterostigma* in forewing 2.6, in hindwing 2.8 mm., greyish-brown enclosed by black veins.

Head: *eyes* grey-brown; *vertex* black; occipital tubercle small, brownish; *frons* black above, with two conspicuous creamy-white spots; anterior part of frons dark brown, sides creamy-white; *anteclypeus* creamy-white touched with grey, and with two ill-defined squarish brown marks just above postclypeus; *postclypeus* dark brown; *labrum* dark brown, with two contiguous yellow spots at base; *mandibles* with a yellow spot; *labium* dark brown.

Thorax shiny dark brown mottled with pale grey above, and with a large number of irregular creamy-white spots and patches on sides; *notum* mostly greyish. *Legs* large and strong, black, except the basal portion of femora, which is bright brown.

Abdomen: 1-2 swollen, 3 very pinched, 4-10 gradually widening, 10 very wide; 1-2 very hairy at sides. *Colour* black, with numerous pale greyish markings of very irregular shape; 2, with the auricles greyish bordered with black, and the segmental pattern so arranged as to isolate a black X surmounting a thicker V; 3, with two pairs of small spots arranged dorsally about the transverse carina, and a pair of larger apical spots; 4-7, on the basal half of each segment four pale blotches isolate a black cross; rest of segment black except for two large apical spots; 8, mostly black; 9-10, with pale markings apically. Seg. 10 well rounded and convex above, *without a dorsal tubercle*.

Appendages: *superior* 3.6 mm., black, very wide apart, sublanceolate, shortly stalked, tips very blunt; each appendage

carries a large spine or tooth beneath its basal half: *inferior* 1·8 mm., very wide and truncated at tip, much upcurved, brown bordered with black. (Plate xxiii., figs.5-6).

♀. *Total length*, 60: *abdomen*, 44; *forewing*, 41; *hindwing*, 39·5 mm. Very similar to ♂, but colours somewhat duller. *Abdomen* with 1-2 very swollen, 3 not pinched, 8-9 only slightly widened, 10 narrower. *Dentigerous plate* of seg. 10 with nine or ten closely set teeth. *Appendages* 1·4 mm., short, lanceolate, rather thick, black.

In the above descriptions, the colouration is probably that of individuals not fully matured.

Types in Coll. Tillyard (Cradle Mt., N.W. Tasmania, Jan. 16th, 1917).

Hab.—Cradle Mountain and Middlesex Plains districts, N.W. Tasmania, altitude 2,500-4,000 feet. At the beginning of January, the insect was very immaturesly coloured, and immature specimens were met with right through the visit. The insect is a large one, and flies only in sunshine, and chiefly in the afternoons. As rain usually sets in between 2 and 3 p.m., the task of obtaining sufficient food is not an easy one. We did not meet with a single well-nourished specimen, even those that had apparently been out longest being somewhat flabby and evidently not fully coloured.

This insect loves most of all to lurk in the patches of thick forest-country, and, like most of the duller-coloured members of the genus, it is usually to be seen resting on tree-trunks, where its dull grey-brown colouration renders it quite inconspicuous.

This species is very closely related to *A. tasmanica* Tillyard, from Hobart, to which it bears much the same relationship that *A. multipunctata* Martin, does to *A. parvistigma* Selys. The male may be at once distinguished by lacking the immense dorsal tubercle on seg. 10, and by the inferior appendage not being deeply bifid, as in *A. tasmanica*, but merely truncated. Also the superior appendages in *A. tasmanica* are somewhat longer and narrower, and less blunt at the tip, than in the new species. The female of *A. tasmanica* is not known.

Family LIBELLULIDÆ.

Subfamily CORDULINÆ.

Tribe **Synthemini.**

Genus **SYNTHEMIOPSIS**, n.g. (Text figs. 4-5).

Characters intermediate between those of the Australian genus *Synthemis* and the Chilean genus *Gomphomacromia* (*G. paradoxa* Br.). Wings with the venation more open than usual in the former, but denser than in the latter. Median space with one cross-vein in all four wings; submedian with three cross-veins in forewing, two in hindwing. In forewing, the triangle is somewhat broader than in *Synthemis*, its basal side being placed at a level about half-way along the hypertrigonal space, as in *Gomphomacromia*; the subtriangle is broad, with its posterior side bent; the triangle is followed by two rows of post-trigonal cells; M_4 and Cu_1 diverge widely towards the wing-margin. Excess bridge-crossveins present in both wings. In hindwing, the triangle is longer and much more recessed towards arculus than in *Synthemis*, the basal side of the triangle being placed at a level less than 1 mm. distad from arculus; the subtriangle is still quadrangular and small. Anal loop of hindwing short, with about five large cells in male, more in female. Anal triangle of male 2-celled, very narrow, the anal angle very prominent; the membranule large. In all four wings, pterostigma weakly braced; $Rspl$ and $Mspl$ not definitely formed. Wings blotched with black at base and upon nodus.

General facies of the insect resembles that of *Gomphomacromia paradoxa* Br. Frons prominent and more squarely cut than in *Synthemis*. Ovipositor of female with valves absent; the anterior processes fused basally (as in *Gomphomacromia*), somewhat knobbed distally; median processes small, each carrying, projecting from its base, a large tuft of long stiff bristles. (Text-fig. 5).

Larva resembling that of *Synthemis*, but of slenderer build; wing-sheaths divergent; body hairy; teeth of the lateral lobes of the labial mask fairly large.

Genotype, *Synthemiopsis gomphomacromioides*, n.sp.

The presence of a cross-vein in the median space places this insect definitely within the tribe *Synthemini*, as does also the larval character of the possession of divergent wing-sheaths, and the general form of the larva, which closely resembles that of *Synthemis eustalacta* Burm. But, in many other respects, as clearly shown in the generic definition, the insect is more closely allied to *Gomphomacromia*. It does, in fact, very neatly bridge the gulf between the two tribes *Synthemini* and *Idocordulini*, thus suggesting the possibility of the origin of both these tribes from an ancestor not far removed in structure from the present genus. One might also be led to infer from this that the whole subfamily *Cordulinae* was originally either of Australian or Antarctic origin, an origin which would accord very well with its present remarkable distribution.

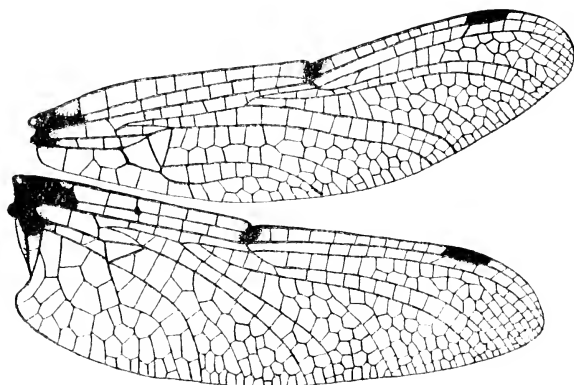

Text-fig. 4.

Wings of *Synthemiopsis gomphomacromioides*, n.g. et sp., ♂.
(Hindwing, 25 mm.).

4. *SYNTHEMIOPSIS GOMPHOMACROMIOIDES*, n.sp.

(Plate xxiii., figs. 7-8; Text-figs. 4-5).

Total length, 41; *abdomen*, 30; *forewing*, 26; *hindwing*, 25 mm.

Wings mostly hyaline, venation black; base of costa of all four wings with a conspicuous cream-coloured spot. Bases of wings heavily marked with an irregular black patch, extending

2-3 mm. into subcostal space, very little into median space, but further again into submedian space and down into anal triangle of hindwing. *Nodus* with a black patch. Usually a very small spot of black on *Sc* in hindwing, about half-way between base and *nodus*. *Antenodals* 7-9 in forewing, usually 6 in hindwing, all complete, but the corresponding parts in costal and subcostal spaces not always coterminous. *Postnodals* usually 7 in forewing, 7-9 in hindwing, first three incomplete. *Pterostigma* 1-8 in forewing, 2 mm. in hindwing, black.

Head: *eyes* just touching, dark brown, orbits pale yellow beneath. *Vertex* black; occipital tubercle blackish above, yellow posteriorly, hairy. *Frons* black, with two large pale yellow spots above, separated by the median depression: these spots extend over on to the anterior part of the frons, the rest of which is dark metallic purplish. *Clypeus* and *labrum* blackish, touched with brown in the middle: *labium* black.

Thorax black, with very long greyish hairs dorsally; a pair of conspicuous pale yellow antehumeral spots placed well forward. On each side is a large crescentic marking, also a large oval spot close to base of abdomen, both cream-coloured. *Notum* black, scuta yellowish. *Legs* black, except trochanters, which are brown basally and cream-coloured apically: tibial keel narrow but long, half as long as tibiae on forelegs, longer still on the others.

Abdomen: 1-2 widened, 3 narrowed, rest narrowly corduliform, as in *Sythemis*. *Colour* black, marked with lemon-yellow as follows:—2, a pair of small dorsal spots and yellow on auricles; 3-7, a pair of rounded dorsal spots placed nearer to base than to apex; 8, two very large confluent spots, occupying almost the whole of the basal three-fifths of the segment; 9, two medium basal spots, well-rounded, close together. On either side of 3-8, a basal lateral spot.

Appendages: *superior* 1.8 mm., black, curved near bases, tips well-pointed; each carries a sharp tooth or spine beneath; *inferior* 1.2 mm., wide, upcurved, tip truncated: dark brown. (Plate xxiii., figs. 7-8).

♀. *Total length*, 43; *abdomen*, 31; *forewing*, 38·5; *hindwing*, 37·5 mm. Very similar to ♂, but differing as follows:—

Wings broader, anal loop of hindwing larger, with 7 or more cells: pterostigma of hindwing 2·5 mm. Black markings on

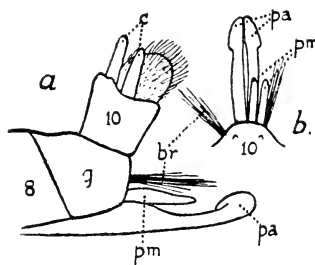

Text-fig. 5. †

in Text-fig. 5. † *Ovipositor* as described in generic definition, black. *Appendages* 0·5 mm., straight, black. (Text-fig. 5).

Types in Coll. Tillyard (Cradle Mt., N.W. Tasmania, taken *in cop.*, January 18th, 1917).

Hab.—Small swamps on the watersheds around Cradle Mountain, altitude 4,000 feet. ‡ Only seen in two localities, from which about forty specimens were taken; of these, all but six were males. Mr. G. H. Hardy, of the Tasmanian Museum, also captured a single male at Flowerdale Creek, near Wynyard, Tas., in January, 1916. This male is slightly larger and more heavily marked than the Cradle Mountain series.

The insect flies fairly rapidly over the swamps, frequently settling on the reed-stems. Owing to its rich black and lemon-

‡ End of abdomen of *Synthemiopsis gomphomacromioides*, n.g. et sp. ♀: *a*, lateral view; *b*, dorsal view; (*c* = 10); *br*, bristles; *c*, anal appendages; *pa*, anterior processes of ovipositor; *pm*, median processes of ovipositor; 8-10, abdominal segments.

† In some other females captured, the position of segs. 9-10 was not quite so abnormal.

‡ The first specimen of this insect taken was captured at Cradle Mountain by Professor T. T. Flynn, of Hobart, in December, 1915. When it came into my possession in June, 1916, it was badly crushed. It was this discovery that led me to visit the locality.

yellow colouring, it much resembles a small *Synthemis regina* Selys. Along the small rivulets close by, the very similar dragon-fly, *Synthemis tasmanica* Tillyard, was on the wing much more abundantly. This latter species also frequently intruded upon the domain of *Synthemiopsis*, and sometimes the latter would make short excursions along the rivulets. *S. tasmanica* was, however, easily distinguished by its duller colouration, which is dark brown, with ochreous-yellow markings.

A search was made for the larva of this species. Seeing a newly-emerged specimen fly off from the side of a small rivulet close to the swamp, a search amongst the reed-stems resulted in the discovery of a fresh larval skin; the next day, another imago was found transforming, and the exuviae secured. For comparison, the exuviae of *Synthemis tasmanica* were secured. These latter closely resemble those of *S. eustalacta* Burm. The exuviae of *Synthemiopsis* are closely similar to those of *S. tasmanica*, but may be at once distinguished by their more slender build, more prominent eyes, and more projecting frontal shelf. The wing-sheaths are divergent, and the whole body hairy, as in all larvae of *Synthemiini*; while the teeth of the lateral lobes of the labium are of about the same size and number as in *S. eustalacta*. The whole larva strongly resembles that of *Cordulegaster*, though of course considerably smaller.

Tribe **Cordulephyini.**

Genus **CORDULEPHYA** Selys.

5. **CORDULEPHYA DIVERGENS**, n.sp.

(Plate xxiii., figs.9-10; Text-fig.6).

♂. *Total length*, 31·5; *abdomen*, 27·5; *forewing*, 24·5; *hindwing*, 23 mm.

Closely related to *C. pygmaea* Selys, from which it differs as follows:—

Wings: *antennodals* 9-10 in forewing, 8 in hindwing. *Post-nodals* 6-7 in both wings. *Pterostigma* short, thick, black, 1·4 in forewing, 1·7 mm. in hindwing.

General body-colouration duller; frons and face with scarcely any metallic purplish colouring.

Abdomen very slender, cylindrical. Segs. 1-2, ochreous, with a touch of black apically; 3-7, with the basal half ochreous, the apical half black; 8, black, with ochreous base; 9-10, black.

Appendages very different from those of *C. pygmaea*. *Superior* 1.2 mm., black, diverging, tips clubbed; each appendage carries a small inferior tooth about half-way; *inferior* 0.8 mm., subtriangular, dark brown, tip upcurved and fairly pointed. (Plate xxiii., figs.9-10).

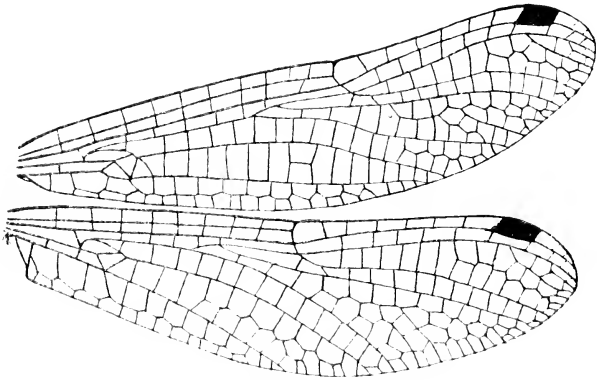

Text-fig.6.

Wings of *Cordulephya divergens*, n.sp. ♂. (Hindwing 23 mm.).

♀. *Total length*, 31.5; *abdomen*, 26.5; *forewing*, 27; *hindwing*, 26 mm. Closely resembles the male. *Pterostigma* very thick in forewing. *Abdomen* slender (much slenderer than in ♀ of *C. pygmaea*), cylindrical, the ochreous markings more definite than in ♂. *Valvula vulvae* almost obsolete. *Appendages* 0.4 mm., black, bluntly pointed.

Types, ♂♀, in Coll. Tillyard. (Hornsby, N.S.W., taken *in cop.*, resting upon a tree-trunk, May 8th, 1916).

Hab.—Upper end of Old Man's Valley, Hornsby. Eight males and two females were taken during May, 1916. The species was looked for again in 1917, but without success. The much commoner *C. pygmaea* Selys, occurs with it, but is nearly

over by the time this species comes out. It is the latest dragonfly to emerge in the season, as far as I know; and, to this fact, may be attributed its non-discovery before last year, since it is seldom that one goes looking for Odonata so late in the year.

This species, like the others of the genus, is very fond of settling on tree-trunks in the sunshine. Unlike *C. pygmaea*, it does not *quite* close its wings over its back, but usually holds them apart at an angle of 10° or so. Owing to its slender body, it looks exactly like a Zygopterid Dragonfly. This led to its discovery; for I netted it because I thought it was a new Zygopterid, whereas if I had thought it was *C. pygmaea*, I should probably have left it alone.

Three species of the interesting genus *Cordulephyia* are now known and may be separated as follows:—

- | | | | |
|----|---|--|-----------------------------|
| I. | } | Bright yellow and black colouration; superior appendages of ♂ not divergent | l. |
| | | Duller ochreous and black colouration; superior appendages of ♂ distinctly divergent | <i>C. divergens</i> , n.sp. |
| I. | } | Small species; superior appendages of ♂ straight | <i>C. pygmaea</i> Selys. |
| | | Larger species; superior appendages of ♂ convergent | <i>C. montana</i> Tillyard. |

Suborder **ZYGOPTERA.**

Family **LESTIDÆ.**

Subfamily **SYNLESTINÆ.**

Genus **SYNLESTES** Selys.

Amongst the numerous specimens in my collection, from many localities, which belong to the genus *Syolestes*, I find a very great diversity in size, structure, and colouration. Only two species have so far been described, viz., *S. weyersi* Selys, and *S. albicauda* Tillyard. The latter is a very distinct species, which can be recognised at once, without the slightest difficulty. The former is, however, somewhat of a puzzle, so that it would be advisable, at the very start, to state the difficulties surrounding it, and to attempt a solution of them.

Unfortunately, de Selys originally described *S. weyersi* from a broken female only. This specimen was labelled "Port Denison,

Queensland," and was described in 1868. In 1886, de Selys added, under the same name, the descriptions of two complete males, one from Sydney and another from Queensland. Now the large, common species, so conspicuous for its brilliant metallic green colouring, which at present passes in all collections as *S. weyersi*, is found very abundantly in many localities in Victoria and New South Wales, but never, so far as I know, in Queensland. In the latter State, two smaller, much rarer, and much less conspicuous species occur, which closely resemble the Southern form in general colouring, but can at once be distinguished from it on good morphological grounds. Further, one of these species extends southwards down the coastline, and can be taken in the Sydney district, though much more rarely than the commoner and larger species.

We have, therefore, three possibilities:—

(1) The three specimens described by de Selys may all belong to one species, and the locality-labels may all be correct. In that case, one would naturally expect that species to be the one that occurs in Queensland and also extends down the coastline to Sydney.

(2) The three specimens may all belong to one species, but the locality-labels may not all be correct. (Wrong locality-labels are not unknown in the case of specimens sent from Australia in early days, *e.g.*, the tropical *Hydrobasileus brevistylus* was sent home labelled both "Melbourne" and "Sydney," though it does not occur within hundreds of miles of either locality). Under such a supposition, one would admit the probability of the three specimens belonging to the common large Southern species.

(3) The three specimens may not all belong to the same species, even though de Selys considered them to be so.

As the original type-female, in the de Selys Collection at Brussels, cannot now be studied, we have to fall back upon de Selys' description, and try to find in it evidence as to which form is really the original *S. weyersi* of de Selys. There are three points in this description which seem to me to point definitely to the fact that de Selys' original female belonged to the common

Southern form, in spite of its Queensland label. These are (a) the colour of the prothorax, metallic green with the margins and the rounded posterior lobe yellow, (b) the colour of the pterostigma, yellowish, surrounded by thick black veins, and (c) the yellow colour of the "deuxième article" of the antennæ (the actual joint that is yellow is the scape, but de Selys' measurements show that he mistook the scape for the second joint, or pedicel, owing to the swollen base of insertion appearing like a true joint). All these three characters are distinctive of the common Southern form. On the other hand, all the specimens that I have seen from Queensland have the prothorax almost entirely yellow, the pterostigma black, and the scape of the antennæ also black.

The two males described by de Selys in 1886 clearly belong to the common Southern form, as both the measurements and the description of the appendages testify.

Thus we have to conclude that possibility (2) above is the correct solution of this difficult problem. The key to the species here given, and the naming of the new species described here, are both based on that supposition being correct.

Key to the Species of the Genus *Synlestes*.

- | | | | |
|----|---|---|----------------------------|
| 1. | { | ♂ with superior appendages strongly forcipate, blackish; | |
| | | ♀ with seg. 10 and appendages dark (either metallic green or black) | 1. |
| | { | ♂ with superior appendages elongated, creamy-white; ♀ | |
| | | with seg. 10 and appendages creamy-white. <i>S. albicauda</i> Tillyard. | |
| 1. | { | Very slender forms (hindwing about 27 mm.), with very | |
| | | narrow wings and short black pterostigma | 2. |
| | { | Larger species (hindwing about 32 mm.), not so slender, | |
| | | with more densely-veined wings and longer yellowish | |
| | | or brownish pterostigma | 3. |
| 2. | { | Superior appendages of ♂ with a prominent inner tooth at | |
| | | about one-fourth of the length from the apex; abdomen | |
| | | 0.6 mm. wide in middle; greatest width of fore- | |
| | | wing 4.5 mm | <i>S. selysi</i> , n.sp. |
| | { | Superior appendages of ♂ without a prominent inner tooth | |
| | | towards apex; abdomen only 0.4 mm. wide in middle; | |
| | | greatest width of forewing only 4 mm. | <i>S. tropicus</i> , n.sp. |

3. { Colour brilliant metallic green; scape of antenna yellow...
 *S. weyersi weyersi* Selys.
 { Colour black or bronze-black; scape of antenna black.....
 *S. weyersi nigrescens*, n.subsp.

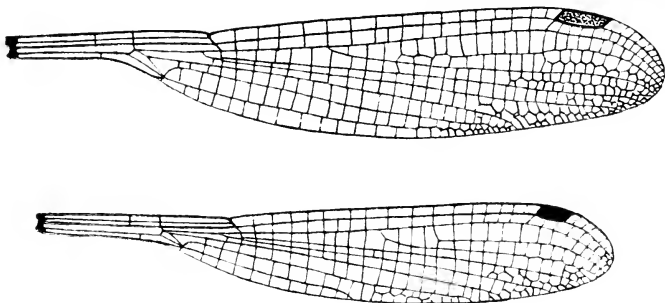

Text-fig. 7.

Forewings of *Sylestes weyersi weyersi* Selys. ♂, (32 mm.), (above); and
Sylestes selysi, n.sp., ♂ (28 mm.), (below).

SYLESTES WEYERSI Selys. (Plate xxiii., fig. 11; Text-figs. 7, 8a).

This very common but beautiful species occurs throughout Victoria, and in many parts of New South Wales: in particular, the Blue Mountains, the Southern Highlands, the Dorrigo Plateau, and the New England district, ranging up to 5,000 feet at Elbor. Average measurements: total length, ♂ 60, ♀ 53; abdomen, ♂ 50, ♀ 43; forewing, ♂ 32, ♀ 35; hindwing, ♂ 31, ♀ 34 mm. The wing-venation is shown in Text-fig. 7 (upper figure), the appendages of the male in Plate xxiii., fig. 11.

6a. *SYLESTES WEYERSI NIGRESCENS*, n.subsp. (Text-fig. 8b).

Size about the same as, or a little smaller than, the type-form. the wings distinctly more pointed at the tips. *Pterostigma* shorter and narrower than in type-form, in ♂ 1.8 mm., covering 3-4 cellules (cf. Text-figs. 8a and 8b); usually darker than in type-form.

Head: eyes black; *epicranium*, *frons*, *clypeus*, and *labrum* nearly black, with deep metallic green reflections; *antennae* black, with no yellow on basal segment; *genae* and *labium* pale yellow.

Thorax dull blackish. *Prothoracæ* with a fine yellow line on

posterior border. *Syngthorax* with a pale yellow lateral stripe on each side of mesothorax, close to suture, which carries a black band: sides of metathorax pale yellow. *Legs* black, except coxæ and trochanters, which are pale yellow.

Abdomen blackish, sides of 1-2 pale yellow: 3-6 with a pair of small basal lateral yellow spots.

Appendages closely similar to those of type-form. *Superior appendages* of male with a large inner tooth close to base, two small teeth on inner border at about half-way, followed by very fine denticulation of the inner border for a short distance: tips well rounded.

Types, ♂♀, in Coll. Tillyard (Lily Vale, Feb. 11th, 1911).

Hab.—Heathcote, Waterfall, and Lily Vale, Illawarra Line, New South Wales. December to March. Not uncommon.

This subspecies is at once strikingly distinguished from the type-form by its dull colouration: but it does not differ from it morphologically sufficiently to warrant its elevation to full specific rank.

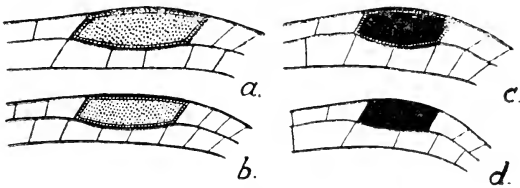

Text-fig. 8.

Pterostigma of *a*, *Syngthorax weyersi weyersi* Selys, ♂; *b*, *S. weyersi nigrescens*, n. subsp., ♂; *c*, *S. selysi*, n. sp. ♂; *d*, *S. tropicus*, n. sp., ♂; (> 6).

7. *SYNGLESTES SELYSI*, n. sp. (Plate xxiii., fig. 12; Text-figs. 7-8).

♂. *Total length*, 58.5; *abdomen*, 48.5; *forewing*, 28; *hindwing*, 27 mm.

Wings with 15-16 postnodals; *pterostigma* 1.5 mm. in forewing, black, covering only two cells (Text-fig. 8c). Greatest width of forewing, 4.5 mm.

Head: *eyes* dark green; *vertex*, *frons*, *clypeus*, and *labrum* brilliant metallic green; *gena* and *labium* pale yellow; *antenna*

black, the basal joint very short, only about one-fifth as long as the very long and thin second joint.

Thorax: *prothorax* dull yellow edged with dark brown; posterior border edged with lemon-yellow. *Syothorax* brilliant metallic green above, also on sides of mesothorax; a pair of pale yellow humeral rays present; sides of metathorax lemon-yellow, with a rectangular patch of metallic green running forward for 2.5 mm. beneath hindwing. *Notum* dark green, with pale yellow spots on scuta. *Legs* with the coxæ, trochanters, and bases of femora in fore and middle legs pale yellow; the rest of the femora, the tibiæ of forelegs, and all the tarsi black; tibiæ of middle legs mostly brownish; hindlegs all black, except the dark brown tibiæ.

Abdomen very slender, 1-2 and 8-10 slightly widened; width at segs. 5-6 only 0.6 mm. *Colour* metallic green, pale yellow on sides, especially on 1-2.

Appendages: *superior* 1.4 mm., black, forcipate, shaped as shown in Plate xxiii., fig.12; each appendage carries a large inner basal tooth, a second tooth ventrally placed at about half-way (not visible in figure), and a third large tooth on inner margin, at about one-fourth of the way from the tip. (Contrast the same appendages in *S. weyersi*, Plate xxiii., fig.11). *Inferior* very short, blunt, rounded.

♀. *Total length*, 51.5; *abdomen*, 40; *forewing*, 31.5; *hindwing*, 30 mm. Closely resembles the male, from which it differs only in the shorter and thicker abdomen, and the longer and slightly wider wings, with slightly larger pterostigma. Segs 8-9 of abdomen much swollen, 10 very small and narrow; *appendages* 0.3 mm., pointed.

Differs from *S. weyersi* Selys, by its much slenderer build, smaller size, narrower wings, with M_2 leaving M_1 nearly half-way between nodus and pterostigma, the latter structure being black, and much shorter than in *S. weyersi*; antennæ without any yellow on the basal joint, which also is smaller than in *S. weyersi*; superior appendages of male differently shaped from those of *S. weyersi*.

Types in Coll. Tillyard (Hornsby, March 31st, 1917).

Hab.—Hornsby and Ourimbah, N.S.W.: Mount Tambourine, S. Queensland; rare. February to April. Probably it would be found all up the Eastern Coast, if searched for. Its late appearance in the season is in marked contrast with the habit of *S. weyersi*, which can be found at the end of October, and seldom lasts until the end of January. Thus, even if the two species were to be found in the same locality, there would be practically no chance of their intercrossing.

S. SYNLESTES TROPICUS, n.sp. (Text-figs. 8*d*, 9).

This species differs from *S. selysi* in its excessively slender build, its very narrow wings, very short black pterostigma (Text-fig. 8*d*), and in the different form of the superior appendages, which are slenderer, and lack the large inner tooth on the apical half (Text-fig. 9). *Abdomen* 51 mm. long, width at segs. 5-6 only 0.4 mm. *Forewing* 29 mm. long, greatest width only 4 mm. *Pterostigma* of forewing 1 mm. long, covering only a little more than one cellule; jet black. ♀. Not known.

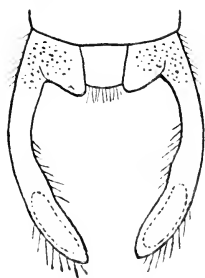

Text-fig. 9.*

Type, ♂, in Coll. Tillyard (Kuranda, F. P. Dodd; December 20th, 1912).

Hab.—Kuranda and Herberton, North Queensland. Only two males known, the second taken by Mr. F. P. Dodd, at Herberton, on October 22nd, 1910: not so mature as the type.

Family AGRIONIDÆ.

Subfamily MEGAPODAGRIONINÆ.

Genus ARGIOLESTES, Selys.

9. ARGIOLESTES CHRYSOIDES Tillyard. (Text-fig. 10, *a*, *c*).

This species was originally described by me from a single male taken by Dr. A. J. Turner, at Montville, Blackall Ranges, Queensland. In October, 1915, I visited the Blackall Ranges, staying at Maleny, some twelve miles south of Montville. The district

* Appendages of *Synlestes tropicus*, n.sp., ♂; (× 14). Compare Plate xxiii., figs. 11, 12.

is highly cultivated, and very little of the rich scrub is now left. The lovely *Argiolestes chrysoïdes* was found in only one locality, where a patch of scrub, about one square mile in area, had been left by an owner desirous of obtaining a higher price for it in the future. Through this scrub, a beautiful little stream meandered. *A. chrysoïdes* was practically confined to the small glade formed by the approach of the track through the scrub to this stream on either side—the only place in the scrub where there was any clear sunlight. By working this glade every day, I obtained, in the course of about a fortnight, nearly twenty males and ten females of this rare species. I am now able to offer a description of the female, which differs very markedly from the male in its colour-pattern:—

Total length, 41; *abdomen*, 32; *forewing*, 30; *hindwing*, 29 mm.

Wings much longer than in male: *postnodals* 22-23 in forewing, 20-21 in hindwing; *ptero stigma* black, 1.3 mm. in forewing.

Colour-pattern very different from that of male, and more resembling that of the female of *A. amabilis* Foerster. When mature, the groundcolour is velvety-black, with deep purplish reflections on the abdomen; the markings are a rich red, the pattern being that shown in Text-fig. 10c; all the rest of the abdomen not shown in this figure is black.

For comparison, I have figured also the colour-pattern of the male (Text-fig. 10a), and those of the male and female of *A. amabilis* (10b and 10d respectively). It will at once be seen that the sexes differ much more markedly in *A. chrysoïdes* than they do in *A. amabilis*.

Types in Coll. Tillyard (♂ taken by Dr. A. J. Turner, at Montville, October 6th, 1912; ♀ taken by myself at Maleny, October 12th, 1915).

Hab.—Blackall Ranges, Queensland. October. Very rare.

The changes in colouration in this species from emergence to maturity are very remarkable. At emergence, all the parts destined ultimately to become red are pure white in the male, while, in the female, they are white with slight blackish cloudiness encroaching from the black groundcolour on to the sides of the

white area. This white colour deepens very slowly, becoming first of all cream-coloured, then lemon-yellow, then a rich golden (the stage at which the type-male was described), and finally a rich orange-red in the male. The female darkens further to a deep red. These changes take about six days to accomplish. In *A. amabilis*, the parts destined to become red are at first a dirty white, soon becoming straw-colour, then ochreous, then dull orange, and finally brick-red in both sexes. The changes in this species are accomplished in three days or less, as I observed on Mount Tambourine in October, 1915, a week after my visit to Maleny.

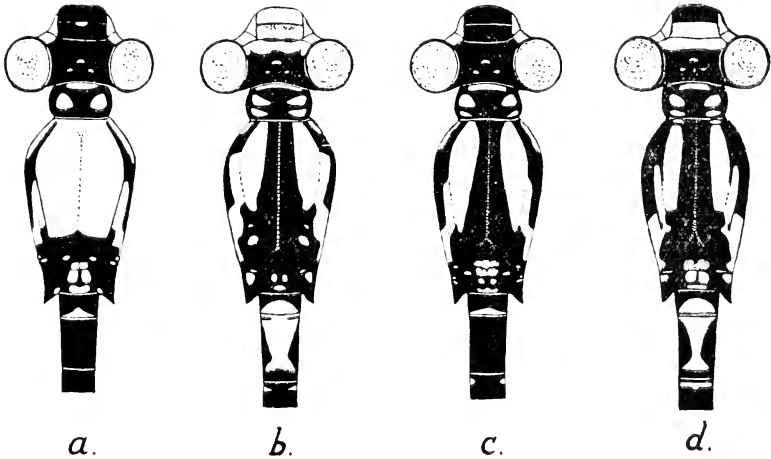

Text-fig. 10.

Colour-scheme of head, thorax, and first three abdominal segments in *Argiolestes chrysoïdes* Tillyard; (*a*, male; *c*, female); and in *A. amabilis* Förster; (*b*, male; *d*, female). The black represents black or deep metallic purple, the white either red or orange-red, in the mature insect.

Subfamily AGRIONINÆ.

Genus AGRION Selys et auct.

10. AGRION BRISBANENSE, n.sp. (Plate xxiii., figs. 13-14).

♂ (unique). Total length, 31·5; abdomen, 25; forewing, 18·5; hindwing, 17·5 mm.

Head very hairy. Eyes bluish-grey; *epicranium* black, with large blue postocular spots; *frons* pale blue; *postclypeus* black; *anteclypeus* and *labrum* blue; *labium* pale yellowish-brown.

Thorax hairy. *Prothorax* black, sides and posterior rim brownish. *Syuthorax* black above, with a pair of straight, moderately broad, bluish-green, antehumeral bands; sides pale bluish-green, shading to whitish below, with black markings in sutures. Legs short, dull black above, pale brown beneath.

Abdomen slender, cylindrical, 1-2 and 8-10 slightly enlarged. Colour: 1, black, with two round brownish lateral spots; 2, basal half blue, rest black, with a clepsydrate brown dorsal mark; 3-5, blue, except apical fifth, which is black; 6, all black; 7, basal fourth and apical fifth black, rest blue; 8, basal two-thirds blue, apical third black; 9, basally blue, the apical suture and two large lateral blotches, occupying about half the segment, black; 10, black, with a large blue dorsal patch.

Appendages shaped as shown in Plate xxiii., figs. 13-14; *superiors* 0.3 mm., *inferiors* very minute; colour black, with pale brownish hairs.

Type, ♂, in Coll. Tillyard. (Brisbane, a unique specimen, taken by myself on Kedron Brook, January 22nd, 1913).

Hab.—Brisbane, Q. It flies in company with *Pseudagrion australasie*, which it resembles closely in colour, though not quite so brilliant; the differences in shape and length of abdomen are considerable.

Two species are now known from Australia (*viz.*, *Agrion lyelli* Tillyard, from Tasmania and Victoria, and *A. brisbanense*, n.sp.), which appear to me to belong to the Palearctic genus *Agrion*, with which they agree in their venation, general facies, and colouration. The only difference seems to be the form of the appendages, which are intermediate between the bifid type found in European species of *Agrion*, and the simpler form exhibited in the Australian genus *Austroagrion*. I cannot at present see my way to placing these two Australian species in a new genus; so that, as they stand, they present somewhat of an anomaly in zoogeographical distribution for this well-known genus.

Agrion brisbanense differs from its near ally, *A. lyelli*, by its larger size, greater hairiness of head and thorax, broader and more regular blue antehumeral bands on thorax, slightly less blue abdomen, and somewhat differently shaped appendages.

EXPLANATION OF PLATE XXIII.

- Fig.1.—*Archipetalia auriculata*, n.g. et sp., ♂, appendages, dorsal view; (× 11).
 Fig.2.—*Archipetalia auriculata*, n.g. et sp., ♂, appendages, lateral view; (× 11).
 Fig.3.—*Telephlebia tryoni*, n.sp., ♂, appendages, dorsal view; (× 7).
 Fig.4.—*Telephlebia tryoni*, n.sp., ♂, appendages, lateral view; (× 7).
 Fig.5.—*Austroeschna hardyi*, n.sp., ♂, appendages, dorsal view; (× 7).
 Fig.6.—*Austroeschna hardyi*, n.sp., ♂, appendages, lateral view; (× 7).
 Fig.7.—*Synthemiopsis gomphomacromioides*, n.g. et sp., ♂, appendages, dorsal view; (× 11).
 Fig.8.—*Synthemiopsis gomphomacromioides*, n.g. et sp., ♂, appendages, lateral view; (× 11).
 Fig.9.—*Cordulephya divergens*, n.sp., ♂, appendages, dorsal view; (× 11).
 Fig.10.—*Cordulephya divergens*, n.sp., ♂, appendages, lateral view; (× 11).
 Fig.11.—*Syulestes weyersi weyersi* Selys, ♂, appendages, dorsal view; (× 14).
 Fig.12.—*Syulestes selysi*, n.sp., ♂, appendages, dorsal view; (× 14).
 Fig.13.—*Agrion brisbanense*, n.sp., ♂, appendages, dorsal view; (× 34).
 Fig.14.—*Agrion brisbanense*, n.sp., ♂, appendages, lateral view; (× 34).

THE SILURIAN TRILOBITES OF NEW SOUTH WALES,
WITH REFERENCES TO THOSE OF OTHER
PARTS OF AUSTRALIA.

PART VI.—THE *CALYMENEIDÆ*, *CHEIRURIDÆ*, *HARPEIDÆ*,
BRONTEIDÆ, ETC., WITH AN APPENDIX.

BY R. ETHERIDGE, JUNR., DIRECTOR AND CURATOR OF THE
AUSTRALIAN MUSEUM, AND JOHN MITCHELL, LATE PRINCIPAL
OF THE NEWCASTLE TECHNICAL COLLEGE.

(Plates xxiv.-xxvii.)

Genus *CALYMENE* A. Brongniart, 1822.

(Hist. Nat. Crust. Foss., 1822, p.22).

History.—It is to be regretted that Mr. J. W. Salter, whose masterly descriptions of British Trilobites have been of such assistance to us, did not live to describe the New South Wales species submitted to him by the Rev. W. B. Clarke; it is more than possible that some of his MS. names would fit several of the trilobites described by us.

Calymene was first reported as an Australian fossil by Dr. A. R. C. Selwyn, from Simmonds' Bridge, Upper Yarra, and Duck Creek, near Melbourne;* and was followed by Salter, who named one of Clarke's specimens *C. Macleayi*, from somewhere in the "Southern Districts."† It would appear that one or more of the Victorian specimens was named *C. tuberculata* by McCoy,‡ but, as no author's name is attached, it is impossible to say whether this was a MS. name of McCoy's, or intended for *C. tuberculosa* Salter, a well known species of the Wenlock Series. Next in order, we again meet with our friend De Koninck, who reported

* Selwyn, Quart. Journ. Geol. Soc., xiv., 1858, p.538.

† Clarke, S. Goldfields N. S. Wales, 1860, p.286.

‡ Smyth, Geol. Survey Vict., Progress Rept., 1874, p.34.

the occurrence of the cosmopolitan *C. blumenbachii* at Yarralunla. A remarkably fine example referred to this same genus was figured by Mr. Jenkins from the Hume beds.* He termed it *Calymene duplicata*, and gave $2\frac{1}{4}$ inches long as the size. In 1886, Mitchell recorded the occurrence of *Calymene* from Bowning.† In 1900, R. Etheridge described portions of two cephalons from Cooper's Creek, Walhalla, of doubtful identity.‡ *C. blumenbachii* is stated by F. Chapman to occur in the Upper Yarra beds, and also a species which he suggested to be *C. tuberculata* Salter.§ Lastly, the same author described a *Calymene* as *C. angustior* from Ruddock's Quarry, near Lilydale, Victoria.||

CALYMENE AUSTRALIS, sp.nov.

(Plate xxiv., figs. 1-7 and 9; Plate xxvii., fig. 1).

Complete form ovoid.

Sp. Chars. — *Cephalon* sub-semielliptical, moderately inflated, strongly granulated; average proportion of length to width approximately 17 : 40; glabella large, bell-shaped, inflated moderately, arched transversely, with a gentle slope anteriorly to the deep and wide furrow separating it from the highly thickened labrum or front margin, four pairs of glabella-furrows present, the anterior pair only faintly visible on the upper surface, but deeply indenting the sides and the axial furrows and thus forming a bar or ridge between the front angles of the glabella and the fixed cheeks, third and fourth pairs of lobes completely circumscribed, but circumscribing furrows shallow above; neck-furrow shallow medially but deep behind the basal glabella-lobes, its extension across the fixed cheek wide and shallow; neck-ring strongly arched, wide, extensions across the free cheeks proximally very narrow but

* Jenkins, Proc. Linn. Soc. N. S. Wales, iii., Pt. i., 1878, pp. 24, 27, 32, Pl. vi., fig. 4.

† Mitchell, Proc. Linn. Soc. N. S. Wales, i. (2nd Ser.), Pt. 4, 1886, pp. 1199 and 1203.

‡ Etheridge, Geol. Survey Vict., Monthly Progress Report, No. 11, 1900, p. 23.

§ Chapman, Report Austr. Assoc. Adv. Sci., xiv., 1913, p. 228.

|| Chapman, Proc. Roy. Soc. Vict., xxviii. (N.S.), Pt. 1, 1915, pp. 165-6, Pl. xv., figs. 8, 9, 10, and 11.

thickening distally; axial furrows deep and distinct; fixed cheeks large, tumid, steeply sloping into the axial furrows, highest at the eye-lobes, always less elevated than the glabella; free cheeks large, high, borders strongly thickened, corresponding with the limb; marginal furrows shallow and wide, continuous with the frontal and posterior furrows; eyes placed well outward from the axial grooves; facial sutures straight anteriorly, posteriorly for the first half straight outwardly and thence obliquely to the lateral margin in front of the very rounded and rather depressed genal angles.

Thorax subrectangular, rather strongly inflated, surface apparently granulate, length much less than the width in mature specimens, and apparently about equal to twice the length of cephalon; axis slightly less wide than the pleural lobes, strongly arched, most strongly elevated towards the pygidium; bases of each ring strongly tuberculate; pleural lobes of the usual Calymene-type, axial groove distinct.

Pygidium sub-semicircular or widely triangular when normal, highly inflated, with a general tendency to droop, strongly granulated, with centrally a distinct arch in the posterior margin; axis very strongly arched and prominent anteriorly, and diminishing rapidly in these features terminally; annulations five in number, with a semicircular terminal piece (which is separated from the steeply bent-down, smooth, boss-like end by a low, semicircular fillet) in all specimens, which have come under our notice, up to three inches in length; some pygidia of the species which exceed this length show seven or more annulations; pleuræ similar in character to those of thorax, and divided into five segments, each succeeding one, from the front, becoming very slightly more backwardly directed, until the last is reached, and this one abruptly becomes parallel with the axial groove, making the medial furrows of the fifth pair of pleuræ unusually wide, as they are in *C. blumenbachii*.*

Obs.—For some years past, we have looked upon the Bowring *Calymene* as the widely distributed *C. blumenbachii*, but, after a critical examination of many specimens, and careful study and

* This description has been made from non-testiferous specimens.

appreciation of the characters used by Salter to distinguish *C. blumenbachii* from other forms, we are forced to change our views and conclude that the Bowring species, though it has some characters similar, is specifically different. Again, by a study of Salter's description and figures of *C. tuberculosa*, we were impressed with the similarity between the Bowring species and this one, but failed to reconcile their identity. We had revealed to us, however, by our study of the characters of these two species, how fully the Bowring one possessed those of both, and, in addition, has a fourth pair of glabella-furrows. The attached tabulation of the structural features of the three species will show the resemblances and differences. A study of this tabulation will establish the separation of our trilobite-form from the other two, but there is a Bohemian species with which our species must be compared, viz., *Calymene incerta* Barr.,* which shows four pairs of glabella-furrows, and, in this important feature, agrees with our form. The distance of the eyes from the axial grooves, the highly thickened (pig-snouted) frontal margin are common to the two forms; but in *C. incerta* Barr., the latter is said to be straight in front, and continuing along the free cheeks, becomes effaced at the genal angles. In our form, on the other hand, the thickened border continues along the free cheeks and round the genal angles, joining with the thickened posterior borders of the fixed cheeks, and is always gently curved or segmental in front. The proportion of length to width is said by Barrande to vary much in his species, but, in our form, these proportions are fairly constant.

Comparing the thoraces of the two forms, we find, in *C. incerta*, that the axis reaches the maximum spread at the fourth ring; in ours, the neck-ring and the first five axial rings have practically the same spread or width. Again, in *C. incerta*, the axis is wider than the pleural lobes; in ours, on the other hand, the axis is a little narrower than the pleural lobes. The axial rings have their bases very nodular, but this feature in *C. incerta* is inconspicuous. The rings of the axis in both agree in

* Barrande, Syst. Sil. Bohême, Pl. 19, figs. 30, 31.

possessing the double curve referred to in Barrande's description of *C. incerta*, and this seems to us to be a feature present in other species of *Calymene*. The pleuræ in Barrande's species are represented as depressed towards the axis and rising towards the fulcra, and then dipping at right angles; the pleuræ in our form slope *very* gently from the axial grooves towards the fulcra, and then turn downwards at an angle much greater than a right angle. The axis of the pygidium of *C. incerta* is represented to be nearly as wide as the pleuræ, and reaches nearly to the edge of the border. In our form, the pleural lobes of the pygidium are much wider than the axis, and the axis terminates much short of the edge of the margin. Centrally, under the terminal piece of the pygidial axis, there is, in ours, a distinct arch. In other respects, the two pygidia agree. Finally, it seems to us that, in our form, we have a species possessing a cephalon in which are blended the characteristic features of *C. tuberculosa* and *C. incerta*, the thorax of *C. tuberculosa*, and a pygidium resembling that of *C. blumenbachii* and *C. incerta*. We have, therefore, reluctantly been unable to place it with either of those species.

It was only after the above description, etc., of *C. australis* was completed by us, that we became aware of Mr. Chapman's paper on Victorian Fossils, Part xviii., in which occurs his description of *C. angustior*. With this species, we have now to compare the Bowring form. As we have shown in the case of *C. australis*, Mr. Chapman points out that his species resembles *C. tuberculosa* Dalm., and *C. blumenbachii* Brongniart, and, therefore, possesses features represented in the Bowring form. It would not have surprised us to have found our species identical with Chapman's *C. angustior*; but, judging from description and illustrations of it, we must claim for ours separate specific rank. Mr. Chapman depends mainly on the relative narrowness of the form in his species, and particularly of the glabella, for its separation from *C. tuberculosa* and *C. niagarensis*. It is questionable whether a mere difference of form of this kind is a sufficient basis for the erection of species. Certainly another feature, the bifurcation of the distal ends of the pygidial ribs, is

another reason advanced; but this may be an accidental one. In our species, the sutures separating the pleural divisions of the pygidium always widen towards the thickened border; but the divisions never show free ends, nor do those sutures cross the margin.

The chief difference between our species and *C. angustior* is the presence, in the former, of a fourth lateral glabella-furrow; but if future inspection of better preserved specimens of the Victorian species, shows it to be possessed of four lateral glabella-furrows, our species will fail probably. The position of the eyes in each species agrees. There is also fairly close agreement in the dimensions of the two, as will be seen by the measurements of our fossil given below.

Dimensions.—The total length of the whole fossil, cephalon, thorax, and pygidium, and the width between the genal angles are respectively as follows, for three specimens, in mms. — No.1 : 59, 16, 32, 10, 37. No.2 : 73, 18, 39, 16, 40. No.3 : 54, 16, 28, 10, 38. The averages of the three are :—62, 16·6, 30, 12, and 38·5. The dimensions are not greatly different from those given by Mr. Chapman for his species; but the proportionate length of the thoraces in ours seems to be, in every instance, greater relatively to the other parts than in his. The measurement of the specimen No.3 shows its length to be the same as the one Mr. Chapman has used to obtain his dimensions, and illustrates the discrepancies in the proportionate lengths of the parts. In referring to the relationship of our species to *C. incerta*, we omitted to point out above the great difference there is between the glabellæ of the two species. In our species, the length of the glabella is only a little less than its width between the basal or posterior lobes, measured from outside to outside; in *C. incerta*, the width between these same lobes is very much greater than is the length of the glabella. In the glabella of some of our specimens, these measurements are practically equal.

Calymene australis may well be regarded as the typical and most characteristic trilobite of the Bowring Series. It persists from the Lower Trilobite bed to the top of the series; and it may be regarded as typifying the Upper Silurian Formation in

Table showing the resemblances and differences of *C. blumenbachii*, *C. tuberculosa*, and *C. australis*.

Structural Parts.	<i>C. blumenbachii</i> .	<i>C. tuberculosa</i> .	<i>C. australis</i> .
Form (A)	Ovate-oblong.	Broad and depressed.	Ovate or ovate-oblong, sides somewhat straight.
Cephalon (B)	Large and wide, the front sharply semicircular.	Short and wide, roundly semicircular.	Short, widely semicircular, or more correctly semi-elliptic.
Glabella (C)	Large, greatly extended, and always more prominent than the cheeks, bell-shaped, touching the front margin.	Not more prominent than cheeks, narrow, constricted in front, not touching the front margin.	Always a little more prominent on the cheeks, bell-shaped, slightly constricted, not touching the front margin.
Front Margin (D)	Neither produced nor much reflected.	Projecting and recurved, semi-snoutlike.	Projecting, very pig-snouted.
Fixed Cheeks (E)	Not as convex as the glabella.	Gibbous, often more elevated than the glabella.	Gibbous, always less elevated than glabella.
Eyes (F)	Opposite the middle and basal glabella-lobes, and near to the glabella.	Opposite middle lobes of glabella, and at some distance from them.	Opposite middle 2nd and 3rd lobes of glabella, and at some distance from them.
Eye-Battress (G)	Absent.	Present.	Absent.
Free Cheeks (H)	Well bent downwards.	Strongly bent downwards.	Well bent downwards.
Thoracic Axis (I)	As wide as pleurae, not tubercular at bases.	Narrower than pleurae, distally semicircular and tubercular.	Slightly narrower than pleurae, tubercular.
Pygidium (J)	Triangular.	Nearly semicircular.	Subsemicircular or subtriangular, distinctly arched under the terminal piece.
Pygidium (Axis) (K)	Convex, continued by a short appendix to the very end.	Not prominent, and with a terminal boss.	Prominent, strongly arched anteriorly, continued to end by an appendix or boss.
Pygidium (L) (Pleurae)	Five pairs, the last abutting the appendix anteriorly, as wide as the axis, mostly steeply bent down posteriorly.	Six to seven pairs, the last not close to the terminal boss of axis.	Five pairs, the last close to the axial appendix, wider than the axis, steeply bent down, border distinct, arched centrally.

this State equally as well as does *C. blumenbachii* that formation in the British Isles

Loc. and Hor.—Parishes Bowning, Yass, and Derringullen; Counties Harden, Murray, and King. Lower, Middle and Upper Trilobite beds, Bowning and Yass Series.

CALYMENE DUNI, *sp. nov.*

(Plate xxiv., fig. 8; and Plate xxvii., fig. 12).

Obs.—Two specimens of *Calymene*, among those which have come under review, exhibit one or two features so different from those noticed in the foregoing species, that we are compelled to treat them separately. They belong to the *C. blumembachii*-type in possessing the five divisions in the pleuræ of the tail, and the last being parallel with the axial groove. The axis has eight annulations, is very strongly arched, and the bases of annulation are not tuberculated, the arching is apparently highest at the second and third rings and diminishes gradually posteriorly, the last ring is subtended by a subsemicircular piece succeeded by a less prominent area between it and the margin; the axial grooves are wide and shallow, and very distinctly separate the pleuræ from the axis; the pleural divisions are traversed by very wide and moderately deep medial furrows, quite unlike the furrows of any species of *Calymene* known to us, reaching apparently to the border; the body of each pleura, formed by the junction of the divisions, is strong and rounded, without median sutures, though such sutures are quite noticeable between the thoracic somites, which would indicate a very complete anchylosis of the parts. This feature, again, is singular, as far as we are aware. One of the specimens shows, near the distal end of the third and fourth ridges, a bifurcation, or, more correctly, free ends.

The pygidia above described represent very large individuals. The larger one has a length of 36 mm., and the other 27 mm.; one of the axial rings of the former has a length of 8 mm., which would give, for the thorax, a total length of 104 mm.; and, assuming the cephalon to have been half as long again as the pygidium, or 54 mm., the total length of the specimen, to which the larger pygidium belonged, must have had a length of 194 mm., equal to $7\frac{3}{4}$ inches, far exceeding the length of any *Calymene* known to us.

We have no hesitation in giving specific rank to this singular form. Named after Mr. W. S. Dun, Palæontologist, Department of Mines, New South Wales.

Loc. and Hor.—Goodradigbee River, near the Wee Jasper

Crossing (not *in situ*). Parish East Goodradigbee, County Cowley, or Parish West Goodradigbee, County Buccleuch; and from "near Yass," but probably from the black Cave Limestone, Cave Flat, Murrumbidgee, Parish Childowla, County Harden. Probably Upper Silurian.

Genus CHEIRURUS Beyrich, 1845.

(Ueber Böhmischen Trilobiten, 1845, *vide* Barrande).

Section *Crotalocephalus* Salter, 1853.

(Mem. Geol. Survey Gt. Brit., Dec vii (ii.), 1853, p.10).

"Glabella broadest in front, with furrows continuous across. Body rings 11, nodular."

Crotalocephalus was proposed by Salter, in 1853, as a sub-genus, occurring in the Devonian and Upper Silurian. One British species (*C. articulatus* Münster) occurs in the Devonian, and is about half the size of the Bowning form, with a much more rounded frontal lobe, and no dip in the centre of the anterior furrow.

The Bowning fossil is closely allied to three Upper Silurian species — *C. quenstedti* Barr., *C. sternbergi* Boeck, and *C. gibbus* Beyrich — in the divisions of the glabella, and to some extent in its outline. Of the three, it approaches nearest to *C. quenstedti*.

The relation of the Bowning fossil to these really turns on the number of thoracic somites; *C. quenstedti* has 11, *C. gibbus* 9, and, in *C. sternbergi*, the number is unknown. The Bowning species has eleven, and agrees in that with *C. quenstedti*. The pleuræ are quite different from those of either of the above.

History.—The first intimation we possess of the occurrence of this genus in Australia, we owe to Dr. A. R. C. Selwyn, through specimens found by the Geological Survey of Victoria at Keilor, near Melbourne, Yerring on the Upper Yarra, and at Woori-Yallock Creek junction with the Yarra River;* these were doubtless determined by Prof. F. McCoy. Mr. J. W. Salter included the genus in his list of "Fossils of the Southern Districts" of New South Wales as *C. murrayi*.† We do not

* Selwyn, Quart. Journ. Geol. Soc., xiv., 1858, pp.537-8.

† Clarke, S. Goldfields of N. S. Wales, 1860, p.286.

know what this fossil was, but possibly that now dealt with as *Crotalocephalus*. At any rate, it was no doubt intended as a name in honour of Sir Terence Aubrey Murray, Speaker of the Legislative Assembly in 1860-61, and President of the Legislative Council in 1862.

Next on the scene, we have Prof. L. G. de Koninck, who referred a pygidium from Yarralumla to *Cheirurus insignis* Beyrich.* The nearly perfect cephalon, imperfect glabella, and thoracic fragment termed *Cheirurus insignis*, by Mr. C. Jenkins, from his Hume beds of the Yass River,† are in all probability referable to the form herein described as *Crotalocephalus*. Next in order, one of us (J. Mitchell) referred to the occurrence of *Cheirurus* in the Bowring beds.‡ In 1900, R. Etheridge figured a fragmentary glabella from Cooper's Creek, Walhalla, Victoria, after the type of *Crotalocephalus gibbus* Barrande, thus indicating the presence of this section of the genus in Australian rocks.§ In 1908, Mr. F. Chapman referred to two pygidia from the Silurian of Dolodrook River, North Gippsland.|| Again, in 1915, the same author recorded the presence of *Cheirurus sternbergi* from Ruddock's Quarry, near Lilydale, Victoria.¶ This concludes the history of *Cheirurus* in Australia, as far as known to us. The repeated reference to *Cheirurus insignis* is remarkable, because our New South Wales *Cheirurus* is perfectly distinct from that species, and appertains to an entirely different section of the genus. It must be admitted, however, that some of our pygidia bear a strong resemblance to the pygidium of that species.

* De Koninck, Foss. Pal. Nouv. Galles du Sud, Pt. i., 1876, p.48.

† Jenkins, Proc. Linn. Soc. N. S. Wales, iii., Pt.3, 1878, p.217, Pl. 6, fig.8.

‡ Mitchell, Proc. Linn. Soc. N. S. Wales, i., (2nd ser.), 1886, p.1199.

§ Etheridge, Geol. Survey Viet., Monthly Progress Reports, No.11, 1900, p.23.

|| Chapman, Proc. Roy. Soc. Vict., xxi. (N.S.), 1908, p.269.

¶ Chapman, Proc. Roy. Soc. Vict., xxviii. (N.S.), 1915, pp.167-8. Unfortunately this paper of Mr. Chapman's did not come under our notice until after we had completed our paper.

CROTALOCEPHALUS SILVERDALENSIS, *sp.nov.*

(Plate xxiv., fig.10: Plate xxv., figs.1-3 and 9).

Sp. Chars.—Complete form straight-sided, ovate.

Cephalon semicircular and only gently inflated, length a little less than half the width between the genal angles. Glabella subquadrate or subpyriform, large, finely granulate, very moderately tumid, highest centrally between the first and second pairs of lateral furrows: frontal lobe large, spindle-shaped or sub-elliptical, second and third pairs of lobes very openly V-shaped, continuous, basal pair circumscribed, but joined by a low ridge on which are four to six small tubercles: lateral furrows continuous, deep, wide, widely V-shaped; neck-furrow centrally wide and deep, more or less communicating with the third lateral furrows, very narrow behind the basal glabella-lobes; neck-ring wide, strong, centrally arching anteriorly; axial grooves narrow but distinct; fixed cheeks, practically obsolete in front of the eyes, being represented by a very narrow band on which the free cheeks rest, posteriorly large, subtrapezoidal, depressed, beautifully and coarsely punctated; posterior and lateral furrows very distinct; posterior borders strong; genal angles bearing short claw-like spines; eyes small, close to the axial grooves, and opposite the second glabella-lobes; facial sutures from the posterior angles of the eyes run straightly at angles of 75° to 80° with the axial centre-line to the lateral margin, but, anteriorly, they follow the glabella-boundary to the frontal angles, thence inwards and pass out medially: free cheeks have not been found in position.

Thorax quadrate or suboblong, of eleven somites, length about five-sixths of the width between the genal angles, width, inclusive of the spines, equal to the distance between these same angles; depressed, whole surface finely granulate; axis depressed, much wider than the pleural lobes exclusive of the spines, about two-sevenths of the greatest cephalic width; six anterior rings practically equal in width and very slightly wider than the neck-ring, the remainder contracting very gradually to the pygidium, but little arched: the tenth and eleventh more strongly than the rest; axial grooves narrow but distinct: pleural lobes of the

usual Cheirurid type, with strong tubercles on the fulcra, separated from the inner portions by relatively wide and distinct furrows running parallel with the axial grooves, on their outer boundaries these tubercles are bounded by similar but less distinct furrows, distinctly indicating the position of the origin of the spines, which are in length equal to the width of the pleural lobes from which they subtend; they are flat, little or not at all directed backwards, free, gradually tapering to sharp, small, subclaw-like points.

Pygidium.—Not yet found attached; but the following is the description of one associated with the cephalon and thorax above described:—Outline widely triangular, granulate; axis slightly arched, rings three in number and a depressed terminal piece, bounded laterally by a deep sulcus; pleuræ of three segments each bearing spines similar to those of the thoracic pleuræ, but rather more falcate in outline; centrally is a short, flat, rounded spine.

Obs.—The cephalon of this species, as pointed out, approaches more closely in general characters to *C. quenstedti* and *C. gibbus* than to any others we are acquainted with; but, nevertheless, the species is widely different from either of them. The cephalon of our trilobite and that of *C. insignis* are even generically different, but, between the thoraces and pygidia of these species, there is much in common with each other. For instance, the spines of the pleural lobes of both thorax and pygidium are much alike, the width of the thorax including the spines in both is equal to the width of the cephalon between the genal angles, and the spines are very similar; but the differences in the glabella of these two separate them completely, and many less important differences could, were it necessary, be pointed out. It is remarkable that this Bowning fossil, as is also the case with other trilobites from the same area, should possess striking features of structure common to two or more Bohemian species of Cheiruridæ.

Loc. and Hor.—Bowning Creek, Parish Bowning, County Harden; Limestone Creek, Parish Derringullen, County King (J.M.): Hume beds. Parish Yass, County Murray (Jenkins): Bowning Series (Yass-Hume beds). Upper Silurian.

CROTALOCEPHALUS SCULPTUS.

(Plate xxv., figs.4-8).

Obs.—Several heads of *Crotalocephalus* have come under our notice, which disagree with the species above described in having the frontal lobe of the glabella very much larger and more anteriorly produced. The glabella-furrows appear more acutely V-shaped, but, in other respects, they agree with our *C. silverdalensis*.

A portion of a similar cephalon was figured by Mr. Charles Jenkins,* and, associated with this cephalon, occur portions of pygidia, and of a thorax consisting of four conjoined somites. These pygidial fragments agree, in the character of their structure, with each other. The chief features of the thoracic fragments are:—(1) the axis is exceedingly prominent, strongly arched transversely, and forward; (2) axial furrows deep; (3) pleuræ deeply incised by the oblique furrows, and the distal ends of the anterior portions of the segments intensely tuberculate, as are also the fulcral parts; (4) pleural spines longer than the pleuræ, from which they subtend; (5) in the proportions of length of the cephalon to width, across the neck-ring, the two forms materially differ. For instance, three cephalons of *C. silverdalensis* gave the following lengths and widths, respectively—14 : 8, 25 : 15, 35 : 21; and the only complete cephalon of *C. sculptus* yielded 31 : 15 for the same parts. In the one case, the length is much less than double the width, and, in the other, practically just double the width of the neck-ring. These differences lead us to give specific rank to the form.

Loc. and Hor.—Bowning Creek, Parish Bowning, County Harden: Hume beds. Parish Warroo, County Murray (Jenkins): Lower Trilobite Beds. Upper Silurian.

CROTALOCÆPHALUS (?) sp.

A very fine cephalon, minus the free cheeks, has been brought under our notice by Mr. C. Süßmilch, Principal of the Newcastle Technical College, and collected by him from the Molong Lime-

* Jenkins, Proc. Linn. Soc. N. S. Wales, iii., Pt. 1, 1878, Pl. 6, fig. 5.

stone, Parish Bell, County Ashburnham, where it was associated with *Bronteus angusticaudatus*. It appears to be more closely related to *Urotalocephalus (Cheirurus) sternbergi* Boeck, than to any other known to us, though there appear to be some differences between it and that species, which lead us to defer our determination for the present. For instance, the glabella of *C. sternbergi* has its greatest width across the frontal lobe; in the present form the greatest glabella-width is across the second lobe. The proportions of the length of the cephalon to the greatest transverse width of the frontal glabella-lobe, as shown by measurements made of two cephala of *C. sternbergi* figured by Barrande,* are respectively, 21:17, and 27:21 mm.; and, for the Molong species, the proportions are, 18:10. These proportions of the two widely differ. The ornamentation of the fixed cheeks of the Molong specimen is finer and more granulate than that of the free cheeks of *C. sternbergi*, and approaches, in character, nearer to the ornamentation on the similar parts of *Ch. insignis* Barr. The Molong form, too, seems to have borne short genal spines, resembling those of *Ch. insignis* rather than *C. sternbergi*. The subparallel-sided glabella, fixed cheek ornamentation, narrow frontal glabella-lobe, and the transversely nearly straight course of first and second glabella-furrows serve to separate the Molong from the Bowring forms.

Genus SPHÆROXOCHUS Beyrich, 1845.

(Ueber Böhmischen Trilobiten, 1845, p.21, *vide* Salter).

History.—Dr. A. R. C. Selwyn was the first to record the occurrence of this interesting genus in Australia. Specimens were found by the Geological Survey of Victoria at the junction of Woori-Yallock Creek with the Yarra River.† In New South Wales, Mr. C. Jenkins had the honour of announcing its first discovery. He figured a remarkably good example, presumably from the Yass-Hume beds.‡ He remarks: "The *Sphærocochus* is almost identical with *Sphærocochus* as figured by Murchison."

* Barrande, Syst. Sil. Bohême.

† Selwyn, Quart. Journ. Geol. Soc., xiv., 1858, p.538.

‡ Jenkins, Proc. Linn. Soc. N. S. Wales, iii., Pt.1, 1878, pp.26-27, Pl.6, fig.2.



Subsequently one of us announced the occurrence of *Sphærexochus mirus* in the Bowning beds.*

SPHÆREXOCHUS MIRUS Beyrich.

(Plate xxvi., figs. 1-5).

S. mirus Beyrich, Ueber Böhmischen Trilobiten, 1845, p. 21, *vide* Salter. *S. mirus* Salter, Mon. Brit. Trilobites, Pt. i., 1864, p. 76, Pl. vi., fig. 6.

Obs.—In the Bowning and Yass specimens, we cannot detect any characters by which they can be separated from the widely distributed *S. mirus*; and as this fossil has already been fully described by the able palæontologists referred to above, we think it unnecessary to give any further details of its specific features, which may be observed in the figures of the local representative fossils illustrating this paper. Mr. Johannes Nieszkowski proposed a classification of the species known up to the time he wrote, in accordance with the degree of development of the glabella-furrows.† *S. mirus* falls within his first section, “posterior lateral furrows opening into the neck-furrow.”

Loc. and Hor.—Bowing Creek, Parish Bowning, County Harden; Limestone Creek and Derringullen Creek, Parish Derringullen, County King (Mitchell): Yass and Hume beds. Parishes Yass and Hume, County King: Middle Limestone and Lower Trilobite beds of the Bowning and Yass Series. Upper Silurian.

Genus STAUROCEPHALUS Barrande.

(Notice préliminaire Syst. Sil. Trilobites Bohême, 1846, p. 52).

History.—Prof. de Koninck recorded what he believed to be a *Staurocephalus*, from Rock Flat Creek, near Cooma § The next record was by one of us.‡ Subsequently, Mr. F. Ratte described and figured several specimens from Bowning, which he compared with *Staurocephalus purchisoni*.

* Mitchell, Proc. Linn. Soc. N. S. Wales, i. (2nd ser.), 1886, p. 1203.

† Nieszkowski, Archiv Naturkunde Liv.-Ehst.-Kurland, i. (1), 1857, p. 596.

§ De Koninck, Foss. Pal. Nouv. Galles du Sud. Pt. i., 1876, p. 47, Pl. i., figs. 13 and 13a.

‡ Mitchell, Proc. Linn. Soc. N. S. Wales, i. (2nd ser.), 1886, p. 1199.

STAUROCEPHALUS MURCHISONI Barrande.

(Plate xxvii, figs.6-11 and 13).

S. murchisoni Barrande, *loc. cit.*, p.53; Syst. Sil. Bohême, 1 te. pt., i., 1852, Pl.43, figs.28-32; Salter, Mon. Brit. Trilobites, Pt. i., 1864, p.84, Pl. vii., figs.13-20. *Staurocephalus* near *S. murchisoni* Ratte, Proc. Linn. Soc. N. S. Wales, ii. (2nd ser.), Pt. i., 1887, p.100, Pl. ii., figs.5-9.

Obs.—After careful examination of numerous specimens of *Staurocephalus* from Bowning, we are unable to separate our species from *S. murchisoni*. In some of the figures of this species given by Salter (*loc. cit.* above), the free cheeks are shown to join the glabella anteriorly just behind the glabella frontal lobe. In one figure, however, it is shown to junction much in advance of this, and well on the globular front lobe. This latter seems to be the manner in which the free cheeks are attached in the Bowning species. The pleural appendages, both of the thorax and pygidium, in ours are similar to those of the same parts of the European *S. murchisoni*, but those borne by the pygidial pleura, if truly represented by Salter, are somewhat longer than they are in the Bowning specimens. The dimensions of the European and New South Wales forms agree.

Loc. and Hor.—Bowing Creek, Parish Bowning, County Harden: Lower Trilobite Bed, Bowning Series (Yass-Hume Beds). Upper Silurian.

STAUROCEPHALUS(?) CLARKII De Koninck.

S. clarkii De Koninck, Foss. Pal. Nouv. Galles du Sud, Pt. i., 1876, p.47, Pl. i., figs.13, 13a.

Obs.—We have never seen a New South Wales trilobite approaching De Koninck's figures, portion of a cephalon and a pygidium. If a *Staurocephalus*, it is certainly a very abnormal species. With the Upper Silurian *S. murchisoni*, these portions have no relation, but *S. (?) unicus* Wy. Thomson,* has somewhat similar glabella-furrows, although only two, instead of three, as in the present instance, but there the difference ends. The pygidium associated with this fragmentary glabella is quite unlike that of

* Salter, Mon. Brit. Trilobites, Pt. i., 1864, Pl. vi., figs.22a and c.

Staurocephalus, and resembles more that of the genus *Deiphon* than it does the tail of any other trilobite known to us.

Genus HARPES Goldfuss, 1839.

(Nova Acta Phys. Med. Acad. Cesareæ Leop. Carol. Nat. Curios.,
xix., Pt. 1, 1839, p.358).

History.—We know of only two previous references to this genus in Australia, that of de Koninck,* who gave Boree Cavern as a locality for *Harpes unguis* Sternberg, but as neither description nor figure accompany the statement, it is impossible to check the determination. In 1886, one of us recorded the occurrence of the genus in the Bowning beds.†

HARPES TRINUCLEOIDES‡ *sp. nov.*

(Plate xxvii, figs. 2-5.)

Sp. Chars.—Complete form oval.

Cephalon approximately semicircular, and generally agreeing with that of *Harpes unguis* Sternb., but always less tumid. Glabella relatively small, conoid, rather parallel-sided, moderately arched and tumid; basal pair of furrows faintly shown; basal lobes bordered by sulci arching out of the axial furrows in front and returning into them behind; neck-furrow and ring weak; cheeks moderately inflated, lower or basal half finely granulated and irregularly striated, upper surface so finely granulated that it might be termed smooth; eyes small, almost level with the front of the glabella, joined to the axial grooves by narrow, shallow sulci; axial furrows distinct, anteriorly and posteriorly interrupted by the basal glabella-lobes; limb flat, long, wide, the produced horns tapering to a point, pitted and granulated, outer margin thickened and narrow, joined to the glabella and cheeks by stitch-like seams.

Thorax subfusiform, depressed, smooth, or microscopically granulated; greatest number of somites yet observed, twenty-two; axis prominent, origin of each arch distinctly tuberculate, taper-

* De Koninck, Foss. Pal. Nouv. Galles du Sud, Pt. i., 1876, p.59.

† Mitchell, Proc. Linn. Soc. N. S. Wales, i. (2nd ser.), Pt. 4, 1886, p.119.

‡ Resembling the genus *Trinucleus*.

ing very gradually posteriorly; pleuræ flat, extremity of each segment sharply depressed, free and claw-like.

Pygidium exceedingly small, the largest that has come under our notice being not more than $1\frac{1}{4}$ mm. in length, and $2\frac{1}{2}$ mm. wide; axis distinct, but not quite reaching the margin, two rings present, side-lobes with three pleuræ in adult specimens.

Obs —This fossil very closely resembles *Harpes unguia*, and it was with some degree of hesitation that we decided to give it full specific rank. The features on which we rely to justify this course are —(1) the thoracic somites of our species, in any of the numerous specimens which have come under our notice, have not exceeded twenty-two; (2) the relatively small size of the glabella; (3) the greater length of the horns of the limb or border, and their extension, in specimens of those which had not reached maturity, beyond the end of the pygidium, and approximately to the end of the thorax in those which had reached that condition; (4) in our species, a sulcus joins each eye with the axial furrow, but, in *Harpes unguia*, a ridge is said to serve this purpose; (5) the arching of the glabella is low and convex. The largest specimens just exceed an inch in length, with a width of thirteen-sixteenths of an inch.

Loc. and Hor. —Bowning Creek, Parish Bowning, County Harden: Lower Trilobite Bed. Upper Silurian.

CERATOCEPHALA Warder, 1838.

(See Proc. Linn. Soc. N. S. Wales, 1896, xxi., Pt.4, p.707).

Subgenus BOUNYONGIA,* *s.g.nov.*

The trilobite which serves us for the type of this subgenus differs from others known to us in having a pair of cephalic spines originating on the glabella in front of the neck-ring, and it is this feature on which we found the subgenus. It may also be noted that the eyes are apparently pedunculate, overhanging the cheeks somewhat, and directed outwards at an angle of about 45° .

* Bounyong is the Aborigines' name of Bowning.

BOUNYONGIA BOWNINGENSIS, *sp.nov.*

(Plate xxvi., figs. 12, 13; Plate xxvii., fig. 14.)

Whole form unknown.

Var. Chars.—*Cephalon* sub-oblong, moderately inflated, very finely granulated with large tubercles sparsely and regularly distributed, approximately half as long as wide; glabella moderately inflated, highest medially, sloping rapidly anteriorly, less so posteriorly; axial grooves shallow, indistinct; neck-furrow indefinite; neck-ring narrow and indefinite, but subtuberculate at the bases; fixed cheeks large, rather flat, false lateral lobes, and furrows indistinct; ocular ridges and palpebral furrows present; genal spines long and falcate; free cheeks small, ankylosed to the fixed cheek; eyes small, slightly pedunculate, obliquely directed outwards, and overhanging the free cheeks.

Thorax unknown in the complete state; axis slightly arched transversely and longitudinally, bases of rings tuberculate and joint-like; axial furrows shallow and wide; pleuræ flat, about half as wide as the axis, finely granulate, each pleura bearing, on its inner posterior angle, a prominent tubercle adjacent to the axial groove, and another at the distal end; apparently bispinate, spines themselves also spinate.

Pygidium unknown.

Obs.—This is a rare trilobite apparently, as only two fragmental specimens are known. The glabella and lobes, or false lobes, resemble those of *Ceratocephala longispina*; but here the resemblance between them ceases, and to no other known to us does the cephalon bear any marked likeness. In the possession of articular-like bases to the axial rings, and the wide, flat, tuberculate pleural segments and barbed spines, this new type bears a strong resemblance to *C. rogersi*; but the cephalon is quite different. It is unnecessary to compare it with any other Odontopleurid that has come under our notice.

Loc. and Hor.—Bowning Creek, Parish Bowning, County Harden: Lower Trilobite bed, Bowning Series (Yass and Hume beds). Upper Silurian.

Genus BRONTEUS Goldfuss, 1839.

(Nova Acta Phys. Med. Acad. Cæsareæ Carol. Nat. Curios., xix., Pt.1, 1839, p.360).

History.—The first recognition of *Bronteus* in Australia was another of Mr. Salter's determinations.* Nothing further seems to have eventuated until De Koninck investigated the Clarke Collection. He described a new form as *B. goniopeltis*, and referred a second to *B. partschi* Barr., from "Boree Cavern." Jenkins reported the discovery of a large individual in his Hume beds in 1878. and subsequently described and figured it in the same year. He did not apply a name, but the figures are good, and, with the assistance of specimens, enabled us to describe it in 1890 as *B. jenkinsi*. In the meantime, J. Mitchell had described a small Bowring form as *B. longispinifer*.† In 1890, the description of a very large but ill-preserved pygidium by R. Etheridge appeared,‡ found by Mr. G. Sweet at Delatite, Victoria; this was named *B.(?) enormis*. A record of two species from the Lilydale Limestone by Mr. F. Chapman, one allied to *B. oblongus* Barr., and the other to *B. formosus* Barr.,§ described in 1915, under the name of *Goldius greenii* and *G. cresswelli* from Ruddock's Quarry, near Lilydale, and Cooper's Creek, Victoria, respectively,|| concludes the history of *Bronteus* in Australia.

Corda divided this family into three sections.¶ The reasons advanced for these divisions have been considered by us, and we have elected to follow the example of Barrande, and reject them. We are, however, inclined to the opinion that Brontei might be divided into sections, with some advantage to Science, but it is questionable whether slight pygidial variations alone are sufficient grounds on which to form subgenera.

* Clarke, Southern Gold Fields N. S. Wales, 1860, p.286.

† For etymological reasons, we suggest a slight alteration in the specific name of this well-marked Brontens, viz., *B. longispinosus*.

‡ Etheridge, Proc. Roy. Soc. Viet., v. (N.S.), 1893, p.189, Pl. xi.

§ Chapman, Report Austr. Assoc. Adv. Sci., xiv., 1913, p.228.

|| Chapman, Proc. Roy. Soc. Viet., xxviii. (N.S.), 1915, pp.159 and 160, Pl. xiv., figs.1, 2, 3, and Plate xvi., fig.17.

¶ Corda, Prod. Mon. Böhmischen Trilobiten, 1847, pp.57, 58.

We also refuse to accept Mr Chapman's substitution of *Goldius* for *Bronteus*, believing the latter to be too deeply engraven in palaeontological literature for replacement by any other term, even if possessing priority.

BRONTEUS MESEMBRINUS, * *sp. nov.*

(Plate xxvi., fig. 7.)

Sp. Chars.—*Pygidium* subsemicircular, sides rather straight for two thirds of length; most tumid centrally, and becoming flat to slightly concave towards the border; articulating face straight, forming the greatest pygidial width; surface tuberculated and striated; axis dome-shaped, moderately tumid, wider than the pleural lobes, articulating ring strong; coarsely and irregularly tuberculate; axial furrow faint, and not continuous behind; pleuræ strongly ridged along the inner edges except in the case of the median one, in which the ridge is central; ridges strongly tuberculate, and most pronounced towards the middle of their length, disappearing just before the border is reached; the first rib of each lobe and the medial one are straight, the others have a gentle curve.

Obs.—The only other tuberculate pygidium of a *Bronteus* occurring in Australia, known to us, is that of *Bronteus longispinosus* Mitchell, but it so widely differs from this one, that to compare them is not necessary. This pygidium is also widely separated from the typical Devonian *Bronteus flabellifer*, as well as from all others known to us.

Since writing the above, Mr. Chapman's description and figure of *B. (Goldius) cresswelli* have come under our notice (*loc. cit., ante*). The two species are apparently so dissimilar, that a detail of their relationship also appears unnecessary. We may point out, however, that, in the text, *B. (Goldius) cresswelli* is said to have only six ribs on each side of the central one of the pygidium; but his figure shows seven. Which is correct?

Loc. and Hor.—Molong, Parish Bell, County Ashburnham; limestone-beds adjacent to Molong. (?) Upper Silurian.

* *μεσημβρινός* = southern.

BRONTEUS BOWNINGENSIS, *sp.nov.*

(Plate xxvi, fig.6.)

Sp. Chars.—*Pygidium*: exact shape unknown; type-specimen smooth, but there is faint evidence of sparse granulation, the characteristic striation of the Bronteidæ distinct (especially on the axis and central rib), flat, hardly at all tumid; articulating border straight, and apparently forming the line of greatest width: axis truncate-pyramidal, slightly tumid and distinctly trilobed, less wide than the pleural lobes, articulating ring narrow; axial grooves shallow, distinct and continuous along each side of the central rib; pleuræ flat, wide, separated by relatively narrow sulci, four on each side of central one, ridged near their origin, central one wide, flat, and depressed

Obs.—This pygidium, though very imperfect, exhibits features so very different from all other Australian *Brontei* known to us, that it is needless to discuss them; and it stands apart from all foreign species with which we have been able to compare it. For this reason, we venture to give it specific rank.

Loc. and Hor.—Parish Bowning, County Harden: Upper Tri-lobite beds, Bowning Series. Upper Silurian.

BRONTEUS MOLONGENSIS, *sp.nov.*

(Plate xxvi., fig.8.)

Cephalon and thorax unknown.

Sp. Chars.—*Pygidium* sub-semielliptic, width 36 mm., length 29 mm., surface smooth, bearing numerous very fine, subconcentric, anastomosing lines: greatest width at one-third of total length from the articulating border, which is straight, 28 mm. long, its outer angles rounded; axis(rudimentary) widely triangular, rather strongly inflated, trilobed, central lobe strongly arched: axial furrow shallow, and practically interrupted by the central rib, which bifurcates at a point nearly two-thirds of the length from the articulating border; this central ridge or extension of the axis is distinctly arched and slightly more prominent between the rudimentary axis and point of bifurcation, than are the pleural ribs; the pleuræ are divided into segments or ribs, these are moderately rounded, wide and separated by well-defined furrows nar-

rower than the raised medial parts: both ridges and furrows disappear just before reaching the margin: the first lobe of each pleura is distinctly falcate and wider than the others, the second is slightly falcate, the others are straight.

Obs.—This is the first *Bronteus* with a bifurcate central pygidial rib to be described from New South Wales. It resembles, in some features, *B. palifer* Barr., *B. angusticeps* Barr., and *B. transversus* Barr. With the first of these, it agrees in the character of the pleural ribs, in having the axis wider than the pleuræ, wide valleys between the ribs, and in the trilobation of the rudimentary axis: but differs from it in having the bifurcate portion relatively much shorter, the lower portion concave, and in contour, &c. With *B. angusticeps*, it agrees in the character of the articulating border, and the pleural segments, but differs in having a much longer bifurcation of the central ridge or rib, stronger pleuræ, and the axis wider than the pleuræ. *B. transversus* Barr., agrees with our species in contour, trilobation of the axis, and in the relative length of the bifurcation of the central rib, though this does not appear to be as long as it is in ours. The axis in *B. transversus* is narrower than the pleuræ, and the whole tail is flat, instead of being inflated in the anterior half and concave in the posterior portion, as is the case with ours; but, between that and the present fossil, there is little other relationship.

Loc. and Hor.—Molong, Parish Bell, County Ashburnham: Molong Limestone. (?)Upper Silurian.

BRONTEUS ANGUSTICAUDATUS, *sp. nov.*

(Plate xxvi., figs. 9, 10.)

Sp. Chars.—*Pygidium*: length and width practically equal, upper surface smooth, undersurface distinctly covered with concentric striæ, gently convex medially and subconcave towards the margin: axis ill-defined, gently tumid; axial grooves very faint; articular border straight, reaching nearly to the lateral angles, which are slightly rounded; pleuræ consist of six ribs on each side of the central one, separated by distinct sulci, less than half the width of the ribs, and becoming effaced just before reaching the margin;

all the ribs are gently convex, but vanish before the margin is reached, thus forming a well-defined border.

Obs.—This pygidium is clearly separable from all other similar portions of *Brontei*, except Chapman's *Bronteus (Goldius) cresswelli*,* but this belongs to a different type—tuberculate. Its narrow and elongate shape makes it quite singular.

We are indebted to Mr. C. Süssmilch for the privilege of describing this species.

Loc. and Hor.—Oakly Creek, Parish Barton, County Ashburnham (Süssmilch). (?) Upper Silurian.

Genus *LICHAS* Dalman, 1826.

(Kongl. Vet. Akad. Handl. Stockholm, 1826, p.278.)

History.—Hitherto *Lichas* has been represented in Australia by two well-marked species—*L. australis* McCoy, and *L. palmata* var. *sinuata* Ratte, to which may be added an indicated species by de Koninck.

The first of these was described by Sir F. McCoy in 1876, from specimens from the Upper Silurian rocks at the junction of the Woori-Yallock Creek and Yarra River. Mr. Ratte's trilobite, originally figured as *L. sinuata*, is of great interest from its locality. Ratte remarked on its close relation to the Bohemian *L. palmata* Barr., and, in a subsequent paper, adopted Barrande's specific name, adding his own in a varietal sense.

De Koninck's *Lichas*, from Rock Flat Creek, which takes its place as the second reference in chronological order, was too imperfect for determination, but on account of the irregularity of its general sculpture, he also called attention to *L. palmata*. One of us recorded, in error, the occurrence of *Lichas* from the Bowning area (*loc. cit., ante*).

Mr. F. Chapman records *L. australis* in his list of Victorian Trilobites.†

Section *ACANTHOPYGÆ* Corda, 1847.

(Prod. Mon. Böhmischen Trilobiten, 1847, p.144).

One segmental lobe on each side of the glabella.

* Chapman, Proc. Roy. Soc. Vict., xxviii. (N.S.), Pt.1, 1915, p.160, Pl. 16, fig.17.

† Chapman, Report Austr. Assoc. Adv. Sci., xiv., 1913, p.229.

ACANTHOPYGE AUSTRALIS McCoy, sp.

Lichas australis McCoy, Geol. Survey Vict., Dec. iii., 1876, p.18, Pl. xxii., fig.11.

Obs.—McCoy pointed out the near relation of this, *C. haueri* Barr., a Bohemian species.

Loc. and Hor.—Junction of Woori-Yallock Creek with Yarra River, Victoria. Upper Silurian (National Museum, Melbourne).

Section CORYDOCEPHALUS Corda, 1847.

(Prod. Mon. Böhmischen Trilobiten, 1847, p.139).

Two highly segmental lobes on each side of the glabella.

CORYDOCEPHALUS PALMATA var. SINUATA Ratte.

Lichas sinuata Ratte, Proc. Linn. Soc. N. S. Wales, i. (2), Pt. iv., p.1065, 1887, Pl. xv., fig.15. *Lichas palmata* var. *sinuata* Ratte, *loc. cit.*, ii. (2), Pt. i., p.95, Pl. i., fig 6.

Obs.—The name given by Mr. Ratte was founded on a pygidium figured but hardly described. He contented himself with calling attention to its resemblance to the pygidium of *Lichas palmata* Barr., in consequence of the existence of "deep sinuses situated at the posterior angles of the four lateral ribs of the pygidium." *Lichas palmata* Barr., clearly falls within the Section *Corydocephalus* Corda, but until the remainder of Ratte's trilobite is discovered, the reference of the pygidium in question to this section must be regarded as purely provisional. At the same time, it is of considerable interest to us, being one of the few trilobites from any of our Cave limestones.

De Koninck's ill-preserved *Lichas* from Rock Flat Creek* may belong here.

Loc. and Hor.—Wellington Caves, N. S. Wales. (b)Upper Silurian (Australian Museum).

APPENDIX.

Genus TRINUCLEUS Lhud, 1699.

(Lith. Brit. Ichnographia, 1699, p.52).

Obs.—"At Burrageood," said Clarke, "the genera of Trilobites

* De Koninck, Foss. Pal. Nouv. Galles du Sud, Pt. i., 1876, p.57.

are chiefly *Trinuclens* and *Asaphus*. Mr. Macleay has done me the honour of calling one of the former after its finder, *T. Clarkei*." Again:—"The existence of Trinuclei at Yarralumla, and especially of one species which I cannot separate from *T. Caractaci*, is an important fact which must not be lost sight of."*

We have never had the good fortune to see an example of this interesting genus from the Silurian rocks of the Continent, but the thought has on several occasions crossed our minds, whether or no examples of *Harpes* were mistaken for it by Messrs Clarke and Macleay.

Genus *ASAPHUS* Brongniart, 1822.

(Hist. Nat. Crust. Foss., 1822, p.17).

Obs.—Beyond Clarke's casual remark quoted above, nothing is known of the presence of this genus in the Silurian rocks of Australia, but from the "Despatch Limestone" of Zeehan, Tasmania, a single small pygidium was obtained "sufficiently well preserved to show the presence of the genus in these rocks, and no more."†

Genus *AMPHION* Pander, 1831.

(Beiträge Geog. Russisch. Reiches, 1831, p.139).

Obs.—Under the name of *A. (?) brevispinus*, one of us described two small pygidia from the "Despatch Limestone" at Zeehan, Tasmania, believed to be allied to the British *A. pseudoarticulatus* Portlock.‡ The genus is unknown in Australia.

Genus *ILLÆNUS* Dalman, 1826.

(Kongl. Vet. Akad. Handl. Stockholm, 1826, p.248).

History.—The history of this genus is comprised within that of two species, one purely Australian, the other both Australian and Tasmanian. The former is a pygidium recorded by De Koninck from "Boree Cavern," provisionally referred to *I. wahlenbergi* Barr.§ The second species, *I. johnstoni*, was established

* Clarke, Quart. Journ. Geol. Soc., iv., 1848, pp.64, 66.

† Etheridge, Tasmania, Rept. Secy. Mines for 1895-6 (1896), p. xiii., Pl. fig.2.

‡ Etheridge, Tasmania. Rept. Secy. Mines for 1895-6.

§ De Koninck, Foss. Pal. Nouv. Galles du Sud, Pt. 1, 1176, p.46.

in the first instance for a cephalon occurring again in the "Despatch Limestone" at Zeehan,* and the name adopted for another cephalon from near Orange.†

Genus HOMALONOTUS Koenig, 1820.

(Icones Foss. Sectiles, 1820, p.4).

History.—To Mr. T. Harrison, we owe the first notice of this genus in Australia, as *Homalonotus delphinocephalus*, presumably of Green,‡ and found at Moonee Ponds, near Melbourne. This was subsequently described by Prof. McCoy as *H. harrisoni*§ at the same time he referred to its close relation to the American and European *H. delphinocephalus* Green, but gives a different locality—"Royal Park, Flemington." It appertains to the Section *Trimerus* Green.||

Mr. C. Jenkins mentioned *Homalonotus* as one of the trilobites occurring in the Hume beds of the Yass River,¶ but which is not of the characteristic type. Although the figure given is very unsatisfactory, we venture to suggest that it represents a Pteropod, of the Bowring beds, and not the remains of a trilobite at all.

Mr. F. Chapman described and figured a *Homalonotus* under the name *H. vomer*,** from Wandong, Victoria.

In New South Wales, we have never met with a specimen which could with certainty be referred to this genus. One of us (Mitchell) saw the original fossil referred to *Homalonotus*, and figured by Jenkins (*loc. cit.*), but cannot confirm the determination.

Genus ONYCHOPYGE H. Woodward, 1880.

(Geol. Mag., vii., dec. ii., 1880, p.97).

Under the name of *Onychopyge liversidgei*, Dr. H. Woodward

* Etheridge, Tasmania. Rept. Secy. Mines for 1895-6 (1896), p. xiv., Pl. fig.3.

† Etheridge, Rec. Geol. Survey N. S. Wales, viii., Pt. 4, p.319, figs.1, 2.

‡ Harrison, Trans. Roy. Soc. Viet., vii., 1866, p.17.

§ McCoy, Geol. Survey Vict., Dec. iii., 1876, p.19, Pl. xxiii., fig.11.

Green, Mon. Tril. N. America, 1832.

¶ Jenkins, Proc. Linn. Soc. N. S. Wales, iii., Pt. i., 1878, pp. 26, 30 : *ibid.*, Pt. iii., 1878, p.221, Pl.17, fig.1.

** Chapman, Proc. Roy. Soc. Viet., xxiv. (N.S.), Pt. ii., 1911, pp.298-9, Pl. lii., figs.2, 3.

described a new and remarkable trilobite from the Bombala District of New South Wales, probably of Silurian age. The material used by Dr. Woodward, for his description of this new form, was brought under his notice by one of us (Etheridge), but no specimen of the above has since been seen.

Genus *NOTASAPHUS* J. W. Gregory, 1903.

(Proc. Roy. Soc. Vict., xv. (N.S.), Pt. ii., 1903, p.155).

Prof. J. W. Gregory described one form of this new genus under the name *Notasaphus fergusonii*. This is unknown to us as a New South Wales species.

Genus *CYPHASPIS* Burmeister, 1843.

(Organ. Trilobiten, 1843, p.103).

CYPHASPIS LILYDALENSIS Chapman.

Cyphaspis lilydalensis Chapman, Proc. Roy. Soc. Vict., xxviii. (N.S.), Pt. i., 1915, p.163, Pl. xix., fig.6, and Pl. xvi., fig.19.

Wilson's Quarry, near Lilydale, Victoria. Not known to occur in New South Wales.

Genus *PROETUS* Steininger.

(Mém. Soc. Geol. France, i., p.355).

PROETUS (FORBESIA) EURYCEPS McCoy.

Forbesia euryceps McCoy, Prod. Pal. Vict., Dec. iii., 1876, p.17, Pl. xxii., figs.10, 10a.

Proetus euryceps Chapman, Proc. Roy. Soc. Vict., xxviii.(N.S.), Pt. i, 1915, p.161, Pl. xiv., fig.4.

Not known to us from New South Wales.

EXPLANATION OF PLATES XXIV.-XXVII.

Plate xxiv.

Calymene australis E. & M.

Fig.1.—A nearly perfect specimen, except for the absence of the free cheeks, showing the four lateral glabella-furrows, and the nodules of the axial rings very distinctly.

Fig.2.—An almost perfect cephalon, showing the four lateral furrows of the glabella, position of the eyes, facial sutures, and the normal outline; (slightly less than natural size).

Fig.3.—Another cephalon with the free cheek in position, exhibiting well the pig-snouted labrum, etc.; (reduced).

Fig.4.—Cephalon without the free cheeks, showing a rather thin and straight frontal border.

Fig.5.—Cephalon with the test preserved, exhibiting the granulation: (reduced).

Fig.6.—Portion of a cephalon showing the four lateral glabella-furrows: (reduced).

Fig.7.—Pygidium showing the normal form, the strong arching of the anterior axial rings, the arching imargination centrally in the posterior border, and granulation.

Calymene duni E. & M.

Fig.8.—A very large pygidium with a few somites attached, showing well the features referred to in the text.

Calymene australis E. & M.

Fig.9.—A perfect specimen contorted and flattened, showing subquadrate or subfusiform shape assumed by the pygidium when it has been depressed by pressure.

Crotalocephalus silvertalensis E. & M.

Fig.10.—Fragmentary pygidium of a *Crotalocephalus*, assumed to belong to this species.

(Photos by C. Clutton.)

Plate xxv.

Crotalocephalus silvertalensis E. & M.

Fig.1.—A fairly good cephalon and thorax of a specimen, three-fourths mature, exhibiting, on the right, genal spine and general features of those parts. (Coll. Mitchell).

Fig.2.—Portion of a cephalon of a mature individual, which probably had a length of 10 cm. (Coll. Mitchell).

Fig.3.—A well-preserved, perfect cephalon, except for the absence of the free cheeks. (Coll. Mitchell).

Crotalocephalus sculptus E. & M.

Fig.4.—Almost complete pygidium. Probably the one figured by Jenkins. (Coll. Sydney University).

Fig.5.—Four somites of a thorax exhibiting the rugged sculpturing, the strongly arched axial rings, and some of the pleural spines very clearly. (Coll. Mitchell).

Fig.6.—An imperfect pygidium showing one perfect pleural spine.

Figs.7, 8.—Imperfect cephalons, assumed to belong to the same species as represented by Figs.4, 5, and 6. (Coll. Mitchell).

Crotalocephalus silvertalensis E. & M.

Fig.9.—A squeeze from the cover of Fig.1, showing the ornamentation on the fixed cheeks very plainly. (Coll. Mitchell).

(Photos by C. Clutton.)

Plate xxvi.

Sphaerocochus mirus Beyrich.

- Fig. 1.—A small, nearly complete specimen. (Coll. Sydney University).
This is probably the specimen figured by C. Jenkins (*loc. cit.*, ante).
- Fig. 2.—Thorax and pygidium, with a detached free cheek and hypostome on the right. (Coll. Mitchell).
- Fig. 3.—A rather imperfect individual. (Coll. Mitchell).
- Fig. 4.—A rather large cephalon; depressed. (Coll. Mitchell).
- Fig. 5.—Cephalon exhibiting normal tumidity.

Bronteus howningensis E. & M.

- Fig. 6.—Imperfect pygidium, showing specific features very clearly. (Coll. Mitchell).

Bronteus mesebrinus E. & M.

- Fig. 7.—A complete pygidium. (Coll. Mitchell).

Bronteus molonyensis E. & M.

- Fig. 8.—Pygidium almost complete. (Coll. Mitchell).

Bronteus angusticaudatus E. & M.

- Fig. 9.—Portion of a pygidium, showing the ill-defined axis, axial furrows, and pleural features very well. (Coll. Sydney Technical College).
- Fig. 10.—The complete pygidium with only a part of the test on, exhibiting the relatively long and narrow outline. (Coll. Sydney Technical College).

Crotalocephalus sculptus E. & M.

- Fig. 11.—Cephalon without free cheeks. (Coll. Sydney Technical College).

Bouyongia howningensis E. & M.

- Fig. 12.—A nearly perfect head, and portions of five somites of the thorax. The head shows the two tuberculate spine-scars in front of the neck-ring, and other specific features. (Coll. Mitchell).
- Fig. 13.—A younger specimen, showing neck-ring and furrow plainly, and the obsolescence of the latter medially. Features have been inked in. (Coll. Mitchell).

(Photos by C. Clutton and J. Mitchell).

Plate xxvii.

Calymene australis E. & M.

- Fig. 1.—A specimen showing the nodules at the bases of the axial rings very distinctly. (Coll. Mitchell).

Harpes trinucleoides E. & M.

- Fig. 2.—A very fine, mature specimen, showing twenty to twenty-one somites; ($\times \frac{1}{2}$). (Coll. Mitchell).
- Fig. 3.—Cephalon showing the eyes, glabella, and ornamentation very clearly under magnifying glass; (slightly enlarged). (Coll. Mitchell).

Fig. 4.—A complete individual, except for the absence of tail, showing the genal horns reaching beyond the tail; ($\times \frac{1}{7}$; about). (Coll. Mitchell).

Fig. 5.—A very fine fragment showing twenty-one somites on the thorax; ($\times \frac{1}{7}$; about). (Coll. Mitchell).

Staurocephalus murchisoni Barr.

Fig. 6.—Cephalon of a mature specimen, showing the ornamentation distinctly; ($\times \frac{3}{2}$). (Coll. Mitchell).

Fig. 7.—Cephalon and thorax. Cephalon incomplete. (Coll. Mitchell).

Fig. 8.—Thorax and pygidium, showing structural features very clearly; (enlarged). (Coll. Mitchell).

Fig. 9.—Cephalon nearly perfect, showing ornamentation of the frontal lobe of the glabella; (slightly enlarged). (Coll. Mitchell).

Fig. 10.—A drawing of the specimen represented in figure 9; (much enlarged). (Coll. Mitchell).

Fig. 11.—A nearly perfect specimen; (much enlarged). (Coll. Mitchell).

Calymene duni E. & M.

Fig. 12.—A nearly perfect pygidium, showing the bifurcate distal end of the pleural ribs, etc. (Coll. Geological and Mining Museum, Dept. of Mines, Sydney).

Staurocephalus murchisoni Barr.

Fig. 13.—Almost perfect specimen; (slightly enlarged). Fig. 11 is an enlarged drawing.

Bowonygia bowningensis E. & M.

Fig. 14.—A photo, in which the features are intensified and restored.

(Photos by C. Clutton and J. Mitchell).

ORDINARY MONTHLY MEETING.

OCTOBER 31st, 1917.

Dr. H. G. Chapman, President, in the Chair.

The President announced that the Council was prepared to receive applications for four Linnean Macleay Fellowships, tenable for one year from April 1st, 1918, from qualified Candidates. Applications should be lodged with the Secretary, who would afford all necessary information to intending Candidates, not later than 30th November, 1917.

The Donations and Exchanges received since the previous Monthly Meeting (26th September, 1917), amounting to 47 Parts or Nos., 10 Bulletins, one Report, and 6 Pamphlets, received from 33 Societies, etc., and two private donors, were laid upon the table

NOTES AND EXHIBITS.

Mr. Fred Turner exhibited a specimen of *Tecoma jasminoides* Lindley, var. *amabilis* Turner, from the garden of Mr. G. Finlay, Chatswood. This lovely pink-flowering variety has rather smaller leaves, leaflets, and flowers than the typical form. The corolla is velutinous, the inside of the tube is deep red, and densely bearded with short hairs. The origin of the plant is not known, but it is thought to have been brought from the Clarence River. There are two plants of this variety growing in different parts of Chatswood. Another garden-variety, var. *albiflora* Guilfoyle (Catalogue of Plants, Botanic Gardens, Melbourne, p.157, 1883) is also a desirable addition to a garden.

Mr. Froggatt exhibited a new and remarkable Wax-Scale (*Ceroplastes*, n.sp.), discovered at Kinkori River, New Guinea, by Mr. George H. Murray. —Also, for Archdeacon Haviland, of Cobar, a perforated nodule of sandstone, taken from an ants' nest, which was utilised by the ants as an entrance to the nest.

Mr. A. A. Hamilton showed a series of botanical specimens collected in Egypt and Palestine, by Mr. W. M. Carne, a Member, while serving with the Australian Imperial Forces.

Mr. E. Cheel exhibited—Fresh, flowering-specimens of two hybrid *Callistemons* raised from seed received from a European seedsman, under the names of *C. amœnus*, and *C. lanceolatus* var. *lilacina*; the first with filaments of a purplish-garnet colour (not yellowish, as figured by Lemaire, in *Illust. Hort.*, vii., t.247); the second with creamy-white filaments (not (a) deep carmine-violet to reddish-violet or pure mauve, or (b) reddish-purple—as in other plants from the same batch of seedlings, recorded in these Proceedings, 1916, p.219).—Examples of the rare occurrence of a solitary, small bracteole, or of a pair of bracteoles, at the base of the flower, in addition to the bract, in a hybrid *Callistemon* (*C. acuminatus* × *C. lanceolatus*).—Specimens of an introduced weed, *Linaria Pellisseriana* Mill., commonly called “Billy Goats,” collected at Albury, N.S.W. (A. H. Patterson).

Miss Hynes showed examples of—a white-flowered variety of *Epacris longiflora* Cav.; fasciation of the stem in *Antirrhinum*; synanthic flowers of *Digitalis*; and spikes of a form of *Callistemon linearis* with the filaments greenish, crimson, or of intermediate tints, on portions of the same plant.

The Secretary communicated particulars of some recently discovered, Aboriginal carvings on a flat rock, near Palm Beach, north of Manly (furnished by the Secretary of the Barrenjoy Company, Ltd.).

Dr. H. G. Chapman exhibited—A sample of an extract of the pancreas of the ox, made with chloroform-water; and showed tubes illustrating the coagulative action of this extract on milk in neutral or acid solutions; and the absence of such action in alkaline solution.—An example of synanthic flowers of *Fuchsia* (the fusion including the petioles), received from Mr. J. T. Kelly, of Burwood.

AUSTRALIAN TABANIDÆ [DIPTERA]. No. iii.*

BY FRANK H. TAYLOR, F.E.S.

(From the Australian Institute of Tropical Medicine, Townsville.)

(Plate xxviii.)

The Tabanidæ comprising the subject-matter of this paper were mainly received from Dr. Hamlyn Harris, Director of the Queensland Museum, whom I wish to thank for giving me the opportunity to study these forms.

One new genus and ten new species are described, and are distributed in the following genera—*Pelecorhynchus* (one), *Diatomi-neura* (one), *Palimmecomyia* (g. et sp.n.), *Silvius* (two), *Cenoproson* (one), and *Tabanus* (four).

The disposition of the type-specimens is noted in the text.

Subfamily PANGONINÆ.

PELECORHYNCHUS MACULIPENNIS Macquart.

Dipt. Exot., Suppl., iv., p.332, Pl. ii., fig.6 (1850); Ricardo, Ann. Mag. Nat. Hist., (8), v., p.403 (1910).

Hab.—Queensland: Stradbroke Island (H. Hacker; Sept., 1915).

PELECORHYNCHUS FUSCONIGER Walker.

List. Dipt., i., p.192 (1848) [*Silvius*]; v., Suppl. i., p.267 (1854) [*Dasybasis*]; Ricardo, Ann. Mag. Nat. Hist., (8), v., p.407 (1910).

Hab.—Q.: Stradbroke Island (H. Hacker; Sept., 1915).

PELECORHYNCHUS MIRABILIS, sp.n.

(Plate xxviii., fig.1).

Length, ♂, 10.75-11.5; ♀, 11; width of head, ♂, 4; ♀, 3.75; length of wing, ♂, 10.25; ♀, 10 mm.

A striking species owing to the brightly coloured abdomen in

* Continued from Vol. xli., p.762, 1916(1917).

the ♀, while that of the ♂ is dark chocolate-brown, with paired spots. Legs black, tarsi pale, wings with prominent brown markings. Eyes of ♂ *not* contiguous.

♂. *Head* clothed with grey pubescence, with two brown stripes, groove beneath antennæ deep brown, clothed with long, erect, black hairs; front broad, brown, with a narrow grey streak on either side and above the antennæ, clothed with long, erect, black hairs; ocellar triangle black, ocelli pale, prominent; antennæ subulated, first joint black, with long, black hairs; second joint yellowish, about two-thirds the length of first, with scattered, short, black hairs; third joint orange-rufous, with eight divisions; palpi black, apex reddish, sparsely clothed with black hairs; proboscis black, short; beard white; eyes black, *not* contiguous.

Thorax with a broad, median, dark chocolate-brown stripe with a brown wedge-shaped stripe in it from the anterior margin to the middle, outside the chocolate-brown stripe is a grey one, then another dark chocolate-brown stripe toward the lateral margin, the rest of the thorax olive-citrine, pubescence black, erect; scutellum greyish laterally, the rest dark chocolate-brown, pubescence black, erect, posterior margin with black hairs in the middle, pale laterally; pleuræ black, with pale pubescence, two white hair-tufts at the wing-roots.

Abdomen dark chocolate-brown; first segment with two, large, submedian, olive-citrine spots; segments two to four with smaller, submedian, apical, olive-citrine spots; lateral borders of first to third segments with white hairs, the rest with black ones; genitalia shining black, reddish at the apex; venter black, with traces of grey tomentum.

Legs: coxæ black, with pale pubescence; femora shining black, with long, black pubescence; fore and mid with pale pubescence also, knee-spots pale, fore- and mid-tibiæ yellowish, with dense black pubescence; first with golden pubescence beneath, hind tibiæ reddish-brown, with dense black pubescence; tarsi yellow, pubescence golden; spurs on mid- and hind-tibiæ yellowish, prominent.

Wings with a sloping, brown band from the first longitudinal vein to the base of the discal cell, the apex of the latter and

apex of wing clouded-brown, rest of wing light brown; veins dark brown, subcostal cell yellow; halteres with base of stem reddish, rest dark brown.

♀. *Head* similar to ♂; thorax with a narrow, dark, brownish-olive stripe, then a creamy-white along the median, dark chocolate-brown stripe; the olive-citrine colour of the ♂ gives place to dark brownish-olive on the thorax.

Abdomen blackish-brown laterally, and a median chocolate-brown stripe, which does not reach the posterior margins of the segments, rest of the dorsum bright orange-rufous, pubescence black and orange-rufous respectively, lateral pubescence as in ♂.

Legs as in ♂, except the hind-tibiæ, which are black. *Wings* as in ♂.

Hab.—Q.: Stradbroke Island (H. Hacker); Brisbane (F. H. Taylor).

Type ♀ in the Queensland Museum, type ♂ in the Institute Collection.

A species well-defined by its markings and colour. That the ♂ and ♀ represent one species is beyond all doubt, as Mr. Hacker has taken them *in coitu*. It is remarkable that, in the male, the eyes are *not* continuous. Beyond this, I can, at present, find no tangible reason for separating this species from *Pelecorhynchus*, but when specimens of *P. maculipennis* Macq., and *P. fusconiger* Walker, are available, their genitalia will be compared. *P. mirabilis* conforms to the genus *Pelecorhynchus* in having a hatchet-shaped proboscis, the curved anal vein of the wing, open anal cell, and the subulated antennæ.

EREPHOPSIS GIBBULA Walker.

List. Dipt., i., p.140 (1848); Ricardo, Ann. Mag. Nat. Hist., (8), xix., p.210 (1917).

Hab.—Q.: Brisbane (H. Hacker; Sept., 1916).

DIATOMINEURA AURIFLUA Donovan.

Gen. Illustr. Ent. Hym. et Dipt. (1805) [Tabanus]; Ricardo, Ann. Mag. Nat. Hist., (8), xvi., p.27 (1915).

Hab.—Q.: Brisbane (H. Hacker; Oct., 1916).

DIATOMINEURA TESTACEA Macquart.

Dipt. Exot., i., p.103 (1838); Ricardo, Ann. Mag. Nat. Hist., (8), xvi., p.31 (1915).

Hab.—Q.: Brisbane (H. Hacker; Sept., 1916).

DIATOMINEURA PULCHRA Ricardo.

Ann. Mag. Nat. Hist., (8), xvi., p.35 (1915).

Hab.—Q.: Toowoomba.

DIATOMINEURA MONTANA Ricardo.

Ann. Mag. Nat. Hist., (8), xvi., p.34 (1915).

Hab.—M.S.W.: Ebor.

DIATOMINEURA AURIPLEURA, sp.n.

Length, ♂, 11; ♀, 11·5: length of proboscis, ♂, 5·5; ♀, 4: width of head, ♂, 4; ♀, 4: length of wing, ♂, 11·25; ♀, 11 mm.

♂. *Head*: face dusky, clothed with grey tomentum and long, golden and scattered, black pubescence; palpi dark reddish-brown, tapering to a blunt point, clothed with grey tomentum, with long golden hairs above, and black ones on the sides and beneath, with a moderately deep, lateral, apical groove, reddish in colour; antennæ with first two joints dull reddish-yellow, with grey tomentum, and densely clothed with long, black hairs; third bright reddish-yellow, apex darker, with a few black hairs at the tip; eyes black, pubescence pale, dense and fairly long; ocellar triangle black, with long black hairs, ocelli reddish; proboscis black, long

Thorax: dark chocolate-brown, with long, black, erect pubescence mixed with scanty yellowish hairs more pronounced on the anterior and posterior borders; sides with conspicuous, long, black hairs, with a patch of yellow ones at the wing-roots; scutellum similar to thorax, with long, black pubescence; pleuræ densely clothed with golden hairs.

Abdomen black; first segment with a posterior, pale reddish-yellow patch on either side, second and third segments pale reddish-yellow with median, black spots, that on the second about as broad again as that on the third, rest of segments with well-

defined, yellow, lateral margins, segmentations pale: pubescence black, appressed, segmentations with pale pubescence, that on lateral margins of fifth and sixth segments pale; genitalia black, pubescence black; venter yellowish, with fairly long, yellowish, dense pubescence.

Legs: base of femora black, rest of legs reddish-yellow, tarsi darker, pubescence black, longer on the hindlegs.

Wings yellowish, veins dark yellowish-brown, base of the discal cell and fork of third long vein clouded-brown; no appendix; squamæ yellowish; first posterior cell not narrowed toward the margin.

♀. Front covered with brownish tomentum, and long, erect, black hairs; face similar, with mixed black and yellowish hairs; first and second joints of antennæ not so densely clothed as in ♂: palpi yellowish-red, ending in a fine point, with short, black pubescence, sides of second joint concave for about two-thirds its length from the base; beard yellow; apical segments of abdomen dark brown, the spots on the second and third segments being continued to the apex, forming a median, black stripe; pubescence similar to but not so dense as in ♂. Legs and wings similar to ♂.

Hab.—♀: Stradbroke Island (H. Hacker; Sept., 1915).

This species bears a close resemblance to *Erephopsis lasiophthalma* Boisd., judging from the description given by Miss Ricardo (Ann. Mag. Nat. Hist., (8), xix., p.210, 1917), but is at once separated by its generic position.

CORIZONEURA FULVA Macquart.

Dip. Exot., Suppl., iv., p 323 (1849); Ricardo, Ann. Mag. Nat. Hist., (8), xvi., p.36 (1915).

Hab.—♀: Stradbroke Island (H. Hacker).

ELAPHROMYIA Taylor.

Proc. Linn. Soc. N. S. Wales, 1916, p.749 (1917).

I omitted to state, when characterising this genus, that the face was markedly protuberant, almost pyramidal in shape when viewed from the side. The antennæ also rise from a well-defined, raised tubercle; eyes nude.

PALIMMECOMYIA, gen.nov.

Ocelli, and spurs on hind-tibiæ present; face protuberant; antennæ rising from a well-defined tubercle, the third joint subululated, with eight divisions; first long, almost cylindrical, slightly narrower at the base; second very small, narrower than the first, and less than one-fourth its length; palpi short, first segment short, swollen, about twice as wide and two-thirds the length of the second, the latter cylindrical; eyes hairy; wings long, all posterior cells open, anal cell closed before it reaches the border, anal vein very slightly curved at the base.

Genotype, *P. celænospila* Taylor. ♀. Unknown.

The genus may be distinguished from *Cænoproson* by its differently shaped palpi and antennæ. In *Palimmecomyia*, the first joint of the antennæ is long, the second very short; while, in *Cænoproson*, the first and second joints are short and stout. From *Elaphromyia*, it may be separated by its different antennæ, palpi, and hairy eyes.

PALIMMECOMYIA CELÆNOSPILA, sp.n.

(Plate xxviii., fig.2).

Length, 15; width of head, 5; width of abdomen, 5; length of wing, 14; proboscis, 6 mm.

♂. *Head*: face shining black, brownish towards the edges; cheeks dusky, covered with dense, grey tomentum, and long, grey hairs; beard white, dense; antennæ rising from a well-defined tubercle, which is densely covered with creamy-yellow tomentum; first joint long, almost cylindrical, black, base reddish, densely covered with long, grey and black hairs; second joint very small, narrower than the first, yellowish-red, with mixed pale and dark hairs; third joint subululated, orange-rufous; palpi black, clothed with mixed, black and grey hairs, apex of second joint reddish, tapering to a wedge-shaped point, cup-shaped on the inner side; first segment swollen, second cylindrical; ocellar triangle black, prominent, ocelli yellowish; eyes black, facets small, densely covered with orange pubescence; proboscis long, black.

Thorax bright, shining, reddish-yellow, dark toward the sides,

with a median black spot on the anterior margin, densely clothed with golden pubescence; shoulders with a dense tuft of golden hairs, wing-roots with mixed black and grey hairs beneath, and grey ones above; scutellum shining black, with golden pubescence laterally; pleuræ black, with grey pubescence.

Abdomen pale yellowish-brown, first three segments with median, black, almost square, plugs, that on the second tapering to a blunt point, the third not reaching the posterior margin, lateral, basal, black spots on the first four segments; pubescence orange-coloured, dense, apex with a few black hairs; venter black, segmentations and lateral borders with greyish-white hairs.

Legs: coxæ black, femora of fore- and midlegs reddish-brown, fore-femora with a black streak above on the basal half, hind black above, reddish-brown beneath, tibiæ and tarsi reddish-brown, the latter darker, pubescence pale.

Wings orange-coloured, veins orange-yellow, except the apical half of the radial, anterior branch of the cubital, and the first and third posterior veins, which are brown, and faintly clouded, apical cell and portion of the apex of the cubital dark dusky-brown; stigma orange-yellow.

Hab.—Q.: Brisbane (H. Hacker; Sept., 1914).

Type in Queensland Museum.

SILVIUS STRADBROKEI, sp.n.

Length, 13; width of head, 4; length of wing, 10 mm.

An elongate species. Abdomen light mummy-brown. Legs pale; antennæ reddish.

♀. *Head*: face cinnamon-rufous, cheeks black, with grey tomentum and black pubescence; front parallel, cinnamon-rufous, with dark tomentum and pale pubescence; beard grey, scanty; frontal callus yellowish-red, wedge-shaped, tapering to a fine point, basal half with a deep median groove, base about one-third the width of front; subcallus shining yellowish-red; palpi yellow, nearly the length of proboscis, pubescence black, dense; antennæ with first two joints pale yellowish-red, with golden tomentum, pubescence black, scanty, short except at the apex

of first joint, third joint broad, *Tabanus*-like, no angle or tooth, tomentum pale; eyes bare.

Thorax [denuded], cinnamon-rufous, lateral borders and scutellum paler, pubescence apparently pale, dark laterally, a small pale patch above the wing-roots; pleuræ cinnamon-rufous, covered with grey tomentum and scattered, pale hairs.

Abdomen mummy-brown, with indistinct, small, grey, apical spots, apparently forming a median stripe, segmentations pale. pubescence very short, black, pale on the spots; venter dark yellowish-brown, tomentum pale.

Legs reddish-yellow, tarsi darker, pubescence black, dense on tarsi, mid-tibial spurs stout, prominent.

Wings clear, veins yellowish-brown, stigma yellowish; no appendix.

Hab.—Q.: Stradbroke Island (H. Hacker; Dec., 1913).

This species bears a certain resemblance to *S. subluridus* mihi, but may be distinguished from it by the differently shaped, frontal callus, subcallus, and thorax.

Type in Queensland Museum.

SILVIUS PSAROPHANES, n.sp.

Length, 14; width of head, 5; width of thorax, 4; length of wing, 10 mm.

A medium-sized, grey species, with median, abdominal stripe composed of apical, triangular spots on the segmentations; thorax with four, indistinct, brownish stripes; wings clear; legs reddish.

♂. *Head*: face covered with dense grey tomentum and mixed black and grey hairs; subcallus shining-black; antennæ reddish-yellow, situated on a slight tubercle, third segment darker, first and second densely covered with creamy-yellow tomentum, and short, black pubescence; palpi half the length of proboscis, reddish-yellow, darker towards the apex, covered with mixed, light and dark pubescence; eyes black, nude, the large facets occupying about two-thirds of the eye, the small ones commencing as a narrow band at the ocelli, which are yellowish, and expand in width towards the base of the eye; beard grey, scanty.

Thorax: grey, with two, indistinct, median, brownish stripes terminating in the middle, and lateral, brownish ones; pubescence mixed, copper-coloured and black, laterally dense, grey; scutellum grey; pubescence similar to thorax; pleuræ grey, with scanty, grey clothing.

Abdomen showing faintly reddish through the grey tomentum: viewed laterally, it is distinctly humped, densely clothed with black, appressed hairs, except on the posterior margins of segments two to the apex, where it is creamy, triangular spots creamy; venter reddish, with grey tomentum.

Legs: coxæ, femora, and tibiæ reddish-brown, tarsi darker, pubescence pale, black on tarsi; spurs on hind-tibiæ small.

Wings clear, veins brown, stigma yellowish, inconspicuous; posterior cells widely open; no appendix.

Hab.—Q.: Townsville (F. H. Taylor; Dec., 1914).

A single specimen, attracted to light, one night in December, 1914. It has a striking, *Tabanus*-like appearance, especially about the head; and is easily distinguished from its other Australian congeners.

Type in the Institute Collection.

ECTENOPSIS sp

A specimen from Brisbane, Queensland (H. Hacker), may possibly belong here, but the antennæ are missing.

DEMOPLATUS AUSTRALIS Ricardo.

Ann. Mag. Nat. Hist., (8), xvi., p.270 (1915).

Hab.—Q.: Brisbane (H. Hacker; March, 1914).

CÆNOPROSOPON HAMLYNI, sp.n.

(Plate xxviii., fig.3).

Length, 12.5; width of head, 5; length of wing, 12 mm.

Thorax densely clothed with long, yellow, and short, black pubescence; abdomen brownish, with paler segmentations; legs yellowish, tarsi darker; wings faintly dusky, a long appendix present.

♂. *Head*: face protuberant, with yellow tomentum and long golden hairs, cheeks similar: antennæ yellow, apex blackish, first

and second joints clothed with fairly long, black hairs, dense on the second joint, which is half the length of the first, base of third with a wide angle, and a dorsal and ventral row of black bristles; palpi yellow, first joint egg-shaped, with long, golden hairs, black on the apex; second joint about one-third longer than first, densely clothed with long, black pubescence, and gradually tapering to a blunt point; proboscis black, slightly more than twice the length of palpi; eyes black, nude; ocellar triangle prominent, golden, with long, black and golden hairs, ocelli pale; beard yellowish, dense.

Thorax black, with golden tomentum, and long, golden, and short, black pubescence, laterally with a dense border of golden hairs; scutellum similar to thorax; pleuræ with grey tomentum and dense, yellowish hairs.

Abdomen densely clothed with black pubescence, first and second segments golden, third brown, fourth darker, with a broad, posterior band, remaining segments golden, segmentations paler, mainly with golden pubescence, lateral pubescence golden, venter covered with golden tomentum and hairs, with scattered, black ones.

Legs: coxæ, femora, and tibiæ golden; coxæ with dense, golden hairs; tibiæ mainly with black ones, dense on the hind-tibiæ; tarsi reddish-yellow, pubescence black, dense; spurs on hind-tibiæ reddish, prominent.

Wings faintly dusky, yellow at base and along costa; veins yellowish-brown; a long appendix present.

Hab.—Q.: Brisbane (H. Hacker; Oct., 1916).

Differs from *C. wainwrighti* Ricardo, *inter alia*, in size, colour, thoracic and abdominal markings—the thorax and abdomen of *C. hamlyni* lacking stripes. The tarsi are also very different.

I have much pleasure in dedicating this species to Dr. R. Hamlyn Harris, Director of the Queensland Museum.

Subfamily TABANINÆ.

Group iv. Forehead with no callus.

TABANUS HACKERI, sp.n.

Length, 11·5-13; length of wing, 11-12; width of head, 4·5-5 mm.

♀. *Head*: face and front buff-yellow, the latter with its sides parallel, and clothed with short, erect, yellow and black hairs; beard yellowish; antennæ with first two joints yellowish, clothed with yellow hairs; third joint rufous, the expanded portion broad, with a small tooth; palpi yellowish, clothed with pale hairs; proboscis dark brown, undersurface pale; eyes bare.

Thorax olive-grey, clothed with golden hairs, with pale yellowish ones laterally and at the wing-roots; scutellum similar to thorax.

Abdomen buff-yellow, with scattered, yellow pubescence, black toward apex; venter buff-yellow.

Legs yellowish; tarsi dark, with black pubescence.

Wings clear, veins and stigma yellow; appendix long.

Hab.—Q.: Bribie Island (H. Hacker; Jan., 1915).

A medium-sized, yellowish species, which may be placed in Group iv., the frontal callus being scarcely represented. Related to *T. angusticallus* Ricardo, but differs, *inter alia*, in its larger size, colour, and in the presence of a tooth on the third joint of the antennæ.

Type in Queensland Museum.

TABANUS CONFUSUS, sp.n.

Length, 12; length of wing, 11; width of head, 5 mm.

A medium-sized, black species, with the first three abdominal segments light reddish-brown. Antennæ dusky. Legs black. Wings clear, with long appendix.

♀. *Head*: face and cheeks pale reddish, densely clothed with grey tomentum; beard white, fairly long; front black, covered with silvery tomentum, with a short, fairly deep groove, about one-third wider anteriorly than at vertex, latter brown; antennæ dark reddish-brown, annuli black, first segment with black hairs above and grey ones in addition on the sides, second with black ones, basal portion of third forming a broad angle with a small tooth, with short, dense, black tomentum; palpi dusky, with long, dense, white hairs at base and short, grey pubescence, changing to black at apex; proboscis about four times the length of palpi.

Thorax shining black, with two faint greyish stripes, shoulders reddish, with long black hairs, and a tuft of white ones beneath at the wing-roots; scutellum black.

Abdomen: first segment dark brown in the centre, reddish-yellow laterally; second and third segments reddish-yellow, with indefinite, dusky, median spots, the remaining segments black; segments two to the apex with faint, greyish segmentations, second segment with a grey, irregular, basal patch on either side of the spot; venter reddish-yellow, darker toward the apex, the grey segmentations well-defined.

Legs black; coxæ greyish-black, with grey tomentum: fore-coxæ with long, grey hairs; knees and base of tibiæ reddish-yellow, pubescence black.

Wings clear, veins dark brown; stigma reddish-brown; squamæ light brown; halteres with dusky knobs and reddish stems; a long appendix present.

Hab. Q.: Brisbane (H. Hacker: Oct., 1914).

This species is easily distinguished from other members of Group iv., by its colour alone.

Type in the Queensland Museum.

Group vii. Abdomen with one or more stripes, usually continuous.

TABANUS PARVICALLOSUS Ricardo.

Ann. Mag. Nat. Hist., (8), xiv., p.394 (1914).

Hab.— Q.: Eidsvold (Dr. Bancroft), Maloolah (W. W. Froggatt), Brisbane (H. Tryon and H. Hacker).

TABANUS LATICALLOSUS Ricardo.

Ann. Mag. Nat. Hist., (8), xiv., p.395 (1914).

Hab.— Q.: Brisbane (H. Hacker: Feb., 1917).

A specimen in the Queensland Museum agrees with the description in all respects but the legs. The basal half of the tibiæ, except the knees, is pale yellowish-red, with creamy pubescence; femora of mid-legs reddish-yellow except the base, tibiæ paler, first tarsus reddish-yellow, the rest black, pubescence pale on femora and tibiæ, hind-femora reddish-yellow, tibiæ similar to

mid-ones, pubescence pale, first tarsi dark reddish-brown, the rest black, pubescence black.

Group viii Species with median or lateral spots, or both, on abdomen, not usually forming a continuous stripe.

TABANUS RUFOABDOMINALIS, sp.n.

Length, ♂, 16: ♀, 15: width of head, ♂, 6: ♀, 5·5: length of wing, ♂♀, 14·5 mm.

A robust species, with black thorax and reddish abdomen, the latter with an indistinct median stripe, both with the sides clothed with orange pubescence. Antennæ and legs black.

♂. *Head*: face dull yellow, densely clothed with black pubescence: beard scanty, golden; antennæ black, first and second joints clothed with dense black hairs and grey tomentum, the base of the third clothed with black pubescence, base broadly angulated, with a small, blunt tooth at the apex: palpi reddish-brown, with golden hairs beneath; second joint paler, ending in a blunt point, densely clothed with long, black hairs beneath, and a few golden ones at the base: eyes black, copper-coloured when viewed in a slanting position facing the light, facets very small; proboscis black, slightly longer than the palpi.

Thorax deep chocolate-brown, almost black, clothed with dense, moderately long, erect, black and scattered, appressed, golden pubescence, with a dense, lateral border of orange pubescence; shoulders reddish, with long, erect, black hairs; scutellum similar to thorax in colour, clothed with erect, black pubescence: pleuræ clothed with yellowish-orange pubescence.

Abdomen reddish-yellow, becoming darker toward the apex, with a median black stripe, indistinct on the third and fourth segments, prominent on the first and second, posterior and lateral borders of segments with orange-coloured pubescence, except on the apical segment and genitalia, where it is black; dorsal pubescence black: venter reddish-yellow, with dense, orange, and scattered, black pubescence.

Legs: coxæ grey-black, clothed with grey tomentum, and scattered, orange hairs: femora, tibiæ, and tarsi black, with black pubescence.

Wings yellowish, grey on apical half; the costal, subcostal, radial, third long vein, and veins of the posterior cells black, the remaining veins yellowish-brown; stigma yellowish-brown, inconspicuous; no appendix.

♀. Face yellowish-brown, with dull yellow tomentum, and black pubescence; front parallel, narrow, black, covered with dull yellow tomentum, and scattered, yellow hairs; frontal callus black, shining, oblong, about two-thirds the width of the front, with a long, linear extension almost reaching the ocellar triangle; palpi black, ending in a blunt point, nearly the length of the proboscis, the latter black, short; beard scanty, orange-yellow. Abdomen, legs, and wings as in ♂.

Hab.—Q.: Stradbroke Island (H. Hacker; Sept., 1915).

A comparatively robust species, unlike the known species of Group viii. from Australia. The bright orange-coloured pubescence on the abdomen and sides of the thorax gives it a distinctive appearance.

T y p e s in the Queensland Museum.

Group xi. Species with pubescence on the eyes (*Theriopectes*).

TABANUS DUBIOSUS Ricardo.

Ann. Mag. Nat. Hist., (8), xvi., p.284 (1915).

Hab.—Q.: Brisbane (H. Hacker; Sept., 1916).

TABANUS FROGGATTI Ricardo.

Ann. Mag. Nat. Hist., (8), xvi., p.285 (1915).

Hab.—N.S.W.: Ebor, Kosciusko (Dr. A. J. Turner).

TABANUS EDENTULUS Macquart.

Ricardo, *Ann. Mag. Nat. Hist.*, (8), xvi., p.275 (1915); White, *Pap. and Proc. Roy. Soc. Tasmania*, 1915, p.10.

Hab.—Q.: Brisbane (H. Hacker; Sept., 1916).

TABANUS BRISBANENSIS, sp.n.

Length, ♂, 10; ♀, 11; width of head, ♂, 4; ♀, 4; length of wing, ♂, 5.5; ♀, 10 mm.

A species with four thoracic stripes; abdomen of ♂ yellowish-brown, second segment with a dusky spot; of ♀ reddish-yellow,

changing to brown toward the apex, with a distinct, grey stripe. Legs black. Wings clear.

♂. *Head*: face grey, with fairly long, mixed grey and dark hairs: beard grey, scanty, long; antennæ with the first two joints yellowish, with long, black hairs; third joint reddish-yellow, with a small tooth on the expanded basal portion: palpi more than half the length of the proboscis, first joint dark, slender, second pale, long and swollen, tapering to a blunt point, clothed with long, mixed, pale and black hairs; eyes with long, black pubescence, the large facets copper-coloured, the small ones black.

Thorax light greyish-olive, with two lateral black stripes, and two indistinct submedian ones reaching the middle of the thorax; pubescence black, long, erect, mixed with shorter, pale hairs: shoulders paler, with long, grey hairs which extend to the scutellum, the latter greyish, with an olive tint basally: there is also a short, narrow, dark stripe above the wing-roots.

Abdomen: first segment brown, posterior border yellow, second yellowish, with a median, basal, dark brown spot; rest of abdomen reddish-yellow, becoming darker apically, pubescence on the posterior borders pale, long, pale laterally: venter reddish-yellow, with dense, yellowish pubescence.

Legs: coxæ dusky, with pale pubescence, fore- and hind-femora dusky, mid-femora and all tibiæ reddish-yellow, pubescence pale, tarsi dusky, with black pubescence.

Wings clear, veins dark brown, basal half of submedian vein yellow; squamæ creamy-white; stigma reddish-brown, prominent; a long appendix present.

♀. Front converging towards the vertex, about one-third wider anteriorly; frontal callus a reddish-brown, shining plug, almost reaching the eyes, and resting on the subcallus, posterior edge convex; abdomen with the second segment yellowish-brown, paler laterally, with a large, irregularly-shaped, reddish-brown spot in the centre; all segments with median, greyish, triangular spots forming a stripe, pubescence black, pale on the stripes, posterior borders yellowish-brown, pubescence pale.

Hab.—Q.: Brisbane (H. Hacker; Sept., 1916).

The abdominal markings differ considerably in the sexes; but

there is little doubt that they represent one species, as they agree in other details.

T y p e s in the Queensland Museum.

REFERENCES.

- RICARDO (1910)—Ann. Mag. Nat. Hist., (8), v.
 ——— (1915)—*Op. cit.*, (8), xvi.
 ——— (1917)—*Op. cit.*, (8), xix.
 RIDGWAY (1912)—Colour-Standards and Colour-Nomenclature.
 WHITE (1915)—Papers and Proceedings Royal Soc. Tasmania.

EXPLANATION OF PLATE XXVIII.

- Fig. 1.—*Pelecorhynchus mirabilis*, sp.n.: wing.
 Fig. 2.—*Palimnecomyia celenospila*, sp.n.: wing.
 Fig. 3.—*Ctenoprosopeon hamlyni*, sp.n.: palp.

ODONATA, PLANIPENNIA, AND TRICHOPTERA
FROM LORD HOWE AND NORFOLK
ISLANDS.

BY R. J. TILLYARD, M.A., B.Sc., F.L.S., F.E.S., LINNEAN
MACLEAY FELLOW OF THE SOCIETY IN ZOOLOGY.

(With ten Text-figures.)

The small but interesting collection of Odonata, Planipennia, and Trichoptera dealt with in this paper was made by Mr. A. M. Lea, F.E.S., Entomologist to the South Australian Museum. Mr. Lea collected on Norfolk Island from November 23rd to December 7th, 1915, and on Lord Howe Island from December 10th, 1915, to January 17th, 1916. I have to thank Mr. E. R. Waite, F.L.S., Director of the South Australian Museum, for the opportunity of studying this collection.

I am not able to accept the record of this collection, in the three Orders here dealt with, as in any probability at all a complete one. The result from Lord Howe Island is particularly disappointing, only two Planipennia, and no Odonata or Trichoptera being recorded. Probably the amount of permanent fresh-water on the Island is not sufficient to allow of the existence of many species of the last two Orders: but, at any rate, the flora is rich, and the Island would appear to be well suited to the existence of Planipennia. It is, indeed, remarkable that one of the two species recorded should belong to the purely Australian family *Nymphidae*. A dweller in dense scrub, both in the larval and imaginal states, this insect flies very little; so that it would not be easy to explain its presence on the Island, unless it had come there originally from Australia, viâ some lost land-connection. The family is a very ancient one, and the Lord Howe Island species appears to be quite unlike the known Aus-

tralian species. These two facts suggest that it reached the Island a very long time ago.

With regard to Norfolk Island, the collection is a more extensive one, containing two species of Odonata, nine of Planipennia, and one of Trichoptera. The most striking feature here is the abundance of *Chrysopidae*, of which seven species, apparently all new to science, were obtained. None of the species are the same as any known Australian species; so that the supposition, that these insects have been imported into the Island with Citrus fruit-trees, cannot be entertained. It seems much more likely that there is a large, indigenous, Chrysopid fauna in connection with the Norfolk Island Pine, *Araucaria excelsa*, since many Chrysopids are known to frequent the trees of this genus.

It is noteworthy that not a single species was found common to both Islands. The two Dragonflies from Norfolk Island are both found in the Kermadecs, and also in Australia, but are not known from New Zealand. The Caddis-fly is a common Australian species.

Of the Planipennia, all those already known to science are Australian species, the fauna showing a marked resemblance to that of Southern Queensland. The occurrence of the very rare and tiny Hemerobiid, *Carobius pulchellus* Banks, is noteworthy, since this is another very weak and inert species, which could scarcely have reached Norfolk Island except by means of some definite land-connection in the past. The forms of *Drepanacra* found on Norfolk island are dwarfed, and differ from both Australian and New Zealand forms sufficiently to merit new names. Insects of this genus would certainly not be transported by winds or storms, and must, like *Carobius*, be reckoned as definite evidence of a former land-connection between the Island and Australia.

The following is a list of the species in the collection:—

Order **ODONATA**.

Family LIBELLULIDÆ.

Subfamily CORDULINÆ

- (1) *Hemicordulia australis* Ramb. Norfolk Island.

Family AGRIONIDÆ.

Subfamily AGRIONINÆ.

- (2)
- Ischnura aurora*
- Br. Norfolk Island.

Order PLANIPENNIA.

Family HEMEROBIIDÆ.

- (3)
- Drepanacra instabilis*
- (McLach.)
- insularis*
- , n.subsp. Norfolk Island.

- (4)
- Drepanacra norfolkensis*
- , n.sp. Norfolk Island.

- (5)
- Micromus tasmanic*
- Walker. Norfolk Island.

- (6)
- Carobius pulchellus*
- Banks. Norfolk Island.

Family CHRYSOPIDÆ.

- (7)
- Chrysopa anomala*
- , n.sp. Norfolk Island.

- (8)
- Chrysopa metastigma*
- , n.sp. Norfolk Island.

- (9)
- Chrysopa nautarum*
- , n.sp. Norfolk Island.

- (10)
- Chrysopa leai*
- , n.sp. Norfolk Island.

- (11)
- Chrysopa araucariæ*
- , n.sp. Norfolk Island.

- (12)
- Chrysopa waitei*
- , n.sp. Norfolk Island.

- (13)
- Chrysopa norfolkensis*
- , n.sp. Norfolk Island.

Family NYMPHIDÆ.

- (14)
- Myiodactylus howensis*
- , n.sp. Lord Howe Island.

Family MYRMELEONTIDÆ.

- (15)
- Myrmeleon pictifrons*
- Gerst. Lord Howe Island.

Order TRICHOPTERA.

Family LEPTOCERIDÆ.

- (16)
- Notanatolica magna*
- Walker. Norfolk Island.

ODONATA.

I. HEMICORDULIA AUSTRALIÆ Ramb.

Four males and one female of this common but handsome species were taken on Norfolk Island. The specimens are dark, like those recorded from the Kermadec Islands. In Australia,

this species ranges along the Eastern Coast from Victoria to Queensland, becoming darker as it goes north. The Norfolk Island form closely resembles the specimens found round Sydney and northwards to Queensland.

2. ISCHNURA AURORA Br.

This tiny and very beautiful Dragonfly is evidently abundant on Norfolk Island, the collection containing 39 males and three females. Of the latter, one is the rare homochrome form (colouration as in the male); this form has only so far been recorded from Western Australia and the Northern Territory. The other two are the common heterochrome (black) form. The insect is abundant all over Australia, but does not occur in New Zealand.

PLANIPENNIA.

Family HEMEROBIIDÆ.

3. DREPANACRA INSTABILIS (McLach.) INSULARIS, n. subsp.

Differs from the type-form in its small size (forewing 6.5 mm. long by 3.6 mm wide), and in its general resemblance to *D. humilis* McLach. The Radial Formula is $2 + 1 + 1 + 1 + 1 + 3 = 9$, as in the type-form. Forewings distinctly falcate, with four small lunules not very well formed; costal area exceedingly broad at base.

Head, thorax, and abdomen brown; *antenna* and *legs* paler brown. *Forewing* pale transparent brownish, with very indistinct transverse irroration of darker brown; a small hyaline area on the median fork; fenestella very small and indistinct. *Hindwing* very pale, almost hyaline, very slightly clouded along posterior margin to Cu_{1b} .

Type in Coll. South Australian Museum, Adelaide. Cotype in Coll. Tillyard.

Two specimens from Norfolk Island.

4. DREPANACRA NORFOLKENSIS, n. sp.

Forewing well pointed, but *not at all falcate*, 6.5-7.5 mm. long by about 3.5 mm. wide. Radial Formula $3 + 1 + 1 + 1 + 3 = 9$, or $3 + 1 + 1 + 1 + 1 + 2 = 9$; costal area excessively broad at base, so

that Sc appears to lie nearer to posterior than to costal border of wing. A distinct darkened pterostigma on all wings, that of forewing lying above the end of Sc, but not reaching the costal margin.

Head, thorax, and abdomen dark brown; antennæ and legs paler brown. *Forewing* dark brown, richly irrorated with blackish-brown, irregular, transverse stripes and patches; lunules three, small; fenestella present, but indistinct; a large triangular area proximad from the lunules, and a smaller blotch between R and Cu, at about one-third of the wing-length from the base, dull blackish-brown: within the latter area is a tiny white spot on M. *Hindwing* tinged with pale brown, with a darker clouding along both costal and posterior margins, and upon the gradate veins.

Type in Coll. South Australian Museum, Adelaide.

A second specimen, obviously belonging to this species, lacks the two dark areas on the forewing, but possesses instead a longitudinal line of blackish-brown, running about midway through the forewing, from base to just below apex. I propose to name this var. *lineata*. It corresponds with the well known var. *longitudinalis* Tillyard, of *D. humilis* McLach. This specimen is in Coll. Tillyard.

5. MICROMUS TASMANIÆ Walker.

Six specimens of this common Australian lacewing occur in the collection, from Norfolk Island. It is quite possible that they might have been introduced as eggs or larvæ on Citrus-trees or roses. The species also occurs in New Zealand.

6. CAROBIUS PULCHELLUS Banks.

A single, beautifully marked, but somewhat damaged, specimen of this very rare insect, from Norfolk Island. Only two or three specimens of this insect are known, from S. Queensland.

Family CHRYSOPIDÆ.

Key to the Norfolk Island Species.

(As the specimens are much faded and shrunken, neither the form of the prothorax nor the colour of the veins can be used as a reliable character).

- | | | | |
|----|--|----|--|
| 1. | { Median loop of forewing ending up coterminously with the third median cell; inner row of gradate cross-veins in forewing partially duplicated <i>C. anomala</i> , n.sp.
{ Median loop ending well before the upper distal angle of the third median cell; inner row of gradate cross-veins in forewing not duplicated..... 1.
{ Median loop of forewing ending up very little beyond the first cross-vein descending from Rs 2.
{ Median loop of forewing ending up well beyond the first cross-vein descending from Rs. at nearly half-way between this cross-vein and the upper distal angle of the third median cell..... 3. | | |
| | | 2. | { Costal margin of forewing much arched, so that costal area is very wide for most of its length; pterostigma reddish-brown, very large in hindwing..... <i>C. metastigma</i> , n.sp.
{ Costal margin less arched, the costal area narrower at base and towards pterostigma; the latter very weakly formed, not dark in colour <i>C. nautarum</i> , n.sp. |
| | | | |
| 4. | { Antennæ darkened at base: 7 inner and 7 outer gradate cross-veins in forewing <i>C. leai</i> , n.sp.
{ Antennæ pale throughout: 6 inner and 8 outer gradate cross-veins in forewing <i>C. araucariæ</i> , n.sp. | | |
| | | 5. | { Forewing as narrow as hindwing; latter with 6 to 7 inner gradate cross-veins <i>C. waitci</i> , n.sp.
{ Forewing much wider than hindwing; latter with from 3 to 5 inner gradate cross-veins <i>C. norfolkensis</i> , n.sp. |

Owing to the peculiar structure of its median loop, and the partial duplication of the inner gradate series of its forewing, *C.*

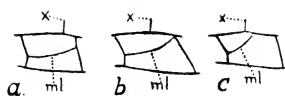

Text-fig. I. *

anomala, n.sp., might perhaps be regarded as forming the type of a new genus, intermediate in position between *Nothochrysa* and *Chrysopa*.

I think it best, however, to leave it in *Chrysopa* for the present, until some really natural scheme of subdividing that enormous genus can be discovered. The differences in the formation of the median loop in *Nothochrysa*,

* Third median cell of forewing in—*a*, *Nothochrysa*; *b*, *Chrysopa anomala*, n.sp.; *c*, *Chrysopa*, usual form; *ml*, median loop; *x*, first cross-vein below Rs.

Chrysopa anomala, n.sp., and the usual form in *Chrysopa*, are shown in Text-fig.1, *a*, *b*, *c*, respectively.

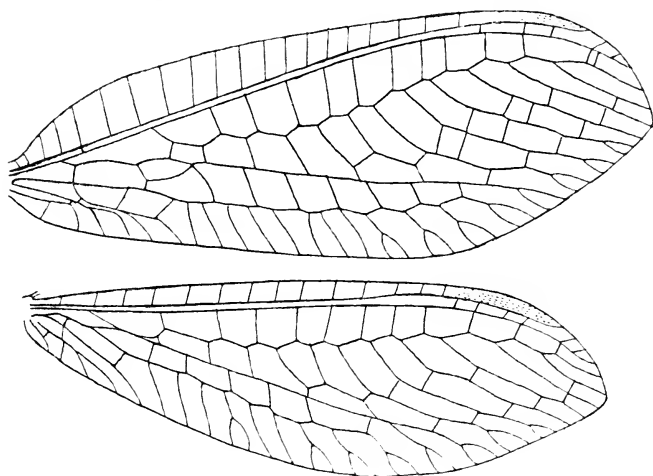

Text-fig.2.

Wings of *Chrysopa anomala*, n.sp.: ($\times 7$).

7. **CHRYSOPA ANOMALA**, n.sp. (Text-figs.1*b*, 2).

Total length, 7.5 mm.; forewing, 12 mm

Wings distinctly pointed at apex, especially hindwing. All veins apparently originally green, except gradate series of forewing, which are darkened. Costal area of forewing only moderately wide, with 19 cross-veins. Median loop ends coterminously with the third median cell; the basal and distal sides of this cell very oblique. Pterostigma pale and weakly formed, with 3 cells below it in forewing, 4 in hindwing. Gradate cross-veins of forewing, 6 in each series, the inner series with three extra cross-veins placed just above it; in hindwings, 4 cross-veins in the inner, 5 in the outer series. Number of cells below M' from median loop to wing-border in forewing, eight.

Head brownish; antennae pale brownish, the basal joint much swollen.

Thorax: prothorax slightly longer than wide, much narrowed anteriorly. Pterothorax orange-brown. Legs very pale yellowish-brown.

Abdomen brownish, apparently with dark longitudinal bands; [much shrunken].

Type in Coll. South Australian Museum.

A unique specimen from Norfolk Island.

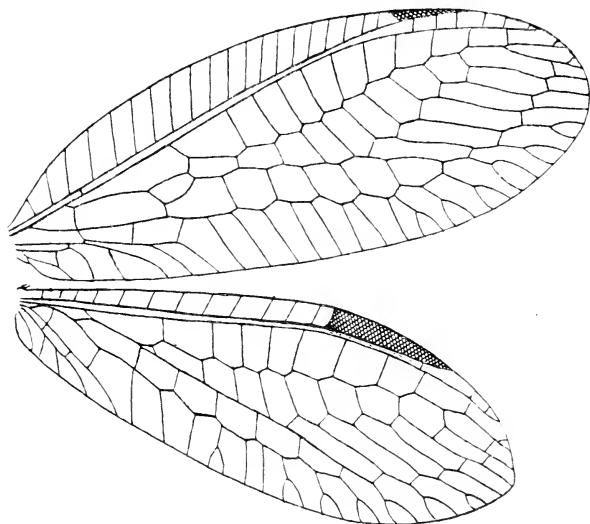

Text-fig.3.

Wings of *Chrysopa metastigma*, n.sp.: ($\times 7$).

8. *CHRYSOPA METASTIGMA*, n.sp. (Text-fig.3).

Total length, 7 mm.: forewing, 11 mm.

Wings broad, with well rounded tips. All the veins apparently originally green, except the gradate cross-veins, which are slightly darkened. Costal area of forewing much widened for most of its length, with 20 cross-veins. Median loop ends just beyond the first cross-vein descending from Rs. Pterostigma 1 mm. in forewing, 2.3 mm. in hindwing, narrowly triangular, dark reddish-brown; 3 cross-veins below it in forewing. Gradate cross-veins 5 in inner, 6 in outer series in all wings. Number of cells below M' from median loop to wing-border in forewing, seven.

Head orange-brown; antennae pale brownish, the basal joint much swollen.

T h o r a x: *prothorax* large, about as long as wide, rich brown. *Pterothorax* yellowish-green. *Legs* pale yellowish-brown.

A b d o m e n pale brownish, marked with black lines dorsally along each side, and also in the sutures: [much shrunken].

T y p e in Coll. South Australian Museum.

A unique specimen from Norfolk Island.

This species resembles the Australian *C. olatatis* Banks, (Darwin, N.T.) in possessing a very prominent, reddish-brown pterostigma in the hindwing; but is at once distinguished from it by the more rounded wings, and the enlarged costal area of the forewing.

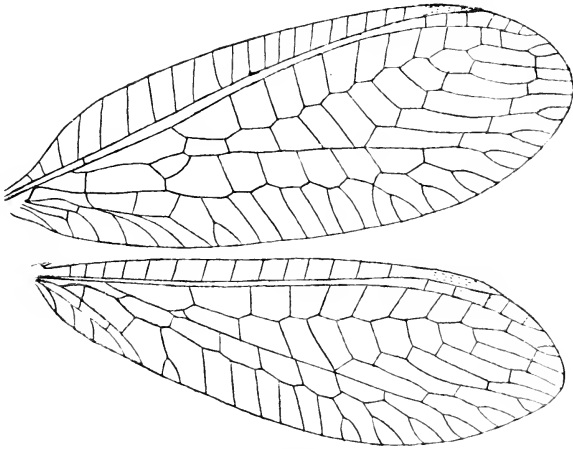

Text-fig. 4.

Wings of *Chrysopa nautarum*, n.sp.: ($\times 7$).

CHRYSOPA NAUTARUM, n.sp. (Text-fig. 4).

This species closely resembles *C. metastigma*, n.sp., in general shape, size, and structure, but may be distinguished from it as follows:—

Size slightly smaller, *forewing* 10 mm. *Head* smaller, only just as wide as *prothorax*. Both head and *prothorax* reddish-brown; *pterothorax* and *abdomen* dark brown.

W i n g s broad, with well rounded tips, but hindwing not so broad in the pterostigmatic region as in *C. metastigma*, n.sp.

All the veins apparently originally green, without exception. Costal area of forewing wide, but not so wide basally and towards stigma as in *C. metastigma*. *Pterostigma* pale, weakly formed. Median loop, gradate series, and number of cells below M' as in *C. metastigma*. (Cf. Text-figs.3, 4).

Type in Coll. South Australian Museum. Cotype in Coll. Tillyard.

Two specimens from Norfolk Island. Named after the early colonisers of the Island.

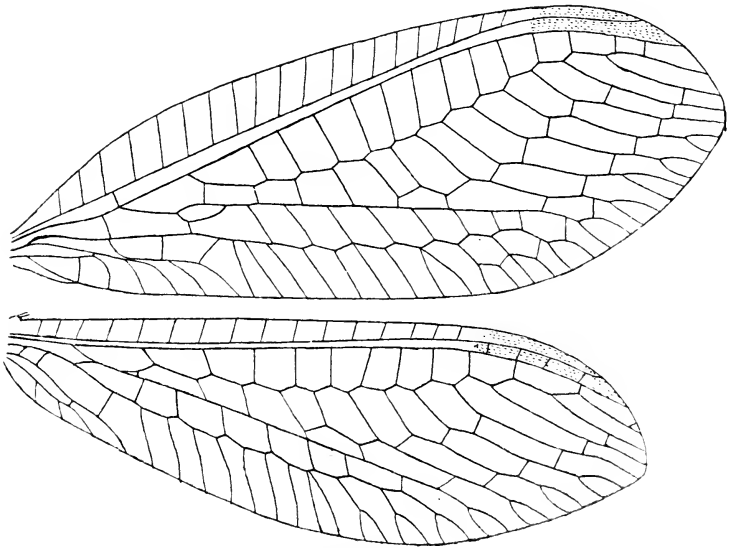

Text-fig.5.

Wings of *Chrysopa leai*, n.sp.: ($\times 7$).

10. *CHRYSOPA LEAI*, n.sp. (Text-fig.5).

Total length, 7 mm.: forewing, 13.5 mm.

Wings broad, the forewing somewhat rounded at tip, the hindwing slightly pointed. Venation apparently originally green, with the gradate series, costals, and some of the inter-radials darkened. Costal area of forewing only moderately wide, with 20 cross-veins. *Median loop* ends well beyond the first cross-vein descending from Rs. *Pterostigma* pale, well-formed, over

2 mm. long; 5 cross-veins below it in forewing. *Gradate cross-veins* in the forewing, 7 in each series; in the hindwing, 5 in inner, 6 in outer series. Number of cells below M' from median loop to wing-border in forewing, ten.

Head dark brown; *antennae* dark brown at bases, rest pale brown.

Thorax and abdomen brown. *Legs* pale brown. *Prothorax* slightly shorter than wide, dark brown.

Type in Coll. South Australian Museum.

A unique specimen from Norfolk Island.

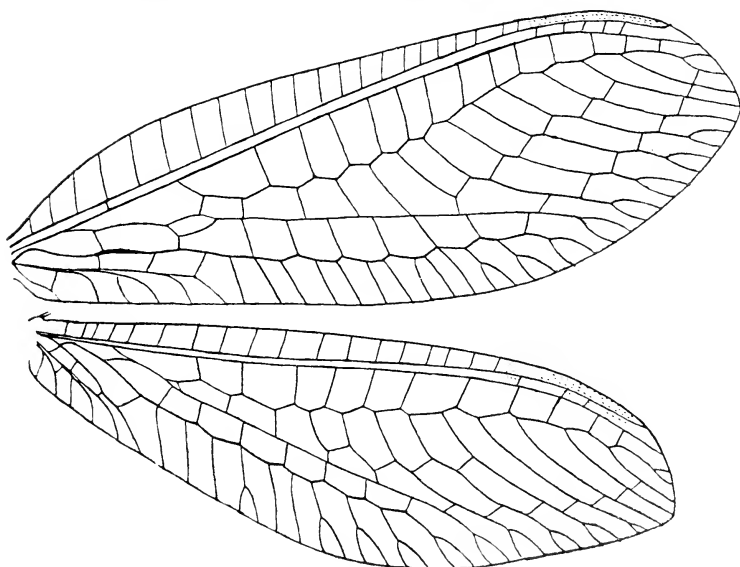

Text-fig. 6.

Wings of *Chrysopa araucariæ*, n.sp.: ($\times 7$).

11. *CHRYSOPA ARAUCARIÆ*, n.sp. (Text-fig. 6).

This species is closely allied to *C. leai*, n.sp., from which it may be distinguished as follows:--

Size a little larger, *forewing* 13.8 mm., the wings slightly more pointed. Costal area of forewing with 22 cross-veins. Only the gradate series of forewing darkened. *Pterostigma* pale and long in all wings; four cross-veins beneath it in the forewing. *Gradate*

cross-veins in the forewing, 6 in the inner, 8 in the outer series, both series slightly darkened; in the hindwing, 4 in the inner, 7 in the outer series. Number of cells below M' from the median loop to the wing-border in the forewing, eight. The minute triangle of the hindwing is somewhat more evident than usual.

Type in Coll. South Australian Museum. Cotype in Coll. Tillyard.

Two specimens from Norfolk Island. The insect appears to be related to *C. latotalis* Banks, from Queensland.

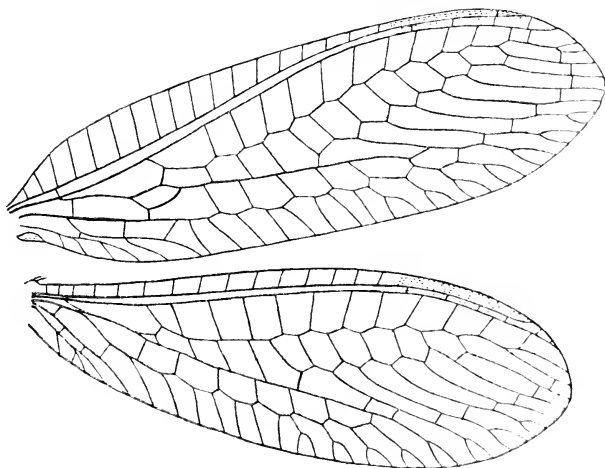

Text-fig.7.

Wings of *Chrysopa waitei*, n.sp.: ($\times 7$).

12. CHRYSOPA WAITEI, n.sp. (Text-fig 7).

Total length, 8 mm.; forewing, 11 mm.

Wings: all veins originally green. Costal area of forewing only moderately wide, with 15 cross veins. Median loop ends well beyond the first cross-vein descending from Rs. *Pterostigma* pale, transparent, less than 2 mm. in both wings; three cross-veins below it in both wings. *Graduate cross-veins* in the forewing, 7 in inner, 7-8 in outer series; in the hindwing, 6-7 in inner, 7 in outer series; between the two series, in both wings, an extra cross-vein above M', placed, in the forewing, very ob-

liquely, at a point where M' bends suddenly downwards. Number of cells below M' from the median loop to the wing-border in the forewing, eight.

Head very small, orange-brown; *antennae* pale brown, the basal joint much swollen.

Thorax: *prothorax* brown, longer than wide, narrowing anteriorly. *Pterothorax* brown, tinged with olive-green. *Legs* short, pale brownish.

Abdomen dull brownish; [much shrunken].

Type in Coll. South Australian Museum.

A unique specimen from Norfolk Island.

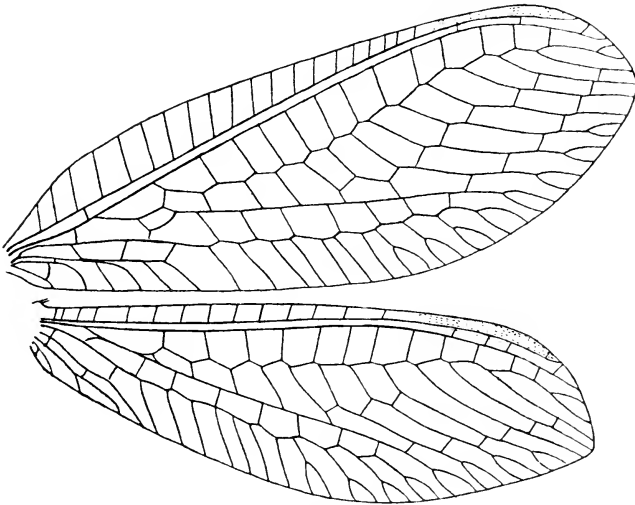

Text-fig. 8.

Wings of *Chrysopa norfolkensis*, n.sp.; ($\times 7$).

13. CHRYSOPA NORFOLKENSIS, n.sp. (Text-fig. 8).

Total length, 7.5 mm.: forewing, 12 mm.

Wings: all veins originally green, except the two gradate series of forewing, which are slightly darkened. Costal area of forewing only moderately wide, with 20 cross-veins. Median loop ends well beyond the first cross-vein from Rs. *Pterostigma* scarcely formed, 3 cross-veins below it in forewing. *Gradate*

cross-veins in the forewing, 7 in each series; in the hindwing, 3-5 in the inner, 6 in the outer series. Number of cells below M' from the median loop to the wing-border in the forewing, eight.

Head brownish, moderately large; *antennæ* pale brownish.

Thorax: *prothorax* short, rather wide posteriorly, brown. *Pterothorax* brown. *Legs* pale brownish.

Abdomen dark brown, [much shrunken].

Type in Coll. South Australian Museum. Cotype in Coll. Tillyard.

Two specimens from Norfolk Island.

N.B.—In all the above descriptions of *Chrysopa*, n.spp., it should be borne in mind that the body is much shrunken, and the original colouration more or less lost. Probably there is a considerable amount of green or yellow on the thorax and abdomen of most of the species. For determination of the species, it is best to rely upon the wing-venational characters. In nearly all cases, the antennæ are more or less broken, so that they could not be used very well in the specific determinations.

Family NYMPHIDÆ.

14. MYIODACTYLUS HOWENSIS, n sp. (Text-figs.9-10).

Total length, 15 mm.: forewing, 22 mm.

Wings rather narrow, well pointed, the veins very pale yellowish-green, touched here and there with blackish on some of the junctions and cross-veins of the forewings. *Pterostigma* 1 mm., trapezoidal, rose-pink. *Rs* with 9 branches in forewing, 8 in hind. Central "disc" not so sharply marked off as usual in this genus. Costal area of forewing only moderately widened, but the costal veinlets united for half the length of the wing from the base, by a series of cross veins; between these and the costal margin are five or six more cross-veins, forming a shorter anterior series.

Head wide, dull orange; *antennæ* thick, uniform, 8 mm., orange.

Thorax: *prothorax* narrowed anteriorly, orange-brown, with darker markings dorsally. *Pterothorax* pale orange. *Legs* pale yellowish-brown.

Abdomen lemon-yellow, with a broad, irregular, dorsal band of dark brown, interrupted at the sutures.

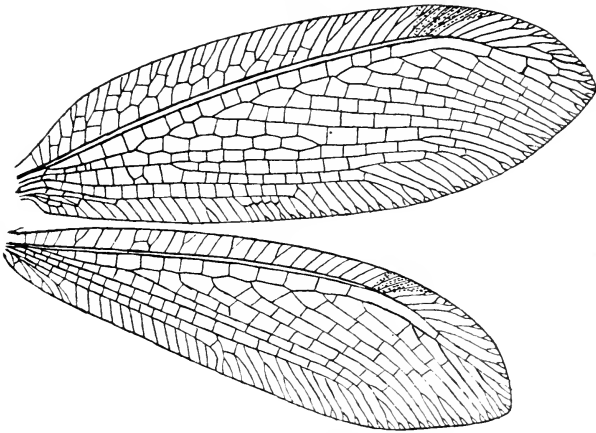

Text-fig. 9.

Wings of *Myiodactylus howensis*, n.sp.; ($\times 3\frac{1}{2}$).

Appendages of male of extraordinary shape, as shown in Text-fig. 10; those of female not conspicuous.

Types, ♂♀, in Coll. South Australian Museum. Cotypes in Coll. Tillyard.

Two males, a female, and a damaged specimen [half of abdomen lost], probably a female, taken on Lord Howe Island. In colouration, this species closely resembles *M. roseistigma* Esb.-Pet. It can at once be distinguished from that species by its much narrower and more pointed wings, by the two series of connecting cross-veins in the costal area of the forewing, and by the less definite closure of the "disc." In this last character, it approaches the genus *Osmylops*.

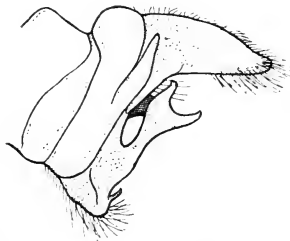

Text-fig. 10.*

There is also, in the collection, a single larva of this species,

* Appendages of *Myiodactylus howensis*, n.sp., ♂, lateral view; ($\times 15$).

about one-third grown, mounted on card, and somewhat shrivelled. This will be described later on, in a paper dealing with the life-histories of the Family *Nymphidae*.

Family MYRMELEONTIDÆ.

15. MYRMELEON PICTIFRONS Gerst.

This very common Queensland species is represented in the collection by four specimens from Lord Howe Island. These differ from the typical Australian form only by being slightly paler in colour, and in possessing a slightly more definite pterostigma.

Order TRICHOPTERA.

Family LEPTOCERIDÆ.

16. NOTANATOLICA MAGNA Walker.

A single female of this very common Australian species comes from Norfolk Island. The specimen is in good preservation, the greyish-brown colour of the forewings, in freshly-emerged specimens, being well in evidence.

DESCRIPTIONS OF NEW SPECIES OF AUSTRALIAN
COLEOPTERA. PART XIII.

By ARTHUR M. LEA, F.E.S.

(Plate xxix.)

SCARABÆIDÆ.

DIPHUCEPHALA TANTILLA, n.sp.

♂. Bright metallic-green; sides and tips of elytra, tibiæ, and sometimes the tip of pygidium, coppery or coppery-red, antennæ (some joints obscurely diluted with red) and tarsi purplish-black. Clothed with short, stout, depressed, whitish setæ, becoming stramineous on prothorax and elytra.

Head with crowded, shallow punctures; clypeus strongly produced in front, the notch deep and almost rectangular, sides almost parallel. *Prothorax* lightly transverse; with crowded, shallow, reticulate, shagreened punctures; front angles rather acute; disc with a shallow, medio-basal, semi-double impression; lateral impressions deep and traceable almost to middle, the side close to each angulate. *Scutellum* flat and shagreened. *Elytra* very little wider than prothorax; with irregular rows of moderately large punctures; rather coarsely shagreened. Front *tibiæ* with subapical tooth rather feeble. Length (♂♀), 4½-5 mm.

♀. Differs in having the clypeus with a transverse carina dividing it into two almost equal portions, of which the front one is shining; the tips are also much smaller, and the tarsi are shorter.

Hab. Queensland: Blackall Range (H. Hacker's No.701).—New South Wales: Dorrigo (H. J. Carter).

In Blackburn's table, would be associated with *D. pygmaea*, from which it differs in its smaller size, sparser clothing, and feeble subapical tooth of front tibiæ: but regarding the subapical tooth as absent, it would be associated with *D. parvula*, from which it differs in its much smaller size, much smaller and

denser punctures, shagreened surface, &c. The doubling of the medio-basal depression of the pronotum is fairly distinct when viewed obliquely from behind, but rather indistinct from other directions. The tip of the pygidium is highly polished.

CACOCHROA MARGINICOLLIS, n.sp.

♂. Black, antennæ and palpi castaneous. Sterna and hind part of hind femora with dense, stramineous hair, all tibiæ with a fringe of similar hair, rest of legs with numerous stiff setæ, sides of abdomen moderately clothed towards base.

Head with fairly numerous, sharply defined, but not very large punctures between eyes, becoming crowded and rugose on clypeus; also with numerous minute punctures on the intervening spaces; clypeus with sides moderately dilated from base to near apex, and then rounded, with the apex feebly incurved to middle. Club about as wide as the head across eyes. *Prothorax* rather lightly transverse, sides not conspicuously bisinuate, base twice the width of apex, strongly trisinate, median sinus slightly posterior to and narrower than the others; sides with punctures about the size of those on clypeus, but not so dense, becoming sparser and smaller towards and almost absent from middle of disc, in addition with numerous, minute punctures. *Scutellum* with very minute punctures, and a few larger ones (but still small) on sides. *Elytra* not much wider than prothorax; with irregular rows of shallow punctures, sides posteriorly and apical slope irregularly strigose; suture distinctly elevated from about the middle, the apex lightly mucronate. *Abdomen* gently flattened along middle; pygidium strongly concentrically strigose. Mesosternal process produced to between front coxæ, and rather obtusely pointed. Front *tibiæ* tridentate, the two smaller teeth rather obtuse, middle pair triangularly bidentate at apex and with two long spurs, hind pair tridentate at apex, but two of the teeth small and round, the spurs unequal, and slightly longer than on the middle pair. Length, 21-22 mm.

Hab. Northern Queensland (Dr. E. W. Ferguson), Cape York (Macleay Museum).

With the general appearance of *Ablacopus ater*, and of large

specimens of *C. pullata*, but with prothorax more transverse, sides not conspicuously bisinuate, elytra less narrowed posteriorly, and with distinct striation, &c. Each side of the prothorax, instead of being conspicuously bisinuate as on most species of the subfamily, sweeps round in an even curve from the base to beyond the middle, and then obliquely to the apex, so that the sides (but not the base) more nearly approach those of the species of *Glycyphana*, than of its own allies. It has been referred to *Cacochroa*, with some doubt, but the mesosternal process is too long for it to be placed in *Diaphonia*, or a closely allied genus. The specimen in the Macleay Museum is obscurely diluted with red towards the elytral suture and towards the sides of the pronotum, but, to the naked eye, appears as dark as the type. The abdomen is not concave along the middle, and the flattening is such as occurs on some females in the subfamily; but, on dissection of the type, an œdeagus was found.

XYLOPHILIDÆ.

XYLOPHILUS MIROCERUS, n.sp. (Plate xxix., fig. 1).

♂. Piceous-brown; elytra flavous, with conspicuous brown markings and a vague pruinose gloss, antennæ and legs brownish-flavous or castaneous, tarsi paler. Upper surface sparsely pubescent, elytra almost glabrous.

Head with eyes large, deeply notched, and almost touching in front. Antennæ moderately long, inserted in ocular notches: second joint short, as wide as tip of first, third subquadrate, much wider than second, fourth to seventh about as wide as third but slightly decreasing in length, eighth and ninth distinctly smaller, tenth and eleventh distorted. *Prothorax* decidedly transverse, sides gently rounded; with fairly dense and sharply defined, but not very large punctures; with two distinct and lightly separated medio-basal impressions. *Elytra* about one-fourth wider than prothorax, sides almost parallel to beyond the middle; with fairly numerous punctures, sharply defined and of moderate size only about a feeble, subcutellar elevation. *Hind femora* inflated towards, and subangular near apex; hind-tibiae long, thin, and lightly bisinuate. Length, 2 mm.

Hab.—Queensland: Dalby (Mrs. F. H. Hobler). Unique.

On the type, the head is darker than the prothorax, and the latter has the base (and the apex more narrowly) somewhat flavous. The dark markings on the elytra are so disposed that the flavous parts are isolated as follows: a large patch on each shoulder, almost touching the suture, and on the side extending to the basal fourth (in some lights, a feebly infuscated line appears to divide each humeral spot into two); a large, trilobed, median patch, of which the median lobe is advanced along the suture to about the basal fourth; and a bisinuate fascia near the apex, but slightly interrupted by the suture; the three apical segments of the abdomen are paler than the others. The antennæ are very peculiar; the joints actually decrease in size from the fourth to the ninth; the tenth varies in appearance with the point of view; from one direction, it appears to be thinner than the ninth, and almost as long as the ninth and tenth combined: it is joined to the ninth near its base, which is produced to one side as a rather acute point; the eleventh is much wider than long, and very acute at its inner apex (in general appearance, the eleventh joint is curiously suggestive of a small, geological pick-head, or of the apical joint of a scorpion's tail): from some directions, however, the joints of the antennæ appear to be of even width from the third to the tip, with the tenth joint conspicuously longer than the eleventh, and the latter very similar to the ninth.

XYLOPHILUS INTRICATUS, n.sp.

♂. Flavous; prothorax and elytra with conspicuous, dark brown markings; head, sterna, and part of abdomen blackish, antennæ reddish-flavous, but apical parts much darker, four hind-femora deeply infuscated towards base. Clothed with short, whitish pubescence, inconspicuous on prothorax and elytra, dense on head and undersurface.

Head with eyes large, deeply notched, and almost meeting at their nearest point. Antennæ moderately long, some of the joints curiously formed. *Prothorax* moderately transverse: punctures irregular and partially concealed; with a conspicuous, transverse impression on each side in front, and another (divided

into two by an elevated median line) near the base in the middle. *Elytra* much wider than prothorax: with dense, sharply defined, and moderately large punctures on and about a subscutellar elevation on each elytron, but smaller and sparser elsewhere. *Legs* rather long and thin; hind-femora stout; hind-tibiæ not notched, and not dilated at apex. Length, $1\frac{3}{4}$ mm.

♀. Differs in having smaller eyes, not quite so close together in front (but still very close), antennæ shorter and otherwise different, abdomen more convex, and legs somewhat shorter.

Hab.—N.S.W.: National Park, near Sydney. —Tasm: Hobart and Swansea (A. M. Lea).

The markings on the prothorax consist of a transverse, median fascia, somewhat irregular on its posterior edge, and trilobed in front; on each elytron, the markings are rather narrow; the first is somewhat like an interrogation-mark (? but without the lower dot), touches the suture near the base, and terminates near the middle; the second commences near the suture, runs down it for a short distance, curves upwards and outwards, then outwards, and is then marginal to the base; the third is shorter than the second, and parallel to its median portion; between the two, the derm is paler than the marks, but darker than the general colour of the elytra, and the suture and tips are of a similar shade to, and connected with, the part between the second and third marks. On the male, the markings are more sharply defined than on the female, but exactly the same in pattern. The pubescence is so dense and short on the head and under-surface, that, at first glance, these parts have a somewhat mouldy appearance. The ocular notches are so large, that each eye appears to be almost divided into two. The antennæ of the male are very remarkable; the first joint is stouter and larger than usual in the genus, the second is short and transverse; the third is slightly more than the combined length of the fourth and fifth (these being simple); the sixth is dilated on one side, and quadrangular; the seventh and eighth are rather short, but each has an acute process on one side; the ninth is thin and curved; the tenth is large, very irregular in shape, its extreme length about equal to that of the four preceding joints combined,

curved and inwardly concave; the eleventh is of very curious shape, and very narrowly joined to the tenth. On the type, the three apical joints of each antenna are closely applied to each other, the eleventh being apparently received into a groove in the tenth, and the latter is folded back on the ninth; but a specimen from Gosford (in Coll. H. W. Cox) has the three apical joints separated, when it may be seen that the ninth is very thin, the tenth irregularly convex on one side, and irregularly concave on the other, with the tip acutely produced for a short distance; the eleventh is joined to the tenth near its base (so that the mass of the tenth joint appears to be forced to one side), strongly and suddenly curved at its middle, and with a small spine on one side; so that probably these two joints form a clasping organ, as in the equally remarkable antennæ of *X. malleifer*: the tenth joint is much larger than the eleventh, but, from some directions, it appears to be actually smaller. On the female, the second joint is stouter and shorter than the third; the third is distinctly longer than the fourth; the seventh to tenth are strongly transverse, and gradually dilated to form a club with the eleventh, this being briefly ovate, and about as long as the ninth and tenth combined. The head, as viewed from in front, appears to have four eyes, the two median ones of which are closer together than the two on each side, their outlines being rendered more conspicuous by the dense pubescence covering all the adjacent surface.

XYLOPHILUS PENTAPHYLLUS, n.sp.

♂. Of a dingy, testaceous-brown, parts of appendages somewhat paler; head blackish. Clothed with short, ashen pubescence, denser on undersurface than on upper.

Head with small and rather dense punctures. Eyes prominent and widely separated, lightly notched in front. Antennæ with first joint stout and moderately long, second short and transverse, third rather long, fourth partly concealed by third, fifth small and partially concealed by fourth, sixth to tenth very short but each with a long ramus, eleventh almost as long as ramus of tenth, rather thin at base but dilated towards apex. *Prothorax*

moderately transverse, sides wider near apex than elsewhere; with numerous, fairly strong punctures; with a fairly large fovea on each side of middle of base; a shallow, longitudinal impression, and a shallow, transverse one slightly in advance of the middle. *Elytra* much wider than prothorax, sides gently dilated to beyond the middle; with dense and sharply defined, but not very large punctures, rather larger on and about some feeble basal swellings than elsewhere. *Legs* rather long; hind-tibiae thin and parallel-sided except at extreme base. Length, 2 mm.

Hab.—Tasm.: Mount Wellington (A. M. Lea).

The two males before me (one of which belongs to Mr. H. H. D. Griffith) at first glance appear like small, dingy specimens of *A. pectinicornis*, but may be at once distinguished by the eyes. Champion says of the eyes of that species, "very large, narrowly separated in front"; and a specimen before me, that agrees well with his description and figure, has the eyes so close together that, at first glance, they appear to be touching, and the distance separating them is only about the width of a facet, certainly distinctly less than the *thickness* of the basal joint of an antenna. On the present species, the eyes, although large, are much smaller than on that species, and even more apart than those of its female, the distance between them at their nearest being about equal to the diameter of an eye, and quite as much as the *length* of the basal joint of an antenna: there are also slight differences in the sculpture elsewhere.

NYLOPHILUS SPINIPES, n.sp.

♂. Black; prothorax, shoulders, palpi, four front legs, and hind-tarsi reddish. Moderately clothed with ashen or whitish pubescence.

Head with small but fairly dense punctures. Eyes large, close together, and subtriangularly notched. Antennæ moderately long and not very thin, second joint small, third to tenth each almost as long as wide, eleventh slightly longer than ninth and tenth combined. *Prothorax* rather small, almost parallel-sided from base to near apex: with a shallow and irregular median line, and a small depression on each side of base; punctures

sharply defined, and very little larger than on head. *Elytra* much wider than prothorax, parallel-sided from shoulders to near apex, with a feeble swelling on each near scutellum; punctures dense, sharply defined and of moderate size near base, becoming much smaller posteriorly. *Legs* rather long; front trochanters acutely spined; hind-femora stout; front tibiæ bisinuate on lower surface, and dentate at tip; hind pair not much thicker than middle ones. Length, $2\frac{3}{4}$ mm.

Hab. — N.S.W.: Wollongong (A. M. Lea). Unique.

Structurally close to *X. abnormis*, but elytra entirely dark, except for a spot about the size of an eye on each shoulder. The distance between the eyes at their nearest point is about equal to the thickness of the basal antennal joint. The basal joint of the hind-tarsi is rather more strongly curved than usual; the armature of the front trochanters is much as in many *Pselephidae*.

XYLOPHILUS OPACICOLLIS, n.sp.

Black; prothorax, palpi, four front legs, and hind-knees flavous, head of a dingy flavous with the base infuscated, three basal joints of antennæ obscurely testaceous, the others darker. Rather densely clothed with very short, pale pubescence.

Head moderately convex: with dense, partially concealed punctures. Eyes large, lightly notched in front, separated for about the length of two basal joints of antennæ. Antennæ moderately long, second joint short and subglobular, third thinnest of all and slightly longer than first, fourth to tenth very feebly decreasing in length, and very feebly increasing in width, eleventh distinctly wider than tenth, and almost as long as ninth and tenth combined. Apical joint of palpi very large and strongly securiform. *Prothorax* about as long as wide, moderately convex, nowhere shining, sides very feebly dilated from base to near apex, with a vague depression on each side of middle of base, and a still more feeble one on each side, with vague remnants of a median, transverse impression and a median line; punctures much as on head. *Elytra* long, thin, and parallel-sided to near apex, basal swellings extremely feeble; with dense and sharply defined punctures of moderate size about base,

becoming very small posteriorly. *Legs* rather long and thin; hind-tibiae no wider at apex than at apical third, and not notched; hind-tarsi with basal joint distinctly curved, and much longer than the rest combined. Length, 4 mm.

Hab.—N.S.W.: Jenolan (J. C. Wiburd). Unique.

An unusually elongate species, which I was at first disposed to consider as not belonging to the genus: but the metasternum and abdomen, although longer than usual, are not otherwise aberrant. The type is probably a male.

XYLOPHILUS LONGICORPUS n.sp.

♂. Blackish, prothorax, palpi, and legs (hind-tibiae slightly infuscated at apex) flavous. Closely covered with very short, pale pubescence.

Head rather convex: with dense and rather small, partially concealed punctures. Eyes large, prominent, lightly notched, separated for slightly more than the length of the two basal joints of antennae. Apical joint of palpi large, and strongly securiform. *Prothorax* slightly longer than the basal width, sides lightly dilated to near apex and then rounded, with a rather shallow, semidouble, medio-basal impression, and a feeble depression on each side, with a fairly distinct but shallow, transverse impression slightly nearer apex than base; punctures somewhat as on head. *Elytra* long and thin, much wider than prothorax; basal swellings and punctures much as on preceding species. *Legs* moderately long and rather thin: hind-tibiae conspicuously dilated to, and strongly notched at apex; hind-tarsi with basal joint moderately curved, and more than twice as long as the rest combined. Length, $3\frac{1}{2}$ mm.

Hab.—N.S.W.: National Park, near Sydney (A. M. Lea). Unique.

An unusually long, thin species, in general appearance closely allied to the preceding one, but readily distinguished by the hind-tibiae; in addition, there are many slight differences in the prothorax and legs. The first joint of the antennae is of the usual size, the second is short and subglobular, [the others are

missing];* but the species has been described on account of its close resemblance to the preceding one, from which it is strikingly distinct by the hind-tibiæ. The colours of both species are somewhat as in *X. eucalypti* and *X. flavicollis*, but otherwise they have little in common with those species.

XYLOPHILUS MICRODERES, n. sp.

♀. Bright castaneo-flavous, head deeply infuscated. Moderately densely clothed with (for the genus) not very short, stramineous pubescence.

Head with rather dense and sharply defined, but not very large, punctures. Eyes prominent, separated for about the length of the two basal joints of antennæ, lightly notched in front. Antennæ moderately long, second joint slightly stouter and slightly shorter than third, eleventh slightly wider than tenth, and almost as long as ninth and tenth combined. *Prothorax* small, strongly transverse; with a vaguely impressed, median line, a feeble depression on each side of base: with dense and sharply defined punctures. *Elytra* comparatively large, much wider than prothorax, parallel-sided to near apex, with a feeble impression on each side at base: punctures dense, sharply defined and moderately large about base, becoming smaller posteriorly. *Legs* rather long and thin: hind-tibiæ no wider at apex than in middle. Length, $2\frac{1}{2}$ mm.

Hab.—Tasm.: Huon River (A. M. Lea). Unique.

A pale species, with infuscate head and conspicuous punctures. From *X. flavescens*, it differs in being larger, prothorax considerably smaller in proportion to the elytra, eyes larger and closer together than in the female of that species, and hindlegs very different from its male. The hind-tibiæ (not dilated, and not notched at the apex) are different from those of *X. dicisus*, and several other pale species.

XYLOPHILUS IMPRESSICEPS, n. sp.

Black, parts of appendages reddish. Moderately densely clothed with fairly long, stramineous pubescence.

* The species, however, belongs to a group without strikingly distinctive antennæ.

Head with numerous, small punctures; with a shallow but fairly distinct, median line. Eyes prominent, lightly notched, separated for about the length of the basal, antennal joint. Antennae moderately long and not very thin, second joint slightly shorter than third, eleventh distinctly wider than tenth, and almost as long as ninth and tenth combined. *Prothorax* rather small, moderately transverse; with dense but somewhat irregular punctures; with a distinct, medio-basal impression (evidently the remnant of a median line) and a transverse one on each side near base, and with remnants of a very feeble one across middle. *Elytra* much wider than prothorax, parallel-sided to near apex, with a moderate swelling close to scutellum on each side of base; and a shallow depression commencing between each swelling and the shoulder, and ending behind the swelling; with dense and sharply defined punctures of moderate size, but becoming small posteriorly. *Legs* rather long and thin; hind-tibiae no wider at apex than in middle. Length, $2\frac{1}{4}$ mm.

Hab.—Tasm.: Mole Creek (A. M. Lea).

The type appears to be a female, and, in general appearance, is close to *X. immaculatus*; but the antennae are darker, prothorax with three basal impressions, and head with a distinct, median line towards base. The elytra are uniformly blackish, but not of quite so deep a black as the head and prothorax; the appendages are more or less piceous-brown, with the tarsi paler.

XYLOPHILUS VARIICORNIS, n.sp.

♂. Piceous-brown, appendages paler, head and undersurface black or blackish. Closely covered with very short, ashen pubescence.

Head rather strongly transverse, with small but fairly distinct punctures. Eyes large, prominent, lightly notched, distance between them at their closest about equal to the length of the two basal joints of antennae. Antennae rather long and thin, second joint small and subglobular, none of the others transverse, eleventh not much wider or longer than tenth. *Prothorax* small and lightly transverse; with dense and rather distinct punctures; with a transverse depression (dilated on each side) across middle,

and four depressions at base. *Elytra* much wider than prothorax, very feebly dilated to beyond the middle, with a feeble swelling on each side of scutellum, and a shallow depression at the side of, and behind, each swelling; with dense and sharply defined, but not very large punctures on basal half, becoming smaller posteriorly. *Legs* rather long and thin: hind-tibiæ no wider at apex than in middle. Length, $1\frac{3}{4}$ - $2\frac{1}{4}$ mm.

♀. Differs in having the eyes smaller and less close together; antennæ much shorter, with several of the joints transverse; abdomen more convex, and legs somewhat shorter.

Hab.—Tasm.: Waratah, Swansea, Frankford, Hobart, Mount Wellington, Huon River (A. M. Lea).

In general appearance, close to *X. acacie*, but antennæ of male conspicuously longer, punctures distinctly coarser, and upper surface without apparent "bloom," owing to the pubescence being somewhat longer, although still very short. At first glance, the antennæ of the male resemble those of the male of *X. conspicillatus*, but all the joints are distinct. The antennæ are considerably longer than in *X. inconspicuus*; they are usually infuscated from near the base, but sometimes are entirely pale; occasionally parts of the femora are lightly infuscated. One specimen has the prothorax quite as black as the head, and the elytra almost as black. The specimen (♂) from Waratah has the antennæ rather longer than usual, and entirely infuscated; the femora deeply, and the tibiæ lightly, infuscated; and almost the whole of the body-parts deep black. It certainly "looks" as if it belonged to a different species, and to a thinner and longer male from Frankford; but the differences appear to be varietal only from the normal form.

Two males from Western Australia (Donnybrook and Karri-dale) are paler than the Tasmanian specimens, with thinner and longer antennæ and legs, and more conspicuous, elytral punctures; they appear to represent a variety only.

XYLOPHILUS MICROMELAS, n.sp.

♂. Black, parts of undersurface and of appendages obscurely paler. With rather sparse and minute, ashen pubescence.

Head with dense and small punctures. Eyes prominent, widely separated, moderately notched and (for the genus) decidedly small. Antennæ moderately long, second joint subglobular, decidedly shorter and stouter than third, none of the others transverse, eleventh slightly longer and wider than tenth. *Prothorax* rather small, distinctly transverse, sides gently rounded; punctures dense and rather sharply defined; with three feeble impressions across middle, and four at base, the two median ones of the latter more conspicuous than the others. *Elytra* much wider than prothorax, parallel-sided to near apex, with two, feeble, sub-basal impressions; with dense and sharply defined punctures of moderate size, becoming smaller (but quite distinct) posteriorly. *Legs* rather long and thin. Length, $1\frac{1}{4}$ mm.

♀. Differs in being rather more robust, eyes smaller and more distant, antennæ shorter, second joint larger and some of the others lightly transverse, abdomen more convex, and legs slightly shorter.

Hab.—Tasm.: Huon River, Mole Creek (A. M. Lea).

A short, dumpy species, with blackish antennæ, rather close to *X. 4-foveatus*, but slightly smaller, antennæ and legs darker, prothoracic impressions not quite the same at the base, and with an additional (but feeble) one in middle of the disc. At first glance, the whole of the appendages appear to be blackish; but, on close examination, the coxæ, and parts of the tibiæ and tarsi are seen to be obscurely testaceous. In the type-female, the subscutellar elevations are feeble, but traceable; but they are practically absent from the male.

XYLOPHILUS BIMACULIVENTRIS, n.sp.

Of a dingy piceous-brown; head almost black, elytra, muzzle, antennæ, palpi and legs of a more or less dingy brownish-testaceous; a fairly large, oblique, elliptic, flavous spot on each side of base of abdomen. With very short, ashen pubescence.

Head with minute punctures. Eyes prominent, widely separated, moderately notched in front, and (for the genus) rather small. Antennæ rather long and thin, second joint subglobular, slightly shorter than third, none transverse, eleventh wider than

tenth, but shorter than ninth and tenth combined. *Prothorax* rather small and slightly transverse, with a shallow, twice interrupted impression across middle, and with four impressions at base, of which the two median ones are oblique, larger and more distinct than the others, and almost touch. *Elytra* comparatively large, much wider than prothorax, sides feebly dilated to beyond the middle, with a feeble swelling on each side of scutellum, and a depression behind each swelling; with dense and sharply defined punctures on basal half, becoming very small posteriorly. *Legs* long and thin; hind-tibiæ thin throughout. Length, $1\frac{1}{4}$ - $1\frac{1}{2}$ mm.

Hab.—N.S.W.: Jenolan (J. C. Wiburd), Wollongong (A. M. Lea).

Readily distinguished from all the other, small, dingy species of the genus, by the two, conspicuous, abdominal patches; although these are probably sexual (and masculine), they are slightly elevated, and have denser clothing than elsewhere. The elytra are distinctly paler than the prothorax, and the latter is somewhat paler than the head; the basal joints of the antennæ are somewhat paler than the others. On one specimen, each segment of the abdomen is flattened in the middle; on another, they are similarly flattened, but the apical segment has a conspicuous depression on each side of the middle; probably, however, the flattening was due to the specimens being mounted when the abdomen was in a soft condition.

XYLOPHILUS CONVEXICEPS, n.sp.

♂. Blackish; palpi, tarsi, and coxæ obscurely paler. Moderately clothed with very short, depressed, ashen pubescence; the elytra, in addition, with a few, fine, upright hairs.

Head of moderate size and rather strongly convex, narrowed behind eyes and at base, with a distinct (but normally concealed) neck, median line vaguely traceable, semicircularly depressed in front: with dense and sharply defined, but rather small punctures. Eyes rather small, lateral, very prominent, entire, rather distant from base. Antennæ long and thin, each inserted in front of a slight ridge placed obliquely inwards from the eye,

first joint not very long, its apical portion subglobular, second small and subglobular, third slightly longer than first or fourth, feebly dilated to apex, fourth to tenth subequal in length, each lightly and regularly dilated to apex, eleventh slightly longer than tenth, its tip moderately acute. Apical joint of palpi securiform. *Prothorax* rather small, about as long as wide, distinctly narrower than head; with a conspicuous, semidouble, medio-basal impression, and a smaller but distinct one on each side of base, a distinct impression across middle at apical third, but rather shallow in middle, and with a vague, median line: with dense punctures, slightly larger than on head. *Scutellum* minute. *Elytra* lightly convex, distinctly wider than prothorax, almost parallel-sided to near apex, with a vague swelling on each side of scutellum: punctures crowded, sharply defined, and slightly larger than on prothorax, becoming smaller (but still distinct) posteriorly. *Sterna* with crowded and moderately large punctures: metasternum elongate, with a distinct, medio-apical fovea. *Abdomen* large, all sutures distinct: with dense, sharply defined punctures, rather smaller than on sterna; second and fifth segments slightly larger than each of the others. *Legs* rather long and thin; front coxæ touching, middle pair lightly, the hind ones moderately separated, hind-femora moderately stout, hindmargin with a conspicuous patch or fringe of pale pubescence, shorter near base than in middle, so as to cause a notched appearance. Length, $2\frac{1}{4}$ - $2\frac{1}{2}$ mm.

Hab.—Tasm.: Hobart (A. M. Lea).

The suture between the two basal segments of abdomen is quite distinct across the middle; the margins of the prothorax are not keeled, and the prosternal sutures are rather distinct: the clothing of the hind-femora is remarkable, but there are many Xylophili with curious, femoral clothing. Under a compound power, the hind-tibiæ appear to be terminated by two small spines (invisible under a Coddington lens), and the hind-tarsi to have the basal joint as long as the rest combined, the second short, the third produced as a lobe under the base of the fourth, and each claw to have an obtuse swelling at its base.

I am satisfied that all the preceding species belong to *Xylophilus*, or to some of the many subgenera proposed at its expense: but so many, apparently strikingly distinct forms have been separated from that genus, and later on reunited with it, that it seems desirable not to propose any new genus on species that could, by any reasonable probability, be referred to it. It is probable that the present, and some of the following species, may be considered worthy of generic rank, but, for the present, they are referred to the main genus. Whether this and the next species are allowed to remain in *Xylophilus* or not, however, they should always be generically associated.

XYLOPHILUS SUBSERRATICORNIS, n.sp.

♂. Black, prothorax flavous, parts of legs obscurely flavous. Moderately clothed with short, depressed, ashen pubescence; elytra, in addition, with a few, fine, upright hairs.

Head and appendages as in preceding species, except that the median line is still more feebly impressed, that the punctures are slightly more distinct, and that the antennæ have a slightly more serrated appearance. *Prothorax* slightly transverse, and distinctly narrower than head, base and apex equal, sides gently rounded, with an impression across middle at apical third, rather shallow on disc but fairly deep on sides, with a conspicuous, curved, medio-basal impression, and a small, round fovea on each side; punctures much as on head. *Scutellum* minute, within a shallow depression. *Elytra* rather long, much wider than prothorax, almost parallel-sided to near apex, with a vague swelling on each side of scutellum: punctures dense, sharply defined and of moderate size, becoming smaller posteriorly. *Sterna* and *abdomen* much as in preceding species. *Hind-femora* each with a conspicuous pad of pale pubescence on hind-margin from base to near apex. Length, $2\frac{1}{2}$ mm.

Hab.—N.S.W.: Jenolan (J. C. Wiburd). Unique.

Structurally close to the preceding species, but with flavous prothorax, and clothing of hind-femora somewhat different. The eleventh joint of both antennæ, and the middle legs are missing from the type.

XYLOPHILUS INFLATIPENNIS, n.sp.

Of a dingy piceous-brown, head and prothorax almost black. Moderately clothed with very short, ashen pubescence.

Head transverse, rather convex, shining; with some distinct punctures between eyes but sparse elsewhere; muzzle short. Eyes rather large, lateral, prominent, coarsely faceted, scarcely notched, rather distant. Antennæ long and thin, second joint small and subglobular, third to tenth equal and cylindrical, eleventh slightly longer and wider than tenth. Apical joint of palpi securiform. *Prothorax* rather small, slightly wider than long, base considerably wider than apex, with a conspicuous, oblique, slightly curved impression, commencing near middle of base, and ending on each side near apex, a shallow median line on apical two-thirds; punctures dense and somewhat irregular, but usually sharply defined. *Scutellum* small. *Elytra* flat, much wider than prothorax, considerably dilated to near apex, and then widely rounded, with an extremely feeble swelling on each side of scutellum; punctures dense, sharply defined, and of moderate size near base, becoming smaller posteriorly. *Metasternum* shining, with distinct punctures at base and sides, and with a conspicuous, medio-apical impression. *Abdomen* with second segment slightly longer than first, the suture between them distinct across middle. *Legs* long and thin; front coxæ touching, the others lightly separated; penultimate joint of tarsi produced below claw-joint. Length, $2\frac{1}{4}$ - $2\frac{1}{2}$ mm.

Hab.—Tasm.: Mount Wellington, Ulverstone (A. M. Lea).

In general appearance, like a minute *Trichosalpingus*. The oblique impression on each side of the pronotum is considerably deeper in front than where the two join near the base (although very conspicuous there); as a result, the apical portion appears to be rather strongly convex in the middle, and much deeper than the basal portion. In the male, the antennæ distinctly pass the metasternum; in the female, they scarcely extend so far, and the joints (especially after the fifth) are less cylindrical.

The dilated elytra, and suture between the two basal segments

of abdomen distinct across the middle, are aberrant features; the sculpture of the prothorax is also peculiar. If it should eventually be considered necessary to refer it to a new genus, the next species should probably also be associated with it.

XYLOPHILUS VILLOSICORNIS, n.sp.

♂. Of a dingy piceous-brown, appendages somewhat paler. Clothed with short, ashen pubescence, but the antennæ with numerous, rather long hairs.

Head transverse, shining, rather convex; with distinct punctures; muzzle short. *Eyes* moderately large, lateral, prominent, coarsely faceted, lightly notched, rather distant. *Antennæ* decidedly long and thin, second joint small and subglobular, third to tenth cylindrical, third slightly longer than fourth, fourth to tenth subequal, eleventh distinctly longer than tenth and slightly wider. Apical joint of palpi strongly securiform. *Prothorax*: rather small, lightly transverse, with a conspicuous, curved, medio-basal, semidouble impression, and a small impression near it on each side: a strong, transverse impression on each side near apex, but not traceable to middle, with a very vague, median line on apical half: punctures small, and moderately dense. *Scutellum* small. *Elytra* long and feebly convex, much wider than prothorax, basal third parallel-sided, and then very feebly dilated to near apex, with a very vague swelling on each side near scutellum: punctures dense and sharply defined, but not very large near base, becoming smaller posteriorly. *Metasternum* rather elongate; with numerous, sharply defined punctures; a distinct, medio-apical impression. *Abdomen* with second segment slightly larger than first, the suture between them distinct across middle, third and fourth segments small. *Legs* long and thin, their coxæ and tarsi as in the preceding species. Length, $1\frac{3}{4}$ mm.

Hab.—Tasm.: Mount Wellington (A. M. Lea). Unique.

With the general appearance of some of the thinner specimens of *X. tenuicornis*, but prothoracic impressions, antennæ, and abdomen different. The head and abdomen are rather darker than the other parts.

XYLOPHILOSTENUS, n.g.

Head of moderate size, with a distinct neck. Eyes large, transverse, coarsely faceted, deeply notched; rather close together in front. Antennæ of moderate length, some of the joints strongly ramose in male, simple in female. Palpi with apical joint strongly securiform. *Prothorax* strongly transverse, margins keeled. *Scutellum* small. *Elytra* long and almost parallel-sided, not much wider than prothorax. *Mesosternum* moderately long; episterna wedge-shaped; epimera briefly triangular. *Metasternum* elongate; episterna rather narrow, conspicuously narrowed posteriorly. *Abdomen* with all sutures distinct, first segment shorter than second along middle, but longer at sides; second slightly longer than third or fourth, the latter slightly longer than fifth. *Legs* rather long and thin; front coxæ touching, coxal cavities widely open behind, middle coxæ separated in front, but touching behind; hind-coxæ almost touching; femora unarmed; tibiæ lightly spurred, hind pair slightly dilated to and feebly notched at apex; tarsi with penultimate joint produced as a lobe under base of claw-joint, claws small and apparently simple.

The typical species is a narrow, depressed insect, in general appearance strikingly close to many species of *Heteromastix* of the *Malacodermidae*; it differs from *Xylophilus* in its decidedly more elongate form, and distinct suture between the first and second abdominal segments. The wings are large and blackish.

XYLOPHILOSTENUS OCTOPHYLLUS, n.sp. (Plate xxix., fig.2).

♂. Black or blackish, prothorax flavous; legs and palpi of a more or less dingy flavous or testaceous, the hindlegs sometimes piceous. Moderately clothed with whitish or ashen, suberect pubescence, on the prothorax with a somewhat golden tone; undersurface and legs with shorter, depressed pubescence.

Head with minute and not very dense punctures; with a shining, oblique ridge near each eye, the space between the ridges subtriangular, depressed, and with more conspicuous punctures than elsewhere. Eyes some distance from the base, at their

closest separated from each other for about the length of second joint of antennæ. Antennæ inserted in front of the ocular notches, first joint moderately long, dilated to apex, second small, third almost as long as first but rather less dilated to apex, fourth to tenth very short but each with a long and thin ramus, eleventh long, thin, and resembling the ramus of the preceding joint. *Prothorax* about twice as wide as long, base truncate, sides gently rounded; with small and fairly dense punctures; with a rather small and deep fovea on each side of base, and a wider and shallow depression between them. *Elytra* more than thrice as long as head and prothorax combined: with dense, sharply defined punctures of moderate size, becoming rather small posteriorly, but nowhere lineate in arrangement. Front *tarsi* not very long, first joint slightly shorter than fourth: hind-tarsi with first joint lightly curved and longer than the rest combined. Length, $3\frac{3}{4}$ -4 mm.

♀. Differs in having the eyes not quite so close together, antennæ longer and without rami, fourth joint slightly longer than third, the others very feebly decreasing in length, elytra slightly wider posteriorly, abdomen more convex, and legs somewhat shorter.

Hab.—Tasm.: Mole Creek, Ulverstone, Burnie, Hobart (A. M. Lea).

The antennal rami appear to be of a very fragile nature, as most of them are damaged on the two males before me: each of them is about as long as the elytra are wide, and slightly knobbed at the tip.

RHIPIDOPHORIDÆ.

PELECOTOMOIDES SUBPARALLELA, n.sp.

Black, claws and tibial spurs reddish. Densely clothed with short, ashen pubescence.

Antennæ rather stout, third joint almost as long as fourth and fifth combined, fifth slightly longer and distinctly wider than fourth, sixth to tenth strongly serrated, eleventh notched on each side near apex. *Prothorax* with sides strongly rounded, apex

not half the width of base, with three feeble depressions in a transverse series across middle. *Elytra* a trifle wider than prothorax; almost parallel-sided to beyond the middle, each with a shallow, longitudinal depression, and with traces of feeble costæ. Length, 12-16 mm.

Hab.—N.S.W.: Jenolan (J. C. Wiburd), Mount Kosciusko (R. Helms).

A rather large, dingy species (although much smaller than *P. conicollis*), that might be referred to Gerstäcker's first section of the genus. The elytra are much less narrowed posteriorly than any of the species named by Macleay. The specimens from Mount Kosciusko have the elytra and tarsi of a dingy brown, the abdomen and antennæ somewhat darker; on the type, part of the elytra and scutellum are obscurely brownish, but on a second specimen, from Jenolan, these parts (except as to their clothing) are entirely black.

CEDEMERIDÆ.

PSEUDOLYCUS TARSALIS, n.sp. (Plate xxix., fig.3).

♀. Black, opaque, elytra of a brick-red. Densely clothed with short pubescence, similar in colour to the derm on which it rests.

Head strongly convex between eyes. *Antennæ* with third to sixth joints flat, strongly inflated and subtriangular, seventh also flat and inflated, but lop-sided, eighth to eleventh much thinner and cylindrical, eleventh semi-double. *Prothorax* strongly transverse, widest close to apex, angles evenly rounded off, with a vague, median depression somewhat deeper at base and apex, and with a large, irregular excavation towards each side of disc. *Elytra* much wider than prothorax, slightly dilated posteriorly; each with four, conspicuous, subcostal elevations on disc, suture also elevated but not to base; surface densely and finely granulate but partially concealed by clothing. Basal joint of hind-tarsi with a conspicuous setæ-tipped projection at the outer base. Length, 12½ mm.

Hab.—Tasm.: Frankford (A. M. Lea). Unique.

In general appearance, strikingly close to var. *rufipennis* of *P. hæmorrhoidalis*, but at once distinguished by the hind-tarsi

(the remarkable sculpture may be sexual, but, as the type is a female, this is unlikely); the prothorax is also very much shorter, and without the conspicuous medio-basal impression bounded posteriorly by oblique ridges, being even shorter than in *P. wallacei*. The semi-doubling of the apical joint of the antennæ is so conspicuous, that that joint appears to be really two; and these regularly decrease in length, with the others, from the eighth. On the type, the elytra are not entirely red, as the suture, for a short distance, is black; and there is a slight infuscation on the disc of each at about the basal fourth; the latero-basal margins (concealed from above) are also black; the legs (except for the claws and tibial spines) and antennæ are entirely black.

PSEUDOLYCUS BIVITTICOLLIS, n.sp.

♀. Black, opaque; elytra and two prothoracic vittæ of a bright brick-red; antennæ with most of the eighth and ninth joints, and the bases of the tenth and eleventh, obscurely red. Densely clothed with pubescence, similar in colour to the derm on which it rests.

Head strongly convex between eyes. Antennæ with third to seventh joints wide, flat, and subtriangularly dilated to near apex, eighth to eleventh much narrower and cylindrical, eleventh conspicuously semi-double. *Prothorax* widest near apex, where the width is slightly more than the length, but base less than the length; with a shallow, median line from apex to base, and somewhat dilated posteriorly; a shallow depression on each side in front. *Elytra* much wider than prothorax; each with four, conspicuous, costal elevations on disc; surface finely granulate. Length, 14 mm.

Hab.—N.S.W.: Galston (D. Dumbrell).

In general appearance (except for the prothoracic vittæ) much like the var. *rufipennis* of *P. hæmorrhoidalis*, and with antennæ of very similar shape (but not colour); but differs in having the depressed median line of the prothorax commencing almost at the extreme apex, and gradually dilating to the base, so that there is not a medio-basal triangle. The eighth joint of antennæ

is almost entirely of a dingy flavo-testaceous, the ninth and tenth partly so, the eleventh is distinctly semi-double, the apical portion being conspicuously shorter and narrower than the basal portion. The prothoracic vittæ are almost parallel-sided, and parallel to each other, in which they differ from the form of *P. hæmopterus* having the pronotum bivittate; but the females of both species may be distinguished by the seventh and eighth joints of antennæ; in the present species, their proportions being as in *P. hæmorrhoidalis*, although, in colour, the apical joints approach those of *P. hæmopterus*. A specimen from Beechworth (Victoria; in Coll. Carter), has the prothoracic vittæ considerably reduced in size, so that they do not quite touch the base, and terminate about the middle.

Table of the Species of *Pseudolycus*.

- A. Antennæ conspicuously eleven-jointed.
- a. Sutural costa near base curving round to join first discal costa *wallacei*.
 - aa. Sutural costa not joined to first discal costa.
 - b. Median vitta of prothorax continuous throughout *carteri*.
 - bb. Median vitta terminated before apex *ritticollis*.
- AA. Antennæ with apical joint semidouble, causing them to appear almost or quite twelve-jointed.
- B. Pronotum polished and glabrous *hilaris*.
- BB. Pronotum densely clothed (at any rate in parts).
- C. Basal joint of hind-tarsi not simple *tarsalis*.
- CC. Basal joint simple.
- D. Prothorax having two ridges, which diverge obliquely hindward from the middle of the median line, enclosing a triangular depression.
 - c. Eighth joint of antennæ quite as flat as, and more than half the width of seventh *niger*.
 - cc. Eighth joint subcylindrical, and less than half the width of seventh *hæmorrhoidalis*.
- DD. Prothorax not as in D.
- E. Pronotum red along middle *torridus*.
- EE. Pronotum black (or, if partly red, then black along middle).
- F. Eighth joint of antennæ of female much less than half the width of seventh *biritticollis*.
- FF. Eighth joint of female more than half the width of seventh *lucæmopterus*.

Notes on Table.

c. P. niger is placed here with hesitation, as the medio-basal depression is less triangular than in *P. hæmorrhoidalis*, and the posterior bounding lines are more obtuse and less straight.

P. canaliculatus was not included in the table, owing to the broken antennæ of the type: but it would probably be associated with *P. hilaris*.

DOHRNIA UNDULATICOLLIS, n.sp.

♂. Black, front of head (except labrum) and its undersurface except behind eyes), prothorax, most of legs, and parts of antennæ and palpi flavous. Densely clothed with pale, depressed pubescence; less conspicuous on head and prothorax than elsewhere.

Head gently convex towards base, and obliquely flattened in front; with dense and small, but rather sharply defined punctures. Eyes large, prominent, and entire. Antennæ rather long and thin, eleventh joint slightly longer than tenth, and feebly semi-double. *Prothorax*: distinctly transverse, sides moderately dilated towards apex, apex gently rounded, base bilobed and narrowly upturned; with a wide, transverse depression near apex, a smaller medio-basal depression, and a shallow impression on each side about the middle; with very small punctures. *Elytra* much wider than prothorax, parallel-sided to near apex; each with two, feeble, discal costæ: punctures crowded and small, but sharply defined. Tip of *abdomen* triangularly notched. *Legs* rather long and thin: claws each with a small but distinct basal swelling. Length (♂♀), 6-7½ mm.

♀. Differs in being somewhat wider, eyes rather less prominent, antennæ and legs a little shorter, and abdomen not notched.

Hab.—N.S.W.: Blackheath (G. Masters), Jenolan (J. C. Wiburd), National Park (A. M. Lea).—Victoria (H. J. Carter).

In general appearance very close to *D. bifoveicollis*, and with the labrum quite as conspicuously black, but the prothorax with a transverse impression covering the whole of the space near the apex, instead of with two, large, disconnected excavations. The eight apical joints of the antennæ are narrowly flavous at base,

but the three other joints have most of their underparts pale: the tips of the palpi are infuscated: the tarsi are mostly black or infuscated, the front tibiae infuscated about apex, the middle ones have the infuscation more extended, and the hind ones still more so; on two specimens, the hind-femora are stained with black about the middle; on several specimens, the head has a vague, brassy gloss; the scutellum is black, except that, on one specimen, its tip is obscurely diluted with red.

Table of the Species of *Dohrnia*.

Antennae of male with some joints distorted	<i>miranda</i> .
Antennae of male with no joints distorted.	
Pronotum with two, large, disconnected, subapical excavations	<i>bifoveicollis</i> .
Pronotum without such excavations.	
Middle femora entirely black or blackish	<i>boisdurati</i> .
Middle femora about half pale and half black	<i>eremita</i> .
Middle femora entirely pale	<i>undulaticollis</i> .

COPIDITA INCISA, n.sp. (Plate xxix., fig.4).

♂. Flavous and black, elytra dark metallic blue (or green). Rather densely clothed (more sparsely on the prothorax than elsewhere) with subdepressed, ashen or sooty pubescence.

Head rather strongly convex: with dense and sharply defined punctures, becoming crowded near base; mandibles bifid. Eyes large, prominent, and rather lightly notched. Antennae long and thin, eleventh joint slightly longer than tenth, and feebly semi-double. Maxillary palpi with the outer joint large, and strongly notched on the outer side. *Prothorax* slightly longer than wide, sides dilated to near apex, apex gently incurved at middle, base narrowly upturned: with three, vague depressions; punctures fairly dense and large about base and sides, but rather shallow, becoming smaller elsewhere. *Elytra* much wider than prothorax, with remnants of feeble, discal costae; with crowded and rather coarse punctures, in places becoming granulate-punctate. Length (♂♀), 6½-7 mm.

♀. Differs in being somewhat wider, prothorax lightly trans-

verse, apical joint of palpi longer and not notched, in the tip of the abdomen, and the claws.

Hab.—N.S.W.: Mount Victoria (A. M. Lea).

In general appearance, fairly close to *C. apicalis*, but readily distinguished by the palpi of the male. In some respects, the specimens agree with the description of *C. pulchra*, but the apical joint of the maxillary palpi is fully twice the length of the penultimate (instead of scarcely longer) in both sexes, and in the male is very distinctive. The male certainly has bifid claws; in the female, each claw, from some directions, is seen to have a conspicuous, basal swelling, rather acutely pointed, but the claws are not bifid. The flavous parts are the clypeus and middle of undersurface of head, prothorax, scutellum, mesosternum, metasternum, basal half of femora, and the coxæ.

COPIDITA PACHYMERÆ, n.sp. (Plate xxix., fig.7).

♂. Flavous: head (except for parts of muzzle), antennæ, palpi, knees, tibiæ, and tarsi black or infuscated; elytra black, with a purplish gloss, and a conspicuous, median, flavous patch. Rather densely clothed (sparser on the prothorax than elsewhere) with subdepressed, ashen or sooty pubescence.

Head moderately convex: with dense and sharply defined, but not very large punctures, becoming crowded at base, and smaller in front; mandibles bifid. Eyes large, prominent, and feebly notched in front. Antennæ long and thin, eleventh joint no longer than tenth, and conspicuously semi-double. Apical joint of maxillary palpi long, and conspicuously incurved on outer side. *Prothorax* distinctly longer than wide, sides moderately dilated near apex, base narrowly upturned; with vague, discal depressions; and dense and fairly large, subasperate punctures, becoming smaller and shallower in front. *Elytra* much wider than base of prothorax; each with four discal costæ, moderately distinct in places; densely granulate-punctate. *Hind-femora* very stout; hind-tibiæ with a small, acute tooth one-third from the inner apex. Length, $7\frac{1}{2}$ -8 mm.

Hab.—N.S.W.: Sydney (H. J. Carter), Galston (D. Dumbrell).

In general appearance much like *C. sloanei*, but the male without a supplementary process to the palpi, hind-femora unusually stout (fully twice as thick as the others), and hind-tibiæ dentate. The abdomen appears to be composed of but four ventral segments, with the apical one large, lightly produced at the middle of its apex, and not concealing the complicated genitalia; the true first segment, however, is visible at the sides. The elytra have the suture narrowly pale, but, in the middle, there is a suddenly dilated, subquadrate patch, rather sharply defined, but with somewhat jagged edges.

Five females from Galston probably belong to this species; they have the hind-femora not, or scarcely, stouter than the others, and the hind-tibiæ simple; the dark parts of the appendages rather less deeply infuscated, and the median patch of the elytra is more regularly quadrate.

COPIDITA MEDIOFLAVA, n.sp. (Plate xxix., figs. 5, 6).

♂. Flavous and black or blackish, elytra black with a purplish gloss, the suture and a conspicuous median patch flavous. Clothing much as in preceding species.

Head with eyes, mandibles, and antennæ as in preceding species. Apical joint of maxillary palpi large and conspicuously notched on outer side. *Prothorax* with outlines and discal impressions as on preceding species, but with smaller punctures. *Elytra* much as in that species, except that the costal elevations are even less pronounced. *Legs* long and thin. Length, $6\frac{1}{4}$ - $6\frac{1}{2}$ mm.

Hab.—N.S.W.: Canterbury, near Sydney (H. J. Carter), Galston (A. M. Lea).

In general appearance strikingly close to the preceding species, but the apical joint of the palpi with a strong, median notch; the notch rendered more conspicuous by the space behind it being pale and membranous (it is much as on *C. incisa*) the hind-femora also are no stouter than the others; and the basal segment of the abdomen is quite distinct; the genitalia of the type are very conspicuous. *C. sloanei*, which it somewhat resembles, has, in the male, a conspicuous basal appendage to the apical joint of the palpi. The undersurface (except the three median segments

of the abdomen, which are deeply infuscated) is paler than the prothorax and elytra, these being of a rather bright flavous; the infuscation of the legs is not very deep. The dilated, sutural patch is much as in the preceding species.

The five females commented upon, under the preceding species, may possibly belong to this one, but the abdomen of each is entirely pale (as in the male of that species), not bicolorous (as in the male of this species).

COPIDITA TENUICORNIS, n.sp.

♀. Pale flavous, tips of mandibles blackish, pronotum with three, conspicuous, but not very sharply defined, infuscate lines, elytra with very feeble infuscate lines.

Head rather large, with irregularly distributed and not very large, but sharply defined punctures; mandibles bifid. Eyes large, prominent, widely notched, and rather closer together than usual in the genus. Antennæ very long and thin, eleventh joint moderately curved, distinctly longer than tenth, and with a vague remnant of doubling at the apical third. *Prothorax* slightly longer than wide, sides gently dilated from near the base, which is narrowly upturned, with a shallow and vaguely impressed, irregular, median line, and feeble impressions elsewhere; with fairly dense punctures. *Elytra* much wider than prothorax, each with four discal elevations, of which the third (apart from its colour) is scarcely traceable; with dense but rather ill-defined punctures. Fifth segment of *abdomen* rather long, its tip rounded. *Legs* rather long and thin. Length, 12-15 mm.

Hab.—Queensland: Cairns (E. Allen).

The three specimens before me are apparently all females; they are not very close in appearance to any previously described species. The infuscated lines on the elytra are fairly distinct to the naked eye, but less defined under a lens, and are due to the elevations being somewhat paler than the adjacent parts. The antennæ are unusually thin, and extend to the tip of the elytra. The prothoracic punctures are sharply defined on one specimen, much more so than on the type.

COPIDITA GRACILIS, n.sp.

♂. Flavous; tips of mandibles blackish, elytra with an infuscate, purplish vitta, extending from each shoulder to near the apex. Rather densely clothed with short, somewhat golden pubescence.

Head rather convex; with sharply defined but rather sparse and small punctures, becoming crowded about base; mandibles bifid. Eyes large, rather shallowly notched in front. Antennæ long and thin, eleventh joint slightly shorter than tenth, and conspicuously semi-double. *Prothorax* much longer than wide, sides gently dilated from near base to near apex; base narrowly upturned, with three, very vague, discal impressions; with dense and sharply defined punctures, larger and less crowded along middle than elsewhere. *Elytra* much wider than prothorax; each with two, rather distinct, costal elevations; with dense and sharply defined, but somewhat asperate punctures. Apical segment of *abdomen* conspicuously bilobed. *Legs* long and thin. Length (♂♀), 8-9½ mm.

♀. Differs in being rather more robust, prothorax shorter, apical segment of abdomen longer, with the tip rounded, and the legs and antennæ slightly shorter.

Hab.—Queensland: Little Mulgrave River (H. Hacker).

With the general outlines of *C. apicifusca*, but rather flatter; antennæ not quite so thin, with the terminal joint distinctly shorter; more shining, and less densely clothed, and with all the appendages and the undersurface pale. The elytral vittæ on the male are very conspicuous; from above, they appear to be marginal, from the base to near the apex; but, from the sides, the margins are seen to be narrowly flavous; on the female, the vittæ are distinct on the shoulders, but are little more than vague infuscations posteriorly. The joints of the palpi are elongate, and scarcely differ sexually; the genitalia of the type-male are conspicuously protruding.

COPIDITA FLAVA, n.sp.

♂. Flavous, opaque; tips of mandibles blackish. Densely clothed with very short, somewhat golden pubescence.

Head rather convex between eyes, vaguely depressed in front: with dense and sharply defined, but rather small punctures: mandibles bifid. Eyes large, conspicuously (but not deeply) notched in front. Antennæ long and thin, eleventh joint distinctly shorter than tenth, and with scarcely a trace of doubling. *Prothorax* distinctly longer than wide, sides moderately inflated near apex, base narrowly upturned, with three, vague, discal impressions: punctures much as on head. *Elytra* much wider than prothorax; each with four, discal costæ, of which the third is scarcely traceable. Length ($\sigma\varphi$), $8\frac{1}{2}$ - $10\frac{1}{2}$ mm.

φ . Differs in being more robust, with somewhat shorter prothorax, antennæ, and legs.

Hab.—Queensland (E. Allen).

In general sculpture fairly close to *C. apicifusca*, but entirely pale (except for the eyes and tips of mandibles), with somewhat different clothing and punctures, and slightly stouter antennæ: from the preceding species, it differs in being opaque, the punctures less conspicuous, prothorax more dilated to near apex, &c. The surface of the elytra could fairly be regarded as shagreened, as the punctures are much smaller, denser, and more asperate than on the prothorax. The apical segment of the abdomen is similar sexually, but from it, on the type-male, the tip of an ædeagus is protruding: and, from the type-female, an ovipositor: the palpi have the apical joint rather longer on the male than on the female.

CURCULIONIDÆ.

EPACTICUS SUTURALIS, n.sp.

Castaneous: head and rostrum black, funicle, club, tarsi, and undersurface almost black. Densely clothed with white, depressed, stout setæ or scales, conspicuously denser on scutellum, suture, sides of mesosternum and of metasternum than elsewhere: elytra, in addition, with some conspicuous setæ.

Rostrum slightly longer than prothorax, moderately curved; apical two-thirds shining and with minute punctures, basal third with rows of large, partially concealed punctures. Antennæ thin, inserted slightly nearer base than apex of rostrum; club rather

short. *Prothorax* about as long as wide, sides moderately rounded, base slightly wider than apex; with dense, partially concealed punctures. *Elytra* elongate, distinctly wider than prothorax, parallel-sided to near apex; with rows of rather large punctures, more or less concealed by clothing. Length, $2\frac{1}{4}$ - $2\frac{1}{2}$ mm.

Hab.—Victoria (Australian Museum).

Allied to *E. nigrirostris* but larger, and with the clothing on the suture conspicuously white throughout; at first glance, the upper surface is strongly suggestive of several species of *Misophrice*. The sixth interstice on each elytron towards the apex is more densely clothed than the adjacent surface, but not so conspicuously as the suture. The four specimens before me are probably females.

EPACTICUS ASPRATILIS, n.sp.

Black, parts of legs diluted with red, scape and club castaneous, funicle somewhat darker. Densely clothed with large scales, on the upper surface mostly of a dingy white and fawn-coloured, on the lower surface and legs mostly white with a silvery gloss.

Rostrum long, thin, and lightly curved; apical half shining, and with rows of small punctures, basal half with larger punctures, but more or less concealed by clothing. Antennæ thin, inserted just perceptibly nearer base than apex of rostrum; club moderately long. *Prothorax* slightly longer than wide, sides moderately rounded, base slightly wider than apex; punctures dense but normally concealed. *Elytra* considerably wider than prothorax, almost parallel-sided to apical third; with rows of fairly large, concealed punctures. Length, 3 mm.

Hab.—Western Australia: Geraldton (A. M. Lea).

More robust than any previously described species of the genus. The rostrum is less curved than on *E. ruber*, but the club is much the same. In some lights, the scales on the head and rostrum have a silvery gloss, but most of the scales on the upper surface are dingy; they are large and rough, and (except where abraded) completely conceal the derm; from above, the elytra appear to be uniformly and densely clothed with stout scales; but, from the

sides, some semi-decumbent setæ are visible. The type appears to be a female, and its rostrum is about once and one-half the length of the prothorax.

CERAMBYCIDÆ.

MERIONCEDA.

Pascoe, Trans. Ent. Soc. Lond., (2), iv., p.237; (3), iii., p.570.

This genus (represented by many species in the Malay Archipelago and New Guinea) does not appear to have been previously recorded from Australia. It is distinct by the acutely pointed elytra, pedunculate hind-femora, large basal segment of abdomen (which is also curiously clothed towards the apex in the male), deep impressions behind the clypeus, and very finely faceted eyes. In our catalogues, it should be placed near *Mecynopus*: it is a very interesting addition to the Australian genera of longicorn-beetles.

MERIONCEDA AUSTRALIS, n.sp. (Plate xxix., fig.8).

♂. Bright flavous: swollen parts of femora, hind-tibiæ, antennæ, and apical half of elytra black or blackish. Elytra and base and sides of prothorax sparsely pubescent, head with a few hairs between eyes; rest of upper surface glabrous.

Head rather long; with coarse punctures between eyes, small and sparse elsewhere: a deep, curved, clypeal suture, which has a short, deep impression extending backwards from its middle. Eyes deeply notched, distant from prothorax. Antennæ extending to tips of elytra, first joint not much longer than third, third and fourth cylindrical and equal, the following ones somewhat wider and depressed, eleventh slightly narrower and slightly longer than tenth. *Prothoracæ* about as long as greatest width, with a deep, bisinuate impression near apex, behind same with five longitudinal elevations; the median are elliptic and slightly posterior to the others; the outer ones lateral and obtuse; with rather sparse punctures in the depressed parts. *Elytra* much wider than prothorax, suddenly and strongly narrowed from near

base, with the tips acutely pointed; with almost regular rows of large punctures, but becoming irregular posteriorly: a rather obtuse carina along middle of apical fourth. Basal segment of *abdomen* almost as long as the rest combined, second large, widely semicircularly notched, the notch fringed with golden hairs, the following segments also with dense hairs in middle. Four front *legs* moderately long, the femora subpedunculate; hindlegs much longer, the femora strongly pedunculate, hind-tibiæ curved, with numerous, short spines, and a strong one at inner apex. Length, 8 mm.

Hab.—Queensland: Kuranda (H. Hacker). Unique.

The antennæ are uniformly dark, except that towards the tip there is a slight dilution of colours, but not one of the joints is conspicuously pale, as on many species of the genus: the basal joint of the hind-tarsi is black [the others are missing]: the dark apical portion of each elytron extends slightly beyond the middle on the inner side, but not to the middle on the outer side.

CHRYSOMELIDÆ.

OOMELO COCCINELLOIDES, n.sp.

Bright flavous, apical half of antennæ somewhat infuscated, elytra black, with a conspicuous, irregular, transverse spot on each (or interrupted fascia), slightly before the middle.

Head impunctate: with a vague, medio-basal impression. *Prothorax* almost four times as wide as long, base almost evenly rounded, sides rather strongly rounded in front: with fairly numerous, but very minute punctures. *Elytra* with rather strongly rounded sides; with rows of very small punctures, almost disappearing posteriorly; interstices very minutely punctate. Length, 4 mm.

Hab.—Queensland: Cairns (E. Allen). Unique.

The transverse mark on each elytron extends fairly close to the side and suture, but touches neither: it is evident close to the suture. The abdominal lamellæ are small. The elytral epipleuræ are concave throughout. In general appearance, the type is much like some small *Coccinellidæ*.

OOMELA BIMACULATA, n.sp.

Reddish-castaneous, elytra blackish with a greenish gloss, and with two reddish spots; most of antennæ infuscated.

Head with sparse and very feeble punctures, becoming slightly more distinct on clypeus. *Prothorax* at base fully four times as wide as long, sides rather strongly rounded in front; with numerous, but very small punctures. *Elytra* wider than prothorax at base, sides evenly rounded; with regular rows of rather small punctures, interstices almost impunctate. Length, $2\frac{3}{4}$ mm.

Hab.—Queensland: Port Denison (Macleay Museum).

The character distinguishing this species from *O. elliptica* in the table is a rather feeble one; but the two species differ as well by the former being much smaller, rather more elongate, base of elytra proportionately wider than base of prothorax, and to some extent in the punctures. The spot on each elytron is fairly large but not very sharply defined, and is placed at about the basal third (on the third, and on part of the second and fourth interstices), the extreme base of the elytra, and the suture near the base are also somewhat obscurely reddish; there is a vague infuscation of the base of the head in both specimens. The abdominal lamellæ are rather short.

OOMELA DISTINCTA, n.sp. (Plate xxix., fig.9).

Bright reddish-flavous: apical two-thirds of antennæ, lateral margins of prothorax, a transverse subelliptic spot behind scutellum, an oblique somewhat sinuous latero-median stripe on each elytron, a bisinuate subapical fascia, and most of the legs black, or deeply infuscate.

Head with some small punctures on clypeus, but elsewhere almost impunctate. *Prothorax* almost four times as wide as long, sides feebly rounded on basal half, more strongly on apical; with very minute punctures. *Elytra* not much wider than prothorax, sides gently rounded; with regular rows of rather small punctures, becoming much smaller posteriorly; interstices sparsely and minutely punctate. Length, $3\text{-}3\frac{1}{4}$ mm.

Hab.—N.S.W.: Gosford (H. J. Carter).

The elytral markings are identical on the three specimens under examination, but the degree of infuscation of the sides of the prothorax varies. The abdominal lamellæ are small, and usually concealed by the legs.

Table of the Species of *Oomela*.

- A. Elytra uniformly dark.
a. Elytra purple..... *pulchripennis*.
aa. Elytra not purple *elliptica* (partim).
 AA. Elytra dark, each with one pale spot.
b. The spot sharply defined, and transverse..... *coccinelloides*.
bb. The spot less sharply defined, and rounded.
c. An infuscate stain on pronotum adjacent to scutellum *elliptica* (partim).
cc. Without such a stain *bimaculata*.
 AAA. Elytra not as in A or AA.
 B. Elytra with a large, black spot surrounding scutellum *trimaculata*.
 BB. Elytra with a transverse, isolated spot close behind scutellum *distincta*.
 BBB. Elytra either immaculate, or with markings not as in B or BB *variabilis*.

GEOMELA LAMELLIFERA, n.sp.

Blackish or piceous-brown, with a slight metallic gloss; the appendages somewhat paler, but not strikingly so.

Head with numerous, distinct punctures; with two, small, round foveæ in front. *Antennæ* rather long, first joint stout, its apex subglobular, third as long as fourth and fifth combined, eighth feebly, ninth and tenth moderately transverse. *Prothorax* more than thrice as wide as long, base gently rounded; punctures much as on head but not quite so dense, and absent close to the margins. *Elytra* with sides gently rounded, and subcontinuous with those of prothorax; with regular rows of fairly large punctures: interstices densely and minutely punctate. Intercostal process of *prosternum* rather feebly elevated in front. *Abdomen* with basal lamellæ, each with a conspicuous, acute process, projecting obliquely backwards almost to apex of segment. Length, $2\frac{1}{4}$ mm.

Hab.—W.A.: Beverley, Pinjarrah (A. M. Lea).

The process on each of the abdominal lamellæ is notably longer than in *G. blackburni*, and the punctures on the head are more evenly distributed: on the latter species they are confined to a rather narrow space between the eyes; the antennæ also are longer and thinner than in that species. On close examination, the whole of the upper surface (more noticeably on the head than elsewhere) appears to be finely shagreened.

GEOMELA TASMANIENSIS, n.sp.

Black, with a distinct coppery gloss; appendages (five apical joints of antennæ blackish) reddish.

Head with dense and small but distinct punctures, and with some rather coarse ones between eyes; two small foveæ in front. Antennæ moderately long, first joint rather stout, third almost as long as fourth and fifth combined, seventh to eleventh rather wide, seventh moderately, the eighth to tenth strongly transverse. *Prothorax* with dense, small punctures, some larger ones on sides and across middle of apex. *Elytra* with regular rows of fairly large punctures; the interstices with numerous small but distinct ones. Intercostal process of *prosternum* rather feebly elevated in front. Basal lamellæ of *abdomen* large, each with a subtriangular process. Length, 3 mm.

Hab.—Tasm.: Waratah, Launceston (A. M. Lea).

The tip of the abdomen is obscurely reddish, and the femora are lightly infuscated. The outlines of the prothorax and elytra are much as on the preceding species, and on *G. blackburni*; but the process on each of the abdominal lamellæ is conspicuously shorter than on those species, and is triangular in shape.

GEOMELA MONTANA, n.sp.

Black, with a slight greenish gloss, part of head and under-surface more or less obscurely reddish, appendages paler.

Head with fairly numerous but small punctures; clypeal suture curved, well-defined, and without foveæ. Antennæ rather long and thin, third joint about as long as fourth and fifth combined, the five apical ones gently increasing in width but none transverse. *Prothorax* more than thrice as wide as long; with numer-

ous, minute punctures, and some slightly larger but still small ones. *Elytra* with regular rows of fairly large punctures: the interstices with very small ones. Intercostal process of *prosternum* rather narrowly elevated. Basal lamellæ of *abdomen* large, and rounded posteriorly. Length, 3 mm.

Hab.—Victoria: Mount Buffalo (H. J. Carter).

The general outlines are much as those of *G. blackburni*, but the abdominal lamellæ are very different. The front coxal cavities are apparently open behind, but the type, being unique, has not been broken to make sure of this.

GEOMELA NOBILIS, n.sp.

Dark metallic blue, with a purplish gloss: undersurface, femora, and antennæ purple, scutellum bronzy.

Head with minute punctures, and with some larger ones about eyes and on clypeus. Eyes more transverse than usual. Antennæ moderately long, third joint as long as fourth and fifth combined, seventh lightly transverse, the four following ones somewhat wider. *Prothorax* about thrice as wide as long; with numerous small but distinct punctures, and a few of larger size. *Elytra* with rows of not very large but sharply defined punctures; the interstices with sparse, and rather minute ones. Intercostal process of *prosternum* wedge-shaped. Basal lamellæ of *abdomen* large, rounded posteriorly, bronzy and shagreened. *Tibiae* wide, incurved near apex, basal joint of tarsi strongly inflated. Length, 5 mm.

Hab.—N.S.W.: Jenolan (J. C. Wiburd).

The largest and most beautifully coloured of the genus. The type, being unique, has not been broken to make sure of the front coxal cavities, but they appear to be rather widely open. The general outlines are much as those of *G. blackburni*, but the eyes, when seen from the side, appear to be fully four times as wide as long. The clypeal suture is feebly defined, but the clypeus itself, owing to its deeper colour and larger punctures, is very conspicuous. The abdominal lamellæ are larger than in any other species of the genus. The type, judged by the tarsi, is a male.

Table of the Species of *Geomela*.

- A. Abdominal lamellæ each with a process projecting conspicuously backwards.
- a.* Process subtriangular throughout *tasmaniensis*.
- aa.* Process with its apical portion parallel-sided.
- b.* Process produced backwards almost to apex of segment *lamellifera*.
- bb.* Prothorax terminated at least one-half from apex.... *blackburni*.
- AA. Abdominal lamellæ evenly rounded posteriorly.
- B. Of comparatively large size (5 mm.), and more or less purplish *nobilis*.
- BB. Much smaller (3½ mm. at most) and not at all purplish.
- C. Prothorax and elytra with margins more or less flavous.
- c.* Third joint of antennæ almost as long as fourth and fifth combined *circumflava*.
- cc.* Third joint scarcely, if at all, longer than fourth... *lucyophaga*.
- CC. Prothorax and elytra with margins not paler than disc.
- D. Bifoveate between antennæ *bifoveata*.
- DD. Not bifoveate there *montana*.

EXPLANATION OF PLATE XXIX.

Fig. 1.—*Xylophilus microcerus* Lea.

Fig. 2.—*Xylophilostenus octophyllus* Lea; antenna.

Fig. 3.—*Pseudolygus tarsalis* Lea; hind-tarsus.

Fig. 4.—*Copidita incisa* Lea; palpus.

Fig. 5.—*C. medioflava* Lea; palpus.

Fig. 6.—*C. medioflava* Lea; elytral markings.

Fig. 7.—*C. pachymera* Lea; elytral markings.

Fig. 8.—*Mecionada australis* Lea.

Fig. 9.—*Oomela distincta* Lea.

NOTES ON THE "COMMON NIGHTSHADE" (*SOLANUM NIGRUM* LINN.) AND SOME CLOSELY RELATED FORMS AND SPECIES THAT HAVE BEEN CONFUSED WITH IT.

BY EDWIN CHEEL, BOTANICAL ASSISTANT, NATIONAL HERBARIUM, SYDNEY.

(Plates xxx.-xxxiii.)

As far back as 1797, a common weed in Europe, popularly known under the name "Common Nightshade," was classified by Carl von Linné (47) under the botanical name of *Solanum nigrum*. Since that time, a number of forms or species, which have some superficial resemblance to the European species, have been mistaken for this plant by some authors, while others have recognised the differences, and have given them distinctive specific names.

A few of the most noteworthy species that have been confused with *S. nigrum* are as follow:—

- Solanum guineense* Lam. (Guinea Nightshade).
- „ *hirsutum* Dunal (Hairy Nightshade).
- „ *incertum* Dun. (Uncertain Nightshade).
- „ *humile* Bernh. (Humble Nightshade).
- „ *Forsteri* Seem. (Forster's Pacific Island Nightshade).
- „ *astroites* Forst.
- „ (*oleraceum* Dun.) (Herb-like Nightshade).
- „ *opacum* A.Br. (Dull Nightshade).
- „ *nodiflorum* Jacq. (Nodding Nightshade).
- „ *pterocanton* Dun.. (Winged Nightshade).
- „ *miniatum* Bernh.
- „ *rubrum* Mull. (Red-berried Nightshade).
- „ *villosum* Lam. (Yellow-berried, villous Nightshade).

In addition to the above, quite a number of distinctive botanical names have been recorded, which appear to apply to the same plants, so that the synonyms are very numerous, as

will be seen by referring to the list I have drawn up in the following pages. Although Lamarek(46), Miller(61), Persoon(66), Aiton(1), Link(46a), Don(20), and other botanists in the early days, regarded the plants as belonging to distinct species, and have recorded them under the names mentioned on the preceding page, we find that C. B. Clark(17), Bentham(11), Hooker(41-42), and other authorities, who have studied these plants in the Kew Herbarium, have united them under one species, namely, *S. nigrum*, so that we find upwards of fifty specific names recorded in botanical works which, according to the latter authorities, belong to one and the same species.

In Australian botanical works, the various authors have adopted the nomenclature of Bentham, so that the plants commonly known to Australians as "Native Black Currants," are known in botanical works under the name *S. nigrum* Linn., which, in Europe, is referable to the "Common Nightshade."

In view of the numerous reports, received from various parts of the Commonwealth, of animals, and even children, being suspected to have been poisoned through eating the berries of these plants, while others state that the berries make an excellent conserve or jam, it seems desirable that the various plants should be more carefully examined and investigations made in the light of more modern knowledge. Tests should be made of the distinctive forms, so as to prove whether the plants are deleterious or not. We know that there are at least three distinctive forms found in Australia, which are easily recognised by the different habit, colour of foliage, and other distinctive characters; and that there are still others which have been introduced from other countries, which are easily recognised as distinct from those growing wild in Australia, in that their berries are distinctly of a reddish or yellowish colour, while those of our forms are of varying shades of black or purple. Even as far back as 1868, it was pointed out by Wools(78) that we have in Australia two distinct forms of what is commonly known here as "Native Black Currants." His remarks are recorded as follows:—"Solanum seems to have two varieties here. The one is indigenous; the

other is identical with the European plant, and has probably come here with English seeds. It is remarkable that the children eat the berries of *S. nigrum* with impunity." The late F. M. Bailey, C.M.G., Colonial Botanist of Queensland, has also noted two distinct forms, as will be seen by his statement which I will give further on. Mr. C. T. Musson, in submitting specimens to the National Herbarium for determination, has also drawn attention to two distinct forms. In studying the plants in the field, as well as the numerous herbarium-specimens contained in the National Herbarium Collection from a large number of localities in Australia and the Pacific Islands, it seems to me that we have at least three species which may be regarded as indigenous, and easily recognised as distinct from the European species. As stated above, a variety has been recorded for Queensland by Bailey(5, 6) under the name *Solanum nigrum* var. *humile*, but whether this is the same as *S. humile* of Bernhardt(12) or of Lowe(50), I am not at present in a position to state, as I have not had an opportunity of examining the living plants in Queensland. It would appear, however, that the plants mentioned by Bailey, are different from those quoted by Lowe from Mogador, as the latter are described as being "very like *S. nigrum* L., but of humble growth, with smoother, somewhat smaller leaves, and waxy-looking, pale, dull ochre-yellow berries."

If we review the various statements made in connection with the poisonous or edible qualities of the plants recorded under the name *S. nigrum*, it will be found that the evidence is very conflicting, and that it is highly necessary to examine each form of the so-called species separately, so as to be able to say whether the berries of the decumbent plants are poisonous, and those of the upright form are not, or *vice versa*, or if both forms are equally bad.

For the benefit of those who may be interested in the subject as to whether the berries may be utilised as food for animals or as a conserve or jam for human beings, I have gathered together the following statements, which will give some idea as to the different opinions.

In a letter to Sir Joseph Hooker in 1864 (42a), Mr. W. S. M. D'Urban, F.L.S., states that "*Nicandra physaloides* and *Solanum nigrum* are abundant in British Kaffraria in gardens. The soldiers stationed in the colony often eat the black berries of the latter, and they appear to be innocuous." Then we have reports from Messrs. W. Kyle, Inspector of Stock, and Graham Mitchell, in relation to the mortality among Mr. Dutton's cattle at Broadmeadows, in Victoria; also a report from Mr. W. Johnston, Analytical Chemist, on the analysis of the stomach of one of the dead cows; and from Mueller upon the properties of the plant to which the deaths are attributed. All these reports agree in the opinion that the mortality is owing to another form of poisoning, caused by the feeding on *S. nigrum*, commonly known as "Annual Nightshade." In a further report, Mueller (62) published the following remarks, together with a figure of the plant: "the herb which produced poisonous effect on the cattle of Broadmeadows is the *Solanum nigrum*, called in Britain the 'Annual Nightshade'." It is a cosmopolitan plant, since ancient times known as poisonous, and mentioned under the name of *Strychnos* along with *Atropa belladonna* in the writings of Dioskorides already, it belonging, indeed, with the Belladonna, Madragora, and Stramonium, to the same Order of plants (Solaneæ). The most active principle of *Solanum nigrum* is a glucoside (Solanin), and this is most strongly developed in the unripe berries. The plant, however, acts not with the dreadful intensity of the deadly Nightshade (*Atropa belladonna*), but it is far more commonly dispersed, and disseminates itself with celerity, particularly on road-sides, waste places, in gardens, &c. It being, however, an annual, it can be readily enough destroyed by weeding prior to its ripening its berries. The solanin produces paralysis of the extremities prior to death when consumed in quantity."

Bailey and Gordon (7) made the following statement about the plant:—"Small Black Nightshade (*Solanum nigrum*) White flowers are succeeded by usually black berries, but in the more downy plant often greenish; this latter form has often a

more prostrate, spreading habit, and is considered to possess more poisonous properties. A world-wide weed. This widespread weed has very frequently been brought under notice as poisonous both in this and in other colonies. Some years ago it was reported to have poisoned a number of cattle in Victoria, and those appointed to inquire into the matter gave it as their opinion that the deaths occurred from this cause. The evidence, however, as to the fruit being poisonous is very conflicting. It has been asserted that children have been poisoned by eating the berries raw, but cooked they may be partaken of with impunity. There are two forms of the plant met with in Queensland, as before stated, and in all probability the more straggling form with greenish berries is the dangerous kind, and probably, as has been asserted, the plant may possess more or less poisonous properties according to the soil upon which it is grown; thus it may be most dangerous when growing on rich soil, rubbish-heaps, &c., and perhaps quite harmless when growing upon dry, poor soil, enjoying the full rays of the sun." In a subsequent publication, Bailey(5) makes a statement as follows:—"There are two forms of this plant in Queensland, the one nearly glabrous, which has an erect growth; the other having a somewhat procumbent habit and clothed with a glandular pubescence. This latter is sometimes called var. *humile*; its fruit is of a somewhat greenish-yellow, and when we hear of children being poisoned from eating the fruit of this species, it has probably been the fruit of the latter variety that has caused the mischief. The herbage of both varieties is considered poisonous to stock. It has, however, been used both here and elsewhere as a substitute for spinach." Dr. Aitchison, in writing on the Botany of the Afghan Delimitation Commission, states(2) "that *Solanum nigrum* grew in quantity, and was employed as a pot-herb by the camp followers."

In a list entitled "The supposed Poisonous Plants of West Australia," Mr. F. Turner(73) gives *Solanum nigrum* L., "Nightshade," together with a brief description and the following remarks:—"Flowers small and white, arranged in little cymes. These are succeeded by small, globular berries, usually nearly

black, but sometimes greenish-yellow or dingy red. The forms that bear the two last coloured fruits are considered the most dangerous. The black-coloured berries are frequently eaten by children."

In the *Western Mail* for April 30th, 1911, it was reported that two children (a girl 3½ and a boy 6 years of age) at Bunbury, W. A., ate some berries of *Solanum nigrum*, and that the little girl died. Mr. J. H. Maiden, F.R.S., Director of the Botanic Gardens, Sydney, has also made several references to *Solanum nigrum*. The first account appears to be in 1895 (52), where he states that it is "supposed to be the cause of blindness in horses, particularly young animals, who unknowingly eat the plant." In the *Daily Telegraph*, May 14th, 1906, Mr. Maiden further states, "I have eaten jam made of the fruits. I do not believe that stock have been poisoned by this plant, and it is one which has often been the subject of special enquiry in regard to this particular plant." This latter statement was made in reply to an enquiry if the plant was likely to have caused the death of some cattle on Daisy Piper's Flat. In a further note on this species, Mr. Maiden (53) reaffirms the above statement, as will be seen by the following remarks:—"This widely diffused weed is by some persons believed to be poisonous, by others innocuous. . . . My own opinion is that it is not poisonous, though it is quite possible that if the fruits be eaten unripe, or if the plant be grown in damp, shady places, it may possess acidity and produce gastric disturbance. The ripe fruits are made into jam in parts of this Colony, and are also eaten by human beings in other parts of the world." Ewart & Tovey (25) state that "although useless as a fodder plant, it possesses no virulent poisonous properties, and as a rule stock do not touch it. The plant is commonly regarded as highly poisonous, partly owing to confusion with the "Deadly Nightshade" (*Atropa belladonna*), which is fortunately rare, and partly owing to hasty generalisation. A small amount of solanin is present in the stem and berries of *Solanum nigrum*, but these are usually less poisonous than green potatoes, in which alkaloids also appear. In addition, stock do not touch it at all unless starved. . . . The "Black

Nightshade" berries are often eaten by children without any ill-effects beyond, perhaps, a stomach-ache, or, if eaten in excess, sickness or purging. They have often been used instead of raisins for plum pudding, with no results out of the ordinary. It is possible that *Solanum nigrum* may develop more solanin in the dry climate of Australia than elsewhere, but, if so, we have no evidence of the fact." In Contributions from the U.S. National Herbarium (81), the following statement also appears:—"The common Black Nightshade (*Solanum nigrum*), fig. 78, which occurs somewhat plentifully as a garden weed throughout the district. The berries are used for food, but only when fully ripe. The green fruit is looked upon as poisonous, one case being cited by Mr. C. M. Brown, of Covelo, where, in 1893, a white child was seriously but not fatally poisoned by eating the berries, some of which were supposed to have been unripe. The prominent symptoms were vomiting and spasms." Mrs. V. K. Chestnut (18) also gives the following particulars:—"The Black Nightshade is a common introduced weed in rich, shaded grounds and fields east of South Dakota and Arkansas, and in damp places westward of the Pacific Ocean. . . . The amount of poison present in any part of this plant varies with the conditions of growth. The more musky-odored plants are the most poisonous. In some the amount of alkaloid in the ripe fruit and leaves is so small that the parts may be, and are, consumed in considerable quantity without any ill consequences. Poisoning does sometimes follow, but it is not clear whether this is due to improper preparation or to careless selection of the parts used. In Europe cases of poisoning are said to occur in infants over whom the plants are hung to induce sleep. The use of Black Nightshade for food is certainly not to be recommended. Cases of poisoning are recorded for calves, sheep, goats, and swine."

COMPARISON OF AUSTRALIAN FORMS WITH PLANTS GROWN FROM SEED OF SEVERAL SPECIES RECEIVED FROM OTHER COUNTRIES.

During the years 1913-1916, we have received at the Botanic Gardens, Sydney, by way of exchange, a large number of *Solanums*, including eleven species of the "*Morellæ veræ*" group, which includes *S. nigrum* and closely related forms. Seeds of

the different species were sown, and eventually planted out in a plantation in the lower garden for observation and comparison with the plants found naturalised in New South Wales. The plants raised were as follows :—

SOLANUM GUINEENSE Lam. (Plates xxxii. and xxxiii., fig. *d*),
(Received from Botanic Gardens, Madrid, Spain).

The plants proved to be fairly robust and rather coarse, reaching a height of about 2 feet or rarely more than 2½ feet, with rather strong branches more or less pubescent, and large, almost entire leaves. Flowers white, with yellowish-brown coloured anthers, and large purplish-black berries, nearly as large as *Morella* cherries.

Plants identical with the above were also grown in the propagating ground in 1913, from seed received from the Natural History Museum, Paris, France, in May, 1912, under the name *S. nigrum* var. *guineense*. Seeds of the latter were saved by the late Superintendent (Mr. G. Harwood), and were labelled "Burbank's Wonderberry." These were re-sown by the present Superintendent (Mr. E. N. Ward), who had fifty seedlings of the batch planted in unmanured soil in the trial ground in August, 1914. On February 20th, 1915, Mr. Ward submitted to the Director (Mr. J. H. Maiden) the following report concerning them :—"The plants have proved easy to grow, and are wonderfully prolific. Fruit began to set when the plants were only 6 inches high. They are still flowering and setting fruit at 2 ft., which appears to be their maximum height. The fruit is uneatable raw, but excellent cooked, also when made into jam or jelly; in flavour and appearance, when cooked, it resembles an improved English Cranberry. The fruit is firm, making it a good carrier, and is easily gathered. The plants at first resemble *S. nigrum*, but later are different in many ways, especially in their upright growth as against the partially prostrate growth of *S. nigrum*." I can fully endorse Mr. Ward's remarks that "the plants are easy to grow" and wonderfully prolific, and also his statement that the fruit is firm, making it a good carrier, and is easily gathered, as I have grown several plants from the seeds obtained from the plants grown by Mr. Ward, in

my garden at Ashfield, and at Hill Top, on the Southern Line. I have also had some of the fruit made into jam, but although it had a very nice colour and appearance, somewhat resembling the true black currant jam made from the fruit of *Ribes nigrum*, I must confess that the flavour did not suit my palate. Whether one could acquire a taste for this particular jam, I am not prepared to say, but it seemed to me to have a peculiar taste.

With regard to the name "Wonderberry" being attached to this plant, there seems to be some doubt if the plants grown by Mr. Ward and myself are really the same as those sold by the American seedsmen under that name. Some few years ago, some seeds, reputed to be the true "Wonderberry" of Burbank, were purchased by a leading firm of seedsmen in Sydney, and some of these were sown in the Botanic Gardens, Sydney, for observation and report.

The seeds were sown by Mr. J. L. Boorman on the 4th June, 1909, and a report furnished by him on the 6th of January, 1910, is as follows:—"The Wonderberry sent to the Gardens for testing and for correction in naming according to Mr. Betcher, the general opinion of those acquainted with *S. nigrum* all emphatically state it to be merely the normal form of *S. nigrum*, without any appreciable difference from the common introduced New South Wales plant."

As the resultant plants seemed to be so near the plants commonly known in the Sydney District as "Native Black Currants" or Common Nightshade (*S. nigrum*), it was thought desirable by the firm of seedsmen to hold the seed back from sale. On the 6th of March, 1917, I gathered some fresh berries from a solitary plant in my garden at Ashfield, which weighed 2lbs. 6oz.; these were submitted to Mr. F. B. Guthrie, Chemist to the Department of Agriculture, for examination and report as to whether any poisonous properties were present. I received the following reply:—"The sample submitted contains very minute quantities of a crystalline alkaloid, presumably solanine. The quantity obtained from 200 grms. berries was too small to weigh. The crystals obtained were in small groups, were needle-shaped, soluble in alcohol, insoluble in water, and precipitated

by Sonnenschein's reagent. If it is necessary to isolate and purify the alkaloid for identification, it would be necessary to work on not less than 20 to 25 pounds of Wonderberries."

It will be seen from the above report, that the evidence points to solanine being present, so that it would seem to me advisable to discontinue the cultivation of this fruit for edible purposes. Especially when we read in Henry's work ("The Plant Alkaloids, p.434, 1913) that "the physiological action of solanine destroys red blood-corpuscles." It would seem from the following particulars given by Groth(37) that the "Prairie Berry" (*S. nigrum*, form or strain) is apparently the same as *S. guineense*, and that he also regards it as a useful commodity together with two other varieties as follows: - "Red-fruited *S. nigrum aurantiacum*, Green-fruited *S. nigrum chlorocarpum*. . . . The green-fruited variety has a sweet, pleasant flavour, strongly resembling the 'orange flavour' sold in packages for flavouring cornstarch puddings. It is, however, so soft that it cannot be picked, much less shipped, without mashing. The "Prairie Berry" has an insipid, somewhat disagreeable flavour when ripe, but it makes excellent preserves. It is so tough that it will keep for a month after being picked, and can be shipped to any distance. Both are good bearers. It is likely that sooner or later a plant will appear which will combine all these characters and breed true to them. If so, it will be preserved; but, as stated above, there is no fund available under which systematic work could be done with the object in view of establishing such a desirable type. Such a berry, coming at a season when no other berries are on the market (October), and when coal fires are kept going in the kitchens, would present a preserving berry of great value to the State." In England, a good deal of interest has been taken in connection with the "Wonderberry," as will be seen by the following abstracts.

In the Gardeners' Chronicle, October 31st, p.291 (1901), it is stated that "three forms of *S. nigrum* (including *S. guineense* or so-called "Wonderberry") were sent to Dr. Greshoff, of Haarlem, for chemical investigation, and in his reports he states that all three forms contain solanine - the British form having

the least poison, and the "Wonderberry" the most." A figure of each of the three forms is given, and it is suggested that fig.128, from Mr. Burbank's Wonderberry, is a cross between *S. guineense* and *S. villosum*, the latter a native of the west coast of America, and the former of Guinea, on the west coast of Africa.

A further account is given in Gardeners' Chronicle for December 18th, 1909, p.419, as follows:—"We have received a letter from Mr. J. Lyon Whittle, Town Clerk of Warrington, enclosing a report from the official analyst for the County Borough of Warrington, Mr. Frederick G. Ruddock, F.I.C., on the result of the chemical analysis of the fruits of "Wonderberry" grown in this country from seed obtained from New York. Mr. Ruddock states that he has analysed both the leaves and fruit of this sample of "Wonderberry," making a special search for the alkaloids atropine and solanine; and he is of the opinion that neither solanine, atropine, or other poisonous alkaloids are present in either leaves or fruit of this sample."

SOLANUM ASTROITES Forst.

Seeds of this were obtained from the Botanic Gardens, Madrid, Spain: and sown under No.31, on 17th May, 1916.

It is a rather soft, herbaceous plant, the leaves being quite entire and membranous. Flowers white, succeeded by greenish berries, which become black at maturity. It was originally described by Forster(26) in 1786, from plants collected in the Society Islands by Banks and Solander. Guillemín(36) also quotes Forster's species from the Society Islands. Seemann(68) gives this as a synonym of *S. oleraceum* Dunal, and states that it was collected on Norfolk Island by Milne, and at the Society Islands by Banks & Solander. The local name, according to Seemann, is "Boro ni yaloka ni gata." Seemann further states, "I have also seen it wild about Sydney," but it seems to me that this is either *S. pterocaulon* or *S. opacum*, as I have not seen any specimens growing wild about the Sydney district that would agree with *S. astroites*. I have closely examined the specimens in the National Herbarium, Sydney, and find that the following may be referred to this species.

New Zealand: One Tree Island, Auckland (D. Petrie; April, 1901), Wanganui (W. A. Allison, 1913).

Norfolk Island (ex Australian Museum, April, 1898; and J. H. Maiden and J. L. Boorman, November, 1902).

Jaluit, Marshall Island (Dr. Schnee, 1902).

Upolu, Samoa Island (Dr. B. Funk, 1902).

New Britain, Bismarck Archipelago (R. Parkinson, 1901).

New South Wales: Broadwater, Richmond River (E. Cheel; September, 1916).

With regard to the plants from Norfolk Island, Mr. Maiden(59) gives the following particulars:—"Common everywhere (A. Cunningham, in Heward). Found by him also on Phillip Island. Eaten by prisoners, who collect and cook the berries of the "Black Nightshade" (*S. nigrum*). The berries are accounted virulently poisonous in England, but their character may possibly be changed by the warmer climate of Norfolk Island." Mr. Maiden(57) also records a *S. nigrum* for Lord Howe Island, and for Pitcairn Island(58); and states that it "springs up wherever land is cleared. It is known as "Black Currants," the fruits being occasionally used for jam, as on the mainland."

In the exotic collection, there are specimens from Philippine Islands, which seem to belong to this species.

SOLANUM MEMPHITICUM (*S. nigrum* var. *memphiticum* Walp.).

Seeds of this were obtained from Botanic Gardens, Madrid, Spain; and sown under No.31, on 17th May, 1916. They were rather tall, and very similar to *S. guineense*, in that the leaves were entire; but the flowers, however, were whitish, with a decided tinge of purple, or, in some, distinctly purplish. The berries are at first green, and become blackish with age, tinged with purple and green, and are not so large as those of *S. guineense*. In Dunal's Monograph(24), this is regarded as a valid species.

SOLANUM DOUGLASI Dun.

Seeds of this were obtained from the Botanic Gardens, Madrid, Spain. It was originally described by Dunal in 1852(24), from specimens collected in California by Douglas, in 1833. The

plants grown from the seeds obtained from Madrid are scarcely distinguishable from the next.

SOLANUM OPACUM A.Br.(15). (Plate xxx.; xxxiii., fig.c).

Seeds of this were obtained from the Botanic Gardens, Madrid, Spain. The species was described in 1858, apparently from plants cultivated in Berlin, from seeds originally obtained from Australia. The habitat is given in Index Kewensis as Australia, but apparently has been overlooked by Bentham, and by Australian botanists. The cultivated plants are identical with the sub-procumbent form, with pubescent branches and leaves, which is common in many parts of the State, especially in the Port Jackson District. It somewhat resembles the *S. nigrum* of Great Britain, and has probably been mistaken for that species, but the figure in English Botany, t. 566, seems to me quite distinct from any plant in our collection, except one from Eton Hill, Clevedon, Somerset, collected in 1849; and another from Herb. Laurer (Germany) without any specific locality. These two specimens have a superficial resemblance to *S. opacum*. Lowe(50) states that "the figure in English Botany, tab. 566, represents a luxuriantly succulent, spreading and widely branched state of the plant with thick, juicy, strongly winged stems or branches, shortly stalked, entire repandly waved subcordate leaves and larger berries, occurring in Madeira occasionally in moist or shady spots." The *S. nigrum* of Forster(26) (*S. Forsteri* Seemann), recorded for Easter Island, Tahiti, and Vavao, Friendly Islands, which, according to Seemann(68) "have berries the size of peas, and are black, and nearer to *S. villosum* than to *S. nigrum*, but with less cut leaves," may probably belong to this species. In the National Herbarium, there are specimens from the following localities, which may be referred to *S. opacum* :—

New South Wales: Kogarah (J. H. Camfield; February, 1898), Government Domains (J. H. Camfield; July, 1902; and E. Cheel; March, 1916), Medlow, Blue Mountains (A. Griffiths; May, 1916), Hill Top, Southern Line (E. Cheel; April, 1916; some berries from these plants were fed to guinea-pigs by Dr. J. B. Cleland, who states that they ate them without any ill effects), Dubbo (E.

Betche: November, 1887), Kangiara Mines, viâ Bowning (H. J. Cocks: April, 1917), Zara, viâ Hay (Miss E. Officer: February, 1904), Louth (A. Abrahams, No.315; September, 1910), Woy Woy (E. Cheel; October, 1916); Arrara, Lake Eliza (J. L. Boorman; October, 1912)

Victoria: Hawksdale (H. B. Williamson; January, 1902), Mildura (Dr. J. B. Cleland; March, 1916).

South Australia: near Quorn (J. H. Maiden; January, 1907).

SOLANUM PTEROCAULON Dunal. (Plates xxxi., xxxiii., a).

(*S. nigrum vulgare* simile caulibus exasperatis Dill., Elth. p.367, t.275, fig.356), *S. nigrum* var. *virginicum* L., Spec. i., p.266; Willd., Spec. i., 1053; *S. alatum* Moench, Meth., p.474 (?) *vide* Persoon, Ench., t. 224; *S. nigrum* R.Br., Prod., p.445, but not Linn.

This species, according to Dunal(23) and Don(20), is a native of South America, and of New Holland (Australia). It may be briefly described as follows:—Plants of perennial habit or at least biennial, usually upright, glabrous (or very rarely minutely puberulous), branches more or less spreading, with distinctly winged angles or margins, the winged margins minutely but distinctly jagged so that they appear somewhat serrulate or prickly, as seen in Plate xxxiii., fig. a. Leaves glabrous, more or less crenate-sinuated. Flowers white, with pale yellow anthers, on slender pedicels, usually in threes, or rarely four or more in the raceme. Berries at first green, afterwards shiny black, smaller than those of *S. opacum* and *S. astroites*.

Specimens in the National Herbarium are from the following localities:—New Holland (Banks and Solander, 1770), Broad Sound (R. Brown, Iter Aust. 1802-1805), Kurnell (J. L. Boorman: April, 1906), Penshurst (E. Cheel; May, 1911), Kensington (E. Cheel; May, 1917), Neutral Bay (Dr. J. B. Cleland; March, 1916), Domain (J. H. Camfield; July, 1902), Parramatta (E. Cheel: October, 1916), Emu Plains (F. W. Chapman; February, 1915), Ashfield (E. Cheel; May, 1916), Woy Woy (E. Cheel; October, 1916), Hill Top (E. Cheel; May, 1916), Wagga (E. Breakwell; October, 1912).—Queensland: Brisbane River (C.

T. White; March, 1915).—South Australia : near Adelaide (Dr. J. B. Cleland; 1898).

Specimens from plants growing wild at Ashfield and Summer Hill were fed to a guinea-pig, which ate the leaves without any ill effects. In addition to the above, plants of the following have been grown from seed, which have produced reddish or yellowish-coloured berries when fully ripe, but none of these appear to have become naturalised in Australia, so far as can be ascertained.

S. miniatum Bernh. Seeds were obtained from Madrid, Spain, and produced plants having very downy branches and leaves, white flowers, and pink or reddish berries.

S. flavum and *S. rubrum* also had pink berries, and seem to belong to *S. miniatum*.

S. ochroleucum had green berries with yellowish stripes, when fully matured.

SUMMARY.

(1) It will be seen from the foregoing that *S. nigrum* of Europe, figured in English Botany, tab. 566, has not yet been found in Australia.

(2) That there are at least three distinct species or subspecies found in Australia and the Pacific Islands, namely, *S. opacum*, *S. pterocaulon*, and *S. astroites*.

(3) That although the evidence seems to indicate that some of the plants are harmful, no definite evidence has been furnished as to which of the three species found in Australia are harmful.

(4) That as solanine is present, at least in some of the species, it would be unwise to use the fruits for edible purposes unless it could be proved that the alkaloid was volatile, and its harmful effects destroyed by cooking.

BIBLIOGRAPHY.

1. ARTON, W. J.—Hortus Kewensis, Vol. i., p.399 (1810).
2. AITCHISON, Dr. J. E. T.—Trans. Linn. Soc. (2nd Ser.), iii., pp. 9, 91 (1888).
3. BACKHOUSE, J. A.—Narrative of a Visit to the Australian Colonies, p.264 (1843).
4. BAILEY, F. M.—A Classified Index of the Indigenous and Naturalised Plants of Queensland, p.28 (1883).

5. BAILEY, F. M.—Weeds and Suspected Poisonous Plants, p.119 (1906).
6. ——————Queensland Flora, iv., p.1080 (1901).
7. ————— & GORDON, P. R.—Plants reputed to be Poisonous to Stock, p.49 (1887).
8. BAKER, J. G., F.L.S.—Flora of Mauritius and Seychelles, p.214 (1877).
9. BALL, W.—Journ. Linn. Soc. (Bot.), v., p.42 (1861).
10. —————*Op. cit.*, xv., p.580 (1878).
11. BENTHAM, G.—Flora Australiensis, iv., p.446 (1869).
12. BERNHARDI, ex Willdenow, Enum. Hort. berolinensis.
13. BLUME—Bijid. 694, 695.
14. BROWN, R.—Prodromus, p.445 (1810).
15. BRAUN, A. (A.Br.) & C. BOUCHE—Ind. Sem. Hort. berolinensis (1853).
16. BURBANK, L.—Catalogue, February (1910).
17. CLARKE, C. B., in Hooker's Flora British India, iv., p.229 (1885).
18. CHESTNUT, Mrs. V. K.—Principal Poisonous Plants of the United States. Bull. No.20, U. S. Dept. of Agriculture (Div. of Bot.), p.52 (1898).
19. DILLENIUS, JOH. JAC.—Hortus Elthamensis, Tome ii. (1732).
20. DON, G.—History of Gardening and Botany, iv., pp.411-413 (1832).
21. D'URBAN, *see* Hooker.
22. DUNAL, T.—Poir., Encycl. Suppl., iii., p.750.
23. ——————Hist. Sol., p.155 (1813).
24. ——————in DC., Prod., xiii., i. pp.45-49 (1852).
25. EWART, Prof. A. J., & TOVEY, J. R.—The Weeds, Poisonous Plants, and Naturalised Aliens of Victoria (1909).
26. FORSTER, G.—Florule Insularum Australium, p.89 (1786).
27. GARDENERS' CHRONICLE, March 13th, p.172 (1909).
28. ——————March 27th, p.204 (1909).
29. ——————June 19th, p.393 (1909).
30. ——————October 31st, p.291 (1909).
31. ——————December 18th, p.419 (1909).
32. GÆRTNER, J.—De Fructibus et Seminibus Plantarum, ii., p.239 (Tab. 131, f.4) [1802].
33. GMELIN, J. F., Hist. ven. veg. Sueviæ (1778).
34. GRESHOFF, Dr. M., *see* Gardeners' Chronicle.
35. GRISEBACH, A. H. R.—Flora of British West India Islands, p.437 (1864).
36. GUILLEMIN, J. A. Eumeration des plantes découvertes par les voyageurs dans les Isles de la Société, principalement dans celle de Taïti, Paris, p.44 (1837).
37. GROTH, B. H.—Cell Number in "Prairie Berry" (*Solanum nigrum*, form or strain), 34th Annual Report, New Jersey State Agricultural Experiment Station, p.618 (1913).

38. GUILFOYLE—Australian Plants, p.334.
- 38a.—HEWARD.—Biographical Sketch of A. Cunningham, in Hooker's Journ. of Botany, i., p.116.
39. HILLMAN, F. H.—"Nevada Weeds," in Nevada State University Agric. Exp. Station, Bull. No.38, p.87 (1897).
40. HOLMES, E. M.—Pharm. Journ., p.419 (1909).
41. HOOKER, SIR J. D.—Flora of New Zealand, i., p.182 (1853).
42. ——————Flora of Tasmania, i., p.288 (1860).
43. JACQUIN—
44. JACKSON, H. V., in Agricultural Gazette of N. S. Wales, p.827 (1899).
45. KIT, in Schultes Aust. ed. 2nd. Vol. i. (No.891).
46. LAMARCK, in Dill, Hort. Elth., ii.
- 46a. LINK, H. F.—Enum. Pl., i., p.183 (1821).
47. LINNE, CARL VON.—Sp. Pl., ed. i., 186.
48. ——————Spec., 266.
49. ——————Syst. Veg., 224.
50. LOWE, R. T.—Manual Flora of Madeira, and adjacent Islands of Porto Santo and the Desertas, Vol. ii., p.73 (1868).
51. ——————Journ. Linn. Soc. (Bot.), v., p.42 (1861).
52. MAIDEN, J. H., in Agricultural Gazette of N.S.Wales, viii., p.293 (1895).
53. ——————*Op. cit.*, p.16 (1897).
54. ——————*Op. cit.*, p.3 (1897).
55. ——————*Op. cit.*, p.625 (1899).
56. ————Daily Telegraph (14/5/96).
57. ——————"Vegetation of Lord Howe Island." Proc. Linn. Soc. N. S. Wales, 1898, p.150.
58. ——————"Botany of Pitcairn Island." Report Aust. Assoc. Adv. Science, p.267 (1901).
59. ——————"Flora of Norfolk Island." Proc. Linn. Soc. N. S. Wales, 1903, xxviii., p.711.
60. ——————"Australian Solanaceae considered as Narcotics and Poison-Plants." Extract. Proc. Therapeutical Soc., London (1906) 2.
61. MILLER.—Gardeners' and Botanists' Directory (1807).
62. MUELLER, BARON F. VON.—First Report of the Secretary for Agriculture, Dept. of Lands and Agriculture, Victoria, p.110 (1873).
63. ——————Key to the System of Victorian Plants, i., p.361 (1887-1888).
64. NEES, C. G. VON.—"Monograph of the East Indian Solanaceae." Trans. Linn. Soc., xvii., p.42 (1834).
65. LEHMANN.—Plantæ Preiss., i., p.345 (1844).
66. PERSOON, C. H.—Synopsis Plantarum, i., p.224 (1805).
67. SMITH, J. E.—English Botany, t.566 (1803).
- 67a. ——————English Flora, i., p.319 (1823).

68. SEEMANN, B.—“The Solana of Tropical Polynesia.” Journ. Botany, i., p.206 (1863).
69. SELBY, A. D.—A First Ohio Weed Manual. Bull. Ohio Agric. Exp. Station (No.83), p.337 (1897).
70. SPRENGEL.—Systema Vegetabilium, i., p.680 (1825).
71. SYDNEY MORNING HERALD, 29/6/09 and 30/8/09).
72. TURNER, F., in Agricultural Gazette of N. S. Wales, p.126 (1891).
73. —————Report Aust. Assoc. Adv. Sci., vii., p.917 (1898).
74. WATT, G.—Dictionary of Economic Products of India, vi., p.263 (1893).
75. WILDENOW.—Enum. Hort. Berol., 236.
76. —————Sp. Pl. i., 1035.
77. WESTERN MAIL, 30/4/11.
78. WOOLLS, REV. W., in Horticultural Magazine and Gardeners' Calender of N. S. Wales, v., p.305 (1868).
79. ————— in Journ. Linn. Soc. (Bot.), x., p.41 (1869).
80. WRIGHT, C. H. — Flora Capensis, iv., p.89 (1904).
81. AUTHOR(?) in Contributions from U. S. Nat. Herbarium, U. S. Dept. Agric., Division of Botany, vii., p.387 (1900-1902).

The names in the following list have been recorded in the various works enumerated in the Bibliography herewith, and in many cases are synonyms of *S. nigrum*, *S. opacum*, *S. pterocaulon*, and *S. astroites*, or well-marked forms or varieties, and have to be carefully considered when working with these species.

Solanum acuminatum Dun., *S. nodiflorum* var.

- “ *egyptiacum* Forsk.
- “ *alatum* Mœnch = *S. pterocaulon*.
- “ *angulosum* Sendt., *S. nigrum* var.
- “ *astroites* Forst. f.
- “ *atriplicifolium* Dun., *S. nigrum* var.
- “ *Besseri* Weimm., in litt., Roem. et Schult.
- “ *chenopalioides* Desc. = *S. astroites*.
- “ *chlococarpum* Spenner, *S. nigrum* var.
- “ *Deppci* = *S. Dillenii*.
- “ *Dillenii* Schult.
- “ *Douglasii* Dun. = (?) *S. opacum*.
- “ *erythraum* Dun.
- “ *erythraum* Mey. = *S. nodiflorum* var. *rubrum*, according to Griseb.

Solanum fistulosum Rich.

- „ *flavum* Dun., *S. ochroleucum* var.
 „ *glabrum* Lowe, *S. nigrum* var.
 „ *glabrum* Dun.
 „ *guineense* Lam.
 „ *guineense* Willd., *S. nigrum* var. = *supra*.
 „ *hebecaulon* Lowe, *S. nigrum* var.
 „ *hirsutum* Dun.
 „ *hortense* Fuchs.
 „ *hortense* Mill., *S. nigrum* var.
 „ *humile* Bernh.
 „ *humile* Bailey, *S. nigrum* var. = *S.(!) opacum*.
 „ *humile* Ball (non Bernh.) = *S. patens*.
 „ *incertum* Dun.
 „ *judaicum* Schult. = *S. guineense*.
 „ *luteo-virens* Walp., *S. nigrum* var.
 „ *luteo-virens* Gmel.
 „ *macrophyllum* Dun., *S. nodiflorum* var.
 „ *melanocerasum* Dun., *S. nigrum* var.
 „ *memphiticum* Martius.
 „ *memphiticum* J. F. Gmel.
 „ *miniatum* Bernh.
 „ *nigrum* L.
 „ *nigrum* R.Br. = *S. pterocaulon*.
 „ *nodiflorum* Jacq.
 „ *ochroleucum* Bast.
 „ *oleraceum* Dun. = *S. astroites*.
 „ *opacum* A.Br.
 „ *paludosum* Dun.
 „ *patens* Lowe. Raised in Northampton (England) in

1860, by Rev. M. J. Birks from Madeira seed, *cide* Lowe.

Solanum patulum Pers. = *S. Dillenii*.

- „ *patulum* Willd., *S. nigrum* var. = *S. Dillenii*.
 „ *patulum* Lowe.
 „ *parviflorum* Badaro.
 „ *petiolastrum* Dun., *S. nodiflorum* var.

- Solanum procerius patulum* Lam., in Dill. Elth.
 ,, *puberulum* Dun., *S. nodiflorum* var.
 ,, *puberulum* Nutt.
 ,, *pteroaulon* Dun.
 ,, *retroflexum* Dun.
 ,, *rigidum* Dun., *S. nigrum* var.
 ,, *rhinozerthis* Blume.
 ,, *Roxburghii* Dun.
 ,, *rubrum* Mill.
 ,, *Rumphii* Dun.
 ,, *suffruticosum* Dun.
 ,, *suffruticosum* Ball, *S. nigrum* var.
 ,, *triangulare* Lam.
 ,, *villosum* Lam.
 ,, *villosum* Willd., *S. nigrum* var.
 ,, *villosum* Mill.
 ,, *virginianum* L., *S. nigrum* var. = *S. pterocaulon*.
 ,, *virginicum* Pers.
 ,, *vulgare* Hegets
 ,, *vulgatum* Mill., *S. nigrum* var.

Thirty-four names are given as synonyms of *S. nigrum* Linn., in the Index Kewensis. Six of the names in the foregoing list are included among these.

EXPLANATION OF PLATES XXX.-XXXIII.

Plate xxx.

Solanum opacum A.Br., part of plant showing buds, flowers, and mature fruits; all reduced.

Plate xxxi.

Solanum pterocaulon Dun., part of plant; reduced.

Plate xxxii.

Solanum guineense Lam., part of plant showing matured fruits; reduced.

Plate xxxiii.

Fig. a.—*Solanum pterocaulon* Dun., showing portion of winged stem with denticulate or toothed margin.

Fig. b.—*Solanum pterocaulon* Dun., fruits, natural size.

Fig. c.—*Solanum opacum* A.Br., fruits, natural size.

Fig. d.—*Solanum guineense* Lam., (so-called "Wonderberry"), fruits, natural size.

ORDINARY MONTHLY MEETING.

NOVEMBER 28th, 1917.

Dr. H. G. Chapman, President, in the Chair.

Candidates for Fellowships, 1918-19, were reminded that the 30th inst., was the last day on which applications would be received.

The Donations and Exchanges received since the previous Monthly Meeting (31st October, 1917), amounting to 4 Vols., 49 Parts or Nos., 10 Bulletins, 5 Reports, 1 Map, and 7 Pamphlets, received from 40 Societies, etc., were laid upon the table.

NOTES AND EXHIBITS.

Mr. Baker showed portion of a log of *Banksia latifolia* R.Br., [= *B. robur* Cav.] recently received at the Technological Museum, Sydney, from Port Macquarie, where it is known as "Bastard Honeysuckle." Mr. L. C. Maxwell, who collected the material, reports that the largest plant, he had seen, had a height of about 25½ feet, and a diameter of about 16 inches; but that he had heard, from old residents, of trees as large as 2½ feet in diameter, with a corresponding height. It is to be found, growing under similar conditions, in swamps or on the banks of creeks, also at Taree. The timber has a distinct pale pink or bluish tint, different from that of its congeners. It is light in weight, soft, gives a good figure in radial section, but is not strong; so that it may be classed as a cabinet-timber. Robert Brown, in discarding the earlier name, said—"Hujus speciei nomen Cavanillesii mutare coactus sum, quoniam nunquam arborescit sed frutex humilis est" [Trans. Linn. Soc., x., p.208]. Either the plants did not attain tree-size about Port Jackson, or the largest ones may have been cut down by the earliest settlers before R. Brown had a chance of seeing them. As Mr. Maiden has pointed out [Forest Flora of N.S. Wales, iv., Pt.7, p.102], Baron von Mueller

reverted to the original name in his "Census" [1889]; and the evidence given above shows that R. Brown's change of name was not warranted. The only obstacle in the way of following the Baron's example seems to be, that the name, *B. latifolia*, has been in undisputed use for more than fifty years.

Dr. Cleland exhibited specimens of *Silene gallica* var. *quinquevulnera* Linn., an introduced weed, collected by him at Thirroul. Mr. Cheel remarked that Bentham, in his Handbook of the British Flora (1858) recorded *S. gallica* Linn., as a native, and quoted *S. anglica* Linn., as a synonym; adding that a "variety with a dark spot on the petals, *S. quinquevulnera* Linn., used to be cultivated in flower-gardens." On the other hand, in the third edition of the Student's Flora of the British Islands (1884), Sir J. D. Hooker recognised *S. gallica* proper [flowers white or pink], and var. *S. quinquevulnera* [petals white with a red spot], and var. *S. anglica* [petals small, white, often jagged]. *S. gallica* is the most common in Australia, and there are specimens of it in the National Herbarium from numerous localities in New South Wales. There are also specimens of var. *quinquevulnera*, with deep blood-red spots on the petals, from the following localities. New South Wales: Boonoo Boonoo (J. L. Boorman: November, 1904); Milton (R. H. Cambage: December, 1903); Walcha Road (J. L. Boorman: December, 1912).—Victoria: Lilydale (A. H. S. Lucas: November, 1885). West Australia: Karridale (R. Helms: October, 1898).

Dr. H. Leighton Kesteven communicated the following Note.
—Examination of a series of skulls of *Crocodylus porosus* leads me to record that, after a stage of development within the egg at which the skull measures 25 mm. in length, the two pterygoids are united to form one median bone. This bone shows no trace of a median suture, beyond that between its two naso-palatine plates, which form the false palate and floor of the postnasal canals behind the palatine bones. These skulls, therefore, present the median parasphenoid which, in the Journal of Anatomy and Physiology (Vol. I.), I postulated as the ancestral condition of the reptilian pterygoids.

Mr. John Mitchell communicated the following Note.—On one of a number of fossiliferous rock-specimens, submitted for determination by Mr. B. Dunstan, F.G.S., Chief Government Geologist of Queensland, there is present a beautiful intaglio impression of the head of a Trilobite, referable to the genus *Brachymetopus* McCoy, hitherto unrecorded from Queensland. The specimen, which apparently represents a new species, was collected in the Mt. Morgan district, and will materially help in determining the geological age of the rocks of that area. Professor McCoy described *B. Strzeleckii*, n.g. et n.sp., from Dunvegan, N.S.W., seventy years ago (Ann. Mag. Nat. Hist., xx., p.231, 1847).

ON THE MORPHOLOGY OF THE CAUDAL GILLS OF
THE LARVÆ OF ZYGOPTERID DRAGONFLIES.

PART III. (ONTOGENY), AND PART IV. (PHYLOGENY).

BY R. J. TILLYARD, M.A., B.Sc., F.L.S., F.E.S., LINNEAN
MACLEAY FELLOW OF THE SOCIETY IN ZOOLOGY

(With fifteen Text-figures).

INDEX.

	PAGE.
INTRODUCTION	606
PART III.—ONTOGENY.	
Second Instar	608
Third Instar	610
Fourth Instar	610
Fifth Instar	611
Sixth Instar	613
Seventh Instar... ..	614
PART IV.—PHYLOGENY.	
Caudal Filaments of the Perlaria	615
Caudal Filaments of the Plectoptera	617
Phylogenetic Conclusions	618
Evolution of the Caudal Gills within the Suborder Zygoptera .	620
Evolution of the Blood-System	628
Evolution of the Nervous System	629
Evolution of the Tracheal System	629
Evolution of the Internal Laminae and Alveolar Meshwork ...	630
Table of Evolutionary Changes	631
Note on the Problem of the Origin of the Constricted or Two- jointed Gill	632

INTRODUCTION.

In dealing with the Ontogeny of the Caudal Gills, it was found necessary to study, by means of sections, all instars of the growing larva up to the attainment of the complete internal form of structure. As this was found not to be reached until the seventh

instar, there was necessarily a considerable delay in raising the larvæ required from the egg, and in taking them successfully through all the stages to the seventh. It was for this reason that Parts iii. and iv. were not published with Parts i. and ii. in a single complete paper.

Even with the successful raising of several batches of larvæ to the seventh instar, it has turned out that not sufficient evidence has been obtained to throw much light upon one very interesting problem, viz., the origin of the constricted or two-jointed gill. The reason for this appears to be, that the only larvæ that I was able to raise were not of the Constricted Type. I had hoped that the gills of *Austroagrion cyane* Selys, which are classed as a Nodate Type, would offer some evidence, in their ontogeny, as to how the node developed. But, up to the seventh instar, this larva shows no sign of any division of the gill at all; so that one must evidently examine several more instars, before the beginning of the node would be made apparent. This meaning further delay, and the main objects of the paper having been in every other respect attained, I have judged it best to conclude my observations at this stage; being content to indicate, with regard to this one unsolved point, exactly how the problem stands, so that any student of Odonata, who is fortunate enough to obtain material, can pursue it to the end.

The results of Part iii. were obtained from the study of three species, viz., *Austroagrion cyane* Selys, *Ischnura heterosticta* Burn., and *Neosticta canescens* Tillyard. The larvæ of the first two were bred from the egg, and every instar up to and including the seventh (counting the pronymph as the first) was carefully studied by means of sections.* The *Neosticta* larvæ, belonging probably to the fourth and fifth instars, were only a fortunate find; not having been raised from the egg, their instars cannot be stated with absolute certainty.

I need add little to the account of the methods employed, as

* As the series of sections obtained from *Austroagrion* were better than those obtained from *Ischnura*, I have figured only the former. *Austroagrion* has nodate gills, *Ischnura* subnodate; but, up to the seventh instar, the two forms show no important differences.

given in Part i. of this paper (These Proceedings, 1917, Vol. xlii., Part i., pp.39-44). The method of double-embedding is *essential* for these tiny structures, and every detail must be carried out with the greatest care, if one would have a final result of any value at all. The best results were those that, after staining, were de-stained back almost to the lightest possible limit. Such preparations should, of course, be fully studied at once, unless one is willing to risk the chance of their fading before the work is completed.

In Part iv., the results obtained in Part iii. are considered in conjunction with those obtained from a study of the caudal filaments of the Perlaria and Plectoptera, the combined evidence from all those sources giving us some valuable phylogenetic results.

Part iii. ONTOGENY OF THE CAUDAL GILLS.

Structure of the Gills in the newly-hatched larva or Second Instar.
(Text-figs. 33, 34).

Text-fig. 33 shows the external form of the gills in the newly-hatched larva of *Austroagrion cyane* Selys, which is typical of all Vertical Lamellar Gill-types. The gills are elongated, slender filaments, clothed with short, stiff hairs externally, for most of their length, but carrying, near the tip, a few longer and more pliable hairs. The tip itself is bluntly pointed, and carries a long, stiff, bristle-like hair. The gills are quite transparent and without pigmentation. The median (dorsal) gill possesses two main longitudinal tracheæ, one derived from each dorsal trunk of the abdomen. The lateral gills, however, each possess only one main longitudinal trachea, derived from the dorsal trunk of its own side. The tracheæ do not reach as far as the tip of the gill.

In transverse section, the gills are nearly circular (Text-fig. 34). The cuticle is thin, and is followed, on its inner side, by the almost equally thin hypodermis, which shows only from four to six nuclei in any given section. The interior of the gill consists of an undifferentiated blood-space, or portion of the hæmocœle. In the median gill, the two main tracheæ lie mid-laterally, one on either side, close to the hypodermis. In each lateral gill, the

single main trachea lies latero-ventrally, on the inner side of the gill. Neither definite blood-canals, internal laminae, nor alveolar meshwork are developed.

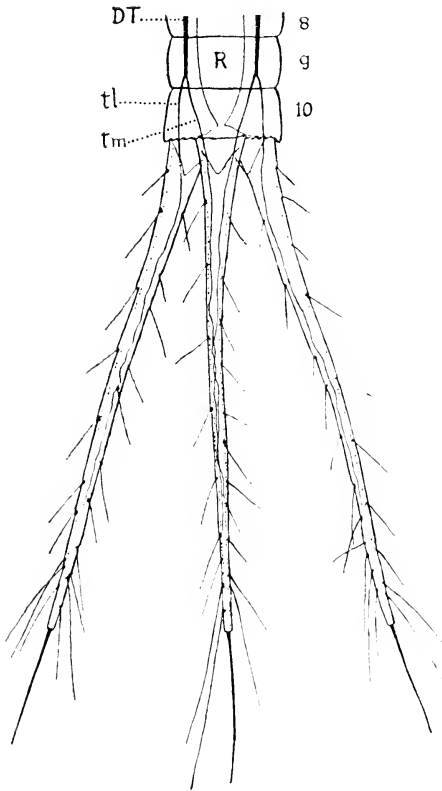

Text-fig. 33.*

The nerve-supply can be followed with difficulty from the eighth ganglion to the bases of the gills, but cannot be seen in sections of the gills themselves, probably owing to its extreme fineness. It is clear, however, that the median gill receives two main nerves dorso-laterally at its base, while

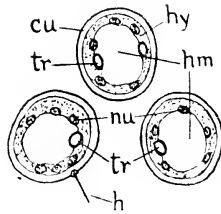

Text-fig. 34.†

each lateral gill receives only a single nerve placed somewhat ventrally. As it is impossible to follow the changes

in the nervous system in such tiny organs as these gills, I shall not mention them further, until they come plainly into view in much larger gills.

* Caudal gills of *Austrogrion cyane* Selys, second instar; dorsal view; ($\times 90$).

† T.S. through caudal gills of *Austrogrion cyane* Selys, second instar, at about one-third from base; *cu*, cuticle; *h*, hair; *hm*, haemocoel; *hy*, hypodermis; *nu*, nucleus of same; *tr*, trachea: (> 370).

Structure of the Gills in the Third Instar.

(Text-fig.35).

The gills are still filiform, and resemble those of the second instar very closely; the principal difference being that, in each lateral gill, a branch-

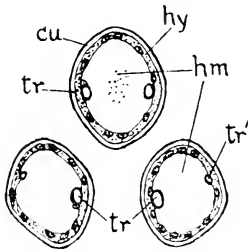

Text-fig.35.*

trachea of small calibre is developed from the base of the main trunk, and runs for some distance up the gill. This branch lies on the outer side of the gill, a little more dorsally placed than the larger trachea from which it is derived. It is very difficult to make it out in sections, as it is usually completely collapsed. The main trunk now lies very little below mid-laterally on the inner side of the gill, and projects very definitely into the hæmocœle. It also reaches nearly to the gill-tip.

Structure of the Gills in the Fourth Instar.

(Text-figs.36, 37).

In this instar, we notice the first external sign of a change from the filiform to the lamellar type of gill, slight though it be. For at least half of its length, the gill remains filiform. But the distal half shows a distinct, though very slight, attempt at flattening and widening out, so that the gill becomes shaped as shown in Text-fig.36. In the lateral gills, the branch-trachea is now very distinct, being at least half the calibre of its parent-trunk, and running along more than three-fourths of the length

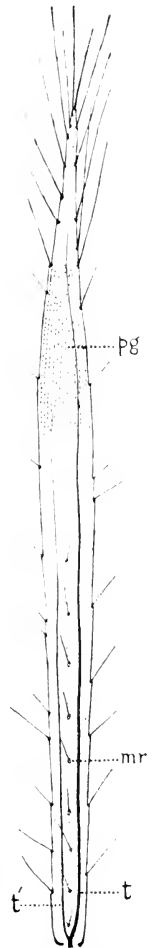

Text-fig.36.†

* T.S. through caudal gills of *Austrocyprion cyane* Selys, third instar, at about one-third from base. Lettering as in Text-fig.34; *tr'*, branch-trachea from near base of main trachea (*tr*) in lateral gills; ($\times 370$).

† Lateral caudal gill of *Austrocyprion cyane* Selys, fourth instar; side-view; ($\times 90$).

of the gill. In *Austroagrion cyane*, but not in *Ischnura heterosticta*, this stage is marked by the presence of a distinct pigment-zone on the distal fourth of the gill.

Sections of the gills at this stage show some important developments internally (Text-fig.37). Their form, in the basal half, now begins to approach the Triquetro-quadrato Type; while, in the slightly widened and flattened distal half, they have taken on, in cross-section, a distinctly oval form, which is the preliminary step to the differentiation of the rhachis and blade of the true Lamellar Type. The tracheæ are now much larger, even the second longitudinal trachea of the lateral gills being easily made out. They project definitely into the hæmocéle, and both lie at the mid-lateral level. But, most important of all, is the division of the hæmocéle into two parts, by an outgrowth of the hypodermis forming a definite internal lamina across its cavity, between the two main tracheæ. This is the first differentiation of the dorsal and ventral blood-canals.

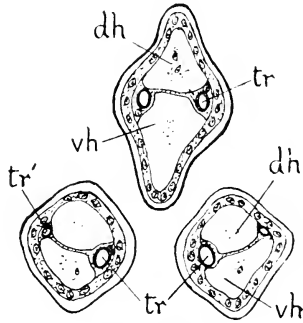

Text-fig.37.*

Structure of the Gills in the Fifth Instar. (Text-fig.38).

Externally, there is only a slight increase in the width of the distal half of the gill, so that the difference in shape from that shown in Text-fig 36 is scarcely appreciable. Internally, the differentiation of the hæmocéle has proceeded one step further. The internal lamina has split up to form the inner boundaries of four separate divisions, viz., the dorsal and ventral blood-canals, and two smaller divisions to enclose the two main tracheæ respectively. It is important to notice here that, in the median gill, the dorsal blood-canal is smaller than the ventral, while, in

* T.S. through the caudal gills of *Austroagrion cyane* Selys, fourth instar, at about one-third from base; *dh*, dorsal blood-canal; *tr*, main trachea; *tr'*, branch-trachea destined to become second main trachea in lateral gills; *vh*, ventral blood-canal; ($\times 370$). [N.B.—In this instar, the division of the hæmocéle does not extend much beyond half-way].

the lateral gills, the opposite is the case. Thus the blood will flow faster dorsally than ventrally in the median gill, but faster ventrally than dorsally in the lateral gills. Therefore, in each case, the afferent blood-stream is the faster of the two, flowing along the narrower channel. Thus arises the first sign of a differentiation between the primary or afferent blood-canal, and the secondary or efferent blood-canal.

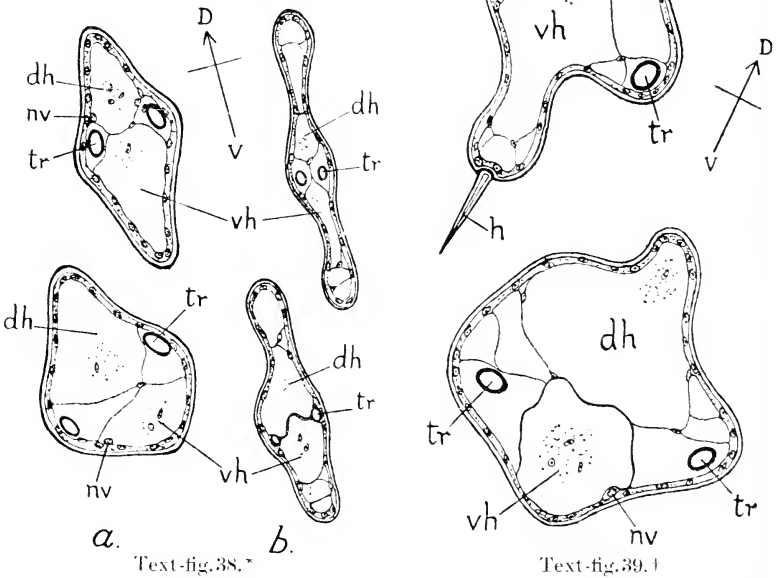

In Text-fig. 39, I have shown a transverse section across the gills of a small larva of *Neosticta canescens* (Saccoid Type), which

* Two T.S. through median and left lateral caudal gills of *Austroagrion cyani* Selys, fifth instar. *a* at about one-third from base, *b* at beyond half-way along the gill. Lettering as in Text-fig. 37; *nv*, main nerve; the arrow VD shows the direction of the sagittal plane, the median dorsal gill being uppermost; ($\times 370$).

† T.S. through median and right lateral caudal gills of *Neosticta canescens* Tillyard, fourth or fifth instar. Lettering as in Text-figs. 37 and 38; *h*, hair; ($\times 370$).

I judge to be either of the fourth or fifth instar. The differentiation of the hæmocoel is much more clearly shown in this type, the primary or afferent blood-canal being much smaller, more regularly formed, and more strongly walled than the secondary; the latter indeed appears to be merely the large remainder of the hæmocoel left over after the tracheæ and the primary blood-canal have been closed off. The beginnings of the alveolar meshwork can be clearly seen within it. It is much to be regretted that I could not obtain a series of this very rare, archaic, larval type, so as to follow out the changes in the blood-canals more fully.

Structure of the Gills in the Sixth Instar. (Text-figs.40, 41).

At this stage, the gill is definitely flattened for about two-thirds of its length, though still very narrow (Text-fig.40). The blood-canals are distinguishable in the whole gill, particularly where they run through the pigment-zone in *Austroagrion cyane*. Transverse sections now begin to show the definite differentiation into rhachis and blade, as may be seen from Text-fig.41, which is taken from a little beyond half-way along the gill. At this stage, the

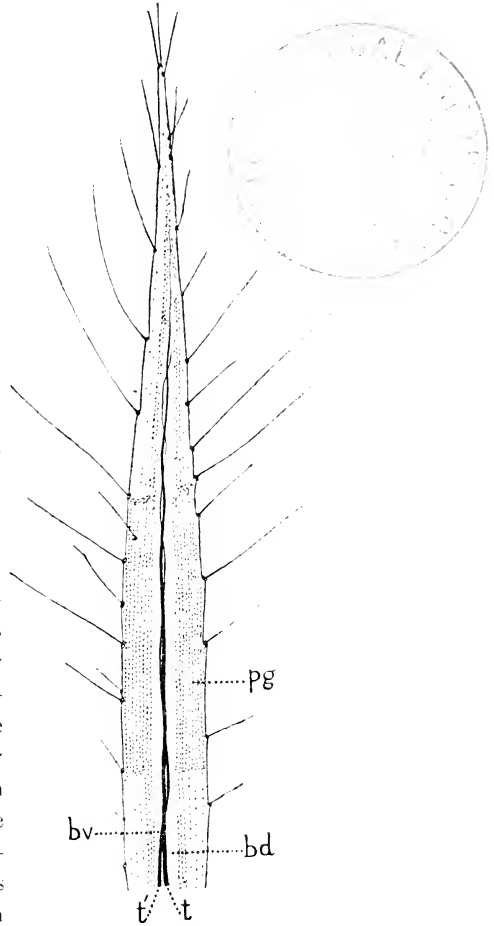

Text-fig.40.*

* Distal expanded portion of a lateral gill of *Austroagrion cyane* Selys, sixth instar, side-view; *bd*, dorsal blood-canal; *bv*, ventral blood-canal; *pg*, pigmented zone; *t*, main trachea; *t'*, branch-trachea, which has become the second main trachea; ($\times 90$).

primary and secondary internal laminae begin to develop. It is also possible, in some sections, to make out the main longitudinal nerves, which do not appear to differ in position from those of the gills in the fully grown larva.

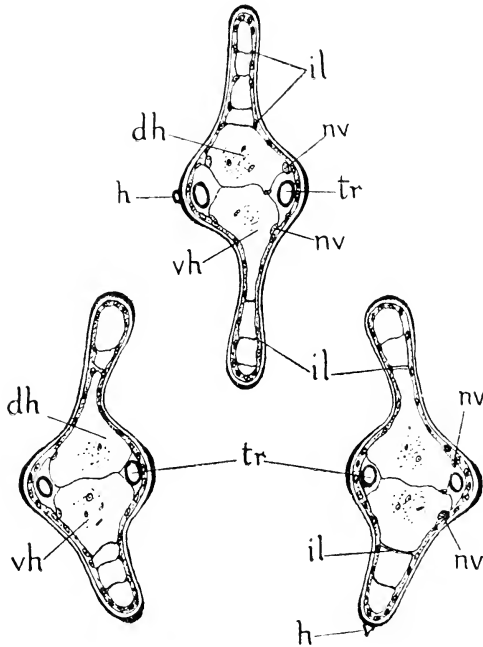

Text-fig. 41.

T.S. through caudal gills of *Austrocyprion cyane* Selys, sixth instar, at about half-way along the gill. Lettering as in Text-fig. 37; *h*, hair; *il*, internal lamina; *nv*, main nerve; ($\times 370$).

Structure of the Gills in the Seventh Instar.

In this stage, the gills only differ from those of the Sixth Instar by their slightly broader lamellar form, and by the more definite formation of the internal laminae, together with the first beginnings of the alveolar meshwork. Having reached this stage, the gill contains all its essential structures. Further de-

velopment consists only in the broadening of the blade of the lamella. With this is correlated the formation of the rich tracheal branchings into the blade, which are such a conspicuous feature of the gills in older larvæ.

Part iv. PHYLOGENY OF THE CAUDAL GILLS.

In attempting to work out the Phylogeny of the Gills, it is legitimate not only to seek for the evidence afforded by their Ontogeny, but also to turn to the study of the homologous organs in those Orders most closely related to the Odonata. Since the Caudal Gills of Zygoptera are the modified cerci and appendix dorsalis of the larva, and since the only other Orders that can come into the question are the Perlaria and Plectoptera, we must turn to the study of the *caudal filaments* of their larvæ.

The Caudal Filaments of the Perlaria. (Text-fig.42).

The larvæ of the Stone-Flies or Perlaria possess only two caudal filaments, viz., the *cerci*. These are, therefore, the homologues of the two lateral gills of the Zygoptera. They are usually

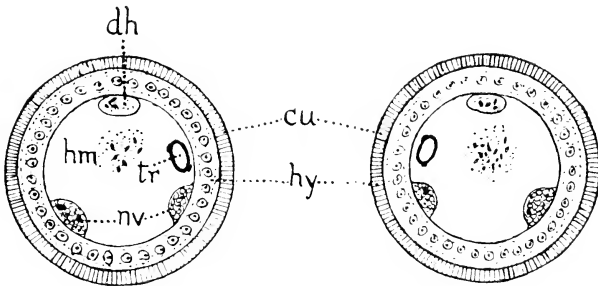

Text-fig.42.

T.S. through the two caudal filaments of a well-grown Perlid larva, sub-family *Leptoperlineæ*; *cu*, cuticle; *dh*, dorsal blood-canal; *hm*, hæmocoel; *hy*, hypodermis; *nv*, main nerve; *tr*, main trachea; ($\times 120$).

very long and many-jointed, but there are not lacking a number of genera in which a great reduction in length, and also in the

number of joints, points the way by which the cerci of the Zygopterid larva arrived at its present one- or two-jointed state.

In transverse section, these organs are absolutely circular. The cuticle and hypodermis are thick, the nuclei of the latter numerous and closely-placed. The interior of the organ is a hollow blood-space, or extension of the hæmocœle, showing the presence of both plasma and corpuscles in almost every section. Laterally, on the outer side, close to the inner border of the hypodermis, there is a single main trachea. Latero-ventrally, on either side, seated upon the inner border of the hypodermis, there are two large longitudinal nerves, whose cross-section is greater than that of the trachea. As the caudal filaments of the *Perlaria* are organs of touch rather than gills, the greater size of the nerves, and the smallness of the trachea, in comparison with those of Zygopterid gills, is only to be expected.

The most interesting structure in these caudal filaments is the very small but definite dorsal blood-vessel, situated mid-dorsally below the inner border of the hypodermis. This structure has a well-defined wall, and might be mistaken for a trachea, were it not always quite full of blood-plasma and corpuscles. It continues far along the filament, opening distally into its main interior, *i.e.*, the hæmocœle.

The comparison between these organs and the lateral caudal gills of Zygoptera may be summarised as follows:—

(1) Only the afferent or primary blood-canal is marked off in the *Perlaria*; but it is much smaller and more definitely separated out than in the Zygoptera; moreover, it is placed mid-dorsally, as in the *median* gill of Zygoptera; whereas, in the lateral gills of the latter, the afferent canal is ventral.

(2) Only one main trachea is developed, on the inner side of the hæmocœle. Thus the tracheation remains at the same stage as that shown in the Second Instar of Zygopterid larvæ (Text-fig. 34).

(3) Two main longitudinal nerves are developed, as in the lateral caudal gills of Zygoptera; but their position is not quite the same, both being ventrally placed, whereas those of the Zygoptera lie both on the outer side, one ventral and one dorsal.

The Caudal Filaments of the Plectoptera. (Text-fig.43).

The larvæ of the May-Flies or Plectoptera possess three caudal processes, viz., the two latero-ventral *cerci*, and the single median dorsal *appendix dorsalis*. Thus the former are the homologues of the lateral caudal gills of the Zygopterid larva, while the latter is the homologue of the median caudal gill.

All three of these filaments closely resemble those of the *Perlaria* externally, being long, slender, and many-jointed.

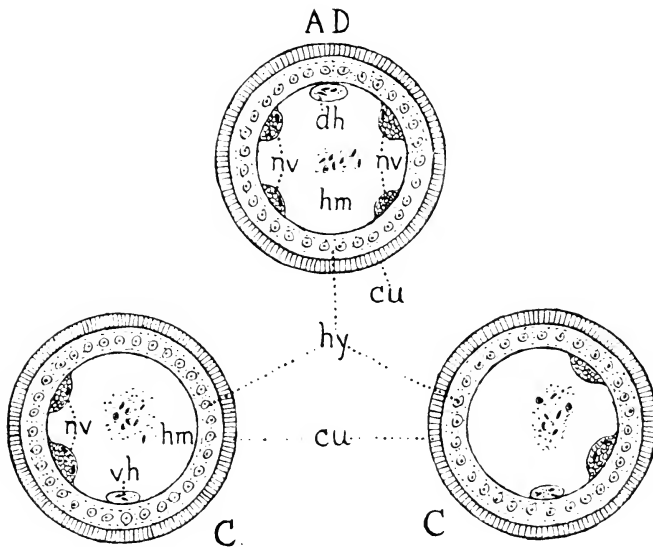

Text-fig.43.

T.S. through the three caudal filaments of a well-grown Plectopterous larva, *Atalophlebia* sp. Lettering as in Text-fig.42: AD, appendix dorsalis; C, cercus; *ch*, ventral blood-canal; ($\times 130$).

In transverse section (Text-fig.43), the structure of these organs is of great interest. In all three, the transverse section is circular, the cuticle and hypodermis fairly thick, the latter with many closely-arranged nuclei, and the interior an open prolongation of the hæmocœle, as in the filaments of the *Perlaria*. Beyond this, the cerci differ so much from the appendix dorsalis that we must deal with them separately.

Cerci.—Comparing these with the cerci of *Perlaria*, we see that both possess two main nerves and a single closed afferent blood-canal. But, in the *Plectoptera*, the closed blood-canal is ventral in position, as in the lateral caudal gills of *Odonata*, and not dorsal, as in the *Perlaria*. The two main nerves also lie in the same positions as in the *Zygoptera*, and not as in the *Perlaria*. There is no main longitudinal trachea developed at all in the cerci of the *Plectoptera*.*

Appendix Dorsalis.—As this is absent in the *Perlaria*, we must confine our comparison to the median caudal gill of the *Zygoptera*. We then notice a remarkable similarity in the two homologous organs. *For the closed afferent blood-canal is dorsally placed in both, and both possess four main nerves, two being latero-dorsal, and two latero-ventral.* The only differences are that there is no main trachea in the appendix dorsalis of the *Plectoptera*, and no development of internal laminae or alveolar meshwork.

Phylogenetic Conclusions.

The following conclusions may, I think, be safely drawn from the combined evidence of the Ontogeny and the comparison with the homologous organs of the *Perlaria* and *Plectoptera*.

(1) *The relationship between the Perlaria, Plectoptera, and Odonata.*

Firstly, as regards the *Perlaria*, there are some fundamental differences in the arrangement of the internal structures of the cerci, as compared with those of the *Zygoptera*. These are (*a*) the position of the main nerves, and (*b*) the dorsal position of the closed afferent blood-canal. I think that these differences are great enough to make us conclude that the evidence from the cerci only reinforces the opinion which I had previously stated,† from a consideration of other morphological characters, viz.,

* This applies to *Atalophlebia*, the only genus available here for study. I cannot say whether it is true for the whole Order or not.

† "The Biology of Dragonflies." Cambridge University Press, 1917, pp. 5-6.

that no close relationship exists between the Perlaria and the Odonata

Secondly, as regards the Plectoptera. The close resemblance in the arrangement of the internal structures of the caudal processes, as compared with those of the caudal gills of Zygoptera, is indeed a striking one, since the number and position of the main nerves, and the positions of the primary afferent blood-canals in the three processes are the same in both. The only differences are the long, many-jointed condition of the filaments in Plectoptera, and the absence of a main longitudinal trachea (assuming that this character holds for all Plectoptera). We are, I think, bound to conclude that the relationship between the Plectoptera and Odonata is a more definite one than that between the Perlaria and Odonata, and that, in particular, the Zygopterid gill has been derived from a caudal process closely similar to that of the Plectoptera, by reduction from a many-jointed to a one- or two-jointed condition.

(2) *Steps in the evolution of the Zygopterid Gill.*

If we examine in section any simple evagination of the body-wall of an Insect Larva, forming a short process—such as, for instance, the *cercoids* of the Odonate Larva—we shall find that they show only cuticle, hypodermis, and internal blood-space (Text-fig. 44). No longitudinal nerves, tracheæ, or closed blood-canals are present. Thus the first stage in the evolution may be assumed to have been a many-jointed process, long, slender, circular in section, with fairly stout cuticle and hypodermis enclosing an undifferentiated blood-canal, and without either main nerves, tracheæ, or closed afferent blood-canals.

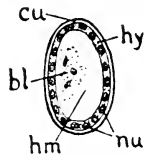

Text-fig. 44.*

The next stage would be the development of this organ into an organ of touch, by the outgrowth of longitudinal nerves along

* T.S. through a cercoid of the well-grown larva of *Synlestes weyersi* Selys; *bl*, blood; *cu*, cuticle; *hm*, hemocoel; *hy*, hypodermis; *nu*, nucleus of same; ($\times 88$).

it, as branches of the tenth-segment nerves of the abdomen. Probably correlated with this would be the regulation of the blood-circulation, by the development of a closed afferent canal, the *primary blood-canal*. As the positions of both these structures are different in Perlaria and Odonata, it is logical to assume that the two Orders became separated at a stage in the evolution of the Insect Larva earlier than is here indicated.

The third stage would be the development of the main trachea along the interior of the processes, the cerci receiving one each, from the dorsal trunk of its own side, but the median appendix dorsalis receiving two, one from each side. Unless these tracheæ can be shown to exist in some Plectopterous larvæ, we must hold that the Odonata became differentiated from their common stock with the Plectoptera before this outgrowing of the tracheæ took place.

Finally, as all the appendages of the Odonata, in every part of the body, show a great reduction in the number of joints (*e.g.*, the antennæ, the tarsal joints, the labial and maxillary palpi), we must assume that the reduction of the caudal processes to a one- or two-jointed form proceeded parallel with these other reductions; in other words, the original Protodonate ancestor already possessed all these reductions, derived from a Palæodictyopterous ancestor.

Thus we conclude, that the original form of Zygopterid caudal process was a short, one- or two-jointed appendage, in which the nerves and blood-canals were developed as in the caudal processes of the Plectoptera, and with the addition of a single longitudinal trachea in each cercus, and two in the appendix dorsalis. In this organ, neither internal laminæ nor alveolar meshwork were developed.

Evolution of the Caudal Gills within the Suborder Zygoptera.

We have now to consider the evidence of the Ontogeny, with respect to the further evolution of gill-types within the Suborder.

As far as I can ascertain, all newly-hatched Zygopterid larvæ have the gills filiform, one-jointed, and hairy. We may safely assume that the filiform condition is primitive, since all the evi-

dence gathered in the preceding section points also in this direction. Probably also the hairiness is primitive too, since all aquatic groups tend to become smooth in the course of evolution. But the one-jointed condition may not be taken as primitive: because, in the case of other organs, *e.g.*, the antennæ, tarsi, etc., the number of joints increases as the larva grows, and yet it is certain that the last and highest number of joints attained is the most primitive number, or, in some cases, even less than that (*e.g.*, in the tarsi, the fossil *Tarsophlebiinæ* had four joints, whereas no existing Odonate has more than three). Thus we must assume that, in the case of a larva that develops two-jointed gills, such as *Neosticta*, the two-jointed condition is probably primitive. But, in the case of those larvæ which always have unjointed gills, it is not necessary to assume that they are derived from two-jointed forms, unless there is evidence for it.

In the case of the gills of *Calopterygidae* and *Lestidae*, there is absolutely no evidence that these gills were ever more than one-jointed. But in the *Agrionidae*, the existence of two-jointed forms in the *Protoneurinae* and *Agrioninae* strongly suggests that the common ancestor of these two groups had a larva with two-jointed gills. As no larvæ of the most primitive subfamily of the *Agrionidae* (*viz.*, the *Megapodagrioninae*) are known to possess two-jointed gills, I am inclined to suspect that the original *Agrionidae*, like the other two families of *Zygoptera*, possessed only one-jointed gills, and that the two-jointed condition arose in the common ancestor of only those subfamilies still possessing it, and, failing to become of any definite service to the larva, is now again reverting to the one-jointed form, by degradation through the Nodate, Subnodate, and finally Denodate stages.

The most ancient existing forms of *Zygoptera* possess gills of the Saccoid Type; for this type appears to be universal throughout the two subfamilies *Epallaginae* and *Thorinae*. As such a type could be easily produced from an original caudal filament, by simple enlargement of its internal cavity, we shall probably be right in assuming that the Saccoid Gill is the most primitive type. One might expect this line of evolution, once begun, to run to an extreme; and this is probably the reason for the exist-

ence of the huge, cumbersome, bladder-like gills of *Diphlebia* and *Cora*. It seems clear, also, that these organs are primarily an attempt to evolve *blood-gills*, and not *tracheal-gills*; since it is the blood-space that undergoes an immense increase in volume,—the tracheal supply remaining far inferior, in these gills, to that to which it eventually attains in the Lamellar Gill.

Although we designate the Saccoid Type as the most archaic of all, there is one qualification to add. These huge bladder-like gills could not be held apart in the water. The two lateral ones must always have rested either on the river-bed, a rock, or a convenient stem, on which the larva may have been resting.

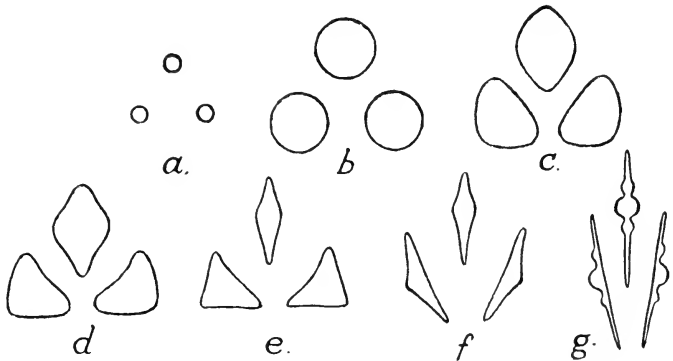

Text-fig. 45.

Evolution of the outward form of the caudal gills, as shown in T.S. Phylogenetic series from caudal filament, through simple Saccoid and Triquetro-quadrate Types, to Lestid form of Vertical Lamellar Type: *a*, caudal filament; *b*, simple saccus; *c*, *Diphlebia*-stage of same; *d*, *e*, evolution of the Triquetro-quadrate Type (*a*); *f*, *g*, evolution of the Lestid form of Vertical Lamellar Type (*g*).

The median gill must also have rested symmetrically upon the other two. Hence, even in the huge bladder-like gills of *Diphlebia*, the *beginnings* of the Triquetro-quadrate Type are evident. That type, as seen in its highest development in the *Calopteryginae*, is clearly a specialised development from the older Saccoid Type (Text-fig. 45, *a-e*). Thus we may say that a single line of

evolution, from the archaic Saccoid Type to the highly specialised Triquetro-quadrate Type, characterises the family *Calopterygidae* as a whole.

From the Triquetro-quadrate Type of the *Calopterygina*, the Lestid form of Lamellar Gill-Type is undoubtedly derived. This can be seen in Text-fig. 45, *e-g*, where I have shown diagrammatically the probable stages in the reduction-process. In connection with this, the following points are of importance:—

(1) There is no evidence of the *Lestidae* ever having possessed the division of the blood-canals into two, in their lateral gills, as seen in these gills in the *Calopteryginae*. This must be regarded as a specialisation confined to that subfamily.

(2) There is strong evidence that the Lestid gill-form is derived from a form in which the tracheation was the same as in the Triquetro-quadrate Type:—

For (*a*), regenerated gills of Lestid larvæ always show an increase in the number of tracheæ; and, in most cases, this increase takes the form of a doubling of the original number of tracheæ, and therefore agrees with the original Triquetro-quadrate arrangement; and (*b*) the reduction of the number of main nerves in the median gill in the *Lestidae* is unique in *Zygoptera*, and only to be explained as a specialisation from the original arrangement of four nerves in the median gill and two in each of the laterals.

Within the *Lestidae*, it is clear that the gills of the *Synlestinae* are the more primitive type; for (*a*), regenerated gills of the subfamily *Lestinae* assume the *Synlestinae* form, with the branch-tracheæ obliquely placed in the main stem: and (*b*), the arrangement of these branch-tracheæ at right angles to the main stem in *Lestinae*, and the development of the pigment-bands, are evidently high specialisations, the former being unique in the Sub-order.

The evidence of the structure of the Caudal Gills, then, tends to bring the *Lestidae* into closer relationship with the *Calopterygidae* than a study of the imaginal characters alone would warrant. In particular, it would seem that the larvæ of the *Calopteryginae* and *Synlestinae* are very closely allied.

Turning next to the *Agrionidae*, we have a very distinct problem to deal with. I think that the evidence here is all in favour of the development of the Agrionid form of Vertical Lamellate Gill-type direct from a two-jointed or constricted Saccoid Type, such as still exists in *Neosticta*, without the intervention of a *Triquetro-quadrate Type* at all. The reasons for this are as follows: —

(a) *Neosticta* can hold its gills fairly widely apart, and they are not swollen out so greatly (as in the case of *Diphlebia*) that the lateral gills would be compelled, in time, to take on a triquetral form, by pressure of the median gill from above and between them. Consequently, there is an opportunity for the development of a quadrate form in all three gills.

(b) The gill being two-jointed, such a quadrate form naturally suggests itself as suitable for the basal joint or *stalk* of the gill.

(c) All three gills of the Agrionid form of Vertical Lamellar Gill-Type *do actually show this quadrate form* in transverse section. (See Text-fig.22 in Part ii. of this paper, p.90).

(d) The internal arrangement of parts in these gills is that of the Saccoid Type, except only that the median gill possesses *two* main tracheæ, instead of four. That this is due to reduction is shown by the fact that regenerated median gills of the Agrionid form of Vertical Lamellar Gill-type show an increase in the number of main tracheæ to *four*, as well as a distinct tendency to a narrow Saccoid form. (N.B.—Regenerated lateral gills also show an increase to three or four tracheæ, but *three* main tracheæ are also quite frequently met with in *Neosticta*, as well as in other Saccoid Types).

The Constricted or two-jointed Lamella of *Isosticta* is clearly a direct development from the Constricted Saccus of *Neosticta*. The two genera are too closely allied to admit of any doubt on that point.

The larva of *Caliagrion billinghami*, when half-grown, (probably the tenth or eleventh instar) shows the constricted condition almost as completely as in *Isosticta*. Thus the Nodate form finally attained in this and other Agrionine genera must be derived from the older Constricted form, as seen in *Isosticta*.

But we may not argue from this that the *Agrioninae* are descended from the *Protoneurinae*, since such a supposition is negated on all other morphological grounds. The wing-venation of the *Protoneurinae* is reduced far beyond the Agrionine stage. It is quite possible that the larvæ of some archaic Agrionine genus may still retain gills of constricted form. We can only say that such a form must have existed once within the *Agrioninae*, even if no longer existing to-day. The phylogenetic series of gill-types (Constricted Saccus, Constricted Lamella, Nodate Lamella, Subnodate Lamella, Denodate Lamella) is strictly correct. But it does not follow that the series of generic types which to-day exhibit these gill-types (*e.g.*, *Neosticta*, *Isosticta*, *Caliaagrion*, *Ischnura A. gioenemis*) is a true phylogenetic sequence. The sequence *Neosticta*, *Isosticta* must be admitted. Then there is a break: for, as far as we know, the larvæ of the

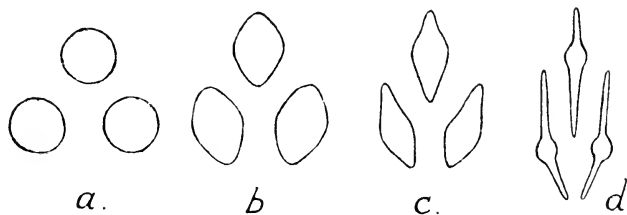

Text-fig. 46.

Evolution of the Agrionid form of the Vertical Lamellar Type direct from the Constricted Saccoid Type: *a*, Saccoid Type; *b*, *c*, intermediate stages; *d*, Agrionid form of Vertical Lamellar Type.

Protoneurinae have reached no higher stage than that shown by *Isosticta*. There is also a break on the side of the *Agrioninae*: for, as far as we know, no larva of this subfamily possessing vertical lamellar gills shows any older form than the Nodate of *Caliaagrion*. Thus the constricted stages still present in the larvæ of *Protoneurinae* have been *passed and lost* by the more highly specialised larvæ of the *Agrioninae*; so that it is pure chance that *Caliaagrion* picks up the sequence of forms at the stage next beyond that to which *Isosticta* has attained. There

might just as well have been a gap, or an overlapping, in the two subfamilies.

Within the subfamily *Agrioninae*, we can follow the phylogenetic sequence of gill-forms from the Nodate, through the Subnodate, to the Denodate, which reaches its final form in the tough, thickened, opaque gills of *Austrocnemis* and some species of *Agrion*. From such a type as this, a retrogression due to loss of function, (the gills no longer serving as breathing-organs) will explain the presence of the Reduced (Non-functional) Type in such a highly specialised case as the larva of *Agrion astelivæ*, which dwells in the water collected at the bases of the leaves of certain plants, in a region of high rainfall.

Text-fig.46 shows diagrammatically the stages in the development of the Agrionid form of Vertical Lamellar Gill from its Saccoid ancestor.

There remains now only the Horizontal Lamellar Type of gill to deal with, as we see it developed in the genus *Argiolestes*. It seems to me that the development of the two types of Lamellar Gills, vertical and horizontal, is obviously a case of the accumulated result of habit on the form of an organ.* If the original Saccoid Gills were held out separately in the water, as in the case of *Neosticta*, then, in course of time, it is inevitable that the Vertical Lamellar Type must be developed. But if, on the other hand, the ancestral form, possessing a Saccoid Gill-system, remains a rock-dweller, and adopts the habit of clinging closely to the rock-surface to escape detection, then the natural result must be, in course of time, that the gills will become horizontally flattened. They will, therefore, pass through a triquetro-quadrate stage, represented in Text-fig.47, *b, c*, and this stage must be observable in a difference between the form of the lateral and median gills. The gills of *Argiolestes* do show this difference, though slightly; for the lateral gills are completely triquetral in section, while the median gill still preserves the quadrate shape,

* Since the organs with whose evolution we are dealing are purely larval structures, not present in the imago, this appears to be a very interesting problem for the consideration of Lamarckians and Darwinians.

especially near the base of the gill. Text-fig.47 shows diagrammatically the derivation of the Horizontal Lamellar Type from the Saccoid Type.

The gills of *Argiolestes* are composed of a single joint. There is nothing in their structure to suggest that they are derived from two-jointed, ancestral forms.* I think, therefore, that the archaic subfamily *Megapodagrioninae*, to which this genus belongs, will prove (when its larvæ are known) to possess, throughout, one-jointed gills, and that most of these are more likely to be saccoid, triquetro-quadrate, or vertical lamellar types, rather than of the highly specialised form found in our Australian *Argiolestes*.

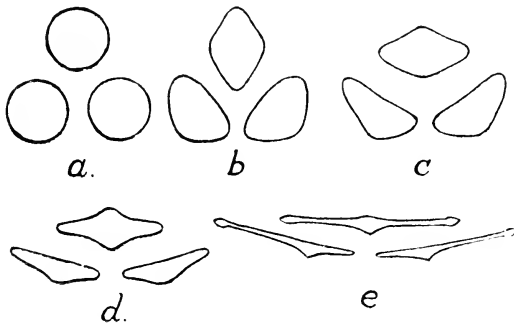

Text-fig.47.

Evolution of the Horizontal Lamellar Type: *a*, saccoid type; *b*, *c*, *d*, successive stages in the horizontal flattening; *e*, horizontal lamellar type.

The number of forms studied in this paper, particularly in the case of the extensive family *Agriionidae* (within which, not a single representative of either of the two subfamilies *Pseudostigmatinae* and *Platycneminae* is available in Australia for study), is far too small for us to draw any very definite conclusions as to the course of evolution of the various groups within the Sub-

* Except, perhaps, the peculiar form of the regenerated gill in *Argiolestes griseus*; see Part ii. of this paper. Plate i., fig.11.

order. But there are certain conclusions in which the evidence from the structure of the Caudal Gills reinforces that already gained from the study of other larval and imaginal organs: and these, I think, may by now be considered as reasonably proved. They are as follows:—

(1) Of the three families, the *Calopterygidae* are the oldest. Within the *Calopterygidae*, the *Epallaginae* on the one hand, and the *Thorinae* on the other, remain primitive; but the *Calopteryginae* must be reckoned as considerably more specialised.

(2) The *Lestidae* appear as a very distinct family, apparently derived from ancestors having close affinity with *Calopterygidae*. If we could obtain the larva of *Epiophlebia*, it is probable that some valuable evidence would be forthcoming as to the more exact origin of this interesting family. The evidence of the Caudal Gills, in any case, reinforces that of the venation on the point that the *Lestidae* are most certainly distinct from the *Agrionidae*.

(3) The *Agrionidae* are the dominant family, and contain the most highly specialised types of the Suborder. But the *Megapodagrioninae* remain still archaic, and far removed from the higher forms. The larval development of *Argiolestes* is specialised along a line quite unique within the Odonata. The two-jointed gills offer strong evidence in favour of the origin of the *Protoneurinae* and *Agrioninae* from a common ancestor, whose larval form must have closely resembled that still extant in the former subfamily. As the *Platyneminae* (about whose larvæ little is known) clearly connect the *Protoneurinae* on the one hand, and the *Agrioninae* on the other, with the archaic *Megapodagrioninae*, it is to be hoped that the study of their larvæ will soon be undertaken.

Apart from the Phylogeny of the Gill-System as a whole, it would be advisable to state briefly the stages through which the different internal structures of the gills have passed:—

(1) *The Blood-System*:—Originally a simple extension of the hæmocoel into the caudal process, this early became differentiated by the closing-off of a narrow canal for the afferent blood-flow. We have already given reasons for supposing that

this *primary blood-canal* existed in the earliest Odonata. When the caudal process swelled out into the Saccoid Type of Gill, a great increase must have taken place in the size of the hæmocoel within it; and this increase must have affected the afferent canal, as well as the rest of the blood-space. At this stage, the efferent or return-current must have proceeded sluggishly back along the undifferentiated portion of the hæmocoel. The subsequent development of the *internal laminae* and the *alveolar meshwork*, within this undifferentiated portion, closed-off the *secondary or efferent canal*, which we have seen, from the ontogenetic evidence afforded by an early instar of *Nycticteta*, is larger and less definitely developed than the older primary or afferent canal. The final result is that the original hæmocoel of the gill becomes divided up into two distinct canals, surrounded by a mass of alveolar tissue, with zones of internal laminae.

(2) *The Nervous System*:—The original Odonata must have possessed caudal processes with a nerve-supply similar to that found in the Plectoptera, viz., two main nerves in each cercus (both on the outer side), and four in the appendix dorsalis (two dorsal and two ventral). This remains the same throughout all subsequent developments of gill-types, except only in the case of the Lestid form of the Vertical Lamellar Gill-Type, in which the median gill has its nerve-supply reduced to two only, by the suppression of the two ventral nerves.

(3) *The Tracheal System*:—It seems clear that the original caudal processes could not have accommodated more longitudinal tracheæ than one each in the cerci (on the outer side), and a single pair in the appendix dorsalis. As this is the arrangement also in the filiform gills of the second larval instar (Text-fig. 34), we may take it as the primitive condition in the Zygoptera. When the Saccoid Type developed, each of these main tracheæ gave off a branch from the base; so that there were then two main tracheæ in each lateral gill, and four in the median. One of the two tracheæ in the lateral gills frequently divided a second time: so that the Saccoid Type, as it stands to-day, may show either two or three main tracheæ in the lateral gills.

From this primitive type, the Triquetro-quadrate Type developed, with four tracheæ still present in the median gill, and two in each lateral gill. Each of these numbers became reduced to one-half in the evolution of the Lestid form of gill.

From the Saccoid Type also, the Agrionid gill-forms were developed, with two tracheæ only in each of the three gills, both in the Vertical and Horizontal Types; *i.e.*, these lines of evolution only involved a reduction from four to two in the median gill, the number in the lateral gills remaining the same as before.

(4) *The Internal Laminae and Alveolar Meshwork*:—These must be regarded as developments peculiar to the Odonata. Probably both reached their maximum development in the spacious interior of the archaic Saccoid Type, with reductions or restrictions in later types, culminating in almost complete loss of both structures in the Lestid form of gill.

These changes may be readily exhibited in the following Table:—

TABLE OF PRINCIPAL DIFFERENCES IN INTERNAL STRUCTURE OF CAUDAL GILLS.

Group.	Blood-System.		Internal Laminae and Alveolar Meshwork.	Main Nerves.	Main Tracheae.
	Primary (Afferent) Canal.	Secondary (Efferent) Canal.			
Plecoptera	×			4, 2, 2.	0, 0, 0.
Ancestral Odonata				4, 2, 2.	2, 1, 1.
<i>Calopterygidae</i> —					
Simple Saccus	×	×	×	4, 2, 2.	4, 3 or 2, 3 or 2.
Triquetro-quadrate	×	×	×	4, 2, 2.	4, 2, 2.
<i>Lesotha</i> —					
Vertical Lamella	×	×	almost absent.	2, 2, 2.	2, 1, 1.
<i>Agriionidae</i> —					
Constricted Saccus	×	×	×	4, 2, 2.	4, 2, 2.
Constricted Vertical Lamella	×	×	×	4, 2, 2.	2, 2, 2.
Nodate, etc., Vertical Lamellae	×	×	×	4, 2, 2.	2, 2, 2.
Horizontal Lamella	×	×	×	4, 2, 2.	2, 2, 2.
Reduced (Non-functional) Type	×	×	laminae absent, mesh-work present.	reduced or absent.	reduced.

In the above Table, × means present, — absent. In the last two columns, the first number stands for the condition in the median gill, the other two for that in the laterals.

Note on the Problem of the Origin of the Constricted or Two-jointed Gill:—The known facts for the solution of this incomplete problem are as follows:—

(1) In the Ontogeny of the Nodate and Subnodate Types (*Austroagrion* and *Ischnura*) no sign of a division of the gill into two parts is to be seen up to the seventh instar.

(2) In the fourth or fifth instar of *Neosticta*, the gill is a two-jointed or constricted saccus, but the distal joint is very small.

(3) Half-grown larvæ of *Caliagrion billinghursti* (Nodate Type) show the constriction almost as marked as in *Isosticta*. These larvæ are probably of the tenth or eleventh instar.

Statements (1) and (3) might appear to be antagonistic: since, at the most, only four instars could intervene for the change from a simple to a constricted gill. But, as a matter of fact, the node in *Caliagrion* is much more strongly developed (in the full-grown larva) than it is in *Austroagrion*, though both are classed as of Nodate form. Consequently, if a series of instars of the rare larva of *Caliagrion* could be obtained, say, from the fourth upwards, the problem would very probably be solved. It would also be necessary to breed the larvæ of *Neosticta* or *Isosticta* from the egg, and raise them to the fourth or fifth instars, to complete the chain of evidence.

Thus we see that the solution of this interesting problem now rests only with him who can obtain two lots of very rare larvæ, and keep them alive through a sufficient number of instars. So far, I have not succeeded in doing this.

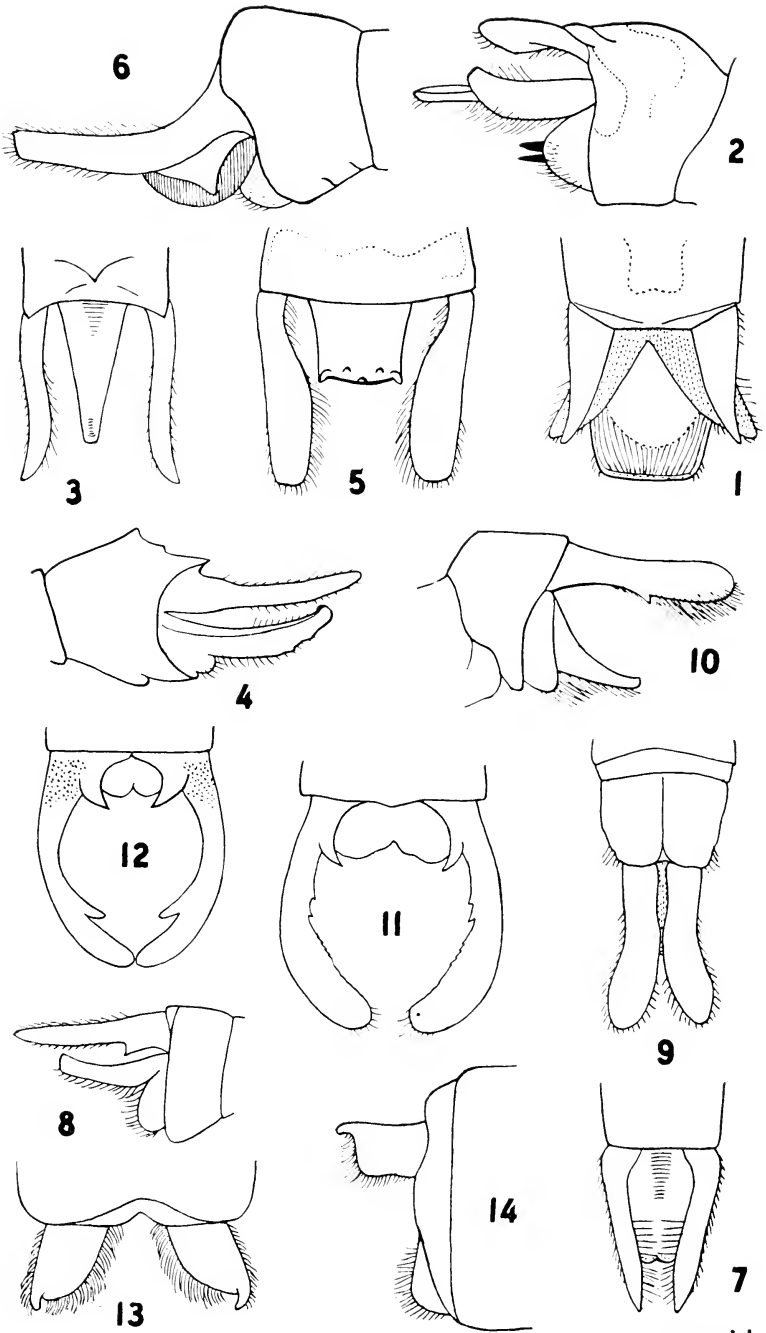

R.J.T. del.

Appendages of new Australian Dragonflies.

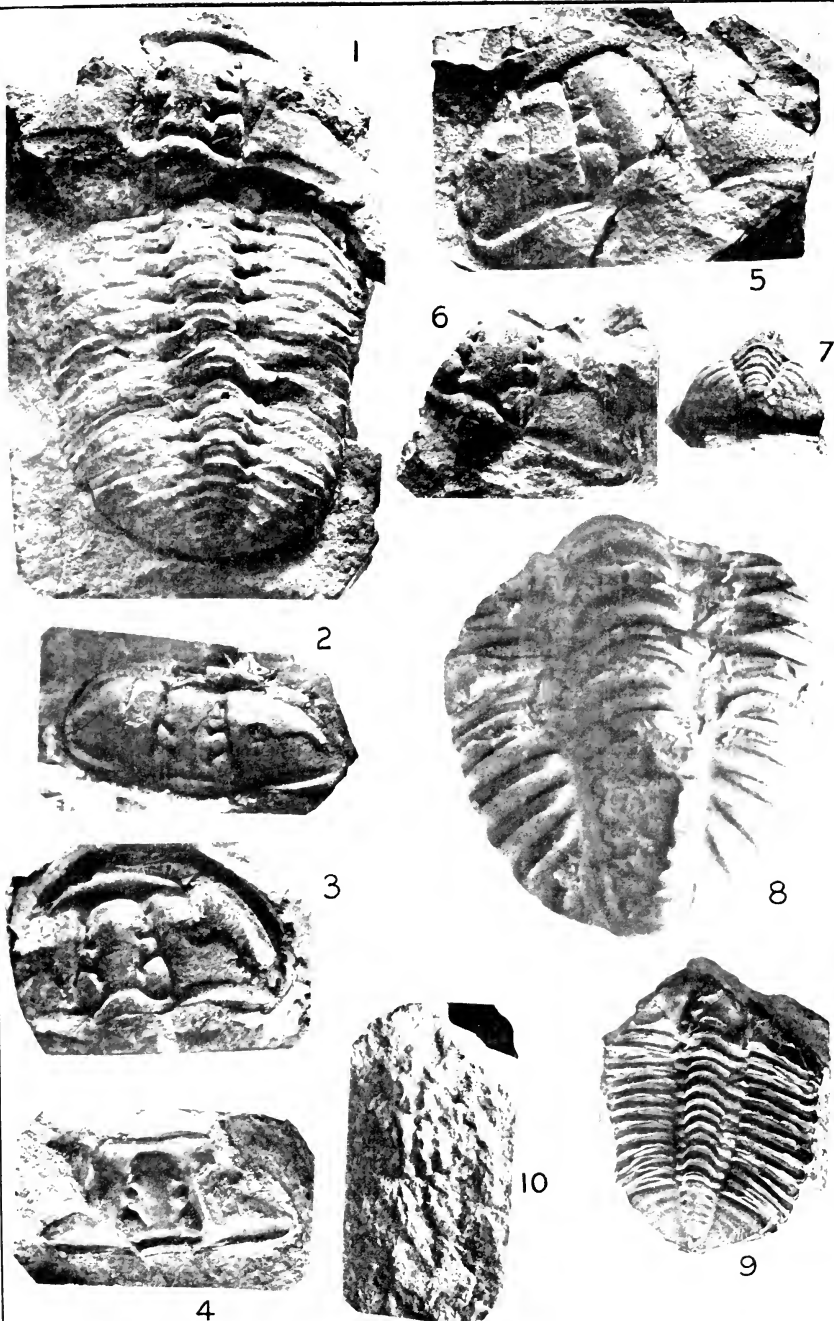

Silurian Trilobites (*Calymene*, *Crotalocephalus*).

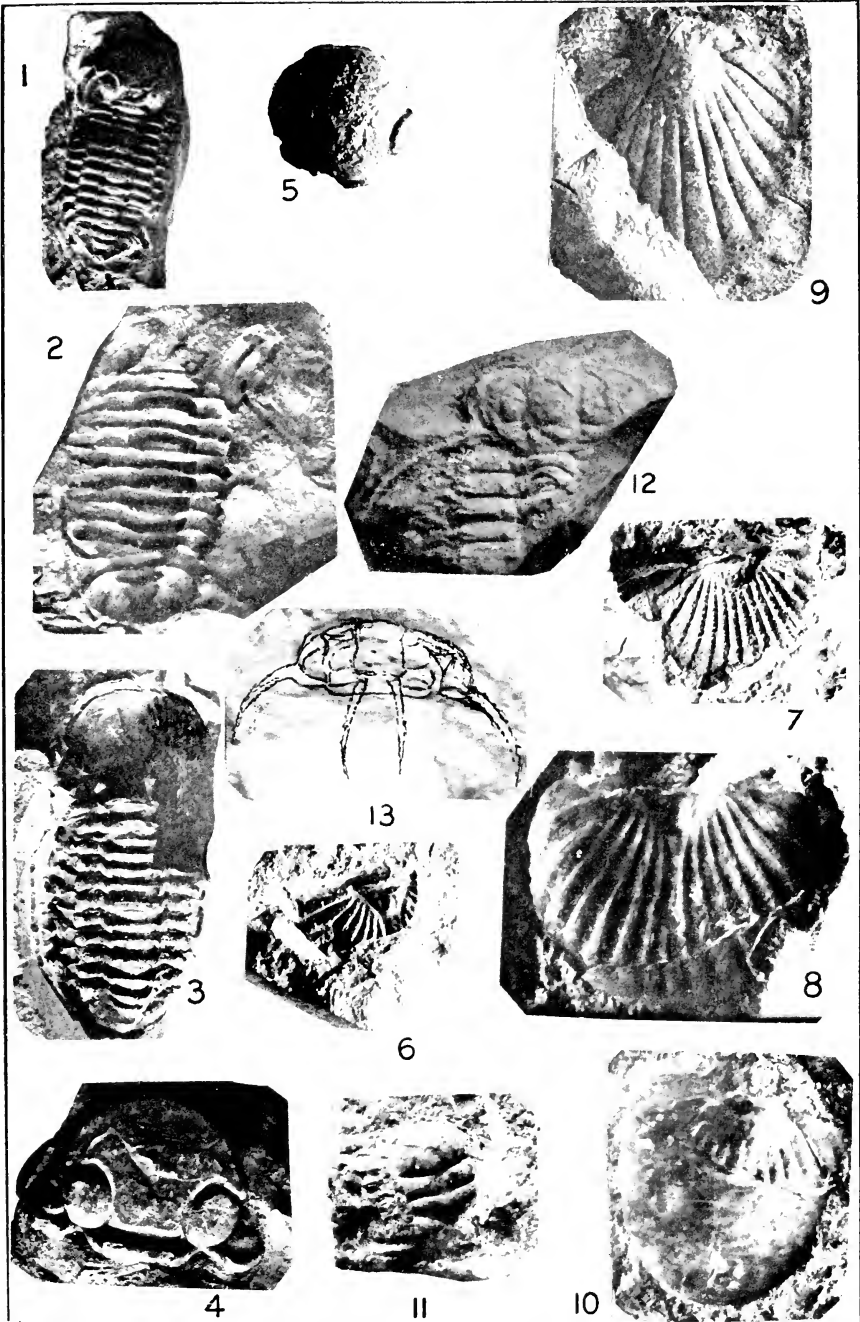

Silurian Trilobites (*Sphaerocochus*, *Bronteus*, *Cataloccephalus*, *Boninonychia*).

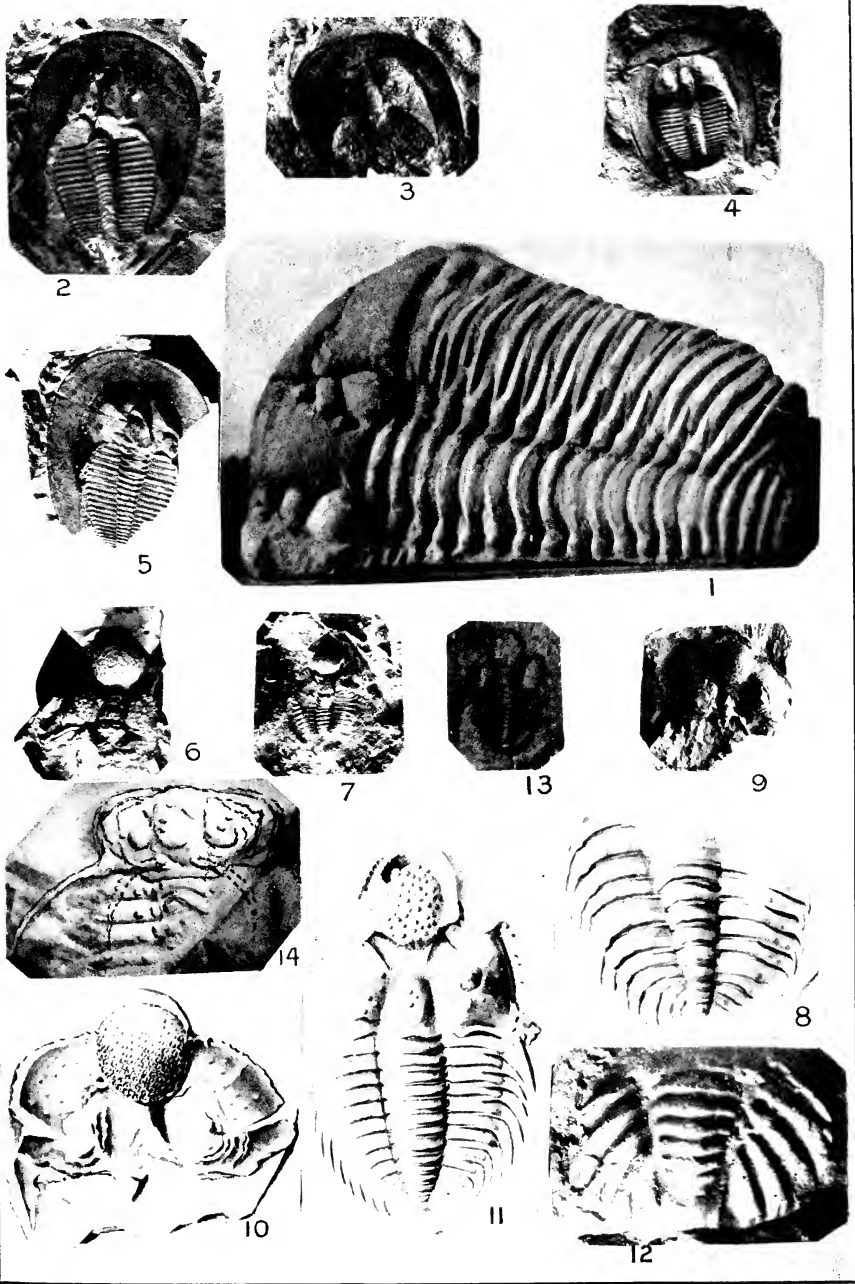
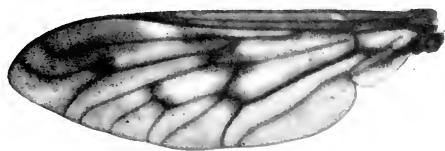

Photo. n.c. et del. p.c.

Silurian Trilobites (*Calymene*, *Harpos*, *Stanurocephalus*, *Botryongia*).



1



2

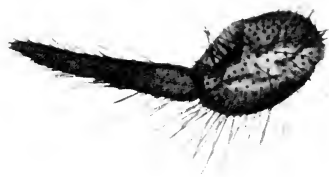

3

1. *Pelecorhynchus mirabilis*, sp. n. : wing. 2. *Palimmecomyia celanospila*, sp. n. : wing.
3. *Cenoprosopon hamlyni*, sp. n. : palp.

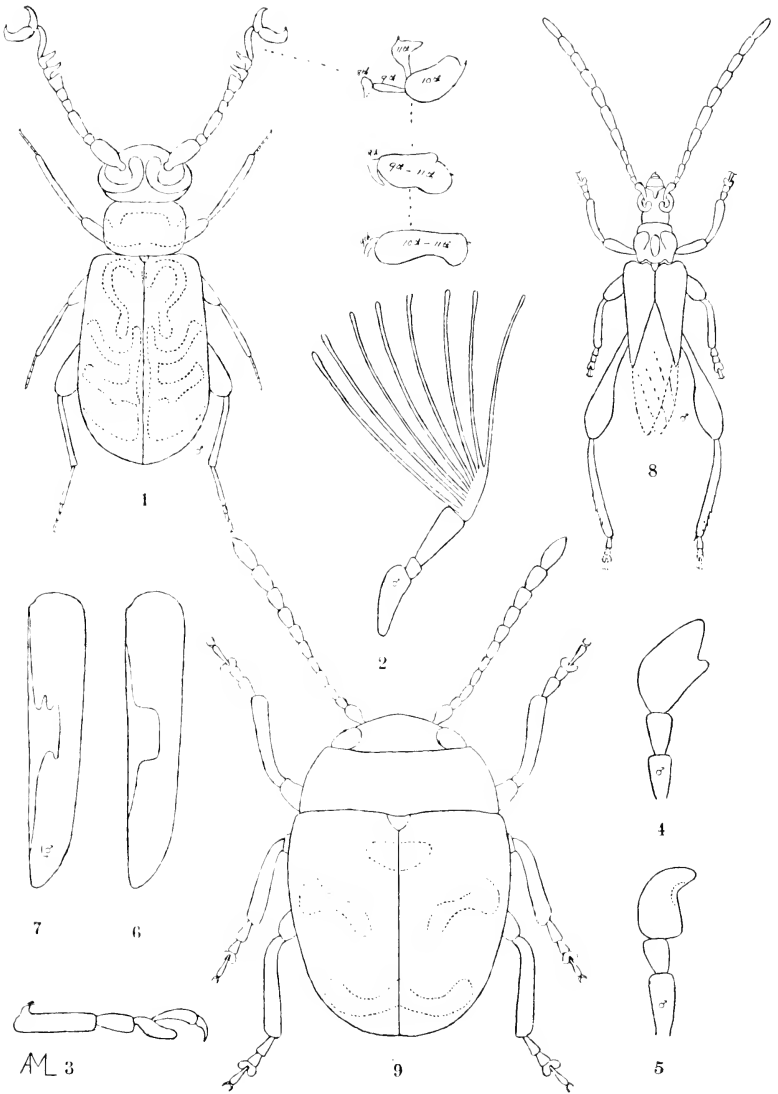

Australian Coleoptera



Solanum opacum A. Br.



Solanum pterocaulon Dunal.



Solanum guineense Lam.

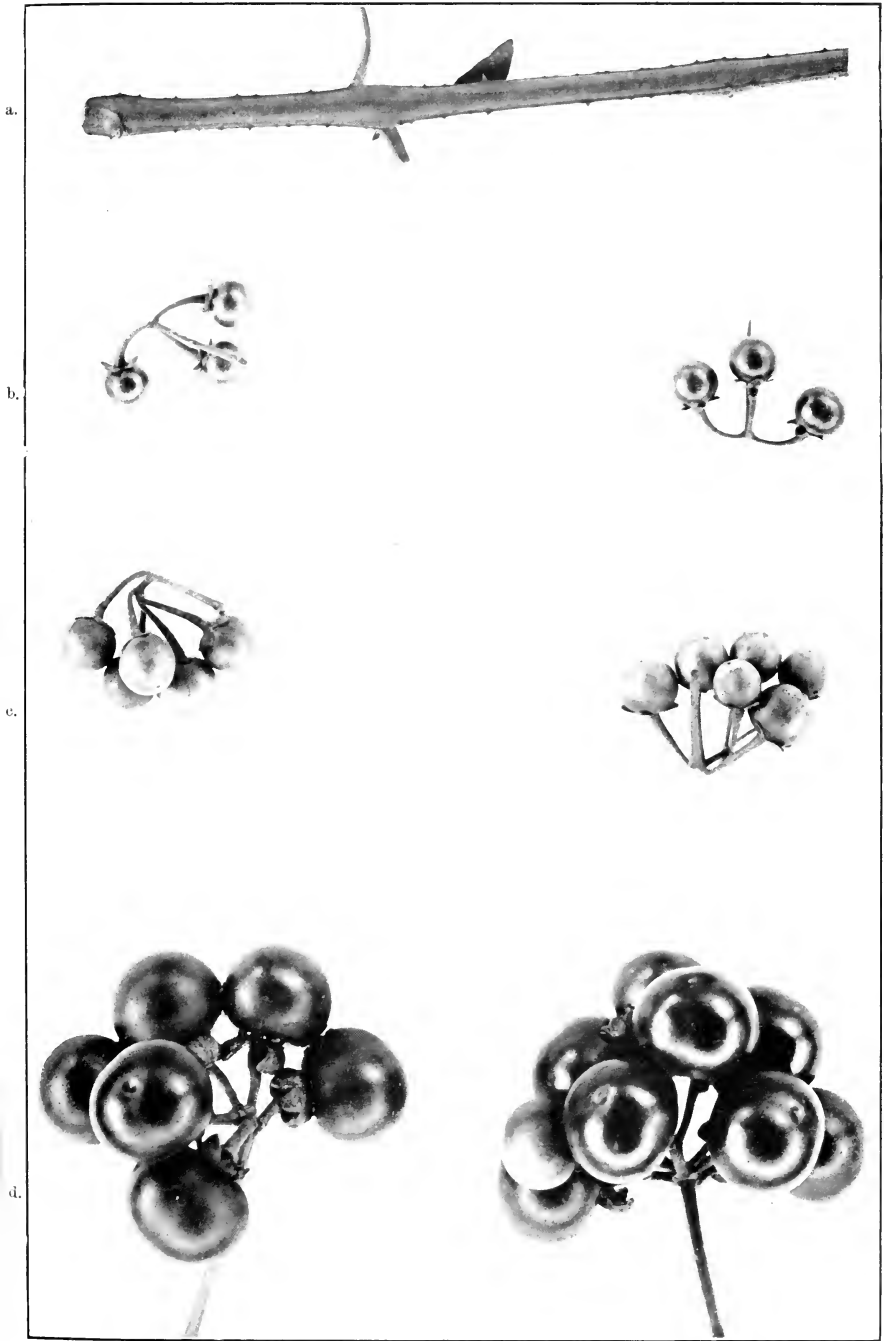

a-b. *Solanum pterocaulon* Dun.

c. *S. opatum* A. Br.

d. *S. guineense* Lam., ("Wonderberry").

RHIZOPODS OF SYDNEY AND LISMORE.

BY G. I. PLAYFAIR, SCIENCE RESEARCH SCHOLAR OF THE
UNIVERSITY OF SYDNEY.

(Plates xxxiv.-xli., and seven Text-figures).

The summer of 1916-17, with its alternate rain and shine at Lismore, was highly favourable to every form of pond- and swamp-life, and among a host of interesting organisms that came to light, was a varied assortment of Rhizopods. I thought it a good opportunity, therefore, to write up this group, particularly as I had reason to believe that the species were to be found in considerable variety in my gatherings. A microscopical survey of the latter was accordingly made, with very satisfactory results.

Samples.—Out of about 340 gatherings, not made for the collection of Rhizopods, but principally for *Desmidiaceæ* and *Protococcaceæ*, 90 were found to contain tests of the *Rhizopoda* to a greater or less extent; 43 of these were from Sydney, and 47 from Lismore. The localities and numbers of the samples are given in the notes on the various species, but as very few gatherings are out of *Sphagnum* (the chief haunt of the *Rhizopoda*), a note here on the character of the various habitats may be useful.

Sphagnum:—all marked Coogee. Weeds (*Myriophyllum*, *Elodea*, &c.) in pond, creek, or river:—Botany 50, 151; Lismore 181, 188-197, 273-278, 303; Woodlawn 225; Casino 189; all those marked Botanic Gardens, Guildford, Centennial Park, and Clyde, Duck Creek. Plankton:—Sydney Water-Supply 66, 100; Grafton 265. Swamp:—all others marked Botany,* Auburn, Rookwood, Wyrallah, Kyogle, Byron Bay; and Lismore 223-263, 285, 292, 298, 307-340. By "swamp" should be understood all ground-collections.

* Of these, Nos. 15, 17, 37, 51, and 152 are from the water-reserve, which is an old *Sphagnum*-bog; patches of *Sphagnum* may still be met with here and there.

Results.—Altogether 174 forms have been listed (including a few *Heliozoa*), representing 118 species belonging to 40 genera, a very fair result considering the character of the habitats, and that, with the exception of Lismore, the gatherings in each locality are mostly from one and the same spot. Of these, 80 are here described as new, 30 being accorded specific, and 50 varietal rank. Three new genera are proposed.

Amœbina.

Genus AMŒBA Ehr.

AMŒBA PROTEUS v. NOBILIS (Penard) mihi.

Syn., *Amœba nobilis* Penard, Faune Rhiz., p.65. In a gathering out of a mere on grass-land, I came across this immense form, equal in size to ten ordinary specimens, which, though in motion and spread out in front in a palmate-digitate shape, measured no less than 950μ long and 350μ broad, more than twice as large as Cash's var. *granulosa*. Nor was it a solitary example; with a Coddington lens, I noted many others on the sides of the glass phial. Passing under a filament of *Spirovogya*, the tail-end, the size of an ordinary specimen and containing three empty tests of *Lesquereusia*, got caught, and the main body broke away from it. The deserted portion exhibited slight amœboid movements for a time, but did not move from its place or throw out any pseudopodia.

Lismore (254).

AMŒBA VERRUCOSA v. QUADRILINEATA (Carter) Playf.

Biol. Richm. R., p.144, Pl. viii., f.17, 19. Syn., *A. quadrilineata* Carter, in Ann. Nat. Hist., 1856, p.243, T. v., f.3; *A. striata* Penard, Mém. Soc. Phys. Genève, 1890, p.127, T. ii., ff.31-34. Var. *maxima* Playf., *l.c.*, must be included here, as the type appears to run to vastly greater dimensions in Europe. The usual size here is about $50-60\mu$ long; the largest, I have seen, reached only double that amount. If this form is to be raised to specific rank, Carter's name has priority, unless it can be proved identical with *A. striolata* Perty; Kleinst. Lebensf., 1852, p.188, T. viii., f.15. *A. limax* Duj., which seems to me a form of *A. verrucosa*, I have also noted here.

Genus *DACTYLOSPHÆRIUM* Hertw. & Less.*D. RADIOSUM* var. *MINUTISSIMUM* Playf.

Syn., *Amœba radiosa* v. *minutissima* Playf., Biol. Richm. R., p.144, Pl. viii., f.20. The diameter of the body, which Cash gives as "usually about 30μ " for the type, is only $4-8\mu$ in this minute form, with pseudopodia extending to $20-30\mu$.

Var. *STELLATUM* Playf.

Syn., *Amœba radiosa* v. *stellata* Playf., l.c., p.145, Pl. viii., f.21. Diam. of the body about 50 , pseudopodia to 150μ . With the type.

Genus *MASTIGAMÆBA* Schulze.*MASTIGAMÆBA LONGIFILUM* Stokes.

Length of body, $10-30$, flagellum about 40μ .

Stokes, Proc. Amer. Phil. Soc., xxiii., No.124, 1886; Infus. U.S., p.72, Pl. i., f.1-4. (?)Syn., *M. reptans* Stokes, New Frw. Infus., l.c., 1890, p.74, f.1-5. A minute, smooth form, generally with relatively long flagellum, the body irregularly amœboid.

Botany; Lismore, Richmond R.

Genus *PELOMYXA* Greeff.*PELOMYXA ECHINULATA* Playf.

The entire body is clothed all over with short, slightly curved spines. Syn., *P. palustris* v. *echinulata* Playf., Plankt. Syd. Water Supply, p.548, Pl.57, f.16, 17.

Length of body about 100 , spines $8-20\mu$.

Pott's Hill, pond; Botanic Gardens, tank; Lismore, swamp.

PELOMYXA HIRSUTA, n.sp.

Body densely clothed all over with fine, bristle-like hairs. The hairs are blunt, straight or very slightly curved, a mere line in thickness even under a high magnification; nor could I, even with a $\frac{1}{12}$ oil imm. obj., detect any bacillar structure. As in all forms of *Pelomyxa*, the margin showed a double line in

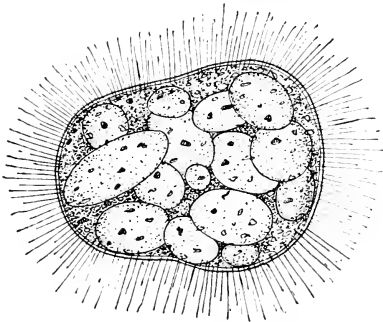

Fig.1.—*Pelomyxa hirsuta*, n.sp.; ($\times 500$).

optical section. The specimens, I saw, were stuffed full of tests of *Euglena*, *Lepocinclis*, *Trachelomonas*, &c.

Length of body 70, breadth 60, hairs 15μ .

Lismore (328, 337).

Genus CHLAMYDOMYXA Archer.

(?)CHLAMYDOMYXA LABYRINTHULOIDES Archer.

In a gathering of a miscellaneous character from a small piece of swampy ground, I came across a number of specimens of a Rhizopod, which can only, I think, be identified as above, cf. Cash, Brit. Frw. Rhiz., i., Pl. xiv., f.1. Our specimens agree with his figure, but not too well with the description. The cysts were apparently of a tough, mucous nature, pale yellow, of irregular shape and large size. The plasma, which entirely filled the capsule and protruded slightly beyond it, was of a dark purple colour from the presence of quantities of minute purple granules. None of the creatures were active, save for a few sluggish, amœboid movements. The cysts seemed to have been pedunculate.

Length of cyst 120-280, breadth 130-140 μ .

Auburn (140). (Pl. xxxix., f.12, 13).

Incertæ sedis.

Genus CYSTAMŒBA, gen.nov.

CYSTAMŒBA DIGITATA, gen.nov. et sp.

Living creature of an amœboid nature, inhabiting an oval, chitinous, thick-walled cyst. The cyst is perforated by small foramina, through which the animal protrudes short, blunt, digitate pseudopodia. Plasma hyaline, refractive, reminiscent of *Dactylosphaerium radiosum* (*Amœba radiosa*).

Length of cyst 20, breadth 16, pseudopod. about 10 long, $1\frac{1}{2}$ -2 μ broad.

Lismore (233).

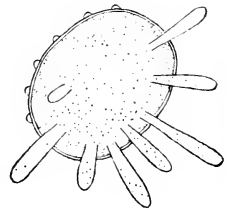

Fig.2.

Cystamœba digitata,
gen.nov. et sp.: ($\times 1000$)

CONCHULINA.

Arcellina.

Genus ARCELLA Ehr.

ARCELLA VULGARIS Ehr.

Cash, Brit. Frw. Rhiz., i., Pl. xv., gives two entirely different forms for the type (figs. 1 and 14). The latter, with the turned-up base, is the one given by Penard, Faune Rhiz., p. 398; and I have, therefore, considered it to be Ehrenberg's type. In the arrangement of a maze of polymorphic forms such as we have in the Rhizopoda, the only hope of producing any order is that every distinct form, which retains its characteristics in many localities, shall have a distinct name. This rule, I have endeavoured to follow out here. *A. vulgaris* is extremely rare in my gatherings; in ten years, I have seen only three specimens.

Diam. 137-140, alt. 60-63; orif. 30-38, alt. 23 μ .

Lismore.

ARCELLA ROTUNDATA, nom. nov. (Pl. xxxiv., f. 1).

Test with a depressed dome in side-view, expanded at the sides above the base-line. No basal angles, the margin of the dome merging into the base in a single, broadly rounded curve. Syn., *A. vulgaris* Cash, *partim, l.c.*, Pl. xv., f. 1-3.

Diam. 47-54, alt. 25-30; orif. 17, alt. 8-9 μ .

Lismore (197) Richmond R.; Wyrallah.

Var. ALTA, n. var. (Pl. xxxiv., f. 2).

Test with a high, arched dome, everywhere evenly rounded

Diam. 35-53, alt. 22-32; orif. 10-15, alt. 4-9 μ .

Botany (152); Lismore (337).

Var. SCROBICULATA, n. var. (Pl. xxxiv., f. 3).

Test devoid of the usual markings, but covered with coarse, closely set scrobiculations having the appearance of rough granules irregularly disposed.

Diam. 38-60, alt. 23-35; orif. 12-28, alt. 8-9 μ .

Lismore (197, 263, 292, 307, 327, 328); Wyrallah (310).

I have never observed this scrobiculation in any except this rounded form. The markings do not show at the edge in

tangential view and seem to be, therefore, excavations or granules on the inner side of the test, or else chitinous deposits actually within the substance of the test itself. Curious colours are sometimes met with in this form; a dull green is not uncommon, and I have met with a specimen rose-pink.

ARCELLA CRENATA, n.sp. (Pl. xxxiv., f.4, 5).

Test in side-view with a high, arched dome, sometimes very much inflated, and as broad as the base, the margin showing sometimes smooth, but generally crenate. The surface dented-in, all over the dome, with small, equal-sized pits. Base sometimes with a rolled edge in side-view. Many forms of this type are found, but the pitted test and high, arched dome are characteristic.

Diam. 50-84, alt. 31-53; orif. 15-20, alt. 8-11 μ .

Everywhere, common.

ARCELLA HEMISPHERICA Perty. (Pl. xxxiv., f.6).

Cf. Penard, Faune Rhiz., p.400. Cash, Br. Frw. Rhiz., i., p.120, makes this a synonym of *A. vulgaris*, but the shape is quite distinct. Many varieties may be noted, but a more or less hemispherical dome, with sides running evenly down at nearly right angles to the base, is characteristic.

Diam. 38-68, alt. 23-37; orif. 10-20, alt. 8-9 μ .

Everywhere, common.

Var. DEPRESSA, n.var. (Pl. xxxiv., f.7).

Test with the dome in side-view somewhat depressed above.

Diam. 34-57, alt. 21-36; orif. 10-15, alt. 4-8 μ .

Botany (152); Wyrallah (310); Lismore.

ARCELLA DISCOIDES v. SCUTELLIFORMIS, n.var.

Test much smaller than the type, with somewhat higher dome, and much more rounded, basal angles. The orifice projects about half-way into the interior, and is relatively very wide.

Diam. 44-95, alt. 15-25; orif. 14-34, alt. 7-11 μ .

Auburn (139, 159); Wyrallah (310); Lismore (337).

The type, as given by Penard and by Cash, is extremely rare here. I have seen but a single specimen. (Pl. xxxiv., f.8).

Var. *FOVEOSA*, n.var. (Pl. xxxiv., f.9).

Dome of the test covered with small, shallow indentations of equal size, evenly disposed. The margin of the dome, however, is often not crenate.

Diam. 53-61, alt. 16-23; orif. 20-24, alt. 8-11 μ .

Lismore (316, 337).

ARCELLA DENTATA Ehr.

Syn., *A. stellaris* Perty. Extremely rare; I have seen only one example, diam. overall 200 μ , out of weeds in a small pool at Auburn. In outline, it was exactly as given by Penard, Faune Rhiz., p.411, and by Cash, *l.c.*, i., p.127, f.21.

ARCELLA MEGASTOMA Penard. (Pl. xxxiv., f.10).

Test with a low dome, regularly arched in an even curve from one side to the other, not angled nor flattened above. Base the full breadth of the test, sides of the dome meeting the base at an acute angle, only the extreme tip of which is rounded off. No constriction above the base.

Diam. 51-106, alt. 19-32; orif. 17-42, alt. 8-15 μ .

Auburn (159); Botany (144); Wyrallah (310); Lismore (192, 225).

Var. *ALTA*, n.var. (Pl. xxxiv., f.11).

Test with a dome more highly arched, but having the same regular and even curve as in the type. This curve and the sharp basal angles are characteristic of the species.

Diam. 95-160, alt. 42-53; orif. 32-42, alt. 15-21 μ .

Auburn (57, 104); Botany; Wyrallah (310); Lismore (260, 316, 327).

A larger size, diam. 300-306 μ , was noted out of the Richmond River, but this is exceptional; and whether the specimens belonged to the type or the variation, I cannot say, as they were too broad to get on edge. The species is common and widespread in this country; any large specimen of *Arcella* is almost sure to belong to it. Cf. Wailes, Rhiz. fr. N. and S. America, p.204, Pl.15, f.1, 2.

ARCELLA CATINUS Penard. (Pl. xxxiv., f.12).

Etudes s.l. Rhiz., p.154, Pl. v., f.87. Incorrectly identified with *A. artocrea* Leidy, by Penard in Faune Rhiz., p.405, f.3, which is quite a different shape. Syn., *A. vulgaris* v. *compressa* Cash, *l.c.*, i, p.138, f.28.

Diam. 90, alt. 25; orif. 31, alt. 12 μ .

Lismore (192).

Var. AUSTRALIS, n.var. (Pl. xxxiv., f.13).

Test with lateral angles much more elevated above the base, the dome less angular.

Diam. 122, alt. 46; orif. 40, alt. 12 μ .

Lismore (316).

Both type and variation extremely rare, only one specimen of each observed. The two just cover the range of dimensions as laid down by Penard, *l.c.* In var. *australis*, the basal angles have become lateral, their elevation above the base in the specimen measured being 17 μ . Penard considers this a *Sphagnum*-form, but I have the type from the river, and the variation from a swamp.

ARCELLA COSTATA Ehr. (Pl. xxxiv., f.14).

End-view circular. Diam. 64, alt. 44; orif. 17 μ .

Lismore (337).

Var. ANGULOSA (Perty) mihi. (Pl. xxxiv., f.15).

End-view angular. Syn., *A. angulosa* Perty.

Diam. 60-63, alt. 32, ap. 39; orif. 11, alt. 8 μ . Lismore (337).

Var. CONICA, n.var. (Pl. xxxiv., f.16, 17).

Test in side-view broader above than in the type, with sides more vertical. The apex, instead of being flat, rises from the shoulder into a peak, giving the test the shape of a marquee-tent. The peaked apex is sometimes shaped like the roof of a house, showing as an angle from one point of view, as a ridge from another. End-view generally circular, with 7-10 irregular-sized panels within the margin, formed by as many costae. The orifice is always remarkably small.

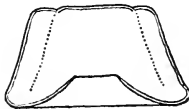

Fig.3.

Arcella costata var.
angulosa (Perty)
mihi; ($\times 400$).

Diam. 50-80, alt. 31-48; orif. 13-20, alt. 6-10 μ .

Auburn (57); Lismore (260, 308, 327, 337); Woodlawn (225).

The type, and var. *angulosa* Perty, are very rare; I have seen but one or two specimens. Var. *conica* seems to be very rare round Sydney, but fairly common in the Lismore district.

ARCELLA MITRATA var. DEPRESSA, n.var.

Test in side-view inflated above the base, but not so much as in the type, dome often much depressed above. Sides diverging from the base at a decided angle. Sometimes very slightly constricted above the base, enough to form a rectangular neck, as in the type. (Pl. xxxiv., f. 18, 19).

Diam. 32-42, alt. 20-30; orif. 9-12, alt. 4 6 μ .

Botany (37, 152); Lismore (337); Wyrallah (310).

Var. ANGULATA, n.var. (Pl. xxxiv., f. 20).

Dome in side-view angular at intervals, by reason of a series of wide, shallow depressions, which cover the surface.

Diam. 72, alt. 59; base 65 μ . Lismore, very rare.

Genus LEPTOCYSTIS, gen.nov.

LEPTOCYSTIS ARCELLOIDES, n.sp.

Test minute, spherical, truncate below; orifice central, the whole width of the base, shortly invaginate, the inner rim strongly everted. Membrane pink, transparent, smooth, without a trace of structure.

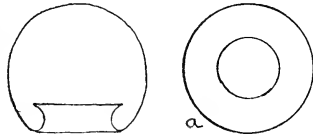

Fig. 4.

Diam. 20, alt. 19, base 12 $\frac{1}{2}$; orif. 12 $\frac{1}{2}$ (rim), alt. 4 μ .

Guildford (77).

Leptocystis arcelloides, gen. nov.
et sp.: (a) end-view; ($\times 900$).

I have seen only the empty test, but its minute size, the character of the orifice, and, above all, the structureless, transparent membrane, which shows no markings even under the $\frac{1}{12}$ oil imm. obj., seem to mark it off from the genus *Arcella*.

Genus PYXIDICULA Ehr.

PYXIDICULA SCUTELLA, n.sp.

Test minute, very depressed, almost saucer-shaped; dome very slightly arched above, rounded at the sides, slightly broader

than the base. Orifice very wide, nearly as broad as the base, not at all invaginate nor re-entrant, not furnished with any dependent membrane. Membrane of the test pale yellow-red, always showing at least a faint punctulation, sometimes very distinctly and coarsely scrobiculate.

Diam. 16-22, alt. 8; orif. 13-17 μ .

Sydney Water-Supply (100); Lismore (195, 316, 333); Woodlawn (225).

Var. ALTA, n. var.

Test with a more arched dome, otherwise like the type.

Diam. 20, alt. 10; orif. 16 μ .

Botanic Gardens (150); Lismore (195, 196).

This species is a lover of weeds, and is generally found in gatherings shaken out of *Myriophyllum* and *Elodea*.

Var. *alta* is something like *P. operculata* Ehr., but the mouth is never invaginate, nor is there any dependent membrane. Scrutiny with the $\frac{1}{12}$ oil imm. obj. shows that the scrobiculæ, which are so much in evidence in some specimens, are present as faint

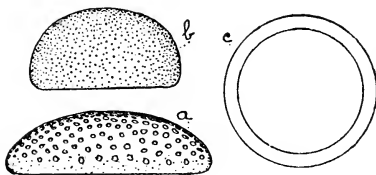

Fig. 5.

(a) *Pyrilicula scutella*, n. sp., ($\times 1330$), scrobiculate form; (b) var. *alta*, n. var., ($\times 1000$), punctate form; (c) end-view, ($\times 1000$).

white spots, even in tests that appear quite clear.

Genus PSEUDOCHLAMYS Cl. & Lachm.

PSEUDOCHLAMYS PATELLA C. & L.

Diam. 45-48, alt. 10 μ . Grafton (265); Nymboidia R.; Lismore (328).

Genus CENTROPYXIS Stein.

CENTROPYXIS ARCELLOIDES Penard.

Diam. 59, alt. 42; orif. 27, alt. 4 μ . Botany (152).

CENTROPYXIS LEVIGATA Penard.

Diam. 65-70, alt. 42-51, base 53; orif. 17-20, alt. 10 μ . Lismore (190).

Two rare species noted here; *C. aculeata* and v. *ecornis* common everywhere.

Difflugina.

Genus DIFFLUGIA Leclerc.

DIFFLUGIA OVIFORMIS Cash.* (Pl. xxxv., f.1-3).

Length 70-100, breadth 48-68, orif. 25-34 μ .

Botany (15, 37, 144, 145, 152); Botanic Gardens (150); Centennial Park (6, 11, 72, 133); Lismore (188, 260, 285).

Cash, *l.c.*, ii., p.52, Pl. xx., f.8-12; *not* Leidy, Rhiz. U.S., Pl. xv., f.16, 17, as given by Cash (= *D. lobostoma* forma). Only known hitherto from a single locality in England, but one of our most common and wide-spread Diffugiæ here. The figure given by Cash leaves nothing to be desired, except that he does not figure the plating of the test, which he gives as "elongated rectangular scale-like particles." In our specimens, the test is almost always formed of a mosaic of small, irregularly-shaped, angular plates embedded in a cement, which gives the test a reticulate character, like the skin of a rock-melon. The test also has a tendency to be more cuneate than ovate, with sides flattened towards the mouth. The orifice is always 3-lobed; I have never seen it otherwise; rim entirely chitinous, ($\times 3\mu$) broad. Very rarely, specimens may be seen with a rim uncoloured, not projecting, and inconspicuous; and sometimes the points of the three lobes of the orifice project upwards. (Pl. xxxv., f.3).

Forma. (Pl. xxxvii., f.1).

Test composed of grains and rectangular spicules, with a number of large, circular, transparent, nebeloid plates, some distance apart, towards the hinder part of the test. The general substance of the test seems to resemble the British specimens. An unusual form. Size 63×55 , orif. 21 μ . Lismore (337).

Var. MOLLIS, n. var. (Pl. xxxv., f.4).

Test delicate, apparently entirely chitinous, without plates or

* I am morally certain that this is *D. tricuspis* Carter (*cf.* Cash, *l.c.*, p.48, f.64), but, as the very distinct, chitinous collar has been omitted from his figure, it is impossible to prove it. It is the only *Difflugia* of its size, which is transparent enough to show the details of the body within.

reticulations, just slightly rough with irregular granulations, ridges and minute depressions, shape very often irregular.

Length 72-74, breadth 47-58, orif. 25-27 μ .

Botany (17); Botanic Gardens (3); Centennial Park (133); Lismore (308).

Var. *SUBGLOBOSA*, n.var. (Pl. xxxv., f.5).

Test proportionately very short, subglobose. Size 57 \times 44; orif. 25 μ . Lismore (333).

DIFFLUGIA LOBOSTOMA Leidy.

Length 60-100, breadth 40-82; orif. 15-38 μ

Auburn (47); Guildford (23); Botany (144, 152); Casino (189); Lismore (188).

Var. *TRUNCATA*, n.var. (Pl. xxxv., f.6, 7).

Test smaller than usual, ovate or subglobose, truncate below, the orifice being invisible in side-view and generally a little smaller than the base. Orifice, as in the type, slightly and often irregularly 3-4 lobed.

Length 55-67, breadth 49-59, base 23-38 μ .

Everywhere, common.

Var. *GLOBULUS*, n.var. (Pl. xxxv., f.8, 9).

Test almost exactly spherical, with truncate base turned out into a slight rim. Orifice, as in the type, of 3 or 4 irregular lobes; the margin, however, often with a regular edging of flints.

Length 63-76, breadth 59-72, base 32-36 μ .

Botany (152); Lismore (337).

Cf. *D. lobos'oma* b, Levander, Wasserfauna, p.16, T. i., f.10, 11 (out of sea-water). This beautiful form counterfeits the best specimens of *D. globulus* Ehr. The test, as also in the type (but not, I think, in var. *truncata*), is often just a clear, chitinous bubble, with segregated flints studding the surface. Orifice never more than 4-lobed.

DIFFLUGIA GRAMEN Penard. (Pl. xxxv., f.10).

Length 53-68, breadth 42-60, base 21-38; orif. 19-22 μ .

Clyde, Duck Creek (74); Botany (50); Lismore (308, 316, 333).

Our specimens are small, ovate or subglobose, truncate in

front, not pointed, agreeing exactly with the type in Penard, Faune Rhiz., p.282; but the orifice has the irregular, pentagonal lobes shown by Cash, *l.c.*, ii., Pl.22, f.1-2, whose form should stand as a variation.

DIFFLUGIA VARIANS Penard, forma. (Pl. xxxv., f.11).

Length 133, breadth 76, orif. 34, thick 70, processes 16-20 μ long. Kyogle (219); Lismore (335).

Cf. Penard, Faune Rhiz., p.241, f.4. Known hitherto only from the neighbourhood of Lake Geneva, in Switzerland.

DIFFLUGIA LITHOPLITES v. *PULCHERRIMA*, n.var.

Test much smaller than the type, perfectly spherical, as a rule, but very rarely somewhat ovate. Orifice always beautifully 6- or 7-lobed, the margin edged with small plates side by side, with the chitin darkened towards the edge just as in the type: occasionally, also, the angles are tipped with the clear, sharp-pointed flint mentioned by Penard, but this is not the rule. Generally, there is no turned-up edge to the orifice, but sometimes a very slight rim is present, and very rarely a decided collar, as much as 6 μ high. The test is strengthened with minute, flat plates of irregular shape, but about equal size (2-3 μ). The processes are usually wanting, and, when present, very small and inconspicuous.

Length 70-100, breadth 60-90; orif. 27-42 μ .

Lismore (308, 311, 322). (Pl. xxxv., f.12, 13).

Cf. Penard, Faune Rhiz., p.284. A very beautiful species, which is plentiful locally. The lobes of the orifice are not always quite regular, though more so than in the type. A pretty test was noted, composed entirely of circular, nebeloid plates (Pl. xxxv., f.14); sometimes, also, thickened, circular plates, apparently with a slight depression in the centre, are interspersed among the small angular ones (Pl. xxxv., f.15).

DIFFLUGIA LISMORENSIS, n.sp. (Pl. xxxvi., f.1).

Test broadly ovate or subglobose, composed of coarse flints closely disposed, or of flat plates of irregular shape (not so small, however, as in the preceding species). Dome broadly rounded,

without processes. Orifice 6-lobed, without any distinct, regular edging of flints or plates, lobes very deep, ovate, narrowed within, rounded or somewhat flattened behind, the angles between the lobes thrust forward into the orifice as broad, blunt processes, leaving only a clear space equal to about one-third of the diameter of the orifice. The tips of these processes are chitinous, and so darkened that, if they are composed of small flints or plates, the latter cannot be seen.

Length 120-150, breadth 110-120; orif. 42-63 μ .

Lismore (335).

Var. *CRUCIFERA*, n.var. (Pl. xxxvi., f.2).

Test as in the type, but orifice 4-lobed. The lobes are occasionally nearly the same as in the type, rounded behind (sometimes with a slight angle at the back) and narrowed in front, but generally they are much deeper, cuneate in shape, the central aperture being only about 10 μ wide.

Length 120-137, breadth 105-123; orif. 32-53 μ .

Fairfield; Lismore (260, 335).

Var. *TRILOBULATA*, n.var. (Pl. xxxvi., f.3).

Test smaller, as far as my observations go, globose or very broadly ovate. Orifice 3-lobed, lobes deep, cuneate, flat behind, narrowed a little inwardly, angles between the lobes merely broad, triangular wedges.

Length 85-90, breadth 78-90; orif. 32-42 μ .

Lismore (327).

DIFFLUGIA BREVICOLLA Cash. (Pl. xxxvi., f.4).

Length 112, breadth 106; orif. 47 μ . Lismore (308).

Cash, *l.c.*, ii., p.38, Pl. xix., f.12, 13. I have noted one specimen which, though a little larger, seems to agree very well with the figures given by Cash. It is spherical, inflated immediately above the narrow neck, the test composed of circular, fusiform, bacillar, or irregularly rectangular plates filled in with fine granules. At the same time, I think this species doubtfully distinct from the next; my specimen of each is from the same piece of swamp.

DIFFLUGIA HELVETICA var. LITHOPHILA (Penard) mihi.

Length 60, breadth 55; orif. 34μ . Syn., *D. hydrostatica* Zach., v. *lithophila* Penard, Faune Rhiz., p.274. The latter identifies *D. hydrostatica* Zach., with *D. urceolata* v. *helvetica* Heuscher, the priority of which he recognises, but without adopting the name. Penard gives 100-140 long for Swiss specimens; the only example I have seen agreed in size more with *D. brevicolla* Cash, whose likeness to this species I have already remarked on, cf., Cash, l.c., p.38, f.55. According to Penard, *D. cyclotellina* Garbini, differs only in a test garnished entirely with *Cyclotella* frustules; it is not improbable, therefore, that *D. Casinoensis* Playf., Biol. Richm. R., p.142, Pl. viii., f.9, may be identical with that form; I have not seen Garbini's figure or description. (Pl. xxxvi., f.5). Lismore (327).

DIFFLUGIA CONSTRICTA (Ehr.) Leidy.

Length 55-72, breadth 39-57; orif. $21-31\mu$ high.

Coogee (14); Botany (17, 155).

Var. SPINIFERA, nom.nov. (Pl. xxxvi., f.6).

The spinous form. Length 87, breadth 72, spines 20μ .

Coogee (14).

DIFFLUGIA URCEOLATA Carter.

Length 180-210, breadth 150-152; orif. 95μ .

Auburn: Wyrallah; Lismore (314, 335).

Var. AMPHORA Leidy.

Rhiz. U.S.A., Pl. xvi., f.54. *D. amphoralis* Hopkinson in Cash, ii., p.43, Pl.21, f.13. It is impossible to draw any specific distinction between forms that are rounded behind and those that are acuminate.

Length 200, breadth 158; orif. 116μ . Lismore (311).

Var. SPHÆRICA, n.var. (Pl. xxxvi., f.7).

Test spherical, not oval or ovate, orifice furnished with the usual collar.

Length 275, breadth 275, collar 200, constr. 175, neck 50μ high.

Lismore (260).

DIFFLUGIA CORONA Wallich.

Length of body 144, breadth 156, orif. 84, proc. $64 \times 36\mu$.
Auburn; Wyrallah.

Var. FOLEYANA, n.var. (Pl. xxxvi., f.8).

Test mitriform, expanded above, crown flattened, sides arching to the orifice, which, as usual, is without any rim or constriction. Dome furnished with four, long, conical, diverging processes. End-view compressed. Length 133, breadth 140, proc. 38μ long.

Lismore, swamp near Foley's.

DIFFLUGIA TUBERCULATA v. SPHERICA, n.var. (Pl. xxxvi., f.9, 10).

Test of the same character as the type, but spherical, with a very decided collar. Orifice 6 or 7-lobed, with the usual angular lobation, sides of lobules straight.

Length 115-127, breadth 104-118, orif. 32-52, collar $8-12\mu$ high.

Auburn (68); Lismore (332, 337).

(*Cf.* Penard, Faune Rhiz., p.293, where he says of the test, "*toujours ovoid*"; ours, on the contrary, are globose, with a much deeper collar. The test in this species cannot be mistaken, being covered all over with very low swellings of equal size, which are best seen when the surface is a little out of focus. The bases of these swellings seem to be outlined with flinty plates and grains formed into distinct rows. The whole of the test is composed of a conglomeration of minute, flinty grains, spicules, rectangles and irregular plates, the largest of which, as a rule, are not over 10μ , and these rare.

Var. NODOSA, n.var. (Pl. xxxvi., f.11).

Test as in var. *spherica*, but furnished behind with four, low, rounded tumours set crosswise. Breadth across the four tumours $\frac{1}{2}$ to $\frac{2}{3}$ diam. of the test. Tumours about 20μ broad, $8-10\mu$ high.

Length 100-132, breadth 90-120, orif. 32-48, collar $8-12\mu$ high.

Lismore (337, 340); Coogee.

Var. CORONATA, n.var. (Pl. xxxvi., f.12).

Test as in var. *spherica*, but with four conical processes set crosswise behind. Breadth across the processes about $\frac{1}{2}$ to $\frac{2}{3}$ diam. of the test.

Length 127, breadth 127, orif. 63μ . Lismore (335).

DIFFLUGIA BACILLARIARUM Perty. (Pl. xxxvii., f.2, 3).

Length 90-200, breadth 57-84, orif. 34-61 μ .

Botany (144); Coogee (58); Lismore (188, 337, 338).

Syn., *D. acuminata* var. *bacillifera* Playf., Biol. Richm. R., p.142, Pl. viii., f.11. I give a figure, among others, of Perty's type as found here, cf. Cash, ii., p.26, f.45. The type itself seems to be symmetrical, but the specimens met with are quite asymmetrical, except from one point of view.

Var. AUSTRALIS, n.var. (Pl. xxxvii., f.4, 5).

Test broadly ovate, with rounded dome and convex sides converging right down to within a very short distance of the orifice, at which point they diverge suddenly into a slight rim. The test is very often more or less asymmetrical, one side being more inflated than the other, and the tail slanting. Orifice circular, simple. Crown furnished with a tail-like appendage. Test smooth, composed of flat, siliceous plates of irregular shape and size, mixed with fine grains; collar of very small plates of equal size.

Length 100-120, breadth 57-72, orif. 23-36, tail 12-19, collar 6 μ high.

Botany (51, 152); Coogee (58); Lismore (254, 308, 311, 327).

One of our commonest and most widespread types, with very characteristic shape and, even when asymmetrical, its lines are always the same. It is a finer, broader form than *D. bacillariarum* v. *elegans* (*D. elegans* Penard, Faune Rhiz., p.237, f.1; Cash, l.c., ii., p.29, f.48), from which it differs also in shape, being ovate and not urceolate-pyriform, and having a very narrow and distinctive collar. The type here has the same form, with a wider mouth, and the same tendency to be asymmetrical. The test is always smooth and plated, not rough with coarse flints. One very beautiful test was noted, formed entirely (except the collar) of oval, nebeloid plates (Text-fig.6). One example of var. *elegans* (Penard) Cash, was noted,

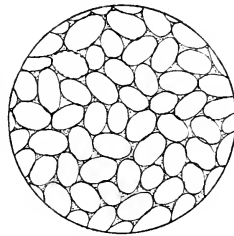

Fig.6.

Diffugia bacillariarum
var. *australis*, with
nebeloid plates.



102 × 70, orif. 34 μ ; and one of var. *teres* (Penard) Cash, length 250 μ , both composed of exceedingly coarse flints.

Forma. (Pl. xxxvii., f.6).

Test asymmetrical, with merely a point behind, not a tail. Collar sometimes wanting. Test inclined to be chitinous, with small, detached flints or minute grains. Length 97-100, breadth 70-72, orif. 27 μ .

Guildford (23); Lismore (185).

DIFFLUGIA PENARDI Hopkinson. (Pl. xxxvii., f.7).

Length 74, breadth 48, orif. 30 μ . Lismore (335).

Syn., *D. fallax* Penard, Faune Rhiz., p.245; cf. Hopkinson in Cash, *l.c.*, ii., p.14. Penard gives 65-80 μ long, but no breadth. Cash gives the breadth as 30 μ . The only example I have noted was half as broad again. This is perhaps the *D. acuminata* b, of Levander, Wasserfauna, p.14, T. i., f.8 (60 × 30 μ).

DIFFLUGIA LEVANDERI, n.sp. (Pl. xxxvii., f.8, 9).

Test lanceolate or mitriform, short and broad; dome shaped like a pointed arch, the sides arched and converging right down to the orifice. Orifice wide, circular, simple, without rim or collar. Test rough with large flints, or chitinous with very small granules, orifice not specially margined.

Length 78-116, breadth 51-78, orif. 32-42 μ .

Lismore (335).

Two different sizes are combined in the dimensions above, the larger coarsely stony, the smaller chitinous, with small, scattered grains. They seem to be identical with *D. acuminata* c, Levander, Wasserfauna, p.15, T. i., f.9, who also gives two distinct sizes, viz., 110 × 60, and 70 × 40; orif. 24 μ .

DIFFLUGIA AMPULLULA, n.sp. (Pl. xxxvii., f.10, 11).

Test broadly ovate, with a hemispherical dome, and sides gradually converging in almost straight lines to the broadly truncate base, where the test is suddenly constricted into a narrow, slightly everted collar. Dome sometimes capped with a minute, pointed, apiculate process. Orifice circular, simple.

Length 72-89, breadth 52-65, orif. 21-30, collar 4-8 μ high.

Guildford (23): Lismore (337).

Syn., *D. tuberculata* forma, Penard, Faune Rhiz., p.295 (70-80 μ long). The test is composed of rectangular plates, splinters, and fine grains, the collar of fine grains only.

DIFFLUGIA ACUMINATA Ehr.

Length 170-252, breadth 52-120, orif. 30-50 μ .

Guildford; Lismore (327, 337).

Very rare here, as is also *D. pyriformis* Perty. Only two examples of the latter noted, from the Sydney Water-Supply (66), and Kyogle (217); length 82-250, breadth 52-175, orif. 23-90 μ .

Var. LEVANDERI Playf.

Length 190, breadth 60, orif. 48 μ : Biol. Richm. R., Pl. viii., f.10; Levander, Wasserfauna, T. i., f.7. This has some likeness to *D. curricula* Penard, Faune Rhiz., p.243.

DIFFLUGIA GIBBEROSA, n.sp. (Pl. xxxvii., f.12, 13).

Test very asymmetrical, irregularly ovate; dome broadly rounded, sides converging almost up to the orifice, just above which the test is constricted slightly to form a collar; at one side a short, conical process. Orifice circular, simple.

Length 82-100, breadth 72-84, orif. 23-28 μ .

Coogee (58): Lismore (338).

This might appear simply a monstrous form, but its occurrence in two widely separated districts forbids this view. The test in both instances was plated, in the one, of angular plates of irregular shape and size; in the other, a very beautiful test, of large, clear, more or less rectangular plates, the interspaces filled with smaller, irregular pieces, and the angles filled in with minute grains.

DIFFLUGIA GLOBULUS (Ehr.) Hopkinson.

Syn., *D. globulosa* (of various authors, not *D. globulosa* Duj.); *D. globularis* Wallich. Cf. Leidy, Rhiz. U.S.A., Pl. xvi., f.1-10; Penard, Faune Rhiz., p.258, f.1.

Var. CASHII, n.var. (Pl. xxxvii., f.14, 15).

Test globular, very small and chitinous, studded with very fine grains, which are generally widely scattered. Orifice circular;

simple, sharp-edged, as a rule not margined with flints, sometimes smaller than the base.

Length 21-30, breadth 19-31, base (= orif.) 6-18; or base 11-21, orif. 6-16 μ .

Auburn (68): Botany (17): Coogee (14, 93): Lismore (181, 273, 274, 316).

This is the very small, chitinous form figured by Cash, *l.c.*, ii., Pl. xxi., f.8, 9, whose figure works out at 30 μ broad. It is very common and widespread here, while I have never met with a specimen anything near the size of the type (30 \times 34, my largest) which Penard gives as 70-100 μ , and Leidy 65-260 μ . The latter mentions these small, chitinous tests at about 24 \times 32 μ . Their very small size, delicate test, and orifice smaller than the truncate base give them a claim to be set apart as a distinct variation.

DIFFLUGIA PULEX Penard. (Pl. xxxvi., f.13).

Length 24-42, breadth 16-24, orif. 7-13 μ .

Auburn (139*b*, 159): Clyde, Duck Creek (26): Guildford (23); Lismore (185).

Var. CUNEATA, nom.nov. (Pl. xxxvi., f.14).

Test cuneate, not pyriform; sides straight; rounded behind.

Length 30-42, breadth 15-25, orif. 9-15 μ .

Auburn (139*b*); Clyde, Duck Creek (26).

Penard, Faune Rhiz., p.230, f.4, who gives length 22-30 μ ; ours were all above 30 μ , except one specimen, which was of doubtful identity.

DIFFLUGIA MITRATA, n.sp. (Pl. xxxvii., f.16).

Test small, mitriform, broadly ovate, with hemispherical dome, and sides converging almost straight to the truncate base. Orifice full breadth of the base, circular, simple, sharp-edged. Test chitinous, studded with small flints, orifice not margined, as a rule.

Length 21-24, breadth 19-26, orif. 8-12 μ .

Botany (17, 109): Lismore (308).

Var. MAJOR, n.var.

Test twice as large; orifice, however, not proportionately so.

Length 42, breadth 36, orif. 11μ .

Lismore (308).

I have not seen the living creature, and, therefore, this species might possibly be a *Pseudodiffugia*.

Genus CUCURBITELLA Penard.

CUCURBITELLA AUSTRALICA, n.sp. (Pl. xxxvii., f.17).

Test minute, hyaline, transparent, in shape ovate, circular in section, rounded behind; sides arched, becoming more or less straight near the orifice, towards which they converge rapidly. Orifice circular, surrounded by an everted collar, smooth, structureless, transparent. Tests without scales or flints, structureless, covered with coarse, papilliform granules.

Length 19, breadth 15, collar $8\frac{1}{2}$, constriction $6\frac{1}{2}\mu$.

Lismore (308).

I have not seen the living creature, but contents, exactly resembling those of a rhizopod, were noted in preserved specimens.

Genus LESQUEREUSIA Schlumberger.

LESQUEREUSIA SPIRALIS Ehr.

Test rough with coarse flints. Syn., *Lesquereusia modesta* of various authors, not *L. modesta* Rhumbler. The editorial note in Cash, Brit. Frw. Rhiz., ii., p.66, leaves no doubt at all that Ehrenberg's species is the rough, flint-covered one, and that the species with vermiform pellets is *L. jurassica* Schlumberger. Cf. Leidy, Rhiz. U.S.A., p.127 (under *D. spiralis*), who quotes Schlumberger's words with regard to the test being composed of a paste of minute, bacillar bodies. Again, *L. modesta* Rhumbler, is not the sandy form. I have not been able to obtain Rhumbler's memoir, but Penard, Faune Rhiz., p.329, quotes that author's own words, "le plus souvent composé de plaques arrondies irrégulières qui dans certains cas montrent une zone intérieure plus fortement réfringente. Leidy a sans aucun doute représenté un exemplaire appartenant à cette espèce. . . . (Pl. xix., fig.23)." The latter then, an excellent figure, is the type of *L. modesta*. I have not met with the species, but I know well the class of plating to which Rhumbler refers, which is found also in

Diffugia lithoplites v. *pulcherrima* (Pl. xxxv., f.15), thickened plates or cushions with, apparently, a hollow in the centre, which causes the outer zone to appear specially refringent. Small plates of this description sometimes entirely compose the test, both in *Diffugia* and *Lesquereusia*. Cf., *L. carinata*, infra.

Var. CAUDATA, n.var. (Pl. xxxviii., f.1).

Test very regular, with an almost circular outline; orifice circular, simple, placed somewhat on the slant, tube projecting beyond the body for about half the diameter of the orifice. Dome furnished with a conical process set somewhat obliquely, eccentrically below the orifice. Test composed always of rough flints, orifice not specially margined.

Length 127-174, breadth 106-123, orif. 38-48, tail 17-21 μ .

Coogee (58); Lismore (308, 314).

Both *L. spiralis* and *L. jurassica*, as determined above, are common here, and widespread. This form is not uncommon. I have never seen a similar test of *L. jurassica*.

Var. INÆQUALIS, n.var. (Pl. xxxviii., f.2).

Test very much smaller than usual, dome flattened above, and humped towards the side of the orifice. Cf., *L. inaequalis* Cash, ii., p.72, Pl.23, f.12.

Length 91, breadth 91 μ . Lismore (316).

LESQUEREUSIA CARINATA, n.sp. (Pl. xxxviii., f.3).

Test smooth, beautifully regular in curvature. Orifice circular, simple, tube projecting for about one-third the diameter of the orifice. Dome furnished with a slight, concave keel, or conical projections connected by a keel, tangential to the surface, equal to about three-fourths the diameter of the test. Test entirely composed of minute, round, cushion-like pellets, 2-3 μ in diameter, orifice edged with a level series.

Length 133, breadth 100, orif. 36, keel 72 broad, 13 μ high.

Lismore.

The plating in this species is something of the same character as in *L. modesta* Rhumbler, but the thickened plates are here mere pellets.

LESQUEREUSIA SPICULOSA, n.sp. (Pl. xxxviii., f.4).

Test broader than long, the tube very straight and distinct, and much to one side, the body with beautifully circular outline. Test smooth, and apparently rather more chitinous than usual, studded with small, straight spicules disposed confusedly, here and there a few coarse flints, especially towards the centre of the test. The spicules do not appear to be diatoms.

Length 108, breadth 127, orif. 42μ . Lismore.

Genus PHRYGANELLA Penard.

PHRYGANELLA ACROPODIA (Hertw. & Less.) Hopkinson.

Diam. 38-54, alt. 21-30; orif. 21-24 μ .

Lismore (278, 321). (Pl. xxxviii., f.5).

Syn., *Pseudodifflugia hemisphaerica* Penard, Etudes s.l. rhiz., p.169; *Phryganella hemisphaerica* Penard, Faune Rhiz., p.421. I find it difficult to make out the type of this species, and, in the synonymy, have simply followed Hopkinson. Three different forms occur here (Pl. xxxviii., f.5-7). Cash gives no figure of the side-view, and Penard two different figures. I have adopted the later of these as the type.

Var. AUSTRALICA, n.var. (Pl. xxxviii., f.6).

Test in side-view subtriangular, depressed; basal angles sharper; base almost equal to the diameter of the test: orifice, as in the type, narrower than the base, not visible in side-view.

Diam. 42-63, alt. 28-33; orif. 34-36 μ .

Botanic Gardens (3); Lismore (273, 308).

Var. DEPRESSA, n.var. (Pl. xxxviii., f.7).

Test in side-view depressed, very little arched above, often nearly flat, very broadly rounded at the sides, sides running down at an angle to the base, orifice the full breadth of the base, not tucked under the test as in the other two forms, the margin visible in side-view.

Diam. 40-46, alt. 23-31; orif. 27-34 μ .

Auburn (46); Coogee (58); Guildford (23); Lismore (185).

The type is rarer here than the other two forms.

Genus CRYPTODIFFLUGIA Penard.

CRYPTODIFFLUGIA OVIFORMIS Penard. (Pl. xxxviii., f.8).

Length 17-23, breadth 13-17; orif. 4-8 μ .

Lismore (185, 197, 316).

Only known from a single locality in Switzerland, and one in Wales. Plentiful in sample 197.

CRYPTODIFFLUGIA COMPRESSA Penard. (Pl. xxxviii., f.9).

Length 19-21, breadth 18-21, orif. 6-8, thick 10 μ .

Auburn(104); Botany(17, 37); Clyde, Duck Creek(26); Coogee (93); Guildford (45, 77, 88, 173).

Penard, Faune Rhiz., p.428. Only found hitherto in the neighbourhood of Lake Geneva. Widespread in this country, though I have never seen it in quantity. Like all the Cryptodiffugiæ, it is a lover of pondweeds such as *Myriophyllum* and *Elodea*. Our specimens very often have a minute, darker-coloured collarette, or thickening of the rim, which gives the appearance of one. Some error has crept into Penard's side-view, *i.e.*, f.2; the orifice, being circular, must be the same breadth in side- and end-views as in front.

Var. AUSTRALIS, n.var. (Pl. xxxviii., f.10).

Test broader than long, drawn out somewhat at the sides.

Length 16-19, breadth 18-21, orif. 6-7 $\frac{1}{2}$ μ .

Lismore (191, 308).

Var. OVATA, n.var. (Pl. xxxviii., f.11).

Test narrower and more ovate than the type, without a thickened rim.

Length 19, breadth 17-18, orif. 5 μ .

Guildford (173); Lismore (308, 314).

CRYPTODIFFLUGIA MINUTA, n.sp. (Pl. xxxviii., f.12, 13).

Test minute, ovate, circular in section, rounded behind, sides converging to a very narrow base. Orifice very narrow, often a mere foramen, with thickened rim, or sometimes a very narrow but distinct collarette. Membrane thick, smooth, inclined to be rufescent.

Length 10-13, breadth 8-9, rim of the orif. 2-3 μ .

Auburn (159); Lismore (258).

CRYPTODIFFLUGIA ANGULATA, n.sp. (Pl. xxxviii., f.14).

Test ovate, rather angular at the sides, conically rounded behind; sides converging strongly, and turned in at the orifice, which is very small. Membrane smooth. Length 13-14, breadth 10 μ . Guildford (77).

CRYPTODIFFLUGIA SACCULUS Penard, formæ.

Length 23-30, breadth 17-22, neck 10-12, orif. 12-14, rim 4-8 μ high.

Centennial Park (72, 133); Clyde, Duck Creek (26).

Another very rare form recorded only from Switzerland. Our specimens, while exhibiting a general likeness, are very variable in shape (Pl. xxxviii., f.15).

CRYPTODIFFLUGIA VALIDA, n.sp. (Pl. xxxviii., f.16).

Test ovate, circular in section: dome circular: sides arched, rapidly converging to the abruptly truncate base: no neck, constriction or collarette. Orifice circular. Membrane pale rufescent, smooth, no markings, thickened at the orifice, where it has the appearance of being doubled over.

Length 55, breadth 40, orif. 15 μ . Botany (151).

I have seen only the empty test, but it agrees in character with other species of this genus.

CRYPTODIFFLUGIA CRENULATA, n.sp. (Pl. xxxviii., f.17, 18).

Test ovate, with truncate base, above which it is sometimes slightly constricted to form an obscure neck, end-view circular, crenulate. Membrane smooth, thick, chitinous, hyaline or pale yellow, indented all over so as to appear broadly crenulate in optical section, both front and end. Orifice circular, simple, slightly smaller than the base.

Length 17-20, breadth 14-16, base 6-9 μ . Lismore (195*b*).

Cf. *Platoum* sp., Penard, Faune Rhiz., p.430. Obtained in quantity out of weeds in the Richmond River. A nucleus ($\times 4\mu$) was noted in one specimen, containing a granule ($\times 1\frac{1}{2}\mu$). The

membrane is perfectly smooth and free from flints, and observation with $\frac{1}{2}$ oil imm. obj. failed to show any trace of plates or of structure.

Var. *GLOBOSA*, n.var. (Pl. xxxviii., f.19).

Test subglobose. Length 17-20, breadth 15-18, base 7-8 μ . With the type.

CRYPTODIFFLUGIA PUSILLA, n.sp. (Pl. xxxviii., f.20).

Test minute, subquadrate, as broad as high, with broadly rounded dome, straight sides almost vertical, base full width of the test or nearly so. End-view circular, simple, almost as broad as the base. Membrane smooth, thick, chitinous, structureless, without flinty particles.

Length = breadth = 10 μ . Guildford (23).

Var. *CONICA*, n.var. (Pl. xxxviii., f.20a).

Test longer than broad, conical or truncate-oval; dome rounded; sides arched; base equal or almost equal to the breadth of the test.

Length 12, breadth 10 μ . With the type.

Nebelina.

Genus *HYALOSPHENIA* Stein.

HYALOSPHENIA NOBILIS v. *COMPRESSA*, n.var. (Pl. xxxix., f.1).

Body of the test compressed somewhat, neck circular in section, orifice circular. Cf. Cash, *l.c.*, ii., p.92, Pl.25, f.1 3.

Length 154-175, breadth 70, orif. 27-30, thick 50 μ .

Coogee.

HYALOSPHENIA COOGEEANA, n.sp. (Pl. xxxix., f.2).

Test the shape of a soda-water bottle, body broadly elliptical, conical behind, contracted in front into a long, distinct neck with nearly parallel sides. Orifice with slight everted rim. Neck three times suddenly constricted as if with string, at its junction with the body, immediately below the orifice and at the anterior third below. Membrane smooth, structureless, apparently chitinous, faintly rufescent. End-view circular(!), compressed(!).

Length 157, breadth 70, orif. 23 μ . Coogee.

These are the only two members of the genus I have seen. They are old finds, known to me only as well-drawn figures, and I have not been able to unearth even one specimen, from my preserved samples, for further information. Of the genus *Heleopera*, I have seen no form at all.

Genus N E B E L A Leidy.

NEBELA MILITARIS v. TUBULATA BROWN. (Pl. xxxix., f.3).

Test lageniform, with a very distinct neck having straight, parallel sides, the least bit wider at the orifice, the margin of which is thickened and strongly arched. Side-view as in the type. Test composed of small, round plates.

Length 60-64, breadth 26-30, orif. 9-14 μ .

Coogee (14); Botany (17).

J. M. Brown, Frw. Rhiz. Eng. Lake Distr., p.365, Pl.50, f.9, 10.

Cf. Penard, Faune Rhiz., p.369, where he gives two distinct forms for the type; from both of these, ours may be distinguished by the parallel sides of the neck. In a specimen 64 μ long, they extend to 24 μ from the centre of the orifice.

NEBELA CAUDATA Leidy. (Pl. xxxix., f.4).

Length of body 76, breadth 58, orifice 21, tails 12 μ long.

Botany (17).

The shape of the test and the slight crenulation of the orifice by a distinct series of marginal plates remind one very much of *N. dentistoma*. Walls of the test composed of small, circular plates. This species seems to be a great rarity. It is one of the few recorded as absentees by Penard in his monumental work, Faune Rhizopodique du bassin du Léman, p.572, f.5 (after Leidy). Cash also, *l.c.*, p.125, f.99, could only reproduce Leidy's figures. An Australian example is shown in Pl. xxxix., f.4.

NEBELA DENTISTOMA v. LAGENIFORMIS, n.var. (Pl. xxxix., f.5).

Test broadly ovate as in the type, but drawn out and constricted above the orifice into a short neck. Orifice minutely crenulate by a regular series of marginal plates. Wall of the test formed of minute, irregular, angular plates (diam. about 6 μ).

Length 126, breadth 90, orif. 38 μ .

Auburn (149).

Besides those mentioned above, the only forms of the genus, that I have met with, are *N. tubulosa* Penard, and *N. lageniformis* Penard (Coogee, 14): also *N. carinata* in the Sydney Water-Supply, and *N. sinuosa* Cash, from Coogee.

Genus QUADRULA Schultze.

QUADRULA SYMMETRICA v. LONGICOLLIS Taránek.

Form with the plates in very regular, exactly vertical and transverse, series.

Length 95-130, breadth 48-72, orif. 22-30, thick 32 μ .

Coogee (14, 24, 58): Botany (17).

Cf. Taránek, Monog. d. Nebeliden, p.48, T.10, f.19. The European type is ovate, with sides arched right down to the orifice, *see* Cash, *l.c.* ii., Pl.29, f.1-3. Ours are pyriform, sometimes even clavate. (Pl. xxxix., f.6, 7).

Genus COCHLIOPODIUM Hertw. & Less.

COCHLIOPODIUM ASPERUM, n.sp. (Pl. xxxix., f.8).

Test hemispherical, slightly drawn in at the base; dome arched; sides at the base nearly vertical. Substance chitinous, strengthened with flint-grains, large and small, scattered. End-view circular.

Diam. 13-15, dome 10 μ high. Lismore.

There are plenty of these tests in sample 248a, out of a ditch on the Wyrallah road. I have not seen the living creature, so cannot be quite certain of the genus. *C. bilimbosum* is also found here.

Euglyphina.

Genus EUGLYPHA Dujardin.

EUGLYPHA AUSTRALICA, n.sp. (Pl. xl, f.1).

Test ovate, or broadly oval, broadest about one-third in from the fundus; dome rounded, somewhat narrowed, not semicircular; sides arching gently down to the orifice, but occasionally slightly flattened; orifice narrow, surrounded by two rows of ovate plates (5-7 visible), pointed in front, with serrated edges. Body-plates very characteristic, being recessed both front and back, with a central, projecting spike in each recess. Tests may be found

smooth or armed behind with a circle of spines, in number 1 to 5, generally 2 or 3.

Length 64-137, breadth 32-72, orif. 16-36, spines up to 45μ long.

Everywhere, common.

This species is liable to be confounded, at first sight, with *Eu. acanthophora*, in company with which it is often found. The test is, however, more robust and siliceous, and the segregated plates are unmistakable. It is impossible to discern the shape of the plates in the unbroken test, yet specimens may be recognised with a lens of even small definition by one point alone. With the objective a little out of focus, a dark spot, or a pair of minute, circular spots, appears at the top and bottom of each plate; the body-scales are recessed at each end, and only the two minute spikes overlap, leaving a minute foramen on either side. The cement-marks also are not thin and fusiform as in *Eu. acanthophora*, but broad, rectangular slabs. The species is our most common *Euglypha*. It has a wide range of dimensions, but a regular series is found connecting its extreme sizes. Body-scales 10×8 , 11×7 , $11\frac{1}{2} \times 10\frac{1}{2}$, $12 \times 10\mu$. I have never seen this species encysted. Cf. *Eu. crenulata* Wailes, Frw. Rhiz. fr. the States, p.147, Pl.12, f.34-37.

Var. ELEGANS, n.var. (Pl. xl., f.2).

Test elliptical or long-ovate, narrowed behind, not hemispherical; sides slightly arched, sometimes a little flattened towards the orifice. Otherwise as in the type.

Length 67-137, breadth 32-72, orif. 19-36, sp.long 10-45 μ .

Auburn (149): Botany (152): Coogee (58): Lismore (308, 312, 327).

In this form, the test is elliptical rather than ovate or oval, and the breadth about half the length, the orifice again being about half the breadth.

Var. CYLINDRACEA, n.var. (Pl. xl., f.3).

Test slightly cuneate, nearly cylindrical; dome semicircular; sides straight from dome to mouth, very slightly converging.

Orifice proportionately wider than in the type. Generally armed with a circle of spines behind, 1 to 10 in number, generally 3 or 4. Scales as in type.

Length 65-133, breadth 30-76, orif. 15-38, spines up to 60μ long.

Lismore (185, 308, 312, 327, 337); Botany (155).

Apparently much rarer than the type, though common enough locally at Lismore; even the Botany specimen is not exact. It has the same range of dimensions as the type, but is of quite a distinct shape. Body-scales 8×6 , 10×8 , 11×8 , $11\frac{1}{2} \times 10\frac{1}{2}\mu$.

EUGLYPHA ACANTHOPHORA (Ehr.) Perty. (Pl. xl., f.4).

Length 49-70, breadth 30-45, orif. 12-19, spines up to 27μ long. Everywhere, common. (*Eu. alveolata* Duj.).

Var. ELLIPTICA, n.var. (Pl. xl., f.5).

Test narrow, elliptic, almost cylindrical, rounded behind: sides very slightly arched, in general direction parallel, slightly turned in at the mouth. Generally without spines.

Length 70-90, breadth 30-47, orif. 13-19 μ .

Guildford (45, 60): Auburn (146): Lismore (185, 308, 337).

This form, not uncommon where the type is found, is exactly like *Eu. tuberculata* v. *minor* (Taránek) Wailes in Cash, *l.c.*, iii., Pl.35, f.3, but more than twice the size. I do not see how *Eu. tuberculata* is to be identified from Dujardin's figure and description, the shape of the body-scales not being given. The form that I figure certainly belongs to *Eu. acanthophora*, as I have noted it with the typical encystment figured by Penard (under *Eu. brachiata*), Faune Rhiz., p.505.

Var. GRACILLIMA, n.var. (Pl. xl., f.6).

Test slender, almost exactly cylindrical, generally spineless but noted with spines: dome hemispherical; sides flat, running straight down to the mouth.

Length 70-76, breadth 25-32, orif. 13-15, spines 26μ long.

Auburn (68): Guildford (84): Lismore (338).

A very beautiful but very rare form. There seems to be considerable doubt about the characteristics of *Eu. acanthophora*

Ehr. (= *Eu. alveolata* Duj.). What Ehrenberg's form exactly is, I have no means of knowing. Dujardin, however, shows, in his figure, the criss-cross cement-marks forming diamond-shaped lozenges. These, running together almost to a point above and below, indicate a test with oval plates close together, side by side. In our forms, there is a minute dot in the focus of the cement-marks, and, in broken specimens, this shows as a minute bead of cement at the extreme end of the plate, giving the latter very often a pointed appearance. Wailes, in Cash, *l.c.*, iii., gives a figure with widely separated scales, almost circular, though in description he says "body-scales elliptical." Penard (under *Eu. brachiata*) gives broadly oval scales, widely separated, and with a gap at top and bottom. Again the species gets the credit (Wailes, *l.c.*, p.5) of being the most spinous form of its class but our specimens are generally without spines, which, when present, are nearly always weak or little developed.

EUGLYPHA CRISTATA Leidy.

Length 52-63, breadth 13-19, orif. $7\frac{1}{2}$ - $11\frac{1}{2}\mu$, spines up to 20μ long.

Coogee (24); Botany (109); Lismore (185, 337); Byron Bay.

Var. MAJOR Wailes. (Pl. xl, f.7).

Length 74-84, breadth 21-23, orif. $13\frac{1}{2}$, spines up to 30μ long. Coogee (14).

Var. LANCEOLATA, n.var. (Pl. xl, f.8).

Test lanceolate, slightly acuminate behind, not constricted at all in front; sides almost straight, converging very slightly to the orifice. Apical scales blunt, square-ended.

Length 44, breadth 17, orif. $8\frac{1}{2}\mu$.

Coogee (14).

This form shows a probable connection between *Eu. cristata* and *Eu. levis*. It has the shape of *Eu. levis* v. *lanceolata*; and the blunt, square-ended, apical plates are also found in forms of *Eu. levis*.

EUGLYPHA FILIFERA v. ELEGANS, n.var. (Pl. xl, f.9).

Test slender, elliptic rather than ovate, with a slight tendency

to be pointed behind, decidedly compressed. Orifice circular or subcircular, apical scales three-lobed, not serrate. Body-scales typical. Spines always seven in full complement, three on one side, 4 on the other, the odd one never terminal.

Length 57-66, breadth 25-26, orif. 10-13, thick 18, sp. 17-20 μ long.

Coogee (24); Centennial Park (11); Botany (151).

Cf. Wailes in Cash, Brit. Frw. Rhiz., iii., Pl.34, f.6-8. Our forms differ from Penard's type, Faune Rhiz., p.510, in general shape of the test, in the spines, and in the apical plates, which here are invariably obscurely three-lobed, not serrate. Body-scales (hexagons) $7 \times 3\frac{1}{2}$, $8 \times 4\mu$. Four or five apical plates visible.

Var. PYRIFORMIS Wailes. (Pl. xl, f.10).

Length 68, breadth 25, orif. $10\frac{1}{2}$, sp. 20 long, plates $8 \times 6\mu$.
Coogee (14).

Var. CYLINDRACEA, n.var. (Pl. xl, f.11).

Test slender, almost cylindrical, rounded or slightly pointed behind; sides almost straight to the orifice. Apical plates three-lobed, four visible; body-scales as in the type. Spines 7 in full complement.

Length 65-68, breadth 23-24, orif. $9\frac{1}{2}$ -10, sp.21-23 μ long.
Botany (155); Lismore (337).

Var. CUNEATA, n.var. (Pl. xl, f.12).

Test cuneate, rounded behind; sides straight, converging rapidly to the orifice. Scales and spines as above, four apical plates visible.

Length 57, breadth 25, orif. $8\frac{1}{2}$, sp. 17 μ long.
Rookwood (107); Botany (155).

In all these forms of *Eu. filijera*, the apical scales are gradually thickened towards the tip, the end being almost knobby.

EUGLYPHA COMPRESSA Carter.

Length 50-80, breadth 43-55, thick 18, orif. 18-25, sp. 9-23 μ long.

Botany (17); Coogee (14, 24); Byron Bay (325).

Var. *OBSCURA*, n.var. (Pl. xl., f.13).

Test smaller than the type, ovate, compressed, broadly rounded behind; sides arching gradually down to the mouth. Orifice elliptical, surrounded by pointed, obscurely three-lobed scales, five visible in front. Wall of the test apparently chitinous, very slightly silicified; no scales or cement-marks are to be seen. The only markings are a series of broad, longitudinal striæ faintly indicated. With the $\frac{1}{12}$ oil imm. obj., these break up into series of faint, brick-shaped marks separated by short, transverse lines. No spines noted.

Length 42-54, breadth 25-35, thick 18, orif. 10-13 μ .

Botany (17).

Seems to be a low form of *Eu. compressa*; found in company with the type. In size, it is, as might be expected, just a little smaller, and they agree in general shape, compression, and apical plates. It is hardly to be expected that spines should be present; they were exhibited very sparingly by the specimens of the type. Cf. *Eu. denticulata* Brown, in Cash, *l.c.*, iii., p.41, Pl.36, f.7-13, for a similar form.

EUGLYPHA LÆVIS Perty. (Pl. xl., f.14-16).

Length 30-55, breadth 15-30, orif. 8-15 μ .

Everywhere.

Eu. alveolata v. *lævis* (Perty) Playf., Biol. Richm. R., p.143, Pl. viii., f.14. The type is oval, or oval-cylindrical, the former Penard's, the latter Perty's type, according to the figure given by Wailes in Cash, *l.c.*, iii., p.27. All that can be seen of the apical scales is a row of four or five refringent beads across the orifice, the tips of these scales being much thickened. Specimens are not infrequent here, however, in which the apical plates are broad and square in front (Pl. xl., f.16).

Var. *LANCEOLATA*, n.var. (Pl. xl., f.17).

Test smaller than the type, more slender, compressed, lanceolate, pointed behind, the sides running slightly arched, sometimes nearly straight, to the orifice. In side-view, narrowly lanceolate. Scales as in the type(?).

Length 24-34, breadth 12-16, thick 12-13, orif. 6-10 μ .

Everywhere, common.

Penard, Etudes s.l. rhiz., p.182, Pl. ix., f.97-104, has described a var. *minor* (long. 15-25 μ) which is a small form of the type. I have not met with that form; it is replaced by var. *lanceolata*, which here almost invariably accompanies the type. On the face of the tests, five or six, broad, longitudinal striæ are often faintly indicated, which break up, on examination, into series of broad dashes, as in *Eu. compressa* var. *obscura*. These are the optical expression of the body-scales.

EUGLYPHA DENTATA v. ELONGATA, n.var. (Pl. xli., f.1, 2).

Test elongate, elliptical or subcylindrical, often asymmetrical, circular in section, rounded behind; sides gently arched, often nearly parallel, converging to the orifice. Orifice chitinous, fimbriated, rarely angular or straight-edged. Body-scales always perfectly circular, quincuncially arranged, very slightly overlapping and equally on all sides.

Length 44-51, breadth 21-25, orif. 8-10 $\frac{1}{2}$, scales 6 μ .

Lismore (187, 188, 195*b*, 197); Coogee (14).

This form is abundant in the Lismore samples noted, out of weeds (*Myriophyllum*) in the river (deep water). Both in shape and in the body-scales, it differs entirely from the descriptions and figures of Penard, Faune Rhiz., p.524, and Wailes in Cash, iii., pp.63-65, Pl.43, f.14, 15. In details of the dimensions and character of the nucleus, however, they agree perfectly. Nucleus distinct ($\times 10\mu$), always containing 3-8 dark granules towards the centre. Described originally by Moniez as a *Euglypha*, I cannot see any reason why this species should ever have been placed under *Sphenoderia*. The orifice is peculiar certainly, but does not in the least recall the characteristic orifice of the latter genus; and the general character of both test and body-scales is that of *Euglypha*. Moreover, mixed with it here, I find specimens with distinct, angular, apparently siliceous, apical plates, see var. *hamulifera*, below. The asymmetrical character of the test leads me to consider the fimbriation of the orifice as an accidental occurrence in a soft, chitinous form, due to the tests

(in division) being drawn apart before silicification was complete. The exact formation of the orifice, I found very difficult to make out, and only achieved it with the $\frac{1}{12}$ oil imm. obj., aided by the condenser.

Var. *HAMULIFERA* Playf. (Pl. xli., f.4).

Syn., *Euglypha alveolata* var. *hamulifera* Playf., Biol. Richm. R., p.143, Pl. viii., f.13. Test ovate (rarely elliptical?), broadly rounded behind; sides arched, converging rapidly to the mouth. Apical scales distinct, angular, pointed, apparently siliceous, but edges not serrate, 4 visible. Body-scales circular, same size, character and overlap exactly as in var. *elongata* above; a minute foramen showing in this form, however, at the intersection of every three scales.

Length 45-60, breadth 24-38, orif. $10\frac{1}{2}$ - $13\frac{1}{2}\mu$. Lismore (197).

In sample 195*b*, along with var. *elongata*, is found more rarely an ovate form, in shape agreeing with Wailes' figure, *l.c.*, Pl.43, f.15, but all other details as in our Australian specimens, size 44×25 , orif. 9μ : (Pl. xli., f.3).

Genus *SPHENODERIA* Schlumberger.

SPHENODERIA AUSTRALIS, n.sp. (Pl. xli., f.5, 6).

Test very broadly ovate or subglobose, very slightly compressed if at all, broadly rounded behind; sides strongly arched, converging to the orifice. Orifice a mere slit at the apex of a structureless collar. Body-scales of varying sizes and shapes in the same test, and without any regular arrangement, overlapping slightly. Side-view ovate.

Length 57-70, breadth 32-60, collar 17-28, 5-6 μ high.

Coogee; Centennial Park (6, 11); Guildford (77); Lismore (298, 308).

This is the common *Sphenoderia* of this country; *Sph. lenta* I have never seen. Our form is sufficiently distinguished from the latter by the irregular disposition of the scales, and their varying size and shape. At their best, they exhibit a tendency to be circular.

SPHENODERIA FOVEOSA, n.sp. (Pl. xli., f.7).

Test broadly ovate, rounded everywhere, slightly compressed,

side-view ovate, and broadly oval. Orifice a mere slit at the summit of a structureless collar; collar conical in side-view. Body-scales very ill-defined and lacking cement-marks at the overlap, irregular in shape and size, oval or circular, mixed in the same test, irregularly disposed. Each scale is furnished with a depressed centre of similar outline, and these depressions are often all the markings that can be seen on the test.

Length 48-63, breadth 35-45, thick 34; collar 18-21, 5-7 μ high.

Coogee (24); Auburn (68); Botany (155); Lismore (185, 240, 307, 308).

Var. *TENUIS*, n.var. (Pl. xli., f.8).

Test ovate, much more slender than the type, rounded behind; sides straight, or nearly so, towards the collar. Collar just a mere constriction of the test, rectangular. No body-scales visible, surface covered with large, shallow depressions, which are really the depressed centres of the scales.

Length 60, breadth 42, collar 23 μ . Botany (17).

SPHENODERIA SPHERICA, n.sp. (Pl. xli., f.9).

Test almost spherical, very slightly compressed, side-view ovate-subglobose, end broadly oval. In front-view circular, truncate anteriorly. Orifice a mere slit at the end of an invaginate, structureless collar. Body-scales distinct, oval, about five across the face, overlapping, all about the same size but irregularly disposed.

Length 57-63, breadth 57, thick 53; collar 21-23, scales 20 \times 13 μ .

Coogee (58).

A rare species, found only in sample 58 (from *Sphagnum* at Coogee) in which it is fairly plentiful. The collar is invaginate in every specimen.

SPHENODERIA MACROLEPIS Leidy, forma.

Length 32, breadth 23, orifice 13 μ . A single specimen noted from Byron Bay.

Test ovate, no neck at all, abruptly truncate in front, rim not everted. The same three large scales in front-view, but broadly rounded at the sides, not angular as in the type. (Pl. xli., f.10).

SPHENODERIA FISSIROSTRIS Penard, forma.

Test with relatively large scales, but the latter are irregularly disposed in front-view. End-view circular. Length 40, breadth 19, thick 19, orif. $10\frac{1}{2}\mu$. Botany (17). (Pl. xli., f.11).

Var. SPLENDIDA, n.var. (Pl. xli., f.14).

Test covered with small, oval body-scales in a regular imbrication, about six series vertical, and six horizontal.

Length 40-49, breadth 22-28, collar 15-16 μ . Coogee (14).

This is the only form of *Sphenoderia* I have noted with a regular imbrication. *Assulina muscorum* Greeff (*A. minor* Penard), *Cyphoderia ampulla* (Ehr.) Leidy, and *Corythion dubium* Taránek, are also found here.

Genus CYPHODERIOPSIS, gen.nov.

Test in shape like a *Cyphoderia*, but with scales as in *Trinema* or *Nebela*.

CYPHODERIOPSIS LONGICOLLIS, sp.unica. (Pl. xli., f.12).

Test smooth, hyaline, very like *Cyphoderia ampulla*, but with a long, curved neck. Orifice circular(?), simple, with or without a narrow, projecting, chitinous collar. Body-scales nebeloid, circular, of various sizes, smaller on the neck, contiguous but not overlapping, fastened at the edges by little dots of cement.

Length 76-78, breadth 29-32, orifice 11-12 $\frac{1}{2}$, scales up to 6 μ .

Coogee (14, 24).

A rare form out of *Sphagnum*. It is possible that the collar becomes invaginate sometimes, but I have not seen it so. In its characteristics, the test combines the features of *Cyphoderia*, *Nebela*, and possibly also *Trinema*.

Genus TRINEMA Dujardin.

TRINEMA CAUDATUM, n.sp. (Pl. xli., f.13).

Test in front-view subcylindrical, a little narrowed towards the mouth, conical behind, where it is drawn out into a very decided tail, slightly constricted near the centre and below the mouth. Orifice circular, strengthened with a palisade of short, wick-like rods (or plicæ) about a diameter apart. Body-scales

circular, of equal size, showing slightly curved at the margin, neither contiguous nor overlapping (in the specimen observed) but a slight distance apart, the interspaces marked with little flecks of cement(?). Tail without plates, chitinous, rough-surfaced. Test in side-view somewhat like a *Cyphoderia* with pointed fundus, mouth projecting, oblique, evaginate.

Length 100, breadth 25, orif. 15, tail 27×4 , scales $\times 5\mu$.

Botany (155).

Cf. *Pareuglypha* Penard, Faune Rhiz., p.492. Only one specimen seen, and the test was empty. I was in doubt whether the species should not go under *Cyphoderiopsis*, but if the mouth were invaginate, and it looks as if it might be, there would be a very great likeness to *Trinema*. *Tr. enchelys* Ehr., and *Tr. lineare* Penard, are, of course, common everywhere.

Gromiina.

Genus PSEUDODIFFLUGIA Schlumberger.

PSEUDODIFFLUGIA GRACILIS Schlumb.

Length 27-47, breadth 18-34, base 8-15 μ .

Coogee (14); Botany (37); Lismore (308, 333).

PSEUDODIFFLUGIA FULVA (Arch.) Penard.

Length 15-23, breadth 11-19, base 4-10 μ .

Auburn (139b); Guildford (23 77); Lismore (321).

The only difference, that I can see, between these two species is that one is smaller than the other. I have made, here, 25 μ long the dividing line between them.

PSEUDODIFFLUGIA MICROSTOMA, n.sp. (Pl. xxxix., f.9).

Test chitinous, with fine, scattered grains, sometimes with coarser flints. In shape ovate, rounded behind; sides gently arched, converging rapidly down to a very small, indefinite orifice not specially margined. Test not compressed, section circular.

Length 30-31, breadth 17-23, orif. 4 μ .

Guildford (173); Lismore (333).

Var. OBESA, n.var. (Pl. xxxix., f.10).

Test very broadly ovate, almost globose, section circular, orifice very small.

Length 44, breadth 38, orif. 8μ . Lismore (327).

This species recalls *Ps. compressa* Schultze, but the test is smaller and not compressed. *Ps. fascicularis* Penard, I have noted here once.

Genus DIAPHOROPODON Archer.

DIAPHOROPODON PYRIFORME, n.sp. (Pl. xxxix., f.11).

Test membranous, flexible, dark smoky colour, with small grains here and there. Varying in shape, but generally to some extent pyriform. It seems to have an orifice like the opening of a purse, capable of being drawn together. Pseudopodia filose.

Length 67-82, breadth 53-59 μ . Lismore (339).

There were plenty in this sample, and all alive, but the indistinct, membranous test, and the plasma with which it was filled, made it very difficult to get any definite observations.

Genus FRENZELINA Penard.

FRENZELINA GLOBOSA, n.sp.

Body globose, throwing out long, filose pseudopodia from a slight, central protuberance. Test apparently chitinous, covered to a varying thickness with fine floccose and minute flint-grains, transparent, however, and permitting a view of the creature within; close-fitting all round, but with a slight space between it and the body. Body-plasma very refractive, a small nucleus at the back.

Diam. 21-25, height 17-19; body 15-17 \times 12 $\frac{1}{2}$ -14 $\frac{1}{2}\mu$.

Lismore.

Cf. *Frenzelina reniformis* Penard, Faune Rhiz., p.464. Obtained in some quantity from a waterhole, alive, in company with *Diplophrys Archeri* Barker, and others. I have a single record of what looks like an empty test of *Amphitrema flavum* (Arch.) Penard, also from Lismore.

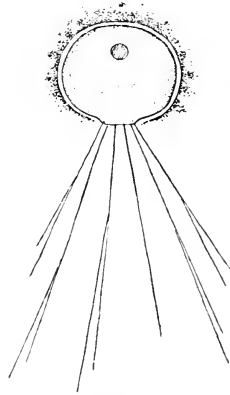

Fig.7.

Frenzelina globosa, n.sp.;
($\times 800$).

EXPLANATION OF PLATES XXXIV.-XLI.

Plate xxxiv.

- Fig. 1.—*Arcella rotundata*, nom. nov.; ($\times 660$).
 Fig. 2. „ „ var. *alta*, n. var.; ($\times 660$).
 Fig. 3. „ „ var. *scrobiculata*, n. var.; ($\times 660$).
 Fig. 4. „ *crenata*, n. sp.; ($\times 600$).
 Fig. 5. „ „ forma; ($\times 500$).
 Fig. 6. „ *hemisphaerica* Perty; ($\times 660$).
 Fig. 7. „ „ var. *depressa*, n. var.; ($\times 600$).
 Fig. 8. „ *discoides* v. *scutelliformis*, n. var.; ($\times 660$).
 Fig. 9. „ „ var. *foreosa*, n. var.; ($\times 660$).
 Fig. 10. „ *megastoma* Penard; ($\times 400$).
 Fig. 11. „ „ var. *alta*, n. var.; ($\times 400$).
 Fig. 12. „ *catinus* Penard; ($\times 500$).
 Fig. 13. „ „ var. *australis*, n. var.; ($\times 350$).
 Fig. 14. „ *costata* Ehr.: *a*, end-view; ($\times 400$).
 Fig. 15. „ „ var. *angulosa* (Perty) mihi, end-view; ($\times 400$).
 Figs. 16, 17.—*Arcella costata* var. *conica*, n. var.; *a*, end-view; (16) $\times 500$,
 (17) $\times 400$.
 Figs. 18, 19.—*Arcella mitrata* var. *depressa*, n. var.; (18) $\times 500$, (19) $\times 660$.
 Fig. 20.—*Arcella mitrata* var. *angulata*, n. var.; ($\times 400$).

Plate xxxv.

- Fig. 1.—*Difflugia oriformis* Cash, forma; ($\times 500$).
 Fig. 2. „ „ encysted, outline only; ($\times 400$).
 Fig. 3. „ „ with angles of the lobes projecting; ($\times 500$).
 Fig. 4. „ „ var. *mollis*, n. var.; ($\times 500$).
 Fig. 5. „ „ var. *subglobosa*, n. var.; ($\times 500$).
 Figs. 6, 7. „ *lobostoma* var. *truncata*, n. var.; ($\times 500$).
 Figs. 8, 9. „ „ var. *globulus*, n. var.; (8) from Lismore ($\times 330$),
 (9) from Botany ($\times 400$); *a*, end-view ($\times 660$).
 Fig. 10.—*Difflugia gramen* Penard, ($\times 330$); *a*, end-view ($\times 500$).
 Fig. 11. „ *rarius* Penard, forma; *a*, side-view ($\times 330$).
 Fig. 12. „ *lithoplites* v. *pulcherrima*, n. var.; ($\times 250$).
 Fig. 13. „ „ „ „ orifice; *a*, with blunt angles
 ($\times 500$); *b*, with angles tipped by a sharp flint ($\times 500$); *c*, the latter
 enlarged; *d*, another form of angle ($\times 660$).
 Fig. 14.—*Difflugia lithoplites* v. *pulcherrima*, forma; ($\times 400$).
 Fig. 15. „ „ „ „ another form; ($\times 400$).

Plate xxxvi.

- Fig. 1.—*Difflugia Lismorensis*, n. sp., ($\times 330$); *a*, orifice ($\times 660$).
 Fig. 2. „ „ var. *crucifera*, n. var., ($\times 250$); *a*, *b*, orifice
 ($\times 660$).
 Fig. 3. „ „ var. *trilobulata*, n. var., orifice; ($\times 330$).

- Fig. 4.—*Difflugia brevicollis* Cash, forma; ($\times 270$).
 Fig. 5. ,, *helvetica* v. *lithophila* (Penard) mihi, forma; ($\times 500$).
 Fig. 6. ,, *constricta* var. *spinifera*, nom. nov.; ($\times 330$).
 Fig. 7. ,, *urceolata* var. *sphaerica*, n. var.; ($\times 130$).
 Fig. 8. ,, *corona* var. *Foleyana*, n. var.; ($\times 230$).
 Figs. 9, 10. ,, *tuberculata* var. *sphaerica*, n. var., orifice; (9) $\times 300$, (10) $\times 660$. For shape of the test, take Figs. 11 or 12 without the processes.
 Fig. 11.—*Difflugia tuberculata* var. *nodosa*, n. var.; ($\times 330$).
 Fig. 12. ,, ,, var. *coronata*, n. var.; ($\times 240$).
 Fig. 13. ,, *pulex* Penard; ($\times 660$).
 Fig. 14. ,, ,, var. *cuneata*, nom. nov.; ($\times 1000$).

Plate xxxvii.

- Fig. 1.—*Difflugia oriformis* Cash, forma; ($\times 500$).
 Fig. 2. ,, *bacillariarum* Perty, type; ($\times 400$).
 Fig. 3. ,, ,, unsymmetrical form, more common; ($\times 400$).
 Fig. 4. ,, ,, var. *australis*, n. var.; ($\times 400$).
 Fig. 5. ,, ,, ,, ,, unsymmetrical form; ($\times 400$).
 Fig. 6. ,, ,, ,, ,, forma; ($\times 330$).
 Fig. 7. ,, *Penardi* Hopkinson; ($\times 330$).
 Figs. 8, 9. ,, *Leranderi*, n. sp.; (8) stony test $\times 330$; (9) chitinous $\times 400$.
 Figs. 10, 11.—*Difflugia ampullula*, n. sp.; (11) with deeper collarette; ($\times 500$).
 Figs. 12, 13. ,, *gibberosa*, n. sp.; (12) from Coogee, (13) from Lismore; ($\times 400$).
 Figs. 14, 15. ,, *globulus* var. *Cashii*, n. var., (14) from Auburn, *a*, end-view; (15) from Lismore; ($\times 660$).
 Fig. 16.—*Difflugia mitrata*, n. sp.; *a*, end-view; ($\times 1000$).
 Fig. 17.—*Cucurbitella australica*, n. sp.; ($\times 1000$).

Plate xxxviii.

- Fig. 1.—*Lesquerensia spiralis* var. *caudata*, n. var.; ($\times 250$).
 Fig. 2. ,, ,, var. *inqualis*, n. var.; ($\times 330$).
 Fig. 3. ,, *carinata*, n. sp.; ($\times 300$).
 Fig. 4. ,, *spiculosa*, n. sp.; ($\times 300$).
 Fig. 5.—*Phryganella acropodia* (Hertw. & Less.) Hopkinson, ($\times 500$); *a*, end-view ($\times 400$).
 Fig. 6. ,, ,, var. *australiana*, n. var.; ($\times 500$).
 Fig. 7. ,, ,, var. *depressa*, n. var.; ($\times 660$).
 Fig. 8.—*Cryptodifflugia oriformis* Penard, encysted; ($\times 1000$).
 Fig. 9. ,, *compressa* Penard; *a*, end-view; *b*, side-view; ($\times 1000$).
 Fig. 10. ,, ,, var. *australis*, n. var.; *a*, end-view; *b*, side-view; ($\times 1000$).
 Fig. 11. ,, ,, var. *orata*, n. var.; ($\times 1000$).

Figs. 12, 13.—*Cryptodifflugia minuta*, n.sp.; (12) from Auburn, (13) from Lismore; ($\times 1330$). The little bubble and streamer are the preserved remains of the pseudopodium.

Fig. 14.—*Cryptodifflugia angulata*, n.sp.; ($\times 1000$).

Fig. 15. ,, *sacculus* Penard, formæ; *a*, *b*, from Centennial Park; *c*, from Duck Creek, Clyde; ($\times 660$).

Fig. 16. ,, *valida*, n.sp., ($\times 500$); *a*, orifice much enlarged.

Figs. 17, 18. ,, *crenulata*, n.sp.; ($\times 1330$).

Fig. 19. ,, ,, var. *globosa*, n.var.; ($\times 1000$).

Fig. 20. ,, *pusilla*, n.sp.; *a*, var. *conica*, n.var.; ($\times 1000$).

Plate xxxix.

Fig. 1.—*Hydrosphenia nobilis* var. *compressa*, n.var.; *a*, side-view ($\times 330$).

Fig. 2. ,, *Coogeeana*, n.sp.; ($\times 330$).

Fig. 3.—*Nebela militaris* var. *tubulata* Brown; *a*, side-view outline; ($\times 660$).

Fig. 4. ,, *candata* Leidy; ($\times 500$).

Fig. 5. ,, *dentistoma* var. *lageniformis*, n.var.; ($\times 300$).

Figs. 6, 7.—*Quadrula symmetrica* var. *longicollis* Taránek; ($\times 500$).

Fig. 8.—*Cochliopodium asperum*, n.sp.; *a*, end-view; ($\times 1000$).

Fig. 9.—*Pseudodifflugia microstoma*, n.sp.; ($\times 660$).

Fig. 10. ,, ,, var. *obesa*, n.var.; ($\times 500$).

Fig. 11.—*Diaphoropodon pyriforme*, n.sp.; ($\times 400$).

Figs. 12, 13.—(?*Chlamydomyxa labyrinthoides* Archer; (12) $\times 270$, (13) $\times 200$).

Plate xl.

Fig. 1.—*Euglypha australica*, n.sp.; ($\times 400$).

Fig. 2. ,, ,, var. *elegans*, n.var., ($\times 440$); *a*, body-scale ($\times 1330$).

Fig. 3. ,, ,, var. *cylindracea*, n.var., with surface a little out of focus, showing the twin foramina at the ends of the body-scales. The points of the two scales overlap between them; ($\times 400$).

Fig. 4.—*Euglypha acanthophora* Ehr.; ($\times 660$).

Fig. 5. ,, ,, var. *elliptica*, n.var.; ($\times 600$).

Fig. 6. ,, ,, var. *gracillima*, n.var.; ($\times 660$).

Fig. 7. ,, *cristata* var. *major* Wailes; ($\times 600$).

Fig. 8. ,, ,, var. *lanceolata*, n.var.; ($\times 660$).

Fig. 9. ,, *filifera* var. *elegans*, n.var.; ($\times 660$).

Fig. 10. ,, ,, var. *pyriforme* Wailes; ($\times 660$).

Fig. 11. ,, ,, var. *cylindracea*, n.var.; ($\times 660$).

Fig. 12. ,, ,, var. *cuneata*, n.var.; ($\times 660$).

Fig. 13. ,, *compressa* var. *obscura*, n.var.; the left side shows all the markings to be made out with the $\frac{1}{8}$ in., on the right with a $\frac{1}{2}$ in. oil imm. obj.; *a*, side-view outline; ($\times 880$).

Fig. 14.—*Euglypha larvis* Perty, type; ($\times 660$).

Fig. 15. ,, ,, Penard's form, encysted; ($\times 660$).

Fig. 16. ,, ,, Penard's form, with square-ended, apical plates, quite smooth sides, and no apparent markings; ($\times 660$).

Fig. 17.—*Euglypha larvis* var. *lanceolata*, n. var.; markings as in Fig. 13; *a*, side-view outline; ($\times 1000$).

Plate xli.

Figs. 1, 2.—*Euglypha dentata* var. *elongata*, n. var.; (1) with preserved body of the creature ($\times 660$); (2) empty test ($\times 1000$).

Fig. 3.—*E. dentata*, ovate form, in shape more like the type; ($\times 1000$).

Fig. 4.—*E. dentata* var. *hamulifera* Playf., ($\times 1000$); *a*, circular body-scale slightly overlapping six others, showing the foramina, one at the intersection of every three plates, much enlarged.

Figs. 5, 6.—*Sphenoderia australis*, n. sp.; (5) $\times 500$, (6) $\times 660$.

Fig. 7. ,, *foreosa*, n. sp.; ($\times 660$).

Fig. 8. ,, ,, var. *tenuis*, n. var.; ($\times 530$).

Fig. 9. ,, *spherica*, n. sp.; *a*, side-view of orifice; *b*, end-view; ($\times 500$).

Fig. 10. ,, *macrolepis* Leidy, forma; ($\times 800$).

Fig. 11. ,, *fissirostris* Penard, forma, ($\times 800$); *a*, side-view.

Fig. 12.—*Cyphoderiopsis longicollis*, gen. nov. et sp.; *a*, another form of orifice; ($\times 660$).

Fig. 13.—*Trinema caudatum*, n. sp.; *a*, side-view; ($\times 660$).

Fig. 14.—*Sphenoderia fissirostris* var. *splendida*, n. var.; ($\times 660$).

MESOZOIC INSECTS OF QUEENSLAND.

NO. 2. THE FOSSIL DRAGONFLY *ÆSCHNIDIOPSIS* (*ÆSCHNA*) *FLINDERSIENSIS* Woodward), FROM THE ROLLING DOWNS (CRETACEOUS) SERIES.

BY R. J. TILLYARD, M.A., B.Sc., F.L.S., F.E.S., LINNEAN
MACLEAY FELLOW OF THE SOCIETY IN ZOOLOGY.

(Plates xlii.-xliii.)

The very interesting, fossil Dragonfly-wing, that forms the subject of this paper, was found associated with the small bivalve Mollusc, *Aucella hughendensis* Eth., in the chocolate-coloured limestone of the Flinders River, North Queensland,* seven miles above Marathon Station. This limestone is of Cretaceous age. The fossil was sent to Dr. Henry Woodward, F.R.S., etc., and was described by him (5) in 1884 as *Æschna flindersiensis*, "as recognising its locality on the Flinders River, and one of Australia's earliest explorers and heroes."

That the wing did not belong to the recent genus *Æschna*, nor to any recent subfamily, was obvious enough from Woodward's own figure. In 1908, Handlirsch, who had never seen the fossil itself, removed it to the extinct family *Æschnidiidae* (2), and placed it in the genus *Æschnidium*.

Wishing to study this insect, I wrote some years ago to the Director of the Queensland Museum, to try and find its whereabouts. He soon satisfied me that it was not in the Museum Collection. Inquiries from Mr. Dunstan, Chief Government Geologist of Queensland, at the Geological Survey, elicited the

* The locality is not far from the town of Hughenden, and is now classed as Western Queensland; it lies almost exactly half-way along a North-South line drawn from Cape York to the New South Wales border.

fact that nothing was known of it there. I wrote, therefore, to the British Museum authorities for information, and was informed that the fossil had undoubtedly been returned by Dr. Woodward to the Queensland Geological Survey Collection; where it was ultimately found, without a label, in an accumulation of odd specimens.

The rock-specimen, on which a number of fragments of *Aucella* are plainly visible, is hard, dark greyish-brown, and moderately finely grained. The dragonfly-wing lies upon a fairly even plane of fracture, and has its apical third, or a little more, and also a small piece of the broad anal area at the base, cut off by two parallel fractures of the rock running obliquely across the wing. Unfortunately, a further irregularity in the fracture-plane has extended up from the posterior margin near the base, well into the middle of the wing, and has thus removed a considerable amount of the interesting area lying below the triangle, as can be seen in the photographs on Plate xlii.

The description and figure given by Dr. Woodward, in 1884, may be described as broadly accurate, as far as the requirements of the day were supposed to go, with the exception of a few misstatements which should have been avoided, even by one who claimed no special knowledge of Dragonfly Wing-Venation. For instance, in describing the main veins or "nervures" of the anterior border of the wing, we are told that the "costal nervure," the "sub-costal," and the "median" (in modern terminology, C, Sc, and R) "pass along the anterior border until they reach the 'node,' or cubital point"; after passing which, only the two anterior ones "are continuous to the extremity of the wing, and support the pterostigma." Now this is not true of any Dragonfly, for it is, in every case, the *first* and *third* of these veins (C and R) that run past the nodus and support the pterostigma. Further, in the fossil under discussion, it is less than ever true, for it is easily seen that, in this case, *all three* of these veins appear to pass the nodus, and Woodward's own figure shows them so doing. Again, it is somewhat puzzling to be told, on p.338, that the fossil is "perhaps referable to the subfamily

Gomphinae," and to have it placed, on p.339, in the genus *Eschna*; since, long before 1884, the two subfamilies *Eschninae* and *Gomphinae* had been clearly recognised and distinguished.

However, Woodward got very close to the mark, as regards the true relationships of this fossil wing, when he noticed its close resemblance to a fossil wing found in the Lower Purbecks of Durdlestone Bay, Dorset, England, and figured by Prof. J. O. Westwood(4) in 1854. Though Woodward does not mention the name of this specimen, there can be little doubt that he referred to *Eschnidium bubas* Westwood, a form so similar to the more complete *Eschnidium densum* Hagen, that Handlirsch thinks that the two may very well be specifically the same.

Woodward's figure (5, Pl. xi., fig.1) shows a wing undoubtedly belonging to the *Eschnidiidae* in its general features, but apparently differing from the type-genus, *Eschnidium*, in some important points, notably in the extraordinary, transversely narrowed triangle, the incomplete areculus, and the weakly-formed nodus. These points are so important that, if the fossil really agrees with Woodward's figure, it would be impossible to endorse Handlirsch's removal of it to the genus *Eschnidium*. It would be necessary to propose a new genus for its reception. Hence, in making a careful study of the wing, I have paid special attention to these three important areas, with the results that I now propose to give in this paper.

It is necessary to state, first of all, what is the degree of preservation of the fossil wing, and, in particular, of the small veinlets and areolets that cover it so abundantly. The rock on which the wing is impressed is very hard. The outlines of the main veins, and their concavity or convexity, are preserved to perfection. On the other hand, the finer veinlets and areolets are not thus perfectly preserved, yet they can be seen to be present in all parts of the wing. It may be stated that every polygonal areolet is preserved in such a way that its *interior* is indicated on the rock as a small depression, while the veins, that form its periphery, are not usually clearly marked (except only in the case of cross-veins passing direct from one main vein to

another); so that, if one attempts to draw the outline of a cell under the camera lucida, its exact shape and position depend partly upon the direction of light. In order to show up these areolets, it is necessary to use very oblique light. Consequently, if the light be directed from the right side of the areolet, the dividing lines between light and shade (which are the lines that give us the rough outline of the cell) will lie too far to the right; while, with light directed from the left, they will lie too far to the left. That this is so, I easily proved by drawing a typical areolet or two, with two or more different lightings, when the outlines of the cells did not wholly coincide. Therefore, in all important cases, it was essential to make at least two drawings, and to gauge the true outline of the cell as a middle position between them. By this somewhat laborious method, I hope that I have succeeded in obtaining a more accurate result of the details of this wing than would otherwise have been possible.

The general appearance of the fossil is seen from the two photographs in Plate xlii. In Fig.9,* the light was directed on to the fossil from the left, or basal side, at an angle of about 20° to the plane of the wing. In fig.10, the light was similarly directed from the right or distal side. A comparison of the two figures shows the strong convexity and concavity of the veins very clearly. The following are the convex veins:—C (very slightly), R + M to arculus, R beyond arculus, Ms, M₄, A and all its descending branches, and the distal side of the triangle.

The following are the concave veins:—Sc, its apparent continuation beyond the nodus, the nodus itself, the subnodus and its continuation Rs; M₁, M₂, M₃, Rspl, Mspl, Cu, and the anterior and proximal sides of the triangle.

It will be seen from this, that the plane of the triangle is not horizontal, but inclined upwards distally, so that this area

* The numbers of the figures and text-figures in this series of papers are made concurrent from one paper to another. In No.1, the figures in Pl. ix. were inadvertently left unnumbered; the forewing of *Archiphanorpa magnifica* should have been fig.7, the hindwing fig.8. Fig.9 of Pl. xlii. in this paper follows on consecutively.

catches the light directed from the base (Plate xlii., fig.9) but lies in deep shade when the light is directed from the distal side.

It should also be noticed that the numerous convex branches of A are separated by concave supplements. None of these are true branches of A, for it can easily be seen that they are all incompletely formed as they approach A from below. Woodward's figure shows this fairly well, but an examination of the actual fossil (Plate xlii., fig.10) shows, along the broken-off edge below and proximad from the triangle, how very marked this alternate convexity and concavity really is.

The *costa* (C) is much thickened at the base, for a distance of about 2 mm.: there are only very faint indications of the typical "ribbing" of this vein. For most of its length, it appears to be a rather weak vein, very little stronger than Sc. Between C and Sc, a parallel supplement (Cspl) is developed, beginning weakly just above the arculus, and continuing more strongly right to the nodus. This is not shown at all in Woodward's figure. The cross-veins between C and R are mostly weak and irregularly placed: but two complete ones can be made out, which are shown slightly thickened in Plate xliii., fig.11. These probably represent the two hypertrophied antenodals of recent *Eschnide*. Beyond the nodus, there is only a much fainter indication of a corresponding supplement, though Woodward figures this as if it were quite obvious.

The *subcosta* (Sc) is very plainly marked, lying in a moderate furrow from base to nodus. At that point, it *appears* to divide into three, one branch turning sharply upwards to join the costa, a second running straight on through the nodus, parallel to and between C and R, and a third turning obliquely downwards to meet R at the subnodus. The actual structure of these three veins will be fully discussed when we come to deal with the nodus itself.

The *radius* (R) and *media* (M) appear to be very slightly separated at the extreme base of the wing, but fuse together almost immediately, and continue to the arculus as a single, thick, convex vein, R + M. Thence onward, R runs almost

straight—actually with a very slight double-curving—below and parallel to C and Sc. The question of the formation of the *radial sector* (Rs) must be dealt with under the discussion of the nodus.

The *media* (M) divides at the arculus into the concave and weak M_{1+3} , and the stronger, convex vein, M_4 . At a point a little beyond the distal end of the triangle, M_{1+3} divides into M_{1+2} above, and M_3 below, both weakly formed and concave. Immediately afterwards, M_{1+2} gives off, posteriorly, a strong concave vein, corresponding with the *bridge-vein* of recent Anisoptera. This vein, for the reasons given below in my discussion of the nodus, I have definitely decided to call the *Zygopterid sector* (Ms). It runs parallel to, and a little below, M_2 . M_{1+2} divides into M_1 and $M_{1'}$, just before these two veins are crossed by the vein descending from the subnodus, as Woodward's figure accurately shows. Below Ms, there is a slight indication of the formation of a *radial supplement* (Rspl). M_4 runs from the arculus to the upper distal angle of the triangle, and, from there on, curves gently downwards, beneath and subparallel to Ms, to reach the posterior wing-border far beyond the level of the nodus. Beneath M_4 , a very long, *median supplement* (Mspl) is developed, lying slightly concave to M_4 , but not linked up with the triangle (as would appear from Woodward's figure).

The *cubitus* (Cu) is a fairly strong, concave vein, running, with a very slight double-curving, below the arculus, to join the triangle at its proximal angle. There it turns sharply downwards, at right angles to its previous course, forming the proximal side of the triangle itself. Its further course is unfortunately lost, owing to the fracture below the triangle, already mentioned. But, at the distal side of this fracture, it is easy to pick up again a strongly concave vein descending to the wing-border almost directly under the nodus. This must certainly be Cu_1 ; but where Cu_2 is, or whether it is present at all, is not so easy to determine.

The *analis* (A) is a very strongly-marked, convex vein, running in a gentle curve (concave to the costa) from the base to the proximal angle of the triangle, where it meets Cu. I can find

no absolutely satisfactory evidence of the existence of an *anal crossing*; but the oblique vein descending from Cu just below the arculus, to meet A at the point where A_3 descends from it, may possibly represent this vein. If we reckon the distal portion of A, which links up with Cu, and forms the upper side of the large subtriangle, to be a secondary formation (as in recent Anisoptera), we can call the seven clearly-marked, convex, descending branches A_1 , A_2 , etc., to A_7 . There may be one or two more similar branches in the narrow anal portion of the base, that is missing in the fossil.

We can now proceed to discuss the three most important areas of the fossil wing, viz., the *arculus*, the *triangle*, and the *nodus*.

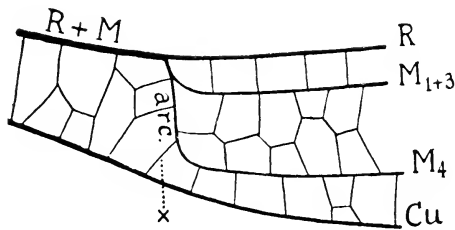

Text-fig. 8.

Eschnidiopsis flindersiensis (Woodward), hindwing; region of arculus; ($\times 12\frac{1}{2}$).

The *Arculus* (Text-fig. 8).

This area is very beautifully preserved, so that a little care in arranging the lighting allows us to draw every cross-vein in its exact position. The arculus itself exhibits two very primitive features to perfection:—

(a) It is incomplete posteriorly, the cross-vein (x) destined to complete it having not yet fully taken up its position.

(b) The upper sector of the arculus (M_{1+3}) leaves the main stem of M very close under R, as in the recent *Thorinae*.

As a contrast to this, the actual angle made by M_4 with R is greater than that seen in many recent Dragonflies, being very nearly a right-angle. Woodward's figure makes this angle much

too small, and is also inaccurate in showing the two sectors of the arculus as if they came off separately from R.

If Handlirsch's figure of *Eschnidium densum* Hagen, is correct, that dragonfly had a much more specialised form of arculus; so that the differences between it, and the species under discussion, would alone be sufficient to admit of placing the latter in a new genus.

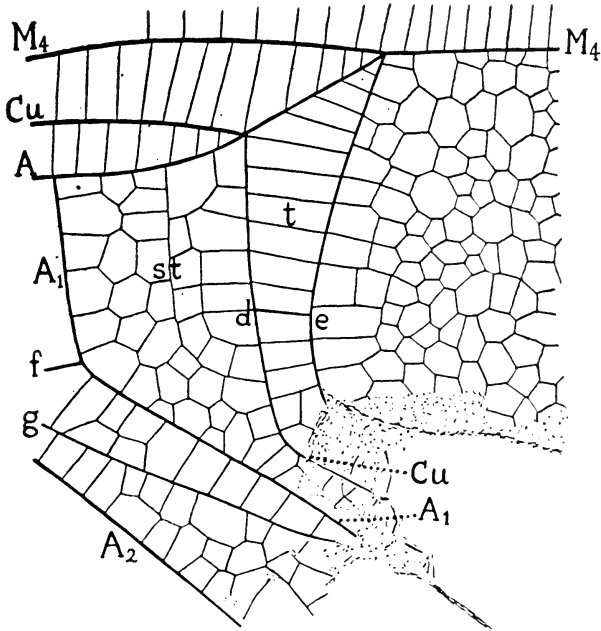

Text-fig. 9.

Eschnidiopsis flindersiensis (Woodward), hindwing; region of triangle;
($\times 12\frac{1}{2}$).

The *Triangle* (Text-fig. 9).

The anterior portion of the triangle and its broad supporting subtriangle are very well preserved. Unfortunately, as we follow these structures posteriad, their formation becomes less easy to make out; and, finally, just at the extreme posterior end

of the triangular region, the fracture already mentioned cuts us off from completing our survey. Woodward, in his figure, traces the veins, called by me A_1 and A_2 , across this fracture, together with two interpolated supplements. This is quite unjustifiable, particularly as he makes both these veins, which, before crossing the fracture, are strongly convex, pass, on reaching the other side, into veins which are *quite as strongly concave*, and which, therefore, if they are parts of the main veins at all, and not mere supplements, must belong to Cu. The only ridgings that can be seen running across the area of bare rock forming the fracture are shown by dotted lines in Plate xliii., fig. 11. As these are continued far beyond the posterior border of the wing, and as similar, though not quite so plain, ridgings can be made out in the area beyond the costal margin of the wing, I can only conclude that they are part of the structure of the fracture, or of the grain of the rock, and have nothing whatever to do with the wing itself.

The *triangle* itself is certainly the most remarkable structure of the kind known in the hindwing of any Anisopterous Dragonfly, owing to its intense narrowing in a transverse plane. Its shape, taken in conjunction with its broad and somewhat quadrangular subtriangle, at once suggests a comparison with the same structures in the *forewings* of the most highly-developed recent *Libellulide*. The two formations are certainly parallel; but, as we cannot trace out the course of the cubitus and its branches with certainty in our fossil, it does not seem possible to institute a detailed comparison.

Text-fig. 10 shows the actual shape of the triangle and subtriangle. In Woodward's figure, the shape of the triangle is not quite correctly indicated, and it is made to appear wider anteriorly than it really is. Further, the long, distal side is not so curved as in Woodward's figure; and the short, upper side is *absolutely straight*, with both Cu and A meeting it together at its extreme, proximal end. The cross-veins in the triangle itself are all simple and subparallel, and are more numerous than would appear from Woodward's figure. One of these cross-veins, the

seventh from the basal to the distal side, is very clearly visible in whatever direction the light may be arranged, and is evidently much thicker than the others. Further, it is very distinctly concave. It would seem, therefore, very likely that this vein is really part of Cu_1 , so that the forking of the cubitus takes place at the posterior basal angle of the triangle (the point d in the figure). If this be so, then the continuation of the proximal side must be Cu_2 ; while Cu_1 , after leaving d , crosses to meet the long distal side at the point e , where it turns sharply downwards to continue the line of that side posteriad. It must be noted, however, that this continuation remains highly convex. In all recent Anisoptera, Cu_1 remains concave throughout its length, whereas Cu_2 becomes convex after leaving the triangle. That the convex vein does not continue to the wing-border in our fossil, is quite evident, since, on the other side of the fracture, one finds a strongly concave vein running to the border, just in the usual position for Cu_1 . We have, therefore, two alternatives: either (*a*) if the cubital fork is at d , then the local convexity of Cu_1 just below the triangle must be attributed to the influence of the strong distal side of the triangle dominating it for some distance, though it soon sinks into the usual concavity; or (*b*) the vein de may be only a strengthened cross-vein, and the distal side may continue below it to meet the proximal side at some point just within the obliterated area, so that the triangle is really triangular, and not quadrangular; if so, then the cubital fork is at this latter point, and the two branches of Cu may very well possess their usual characters from the very start. A study of Handlirsch's figure of this part of the hindwing of *Aeschnidium densum* Hagen, (2, Atlas, Plate xlvii., fig. 16) fails to help us here, though it is quite likely that an examination of the actual fossil might give us the necessary clue. Thus the actual shape of the triangle, and the position of the cubital fork in our fossil, must remain doubtful. It is, indeed, just possible that the triangle may remain open posteriorly, as the subtriangle appears to do also in this remarkable wing-form.

The *subtriangle* is a wide, irregularly quadrangular area,

bounding the triangle proximally, and enclosed by a continuation of A above (this must be a specialised cross-vein, if the formation is the same as in recent Anisoptera), A_1 proximally, and the bent-down portion of Cu distally. Posteriorly, the area is narrowed by the converging of A_1 towards Cu; but whether they ever meet, so as to complete the closure of the subtriangle, there is unfortunately not quite enough of the wing preserved to show us. At the edge of the fracture, Cu appears definitely to have turned, so as to run closely parallel to and above A_1 ; so that the chances are that this area is not closed off posteriorly by any strong vein. Within the subtriangle, a number of small, irregular, polygonal areolets form a close meshwork, four cells wide in the broadest portion. Proximally, the subtriangle itself is supported by two struts, f' and g , formed by alignment of the boundaries of numerous cellules. Of these, f' passes from A_2 to A_1 almost at right angles, meeting the latter at its bend; while g is much longer and very oblique, meeting A_1 just on the edge of the fracture.

Distally from the triangle, there lies a broad area containing a very large number of small, irregular, unspecialised, polygonal cellules. As far as I can make these out, they are much more numerous than Woodward's figure would indicate; and I can find only the slightest traces of the supplements indicated by him as descending obliquely from the most proximal portion of Mspl; nor is that part of Mspl itself at all evident. Plate xliii., fig. 11, shows more accurately the appearance of this area.

The *Nodus* (Text-fig. 10).

This area is very well preserved, on the whole; but, unfortunately, the nodus itself is a weak formation, so that its exact structure is not easy to determine. I have studied it under oblique light from several different directions. A correlation of the drawings obtained in this manner gives the result shown in Text-fig. 10, which, I think, is as accurate as we can hope to get.

Approaching the nodus, the costal vein is not strongly formed, and shows practically no sign of "ribbing." At the nodus itself,

the break in the costa is not very strongly marked, but is evident from the sudden drop in level. Examination in certain lights shows the presence of *two* distinct veins, both weakly formed, bounding the nodal furrow, one on either side. Of these, the proximal is the upturned end of Sc, the distal is the *nodal cross-vein* (Nc). This latter is prolonged below Sc, for a short distance, before it receives the downwardly-arching end of the *subcostal supplement* (Scspl), or vein which appears to form a prolongation of Sc beyond the nodus. That there is a distinct gap

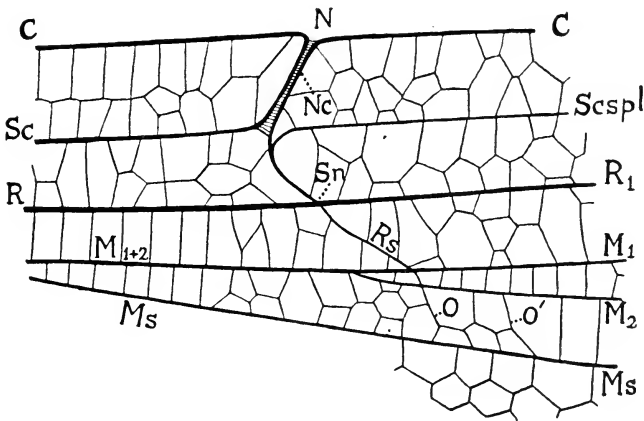

Text-fig. 10.

Eschuidiopsis flindersiensis (Woodward), hindwing; region of nodus and radial sector; ($\times 12\frac{1}{2}$).

between Sc proper, proximal to the nodus, and Scspl distal from it, can be clearly seen, so that the second branch of Sc spoken of, on p. 680, as apparently running straight through the nodus, does not really exist at all. It can also be seen, that the supposed third branch mentioned on the same page is non-existent, being none other than the downward production of the nodal cross-vein itself, which curves round, posteriad and distad, to meet R at the *subnodus* (Sn). At this point the vein, which is clearly the true Radial Sector (Rs) comes off posteriad from R,

and shows a slight curving close to its origin. This Rs crosses from R to M obliquely, reaching the latter *just after it has divided into* M_1 and M_2 , and crosses over both these branches. It then becomes a very weakly-formed vein, which drops less obliquely towards M_s , but fails to reach it, being caught up at the upper proximal angle of a small, but clearly-marked, trapezoidal cellule standing upon M_s itself.

This formation certainly supports the theory, advanced by me in a previous paper, concerning the true nature of the Bridge in Anisoptera (3)—written before I had seen this fossil—except in one particular. I suggested that, in the Anisoptera, trachea M_s “becomes hitched on to Rs,” so that the bridge itself represents, in the imaginal venation, the original course of M_s , while its distal prolongation beyond the oblique vein (this latter represented in our fossil by the piece of Rs lying below M_1) represented Rs (*i.e.*, pp.883-4). Now, in our fossil wing, Rs practically fails to reach M_s , so that the natural interpretation of the venation is that not only the bridge itself, but also its continuation right to the wing-border, belongs altogether to M_s , while Rs only forms the subnodal vein between R and M_1 , the minute crossing between M_1 and M_2 , and the *incomplete oblique vein* (O) descending towards M_s , but failing to reach it. A very little advance in specialisation in this latter region would straighten out the lower end of Rs, so that the oblique vein would appear completed, as in all recent Anisoptera.*

Woodward's figure correctly shows the point of crossing of Rs over M_1 and its failure to reach M_s , but quite fails to give the peculiar and distinctive features of the nodus itself, and the dense structure of the cellular meshwork in that region.

* It is possible that Rs actually continues along the zigzag between M_2 and M_s for three cellules' distance, so that, if further evolution simplified this part to single cross-veins, the slanting vein marked O' in the figure might appear as an “oblique vein.” This process might account for the carrying on of the oblique vein far beyond the level of the nodus in *Eschuidium*, and in many recent Anisoptera.

We may summarise the chief points of interest in this region of the wing as follows:—

(1) The nodus is fully formed, but weak.

(2) The subnodus is also complete.

(3) The apparent prolongation of Sc through the nodus is of the same nature as that seen in *Telephlebia*, i.e., due to the secondary formation of a supplement between C and R, by alignment of the boundaries of numerous cellules of the dense mesh-work to form a *subcostal supplement*, Scspl; but, in the fossil, this Scspl is completely formed, whereas, in *Telephlebia*, it is of only about two cellules' length.

(4) Supplements similar to Scspl, and due to the same cause, are formed proximally to the nodus, between C and Sc, and distally from the nodus, between C and Scspl; but the latter of these does not reach back proximally to the nodus (see Plate xliii., fig.11).

(5) Rs arises from R directly under the subnodus. It is a weak vein, running obliquely to M, crossing M_1 and M_2 not far distad from their point of union, and then dropping towards Ms as the incomplete, oblique vein O.

It will be seen that, if this fossil gives us the right interpretation of the structure of Rs and Ms, the distinction between the Anisoptera and Zygoptera in this region almost disappears. The only difference would be that, in the former, trachea Rs has become strengthened by capturing Ms, so that the basal part of the latter (the bridge) has become aborted; while, in the latter, it continues to weaken, and fails ever to cross M_{1+2} .

Classification of the Fossil Wing.

As long as we decide to keep to the old classification of the Anisoptera, in which only two families are recognised (the *Eschnidae* and the *Libellulidae*), it seems to me that we cannot grant full family-rank to the *Eschnidiidae*. These latter have the triangles of the fore- and hindwings alike (both being elongated transversely to the wing-axis), and the antenodals of the first and second series not corresponding. Hence they are,

within the broad definition of that family, true *Æschnidæ*. I propose, therefore, to regard Handlirsch's family *Æschnidiidae* as only a subfamily, *Æschnidiinae*, within the family *Æschnidæ*, and of equivalent rank with the subfamilies *Petalurinae*, *Cordulegastrinae*, and *Chlorogomphinae*. This last group, I consider to be the nearest living type to the fossil *Æschnidiinae*, owing to the shape of its triangles.

At present, the fossil wings (Jurassic and Cretaceous) assigned to the subfamily *Æschnidiinae* are all comprised within the single genus *Æschnidium* Westwood. I now propose to separate out the Queensland fossil wing as the type of a distinct, new genus, *Æschnidiopsis*, according to the following Table:—

Subfamily ÆSCHNIDIINÆ.

Key to the Genera.

- Arculus complete posteriorly; triangles not excessively narrowed transversely to the wing-axis Genus *Æschnidium* Westwood.
(Jurassic, Europe). Type, *Æschnidium hubas* Westwood. (Lower Purbecks, Durdlestone Bay, England).
- Arculus incomplete posteriorly; triangle of hindwing excessively narrowed and elongated transversely to the wing-axis
..... Genus *Æschnidiopsis*, n.g.
(Cretaceous, Australia). Type, *Æschua flindersiensis* Woodward.
(Flinders River Beds, N. Queensland).

ÆSCHNIDIOPSIS, n.g.

Large Dragonflies (hindwing about 40 mm. long) with exceedingly dense reticulation, as in *Æschnidium*. *Nodus* completely formed, but weak; *subnodus* also present. *Rs* arises at the subnodus, crosses M_1 and M_2 just distad from their point of union, and drops towards M_s as an incomplete, oblique vein. (In *Æschnidium*, as figured by Handlirsch, the oblique vein is complete in the hindwing, and lies far distad from the nodus). *Arculus* strongly formed, but incomplete posteriorly; M_{1+3} leaving it very close up to *R*; M_4 lying well below M_{1+3} , separated from the latter by two rows of cellules. *Triangle* of hindwing very long, and excessively narrowed transversely to the wing-axis; crossed by a number of simple, subparallel cross-veins;

either quadrangular in form (closed posteriorly by the thickened cross-vein *de* of Text-fig.9), or open posteriorly; far removed from arculus. *Subtriangle* broad, quadrangular, filled with a mesh-work of irregular cellules; probably narrowly open posteriorly. *M*_{spl} well-developed, slightly concave to *M*₄. *R*_{spl} apparently fairly well-developed. *Anal crossing* not clearly indicated. *Anal vein* with at least seven, well-formed, convex, descending branches in hindwing, subparallel, separated by concave supplements.

Type, *Æschna flindersiensis* Woodward.

ÆSCHNIDIOPSIS FLINDERSIENSIS (Woodward).

Æschna flindersiensis Woodward, Geol. Mag., New Series, Dec. iii., Vol. i., No. viii., 1884, pp.337-339, Plate xi., fig.1.

Æschnidium flindersiense Handlirsch, Die fossilen Insekten, p.667.

Total length of specimen (hindwing) measured along the radius, 22.5 mm. Greatest breadth (at level of origin of *M*_s), 12.6 mm. Probable total length of wing, about 40 mm.

Description as given in this paper.

Locality.—Flinders River Beds (Cretaceous), N. Queensland.

Type in Coll. Queensland Geol. Survey, Brisbane, Q.

BIBLIOGRAPHY.

1. GIEBEL.—*Ins. Vorw.*, 1856, p.287. (*Estemoa bubas* = *Æschnidium bubas* Westwood).
2. HANDLIRSCH.—*Die Fossilen Insekten*, etc., 1908, and Atlas. (*Æschnidiide* and *Æschnidium* defined, pp.593-4. Figure of *Æschnidium densum* Hagen, Atlas, Plate xlvii., figs.16, 17).
3. TILLYARD.—“Further Researches upon the Problems of the Radial and Zygopterid Sectors in the Wings of Odonata, and upon the Formation of Bridges.” *Proc. Linn. Soc. N. S. Wales*, 1916, Pt. 4, pp. 871-887. (See p.883).
4. WESTWOOD.—*Quart. Journ. Geol. Soc.*, x., 1854, pp.387, 393, Plate 15, fig.5.
5. WOODWARD.—“On the Wing of a Neuropterous Insect from the Cretaceous Limestone of Flinders River, North Queensland, Australia.” *Geol. Mag., New Series*, Dec. iii., Vol. i., No. viii., 1884, pp.337-339, Plate xi., fig.1. (*Æschna flindersiensis*).

EXPLANATION OF PLATES XLII.-XLIII.

Plate xlii.

Figs. 9-10.—*Eschnidiopsis flindersiensis* Woodward, hindwing; photographed by strong oblique, artificial light; ($\times 4$). In Fig. 9, the light is directed from the left; in Fig. 10, from the right.

Plate xliii.

Fig. 11.—*Eschnidiopsis flindersiensis* (Woodward), hindwing; ($\times 6$). Camera lucida drawing to show full details of venation.

LETTERING FOR PLATES AND TEXT-FIGURES.

A, analis; A₁-A₇, its descending branches; *arc*, arculus; C, costa; Cu, cubitus; Cu₁, Cu₂, its branches; *de*, thickened cross-vein in triangle; *f*, *g*, struts supporting subtriangle; M, media; M₁-M₄, its branches; Ms, Zygopterid sector; Mspl, median supplement; N, nodus; Nc, nodal cross-vein; O, oblique vein (incomplete); O', possible second oblique vein; R, radius; R₁, its main stem; Rs, radial sector; Rspl, radial supplement; Sc, subcosta; Scspl, subcostal supplement; Sn, subnodus; *st*, subtriangle; *t*, triangle; *x*, cross-vein tending to complete arculus posteriorly.

THE GEOLOGY AND PETROLOGY OF THE GREAT
SERPENTINE BELT OF NEW SOUTH WALES.

PART VI. APPENDIX. THE ATTUNGA DISTRICT.

BY W. N. BENSON, B.A., D.Sc., F.G.S., PROFESSOR OF GEOLOGY,
UNIVERSITY OF OTAGO, N.Z.; FORMERLY LINNEAN MACLEAY
FELLOW OF THE SOCIETY IN GEOLOGY.

(One Text-figure.)

In the main portion of this report (1, *d*), an account was given of the region extending from Warialda, the northern limit of the visible part of the Serpentine Belt, to the Namoi River. It was intended to survey in greater detail the complex region between the river and Moore Creek, thus joining on to the area already mapped in the Tamworth District south of Moore Creek, and with the survey of the Loomberah District to be considered in Part vii., of this series of papers, in order to complete the mapping of the Great Serpentine Belt, in greater or less detail, from Warialda to Nundle. The writer's removal from Australia makes this now impossible. It seems advisable, therefore, to place on record the work already done, upon which was based the mapping of this area in the Plate accompanying Parts i. and vi.; and to indicate the modifications required, as shown by later information obtained by the writer, by Lieut. Arousseau, B.Sc., M.C., and by Mr. S. M. Tout, and by Mr. L. J. Jones. The present communication, therefore, is a compilation of incomplete information gathered by several workers, and will serve chiefly to draw attention to the interesting nature of the material awaiting further research. The writer's thanks are due to the generous permission given by the gentlemen named to make use of their work, and to the Government Geologist, Mr. J. E. Carne, for permission to show, on the accompanying sketch-map, the boundaries of the limestones in the area between Attunga Creek and the Namoi River, which are copied from the surveys of Mr.

L. J. Jones, to be described in the forthcoming report upon the limestones of New South Wales by Mr. Carne and Mr. Jones(2).

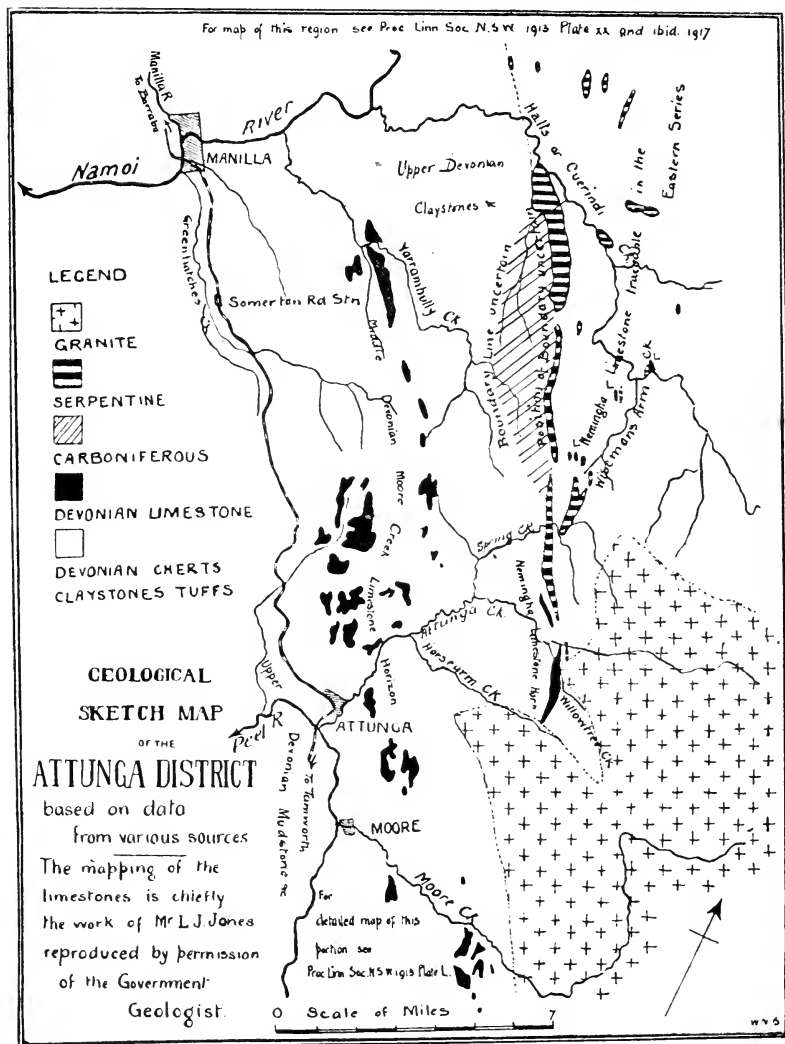

He must also thank Mr. D. A. Porter, who first directed him to the regions of contact-altered limestone.

The region exhibits a varied series of formations. From Willowtree Creek northwards, there extends intermittently the line of serpentine-intrusions. To the east of this are the crushed and altered rocks of the "Eastern Series," which here belong, apparently, to the Lower Middle Devonian formation, in great measure. They consist of crushed and sheared, banded cherts, agglomerates, and volcanic breccias, with lenticular masses of limestone, probably of the Nemingha horizon; and, here and there, a mass of serpentine. This can be well seen along the Valley of Wiseman's Arm Creek. Between these and the Serpentine, however, is a long ridge of red jasper culminating in the peak Bungemullagalarno, south of Hall's Creek. North of this creek is a low gap leading to the Namoi River between the jasper ridge by the Serpentine line to the west, and the scarp of the New England plateau to the east, a scarp which is, in part, of tectonic origin.

The serpentine varies greatly in width. It is scarcely more than a yard wide near Willowtree Creek, but is nearly a quarter of a mile wide by Hall's Creek. The larger masses of serpentine here do not occur in the Serpentine Line, but strike north from near Ukolan through the above-mentioned gap to Mundowey, thus indicating a virgation of the tectonic lines.

Returning to the south: near the head of Horsearm Creek, limestone occurs, and extends across into Willowtree Creek, where the outcrop reaches a width of nearly 400 yards, probably broken by faults. It dies out before reaching Attunga Creek, but appears again north of the creek (in Portion 151, Burdekin), where it is very tuffaceous, weathering to a cavernous rock. This suggests that this limestone belongs to the Nemingha horizon, which is supported by the abundance of igneous material, tuffs, breccias, dolerite, etc., immediately west and stratigraphically above the limestone, which probably indicates the position of the Igneous Zone known to overlie the Nemingha limestone (1, c). Beyond Portion 151, the Nemingha limestone passes to the east of the Serpentine Line, and its extension has been traced up through Wiseman's Arm Creek to Crow Mountain. It does

not return to the west of the Serpentine Line until near Bingara.

The granites are of the type of the Moonbi, hornblendic granite, with numerous basic inclusions(1, *b*, p.696). They invade the limestone on Horsearm Creek, truncate the Serpentine Line, and pass obliquely through the Eastern Series to Mt. Abundance, where the margin of the granite turns to the east. Especially interesting and varied examples of contact-metamorphism occur along the margin of the granite. At the head of Horsearm Creek, the claystones have been entirely recrystallised, with the formation of sillimanite(1, *b*, p.704). Nearby, the limestones are intensely altered, especially in Portion 226, Attunga. Here they have been largely replaced by brown garnet, and impregnated with orthoclase and albite; while copper-ores have been introduced. Many, beautiful, partially oxidised specimens may be obtained from the dump of a small prospecting pit near here. (See, for example, the specimens now in the Mining Museum, Sydney). At the head of Willowtree Creek, the copper minerals are sufficiently abundant, in the contact-altered rock, to warrant exploitation. A brief account of the Attunga Copper Mine here has been given by Mr. Carne(3). The petrological features of these contact-altered rocks have been described by the writer(1, *b*, pp.713-714).

Very interesting, too, are the contact-effects of the granite upon the rocks of the Igneous Zone overlying the limestone, in which are a number of types of altered tuff and breccia, which have been already briefly described, and may be compared with similar rocks from the head of Seven Mile Creek, in the Tamworth district, eight miles to the south(1, *b*, pp.710-711; and 1, *c*, pp.607-608). In addition, a massive dolerite has been observed in which the augite has been replaced by strongly pleochroic hornblende, and secondary biotite has been developed(1, *b*, p.668).

West of the granite is a series of dykes of lamprophyre, usually pink in colour, with finely divided, ferromagnesian minerals. These are chiefly vosgesites, and occur, *e.g.*, at Bunge-mullagalarno, and on Wiseman's Arm Creek, and at Mundowey to the north. A typical minette was obtained on Willowtree

Creek (1, *b*, pp.697-8; p.706, analysis); and a lamprophyre, the nature of which is not known to the writer, was found by Lieut. Aourousseau in Portion 159, Attunga (see below).

West of the Igneous Zone, there extends, through the Parishes of Attunga and Burdekin, a monotonous series of banded cherts and claystones with interbedded tufts, giving, as a rule, very unsatisfactory outcrops. These belong to the Upper Middle Devonian Series, and contain masses of limestone. To the west, the Upper Devonian rocks follow, forming the plains of the Peel River. North of this, however, the central mass of Upper Middle Devonian rocks seems to be flanked, to the east as well as to the west, by Upper Devonian Mudstones: and, in Portions 47 and 48, Parish of Halloran, evidence of the occurrence of an unfolded strip of Carboniferous rocks has been found by Mr. S. M. Tout, lying adjacent to the serpentine, repeating, in this manner, the features observed at Crow Mountain, and extending thence down to the Namoi River (1, *d*).

The chief interest lies in the great masses of limestone, which occurs here in greater abundance than in any other part of the Great Serpentine Belt. Numerous separated masses lie within the broad area marked as limestone in the map given in Part i. (1, *a*). The resistance offered to erosion by the limestones is so much greater than that of the claystones in which they occur, that they generally rise into sharp hills, often thickly wooded with pines. Just as in the region south of Moore Creek, these masses of limestone prove to be isolated portions of folds, compressed and faulted, the whole indicating an extremely complex tectonic structure, though the intervening mass of claystone is so imperfectly exposed, that no complete solution of the structural problem can be obtained. Thus, in the Parish of Attunga, the mass in Portions 158 and 74 has the structure of a laterally compressed dome or anticline, the axis of which pitches to the north-west at the northern end of the hill, and south-west at the southern end. It is faulted along the eastern side. The limestone here is very thick, probably at least four hundred feet, the lower two hundred feet or so being pure limestone, the remainder with siliceous and other impurities. The hill behind the Burde-



kin Homestead, south of Attunga Creek, similarly is a strongly compressed fold, apparently a syncline, in which the limestone must be not less thick than the above. Faulted against this, on its north-western side, is a mass of claystone and limestone (60 feet thick of pure limestone, above 70 feet thick of siliceous limestone dipping E.N.E. at 10°). The very irregular outline of the masses of limestone north of Attunga Creek, the mapping of which is due to Mr. L. J. Jones, suggests that a similar complexity of tectonic structure prevails here. This is confirmed by the extraordinarily disturbed character of the sediments on Yarrambully Creek. The following fossils have been obtained from the Attunga limestones by various collectors,* the determinations being due to Mr. W. S. Dun, for the most part (4, 5).

<i>Tryplasma</i> , sp.n.	<i>Actinocystis cornuboris</i> .
<i>Cyathophyllum</i> , sp.n.	<i>Aulopora</i> sp.
<i>Phillipsastræa</i> sp.n.	<i>Microplasma parallelum</i> .
<i>Litophyllum Konincki</i> .	<i>Litophyllum</i> , sp.n.
<i>Heliolites porosa</i> .	<i>Syringopora auloporoides</i> .
<i>Syringopora</i> , sp.n.	<i>Favosites gothlandica</i> .
<i>Favosites multitabulata</i> .	<i>Pentamerus</i> cf. <i>Knightii</i> .
<i>Chonetes</i> sp.	<i>Atrypa</i> sp.
<i>Euomphalus</i> sp.	Crinoid ossicles.

Unfortunately, the exact localities from which these fossils were derived are not known to the writer; the majority are not frequently found in Moore Creek limestone, to which must belong the bulk, if not all, the masses of limestone. The presence of *Phillipsastræa*, *Tryplasma* sp., and *F. multitabulata* suggests that the Loomberah limestone may also be represented. If this be so, we may have here an opportunity of checking the present tentative assumption that the Loomberah limestone is stratigraphically intermediate between the Moore Creek and Nemingha limestones, though nearer to the former. It should be noted that, in one place at least, namely on the top of the hill behind the Burdekin Homestead, the limestone of the Moore Creek horizon is brecciated, and set in a red matrix, in a manner previously believed to be confined to the Nemingha limestone. For

* W. Anderson, M. Arousseau, J. Campbell, C. Cullen, R. Etheridge, D. Porter.

further details of the field-occurrence, chemical composition, etc., of these limestones, reference must be made to Messrs. Carne & Jones' forthcoming work(2).

In Portion 159, Attunga, the western of the two large masses of limestone (carefully surveyed by Lieut. Aurousseau), has a locally developed, strong contact-alteration. In the dusk of an evening, in 1910, the writer collected a number of specimens from here, but did not work out their field-relationships. These were subsequently described in detail, and, from the occurrence of cassiterite and scapolite in them, it was concluded that they lay near the end of a granitic apophysis with a pneumatolytic, metamorphosing effect. A few felspathic rocks, rich in calcite, etc., suggested an endogenous alteration of such an intrusive mass(1, b, pp.714-716). Lieut. Aurousseau, however, discovered a vein of lamprophyre invading the limestone, and he believes that it was the cause of the metamorphism. He gives the following account of the change of the limestone in the few yards adjacent to the lamprophyre:—i., The dyke; ii., calcite-phlogopite rock; iii., dark limestone; iv., phlogopite rock; v., melanite-wollastonite rock, with clinozoisite, vesuvianite, calcite, mica(?), and pyroxene; vi., vesuvianite-wollastonite rock with a little melanite; vii., saccharoidal limestone. Evidently, the small collection, already described by the writer, is fairly typical of the whole occurrence. The nature of the intrusive rock is not known. There is here, accordingly, an interesting field for study in comparison with Bergeat's descriptions of endogenous and exogenous contact-metamorphism in Mexico(5).

The only other feature of interest, in the Middle Devonian rocks observed by the writer, is a small mass of vesicular spilite, east of the railway near Somerton Road Station.

The passage from the Middle to the Upper Devonian beds is not always marked, as was formerly believed, by the development of an intervening mass of Baldwin Agglomerate. Indeed, the study of the southern part of the Tamworth district shows that passage from the dominantly cherty rocks of the Tamworth type, into the soft mudstones of the Barraba type, may take place considerably below the base of the Barraba system, marked

by Baldwin Agglomerates. (This will be discussed in more detail in Part vii.). There is no reason, therefore, for assuming, from the absence of Agglomerates, the presence of a fault separating the Middle and Upper Devonian beds at Attunga.

To the east of the limestone-occurrences in Parish Cuerindi, the radiolarian cherts give place to claystones and mudstones, which, as shown in the earlier map, are probably of Upper Devonian age; and these are followed by other mudstones and tuffaceous sandstones adjacent to the Serpentine, which are comparable with the Burindi (Carboniferous) rocks by the Serpentine at Crow Mountain. Attention was first called to the fossils obtained from these beds by Mr. S. M. Tout, and their age was determined by Mr. W. S. Dun. *Spirifera* cf. *striata*, var., and *Aviculopecten* sp., were recorded by him in Mr. Tout's collection. No sedimentary formations more recent than these (excepting river-alluvium) have been observed in the area studied.

The dominant physiographic feature in this region is the granite plateau, from which there is a sharp fall to the rocks of the Eastern Series, followed by a series of foothills steadily descending to the Peel River and Namoi plains. The isolated mass of Round Hill, west of Somerton Road, was not visited by the writer, but is probably Baldwin Agglomerate.

BIBLIOGRAPHY.

1. BENSON, W. N.—“The Geology and Petrology of the Great Serpentine Belt of New South Wales.” These Proceedings, (a) Part i., Vol. xxxviii., pp.497-517, Plate 20; (b) Part iii., *ibid.*, pp.662-724; (c) Part v., Vol. xl., pp.540-624, Plate 50; (d) vi., *antea*, pp.223-245, 250-283.
2. CARNE, J. E. and JONES, L. J.—“The Limestone Deposits of New South Wales.” Mineral Resources, No.24. (In preparation).
3. ————— “The Copper Mining Industry of N. S. Wales.” Mineral Resources, No.6. pp.313-6.
4. ETHERIDGE, R., JUN.—“The Corals of the Tamworth District.” Records Geol. Survey N. S. Wales, Vol. vi.
5. BERGÉAT, A.—“Die Granodiorite von Concepcion del Oro und sein Kontakt.” Neues Jahr. für Miner. Beil., Bd.28, 1907, pp.421-573. Also (Spanish) Boletín del Instituto Geológico de Mexico, No.37. See also review of above, by F. Becke, “Fortschritte auf dem Gebiete der Metamorphose.” Fortschritte der Mineralogie n.s.w. 1911, pp.221-256.

SOME NEW *HETEROMERA*, AND ONE *STIGMODERA*,
FROM TROPICAL AUSTRALIA.

BY H. J. CARTER, B.A., F.E.S.

(Ten text-figures).

PLATYDEMA RUFIBASE, n.sp.

Oval, convex; head and prothorax black, elytra black with the basal area (except at the suture) red, antennæ and underside piceous, legs red.

Head coarsely and closely punctate, antennæ extending to base of prothorax, the five penultimate joints transverse, last joint subspherical; eyes large, front unarmed in both sexes. *Prothorax* nearly straight in front, bisinuate behind, sides arcuately narrowed and rounded anteriorly, posterior angles acute, disc strongly subconfluently punctate, with two well-marked foveæ at base. *Scutellum* black, punctate. *Elytra* striate-punctate, intervals convex, and themselves densely punctate; underside closely pitted with large punctures. *Dimensions*: 3×1.5 mm.

Hab.—Cooktown (King's Plains) and Laura, Queensland (T. G. Sloane).

Twenty-one specimens examined, taken by Mr. Sloane, July, 1916. It is nearest to *P. victoriense* Blackb., but can be readily distinguished by the following comparison.

P. rufibase.

P. victoriense.

Elytra with basal mark red.

Elytra with base and apex red.

Prothorax coarsely, subconfluently punctate, posterior angles acute.

Prothorax finely, more distantly punctate, posterior angles rectangular.

Elytral intervals convex and strongly punctate.

Elytral intervals scarcely raised, and very finely punctate.

The whole surface is less nitid and more strongly sculptured than in *P. victoriense*. It is wider than, and easily distinguished from, *P. tetraspilotum* Hope. Type in Coll. Carter.

I append a Table of the Australian species of this cosmopolitan genus.

Table of *Platydemia*.

- 1-7. Elytra unicolorous.
 2-4. Upper surface nitid-black.
 3. Form widely oval and convex *striatum* Montr.; *kanalense* Perr.; *oritica* Pasc.; *Championi* Blackb.; *obscurum* Blackb.
 4. Form narrow and depressed..... *deplanatum* Champ.
 5. Upper surface opaque black..... (*Typhobia*) *fuligineum* Pasc.
 6. Upper surface piceous-brown *laticolle* Mael.
 7. Upper surface metallic violet or blue *metallicum* Cart.
 8-17. Elytra not unicolorous.
 9. Elytra black, with shoulder-spot and margins more or less
 luteous *limacella* Pasc.; *fossulatum* Blackb.
 10. Elytra black with basal parts rufous *rufibase*, n.sp.
 11. Upper surface piceous-brown, prothorax and elytra with
 pale margins *abdominale* Geb.
 12. Elytra red, with large, discal, black macula..... *victoriense* Blackb.
 13-17. Elytra more or less fasciated.
 14-16. Form narrow and subparallel.
 15. Prothorax black (sometimes with narrow red margins).....
 *tetraspilotum* Hope.
 Elytral intervals convex..... *Pascoi* Mael.; *tasmanicum* Mass.
 16. Prothorax red, with black discal markings, elytral intervals
 flat..... *bicinctum* Champ.
 17. Fovea ovate, elytral fasciae pale yellow..... *aries* Pasc.

Note.—*P. novicum* Motsch., has been omitted, as unknown to me; moreover, if the dimensions stated in the description are correct ($3\frac{3}{4} \times \frac{4}{5}$ l.) it is most probably not a *Platydemia*. The width, as printed, is probably an error for $1\frac{4}{5}$ l. If this be so, it is an evident synonym of *Ceropria peregrina* Pasc.

The species in which the ♂ has the head more or less horned are *P. aries* Pasc., *P. limacella* Pasc., *P. striatum* Montr., and *P. fuligineum* Pasc., (in the last, it is only a slight tuberculous elevation).

SARAGUS SUBRETICULATUS, n.sp.

Rather elongate-ovate, whole surface opaque black, sometimes with a brownish indumentum, convex.

Head: labrum prominent and ciliate, epistoma widely incurved at middle of apex, very finely punctate, with short, adpressed, brown hairs, forehead and canthi forming a strongly arched ridge, coarsely and closely punctate, separated from epistoma by a deep arcuate suture; antennæ stout, four apical joints transverse. *Prothorax* arcuate-emarginate at apex, anterior angles prominent and sharply rounded, base with small medial emargination, rounded on discal portion, then sharply oblique to the posterior angles, these acute and produced; sides arcuately widened from apex to base; subexplanate margins not separated nor differentiated in sculpture from disc, these crenulate at base; without any distinct border (as seen from above); disc finely shagreened (under a strong lens seen to be longitudinally rugose); medial depression foveate, sometimes continuous (but narrowed) to apex but not to base, a short carina extending from base to medial depression. *Scutellum* transversely triangular. *Elytra* subovate, the sides parallel to about half-way, and feebly crenulate, humeri obtuse, each elytron with *two* strongly raised narrow and irregularly undulate carinæ, these (in three examples) towards apical declivity throwing off lateral (subreticulate) ridges; apex itself rugose-punctate only; intervals irregularly foveate-punctate, the sutural row only forming a distinct series; suture not or very feebly raised. Underside finely longitudinally rugose, the sides of prosternum with transverse ridges, epipleuræ coarsely punctate, tibiæ rugose, the anterior armed with a short, strong spur. *Dimensions*: $13 \times 7\frac{1}{2}$ mm.

Hab.—King River, Northern Territory (W. McLennan).

Four specimens, sent from the National Museum, Melbourne, show a clear distinction from their allies, *S. levicollis* F., (= *S. reticulatus* Haag), *S. intricatus* Champ., *S. luridus* Haag, *S. crenulatus* Macl., and *S. clathratus* Macl., all of which have *three* elytral carinæ, and the elytral border entire, besides many other differences. It is, perhaps, most like *S. crenulatus* Macl., in

form, being less wide and oval than *S. larvicollis* or *S. intricatus*. Types in the National Museum, Melbourne.

Note.—Mr. K. G. Blair, in his very useful paper "On the Fabrician types of *Tenebrionidae* in the Banks Collection" (*Ann. Mag. Nat. Hist.*, 1914, p.486) has already pointed out that *S. larvicollis* F., is probably *S. reticulatus* Haag, and that the Tasmanian and southern insect commonly so called should be known as *S. costatus* Sol.

ONOSTERRHUS OOLDENSIS, n.sp.

Elongate-ovate, very convex, black, pronotum and underside nitid, head and elytra dull black: antennæ, oral organs, and tarsi reddish, the apical joints of the first distinctly red.

Head: epistoma straight in front, sinuate at junction with canthus, with two elongate depressions within apical border; canthus widely rounded and horizontal; surface without perceptible punctures, last joint of maxillary palpi subtriangular (or narrowly securiform), antennæ with joint 3 as long as 4-5 combined, 4-7 obconic, 8-10 widely ovate, 11 ovate and longer than 10. *Prothorax* 7 × 10 mm. (length measured in middle), widest behind middle, base half as wide again as the apex, arcuate-emarginate at apex, anterior angles very acute, produced obliquely outwards and raised in front of eyes, sides rounded, slightly narrowed behind,

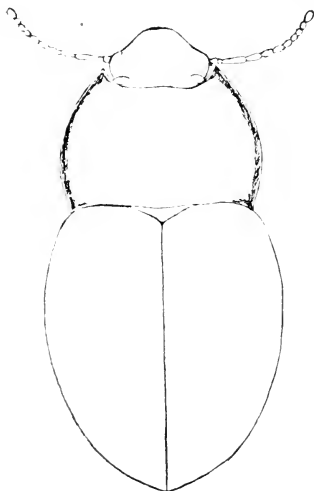

Text-fig. 1.

Onosterrhus ooldensis, n.sp. more strongly so anteriorly, base truncate in middle, oblique near sides, posterior angles sharp and obliquely produced outwards and downwards, extreme margin convex, thick, widened at posterior angles and narrowed to meet the narrower apical border, basal margin narrowly raised; disc impunctate, convex, widely depressed at margins

within extreme border. *Scutellum* very transverse and impunctate. *Elytra* of same width as prothorax at base, and more than twice as long, ovate and convex, shoulders widely obtuse, epipleural fold just visible from above, lateral border very narrow, without interior sulcus or evident row of lateral punctures, disc impunctate, surface slightly uneven, with a faint suggestion of longitudinal depressions and convexities: epipleuræ smooth, basal segments of abdomen lightly striolate, apical segments minutely punctate, sides of submentum with a wide, blunt tooth. Tibiæ without tomentum. *Dimensions*: 24 × 12 mm.

Hab.—Ooldea, South Australia.

A single specimen, probably ♀, sent from the South Australian Museum, is nearest to *O. stephensi* Cart., and *O. lata* Blackb., in my Table (Ann. Queensland Mus., 1911, p.7). From the former, it is separated by its non-parallel elytra, and from both by its strongly acute anterior angles of prothorax ("vix acutis" in *O. lata*). It is the largest of the "elongate-ovate" group. Type in the South Australian Museum.

Note.—Apparently South Australia is the zoo-centre of this and allied genera, which belong to a typically ancient Australian fauna. There is another single specimen of an *Onosterrhus* sent with the above, from the same locality; but I hesitate to describe it as new, without an opportunity of comparing it with Blackburn's three species, *O. letus*, *O. lugubris*, and *O. inconspicuus*.

NYCTOZYLUS PARVUS, n.sp.

Ovate, opaque brownish-black above, subnitid reddish-brown beneath, coxæ red; underside clothed with short, thinly scattered pale red hairs, tarsi with thick golden tomentum beneath.

Head and *pronotum* densely and evenly punctate, labrum emarginate, epistoma truncate in front, then rather abruptly slanting back, the canthus oblique and earlike, extending half-way across the eyes, forehead with medial depression and separated from epistoma by a curved line; antennæ not extending to base of prothorax, joint 3 very elongate, 4-7 elongate-ovate, 8-10 transverse, 11 as wide as 10, and half as long again. *Prothorax* 3 × 4 mm., very little wider at base than at apex, arcuate-emar-

ginate at apex, anterior angles acute, sides very feebly widened to beyond half-way, then slightly sinuous before the sublobate (produced but blunted) hind angles, base feebly bisinuate, sides with narrow raised border, concave within border, but without any differentiation from disc in sculpture, medial line faintly impressed. *Scutellum* widely transverse and punctate. *Elytra* of same width as prothorax at base, widest behind middle, each elytron with four shining black crenulate costæ (the suture also slightly raised), the first joining the third near apex, the second much shorter, joining the first before the apical declivity, the fourth more irregular and discon-

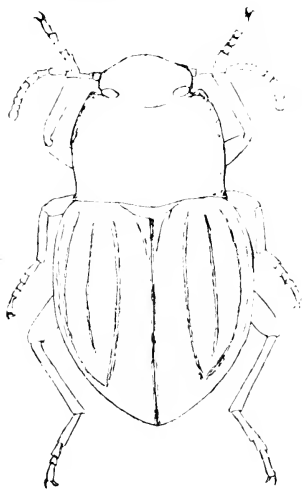

Text-fig. 2.

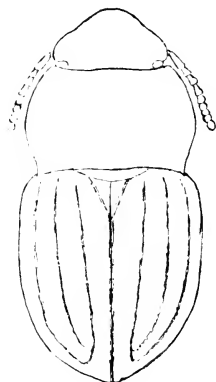
Nyctozoilus parvus, n.sp.

Text-fig. 3.

N. Dameli Haag.

nected; intervals uneven, with a subobsolete indication of vermiculation, and (under a lens) seem to be densely punctate. Underside finely punctate. *Dimensions*: $11\frac{1}{2} \times 5\frac{3}{4}$ mm.

Hab.—Townsville, Queensland (Ejner Fischer; from National Museum, Melbourne).

A single specimen sent, is an ally of *N. Dameli* Haag, from which it differs in its narrower, more straightened prothorax, with its more acute anterior and sublobate posterior angles (acute in *O. Dameli*). The sculpture of the whole upper surface is finer, and the body less widened behind, than in my specimen

of *O. Diemeli* Haag, from Rockhampton. Type in the National Museum, Melbourne.

MENERISTES POROSUS, n.sp.

Elongate-ovate, polished nitid black; antennæ, palpi, and tarsi dark red.

Head finely but distinctly punctate, with a smooth transverse space behind eyes, epistomal suture semicircular, antennæ stout, extending to about half the length of prothorax. *Prothorax* 4.5 × 5 mm., widest at base, arcuate-emarginate at apex, strongly bisinuate at base, anterior angles advanced and acute, posterior angles forming an acute tooth obliquely produced backward, sides rather widely rounded in front of and a little sinuate behind the middle, lateral border raised, narrowly sulcate within, near each posterior angle a large, deep, pear-shaped fovea, and a shallow oval fovea at middle of base; disc (under lens) seen to be finely punctate; an impressed medial line faintly traceable. *Scutellum* triangular. *Elytra* wider than prothorax at base, and twice and two-thirds its length, shoulders rather square, subsulcate-punctate, with nine rows (besides a short scutellary row) of large subrectangular punctures, increasing in size laterally, decreasing towards base and apex, the two striæ nearest suture strongly, others less strongly sulcate, intervals moderately convex, and very minutely punctate; sternum lightly transversely striolate, abdomen longitudinally so, the last segment finely punctate. Front tibiæ of male slightly flattened and widened above middle, enlarged, curved and twisted inwards at apex, mid- and post-tibiæ curved. In female, tibiæ nearly straight. *Dimensions*: 15-19 × 6-7 mm.

Hab. — Atherton and Cairns, Queensland (A. M. Lea).

This is the species mentioned in my revision of the Tenebrioninæ (These Proceedings, 1914, p.54); which, on further examination, is, I am sure, quite distinct from *M. laticollis* Pasc. In my Table (*l.c.*), it should be placed amongst the second group, "polished ebony-black"; and may be readily distinguished from the two species (*M. latior* and *M. proximus*), with unarmed hind tibiæ in male, by the unusual size and form of the seriate punc-

tures of the elytra. The strongly dentate hind angles of prothorax, and the large, deep, foveæ within, are also characteristic of this species. Five specimens under examination, two male, three female. Mr. Lea took many specimens on his Queensland expedition. Types in Coll. Carter.

PLATYPHANES SIMILIS, n.sp.

Elongate-ovate, brilliant metallic and varicoloured above, head and pronotum greenish-purple, the latter colour prevalent towards sides; elytra green with a purple tinge, becoming brassy or purple towards sides; underside and appendages nitid black, penultimate segments of abdomen with narrow red margin.

Head: labrum prominent, epistoma truncate in front, canthus rounded and slightly raised, eyes separated by a space less than the transverse diameter of one eye, closely punctate, antennæ not extending to base of prothorax, joint 3 slightly longer than 4, 8-10 widened and flattened, 11 ovate. *Prothorax*: 5×8 mm., arcuate-emarginate at apex, anterior angles strongly advanced and subacute, sides evenly rounded, wider at base than at apex, posterior angles rectangular, base sinuate, lateral borders rather strongly reflexed and channelled within, apical border narrowly raised but vanishing at middle, disc closely, unevenly punctate, with two basal depressions, and a faint medial depression near base. *Scutellum* triangular, convex, and clearly punctate. *Elytra* convex, slightly wider than prothorax at base, parallel for the greater part; striate-punctate, striæ irregular, with about fourteen rows of large punctures, varying in size, and obsolescent towards apex, besides a short scutellary row: the first ten rows and the external row regular, between these the punctures are close, irregular, or scarcely seriate; intervals convex, lævigata and narrow, except the fourth, this wide and subcostate. *Epi-pleuræ* with scattered punctures, prosternum carinate, produced in front and coarsely punctate, first segment of abdomen strongly rugose-punctate, apical segments finely and closely punctate. *Dimensions*: 23×11 mm.

Hab.—Dalby (Mrs. Hobler), and Endeavour River, Queensland. Coll. French, in National Museum, Melbourne.

Two specimens examined, both ♀, I think, belong to a species singularly like *P. chalcoptroides* Cart., in form, size, and colour. It may be readily distinguished from it, however, by the following differences, *inter alia*. Anterior angles of prothorax more acute (though slightly blunted at tips), and more strongly produced; disc of prothorax and epipleuræ of elytra more strongly punctured: the elytral sculpture entirely different, as follows:—

P. chalcoptroides.—With ten rows of small punctures, intervals wide and flat.

P. similis.—About fourteen rows of large punctures, including a sublateral irregular system: intervals narrow and convex, with one wider subcostate interval.

Type in Coll. Carter: cotype in National Museum, Melbourne.

ECTYCHE BICOLOR, n.sp.

Head, prothorax, and underside dull black, elytra bright metallic blue-green, antennæ and legs piceous, the basal joints of the former, and the tarsi reddish, the whole upper surface (including antennæ and legs) clothed with long, erect, black hairs.

Head and *prothorax* densely rugose-punctate, the ridges arranged in a longitudinal direction, eyes transverse, basal joints of antennæ obconic, apical joints moniliform and larger. *Prothorax* moderately convex, arcuate at apex, anterior angles obtuse, sides evenly rounded, base with acute teeth in the middle of the posterior emargination (as in *E. sculpturata* Bates), disc without any trace of medial line. *Scutellum* small, triangular. *Elytra* ovate, base truncate, shoulders sharply obtuse, coarsely crenate striate-punctate, the seriate punctures large and close, intervals convex and setose-punctate, underside setose-punctate. *Dimensions*: $5\frac{1}{2} \times 2\frac{1}{4}$ mm.

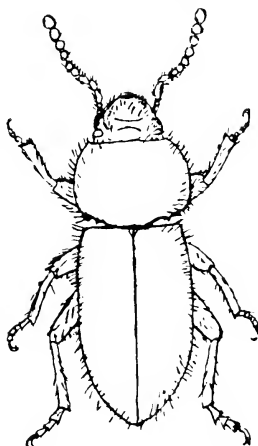

Text-fig. 4.

Ectyche bicolor, n.sp.

Hab.—King River, Northern Territory (W. McLennan).

Two specimens, sex doubtful, sent from the National Museum, Melbourne, differ from *E. cœrulea* Champ., in the following, *inter multa alia*. Size smaller, prothorax black, the sculpture closer and rugose, basal teeth more acute, elytra of that elusive colour peacock-blue-green, which is blue or green according to the point of view (*E. cœrulea* is purple-blue), the sculpture throughout coarser, elytral intervals more convex. Of the genus *Ectyche*, six species have been described, of which I think I possess five. These are all black except *E. cœrulea* Champ., of which I have cotypes from the author. Type in the National Museum, Melbourne.

DÆDROSIS INTERRUPTA, n.sp.

Elongate-ovate, dark bronze, nitid, strongly pilose, antennæ piceous with apical joints opaque.

Head irregularly punctate, a few large punctures on epistoma and forehead, epistomal suture wide and deep, antennæ extending to base of prothorax, 3rd joint as long as 4.5 combined, 8-10 strongly widened, 11 ovoid, once and one-half as long as 10. *Prothorax* rather convex, apex semicircularly emarginate, base truncate, wider than apex, anterior angles prominent, slightly rounded, posterior obtusely angulate, sides evenly and widely rounded, widest at middle, disc with very coarse punctures, sparsely and irregularly placed, each bearing a long, upright, dark hair. *Scutellum* subtriangular, rounded behind, punctate. *Elytra* slightly wider than prothorax at base, shoulders rather squarely rounded, sides subparallel, substriate-punctate, the striae irregularly interrupted by smooth, transverse cancellation, towards the sides becoming series of elongate foveæ of irregular length, the punctures in striae large, intervals themselves with large setiferous punctures, each bearing an upright hair. Fore- and mid-tibiæ slightly curved; underside with a few scattered setæ, apical segment of abdomen coarsely punctate. *Dimensions*: 10 × 4 mm.

Hab.—Cairns, Queensland.

A specimen given to me by Mr. A. M. Lea, some time ago,

differs from all described species in the combination of strongly pilose body, robust form, coarse and irregular punctures of pronotum, and an elytral sculpture *sui generis*. In my Table of the genus (Trans. Roy. Soc. S. Aust., 1914, p.388), it should follow *D. hirsuta* Cart. Type in Coll. Carter.

OMOLIPUS CÆRULEUS, n.sp.

Oval, convex, upper surface and abdomen nitid blue: prosternum, legs, and tarsi black, antennæ with basal joints blue, apical joints opaque black. (Pronotum sometimes purplish).

Head finely and densely punctate, epistomal area depressed, rounded in front, limited behind by arcuate suture, antennæ with joints strongly widened to apex, the last four joints wider than the rest, eleventh elongate-ovate. *Prothorax* $2 \times 2\frac{1}{4}$ mm., very convex, base and apex subtruncate, widest in front of middle, sides rather straightly narrowed behind, anterior angles depressed and rounded, posterior angles obtuse; basal margin raised, lateral margins not evident from above, disc very finely and closely punctate without medial line. *Scutellum* very small and transverse. *Elytra* oval, convex, of same width as prothorax at base, and twice as long: striate-punctate, the striae clearly defined throughout, the punctures therein round and fairly regular, those in sutural region less evident than in the exterior striae, intervals (especially near suture) convex and microscopically punctate. Prosternal intercoxal process small, not produced, abdomen very finely and closely punctate. *Dimensions*: 7-8 \times $2\frac{1}{2}$ -3 mm.

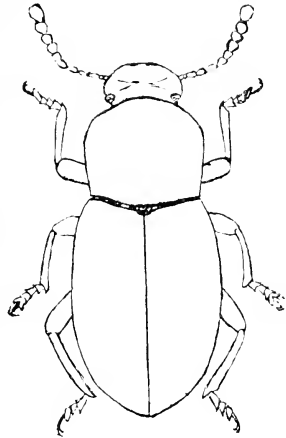

Text-fig.5.
Omolipus caeruleus, n.sp.

Hab.—King River, Northern Territory (W. McLennan).

Three specimens (one, I think, ♂) sent from the National Museum, Melbourne, labelled as above. The species is clearly

distinct from all described species, in the combination of short mesosternum, blue surface, and clearly striate elytra. In my Table (These Proceedings, 1915, p.535) it should stand next to *O. bimetallicus* Cart. Types in National Museum, Melbourne.

TARPELA DODDI, n.sp.

Elongate, subnavicular, convex, brilliant violet-purple above, nitid black beneath, antennæ and tarsi red, legs reddish

Head rather square, epistoma truncate, eyes large, reniform,

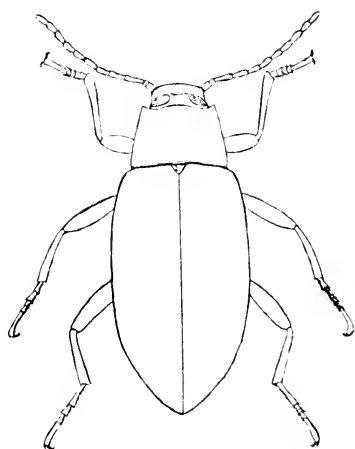

Text-fig.6.

Tarpeia doddi, n.sp.

impinged on by canthus, and separated by a space less than half the diameter of one eye; forehead closely and coarsely punctate, antennæ extending considerably behind the base of prothorax, joints 3-5 subcylindric, gradually diminishing in length, 6-10 elongate-obconic, 11 oblong-ovate. *Prothorax*: ($3\frac{1}{2} \times 4$ mm.), widest at base, sides nearly straight, gently narrowing to apex, anterior angles sharply acute and produced forward and downward; base truncate; posterior angles, seen from above, subrectangu-

lar, sides deflexed without lateral border, basal border raised, surface rather strongly, irregularly, not closely punctate, medial line clearly marked on basal two-thirds at the bottom of a wide depression. *Scutellum* curvilinear-triangular, punctate. *Elytra* slightly wider than the prothorax at base, and nearly thrice as long, strongly convex with steep apical declivity, and acute depressed apex: striate-punctate, with nine rows of large, irregular, rectangular or square, foveate punctures, crenulating the sides of the costate intervals, these punctures obsolete on the apical declivity and subobsolete in the first, or sutural row; a short, extra-scutellary row of smaller foveæ; intervals smooth;

towards apex the third, fifth, and seventh intervals forming prominent ridges, the third and seventh joining close to apex. *Prosternum* punctate, its process declivous, mesosternum widely excavate, abdomen smooth, or only microscopically punctate on last segment; tibiæ unarmed at apex. *Dimensions*: 14 × 6 mm.

Hab.—North Queensland (? Kuranda; H. Dodd).

A single female specimen, with prominent ovipositor, received some time ago from Mr. Dodd, of Kuranda, without special locality-label. The only other species of this genus described from Australia is *T. catenulata* Allard, from which the above may be easily distinguished by noting the following details in the description of Allard's species. Size 7 × 3 mm. Colour reddish-brown or bronzy; prothorax strongly bisinuate at base, posterior angles directed backward, and acute. Elytra with thirteen furrows. Type in Coll. Carter.

CATOPHERUS, n.g.

Apterous; ovate; head vertical, labrum prominent, showing membranous hinge; mandibles singly pointed at apex, epistoma convex, squarely rounded, limited behind by a well-marked suture; eyes horizontal, wide, nearly enclosed by prothorax, and impinged on by the obliquely-raised canthus, last joint of maxillary palpi securiform; antennæ long, slender, apical joints not enlarged nor flattened, joint 1 large, swollen at apex, 2 bead-like, the other joints obconic. Prothorax bulbous, largely enclosing head, sides continuous with episterna (upper and lower surface subcontinuous). Elytra very convex and ovate, nearly twice as wide, and more than thrice as long as prothorax, seriate-punctate. Prosternum narrowly declivous, mesosternum widely excavate, posterior intercoxal process widely arcuate, front coxæ round, mid coxæ with trochantins, hind coxæ widely separated. Legs long, femora swollen, pro- and mid-tibiæ slightly curved, tibial spurs small; apex of tibiæ and tarsi clothed with fine short hairs, first joint of hind-tarsi longer than claw-joint.

An aberrant genus, unlike any Australian Tenebrionid known to me. The form, curiously humped, with head quite invisible from above, except for the tips of the canthi, suggest some of

the Amycterid weevils. It may be tentatively placed in the tribe *Meacanthini*, as defined by Leconte and Horne.

CATOPHERUS CORPULENTUS, n.sp.

Stoutly ovate; head, thorax, abdomen, and legs polished ebony-black, elytra metallic green with a purple tinge, suture of elytra green.

Head closely and strongly punctate, antennæ with joint 3 cylindrical, as long as 4-5 combined, 4-8 successively increasing in thickness and length, 9-11 thinner, the apical joint tapering.

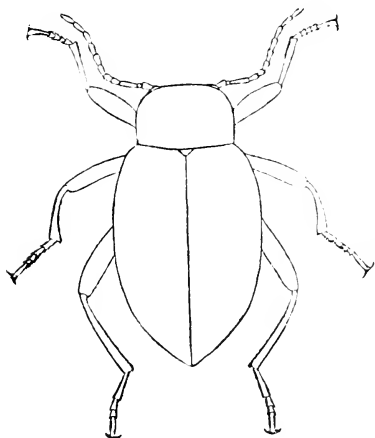

Text-fig. 7.

Catopherus corpulentus, n.sp.

Prothorax $3\frac{1}{2} \times 5$ mm, truncate at apex and base, anterior angles obsolete, widest in front of middle, sides nearly straight behind, widely rounded towards apex; posterior angles subrectangular but depressed, disc smooth with small medial dent at apex and base, and (under a strong lens) showing minute shallow punctures; basal border narrowly raised. *Elytra* of same width as prothorax at base, soon widening—shoulders ob-

solete—widest behind middle: seriate-punctate, with nine rows of large punctures, forming crenulations on the raised, but not costate intervals; these smooth and impunctate. Epipleuræ narrow and smooth; apical segment of abdomen minutely punctate, other segments polished. *Dimensions*: $16\frac{1}{2} \times 8$ mm.

Hab.—Yorkshire Downs, North Queensland.

A single specimen, probably female, was sent me some years ago by Mr. C. French, but I have hesitated to describe it through the uncertainty of its position. The vertical head, vertically rounded prothorax, with the pronotum embracing and subcontinuous with the episterna, long and slender antennæ, and long

legs form a combination of characteristics at variance with any described genus of Australian Tenebrionidæ. Type in Coll. Carter.

AMARYGMUS SULCATUS, n.sp.

Ovate, subnitid black; oral organs, antennæ, legs, and tarsi red, the last clothed with pale red tomentum.

Head finely and densely punctate, eyes moderately close, space between them about half the length of the first antennal joint, antennæ long and thin, exterior joints slightly enlarged, joint 1 stout, as long as 3, 4-10 subequal in length but successively thicker. *Prothorax* convex, very transverse, base twice as wide as apex, both subtruncate, sides arcuately widened from apex to base, anterior angles depressed and obtuse, posterior widely obtuse, disc minutely punctate, medial line faint. *Scutellum* arcuate-triangular. *Elytra* of same width as prothorax at base, and more than thrice as long, punctate-sulcate, the punctures large, evenly placed, and impinging on the strongly convex sides of the intervals, the first two intervals wider and flatter than the rest, but with them continuous to and strongly carinate on apex, intervals microscopically and closely punctate; prosternum smooth, abdomen rather strongly longitudinally striolate, tibiæ, especially the post-tibiæ, curved. *Dimensions*: 9-10 × 5 mm.

Hab.—Melville Island (W. D. Dodd).

Nine specimens, sent from the South Australian Museum, differ from all described Australian species in the deep sulci, and strongly raised elytral intervals. It is nearest to *A. striatus* Macl., from which it obviously differs in the larger seriate punctures, deeper sulci, and less nitid surface. Types in the South Australian Museum.

TANYCHILUS OPACUS, n.sp.

Elongate, navicular, opaque black above, nitid black beneath, antennæ and tarsi piccous.

Head and prothorax densely, subconfluently punctate, labrum strongly produced, eyes large, prominent, coarsely faceted, separated by a space less than the diameter of one; canthus with a carinate ridge, antennæ long, joint 3 cylindric, longer than 4,

4-10 sub-subulate, apical joint elongate-ovate. *Prothorax* slightly narrower than head at apex, feebly widened to the middle, then subparallel to base; (in the male specimen, nearly cylindrical), truncate at apex and base, a wide medial depression (varying in depth and extent in the three specimens), posterior angles rectangular. *Scutellum* oval. *Elytra* considerably wider than prothorax at base, tapering to the apex; (in female specimens, slightly widened behind middle), striate-punctate, the punctures in striæ square, close and separated by cancellate ridges, more obvious towards sides; intervals finely costate and longitudinally rugulose. Underside coarsely and rather distantly punctate, the punctures finer and denser towards the apex of abdomen, legs long and longitudinally rugulose. *Dimensions*: 9-10 × 2½-3 mm.

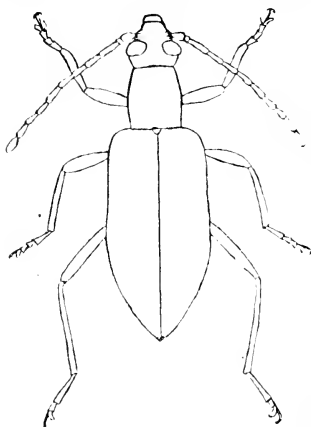

Text-fig.8.

Tanychilus opacus, n.sp.

separate it from *Tanychilus*, with which it corresponds in other respects, notably in the head and carinate canthus-ridges, the long antennæ and legs, basal joint of posterior tarsi as long as the rest combined. Its small size, opaque colour, and distinct elytral sculpture easily distinguish it from other described species. The outline figure given is that of a ♀, as being better set for drawing. Types in the National Museum, Melbourne.

Hab.—King River, Northern Territory (W. McLennan).

Three specimens (one ♂) of a puzzling species to place, have been sent from the National Museum, Melbourne. I cannot, however, find any character beyond the more elongate, subcylindric prothorax to

Strongylium longicrurum, nov.nom. = *S. longipes* Carter, nom. præocc. —Mr. K. G. Blair has been good enough to inform me that the name *longipes*, which I used in describing a Queensland species (These Proceedings, 1915, xl., Pl. 3, p.525), has been already twice used, once by Hope (Zool. Misc., i., 1831, p.31), a

paper omitted from the Catalogues; secondly by Gebien (Notes Leyd. Mus, xxxvi., p.79). The latter was not then included in the Junk Catalogue (1911), edited by Gebien. I therefore propose the name *S. longicrurum* for my species.

The following synonymy may be noted :—

- (1) *Hyocis Bakewelli* Pasc. = *H. cancellata* Lea
- (2) *Saragus sphaeroides* Cart. = *S. strigiventris* Lea.
- (3) *Platydemus striatum* Montr. = *P. kanalense* Perr. = *P. oritica* Pasc. = *P. Championi* Blackb. = *P. obscurum* Blackb.
- (4) *Platydemus limacella* Pasc. = *P. fossulatum* Blackb.
- (5) (?) *Onosterrhus major* Blackb. = *O. heroina* Blackb.
- (6) *Prophanes aculeatus* Westw. = *Marodes Westwoodi* Macl.

With regard to Nos.(1) and (2), I have examined Mr. Lea's types. *Hyocis cancellata* cannot, I think, be considered more than a variety of *H. Bakewelli* Pasc. No.(2) is certain by comparison of types.

(3) Bates pointed out the synonymy of *P. striatum* Montr., and *P. oritica* Pasc. That *P. Championi* Blackb., is the same species, is my own conviction deduced from the descriptions, and from Queensland specimens in my collection.

(4) I had also similarly marked down the identity of Blackburn's *P. fossulatum* with *P. limacella* Pasc., when Mr. Blair wrote to me that "a comparison of the types makes the identity certain."

(5) I have placed a query before the synonymy of *Onosterrhus major* Blackb., with that of *O. heroina* Blackb., since I have only one specimen that exactly corresponds to the description of the latter. Five other specimens, evidently *O. major* (from Yalgoo, Kalgoorlie, Shark's Bay, and Cue) show variations that are intermediate forms. It is unnecessary, to my mind, to separate them.

(6) I have already noted in my "Revision of the Cyphaleinae" (These Proceedings, 1913, p.63) the strong presumption that *Marodes Westwoodi* Macl., was *Prophanes aculeatus* Westw. The type of the latter appears to have been lost. I believe now this synonymy to be correct, consequently the generic name *Marodes*

must disappear, since the same insect has been used as the type of *Prophanes*. The fine distinctions drawn between these genera seem to render it unnecessary to suggest a new generic term for the more widely ovate and coarsely punctured species *P. ducalis* Cart., and *P. mastersi* Macl.

The genus *Prophanes* will thus contain the following species—*P. aculeatus* Bates = (*Mærodes*) *Westwoodi* Macl.; *P. brevispinosus* Cart.; *P. Browni* Cart.; *P. ducalis* Cart.; *P. Kershawi* Cart., (*Mærodes*); *P. Mastersi* Pasc. = *P. chalybeipennis* Macl.

STIGMODERA ROSTRALIS, n.sp.

Rather widely oval; head, prothorax, abdomen, and appendages coppery-bronze; elytra orange with blue markings as follows: base and suture widely, large subrectangular apical patch and fasciæ; the first postbasal, joining the basal blue margin on shoulders, and bifurcating at sides; the second postmedian, irregular in outline and extending to the sides.

Head unusually elongate, labrum emarginate, epistoma with triangular excision, forehead channelled, strongly punctate. *Prothorax* convex, truncate at apex, rather strongly trisinate at base, sides widely rounded, widest at middle, posterior angles obtuse, closely punctate, the punctures finer in the middle, coarse towards

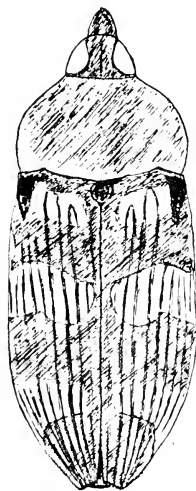

Text-fig. 9.

Stigmodera rostralis, n.sp.

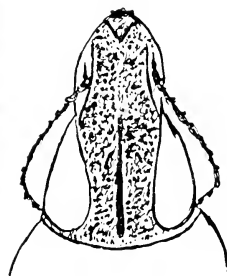

Text-fig. 10.

sides. *Scutellum* cordate, concave, channelled medially, smooth. *Elytra* with humeral angle sharply rectangular, sides slightly enlarged behind middle, each apex obliquely truncate, latero-apical sides clearly serrated; striate-punctate, intervals everywhere convex, becoming carinate at

sides and apex, and themselves coarsely punctate; prosternum

horizontally strigose, its flanks and the whole meso- and metasternum coarsely punctate; abdomen finely and closely punctate, and rather thickly clothed with short whitish hair. *Dimensions* : $14 \times 10\frac{1}{2}$ mm.

Hab.— Queensland.

A single specimen (♀) was generously given to me by Mr. J. C. Goudie, who tells me that he received it from Mr. C. French. It bears a label "Q. 1902." It is remarkable for its prolonged beak (Text-figs. 9-10). The length of the head thus prolonged is almost exactly the same as that of the prothorax, viz., $3\frac{1}{2}$ mm. This character, combined with its robust form, and the truncate apices of the elytra, make it easy to identify. The elytral pattern is somewhat as in *S. cupreoflava* Saund. Type in Coll. Carter.

PERMIAN AND TRIASSIC INSECTS FROM NEW
SOUTH WALES, IN THE COLLECTION OF MR.
JOHN MITCHELL.

BY R. J. TILLYARD, M.A., B.Sc., F.L.S., F.E.S., LINNEAN
MACLEAY FELLOW OF THE SOCIETY IN ZOOLOGY

(With seventeen Text-figures).

INDEX.

	PAGE.
INTRODUCTION	721
SECTION A.—The Permian Insects	724
i. Newcastle Insect :—	
Order HEMIPTERA, Suborder HOMOPTERA.	
Family CERCOPIDÆ.	
<i>Permosecta mitchelli</i> , n.g. et sp.	728
ii. Belmont Insects :—	
Order HEMIPTERA, Suborder HOMOPTERA.	
Family PERMOFULGORIDÆ, fam.nov.	729
<i>Permofulgor belmontensis</i> , n.g. et sp.	731
Order MECOPTERA.	
Family PERMOCHORISTIDÆ, fam.nov.	732
<i>Permochorista australica</i> , n.g. et sp.	733
<i>Permochorista mitchelli</i> , n.g. et sp.	734
Restoration of the Wing-venation in the Genus <i>Permochorista</i> ...	736
iii. Permian Insects Incertæ Sedis	740
SECTION B.—The Triassic Insects	742
Order PROTORTHOPTERA.	
<i>Notoblattites wianamattensis</i> , n.sp.	743
<i>Notoblattites mitchelli</i> , n.sp.	745
Order MECOPTERA.	
Family MESOPANORPIDÆ, fam.nov.	746
<i>Mesopanorpa wianamattensis</i> , n.g. et sp.	747
Order COLEOPTERA.	
Family HYDROPHILIDÆ(?)	750
<i>Adamosque wianamattensis</i> , n.sp.	750

Family ELATERIDÆ(?)	751
<i>Elateridium</i> (n.n.) <i>angustum</i> , n.sp.	751
Family TENEBRIONIDÆ	752
<i>Addidium cordatum</i> , n.g. et sp.	752
Family MALACODERMIDÆ	752
<i>Metrorhynchites grandis</i> , n.sp.	753
Order HEMIPTERA, Suborder HOMOPTERA.						
Family PSYLLIDÆ	753
<i>Triassopsylla plecioules</i> , n.g. et sp.	754
Triassic Insects Incertæ Sedis	754
Note on a Silurian Fossil	756

INTRODUCTION.

In 1916, Mr. John Mitchell, late Principal of the Newcastle Technical College, very kindly sent me the fossil insects in his collection, for study. The collection consisted of thirty-six specimens, of which twenty-five were from the Wianamatta Shale deposits of Narellan and Glenlee, ten from the Upper Coal-Measures of the Newcastle District, and a single specimen from Silurian strata. This last, as might be expected, proved, on examination, not to belong to the Insecta. In forwarding these specimens, Mr. Mitchell also told me that the most perfect specimen of all, from the Coal-Measures, was not included in the collection, as it had been stolen during an exhibition of the specimens at Newcastle.

Several of the specimens forwarded do not belong to the Insecta, while there are a number that are too fragmentary to enable me to place them at all definitely. When all these have been eliminated, there remain twelve specimens which I considered it worth while to name, figure, and study in detail. Of these, eight are from the Wianamatta Shale, and four from the Coal-Measures. The other specimens are dealt with more briefly, under the headings of Insects Incertæ Sedis, for their respective geological horizons. The numbers, by which the specimens are alluded to, are those affixed to the actual specimens by Mr. Mitchell. The specimens carry no other labels, unless such are specially mentioned. To each specimen which I have made the type of a new species, I have affixed a label in my own handwriting, indicating that fact.

I should like here to express my grateful thanks to Mr. Mitchell for his kindness in allowing me to study these valuable fossils. As I hope to show in this paper, the conclusions to be drawn from even this small collection, particularly with regard to the Permian fossils, are far-reaching, and of great importance in the study of the Phylogeny of the Insecta. I desire also to thank him for supplying me with interesting data as to the age and position of the fossils. The details given in this paper, as to the exact horizons of the various Insect-bearing Beds, are compiled from very complete and detailed information contained in a series of letters sent to me by Mr. Mitchell on this subject. As regards the age of the Upper Coal-Measures and of the Wianamatta Shale beds, I have to thank both Mr. Mitchell and Mr. A. B. Walkom, B.Sc., Assistant Lecturer in Geology in the University of Queensland, for their valuable help in deciding these questions for the purposes of this paper.

The geological evidence has been given at some length, because the character of the Permian fossils here described is such that the age assigned to them might well be questioned by geologists in the Northern Hemisphere, if the evidence admitted of any doubt on the matter. I believe I am right in stating that *no remains of undoubted Holometabolous Insects are, so far, known from any Paleozoic strata*. As the Mecoptera appear to have been well represented in the Newcastle Coal-Measures, by forms differing little from those still living in Australia, the importance of this discovery will be at once recognised. Further, as the subdivision of the extensive Order Hemiptera into its two Suborders, Heteroptera and Homoptera, is generally supposed not to have taken place before Triassic times, the occurrence of an almost perfect tegmen of a definite Cercopid type in these Coal-Measures is of very great interest.

The fossils from the Wianamatta Shale are mostly similar to forms already described from the St Peter's beds, near Sydney. The single specimen from the later horizon at Narellan belonged to a genus so far confined to Ipswich, where it is abundant. Thus there is a basis for the suggestion that further work at this particular horizon of the Wianamatta Shale beds might result

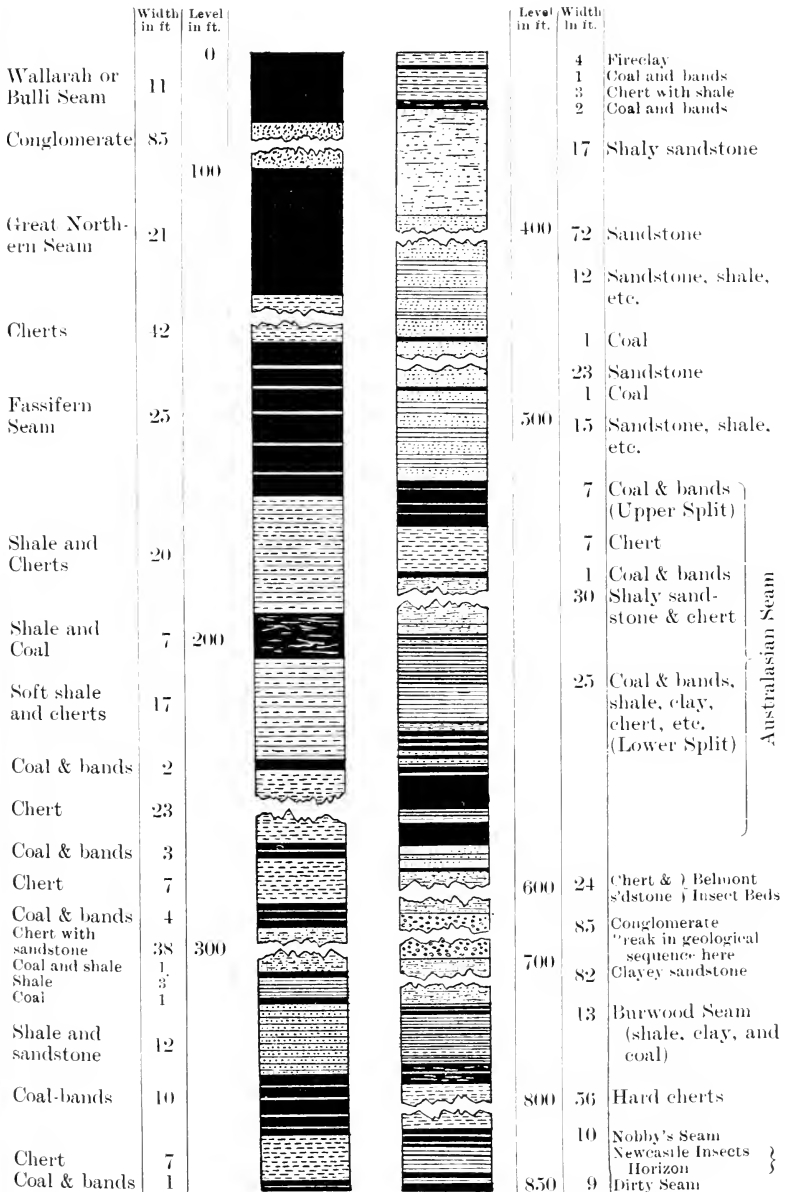

Text-fig. 1.—Section through the Upper Coal-Measures, Lake Macquarie Basin to Newcastle, N.S.W., from the top (Wallarrah Seam) to the Dirty Seam. Reduced and simplified from original section by Prof. T. W. E. David, F.R.S.

in the establishment of a correlation between it and the Insect-Bed at Ipswich. It is, in any case, important to have both the Wianamatta and Ipswich Beds definitely fixed as Upper Triassic, a conclusion which Mr. Walkom's recent researches seem to make fully justified.

SECTION A. THE PERMIAN INSECTS.

The ten specimens from the Newcastle Coal-Measures are numbered 23 to 32 inclusive. Of these, Nos. 23 and 32 were taken from just above the Dirty Seam at Newcastle, at a place near the Soldiers' Baths, about two feet above high water-mark. Nos. 24 to 31 inclusive come from the Belmont Fossil Beds, about two miles on the Newcastle side of Belmont, a village on the northern shore of Lake Macquarie, some three miles from the Pacific Ocean.

Both the Newcastle and the Belmont specimens come from well within the Upper Coal-Measures. In Text-fig. 1, I offer a section taken through the upper two thirds of these measures, from the shores of Lake Macquarie up to Newcastle. This section is simplified and abbreviated from Section No. 12, published by Professor David in his well-known work on the Geology of the Newcastle and Greta Coal-Measures (Mem. Geol. Survey, New South Wales, Geol. No. 4). It gives the succession of strata from the top of the Coal-Measures (Wallarah Coal-Seam) to a vertical depth of about 850 feet (top of the Dirty Seam). Below this, there lies a thickness of another 400 feet, not shown in the figure, including the Borehole and Waratah Coal-Seams.

Mr. Mitchell has kindly marked for me the exact positions of the strata from which the insects were taken. The Belmont Insect-Beds consist chiefly of hard cherts and shaly sandstones, lying at a vertical level of about 600 feet below the top of the Upper Coal-Measures, and succeeded by a very thick stratum of conglomerate, containing waterworn pebbles of coal. Below this, in the actual section shown by Professor David, there is a definite break in the geological sequence; but Mr. Mitchell informs me that this break is only a local one, and not of much consequence. Its only effect would be to increase somewhat the

actual difference in geological time between the Belmont fossils and those from the top of the Dirty Seam at Newcastle. These latter, even if nothing is allowed for the break, lie some 250 feet below the horizon of the Belmont Beds. They are, therefore, by far the oldest, fossil insect-wings so far discovered in Australia.

The Upper Coal-Measures, in which the insects are found, are generally classed in text-books as Permo-Carboniferous. This name, first suggested by Mr. R. Etheridge, Junr., is applied to the immense series of marine and freshwater beds, totalling a maximum thickness of about 17,000 feet, which overlie the true Carboniferous Beds in New South Wales, and are, in turn, followed by the freshwater Triassic strata. The marine beds contain a fauna which shows affinities with both Carboniferous and Permian marine faunas of the Northern Hemisphere. The name Permo-Carboniferous is an attempt to emphasise this fact. When, however, we come to apply the term to the freshwater beds of the Upper Coal-Measures, we are met with the difficulty that this Permo-Carboniferous affinity with the Northern Hemisphere faunas does not exist in this case, since the flora displays a more decidedly Mesozoic aspect, and does not possess a single one of the Carboniferous genera. The *Calamites*, *Lepidodendron*, and *Rhucopteris* of the Carboniferous have disappeared; and, in their places, we find *Phyllothea*, *Schizoneura*, *Alethopteris*, *Sphenopteris*, and *Baiera*, all represented also in the Triassic, together with an abundant *Glossopteris*-flora (which is typical of the Permo-Carboniferous only), *Annularia*, *Gangamopteris*, *Vertebraria*, *Dadoxylon*, and other genera not found in the Trias. Thus, as far as the flora is concerned, it would be more logical to coin the term Triasso-Permian for it, than to retain the term Permo-Carboniferous. As the Insects studied in this paper have nothing in common with any known Carboniferous fauna, but show distinct affinity with the Triassic forms already brought to light, I think that I should be open to the charge of misleading students of Palæo-entomology in other parts of the world if I classed them as Permo-Carboniferous. The term Permian is less open to objection, and I have adopted it in this paper. As all the

insects occur within the first 1,000 feet in vertical depth below the bottom of the Triassic, out of a total of 17,000 feet for the whole of the Permo-Carboniferous strata, it will be seen that one might even be justified in describing them as Upper Permian.

Geologists recognise the dividing line between the Permian and Lower Triassic strata to be the disappearance of *Glossopteris*, and the advent of the various species of *Thinnfeldia* and *Tanipteris*. The Belmont insects are found associated with various species of *Glossopteris*, and with the interesting bivalved Crustacean, *Levia mitchelli* Eth., belonging to a genus of which the type-species is found in the Permo-Carboniferous of the United States. The Newcastle Insects, Nos. 23 and 32, were found associated with *Glossopteris linearis* McCoy, *G. browniana* Brongn., and many other species of this genus, together with *Sphenopteris germanus* McCoy, and with *Phyllotheca*.

The important point to bear in mind, for students of Palæoentomology, is that these insects are undoubtedly Palæozoic; and, as such, they exhibit a fauna which promises to be, when more fully explored, quite unlike anything at present known from Palæozoic strata.

DESCRIPTIONS OF THE SPECIMENS.

i. *Insect from the top of the Dirty Seam, Newcastle.*

Order **HEMIPTERA.**

Suborder **Homoptera.**

Family **CERCOPIDÆ.**

Subfamily **CERCOPINÆ.**

Genus **PERMOSCARTA**, n.g. (Text-fig.2).

Fairly small insects (tegmen about 6 mm.), with strongly built tegmina, finely tuberculate all over; the claval area of the usual Cercopid form, bounded anteriorly by the straight and strongly-formed vein 1A, and traversed near the middle by the subparallel and slightly wavy 2A; anal angle of the clavus not very sharply formed; the tuberculation extends all over the claval area. The tuberculation of the rest of the wing (corium) is slightly more definite in the basal than in the distal half, the

division between the two portions being faintly visible as an oblique line running from the costa, just above the origin of R_s , obliquely outwards and downwards to join the clavus close up to its distal angle. Costa edged by a distinct coriaceous border, which probably extended right round to 1A, as in most recent forms. R_s arising from R at about two-fifths of the wing-length, and continuing the line of R directly distad: R_1 arching strongly up anteriorly, and then turning so as to run halfway between C and R_s , parallel to both, and connected with both by a number of faintly indicated, slightly oblique cross-veins. M leaving R a little before one-fourth of the wing-length, and, very soon after, meeting Cu near its base, fusing with it for a very short distance,

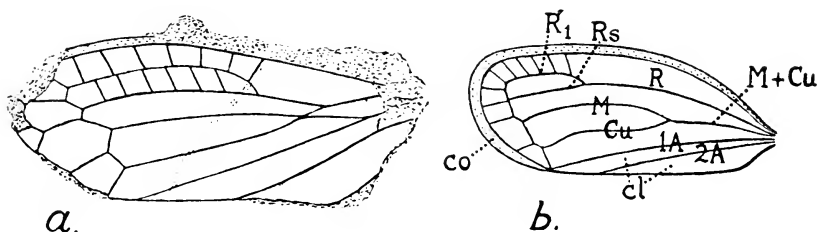

Text-fig. 2.

a., *Permoscarta mitchelli*, n.g. et sp., tegmen (length 6.4 mm.). Newcastle, Permian. The division between the stronger basal and weaker distal tuberculation of the wing-membrane is marked by the double dotted line, but the tuberculation itself is omitted. *b.*, Tegmen of *Eoscarta semirosea* (Walk.). Recent; Oriental Region. Tuberculation omitted; *cl*, claval area; *co*, coriaceous border.

and then diverging from it in the usual manner, so as to run longitudinally through the middle of the corium. Cu runs nearly parallel with 1A. R_1 , R_s , M, and Cu all fork widely in the last quarter of the wing-length, the branches of the forks uniting in the usual manner to form a series of four *apical cells*; but the stem formed by the union of the lower branch from R_s and the upper branch from M again forks widely as it approaches the wing-border. The lower branch from Cu reaches the border just beyond 1A.

Genotype: *Permoscarta mitchelli*, n.sp.

Horizon: Upper Coal-Measures of Newcastle, N.S.W.

So little appears to be known about the *Cercopinae* of Australia, that I am not able to indicate any named Australian species as showing affinity with this form. But there are a number of genera figured in Distant's excellent work on the Rhynchota of British India, Vol. iv., (in the "Fauna of British India") which appear to be closely related to this Permian fossil. For example, the genus *Eoscarta* Bredd., widely distributed in the Oriental Region, might well be the direct descendant of a form such as *Permoscarta*, as may be seen by referring to Text-fig. 2. A shifting of the origin of R_s distad along R to beyond halfway, a consequent reduction in the number of cross-veins connecting R with C and R_s , a simplification of the basal union of M and Cu , and finally a shortening of the apical cells, with elimination of the anomalous extra fork already noted at the tip of the wing, would convert *Permoscarta* by reduction into *Eoscarta*. Very possibly there still exist in Australia to-day forms more closely allied to *Permoscarta* than this Oriental genus is. It is to be hoped that the discovery of this fine fossil will stir up interest in our beautiful *Cercopidae*, amongst the smaller forms of which much work still remains to be done.

PERMOSCARTA MITCHELLI, n sp. (Text-fig. 2a).

Characters as given for the genus, with the following additions: *Total length of tegmen*, 6.4 mm; *greatest breadth*, 2.7 mm., at level of distal end of 1A.

All the veins very distinctly marked, except the small basal portion of Cu and the whole of R_1 , with its upper and lower series of cross-veins. In the first two drawings that I made of this insect, I completely failed to detect R_1 ; the third drawing was made under the camera-lucida in very strong, oblique, evening sunlight, in which, to my surprise, the whole of R_1 and its cross-veins showed up very clearly, when the wing was placed in a certain position only.

The specimen, which is beautifully preserved, is complete except for the absence of the greater part of the coriaceous border (which is, however, very distinctly marked distally above R_1), a

small piece cut out from the apex of the wing above the upper branch of Rs, and slight breaking away of the border distally beyond the end of 1A, and also basally on the clavus.

The specimen lies on the smooth, ochreous-grey surface of a very hard rock, and is of a somewhat darker colour (ochreous-brown) than the rock-surface. It also carries black, carbonised patches, which are quite absent from the rock itself, and may possibly be due to the carbonisation of an original wing-pigment. These markings take the form of a black band along the coriaceous border, with irregular patches extending in as far as R₁, a very definite mottling of black specks, inclined to run together, on the distal half of the corium, and a similar but less distinct mottling on the broad basal half of the clavus.

Type, Specimen No.23 in Coll. Mitchell.

Locality:—Taken from the top of the Dirty Seam, Newcastle, N.S.W., near the Soldiers' Baths, at a level about two feet above present highwater-mark. The depth of this horizon below the top of the Permian Coal-Measures is, as has been already indicated, at least 850 feet.

ii. *Insects from the Belmont Beds.*

Order **HEMIPTERA.**

Suborder **Homoptera.**

Family PERMOFULGORIDÆ, fam.nov.

Medium-sized insects, with rather narrow, elongated tegmen, in which certain cross-veins join obliquely with the main veins, so as to simulate dichotomous branchings of the latter, and thus form a series of apical cells, after the manner of recent *Cicadidae*. Claval area with unspecialised, anal veins; the typical Y-vein of recent *Fulgoridae* not formed. Coriaceous border of posterior margin of wing runs on distally beyond the end of the claval area.*

* This extraordinary character at once suggests the *suture* of the Coleopterous elytron. It is possible that we have here the first formation of that structure; but the Homopterous nature of this fossil seems fairly clear.

Genus *PERMOFULGOR*, n.g. (Text-fig.3).

Characters as for the family, with the following additions. Tegmen of delicate structure, not tuberculate, broadest not far from the base; costal border slightly convex. Veins of the clavus very strongly developed; those of the corium much weaker, and not easy to make out. Veins 1A and 2A apparently both two-branched from near their bases. Sc present, but ending up on the costal border well before halfway along the wing. R, M, and Cu apparently all closely united near their bases. R leaves M to run obliquely towards the costal border, and, at a level a little before the end of Sc, divides into R_1 and R_s , the latter continuing the line of the main stem, while R_1 arches upwards

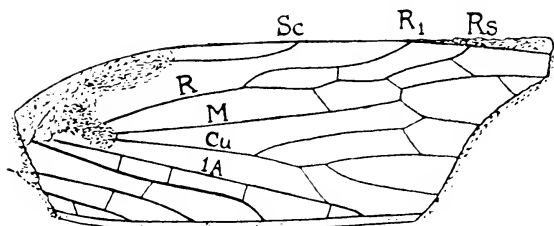

Text-fig.3.

Permofulgor belmontensis, n.g. et sp.; tegmen (length of fragment 9.5mm.).
Belmont; Permian.

towards Sc, then runs parallel to the wing-border for some distance, and finally meets it in an upward curve: about halfway along R_1 , a cross-vein connects it with R_s . M runs straight below R, gradually approaching the costal border, but not reaching it. Cu diverges from M, becoming subparallel to 1A; Cu gives off an anterior branch Cu_1 a little beyond the level of the origin of R_s ; the main stem (Cu_2) is broken a little further on, at a point where a long, oblique cross-vein connects it with 1A, and shortly afterwards divides into Cu_{2a} and Cu_{2b} . At about two-thirds of the wing-length, R_s , M, Cu_1 , and Cu_{2a} are connected by a set of three oblique cross veins, forming the bases of three *apical cells*, of which the two uppermost, at least, are again divided by oblique cross-veins nearer to the apical border. [Rest of tegmen missing].

Genotype, *Permofulgor belmontensis*, n.sp.

Horizon: Upper Coal-Measures of Newcastle, N.S.W.

Although this fossil appears, at first sight, to belong to the *Fulgoridae*, yet it differs from that family, as known to us at the present day, in a number of characters, chiefly amongst which must be reckoned the absence of the typical Y-vein of the claval area, which is peculiar to the *Fulgoridae* alone amongst the Homoptera. Hence it is necessary to place it in a new family, which probably had close affinity with the ancestors of our recent *Fulgoridae*, but clearly also does not lie in their direct ancestral line. This family also foreshadowed, in the arrangement of the oblique cross-veins in sets, the later development of the *Cicadidae*, which appear to have arisen in Cretaceous times.

In spite of its occurrence at a higher level in the Permian than the Newcastle fossil *Permoscarta* described above, this insect is clearly of a far more archaic type than the latter. But this need not surprise us, when we consider that the *Fulgoridae* of to-day still contain numerous forms with a dense, archaic, almost Neuropteroid venation, which must have been handed down with little change from very early ancestors.

PERMOFULGOR BELMONTENSIS, n.sp. (Text-fig.3).

Characters as given for the genus, with the following additions. Total length of the wing-fragment, 9.5 mm; greatest breadth, 3 mm.; probable total length of tegmen, 11 mm. The extreme base, as well as a considerable part of the apical area of the wing, is missing. There appear to be at least five weak cross-veins connecting the main veins of the claval area, as shown in Text-fig.3; but there may be more. Very careful manipulation of strong oblique light is necessary to follow the venation of the corium, and it is possible that I have omitted some cross-veins in this part of the wing also.

The specimen lies on the smooth, pale grey surface of a cherty rock, and would certainly have shown more detail if its actual venation had been strongly formed. This is proved by the fact, that the veins of the clavus stand up clearly and sharply from the smooth surface of the impression, whereas the veins of the corium are scarcely to be detected in a cursory glance.

Type, Specimen No.31 in Coll. Mitchell.

Locality: Belmont Beds at a depth of about 600 feet below the top of the Permian Coal-Measures.

Specimen No.25 appears to belong to this genus also; but, as it shows clearly only the strong veins of the clavus, I have not considered it worth naming.

Order **MECOPTERA**.

Family PERMOCHORISTIDÆ, fam.nov.

Scorpion-flies closely resembling the recent Australian *Choristida*, especially the genus *Teniochorista*, with which they agree in having many of the cross-veins very weakly formed and almost obsolete. Rs four-branched, the bifurcation of R_{2+3} taking place much further distad than that of R_{4+5} . M sends six branches to the apical margin of the wing. Cu_1 a straight vein without any branches. The main stem of M is fused basally with Cu_1 , and arises from it at a level far basad from that of the origin of Rs.

Genus PERMOCHORISTA, n.g. (Text-figs.4-6).

Medium sized insects (forewing about 10 mm. long) with moderately broad, well-rounded wings. Sc well-developed, reaching beyond half-way along the costal margin. Pterostigma well-developed, elongated, crossed by some weak cross-veins. Cross-veins moderately numerous, very weakly formed, and not specially arranged in such a way as to cause any bendings of the main veins, or the formation of the typical elongated hexagonal cells of more recent Mecoptera. Towards the apex, the cross-veins are either completely absent, or so weakly formed that they cannot be identified in the fossils.

Genotype, *Permochorista australica*, n.sp.

Horizon: Upper Coal-Measures of Newcastle, N.S.W.

The fossil wings of this genus already known are certainly three, and probably four, in number. Two are in Mr. Mitchell's Collection, and are here described. A third is at present on loan to the Natural History Museum in Paris, and would by now have been returned to me for study, had it not been for the risk

of sending so valuable a specimen by sea. This specimen is absolutely perfect, as far as my memory of it goes, and is the property of one of Mr. Süssmilch's students at Newcastle. The specimen stolen from Mr. Mitchell was also, I gather, a perfect specimen of this or a closely allied genus. It would appear, therefore, that the Mecoptera were quite abundantly represented in the fauna of the Permian Coal-Measures at Newcastle. As there has not been, up to the present, a single fossil Holometabolous Insect described from any Palæozoic strata, the discovery of these insects is of outstanding importance, suggesting, as it does, that the Mecoptera may prove to be the most ancient of all Holometabolous Insects. In this connection, it will be necessary for special search to be made for the elytra of Coleoptera in the Belmont and Newcastle beds; since, if such existed at that period, they will almost certainly soon be brought to light.

The two species described here under this genus are clearly closely allied, and it is even possible that they may really be the fore- and hindwing respectively of a single species.

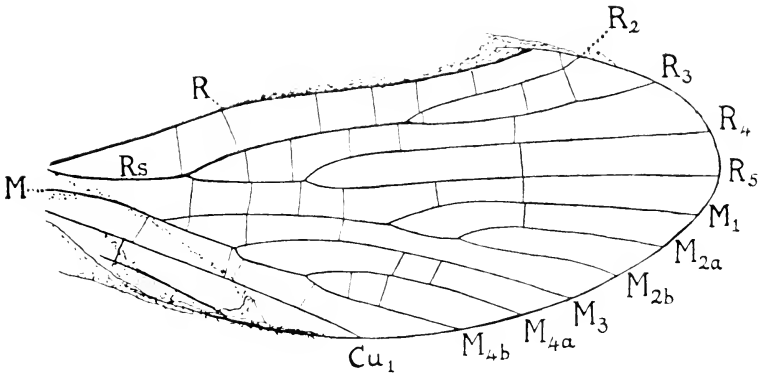

Text-fig. 4.

Permochorista australica, n.g. et sp., wing (length 8.5 mm.). Belmont; Permian.

PERMOCHORISTA AUSTRALICA, n.sp. (Text-fig. 4).

An almost complete wing, 8.5 mm. long, with only the costa, subcosta, and the portion of the base of the wing missing. The impression is a good one, upon the smooth surface of a dark grey

cherty rock. All the main veins are outlined to perfection, but the cross-veins are mostly only to be made out very indistinctly, in strong oblique light. A few cross-veins are somewhat more distinct; such as, for instance, the strong cross-vein passing from M_4 , just distally from its origin, to Cu_1 , and causing a distinct bend in the former vein, and also the cross-vein descending from close up to the bifurcation of R_{2+3} upon R_4 . The feeble development of the cross-veins in such an excellently preserved wing proves them to have been at the stage seen in the recent genus *Teniochorista*—a stage preliminary to the complete elimination of all except a very few advantageously placed cross-veins, such as we find in the derived Orders Trichoptera, Lepidoptera, and Diptera.

As far as can be gathered from this impression, the wing was quite smooth except in the pterostigmatic region, which appears to have been either granulate, or beset with rather crowded macrotrichia. The main veins probably carried macrotrichia of rather small size, and closely set together; in some places, as, for instance, on the stem of R_s , there are indications that the macrotrichia were arranged in two rows close together. But the grain of the rock prevents us from determining this point with certainty. Microtrichia may, or may not, have been present, as the grain of the rock is not fine enough to show them in any case.

Type, Specimen No.24 in Coll. Mitchell.

Locality: Belmont Beds, at a depth of about 600 feet below the top of the Permian Coal-Measures.

PERMOCHORISTA MITCHELLI, n.sp. (Text-fig.5).

A fragment comprising about two-thirds of a complete wing, with a considerable part of the apical area missing, but the base and costa more complete than in the previous specimen. Total length of the fragment 7.5 mm.; this indicates a somewhat larger, and certainly a distinctly broader wing than that of *P. australica*. The end of Sc , with three cross-veins running to the costa above it, is very clearly marked: likewise the pterostigma, with signs of three cross-veins within its distal half, and

distinct indications of the pterostigmatic furrow below R_1 . The origin of R_s , which is just missing in *P. australica*, is beautifully shown in this specimen, as is also the origin of M from Cu_1 at a level considerably basad from that of the origin of R_s , and the approach of R to the combined stalk $M + Cu_1$ close to the base. There are also signs that this fusion of M with Cu_1 is not complete basally, Cu_1 appearing distinctly bent basad from the combined stem, while a tiny portion of M is preserved running basad towards R . All four branches of R_s are shown, the bifurcations of R_{2+3} being placed at a level far distad from that of R_{4+5} . Correlated with the evident greater breadth of the wing, in comparison with that of *P. australica*, is the wider form of the bifurcations of M , of which there are five distinct branches shown, as far as the wing is preserved distally. A greater length of M_2 is preserved unbranched, than that of the basal stalk of this vein before it branches in *P. australica*: yet it would be unwise to assert that this vein remains unbranched, since the wing is evidently somewhat larger.

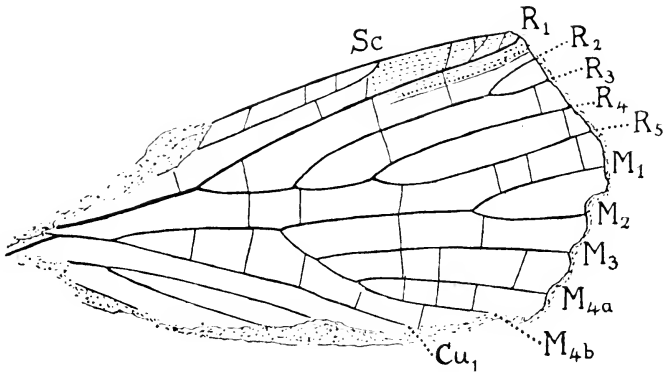

Text-fig. 5.

Permochorista mitchelli, n.g. et sp., wing (length 7.5 mm.). Belmont; Permian.

Of the cross-veins shown in the figure, some are approximately in the same positions as those of *P. australica*, others not. Probably the position of the cross-veins was as variable as it is

in the recent genera *Chorista* and *Taniocho ista*; in any case, it is not at all likely that I have been able to discover by any means all of the cross-veins actually existing in either specimen.

Below Cu_1 there is a nearly parallel vein, giving off a posterior branch which runs nearly parallel with it. As this appears to be a somewhat weak vein, and there is a portion of a much stronger vein running below it, I think that its upper branch may prove to be Cu_2 , the stronger vein being 1A, which unites with Cu_2 near the base by a weaker branch. If the basal stem of this weak vein be continued proximad, it will run into the bent basal end of Cu_1 above it. This would agree very well with the peculiar formation of Cu and 1A basally in recent Mecoptera, allowing for greater specialisation in this respect in the recent forms. I have, therefore, marked the straight, strong vein, which fuses with M for a short distance near the base, Cu_1 , and the upper branch of the weak, branched vein Cu_2 ; but I do not consider that the naming of these veins is placed beyond doubt.

The impression is a fairly good one, upon the smooth surface of a cherty rock of a somewhat lighter colour than that on which the former specimen is impressed; the main veins are also somewhat fainter.

Type, Specimen No.26 in Coll. Mitchell.

Locality: Belmont Beds, at about the same level as the previous specimen.

RESTORATION OF THE WING-VENATION IN THE GENUS PERMOCHORISTA. (Text-figs.6-7).

The preservation of the two wings, *Permochorista australica* and *P. mitchelli*, is sufficiently complete to enable us to restore the venational type of the genus with very fair accuracy. To do this, we must call to our aid the recent genus *Taniochorista*, which, as I have already indicated, is clearly a close ally, and possibly even a direct descendant, of *Permochorista*.

The venation of *T. pallida* Esb.-Pet., from Brisbane, is shown in Text-fig.7. It will be noticed at once that the forewing is distinctly broader in the basal half than is the hindwing; also

that, in the forewing, the branchings of M spread out more widely from their common stalk than they do in the hindwing. Now, if we compare these conditions with the two fossil wings of *Permochorista*, we shall see at once that *P. australica* resembles the hindwing of *T. pallida*, both in its narrowing towards the

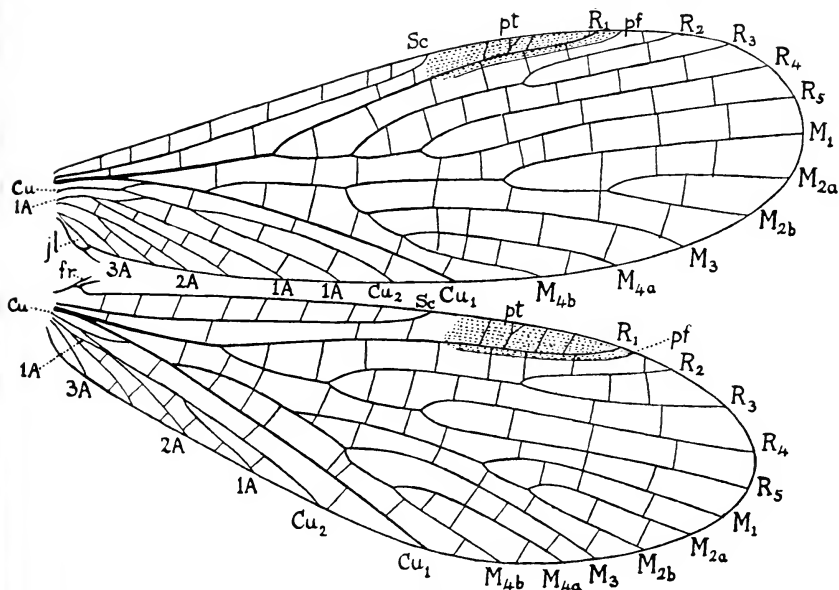

Text-fig.6.

Restoration of the typical venation for the genus *Permochorista*, n.g.

Forewing restored from *P. mitchelli*, hindwing from *P. australica*; fr.,

frenulum; jl., jugal lobe; pf, pterostigmatic furrow; pt, pterostigma.

base, and in the direction taken by the branches of M from their common stalk; the principal difference being that, in *T. pallida*, M sends only *four* branches to the wing-border (as in all recent Mecoptera, except *Merope*, which has five), whereas in *P. australica* there are no less than *six*. The position and number of the branches of Rs is the same in both *P. australica* and *T. pallida*. The only other important difference is to be found in the slight irregularity of the courses of the main veins in *T. pallida*, as contrasted with the absolutely regular main veins of

P. australica. This irregularity takes the form of a very weak zigzagging of the main veins as they pass from one cross-vein below to another above, alternately. It is a specialisation from an originally regular condition, and is the direct result of the cross-veins becoming arranged in the most advantageous position as supports, *i.e.*, alternately above and below each main vein. The same line of evolution can be seen in the Odonata, where it affects alternate main veins only (*e.g.*, M_4 and Cu_2 in many *Agrionidae*), and in the radial sector of *Planipennia*. On these grounds, therefore, we are justified in considering *P. australica* to be represented by a *hindwing*.

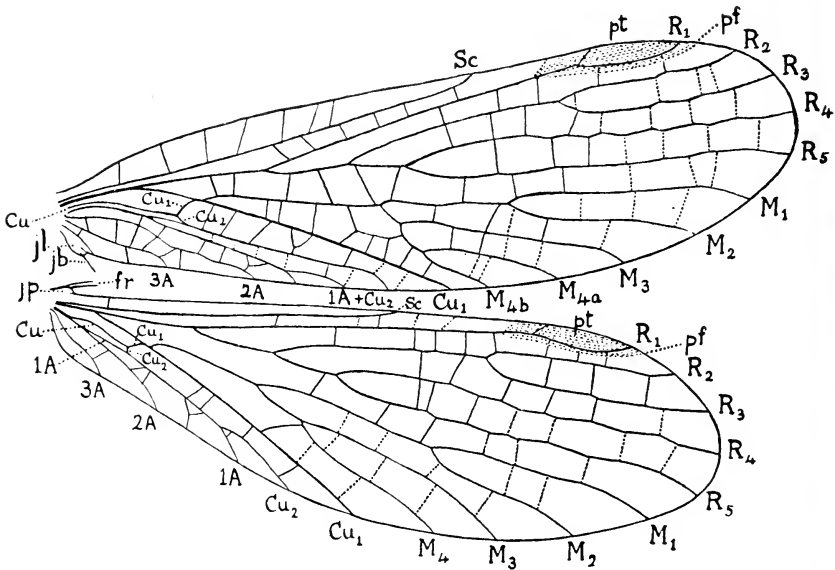

Text-fig. 7.

Tenuiochorista pallida Esb.-Pet.; wings. Recent; Brisbane. For comparison with *Permochorista*. The dotted cross-veins are obsolescent; *fr*, frenulum; *jb*, jugal bristle; *jl*, jugal lobe; *jp*, jugal process; *pf*, pterostigmatic furrow; *pt*, pterostigma.

Turning now to the less complete *P. mitchelli*, we see at once that it more closely resembles the *forewing* of *T. pallida*, not only because of its greater breadth towards the base, but also

because of the very typical formation of the branches of M, which are, as far as they are preserved, practically identical, in number, position, and amount of divergence from their common stalk, with those of *T. pallida*. The branches of the radius also agree in the two forms; and it should be noticed that the difference in level between the bifurcation of R_{4+5} and R_{2+3} is greater in these two wings than in the hindwing. We are justified, therefore, in concluding that *P. mitchelli* represents a forewing, and quite likely the forewing of the species of which *P. australica* is the hindwing; though, as this cannot be proved, I think we should retain the two names for the two separate specimens. As, however, the venation of different species of the genus *Permochorista* probably did not vary more than it does at the present day in species of *Teniochorista* and *Chorista*, I have shown the restoration given in Text-fig.6 as that of a *typical pair of wings* for the genus *Permochorista*, the forewing being restored from *P. mitchelli*, the hindwing from *P. australica*. A comparison of this restoration with the wings of *T. pallida* will show us the small extent of the evolutionary process which has occurred in this very stable wing-type between Permian and recent times. It may be briefly summarised as follows:—

(1) Reduction in the number of branches of M, from six to four in the hindwing, and from six* to five in the forewing.

(2) A tendency for the cross-veins to arrange themselves more advantageously as supports for the main veins, alternately above and below any given main vein; and hence

(3) The breaking of the original regular course of the main veins into a very slight irregularity or zigzagging.

(4) Greater specialisation of the basal portion of Cu. In the Permian genus, Cu_1 has already fused with the main stem of M basally, and probably Cu_2 with 1A. In *Teniochorista* and other

* Although only *five* branches are to be seen in the part of the wing of *P. mitchelli* preserved to us, it will be quite evident that *at least* one extra branch is required more distally along M_2 in restoring this wing, unless we are going to allow a much greater divergence in the direction of these branches of M than is warranted by our knowledge of Mecopterous venation.

recent Mecoptera, the short basal pieces of Cu_1 and Cu_2 , from the cubital fork up to the point of fusion, tend to become perpendicular to the veins with which they junction, and so have at last assumed the appearance of mere cross-veins.

In concluding the account of this interesting fossil genus, I think that it may be reasonably claimed that *Permochorista* differed very little, either in its structure or its life-history, from the archaic genus *Tæniochorista* still existing in Australia at the present day.

The bearing of these Permian Mecoptera, and the still more archaic type, *Archipanorpa*, from the Ipswich Trias, on the problem of the origin of the Holometabolous insects as a whole, must be left to a later paper. It is only necessary to remark here, that the existence of a more archaic form (*Archipanorpa*) at a later horizon (Upper Triassic) need not cause us any surprise or misgivings. At the present day, we have in North America a species, *Merope tuber*, which is in many ways more archaic than even *Permochorista*; while, in the same region, there flourish the highly specialised types of the *Bittacideæ* and the wingless *Boreideæ*. The direct ancestors of *Archipanorpa* must have existed in the Permian, alongside *Permochorista*, and must have also been in existence long before this latter genus became evolved. In the finding of a few fossil types from two horizons in the Permian and Trias, from faunas that were probably highly complex in their composition, chance has happened to put into our hands one of the oldest types from the later horizon; whereas, from the earlier horizon, we have, in *Permochorista*, probably one of the most advanced insect-types of the age. One might, as a parallel, think of the possibility, at the present day, of finding a Butterfly-wing in the Miocene strata at Florissant, and a few days later picking up a much more archaic *Hepialid*-wing from the ground where it had just fallen. The amount of incongruity in both cases would be very much the same.

iii. Permian Insects *Incertæ Sedis*.

Specimen No. 25.—An insect-wing with beautifully preserved outline, 10 mm. long by 3.3 mm. wide, with anterior and pos-

terior margins almost parallel. Anal veins very distinct; the rest obsolescent. Apparently R, M, and Cu arise from a common basal stalk, and diverge slightly distad. This wing might be the tegmen of a Permofulgorid closely resembling No.31 described above.

Specimen No.27.—The poorly-preserved distal portion, 6·5 mm. long, of a wing resembling No.25.

In both the above specimens, the posterior margin shows a very definite coriaceous border about 0·2 mm wide, along its entire length. I know of no Palæozoic type that shows this structure, which strongly suggests the suture of a Coleopterous elytron. The hypothesis that these wings might represent the first stages in the evolution of this latter type is a very tempting one, but should not, I think, be entertained on the basis of such poor material as we have in hand at present.

Specimen No 28.—A portion of a wing, 10 mm. long, showing indistinct subparallel veining. Not sufficiently characterised to classify.

Specimen No.29.—A small, broadly ovate fragment, 1·5 mm. long by nearly 1 mm. broad, carrying nine longitudinal veins, and distinctly convex. At first sight, this specimen is very much like the elytron of a Beetle. Careful examination shows, however, that the supposed margin is in reality only a broken edge, with no sign of a suture. Probably a small portion of a larger wing, and not sufficiently characterised to classify.

Specimen No.30.—Cannot be referred to the Insecta with any certainty.

Specimen No.32.—An impression of a small portion of a wing, 5·6 mm. long by 1·2 mm. wide, resembling, at first sight, the wing of a small Tipulid or a Mosquito. The venation is only visible in the short petiole, and along a very strong vein, probably the cubitus, which curves to the posterior border at about two-thirds the length of the wing. In strong oblique light, a row of large, widely-spaced cross-veins can be seen above this vein. Thus the impression is probably only a small fragment of a very large wing, and too incomplete to classify.

All the specimens here mentioned, except No.32, were found at Belmont.

SECTION B. THE TRIASSIC INSECTS.

Mr. Mitchell's Collection contains twenty-five specimens from the Wianamatta Shale Beds. Of these, No.10 is from Narellan, about five miles from Campbelltown, along the branch line from this latter town to Camden. The horizon of this specimen is probably about 700 feet above the top of the Hawkesbury Sandstone. The rest of the specimens, numbered 1-9, 11-22, and 34-36 inclusive, were taken in the railway-cutting at Glenlee, some four miles south of Campbelltown, on the main Southern Line. The horizon of these specimens is between 300 and 400 feet above the top of the Hawkesbury Sandstone.

The succession of strata from the Hawkesbury Sandstone to the Wianamatta Shales is not by any means continuous. For a long period subsequent to the elevation of the former, this series of rocks was subject to sub-aërial forces. Afterwards, the great subsidence of the area occurred, from the Blue Mountains to Bowral in the South. Into this depression, the Hawkesbury River emptied itself near Mulgoa, forming the Wianamatta Lake. When this lake was filled up, the excess of water was drained off through the original channel of the Hawkesbury River, until this became sufficiently degraded to cause the lake to disappear, and its area to be denuded, as we now observe it to be. Thus a length of time sufficiently long elapsed, between the end of the Hawkesbury Series and the beginning of the Wianamatta, to allow of the advent of many new forms of plants and animals, though *Teniopteris* and *Thinnfeldia* persisted through the two series.

As regards the age of the Wianamatta Series, I cannot do better than quote Mr. Walkom. In his last letter to me he writes, "On the evidence available, the Ipswich flora indicates distinctly an Upper Triassic age, possibly Rhætic, but more probably older (Keuper); also, the Wianamatta is probably of the same age." In the concluding portion of his work on the Flora of the Ipswich and Walloon Series,* which has just been pub-

* Mesozoic Floras of Queensland. Part i., concluded. The Flora of the Ipswich and Walloon Series. (d) Ginkgoales, (e) Cycadophyta, (f) Coniferales. By A. B. Walkom, B.Sc. Queensland Geological Survey, Publication No.259. Brisbane, 1917.

lished, Mr. Walkom sums up the evidence as follows:—"The Ipswich Series must be regarded as Triassic, perhaps homotaxial with the so-called Rhætic Beds of various areas, but possibly older."

DESCRIPTIONS OF THE SPECIMENS.

Order **PROTORTHOPTERA.**

Genus **NOTOBLATTITES** Tillyard.

Originally, I placed this genus in the Order Blattoidea. However, its wing-venation shows it to belong to Handlirsch's Order Protorthoptera, to which I now remove it. But it should be noted that the fossils of this genus preserved *in the resting-position* show us that it carried the tegmina folded flat along the back, as in the true Cockroaches; the hindwings being folded beneath them, and projecting a little beyond them. This shows, I think, that the Cockroaches do not really belong to a separate Order, but are a specialisation from a very ancient Protorthopterous type, the anal area of the tegmen becoming developed into a specialised convex clavus; whereas, in *Notoblattites* and other insects placed in the Protorthoptera, the wing-venation remained more primitive, with no specialisation of the anal area.

Notoblattites shows us that the typical resting-position of the Cockroaches was assumed *before* the specialisation of the tegmen set in. This resting-position is a specialisation from an original, flattened, roof-shaped position of holding the wings, which has become accentuated in most recent Orthoptera. It can be paralleled by the development of the same process in the Diptera, from a similar roof-shaped position of the wings in the ancestral Order Mecoptera.

The type of this genus is the large wing, *Notoblattites subcostalis* Tillyard, from the Wianamatta beds of St. Peter's, near Sydney. Two fragments of very fine wings, closely allied to this, are here described as new species.

NOTOBLATTITES WIANAMATTENSIS, n.sp. (Text-fig.8).

Greatest length of fragment, 28 mm., (measured from base of Sc to the distal broken end of C). The specimen shows the basal

half, or a little more, of the costal area, about half of Sc, a little less than half of R, but including the origins of the first two radial sectors, together with a short piece of the basal part of M and a fragment of Cu. The formation of this area is closely similar to that of the type-species, as regards the position of the main veins, but differs from it in the formation of the cross-veins. In the costal area of *N. subcostalis* (i.e., between C and Sc), the veins running from Sc to the border are mostly simple,

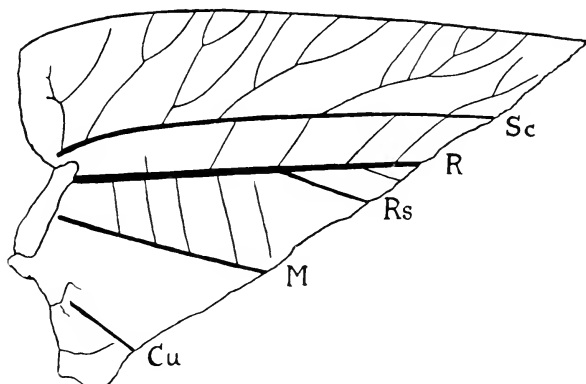

Text-fig. 8.

Notoblattites wianamattensis, n.sp., (length of fragment 28 mm.).
Glenlee; Triassic.

and never more than once branched. In the present species, they show considerable branching, one of the series preserved sending as many as five veinlets to the costal border. Again, in the area below Sc, the spaces between R and M, and again between M and Cu, are filled, in *N. subcostalis*, by a close meshwork of tiny cellules; whereas, in the present species, these areas are only crossed by a few straight, oblique veins.

The fragment is beautifully preserved, on a dark greyish-black rock of fairly smooth surface, and bears the label "Glenlee, 18.9.92" in pencil in Mr. Mitchell's handwriting.

Type, Specimen No. 3, in Coll. Mitchell.

NOTOBLATTITES MITCHELLI, n.sp. (Text-fig 9).

Greatest length of fragment, 24 mm. This specimen, which shows a remarkably close resemblance to the type-species, *N. subcostalis* Tillyard, is a beautifully preserved fragment, showing an area of the tegmen crossed by the distal half of the median vein, with a small portion of the radial sectors above it, and a considerable part of the cubital and first anal veins below it. The forkings of these veins are very regular and narrow, and the spaces between them are closely filled with a typical Palæodictyopterous meshwork, which is very well preserved. A comparison with the figure of the type-species of this genus, shows how closely similar this area of the tegmen is in the two species. Nevertheless, as the second branch of the radial sector above M

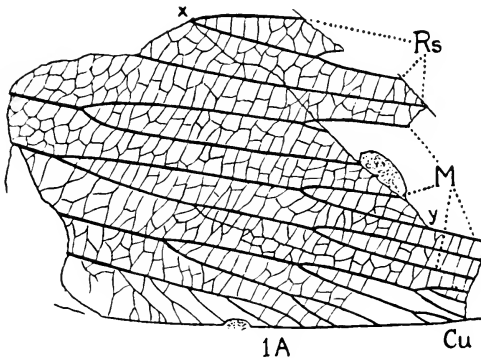

Text-fig.9.

Notoblattites mitchelli, n.sp., (length of fragment 24 mm.).

Glenlee; Triassic.

in the new species is definitely forked, whereas, at this same point in the type-species, there is only a simple longitudinal vein, I have decided to place this specimen as a new species, which I dedicate to its discoverer.

In the Collection, there were two specimens, Nos 1 and 2, which contained closely similar fragments of this insect. On fitting these together, I discovered that they were part and counterpart, respectively, of the same impression. As the two specimens do not cover quite the same area of the wing, I made

drawings of both. Then, having reversed one of these, I superimposed it upon the other, so that the greater part of the two fitted exactly. The complete figure in Text-fig.9 is the result of this process. The oblique line *xy* represents the broken edge of the rock on specimen No.1, the portion lying above and to the right of this line being present only in No.2, as well as a very small part of the extreme base of the fragment in the region of 1A.

Type, Specimens Nos.1 and 2 (part and counterpart) in Coll. Mitchell. No.1 bears, on its back, a circular label, with the words "Neuropterid, Glenlee Rwy. cttg., Narellan."

I have not indicated here to what family these interesting insects belong. It is probable that a new family will have to be formed for their reception later on. I will only mention here two interesting points about them; firstly, that, if the Palæodictyopterous meshwork were to become obsolescent, the dichotomous branchings of the veins in the distal part of the tegmen would show considerable similarity to the remarkable venational type of the Protomecoptera, as exemplified by *Archipanorpa magnifica* Tillyard, from Ipswich; and, secondly, that these large insects show no sign of the typical curvature of the anal veins found in the Blattoidea, and are more correctly placed, therefore, in the Order Protorthoptera of Handlirsch.

Order **MECOPTERA.**

Family MESOPANORPIDÆ, fam.nov.

Scorpion-flies with broadly rounded wings, narrow at the base. Pterostigma large, well-developed, bordered posteriorly between R_1 and R_2 by a strongly marked pterostigmatic furrow. Both R_s and M normally four-branched, but the dichotomy of R_{2+3} taking place *at a level nearer to base* than does that of R_{4+5} . This character appears to be unique amongst Mecoptera, both fossil and recent. Cu_1 a strong, straight vein, from which M arises not far distad from base. Cross-veins mostly indistinct, but a number of stronger ones placed in advantageous positions, resulting in a certain amount of bending of the main veins at the points of junction.

Genus *MESOPANORPA*, n.g. (Text-fig.10).

Characters as for the family, with the following additions. Rather small insects, wings about 8 mm. long. Sc well-developed, running into the pterostigma; its distal end somewhat indistinct. R_{4+5} and M_{1+2} connected just before midway by a strong cross-vein, towards which both are somewhat bent at their points of junction with it. The levels of the forkings of these two veins are the same, and lie much further distad than the levels of the forkings of both R_{2+3} and M_{3+4} . The fourth apical fork, between M_3 and M_4 , is exceptionally broad.

Genotype, *Mesopanorpa wianamattensis*, n.sp.

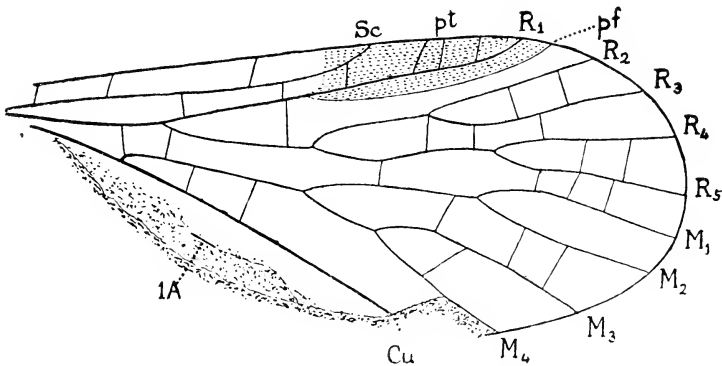

Text-fig.10.

Mesopanorpa wianamattensis, n.g. et sp., (length of fragment 7.5 mm.).
Glendale; Triassic; pf, pterostigmatic furrow; pt, pterostigma.

MESOPANORPA WIANAMATTENSIS, n.sp. (Text-fig.10).

An almost complete wing, well preserved, but with the extreme base and the anal area missing as far as the whole of 1A. Total length of fragment, 7.5 mm., (complete wing probably 8 or 8.5 mm.). Greatest breadth, 3 mm., in region of pterostigma. Probably three strong cross-veins in costal space; three weak ones in pterostigma, and a number of weak ones placed irregularly on the wing, as indicated in Text-fig.10. Rs arising from R at a level slightly distad from that of the origin of M from Cu.

Type, Specimen No.5 in Coll. Mitchell. The impression is

on a hard, dark brown rock with rather uneven surface; the main veins are beautifully preserved, and were evidently strongly chitinised.

It is not easy to determine whether this wing should be placed in the Order Mecoptera or in the Trichoptera, which, in Mesozoic times, were only just separated off from the older Mecoptera, and closely resembled them in the venation of the *forewing*. But the following considerations have all weighed with me in placing it in the older Order Mecoptera.

(1). The presence of numerous cross-veins, many irregularly placed in positions of no special advantage. (Probably there were other cross-veins as well as those I have shown, but not sufficiently well preserved to be visible).

(2). The absence of the typical Trichopterous wing-spot between R_4 and R_5 , not far from the origin of these two veins. If this spot had been present, I think the wing is well enough preserved for it to have shown up quite clearly.

(3). The close resemblance in shape to the wing of *Panorpodes*, in the narrow base and well-rounded tip of the wing.

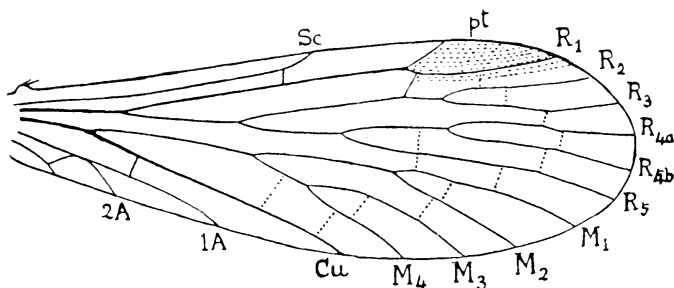

Text-fig. 11.

Panorpodes carolinensis Banks, hindwing. Recent; N. America. For comparison with *Mesopanorpa*. The dotted cross-veins are almost obsolete; *pt*, pterostigma.

(4). The close resemblance between the venation of the fossil and that of the *hindwing* of *Panorpodes* (Text-fig. 11). The only important difference is that, in *Panorpodes*, R_{4+5} sends three veins to the apical border. Now, *if the most posterior of these*

three veins became suppressed, the result would be to place the remaining dichotomies of Rs in this recent genus at about the same levels as they are in *Mesopanorpa*

Of course, if it is agreed that the specimen represents a hind-wing (and I think that the condition of the forking of M from Cu strongly indicates this), then the Trichoptera are put clean out of court, since their hindwings are developed on quite different lines, besides being mostly much too weakly chitinised to be preserved in the fossil state.

The genus *Mesopanorpa* is evidently not at all closely related to the Permian *Permochoristidae* dealt with in the first section of this paper, nor to the recent Australian *Choristidae*. The genus *Mesochorista* from the Ipswich Trias is, however, a Mesozoic link between these two families. Hence *Mesopanorpa*, like the Triassic *Archipanorpa* and the recent *Nannochoristidae*, is a representative of quite another line of Mecopterous development. We may confidently expect that, when the Australian Permian and Mesozoic insect-faunas are better known, many new types of development of this ancient and once dominant Order will be brought to light.

Order **COLEOPTERA.**

The placing of single elytra, however perfect, can seldom be more than a matter of conjecture, since there are scarcely any types of sculpture that are confined to one family only. But, where the fossil specimen is well enough preserved, it is nevertheless usual to name it. Thus, a number of what may be termed "genera of convenience" have arisen, of which it may be said that each one serves to gather together, as a single group, all those fossil elytra which show correspondence in shape and sculpture, within certain limits. An example of such a genus is *Ademosyne* Handlirsch, from the Ipswich beds. Under this name are now comprised no less than ten species, which might belong to the *Hydrophilidae*, *Parnidae*, or *Tenebrionidae*, the type of elytron which they represent being commonly found in all three families.

Most of the elytra in the present collection are not well enough preserved to merit names; but there are five which I

consider of sufficient interest to name, placing them only provisionally in families to which they may possibly belong.

Family HYDROPHILIDÆ(?).

Genus ADEMOSYNE Handlirsch.

ADEMOSYNE WIANAMATIENSIS, n.sp. (Text-fig.12).

Total length of elytron 4.5mm.; greatest breadth 1.5mm. Shape elongate-oval, closely similar to that of *A punctata* Tillyard, from the Ipswich beds. *Sculpture*: nine longitudinal striæ carrying very fine, closely-set punctures, and separated by smooth interstices of slightly greater width than the striæ. The suture is well-marked, and is not straight, but slightly waved, as in the type species, *A. major* Handlirsch, from Ipswich.

Type, Specimen No.10 in Coll. Mitchell.

Locality: Narellan, near Campbelltown, N.S.W. Not

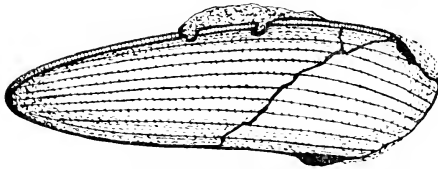

Text-fig.12.

Ademosyne wianamattensis, n.sp., elytron
(length 4.5mm.). Narellan; Triassic.

taken from the same locality as the other Wianamatta fossils here described, but from an horizon some three or four hundred feet higher, *i.e.*, about 700 feet above the top of the Hawkesbury Sandstone. The specimen is preserved in a soft, yellowish mudstone, and is remarkable for its state of preservation. A portion of the base of the elytron has peeled away, leaving only a faint impression on the rock; but all the rest, including the whole of the apical half, and nearly all the margin up to the base, shows *the original elytron in position*, darkly coloured, and exhibiting a peculiar kind of iridescence. It would thus appear that this elytron has been preserved almost without change of the chitin of which it is composed, as is often the case in *Tertiary* fossils, but, as far as I know, never before recorded for *Mesozoic* fossils of this kind. I think the explanation lies in the type of rock in which it is embedded, which may be particularly suitable for the preservation of chitinous objects.

This fossil is closely allied to *A. punctata* Tillyard, from the Ipswich beds, from which it differs in its slightly greater length

and width (*A. punctata* is 4 mm. long, by 1 mm. wide) and in lacking the interstitial punctures peculiar to that species.

It is possible that this fossil may prove to be of some considerable geological interest, especially if a further search in the same locality were to reveal specimens of the genus *Ademosyne* in great numbers. For these beetles are very common in the Ipswich beds; and, indeed, form a unique fauna there, since they have hitherto not been found in the Wianamatta Shale or in any other Mesozoic beds. If, therefore, it could be shown, by further investigations, that there exists a definite *Ademosyne*-zone at Ipswich, and that the same zone occurs at Narellan at the horizon of this specimen, it would be logical to regard the result as a proof of the correlation of the Ipswich Fossil Bed with this upper zone of the Wianamatta Shale Beds. Such a conclusion would agree very well with the indicated view that the Wianamatta Beds at St. Peter's and Glenlee (*i.e.*, from six to three hundred feet lower in horizon than the supposed *Ademosyne*-zone), show a fauna and flora somewhat older than those found at Ipswich.

Family ELATERIDÆ(?).

Genus ELATERIDIUM, nom.nov.

Elaterites Tillyard, Mesozoic and Tertiary Insects of Queensland and New South Wales, 1916, p.41.

Genotype, *E. wianamattense* Tillyard, from St. Peter's, near Sydney.

I propose this name for my genus, the name *Elaterites* being preoccupied by a genus of Upper Miocene elytra from Oeningen, Switzerland. The type of this latter genus is *E. lavateri* Heer.

ELATERIDIUM ANGUSTIUS, n.sp. (Text-fig.13).

An almost complete specimen of a long, narrow elytron, closely resembling the type-species, *E. wianamattense*, but differing from it in its greater narrowness in comparison with its length. Total length, 9 mm.; greatest breadth, 2 mm., not far

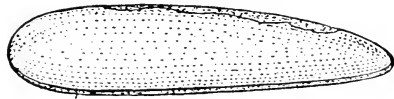

Text-fig.13.

Elateridium angustius, n.sp., elytron (length 4 mm.). Glenlee; Triassic.

from base. The suture is well-marked; the whole elytron, including the suture, is very finely but distinctly granulate all over. Convexity slight.

Type, Specimen No.14 in Coll. Mitchell

Family TENEBRIONIDÆ.

Genus ADELIDIUM, n.g.

Broad, highly convex elytra of small size, evidently belonging to a beetle with a broad, heart-shaped body. Suture narrow. Sculpture consists of about nine slightly raised, longitudinal striæ, separated by wider interstices; the former regularly punctate, each puncture being a tiny, shallow, circular depression.

Genotype, *Adelidium cordatum*, n.sp.

The name is given to suggest the close resemblance between this elytron and those of the recent genus *Adelium*, well represented in Australia at the present day.

ADELIDIUM CORDATUM n.sp. (Text-fig.14).

A beautifully preserved elytron, 4 mm. long, by 2.2 mm. wide at its greatest width, near the base. *Shape* well rounded towards the base, strongly pointed at apex. *Sculpture*: the longitudinal striæ very regularly punctate, the distance between the punctures being slightly less than the width of the inter-

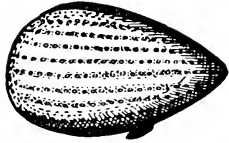

Text-fig.14.*

stices.

Type, Specimen No.17 in Coll. Mitchell.

It is possible that this species is closely related to some of the species of *Ademosyne* described from Ipswich, but none of these approach it in breadth or convexity.

Family MALACODERMIDÆ.

Genus METRORHYNCHITES Tillyard.

Tillyard, *loc. cit.*, p.41.

Genotype, *M. sydneyensis* Tillyard, *l.c.*, p.41.

* *Adelidium cordatum*, n.g. et sp., elytron (length 4 mm.). Glenlee; Triassic.

METRORHYNCHITES GRANDIS, n.sp. (Text-fig.15).

This specimen consists of a considerable portion of a large, elongated, and highly convex elytron, with sharply pointed apex.

The suture is well preserved, from apex nearly to base; but a fracture of the rock, running obliquely across the elytron, has cut off all but a small portion of the margin. *Total length*

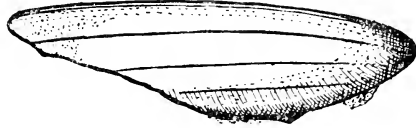

Text-fig.15.

Metrorhynchites grandis, n.sp., elytron (length of fragment 14·4 mm.). Glenlee; Triassic.

of fragment, 14·4 mm.; *greatest breadth preserved*, 3·7 mm., but the elytron was evidently considerably wider towards the base. *Sculpture*: finely granulate all over, including suture; three weakly impressed, longitudinal striæ at wide intervals apart, and tending to vanish towards the apex.

Type, Specimen No.20 in Coll. Mitchell.

Only doubtfully referable to *Metrorhynchites*, from which it differs in its greater size, its more sharply pointed apex, and in the fact that the three longitudinal striæ are not nearly so well marked as in the type-species, and do not unite together towards the apex.

The specimen is a cast of a left elytron, very well preserved, except for the fracture.

Order **HEMIPTERA**. Suborder **Homoptera**.

Family **PSYLLIDÆ**.

Genus **TRIASSOPSYLLA**, n.g. (Text-fig.16).

Moderate-sized insects, forewing probably about 6 mm. Forewing broad, with well-rounded apex. Five separate veins ending up on the apical portion of the wing-margin; of these, the two anterior probably represent branches of R_1 , the third appears to be the unbranched R_s , the fourth and fifth M_1 and M_2 respectively. Sc present, almost, if not quite, fused with R . Wing-membrane quite smooth.

Genotype, *Triassopsylla plecioides*, n.sp.

In spite of some obvious resemblance to the wings of the family *Bibionidæ* in the Diptera Nematocera, and in particular

to the recent genus *Plecia*, I think that this wing is more properly placed with the *Psyllidæ*; or perhaps it might be put into a new family, which would represent the ancestral form from which both *Psyllidæ* and *Aphidæ* later sprung. The resemblance, both to certain types amongst the *Psyllidæ* of the present day, and also to the genus *Schizoneura* amongst the *Aphidæ*, is marked enough to make this possible.

TRIASSOPSYLLA PLECIOIDES, n.sp. (Text-fig.16).

A portion of a wing 4.6 mm. long, by 2.8 mm. wide, with most

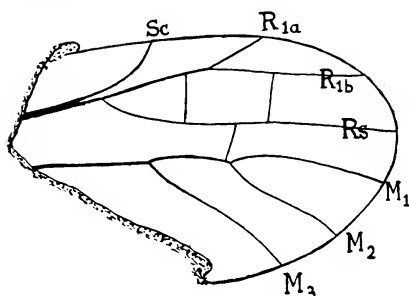

Text-fig.16.

Triassopsylla plecioides, n.g. et sp., wing
(length of fragment 4.6 mm.). Glenlee;
Triassic.

of the basal half missing, but the whole of the apical half preserved. The main veins are very well shown, and appear to consist of the upcurved end of Sc, the forked end of R₁, a simple Rs reaching the border at the extreme apex, and a three-branched M whose stem is converging basad towards R. Type, Specimen No.4 in Coll. Mitchell.

The specific name, *plecioides*, has been given to this type, to indicate the resemblance in its venation to that of the genus *Plecia* of the family *Bibionidæ*. Unless the basal portion of the wing is preserved, it is quite impossible to separate certain reduced types of venation in the Diptera from similar types in the Homoptera. No undoubted Diptera have yet been found earlier than the Lias, whereas the Hemiptera go back to the Permian. These facts alone must make one hesitate as to any possible Dipterous affinities for this wing.

TRIASSIC INSECTS INCERTÆ SEDIS.

1. *Coleoptera incertæ sedis*. (Text-fig.17).

Specimen No.9.— A well-preserved fragment of a large elytron, measuring 11 mm. by 4.7 mm., and showing part of the suture,

but without any sculpture whatever. What appears to have been a crack or break in the original elytron, before it became fossilised, is strongly marked on it far from the margin, as shown in Text-fig.17*a*.

Specimen No.12.—A well-preserved and nearly complete elytron of considerable size, with only the base missing; 12·5 mm. long by 4·8 mm. wide. Suture very narrow; apex moderately pointed. Sculpture: very finely granulated all over. (Text fig. 17*b*).

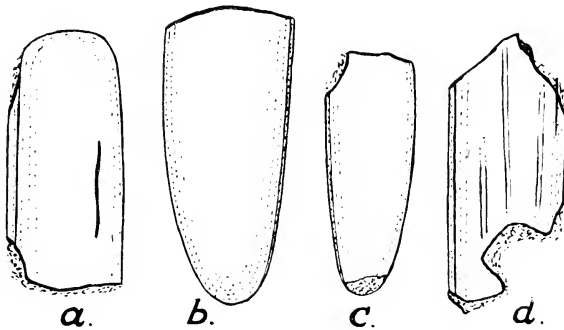

Text-fig.17.

Elytra of Coleoptera Incertae Sedis, from the Wianamatta Shale Beds at Glenlee; Triassic.

Specimen No.16.—A small convex elytron, 2·7 mm. long, by 1 mm. wide, without any definite markings.

Specimen No.34.—A nearly complete, very convex, elongated elytron, 10 mm. long, by 3·3 mm. wide, sculptured all over with shallow pits arranged in longitudinal lines. (Text-fig 17*c*).

Specimen No.36.—A portion of the mould of a large elytron, 8·8 mm. long, measured along the preserved portion of the suture, and 5·5 mm. wide. Sculpture: finely punctate all over, with traces of three double longitudinal ribs, as in Text-fig.17*d*.

2. Hemiptera incertae sedis.

Specimens numbered 7, 8, 11, 13, are fragments of strongly tuberculate Hemipterous tegmina, but there is not sufficient of the venation preserved to allow of classification into any definite families.

Specimens numbered 6, 15, 18, 19, 21, 22, and 35 are not characterised, as far as I can see, by anything that would enable them to be definitely determined as insect-remains. Nos. 6, 18, 19, and 35 are densely veined fragments, which appear to me to be plant- rather than insect-remains.

Note on a Silurian Fossil.—The specimen numbered 33, found in Silurian rock, appears, at first sight, to be a passable beetle-elytron. On closer examination, no trace of a true suture or margin can be seen, and the longitudinal striæ show a characteristic, oblique cross-striation which does not occur in any insect known to me. This fossil would appear to be a small portion of a closely ribbed Brachiopod shell, very probably belonging to the genus *Pentamerus*.

Note.—Only a week or two after the completion of this paper, I received from Mr. Herbert Bolton, M.Sc., Director of the Bristol Museum, England, a copy of his paper on the "Mark Stirrup" Collection of Fossil Insects from the Coal-Measures of Commentry (Allier) France (Mem. Proc. Manchester Lit. Phil. Soc., 1917, Vol.61, Pt.1). Amongst these Upper Carboniferous Insects described in this excellent paper, there is one, *Sycopteron symmetrica*, n.g. et sp., which the author considers to be most probably a Panorpid. After reading the description and studying the figures, it is clear to me that this insect is more likely to be an archaic type of Psocid; but it is not well enough preserved for its affinities to be determined with certainty.—R.J.T.

ON THE *CHÆTOSOMATIDÆ*, WITH DESCRIPTIONS
OF NEW SPECIES, AND A NEW GENUS FROM
THE COAST OF NEW SOUTH WALES.

BY VERA A. IRWIN-SMITH, B.Sc., SCIENCE RESEARCH SCHOLAR
IN THE UNIVERSITY OF SYDNEY.

(Plates xlv.-l., and 59 Text-figures.)

INTRODUCTION.

The *Chætosomatidæ* are a group of curious, little, free-living, marine worms, which appear to be related to the Nemathelminthes, more especially to the Nematoda, though they cannot at present be directly included in any recognised class. They have been found only along the shore line, and at shallow depths off the coast, where they live on the rocky or stony sea-floor, among clumps of seaweed and shell-fish; and creep along by curious, looping movements like those of a leech. In this movement, they are assisted by adhesive setæ situated in rows on the undersurface of the body towards the posterior end, and in a fringe round the anterior margin of the "head-swelling." These setæ, and the enlargement of the anterior end of the body to form a head-like swelling, constitute two of the most prominent characteristics of the animal, by which it is distinguished from any other known worm. All the *Chætosomatidæ* are very small, rarely exceeding 1 mm. in length, and cannot be detected by the unaided eye.

HISTORICAL.

They escaped observation until 1863, when Claparède(1) discovered a single female specimen on the coast of Normandy. To this, he gave the name *Chætosoma ophiocephalum*.

Three years later, Metschnikoff found them in considerable numbers in the Mediterranean Sea, near Salerno; and, in 1867, published a brief description(2) of a species differing slightly from that found by Claparède.

Between 1867 and 1881, four zoologists, Greef(3), Barrois(4), Panceri(5), and Levinsen(6) recorded the finding of *Chætosoma* in such widely separated localities as the Canary Islands, Brittany, Ischia, and Greenland, but added little or nothing to the description given by Metschnikoff, though Panceri added another species, *C. tristicochaeta* Panceri. He himself considered this to be a new genus, to which he gave the name *Tristicochaeta inarimense*; but it is now thought that the difference on which he based his classification is not of generic importance. Nothing further is recorded of *Chætosoma* for twenty-six years. Then, in 1907-1908, Schepotieff(7-8) published a brief, general account of the group, including a description of two new species, which he had found at Bergen and Naples. Seven years later, a short, systematic description of two additional species appeared in a paper by Southern in the Clare Island Survey Series(8).

I have not had an opportunity of seeing the original papers by some of the earlier workers(4-6), but Schepotieff states that they are all brief and superficial, and based almost exclusively on studies of whole preparations.

Levinsen's description is not made clear by illustrations, and is so imperfect otherwise, that identification of the new species he reported is uncertain. According to Schepotieff(8), it is probably identical with *Chætosoma tristicochaeta*. Greef(3) confines himself to the statement that he frequently found *Chætosoma* in different localities on the coast of the North Sea and the Canary Islands, but, beyond a few new species (which he does not describe or name), he could add nothing of importance to Metschnikoff's description. His paper, on some remarkable forms of Arthropod- and Worm-Types, deals mainly with the consideration of the systematic positions of this and other genera, which he designates as remarkable creatures, new or incompletely described, which bear in themselves the characteristics of different classes of animals, without inclining, with any decision, to one or other of them. He considers that the study of these yet living transition-forms between different classes of worms offers a great attraction to investigators, and demands as complete an investigation as possible, from every point of view,

of their organisation and life-history. Schepotieff's papers(7-8) deal with what he terms "The Nematoid representatives of the microscopic fauna of the rocky sea-bottom." including, in this term, the *Desmoscolecidae*, *Echinoderidae*, *Chaetosoma*, *Rhabdogaster*, and *Trichoderma*. His description is based on collections made on the coasts of the Adriatic, the Gulf of Naples, and the fjords of Norway. In the latter place, he had made extensive dredgings on a submarine reef running across the Byfjord near Bergen, and obtained *Chaetosoma* in large numbers in the coast-zone (10-15 mètres), in the years 1903 and 1905.

In his first paper(7), he gives a brief description of the external features only, explaining that the internal organisation is very difficult to investigate, owing to the strong development of the external cuticle, and its impenetrability to reagents. A year later, 1908, he published a fuller account(8), including in it observations on the internal anatomy made by means of transverse sections of a single species, *Chaetosoma longirostrum*. This, apparently, was the first time a successful attempt had been made to section the worm. But the drawings are lacking in detail, and a much fuller description is required to complete our knowledge of the anatomy of this group. As yet, too, no work at all has been done on the life-history.

Until 1914, the *Chaetosomatidae* were not known to occur outside the waters of the North Atlantic and Mediterranean Seas, though Schepotieff expresses the opinion that they are cosmopolitan, and belong to the most numerous and most typical representatives of the microscopic fauna of the rocky sea-bottom. In that year, Professor Haswell found a few individuals of two new species in Port Jackson, N.S.W.; and, some time later, he drew my attention to them.

During the past year, I have collected and examined specimens of these, and two additional species from the sea-shore in the vicinity of Sydney. The present paper is a record of that work, and an attempt to follow Greef's advice(3), and give as complete an account as possible of the anatomy of these curious, little creatures.

MODE OF OCCURRENCE.

I have not found the *Chætosomatidæ* anywhere in the great numbers mentioned by Greef (3) and Schepotieff (7), but I have not been able to make dredgings on the sea-floor at depths of 10-15 mètres, where Schepotieff found them to be most numerous in the Byfjord. My search has been confined to depths accessible from the shore, from lowwater-mark to 5-6 feet below it, obtaining material from this depth by means of a long-handled net, and a bucket.

Long and careful searching has revealed a few scattered representatives in most of the material collected from clumps of molluscs and seaweed in different parts of Port Jackson and Broken Bay, and along the ocean-shore between these two bays. Round Circular Quay, they are to be found in fair numbers on the growth on the jetties; but, in the very dirty water of Darling Harbour, they appear to be almost entirely absent. I found only one in a very large quantity of material collected from an old pile, 40 feet long, which had just been pulled up, this specimen coming from a depth of 16-18 feet below lowwater-mark. Further up Port Jackson than this, (a distance of some $4\frac{1}{2}$ miles from the ocean), I have not found any. In all, I have secured about 100 specimens as a result of collections extending over six to eight months in 1916 and 1917. The majority of these came from Circular Quay, Cremorne, and Vaucluse, in Port Jackson; and Lion Island and Pitt Water, in Broken Bay. Most of them, I have found at very shallow depths, a few actually above lowwater-mark, and all of them among the growth of Algæ, Sponges, Molluscs, etc., on rocks or piles. They do not appear to be present where the sea-floor is composed of pure sand or mud, nor in coralline zones.

METHODS OF COLLECTING EMPLOYED

The methods of collecting adopted varied only slightly with the different species. When dealing with large quantities of material, the clumps of seaweed, sponges, etc., were transferred to a large bucket of sea-water, broken up, and thoroughly washed. The fine mud in suspension in the water was washed off by means of a siphon-funnel, the mouth of the funnel dipping into the

bucket being covered by miller's silk, to prevent the escape of anything but the finest sediment. Fresh water was continually added, till that in the bucket became fairly clear. It was then poured off into another vessel through a coarse wire-sieve to get rid of the more bulky material (some of which was kept for later examination), and concentrated by siphoning or filtering off most of the water through miller's silk.

The constant choking up of the silk by the fine sediment caused a good deal of difficulty in the use of the siphon. The same difficulty was experienced in filtering, when the finer quality of miller's silk was used, but I was uncertain whether the coarser quality would catch the *Chaetosoma*. It was necessary, therefore, to keep the filtrate from the coarser silk, filter it through the finer, and examine the material caught on this, and the water which passed through it. I was also uncertain whether the washings given to the bulky material collected were effectual in detaching the worms adhering to the seaweed, etc.

Until these points were settled, it was necessary to make four separate examinations under the dissecting microscope of each lot of material.

- (1). Seaweed, shales, sponges, etc.
- (2). Material caught on coarser silk.
- (3). Material caught on finer silk.
- (4). Filtrate from the finer silk.

I have never found anything but finely suspended mud in No.4, and, so far, no *Chaetosoma* in No.3; so that I think the coarser silk, which filters much more rapidly, can be used with safety. When dealing with small quantities of material gathered along the shore, I shake and wash it thoroughly in a jar, and filter off the water directly through the coarser silk, without making use of the siphon. The material caught on the cloth is either washed into a small dish of sea-water for immediate microscopical examination, or fixed for later examination.

Whether the washing is effective or not, seems to depend on the species of worm present. *Notochaetosoma tenax* clings so firmly to any support, that it is most difficult to detach it. I had found several worms of this species in material which had

been fixed before washing, but six hours' search through a second lot of material (fresh) from the same spot yielded only a single specimen. A careful examination of shells and seaweed revealed the living worms still clinging to them, after a very thorough washing. It is most difficult to detect the worm against the dark background of seaweed, so that, unless living specimens are required, the material collected is fixed before washing. With *C. haswelli*, there is not the same difficulty, as they wash off much more readily.

METHODS OF PREPARATION.

Various fixatives have been tried—formalin, sublimate-acetic, Carl's, glycerine-alcohol, and 70% alcohol, hot and cold. Formalin or sublimate-acetic, which for bulk-fixing are the most convenient, seem to give as good results as any.

Stains used in the preparation of whole mounts include Erlich-hæmatoxylin, picro-hæmatoxylin, picro-carmin, borax-carmin, and para-carmin. The picro-stains give very poor results. Erlich-hæmatoxylin and borax-carmin seem to be the most satisfactory; but the worm requires prolonged immersion in these, especially in the first, owing to the thickness of the cuticular covering. The length of time required varies with the species; three or four days for the species which have a very thick cuticle.

Clearing is a very difficult process, as most clearing agents, unless very carefully applied, shrivel and distort the animal. The more delicate *C. haswelli* mounts well in glycerine-jelly, when cleared for some time in glycerine-alcohol (glycerine, 10%; alcohol, 90%) under a bell-jar; but for the species with thicker cuticle, clove-oil or cedarwood-oil must be used, and the mounting done in Canada balsam. I have found clove oil the best, but it is necessary to add it very gradually, drop by drop, to the absolute alcohol, bringing up to pure clove-oil only after a day or two.

For section-cutting, the double embedding, paraffin-celloidin method was used. A few worms were embedded direct in paraffin, after clearing in cedar-oil, but the result was unsatisfactory; as was also the case when a celloidin-block was dispensed with, the worm being transferred direct from $\frac{1}{2}$ % celloidin-solution to

chloroform. In these cases, the handling of the minute specimens was a great difficulty. In all cases, I found it necessary to stain the worm slightly before embedding, in order to locate it with the dissecting microscope when cutting out the celloidin or paraffin block.

The mounted sections were afterwards double-stained with Erlich-hæmatoxylin and eosin. Satisfactory sections are difficult to obtain. *Chaetosoma haswelli* is so delicate, that the body-walls tend to fall together during the embedding process; and, when this occurs, the transverse sections take the form of a narrow thread, in which it is impossible to make out details of internal structure. *Chaetosoma falcatum* and *Notochaetosoma tenax*, which have a very thick, external cuticle, and, consequently, a firmer outline, sometimes give good transverse sections, but they tend to tear out of the block, especially in longitudinal section.

For many of the specimens examined, I am indebted to Professor Haswell, whom I have to thank for the direction of the work, and in whose laboratory it was carried out.

I have also to thank Acting-Professor S. J. Johnston for the valuable assistance he has given me in the preparation, both of the material and the paper; and Mr. R. J. Tillyard for his kindly and helpful criticism and interest during the progress of the work.

STRUCTURAL FEATURES OF THE CHÆTOSOMATIDÆ.

All the *Chaetosomatidæ* have an elongated, cylindrical, worm-like body, tapering posteriorly to a sharply pointed tail, and usually swollen anteriorly to form a more or less distinct head.

For purposes of classification into genera and species, the distinguishing features are the shape and size of the head-swelling, and the extent of its demarcation from the trunk; the character of the pharynx; the number of rows of ventral and head-setæ, and their position; the character of the setæ; the relative proportions of the trunk; the thickness of the external, cuticular covering; the variations in the character of the transverse striations, and in the size and arrangement of the body-hairs with

which it is beset; and the general shape which the worm tends to assume, when fixed.

In all species hitherto described, the head-area is clearly distinguishable into three regions.

(1). The frontal part, known as the rostrum, on which the cuticle is not striated. This, as a rule, bears the anterior "head-hairs" or setæ, and a pair of curious, laterally situated, spiral grooves.

(2). The middle part, always the narrowest of the three regions, which is ringed by cuticular striations, much coarser and more strongly marked than on any other part of the body.

(3). The hinder part, only distinguishable from the trunk by its greater thickness, and the "neck"-constriction which marks it off from the latter.

But in two of the New South Wales species now described, there is little or no demarcation of a head-region. The pharynx lacks the typical, swollen "bulbs," and, in consequence, the anterior end of the body is very little, if at all, enlarged. The worm can be distinguished from a Nematode only by the rows of ventral setæ, and its characteristic creeping mode of locomotion.

The absence of a head-swelling would seem to suggest that these worms are more nearly allied to *Rhabdogaster* (2, 10) than to *Chaetosoma*. But, in the general structure of the body, they differ considerably from *Rhabdogaster*; and are very similar to other species of *Chaetosoma*. There is no median constriction of the trunk; the ventral setæ are stout, hollow rods, with distal segments, not delicate and crook-like, as in *Rhabdogaster*; and the female genital pore and genital organs are situated in the anterior, not the posterior half of the body.

I have, therefore, placed these two worms as a new genus, *Notochaetosoma*, in the family *Chaetosomatidæ*. The typical rostrum is present in both species of *Notochaetosoma*, but there is no special "banded" area of coarsely striated cuticle behind it. This banded area is also absent in one of the New South Wales species of *Chaetosoma*, described as *C. falcatum*.

The number of rows of ventral, locomotor setæ is of considerable systematic importance. All four New South Wales species

have four rows. Of the *Chaetosomatidae* hitherto described, three species have two rows; three species, three rows; and two species, four rows. It has been suggested that these three types should be placed in three distinct genera.

The number of setæ in each row varies in all cases with the age of the animal, and is, therefore, not altogether a specific character; but the relative extent of the body covered by the rows varies considerably in the different species, as does, also, the character of the setæ.

Two species have been described in which the setæ are all simple; in the others, either the setæ are all compound, with a small distal segment, or both simple and compound setæ are present.

In all species, the part of the trunk on which the setæ are situated serves as a sole, the ventral setæ become firmly attached to some support; and the worm rears itself up and stretches the anterior part of its body forward, when about to move. Schepotieff states(7) that it then attaches itself, and draws itself forward by means of mouth-teeth. But in all cases in which I have been able to observe the *Chaetosomatidae* alive, it is the dorsal 'head-hairs,' or setæ arranged in a semicircle on the hinder part of the rostrum, which perform this function. In the case of *N. tenuis*, I have been able to make out small, distal segments on the dorsal setæ, very similar to those on the ventral setæ. The adhesive power of these setæ seems to be very great, and the animal can only detach itself by a sharp jerk after each forward-movement.

The character and arrangement of the trunk-hairs varies considerably in the four New South Wales species. In *Ch. falcatum*, they are so short and scattered as to be hardly noticeable; while, in *Ch. haswelli*, they are very long and prominent, and are markedly swollen at the base.

The internal organisation is simple. There is a body-cavity, and the alimentary canal is a simple, straight tube extending through the body from the mouth, at the anterior end, to the anus on the ventral surface close up to the posterior end of the body. A glandular mass, lying dorsal to the posterior end of

the alimentary canal, and opening by a pore at the posterior extremity of the tail, is evidently excretory in function. Glands of some kind are also present in the head-region of some, if not all, the species, lying above the pharynx. They appear to be connected with the hollow, dorsal, locomotor setæ.

Some species show traces of a nervous system, in the shape of an ill-defined ring round the pharynx. The peculiar, lateral grooves on the rostrum are probably sense-organs of some kind. In the possession of a 'tail-gland,' and these lateral grooves, the *Chætosomatidæ* resemble many free-living, marine Nematodes. The resemblance is discussed in the detailed description of *Ch. falcatum*.

The sexes are separate. In the male, a single, simple tube extends from the anterior region to open with the rectum at the anus, and two, equal, penial setæ are present. The female sexual organs consist of paired ovaries, anterior and posterior, each opening by an oviduct into a common uterus. The female genital pore is situated on the ventral surface, about or in front of, the middle of the body. The ova are relatively few, and fairly large; and the animal appears to be oviparous.

DESCRIPTIONS OF THE SPECIES.

CHÆTOSOMA FALCATUM, n.sp. (Plates xlv.-xlv.).

A few individuals of this species were found in 1914, by Professor Haswell, in material collected at Cremorne, Port Jackson; and the majority of the specimens, which I have obtained since, have come from the same locality. I have obtained only four specimens elsewhere; one in material from Vacluse, in which, also, I found *N. tenax*; and three from the rocks between tide-marks at Long Reef, a very exposed portion of the ocean-coast. At Cremorne, they were all taken from among the growth of shells and seaweed on a vertical rock-face, at a depth of from 4.5 feet below low water mark. They are scattered very sparsely through the material, and the search for them is a lengthy one, necessitating a preliminary fixation; and I have not yet been able to obtain any living specimens.

Ch. falcatum is an elongated, approximately cylindrical, worm-like animal, greyish-white in colour. In length, it does not

exceed 1.10 mm., and proportionally it is unusually broad, the trunk, in the largest specimens, attaining, at its widest part, a width of 0.092 mm. Dorsal and ventral surfaces are recognisable, and anterior and posterior ends. Anteriorly, the body is enlarged to form a head-like swelling (Pl. xlv., *hd.*) marked off from the trunk by a well-defined neck-constriction (Pl. xlv., *nk.*). Posteriorly, the trunk terminates in a short, sharply pointed, downwardly directed tail (Pl. xlv., *tl.*). The mouth-opening (*m.*) is anterior and terminal, and the anus (*a.*) is situated on the ventral surface, a short distance in front of the tail (0.06 mm. to 0.09 mm., according to the length of the animal). The sexes are separate, and, in the female, the external genital aperture is situated on the ventral surface, a little in front of the middle of the body (Pl. xlv., ♀, *g.p.*). When fixed, the animal usually assumes the shape of a query-mark, or a sickle, the anterior half of the body being strongly arched, with the concavity of the arch directed ventrally; while the posterior half is straight, or only very slightly bent in the opposite direction (Pl. xlv.-xlv.). The female genital aperture is situated close to the beginning of the anterior arch, in the region where the body attains its greatest width. Even in sexually immature worms, the anterior half of the trunk is always slightly wider than the posterior half, which is further distinguished by the presence, along the whole length of its ventral surface, of four longitudinal rows of stout, locomotor rods or setæ (Pl. xlv.-xlv., *i.r.*, *o.r.*). The whole body is enclosed in a thick, opaque cuticle, which, except at the extreme anterior and posterior ends, is divided up by close-set, transverse grooves, into numerous minute annuli or striæ (Pl. xlv.-xlv., *cut.*). The grooves are broad, and penetrate to nearly the full depth of the cuticle (Text-fig. 12, *cut.*). For the most part, they encircle the body in parallel lines, but, occasionally, adjoining grooves anastomose. On no part of the head or trunk is any variation in the size and thickness of the striæ to be recognised. The head-swelling is large in proportion to the size of the trunk, attaining a length of $\frac{1}{4}$ th to $\frac{1}{3}$ th that of the trunk; and a breadth usually slightly greater than the average breadth of the trunk. It is elongated-oval in shape, and is bluntly

rounded off anteriorly. Here, for a length of about one-fourth the total length of the head, the cuticle is devoid of striae, and is beset with numerous, very long hairs (Pl. xlv.-xlv.; Text-fig.1). Three transverse rows of setæ are arranged in a semicircle far forward on the dorsal side of the rostrum. The corresponding setæ of the three rows are in line, and form portions of longitudinal rows: the remaining portions of which are formed of unmodified hairs, extending from the junction of the striated cuticle with the rostrum, to its anterior margin (Text-fig.1, *d.s.*). A second row, consisting entirely of unmodified hairs, is inserted close beside each of these rows (Text-fig.1, *h.h.*). The hairs are

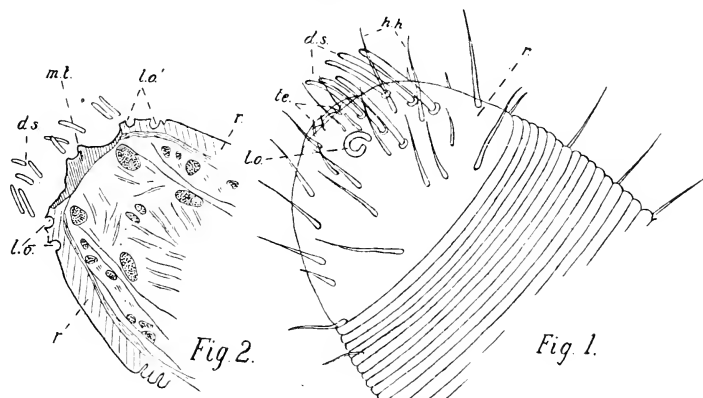

Figs.1-2.—*Chatosoma falcatum*, n.sp.

Fig.1.—Surface-view of rostrum, showing arrangement of hairs and setæ; ($\times 630$).

Fig.2.—Longitudinal section through the rostrum in the plane of the lateral sense-organs. The cut ends of the dorsal setæ show above the section; *m.t.*, tissue surrounding the mouth; *l.s.*, mouth-setæ.

For other lettering in these and other legends, see *postea*, under Explanation of Plates.

long and slender, having an average length of 0.022 mm., and taper to a fine point. They project vertically up from their point of insertion in the rostrum, but the setæ, which are stout and blunt, and about 0.015 mm. long, are inserted by broad bases in depressions in the cuticle; and are strongly arched forward and downward, bending over the anterior margin of the

head, and forming a semicircular fringe above the dorsal side of the mouth-opening (Text-fig. 2, *d.s.*). These 'setæ' probably correspond to the hinder head-hairs described by Schepotieff (7-8) for other species of *Chatosoma*, but do not correspond in position with either the hinder circle of head-hairs or the frontal head-hairs mentioned by him. Unmodified hairs, similar to those on the rostrum, 0.022 to 0.026 mm. long, occur on the posterior part of the head, and appear to be arranged more or less regularly in longitudinal rows. The cuticle of the rostrum stops short of the extreme anterior end (Text-fig. 2, *r.*), leaving a circular aperture through which the body-tissue projects in a lip-like arrangement surrounding the mouth. On this, there is a circle of very minute hairs or setæ (Text-fig. 1, *te.*), apparently six to eight in number, but, on account of the extremely small size of all these parts, details are difficult to determine with accuracy.

On either side of the rostrum, very close to the anterior margin of the cuticle, there appears a curious cuticular marking in the form of an open, spiral groove, the open end being directed posteriorly (Text-figs. 1, 2, *l.o.*). Similar cuticular markings are mentioned by Metschnikoff (2) and Schepotieff (7-8) as occurring on all species of *Chatosoma* hitherto recorded. Schepotieff seems to think they are peculiar to the *Chatosomatidae*, and compares them (7) with the wing-like head-appendages of the *Desmoscolecidae*. But I have seen similar markings on some small marine Nematodes, and Bastian has figured them in some of the illustrations to his monograph on the *Anguillulidae* (11), notably on *Comesoma vulgaris*, though he does not mention them in his description. De Man, in his 'Nordsee Nematoden' (12), also records them as occurring in *Enoplus*, *Oncholaimus*, *Anticomus*, and *Tripylloides*, in conjunction with the "paired lateral organs," which, he suggests, may be either excretory or sensory in function. So far as I have been able to determine, they are purely superficial cuticular structures. I cannot detect any sign of ducts leading away from them, nor any connection with the deeper layers of the body. But it is possible that such connection does occur, being difficult to detect on account of its extreme minuteness.

Immediately behind the 'head,' the trunk is sharply constricted to form a narrow 'neck' which is less than one-third the width of the head (Pl. xlv.-xlv., *nk.*). Behind the neck, the trunk rapidly broadens to its widest part in the anterior region of the body, becoming slightly narrower again in the posterior region, which bears the locomotor rods. The terminal portion of the trunk, distinguished as the 'tail,' is very short in this species,

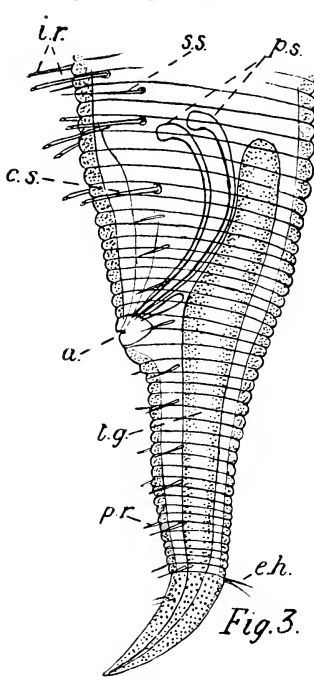

Fig. 3.—*Ch. fulcatum*.
Posterior end of male; ($\times 520$).

being not more than 0.051 mm. long in the largest individuals. While devoid of striæ, its cuticle is not quite smooth, being minutely pitted all over (Pl. xlv., fig. 2*a*; Text-fig. 3, *tl.*). A few, very fine hairs are scattered over the surface of the trunk (Pl. xlv., *lh.*). These are never more than 0.007 mm. long, except towards the posterior end, where three or four pairs of much longer hairs occur on the dorsal surface. The last and longest of these, 0.026 mm. long, are inserted very close together just at the junction of the striated trunk-region with the tail (Text-fig. 3; Pl. xlv., xlv., *eh.*). The ventral rows of locomotor setæ extend from behind the anus nearly half-way up the trunk, to the beginning of the anterior curve. The number of setæ in each row varies with the size and age of the animal; but the relative extent of ventral surface covered by them remains about the same in specimens varying in length from 0.528 mm. (the smallest) to 1.104 mm. (the largest obtained by me). The two inner of the four rows are situated close together along the middle of the ventral surface, each row consisting of from 12 setæ in the smaller to 23 in the larger

individuals (Pl. xlv., xlv., *i.r.*). The setæ (0.018 mm. to 0.022 mm. long) are all compound, each consisting of a stout, tubular rod inserted by a broad base in the cuticle, bearing, at its distal end, a very small, leaf-like, movably-jointed segment (Pl. xlv., fig. 2*b*). They are separated by fairly wide intervals posteriorly, but are more closely crowded anteriorly, especially in the older individuals. In front of each inner row, and directly continuous with it, there are, in individuals of all ages, three or four, small, simple setæ of the same length (0.007 mm.) as the trunk hairs lying in front of them (Pl. xlv., *s.*). The trunk-hairs continue the ventral rows to the anterior end of the trunk (Pl. xlv., *t.h.*). The two outer rows of locomotor setæ begin, as a rule, about three setæ further back than the inner rows (Pl. xlv., *o.r.*), and are situated ventro-laterally, separated by a fairly wide interval (0.018 mm.) from the inner rows. In the male (Pl. xlv.), they consist of simple and compound setæ, alternating fairly regularly, there being, in the adult worm, about twelve compound and seven simple setæ in each row. The compound setæ (*c.s.*) are quite similar in size and character to those of the inner rows; the simple setæ (*s.s.*) are the same length, but are very slender and taper to a fine point. In the female, the outer rows are composed entirely of compound setæ, about twenty-one in number in the adult (Pl. xlv.). The inner rows cease before the anus, but the outer rows are continued back on either side of it, almost to the junction of the trunk with the tail. In the female, the postanal portion of the row consists of three or four compound setæ exactly like those further forward (Pl. xlv., fig. 2*a*). But, in the male, the compound setæ stop some little distance in front of the anus, and the posterior portion of the row consists of eight or nine simple setæ, shorter than those between the compound setæ, but stronger, stouter, and very sharply pointed. The last pair are frequently inserted right on the tail-point (Pl. xlv., fig. 1*a*). They appear to correspond closely with the double row of setæ present in the region of the anus, in some of the free-living marine Nematodes, where they constitute one of the external characteristics of the male. They are described by Bastian (11) for the genera *Anticomus*, *Enoplus*, and *Comesoma*; and in greater

detail by De Man(12), for several species of these genera, *e.g.*, *Enoplus communis*, in the male of which are found, "between the anus and the aperture of the accessory organ, eighteen setæ on each side of the ventral middle line."

In the adult female, the trunk is circular in cross-section in front (Text-fig.5), slightly flattened dorso-ventrally into a more oval form in the region of the genital organs (Text-fig 20), and posteriorly is broadly ovate (Text-fig.15), the narrowest part lying between the ventral locomotor setæ. The cuticle, which

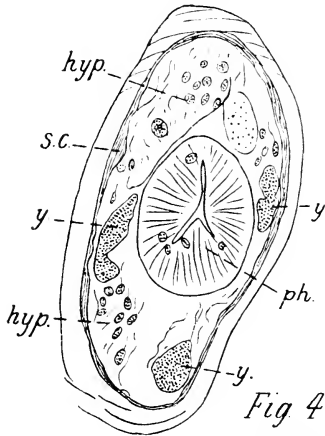

Fig 4

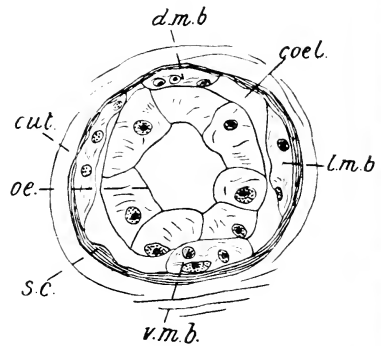

Fig 5

Figs.4, 5.—*Ch. falcatum*

Fig.4.—Transverse section through head in the region of the anterior pharyngeal bulb: ($\times 610$).

Fig.5.—T.S. through anterior part of trunk of same specimen: ($\times 610$); *hyp.*, hypodermis; *s.c.*, subcuticular layer of body-wall; *l.m.b.*, lateral mesodermal band; *y.*, glandular masses round pharynx.

forms the external covering of the body, is structureless, and quite homogeneous. It forms a relatively broad layer (0.004 mm., in a worm which has an average diameter of 0.048 mm.), and is of uniform thickness throughout (Text-figs.5-8, *cut.*). Beneath the cuticle is a much narrower layer (*s.c.*), in which it is impossible to make out any definite structure. It is strongly refractive, and appears bright yellow in sections stained with hæmatoxylin and eosin. Its internal outline is very irregular, both

in transverse and in longitudinal sections, due to variations in its thickness. In places, it projects into the body-cavity in the form of sharply angular thickenings (Text-fig.20, *s.c.*), but these thickenings are not constant in position, and there is no indication whatever of definite longitudinal lines in it. No cell-boundaries and no nuclei are visible within it, but scattered nuclei may occasionally be seen, lying along its inner surface (Text-fig. 12*a*). Four very definite thickenings of mesodermal tissue lie along the inner surface of this, and are respectively dorsal, ventral, and lateral in position (Text-fig.5, *d.m.b.*, *v.m.b.*, *l.m.b.*). They extend throughout the length of the trunk, from the neck-constriction to the beginning of the tail-region, forming four longitudinal ridges on the body-wall (Text-figs.12, 13). They appear to consist of a clear, net-like protoplasm, containing

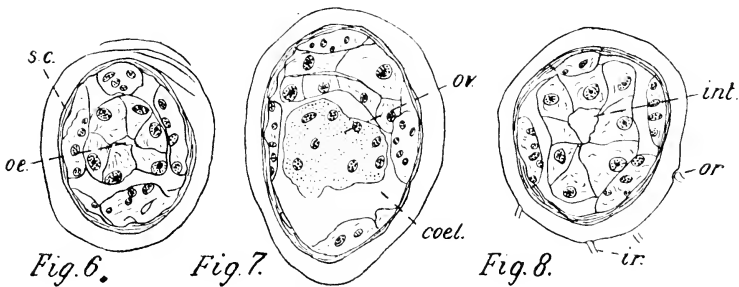

Figs.6-8.—*Ch. fulcatum*.

Tr. secs. through trunk of a young specimen, showing the four, large mesodermal ridges on the body-wall, and the structure of the alimentary canal; ($\times 830$).

Fig.6.—Section through anterior region.

Fig.7.—Section through middle region, showing rudiment of genital system.

Fig.8.—Section through region of the ventral setae.

granules and nuclei, the latter being crowded along the inner surface of the ridge. These ridges are most clearly distinguishable in a young and immature worm, where they are relatively much larger than in the adult (Text-figs.6-8). In a worm, in which the alimentary canal and genital organs completely fill out the coelomic cavity, and press closely against the body-wall

in the middle region of the body, the ridges, especially the lateral ridges, are only recognisable as thin strands containing a few

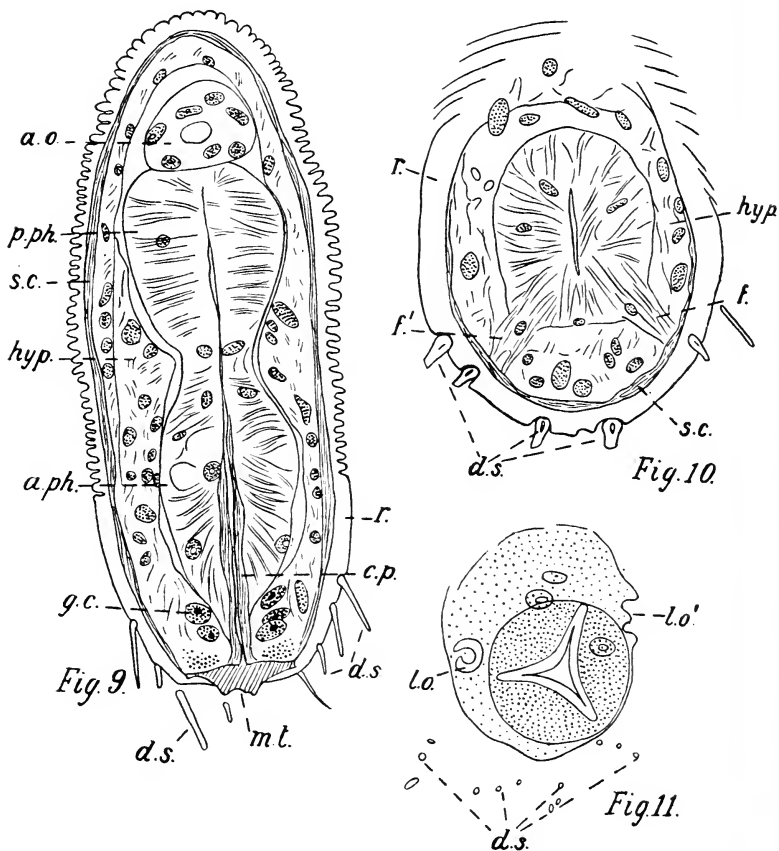

Figs. 9-11.—*Ch. fulcatum*.

Fig. 9.—Horizontal longitudinal section through head; ($\times 830$).

Fig. 10.—T.S. through rostrum, showing insertion of dorsal setae.

Fig. 11.—T.S. through anterior extremity of head, showing mouth-opening, and cut ends of dorsal setae; *c.p.*, cuticle lining pharynx; *f, f'*., bands attaching pharynx to body-wall; *g.c.*, glandular cells surrounding anterior end of pharynx; *m.t.*, tissue surrounding mouth-opening.

deeply stained nuclei and granules (Text-figs. 14, 15). The dorsal

ridge is more definite in outline and appears to be in contact with the alimentary canal throughout its length. In the head, the space between the pharynx and the body-wall is almost completely filled out with a loose, hypodermal tissue (Text-figs.9, 10, *hyp*), but, in the trunk, a definite cœlome is present, between the enteric canal and the body-wall. In the young worm, this space is relatively large, and extends uninterruptedly from the neck to the tail-region, where it is again filled out with protoplasmic tissue. But, in the adult, it is extensive only in the region of the œsophagus (Text-fig.5, *cœl.*). Further back, it becomes almost completely occluded by the growth of the genital organs and intestine. The enteric canal is a straight tube running through the length of the body, from the mouth, at the anterior end, to the anus near the posterior end. By variations in its width, and in the thickness of its walls, it is distinguishable into pharynx, œsophagus, intestine, and rectum.

The three-rayed mouth-opening (Text-fig.11) leads, through a very short and narrow passage, into a rounded bulb with thick, muscular walls, the anterior pharyngeal bulb (Text-fig.9, *a.ph.*). Its narrow cavity is rayed in cross-section, and is lined by cuticle (*c.p.*) which, everywhere thick, is thickest in the anterior portion, where the lumen is slightly larger than it is further back. Its walls are composed of a complicated system of circular, longitudinal, and radial muscle fibres. Bands of muscle-fibres (Text-fig.10, *f, f'*.) attach its anterior end to the cuticle of the body-wall dorso- and ventro-laterally, and further back, towards its posterior end, there appear to be finer strands of fibrils running forward to attach it laterally. The anterior pharyngeal bulb extends through a little more than one-third of the length of the head, and is followed immediately by a second rounded swelling of equal length and width, the posterior pharyngeal bulb, the walls of which are composed of a less complicated system of radial muscle-fibres. Its lumen is still very narrow, and is lined with cuticle (Text-fig 9, *p.ph.*). It is divided by a well-marked constriction from the œsophagus, which is slightly swollen in the head-region to form a third, much smaller bulb (Pl. xlv., *a.o.*). This, however, differs from the pharyngeal bulbs in having non-

muscular walls, and a fairly wide cavity not lined by cuticle (Text-fig.9, *a.o.*). Behind the neck-constriction, the œsophagus extends back to the region of the genital organs as a cylindrical tube of uniform diameter, occupying a large part of the space enclosed by the body-walls (Text-fig.5, *œ.*). In an adult female

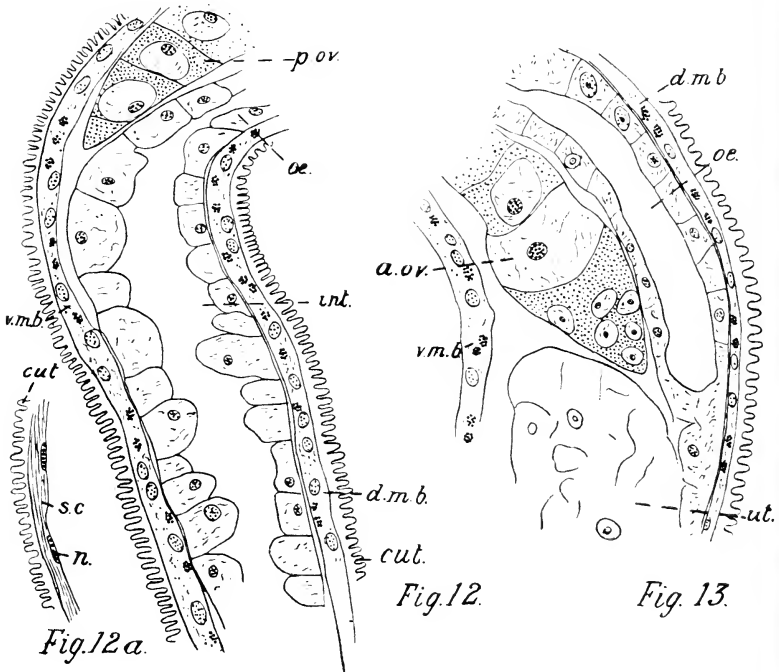

Figs. 12-13.—*Ch. falcatum*.

Fig. 12.—L.S. through female, in region of ventral setae; ($\times 610$).

Fig. 12a.—L.S. through body-wall between the mesodermal bands, showing the subcuticular layer with nuclei (*n.*).

Fig. 13.—L.S. through body in region of anterior ovary and uterus. At the back of the uterus, the section passes through wall of intestine only.

worm, which is 0.055 mm. in cross-section, the diameter of the œsophagus is 0.033 mm. The walls are relatively thick, and composed of a single layer of large, rectangular cells, with thin

but easily recognisable walls and loose, granulated protoplasm. Each cell contains a large, oval nucleus, having a single, more darkly staining nucleus in it. There are from six to eight cells in cross-section. Further back, the entire canal becomes crushed up against the dorsal body-wall by the growth of the genital organs, and the walls become thinner (Text-figs.12, 13, 20-22, *æ.*). Behind the genital pore, where it passes backward to the left of the posterior ovary, its walls are very thin, and the cell-boundaries and nuclei are difficult to distinguish, while the protoplasmic contents become denser (Text-figs.23-24, *æ.*). Vacuoles (Fig.24, *v.*) and numerous rounded bodies, staining deeply pink with eosin, are present.

Immediately behind the posterior ovary, at the level where the first setæ of the ventral rows appear, it completely fills up the cœlomic cavity (Text-figs.12, 14, 15, *int.*). Here, the walls are still thin, so that the lumen is relatively very large, and this part of the canal may, perhaps, be regarded as a stomach. The walls increase in thickness as it passes back, though still formed of a single layer of from 15-20 cells, which vary considerably in size. A short distance in front of the anal aperture, it passes suddenly into the rectum through a narrow passage surrounded by eight or nine very large, wedge-shaped cells with clear, protoplasmic contents, and large, round nuclei (Text-fig.16, *x.*). Behind the constriction, the walls are extremely thin (Text-fig.17, *rc.*), the passage is dorso-ventrally compressed, and lined with cuticle, and the anus, by which it opens on the ventral surface, is a transverse slit situated on a slight projection. A good deal of food-matter is present in all parts of the enteric canal in the adult worm, but it consists of a kind of granular *débris*, in which it is difficult to recognise anything definite. I have seen, however, a Desmid, a small Foraminiferal shell, and several chains of minute Algal cells among the *débris*. In an immature female worm, the cells forming the wall of the enteric canal are relatively very large, and few in number; and the lumen is very small, in parts almost completely closed-up (Text-figs.6-8). Surrounding the anterior end of the pharynx, there is a group of large cells staining deeply blue with hæmatoxylin, which pro-

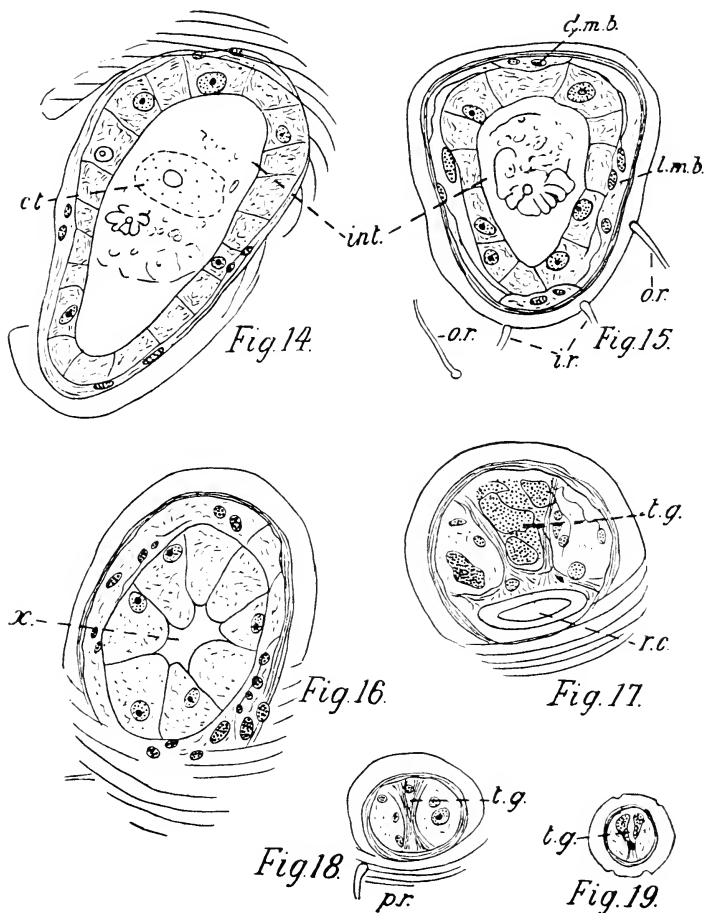
Figs. 14-19. —*Ch. jalcatum*.

Series of Tr. Secs. through trunk of female from middle region to tail; ($\times 610$).

Fig. 14.—An oblique section through body, just behind posterior ovary.

Fig. 15.—Section in region of ventral setae.

Fig. 16.—Section in region of constriction (c.) between intestine and rectum.

Fig. 17.—Section just in front of anus.

Fig. 18.—Section behind anus.

Fig. 19.—Section through tail; c.t., contents of intestine.

bably function as digestive glands (Text-fig. 9, *g.c.*), and in addition, there are several granular masses of a yellow colour embedded in the hypodermal tissue immediately surrounding the mouth, which may be glandular. Possibly the pink-stained bodies and the vacuoles in the wall of the stomach have a glandular function. In addition, there is a large, granular mass of tissue, staining deeply blue with hæmatoxylin, situated immediately above the rectum (Text-figs. 3, 17-19, *t.g.*). It occupies most of the space between the dorsal wall and the rectum, and extends as a longitudinal strand into the tail-region, opening by a duct at the extremity of the tail. This may correspond to the tail-gland described in many marine Nematodes, and thought to be excretory in function.

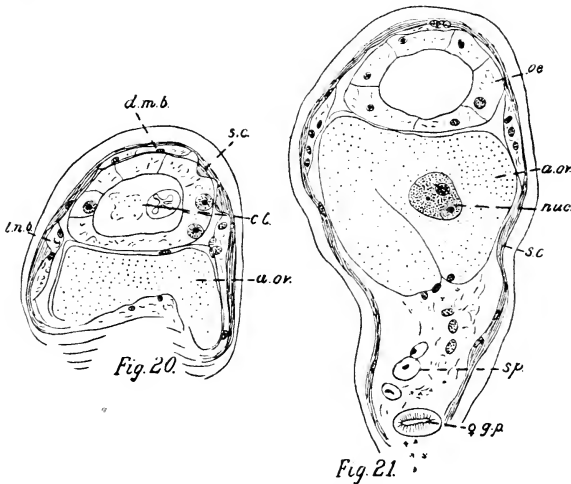

Figs. 20-21. — *Ch. falcatum*.

Fig. 20.—T.S. through body of female at beginning of anterior ovary; ($\times 450$).

Fig. 21.—Very oblique section through region of female genital aperture, showing portion of anterior ovary and uterus.

There is no trace of the longitudinal lateral vessels found in Nematodes, and the only indication of a nervous system is in the shape of an ill-defined granular mass of tissue round the constriction between the two pharyngeal bulbs.

In the female, there are two ovaries lying in the cœlome below the enteric canal, one behind, and one in front of the genital aperture (Pl. xlv., *a.ov.*, *p.ov.*). They are thick and short (about 0.066 mm. long), and the free end of each appears to be bent over on the remainder. The portion of each furthest removed from the genital pore, consists of finely granulated substance in which a few, very large nuclei are scattered (Text-figs. 20-21, *a.ov.*). The remaining part is divided by distinct walls into large cells, each

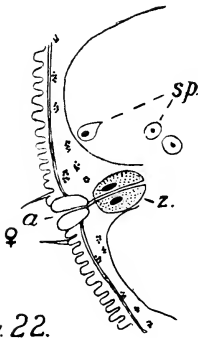

Fig. 22.

Fig. 22.*

containing a large, round nucleus. These are probably ova in process of formation. The ovaries open into a single large uterus, which, in the adult, always seems to contain numerous sperms. The genital pore, by which it opens on the surface, is a transverse slit, 0.01 mm. wide, situated on a slightly raised papilla. It appears to be surrounded by very small setæ, and has thick, chitinous walls. Immediately below the aperture, lie two, thick, elongated cells, with very large nuclei, apparently enclosing the uterine passage (Text-fig. 22). Embedded in the wall of the uterus, and lying free in its cavity, are numerous rounded spots, stained bright pink with eosin.

In the male, the genital apparatus is in the form of a straight tube, lying ventral to the alimentary canal, throughout a greater part of the length of the trunk (Pl. xlv.). It is distinctly divided into three portions. At the anterior end, beginning 0.055 mm. from the neck, is the testis (*t.*), a narrow cord consisting of a solid mass of granular matter not divided into cells. Further back, cells become gradually differentiated, and pass into a wide, tubular cavity, the vas deferens, where they lie loose. At the level of the anterior end of the rows of ventral setæ, the vas deferens passes very abruptly into a narrow,

* L.S. through female genital aperture (*a.*), showing the large cells (*z.*) surrounding the passage into the uterus; ($\times 610$); *sp.*, sperms in uterus.

thick-walled duct, the vesicula seminalis (*v.s.*), which runs back to open with the rectum at the anus. At the junction of the vas deferens with the vesicula seminalis, the wall of the latter is very thick, opaque, and finely granular, and probably functions as a gland for secreting a seminal fluid. The lumen of the vesicula seminalis is difficult to make out. In all fixed specimens, it is filled with what is probably a coagulated fluid. The sperms are small and rounded, with a very distinct nucleus, but show no trace of the characteristic tail of the typical sperm.

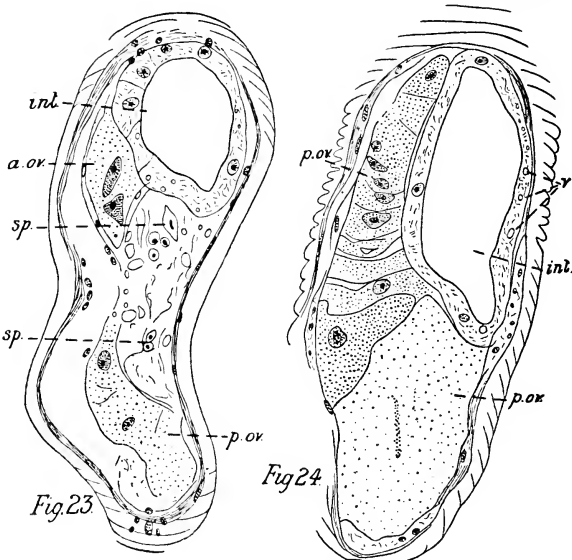

Figs. 23-24.—*Ch. fulcatum*.

Fig. 23.—Oblique section through middle region of trunk of female, showing portion of uterus, and anterior and posterior ovaries; ($\times 450$).

Fig. 24.—Section through the same worm, a little further back, showing cellular portion of posterior ovary (*p. ov.*); *sp.*, sperms in uterus; *v.*, vacuoles in wall of intestine.

Two, equally long, curved, penial setae, and a small, accessory piece lie dorsal to the rectum. The setae are bow-shaped, and have enlarged, proximal ends (Text-fig. 3, *p.s.*). Between the sperm-duct and the ventral body-wall, there is a row of block-

like, granular bodies, staining deeply blue with hæmatoxylin. Similar structures appear to be present in the female, connected with the ventral ridge of protoplasmic tissue. They probably have some relation to the locomotor setæ, though I cannot find any trace of communication between them.

Type-specimens, Nos. W, 452, 453; in the Australian Museum, Sydney.

Chatosoma falcatum, n.sp. Measurements in mms.

	♀	♂
Total length	0·888	0·840
Length of head	0·144	0·168
Length of trunk	0·744	0·672
Length from tip of tail to anterior end of rows of ventral setæ	0·408	0·360
Length from tip of tail to anus	0·092	0·077
Length of tail	0·051	0·033
Length from neck to ♀ pore	0·312	—
Greatest width of head	0·063	0·063
Greatest width of trunk	0·092	0·081
Width at level of ventral setæ	0·048	0·055
Width at level of neck-constriction	0·026	0·026
Length of rostrum	0·040	0·033
Length of setæ on rostrum	0·018	0·015
Length of hairs on head	0·022	0·022
Length of ventral setæ	0·018-0·016	0·018-0·016
Number of setæ in ventral rows—outer... ..	21 compound.	12 compound, 7 simple, 9 anal.
Number of setæ in ventral rows—inner... ..	23 compound.	17

CHÆTOSOMA HASWELLI, n.sp. (Plates xlv.-xlvii.).

In 1914, Professor Haswell obtained a few individuals of this species from material collected along the shores of Port Jackson and Broken Bay, N.S.W. These were the first of the *Chatosomatidæ* found south of the Equator. In the following year, he drew my attention to them, and afforded me the opportunity of examining these and other specimens, which he subsequently collected. During the last twelve months, I have myself collected some fifty of the same species from various localities round the shores of these bays, and along the ocean-coast in the vicinity. *Ch. haswelli* appears to be the most generally dis-

tributed of the New South Wales species. I have found it in the same material with each of the other three species; and, in addition, at nearly every spot, where a search has been made, to a distance as far up the harbour as Circular Quay, and to a depth of 18 feet below lowwater-mark. No collections were made at a greater depth than this; and the majority of the specimens were obtained just below tide-marks.

I have been able to observe a fairly large number of living individuals. In one case, all the specimens were found alive in material which had been collected four days previously. Two were kept alive for fourteen days in a crystal-dish, by changing the water every day; and were then accidentally crushed during an examination under the microscope. A third worm, a young specimen, was kept alive for five weeks; and was still active, and apparently quite healthy, when it was lost during transference to fresh seawater. It had not then reached mature size. All the specimens found alive were very dirty, being covered with grit. They required frequent cleaning with a very fine camel's hair brush, as it was found that they continued to accumulate grit every day during the time they were alive, the dirt apparently adhering to a sticky secretion over the whole surface.

Ch. haswelli is the largest of the species found here. The length of the largest male obtained was 1.32 mm., and of the largest female, 1.44 mm. Sexual organs had not developed in the smallest specimen found, which was 0.60 mm. long. The worms are mostly S-shaped when fixed (Pl. xlvi.). They are long and slender, and narrower, in proportion to their length, than the other species. The females are, on an average, longer than the males; and, in both sexes, the head is broader than the average width of the trunk. In the male, there is very little variation in the width of the trunk, though there is a slight increase in size in the middle region. The female is markedly wider in the middle. Typical measurements are given in the accompanying Table p.798).

The head is oval in shape, and well marked off from the rest of the body. In length, it is only one-ninth to one-tenth of the

total body-length. The tail is fairly long and slender, tapering gradually to a fine point; and is longer in the male than in the female. The body is covered by a thin, delicate, semitransparent cuticle, which is marked by very delicate, transverse striations, except at the two extremities, where it is quite smooth; and in

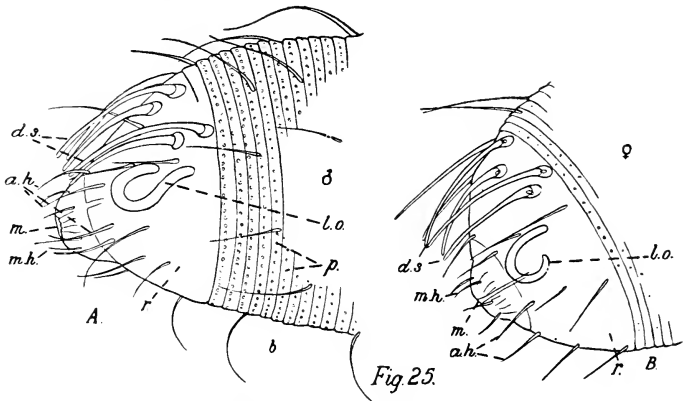

Fig.25.—*Ch. haswelli*, n.sp.

A., Anterior extremity of head of male, showing details of structure of rostrum (*r.*), and banded area (*b.*), lateral view.—B., similar view of head of female, to show difference in form of lateral sense-organ (*l.o.*); ($\times 630$); *m.h.*, hairs surrounding mouth; *a.h.*, terminal hairs of the rows extending down the trunk; *p.*, pores in the striae of banded area.

the middle region of the head, where there are from eight to fifteen much thicker ridges, forming a well marked band. The head, therefore, is distinguishable into three regions, a smooth, anterior end or 'rostrum' (Pl. xlvii., *r.*); a banded area (*b.*); and a broader region behind it, on which the transverse striations are inconspicuous. The rostrum is short, about one-fifth to one-sixth the total length of the head, and is blunted off in front. The banded area is of about equal length, and appears to constrict the head, which broadens out considerably behind it. The ridges forming this band slightly overlap one another from behind forward (Fig.25, *b.*); and, in each ridge, continuing right round its circumference, there is a single row of fine pores set very

close together (Fig.25, *p.*). The pores are very deeply embedded (Fig.30, *p.*), but show, on the surface, as a row of fine, bright dots. They appear to be present only in this region, though the surface of the rostrum also is very finely, but irregularly, pitted all over.

The lateral, spiral grooves on the rostrum are large and conspicuous; the spiral is simple and very open, and is turned away from the dorsal hairs in the female, and towards them in the male (Fig.25, *l.o.*). Embedded in the hypodermis, below the groove on each side, is a peculiar cell, probably sensory in character (Fig.31, *x*), which may have some relation to these lateral organs, though I cannot trace any direct connection between them. The dorsal semicircle of stout 'head-hairs' or setæ, in the adult, consists of five or six pairs arranged in two rows close to the posterior margin of the rostrum (Fig.25, *d.s.*), the setæ of the posterior row being wedged against the most anterior of the ridges of the banded area. They have an average length of 0.025 mm. All the setæ are bent forward to such a degree, that they lie close to the surface of the rostrum, and follow its shape. They are enlarged at the base, and are long enough to project over the anterior end, where there is a lip-like arrangement surrounding the mouth (Fig.25, *m.*).

One immature female, without a genital pore, was found, in which there were only four setæ in a single row (Pl. xlvii., *b.*). In this case, the two inner setæ were inserted very close together in the dorsal mid-line; and the outer ones, separated from them by a fairly wide interval, are just dorsal to the spiral groove on each side. Close to the outer side of each seta is a long, fine hair.

The ventral setæ (Pl. xlvi., *i.v., o.v.*) are confined to a small portion of the trunk, usually about one-seventh the total length of the body, whether this is 0.60 or 1.44 mm. The setæ are arranged in four rows, beginning some little distance in front of the anus, about 0.051 mm., in mature worms of both sexes, and 0.034 mm., in young worms.

The two inner rows are situated very close together, and con-

sist each of 14-17 compound setæ (Figs. 26, 27, *i.r.*, *i.r'*). The composition of the outer rows differs in the two sexes. In the female (Fig. 27, *ov.*), there are 10-14 compound setæ in each row; in the male, 7-11 compound setæ, and 4-5 simple setæ alternating irregularly (Fig. 26, *s.s.*, *c.s.*). In young worms, the number is

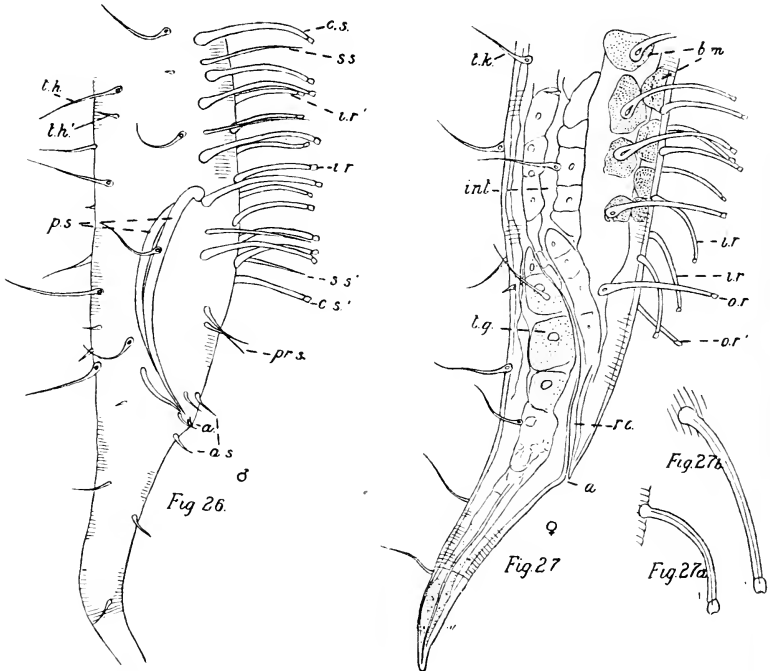

Fig. 26.—*Ch. hasrelli*,*

Fig. 27.—*Ch. hasrelli*,†

much less. In one specimen, which has only a single row of four head-setæ, there are five setæ in each outer row. Another young worm, 0.60 mm. long, which appeared to belong to this species,

* Posterior end of male, showing the arrangement of trunk-hairs and ventral setæ; ($\times 400$). The penial setæ are visible through the body-wall (*p.s.*); *a.s.*, setæ surrounding the anus; *pr.s.*, pre-anal setæ.

† Posterior end of female, showing the arrangement of hairs and setæ on the surface, and also some of the internal structure, as seen through the body-wall; ($\times 400$). Fig. 27*a.*—Seta of inner row of ventral setæ; ($\times 630$). Fig. 27*b.*—Seta of outer row; ($\times 630$).

had only a single row of head-setæ, and only three pairs of ventral setæ (Pl. *xlvii.*, *b*). But it is possible that this was a damaged specimen, since the setæ in some of the others examined broke off with handling.

The setæ of the inner rows (Fig. *27a*) are much shorter than those of the outer rows (Fig. *27b*), which are often longer than the width of the body in that region; and longer in the male than in the female, averaging, in the former, 0.045 mm., and 0.040 mm. in the latter. The longest setæ are at the anterior end of the rows. Here, they are more closely crowded than they are further back. All the compound setæ are similar in character. Each consists of a proximal, elongated, hollow rod, and a small, expanded, movably-jointed end-segment, with a deep indentation in its distal margin. The simple setæ, which alternate with them in the male, are of equal length, but very slender and delicate, and tapering to a fine point. The body-hairs are a very conspicuous feature in this species. They are very long, relatively to the width of the trunk; and all have a bulb-like swelling at the base (Figs. *26, 27, 35, t.h.*). They are arranged in eight longitudinal rows, two lateral rows on each side, two dorsal, and two ventral, which are all continued over the head to the anterior end of the rostrum (Pl. *xlvi.*). The dorsal and dorso-lateral rows extend down to the margin of the tail, but the ventral and ventro-lateral rows only to the beginning of the ventral setæ, with the inner and outer rows of which they are respectively continuous. The number of hairs in each row is limited, and appears to be fairly constant. On the trunk, there are, in the dorsal rows, 20-30 long hairs; dorso-lateral rows, 19-27; ventro-lateral, 15-17; and ventral, 15-23. On the head, there are, on the hinder region, 3-5 hairs; on the banded area, two; and, on the rostrum, 3-4, the terminal hair of each of the eight rows being situated right at the anterior margin of the cuticle, so that there are eight hairs forming a circle surrounding the lip-like prominence, in the centre of which, the mouth is situated (Fig. *25, a.h.*). Immediately round the small mouth-opening, there is another ring of small hairs, about six apparently,

but the number is difficult to determine (Fig.25, *m.h.*). On the dorsal side of the rostrum, the rows of hairs are distinct from, and lie between, the stout 'dorsal hairs,' or setæ, already described. On the trunk, in each row, there are, alternating fairly regularly with the long hairs, very short, blunt hairs (Fig.26, *t.h'*), which have a similar bulb-like swelling at the base. This, in all the hairs, seems to be hollow. Particles of dirt are frequently found adhering to the hairs, and it appears probable that these are glandular, and secrete some sort of mucilage. The 'long trunk-hairs' of the dorsal rows are longer than those of the other rows, especially over the region of the genital organs in the female, but the variation in length is not marked. In different specimens, the length varies from 0.025 mm. to 0.05 mm., and seems to average about two-thirds the average width of the body.

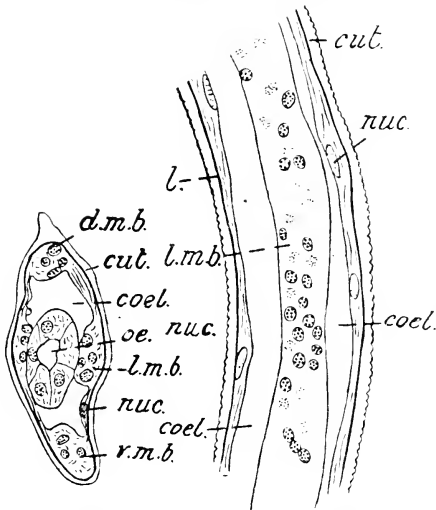

Fig.28a. Fig.28.

Figs.28, 28a.—*Ch. hasrelli*.*

level of the anus and the beginning of the tail. The cuticle of

In the male, there are, in the region of the anus, several hairs differing in character from the ordinary trunk-hairs, stronger and stouter, and without the basal swelling. These appear to be very constant in position, *i.e.*, two inserted very close together about half-way between the outer, ventral row of setæ and the anus (Fig.26, *pr.s.*), two on each side at the anus, one behind, and one in front of it, in the mid-ventral line (Fig.26, *a.s.*), and one or two others between the

* Fig.28.—L.S. through body-wall, cutting through one of the mesodermal bands, and the subcuticular layer on either side of it; ($\times 950$). Fig.28a.—T.S. through anterior region of trunk of a young *Ch. hasrelli*; ($\times 950$).

the body-wall is a thin, homogeneous layer, about 0.001 mm. thick (Fig. 28, *cut.*). An extremely thin, dark line (*l.*), which, however, becomes much thicker in the head, divides it from the next layer. This is of about the same thickness as the cuticle. It is difficult to make out any structure in it, but it appears to be of fibrous composition; and, lying along its inner border, there are, at wide intervals, elongated, oval nuclei (*nuc.*). Below it, at about equally spaced intervals, there run four longitudinal bands of mesoderm, containing numerous, crowded, round nuclei (*d.m.b.*, and *l.m.b.*). These bands are continuous from the neck to the tail, and form the innermost layer of the body-wall. Within it is a wide cœlomic cavity (*cœl.*), in which lie the enteric canal and the genital organs. In the head, a loose sort of protoplasmic tissue fills up a great part of the cavity, between pharynx and body-wall. Below the ventral body-wall, in the region of the ventral

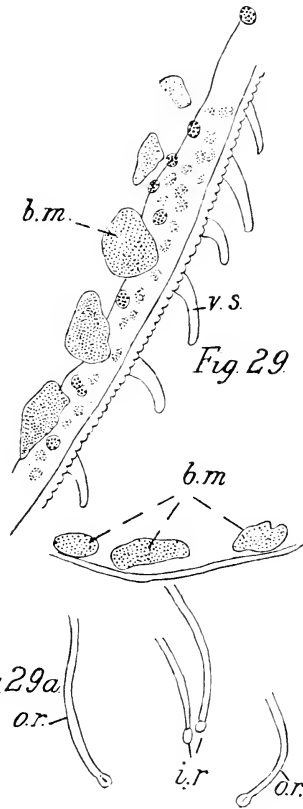

Figs. 29, 29a.—*Ch. haswelli*.*

setae, there are four rows of block-like, finely granular masses, staining deeply blue with hæmatoxylin (Pl. xlvii., *b.m.*). They are quite separate from one another, about ten to twelve in each

* Fig. 29.—L.S. through body-wall in region of ventral setae; ($\times 950$). Fig. 29a.—T.S. in same region; ($\times 610$). The section has been flattened out in cutting; *v.s.*, bases of ventral setae.

row; and they lie directly under the rows of locomotor setæ throughout their length (Figs.27, 29, *b.m.*). It is probable that they have some relation to the setæ, since they are found only in this region; but I cannot trace any direct connection between them.

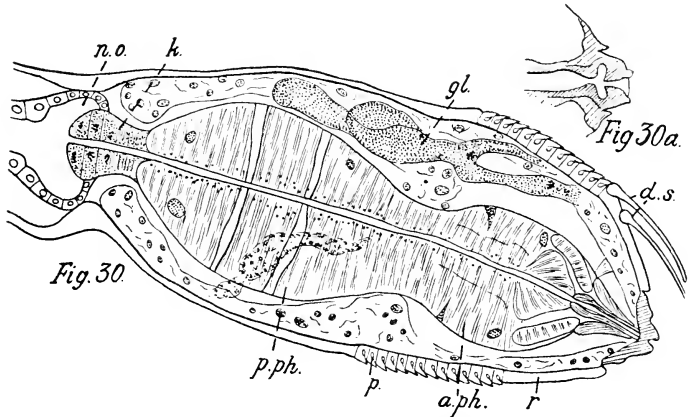

Figs.30, 30a.—*Ch. haswelli*.

Fig.30.—Sagittal, longitudinal section through head; ($\times 660$).

Fig.30a.—Section through mouth-opening; ($\times 760$).

The mouth-opening is surrounded by a circular projection, which seems to be protrusible, and bears a circlet of fine teeth (Fig.30a). The mouth leads directly into the pharynx, which has very thick, muscular walls, and extends through the full length of the head. It is constricted in the middle to form anterior and posterior bulbs, of which the posterior is the larger (Fig.30, *a.ph.*, *p.ph.*). Both bulbs are slightly larger in the female than in the male, corresponding to a difference in the size of the head. The walls of the anterior pharyngeal bulb consist of a complicated system of muscle-fibres, the arrangement of which is shown in Fig.30. The passage is narrow, and lined with cuticle, which is thickest towards the mouth-opening. Immediately surrounding the passage, there is a mass of finely pigmented granules; and deeply embedded in the muscle-fibres are numerous, small glands, probably digestive, which open into the

pharynx by fine ducts (Fig.33, *d.g.*). Strands of tissue connect the bulb with the inner wall of the rostrum, both at the anterior end and further back (Fig.32, *c.*). The muscle-fibres in the posterior bulb are all radial, and are divided into three sections by two radial gaps, which are very constant in position in different

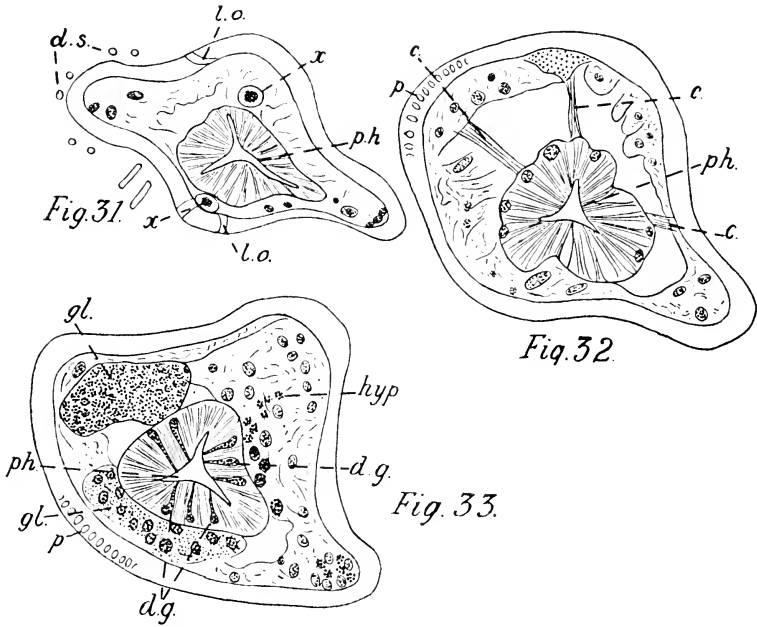

Figs.31-33.—*Ch. haswelli*.

Series of tr. secs. through the head; ($\times 950$). The head has been distorted in shape during the process of embedding.

Fig.31.—Section through the rostrum.

Fig.32.—Section through the 'banded' area.

Fig.33.—Section through the hinder part of the anterior pharyngeal bulb; *c.*, sensory cells; *d.g.*, digestive glands; *p.*, pores in the striae of the banded area; *c.*, fibres from pharynx to body-wall.

specimens. This gives the appearance of a broad band surrounding the middle region of the bulb. The gaps contain a granular substance, which is probably glandular in character. The terminal portion of the pharynx consists of a knob (Fig.30, *k.*),

formed of a little group of dark granular cells, which projects into a wide, thin-walled chamber formed by a swelling of the œsophagus in the neck (Fig. 30, *n.o.*). This swelling is supported

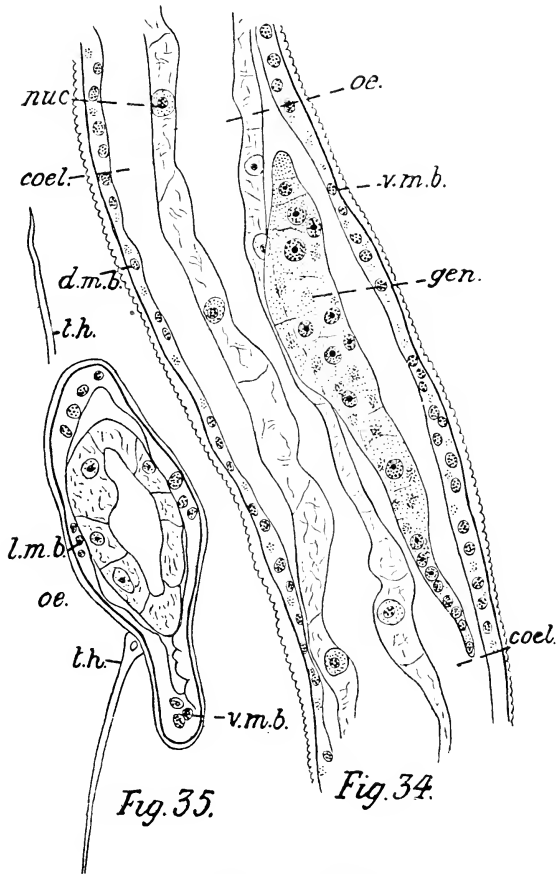

Figs.34-35.—*Ch. haswelli*.

Fig.34.—L.S. through trunk of a young specimen in middle region, showing rudiment of a genital system (*gen.*); ($\times 950$).

Fig.35.—T.S. through trunk anterior to genital system; ($\times 950$).

by inward projections of the body-wall. Behind it, the lumen of the œsophagus is narrow throughout its length, and the wall

is one cell thick (Figs.34, 35, *α*). The cells are thin-walled, and roughly rectangular in cross-section, measuring about 0.014×0.007 mm. The protoplasmic contents are clear; and a large, round nucleus (*nuc.*) is situated about the middle of each cell. In the mid-region of the body, in the female, the intestine is constricted to a narrow tube pressed up against the dorsal wall by the genital organs. Below the posterior ovary, it widens so as nearly to fill the coelome. The cells of the wall are here very large, and the cell walls, forming the lining of the passage, are

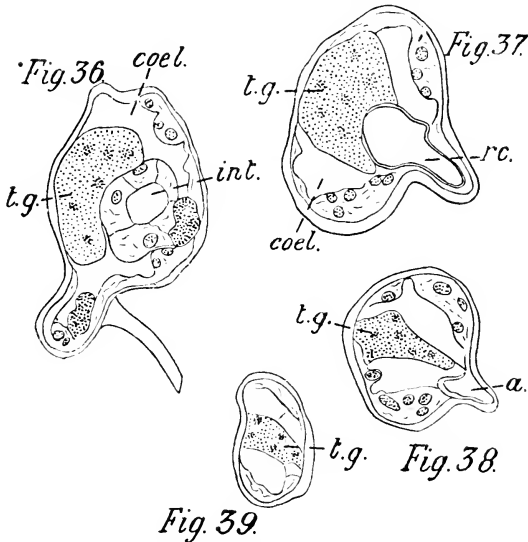

Figs.36-39.—*Ch. haswelli*.

Series of tr. secs. through posterior region. Like most of the transverse sections, they have become distorted in shape during embedding; ($\times 950$).

Fig.36.—Section through constriction between intestine and rectum. Fig. 37, through rectum. Fig.38, through anal aperture. Fig.39, through tail.

slightly thickened. The cells vary in shape, and project into the intestinal cavity, leaving only a narrow passage. The tube is constricted again in the region of the ventral setæ (Fig.27, *int.*).

About the level of the last of the ventral setæ, the intestine

passes, by a narrow constriction, into the rectum (Fig.37, *rc.*), a wide, thin-walled tube lined with cuticle. This opens by the anus (Fig.38, *a.*) on the mid-ventral surface, at an average distance of 0.080 mm., from the posterior end, in the female; and 0.099 mm., in the male.

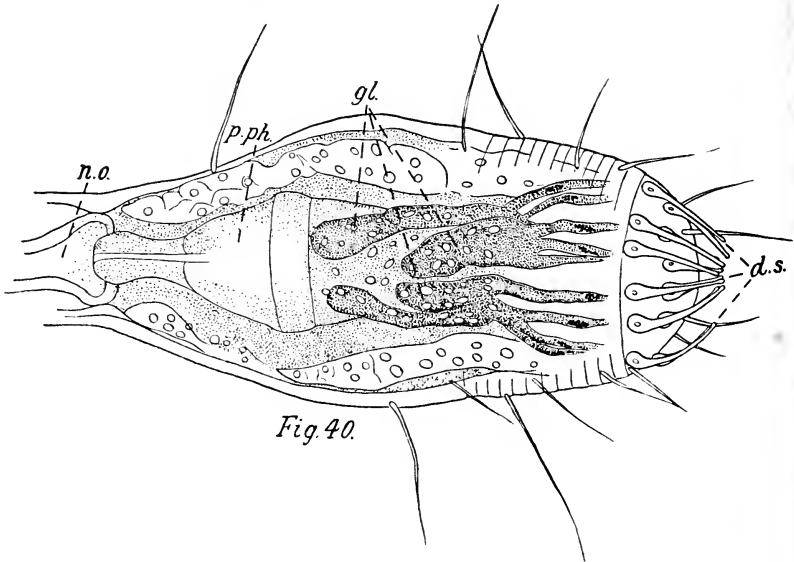

Fig.40.—*Ch. hasrelli*.

Dorsal view of head, showing arrangement of dorsal setæ, and the glandular bodies (*gl.*) lying above the pharynx; ($\times 660$).

Nerve-cells and nerve-fibres are distinguishable in the protoplasmic tissue in the head. They seem to form an ill-defined ring surrounding the constriction between the two pharyngeal bulbs, and give off strands forward and backward.

Lying above the pharynx, and embedded in the hypodermis, there is a group of densely granular bodies (Figs.30, 40, 41, *gl.*), staining dark blue, from each of which, a strand runs forward, and apparently connects with the base of one of the dorsal setæ. One or several thickenings occur in each of these strands, towards the anterior end. I have been able to observe these bodies only in a few specimens, and have failed to determine their exact

nature. The thickenings on the strands seem to suggest nerve-matter, but I think it more probable that they are glandular in character, and secrete a fluid which assists the hollow, dorsal setae in their locomotory function.

Another body, of a glandular character, lies in the posterior end of the trunk, just dorsal to the rectum. It is club-shaped, composed of several, large, finely granular cells containing numerous vacuoles and large nuclei, and is bounded by a distinct wall (Figs. 27, 36-39, *t.g.*). It is connected with

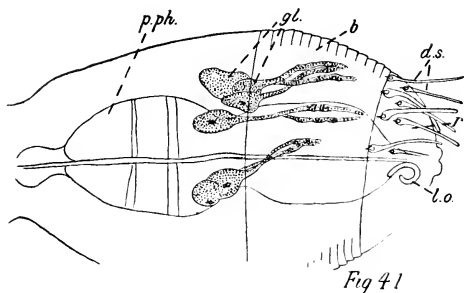

Fig. 41.—*Ch. haswelli*.

Lateral view of dorsal setae and glands (*gl*) in the head; ($\times 400$).

a fine duct, which runs back through the tail, and opens by a fine pore at the posterior extremity. Large, bright drops of fluid are distinguishable in the duct, in some specimens; it seems probable that this organ is an excretory 'tail-gland.'

In the male, the reproductive apparatus consists of a single cord, which begins at a distance of 0.074 to 0.140 mm., from the neck, and extends straight back below the alimentary canal, to open with it at the anus. The anterior portion is solid, and terminates in a fine point (Pl. xlvi., *t.*). It has an average width of 0.007 mm., and consists of a closely packed mass of small cells enclosed by a firm wall. Further back, the cells become larger and more loosely arranged, and take on the definite character of sperms, of rounded or somewhat irregular shape, with fragments of connective tissue between them (Figs. 42-43, 45). This portion, which has a width of 0.014 mm., passes abruptly, towards the middle of the body, into a definite tube, with very wide, cellular walls (Fig. 44, *r.s.*). The lumen is extremely small, and, in cross-section, is surrounded by four or five, large cells, with very large nuclei. In longitudinal section, it has the ap-

pearance of being a solid cord, but the dense, finely granular substance filling it, is probably a spermiatic fluid, which has become coagulated in the fixing. It is impossible to examine it in the living state, owing to the difficulty of keeping the actively moving worm in the field, under a high power. Posteriorly, the sperm-duct diminishes in width. There are two, equal, penial setæ (Pl. xlvii.; Text-fig.26, *p.s.*), and an accessory organ. The setæ are long, and are curved into a bow-shape, with enlarged, club-like, proximal ends.

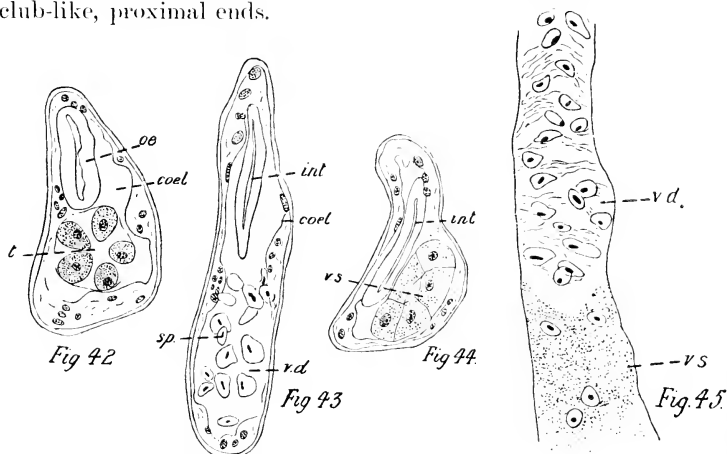

Figs 42-44.—*Ch. haswelli*, ♂.*

Fig. 45.—*Ch. haswelli*, †

The female genital pore (Figs.46, 47, ♀ *g.p.*) is a transverse slit, with prominent lips, situated on the ventral surface just about the middle of the trunk. There are two, large and well-developed ovaries (Fig.46, *a.ov.*, *p.ov.*) situated, one anterior and one posterior to the genital pore. The end of each, furthest from the pore, is roughly conical in shape, about 0.074 mm. long,

* Series of sections through the trunk; ($\times 630$). The sections have been laterally compressed, and the internal structure somewhat distorted. Fig.42—A section through the anterior part of testis. Fig.43, through the vas deferens. Fig.44, through the sperm-duct, in the region of the ventral setæ.

† L.S. through male genital tube, in region between the vas deferens and the vesicula seminalis, showing the finely granular matter in which the sperms are embedded at the junction; ($\times 630$).

and 0.026 mm. broad at the widest part; and contains large nuclei embedded in finely granular substance. It is continuous

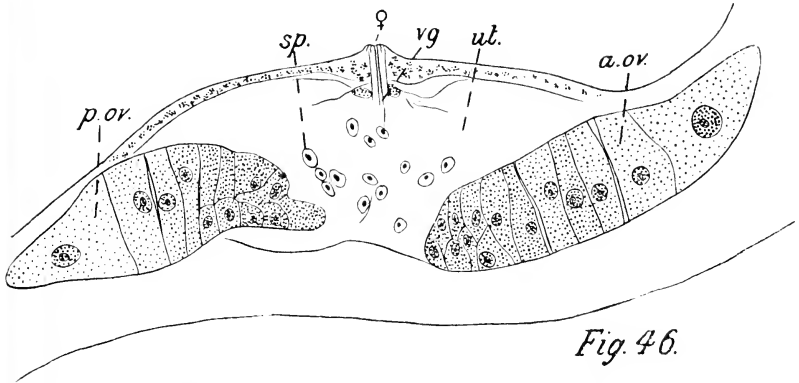

with a much broader portion, where there is a differentiation of the contained matter into long, thin cells, cut off in a transverse direction. There are distinct spaces between some of the cells, which appear to be ova in process of formation. This part may, perhaps, be looked upon as an oviduct. A definite, tubular duct, connecting it with the uterus, is not discernible in any of the specimens, which I have examined. Some individuals examined had a single, large, oval egg in the common uterus (Fig. 47, o.). The uterus measures 0.092 ×

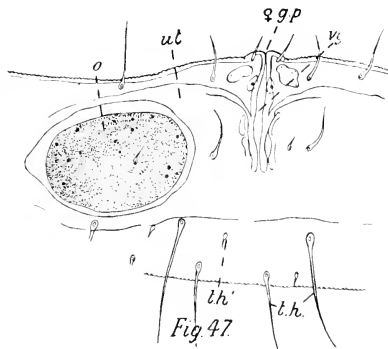

0.055 mm. A large receptaculum seminis seems to be a diverticulum from it. It lies to one side of the oviducts, and extends out towards the anterior and posterior ovaries. In all the specimens examined, it is full of sperms (Fig. 46, sp.). The narrow passage, leading from the uterus to the vulva, has thick walls,

Fig. 47.—*Ch. haswelli*. Ovum in uterus; ($\times 320$).

and, at its junction with the uterus, is surrounded by a few large cells, which probably act as a sphincter (Fig. 47, *vy.*). The development of the fertilised ovum has not been followed.

Type-specimens, Nos. W, 454, 455; in the Australian Museum, Sydney.

Chaetosoma haswelli, n.sp. Measurements in mms.

	♀	♂
Total length	1.39	1.128
Length of head	0.144	0.120
Length of trunk... ..	1.248	1.008
Length of trunk covered by rows of setæ	0.185	0.166
Length from tip of tail to ant. end of rows of setæ... ..	0.333	0.333
Length from tip of tail to anus	0.092	0.107
Length of tail	0.037	0.037
Length from neck to genital pore	0.600	—
Greatest width of head	0.070	0.066
Greatest width of trunk	0.085	0.059
Width at level of ventral setæ	0.047	0.030
Width at level of neck-constriction	0.029	0.033
Length of rostrum	0.026	0.022
Length of setæ on rostrum	0.022	0.022
Length of hairs on trunk	0.037	0.025
Length of ventral setæ, outer rows	0.044	0.055
Number of setæ in ventral rows—outer	13	7 + 4
inner	15	12

NOTOCHÆTOSOMA, gen.nov.

The two species, included in this genus, differ considerably from any of the Chaetosomatidæ hitherto described, in that a well marked head-swelling is absent. There is a corresponding difference in the structure of the pharynx, which lacks the typical pharyngeal bulbs, and is only slightly swollen posteriorly. The structure otherwise is very similar to that of the Chaetosomatidæ, but the differences indicated seem to be of sufficient importance to constitute a new genus of this family.

Genotype, *N. tenax*, n.sp.

NOTOCHÆTOSOMA TENAX, g. et sp.nov. (Plates xlvi. xlix.).

Only a few specimens have, so far, been obtained, all taken from a single locality in Port Jackson. I first found four in the

winter of 1916, in material collected at Vacluse, on the rocks between, and just below tide-marks. Since then, about thirty worms of the same species have been obtained from the same place; but extensive searches, in other localities, have proved fruitless.

The ventral, adhesive setæ are very powerful, and it is difficult to dislodge the animal from its support, so that I have been able to observe only five living individuals. These were taken from the concentrated washings of some thirty jars of fresh material. Two of the worms were kept alive in a crystal-dish, with two changes of sea-water, for a period of eight days, and a third for nine days. They have the characteristic, creeping mode of locomotion of the Chatosomatidæ; and are more easily distinguishable from marine Nematodes when alive, than after death. When fixed, the general appearance of the body so closely resembles that of a small Nematode, that it is only possible to detect them by means of the minute setæ on the head and ventral surface.

The largest individuals attain a size of 1.0 mm., but the average size is somewhat less than this, from 0.8 to 0.9 mm. Male and female appear to be of the same length. The shape assumed, when fixed, is not constant; but the posterior third of the body is usually straight, while the region in front is more or less arched in a dorsal direction. The anterior end is only slightly enlarged, and is distinguishable as a head-region by its curvature, rather than by any definite neck-constriction. It is usually more or less bent in a ventral direction, but the curvature varies considerably in different specimens, as will be seen in the Plates. The cuticle covering the body is very thick, and, from the rostrum to the beginning of the tail, is transversely striated. There is no special banded area behind the rostrum, the striæ being all broad and deep, of the same thickness all over the body, though there is a difference in character between the striæ of the head-region and those behind, the former overlapping one another, from behind forward, to a much greater extent than the striæ on the trunk (Fig. 53, *cut.*). The rostrum (Figs. 48, 53, *r.*), is short, 0.014 to 0.018 mm. long; and the smooth cuticle

covering it is very thick, and has a serrated anterior margin. Beyond it, is a projection of tissue, 0·011 mm. long, with a rounded extremity, in the middle of which the very small, circular mouth-opening (Fig. 48, *m.*) is situated. The width of the body, just behind the rostrum, is 0·040 to 0·050 mm., which decreases, at the level of the neck-curve, to a width of 0·033 to 0·037 mm. The length of this anterior, ventrally curved portion varies, in different individuals, from 0·122 to 0·150 mm. Behind it, the body gradually increases to a width, in the male, of 0·050 to 0·060 mm., and, in the female, in the region of the genital organs, of 0·070 to 0·096 mm.

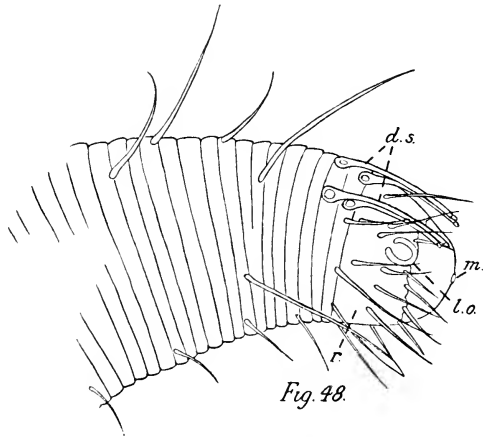

Fig. 48.—*Notochaetosoma tenuis*, n.sp.

Lateral view of anterior extremity; ($\times 630$).

The tail (Fig. 49, *t.*) is narrow, and sharply pointed. In the male, it averages 0·085 mm. from anus to tip; in the female, 0·077 mm. Cuticular striations are absent from the terminal portion (0·040 mm. long), and the anterior half of this part is closely pitted. A pair of long hairs is inserted on its dorsal surface, just at its junction with the striated area (Fig. 49, *e.h.*). As in the other species, the anus is situated on the mid-ventral surface, close to the posterior end (Fig. 49, *a.*). The ventral setae are arranged in four rows, and cover a length of about one-sixth

to one-fifth the total length of the body. The rows begin about 0.045 mm. in front of the anus, and extend forward for a distance, which varies from 0.092 to 0.188 mm., according to the age of the animal, and the number of setae. The outer rows (Figs. 49, 50, *o.r.*) are laterally situated, separated by a wide interval from the inner rows (*i.r.*), which are inserted very close together, and in pairs anteriorly. Further back, they alternate irregularly, and the two rows are not so clearly distinguishable. They usually begin further forward, and their setae are much shorter than those of the outer rows.

In the male, the outer rows are composed of compound and simple setae alternating irregularly, the simple setae (Fig. 49, *s.s.*), being fewer in number, and shorter than the compound (*c.s.*), and very slender. Four or five, short, simple setae continue the outer rows back on either

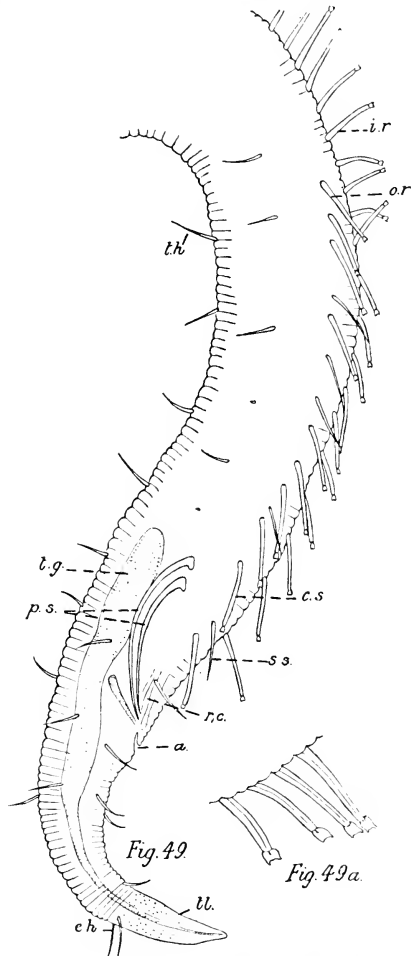

Figs. 49, 49a.—*N. tenuis*, ♂.

* Posterior region of trunk. The tail-gland and penial setae are seen in outline through the body-wall; ($\times 386$).

Fig. 49a.—Compound setae of ventral row; ($\times 630$).

side of the anus. The number varies, in the specimens examined, from seven compound and five simple, to fifteen compound and seven simple setæ. In the inner rows, the setæ are all compound, and vary in number from 10-17.

In the female (Pl. xlix.), all the setæ, of both outer and inner rows, are compound, and vary in number, from nine in the outer and ten in the inner, to twenty in the outer and twenty-two in the inner rows. All the compound setæ in this species are comparatively short and stout. The proximal segment is hollow;

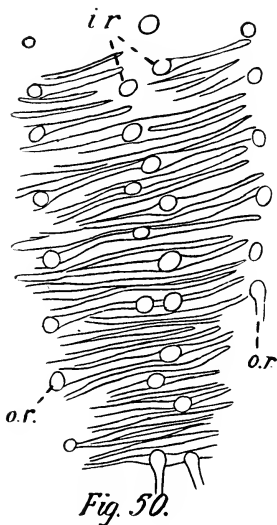

Fig. 50.—*N. tenax*.

L.S. through cuticle, and bases of ventral setæ; ($\times 830$).

while the distal segment is very broad, with two, curious, lateral processes, which are very characteristic (Fig. 49*a*). In some of the younger specimens, two, distinct, inner rows of setæ are not fully developed. The head-setæ are not inserted on the rostrum, but immediately behind it, on the margin of the striated area (Fig. 48, *d.s.*). They are arranged in a semicircle on the dorsal side of the head; and, in most adult worms examined, are eight in number, forming two rows of four each. But, in one female specimen, there is a third row of two behind the other rows, the two being inserted in a line with the middle two of the rows in front. Several young specimens have only one row of four setæ, with a fine hair

inserted close to the outer margin of each. In one case, a second row appears to be just in process of formation, in front of that which is fully developed. In specimens deeply stained with hæmatoxylin, a small, jointed, distal segment is clearly discernible on each seta, the only case in which I have been able to distinguish this; though, in the other species examined, I have thought it probable that the head-setæ, as well as the ventral

setæ, were compound. The distal segment is much smaller than in the case of the ventral setæ, and can be seen only with the aid of an oil immersion lens. The setæ are hollow, and slightly swollen at the base. They are bent forward, arching over the rostrum, but do not reach quite to the anterior margin.

The trunk-hairs (Fig.49, *t.h.*) are short and slender, not more than 0.012 mm. long, and are not swollen at the base. They are arranged in eight longitudinal rows, the two rows on each surface, dorsal, ventral, and lateral, being situated close together. Each hair is inserted in a pit-like depression in the cuticle, from the base of which, a fine canal runs inward to the inner body-wall (Fig.51, *t.h.*). The rows extend over the rostrum to the serrated margin of the cuticle, where the terminal hairs form a circle surrounding the prominence on which the mouth is situated (Fig.48). The hairs become longer towards the anterior end (0.022 mm.), and are especially long on the rostrum, where there are three strong hairs in each row. Those on the ventral side of the rostrum are nearly as stout as the dorsal setæ, so that, under low magnification, they give the appearance of a circular fringe of stout hairs surrounding the anterior end. The ventral rows of trunk hairs are continuous with the rows of ventral setæ. The lateral grooves (Fig.48, *l.o.*) lie between the two lateral rows of hairs on each side of the rostrum. They are large, and horseshoe-shaped or hook-shaped, with the open end directed posteriorly.

On account of the toughness of the cuticle, satisfactory longitudinal sections are difficult to obtain, but some transverse sections show the internal structure fairly well. The thick cuticle (Fig.51,

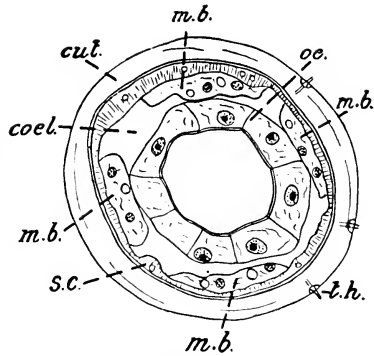

Fig. 51.

Fig.51.—*N. tenax*.
Transverse section through anterior
region of trunk; ($\times 950$).

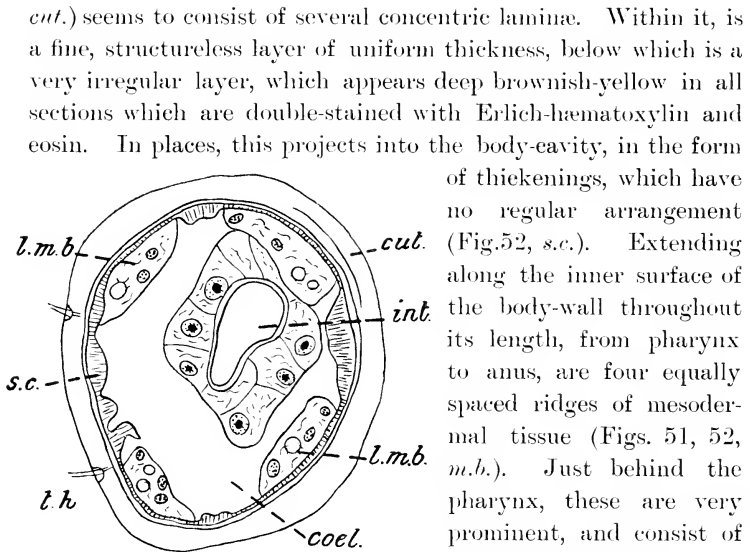

Fig. 52.

Fig. 52.—*N. tenax*.

T.S. through posterior region of trunk;
($\times 950$).

of thickenings, which have no regular arrangement (Fig. 52, *s.c.*). Extending along the inner surface of the body-wall throughout its length, from pharynx to anus, are four equally spaced ridges of mesodermal tissue (Figs. 51, 52, *m.b.*). Just behind the pharynx, these are very prominent, and consist of a loose, vacuolated tissue containing large nuclei. In the mid-region, the ridges are barely distinguishable, but, towards the posterior end, they again become very prominent, especially the two lateral ridges, which are here very large, and enclose large spaces which, in places, are almost filled-out with fine granules, staining a deep pink with eosin.

The body-wall encloses a coelomic cavity (Figs. 51, 52, *coel.*), which is extensive in the anterior region of the trunk, but, further back, becomes nearly filled up by the alimentary canal and genital organs.

The alimentary canal extends straight through the body, from mouth to anus. The mouth leads into a muscular pharynx, which is elongated and slender (Fig. 53, *ph.*). The posterior end is slightly enlarged, but there is no definite bulb. Its walls are one cell thick, the cells being few in number, and very large, with a large nucleus in each. Round its anterior end, is a group of elongated, slender, yellowish bodies, which seem to open into the

mouth-cavity. They are probably digestive glands (Fig.53, *d.gl.*). The pharynx is separated from the remainder of the alimentary canal by a sharp constriction. Behind this, the canal soon widens out into a thin-walled tube (Fig.51, *a.*) formed of a single layer of large cells, from five to ten in cross-section, bounded internally by a fairly thick wall, apparently composed of cuticle. In side-view, the cells are pentagonal in shape, and very large. In the mid-region of the body, the alimentary canal becomes narrower, and lies dorsal to the genital organs (Fig.55, *int.*). At the level of the ventral setae, it again widens (Fig.52, *int.*), and its inner wall is thickened. Posteriorly, the intestine passes into a wide rectum (Fig.56, *re.*) with thin walls of cuticle, which opens on the ventral surface by a narrow, transverse slit, the anal aperture (*a.*).

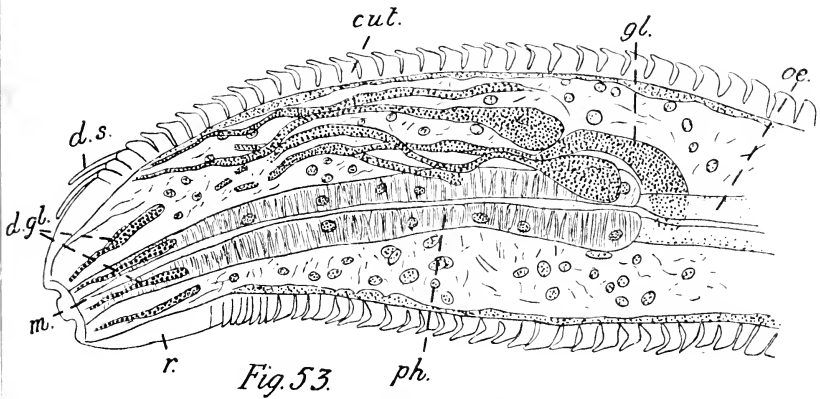

Fig.53.—*N. tenuis*.

Sagittal, longitudinal section through anterior end; ($\times 830$).

A group of finely granular, somewhat pear-shaped bodies lies above the posterior end of the pharynx (Fig.53, *g/s.*). From each of these, one or more strands run forward towards the anterior end. It is not possible, in any of the specimens examined, to trace them to their termination: but it seems evident that they end in the bases of the dorsal setae, and that the bodies are glands supplying the setae with some sort of fluid.

Lying in the mesodermal tissue, just below the ventral setæ, there are, in addition, several rows of block-like, granular masses (Fig. 56, *b.m.*), similar to those described in *Ch. haswelli*. They correspond fairly closely with the posi-

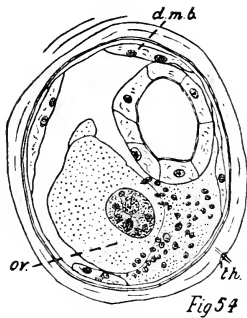

Fig. 54

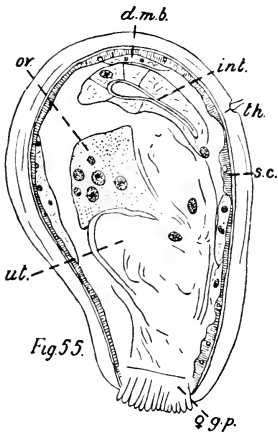

Fig. 55.

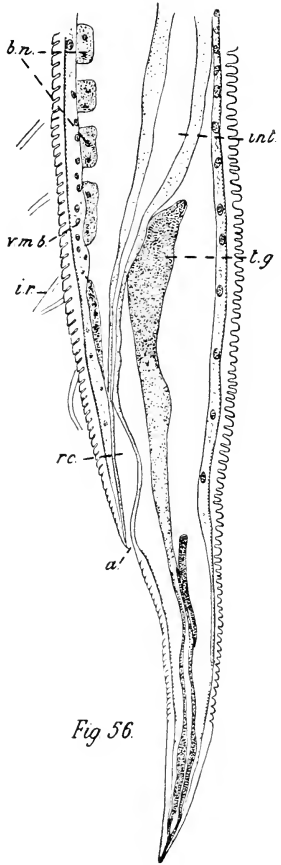

Fig. 56.

Figs. 54, 55.—*N. tenax*, ♀.*

Fig. 56. *N. tenax*, ♀.†

tion of the setæ, though they are fewer in number, as a rule. They do not appear to communicate directly with the setæ, and

* T.S. through genital region; ($\times 630$). Fig. 54.—Section through anterior ovary. Fig. 55.—Section through ♀ genital aperture, and uterus.

† Posterior end, as seen in longitudinal section; ($\times 550$).

I have not been able to determine their exact nature, but they evidently bear some relation to the setæ, and are probably glandular. A large and prominent tail-gland (*t.g.*) lies dorsal to the rectum. From this, a narrow duct, with very definite walls, runs backward to open by a prominent pore, situated at the posterior extremity of the tail. In several specimens, clear, oval drops may be seen lying in the duct.

The male genital apparatus (Pl. xlviiii., *t.*) consists of a single, straight cord running through the body-cavity ventral to the alimentary canal. It begins towards the anterior end, and appears to open posteriorly into the rectum. Its anterior end consists of a solid mass of oval sex-cells in two or three closely packed rows. Further back, the sperms become gradually differentiated, and lie free in a wide tube, which passes abruptly, about the middle of the body, into a thick-walled passage, apparently filled with a solid, granular matter. There are two, equal, penial setæ (Fig. 49, *p.s.*) lying dorsal to the rectum. Each is a long, slender, curved rod, with an expanded, flattened, proximal end.

The reproductive organs of the female (Pl. xlix.) consist of two ovaries, anterior and posterior (*a.ov.*, *p.ov.*) which are connected by a wide, median uterus. The latter opens on the ventral surface, in front of the middle of the body, by a wide, transverse slit, with thick walls. The ovaries are straight, fairly elongated, and broadly spindle-shaped. Towards the uterus, each becomes divided into a single row of long, narrow cells, cut off in a transverse direction across it. It narrows as it approaches the uterus, and is here sharply pointed, the contained cells being smaller and more numerous. The uterus forms a receptaculum seminis which, in most specimens examined, contains sperms. None of the specimens examined contained ripe ova, and the development has not been followed out.

Type-specimens, Nos. W, 456, 457; in the Australian Museum, Sydney.

Notochætosoma tenax, gen. et sp.nov. Measurements in mms.

	♀	♂
Total length	1·056	1·056
Length from anterior end to neck-curve ...	0·129	0·140
Length of trunk covered by rows of setæ ...	0·188	0·133
Length from tip of tail to anterior end of rows of setæ... ..	0·328	0·284
Length from tip of tail to anus	0·092	0·103
Length of tail	0·044	0·044
Greatest width at anterior end	0·048	0·048
Width at neck-curve	0·037	0·037
Greatest width of trunk	0·074	0·070
Width at level of ventral setæ	0·040	0·051
Width at beginning of smooth tail-part ...	0·014	0·014
Length of rostrum	0·025	0·025
Length of setæ on rostrum	0·022	0·023
Length of hairs on head	0·022	0·025
Length of hairs on trunk... ..	0·011	0·018
Length of ventral setæ, outer rows	0·022	0·026
Length of ventral setæ, inner rows	0·015	0·015
Number of setæ in ventral rows, outer... ..	18	8 compound } 7 simple })
Number of setæ in ventral rows, inner... ..	21	14 compound
Length of penial setæ	—	0·050
Length from anterior end to genital pore ...	0·432	—

NOTOCHÆTOSOMA CRYPTOCEPHALUM, gen. et sp.nov. (Plate l.).

In the same material from Vacluse, Port Jackson, in which specimens of *N. tenax* were obtained, I found a single male individual of another species, which very closely resembles it in general form. There is a total absence of a head-demarkation, and, in shape, the worm looks very like a Nematode (Plate l.). It is elongated and cylindrical, 1·056 mm. long, and tapers gradually towards each end. The anterior end is rounded; the posterior end terminates in a sharply pointed tail.

Four rows of ventral, locomotor setæ (Text-fig. 57) are present, beginning 0·048 mm. in front of the anus. The body is broken in the region of the setæ, so that the number of the setæ and the length of the body covered by them, cannot be determined with accuracy; but there are about seven compound setæ in each

outer row (*o.r.*), and eight in each inner row (*i.r.*, *i.r'*); and the length of the rows is about 0.148 mm. The setæ are short, the inner shorter than the outer. They measure respectively 0.015 mm., and 0.026 mm. They are all rather slender, and taper distally. The end-segments are small and expanded, with two, small, lateral processes.

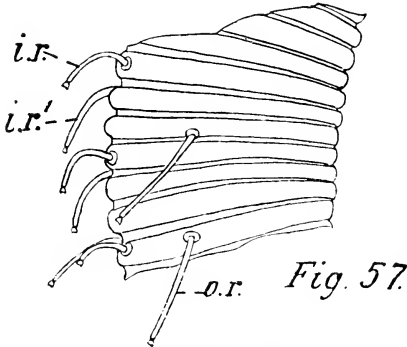

Fig. 57.—*N. cryptocephalum*, n.sp. Trunk in region of ventral setæ, showing the character of the striations on cuticle, and the arrangement of the setæ; ($\times 650$).

They number about 200, and are of the same character and size all over the body.

The cuticle covering the body is much thicker than in any other species examined from New South Wales; and the striae are very broad, with fairly wide intervals between them (Fig. 57).

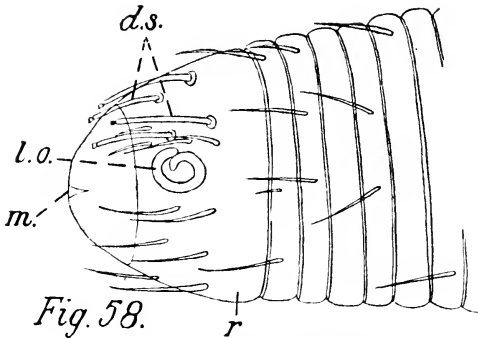

Fig. 58.—*N. cryptocephalum*. Lateral view of anterior end; ($\times 860$).

The smooth rostrum (Text-fig. 58, *r.*) at the anterior end is 0.033 mm. long. It bears two rows, each of four dorsal setæ (*d.s.*), about midway between the beginning of the striated area and

the anterior extremity. They are comparatively short, 0.015 mm., and do not extend over the anterior margin of the rostrum. There are no hairs or setæ on the posterior portion of the rostrum, but several rows of hairs lying ventrad of the dorsal setæ, which are almost as stout and as long as the setæ, are on a level with them, and are arranged in an exactly similar way. The hairs on the trunk are fine and short, not more than 0.007 mm. long, and are quite inconspicuous.

The lateral grooves on the rostrum (*l.o.*) are in the shape of a strongly curved spiral, with the opening turned towards the dorsal setæ.

The anus is a transverse slit, 0.140 mm. from the tip of the tail (Text-fig.59, *a*). It is surrounded by an oval, flattened patch of cuticle, which is finely pitted. Just behind it, two stout hairs are inserted, and bend over towards it.

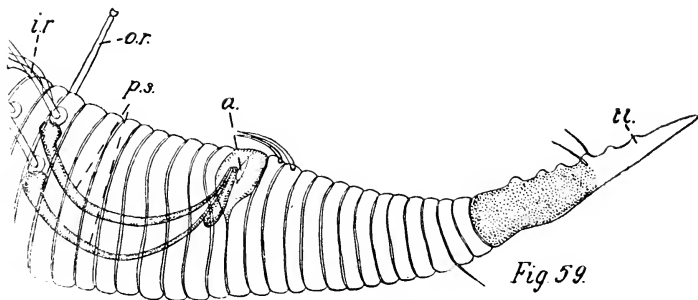

Fig.59.—*N. cryptocephalum*, ♂.

Posterior end; the penial setæ are seen through the body-wall; ($\times 480$).

The shape of the tail is peculiar. It is 0.066 mm. long, slender, and sharply pointed. The cuticle covering it is finely pitted for two-thirds of the distance to the tip, and, on the ventral side, it is raised into six sharp ridges or serrations, which give it the appearance of a saw (Text-fig.59, *t.*). About midway along its ventral surface, there are two hairs inserted close together.

The cuticle is so thick that it is almost impossible to make out any details of the internal structure.

The alimentary canal (Plate I, *a., int.*) is a tube continuous

from the mouth, at the anterior, to the anus, near the posterior end, but the structure of its walls is not visible. The pharynx (*ph.*) is slender, with a slight enlargement at its posterior end.

The male genital apparatus (*t., v.s.*) is just visible in outline, and appears to be very similar in structure to that of the other species described. Two, equal, penial setæ are present (Text-fig. 59, *p.s.*). They are 0.066 mm. long, and are very slender, and strongly curved, with enlarged, proximal ends.

Type-specimen, No. W, 458; in the Australian Museum, Sydney.

Notochatosoma cryptocephalum, gen. et sp. nov. Measurements in mms.

	♂
Total length	1.056
Length of rostrum	0.033
Width behind rostrum	0.052
Width of narrowest part behind anterior end ..	0.048
Greatest width of trunk	0.066
Width in region of ventral setæ	0.048
Width at beginning of tail... ..	0.015
Length from tip of tail to anus	0.140
Length of tail	0.066
Length from anus to rows of ventral setæ	0.048
Length of body covered by ventral setæ... ..	0.148
Length of body-hairs	0.007
Length of dorsal setæ	0.015
Length of hairs on rostrum	0.011
Length of penial setæ	0.066
Length of ventral setæ, outer rows	0.026
Length of ventral setæ, inner rows	0.015

Key to the Genera of the Family *Chatosomatida*.

- a.* Head-swelling well developed, and well marked off from the trunk by neck-constriction; pharynx enlarged in head-region to form one or more bulbs *CHLETOSOMA*
- aa.* No well developed head-swelling, and no definite neck-constriction; pharynx not enlarged in head to form bulbs.....
..... *NOTOCHLETOSOMA*.

Key to the Species of the Genus *Chatosoma*.

- a.* Not more than two rows of ventral setæ.
 - b.* Without head-setæ *C. ophioccephalum*.
 - bb.* With head-setæ.

- c. Setae of ventral rows compound *C. claparèdii*.
 cc. Setae of ventral rows simple, and very delicate...*C. macrocephalum*.
 aa. More than two rows of ventral setae.
 d. With three rows of ventral setae.
 e. Inadequately described species *C. groenlandicum*.
 ee. Recognisable species.
 f. Rostrum short and straight; head-setae poorly developed,
 and not hook-like *C. tristicocheta*.
 ff. Rostrum very long and sharply bent in a ventral direction;
 head-setae well-developed and hook-like *C. longirostrum*.
 dd. With four rows of ventral setae.
 g. With a conspicuous band of transverse striae behind rostrum.
 h. With only one row of dorsal head-setae; rostrum provided
 with spines. *C. spinosum*.
 hh. With more than one row of dorsal head-setae; rostrum not
 provided with spines.
 i. With two rows of dorsal head-setae; trunk-hairs arranged
 in eight longitudinal rows *C. haswelli*.
 ii. With three rows of dorsal head-setae; trunk-hairs arranged
 in six longitudinal rows... *C. hibernicum*.
 gg. Without a conspicuous band of transverse striae behind rostrum.
 j. With three rows of dorsal head-setae; rows of trunk-setae
 very long, extending halfway up trunk *C. fulcatum*.

Key to the Species of the Genus *Notochetosoma*.

- a. Dorsal head-setae not inserted on rostrum; tail not serrated. . *N. tenuis*.
 aa. Dorsal head-setae inserted on rostrum; tail serrated along ventral
 surface *N. cryptocephalum*.

All the figures, for both Plates and Text-figures, were drawn with the help of the camera lucida, the finished drawings being prepared by Mr. F. W. Aitkins, of the Technical High School, Sydney.

LITERATURE.

1. CLAPAREDE, R.—Beobachtungen über Anatomie und Entwicklungsgeschichte wirbelloser Thiere, u.s.w. Leipzig, 1863.
2. METSCHNIKOFF, E.—"Beiträge zur Naturgeschichte der Würmer, i. Ueber Chetosoma und Rhabdogaster." Zeitschr. f. wiss. Zool., xvii., 1867.
3. GREEF, R.—"Untersuchungen über einige merkwürdige Formen des Arthropoden- und Wurm-typus." Arch. f. Naturgesch., Jahrg. 35, Bd. i., 1869.

4. BARROIS, J., et A. GIARD.—“Note sur un *Chaetosoma* et une *Sagitta*.”
Rev. Sc. Nat., T. iii., 1875.
5. PANCERI, P.—“Osservazioni intorno a nuove forme di Nematodi marini.” Atti Accad. Sc. fis. mat. di Napoli, Vol. vii., 1878.
6. LEVINSEN, J.—“Smaa Bidrag til den grønlandske Fauna.” Videnskab. Meddel. naturk. Foren., Kjöbenhavn, 1881.
7. SCHEPOTIEFF, A.—“Zur Systematik der Nematoiden.” Zool. Anzeiger, Bd. xxxi., 1907.
8. ————— “Die Chaetosomatiden. (Untersuchungen über einige wenig bekannte freilebende Nematoden. iii.)” Zool. Jahrb., Bd. 26, 1908.
9. SOUTHERN, R.—“Nemathelmia, Kinorhyncha, and Chaetognatha.” Proc. Roy. Irish Acad., Vol. 31. Clare Island Survey, Pt. 54, 1914.
10. SCHEPOTIEFF, A.—“*Rhabdogaster cypnoides* Metschn.” Zool. Jahrb., Bd. 26, 1908.
11. BASTIAN, H. C.—“Monograph on the *Anguillulida* or free Nematoids.” Trans. Linn. Soc. London, Vol. xxv., 1865.
12. MAN, J. G. de.—Anatomische Untersuchungen über freilebende Nordsee-Nematoden. Leipzig, 1886.

EXPLANATION OF PLATES XLIV.-L.

Reference letters.—*a.*, Anus—*a.o.*, Swollen anterior end of œsophagus in head—*a.ov.*, Anterior ovary—*a.ph.*, Anterior pharyngeal bulb—*b.*, Banded area on head—*b.m.*, Block-masses of granular tissue below ventral setæ—*c.s.*, Compound seta of outer row of ventral setæ—*col.*, Cœlome—*cut.*, Cuticle—*d.s.*, Dorsal locomotor setæ—*d.m.b.*, Dorsal, longitudinal, mesodermal band—*e.h.*, End-hairs—*♀*, *g.p.*, Female genital aperture—*gl.*, Glands lying above pharynx—*hd.*, Head—*h.h.*, Head-hairs—*int.*, Intestine—*i.r.*, Inner row of ventral setæ—*i.r'*, Second inner row of ventral setæ—*l.o.*, Lateral sense-organ—*m.*, Mouth—*nk.*, Neck—*n.o.*, Swollen anterior end of œsophagus in neck—*o.r.*, Outer row of ventral setæ—*œ.*, Œsophagus—*ph.*, Pharynx—*p.ov.*, Posterior ovary—*p.v.*, Postanal portion of outer row of ventral setæ—*p.ph.*, Posterior pharyngeal bulb—*p.s.*, Penial setæ—*r.*, Rostrum—*rc.*, Rectum—*s.*, Simple setæ in front of inner rows of ventral setæ—*s.c.*, Subcuticular layer of body-wall—*s.s.*, Simple seta of outer row of ventral setæ—*sp.*, Sperms in uterus—*t.*, Testes—*t.h.*, Trunk-hairs—*t.h'*, Short trunk-hairs between the long hairs—*tl.*, Tail—*t.g.*, Tail-gland—*ut.*, Uterus—*v.m.b.*, Ventral, longitudinal, mesodermal band—*v.s.*, Vesicula seminalis.

Plate xlv.—*Chaetosoma falcatum*, sp.n., ♂.

Fig. 1;—Side-view of a whole mount, ($\times 240$), with the cuticle drawn in outline only, in order to show the position of the internal organs, the structure of which is only faintly discernible through the thick body-wall.

Fig. 1*a*.—Latero-ventral view of the posterior end of a male specimen, showing the arrangement of the four rows of ventral setæ, and the character of the striated cuticle; ($\times 520$).

Plate xlv.—*Ch. falcatum*, sp.n., ♀.

Fig. 2.—Side-view of a whole mount; ($\times 240$). The structure of the internal organs is not clearly visible through the thick cuticle.

Fig. 2*a*.—Posterior end of a female specimen, seen from the side; ($\times 520$).

Fig. 2*b*.—A compound seta; (\times about 2000).

Plate xlvi.—*Ch. haswelli*, sp.n., ♂.

Surface-view, from the side, of a whole male specimen; ($\times 240$). The very fine striations on the cuticle are only indicated in places.

Plate xlvii.—*Ch. haswelli*, sp.n., ♀; ($\times 240$).

Fig. 4*a*.—Sagittal, longitudinal section through anterior and middle region of body, showing alimentary and genital systems. The body-wall has been crushed out of its normal position during the process of embedding and section-cutting, so that the coelome is almost obliterated, and the section is narrower than the true width of the animal. The posterior end is cut out, and hairs and other delicate external structures do not show in a mount in Canada balsam.

Fig. 4*b*.—Whole mount of an immature specimen, with only a single row of dorsal setæ, and three pairs of ventral setæ.

Fig. 4*c*.—Anterior end of specimen shown in Fig. 4*b*.

Plate xlviii.—*Notochatosoma tenax*, gen. et sp.n., ♂.

Side-view of a whole mount, ($\times 240$), showing the character of the thick, striated cuticle, and other external features. The sharp curvature at the anterior end is more pronounced in this specimen than is usually the case. Plate xlix. shows the more normal curvature.

Plate xlix.—*N. tenax*, n.sp., ♀; ($\times 240$).

Side-view of a whole mount, with the cuticle drawn only in outline, and the internal structure shown.

Plate l.—*N. cryptocephalum*, n.sp., ♂.

A whole mount, ($\times 240$). The posterior end was broken off during mounting, and is shown separated from the rest of the body. The strong, broadly ringed cuticle does not permit of a clear view of the internal structure.

THE VARIABILITY OF COWS' MILK.

PART I. THE AFTERNOON-MILK.

BY H. S. HALCRO WARDLAW, D.Sc., LINNEAN MACLEAY FELLOW
OF THE SOCIETY IN PHYSIOLOGY.

(From the *Physiological Laboratory of the University of Sydney.*)

(With six Text-figures.)

SYNOPSIS.							PAGE.
Introduction...	815
Methods	824
Results	832
Discussion of results	838
Relations between constituents and properties...	852
Influence of breed	854
Influence of age of cow	856
Influence of stage of lactation	858
Summary	862
References	863

INTRODUCTION.

Although cows' milk has been used by man as a food so long, only during the last fifty years have precise methods been developed for the determination of its quality.

The keeping of herds is one of the most ancient of human industries, and the forerunner of the dairy farmer must soon have noticed that the milk obtained from different cows differed in quality. The differences first observed were, no doubt, merely differences of taste; their detection arose directly from the evidence of the senses. But later, when the arts of cheese- and butter-making were acquired, arts which are themselves older than any human record, differences in the amounts of these products obtained from different samples of milk must have made themselves apparent. Rich milk was distinguished from poor; and so

the first knowledge of the quantitative variation of the composition of cows' milk was obtained.

Towards the end of the eighteenth century, man's attention began to turn seriously to the quantitative investigation of the composition of substances; and, during that period, Parmentier and Deyeux (1790) published their quantitative analyses of cows' milk, which are among the first recorded. By that time, a fairly complete knowledge of the qualitative composition had already been acquired. As early as 1615, Bartoletti had shown that milk contains a sugar, in addition to fat and the cheese-forming substance known even then.

The first quantitative analyses of milk were, no doubt, of purely scientific interest, but, as the dairying industry has grown, and the output of its products has increased, the demand for precise methods for determining the value of these products has become more insistent. For milk is the most easily adulterated of foods. Its bulk may be increased by the mere addition of water, and the unscrupulous milk-vendor has been only too ready to avail himself of this simple method of adding to his profits. In all civilised countries, therefore, administrative bodies have been appointed to control the sale of milk and of other foods. On the recommendation of these bodies, standards are fixed by law from time to time. To these standards all milk produced for sale is required to conform. The standards vary in different countries, and in different districts of the same country. They were primarily devised for the detection of the addition of water to milk, and generally consist of statements of the percentage values of certain constituents, fat, solids not fat, and total solids, below which the values in the milk sold may not fall. The addition of substances foreign to the milk to preserve it is also forbidden, and, recently, a certain value of the freezing point has been added to the standards required in some districts.

As a result of these regulations, the chemical examination of milk has become a daily necessity, and, in the last quarter of a

century, an enormous number of analyses has been carried out, both by the authorities responsible for the control of the food-supply, and by the producers who wish to know the value of their product.

The standards set by the authorities were considered by them to be such as would be complied with by any normal, unadulterated milk. These standards, of course, were based on extensive series of investigations, and, for a time, all milk not complying with the standards was regarded as adulterated. Those engaged in the dairying industry, however, soon found that, even under normal conditions, the composition of cows' milk sometimes varied between wider limits than those prescribed by the standards. This fact has been somewhat tardily recognised, in some cases, by the authorities controlling the sale of foods, but a distinction is now made in most countries, between the sale of adulterated or pathological milk, and the sale of milk which may be simply below standard in some of its constituents.

The question whether milk has been adulterated with water, or is naturally deficient in solids, is one which is extremely difficult to settle by chemical means alone. The early investigations of Beckmann (1894), Winter (1895), Carlinfanti (1897), and others, on the freezing point of milk showed that, in the measurement of this property, lay a convenient means of detecting the addition of water. They showed that the freezing point of milk remains extremely constant, no matter how the composition may vary. The work of subsequent investigators, notably that of Brownlie Henderson and Meston (1913, 1914), in Queensland, has confirmed and extended these results. This method, however, does not detect the addition of solutions which do not alter the osmotic pressure of the milk.

The relatively large variations to which the composition of normal cows' milk is subject, and the consequent fluctuations in its butter-value, have induced dairy farmers to carry out numerous investigations with the object of determining the cause of the variations. The possession of this knowledge would be of use in

suggesting means by which the variation might be controlled and made to proceed in a desired direction, or, at least, predicted. The researches which were undertaken to acquire this information were at first confined almost entirely to determinations of the amounts of butter-fat yielded by cows.

The two outstanding factors which have been recognised to play the chief parts in determining the amount of fat which a cow yields in its milk are, firstly, the breed and individual peculiarities of the animal; and, secondly, the method of milking. The factors were recognised vaguely before any quantitative work was done on the subject, and the investigations so far carried out have done little more than confirmed and made precise the prevailing impression. Unfortunately, the investigators have concerned themselves chiefly with the output of herds, and not of single cows. For the herd is the commercial unit: it is the mixed milk from his herd that a dairyman usually sells.

Certain breeds of cow, such as the Jersey, habitually yield a milk which is rich in fat, while other breeds, such as the Holstein, give a more copious flow of a poorer milk. It has been pointed out by von Wendt (1903), that cows yielding a rich milk are, in general, small. Their calves will, therefore, lose heat more rapidly in proportion to their weight than the calves of larger animals, and will require a relatively greater supply of heat-producing material in their food. Conversely, the larger breeds of cows produce a greater quantity of milk poorer in fat, since their larger offspring require more nutritive material, but do not lose heat so rapidly, in proportion to their weight, as those of the smaller animals.

Although the breed of a cow is, for practical purposes, the most important factor determining the quality of its milk, since herds are usually dealt with, it must be remembered that the individual peculiarities of an animal are of even more fundamental importance. The formation of a breed is, after all, only a means adopted to perpetuate the qualities of certain individuals, which are superior in some way to their fellows, either in their suitability to environment, as in the natural breeds, or in their economic value, as in the breeds produced by human selection.

The breed and individuality of a cow are thus the principal factors determining its total output of milk from day to day. But the amount and quality of a sample of milk, obtained from a cow at any particular time, are subject to great variations, and these variations are dependent on the manner in which the cow is milked. It is obvious that, if a cow yields a certain amount of milk *per diem*, the more frequently it is milked, the smaller will be the quantity obtained at each milking; for it has been shown, that the number of milkings *per diem* only slightly affects the total yield (Lalim and Grande, 1913). The amount of milk which is obtained at a milking is proportional to the period which has elapsed since the last milking.

The quality of milk is also profoundly affected by the stage of milking at which the sample is collected. This fact was known to Pélégot (1836), who showed that the milk first drawn from the udder is considerably poorer in fat than the last portions of a milking. Numerous subsequent investigations have confirmed this observation, and the work on the subject was reviewed and extended by Ackermann in 1913, and again by Isaachsen, Lalim, and Grande in 1913. The first portions of a milking may contain less than 1% of fat, while the last portions contain more than 10%.

The quality of the milk obtained is affected in the opposite direction to the quantity by the periods which elapse between successive milkings. The milk obtained after a short period of rest contains a higher percentage of fat than the milk obtained after a longer period (Melander, 1892; Petersen, 1894). For this reason, the milk obtained in the morning, when cows are milked twice a day, contains a lower percentage of fat than that in the milk of the afternoon. The period elapsing between the milking in the morning and that in the afternoon is generally greater than that elapsing between the milking in the afternoon and that on the following morning.

The food which a cow eats naturally exerts a great influence on the quantity and the quality of the milk which the animal pro-

duces. But this influence seems to be nothing more than the general effect of food on the health and activity of a living organism; a well-nourished cow yields more and better milk than a poorly nourished animal. An enormous amount of work has been done to determine the relation between the food of a cow and its production of milk. The co-operative experiments which have been in progress in Denmark, since 1887, may be referred to as an instance. In these experiments, more than 4,000 cows have been examined, but the results, which have been reviewed by Annett (1915), show that the food has practically no influence on the composition or quantity of fat in the milk produced, as long as the food is sufficient to maintain the cow in vigorous health. These statements refer only to feeding on a commercial scale, and not to the administration of special substances, nor to the eating of plants which may impart distinctive odours or tastes to the milk.

Much work has also been done to determine the effect of the addition of various inorganic salts to the diet of a cow, but the investigations of von Wendt (*loc. cit.*), and of Schulte-Bäuminghaus (1903), have shown that, in this case, too, no definite effect can be produced on the quality or quantity of the milk secreted. The only effect noticed was a slight increase of calcium in the milk after the administration of calcium salts. The amount of phosphate could not be correspondingly increased.

It appears from the work of Graham (1904), however, that the amount of water, which a cow receives with its food, has a definite effect on the yield of milk. A copious water-ration appears to lead to the secretion of a larger volume of more dilute milk. "Milk may be watered through the mouth of the cow."

The effect of the injection of so-called galactogogues into the circulations of lactating animals may be mentioned here. The most effective and best known of these substances is pituitary extract. It was thought by some investigators that the injection of these substances acted as a stimulus to the secreting cells of the mammary glands, and led to an increased production of milk (Hammond, 1913; Maxwell and Rothera, 1915). The work of

Gaines (1915) demonstrated, however, that pituitary extract exerts its effect by stimulating the smooth musculature of the mammary gland, and leads to an increased extrusion, but not to an increased secretion of milk (see also Mackenzie, 1911), since the volume of milk produced under its influence is no greater than the decrease of the volume of the udder.

The effect of the seasons of the year, on the mean composition of cows' milk in Great Britain, is well shown by the monthly averages which are published, from year to year, by Droop Richmond (1887 onwards). The milk secreted during the winter-months has slightly higher percentages of fat, and of solids not fat, than the milk secreted during the summer-months. The work of Lythgoe (1914) has shown that a similar effect is exerted in North America, and that the behaviour of the percentage of solids not fat is due chiefly to variation of the percentage of protein.

Seasons, in the sense of good and bad seasons, of course, have a very marked effect on the milk-production of a cow, but this effect is an indirect one, and is due to variations in the quality and quantity of the food-supply of the animals.

The effect of the course of lactation on the composition of cows' milk has been studied in some detail. The greatest changes occur, as is well known, during the period immediately after calving. Colostrum, the milk secreted during the first day or two of lactation, contains a much larger percentage of protein than ripe milk. The extra protein, which is present in colostrum, has been shown by Crowther and Raistrick (1916) to be a globulin, identical with the globulin of the blood-plasma of the cow. In ripe milk, the amount of this globulin is very small (0.03%).

After the first week of lactation, the composition of the milk does not vary rapidly in any one direction, although it is subject to daily fluctuations. No precise generalisation can be formulated for the variation of composition during lactation. Recent work shows, however, that, on the whole, the average percentages of fat, protein and ash fall during the first three to six weeks of the post-colostral period, vary about constant values during the greater

part of the period of lactation, and increase again towards the end of the period. The yield of milk, and the percentage of sugar, on the other hand, decrease steadily during the whole period of lactation. (Crowther and Ruston, 1911; Eckels and Shaw, 1913).

The factors which determine the composition of the milk secreted by a cow thus fall into two groups: those which are due to conditions independent of the animal itself, and those which are fixed by the animal. The chief extrinsic factors are: the food, the seasons, and the methods of milking. As long as the variations of these factors are not such as to disturb the health of the cow, they have very little effect on the average output or quality of the milk. The main intrinsic factors are: the idiosyncrasy of the cow, its inherited characters or breed, and the stage of its lactation. These are the factors which determine the kind and amount of milk that a cow secretes, and, of these factors, the first two are predominant, except at the beginning and end of the period of lactation.

A cow, then, is not to be regarded as a milk-producing machine, whose output is determined by the nature of the raw material supplied, and by the conditions of working. It is a physiological mechanism whose product, though not uniform, is independent of considerable variations of the external conditions. The variations of the product are determined by the mechanism itself. This great fact is now fully recognised by the dairy-farmer, who realises that the output of his herds is to be improved by paying attention, not so much to the feed, as to the breed of the cows.

Since the composition and amount of the milk produced by a cow cannot be varied at all, by adjusting the external conditions and diet, it is important to know over what range of values the spontaneous variations of composition and properties may be expected. Such information is only to be obtained by examining specimens of milk from a large number of single cows. The paucity of complete analyses of the milk of individual cows has already been referred to. The bulk of the analyses of this kind have estimated only the volume of milk yielded by the cow and the percentage of fat; the investigators have been con-

cerned solely with the butter-producing quality of the animal. The series of more complete analyses are, in general, too short to allow any useful conclusions to be drawn from them. Among the few extensive series of analyses may be mentioned those of Collins (1904), whose object was to calculate the probabilities of deviations of different magnitude from the legal standard; and of Fresenius (1909). This work, too, however, was confined chiefly to an examination of the fat-content. Lythgoe (*loc. cit.*) carried out a very extensive investigation of a similar character, in which other constituents besides fat were determined.

The statements of the different investigators, as to the relative variabilities of the constituent of milk, are not very concordant. Nearly all agree in one conclusion, however, and that is that the most variable constituent of milk is the fat. The majority of investigators also find milk-sugar to be the least variable of the constituents, but, on this point, the agreement is not so complete.

Scope of Present Work.

The object of the work recorded in this paper is to present a series of complete analyses of samples of the evening-milk of individual cows. The cows examined were not chosen for the possession of any special qualities. They were, however, members of herds which were maintained under the most favourable conditions, and were not kept for profit. All the cows examined were supplying milk which was being used for human consumption, and all were milked under the same conditions, as regards time of milking and period since last milking. The cows had not been subjected to any change of diet for several weeks, at least, before the collection of the samples. The collection of samples extended over three seasons of the year. Over one hundred samples of milk were examined, and determinations were made of: (1) the yield of milk; (2) density; (3) freezing-point; (4) electrical conductivity; (5) total solid matter; (6) fat; (7) sugar; and (8) ash. From these results, the percentages of protein and extractives, and of solids not fat, and the total quantities of fat yielded were calculated.

The results obtained have been submitted to a simple statistical treatment, by which the most probable values of the quantities measured, and their relative variabilities, have been determined. It has been found that the quantities measured fall into three sharply defined groups, as regards their variability: the values of certain physical properties are least variable, the concentrations of the substances present are more variable, and the amounts of these substances obtained at a milking are most variable. The concentrations of the substances in solution are considerably less variable than those of the substances in suspension.

METHODS.

The cows examined—The cows, from which the samples of milk described were obtained, were all kept in the dairies attached to certain Government Mental Hospitals in the vicinity of Sydney. The whole output of the cows was consumed in the Institutions to which they were attached. The following data with regard to the cows were obtained from the dairy stock-books.

(1) The breed of the cow. In nearly all instances, the cows were crossbred, and the breed given is that of the predominating strain.

(2) The number of calves, to which the cow had given birth at the time of the collection of the samples of milk. In the cases of cows Nos. 23-46, records of the numbers of calves could not be obtained. Records of the ages of the cows were available, however; and to make the data for these cows uniform with those for the others, the numbers of calves have been calculated from the ages, on the assumption that the first calf was born when the cow was two years old, and that, after that age, one calf was born every year. The numbers of calves calculated in this way are only approximate.

(3) The period which had elapsed between the birth of the last calf, and the collection of the sample of milk. This period is expressed in Table ii. below, in days.

The following data were also obtained at the time of the collection of the samples:—

(4) The diet of the cows. The daily rations of the various cows were as follows:—

Cows, Nos. 1-22—Pollard, 2.5lbs.; bran, 7.0lbs.; green barley-chaff, *ad lib.*

Cows, Nos. 23-34—Bran, 8lbs.; green chaffed oats, 60lbs.

Cows, Nos. 35-46—Bran, 8lbs.; lucerne-hay, 30lbs.

Cows, Nos. 47-109—Bran, 8lbs.; cow-meal, 2lbs.; lucerne-chaff, 16lbs.

In no instance had the diet of the cows been changed immediately before the collection of the samples of milk. The shortest period, which elapsed between a change of diet and the collection of samples, was three weeks. It occurred in the case of cows, Nos. 35-46.

The period during which samples of milk were collected extended from October 31st, 1916, to April 30th, 1917. This period was one of six months, and included the latter half of Spring, the whole of Summer, and the first half of Autumn.

The cows examined were all milked twice each day. The morning-milking occurred between six and seven o'clock, the afternoon-milking between three and four o'clock. The period between the milking on one morning, and that on the following afternoon, was thus about half that between the afternoon-milking and that of the following morning. It is to be expected, from what has been stated already with regard to the proportionality between the time of rest and the yield of milk, that the amount obtained at the afternoon-milkings, from which the samples were obtained, would be about half that obtained at the corresponding morning-milkings. To test this supposition, the weights of milk obtained in the morning were measured, as well as the weights obtained in the afternoon, in the cases of a number of cows. The following Table gives the results obtained.

TABLE i.
Weights of milk obtained at morning- and afternoon-milkings.

Cow.	Weight of milk.		Cow.	Weight of milk.	
	Afternoon.	Morning.		Afternoon.	Morning.
1	4.9	8.4	12	2.0	4.8
2	4.1	8.0	13	2.5	3.7
3	3.7	6.6	14	3.5	6.4
4	6.7	11.2	15	1.7	4.6
5	5.3	8.9	16	2.8	2.5
6	6.8	13.7	17	1.2	3.0
7	1.3	2.1	18	2.6	5.9
8	5.8	11.0	19	2.4	3.7
9	4.9	9.4	20	1.2	3.2
10	5.0	8.7	21	3.0	5.5
11	8.1	14.6	22	2.3	4.3

Mean: morning, 3.76; afternoon, 7.03; ratio, 1.87.

The average ratio of the weight of the morning-milk to the weight of the afternoon-milk is thus very nearly 2, and is practically the same as the ratio between the times between the consecutive milkings.

The cows, from which the samples of milk were obtained, were milked by hand in the ordinary way, in every case. No attempt was made to strip the udders.

The whole of the milk yielded by each cow at the milking was thoroughly mixed together by pouring from one vessel into another, six times. This is the method recommended by the Committee appointed by the London Board of Agriculture, to enquire into the methods of sampling milk (1911). In the present case, an additional precaution was taken to secure a thoroughly representative sample. The sample was not taken from one portion of the mixed milking, but, as the milk was being finally poured into the container, a portion of the stream was diverted into the sampling vessel. In this way, a sample was obtained from all portions of the mixed milk.

After what has been written above, with regard to the extreme variation of the fat-content, between the first and last portions of a milking, it is unnecessary to emphasise the importance of

thoroughly mixing the milk before taking a sample, if the sample is required to give information about the total amount of milk yielded by the cow at the particular milking under examination.

The quantity of milk obtained from each cow was determined by weighing with a spring balance. These weights are correct to about 0.1 kg.

The examination of the milk was commenced on the afternoon on which it was collected. The milk was kept in an ice-chest, at a temperature of about 5°C., during the following night. Whenever possible, all the operations, which it was necessary to carry out upon the fresh milk, were completed before the following afternoon, *i.e.*, before the milk was 24 hours old. During this period the milk was kept for about 14 hours in the ice-chest, so that it was exposed for less than 10 hours to ordinary temperatures. The temperature of the milk never rose above 20°C., and Chapman (1908) has shown that, even at temperatures as high as over 30°C., souring does not commence until about 11 hours have elapsed since milking. Whenever it became impossible, for any reason, to complete the examination of the milk in the unaltered state within the specified time, 5 drops of formalin were added to each 100 c.c. as a preservative. The addition of this small amount does not measurably alter the properties of the milk under investigation (Reiss and Sommerfeld, 1909).

Density.—The density of the samples of milk was determined by weighing in a pycnometer of 25 cc. capacity, provided with a thermometer. To save time, no attempt was made to fill the pycnometer at a constant temperature. The weights when filled at different temperatures were determined, and a graph was drawn, from which the corresponding weight at 25°C. could be read off. Observations were made at temperatures ranging from 10° to 30°C. Above 17°C., the points plotted lay upon, or very close to, a smooth curve, the maximum deviation being less than 2 mg. Below 17°C., the points obtained were rather scattered. This behaviour is due to the fact, which was noted as early as 1841 by Quevenne, that, at a temperature in the

vicinity of 15°C., a sudden increase of density, which has been termed the thickening of milk, takes place. Fleischmann and Wiegner (1913) have shown that this change is due to the solidification of the milk-fat, which causes a discontinuous change of density. In the present case, all the determinations of density were made at temperatures within 17°C. and 22°C. Within this range of temperature, the coefficient of expansion is practically independent of the fat-content (*cf.* Müller's Tables, 1892). The pycnometer was weighed to the nearest 25 mg., a weight which corresponds to a difference of density of 1 in 10,000. This difference is, therefore, the limit of accuracy of the determination. The pycnometer was standardised with water at 25°C., and the densities are those of milk compared with water at this temperature.

D e p r e s s i o n o f f r e e z i n g - p o i n t .—The freezing-points of the samples of milk were determined by the method described in a previous paper (Wardlaw, 1914). The greatest variation observed between duplicate estimations was 0.002°C. The freezing point of water could be determined within the same limits. The depression of freezing point (Δ) is the difference between these two values; its possible range of variation is, therefore, 0.004°. As this variation is on a depression of the freezing point of water of about 0.55°C., the results obtained are comparable to 1 in 125. Milk contains substances in suspension. Its value of Δ is, therefore, slightly lower than that corresponding to the actual amount of substances in true solution (Tezner and Roska, 1908). In the present work, only comparable values of the depression of the freezing point are required, and no attempt was made to obtain absolute values, to obtain which, special apparatus and precautions are required (Raoult, 1898). The difference from the absolute values of the present results is very unlikely to be more than 0.01°C.

E l e c t r i c a l c o n d u c t i v i t y .—The electrical conductivities of the samples of milk were determined by the usual method of Kohlrausch and Nippoldt (1869). The secondary circuit of an induction coil was used as the source of current, a

telephone was used as the null instrument, and the readings of resistance was made on a Wolff's pattern Wheatstone-bridge. The conductivity-vessel was made with vertical electrodes to hinder any settling of particles upon them. The cell-constant of the vessel was determined by measurement of the resistance of N/50 KCl solution. The determinations were all made in a thermostat at 25°C. Readings of the bridge could be made within a range of 1 in 200, and as the determination of the cell-constant was subject to about the same variation, the values obtained for the conductivities are subject to an error of 1 in 100.

Total solids.—The percentage of total solid matter in the samples of milk was determined by evaporating 1 cc. to dryness in a watch-glass at 102 C., in a glycerine-oven. The heating was continued for about 18 hours. The solids were cooled over CaCl_2 in a desiccator before weighing. The amount of milk used was measured from a pipette which had been calibrated by weighing, the calculations being made on the weight of milk delivered. It has been shown by Poetschke (1911), that the weights of successive portions of a sample of milk, delivered from the same pipette, agree together very closely. This result was also obtained in the present case, when the extreme difference between the weights of five portions of a sample of milk, delivered from the pipette used for the analyses, was 0.0004 gm., or 0.04%. The extreme variation observed in two series of 12 test-determinations each, of the weight of total solids obtained from 1 cc. of milk, as described above, was 0.0016 gm. The results obtained in the remaining determinations are assumed to be comparable within this limit of variation (0.7%). The solids of milk are very hygroscopic, when nearly dry, and it has been shown by Leavitt (1910) and by other workers that, although closely agreeing values may be obtained for the percentage of moisture in substances like this when the estimations are carried out under uniform conditions, it is a matter of some difficulty to determine the absolute amount of water present. Further, dehydration of lactose proceeds slowly at temperatures of about 100° (Soldner, 1896).

Fat.—The percentage of fat in the samples of milk was determined by the method of Röse (1887), as modified by Gottlieb (1890). Milk, mixed with ammonia and an equal volume of alcohol, is shaken up with ether; petroleum spirit is then added, and the mixture shaken up again. After standing, the mixture separates into aqueous and ethereal layers. The levels of the two liquids are read off, an aliquot part of the ethereal layer is evaporated down, and the fat left is weighed. The relative accuracy of the method depends chiefly on the precision with which the levels can be read. In the present case, the volume of the ethereal layer was about 50 cc., and this volume could be determined to 0.5 cc., or about 1%. The difference between duplicate estimations might thus amount to double this value, if the errors in the two estimations were to fall in opposite directions. The actual range of variation observed in six control estimations was 2.3%, a value sufficiently close to the calculated maximum variation. The deviation from the mean is half this value, and the results are given in the Table to 1 in 100. Ten cc. of milk were used for each estimation. The milk was delivered from a pipette delivering a known weight, as described previously.

Lactose.—The percentage of milk-sugar was determined by the method of Salkowski (1912). In this method, milk is almost saturated with ammonium sulphate, and mixed with an equal volume of a saturated solution of ammonium sulphate. The liquid is filtered, and the specific rotation of the clear filtrate is determined, $[\alpha]_D$ being taken as 52.53° . Jahnsen-Blohm (1913), and Rösemann (1914) have shown that the presence of ammonium sulphate, in the concentration used by Salkowski, lowers the optical rotation of a solution of pure lactose by about 2%. Scheibe (1901) showed, however, that, in the case of milk, optical methods in general gave higher results than gravimetric methods. This is due to the fact that, in precipitating the proteins, the volume, through which the lactose is distributed, is reduced, and its concentration is raised. Kretschmer (1913) has shown that the results obtained by Salkowski's method are about 1% higher than those obtained gravimetrically.

In the present work, the rotations could be read to 0.02° , or a variation of about 1%. The volume of the liquid, in the cylinders in which the precipitations were carried out, could be read to 0.5 cc. in 100. The total range of variation is thus 1.5%, which would give a possible difference between duplicate estimations of 3.0%, if all the errors in the two cases fell in opposite directions. The difference actually found between duplicate estimations was 2%. The results given are regarded as relatively accurate to 2 in 100, and are given to the nearest 0.05%. As this variation is greater than the correction proposed by Kretschmer, this correction has not been applied in the present case.

Ash.—The percentages of ash in the samples were determined on the weight of milk delivered from a 5 cc. pipette, calibrated as described. The samples were first dried at 103°C ., and then ashed in a muffle-furnace at a low red heat. In order to determine what loss of chlorides occurred in the ashing carried out in this way, control-determinations were made by charring the milk at a temperature below red heat, leaching out the chloride, ashing the remainder, adding the solution of chlorides, and evaporating to dryness. The results by the two methods differed by only 0.4% of the weights of ash obtained. The values in the Table are given to 0.01%, or to 1 in 70.

The substances left, after the estimation of fat, sugar and ash, consist of protein, citric acid (0.2%, Scheibe, 1891), and substances containing about 5% of the total nitrogen of the milk. Of these residual substances, the protein forms more than 90% (Munk, 1893; Canerer and Söldner, 1893). Numerous attempts were made to estimate the protein directly by precipitation with alcohol, according to the method previously described for human milk (Sikes, 1906; Wardlaw, 1914). With cows' milk, however, the precipitate obtained in this way contains a very high percentage of ash (over 10%), and in the time available for this portion of the work, it was found to be impossible to dry the precipitate to constant weight. The figures given for the percentage of protein and the remaining constituents of the milk were obtained by sub-

traction of the percentage of fat, milk-sugar, and ash, from the percentage of total solid matter. The values given for protein and the remaining substances are, therefore, subject to the variations of all the values for the percentages of fat, milk-sugar, ash, and solids; and if all these errors happened to fall in the same direction, the corresponding error of the percentage of protein, etc., might amount to as much as 5%. In practice, however, the errors will be more likely to balance one another. The figures for the percentages have been given to the nearest 0.05.

RESULTS.

The numerical results of the chemical and physical examination of the samples of milk discussed in this paper are given in Table ii. The Table also contains the data for the breed, age, and stage of lactation of the cows from which the samples were obtained. The entries in the several columns are as follows:—

- (1) Serial number of sample.
- (2) Date of collection.
- (3) Chief strain of breed.
- (4) Number of calf.
- (5) Age of calf in days.
- (6) Weight of sample in kg.
- (7) Density at 25 C.
- (8) Depression of freezing point (Δ).
- (9) Electrical conductivity in reciprocal ohms $\times 10^{-13}$, at 25 C.
- (10) Percentages of total solid matter.
- (11) Percentage of water.
- (12) Percentage of fat.
- (13) Percentage of solids not fat (S.n.F.).
- (14) Percentage of lactose.
- (15) Percentage of ash.
- (16) Percentage of protein and extractives.

TABLE II.
Composition and properties of milk from individual cows at single milkings.

No.	Date.	Breed.	Cat.	Age.	Wt.	Dens.	Δ	Cond.	Solids.	Water.	Fat.	S.n.F.	Lactose.	Ash.	Protein, etc.
1	31/10/16 (Spring)	Ayrshire	4	186	4.9	1.0292	0.558	4.55	13.45	86.55	4.65	8.8	4.85	0.59	3.35
2		Jersey cross	9	187	4.11	1.0306	0.552	4.65	12.1	87.9	3.3	8.8	5.3	0.57	3.25
3		Ayrshire	1	—	3.7	1.0302	0.558	4.3	13.05	86.95	4.2	8.85	5.45	0.75	2.65
4		"	8	77	6.7	1.0291	0.553	4.45	13.45	86.55	4.75	8.7	5.25	0.58	2.8
5		"	2	58	5.3	1.0313	0.553	4.25	13.95	86.05	4.55	9.4	5.15	0.64	3.6
6		Shorthorn	6	36	6.8	1.0296	0.554	4.2	13.25	86.75	4.65	8.6	5.55	0.59	2.45
7		Ayrshire	3	320	1.3	1.0314	0.552	5.2	13.15	86.85	4.05	9.2	4.55	0.70	3.95
8		"	3	17	5.8	1.0294	0.547	4.4	12.1	87.9	3.9	8.2	5.25	0.52	2.45
9		"	4	26	4.9	1.0301	0.548	4.65	12.1	87.9	3.65	8.45	5.15	0.60	2.8
10		"	3	90	5.0	1.0298	0.548	5.1	12.25	87.75	3.75	8.5	4.8	0.63	3.05
11		Holst.-J. Sh.	5	36	8.0	1.0299	0.554	3.95	13.9	86.1	5.2	8.7	5.6	0.52	2.6
12	6/11/16	Ayrshire	—	162	2.0	1.0272	0.559	5.1	13.25	86.75	5.2	8.05	4.85	0.53	2.65
13	(Spring)	Jersey cross	3	290	2.5	1.0294	0.555	4.75	13.4	86.6	4.2	9.2	4.55	0.51	4.1
14		Ayrshire	3	192	3.5	1.0298	0.565	5.05	13.45	86.55	5.35	8.1	4.5	0.47	3.15
15		Ayrs. cross	4	179	1.7	1.0296	0.560	4.4	15.05	84.95	6.3	8.75	5.0	0.58	3.15
16		Jersey	2	115	2.8	1.0306	0.568	4.55	15.0	85.0	5.0	10.0	5.05	0.56	4.4
17		Ayrshire	5	157	1.2	1.0292	0.572	7.5	10.5	89.5	3.8	6.7	2.7	0.52	3.5
18		"	—	—	2.6	1.0304	0.559	4.45	14.85	85.15	5.45	9.4	5.05	0.75	3.6
19		"	—	—	2.4	1.0291	0.568	4.75	13.0	87.0	4.5	8.5	4.75	0.69	3.05
20		"	2	287	1.2	1.0280	0.565	5.5	12.9	87.1	4.8	8.1	4.55	0.73	2.8
21		"	2	209	3.0	1.0304	0.575	4.35	14.0	86.0	5.15	8.85	4.45	0.68	3.7
22		"	3	229	2.3	1.0272	0.570	5.65	12.45	87.55	4.25	8.2	4.4	0.64	3.15

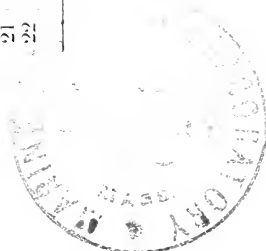

TABLE ii.—(Continued).

No.	Date.	Breed.	Calif.	Age.	Wt.	Dens.	Δ	Cond.	Solids.	Water.	Fat.	S.n.F.	Lactose.	Ash.	Protein, etc.
23	13/11/16	Shorthorn.	3	164	3.2	1.0308	0.557	4.0	13.9	86.1	4.8	9.1	5.2	0.65	3.15
24	(Spring)	"	8	157	5.0	1.0291	0.558	4.4	12.7	87.3	6.2	6.5	5.05	0.61	0.85
25		"	8	262	2.5	1.0299	0.564	3.95	14.55	85.45	5.65	8.9	4.9	0.64	3.35
26		"	6	136	3.9	1.0304	0.560	4.05	13.55	86.45	4.5	9.05	5.2	0.58	3.25
27		"	6	519	2.9	1.0314	0.565	4.3	13.35	86.65	4.4	8.95	5.05	0.45	3.45
28		"	7	88	3.2	1.0295	0.563	4.6	13.0	87.0	4.45	8.55	5.0	0.63	2.9
29		"	8	113	3.0	1.0297	0.562	4.7	13.6	86.4	4.85	8.75	4.9	0.65	3.2
30		"	5	261	1.4	1.0302	0.562	4.65	13.2	86.8	4.6	8.6	4.8	0.74	3.05
31		"	6	69	2.9	1.0269	0.573	4.9	12.5	87.5	4.4	8.1	4.7	0.64	2.75
32		"	6	151	1.8	1.0300	0.580	4.55	13.9	86.1	4.9	9.0	4.85	0.71	3.45
33		"	6	36	2.5	1.0304	0.568	4.4	13.05	86.95	4.3	8.75	5.0	0.71	3.05
34		"	5	24	4.1	1.0298	0.558	4.6	13.0	87.0	4.4	8.6	4.75	0.74	3.1
35	2/1/17	"	8	72	7.1	1.0294	0.564	4.6	13.8	86.2	5.05	8.75	5.4	0.61	2.75
36	(Summer)	"	8	186	3.4	1.0296	0.577	4.6	14.3	85.7	5.0	9.3	4.9	0.59	3.8
37		"	2	142	5.9	1.0300	0.566	4.9	12.25	87.75	3.75	8.5	5.05	0.56	2.9
38		"	3	195	2.3	1.0318	0.563	3.95	15.15	84.85	5.45	9.7	5.15	0.66	3.9
39		"	8	200	5.4	1.0316	0.559	4.9	11.25	88.75	2.6	8.65	5.1	0.63	2.9
40		"	9	198	3.4	1.0288	0.565	5.2	12.8	87.2	4.0	8.8	4.75	0.60	3.45
41		"	5	151	3.2	1.0306	0.567	5.0	13.0	87.0	3.5	9.5	4.55	0.76	4.2
42		"	5	132	3.6	1.0313	0.570	4.75	12.35	87.65	4.1	8.25	5.15	0.45	2.65
43		"	8	32	4.3	1.0274	0.560	4.35	14.85	85.15	5.85	9.0	5.15	0.52	3.35
44		"	6	68	1.4	1.0294	0.563	4.7	12.15	87.85	3.85	8.3	4.05	0.76	3.5
45		"	8	244	2.7	1.0281	0.563	5.05	14.05	85.95	5.15	8.9	4.55	0.72	3.65
46		"	9	109	4.1	1.0309	0.551	4.5	13.4	86.6	4.4	9.0	5.0	0.43	3.55

TABLE ii.—(Continued).

No.	Date.	Breed.	Calf.	Age.	Wt.	Dens.	Δ	Cond.	Solids.	Water.	Fat.	S. n. F.	Lactose.	Ash.	Protein,
47	15/1/17	Shth. cross	1	174	3.4	1.0332	0.554	4.05	13.6	86.4	4.2	9.4	5.2	0.74	3.45
48	(Summer)	Shorthorn	3	132	3.0	1.0319	0.565	4.85	13.3	86.7	4.35	8.95	5.0	0.74	3.2
49		Crossbred	1	46	3.9	1.0307	0.563	4.0	13.6	86.4	5.25	8.35	5.1	0.66	2.6
50		"	1	45	3.9	1.0303	0.570	4.45	13.35	86.65	4.7	8.65	5.2	0.70	2.75
51		Jersey	3	104	3.9	1.0312	0.580	4.65	11.6	88.4	3.85	7.75	5.05	0.69	2.0
52		Crossbred	5	57	5.7	1.0290	0.560	5.3	11.95	88.05	3.8	8.15	4.65	0.71	2.8
53		Ayrshire	1	77	4.3	1.0301	0.594	4.7	13.05	86.95	5.35	7.7	5.05	0.72	1.95
54		Crossbred	2	63	3.4	1.0282	0.575	4.5	15.05	84.95	6.4	8.65	5.0	0.72	2.95
55		Shth. Jersey	3	174	3.0	1.0301	0.590	4.2	14.55	85.45	5.6	8.95	4.85	0.79	3.3
56		Crossbred	3	131	3.4	1.0307	0.565	4.6	12.8	87.2	4.15	8.65	4.85	0.69	3.1
57		"	3	22	5.7	1.0308	0.570	4.15	13.95	86.05	5.0	8.95	5.3	0.70	2.95
58		Ayrsh. cross	4	259	4.8	1.0288	0.560	4.15	15.5	84.5	6.5	8.85	5.15	0.77	3.0
59	12/3/17	Ayrshire	2	221	1.8	1.0274		5.2	14.45	85.55	5.55	8.9	4.4	0.71	3.8
60	(Autumn)	Crossbred	2	67	3.4	1.0280		4.5	16.1	83.9	7.75	8.35	4.65	0.86	2.85
61		Shth. cross	2	188	3.2	1.0298		4.6	13.3	86.7	5.8	7.5	4.8	0.76	1.95
62		Crossbred	3	8	3.2	1.0298		4.55	13.85	86.15	5.2	8.65	5.1	0.71	2.8
63		Shth. cross	4	8	4.3	1.0284		4.5	13.6	86.4	5.25	8.35	5.05	0.73	2.55
64		Shorthorn	2	35	5.5	1.0284		4.5	14.0	86.0	5.9	8.1	5.05	0.70	2.35
65		Ayrshire	3	61	4.5	1.0293		4.2	13.8	86.2	5.4	8.4	5.2	0.70	2.5
66		Shorthorn	3	57	4.1	1.0292		4.0	15.0	85.0	6.25	8.75	5.25	0.71	2.8
67		Crossbred	3	67	5.0	1.0290		4.55	12.75	87.25	4.65	8.1	5.1	0.73	2.25
68		"	5	49	3.6	1.0296		4.35	13.3	86.7	4.85	8.45	5.2	0.81	2.45
69		"	2	140	3.6	1.0302		3.95	14.6	85.4	5.85	8.75	5.25	0.79	2.7
70		Shth. cross	4	346	1.8	1.0312		4.3	16.35	83.65	6.8	9.55	5.05	0.74	3.75

TABLE II.—(Continued).

No.	Date.	Breed.	Calif.	Age.	Wt.	Dens.	Δ	Cond.	Solids.	Water.	Fat.	S.n.F.	Lactose.	Ash.	Protein, etc.
71	27/3/17 (Autumn)	Shorthorn	3	125	4.1	1.0308	0.560	3.75	15.35	84.65	6.1	9.25	5.2	0.76	3.3
72		Black Jers.	5	5	4.1	1.0324	0.565	4.55	13.65	86.35	5.65	8.0	4.9	0.71	2.4
73		Ayrshire	4	12	5.8	1.0314	0.563	4.3	13.55	86.45	4.8	8.75	5.3	0.76	2.7
74	3/4/17	Crossbred	3	199	2.7	1.0300	0.547	4.55	14.7	85.3	5.75	8.95	4.4	0.77	3.8
75	(Autumn)	"	1	179	1.8	1.0290	0.564	4.7	13.55	86.45	5.15	8.4	4.75	0.71	2.95
76		Devon	2	269	1.8	1.0289	0.560	4.05	15.75	84.25	5.85	9.9	4.8	0.77	4.35
77		Shth. cross	5	134	3.9	1.0291	0.552	4.65	12.5	87.5	4.35	8.15	4.85	0.68	2.6
78		"	2	510	2.0	1.0290	0.541	5.35	13.15	86.85	4.75	8.4	4.1	0.61	3.7
79		Jersey cross	6	118	2.3	1.0308	0.581	4.75	14.55	85.45	5.1	9.45	4.7	0.80	3.95
80		Crossbred	5	223	2.3	1.0276	0.556	5.0	14.7	85.3	6.35	8.35	4.25	0.74	3.35
81		Shorthorn	3	28	4.1	1.0300	0.566	4.15	12.75	87.25	4.15	8.6	5.4	0.65	2.55
82		Devon-Shth.	4	215	1.4	1.0308	0.550	4.9	13.6	86.4	4.9	8.7	4.4	0.79	3.5
83		Crossbred	3	237	3.4	1.0307	0.553	4.15	14.15	85.85	4.8	9.35	5.05	0.72	3.6
84		"	2	197	1.4	1.0298	0.569	4.5	14.3	85.7	5.7	8.6	4.9	0.76	2.95
85		Ayr. cross	3	181	2.7	1.0308	0.558	4.5	14.45	85.55	7.65	6.8	4.85	0.68	1.25
86	16/4/17	Ayrshire	4	—	4.1	1.0305	0.572	4.3	14.75	85.25	6.2	8.55	5.15	0.76	2.65
87	(Autumn)	Shorthorn	5	73	4.1	1.0297	0.570	5.25	12.3	87.7	4.1	8.2	4.75	0.75	2.7
88		Crossbred	4	—	5.5	1.0291	0.565	4.55	14.85	85.15	5.2	9.65	5.1	0.74	3.8
89		"	5	288	2.3	1.0293	0.572	5.35	14.5	85.5	5.9	8.6	4.55	0.71	3.3
90		Shth. cross	3	241	3.2	1.0305	0.559	4.6	14.65	85.35	5.9	8.75	4.8	0.73	3.2
91		Ayrshire	3	47	5.0	1.0285	0.557	4.25	14.85	85.15	5.35	9.5	5.05	0.68	3.75
92		Shth. Jersey	4	52	7.7	1.0301	0.555	4.35	14.7	85.3	4.55	10.15	5.1	0.69	4.35
93		Jersey	3	18	6.4	1.0254	0.548	4.25	12.9	87.1	6.5	6.4	5.15	0.72	4.55
94		Ayrs. cross	5	11	6.4	1.0302	0.561	4.45	16.1	83.9	5.35	10.75	5.1	0.72	4.95

TABLE II.—(Continued).

No.	Date.	Breed.	Clf.	Age.	Wt.	Dens.	Δ	Cond. Solids.	Water.	Fat.	S n. F.	Lactose.	Ash.	Protein, etc.
95	16/4/17	Shorthorn:	5	8	3.4	1.0316	0.565	5.0	14.2	85.8	10.05	4.75	0.80	4.5
96	(Autumn)	Shh. cross	3	3	4.1	1.0361	0.593	4.55	12.65	87.35	8.3	5.3	1.06	1.95
97		Black Jersey	2	66	3.2	1.0300	0.543	4.25	14.3	85.7	8.5	5.0	0.72	2.8
98	30/4/17	Black Jersey	1	146	3.9	1.0505		4.1	13.7	86.3	7.85	5.25	0.77	1.85
99	(Autumn)	Shorthorn	4	121	2.7	1.0297		4.95	13.5	86.5	8.3	4.85	0.79	2.65
100		Ayrshire	4	155	4.5	1.0301		4.75	12.95	87.05	8.45	4.9	0.71	2.85
101		Shorthorn	6	5	5.2	1.0317		5.35	13.15	86.85	10.5	4.55	0.80	4.15
102		Shh. cross	3	86	3.6	1.0290		4.85	12.4	87.6	7.2	4.9	0.72	1.6
103		Crossbred	2	118	3.4	1.0295		4.0	15.25	84.75	8.7	5.2	0.72	2.8
104		Shorthorn	4	106	4.1	1.0294		5.55	12.6	87.4	8.15	4.45	0.75	2.95
105		"	5	109	5.7	1.0294		5.05	12.95	87.05	8.3	4.7	0.74	2.85
106		Crossbred	2	156	3.0	1.0290		4.15	16.65	83.35	8.6	5.15	0.69	2.75
107		Shorthorn	4	158	3.4	1.0298		5.0	13.75	86.25	8.35	4.45	0.75	3.3
108		Shh. cross	3	106	3.6	1.0290		4.8	13.45	86.55	8.3	4.6	0.60	3.1
109		"	1	57	1.8	1.0292		5.55	12.4	87.6	8.2	4.2	0.78	3.2

To obtain some general idea of the significance of series of figures like those in the above Table, it is usual to calculate from them certain representative or mean values. The commonest form of mean value is the arithmetic mean, and this is meant by the word, unless something else is specified. The arithmetic mean, however, is only truly representative of a series of results when all these results may be considered as equally likely to occur. A few exceptional results do not really alter a series as a whole, but such exceptional results affect the arithmetic mean value, and their effect becomes more noticeable as these results become more unlikely to occur. Such a mean value, which is unduly affected by exceptional results, has, therefore, obvious defects as the representative value of a series. Further, the arithmetic mean takes no account of the manner in which the results in a series are grouped. It gives no information whatever about the distribution of the results within the series. The arithmetic mean, on the other hand, is very simply calculated, and in series of values that have no definite grouping, it is the only form of mean value which can be obtained.

Attention may be drawn here to the fact, that the mean values of the composition and properties of a number of samples of milk are not necessarily the same as those of the milk obtained by mixing together all these samples. In calculating the arithmetic mean, no account is taken of the varying sizes of the samples. In mixing together a number of samples, however, the size of each will have an effect on the composition and properties of the mixed milk. As it is the mixed milk, and not a hypothetical mean milk which is sold, the values of the composition of the mixed milk have been calculated, and the figures for them have been inserted in brackets under the corresponding mean figures. As will be seen, the difference between the two figures in no case exceeds 2% of their value. The "mixed" values of the physical properties have not been calculated, as the variation of these is so small, that the differences from the mean values must be even less than in the case of the composition.

The sums of the percentages of the constituents in the above Table do not exactly equal the percentages of total solids. This

is due to the fact that the percentages of the constituents are not given nearer than 0·5%, except in the case of the percentage of ash.

The mean values of the results in Table ii. are given below (Table iii.). The maximal and minimal values of each quantity

TABLE iii.

Maximal, minimal, and mean values of the composition and properties of cows' milk; and actual and relative ranges of variation of the results.

	Max.	Min.	Mean.	Range.	Range Mean.
Number of calves ...	9	1	4	8	2
Age of calf ...	519	3	133	516	3·9
Weight of milk...	8·0	1·0	3·7	7·0	1·9
Weight of fat ...	416	53	182	365	2·0
Density ...	1·0332	1·0254	1·0297	0·0078	0·26
Depression of freezing point	0·594	0·547	0·563	0·047	0·084
Conductivity ...	7·5	3·75	4·55	3·75	0·66
Total solids, p.c.	16·65	10·5	13·55 (13·55)	6·15	0·45
Fat, p.c.	7·75	2·6	5·0 (4·9)	5·15	1·0
Solids not fat, p.c.	10·75	6·4	8·65 (8·6)	4·35	0·50
Lactose, p.c.	5·6	2·7	4·9 (4·95)	2·9	0·59
Ash, p.c.	1·06	0·43	0·69 (0·68)	0·63	0·91
Protein & extractives, p.c.	5·5	0·85	2·9 (2·95)	4·65	1·5
Water, p.c.	89·5	83·35	86·45	6·15	0·45

are also given, so that its range of variation may be seen. To make possible a comparison of the ranges of variation of the different quantities, the extreme range has been divided in each case by the mean value of the series. The relative ranges of variation obtained in this way may be compared together directly.

The relative variation of the density has been calculated by dividing the range, not by the mean density, but by the difference between the mean density and the density of water. The greatest range of the values of density of milk in a series of observations

is not from zero to the maximal value, but from the density of water to this value.

Similarly, the greatest range of the percentage of water in the milk is not from zero to 100%, but from the minimal percentage to this value, and the relative variation is the same as that calculated for the range of the percentage of total solid matter.

The above results show that the greatest relative variation of the values of the quantities observed is in the weight of fat obtained at a milking. This weight varies from 416 to 53 gm. The maximal weight is nearly 8 times the minimal, and the relative range is 2.

The quantity having the least relative variation is the depression of freezing point of the milk, for which the value is 0.084. For the weight of fat, the relative variation is more than 20 times as great as this.

The greatest relative variation of the percentage of a constituent of milk is that shown by the protein, in which it is 1.5. The percentage of total solid matter shows the least relative variation, the value in this case being 0.45.

Among the single constituents of the milk, the least relative variation is that shown by the lactose, in which it amounts to 0.59. The relative variation of the percentage of fat is 1.0, or nearly double that of the lactose.

In the following Table are given the mean values of the composition and properties of the samples of milk obtained at the same milkings. Each mean figure, except the first two, is for the milk of 12 cows; the first two series of mean values are for the milk of 11 cows. From these figures, comparisons may be made of the average milk obtained from small herds at single milkings. For the reasons already mentioned, these figures are not necessarily identical with the figures for the values of the composition and properties of the mixed milks of the herds.

The actual and relative variations of the different quantities are given as before. In addition, the ratios of the ranges of variation of the mean figures (Range 2) to the ranges of variation of the individual figures (Range 1) given in the previous Table are also shown.

TABLE IV.
Mean values of composition and properties of samples of cows' milk collected at the same milking.

Samples.	1-11	12-22	23-34	35-46	47-58	59-70	74-85	86-97	98-109	Range		Mean
										Range 1	Range 2	
Number of calves..	...	5	6	7	3	3	3	4	3	4	0.50	1.0
Age of calf	...	103	165	135	107	119	207	81	110	126	0.25	0.35
Weight of milk	...	5.2	3.0	3.9	4.0	3.7	2.5	4.6	3.7	2.9	0.41	0.78
Weight of fat	...	232	147	170	190	209	131	243	188	133	0.36	0.73
Density	...	1.0300	1.0298	1.0299	1.0304	1.0292	1.0297	1.0301	1.0297	0.002	0.26	0.067
Depression of freezing-point	...	0.553	0.565	0.565	0.571	—	0.559	0.564	—	0.018	0.38	0.032
Conductivity	...	4.5	4.45	4.7	4.45	4.45	4.6	4.6	4.85	0.65	0.21	0.14
Total solids, p.c.	...	12.95 (12.9)	13.35 (13.4)	13.3	13.55 (13.6)	14.25 (14.0)	14.0 (13.75)	14.2 (14.5)	13.55 (13.65)	1.3	0.27	0.096
Fat, p.c....	...	4.25 (4.45)	4.8 (4.9)	4.4	4.95 (4.75)	5.75 (5.65)	5.4 (5.25)	5.25 (5.3)	5.15 (5.1)	1.5	0.30	0.30
Solids not fat, p.c.	...	8.7 (8.6)	8.55 (8.55)	8.9	8.65 (8.65)	8.5 (8.4)	8.6 (8.5)	8.9 (9.1)	8.4 (8.55)	0.5	0.12	0.058
Lactose, p.c.	...	5.1 (5.15)	4.95 (5.05)	4.9	5.05 (5.0)	5.0 (5.0)	4.7 (4.75)	5.0 (5.05)	4.75 (4.85)	0.55	0.19	0.11
Ash, p.c....	...	0.61 (0.58)	0.65 (0.65)	0.61	0.72 (0.73)	0.74 (0.74)	0.72 (0.71)	0.76 (0.76)	0.74 (0.74)	0.15	0.24	0.22
Protein and extractives, p.c.	3.0	3.4	2.95	3.4	2.85	2.75	3.2	3.2	2.9	0.75	0.17	0.25
Water, p.c.	...	87.05	86.65	86.7	86.45	85.75	86.0	85.8	86.45	1.3	0.27	0.096

The ranges of variation of these mean values of the composition and properties of the milk of groups of cows are, of course, less than those of the individual samples. The extents to which the individual variations are masked by this process of averaging are widely different in the different quantities measured. The relative values of this masking-effect are shown by the figures in the column headed Range 2, Range 1. These figures show that, in the case of the values of the weight of milk obtained at a milking, the mean results have a range of variation 0.41 of the range of the individual results. The masking of the individual variation, produced by taking the mean figures, is less in the present case than in the case of the values of any of the other quantities.

The mean values of the percentages of solids not fat, on the other hand, show a range of variation which is only 0.11 of that of the individual results. The process of taking the mean values of the percentages of these substances has, therefore, a very pronounced effect of obscuring the range of variation which actually occurs, even in the case of small groups of samples, like the present.

The difference between the mean composition and the composition of the mixed milk is more pronounced in the case of these smaller numbers of samples than it was in the case of the larger number. The difference does not in any case exceed 5% of the value in question, however.

These results raise the question, whether the fact, that the samples of milk examined for commercial or legal purposes are almost invariably mixed samples, may not have given rise to an exaggerated notion of the constancy of the percentage of solids not fat. The existence of such a notion would, perhaps, lead to the establishment of a standard for the percentages of these substances, which would be too close to the mean value to make allowance for the variation met with in individual samples of milk.

The standard for the percentage of solids not fat is 8.5 in all the States of Australia, and in England. It is interesting to observe that, even among the above mean and "mixed" values of the percentage of solids not fat, one is at the standard, and one is below it. Of the individual values, nearly one-half are at or below

this standard. This fact is discussed in greater detail later.

It is interesting to notice that the group of samples (98-109), the mean value of whose percentage of solids not fat is below standard, is not the same as the group (59-70), whose "mixed" percentage is below standard. Such an instance emphasises the importance, for some purposes, of distinguishing between the mean composition and the composition of the mixed milk.

DISTRIBUTION OF RESULTS.

A knowledge of the distributions of the values obtained for the different properties and constituents of milk is of much greater practical importance than information about their mean values, or the extreme ranges over which they may vary. The practical question which must be answered is: Of a given number of samples of milk, how many may be expected to have values of their composition or properties below or above certain limits?

Although the limits may be chosen arbitrarily, it is useful to have some central value about which to fix them. The objection to the arithmetic mean, as already stated, is that it is unduly influenced by exceptional results. A value which is even more simply obtained than the arithmetic mean, and which is not affected by exceptional results, is the median. The median value of a series of observations is that value, above and below which 50% of the results lie. The position of the median is most easily determined graphically by plotting the values of the observations as abscissæ, and the numbers of results below each value as ordinates. The median value is that whose ordinate is equal to half the maximal ordinate. The curve drawn through the points obtained in a diagram of this kind is usually S-shaped, and was termed the ogive by Galton (1879), by whom this method of examining a series of observations was very extensively used.

The median, then, is a convenient central value about which to measure the distribution of a series of measurements. In the following Table are given the numbers of results lying between certain percentage differences from the median values of the composition and properties of the samples of milk under discussion. The numbers of results are expressed as percentages of the total and are given to the nearest whole number.

The above table shows the differences of closeness of grouping about the median of the values of the different quantities measured. The general shape of the table shows almost graphically the different ranges of variation which have been discussed above.

If a range of, say, 10% from the median be considered, the grouping of the results in the immediate vicinity of the central value may be compared. The results within this range indicate that the quantities measured may be divided into three main groups as regards their relative variability:—

(1) The total amounts of substances produced by the cows in the period which had elapsed since last milking, about 8 hours. These quantities are the most variable.

(2) The concentrations in which these substances appear in the milk. The variations of the concentrations are less, and in some cases very considerably less, than the variations of amount.

(3) The values of certain physical properties. These are the least variable of all the quantities measured.

The quantity of the milk secreted by a cow in a given time is the most variable quantity observed. As the above Table shows, only 22% of the results fall within a range of 10% from the median value.

The quantity of fat produced by the cow in the same time is rather less variable, as 33% of the results occur within 10% of the median value. This method of examining the figures, therefore, shows that there is some tendency of the amount of fat produced to be more "constant" than the total quantity of milk.

The variations of the quantities of the remaining constituents of the milk must be between that of the amount of milk, and that of the amount of fat, since, as will be seen below, the amounts of these substances produced are more dependent on the amount of milk than is the amount of fat. Their concentrations are more constant.

As regards the concentrations of the components of the milk, the substances present in milk may be divided into two classes: those which exist in suspension, and those which are in true solu-

tion. The variability of the former class of substances is much greater than that of the latter. The greatest variation is shown by the values for the percentage of fat. Within 10% of the median, 38% of the results lie. The amount of fat produced, therefore, is less influenced by the amount of milk secreted than are the amounts of the other constituents.

The percentage of protein is somewhat less variable than that of the fat, although its extreme range is the same. In this case, 42% of the results lie within 10% of the median value.

The percentage of ash is considerably less variable, as 61% of the results lie within the range specified.

The percentages of total solids, and of solids not fat are again considerably less variable. In the case of the former values, 79% of the results are within 10% of the median, and in the case of the latter values, 82% of the results are within this range.

The constituent of milk, the percentage of which is least variable, is lactose. Within 10% of the median, 84% of the values for the concentration of this substance lie.

Among the physical properties estimated, the most variable is the electrical conductivity; 70% of the values of this property lie within 10% of the median. This variability is rather less than that of the ash, but considerably greater than that of the percentage of lactose.

The values of the other physical properties determined are much less variable than that of the electrical conductivity. The whole of the results for the values of the density and of the depression of the freezing-point lie within 10% of the median values. The whole of the results for the depression of the freezing point lie within 5% of the median, in fact. The molecular concentration of the dissolved substances is, therefore, the most constant property of milk.

It should be noted that the variability of the density has been calculated not on the actual values obtained, but on the differences between these values and the density of water, for the reasons stated above.

The distributions of the above series of values is shown more

clearly in the accompanying diagram (Text-fig.1). The curves are the probability or frequency curves. They show the relative closeness of grouping of the results about their most probable values. The abscissæ represent the values of the different quantities measured. To facilitate comparison, the values are expressed as percentages of the most probable values, or of the values corresponding to the maximal ordinates. Each ordinate represents the percentages of the total number of results within a certain range of values on either side of it. The range chosen is 5% of the most probable value.

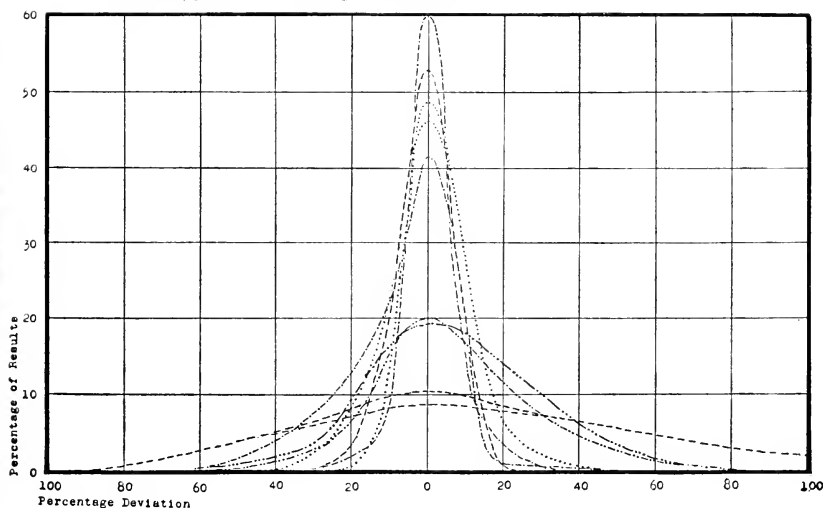

Text-fig. 1.

Relative variabilities of constituents of cows' milk. Frequency or probability curves showing percentages of total number of results (ordinates) occurring within $\pm 5\%$ of various percentage-differences from most probable values (abscissæ). The curves, taken in order from above downwards, represent: percentages of lactose, of solids not fat, and of total solids; conductivity; percentages of ash, of protein, and of fat; total weights of fat, and of milk.

These frequency curves are the derived curves of the simply obtained ogival curves of Galton. The frequency curves have been drawn by taking, as their ordinates, lengths proportional to the slopes of the corresponding points of the ogive.

The values corresponding to the maximal ordinates of these curves are the most probable values or modes, of the quantities whose variations are represented. The figures for the modes of the different quantities are given in Table vi. (p.851).

The frequency curves of the values of the depression of the freezing point, and of the density, are not shown in the diagram, as their ordinates are too high, in proportion to the range of their abscissæ, to allow them to be conveniently represented on the same scale as the other curves: all the results occur within a very small range of the most probable values.

The curves for the distribution of the other values fall obviously into three groups.

In the first group are the curves for the values of the percentages of lactose, solids not fat, total solids, and ash, and the value of the conductivity. The percentages of these values, within 5% of the most probable values, range from 53%, in the case of the concentration of lactose, to 41%, in the case of the concentration of ash.

In the second group are the curves for the values of the percentages of protein, and of fat. The percentages of results within 5% of the modes are 19% and 20% respectively.

The values of the weight of milk, and of the weight of fat, form the third group. Between these two curves, lie those for the distribution of the weights of the other constituents, as was explained above. These two curves show that, in the case of the weights of substances obtained at a milking, only 8.5 to 10% of the results lie within a range of 5% of the mode.

The concentrations of the substances in the first group are thus at least twice as constant as those of the substances in the second group.

The concentrations, however, even of substances in the second group, are at least twice as constant as the total weights produced, the curves for which are in the third group.

The values of the percentages of fat, and of solids not fat, are of great importance, as certain values of these quantities are chosen as standards of the quality of milk. The distribution of

these values will, therefore, be considered separately in greater detail.

In the following diagram (Text-fig.2), the ogive of the percentages of fat in the present samples of milk is given. The corresponding derived or frequency curve is shown by a discontinuous line. The percentages of fat are plotted as abscissæ. The ordinates represent the numbers of results, out of a total of 109, which occur at, or below, given values of the percentage. The circles correspond to the actual numbers of results. The ordinates refer only to the ogive, and not to the frequency

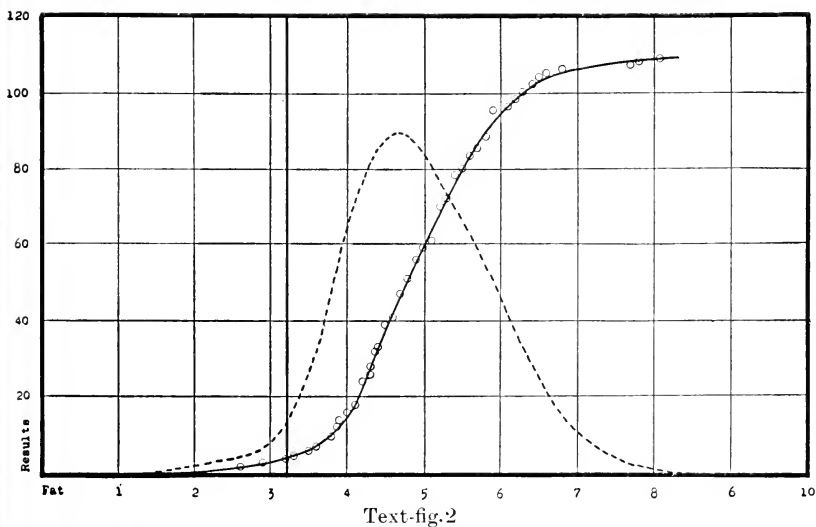

Ogive and frequency curve of concentrations of fat in cows' milk. Abscissæ: percentages of fat. Ordinates: numbers of results; ordinates refer only to ogive.

curve. The latter has been inserted only to render more obvious the information contained in the ogive. The heavy line at 3.2% indicates the position of the standard for the percentage of fat in New South Wales. The values of this standard in the other Australian States are as follows: Victoria, 3.5; Queensland, 3.3; South Australia, 3.25; Western Australia, 3.2%. The standard percentage of fat in England is 3.0.

It will be seen from the above diagram that only a small proportion of the samples examined contained percentages of fat below the legal standard of the State in which they were obtained.

The frequency curve shows that the most probable percentage of fat in these samples of milk is 4.65. It must be borne in mind, however, that the samples are of the afternoon-milk, which is richer in fat than the milk obtained in the morning.

In the next diagram (Text-fig.3), the ogive and the frequency curve of the percentages of solids not fat are given. As before, the abscissæ represent the percentage-values of the quantity measured, and the ordinates, the numbers of results at and below these values. The ordinates again refer only to the ogive. The heavy line at 8.5% indicates the position of the standard percentage of solids not fat.

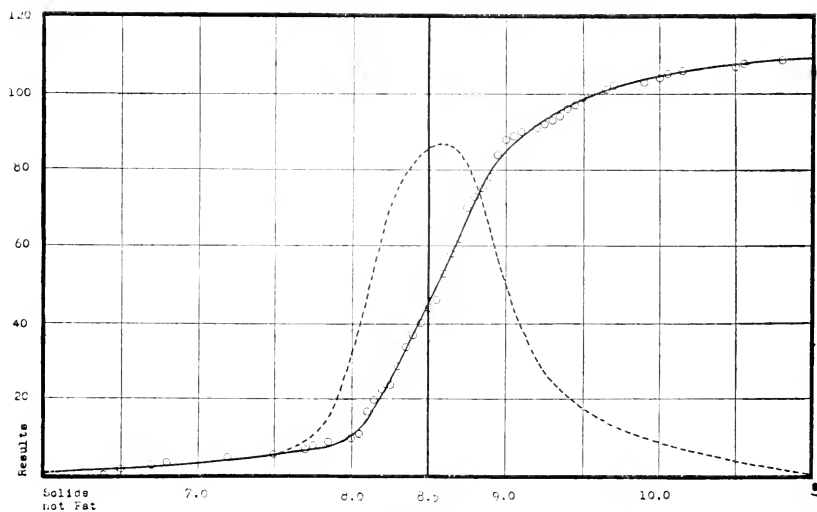

Text-fig 3,

Ogive and frequency curve of concentrations of solids not fat in cows' milk. Abscissæ: percentages of solids not fat. Ordinates: numbers of results; ordinates refer only to ogive.

The above diagram shows that over 40% of the samples examined contain a percentage of solids not fat below the legal

standard. The frequency curve also shows that, in the present results, the most probable value of the percentage of solids not fat is 8.65. This value is very close to the standard, which, therefore, allows a very small margin of variation. Over 90% of these results, on the other hand, lie above a percentage of solids not fat of 7.9.

In the preceding discussion, three forms of mean value have been used, the arithmetic mean, the median, and the mode or most probable value. In series of results which are symmetrically arranged about their central values, these three means are identical. Actual series of results are rarely quite symmetrical, however, and in such cases the three means may differ. In the accompanying Table, the three forms of mean values of the results of the present series are placed together for comparison.

TABLE VI.

Arithmetic means, medians, and modes or most probable values, of the composition and properties of cows' milk.

	Mean	Median.	Mode.
Weight of milk	3.7	3.75	3.5
Weight of fat	182	173	150
Density	1.0297	1.0297	1.0297
Depression of freezing-point ...	0.563	0.562	0.562
Conductivity	4.55	4.55	4.5
Total solids, p.c.	13.65	13.45	13.24
Fat, p.c.	5.0	4.85	4.65
Solids not fat, p.c.	8.65	8.65	8.65
Lactose, p.c.	4.9	5.0	5.0
Ash, p.c.	0.69	0.70	0.72
Protein, etc., p.c.	2.9	3.0	2.9
Water, p.c.	86.45	86.55	86.75

The figures in the above Table show that the three forms of mean value are very close together for most of the quantities measured. The greatest variation is to be seen in the case of the weight of fat obtained at a milking. The mode of this weight is about 14% less than the mean. The modes of the percentage of fat and of the weight of milk obtained at a milking

are also less than the mean values, the former to the extent of about 7%, the latter to the extent of about 6%. The mode of the percentage of total solids is also less than the mean value, as a consequence of the behaviour of the values of the percentage of fat. The three forms of mean of the percentage of solids not fat, however, are practically identical.

RELATIONS BETWEEN CONSTITUENTS AND PROPERTIES.

Although no general relations, between the percentages of the various constituents of the milk and the values of the various properties, are at once apparent from an examination of the figures for the individual samples, such relations do exist. So definite is the relation between the density, the percentage of fat, and the percentage of solids not fat, or total solids, for example, that Fleischmann (1885), and Helmer and Droop Richmond (1888) have devised formulæ by which the value of one of these three quantities may be calculated from the values of the other two.

From the figures for the mean values of the composition and properties of the milk collected on the same days, however, it may be seen more readily whether any relations exist between the different quantities. To display graphically any such relation, the mean values of the quantities for the several days have been plotted as ordinates in the following diagram (Text-fig.4). The different ordinates on which the values are measured are spaced equally along the abscissa, and represent the different days on which the samples were collected. The points representing the different mean values of the same quantity have been joined by straight lines. It is to be borne in mind, that the lines obtained in this way are not graphs in the ordinary sense of the word. They do not represent the values of the ordinates corresponding to given values of the abscissæ. The points on the abscissa have no "values," they simply represent different groups of samples; and the ordinates for the different values of each quantity have been joined by lines merely to connect them together, and to facilitate their comparison with the corresponding points for the values of other quantities.

The values for the electrical conductivity have been measured downwards in the above diagram to render them more easily comparable with the values of the other quantities, which have been measured upwards in the ordinary way.

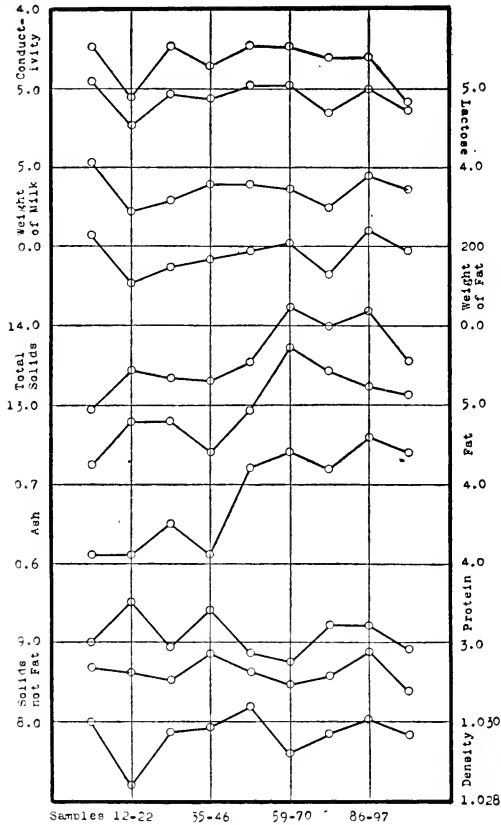

Text-fig. 4.

Diagram showing relation between various properties and constituents of cows' milk. Ordinates: values of quantities measured. Points on abscissa represent corresponding values of different quantities.

The diagram shows, at once, that there is a distinct, inverse relation between the mean percentage of lactose, and the mean conductivity. Jackson and Rothera (1914) showed that a similar

definite relation between these quantities exists in the samples of milk obtained from the different quarters of a cow's udder at one milking. Their measurements of conductivity were made, however, upon milk from which the fat had been removed. These relations are also shown by the diagrams representing the effect of the number of calves or age of the cow, and the stage of lactation or age of the calf, on the mean composition and properties of the milk (Text-figs. 5 and 6).

Text-fig. 4 also indicates the existence of a direct relation between the weights of milk obtained at a milking, and the corresponding weights of fat. The mean weights of fat fluctuate in the same direction as the mean weights of milk, and do not show any tendency to remain constant and independent of the amounts of milk. The present results are for single milkings, however, and not for the daily outputs of the cows. The above Figure shows also that there is a relation between the percentages of lactose and the conductivity, and the weights of milk and of fat. Cows producing larger quantities of milk thus show no tendency to yield a secretion poorer in fat or in lactose than those producing less milk under the same circumstances.

Between the remaining mean values of the composition and properties of the milk no distinct relations are shown by the above diagram. The dependence of the density on the percentages of fat and of ash, which is to be observed in certain individual samples, is not seen when the mean values are considered. There is also no evidence that a higher percentage of fat is generally associated with a higher percentage of protein, as was thought to be the case by Hart (1906), and by Eckels and Shaw (1913).

These results do not show the direct relation between the percentage of ash and the conductivity, which was observed by F. Petersen (1904).

EFFECT OF BREED.

In the following Table are given the mean composition and properties of the milks of cows of different predominant strains of breed. The numbers of cows of each strain vary from 51 to

12. The calculated mean values are, therefore, not so strictly comparable as if the numbers of the cows of each strain were approximately equal.

TABLE VII.

Predominant strain.	Shorthorn.	Crossbred.	Ayrshire.	Jersey.
Number of cows ...	51	18	19	12
Number of calves ...	5	3	3	4
Age of calves... ..	4.5	4.8	4.5	3.9
Weight of milk ...	3.8	3.4	3.9	4.3
Weight of fat ...	179	186	197	213
Density	1.0301	1.0293	1.0294	1.0301
Freezing-point ...	0.564	0.564	0.562	0.562
Conductivity	4.65	4.55	4.75	4.45
Total solids, p.c. ...	13.5	14.25	13.55	13.7
Water, p.c.	86.5	85.75	86.45	86.3
Fat, p.c.	4.8	5.55	5.0	4.85
Solids not fat, p.c. ...	8.7	8.7	8.55	8.65
Sugar, p.c.	4.9	4.85	4.85	5.05
Ash, p.c.	0.69	0.72	0.66	0.67
Protein, etc., p.c. ...	3.05	3.0	3.0	3.0

The values given in this Table show that the greatest range of variation occurs in the mean percentage of fat, which is greatest in the case of Crossbred cows (5.5%), and least in the case of Shorthorn strains (4.8%). The mean yield of milk, on the other hand, is greatest in the case of the Jersey strain (4.3 kg.), and least in the case of the Crossbred (3.4 kg.). The mean total weight of fat obtained at a milking is greatest in the case of the Jersey strain (213 gm.), and least in the case of the Shorthorn (179 gm.). The mean percentage of lactose is highest in the Jersey strain (5.05%), and lowest in the Crossbred and Ayrshire (4.85%). The mean percentage of ash is greatest in the Crossbred cows (0.72%), and least in the case of the Ayrshire strains (0.66%). The mean percentage of protein and extractives is greatest in the milk of cows of Ayrshire strain (3.1%), and least in that of cows of Crossbred and Ayrshire strains (3.0%). Its range of variation is small.

Among the physical properties, the greatest variation is shown by the electrical conductivity, which ranges from 4.75×10^{-2} reciprocal ohms in the case of the Jersey strain, to 4.55×10^{-2} in the case of the Crossbred strain. The variation of the mean freezing point is within the limits of error of the determination. The density varies from 1.0301 in the milk of Jersey and Short-horn strains, to 1.0293 in that of Crossbred cows.

The average numbers of calves of the cows of the different strains range from 5 to 3. The average ages of the calves range from 3.9 to 4.8 months. The data for the effect of the number of calves or age of the cows, and of the period of lactation or age of the calves, show that these variations are not large enough to affect appreciably the present comparison of the mean values of the composition and properties of the milk of cows of different predominant strains.

EFFECT OF NUMBER OF CALVES OR AGE OF COW.

In the following Table are given the mean values of the composition and properties of the milk of cows which have had different numbers of calves, that is, of cows of different ages. The number of cows at each age varies from 7 to 28. In this case the means compared are those of rather widely varying numbers of results, and are not so strictly comparable as they would be, if the numbers of the cows at the different ages were approximately equal. The numbers of calves of the cows examined range from 1 to 9; the ages of the animals, therefore, range from 2 to 10 years.

TABLE VIII.

Effect of number of calves or age of cow on mean composition and properties of its milk.

Number of calves.	1	2	3	4	5	6-7	8-9
Number of cows ...	7	16	28	16	16	10	12
Age of calf ...	3.5	5.5	4.5	4.5	3.6	4.1	5.1
Weight of milk ...	3.3	3.2	3.7	4.2	3.9	3.3	4.3
Weight of fat ...	165	175	188	206	185	140	202
Density ...	1.0304	1.0293	1.0300	1.0299	1.0295	1.0300	1.0295
Depression of f.pt. ...	0.570	0.562	0.563	0.559	0.568	0.562	0.562
Conductivity ...	4.5	4.6	4.5	4.6	4.95	4.6	4.6
Total solids, p.c. ...	13.35	14.45	13.6	13.95	13.25	13.15	13.45
Water, p.c. ...	86.65	85.55	86.4	86.05	86.75	86.85	86.55
Fat, p.c. ...	4.95	5.7	5.1	5.15	4.65	4.3	4.75
Solids not fat, p.c. ...	8.4	8.75	8.58	8.8	8.6	8.85	8.7
Lactose, p.c. ...	4.95	4.85	4.95	4.95	4.7	4.85	5.0
Ash, p.c. ...	0.73	0.70	0.69	0.72	0.71	0.67	0.60
Protein & ext., p.c.	2.7	3.2	2.85	3.1	3.2	3.3	3.1

The mean ages of the calves of the cows of different ages are shown by the above Table to range from 5.5 to 3.5 months. The data given for the variation of composition and properties, with the period of lactation, show that this range is small enough to be without noticeable effect on the present comparisons.

In the accompanying diagram (Text-fig.5), the mean values of the composition and properties of the milk of cows of different ages, or which have had different numbers of calves, have been plotted as ordinates, against the numbers of calves as abscissæ.

This diagram shows at once that the mean values of the physical properties of milk, density, freezing point, and electrical conductivity are unaffected by the age of the cow. The weight of milk yielded, and the percentage of sugar present are also unaffected. The mean percentage of protein increases from 3.0 to 3.3 during the period examined. The mean percentage of fat, on the other hand, decreases from 5.4 to 4.3, and the mean percentage of ash decreases from 0.75 to 0.62, during the same period. The percentage of total solids falls, as the age of the cow increases, from 14.0 to 13.2.

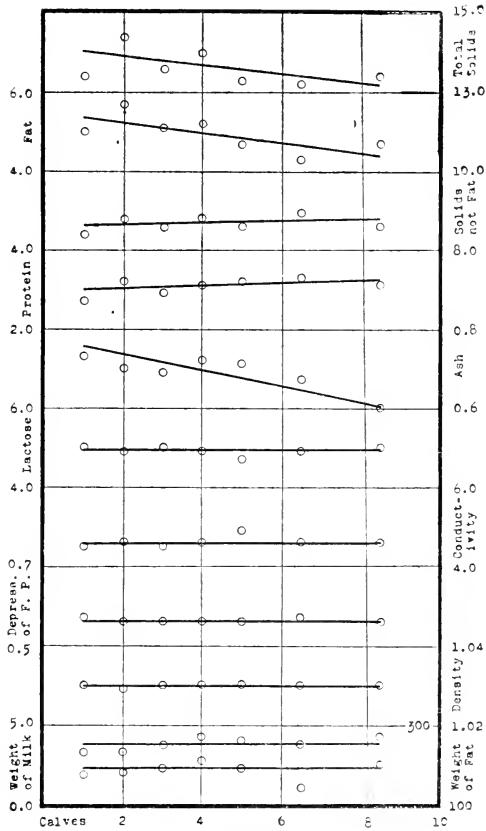

Text. fig. 5.

Effect of number of calves, or age of cow, on composition and properties of milk. Ordinates: values of composition and properties. Abscissae: numbers of calves.

EFFECT OF PERIOD OF LACTATION.

The effect of the period of lactation on the composition and properties of cows' milk is shown by the figures in the following Table. The periods have been expressed as months of thirty days each. The number of cows at each stage of lactation is also given. The values of the composition and properties are the mean values for the number of cows at each stage.

TABLE IX.
Variation of mean composition and properties of cows' milk with stage of lactation.

Month of lactation.	1	2	3	4	5	6	7	8	9	10-11	Over 10-11
Number of cows ...	13	14	14	10	10	13	12	5	6	5	2
Number of calves ...	4.1	3.7	4.2	4.5	3.4	3.8	4.8	3.4	5.0	3.4	4.0
Weight of milk, kg. ...	4.9	4.9	4.1	3.7	3.8	2.9	3.3	2.2	2.2	1.8	2.5
Density ...	1.0306	1.0295	1.0291	1.0299	1.0305	1.0294	1.0299	1.0287	1.0294	1.0299	1.0302
Depression of f. point	0.561	0.560	0.566	0.568	0.563	0.566	0.563	0.557	0.561	0.561	0.560
Conductivity ...	4.5	4.4	4.7	4.7	4.45	4.75	4.7	5.0	4.4	5.0	4.8
Total solids, p.c. ...	13.4	13.7	13.35	13.6	13.4	13.65	13.6	13.85	14.6	14.05	13.25
Fat, p.c. ...	4.6	4.95	5.05	4.95	4.8	5.3	5.05	5.15	5.6	5.1	4.6
Solids not fat, p.c. ...	8.8	8.75	8.3	8.7	8.6	8.35	8.55	8.7	9.0	8.95	8.65
Lactose, p.c. ...	5.1	5.1	4.9	4.85	5.05	4.75	4.8	4.5	4.85	4.65	4.6
Ash, p.c. ...	0.73	0.67	0.70	0.67	0.68	0.67	0.65	0.72	0.73	0.68	0.53
Protein & extrives, p.c.	2.9	3.0	2.65	3.15	2.8	3.1	3.1	3.5	3.45	3.65	3.6
Water, p.c. ...	86.6	86.3	86.65	86.4	86.6	86.35	86.4	86.15	85.4	85.95	86.75
Weight of fat, gm. ...	227	243	208	182	182	150	159	115	15.8	88	112

The mean number of cows at each month of lactation up to and including the seventh, is 12, and the maximum deviation from this mean is 2. After the seventh month, the number of cows in milk shows a sudden falling off.

The average number of calves to which the cows at each month of lactation had given birth is given in the third column, to the nearest whole number. This number, for the first seven months, varies between 4 and 5. The average values of the composition and properties are thus quite comparable for these months, both as regards the numbers of samples examined at each month, and as regards the mean age or number of calves of the cows. After the seventh month, the variation of the number of calves is from 3 to 5, and as the numbers of results examined at each month are only half those examined in the earlier period, the mean values of the composition and properties of the milk secreted during the eighth and later months are, perhaps, not so strictly comparable with those of the milk secreted during the earlier periods of lactation. Of the total number of samples examined, 86 were of the milk obtained during the first seven months of lactation, 16 were of the milk of the eighth to eleventh months, and 2 were of the milk of later periods.

In the accompanying diagram (Text-fig. 6) the values of the properties and composition given in Table ix., have been plotted as ordinates, while the corresponding periods of lactation have been plotted as abscissæ. Smooth curves have been drawn through the points obtained in this way.

The scales of the ordinates are not the same for each curve. In the case of the curves for percentages of total solids, fat, solids not fat, protein, and sugar, the distance between adjacent horizontal lines represents a variation of 2%. In the case of curve for the percentages of ash, this distance represents a variation of 0.2%. For the other curves, this distance corresponds to the following variations: density, 0.02; freezing-point, 0.02°C.; conductivity, 2.0×10^{-2} reciprocal ohms; weight of milk, 5.0 kg., weight of fat, 200 gm. The scales of the ordinates are the same as in Text-figure 5.

The curves show that the percentage of fat in cows' milk tends to rise slowly during the whole period of lactation.

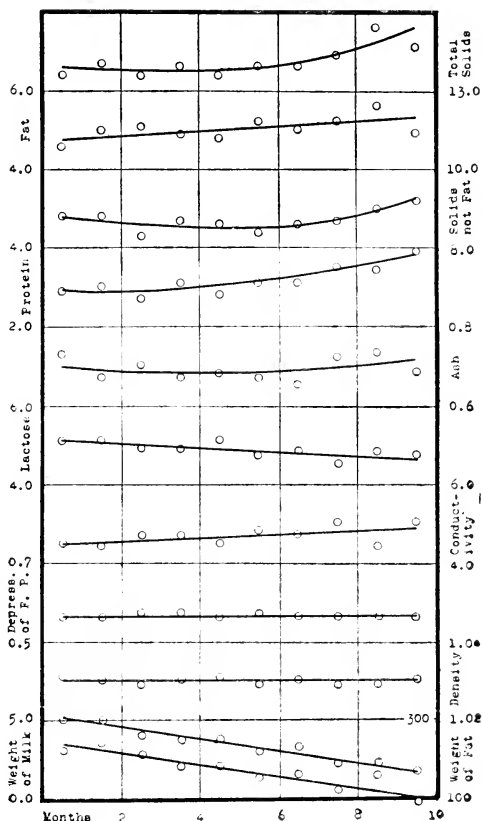

Text-fig. 6.

Effect of age of calf or stage of lactation on composition and properties of cows' milk. Ordinates: values of composition and properties. Ab-scissæ: ages of calves (months).

The percentage of protein falls slightly during the first three months, and then rises till the end of lactation, when its value is nearly 30% higher than it was in the first month.

The percentage of ash falls slightly during the first five months,

and during the remainder of the period rises again, finally reaching its initial value.

The percentage of lactose falls steadily during the whole period of lactation, the final value being about 10% lower than the initial value.

The variation of the percentage of total solids is dependent on that of the separate constituents. This value, like that of the percentage of protein and of ash, falls at first, and then rises again.

The value of the conductivity increases steadily during the whole period of lactation; the final value being about 10% higher than the initial.

The values of the density and of the freezing-point remain constant through the whole course of lactation.

The weight of milk obtained at a milking falls steadily and rapidly as lactation proceeds, the yield towards the end being less than half of what it was at the beginning.

The weight of fat obtained at a milking also tends to fall steadily during the whole period of lactation, and to about the same extent as the weight of milk, in spite of the fact that the percentage of fat tends to increase.

As was stated above, the weights of the remaining constituents are more dependent on the total amount of the milk than is the weight of fat. The weights of these constituents will, therefore, fall steadily during lactation with the weight of the milk.

In conclusion, I wish to express my indebtedness to Professor Sir Thomas Anderson Stuart, in whose laboratory this work was done; and to Dr. E. Sinclair, Inspector General of the Insane, by whose courtesy the samples of milk discussed in this paper were obtained. I also wish to thank Dr. H. G. Chapman for his helpful criticism during the progress of the work.

SUMMARY.

The variations of the composition and properties of samples of afternoon-milk from 109 normal cows are discussed.

The following were the most probable values of the quantities measured: depression of freezing-point, 0.562°C.; density, 1.0297;

electrical conductivity, 4.5×10^{-3} reciprocal ohms; total solids, 13.24%; fat, 4.65%; solids not fat, 8.65%; lactose, 5.0%; ash, 0.72%; protein and extractives, 2.9%.

The depression of the freezing-point, and the density were the least variable quantities measured.

The concentrations of the constituents were much less variable than the total quantities obtained at a milking.

The concentrations of the soluble constituents were much less variable than those of the constituents in suspension. The concentration of lactose was the least variable, that of fat the most variable.

About 3% of the samples contained a percentage of fat below 3.2; about 40% of the samples contained a percentage of solids not fat below 8.5.

The mean percentages of fat and of ash were greater in the milk of older cows; the mean percentage of protein was less. The percentages of the other constituents, and the properties, were not affected by the age of the cow.

The mean yields of milk became lower in the later stages of lactation; the mean percentages of lactose was also slightly lower in the milk of the later stages of lactation, but the electrical conductivity, and the percentages of fat and of protein became higher as the stage of lactation became later.

REFERENCES.

- ACKERMANN, *Jahresber. f. Tierch.*, 32, 1013, 1903; (from *Milchztg.*, 31, 166 & 611, 1902).
- ANNETT, *Agr. Journ. of India*, 10, 63, 1915.
- BARTOLETTI, *Encyclopaedia dogmatica*, 1615; (cited by Abderhalden, *Text-book of physiol. Chem.*, 39, 1908, trans. by Hall and Defren. New York: John Wiley and Sons.
- BECKMANN, *Jahresber. f. Tierch.*, 24, 225, 1894.
- BOARD OF AGRICULTURE, LONDON, *Journal*, 18, 30, 1911.
- CAMERER and SOELDNER, *Zeitschr. f. Biol.*, n. F., 535, 1859.
- , *Ibid.*, n. F., 18, 277, 1898.
- CARLINFANTI, *Gazz. chim. ital.*, 27, (1), 460, 1897.
- CHAPMAN, *Proc. Linn. Soc. N. S. Wales*, 33, 436, 1908.
- 

- COLLINS, Journ. Soc. Chem. Ind., 21, 1512, 1902.
 ———, *Ibid.*, 23, 3, 1904.
- CROWTHER and RAISTRICK, Biochem. Journ., 10, 434, 1916.
 ——— and RUSTON, Trans. Highland and Agr. Soc. of Scotland,
 5th ser., 23, 93, 1911.
- ECKELS and SHAW, U. S. Dept. of Agr., Bur. of Animal Ind., Bull.
 155, 1913.
 ———, *Ibid.*, Bull. 156, 1913.
- FLEISCHMANN and WIEGNER, U. S. Expt. Stn. Record, 30, 272, 1914,
 (from J. Landw., 61, 283, 323, 1913).
 ———, J. f. Landwirts., 33, 251, 1885 (cited by Sommer-
 feld's Handb. d. Milchk., 269, 1909. Wiesbaden: Bergmann).
- FRESENIUS, Zeitschr. f. analyt. Chem., 48, 559, 1909.
- GAINES, Amer. Journ. Physiol., 38, 285, 1915.
- GOTTLIEB, Jahresber. f. Tierch., 21, 151, 1891 (from Tidskrift for
 Physik og Chemie, 1890).
- GRAHAM, Trans. Highland and Agric. Soc. of Scotland, 5th ser., 16,
 43, 1904.
- HAMMOND, Quart. Journ. of Expt. Physiol., 4, 311, 1913.
- HART, Journ. Amer. chem. Soc., 30 (i), 281, 1908.
- HEHNER and DROOP RICHMOND, Analyst, 13, 26, 1888.
- HELLE, MUELLER, PRAUSNITZ, and PODA, Zeitschr. f. Biol., n. F., 40,
 355, 1912.
- HENDERSON and MESTON, Proc. Roy. Soc. Q., 24, 165, 1913.
 ———, *Ibid.*, 26, 85, 1914.
- ISAACHSEN, LALIM, WOLD, and GRANDE, Chem. Abstracts, 7 (3),
 3800, 1913. (from Report of Exp. Feeding-station of Agr.
 High School of Norway, 8, 48, 1913).
- JACKSON and ROTHERA, Biochem. Journ., 8, 1, 1914.
- JAHNSON-BLOHM, Zeitschr. f. physiol. Chem., 83, 441, 1913.
- KRETSCHMER, Zeitschr. f. physiol. Chem., 85, 286, 1913,
- KOHLRAUSCH and NIPPOLDT, Ann. d. Phys. u. Chem. (Poggendorf),
 18, 280 and 370, 1869.
- LALIM and GRANDE, biochem. Zentralbl., 15, 493, 1913; (from Report
 of Exp. Feeding-station of Agr. High School of Norway, 8,
 11, 1913).
- LAUDER, Edinburgh and E. of Scotland Coll. of Agr., Bull. 11, 52,
 1906.
- LEAVITT, Journ. of Ind. and Eng. Chem., 2, 19, 1910.
- LYTHGOE, Journ. of Ind. and Eng. Chem., 6, 899, 1914.
- MAXWELL and ROTHERA, Journ. of Physiol., 49, 483, 1915.

- MELANDER, Jahresber. f. Tierch., 22, 180, 1893 (from Nordisk Mejerie-Tidning, Nr. 48 and 49, 1892).
- MUELLER, Anleitung zur Prüfung der Kuhmilch, 1892; (cited in Sommerfeld's Handb. d. Milchk., 244, 1909. Wiesbaden: Bergmann).
- MUNK, Arch. f. path. Anat. u. Physiol., 134, 501, 1893.
- PARMENTIER and DEYEUX, Traité sur le Lait, 1790. (cited by Reiset, Ann. de Chim. et de Phys., sér. 3, 25, 83, 1849).
- PELIGOT, Ann. de Chim. et de Phys., 62, 432, 1836.
- PETERSEN, F., U. S. Expt. Stu. Record, 16, 504, 1904-5, (from Milchzeitung, 33, 567, 1904).
- PETERSEN, P., Jahresber. f. Tierch., 26, 265, 1897, (from Milchzeitung, 25, 70, 1896).
- POETSCHKE, Journ. of Ind. and Eng. Chem., 3, 405, 1911.
- QUEVENNE, Ann. d'Hygiène 26, 257, 184 (cited by Raudnitz, Ergeb. d. Physiol. 2 (1), 193, 1903).
- RAOULT, Zeitschr. f. physikal. Chem., 27, 617, 1898.
- REISS and SOMMERFELD, Sommerfeld's Handbuch der Milchkunde, p. 241, 1909. Wiesbaden: Bergmann.
- ROESE, Jahresber. f. Tierch., 17, 167, 1888. (from Zeitschr. f. angew. Chem., Heft 4, 1887).
- ROSEMAXX, Zeitschr. f. physiol. Chem., 89, 133, 1914.
- SALKOWSKI, *Ibid.*, 78, 89, 1912.
- SCHEIBE, Zeitschr. f. anal. Chem. 40, 1, 1901.
- , Sommerfeld's Handb. d. Milchkunde, 299, 1909 (from Landwirts. Versuchsstationen, 39, 153, 1891).
- SCHULTE-BAEUMINGHAUS, U. S. Expt. Stu. Record, 15, 811, 1903-4. (from Mitt. d. landw. Inst. d. Univ. Breslau, 2(1), 25, 1902).
- SIKES, Journ. of Physiol., 34, 481, 1906.
- SOELDNER, Zeitschr. f. Biol. n. F., 15, 43, 1896.
- TEZNER and ROSKA, Zeitschr. f. physiol. Chem., 56, 502, 1908.
- VON WENDT, skand. Arch. f. Physiol., 21, 89, 1903.
- WARDLAW, Journ. and Proc. Roy. Soc. N. S. Wales, 48, 152, 1914.
- , *Ibid.*, 49, 169, 1915.
- WINTER, Comptes rendus, 121, 696, 1895.

THE COMPOSITION OF EXPIRED ALVEOLAR AIR.

BY ETHEL C. PINKERTON, B.Sc. (SYD.), SCIENCE RESEARCH
SCHOLAR IN THE UNIVERSITY OF SYDNEY.

(*From the Physiological Laboratory of the University of Sydney.*)

In a previous communication(1) dealing with the percentage of carbon dioxide in expired alveolar air, it has been shown that the amount of carbon dioxide in the last 625 c.c. of expired air does not vary beyond the error of the analytical method, when the expulsion has been performed within two seconds, for quantities of air of two litres or over, and within one second for quantities of one to two litres of expired air. The investigation of the composition of expired alveolar air has now been extended to the estimation of oxygen as well as carbon dioxide, and more accurate analytical methods have been employed for the determinations of the amounts of the gases.

Methods.—The samples of air have been obtained in the same way as in the previous research(1) by collecting them through small capillary pipes set in a long brass tube, into which the subject of the experiment breathed. The tube is the same as used previously, and the capillary tubes have been fixed 250, 500, 1750 and 2000 mm. from the mouthpiece. The analyses of the gases of the samples have been performed in a large Haldane apparatus, the carbon dioxide being absorbed by potash, and the oxygen by alkaline pyrogallie acid. The carbon dioxide can be estimated to 0.01 c.c. in a measurement of 1 c.c., giving an analytical error of 1 in 100. The percentages of carbon dioxide in the samples are calculated, therefore, to the second decimal place. The error in the determinations of oxygen has been ascertained in a series of

estimations of the amount of oxygen in the air of the room. The results of these analyses are given in Table i.

TABLE i.

Date.	Bar. Press. mm. Hg.	Temp. °C.	Percentage of oxygen obtained.	Average per-centage.	Range.
11. vii. 17	764.8	16.1	20.90, 20.87, 20.87, 20.88, 20.84, 20.81	20.86	+ 0.05
12. vii. 17	758.0	14.7	20.93, 20.94, 20.97	20.95	± 0.02
16. vii. 17	755.6	16.5	20.87, 20.86, 20.89	20.87	± 0.02
18. vii. 17	747.0	14.3	20.89, 20.87, 20.88, 20.85, 20.90, 20.91	20.88	± 0.03

The figures in this Table for the oxygen in the air of the room have varied from 20.81 to 20.97₁₀₀. These figures are all somewhat lower than 20.96, but the differences between the analyses on different days do not exceed 0.16 parts in 20.89 parts of air, and the duplicates do not vary by more than 0.09 parts in the same quantity. In the first series of experiments, a plug of glass-wool was placed in the brass tube, as proposed by Henderson, Chillingworth and Whitney(2), but this was omitted in a second series. The omission of the plug of cotton-wool has made no difference to the ease with which the breath displaced the air in the brass tube. It would appear that the expired air is driven into the tube at such a rate, that the air already in the tube is displaced by the advancing wave of the entering air. I am indebted to Mr. F. W. Carpenter for the suggestion, that the air respired into the brass tube behaves like an "explosive wave," driving the contents of the tube before it.

Results.—As it felt easier to breathe quickly into the empty brass tube, and as the results of the analyses show the least change along the tube, the results of the second series of experiments, in which no glass-wool was placed in the brass tube, will be described first. The figures are given in Table ii.

TABLE II.

No. of expt.	Volume of exp- ired air in c.c.	Percentage of O ₂ in samples of expired alveolar air, col- lected at distances from the mouthpiece of				Percentage of CO ₂ in samples of expired alveolar air, col- lected at distances from the mouthpiece of			
		25 cm.	50 cm	175 cm.	200 cm.	25 cm.	50 cm.	175 cm.	200 cm.
1	1150	15·73	15·58	15·77	15·77	4·80	4·83	4·72	4·72
2	1250	16·40	16·42	16·47	16·46	4·52	4·54	4·45	4·41
3	1250	16·35	16·41	16·44	16·45	4·44	4·47	4·41	4·37
4	1275	15·94	16·02	16·04	16·01	4·71	4·71	4·68	4·64
5	1300	16·17	16·22	16·19	16·21	4·65	4·66	4·59	4·57
6	1300	16·32	16·40	16·58	16·61	4·42	4·43	4·32	4·32
7	1450	16·44	16·39	16·69	16·54	4·41	4·44	4·29	4·26
8	1475	15·74	15·71	15·89	15·91	5·02	5·00	4·87	4·89
9	1550	16·92	16·93	16·97	17·03	4·34	4·26	4·27	4·26

The results are arranged in the order of the volume of the expired air. The expired air has been expelled as quickly as possible from the lungs. The brass tube contains 625 c.c. between the mouthpiece and the outlet, 200 cm. from the mouthpiece. The results show that the air, filling the brass tube, in the neighbourhood of the outlets at 25 cm., and 50 cm., invariably contains slightly less oxygen, and slightly more carbon dioxide than that in the neighbourhood of the outlets at 175 cm., and 200 cm., from the mouthpiece. The difference in experiment 9 amounts to less than 0·07% oxygen, and to less than 0·04% carbon dioxide: while, in experiment 7, the difference amounts to 0·02% oxygen, and to 0·15% carbon dioxide, the greatest difference observed in this series. It would thus appear that, in a respiration of about 1300 c.c., the last 625 c.c. show a change in composition of not more than 0·15% carbon dioxide, and 0·20% oxygen. The range of variation in the composition of the last 625 c.c. to be expelled from the lungs depends on the speed with which the air is driven into the brass tube. The quicker the air enters, the more uniform is the composition of the last portion. As the period of expiration becomes prolonged, the percentage of carbon dioxide in the last part of the expired alveolar air rises, while the percentage of oxygen falls (*vide* experiment 4 of Table iii.).

A more extensive series of figures has been obtained in the first set of experiments, in which glass-wool was placed in the brass tube. The results, arranged according to the depth of the expiration, which varied from 900 c.c. to 1625 c.c., are recorded in Table iii.

TABLE iii.

No. of expt.	Volume of expired air in c.c.	Percentage of O ₂ in samples of expired alveolar air, collected at distances from the mouthpiece of				Percentage of CO ₂ in samples of expired alveolar air, collected at distances from the mouthpiece of			
		25 cm.	50 cm.	175cm.	200cm.	25 cm.	50 cm.	175cm.	200cm.
1	900 (duplicates)	16.62	16.58	16.69	16.68	4.24	4.21	4.11	4.08
		16.54	16.57	16.70	16.70	4.20	4.23	4.12	3.99
2	1000	16.62	16.69	16.98	17.06	3.98	3.97	3.77	3.74
3	1025	17.05	16.99	17.24	17.30	4.02	4.08	3.91	3.84
4	1050	16.68	16.86	16.92	16.95	4.37	4.14	4.24	4.17
5	1100	16.12	16.30	16.36	16.52	4.62	4.51	4.46	4.35
6	1125	15.99	16.05	16.07	16.13	4.48	4.43	4.53	4.37
7	1175	16.77	16.76	16.77	16.71	4.03	4.12	4.09	4.03
8	1175	16.56	16.57	16.75	16.74	4.28	4.27	4.22	4.15
9	1200	15.70	15.76	15.93	15.98	4.70	4.71	4.54	4.54
10	1290	16.81	16.71	16.84	16.87	4.04	4.03	3.94	3.88
11	1200	16.99	16.88	16.98	17.08	4.26	4.28	4.13	4.08
12	1300	16.62	16.70	16.83	16.90	4.17	4.13	4.05	3.99
13	1325	16.82	16.94	17.03	17.08	4.25	4.18	4.12	4.08
14	1325	16.73	16.77	16.97	17.00	4.23	4.22	4.10	4.04
15	1325	16.27	16.28	16.30	16.39	4.39	4.40	4.35	4.30
16	1325	16.61	16.70	16.80	16.81	4.04	4.06	3.88	3.88
17	1350	16.37	16.42	16.39	16.48	4.20	4.17	4.13	4.10
18	1400	15.90	15.96	16.08	16.10	4.76	4.70	4.71	4.63
19	1425	16.26	16.35	16.54	16.60	4.31	4.31	4.19	4.13
20	1425	16.23	16.30	16.47	16.56	4.29	4.30	4.18	4.13
21	1450	16.47	16.54	16.64	16.66	4.57	4.58	4.53	4.51
22	1450	16.64	16.56	16.63	16.66	4.22	4.31	4.27	4.24
23	1625	16.40	16.35	16.51	16.56	4.41	4.32	4.18	4.22

The figures show that the expired air, which is collected at a distance of 200 cm. from the mouthpiece, contains more oxygen and less carbon dioxide than that leaving the lungs at the end of expiration. In two experiments, viz., Nos. 7 and 22, there appears to be no evidence of any change in composition in the portion of expired alveolar air examined. In experiment 2, the difference amounts to 0.36% oxygen, and to 0.22% carbon dioxide, the

greatest difference observed in this investigation. The total volume expired in experiment 2 is 1000 c.c., so that the composition of the last 600 c.c. does not vary by more than 0.36% oxygen, and 0.22% carbon dioxide. In experiment 9, which is typical of many, the oxygen has decreased 0.22%, and the carbon dioxide diminished 0.16%.

From these two series of experiments, it appears that the carbon dioxide increases slowly in the expired air during a rapid expiration. The rate of increase varies, but, in the last 600 c.c. expelled from the lungs, the increase is not more than 0.22% carbon dioxide, while it is not more than half this figure in 17 out of 32 experiments.

Discussion of Results.—Two methods have been used recently to examine the composition of successive portions of the air expired. Haldane(3) has measured the percentage of carbon dioxide in the final portion of the air breathed out during a series of expirations of increasing depth. He has concluded, from his results, that the deeper part of an expiration contains no more carbon dioxide than the middle part. Krogh and Lindhard(4) have examined successive portions of the air breathed out during work, the samples being collected at intervals of some hundredths of a second. They have found that each successive portion of the expired air contains more carbon dioxide than that which precedes it, and less than that which follows it. They have been unable to apply this method to the examination of the breath expired when the body is at rest, but they have employed a modification, whence they conclude that the percentage of carbon dioxide rises slowly at the end of a normal respiration, the curve of the concentration of carbon dioxide in the breath showing a marked tendency to become asymptotic.

The method used in this paper makes it possible to examine the composition of a part of the air of the same breath to a certain degree of accuracy. When the analysis is made sufficiently delicate, it is possible to detect a change in the composition of the final 600 c.c. expelled from the air-passages. The concentration

of carbon dioxide increases by a variable amount in different experiments, but never more than 0.22%, while the increase can hardly be detected in some experiments. The percentage of oxygen diminishes by not more than 0.36%.

In considering which of these methods yields the most correct information as to the composition of the expired air, it may be noted that Haldane's experiments have been made on different respirations. His method of estimating carbon dioxide has been sufficiently accurate to detect the change of composition, but the fact that he obtained his samples at various depths of respiration from different breaths has not permitted him to recognise small differences in concentration. Krogh observed the change of concentration during work by analysis of successive samples collected at consecutive intervals of time, but, for conditions of rest, his curve was mainly the result of interpolation. In the method employed in this investigation, the analyses are made on successive portions of the same respiration. When the gaseous analysis has only been capable of recognising the change of concentration of 0.2% in the amount of carbon dioxide, the composition of the final 600 cc. expired has appeared uniform; but, with greater delicacy, a change in concentration of not more than 0.22% of carbon dioxide, and 0.36% oxygen has been observed.

These results are in accord with the results of Krogh and Lindhard. They support Lindhard's contention(4), that the final portion of the expired air has not the same composition as the air in the alveoli of the lungs, since the portion of the alveolar air in the trachea and bronchioles will contain more carbon dioxide, than the air expelled from the mouth, as it leaves the alveoli later.

Conclusions.

(1) Estimations of the percentage of oxygen and carbon dioxide in the successive portions of air rapidly expelled from the lungs, show that the concentration of carbon dioxide diminishes by not more than 0.22% in the final 600 c.c., respired, and that the concentration of oxygen augments by not more than 0.36% in the same portion of the breath.

(2) The change in concentration is independent of the depth of respiration, but depends on the speed with which the air is expired. The more slowly the air is breathed out, the greater the change in concentration of the gases of the final portion.

(3) These results lead to the inference, that the alveolar air in the pulmonary atria at the end of an expiration contains a lower concentration of oxygen and a higher concentration of carbon dioxide, than the air last expelled from the mouth in the rapid expiration.

I beg to express my indebtedness to Professor Sir Thomas Anderson Stuart, in whose Department this research has been conducted, and to thank Dr. H. G. Chapman for his encouragement and assistance in this work.

REFERENCES.

1. ETHEL C. PINKERTON—*Proc. Linn. Soc. N. S. Wales*, 1917, xlii., p. 146.
2. HENDERSON, Y., CHILLINGWORTH, E. P., and WHITNEY, J. L.—*Amer. Journ. Phys.*, xxxviii., p. 1, 1915.
3. HALDANE, J. S.—*Amer. Journ. Phys.*, xxxviii., p. 20, 1915.
4. KROGH, A., and LINDHARD, J.—*Journ. Phys.*, xlvii., p. 30, 1913; p. 430, 1914.

Addendum.—Seven sets of analyses with Haldane's apparatus were made on the contents of the brass tube after washing it out with gaseous mixtures containing known amounts of carbon dioxide. The results demonstrated the completeness of the replacement.

DONATIONS AND EXCHANGES.

Received during the period November 27th, 1916,
to November 28th, 1917.

(From the respective Societies, etc., unless otherwise mentioned.)

Adelaide.

AUSTRALASIAN ANTARCTIC EXPEDITION, 1911-14—
Scientific Reports Series C.: Zoology and Botany. Vols.
iv., 1-2; v., 1 (1916-17).

DEPARTMENT OF CHEMISTRY OF SOUTH AUSTRALIA—
Bulletin, Nos.2-6, 8-9(1916-17).

DEPARTMENT OF MINES: GEOLOGICAL SURVEY OF S. AUSTRALIA—
Annual Report of the Government Geologist for 1915(1916).
Bulletin No.6(1917).

Metallurgical Report No.2(1917).

Review of Mining Operations in the State of South Aus-
tralia during the Half-years ended December 31st, 1916,
and June 30th, 1917, Nos.25-26(1917).

PUBLIC LIBRARY, MUSEUM, ETC., OF SOUTH AUSTRALIA—
Report of the Board of Governors for 1915-16(1916).

ROYAL SOCIETY OF SOUTH AUSTRALIA —
Transactions and Proceedings, and Report. xl.(1916).

WOODS AND FORESTS DEPARTMENT OF SOUTH AUSTRALIA—
Annual Progress Report upon State Forest Administration
for the years 1915-16, 1916-17(1916-17). By W. Gill,
F.L.S., F.R.H.S., Conservator of Forests.

Baltimore.

JOHNS HOPKINS UNIVERSITY—
Hospital Bulletin. xxvii., 309,310; xxviii., 311-320(1916-17).
University Circulars. 1916, 1-10; N.S., 1917, 1(1916-17).

Barcelona.

JUNTA DE CIENCIAS NATURALES DE BARCELONA—

Musei Barcinonensis Scientiarum Naturalium Opera Series
Zoologica, ii., et vii.(1917).

Basle.

NATURFORSCHENDE GESELLSCHAFT IN BASEL—

Verhandlungen. xxvii.(1916).

Berkeley, Cal.

UNIVERSITY OF CALIFORNIA—

Publications.—*Botany*, v., 10-11 ; vi., 13-14 ; vii., 3-4.—
Entomology, i., 7.—*Geology*, T.p.&c. of ix.: x., 5-12, 14-17,
19.—*Zoology*, T.p.&c. of xii.; xiii., 13, T.p.&c.: xv., 2-3;
xvi., 18-24; xvii., 6-11; xviii., 1, 3, 4(1916-17).

Six Reprints: (*a*) "Further Studies on Typhoidin," by J.
N. Force and J. M. Stevens [Archives Int. Med., xix.,
March, 1917]; (*b-c*) "Infectious Diseases as a Field of
Investigation in Pathology" [Journ. Amer. Med. Assocn.
lxvii., Oct. 1916], and "Further Experience in the Treat-
ment of Typhoid Fever," &c. [Journ. Lab. Clin. Med., ii.,
Aug., 1917], by F. P. Gay; (*d*) "Application of the Ty-
phoidin Test," &c., by F. P. Gay and A. R. Lamb [Journ.
Lab. Clin. Med., ii., Jan., 1917]; (*e*) "Comparison of the
Antigenic Properties of different Strains of Bacillus
typhosus," by S. B. Hooker [Journ. Immun., ii., Dec.,
1916]; (*f*) "Treatment of Experimental Tuberculosis in
Guinea-pigs," &c., by M. Takeoka [Journ. Infec. Diseases,
xx., April, 1917].

Brisbane.

BOTANIC GARDENS, BRISBANE—

Botany Bulletin, No. xix.(1917).

DEPARTMENT OF AGRICULTURE AND STOCK—

Queensland Agricultural Journal, N.S. vi., 6; vii., 1-6; viii.,
1-5(1916-17).

GEOLOGICAL SURVEY OF QUEENSLAND—

Publications. Nos. 221A-221B (in one), 250, 257, 259, 260
(1910-17).

ROYAL GEOGRAPHICAL SOCIETY OF AUSTRALIA (QUEENSLAND
BRANCH)—

Queensland Geographical Journal. N.S. xxx.-xxxi. (in one),
1914-16(1917).

Brooklyn.

BROOKLYN INSTITUTE OF ARTS AND SCIENCES—

Brooklyn Museum Science Bulletin. ii., 6(1916).

Buenos Aires.

SOCIEDAD ARGENTINA DE CIENCIAS NATURALES—

“Physis.” ii., 9-10, 12(1915-16).

Calcutta.

GEOLOGICAL SURVEY OF INDIA —

Memoirs. xliii., 2; xlv., 1(1916-17).

Records. xlvii., 3-4(1916-17).

Cambridge, England.

CAMBRIDGE PHILOSOPHICAL SOCIETY—

Proceedings. xix., 1(1917).

Transactions. xxii., 10-11(1917).

Cambridge, Mass.

MUSEUM OF COMPARATIVE ZOOLOGY AT HARVARD COLLEGE—

Annual Report of the Director, 1913-14, 1914-15, 1915-16
(1914-16).

Bulletin. lv., 3-4; lvi., 3-4, T.p.&c.; lvii., 3; lviii., 8-11, T.p.
&c.; lix., 1-8, T.p.&c.; lx., 1-9; lxi., 2, 4-12(1914-17).

Cape Town.

ROYAL SOCIETY OF SOUTH AFRICA—

Transactions. v., 6; vi., 1(1917).

SOUTH AFRICAN ASSOCIATION FOR THE ADVANCEMENT OF
SCIENCE—

South African Journal of Science. i.-iv., vii.-x.; xi., 2; xii.,
12-13; xiii., 2-10; xiv., 1(1903-17).

SOUTH AFRICAN MUSEUM—

Annals. ix., 5; xi., 6; xii., 4; xiii., 5-6; xv., 4-6; xvi., 1;
xvii., 1(1916-17).

Report for the year 1916(1917).

Chicago.

FIELD MUSEUM OF NATURAL HISTORY—

Botanical Series. ii., 11, T.p.&c.; Geological Series. iii., 10,
T.p.&c.; Report Series. v., 1, 2(1916-17).**Christchurch, N.Z.**

CANTERBURY COLLEGE—

Notes from the C.C. Mountain Biological Station, Cass.
Nos.1-4(1915-16)[Reprinted from Trans. N.Z. Inst.].**Cincinnati, Ohio.**

LLOYD LIBRARY—

Bibliographical Contributions. ii., 10-12, T.p.&c.; iii., 1
(1916-17).**Colombo, Ceylon.**

COLOMBO MUSEUM—

Spolia Zeylanica. x., No.38(1916).

Columbus, Ohio.OHIO ACAD. SCI. AND BIOLOGICAL CLUB OF THE OHIO STATE
UNIVERSITY—

Ohio Journal of Science. xvii., 1-8(1916-17).

OHIO STATE UNIVERSITY—

University Bulletin. xxi., 6, 11, 28(1916-17).

Copenhagen.ACADEMIE ROYALE DES SCIENCES ET DES LETTRES DE DAN-
MARK—

Bulletin. 1916, 3(1916).

UNIVERSITETS ZOOLOGISKE MUSEUM—

Danish Ingolf-Expedition. iii., 5; iv., 4; v., 6(1916-17).

Danmark-Ekspeditionen til Grenlands Nordøstkyst, 1906-
08. iii., 17-18(1916).**Darwin, N.T.**DEPARTMENT OF MINES OF THE NORTHERN TERRITORY OF
AUSTRALIA—

Bulletin of the Northern Territory. Nos.16, 21(1916).

Decatur, Ill.

AMERICAN MICROSCOPICAL SOCIETY—

Transactions. xxxv., 3-4; xxxvi., 1(1916-17).

Edinburgh.

ROYAL PHYSICAL SOCIETY OF EDINBURGH—

Proceedings. xx., 2(1917).

ROYAL SOCIETY OF EDINBURGH—

Proceedings. xxxvi., 1-4, T.p.&c.; xxxvii., 1-4, T.p.&c.
(1916-17).

Transactions. li., 1-4(1916-17).

Garrison, N. Y.

AMERICAN NATURALIST. l., 600, T.p.&c.; li., 601-602(1916-17).

Geneva.

SOCIETE DE PHYSIQUE ET D'HISTOIRE NATURELLE DE GENEVE—

Compte Rendu, xxxii., 1915(1916).

Genoa.

MUSEO CIVICO DI STORIA NATURALE—

Annali. Serie 3^a, Vol. vii.,(xlvii.) [1916].**Hague.**

NEDERLANDSCHE ENTOMOLOGISCHE VEREENIGING—

Tijdschrift voor Entomologie. lix, 4, T.p.&c.(1916).

Halifax, N.S.

NOVA SCOTIAN INSTITUTE OF SCIENCE—

Proceedings and Transactions. xiv, 2, 1915-16(1916).

Hobart.

DEPARTMENT OF MINES—

Geological Survey Bulletins. No.25(1916).

Geological Survey: Mineral Resources, Nos.1, Pt. iii., 2-4
(1916-17).

Geological Survey Record. No.1(1913)

ROYAL SOCIETY OF TASMANIA—

Papers and Proceedings, 1916(1917).

Honolulu, T.H.

BERNICE PAUAHI BISHOP MUSEUM—

Memoirs. iv., 2(1917).

Occasional Papers. iii., 3-4; vi., 4(1917).

East Lansing, Michigan.

LABORATORY OF BACTERIOLOGY AND HYGIENE, MICHIGAN AGRICULTURAL COLLEGE—

Report of the Bacteriologist, 1915-16(1916).

One Separate: "The Soil-solution obtained by the Oil-pressure Method," by J. F. Morgan [Soil-Science, iii., 1917].

La Jolla, Cal.

SCRIPPS INSTITUTION FOR BIOLOGICAL RESEARCH OF THE UNIVERSITY OF CALIFORNIA, LA JOLLA—

Bulletin, Nos.1-4(1916-17)—Reprint from "Science," xliv., Decr. 8th, 1916.

Launceston, Tasm.

VICTORIA MUSEUM AND ART GALLERY—

Report, 1915-16(1916).

Leyden.

RIJKS HERBARIUM—

Mededeelingen, Nos.21-27(1914-15).

Liverpool.

LIVERPOOL BIOLOGICAL SOCIETY—

Proceedings and Transactions. xxix.-xxx.(1915-16).

London.

BOARD OF AGRICULTURE AND FISHERIES—

Journal of the Board of Agriculture, xxiii., 7-12; xxiv., 1, 3-6(1916-17).

Special Leaflet, No.7(1917).

BRITISH MUSEUM (NATURAL HISTORY)—

Catalogues: (a) Freshwater Fishes of Africa (G. A. Boulenger), iv.(1916); (b) Mesozoic Plants: Cretaceous Flora, (Dr. M. C. Stopes), Part ii.(1915); (c) Ungulate Mammals (R. Lydekker), v.(1916)—Guides: Economic Series, No.2

(1915)—Special Guide No.7. Specimens and Models of
Insects and Ticks, &c.(1916).

GEOLOGICAL SOCIETY—

List, September, 1917(1917).

Quarterly Journal. lxxi., 4; lxxii., 1(1917).

LINNEAN SOCIETY—

Journal. *Botany*, xlirii., 292-294, T.p.&c.(1916-17). *Zoology*,
xxxiii., 223(1916).

List of the Society, 1916-17(1916).

Proceedings, 128th Session, 1915-16(1916).

ROYAL BOTANIC GARDENS, KEW—

Bulletin of Miscellaneous Information, 1916(1917).

ROYAL MICROSCOPICAL SOCIETY—

Journal. 1916, 5-6; 1917, 1-4(1916-17).

ROYAL SOCIETY—

Philosophical Transactions. Series B. ccviii., Nos.B351-354
(1916-17).

Proceedings. Series B. lxxxix., Nos. B 617-622, T.p.&c.
(1916-17).

ZOOLOGICAL SOCIETY—

Abstract of Proceedings. Nos.147, 160-169, 171(1916-17).

Madison, Wis.

WISCONSIN ACADEMY OF SCIENCES, &c. —

Transactions. xviii., 1-2, T.p &c.(1915-16).

Madrid.

REAL SOCIEDAD ESPAÑOLA DE HISTORIA NATURAL—

Boletín, xvi., 7-10; xvii., 1-3, 5, 7(1916-17).

Memoirs. viii., 9, T.p.&c.; x., 6-8(1916-17).

Manchester.

MANCHESTER LITERARY AND PHILOSOPHICAL SOCIETY—

Memoirs and Proceedings. lx., 3, T.p.&c.: lxi., 1(1917).

UNIVERSITY OF MANCHESTER: MANCHESTER MUSEUM—

Publications of the Manchester Museum. No.79(1916).

Manila, P.I.

BUREAU OF FORESTRY: DEPT. OF THE INTERIOR—

Annual Report of the Director for the year 1916(1917).

BUREAU OF SCIENCE OF THE GOVERNMENT OF THE PHILIPPINE ISLANDS—

Philippine Journal of Science. Section A, xi., 4-6; xii., 1—
Sec. B, xi., 4-6; xii., 1-4—Sec. C, xi., 6; xii., 1-2—Sec. D,
xi., 5-6; xii., 1-3(1916-17).

Massachusetts.

TUFTS COLLEGE—

Tufts College Studies (Scientific Series). iv., 3-4(1916).

Melbourne.

AUSTRALASIAN JOURNAL OF PHARMACY— Vols xxxi., 372; xxxii.,
373-383(1916-17). *From the Publisher.*

COMMONWEALTH OF AUSTRALIA: DEPARTMENT OF TRADE AND
CUSTOMS—

Pamphlet: "Investigations into the Causes of Worm-
Nodules in Cattle." By C. G. Dickinson and G. F. Hill
(8vo., 1917).

COMMONWEALTH BUREAU OF CENSUS AND STATISTICS—

Census of the Commonwealth, 1911. Vol. i., and Appendix
A, Vol. i.(1917).

DEPARTMENT OF AGRICULTURE OF VICTORIA—

Journal. xiv., 12; xv., 1-11(1916-17).

Pamphlet: "Agricultural Education" [reprint of a series
of four Articles, which appeared in the "Herald," May
23rd-26th, 1917, by C. G. Ross].

FIELD NATURALISTS' CLUB OF VICTORIA—

"Victorian Naturalist." xxxiii., 8-12; xxxiv., 1-7(1916-17).

PUBLIC LIBRARY, MUSEUMS, &C., OF VICTORIA—

Report of the Trustees for 1916(1917).

ROYAL AUSTRALASIAN ORNITHOLOGISTS' UNION—

"The Emu," xvi., 2-4; xvii., 1-2(1916-17).

ROYAL GEOGRAPHICAL SOCIETY OF AUSTRALASIA: VICTORIAN
BRANCH.

Victorian Geographical Journal. xxxiii.(1917).

ROYAL SOCIETY OF VICTORIA—

Proceedings. New Series. xxix., 1-2; xxx., 1(1916-17).

UNIVERSITY OF MELBOURNE—

Calendar. 1917(1916).

Mexico

INSTITÚTO GEOLOGICO DE MEXICO—

Anales. No. i.(1917).

Boletin. Núm.34(1916).

Modena.

LA NUOVA NOTARISIA—*From the Editor, Dr. G.B. De Toni*
Serie xxiv., Gennaio, 1913; xxv., Aprile, 1914(1913-14).

Montreal.

NATURAL HISTORY SOCIETY OF MONTREAL—

Canadian Record of Science. ix., 8, T.p.&c.(1916).

ROYAL SOCIETY OF CANADA—

Proceedings and Transactions. Third Series. x., Parts 2-4
of Sections i.-iv.(1916-17).

New Haven, Conn.

CONNECTICUT ACADEMY OF ARTS AND SCIENCES—

Transactions. xxi., pp.1-144(1916).

New York.

AMERICAN GEOGRAPHICAL SOCIETY—

Geographical Review, ii, 2-6; iii., 1-6; iv., 1-4(1916-17). *

AMERICAN MUSEUM OF NATURAL HISTORY—

Bulletin. xxxv.(1916).

(a) Bibliography of Fishes, by B. Dean, enlarged and edited
by C. R. Eastman. Vol. i.(1916).— (b) Bibliography of the
Published Writings of H. F. Osborn, 1877-1915, and
Supplement for 1916. Second Edition (1916-17).—(c)

Check-list of Mammals of the N. A. Continent, the West Indies and the neighbouring Seas. Supplement by D. G. Elliott(1917).

NEW YORK ACADEMY OF SCIENCES—

Annals. xxv., pp.1-308; xxvii., pp.31-38, 39-191, 193-203, 205-214(1916-17).

Ottawa.

GEOLOGICAL SURVEY OF CANADA—

Map No.57A, Frank Alberta (showing the Landslide of 1903)[1917].

Memoirs. Nos 51, 73, 84, 85, 87, 89, 92, 93, 97, 98, Supplement to No.31(1914-17).

Museum Bulletin, Nos.23-25(1916-17).

Summary Report for 1916(1917).

Oxford.

RADCLIFFE LIBRARY, OXFORD UNIVERSITY MUSEUM—

Catalogue of the Books added during 1916(1917).

Palo Alto.

LELAND STANFORD JUNIOR UNIVERSITY—

Publications (University Series). No.22(1916).

Paris.

"Journal de Conchyliologie." lxii., 4; lxiii., 1(1917).

SOCIETE ENTOMOLOGIQUE DE FRANCE—

Annales. lxxxv., 3-4(1917).

Bulletin, 1916, 15-21, T.p.&c.; 1917, 1-6, 9-14(1916-17).

Pavia

ISTITUTO BOTANICO DELL' R. UNIVERSITA DI PAVIA—

Atti. ii. Serie. Vol. vii.(1902).

Perth, W.A.

GEOLOGICAL SURVEY OF WEST AUSTRALIA—

Annual Progress Report for the Year 1916(1917).

Bulletin, Nos. 66, 67, 68 (Text and Atlas), 69 (Text and Atlas), 72(1916-17).

GOVERNMENT STATISTICIAN, WEST AUSTRALIA—

Monthly Statistical Abstract. 1916, 197-199; 1917, 200-207²
(1916-17).

ROYAL SOCIETY OF WEST AUSTRALIA—

Journal and Proceedings. i, 1914-15(1916).

Petrograd.

SOCIETAS ENTOMOLOGICA ROSSICA—

Horæ Entomologicae. xli., 7, T.p.&c.; xlii., 2(1916).

Revue Russe d'Entomologie. xv., T.p.&c ; xvi., 1-4(1916-17).

Philadelphia.

ACADEMY OF NATURAL SCIENCES—

Proceedings. lxxviii., 3(1917).

AMERICAN PHILOSOPHICAL SOCIETY—

Proceedings. lv, 6-8, T.p.&c.(1916).

ZOOLOGICAL SOCIETY OF PHILADELPHIA—

Forty-fifth Annual Report of the Board of Directors, April,
1917(1917).

Pietermaritzburg.

NATAL MUSEUM—

Annals. Vol. ii., Index No.; iii., 3(1916-17).

Portici.LABORATORIO DI ZOOLOGIA GENERALE E AGRARIA DELLA R.
SCUOLA SUP. D'AGRICOL. —

Bollettino, viii.(1914).

Port Moresby, N.G.

GOVERNMENT GEOLOGIST OF PAPUA—

Bulletin of the Territory of Papua, No.3(1915).— Report on
the Geology of Woodlark Island. By E. R. Stanley,
Government Geologist (n.d.).

Pusa, India.

AGRICULTURAL RESEARCH INSTITUTE—

Memoirs of the Department of Agriculture in India. *Botanical Series*. T.p.&c. of Vol. vii.; viii., 2, 4-6, T.p.&c.;

ix, 1 and 3(1916-17).— *Entomological Series*. v., 2-3(1917).
 — Bulletin, No.64(1916).— Report of the Agricultural
 Research Institute and College, Pusa, 1915 16(1916).—
 Report on the Progress of Agriculture in India for 1915-
 16(1917).

Richmond, N.S.W.

HAWKESBURY AGRICULTURAL COLLEGE—

H. A. C. Journal. xiii., 12; xiv., 1-11(1916-17).

Rio de Janeiro.

MUSEU NACIONAL DO RIO DE JANEIRO—

Archivos. xvii.(1915).

San Francisco.

CALIFORNIA ACADEMY OF NATURAL SCIENCES—

Proceedings. Fourth Series v., 7-8; vi., 1-7(1916).

Santiago de Chile.

SOCIETE SCIENTIFIQUE DU CHILI —

Actes. xxii., 1912(1913).

Sao Paulo.

MUSEU PAULISTA —

Revista, ix.(1914).

Sendai, Japan.

TOHOKU IMPERIAL UNIVERSITY—

Science Reports. Second Series (Geology). iv., 2(1917).

Stockholm.

ENTOMOLOGISKA FORENINGEN I STOCKHOLM—

Entomologisk Tidskrift. xxxvii., 1-4(1916).

KONGL. SVENSKA VETENSKAPS-AKADEMIE—

Arkiv f. *Botanik* xiv., 3(1916)—*Kemi*. &c., vi., 2-3(1916) —

Mathematik, &c., xi., 1-3(1916)—*Zoologi*. x., 1-3(1916).

Arsbok, 1916(1916).

Handlingar. lv., 1-6, T.p.&c.(1915-16)

Lefnadsteckningar. v., 1(1915).

Meddelanden från K. Vetenskapsakademiens Nobelinstitut.
 iii., 3(1916).

Sydney.**AUSTRALIAN MUSEUM—**

Annual Report, 1915-16(1916).

Records. xi, 6-12, T.p.&c.(1916-17).

BOTANIC GARDENS AND DOMAINS, SYDNEY—

Annual Report for 1915(1916).

Census of New South Wales Plants. Supplement i.: Fresh-water Algae(1917). By G. I. Playfair.

Critical Revision of the Genus *Eucalyptus*. iii, 8-10; iv., 1-2 (1916-17). By J. H. Maiden, Government Botanist, &c.

BUREAU OF STATISTICS—

Official Year Book of New South Wales, 1915, 14-19, T.p. &c.; 1916, 1, 3-11, 14-16(1916-17).

Statesman's Year Book of New South Wales, 1917(1917).

CHIEF SECRETARY'S DEPARTMENT: FISHERIES—

Report on the Fisheries of New South Wales for the Year 1916(1917).

DEPARTMENT OF AGRICULTURE, N.S.W.—

Agricultural Gazette of New South Wales. xxvii., 12, T.p. &c.; xxviii., 1-11(1915-16).

DEPARTMENT OF AGRICULTURE: FOREST BRANCH, N.S.W.—

Annual Report, 1915-16(1916).

Forest Flora of New South Wales By J. H. Maiden, Government Botanist, &c. vi., 10, T.p.&c.; vii., 1(1916-17).

The "Austral-Briton" for August 31st, 1917 [containing an article on "The Great Australian Bush" (by the authority of the N. S. Wales Forestry Commission).

DEPARTMENT OF MINES --

Annual Report of the Department of Mines for 1916(1917).

Mineral Resources. Nos.24, 26(1916-17).

Records. ix., 3(1916).

DEPARTMENT OF PUBLIC HEALTH—

Report of the Director General for the years 1914, 1915 (1916).

EDUCATION DEPARTMENT—

Education Gazette of New South Wales, x., 12; xi., 1-11, and two Supplements(1916-17).

Report of the Executive Committee of the Advisory Council of Science and Industry, Commonwealth of Australia, 14th April-30th June, 1917 (July, 1917).

EDUCATION DEPARTMENT: TEACHERS' COLLEGE—

Records of the Education Society. Nos.27, 30(1916-17).

Teacher's College Calendar, 1917(1917).

EDUCATION DEPARTMENT: TECHNICAL EDUCATION BRANCH —

Annual Report, 1915(1916)

Technical Gazette of New South Wales. vii., 1(1917).

Technical Education Series, Nos.18, 21, 22(1913-16).

NEW SOUTH WALES NATURALISTS' SOCIETY—

"Australian Naturalist." iii., 13-14(1917).

PUBLIC LIBRARY OF NEW SOUTH WALES —

Special Donation:—(a) American Anthropologist, N.S., Vols. i., ii., 2-4, iii.(1899-1901). (b) Annual Report for 1899, 1900, 1902, 1903; and Transactions, Nos.55, 57, 59-68(1900-05), of the Historical and Scientific Society of Manitoba. (c) Bulletin of the Philosophical Society of Washington, xiv.-xv.(incomplete)[1907-10]. (d) Bulletin, i., 1-3; ii., 1-4; iii., 1-4(1897-1902); and Transactions, i., 1-3; ii., 1-2(1904-07), of the Free Museum of Science and Art of the University of Pennsylvania (Dept. of Archaeology). (e) Journal of the Anthropological Society of Bombay, Vols. vi.-viii.(1901-08) [incomplete]. (f) Journal of the Polynesian Society (New Plymouth, N.Z.), Vols. i.-xvi., xvii.(1892-1913), and Vols. xvii.-xxiii.(incomplete)[1908-14]. (g) Journal of the Straits Branch of the Royal Asiatic Society, Nos. 30-32, 35-45, 47, 48(1897-1907). (h) Korrespondenz-Blatt der Deutschen Gesellschaft für Anthropologie, Ethnologie, und Urgeschichte (München), xxix.-xxxv., xxxvii., xxxix.(incomplete) [1898-1908]. (i) Man: A Monthly Record of Anthropological Science (London), i.-xv.(incomplete) [1901-15]. (j) Rijks Ethnographisch Museum te Leiden: Verslag van den Directeur, 1898-1915 (incomplete)[1899-1916]. (k) Smithsonian Contributions to Knowledge, Nos.208, 220, 259, 267, 331, 383, 489(1869-

83).—Smithsonian Miscellaneous Collections, Nos. 216, 544, 630, 969 (1867-94). (*l*) Zeitschrift für Ethnologie (Berlin), xxviii.-xxxix.(incomplete) [1896-1907].

ROYAL SOCIETY OF NEW SOUTH WALES—

Journal and Proceedings. 1., 1-3, T.p.&c.(1917).

ROYAL ZOOLOGICAL SOCIETY—

“Australian Zoologist.” i., 2-3(1915-16).

“SCIENTIFIC AUSTRALIAN,” xxii., 2-4; xxiii., 1(1917). *From the Publishers (Bishop Bros.)*.

UNIVERSITY OF SYDNEY—

Calendar, 1917(1917).

Reprints of Papers from the Science Laboratories, 1909-16, B., Vols. i.-ii., 1909-16(1916).

Taihoku.

**BUREAU OF PRODUCTIVE INDUSTRIES, GOVERNMENT OF FORMOSA,
JAPAN—**

Icones Plantarum Formosanarum. Vol. vi.(1916).

Tokyo.

COLLEGE OF SCIENCE, IMPERIAL UNIVERSITY OF TOKYO—

Calendar, 1915-16(1917).

Journal. xxxvii., 6-8; xxxviii., 2-5; xxxix, 1-5(1916-17).

TOKYO ZOOLOGICAL SOCIETY—

Annotationes Zoologicae Japonenses. ix., 3(1917).

Tring, Herts.

ZOOLOGICAL MUSEUM—

Novitates Zoologicae. xxiii., 3, 4; xxiv., 1-2(1916-17).

Trondhjem.

KONGELIGE NORSKE VIDENSKABERS SELSKAB—

Aarsberetning for 1914 (1915).—Skrifter, 1914 (2 vols.; 1915).

Tunis.

INSTITUT PASTEUR DE TUNIS—

Archives. T. ix., 4(1916).

Upsal.

ROYAL UNIVERSITY OF UPSAL—

Bref Och Skrifvelser af och till Carl von Linné, &c. Afd. ii., Del 1(1916).

Urbana, Ill.

UNIVERSITY OF ILLINOIS —

Illinois Biological Monographs. i., 1-4, T.p.&c.; ii., 1-3; iii., 1(1914-16).

Washington, D.C.

BUREAU OF AMERICAN ETHNOLOGY—

Bulletin. No.55(1916).

Pamphlet: "The most ancient Skeletal Remains of Man."

By Dr. A. Hrdlicka. Second Edition (1916).—Twenty-ninth, Thirtieth, and Thirty-first Annual Reports, 1907-08, 1908-09, 1909-10(1915-16).

CARNEGIE INSTITUTE OF WASHINGTON—

Department of Experimental Evolution: Annual Report of the Director, 1916 [Reprint from the Year Book, No. xv.] (1916).

NATIONAL ACADEMY OF SCIENCES—

Proceedings. ii., 11-12; iii., 1-10(1916-17).

SMITHSONIAN INSTITUTION—

Annual Report of the Board of Regents, 1914-15(1916).

U. S. DEPARTMENT OF AGRICULTURE—

Bulletin. Nos. 344, 408, 416, 419, 421, 424, 427, 429, 431, 432, 435-438, 484, 489, 513, 539, 550, 553, 554, 566(1916-17).—*Bureau of Entomology*: Technical Series, Contents, T.p.&c. of No.19(1916).

Entomological Reprints (12) from the Journal of Agricultural Research, vii., 4, 7, 8, 11(2); viii., 6, 7, 11; ix., 10; x., 6; xi., 1-2(1916-17).

Pamphlet: "Suggestions for Owners of Wood-lots in New England." By F. H. Mosher(1917)

Year Book, 1916(1917).

U. S. GEOLOGICAL SURVEY—

Bulletin. Nos.610, 618-620O, 621M-P, 623 and Maps, 626-630, 632-636, 638, 640A-E, 641A-E, 645, 649(1916).

Mineral Resources. 1914, i., 25, 26: 1915, i., 1-5, 7; ii., 1-14, 16-17, 19-20(1916).

Professional Papers. Nos.89, 91, 98A-K, M, N(1916).

Water-Supply and Irrigation Papers. Nos. 332, 360, 369, 374, 375G, 383, 384, 387, 395, 398, 399(1916).

U. S. NATIONAL MUSEUM—

Bulletin. Nos.93, 95, 96(1916-17).

Contributions from the U. S. National Herbarium. T.p.&c. of Vol. xvii.; xviii., 7: xx., 1-2(1916-17).

Proceedings. 1.(1916).

Wellington, N.Z.**DEPARTMENT OF MINES: NEW ZEALAND GEOLOGICAL SURVEY—**

Bulletin. N.S. No.18(1917).

Eleventh Annual Report. N.S., 1916-17(1917).

Palæontological Bulletin. Nos.4-5(1917).

DOMINION MUSEUM—

Annual Report for 1916-17(1917).

Bulletin. No.5(1916).

PRIVATE DONORS (and authors, unless otherwise stated).

BONAPARTE, LE PRINCE, Paris — “Notes Ptéridologiques.” Fascs. ii-iv. (Paris, 1915-17).—Two Reprints: “Fougères d’Afrique,” et “Fougères de l’Herbier du Museum [Bull. Mus. d’Hist. nat., Paris, 1917, Nos. 1 and 7].

FROGGATT, W. W., F.L.S.—One Pamphlet [Farmers’ Bulletin, Dept. Agric. N. S. Wales, No.113(June, 1917)].

SMITH, R. GREIG, D.Sc., Sydney (donor)—Report of the Dove Marine Laboratory, Cullercoats, Cumberland, 1915-16(1916)
—County of Northumberland Education Committee: County Agricultural Experiment Station, Cockle Farm: Guide to Experiments for 1917. Report by Prof. D. A. Gilchrist (1917).

- TILLYARD, R. J., M.A., B.Sc., Sydney—Three Reprints: (a) “Life-Histories, &c., of Australian *Aeshninae*,” &c., and (b) “A Study of the Rectal Breathing Apparatus in Larvæ of Anisopterid Dragonflies” [Journ. Linn. Soc. London, Zoology, xxxiii., July and Nov., 1916]; (c) “Mesozoic and Tertiary Insects,” &c. [Publication No. 253, Geol. Surv. Queensland].—The Biology of Dragonflies [Cambridge Zoological Series] (1917).
- VEITCH, R., B.Sc., F.E.S., Fiji—Agricultural Reports of the Colonial Sugar-Refining Company, Ltd., Fiji. Nos. 1-2 (1916-17).

INDEX.

(1917.)

(a) GENERAL INDEX

- Acacia*, on a new species of, 441.
———, seedlings, exhibited, 303.
Address, Presidential, March 28th, 1917, 1.
Aeschnidopsis, fossil dragonfly, 676.
Air, expired alveolar, composition of, 866; percentage of CO₂ in, 146.
Alkaloids of *Duboisia Leichhardtii*, 137.
Announcements, 11, 25, 136, 202, 249, 511, 603.
Antirrhinum, fasciated, exhibited, 512.
Appeal for support of pendulum work, 202.
Attunga district, geology of, 693.
Australia Tropical, *Carabida*, from, 406—*Heteromera* and *Stigmodera* from, 701.
Australian Coleoptera, 545—Dragonflies, 450—Lepidoptera, 303, 344—Mecoptera, 284, 302—Neuroptera, 203—Plants, pollination of, 12—Tabanidae, iii., 513—Trilobites, 480.
Bacteria in soil, action of microorganisms on numbers of, 162.
Bacteriologist, summary of year's work, 10.
Baker, R. T., *see* Exhibits.
Balance Sheet, etc., 1916, 26.
Bamboo in flower, exhibited, 246.
Banksia latifolia, section of log of, exhibited, 603.
Benson, W. N., Geology and Petrology of the Great Serpentine Belt of New South Wales. Pt. vi., General Account of the Geology and Physiography of the Western Slopes of New England, 223, 250—Appendix, 693.
Bezyria wax, exhibited, 247.
"Billy-goats" (*Linaria*), exhibited, 512.
Blakeley, W. F., On a new Species of *Acacia*, 441.
Blowflies, parasitic wasp from pupae of, exhibited, 302.
Brachymetopus, first record of, from Queensland, 605.
Bracteoles in *Callistemon*, exhibited, 512.
Breakwell, E. A., remarks on distribution and evolution of Grasses, 303.
Brontocida, Australian, 480.
Callistemon, bracteoles of, exhibited, 512—flowering specimens of, exhibited, 343, 440, 512.
Calymeneida, Australian, 480.
Campbell J. H., Hon. Treasurer's Financial Statement, and Balance Sheet, 25-29—Re-elected Hon. Treasurer, 136.
Carabida, endoskeleton of head, etc., in, 339—From Tropical Australia, 406.
Carbon dioxide in expired, alveolar air, 146.
Carne, J. E., re-elected to the Council, 25.
———, W. M., plants collected by, exhibited, 512.
Carter H. J., On some new *Heteromera* and a new *Stigmodera* from Tropical Australia, 701.
Carvings, Aboriginal, notice of some, 512.
Cavities coxal, in *Carabida* and *Cicindelida*, 339.
Cell-cultivation of Yeast, 220.

- Chatosomatida*, descriptions of, 757.
- Chapman, H. G., elected President, 25—See Exhibits.
- Cheel, E., remarks on *Callistemon*, 440; on *Silene*, 604—See Exhibits.
- , Notes on the "Common Nightshade" (*Solanum nigrum* Linn.), and some closely related Forms and Species that have been confused with it, 583.
- Cheirurida*, Australian, 480.
- Chemistry of the Duboisias, 118.
- Cicindelida*, endoskeleton of head, &c., in, 339.
- Cleland, J. B., see Exhibits.
- Cobar, pendulum-investigations at, 202.
- Coccid (Brachyseelid) galls, exhibited, 302.
- Coleoptera, descriptions of new, 545.
- Composition of expired, alveolar air, 866.
- Coxæ, anterior, and coxal cavities in *Carabida* and *Cicindelida*, 339.
- Cows' milk, variability of, 815.
- Cradle Mt., Tasmania, insects from, and lantern-slides of, exhibited, 201.
- Cretaceous dragonfly, 676.
- Crocodile, median parasphenoid of, 604.
- Cultivation of Yeast, single cell, 220.
- David, T. W. E., re-elected to the Council,
- Digitalis*, synanthic flowers of, exhibited, 512.
- Donations and Exchanges, 30, 136, 202, 249, 303, 343, 439, 511, 603.
- Dragonflies, caudal gills of larvæ of Zygopterid, 31, 606—From Australia and Tasmania, 450—Fossil, from Queensland, 676.
- Duboisias, alkaloids of the, 118, 137.
- Dun, W. S., re-elected to the Council, 25—Re-elected a Vice-President, 136.
- Echinaria*, n.g., description of, 391.
- Egypt, plants from, exhibited, 512
- Elections, 25, 136, 202, 249.
- Endoskeleton of head in Carabida and Cicindelida, 339.
- Epacris longiflora*, white-flowered, exhibited, 512.
- Eremophila*, lepidopterous galls on, exhibited, 439.
- Etheridge, R., and Mitchell, J., Silurian Trilobites of New South Wales, with references to those of other parts of Australia. Pt. vi. *Calymenida*, *Cheirurida*, *Harpida*, *Bronteida*, &c., with an Appendix, 480.
- Eucalyptus erythrocorys* in flower, exhibited, 201.
- Exhibits:—
- Baker, R. T., section of trunk of California Redwood showing annual rings; Vegetable wax from Beyeria, 246-247—Section of log of Bastard Honeysuckle (*Banksia latifolia*), 603.
- Chapman, H. G., peptone prepared from proteins of egg white, 247—Extract of the pancreas of the ox, and its coagulative action on milk; synanthic flowers of Fuchsia, 512.
- Cheel, E., abnormal inflorescences of Waratah, 440—Flowering *Callistemon* hybrids; examples of bracteoles, in addition to bracts in *Callistemon*; an introduced weed, *Linaria Pellisseriana*, 512.
- Cleland, J. B., oyster-shells from the bank of the Namoi R., 247; an introduced weed (*Silene*) from Thirroul, 604.
- Fletcher, J. J., abnormal flowers of *Grevillea burrifolia*, 247—Reversion-shoots and Aca-

- Exhibits: =
 cia-seedlings, 303 — Three crimson-flowered Callistemons, 343—*Callistemon* sp., 440.
- Froggatt, J. L., parasitic wasp from pupæ of Blowflies, 302.
- , W. W., mosquitoes from Riverina; destructive insects from wheat-stacks, 246 — Brachysectid galls, 302 — Grain-weevils from Sydney and Melbourne, 343 — Lepidopterous galls on *Ercmophila*, 439 — New Wax-Scale from New Guinea; perforated nodule from an ants' nest, 511.
- Hamilton, A. A., specimens of an introduced Tetragonia, 247 — Plants from Egypt and Palestine, collected by Mr. W. M. Carne, 512.
- Hynes, Miss S., white-flowered var. of *Epacris longiflora*; fasciated *Antirrhinum*; synanthic flowers of *Digitalis*; spikes of *Callistemon linearis* var., with flowers of different colours, 512.
- Maiden, J. H., flowering twig of *Eucalyptus erythrocorys*, 201.
- Tillyard, R. J., collection of insects from, and lantern slides illustrating the natural history of, Cradle Mt., N.W. Tasmania, 201 — Collection of Mecopterous insects (*Panorpa*), 302.
- Turner, F., flowering Bamboo; Timothy-grass from the Adelong district; a poison-plant (*Gastrolobium*), from W.A.; a poisonous Chilian Lobelia, 246 — Star-grass from the Inverell district, 302 — Fruits of Red Quandong; a specimen of an introduced Liliaceous plant (*Triteleia*) spreading in the Coolamon district; fasciated Red Lac Sumach, 439, 440 — Pink-flowering variety of *Tecoma jasminoides*, 511.
- Fasciation in Sumach, exhibited, 440; in *Antirrhinum*, exhibited, 512.
- Fellows, Linnean Macleay, summaries of year's work, 10, 11.
- Fellowships, appointments to, 11 — Announcements, 511, 603.
- Fletcher, J. J., remarks on two Australian plants naturalised in S. Africa and New Zealand, 302; on Aboriginal Carvings at Palm Beach, 512 — See Exhibits.
- Flowers, abnormal, exhibited, 247, 512.
- Froggatt, J. L., see Exhibits.
- , W. W., re-elected a Vice-President, 136 — See Exhibits.
- Fry, D. B., Member, notice of his decease, 202.
- Fuchsia, synanthic flowers of, exhibited, 512.
- Galls, Brachysectid, exhibited, 302; lepidopterous, exhibited, 439.
- Gastrolobium*, poison-plant, exhibited, 246.
- Geology of the Great Serpentine-Belt, 223, 250, 693 — Of the Western Slopes of New England, 223, 250.
- Gills, caudal, of the larvæ of Zygoterid Dragonflies, 31, 606.
- Grevillea burifolia*, abnormal flowers of, exhibited, 247.
- Hallmann, E. F., Linnean Macleay Fellow in Zoology; summary of year's work, 10 — Re-appointed, 1917-18, 11.
- , On the Genera *Echinaria* and *Rhabdosigma* [PORIFERA], 391.
- Hamilton, A. A., Notes on the Genus *Lepidium*, from the National Herbarium, 445 — See Exhibits.
- , A. G., Presidential Address, 1 — Elected a Vice-President, 136.
- Hardy, G. H. H., elected a Member, 202.

- Harpeida* of Australia, 480.
 Haswell, W. A., re-elected to the Council, 25.
 Head, endoskeleton of, in *Carabida* and *Cicindelida*, 339.
 Hedley, C., re-elected a Vice-President, 136.
 Herbarium, National, Notes on *Lepidium*, from, 445.
 Heteromera, some new, from Tropical Australia, 701.
 Honeysuckle, Bastard, section of log of, exhibited, 603.
 Howe Island, Lord, Odonata, Planipennia, and Trichoptera from, 529.
 Hydrocyanic Acid in Plants, Pt. iii., 113.
 Hynes, Miss S. A., *see* Exhibits.
- Insects, Mesozoic, of Queensland, No. i., 175; No. ii., 676—Tasmanian, exhibited, 201—Destructive in wheat-stacks, exhibited, 246—Mecopterous, exhibited, 302 — Permian and Triassic, 720.
- Investigation, chemical, of poisonous, Solanaceous Plants, Pts. iv.-v., 118, 137.
- Jacobs, E. G., elected a Member, 202.
- Kesteven, H. L., Note on the median Parasphenoid of the embryonic Crocodile, 604.
- Lea, A. M., Descriptions of new Species of Australian Coleoptera, xiii., 545.
Lepidium, notes on the genus, 445.
 Lepidoptera, wing-venation of, 167 — Revision of Australian, Pt. vi., 304, 344—Galls of, exhibited, 439.
Linaria, naturalised, exhibited, 512.
 Lismore, Rhizopods of, 633.
Lobelia, poisonous Chilian, exhibited, 246.
- Lord Howe Island, Odonata, &c., of, 529.
 Lucas, A. H. S., re-elected to the Council, 25.
- McKeown, K. C., elected a Member, 136.
 McQuiggin, H. G., elected a Member, 249.
- Maiden, J. H., re-elected to the Council, 25—*See* Exhibits.
 May, J. H., obituary notice of, 7.
 Mecoptera, Studies in Australian, No. i., 284—From New Zealand, 284—Exhibited, 302.
 Mesozoic Insects of Queensland, 175, 676.
 Micro-organisms, action of, on soil-bacteria, 162.
 Milk, coagulative action of pancreatic extract on, 512—Variability of, 815.
- Mitchell, J., Note on a Trilobite (*Brachymetopus*) from Queensland, 605—Permian and Triassic insects from his Collection, 720.
 ——— and Etheridge, R., Silurian Trilobites of New South Wales, with references to those of other Parts of Australia, Pt. vi., 480.
- Morphology of caudal gills of the larvæ of Zygopterid Dragonflies, 31, 606.
- Mosquitoes, exhibited, 246.
- Namoi, oyster-shells deposited by human agency in bank of, 247.
Nannochoristida, new family of Mecoptera, 284.
 Neuroptera, Australian, Pt. iii., 203.
- New England, Geology of Western Slopes of, 223, 250.
 New Guinea, new Wax-scale from, exhibited, 511.
 New South Wales, Great Serpentine Belt, 223, 250 — Silurian Trilobites, 480—Permian and Triassic Insects, 720 — *Chatosomalida*, 757.

- New Zealand, California Redwood from, exhibited, 246—Mecoptera, 284.
- "Nightshade, Common," and forms and species confused with it, 583.
- Nodule, perforated, exhibited, 511.
- Norfolk Island, Odonata, Planipennia, and Trichoptera from, 529.
- North, A. J., Member, notice of his decease, 202.
- Northern Territory, new Tiger-beetle from, 201, 337.
- Note on the median parasphenoid of the embryonic Crocodile, 604—On a Trilobite (*Brachymetopus*), from Queensland, 605.
- Odonata from Lord Howe and Norfolk Islands, 529.
- Oyster-shells from Namoi River, exhibited, 247.
- Palestine, plants from, exhibited, 512.
- Palm Beach, aboriginal carvings at, 512.
- Pancreas of ox, action of extract of, on milk, 512.
- Pendulum investigations at Cobar, 202.
- Peptone, locally made, exhibited, 247.
- Permian Insects from N.S. Wales, 720.
- Petersen, E., Australian Neuroptera, Pt. iii., 203.
- Petrie, J. M., Linnean Macleay Fellow in Biochemistry: summary of year's work, 10—Re-appointed, 1917-18, 11.
- , Hydrocyanic Acid in Plants, Pt. iii., 113—Chemical Investigation of Poisonous Plants in the N.O. *Solanaceæ*, Pt. iv., Chemistry of the Duboisias, 118; Pt. v., Alkaloids of *Duboisia Leichhardtii*, 137.
- Petrology of the Great Serpentine Belt, 223, 250, 693.
- Physiography of New England, 223, 250, 693.
- Pinkerton, Miss E. C., Percentage of CO₂ in expired alveolar Air, 146—Composition of expired alveolar Air, 866.
- Planipennia, fossil, 175—From Lord Howe and Norfolk Islands, 529.
- Plants, pollination of Australian, 12—Poisonous Solanaceous, 118, 137—Exhibited, 201, 246, 247, 302, 303, 343, 439, 440, 511, 512, 603, 604.
- Playfair, G. L., Rhizopods of Sydney and Lismore, 633.
- Pollination of Australian plants, 12.
- Protomecoptera, fossil, 175.
- Quandong, Red, fruits exhibited, 439.
- Queensland, Mesozoic insects, 175, 676—Unre-ordered Trilobite from, 605.
- Ramsay, E. P., obituary notice of, 7.
- Redwood, California, exhibited, 246.
- Reversion-shoots, exhibited, 303.
- Revision of Australian Lepidoptera, vi., 304.
- Rhabdosigma*, n.g., description of, 391.
- Rhizopods of Sydney and Lismore, 633.
- Riverina, mosquitoes from, exhibited, 246.
- Rolling Downs Series, fossil dragonfly from, 676.
- Serpentine Belt of N.S. Wales, 223, 250, 693.
- Silene*, introduced weed, exhibited, 604.
- Silurian Trilobites, 480.
- Sloane, T. G., Descriptions of two new Tiger-beetles from the Northern Territory [Title], 201—Description of a new Tiger-beetle from the N.T., 337—On the Endoskeleton of the Head, the anterior Coxæ, and the an-

- terior Coxal Cavities in the Families *Carabidae* and *Cicindelidae*, 339—*Carabidae* from Tropical Australia (New Genera, Species, Notes and Synonymy, and Synoptic Tables, Tribes *Scaritini*, *Harpalini*, *Odacanthini*, *Lebiini*, and *Helluonini*), 406.
- Smith, E. A., Corr. Member, obituary notice of, 7.
- , R. Greig, Macleay Bacteriologist to the Society: summary of year's work, 10.
- , Contributions to our Knowledge of Soil-Fertility, xv., Action of certain Microorganisms upon the numbers of Bacteria in the Soil, 162—The Single Cell Cultivation of Yeast, 220.
- Smith, Miss V. A. Irwin, On the *Chatosomatidae*, with Descriptions of a new Genus and four new Species from the coast of New South Wales, 757.
- Soil bacteria, action of microorganisms on, 162.
- Soil-fertility, contributions to a knowledge of, 162.
- Solanaceae*, chemical investigation of poisonous plants in the N.O., iv., 118; v., 137.
- Star-grass, exhibited, 302.
- Stigmocera*, new, from Tropical Australia, 701.
- Sumach, fasciated, exhibited, 440.
- Sydney, Rhizopods of, 633.
- Tabanidae, Australian, iii., 513.
- Tasmania, insects from, exhibited, 201—New dragonflies from, 450.
- Taylor, F. H., Australian *Tabanidae*, iii., 513.
- Tecoma jasminoides*, pink-flowering, exhibited, 511.
- Tetragonia*, introduced, exhibited, 247.
- Tiger beetle, new, from Northern Territory, 201, 337.
- Tillyard, R. J., Linnean Macleay Fellow in Zoology: summary of year's work, 10—Re-appointed, 1917-18, 11—Congratulations to on the award of the Crisp Medal and Prize, 202—*See* Exhibits.
- , On the Morphology of the Caudal Gills of the Larvæ of Zygopterid Dragonflies, Introduction, Pt. i. (General Morphology), and Pt. ii. (Studies of the Separate Types), 31; Pt. iii., (Ontogeny), and Pt. iv. (Phylogeny), 606—Wing Venation of *Lepidoptera* (Preliminary Report), 167—Mesozoic Insects of Queensland, No. 1. *Planipennia*, *Trichoptera*, and the new Order *Protamecoptera*, 175; No. 2, The fossil Dragonfly *Æschnidopsis* (*Æschna*) *flindersiensis* (Woodward) from the Rolling Downs (Cretaceous) Series, 676—Studies in Australian *Mecoptera*, No. i., The new Family *Nannochoristidae*, with descriptions of a new Genus and four new Species; and an Appendix descriptive of a new Genus and Species from New Zealand, 284—On some new Dragonflies from Australia and Tasmania, 450—*Odonata*, *Planipennia*, and *Trichoptera* from Lord Howe and Norfolk Islands, 529—Permian and Triassic Insects from New South Wales, in the Collection of Mr. J. Mitchell, 720.
- Timothy-grass, exhibited, 246.
- Triassic insects from N.S.W., 720.
- Trichoptera*, fossil, 175—From Lord Howe and Norfolk Islands, 529.
- Trilobites*, Silurian, 480.
- Turner, A. J., Revision of Australian *Lepidoptera*, Pt. vi., 304, 344.
- , F., *see* Exhibits.
- Variability of Cows' Milk, 815.
- Veitch, R., elected a Member, 136.

INDEX.

vii.

- Waratah, abnormal inflorescences, exhibited, 440.
- Wardlaw, H. S. H., Linnean Macleay Fellow in Physiology: summary of year's work, 11—Re-appointed, 1917-18, 11.
- , Variability of Cows' Milk, Pt. I., 815.
- Wasp, parasites on pupae of Blowflies, exhibited, 302.
- Wax-scale, new, from New Guinea, exhibited, 511.
- Wax, vegetable, from *Beyeria*, exhibited, 247.
- Weevils from wheat-stacks, exhibited, 343.
- West Australia, poison-plant from, exhibited, 246.
- Wheat, insects destructive to, exhibited, 246, 343.
- Wing-venation of Lepidoptera, 167.
- Yeast, single cell cultivation of, 220.

(b) BIOLOGICAL INDEX.

Names in italics are synonyms.

	PAGE.		PAGE
Ablacopus ater	546	Aethaloptera	186
Abraxas	306, 382, 386	<i>Agonochila lineella</i>	433
<i>expectata</i>	382, 383	<i>littera-r</i>	433
<i>flavimacula</i>	382	<i>minima</i>	433
<i>grossulariata</i>	382	Agrion	104, 454, 477, 478, 626
Acacia	14, 21, 23	<i>asteliae</i> , 37, 38, 104, 105, 106, 626	
<i>aulacocarpa</i>	140	<i>brisbanense</i>	454, 477, 478, 479
<i>celastrifolia</i>	15, 24	<i>lyelli</i>	478, 479
<i>Cheeli</i>	441	<i>mercuriale</i>	98, 99
<i>Cunninghamii</i>	140, 442	<i>puella</i>	98, 454
<i>dealbata</i>	22, 302	<i>pulchellum</i>	98
<i>decurrens</i> var.	140	Agrionidae, 34, 36, 38, 57, 65, 85,	
<i>glaucescens</i>	442, 443	89, 107, 454, 475, 531, 621, 624,	
<i>implexa</i>	140	627, 628, 631, 738.	
<i>penminervis</i>	140	Agrioninae, 38, 108, 454, 477, 531,	
<i>sp.</i>	15, 303	621, 625, 626, 628	
<i>Acadra tessellata</i>	315	Agrionini	96
<i>Acanthaclisini</i>	210	<i>Alcis</i>	370, 371
<i>Acanthaclis</i> <i>annulata</i>	210	<i>repandata</i>	371
<i>Acanthopyge</i>	503	<i>Aethopteris</i> <i>sp.</i>	232, 725
<i>australis</i>	504	<i>Alloformicaleon</i>	208
<i>Acidalia imprimata</i>	311	<i>canifrons</i>	208, 219
<i>Actinocystis cornubovis</i>	698	<i>Alocasia angustiana</i>	113, 116
<i>sp.</i>	242	<i>indica</i>	116
<i>Actinomyces</i>	162, 163, 164	<i>intermedia</i>	113, 116
<i>chromogenus</i>	162	<i>macrorrhiza</i>	113, 114
<i>Adelidium</i>	752	<i>r. variegata</i>	113, 116
<i>cordatum</i>	721	<i>mallicca</i>	116
<i>Adelium</i>	752	<i>Sanderiana</i>	113, 116
<i>Ademosyne</i>	749, 750, 751, 752	<i>sp.</i>	116
<i>major</i>	750	<i>spectabilis</i>	113, 116
<i>punctata</i>	750, 751	<i>zebrina</i>	117
<i>wianamattensis</i>	720, 750	<i>Amarygmus striatus</i>	715
<i>Æschma</i>	676, 678	<i>sulcatus</i>	715
<i>flindersiensis</i>	676, 690, 691	<i>Amblychia</i>	312, 366
<i>Æschnidae</i> 453, 454, 680, 689, 690		<i>angeronaria</i>	366
<i>Æschnidiidae</i> 676, 678, 689, 690,		<i>subrubida</i>	367
691		<i>Amblygnathus philippensis</i>	411
<i>Æschnidiinae</i>	690	<i>Amelora</i>	305, 306
<i>Æschnidiopsis</i>	690	<i>Amoeba</i>	634
<i>flindersiensis</i> , 676, 682, 683, 687,		<i>limax</i>	634
691, 692		<i>nobilis</i>	634
<i>Æschnidium</i> , 676, 678, 688, 690,		<i>pretus r. granulosa</i>	634
691		<i>r. nobilis</i>	634
<i>bubas</i>	678, 690, 691	<i>quadrilineata</i>	634
<i>densum</i>	678, 683, 685, 691	<i>radiosa</i>	636
<i>flindersiense</i>	691	<i>v. minutissima</i>	635
<i>Æschniinae</i>	453, 454, 458, 678	<i>v. stellata</i>	635

	PAGE.		PAGE.
<i>Amceba striata</i>	634	<i>Arcella catinus</i>	640, 672
<i>striolata</i>	634	<i>r. australis</i>	640
<i>verrucosa</i>	634	<i>costata</i>	640, 672
<i>v. maxima</i>	634	<i>r. angulosa</i>	640, 641, 672
<i>r. quadrilineata</i>	634	<i>r. conica</i>	640, 641, 672
<i>Amcebina</i>	634	<i>crenata</i>	638, 672
<i>Amphion</i> (?) <i>brevispinus</i>	505	<i>dentata</i>	639
<i>pseudoarticulatus</i>	505	<i>discoides r. foveosa</i>	639, 672
<i>Amphipsyche</i>	186	<i>r. scutelliformis</i>	638, 672
<i>Amphitrema flavum</i>	671	<i>hemisphærica</i>	638, 672
<i>Anchomenini</i>	413	<i>r. depressa</i>	638, 672
<i>Anchonoderides</i>	413	<i>megastoma</i>	639, 672
<i>Angelia</i>	305	<i>r. alta</i>	639, 672
<i>Angophora cordata</i>	12	<i>mitrata r. angulata</i>	641, 672
<i>lanceolata</i>	140	<i>r. depressa</i>	641, 672
<i>subvelutina</i>	140	<i>rotundata</i>	637, 672
<i>Anguillulide</i>	769, 813	<i>r. alta</i>	637, 672
<i>Anisocentropus</i>	186	<i>r. scrobiculata</i>	637, 672
<i>Anisodes pardaria</i>	313	<i>stellaris</i>	639
<i>Anisographe</i>	309, 311	<i>vulgaris</i>	637, 638
<i>dissimilis</i>	309	<i>r. vulgaris</i>	637
<i>subpulchra</i>	310	<i>v. compressa</i>	640
<i>Anisoptera</i>	32, 43, 45, 453, 454, 681, 682, 686, 688, 689	<i>Arcellina</i>	637
<i>Ankryopteris grayi</i>	265	<i>Archipanorpa</i>	191, 193, 195, 197, 198, 199, 200, 740, 749
<i>Annularia</i>	725	<i>magnifica</i>	191, 194, 197, 200, 679, 746
<i>Anomotena</i>	319	<i>Archipanorpidæ</i>	191
<i>trisecta</i>	319	<i>Archipetalia</i>	451, 453, 454, 455, 459
<i>Anomotarus</i>	435, 436	<i>auriculata</i>	450, 453, 455, 456, 457, 479
<i>aneus</i>	435	<i>Argiocnemis</i>	47, 98, 99, 625
<i>crudelis</i>	435	<i>rubescens</i>	38, 99, 110
<i>humeralis</i>	435, 436, 437	<i>Argiolestes</i>	39, 71, 100, 101, 454, 475, 626, 627, 628
<i>minor</i>	435	<i>amabilis</i>	476, 477
<i>olivaceus</i>	435	<i>australis</i>	454
<i>ruficornis</i>	436	<i>chrysoides</i>	450, 475, 476, 477
<i>tumidiceps</i>	435	<i>griseus</i>	38, 103, 110, 627
<i>umbratus</i>	435	<i>icteromelas</i>	38, 47, 49, 103, 110, 111, 112
<i>unimaculatus</i>	435	<i>Asaphus</i>	505
<i>Anthocercis Hopwoodii</i>	119, 137	<i>Asilidæ</i>	288
<i>Anticoma</i>	769, 771	<i>Aspergillus</i>	162
<i>Antirrhinum</i> sp.	512	<i>Aspidoptera navigata</i>	309
<i>Aphidæ</i>	754	<i>Aspilates clarissa</i>	346
<i>Apiomorpha pharatrata</i>	302	<i>exfusaria</i>	319
<i>Aporoctena aprepes</i>	321	<i>Assulina minor</i>	669
<i>scierodes</i>	320	<i>muscorum</i>	669
<i>Aprositæ</i>	387	<i>Atalophlebia</i> sp.	617, 618
<i>macrocosma</i>	387		
<i>Araucaria excelsa</i>	530		
<i>Arcella</i>	637, 639, 641		
<i>angulosa</i>	640		
<i>artocrea</i>	640		

	PAGE.		PAGE.
<i>Atropa belladonna</i>	586, 588	<i>Banksia robur</i>	603
<i>Atrypa</i> sp.	698	<i>Basistichus</i>	413, 415
<i>Aucella hughendensis</i>	676, 677	<i>micans</i>	414, 415
<i>Aulopora</i> sp.	698	<i>Berotha neuropunctata</i>	213, 214,
<i>Aulospongus monticularis</i>	393	219
<i>tubulatus</i>	393	<i>rufa</i>	213
<i>Austroaeschma</i>	453, 461	<i>Berothide</i>	213
<i>hardyi</i>	453, 461, 479	<i>Beyeria opaca</i>	247
<i>multipunctata</i>	462	<i>Bibionide</i>	753, 754
<i>parvistigma</i>	453, 462	<i>Bithia lignaria</i>	311
<i>tasmanica</i>	462	<i>Bittacide</i>	174, 200, 286, 302, 740
<i>Austroagrion</i> , 90, 93, 95, 478, 632		<i>Bittacus</i>	296
<i>cyane</i> , 38, 65, 68, 71, 95, 110,		<i>australis</i>	286
111, 607, 608, 609, 610, 611,		<i>corcthrarius</i>	286
612, 613, 614.		<i>intermedius</i>	286
<i>Austrocnemis</i>	39, 98, 626	<i>microcerus</i>	286
<i>splendida</i>	38, 47, 98, 99, 110	<i>Blattoidea</i>	176
<i>Austrogymnocyenia</i>	206, 207	<i>Blepharoceride</i>	298
<i>bipunctata</i>	206	<i>Boarmia</i> , 305, 306, 308, 311, 312,	
<i>interrupta</i>	206	317, 319, 320, 321, 326, 335, 336,	
<i>maculata</i>	206	344, 364, 381.	
<i>pentagramma</i>	206	<i>acaciaria</i>	375
<i>tipularia</i>	206	<i>acrotypa</i>	351
<i>Austrolestes</i> , 36, 44, 67, 86, 87, 88		<i>adelphodes</i>	357
<i>analis</i>	38, 88, 89	<i>aganopa</i>	356
<i>cingulatus</i>	38, 88, 89, 110	<i>agoraea</i>	356
<i>colsonis</i>	37, 38, 89, 110	<i>amphiclina</i>	350
<i>leda</i>	38, 89, 111	<i>atmocyna</i>	349
<i>psyche</i>	38, 47, 89, 110	<i>attacta</i>	366
<i>Austropetalia</i>	450, 454	<i>attenta</i>	358
<i>patricia</i>	451, 458, 459	<i>attributa</i>	330
<i>Authaemon</i>	305	<i>bitonitaria</i>	373
<i>Aviculopecten</i> sp.	700	<i>callicrossa</i>	373
<i>Axinectya</i>	391, 393, 394	<i>camelaria</i>	333
<i>mariana</i>	393	<i>canescaria</i>	352
<i>Axinella</i>	391, 393	<i>clarissa</i>	346
<i>frondula</i>	394	<i>cognata</i>	354
<i>mariana</i>	393	<i>compactaria</i>	376
<i>monticularis</i>	393	<i>erimodes</i>	360
<i>Axinecillide</i>	391	<i>curtaria</i>	350
<i>Actina biplaga</i>	380	<i>deccrtaria</i>	330
<i>Bacillus mycoides</i>	162	<i>delosticha</i>	355
<i>vulgatus</i>	162	<i>destinataria</i>	358
<i>Baiera</i>	725	<i>displicata</i>	377
<i>Bambusa glauca</i>	246	<i>disrupta</i>	364
<i>glaucescens</i>	246	<i>epistictis</i>	375
<i>nana</i>	246	<i>eremias</i>	350
<i>viridi-glaucescens</i>	246	<i>eudela</i>	347
<i>Banksia</i>	15, 20	<i>eugraphica</i>	359
<i>latifolia</i>	603, 604	<i>evsuperata</i>	331
		<i>externaria</i>	352

	PAGE.		PAGE.
<i>Calymene blumenbachii</i> , 481, 482,	483, 484, 486, 487	<i>Ceratocephala longispina</i> ..	498
<i>duni</i>	487, 508, 510	<i>vogdesi</i>	498
<i>duplicata</i>	481	<i>Ceratoleon</i>	207
<i>incerta</i>	483, 484, 485	<i>brevicornis</i>	207, 218, 219
<i>Macleayi</i>	480	<i>Cercopidae</i>	720, 726, 728
<i>niagarensis</i>	484	<i>Cercopinae</i>	726, 728
<i>sp.</i>	481	<i>Ceriagrion</i>	39, 96, 97
<i>tuberculata</i>	480, 481	<i>erubescens</i>	38, 97, 110
<i>tuberosa</i> , 480, 483, 484, 486		<i>Ceroplastes sp.</i>	511
<i>Calymeneide</i>	480	<i>Ceropria peregrina</i>	702
<i>Calypte anna</i>	22	<i>Chaetosoma</i> .. 758, 759, 761, 761,	769, 811
<i>Campanulate</i>	18	<i>claparedii</i>	812
<i>Candollea</i>	18	<i>falcatum</i> .. 763, 764, 765, 766,	768, 770, 772, 773, 774, 776,
<i>Candolleaceae</i>	19	778, 779, 781, 782, 812, 813,	814,
<i>Carabidae</i> .. 339, 340, 341, 342, 406		<i>groenlandicum</i>	812
<i>Carabini</i>	342	<i>haswelli</i> .. 762, 763, 765, 782,	783, 784, 786, 788, 789, 790,
<i>Cardamine dictyosperma</i> .. 113		791, 792, 793, 794, 795, 796,	797, 798, 806, 812, 814,
<i>Carcomotis perfumosa</i> 374		<i>hibernicum</i>	812
<i>Carenum</i>	407	<i>longirostrum</i>	759, 812
<i>bellum</i>	408	<i>macrocephalum</i>	812
<i>eximium</i>	410	<i>ophiocephalum</i>	757, 811
<i>floridum</i>	407	<i>spinosum</i>	812
<i>fulgidum</i>	407	<i>tristichosta</i>	812
<i>lepidum</i>	407	<i>Chaetosomatidae</i> , 757, 759, 760, 763,	764, 765, 766, 769, 782, 798, 799,
<i>lepidum</i>	407	811,	
<i>longulum</i>	410	<i>Chauliodinae</i>	297
<i>nitidipes</i>	408	<i>Cheiruridae</i>	480, 491
<i>quadripunctatum</i>	408	<i>Cheirurus</i>	488, 489
<i>splendidum</i>	410	<i>insignis</i>	489, 491, 493
<i>sumptuosum</i>	408	<i>sternbergi</i>	489
<i>Carobius pulchellus</i> , 530, 531, 533		<i>Chizala deceptatura</i>	318
<i>Casbia</i>	305, 596	<i>Chlamydomyxa</i>	636
<i>rectaria</i>	305	<i>labyrinthuloides</i>	636, 674
<i>Casnonia</i>	413, 414	<i>Chlenias</i>	306
<i>aliena</i>	413	<i>Chloris divaricata</i>	302
<i>amplipennis</i>	413, 418	<i>Chlorogomphinae</i>	690
<i>globulicollis</i>	413	<i>Chloropsyche</i>	186
<i>obscura</i>	413	<i>Chogada perlepidaria</i>	373
<i>pennsylvanica</i>	414	<i>Chonetes sp.</i>	698
<i>viverrina</i>	413	<i>Choorcechillum distitans</i> ..	382
<i>Castnia</i>	170, 173	<i>Chorista</i>	736, 739
<i>sp.</i>	170	<i>ruficeps</i>	286
<i>Catopherus</i>	713	<i>Choristella</i>	298, 300
<i>corpulentus</i>	714	<i>philpotti</i>	299
<i>Centropxyxis aculeata</i>	643	<i>Choristidae</i>	174, 302, 732, 749
<i>r. eornis</i>	643		
<i>arcelloides</i>	642		
<i>levigata</i>	642		
<i>Cerambycidae</i>	576		
<i>Ceratocephala</i>	497		

	PAGE.		PAGE.
Choristinae	286, 296, 297	Colocasia antiquorum.. . . .	117
Chrostobapta	305	<i>r. esculenta</i>	117
Chrysomelidae	577	Comesoma	771
Chrysopa. 214, 216, 217, 534, 535,	542	<i>vulgaris</i>	769
<i>anomala</i>	531, 534, 535	Commelyna	14
<i>araucariae</i>	531, 534, 539	Compositae	18
<i>extranea</i>	216, 219	Conchulina	637
<i>latofalis</i>	540	Conchylosmilus.. . . .	213
<i>leai</i>	531, 534, 538	<i>triseriatus</i>	213, 219
<i>metastigma</i>	531, 534, 536,	Conospermum	19
537, 538		Copidita apicalis	570
<i>nautarum</i>	531, 534, 537	<i>apicifusca</i>	573, 574
<i>norfolkensis</i>	531, 534, 541	<i>flava</i>	573
<i>olatatis</i>	537	<i>gracilis</i>	573
<i>ramburi</i>	216	<i>incisa</i>	569, 571, 582
<i>signata</i>	216	<i>medioflava</i>	571, 582
<i>waitai</i>	531, 534, 540	<i>pachymera</i>	570, 582
Chrysopidae.. . . .	214, 530, 531, 533	<i>pulehra</i>	570
Cicadidae	729, 731	<i>sloanei</i>	571
Cicindela aeneodorsis.. . . .	337	<i>tenuicornis</i>	572
<i>albolineata</i>	338	Coptoderides.. . . .	432
<i>aurita</i>	337	Cora	74, 107, 622
<i>tetragramma</i>	338	Cordulegaster	467
Cicindelidae	339, 340, 341, 342	Cordulegastrinae	458, 690
Clarencia	413, 415	Cordulephyta	454, 467, 469
<i>aliena</i>	413	<i>divergens</i> , 454, 467, 468, 469,	479
Cleora, 306, 363, 366, 369, 370, 377		<i>montana</i>	469
<i>acaciaria</i>	371, 375	<i>pygmaea</i>	454, 467, 468, 469
<i>bathyscia</i>	371	Cordulephyini	467
<i>biteniaria</i>	371, 373	Corduliinae.. . . .	453, 463, 464, 530
<i>callicrossa</i>	371, 373	Corizoneura fulva	517
<i>cinctaria</i>	370	Corydocephalus	504
<i>compactaria</i>	371, 376	<i>haueri</i>	504
<i>displicata</i>	371, 376, 377	<i>palmata r. sinuata</i>	504
<i>euboliaria</i>	371, 372, 373	Corymica.. . . .	307
<i>illustraria</i>	371, 376, 377	<i>arnearia</i>	307
<i>inflexaria</i>	371, 375	Corythion dubium.. . . .	669
<i>perlepidaria</i>	371, 373	Cosina.. . . .	210
<i>praecisa</i>	371, 372	<i>maclachlani</i>	210
<i>pupillata</i>	371, 374	<i>Cosymbia clarissa</i>	346
<i>reclinaria</i>	333	<i>penthearia</i>	346
Clepsyropsis	265	<i>rupicolor</i>	346
Clivina brevistera	406	<i>Craspedosis</i>	384
<i>r. major</i>	406	<i>leucosticta</i>	386
Coccinellidae.. . . .	577	Cratystylis conocephala	449
Cochliopodium asperum.. . . .	660, 674	Creagrini	203, 204
<i>bilimbosum</i>	660	<i>Creagrís nubecula</i>	204
Coleoptera, 176, 201, 720, 733, 749,	754, 755	Crocodylus porosus.. . . .	604
		Crotalocephalus.. . . .	488, 489, 492
		<i>articulatus</i>	488

	PAGE.		PAGE
<i>Crotalocephalus gibbus</i> , 488, 489.	491	<i>Datura stramonium</i>	122
<i>murrayi</i>	488	<i>Deilinia</i>	305, 306
<i>quenstedti</i>	488, 491	<i>Deiphon</i>	496
<i>sculptus</i>	492, 508, 509	<i>Demetrias brachinoderus</i>	427
<i>silverdalensis</i>	490, 492, 508	<i>rufescens</i>	427
<i>sp.</i>	492	<i>tweedensis</i>	426
<i>sternbergi</i>	488, 493	<i>Demoplatus australis</i>	521
Crustacea	45, 100	<i>Dendroleonini</i>	205
<i>Cryptodiffugia</i>	656	Desmacidionidae	391
<i>angulata</i>	657, 674	Desmidiaceae	633
<i>compressa</i>	656, 673	Desmoscolecidae	759, 769
<i>r. australis</i>	656, 673	Desmospongiae	10
<i>r. ovata</i>	656, 673	<i>Diabaticus minor</i>	435
<i>crenulata</i>	657, 674	<i>tumidiceps</i>	435
<i>r. globosa</i>	658, 674	<i>Diaphonia</i>	547
<i>minuta</i>	656, 674	<i>Diaphoropodon pyriforme</i> , 671, 674	
<i>oviformis</i>	656, 673	<i>Diastictis</i>	314
<i>pusilla</i>	658, 674	<i>australiaria</i>	314, 315
<i>r. conica</i>	658, 674	<i>glareosa</i>	314, 316
<i>sacculus</i>	657, 674	<i>hypomochla</i>	314, 316
<i>valida</i>	657, 674	<i>margaritis</i>	314, 315
<i>Ctenodactylides</i>	413	<i>odontias</i>	314, 315
<i>Cucurbitaceae</i>	18	<i>tessellata</i>	314, 315
<i>Cucurbitella australica</i>	653, 673	<i>Diatomineura</i>	513
<i>Culicidae</i>	297	<i>auriflua</i>	515
<i>Curculionidae</i>	574	<i>auripleura</i>	516
<i>Cyathophyllum sp.</i>	242, 271, 698	<i>montana</i>	516
<i>Cyclotella sp.</i>	647	<i>pulchra</i>	516
<i>Cylindrides</i>	435, 436	<i>testacea</i>	516
<i>Cymindis æneus</i>	435	<i>Dictyochrysa</i>	214
<i>crassiceps</i>	438	<i>fulva</i>	214, 219
<i>illawarra</i>	435	<i>Difflugia</i>	643, 654
<i>longicollis</i>	427	<i>acuminata</i>	650, 651
<i>stigmula</i>	436	<i>v. bacillifera</i>	649
<i>Cyphaspis</i>	507	<i>r. Levanderi</i>	651
<i>lilydalensis</i>	507	<i>amphoralis</i>	647
<i>Cyphoderia</i>	669, 670	<i>ampullaria</i>	650, 673
<i>ampulla</i>	669	<i>bacillarium</i>	649, 673
<i>Cyphoderiopsis</i>	669, 670	<i>r. australis</i>	649, 673
<i>longicollis</i>	669, 675	<i>r. elegans</i>	649
<i>Cystamœba</i>	636	<i>r. teres</i>	650
<i>digitata</i>	636	<i>brevicolla</i>	646, 647, 673
<i>Dactylosphaerium</i>	635	<i>Casinoensis</i>	647
<i>radiosum</i>	636	<i>constricta</i>	647
<i>r. minutissimum</i>	635	<i>r. spinifera</i>	647, 673
<i>r. stellatum</i>	635	<i>corona</i>	648
<i>Dadoxylon</i>	725	<i>r. Foleyana</i>	648, 673
<i>Dædrosis hirsuta</i>	711	<i>curvicaulis</i>	651
<i>interrupta</i>	710	<i>cyclotellina</i>	647
<i>Dampiera</i>	16, 17	<i>elegans</i>	649
		<i>fallax</i>	650

	PAGE.		PAGE.
<i>Diffugia gibberosa</i>	651, 673	Diptera, 11, 21, 167, 195, 201, 285,	287, 297, 298, 299, 300, 513, 734,
<i>globularis</i>	651	743, 753, 754.	
<i>globulosa</i>	651	<i>Discalma</i>	318
<i>globulus</i>	644, 651	<i>normata</i>	319
<i>r. Cashii</i>	651, 673	<i>Distoleonini</i>	206
<i>gramen</i>	644, 672	<i>Dohrnia bifoveicollis</i> ..	568, 569
<i>helvetica r. lithophila</i> , 647,		<i>boisduvali</i>	569
673		<i>eremita</i>	569
<i>hydrostatica</i>	647	<i>miranda</i>	569
<i>v. lithophila</i>	647	<i>mdulaticollis</i>	568, 569
<i>Levanderi</i>	650, 673	<i>Dolichoctis tetrastigma</i> ..	432
<i>Lismorensis</i>	645, 672	<i>Drepanacra</i>	530
<i>r. crucifera</i>	646, 672	<i>humilis r. longitudinalis</i> 533	
<i>r. trilobulata</i>	646, 672	<i>instabilis insularis</i> ..	531, 532
<i>lithoplites r. pulcherrima</i> , 645,		<i>norfolkensis</i>	531, 532
654, 672		<i>r. lineata</i>	533
<i>lobostoma</i>	643, 644	<i>Dromiides</i>	436
<i>r. globulus</i>	644, 672	<i>Dromius crudelis</i>	435
<i>r. truncata</i>	644, 672	<i>Drosera</i>	14
<i>mitrata</i>	652, 673	<i>Dryptini</i>	413
<i>r. major</i>	652	<i>Duboisia</i> .. 10, 118, 122, 124, 131	
<i>oviformis</i>	643, 672, 673	<i>Campbelli</i>	118
<i>r. mollis</i>	643, 672	<i>Hopwoodii</i> , 118, 119, 121, 122,	
<i>r. subglobosa</i>	644, 672	124, 125, 128, 132, 133, 134,	
<i>Penardi</i>	650, 673	138, 145,	
<i>pulex</i>	652, 673	<i>Leichhardtii</i> .. 118, 132, 133,	
<i>r. cuneata</i>	652, 673	137, 138, 139, 144, 145	
<i>pyriformis</i>	651	<i>myoporoides</i> , 118, 119, 120, 121,	
<i>spiralis</i>	653	123, 125, 128, 129, 132, 133,	
<i>tuberculata</i>	651	134, 135, 138, 139, 145.	
<i>r. coronata</i>	648, 673	<i>Dysphania littoralis</i>	113..
<i>r. nodosa</i>	648, 673	<i>myriocephala</i>	113
<i>r. spherica</i>	648, 673	<i>Echinaxia</i> , 391, 392, 393, 394, 405	
<i>tricuspis</i>	643	<i>folium</i>	392
<i>urceolata</i>	647	<i>frondula</i> .. 391, 392, 394, 397	
<i>r. amphora</i>	647	<i>hirsuta</i>	392
<i>r. helvetica</i>	647	<i>Echinoderidae</i>	759
<i>r. spherica</i>	647, 673	<i>Ectenopsis</i> sp.	521
<i>varians</i>	645, 672	<i>Ectroma</i>	422, 423
<i>Diffugina</i>	643	<i>Ectropis</i>	305, 326, 328
<i>Digitalis</i> sp.	512	<i>argalea</i>	327, 331
<i>Diphlebia</i> , 36, 39, 40, 47, 50, 52, 73,		<i>camelaria</i>	327, 333
74, 75, 77, 109, 622, 624		<i>despicata</i>	327, 330
<i>euphloeoides</i>	37, 38, 77	<i>desumpta</i>	327, 331
<i>lestoides</i> .. 37, 38, 75, 76, 109		<i>elongata</i>	327, 329
<i>nymphoides</i>	38, 76	<i>excursaria</i>	327, 330
<i>Diphucephala parvula</i>	545	<i>fraxuperata</i>	327, 331
<i>pygmaea</i>	545	<i>excursaria</i>	327, 329
<i>tautilla</i>	545	<i>hemiprosopa</i>	327, 333
<i>Diphyphyllum</i> sp.	271		
<i>Diplophrys Archeri</i>	671		

	PAGE.		PAGE.
Ectropis isombra	327, 331	Eucalyptus hemiphloia	140
<i>nniara</i>	327, 334	<i>melanophloia</i>	140
<i>mochlosema</i>	327, 328	<i>paniculata</i>	140
<i>odontophora</i>	327, 334	<i>sp.</i>	276, 433, 434
<i>pristis</i>	327, 331	<i>tereticornis</i>	140
<i>rufibrunnea</i>	327, 329	Euclimacia	217
<i>sabulosa</i>	327, 330, 332	<i>erythraea</i>	218
<i>subtinctaria</i>	327, 330	<i>flavicostata</i>	217, 219
Ectyche	710	<i>nuchalis</i>	218
<i>bicolor</i>	709	<i>torquata</i>	218
<i>cœrulea</i>	710	Eudalia	413, 415, 416, 417, 418
<i>sculpturata</i>	709	<i>amplipennis</i>	418
Elaphromyia	517, 518	<i>brunneipennis</i>	418, 420, 421
Elateridæ	721, 751	<i>castelnaui</i>	415, 417
Elateridium	751	<i>froggatti</i>	418, 420
<i>angustius</i>	721, 751	<i>latipennis</i>	417, 418
<i>wianamattense</i>	751	<i>macleayi</i>	417
Elaterites	751	<i>nigra</i>	417, 418, 419
<i>lavateri</i>	751	<i>nitida</i>	418, 420
<i>Elaterites</i>	751	<i>obliquiceps</i>	418, 420
<i>wianamattensis</i>	751	<i>obscura</i>	415, 518
Elodea sp.	633, 642, 656	<i>sublavis</i>	418, 421
Elphos	366	<i>waterhousei</i>	418
<i>hymenaria</i>	366	Euglena sp.	636
<i>subrubida</i>	367	Euglypha	660, 661, 666
Embothriæ	20	<i>acanthophora</i>	661, 662, 674
Enoplos	769, 771	<i>r. elliptica</i>	662, 674
<i>communis</i>	772	<i>r. gracillima</i>	662, 674
Eoscarta	728	<i>alveolata</i>	662, 663
<i>semirosea</i>	727	<i>v. hamulifera</i>	667
Epacris longiflora	512	<i>v. lacris</i>	665
Epacticus aspratilis	575	<i>australis</i>	660, 674
<i>nigrirostris</i>	575	<i>r. cylindracea</i>	661, 674
<i>ruber</i>	575	<i>r. elegans</i>	661, 674
<i>suturalis</i>	574	<i>brachiata</i>	662, 663
Epallaginæ	33, 38, 74, 621, 628	<i>compressa</i>	664, 665
Epidesma	386, 387	<i>r. obscura</i>	665, 666, 674
<i>queenslandica</i>	386	<i>crenulata</i>	661
Epiphlebia	628	<i>cristata</i>	663
Eranthemum	14	<i>r. lanceolata</i>	663, 674
Eremophila latifolia	439	<i>r. major</i>	663, 674
Erephopsis gibbula	515	<i>dentata</i>	675
<i>lasiophthalma</i>	517	<i>r. elongata</i>	666, 667, 674
Erythromma	93, 96	<i>r. hamulifera</i>	666, 667, 675
<i>najas</i>	96	<i>denticulata</i>	665
Erythroxyton	131	<i>filifera</i>	664
Escura	204	<i>r. cuneata</i>	664, 674
<i>divergens</i>	204	<i>r. cylindracea</i>	664, 674
<i>Estemoa bubas</i>	691	<i>r. elegans</i>	663, 674
Eucalyptus	14, 15, 21, 23	<i>r. pyriformis</i>	664, 674
<i>crebra</i>	140	<i>lavis</i>	663, 665, 674
<i>erythrocorys</i>	201	<i>r. lanceolata</i>	663, 665, 666,
<i>ficifolia</i>	14		674

	PAGE.		PAGE.
Euglypha kevis <i>r. minor</i>	666	Glycine	14
tuberculata	662	Glycyphana	547
<i>r. minor</i>	662	Gnathaphanus <i>lariceps</i>	411
Euglyphina	660	philippensis	411
<i>Eulebia</i>	424	vulneripennis	411
<i>picipennis</i>	424	whitei	410
<i>plagiata</i>	424	<i>Gnophos destinataria</i>	358
Euomphalus sp.	698	<i>Goldius</i>	500
<i>Euphania luteola</i>	286	<i>cresewellii</i>	499, 500, 503
Euphcea	108	<i>greenii</i>	499
Euphlea	170	Gomphinae	678
corinna	171	Gomphomacromia	453, 463, 464
<i>Euscimia mariana</i>	385	<i>paradoxa</i>	453, 463
Euthenarus	412, 413	<i>Gonophya albipuncta</i>	310
brunneus	412, 413	<i>subpulchra</i>	310
<i>Erarsia marginata</i>	308	Goodenia	16
Favosites gothlandica	698	cycloptera	17, 18, 24
multitabulata	242, 698	hederacea	17, 24
pittmani	242	ovata	16, 17
sp.	239	Goodeniaceae	15, 18, 19, 24
Fenestella	271	Goodenovieae	15, 16, 24
<i>Forbesia curyiceps</i>	507	Gramineae	303
<i>Formicaleo canifrons</i>	208	Grevillea acanthifolia	20
Frenzelina globosa	671	buxifolia	247
reniformis	671	laurifolia	20
Fuchsia sp.	512	punicea	247
Fulgoridae	729, 731	robusta	20
Fusanus acuminatus	439	sp.	15, 20, 21
<i>r. chrysocarpus</i>	439	Gromiina	670
Gangamopteris	725	Gymnocnemis	206
Gastrina	377	<i>bipunctata</i>	206
<i>catacticta</i>	377	<i>interrupta</i>	206
<i>crebina</i>	373	<i>maculata</i>	206
Gastrolobium spinosum <i>r. tri-</i>		<i>pentagramma</i>	206
<i>angulare</i>	246	<i>tipularia</i>	206
Geomela	582	<i>variegata</i>	206, 218
bifoveata	582	<i>Gympteryx ada</i>	380
blackburni	580, 581, 582	Hakea acicularis	302
bryophaga	582	<i>Halia australiarum</i>	314
circumflava	582	Harpalini	406, 410
lamellifera	579, 582	Harpeidae	480
montana	580, 582	Harpes	496, 505
nobilis	581, 582	trinucleoides	496, 509
tasmaniensis	580, 582	ungula	496, 497
Geometridae	304	Harpobittacus	286, 296
Glenoleon annulicornis	205	australis	286
indecisus	206	nigriceps	286
Glossopteris	725, 726	tillyardi	286
browniana	726	Heleopera	659
linearis	726	Heliolites porosa	698

	PAGE.		PAGE.
Heliolites sp.	258	Hypochrosis	381
Heliozoa	634	<i>chlorosticha</i>	381
Helluodema brunneum	438	<i>cryptorhodata</i>	382
<i>unicolor</i>	438	Hypopetalia	450, 454
Helluonini	341, 406, 413, 438	Hyposidra	317
Hemerobiidae	180, 290, 531, 532	<i>australis</i>	318
<i>Hemerophila</i> <i>exclusa</i>	311	<i>januaria</i>	317, 318
<i>excursaria</i>	364	<i>schistacca</i>	318
<i>lucaria</i>	354	<i>talaca</i>	317, 318
<i>mundifera</i>	364	<i>variabilis</i>	318
<i>pratereuns</i>	311	Hypoxis	14
<i>silicaria</i>	364	<i>pusilla</i>	24
<i>stricaria</i>	312		
<i>vestita</i>	330	Idocordullini	464
Hemicordulia australie	530, 531	Ilkenus	505
Hemiptera, 176, 720, 721, 726, 729,		<i>johnstoni</i>	505
753, 754, 755		<i>wahlenbergi</i>	505
Hepialidae	173, 174, 296	Ischnura, 96, 97, 99, 100, 108, 625,	
Hepialus eximius	169	632	
Heterina	36, 37, 79	<i>aurora</i>	38, 97, 531, 532
sp.	33, 38	<i>heterosticta</i> , 38, 58, 62, 96, 97,	
Heterectya	391, 394, 405	110, 607, 611	
Heterodendron oleefolium	113	Isosticta	92, 95, 624, 625, 632
Heteromastix	563	<i>simplex</i>	38, 92, 110
Heteromera	701		
Heteroptila	305, 369	Juncus	14
<i>argoplaca</i>	369	<i>prismatocarpus</i>	113
<i>xylina</i>	369		
Hiletini	342	Laccoscaphus doddi	406, 407
Homalonotus	506	<i>r. triordinata</i>	406
<i>delphinocephalus</i>	506	Lachnothorax	413, 414
<i>harrisoni</i>	506	<i>formicoides</i>	413
<i>vomer</i>	506	<i>palustris</i>	414, 415
Homoptera, 190, 720, 721, 726, 729,		<i>riverina</i>	414, 415
731, 753, 754		<i>Lagya agrcalesaria</i>	318
Hyalosphenia Coogeeana, 658, 674		<i>bombycaria</i>	318
<i>nobilis</i> <i>r. compressa</i> , 658, 674		<i>diffusata</i>	318
Hybernia	305, 324	<i>flaccida</i>	318
<i>borcophilaria</i>	325	<i>infusata</i>	318
<i>indocilis</i>	325	<i>rigusaria</i>	318
Hydrobasileus brevistylus	470	<i>talaca</i>	318
Hydrophilidae	720, 749, 750	<i>Larentia c-primataria</i>	321, 322
Hydropsyche sp.	185, 186, 187	<i>feraria</i>	332
Hydropsychinae	185, 187	Larophylla	389
Hymenoptera	21, 201, 297	<i>amimeta</i>	389
Hyocis Bakewelli	717	Lasiocampidae	384
<i>cancellata</i>	717	Leaia mitchelli	726
Hyperythra	305	Lebia <i>benefica</i>	423
<i>Hypochroma dissonata</i>	329	<i>cirica</i>	423
<i>maculata</i>	362	<i>melanota</i>	424
<i>nigraria</i>	329	<i>papuensis</i>	424

	PAGE.		PAGE.
<i>Lebia picipennis</i>	424	<i>Lesquereusia spiculosa</i>	655, 673
<i>plagiata</i>	424	<i>spiralis</i>	653, 654
<i>Lebiides</i>	424	<i>r. caudata</i>	654, 673
<i>Lebiini</i>	341, 406, 422	<i>r. inaequalis</i>	654, 673
<i>Lebiomorpha</i>	422, 423	<i>Lestidae</i> , 34, 36, 38, 57, 65, 67, 82,	
<i>benefica</i>	423	84, 85, 89, 90, 91, 454, 469, 621,	
<i>civica</i>	423	623, 628, 631.	
<i>fragilis</i>	422	<i>Lestinae</i>	38, 87, 91, 623
<i>gravis</i>	422	<i>Leucochrysa</i>	217
<i>Lecanomerus lucidus</i>	411	<i>Libellulidae</i> , 453, 463, 530, 684, 689	
<i>Lepidium</i>	445	<i>Lichas</i>	503
<i>Ascheronii</i>	445	<i>australis</i>	503, 504
<i>Desvauxii</i>	445	<i>palmata</i>	503, 504
<i>r. typicum</i>	446	<i>v. sinuata</i>	503, 504
<i>r. gracilescens</i>	446	<i>sinuata</i>	503, 504
<i>dubium</i>	445, 448	sp.	504
<i>fasciculatum</i>	445, 447	<i>Limnephilidae</i>	181
<i>foliosum r. fruticosum</i>	445	<i>Linaria Pellisseriana</i>	512
<i>Howei insule</i>	448	<i>Lipogya</i>	321
<i>hyssopifolium</i>	445, 446	<i>Lithostrotion</i> (?) <i>columnare</i>	269
<i>leptopetalum</i>	449	sp.	242, 269
<i>Merralli</i>	445	<i>Lithostrotus</i>	435
<i>Muelleri Ferdinandi</i>	448	<i>Lithophyllum Konineki</i>	698
<i>pseudo-ruderale</i>	445, 447	sp.	698
<i>pseudo-tasmanicum</i> ,	445, 446	<i>Lobelia</i>	18
<i>puberulum</i>	445	<i>feucillei</i>	246
<i>ruderale</i>	445, 447, 448	<i>tupa</i>	246
<i>r. spinescens</i>	445, 448	<i>Lobeliaceae</i>	18
<i>ruderale</i>	445, 447	<i>Lomatia</i>	20
<i>sagittulatum</i>	445	<i>Lomographa</i>	305
<i>tasmanicum</i>	445	<i>Lophodes</i>	325
<i>Lepidodendron</i> , 224, 257, 268, 269,	725	<i>sinistraria</i>	326
<i>australe</i>	256, 263, 264, 266,	<i>Lophosema</i>	377
270, 276		<i>catasticta</i>	377
<i>Lepidoptera</i> , 11, 167, 168, 172, 173,		<i>Luxiaria caelusa</i>	311
174, 176, 195, 201, 285, 291, 296,		<i>Lychnographa</i>	387, 389
297, 298, 299, 301, 311, 734.		<i>agaura</i>	388
<i>Lepocinelis</i>	636	<i>heroica</i>	388
<i>Leptoceridae</i>	187, 531, 544	<i>Lyelliana</i>	306, 378
<i>Leptocystis arcelloides</i>	641	<i>ancyloma</i>	378, 379
<i>Leptoperlinea</i>	615	<i>dryophila</i>	378
<i>Leschenaultia</i>	16	<i>phaeochlora</i>	378
<i>formosa</i>	16	<i>Macaria complata</i>	315
<i>Lespedeza</i>	14	<i>frontaria</i>	314
<i>Lesquereusia</i>	634, 653, 654	<i>gratularia</i>	314
<i>carinata</i>	654, 673	<i>infiraria</i>	314
<i>inaequalis</i>	654	<i>lucidata</i>	308
<i>jurassica</i>	653, 654	<i>obstataria</i>	311
<i>modesta</i>	653, 654	<i>panagraria</i>	314
<i>modesta</i>	653	<i>porrectaria</i>	315

	PAGE.		PAGE.
<i>Macaria remotaria</i>	314	<i>Metrocampa glaucias</i>	380
Malacodermide	563, 721, 752	<i>Metrorhynchites</i>	752, 753
Mantispa erythraea	218, 219	<i>grandis</i>	721, 753
Mantispidæ	217	<i>sydnei</i> ensis.. . . .	752
Mastigamoeba longifilum	635	Micromus tasmanie	531, 533
<i>reptans</i>	635	Microplasma parallelum.. . . .	698
<i>Mecaptera</i>	284	Micropterygidæ.. . . .	168, 173, 174
Mecistogaster modestus	107	<i>Milionia</i>	386
Mecoptera, 167, 168, 174, 176, 188,		<i>qucenstandica</i>	386
189, 190, 193, 196, 197, 198, 199,		<i>Milla uniflora</i>	439
200, 201, 284, 285, 287, 289, 296,		Misophrice	575
297, 298, 300, 302, 720, 732, 733		<i>Mochtherus macleayi</i>	432
736, 737, 740, 743, 746, 748,		Mœrodes.. . . .	717
Mecynopus	576	<i>Kershawi</i>	718
Medasina	312	<i>Westwoodi</i>	717, 718
<i>strixaria</i>	312	<i>Myiodactylida</i>	210
Megaloptera	296, 297	<i>Myiodactylus</i>	210
Meganeuridæ	197	<i>armatus</i>	212
Megapodagrioninae.. . . .	38, 100, 454,	<i>osmyloides</i>	531, 542, 543
475, 621, 627, 628		<i>placidus</i>	212
Melanodes.. . . .	305, 325	<i>roseistigma</i>	211, 219, 543
<i>anthracitaria</i>	325	<i>sejunctus</i>	212
Meliphagidæ	24	<i>Myriophyllum</i> sp.	633, 642, 656,
Melosira	226, 276	666	
Meneristes laticollis	707	<i>Myrmeleon</i>	193, 209
<i>latior</i>	707	<i>loweri</i>	210
<i>porosus</i>	707	<i>nigromarginatus</i>	209, 249
<i>proximus</i>	707	<i>pictifrons</i>	531, 544
Meracanthini	714	Myrmeleonidæ	203
Merionoeda	576	Myrmeleonini	209
<i>australiae</i>	576, 582	Myrmelontidæ.. . . .	531, 544
Merope	193, 736		
<i>tuber</i>	740	<i>Nannochorista</i> , 292, 295, 296, 297,	
Meropidæ	302	298, 299, 301	
Mesochorista	749	dipteroides, 291, 293, 294, 295,	
<i>proavita</i>	285	301	
Mesogereon	189	<i>eboraca</i>	293, 295, 301
Mesopanorpa	747, 748, 749	<i>holostigma</i>	203, 294, 301
<i>wianamattensis</i>	720, 747	<i>maculipennis</i>	294, 300, 301
Mesopanorpidae	720, 746	<i>Nannochoristidæ</i>	284, 289, 298,
Mesophlebia	177	300, 302, 749	
<i>antinodalis</i>	176	<i>Nebela</i>	659, 669
Mesopsyche	180, 181, 182, 183,	<i>carinata</i>	660
184, 186, 187		<i>caudata</i>	659, 674
<i>triareolata</i>	181, 182, 200	<i>dentistoma</i>	659
Mesopsychidæ	180, 182, 186, 187	<i>r. lageniformis</i>	659, 674
Mesopsychopsis	179	<i>lageniformis</i>	660
Metrocampa	305, 306, 379, 381	<i>militaris r. tubulata</i> , 659, 674	
<i>ada</i>	380, 381	<i>sinuosa</i>	660
<i>biplaga</i>	380, 381	<i>tubulosa</i>	760
<i>celenephes</i>	380		

PAGE.	PAGE.		
Nebelina	658	Edemeridæ	565
Nebriini	342	Omolipus bimetallicus	712
Necrotauliidæ	184, 185	cæruleus	711
Necrotaulius major	185	Omophron	340, 342
<i>Nyogyne clongata</i>	327	Oncholaimus	769
Neosticta, 39, 48, 50, 74, 77, 79, 92, 93, 621, 624, 625, 626, 629, 632 canescens, 37, 38, 77, 78, 110, 111, 607, 612		Onosterrhus heroina	717
Neritodes	305	inconspicuus	705
Nesydrion fuscum	210	lætus	705
Neurobasis	79	lugubris	705
Neuroptera, 10, 11, 174, 178, 189, 203, 284		major	717
Nicandra physaloides	586	ooldensis	704
Nososticta	77, 79	stepheni	705
solida	37, 38	<i>Onychodes euchrysa</i>	314
Notanatomica magna	531, 544	Onychopyge	506
Notasaphus fergusonii	507	liversidgei	506
Nothochrysa	214, 215, 534	Oomela	579
chloromelas	215	bimaculata	578, 579
insignata	215	coccinelloides	577, 579
nigrinervis	215, 219	distincta	578, 579, 582
Notoblattites	743	elliptica	578, 579
mitchelli	720, 745	pulchripennis	579
subcostalis	743, 744, 745	trimaclulata	579
wiamamattensis	720, 743	variabilis	579
Notochaetosoma, 764, 798, 811, 812, cryptocephalum, 908, 809, 810, 811, 812, 814		Ophionea	413, 415
tenax, 761, 763, 765, 766, 798, 800, 801, 802, 803, 804, 805, 806, 808, 812, 814,		<i>Ophthalmodes pupillata</i>	374
Nototarus	435, 538	Orthophlebia	285, 295
morosus	438	Orthoptera	743
puncticollis	437, 438	Osmylidæ	212, 297
Nyctozoilus Dæmeli	706, 707	Osmylops	210, 212, 543
parvus	705, 706	armatus	212
Nymphes sejunctus	212	sejunctus	212, 219
Nymphidæ, 210, 529, 531, 542, 544		Osteodes	368
Odacantha	413, 414	procidata	368
melanura	414	procurata	368
<i>Odacantha</i>	413	Oxalis	14
micans	413	Pachauchenius leviceps	411
Odacanthidæ	413	Pachyplocia	335
Odacanthides	413	griseata	335
Odacanthini	406, 413, 414	Palaodictyoptera	189
Odonata, 10, 11, 176, 189, 450, 529, 530, 531, 618, 619, 620, 631		Palimnecomymia	513, 518
Oecetis	197	celenospita	518, 528
		Pamborini	342
		Pamborus	342
		<i>Panathia matutinata</i>	384
		<i>Panagra ferritinclaria</i>	368
		rubicolor	346
		Pangoninae	573
		Panorpa	196, 197, 198, 291, 296
		confusa	192, 196
		Panorpatæ	284, 302

	PAGE.		PAGE.
Panorpidae	284, 286, 302	Phleocarabus	433
Panorpidos	190, 196, 297, 748	anchoralis	433
<i>carolinensis</i>	748	<i>farinae</i>	434
Panorpoidea	285	<i>nigricollis</i>	434
Papilio <i>Sarpedon</i>	13	<i>semivittatus</i>	434
Paramelora	305	<i>umbratus</i>	435
<i>Parathemis irrorata</i>	352	<i>unimaculatus</i>	435
<i>violescens</i>	352	Phryganeidae	184
Pareuglypha	670	Phryganella <i>acropodia</i>	655, 673
Parnidae	749	<i>c. australica</i>	655, 673
Passiflora <i>alba</i>	113	<i>c. depressa</i>	655, 673
Pavonia	14	<i>hemisphaerica</i>	655
Pelecorhynchus	513, 515	Phyllopetalia	450, 454
<i>fusciger</i>	513, 515	Phyllopteris <i>sp.</i>	232
<i>maculipennis</i>	513, 515	Phyllothea	725, 726
<i>mirabilis</i>	513, 515, 528	Phymatocaryon <i>Mackayi</i>	264
Pelecotomoides <i>conicollis</i>	565	Planipennia	174, 175, 178, 193,
<i>subparallela</i>	564	195, 199, 200, 291, 296, 297, 529,	
Pelomyxa	635	530, 531, 532, 738.	
<i>echinulata</i>	635	Platia	432, 433
<i>hirsuta</i>	635	<i>froggatti</i>	432
<i>palustris</i> v. <i>echinulata</i>	635	<i>lineella</i>	433
Penicillium	162	<i>minima</i>	433
Pentamerus <i>knightii</i>	698	<i>papuana</i>	433
<i>sp.</i>	756	<i>queenslandica</i>	432, 433
Perlaria	11, 201, 615, 616, 617,	Platoom <i>sp.</i>	657
618, 619, 620		Platyphila	342
Permochorista, 720, 732, 736, 737,		Platychemine	627, 628
738, 739, 740		Platydema	702
<i>austratica</i> , 720, 732, 733, 734,		<i>abdominale</i>	702
735, 736, 737, 738, 739		<i>aries</i>	702
<i>mitchelli</i>	720, 734, 735, 736,	<i>biinctum</i>	702
737, 738, 739		<i>Championi</i>	702, 717
Permochoristidae	720, 732, 749	<i>deplanatum</i>	702
Permofulgo	730	<i>fossulatum</i>	702
<i>belmontensis</i>	720, 730, 731	<i>fuligineum</i>	702
Permofulgoridae	720, 729	<i>kanalense</i>	702, 717
Permoscarta	726, 728, 731	<i>laticolle</i>	702
<i>mitchelli</i>	720, 727, 728	<i>limacella</i>	702
Petalia	450, 454	<i>metallicum</i>	702
Petaliini	450, 454, 458	<i>novicum</i>	702
Petalurinae	458, 690	<i>obscurum</i>	702, 717
Petrosia	395	<i>orbitica</i>	702, 717
Phanostoma	186	<i>Pascoei</i>	702
<i>Phibalapteryx striata</i>	365	<i>rufibase</i>	701, 702
Philanisus <i>plebejus</i>	187	<i>striatum</i>	702, 717
Phillipsastraea <i>sp.</i>	698	<i>tasmanicum</i>	702
Philolochma	363	<i>tetraspilotum</i>	702
<i>celenochroa</i>	363	<i>victoriense</i>	701, 702
<i>Philophleus froggatti</i>	432, 433	Platyphanes <i>chalcopteroides</i>	709
Phleum <i>pratense</i>	246	<i>similis</i>	709

	PAGE.		PAGE.
Plecia	754	Pseudagrion australasiae	38, 47,
Plectoptera, 64, 615, 617, 618, 619.			95, 110, 478
	620, 631	Pseudagrionini	92, 96
Plesiocapparis leptocelyphis	264	Pseudochlamys patella	642
Pleurolopha	324	Pseudodiffugia	653
nebridota	324	compressa	671
<i>Pluchea conoccephala</i>	449	fascicularis	671
Polymorphanisus	186	fulva	670
Porocara	414, 415	gracilis	670
punctata	416	<i>hemispharica</i>	655
<i>Potera flavimacula</i>	382	microstoma	670, 674
Prasos	384	<i>v. obesa</i>	670, 674
catadela	384, 385	Pseudofornicaleo	204
leucosticta	384, 386	jacobsoni	204
mariana	384, 385, 386	nubeculus	204
matufinata	384	Pseudolycus	567
rotundata	384, 385	bivitticollis	566, 567
<i>Praxis corrus</i>	325	canaliculatus	568
Probitbia	309, 311	carteri	567
exclusa	311	haemopterus	567
Proctus	507	haemorrhoidalis	567, 568
euryceps	507	<i>v. rufipennis</i>	565, 566
Prohemerobiidae	178, 180	hilaris	567, 568
Prophanes	718	niger	567, 568
aculeatus	717, 718	tarsalis	565, 567, 582
brevispinosus	718	torridus	567
Browni	718	vitticollis	567
<i>chalybipennis</i>	718	wallacei	566, 567
dualis	718	Pseudomorphae	341
Kershawi	718	Pseudophaea, 36, 41, 50, 52, 53, 57,	
Mastersi	718		58, 74
Proteaceae	15, 19, 24, 25	variegata	111
Protococcaceae	633	Pseudoplectron	204
Protodonata	176, 197	<i>costatum</i>	204
Protohemiptera	176, 190	Pseudostigmatinae	627
Protomecoptera, 168, 175, 178, 188,		Psilosticha	366
189, 190, 200, 746		mactaria	366
Protoneurinae, 38, 74, 77, 92, 621,		Psychopsidae	180
625, 628		Psychopsis	178, 179
<i>Protoplectrini</i>	203	elegans	179
Protoplectron	204	illidgei	179
<i>costatum</i>	204	Psyllidae	721, 753, 754
eremie	205	Pyenosoma rufifacies	302
striatellum	204, 218	Pyrrhosoma nymphula	98, 99
Protopsychopsis	178, 179	Pyxidicula operculata	642
venosa	179, 180, 200	scutella	641, 642
Protorthoptera, 176, 190, 720, 743		<i>v. alta</i>	642
Pselaphide	552	Quadrula	660
Pseudagrion	93, 95	symmetrica <i>v. longicollis</i> , 660,	
aureofrons	38, 95		674

	PAGE.		PAGE
<i>Rapuntium tupa</i>	246	<i>Satraparchis(?) macrocosma</i> ..	387
Raspailia	392, 393	Scævola	17
<i>folium</i>	392	Scarabæidae	545
<i>hirsuta</i>	392	Scarites	340
<i>villosa</i>	393	Scaritini	406
Raspaxilla	392, 393, 394	Schizoneura	725, 754
Rhabderemia	398, 399	Scoliglyptis	336
<i>guernei</i>	399	<i>emmelodes</i>	364
<i>indica</i>	398, 399	<i>hemcropa</i>	365
<i>intexta</i>	399	<i>lithina</i>	346
<i>prolifera</i>	399	<i>lithinopa</i>	336
<i>pusilla</i>	399	<i>Scotosia fractata</i>	372
<i>spinosa</i>	399	Selenia apamaria	314
<i>toxigera</i>	399	<i>Scridosema</i>	322, 344
Rhabdogaster	759, 764	<i>acaciaria</i>	376
<i>cygnoides</i>	813	<i>adelpnodes</i>	357
Rhabdosigma	391, 398	<i>aganopa</i>	356
<i>mammillata</i>	398, 399, 403, 405	<i>agoraa</i>	356
Rhacopteris sp.	225, 270, 725	<i>amphicliua</i>	350
Rhinodia	306	<i>argoplaca</i>	369
Rhipidophoridae	564	<i>bitæniaria</i>	373
Rhizopoda	633	<i>cancscaria</i>	352
Rhus succedanea	440	<i>capuota</i>	322
Ribes nigrum	591	<i>chevluta</i>	365
Ruellia	14	<i>cognata</i>	354
Saragus clathratus	703	<i>curtaria</i>	350
<i>costatus</i>	704	<i>despicata</i>	330
<i>crenulatus</i>	703	<i>destinataria</i>	358
<i>intricatus</i>	703, 704	<i>epistictis</i>	375
<i>levicollis</i>	703, 704	<i>eremias</i>	350
<i>luridus</i>	703	<i>cuboliaria</i>	372
<i>reticulatus</i>	703, 704	<i>excursaria</i>	330
<i>spheroides</i>	717	<i>exprimataria</i>	322, 324
<i>strigicentris</i>	717	<i>externaria</i>	352
<i>subreticulatus</i>	703	<i>illustraria</i>	376
Sarothrorepides	422	<i>leptodesma</i>	354
Sarothrocepis	422, 423	<i>leucoplecta</i>	346
<i>bimaculata</i>	423	<i>leucodesma</i>	329
<i>blackburni</i>	423	<i>luraria</i>	354
<i>corticalis</i>	422, 423	<i>lyciaria</i>	353
<i>dimidiata</i>	423	<i>pallidiscaria</i>	357
<i>humerala</i>	423	<i>penithcaria</i>	346
<i>infuscata</i>	423	<i>perfectaria</i>	358
<i>luctuosa</i>	423	<i>silicaria</i>	364
<i>mastersi</i>	423	<i>symmorpha</i>	354
<i>m-nigra</i>	423	<i>thermax</i>	350
<i>obtusa</i>	423	<i>viridis</i>	359
<i>pallida</i>	423	<i>zascia</i>	357
<i>setulosa</i>	422	Selliera	17
<i>suavis</i>	423	<i>Semiothisa fusca</i>	315
		<i>Sequoia sempervirens</i>	246

	PAGE.		PAGE.
Sialidæ	297	Solanum nigrum <i>r.</i> guineense	590
Sigmaxinella	391	<i>r.</i> humile	585, 587
<i>mammillata</i>	399	<i>v.</i> <i>memphiticum</i>	594
Silene <i>anglica</i>	604	<i>v.</i> <i>virginicum</i>	596
<i>gallica</i>	604	<i>v.</i> <i>vulgare</i>	596
<i>r.</i> <i>anglica</i>	604	<i>nigrum</i>	596, 601
<i>r.</i> <i>quinquevulnera</i>	604	<i>nodiflorum</i>	583, 601
<i>quinquevulnera</i>	604	<i>var.</i>	600, 601, 602
Silphomorpha	340	<i>r.</i> <i>rubrum</i>	600
Silvius	513	<i>ochroleucum</i>	597, 601
<i>psarophanes</i>	520	<i>var.</i>	601
<i>stradbrokei</i>	519	<i>oleraceum</i>	583, 593, 601
<i>subluridus</i>	520	<i>opacum</i>	583, 593, 595, 596, 597, 600, 601, 602
Smicridea	186	<i>paludosum</i>	601
Solanaceæ	19, 118, 137	<i>parviflorum</i>	601
Solandra longiflora	10, 139	<i>patens</i>	601
Solanum acuminatum	600	<i>patulum</i>	601
<i>egyptiacum</i>	600	<i>petiolastrum</i>	601
<i>alatum</i>	596, 600	<i>procerius patulum</i>	602
<i>angulosum</i>	600	<i>pteroaulon</i>	583, 593, 597, 600, 601, 602
<i>astroites</i> , 583, 583, 596, 597, 600		<i>puberulum</i>	602
<i>atriplicifolium</i>	600	<i>retroflexum</i>	602
<i>Besseri</i>	600	<i>rhinozerothis</i>	602
<i>chenopodioides</i>	600	<i>rigidum</i>	602
<i>chlorocarpum</i>	600	<i>Roxburghii</i>	602
<i>Deppci</i>	600	<i>rubrum</i>	583, 597, 602
<i>Dilleni</i>	600, 601	<i>Rumphii</i>	602
<i>Douglasi</i>	594, 600	<i>suffruticosum</i>	602
<i>erythraeum</i>	600	<i>triangulare</i>	602
<i>fistulosum</i>	601	<i>villosum</i>	583, 593, 595, 602
<i>flavum</i>	597, 601	<i>virginianum</i>	602
<i>Forsteri</i>	583, 595	<i>virginicum</i>	602
<i>glabrum</i>	601	<i>vulgare</i>	602
<i>guineense</i> , 583, 590, 592, 593, 594, 601, 602		<i>vulgatum</i>	602
<i>hebecaulon</i>	601	Sphaerexochus	493
<i>hirsutum</i>	583, 601	<i>mirus</i>	494, 509
<i>hortense</i>	601	Sphagnum sp.	633, 640, 668, 669
<i>humile</i>	583, 585, 691	Sphenoderia	666, 667, 669
<i>incertum</i>	583, 601	<i>australis</i>	667, 675
<i>judaicum</i>	601	<i>fissirostris</i>	669, 675
<i>luteo-virens</i>	601	<i>r.</i> <i>splendida</i>	669, 675
<i>macrophyllum</i>	601	<i>foveosa</i>	667, 675
<i>melanocerasum</i>	601	<i>r.</i> <i>tenuis</i>	668, 675
<i>memphiticum</i>	594, 601	<i>lenta</i>	667
<i>miniatum</i>	583, 597, 601	<i>macrolepis</i>	668, 675
<i>nigrum</i>	583, 584, 585, 586, 587, 588, 589, 590, 591, 592, 594, 595, 597, 598, 600, 601, <i>var.</i>	<i>sphaerica</i>	668, 675
<i>var.</i>	600, 601, 602	Sphenopteris	725
<i>r.</i> <i>aurantiacum</i>	592	<i>germanus</i>	726
<i>r.</i> <i>chlorocarpum</i>	592		

	PAGE.		PAGE.
Spilosmylus	213	Synthemis	453, 463, 465
<i>triseriatus</i>	212	<i>eustalacta</i>	464, 467
Spirifera convoluta	271	<i>regina</i>	467
sp.	263, 271, 698	<i>tasmanica</i>	467
<i>striata</i>	698	Syringella	393
Spirogyra sp.	634	Syringopora	230, 242, 258
Spongilla	226, 276	<i>auloporoides</i>	698
Staurocephalus	494, 495, 496	sp.	271, 698
<i>clarkii</i>	495	<i>syrinx</i>	269
<i>murchisoni</i>	494, 495, 510	Tabanida	513
<i>unicus</i>	495	Tabaninae	522
Stigmodera	701	Tabanus	513, 520, 521
<i>cupreo-flava</i>	719	<i>angusticallus</i>	523
<i>rostralis</i>	718	<i>brisbanensis</i>	526
Streptothrix	162	<i>confusus</i>	523
Stromatopora	242, 258	<i>dubiosus</i>	526
Stromatoporella	242	<i>edentulus</i>	526
Strongylium longicrurum, 716, 717		<i>froggatti</i>	526
<i>longipes</i>	716	<i>hackeri</i>	522
<i>longipes</i>	716	<i>laticallosus</i>	524
Strophomena sp.	271	<i>parvicallus</i>	524
Strychnos	131	<i>rufoabdominalis</i>	525
Stylidium	18	Tacsonia mixta	113
Sycopteron symmetrica	756	Teniochorista, 190, 732, 734, 736,	
Symmetroctena	321, 369	739, 740
<i>capnota</i>	322	<i>pallida</i> , 286, 736, 737, 738, 739	
<i>eutheta</i>	322	Teniopteris sp.	225, 726, 742
<i>exprimataria</i>	322	<i>Tahulus caligatus</i>	204
<i>fumosa</i>	322	Tanychilus	716
<i>scotina</i>	322, 323	<i>opacus</i>	715, 716
Syneora	363, 366	Tarpela catenulata	713
<i>emmelodes</i>	364	<i>Doddi</i>	712
<i>hemeropa</i>	364, 365	Tarsophlebiinae	621
<i>lygdina</i>	364, 365	Tecoma jasminoides <i>v.</i> <i>albi-</i>	
<i>mundifera</i>	363, 364	<i>flora</i>	511
<i>silicaria</i>	363	<i>v. amabilis</i>	511
<i>strixata</i>	364, 365	Telephlebia	453, 459, 689
Synlestes	48, 67, 81, 87, 88, 454,	<i>godeffroyi</i>	453, 460
.	469, 471	<i>tryoni</i>	453, 459, 479
<i>albicauda</i> , 38, 87, 110, 469, 471		Telopea speciosissima	440
<i>ni-grescens</i>	454, 472, 473	Tenebrionidae	704, 715, 721, 749,
<i>selysi</i> , 454, 471, 472, 473, 475,		752
.	479	<i>Tephriua adustaria</i>	346
<i>tropicus</i>	454, 471, 473, 475	<i>dessicata</i>	319
<i>weyersi</i> , 38, 87, 110, 454, 469,		<i>normata</i>	319
470, 472, 473, 474, 475, 479,		<i>paralictaria</i>	319
619.		<i>procurata</i>	368
Synlestinae	38, 87, 454, 469, 623	<i>Tephriopsis gratiosa</i>	315
Synthemini	453, 463, 464, 467	<i>plana</i>	368
Synthemiopsis	453, 463	<i>Tephrosia absorpta</i>	366
<i>gomphomacromioides</i> , 453, 463,		<i>curtaria</i>	350
.	464, 466, 467, 479		

	PAGE.		PAGE.
<i>Tephrosia despiciata</i>	330	<i>Trinema</i>	669, 670
<i>desumpta</i>	332	<i>caudatum</i>	669, 675
<i>disperdita</i>	354	<i>enchelys</i>	670
<i>disposita</i>	331	<i>lineare</i>	670
<i>emboliaria</i>	372	<i>Trinucleus</i>	496, 504, 505
<i>excursaria</i>	330	<i>Caractaci</i>	505
<i>erportaria</i>	330	<i>Clarkei</i>	505
<i>externaria</i>	352	<i>Triplectides</i>	187
<i>fractaria</i>	329	<i>Triploides</i>	769
<i>fulgurigera</i>	330	<i>Tristichochacta inarimeuse</i> ..	758
<i>gratularia</i>	348	<i>Triteleia uniflora</i>	439
<i>indirecta</i>	358	<i>Tryplasma</i> sp.	698
<i>integraria</i>	366	<i>Typhobia fuliginca</i>	702
<i>mactaria</i>	366		
<i>mollisata</i>	348	<i>Unio Wilkinsoni</i>	264
<i>perfectaria</i>	358	<i>Uvea</i>	435, 436
<i>phibalapteraria</i>	330	<i>stigmula</i>	436
<i>propinquaria</i>	348		
<i>scitiferata</i>	364	<i>Vallisneria</i>	39
<i>subinctaria</i>	330	<i>Vertebraria</i>	725
<i>vagaria</i>	358	<i>Viola</i>	14
<i>Tetragonia nigrescens</i> v. <i>maritima</i>	247		
<i>Tetragonoderides</i>	422	<i>Wahlenbergia</i>	18
<i>Tetragonoderini</i>	422		
<i>Thalaina</i>	306	<i>Xanthocnemis</i>	98, 99
<i>Thaumatoneura</i>	36, 107	<i>zelandica</i>	37, 38, 100
<i>Thelymitra</i>	14	<i>Xanthophaea</i>	425
<i>Theriopectes</i>	526	<i>angusticollis</i>	425
<i>Thinnfeldia</i>	726, 742	<i>angustula</i>	427
<i>Thorine</i>	33, 74, 621, 628, 682	<i>apicalis</i>	426
<i>Tigridoptera</i>	384	<i>brachinoderus</i>	426, 427
<i>mariana</i>	385	<i>chaudoiri</i>	427
<i>matutinata</i>	384	<i>concima</i>	427
<i>rotundata</i>	385	<i>constricticeps</i>	427
<i>Tipulide</i>	286, 297	<i>cylindricollis</i>	426
<i>Trachelomonas</i> sp.	636	<i>doddi</i>	426, 429
<i>Trachypachini</i>	342	<i>dorsalis</i>	426, 431
<i>Triassopsyche</i> , 180, 182, 184, 186, 187		<i>elongata</i>	425
<i>dunstani</i>	183, 184, 200	<i>fasciata</i>	425
<i>Triassopsylla</i>	753, 754	<i>ferruginea</i>	426, 427
<i>plecioides</i>	721, 753	<i>filiformis</i>	427
<i>Trichoderma</i>	759	<i>grandis</i>	425
<i>Trichoptera</i> , 11, 167, 175, 178, 180, 187, 197, 198, 199, 200, 201, 285, 296, 297, 299, 529, 530, 531, 544, 734, 748, 749.		<i>infuscata</i>	425, 427
<i>Trichosalpingus</i>	561	<i>lineolata</i>	427
<i>Trigonodaetylus</i>	413	<i>lissodera</i>	427
<i>Trimerus</i>	506	<i>loweri</i>	425
		<i>marginipennis</i>	426, 427
		<i>nigricincta</i>	426, 431
		<i>ornata</i>	425, 427
		<i>pallida</i>	426

	PAGE.		PAGE.
<i>Xanthophœa parallela</i>	427	<i>Xylophilus inflatipennis</i>	561
<i>picipennis</i>	427	<i>intricatus</i>	548
<i>pilosula</i>	427	<i>longicarpus</i>	553
<i>plagiata</i>	426	<i>longicarpus</i>	553
<i>quadricollis</i>	426, 428, 430	<i>malleifer</i>	550
<i>rufescens</i>	427	<i>microcerus</i>	547, 582
<i>satelles</i>	427	<i>microderes</i>	554
<i>sp.</i>	427	<i>micromelas</i>	556
<i>suturata</i>	425, 427	<i>opacicollis</i>	552
<i>tweedensis</i>	426, 429	<i>pectinicornis</i>	551
<i>variabilis</i>	426, 428	<i>pentaphyllus</i>	550
<i>vittata</i>	425, 427	<i>4-foveatus</i>	557
<i>Xanthorrhœa</i> <i>sp.</i>	236	<i>spinipes</i>	551
<i>Xenoneura tephriata</i>	315	<i>suberraticornis</i>	560
<i>Xylophilidæ</i>	547	<i>tenuicornis</i>	562
<i>Xylophilus</i>	560, 563	<i>varicornis</i>	555
<i>abnormis</i>	552	<i>villosicornis</i>	562
<i>acaciæ</i>	556	<i>Xylophilostenus</i>	563
<i>bimaculiventris</i>	557	<i>octophyllus</i>	563, 582
<i>conspicillatus</i>	556	<i>Zaphrentis</i> <i>sp.</i>	271
<i>convexiceps</i>	558	<i>Zeheba</i>	308
<i>divisus</i>	554	<i>aureata</i>	308
<i>eucalypti</i>	554	<i>lucidata</i>	308
<i>flavescens</i>	554	<i>Zermizinga mdocilisaria</i>	325
<i>flavicollis</i>	554	<i>Zeuzera d'urvillei</i>	170
<i>immaculatus</i>	555	<i>Zygoptera</i> , 32, 33, 43, 45, 64, 109,	
<i>impressiceps</i>	554	454, 469, 615, 616, 618, 620, 621,	
<i>inconspicuus</i>	556	623, 629, 689.	

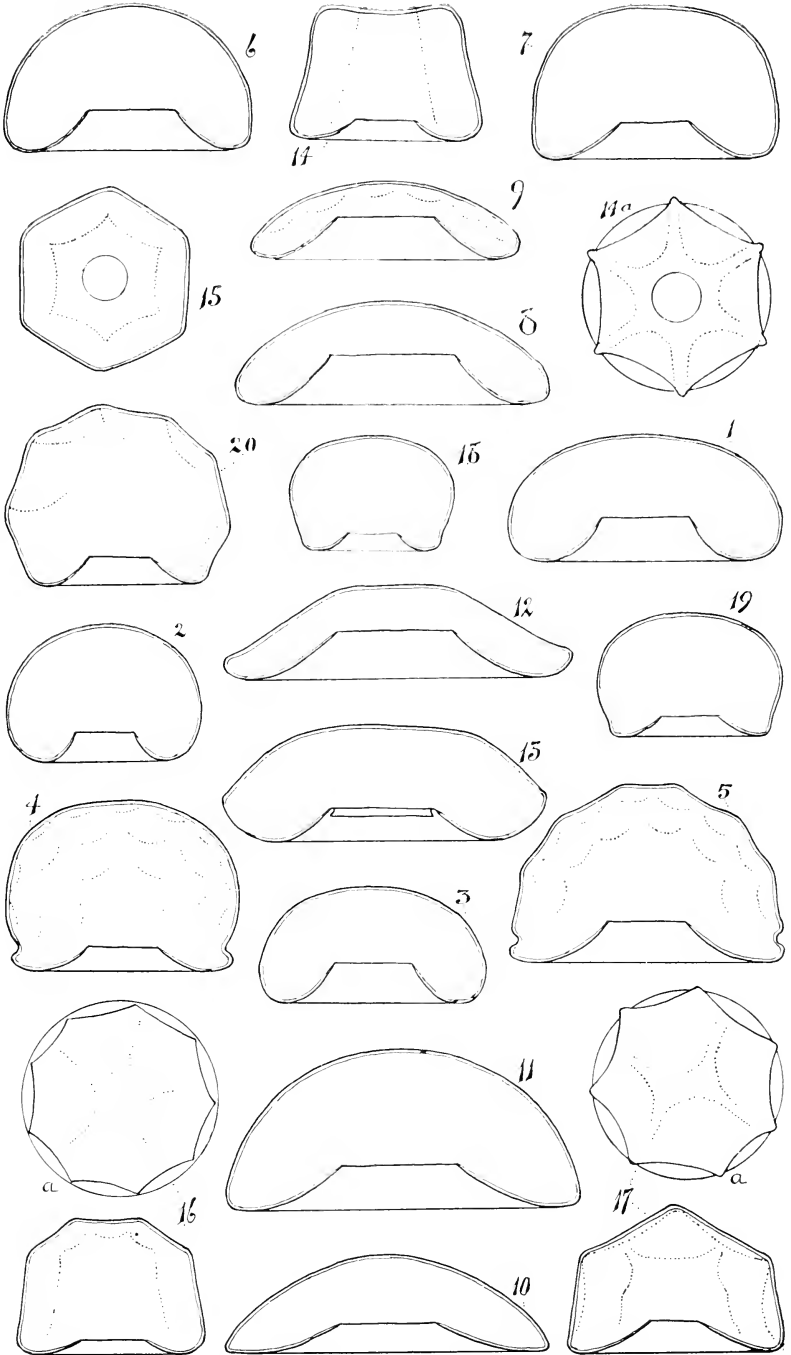

Rhizopods of Sydney and Lismore, N.S.W., (*Arcella*).

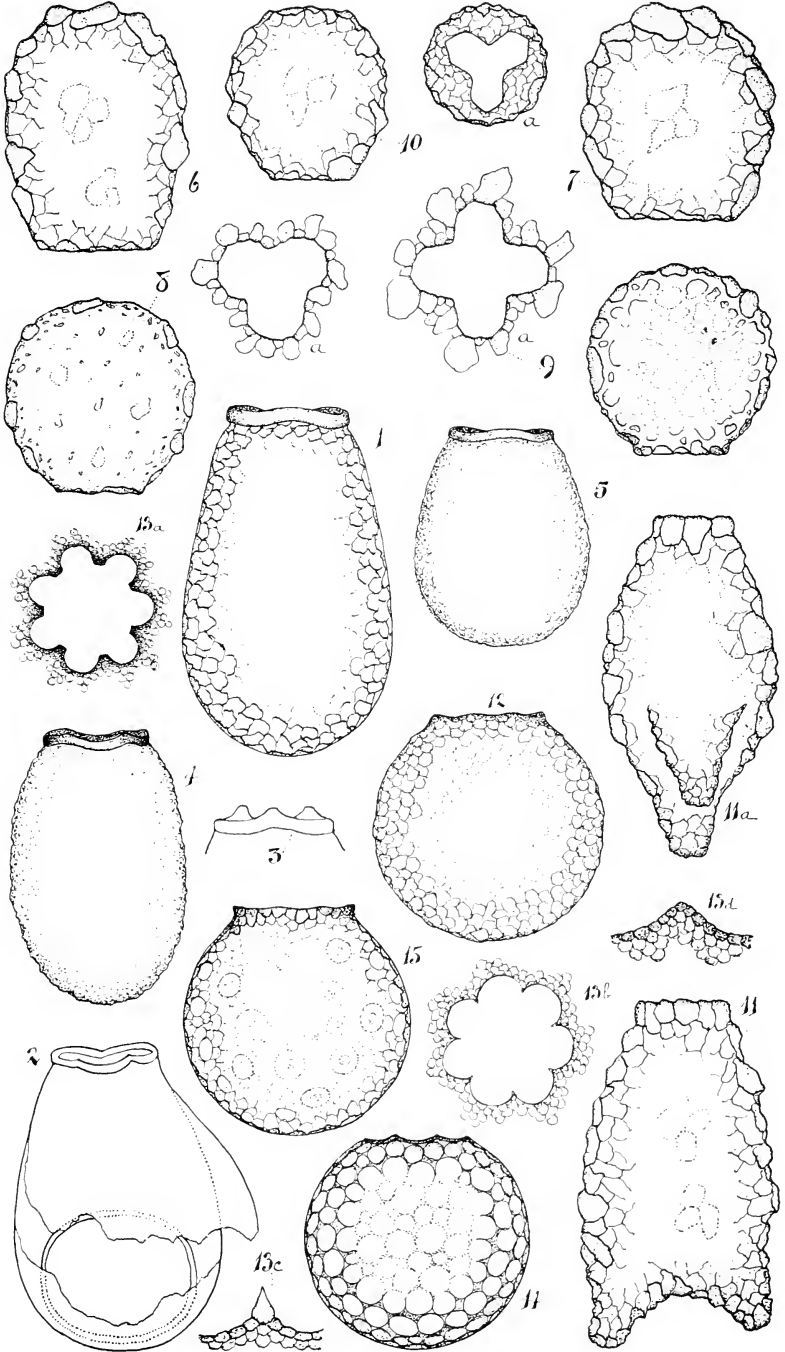

Rhizopods of Sydney and Lismore, N S.W., (*Difflugia*).

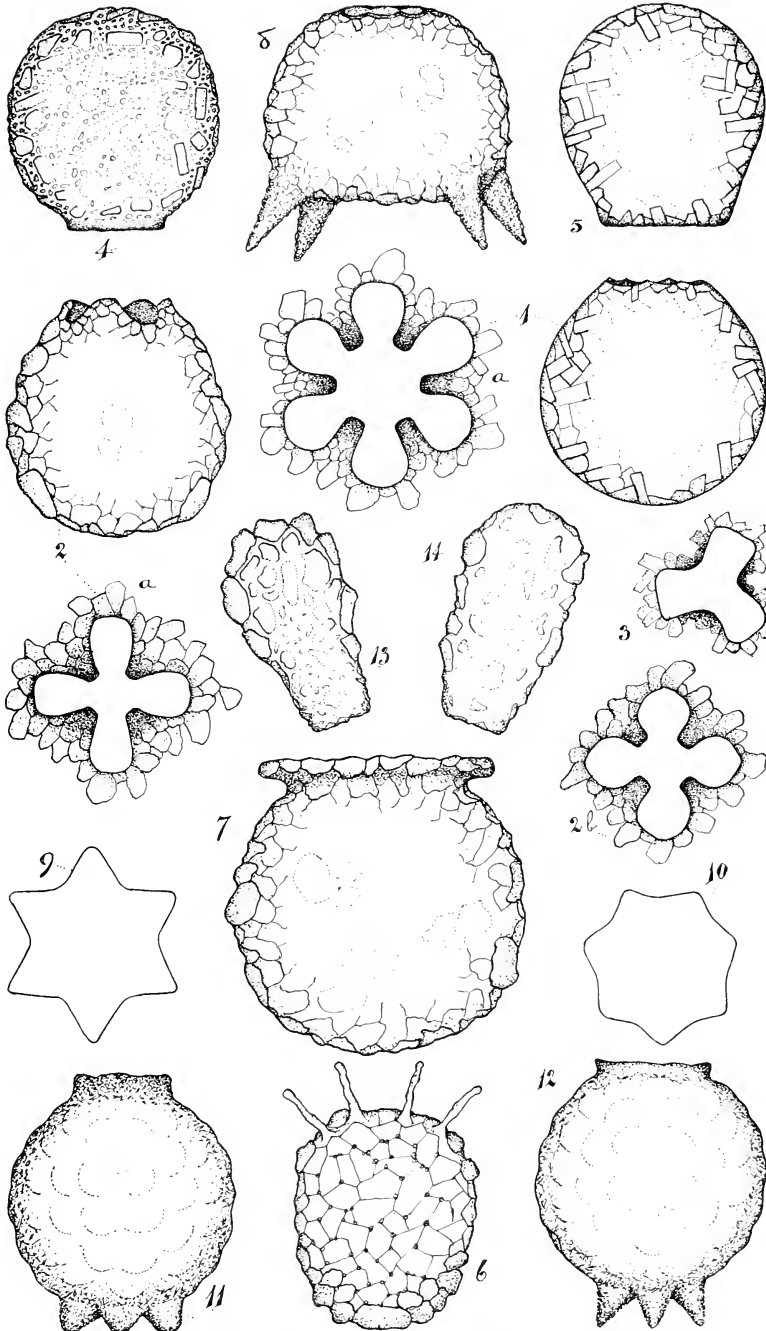

Rhizopods of Sydney and Lismore, N.S.W., (*Difflugia*).

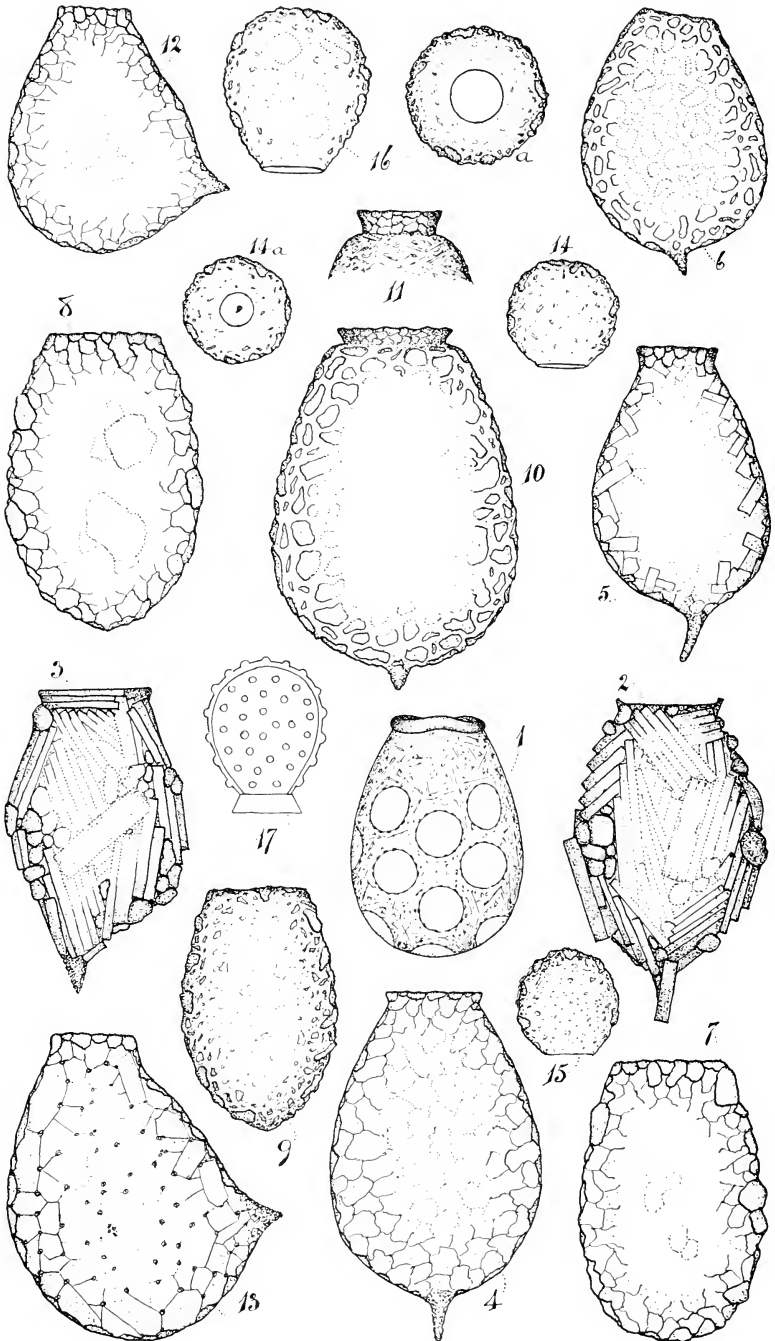

Rhizopods of Sydney and Lismore, N.S.W., (*Difflugia*, *Cucuchitella*).



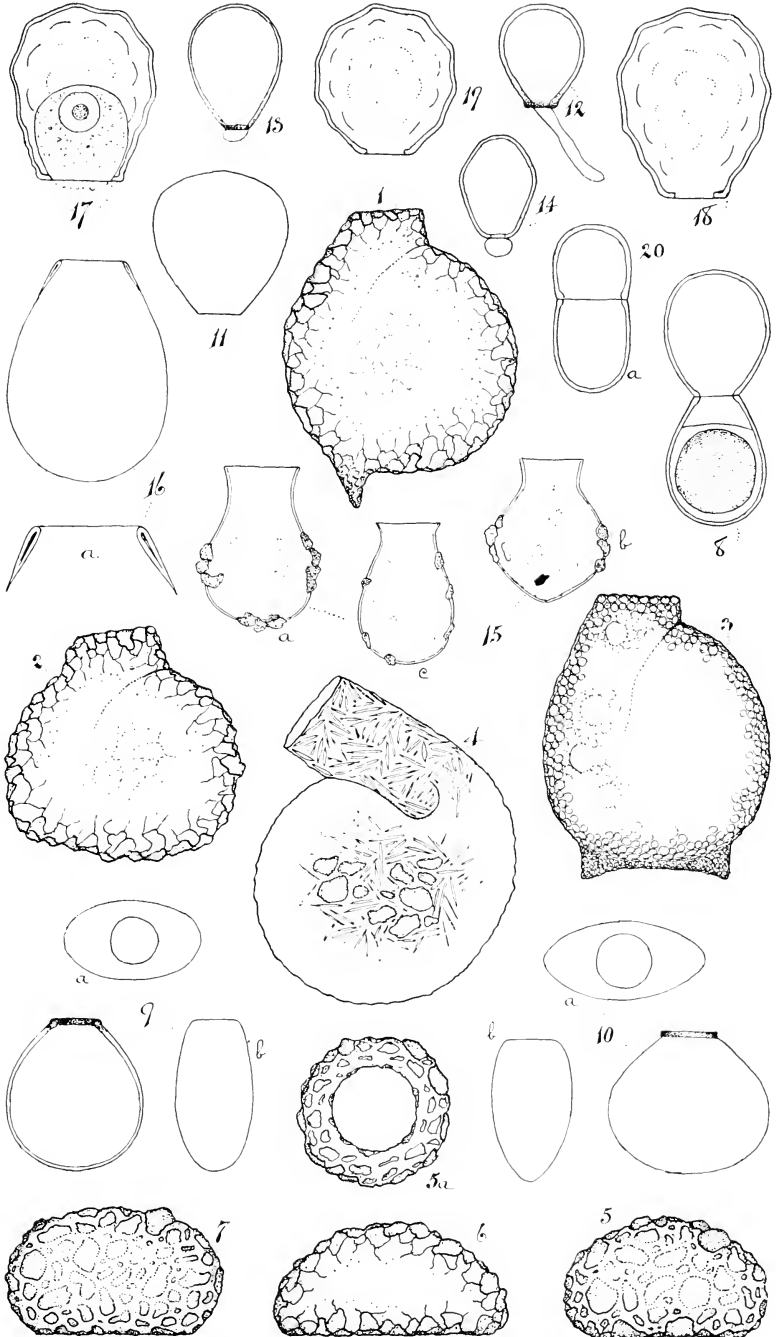

Rhizopods of Sydney and Lismore, N.S.W., (*Lesqueriscusia*, *Phryganella*, *Cryptodifflugia*).

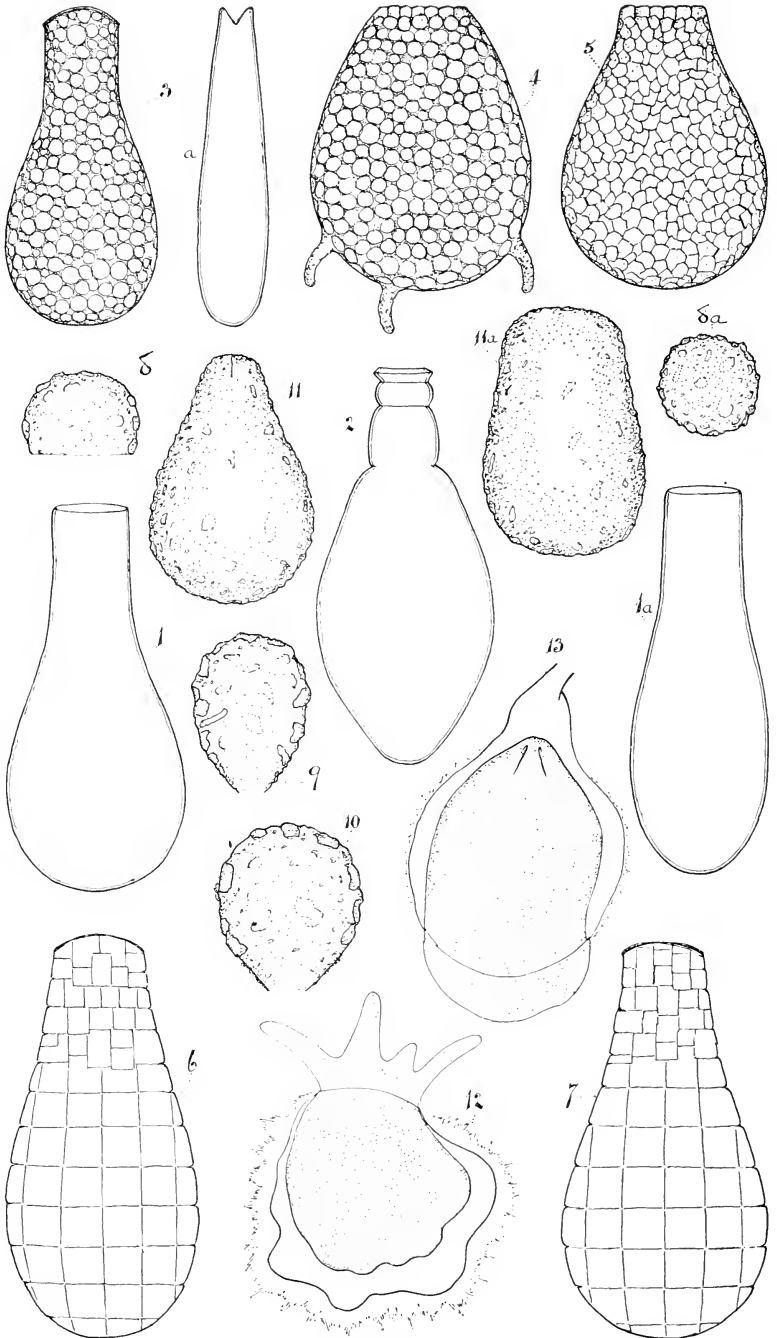

Rhizopods of Sydney and Lismore, N.S.W., (various genera).

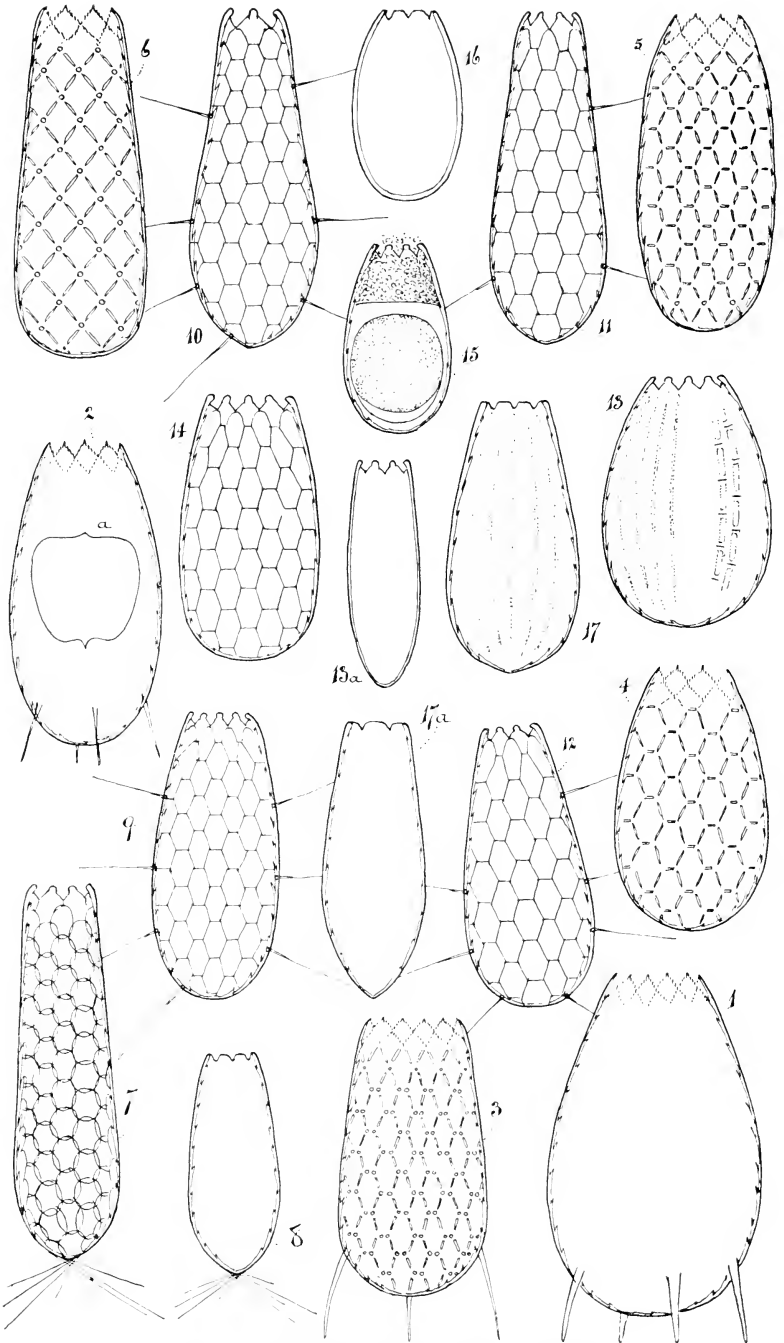

Rhizopods of Sydney and Lismore, N.S.W., (*Euglypha*).

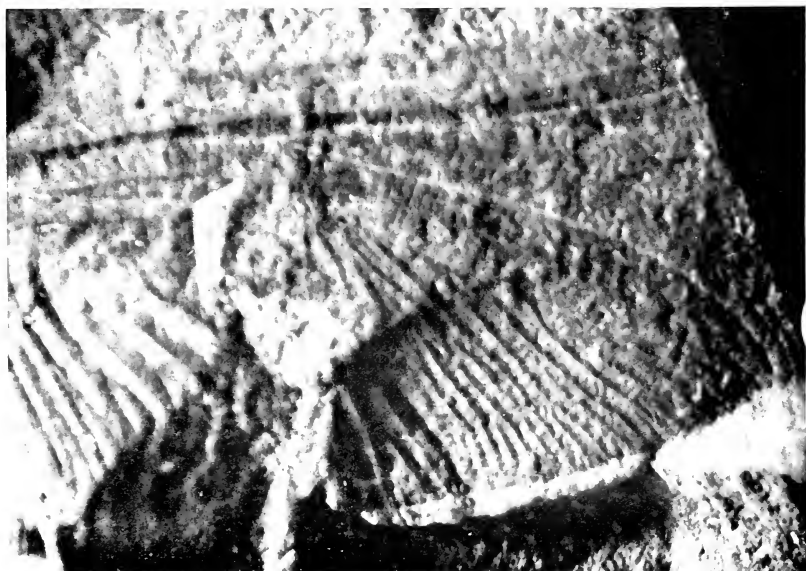

Fig. 9. *Eschadiopsis ludlowensis* (Woodward); hindwing; C-D.

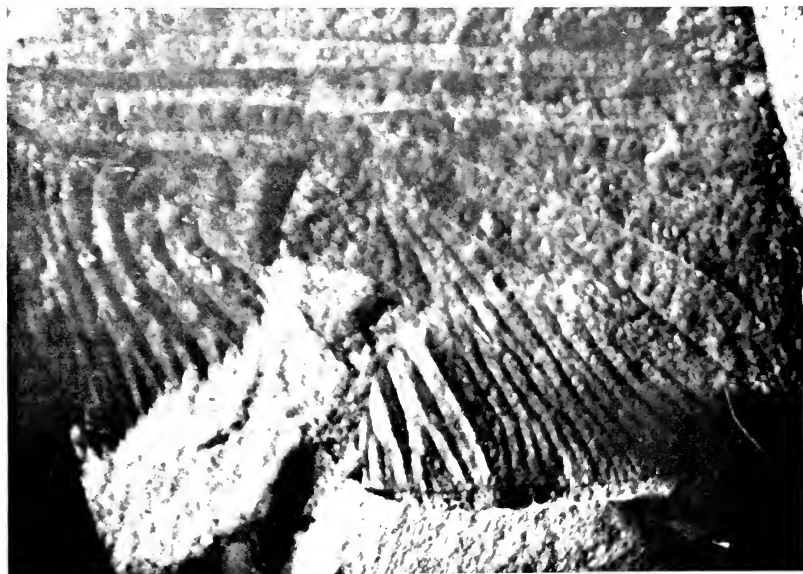

Fig. 10. *Eschadiopsis ludlowensis* (Woodward); hindwing; C-D.

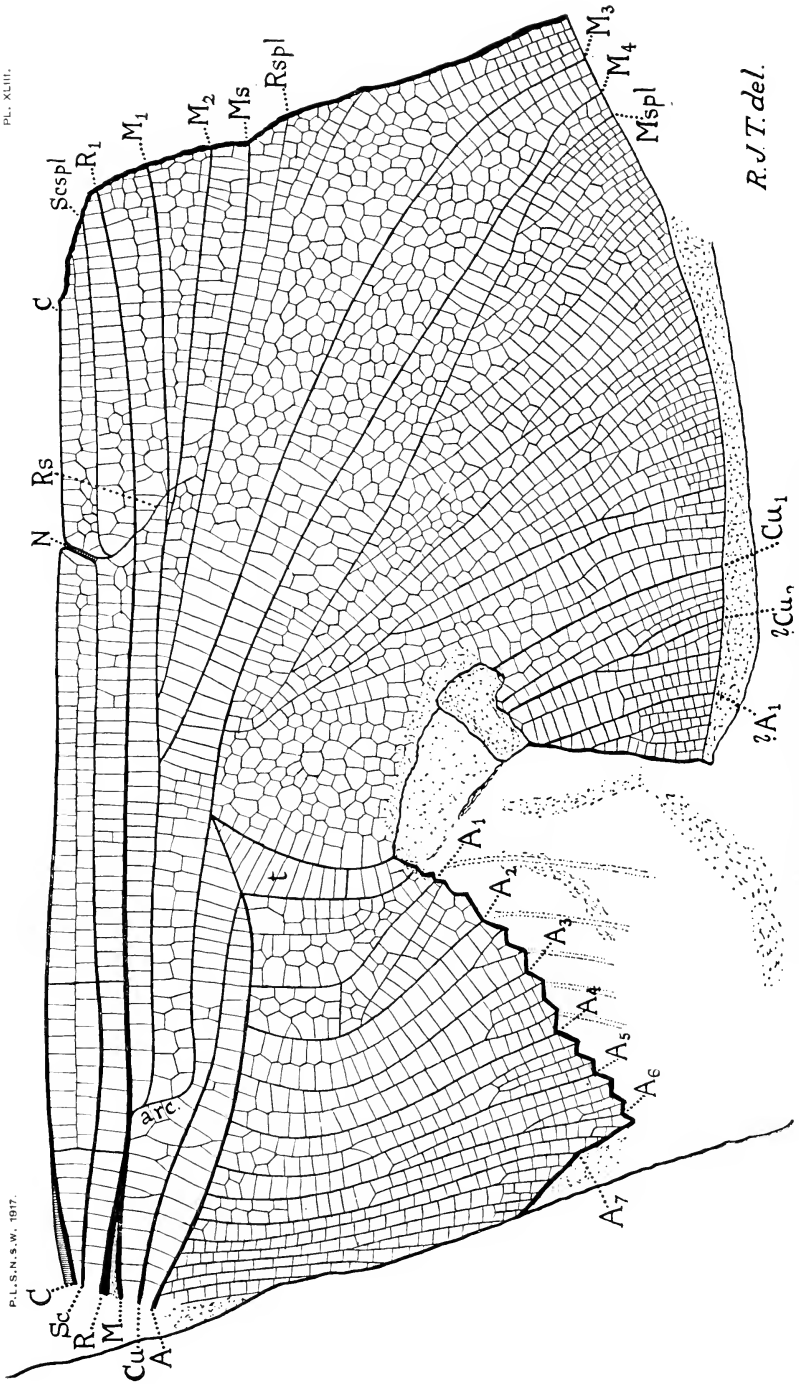
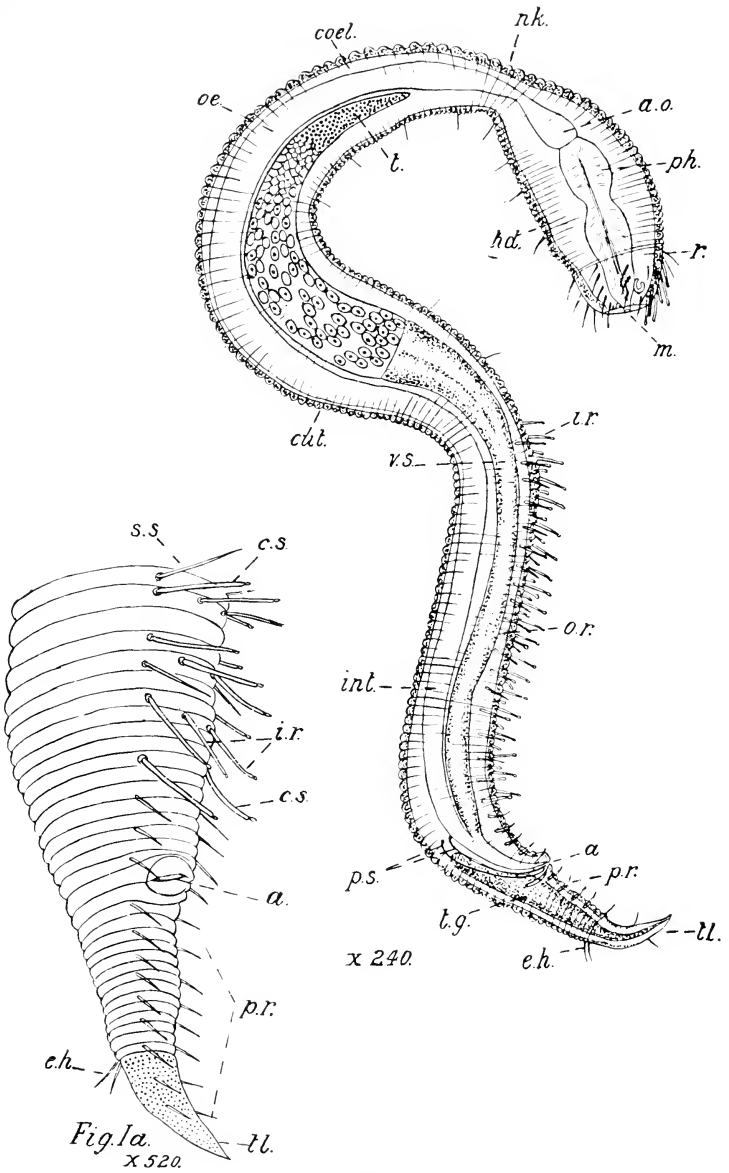

Fig. II. *Eschscholopsis flindersensis* (Woodward); hindwing; ($\times 6$).

R. J. T. del.



Chatosoma falcatum, sp. n.

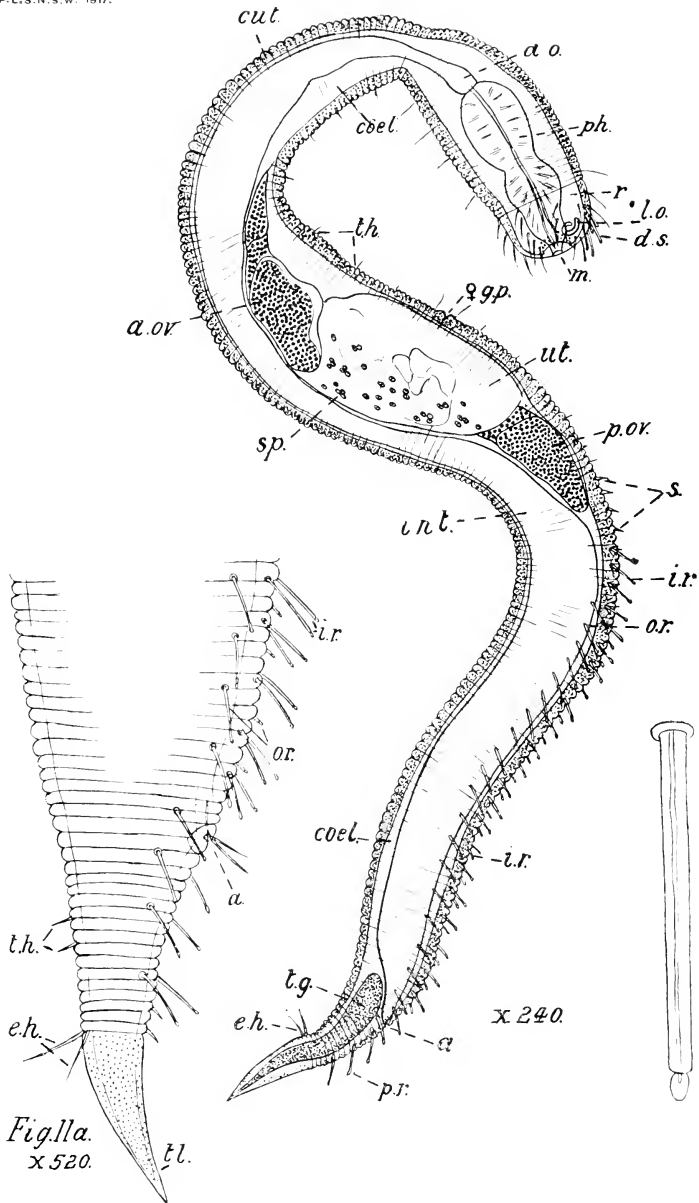
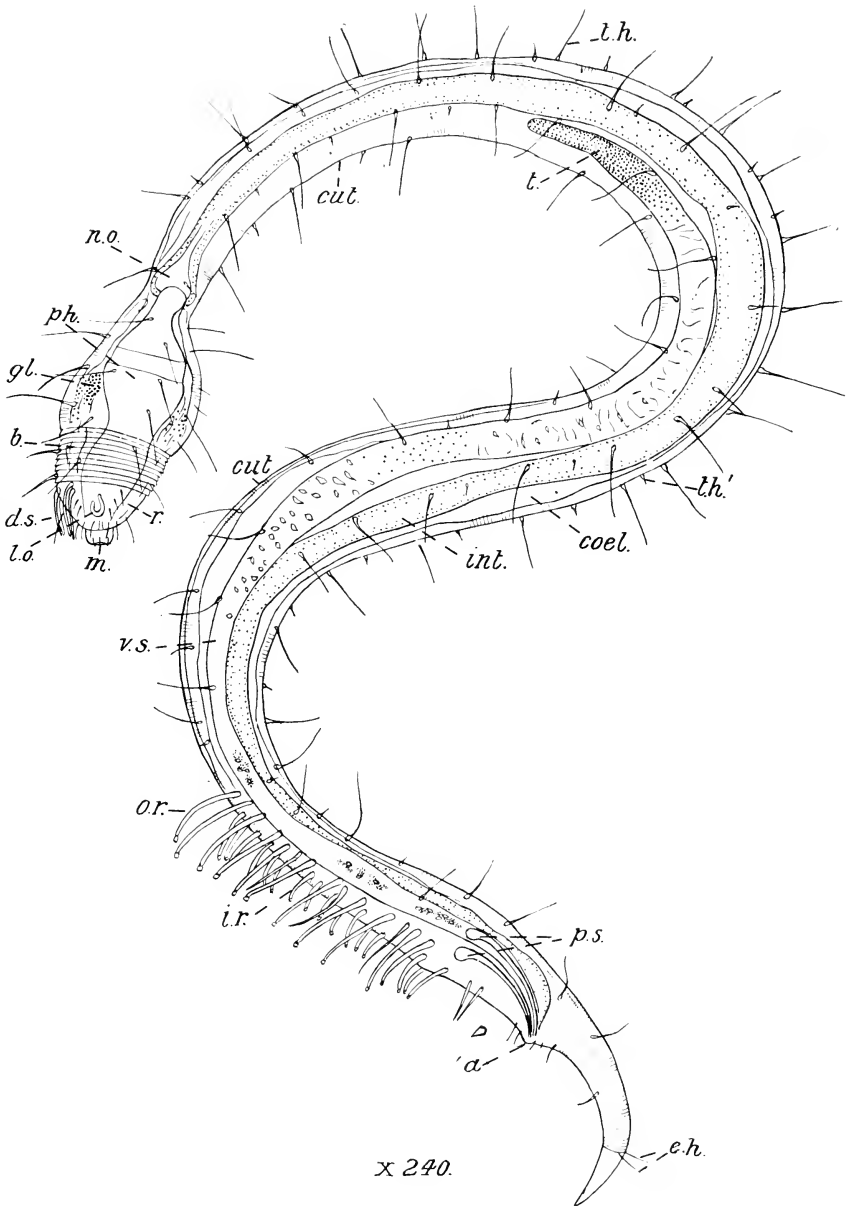

Fig. 11a.
x520.

Fig. 11b.

Chalosoma fulcatum, sp. n.





Chalosoma haswelli, sp. n



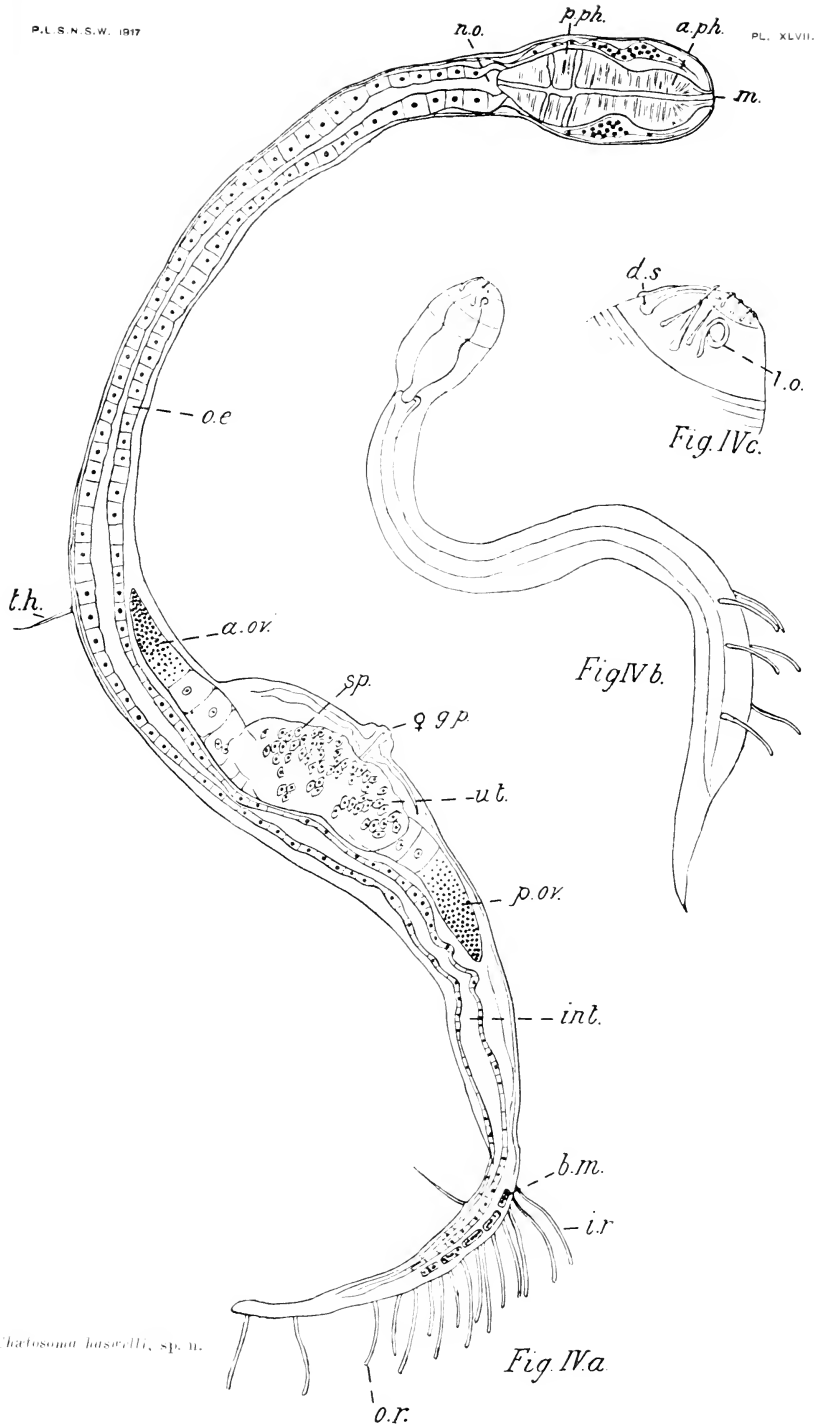

Chatosoma baswelli, sp. n.

Fig. IVa

Fig. IVc.

Fig. IVb.

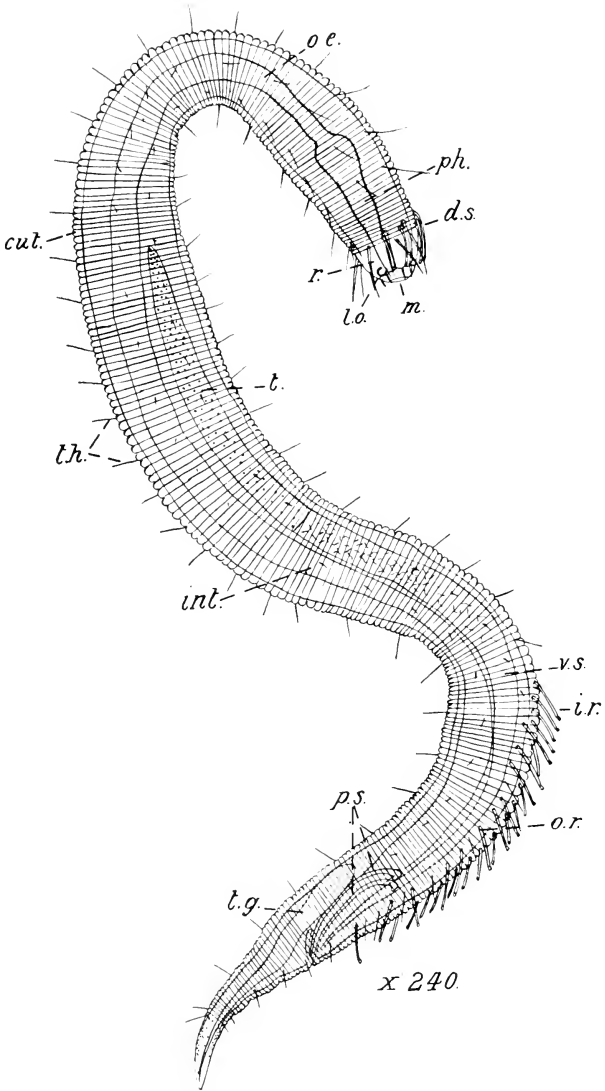

Xolochelosoma leuax, n. sp. n.

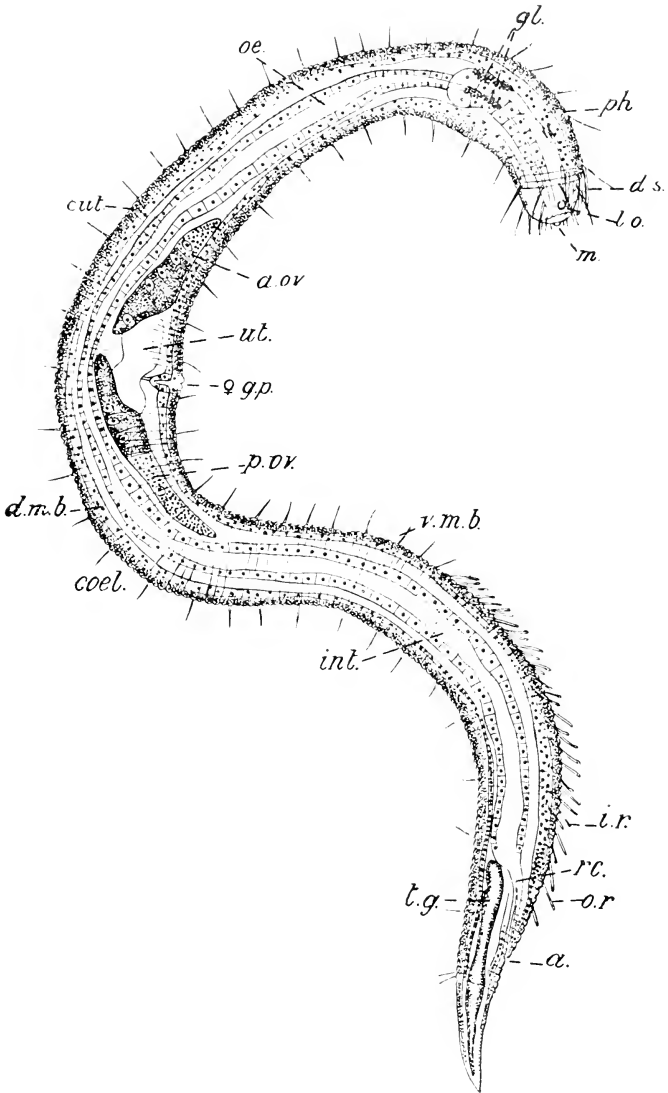

Xolochelosoma leuati, g. et n. sp.

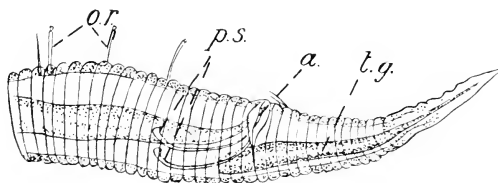
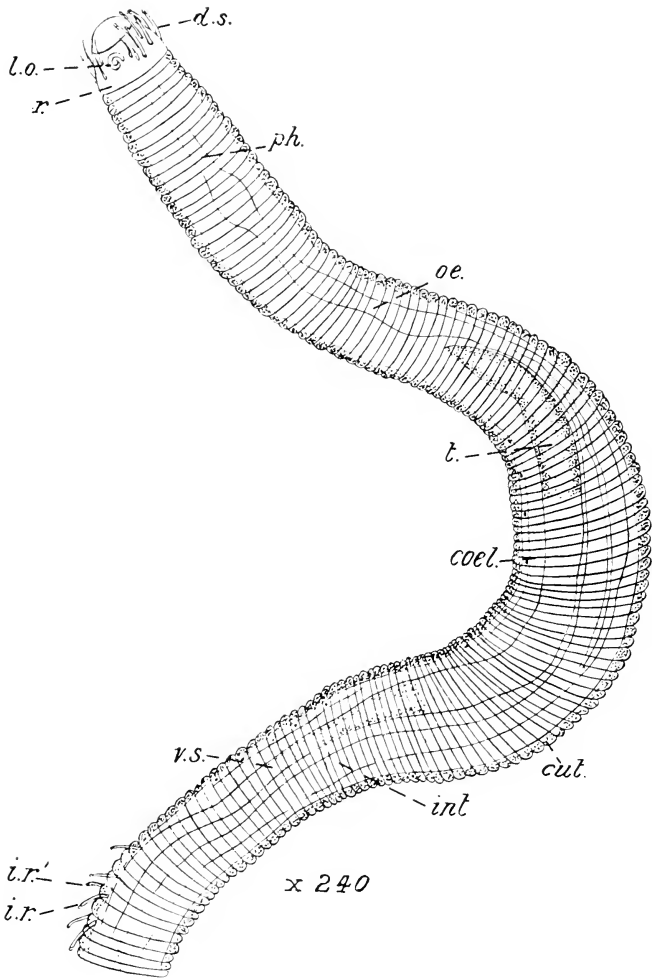

Notochatosoma cryptocephalum, sp. n.

Issued 11th July, 1917.

Vol XLII.

Part 1,

No. 165

THE
PROCEEDINGS
OF THE
LINNEAN SOCIETY
OF
NEW SOUTH WALES

FOR THE YEAR

1917

PART I. (pp. 1-220)

Containing Papers read in

MARCH-MAY (in part).

WITH FIFTEEN PLATES

[Plates i.-xv.]

SYDNEY:

PRINTED AND PUBLISHED FOR THE SOCIETY

BY

W. A. PEPPERDAY & CO., 119A PITT STREET

AND

SOLD BY THE SOCIETY

1917.

PRICE - 14 -

AGENT IN EUROPE:

Messrs. DULAU & Co., 37 Soho Square, London, W.

NOTICE.

WITH the exception of Volumes I.-VI. of the PROCEEDINGS—of which the Society's stock was totally destroyed in the Garden Palace Fire—the Publications of the Linnean Society of N.S.W. may be obtained at the Society's Hall, Ithaca Road, Elizabeth Bay, Sydney, or from Dulau & Co., 37 Soho Square, London, W., at the following prices:—

FIRST SERIES.

Proceedings for 1882, Vol. VII.—Part 1, 7s. 6d.; Part 2, 10s.; Part 3, 5s.; Part 4, 10s.

Proceedings for 1883, Vol. VIII.—Part 1, 10s.; Part 2, 5s.; Part 3, 7s.; Part 4, 8s.

Proceedings for 1884, Vol. IX.—Part 1, 8s.; Part 2, 12s.; Part 3, £1 5s.; Part 4, £1 5s.

Proceedings for 1885, Vol. X.—Part 1, 12s.; Part 2, 7s. 6d.; Part 3, 15s.; Part 4, 17s. 6d.

SECOND SERIES.

Proceedings for 1886, Vol. I.—Part 1, 10s. 6d.; Part 2, 12s.; Part 3, 13s.; Part 4, 12s. 6d.

Proceedings for 1887, Vol. II.—Part 1, 7s.; Part 2, 8s.; Part 3, 12s.; Part 4, £1 7s.

Proceedings for 1888, Vol. III.—Part 1, 15s.; Part 2, £1 4s.; Part 3, £1; Part 4, 18s.

Proceedings for 1889, Vol. IV.—Part 1, 11s.; Part 2, 16s.; Part 3, 19s.; Part 4, 11s.

Proceedings for 1890, Vol. V.—Part 1, 11s.; Part 2, 9s.; Part 3, 9s.; Part 4, 9s.

Proceedings for 1891, Vol. VI.—Part 1, 10s.; Part 2, 9s. 6d.; Part 3, 17s.; Part 4, 7s. 6d.

Proceedings for 1892, Vol. VII.—Part 1, 6s. 6d.; Part 2, 4s. 6d.; Part 3, 8s.; Part 4, 8s.

Proceedings for 1893, Vol. VIII.—Part 1, 5s.; Part 2, 11s.; Part 3, 6s.; Part 4, 9s.

Proceedings for 1894.—Vol. IX.—Part 1, 12s.; Part 2, 12s.; Part 3, 13s.; Part 4, 8s.

Proceedings for 1895, Vol. V.—Part 1, 15s.; Part 2, 8s. 6d.; Part 3, 10s., Supplement, 1s. 6d.; Part 4, 12s.

Proceedings for 1896.—Part 1, 9s., Supplement, 2s. 6d.; Part 2, 6s. 6d.; Part 3, 7s. 6d.; Part 4, £1 7s. 6d.

Proceedings for 1897.—Part 1, 10s.; Part 2, 8s. 6d.; Part 3, 9s.; Part 4, 12s. 6d.

Proceedings for 1898.—Part 1, 3s.; Part 2, 6s.; Part 3, 12s.; Part 4, 14s.

Proceedings for 1899.—Part 1, 12s. 6d.; Part 2, 12s.; Part 3, 10s.; Part 4, 10s. 6d.

Proceedings for 1900.—Part 1, 8s.; Part 2, 10s. 6d.; Part 3, 10s. 6d.; Part 4, 17s. 6d.

Proceedings for 1901.—Part 1, 10s.; Part 2, 9s.; Part 3, 5s.; Part 4, 17s. 6d.

Proceedings for 1902.—Part 1, 7s.; Part 2, 7s. 6d., Part 3, 7s. 6d., Supplement, 3s.; Part 4, 15s.

Proceedings for 1903.—Part 1, 9s.; Part 2, 12s. 6d.; Part 3, 14s.; Part 4, 15s.

Proceedings for 1904.—Part 1, 10s.; Part 2, 7s. 6d.; Part 3, 9s., Part 4, 10s.

Proceedings for 1905.—Part 1, with Supplement, 7s.; Part 2, 10s.; Part 3, 12s. 6d.; Part 4, with Supplement, 10s. 6d.

Proceedings for 1906.—Part 1, 12s. 6d.; Part 2, 12s. 6d.; Part 3, 12s. 6d.; Part 4, 15s.

Proceedings for 1907.—Part 1, 8s.; Part 2, 8s. 6d.; Part 3, 15s.; Part 4, 18s.

Proceedings for 1908.—Part 1, 7s.; Part 2, 9s.; Part 3, 14s.; Part 4, 12s. 6d.

Proceedings for 1909.—Part 1, 12s.; Part 2, 17s.; Part 3, 14s.; Part 4, 16s. 6d.

Proceedings for 1910.—Part 1, 11s.; Part 2, 11s.; Part 3, 7s.; Part 4, 12s. 6d.

Proceedings for 1911—Part 1, 9s. 6d.; Part 2, 9s. 6d.; Part 3, 9s. 6d.; Part 4, 10s.

Proceedings for 1912—Part 1, 8s. 6d.; Part 2, 25s. 0d.; Part 3, 12s. 6d.; Part 4, 15s.

Proceedings for 1913 - Part 1, 14s.; Part 2, 7s. 6d.; Part 3, 6s.; Part 4, 13s.

Proceedings for 1914—Part 1, 13s.; Part 2, 17s.; Part 3, 25s.; Part 4, 19s.

Proceedings for 1915—Part 1, 17s.; Part 2, 12s. 6d.; Part 3, 10s.; Part 4, 11s.

Proceedings for 1916—Part 1, 10s.; Part 2, 12s.; Part 3, 15s.; Part 4, 19s.

Proceedings for 1917—Part 1, 14s.

THE MACLEAY MEMORIAL VOLUME [issued October 13th, 1893]. Royal 4to., LI. and 308 pages, with Portrait, and forty-two plates. Price £3 3.

DESCRIPTIVE CATALOGUE OF AUSTRALIAN FISHES. By William Macleay, F.L.S. [1881]. A few copies only. Price £1, net.

THE TRANSACTIONS OF THE ENTOMOLOGICAL SOCIETY OF NEW SOUTH WALES, 2 vols., 8vo [Vol. I. five Parts, 1863-66; Vol. II. five Parts, 1869-73; all published], price £2, net, are also obtainable, but neither the Parts nor the Volumes are sold separately.

PROCEEDINGS, 1917, PART 1.

CONTENTS.

	PAGES
Presidential Address delivered at the Forty-second Annual Meeting, March 28th, 1917, by ALEX. G. HAMILTON	1-25
On the Morphology of the Caudal Gills of the Larvæ of Zygopterid Dragonflies. Introduction, Part i. (General Morphology), and Part ii. (Studies of the Separate Types). By R. J. TILLYARD, M.A., B.Sc., F.L.S., F.E.S., Linnean Macleay Fellow of the Society in Zoology. (Plates i.-vi., and 32 text-figures)	31-112
Hydrocyanic Acid in Plants. Part iii. By JAMES M. PETRIE, D.Sc., F.I.C., Linnean Macleay Fellow of the Society in Biochemistry	113-117
The Chemical Investigation of some Poisonous Plants of the N.O. Solanaceæ. Part iv. The Chemistry of the Duboisias. By JAMES M. PETRIE, D.Sc., F.I.C., Linnean Macleay Fellow of the Society in Biochemistry	118-135
The Chemical Investigation of some Poisonous Plants of the N.O. Solanaceæ. Part v. The Alkaloids of <i>Duboisia Leichhardtii</i> F.v.M. By JAMES M. PETRIE, D.Sc., F.I.C., Linnean Macleay Fellow of the Society in Biochemistry	137-145
The Percentage of Carbon Dioxide in Expired Alveolar Air. By ETHEL C. PINKERTON, B.Sc., Government Research Scholar in the University of Sydney	146-161
Contributions to our knowledge of Soil-Fertility. No. xv. The Action of certain Micro-organisms upon the numbers of Bacteria in the Soil. By R. GREIG-SMITH, D.Sc., Macleay Bacteriologist to the Society	162-166
The Wing-Venation of <i>Lepidoptera</i> (Preliminary Report). By R. J. TILLYARD, M.A., B.Sc., F.L.S., F.E.S., Linnean Macleay Fellow of the Society in Zoology. (Seven text-figures)	167-174
Mesozoic Insects of Queensland. No. I. <i>Planipennia</i> , <i>Trichoptera</i> , and the new Order <i>Protomecoptera</i> . By R. J. TILLYARD, M.A., B.Sc., F.L.S., F.E.S., Linnean Macleay Fellow of the Society in Zoology. (Plates vii.-ix., and seven text-figures).	175-200
Descriptions of two new Tiger-Beetles from the Northern Territory. By T. G. SLOANE. [Title]	201
Australian <i>Neuroptera</i> . Part iii. By ESBEN-PETERSEN. (<i>Communicated by W. W. Froggatt, F.L.S.</i>). (Plates x.-xv.)	203-219
Hon. Treasurer's Financial Statement and Balance Sheet	25-29
Elections and Announcements	30, 136
Notes and Exhibits	201

Issued 3rd October, 1917.

Vol XLII.

Part 2,

No. 166

THE
PROCEEDINGS
OF THE
LINNEAN SOCIETY
OF
NEW SOUTH WALES

FOR THE YEAR

1917

PART II. (pp. 221-404)

Containing Papers read in
MAY (in part) - *AUGUST* (in part),

WITH SEVEN PLATES

[Plates xvi. - xxii.]

SYDNEY

PRINTED AND PUBLISHED FOR THE SOCIETY

BY

W. A. PEPPERDAY & CO., 119A PITT STREET

AND

SOLD BY THE SOCIETY

1917.

PRICE - 9 -

AGENT IN EUROPE:

Messrs. DULAU & CO., 37 Soho Square, London, W.

THE SINGLE CELL CULTIVATION OF YEAST.

BY R. GREIG-SMITH, D.Sc., MACLEAY BACTERIOLOGIST TO THE SOCIETY.

The method of isolating single cells of yeast by means of the pen, and growing them in tiny drops of nutrient fluid on cover-glasses in a moist chamber, as recommended by Paul Lindner, was a great advance upon the older gelatine process as practised by Hansen. The Lindner-method is in general use at the present time. It has some disadvantages, however, as will be recognised when the method, which I am about to describe, has been tried.

The pen acts by the capillary nature of its split, and it is a simple step to adopt a glass capillary, such as may be obtained by drawing out a heated piece of glass tubing until the tube is of the necessary bore. A four-inch piece of glass tubing of 4 mm. bore, heated in the bunsen flame until soft, and drawn out to about thirty inches, will furnish several suitable capillaries. The heating sterilises the glass, and the capillary is ready for use when broken or cut into short lengths of, say, five inches. It is better to cut the capillary with a fine file to ensure a clean cut. A broken end will not make a good contact with the cover-glass, when the yeast-suspension is spotted. If the hand is used to cut or break the tube, the capillary can be sterilised by passing it rapidly through the flame before using.

The capillary is dipped into the suspension of yeast-cells, and inclined at an angle. The liquid rushes up the capillary but soon stops. The capillary is withdrawn, and 16 to 20 spots are dotted upon a sterile cover-glass, just as in the Lindner-method. The size of the spot can be regulated by inclining the capillary more or less to the vertical, and by the duration of contact with the cover-glass. The aim is to have the spot of such a size as can be included in the field of the microscope.

6. TOPSENT, E.—“Contributions à l'Étude des Spongiaires de l'Atlantique Nord.” Resultats des Camp. Scient. du Pr. de Monaco, 1892, Fasc. ii., p.116, Pl. xi., fig.7.
7. —————“Diagnoses d'Eponges Nouvelles de la Méditerranée et plus particulièrement de Banyuls.” Arch. Zool. Exp. et Gen., 1892, (2), x., Notes et Revue, p. xxv.
8. —————“Materiaux pour servir à l'Étude de la Faune des Spongiaires de France.” Mém. Soc. Zool. France, 1896, ix., p.121.
9. —————“Spongiaires des Açores.” Resultats des Camp. Scient. du Pr. de Monaco, 1904, Fasc. xxv.; (a) p.152, Pl. i., fig.10; Pl. xiii., fig.13; (b) p.138.
10. —————“Spongiaires de l'Expédition Antarctique Nationale Écossaise.” Trans. Roy. Soc. Edinburgh, 1913, xlv., Part 3, p.616, Pl. i., fig.4; Pl. vi., fig.15.
11. WHITELEGGE, T.—“Scientific Results of the Trawling Expedition of H.M.C.S. ‘Thetis’.—Sponges, Part ii.” Mem. Austr. Mus., iv., Part 10, 1907, pp.509, 512.

EXPLANATION OF PLATES XXI.-XXII.

Plate xxi.

Rhabdosigua mammillata Whitelegge.

Fig.1.—Longitudinal (desarcodised) section of the skeleton (of a digitiform lobe), showing extra-axial region thereof and also portion of the axial region; ($\times 15$).

Fig.2.—Entire specimen; ($\times \frac{2}{3}$).

Echinaria froudula Whitelegge.

Figs.3, 4.—Pattern of the skeleton as shown in longitudinal section parallel to and in the mid-plane of the (lamelliform) sponge. Fig.3 shows more distinctly the longitudinal spicule-strands; in Fig.4, which is from a thinner section, many long interstitial megascleres are also to be seen; ($\times 50$).

Plate xxii.

Echinaria froudula Whitelegge.

Figs.1, 2.—Skeleton as seen in longitudinal section perpendicular to the surface of the (lamelliform) sponge. The desarcodised section (shown in Fig.1) is from near the upper margin of the sponge; the other (undesarcodised) is from near its base; ($\times 50$).

PROCEEDINGS, 1917, PART 2.

CONTENTS.

	PAGES
The Single Cell Cultivation of Yeast. By R. GREIG-SMITH, D.Sc., Macleay Bacteriologist to the Society	220-222
The Geology and Petrology of the Great Serpentine Belt of New South Wales. Part vi. A General Account of the Geology and Physiography of the Western Slopes of New England. By W. N. BENSON, D.Sc., B.A., F.G.S., Professor of Geology, University of Otago, N.Z.; formerly Linnean Macleay Fellow of the Society in Geology. (Plates xviii.-xx.; and ten Text-figs.)... ..	223-245, 250-283
Studies in Australian <i>Mecoptera</i> . No. i. The new Family <i>Nannochoristidae</i> , with descriptions of a new Genus and four new Species; and an Appendix descriptive of a new Genus and Species from New Zealand. By R. J. TILLYARD, M.A., B.Sc., F.L.S., F.E.S., Linnean Macleay Fellow of the Society in Zoology. (Plates xvi.-xvii.; and three Text-figures)	284-301
Revision of Australian <i>Lepidoptera</i> , vi. By A. JEFFERIS TURNER, M.D., F.E.S.	304-336
Description of a new Tiger-beetle from the Northern Territory. By T. G. SLOANE	337-338
On the Endoskeleton of the Head, the Anterior Coxæ, and the Anterior Coxal Cavities in the Families <i>Carabida</i> and <i>Cicindalida</i> [COLEOPTERA]. By T. G. SLOANE	339-342
Revision of Australian <i>Lepidoptera</i> , vi. (continued). By A. JEFFERIS TURNER, M.D., F.E.S.	344-390
On the Genera <i>Echinacia</i> and <i>Rhabdosigma</i> [PORIFERA]. By E. F. HALLMANN, B.Sc., Linnean Macleay Fellow of the Society in Zoology. (Plates xxi.-xxii.; and two Text-figures)	391-405
Elections and Announcements	249, 303, 343
Notes and Exhibits	246-248, 302, 303, 343

CORRIGENDA.

Page 47, line 7, and p.48, line 17—*for* Text-fig.1, *read* Text-fig.3.

Page 60, line 7—*for* formation, *read* function.

Page 70, last line of note—*for* nucleus of *cut.*, *read* nucleus of alveolar tissue.

Page 98, line 5) *for* *Argiocygnis*, *read* *Argioocygnis*.
 Page 99, line 29)

Issued 22nd December, 1917.

Vol. XLII.

Part 3,

No. 167

THE
PROCEEDINGS
OF THE
LINNEAN SOCIETY
OF
NEW SOUTH WALES

FOR THE YEAR

1917

PART III. (pp. 405-632)

Containing Papers read in

AUGUST (in part)-NOVEMBER (in part).

WITH ELEVEN PLATES

[Plates xxiii.-xxxiii.]

SYDNEY

PRINTED AND PUBLISHED FOR THE SOCIETY

BY

W. A. PEPPERDAY & CO., 119A PITT STREET

AND

SOLD BY THE SOCIETY

1917.

PRICE - 12 6

AGENT IN EUROPE:

Messrs. DULAU & Co., 37 Soho Square, London. W

NOTICE.

WITH the exception of Volumes I.-VI. of the PROCEEDINGS—of which the Society's stock was totally destroyed in the Garden Palace Fire—the Publications of the Linnean Society of N.S.W. may be obtained at the Society's Hall, Ithaca Road, Elizabeth Bay, Sydney, or from Dulau & Co., 37 Soho Square, London, W., at the following prices:—

FIRST SERIES.

Proceedings for 1882, Vol. VII.—Part 1, 7s. 6d.; Part 2, 10s.; Part 3, 5s.; Part 4, 10s.

Proceedings for 1883, Vol. VIII.—Part 1, 10s.; Part 2, 5s.; Part 3, 7s.; Part 4, 8s.

Proceedings for 1884, Vol. IX.—Part 1, 8s.; Part 2, 12s.; Part 3, £1 5s.; Part 4, £1 5s.

Proceedings for 1885, Vol. X.—Part 1, 12s.; Part 2, 7s. 6d.; Part 3, 15s.; Part 4, 17s. 6d.

SECOND SERIES.

Proceedings for 1886, Vol. I.—Part 1, 10s. 6d.; Part 2, 12s.; Part 3, 13s.; Part 4, 12s. 6d.

Proceedings for 1887, Vol. II.—Part 1, 7s.; Part 2, 8s.; Part 3, 12s.; Part 4, £1 7s.

Proceedings for 1888, Vol. III.—Part 1, 15s.; Part 2, £1 4s.; Part 3, £1; Part 4, 18s.

Proceedings for 1889, Vol. IV.—Part 1, 11s.; Part 2, 16s.; Part 3, 19s.; Part 4, 11s.

Proceedings for 1890, Vol. V.—Part 1, 11s.; Part 2, 9s.; Part 3, 9s.; Part 4, 9s.

Proceedings for 1891, Vol. VI.—Part 1, 10s.; Part 2, 9s. 6d.; Part 3, 17s.; Part 4, 7s. 6d.

Proceedings for 1892, Vol. VII.—Part 1, 6s. 6d.; Part 2, 4s. 6d.; Part 3, 8s.; Part 4, 8s.

Proceedings for 1893, Vol. VIII.—Part 1, 5s.; Part 2, 11s.; Part 3, 6s.; Part 4, 9s.

Proceedings for 1894.—Vol. IX.—Part 1, 12s.; Part 2, 12s.; Part 3, 13s.; Part 4, 8s.

Proceedings for 1895, Vol. V.—Part 1, 15s.; Part 2, 8s. 6d.; Part 3, 10s.. Supplement, 1s. 6d.; Part 4, 12s.

Proceedings for 1896.—Part 1, 9s., Supplement, 2s. 6d.; Part 2, 6s. 6d.; Part 3, 7s. 6d.; Part 4, £1 7s. 6d.

Proceedings for 1897.—Part 1, 10s.; Part 2, 8s. 6d.; Part 3, 9s.; Part 4, 12s. 6d.

Proceedings for 1898.—Part 1, 3s.; Part 2, 6s.; Part 3, 12s.; Part 4, 14s.

Proceedings for 1899.—Part 1, 12s. 6d.; Part 2, 12s.; Part 3, 10s.; Part 4, 10s. 6d.

Proceedings for 1900.—Part 1, 8s.; Part 2, 10s. 6d.; Part 3, 10s. 6d.; Part 4, 17s. 6d.

Proceedings for 1901.—Part 1, 10s.; Part 2, 9s.; Part 3, 5s.; Part 4, 17s. 6d.

Proceedings for 1902.—Part 1, 7s.; Part 2, 7s. 6d.; Part 3, 7s. 6d., Supplement, 3s.; Part 4, 15s.

Proceedings for 1903.—Part 1, 9s.; Part 2, 12s. 6d.; Part 3, 14s.; Part 4, 15s.

Proceedings for 1904.—Part 1, 10s.; Part 2, 7s. 6d.; Part 3, 9s.; Part 4, 10s.

Proceedings for 1905.—Part 1, with Supplement, 7s.; Part 2, 10s.; Part 3, 12s. 6d.; Part 4, with Supplement, 10s. 6d.

Proceedings for 1906.—Part 1, 12s. 6d.; Part 2, 12s. 6d.; Part 3, 12s. 6d.; Part 4, 15s.

Proceedings for 1907.—Part 1, 8s.; Part 2, 8s. 6d.; Part 3, 15s.; Part 4, 18s.

Proceedings for 1908.—Part 1, 7s.; Part 2, 9s.; Part 3, 14s.; Part 4, 12s. 6d.

Proceedings for 1909.—Part 1, 12s.; Part 2, 17s.; Part 3, 14s.; Part 4, 16s. 6d.

Proceedings for 1910.—Part 1, 11s.; Part 2, 11s.; Part 3, 7s.; Part 4, 12s. 6d.

Proceedings for 1911.—Part 1, 9s. 6d.; Part 2, 9s. 6d.; Part 3, 9s. 6d.; Part 4, 10s.

Proceedings for 1912.—Part 1, 8s. 6d.; Part 2, 25s. 0d.; Part 3, 12s. 6d.; Part 4, 15s.

Proceedings for 1913.—Part 1, 14s.; Part 2, 7s. 6d.; Part 3, 6s.; Part 4, 13s.

Proceedings for 1914.—Part 1, 13s.; Part 2, 17s.; Part 3, 25s.; Part 4, 19s.

Proceedings for 1915.—Part 1, 17s.; Part 2, 12s. 6d.; Part 3, 10s.; Part 4, 11s.

Proceedings for 1916.—Part 1, 10s.; Part 2, 12s.; Part 3, 15s.; Part 4, 19s.

Proceedings for 1917.—Part 1, 14s.; Part 2, 9s.; Part 3, 12s. 6d.

THE MACLEAY MEMORIAL VOLUME [issued October 13th, 1893]. Royal 4to., LI. and 308 pages, with Portrait, and forty-two plates. Price £3 3.

DESCRIPTIVE CATALOGUE OF AUSTRALIAN FISHES. By William Macleay, F.L.S. [1881]. A few copies only. Price £1, net.

THE TRANSACTIONS OF THE ENTOMOLOGICAL SOCIETY OF NEW SOUTH WALES, 2 vols., 8vo [Vol. I. five Parts, 1863-66; Vol. II. five Parts, 1869-73; all published], price £2, net, are also obtainable, but neither the Parts nor the Volumes are sold separately.

PROCEEDINGS, 1917, PART 3.

CONTENTS.

	PAGES
<i>Carabidae</i> from Tropical Australia. (New Genera and Species. Notes and Synonymy, and Synoptic Tables. Tribes SCARTINI, HARPALINI, ODACANTHINI, LEBIINI, and HELUCONINI). By THOMAS G. SLOANE	406-438
On a new Species of <i>Acacia</i> . By W. F. BLAKELEY, National Herbarium, Botanic Gardens, Sydney	441-444
Notes on the Genus <i>Lepidium</i> [N.O. CRUCIFERÆ] from the National Herbarium, Sydney. By A. A. HAMILTON	445-449
On some new Dragonflies from Australia and Tasmania [Order ODONATA]. By R. J. TILLYARD, M.A., B.Sc., F.L.S., F.E.S., Linnean Macleay Fellow of the Society in Zoology. (Plate xxiii., and ten Text-figures)	450-479
The Silurian Trilobites of New South Wales, with References to those of other Parts of Australia. Part vi. The <i>Calymenoidæ</i> , <i>Cheiruridæ</i> , <i>Harpeidæ</i> , <i>Bronteidæ</i> , &c., with an Appendix. By R. ETHERIDGE, JUNR., Director and Curator of the Australian Museum, and JOHN MITCHELL, late Principal of the Newcastle Technical College. (Plates xxiv.-xxvii.)	480-510
Australian <i>Tabanida</i> [DIPTERA]. No. iii. By FRANK H. TAYLOR, F.E.S. (Plate xxviii.)	513-528
<i>Odonata</i> , <i>Planipennia</i> , and <i>Trichoptera</i> from Lord Howe and Norfolk Islands. By R. J. TILLYARD, M.A., B.Sc., F.L.S., F.E.S., Linnean Macleay Fellow of the Society in Zoology. (Ten Text-figures)	529-544
Descriptions of new Species of Australian Coleoptera. Part xiii. By ARTHUR M. LEA, F.E.S. (Plate xxix.)	545-582
Notes on the "Common Nightshade" (<i>Solanum nigrum</i> Linn.) and some closely related Forms and Species that have been confused with it. By EDWIN CHEEL, Botanical Assistant, National Herbarium, Sydney. (Plates xxx.-xxxiii.)	583-602
On the Morphology of the Caudal Gills of the Larvæ of Zygopterid Dragonflies. Part iii. (Ontogeny), and Part iv. (Phylogeny). By R. J. TILLYARD, M.A., B.Sc., F.L.S., F.E.S., Linnean Macleay Fellow of the Society in Zoology. (Fifteen Text-figures)	606-632
Elections and Announcements	439, 511, 603
Notes and Exhibits	439-440, 511-512, 603-605

Issued 3rd April, 1918.

Vol. XLII.

Part 4,

No. 168

THE
PROCEEDINGS
OF THE
LINNEAN SOCIETY
OF
NEW SOUTH WALES

FOR THE YEAR

1917

PART IV. (pp. 633-890, i-xviii.)

Containing Papers read in

NOVEMBER (in part).

WITH SEVENTEEN PLATES

(Plates xxxiv. l.)

SYDNEY

PRINTED AND PUBLISHED FOR THE SOCIETY

BY

W. A. PEPPERDAY & CO., 119A PITT STREET

AND

SOLD BY THE SOCIETY

1917-18.

PRICE - 16 6

AGENT IN EUROPE:

Messrs. DULAU & Co., 37, Soho Square, London, W.

NOTICE.

WITH the exception of Volumes I.-VI. of the PROCEEDINGS—of which the Society's stock was totally destroyed in the Garden Palace Fire—the Publications of the Linnean Society of N.S.W. may be obtained at the Society's Hall, Ithaca Road, Elizabeth Bay, Sydney, or from Dulau & Co., 37 Soho Square, London, W., at the following prices:—

FIRST SERIES.

Proceedings for 1882, Vol. VII.—Part 1, 7s. 6d.; Part 2, 10s.; Part 3, 5s.; Part 4, 10s.

Proceedings for 1883, Vol. VIII.—Part 1, 10s.; Part 2, 5s.; Part 3, 7s.; Part 4, 8s.

Proceedings for 1884, Vol. IX.—Part 1, 8s.; Part 2, 12s.; Part 3, £1 5s.; Part 4, £1 5s.

Proceedings for 1885, Vol. X.—Part 1, 12s.; Part 2, 7s. 6d.; Part 3, 15s.; Part 4, 17s. 6d.

SECOND SERIES.

Proceedings for 1886, Vol. I.—Part 1, 10s. 6d.; Part 2, 12s.; Part 3, 13s.; Part 4, 12s. 6d.

Proceedings for 1887, Vol. II.—Part 1, 7s.; Part 2, 8s.; Part 3, 12s.; Part 4, £1 7s.

Proceedings for 1888, Vol. III.—Part 1, 15s.; Part 2, £1 4s.; Part 3, £1; Part 4, 18s.

Proceedings for 1889, Vol. IV.—Part 1, 11s.; Part 2, 16s.; Part 3, 19s.; Part 4, 11s.

Proceedings for 1890, Vol. V.—Part 1, 11s.; Part 2, 9s.; Part 3, 9s.; Part 4, 9s.

Proceedings for 1891, Vol. VI.—Part 1, 10s.; Part 2, 9s. 6d.; Part 3, 17s.; Part 4, 7s. 6d.

Proceedings for 1892, Vol. VII.—Part 1, 6s. 6d.; Part 2, 4s. 6d.; Part 3, 8s.; Part 4, 8s.

Proceedings for 1893, Vol. VIII.—Part 1, 5s.; Part 2, 11s.; Part 3, 6s.; Part 4, 9s.

Proceedings for 1894.—Vol. IX.—Part 1, 12s.; Part 2, 12s.; Part 3, 13s.; Part 4, 8s.

Proceedings for 1895, Vol. V.—Part 1, 15s.; Part 2, 8s. 6d.; Part 3, 10s., Supplement, 1s. 6d.; Part 4, 12s.

Proceedings for 1896.—Part 1, 9s., Supplement, 2s. 6d.; Part 2, 6s. 6d.; Part 3, 7s. 6d.; Part 4, £1 7s. 6d.

Proceedings for 1897.—Part 1, 10s.; Part 2, 8s. 6d.; Part 3, 9s.; Part 4, 12s. 6d.

Proceedings for 1898.—Part 1, 3s.; Part 2, 6s.; Part 3, 12s.; Part 4, 14s.

Proceedings for 1899.—Part 1, 12s. 6d.; Part 2, 12s.; Part 3, 10s.; Part 4, 10s. 6d.

Proceedings for 1900.—Part 1, 8s.; Part 2, 10s. 6d.; Part 3, 10s. 6d.; Part 4, 17s. 6d.

Proceedings for 1901.—Part 1, 10s.; Part 2, 9s.; Part 3, 5s.; Part 4, 17s. 6d.

Proceedings for 1902.—Part 1, 7s.; Part 2, 7s. 6d.; Part 3, 7s. 6d., Supplement, 3s.; Part 4, 15s.

Proceedings for 1903.—Part 1, 9s.; Part 2, 12s. 6d.; Part 3, 14s.; Part 4, 15s.

Proceedings for 1904.—Part 1, 10s.; Part 2, 7s. 6d.; Part 3, 9s.; Part 4, 10s.

Proceedings for 1905.—Part 1, with Supplement, 7s.; Part 2, 10s.; Part 3, 12s. 6d.; Part 4, with Supplement, 10s. 6d.

Proceedings for 1906.—Part 1, 12s. 6d.; Part 2, 12s. 6d.; Part 3, 12s. 6d.; Part 4, 15s.

Proceedings for 1907.—Part 1, 8s.; Part 2, 8s. 6d.; Part 3, 15s.; Part 4, 18s.

Proceedings for 1908.—Part 1, 7s.; Part 2, 9s.; Part 3, 14s.; Part 4, 12s. 6d.

Proceedings for 1909.—Part 1, 12s.; Part 2, 17s.; Part 3, 14s.; Part 4, 16s. 6d.

Proceedings for 1910.—Part 1, 11s.; Part 2, 11s.; Part 3, 7s.; Part 4, 12s. 6d.

Proceedings for 1911—Part 1, 9s. 6d.; Part 2, 9s. 6d.; Part 3, 9s. 6d.; Part 4, 10s.

Proceedings for 1912—Part 1, 8s. 6d.; Part 2, 25s. 0d.; Part 3, 12s. 6d.; Part 4, 15s.

Proceedings for 1913—Part 1, 14s.; Part 2, 7s. 6d.; Part 3, 6s.; Part 4, 13s.

Proceedings for 1914—Part 1, 13s.; Part 2, 17s.; Part 3, 25s.; Part 4, 19s.

Proceedings for 1915—Part 1, 17s.; Part 2, 12s. 6d.; Part 3, 10s.; Part 4, 11s.

Proceedings for 1916—Part 1, 10s.; Part 2, 12s.; Part 3, 15s.; Part 4, 19s.

Proceedings for 1917—Part 1, 14s.; Part 2, 9s.; Part 3, 12s. 6d.; Part 4, 16s. 6d.

THE MACLEAY MEMORIAL VOLUME [issued October 13th, 1893]. Royal 4to., LI. and 308 pages, with Portrait, and forty-two plates. Price £3 3.

DESCRIPTIVE CATALOGUE OF AUSTRALIAN FISHES. By William Macleay, F.L.S. [1881]. A few copies only. Price £1, net.

THE TRANSACTIONS OF THE ENTOMOLOGICAL SOCIETY OF NEW SOUTH WALES, 2 vols., 8vo [Vol. I. five Parts, 1863-66; Vol. II. five Parts, 1869-73; all published], price £2, net, are also obtainable, but neither the Parts nor the Volumes are sold separately.

PROCEEDINGS, 1917, PART 4.

CONTENTS.

	PAGES
Rhizopods of Sydney and Lismore. By G. I. PLAYFAIR, Science Research Scholar of the University of Sydney. (Plates xxxiv.-xli.; and seven Text-figures)	633-675
Mesozoic Insects of Queensland. No.2. The Fossil Dragonfly <i>Æschidopsis</i> (<i>Æschua</i>) <i>flindersiensis</i> (Woodward) from the Rolling Downs (Cretaceous) Series. By R. J. TILLYARD, M.A., B.Sc., F.L.S., F.E.S., Linnean Macleay Fellow of the Society in Zoology. (Plates xlii.-xliii.)	676-692
The Geology and Petrology of the Great Serpentine Belt of New South Wales. Appendix to Part vi. The Attunga District. By Professor W. N. BENSON, B.A., D.Sc., F.G.S., formerly Linnean Macleay Fellow of the Society in Geology. (One Text-figure)... ..	693-700
Some new <i>Heteromera</i> , and a new <i>Stigmomera</i> from Tropical Australia. By H. J. CARTER, B.A., F.E.S. (Ten Text-figures)	701-719
Permian and Triassic Insects from New South Wales, in the Collection of Mr. John Mitchell. By R. J. TILLYARD, M.A., B.Sc., F.L.S., F.E.S., Linnean Macleay Fellow of the Society in Zoology. (With seventeen Text-figures)	720-756
On the <i>Chatosomatida</i> , with Descriptions of new Species, and a new Genus from the coast of New South Wales. By VERA A. IRWIN-SMITH, B.Sc., Science Research Scholar in the University of Sydney. Plates xlv.-l.; and fifty-nine Text-figures)	757-814
The Variability of Cows' Milk. Part i. By H. S. HALCRO WARDLAW, D.Sc., Linnean Macleay Fellow of the Society in Physiology. (Six Text-figures)	815-865
The Composition of expired alveolar Air. By ETHEL C. PINKERTON, B.Sc., Science Research Scholar in the University of Sydney	866-872
Donations and Exchanges, 1916-17	873-890
Title-page	i.
Contents	iii.
Corrigenda	vii.
List of new Generic Names... ..	viii.
List of Plates... ..	viii.
Index	i.-xxviii.



MBL WHOI LIBRARY



WH LADN A

